

Figure 9-69 Pass lower-guide assembly (booklet-maker)

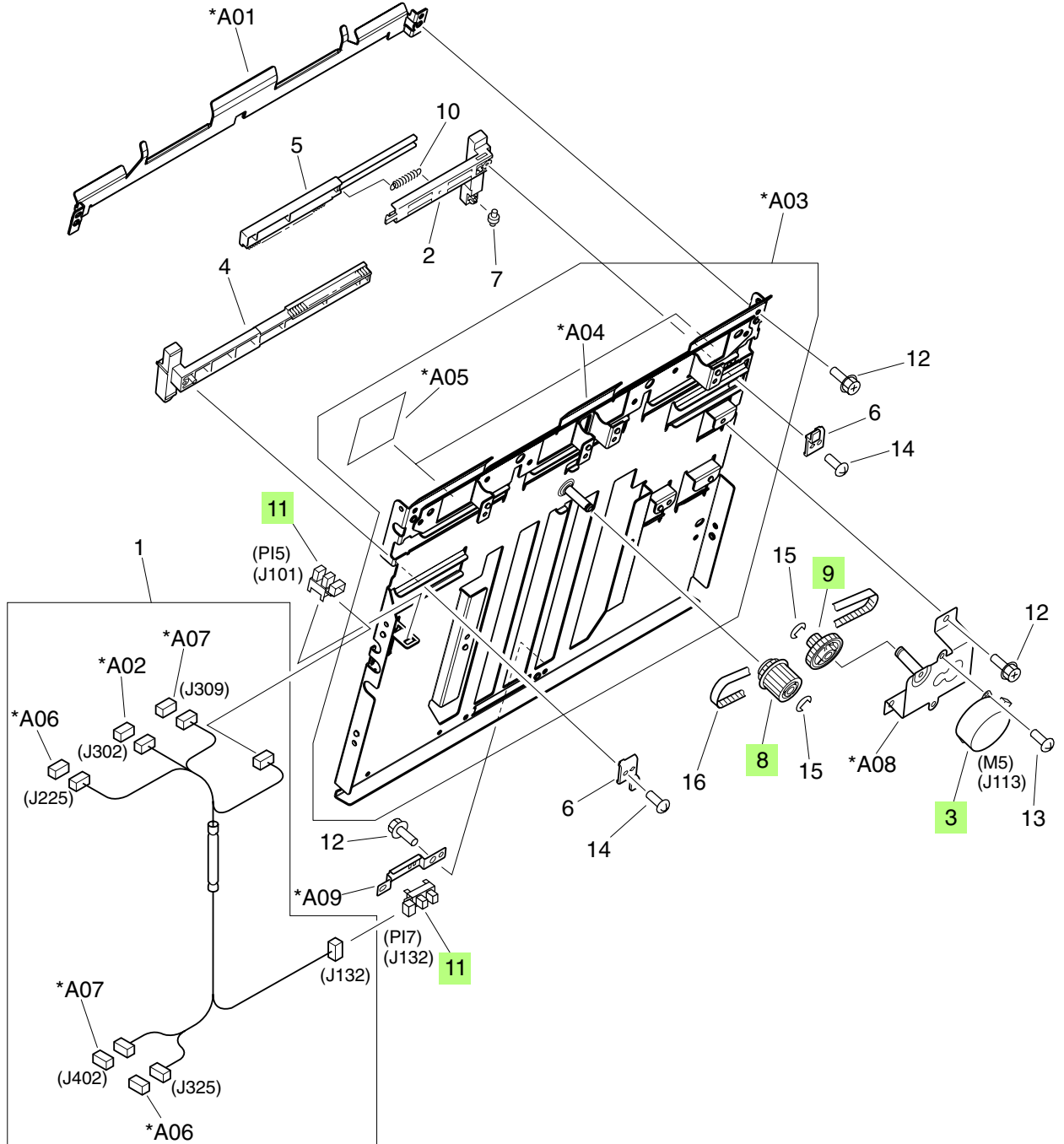



Table 9-53 Pass lower-guide assembly (booklet-maker)

Ref	Description	Part number	Qty
3	Motor, stepping	4K1-1103-000CN	1
8	Pulley, 32T/gear, 16T	FS6-0814-000CN	1
9	Pulley, 16T/gear, 32T	FS6-0815-000CN	1
11	Photo interrupter, TLP1242	WG8-5593-000CN	2

 **NOTE:** Only highlighted parts are orderable.