

HCI components (1 of 2)

Figure 2-18 HCI components (1 of 2)

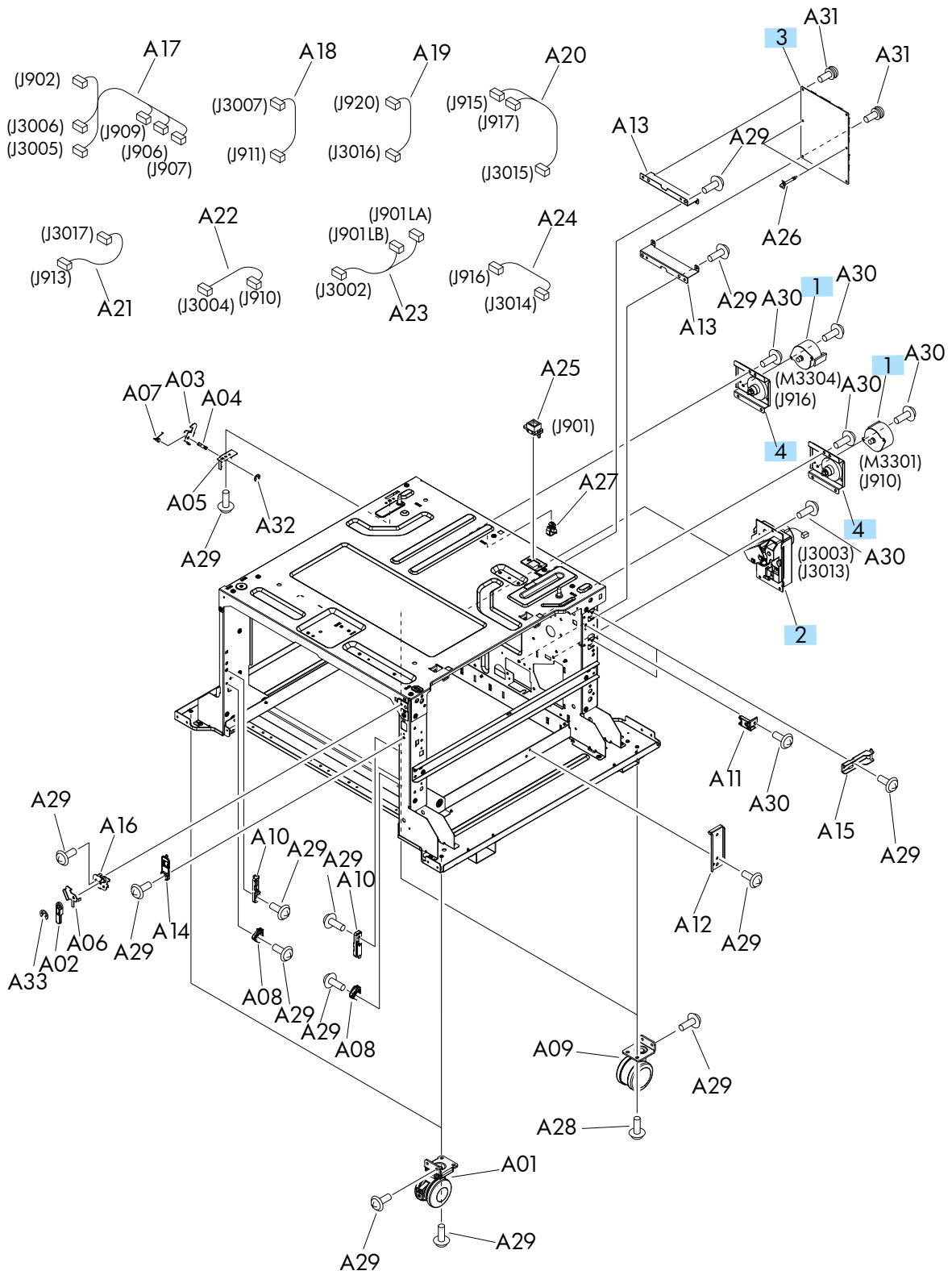

Table 2-22 HCI components (1 of 2)

Ref	Description	Part number	Qty
1	Motor, stepping, DC	RK2-1331-000CN	2
2	Lifter drive assembly	RM1-8879-000CN	2
3	Controller PCA	RM1-9057-000CN	1
4	Paper pickup motor assembly	RM1-8872-000CN	2