

Internal components (2 of 4)

Figure 2-9 Internal components (2 of 4)

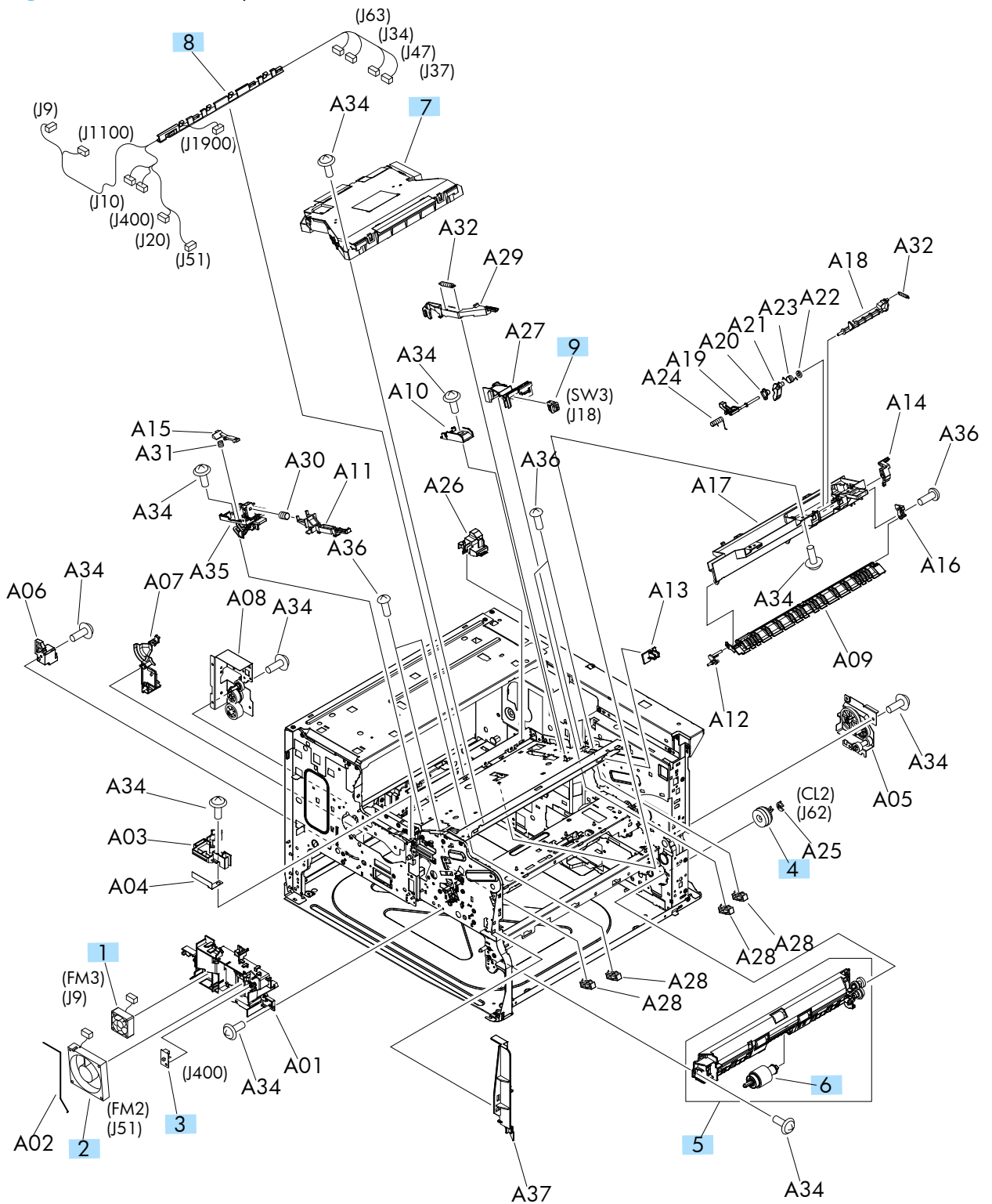

Table 2-13 Internal components (2 of 4)

Ref	Description	Part number	Qty
1	Fan	RK2-1092-000CN	1
2	Fan	RK2-3244-000CN	1
3	Sensor, humidity	WP2-5316-000CN	1
4	Clutch, electromagnetic	RM1-8946-000CN	1
5	Lower cassette (Tray 3) pickup assembly	RM2-0183-000CN	1
6	Roller, cassette pickup (part of Tray 2 or 3 pickup roller and separation pad kit)	CF235-67909	1
7	Laser scanner assembly	RM1-8679-000CN	1
8	Cable, multi, front	RM1-8971-000CN	1
9	Cartridge door open switch	WC2-5637-000CN	1