

1x500 and 3x500 paper deck

1x500 and 3x500 paper deck covers

Figure 2-19 1x500 and 3x500 paper deck covers

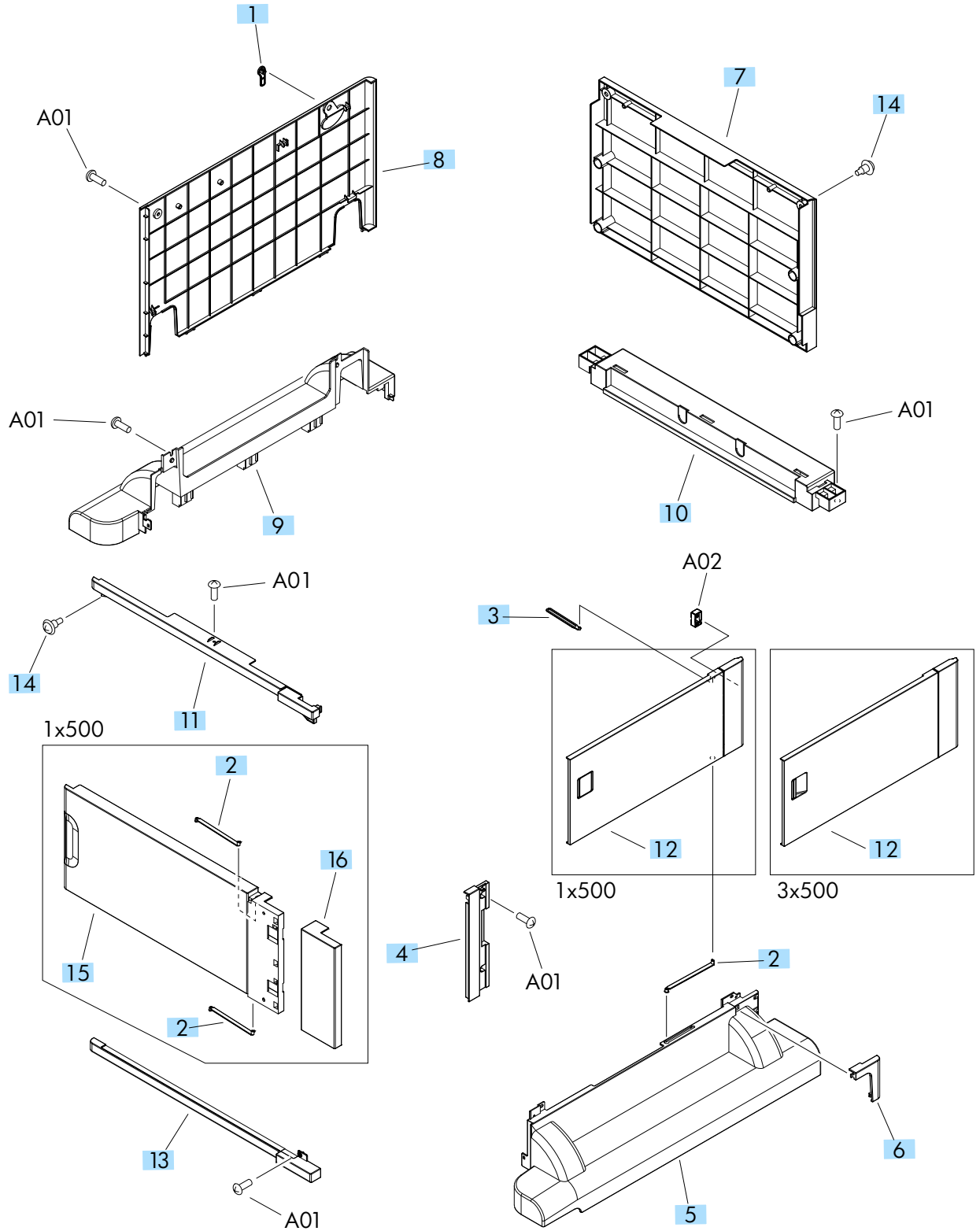

Table 2-24 1x500 and 3x500 paper deck covers

Ref	Description	Part number	Qty
	1x500 feeder and stand assembly kit	CF235-67915	1
	3x500 feeder and stand assembly kit	CF235-67916	1
1	Handle, lock, rear	RC2-9303-000CN	1
2	Link, right door, lower	RC2-9327-000CN	3
3	Link, right door, upper	RC2-9335-000CN	1
4	Cover, right corner	RC2-9343-000CN	1
5	Cover, right lower, 1	RC2-9346-000CN	1
6	Cover, right lower, 2	RC2-9347-000CN	1
7	Cover, rear	RC2-9348-000CN	1
8	Cover, left	RC2-9349-000CN	1
9	Cover, left lower	RC2-9350-000CN	1
10	Cover, rear lower	RC2-9357-000CN	1
11	Front upper cover assembly	RM1-6949-000CN	1
12	Right door assembly (1x500 paper deck)	RM1-6952-000CN	1
12	Right door assembly (3x500 paper deck)	RM1-6953-000CN	1
13	Front lower cover assembly	RM1-6958-000CN	1
14	Screw, stepped	RU5-9056-000CN	3
15	Door, stock, 1 (1x500 paper deck only)	RC2-9353-000CN	1
16	Door, stock, 2 (1x500 paper deck only)	RC2-9354-000CN	1