

i n v e n t

hp color LaserJet
1500 • 2500 series

service

hp color LaserJet 1500/2500 series printers

service

Copyright Information

© 2003 Hewlett-Packard Company

All Rights Reserved.
Reproduction, adaptations, or translation without prior written permission is prohibited except as allowed under copyright laws.

Part number Q2488-90901
Edition 1, 1/2003
Printed in USA

Warranty

The information contained in this document is subject to change without notice.

Hewlett-Packard makes no warranty of any kind with respect to this information.
HEWLETT-PACKARD SPECIFICALLY DISCLAIMS THE IMPLIED WARRANTY OF MERCHANTABILITY AND FITNESS FOR A PARTICULAR PURPOSE.

Hewlett-Packard shall not be liable for any direct, indirect, incidental, consequential, or other damage alleged in connection with the furnishing or use of this information.

NOTICE TO U.S. GOVERNMENT USERS:
RESTRICTED RIGHTS COMMERCIAL COMPUTER SOFTWARE: "Use, duplication, or disclosure by the Government is subject to restrictions as set forth in subparagraph (c) (1)(ii) of the Rights in Technical Data Clause at DFARS 52.227-7013."

Trademark Credits

Adobe®, Acrobat®, PostScript™, and the Acrobat logo are either registered trademarks or trademarks of Adobe Systems Incorporated in the United States and/or other countries/regions.

Netscape™ and Netscape Navigator™ are U.S. trademarks of Netscape Communications Corporation.

Microsoft®, Windows®, Windows NT®, and MS-DOS® are U.S. registered trademarks of Microsoft Corporation.

TrueType™ is a U.S. trademark of Apple Computer, Inc.

UNIX® is a registered trademark of The Open Group.

ENERGY STAR® is a U.S. registered service mark of the U.S. Environmental Protection Agency.



Safety Information

WARNING!

Potential Shock Hazard

Always follow basic safety precautions when using this product to reduce risk of injury from fire or electric shock.

1. Read and understand all instructions in the user guide.
2. Observe all warnings and instructions marked on the product.
3. Use only a grounded electrical outlet when connecting HP LaserJet 1500/2500 series printers to a power source. If you do not know whether the outlet is grounded, check with a qualified electrician.
4. Do not touch the contacts on the end of any of the sockets on HP LaserJet 1500/2500 series printers. Replace damaged cords immediately.
5. Unplug this product from wall outlets before cleaning.
6. Do not install or use this product near water or when you are wet.
7. Install the product securely on a stable surface.
8. Install the product in a protected location where no one can step on or trip over the power cord and where the power cord will not be damaged.
9. If the product does not operate normally, see the online user guide.
10. Refer all servicing questions to qualified personnel.

Information regarding FCC Class B, Parts 15 and 68 requirements can be found in the user guide.



Contents

1 Product Information

Introduction	16
HP color LaserJet 1500 series printer features and configurations	16
HP color LaserJet 2500 series printer features and configurations	17
Product specifications	18
Media specifications	22
Model and serial numbers	23
Printer overview	24
HP color LaserJet 1500 series printer	24
HP color LaserJet 2500 series printer	25
Warranty statements	26
HP color LaserJet 1500 series printer	26
HP color LaserJet 2500 series printer	27
Limited warranty for the print cartridges and imaging drum	28
Regulatory statements	29
HP color LaserJet 1500 series printer declaration of conformity	29
HP color LaserJet 2500 series printer declaration of conformity	30
Laser safety statement	31
Canadian DOC statement	31
VCCI statement (Japan)	31
Korean EMI statement	31
Finnish laser statement	32

2 Installation and operation

Operating environment	34
Interface ports	35
HP color LaserJet 1500 series printer	35
HP color LaserJet 2500 series printer	36
Control panel features	37
Understanding supplies status	38
Understanding printer status	39
Selecting media	40
Input trays	40
Supported print media	42
Printer output paths	43
Top output bin	43
Rear output door	43

Loading media	44
Loading tray 1	44
Loading optional tray 2	45
Loading optional tray 3	46
Using the embedded Web server	47
Information tab	48
Settings tab	48
Networking tab	48
Other links	49
Using Printer Status and Alerts	50
HP color LaserJet 1500 series printers	50
HP color LaserJet 2500 series printers	51

3 Maintenance

Life expectancies of supplies	54
User-replaceable parts	55
Replacing the pickup roller and separation pad	55
Replacing the separation pad in optional tray 2 or in optional tray 3	59
Cleaning the printer	61
Cleaning the engine	61
Calibrating the printer	62
Managing supplies	63
Supplies life	63
Checking and ordering supplies	63
Storing supplies	64
Replacing and recycling supplies	65
HP policy for non-HP supplies	65
HP fraud hotline	66

4 Theory of operation

Introduction	68
Engine control system	69
Basic sequence of operation	70
Power-on sequence	71
Motors and fans	72
Laser/scanner system	73
Pickup and feed system	74
Paper trays	76
Jam detection	77
Photosensors and switches	78
Solenoid and clutches	79
Printed circuit assemblies	80
Image-formation system	81
Image-formation process	82
Latent-image-formation stage	83
Developing stage	84
Transfer stage	85
Fusing stage	87
Print cartridge	91
Imaging-drum E-label	92

5 Removal and replacement

Introduction	95
Removal and replacement strategy	95
Electrostatic discharge	95
User-replaceable parts	95
Required tools	95
Before performing service	96
Pre-service procedures	96
Parts removal order	97
Removal and replacement	98
Imaging drum	98
Print cartridges	99
Jetdirect card	99
Fuser cover (and fuser)	100
Right- and left-side covers	101
Control panel	103
On-off switch	105
Interface cover	106
Formatter assemblies—HP color LaserJet 1500 series printers	107
Formatter assemblies—HP color LaserJet 2500 series printers	111
Fuser motor (J702)	115
Dc controller	116
Optional tray 2 (250-sheet tray)	118
Carousel motor (J704)	120
Front lower cover	121
Back cover	122
Top cover	123
Top door	126
Air duct and fan	128
Laser/scanner assembly	129
Front cover	131
Density sensor and top-of-page sensor	132
E-label reader (for imaging-drum E-labels)	133
Tray 1 (multipurpose tray)	135
Tray 1 separation pad assembly	137
Gear assembly	138
Waste-toner sensor	140
Rotary-drive assembly	141
Top plate	144
Print-cartridge carousel	147
Registration-roller assembly	152
Toner-catch tray	153
Transfer-roller plate	154
Transfer roller	155
Feed-drive shaft	156
ECU pan	157
Sub-high-voltage transformer PCA	160
High-voltage transformer PCA	161
Low-voltage PCA	162
Paper-top sensor	164
Fuser-wrap sensor	165
250-sheet feeder pickup roller	166
250-sheet feeder cover	167
250-sheet feeder PCA	168
500-sheet feeder pickup roller	169
500-sheet feeder cover	171
500-sheet feeder motor	172

6 Troubleshooting

Basic troubleshooting	174
Clearing jams	176
Control panel light messages	181
Supplies Status lights	182
Printer Status lights	186
Attention with Ability to Continue secondary messages	189
Accessory error secondary messages	191
Service error secondary messages	193
Solving image-quality problems	195
Solving image-quality problems (all print jobs)	196
Solving image-quality problems (color print jobs)	203
Resolving problems that generated messages	206
Messages for both Windows and Macintosh	206
Messages for Windows only	206
Resolving problems that did not generate messages	207
Solving general printing problems	209
Solving PostScript (PS) errors	213
Solving common Macintosh problems	214
Manually rotating the print-cartridge carousel	216
Functional checks	218
Engine test	218
High-voltage power-supply check	219
Paper-path check	220
Service mode functions	221
Cold reset	221
NVRAM initializer	221
Using PJI commands	222
Troubleshooting tools	224
Demo page	224
Configuration page	224
Supplies Status page	226
Repetitive image defect ruler	227
General timing charts	228
Locations of connectors	231
Dc controller connections	234
Main wiring diagram	235
The HP Color LaserJet 1500 Series Toolbox	237
The HP Color LaserJet 2500 Series Toolbox	240

7 Parts and diagrams

Ordering parts and supplies	244
Parts	244
Related documentation and software	244
Supplies	244
Accessories	245
How to use the parts lists and diagrams	246
Assembly locations	247
Printer (without optional trays)	247
Covers	248
Internal assemblies	250
Front frame assembly	250
Internal components (1 of 2)	252
Internal components (2 of 2)	254
Main drive assembly	256
Rear frame assembly	258
Middle frame assembly	260
Rotary (carousel) assembly	262
Power-supply base assembly	264
Fuser assembly	266
Rotary-drive assembly	268
PCA assemblies	269
Optional tray 2	270
Covers for optional tray 2	270
Center frame assembly—optional tray 2	272
Optional tray 2	274
Right cover assembly—optional tray 2	275
Optional tray 3	276
Covers for optional tray 3	276
Internal components—optional tray 3	278
Feed drive assembly—optional tray 3	280
Media tray—optional tray 3	282
Alphabetical parts list	284
Numerical parts list	291

Index

Figures

Figure 1.	Front and left-side view—HP color LaserJet 1500 series printers	24
Figure 2.	Back and right-side view—HP color LaserJet 1500 series printers	24
Figure 3.	Front and left-side view—HP color LaserJet 2500 series printers	25
Figure 4.	Back and right-side view—HP color LaserJet 2500 series printers	25
Figure 5.	Space required	34
Figure 6.	HP color LaserJet 1500 series printer interface port.	35
Figure 7.	HP color LaserJet 2500 series printer interface ports.	36
Figure 8.	Control panel lights and buttons	37
Figure 9.	Standard and optional input trays—HP color LaserJet 1500 series printers	40
Figure 10.	Standard and optional input trays—HP color LaserJet 2500 series printers	41
Figure 11.	Printer output paths.	43
Figure 12.	Toner specks and smearing	61
Figure 13.	Loading the cleaning page in tray 1	61
Figure 14.	Cross-section of the printer.	68
Figure 15.	Engine control system (includes the basic configuration of the printer)	69
Figure 16.	Power-on sequence	71
Figure 17.	Motors and fans	72
Figure 18.	Laser/scanner system.	73
Figure 19.	Pickup and feed system	75
Figure 20.	Optional tray 2 (250-sheet paper tray)	76
Figure 21.	Photosensors and switches (1 of 2)	78
Figure 22.	Photosensors and switches (2 of 2)	78
Figure 23.	Solenoid and clutches (1 of 2)	79
Figure 24.	Solenoid and clutches (2 of 2)	79
Figure 25.	Printed circuit assemblies (1 of 2).	80
Figure 26.	Printed circuit assemblies (2 of 2).	80
Figure 27.	Image-formation system	81
Figure 28.	Image-formation process	82
Figure 29.	Step 1: primary charging.	83
Figure 30.	Step 2: laser-beam exposure	83
Figure 31.	Developing block.	84
Figure 32.	Step 3: developing	84
Figure 33.	Step 4: primary transfer	85
Figure 34.	Step 5: secondary transfer	86
Figure 35.	Step 6: separation.	86
Figure 36.	Step 7: fusing	87
Figure 37.	Step 8: roller charging (auxiliary transfer belt cleaning roller).	87
Figure 38.	Step 9: roller charging (transfer belt cleaning roller).	88
Figure 39.	Step 10: transfer belt cleaning	89
Figure 40.	Step 11: drum cleaning.	90
Figure 41.	Print cartridge	91
Figure 42.	Print-cartridge E-label.	92
Figure 43.	Removing the fuser cover (and fuser).	100
Figure 44.	Removing the right-side cover (1 of 2)	101
Figure 45.	Removing the right-side cover (2 of 2)	102
Figure 46.	Removing the control panel (1 of 2)	103
Figure 47.	Removing the control panel (2 of 2)	104
Figure 48.	Removing the on-off switch.	105
Figure 49.	Removing the interface cover	106
Figure 50.	Removing the formatter cage—HP color LaserJet 1500 series printers (1 of 2) .	107
Figure 51.	Removing the formatter cage—HP color LaserJet 1500 series printers (2 of 2) .	108
Figure 52.	Removing the formatter—HP color LaserJet 1500 series printers (1 of 2)	109

Figure 53.	Removing the formatter—HP color LaserJet 1500 series printers (2 of 2)	110
Figure 54.	Formatter clips—HP color LaserJet 1500 series printers	110
Figure 55.	Removing the formatter cage—HP color LaserJet 2500 series printers (1 of 2) .	111
Figure 56.	Removing the formatter cage—HP color LaserJet 2500 series printers (2 of 2) .	112
Figure 57.	Removing the formatter—HP color LaserJet 2500 series printers (1 of 2)	113
Figure 58.	Removing the formatter—HP color LaserJet 2500 series printers (2 of 2)	114
Figure 59.	Removing the fuser motor	115
Figure 60.	Removing the dc controller (1 of 2)	116
Figure 61.	Removing the dc controller (2 of 2)	117
Figure 62.	Removing optional tray 2 (1 of 2)	118
Figure 63.	Removing optional tray 2 (2 of 2)	119
Figure 64.	Removing the carousel motor	120
Figure 65.	Removing the front lower cover	121
Figure 66.	Removing the back cover	122
Figure 67.	Removing the top cover (1 of 2)	123
Figure 68.	Removing the top cover (2 of 2)	124
Figure 69.	Reinstalling the top cover.	125
Figure 70.	Removing the top door (1 of 2)	126
Figure 71.	Removing the top door (2 of 2)	127
Figure 72.	Removing the air duct	128
Figure 73.	Removing the laser/scanner assembly	129
Figure 74.	Reinstalling the top output bin cover	130
Figure 75.	Removing the front cover.	131
Figure 76.	Removing the density sensor cover.	132
Figure 77.	Removing the density sensor.	132
Figure 78.	Removing the E-label reader (1 of 2)	133
Figure 79.	Removing the E-label reader (2 of 2)	134
Figure 80.	Removing tray 1 (1 of 2)	135
Figure 81.	Removing tray 1 (2 of 2)	136
Figure 82.	Removing the tray 1 separation pad assembly	137
Figure 83.	Removing the gear assembly (1 of 2)	138
Figure 84.	Removing the gear assembly (2 of 2)	139
Figure 85.	Removing the waste-toner sensor	140
Figure 86.	Removing the rotary-drive assembly (1 of 3)	141
Figure 87.	Removing the rotary-drive assembly (2 of 3)	142
Figure 88.	Removing the rotary-drive assembly (3 of 3)	143
Figure 89.	Removing the top plate (1 of 3)	144
Figure 90.	Removing the top plate (2 of 3)	145
Figure 91.	Removing the top plate (3 of 3)	146
Figure 92.	Removing the print-cartridge carousel (1 of 3)	147
Figure 93.	Removing the print-cartridge carousel (2 of 3)	148
Figure 94.	Removing the print-cartridge carousel (3 of 3)	149
Figure 95.	Reinstalling the print-cartridge carousel.	151
Figure 96.	Removing the registration-roller assembly.	152
Figure 97.	Removing the toner-catch tray.	153
Figure 98.	Removing the transfer-roller plate	154
Figure 99.	Removing the transfer roller.	155
Figure 100.	Removing the feed-drive shaft.	156
Figure 101.	Removing the ECU pan (1 of 2)	157
Figure 102.	Removing the ECU pan (2 of 2)	158
Figure 103.	ECU connections	159
Figure 104.	Removing the sub-high-voltage transformer PCA	160
Figure 105.	Removing the high-voltage transformer PCA	161
Figure 106.	Removing the low-voltage PCA (1 of 2)	162
Figure 107.	Removing the low-voltage PCA (2 of 2)	163
Figure 108.	Removing the paper-top sensor.	164
Figure 109.	Removing the fuser wrap sensor	165
Figure 110.	Removing the 250-sheet feeder pickup roller	166
Figure 111.	Removing the 250-sheet feeder cover.	167

Figure 112.	Removing the 250-sheet feeder PCA	168
Figure 113.	Removing the 500-sheet feeder pickup roller (1 of 2).	169
Figure 114.	Removing the 500-sheet feeder pickup roller (2 of 2).	170
Figure 115.	Removing the 500-sheet feeder cover	171
Figure 116.	Removing the 500-sheet feeder motor	172
Figure 117.	Control panel lights	181
Figure 118.	Manually rotating the print-cartridge carousel (guide installed)	216
Figure 119.	Manually rotating the print-cartridge carousel (no guide installed)	217
Figure 120.	Location of the engine-test switch.	218
Figure 121.	Print cartridge high-voltage connection points	219
Figure 122.	Overriding SW301 and the laser/scanner switch	220
Figure 123.	Repetitive image defect ruler	227
Figure 124.	General timing chart—WAIT period	228
Figure 125.	General timing chart—one page, full-color, normal speed	229
Figure 126.	General timing chart—one page, full-color, half speed.	230
Figure 127.	Locations of printer connectors (1 of 3)	231
Figure 128.	Locations of printer connectors (2 of 3)	231
Figure 129.	Locations of printer connectors (3 of 3)	232
Figure 130.	Locations of 250-sheet tray connectors	232
Figure 131.	Locations of 500-sheet tray connectors (HP color LaserJet 2500 only)	233
Figure 132.	Dc controller connections	234
Figure 133.	Main wiring (1 of 2)	235
Figure 134.	Main wiring (2 of 2)	236
Figure 135.	Assembly locations	247
Figure 136.	Covers.	248
Figure 137.	Front frame assembly	250
Figure 138.	Internal components (1 of 2).	252
Figure 139.	Internal components (2 of 2).	254
Figure 140.	Main drive assembly	256
Figure 141.	Rear frame assembly	258
Figure 142.	Middle frame assembly	260
Figure 143.	Rotary (carousel) assembly	262
Figure 144.	Power-supply base assembly	264
Figure 145.	Fuser assembly.	266
Figure 146.	Rotary-drive assembly	268
Figure 147.	PCA assemblies	269
Figure 148.	Covers for optional tray 2	270
Figure 149.	Center frame assembly—optional tray 2.	272
Figure 150.	Media tray—optional tray 2.	274
Figure 151.	Right cover assembly—optional tray 2	275
Figure 152.	Covers for optional tray 3	276
Figure 153.	Internal components—optional tray 3	278
Figure 154.	Feed drive assembly—optional tray 3.	280
Figure 155.	Media tray—optional tray 3.	282

Tables

Table 1.	Product features	18
Table 2.	Physical specifications	20
Table 3.	Consumables specifications	21
Table 4.	Electrical specifications	21
Table 5.	Environmental specifications	21
Table 6.	Acoustic emissions (declared per ISO 9296)	21
Table 7.	Tray 1 specifications	22
Table 8.	Optional tray 2 specifications	22
Table 9.	Optional tray 3 specifications (HP LaserJet 2500 series printers only).	23
Table 10.	Supplies-status messages and actions.	38
Table 11.	Printer-status messages and actions	39
Table 12.	Input tray configuration	40
Table 13.	Input tray configuration	41
Table 14.	Supported sizes and types of print media.	42
Table 15.	Life expectancies of supplies	54
Table 16.	Basic sequence of operation.	70
Table 17.	Motors and fans	72
Table 18.	Photosensors and switches	78
Table 19.	Solenoid and clutches.	79
Table 20.	Printed circuit assemblies	80
Table 21.	Basic troubleshooting	174
Table 22.	Control panel lights legend	181
Table 23.	Supplies Status light messages	182
Table 24.	Printer Status light messages	186
Table 25.	Attention with Ability to Continue secondary messages	189
Table 26.	Accessory error secondary messages	191
Table 27.	Service error secondary messages	193
Table 28.	Solving general printing problems.	209
Table 29.	Technical support websites	244
Table 30.	Accessories.	245
Table 31.	Covers.	249
Table 32.	Front frame assembly	251
Table 33.	Internal components (1 of 2).	253
Table 34.	Internal components (2 of 2).	255
Table 35.	Formatter assemblies (not pictured).	255
Table 36.	Main drive assembly	257
Table 37.	Rear frame assembly	259
Table 38.	Middle frame assembly	261
Table 39.	Rotary assembly	263
Table 40.	Power-supply base assembly	265
Table 41.	Fuser assembly.	267
Table 42.	Rotary-drive assembly	268
Table 43.	PCA assemblies	269
Table 44.	Covers for optional tray 2	271
Table 45.	Center frame assembly.	273
Table 46.	Media tray—optional tray 2.	275
Table 47.	Right cover assembly—optional tray 2	275
Table 48.	Covers for optional tray 3	277
Table 49.	Internal components—optional tray 3	279

Table 50.	Feed drive assembly—optional tray 3.	281
Table 51.	Media tray—optional tray 3.	283
Table 52.	Alphabetical parts list	284
Table 53.	Numerical parts list	291

1

Product Information

Chapter contents

Introduction	16
HP color LaserJet 1500 series printer features and configurations	16
HP color LaserJet 2500 series printer features and configurations	17
Product specifications	18
Media specifications	22
Model and serial numbers	23
Printer overview	24
HP color LaserJet 1500 series printer	24
HP color LaserJet 2500 series printer	25
Warranty statements	26
HP color LaserJet 1500 series printer	26
HP color LaserJet 2500 series printer	27
Limited warranty for the print cartridges and imaging drum	28
Regulatory statements	29
HP color LaserJet 1500 series printer declaration of conformity	29
HP color LaserJet 2500 series printer declaration of conformity	30
Laser safety statement	31
Canadian DOC statement	31
VCCI statement (Japan)	31
Korean EMI statement	31
Finnish laser statement	32

Introduction

HP color LaserJet 1500 series printer features and configurations

The HP color LaserJet 1500 series printer is a four-color laser printer that prints at 16 pages per minute (ppm) in black, and 4 ppm in color.

- **Trays**—The printer comes with a multipurpose tray (tray 1) that holds up to 125 sheets of various print media or 10 envelopes. The HP color LaserJet 1500L printer is compatible with a 250-sheet tray (optional tray 2) for standard sizes of paper. HP color LaserJet 1500 printer comes with both tray 1 and tray 2.
- **Connectivity**—The printer provides a HI-SPEED universal serial bus (USB) port for connectivity.
- **Memory**—The printer contains 16 MB RAM, which cannot be expanded.



HP color LaserJet 1500L printer

The HP color LaserJet 1500L printer comes with tray 1 (multipurpose tray), and accepts the optional tray 2.



HP color LaserJet 1500 printer

The HP color LaserJet 1500 printer comes with tray 1 and tray 2.

Note

Because tray 2 is not included with both models, it is referred to as optional tray 2 in this documentation.

HP color LaserJet 2500 series printer features and configurations

The HP color LaserJet 2500 series printer is a four-color laser printer that prints at 16 pages per minute (ppm) in black, and 4 ppm in color.

- **Trays**—The printer comes with a multipurpose tray (tray 1) that holds up to 125 sheets of various print media or 10 envelopes. The HP color LaserJet 2500L is compatible with a 250-sheet tray (optional tray 2) for standard sizes of paper and a 500-sheet tray (optional tray 3) for A4 and letter sizes. (Optional tray 2 must be installed in order to install optional tray 3.)
- **Connectivity**—The printer provides parallel and USB ports for connectivity. The printer also contains an EIO slot for installing an optional HP Jetdirect print server.

Note

The parallel and USB ports cannot be connected at the same time.

- **Memory**—The printer contains three DIMM slots. The standard 64-MB RAM DIMM resides in one of the slots. The printer memory can be expanded to a total of 256 MB using 32-, 64-, or 128-MB RAM DIMMs. A language font DIMM can be installed in one of the DIMM slots.



HP color LaserJet 2500L printer

The HP color LaserJet 2500L printer comes with tray 1 (multipurpose tray), and accepts optional trays 2 and 3.



HP color LaserJet 2500 printer

The HP color LaserJet 2500 printer comes with tray 1 and tray 2, and accepts optional tray 3.



HP color LaserJet 2500n printer

- The HP color LaserJet 2500n printer comes with tray 1 and tray 2, and accepts optional tray 3.
- The printer comes with an HP Jetdirect 615n print server card for connecting to a 10/100Base-T network.



HP color LaserJet 2500tn printer

- The HP color LaserJet 2500tn printer comes with tray 1, tray 2, and tray 3.
- The printer comes with an HP Jetdirect 615n print server card for connecting to a 10/100Base-T network.

Note

Because tray 2 and tray 3 are not included with all models, they are referred to as optional tray 2 and optional tray 3 in this documentation.

Product specifications

Table 1. Product features

Category	HP color LaserJet 1500 series printer feature	HP color LaserJet 2500 series printer feature
Color printing	<ul style="list-style-type: none"> Prints in color using the four process colors: cyan, magenta, yellow, and black. 	<ul style="list-style-type: none"> Prints in color using the four process colors: cyan, magenta, yellow, and black.
Fast print speed	<ul style="list-style-type: none"> Prints letter-size paper at 16 ppm for black or 4 ppm for color. 	<ul style="list-style-type: none"> Prints letter-size paper at 16 ppm for black or 4 ppm for color.
Excellent print quality	<ul style="list-style-type: none"> True 600-by-600 dpi text and graphics. ImageREt 2400 provides 2400-dpi color laser print quality through a multilevel printing process. Adjustable settings to optimize print quality. The HP UltraPrecise print cartridge has a finer toner formulation that provides sharper text and graphics. 	<ul style="list-style-type: none"> True 600-by-600 dpi text and graphics. ImageREt 2400 provides 2400-dpi color laser print quality through a multilevel printing process. Adjustable settings to optimize print quality. The HP UltraPrecise print cartridge has a finer toner formulation that provides sharper text and graphics.
Ease of use	<ul style="list-style-type: none"> Few supplies to order. Supplies are easy to install. Convenient access to printer information and settings using software tools (HP color LaserJet 1500 Series Toolbox). 	<ul style="list-style-type: none"> Few supplies to order. Supplies are easy to install. Convenient access to printer information and settings using software tools (HP color LaserJet 2500 Series Toolbox, embedded Web server, Printer Status and Alerts).
Expandability	<ul style="list-style-type: none"> Optional tray 2 is included with the HP color LaserJet 1500 printer and is compatible with the HP color LaserJet 1500L model. This 250-sheet tray for standard paper sizes reduces the frequency with which you have to add paper to the printer. Only one 250-sheet tray can be installed on the printer. Optional external HP Jetdirect print server for connecting to a network. 	<ul style="list-style-type: none"> Optional tray 2 is included with the 2500, 2500n, and 2500tn models and is compatible with the 2500L model. This 250-sheet tray for standard paper sizes reduces the frequency with which you have to add paper to the printer. Only one 250-sheet tray can be installed on the printer. Optional tray 3 is included with the 2500tn model and is compatible with the 2500L, 2500, and 2500n models. This 500-sheet tray for letter- and A4-size paper reduces the frequency with which you have to add paper to the printer. Only one 500-sheet tray can be installed on the printer. <p>NOTE: Optional tray 2 must be installed in order to install optional tray 3.</p> <ul style="list-style-type: none"> Optional HP Jetdirect print server card for connecting to a network. Included with the 2500n and 2500tn models; compatible with the 2500L and 2500 models. Two additional DIMM slots for adding memory and fonts. <p>NOTE: The printer has three DIMM slots, but the first slot (the slot on the left) might contain a flash DIMM.</p>

Table 1. Product features (continued)

Category	HP color LaserJet 1500 series printer feature	HP color LaserJet 2500 series printer feature
Flexible paper handling	<ul style="list-style-type: none"> Adjustable tray 1 for letterhead, envelopes, labels, transparencies, custom-sized media, postcards, and heavy paper. Optional tray 2 for standard-size paper. One 125-sheet output bin (top output bin). Select the top output bin (face-down bin) for most jobs, including transparencies. <p>NOTE: HP color LaserJet 1500 series printers do not print in color on transparencies.</p> <ul style="list-style-type: none"> One rear output door. Use the rear output door (face-up) for jobs on heavy paper, light paper, or special print media, excluding transparencies. Straight-through paper path available from tray 1 to the rear output door. Manual duplexing. See the <i>HP Color LaserJet 1500 Series Printer User Guide</i> for more information. 	<ul style="list-style-type: none"> Adjustable tray 1 for letterhead, envelopes, labels, transparencies, custom-sized media, postcards, and heavy paper. Optional tray 2 for standard-size paper. Optional tray 3 for letter- and A4-size paper. One 125-sheet output bin (top output bin). Select the top output bin (face-down bin) for most jobs, including transparencies. <p>NOTE: HP color LaserJet 2500 series printers do not print in color on transparencies.</p> <ul style="list-style-type: none"> One rear output door. Use the rear output door (face-up) for jobs on heavy paper, light paper, or special print media, excluding transparencies. Straight-through paper path available from tray 1 to the rear output door. Manual duplexing. See the <i>HP Color LaserJet 2500 Series Printer User Guide</i> for more information.
Printer control language (PCL) printer language and fonts		<ul style="list-style-type: none"> Fast printing performance, built-in Intellifont and TrueType™ scaling technologies, built-in HP-GL/2 vector graphics, and advanced imaging capabilities are benefits of the PCL 5 and PCL 6 printer languages. PCL 5 and PCL 6 also include 45 scalable TrueType fonts and one bitmapped line printer (LP) font. PCL 5 and PCL 6 printer languages also included.
PostScript® (PS) 3 emulation language and fonts		<ul style="list-style-type: none"> PostScript (PS) 3 emulation with 35 built-in PS language fonts included.
Automatic language switching		<ul style="list-style-type: none"> The printer automatically determines and switches to the appropriate printer language (such as PS) for the print job.
Interface connections	<ul style="list-style-type: none"> Hi-Speed USB port. Optional HP Jetdirect print server. 	<ul style="list-style-type: none"> Bidirectional enhanced capabilities port (ECP) type-B parallel port (IEEE-1284 compliant). USB port. A parallel cable and a USB cable cannot be connected at the same time. If they are, then USB is disabled. EIO slot in the 2500L and 2500 models. The 2500n and 2500tn models include the optional HP Jetdirect 615n print server card.
Networking	<ul style="list-style-type: none"> All common network protocols such as Ethernet, Token Ring, and LocalTalk are available using optional external HP Jetdirect print server cards. Compatible external HP Jetdirect print servers are the HP Jetdirect 175x (model J6035A) and the HP Jetdirect 310x (model J6038A). Wireless networking (802.11b) is available with the HP Jetdirect 380x print server (model J6061A). 	<ul style="list-style-type: none"> The 2500L and 2500 models provide an EIO slot for an optional HP Jetdirect print server card for fast and easy connectivity. (The 2500n and 2500tn models include the HP Jetdirect 615n print server card.) All common network protocols such as Ethernet, Token Ring, and LocalTalk are available using HP Jetdirect print server cards. Wireless networking (802.11b) is available with the HP Jetdirect 615n print server card (model J6058A).

Table 1. Product features (continued)

Category	HP color LaserJet 1500 series printer feature	HP color LaserJet 2500 series printer feature
Enhanced memory	<ul style="list-style-type: none"> The printer comes with 16 MB of memory that cannot be expanded. 	<ul style="list-style-type: none"> The printer comes with 64 MB of memory and can be expanded to 256 MB by using the DIMM slots.
Energy savings	<ul style="list-style-type: none"> The printer automatically conserves electricity by substantially reducing power consumption when you are not printing. As an ENERGY STAR® partner, Hewlett-Packard Company has determined that this product meets ENERGY STAR guidelines for energy efficiency. ENERGY STAR® is a U.S. registered service mark of the United States Environmental Protection Agency. 	<ul style="list-style-type: none"> The printer automatically conserves electricity by substantially reducing power consumption when you are not printing. As an ENERGY STAR® partner, Hewlett-Packard Company has determined that this product meets ENERGY STAR guidelines for energy efficiency. ENERGY STAR® is a U.S. registered service mark of the United States Environmental Protection Agency.
Economical printing	<ul style="list-style-type: none"> Pages-per-sheet printing and two-sided printing using manual duplexing saves paper. See the <i>HP Color LaserJet 1500 Series Printer User Guide</i> for more information. 	<ul style="list-style-type: none"> Pages-per-sheet printing and two-sided printing using manual duplexing saves paper. See the <i>HP Color LaserJet 2500 Series Printer User Guide</i> for more information.
Print cartridges	<ul style="list-style-type: none"> The Supplies Status page includes print cartridge and imaging drum gauges that show life remaining (for HP supplies only). No-shake cartridge design. Authentication for HP print cartridges. Enabled supplies-ordering capability. 	<ul style="list-style-type: none"> The Supplies Status page includes print cartridge and imaging drum gauges that show life remaining (for HP supplies only). No-shake cartridge design. Authentication for HP print cartridges. Enabled supplies-ordering capability.

Table 2. Physical specifications

Category	HP color LaserJet 1500L	HP color LaserJet 1500 with optional tray 2 (250-sheet)	
Height	325 mm (12.80 inches)	376 mm (14.80 inches)	
Width	482 mm (18.98 inches)	482 mm (18.98 inches)	
Depth (body)	451 mm (17.76 inches)	451 mm (17.76 inches)	
Weight (with supplies)	21.5 kg (47.5 lbs)	23.9 kg (52.7 lbs)	

Category	HP LaserJet 2500 without optional trays 2 and 3	HP LaserJet 2500 with optional tray 2 (250-sheet)	HP LaserJet 2500 with optional tray 3 (500-sheet)
Height	325 mm (12.80 inches)	376 mm (14.81 inches)	512 mm (20.16 inches)
Width	482 mm (18.98 inches)	482 mm (18.98 inches)	482 mm (18.98 inches)
Depth (body)	452 mm (17.80 inches)	452 mm (17.80 inches)	452 mm (17.80 inches)
Weight (with supplies)	21.52 kg (47.45 lbs)	23.9 kg (52.7 lbs)	29.27 kg (64.55 lbs)

Table 3. Consumables specifications

Category	Specification
Imaging-drum life	20,000 pages when printing only in black 5,000 pages when printing in color 6,000 to 8,000 pages is the average life
Print-cartridge life	Black: 5,000 pages Yellow, cyan, and magenta: 4,000 pages each

Table 4. Electrical specifications

Category	110-volt models	220-volt models
Power requirements	115 to 127 V (+/- 10%) 60 Hz (+/- 2 Hz)	220 to 240 V (+/- 10%) 50 Hz (+/- 2 Hz)
Minimum recommended circuit capacity for typical product	12 Amps	6 Amps
Average power consumption (watts)	Printing, color = 400 W Printing, monochrome = 224 W Standby = 30 W Off = 0 W	Printing, color = 403 W Printing, monochrome = 217 W Standby = 31 W Off = 0 W

CAUTION

Power requirements are based on the region where the printer is sold. Do not convert operating voltages. This will damage the printer and void the product warranty.

Table 5. Environmental specifications

Category	Operating	Storage
Temperature (printer and print cartridge)	15° to 32.5° C (59° to 90.5° F)	-20° to 40° C (-4° to 104° F)
Relative humidity	10 to 80 percent	95 percent or less

Table 6. Acoustic emissions (declared per ISO 9296)

Category	Printing (16 ppm)	Standby
Sound power	$L_{WA_d} = 6.7$ bels(A)	(not audible)
Sound pressure: Operation position	$L_{pAm} = 62$ dB(A)	(not audible)
Sound pressure: Bystander position	$L_{pAm} = 52$ dB(A)	(not audible)

Note

Acoustic emissions values are subject to change. See <http://www.hp.com/support/clj1500> or <http://www.hp.com/support/clj2500> for current information.

Media specifications

This section contains information about the sizes, weights, and capacities of media that each tray supports.

Table 7. Tray 1 specifications

Tray 1	Dimensions ¹	Weight or thickness	Capacity ²
Paper	Minimum: 76 by 127 mm (3 by 5 inches)	Weight: 60 to 177 g/m ² (16 to 47 lb)	125 sheets of 75-g/m ² (20-lb) paper
Transparencies and opaque film	Maximum: 216 by 356 mm (8.5 by 14 inches)	Thickness: 0.10 to 0.13 mm (0.0039 to 0.0051 inches)	50 typically
Labels ³		Thickness: up to 0.23 mm (up to 0.0091 inches)	50 typically
Envelopes		Weight: Up to 90 g/m ² (16 to 24 lb)	up to 10

1. The printer supports a wide range of standard and custom sizes of print media. Check the printer driver for supported sizes.
2. Capacity can vary depending on media weight and thickness, and environmental conditions.
3. Smoothness: 100 to 250 (Sheffield).

Table 8. Optional tray 2 specifications

Optional tray 2 ¹ (250-sheet tray)	Dimensions ²	Weight	Capacity ³
Letter	216 by 279 mm (8.5 by 11 inches)	60 to 105 g/m ² (16 to 28 lb)	250 sheets of 75-g/m ² (20-lb) paper
A4	210 by 297 mm (8.3 by 11.7 inches)		
A5	148 by 210 mm (5.8 by 8.3 inches)		
B5 (ISO)	176 by 250 mm (6.9 by 9.9 inches)		
B5 (JIS)	182 by 257 mm (7.2 by 10 inches)		
Executive	191 by 267 mm (7.3 by 10.5 inches)		
Legal	216 by 356 mm (8.5 by 14 inches)		
8.5 by 13 inch	216 by 330 mm (8.5 by 13 inches)		

1. Optional tray 2 supports paper only.
2. The printer supports a wide range of standard and custom sizes of print media. Check the printer driver for supported sizes.
3. Capacity can vary depending on media weight and thickness, and environmental conditions.

Table 9. Optional tray 3 specifications (HP LaserJet 2500 series printers only)

Optional tray 3 ¹ (500-sheet tray)	Dimensions ²	Weight	Capacity ³
Letter	216 by 279 mm (8.5 by 11 inches)	60 to 105 g/m ² (16 to 28 lb)	500 sheets of 75-g/m ² (20-lb) paper
A4	210 by 297 mm (8.3 by 11.7 inches)		

- Optional tray 3 supports paper only.
- The printer supports a wide range of standard and custom sizes of print media. Check the printer driver for supported sizes.
- Capacity can vary depending on media weight and thickness, and environmental conditions.

Model and serial numbers

The model number and serial number are listed on an identification label located underneath the top door.

The serial number contains information about the country of origin and the revision level, manufacturing date, production code, and production number of the product.

The label also contains power rating and regulatory information.

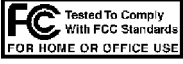

 HEWLETT PACKARD
 11311 CHINDEN BLVD
 BOISE, IDAHO 83714
 USA

Numéro réglementaire du modèle
 Regulatory Model Number BOISB-0209-00

 Tested To Comply
 With FCC Standards
 FOR HOME OR OFFICE USE

invent 110-127V ~AC
 50/60 Hz, 3.5A (3,5A)

Numéro du produit
 Product No. Q2489A

  LISTED
 I.T.E.
 5320
 US

This product conforms with
 CDRH radiation performance
 standard 21 CFR chapter 1,
 sub-chapter J.

Numéro de Série
 Serial No. CNBB123456

Fabriqué le
 Manufactured:
 October 31, 2002



Complies with Canadian EMC
 Class B requirements.
 Conforme à la Classe B des
 normes Canadiennes de
 compatibilité électromagnétiques
 << C E M >>



Assembled in USA; printer engine Made in China
 Assemblé aux États-Unis; moteur de l'imprimante fabriqué au Chine



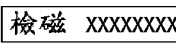

檢磁 XXXXXXXX

SITE:VA2 >PET<

HP color LaserJet 1500 series printer identification label

 HEWLETT PACKARD
 11311 CHINDEN BLVD
 BOISE, IDAHO 83714
 USA

Numéro de Modèle
 Model No. C9706A

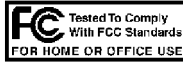

110-127V ~AC
 50/60 Hz, 3.5A (3,5A)

 Tested To Comply
 With FCC Standards
 FOR HOME OR OFFICE USE

invent

Numéro de Série
 Serial No. CNBB123456

Fabriqué le
 Manufactured:
 October 31, 2002

  LISTED
 I.T.E.
 5320
 US

This product conforms with
 CDRH radiation performance
 standard 21 CFR chapter 1,
 sub-chapter J.



Complies with Canadian EMC
 Class B requirements.
 Conforme à la Classe B des
 normes Canadiennes de
 compatibilité électromagnétiques
 << C E M >>



Assembled in USA; printer engine Made in China
 Assemblé aux États-Unis; moteur de l'imprimante fabriqué au Chine





SITE:VA2 >PET<

HP color LaserJet 2500 series printer identification label

Printer overview

HP color LaserJet 1500 series printer

Front and left-side view

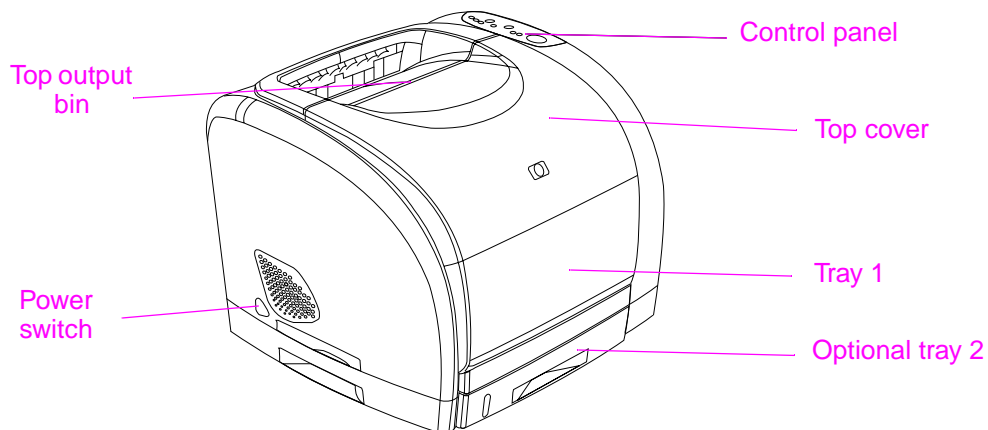

Figure 1. Front and left-side view—HP color LaserJet 1500 series printers

Back and right-side view

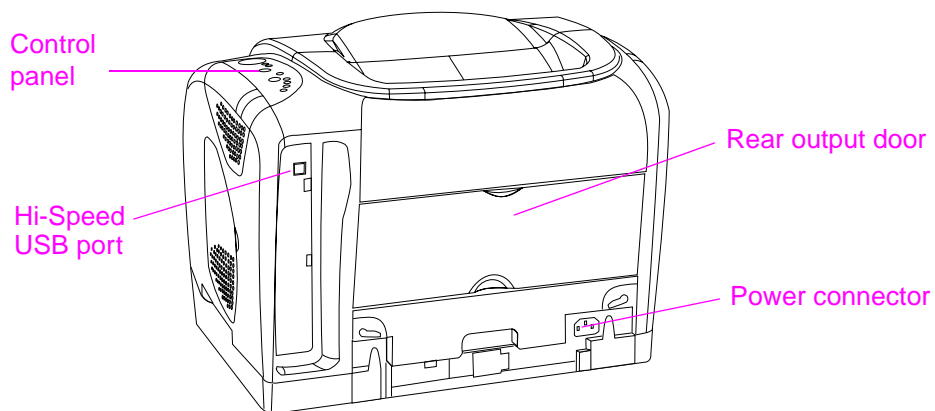

Figure 2. Back and right-side view—HP color LaserJet 1500 series printers

HP color LaserJet 2500 series printer

Front and left-side view

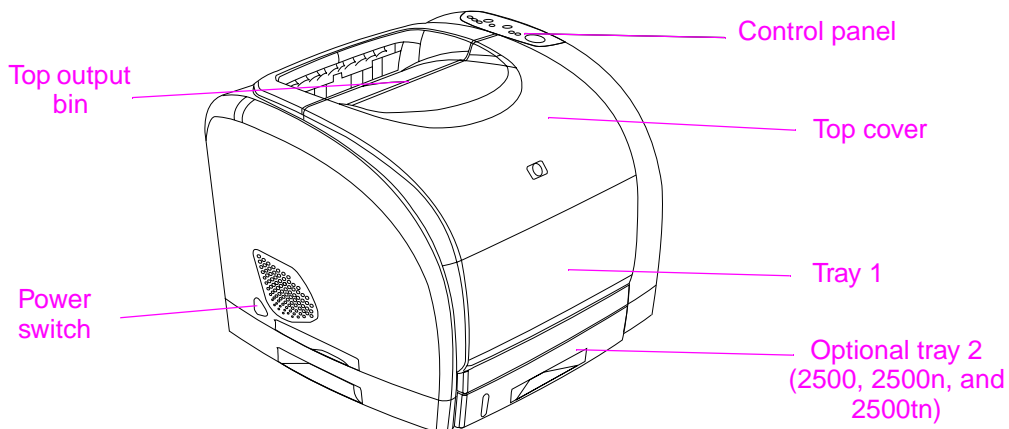

Figure 3. Front and left-side view—HP color LaserJet 2500 series printers

Back and right-side view

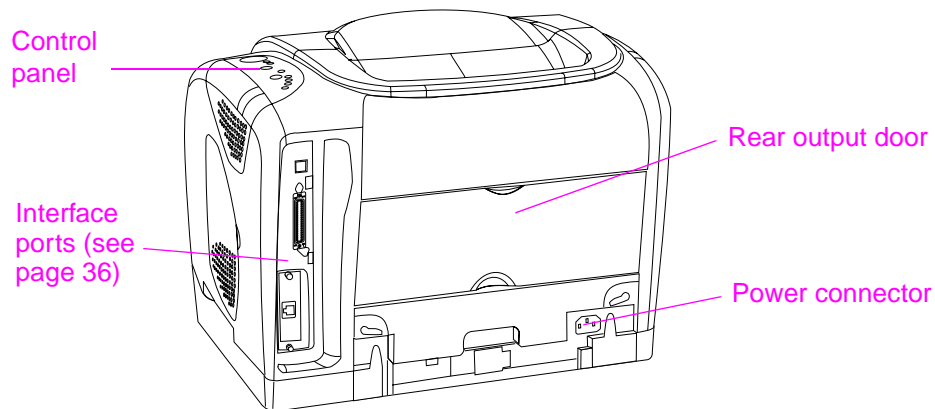

Figure 4. Back and right-side view—HP color LaserJet 2500 series printers

Warranty statements

HP color LaserJet 1500 series printer

Hewlett-Packard limited warranty statement

HP PRODUCT

HP color LaserJet 1500L, 1500

DURATION OF WARRANTY

1 year, Return to Authorized Service Center

1. HP warrants to you, the end-user customer, that HP hardware and accessories will be free from defects in materials and workmanship after the date of purchase, for the period specified above. If HP receives notice of such defects during the warranty period, HP will, at its option, either repair or replace products which prove to be defective. Replacement products may be either new or equivalent in performance to new.
2. HP warrants to you that HP software will not fail to execute its programming instructions after the date of purchase, for the period specified above, due to defects in material and workmanship when properly installed and used. If HP receives notice of such defects during the warranty period, HP will replace software which does not execute its programming instructions due to such defects.
3. HP does not warrant that the operation of HP products will be uninterrupted or error free. If HP is unable, within a reasonable time, to repair or replace any product to a condition as warranted, you will be entitled to a refund of the purchase price upon prompt return of the product.
4. HP products may contain remanufactured parts equivalent to new in performance or may have been subject to incidental use.
5. Warranty does not apply to defects resulting from (a) improper or inadequate maintenance or calibration, (b) software, interfacing, parts or supplies not supplied by HP, (c) unauthorized modification or misuse, (d) operation outside of the published environmental specifications for the product, or (e) improper site preparation or maintenance.
6. TO THE EXTENT ALLOWED BY LOCAL LAW, THE ABOVE WARRANTIES ARE EXCLUSIVE AND NO OTHER WARRANTY OR CONDITION, WHETHER WRITTEN OR ORAL, IS EXPRESSED OR IMPLIED AND HP SPECIFICALLY DISCLAIMS ANY IMPLIED WARRANTIES OR CONDITIONS OF MERCHANTABILITY, SATISFACTORY QUALITY, AND FITNESS FOR A PARTICULAR PURPOSE. Some countries/regions, states or provinces do not allow limitations on the duration of an implied warranty, so the above limitation or exclusion might not apply to you. This warranty gives you specific legal rights and you might also have other rights that vary from country/region to country/region, state to state, or province to province.
7. HP's limited warranty is valid in any country/region or locality where HP has a support presence for this product and where HP has marketed this product. The level of warranty service you receive may vary according to local standards. HP will not alter form, fit or function of the product to make it operate in a country/region for which it was never intended to function for legal or regulatory reasons.
8. TO THE EXTENT ALLOWED BY LOCAL LAW, THE REMEDIES IN THIS WARRANTY STATEMENT ARE YOUR SOLE AND EXCLUSIVE REMEDIES. EXCEPT AS INDICATED ABOVE, IN NO EVENT WILL HP OR ITS SUPPLIERS BE LIABLE FOR LOSS OF DATA OR FOR DIRECT, SPECIAL, INCIDENTAL, CONSEQUENTIAL (INCLUDING LOST PROFIT OR DATA), OR OTHER DAMAGE, WHETHER BASED IN CONTRACT, TORT, OR OTHERWISE. Some countries/regions, states or provinces do not allow the exclusion or limitation of incidental or consequential damages, so the above limitation or exclusion may not apply to you.

THE WARRANTY TERMS CONTAINED IN THIS STATEMENT, EXCEPT TO THE EXTENT LAWFULLY PERMITTED, DO NOT EXCLUDE, RESTRICT OR MODIFY AND ARE IN ADDITION TO THE MANDATORY STATUTORY RIGHTS APPLICABLE TO THE SALE OF THIS PRODUCT TO YOU.

HP color LaserJet 2500 series printer

Hewlett-Packard limited warranty statement

HP PRODUCT

HP color LaserJet 2500L, 2500, 2500n, 2500tn

DURATION OF WARRANTY

1 year, Return to Authorized Service Center

1. HP warrants to you, the end-user customer, that HP hardware and accessories will be free from defects in materials and workmanship after the date of purchase, for the period specified above. If HP receives notice of such defects during the warranty period, HP will, at its option, either repair or replace products which prove to be defective. Replacement products may be either new or equivalent in performance to new.
2. HP warrants to you that HP software will not fail to execute its programming instructions after the date of purchase, for the period specified above, due to defects in material and workmanship when properly installed and used. If HP receives notice of such defects during the warranty period, HP will replace software which does not execute its programming instructions due to such defects.
3. HP does not warrant that the operation of HP products will be uninterrupted or error free. If HP is unable, within a reasonable time, to repair or replace any product to a condition as warranted, you will be entitled to a refund of the purchase price upon prompt return of the product.
4. HP products may contain remanufactured parts equivalent to new in performance or may have been subject to incidental use.
5. Warranty does not apply to defects resulting from (a) improper or inadequate maintenance or calibration, (b) software, interfacing, parts or supplies not supplied by HP, (c) unauthorized modification or misuse, (d) operation outside of the published environmental specifications for the product, or (e) improper site preparation or maintenance.
6. TO THE EXTENT ALLOWED BY LOCAL LAW, THE ABOVE WARRANTIES ARE EXCLUSIVE AND NO OTHER WARRANTY OR CONDITION, WHETHER WRITTEN OR ORAL, IS EXPRESSED OR IMPLIED AND HP SPECIFICALLY DISCLAIMS ANY IMPLIED WARRANTIES OR CONDITIONS OF MERCHANTABILITY, SATISFACTORY QUALITY, AND FITNESS FOR A PARTICULAR PURPOSE. Some countries/regions, states or provinces do not allow limitations on the duration of an implied warranty, so the above limitation or exclusion might not apply to you. This warranty gives you specific legal rights and you might also have other rights that vary from country/region to country/region, state to state, or province to province.
7. HP's limited warranty is valid in any country/region or locality where HP has a support presence for this product and where HP has marketed this product. The level of warranty service you receive may vary according to local standards. HP will not alter form, fit or function of the product to make it operate in a country/region for which it was never intended to function for legal or regulatory reasons.
8. TO THE EXTENT ALLOWED BY LOCAL LAW, THE REMEDIES IN THIS WARRANTY STATEMENT ARE YOUR SOLE AND EXCLUSIVE REMEDIES. EXCEPT AS INDICATED ABOVE, IN NO EVENT WILL HP OR ITS SUPPLIERS BE LIABLE FOR LOSS OF DATA OR FOR DIRECT, SPECIAL, INCIDENTAL, CONSEQUENTIAL (INCLUDING LOST PROFIT OR DATA), OR OTHER DAMAGE, WHETHER BASED IN CONTRACT, TORT, OR OTHERWISE. Some countries/regions, states or provinces do not allow the exclusion or limitation of incidental or consequential damages, so the above limitation or exclusion may not apply to you.

THE WARRANTY TERMS CONTAINED IN THIS STATEMENT, EXCEPT TO THE EXTENT LAWFULLY PERMITTED, DO NOT EXCLUDE, RESTRICT OR MODIFY AND ARE IN ADDITION TO THE MANDATORY STATUTORY RIGHTS APPLICABLE TO THE SALE OF THIS PRODUCT TO YOU.

Limited warranty for the print cartridges and imaging drum

This HP product is warranted to be free from defects in materials and workmanship during its useful life (end of life is indicated by a printer control panel low-life message).

This warranty does not cover products that have been modified, refurbished, remanufactured, misused or tampered with in any way.

This limited warranty gives you specific legal rights. You may have other rights which vary from state to state, province to province and country/region to country/region.

THE ABOVE WARRANTIES ARE EXCLUSIVE AND NO OTHER WARRANTY, WHETHER WRITTEN OR ORAL, IS EXPRESSED OR IMPLIED. THE HEWLETT-PACKARD COMPANY SPECIFICALLY DISCLAIMS THE IMPLIED WARRANTIES OR MERCHANTABILITY AND FITNESS FOR A PARTICULAR PURPOSE. TO THE EXTENT ALLOWED BY APPLICABLE LAW, IN NO EVENT SHALL HEWLETT-PACKARD COMPANY BE LIABLE FOR ANY INCIDENTAL, CONSEQUENTIAL, SPECIAL, INDIRECT, PUNITIVE, OR EXEMPLARY DAMAGES OR LOST PROFITS FROM ANY BREACH OF THIS WARRANTY OR OTHERWISE.

In the event that your product proves to be defective, please return to place of purchase with a written description of the problem.

HP color LaserJet 1500 series printer declaration of conformity

according to ISO/IEC Guide 22 and EN 45014

Manufacturer's Name: Hewlett-Packard Company
Manufacturer's Address: 11311 Chinden Boulevard
Boise, Idaho 83714-1021, USA

declares, that the product

Product Name: HP color LaserJet 1500L, 1500
Including: 250-sheet paper feeder unit

Model Number: BOISB-0209-00

Product Options: ALL

conforms to the following Product Specifications:

Safety: IEC 60950:1991+A1+A2+A3+A4 / EN 60950:1992+A1+A2+A3+A4+A11
IEC 60825-1:1993+A1 / EN 60825-1:1994+A11 (Class 1 Laser/LED Product)
GB4943-1995

EMC: CISPR 22:1993+A1+A2 / EN 55022:1994+A1+A2 Class B^{1*}
EN 61000-3-2:1995 / A14
EN 61000-3-3:1995
EN 55024:1998
FCC Title 47 CFR, Part 15 Class B² / ICES-003, Issue 3/ GB9254-1998
AS / NZS 3548:1995+A1+A2

Supplementary Information:

The product herewith complies with the requirements of the EMC Directive 89/336/EEC and the Low Voltage Directive 73/23/EEC, and carries the CE-marking accordingly.

- 1) The product was tested in a typical configuration with Hewlett-Packard Personal Computer Systems.
- 2) This Device complies with Part 15 of the FCC Rules. Operation is subject to the following two conditions: (1) this device may not cause harmful interference, and (2) this device must accept any interference received, including interference that may cause undesired operation.

**Boise, Idaho USA
1 January, 2002**

For regulatory topics only:

Australia Contact: Product Regulations Manager, Hewlett-Packard Australia Ltd., 31-41 Joseph Street, Blackburn, Victoria 3130, Australia

European Contact: Your Local Hewlett-Packard Sales and Service Office or Hewlett-Packard GmbH, Department HQ-TRE / Standards Europe, Herrenberger Straße 130, D-71034 Böblingen (FAX: +49-7031-14-3143)

USA Contact: Product Regulations Manager, Hewlett-Packard Company, PO Box 15, Mail Stop 160, Boise, ID 83707-0015 (Phone: 208-396-6000)

HP color LaserJet 2500 series printer declaration of conformity

according to ISO/IEC Guide 22 and EN 45014

Manufacturer's Name: Hewlett-Packard Company
Manufacturer's Address: 11311 Chinden Boulevard
Boise, Idaho 83714-1021, USA

declares, that the product

Product Name: HP color LaserJet 2500L, 2500, 2500n, 2500tn
Including: 250-sheet and 500-sheet paper feeder unit

Model Number: C9705A, C9706A, C9707A, C9708A
Including: C9698A, C9699A

Product Options: ALL

conforms to the following Product Specifications:

Safety: IEC 60950:1991+A1+A2+A3+A4 / EN 60950:1992+A1+A2+A3+A4+A11
IEC 60825-1:1993+A1 / EN 60825-1:1994+A11 (Class 1 Laser/LED Product)
GB4943-1995

EMC: CISPR 22:1993+A1+A2 / EN 55022:1994+A1+A2 Class B^{1*}
EN 61000-3-2:1995 / A14
EN 61000-3-3:1995
EN 55024:1998
FCC Title 47 CFR, Part 15 Class B² / ICES-003, Issue 3/ GB9254-1998
AS / NZS 3548:1995+A1+A2

Supplementary Information:

The product herewith complies with the requirements of the EMC Directive 89/336/EEC and the Low Voltage Directive 73/23/EEC, and carries the CE-marking accordingly.

- 1) The product was tested in a typical configuration with Hewlett-Packard Personal Computer Systems.
- 2) This Device complies with Part 15 of the FCC Rules. Operation is subject to the following two conditions: (1) this device may not cause harmful interference, and (2) this device must accept any interference received, including interference that may cause undesired operation.

* This product includes LAN (Local Area Network) options. When the interface cable is attached to LAN connectors, the product meets the requirements of EN55022 Class A in which case the following applies: "Warning — This is a class A product. In a domestic environment this product may cause radio interference in which case the user may be required to take adequate measures."

- 3) The model number may include an additional suffix letter "R".

**Boise, Idaho USA
6 June, 2002**

For regulatory topics only:

Australia Contact: Product Regulations Manager, Hewlett-Packard Australia Ltd., 31-41 Joseph Street, Blackburn, Victoria 3130, Australia

European Contact: Your Local Hewlett-Packard Sales and Service Office or Hewlett-Packard GmbH, Department HQ-TRE / Standards Europe, Herrenberger Straße 130, D-71034 Böblingen (FAX: +49-7031-14-3143)

USA Contact: Product Regulations Manager, Hewlett-Packard Company, PO Box 15, Mail Stop 160, Boise, ID 83707-0015 (Phone: 208-396-6000)

Laser safety statement

The Center for Devices and Radiological Health (CDRH) of the U.S. Food and Drug Administration has implemented regulations for laser products manufactured since August 1, 1976. Compliance is mandatory for products marketed in the United States. The printer is certified as a “Class 1” laser product under the U.S. Department of Health and Human Services (DHHS) Radiation Performance Standard according to the Radiation Control for Health and Safety Act of 1968.

Because radiation that is emitted inside the printer is completely confined within protective housings and external covers, the laser beam cannot escape during any phase of normal user operation.

WARNING!

Using controls, making adjustments, or performing procedures other than those specified in this user guide can result in exposure to hazardous radiation.

Canadian DOC statement

Complies with Canadian EMC Class B requirements.

«Conforme à la classe B des normes canadiennes de compatibilité électromagnétiques (CEM).»

VCCI statement (Japan)

この装置は、情報処理装置等電波障害自主規制協議会（VCCI）の基準に基づくクラスB情報技術装置です。この装置は、家庭環境で使用することを目的としていますが、この装置がラジオやテレビジョン受信機に近接して使用されると、受信障害を引き起こすことがあります。
取り扱い説明書に従って正しい取り扱いをして下さい。

Korean EMI statement

사용자 안내문 (B 급 기기)

이 기기는 비업무용으로 전자파장애검정을 받은 기기로서, 주거지역에서는 물론 모든 지역에서 사용할 수 있습니다.

Finnish laser statement

LASERTURVALLISUUS

LUOKAN 1 LASERLAITE

KLASS 1 LASER APPARAT

HP color LaserJet 1500 -laserkirjoitin on käyttäjän kannalta turvallinen luokan 1 laserlaite. Normaalisessa käytössä kirjoittimen suojakotelo estää lasersäteiden pääsyn laitteen ulkopuolelle.

Laitteen turvallisuusluokka on määritetty standardin EN 60825-1 (1993) mukaisesti.

VAROITUS!

Laitteen käyttäminen muulla kuin käyttöohjeessa mainitulla tavalla saattaa altistaa käyttäjän turvallisuusluokan 1 ylittävälle näkymättömälle lasersäteilylle.

WARNING!

Om apparaten används på annat sätt än i bruksanvisning specificerats, kan användaren utsättas för osynlig laserstrålning, som överskrider gränsen för laserklass 1.

HUOLTO

HP color LaserJet 1500 -kirjoittimen sisällä ei ole käyttäjän huollettavissa olevia kohteita. Laitteen saa avata ja huoltaa ainoastaan sen huoltamiseen koulutettu henkilö. Tällaiseksi huoltotoimenpiteeksi ei katsota väriainekasetin vaihtamista, paperiradan puhdistusta tai muita käyttäjän käsikirjassa lueteltuja, käyttäjän tehtäväksi tarkoitettuja ylläpitotoimia, jotka voidaan suorittaa ilman erikoistyökaluja.

VARO!

Mikäli kirjoittimen suojakotelo avataan, olet alttiina näkymättömälle lasersäteilylle laitteen ollessa toiminnassa. Älä katso säteeseen.

WARNING!

Om laserprinterns skyddshölje öppnas då apparaten är i funktion, utsättas användaren för osynlig laserstrålning. Betrakta ej strålen.

Tiedot laitteessa käytettävän laserdiodin säteilyominaisuuksista:

Aallonpituus 770-795 nm

Teho 5 mW

Luokan 3B laser

2

Installation and operation

Chapter contents

Operating environment	34
Interface ports	35
HP color LaserJet 1500 series printer	35
HP color LaserJet 2500 series printer	36
Control panel features	37
Understanding supplies status	38
Understanding printer status	39
Selecting media	40
Input trays	40
Supported print media	42
Printer output paths	43
Top output bin	43
Rear output door	43
Loading media	44
Loading tray 1	44
Loading optional tray 2	45
Loading optional tray 3	46
Using the embedded Web server	47
Information tab	48
Settings tab	48
Networking tab	48
Other links	49
Using Printer Status and Alerts	50
HP color LaserJet 1500 series printers	50
HP color LaserJet 2500 series printers	51

Operating environment

Place the printer on a sturdy, level surface in a well-ventilated area that meets the following environmental requirements:

- temperature: 15° to 32.5° C (59° to 90.5° F)
- humidity: 10 percent to 80 percent relative humidity (no condensation)
- away from direct sunlight, open flames, and ammonia fumes
- with sufficient space around the printer for access and ventilation

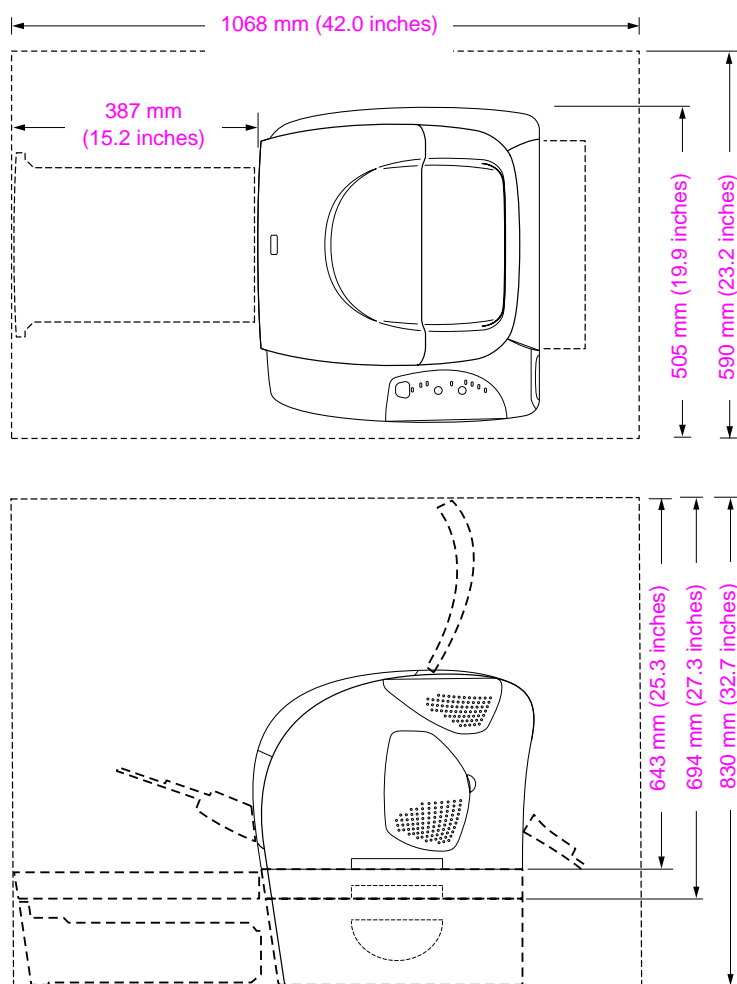

Figure 5. Space required

Note Only the HP color LaserJet 2500 series printer is equipped with the optional tray 3 that is shown in figure 5.

Interface ports

HP color LaserJet 1500 series printer

All HP color LaserJet 1500 series printers have a Hi-Speed USB port.

External HP Jetdirect print servers are not included with HP color LaserJet 1500 series printers.

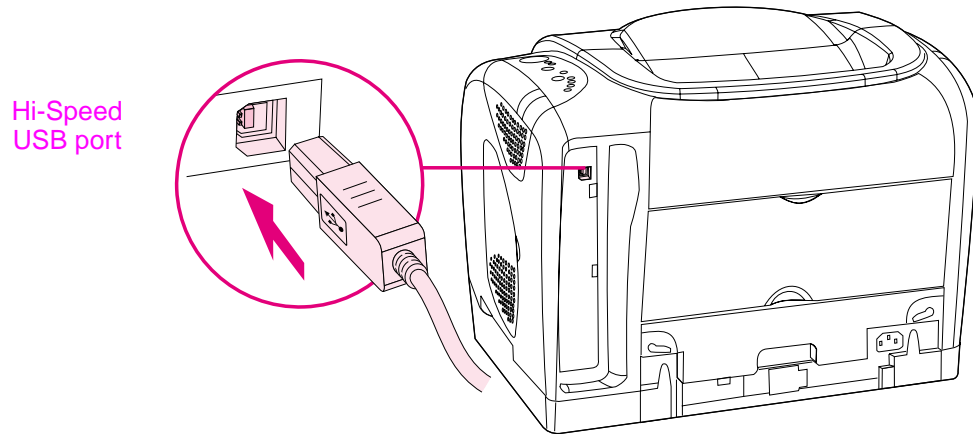

Figure 6. HP color LaserJet 1500 series printer interface port

HP color LaserJet 2500 series printer

HP color LaserJet 2500 series printers have two interface ports: an IEEE-1284B parallel port and a USB port. The 2500L and 2500 models also contain an EIO slot for installing an optional HP Jetdirect print server card. To order a print server card, see chapter 7, or contact your local HP dealer.

The 2500n and 2500tn models include an HP Jetdirect 615n print server card that contains a 10/100Base-T (RJ-45) port.

Because the HP Jetdirect print server card is not included with all models, it will be referred to as the optional HP Jetdirect print server card in this documentation.

Note You cannot connect the printer to one computer with a parallel cable and to another computer with a USB cable. If you connect both types of cables, the USB is disabled. However, you can connect one of the cables while the printer is connected to the network with an installed HP Jetdirect print server card.

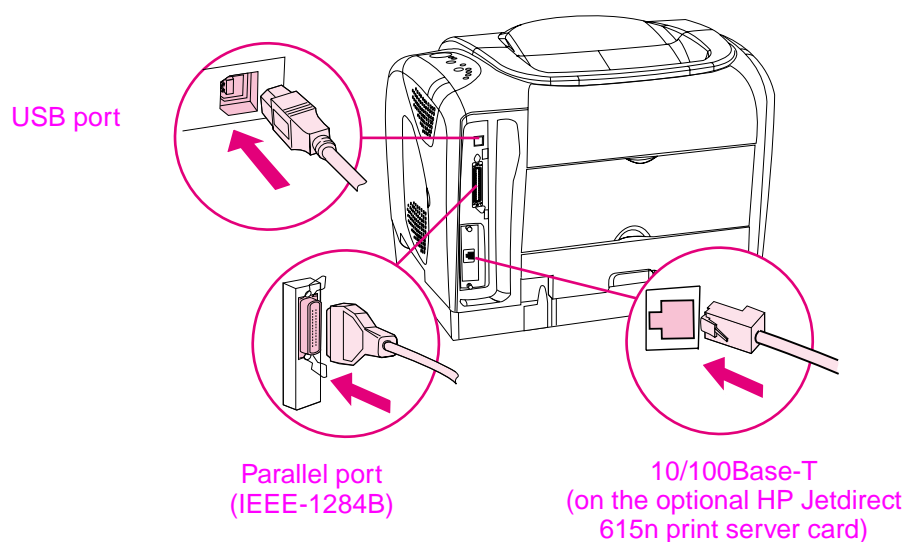

Figure 7. HP color LaserJet 2500 series printer interface ports

Control panel features

The lights and buttons on the control panel are arranged into two main groups: supplies status (top group) and printer status (bottom group). To interpret and troubleshoot control panel light messages, see chapter 6.

The printer control panel contains the following lights and buttons:

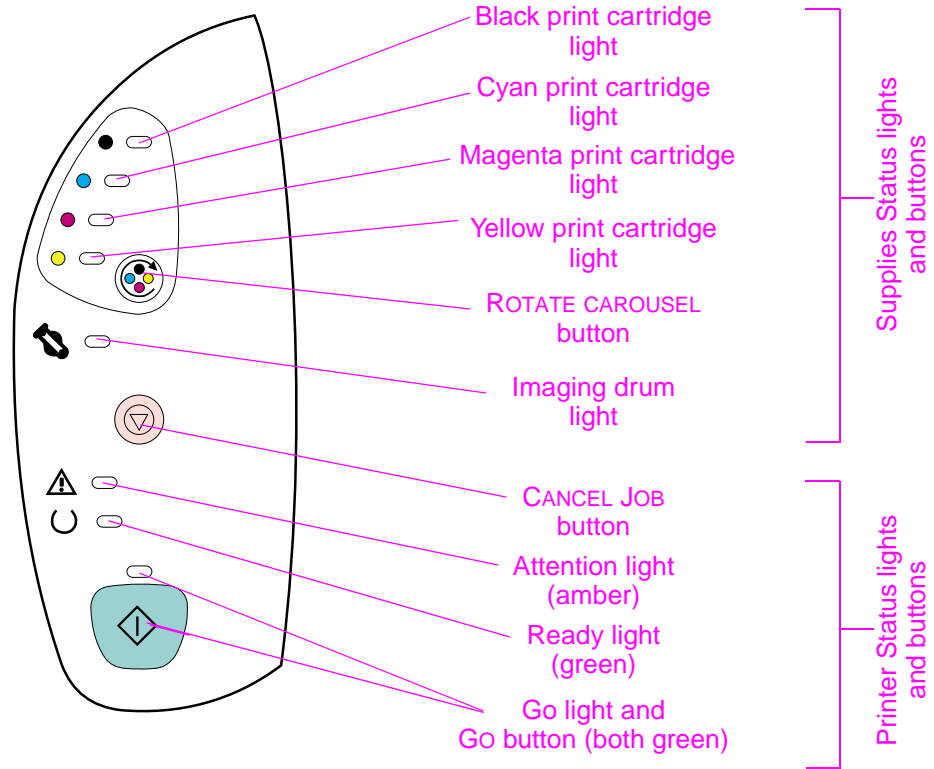



Figure 8. Control panel lights and buttons

Understanding supplies status

Five lights indicate and one button controls the status of the print cartridges and imaging drum. To interpret and troubleshoot control panel light messages, see chapter 6.

Table 10. Supplies-status messages and actions

Light or button	Message or action
Black-supply-status light	<ul style="list-style-type: none">● Light is on—print cartridge is low.● Light is blinking—print cartridge is empty or missing.
Cyan-supply-status light	<ul style="list-style-type: none">● Light is blinking and Attention light is on—a non-HP print cartridge is installed for the first time. For more information about resetting the printer for non-HP supplies, see page 65.
Magenta-supply-status light	(These lights will not indicate low or empty status for non-HP print cartridges.)
Yellow-supply-status light	(These lights will not indicate low or empty status for non-HP print cartridges.)
 ROTATE CAROUSEL button	<ul style="list-style-type: none">● Press this button to rotate the print-cartridge carousel to bring the next print cartridge into the top position. The corresponding light for the print cartridge that is approaching the top position blinks quickly two or three times. (If the top cover is open, then the carousel will not rotate.)
Imaging drum light	<ul style="list-style-type: none">● Light is on—imaging drum is low.● Light is blinking—imaging drum is empty or missing.● Light is blinking and Attention light is on—a non-HP imaging drum is installed for the first time. (These lights will not indicate low or empty status for non-HP imaging drums.)













Understanding printer status

Three lights indicate and two buttons control the printer status. To interpret and troubleshoot control panel light messages, see chapter 6.

CAUTION

You do not receive any indication of when a non-HP supply is empty. If you continue printing after the supply is empty, damage to the printer can occur. See the “Hewlett-Packard limited warranty statement” on page 26.

Table 11. Printer-status messages and actions

Light or button	Message or action
 CANCEL JOB button	<ul style="list-style-type: none"> When the Ready light is blinking, pressing  (CANCEL JOB) cancels the current job. When the printer is not experiencing an error condition, pressing  (Go) and  (CANCEL JOB) simultaneously prints a Configuration page and a Supplies Status page. (With an HP color LaserJet 2500 series printer, if an HP Jetdirect print server card is installed, the printer also prints an HP Jetdirect page.) When a Supplies Status light is blinking and the Attention light is on (indicating that a non-HP supply has been installed), press  (CANCEL JOB) to continue printing.
Attention light	<ul style="list-style-type: none"> When the Attention light is blinking, the printer is out of paper, a jam has occurred, or another problem that needs attention has occurred. When the Attention light is on and one of the supplies status lights blinks, a non-HP supply has been installed for the first time. For more information about resetting the printer for non-HP supplies, see page 65.
Ready light	<ul style="list-style-type: none"> When the Ready light is on, the printer is ready to print (experiencing no errors that prevent printing). When the Ready light is blinking, the printer is receiving data.
 Go light and Go button	<ul style="list-style-type: none"> When the Go light is on and the Attention light is blinking, pressing  (Go) either continues the print job after you load media for a manual feed or clears some errors. When the Go light is blinking, the top cover has been opened and then closed or you have pressed  (ROTATE CAROUSEL). Pressing  (Go) returns the printer to the Ready state. If you do not press  (Go), the printer returns to the Ready state on its own after approximately eight seconds. When the Go light is off, pressing  (Go) prints a Demo page. Pressing  (Go) and  (CANCEL JOB) simultaneously prints a Configuration page and a Supplies Status page. (With an HP color LaserJet 2500 series printer, if an HP Jetdirect print server card is installed, the printer also prints an HP Jetdirect page.)

Selecting media

Input trays

HP color LaserJet 1500 series printer

The HP color LaserJet 1500 series printer comes with one or more input trays. See table 12 for configuration information.

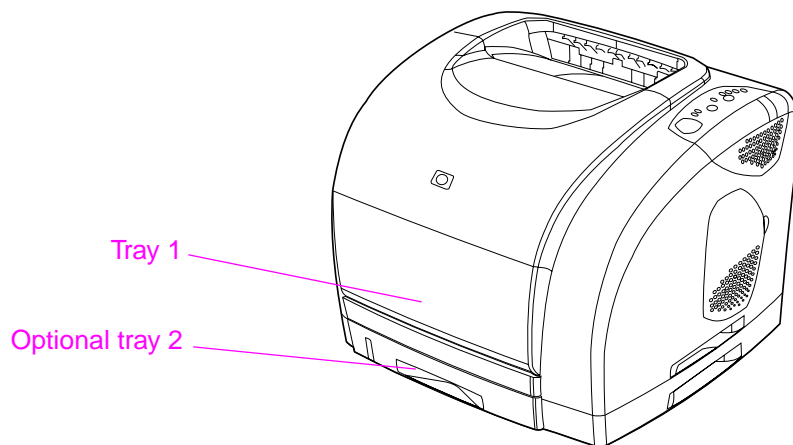

Figure 9. Standard and optional input trays—HP color LaserJet 1500 series printers

Table 12. Input tray configuration

Printer model	Standard input trays	Optional input trays
HP color LaserJet 1500L printer	● tray 1 (125-sheet)	● optional tray 2 (250 sheet)
HP color LaserJet 1500 printer	● tray 1 (125-sheet) ● tray 2 (250-sheet)	

Note Because tray 2 is not included with the HP color LaserJet 1500L printer, it is referred to as optional tray 2 in this documentation.

By default, the printer draws first from tray 1. If tray 1 is empty, the printer draws from optional tray 2 (if installed).

HP color LaserJet 2500 series printer

The HP color LaserJet 2500 series printer comes with one or more input trays. See table 13 for configuration information.

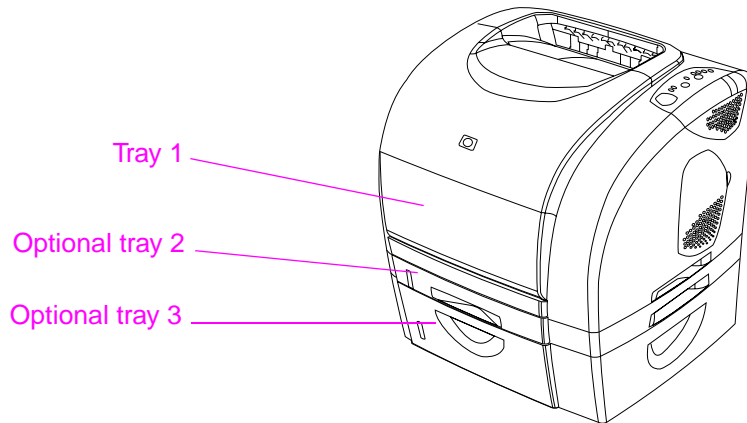

Figure 10. Standard and optional input trays—HP color LaserJet 2500 series printers

Table 13. Input tray configuration

Printer model	Standard input trays	Optional input trays
HP color LaserJet 2500L	<ul style="list-style-type: none">● tray 1 (125-sheet)	<ul style="list-style-type: none">● optional tray 2 (250 sheet)● optional tray 3 (500-sheet)
HP color LaserJet 2500	<ul style="list-style-type: none">● tray 1 (125-sheet)● tray 2 (250-sheet)	<ul style="list-style-type: none">● optional tray 3 (500-sheet)
HP color LaserJet 2500n	<ul style="list-style-type: none">● tray 1 (125-sheet)● tray 2 (250-sheet)	<ul style="list-style-type: none">● optional tray 3 (500-sheet)
HP color LaserJet 2500tn	<ul style="list-style-type: none">● tray 1 (125-sheet)● tray 2 (250-sheet)● tray 3 (500-sheet)	

Note

Because tray 2 and tray 3 are not included with all models, they are referred to as optional tray 2 and optional tray 3 in this documentation.

Optional tray 2 must be installed in order to install optional tray 3.

By default, the printer draws first from tray 1. If tray 1 is empty, the printer draws first from optional tray 3 (if installed) and then from optional tray 2.

Supported print media

The media sizes and types that are supported by the input trays are described in table 14. For more detailed information, see “Media specifications” in chapter 1.

CAUTION

Load only paper in optional tray 2 or optional tray 3 (HP color LaserJet 2500 series printers only). Other types of print media, such as labels or transparencies, might jam if printed from optional tray 2 or optional tray 3.

For information about loading input trays, see “Loading media” on page 44.

Table 14. Supported sizes and types of print media

Tray	Supported media type	Supported media size
Tray 1 (multipurpose)	<ul style="list-style-type: none"> ● various types and weights of paper (within the size and weight limitations) ● envelopes (up to 10) ● labels ● transparencies <p>NOTE: HP LaserJet 1500 series printers and HP LaserJet 2500 series printers do not print in color on transparencies.</p> <ul style="list-style-type: none"> ● custom-sized print media or cardstock ● postcards 	<ul style="list-style-type: none"> ● from 76 by 127 mm (3 by 5 inches) to a legal-size sheet of 216 by 356 mm (8.5 by 14 inches) ● from 60 to 177 g/m² (16 to 47 lb)
Optional tray 2 (250-sheet)	<ul style="list-style-type: none"> ● various types and weights of paper (within the size and weight limitations) ● letterhead ● prepunched paper ● preprinted forms 	<ul style="list-style-type: none"> ● from 60 to 105 g/m² (16 to 28 lb) ● A4 ● A5 ● B5 (ISO and JIS) ● letter ● legal ● executive ● 8.5 by 13 inches
Optional tray 3 (500-sheet) (HP color LaserJet 2500 series printers only)	<ul style="list-style-type: none"> ● various types and weights of paper (within the size and weight limitations) ● A4 ● letter 	from 60 to 105 g/m ² (16 to 28 lb)

Printer output paths

Top output bin

Printed media is collected in the top output bin when the rear output door is closed. Use the top output bin when printing most jobs, including documents on average-weight paper, letterhead, and transparencies.

The top output bin can hold up to 150 sheets. Prevent more than 150 sheets from accumulating in the top output bin, or jams can occur.

Rear output door

Print jobs emerge from the back of the printer when the rear output door is open. Use the rear output door (straight-through paper path) when printing envelopes, labels, heavy- or lightweight paper, and other thick or special print media (except transparencies). Remove each sheet as it exits the printer.

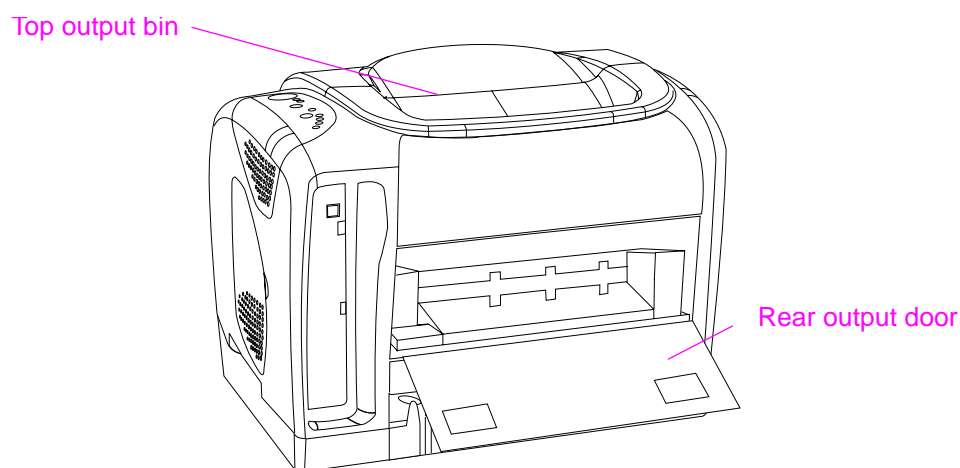
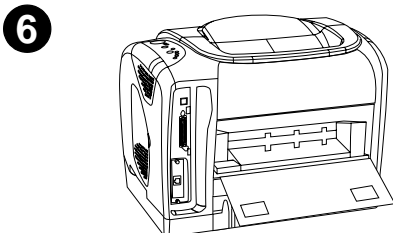
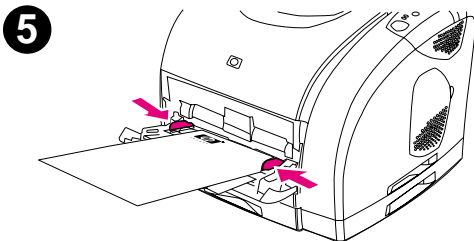
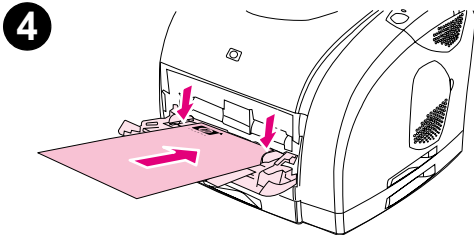
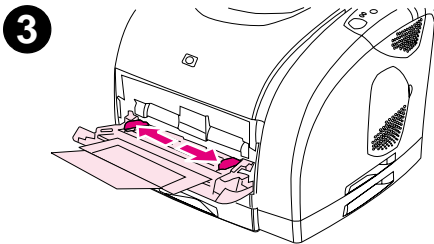
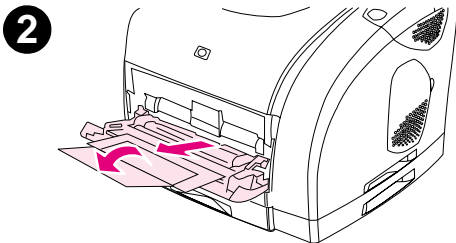
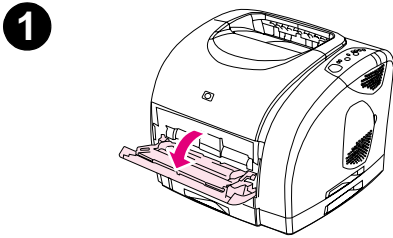

Figure 11.

Printer output paths

Loading media

Load special print media such as envelopes, labels, custom-size media, and transparencies in tray 1 only. Load only paper in optional tray 2 or optional tray 3 (HP color LaserJet 2500 series printer only).



Loading tray 1

Tray 1 (multipurpose tray) holds up to 125 sheets of paper or other print media, or up to 10 envelopes.

For information about loading special print media such as labels and transparencies, see the *HP Color LaserJet 1500 Series Printer User Guide* or the *HP Color LaserJet 2500 Series Printer User Guide*.

To load tray 1

CAUTION

Avoid adding print media to tray 1 while the printer is printing, or jams can occur.

- 1 Open tray 1.
- 2 Slide out the tray extender. If the print media being loaded is longer than 229 mm (9 inches), also open the additional tray extender.
- 3 Slide the width guides slightly wider than the print media.
- 4 Place print media into the tray with the side to be printed up, and the top, short edge in first.

Note

If you are manually duplexing, see the user guide for loading instructions.

- 5 Slide the paper width guides inward until they lightly touch the print media stack on both sides without bending it. Make sure that the print media fits under the tabs on the width guides.

CAUTION

If you choose to close tray 1, first wait for the printer to finish printing. Closing the tray before printing is complete can cause jams.

- 6 On the back of the printer, lower the rear output door if you are printing on special media, such as labels, envelopes, or heavy or light paper, to prevent curl. (Do not lower the door for transparencies.)

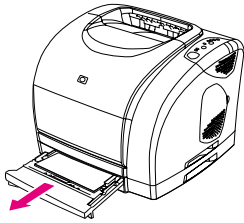
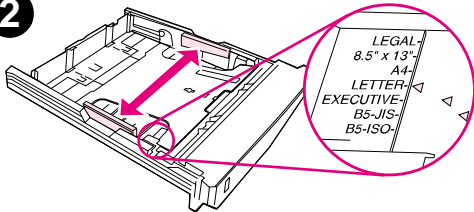
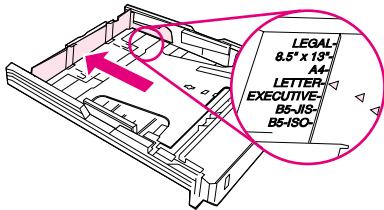
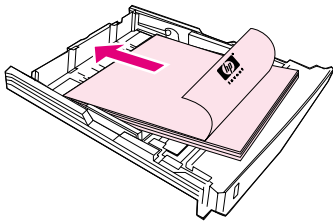
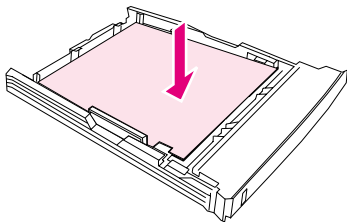
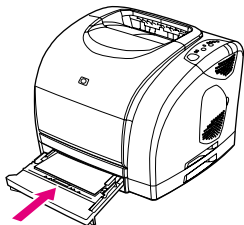
1**2****3****4****5****6**

Loading optional tray 2

Optional tray 2 supports standard-size paper only, including average-weight letterhead and prepunched paper. For additional information about loading letterhead and prepunched paper, see the *HP Color LaserJet 1500 Series Printer User Guide* or the *HP Color LaserJet 2500 Series Printer User Guide*.

CAUTION

Print special print media such as labels and transparencies from tray 1 only. Printing special print media from optional tray 2 or optional tray 3 (HP color LaserJet 2500 series printer only) can cause jams.

To load optional tray 2

- 1 Pull optional tray 2 out of the printer and remove any paper.
- 2 Move the side width guides to match the size of paper you are loading.
- 3 Extend the rear of the tray until the arrow points to the size you are loading.
- 4 Load the paper. If this is special paper such as letterhead, load it with the side to be printed facing down and the top edge toward the front of the tray.

Note

If you are manually duplexing, see the user guide for loading instructions.

- 5 Make sure that the stack of paper is flat in the tray at all four corners, and keep it below the height tabs on the paper length guide in the rear of the tray. Push down on the metal paper-lift plate to lock it into place.
- 6 Slide the tray back into the printer. If you set the rear of the tray to one of the longer sizes, the back of the tray will protrude from the back of the printer.

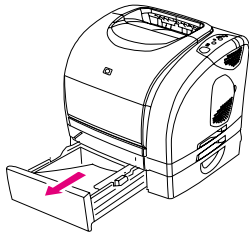
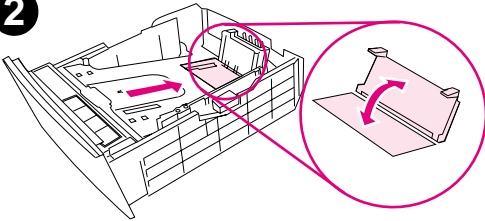
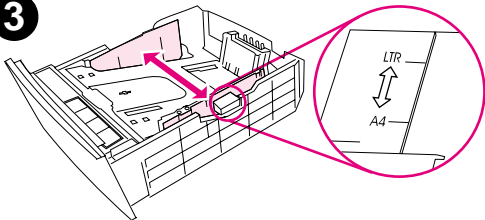
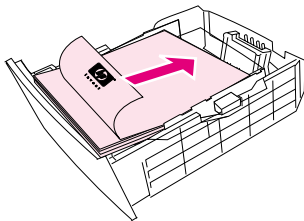
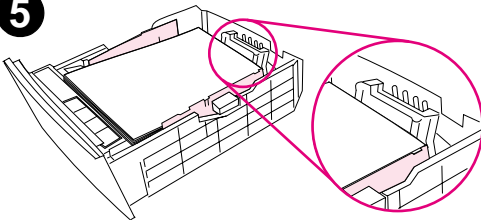
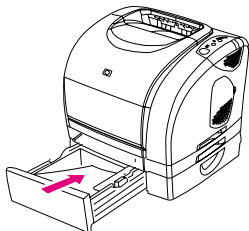
1**2****3****4****5****6**

Loading optional tray 3

The optional tray 3 (available with HP color LaserJet 2500 series printers only) supports A4- and letter-size paper. Optional tray 3 supports only paper, which includes average-weight letterhead and prepunched paper.

For additional information about letterhead and prepunched paper, see the user guide.

CAUTION

Print special print media such as labels and transparencies from tray 1 only. Printing special print media from optional tray 2 or optional tray 3 can cause jams.

To load optional tray 3

- 1 Pull the tray out of the printer and remove any paper.
- 2 For letter-size paper, pull up the rear stop. For A4-size paper, push down the rear stop.
- 3 For letter-size paper, move the side width guides outward as far as possible. For A4-size paper, move the side width guides inward as far as possible.
- 4 Load the paper. If this is special paper such as letterhead, load it with the side to be printed facing down and the top edge toward the front of the tray.

Note

If you are manually duplexing, see the *HP Color LaserJet 2500 Series Printer User Guide* for loading instructions.

- 5 Make sure that the stack of paper is flat in the tray at all four corners, and keep it below the height tabs on the length guide in the rear of the tray.
- 6 Slide the tray back into the printer.

Using the embedded Web server

Note

The embedded Web server (EWS) is available with HP color LaserJet 2500 series printers only.

When the printer is directly connected to a computer, the embedded Web server is supported for Microsoft® Windows® 95, 98, NT® 4.0, Millennium Edition (Me), 2000, and XP. When the printer is connected to the network, the embedded Web server is supported for Windows 95, Mac OS 8.6 and later, UNIX®, Linux, and OS/2.



Use the embedded Web server to view printer and network status and to manage printing functions from your computer instead of at the printer control panel. The following are examples of what you can do using the embedded Web server:

- view printer status information
- view and print internal pages
- determine the remaining life of HP supplies and order new ones
- receive notification of printer and HP supplies events (network only)
- set paper-type
- view and change tray configurations
- view and change the printer control panel menu configuration
- view and change network configuration (network only)

To use the embedded Web server, you must have Microsoft Internet Explorer 4.5 or later or Netscape Navigator 4.6 or later. The embedded Web server works when the printer is directly connected to a computer or connected to an IP-based network. The embedded Web server does not support IPX- or AppleTalk-based printer connections.

You do not have to have Internet access to open and use the embedded Web server. However, if you click a link in the **Other Links** area, you must have Internet access in order to go to the site associated with the link.

To open the embedded Web server

- 1 Open the embedded Web server by using one of these methods:
 - From the HP color LaserJet 2500 Series Toolbox, click the picture of the printer on the **Device** tab (Windows 98, NT 4.0, Me, 2000, and XP only).
 - For networked printers only, type the IP address for the printer. To find the IP address, print a Configuration page at the printer control panel by pressing  (**Go**) and  (**CANCEL JOB**) simultaneously.

Note

When you open the URL, you can bookmark it so that you can return to it quickly in the future.

- 2 The embedded Web server has three tabs that contain settings and information about the printer: the **Information** tab, the **Settings** tab, and, if the printer is connected to a network, the **Networking** tab. Click the tab that you want to view.
- 3 See the following sections for more information about each tab.

Information tab

The **Information** tab contains the following pages.

- **Device Status.** This page shows the printer status of and the life remaining for HP supplies, with 0 percent indicating that a supply is empty. The page also shows the type and size of print media that is set for each tray. To change the default settings, click **Change Settings**.
- **Configuration page.** This page shows the same information that is found on the printer Configuration page.
- **Supplies Status.** This page shows the life remaining for HP supplies, with 0 percent indicating that a supply is empty. This page also provides supplies part numbers. To order new supplies, click **Order Supplies** in the **Other Links** area on the left side of the window. To visit any website, you must have Internet access.
- **Event log.** This page shows a list of all printer events and errors.
- **Usage page.** This page shows a summary of the number of pages the printer has printed, grouped by size and type.
- **Device Information.** This page shows the printer network name, address, and model information. To change these entries, click **Device Information** on the **Settings** tab.

Settings tab

Use the **Settings** tab to configure the printer from your computer. The **Settings** tab can be password protected. If this printer is networked, always consult with the network administrator before changing settings on this tab.

The **Settings** tab contains the following pages.

- **Configure Device.** Configure all printer settings from this page. This page contains the traditional menus found on printers that use a control panel display. These menus include **Information**, **Paper Handling**, **Configure Device**, and **Diagnostics**.
- **Alerts** (network only). Set up to receive e-mail alerts for various printer events.
- **Email** (network only). Use in conjunction with the Alerts page to set up incoming and outgoing e-mail, as well as to set e-mail alerts.
- **Security.** Set a password that must be typed to gain access to the **Settings** and **Networking** tabs. Enable and disable certain features of the EWS.
- **Other Links.** Add or customize a link to another website. This link appears in the **Other Links** area on all embedded Web server pages. These permanent links always appear in the **Other Links** area: **HP Instant Support™**, **Order Supplies**, and **Product Support**. For more information, see [“Other links” on page 49](#).
- **Device Information.** Name the printer and assign an asset number to it. Type the name and e-mail address for the primary contact who will receive information about the printer.
- **Language.** Define the language in which to show the embedded Web server information.

Networking tab

The network administrator uses the **Networking** tab to control network-related settings for the printer when it is connected to an IP-based network. This tab will not appear if the printer is directly connected to a computer, or if the printer is connected to a network by using anything other than an HP Jetdirect print server card.

Other links

This section contains links that connect you to the Internet. You must have Internet access in order to use any of these links. If you use a dial-up connection and did not connect when you first opened the embedded Web server, you must connect before you can visit these websites. Connecting might require that you close the embedded Web server and reopen it.

- **HP Instant Support™.** Connects you to the HP website to help you find solutions. This service analyzes your printer error log and configuration information to provide diagnostic and support information specific to your printer.
- **Order Supplies.** Click this link to connect to the HP website and order genuine HP supplies, such as print cartridges, an imaging drum, and paper.
- **Product Support.** Connects to the support site for the HP color LaserJet 2500 printer. Then, you can search for help regarding general topics.

Using Printer Status and Alerts

HP color LaserJet 1500 series printers

Printer Status and Alerts is supported only for Microsoft Windows operating systems. The Printer Status and Alerts software is available to users of both networked and directly connected printers.

The software generates messages on the computer regarding the status of the printer and print jobs. You can receive alert messages that appear when the printer experiences a problem. You can also receive messages only when supplies are low.

You can set alerts options for a single printer that supports Printer Status and Alerts, or you can set alert options for all printers that support Printer Status and Alerts. For networked printers, these alerts only appear for your jobs.

To choose which status messages appear

- 1 Open Printer Status and Alerts in one of these ways:
 - Double-click the Printer Status and Alerts tray icon, which is near the clock in the Tray Manager.
 - On the Start menu, point to **Programs**, point to **Printer Status and Alerts**, and click **Printer Status and Alerts**.
- 2 Click the Options icon in the left pane.
- 3 Clear the options for the messages that you do not want to appear, and select the options for the messages that you do want to appear.
- 4 Under Status Check Rate, select how frequently you want the software to update the printer status information that the software uses to generate the messages. Status Check Rate might not be available if the network administrator has restricted the rights to this function.

To view status messages and information

On the left side of the window, select the printer for which you want to see information. Information provided includes status messages, supplies status, and printer capabilities.

HP color LaserJet 2500 series printers

Printer Status and Alerts is supported only for Windows 98, NT 4.0, ME, 2000, and XP.

The Printer Status and Alerts software is available to users of both networked and directly connected printers. Use this software to view the embedded Web server information for a particular printer. The software also generates messages on the computer regarding the status of the printer and print jobs. Depending on how the printer is connected, you can receive different messages.

- **Networked printers.** You can receive regular job status messages that appear every time a print job is sent to the printer or every time the print job finishes printing. You can also receive alert messages when two types of problems occur:
 - The printer is experiencing a problem, but it can continue to print (for example, a tray that is not being used is out of print media or is open, or a print cartridge is low).
 - The printer is experiencing a problem that prevents it from printing (for example, the printer is out of paper, or a print cartridge is empty).
- **Directly connected printers.** You can receive alert messages that appear when the printer experiences a problem. You can also receive messages only when supplies are low.

You can set alerts options for a single printer that supports Printer Status and Alerts, or you can set alert options for all printers that support Printer Status and Alerts. For networked printers, these alerts only appear for your jobs.

Note

Even if you are setting alert options for all printers, not all options you select can apply to all printers. For example, if you select the option for notifying you when the print cartridges are low, then all directly connected printers that support Printer Status and Alerts will generate a message when the print cartridges are low. However, none of the networked printers will generate this message, nor will directly connected printers that do not support Printer Status and Alerts.

To choose which status messages appear

- 1 Open Printer Status and Alerts in one of these ways:
 - Double-click the Printer Status and Alerts tray icon, which is near the clock in the Tray Manager.
 - On the Start menu, point to **Programs**, point to **Printer Status and Alerts**, and click **Printer Status and Alerts**.
- 2 Click the Options icon in the left pane.
- 3 In the **For** field, select the printer driver for this printer, or select **All Printers**.
- 4 Clear the options for the messages you do not want to appear, and select the options for the messages you do want to appear.
- 5 Under Status Check Rate, select how frequently you want the software to update the printer status information that the software uses to generate the messages. Status Check Rate might not be available if the printer administrator has restricted the rights to this function.

To view status messages and information

On the left side of the window, select the printer for which you want to see information. Information provided includes status messages, supplies status, and printer capabilities. You can also click the Job History (clock) icon at the top of the window to view a list of previous jobs sent to the printer from your computer.

3 Maintenance

Chapter contents

Life expectancies of supplies	54
User-replaceable parts	55
Replacing the pickup roller and separation pad	55
Replacing the separation pad in optional tray 2 or in optional tray 3	59
Cleaning the printer	61
Cleaning the engine	61
Calibrating the printer	62
Managing supplies	63
Supplies life	63
Checking and ordering supplies	63
Storing supplies	64
Replacing and recycling supplies	65
HP policy for non-HP supplies	65
HP fraud hotline	66

Life expectancies of supplies

Inspect supplies when you service the printer. Replace supplies as needed, based on failure or wear, rather than on usage.

The following table lists approximate schedules for replacing supplies.

Table 15. Life expectancies of supplies

Description	Part number	Estimated life (in number of pages at 5 percent coverage*)	Remarks
Print cartridge, black (user replaceable)	C9700-69701 C9700A	5,000	
Print cartridge, cyan (user replaceable)	C9701-69701 C9701A	4,000	
Print cartridge, yellow (user replaceable)	C9702-69701 C9702A	4,000	
Print cartridge, magenta (user replaceable)	C9703-69701 C9703A	4,000	
Imaging drum	C9704-69701 C9704A	20,000 (black only) 5,000 (color) The average life is 6,000 to 8,000 pages.	
Printer transfer roller	RF5-4040-000CN		Can affect print quality and/or paper movement.
Printer pickup roller	RB3-0160-000CN		Look for glazing and/or cracks.
Printer separation pad	RF5-4012-000CN		Can affect document movement.
Fuser assembly (100 to 127 V)	RG5-6903-000CN		Can affect print quality and paper movement.
Fuser assembly (220 to 240 V)	RG5-6913-000CN		Can affect print quality and paper movement.
Optional tray 2 separation pad	RB2-9960-000CN		Can affect document movement.
Optional tray 3 separation pad (HP Color LaserJet 2500 series printer only)	RB2-9960-000CN		Can affect document movement.

* The estimated print cartridge life is based on letter- or A4-sized paper with an average of five percent toner coverage and a medium density setting. Print cartridge life can be extended further by conserving toner by using draft-mode settings.

User-replaceable parts

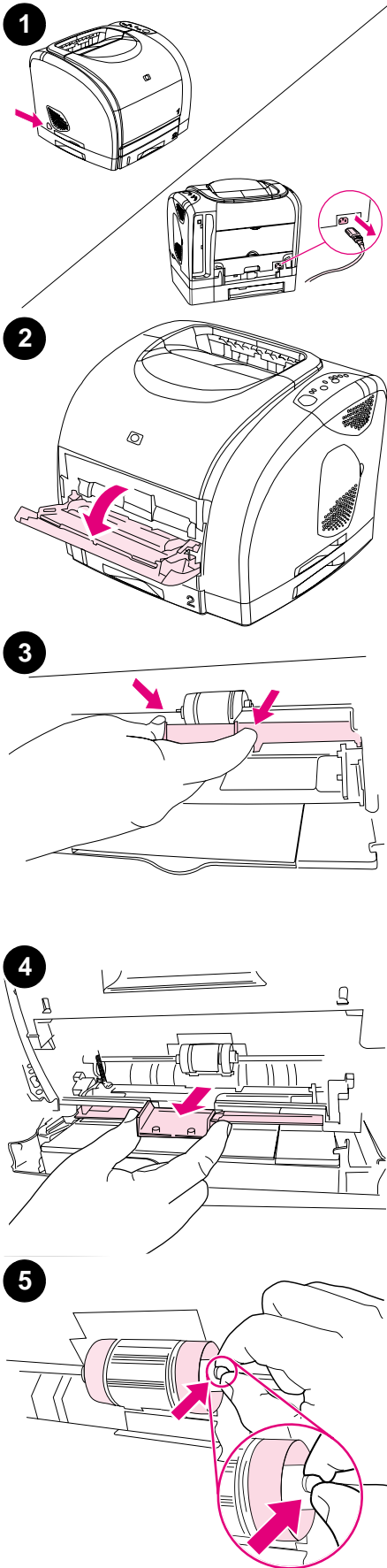

Replacing the pickup roller and separation pad

- 1 Turn the printer off and disconnect the power cable from the back of the printer.
- 2 Open tray 1.
- 3 Find the faceplate cover that is located beneath the pickup roller in tray 1.
- 4 Grasp both sides of the center tab and pull the cover out of the printer.
- 5 Squeeze the tab on the idler roller that is located on the right side of the pickup roller. If the tab is not visible, rotate the idler roller so that the tab is toward the front of the printer.

6

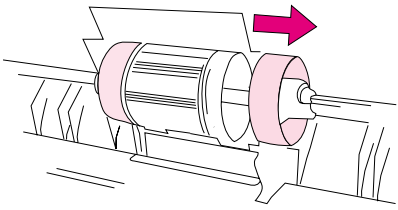

6 Slide the idler roller to the right to separate it from the pickup roller.

7

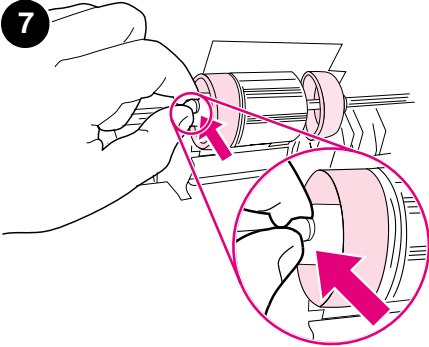

7 Squeeze the tab on the idler roller that is located on the left side of the pickup roller. If the tab is not visible, rotate the idler roller so that the tab is toward the front of the printer.

8

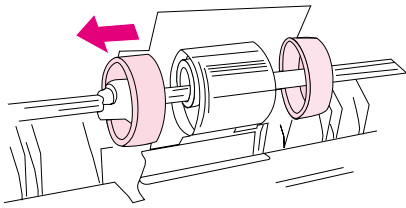

8 Slide the idler roller to the left to separate it from the pickup roller.

9

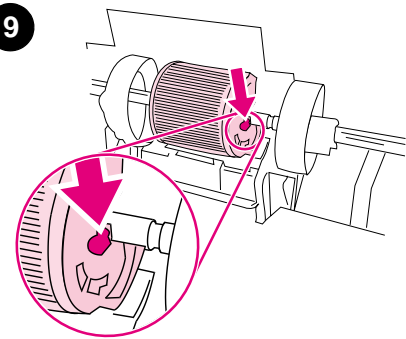

9 Press and hold the button that is located on the right side of the pickup roller. Slide the pickup roller slightly to the right, and then pull it off of the shaft.

10

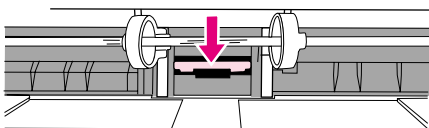

10 Locate the separation pad beneath the area of the shaft from which the pickup roller was removed.

CAUTION

To prevent the shaft retaining pin from falling out, do not move the remaining hub that is located to the left of the pickup roller.

11

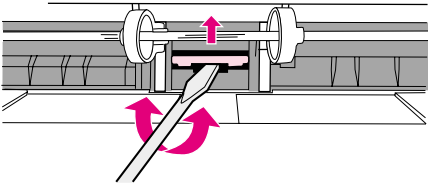

11 Insert a flatblade screwdriver into the slot under the separation pad. Pry the pad up from the spring-loaded base by twisting the screwdriver until the tabs are separated from the printer.

12 Use one hand to push the spring-loaded base down and then use the other hand to pull the separation pad up and out of the printer.

Note

If you feel resistance when you try to remove the pad, make sure that the tabs are completely separated from the printer.

12

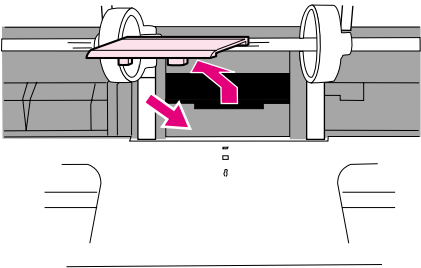

13 Push the spring-loaded base down and position the new separation pad in the empty slot.

Note

Make sure that the two tabs on the edge of the pad are toward the front of the printer.

13

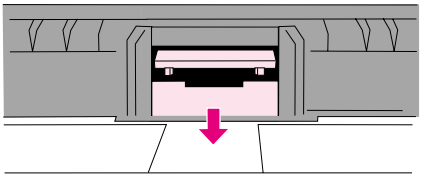

14 Snap both sides of the separation pad firmly into place until they click.

CAUTION

If the pad is not straight, or if space exists between the pad and the base, make sure that the tabs on the pad are toward the front of the printer.

14

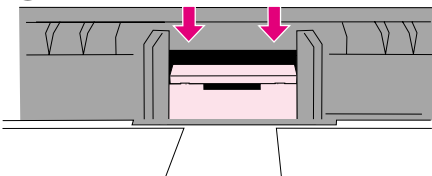

15 Hold down the new separation pad. Position the new pickup roller so that the button is on the right side, and the open side of the roller faces down. Make sure that the small ridge on the open side of the roller aligns with the groove in the shaft.

15

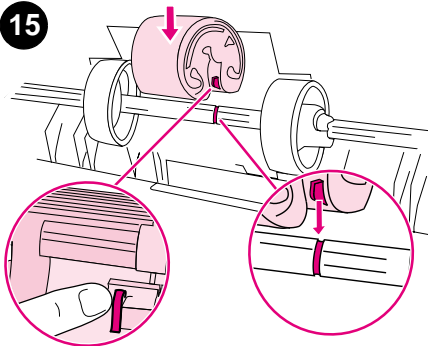

16

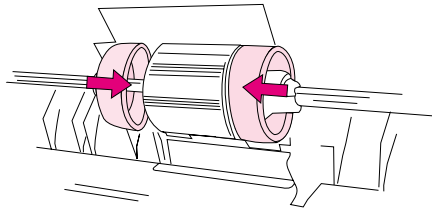

16 Slide the left and right idler rollers inward, against the pickup roller, until the idler rollers click into place.

17 Hold the faceplate cover as shown in the illustration, and align the cover with the rails on the inside of the printer.

18 Grasp both sides of the center tab and insert the cover into the printer until the cover clicks into place. Close tray 1.

17

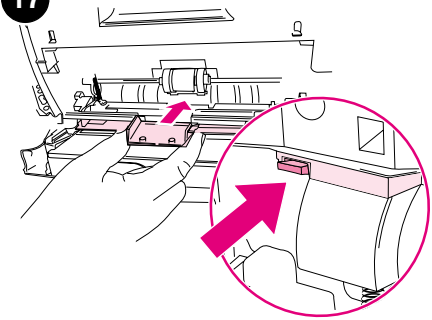

18

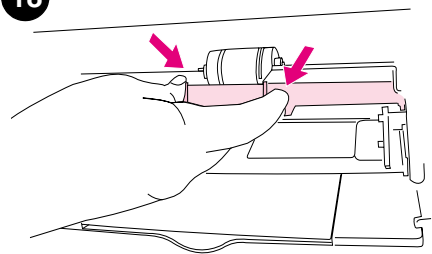

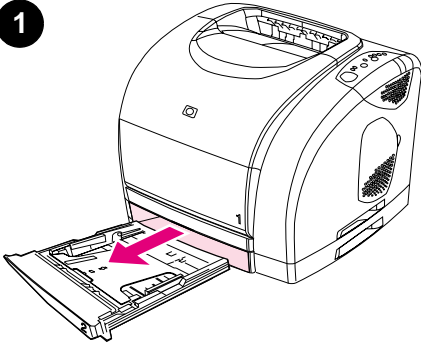
1

Replacing the separation pad in optional tray 2 or in optional tray 3

Note

The 500-sheet optional tray 3 is available with the HP Color LaserJet 2500 series printers only.

- 1 Remove the tray from the printer and place it on a flat surface. Remove any paper from the tray.
 - 2 Locate the separation pad in the base at the inside-front edge of the tray.
 - 3 Press the large metal plate at the bottom of the tray down. Insert a flatblade screwdriver in the slots on each side of the base and push the tabs out of the slots.
-

Note

In a 250-sheet tray, the plate locks down; in a 500-sheet tray, you have to hold the plate down manually.

- 4 Pull the separation pad up and out of the tray.
- 5 Use one hand to position the new separation pad above the empty base. Align the grooves on the sides of the pad with the sides of the base, and then slide the pad down until the tabs snap into the slots on the base.

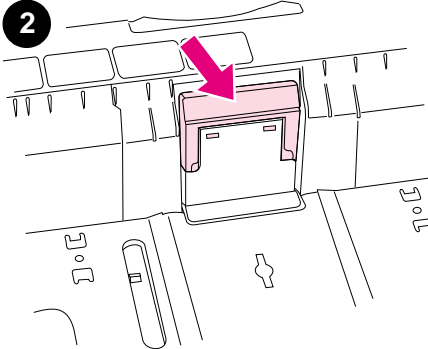
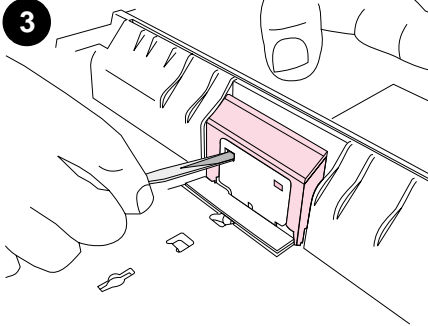
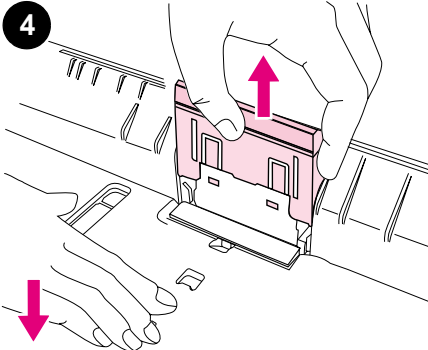
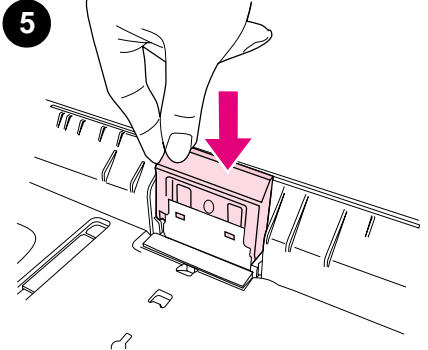
2**3****4****5**

6

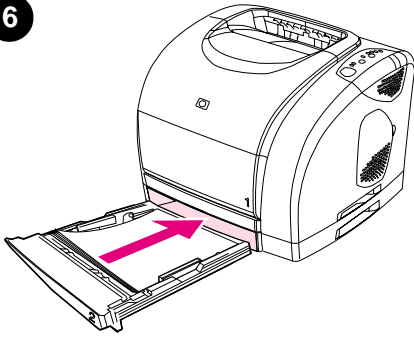

- 6 Reload any print media, and then slide the tray into the printer.
- 7 Reconnect the power cable. Turn the printer on.
- 8 When the green Ready light is on, press **Go** to print a Demo page, which verifies that the printer works and that installation is complete.
- 9 If the page does not print, or to find additional help, go to <http://www.hp.com/support/clj1500> (HP Color LaserJet 1500 series printer) or <http://www.hp.com/support/clj2500> (HP Color LaserJet 2500 series printer).

7

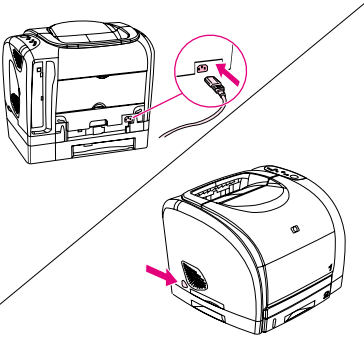

8

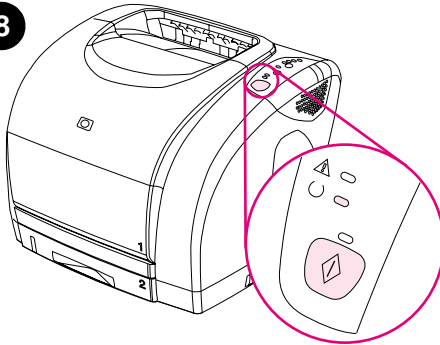

Note

If the page does not print, reconnect the power cable. Make sure that the Ready light is on and that no other lights are on or blinking. Make sure that print media is loaded and that all parts are installed correctly.

Cleaning the printer

Cleaning the engine

During the printing process, paper, toner, and dust particles can accumulate inside the printer. Over time, this buildup can cause print-quality problems such as toner specks or smearing. Use a cleaning page to correct and prevent these types of problems.

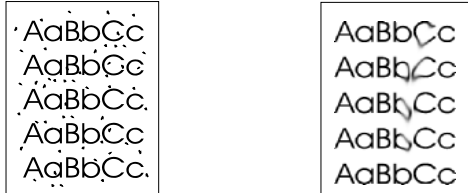

Figure 12. Toner specks and smearing

To use a cleaning page

The following procedure must be performed from the HP Color LaserJet 1500 Series Toolbox or the HP Color LaserJet 2500 Series Toolbox, which are supported for Windows 98, NT 4.0 (HP Color LaserJet 2500 series printers with parallel connections only), Me, 2000, and XP.

Note

The HP Color LaserJet 1500 Series Toolbox is not supported for the Macintosh operating systems.

- 1 Make sure that the printer is turned on and in the Ready state.
- 2 Open the Toolbox.
- 3 On the **Troubleshooting** tab, click **Cleaning Page** and click **Print**. A page with a pattern prints from the printer.
- 4 At the printer, remove any media from tray 1 (multipurpose tray).
- 5 Remove the page that printed and load it face-down into tray 1 (see figure 13).

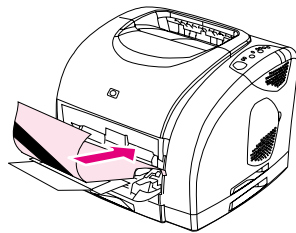

Figure 13. Loading the cleaning page in tray 1

- 6 At the computer, click **Clean**.

Note

For even better results, repeat this procedure several times.

Note

To clean the engine when the computer is running a different supported operating system (HP Color LaserJet 2500 series printer only), see the Readme on the software CD-ROM, or visit <http://www.hp.com/support/clj2500>.

Calibrating the printer

The printer automatically performs a calibration when the imaging drum or a print cartridge is changed, and at set intervals that are determined by the total number of pages the printer has printed. For the HP Color LaserJet 2500 series printers, you can change the interval at which the printer performs automatic calibrations by using the embedded Web server.

To calibrate the printer manually

Turn the printer off, wait one minute, and then turn the printer on again.

To calibrate the printer from the Toolbox

The following procedure must be performed from the HP Color LaserJet 1500 Series Toolbox or the HP Color LaserJet 2500 Series Toolbox, which are only supported for Windows 98, NT 4.0 (HP Color LaserJet 2500 series printers with parallel connections only), Me, 2000, and XP.

Note

The HP Color LaserJet 1500 Series Toolbox is not supported for the Macintosh operating systems.

- 1 Open the Toolbox in one of these ways:
 - On the desktop, double-click the **HP Color LaserJet 1500 Series Toolbox** or **HP Color LaserJet 2500 Series Toolbox** icon.
 - On the **Start** menu, point to **Programs**, point to **HP Color LaserJet 1500** or **HP Color LaserJet 2500**, and select the **HP Color LaserJet 1500 Series Toolbox** or the **HP Color LaserJet 2500 Series Toolbox**.
- 2 On the **Troubleshooting** tab, click **Diagnostic Tools** (on the left side of the screen).
- 3 Click **Calibrate Now**.

Note

To clean the engine when the computer is running a different supported operating system (HP Color LaserJet 2500 series printer only), see the Readme file on the software CD-ROM, or visit <http://www.hp.com/support/clj2500>.

Managing supplies

For warranty information about these supplies, see “Limited warranty for the print cartridge and drum” on page 28.

Supplies life

The life of the imaging drum depends on the number of black-only or color pages that print jobs require. An HP imaging drum lasts an average of 20,000 pages when printing black-only pages and 5,000 pages when printing color pages. Actual life lies somewhere between these two numbers, depending on the number of black-only pages you print versus color. The average life is between 6,000 and 8,000 pages.

The life of a print cartridge depends on the amount of toner that print jobs require. When printing text at five-percent coverage, an HP cyan, magenta, or yellow print cartridge lasts an average of 4,000 pages, and a black print cartridge lasts an average of 5,000 pages.



Checking and ordering supplies

You can check the supplies status by using the printer control panel, printing a Supplies Status page, viewing the Toolbox, viewing Printer Status and Alerts, or viewing HP Web Jetadmin (HP Color LaserJet 2500 series printer only). Hewlett-Packard recommends that you place an order for a replacement print cartridge when you first receive the Low message for a print cartridge. The Low message indicates that approximately two weeks of life remain. When you use a new, authentic HP print cartridge or imaging drum, you can obtain the following types of supplies information:

- amount of cartridge or drum life remaining
- estimated number of pages that can be printed
- number of pages printed
- other supplies information

To check status and order supplies at the control panel

Do one of the following:

- Check the supplies status lights on the printer control panel. These lights indicate when a print cartridge or the imaging drum is low or empty. The lights also indicate when a non-HP print cartridge is first installed. See “Understanding supplies status” on page 38 to interpret the light patterns.
- Press  (GO) and  (CANCEL JOB) simultaneously. A Supplies Status page (and the Configuration page and, possibly, the HP Jetdirect page) prints. Check the supplies levels on the Supplies Status page. See the *HP Color LaserJet 1500 Series Printer User Guide* or the *HP Color LaserJet 2500 Series Printer User Guide* for more information.

If the supplies levels are low, you can order supplies through your local HP dealer, by telephone, or online. See chapter 7 for part numbers. See <http://www.hp.com/go/ljsupplies> to order online.

To check status and order supplies using the HP Color LaserJet 1500 Series Toolbox or the HP Color LaserJet 2500 Series Toolbox

- 1 Open the HP Color LaserJet 1500 Series Toolbox or the HP Color LaserJet 2500 Series Toolbox and then click the **Information** tab.
- 2 Click **Device Status** (on the left side of the window) and then click **Supplies Status** to see more information, such as part numbers.
- 3 If the print cartridges are low or empty, you can click **Order Supplies** in the **Other Links** area. This opens a browser and connects you to the Supplies section of the HP website. You must have Internet access to connect to the website.

Note

You can also click the **Order Supplies** link from the HP Color LaserJet 1500 Series Toolbox or the HP Color LaserJet 2500 Series Toolbox. You must have Internet access to connect to the website.

To check status and order supplies using Printer Status and Alerts

If the printer is directly connected to the computer, you can set Printer Status and Alerts to notify you when the supplies are low. On both directly connected and network printers, you can receive these messages if you choose to receive alerts about events that do not prevent the printer from printing (a print cartridge is low) or that actually prevent the printer from printing (a print cartridge is empty). After receiving a message, click **Order Supplies Online** in Printer Status and Alerts to connect to the Supplies section of the HP website. You must have Internet access to connect to the website.

To check status and order supplies using HP Web Jetadmin

Note

HP Web Jetadmin is available with the HP color LaserJet 2500 series printer only.

In HP Web Jetadmin, select the printer device. The device status page shows supplies information. To order, use the HP Color LaserJet 2500 Series Toolbox or the embedded Web server, or see chapter 7.

Storing supplies

Follow these guidelines for storing print cartridges and the imaging drum:

- Do not remove the print cartridge or imaging drum from its package until you are ready to use it.

CAUTION

To prevent damage, do not expose the print cartridge or imaging drum to light for more than a few minutes.

- See table 5, “Environmental specifications,” on page 21 for operating- and storage-temperature ranges.
- Store the supply in a horizontal position.
- Store the supply in a dark, dry location away from heat and magnetic sources.

Replacing and recycling supplies

To install a new HP print cartridge or imaging drum and recycle the used one, follow the instructions included in the box that contains the new supply, or see the *HP Color LaserJet 1500 Series Printer Getting Started Guide* or the *HP Color LaserJet 2500 Series Printer Getting Started Guide*. See the *HP Color LaserJet 1500 Series Printer User Guide* or the *HP Color LaserJet 2500 Series Printer User Guide* for more information about recycling.

HP policy for non-HP supplies

Hewlett-Packard Company cannot recommend the use of non-HP supplies, either new or remanufactured. Because they are not HP products, HP cannot influence their design or control their quality. Service or repairs that are required as a result of using a non-HP supply will *not* be covered under the printer warranty.

When you insert a supply into the printer, the printer informs you if the supply is not a genuine HP supply. If you insert a genuine HP supply that has reached the low state from another HP printer, the printer identifies the supply as non-HP. Simply return the supply to the original printer to reactivate HP features and functionality.

Resetting the printer for non-HP supplies

When you install a non-HP print cartridge or imaging drum, the light next to the print cartridge or imaging drum you replaced blinks and the Attention light is on. You must press  (CANCEL JOB) the first time you install this non-HP supply. The status lights will not indicate when this type of supply is low or empty.

CAUTION

The printer will not stop printing when a non-HP supply is empty. Printer damage can occur if the printer attempts to print with an empty print cartridge or imaging drum. See “Warranty information” on page 26.

HP fraud hotline

Call the HP fraud hotline if the supplies status lights indicate that the print cartridge or imaging drum is not an HP product and you think that it is genuine. Hewlett-Packard will help determine if the product is genuine and take steps to resolve the problem.

Your print cartridge or imaging drum might not be a genuine HP product if you notice the following issues:

- You are experiencing a large number of problems with the print cartridge or imaging drum.
- The print cartridge or imaging drum does not look like an HP product usually does (for example, the pull tab or the box is different).

In the United States, call toll-free: (1) (877) 219-3183.

Outside the United States, you can call collect. Dial the operator and ask to place a collect call to this telephone number: (1) (770) 263-4745. If you do not speak English, a representative at the HP fraud hotline who speaks your language will assist you. Or, if someone who speaks your language is not available, a language line interpreter will connect approximately one minute after the beginning of the call. The language line interpreter is a service that translates between you and the representative for the HP fraud hotline.

4

Theory of operation

Chapter contents

Introduction	68
Engine control system	69
Basic sequence of operation	70
Power-on sequence	71
Motors and fans	72
Laser/scanner system	73
Pickup and feed system	74
Paper trays	76
Jam detection	77
Photosensors and switches	78
Solenoid and clutches	79
Printed circuit assemblies	80
Image-formation system	81
Image-formation process	82
Latent-image-formation stage	83
Developing stage	84
Transfer stage	85
Fusing stage	87
Print cartridge	91
Imaging-drum E-label	92

Introduction

This chapter presents an overview of the relationships between major components in the printer, and includes a detailed discussion of the image-formation system. The following systems are discussed:

- engine control system
- laser/scanner system
- pickup and feed system
- image-formation system

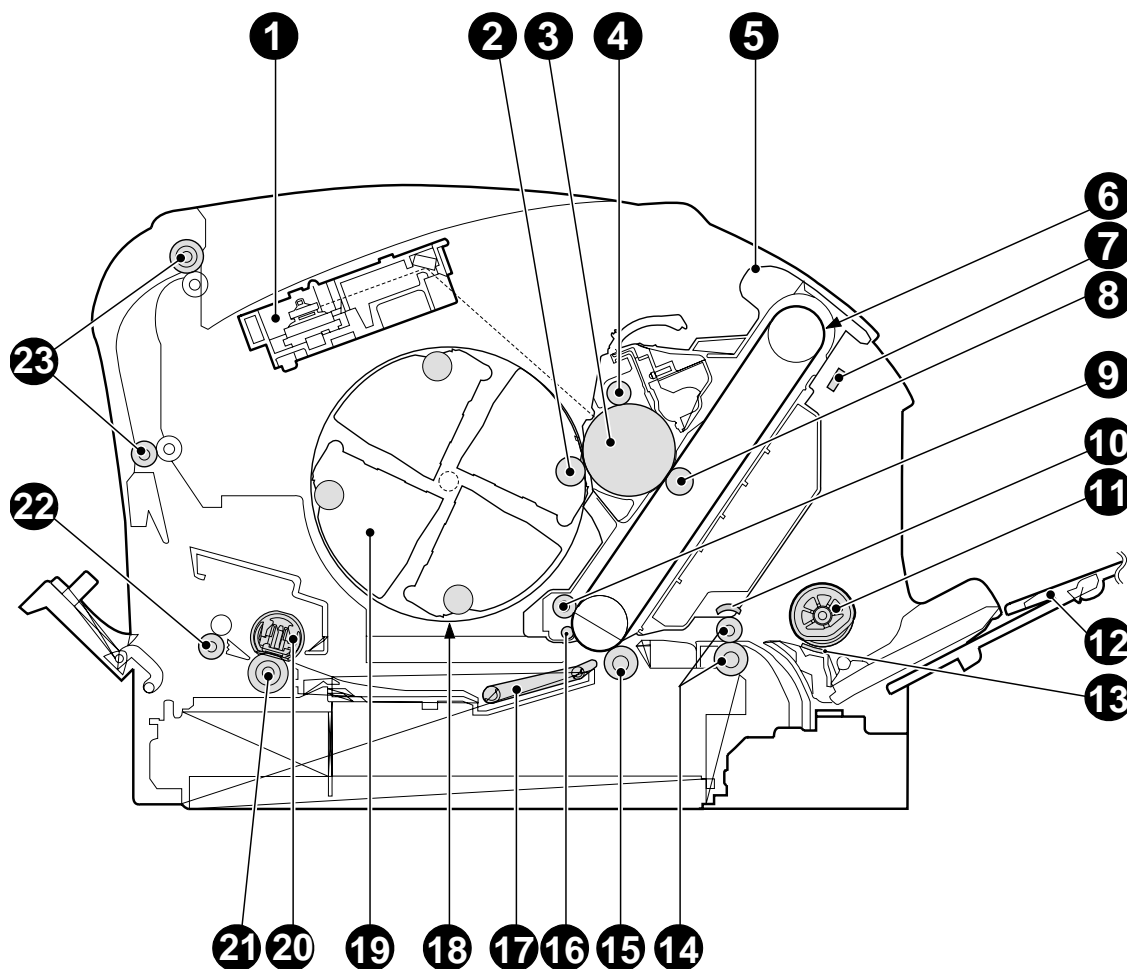

Figure 14. Cross-section of the printer

1	Laser/scanner	9	Transfer-belt cleaning roller	17	Feed belt
2	Developing cylinder	10	Registration shutter	18	Carousel
3	Photosensitive drum	11	Pickup roller	19	Print cartridge
4	Primary charging roller	12	Tray 1	20	Fusing film
5	Imaging drum	13	Separation pad	21	Pressure roller
6	Transfer belt	14	Registration roller	22	Fuser delivery roller
7	Density sensor	15	Secondary transfer roller	23	Top output bin delivery roller
8	Primary transfer roller	16	Auxiliary transfer-belt cleaning roller		

Engine control system

The engine control system coordinates all printer functions. It drives the laser/scanner system, the image formation system, and the pickup and feed system.

The engine control system contains the following components:

- dc controller
- high-voltage power-supply PCB
- low-voltage power unit:
 - fuser-control circuit
 - low-voltage power-supply PCB

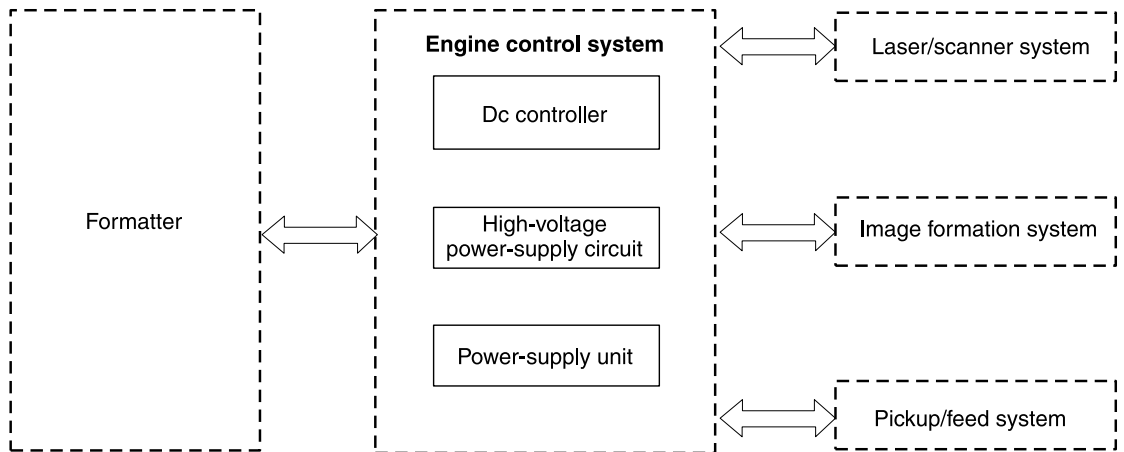

Figure 15. Engine control system (includes the basic configuration of the printer)

Basic sequence of operation

Operation sequences are controlled by the CPU in the dc controller in the engine control system. The following table describes engine operations for each period of a print operation.

Table 16. Basic sequence of operation

Period	Duration	Purpose	Remarks
WAIT (wait)	From the time the power switch is turned on until transfer-belt cleaning is complete.	Clears potential from the drum surface and cleans the transfer belt.	See figure 16 for a complete description of the WAIT (power-on) period. Also see the general timing charts beginning on page 228 for detailed information about timing.
STBY (standby)	From the end of the WAIT or LSTR period until either a print command is sent from the formatter or the power is turned off.	Prepares the printer to receive print commands.	
INTR (initial rotation)	From the time of the print command until detection of the HP1 (transfer-belt home-position detection) signal for the first color.	Prepares the photosensitive drum for printing.	
PRINT (print)	From the end of the INTR period until detection of the transfer-belt home-position signal for the secondary transfer.	Forms the image on the photosensitive drum and transfers the toner image to the transfer belt.	
LSTR (last rotation)	From the end of the PRINT period until the main motor stops rotating.	Transfers the toner image on the transfer belt to the media and delivers the printed media.	After LSTR, the printer returns to STBY.

Power-on sequence

The power-on sequence is represented by the flowchart in figure 16.

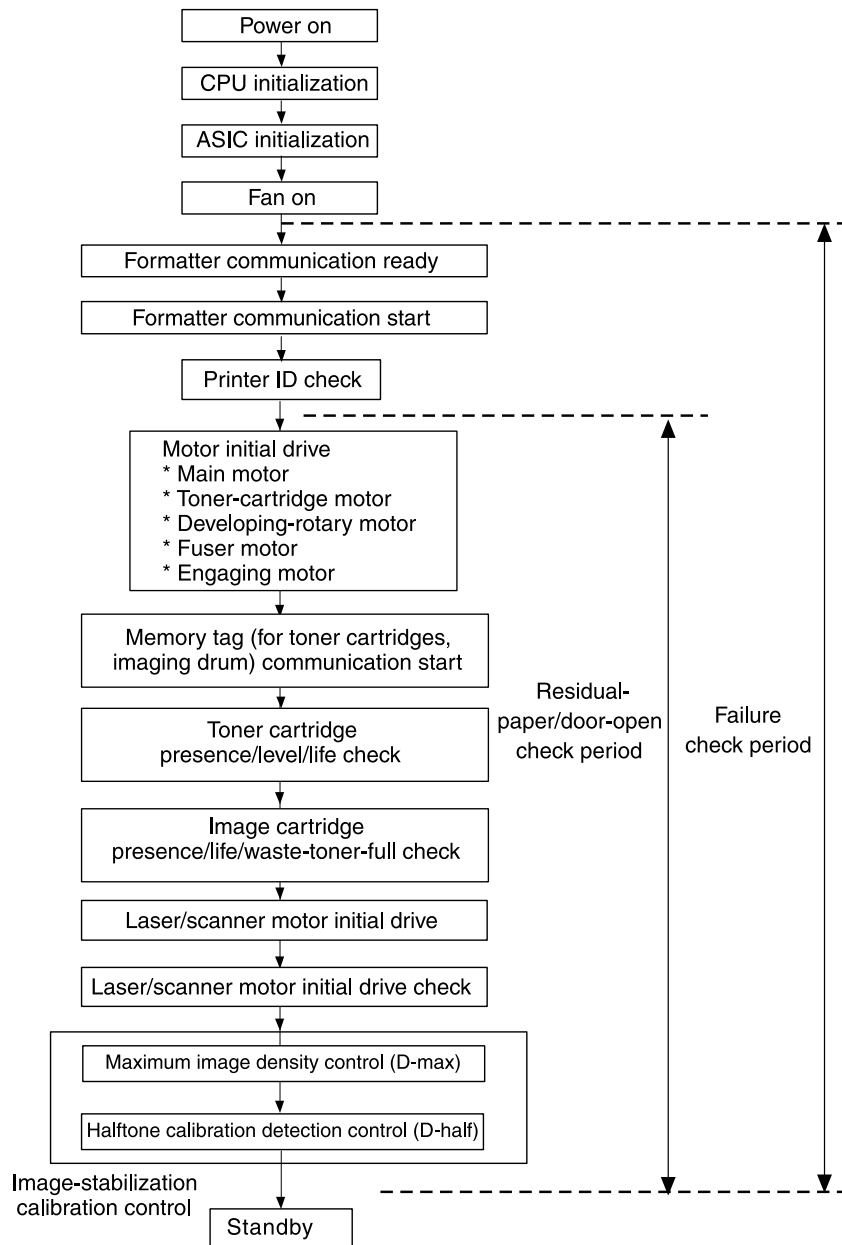

Figure 16.

Power-on sequence

Motors and fans

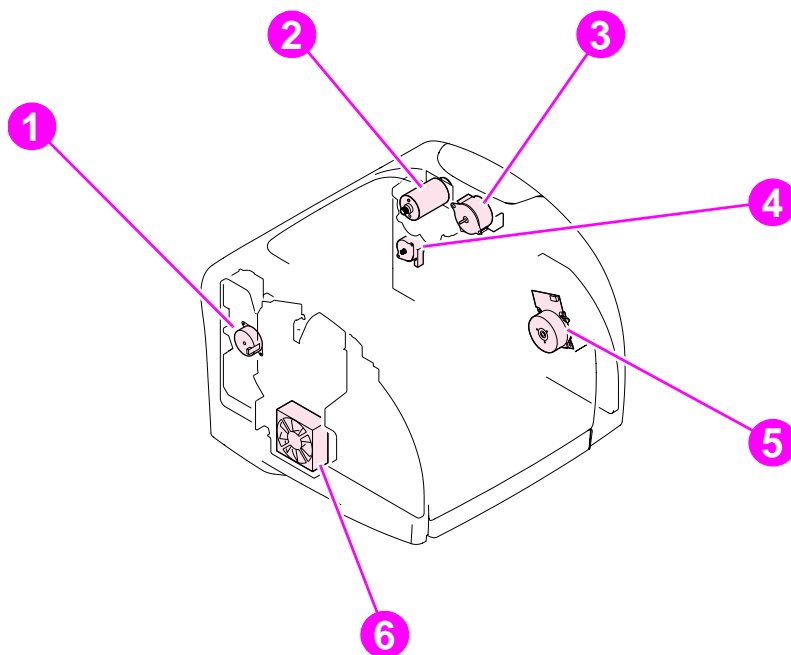

Figure 17. Motors and fans

Table 17. Motors and fans

Reference	Description
1	Engaging motor
2	Developing-rotary motor
3	Toner-cartridge motor
4	Fuser motor
5	Main motor
6	Cooling fan

Laser/scanner system

The laser/scanner system receives video signals from the dc controller, and then it converts the signals into latent images on the photosensitive drum. The dc controller controls the laser/scanner.

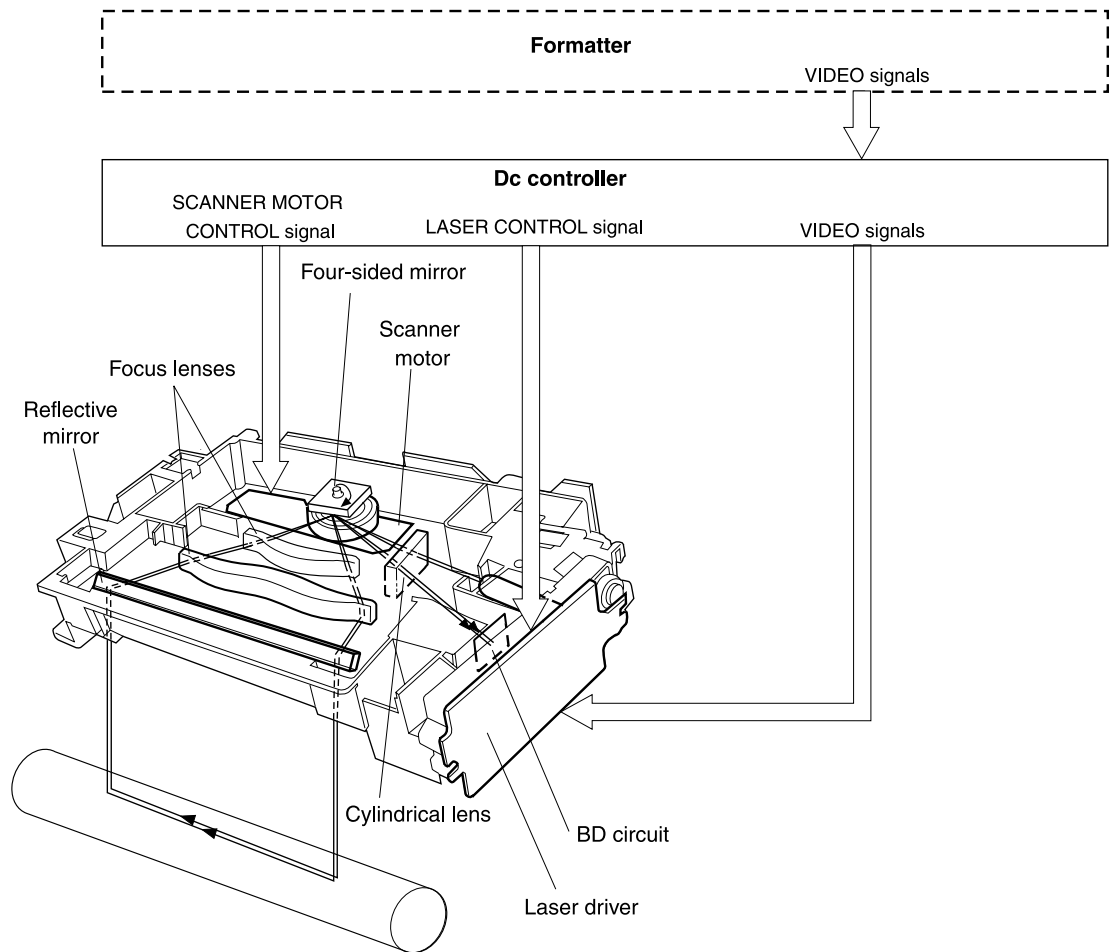

Figure 18.

Laser/scanner system

Pickup and feed system

The pickup and feed system consists of several types of feed rollers and sensors. The dc controller drives the paper and feed system by controlling two motors, two clutches, and the solenoid.

Two photo-interrupters (PS1 and PS711) detect media as it passes. If media does not reach or pass each sensor within the specified time period, the dc controller determines that a jam has occurred and alerts the video controller circuit.

The following components are identified in figure 19:

- **PS1** fusing-delivery paper sensor
- **PS711** registration paper sensor
- **PS718** tray 1 (multipurpose tray) paper sensor
- **PS720** fuser wrap-jam sensor
- **DCM701** main motor
- **PM702** fuser motor
- **SL92** tray 1 pickup solenoid
- **CL1** registration clutch
- **CL2** roller-engaging clutch

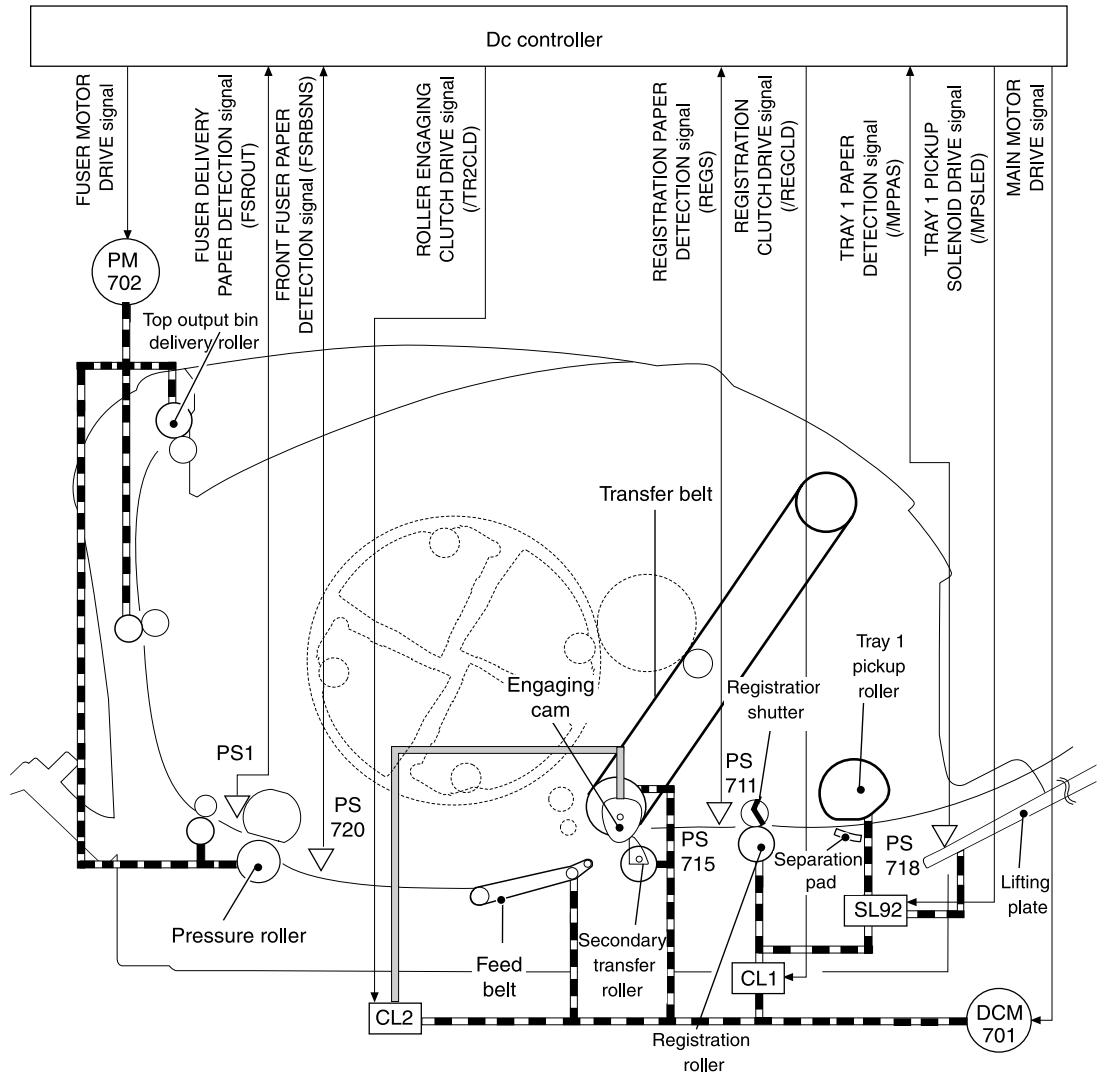

Figure 19. Pickup and feed system

Paper trays

The dc controller drives the operation sequence of the paper trays. It signals the driver PCB in optional tray 2 (250-sheet paper tray) and in optional tray 3 (500-sheet paper tray). In optional tray 2, the printer main motor drives the tray solenoids. In optional tray 3 (HP color LaserJet 2500 series printers only), each driver PCB controls the motors and solenoids in its paper tray.

The following components are identified in figure 20:

- **DCM701** gear-train motor (printer)
- **SL9** pickup solenoid (optional tray 2)
- **PS716** paper sensor (optional tray 2)
- **PS717** paper-feed sensor

Note

Only optional tray 2 is shown in figure 20; optional tray 3 is similar.

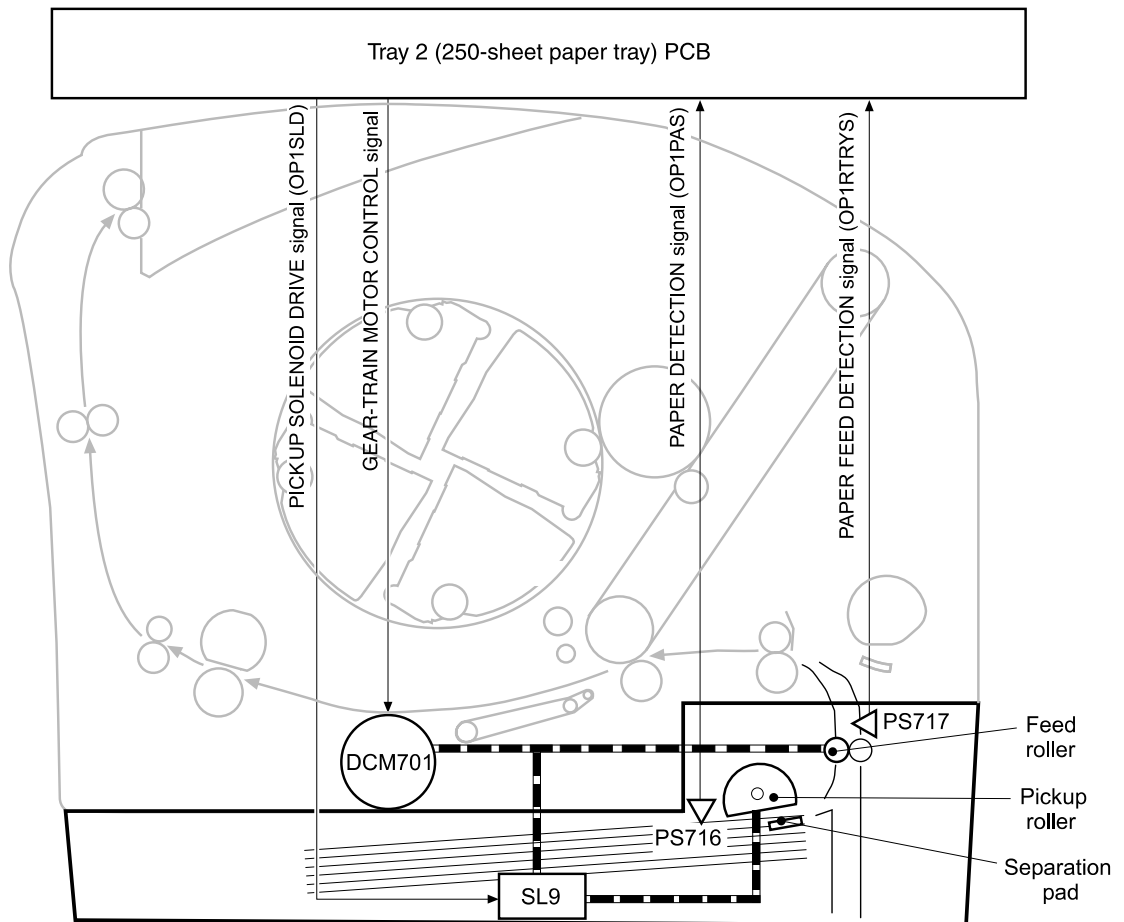

Figure 20. Optional tray 2 (250-sheet paper tray)

Jam detection

The registration sensor (PS711) and the fuser sensor (PS1) detect media that is moving through the printer. If a jam is detected, the dc controller immediately stops the printing process and sends a message to the video controller circuit.

A jam can be detected under any of the following conditions:

- Pickup delay jam. The leading edge of the print media does not reach the registration sensor (PS711) within 1.1 seconds (tray 1), 1.7 seconds (optional tray 2), or 2.8 seconds (optional tray 3—HP color LaserJet 2500 series printer only).
- Pickup stationary jam. The registration clutch is on, and the registration sensor (PS711) does not detect the trailing edge of the media within 3.4 seconds after the start of a re-pickup operation.
- Fuser wrap-jam. The main CPU detects media inside the fuser front sensor (PS720) when the power is turned on or after the top cover is closed.
- Delivery delay jam. The registration clutch is on, and the fuser-delivery sensor (PS1) does not detect the leading edge of the media within 2.3 seconds after the start of a re-pickup operation.
- Delivery stationary jam. The leading edge of media does not pass the fuser-delivery sensor (PS1) within 2.4 seconds after it has passed the registration sensor (PS711).
- Door-open jam. The main CPU detects that the top cover is open during a print operation.
- Residual jam. The main CPU detects one or more of the following conditions:
 - Power is turned on.
 - The printer door is closed after a jam occurrence.
 - The registration sensor (PS711) and fusing-delivery sensor (PS1) detect media.
- Paper pickup failure. The sensor (PS717) near the feed roller does not detect media moving through the printer.

Photosensors and switches

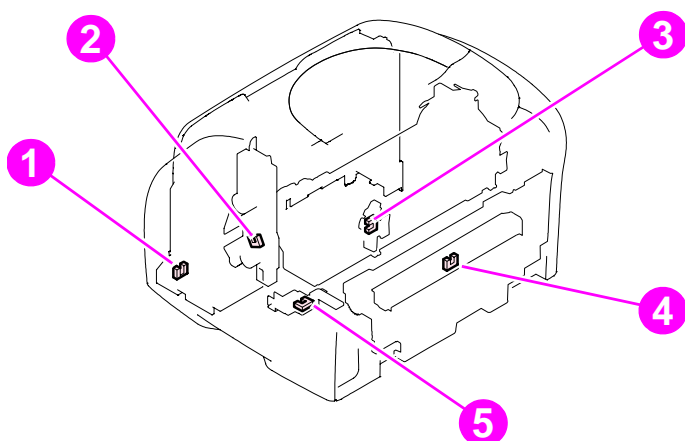

Figure 21. Photosensors and switches (1 of 2)

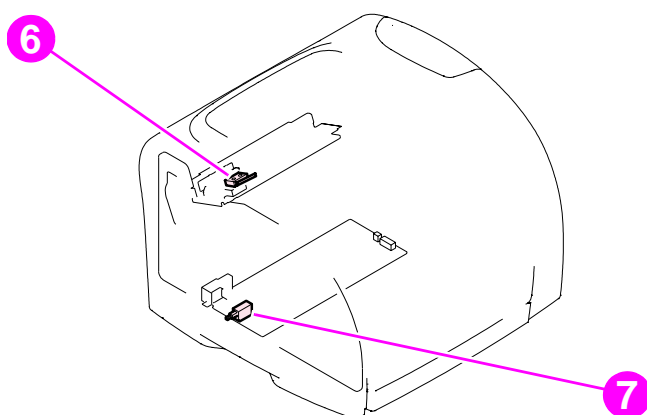

Figure 22. Photosensors and switches (2 of 2)

Table 18. Photosensors and switches

Reference	Description
1	Tray 1 sensor
2	Roller-engaging sensor
3	Developing-rotary-engaging sensor
4	Fuser-delivery sensor
5	Front fuser detection sensor
6	Door-open detection switch
7	Power switch

Solenoid and clutches

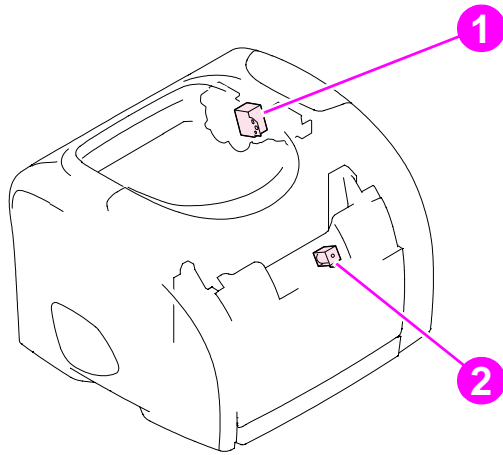

Figure 23. Solenoid and clutches (1 of 2)

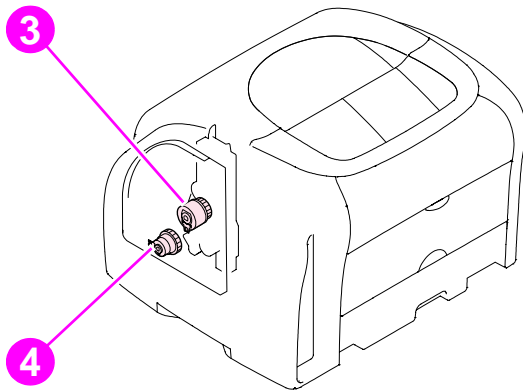

Figure 24. Solenoid and clutches (2 of 2)

Table 19. Solenoid and clutches

Reference	Description
1	Developing-rotary-stopper solenoid
2	Tray 1 pickup solenoid
3	Roller-engaging clutch
4	Registration clutch

Printed circuit assemblies

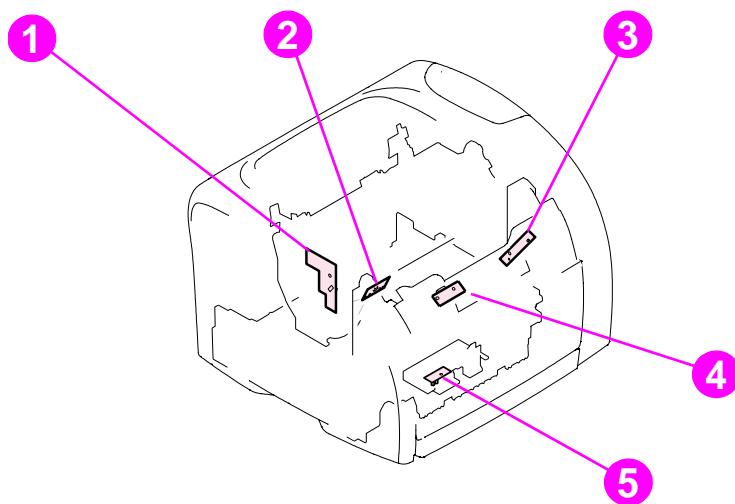

Figure 25. Printed circuit assemblies (1 of 2)

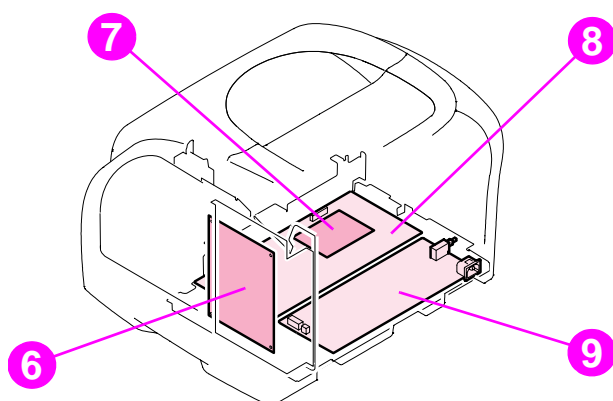

Figure 26. Printed circuit assemblies (2 of 2)

Table 20. Printed circuit assemblies

Reference	Description
1	Developing-rotary/toner-level detection PCA
2	Transfer-belt home-position detection PCA
3	Waste-toner-detection PCA
4	Density-detection PCA
5	Registration-detection PCA
6	Dc controller
7	Sub high-voltage power-supply PCA
8	High-voltage power-supply PCA
9	Power supply

Image-formation system

The image-formation system, which forms a toner image on media, consists of several interdependent systems:

- electrostatic latent-image-formation system
- developing system
- transfer block
- fuser
- transfer beltcleaning block
- imaging drum (with ITB)
- photosensitive drum

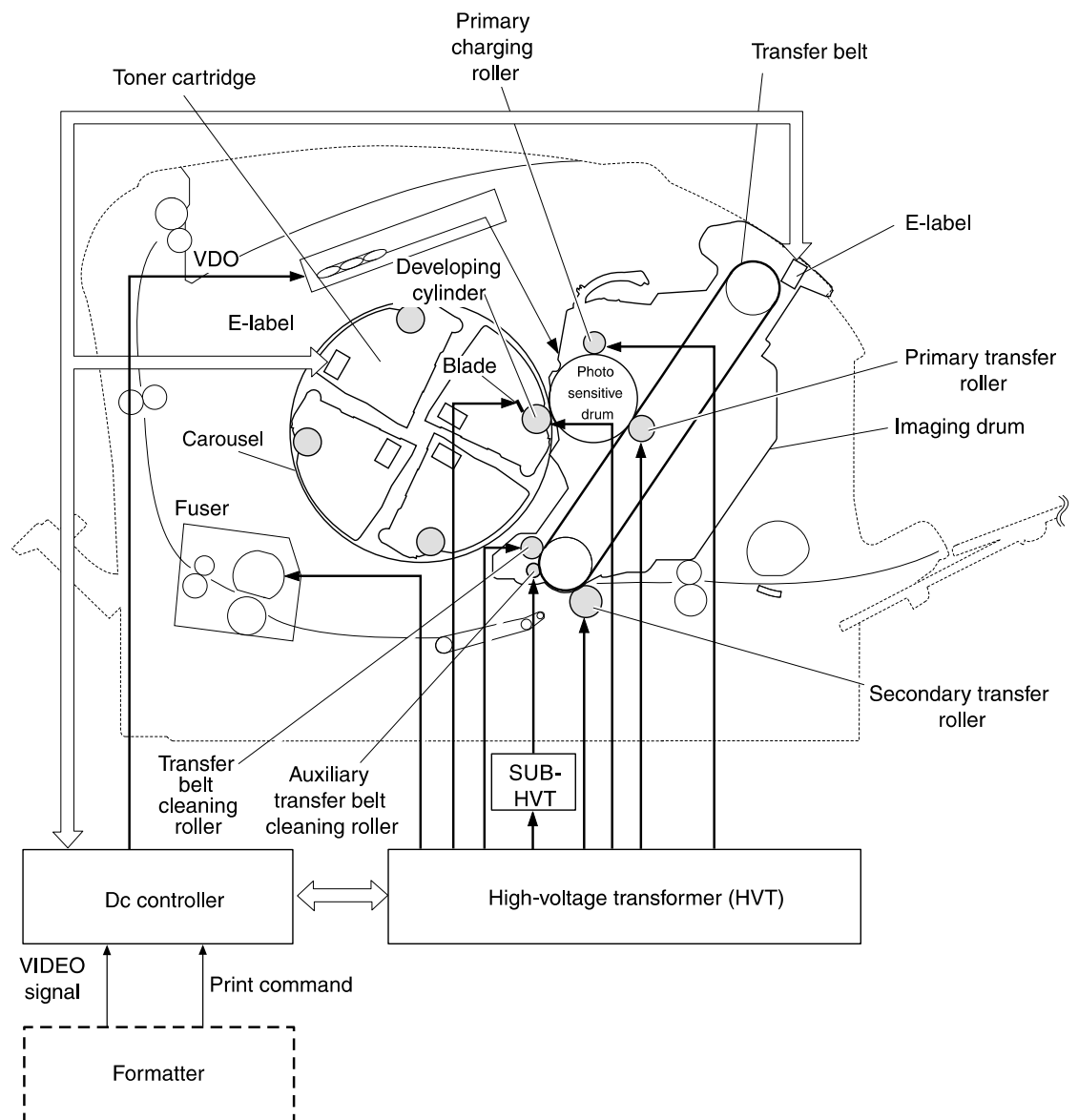

Figure 27. Image-formation system

Image-formation process

Laser printing requires the interaction of several different technologies including electronics, optics, and electrophotographics to produce a printed page. Each process functions independently and must be coordinated with the other printer processes. Image formation consists of the following five processes:

- 1 Latent-image formation
- 2 Developing
- 3 Image transfer
- 4 Fusing
- 5 Transfer-belt cleaning

The five processes are divided into twelve steps, which are shown in figure 28 and described in the following sections.

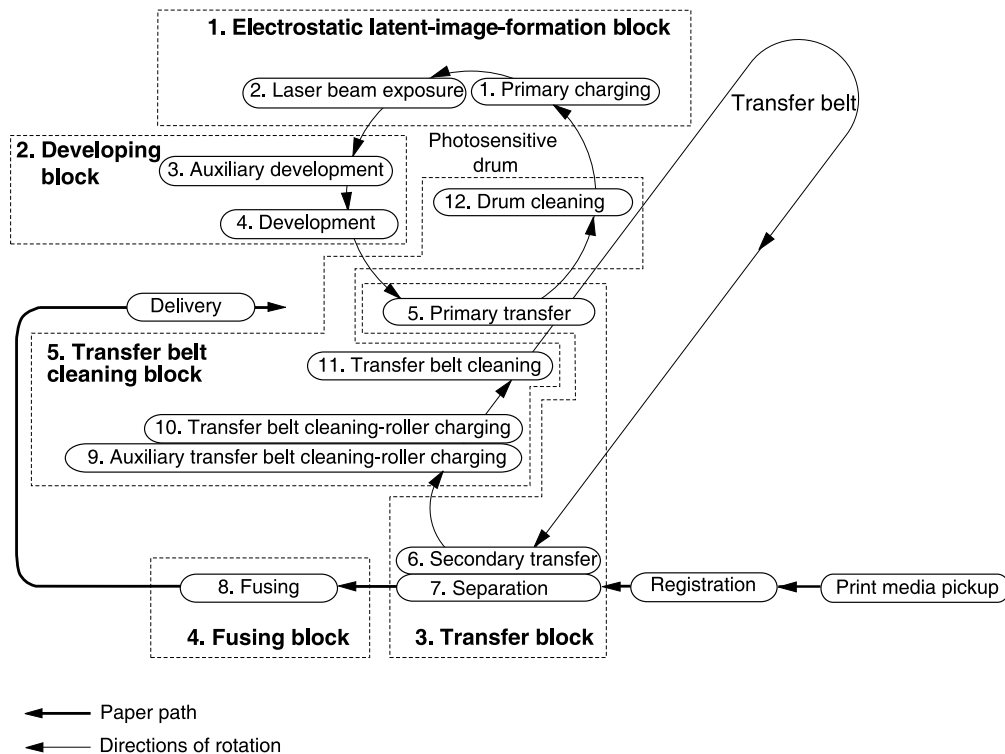

Figure 28. Image-formation process

Latent-image-formation stage

Step 1: primary charging

A dc bias is applied to the primary charging roller, which transfers a uniform negative potential to the photosensitive drum.

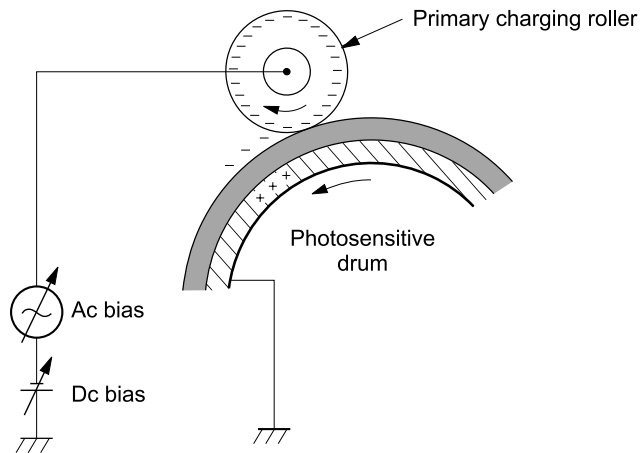

Figure 29.

Step 1: primary charging

Step 2: laser-beam exposure

The laser beam scans the photosensitive drum to neutralize negative charges on parts of the drum. An electrostatic latent image is formed on the drum where negative charges were neutralized.

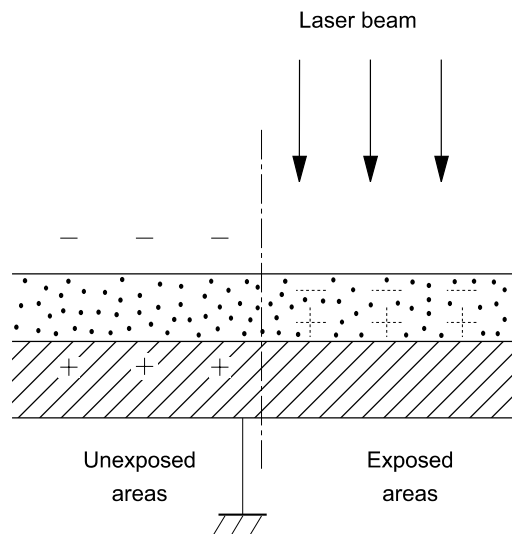

Figure 30.

Step 2: laser-beam exposure

Developing stage

The developing cylinder comes in contact with the photosensitive drum to deposit toner onto the electrostatic latent image.

Note

The charges on the exposed area on the drum are shown as positive in figure 31. The charges are actually negative, but they are more positive than the charges on the developing cylinder.

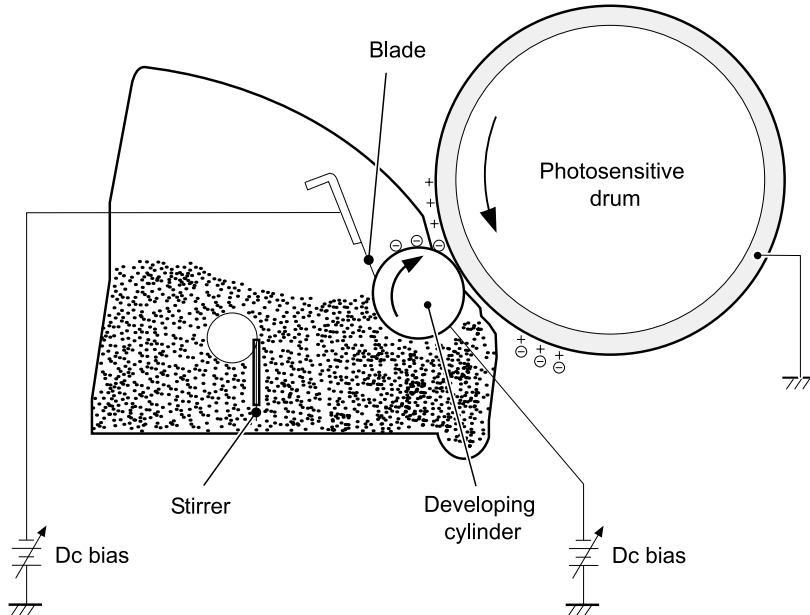

Figure 31.

Developing block

Step 3: auxiliary developing

The dc bias applied to the blade imports a uniform negative potential to the toner.

Step 4: developing

Toner acquires a negative charge through friction from the developing cylinder and the blade. When the negatively charged toner comes in contact with the drum, the toner adheres to the electrostatic latent image. The image on the drum becomes visible because of the toner.

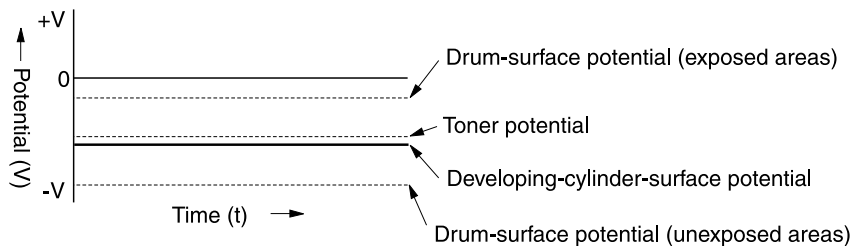

Figure 32.

Step 3: developing

Transfer stage

Step 5: primary transfer

The primary transfer roller, to which a dc positive bias is applied, imparts a positive charge on the transfer belt. The negatively-charged toner on the drum is transferred to the positively-charged transfer belt. This procedure is repeated for each color (yellow, magenta, cyan, and black).

The dc positive bias is increased for each successive color to make sure that all of the colors adhere to the transfer belt.

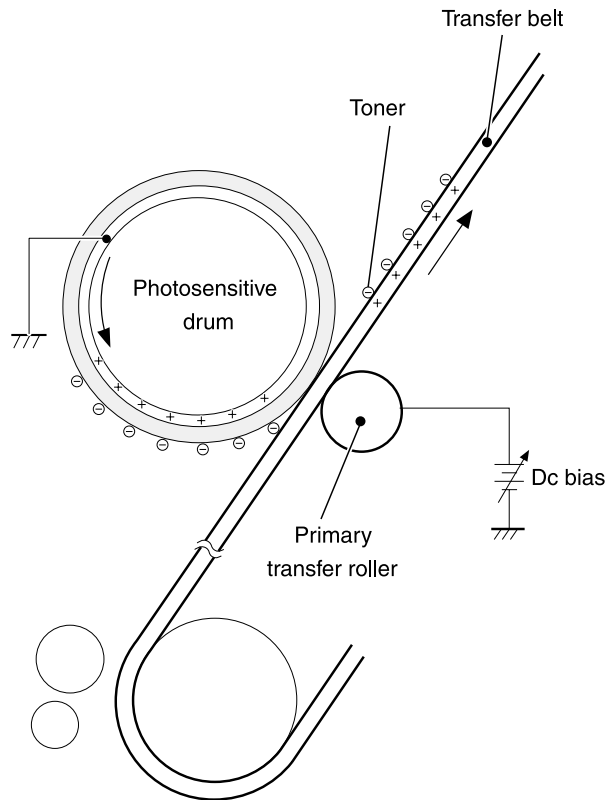

Figure 33.

Step 4: primary transfer

Step 6: secondary transfer

The secondary transfer roller, to which a dc positive bias is applied, imparts a positive charge to the print media. When the print media comes in contact with the transfer belt, the toner is transferred to the print media.

Note

When secondary transfer is complete, a dc negative bias is applied to the secondary transfer roller to prevent toner on the transfer belt from adhering to the secondary transfer roller.

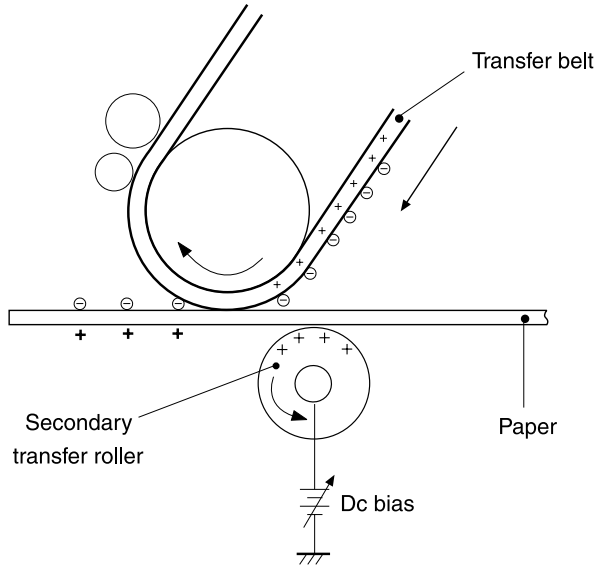

Figure 34.

Step 5: secondary transfer

Step 7: separation

The elasticity of the print media causes it to separate from the transfer belt. A static charge eliminator aids separation by weakening any electrostatic adhesion.

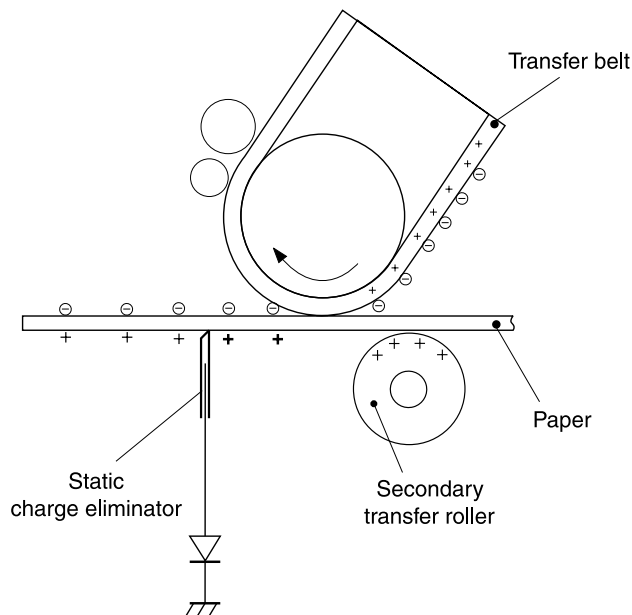

Figure 35.

Step 6: separation

Fusing stage

Step 8: fusing

The dc negative bias applied to the fusing film strengthens the holding force of the toner on the print media and prevents the toner from scattering.

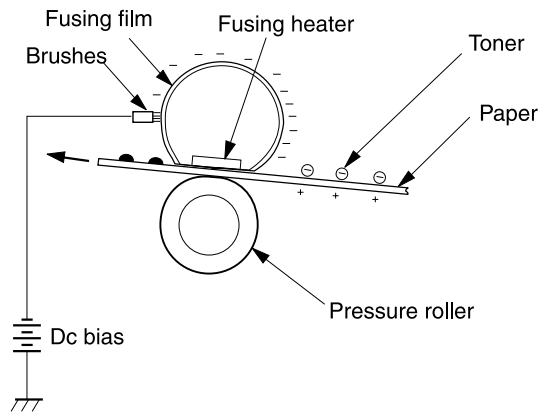

Figure 36.

Step 7: fusing

Step 9: roller charging (auxiliary ITB cleaning roller)

During secondary transfer, not all of the toner on the transfer belt is transferred to the print media. Toner that remains on the belt is called “residual toner.”

The auxiliary transfer belt cleaning roller, to which a dc positive bias is applied, imparts a positive charge to the residual toner, strengthening its hold on the transfer belt. This prevents toner from falling off of the transfer belt and scattering in the printer.

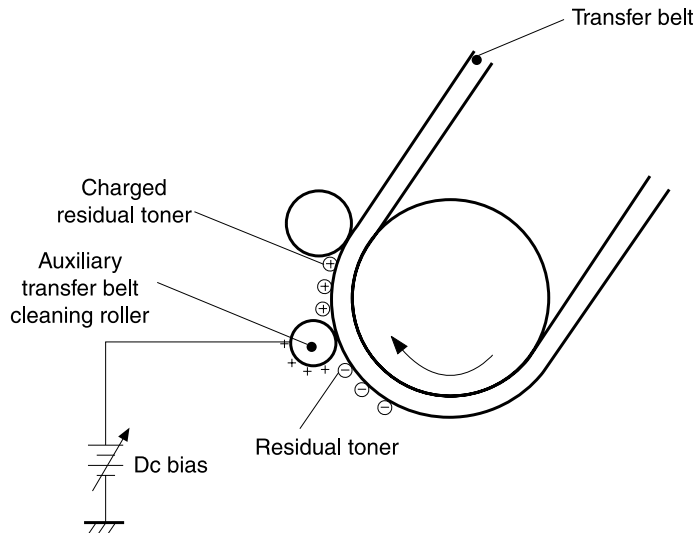

Figure 37.

Step 8: roller charging (auxiliary transfer belt cleaning roller)

Step 10: roller charging (transfer-belt cleaning roller)

The transfer-belt cleaning roller, to which a dc positive bias is applied, imparts a positive charge to the residual toner on the transfer belt. This positive charge is stronger than the positive charge applied in step 8, so the earlier charge now behaves like a negative charge.

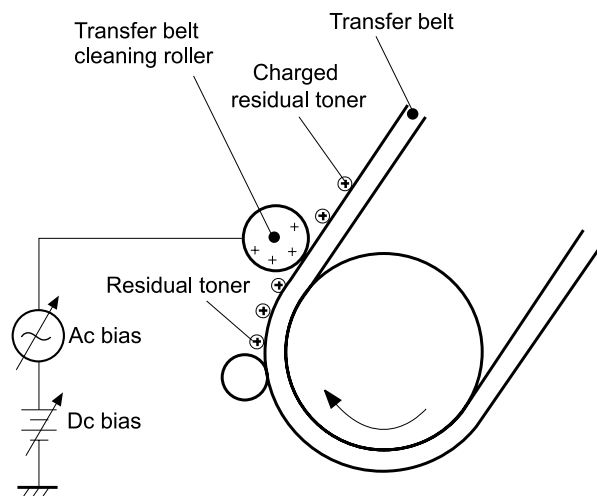

Figure 38.

Step 9: roller charging (transfer belt cleaning roller)

Step 11: transfer belt cleaning

A dc positive bias is applied to the transfer belt to produce a difference in potential between the belt and the photosensitive drum. This causes residual toner to transfer to the drum.

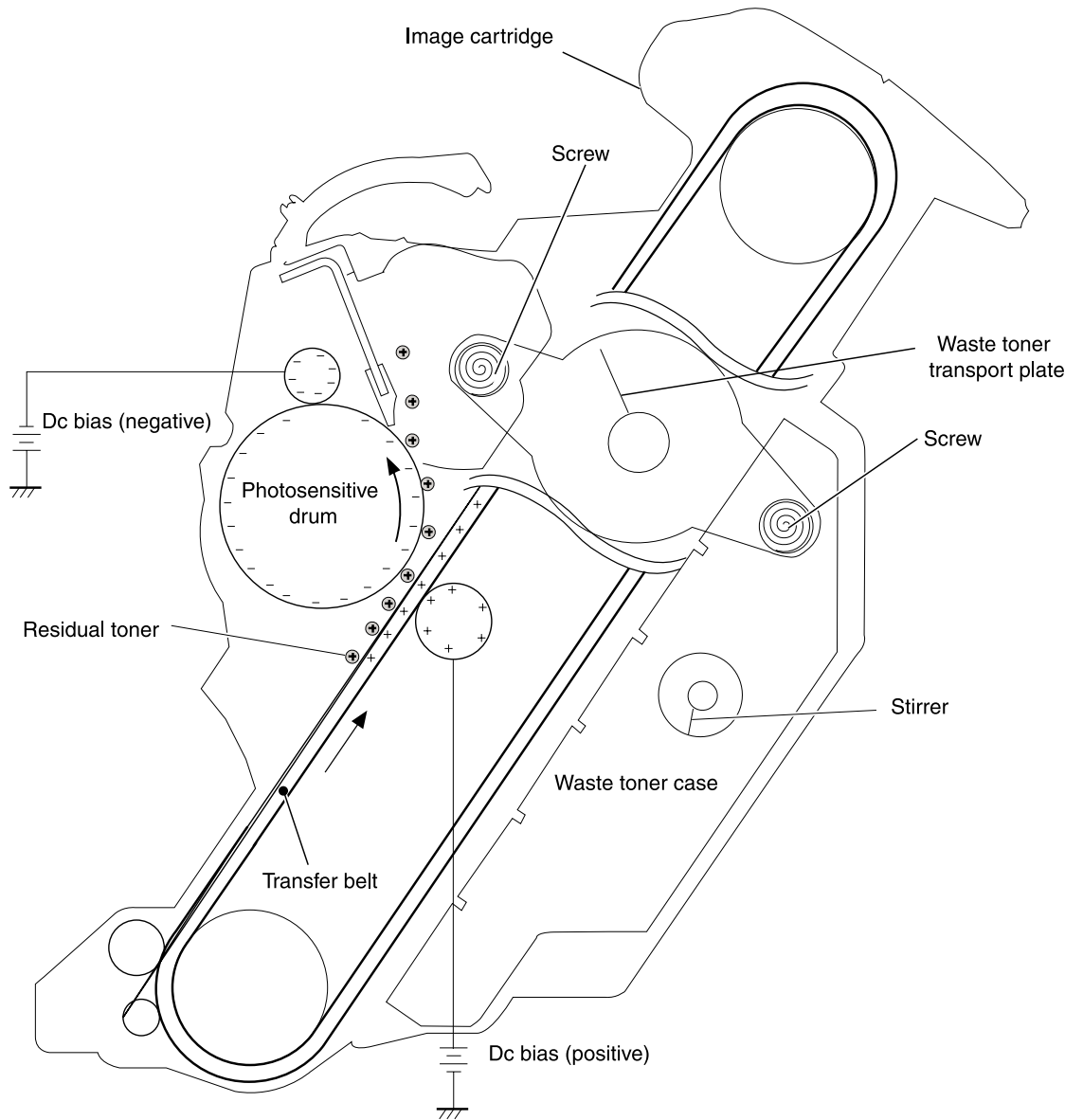

Figure 39.

Step 10: transfer belt cleaning

Step 12: drum cleaning

The cleaning blade scrapes the residual toner off of the photosensitive drum, where the waste toner screws collect the toner and deposit it into the waste toner case.

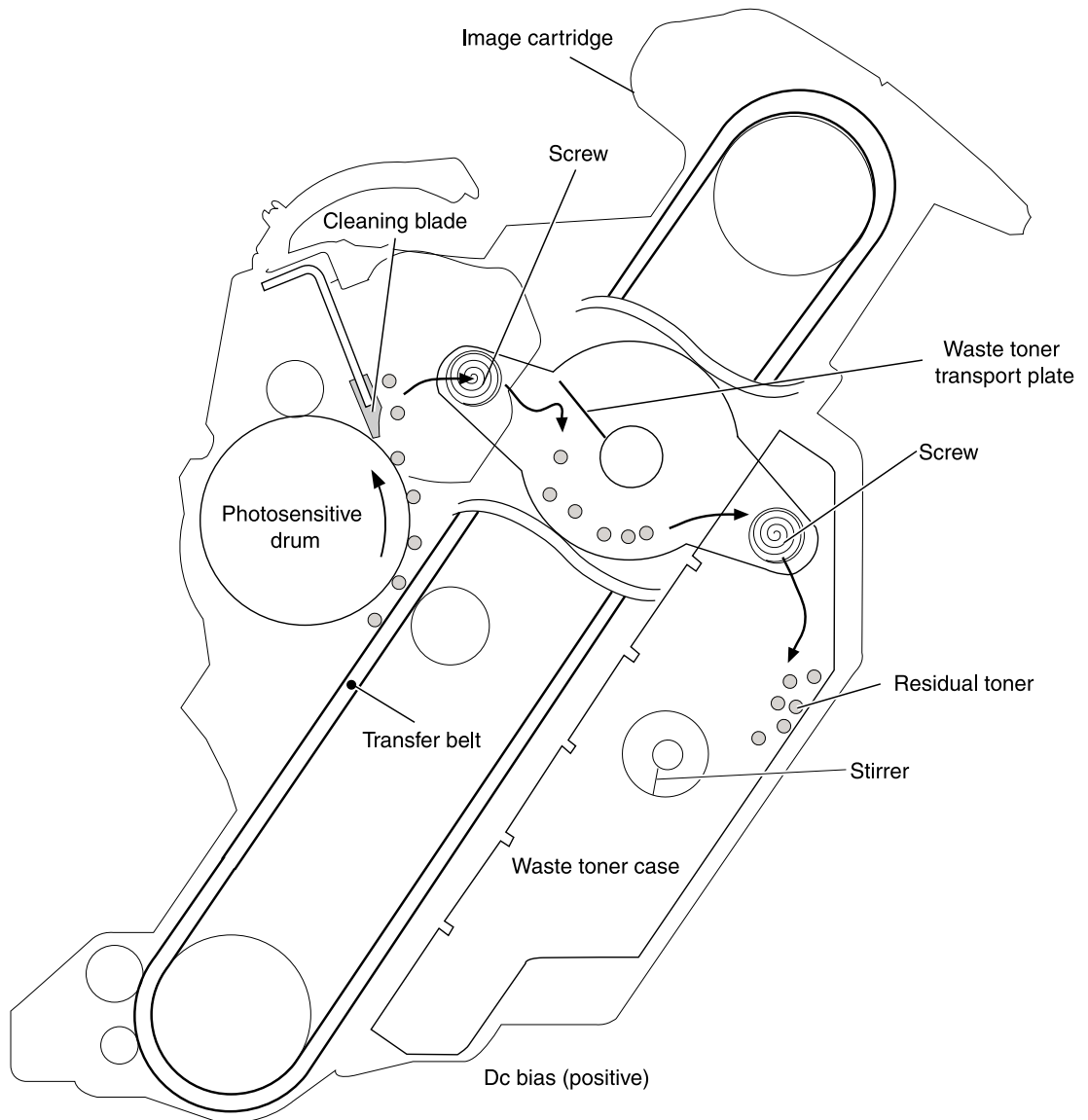

Figure 40.

Step 11: drum cleaning

Print cartridge

The printer has four print cartridges: yellow, magenta, cyan, and black. Each print cartridge contains a developing cylinder, toner-feed roller, and stirrer. The developer motor rotates these parts so that each print cartridge can use toner to form a visible image on the drum.

The carousel motor rotates the E-label reader, which communicates E-label information to the dc controller.

The developing rotary/toner level detection PCB uses an LED (light emitter) and a photodiode (light receiver) to determine the toner level in each print cartridge.

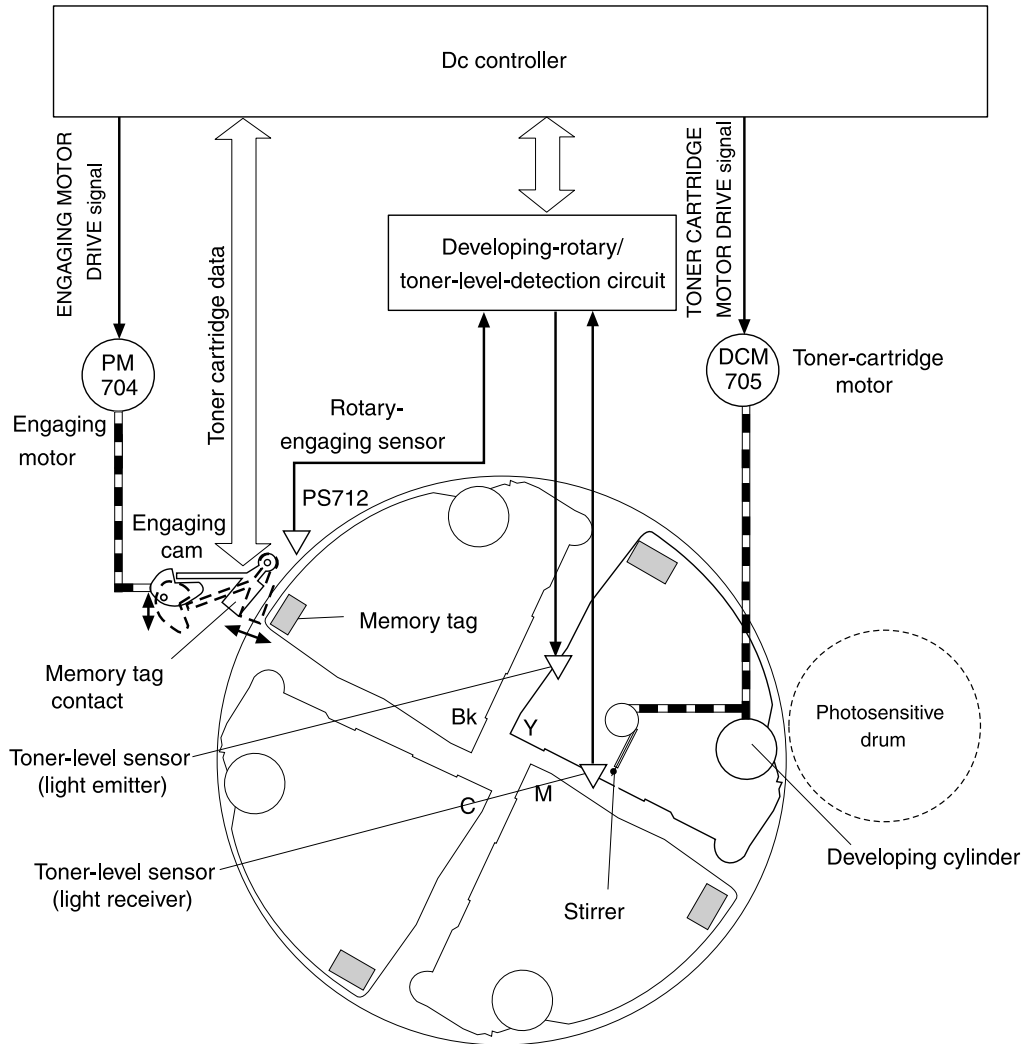

Figure 41.

Print cartridge

Imaging-drum E-label

The E-label is nonvolatile memory, which is built into the imaging drum and stores usage information. When the imaging drum is installed in the printer, the E-label makes constant contact with the E-label reader. The E-label reader sends memory information to the dc controller, which updates the information and sends it back to the E-label.

The dc controller instructs the E-label to read information when:

- the printer is turned on.
- the top cover is closed.
- a command is sent from the video controller.

The dc controller instructs the E-label to write information when:

- a specified period occurs during printing.
- a command is sent from the video controller.

If the E-label reader fails to read or write information four times in a row, the dc controller notifies the video controller that an abnormality exists in the imaging drum.

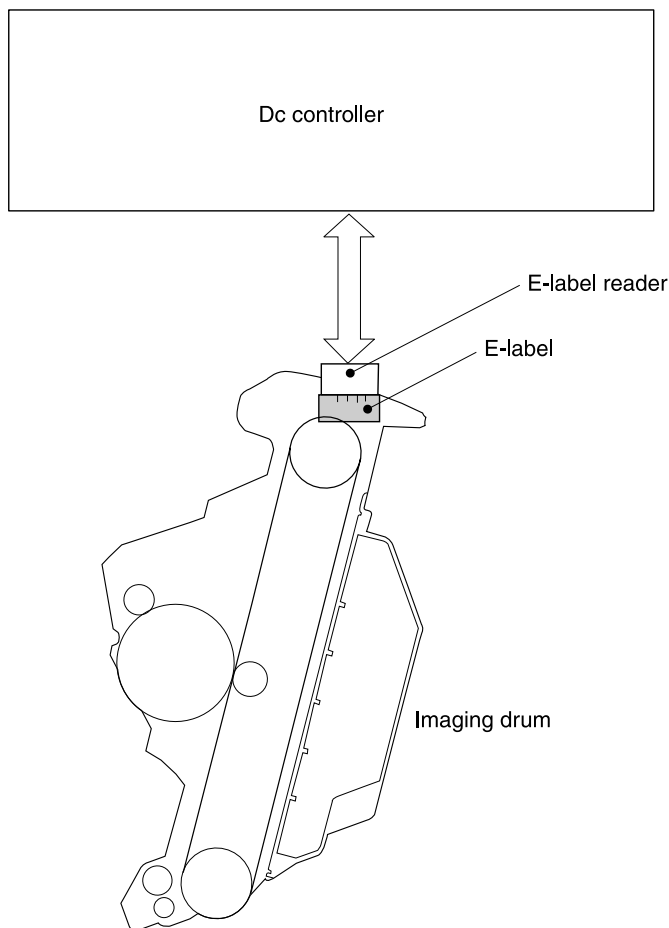

Figure 42. Print-cartridge E-label

5

Removal and replacement

Chapter contents

Introduction	95
Removal and replacement strategy	95
Electrostatic discharge	95
User-replaceable parts	95
Required tools.	95
Before performing service	96
Pre-service procedures.	96
Parts removal order	97
Removal and replacement	98
Imaging drum	98
Print cartridges	99
Jetdirect card	99
Fuser cover (and fuser)	100
Right- and left-side covers	101
Control panel	103
On-off switch.	105
Interface cover	106
Formatter assemblies—HP color LaserJet 1500 series printers	107
Formatter assemblies—HP color LaserJet 2500 series printers	111
Fuser motor (J702).	115
Dc controller	116
Optional tray 2 (250-sheet tray)	118
Carousel motor (J704)	120
Front lower cover	121
Back cover	122
Top cover	123
Top door	126
Air duct and fan.	128
Laser/scanner assembly.	129
Front cover	131
Density sensor and top-of-page sensor	132
E-label reader (for imaging-drum E-labels).	133
Tray 1 (multipurpose tray).	135
Tray 1 separation pad assembly.	137
Gear assembly	138
Waste-toner sensor	140

Rotary-drive assembly	141
Top plate	144
Print-cartridge carousel	147
Registration-roller assembly	152
Toner-catch tray	153
Transfer-roller plate	154
Transfer roller	155
Feed-drive shaft	156
ECU pan	157
Sub-high-voltage transformer PCA	160
High-voltage transformer PCA	161
Low-voltage PCA	162
Paper-top sensor	164
Fuser-wrap sensor	165
250-sheet feeder pickup roller	166
250-sheet feeder cover	167
250-sheet feeder PCA	168
500-sheet feeder pickup roller	169
500-sheet feeder cover	171
500-sheet feeder motor	172

Introduction

Removal and replacement strategy

This chapter documents removal and replacement of field replaceable units (FRUs) only.

Replace parts in the reverse order of their removal. Directions for difficult or critical replacement procedures are included.

WARNING!

The sheet-metal edges of the product can be sharp. Use caution when working on the product.

Note

Note the length, diameter, color, type, and location of each screw. Be sure to return each screw to its original location during reassembly.

Incorrectly routed or loose wire harnesses can interfere with other internal components and can become damaged or broken. Frayed or pinched harness wires can be difficult to locate. When replacing wire harnesses, always use the provided wire loops, lance points, or wire-harness guides.

Electrostatic discharge

CAUTION

The product contains parts that are sensitive to electrostatic discharge (ESD). Always service the product at an ESD-protected workstation, or use an ESD mat.



Watch for the ESD symbol (shown at left) to identify the parts that are sensitive to ESD. Protect these parts by using an ESD wrist strap and by placing ESD-sensitive parts into protective ESD pouches.

User-replaceable parts

This chapter contains removal and replacement procedures for the imaging drum (see page 98) and the print cartridge (see page 99).

To remove and replace the pickup roller or separation pad, see “User-replaceable parts” on page 55.

Required tools

The following tools are needed to service this product:

- #2 Phillips screwdriver with magnetic tip
- Small flatblade screwdriver
- Small needle-nose pliers
- ESD mat
- Penlight

CAUTION

A PoziDriv screwdriver will damage screw heads on the product. Use a #2 Phillips screwdriver.

If you use a multispeed screwdriver, use a torque limiter.

Before performing service

Pre-service procedures

- 1 Remove all media from the product.
- 2 Place the product on an ESD mat. If an ESD mat or an ESD-protected workstation is not available, discharge body static and ground the product chassis *before* servicing the product.
- 3 Remove the imaging drum (see page 98).
- 4 Remove the print cartridges (see page 99).
- 5 Unplug the power cord and the interface cable.
- 6 Lift the printer (and optional tray 2) off of optional tray 3 (if it is installed—HP color LaserJet 2500 series printer only).

Parts removal order

Use the following diagram to determine which parts must be removed before removing other parts.

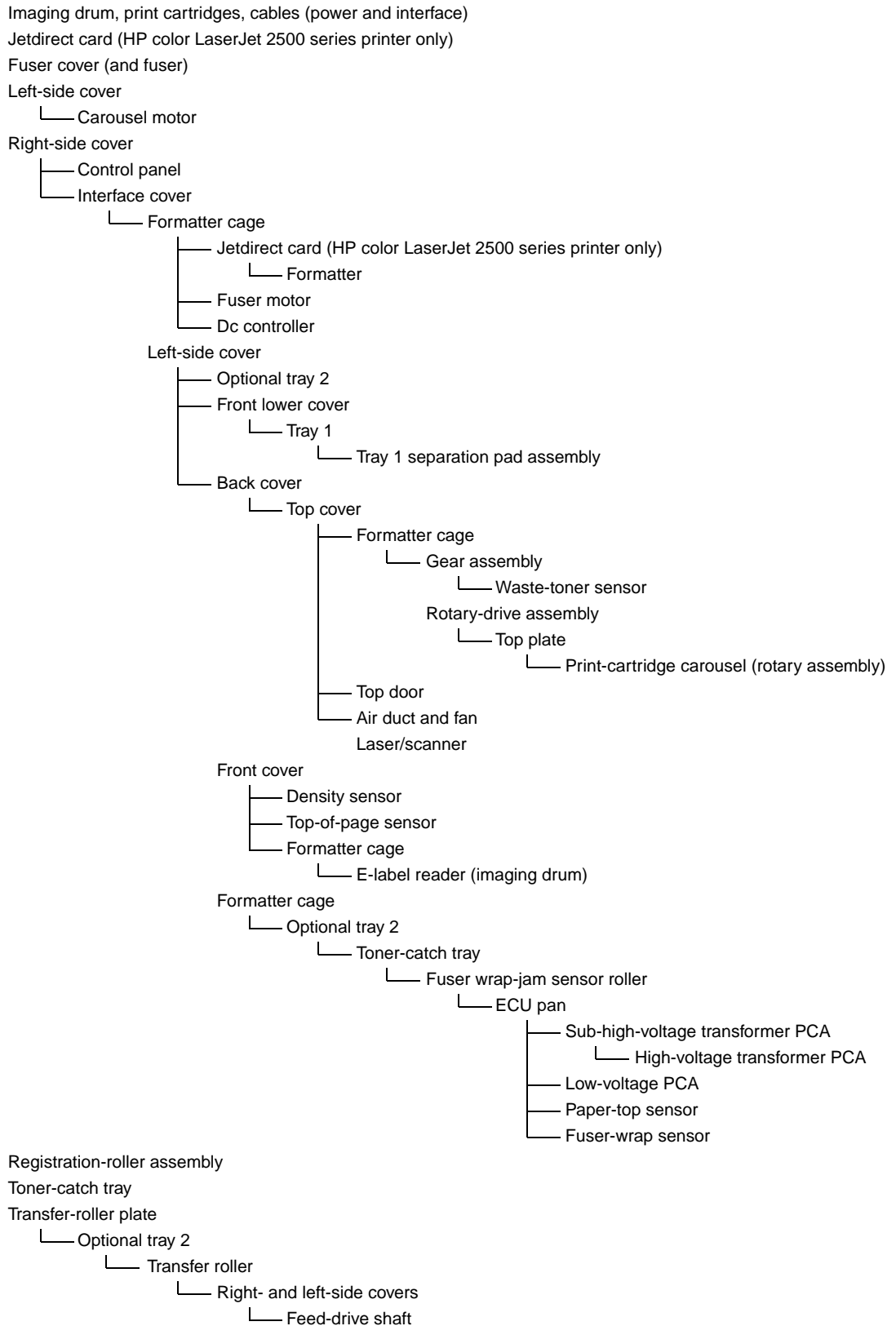

Removal and replacement

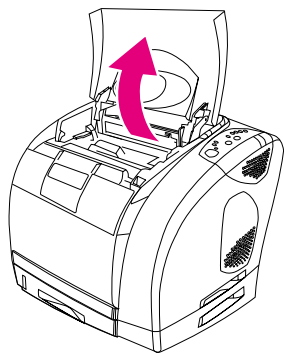

Imaging drum

- 1 Open the top cover.
- 2 Grasp the imaging drum handle and then rotate the imaging drum until the handle is horizontal.
- 3 Lift the imaging drum straight up to remove it from the printer.

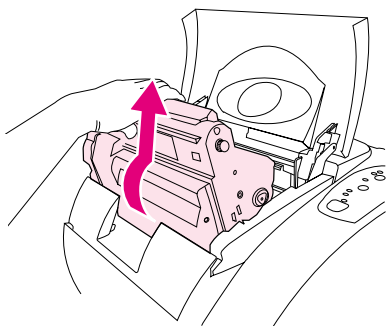

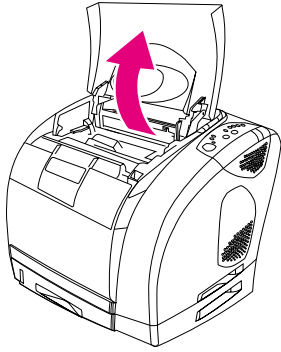

Print cartridges

- 1 Open the top door.
- 2 Remove the imaging drum (see page 98).
- 3 Pinch together the two large blue tabs on the first cartridge and then lift the cartridge straight up to remove it from the carousel.
- 4 Close the top cover, and then press the **ROTATE CAROUSEL** button.

Note

If the print-cartridge carousel does not rotate, see page 216.

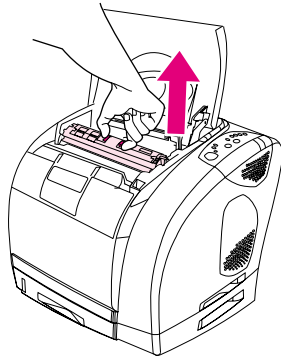

- 5 Open the top cover, and then remove the next cartridge following the procedure in step 3.
- 6 Repeat steps 2 through 5 until all four cartridges have been removed.

Note

When the top door is open, the carousel retracts but does not rotate.

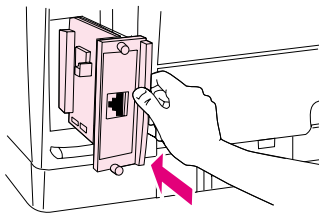
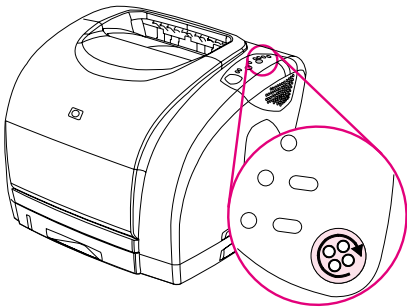

Jetdirect card

Note

The Jetdirect card is available for HP color LaserJet 2500 series printers only.

- 1 Turn the printer off.
- 2 Loosen two thumbscrews.
- 3 Slide the Jetdirect card out of the slot to remove it.

Fuser cover (and fuser)

- 1 Turn the printer off.
- 2 Rotate two locking tabs (callout 1) upward.
- 3 Gently slide the fuser out of the printer.

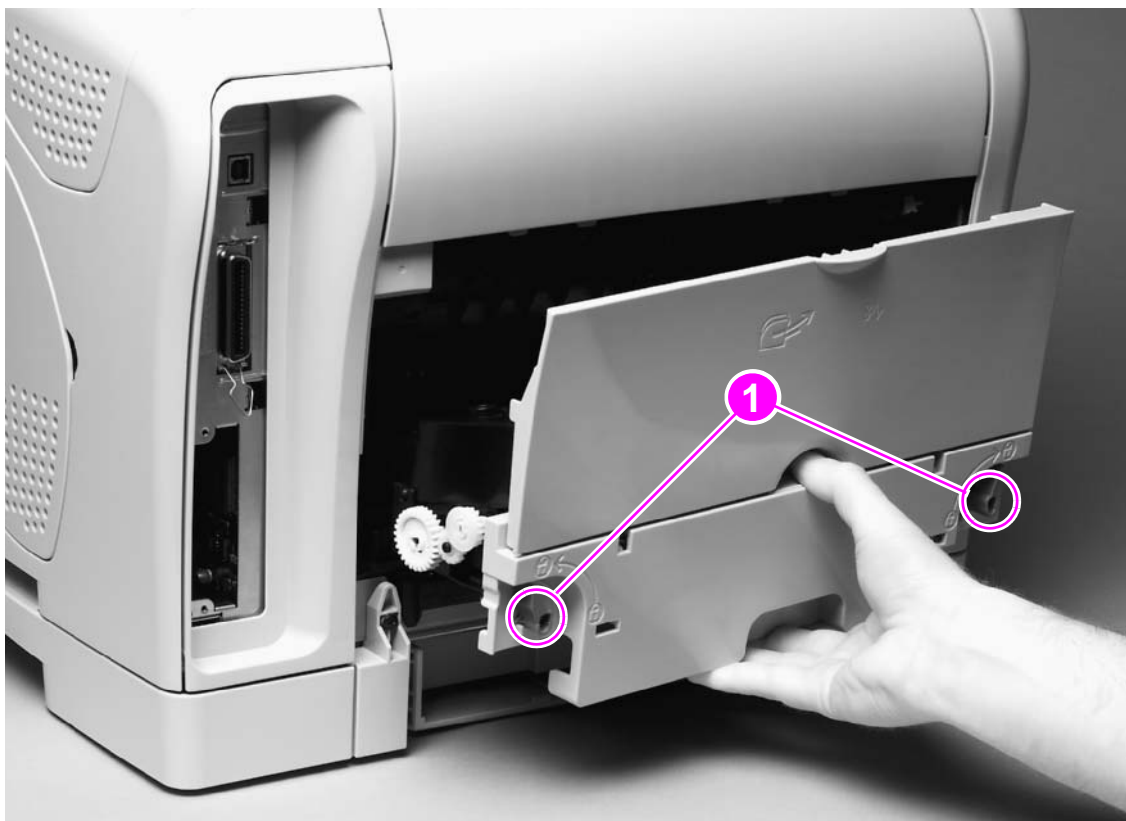

Figure 43.

Removing the fuser cover (and fuser)

Right- and left-side covers

Use the following steps to remove the right-side cover. Then, remove the left-side cover in the same manner.

- 1 Remove one screw (callout 1) from the lower edge of the cover.

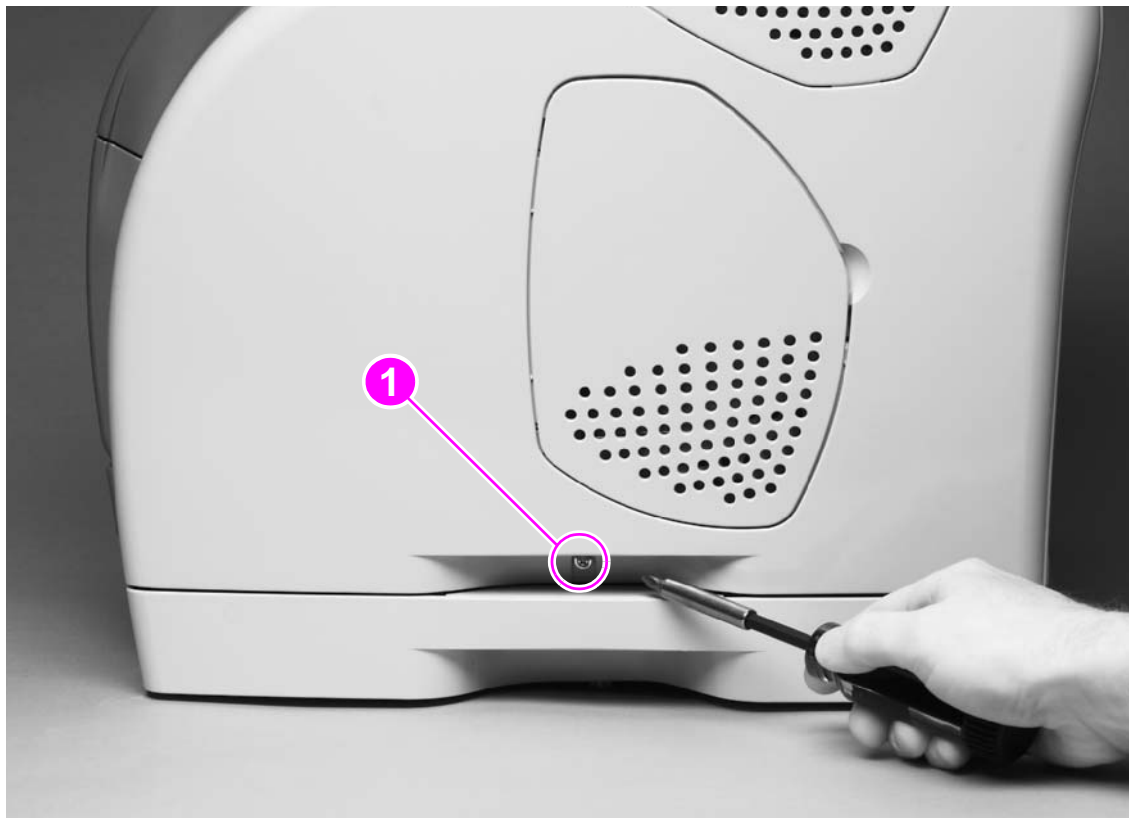

Figure 44. Removing the right-side cover (1 of 2)

- 2 Grasp the cover by the handle and by the top and then pull the cover out gently, rotating the cover away from the printer as you lift it straight up.

CAUTION

To avoid breaking two internal tabs (see detail in figure 45), lift the cover straight up.

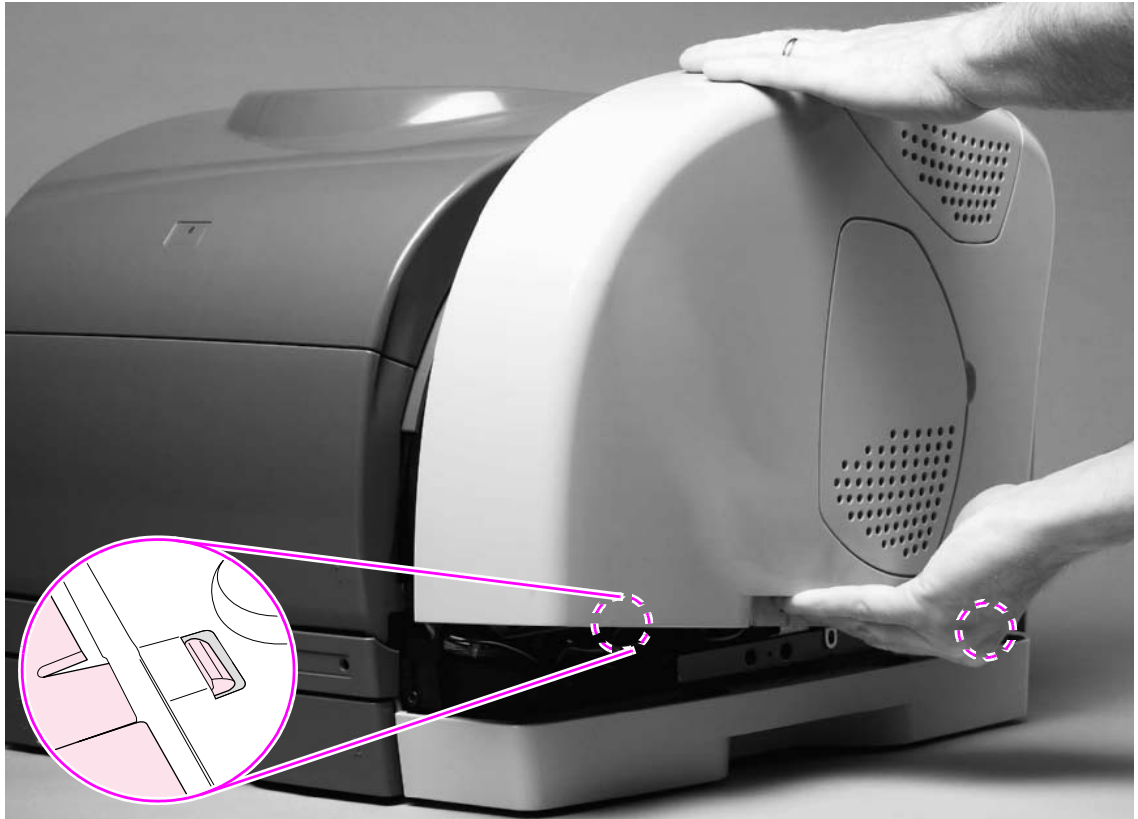

Figure 45.

Removing the right-side cover (2 of 2)

- 3 Repeat steps 1 and 2 to remove the left-side cover.

Reinstall note

Reattach the tab that is closer to the front of the printer before reattaching the back tab.

Control panel

- 1 Remove the right-side cover (see page 101).
- 2 Use a flatblade screwdriver to lift the plastic catch (callout 1) off of the tab.

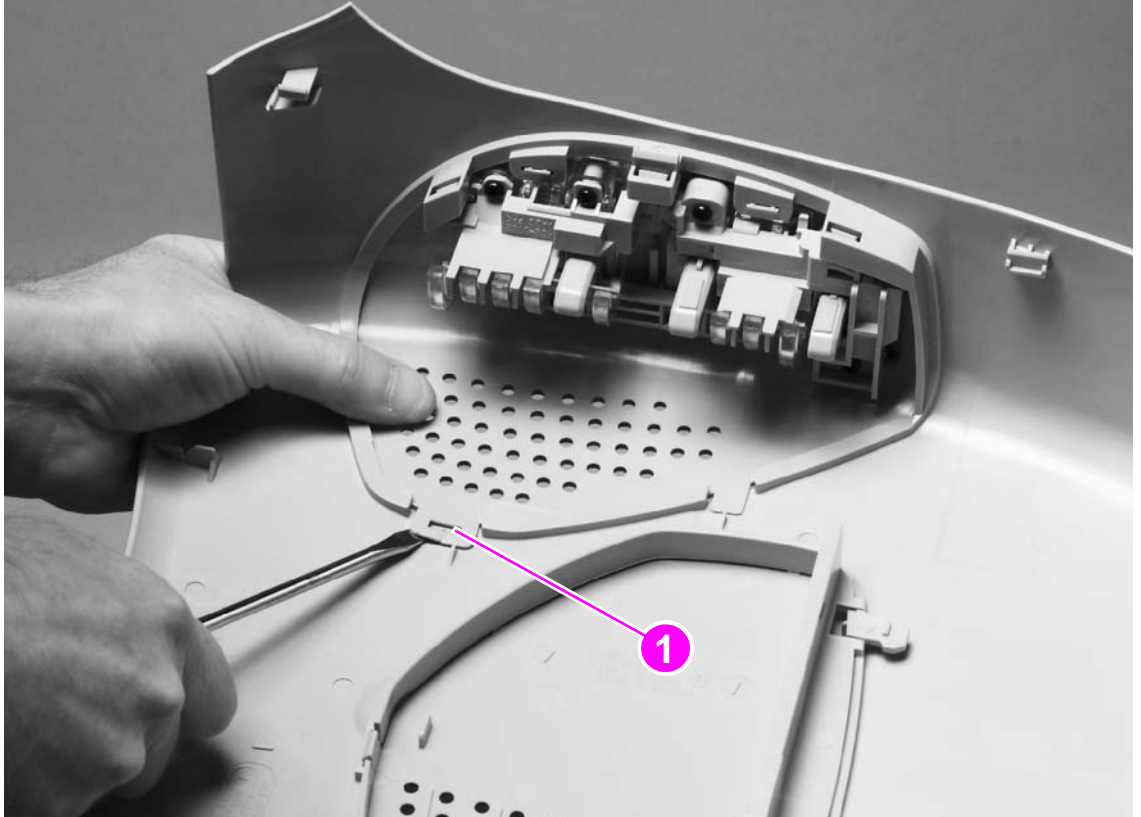

Figure 46.

Removing the control panel (1 of 2)

- 3 Push the control panel away from the right-side cover to release three tabs (callout 2), and then continue pushing the control panel to remove it.

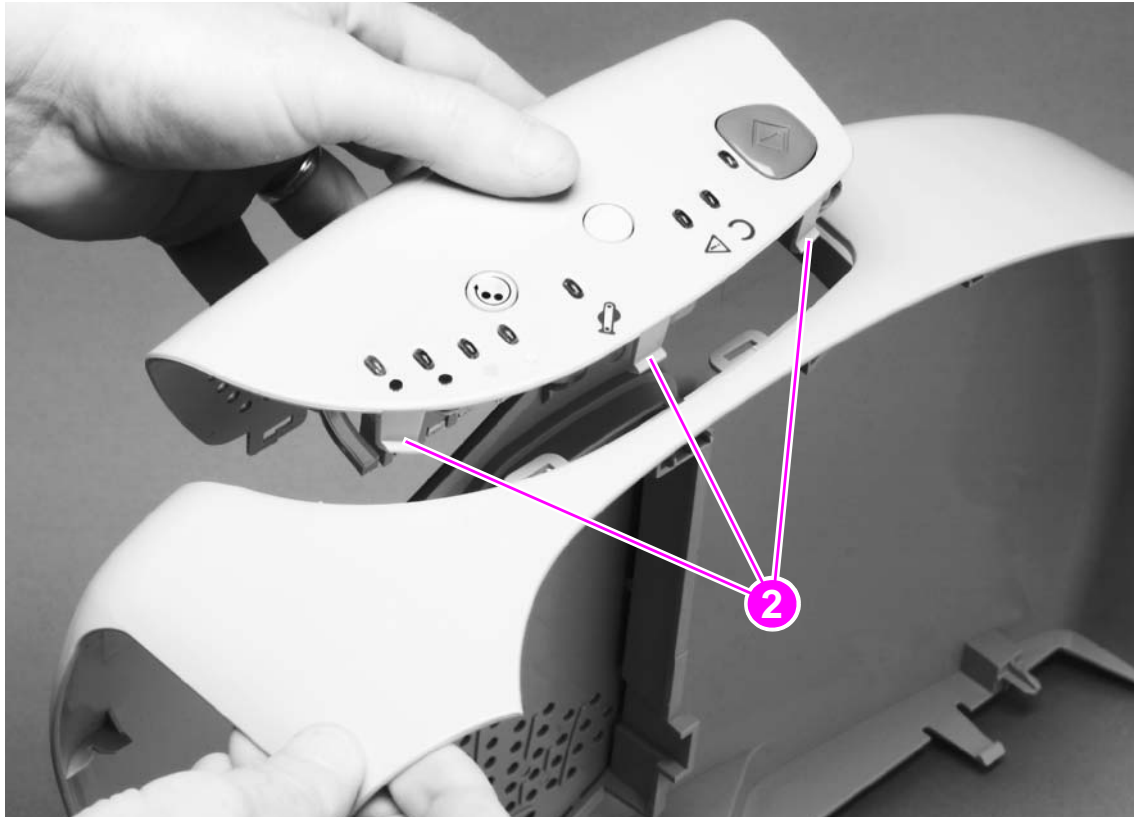

Figure 47. Removing the control panel (2 of 2)

On-off switch

- 1 Remove the left-side cover (see page 101).
- 2 On the inside of the left-side cover, pinch two tabs (callout 1) together to remove the spring (callout 2).
- 3 Pinch the two tabs together, and then press them through the holes in the left-side cover to release the on-off switch.

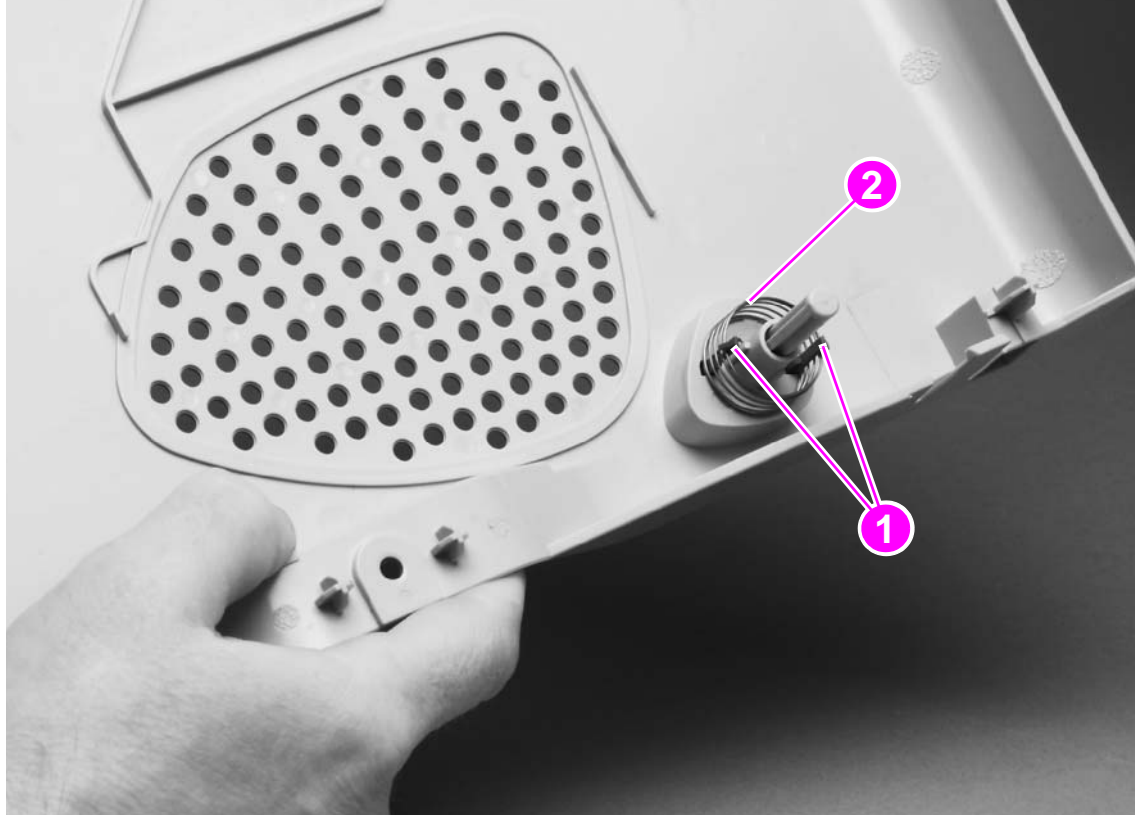

Figure 48.

Removing the on-off switch

Interface cover

- 1 Remove the fuser (see page 100).
- 2 Release the tab (callout 1) at the top of the interface cover and the tab (callout 2) at the back cover.
- 3 Rotate the top of the interface cover away from the printer to remove the cover.

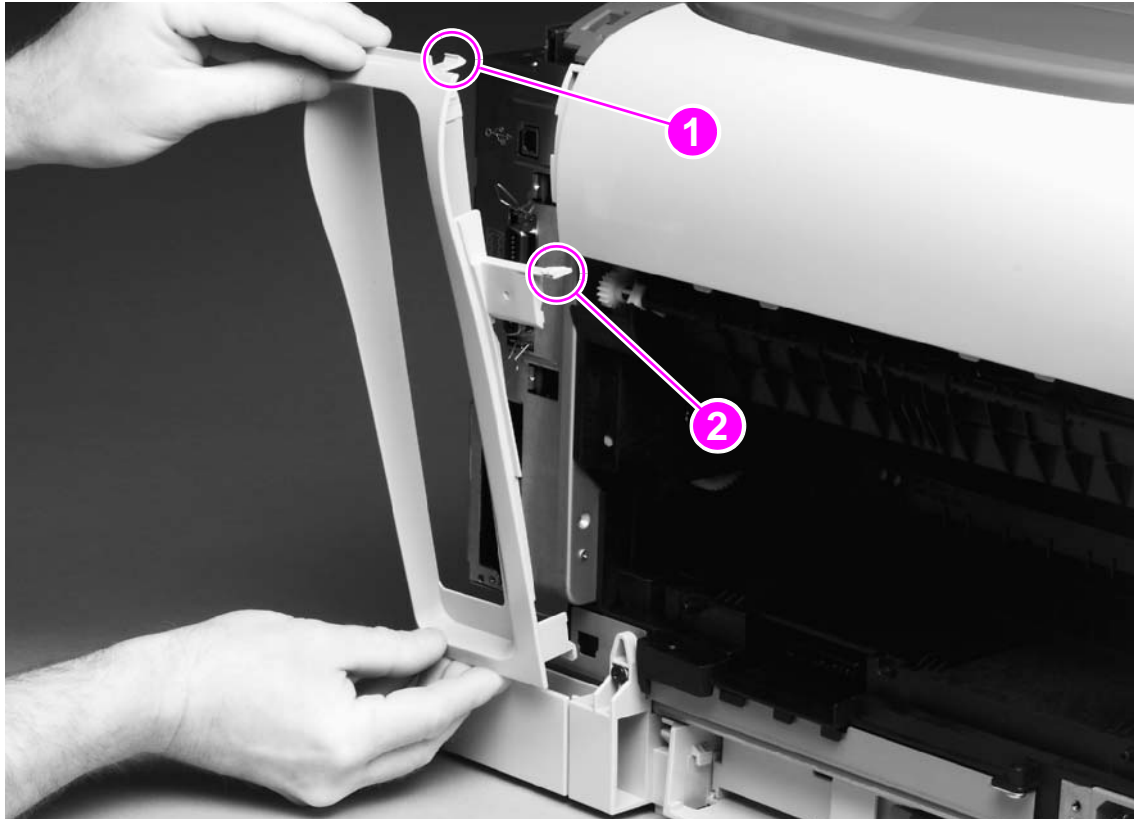

Figure 49.

Removing the interface cover

Formatter assemblies—HP color LaserJet 1500 series printers

Note

See pages 111 through 114 for information about formatter assemblies in HP color LaserJet 2500 series printers.

Formatter cage—HP color LaserJet 1500 series printers

- 1 Remove the following covers:
 - right-side cover (see page 101)
 - interface cover (see page 106)
- 2 Pull one cable through the opening in the formatter cage to reveal its connector (callout 1).
- 3 Use a flatblade screwdriver to pinch the tab on the connector and then unplug the connector.
- 4 Remove three screws (callout 2) from the formatter cage.

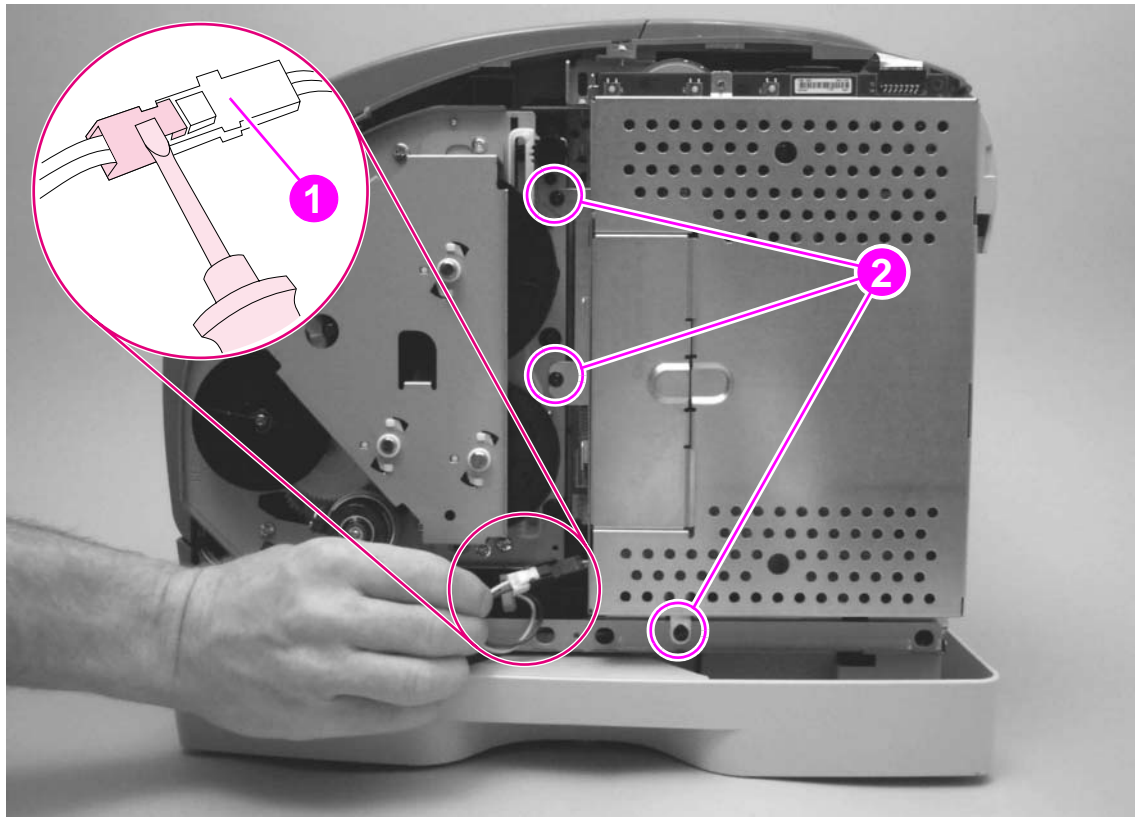

Figure 50.

Removing the formatter cage—HP color LaserJet 1500 series printers (1 of 2)

- 5 Unplug one flat, flexible cable (callout 3).
- 6 Remove two screws (callout 4) from the formatter cage.
- 7 Rotate the formatter cage upward to remove it from two hooks (callout 5).

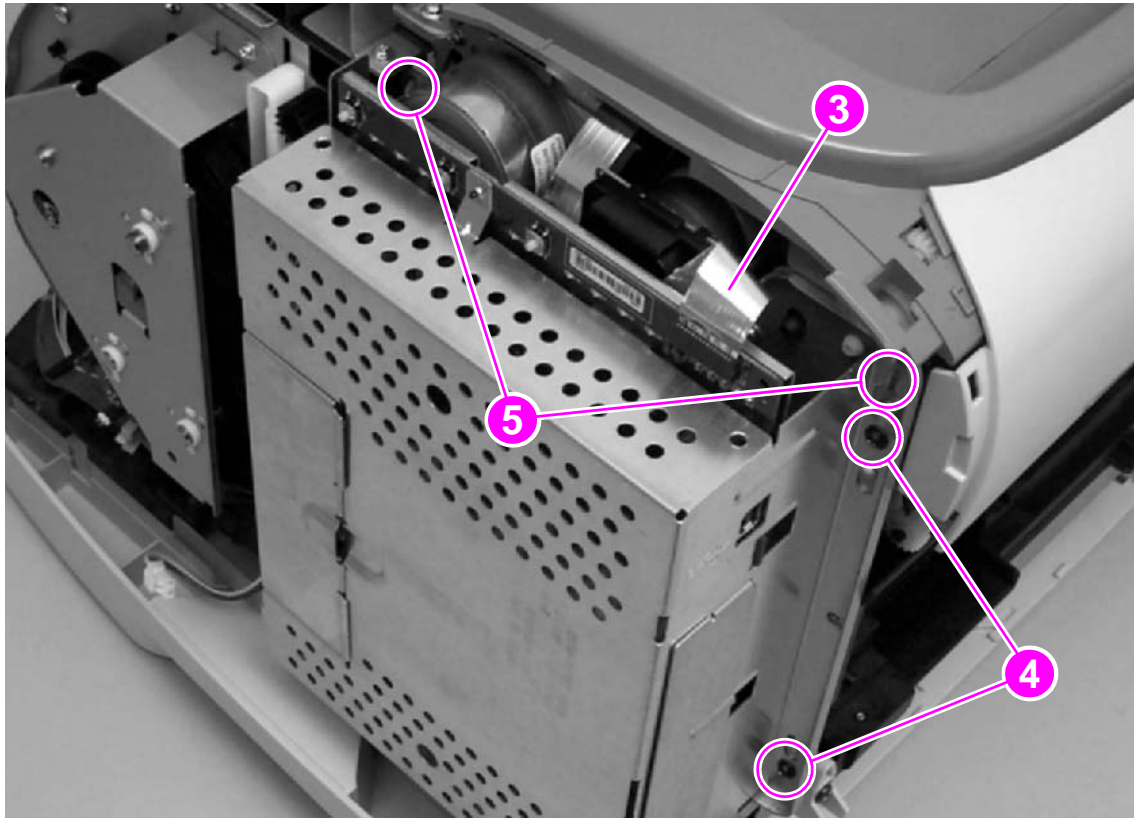

Figure 51. Removing the formatter cage—HP color LaserJet 1500 series printers (2 of 2)

Formatter—HP color LaserJet 1500 series printers

- 1 Remove the following covers and assembly:
 - right-side cover (see page 101)
 - interface cover (see page 106)
 - formatter cage (see page 107)
- 2 Remove six screws (callout 1) from the metal plate on the back of the formatter cage, and then remove the metal plate.
- 3 Lift the front edge (callout 2) of the formatter board upward to clear the tab (callout 3), and then pull the formatter out of the formatter cage.

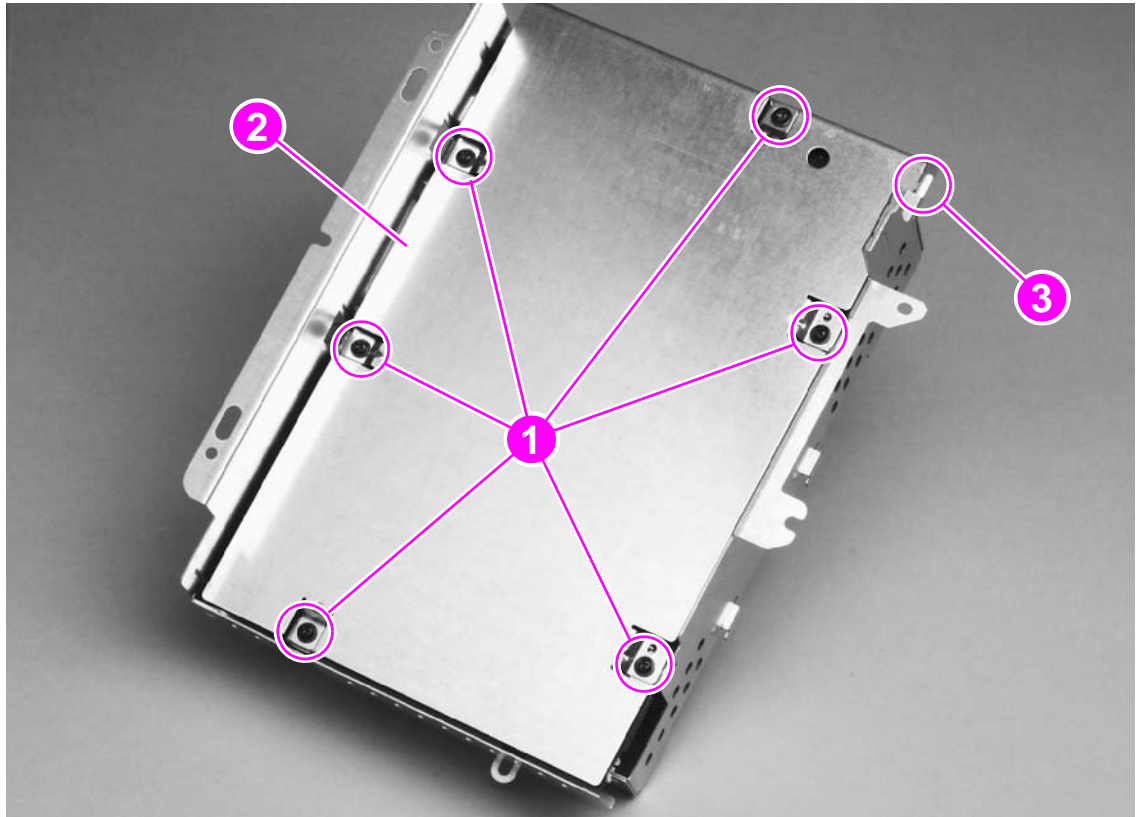

Figure 52.

Removing the formatter—HP color LaserJet 1500 series printers (1 of 2)

- Lift the formatter off of the formatter cage.

Note The formatter shown in figure 53 is the formatter for HP color LaserJet 1500 series printers.

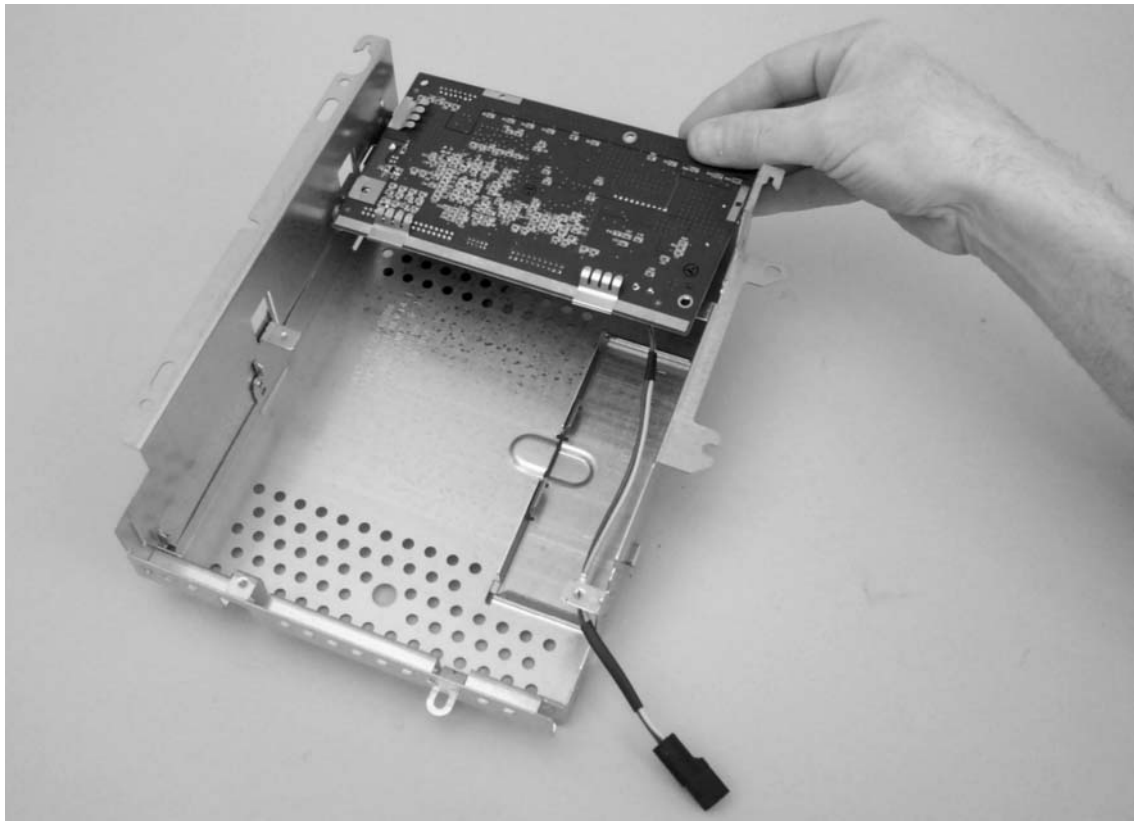

Figure 53. Removing the formatter—HP color LaserJet 1500 series printers (2 of 2)

Reinstall note

Make sure that three formatter clips are attached to the formatter at positions printed on the formatter—SC1, SC2, and SC3.

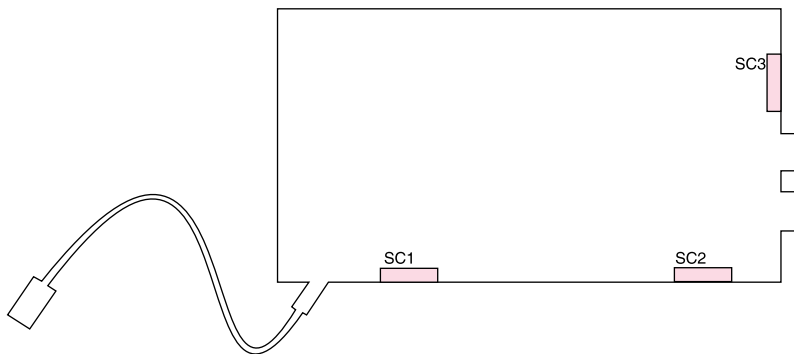

Figure 54. Formatter clips—HP color LaserJet 1500 series printers

Formatter assemblies—HP color LaserJet 2500 series printers

Note

See pages 107 through 110 for information about formatter assemblies in HP color LaserJet 1500 series printers.

Formatter cage—HP color LaserJet 2500 series printers

- 1 Remove the following cover and assembly:
 - right-side cover (see page 101)
 - interface cover (see page 106)
- 2 Unplug the flat flexible cable (callout 1).
- 3 Use a flatblade screwdriver to pinch the tab on the cable connector (callout 2) to unplug the connector.

Note

You might find it easier to unplug the connector after you perform step 7.

- 4 Remove three screws (callout 3) from the formatter cage.

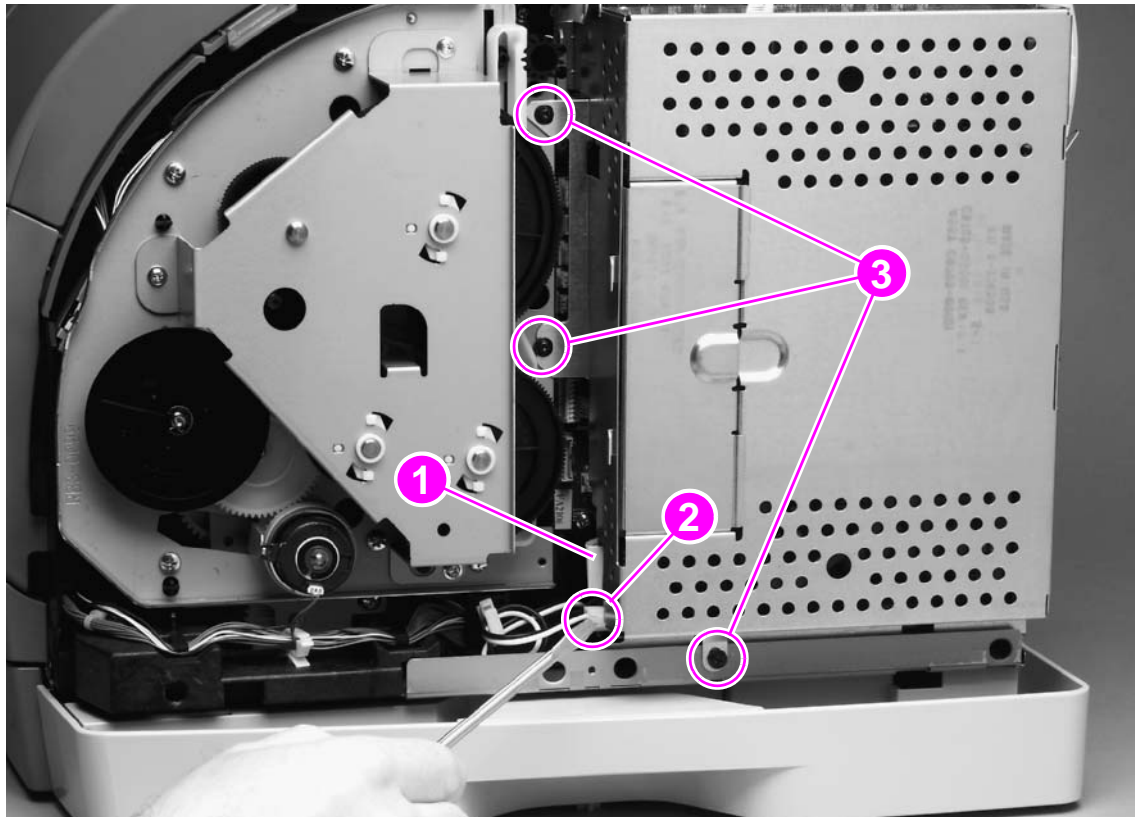

Figure 55.

Removing the formatter cage—HP color LaserJet 2500 series printers (1 of 2)

- 5 Remove two screws (callout 4) from the formatter cage.
- 6 Rotate the formatter cage upward to remove it from two hooks (callout 5).

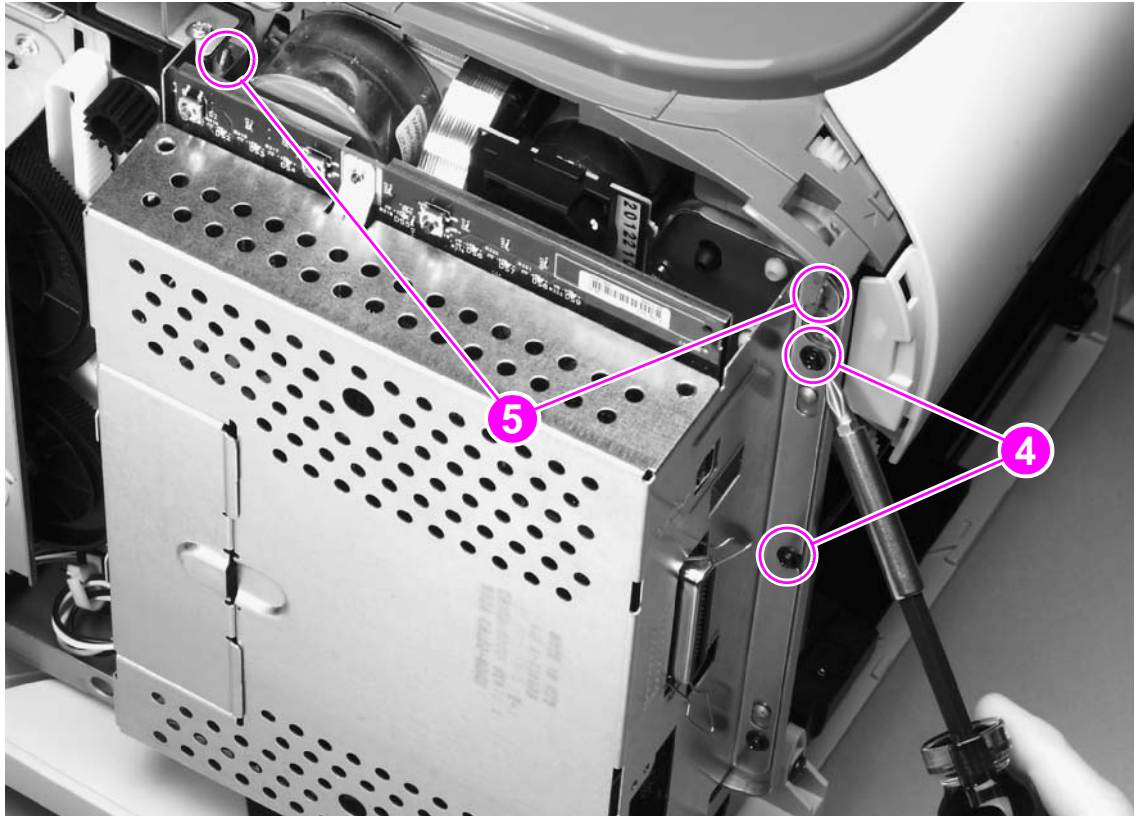

Figure 56.

Removing the formatter cage—HP color LaserJet 2500 series printers (2 of 2)

Formatter—HP color LaserJet 2500 series printers

- 1 Remove the following cover and assemblies:
 - right-side cover (see page 101)
 - interface cover (see page 106)
 - formatter cage (see page 111)
- 2 Remove six screws (callout 1) from the metal plate on the back of the formatter cage, and then remove the metal plate.
- 3 Lift the front edge (callout 2) of the formatter board upward to clear the tab (callout 3), and then pull the formatter out of the formatter cage.

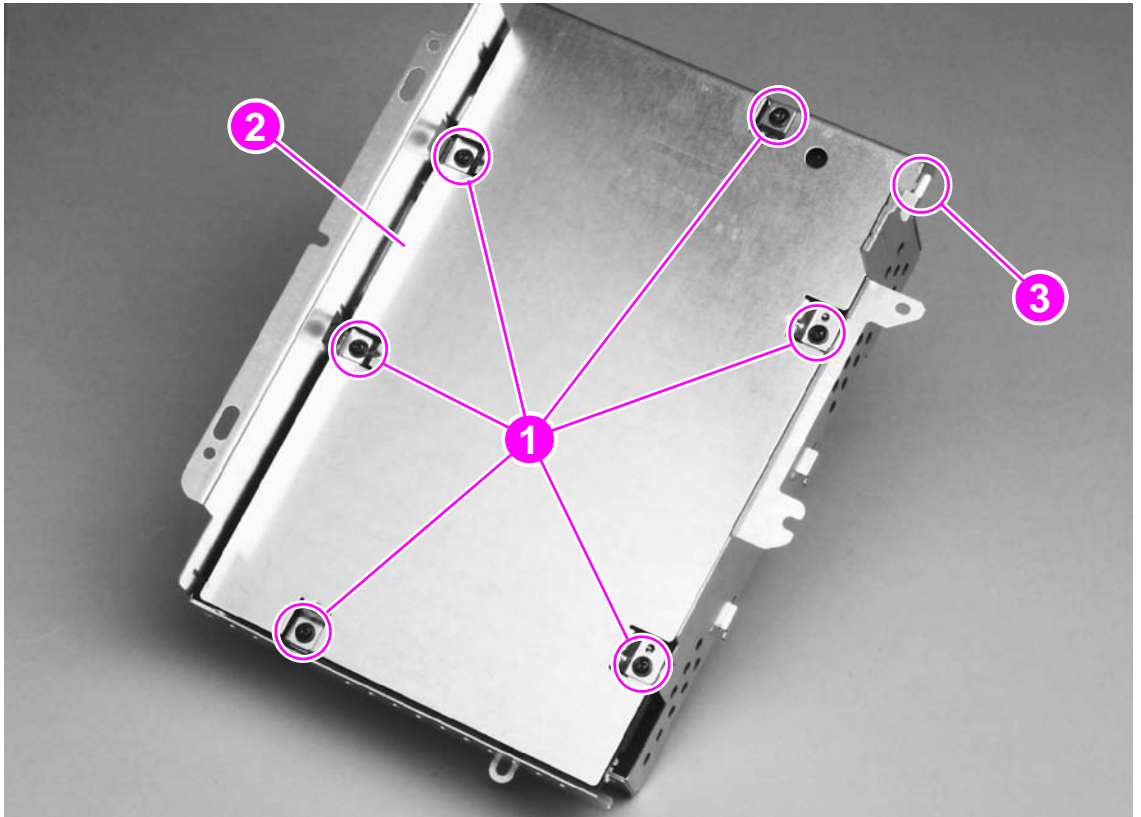
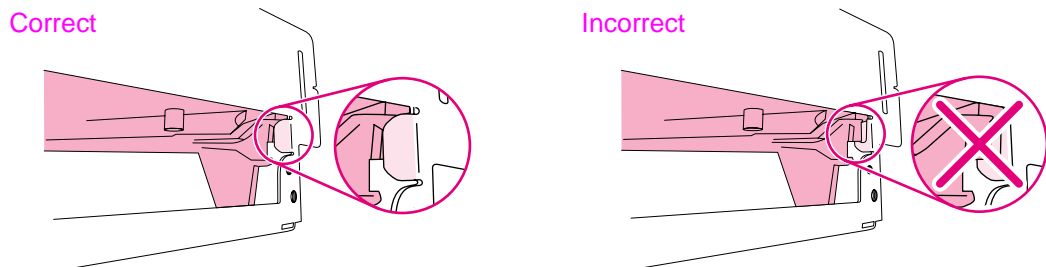

Figure 57.

Removing the formatter—HP color LaserJet 2500 series printers (1 of 2)

Reinstall note

It is possible to reinstall the formatter in such a way that the EIO cage (found only on HP color LaserJet 2500 series printers) is on the incorrect side of the metal tab on the formatter cage. Make sure that the EIO cage is in the correct position before replacing the six screws in the metal plate.



- 4 Release the tabs (callout 4) on the EIO cage and lift the EIO cage off of the formatter.

Note

The formatter shown in figure 58 is the formatter for HP color LaserJet 2500 series printers.

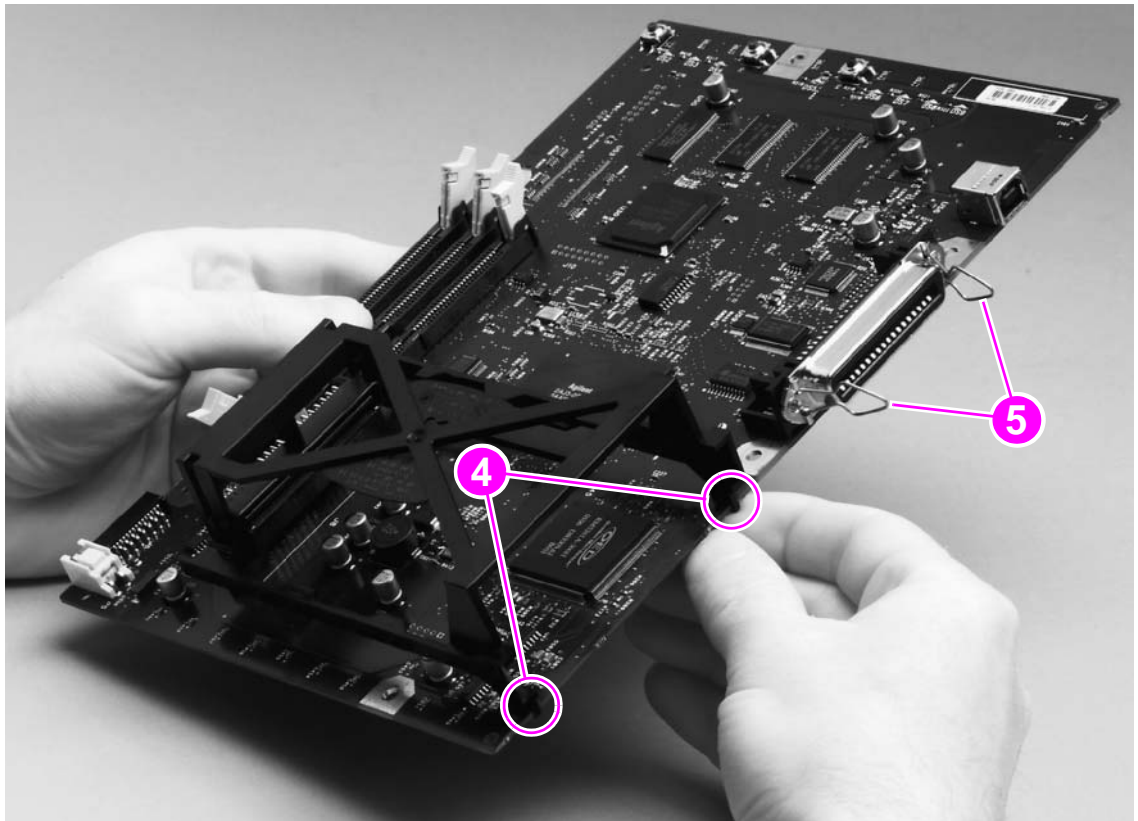

Figure 58.

Removing the formatter—HP color LaserJet 2500 series printers (2 of 2)

Reinstall notesdisdids

Make sure that the metal clips (callout 5) on the interface connector are in the “open” position, perpendicular to the connector. If they are in the “closed” position when the formatter is reinstalled, they do not fit correctly through the hole in the formatter cage.

Fuser motor (J702)

- 1 Remove the following covers and assembly:
 - right-side cover (see page 101)
 - interface cover (see page 106)
 - formatter cage (see page 107)
- 2 Unplug one connector (callout 1).
- 3 Remove two screws (callout 2).
- 4 Slide the motor towards the rear of the printer and then pull it away from the printer.

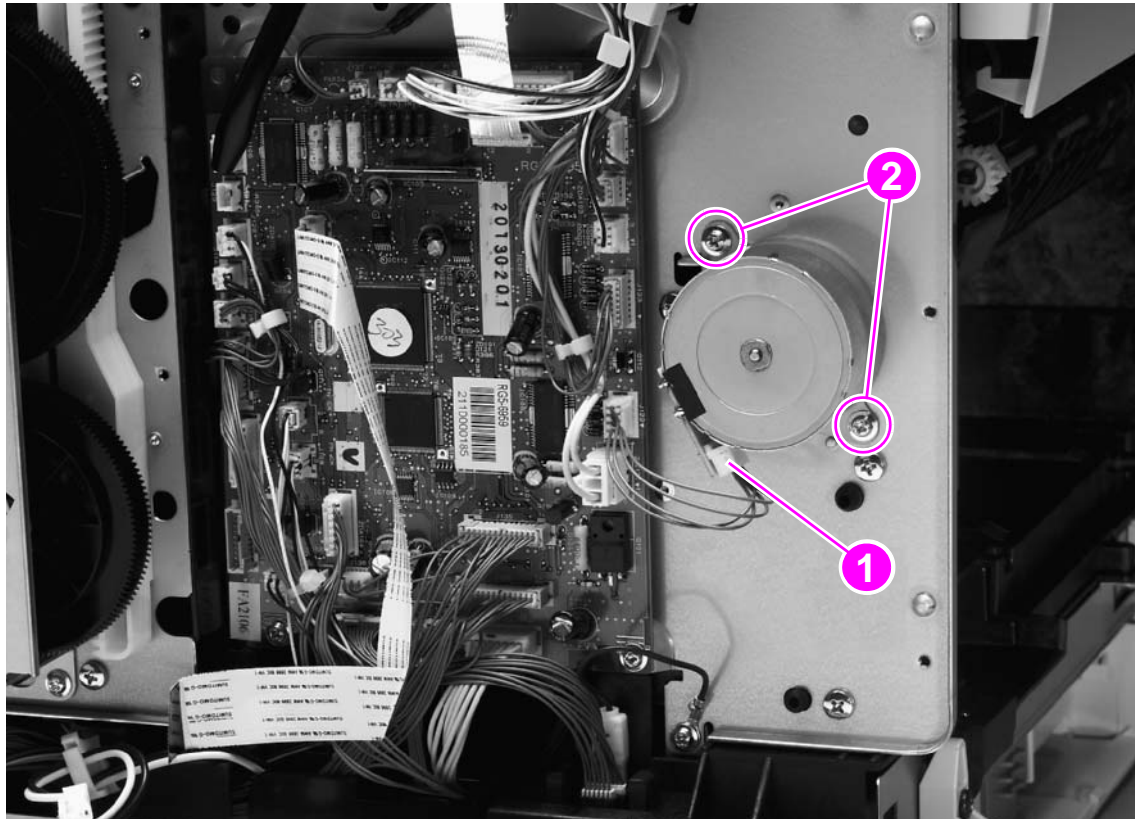

Figure 59. Removing the fuser motor

Dc controller

- 1 Remove the following covers and assembly:
 - right-side cover (see page 101)
 - interface cover (see page 106)
 - formatter cage (see page 107)
- 2 Unplug the flat flexible cable (callout 1).
- 3 Release the cables from two cable-holders (callout 2)
- 4 Unplug one cable connector (callout 3) by pressing and releasing the tab on the side of the connector.
- 5 Unplug two cable connectors (callout 4) by releasing a clip on each connector (see the detail in the lower-left corner of figure 60).
- 6 Unplug the remaining 24 cable connectors.

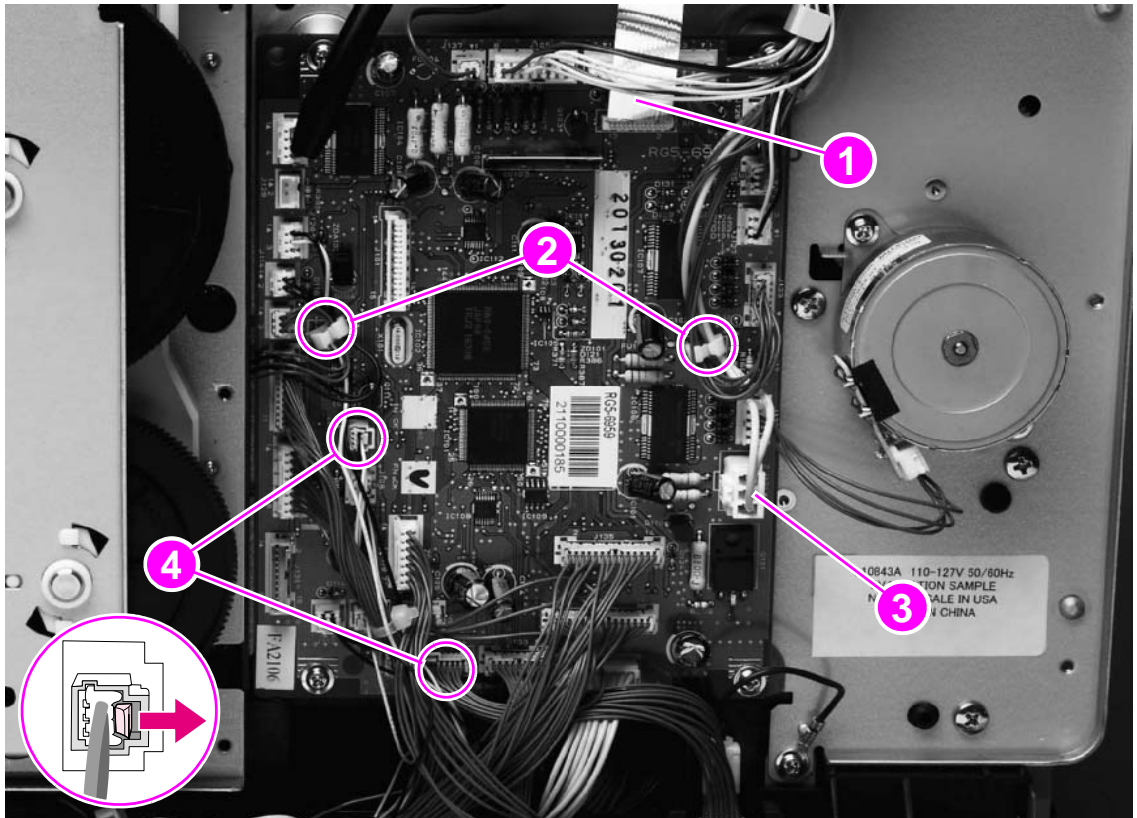

Figure 60.

Removing the dc controller (1 of 2)

- 7 Remove four screws (callout 5).
- 8 Lift the dc controller up and then away from the printer.

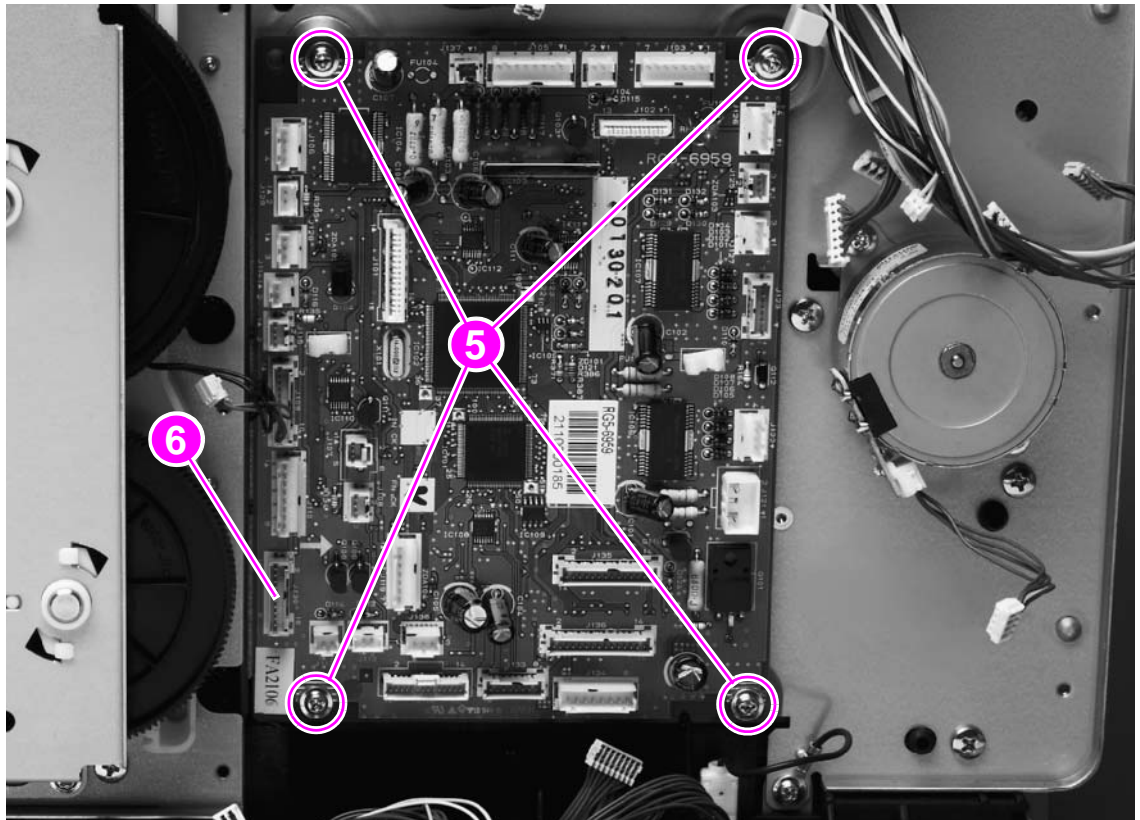

Figure 61. Removing the dc controller (2 of 2)

Reinstall note

The connection that remains empty upon reinstallation is shown in callout 6. The connection is used to “flash” the dc controller.

Optional tray 2 (250-sheet tray)

- 1 Remove the right- and left-side covers (see page 101).
- 2 If optional tray 3 is installed (HP color LaserJet 2500 series printers only), lift the printer (and optional tray 2) up and away from optional tray 3.
- 3 Remove one screw (callout 1) from optional tray 2.

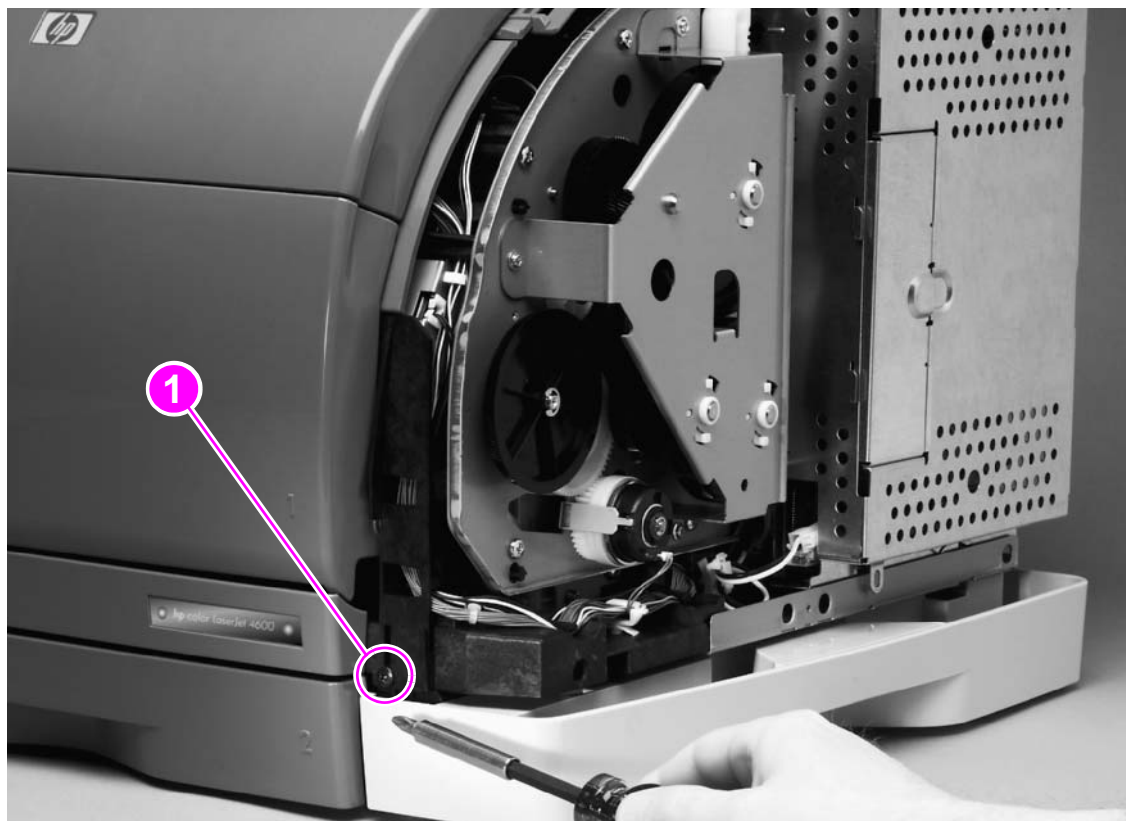

Figure 62.

Removing optional tray 2 (1 of 2)

- 4 Remove one screw (callout 2) from the left side of the printer.
- 5 Remove two screws (callout 3) from the back of optional tray 2.
- 6 Grasp the printer frame on each side, and then carefully lift the printer off of tray 2.

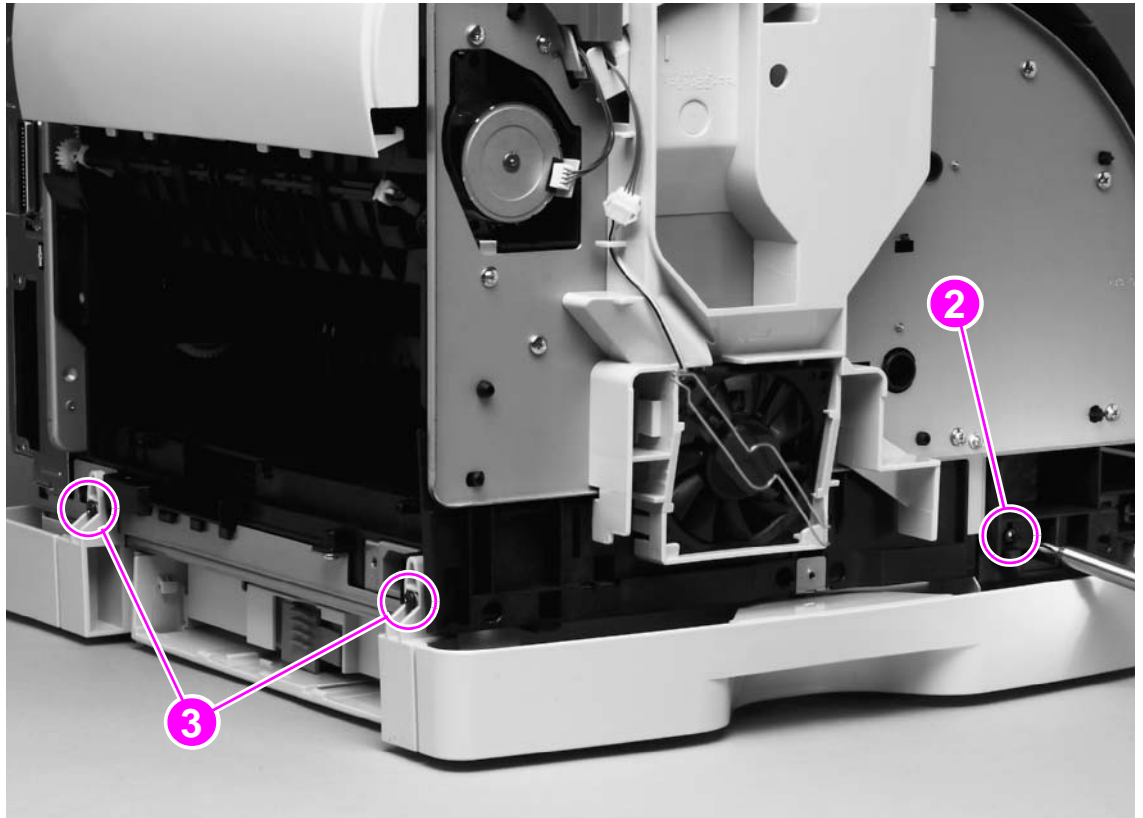

Figure 63.

Removing optional tray 2 (2 of 2)

Carousel motor (J704)

- 1 Remove the left-side cover (see page 101).
- 2 Unplug one cable connector (callout 1).
- 3 Remove two screws (callout 2).
- 4 Rotate the motor counterclockwise to clear the metal lock-tab.
- 5 Lift the carousel motor away from the printer to remove it.

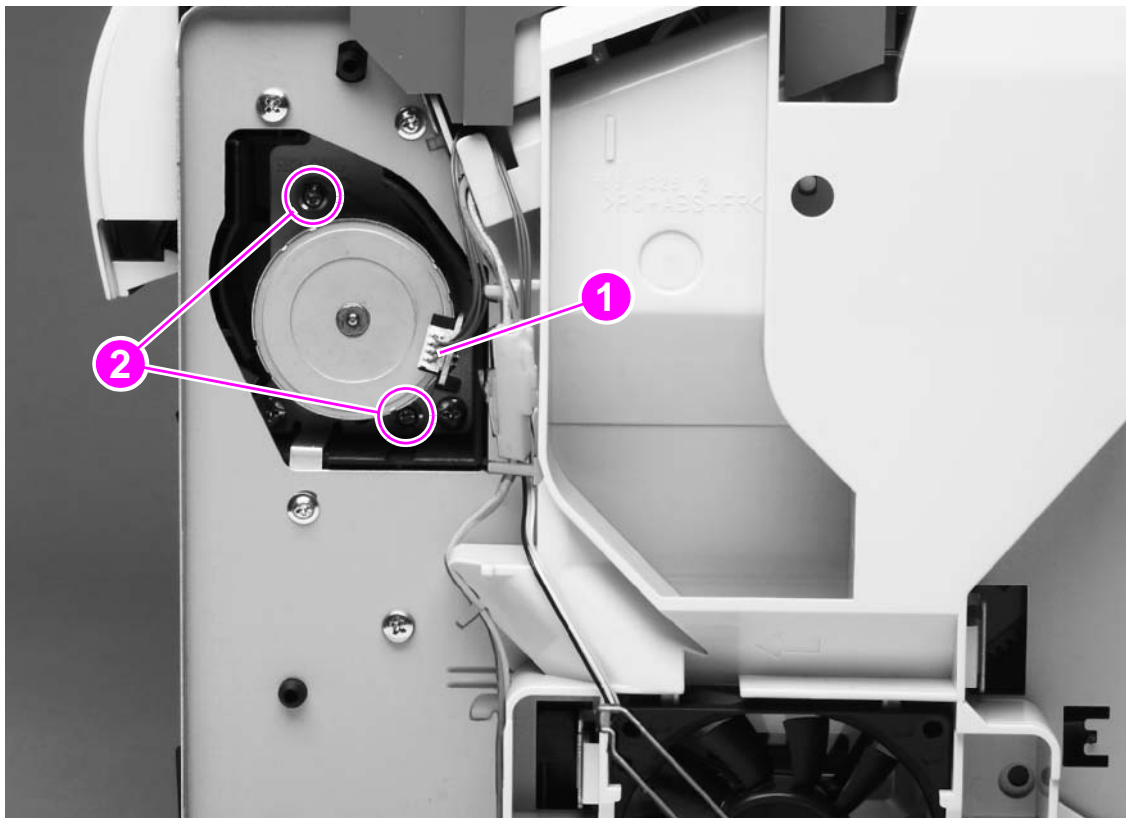

Figure 64.

Removing the carousel motor

Front lower cover

- 1 Remove the right- and left-side covers (see page 101).
- 2 Use the small flatblade screwdriver to lift the plastic catch (callout 1) off of the tab on the left side of the printer.
- 3 Pull the cover away from the printer to remove it.

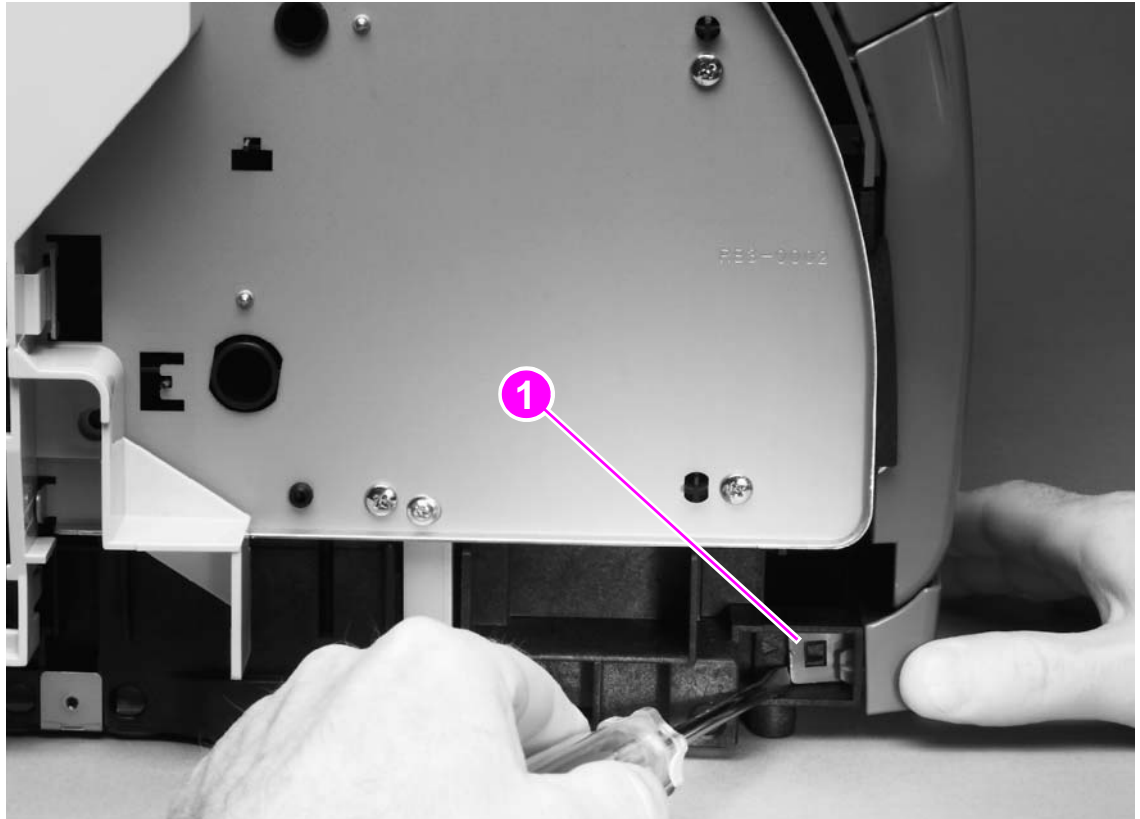

Figure 65.

Removing the front lower cover

Back cover

- 1 Remove the right- and left-side covers (see page 101).
- 2 Use a flatblade screwdriver to release two internal tabs (callout 1), one at each side of the cover.
- 3 Rotate the top of the cover away from the printer and then downward to release the internal tabs under the cover.

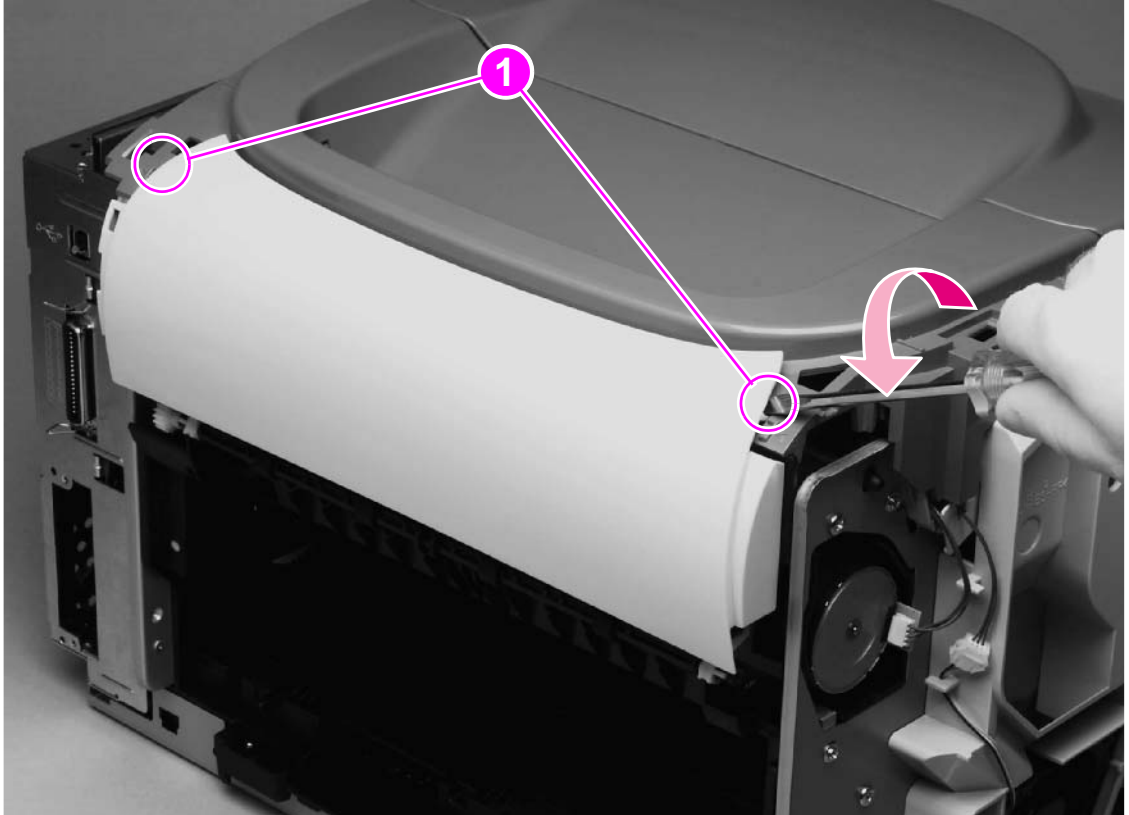

Figure 66.

Removing the back cover

Top cover

- 1 Remove the following covers:
 - right- and left-side covers (see page 101)
 - interface cover (see page 106)
 - back cover (see page 122)
- 2 Open the top door.
- 3 Press the small tab on the gear (callout 1) to release the gear.
- 4 Remove the gear to release the top-door rack (callout 2).

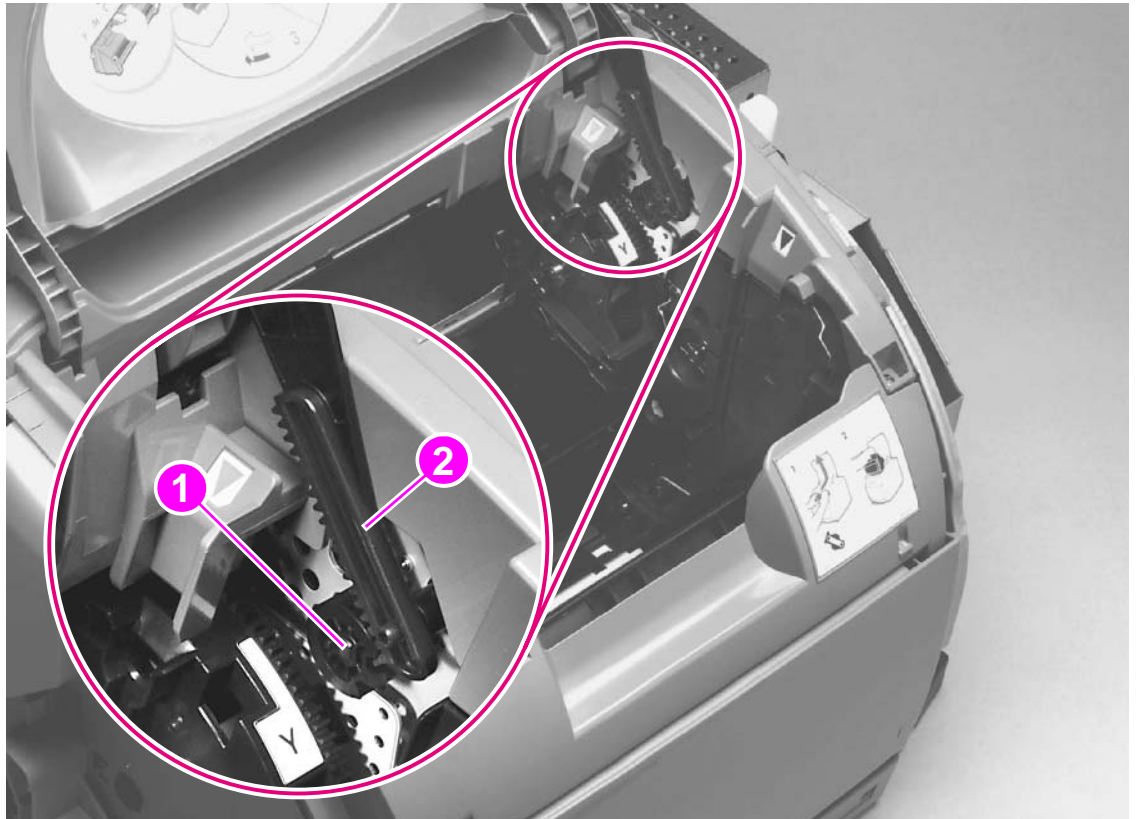

Figure 67. Removing the top cover (1 of 2)

Note Return the gear to its shaft after releasing the top door rack.

- 5 Remove three screws (callout 3) from the top cover.

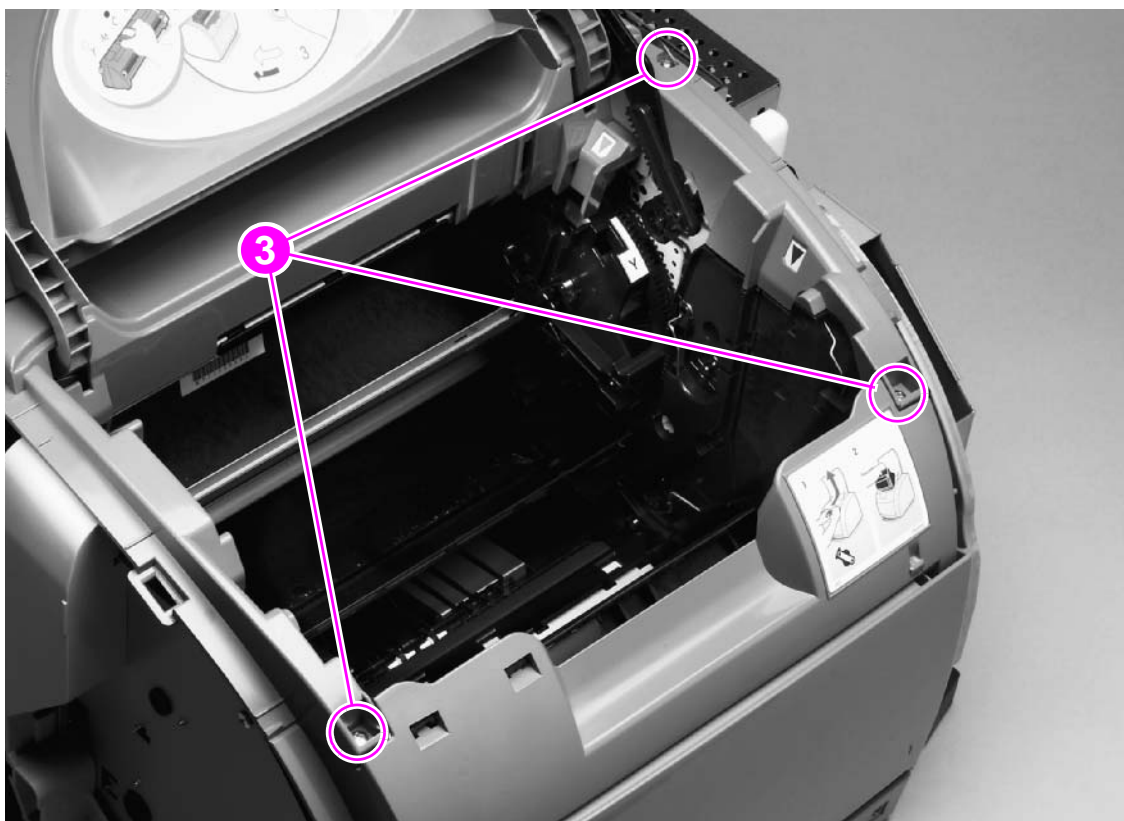

Figure 68.

Removing the top cover (2 of 2)

- 6 Lift the top cover off of the printer.

Reinstall notes

- 1 Lift the vertical rack (callout 4) up to its highest position.
- 2 Align the notch on the gear with the lip on the top-door rack.

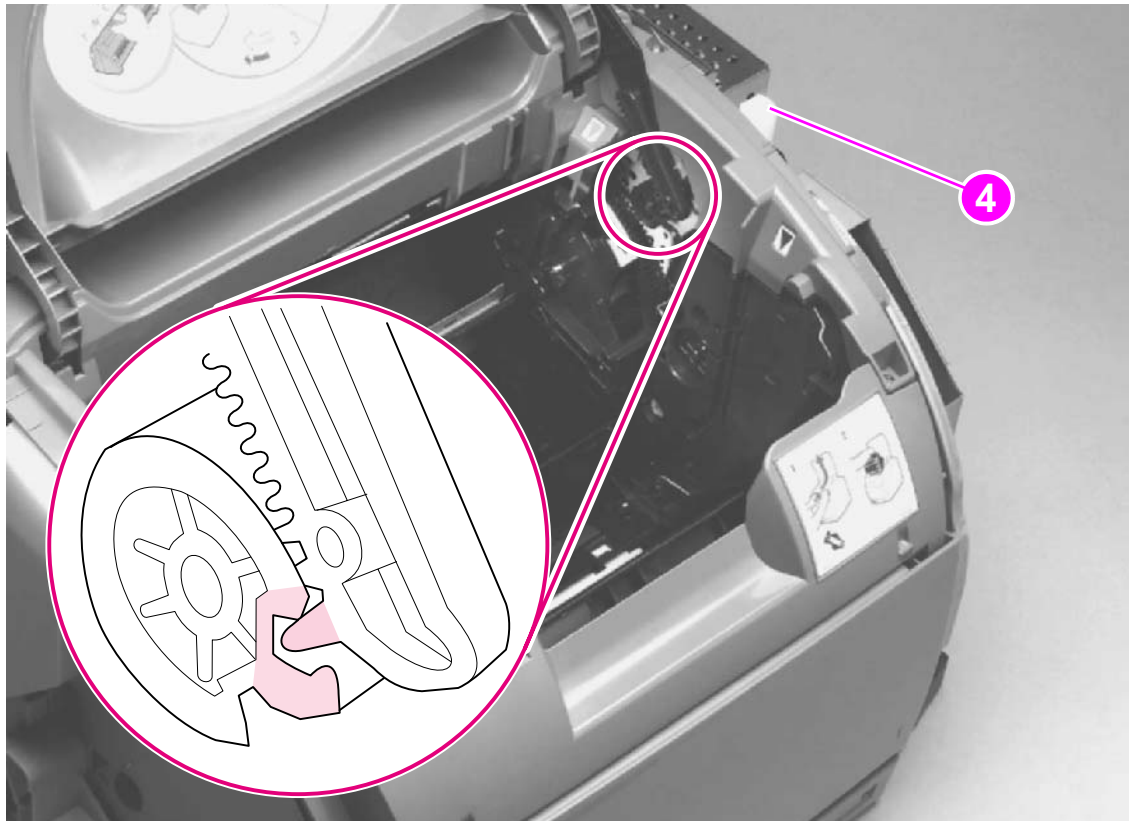

Figure 69.

Reinstalling the top cover

Top door

- 1 Remove the following covers:
 - right- and left-side covers (see page 101)
 - interface cover (see page 106)
 - back cover (see page 122)
 - top cover (see page 123)
- 2 Turn the top cover over.
- 3 Firmly flex the top-door arm (callout 1) to release the plastic pin (callout 2) on either side.
- 4 Release the pin on the other side and slip the top door arms through the holes in the top cover.

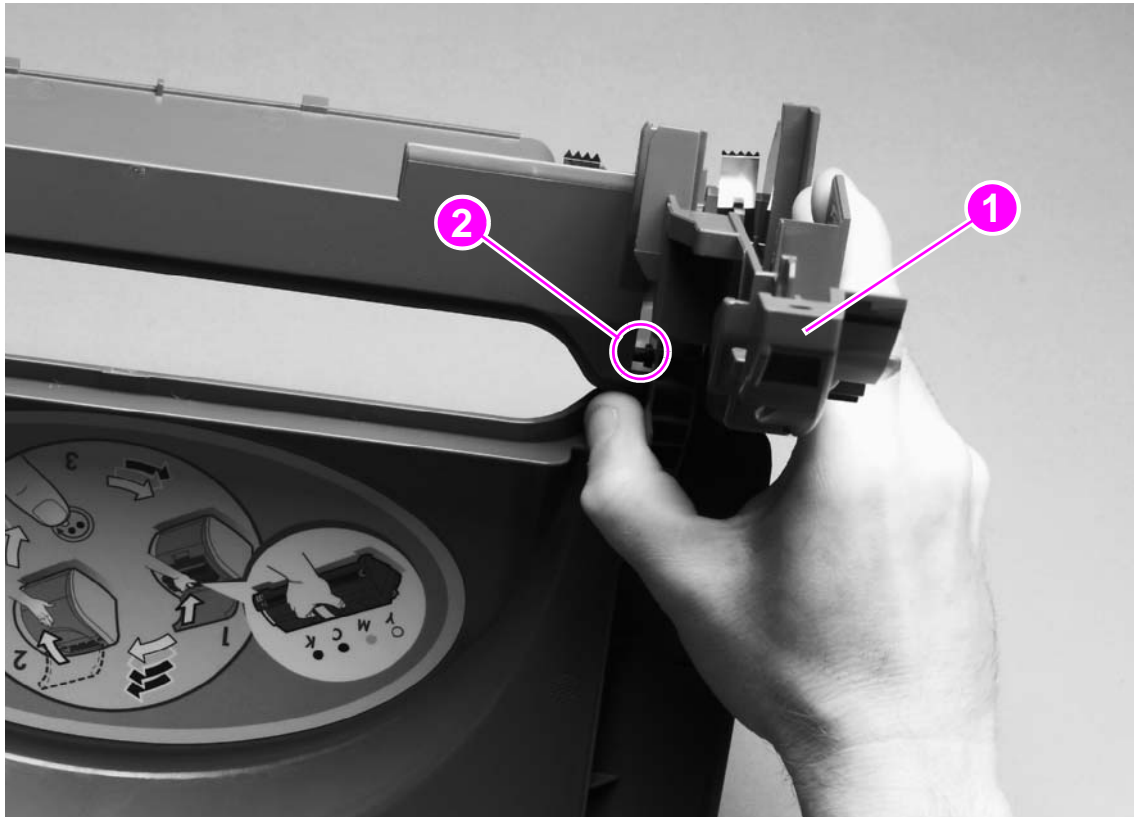

Figure 70. Removing the top door (1 of 2)

Reinstall note

Slide the door arm on one side through the hole in the top cover and into place before you attempt to reattach the other side.

- 5 Slide the top door rack (callout 3) off of its pin at the right side of the cover.



Figure 71.

Removing the top door (2 of 2)

Air duct and fan

- 1 Remove the following covers:
 - right- and left-side covers (see page 101)
 - interface cover (see page 106)
 - back cover (see page 122)
 - top cover (see page 123)
- 2 Remove one connector (callout 1).
- 3 Release two tabs (callout 2).
- 4 Lift the air duct straight up to release two hidden tabs at the top of the air duct, and lift the air duct away from the printer.

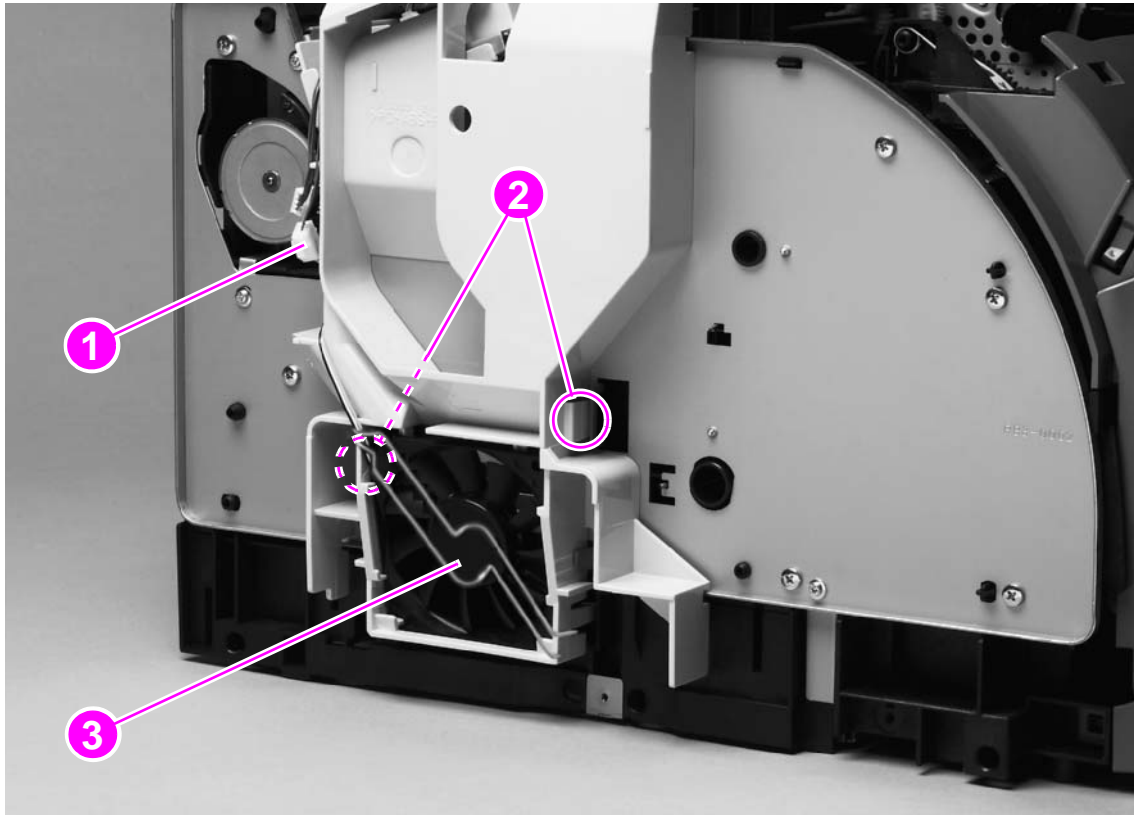

Figure 72.

Removing the air duct

- 5 To remove the fan (callout 3) from the air duct, release two tabs on the side of the air duct that faces the printer and then lift the fan from the air duct.

Laser/scanner assembly

- 1 Remove the following covers:
 - right- and left-side covers (see page 101)
 - interface cover (see page 106)
 - back cover (see page 122)
 - top cover (see page 123)
- 2 Unplug two cable connectors (callout 1), and unroute the cables from the cable holders.
- 3 Disconnect the flat flexible cable from the cable socket (callout 2) on the laser/scanner.
- 4 Rotate the lower part of the top output bin cover (callout 3) toward the front of the printer, and then lift away from the printer.
- 5 Remove four screws (callout 4).
- 6 Unroute the cables from the cable harness attached to the back of the laser/scanner.
- 7 Lift the laser/scanner assembly straight up to remove it from the printer.

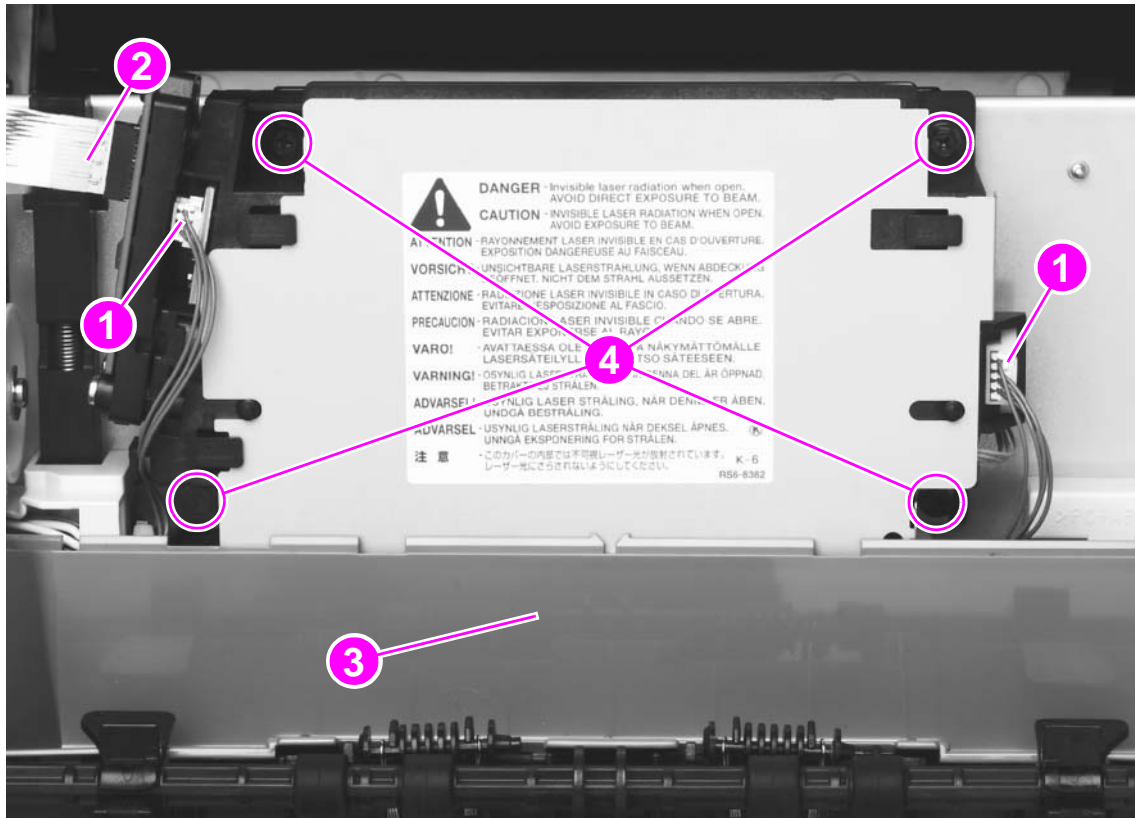

Figure 73.

Removing the laser/scanner assembly

Reinstall note

When replacing the top output bin cover (callout 3 in figure 73), make sure that the guides are on the top output bin roller are on top of the cover, as shown in figure 74.

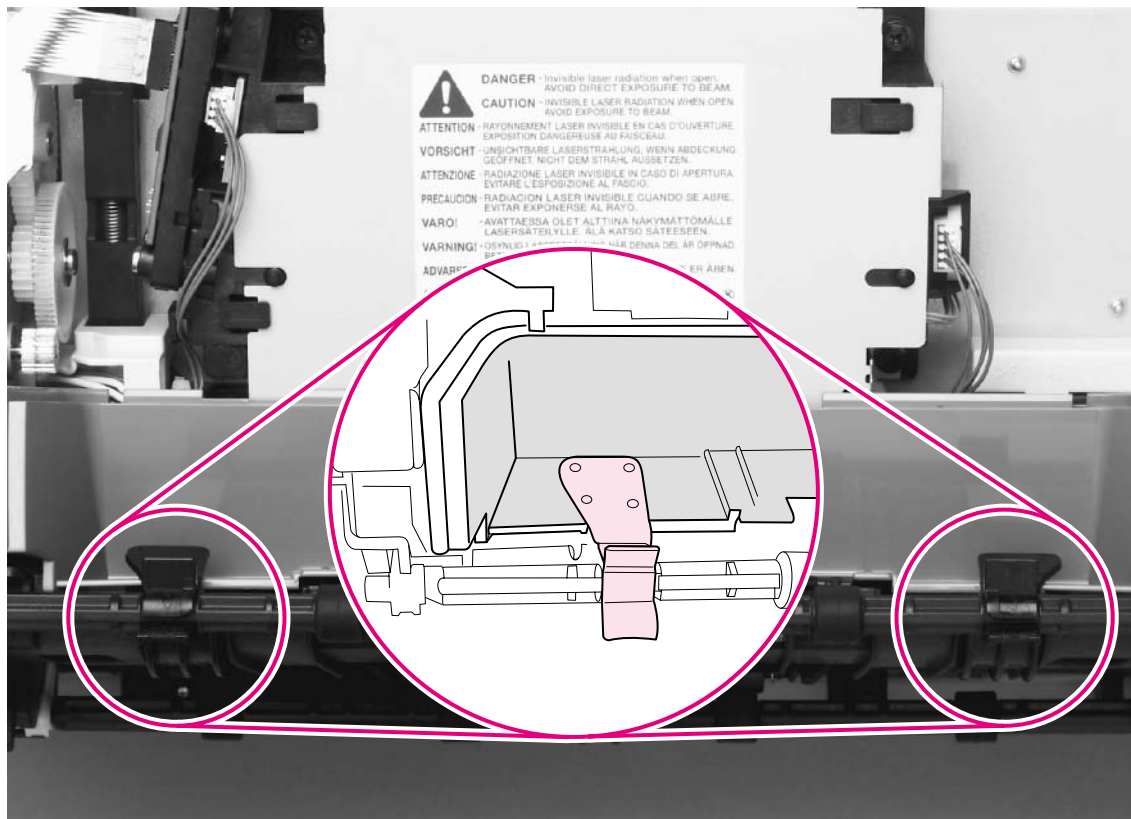

Figure 74.

Reinstalling the top output bin cover

Front cover

- 1 Remove the following covers:
 - right- and left-side covers (see page 101)
- 2 Use a flatblade screwdriver to release two internal tabs (callout 1), one at each side of the printer.
- 3 Rotate the cover upward to release four internal tabs (callout 2) underneath the cover.

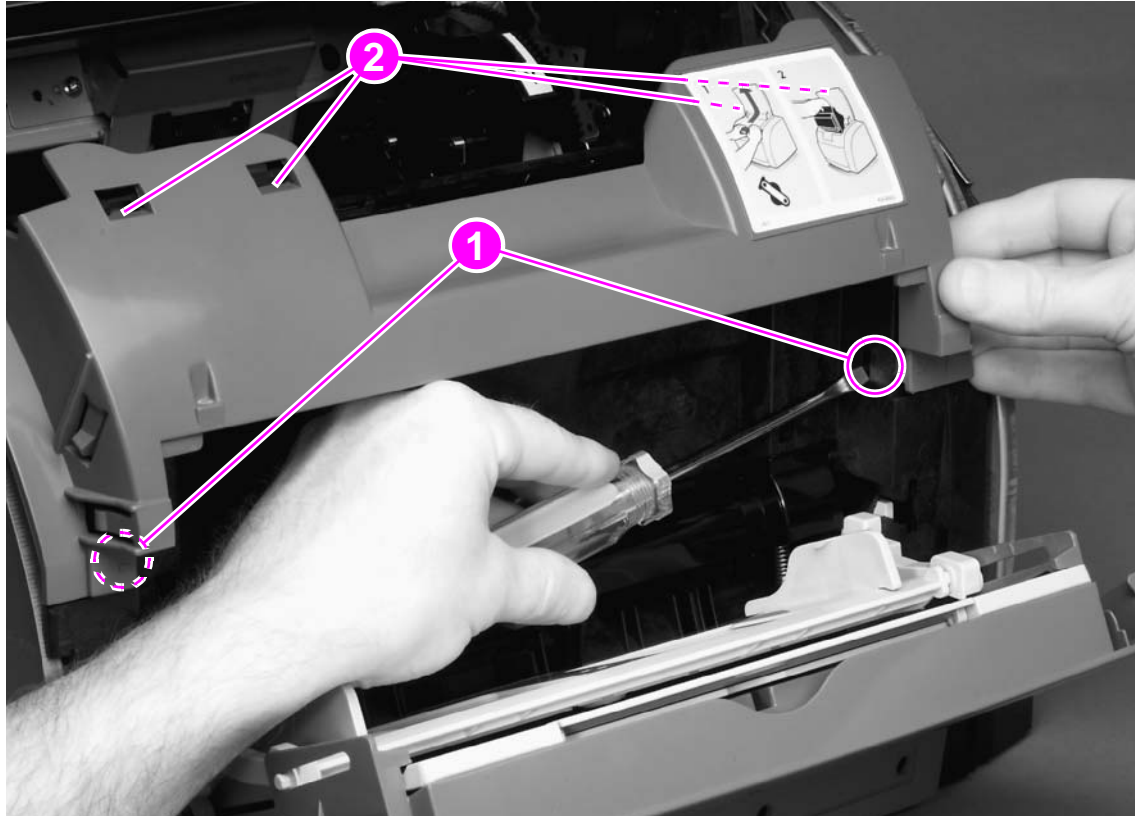

Figure 75.

Removing the front cover

Reinstall note

Make sure that the tabs on each side of the cover click into place.

Density sensor and top-of-page sensor

- 1 Remove the following covers:
 - right- and left-side covers (see page 101)
 - front cover (see page 131)
- 2 Press the tab (callout 1) on the sensor cover to release the cover, and then lift the cover up and away from the printer.

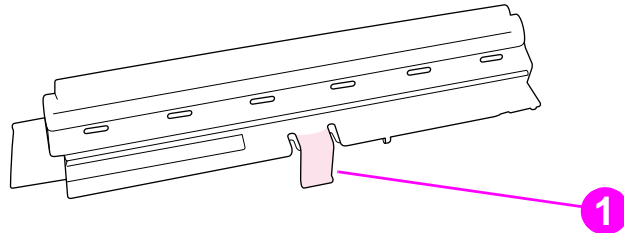

Figure 76.

Removing the density sensor cover

- 3 Unplug one connector (callout 2).
- 4 Remove the two screws (callout 3).
- 5 Lift the density sensor straight up to remove it from the printer.
- 6 Unplug one connector (callout 4) from the top-of-page sensor.
- 7 Remove one screw (callout 5) and then lift the top-of-page sensor straight up and away from the printer.

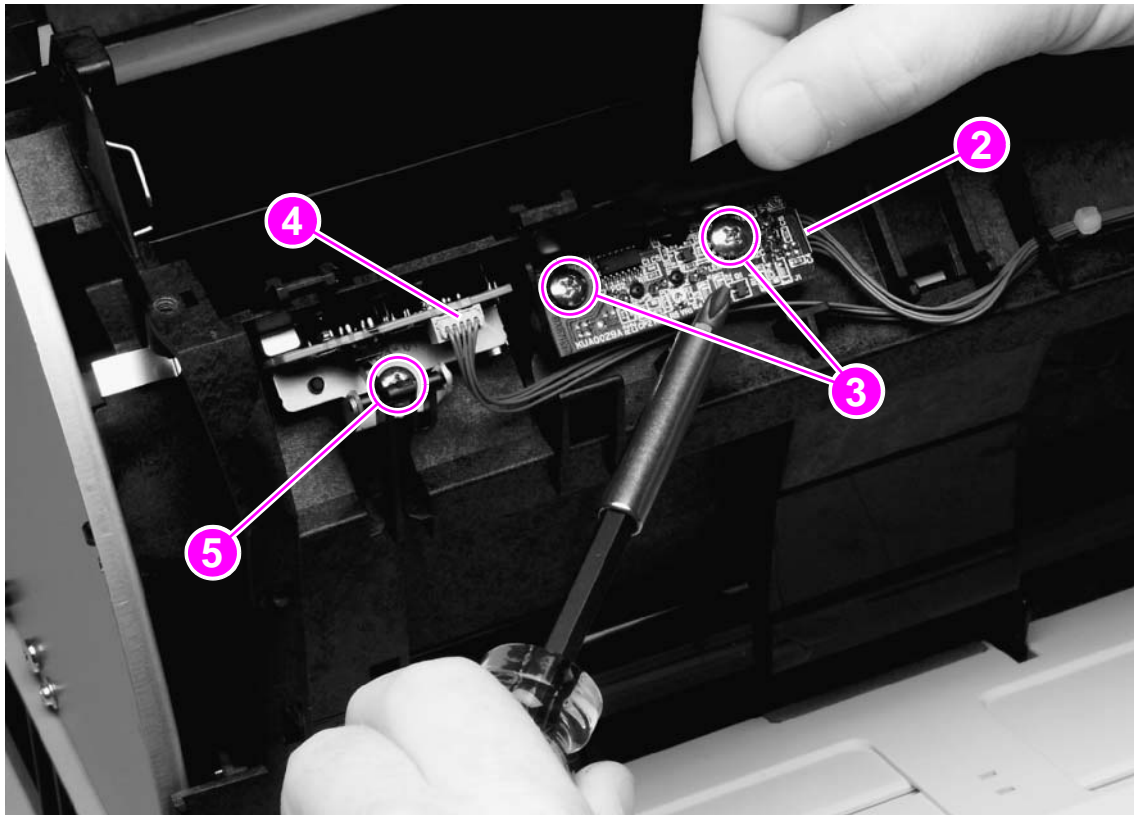

Figure 77.

Removing the density sensor

E-label reader (for imaging-drum E-labels)

- 1 Remove the following covers and assembly:
 - right- and left-side covers (see page 101)
 - interface cover (see page 106)
 - formatter cage (see page 107)
 - front cover (see page 131).
- 2 Use the small flatblade screwdriver to lift two tabs, one on each side of the E-label reader housing.
- 3 Slide the E-label reader off of its rails.

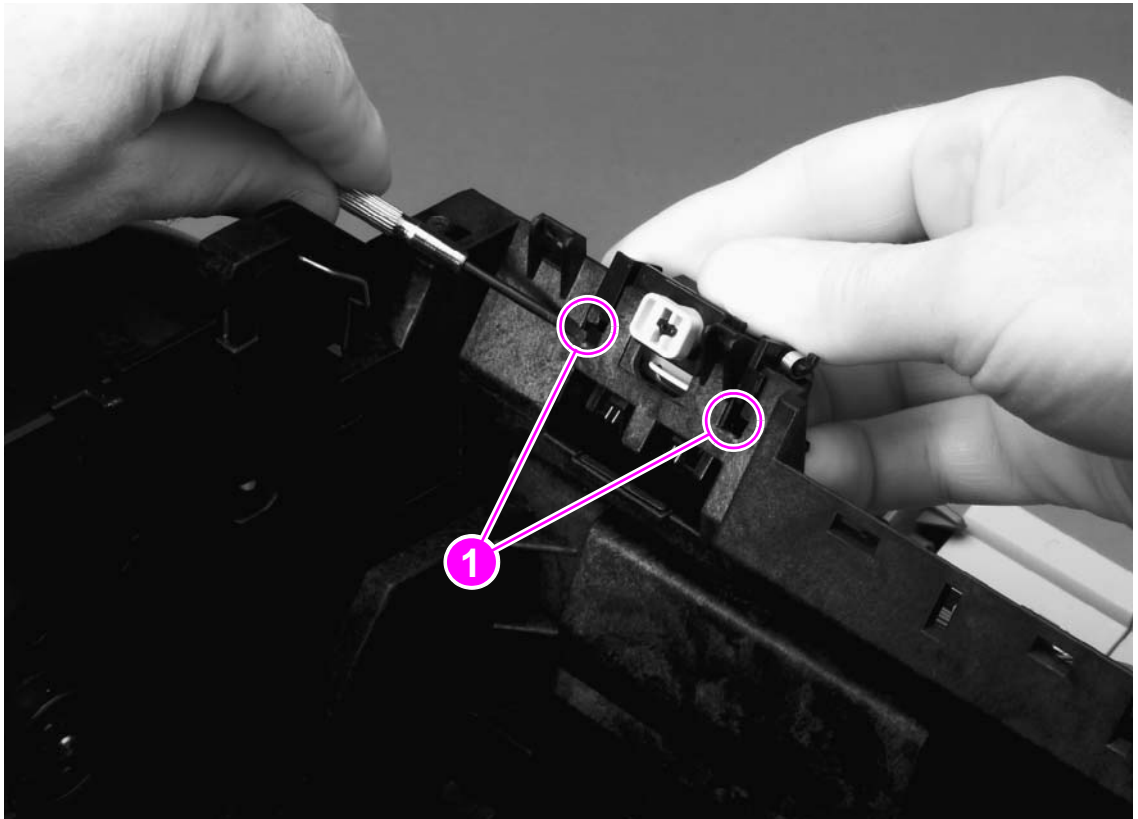

Figure 78. Removing the E-label reader (1 of 2)

- 4 Unplug the E-label reader connector (callout 2) from the dc controller.

Note

Examine the cable routing as you lift the E-label reader from the printer.

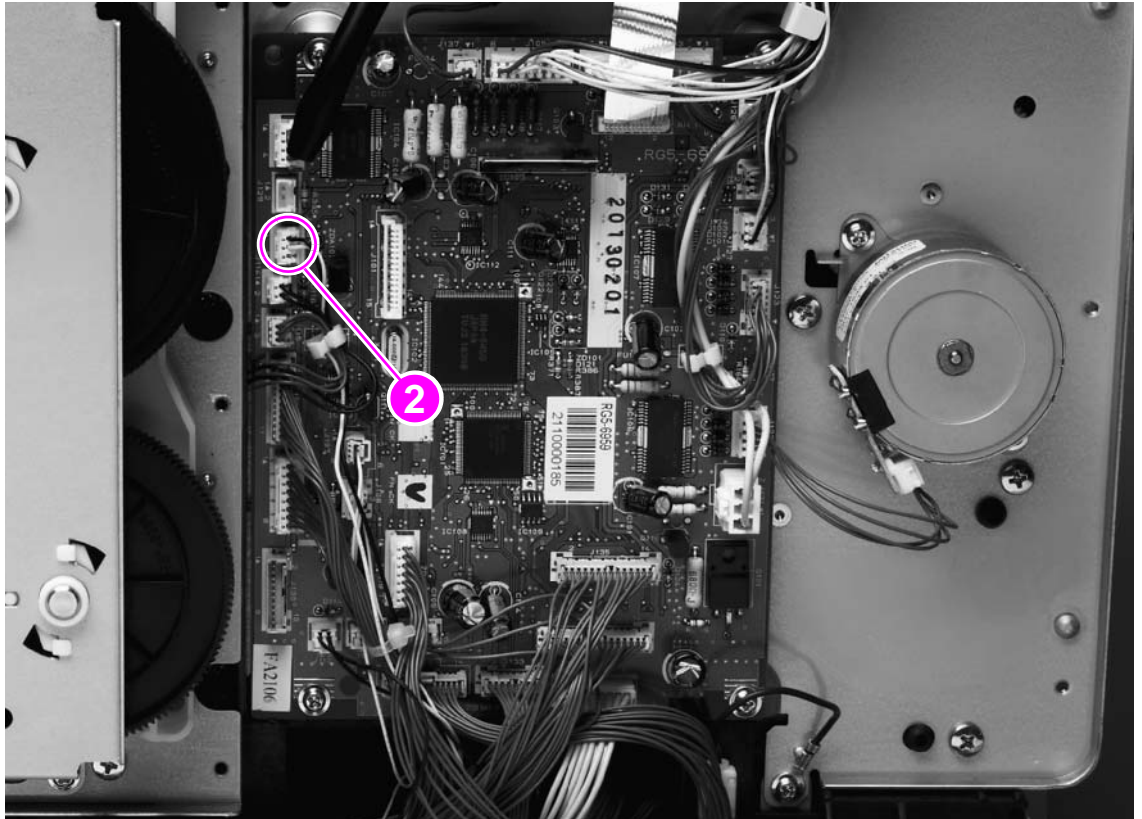

Figure 79.

Removing the E-label reader (2 of 2)

Tray 1 (multipurpose tray)

- 1 Remove the following covers:
 - right- and left-side covers (see page 101)
 - front lower cover (see page 121)
- 2 Open tray 1.
- 3 Press the multipurpose-roller cover (not shown) inward toward the printer, and then grasp the top edge to remove it.
- 4 Lift tray 1 slightly to align the notch (callout 1) in the tray 1 cover (callout 2) with the hinge pins of the tray 1 hinges (callout 3).
- 5 Push the left tray 1 hinge to the right while pulling the tray 1 cover to the left to carefully disengage the hinge pin from the tray 1 cover.
- 6 Disengage the right tray 1 hinge (callout 4) from the tray 1 cover.
- 7 Close the tray 1 guide (callout 5), open the tray 1 cover, and then slide the tray 1 cover to the left to remove it from its pins.

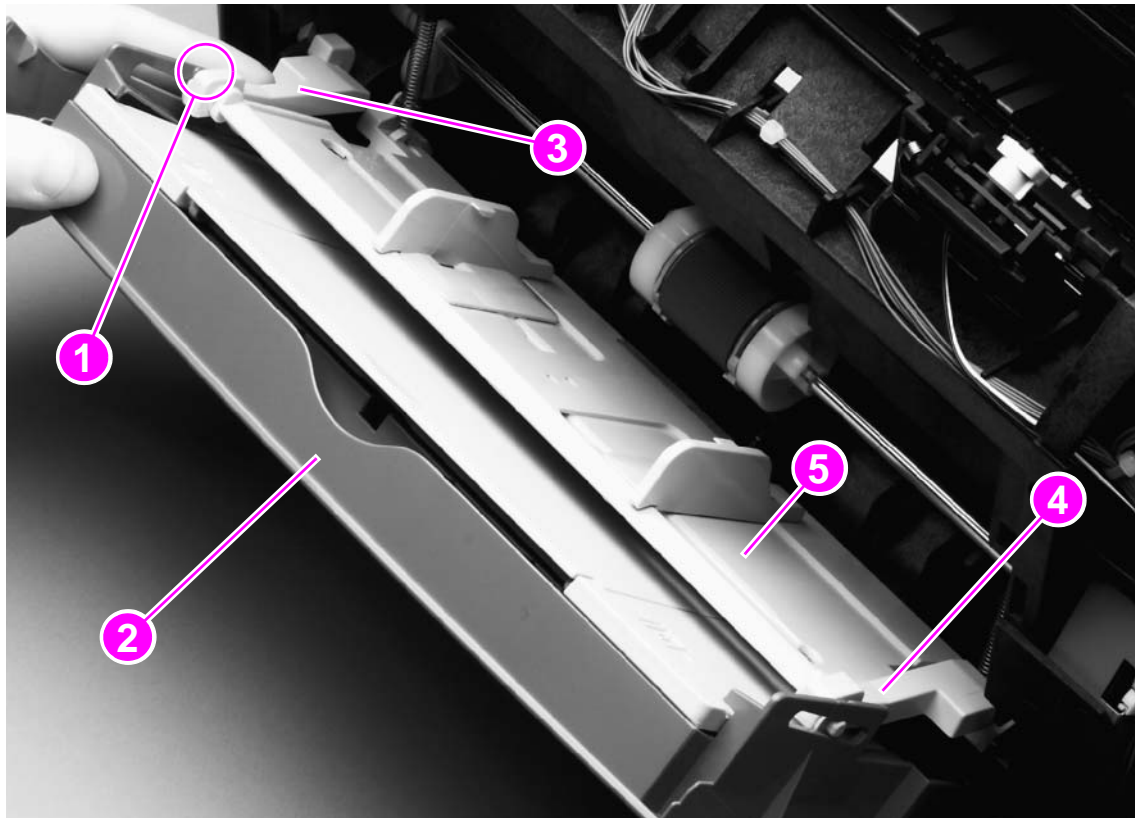

Figure 80.

Removing tray 1 (1 of 2)

- 8 Disengage the left and right hinges from the tray 1 guide and then slide both of the hinges off of their keyed holes (callout 6) in the printer.
- 9 Use needle-nose pliers to unhook two springs (callout 7), one at each side of the tray 1 guide, and then remove the tray 1 guide.

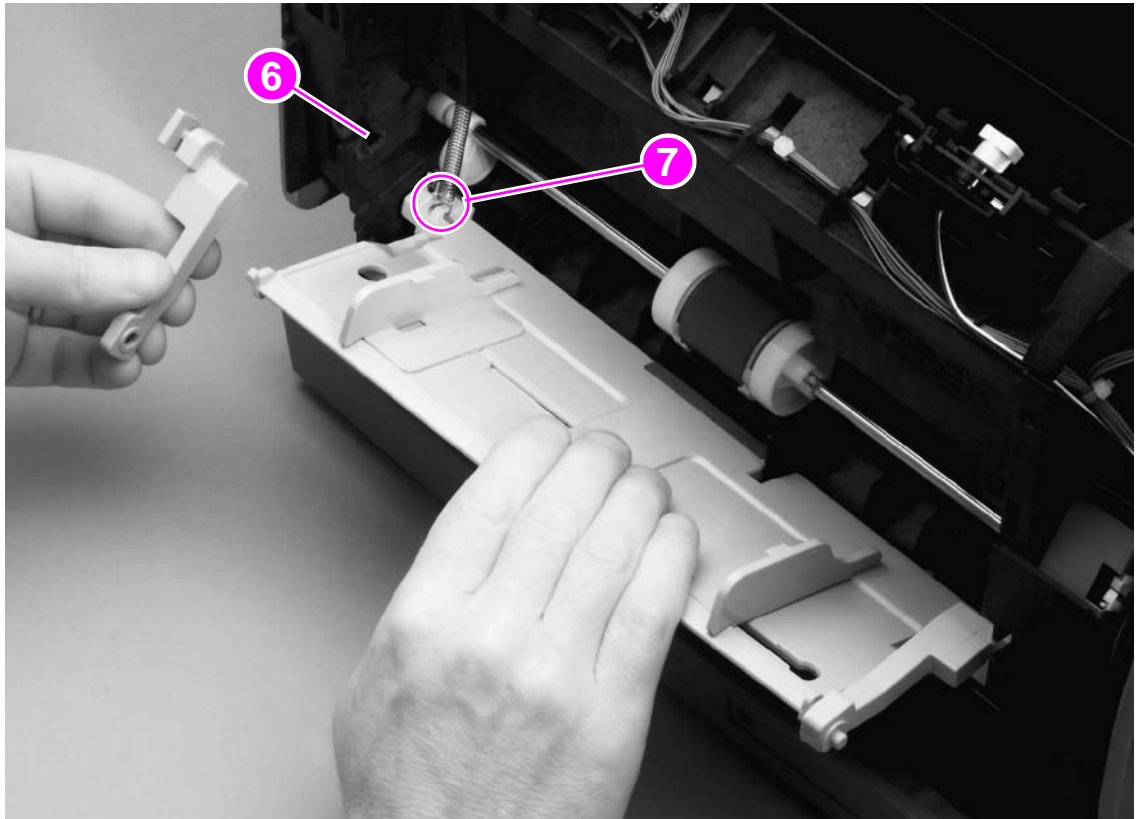

Figure 81.

Removing tray 1 (2 of 2)

Reinstall note

The two springs should remain attached to two pegs inside the printer. If the springs are not attached, use needle-nose pliers to reattach them before reinstalling the tray 1 guide.

Tray 1 separation pad assembly

- 1 Remove tray 1 (see page 135).
- 2 Remove one screw (callout 1) from the separation pad assembly, and then remove the separation pad assembly.

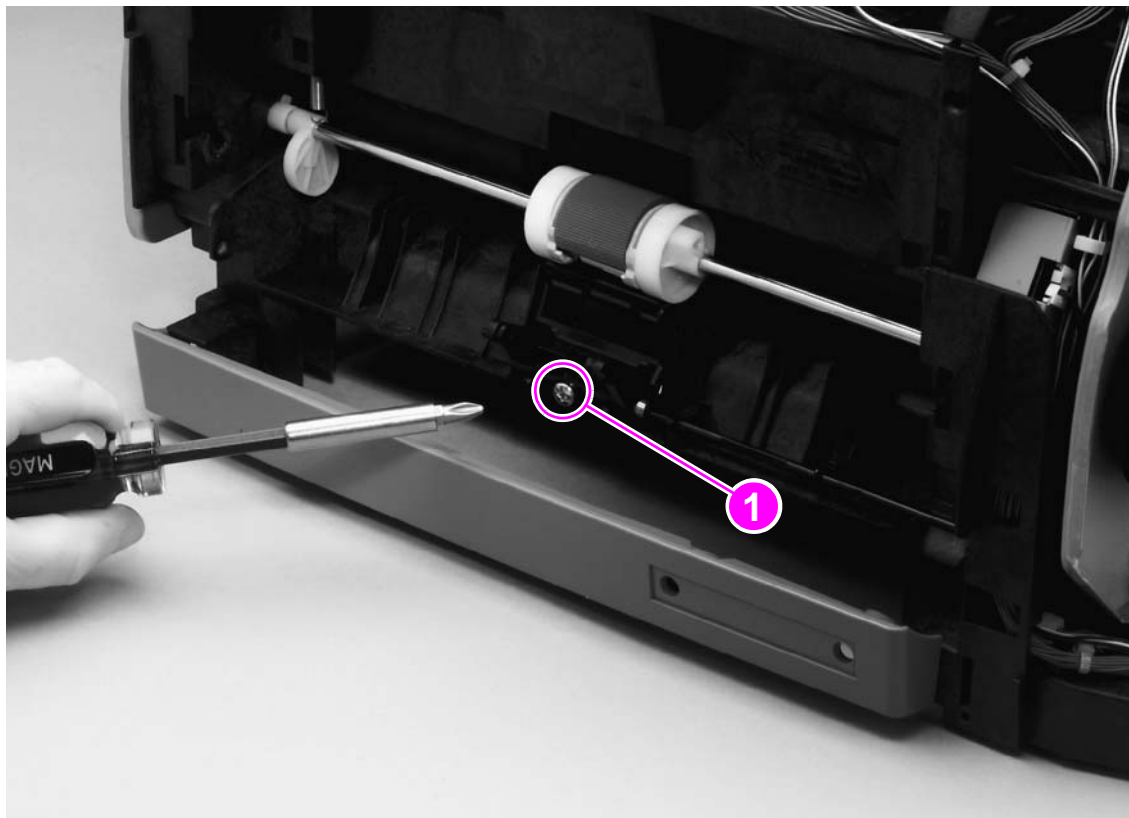

Figure 82.

Removing the tray 1 separation pad assembly

Gear assembly

- 1 Remove the following covers and assembly:
 - right- and left-side covers (see page 101)
 - interface cover (see page 106)
 - formatter cage (see page 107)
 - back cover (see page 122)
 - top cover (see page 123)
- 2 Disconnect one connector (callout 1, hidden—it is the connector to the main motor).
- 3 Disconnect two connectors (callout 2) from the dc controller.

Note

The dc controller has been removed from the printer in figure 83. If it were not, then the connectors in callout 2 would still be attached to the dc controller.

- 4 Pinch the cable holder (callout 3) and then unwind the cable.

CAUTION

Do not attempt to disconnect the clutch cable from the clutch. Doing so can damage the cable.

- 5 Remove the e-clip (callout 4) from the clutch, and then pull the clutch away from the printer.
- 6 From inside the printer, press the small tab on the gear (see callout 1 in figure 67 on page 123) to disengage the inside and outside gears (callout 5) from each other.

Note

To reinstall the gear, lower the vertical rack (callout 6) to its lowest position, and then align the gear with the vertical rack.

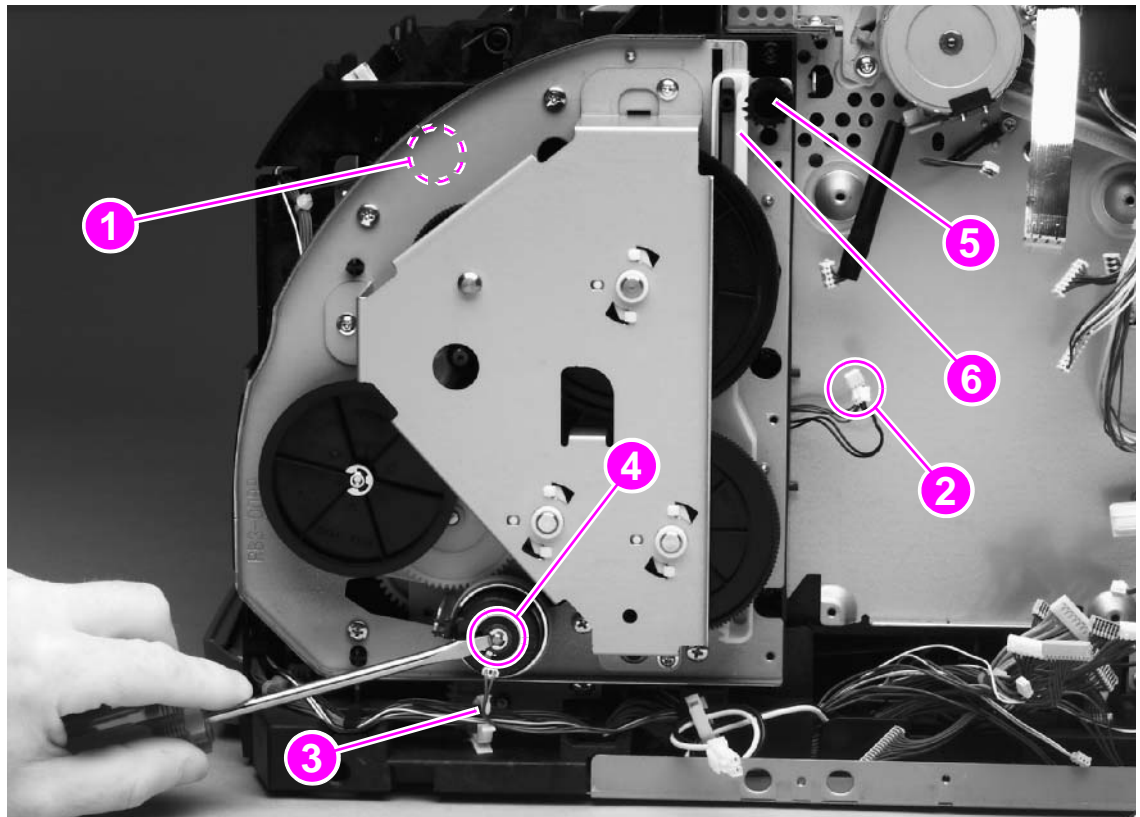

Figure 83. Removing the gear assembly (1 of 2)

Note

The clutch cable routing in more recent versions of the printer is different from the routing shown in figure 83. Examine the routing to make sure that it is reinstalled correctly.

- 7 Remove eight screws (callout 6) from the gear plate.
- 8 Rotate the gear assembly away from the printer, beginning with the front edge.

Note

A grounding spring (callout 7, hidden) should remain attached to the printer chassis. If it does not, then either reattach it to the chassis or place it with the gear assembly to prevent misplacing it.

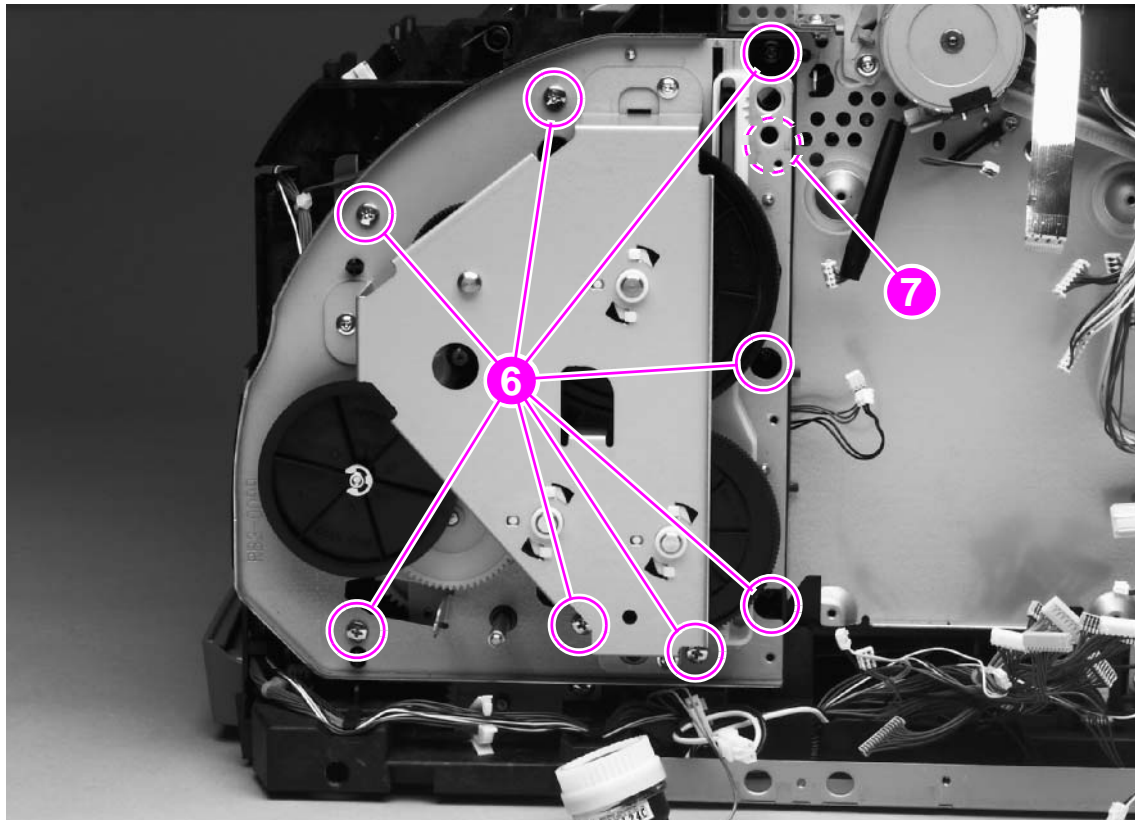

Figure 84. Removing the gear assembly (2 of 2)

Reinstall note

A grounding wire at the lower-back corner of the gear assembly must be hooked around the chassis at reinstallation. Callout 2 in figure 85 on page 140 shows the grounding wire. Callout 3 in figure 85 shows the grounding spring attached to the chassis.

Align the following parts with the printer chassis:

- gear assembly shaft
- grounding spring
- grounding wire

Waste-toner sensor

- 1 Unroute the cable from several cable holders.
- 2 Remove one screw (callout 1).
- 3 Lift the waste-toner sensor away from the printer.

Note

Callout 2 shows the grounding wire that must be hooked around the printer chassis upon reinstallation of the gear assembly. Callout 3 shows the grounding spring.

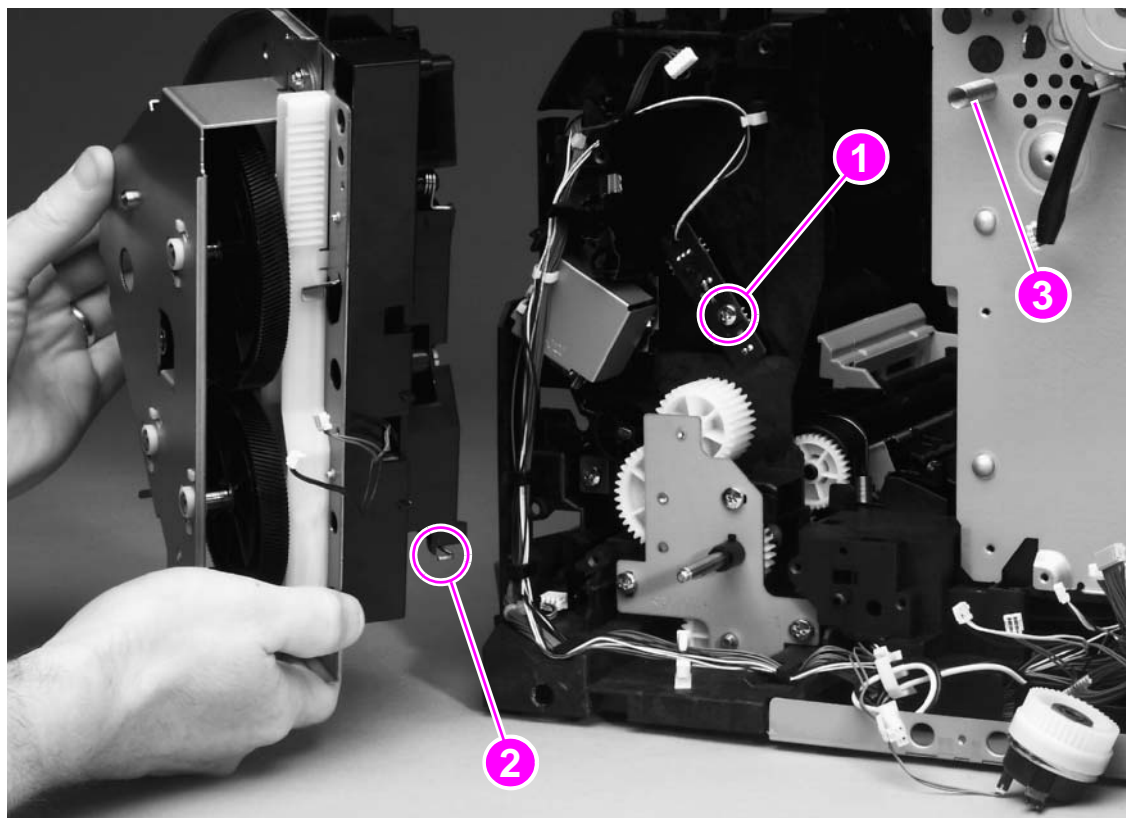

Figure 85.

Removing the waste-toner sensor

Rotary-drive assembly

Note

The rotary-drive assembly includes the developer motor, the brake solenoid, and the encoder motor.

- 1 Remove the following covers and assembly:
 - right- and left-side covers (see page 101)
 - interface cover (see page 106)
 - formatter cage (see page 107)
 - back cover (see page 122)
 - top cover (see page 123)
- 2 Unplug three cable connectors (callout 1) from the dc controller and unplug the flat laser/scanner cable (callout 2) from the laser/scanner.

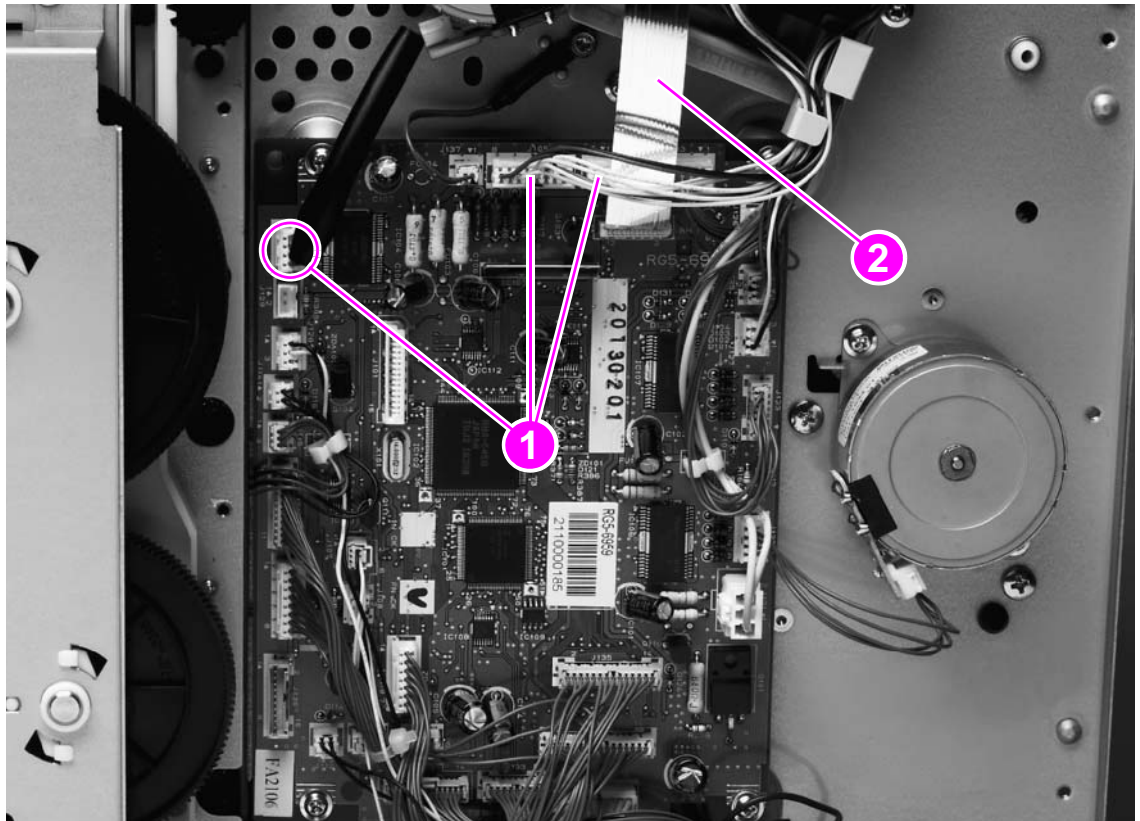

Figure 86.

Removing the rotary-drive assembly (1 of 3)

- 3 Remove one screw (callout 3) from the motor.
- 4 Remove one of the four screws that secures the rotary-drive assembly to the chassis (callout 4).

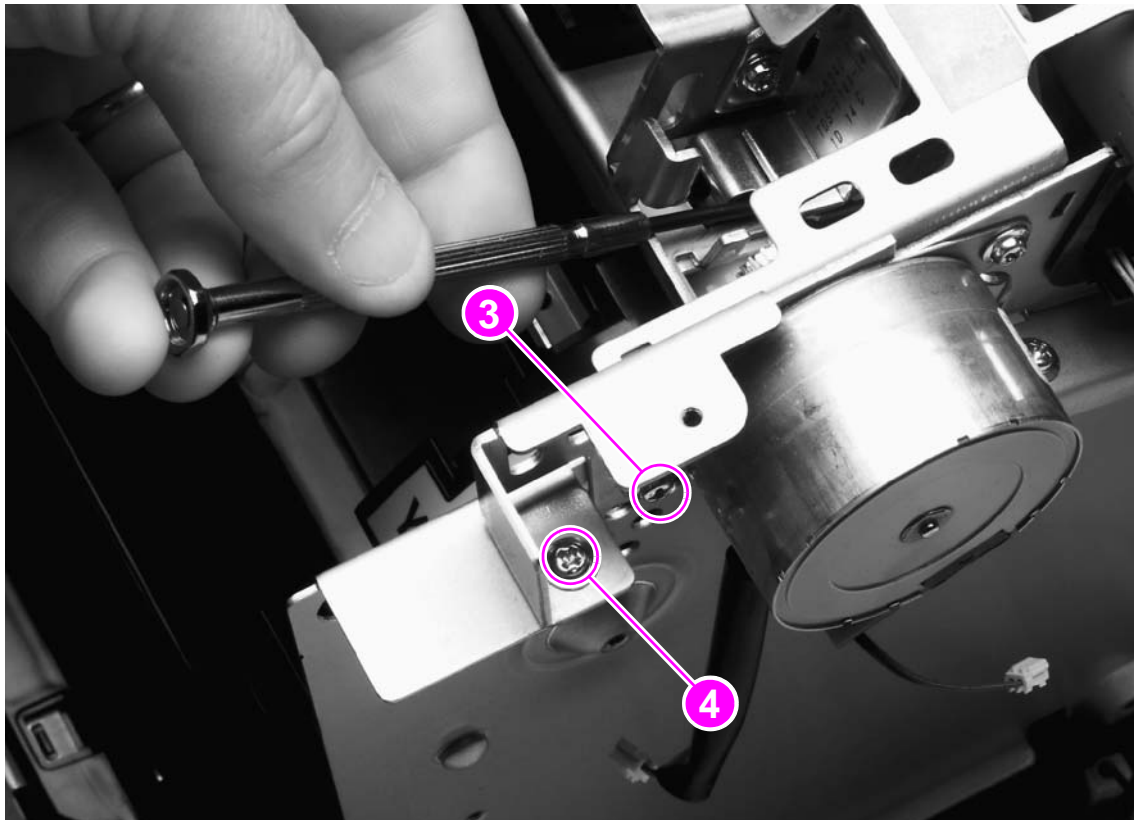

Figure 87.

Removing the rotary-drive assembly (2 of 3)

- 5 Face the top of the printer, and remove the other three screws that secure the rotary-drive assembly to the chassis (callout 5).
- 6 Lift the rotary-drive assembly straight up to remove it from the printer.

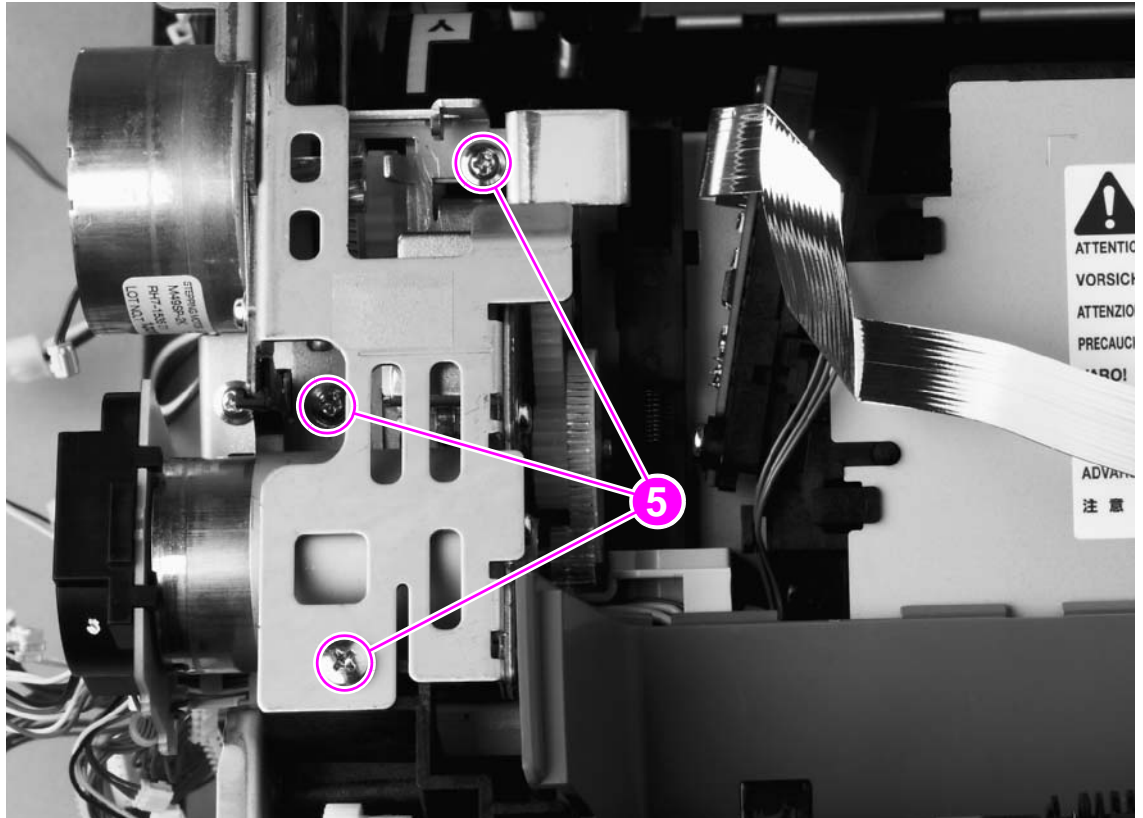

Figure 88. Removing the rotary-drive assembly (3 of 3)

Reinstall note

Insert the metal protrusion at the back of the rotary-drive assembly into the slot in the rear frame assembly and then lower the rotary-drive assembly into position over the alignment pins. Make sure that cables are not pinched.

Top plate

- 1 Remove the following covers and assembly:
 - right- and left-side covers (see page 101)
 - interface cover (see page 106)
 - formatter cage (see page 107)
 - back cover (see page 122)
 - top cover (see page 123)
- 2 Remove the air duct (see page 128).
- 3 Unplug the flat flexible cable (callout 1) from the laser/scanner.
- 4 Release the cables from one cable-holder (callout 2).
- 5 Unplug one cable connector (callout 3) by pressing and releasing the tab on the side of the connector.
- 6 Unplug five connectors (callout 4) from the dc controller.

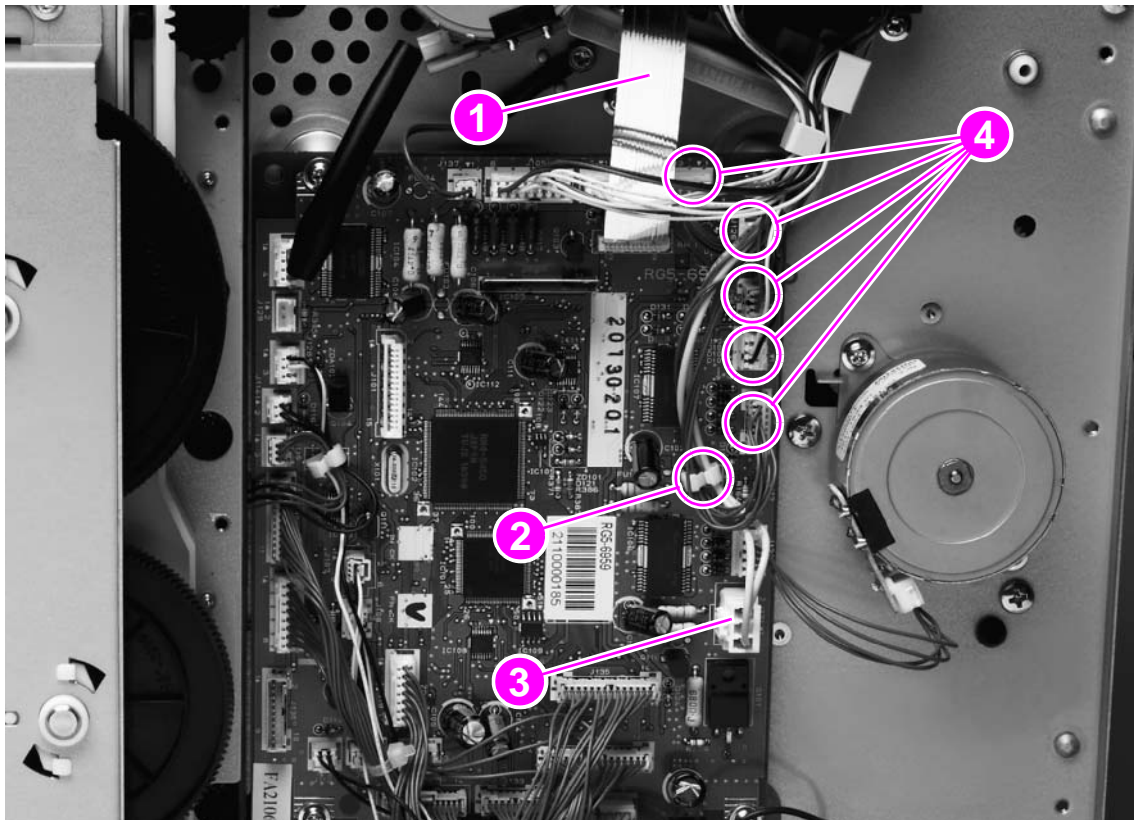

Figure 89. Removing the top plate (1 of 3)

- 7 Unroute two cables (callout 5).

Note

Examine the routing of the cables. If the cables are not reinstalled to their correct routing, then the cables can become pinched by other assemblies.

- 8 Unplug two connectors (callout 6).
- 9 Remove two screws at the left side of the printer (callout 7) and then remove the two corresponding screws from the right side of the printer.

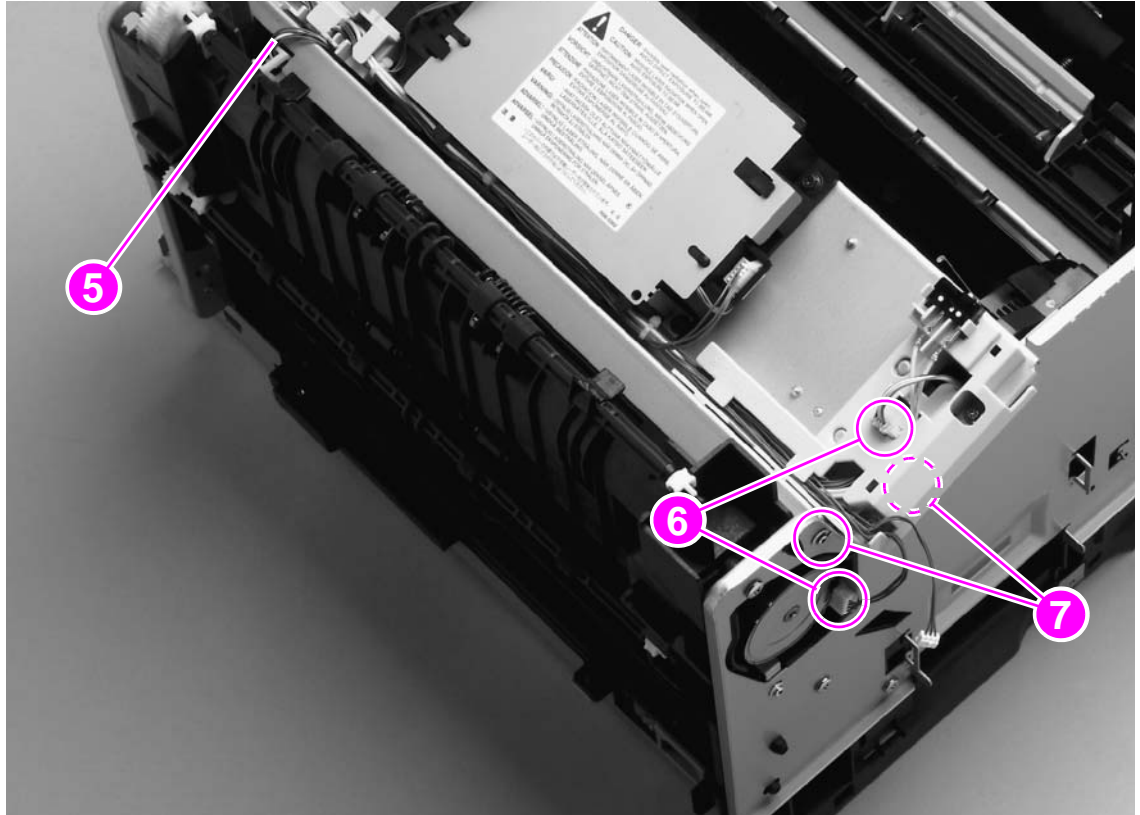

Figure 90.

Removing the top plate (2 of 3)

10 Remove four screws (callout 8) from the top plate.

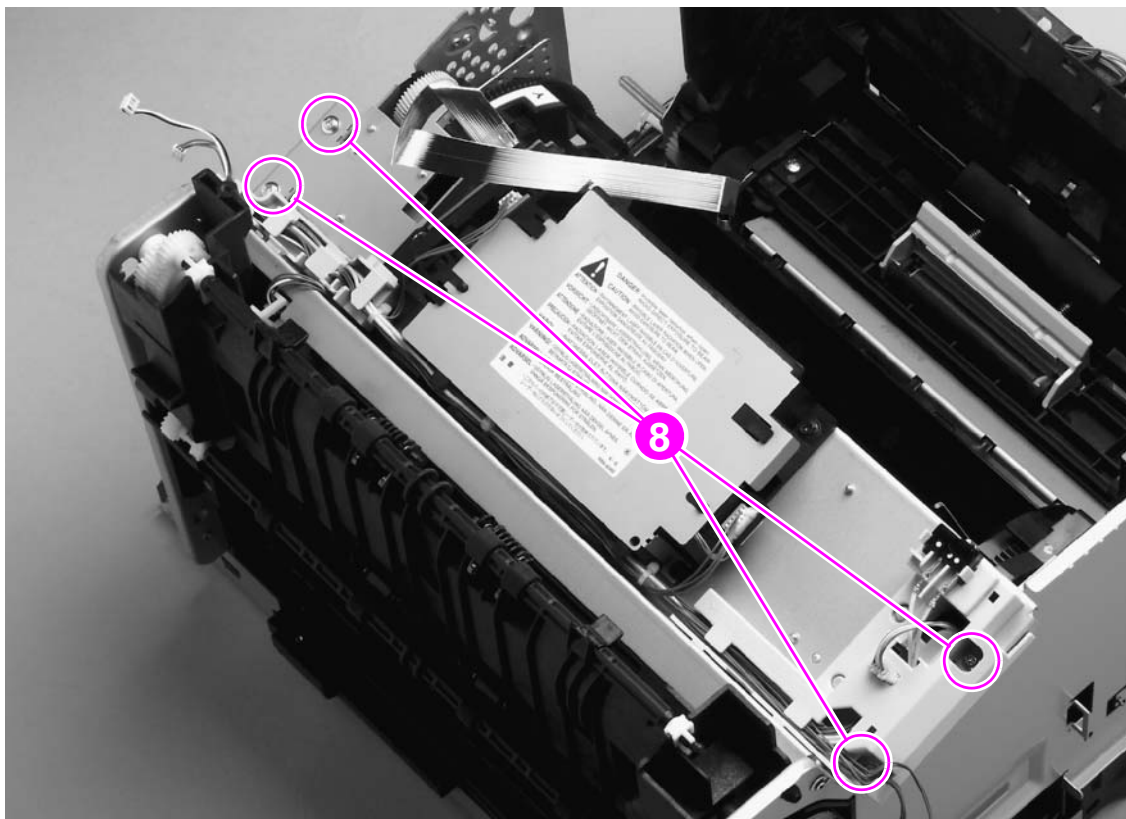

Figure 91.

Removing the top plate (3 of 3)

11 Carefully lift the top plate off of the printer frame.

Print-cartridge carousel

- 1 Remove the following covers and assemblies:
 - right- and left-side covers (see page 101)
 - interface cover (see page 106)
 - formatter cage (see page 107)
 - back cover (see page 122)
 - top cover (see page 123)
 - air duct (see page 128)
 - rotary-drive assembly (see page 141)
 - top plate (see page 144)
- 2 Remove two screws (callout 1) from the back of the printer.

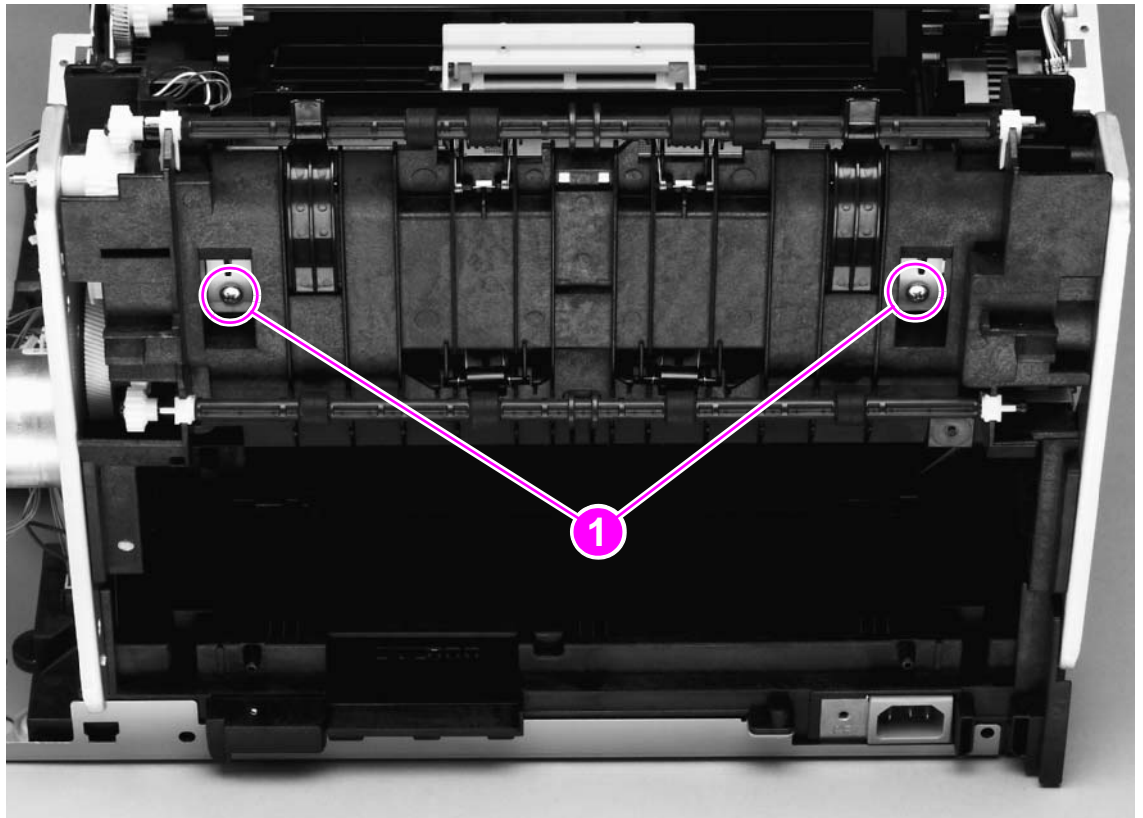

Figure 92. Removing the print-cartridge carousel (1 of 3)

Reinstall note

Because the remainder of the print-cartridge carousel removal procedures are performed from the left, right, and front of the printer, it is easy to forget to replace the two screws at the back of the printer.

- 3 Press the white plastic tab (callout 2) at the left side of the printer to release the white, left swing-shaft bushing, and then rotate the bushing to a vertical position.

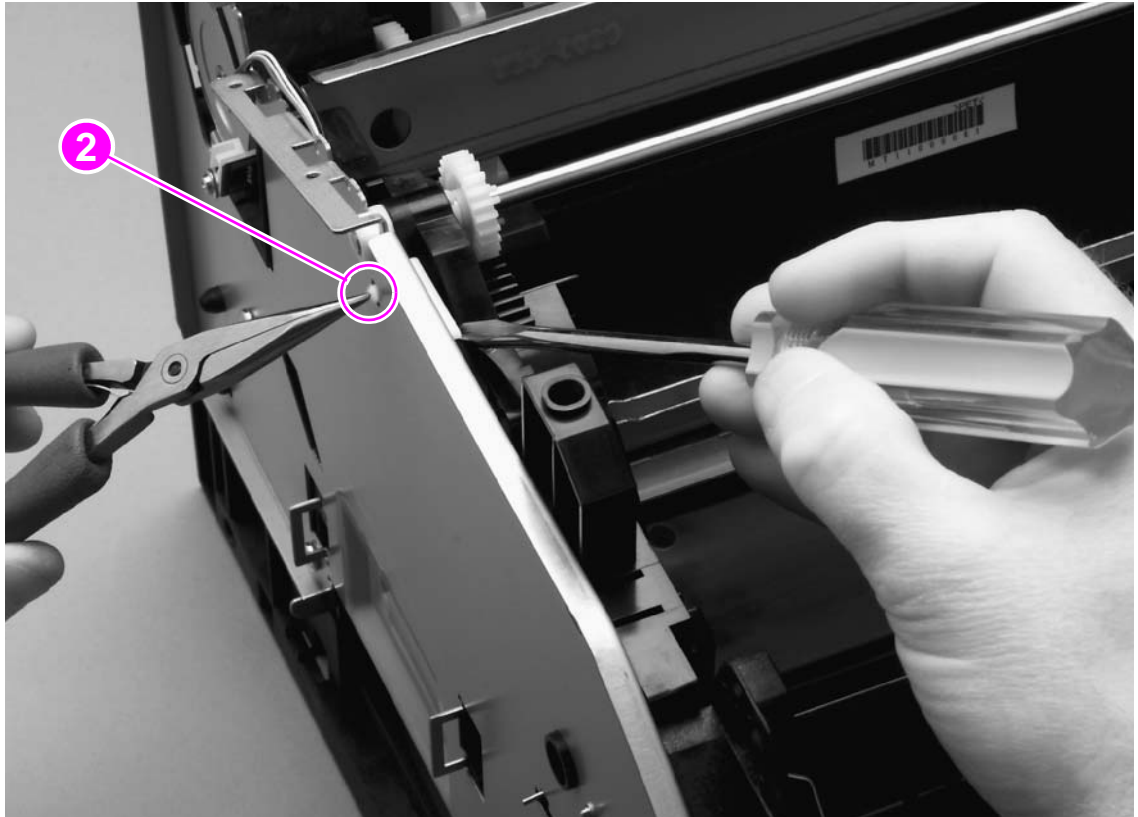

Figure 93. Removing the print-cartridge carousel (2 of 3)

- 4 On the right side of the printer, repeat step 3 on the black, right swing-shaft bushing.

CAUTION

The right swing-shaft bushing is thin and delicate and is easily broken. Be very careful in rotating the bushing in either direction.

Examine the positions of the left pressure-shaft holder (callout 3), the right pressure-shaft holder (callout 4), and the pressure-shaft gear (callout 5) before you perform step 5. The pressure-shaft holders must be reinstalled to their correct positions when reinstalling the print-cartridge carousel.

- 5 Use the flatblade screwdriver to pry two white tabs on the pressure-shaft holders from their seated positions in the rear frame assembly.

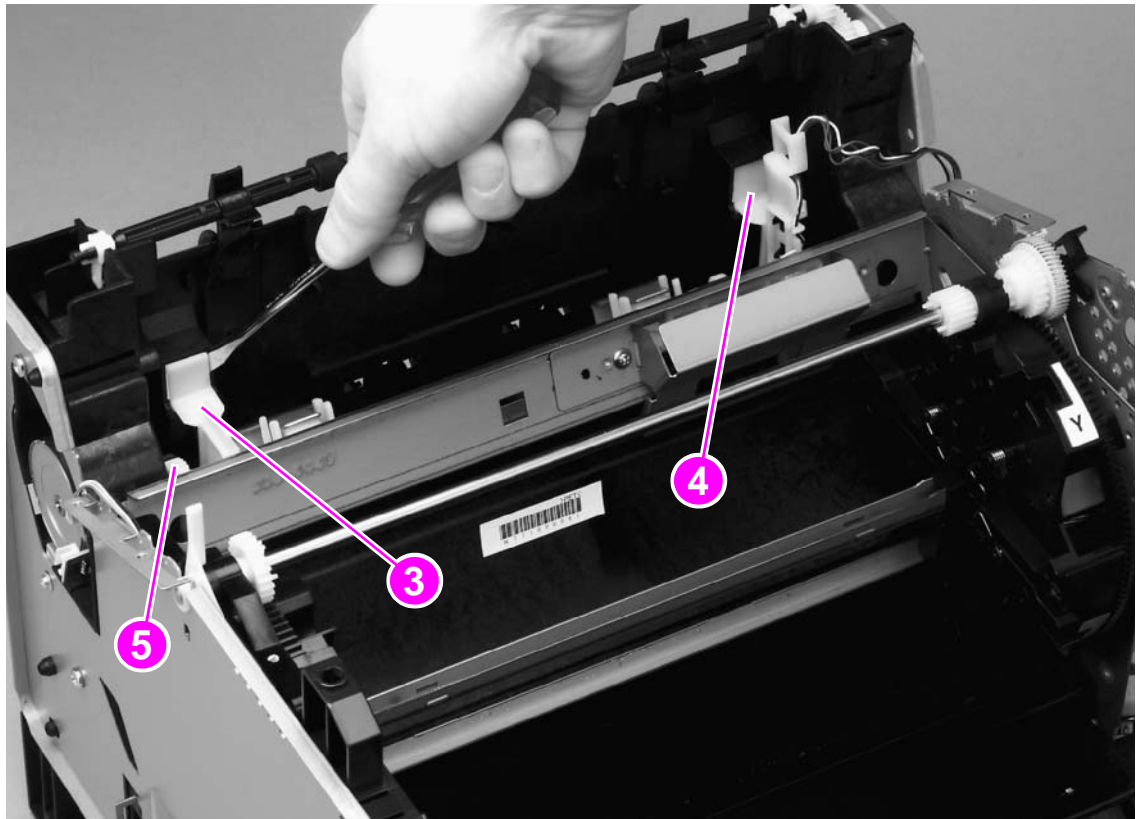

Figure 94. Removing the print-cartridge carousel (3 of 3)

- 6 Lift the print-cartridge carousel out of the printer.

Reinstall notes

Make sure that the “feet” of the pressure-shaft holders fit into the slots in the rear frame assembly. After the “feet” are reinstalled correctly, press the tops of the white tabs firmly into position.

Correct

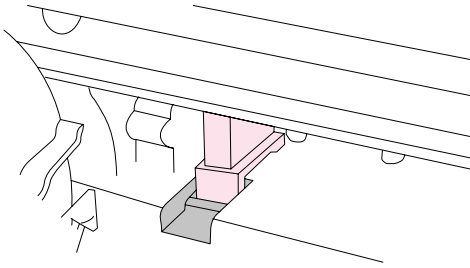

Incorrect

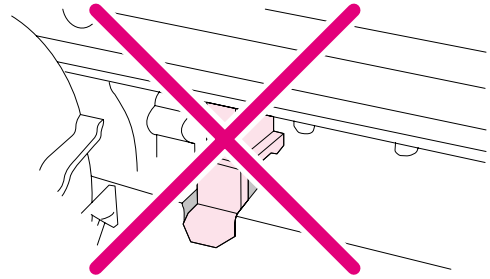

Also make sure that the tab on the pressure-shaft gear points down.

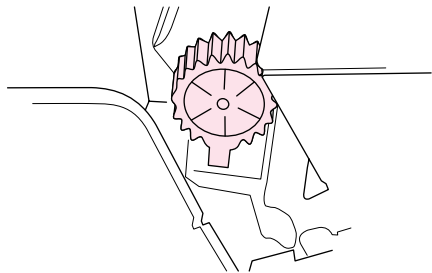

Check to see that the gears in the print-cartridge carousel are aligned correctly before placing the carousel back into the printer.

- 1 Rotate the carousel so that the marker for the yellow print cartridge faces the front of the printer.
- 2 Examine the gears: two marks on the smaller gear should line up with the single mark on the larger gear (see the detail of the gears in figure 95).

Note

The single mark on the larger gear is adjacent to the slot for the black cartridge, marked with a “K.”

- 3 If the gears are not aligned correctly, locate the marks on the gears and realign the gears.

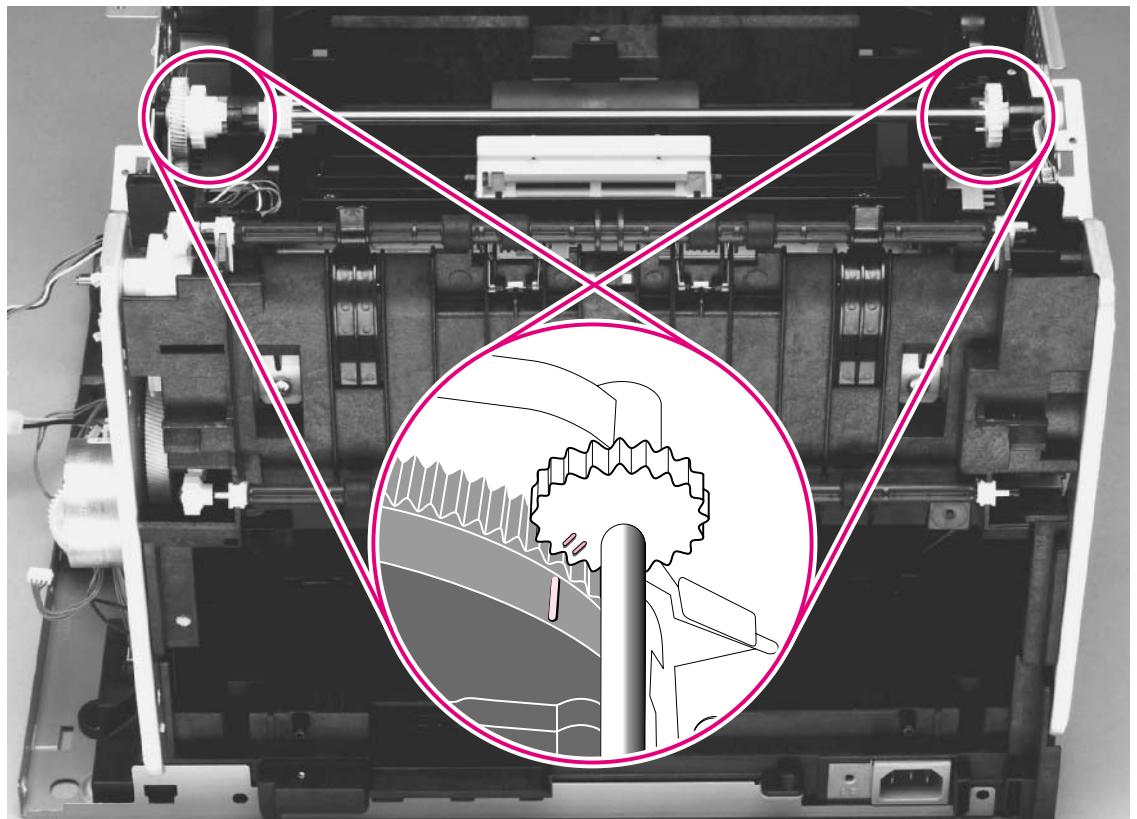

Figure 95.

Reinstalling the print-cartridge carousel

Registration-roller assembly

- 1 Remove two screws (callout 1) from the registration-shutter assembly.
- 2 Rotate the registration-roller assembly toward the front of the printer and then lift it towards the rear of the printer and up to remove it from the printer.

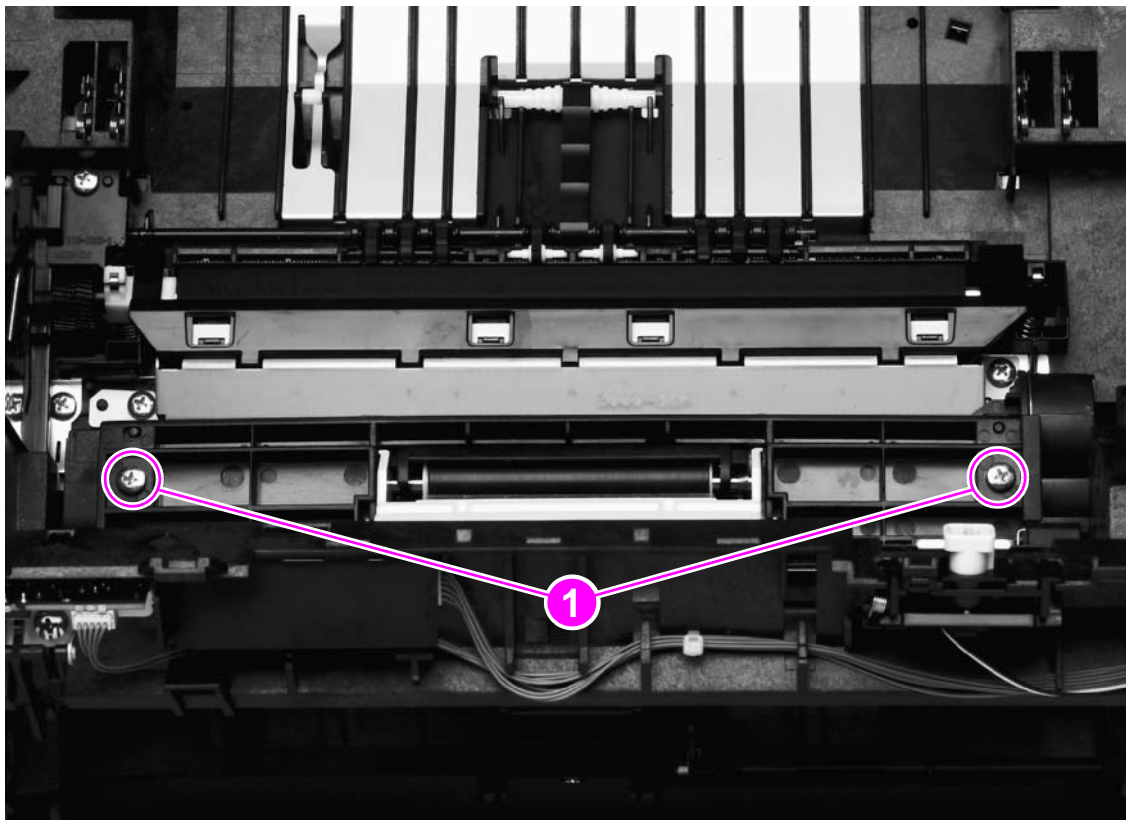

Figure 96.

Removing the registration-roller assembly

Toner-catch tray

The toner-catch tray is secured by two tabs underneath the tray (see figure 97), towards the front of the tray.

- 1 Release one tab on either side of the toner-catch tray and then pull the tray approximately two or three millimeters (approximately 0.125 inch) towards the front of the printer to make sure that the tab does not reseat as you perform step 2.
- 2 Release the tab on the other side and then lift the tray out of the printer.

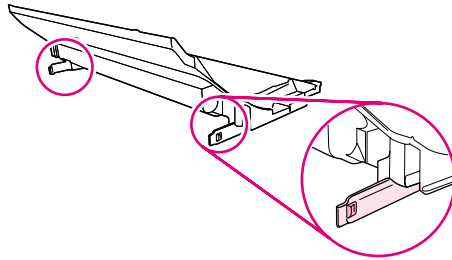

Figure 97.

Removing the toner-catch tray

Transfer-roller plate

CAUTION

Do not touch the black sponge portion of the transfer roller.

- 1 Remove the toner-catch tray (see page 153).
- 2 Remove two screws (callout 1) from the transfer-roller plate.
- 3 Lift the transfer-roller plate straight up to remove it from the printer.

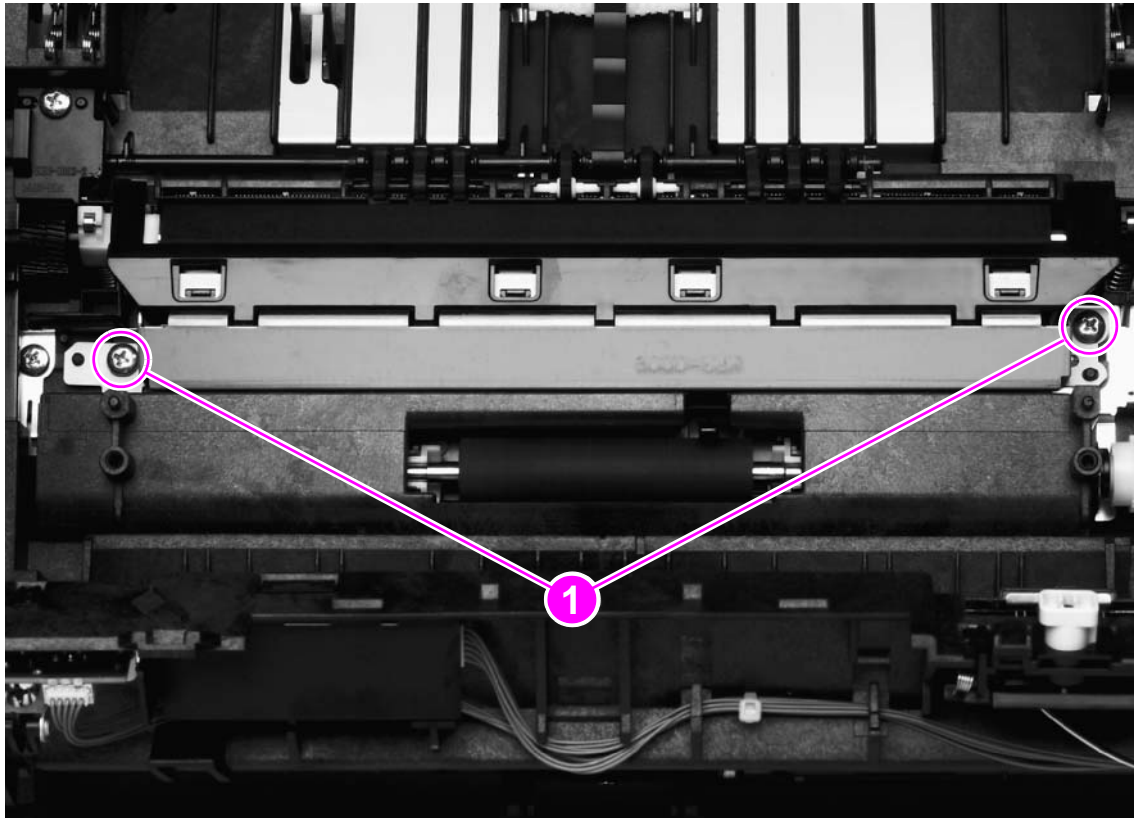

Figure 98.

Removing the transfer-roller plate

Transfer roller

CAUTION

Do not touch the black sponge portion of the transfer roller.

- 1 Remove the following assemblies:
 - toner-catch tray (see page 153)
 - transfer-roller plate (see page 154)
- 2 Use needle-nose pliers to gently squeeze the small tabs at the right side of the transfer roller (see the detail in figure 99) and then also squeeze the tabs at the left side of the transfer roller to release the roller.

Note

Be careful not to bend the thin metal strip adjacent to the tabs on the right side of the roller.

- 3 Lift the transfer roller up from the right side, slide it to the right, and lift it out of the printer.

Note

The small grounding spring that is underneath the left side of the transfer roller is attached to the transfer roller. It is removed with the transfer roller.

The small grounding spring that is underneath the right side of the transfer roller remains in the chassis.

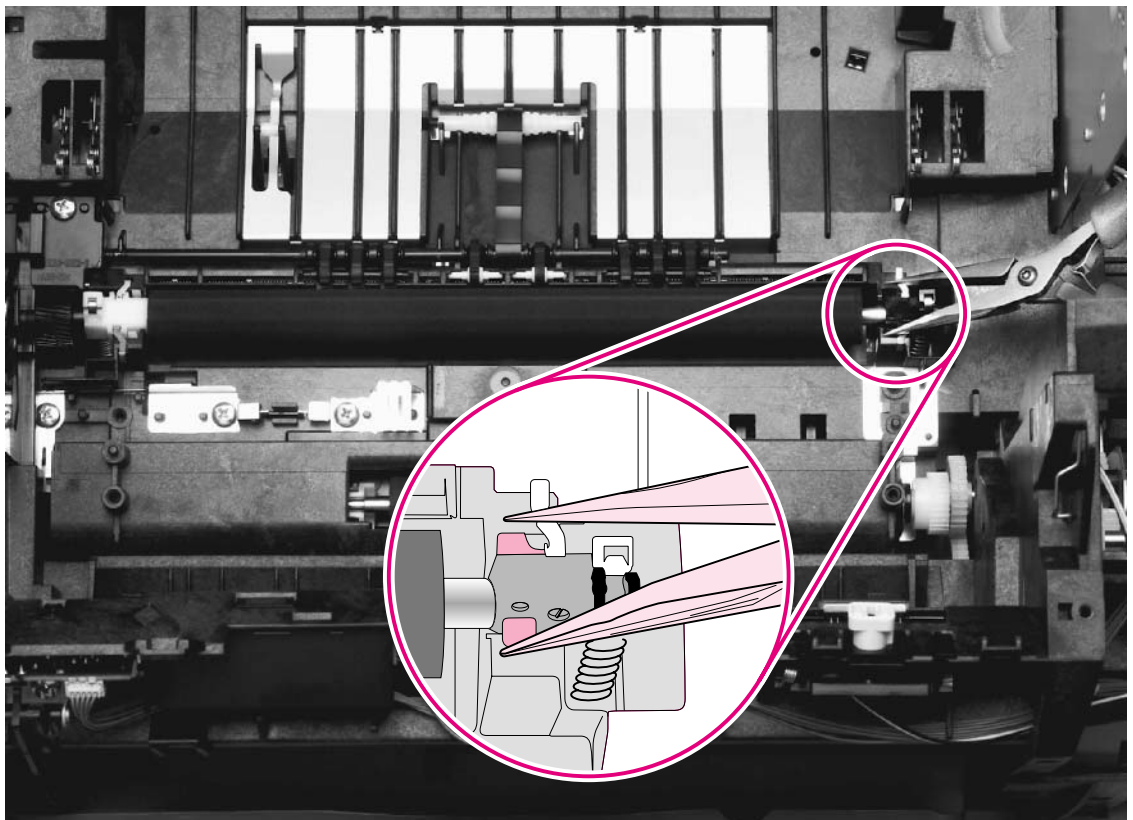

Figure 99.

Removing the transfer roller

Feed-drive shaft

- 1 Remove the following covers and assemblies:
 - right- and left-side covers (see page 101)
 - toner-catch tray (see page 153)
 - transfer-roller plate (see page 154)
 - transfer roller (see page 155)
- 2 Remove one screw (callout 1) from the gear cover, and then lift the gear cover to remove it.
- 3 Lift the belt roller (callout 2) from its hooks.
- 4 Use a small flatblade screwdriver to pry the feed-drive shaft (callout 3) off of the hooks that secure it to the printer.

Note

Unless the feed-drive shaft itself is damaged, there is no need to remove the shaft.

- 5 Use a small flatblade screwdriver to pry four pulleys (callout 4) from their hooks.
- 6 After the feed-drive shaft and the pulleys are released, remove the timing belt (callout 5) and the small feed belts by sliding them off of the right end of the feed-drive shaft.

Note

Callout 6 shows the roller on the fuser wrap-jam sensor. The roller must be removed first if you want to remove the ECU pan (the bottom plate of the printer).

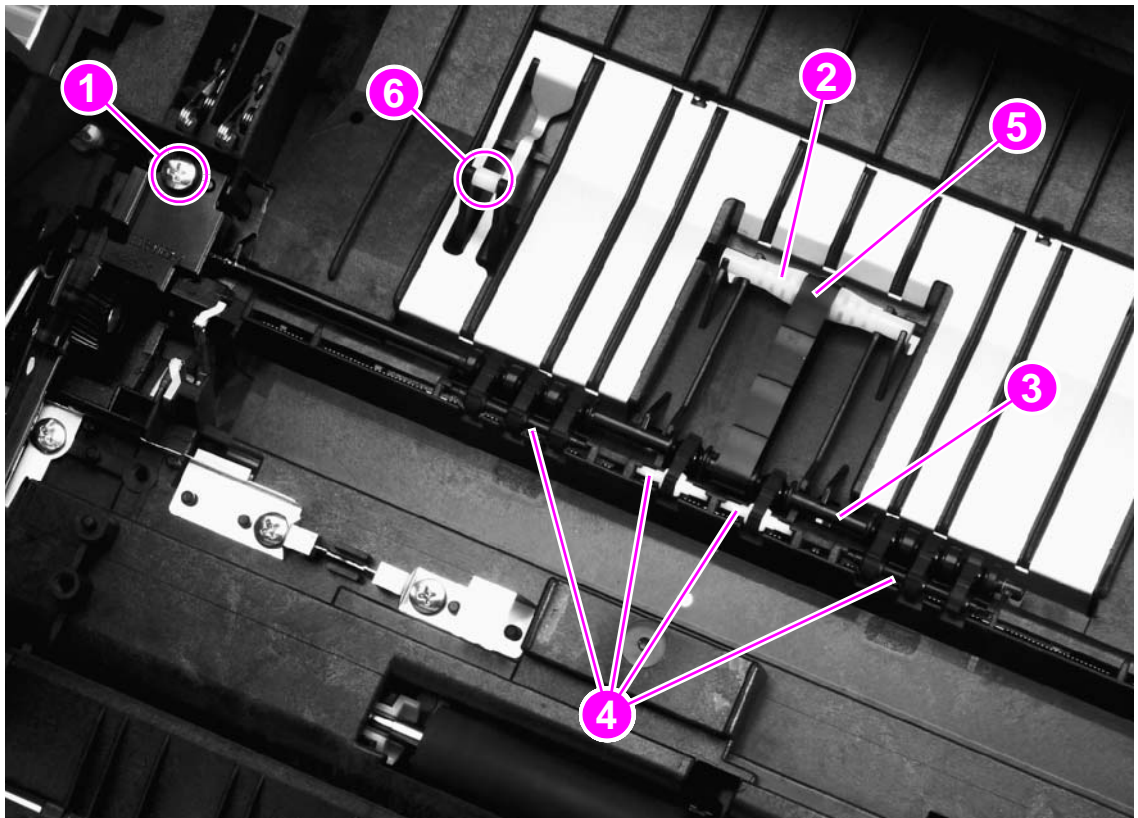

Figure 100. Removing the feed-drive shaft

Reinstall note

Examine the timing belt (callout 5) before removing it from the printer. The leading and trailing sides of the ridges are different and the belt must be reinstalled correctly to prevent media-feed problems.

ECU pan

- 1 Remove the following covers and assemblies:
 - right- and left-side covers (see page 101)
 - interface cover (see page 106)
 - formatter cage (see page 107)
 - optional tray 2 (see page 118)
 - toner-catch tray (see page 153)
- 2 Unplug five cable connectors (callout 1) from the dc controller.
- 3 Remove one screw (callout 2) from the grounding wire.

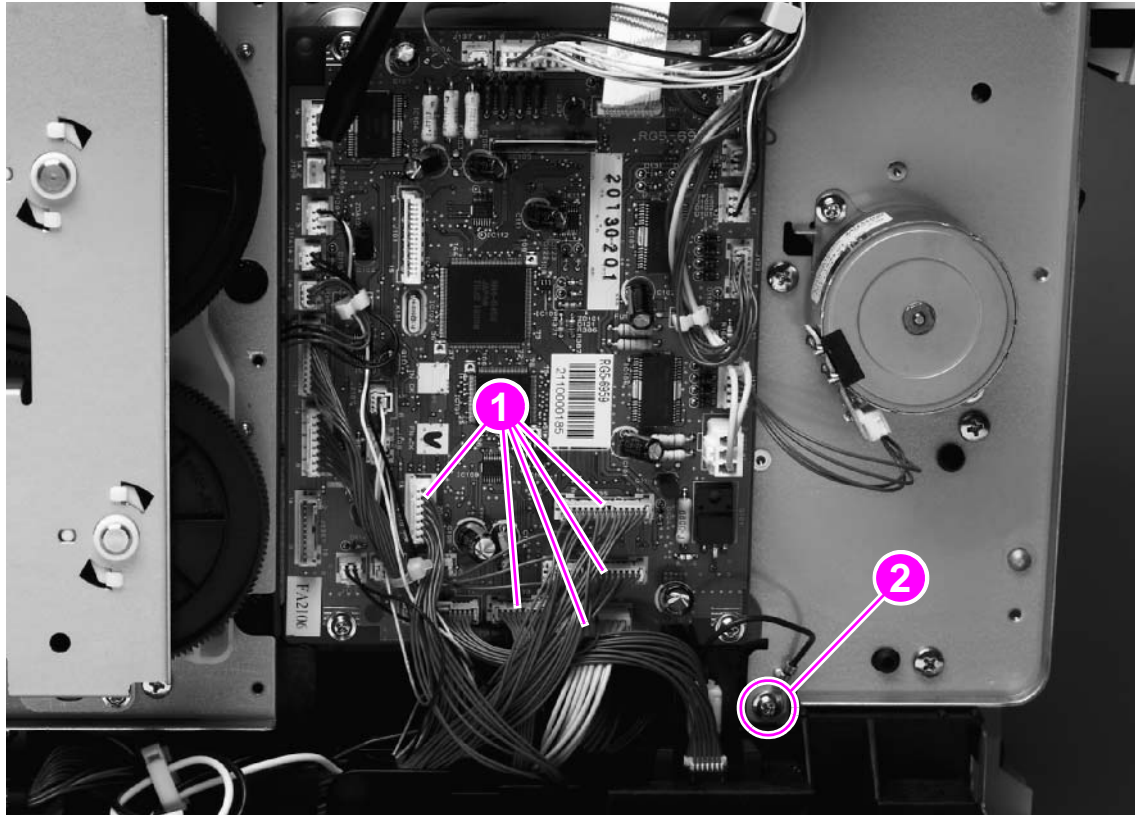

Figure 101. Removing the ECU pan (1 of 2)

- 4 Turn the printer over so that it rests on its top.
- 5 Remove one screw from the left side of the printer (callout 3)
- 6 Remove eight screws (callout 4) from the bottom of the ECU pan.
- 7 Lift the ECU pan off of the printer.

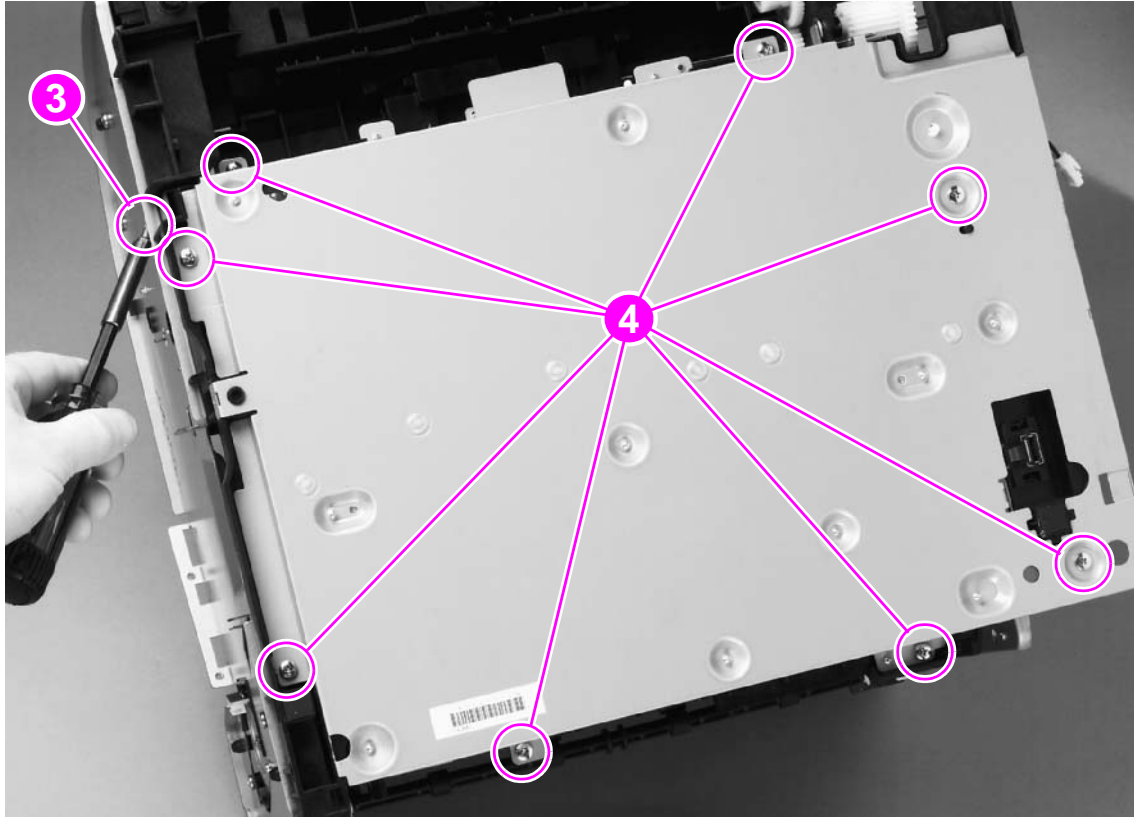

Figure 102.

Removing the ECU pan (2 of 2)

Reinstall note: ECU connections

Make sure that the grounding springs are attached to each of the eight ECU connections before reinstalling the ECU pan.

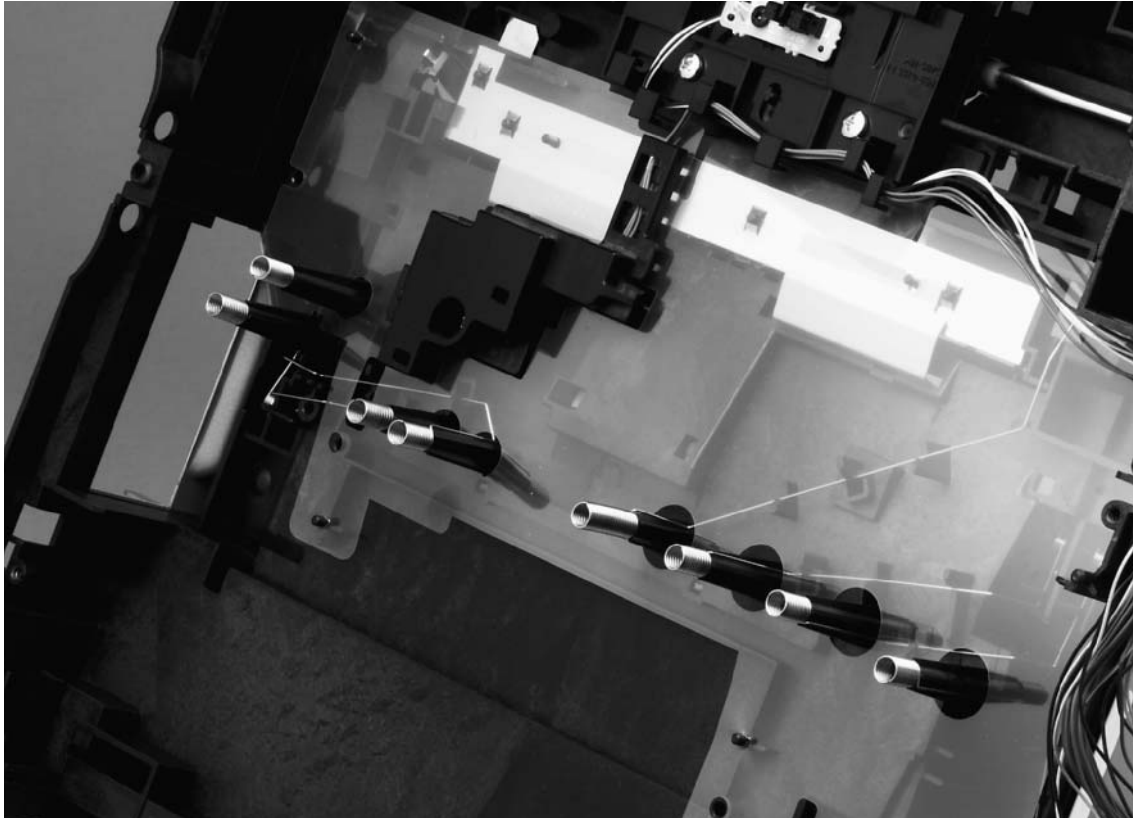

Figure 103.

ECU connections

Sub-high-voltage transformer PCA

- 1 Remove the following covers and assemblies:
 - right- and left-side covers (see page 101)
 - optional tray 2 (see page 118)
 - fuser (see page 100)
 - ECU pan
- 2 Unplug one connector (callout 1) from the high-voltage transformer PCA.
- 3 Remove two screws (callout 2).
- 4 Lift up the sub-high-voltage transformer PCA and its holder, and then unplug one connector (callout 3) from the high-voltage transformer PCA.

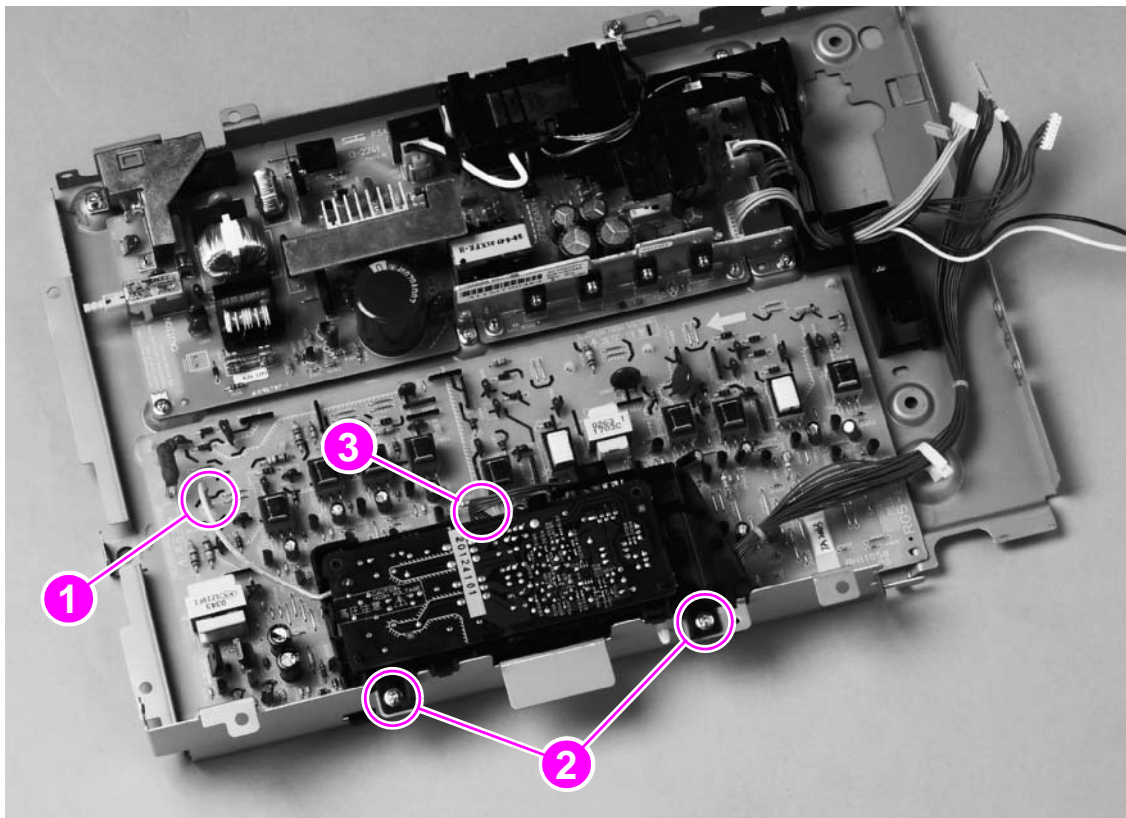

Figure 104. Removing the sub-high-voltage transformer PCA

High-voltage transformer PCA

- 1 Remove the following covers and assemblies:
 - right- and left-side covers (see page 101)
 - interface cover (see page 106)
 - formatter cage (see page 107)
 - optional tray 2 (see page 118)
 - ECU pan (see page 157)
 - sub-high-voltage transformer PCA (see page 160)
- 2 Release two cable holders (callout 1) and then unplug two connectors (callout 2).
- 3 Remove two screws (callout 3).
- 4 Pinch six plastic pins (callout 4) and then lift the high-voltage transformer PCA off of the ECU pan.

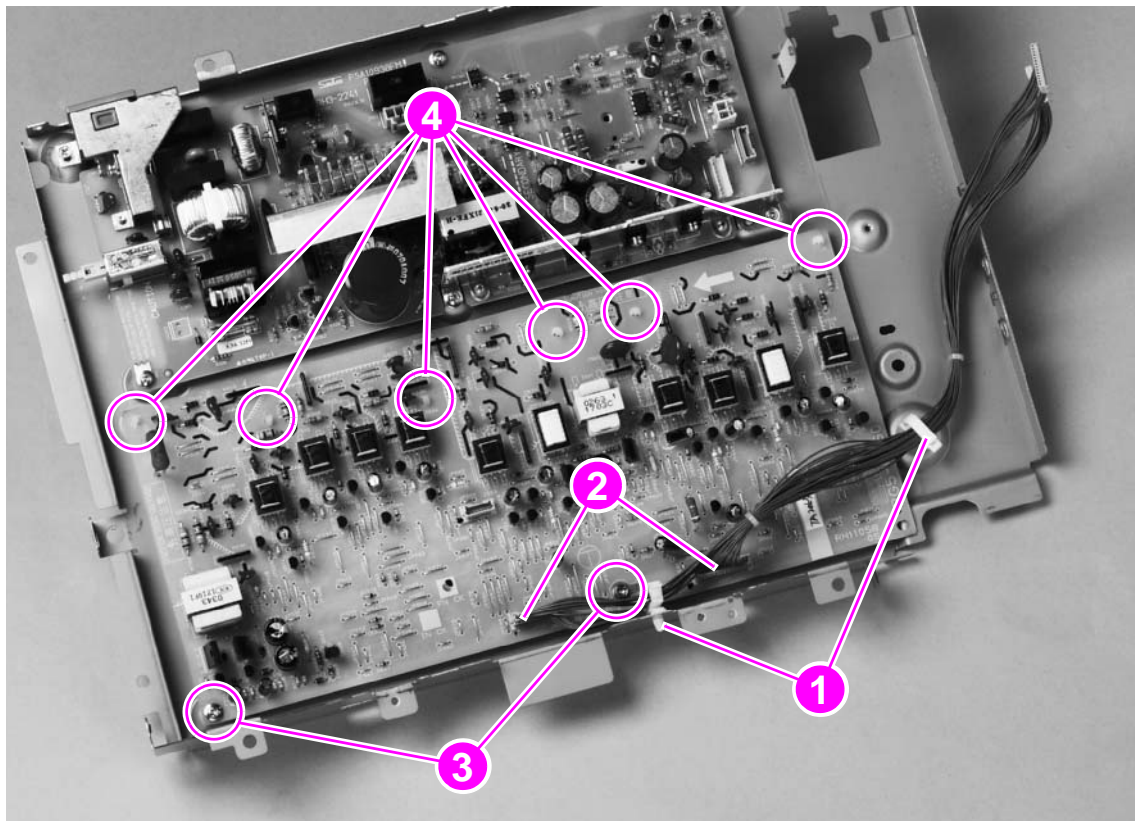

Figure 105. Removing the high-voltage transformer PCA

Low-voltage PCA

- 1 Remove the following covers and assemblies:
 - right- and left-side covers (see page 101)
 - interface cover (see page 106)
 - formatter cage (see page 107)
 - optional tray 2 (see page 118)
 - ECU pan (see page 157)
- 2 Unplug four connectors (callout 1) from the low-voltage PCA.
- 3 Remove one screw (callout 2) from the grounding wire.
- 4 Remove two screws (callout 3) from the fuser-connector holder and lift the holder off of the low-voltage PCA.

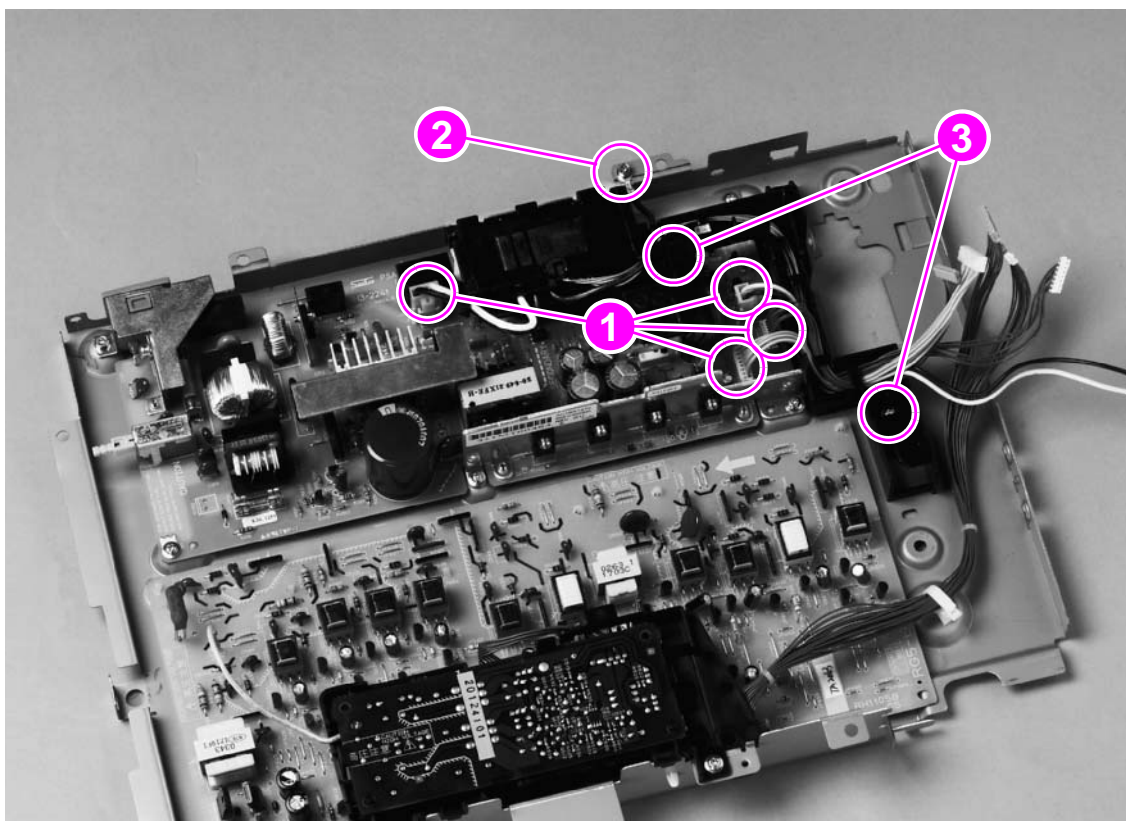

Figure 106. Removing the low-voltage PCA (1 of 2)

- 5 Remove six screws (callout 4) from the low-voltage PCA, and then lift the PCA off of the ECU pan.

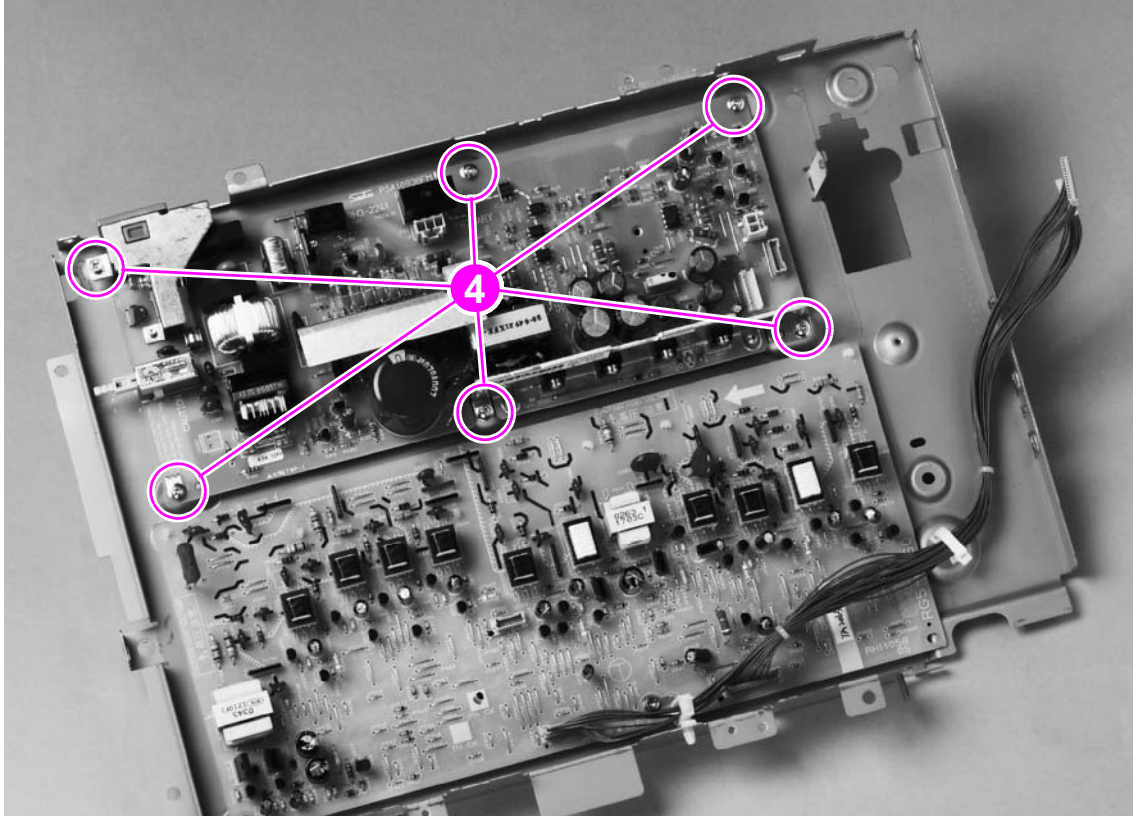

Figure 107. Removing the low-voltage PCA (2 of 2)

Paper-top sensor

- 1 Remove the ECU pan (see page 131).
- 2 Remove one screw (callout 1).
- 3 Lift the paper-top sensor straight up to remove it from the printer.
- 4 Unwind the cable from the cable harness, and unplug the cable from the dc controller.

CAUTION

Do not attempt to disconnect the paper-top sensor cable from the paper-top sensor. Doing so can damage the cable.

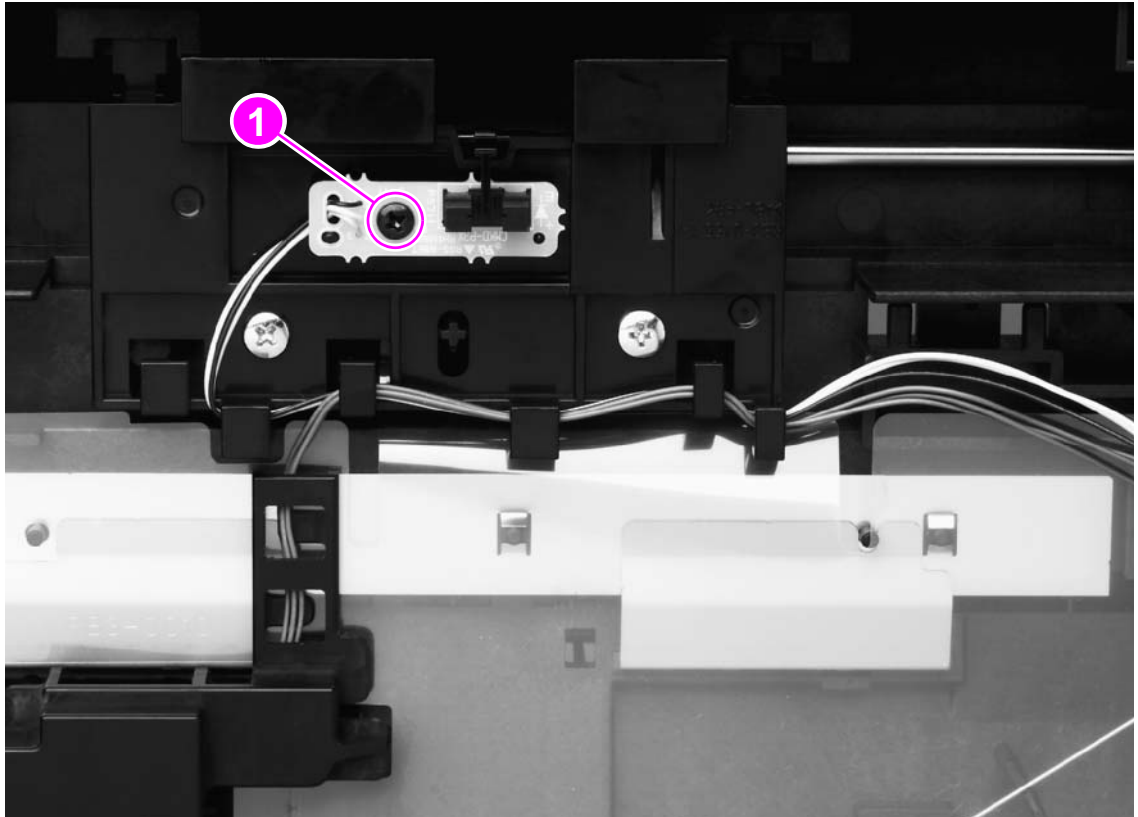

Figure 108. Removing the paper-top sensor

Fuser-wrap sensor

- 1 Remove the ECU pan (see page 157).
- 2 Remove the fuser-wrap sensor roller (see figure 100 on page 156, callout 6).
- 3 Remove one screw (callout 1) from the fuser-wrap sensor.
- 4 Unwind the cable from the cable harness, and unplug the cable from the dc controller.

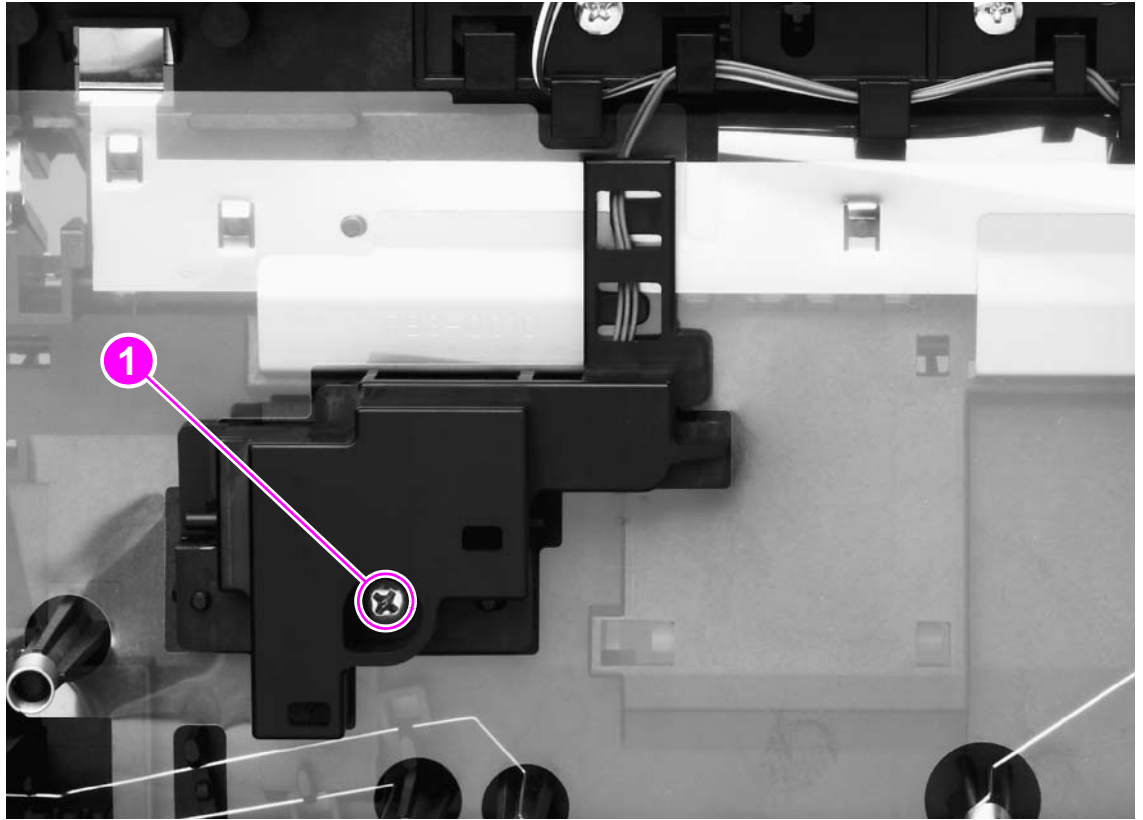

Figure 109.

Removing the fuser wrap sensor

250-sheet feeder pickup roller

- 1 Remove all paper from the 250-sheet feeder and then remove the 250-sheet feeder from the printer.
- 2 Press down the lift plate and pull the tray out of the feeder.
- 3 Turn the feeder upside-down.
- 4 Use a flatblade screwdriver to disengage the white, plastic lever, and then rotate the lever towards the front of the feeder to release the roller.
- 5 Lift the pickup roller up to remove it.

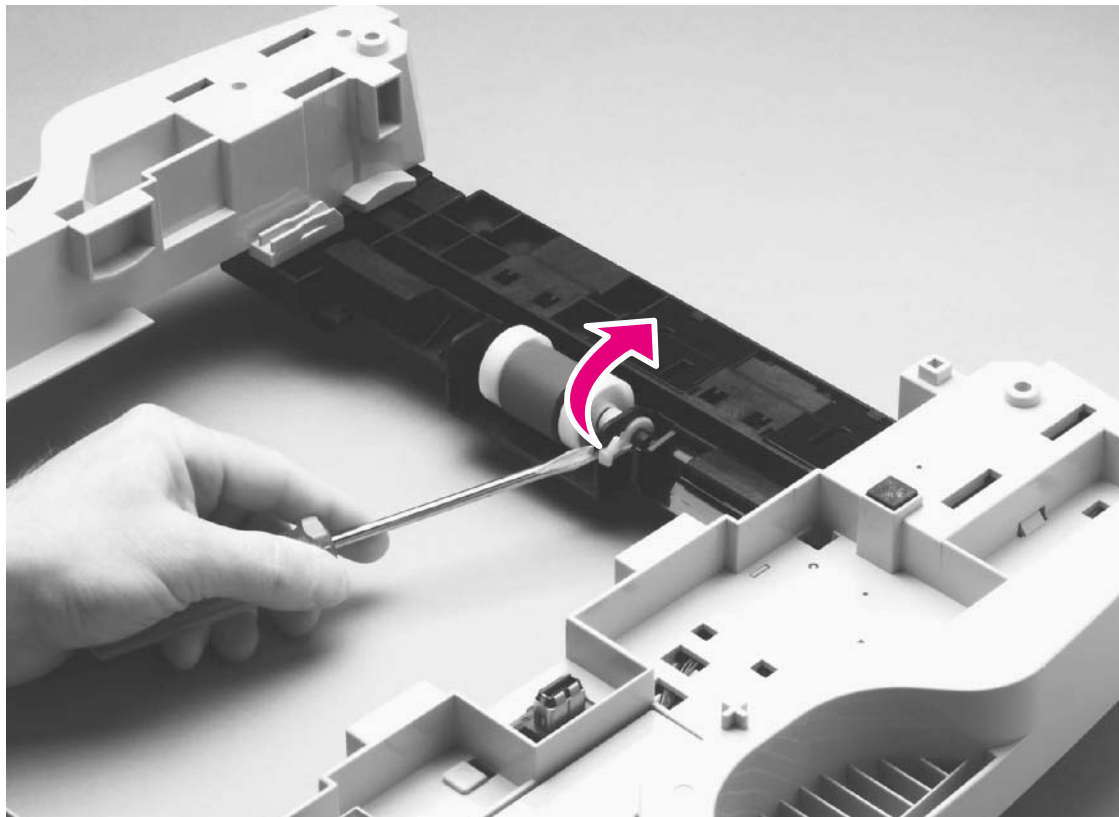

Figure 110. Removing the 250-sheet feeder pickup roller

250-sheet feeder cover

- 1 Use a flatblade screwdriver to release two tabs (callout 1).
- 2 Lift the cover up and away from the 250-sheet feeder.

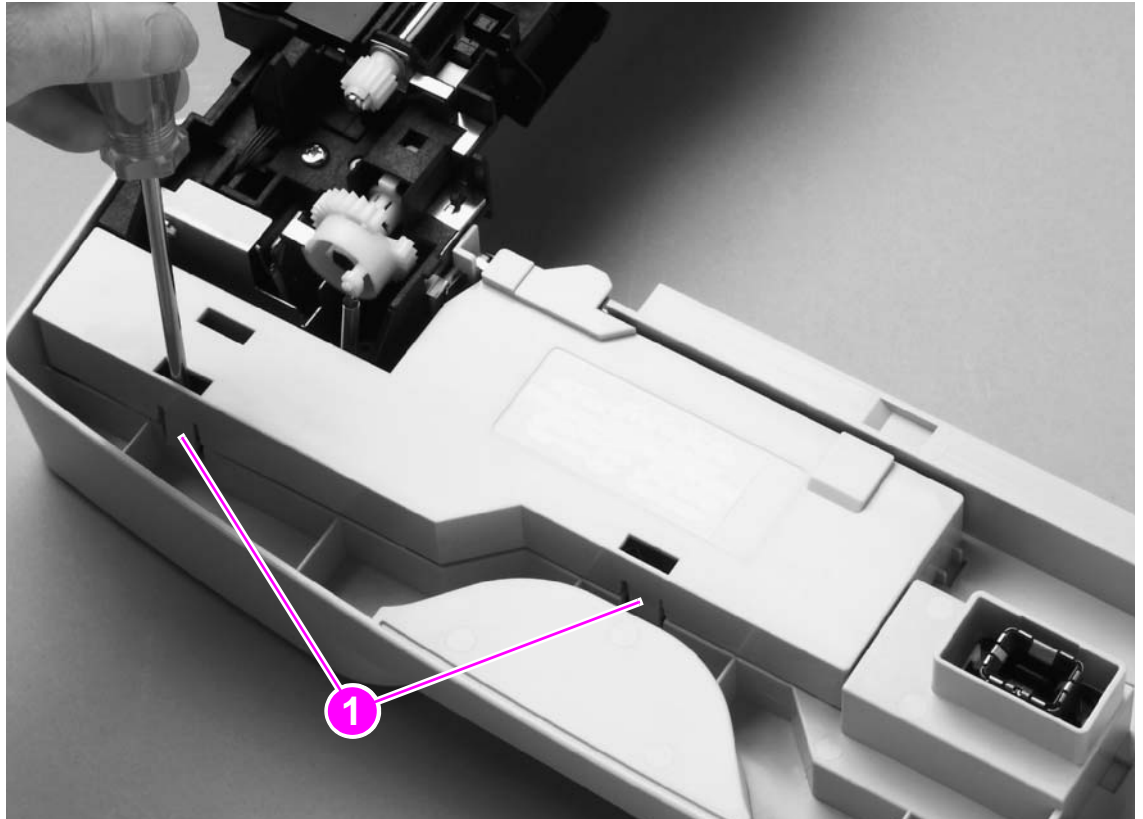

Figure 111.

Removing the 250-sheet feeder cover

250-sheet feeder PCA

- 1 Press the small tab to release one connector (callout 1).
- 2 Unplug the other three connectors (callout 2).
- 3 Remove one screw (callout 3) and lift the 250-sheet feeder PCA from the feeder.

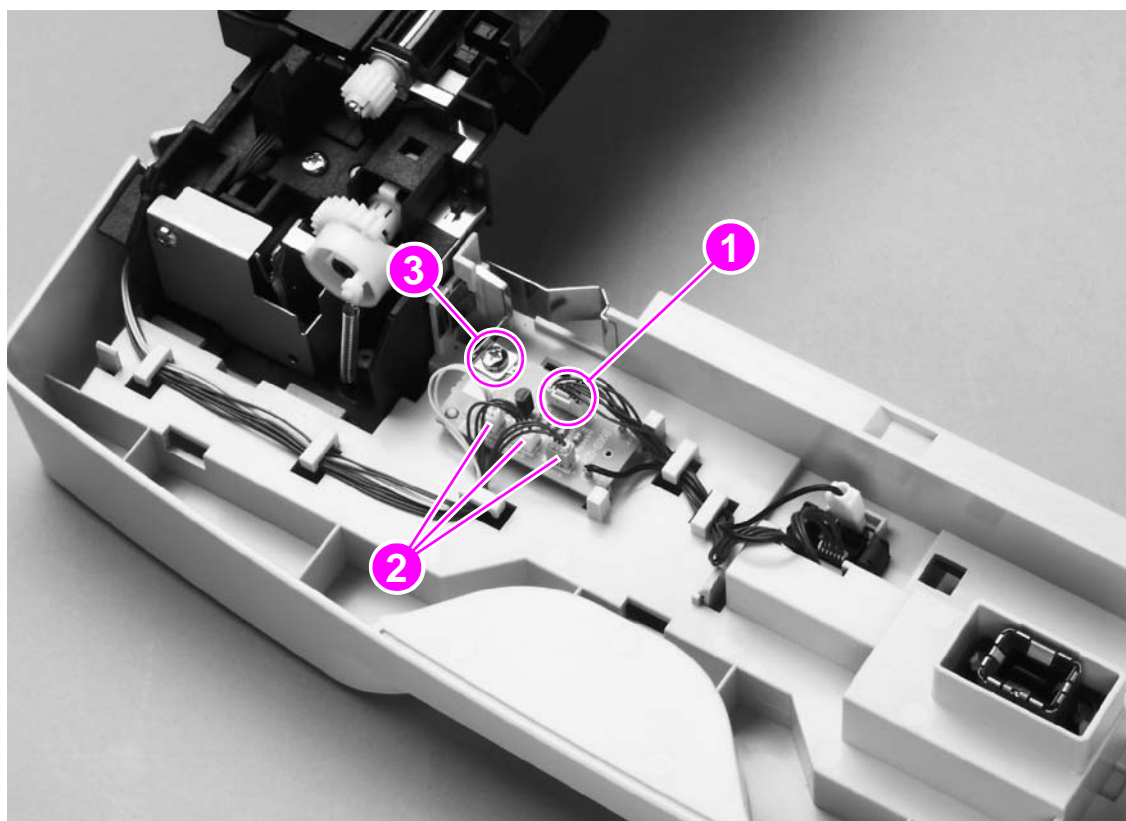

Figure 112. Removing the 250-sheet feeder PCA

500-sheet feeder pickup roller

Note

The 500-sheet feeder is available with HP color LaserJet 2500 series printers only.

- 1 Lift the printer off of the 500-sheet feeder.
- 2 Remove all paper from the 500-sheet feeder.
- 3 Press down the lift plate and pull the tray out of the feeder.
- 4 Turn the feeder so that it rests on its back side.
- 5 Insert the flatblade screwdriver into the slot (callout 1) on the right roller-shaft cover and then pry the cover off of the feeder.
- 6 Insert the flatblade screwdriver into the slot (callout 2) on the left roller-shaft cover and then pry the cover off of the feeder.

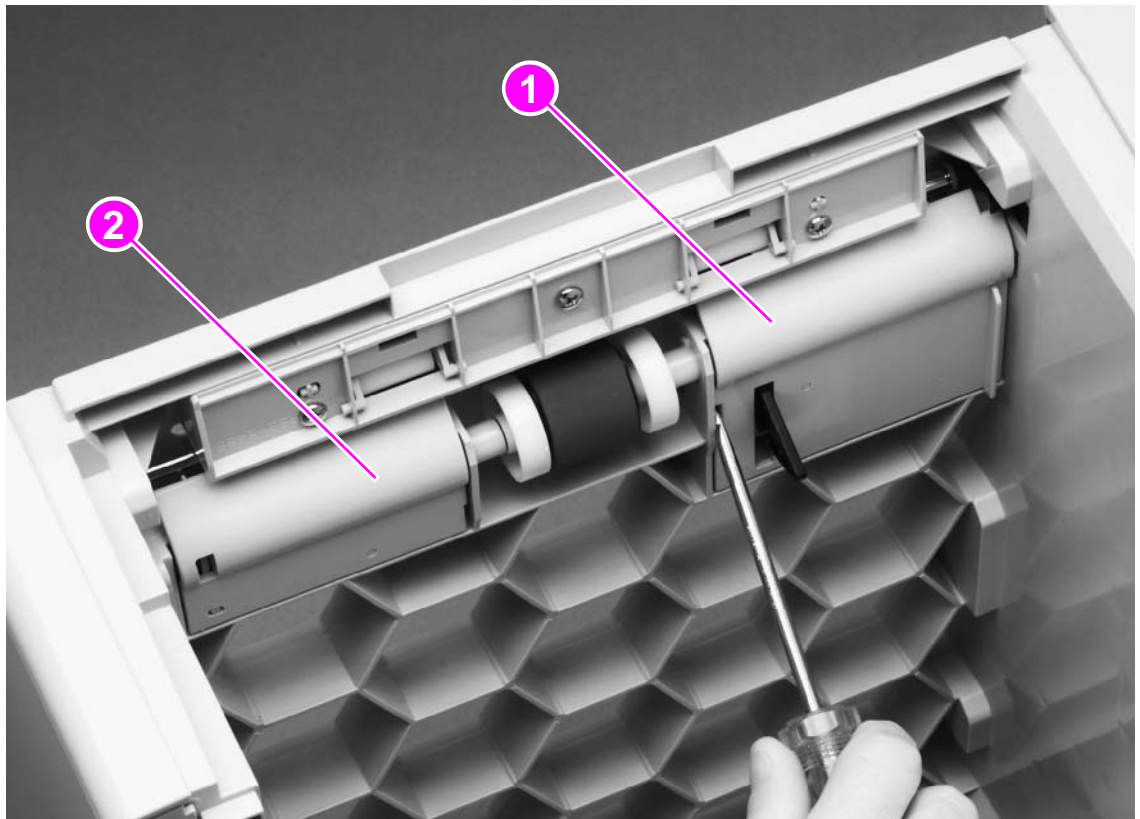

Figure 113. Removing the 500-sheet feeder pickup roller (1 of 2)

- 7 Use the flatblade screwdriver to disengage the white, plastic lever (callout 3), and then rotate the tab towards the front of the tray to release the roller.
- 8 Lift up the pickup roller to remove it.

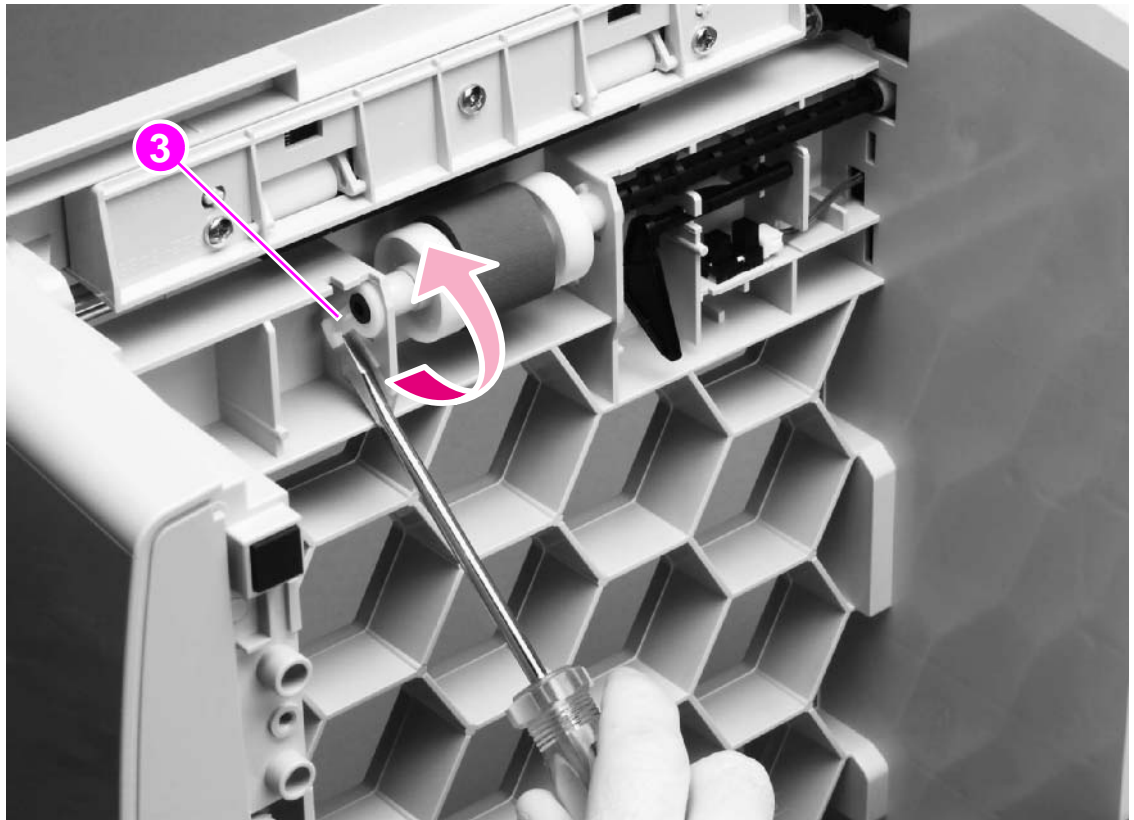

Figure 114.

Removing the 500-sheet feeder pickup roller (2 of 2)

500-sheet feeder cover

Note

The 500-sheet feeder is available with HP color LaserJet 2500 series printers only.

- 1 Turn the 500-sheet feeder so that it rests on its feet.
- 2 Use the flatblade screwdriver to pry up the cover, clearing two tabs (callout 1).
- 3 Rotate the cover away from the feeder to remove it.

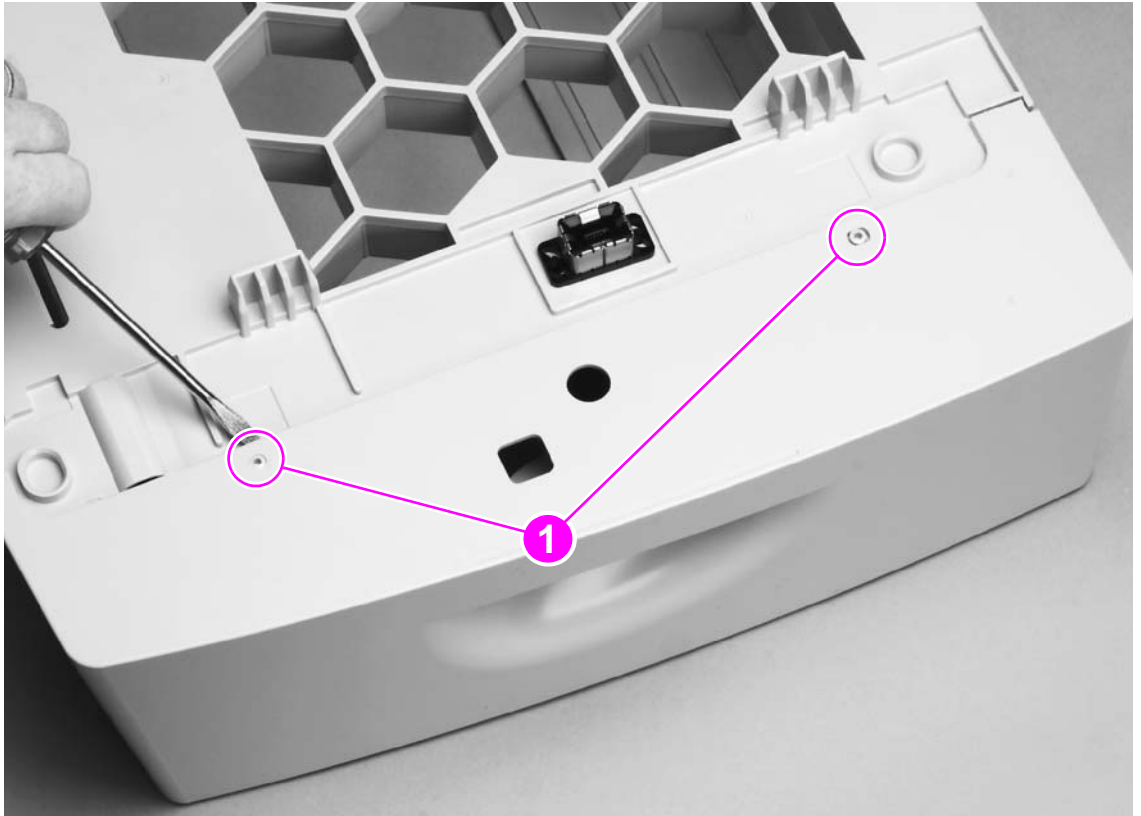

Figure 115.

Removing the 500-sheet feeder cover

500-sheet feeder motor

Note

The 500-sheet feeder is available with HP color LaserJet 2500 series printers only.

- 1 Unplug one connector (callout 1) from the motor.
- 2 Remove two screws (callout 2) and then lift the motor from the feeder

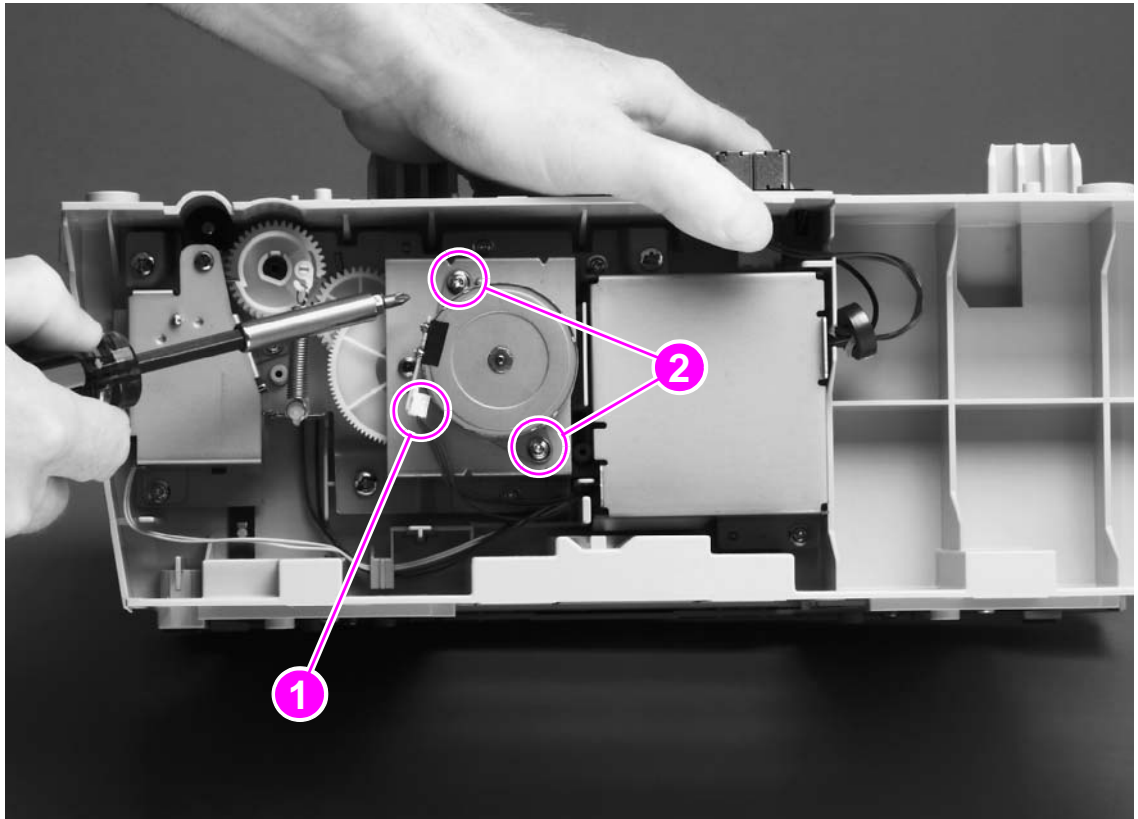

Figure 116.

Removing the 500-sheet feeder motor

6

Troubleshooting

Chapter contents

Basic troubleshooting	174
Clearing jams	176
Control panel light messages	181
Supplies Status lights	182
Printer Status lights	186
Attention with Ability to Continue secondary messages	189
Accessory error secondary messages	191
Service error secondary messages	193
Solving image-quality problems	195
Solving image-quality problems (all print jobs)	196
Solving image-quality problems (color print jobs)	203
Resolving problems that generated messages	206
Messages for both Windows and Macintosh	206
Messages for Windows only	206
Resolving problems that did not generate messages	207
Solving general printing problems	209
Solving PostScript (PS) errors	213
Solving common Macintosh problems	214
Manually rotating the print-cartridge carousel	216
Functional checks	218
Engine test	218
High-voltage power-supply check	219
Paper-path check	220
Service mode functions	221
Cold reset	221
NVRAM initializer	221
Using PJI commands	222
Troubleshooting tools	224
Demo page	224
Configuration page	224
Supplies Status page	226
Repetitive image defect ruler	227
General timing charts	228
Locations of connectors	231
Dc controller connections	234
Main wiring diagram	235
The HP Color LaserJet 2500 Series Toolbox	240

Basic troubleshooting

Table 21. Basic troubleshooting

#	Verification steps	Possible problems	Solutions		
1	<p>Does the printer turn on successfully? When the printer is connected to a grounded power source, the control panel lights should cycle one after another and the cartridge carousel should rotate.</p>	No power.	<p>1 Verify that the printer is plugged in.</p> <p>2 Verify that the power cable is functional and that the power on-off switch is on.</p>		
		Control panel lights do not cycle.	Verify that the control panel cable is seated into both the control panel and the formatter. If the cable is connected correctly, replace the control panel.		
2	<p>Is the printer ready? The printer should function without error-indicator light messages appearing on the control panel or error messages appearing on the Printer Status and Alerts screen.</p>	Control panel lights, other than the Ready light, are on or blinking.	Consult the lists of control panel light messages on page 181 to identify and correct the error.		
		An error message appears in the Printer Status and Alerts screen.	See "Resolving problems that generated messages" on page 206.		
		There is a problem, but no control panel lights are on or blinking, and no messages appear on the Printer Status and Alerts screen.	See "Resolving problems that did not generate messages" on page 207.		
3	<p>Do engine tests and information pages print? Print an engine test (see page 218). The engine test should print without paper-feed problems or print-quality problems. Also print a Demo page or a configuration page (see page 224).</p>	<p>Note</p> <hr/> <p>The engine test is not successful.</p> <ul style="list-style-type: none"> The engine test produces a blank page. The engine test does not produce any pages. 	<p>The formatter must be connected to a power source to perform an engine test.</p> <hr/> <p>Turn off the printer, turn on the printer, and perform another engine test.</p> <hr/> <p>Replace the low-voltage power supply.</p> <hr/> <p>Replace the dc controller.</p>		
		An error-indicator light message appears on the control panel.	Consult the lists of control panel light messages on page 181 to identify and correct the error.		
		Printer Status and Alerts software generates an error message.	See "Resolving problems that generated messages" on page 206.		
		Poor print quality.	See "Solving image-quality problems" on page 195.		
		Software is not installed or an error occurred during software installation.	Uninstall and then reinstall the printer software. Make sure that you use the correct installation procedure and the correct port setting.		
		4	<p>Is the software installed correctly?</p>	<p>Software is not installed or an error occurred during software installation.</p>	<p>Uninstall and then reinstall the printer software. Make sure that you use the correct installation procedure and the correct port setting.</p>

Table 21. Basic troubleshooting

#	Verification steps	Possible problems	Solutions
5	Does the printer print from the computer? Connect the parallel cable (HP color LaserJet 2500 series printer only) or USB cable to the printer and to the computer. Use a word-processing application to send a print job to the printer.	A USB cable and a parallel cable are both connected to the printer (HP color LaserJet 2500 series printer only).	When both cables are connected, the USB automatically disables itself. Disconnect both cables and then reinstall the one you want to use.
		The cable is not connected correctly.	Reconnect the cable.
		An incorrect printer driver is selected.	Reset the printer driver. (Check for the correct port setting.)
		Other devices are connected to the parallel port (HP color LaserJet 2500 series printer only).	Disconnect the other devices and try to print again. Also, try connecting directly to the computer or through a powered USB hub.

Clearing jams

Occasionally, paper or other print media can become jammed during a print job. Causes include the following:

- Input trays are loaded improperly or are overfilled.
- Optional tray 2 or optional tray 3 (HP color LaserJet 2500 series printer only) is removed during a print job.
- The top cover is opened during a print job.
- Too many sheets have accumulated in an output area or blocked an output area.
- The media being used does not meet HP specifications. See the user guide for information about print-media specifications.
- The environment in which the paper was stored is too humid or too dry. See the user guide for information about print-media specifications.
- Non-HP supplies are installed in the printer.

Where to look for jams

Jams can occur in these locations:

- Inside the printer. See “To clear jams from inside the printer” on page 177.
- In input areas. See “To clear jams from input areas” on page 178.
- In output areas. See “To clear jams from output areas” on page 179.

Find and remove the jam by using the instructions on the following pages. If the location of the jam is not obvious, look first inside the printer.

Loose toner might remain in the printer after a jam. This problem should resolve itself after a few sheets have been printed. See “Loose toner” on page 199.

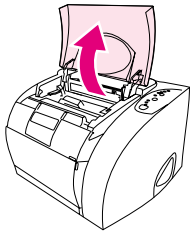
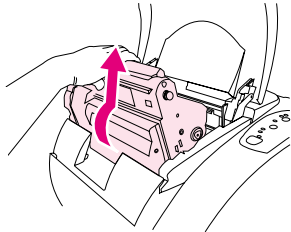
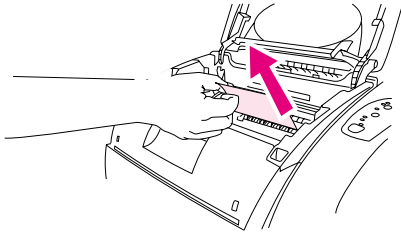
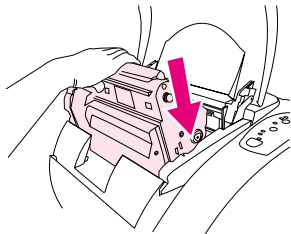
1**2****3****4**

To clear jams from inside the printer

CAUTION

Jams in this area might result in loose toner on the page. If you get toner on your clothes or hands, wash them in cold water. (Hot water sets toner into fabric.)

- 1 Open the top cover.
- 2 Remove the *imaging drum* by pushing it away from you and lifting it out of the printer.

Note

You *cannot* reach jams by removing the print cartridges.

- 3 Complete one of these steps:
 - If the leading edge or the trailing edge of the print media is visible, carefully pull the sheet out of the printer.
 - If the media is too difficult to remove, clear the jam as described in "To clear jams from output areas" on page 179.
- 4 After the jam has been removed, replace the imaging drum and close the top cover.
- 5 Press  (Go) if the Go light is blinking. If the Attention light is still blinking, then another jam is present. See "To clear jams from input areas" on page 178 and "To clear jams from output areas" on page 179.

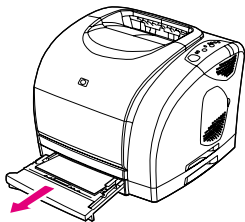
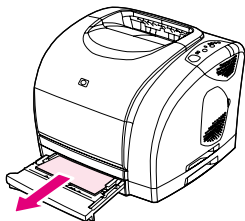
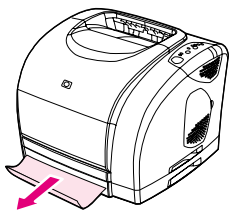
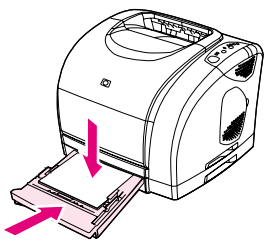
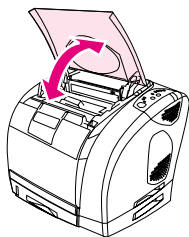
1**2****3****4****5**

To clear jams from input areas

- 1 Open optional tray 2 or optional tray 3 (HP color LaserJet 2500 series printer only) to expose the jam.
- 2 Complete one of these steps:
 - If the media has already partially entered the printer, see “To clear jams from inside the printer” on page 177.
 - If the jam is only in the input tray, remove the jammed media by pulling it out by the visible edge. Realign all of the media in the tray and proceed to step 4.
- 3 If you could not remove the jammed media from inside the printer or by pulling it out of the tray, grasp the sheet from the outside of the printer and carefully pull it free.
- 4 Push the paper down to lock the metal lift plate into place and slide the tray back into the printer.
- 5 Open the top cover, close it again, and then press  (Go) if the Go light is blinking. If the Attention light is still blinking, then another jam is present. See “To clear jams from inside the printer” on page 177 and “To clear jams from output areas” on page 179.

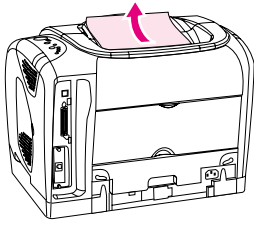
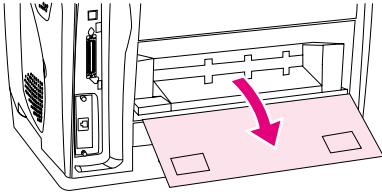
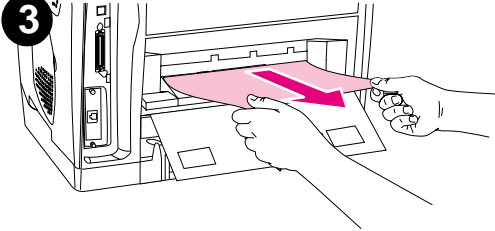
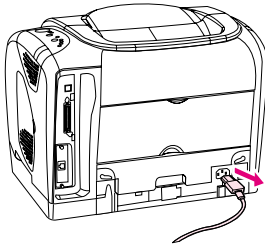
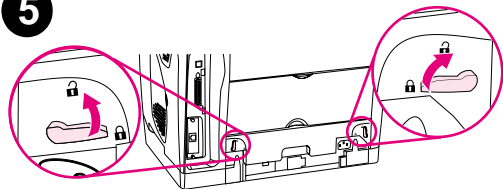
1**2****3****4****5**

To clear jams from output areas

CAUTION

Jams in these areas might result in loose toner on the page. If you get toner on your clothes or hands, wash them in cold water. (Hot water sets toner into fabric.)

1 Complete one of these steps:

- If the media is not almost completely visible from the top output bin, proceed to step 2.
- If the media is almost completely visible, pull it carefully out of the printer and proceed to step 9.

2 Open the rear output door.

3 If the leading edge of the media is visible from the rear opening, carefully pull the it out.

4 If the jam is too far into the printer to remove, turn off the printer and disconnect the power cable.

CAUTION

Always turn off the printer and disconnect the power cable before you remove the fuser.

5 Rotate the locks on the fuser to the unlocked position.

6

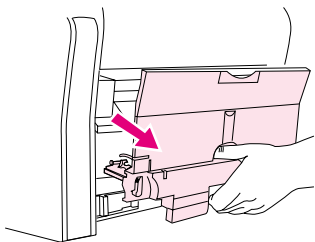



- 6 Grasp the fuser handles and pull to remove the fuser from the printer.

WARNING!

The parts on the internal surface of the fuser are very hot. To avoid burning yourself, do not touch those parts.

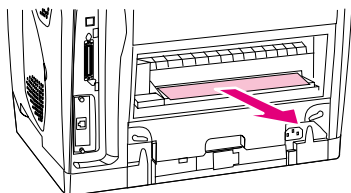
7



- 7 Using both hands, slowly and steadily remove any media from inside the printer. Then, carefully reinsert the fuser and secure the locks.
- 8 Reconnect the power cable and turn on the printer.
- 9 Open the top cover, close it again, and then press  (Go) if the Go light is flashing. If the Attention light is still blinking, then there is another jam. See “To clear jams from inside the printer” on page 177 and “To clear jams from input areas” on page 178.

Control panel light messages

Note

For non-error status messages, see “Supplies Status lights” on page 182 and “Printer Status lights” on page 186.

Each error message is listed in the following tables along with possible causes and steps to resolve the identified errors. See figure 117 and table 22 for descriptions of the control panel elements and a legend for understanding the tables.

Use the HP color LaserJet 1500 series Toolbox or the HP color LaserJet 2500 series Toolbox to view animations of the light patterns and to see their messages. For the HP color LaserJet 2500 series printers, you can also use the embedded Web server to see a text message that correlates with the light pattern.

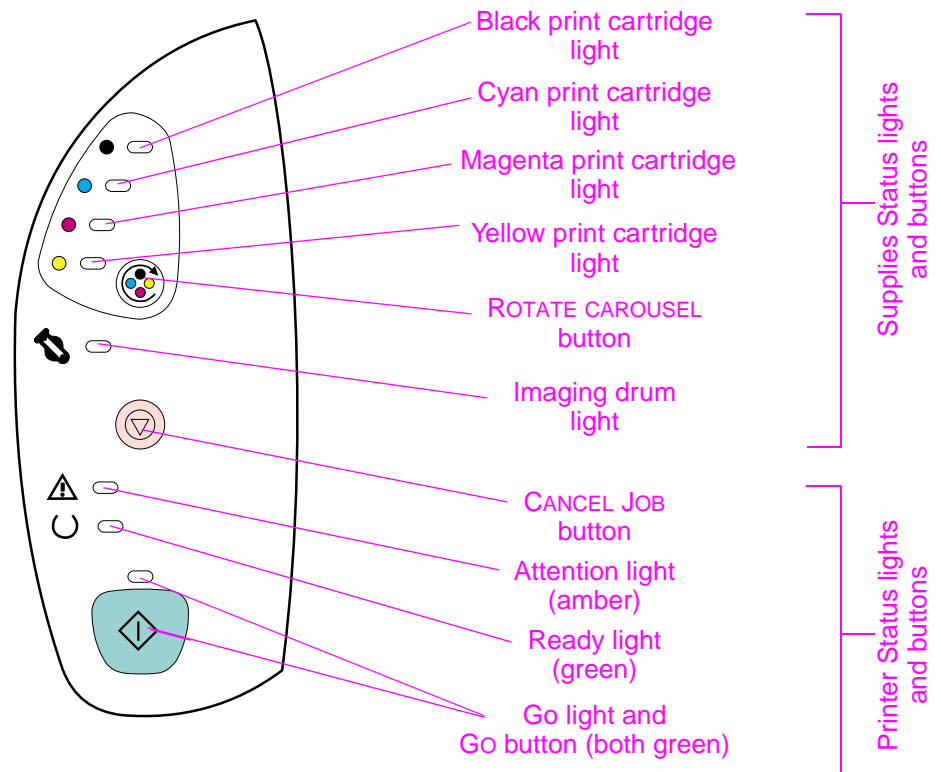

Figure 117. Control panel lights

Table 22. Control panel lights legend

Light symbol	Meaning of symbol
	Light off
	Light on
	Light blinking

Supplies Status lights

This section describes the meaning of the patterns for the lights in the Supplies Status area. Information about supplies also appears in the Printer Status and Alerts software, the embedded Web server (HP color LaserJet 2500 series printers only), and the Toolbox. For more information about how to use and view the embedded Web server, see page 47.

Table 23. Supplies Status light messages

Message	Possible causes	Solutions
	The black print cartridge is low.	<ol style="list-style-type: none"> 1 The printer continues to print without any action required until the print cartridge is empty. 2 Order a new print cartridge.
	The cyan print cartridge is low.	<ol style="list-style-type: none"> 1 The printer continues to print without any action required until the print cartridge is empty. 2 Order a new print cartridge.
	The magenta print cartridge is low.	<ol style="list-style-type: none"> 1 The printer continues to print without any action required until the print cartridge is empty. 2 Order a new print cartridge.
	The yellow print cartridge is low.	<ol style="list-style-type: none"> 1 The printer continues to print without any action required until the print cartridge is empty. 2 Order a new print cartridge.
	The imaging drum is low.	<ol style="list-style-type: none"> 1 The printer continues to print without any action required until the imaging drum fails. 2 Order a new imaging drum.

Table 23. Supplies Status light messages (continued)

Message	Possible causes	Solutions
	<p>The black-print-cartridge light is blinking, and the printer stops printing.</p>	<ul style="list-style-type: none"> ● The print cartridge is empty or missing. ● The printer cannot detect the print cartridge correctly. <ol style="list-style-type: none"> 1 Reinsert or replace the print cartridge. 2 If the print-cartridge light is still blinking but the Attention light is not on, turn the printer off and then back on. 3 If the problem persists, repeat steps 1 and 2 with black print cartridges until the error is resolved. 4 If the problem persists, replace the print-cartridge E-label reader, which is located on the pressure assembly of the print-cartridge carousel.
	<p>The cyan-print-cartridge light is blinking, and the printer stops printing.</p>	<ul style="list-style-type: none"> ● The print cartridge is empty or missing. ● The printer cannot detect the print cartridge correctly. <ol style="list-style-type: none"> 1 Reinsert or replace the print cartridge. 2 If the print-cartridge light is still blinking but the Attention light is not on, turn the printer off and then back on. 3 If the problem persists, repeat steps 1 and 2 with cyan print cartridges until the error is resolved. 4 If the problem persists, replace the print-cartridge E-label reader, which is located on the pressure assembly of the print-cartridge carousel.
	<p>The magenta-print-cartridge light is blinking, and the printer stops printing.</p>	<ul style="list-style-type: none"> ● The print cartridge is empty or missing. ● The printer cannot detect the print cartridge correctly. <ol style="list-style-type: none"> 1 Reinsert or replace the print cartridge. 2 If the print-cartridge light is still blinking but the Attention light is not on, turn the printer off and then back on. 3 If the problem persists, repeat steps 1 and 2 with magenta print cartridges until the error is resolved. 4 If the problem persists, replace the print-cartridge E-label reader, which is located on the pressure assembly of the print-cartridge carousel.
	<p>The yellow-print-cartridge light is blinking, and the printer stops printing.</p>	<ul style="list-style-type: none"> ● The print cartridge is empty or missing. ● The printer cannot detect the print cartridge correctly. <ol style="list-style-type: none"> 1 Reinsert or replace the print cartridge. 2 If the print-cartridge light is still blinking but the Attention light is not on, turn the printer off and then back on. 3 If the problem persists, repeat steps 1 and 2 with yellow print cartridges until the error is resolved. 4 If the problem persists, replace the print-cartridge E-label reader, which is located on the pressure assembly of the print-cartridge carousel.

Table 23. Supplies Status light messages (continued)



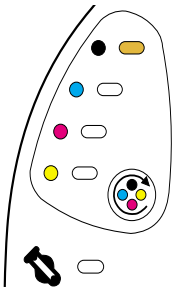
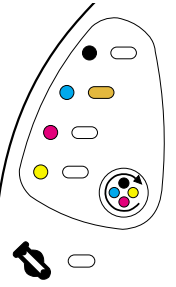
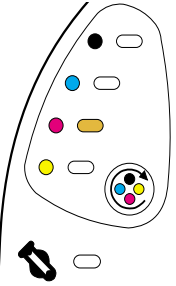
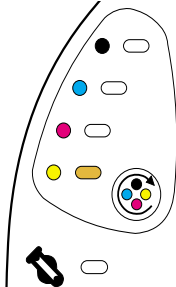
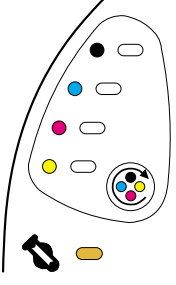



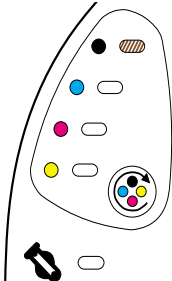
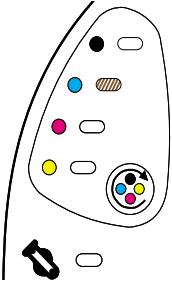
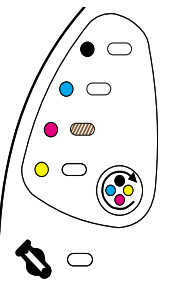
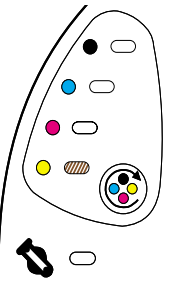

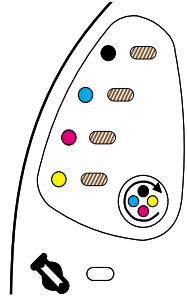
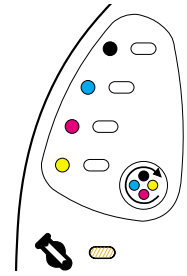
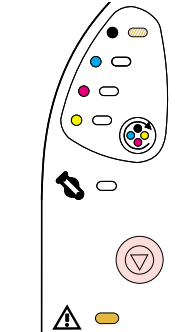

Message	Possible causes	Solutions
	<p>The four print-cartridge lights are blinking, and the printer stops printing.</p> <ul style="list-style-type: none"> • The print cartridges are empty or missing. • The printer cannot detect the print cartridges correctly. 	<ol style="list-style-type: none"> 1 Replace any non-HP print cartridges with HP print cartridges. 2 Reinsert or replace the print cartridges. 3 If the print-cartridge lights are still blinking but the Attention light is not on, turn the printer off and then back on. 4 If the problem persists, repeat steps 1 through 3 with sets of print cartridges until the error is resolved. 5 If the problem persists, replace the print-cartridge E-label reader, which is located on the pressure assembly of the print-cartridge carousel.
	<p>The imaging-drum light is blinking, and the printer stops printing.</p> <ul style="list-style-type: none"> • The imaging drum is empty or missing. • The printer cannot detect the imaging drum correctly. 	<ol style="list-style-type: none"> 1 Reinsert or replace the imaging drum. 2 If the imaging-drum light is still blinking but the Attention light is not on, turn the printer off and then back on. 3 If the problem persists, repeat steps 1 and 2 with imaging drums until the error is resolved. 4 If the problem persists, replace the imaging-drum E-label reader (see page 133).
	<p>The black-print-cartridge light is blinking and the Attention light is on. The printer stops printing.</p> <p>The black print cartridge is a non-HP print cartridge.</p> <p>CAUTION: If you continue printing after this print cartridge is empty, the printer can be damaged. See “Hewlett-Packard limited warranty statement” on page 26.</p>	<p>If you still want to use this non-HP print cartridge, press  (CANCEL JOB) to continue printing.</p> <p>NOTE: You will not receive any indication from the printer Supplies Status lights, the Supplies Status page, or any software component (the Toolbox, Printer Status and Alerts, or the HP color LaserJet 2500 series printers’ embedded Web server) when this print cartridge is low or empty.</p>
	<p>The cyan-print-cartridge light is blinking and the Attention light is on. The printer stops printing.</p> <p>The cyan print cartridge is a non-HP print cartridge.</p> <p>CAUTION: If you continue printing after this print cartridge is empty, the printer can be damaged. See “Hewlett-Packard limited warranty statement” on page 26.</p>	<p>If you still want to use this non-HP print cartridge, press  (CANCEL JOB) to continue printing.</p> <p>NOTE: You will not receive any indication from the printer Supplies Status lights, the Supplies Status page, or any software component (the Toolbox, Printer Status and Alerts, or the HP color LaserJet 2500 series printers’ embedded Web server) when this print cartridge is low or empty.</p>

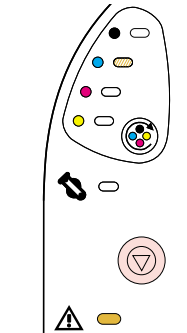
Table 23. Supplies Status light messages (continued)

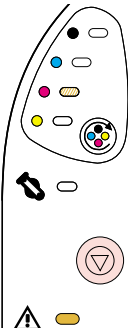
Message	Possible causes	Solutions
	<p>The magenta-print-cartridge light is blinking and the Attention light is on. The printer stops printing.</p>	<p>The magenta print cartridge is a non-HP print cartridge.</p> <p>CAUTION: If you continue printing after this print cartridge is empty, the printer can be damaged. See “Hewlett-Packard limited warranty statement” on page 26.</p> <p>If you still want to use this non-HP print cartridge, press  (CANCEL JOB) to continue printing.</p> <p>NOTE: You will not receive any indication from the printer Supplies Status lights, the Supplies Status page, or any software component (the Toolbox, Printer Status and Alerts, or the HP color LaserJet 2500 series printers’ embedded Web server) when this print cartridge is low or empty.</p>
	<p>The yellow-print-cartridge light is blinking and the Attention light is on. The printer stops printing.</p>	<p>The yellow print cartridge is a non-HP print cartridge.</p> <p>CAUTION: If you continue printing after this print cartridge is empty, the printer can be damaged. See “Hewlett-Packard limited warranty statement” on page 26.</p> <p>If you still want to use this non-HP print cartridge, press  (CANCEL JOB) to continue printing.</p> <p>NOTE: You will not receive any indication from the printer Supplies Status lights, the Supplies Status page, or any software component (the Toolbox, Printer Status and Alerts, or the HP color LaserJet 2500 series printers’ embedded Web server) when this print cartridge is low or empty.</p>
	<p>The imaging-drum light is blinking and the Attention light is on. The printer stops printing.</p>	<p>The imaging drum is a non-HP imaging drum.</p> <p>CAUTION: If you continue printing after this imaging drum is empty, the printer can be damaged. See “Hewlett-Packard limited warranty statement” on page 26.</p> <p>If you still want to use this non-HP imaging drum, press  (CANCEL JOB) to continue printing.</p> <p>NOTE: You will not receive any indication from the printer Supplies Status lights, the Supplies Status page, or any software component (the Toolbox, Printer Status and Alerts, or the HP color LaserJet 2500 series printers’ embedded Web server) when this imaging drum is low or empty.</p>

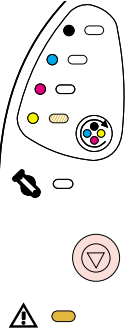
Printer Status lights

The following section describes the meaning of the light patterns in the Printer Status area. With the HP color LaserJet 2500 series printer, information about the printer status also appears in the Printer Status and Alerts software and the embedded Web server. For more information about how to use and view the embedded Web server, see page 47.

Several errors have secondary light patterns, which provide more information about the specific type of error that occurred. The following errors types have secondary light patterns:

- Attention with Ability to Continue errors (see page 189)
- Accessory errors (see page 191)
- Service errors (see page 193)

Table 24. Printer Status light messages







Message	Possible causes	Solutions
<p>All control panel lights</p> 	<p>All control panel lights cycle one after another.</p> <p>The printer is in Startup state.</p>	<p>Pressing buttons has no effect until the printer is in the Ready state.</p>
<p>The Ready (green) light is on and the printer is ready to print.</p> 	<p>The printer is in Ready state.</p>	<ul style="list-style-type: none"> ● No action is needed. ● Pressing  (Go) prints a Demo page. ● Pressing  (Go) and  (CANCEL JOB) simultaneously prints a Configuration page and a Supplies Status page, as well as an HP Jetdirect page if an HP Jetdirect print server card is installed (HP color LaserJet 2500 series printer only).
<p>The Ready (green) light is blinking.</p> 	<p>The printer is receiving or processing data.</p>	<p>Pressing  (CANCEL JOB) cancels the current job. One or two pages might print as the printer clears the print job. The printer returns to the Ready state (Ready light on) after the job has been canceled.</p>
<p>The Attention (amber) light is blinking.</p> 	<p>Attention error. The top cover is open.</p> <p>Attention error. The printer is out of media.</p> <p>Attention error. The printer has a jam.</p>	<p>Close the top cover.</p> <p>Load media.</p> <p>Clear the jam (see pages 176 through 180). If the location of the jam is not apparent, check the embedded Web server (HP color LaserJet 2500 series printers only) to find the jam location.</p> <ul style="list-style-type: none"> ● If the jam is under the imaging drum, toggle the registration sensor to check its movement and replace the registration sensor if it does not move freely. ● If the jam is in the fuser area, toggle the fuser exit sensor to check its movement and replace the fuser exit sensor if it does not move freely.

Table 24. Printer Status light messages (continued)

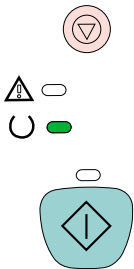
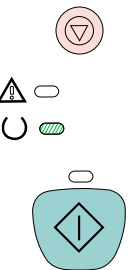



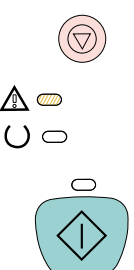





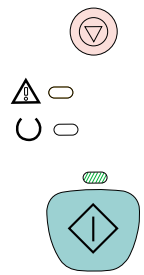



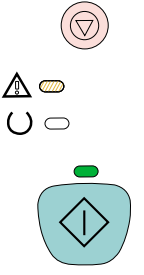





Message	Possible causes	Solutions
	<p>The Go (green) light is blinking.</p> <ul style="list-style-type: none"> The top cover has been opened and then closed You pressed  (ROTATE CAROUSEL). 	<ul style="list-style-type: none"> Pressing  (Go) returns the printer to the Ready state. If you do not press  (Go), the printer automatically returns to the Ready state after approximately 10 seconds. Pressing  (ROTATE CAROUSEL) brings another print cartridge to the top position.
	<p>The Attention light is blinking and the Go light is on. The printer stops printing.</p> <p>A manual-feed job was sent to the printer, and the printer is waiting for the special media.</p>	<ol style="list-style-type: none"> Load media into tray 1. If the printer does not begin printing after the media has been reloaded, press  (Go). Or, press  (Go) to try to print from another tray if another tray is installed.
	<p>The printer has finished printing the first side of a manual-duplex job, and the printer is waiting for the pages to be reloaded so it can print the second side.</p>	<ol style="list-style-type: none"> Reload the pages. If the printer does not begin printing after the pages have been reloaded, press  (Go).
	<p>Someone is trying to print by Source (tray) and there is no media in the selected tray.</p>	<ol style="list-style-type: none"> Add media to the selected tray to print from it. Press  (Go) to try to print from another tray.
	<p>The print image is larger than the size of media in the tray.</p>	<p>Load the correct-size media and press  (Go).</p>
	<p>The printer has an Attention with Ability to Continue error.</p>	<ol style="list-style-type: none"> Press  (Go) for the printer to attempt to recover from the error and print whatever data it can. If successful, the printer completes the job while the Ready light blinks. If unsuccessful, the Attention with Ability to Continue message continues to appear. Perform one of these steps: <ul style="list-style-type: none"> Press and hold  (Go) and  (CANCEL JOB) simultaneously to see a secondary light pattern. (See "Attention with Ability to Continue secondary messages" on page 189.) Press  (CANCEL JOB) to cancel the print job. If the problem has been resolved, the printer returns to the Ready state (Ready light on)
	<p>The Attention light, Ready light, and Go light are blinking. The printer stops printing, and pressing any button has no effect.</p> <p>Accessory error. An error has occurred with either the EIO port or a DIMM slot.</p>	<p>Press and hold  (Go) and  (CANCEL JOB) simultaneously to see a secondary light pattern. (See "Accessory error secondary messages" on page 191.)</p>

Table 24. Printer Status light messages (continued)

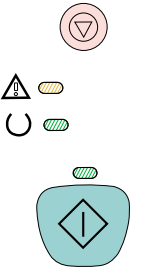
Message	Possible causes	Solutions
	<p>The Attention light, Ready light, and Go light are on. The printer stops printing, and pressing any button has no effect. Perform these steps.</p>	<p>Service error.</p> <ol style="list-style-type: none"> <li data-bbox="914 191 1465 275">1 If the printer is connected to a power strip or surge protector, disconnect it and connect the power cable directly to a working wall outlet. <li data-bbox="914 289 1465 373">2 Turn the printer off and then back on. If the problem persists, leave the printer off for 15 minutes to reset the printer. <li data-bbox="914 388 1465 506">3 If the problem continues, press and hold  (Go) and  (CANCEL JOB) simultaneously to see a secondary light pattern. (See “Service error secondary messages” on page 193.)

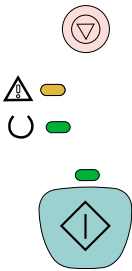

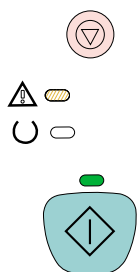
Attention with Ability to Continue secondary messages

If the printer has an Attention with Ability to Continue error (the Attention light is blinking and the Go light is on), press and hold  (Go) and  (CANCEL JOB) simultaneously to see the secondary error message.

You can also view the embedded Web server (HP color LaserJet 2500 series printers only), which provides a text message that corresponds to the error and its secondary light pattern. For more information about how to use and view the embedded Web server, see page 47.

Table 25. Attention with Ability to Continue secondary messages











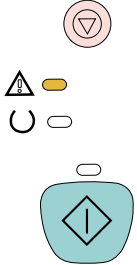

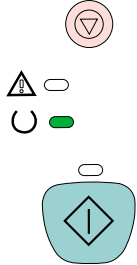

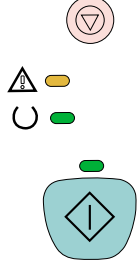

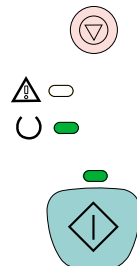
Message	Error and recommended action
	<p>20 Insufficient Memory error</p> <p>NOTE: This error can occur only with an HP color LaserJet 2500 series printer.</p> <p>The Attention light is on. The printer memory is full or the flat formatter cable is disconnected.</p> <p>Ensure that the flat formatter cable is connected. Press  (Go) to resume printing. If you lose some data, try to free some printer memory by removing any unnecessary fonts, macros, or any data currently in printer memory. If you continue to lose data, you might need to add more printer memory. For a temporary solution, simplify the image.</p>
	<p>41.3 Unexpected Size error or 41.x Printer error</p> <p>The Ready light is on.</p> <ol style="list-style-type: none"> 1 Load the correct size of media. If the correct size is loaded, press  (Go). 2 If printing does not resume, open the top cover, remove the imaging drum, and check for a jam inside the printer. 3 Turn off the printer for approximately 10 seconds, and then turn on the printer to power cycle the printer.
	<p>40 Bad Transmission error</p> <p>The Attention light, Ready light, and Go light are on.</p> <ol style="list-style-type: none"> 1 Press  (Go) to try to print a portion of the job. 2 If the printer is connected to the network, make sure that the cable is securely connected between the HP Jetdirect print server card and the network port. 3 If the printer is directly connected to a computer, the cable between the printer and computer has a bad connection or the cable is of poor quality. Disconnect the cable and reconnect it. Make sure that you are using a high-quality USB cable or IEEE-1284-compliant, size-B parallel cable (HP color LaserJet 2500 series printers only). 4 If the error persists, replace the appropriate cable.
	<p>22 Buffer Overflow error</p> <p>The Ready light and Go light are on.</p> <ol style="list-style-type: none"> 1 Press  (Go) to try to print a portion of the job. 2 The connection between the printer and the computer might be loose. Turn the printer off and check the cable connection to make sure that it is secure. 3 The cable is malfunctioning. Try using a different, high-quality USB cable or IEEE-1284-compliant, size-B parallel cable (HP color LaserJet 2500 series printers only). See chapter 7 for ordering information. 4 If the error persists, reduce the complexity of the print job, and try again to print.

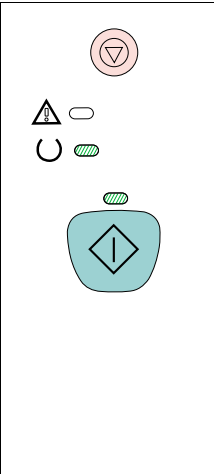
Table 25. Attention with Ability to Continue secondary messages (continued)

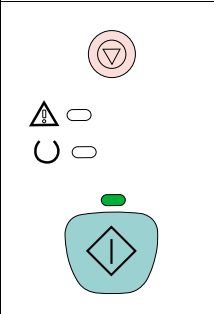

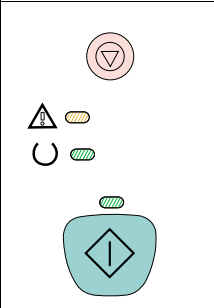
 <p>The icons in this section include: a warning triangle with a downward arrow, a ready light (triangle with a downward arrow), a go light (circle with a rightward arrow), and a printer icon with a diamond-shaped light on top.</p>	<h3>Chosen Personality Not Available error</h3> <p>NOTE: This error can occur only with an HP color LaserJet 2500 series printer.</p> <p>The Ready light and Go light are blinking. The current job was canceled because the printer language (personality) is not supported or the carousel is not positioned correctly.</p> <ol style="list-style-type: none">1 Ensure that the carousel is positioned correctly.2 Press  (Go) to clear the message.3 If you printed the job using one of the PCL drivers, try printing using the PS driver, or vice versa.4 Turn off the printer and remove or replace the language font DIMM (HP color LaserJet 2500 series printers only). <p>CAUTION: You must turn off the printer before inserting or removing DIMMs.</p>
 <p>The icons in this section include: a warning triangle with a downward arrow, a ready light (triangle with a downward arrow), a go light (circle with a rightward arrow), and a printer icon with a diamond-shaped light on top.</p>	<h3>Data Received error</h3> <p>NOTE: This error can occur only with an HP color LaserJet 2500 series printer.</p> <p>The Go light is on.</p> <p>The printer received data and is waiting for a form feed. Press  (Go) to print the last page. Sending another print job can also cause the page to print.</p>
 <p>The icons in this section include: a warning triangle with a downward arrow, a ready light (triangle with a downward arrow), a go light (circle with a rightward arrow), and a printer icon with a diamond-shaped light on top.</p>	<h3>General Attention with Ability to Continue error</h3> <p>The Attention light, Ready light, and Go light are blinking.</p> <ol style="list-style-type: none">1 Press  (Go) to try to continue printing.2 If the error persists, switch printer drivers and try again to print.
 <p>The icons in this section include: a warning triangle with a downward arrow, a ready light (triangle with a downward arrow), a go light (circle with a rightward arrow), and a printer icon with a diamond-shaped light on top.</p>	<h3>68.x Permanent Storage error</h3> <p>The Attention light is blinking. The nonvolatile memory (NVRAM) is temporarily full.</p> <ol style="list-style-type: none">1 Press  (Go) to clear the message. Check the printer settings.2 Remove the Jetdirect card, if it is installed (HP color LaserJet 2500 series printers only), and then perform a cold reset (see page 221).3 Perform a NVRAM init (see page 221).

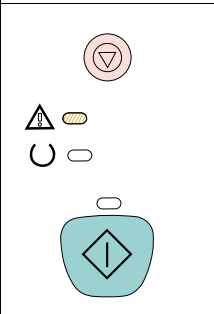
Accessory error secondary messages

Note

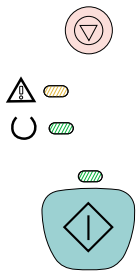
The following errors can occur only with HP color LaserJet 2500 series printers.



If the printer has an Accessory error (the Attention light, Ready light, and Go light are blinking), press and hold  (GO) and  (CANCEL JOB) simultaneously to see the secondary error message.

You can also view the embedded Web server (HP color LaserJet 2500 series printers only), which provides a text message that corresponds to the error and its secondary light pattern. For more information about how to use and view the embedded Web server, see page 47.

Table 26. Accessory error secondary messages







Message	Error and recommended action
	<p>8x.yyyy EIO error The Attention light is blinking. A problem exists with the print server card.</p> <p>CAUTION: You must turn off the printer before inserting or removing the print server card to avoid damaging the print server card.</p> <ol style="list-style-type: none"> 1 Remove the print server card and reinstall it to make sure that it is correctly installed. 2 Make sure that you are using a supported print server card. See chapter 7 for ordering information. 3 To continue printing, remove the print server card from the EIO port and connect a parallel or USB cable. You must change the port or reinstall the software. 4 If the print server card still is not working, replace the print server.
	<p>53.x1.zz Printer (DIMM Slot 1) error The Go light is on. A problem exists with the DIMM in DIMM slot 1.</p> <p>CAUTION: You must turn off the printer before inserting or removing DIMMs to avoid damaging them.</p> <ol style="list-style-type: none"> 1 Remove the DIMM and reinstall it to make sure that it is correctly installed. 2 Make sure that you are using a supported DIMM. See chapter 7 for ordering information. 3 Move the DIMM to a different DIMM slot. If the DIMM works in a different slot, then DIMM slot 1 is malfunctioning. <p>NOTE: Many of the first printers of this model were shipped with an 8 MB flash DIMM in DIMM slot 1. If the printer has an 8 MB flash DIMM in DIMM slot 1, then replace the DIMM. The 8 MB flash DIMM will not work in any DIMM slot other than DIMM slot 1.</p> <ol style="list-style-type: none"> 4 To continue printing, remove the DIMM from DIMM slot 1.
	<p>53.x2.zz Printer (DIMM Slot 2) error The Ready light is on. A problem exists with the DIMM in DIMM slot 2.</p> <p>CAUTION: You must turn off the printer before inserting or removing DIMMs to avoid damaging them.</p> <ol style="list-style-type: none"> 1 Remove the DIMM and reinstall it to make sure that it is correctly installed. 2 Make sure that you are using a supported DIMM. See chapter 7 for ordering information. 3 Move the DIMM to a different DIMM slot. If the DIMM works in a different slot, then DIMM slot 2 is malfunctioning. 4 To continue printing, remove the DIMM from DIMM slot 2.

Table 26. Accessory error secondary messages

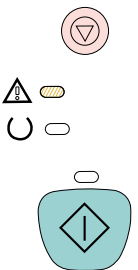
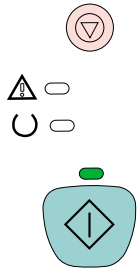
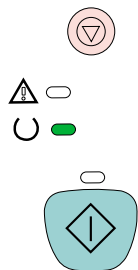
	53.x3.zz Printer (DIMM Slot 3) error
	The Attention light is on. A problem exists with the DIMM in DIMM slot 3.
	CAUTION: You must turn off the printer before inserting or removing DIMMs to avoid damaging them.
	<ol style="list-style-type: none">1 Remove the DIMM and reinstall it to make sure that it is correctly installed.2 Make sure that you are using a supported DIMM. See chapter 7 for ordering information.3 Move the DIMM to a different DIMM slot. If the DIMM works in a different slot, then DIMM slot 3 is malfunctioning.4 To continue printing, remove the DIMM from DIMM slot 3.

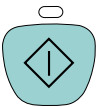
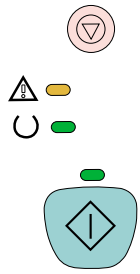

Service error secondary messages

If the printer has a service error (Attention light, Ready light, and Go light are on), press and hold  (Go) and  (CANCEL JOB) simultaneously to see the secondary error message.

You can also view the embedded Web server (HP color LaserJet 2500 series printers only), which provides a text message that corresponds to the error and its secondary light pattern. For more information about how to use and view the embedded Web server, see page 47.

Table 27. Service error secondary messages











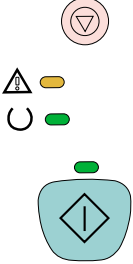

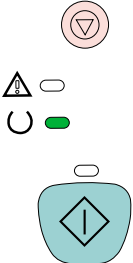

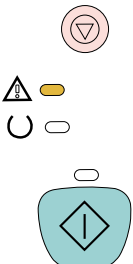
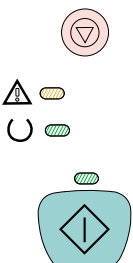

Message	Error and recommended action
	<p>51.x Bad beam detect error The Attention, Ready, and Go lights remain on.</p> <ol style="list-style-type: none"> 1 Press  (Go). The page that contains the error will automatically be reprinted. 2 Turn the printer off and then back on. 3 Replace the laser/scanner (see page 129).
	<p>52.x Scanner error The Ready light is on.</p> <ol style="list-style-type: none"> 1 Press  (Go). The page that contains the error will automatically be reprinted. 2 Turn the printer off and then back on. 3 Turn the printer off, and then reseal the laser/scanner cable. 4 Replace the laser/scanner (see page 129).
	<p>55.x Engine communication error The Attention light is on.</p> <ol style="list-style-type: none"> 1 Turn the printer off and then back on. 2 Check the connections to the formatter and the dc controller. 3 Replace the formatter (see page 109). 4 Replace the dc controller (see page 116). 5 Replace the laser/scanner (see page 129).
	<p>49.xxxxx Formatter/engine error The Go, Ready, and Attention lights are blinking, or the magenta-print-cartridge, yellow-print-cartridge, and imaging-drum lights are on.</p> <ol style="list-style-type: none"> 1 Turn the printer off and then back on. 2 Replace the formatter (see page 109).

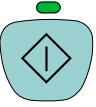
Table 27. Service error secondary messages (continued)

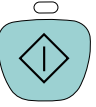

   	<p>50.X Fuser error The Ready and Go lights are on.</p> <ol style="list-style-type: none">1 Turn the printer off for approximately 20 to 30 minutes, and then turn the printer back on.2 If the error persists, replace the fuser (see page 100).
   	<p>57.x Fan motor error The Attention light is blinking.</p> <ol style="list-style-type: none">1 Turn the printer off and then back on.2 Turn the printer off, and then reseal the cable that connects the fan and the formatter.3 Replace the fan (see page 128).4 Replace the dc controller.
   	<p>64 Scan buffer error The Go light is blinking.</p> <ol style="list-style-type: none">1 Turn the printer off and then back on.2 Replace the formatter (see page 109).

Solving image-quality problems

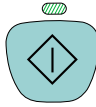
If your document is printing but the quality is not what you expected, start by using the print-quality checklist.

Print-quality checklist

Use the following checklist to solve general print-quality problems:

- 1 Check the printer driver to make sure that you are using the best available print-quality option, or return to the default settings. See the user guide for more information about print-quality options.
- 2 Make sure that the paper or print media you are using meets specifications. See the user guide for more information. Generally, smoother paper provides better results (although coated, photo, and glossy papers are not supported).
- 3 If you are using a special print media such as labels, transparencies, or letterhead, make sure that you selected the correct media type (see the **Paper** tab in the printer driver). See the user guide for information about HP print-media specifications.
- 4 Print a Configuration page and Supplies Status page at the printer by pressing  (Go) and  (CANCEL JOB) simultaneously. If the pages do not print, then the problem is in the hardware rather than in the software.
 - Check printer status messages on the Configuration page.
 - Check the Supplies Status page to see if any supplies are low or empty. Note that no information is provided for non-HP print cartridges. Replace non-HP print cartridges with HP print cartridges.
- 5 Print a Demo page from the HP color LaserJet 1500 series Toolbox or HP color LaserJet 2500 series Toolbox. If the page prints correctly, there might be a problem with the printing software. Uninstall the printing software and then reinstall it (see the getting started guide).
 - With the HP color LaserJet 2500 series printers, the problem also might be in the printer driver. Try printing from one of the other printer drivers. For example, if you are using the PCL 6 printer driver, print from the PCL 5c or PS printer driver.
- 6 Try printing from a different program. If the page prints correctly, the problem might be in the program from which you were printing.
- 7 Restart the computer and the printer and try printing again. If the problem is not resolved, choose one of these options:
 - If the problem is affecting all printed pages, see “Solving image-quality problems (all print jobs)” on page 196.
 - If the problem is affecting only pages that are printed in color, see “Solving image-quality problems (color print jobs)” on page 203.

Solving image-quality problems (all print jobs)

The examples below depict letter-size paper that has passed through the printer short-edge first. These examples illustrate problems that would affect all pages you print, whether you print in color or in black only. The topics that follow list the typical cause and solution for each of these examples.

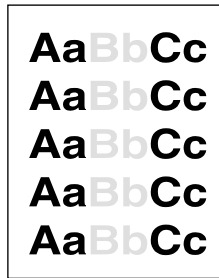

Light print or fade

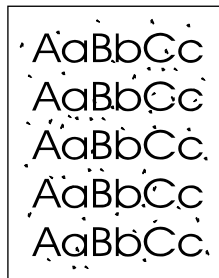

Toner specks

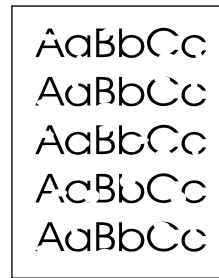

Dropouts

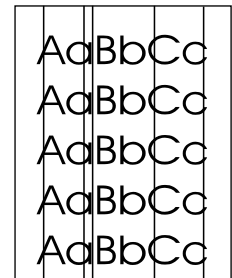

Vertical lines

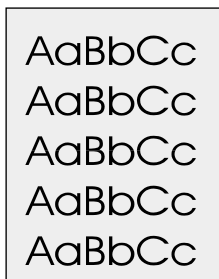

Gray background



Toner smear

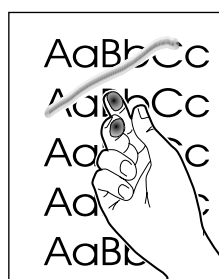

Loose toner

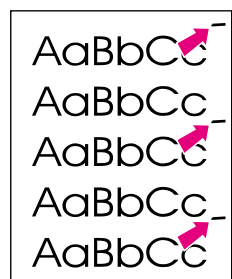

Repetitive defects on the front

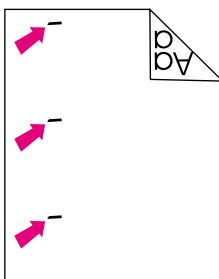

Repetitive defects on the back

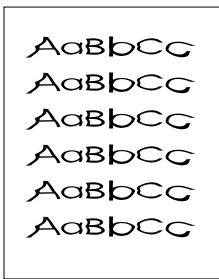

Misformed characters

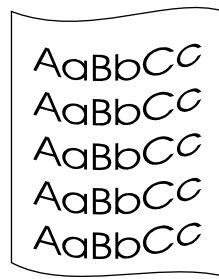

Curl or wave

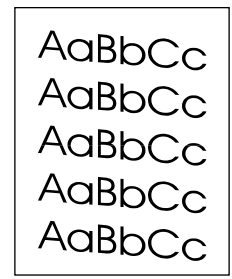

Page skew

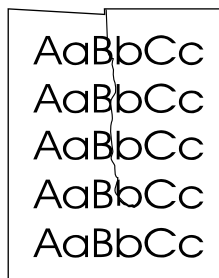

Wrinkles or creases

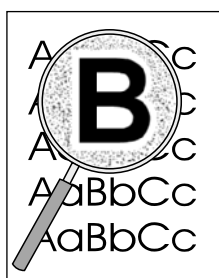

Toner scatter outline

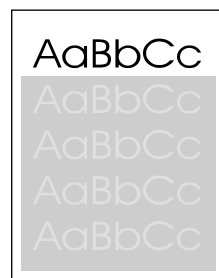

Random image repetition (light)



Random image repetition (dark)

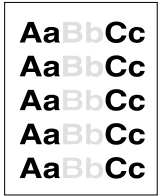

Light print or fade

A vertical streak or an incorrect or faded color area appears on the page.

- The paper might not meet HP's paper specifications (for example, the paper is too moist or too rough). See the user guide for information about print-media specifications.
- One or more print cartridges are low. If you are using non-HP print cartridges, no messages appear on the printer control panel or in the embedded Web server (HP color LaserJet 2500 series printers only).
- The imaging drum might be low or empty. Print the Supplies Status page to check remaining life. Replace the imaging drum if it is low or empty.
- If none of the print cartridges or the imaging drum is low or empty, remove the print cartridges one at a time and inspect the toner roller in each to see if the roller is damaged. If so, replace the print cartridge.
- Inspect the imaging drum for toner dust, oil, or fingerprints.
- If the problem is not resolved, see "If the problem is not resolved" on page 202.



Toner specks

- The paper might not meet specifications. For example, the paper is too moist or too rough. See the user guide for information about print-media specifications.
- The paper path might need to be cleaned. Open the HP color LaserJet 1500 series Toolbox or HP color LaserJet 2500 series Toolbox to use the cleaning page. See "To use a cleaning page" on page 61 for details.
- If using a cleaning page did not solve the problem, then check the fuser for contamination and replace the fuser, if necessary.
- If the problem is not resolved, see "If the problem is not resolved" on page 202.



Dropouts

Faded areas, generally rounded, occur randomly on the page.

- A single sheet of paper might be defective. Try reprinting the job.
- The paper path might need to be cleaned. Open the Toolbox to use the cleaning page. See "To use a cleaning page" on page 61 for details.
- The moisture content of the paper is uneven or the paper has moist spots on its surface. Try different paper, such as high-quality paper designed for laser printers. See the user guide for information about print-media specifications.
- The paper lot is flawed. The manufacturing processes can cause some areas to reject toner. Try a different brand of paper, such as high-quality paper designed for laser printers. See the user guide for information about print-media specifications.
- The imaging drum might be defective. See "Repetitive defects on the front" on page 199.
- If the problem is not resolved, see "If the problem is not resolved" on page 202.

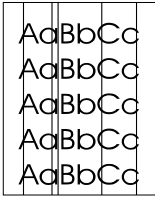

Vertical lines

Vertical streaks or bands appear on the page.

- One or more print cartridges are low or defective. Print the Supplies Status page to check remaining life. If you are using non-HP print cartridges, no messages appear on the printer control panel or in the embedded Web server.
- Clean the printer using a cleaning page. Open the Toolbox to use the cleaning page. See “To use a cleaning page” on page 61 for details.
- Use the tools on the **Troubleshooting** tab of the Toolbox to correct the problem.
- Inspect the imaging drum for toner dust, oil, or fingerprints.
- Check the jam-access door.
- If the problem is not resolved, see “If the problem is not resolved” on page 202.



Gray background

The amount of background toner shading is unacceptable.

- Clean the density sensor and perform a calibration. See “Cleaning the engine” on page 61.
- Use a different paper with a lighter basis weight. See the user guide for information about print-media specifications.
- Check the printer environment. Very dry (low humidity) conditions can increase the amount of background shading.
- One or more print cartridges are low. If you are using non-HP print cartridges, no messages appear on the printer control panel or in the embedded Web server.
- The imaging drum might be low or empty. Print the Supplies Status page to check remaining life. Replace the imaging drum if it is low or empty.
- If the problem is not resolved, see “If the problem is not resolved” on page 202.

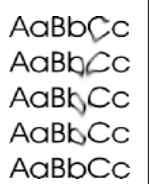

Toner smear

Toner smear appears on the leading edge.

- Check the paper type and quality. Use a different paper, such as high-quality paper designed for laser printers. See the user guide for information about print-media specifications.
- The paper guides is dirty, or debris is in the print path. Open the Toolbox to use the cleaning page. See “To use a cleaning page” on page 61 for details.
- The imaging drum might be low or empty. Check the status of the imaging drum at the printer control panel or in the embedded Web server and replace the imaging drum if it is low or empty.
- The fuser might not be heating correctly. If the printer is plugged into a surge protector, plug it directly into the wall.
- If the problem is not resolved, see “If the problem is not resolved” on page 202.

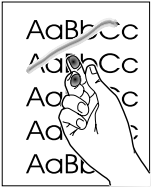

Loose toner

Toner smears easily when touched.

- In the printer driver, select the **Paper** tab and set **Type is** to match the type of paper on which you are printing. Print speed might be slower if you are using heavy paper. For UNIX, Linux, and OS/2, this feature is available in the embedded Web server (HP color LaserJet 2500 series printers only) if the printer is connected to a network.
- Check the paper type and quality. Use a different paper, such as high-quality paper designed for laser printers. See the user guide for information about print-media specifications.
- Clean the inside of the printer. Open the Toolbox to use the cleaning page. See “To use a cleaning page” on page 61 for details.
- The fuser or imaging drum might be damaged.
- If the problem is not resolved, see “If the problem is not resolved” on page 202.



Repetitive defects on the front

Marks repeatedly appear on the printed side of the page at even intervals.

- In the printer driver, select the **Paper** tab and set **Type is** to match the type of paper on which you are printing. Print speed might be slower if you are using heavy paper. For UNIX, Linux, and OS/2, this feature is available in the embedded Web server (HP color LaserJet 2500 series printers only) if the printer is connected to a network.
- Clean the printer. Open the Toolbox to use the cleaning page. See “To use a cleaning page” on page 61 for details.
- Use the tools on the **Troubleshooting** tab of the Toolbox to correct the problem.
- The imaging drum might be defective. Replace the imaging drum.
- The fuser or imaging drum might be damaged.
- One of the print cartridges might be defective. Examine the print cartridges and replace as needed.
- If the problem is not resolved, see “If the problem is not resolved” on page 202.

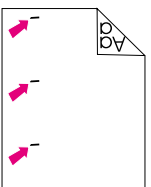

Repetitive defects on the back

Marks repeatedly appear on the unprinted side of the page at even intervals.

- Internal parts might have toner on them. The problem will likely correct itself after a few more pages.
- Clean the printer. Open the Toolbox to use the cleaning page. See “To use a cleaning page” on page 61 for details.
- The fuser or imaging drum might be damaged.
- If the problem is not resolved, see “If the problem is not resolved” on page 202.

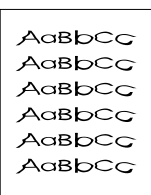

Misformed characters

- If characters are improperly formed so that they produce hollow images, the paper might be too slick (for example, photo, glossy, or coated paper). Use a different paper, such as high-quality paper designed for laser printers. See the user guide for information about print-media specifications.
- If characters are improperly formed so that they produce a wavy effect, the laser/scanner might need service. Verify that the problem also occurs on the Configuration page. If so, replace the laser/scanner
- If the problem is not resolved, see “If the problem is not resolved” on page 202.

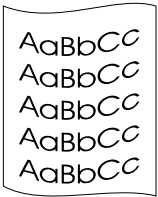

Curl or wave

- Turn over the stack of paper in the tray. Also try rotating the paper 180 degrees in the input tray.
- Set the correct type in the printer driver. Heavier paper might take longer to print.
- Open the rear output door to print to the straight-through paper path.
- Check the paper type and quality. Both high temperature and humidity will cause paper curl. Use a different paper, such as high-quality paper designed for laser printers. See the user guide for information about print-media specifications.
- If the problem is not resolved, see “If the problem is not resolved” on page 202.

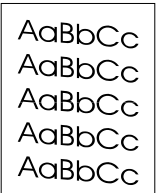

Page skew

- Make sure that the paper or other print media is loaded correctly and that the guides are not too tight or too loose against the stack. See “Loading media” on page 44.
- Check the paper type and quality. Use a different paper, such as high-quality paper designed for laser printers. See the user guide for information about print-media specifications.
- If the problem is not resolved, see “If the problem is not resolved” on page 202.

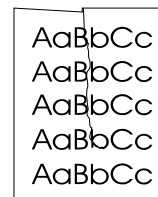

Wrinkles or creases

- Make sure that paper is loaded properly.
- Turn over the stack of paper in the input tray, or try rotating the paper 180 degrees in the input tray.
- Open the rear output door to print to the straight-through paper path.
- Check the paper type and quality. Use a different paper, such as high-quality paper designed for laser printers. See the user guide for information about print-media specifications.
- Reseat the fuser.
- If the problem is not resolved, see “If the problem is not resolved” on page 202.

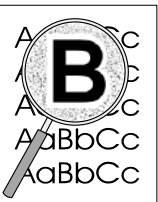

Toner scatter outline

- Turn over the stack of paper in the tray.
- Clean the density sensor and perform a calibration. See “Cleaning the engine” on page 61.
- Small amounts of toner scatter are normal for laser printing.
- If large amounts of toner have scattered around the characters, the paper might have high resistivity. Use a different paper, such as high-quality paper designed for laser printers. See the user guide for information about print-media specifications.
- Change the print mode in the embedded Web server to dry-media mode.
- If the problem is not resolved, see “If the problem is not resolved” on page 202.



Random image repetition

If an image that appears at the top of the page (in solid black) repeats farther down the page (in a gray field), the toner might not have been completely erased from the last print job. The repeated image might be lighter or darker than the field in which it appears.



- Clean the printer. Open the Toolbox to use the cleaning page. See “To use a cleaning page” on page 61 for details.
- In your program, change the tone (darkness) of the field in which the repeated image appears.
- In your program, rotate the whole page 180 degrees to print the lighter image first.
- Change the order in which the images are printed. For example, have the lighter image at the top of the page, and the darker image farther down the page.
- If the defect occurs later in a print job, turn the printer off for 10 minutes, and then turn the printer on to restart the print job.
- Replace the imaging drum.
- Replace the fuser.
- If the problem is not resolved, see “If the problem is not resolved” on page 202.

If the problem is not resolved

If the problem is not resolved, try these steps:

- 1 Perform a cleaning and calibration. See “Calibrating the printer” on page 62.
- 2 Print the Configuration page and Supplies Status page again.
 - If the pages print correctly, then the problem is in the program, the computer, or the printer driver.
 - If the pages do not print correctly, then the problem is in the printer hardware. The problem might be the fuser or the imaging drum.
- 3 Change the **Type** setting in the printer driver, or change the print mode in the embedded Web server (HP color LaserJet 2500 series printers only). If this step does not help, proceed to the next step.
- 4 If the problem persists, check the paper type and quality. (See the user guide for information about print-media specifications.) Use a different paper, such as high-quality paper designed for laser printers. Coated, photo, and glossy papers are not supported.
- 5 Print to a different printer.
 - If the page prints correctly, then the problem might be in the printer driver. Uninstall the printer driver and reinstall it.
 - If the page does not print correctly, the problem is in the program or the computer. See the documentation for the program or the computer.

Solving image-quality problems (color print jobs)

This section describes issues that can occur when you print in color.

Note

Whenever you experience color-related issues, calibrate the printer before trying any other steps. See “Calibrating the printer” on page 62.

Print-quality troubleshooting page

The print-quality troubleshooting page is available through the HP color LaserJet 1500 series Toolbox or HP color LaserJet 2500 series Toolbox. The print-quality troubleshooting page is also available directly from the HP color LaserJet 2500 series printer software CD-ROM for instances in which the printer is not connected to a Windows environment or the Toolbox is otherwise unavailable.

- See page 240 for information about how to view the Toolbox. The print-quality troubleshooting page is located on the **Documentation** tab.

After the page prints, follow the instructions for reading the page and correcting print-quality problems.

- To print the print-quality troubleshooting page from the HP color LaserJet 2500 series printer software CD-ROM, copy the file `pq_diag.prn`, which is located in the `\prnfiles` directory, to the printer. (This method cannot be used with an HP color LaserJet 1500 series printer.)

For example, the following command prints the print-quality troubleshooting page from MS-DOS®:

```
copy d:\prnfiles\pq_diag.prn lpt1
```

Three pages should print. The first page is the print-quality troubleshooting page, which is comprised of horizontal stripes in four colors plus grey. The second and third pages contain instructions for reading the print-quality troubleshooting page and correcting print-quality problems.

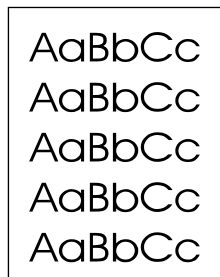

Only black prints

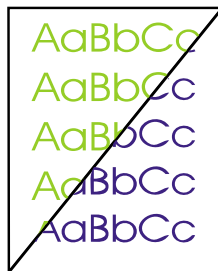

Missing or incorrect color

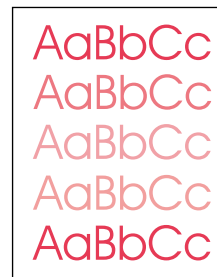

Color prints inconsistently



Colors do not match



Color pages have inconsistent finish



AaBbCc
AaBbCc
AaBbCc
AaBbCc
AaBbCc

Only black prints

Only black is printing when the document should be printing in color.

- Color mode is not selected in your program or printer driver. Select color mode instead of grayscale mode.
- If you are printing on transparencies, all transparencies print in grayscale.
- The correct printer driver is not selected in the program. Select the correct printer driver.
- The printer is not properly configured. Check the printer configuration by printing a Configuration page. If no color appears on the Configuration page, replace the imaging drum.



AaBbCc
AaBbCc
AaBbCc
AaBbCc
AaBbCc

Missing or incorrect color

- You have changed the color settings manually. Return the color setting to Automatic.
 - Windows: On the **Color** tab of the printer driver, click **Automatic**.
 - Mac OS: In the **Print** dialog box, select the **HP ColorSmart** or **HP Color Quality** pop-up menu and then select the **Manual** option.
- Your print media does not meet the specifications for this printer. For example, you are using coated, glossy, or photo paper. Use a different paper, such as a high-quality paper designed for laser printers. See the user guide for information about print-media specifications.
- You are operating the printer in excessively humid or dry conditions. Verify that the printer environment is within humidity specifications.
- A print cartridge might be low on toner. Check the printer control panel, print a Supplies Status page, or view the embedded Web server (HP color LaserJet 2500 series printers only) to see supplies status. (If you are using a non-HP cartridge, none of these sources will provide information about a low or empty print cartridge.) If a cartridge is low on toner, replace the print cartridge.
- Clean the sensors and perform a calibration. See "Cleaning the engine" on page 61.



AaBbCc
AaBbCc
AaBbCc
AaBbCc
AaBbCc

Color prints inconsistently

A color is printing inconsistently after you load a new print cartridge.

- Another print cartridge might be low on toner. Check the supplies status lights or embedded Web server (HP color LaserJet 2500 series printers only) to see if a print cartridge is low, and replace it if necessary. If you are using a non-HP print cartridge, it might be low or empty but you will receive no indication.
- Print cartridges might be improperly installed. Remove the print cartridge for the color that is printing inconsistently and reinstall it.
- Your print media does not meet the specifications for this printer. For example, you are using coated, glossy, or photo paper. Use a different paper, such as a high-quality paper designed for laser printers. See the user guide for information about print-media specifications.



Colors do not match

The colors on the printed page do not match the colors as they appear on the screen.

- Your print media does not meet the specifications for this printer. For example, you are using coated, glossy, or photo paper. Use a different paper, such as a high-quality paper designed for laser printers. See the user guide for information about print-media specifications.
- The colors on your computer monitor differ from the printer output. Try selecting **Screen Match** on the **Color** tab of the printer driver.
- Print the Configuration and Supplies Status pages to make sure that they print correctly. If not, the problem is with the printer.
- Try printing from a different program or from one of the other printer drivers (HP color LaserJet 2500 series printers only). For example, if you are using the PCL 6 printer driver, try the PCL 5c or PS printer driver.
- Extremely light colors or extremely dark colors on screen are not printing. Your program might interpret extremely light colors as white or extremely dark colors as black. If so, avoid using extremely light or extremely dark colors.
- Clean the sensors and perform a calibration. See “Calibrating the printer” on page 62.



Color pages have inconsistent finish

- Use a smooth paper or print media, such as a high-quality paper designed for laser printers. Generally, the smoother the paper, the better the results, although coated, photo, and glossy papers are not supported. See the user guide for information about print-media specifications.

Resolving problems that generated messages

This section helps resolve problems that generated messages on the computer.

Messages for both Windows and Macintosh

This section lists some common errors that only provide a simple message but no information for resolving the error. Errors that you see in Printer Status and Alerts, the Toolbox, or the embedded Web server (HP color LaserJet 2500 series printers only) provide their own instructions for resolving the error. For other errors generated by your operating system, see the documentation for the operating system or computer.

Symptom	Possible Cause	Solution
Limit Check Error	The print job is too complex.	<ul style="list-style-type: none">● Reduce the complexity of the page. For example, try using fewer fonts.
PostScript error (HP color LaserJet 2500 series printers only)	The printer is out of memory.	<ul style="list-style-type: none">● Use one of the other printer drivers.● Send the print job in smaller pieces or with a fewer number of pages.● Install more memory.



Messages for Windows only

Message	Solution
“USB00X” (HP color LaserJet 1500 series printers only) or “Error Writing to DOT 4_00X” (HP color LaserJet 2500 series printers only)	<ul style="list-style-type: none">● Make sure that there is media in the tray.● Make sure the cables are connected correctly, the printer is on, and the Ready light is on.● Make sure that the printer is not connected using both a USB and a parallel cable (HP color LaserJet 2500 series printers only). If it is, disconnect both cables and reinstall one cable.● Print a Configuration page from the Toolbox to make sure that the computer can communicate with the printer.● On the Start menu, point to Settings and click Printers. Right-click the HP color LaserJet 1500 or HP color LaserJet 2500 series printer driver and select Properties. Click Details and then click Port Settings. Clear the Check Port State before Printing check box and click OK. Click Spool Settings, select Print Directly to Printer, and click OK.● Try again to print.
“General Protection Fault” “Exception OE” “Spool32” “Illegal Operation”	<ul style="list-style-type: none">● Restart the computer and try again.● Clear the contents of the computer Temp folder, which is generally located in C:\Windows (95, 98, and Me) or C:\Winnt (NT 4.0, 2000, and XP).
Other Windows messages	See Microsoft Windows 95, 98, 2000, NT 4.0, Me, or XP documentation that came with the operating system or computer for information.

Resolving problems that did not generate messages

Troubleshooting checklist

If the printer is not responding correctly, complete the steps in the following checklist, in order. If the printer does not pass a step, follow the corresponding troubleshooting suggestions. If a step resolves the problem, you can stop without performing the remaining steps on the checklist.

- 1 Make sure the printer Ready light is on. If no lights are on, complete the following steps:
 - a Check the power cable connections.
 - b Make sure that the power switch is on.
 - c Check the power source by plugging the printer directly into the wall or into a different outlet.
 - d If none of these measures restores power, replace the low-voltage power supply.
 - e If replacing the high-voltage power supply does not restore power, replace the dc controller.
- 2 Check the cabling.
 - a Check the cable connection between the printer and the computer or network port. Make sure that the connection is secure.
 - b Make sure that the cable itself is not faulty by using a different cable, if possible.
 - c Make sure that you do not have both a USB and a parallel cable installed (HP color LaserJet 2500 series printers only). If you do, the USB automatically disables itself. Disconnect both cables and then reinstall the one you want to use.
 - d Check the network connection. See “Checking the network” on page 208.
- 3 Press  (Go) and  (CANCEL JOB) simultaneously to print a Configuration page and a Supplies Status page. An HP Jetdirect page also prints, if a print server card (HP color LaserJet 2500 series printers only) is installed.
 - If the Configuration and Supplies Status pages do not print, check the following items:
 - a Check that there is paper in at least one of the printer input trays.
 - b If the page jams in the printer, see “Clearing jams” on page 176.
 - c Make sure that the print media you are using meets specifications. See the user guide for information about print-media specifications.
 - d Try again to print the Configuration and Supplies Status pages.
 - If the Configuration and Supplies Status pages print, check the following items:
 - a If the pages print correctly, then the printer hardware is working. The problem is in the computer you are using, the printer driver, or the program.
 - b If the pages do not print correctly, calibrate the printer. See “Calibrating the printer” on page 62.
 - c Make sure that the print media you are using meets specifications. See the user guide for information about print-media specifications.
 - d Print the pages again. If the pages still do not print correctly, the problem is in the printer hardware.
- 4 At the computer, check the print queue or print spooler (Print Monitor or Print Center Queue for Mac OSs) to see if the printer is paused or set to print offline. Clear the print spooler and bring the printer online as needed.

- 5 Verify that you have installed the correct printer driver. Check the program to make sure that you are using an HP color LaserJet 1500 series printer or HP color LaserJet 2500 series printer driver.
- 6 Use the printer-driver properties to check the assigned port.
- 7 Print a page from the Toolbox (Windows 98 and later only).
 - a If the page prints, then the problem is with the printer driver. Try using one of the other printer drivers. Or, uninstall the printer driver (see the user guide) and reinstall it (see the getting started guide).
 - b If the page does not print, then the problem is with the computer or the program.
- 8 Print a short document by using a different program that has worked in the past. If this solution works, then the problem is with the program you are using. If this solution does not work (the document does not print) complete these steps:
 - a Try printing the job from another computer that has the printer software installed.
 - b If you connected the printer to the network, connect the printer directly to a computer by using a parallel cable (HP color LaserJet 2500 series printers only) or USB cable. Redirect the printer to the proper port, or reinstall the software and select the new connection type you are using.
- 9 If the problem is still not resolved, see “Solving general printing problems” on page 209.

Checking the network

It is recommended that you use the HP color LaserJet 1500 series printer or HP color LaserJet 2500 series printer CD-ROM to install and set up the printer on a network.

Note

The HP color LaserJet 1500 series printer works only with the HP color LaserJet 1500 printer driver.

Follow these steps to see if the problem is caused by the network.

- When the Configuration page printed, an HP Jetdirect configuration page should have printed if an HP Jetdirect print server card (HP color LaserJet 2500 series printers only) is installed. (If these pages do not print in your language, see “Troubleshooting tools” on page 224.) Verify that all network settings are properly configured.
- See the HP Jetdirect Print Server Administrator’s Guide, which can be installed from the **View Documentation** or **User Documentation** sections on the printer CD-ROM.
- Contact the network administrator for assistance.

Solving general printing problems

In addition to the problems listed in this section, see “Solving common Macintosh problems” on page 214 if you are using a Macintosh computer, and see “Solving PostScript (PS) errors” on page 213 if you are using several printer languages.

Table 28. Solving general printing problems

Symptom	Possible Cause	Solution
The print job is extremely slow.	The job might be very complex (for example, if it contains graphics).	<ul style="list-style-type: none"> ● Wait for the job to print. ● Reduce the complexity of the page or try adjusting the print-quality settings. If this problem occurs frequently, add memory to the printer.
	The maximum speed is 16 ppm in black and 4 ppm in color and cannot be exceeded even when more memory is added.	Wait for the print job to finish.
	Printing speeds might be automatically reduced when printing special-size media.	Wait for the print job to finish.
	In the printer driver, the Type or Size is set incorrectly for the media in the printer.	<ul style="list-style-type: none"> ● If you are printing on heavy paper, the Type or Size should be set to a heavy paper setting. The printer prints more slowly to provide better quality. Wait for the job to print. ● If you are not printing on heavy paper, set Type or Size in the printer driver to plain paper. ● In the default settings for this printer, click the Paper tab and make sure that Type is set to plain paper. You can override this setting from the printer driver when you print on heavy paper.
	An issue might exist with the driver.	<ul style="list-style-type: none"> ● If you are printing using a PCL driver, print using the PS driver, or vice versa (HP color LaserJet 2500 series printers only).
The printer pulls paper or print media from the wrong tray.	The Source (tray) selection might be incorrect.	<ul style="list-style-type: none"> ● For Windows, make sure that the Source is selected from the Print dialog box (which is part of the program) if possible or in the printer driver. If you select the Source in the printer driver and then select a different Source in the Print dialog box, the Source setting in the printer driver changes to match the Source setting in the Print dialog box. ● For Macintosh, set the Source in the Print dialog box. ● Remove any media from other trays to make the printer select from the tray you want, and then press  (Go).
	The Type or Size setting does not match the size of paper or print media loaded in the tray.	Using the embedded Web server, change the Type or Size setting for the tray to match the size of print media that is loaded.
	Media is loaded in tray 1.	Remove any media from tray 1. The printer pulls from tray 1 if you did not specify a tray that had a compatible size or type loaded and tray 1 is unconfigured.

Table 28. Solving general printing problems



Symptom	Possible Cause	Solution
Printer does not pull paper from optional tray 2 or optional tray 3.	The rear paper length guide (optional tray 2) or the rear paper stop (optional tray 3) is set incorrectly.	To set the rear guides properly, see “Loading optional tray 2” on page 45 or “Loading optional tray 3” on page 46.
	The tray is not recognized in the printer software.	Configure the printer software to recognize the tray.
	If the printer does not pull paper from either tray, the problem might be the paper.	<ul style="list-style-type: none"> ● Try a different type or brand of paper. ● Make sure that you are using a high-quality paper made for laser printers. Coated, photo, and glossy papers are not supported. See the user guide for information about print-media specifications or to order media.
	The separation pad and the pick-up rollers might be worn out.	Replace the separation pad and pick-up rollers. See table 15 “Life expectancies of consumables” on page 54 for ordering information.
The printer does not recognize a DIMM that is installed (HP color LaserJet 2500 series printers only).	The DIMM is not recognized in the printer software.	Configure the printer software to recognize the DIMM. See the user guide for information.
The printer does not respond when the Print command is selected in the software.	The printer experienced an error.	Check the control panel lights on the printer to determine if an error exists.
	If no control panel lights are on, the printer is not receiving power.	<ol style="list-style-type: none"> 1 Check the power cable connection between the printer and the power source. 2 Check that the power switch is on. 3 Check that the power source (outlet or surge protector) is receiving power. 4 If the problem persists, replace the high-voltage power supply. 5 If, after replacing the high-voltage power supply, the problem persists, replace the dc controller.
	The printer might be in Manual Feed mode (the Attention light is blinking and Go is light on).	Add media to tray 1 if it is empty. If media is already in the tray, press  (Go).
	The wrong printer was selected in the software.	<ul style="list-style-type: none"> ● In the Print or Printer Setup dialog box, make sure that the HP color LaserJet 1500 series printer or HP color LaserJet 2500 series printer is selected as the printer.
	A jam might be present.	Clear any jams. See “Clearing jams” on page 176.
	The printer is on a network and is not receiving a signal.	<ul style="list-style-type: none"> ● Disconnect the printer from the network and attach it directly to a computer using a parallel or USB cable. ● Clear any stopped jobs from the print queue. ● Print a job that you know works. ● Reinstall the printing software.
	The interface cable between the computer (or network) and the printer is not connected properly.	Disconnect and reconnect the interface cable.
	The interface cable is defective.	<ul style="list-style-type: none"> ● If possible, connect the interface cable to another computer (or network port) and print a job that you know works. ● Try using a different cable.
If the printer is connected to a computer, the software for the printer is not configured for the printer port.	<ul style="list-style-type: none"> ● Check the printer selection menu in the software to make sure it is using the correct port. If the computer has more than one port, make sure that the printer is associated with the correct one. ● Remove all shared or third-party devices. 	

Table 28. Solving general printing problems

Symptom	Possible Cause	Solution
Pages print, but all colors do not print or the pages are completely blank.	One of the print cartridges might be low or empty.	Run an engine test (see page 218) and see if all four colors print. If not all colors print, replace one or more of the print cartridges. If the engine test is successful, replace the formatter.
	If the printed pages are completely blank, the file might have blank pages.	Check the file to make sure that it does not contain blank pages.
	A print cartridge might be low or empty.	Check the printer control panel for a Supplies Status message, print a Supplies Status page, or use the embedded Web server (HP color LaserJet 2500 series printers only) to see the levels remaining in the print cartridges. Replace any print cartridges that are low or empty. Messages are not created for non-HP print cartridges.
	If you are using non-HP print cartridges, one or more print cartridges are low or empty. The control panel lights do not indicate low or empty for non-HP print cartridges.	Replace one or more of the print cartridges.
	Font DIMM might be selected but the font DIMM is not physically installed in the printer. (This issue applies only to HP color LaserJet 2500 series printers using an Asian-language font DIMM.)	In the settings for this printer, clear the Font DIMM check box on the Configure tab if no font DIMM is installed in the printer. Select the Font DIMM check box only if the font DIMM is physically installed in the printer. If you think that the font DIMM is installed, make sure that it is installed correctly.
The paper curls when exiting the top output bin.	The paper needs to print to the straight-through paper path.	Open the rear output door to print to the straight-through paper path. Remove each sheet as it exits the printer.
	The stack was slightly curled when it was placed in the tray.	Turn the stack over in the tray.
	The paper does not meet specifications.	See the user guide for information about print-media specifications.
	If you are printing on light media, the Type setting might not be correct.	Select Light in the Type is field in the printer driver.

Table 28. Solving general printing problems

Symptom	Possible Cause	Solution
The printer prints, but the text is wrong, garbled, or incomplete.	The interface cable is loose or defective.	Disconnect the printer cable and reconnect it. Try a print job that you know works. If possible, attach the cable and printer to another computer and try a print job that you know works. Finally, try a new cable.
	The printer is on a network or sharing device and is not receiving a clear signal.	Disconnect the printer from the network or shared drivers and attach it directly to a computer using a parallel cable (HP color LaserJet 2500 series printers only) or USB cable. Print a job that you know works.
	The wrong driver was selected in the software.	In the Print or Printer Setup dialog box, make sure that the HP color LaserJet 1500 series printer or HP color LaserJet 2500 series printer is selected as the printer and that the appropriate port is selected.
	The printer driver is malfunctioning.	Print a page from the printer Toolbox. If the page prints, then the problem is in the printer driver. Uninstall and reinstall the printer driver.
	The program is malfunctioning.	Try printing a job from another program.
	If the printer is connected to a computer, the operating system is malfunctioning.	<p>Check the operating system. If you do not know how to use the method below, see the documentation that came with the computer.</p> <p>NOTE: This method works only for the HP color LaserJet 2500 series printers with Windows 98, NT 4.0, and 2000 (and computers with these operating systems must be connected to a parallel cable).</p> <p>Restart the computer. When it beeps during startup, press F5 and select Command Prompt Only. At the C:\ prompt on the computer, type <code>Dir>LPT1</code> and then press ENTER. (This assumes that the printer is connected to LPT1.) If the Go light comes on at the printer, press  (Go) to print and eject the page. If the page prints correctly, then the operating system is malfunctioning.</p>
	Font DIMM might be selected but the font DIMM might not be physically installed in the printer. (This issue only applies to HP color LaserJet 2500 series printers that have an Asian-language font DIMM installed.)	In the settings for this printer, clear the Font DIMM check box on the Configure tab if no font DIMM is installed in the printer. Select the Font DIMM check box only if the font DIMM is physically installed in the printer. If you think that the font DIMM is installed, make sure that it is installed correctly.

Solving PostScript (PS) errors

Note PostScript errors apply only to the HP color LaserJet 2500 series printers.

The following situations are specific to the PS language and might occur when several printer languages are being used.



Note To receive a printed or an onscreen message when PS errors occur, select this option in the PS printer driver or the embedded Web server.

Symptom	Possible Cause	Solution
The job prints in Courier (the printer default typeface) instead of the typeface you requested.	The requested typeface is not downloaded. A personality switch might have been performed to print a PCL job just before the PS printing job was received.	Download the font you want to use and send the print job again. Verify the type and location of the font. Download the font to printer, if applicable. See the software documentation.
A PS error page prints.	The print job might not be a PS job.	Make sure the print job is a PS job. Check to see whether the program expected a setup or PS header file to be sent to the printer.
VM Error	This is a PS font error that occurs when you are using several fonts.	<ul style="list-style-type: none">● Select Unlimited Downloadable Fonts in the printer driver.
Range Check	The tray settings are incorrect.	<ul style="list-style-type: none">● Try printing from a different tray.● Select Unlimited Downloadable Fonts in the printer driver.
Limit Check	The printer is out of memory.	<ul style="list-style-type: none">● Reduce the complexity of the page.● Use one of the other printer drivers.● Send the print job in smaller pieces with a fewer number of pages.● Install more memory.

Solving common Macintosh problems

In addition to the problems listed in “Solving general printing problems” on page 209, this section lists problems that can happen only when using the Mac OS, versions 9.1 to OS X.

Note HP color LaserJet 1500 series printers support Mac OS 9.x, OS X.1, and OS X.2.

Symptom	Possible Cause	Solution
Problems in the Chooser		
The printer driver icon does not appear in the Chooser (when using Mac OS, version OS X).	The software was not installed correctly.	The LaserWriter driver should be present as a part of the Mac OS. Make sure that the LaserWriter driver is in the Extensions folder within the systems folder. If not, install the LaserWriter driver from your Mac OS CD-ROM.
	The interface cable might not be of high quality.	Make sure that you are using a high-quality interface cable.
	An incorrect network might be selected.	Make sure that the printer is on the correct network. Select the Network or AppleTalk Control Panel from Control Panels in the Apple menu and then select the correct network.
The printer name does not appear in the Select a PostScript Printer box in the Chooser (HP color LaserJet 2500 series printers only).	The printer might not be ready.	Make sure that the cables are connected correctly, the printer is on, and the Ready light is on.
	The correct printer driver might not be selected.	Make sure that the correct printer driver has been selected in the Chooser (for example, LaserWriter).
	An incorrect zone might be selected.	If the printer resides on a network that has multiple zones, make sure that the correct zone is selected in the AppleTalk Zones box in the Chooser.
	The PS driver might not be installed.	Verify that the PS driver is installed.
	The printer might not be selected in the Chooser.	Print a Configuration page to make sure that the printer has been selected in the Chooser. [Simultaneously press  (Go) and  (CANCEL JOB) on the printer.] Check the AppleTalk name of the printer that appears on the Configuration page.
	AppleTalk might be off.	Make sure that AppleTalk is on. (The button next to Active is selected in the Chooser.) You might need to restart the computer to activate the change.
The printer driver does not automatically set up the selected printer even though you clicked Auto Setup in the Chooser.	Reinstall the printer software. See the getting started guide.	
Printing Errors		
A print job was not sent to the printer that you wanted.	Another printer with the same or similar name might have received your print job.	<ul style="list-style-type: none">● Check the AppleTalk name of the printer that appears on the Configuration page.● Make sure that the cables are connected correctly, the printer is on, and the Ready light is on.
You cannot use the computer while the printer is printing.	Background Printing has not been selected.	For LaserWriter 8.6 and later: Turn Background Printing on by selecting Print Desktop on the File menu and then clicking Background Printing .

Symptom	Possible Cause	Solution
An encapsulated PostScript (EPS) file does not print with the correct fonts.	This problem occurs with some programs.	<ul style="list-style-type: none"> ● Try downloading the fonts contained in the EPS file to the printer before printing. ● Send the file in ASCII format instead of a binary encoding.
Your document is not printing with New York, Geneva, or Monaco fonts.	The printer might be substituting fonts.	Select Options in the Page Setup dialog box to clear the substituted fonts.
USB Problems		
You are unable to print from a third-party USB card.	This error occurs when the software for USB printers is not installed.	When adding a third-party USB card, you might need the Apple USB Adapter Card Support software. The most current version of this software is available from the Apple website.
When connected using a USB cable, the printer does not appear in the Macintosh Chooser after the driver is selected.	This problem is caused by either a software or hardware component.	<p>Software troubleshooting</p> <ul style="list-style-type: none"> ● Make sure that your Macintosh supports USB. ● Verify that your Macintosh has Mac OS 8.6 or later. ● Make sure that your Macintosh has the appropriate USB software from Apple. <p>NOTE: The iMac and Blue G3 desktop Macintosh systems meet all of the requirements to connect to a USB device.</p> <p>Hardware troubleshooting</p> <ul style="list-style-type: none"> ● Make sure that the printer is turned on. ● Make sure that the USB cable is properly connected. ● Make sure that you are using the appropriate high-speed USB cable. ● Make sure that not too many USB devices are drawing power from the chain. Disconnect all devices from the chain and connect the cable directly to the USB port on the host computer. ● Check to see if more than two nonpowered USB hubs are connected in a row on the chain. Disconnect all devices from the chain and connect the cable directly to the USB port on the host computer. <p>NOTE: The iMac keyboard is a nonpowered USB hub.</p>

Manually rotating the print-cartridge carousel

CAUTION

Before working on the carousel, turn off the printer.

Under normal conditions, pressing  (ROTATE CAROUSEL) brings another print cartridge to the top position. However, if the carousel does not rotate, then rotate the print-cartridge carousel manually.

Note

All models of the HP color LaserJet 1500 printer and many models of the HP color LaserJet 2500 printer contain a guide that is designed for access to the carousel brake. If the guide is not installed, see “To manually rotate the print-cartridge carousel (no guide installed)” on page 217.

To manually rotate the print-cartridge carousel (guide installed)

- 1 Open the top cover.
- 2 Press the end of a paper clip into the guide (callout 1) to lift up the carousel brake.
- 3 Rotate the carousel manually.

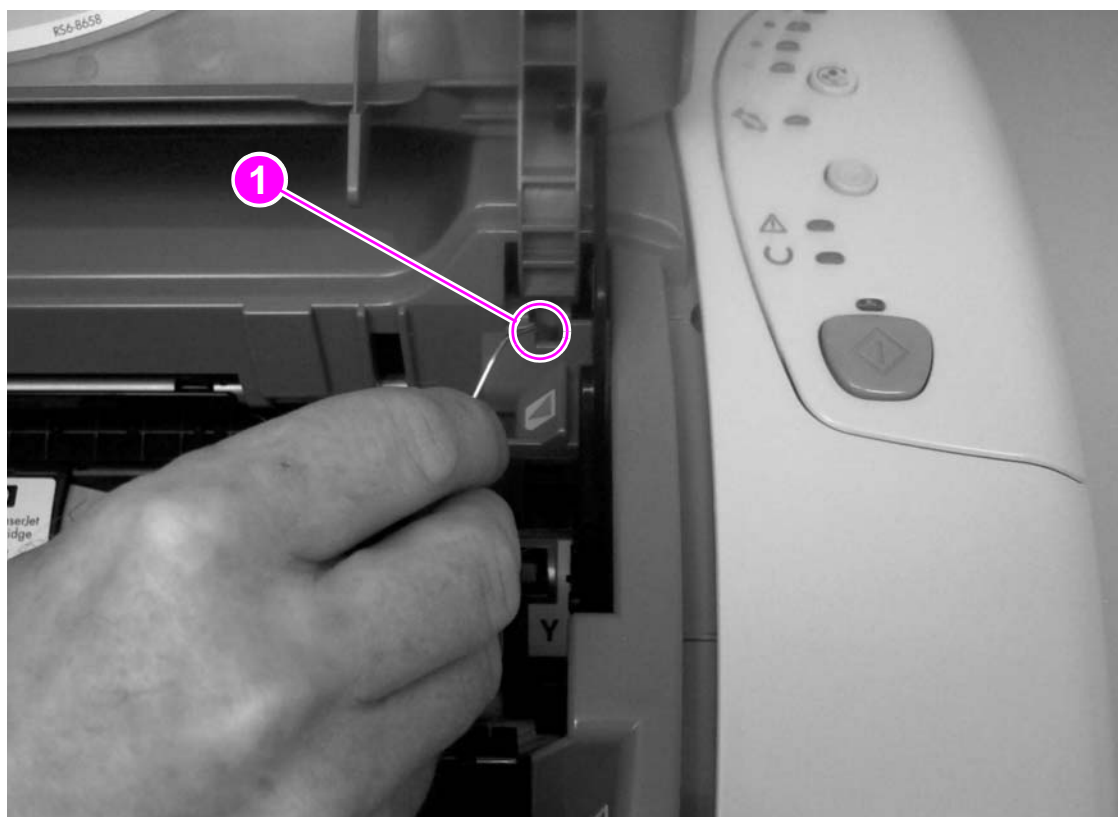

Figure 118.

Manually rotating the print-cartridge carousel (guide installed)

To manually rotate the print-cartridge carousel (no guide installed)

- 1 Open the top cover.
- 2 Use a small flatblade screwdriver to lift up the carousel brake (callout 2).

Note In figure 119, the top cover is removed.

- 3 Rotate the carousel manually.

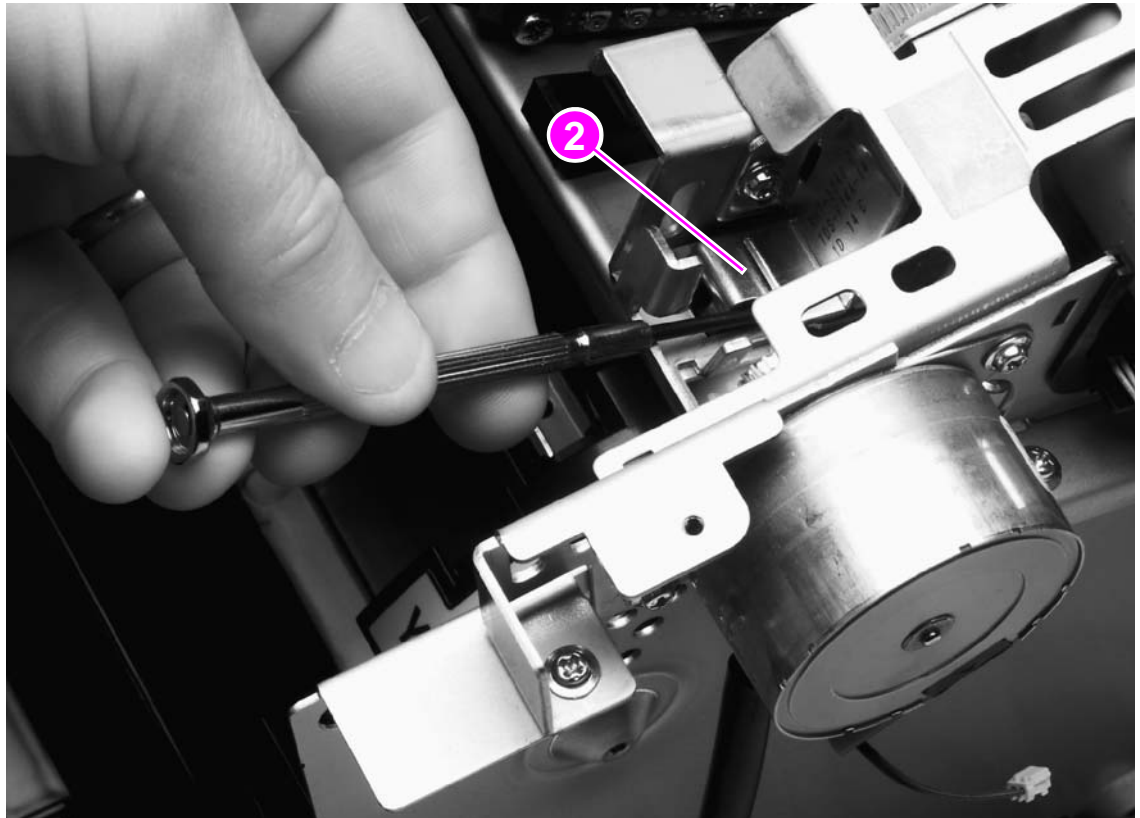

Figure 119. Manually rotating the print-cartridge carousel (no guide installed)

Functional checks

Engine test

The engine test is used to verify that the print engine is functioning correctly. The formatter is bypassed during an engine test, so the engine test is useful for isolating printer problems. Because the engine test prints horizontal lines along the entire printable area of a page, it is also useful for checking and adjusting registration.

Printing an engine test

The engine test switch is inside tray 1, on the left side, just below the front cover.

To print an engine test:

- 1 Turn off the printer.
- 2 Turn on the printer.
- 3 Open tray 1 and load paper.
- 4 Press the engine-test switch (shown below).

Note

The HP color LaserJet 2500 series printer formatter must be connected to the ECU to perform an engine test. Otherwise, the printer does not print the engine test.

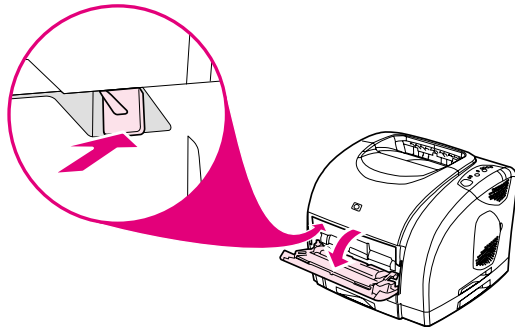

Figure 120.

Location of the engine-test switch

Performing a continuous self-test

- 1 Turn the printer off.
- 2 Press and hold the **Go** button.
- 3 Turn the printer on and continue to hold the **Go** button for 10 to 15 seconds, or until the Attention and Ready lights turn off.
- 4 Release the **Go** button. The device lights begin cycling from front to back. The self-test process runs until the printer is in the Ready state.

Note

This test is similar to the NVRAM initializer; for more information see "NVRAM initializer" on page 221.

To perform other checks

If no image appears on the imaging drum, perform these checks:

- 1 Make sure that you removed the entire length of the sealing tape from the print cartridges before you installed the cartridges.
- 2 Perform a high-voltage power-supply check.

High-voltage power-supply check

The high-voltage power-supply PCA provides the necessary voltages for the electrophotographic processes.

To check the print cartridge connection points

Turn the print cartridge over and visually inspect the two connection points on the ends of the print cartridge. If they are dirty or corroded, clean the connections. If they are damaged, replace the print cartridge.

Note

Use only isopropyl alcohol to clean the connections.

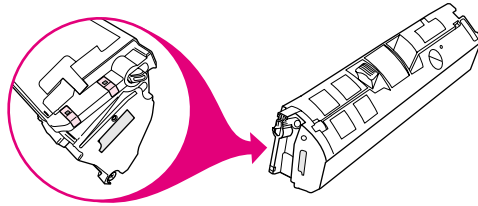

Figure 121. Print cartridge high-voltage connection points

Paper-path check

If media is not being picked up or is not moving through the paper path, you might want to observe all of the paper-motion activities. Override the door interlock (SW301) and the laser/scanner switch to observe the following actions:

- motor rotation
- solenoid action
- pickup-roller motion
- drive-roller, transfer-roller, fuser-roller and gear, and delivery-roller motion

To override SW301

Push a piece of heavy paper into the slot in the top cover (callout 1) to engage SW301.

To override the laser/scanner switch

Use a small flatblade screwdriver to override the laser/scanner switch (callout 2).

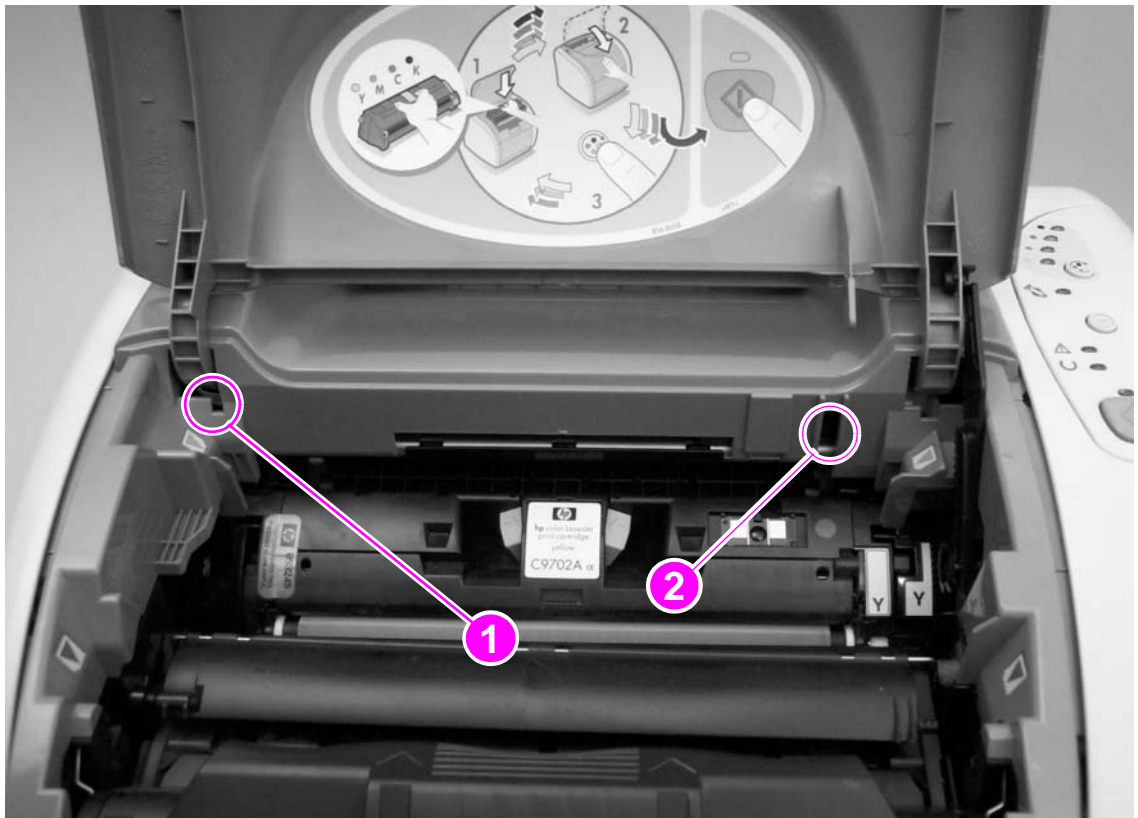

Figure 122. Overriding SW301 and the laser/scanner switch

Service mode functions

Cold reset

A cold reset sets most, but not all, default variables stored in NVRAM back to factory default values. It typically does not reset the page count, paper tray sizes, localization language, or formatter number. To reset all variables, see “NVRAM initializer” on page 221.

To perform a cold reset

- 1 Turn the printer off.
- 2 Press and hold down the **Go** button.
- 3 Turn the printer on and continue to hold the **Go** button.
- 4 After the Go, Attention, and Ready lights turn on, continue holding the **Go** button for approximately five seconds, but not longer than fifteen seconds. During this process, the Attention light will turn off.
- 5 Release the **Go** button.

Note

If either the Go or Ready light turned off or no lights turned off before the **Go** button was released, then repeat steps 1 through 5.

- 6 The printer lights begin cycling from front to back. The cold-reset process runs until the printer is in the Ready state.

NVRAM initializer

NVRAM initializer sets all default variables stored in NVRAM back to factory default values or to a default ROM value, depending on the variable. It also performs a system reset.

NVRAM initializer resets the following:

- all menu settings to factory default values
- factory settings such as formatter number, page counts, factory paper settings

To perform an NVRAM initialization

- 1 Turn the printer off.
- 2 Press and hold the **Go** button.
- 3 Turn the printer on and continue to hold the **Go** button.
- 4 After the Go, Ready, and Attention lights turn on, continue holding for at least 20 seconds. During this process, the Attention, Ready, and Go lights will each turn off.
- 5 Release the **Go** button.
- 6 The device lights will begin cycling from front to back. The NVRAM-initialization process runs until the printer is in the Ready state.

Note

This process is similar to a continuous self-test. For more information, see “Performing a continuous self-test” on page 218.

After the initialization is complete, you can use PJL commands (see “Using PJL commands” on page 222) to restore some of your printer settings.

Using PJL commands

PJL commands are useful when you have performed an NVRAM initialization or replaced the formatter card. Use the following PJL commands to restore the printer information to the new formatter.

```
ESC%-12345X@PJL SET SERVICEMODE=HPBOISEID
@PJL DEFAULT SERIALNUMBER=XXXXXXXXXXXX
@PJL DEFAULT PAGES=XXX
@PJL DEFAULT COLORPAGES=XXX
@PJL SET SERVICEMODE=EXIT
ESC%-12345X
```

The X's in the serial number, formatter number, pages, and color pages fields are variables that you must replace with your printer information. The Configuration page contains the actual information for your printer.

Using the MS-DOS command prompt and the MS-DOS Editor

To enter the PJL commands, you must use the MS-DOS Command Prompt and MS-DOS Editor.

To open a MS-DOS Command Prompt window:

- 1 Click **Start**.
- 2 Select **Programs**.
- 3 Select **Accessories**.
- 4 Select **Command Prompt**. A command prompt window opens.
- 5 Type **EDIT** and press **ENTER**. The MS-DOS Editor window opens.

To create the escape sequence in the MS-DOS Editor:

- 1 Press **CTRL+P**, and then release the keys.
- 2 Press **ESC**. The editor inserts an arrow symbol pointing to the left, which indicates to the printer that the text following the symbol is a command, not text that should be printed.
- 3 Type the rest of the command after the symbol.

Sending the file to the printer (HP color LaserJet 1500 series printers)

Note

These steps send the PJI command to a shared HP color LaserJet 1500 series printer only if the printer and the PC from which the command is sent are on the same network.

To send the file to the printer:

- 1 Save the PJI command and name it.
- 2 In the MS-DOS Command Prompt, type **Copy (filename) \\ (computer name) \ (printer share name)** at the MS-DOS prompt.

Example: `C:\Copy filename.txt \\computer name\printer share name;`

The MS-DOS Command Prompt sends the PJI commands to the printer.

Alternative method

HP color LaserJet 1500 series printers also feature an alternative method to sending the PJI commands to the printer. To use the alternative method, complete the following steps:

- 1 Open the HP color LaserJet 1500 series Toolbox.
- 2 Click the **Troubleshooting** tab.
- 3 Press SHIFT and click the HP logo. A hidden firmware page opens.
- 4 Click **Program Printer**. The Open dialog box appears.
- 5 Browse to the command file created in MS-DOS Editor, and click **Open** to send the file to the printer.

The Ready light blinks several times as the file is sent to the printer and then returns to a solid light.

Sending the file to the printer (HP color LaserJet 2500 series printers)

To send the file to the printer:

- 1 Save the PJI command and name it.
- 2 In the MS-DOS Command Prompt, type **Copy (filename) (printer port)** at the MS-DOS prompt.

Example: `C:\Copy filename.txt LPT1;`

The MS-DOS Command Prompt sends the PJI command file to the printer.

Troubleshooting tools



Demo page

To print the Demo page, press  (Go) when the printer is Ready (Ready light on) and is not printing. You can also view this page from the HP color LaserJet 1500 series Toolbox or HP color LaserJet 2500 series Toolbox.

Configuration page

The Configuration page lists current settings and properties of the printer. You can print a Configuration page at the printer control panel, in the embedded Web server (HP color LaserJet 2500 series printers only), or from the printer Toolbox.

HP color LaserJet 1500 series printers

To print the Configuration page from the printer, press  (Go) and  (CANCEL JOB) simultaneously.

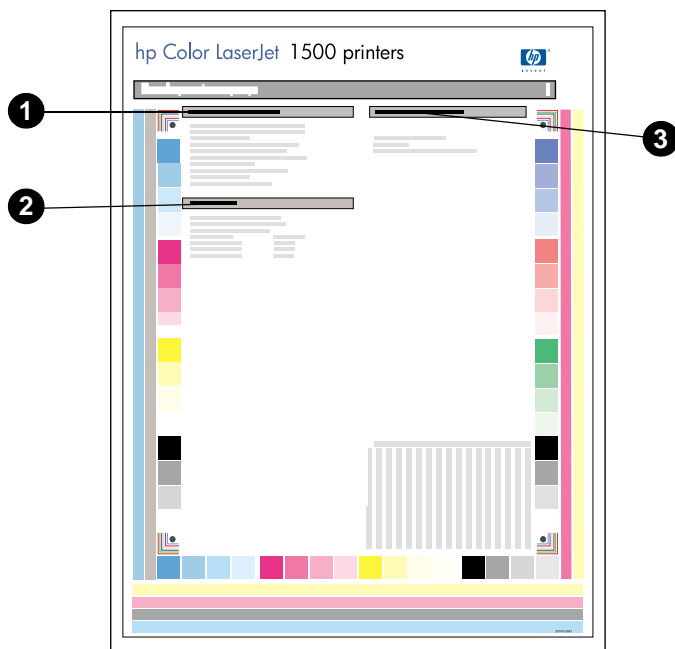

- 1 Printer Information.** This section contains basic information about the printer, such as the product name, printer name, and page count.
- 2 Event Log.** This section contains information about printer errors.
- 3 Paper Trays and Options.** This section contains information about the trays, such as whether optional trays are installed, and the type and size of paper that might be set for each tray.

HP color LaserJet 2500 series printers

To print the Configuration page from the printer, press **GO** and **CANCEL JOB** simultaneously. The Supplies Status page also prints. If you have an HP Jetdirect print server card installed, the HP Jetdirect page listing the HP Jetdirect information also prints.

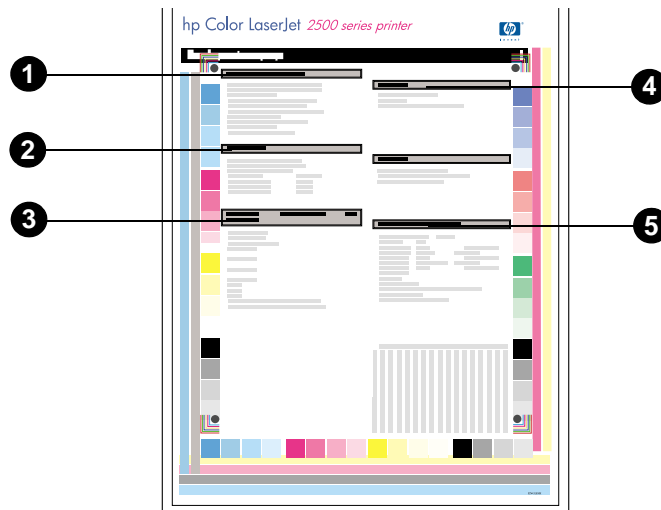

- 1 Printer Information.** This section contains basic information about the printer, such as the product name, printer name, and page count.
- 2 Event Log.** This section contains information about printer errors.
- 3 Installed personalities and options.** This section, found only on HP color LaserJet 2500 series printers, contains information about optional items that might be installed, such as DIMMs or an HP Jetdirect print server card.
- 4 Memory.** This section lists memory-related information, such as the total memory installed.
- 5 Paper Tray Information.** This section contains information about the trays, such as whether optional trays are installed and tray settings.

Supplies Status page

The Supplies Status page lists the remaining life of HP print cartridges and HP imaging drums. It also lists the estimated number of pages that can be printed with the remaining supplies, the number of pages printed, and other supplies information. You can print a Supplies Status page at the printer control panel or from the embedded Web server (HP color LaserJet 2500 series printers only).

To print at the printer, press **(GO)** and **(CANCEL JOB)** simultaneously. The Configuration page also prints.

Note

On HP color LaserJet 2500 series printers, if you have an HP Jetdirect print server card installed, the HP Jetdirect page listing the HP Jetdirect information also prints.

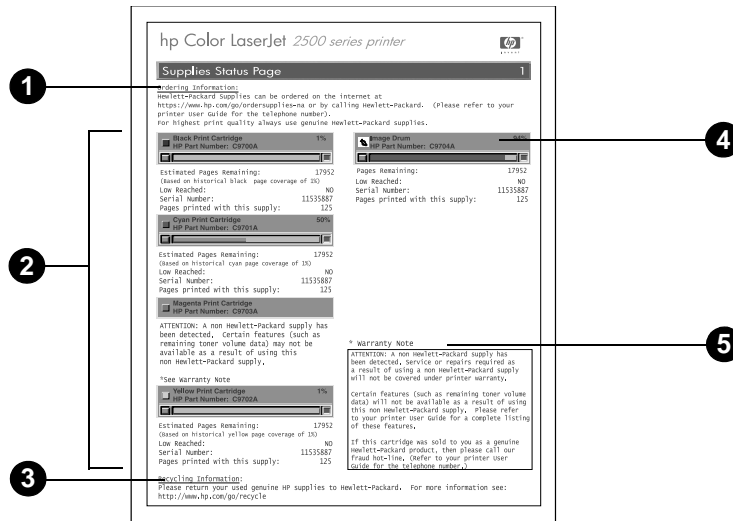

- 1 Ordering Information.** This section contains basic information about how to order new HP supplies.
- 2 Print-cartridge area.** This area contains a section for each of the print cartridges and provides information about HP print cartridges. This information includes the part number for each print cartridge, whether each print cartridge is low, and the life remaining for each print cartridge expressed as a percentage, as a graphic, and as the estimated number of pages remaining. This information is provided only for HP supplies. If a non-HP supply is installed, you see an alert message instead.
- 3 Recycling Information.** This section contains information about the website you can visit for information about recycling.
- 4 Imaging-drum area.** This area contains the same information for the imaging drum that the print-cartridge area provides for the print cartridges.
- 5 Warranty Note.** This section contains information about how the printer warranty is affected when you use non-HP supplies. It also requests that you call the HP fraud hotline if a supply that is being detected as a non-HP supply was sold to you as a genuine HP supply. (See the user guide for information about the HP fraud hotline.)

Repetitive image defect ruler

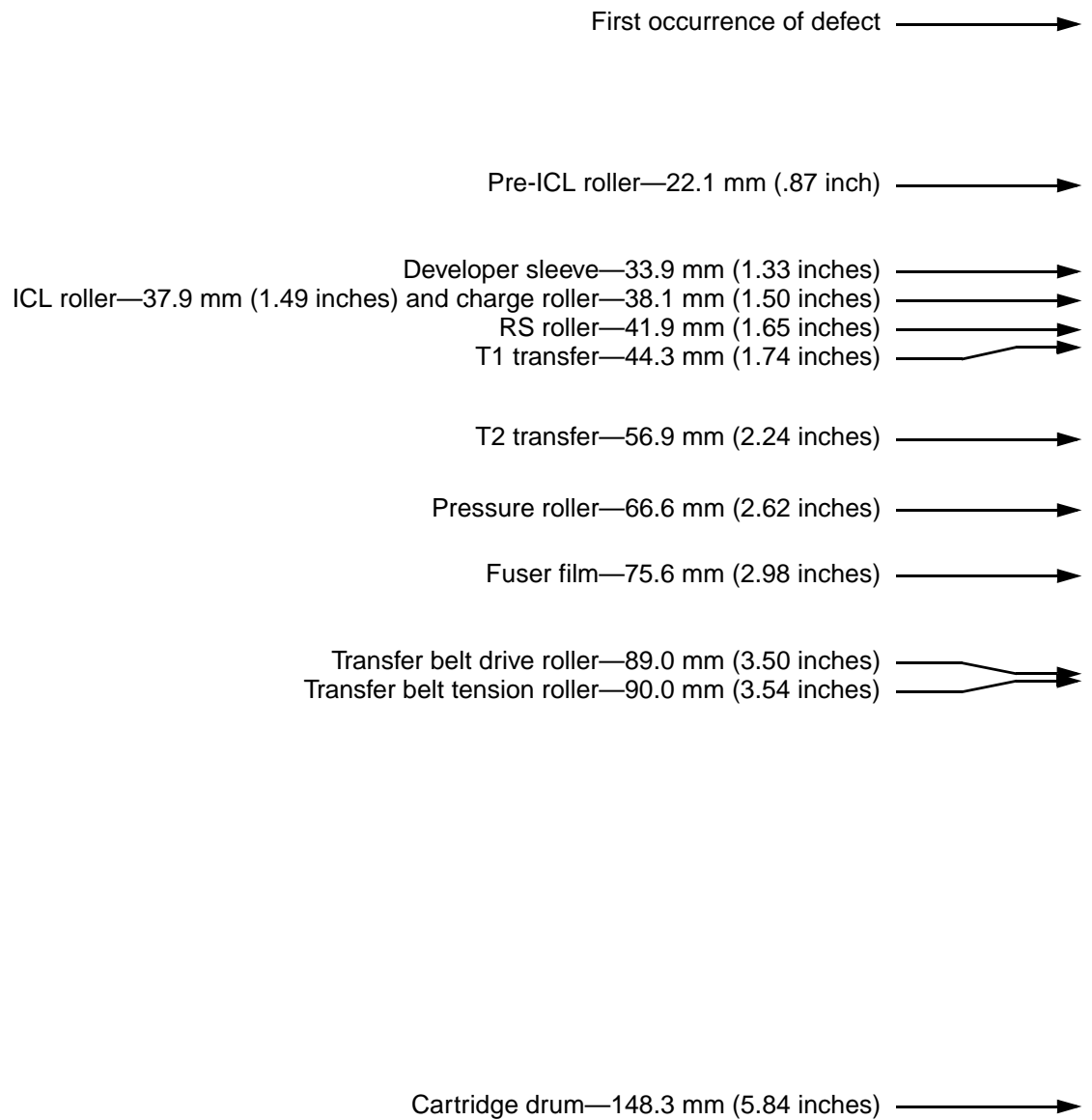

Figure 123. Repetitive image defect ruler

General timing charts

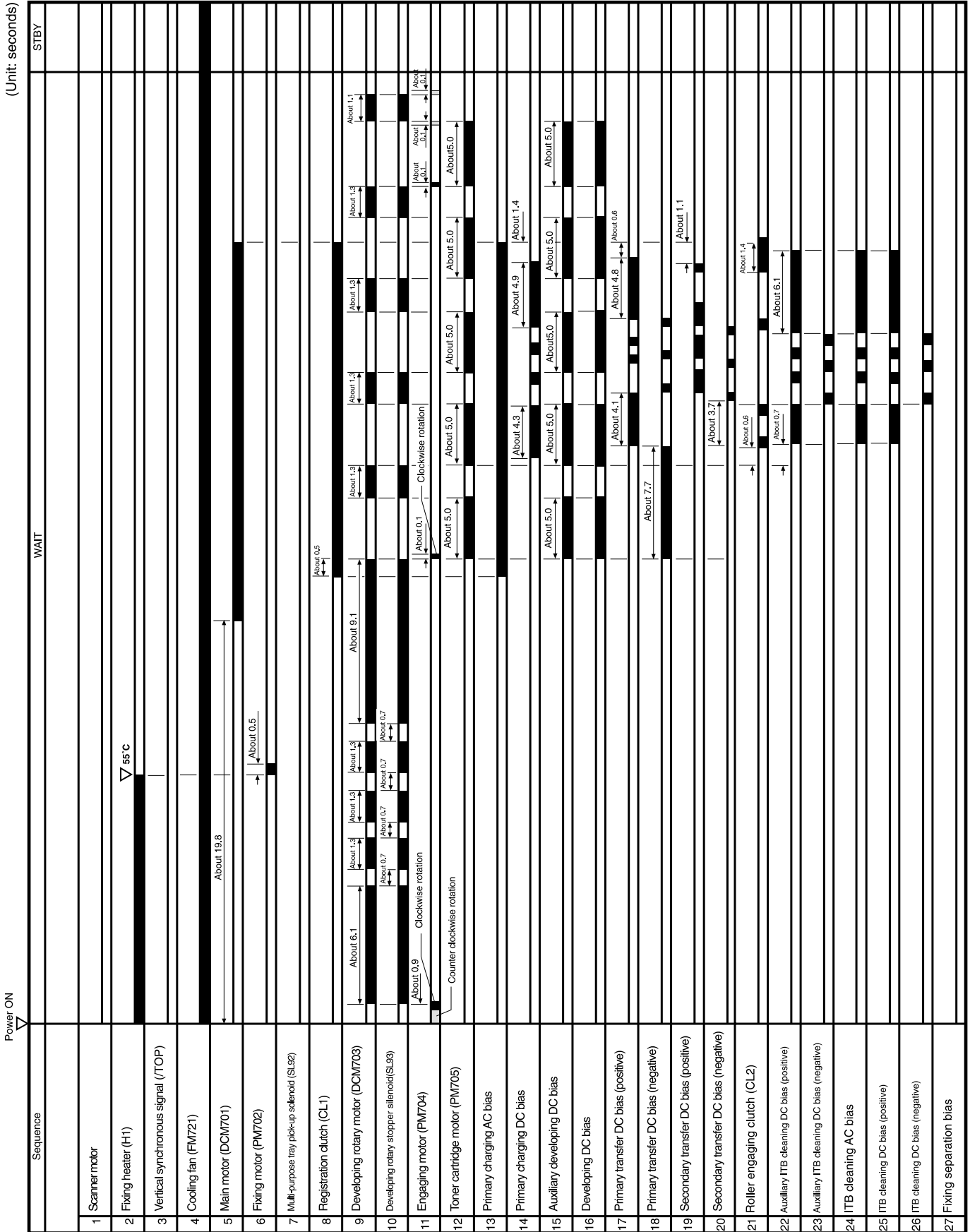

Figure 124. General timing chart—WAIT period

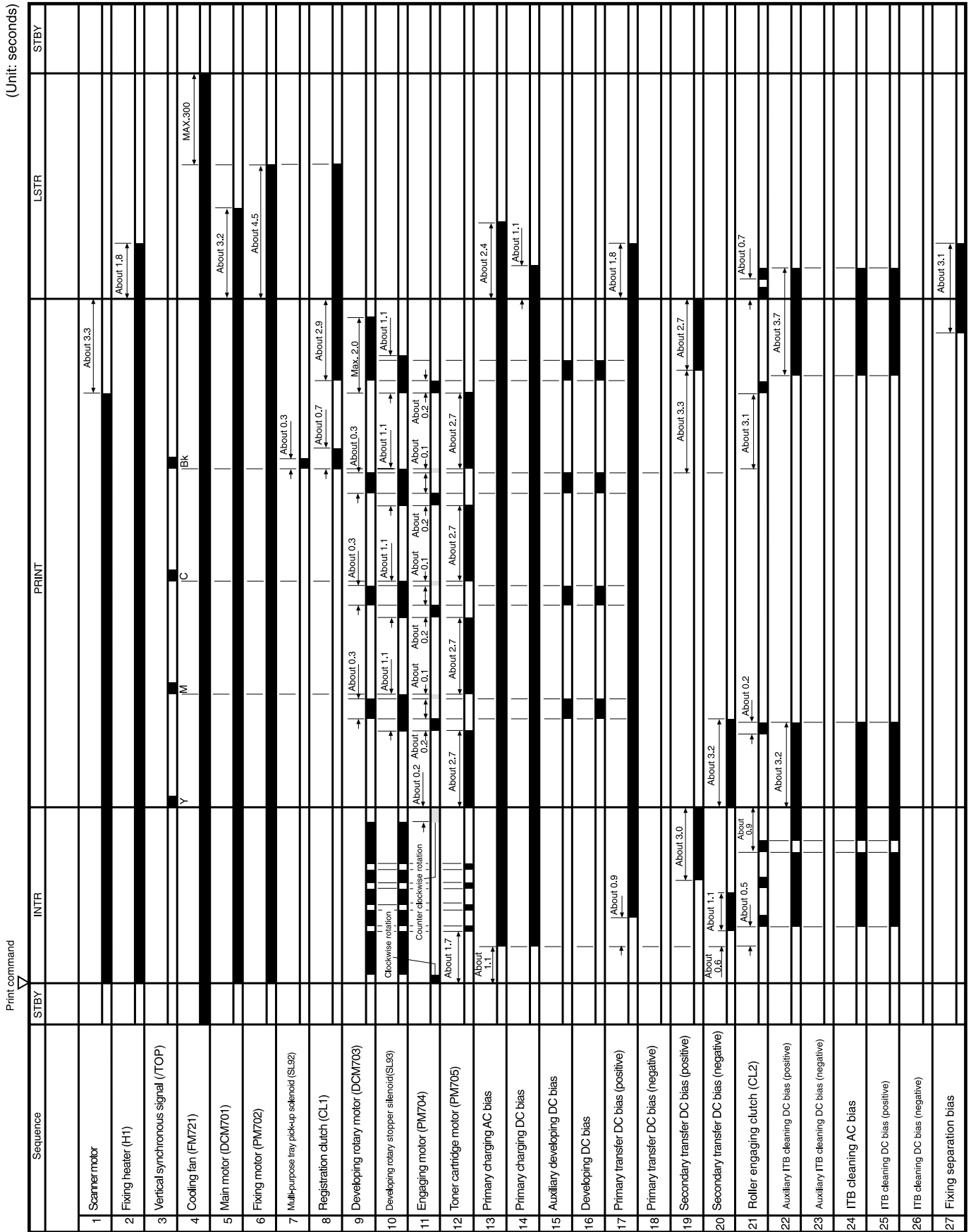

Figure 125. General timing chart—one page, full-color, normal speed

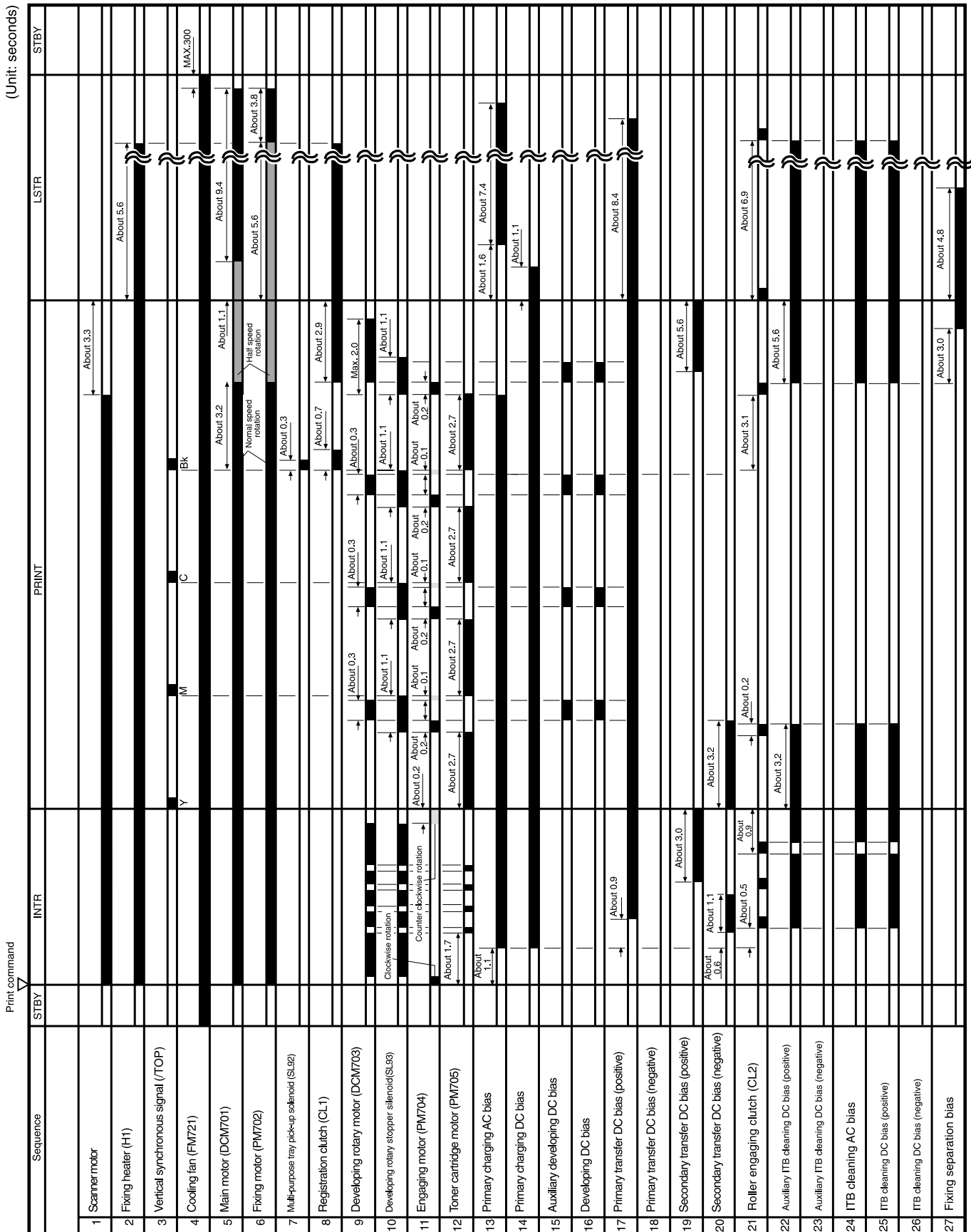

Figure 126. General timing chart—one page, full-color, half speed

Locations of connectors

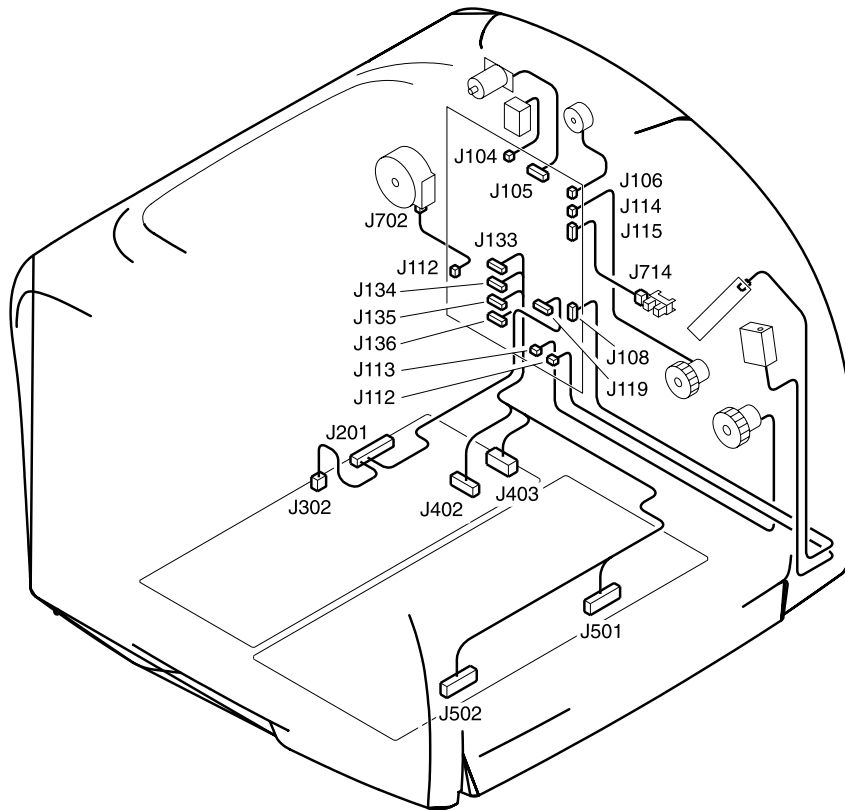

Figure 127. Locations of printer connectors (1 of 3)

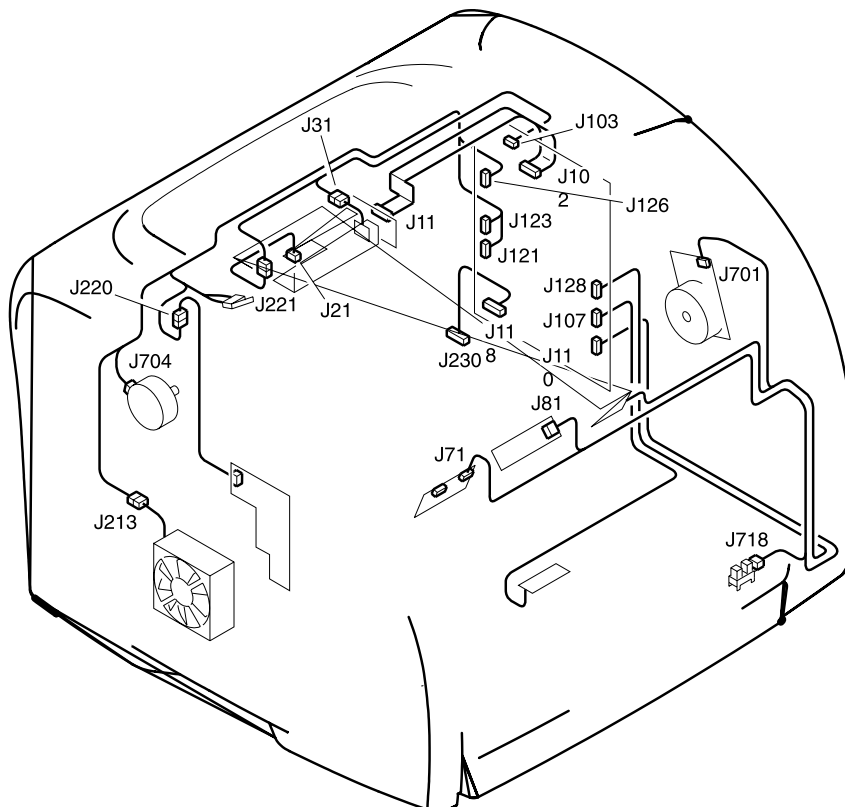

Figure 128. Locations of printer connectors (2 of 3)

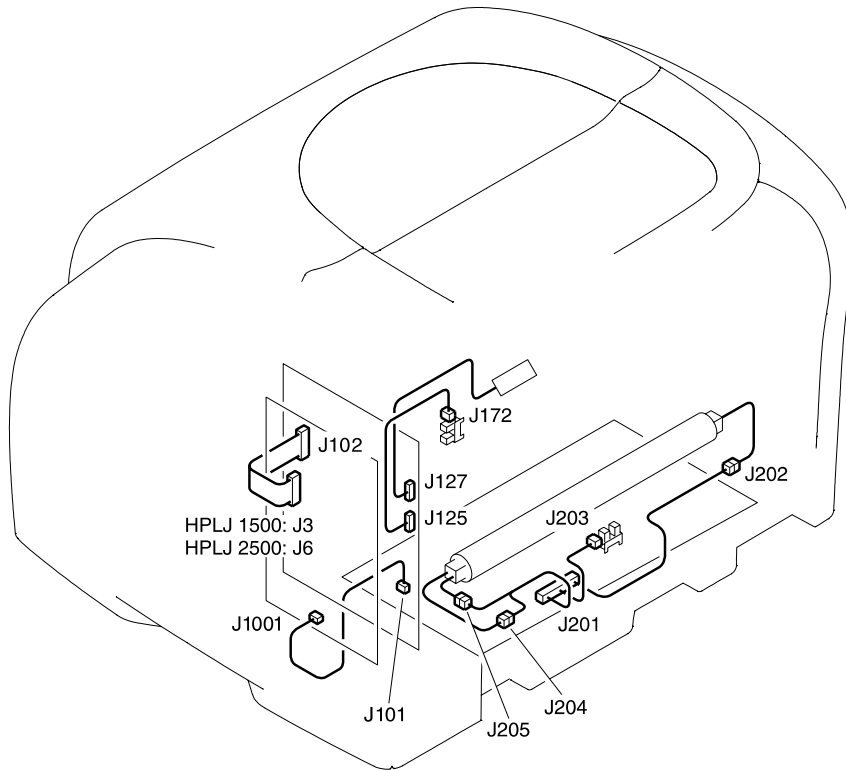

Figure 129. Locations of printer connectors (3 of 3)

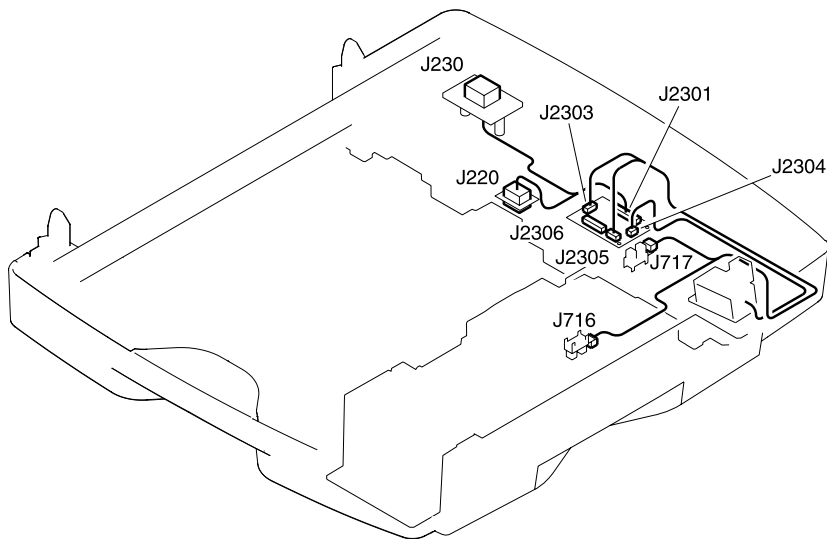

Figure 130. Locations of 250-sheet tray connectors

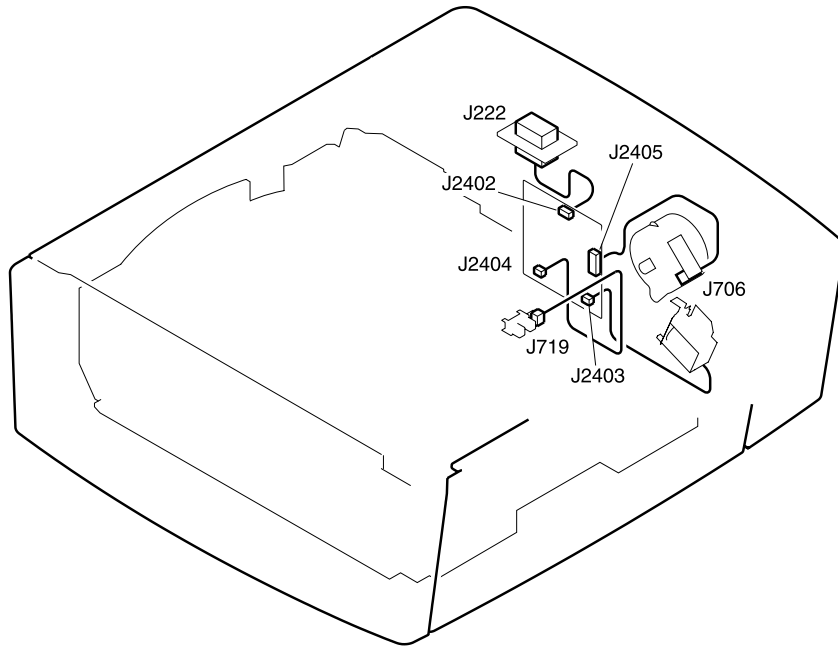

Figure 131. Locations of 500-sheet tray connectors (HP color LaserJet 2500 only)

Dc controller connections

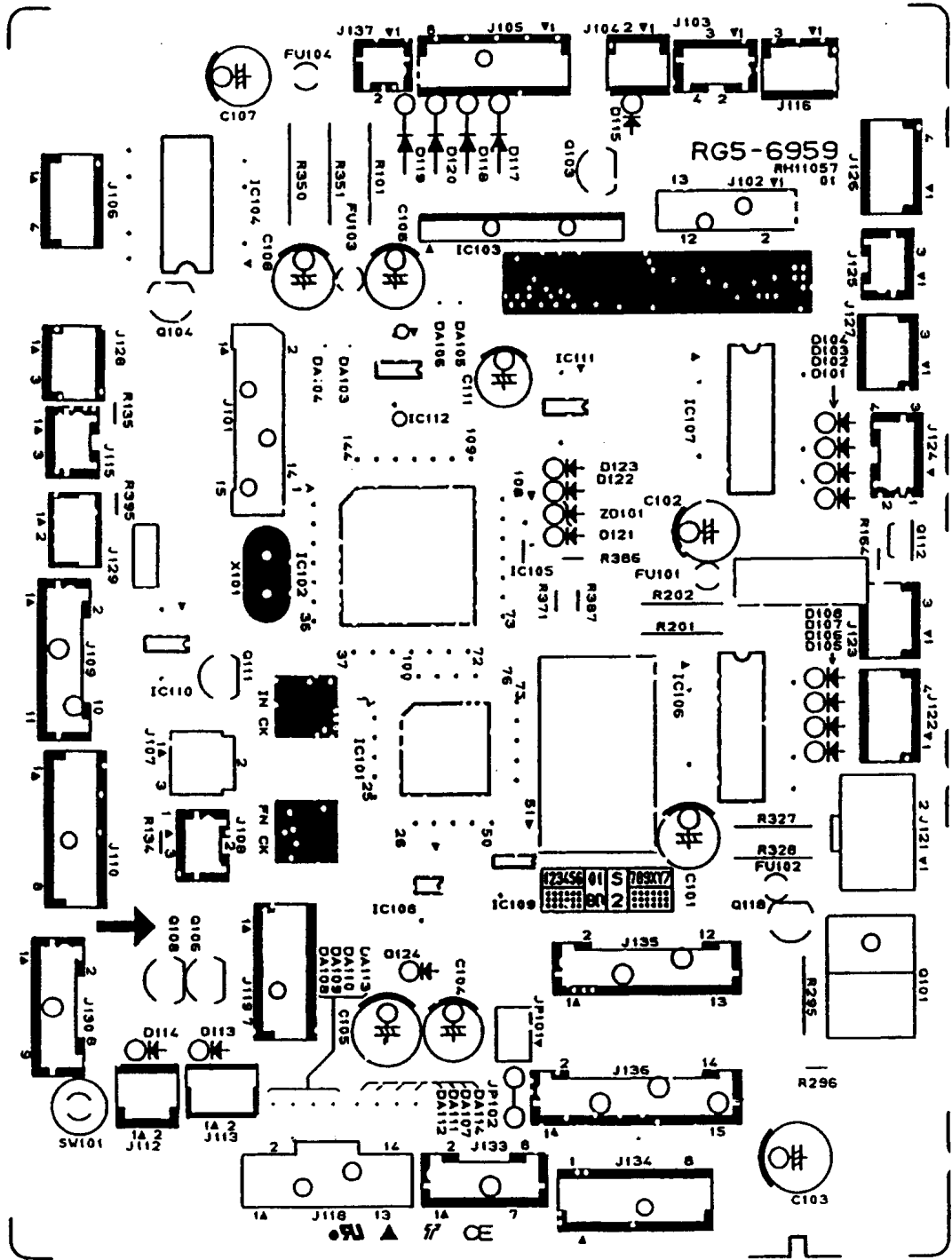

Figure 132. Dc controller connections

Main wiring diagram

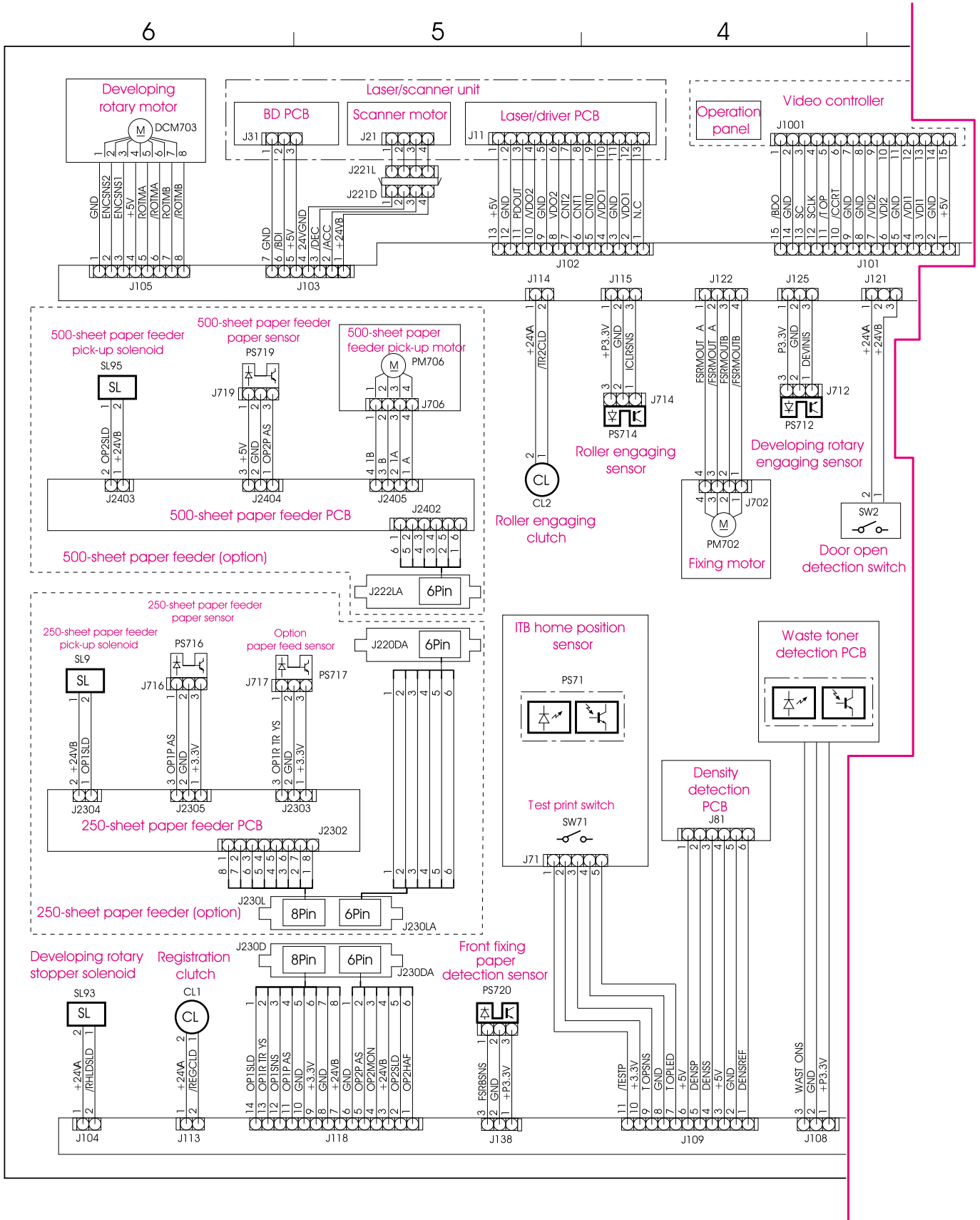

Figure 133. Main wiring (1 of 2)

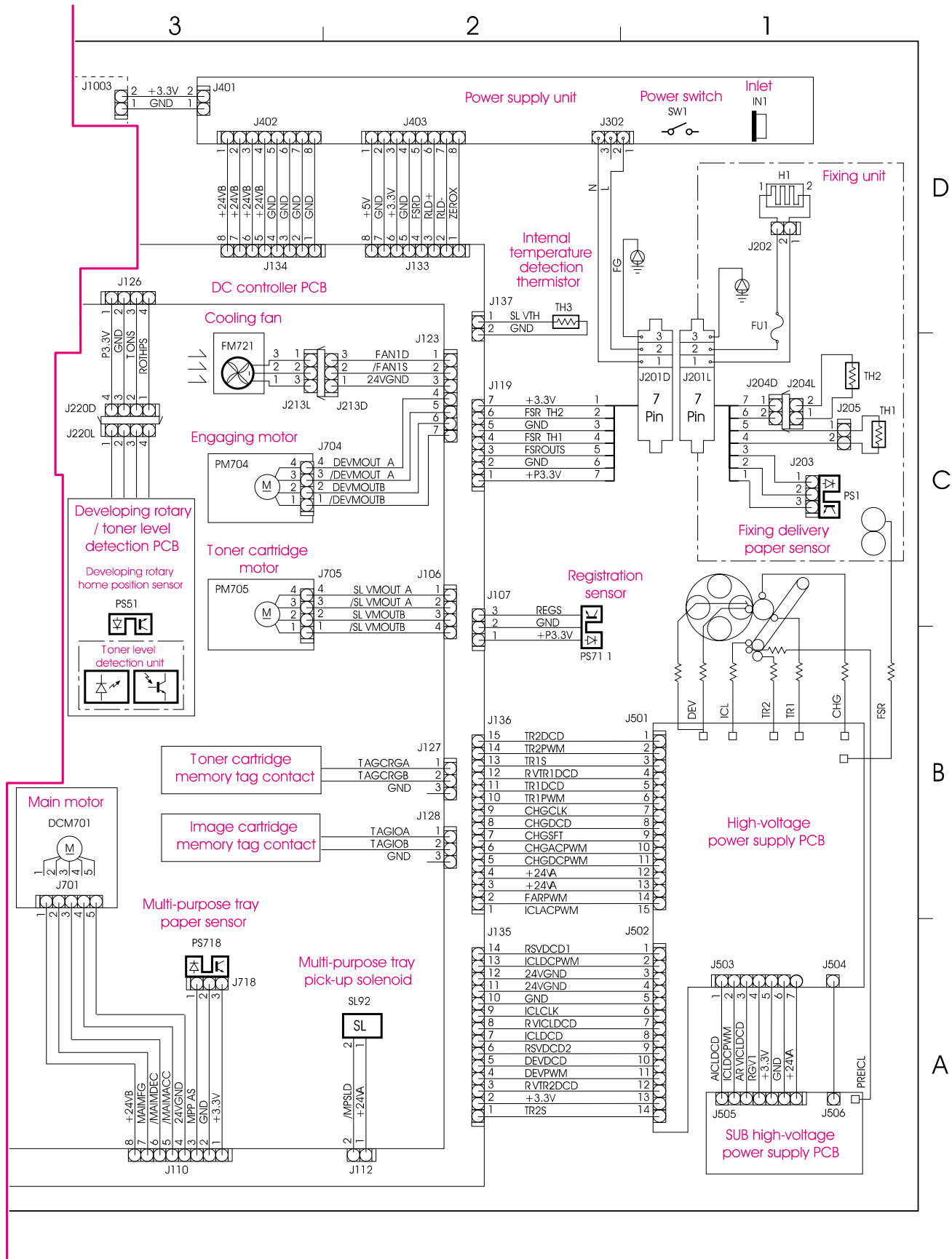

Figure 134. Main wiring (2 of 2)

The HP Color LaserJet 1500 Series Toolbox

The HP color LaserJet 1500 Series Toolbox is supported only for Windows 98, Me, 2000, and XP. Perform a complete software installation to use the Toolbox.

You can view the Toolbox when the printer is directly connected to your computer or connected to the network. The Toolbox is a Web page that opens in a Web browser and provides access to printer documentation, printer management tools, and troubleshooting tools.

To use the Toolbox, you must have Microsoft Internet Explorer 4 or later or Netscape Navigator 4 or later. All pages can be printed from the browser.

You do not have to have Internet access to open and use the Toolbox. However, if you click a link in the **Other Links** area, you must have Internet access in order to view the site associated with the link.

To view the Toolbox

- 1 Open the Toolbox in one of these ways:
 - On the desktop, double-click the HP Color LaserJet 1500 Series Toolbox icon.
 - On the **Start** menu, point to **Programs**, point to **HP Color LaserJet 1500**, and select the **HP Color LaserJet 1500 Series Toolbox**.

Note

After you open the URL, you can bookmark it so that you can return to it quickly in the future.

- 2 The Toolbox opens in a Web browser. The Toolbox software contains these tabs: the **Information** tab, the **Settings** tab, the **Printer** tab, the **Documentation** tab, the **Troubleshooting** tab, and the **Networking** tab. It also contains an area with links to the HP website. See the following sections for more information about each tab or area.

Information tab

The Information pages group consists of the following pages.

- **Device Status.** This page displays the printer status and shows the life remaining of HP supplies, with 0 percent representing that a supply is empty. The page also shows the type and size of print media set for each tray. To change the default settings, click **Change Settings**.
- **Configuration page.** This page shows the information found on the printer Configuration page.
- **Supplies Status.** This page shows the life remaining of HP supplies, with 0 percent representing that a supply is empty. This page also provides supplies part numbers. To order new supplies, click **Order Supplies** in the **Other Links** area on the left side of the window. To visit any website, you must have Internet access.
- **Event log.** This page shows a list of all printer events and errors.
- **Usage page.** This page shows a summary of the number of pages the printer has printed, grouped by size and type.
- **Device Information.** This page also shows the printer network name, address, and model information. To change these entries, click **Device Information** on the **Settings** tab.

Settings tab

This tab allows you to configure the printer from your computer. The **Settings** tab can be password-protected. If this printer is networked, always consult with the printer administrator before changing settings on this tab.

The **Settings** tab contains the following pages.

- **Configure Device.** Configure all printer settings from this page. This page contains the traditional menus found on printers using a control panel display. These menus include **Information**, **Paper Handling**, **Configure Device**, and **Diagnostics**.
- **Alerts.** Network only. Set up to receive e-mail alerts for various printer events.
- **Email.** Network only. Used in conjunction with the Alerts page to set up incoming and outgoing e-mail, as well as to set e-mail alerts.
- **Security.** Set a password that must be entered to gain access to the **Settings** and **Networking** tabs. Enable and disable certain features of the EWS.
- **Other Links.** Add or customize a link to another web site. This link is displayed in the **Other Links** area on HP Color LaserJet 1500 Series Toolbox pages. These permanent links always appear in the **Other Links** area: **HP Instant Support™**, **Order Supplies**, and **Product Support**. For more information, see “Other links” on page 241.
- **Device Information.** Name the printer and assign an asset number to it. Enter the name and e-mail address for the primary contact who will receive information about the printer.
- **Language.** Determine the language in which to display the embedded Web server information.

Printer tab

The **Printer** tab allows you to choose which HP color LaserJet 1500 series printer to print from if more than one printer is connected to the network. More than one HP color LaserJet 1500 series printer can be connected to the computer through a local area network (LAN) or through direct connect.

Documentation tab

This section of the navigation bar contains links to these information sources:

- **Install Notes.** This contains late-breaking information about the printer. In English only.
- **Read Me!** This contains information that was discovered after other documentation, such as the user guide, was developed.
- **User Guide—PDF.** This contains information about the printer usage and warranty, specifications, and support that you are currently reading. This PDF format can be printed by page or by chapter, or you can print the entire document, and which will be formatted as a traditional book.
- **User Guide—HTML.** This contains information about the printer usage and warranty, specifications, and support that you are currently reading. This HTML format allows you to easily search for specific topics and jump between topics. It can be viewed only from Windows-based computers.

Troubleshooting tab

This section of the navigation bar contains links to the information pages of the printer. From this section, you can view the following pages:

- **Control Panel Help.** This allows you to view animations of control panel light messages, identify what the light pattern means, and view information for resolving the message.
- **Cleaning Page.** You can clean the print path by using this tool.
- **Diagnostic Tools.** These pages can help you resolve problems with color-printing tasks and calibrate the printer.
- **Demo pages.** These are additional demonstration pages that you can print.

Networking tab

This tab allows the network administrator to control network-related settings for the printer when it is connected to an IP-based network. This tab will not appear if the printer is directly connected to a computer, or if the printer is connected to a network using anything other than an optional external HP Jetdirect print server.

Other links

This section contains links that connect you to the Internet. You must have Internet access in order to use any of these links. If you use a dial-up connection and did not connect when you first opened the HP color LaserJet 1500 Series Toolbox, you must connect before you can visit these websites. Connecting might require that you close the HP color LaserJet 1500 Series Toolbox and reopen it.

- **HP Instant Support™.** Connects you to the HP website to help you find help for issues that might arise. This service analyzes your printer error log and configuration information to provide diagnostic and support information specific to your printer.
- **Order Supplies.** Click this link to connect to the HP website and order genuine HP supplies, such as print cartridges, an imaging drum, and paper.
- **Product Support.** Connects to the support site for the HP color LaserJet 1500 series printer. Then, you can search for help with a specific problem.

The HP Color LaserJet 2500 Series Toolbox

The HP Color LaserJet 2500 Series Toolbox is only supported for Windows 98, NT 4.0 (with a parallel connection only), Me, 2000, and XP. You must have performed a complete software installation to use the Toolbox.

You can view the Toolbox when the printer is directly connected to your computer or connected to the network. The Toolbox is a Web page that opens in a Web browser and provides access to the embedded Web server, printer documentation, and printer management and troubleshooting tools.

To use the Toolbox, you must have Microsoft Internet Explorer 4 or later or Netscape Navigator 4 or later. All pages can be printed from the browser.

You do not have to have Internet access to open and use the Toolbox. However, if you click a link in the **Other Links** area, you must have Internet access in order to view the site associated with the link.

To view the Toolbox

- 1 Open the Toolbox in one of these ways:
 - On the desktop, double-click the HP Color LaserJet 2500 Series Toolbox icon.
 - On the **Start** menu, point to **Programs**, point to **HP Color LaserJet 2500**, and choose the **HP Color LaserJet 2500 Series Toolbox**.

Note

Once you open the URL, you can bookmark it so that you can return to it quickly in the future.

- 2 The Toolbox opens in a Web browser. The Toolbox software contains these tabs: the **Device** tab, the **Documentation** tab, and the **Troubleshooting** tab. It also contains an area with links to the HP website. See the following sections for more information about each tab or area.

Device tab

The two links on this page, Information and Settings, open the page of the same name from the embedded Web server. To open the embedded Web server and see all of its settings and information, click the picture of the printer in the center of the page. If more than one HP color LaserJet 2500 series printer is connected to the network, you will be prompted to select one.

- **Information.** View printer status information. This information comes from the embedded Web server.
- **Settings.** View and change printer settings. This information comes from the embedded Web server.

Documentation tab

This section of the navigation bar contains links to these information sources:

- **Install Notes.** Contains late-breaking information about the printer. In English only.
- **Read Me!** Contains information discovered after other documentation such as the user guide was developed.
- **User Guide - PDF.** Contains the information about the printer usage, warranty, specifications, and support that you are currently reading. This PDF format can be printed by page, chapter, or the entire document, and will be formatted as a traditional book.
- **User Guide - HTML.** Contains the information about the printer usage, warranty, specifications, and support that you are currently reading. This HTML format allows you to easily search for specific topics and jump between topics. Viewable from Windows-based computers only.

Troubleshooting tab

This section of the navigation bar contains links to the information pages of the printer. (Some of these pages are also available from other sources, such as the embedded Web server or the printer itself.) From this section, you can view the following pages:

- **Control Panel Help.** Allows you to view animations of control panel light messages, identify what the light pattern means, and view information for resolving the message.
- **Cleaning Page.** You can clean the print path using this tool. See “Calibrating the printer” on page 62 for instructions.
- **Diagnostic Tools.** These pages can help you resolve problems with color printing tasks and calibrate the printer.
- **Demo pages.** These are additional demonstration pages you can print.

Other links

This section contains links that connect you to the Internet. You must have Internet access in order to use any of these links. If you use a dial-up connection and did not connect when you first opened the Toolbox, you must connect before you can visit these websites. Connecting might require that you close the Toolbox and reopen it.

7

Parts and diagrams

Chapter contents

Ordering parts and supplies	244
Parts	244
Related documentation and software	244
Supplies	244
Accessories	245
How to use the parts lists and diagrams	246
Assembly locations	247
Printer (without optional trays)	247
Covers	248
Internal assemblies	250
Front frame assembly	250
Internal components (1 of 2)	252
Internal components (2 of 2)	254
Main drive assembly	256
Rear frame assembly	258
Middle frame assembly	260
Rotary (carousel) assembly	262
Power-supply base assembly	264
Fuser assembly	266
Rotary-drive assembly	268
PCA assemblies	269
Optional tray 2	270
Covers for optional tray 2	270
Center frame assembly—optional tray 2	272
Optional tray 2	274
Right cover assembly—optional tray 2	275
Optional tray 3	276
Covers for optional tray 3	276
Internal components—optional tray 3	278
Feed drive assembly—optional tray 3	280
Media tray—optional tray 3	282
Alphabetical parts list	284
Numerical parts list	291

Ordering parts and supplies

Parts

Order replacement parts from the following website:
http://www.hp.com/ssg/parts/direct_order.html

Related documentation and software

Order documentation and software from the companies listed in table 29; some documentation and software is available at the following websites.

Table 29. Technical support websites

HP Customer Care Online Software drivers, support documentation, and answers to frequently asked questions	http://www.hp.com/go/support
HP Technical Training (North America) Classes and schedules	http://www.hp.com/go/resellertraining
Parts Parts information	http://outfield.external.hp.com/spi/welcome.htm

Supplies

Printer supplies are listed in chapter 3, “Maintenance,” in table 15 on page 54. Consumables are available directly from Hewlett-Packard at the following numbers.

- US: (1) (800) 538-8787
- Canada: (1) (800) 387-3154
in Toronto: (1) (416) 671-8383
- United Kingdom: 0734-441212
- Germany: 0130-3322

Contact your local HP Parts Coordinator for other local phone numbers.

Accessories

Table 30. Accessories

Item	Description	Part number
Memory upgrades (DIMMs) (HP color LaserJet 2500 series printers only)	32 MB	C7845A
	64 MB	C7846A
	128 MB	C9121A
Font DIMM (100-pin) (HP color LaserJet 2500 series printers only)	8 MB language font ROM	Go to http://www.hp.com for DIMM availability and ordering
Print cartridges	black print cartridge	C9700-69701 C9700A
	cyan print cartridge	C9701-69701 C9701A
	yellow print cartridge	C9702-69701 C9702A
	magenta print cartridge	C9703-69701 C9703A
Imaging drum		C9704-69701 C9704A
External HP Jetdirect print servers	HP Jetdirect 175x	J6035A
	HP Jetdirect 310x	J6038A
	HP Jetdirect 380x Wireless Networking (802.11b)	J6061A
Internal HP Jetdirect print servers (HP color LaserJet 2500 series printers only)	HP Jetdirect 680n Wireless Networking (802.11b)	J6058A
	HP Jetdirect 600n Ethernet (10 Base-T, RJ-45 only)	J3110A
	HP Jetdirect 600n Ethernet (10 Base-T RJ-45, 10Base2 BNC)	J3111A
	HP Jetdirect 615n Ethernet/Fast Ethernet (10/100Base-tX, RJ-45 only) NOTE: This print server card comes with the HP color LaserJet 2500n and 2500tn printers.	J6057A
	HP Jetdirect 610n Token Ring (RJ-45, DB-9)	J4167A
	HP Jetdirect connectivity card for USB, Serial and LocalTalk connections	J4135A
Cables and interface accessories	USB cable (2-meter standard USB-compatible device connector)	C6158A
	IEEE-1284 parallel cable (2-meter, size B) (HP color LaserJet 2500 series printers only)	C2950A
	IEEE-1284 parallel cable (3-meter, size B) (HP color LaserJet 2500 series printers only)	C2951A
Connectivity accessories (HP color LaserJet 2500 series printers only)	MPI Tech Bluetooth printer adapter	Go to http://www.hp.com for DIMM availability and ordering

How to use the parts lists and diagrams

The figures in this chapter illustrate the major subassemblies in the printer and their component parts. A table (material list) follows each exploded assembly diagram. Each table lists the reference designator, the associated part number for the item, and a description of the part.

Parts that have no reference designator or part number are not field-replaceable units and cannot be ordered.

While looking for a part number, pay careful attention to the voltage listed in the description column to make sure that the part number selected is for the correct printer model.

Assembly locations

Printer (without optional trays)

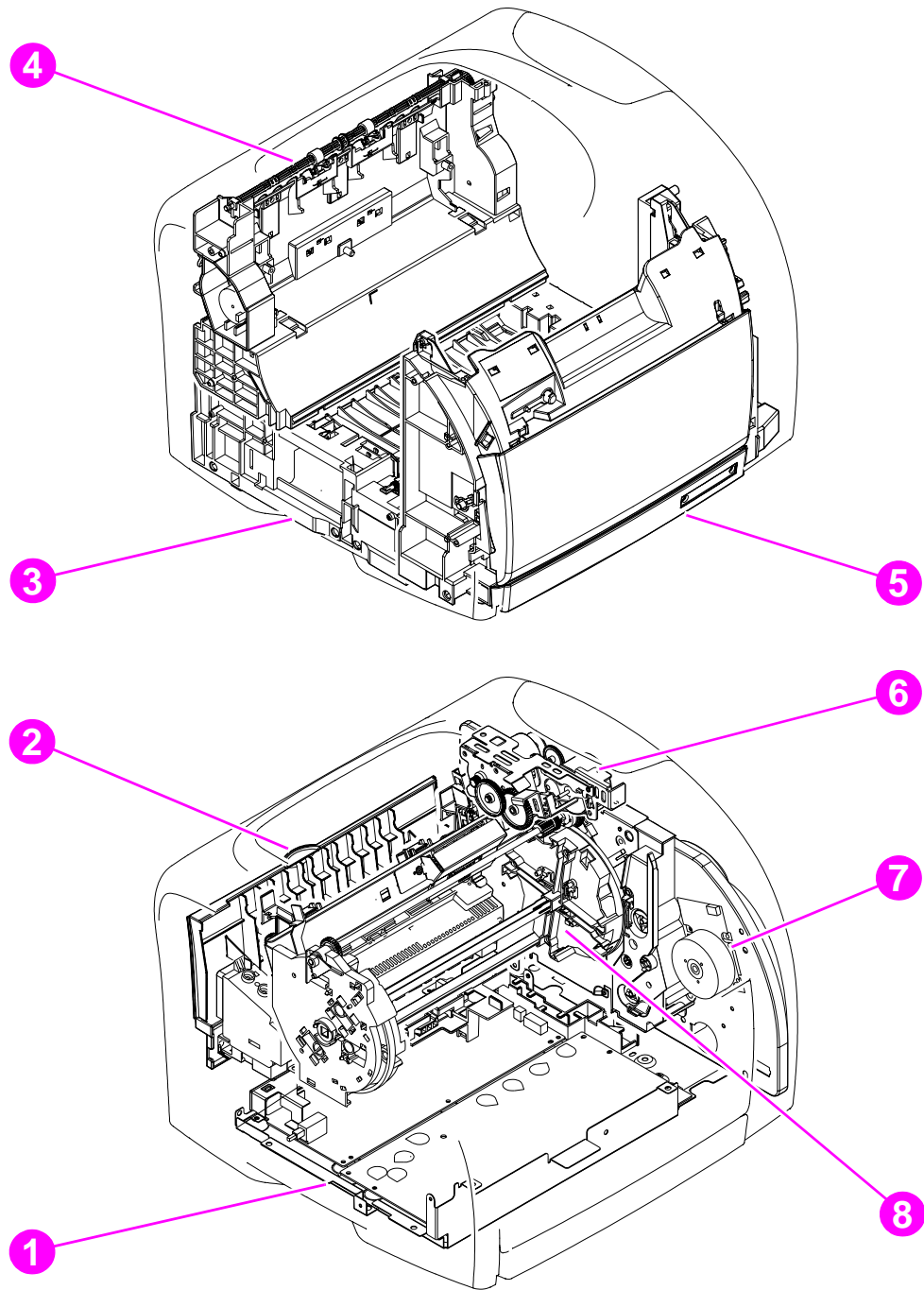

Figure 135.

Assembly locations

1	Power-base assembly	5	Front frame assembly
2	Fuser assembly	6	Rotary-drive assembly
3	Middle frame assembly	7	Main drive assembly
4	Rear frame assembly	8	Rotary (carousel) assembly

Covers

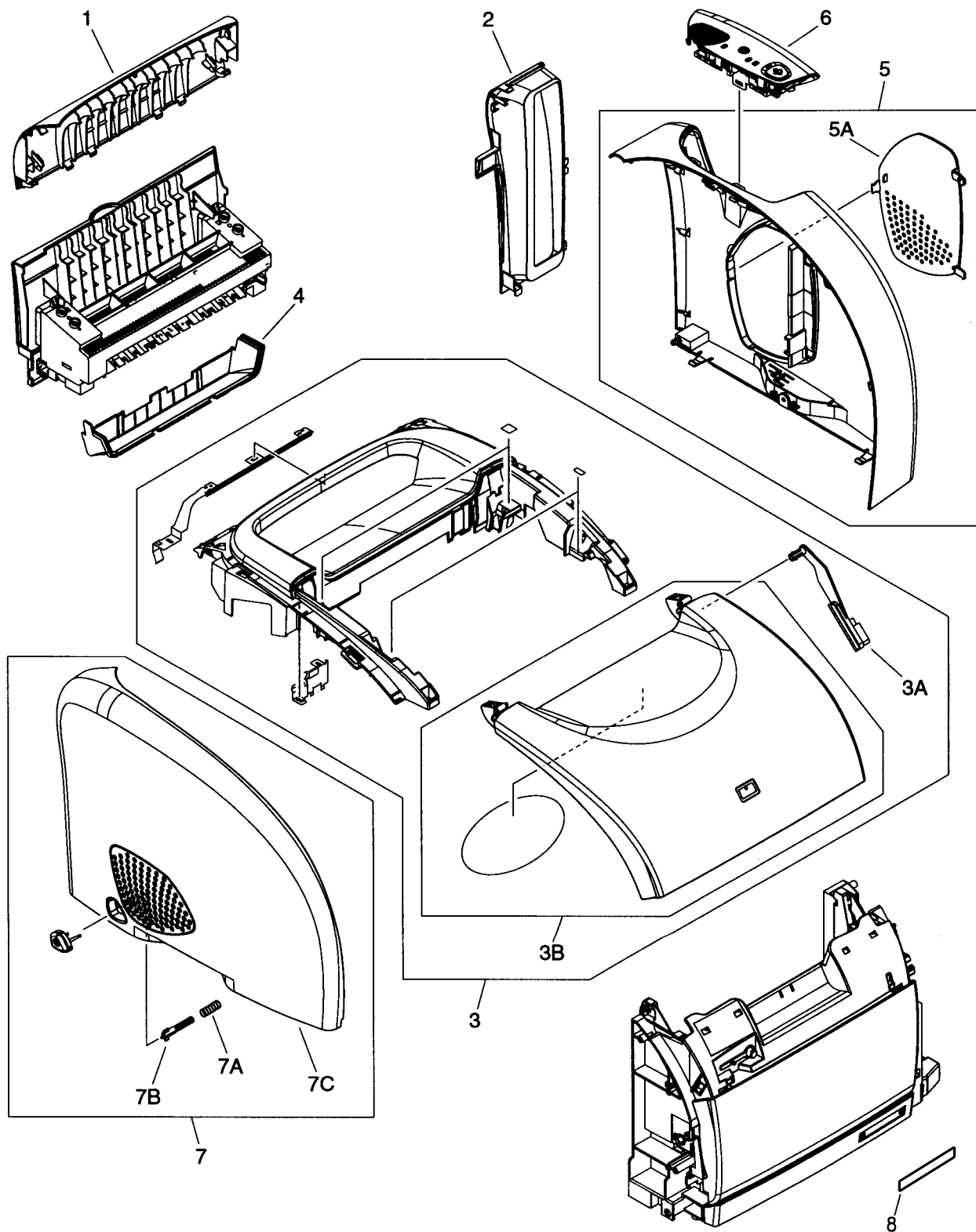

Figure 136. Covers

Table 31. Covers

Reference	Part number	Description	Quantity
1	RB3-0030-000CN	Rear cover	1
2	RB3-0035-000CN	Interface cover	1
3	RG5-6900-000CN	Top cover assembly	1
3A	RB3-0089-000CN	Rack, top cover	1
3B	RF5-4007-000CN	Top door	1
4	RB3-0032-000CN	Top output bin cover	1
5	RG5-6953-000CN	Right-side cover	1
5A	RB3-0033-000CN	DIMM door	1
6	RG5-6927-000CN	Control panel assembly	1
7	RG5-6902-000CN	Left-side cover	1
7A	RS6-2759-000CN	Spring, on/off switch	1
7B	RB3-0037-000CN	Rod, on/off switch	1
7C	RB3-0028-000CN	Left cover	1
8	Q2489-40001	Nameplate—HP color LaserJet 1500 printer	1
	Q2488-40001	Nameplate—HP color LaserJet 1500L printer	1
	C9706-40001	Nameplate—HP color LaserJet 2500 printer	1
	C9075-40007	Nameplate—HP color LaserJet 2500L printer	1
	C9707-40001	Nameplate—HP color LaserJet 2500n printer	1
	C9708-40001	Nameplate—HP color LaserJet 2500tn printer	1

Internal assemblies

Front frame assembly

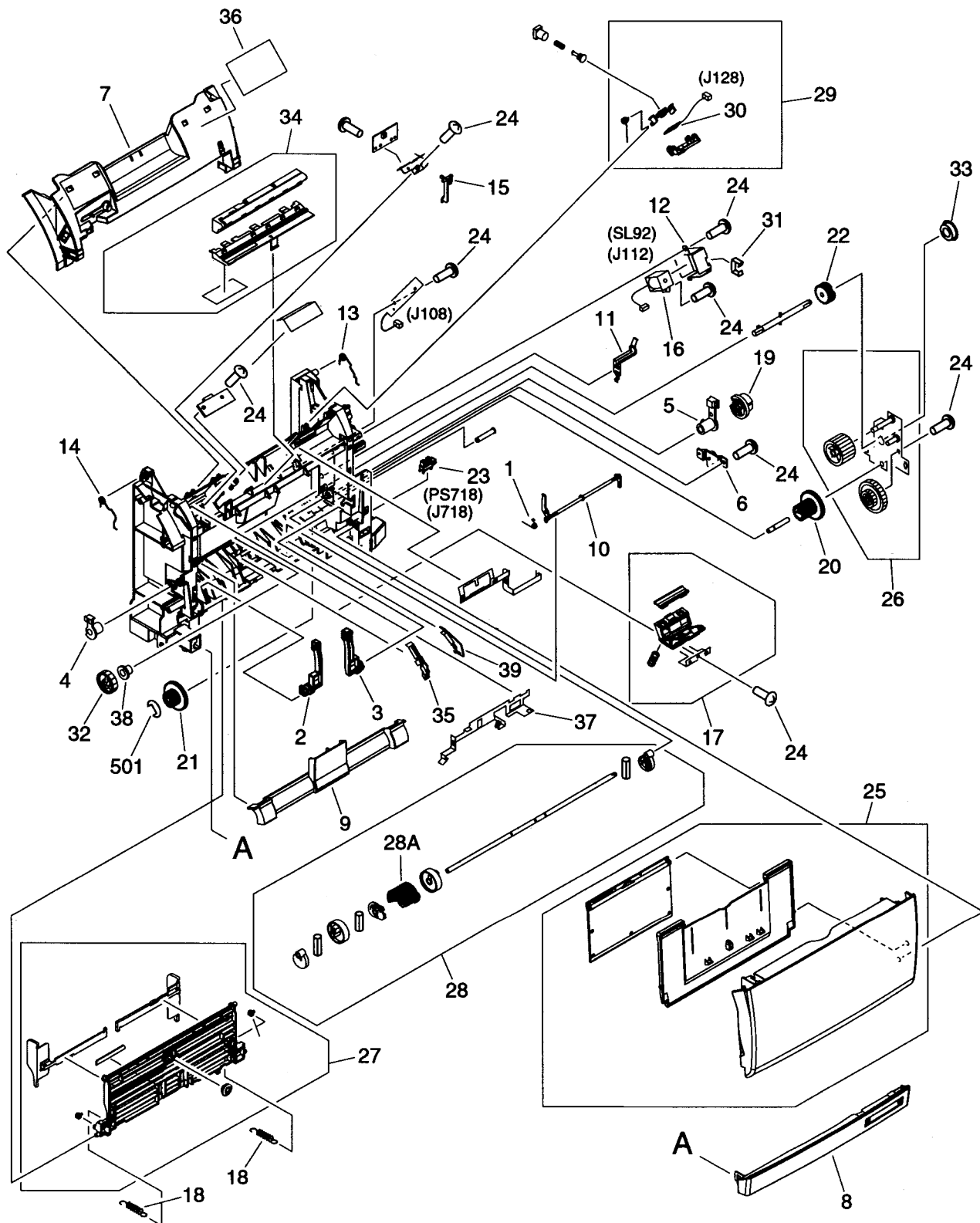

Figure 137. Front frame assembly

Table 32. Front frame assembly

Reference	Part number	Description	Quantity
1	RB2-9952-000CN	Spring, tray 1 flag	1
2	RB2-3041-000CN	Hinge, left, tray 1	1
3	RB2-3042-000CN	Hinge, right, tray 1	1
4	RB2-3043-000CN	Bushing, left	1
5	RB2-3044-000CN	Bushing, right	1
6	RB2-6248-000CN	Damper	1
7	RB3-0102-000CN	Front cover	1
8	RB3-0103-000CN	Front lower cover	1
9	RB3-0104-000CN	Roller cover	1
10	RB3-0111-000CN	Flag, tray 1 sensor	1
11	RB3-0119-000CN	Grounding plate	1
12	RB3-0120-000CN	Cover, solenoid (SL92)	1
13	RB3-0121-000CN	Spring, right	1
14	RB3-0122-000CN	Spring, left	1
15	RB3-0135-000CN	Flag, switch	1
16	RH7-5337-000CN	Solenoid (SL92)	1
17	RF5-4012-000CN	Separation pad assembly	1
18	RS6-2030-000CN	Spring, tray 1 guide	2
19	RS7-0418-000CN	Gear, 26T	1
20	RS7-0424-000CN	Gear, 20T/40T	1
21	RS7-0426-000CN	Gear, 26T/50T	1
22	RS7-0429-000CN	Gear, 26T	1
23	WG8-5382-000CN	Sensor (PS718)	1
24	XA9-1262-000CN	Screw, M4x10	11
25	RG5-6937-000CN	Tray 1 assembly	1
26	RG5-6938-000CN	Gear assembly	1
27	RG5-6951-000CN	Tray 1 guide assembly	1
28	RG5-6952-000CN	Tray 1 pickup assembly	1
28A	RB3-0160-000CN	Pickup roller, tray 1	1
29	RG5-6957-000CN	E-label reader assembly	1
30	RG5-6956-000CN	E-label reader PCA	1
31	WT2-5056-000CN	Clip, cable	1
32	RS7-0425-000CN	Gear, 30T	1
33	RS5-1635-000CN	Bushing, gear assembly	1
34	RF5-4047-000CN	Pad, light-blocking	1
35	RB2-9954-000CN	Guide, left, paper feed	1
36	RS6-8662-000CN	Label, image cartridge	1
37	RB2-9942-000CN	Grounding plate	1
38	RS5-1638-000CN	Bushing	1
39	RB2-9955-000CN	Guide, right, paper feed	1
501	XD2-1100-502CN	E-ring	2

Internal components (1 of 2)

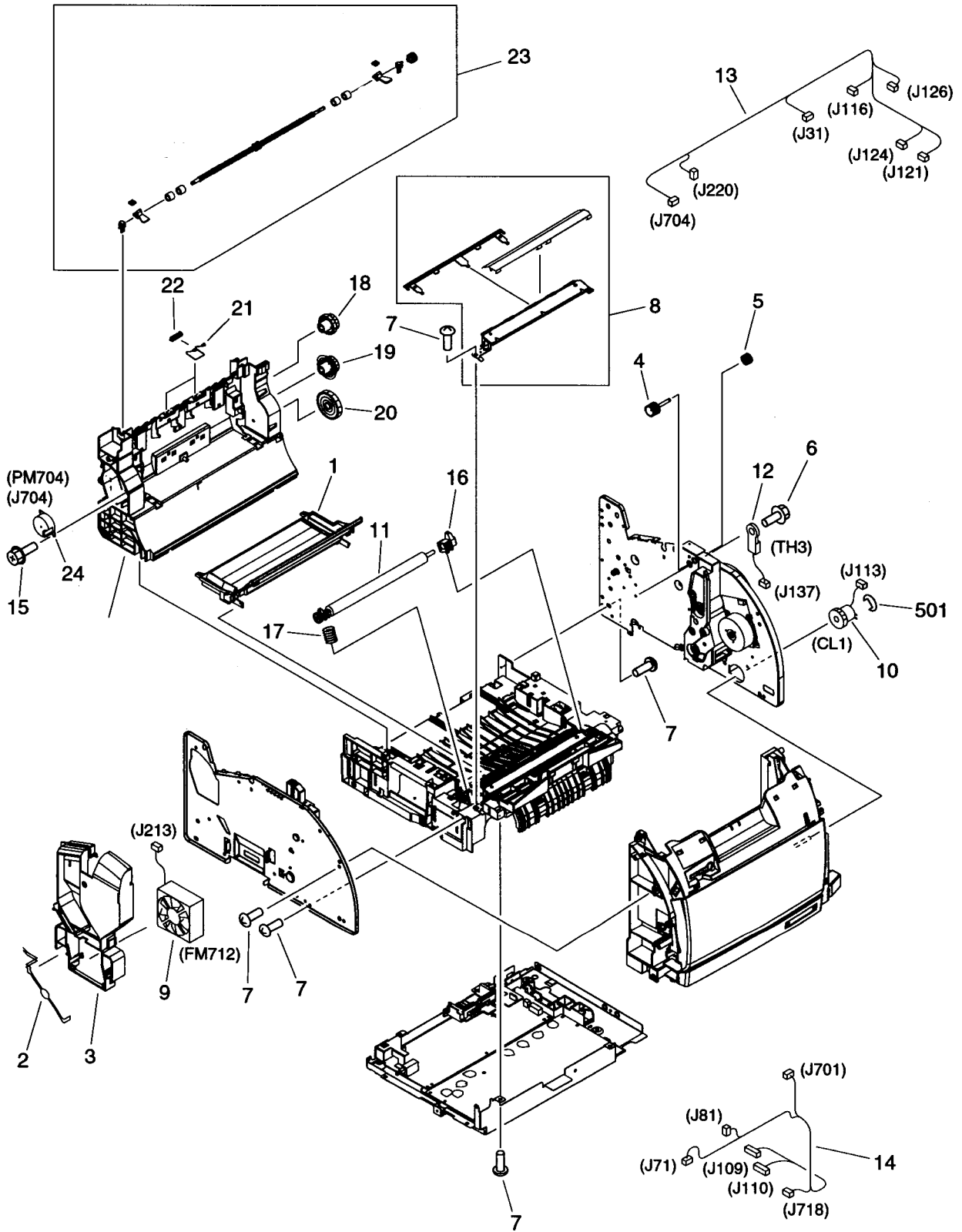

Figure 138. Internal components (1 of 2)

Table 33. Internal components (1 of 2)

Reference	Part number	Description	Quantity
1	RB3-0019-000CN	Toner-catch tray	1
2	RB2-0032-000CN	RFI shield	1
3	RB3-0025-000CN	Air duct	1
4	RB3-0091-000CN	Gear, 16T	1
5	RB3-0092-000CN	Gear, 15T	1
6	XA9-1355-000CN	Screw, M3x8	2
7	XA9-1262-000CN	Screw, M4x10	26
8	RF5-4049-000CN	Entrance guide assembly	1
9	RH7-1537-000CN	Fan (FM712)	1
10	RH7-5366-000CN	Clutch (CL1)	1
11	RF5-4040-000CN	Transfer roller	1
12	RH7-7149-000CN	Thermistor (TH3)	1
13	RG5-7144-000CN	Cable, upper	1
14	RG5-7145-000CN	Cable, front	1
15	XA9-0849-000CN	Screw, RS, M3x6	2
16	RB3-0014-000CN	Bushing, transfer roller	1
17	RB3-0015-000CN	Spring, transfer roller	1
18	RS7-0435-000CN	Gear, 32T/37T	1
19	RS7-0436-000CN	Gear, 37T/43T	1
20	RS7-0437-000CN	Gear, 51T	1
21	RB2-9905-000CN	Spring, torsion	2
22	RB2-9908-000CN	Roller, top output bin	2
23	RG5-6897-000CN	Roller assembly, upper top bin	1
24	RH7-1533-000CN	Motor, dc, 24 V	1
501	XD2-1100-322CN	E-ring	1

Internal components (2 of 2)

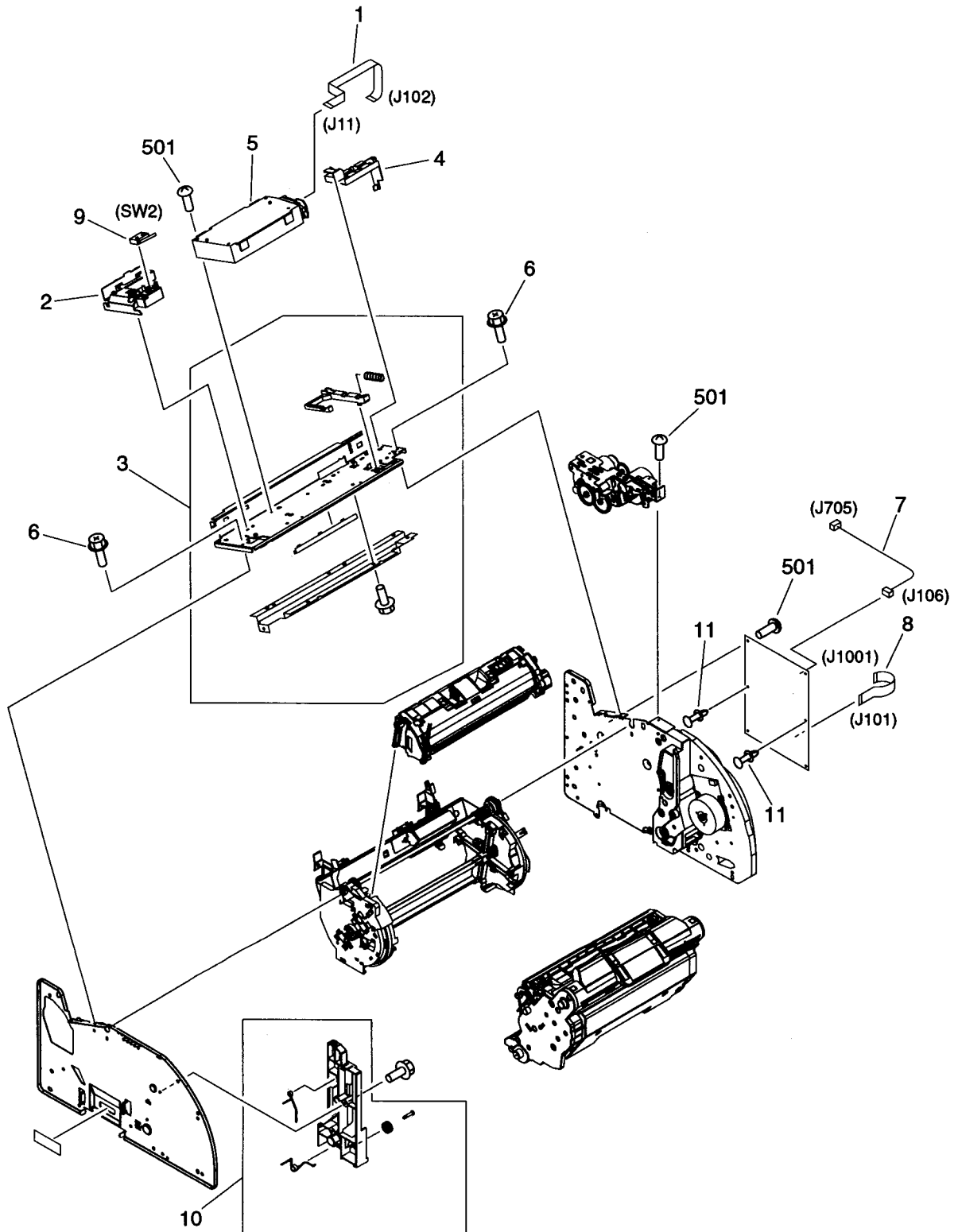

Figure 139. Internal components (2 of 2)

Table 34. Internal components (2 of 2)

Reference	Part number	Description	Quantity
1	RH2-5524-000CN	Cable, flat, flexible, laser/scanner	1
2	RB3-0023-000CN	Holder, interlock switch	1
3	RG5-6907-000CN	Top plate	1
4	RB2-9903-000CN	Cable guide	1
5	RG5-6880-000CN	Laser/scanner	1
6	XA9-0849-000CN	Screw, M3x6	19
7	RG5-7114-000CN	Cable, motor	1
8	Q2488-60104	Cable, flat, flexible, formatter (HPLJ 1500)	1
	RH2-5525-000CN	Cable, flat, flexible, formatter (HPLJ 2500)	
9	RH7-6051-000CN	Switch, interlock	1
10	RG5-6935-000CN	Cartridge guide assembly	1
11	WT2-5778-000CN	Spacer	2
501	XB6-7300-407CN	Screw, M3x4	5

Table 35. Formatter assemblies (not pictured)

Reference	Part number	Description	Quantity
	C9145A	Formatter (DC BOMs) (HPLJ 2500)	1
	Q1894-60001	Formatter (HP color LaserJet 1500 series printers)	1
	C9145-60001	Formatter (HP color LaserJet 2500 series printers)	1
	C9705-6101	Formatter cage assembly	1
	0515-4257	Screw, M3x.5, black, thread rolling (formatter cage)	1
	C9705-00001	Formatter case (formatter cage)	1
	C9705-00002	Memory cover (formatter cage)	1
	C9705-00003	Back panel (formatter cage)	1
	Q2488-00001	Parallel coverplate (HPLJ 1500)	1
	0515-2908	Screw, M3x.5 (parallel coverplate) (HPLJ 1500)	1
	5021-0349	EIO coverplate (HPLJ 2500)	1
	C9705-40006	EIO card guide (HPLJ 2500)	1
	C9145-67901	Kit, replacement	1
	C9145-69001	Exchange assembly, formatter (HPLJ 2500)	1

Main drive assembly

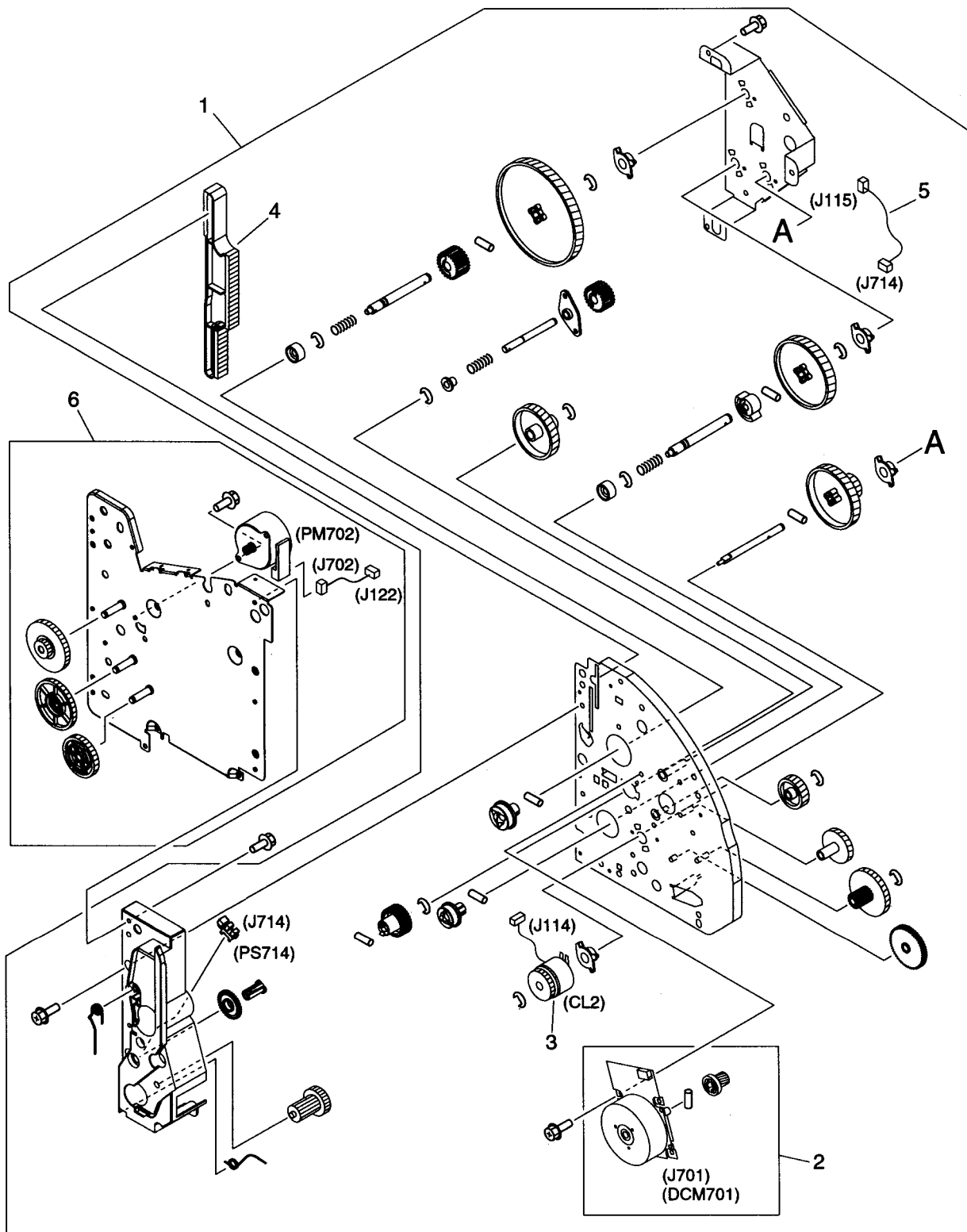

Figure 140. Main drive assembly

Table 36. Main drive assembly

Reference	Part number	Description	Quantity
1	RG5-6932-000CN	Right side plate front assembly	1
2	RF5-4010-000CN	Gear train motor	1
3	RH7-5366-000CN	Clutch, main gear train (CL2)	1
4	RB3-0090-000CN	Rack	1
5	RG5-7115-000CN	Cable	1
6	RG5-6934-000CN	Right side plate rear assembly	1

Rear frame assembly

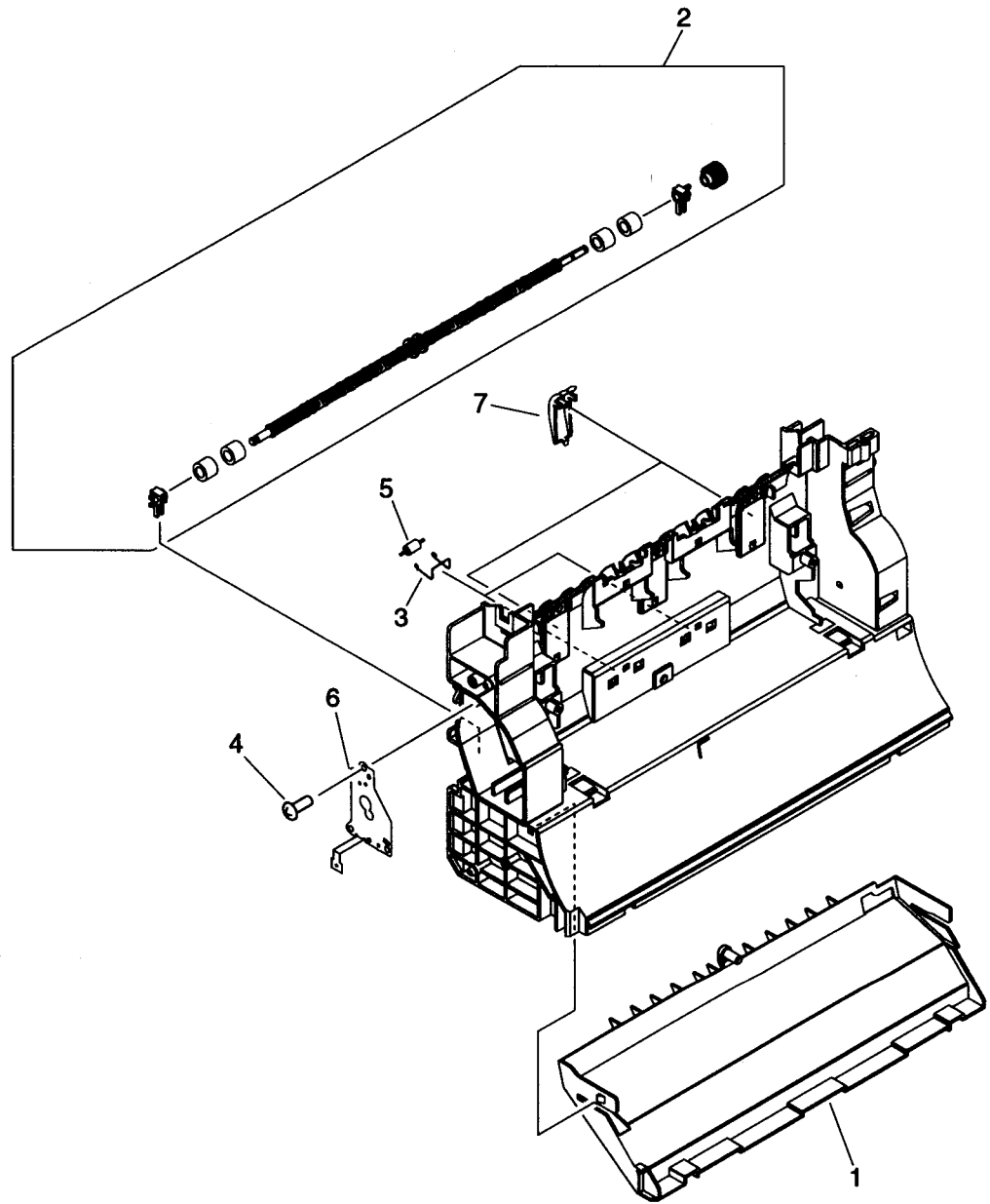

Figure 141. Rear frame assembly

Table 37. Rear frame assembly

Reference	Part number	Description	Quantity
1	RB2-9904-000CN	Fuser duct	1
2	RG5-6936-000CN	Roller, lower, top output bin	1
3	RB2-9906-000CN	Spring, left	2
4	XA9-1262-000CN	Screw, M4x10	2
5	RB2-9909-000CN	Roller, rear output bin	2
6	RB2-9916-000CN	Cover, fuser motor	1
7	RB2-9912-000CN	Guide, top output bin	2

Middle frame assembly

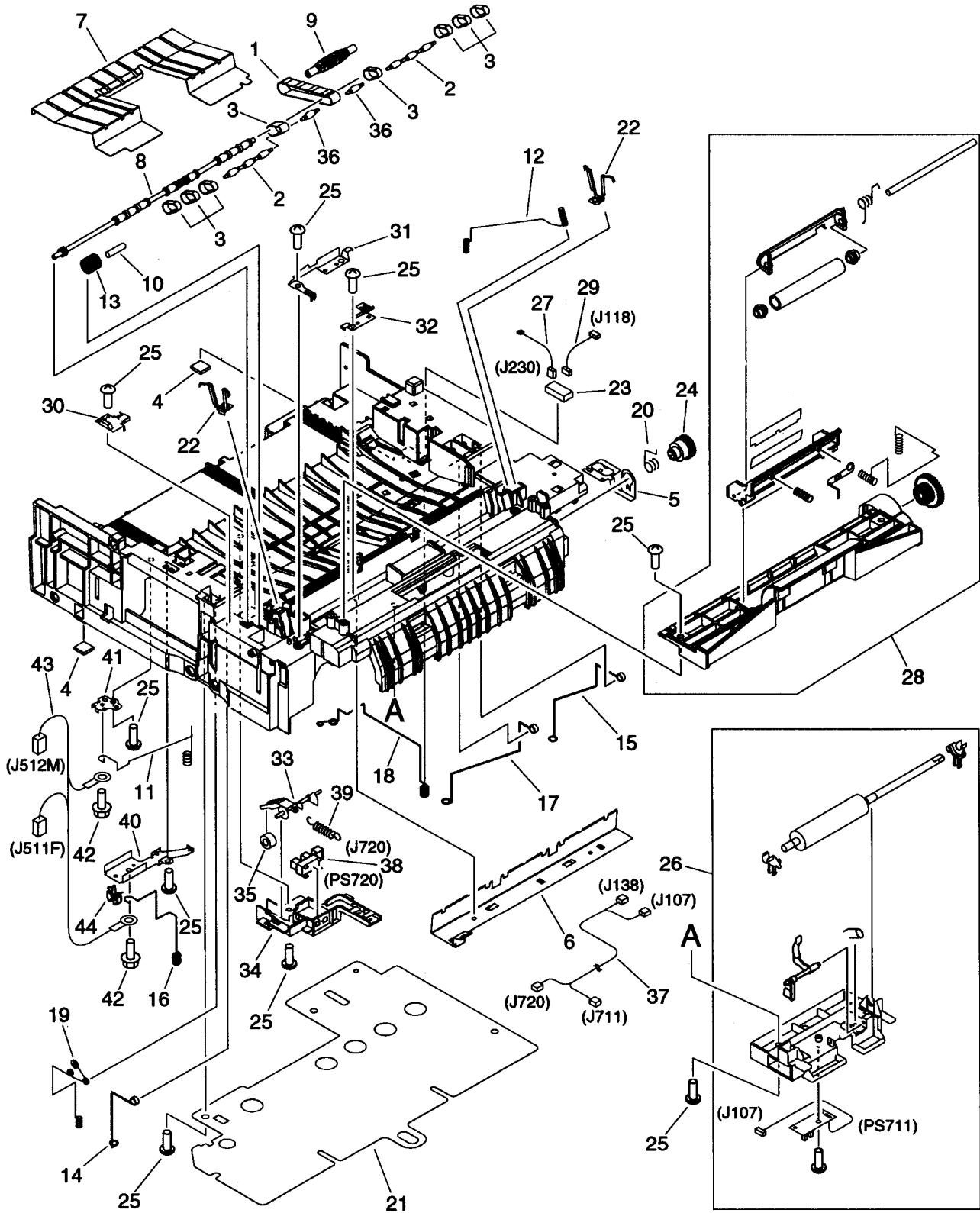

Figure 142. Middle frame assembly

Table 38. Middle frame assembly

Reference	Part number	Description	Quantity
1	RB1-8668-000CN	Timing belt	1
2	RB3-0061-000CN	Pulley	2
3	RB3-0063-000CN	Feed belt	8
4	RB2-6297-000CN	Rubber foot	2
5	RB3-0286-000CN	Grounding plate	1
6	RB3-0009-000CN	Static charge eliminator plate	1
7	RB3-0010-000CN	Feed plate	1
8	RB3-0011-000CN	Shaft, feed drive	1
9	RB3-0012-000CN	Roller, belt	1
10	RB3-0060-000CN	Shaft, idler gear	1
11	RB3-0045-000CN	Spring	1
12	RB3-0016-000CN	Spring	1
13	RB3-0022-000CN	Gear, idler, 23T	1
14	RB3-0042-000CN	Spring	1
15	RB3-0043-000CN	Spring	1
16	RB3-0044-000CN	Spring	1
17	RB3-0046-000CN	Spring	1
18	RB3-0047-000CN	Spring	1
19	RB3-0048-000CN	Spring	1
20	RS5-1637-000CN	Bushing	1
21	RB3-0056-000CN	Insulating sheet	1
22	RB3-0057-000CN	Transfer slide plate	2
23	RH2-5519-000CN	Connector, optional trays	1
24	RS7-0428-000CN	Gear, 30T	1
25	XA9-1262-000CN	Screw, M4x10	6
26	RG5-6939-000CN	Registration roller assembly	1
27	RG5-7123-000CN	Cable, grounding	1
28	RG5-6940-000CN	Registration shutter assembly	1
29	RG5-7122-000CN	Cable, interface	1
30	RB3-0052-000CN	Cover, gear	1
31	RB3-0065-000CN	Grounding spring	1
32	RB3-0066-000CN	Grounding spring	1
33	RB2-9925-000CN	Flag, transfer sensor	1
34	RB2-9924-000CN	Holder, transfer sensor	1
35	RB2-7195-000CN	Roller, transfer sensor	1
36	RB3-0067-000CN	Pulley	2
37	RG5-7128-000CN	Cable	1
38	WG8-5382-000CN	Sensor, transfer (PS720)	1
39	RS6-2766-000CN	Spring	1
40	RB2-9850-000CN	Mount, terminal	1
41	RB2-9851-000CN	Mount, antenna contact	1
42	XA9-0849-000CN	Screw, RS, M3x6	2
43	RG5-7130-000CN	Cable, high-voltage transformer	1
44	WT2-5700-000CN	Clamp, cable	1

Rotary (carousel) assembly

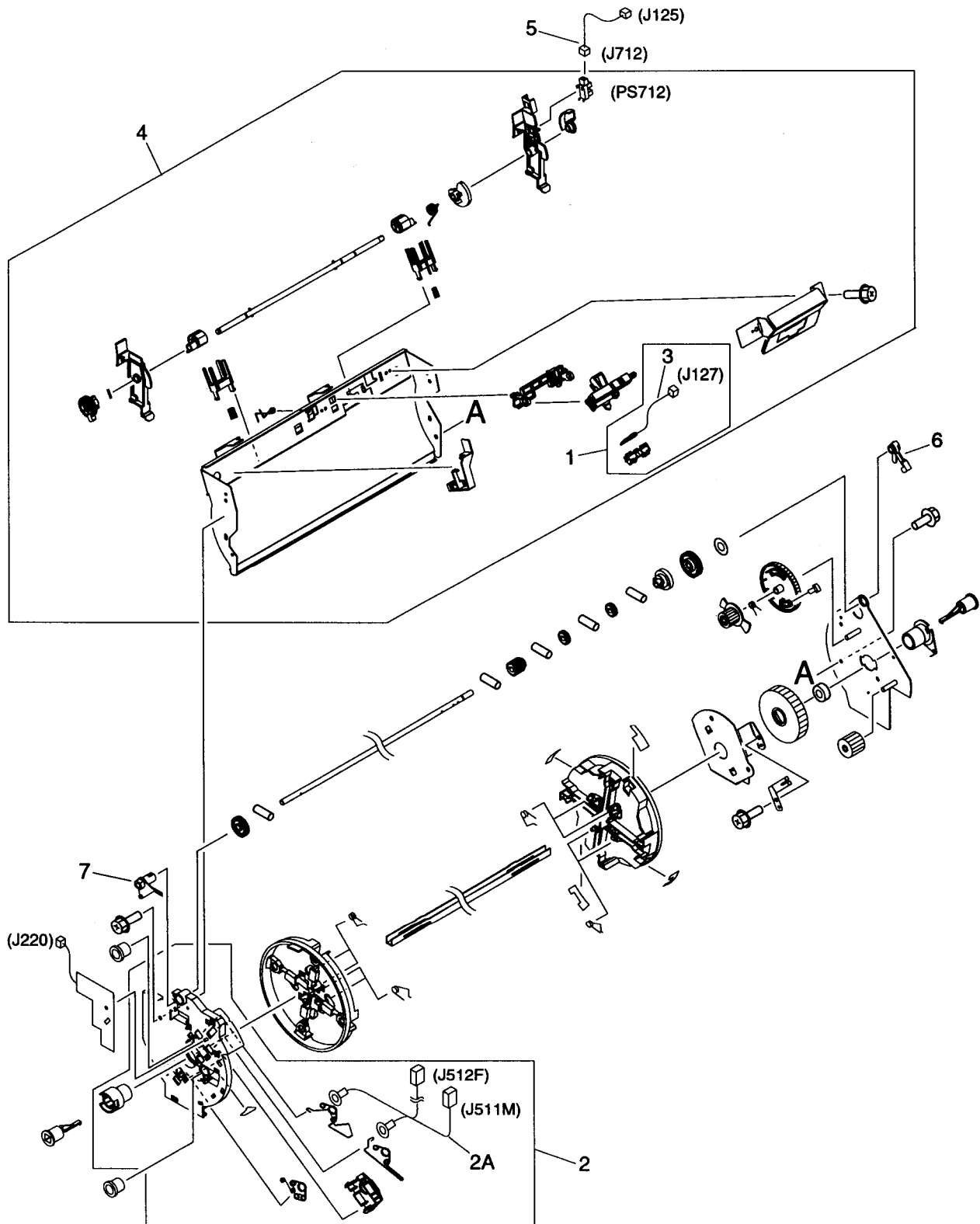

Figure 143. Rotary (carousel) assembly

Table 39. Rotary assembly

Reference	Part number	Description	Quantity
	RG5-6910-000CN	Rotary (carousel) assembly	1
(not pictured)	RB2-9852-000CN	Carousel-brake-release guide	1
1	RG5-6957-000CN	Contact assembly, E-label reader	1
2	RG5-6942-000CN	Rotary plate assembly, left	1
2A	RG5-7129-000CN	Cable, rotary assembly	1
3	RG5-6974-000CN	Cable, E-label reader	1
4	RG5-6943-000CN	Rotary pressure assembly	1
5	RG5-7117-000CN	Cable, sensor	1
6	RB2-9808-000CN	Carousel lock, right (black)	1
7	RB2-9809-000CN	Carousel lock, left (white)	1

Power-supply base assembly

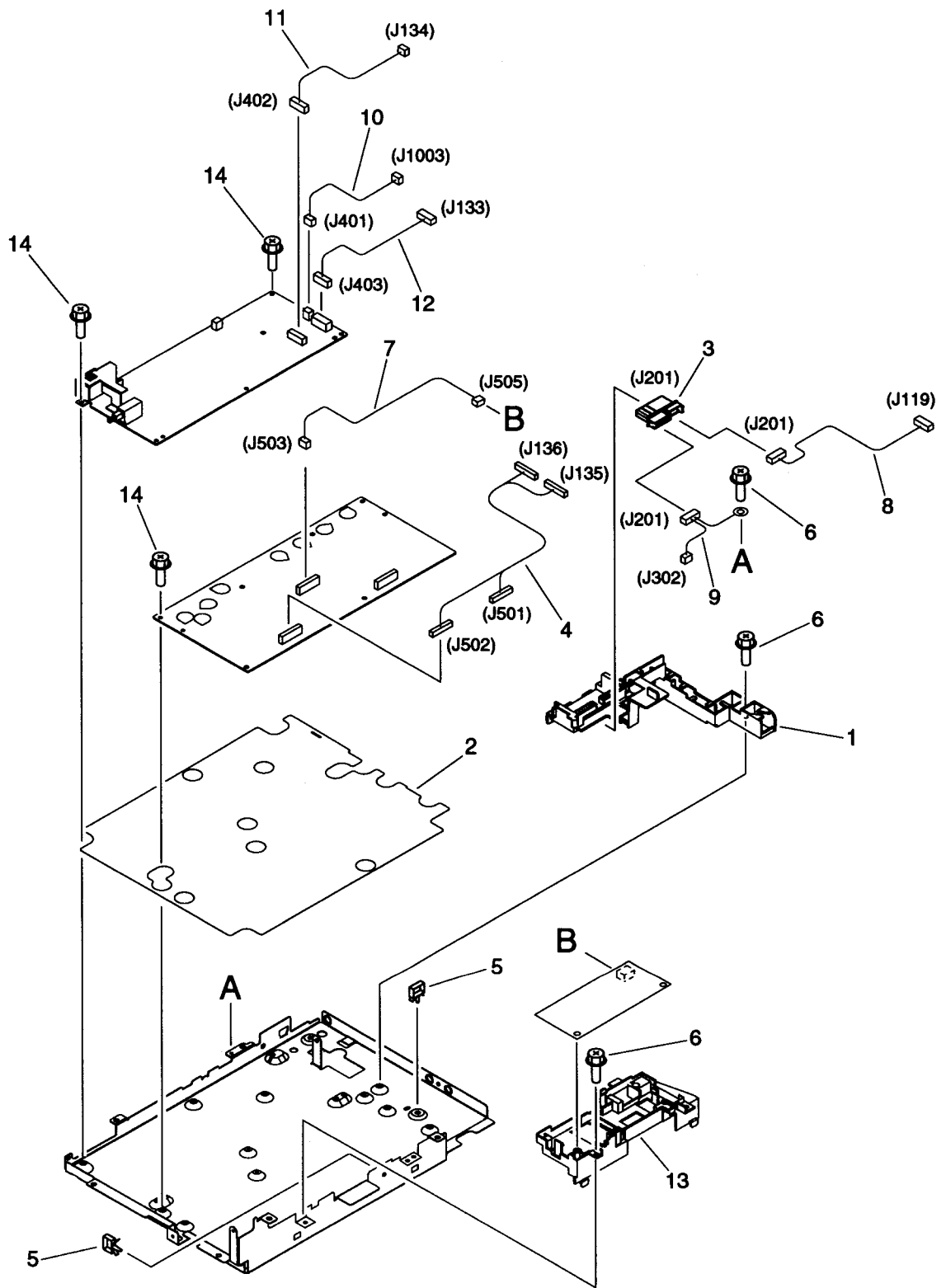

Figure 144. Power-supply base assembly

Table 40. Power-supply base assembly

Reference	Part number	Description	Quantity
1	RB3-0006-000CN	Holder, fuser connector	1
2	RB3-0007-000CN	Insulating sheet	1
3	RH2-5520-000CN	Connector, fuser drawer	1
4	RG5-7146-000CN	Cable, H.V.T.	1
5	WT2-5737-000CN	Cable clip	2
6	XA9-1355-000CN	Screw, M3x8	8
7	RG5-7126-000CN	Cable, sub H.V.T.	1
8	RG5-7109-000CN	Cable, fuser connector, dc controller	1
9	RG5-6971-000CN	Cable, fuser, power	1
10	RG5-7106-000CN	Cable, formatter, power	1
11	RG5-7107-000CN	Cable, power (1)	1
12	RG5-7108-000CN	Cable, power (2)	1
13	RB3-0062-000CN	Holder, high voltage	1
14	XA9-1291-000CN	Screw, M3x8	1

Fuser assembly

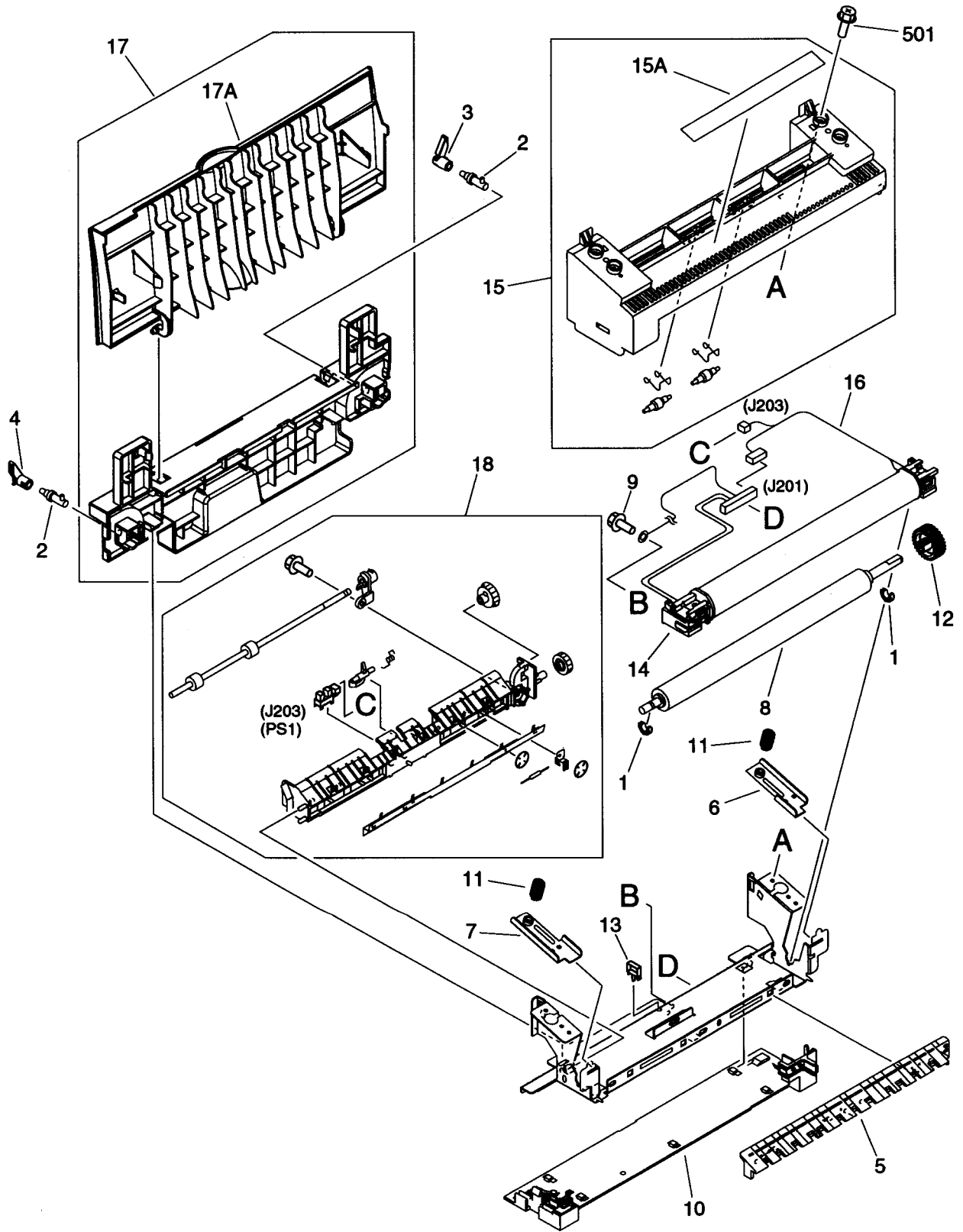

Figure 145. Fuser assembly

Table 41. Fuser assembly

Reference	Part number	Description	Quantity
	RG5-6903-000CN	Fuser, 110-127 V	1
	RG5-6913-000CN	Fuser, 220-240 V	1
1	RB2-2973-000CN	Bushing	2
2	RB2-4933-000CN	Shaft, lever	2
3	RB3-0178-000CN	Lever, right lock release	1
4	RB3-0179-000CN	Lever, left lock release	1
5	RB3-0180-000CN	Guide, inlet	1
6	RB3-0186-000CN	Plate, pressure, right	1
7	RB3-0190-000CN	Plate, pressure, left	1
8	RB3-0191-000CN	Roller, pressure	1
9	XA9-1291-000CN	Screw, RS, M3x8	5
10	RF5-4008-000CN	Base plate, fuser	1
11	RS6-2756-000CN	Spring, compression	2
12	RS7-0432-000CN	Gear, 27T	1
13	WT2-5700-000CN	Clamp, cable	1
14	RG5-6928-000CN	Film assembly, 110-127 V	1
	RG5-6949-000CN	Film assembly, 220-240 V	1
15	RG5-6929-000CN	Separation upper guide assembly	1
15A	RS6-8657-000CN	Label, caution	1
16	RG5-7110-000CN'	Cable, fuser	1
17	RG5-6931-000CN	Rear output bin cover assembly	1
17A	RB3-0176-000CN	Cover, upper rear output bin	1
18	RG5-6930-000CN	Separation lower guide assembly	1
501	XB3-6300-800CN	Screw, RS, M3x8	5

Rotary-drive assembly

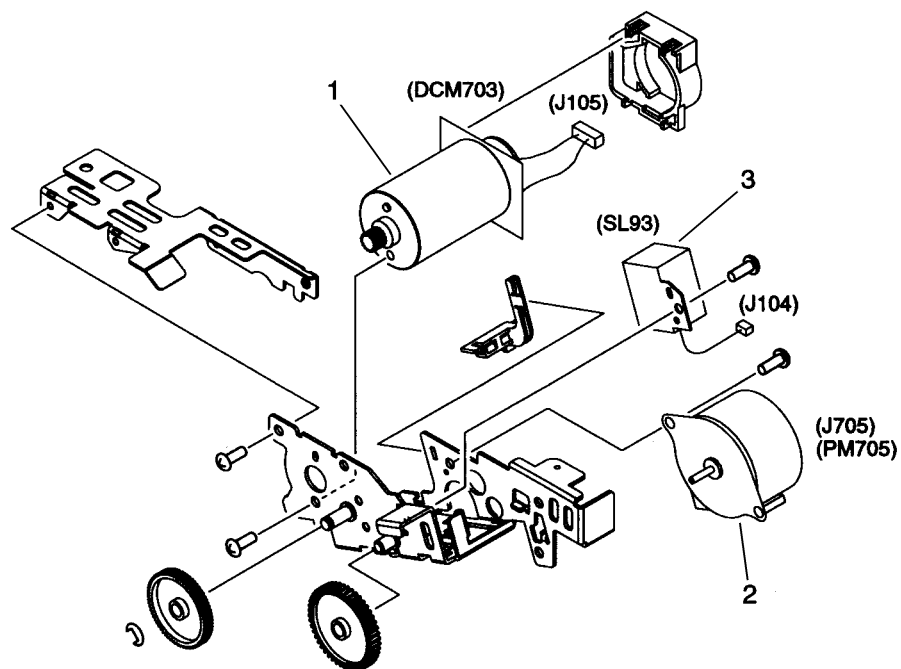

Figure 146. Rotary-drive assembly

Table 42. Rotary-drive assembly

Reference	Part number	Description	Quantity
	RG5-6911-000CN	Rotary drive assembly	1
1	RG5-6958-000CN	Motor (DCM703)	1
2	RH7-1535-000CN	Motor (PM705)	1
3	RH7-5340-000CN	Solenoid (SL93)	1

PCA assemblies

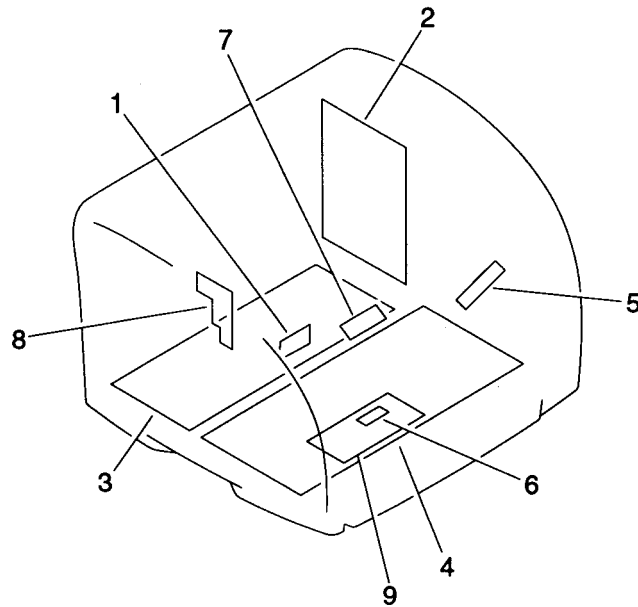

Figure 147.

PCA assemblies

Table 43. PCA assemblies

Reference	Part number	Description	Quantity
1	RG5-6966-000CN	Top-of-page sensor PCA	1
2	RG5-6959-000CN	Dc controller	1
3	RH3-2252-000CN	Low-voltage PCA (110-127 V)	1
3	RH3-2243-000CN	Low-voltage PCA (220-240 V)	1
4	RG5-6960-000CN	H.V.T. PCA	1
5	RG5-6965-000CN	Waste-toner sensor PCA	1
6	RG5-6967-000CN	Registration-sensor PCA	1
7	RH7-7146-000CN	Density-sensor PCA	1
8	RG5-6964-000CN	Toner-sensor PCA	1
9	RG5-7124-000CN	Sub-H.V.T. PCA	1

Optional tray 2

Covers for optional tray 2

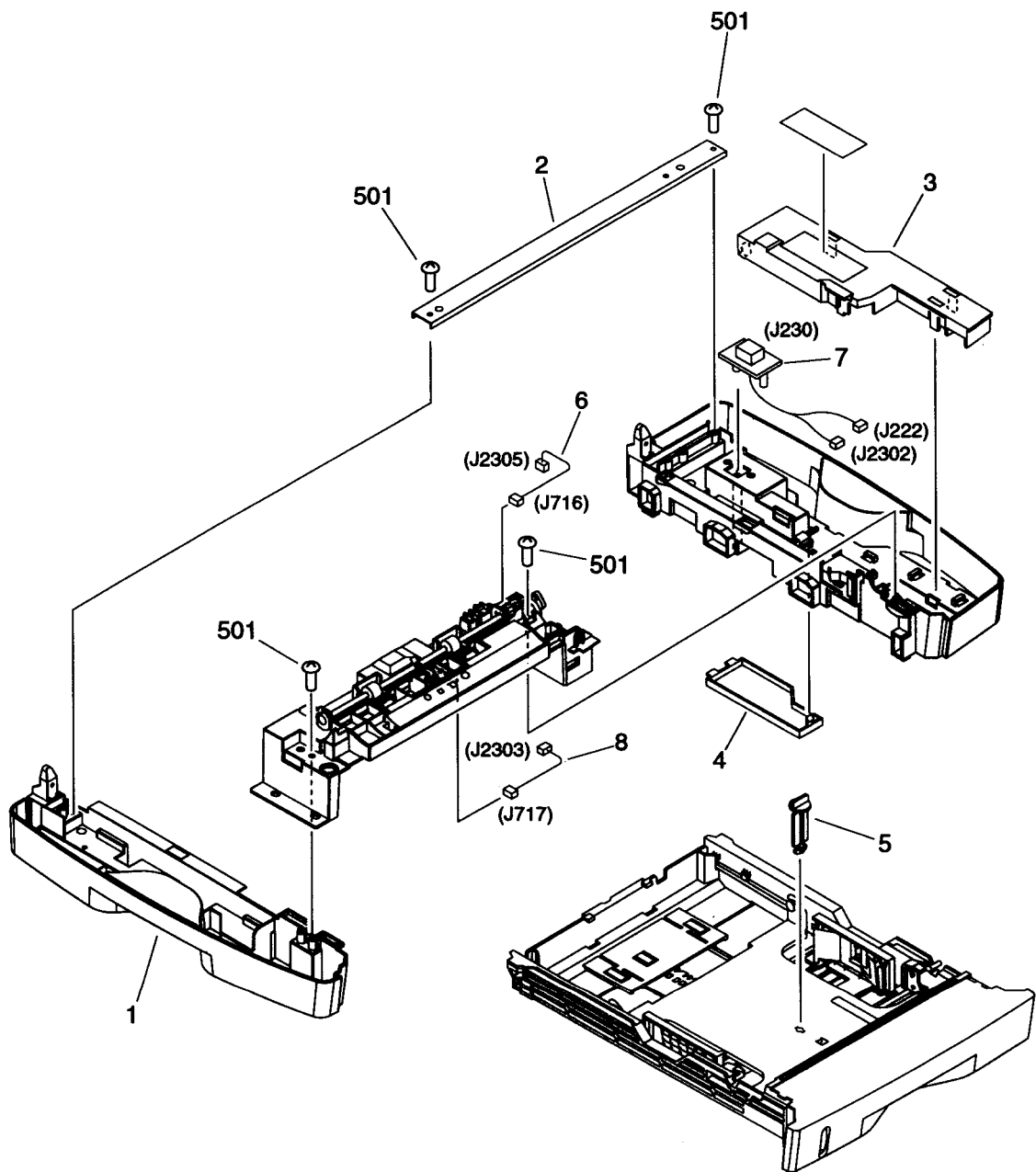

Figure 148. Covers for optional tray 2

Table 44. Covers for optional tray 2

Ref.	Part number	Description	
	C9698A	Optional tray 2	1
1	RB3-0106-000CN	Left cover, tray 2	1
2	RB3-0108-000CN	Crossmember, tray 2	1
3	RB3-0282-000CN	Cover, top, tray 2	1
4	RB3-0283-000CN	Cover, bottom, tray 2	1
5	RB2-3019-000CN	Stopper, lift plate, tray 2	1
6	RG5-7139-000CN	Cable, pickup, tray 2	1
7	RG5-7149-000CN	Cable, drawer, tray 2	1
8	RG5-7138-000CN	Cable, sensor, tray 2	1
501	XB4-7401-007CN	Screw, tapping, pan head, M4x10, tray 2	5

Center frame assembly—optional tray 2

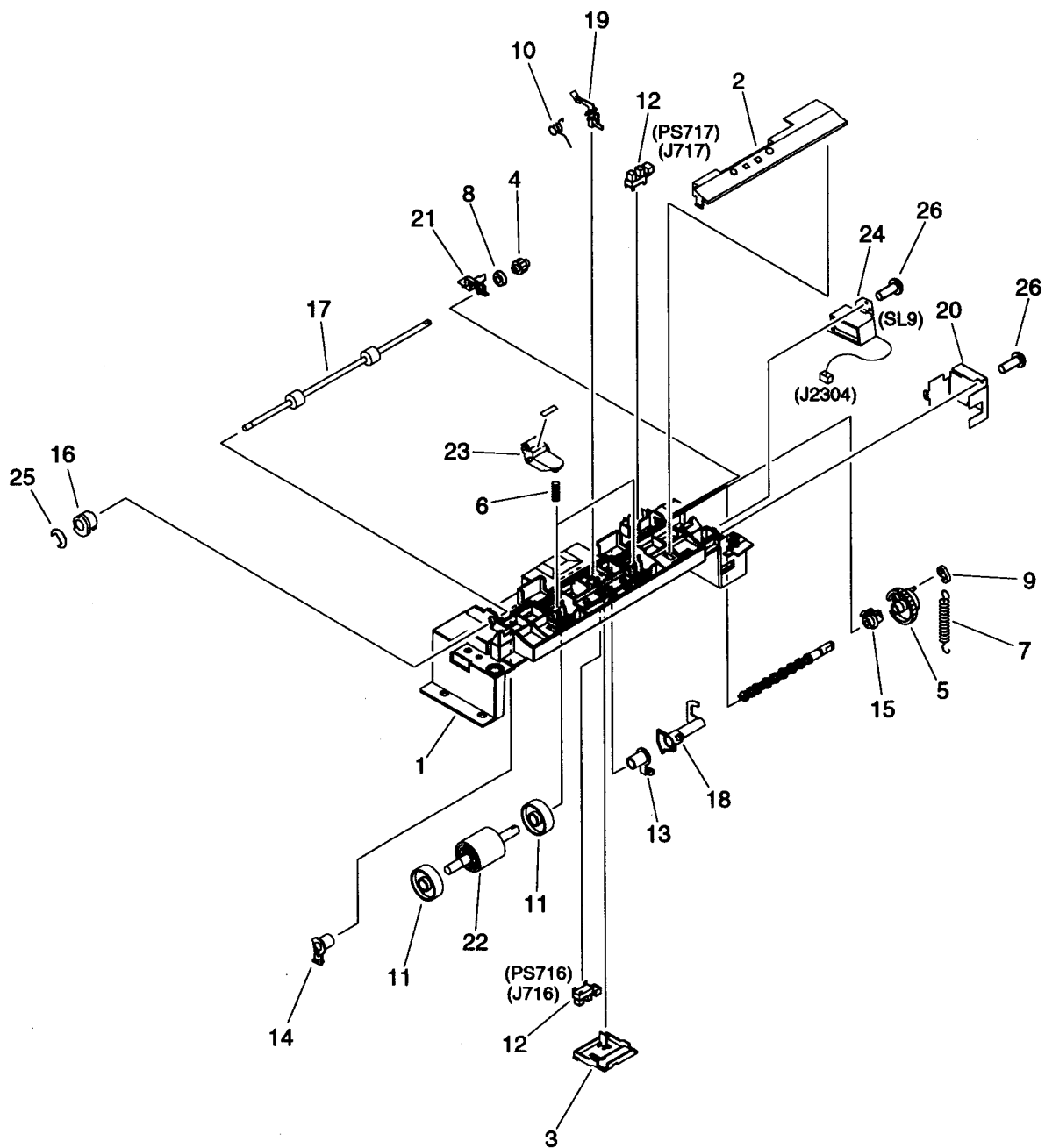

Figure 149. Center frame assembly—optional tray 2

Table 45. Center frame assembly

Ref.	Part number	Description	Quantity
1	RB3-0105-000CN	Cover, center frame, tray 2	1
2	RB3-0165-000CN	Cover, top, center frame, tray 2	1
3	RB3-0166-000CN	Cover, bottom, center frame, tray 2	1
4	RS7-0431-000CN	Gear, 15T, tray 2	1
5	RS7-0430-000CN	Gear, 26T, tray 2	1
6	RS6 2760-000CN	Spring, compression, tray 2	2
7	RS6-2025-000CN	Spring, tension, tray 2	1
8	RS5-1636-000CN	Bushing, tray 2	1
9	RB1-2190-000CN	Collar, spring, tray 2	1
10	RB2-2843-000CN	Spring, torsion, tray 2	1
11	RB2-2892-000CN	Roller, tray 2	2
12	WG8-5382-000CN	Photointerrupter (TLP1242), tray 2	2
13	RB2-2895-000CN	Bushing, right, tray 2	1
14	RB2-2896-000CN	Bushing, left, tray 2	1
15	RB2-2897-000CN	Bushing, tray 2	1
16	RS5-1638-000CN	Bushing, tray 2	1
17	RB3-0129-000CN	Roller, M, tray 2	1
18	RB3-0130-000CN	Flag, set sensor, tray 2	1
19	RB3-0132-000CN	Flag, pickup sensor, tray 2	1
20	RB3-0136-000CN	Cover (gauss-proof), tray 2	1
21	RB3-0137-000CN	Grounding plate, roller, tray 2	1
22	RB3-0161-000CN	Roller, pickup, tray 2	1
23	RF5-4035-000CN	Arm, roller pressure, tray 2	2
24	RH7-5341-000CN	Solenoid (SL9), tray 2	1
25	XD9-0136-000CN	E-ring, tray 2	1
26	XA9-1263-000CN	Screw, TP, M3x5, tray 2	2

Optional tray 2

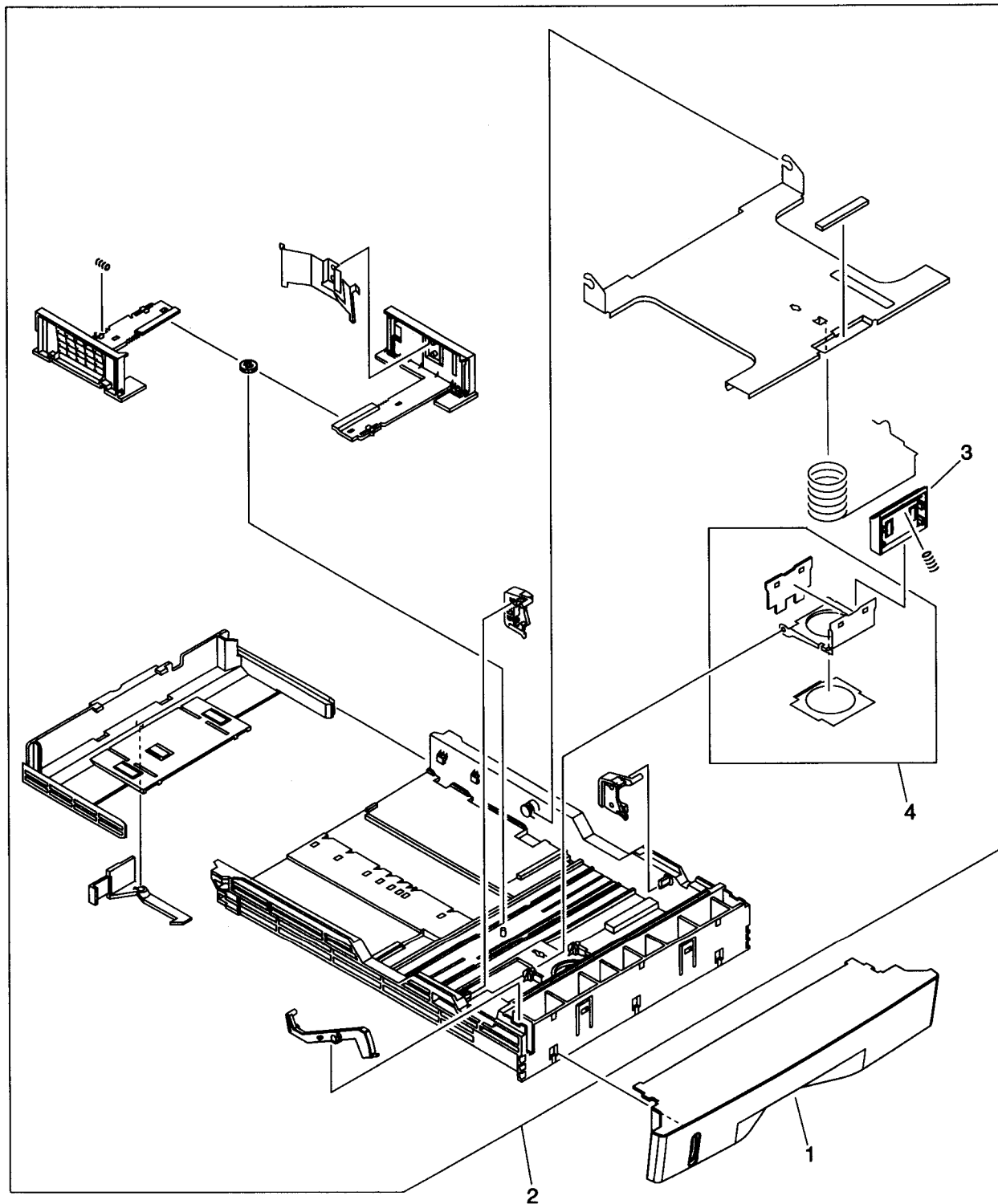

Figure 150. Media tray—optional tray 2

Table 46. Media tray—optional tray 2

Ref.	Part number	Description	Quantity
	RG5-6914-000CN	Media tray—optional tray 2	1
1	RB3-0109-000CN	Cover, media tray, tray 2	1
2	RG5-6915-000CN	Main body assembly, tray 2	1
3	RB2-9960-000CN	Separation pad, tray 2	1
4	RF5-4045-000CN	Separation pad assembly, tray 2	1

Right cover assembly—optional tray 2

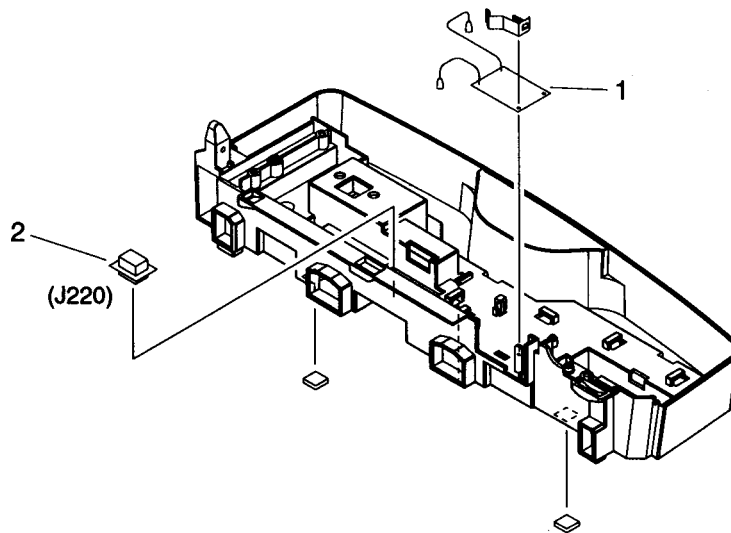

Figure 151. Right cover assembly—optional tray 2

Table 47. Right cover assembly—optional tray 2

Ref.	Part number	Description	Quantity
	RG5-6919-000CN	Right cover assembly, tray 2	1
1	RG5-6968-000CN	Feed-drive PCA, tray 2	1
2	RH2-5519-000CN	Connector, tray 2	1

Optional tray 3

Note Optional tray 3 is available with HP color LaserJet 2500 series printers only.

Covers for optional tray 3

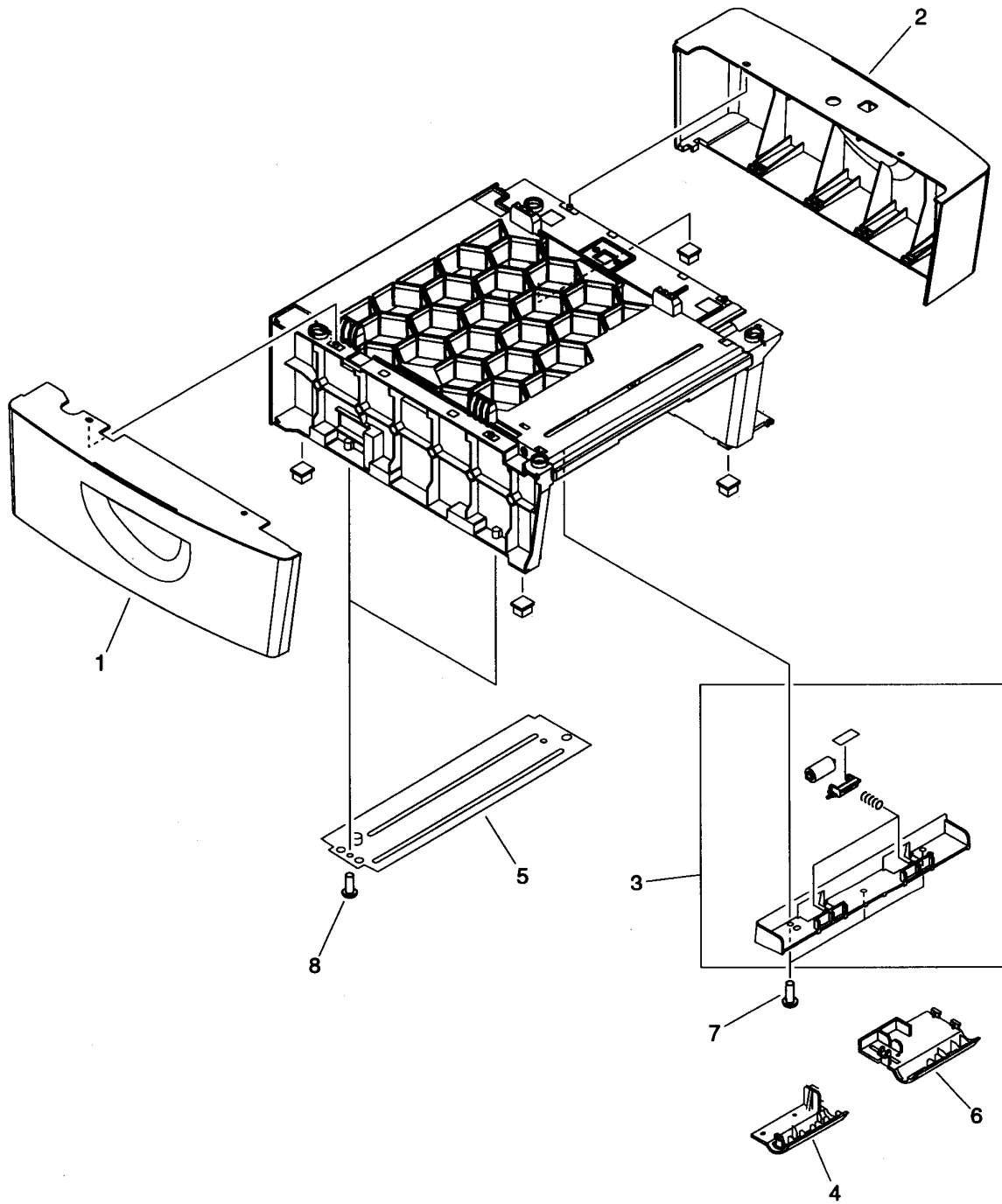

Figure 152. Covers for optional tray 3

Table 48. Covers for optional tray 3

Ref.	Part number	Description	
	C9699A	Optional tray 3	1
1	RB3-0140-000CN	Cover, left, tray 3	1
2	RB3-0141-000CN	Cover, right, tray 3	1
3	RG5-6898-000CN	Feed roller assembly, tray 3	1
4	RB2-3489-000CN	Cover, lower left, tray 3	1
5	RB2-6452-000CN	Crossmember, tray 3	2
6	RB2-6453-000CN	Cover, sensor, tray 3	1
7	XA9-0606-000CN	Screw, M4x10, tray 3	3
8	XA9-1316-000CN	Screw, TP, M4x10, tray 3	4

Internal components—optional tray 3

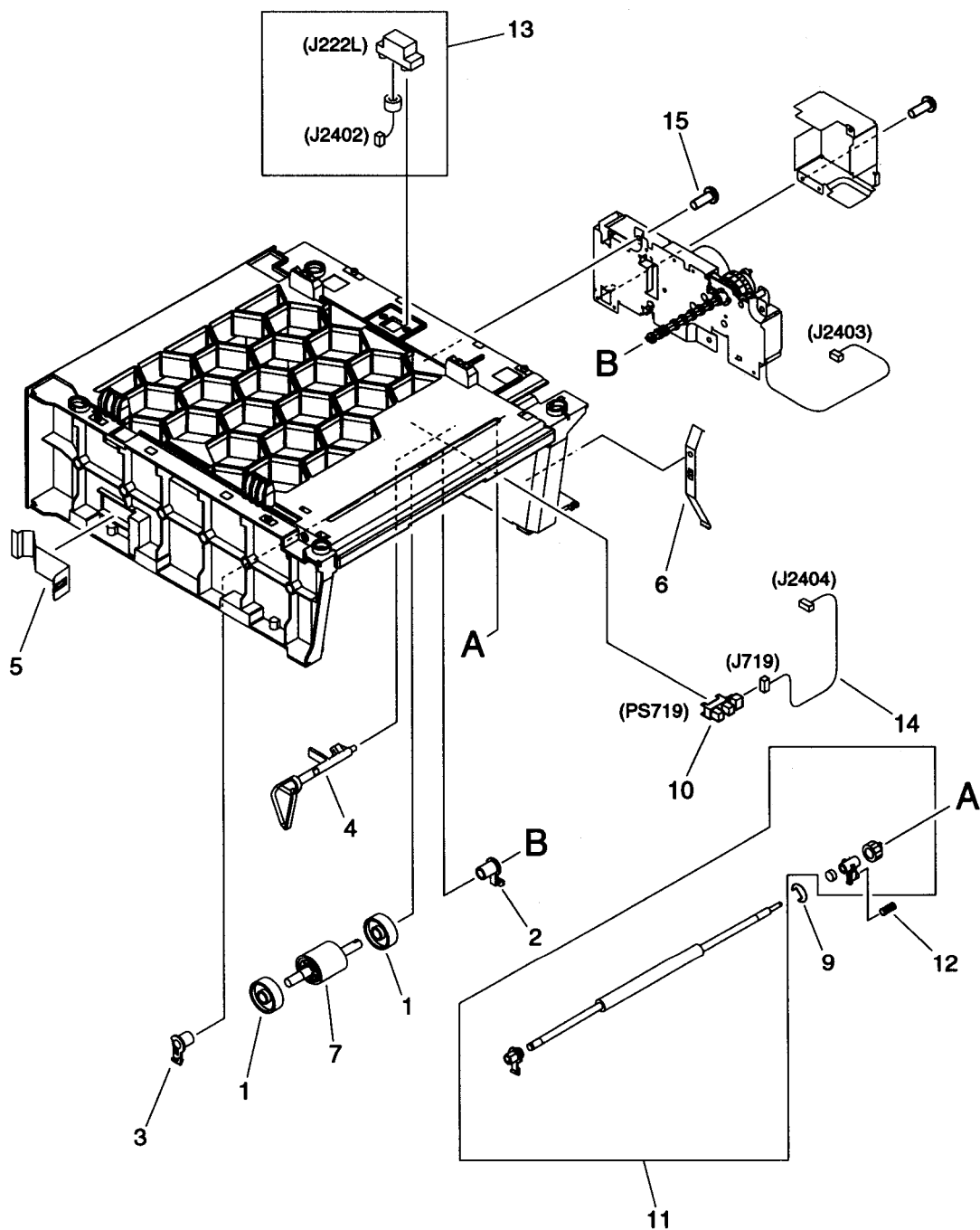

Figure 153. Internal components—optional tray 3

Table 49. Internal components—optional tray 3

Ref.	Part number	Description	
1	RB2-2892-000CN	Roller, tray 3	2
2	RB2-2895-000CN	Bushing, right, tray 3	1
3	RB2-2896-000CN	Bushing, left, tray 3	1
4	RB2-6448-000CN	Arm, sensor, tray 3	1
5	RB2-6450-000CN	Spring, leaf, tray 3	1
6	RB2-6451-000CN	Spring, leaf, tray 3	1
7	RB3-0161-000CN	Roller, pickup, tray 3	1
9	XD9-0136-000CN	E-ring, tray 3	1
10	WG8-5382-000CN	Photointerrupter (TLP1242), tray 3	1
11	RG5-5621-000CN	Feed roller assembly, tray 3	1
12	RS6-2398-000CN	Spring, compression, tray 3	1
13	RG5-7150-000CN	Cable, drawer, tray 3	1
14	RG5-7142-000CN	Cable, sensor, tray 3	1
15	XA9-0606-000CN	Screw, M4x10, tray 3	3

Feed drive assembly—optional tray 3

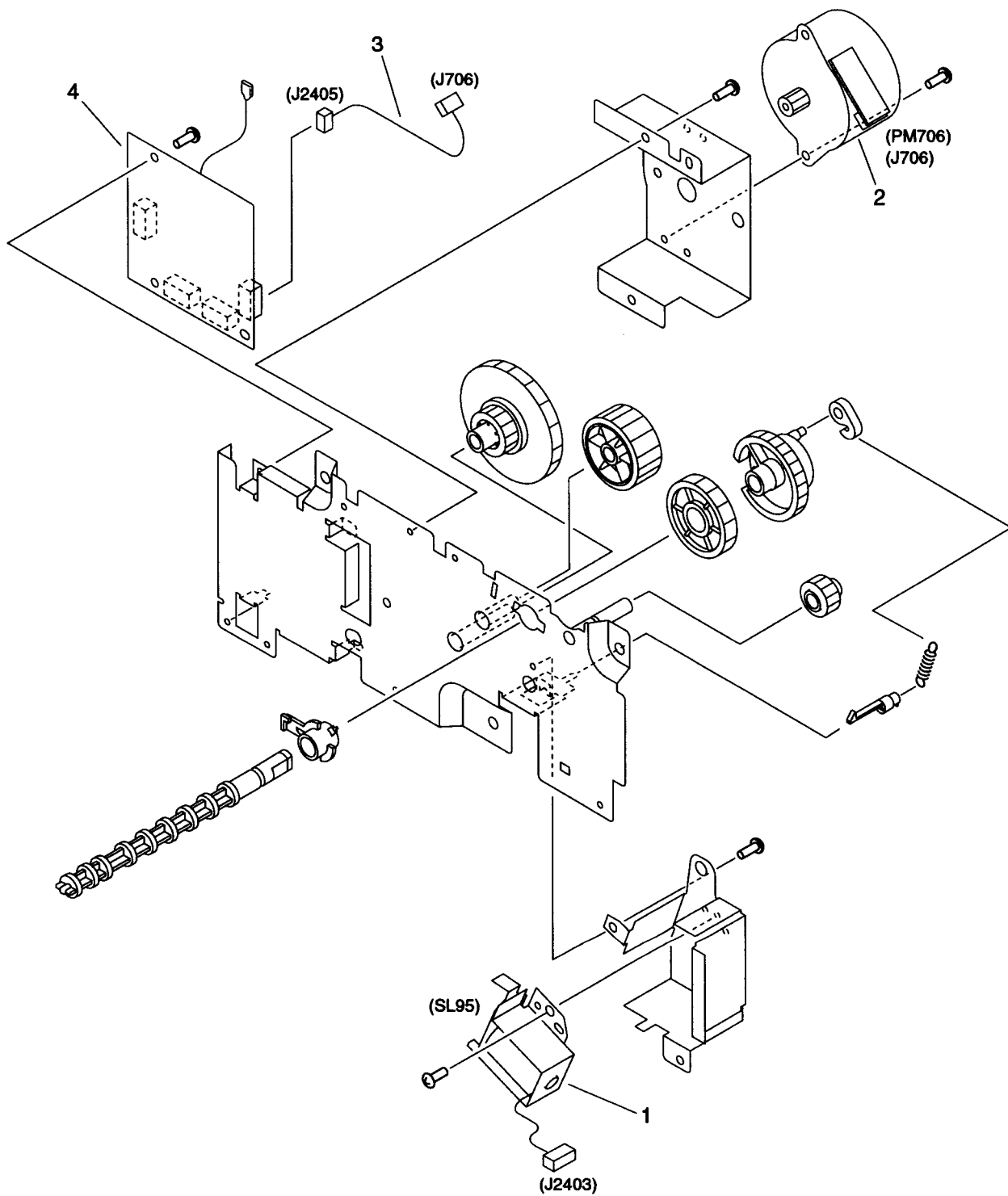

Figure 154. Feed drive assembly—optional tray 3

Table 50. Feed drive assembly—optional tray 3

Ref.	Part number	Description	
	RG5-6925-000CN	Feed drive assembly, tray 3	1
1	RH7-5341-000CN	Solenoid (SL95), tray 3	1
2	RH7-1536-000CN	Motor (M706), tray 3	1
3	RG5-7143-000CN	Cable, motor, tray 3	1
4	RG5-6969-000CN	Feed-drive PCA assembly, tray 3	1

Media tray—optional tray 3

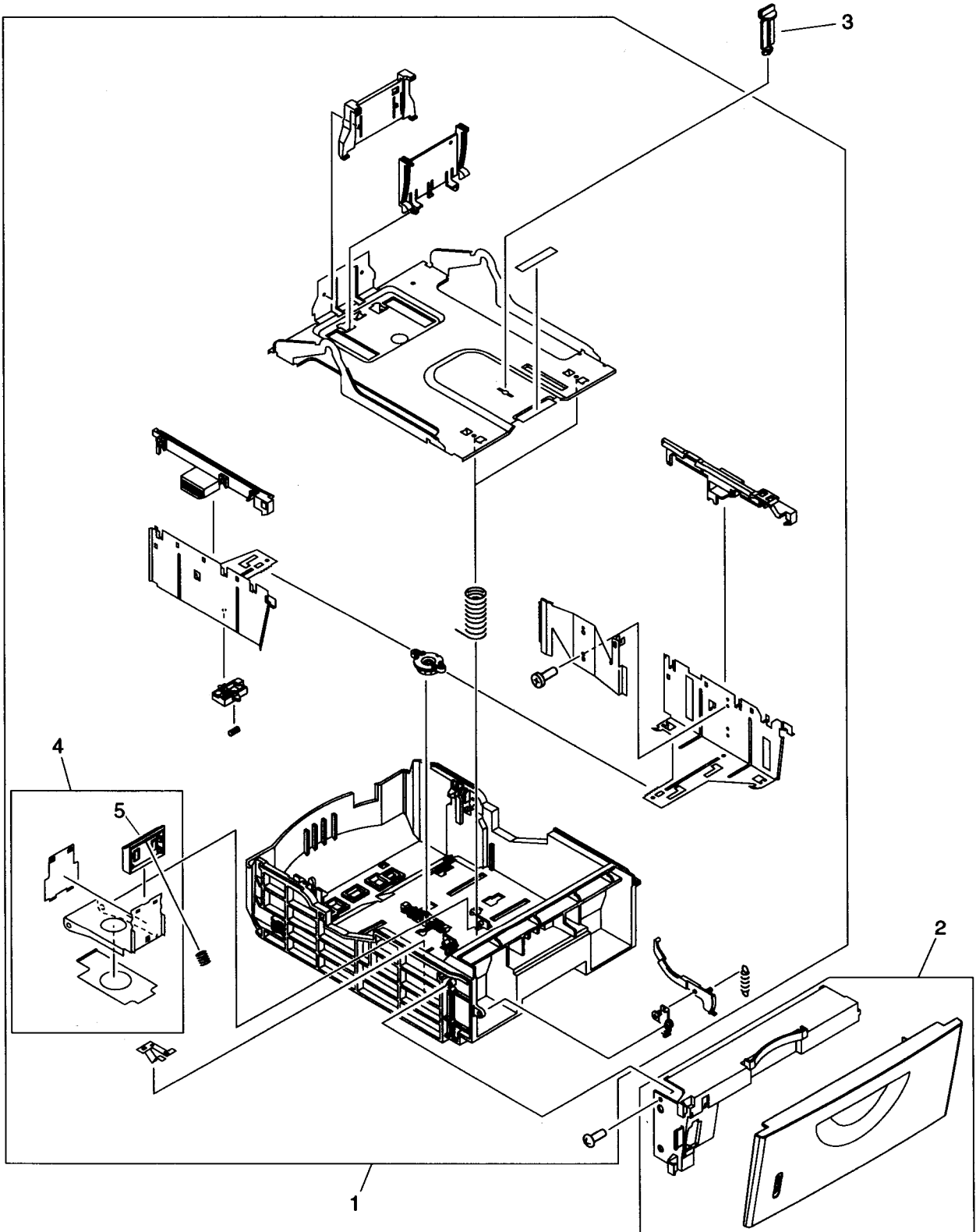

Figure 155. Media tray—optional tray 3

Table 51. Media tray—optional tray 3

Ref.	Part number	Description	
	RG5-6920-000CN	Media tray, tray 3	1
1	RG5-6921-000CN	Main frame assembly, tray 3	1
2	RG5-6922-000CN	Front cover assembly, tray 3	1
3	RB2-6472-000CN	Pin, lift stopper, tray 3	1
4	RG5-6899-000CN	Separation pad assembly, tray 3	1
5	RB2-9960-000CN	Separation pad, tray 3	1

Alphabetical parts list

Table 52. Alphabetical parts list

Description	Part number	Qty.	Figure	Ref.
Air duct	RB3-0025-000CN	1	138	3
Arm, roller pressure, tray 2	RF5-4035-000CN	2	149	23
Arm, sensor, tray 3	RB2-6448-000CN	1	153	4
Base plate, fuser	RF5-4008-000CN	1	145	10
Bushing	RB2-2973-000CN	2	145	1
Bushing	RS5-1637-000CN	1	142	20
Bushing	RS5-1638-000CN	1	137	38
Bushing, gear assembly	RS5-1635-000CN	1	137	33
Bushing, left	RB2-3043-000CN	1	137	4
Bushing, left, tray 2	RB2-2896-000CN	1	149	14
Bushing, left, tray 3	RB2-2896-000CN	1	153	3
Bushing, right	RB2-3044-000CN	1	137	5
Bushing, right, tray 2	RB2-2895-000CN	1	149	13
Bushing, right, tray 3	RB2-2895-000CN	1	153	2
Bushing, transfer roller	RB3-0014-000CN	1	138	16
Bushing, tray 2	RB2-2897-000CN	1	149	15
Bushing, tray 2	RS5-1636-000CN	1	149	8
Bushing, tray 2	RS5-1638-000CN	1	149	16
Cable	RG5-7115-000CN	1	140	5
Cable	RG5-7128-000CN	1	142	37
Cable clip	WT2-5737-000CN	2	144	5
Cable guide	RB2-9903-000CN	1	139	4
Cable, drawer, tray 2	RG5-7149-000CN	1	148	7
Cable, drawer, tray 3	RG5-7150-000CN	1	153	13
Cable, E-label reader	RG5-6974-000CN	1	143	3
Cable, flat, flexible, formatter	RH2-5525-000CN	1	139	8
Cable, flat, flexible, laser/scanner	RH2-5524-000CN	1	139	1
Cable, formatter, power	RG5-7106-000CN	1	144	10
Cable, front	RG5-7145-000CN	1	138	14
Cable, fuser	RG5-7110-000CN'	1	145	16
Cable, fuser connector, dc controller	RG5-7109-000CN	1	144	8
Cable, fuser, power	RG5-6971-000CN	1	144	9
Cable, grounding	RG5-7123-000CN	1	142	27
Cable, H.V.T.	RG5-7146-000CN	1	144	4
Cable, high-voltage transformer	RG5-7130-000CN	1	142	43
Cable, interface	RG5-7122-000CN	1	142	29
Cable, motor	RG5-7114-000CN	1	139	7
Cable, motor, tray 3	RG5-7143-000CN	1	154	3
Cable, pickup, tray 2	RG5-7139-000CN	1	148	6
Cable, power (1)	RG5-7107-000CN	1	144	11
Cable, power (2)	RG5-7108-000CN	1	144	12

Table 52. Alphabetical parts list (continued)

Description	Part number	Qty.	Figure	Ref.
Cable, rotary assembly	RG5-7129-000CN	1	143	2A
Cable, sensor	RG5-7117-000CN	1	143	5
Cable, sensor, tray 2	RG5-7138-000CN	1	148	8
Cable, sensor, tray 3	RG5-7142-000CN	1	153	14
Cable, sub H.V.T.	RG5-7126-000CN	1	144	7
Cable, upper	RG5-7144-000CN	1	138	13
Carousel-brake-release guide	RB2-9852-000CN	1	143	
Carousel lock, left (white)	RB2-9809-000CN	1	143	7
Carousel lock, right (black)	RB2-9808-000CN	1	143	6
Cartridge guide assembly	RG5-6935-000CN	1	139	10
Clamp, cable	WT2-5700-000CN	1	142	44
Clamp, cable	WT2-5700-000CN	1	145	13
Clip, cable	WT2-5056-000CN	1	137	31
Clutch (CL1)	RH7-5366-000CN	1	138	10
Clutch, main gear train (CL2)	RH7-5335-000CN	1	140	3
Collar, spring, tray 2	RB1-2190-000CN	1	149	9
Connector, fuser drawer	RH2-5520-000CN	1	144	3
Connector, optional trays	RH2-5519-000CN	1	142	23
Connector, tray 2	RH2-5519-000CN	1	151	2
Contact assembly, E-label reader	RG5-6957-000CN	1	143	1
Control panel assembly	RG5-6927-000CN	1	136	6
Cover (gauss-proof), tray 2	RB3-0136-000CN	1	149	20
Cover, bottom, center frame, tray 2	RB3-0166-000CN	1	149	3
Cover, bottom, tray 2	RB3-0283-000CN	1	148	4
Cover, center frame, tray 2	RB3-0105-000CN	1	149	1
Cover, fuser motor	RB2-9916-000CN	1	141	6
Cover, gear	RB3-0052-000CN	1	142	30
Cover, left, tray 3	RB3-0140-000CN	1	152	1
Cover, lower left, tray 3	RB2-3489-000CN	1	152	4
Cover, media tray, tray 2	RB3-0109-000CN	1	150	1
Cover, right, tray 3	RB3-0141-000CN	1	152	2
Cover, sensor, tray 3	RB2-6453-000CN	1	152	6
Cover, solenoid (SL92)	RB3-0120-000CN	1	137	12
Cover, top, center frame, tray 2	RB3-0165-000CN	1	149	2
Cover, top, tray 2	RB3-0282-000CN	1	148	3
Cover, upper rear output bin	RB3-0176-000CN	1	145	17A
Crossmember, tray 2	RB3-0108-000CN	1	148	2
Crossmember, tray 3	RB2-6452-000CN	2	152	5
Damper	RB2-6248-000CN	1	137	6
Dc controller	RG5-6959-000CN	1	147	2
Density sensor	RH7-7146-000CN	1	147	7
DIMM door	RB3-0033-000CN	1	136	5A
E-label reader assembly	RG5-6957-000CN	1	137	29
E-label reader PCA	RG5-6956-000CN	1	137	30
Entrance guide assembly	RF5-4049-000CN	1	138	8

Table 52. Alphabetical parts list (continued)

Description	Part number	Qty.	Figure	Ref.
E-ring	XD2-1100-322CN	1	138	501
E-ring	XD2-1100-502CN	2	137	501
E-ring, tray 2	XD9-0136-000CN	1	149	25
E-ring, tray 3	XD9-0136-000CN	1	153	9
Fan (FM712)	RH7-1537-000CN	1	138	9
Feed belt	RB3-0063-000CN	8	142	3
Feed drive assembly, tray 3	RG5-6925-000CN	1	154	
Feed-drive PCA assembly, tray 3	RG5-6969-000CN	1	154	4
Feed-drive PCA, tray 2	RG5-6968-000CN	1	151	1
Feed plate	RB3-0010-000CN	1	142	7
Feed roller assembly, tray 3	RG5-6898-000CN	1	152	3
Feed roller assembly, tray 3	RG5-5621-000CN	1	153	11
Film assembly, 110-127 V	RG5-6928-000CN	1	145	14
Film assembly, 220-240 V	RG5-6949-000CN	1	145	
Flag, pickup sensor, tray 2	RB3-0132-000CN	1	149	19
Flag, set sensor, tray 2	RB3-0130-000CN	1	149	18
Flag, switch	RB3-0135-000CN	1	137	15
Flag, transfer sensor	RB2-9925-000CN	1	142	33
Flag, tray 1 sensor	RB3-0111-000CN	1	137	10
Formatter	See table 35 on page 255 for formatter assembly part numbers.			
Front cover	RB3-0102-000CN	1	137	7
Front cover assembly, tray 3	RG5-6922-000CN	1	155	2
Front lower cover	RB3-0103-000CN	1	137	8
Fuser duct	RB2-9904-000CN	1	141	1
Fuser, 110-127 V	RG5-6903-000CN	1	145	
Fuser, 220-240 V	RG5-6913-000CN	1	145	
Gear assembly	RG5-6938-000CN	1	137	26
Gear train motor	RF5-4010-000CN	1	140	2
Gear, 15T	RB3-0092-000CN	1	138	5
Gear, 15T, tray 2	RS7-0431-000CN	1	149	4
Gear, 16T	RB3-0091-000CN	1	138	4
Gear, 20T/40T	RS7-0424-000CN	1	137	20
Gear, 26T	RS7-0418-000CN	1	137	19
Gear, 26T	RS7-0429-000CN	1	137	22
Gear, 26T, tray 2	RS7-0430-000CN	1	149	5
Gear, 26T/50T	RS7-0426-000CN	1	137	21
Gear, 27T	RS7-0432-000CN	1	145	12
Gear, 30T	RS7-0425-000CN	1	137	32
Gear, 30T	RS7-0428-000CN	1	142	24
Gear, 32T/37T	RS7-0435-000CN	1	138	18
Gear, 37T/43T	RS7-0436-000CN	1	138	19
Gear, 51T	RS7-0437-000CN	1	138	20
Gear, idler, 23T	RB3-0022-000CN	1	142	13
Grounding plate	RB2-9942-000CN	1	137	37

Table 52. Alphabetical parts list (continued)

Description	Part number	Qty.	Figure	Ref.
Grounding plate	RB3-0119-000CN	1	137	11
Grounding plate	RB3-0286-000CN	1	142	5
Grounding plate, roller, tray 2	RB3-0137-000CN	1	149	21
Grounding spring	RB3-0065-000CN	1	142	31
Grounding spring	RB3-0066-000CN	1	142	32
Guide, inlet	RB3-0180-000CN	1	145	5
Guide, left, paper feed	RB2-9954-000CN	1	137	35
Guide, right, paper feed	RB2-9955-000CN	1	137	39
Guide, top output bin	RB2-9912-000CN	2	141	7
H.V.T. PCA	RG5-6960-000CN	1	147	4
Hinge, left, tray 1	RB2-3041-000CN	1	137	2
Hinge, right, tray 1	RB2-3042-000CN	1	137	3
Holder, fuser connector	RB3-0006-000CN	1	144	1
Holder, high voltage	RB3-0062-000CN	1	144	13
Holder, interlock switch	RB3-0023-000CN	1	139	2
Holder, transfer sensor	RB2-9924-000CN	1	142	34
Insulating sheet	RB3-0007-000CN	1	144	2
Insulating sheet	RB3-0056-000CN	1	142	21
Interface cover	RB3-0035-000CN	1	136	2
Label, caution	RS6-8657-000CN	1	145	15A
Label, image cartridge	RS6-8662-000CN	1	137	36
Laser/scanner	RG5-6880-000CN	1	139	5
Left cover	RB3-0028-000CN	1	136	7C
Left cover, tray 2	RB3-0106-000CN	1	148	1
Left-side cover	RG5-6902-000CN	1	136	7
Lever, left lock release	RB3-0179-000CN	1	145	4
Lever, right lock release	RB3-0178-000CN	1	145	3
Low-voltage PCA (110-127 V)	RH3-2252-000CN	1	147	3
Low-voltage PCA (220-240 V)	RH3-2243-000CN	1	147	3
Main body assembly, tray 2	RG5-6915-000CN	1	150	2
Main frame assembly, tray 3	RG5-6921-000CN	1	155	1
Media tray, tray 3	RG5-6920-000CN	1	155	
Media tray—optional tray 2	RG5-6914-000CN	1	150	
Motor (DCM703)	RG5-6958-000CN	1	146	1
Motor (M706), tray 3	RH7-1536-000CN	1	154	2
Motor (PM705)	RH7-1535-000CN	1	146	2
Motor, dc, 24 V	RH7-1533-000CN	1	138	24
Mount, antenna contact	RB2-9851-000CN	1	142	41
Mount, terminal	RB2-9850-000CN	1	142	40
Nameplate—HP color LaserJet 1500 printer	Q2489-40001	1	136	8
Nameplate—HP color LaserJet 1500L printer	Q2488-40001	1	136	8
Nameplate—HP color LaserJet 2500 printer	C9706-40001	1	136	8
Nameplate—HP color LaserJet 2500L printer	C9075-40007	1	136	8
Nameplate—HP color LaserJet 2500n printer	C9707-40001	1	136	8
Nameplate—HP color LaserJet 2500tn printer	C9708-40001	1	136	8

Table 52. Alphabetical parts list (continued)

Description	Part number	Qty.	Figure	Ref.
Optional tray 2	C9698A	1	148	
Optional tray 3	C9699A	1	152	
Pad, light-blocking	RF5-4047-000CN	1	137	34
Photointerrupter (TLP1242), tray 2	WG8-5382-000CN	2	149	12
Photointerrupter (TLP1242), tray 3	WG8-5382-000CN	1	153	10
Pickup roller, tray 1	RB3-0160-000CN	1	137	28A
Pin, lift stopper, tray 3	RB2-6472-000CN	1	155	3
Plate, pressure, left	RB3-0190-000CN	1	145	7
Plate, pressure, right	RB3-0186-000CN	1	145	6
Pulley	RB3-0061-000CN	2	142	2
Pulley	RB3-0067-000CN	2	142	36
Rack	RB3-0090-000CN	1	140	4
Rack, top cover	RB3-0089-000CN	1	136	3A
Rear cover	RB3-0030-000CN	1	136	1
Rear output bin cover assembly	RG5-6931-000CN	1	145	17
Registration roller assembly	RG5-6939-000CN	1	142	26
Registration-sensor PCA	RG5-6967-000CN	1	147	6
Registration shutter assembly	RG5-6940-000CN	1	142	28
RFI shield	RB2-0032-000CN	1	138	2
Right cover assembly, tray 2	RG5-6919-000CN	1	151	
Right side plate front assembly	RG5-6932-000CN	1	140	1
Right side plate rear assembly	RG5-6934-000CN	1	140	6
Right-side cover	RG5-6953-000CN	1	136	5
Rod, on/off switch	RB3-0037-000CN	1	136	7B
Roller assembly, upper top bin	RG5-6897-000CN	1	138	23
Roller cover	RB3-0104-000CN	1	137	9
Roller, belt	RB3-0012-000CN	1	142	9
Roller, lower, top output bin	RG5-6936-000CN	1	141	2
Roller, M, tray 2	RB3-0129-000CN	1	149	17
Roller, pickup, tray 2	RB3-0161-000CN	1	149	22
Roller, pickup, tray 3	RB3-0161-000CN	1	153	7
Roller, pressure	RB3-0191-000CN	1	145	8
Roller, rear output bin	RB2-9909-000CN	2	141	5
Roller, top output bin	RB2-9908-000CN	2	138	22
Roller, transfer sensor	RB2-7195-000CN	1	142	35
Roller, tray 2	RB2-2892-000CN	2	149	11
Roller, tray 3	RB2-2892-000CN	2	153	1
Rotary (carousel) assembly	RG5-6910-000CN	1	143	1
Rotary drive assembly	RG5-6911-000CN	1	146	
Rotary plate assembly, left	RG5-6942-000CN	1	143	2
Rotary pressure assembly	RG5-6943-000CN	1	143	4
Rubber foot	RB2-6297-000CN	2	142	4
Screw, M3x4	XB6-7300-407CN	5	139	501
Screw, M3x6	XA9-0849-000CN	19	139	6
Screw, M3x8	XA9-1291-000CN	1	144	14

Table 52. Alphabetical parts list (continued)

Description	Part number	Qty.	Figure	Ref.
Screw, M3x8	XA9-1355-000CN	2	138	6
Screw, M3x8	XA9-1355-000CN	8	144	6
Screw, M4x10	XA9-1262-000CN	11	137	24
Screw, M4x10	XA9-1262-000CN	26	138	7
Screw, M4x10	XA9-1262-000CN	2	141	4
Screw, M4x10	XA9-1262-000CN	6	142	25
Screw, M4x10, tray 3	XA9-0606-000CN	3	152	7
Screw, M4x10, tray 3	XA9-0606-000CN	3	153	15
Screw, RS, M3x6	XA9-0849-000CN	2	138	15
Screw, RS, M3x6	XA9-0849-000CN	2	142	42
Screw, RS, M3x8	XA9-1291-000CN	5	145	9
Screw, RS, M3x8	XB3-6300-800CN	5	145	501
Screw, tapping, pan head, M4x10, tray 2	XB4-7401-007CN	5	148	501
Screw, TP, M3x5, tray 2	XA9-1263-000CN	2	149	26
Screw, TP, M4x10, tray 3	XA9-1316-000CN	4	152	8
Sensor (PS718)	WG8-5382-000CN	1	137	23
Sensor, transfer (PS720)	WG8-5382-000CN	1	142	38
Separation lower guide assembly	RG5-6930-000CN	1	145	18
Separation pad assembly	RF5-4012-000CN	1	137	17
Separation pad assembly, tray 2	RF5-4045-000CN	1	150	4
Separation pad assembly, tray 3	RG5-6899-000CN	1	155	4
Separation pad, tray 2	RB2-9960-000CN	1	150	3
Separation pad, tray 3	RB2-9960-000CN	1	155	5
Separation upper guide assembly	RG5-6929-000CN	1	145	15
Shaft, feed drive	RB3-0011-000CN	1	142	8
Shaft, idler gear	RB3-0060-000CN	1	142	10
Shaft, lever	RB2-4933-000CN	2	145	2
Solenoid (SL9), tray 2	RH7-5341-000CN	1	149	24
Solenoid (SL92)	RH7-5337-000CN	1	137	16
Solenoid (SL93)	RH7-5340-000CN	1	146	3
Solenoid (SL95), tray 3	RH7-5341-000CN	1	154	1
Spacer	WT2-5778-000CN	2	139	11
Spring	RB3-0016-000CN	1	142	12
Spring	RB3-0042-000CN	1	142	14
Spring	RB3-0043-000CN	1	142	15
Spring	RB3-0044-000CN	1	142	16
Spring	RB3-0045-000CN	1	142	11
Spring	RB3-0046-000CN	1	142	17
Spring	RB3-0047-000CN	1	142	18
Spring	RB3-0048-000CN	1	142	19
Spring	RS6-2766-000CN	1	142	39
Spring, compression	RS6-2756-000CN	2	145	11
Spring, compression, tray 2	RS6-2760-000CN	2	149	6
Spring, compression, tray 3	RS6-2398-000CN	1	153	12
Spring, leaf, tray 3	RB2-6450-000CN	1	153	5

Table 52. Alphabetical parts list (continued)

Description	Part number	Qty.	Figure	Ref.
Spring, leaf, tray 3	RB2-6451-000CN	1	153	6
Spring, left	RB2-9906-000CN	2	141	3
Spring, left	RB3-0122-000CN	1	137	14
Spring, on/off switch	RS6-2759-000CN	1	136	7A
Spring, right	RB3-0121-000CN	1	137	13
Spring, tension, tray 2	RS6-2025-000CN	1	149	7
Spring, torsion	RB2-9905-000CN	2	138	21
Spring, torsion, tray 2	RB2-2843-000CN	1	149	10
Spring, transfer roller	RB3-0015-000CN	1	138	17
Spring, tray 1 flag	RB2-9952-000CN	1	137	1
Spring, tray 1 guide	RS6-2030-000CN	2	137	18
Static charge eliminator plate	RB3-0009-000CN	1	142	6
Stopper, lift plate, tray 2	RB2-3019-000CN	1	148	5
Sub-H.V.T. PCA	RG5-7124-000CN	1	147	9
Switch, interlock	RH7-6051-000CN	1	139	9
Thermistor (TH3)	RH7-7149-000CN	1	138	12
Timing belt	RB1-8668-000CN	1	142	1
Toner-catch tray	RB3-0019-000CN	1	138	1
Toner-sensor PCA	RG5-6964-000CN	1	147	8
Top cover assembly	RG5-6900-000CN	1	136	3
Top door	RF5-4007-000CN	1	136	3B
Top output bin cover	RB3-0032-000CN	1	136	4
Top plate	RG5-6907-000CN	1	139	3
Top-of-page sensor PCA	RG5-6966-000CN	1	147	1
Transfer roller	RF5-4040-000CN	1	138	11
Transfer slide plate	RB3-0057-000CN	2	142	22
Tray 1 assembly	RG5-6937-000CN	1	137	25
Tray 1 guide assembly	RG5-6951-000CN	1	137	27
Tray 1 pickup assembly	RG5-6952-000CN	1	137	28
Waste-toner sensor PCA	RG5-6965-000CN	1	147	5

Numerical parts list

Table 53. Numerical parts list

Part number	Description	Qty.	Figure	Ref.
C9698A	Optional tray 2	1	148	
C9699A	Optional tray 3	1	152	
C9075-40007	Nameplate—HP color LaserJet 2500L printer	1	136	8
C9706-40001	Nameplate—HP color LaserJet 2500 printer	1	136	8
C9707-40001	Nameplate—HP color LaserJet 2500n printer	1	136	8
C9708-40001	Nameplate—HP color LaserJet 2500tn printer	1	136	8
Q2488-40001	Nameplate—HP color LaserJet 1500L printer	1	136	8
Q2489-40001	Nameplate—HP color LaserJet 1500 printer	1	136	8
RB1-2190-000CN	Collar, spring, tray 2	1	149	9
RB1-8668-000CN	Timing belt	1	142	1
RB2-0032-000CN	RFI shield	1	138	2
RB2-2843-000CN	Spring, torsion, tray 2	1	149	10
RB2-2892-000CN	Roller, tray 2	2	149	11
RB2-2892-000CN	Roller, tray 3	2	153	1
RB2-2895-000CN	Bushing, right, tray 2	1	149	13
RB2-2895-000CN	Bushing, right, tray 3	1	153	2
RB2-2896-000CN	Bushing, left, tray 2	1	149	14
RB2-2896-000CN	Bushing, left, tray 3	1	153	3
RB2-2897-000CN	Bushing, tray 2	1	149	15
RB2-2973-000CN	Bushing	2	145	1
RB2-3019-000CN	Stopper, lift plate, tray 2	1	148	5
RB2-3041-000CN	Hinge, left, tray 1	1	137	2
RB2-3042-000CN	Hinge, right, tray 1	1	137	3
RB2-3043-000CN	Bushing, left	1	137	4
RB2-3044-000CN	Bushing, right	1	137	5
RB2-3489-000CN	Cover, lower left, tray 3	1	152	4
RB2-4933-000CN	Shaft, lever	2	145	2
RB2-6248-000CN	Damper	1	137	6
RB2-6297-000CN	Rubber foot	2	142	4
RB2-6448-000CN	Arm, sensor, tray 3	1	153	4
RB2-6450-000CN	Spring, leaf, tray 3	1	153	5
RB2-6451-000CN	Spring, leaf, tray 3	1	153	6
RB2-6452-000CN	Crossmember, tray 3	2	152	5
RB2-6453-000CN	Cover, sensor, tray 3	1	152	6
RB2-6472-000CN	Pin, lift stopper, tray 3	1	155	3
RB2-7195-000CN	Roller, transfer sensor	1	142	35
RB2-9808-000CN	Carousel lock, right (black)	1	143	6
RB2-9809-000CN	Carousel lock, left (white)	1	143	7
RB2-9850-000CN	Mount, terminal	1	142	40
RB2-9851-000CN	Mount, antenna contact	1	142	41
RB2-9852-000CN	Carousel-brake-release guide	1	143	

Table 53. Numerical parts list (continued)

Part number	Description	Qty.	Figure	Ref.
RB2-9903-000CN	Cable guide	1	139	4
RB2-9904-000CN	Fuser duct	1	141	1
RB2-9905-000CN	Spring, torsion	2	138	21
RB2-9906-000CN	Spring, left	2	141	3
RB2-9908-000CN	Roller, top output bin	2	138	22
RB2-9909-000CN	Roller, rear output bin	2	141	5
RB2-9912-000CN	Guide, top output bin	2	141	7
RB2-9916-000CN	Cover, fuser motor	1	141	6
RB2-9924-000CN	Holder, transfer sensor	1	142	34
RB2-9925-000CN	Flag, transfer sensor	1	142	33
RB2-9942-000CN	Grounding plate	1	137	37
RB2-9952-000CN	Spring, tray 1 flag	1	137	1
RB2-0054-000CN	Guide, left, paper feed	1	137	35
RB2-9955-000CN	Guide, right, paper feed	1	137	39
RB2-9960-000CN	Separation pad, tray 2	1	150	3
RB2-9960-000CN	Separation pad, tray 3	1	155	5
RB3-0006-000CN	Holder, fuser connector	1	144	1
RB3-0007-000CN	Insulating sheet	1	144	2
RB3-0009-000CN	Static charge eliminator plate	1	142	6
RB3-0010-000CN	Feed plate	1	142	7
RB3-0011-000CN	Shaft, feed drive	1	142	8
RB3-0012-000CN	Roller, belt	1	142	9
RB3-0014-000CN	Bushing, transfer roller	1	138	16
RB3-0015-000CN	Spring, transfer roller	1	138	17
RB3-0016-000CN	Spring	1	142	12
RB3-0019-000CN	Toner-catch tray	1	138	1
RB3-0022-000CN	Gear, idler, 23T	1	142	13
RB3-0023-000CN	Holder, interlock switch	1	139	2
RB3-0025-000CN	Air duct	1	138	3
RB3-0028-000CN	Left cover	1	136	7C
RB3-0030-000CN	Rear cover	1	136	1
RB3-0032-000CN	Top output bin cover	1	136	4
RB3-0033-000CN	DIMM door	1	136	5A
RB3-0035-000CN	Interface cover	1	136	2
RB3-0037-000CN	Rod, on/off switch	1	136	7B
RB3-0042-000CN	Spring	1	142	14
RB3-0043-000CN	Spring	1	142	15
RB3-0044-000CN	Spring	1	142	16
RB3-0045-000CN	Spring	1	142	11
RB3-0046-000CN	Spring	1	142	17
RB3-0047-000CN	Spring	1	142	18
RB3-0048-000CN	Spring	1	142	19
RB3-0052-000CN	Cover, gear	1	142	30
RB3-0056-000CN	Insulating sheet	1	142	21
RB3-0057-000CN	Transfer slide plate	2	142	22

Table 53. Numerical parts list (continued)

Part number	Description	Qty.	Figure	Ref.
RB3-0060-000CN	Shaft, idler gear	1	142	10
RB3-0061-000CN	Pulley	2	142	2
RB3-0062-000CN	Holder, high voltage	1	144	13
RB3-0063-000CN	Feed belt	8	142	3
RB3-0065-000CN	Grounding spring	1	142	31
RB3-0066-000CN	Grounding spring	1	142	32
RB3-0067-000CN	Pulley	2	142	36
RB3-0089-000CN	Rack, top cover	1	136	3A
RB3-0090-000CN	Rack	1	140	4
RB3-0091-000CN	Gear, 16T	1	138	4
RB3-0092-000CN	Gear, 15T	1	138	5
RB3-0102-000CN	Front cover	1	137	7
RB3-0103-000CN	Front lower cover	1	137	8
RB3-0104-000CN	Roller cover	1	137	9
RB3-0105-000CN	Cover, center frame, tray 2	1	149	1
RB3-0106-000CN	Left cover, tray 2	1	148	1
RB3-0108-000CN	Crossmember, tray 2	1	148	2
RB3-0109-000CN	Cover, media tray, tray 2	1	150	1
RB3-0111-000CN	Flag, tray 1 sensor	1	137	10
RB3-0119-000CN	Grounding plate	1	137	11
RB3-0120-000CN	Cover, solenoid (SL92)	1	137	12
RB3-0121-000CN	Spring, right	1	137	13
RB3-0122-000CN	Spring, left	1	137	14
RB3-0129-000CN	Roller, M, tray 2	1	149	17
RB3-0130-000CN	Flag, set sensor, tray 2	1	149	18
RB3-0132-000CN	Flag, pickup sensor, tray 2	1	149	19
RB3-0135-000CN	Flag, switch	1	137	15
RB3-0136-000CN	Cover (gauss-proof), tray 2	1	149	20
RB3-0137-000CN	Grounding plate, roller, tray 2	1	149	21
RB3-0140-000CN	Cover, left, tray 3	1	152	1
RB3-0141-000CN	Cover, right, tray 3	1	152	2
RB3-0160-000CN	Pickup roller, tray 1	1	137	28A
RB3-0161-000CN	Roller, pickup, tray 2	1	149	22
RB3-0161-000CN	Roller, pickup, tray 3	1	153	7
RB3-0165-000CN	Cover, top, center frame, tray 2	1	149	2
RB3-0166-000CN	Cover, bottom, center frame, tray 2	1	149	3
RB3-0176-000CN	Cover, upper rear output bin	1	145	17A
RB3-0178-000CN	Lever, right lock release	1	145	3
RB3-0179-000CN	Lever, left lock release	1	145	4
RB3-0180-000CN	Guide, inlet	1	145	5
RB3-0186-000CN	Plate, pressure, right	1	145	6
RB3-0190-000CN	Plate, pressure, left	1	145	7
RB3-0191-000CN	Roller, pressure	1	145	8
RB3-0282-000CN	Cover, top, tray 2	1	148	3
RB3-0283-000CN	Cover, bottom, tray 2	1	148	4

Table 53. Numerical parts list (continued)

Part number	Description	Qty.	Figure	Ref.
RB3-0286-000CN	Grounding plate	1	142	5
RF5-4007-000CN	Top door	1	136	3B
RF5-4008-000CN	Base plate, fuser	1	145	10
RF5-4010-000CN	Gear train motor	1	140	2
RF5-4012-000CN	Separation pad assembly	1	137	17
RF5-4035-000CN	Arm, roller pressure, tray 2	2	149	23
RF5-4040-000CN	Transfer roller	1	138	11
RF5-4045-000CN	Separation pad assembly, tray 2	1	150	4
RF5-4047-000CN	Pad, light-blocking	1	137	34
RF5-4049-000CN	Entrance guide assembly	1	138	8
RG5-5621-000CN	Feed roller assembly, tray 3	1	153	11
RG5-6880-000CN	Laser/scanner	1	139	5
RG5-6897-000CN	Roller assembly, upper top bin	1	138	23
RG5-6898-000CN	Feed roller assembly, tray 3	1	152	3
RG5-6899-000CN	Separation pad assembly, tray 3	1	155	4
RG5-6900-000CN	Top cover assembly	1	136	3
RG5-6902-000CN	Left-side cover	1	136	7
RG5-6903-000CN	Fuser, 110-127 V	1	145	
RG5-6907-000CN	Top plate	1	139	3
RG5-6910-000CN	Rotary (carousel) assembly	1	143	
RG5-6911-000CN	Rotary drive assembly	1	146	
RG5-6913-000CN	Fuser, 220-240 V	1	145	
RG5-6914-000CN	Media tray—optional tray 2	1	150	
RG5-6915-000CN	Main body assembly, tray 2	1	150	2
RG5-6919-000CN	Right cover assembly, tray 2	1	151	
RG5-6920-000CN	Media tray, tray 3	1	155	
RG5-6921-000CN	Main frame assembly, tray 3	1	155	1
RG5-6922-000CN	Front cover assembly, tray 3	1	155	2
RG5-6925-000CN	Feed drive assembly, tray 3	1	154	
RG5-6927-000CN	Control panel assembly	1	136	6
RG5-6928-000CN	Film assembly, 110-127 V	1	145	14
RG5-6929-000CN	Separation upper guide assembly	1	145	15
RG5-6930-000CN	Separation lower guide assembly	1	145	18
RG5-6931-000CN	Rear output bin cover assembly	1	145	17
RG5-6932-000CN	Right side plate front assembly	1	140	1
RG5-6934-000CN	Right side plate rear assembly	1	140	6
RG5-6935-000CN	Cartridge guide assembly	1	139	10
RG5-6936-000CN	Roller, lower, top output bin	1	141	2
RG5-6937-000CN	Tray 1 assembly	1	137	25
RG5-6938-000CN	Gear assembly	1	137	26
RG5-6939-000CN	Registration roller assembly	1	142	26
RG5-6940-000CN	Registration shutter assembly	1	142	28
RG5-6942-000CN	Rotary plate assembly, left	1	143	2
RG5-6943-000CN	Rotary pressure assembly	1	143	4
RG5-6949-000CN	Film assembly, 220-240 V	1	145	14

Table 53. Numerical parts list (continued)

Part number	Description	Qty.	Figure	Ref.
RG5-6951-000CN	Tray 1 guide assembly	1	137	27
RG5-6952-000CN	Tray 1 pickup assembly	1	137	28
RG5-6953-000CN	Right-side cover	1	136	5
RG5-6956-000CN	E-label reader PCA	1	137	30
RG5-6957-000CN	Contact assembly, E-label reader	1	143	1
RG5-6957-000CN	E-label reader assembly	1	137	29
RG5-6958-000CN	Motor (DCM703)	1	146	1
RG5-6959-000CN	Dc controller	1	147	2
RG5-6960-000CN	H.V.T. PCA	1	147	4
RG5-6964-000CN	Toner-sensor PCA	1	147	8
RG5-6965-000CN	Waste-toner sensor PCA	1	147	5
RG5-6966-000CN	Top-of-page sensor PCA	1	147	1
RG5-6967-000CN	Registration-sensor PCA	1	147	6
RG5-6968-000CN	Feed-drive PCA, tray 2	1	151	1
RG5-6969-000CN	Feed-drive PCA assembly, tray 3	1	154	4
RG5-6971-000CN	Cable, fuser, power	1	144	9
RG5-6974-000CN	Cable, E-label reader	1	143	3
RG5-7106-000CN	Cable, formatter, power	1	144	10
RG5-7107-000CN	Cable, power (1)	1	144	11
RG5-7108-000CN	Cable, power (2)	1	144	12
RG5-7109-000CN	Cable, fuser connector, dc controller	1	144	8
RG5-7110-000CN	Cable, fuser	1	145	16
RG5-7114-000CN	Cable, motor	1	139	7
RG5-7115-000CN	Cable	1	140	5
RG5-7117-000CN	Cable, sensor	1	143	5
RG5-7122-000CN	Cable, interface	1	142	29
RG5-7123-000CN	Cable, grounding	1	142	27
RG5-7124-000CN	Sub-H.V.T. PCA	1	147	9
RG5-7126-000CN	Cable, sub H.V.T.	1	144	7
RG5-7128-000CN	Cable	1	142	37
RG5-7129-000CN	Cable, rotary assembly	1	143	2A
RG5-7130-000CN	Cable, high-voltage transformer	1	142	43
RG5-7138-000CN	Cable, sensor, tray 2	1	148	8
RG5-7139-000CN	Cable, pickup, tray 2	1	148	6
RG5-7142-000CN	Cable, sensor, tray 3	1	153	14
RG5-7143-000CN	Cable, motor, tray 3	1	154	3
RG5-7144-000CN	Cable, upper	1	138	13
RG5-7145-000CN	Cable, front	1	138	14
RG5-7146-000CN	Cable, H.V.T.	1	144	4
RG5-7149-000CN	Cable, drawer, tray 2	1	148	7
RG5-7150-000CN	Cable, drawer, tray 3	1	153	13
RH2-5519-000CN	Connector, optional trays	1	142	23
RH2-5519-000CN	Connector, tray 2	1	151	2
RH2-5520-000CN	Connector, fuser drawer	1	144	3
RH2-5524-000CN	Cable, flat, flexible, laser/scanner	1	139	1

Table 53. Numerical parts list (continued)

Part number	Description	Qty.	Figure	Ref.
RH2-5525-000CN	Cable, flat, flexible, formatter	1	139	8
RH3-2243-000CN	Low-voltage PCA (220-240 V)	1	147	3
RH3-2252-000CN	Low-voltage PCA (110-127 V)	1	147	3
RH7-1533-000CN	Motor, dc, 24 V	1	138	24
RH7-1535-000CN	Motor (PM705)	1	146	2
RH7-1536-000CN	Motor (M706), tray 3	1	154	2
RH7-1537-000CN	Fan (FM712)	1	138	9
RH7-5335-000CN	Clutch, main gear train (CL2)	1	140	3
RH7-5337-000CN	Solenoid (SL92)	1	137	16
RH7-5340-000CN	Solenoid (SL93)	1	146	3
RH7-5341-000CN	Solenoid (SL9), tray 2	1	149	24
RH7-5341-000CN	Solenoid (SL95), tray 3	1	154	1
RH7-5366-000CN	Clutch (CL1)	1	138	10
RH7-6051-000CN	Switch, interlock	1	139	9
RH7-7146-000CN	Density sensor	1	147	7
RH7-7149-000CN	Thermistor (TH3)	1	138	12
RS5-1635-000CN	Bushing, gear assembly	1	137	33
RS5-1636-000CN	Bushing, tray 2	1	149	8
RS5-1637-000CN	Bushing	1	142	20
RS5-1638-000CN	Bushing	1	137	38
RS5-1638-000CN	Bushing, tray 2	1	149	16
RS6-2760-000CN	Spring, compression, tray 2	2	149	6
RS6-2025-000CN	Spring, tension, tray 2	1	149	7
RS6-2030-000CN	Spring, tray 1 guide	2	137	18
RS6-2398-000CN	Spring, compression, tray 3	1	153	12
RS6-2756-000CN	Spring, compression	2	145	11
RS6-2759-000CN	Spring, on/off switch	1	136	7A
RS6-2766-000CN	Spring	1	142	39
RS6-8657-000CN	Label, caution	1	145	15A
RS6-8662-000CN	Label, image cartridge	1	137	36
RS7-0418-000CN	Gear, 26T	1	137	19
RS7-0424-000CN	Gear, 20T/40T	1	137	20
RS7-0425-000CN	Gear, 30T	1	137	32
RS7-0426-000CN	Gear, 26T/50T	1	137	21
RS7-0428-000CN	Gear, 30T	1	142	24
RS7-0429-000CN	Gear, 26T	1	137	22
RS7-0430-000CN	Gear, 26T, tray 2	1	149	5
RS7-0431-000CN	Gear, 15T, tray 2	1	149	4
RS7-0432-000CN	Gear, 27T	1	145	12
RS7-0435-000CN	Gear, 32T/37T	1	138	18
RS7-0436-000CN	Gear, 37T/43T	1	138	19
RS7-0437-000CN	Gear, 51T	1	138	20
WG8-5382-000CN	Sensor, transfer (PS720)	1	142	38
WG8-5382-000CN	Photointerrupter (TLP1242), tray 2	2	149	12
WG8-5382-000CN	Photointerrupter (TLP1242), tray 3	1	153	10

Table 53. Numerical parts list (continued)

Part number	Description	Qty.	Figure	Ref.
WG8-5382-000CN	Sensor (PS718)	1	137	23
WT2-5056-000CN	Clip, cable	1	137	31
WT2-5700-000CN	Clamp, cable	1	142	44
WT2-5700-000CN	Clamp, cable	1	145	13
WT2-5737-000CN	Cable clip	2	144	5
WT2-5778-000CN	Spacer	2	139	11
XA9-0606-000CN	Screw, M4x10, tray 3	3	152	7
XA9-0606-000CN	Screw, M4x10, tray 3	3	153	15
XA9-0849-000CN	Screw, M3x6	19	139	6
XA9-0849-000CN	Screw, RS, M3x6	2	138	15
XA9-0849-000CN	Screw, RS, M3x6	2	142	42
XA9-1262-000CN	Screw, M4x10	11	137	24
XA9-1262-000CN	Screw, M4x10	26	138	7
XA9-1262-000CN	Screw, M4x10	2	141	4
XA9-1262-000CN	Screw, M4x10	6	142	25
XA9-1263-000CN	Screw, TP, M3x5, tray 2	2	149	26
XA9-1291-000CN	Screw, M3x8	1	144	14
XA9-1291-000CN	Screw, RS, M3x8	5	145	9
XA9-1316-000CN	Screw, TP, M4x10, tray 3	4	152	8
XA9-1355-000CN	Screw, M3x8	2	138	6
XA9-1355-000CN	Screw, M3x8	8	144	6
XB3-6300-800CN	Screw, RS, M3x8	5	145	501
XB4-7401-007CN	Screw, tapping, pan head, M4x10, tray 2	5	148	501
XB6-7300-407CN	Screw, M3x4	5	139	501
XD2-1100-322CN	E-ring	1	138	501
XD2-1100-502CN	E-ring	2	137	501
XD9-0136-000CN	E-ring, tray 2	1	149	25
XD9-0136-000CN	E-ring, tray 3	1	153	9

Index

Numerics

- 250-sheet feeder. *See* tray 2
- 500-sheet feeder. *See* tray 3

A

- accessories
 - configuration page, printing 224, 225
 - error messages 191
 - part numbers 245
- acoustic specifications 21
- air duct, replacing 128
- alerts
 - e-mail 48
 - Printer Status and Alerts 50
- alphabetical list, part numbers 284
- Attention light
 - accessory errors 191
 - Attention with Ability to Continue messages 189
 - locating 37
 - printer status messages 39, 186
 - service error messages 193
 - supplies status messages 184, 185

B

- back cover, replacing 122
- background quality, troubleshooting 198
- Bad Transmission error 189
- beam detect errors 193
- bins. *See* output bins
- Black print cartridge. *See* print cartridges
- Black print-cartridge light
 - blinking 183, 184
 - location 37
 - on 38, 182
- blank pages, troubleshooting 211
- brake solenoid 141
- buffer errors 189, 194
- buttons, control panel 37

C

- cables
 - Macintosh 215
 - part numbers 245
 - troubleshooting 175, 189
- calibrating printer 62
- Canadian DOC statement 31
- Cancel Job button 37, 39
- capacity, trays 16, 17, 22
- carousel
 - motor, replacing 120
 - replacing 147
 - rotating 216

- cartridges
 - carousel, replacing 147
 - carousel, rotating 216
 - high-voltage connection points, checking 219
 - life expectancy 54
 - motor 72
 - non-HP supplies policy 65
 - operations 91
 - part numbers 245
 - recycling 65
 - replacing 99
 - status lights 37, 38, 182
 - status page, printing 226
 - status, checking 48, 63
 - storing 64
 - toner, washing off clothing 177
 - warranty 28
- cassettes. *See* trays
- characters, troubleshooting 197, 199
- checks
 - continuous self-test 218
 - engine 218
 - high-voltage power supply 219
 - paper path 220
- Chooser, troubleshooting 214
- circuit capacity specifications 21
- classes 244
- cleaning operations, image formation 87, 89
- cleaning page 61
- clutches 74, 79
- cold reset 221
- color, troubleshooting 203
- commands, PJI 222
- configuration page
 - printing 224
 - troubleshooting 174
- configurations 16
- configuring printer 48
- connectors, locating 231
- consumables. *See* supplies
- continuous self-test 218
- control panel
 - accessory error messages 191
 - Attention with Ability to Continue messages 189
 - lights and buttons 37
 - locating 24, 25
 - printer status lights 39, 186
 - replacing 103
 - service error messages 193
 - supplies status lights 38, 182
 - supply status, checking 63
 - troubleshooting 174
- cooling fan 72
- cords, power 245
- country of origin 23
- Courier font, troubleshooting 213

- covers
 - back, replacing 122
 - diagrams 248
 - front lower, replacing 121
 - front, replacing 131
 - fuser, replacing 100
 - interface, replacing 106
 - left-side, replacing 101
 - locating 24, 25
 - open, detection operations 77, 78
 - part numbers 249
 - right-side, replacing 101
 - top, replacing 123
 - tray 2, diagrams and part numbers 270, 275
 - tray 2, replacing 167
 - tray 3, diagrams and part numbers 276
 - tray 3, replacing 171
- curl, troubleshooting 200
- customer support 49, 244
- Cyan print cartridge. *See* print cartridges
- Cyan print-cartridge light
 - blinking 183, 184
 - location 37
 - on 38, 182

D

- dc controller
 - connections 234
 - E-label operations 92
 - engine control system 69
 - jam detection operations 77
 - laser/scanner operations 73
 - pickup and feed operations 74
 - printed circuit assembly (PCA) 80
 - replacing 116
 - sequence of operations 70
 - tray operations 76
- declaration of conformity 29
- default settings, restoring 221
- delay jams 77
- delivery delay jams 77
- delivery roller, testing 220
- delivery stationary jams 77
- demo page
 - printing 224
 - troubleshooting 174
- density
 - detection PCA 80
 - sensor 132
 - troubleshooting 197
- developer motor 91, 141
- developing rotary
 - detection PCA 80, 91
 - engaging sensor 78
 - motor 72
 - stopper solenoid 79
- developing system operations 81, 84
- dimensions, printer 20
- DIMMs
 - configuration page, printing 225
 - part numbers 245
 - specifications 17, 18
 - troubleshooting 191, 210
- documentation 240
- door open detection 77, 78
- door, replacing 126
 - See also* covers
- DOS Command Prompt 222
- dots per inch (dpi) 18

- drive assembly, diagrams and part numbers 256
- drive roller 220
- dropouts, troubleshooting 197
- drum, imaging
 - cleaning operations 90
 - E-label 92, 133
 - life expectancy 54
 - non-HP supplies policy 65
 - operations 73, 81, 83
 - replacing 98
 - status light 37, 38, 182
 - status page, printing 226
 - status, checking 63
 - storing 64
 - warranty 28

E

- ECU pan, replacing 157
- EIO errors 191
- E-label
 - operations 91, 92
 - removing 133
- electrical specifications 21
- electrostatic discharge (ESD) 95
- e-mail alerts 48
- embedded Web server 47
- encoder motor 141
- Energy Star 20
- engaging motor 72
- engine communication errors 193
- engine control system 69, 70
- engine test
 - performing 218
 - troubleshooting 174
- engine, cleaning 61
- envelopes
 - loading 44
 - output paths 43
 - tray specifications 22
- environmental specifications 21, 34
- error messages
 - accessory 191
 - Attention with Ability to Continue 189
 - event log 224, 225
 - Low cartridge 63, 182
 - Macintosh 206
 - Printer Status and Alerts 51
 - printer status lights 186
 - service 193
 - supplies status lights 182
 - Windows 206
- ESD (electrostatic discharge) 95
- event log 224, 225

F

- factory defaults, restoring 221
- faded print, troubleshooting 197
- fans
 - diagrams 72
 - errors 194
 - replacing 128
- feed-drive shaft, replacing 156
- Finnish laser safety statement 32
- flash DIMMs 18, 191
- font DIMMs 17
- fonts
 - included 19
 - troubleshooting 213, 215

- formatter
 - errors 193
 - PJL commands 222
 - replacing 109, 113
- formatter cage, replacing 107, 111
- fraud hotline 66
- front cover, replacing 131
- front frame assembly, diagrams and part numbers 250
- front fuser detection sensor 78
- front lower cover, replacing 121
- fuser
 - control circuit 69
 - delivery sensor 78
 - diagram 81
 - diagrams and part numbers 266
 - errors 194
 - front detection sensor 78
 - life expectancy 54
 - operations 87
 - replacing 100
 - roller, testing 220
 - wrap sensor, replacing 165
- fuser motor
 - diagrams 72, 74
 - replacing 115
- fusing delivery paper sensor (PS1) 74, 77

G

- gear assembly, replacing 138
- gear-train motor (DCM701) 76
- Go light/button
 - accessory errors 191
 - Attention with Ability to Continue messages 189
 - locating 37
 - service error messages 193
 - status 39, 187
- gray background, troubleshooting 198
- guides 240

H

- high-voltage power supply
 - locating 69, 80
 - replacing 161
 - troubleshooting 207, 219
- HP Color LaserJet 1500 Series Toolbox
 - accessing 237
 - calibrating printer 62
 - cleaning page, printing 61
- HP Color LaserJet 2500 Series Toolbox
 - accessing 240
 - calibrating printer 62
 - cleaning page, printing 61
 - supplies status, checking 64
- HP Customer Care Online 244
- HP fraud hotline 66
- HP Instant Support 49
- HP Jetdirect print servers
 - EIO errors 191
 - features 19
 - locating 35
 - models including 17
 - settings 48
- HP Technical Training 244
- HP UltraPrecise print cartridges. *See* print cartridges
- HP Web Jetadmin 64
- humidity specifications 21

I

- image formation
 - developing stage 84
 - engine control system 69
 - fusing stage 87
 - laser beam operations 83
 - primary charging stage 83
 - separation stage 86
 - stages 82
 - system components 81
 - transfer stage 85
- image quality
 - color, troubleshooting 203
 - specifications 18
 - troubleshooting 195, 196, 202
- ImageRET 18
- images, repeated 201
- imaging drum
 - cleaning operations 90
 - E-label 92, 133
 - life expectancy 54
 - non-HP supplies policy 65
 - operations 73, 81, 83
 - replacing 98
 - status light 37, 38, 182
 - status page, printing 226
 - status, checking 63
 - storing 64
 - warranty 28
- information pages
 - printing 224
 - troubleshooting 174
- Information tab, embedded Web server 48
- input trays. *See* trays
- installing printer 34
- Instant Support 49
- interface cover, replacing 106
- interface ports
 - cables 245
 - locating 24, 25
 - Macintosh issues 215
 - specifications 35
 - troubleshooting 175, 189
- internal components, diagrams and part numbers
 - printer 252
 - tray 3 278
- INTR (initial rotation) sequence 70
- ITB cleaning operations 81, 87, 89

J

- jams
 - causes of 176
 - detection operations 77
 - input, clearing 178
 - internal, clearing 177
 - locations 176
 - output, clearing 179
- Jetadmin, HP Web 64
- Jetdirect print servers
 - EIO errors 191
 - features 19
 - locating 35
 - models including 17
 - settings 48

K

Korean EMI statement 31

L

labels

- loading 44
- output paths 43
- tray specifications 22

languages, printer

- included 19
- troubleshooting 190

laser beam operations 83

laser safety statements 31, 32

laser/scanner

- engine control system 69
- errors 193
- operations 73
- replacing 129

latent image formation 73, 81

left-side cover, replacing 101

life expectancies, supplies 54

light print, troubleshooting 197

lights, control panel

- accessory error messages 191
- Attention with Ability to Continue messages 189
- locating 37
- printer status 39, 186
- service error messages 193
- supplies status 38, 182
- troubleshooting 174

Limit Check Error 206

lines, troubleshooting 198

loading media

- tray 1 44
- tray 2 45
- tray 3 46

loose toner, troubleshooting 199

Low cartridge message 63, 182

low-voltage power supply

- locating 69
- replacing 162

LSTR (last rotation) sequence 70

M

Macintosh errors, troubleshooting 206, 214

Magenta print cartridge. *See* print cartridges

Magenta print-cartridge light

- blinking 183, 185
- location 37
- on 38, 182

main drive assembly, diagrams and part numbers 256

main motor 72, 74

maintenance

- cleaning 61
- life expectancies of supplies 54

manual-feed errors 187

manuals 240

media

- curl, troubleshooting 200
- error messages 189
- jams. *See* jams
- loading tray 1 44
- loading tray 2 45
- loading tray 3 46
- output paths 43
- path check 220
- skew, troubleshooting 200
- specifications 22
- tray specifications 42
- troubleshooting 209, 210
- wrinkled, troubleshooting 200

media input trays. *See* trays

media output bins. *See* output bins

memory

- configuration page, printing 225
- insufficient 189
- NVRAM errors 190
- part numbers 245
- resetting 221
- specifications 16, 17, 18
- troubleshooting DIMM 191
- troubleshooting DIMMs 210

messages

- accessory errors 191
- Attention with Ability to Continue 189
- event log 224, 225
- Low cartridge 63, 182
- Macintosh 206
- Printer Status and Alerts 51
- printer status lights 186
- service 193
- supplies status lights 182
- Windows 206

middle frame assembly, diagrams and part numbers 260

model number 23

models

- features 16
- trays included 40

motors

- carousel, replacing 120
- diagrams 72
- errors 194
- fuser, replacing 115
- print cartridge 91
- replacing 141
- testing 220
- tray 2 and 3 76
- tray 3, replacing 172

MS-DOS Command Prompt 222

multipurpose tray. *See* tray 1

N

Networking tab, embedded Web server 48

networks

- EIO errors 191
- embedded Web server 47
- features supported 19
- HP Jetdirect print servers, models including 17
- interface ports 36
- Printer Status and Alerts 50
- settings 48
- troubleshooting 208

noise specifications 21

non-HP supplies 65

- non-volatile memory
 - errors 190
 - resetting 221
- numbers, part
 - about 246
 - alphabetical list 284
 - numerical list 291
- NVRAM
 - errors 190
 - PJL commands 222
 - resetting 221
- O**
- on/off switch
 - locating 24, 25, 78
 - replacing 105
- online support 49, 244
- operating environment specifications 21, 34
- operations
 - clutches 79
 - E-label 92
 - engine control system 69
 - fans 72
 - image formation process 82
 - image formation system 81
 - jam detection 77
 - motors 72
 - paper trays 76
 - pickup and feed system 74
 - power-on 71
 - print cartridges 91
 - printed circuit assemblies (PCAs) 80
 - sensors and switches 78
 - sequences 70
 - solenoids 79
 - timing chart 228
- optional tray 2. *See* tray 2
- optional tray 3. *See* tray 3
- ordering
 - parts 244
 - supplies 49, 64, 244
- output bins
 - jams, clearing 179
 - locating 24, 25
 - troubleshooting 211
 - using 43
- output quality
 - color, troubleshooting 203
 - specifications 18
 - troubleshooting 195, 196, 202
- P**
- page skew, troubleshooting 200
- pages per minute 18
- paper
 - curl, troubleshooting 200
 - error messages 189
 - jams. *See* jams
 - loading tray 1 44
 - loading tray 2 45
 - loading tray 3 46
 - output paths 43
 - path check 220
 - skew, troubleshooting 200
 - specifications 22
 - tray specifications 42
 - troubleshooting 209, 210
 - wrinkled, troubleshooting 200
- paper input trays. *See* trays
- paper output bins. *See* output bins
- paper-top sensor, replacing 164
- parallel port
 - locating 24, 25
 - specifications 35
 - troubleshooting 175
- parts
 - alphabetical list 284
 - numbers 246
 - numerical list 291
 - ordering 244
 - removing and replacing 95, 96
- PCAs (printed circuit assemblies) 80, 269
- personalities
 - included 19
 - troubleshooting 190
- phone numbers
 - fraud hotline 66
 - supplies ordering 244
- photosensors
 - density, replacing 132
 - diagrams 78
 - fuser-wrap, replacing 165
 - jam detection 77
 - paper-top, replacing 164
 - pickup and feed system 74
 - top-of-page, replacing 132
 - tray 2 and 3 76
 - waste toner, replacing 140
- physical specifications 20, 34
- pickup and feed system
 - engine control system 69
 - operations 74
- pickup delay jams 77
- pickup rollers
 - printer, replacing 54, 55
 - testing 220
 - tray 2, replacing 166
 - tray 3, replacing 169
- pickup stationary jams 77
- PJL commands 222
- ports
 - cables 245
 - locating 24, 25
 - Macintosh issues 215
 - specifications 35
 - troubleshooting 175, 189
- PostScript errors 206, 213
- power
 - consumption 21
 - troubleshooting 174, 207
- power cords 245
- power supplies
 - base assembly, diagrams and part numbers 264
 - high-voltage, replacing 161
 - locating 69, 80
 - low-voltage, replacing 162
 - operations 71
 - sub-high-voltage, replacing 160
- power switch
 - locating 24, 25, 78
 - replacing 105
- primary charging stage, image formation 83
- primary transfer roller 85

- print cartridges
 - carousel, replacing 147
 - carousel, rotating 216
 - high-voltage connection points, checking 219
 - life expectancy 54
 - motor 72
 - non-HP supplies policy 65
 - operations 91
 - part numbers 245
 - recycling 65
 - replacing 99
 - status lights 37, 38, 182
 - status page, printing 226
 - status, checking 48, 63
 - storing 64
 - toner, washing off clothing 177
 - warranty 28
- print quality
 - color, troubleshooting 203
 - specifications 18
 - troubleshooting 195, 196, 202
- PRINT sequence 70
- printed circuit assemblies (PCAs) 80, 269
- Printer Job Language (PJM) commands 222
- printer languages
 - included 19
 - troubleshooting 190
- Printer Status and Alerts 50, 64
- printer status lights
 - locating 37
 - messages 39, 186
- printing, troubleshooting 175, 210
- production code 23
- PS errors 206, 213

Q

- quality
 - color, troubleshooting 203
 - specifications 18
 - troubleshooting 195, 196, 202

R

- Ready light
 - accessory errors 191
 - locating 37
 - service error messages 193
 - status 39, 186
- rear frame assembly, diagrams and part numbers 258
- rear output door
 - jams, clearing 179
 - locating 24, 25
 - using 43
- recycling supplies 65
- registration clutch (CL1) 74, 79
- registration detection PCA 80
- registration sensor (PS711) 74, 77
- registration-roller assembly, replacing 152
- regulatory statements 29
- removing parts 95, 96
- repetitive defects, troubleshooting 199, 201, 227
- replacement intervals, supplies 54
- replacing parts 95, 96
- resetting NVRAM 221
- residual paper jam detection 77
- restoring factory defaults 221
- revision level 23
- right-side cover, replacing 101
- roller engaging clutch (CL2) 74, 79

- rollers
 - engaging sensor 78
 - life expectancies 54
 - pickup, replacing 55
 - primary charging 83
 - registration assembly, replacing 152
 - testing 220
 - transfer 85, 155
 - transfer belt cleaning 87
 - transfer plate, replacing 154
 - tray 2 pickup, replacing 166
 - tray 3 pickup, replacing 169
- rotary assembly, diagrams and part numbers 262
- rotary-drive assembly
 - diagrams and part numbers 268
 - replacing 141
- Rotate Carousel button
 - locating 37
 - using 38, 216
- ruler, repetitive defect 227

S

- scan buffer errors 194
- screwdrivers 95
- screws, replacing 95
- secondary messages
 - accessory 191
 - Attention with Ability to Continue 189
 - service 193
- secondary transfer roller 85
- sensors
 - density, replacing 132
 - diagrams 78
 - fuser-wrap, replacing 165
 - jam detection 77
 - paper-top, replacing 164
 - pickup and feed system 74
 - top-of-page, replacing 132
 - tray 2 and 3 76
 - waste toner, replacing 140
- separation pads
 - life expectancies 54
 - printer, replacing 55
 - tray 1, replacing 137
 - tray 2 or 3, replacing 59
 - tray 2, replacing 59
- separation stage, image formation 86
- serial number 23
- service error messages 193
- setting up printer 34
- settings
 - configuration page, printing 224
 - restoring factory defaults 221
- Settings tab, embedded Web server 48
- side covers 101
- size specifications
 - media 22, 42
 - printer 20
- skew, troubleshooting 200
- slow printing, troubleshooting 209
- smear toner, troubleshooting 198
- software, troubleshooting 174
- solenoids
 - diagrams 79
 - testing 220
 - tray 1 74
 - tray 2 and 3 76
- space requirements 20, 34

- specifications
 - electrical 21
 - environmental 21, 34
 - features 18
 - interface ports 35
 - media 22
 - model and serial number 23
 - model configurations 16
 - output paths 43
 - physical 20
- speed
 - specifications 18
 - troubleshooting 209
- static precautions 95
- stationary jams 77
- status
 - embedded Web server 47
 - non-HP supplies 65
 - page, printing 226
 - Printer Status and Alerts software 50
 - supplies, checking 48, 63
- status lights
 - accessory error messages 191
 - locating 37
 - printer 39, 186
 - service error messages 193
 - supplies 38, 182
- STBY (standby) sequence 70
- storing
 - printer 21
 - supplies 64
- sub-high-voltage transformer PCA, replacing 160
- supplies
 - fraud hotline 66
 - life expectancies 54
 - non-HP 65
 - ordering 49, 64, 244
 - recycling 65
 - status lights 37, 38, 182
 - status page, printing 226
 - status, checking 48, 63
 - storing 64
- support 49, 244
- switches
 - diagrams 78
 - door interlock (SW301) 220
 - engine test 218
 - power 24, 25, 105

T

- technical support 49, 244
- Technical Training, HP 244
- telephone numbers
 - fraud hotline 66
 - supplies ordering 244
- temperature specifications 21
- tests
 - continuous self 218
 - engine 218
 - high-voltage power supply 219
 - paper path 220
- text, troubleshooting 197, 199, 212
- theory of operations. *See* operations
- timing chart 228

- toner
 - developing stage operations 84
 - level detection PCA 80, 91
 - scatter, troubleshooting 200
 - smear, troubleshooting 198
 - specks, troubleshooting 197
 - transfer operations 85
 - washing off clothing 177
 - waste cleaning operations 87, 89, 90
 - waste detection PCA 80
- toner cartridges. *See* print cartridges
- toner-catch tray, removing 153
- Toolbox, HP
 - accessing 237, 240
 - calibrating printer 62
 - cleaning page, printing 61
 - supplies status, checking 64
- tools, required 95
- top cover
 - locating 24, 25
 - open, detection operations 77, 78
 - replacing 123
- top door, replacing 126
- top output bin
 - jams, clearing 179
 - locating 24, 25
 - troubleshooting 211
 - using 43
- top plate, replacing 144
- top-of-page sensor, replacing 132
- transfer belt operations
 - charging 85
 - cleaning 87, 89
 - home-position detection PCA 80
 - separating 86
- transfer operations, image formation 81, 85
- transfer roller
 - life expectancy 54
 - replacing 155
 - testing 220
- transfer roller plate, replacing 154
- transparencies
 - loading 44
 - output paths 43
 - tray specifications 22
- tray 1
 - configuration page 224, 225
 - default selection 40, 41
 - error messages 187
 - loading media 44
 - locating 24, 25
 - media supported 22, 42
 - replacing 135
 - sensors 74, 78
 - separation pad, replacing 137
 - solenoids 74, 79
 - specifications 16, 17
 - troubleshooting 209, 210

tray 2
center frame assembly, diagrams and part numbers 272
configuration page 224, 225
cover, diagrams and part numbers 270
cover, replacing 167
default selection 40, 41
error messages 187
jams, clearing 178
loading media 45
locating 24, 25
media supported 22, 42
media tray, diagrams and part numbers 274
models including 41
operations 76
PCA, replacing 168
pickup roller, replacing 166
replacing 118
right cover assembly, diagrams and part numbers 275
separation pad, replacing 54, 59
space requirements 20
specifications 16, 17
troubleshooting 209, 210

tray 3
configuration page 224, 225
cover, replacing 171
covers, diagrams and part numbers 276
default selection 40, 41
error messages 187
feed drive assembly, diagrams and part numbers 280
internal components, diagrams and part numbers 278
jams, clearing 178
loading media 46
media supported 23, 42
media tray, diagrams and part numbers 282
models including 41
motor, replacing 172
operations 76
pickup roller, replacing 169
separation pad, replacing 54, 59
space requirements 20
specifications 17
troubleshooting 209, 210

trays
See also tray 1; tray 2; tray 3
configuration page 224, 225
default selection 40, 41
error messages 187
jams, clearing 178
media supported 22, 42
models including 40
operations 76
replacing 118, 135
space requirements 20
specifications 16, 17, 22
toner-catch, removing 153
troubleshooting 209, 210

troubleshooting
accessory errors 191
basic steps 174, 207
blank pages 211
color 203
control panel 174
curl 200
engine test 218
error messages 206
fonts 213, 215
gray background 198
high-voltage power supply 219
HP Color LaserJet 1500 Series Toolbox 237
HP Color LaserJet 2500 Series Toolbox 240
image quality 195, 196, 202
information pages 174, 224
light print 197
lines 198
Macintosh issues 214
networks 208
output bins 211
paper path check 220
PostScript (PS) errors 213
power 174, 207
printer status lights 186
printing 175, 210
repetitive defects 199, 201, 227
resetting NVRAM 221
service error messages 193
skew 200
slow printing 209
software 174
supplies status lights 182
tests 218
text 197, 199, 212
toner specks or smear 197, 198, 200
tools 241
wiring diagrams 235
wrinkled pages 200

U

USB port
locating 24, 25
Macintosh issues 215
specifications 35
troubleshooting 175
user guide 240
user-replaceable parts
life expectancies 54
pickup roller and separation pad 55
tray 2 separation pad 59

V

VCCI statement 31
voltage specifications 21

W

- WAIT sequence 70
- warranty
 - HP Color LaserJet 1500 series printer 26
 - supplies 28
- waste toner
 - cleaning operations 87, 89
 - detection PCA 80
 - drum cleaning 90
 - sensor, replacing 140
- wave, troubleshooting 200
- Web Jetadmin 64
- websites
 - parts ordering 244
 - support 49
- weight specifications
 - media 22
 - printer 20
- Windows error messages 206
- wire harnesses, replacing 95
- wiring diagrams 235
- wrap jam sensor (PS720) 74
- wrinkled pages, troubleshooting 200

Y

- Yellow print cartridge. *See* print cartridges
- Yellow print-cartridge light
 - blinking 183, 185
 - location 37
 - on 38, 182



i n v e n t

copyright © 2003
Hewlett-Packard Company

www.hp.com



Q2488-90901