



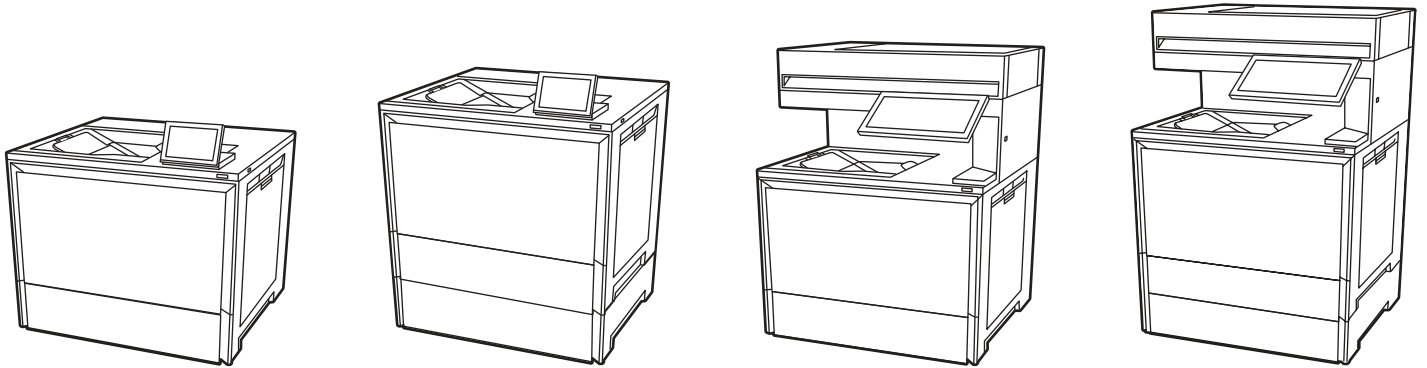
HP Color LaserJet Enterprise 6700, 6701

HP Color LaserJet Enterprise X654, X65455, X65465

HP Color LaserJet Enterprise MFP 6800, 6801

HP Color LaserJet Enterprise MFP X677, X67755, X67765

## Service Manual



[www.hp.com/support/colorlj6700](http://www.hp.com/support/colorlj6700)  
[www.hp.com/support/colorljX654](http://www.hp.com/support/colorljX654)

[www.hp.com/support/colorlj6800MFP](http://www.hp.com/support/colorlj6800MFP)  
[www.hp.com/support/colorljX677MFP](http://www.hp.com/support/colorljX677MFP)



**HP Color LaserJet 6700, 6701, X677,  
X65455, X65465, MFP 6800, 6801, X654,  
X67755, X67765 - Service Manual**

**SUMMARY**

This guide provides theory of operation, troubleshooting, and repair information.

## Legal information

### Copyright and License

© Copyright 2023 HP Development Company, L.P.

Reproduction, adaptation, or translation without prior written permission is prohibited, except as allowed under the copyright laws.

The information contained herein is subject to change without notice.

The only warranties for HP products and services are set forth in the express warranty statements accompanying such products and services. Nothing herein should be construed as constituting an additional warranty. HP shall not be liable for technical or editorial errors or omissions contained herein.

Edition 1, 3/2023

---

# Revision history

View a list of document revisions.

The information contained herein is subject to change without notice. The only warranties for HP products and services are set forth in the express warranty statements accompanying such products and services. Nothing herein should be construed as constituting an additional warranty. HP shall not be liable for technical or editorial errors or omissions contained herein.

**Table** Revision history

Revision number	Revision date	Revision notes
1.1	04/2023	Service manual updates include, but not limited to: <ul style="list-style-type: none"><li>• Updated wast toner duct remove/replace (unseat ITB)</li><li>• Additional reinstall content to main drive assembly remove/replace</li><li>• Updated HCI lifter drive remove/replace</li></ul> Added managed toner cartridges manual unlock procedure. See <a href="#">Removal and replacement: Toner cartridges (manual unlock) (X654/X677 models) on page 666</a> .
1	03/2023	Service manual initial release.

---

# Conventions used in this guide

Learn about the conventions used in this publication.

---



**TIP:** Tips provide helpful hints or shortcuts.



**NOTE:** Notes provide important information to explain a concept or to complete a task.



**CAUTION:** Cautions indicate procedures that you should follow to avoid losing data or damaging the product.



**WARNING!** Warnings alert you to specific procedures that you should follow to avoid personal injury, catastrophic loss of data, or extensive damage to the product.

---

---

# HP service and support

Learn about access to additional service and support information.

## Additional service and support for channel partners

Channel partners can use the HP Partner Portal or the Channel Services Delivery Platform (CSDP) to access the HP Web-based Interactive Search Engine (WISE).

Find information about the following topics.

- Service manuals, service cost data, and service advisories
- The latest control panel message (CPMD) troubleshooting information
- Remove and replace part instructions and videos
- Solutions for printer issues and emerging issues
- Printer specifications, warranty, and regulatory information
- Install, configure, and how to information



[View a video of how to use the HP Partner First Portal to access WISE.](#)

### Access WISE for Channel partners (HP Partner Portal)

1. Sign-in to the HP Partner Portal (click <https://partner.hp.com> to access the sign-in page).
2. Select the **Services & Support** item (near the top of the screen).
3. Select the **Technical Support (WISE)** item.
4. Select the **Technical Documentation** item.
5. Use the WISE portal to search for printer information.

### Access WISE for Channel partners (CSDP)

1. Sign-in to the CSDP portal (click <csdp.hp.com> to access the sign-in page).
2. Select the **Knowledge and Training** item.
3. Select the **HP Technical Documentation** item.
4. Use the WISE portal to search for printer information.

## Additional service and support for HP internal personnel

HP internal personnel, go to one of the following Web-based Interactive Search Engine (WISE) sites:

 [View a video of how to access WISE for internal HP users.](#)

#### Americas (AMS)

- [WISE - English](#)
- [WISE - Spanish](#)
- [WISE - Portuguese](#)
- [WISE - French](#)

#### Asia Pacific / Japan (APJ)

- [WISE - English](#)
- [WISE - Japanese](#)
- [WISE - Korean](#)
- [WISE - Chinese \(simplified\)](#)
- [WISE - Chinese \(traditional\)](#)
- [WISE - Thai](#)

#### Europe / Middle East / Africa (EMEA)

- [WISE - English](#)

### **Additional technical support WISE videos**

The videos below provide additional ways to access printer information using WISE.

 [View a video of how to use WISE to find technical support videos \(model number search\).](#)

 [View a video of ow to use WISE to find technical support videos \(Product detail page \[PDP\] search\).](#)

---

# Table of contents

<b>1 Printer information, configurations, and specifications</b> .....	<b>1</b>
Document feeder / scanner .....	1
Information (document feeder and scanner).....	1
Document feeder and scanner front view .....	1
Technical specifications.....	1
Information (base printer) .....	3
Printer front view (6700 models).....	3
Printer front view (X654 models).....	3
Printer back view (6700/X654 models) .....	4
Printer front view (6800 models).....	5
Printer front view (X677 models).....	7
Printer back view (6800/X677 models) .....	10
Configuration (base printer) .....	10
Configuration (base printer SFP) .....	11
Configuration (base printer MFP) .....	12
Specifications (base printer).....	14
Technical specifications (6700/6701 models).....	14
Technical specifications (X654/X65455/X65465 models).....	16
Technical specifications (6800/6801 models).....	17
Technical specifications (X677/X67755/X67765 models).....	20
Printer dimensions .....	23
Printer dimensions .....	23
Printer dimensions .....	24
Printer dimensions .....	27
Printer space requirements.....	30
Power consumption, electrical specifications, and acoustic emissions .....	30
Operating-environment range .....	30
Information (input devices) .....	31
550-sheet paper feeder front view.....	31
High capacity input (HCI) paper feeder front view .....	32
Information (output devices).....	33
3-bin stapler-stacker front view .....	33
Floor-standing stapler-stacker front view.....	34
Intermediate paper transfer unit (IPTU) front view .....	37
<b>2 Printer installation and maintenance</b> .....	<b>39</b>



Document feeder / scanner .....	39
Clean the pickup rollers and separation pad in the document feeder (MFP) .....	39
Check the scanner glass for dirt and smudges .....	40
Base printer .....	41
Remove and replace the toner cartridges (6700/6800 models) .....	42
Remove and replace the toner cartridges (X654/X677 models) .....	43
Remove and replace the imaging drums (X654/X677 models) .....	45
Clean the Tray 1 pickup and separation rollers .....	48
Clean the Tray 2 pickup and separation rollers .....	51

### 3 Theory of operation ..... 54

Document feeder / scanner .....	54
Document feeder simplex operation .....	54
Scanning and image capture system .....	55
Base printer .....	55
Basic operation .....	55
Sequence of operation .....	56
Formatter-control system .....	57
Power management .....	58
Set the sleep timer and configure the printer to use 1 watt or less of power .....	59
Set the sleep schedule .....	59
Printer job language (PJM) .....	59
Control panel .....	60
Walk-up USB .....	60
Low end data model (LEDM) overview .....	60
CPU .....	60
Input/output (I/O) .....	60
Memory .....	61
Engine-control unit .....	62
DC controller .....	62
Motors .....	66
Fans .....	68
Low-voltage power supply .....	68
Low-voltage power supply voltages description .....	69
Over-current/over-voltage protection .....	70
Low-voltage power supply safety .....	70
Low-voltage power supply functions .....	70
High-voltage power supply .....	71
Fuser control .....	72
Fuser heater protection .....	77
Fuser control functions .....	78
Engine laser/scanner system .....	78
Laser scanner failure detection .....	79
Laser scanner safety .....	79
Image-formation process .....	80
Step 1: Pre-exposure (X654/X677 models only) .....	82
Step 2: Primary charging .....	83
Step 3: Laser-beam exposure .....	83

Step 4: Development .....	84
Step 5: Primary transfer .....	84
Step 6: Secondary transfer .....	85
Step 7: Separation .....	85
Step 8: Fusing .....	86
Step 9: ITB cleaning .....	86
Toner cartridges .....	87
Design .....	87
Toner cartridge functions .....	89
Intermediate transfer belt assembly .....	89
Intermediate transfer belt (ITB) functions .....	90
Secondary transfer roller assembly .....	91
Secondary transfer roller functions .....	91
Calibration .....	91
Calibration functions .....	91
Engine pickup, feed, and delivery system .....	92
Sensors and switches .....	94
Motors, clutches, and solenoids .....	96
Feed speed control .....	98
Pickup and feed delivery features .....	98
Media detection .....	99
Jam detection/prevention .....	100
Input devices .....	103
550-sheet paper feeder .....	103
550-sheet paper feeder paper path .....	103
Paper feeder controller .....	104
550-sheet paper feeder electrical components .....	104
550-sheet paper feeder motor control .....	105
550-sheet paper feeder other functions .....	106
550-sheet feeder jam detection .....	106
High capacity input (HCI) paper feeder .....	106
HCI paper path .....	106
HCI controller .....	107
HCI electrical components .....	108
HCI motor control .....	109
HCI other functions .....	109
HCI jam detection .....	110
Output devices .....	110
3-bin stapler-stacker .....	110
3-bin stapler-stacker paper path .....	110
3-bin stapler-stacker controller .....	111
3-bin stapler-stacker electrical components .....	112
3-bin stapler-stacker motor control .....	114
3-bin stapler-stacker fan control .....	114
3-bin stapler-stacker other functions .....	114
3-bin stapler-stacker jam detection .....	115
Floor-standing stapler-stacker .....	115
Floor-standing stapler-stacker paper path .....	115

Floor-standing stapler-stacker controller .....	116
Floor-standing stapler-stacker electrical components .....	117
Floor-standing stapler-stacker motor control.....	121
Floor-standing stapler-stacker fan control .....	122
Floor-standing stapler-stacker other functions .....	122
550-sheet feeder jam detection .....	123
<b>4 Solve problems .....</b>	<b>124</b>
How to search for printer documentation.....	124
How to search WISE for printer information and documentation .....	124
Accessing WISE for HP channel partners (CSDP).....	130
Accessing WISE for HP channel partners (HP Partner Portal) .....	131
Determine the problem source.....	133
Pre-troubleshooting checklist.....	134
Troubleshooting flowchart .....	135
Firmware upgrades.....	137
Determine the installed revision of firmware .....	137
HP Embedded Web Server.....	138
USB flash drive firmware (Pre-boot menu) .....	139
USB flash drive firmware (control panel menu) .....	139
Comprehensive list of troubleshooting tools.....	140
Engine test .....	140
Control panel checks .....	141
Touchscreen diagnostic mode.....	141
Open the control panel system diagnostic tests .....	142
Screen test .....	144
Touch test .....	148
SoftKey test .....	149
Backlight test.....	151
Sound test.....	151
Keyboard test (flow models only) .....	152
Version .....	153
Control panel diagnostic flowcharts .....	154
Touchscreen black, white, or dim (no image) .....	154
Touchscreen has an unresponsive zone .....	155
No control panel sound .....	156
Home button is unresponsive .....	157
Hardware integration pocket (HIP) is not functioning (control panel functional).....	158
Print menu (SFP) and Copy/Print menu (MFP) .....	159
Defeating interlocks .....	180
LED diagnostics (formatter) .....	181
Scanner tests (MFP) .....	182
Disable cartridge check .....	183
Print/stop test.....	183
Individual component diagnostics .....	184
Paper path test .....	184
Paper path sensors test .....	185
Individual component test .....	185

Manual sensor test .....	185
Tray/bin manual sensor test .....	186
Diagrams: Block diagrams .....	186
Diagrams: External plug and port locations .....	186
Sensors and switches .....	187
Diagrams: Major component locations .....	193
Printed circuit assembly (PCA) connector locations .....	214
Diagrams: General timing chart .....	222
Diagrams: General circuit diagrams .....	223
Internal test and information pages .....	234
Reports menu .....	238
Settings menu .....	239
General menu .....	240
Scan/Digital Send Settings menu (MFP) .....	246
Fax menu (MFP) .....	255
Manage Supplies menu .....	266
Networking menu .....	269
Support Tools menu .....	274
Maintenance menu .....	274
Backup/Restore menu .....	274
Calibration/Cleaning menu .....	275
USB Firmware Upgrade menu .....	276
Service menu .....	276
Troubleshooting menu .....	277
Service menu .....	281
Printer resets .....	285
Format Disk and Partial Clean functions .....	287
Power on troubleshooting .....	290
Power-on checks .....	290
Power on troubleshooting overview .....	290
Troubleshooting power-on or blank control panel problems .....	291
Engine diagnostics .....	292
Engine test .....	292
Defeating interlocks .....	293
Disable cartridge check .....	295
LED diagnostics (formatter) .....	295
Use the solve problems checklist .....	296
Control panel troubleshooting .....	298
Control panel system diagnostics .....	298
Open the control panel system diagnostic tests .....	299
Screen test .....	301
Touch test .....	304
SoftKey test .....	306
Backlight test .....	307
Sound test .....	308
Version .....	309
How to search for printer documentation .....	310
How to search WISE for printer information and documentation .....	310

Accessing WISE for HP channel partners (CSDP).....	316
Accessing WISE for HP channel partners (HP Partner Portal) .....	317
Control panel messages document (CPMD) .....	319
Print the supplies status page .....	320
Pre-boot menu options .....	320
Open the Pre-boot menu from a touchscreen control panel.....	320
Cold reset using the Pre-boot menu from a touchscreen control panel .....	322
Remote Admin .....	322
Required software and network connection.....	322
Connect a remote connection .....	324
Disconnect a remote connection.....	328
Print the event log .....	330
How to search for printer documentation.....	330
How to search WISE for printer information and documentation .....	330
Accessing WISE for HP channel partners (CSDP).....	336
Accessing WISE for HP channel partners (HP Partner Portal) .....	337
Error-code and control-panel-message troubleshooting overview.....	339
Error codes (types and structure) .....	339
Solve paper handling problems.....	341
Clear paper jams (SFP models).....	341
Paper jam locations .....	342
Auto-navigation for clearing paper jams .....	342
Experiencing frequent or recurring paper jams? .....	342
13.B2.D1 jam error in Tray 1 (multipurpose tray).....	343
13.B2.D2 jam error in Tray 2 .....	346
13.A3 jam error in Tray 3 .....	351
13.A4 jam error in Tray 4 .....	357
13.A4 jam error in Tray 4 (2,100 sheet feeder HCI) .....	364
13.B2 jam error in right door .....	371
13.B4 jam errors in the right door .....	374
13.B9 jam errors in the fuser .....	376
13.D3 jam errors in the duplexer .....	380
13.E1 jam error in the output bin .....	382
Clear paper jams (MFP models).....	383
Paper jam locations .....	383
Auto-navigation for clearing paper jams .....	385
Experiencing frequent or recurring paper jams? .....	385
31.13.yz jam error in the document feeder .....	385
13.B2.D1 jam error in Tray 1 (multipurpose tray).....	390
13.B2.D2 jam error in Tray 2 .....	393
13.A3 jam error in Tray 3 .....	398
13.A4 jam error in Tray 4 .....	404
13.A4 jam error in Tray 4 (2,100 sheet feeder HCI) .....	411
13.B2 jam error in right door .....	418
13.B4 jam errors in the right door .....	421
13.B9 jam errors in the fuser .....	423
13.D3 jam errors in the duplexer .....	427
13.E1 jam error in the output bin .....	429

13.E2 jam error in top cover .....	430
13.60 jam errors in the fuser exit area when printing to a stapler/stacker or floor-standing finisher .....	432
13.80, 13.83, or 13.84 jam errors in the 3 Bin Stapler/Stacker .....	434
13.40 or 13.47 Punch jam error in the Floor-standing finisher .....	438
13.6, 13.7, or 13.8 jam error in the Floor-standing finisher .....	441
Printer feeds incorrect page size .....	445
Printer pulls from incorrect tray .....	445
Printer will not duplex or duplexes incorrectly (duplex models) .....	446
Paper does not feed from Tray 2-X .....	446
Output is curled or wrinkled .....	447
The printer does not pick up paper .....	447
The printer picks up multiple sheets of paper .....	448
The document feeder jams, skews, or picks up multiple sheets of paper (MFP) .....	448
Paper does not feed automatically .....	449
Image-quality troubleshooting .....	449
Print-quality troubleshooting .....	450
Repetitive image defect ruler .....	450
Use a ruler to measure between repetitive defects .....	451
Print from a different software program .....	454
Check the paper-type setting for the print job .....	454
Check the paper type setting on the control panel .....	454
Check the paper type setting (Windows) .....	455
Check the paper type setting (macOS) .....	455
Check toner-cartridge status .....	455
Step one: Print the Supplies Status Page .....	455
Step two: Check supplies status .....	456
Print a cleaning page .....	456
Check paper and the printing environment .....	456
Step one: Use paper that meets HP specifications .....	456
Step two: Check the environment .....	457
Step three: Set the individual tray alignment .....	457
Try a different print driver .....	457
Troubleshoot image defects .....	457
Copy-quality troubleshooting .....	465
Check the scanner glass for dirt and smudges .....	466
Vertical lines, bands, or streaks .....	467
Modify printer settings to improve scan or copy quality .....	471
Light or faint copies (color models) .....	472
Performance and connectivity troubleshooting .....	474
Solve fax or email problems .....	474
Solve performance problems .....	475
Factors affecting print performance .....	475
Print speeds .....	476
The printer does not print .....	477
The printer prints slowly .....	477
Solve connectivity problems .....	478
Solve USB connection problems .....	478
Solve wired network problems .....	478

Introduction .....	478
Poor physical connection .....	478
The computer is using the incorrect IP address for the printer .....	479
The computer is unable to communicate with the printer .....	479
The printer is using incorrect link and duplex settings for the network .....	479
New software programs might be causing compatibility problems .....	479
The computer or workstation might be set up incorrectly .....	479
The printer is disabled, or other network settings are incorrect.....	479
<b>5 Removal and replacement.....</b>	<b>480</b>
1 Customer self-repair (CSR) A parts and accessories .....	480
Customer-replaceable units .....	480
Internal parts and assemblies.....	480
Removal and replacement: Toner cartridges (6700/6800 models).....	480
Removal and replacement: Toner cartridges (X654/X677 models).....	484
Removal and replacement: Imaging drums (X654/X677 models).....	489
Removal and replacement: Toner collection unit (TCU).....	493
Removal and replacement: 3-bin stapler-stapler staple cartridge (3-bin stapler-stapler) .....	496
Removal and replacement: Finisher staple cartridge (floor-standing stapler-stapler) .....	498
Removal and replacement: Convenience staple cartridge (convenience stapler models) .....	501
Removal and replacement: Fuser .....	503
Removal and replacement: Image transfer belt (ITB).....	506
Removal and replacement: Secondary transfer roller.....	508
Removal and replacement: Document feeder rollers (MFP models) .....	511
Installation: Keyboard overlay (Flow MFP models) .....	513
Removal and replacement: Tray 1 pickup and separation rollers.....	517
Removal and replacement: Tray 2 paper pickup roller and separation roller assemblies .....	522
2 Customer self-repair (CSR) B parts and accessories .....	525
Customer-replaceable units .....	525
Internal parts and assemblies.....	525
Removal and replacement: Keyboard (Flow MFP models) .....	525
Removal and replacement: Hard-disk drive (HDD) .....	530
Removal and replacement: Dual in-line memory module (DIMM) (SFP models) .....	534
Removal and replacement: Fax PCA (fax models) .....	538
Removal and replacement: Workflow accelerator.....	541
Removal and replacement: USB expansion kit .....	545
Removal and replacement: Solid state drive (SSD) .....	549
Installation: Near field communication (NFC) PCA.....	567
Removal and replacement: embedded MultiMedia Card (eMMC) (SFP models).....	570
3 Document feeder / scanner .....	574
Field-replaceable units (FRUs) .....	574
Internal parts and assemblies.....	574
Removal and replacement: Scanner control board (SCB) (MFP models).....	574
Removal and replacement: White backing (MFP models) .....	579
Whole-unit replacement (WUR) .....	581
Automatic document feeder (WUR) .....	581
Removal and replacement: Document feeder (MFP models).....	581
Integrated scanner assembly (WUR).....	585

Removal and replacement: Flatbed scanner assembly (MFP models).....	585
4 Removal and replacement: Internal parts and assemblies (base printer) .....	591
Field-replaceable units (FRUs) .....	591
Covers, panels, and doors .....	591
Removal and replacement: Formatter cover .....	591
Removal and replacement: Front door .....	593
Removal and replacement: Toner cartridge access door (X654/X677 models) .....	596
Removal and replacement: Rear cover .....	599
Removal and replacement: Rear upper cover (MFP models).....	602
Removal and replacement: Left upper cover (MFP models).....	605
Removal and replacement: Left cover .....	607
Removal and replacement: Left handle .....	611
Removal and replacement: Front left cover .....	615
Removal and replacement: Front right cover .....	617
Removal and replacement: Right door .....	619
Removal and replacement: Right lower door (X654/X677 models) .....	624
Removal and replacement: Rear lower cover (X654/X677 models) .....	627
Removal and replacement: Left lower cover (X654/X677 models) .....	630
Removal and replacement: Output bin .....	635
Removal and replacement: Right handle .....	638
Removal and replacement: Top cover (SFP models) .....	644
Removal and replacement: Top cover (MFP models).....	650
Removal and replacement: Top front cover (MFP models).....	653
Removal and replacement: Hardware Integration Pocket (HIP) cover .....	659
Removal and replacement: Control panel (SFP models) .....	661
Removal and replacement: Control panel (MFP models) .....	664
Internal parts and assemblies.....	666
Removal and replacement: Toner cartridges (manual unlock) (X654/X677 models) .....	666
Removal and replacement: Secondary transfer assembly.....	670
Removal and replacement: Registration density sensor assembly .....	674
Removal and replacement: Registration assembly .....	680
Removal and replacement: Paper pickup assembly (6700/6800 models) .....	685
Removal and replacement: Paper pickup assembly (X654/X677 models).....	690
Removal and replacement: Delivery assembly.....	694
Removal and replacement: Laser scanner assembly .....	698
Removal and replacement: DC controller (DCC).....	702
Removal and replacement: Formatter .....	706
Removal and replacement: Formatter cage assembly (SFP models) .....	709
Removal and replacement: Formatter cage assembly (MFP) models.....	713
Removal and replacement: Feed drive assembly (X654/X677 models) .....	717
Removal and replacement: Pickup drive assembly (6700/6800 models) .....	723
Removal and replacement: Pickup drive assembly (X654/X677 models) .....	729
Removal and replacement: Toner supply motor assembly (X654/X677 models) .....	735
Removal and replacement: Lifter drive assembly (6700/6800 models) .....	739
Removal and replacement: Lifter drive assembly (X654/X677 models) .....	744
Removal and replacement: Auto close assembly (6700/6800 models) .....	749
Removal and replacement: Auto close assembly (X654/X677 models) .....	754
Removal and replacement: Tray 2 media size detect assembly (6700/6800 models).....	759



Removal and replacement: Tray 2 media size detect assembly (X654/X677 models) .....	764
Removal and replacement: Fuser drive assembly .....	769
Removal and replacement: Main-drive assembly .....	778
Removal and replacement: Interlock assembly.....	795
Removal and replacement: Waste toner duct assembly (X654/X677 models) .....	814
Removal and replacement: Waste toner duct assembly (6700/6800 models) .....	833
Removal and replacement: Pre-exposure PCA holder assembly (6700/6800 models) .....	840
Removal and replacement: Pre-exposure PCA holder assembly (X654/X677 models) .....	853
Removal and replacement: Toner supply drive assembly (X654/X677 models).....	868
Removal and replacement: Toner supply assembly (X654/X677 models).....	873
Removal and replacement: Toner supply buffer assembly/intermediate pipe (X654/X677 models).....	875
Removal and replacement: Feed assembly (X654/X677 models) .....	882
Removal and replacement: Low-voltage power supply (LVPS).....	889
Removal and replacement: High-voltage power supply (HVPS) .....	894
Removal and replacement: Drive PCA.....	901
Removal and replacement: Feed/toner supply controller PCA (X654/X677 models) .....	907
Removal and replacement: Right PCA.....	911
Removal and replacement: Rear PCA.....	914
Removal and replacement: Environmental sensor PCA .....	921
Removal and replacement: Drum home position PCA.....	924
Removal and replacement: Drum motor .....	929
Removal and replacement: Developer motor .....	934
Removal and replacement: Image transfer belt (ITB) motor.....	939
Removal and replacement: Developer alienation motor.....	945
Removal and replacement: Fuser motor .....	953
Removal and replacement: Duplex motor .....	958
Removal and replacement: Power-supply fan.....	964
Removal and replacement: Cartridge fan .....	969
Removal and replacement: Fuser fan .....	975
Removal and replacement: Exhaust fan .....	981
5 Input device - 550-sheet paper feeder .....	984
Field-replaceable units (FRUs) .....	984
Covers, panels, and doors .....	985
Removal and replacement: Front left cover (550-sheet paper feeder) .....	985
Removal and replacement: Front right cover (550-sheet paper feeder) .....	987
Removal and replacement: Right door (550-sheet paper feeder) .....	988
Removal and replacement: Rear cover (550-sheet paper feeder) .....	991
Removal and replacement: Left cover (550-sheet paper feeder) .....	994
Internal parts and assemblies.....	998
Removal and replacement: Pickup assembly (550-sheet paper feeder) .....	998
Removal and replacement: Lifter drive assembly (550-sheet paper feeder).....	1003
Removal and replacement: Pickup drive assembly (550-sheet paper feeder).....	1007
Removal and replacement: Auto close assembly (550-sheet paper feeder).....	1013
Removal and replacement: Media size detection assembly (550-sheet paper feeder) .....	1018
Removal and replacement: Controller PCA (550-sheet paper feeder).....	1023
Removal and replacement: Separation roller assembly (550-sheet paper feeder) .....	1027
Removal and replacement: Pickup roller assembly (550-sheet paper feeder) .....	1029

6	Removal and replacement: 2,100-sheet paper deck.....	1031
	Field-replaceable units (FRUs) .....	1031
	Covers, panels, and doors .....	1031
	Removal and replacement: Right door (HCI).....	1031
	Removal and replacement: Front left cover/left cover (HCI) .....	1033
	Removal and replacement: Rear cover (HCI).....	1036
	Removal and replacement: Rear lower cover (HCI).....	1038
	Internal parts and assemblies.....	1041
	Removal and replacement: Cassette assembly (HCI) .....	1041
	Removal and replacement: Pickup assembly (HCI).....	1043
	Removal and replacement: Auto close assembly (HCI) .....	1046
	Removal and replacement: Lifter drive assembly (HCI) .....	1049
	Removal and replacement: Pickup alienation assembly (HCI) .....	1053
	Removal and replacement: Pickup drive assembly (HCI) .....	1057
	Removal and replacement: Controller PCA (HCI) .....	1061
	Removal and replacement: Separation roller assembly (HCI).....	1065
	Removal and replacement: Pickup roller assembly (HCI).....	1067
7	Output device - 3-bin staple stacker multi-bin mailbox .....	1069
	Field-replaceable units (FRUs) .....	1069
	Covers, panels, and doors .....	1070
	Removal and replacement: Rear cover (3-bin stapler-stacker) .....	1070
	Removal and replacement: Staple cover and staple door (3-bin stapler-stacker) .....	1072
	Removal and replacement: Right upper cover (3-bin stapler-stacker).....	1074
	Removal and replacement: Right corner cover (3-bin stapler-stacker).....	1076
	Removal and replacement: Right lower cover (3-bin stapler-stacker) .....	1079
	Removal and replacement: Rear inner cover (3-bin stapler-stacker) .....	1083
	Removal and replacement: Stapler-stacker door assembly (3-bin stapler-stacker).....	1086
	Removal and replacement: Stacking wall assembly (3-bin stapler-stacker).....	1093
	Internal parts and assemblies.....	1105
	Removal and replacement: Stapler assembly (3-bin stapler-stacker) .....	1105
	Removal and replacement: Jogger assembly (3-bin stapler-stacker) .....	1109
	Removal and replacement: Output bin 1 (3-bin stapler-stacker) .....	1113
	Removal and replacement: Upper feed assembly (3-bin stapler-stacker) .....	1115
	Removal and replacement: Lower feed assembly (3-bin stapler-stacker) .....	1124
	Removal and replacement: Solenoid assembly (3-bin stapler-stacker) .....	1139
	Removal and replacement: MBM fan (3-bin stapler-stacker).....	1146
	Removal and replacement: Stapler-stacker feed motor (3-bin stapler-stacker) .....	1149
	Removal and replacement: Controller PCA (3-bin stapler-stacker) .....	1152
8	Output device - floor-standing staple stacker .....	1155
	Field-replaceable units (FRUs) .....	1155
	Covers, panels, and doors .....	1155
	Removal and replacement: Front door (floor-standing stapler-stacker).....	1155
	Removal and replacement: Upper and lower output bins (floor-standing stapler-stacker) .....	1157
	Removal and replacement: Left upper rear cover (floor-standing stapler-stacker).....	1160
	Removal and replacement: Left lower rear cover (floor-standing stapler-stacker) .....	1162
	Removal and replacement: Rear cover (floor-standing stapler-stacker).....	1164
	Removal and replacement: Rear upper cover (floor-standing stapler-stacker) .....	1168
	Removal and replacement: MBM front cover (floor-standing stapler-stacker) .....	1173

Removal and replacement: MBM rear cover (floor-standing stapler-stacker).....	1175
Removal and replacement: MBM top cover (floor-standing stapler-stacker).....	1179
Removal and replacement: MBM output bin (floor-standing stapler-stacker).....	1185
Removal and replacement: Front inner upper cover (floor-standing stapler-stacker).....	1190
Removal and replacement: Front inner lower cover (floor-standing stapler-stacker).....	1193
Removal and replacement: Front inner cover (floor-standing stapler-stacker).....	1196
Removal and replacement: Foot front cover (tall model only) (floor-standing stapler-stacker).....	1201
Removal and replacement: Foot front cover (floor-standing stapler-stacker).....	1205
Removal and replacement: Foot rear cover (floor-standing stapler-stacker).....	1208
Removal and replacement: Foot center cover (floor-standing stapler-stacker).....	1213
Removal and replacement: Foot cover (floor-standing stapler-stacker).....	1221
Internal parts and assemblies.....	1230
Removal and replacement: Stapler (floor-standing stapler-stacker).....	1230
Removal and replacement: Controller PCA (floor-standing stapler-stacker).....	1233
Removal and replacement: Power supply assembly (floor-standing stapler-stacker).....	1238
Removal and replacement: Height wall upper assembly (floor-standing stapler-stacker).....	1245
Removal and replacement: Height wall lower assembly (floor-standing stapler-stacker).....	1251
Removal and replacement: Lifter base upper assembly (floor-standing stapler-stacker).....	1259
Removal and replacement: Lifter base lower assembly (floor-standing stapler-stacker).....	1267
Removal and replacement: Delivery assembly (floor-standing stapler-stacker).....	1273
Removal and replacement: Punch assembly (floor-standing stapler-stacker).....	1285
Removal and replacement: SWB assembly (floor-standing stapler-stacker).....	1296
Removal and replacement: Drum assembly/door handle rail assembly (floor-standing stapler-stacker).....	1312
Removal and replacement: Drum drive assembly (floor-standing stapler-stacker).....	1320
Removal and replacement: IMF assembly (floor-standing stapler-stacker).....	1333
Removal and replacement: Alignment assembly (floor-standing stapler-stacker).....	1359
<b>6 Parts and diagrams.....</b>	<b>1390</b>
Document feeder / scanner.....	1390
Integrated scanner assembly.....	1390
Base printer.....	1392
Control panels.....	1392
Control panels.....	1392
Covers, panels, and doors.....	1394
Parts and diagrams: Covers 6700 models.....	1394
Parts and diagrams: Covers X654 models.....	1396
Parts and diagrams: Covers 6800 models.....	1398
Parts and diagrams: Covers X677 models.....	1400
Internal parts and assemblies.....	1402
Parts and diagrams: Internal assemblies (1 of 7)6700/6800 models.....	1402
Parts and diagrams: Internal assemblies (2 of 7)6700/6800 models.....	1404
Parts and diagrams: Internal assemblies (3 of 7)6700/6800 models.....	1406
Parts and diagrams: Internal assemblies (4 of 7)6700/6800 models.....	1409
Parts and diagrams: Internal assemblies (5 of 7)6700/6800 models.....	1411
Parts and diagrams: Internal assemblies (6 of 7)6700/6800 models.....	1412
Parts and diagrams: Internal assemblies (7 of 7)6700/6800 models.....	1414
Parts and diagrams: Internal assemblies (1 of 9)X654/X677 models.....	1416
Parts and diagrams: Internal assemblies (2 of 9)X654/X677 models.....	1418

Parts and diagrams: Internal assemblies (3 of 9)X654/X677 models .....	1420
Parts and diagrams: Internal assemblies (4 of 9)X654/X677 models .....	1422
Parts and diagrams: Internal assemblies (5 of 9)X654/X677 models .....	1424
Parts and diagrams: Internal assemblies (6 of 9) X654/X677 models .....	1425
Parts and diagrams: Internal assemblies (7 of 9) X654/X677 models .....	1427
Parts and diagrams: Internal assemblies (8 of 9)X654/X677 models .....	1428
Parts and diagrams: Internal assemblies (9 of 9)X654/X677 models .....	1430
Input devices.....	1431
Input device - 550-sheet paper feeder .....	1431
Covers, panels, and doors .....	1431
Covers, panels, and doors (550-sheet paper feeder) .....	1431
Internal parts and assemblies.....	1432
Internal parts and assemblies (550-sheet paper feeder) .....	1432
Input device - 2,100-sheet high capacity input (HCI) paper feeder.....	1434
Parts and diagrams: HCI covers.....	1434
Parts and diagrams: HCI main body .....	1435
Output devices.....	1436
Output device - Floor stand staple stacker (FSSS).....	1436
Covers, panels, and doors .....	1436
Parts and diagrams: Floor stand staple stacker (FSSS) covers 6800/X677 models.....	1436
Internal parts and assemblies.....	1438
Parts and diagrams: Floor stand staple stacker (FSSS) main body 6800/X677 models (1 of 2).....	1438
Parts and diagrams: Floor stand staple stacker (FSSS) main body 6800/X677 models (2 of 2).....	1440
Output device - Intermediate paper transfer unit (IPTU).....	1441
Parts and diagrams: Intermediate paper transfer unit 6800/X677 models.....	1441
Output device - 3-bin staple stacker .....	1441
Covers, panels, and doors .....	1442
Parts and diagrams: 3 bin staple stacker covers 6800/X677 models.....	1442
Internal parts and assemblies.....	1443
Parts and diagrams: 3 bin staple stacker main body 6800/X677 models .....	1443
Alphabetical parts list.....	1445
Document feeder / scanner.....	1390
Integrated scanner assembly.....	1390
Base printer .....	1392
Control panels.....	1392
Control panels .....	1392
Covers, panels, and doors .....	1394
Parts and diagrams: Covers 6700 models .....	1394
Parts and diagrams: Covers X654 models .....	1396
Parts and diagrams: Covers 6800 models .....	1398
Parts and diagrams: Covers X677 models .....	1400
Internal parts and assemblies.....	1402
Parts and diagrams: Internal assemblies (1 of 7)6700/6800 models .....	1402
Parts and diagrams: Internal assemblies (2 of 7)6700/6800 models .....	1404
Parts and diagrams: Internal assemblies (3 of 7)6700/6800 models .....	1406
Parts and diagrams: Internal assemblies (4 of 7)6700/6800 models .....	1409
Parts and diagrams: Internal assemblies (5 of 7)6700/6800 models .....	1411

Parts and diagrams: Internal assemblies (6 of 7)6700/6800 models .....	1412
Parts and diagrams: Internal assemblies (7 of 7)6700/6800 models .....	1414
Parts and diagrams: Internal assemblies (1 of 9)X654/X677 models .....	1416
Parts and diagrams: Internal assemblies (2 of 9)X654/X677 models .....	1418
Parts and diagrams: Internal assemblies (3 of 9)X654/X677 models .....	1420
Parts and diagrams: Internal assemblies (4 of 9)X654/X677 models .....	1422
Parts and diagrams: Internal assemblies (5 of 9)X654/X677 models .....	1424
Parts and diagrams: Internal assemblies (6 of 9) X654/X677 models .....	1425
Parts and diagrams: Internal assemblies (7 of 9) X654/X677 models .....	1427
Parts and diagrams: Internal assemblies (8 of 9)X654/X677 models .....	1428
Parts and diagrams: Internal assemblies (9 of 9)X654/X677 models .....	1430
Input devices .....	1431
Input device - 550-sheet paper feeder .....	1431
Covers, panels, and doors .....	1431
Covers, panels, and doors (550-sheet paper feeder) .....	1431
Internal parts and assemblies .....	1432
Internal parts and assemblies (550-sheet paper feeder) .....	1432
Input device - 2,100-sheet high capacity input (HCI) paper feeder .....	1434
Parts and diagrams: HCI covers .....	1434
Parts and diagrams: HCI main body .....	1435
Output devices .....	1436
Output device - Floor stand staple stacker (FSSS) .....	1436
Covers, panels, and doors .....	1436
Parts and diagrams: Floor stand staple stacker (FSSS) covers 6800/X677 models .....	1436
Internal parts and assemblies .....	1438
Parts and diagrams: Floor stand staple stacker (FSSS) main body 6800/X677 models (1 of 2) .....	1438
Parts and diagrams: Floor stand staple stacker (FSSS) main body 6800/X677 models (2 of 2) .....	1440
Output device - Intermediate paper transfer unit (IPTU) .....	1441
Parts and diagrams: Intermediate paper transfer unit 6800/X677 models .....	1441
Output device - 3-bin staple stacker .....	1441
Covers, panels, and doors .....	1442
Parts and diagrams: 3 bin staple stacker covers 6800/X677 models .....	1442
Internal parts and assemblies .....	1443
Parts and diagrams: 3 bin staple stacker main body 6800/X677 models .....	1443
Numerical parts list .....	1469
Document feeder / scanner .....	1390
Integrated scanner assembly .....	1390
Base printer .....	1392
Control panels .....	1392
Control panels .....	1392
Covers, panels, and doors .....	1394
Parts and diagrams: Covers 6700 models .....	1394
Parts and diagrams: Covers X654 models .....	1396
Parts and diagrams: Covers 6800 models .....	1398
Parts and diagrams: Covers X677 models .....	1400

Internal parts and assemblies.....	1402
Parts and diagrams: Internal assemblies (1 of 7)6700/6800 models .....	1402
Parts and diagrams: Internal assemblies (2 of 7)6700/6800 models .....	1404
Parts and diagrams: Internal assemblies (3 of 7)6700/6800 models .....	1406
Parts and diagrams: Internal assemblies (4 of 7)6700/6800 models .....	1409
Parts and diagrams: Internal assemblies (5 of 7)6700/6800 models .....	1411
Parts and diagrams: Internal assemblies (6 of 7)6700/6800 models .....	1412
Parts and diagrams: Internal assemblies (7 of 7)6700/6800 models .....	1414
Parts and diagrams: Internal assemblies (1 of 9)X654/X677 models.....	1416
Parts and diagrams: Internal assemblies (2 of 9)X654/X677 models.....	1418
Parts and diagrams: Internal assemblies (3 of 9)X654/X677 models.....	1420
Parts and diagrams: Internal assemblies (4 of 9)X654/X677 models.....	1422
Parts and diagrams: Internal assemblies (5 of 9)X654/X677 models.....	1424
Parts and diagrams: Internal assemblies (6 of 9) X654/X677 models .....	1425
Parts and diagrams: Internal assemblies (7 of 9) X654/X677 models .....	1427
Parts and diagrams: Internal assemblies (8 of 9)X654/X677 models.....	1428
Parts and diagrams: Internal assemblies (9 of 9)X654/X677 models.....	1430
Input devices.....	1431
Input device - 550-sheet paper feeder .....	1431
Covers, panels, and doors .....	1431
Covers, panels, and doors (550-sheet paper feeder).....	1431
Internal parts and assemblies.....	1432
Internal parts and assemblies (550-sheet paper feeder) .....	1432
Input device - 2,100-sheet high capacity input (HCI) paper feeder .....	1434
Parts and diagrams: HCI covers.....	1434
Parts and diagrams: HCI main body .....	1435
Output devices.....	1436
Output device - Floor stand staple stacker (FSSS).....	1436
Covers, panels, and doors .....	1436
Parts and diagrams: Floor stand staple stacker (FSSS) covers 6800/X677 models.....	1436
Internal parts and assemblies.....	1438
Parts and diagrams: Floor stand staple stacker (FSSS) main body 6800/X677 models (1 of 2).....	1438
Parts and diagrams: Floor stand staple stacker (FSSS) main body 6800/X677 models (2 of 2).....	1440
Output device - Intermediate paper transfer unit (IPTU) .....	1441
Parts and diagrams: Intermediate paper transfer unit 6800/X677 models.....	1441
Output device - 3-bin staple stacker .....	1441
Covers, panels, and doors .....	1442
Parts and diagrams: 3 bin staple stacker covers 6800/X677 models .....	1442
Internal parts and assemblies.....	1443
Parts and diagrams: 3 bin staple stacker main body 6800/X677 models.....	1443
<b>Appendix A Certificate of Volatility.....</b>	<b>1493</b>
Certificate of Volatility.....	1493
<b>Appendix B Glossary of terms.....</b>	<b>1497</b>
<b>Index .....</b>	<b>1507</b>

---

# List of videos

View a video of how to use the HP Partner First Portal to access WISE.....	v
View a video of how to access WISE for internal HP users.....	vi
View a video of how to use WISE to find technical support videos (model number search).....	vi
View a video of ow to use WISE to find technical support videos (Product detail page [PDP] search).....	vi
View a video of cleaning the document feeder glass and flatbed glass.....	40
View a video of how to replace the toner cartridges.....	42
View a video of how to replace the toner cartridges.....	43
View a video of how to replace the imaging drums.....	45
View a video of how to access WISE for HP channel partners.....	131
View a video of how to access WISE for HP channel partners.....	317
View a video of how to access WISE for HP channel partners.....	337
View a video that demonstrates how to load paper in a way that reduces the number of paper jams.....	342
View a video of how to clear a jam in Tray 1.....	343
View a video of how to clear a jam in Tray 2.....	346
View a video of how to clear a jam in Tray 3, and the optional trays.....	352
View a video of how to clear a jam in Tray 4.....	358
View a video of how to clear a jam in the high-capacity input Tray 4.....	364
View a video of how to clear a jam in the right door and fuser area.....	371
View a video of how to clear a jam in the right door and fuser area.....	374
View a video of how to clear a jam in the right door and fuser area.....	376
View a video of how to clear a jam in the right door and fuser area.....	380
View a video of how to clear a jam in the output bin.....	382
View a video that demonstrates how to load paper in a way that reduces the number of paper jams.....	385
View a video of how to clear a jam in the document feeder.....	386
View a video of how to clear a jam in Tray 1.....	390

View a video of how to clear a jam in Tray 2.....	393
View a video of how to clear a jam in Tray 3, and the optional trays.....	399
View a video of how to clear a jam in Tray 4.....	405
View a video of how to clear a jam in the high-capacity input Tray 4.....	411
View a video of how to clear a jam in the right door and fuser area.....	418
View a video of how to clear a jam in the right door and fuser area.....	421
View a video of how to clear a jam in the right door and fuser area.....	423
View a video of how to clear a jam in the right door and fuser area.....	427
View a video of how to clear a jam in the output bin.....	429
View a video of how to clear a jam in the output bin.....	430
View a video of how to clear a jam in the output bin.....	432
View a video of how to clear a jam in the output bin.....	434
View a video of how to clear a jam in the floor-standing finisher punch area.....	439
View a video of how to clear a jam in the floor-standing finisher.....	441
View a video of cleaning the document feeder glass and flatbed glass.....	466
View a video of removing and replacing the toner cartridges.....	480
View a video of removing and replacing the toner cartridges.....	484
View a video of removing and replacing the image drums.....	489
View a video of removing and replacing the TCU.....	493
View a video of removing and replacing the staple cartridge.....	496
View a video of removing and replacing the staple cartridge.....	498
View a video of removing and replacing the staple cartridge.....	501
View a video to remove and replace the fuser.....	503
View a video demonstration of removing and replacing the image transfer belt.....	506
View a video of removing and replacing the T2 roller.....	508
View a video of removing and replacing the document feeder rollers.....	511
View a video of how to install the keyboard overlay.....	513
View a video of removing and replacing the Tray 1 rollers.....	517
View a video of removing and replacing the Tray 2 rollers.....	522
View a video of how to remove and replace the keyboard.....	525
View a video demonstration of removing and replacing the hard-disk drive.....	530
View a video demonstration of removing and replacing the DIMM.....	534



View a video demonstration of removing and replacing the fax PCA.....	538
View a video demonstration of removing and replacing the workflow accelerator.....	541
View a video demonstration of removing and replacing the USB expansion kit.....	545
View a video demonstration of removing and replacing the SSD.....	549
View a video demonstration of removing and replacing the NFC PCA.....	567
View a video demonstration of removing and replacing the eMMC.....	570
View a video demonstration of removing and replacing the control panel.....	664
View a video of removing and replacing the toner cartridges (manual unlock).....	666
View a video demonstration of removing and replacing the paper pickup assembly.....	685
View a video demonstration of removing and replacing the lifter drive assembly.....	739
View a video demonstration of removing and replacing the fuser drive assembly.....	769
View a video demonstration of removing and replacing the main drive assembly.....	778
View a video demonstration of removing and replacing the HVPS.....	894
View a video demonstration of removing and replacing the drive PCA.....	901
View a video demonstration of removing and replacing the rear PCA.....	915
View a video demonstration of removing and replacing the fuser fan.....	975
View a video demonstration of removing and replacing the lifter drive assembly.....	1003
View a video demonstration of removing and replacing the pickup drive assembly.....	1007
View a video demonstration of removing and replacing the auto close assembly.....	1013
View a video demonstration of removing and replacing the media size detection assembly.....	1018
View a video demonstration of removing and replacing the pickup drive assembly.....	1057
View a video demonstration of removing and replacing the upper feed assembly.....	1115
View a video demonstration of removing and replacing the lower feed assembly.....	1124
View a video demonstration of removing and replacing the solenoid assembly.....	1139
View a video demonstration of removing and replacing the upper and lower output bins.....	1157
View a video demonstration of removing and replacing the left lower rear cover.....	1162
View a video demonstration of removing and replacing the foot cover.....	1221
View a video demonstration of removing and replacing the delivery assembly.....	1273
View a video demonstration of removing and replacing the punch assembly.....	1285
View a video demonstration of removing and replacing the SWB assembly.....	1296
View a video demonstration of removing and replacing the IMF assembly.....	1333
View a video demonstration of removing and replacing the alignment assembly.....	1359


---

# 1 Printer information, configurations, and specifications

Learn about printer configuration and specifications.

## Document feeder / scanner

Learn about the printer document feeder and scanner configuration and specifications.

 **NOTE:** This section is for MFP printers only.

---

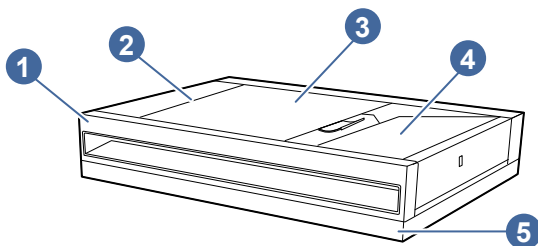
### Information (document feeder and scanner)

Learn about the document feeder and scanner.

#### Document feeder and scanner front view

Learn about the document feeder and scanner components.

**Figure 1-1 Document feeder and scanner front view**



Item	Description
1	Document feeder
2	Output bin
3	Jam access
4	Input tray
5	Flatbed scanner

#### Technical specifications

Learn about the document feeder and scanner specifications.

Review the technical specifications for the document feeder and scanner.

See <http://www.hp.com/support/colorlj6800MFP> or <http://www.hp.com/support/colorlj6801MFP> or <http://www.hp.com/support/colorljX677MFP> for current information.

**Table 1-1 Copy and scan specifications (document feeder and scanner) (1 of 3)**

Copy and scan features	6800dn	6800zf	6800zfs	6800zfw+	6801zfs	6801zfw+
Copies and scans up to 80 pages per minute (ppm)	✓	Not available	Not available	Not available	Not available	Not available
Copies and scans up to 110 ppm	Not available	✓	✓	✓	✓	✓
150-page document feeder with dual-head scanning for single-pass duplex copying and scanning	✓	✓	✓	✓	✓	✓
Scan to E-mail, Scan to USB, and Scan to Network Folder option	✓	✓	✓	✓	✓	✓

**Table 1-2 Copy and scan specifications (document feeder and scanner) (2 of 3)**

Copy and scan features	X677dn	X677zs	X677z+
Copies and scans up to 80 pages per minute (ppm)	✓	Not available	Not available
Copies and scans up to 110 ppm	Not available	✓	✓
150-page document feeder with dual-head scanning for single-pass duplex copying and scanning	✓	✓	✓
Scan to E-mail, Scan to USB, and Scan to Network Folder option	✓	✓	✓

**Table 1-3 Copy and scan specifications (document feeder and scanner) (3 of 3)**

Copy and scan features	X6775dn	X6775zs	X6775z+	X6776dn	X6776zs	X6776z+
Copies and scans up to 80 pages per minute (ppm)	✓	Not available	Not available	✓	Not available	Not available
Copies and scans up to 110 ppm	Not available	✓	✓	Not available	✓	✓
150-page document feeder with dual-head scanning for single-pass duplex copying and scanning	✓	✓	✓	✓	✓	✓
Scan to E-mail, Scan to USB, and Scan to Network Folder option	✓	✓	✓	✓	✓	✓

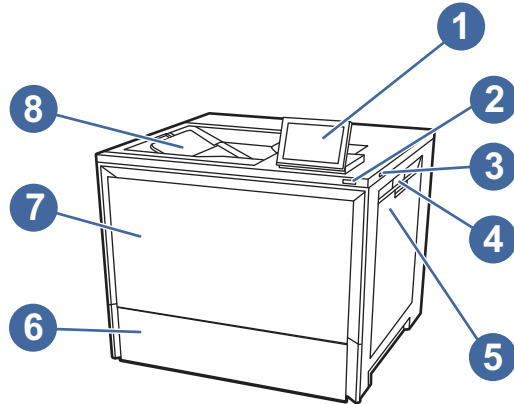
# Information (base printer)

Learn about the base printer.

## Printer front view (6700 models)

Identify the parts on the front of the printer (6700 models).

Figure 1-2 Printer front view (6700 models)

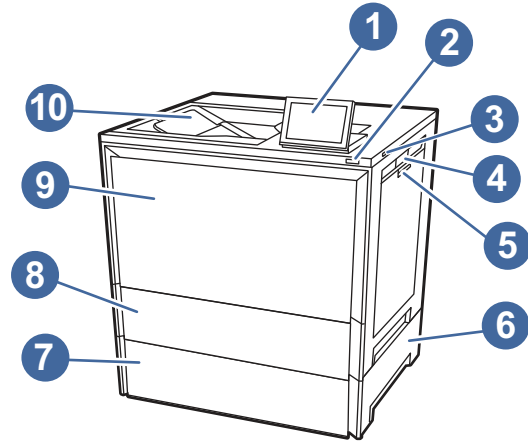


Item	Description
1	Control panel with color touchscreen display (tilts up for easier viewing)
2	On/off button
3	Easy-access USB port Insert a USB flash drive for printing without a computer or to update the printer firmware. <b>NOTE:</b> An administrator must enable this port before use.
4	Right door, access for clearing jams
5	Tray 1 (multipurpose tray) and right door (access for clearing jams)
6	Tray 2
7	Front door, for access to the toner cartridges
8	Output bin

## Printer front view (X654 models)

Locate features on the front of the printer.

Figure 1-3 Printer front view

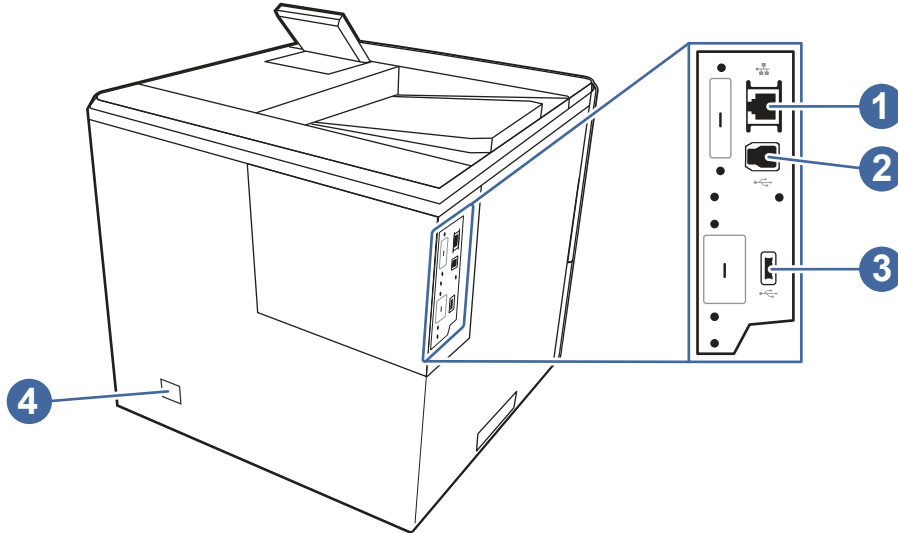


Item	Description
1	Control panel with color touchscreen display (tilts up for easier viewing)
2	On/off button
3	Easy-access USB port Insert a USB flash drive for printing or scanning without a computer or to update the printer firmware. <b>NOTE:</b> An administrator must enable this port before use.
4	Right door, for access for clearing jams
5	Tray 1 (multipurpose tray)
6	Tray 2 jam access door
7	Tray 2
8	Toner cartridge access door
9	Front door, for access to the imaging drums and toner collection unit
10	Output bin

## Printer back view (6700/X654 models)

Identify the parts on the back of the printer (SFP).

Figure 1-4 Printer rear view, 6700/X654 models

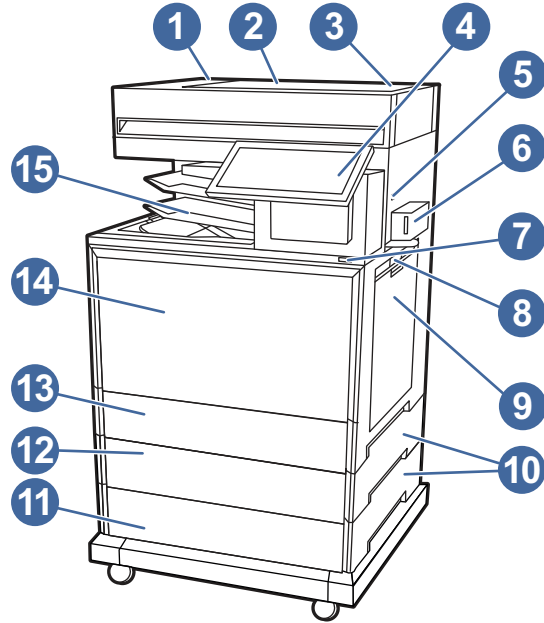


Item	Description
1	Local area network (LAN) Ethernet (RJ-45) network port
2	SuperSpeed USB 3.0 interface port
3	SuperSpeed USB 3.0 host port (for job storage and private printing)
	<b>NOTE:</b> This port should remain covered when not in use.
4	Power connection

## Printer front view (6800 models)

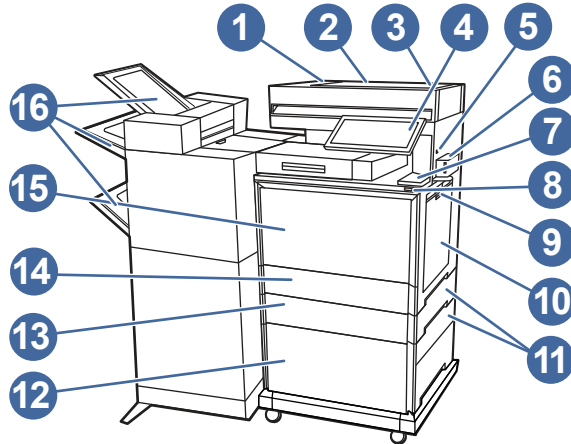
Identify the parts on the front of the printer (6800 models).

**Figure 1-5 Printer front view - dn, zf, zs, and zfs models (6800 models)**



Item	Description
1	Automatic document feeder output tray
2	Automatic document feeder cover, for access for clearing jams
3	Automatic document feeder input tray
4	Control panel with color touchscreen display (tilts up for easier viewing)
5	Easy-access USB port Insert a USB flash drive for printing or scanning without a computer or to update the printer firmware. <b>NOTE:</b> An administrator must enable this port before use.
6	Convenience stapler
7	On/off button
8	Right door, for access for clearing jams
9	Tray 1 (multipurpose tray)
10	Tray jam access doors
11	Optional Tray 4
12	Optional Tray 3
13	Tray 2
14	Front door, for access to the toner cartridges
15	Output bin (multi-bin output included with the zfs models)

**Figure 1-6 Printer front view - z+ and zfw+ models**



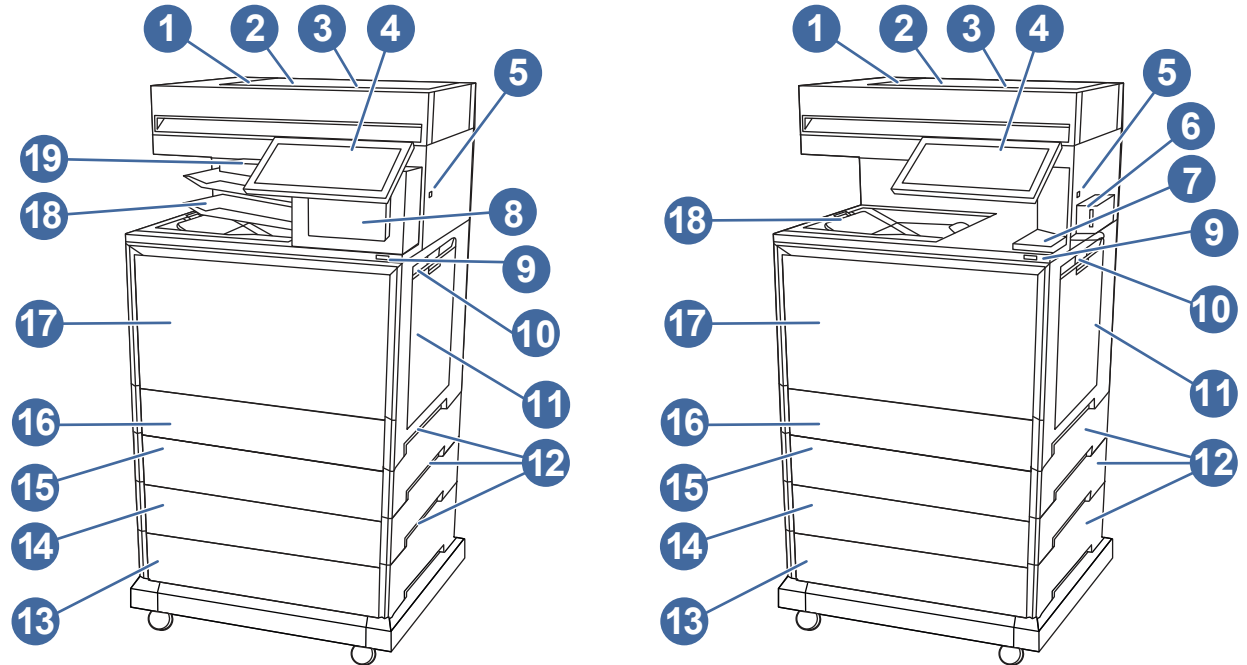
Item	Description
1	Automatic document feeder output tray
2	Automatic document feeder cover, for access for clearing jams
3	Automatic document feeder input tray
4	Control panel with color touchscreen display (tilts up for easier viewing)
5	Easy-access USB port Insert a USB flash drive for printing or scanning without a computer or to update the printer firmware. <b>NOTE:</b> An administrator must enable this port before use.
6	Convenience stapler
7	On/off button
8	Right door, for access for clearing jams
9	Tray 1 (multipurpose tray)
10	Tray jam access doors
11	High-capacity input Tray 4
12	Tray 3
13	Tray 2
14	Front door, for access to the toner cartridges
15	Front door (base printer)
16	Output bins on the floor-standing finisher

## Printer front view (X677 models)

Locate features on the front of the printer.



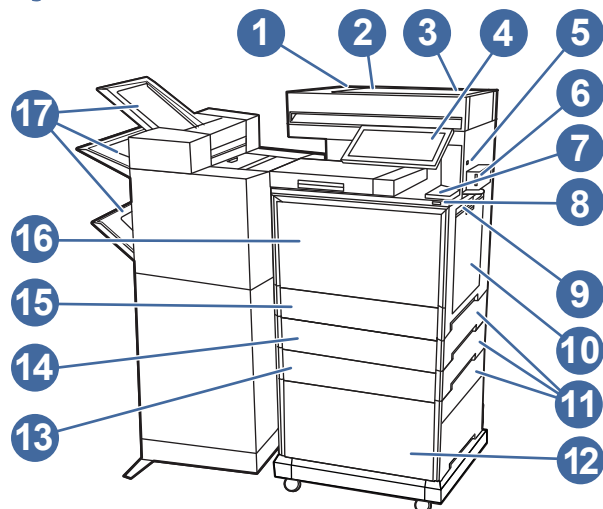
Figure 1-7 Printer front view - dn and zs models



Item	Description
1	Automatic document feeder output tray
2	Automatic document feeder cover, for access for clearing jams
3	Automatic document feeder input tray
4	Control panel with color touchscreen display (tilts up for easier viewing)
5	Easy-access USB port Insert a USB flash drive for printing or scanning without a computer or to update the printer firmware. <b>NOTE:</b> An administrator must enable this port before use.
6	Convenience stapler <b>NOTE:</b> Not available on models that have the 3-bin stapler/stacker.
7	Hardware integration pocket (HIP) for connecting accessory and third-party devices
8	Staple access door (models with inner finisher)
9	On/off button
10	Right door, access for clearing jams
11	Tray 1 (multipurpose tray)
12	Tray jam access doors
13	Optional Tray 4
14	Optional Tray 3
15	Tray 2
16	Toner cartridge access door
17	Front door, for access to the imaging drums and toner collection unit

Item	Description
18	Output bin
19	Hardware integration pocket (HIP) location for models with an inner finisher

**Figure 1-8 Printer front view - z+ models**

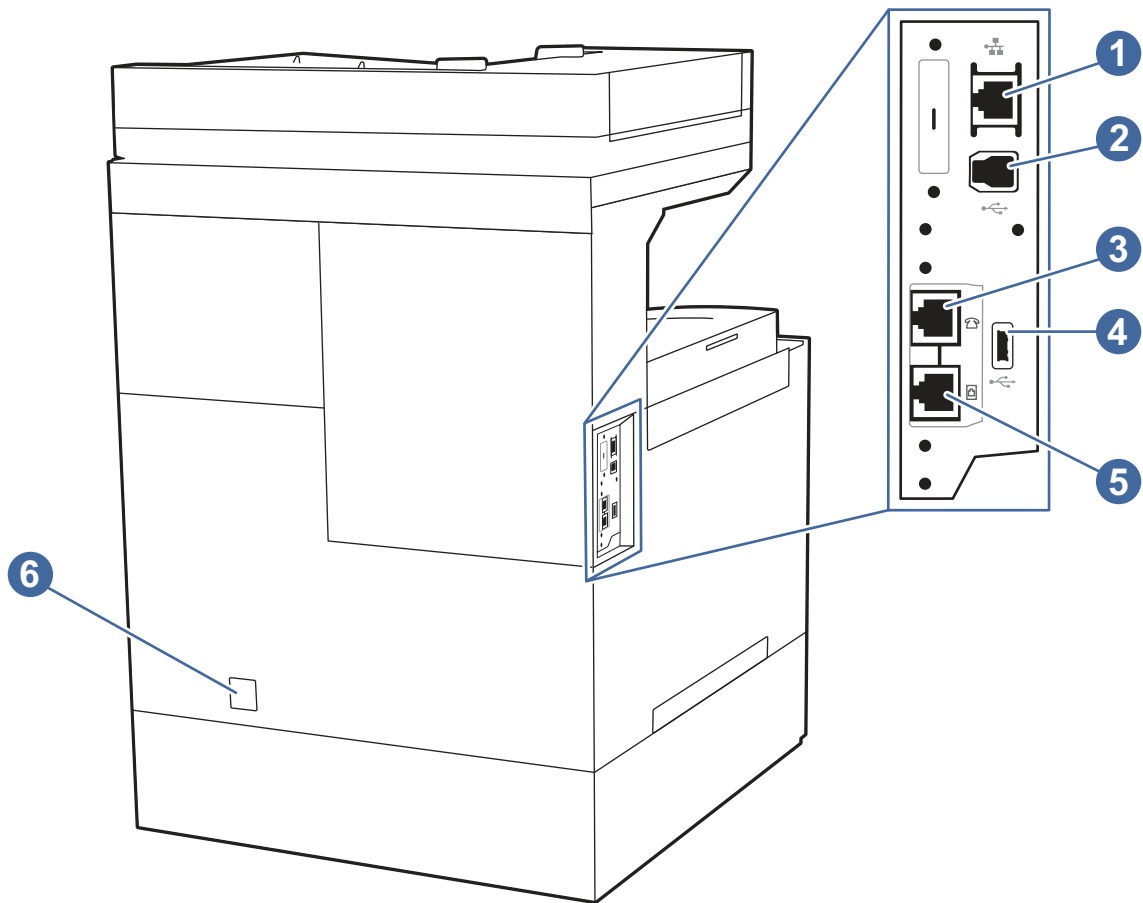


Item	Description
1	Automatic document feeder output tray
2	Automatic document feeder cover, for access for clearing jams
3	Automatic document feeder input tray
4	Control panel with color touchscreen display (tilts up for easier viewing)
5	Easy-access USB port Insert a USB flash drive for printing or scanning without a computer or to update the printer firmware. <b>NOTE:</b> An administrator must enable this port before use.
6	Convenience stapler
7	Hardware integration pocket (HIP) for connecting accessory and third-party devices
8	On/off button
9	Right door, for access for clearing jams
10	Tray 1 (multipurpose tray)
11	Tray jam access doors
12	High-capacity input Tray 4
13	Tray 3
14	Tray 2
15	Toner cartridge access door
16	Front door, for access to the imaging drums and toner collection unit
17	Output bins on floor-standing finisher

## Printer back view (6800/X677 models)

Identify the parts on the back of the printer (MFP).

Figure 1-9 Printer back view, 6800/X677 models



Item	Description
1	Local area network (LAN) Ethernet (RJ-45) network port
2	SuperSpeed USB 3.0 interface port
3	<b>Fax models only:</b> Telephone "line out" port (for attaching an extension phone, answering machine, or other device) <b>NOTE:</b> This port should remain covered when not in use.
4	SuperSpeed USB 3.0 host port (for job storage and private printing) <b>NOTE:</b> This port should remain covered when not in use.
5	<b>Fax models only:</b> Fax "line in" port (for attaching the fax phone line to the printer)
6	Power connection

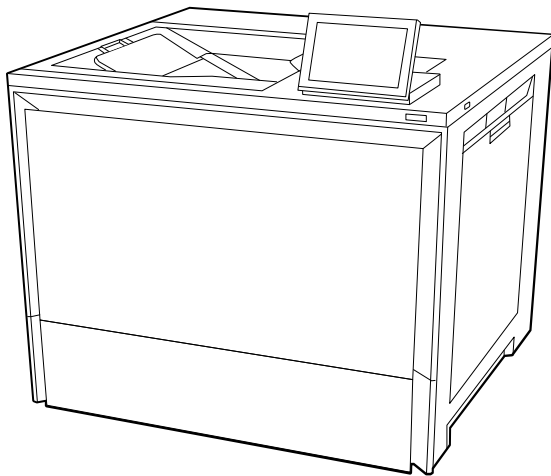
## Configuration (base printer)

Learn about the base printer configurations.

## Configuration (base printer SFP)

Learn about the base printer SFP configurations.

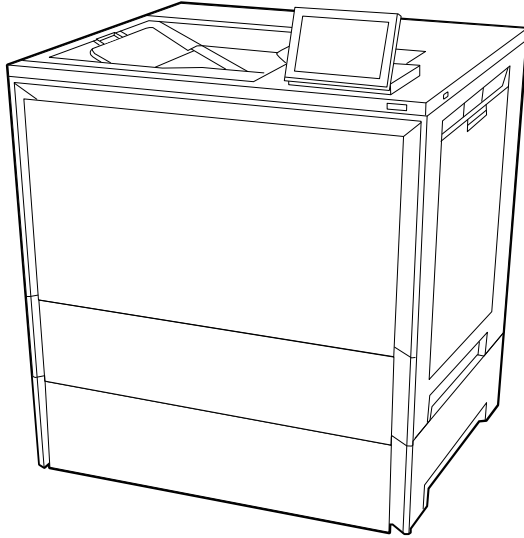
**Figure 1-10** HP Color LaserJet Enterprise 6700 printer



### HP Color LaserJet Enterprise 6700

- **6700dn:** 55/52 pages per minute (letter/A4)
- **6701dn:** 65/61 pages per minute (letter/A4)
- FutureSmart 5 firmware
- Trusted platform module 2.0 (security)
- HP Web JetAdmin
- Automatic duplex printing
- 300-sheet standard capacity
- 850-sheet maximum capacity
- 109.2 mm (4.3 in) color touchscreen control panel
- 1.5 GB RAM memory
- 16 GB eMMC mass storage

**Figure 1-11 HP Color LaserJet Enterprise X654/X65455/X65465**



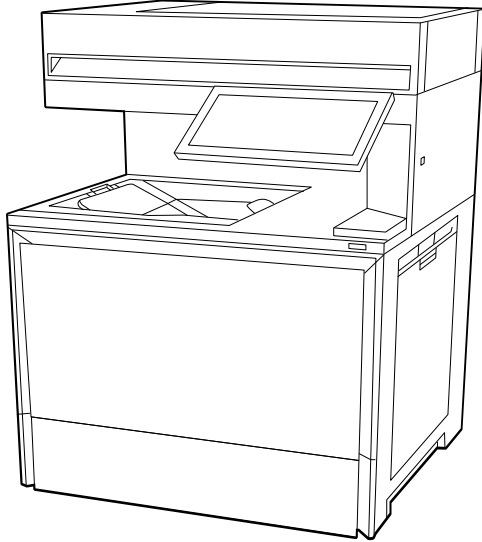
HP Color LaserJet Enterprise X654/X65455/X65465

- Same features as the HP Color LaserJet Enterprise 6700
- Managed contractual cartridge with lowest possible cost per page
- **X654dn and X65455dn:** 55/52 pages per minute (letter/A4)
- **X65465dn:** 65/61 pages per minute (letter/A4)
- 2 GB RAM memory
- Locking tray guides
- Smart device services (SDS) firmware features

## **Configuration (base printer MFP)**

Learn about the base printer MFP configurations.

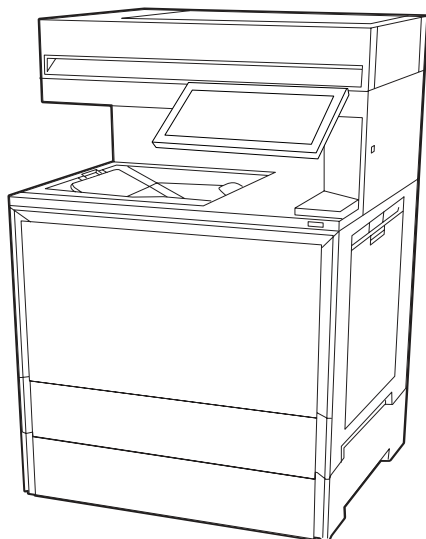
**Figure 1-12 HP Color LaserJet Enterprise 6800/6801 printer**



**HP Color LaserJet Enterprise 6800/6801**

- 55/52 pages per minute (letter/A4)
- FutureSmart 5 firmware
- Trusted platform module 2.0 (security)
- HP Web JetAdmin
- Automatic duplex printing
- 150-sheet document feeder (duplex scanning)
- Single pass double sided scan/copy
- Fax (optional on 6800dn models; standard on all other models)
- **6800zfs, 6801zfs**: 1,750-sheet maximum capacity
- **6800dn, 6800zf, 6800zfw+, 6801zfw+**: 3,300-sheet maximum capacity
- **6800dn**: 203 mm (8 in) color touchscreen control panel
- **6800zf, 6800zfs, 6800zfw+, 6801zfs, 6801zfw+**: 256.5 mm (10.1 in) color touchscreen control panel
- 6 GB RAM memory
- 500 GB hard disk drive (HDD)

**Figure 1-13 HP Color LaserJet Enterprise X677/X67755/X67765 printer**



HP Color LaserJet Enterprise X677/X67755/X67765

- Same features as the HP Color LaserJet Enterprise 6800
- Managed contractual cartridge with lowest possible cost per page
- **X677dn, X677zs, X677z+, X67755dn, X67755zs, and X67755z+**: 55/52 pages per minute (letter/A4)
- **X67765dn, X67765zs, and X67765z+**: 65/61 pages per minute (letter/A4)
- **X677dn, X67755dn, and X67765dn**: 203 mm (8 in) color touchscreen control panel
- **X677zs, X677z+, X67755zs, X67755z+, X67765zs, and X67765z+**: 256.5 mm (10.1 in) color touchscreen control panel
- Fax is optional on all X677/X67755/X67765 models
- Locking tray guides
- Smart device services (SDS) firmware features

## Specifications (base printer)

Learn about the base printer specifications.

## Technical specifications (6700/6701 models)

Review the technical specifications for the printer.

See <http://www.hp.com/support/colorlj6700> or <http://www.hp.com/support/colorlj6800MFP> or <http://www.hp.com/support/colorlj6801MFP> or <http://www.hp.com/support/colorljX654> or <http://www.hp.com/support/colorljX677MFP> for current information.

### Product numbers for each model

- 6700dn - #6QN33A
- 6701dn - #58M42A

- 6700/6701 Configurable (can be custom-configured when ordered)

**Table 1-4 Paper handling specifications**

Paper handling features	6700dn	6701dn	6700/6701 Configurable
Tray 1 (100-sheet capacity)	✓	✓	✓
Tray 2 (550-sheet capacity)	✓	✓	✓
Optional 550-sheet accessory tray	Optional	Optional	Available option
Printer stand	Optional	Optional	Available option
Printer stand with storage compartment	Optional	Optional	Available option
2,100-sheet High Capacity Paper Tray/Stand	Optional	Optional	Available option
Automatic duplex printing	✓	✓	✓

**Table 1-5 Connectivity specifications**

Connectivity features	6700dn	6701dn	6700/6701 Configurable
10/100/1000 Ethernet LAN connection with IPv4 and IPv6	✓	✓	✓
Dual-band Wireless	✓	✓	✓
Wifi-Direct and BLE	Optional	Optional	Available option
SuperSpeed USB 3.0 rear ports and Hi-Speed USB 2.0 front port for walk-up USB printing	✓	✓	✓
Hardware integration pocket (HIP) for connecting accessory and third-party devices	✓	✓	✓

**Table 1-6 Print specifications**

Print features	6700dn	6701dn	6700/6701 Configurable
Prints 52 pages per minute (ppm) on A4 and 55 ppm on letter-size paper, with a maximum of 61 ppm on A4 and 65 ppm on letter-size paper (configured at time of purchase)	✓	Not included	Available option on the 6700
Prints 61 ppm on A4 and 65 ppm on letter-size paper	Not included	✓	Included for the 6701
Job storage and private printing	✓	✓	✓

**Table 1-7 Other specifications**

Other features	6700dn	6701dn	6700/6701 Configurable
2 GB base memory, expandable to 6 GB	✓	✓	✓
16 GB embedded Multi-Media Controller (eMMC)	✓	✓	Available option
32 GB embedded Multi-Media Controller (eMMC)	Not available	Not available	Available option
256 GB Solid State Drive	Optional	Optional	Available option



**Table 1-7 Other specifications (continued)**

Other features	6700dn	6701dn	6700/6701 Configurable
512 GB FIPS Hard Disk Drive	Optional	Optional	Available option
512 GB Hard Disk Drive	Optional	Optional	Available option
Color touchscreen control panel	✓	✓	✓
HP Trusted Platform Module for encrypting all data that passes through the printer	✓	✓	✓

## Technical specifications (X654/X65455/X65465 models)

Review the technical specifications for the printer.

See <http://www.hp.com/support/colorlj6700> or <http://www.hp.com/support/colorlj6800MFP> or <http://www.hp.com/support/colorlj6801MFP> or <http://www.hp.com/support/colorljX654> or <http://www.hp.com/support/colorljX677MFP> for current information.

### Product numbers for each model

- X654dn - #6QQ00A
- X65455dn - #49L02A
- X65465dn - #49L04A
- X654 Configurable (can be custom-configured when ordered)

**Table 1-8 Paper handling specifications**

Paper handling features	X654dn	X65455dn	X65465dn	X654 Configurable
Tray 1 (100-sheet capacity)	✓	✓	✓	✓
Tray 2 (550-sheet capacity)	✓	✓	✓	✓
Optional 550-sheet accessory tray	Optional	Optional	Optional	Available option
Printer stand	Optional	Optional	Optional	Available option
Printer stand with storage compartment	Optional	Optional	Optional	Available option
2,100-sheet High Capacity Paper Tray/ Stand	Optional	Optional	Optional	Available option
Automatic duplex printing	✓	✓	✓	✓

**Table 1-9 Connectivity specifications**

Connectivity features	X654dn	X65455dn	X65465dn	X654 Configurable
10/100/1000 Ethernet LAN connection with IPv4 and IPv6	✓	✓	✓	✓
Dual-band wireless	Optional	Optional	Optional	Available option
Wifi-Direct and BLE	Optional	Optional	Optional	Available option

**Table 1-9 Connectivity specifications (continued)**

Connectivity features	X654dn	X65455dn	X65465dn	X654 Configurable
SuperSpeed USB 3.0 rear ports and Hi-Speed USB 2.0 front port for walk-up USB printing	✓	✓	✓	✓
Hardware integration pocket (HIP) for connecting accessory and third-party devices	✓	✓	✓	✓

**Table 1-10 Print specifications**

Print features	X654dn	X65455dn	X65465dn	X654 Configurable
Prints 52 pages per minute (ppm) on A4 and 55 ppm on letter-size paper, with a maximum of 61 ppm on A4 and 65 ppm on letter-sized paper (configured at time of purchase)	✓	Not included	Not included	Available option
Prints 52 pages per minute (ppm) on A4 and 55 ppm on letter-size paper	Not included	✓	Not included	Not applicable
Prints 61 ppm on A4 and 65 ppm on letter-sized paper	Not included	Not included	✓	Not applicable
Job storage and private printing	✓	✓	✓	✓

**Table 1-11 Other specifications**

Other features	X654dn	X65455dn	X65465dn	X654 Configurable
2 GB base memory, expandable to 6 GB	✓	✓	✓	✓
16 GB embedded Multi-Media Controller (eMMC)	✓	✓	✓	Available option
32 GB embedded Multi-Media Controller (eMMC)	Not available	Not available	Not available	Available option
256 GB Solid State Drive	Optional	Optional	Optional	Available option
512 GB FIPS Hard Disk Drive	Optional	Optional	Optional	Available option
512 GB Hard Disk Drive	Optional	Optional	Optional	Available option
Color touchscreen control panel	✓	✓	✓	✓
HP Trusted Platform Module for encrypting all data that passes through the printer	✓	✓	✓	✓
Custom color printer skins	Not available	Not available	Not available	Available option

## Technical specifications (6800/6801 models)

Review the technical specifications for the printer.

### Product numbers for each model

- 6800dn - #6QN35A

- 6800zf - #6QN36A
- 6800zfs - #6QN37A
- 6800zfw+ - #6QN38A
- 6801zfs - #76H10A
- 6801zfw+ - #76H11A
- 6800/6801 Configurable (can be custom-configured when ordered)

**Table 1-12 Paper handling specifications**

Paper handling features	6800dn	6800zf	6800zfs	6800zfw+	6801zfs	6801zfw+	6800 Configurable
Tray 1 (100-sheet capacity)	✓	✓	✓	✓	✓	✓	✓
Tray 2 (550-sheet capacity)	✓	✓	✓	✓	✓	✓	✓
Optional 550-sheet accessory tray	Optional	Optional	✓ (2)	✓	✓ (2)	✓	Available option
Printer stand	Optional	Optional	✓	Not available	✓	Not available	Available option
Printer stand with storage compartment	Optional	Optional	Not available	Not available	Not available	Not available	Available option
2,100-sheet High Capacity Paper Tray/Stand	Optional	Optional	Not available	✓	Not available	✓	Available option
Convenience stapler	Optional	Optional	✓	✓	✓	✓	Available option
3-bin Stapler/stacker	Not available	Not available	✓	Not available	✓	Not available	Available option
Floor-standing finisher with edge stapling and hole punch	Not available	Not available	Not available	✓	Not available	✓	Available option
Automatic duplex printing	✓	✓	✓	✓	✓	✓	✓

**Table 1-13 Connectivity specifications**

Connectivity features	6800dn	6800zf	6800zfs	6800zfw+	6801zfs	6801zfw+	6800 Configurable
10/100/1000 Ethernet LAN connection with IPv4 and IPv6	✓	✓	✓	✓	✓	✓	✓
Dual-band wireless	Optional	Optional	✓	✓	✓	✓	Available option
Wifi-Direct and BLE	Optional	Optional	✓	✓	✓	✓	Available option
SuperSpeed USB 3.0 rear ports and Hi-Speed USB 2.0 front port for walk-up USB printing	✓	✓	✓	✓	✓	✓	✓

**Table 1-13 Connectivity specifications (continued)**

Connectivity features	6800dn	6800zf	6800zfs	6800zfw+	6801zfs	6801zfw+	6800 Configurable
Hardware integration pocket (HIP) for connecting accessory and third-party devices	✓	✓	✓	✓	✓	✓	✓

**Table 1-14 Print specifications**

Print features	6800dn	6800zf	6800zfs	6800zfw+	6801zfs	6801zfw+	6800 Configurable
Prints up to 52 pages per minute (ppm) on A4 and 55 ppm on letter-sized paper, with a maximum of 61 ppm on A4 and 65 ppm on letter-sized paper (configured at time of purchase)	✓	✓	✓	✓	✓	✓	✓
Job storage and private printing	✓	✓	✓	✓	✓	✓	✓

**Table 1-15 Copy and scan specifications**

Copy and scan features	6800dn	6800zf	6800zfs	6800zfw+	6801zfs	6801zfw+	6800 Configurable
ADF copy/scan speed 160 images-per-minute (ipm) single-sided, and 80 ipm double-sided	✓	Not included	Not included	Not included	Not included	Not included	Available option
ADF copy/scan speed 220 ipm single-sided, and 110 ipm double-sided	Not included	✓	✓	✓	✓	✓	Available option
150-page document feeder with dual-head scanning for single-pass duplex copying and scanning	✓	✓	✓	✓	✓	✓	✓
Scan to E-mail, Scan to USB, and Scan to Network Folder options	✓	✓	✓	✓	✓	✓	✓

**Table 1-16 Other specifications**

Other features	6800dn	6800zf	6800zfs	6800zfw+	6801zfs	6801zfw+	6800 Configurable
6 GB base memory	✓	✓	✓	✓	✓	✓	✓
500 GB Hard Disk Drive	✓	✓	✓	✓	✓	✓	Available option
256 GB Solid-state drive	Optional	Optional	Optional	Optional	Optional	Optional	Available option

**Table 1-16 Other specifications (continued)**

Other features	6800dn	6800zf	6800zfs	6800zfw+	6801zfs	6801zfw+	6800 Configurable
512 GB FIPS Hard Disk Drive	Optional	Optional	Optional	Optional	Optional	Optional	Available option
32 GB embedded Multi-Media Controller (eMMC)	Not available	Not available	Not available	Not available	Not available	Not available	Available option
Small color touchscreen control panel	✓	Not included	Not included	Not included	Not included	Not included	Available option
Large color touchscreen control panel	Not included	✓	✓	✓	✓	✓	Available option
Fax features	Optional	✓	✓	✓	✓	✓	Available option
HP Trusted Platform Module for encrypting all data that passes through the printer	✓	✓	✓	✓	✓	✓	✓

## Technical specifications (X677/X67755/X67765 models)

Review the technical specifications for the printer.

### Product numbers for each model

- X677dn - #6QQ01A
- X677zs - #6QQ02A
- X677z+ - #6QQ03A
- X67755dn - #49K86A
- X67755zs - #49K87A
- X67755z+ - #49K88A
- X67765dn - #49K90A
- X67765zs - #49K91A
- X67765z+ - #49K92A
- X677 Configurable (can be custom-configured when ordered)

**Table 1-17 Paper handling specifications**

Paper handling features	X677dn	X677zs	X677z+	X67755dn	X67755zs	X67755z+	X677 Configurable
				X67765dn	X67765zs	X67765z+	
Tray 1 (100-sheet capacity)	✓	✓	✓	✓	✓	✓	✓
Tray 2 (550-sheet capacity)	✓	✓	✓	✓	✓	✓	✓
Optional 550-sheet accessory tray	Optional (2)	✓ (2)	✓	Optional	✓ (2)	✓	Available option

**Table 1-17 Paper handling specifications (continued)**

Paper handling features	X677dn	X677zs	X677z+	X67755dn	X67755zs	X67755z+	X677 Configurable
				X67765dn	X67765zs	X67765z+	
Printer stand	Optional	✓	Not available	Optional	✓	Not available	Available option
Printer stand with storage compartment	Optional	Not available	Not available	Optional	Not available	Not available	Available option
2,100-sheet High Capacity Paper Tray/Stand	Optional	Not available	✓	Optional	Not available	✓	Available option
Convenience stapler	Optional	✓	✓	Optional	✓	✓	Available option
3-bin Stapler/stacker	Not available	✓	Not available	Not available	✓	Not available	Available option
Floor-standing finisher with edge stapling and hole punch	Not available	Not available	✓	Not available	Not available	✓	Available option
Automatic duplex printing	✓	✓	✓	✓	✓	✓	✓

**Table 1-18 Connectivity specifications**

Connectivity features	X677dn	X677zs	X677z+	X677 Configurable
	X67755dn	X67755zs	X67755z+	
	X67765dn	X67765zs	X67765z+	
10/100/1000 Ethernet LAN connection with IPv4 and IPv6	✓	✓	✓	✓
Dual-band wireless	Optional	Optional	Optional	Available option
Wifi-Direct and BLE	Optional	Optional	Optional	Available option
SuperSpeed USB 3.0 rear ports and Hi-Speed USB 2.0 front port for walk-up USB printing	✓	✓	✓	✓
Hardware integration pocket (HIP) for connecting accessory and third-party devices	✓	✓	✓	✓

**Table 1-19 Print specifications**

Print features	X677dn	X67755dn	X67765dn	X677 Configurable
	X677zs	X67755zs	X67765zs	
	X677z+	X67755z+	X67765z+	
Prints up to 52 pages per minute (ppm) on A4 and 55 ppm on letter-sized paper, with a maximum of 61 ppm on A4 and 65 ppm on letter-sized paper (configured at time of purchase)	✓	Not included	Not included	Available option

**Table 1-19 Print specifications (continued)**

Print features	X677dn	X67755dn	X67765dn	X677 Configurable
	X677zs	X67755zs	X67765zs	
	X677z+	X67755z+	X67765z+	
Prints up to 52 pages per minute (ppm) on A4 and 55 ppm on letter-sized paper	Not included	✓	Not included	Available option
Prints up to 61 pages per minute (ppm) on A4 and 65 ppm on letter-sized paper	Not included	Not included	✓	Available option
Job storage and private printing	✓	✓	✓	✓
Inline scan bar analyzes output for print quality issues	Included on z+ models	Included on z+ models	Included on z+ models	Available option

**Table 1-20 Copy and scan specifications**

Copy and scan features	X677dn	X677zs	X677z+	X677 Configurable
	X67755dn	X67755zs	X67755z+	
	X67765dn	X67765zs	X67765z+	
ADF copy/scan speed 160 images-per-minute (ipm) single-sided, and 80 ipm double-sided	✓	Not included	Not included	Available option
ADF copy/scan speed 220 ipm single-sided, and 110 ipm double-sided	Not included	✓	✓	Available option
150-page document feeder with dual-head scanning for single-pass duplex copying and scanning	✓	✓	✓	✓
Scan to E-mail, Scan to USB, and Scan to Network Folder options	✓	✓	✓	✓

**Table 1-21 Other specifications**

Other features	X677dn	X677zs	X677z+	X677 Configurable
	X67755dn	X67755zs	X67755z+	
	X67765dn	X67765zs	X67765z+	
6 GB base memory	✓	✓	✓	✓
500 GB Hard Disk Drive	✓	✓	✓	Available option
256 GB Solid-state drive	Optional	Optional	Optional	Available option
512 GB FIPS Hard Disk Drive	Optional	Optional	Optional	Available option
32 GB embedded Multi-Media Controller (eMMC)	Not available	Not available	Not available	Available option
Small color touchscreen control panel	✓	Not included	Not included	Available option
Large color touchscreen control panel	Not included	✓	✓	Available option
Fax features	Optional	Optional	Optional	Available option

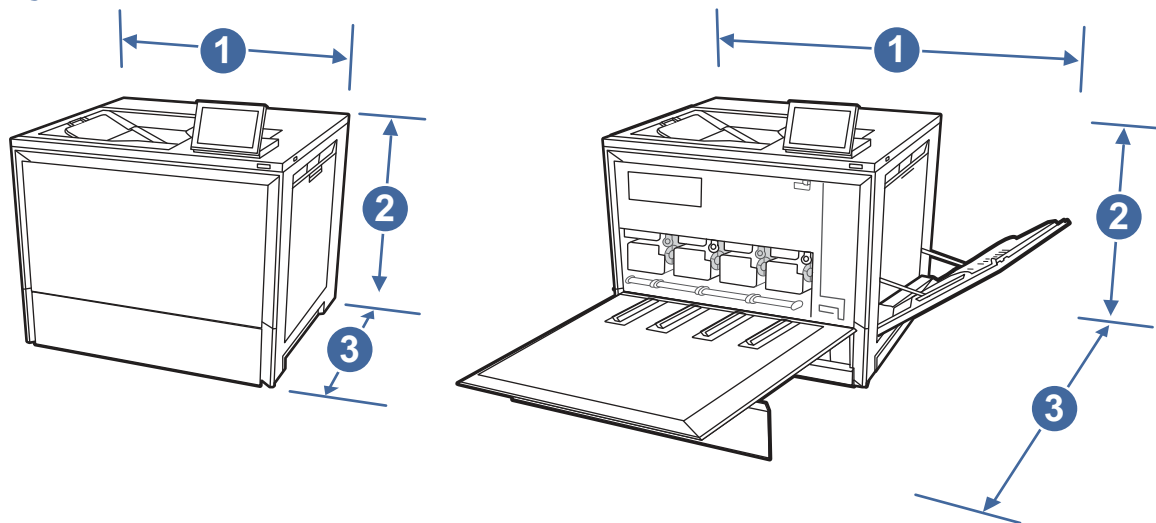
**Table 1-21 Other specifications (continued)**

Other features	X677dn	X677zs	X677z+	X677 Configurable
	X6775dn	X6775zs	X6775z+	
	X67765dn	X67765zs	X67765z+	
HP Trusted Platform Module for encrypting all data that passes through the printer	✓	✓	✓	✓
Custom color printer skins	Not available	Not available	Not available	Available option

## Printer dimensions

Make sure your printer environment is large enough to accommodate the printer.

**Figure 1-14 Printer dimensions**



**Table 1-22 Dimensions for the printer**

Measurement	Printer fully closed	Printer fully opened
1. Width	500 mm (19.7 in)	860 mm (33.8 in)
2. Height	417 mm (16.4 in)	417 mm (16.4 in)
3. Depth	460 mm (18.1 in)	770 mm (30.3 in)
Weight (with cartridges)	29.03 kg (64 lb)	29.03 kg (64 lb)

## Printer dimensions

Make sure your printer environment is large enough to accommodate the printer.



Figure 1-15 Printer dimensions

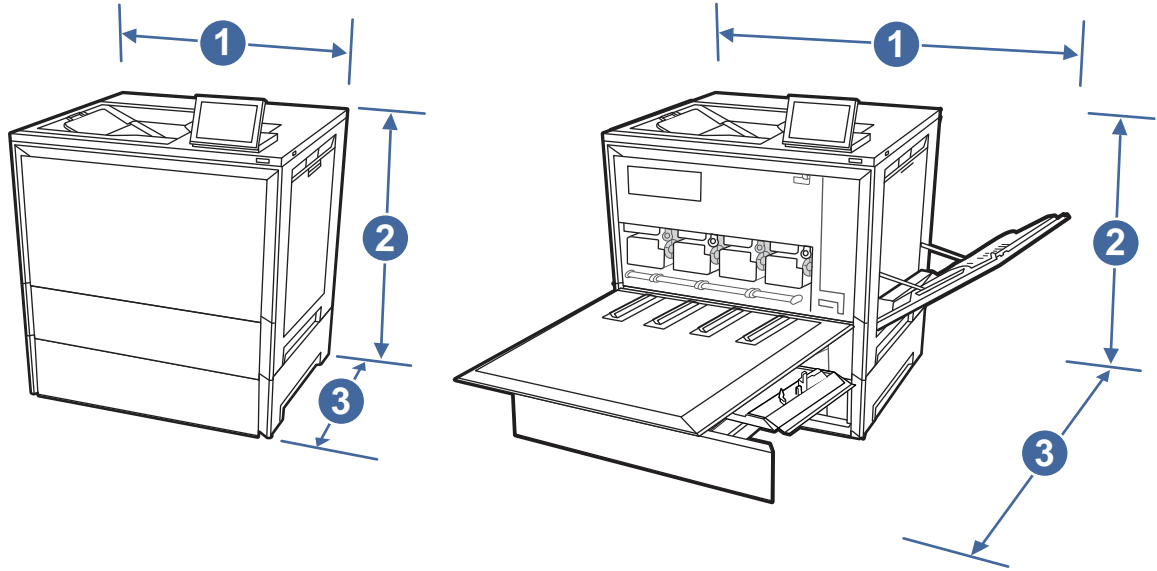


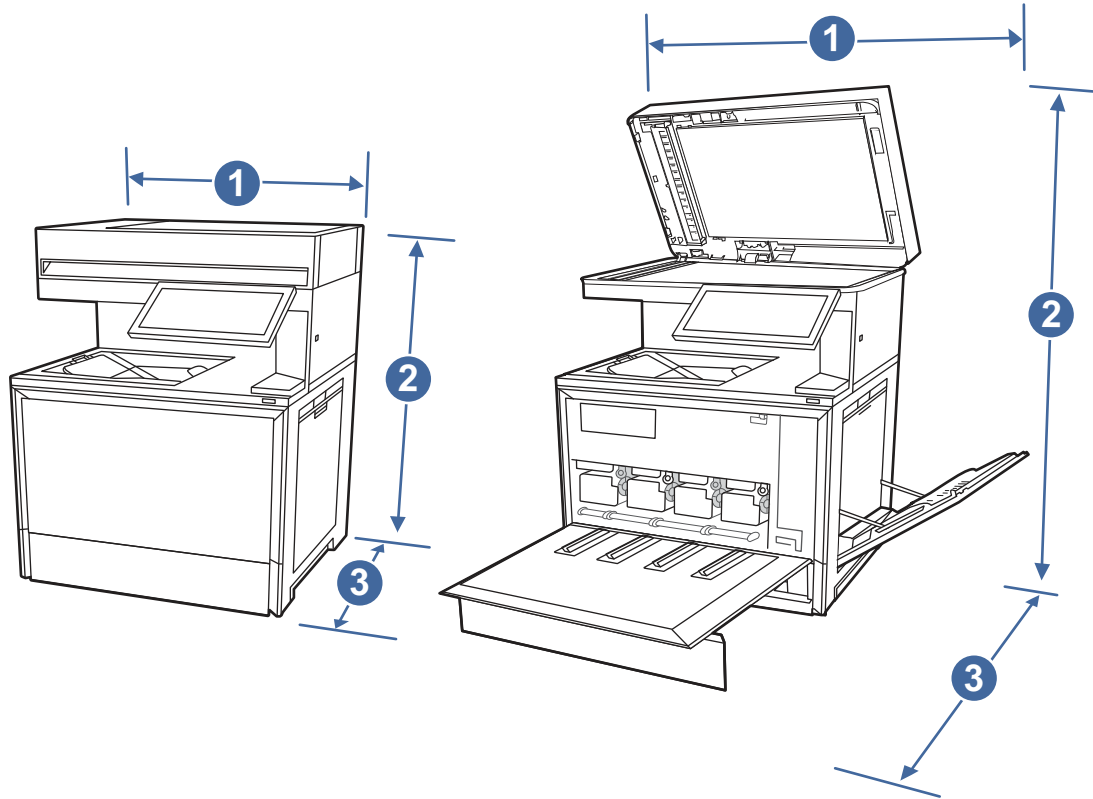
Table 1-23 Dimensions for the printer

Measurement	Printer fully closed	Printer fully opened
1. Width	500 mm (19.7 in)	860 mm (33.8 in)
2. Height	417 mm (16.4 in)	417 mm (16.4 in)
3. Depth	460 mm (18.1 in)	770 mm (30.3 in)
Weight (with cartridges)	38.1 kg (84 lb)	38.1 kg (84 lb)

## Printer dimensions

Make sure your printer environment is large enough to accommodate the printer.

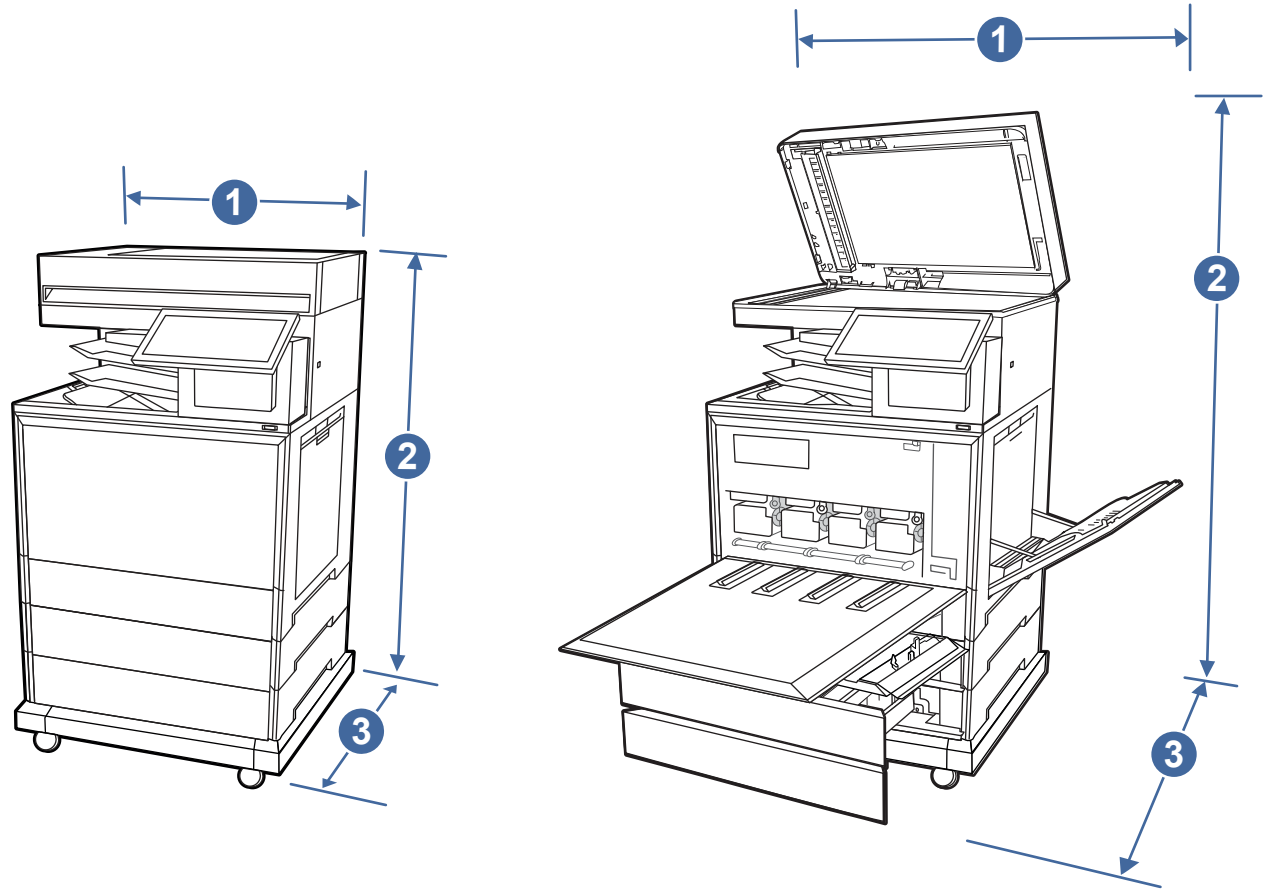
**Figure 1-16 Printer dimensions (dn and zf models)**



**Table 1-24 Dimensions for the printer (dn and zf models)**

Measurement	Printer fully closed	Printer fully opened
1. Width	500 mm (19.6 in)	860 mm (33.8 in)
2. Height	657 mm (25.8 in)	912 mm (36 in)
3. Depth	460 mm (18.1 in)	770 mm (30.3 in)
Weight (with cartridges)	42.2 kg (93 lb)	42.2 kg (93 lb)

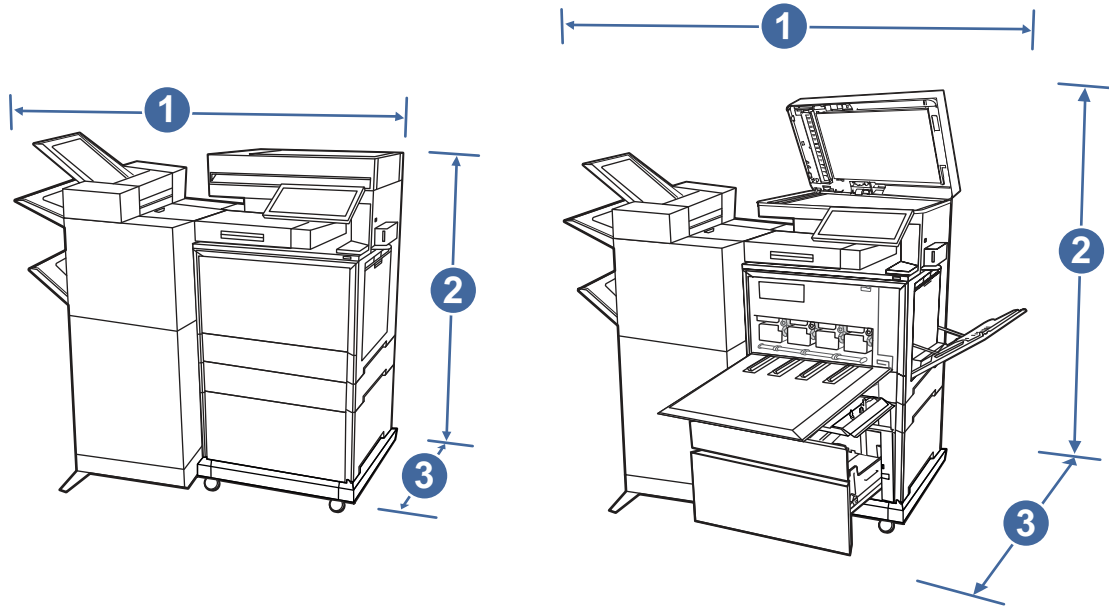
**Figure 1-17 Printer dimensions (zfsw models)**



**Table 1-25 Dimensions for the printer (zfsw models)**

Measurement	Printer fully closed	Printer fully opened
1. Width	520 mm (20.5 in)	860 mm (33.8 in)
2. Height	1155 mm (45.5 in)	1410 mm (55.5 in)
3. Depth	528 mm (20.8 in)	838 mm (33 in)
Weight (with cartridges)	79.45 kg (175.16 lb)	79.45 kg (175.16 lb)

**Figure 1-18 Printer dimensions (zfw+ models)**



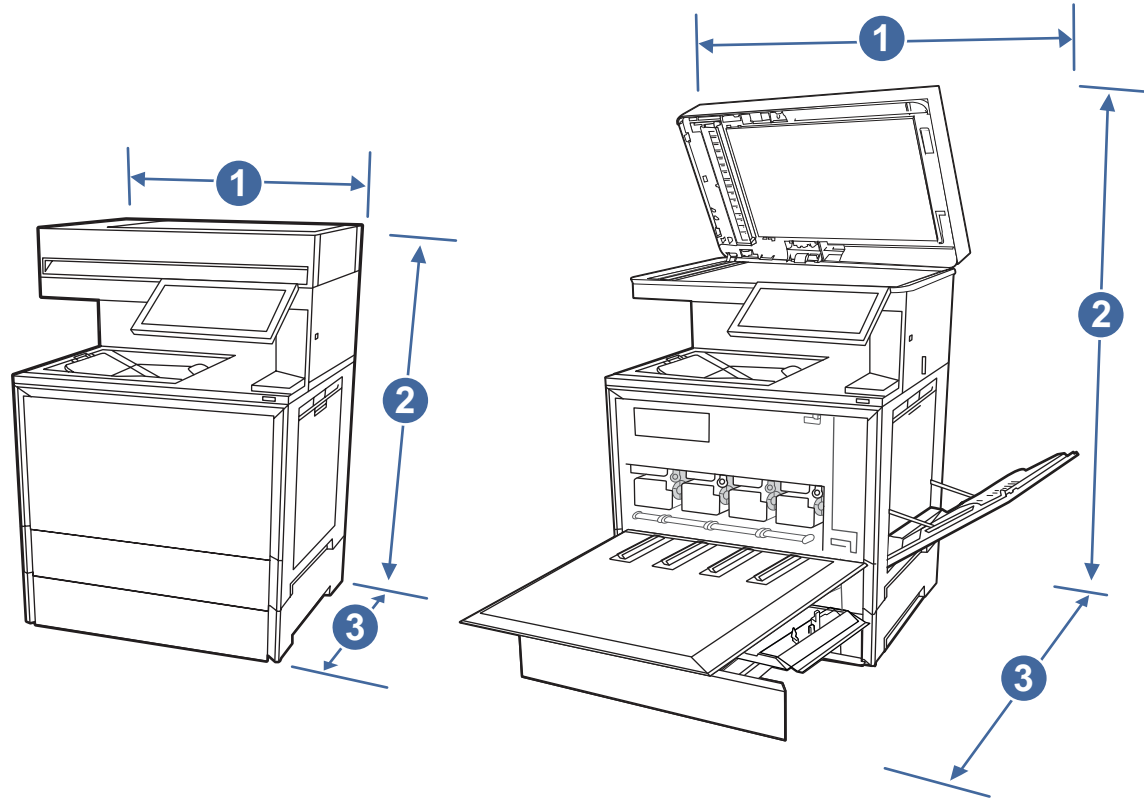
**Table 1-26 Dimensions for the printer (zfw+ models)**

Measurement	Printer fully closed	Printer fully opened
1. Width	1228 mm (48.3 in)	1588 mm (62.5 in)
2. Height	1270 mm (50 in)	1393 mm (54.8 in)
3. Depth	520 mm (20.5 in)	905 mm (35.6 in)
Weight (with cartridges)	84.45 kg (186.2 lb)	84.45 kg (186.2 lb)

## Printer dimensions

Make sure your printer environment is large enough to accommodate the printer.

**Figure 1-19 Printer dimensions (dn, s, and z models)**



**Table 1-27 Dimensions for the printer (dn, s, and z models)**

Measurement	Printer fully closed	Printer fully opened
1. Width	500 mm (19.6 in)	860 mm (33.8 in)
2. Height	777 mm (30.6 in)	1032 mm (40.6 in)
3. Depth	460 mm (18.1 in)	770 mm (30.3 in)
Weight (with cartridges)	54 kg (119 lb)	54 kg (119 lb)

Figure 1-20 Printer dimensions (zs models)

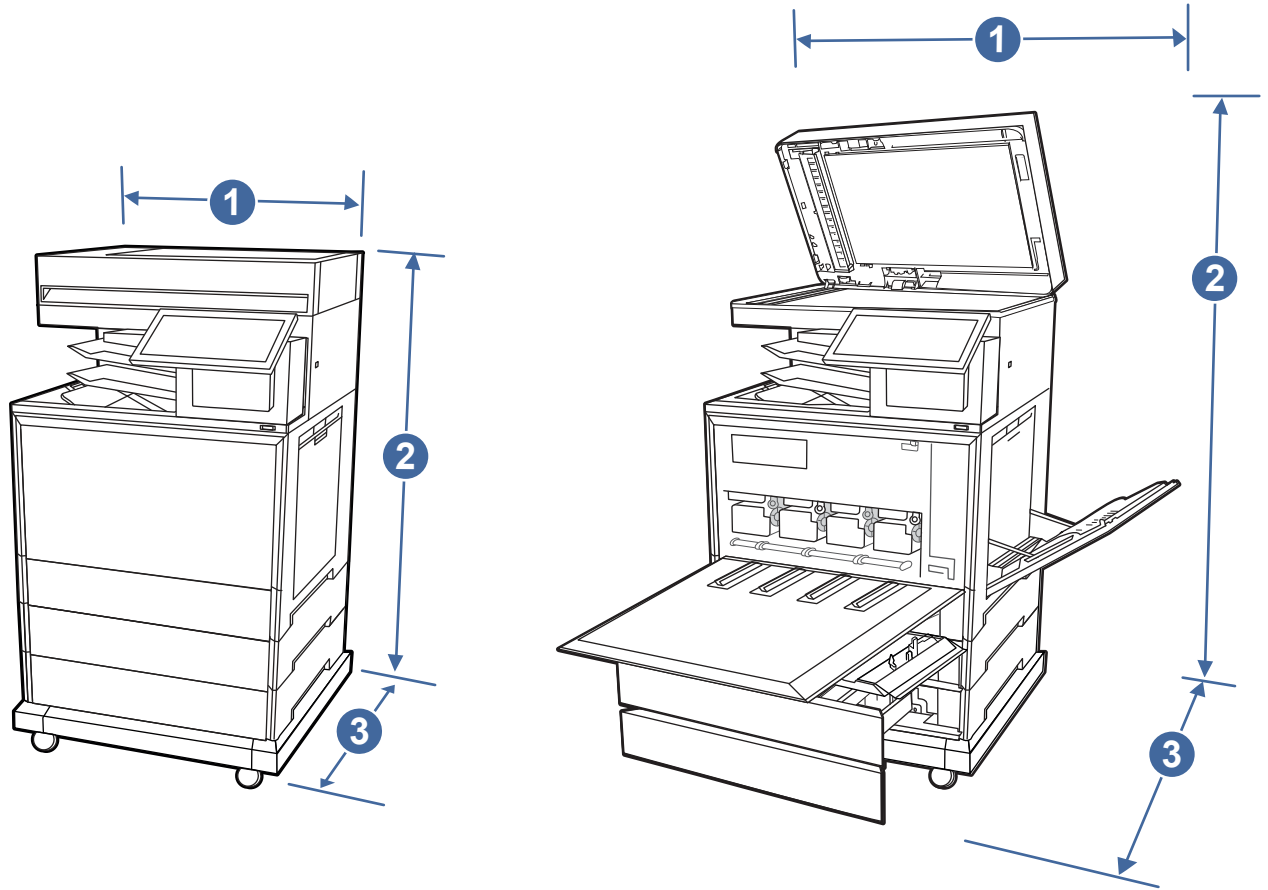


Table 1-28 Dimensions for the printer (zs models)

Measurement	Printer fully closed	Printer fully opened
1. Width	520 mm (20.5 in)	860 mm (33.8 in)
2. Height	1275 mm (50.2 in)	1530 mm (60.2 in)
3. Depth	528 mm (20.8 in)	838 mm (33 in)
Weight (with cartridges)	80 kg (176.4 lb)	80 kg (176.4 lb)

Figure 1-21 Printer dimensions (z+ models)

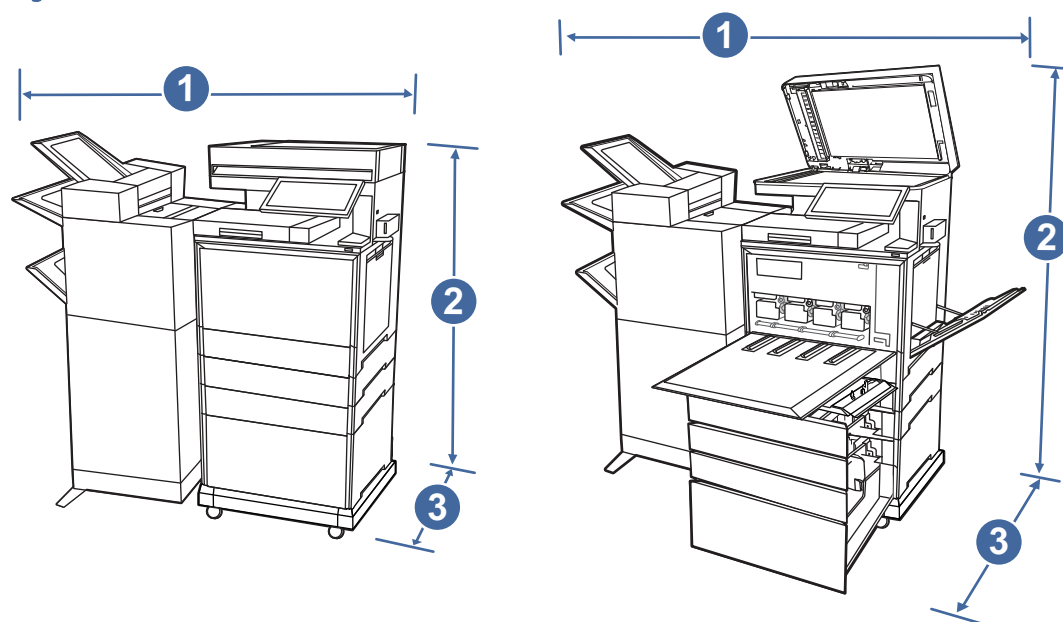


Table 1-29 Dimensions for the printer (z+ models)

Measurement	Printer fully closed	Printer fully opened
1. Width	1228 mm (48.3 in)	1588 mm (62.5 in)
2. Height	1258 mm (49.5 in)	1513 mm (59.5 in)
3. Depth	528 mm (20.8 in)	913 mm (36 in)
Weight (with cartridges)	85 kg (187.4 lb)	85 kg (187.4 lb)

## Printer space requirements

Learn about the printer space requirements

HP recommends that 30 mm ( 1.81 in) be added to the printer dimensions to make sure there is sufficient space to open doors and covers, and to provide proper ventilation. See the printer dimensions sections in this manual.

## Power consumption, electrical specifications, and acoustic emissions

In order to operate properly, the printer must be in an environment that meets certain power specifications.

See <http://www.hp.com/support/colorlj6700> or <http://www.hp.com/support/colorlj6800MFP> or <http://www.hp.com/support/colorlj6801MFP> or <http://www.hp.com/support/colorljX654> or <http://www.hp.com/support/colorljX677MFP> for current information.

**CAUTION:** Power requirements are based on the country/region where the printer is sold. Do not convert operating voltages. This will damage the printer and void the printer warranty.

## Operating-environment range

In order to operate properly, the printer must be in an environment that meets certain specifications.

**Table 1-30 Operating-environment specifications**

Environment	Recommended	Storage
Temperature	15° to 27°C (59° to 80.6°F)	10° to 32.5°C (50° to 90.5°F)
Relative humidity	30% to 70% relative humidity (RH)	10% to 80% RH

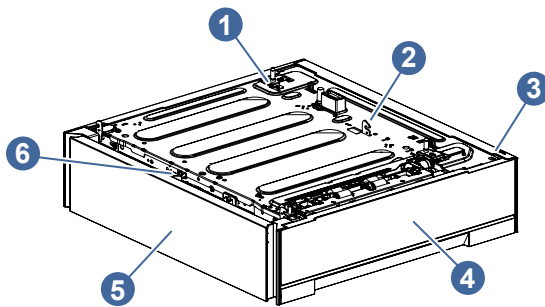
## Information (input devices)

Learn about the printer input devices.

### 550-sheet paper feeder front view

Identify the parts on the 550-sheet paper feeder.

**Figure 1-22 550-sheet paper feeder front view**



Number	Description
1	Connector
2	Lock
3	Right door (for access to tray rollers and jams)
4	Tray cassette
5	Left cover
6	Lock lever

## Technical specifications

**Table 1-31 550-sheet paper feeder technical specifications**

Feature	Specification
Media types	Plain paper, recycled paper, heavy paper, bond paper, glossy paper, label, and index card
Media sizes	Standard: A5-R, B5, A4, Letter, and Legal Custom minimum: 101.6 mm (4 in) (W) x 148 mm (5.8 in) (L) Custom maximum: 215.9 mm (8.5 in) (W) x 355.6 mm (14 in) (L)
Media weights	Non-glossy paper: 60 g/m <sup>2</sup> (16 lb) to 163 g/m <sup>2</sup> (43 lb) Glossy paper: 120 g/m <sup>2</sup> (32 lb) to 200 g/m <sup>2</sup> (53 lb)
Capacity	55 mm (2.2 in) stack (approximately 550 sheets of 75g/m <sup>2</sup> (20 lb) paper)



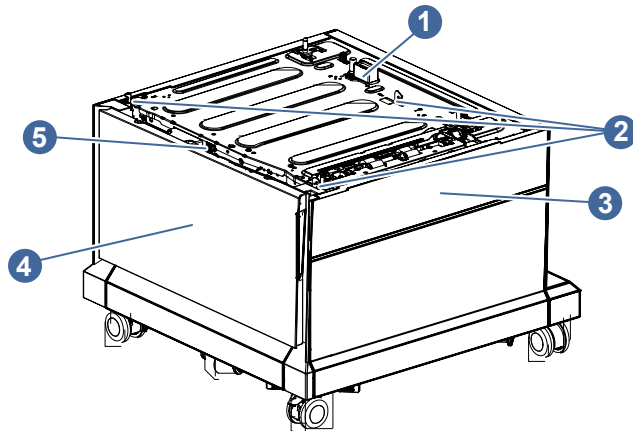
**Table 1-31 550-sheet paper feeder technical specifications (continued)**

Feature	Specification
Dimensions	Width: 500 mm (19.7 in) Depth: 460 mm (18.1 in) Height: 120 mm (4.7 in)
Weight	Approximately 6.2 kg (13.7 lb)
Power requirements	DC24V, DC3.3V (supplied from the printer engine)

## High capacity input (HCI) paper feeder front view

Identify the parts on the HCI paper feeder.

**Figure 1-23 HCI paper feeder front view**



Number	Description
1	Connector
2	Lock
3	Right door
4	HCI cassette
5	Lock lever

## Technical specifications

**Table 1-32 HCI paper feeder technical specifications**

Feature	Specification
Media types	Plain paper, recycled paper, heavy paper, and bond paper
Media sizes	A4, Letter, and Legal
Media weights	60 g/m <sup>2</sup> (16 lb) to 163 g/m <sup>2</sup> (43 lb)
Capacity	210 mm (8.3 in) stack (approximately 2,100 sheets of 75g/m <sup>2</sup> (20 lb) paper)

**Table 1-32 HCl paper feeder technical specifications (continued)**


Feature	Specification
Dimensions	Width: 520 mm (20.5 in) Depth: 520 mm (20.5 in) Height: 364 mm (14.3 in)
Weight	Approximately 21.7 kg (47.8 lb)
Power requirements	DC24V, DC3.3V (supplied from the printer engine)

## Information (output devices)

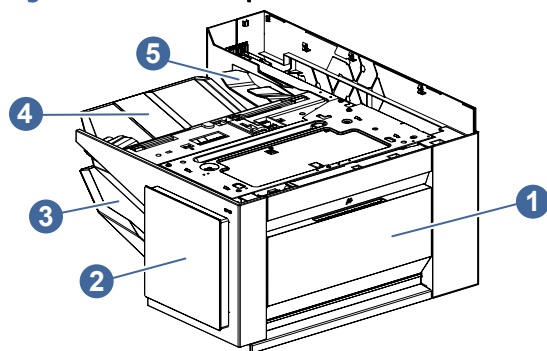
Learn about the printer output devices.

### 3-bin stapler-stacker front view

Identify the parts on the 3-bin stapler-stacker output device.

 **NOTE:** This section is for MFP printers only.

**Figure 1-24 3-bin stapler-stacker front view**



Number	Description
1	Stapler-stacker door
2	Staple door
3	Output bin 2
4	Output bin 1
5	Jogger guide

### Technical specifications

**Table 1-33 3-bin stapler-stacker technical specifications**

Feature	Specification
Media types	Plain paper, recycled paper, heavy paper, bond paper, and glossy paper

**Table 1-33 3-bin stapler-stacker technical specifications (continued)**

Feature	Specification
Media sizes, output bin 1	Stack mode: 148 mm (5.8 in) (W) x 210 mm (8.3 in) (L) to 216 mm (8.5 in) (W) x 355 mm (14 in) (L) Staple mode/job offset mode: A4, Letter, and Legal
Media sizes, output bin 2	Stack mode: 148 mm (5.8 in) (W) x 210 mm (8.3 in) (L) to 216 mm (8.5 in) (W) x 355 mm (14 in) (L)
Media weights, output bin 1	Stack mode/job offset mode, non-glossy paper: 60 g/m <sup>2</sup> (16 lb) to 163 g/m <sup>2</sup> (43 lb) Stack mode/job offset mode, glossy paper: 120 g/m <sup>2</sup> (32 lb) to 200 g/m <sup>2</sup> (53 lb) Staple mode, non-glossy paper: 60 g/m <sup>2</sup> (16 lb) to 120 g/m <sup>2</sup> (32 lb) Staple mode, glossy paper: 120 g/m <sup>2</sup> (32 lb)
Media weights, output bin 2	Stack mode, non-glossy paper: 60 g/m <sup>2</sup> (16 lb) to 163 g/m <sup>2</sup> (43 lb) Stack mode, glossy paper: 120 g/m <sup>2</sup> (32 lb) to 200 g/m <sup>2</sup> (53 lb)
Capacity, output bin 1	Stack mode/job offset mode: 48 mm (1.9 in) stack (approximately 400 sheets of 75 g/m <sup>2</sup> (20 lb) paper) Staple mode: 48 mm (1.9 in) stack (approximately 6 sets of 50 sheets of 75 g/m <sup>2</sup> (20 lb) paper)
Capacity, output bin 2	Stack mode: 19 mm (0.75 in) stack (approximately 100 sheets of 75 g/m <sup>2</sup> (20 lb) paper)
Capacity, staple cartridge	5,000 staples/cartridge
Capacity, stapler	Up to 50 sheets (60 g/m <sup>2</sup> (16 lb) to 120 g/m <sup>2</sup> (32 lb) paper)
Stapling position	Upper left corner at one point
Dimensions	Width: 510 mm (20.1 in) Depth: 475 mm (18.7 in) Height: 280 mm (11 in)
Weight	Approximately 8.7 kg (19.2 lb)
Power requirements	DC24V, DC3.3V (supplied from the printer engine)

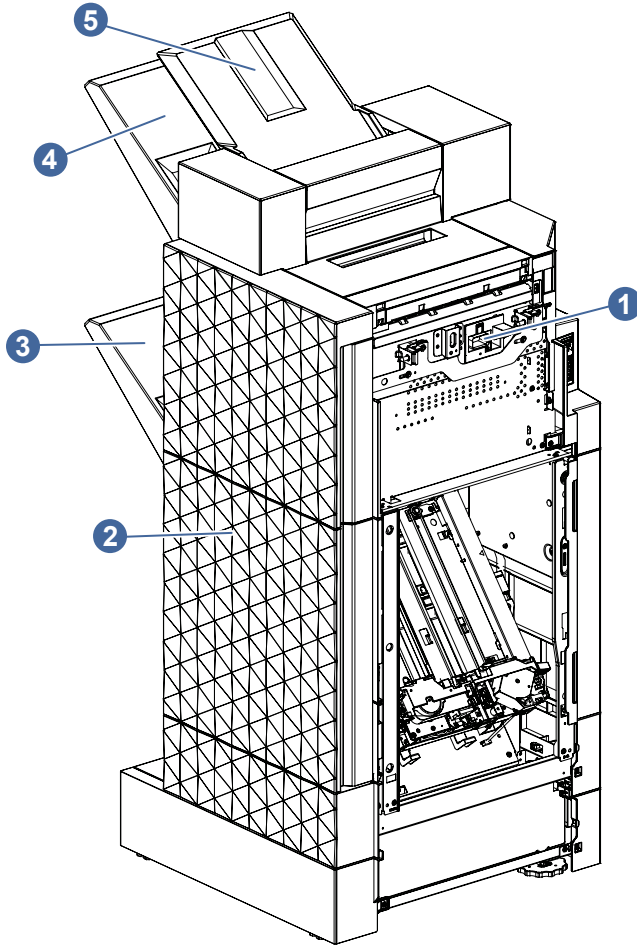
## Floor-standing stapler-stacker front view

Identify the parts on the floor-standing stapler-stacker output device.



**NOTE:** This section is for MFP printers only.

**Figure 1-25 Floor-standing stapler-stacker front view**



Number	Description
1	Connector
2	Front door
3	Output bin 4
4	Output bin 3
5	Output bin 2

## Technical specifications

**Table 1-34 Floor-standing stapler=stacker technical specifications**

Feature	Specification
Media types, output bin 1	Plain paper, recycled paper, heavy paper, bond paper, glossy paper, label, and index card
Media types, output bins 2 and 4	Plain paper, recycled paper, heavy paper, bond paper, and glossy paper
Media types, output bin 3	Plain paper, recycled paper, heavy paper, bond paper, glossy paper, and index card
Media sizes, output bin 1	Stack mode: 76 mm (3 in) (W) x 127 mm (5 in) (L) to 216 mm (8.5 in) (W) x 355 mm (14 in) (L)

**Table 1-34 Floor-standing stapler=stacker technical specifications (continued)**


Feature	Specification
Media sizes, output bin 2	Stack mode: 148 mm (5.8 in) (W) x 210 mm (8.3 in) (L) to 216 mm (8.5 in) (W) x 355 mm (14 in) (L) Punch mode: A5-R, B5, A4, Executive, Letter, and Legal
Media sizes, output bin 3	Stack mode: 101 mm (4 in) (W) x 152 mm (6 in) (L) to 216 mm (8.5 in) (W) x 355 mm (14 in) (L) Job offset mode: A5-R, B5, A4, Executive, Letter, and Legal Punch mode: A5-R, B5, A4, Executive, Letter, and Legal
Media sizes, output bin 4	Stack mode: 148 mm (5.8 in) (W) x 210 mm (8.3 in) (L) to 216 mm (8.5 in) (W) x 355 mm (14 in) (L) Job offset mode: A5-R, B5, A4, Executive, Letter, and Legal Punch mode: A5-R, B5, A4, Executive, Letter, and Legal Staple mode: A5-R, B5, A4, Executive, Letter, and Legal
Media weights, output bin 1	Stack mode: 60 g/m <sup>2</sup> (16 lb) to 216 g/m <sup>2</sup> (80 lb)
Media weights, output bin 2	Stack mode, non-glossy paper: 60 g/m <sup>2</sup> (16 lb) to 163 g/m <sup>2</sup> (43 lb) Stack mode, glossy paper: 120 g/m <sup>2</sup> (32 lb) to 200 g/m <sup>2</sup> (53 lb) Punch mode: 60 g/m <sup>2</sup> (16 lb) to 163 g/m <sup>2</sup> (43 lb)
Media weights, output bin 3	Stack mode/job offset mode: 60 g/m <sup>2</sup> (16 lb) to 216 g/m <sup>2</sup> (80 lb) Punch mode: 60 g/m <sup>2</sup> (16 lb) to 163 g/m <sup>2</sup> (43 lb)
Media weights, output bin 4	Stack mode/job offset mode: 60 g/m <sup>2</sup> (16 lb) to 216 g/m <sup>2</sup> (80 lb) Punch mode: 60 g/m <sup>2</sup> (16 lb) to 163 g/m <sup>2</sup> (43 lb) Staple mode, non-glossy paper: 60 g/m <sup>2</sup> (16 lb) to 163 g/m <sup>2</sup> (43 lb) Staple mode, glossy paper: 120 g/m <sup>2</sup> (32 lb)
Capacity, output bin 1	Stack mode: 19 mm (0.75 in) stack (approximately 100 sheets of 75 g/m <sup>2</sup> (20 lb) paper)
Capacity, output bin 2	Stack mode: 30 mm (1.2 in) stack (approximately 200 sheets of 75 g/m <sup>2</sup> (20 lb) paper)
Capacity, output bin 3	Stack mode/job offset mode: 131 mm (5.2 in) stack (approximately 1,100 sheets of 75 g/m <sup>2</sup> (20 lb) paper)
Capacity, output bin 4	Stack mode/job offset mode: 210 mm (8.3 in) stack (approximately 1,900 sheets of 75g/m <sup>2</sup> (20 lb) paper) Staple mode: 210 mm (8.3 in) stack (approximately 36 sets of 50 sheets of 75 g/m <sup>2</sup> (20 lb) paper)
Capacity, staple cartridge	5,000 staples/cartridge
Capacity, stapler	Up to 50 sheets (60 g/m <sup>2</sup> (16 lb) to 120 g/m <sup>2</sup> (32 lb) paper)
Stapling position	Square binding: binding in one place (upper left, lower left, upper right, lower right) Edge binding: 2-place binding (left edge, right edge), 3-place binding (left edge, right edge)

**Table 1-34 Floor-standing stapler=stacker technical specifications (continued)**

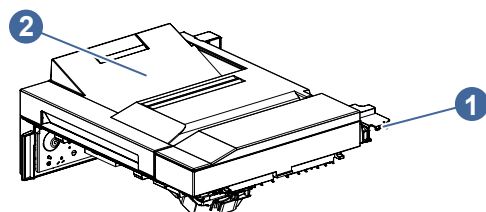
Feature	Specification
Dimensions, standard model	Width: 655 mm (25.75 in) Depth: 503 mm (19.8 in) Height: 1,140 mm (44.9 in)
Dimensions, tall model	Width: 655 mm (25.75 in) Depth: 503 mm (19.8 in) Height: 1,260 mm (49.6 in)
Weight	Standard model: Approximately 38.3 kg (84.4 lb) Tall model: Approximately 41.6 kg (91.7 lb)
Power requirements	DC24V, DC3.3V (supplied from the printer engine) 110 - 127V 50/60Hz (supplied from the printer engine) 220 - 240V 50/60Hz (supplied from the printer engine)

## Intermediate paper transfer unit (IPTU) front view

Identify the parts on the IPTU output device.

 **NOTE:** This section is for MFP printers only.

**Figure 1-26 IPTU front view**



Number	Description
1	Connector
2	Output bin

## Technical specifications

**Table 1-35 IPTU technical specifications**

Feature	Specification
Dimensions	Width: 349 mm (13.75 in) Depth: 380 mm (15 in) Height: 170 mm (6.7 in)
Weight	Approximately 3 kg (6.6 lb)

**Table 1-35 IPTU technical specifications (continued)**

Feature	Specification
Power requirements	DC24V, DC3.3V (supplied from the printer engine) 110 - 127V 50/60Hz (supplied from the printer engine) 220 - 240V 50/60Hz (supplied from the printer engine)

---

## 2 Printer installation and maintenance

Learn about printer installation and maintenance.

### Document feeder / scanner

Learn about the printer document feeder and scanner installation and maintenance.

#### Clean the pickup rollers and separation pad in the document feeder (MFP)

Learn about cleaning the document feeder rollers and pads.

Over time, specks of debris might collect on the document feeder rollers and pads which can affect performance.

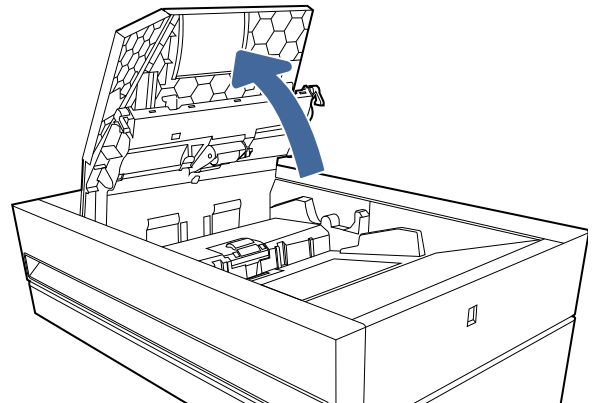


**NOTE:** The figures in this topic show a typical MFP printer. However, the procedure is correct for all MFP printers.

---

1. Open the document-feeder cover.

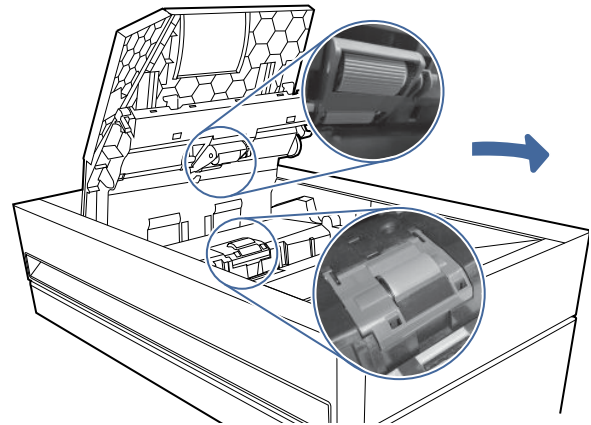
**Figure 2-1** Open the document-feeder cover





2. Remove any visible lint or dust from each of the feed rollers and the separation pad using compressed air or a clean lint-free cloth moistened with warm water. Carefully rotate the roller as you clean it.

**Figure 2-2** Clean the document feeder rollers



3. Close the document-feeder cover.

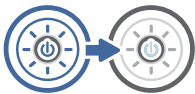
## Check the scanner glass for dirt and smudges

Learn about solving copy-quality debris problems.

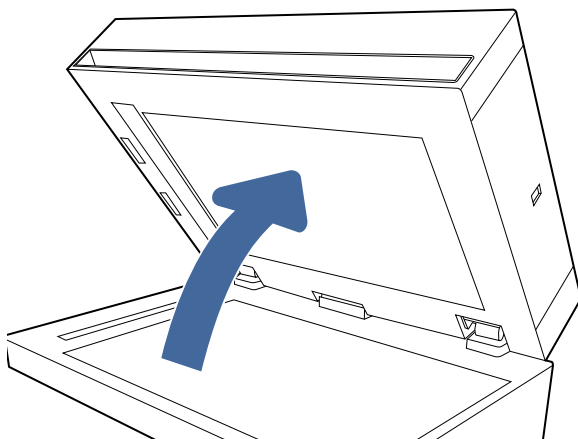
Over time, specks of debris might collect on the scanner glass and document feeder white plastic backing, which might cause print defects. Use the following procedure to clean the scanner if the printed pages have streaks, unwanted lines, black dots, poor print quality, or unclear text.

 [View a video of cleaning the document feeder glass and flatbed glass.](#)

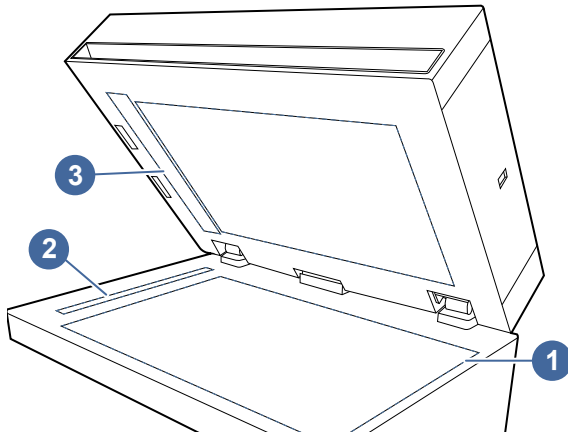
1. Press the power button to turn the printer off, and then disconnect the power cable from the electrical outlet.



2. Open the scanner lid.



3. Clean the scanner glass (callout 1) and the document feeder strips (callout 2, callout 3) with a soft cloth or sponge that has been moistened with nonabrasive glass cleaner.

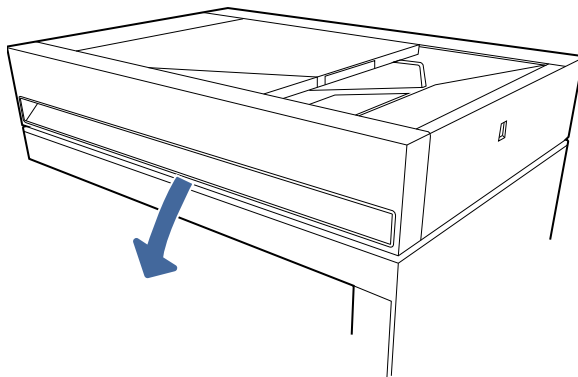


**CAUTION:** Do not use abrasives, acetone, benzene, ammonia, ethyl alcohol, or carbon tetrachloride on any part of the printer; these can damage the printer. Do not place liquids directly on the glass or platen. They might seep and damage the printer.

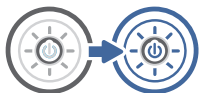
**NOTE:** If you are having trouble with streaks on copies when you are using the document feeder, be sure to clean the small strips of glass on the left side of the scanner (callout 2, callout 3).

4. Dry the glass and white plastic parts with a chamois or a cellulose sponge to prevent spotting.
5. Close the scanner lid.

**Figure 2-3 Close the scanner lid**



6. Connect the power cable to an outlet, and then press the power button to turn the printer on.



## Base printer

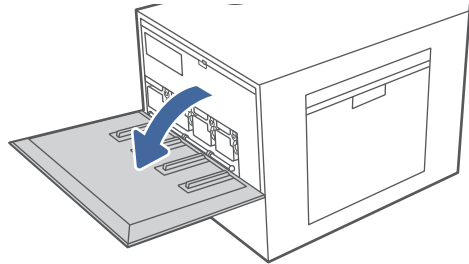
Learn about the base printer installation and maintenance.

## Remove and replace the toner cartridges (6700/6800 models)

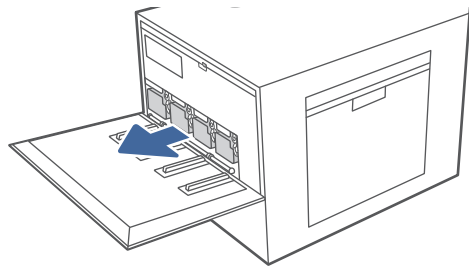
Follow these steps to replace the toner cartridge.

 [View a video of how to replace the toner cartridges](#)

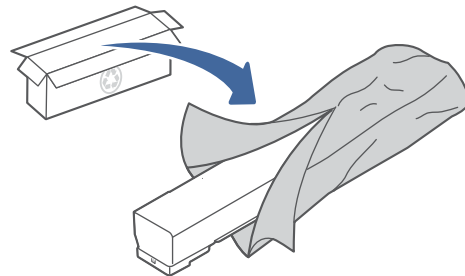
1. Open the front door.



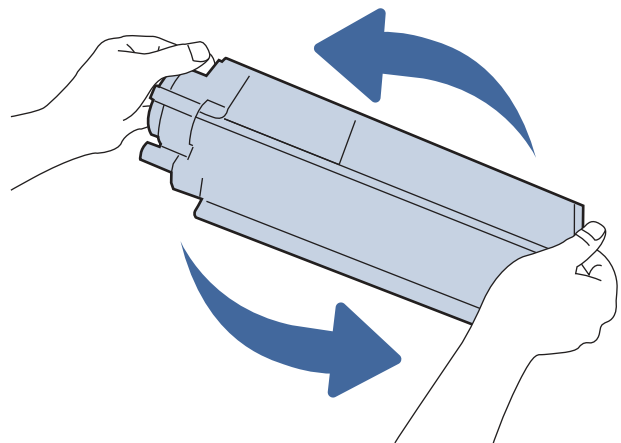
2. Grasp the end of the toner cartridge and pull it straight out of the printer.



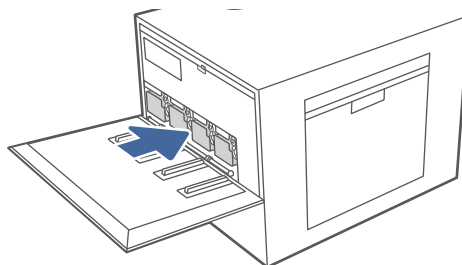
3. Remove the new toner cartridge from its package. Save all packaging for recycling the used toner cartridge.



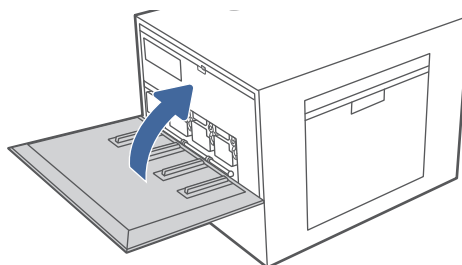
4. Hold both ends of the toner cartridge and rock it back and forth end to end to evenly distribute the toner that is inside.



5. Align the toner cartridge with its slot and insert it into the printer.



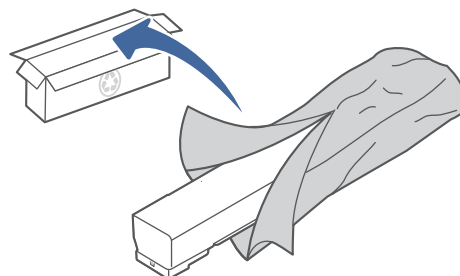
6. Close the front door.



7. Pack the used toner cartridge into the box that the new toner cartridge came in. See the enclosed recycling guide for information about recycling.

In the U.S. and Canada, a pre-paid shipping label is included in the box. In other countries/regions, go to [www.hp.com/recycle](http://www.hp.com/recycle) to print a pre-paid shipping label.

Adhere the pre-paid shipping label to the box, and return the used cartridge to HP for recycling.



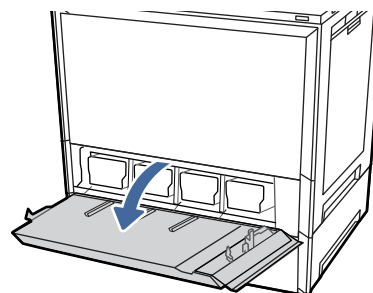
## Remove and replace the toner cartridges (X654/X677 models)

Follow these steps to replace the toner cartridge.

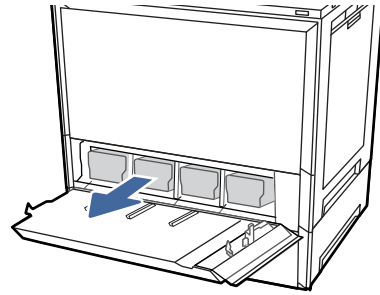


[View a video of how to replace the toner cartridges](#)

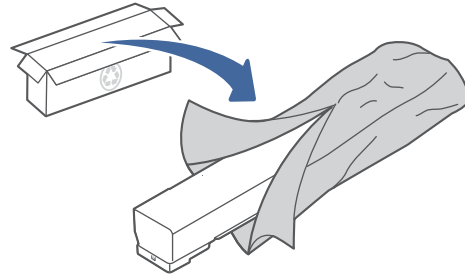
1. Release the toner cartridge by following the instructions on the control panel.
2. Open the toner cartridge door on the front of the printer.



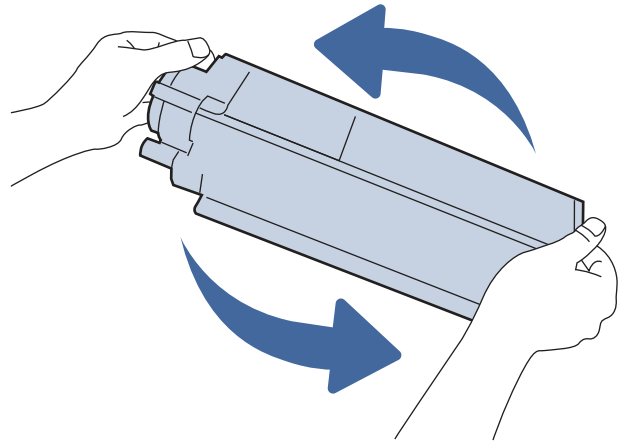
3. Grasp the end of the toner cartridge and pull it straight out of the printer.



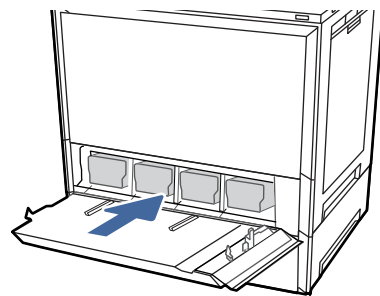
4. Remove the new toner cartridge from its package. Save all packaging for recycling the used toner cartridge.



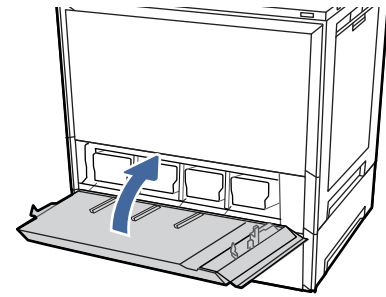
5. Hold both ends of the toner cartridge and rock it to evenly distribute the toner that is inside.



6. Align the toner cartridge with its slot and insert it into the printer.



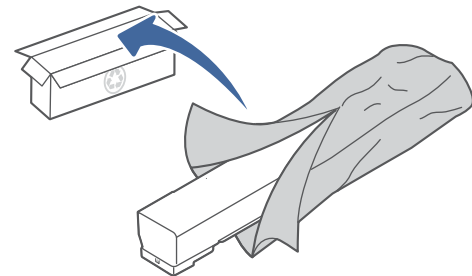
7. Close the toner cartridge door.



8. Pack the used toner cartridge into the box that the new toner cartridge came in. See the enclosed recycling guide for information about recycling.

In the U.S. and Canada, a pre-paid shipping label is included in the box. In other countries/regions, go to [www.hp.com/recycle](http://www.hp.com/recycle) to print a pre-paid shipping label.

Adhere the pre-paid shipping label to the box, and return the used cartridge to HP for recycling.

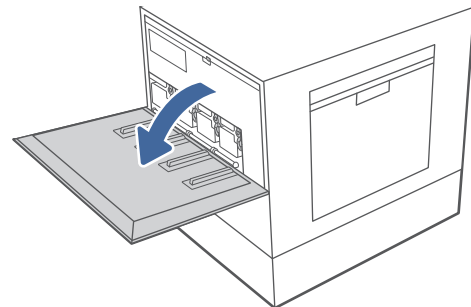


## Remove and replace the imaging drums (X654/X677 models)

Follow these steps to replace the imaging drums.

 [View a video of how to replace the imaging drums](#)

1. Open the front door.




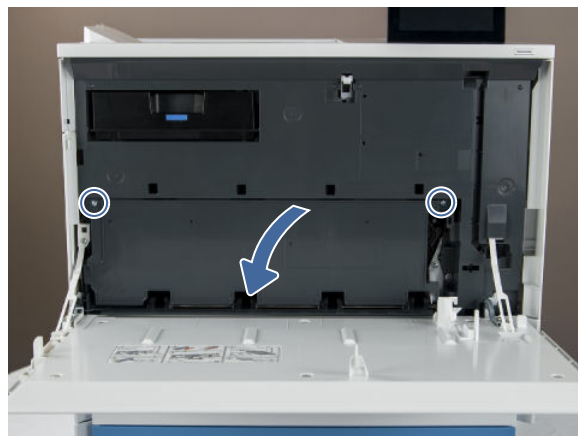
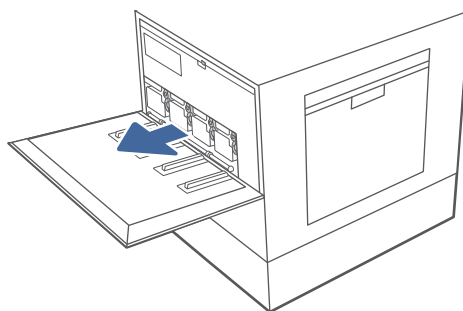
 **NOTE:** If necessary, remove two screws holding the imaging drum access cover in place, and then lower the cover to access the imaging drums. See the figure below.

Figure 2-4 Remove two screws, open the cover

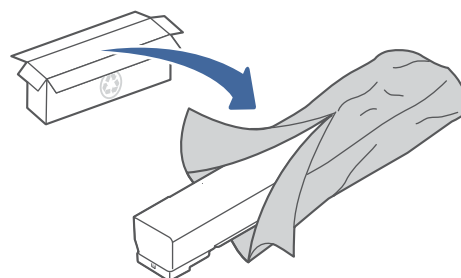


2. Grasp the end of the imaging drum and pull it straight out of the printer.

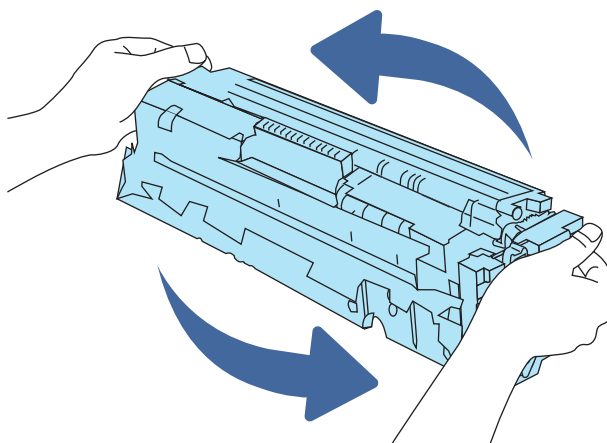


3. Remove the new imaging drum from its package. Save all packaging for recycling the used imaging drum.

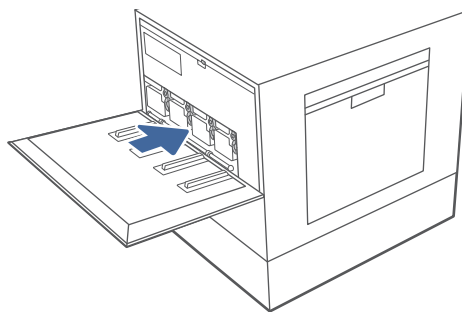
**CAUTION:** To prevent damage to the imaging drum, do not expose it to light for more than a few minutes. Cover the imaging drum if it must be removed from the printer for an extended period of time. Do not touch the blue imaging drum.



4. Hold both ends of the imaging drum and rock it back and forth end to end to evenly distribute the toner that is inside.

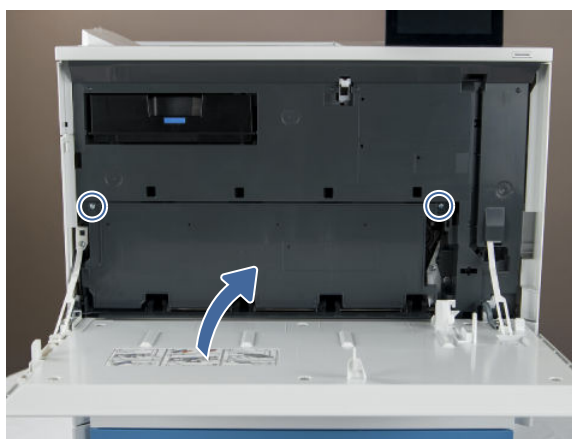


5. Align the imaging drum with its slot and insert it into the printer.

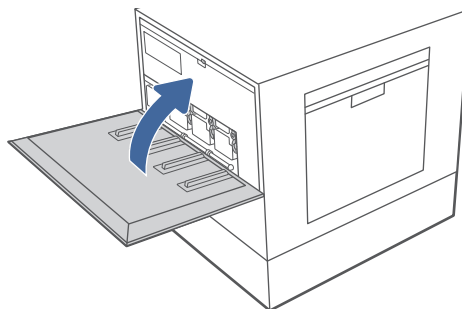


**NOTE:** If necessary, close the imaging drum access cover, and then install the two screws to secure the cover. See the figure below.

**Figure 2-5** Close the cover, install two screws



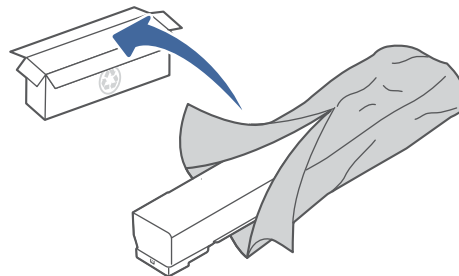
6. Close the front door.



7. Pack the used imaging drum into the box that the new imaging drum came in. See the enclosed recycling guide for information about recycling.

In the U.S. and Canada, a pre-paid shipping label is included in the box. In other countries/regions, go to [www.hp.com/recycle](http://www.hp.com/recycle) to print a pre-paid shipping label.

Adhere the pre-paid shipping label to the box, and return the used imaging drum to HP for recycling.



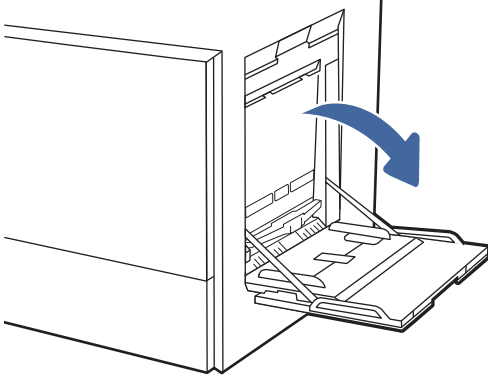


## Clean the Tray 1 pickup and separation rollers

Learn about cleaning the Tray 1 pickup and separation rollers.

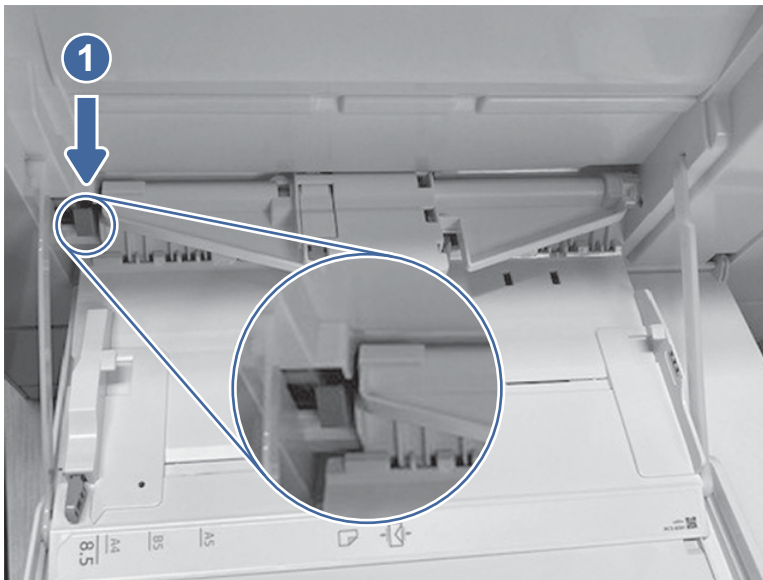
1. Open Tray 1.

**Figure 2-6** Open Tray 1



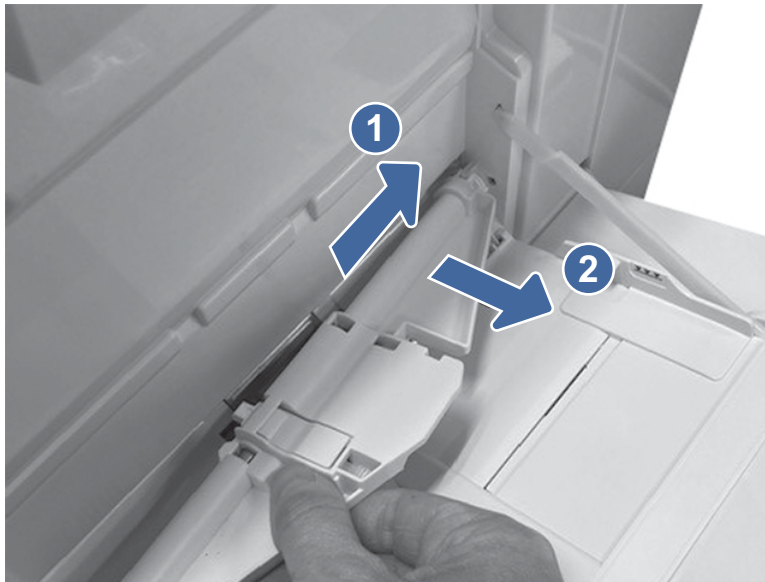
2. Locate and release the blue pickup roller assembly release tab (callout 1).

**Figure 2-7** Locate the pickup roller assembly tab



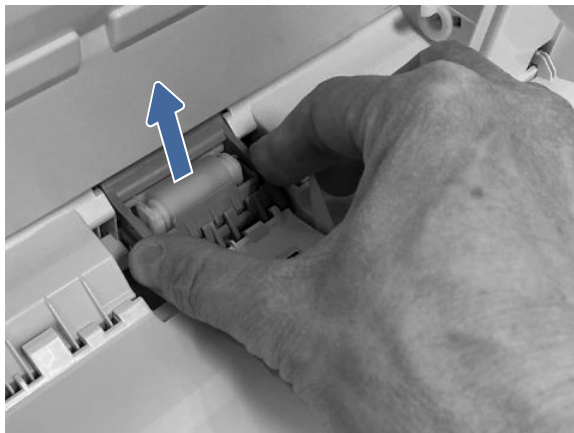
3. Push the pickup roller assembly to the right and then away from the printer.

**Figure 2-8 Remove the pickup roller assembly**



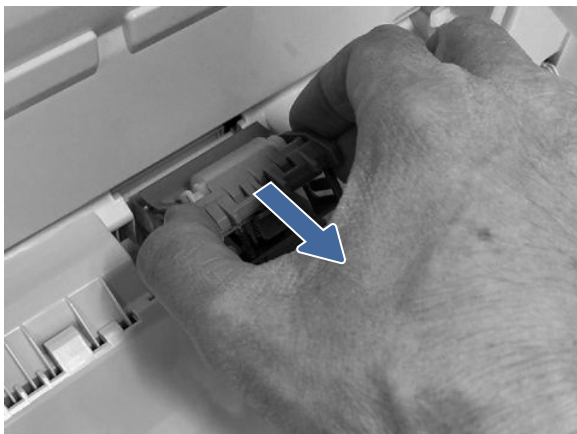
4. Grasp the left- and right-side of the separation roller assembly, and then lift the assembly up.

**Figure 2-9 Lift the separation roller assembly**



5. Pull the separation roller assembly straight out to remove it.

**Figure 2-10 Remove the separation roller assembly**

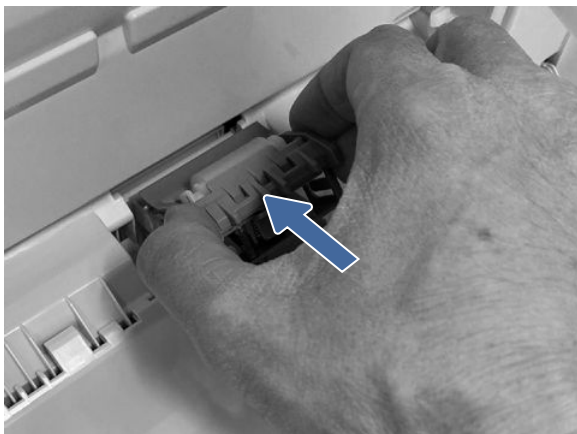


6. Clean the Tray 1 pickup and separation rollers. Use a damp, lint-free cloth to gently clean the rollers.

**⚠ CAUTION:** Do not touch the spongy portion of the roller. Skin oils on the roller can cause paper-handling and print-quality problems. HP recommends using disposable gloves or thoroughly washing your hands before handling the assembly.

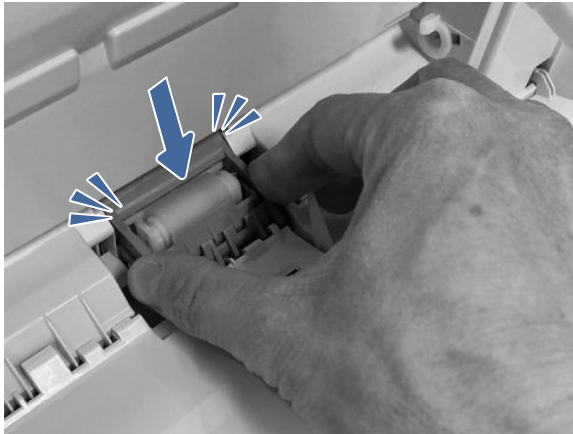
7. Insert the separation roller assembly into the printer.

**Figure 2-11 Insert the separation roller assembly**



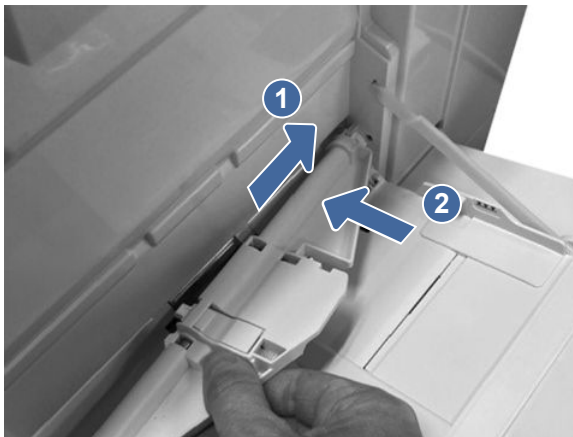
8. Push down on the Tray 1 separation roller until it snaps into place.

**Figure 2-12 Secure the separation roller assembly**



9. Insert the keyed right end of the pickup roller assembly into the provided slot, and then rotate the left end into place to install it.

**Figure 2-13 Install the pickup roller assembly**



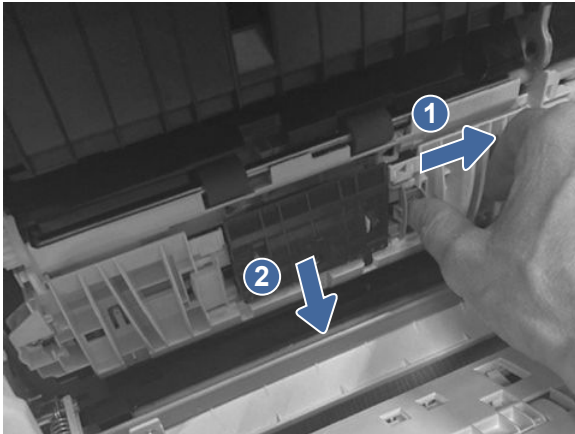
## Clean the Tray 2 pickup and separation rollers

Learn about cleaning the Tray 2 rollers.

1. Depending on the printer model, perform one of the following steps.
  - 6700/6800 models: Open the right door.
  - X654/X677 models: Open the lower right door.

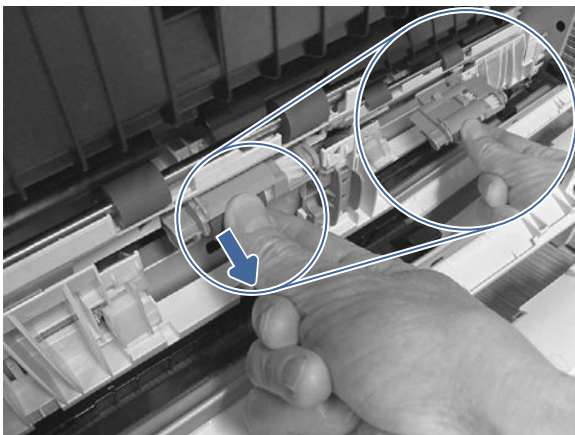
2. Slide the blue lever (callout 1) to the right, and then remove the separation roller assembly (callout 2) by pulling it out from the printer.

**Figure 2-14** Remove the separation roller assembly





3. Locate the pickup roller assembly, and then pull it away from the printer to remove it.

**Figure 2-15** Remove the pickup roller assembly



---

 **NOTE:** As the roller assembly can be hard to grip, you might need to reach under and behind the rollers to securely grip it.

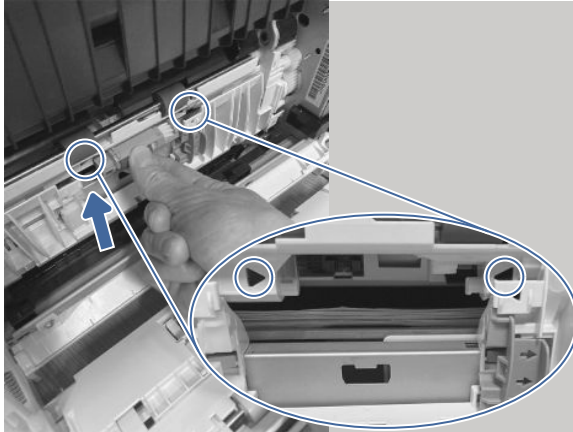
 **CAUTION:** Skin oils on the roller can cause paper-handling and print-quality problems. HP recommends using disposable gloves or thoroughly washing your hands before handling the assembly.

---

4. Clean the Tray 2 pickup and separation rollers. Use a damp, lint-free cloth to gently clean the rollers.

5. Position the pickup roller assembly in the printer in the correct orientation, and then press the assembly into place.

**Figure 2-16** Install the pickup roller assembly



6. Insert the separation roller assembly into the printer to install it.

**Figure 2-17** Install the separation roller assembly



---


## 3 Theory of operation

Learn about the printer theory of operation.

### Document feeder / scanner

Learn about the printer document feeder and scanner components.

---

 **NOTE:** This section is for MFP printers only.

---


### Document feeder simplex operation

Learn about document feeder operation.

The document feeder will not function when the document feeder cover is open. The paper path is incomplete if the document feeder cover is lifted from the glass.

When the printer duplex scans from the document feeder, the paper moves through one time, because the document feeder has a contact image sensor (CIS) scanner for side two which is scanned simultaneously with side one.

---

 **NOTE:** Duplex scanning is model specific. Some printer models might not support duplex scanning and printing.

---

The standard operation of the document feeder consists of the standby (paper loading) mode, pick, feed, and lift steps:

- **Standby (paper-loading) mode**

In standby mode, the lift plate is in the down position. When a document is loaded into the input tray, the paper-present sensor detects its presence.

When a copy/scan is initiated, the document feeder motor engages the gear train and raises the lift plate until the document makes contact with the pick roller. The document feeder then begins the pick, feed, and lower sequence.

- **Pick**

The pick roller rotates and moves one or more sheets forward into the document feeder where the sheets engage with the separation roller. The separation roller contacts the document feeder separation pad, which separates multiple sheets into a single sheet.

- **Feed**

The single sheet continues through the document feeder paper path (aided by the pre-scan rollers) until the leading edge of the page activates the top-of-form sensor. Activation of this sensor initiates the scan process, and the scanner acquires the image as the document moves over the document feeder glass. The post-scan rollers then eject the sheet into the output area. The pick and feed steps are repeated as long as paper is detected by the paper-present sensor.

- **Home**

When the top-of-form sensor detects the trailing edge of the last page, the last sheet is ejected and the motor turns on a sequence that rests the separation floor back down in standby mode, which allows it to detect when more media is loaded.

## Scanning and image capture system

Learn about the scanning and image capture system.



**NOTE:** This section is for MFP printers only.

The flatbed image scanner captures an electronic image of the document on the glass. The scanner does this by illuminating the document with LEDs (red, green, and blue) and capturing the image in the image sensor to create an electronic format of the document. The flatbed scanner consists of three main elements.

- **CIS scanner**

The CIS (contact image sensor) scanner captures an image using the printer's optical path. Red, green, and blue LEDs sequentially illuminate a small strip of the document (often called a raster line), and the optical system captures each color in a single row of CCD sensors that cover the entire page width. Because only one color is captured for each line per exposure, the three colors are recombined electronically to create the full color image. For monochromatic scans or copies, all three LEDs are illuminated to create a white light for the scan so the raster line can be captured in one exposure.

- **Mechanical drive system**

The drive system moves the CIS scanner along the document length to create the image. In this printer, the drive system consists of a small DC motor with an optical encoder, a drive belt, and a guide rod. The speed of the drive system is proportional to the scan resolution (300 ppi is much faster than 1200 ppi) and also proportional to the type of scan (color scans are slower than monochromatic scans).

- **Image processing system (formatter)**

The formatter processes the scanner data into either a copy or a scan to the computer. For copies, the image data is sent directly to the printer without being transmitted to the computer. Depending on user selections for the copy settings, the formatter enhances the scanner data significantly before sending it to the printer. Image data is captured at 300 ppi for copies and is user selectable for scans to the computer. Each pixel is represented by 8 bits for each of the three colors (256 levels for each color), for a total of 24 bits per pixel (24-bit color).

## Base printer

Learn about the base printer components.

### Basic operation

Learn about the basic operation of the printer.

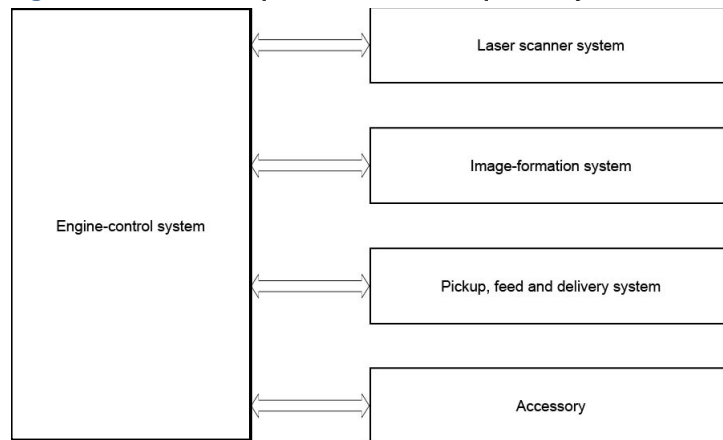
The printer routes all high-level processes through the formatter, which stores font information, processes the print image, and communicates with the host computer.



The basic printer operation comprises the following systems:

- Engine-control system
- Laser/scanner system
- Image-formation system
- Pickup, feed and delivery system
- Accessory (optional paper feeders)
- Integrated scanner assembly (document feeder and sub-scanner assembly) (not shown)

**Figure 3-1 Relationship between the main printer systems**



## Sequence of operation

Learn about the printer sequence of operation.

The DC controller PCA controls the operating sequence, as described in the following table.

**Table 3-1 Sequence of operation**

Period	Duration	Description
Waiting	From the time the power is turned on, the door is closed, or when the printer exits sleep mode until the printer is ready for printing.	<ul style="list-style-type: none"> <li>• Heats the fuser roller in the fuser</li> <li>• Pressurizes the fuser film</li> <li>• Detects the toner cartridges</li> <li>• Separates all of the developing rollers from the photosensitive drums in the toner cartridges</li> <li>• Rotates and stops each motor</li> <li>• Cleans the intermediate transfer belt (ITB) and secondary transfer roller</li> <li>• Detects cable breakage on the thermistor</li> <li>• Rotates and stops each fan</li> <li>• Detects any residual paper in the engine</li> </ul>

**Table 3-1 Sequence of operation (continued)**

Period	Duration	Description
Standby	From the end of the waiting sequence, the last rotation until the formatter receives a print command, or until the printer is turned off.	<ul style="list-style-type: none"> <li>• Is in the Ready state</li> <li>• Enters Sleep mode if the formatter sends the sleep command</li> <li>• The printer calibrates if it is time for an automatic calibration</li> </ul>
Initial rotation	From the time the formatter receives a print command until the paper enters the paper path.	<ul style="list-style-type: none"> <li>• Rotates each motor</li> <li>• Rotates each fan</li> <li>• Activates the high-voltage power supply</li> <li>• Prepares the laser/scanner unit</li> <li>• Warms the fuser to the correct temperature</li> </ul>
Printing	From the time the first sheet of paper enters the paper path until the last sheet has passed through the fuser.	<ul style="list-style-type: none"> <li>• Forms the image on the photosensitive drums</li> <li>• Transfers the toner to the paper</li> <li>• Fuses the toner image onto the paper</li> </ul>
Last rotation	From the time the last sheet of paper exits the fuser until the motors stop rotating.	<ul style="list-style-type: none"> <li>• Moves the last printed sheet into the output bin</li> <li>• Stops each motor</li> <li>• Stops the high-voltage power supply</li> <li>• Stops the laser/scanner unit</li> <li>• Turns the fuser heater off</li> <li>• Cleans the ITB and secondary transfer roller</li> <li>• If another print command is received, the printer enters the initial rotation period when the last rotation is complete.</li> </ul>

## Formatter-control system

Learn about how the formatter operates.

**⚠ CAUTION:** Under **NO** circumstances should a formatter from a different printer be installed during the repair or troubleshooting processes. The formatter stores important data specific to the model of printer it is installed in and is not deigned to be swapped or repurposed in any way. Return a used formatter to HP.

Issues that can occur from swapping a formatter include:

- Serial number, product number, product name, page count, and supported cartridges information change and might make a product unusable
- 33.02.01 Used board/Disk installed errors

If a used formatter is installed and causes this issue, the **partner** must cover the costs of the repair in the form of a product replacement. **There is no method in the field to recover a printer where a used formatter is installed.**

**📄 IMPORTANT:** When a formatter PCA or DC controller is replaced a pairing operation must be completed to make the printer functional.

The formatter performs the following functions:

- Controls the sleep delay function
- Receives and processes print data from the various printer inputs
- Monitors control panel functions and relaying printer status information through the control panel and the network or bi-directional interface
- Develops and coordinates data placement and timing with the DC controller PCA
- Stores customer configuration settings and paper types.
- Stores font information
- Communicates with the host computer through the network or the bidirectional interface

The formatter receives a print job from the network or bidirectional interface and separates it into image information and instructions that control the printing process. The DC controller PCA synchronizes the image formation system with the paper input and output systems, and then signals the formatter to send the print image data.

## Power management

Learn about printer power management.

Power management conserves power after the printer has been idle for an adjustable length of time. When the printer is in sleep mode, the control-panel back-light is turned off, but the printer retains all printer settings, downloaded fonts, and macros. Power management can be modified or turned off from the control-panel menus.

The printer exits sleep mode and enters the warm-up cycle when any of the following occurs.

- A print job, valid data, or a PML or PJJ command is received at the serial port.
- A print job or fax (fax models) is received.
- The control panel is touched (button press or touchscreen touch depending on model).
- A document is loaded in the document feeder (MFP only).
- Opening the scanner lid (model dependent).
- The power button is pressed for 3 seconds or less.
- Connecting an operational live network Ethernet cable or fax line (fax models).
- Inserting a USB drive in either the front USB port or the USB port on the back of the device.
- Connecting a USB cable to an operating computer.
- Opening the cartridge, front, or rear door (model dependent).



**NOTE:** Opening a paper tray does not wake up the printer.



**TIP:** Error messages override the sleep delay message. The printer enters sleep mode at the selected time, but the error message continues to appear.

---

## Set the sleep timer and configure the printer to use 1 watt or less of power

The sleep settings affect how much power the printer uses, the wake/sleep time, how quickly the printer enters sleep mode, and how quickly the printer wakes up from sleep mode.

To configure the printer to use 1 watt or less of power while in sleep mode, enter the time for the [Sleep after Inactivity](#) setting.

1. From the Home screen on the printer control panel, select [Settings](#).
2. Open the following menus:
  - [General](#)
  - [Energy Settings](#)
  - [Sleep Settings](#)
3. Select [Sleep after Inactivity](#) to specify the number of minutes the printer is inactive before it enters sleep mode. Enter the appropriate time period.
4. Select [Done](#) to save the settings.

## Set the sleep schedule

Use the [Sleep Schedule](#) feature to configure the printer to automatically wake or go into Sleep mode at specific times on specific days of the week.

1. From the Home screen on the printer control panel, navigate to the [Settings](#) application, and then select the [Settings](#) icon.
2. Open the following menus:
  - a. [General](#)
  - b. [Energy Settings](#)
  - c. [Sleep Schedule](#)
3. Select the [New Event](#) button, and then select the type of event to schedule: [Wake Event](#) or [Sleep Event](#).
4. For a wake or sleep event, configure the time and the days of the week for the event. Select [Save](#) to save the setting.

## Printer job language (PJM)

Learn about printer job language (PJM).

PJM is an integral part of printer configuration, in addition to the standard PCL and PostScript (PS). With standard cabling, the printer can use PJM to perform a variety of functions.

- **Dynamic I/O switching:** The printer can be configured with a host on each I/O by using dynamic I/O switching. Even when the printer is offline, it can receive data from more than one I/O simultaneously, until the I/O buffer is full.
- **Context-sensitive switching:** The printer can automatically recognize the personality (PS or PCL) of each job and configure itself to serve that personality.
- **Isolation of print environment settings from one print job to the next:** For example, if a print job is sent to the printer in landscape mode, the subsequent print jobs print in landscape only if they are formatted for landscape printing.

## Control panel

Learn about the control panel.

The formatter sends and receives printer status and command data to and from the control panel.

## Walk-up USB

Learn about the walk-up USB function.



---

**NOTE:** Touchscreen models only.

---

This printer features printing from a USB flash drive. This printer supports printing the following types of files from the USB flash drive.

- .pdf
- .jpg
- .prn and .PRN
- .pcl and .PCL
- ps and .PS
- doc and .docx
- .ppt and .pptx

When a USB flash drive is inserted into the front of the printer, the control panel will display the [USB Flash Drive menu](#). The files present on the USB flash drive can be accessed from the control panel.



---

**NOTE:** The USB flash drive must be formatted using the FAT32 format. Drives formatted with NTFS will not work.

---

Any files in a supported format on the USB flash drive can be printed directly from the printer control panel. Pages also can be scanned and saved to the USB flash drive from the control panel.

## Low end data model (LEDM) overview

Learn about the low-end data model (LEDM).

The low-end data model (LEDM) provides one consistent data representation method and defines the dynamic and capabilities tickets shared between clients and devices, as well as the access protocol, event, security, and discovery methods.

## CPU

Learn about the printer microprocessor.

The formatter incorporates a 1200 MHz processor.

## Input/output (I/O)

Learn about printer I/O functionality.



---

**NOTE:** Some of the following printer I/O functions are model specific. For example, not all printer models have a fax function.

---

## Walk-up USB

The printer includes a Hi-Speed USB 2.0 front port for walkup USB printing.

## Universal serial bus (USB) hosts

The printer includes SuperSpeed USB 3.0 rear hosts for USB flash drive and job storage.

## 10/100/1000 networking

The printer includes a 10/100/1000 network (Ethernet) connection.

## Fax

The printer includes a fax phone line connection.



---

**NOTE:** Fax models only. For some fax model printers, the telephone extension port is plugged and not operational.

---

## Wireless

Wireless products contain a wireless card to enable 802.11b/g/n wireless communication with dual band support for 2.4Ghz and 5 Ghz.



---

**NOTE:** Wireless models only.

---

## Memory

Learn about printer memory functionality.



---

**NOTE:** Some of the following printer memory functions are model specific. For example, not all printer models have Flash memory.

---

## Firmware

The formatter stores the printer firmware. A firmware upgrade process is used to overwrite and upgrade the firmware.



---

**NOTE:** For more information about a specific printer model, see the *Printer information, configurations, and specifications* section in the service manual.

---

## Nonvolatile random access memory (NVRAM)

The printer uses nonvolatile memory (NVRAM) to store I/O and information about the print environment configuration. The contents of NVRAM are retained when the printer is turned off or disconnected.

## Flash memory

**NAND:** Stores fax memory.

## Random access memory

The printer uses the following RAM:

- SFP: 1.25 GB
- MFP: 1.5 GB

## HP Memory Enhancement technology (MEt)

The HP Memory Enhancement technology (MEt) effectively doubles the standard memory through a variety of font- and data-compression methods.



**NOTE:** MEt is available only in PCL mode; it is not functional when printing in PS mode.

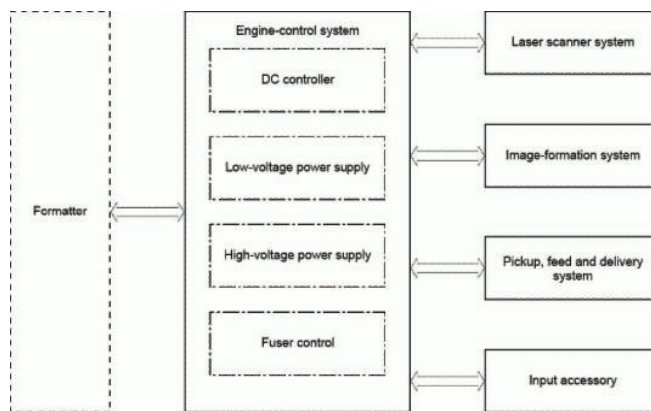
## Engine-control unit

Learn about the engine control unit.

The engine-control unit includes the following:

- DC controller
- High-voltage power supply
- Low-voltage power supply
- Fuser control

**Figure 3-2 Engine-control unit**

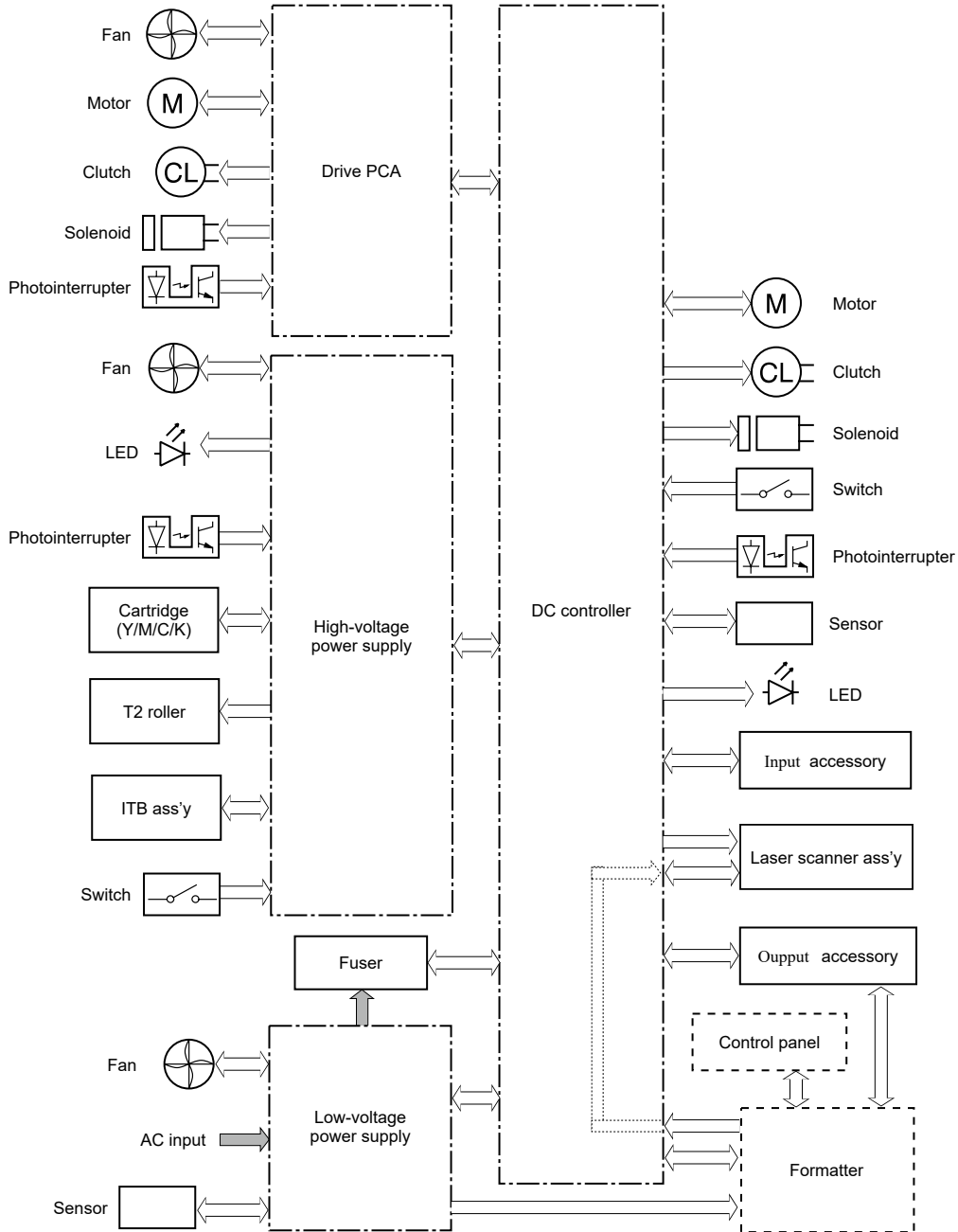


## DC controller

Learn about the DC controller.

The DC controller controls the operation of the printer and its components. The DC controller starts the printer operation when the printer power is turned on and the power supply sends DC voltage to the DC controller. After the printer enters the standby period, the DC controller sends out various signals to operate motors, solenoids, and other printer components based on the print command and image data that the host computer sends.

**Figure 3-3 DC controller diagram**



**Table 3-2 Printer electrical components**

Component type	Abbreviation	Component name
Motor	SCN_MTR_12st	Scanner motor
Motor	SCN_MTR_34st	Scanner motor
Motor	LIFT_MTR	Lifter motor
Motor	FEED_MTR	Pickup motor
Motor	FEED_MTR (X654/X677 models only)	Feed motor



**Table 3-2 Printer electrical components (continued)**

Component type	Abbreviation	Component name
Motor	FSR_MTR	Fuser motor
Motor	ITB_BK_MTR	ITB motor
Motor	3DRM_MTR	Drum motor
Motor	4DEV_MTR	Developer motor
Motor	DEV_MTR	Developer alienation motor
Motor	DUP_MTR	Duplex motor
Motor	TS_MOTOR (X654/X677 modelsonly)	Toner-supply motor
Fan	FSR_FAN	Fuser fan
Fan	CRG_FAN	Cartridge fan
Fan	KB_FAN	Exhaust fan
Fan	PS_FAN	Power supply fan
Solenoid	T1_SL	Tray 1 (MP) alienation solenoid
Solenoid	DUP_SL	Duplex flapper solenoid
Solenoid	MP_SL	Tray 1 (MP) pickup solenoid
Clutch	FEED_CL	Tray 2 pickup clutch
Clutch	REFEED_CL	Duplex re-pickup clutch
Clutch	U_CL1 (X654/X677 models only)	Toner-supply upper feed clutch 1
Clutch	T_CL1 (X654/X677 models only)	Toner-supply clutch 1
Clutch	U_CL2 (X654/X677 models only)	Toner-supply upper feed clutch 2
Clutch	T_CL2 (X654/X677 models only)	Toner-supply clutch 2
Clutch	U_CL3 (X654/X677 models only)	Toner-supply upper feed clutch 3
Clutch	T_CL3 (X654/X677 models only)	Toner-supply clutch 3
Clutch	U_CL4 (X654/X677 models only)	Toner-supply upper feed clutch 4
Clutch	T_CL4 (X654/X677 models only)	Toner-supply clutch 4
Switch	24V_ILK_SW	24V interlock switch
Switch	FR_DOOR_SW	Front door switch
Switch	FDOOR_SW (X654/X677 models only)	Toner-supply door switch
Switch	R_DOOR_SW	Right door switch

**Table 3-2 Printer electrical components (continued)**

Component type	Abbreviation	Component name
Switch	R_DOOR_SW (X654/X677 models only)	Right door switch 2
Switch	POWER_SW	Power supply switch
Switch	CST_SIZE 1	Tray 2 media size switch 1
Switch	CST_SIZE 2	Tray 2 media size switch 2
Switch	CST_SIZE 3	Tray 2 media size switch 3
Switch	CST_SIZE 4	Tray 2 media size switch 4
Photo interrupter	LIFT_SNS	Tray 2 lifter motor rotation sensor
Photo interrupter	DRM_HP123_SNS	Drum home position sensor YMC
Photo interrupter	DRM_HP4_SNS	Drum home position sensor K
Photo interrupter	DEV_HP_SNS	Developer alienation sensor
Photo interrupter	DUP_FL_SNS	Duplex flapper position sensor
Photo interrupter	OUT_FULL_SNS	FD1 media full sensor, fuser output sensor
Photo interrupter	CST_PAP_SNS	Tray 2 media out sensor
Photo interrupter	CST_FACE_SNS	Tray 2 media surface sensor
Photo interrupter	LOOP_SNS	Fuser loop sensor
Photo interrupter	REFEED_SNS	Duplex feed sensor
Photo interrupter	ENC_SNS	Registration roller rotation sensor
Photo interrupter	REG_SNS	Registration sensor
Photo interrupter	RRREG_SNS	Pre-registration sensor
Photo interrupter	MP_PAP_SNS	Tray 1 media out sensor
Photo interrupter	TCU_FULL_SNS	ITB toner collection unit near full sensor
Photo interrupter	T1_HP_SNS	ITB alienation sensor
Photo interrupter	TCU_VSCW_SNS	Toner collection unit screw rotation sensor
Photo interrupter	FSR_PRS_SNS	Fuser pressure release sensor
Photo interrupter	PAPOUT-M_SNS	Fuser output sensor 2
Photo interrupter	TRANS_SNS (X654/X677 models only)	Tray 2 feed sensor
Photo interrupter	CAC_SNS (1st) (X654/X677 models only)	Cartridge release unit home position sensor Y
Photo interrupter	CAC_SNS (2nd) (X654/X677 models only)	Cartridge release unit home position sensor M
Photo interrupter	CAC_SNS (5rd) (X654/X677 models only)	Cartridge release unit home position sensor C
Photo interrupter	CAC_SNS (4th) (X654/X677 models only)	Cartridge release unit home position sensor K
Sensor	- (media sensor PCA)	Media sensor

**Table 3-2 Printer electrical components (continued)**

Component type	Abbreviation	Component name
Sensor	- (RD sensor PCA)	Registration density sensor 1
Sensor	- (RD sensor PCA)	Registration density sensor 2
Sensor	PAPOUT-L_SNS	Fuser output sensor 1
Sensor	ENV SNS	Environment sensor
Sensor	BUFF_PTR_PCA (1st) (X654/ X677 models only)	Toner supply sensor Y
Sensor	BUFF_PTR_PCA (2nd) (X654/X677 models only)	Toner supply sensor M
Sensor	BUFF_PTR_PCA (3rd) (X654/ X677 models only)	Toner supply sensor C
Sensor	BUFF_PTR_PCA (4th) (X654/ X677 models only)	Toner supply sensor K
LED	3rd (X654/X677 models only)	Pre-exposure LED 3
LED	4th (X654/X677 models only)	Pre-exposure LED 4
LED	LED6	Power supply switch LED

## Motors

Learn about the printer motors.

The printer uses several motors for the paper-feed and image-formation processes.



**NOTE:** The DC controller determines the following motor failures.

- Developer motor ([color] developer motor startup failure)
- Developer motor ([color] developer motor rotation failure)
- Drum motor ([color] drum motor startup failure)
- Drum motor ([color] drum motor rotation failure)
- ITB motor (ITB motor start-up failure)
- ITB motor (ITB motor rotation failure)
- Fuser motor (fuser motor start-up failure)
- Fuser motor (fuser motor rotation failure)
- Developer alienation motor (developer alienation motor failure)
- Scanner motor (scanner motor startup failure)
- Scanner motor (scanner motor rotation failure)
- Toner-supply motor ([color] toner replenish motor failure)

**Table 3-3 Motors**

Component name		Components driven
4DEV_MTR	Developer motor	<ul style="list-style-type: none"> <li>• Yellow developer</li> <li>• Magenta developer</li> <li>• Cyan developer</li> <li>• Black developer</li> <li>• Waste toner feed screw</li> </ul>
3DRM_MTR	Drum motor	<ul style="list-style-type: none"> <li>• Yellow photosensitive drum</li> <li>• Magenta photosensitive drum</li> <li>• Cyan photosensitive drum</li> </ul>
ITB_BK_MTR	ITB motor	<ul style="list-style-type: none"> <li>• Intermediate transfer belt (ITB)</li> <li>• Black photosensitive drum</li> <li>• Toner feed screw</li> </ul>
FSR_MTR	Fuser motor	<ul style="list-style-type: none"> <li>• Pressure roller and output roller</li> <li>• Pressurizes/releases the pressure roller</li> <li>• Engages/disengages the T1 roller</li> <li>• Engages/disengages the T2 roller</li> </ul>
FEED_MTR	Pickup motor	<ul style="list-style-type: none"> <li>• Tray 1 pickup roller (6700/6800 models only)</li> <li>• Tray 1 feed roller (6700/6800 models only)</li> <li>• Tray 2 pickup roller</li> <li>• Tray 2 feed roller</li> <li>• Feed roller (X654/X677 models only)</li> <li>• Registration roller (6700/6800 models only)</li> <li>• Intermediate feed roller (6700/6800 models only)</li> <li>• Duplex re-pickup roller (6700/6800 models only)</li> </ul>
FEED_MTR	Feed motor (X654/X677 models only)	<ul style="list-style-type: none"> <li>• Tray 1 pickup roller</li> <li>• Tray 1 feed roller</li> <li>• Registration roller</li> <li>• Intermediate feed roller</li> <li>• Duplex re-pickup roller</li> </ul>
DEV_MTR	Developer alienation motor	Engages/disengages the developer rollers
SCN_MTR_12st	Scanner motor	Scanner mirror
SCN_MTR_34st		
LIFT_MTR	Lifter motor	<ul style="list-style-type: none"> <li>• Lifts up the Tray 2 lifting plate</li> <li>• Engages/disengages the Tray 2 pickup roller</li> </ul>

**Table 3-3 Motors (continued)**

Component name		Components driven
DUP_MTR	Duplex motor	<ul style="list-style-type: none"> <li>Duplex switchback roller</li> <li>Duplex feed roller</li> </ul>
TS_MOTOR	Toner-supply motor (X654/X677 models only)	Toner feed screw

## Fans

Learn about the printer fans.

The printer has three fans for preventing the temperature from rising in the printer and for cooling the printed pages.



**NOTE:** The DC controller determines the following fan failures.

- Cartridge fan (fan motor 1 failure)
- Power supply fan (fan motor 2 failure)
- Fuser fan (fan motor 3 failure)

**Table 3-4 Fans**

Component name	Description	Cooling area	Type	Speed
FSR_FAN	Fuser fan	Around the fuser	Intake	Variable (full/half)
CRG_FAN	Cartridge fan	Around the toner cartridges	Intake	Variable (full/95%/75%)
PS_FAN	Power supply fan	Around the low-voltage power supply unit	Intake	Variable (full/half)
KB_FAN	Exhaust fan	Around the delivery assembly		Variable (full/half)

## Low-voltage power supply

Learn about the low-voltage power supply (LVPS).

The low-voltage power supply converts the AC power into the DC voltage that the printer components use.



**Table 3-5 LVPS voltages (continued)**

DC power supply	Reference item	Inactive OFF	Active OFF	Print/Standby
+3.3V	+3.3VA	ON	ON	ON
+3.3V	+3.3VB	OFF	ON	ON
+3.3V	+3.3VB2	OFF	Intermittent	ON
+3.3V	+3.3VC	OFF	OFF	ON
+3.3V	+3.3VM	OFF	OFF	ON

### Over-current/over-voltage protection

Learn about LVPS protections.

The low-voltage power supply automatically stops supplying the DC voltage to the printer components whenever it detects excessive current or abnormal voltage. The low-voltage power supply has a protective circuit against over-current and over-voltage to prevent failures in the power supply circuit.

**⚠ CAUTION:** If DC voltage is not being supplied from the low-voltage power supply, the protective function might be running. In this case, turn the power switch off and unplug the power cord.

Do not turn the power switch on until the root cause is found and corrected.

If the protective function is active, the DC controller notifies the formatter of a low-voltage power supply failure. In addition, the low-voltage power supply has two fuses to protect against over-current. If over-current flows into the AC line, the fuse stops the AC power.

### Low-voltage power supply safety

Learn about LVPS safety.

For the customer and service technician safety, the printer has a function to stop +24VB power when the 24V interlock switch is turned off. This stops the DC power supply to the following loads.

- High-voltage power supply
- Fuser motor
- Pickup motor
- Developer alienation motor
- Duplex switchback motor

The remote switch control circuit turns on or off the printer power so that the AC power flows even if the power switch is turned off. Unplug the printer power cord before disassembling the printer.

### Low-voltage power supply functions

Learn about LVPS functions.

The printer has the following low-voltage power supply functions.

**Table 3-6 Low-voltage power supply functions**

Function	Description
Active OFF	Inactive OFF is a state that the power supply is OFF.
Inactive OFF	Active OFF is a state of sleep. The low-voltage power supply is output only to formatter and DC controller.
Low-voltage power supply failure detection	When +24V is supplied from the low-voltage power supply, the DC controller always monitors output status of 24VA. The DC controller determines it as low-voltage power supply malfunction if 24VA would not become the specified value at the specified timing. When the DC controller monitors AC voltage input from inlet, it also determines it as low-voltage power supply malfunction if AC voltage input from inlet would not reach the specified voltage.

## High-voltage power supply

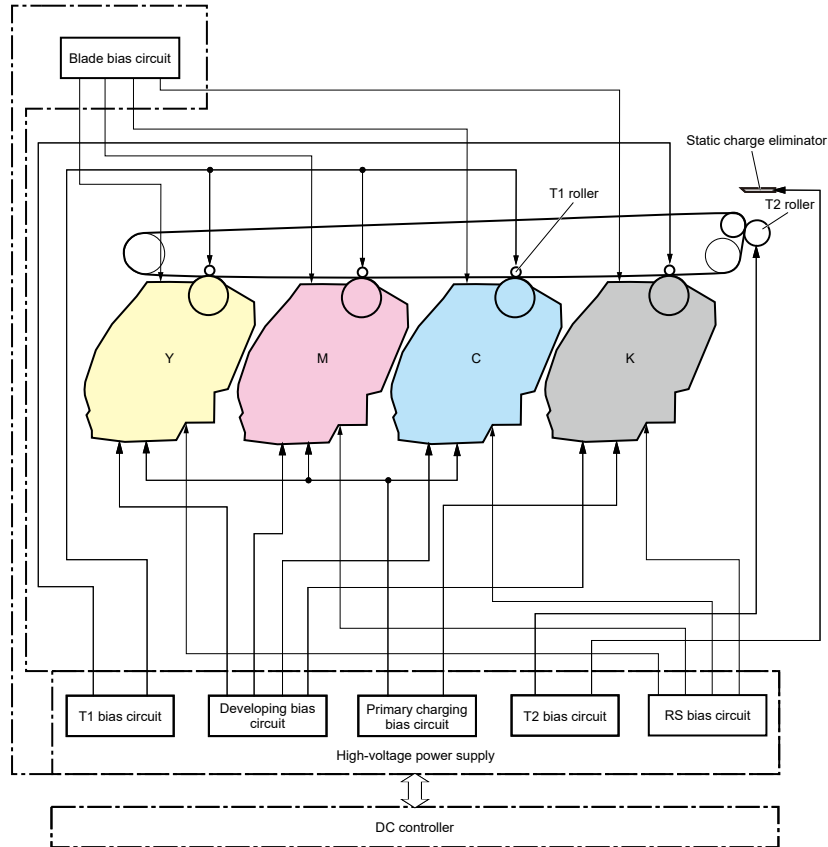
Learn about the high-voltage power supply.

The DC controller controls the high-voltage power supply to generate high-voltage biases. The high-voltage power supply generates the high-voltage biases that are applied to the following components:

- Primary charging roller (in the toner cartridges)
- RS roller (in the toner cartridges)
- Developer blade (in the toner cartridges)
- Developer roller (in the toner cartridges)
- Primary transfer roller
- Secondary transfer roller
- Static charge eliminator



**Figure 3-5 High-voltage power supply**

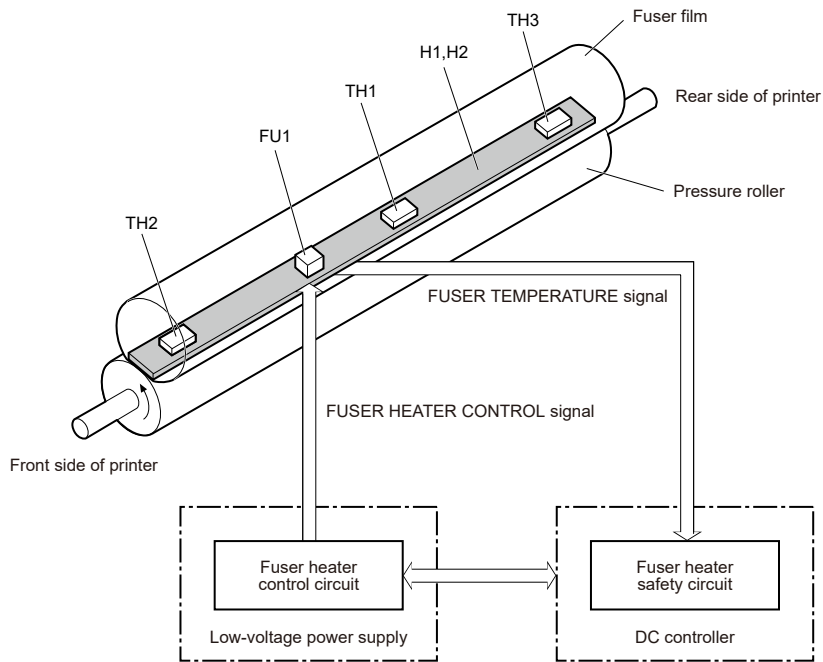


## Fuser control

Learn about the fuser control process.

The fuser heater control circuit and the fuser safety circuit control the fuser temperature based on the commands from the DC controller. The printer uses an on-demand fusing method. There are two types of fusers, a conventional ODF fuser and a zone-heated A2ODF fuser in which a heater is divided into seven zones.

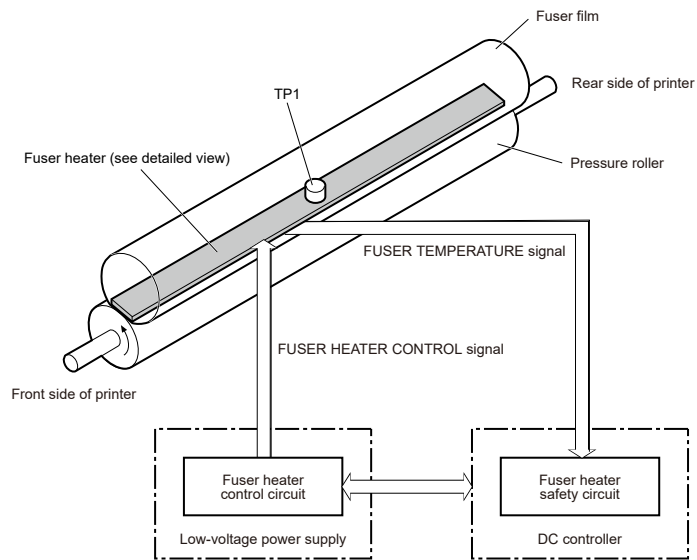
**Figure 3-6 ODF fuser control**



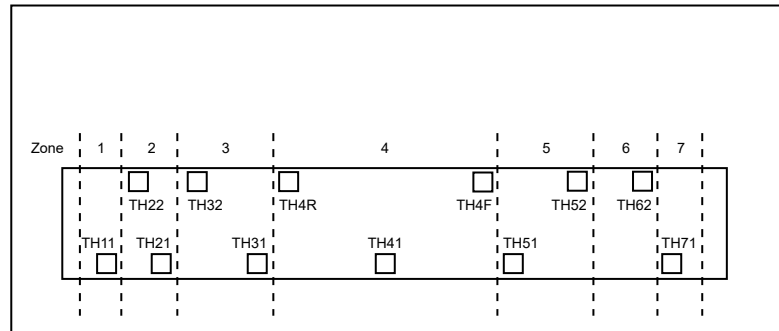
**Table 3-7 ODF fuser components**

Abbreviation	Component name	Function
H1	Fuser main heater	Heats the fuser film (Letter width compatible)
H2	Fuser sub heater	Heats the fuser film (A4 width compatible)
TH1	Main thermistor	Detects the center temperature of the fuser film (contact type)
TH2	Sub thermistor 1	Detects the temperature at one end of the fuser heater (contact type)
TH3	Sub thermistor 2	Detects the temperature at one end of the fuser heater (contact type)
FU1	Thermal fuse	Prevents an abnormal temperature rise of fuser heater (non-contact type)

**Figure 3-7 A<sup>2</sup>ODF fuser control**



Detailed view of fuser heater



**Table 3-8**

Abbreviation	Component name	Function
H1	Fuser heater 1	Heats the fuser film (zone 1)
H2	Fuser heater 2	Heats the fuser film (zone 2)
H3	Fuser heater 3	Heats the fuser film (zone 3)
H4	Fuser heater 4	Heats the fuser film (zone 4)
H5	Fuser heater 5	Heats the fuser film (zone 5)
H6	Fuser heater 6	Heats the fuser film (zone 6)
H7	Fuser heater 7	Heats the fuser film (zone 7)

**Table 3-8 (continued)**

<b>Abbreviation</b>	<b>Component name</b>	<b>Function</b>
TH11	Main thermistor	Detects the temperature of the fuser zone 1 (built-in type)
TH21	Main thermistor	Detects the temperature of the fuser zone 2 (built-in type)
TH41	Main thermistor	Detects the temperature of the fuser zone 4 (built-in type)
TH51	Main thermistor	Detects the temperature of the fuser zone 5 (built-in type)
TH71	Main thermistor	Detects the temperature of the fuser zone 7 (built-in type)
TH22	Sub thermistor	Detects the temperature of the fuser zone 2 (built-in type)
TH32	Sub thermistor	Detects the temperature of the fuser zone 3 (built-in type)
TH4R	Sub thermistor	Detects the temperature of the fuser zone 4 (built-in type)
TH4F	Sub thermistor	Detects the temperature of the fuser zone 4 (built-in type)
TH52	Sub thermistor	Detects the temperature of the fuser zone 5 (built-in type)
TH62	Sub thermistor	Detects the temperature of the fuser zone 6 (built-in type)
TH31	Sub thermistor	Detects the excursion of the fuser heater (built-in type)
TP1	Thermoswitch	Prevents an abnormal temperature rise of fuser heater (non-contact type)

Figure 3-8 ODF fuser control block diagram

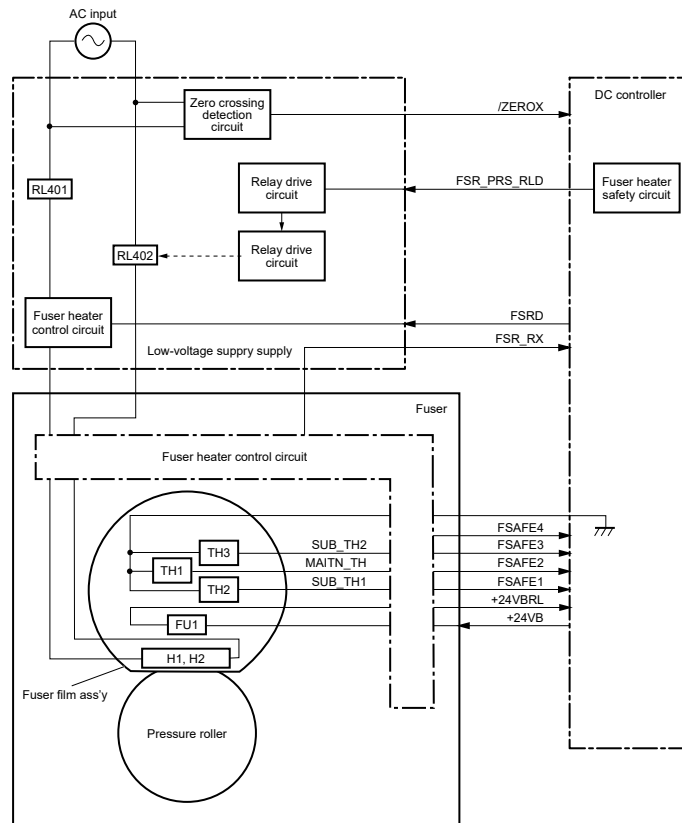
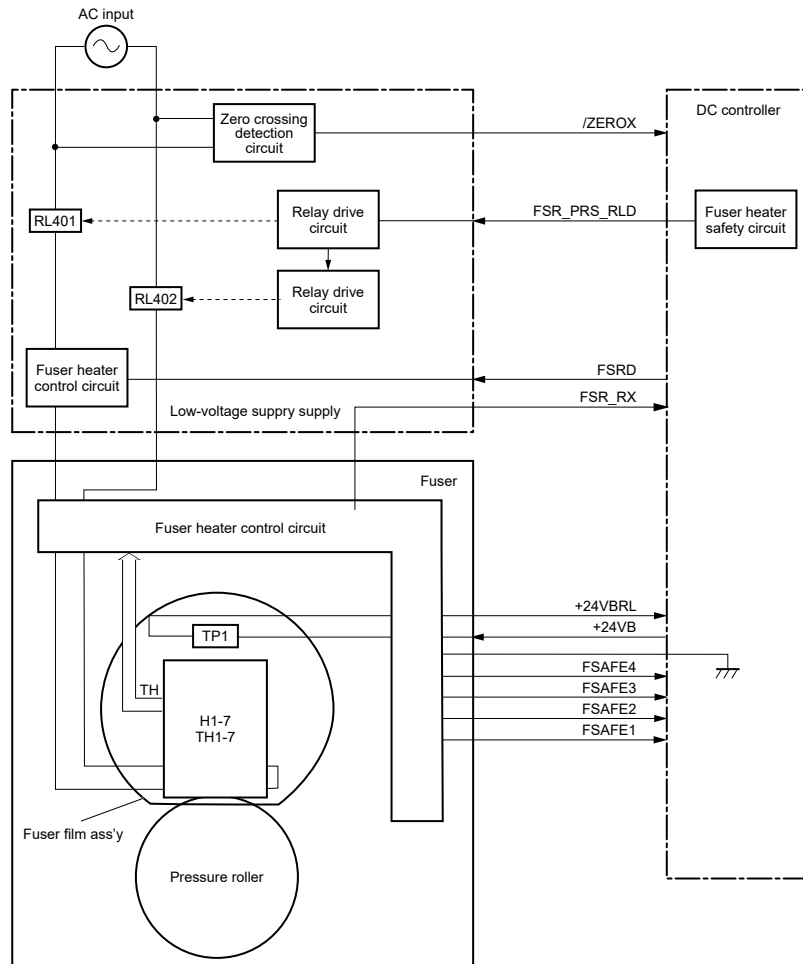


Figure 3-9 A<sup>2</sup>ODF fuser control block diagram



### Fuser heater protection

Learn about fuser heater protection.

The fuser heater protective function detects an excessive temperature rise of the fuser and interrupts power supply to the fuser heater. The printer has the following protective functions to prevent the fuser heater from excessive rising temperature.

- **DC controller:** The DC controller constantly monitors the temperature of the thermistor. The DC controller stops the FUSER HEATER CONTROL signal output and turns off the relays (RL401/RL402) to interrupt power supply to the fuser heater when it detects an excessive temperature.

- **Fuser heater safety circuit:** The fuser heater safety circuit constantly monitors the temperature of the thermistor. The fuser heater safety circuit turns off the relays (RL401/RL402) or the triacs (Q409/Q410/Q411) and the fuser heater control circuit to interrupt power supply to the fuser heater when it detects an excessive temperature. Triac (Q409) corresponds only to the A<sup>2</sup>ODF fuser.
- **Thermal fuse (ODF fuser):** Contact of the thermal fuse opens and it interrupts power supply to the fuser heater when the temperature of the fuser heater is abnormally high.
- **Thermoswitch (A<sup>2</sup>ODF fuser):** The contact of the thermoswitch breaks to interrupt power supply to the fuser heater when the temperature of the fuser heater is abnormally high.

## Fuser control functions

Learn about fuser control functions.

The printer has the following fuser control functions.

**Table 3-9 Fuser control functions**

Function	Supported feature
Fuser temperature control	Yes
Fuser failure detection	Yes
Frequency detection circuit failure detection	Yes
Fuser pressure release mechanism failure detection	Yes
Fuser type discrepancy detection	Yes
Fuser type identification detection	No
Fuser presence detection	Yes
Fuser life detection	Yes
Relay failure detection	No
Pressure roller cleaning	Yes

## Engine laser/scanner system

Learn about the engine laser/scanner system.

The DC controller controls the laser scanner system by following the instruction from the formatter. The DC controller formats the latent electrostatic image on the surface of photosensitive drum by controlling the components of the laser scanner system as dictated by the VIDEO signals.

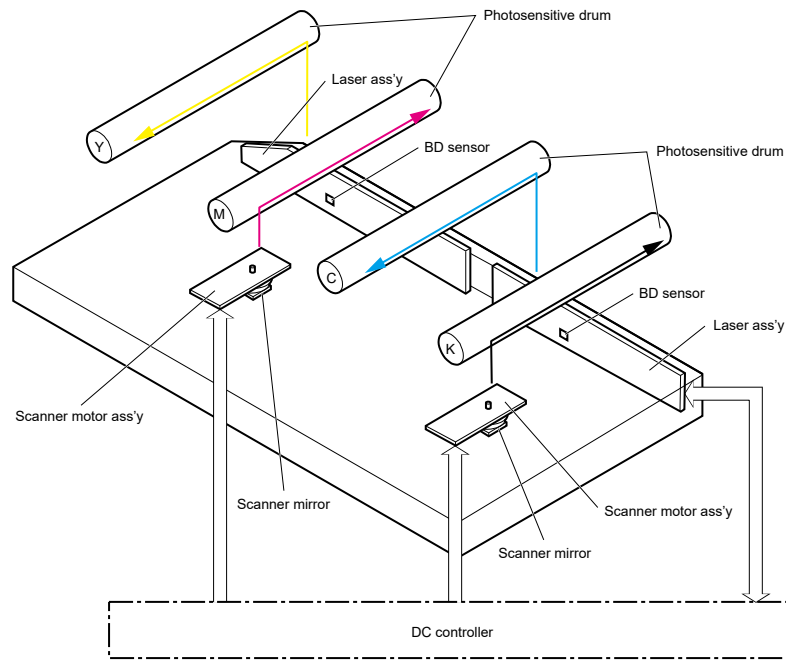
The main components of the image-formation system are as follows:

- Laser assembly
- Scanner motor assembly
- Beam detect (BD) sensor
- Scanner mirror



**NOTE:** The printer has one laser scanner assembly each for yellow, magenta, cyan, and black.

**Figure 3-10 Laser scanner system**



## Laser scanner failure detection

Learn about laser scanner failure detection functions.

The DC controller detects the following laser scanner failures.

**Table 3-10 Laser scanner failure detection**

Function	Supported feature
BD failure detection	No
Scanner motor start-up failure detection	Yes
Scanner motor rotational failure detection	Yes
Laser scanner failure detection	No

## Laser scanner safety

Learn about laser scanner safety.

The printer has door interlock switches. In the case that one of the following doors opens, the interlock switches stop output to the laser for the user or service technician's safety.

- Front door



- Right door

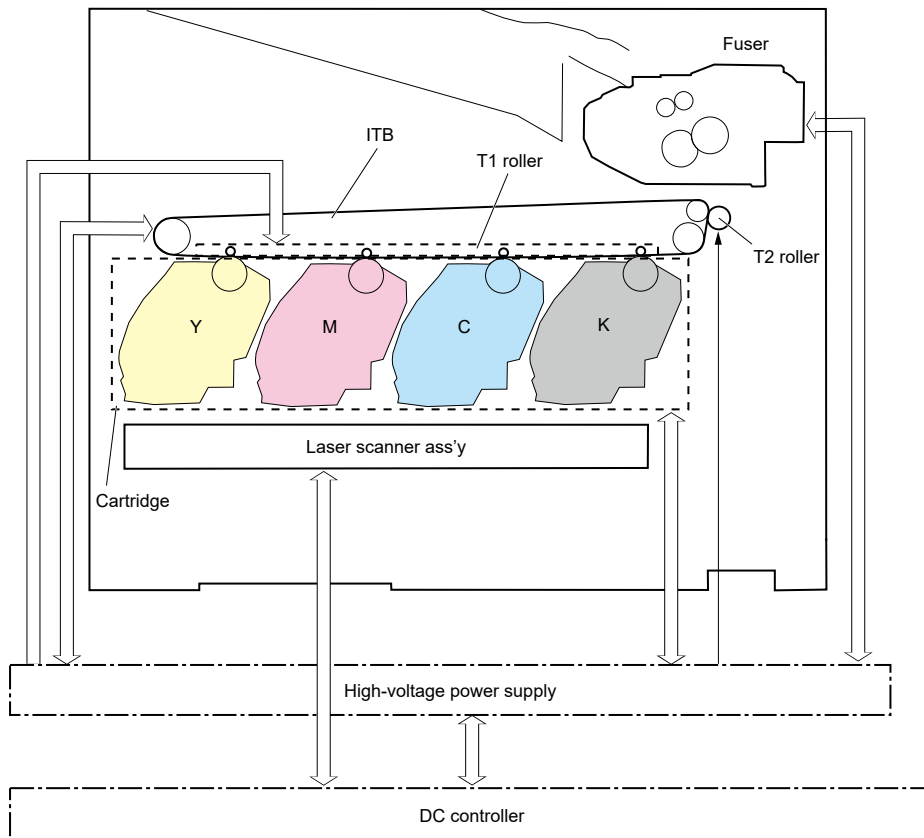
## Image-formation process

Learn about the image-formation process.

The DC controller controls the image-formation system according to commands from the formatter. The DC controller controls the internal components of the image-formation system to form the toner image on the photosensitive drum surface. The toner image is then transferred to the print media and fused. The system consists of the following components:

- Toner cartridges
- Intermediate Transfer Belt (ITB)
- Primary transfer (T1) roller
- Secondary transfer (T2) roller
- Fuser
- Laser scanner assembly
- High-voltage power supply

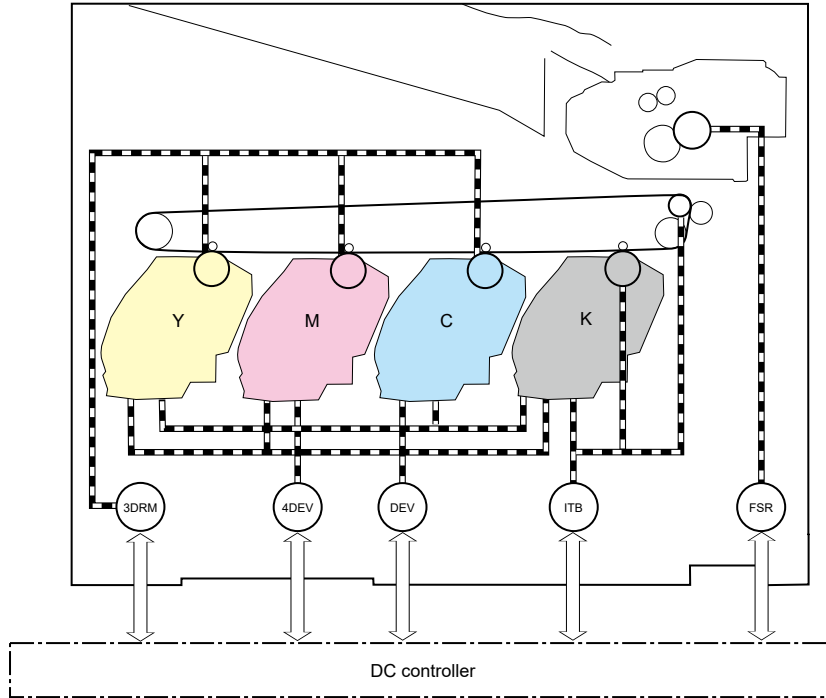
**Figure 3-11 Image-formation system**



## Image-formation system motors

The following figure shows the motors for the image-formation system.

**Figure 3-12 Image-formation system motors**



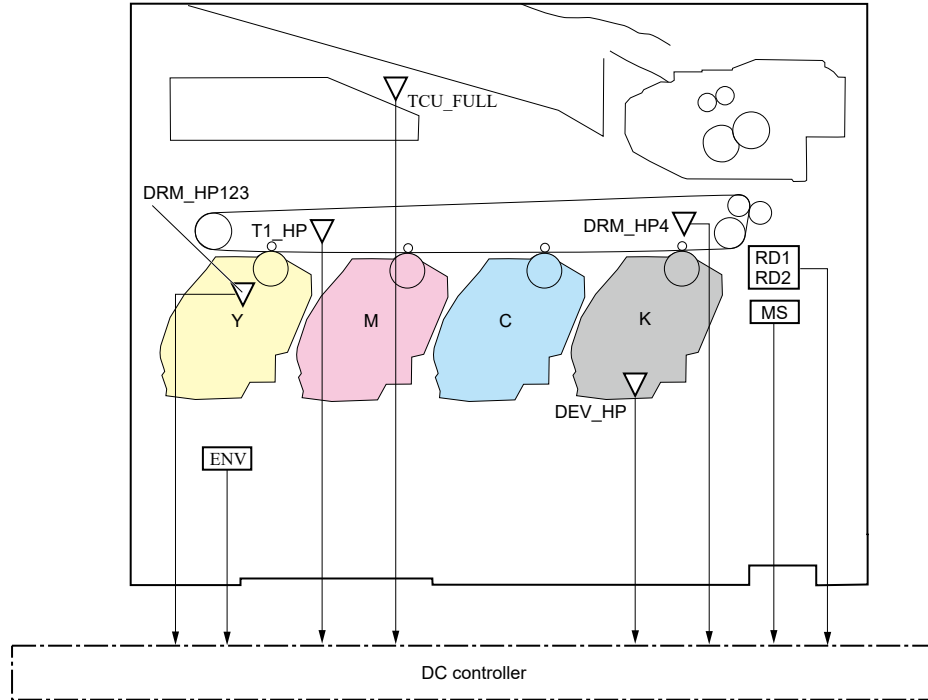
**Table 3-11 Image-formation system motors**

Item	Abbreviation	Component
4DEV	4DEV_MTR	Developer motor
3DRM	3DRM_MTR	Drum motor
ITB	ITB_MTR	ITB motor
FSR	FSR_MTR	Fuser motor
DEV	DEV_MTR	Developer alienation motor

### Image-formation system sensors

The following figure shows the sensors for the image-formation system.

**Figure 3-13 Image-formation system sensors**




**Table 3-12 Image-formation system sensors**

Item	Abbreviation	Name
DRM_HP123	DRM_HP123_SNS	Drum home position sensor YMC
DRM_HP4	DRM_HP4_SNS	Drum home position sensor K
DEV_HP	DEV_HP_SNS	Developer alienation sensor
TCU_FULL	TCU_FULL_SNS	ITB toner collection near full sensor
T1_HP	T1_HP_SNS	ITB alienation sensor
MS	- (Media sensor PCA)	Media sensor
RD1	- (RD sensor PCA)	Registration density sensor 1
RD2	- (RD sensor PCA)	Registration density sensor 2
ENV	ENV_SNS	Environment sensor

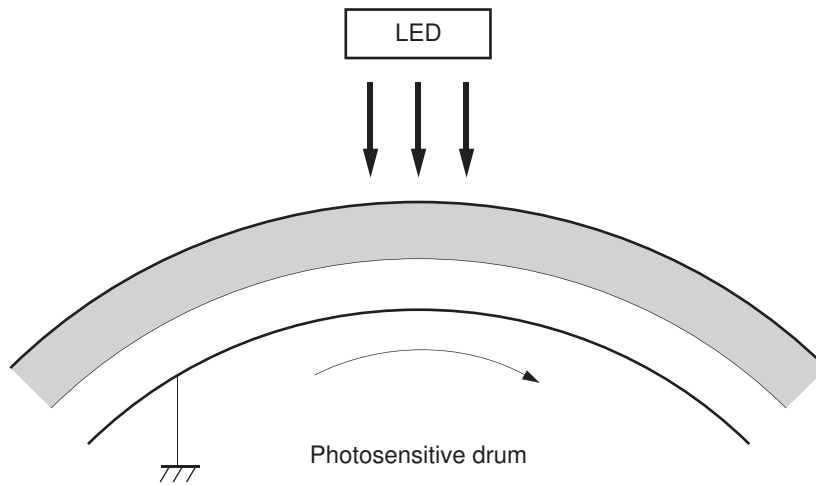
**Step 1: Pre-exposure (X654/X677 models only)**

Learn about the image formation pre-exposure step.

 **NOTE:** This step applies to the X654/X677 models only.

Light from the pre-exposure LED strikes the surface of the photosensitive drum to remove any residual electrical charges from the drum surface.

**Figure 3-14 Pre-exposure**

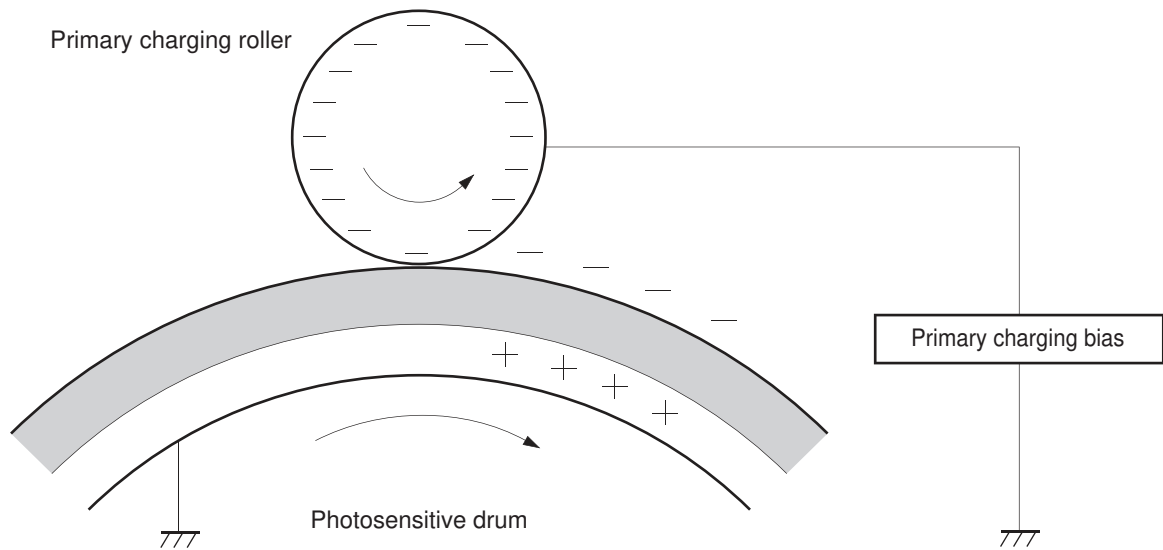


**Step 2: Primary charging**

Learn about the image formation primary charging step.

To prepare for latent image formation, the surface of the photosensitive drum is charged with a uniform negative charge. The primary charging roller receives the primary charging bias, and then the roller charges the drum by direct contact.

**Figure 3-15 Primary charging**

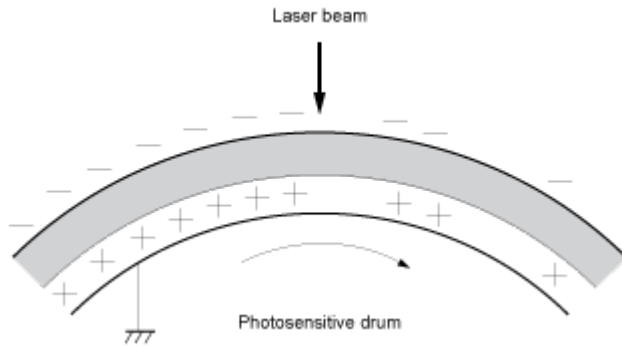


**Step 3: Laser-beam exposure**

Learn about the image formation laser-beam exposure step.

The laser beam strikes the photosensitive drum to neutralize the negative charge on the portions of the drum surface where the image will form. An electrostatic latent image forms where the negative charge was neutralized. The neutralized areas on the drum are ready to accept toner.

**Figure 3-16 Laser-beam exposure**

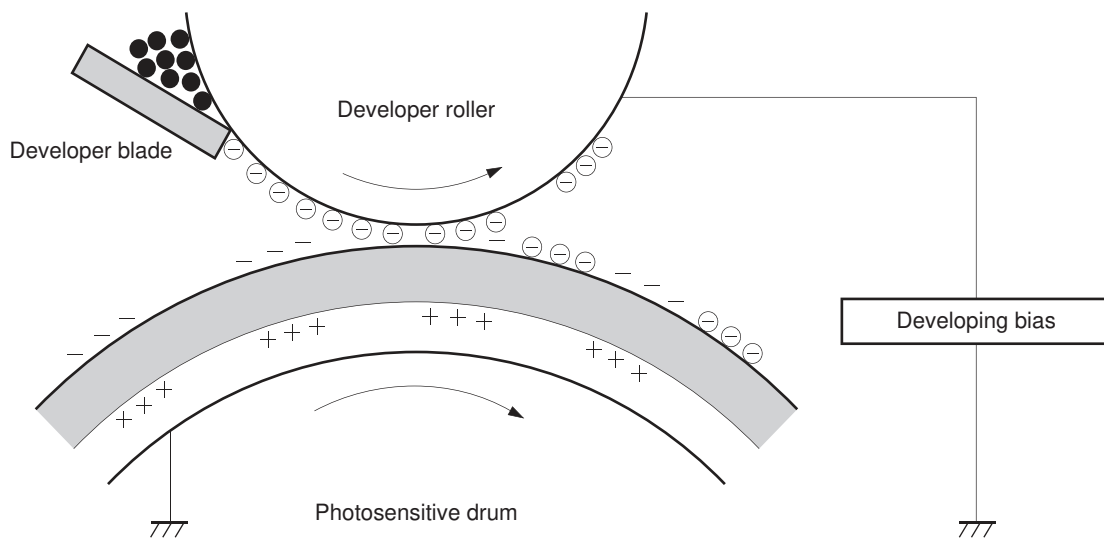


**Step 4: Development**

Learn about the image formation development step.

A developing bias is applied to the developing roller. The toner acquires a negative charge as a result of the friction from the developing roller rotating against the developing blade. Because the negatively charged surface of the photosensitive drums were neutralized where they have been struck by the laser beam, the toner adheres to those areas on the drums. The latent image becomes visible on the surface of the drum.

**Figure 3-17 Development**

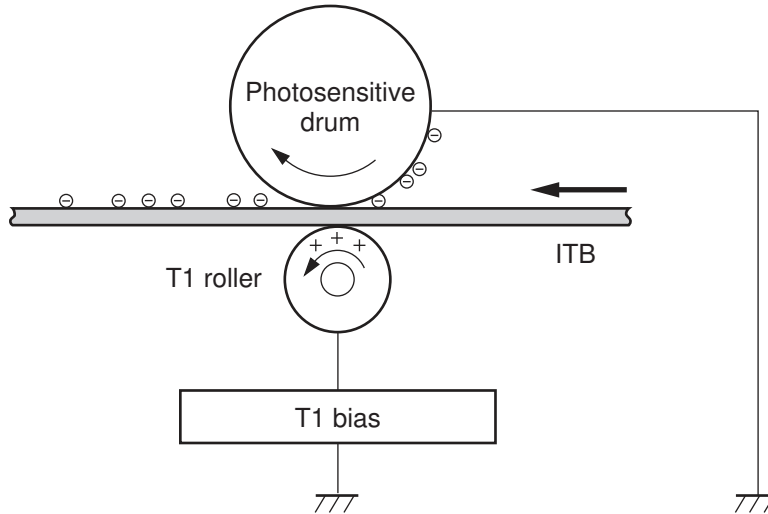


**Step 5: Primary transfer**

Learn about the image formation primary transfer step.

The toner on the photosensitive drum is transferred to the ITB. T1 bias is applied to the T1 roller to charge the ITB positive. The ITB attracts the negatively charged toner from the surface of each photosensitive drum. The complete toner image forms on the ITB.

**Figure 3-18 Primary transfer**

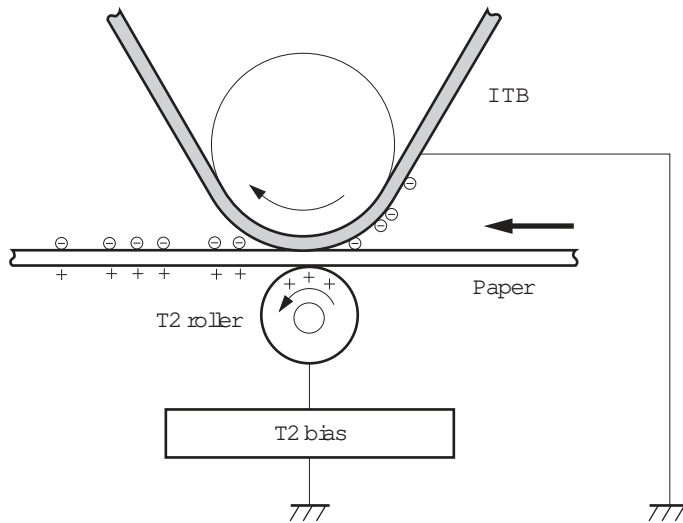


**Step 6: Secondary transfer**

Learn about the image formation secondary transfer step.

The paper acquires a positive charge from the secondary-transfer roller, and attracts the negatively charged toner from the surface of the ITB. The complete toner image transfers onto the paper.

**Figure 3-19 Secondary transfer**

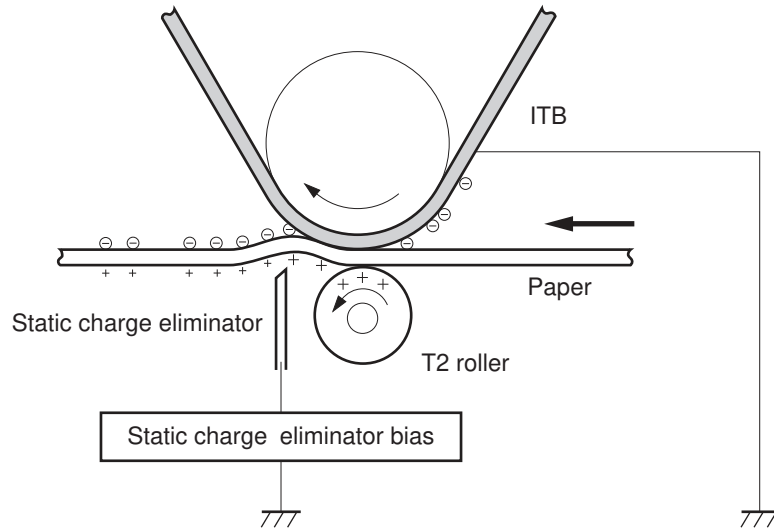


**Step 7: Separation**

Learn about the image formation separation step.

The stiffness of the paper causes it to separate from the ITB as the ITB bends. The static-charge eliminator removes excess charge from the paper for stable paper feeding and print quality.

**Figure 3-20 Separation**

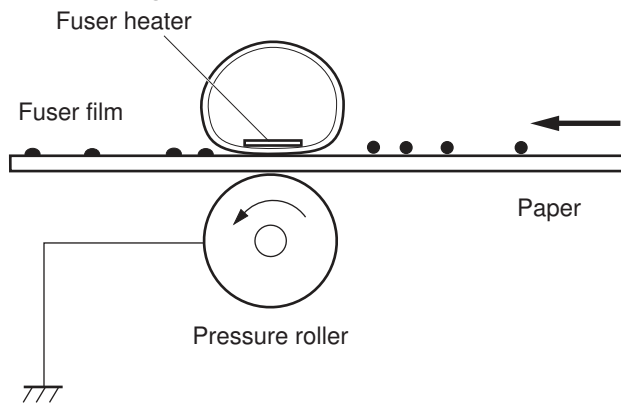


### Step 8: Fusing

Learn about the image formation fusing step.

The printer uses an on-demand fusing method to adhere the toner image onto the page. As the page passes through the heated and pressurized rollers in the fuser the toner melts onto the page. The toner image is now permanently fused to the page. A fusing bias applied to the pressure roller improves image quality.

**Figure 3-21 Fusing**



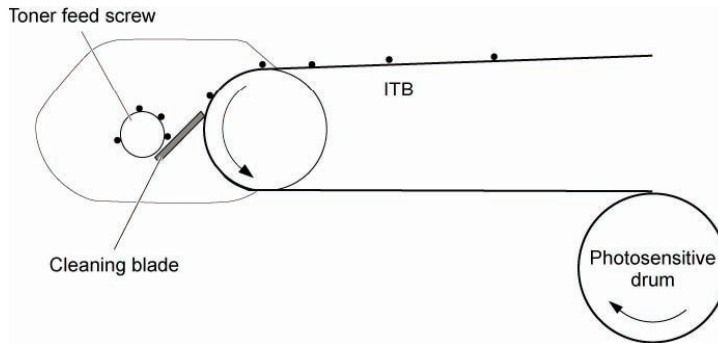
### Step 9: ITB cleaning

Learn about the image formation ITB cleaning step.

ITB cleaning process is to remove the residual toner on the ITB surface.

The residual toner is scraped off by the cleaning blade and then collected into the toner collection box ass'y by the toner feed screw.

**Figure 3-22 ITB cleaning**



## Toner cartridges

Learn about the toner cartridges.

The following sections discuss the printer toner cartridges. The printer has four toner cartridges, one for each color: cyan, magenta, yellow, and black.

## Design

Learn about toner cartridge design.

Each toner cartridge is filled with toner and consists of the following components:

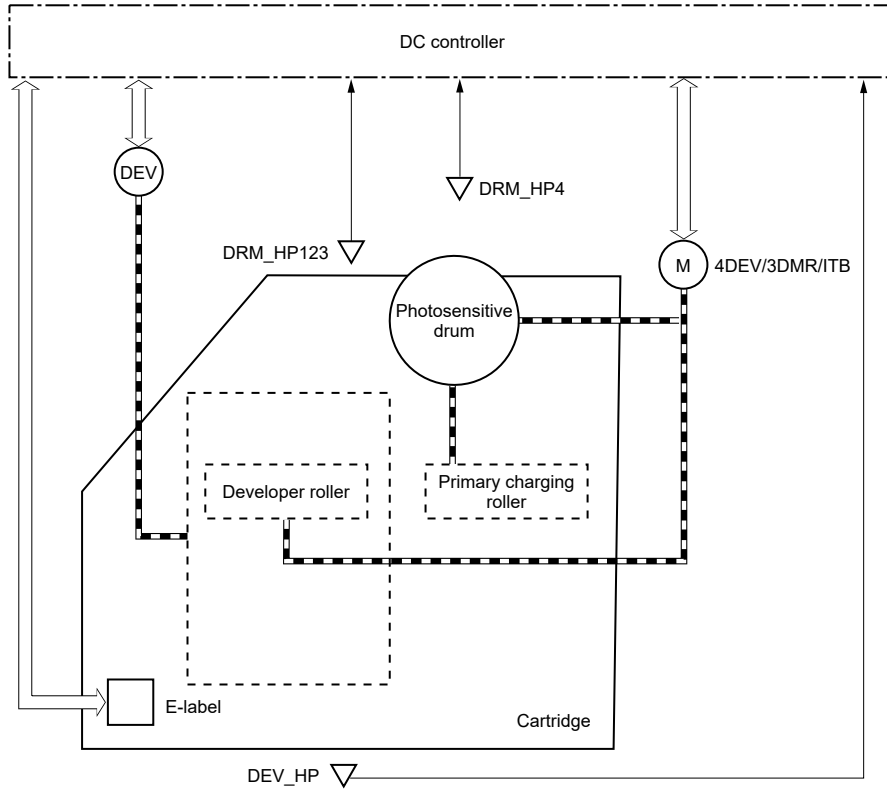
- Photosensitive drum
- Developer
- Primary-charging roller
- Memory chip

The printer has four cartridges, one for each color: yellow, magenta, cyan and black. Each of them has the same structure

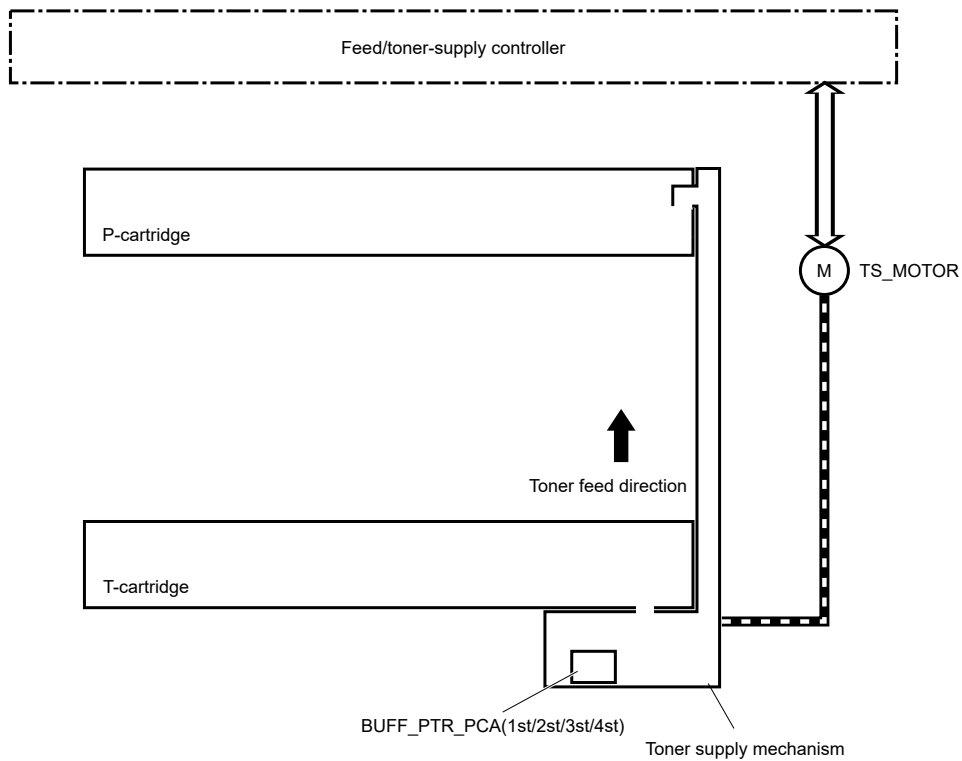
The X654/X677 models have two cartridge types: four (YMCK) toner cartridges and four imaging drums (YMCK).



Figure 3-23 Standard toner cartridge block diagram



**Figure 3-24 Toner cartridge and imaging drum block diagram**



### Toner cartridge functions

Learn about toner cartridge functions.

The printer has the following cartridge functions.

**Table 3-13 Cartridge functions**

Function	Supported feature
Cartridge presence detection (not applicable to T-cartridges)	Yes
Toner level detection	Yes
Cartridge life detection	Yes
Cartridge misinstallation detection	Yes
Developer alienation control	Yes
Developer alienation motor failure detection	Yes
Drum discharge mechanism	No

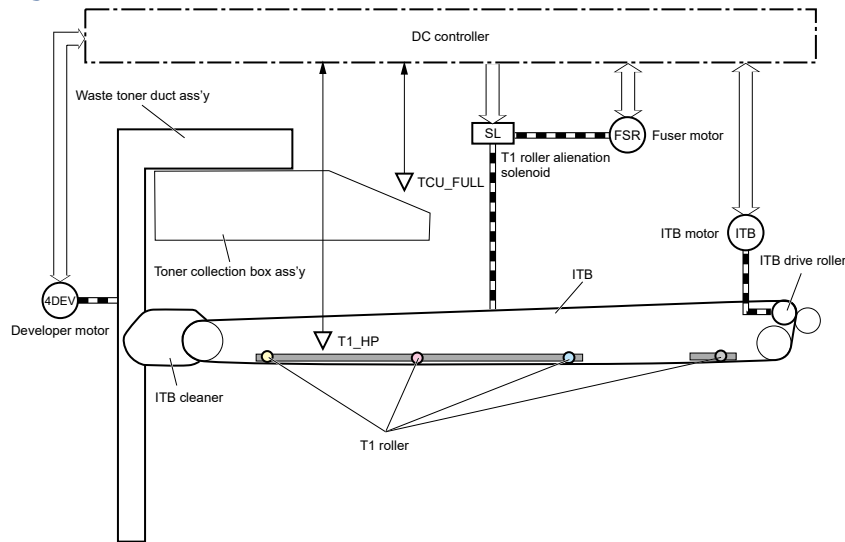
### Intermediate transfer belt assembly

Learn about the intermediate transfer belt (ITB) assembly.

The ITB unit accepts the toner images from the photosensitive drums and transfers the completed image to the paper. The ITB unit has the following main components:

- Intermediate transfer belt (ITB)
- ITB-drive roller
- Primary-transfer roller
- ITB cleaner

**Figure 3-25 ITB unit**



### Intermediate transfer belt (ITB) functions

Learn about intermediate transfer belt functions.

The printer has the following ITB assembly functions.

**Table 3-14 Intermediate transfer belt functions**

Function	Supported feature
T1 roller alienation control	Yes
T1 roller alienation mechanism failure detection	Yes
ITB assembly life detection	Yes
ITB assembly presence detection	No
Blade cleaning mechanism	Yes
Electrostatic cleaning mechanism	No
ITB toner collection box full detection	No
ITB toner collection box presence detection	No
ITB perimeter detection	Yes
ITB seal detection sensor failure detection	No
New ITB detection	Yes
ITB cleaning mechanism	No

**Table 3-14 Intermediate transfer belt functions (continued)**

Function	Supported feature
Toner collection box full detection	Yes
Toner collection box presence detection	No

## Secondary transfer roller assembly

Learn about the secondary transfer roller assembly.

The secondary transfer roller assembly transfers the toner image on the ITB to the paper.

### Secondary transfer roller functions

Learn about secondary transfer roller functions.

The printer has the following secondary transfer roller functions.

**Table 3-15 Secondary transfer roller functions**

Function	Supported feature
Secondary transfer roller cleaning mechanism	Yes
Secondary transfer roller presence detection	No
Secondary transfer roller life detection	Yes
Secondary transfer roller alienation control	Yes

## Calibration

Learn about the printer calibration process.

The printer calibrates itself to maintain proper print-quality. The calibration corrects color-misregistration and color-density variation due to environmental changes or internal variation in the printer.

### Calibration functions

Learn about color calibration functions.

The printer has the following calibration functions.

**Table 3-16 Calibration functions**

Function	Supported feature
Color-plane registration correction control	Yes
Environment correction control	Yes
Image density control (DMAX)	Yes
Image halftone control (DHALF)	Yes
Registration density sensor failure detection	Yes
Color sensor control	No
Gray axis control (GAS)	No

**Table 3-16 Calibration functions (continued)**

Function	Supported feature
Environment sensor failure detection	Yes

## Engine pickup, feed, and delivery system

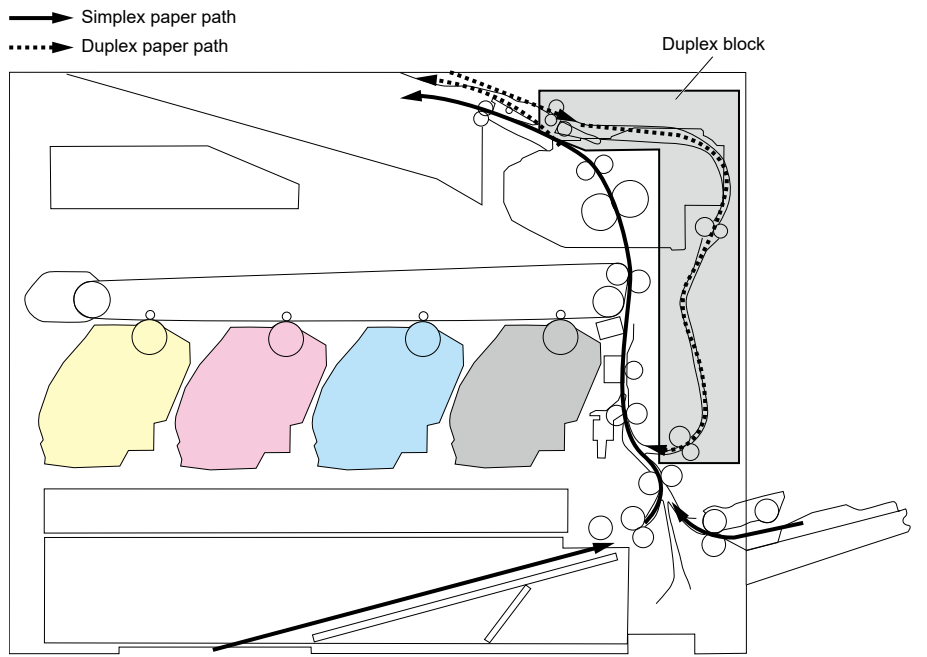
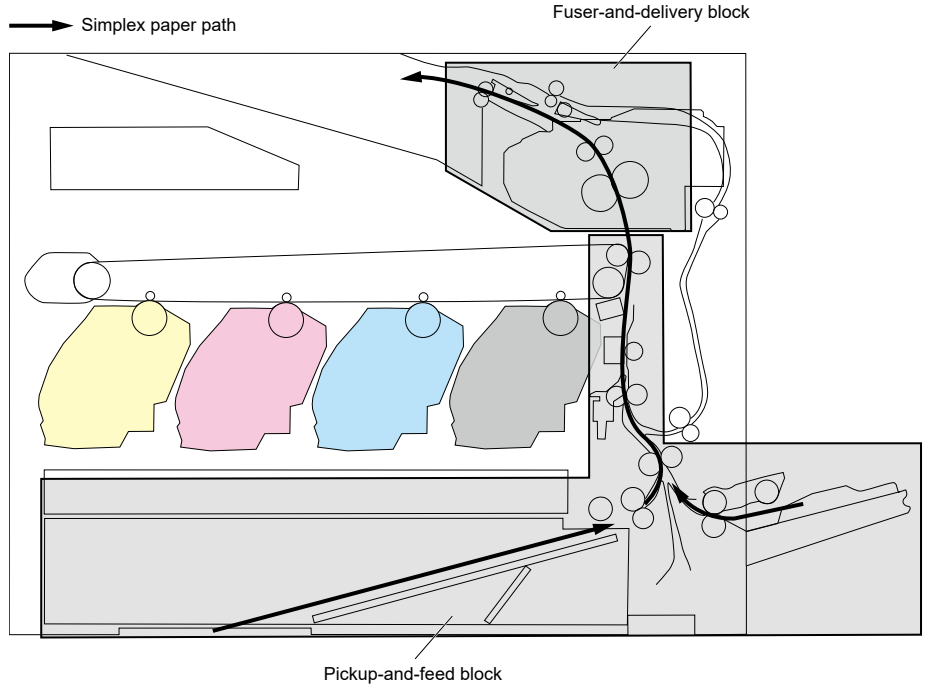
Learn about the printer pickup, feed, and delivery system.

The DC controller controls the pickup, feed, and delivery system according to commands from the formatter. The pickup, feed, and delivery system uses a series of rollers to move the paper through the printer.

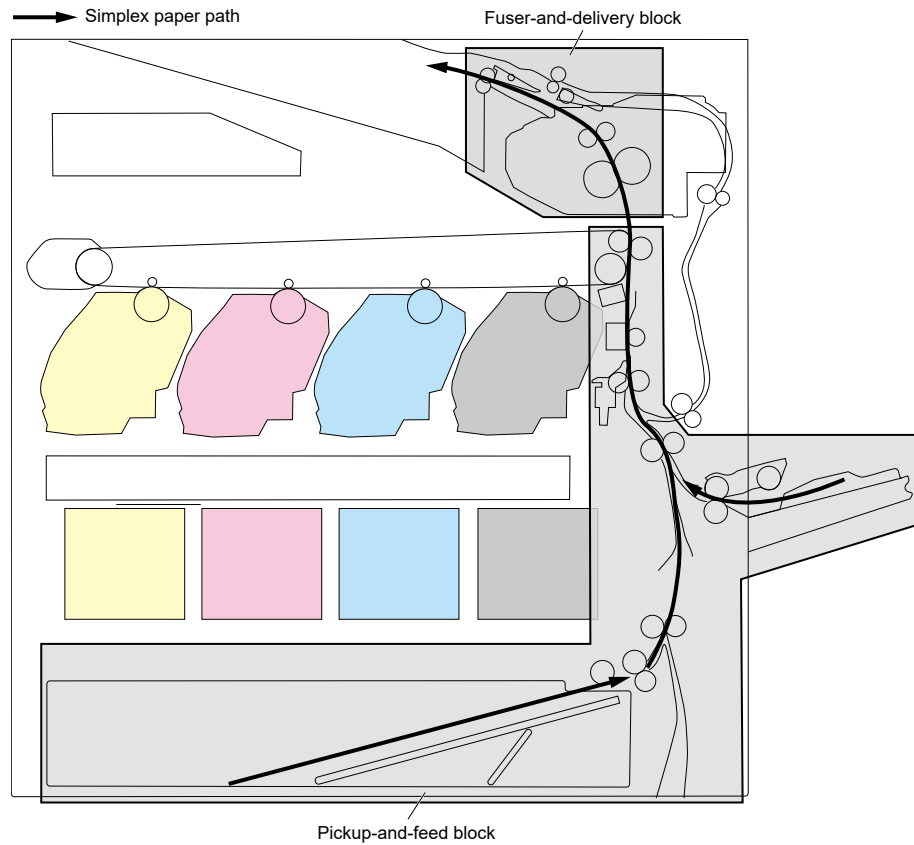
The pickup, feed, and delivery system consists of the following three functional blocks.

- **Pickup-and-feed-block:** Controls the movement of the paper from each pickup source to the fuser inlet
- **Fuser-and-delivery-block:** Controls the movement of the paper from the fuser to the delivery destination
- **Duplex block:** Controls the movement of the paper from the duplex switchback unit to the duplex re-pickup unit

**Figure 3-26 Engine pickup, feed, and delivery system (6700/6800 models)**



**Figure 3-27 Engine pickup, feed, and delivery system (X654/X677 models)**

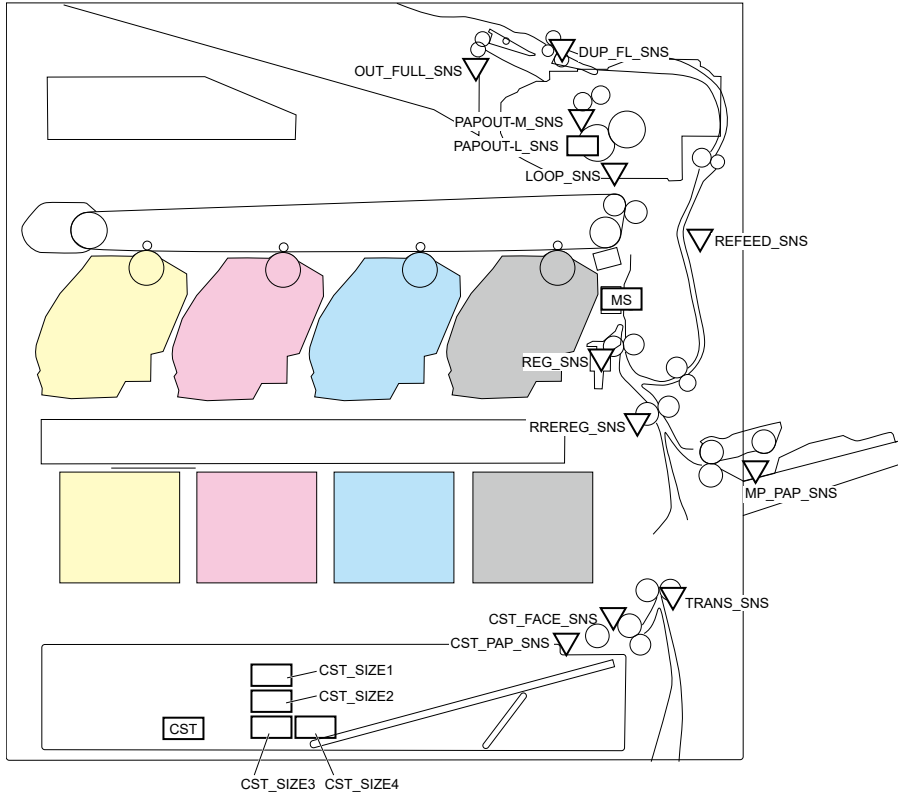


### Sensors and switches

Learn about the pickup, feed, and delivery sensors and switches.

The following figure shows the sensors and switches for the pickup, feed, and delivery system.

**Figure 3-28 Photo sensors and switches**



**Table 3-17 Photo sensors and switches**

Abbreviation	Component
CST_SIZE1	Tray 2 media size switch 1
CST_SIZE2	Tray 2 media size switch 2
CST_SIZE3	Tray 2 media size switch 3
CST_SIZE4	Tray 2 media size switch 4
DUP_FL_SNS	Duplex flapper position sensor
OUT_FULL_SNS	FD1 media full sensor
CST_PAP_SNS	Tray 2 media out sensor
CST_FACE_SNS	Tray 2 media surface sensor
LOOP_SNS	Fuser loop sensor
REFEED_SNS	Duplex feed sensor
REG_SNS	Registration sensor
RRREG_SNS	Pre-registration sensor
MP_PAP_SNS	Tray 1 media out sensor
PAYOUT-M_SNS	Fuser output sensor 2
TRANS_SNS	Tray 2 feed sensor (X654/X677 models only)
MS (Media sensor PCA)	Media sensor



**Table 3-17 Photo sensors and switches (continued)**

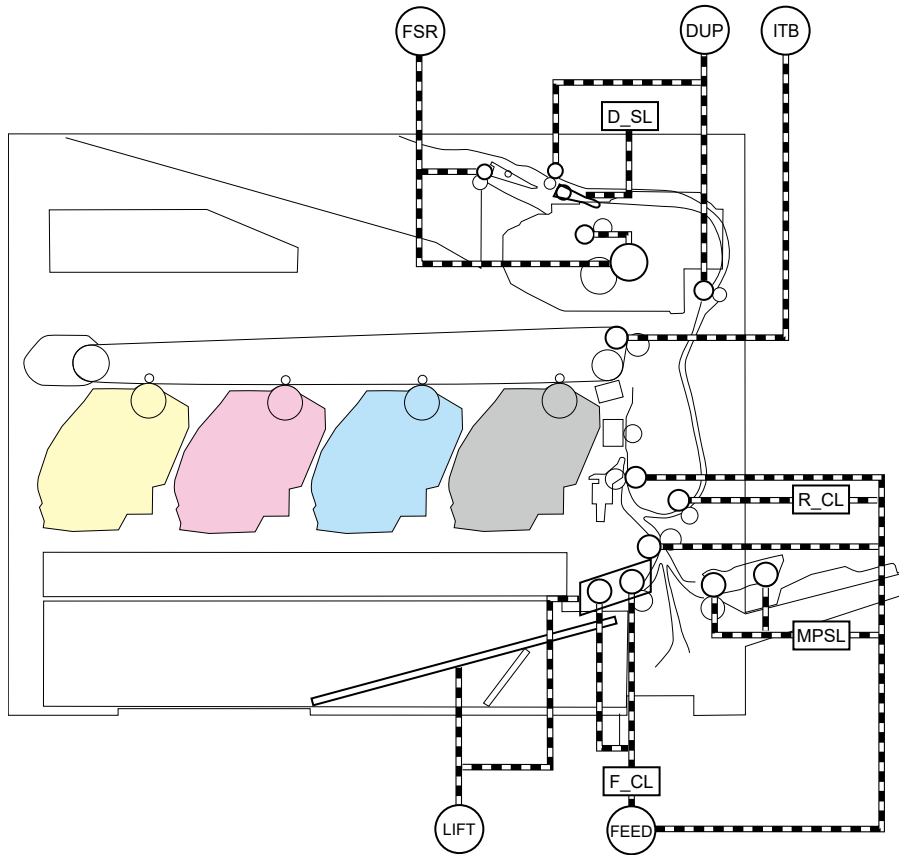
Abbreviation	Component
PAPOUT-L_SNS	Fuser output sensor 1

## Motors, clutches, and solenoids

Learn about the pickup, feed, and delivery motors, clutches, and solenoids.

The following figure shows the motors, clutches, and solenoids for the pickup, feed, and delivery system.

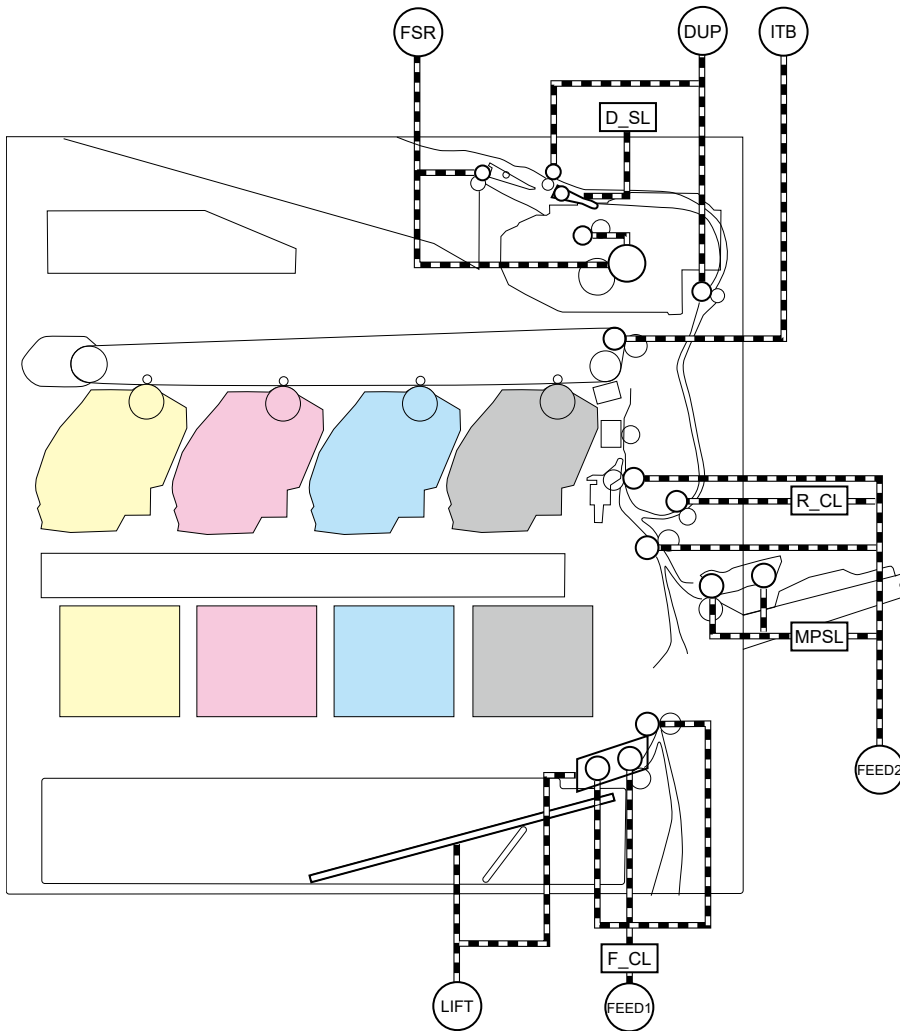
**Figure 3-29 Motors, clutches, and solenoids (6700/6800 models)**



Abbreviation 1	Abbreviation 2	Component
ITB	ITB_BK_MTR	ITB motor
FSR	FSR_MTR	Fuser motor
FEED	FEED_MTR	Pickup motor
LEFT	LIFT_MTR	Lifter motor
DUP	DUP_MTR	Duplex motor
MPSL	MP-SL	Tray 1 pickup solenoid
D_SL	DUP_SL	Duplex flapper solenoid
F_CL	FEED_CL	Tray 2 pickup clutch

Abbreviation 1	Abbreviation 2	Component
R_CL	REFEED_CL	Duplex re-pickup clutch

**Figure 3-30 Motors, clutches, and solenoids (X654/X677 models)**



Abbreviation 1	Abbreviation 2	Component
ITB	ITB_BK_MTR	ITB motor
FSR	FSR_MTR	Fuser motor
FEED1	FEED_MTR	Pickup motor
FEED2	FEED_MTR	Feed motor
LEFT	LIFT_MTR	Lifter motor
DUP	DUP_MTR	Duplex motor
MPSL	MP-SL	Tray 1 pickup solenoid
D_SL	DUP_SL	Duplex flapper solenoid
F_CL	FEED_CL	Tray 2 pickup clutch

Abbreviation 1	Abbreviation 2	Component
R_CL	REFEED_CL	Duplex re-pickup clutch

## Feed speed control

Learn about pickup, feed, and delivery feed speed control.

The DC controller adjusts the feed speed to improve the print quality depending on the paper type. The paper is fed at a specified speed according to the print mode designated by the formatter.

**Table 3-18 Print mode and feed speed**

Print mode	Feed speed, monochrome	Feed speed, full color
Auto	2/3/4/5	2/3/4/5
Normal media 1	2/3/4	2/3/4
Normal media 2	2/3/4	2/3/4
Heavy media 1	3/4	3/4
Heavy media 2	3/5	3/5
Heavy media 3	4/5	4/5
Light media 1	2/3	2/3
Light media 2	2/3	2/3
Light media 3	2/3	2/3
Glossy media 1	5	5
Glossy media 2	5	5
Glossy media 3	5	5
Glossy film	5	5
Photo media 1	Not applicable	Not applicable
Photo media 2	Not applicable	Not applicable
Photo media 3	Not applicable	Not applicable
Envelope	3/4	3/4
OHT	5	5
Extra light media	3	3
Label	3/4	3/4
Designated media 1	3/4	3/4
Designated media 2	4/5	4/5
Designated media 3	3	3

## Pickup and feed delivery features

Learn about pickup, feed, and delivery print mode and feed speed features.

The printer has the following pickup, feed and delivery functions.

**Table 3-19 Print mode and feed speed**

Function	Supported feature
Cassette (Tray 2) media size detection	Yes
Cassette (Tray 2) presence detection	Yes
Cassette (Tray 2) media surface detection	Yes
Cassette (Tray 2) media presence detection	Yes
Cassette (Tray 2) media level detection	Yes
Cassette (Tray 2) lift-up control	Yes
Cassette (Tray 2) lift-down control	Yes
Cassette (Tray 2) multiple-feed prevention mechanism	No
Cassette (Tray 2) pickup roller presence detection	Yes
Cassette (Tray 2) pickup roller alienation detection	Yes
Tray 1 (MP) tray media presence detection	Yes
Tray 1 (MP) tray media width detection	No
Tray 1 (MP) tray last-media detection	No
Skew-feed prevention mechanism	Yes
Feed speed control	Yes
Loop control	Yes
Media detection	Yes
OHT detection	Yes
Image leading edge positioning	Yes
Media length detection	No
Media width detection	Yes
Pressure roller pressure release control	Yes
Output bin media-full detection	Yes
Automatic delivery	Yes
Duplex switchback control	Yes
Duplex feed control	Yes

## Media detection

Learn about pickup, feed, and delivery media detection.

The printer is equipped with media sensor on paper path, and can detect media type fed. The media sensor consists of an optical sensor which detects surface roughness and ultrasonic sensor which detects paper weight, and the distance between the optical sensor and the print media is kept constant by roller.

The DC controller detects media type using the media sensor and switches to an optimized print mode for the media, if Auto mode is designated from the formatter and media type for the specified input source is not designated from the formatter.

The followings are print modes that can be switched for media detection.

- Normal
- Heavy media 1
- Heavy media 2
- Heavy media 3
- Light media
- Glossy media 1
- Glossy media 2
- Glossy media 3
- Rough media
- OHT
- Glossy film

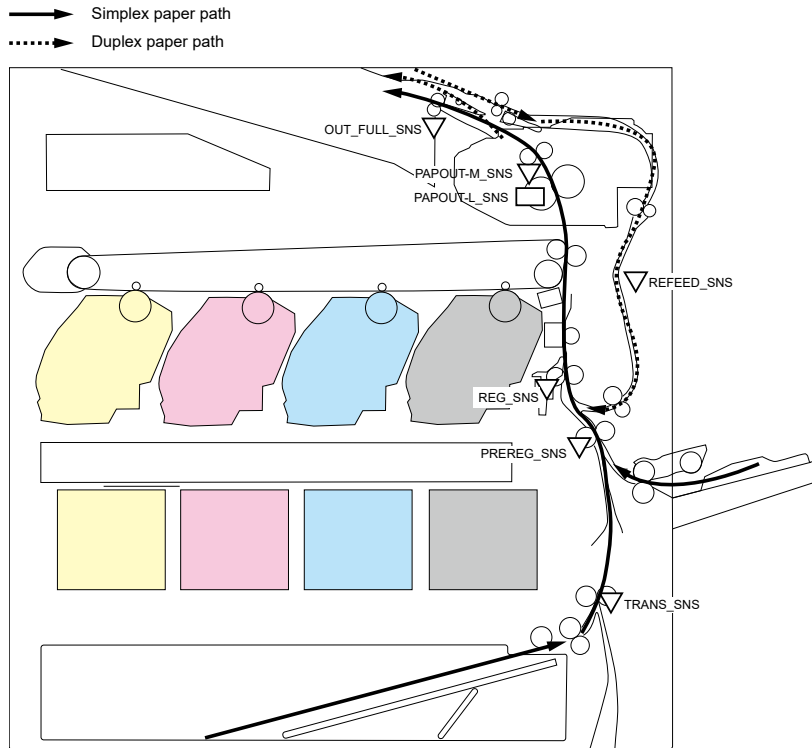
## Jam detection/prevention

Learn about pickup, feed, and delivery jam detection.

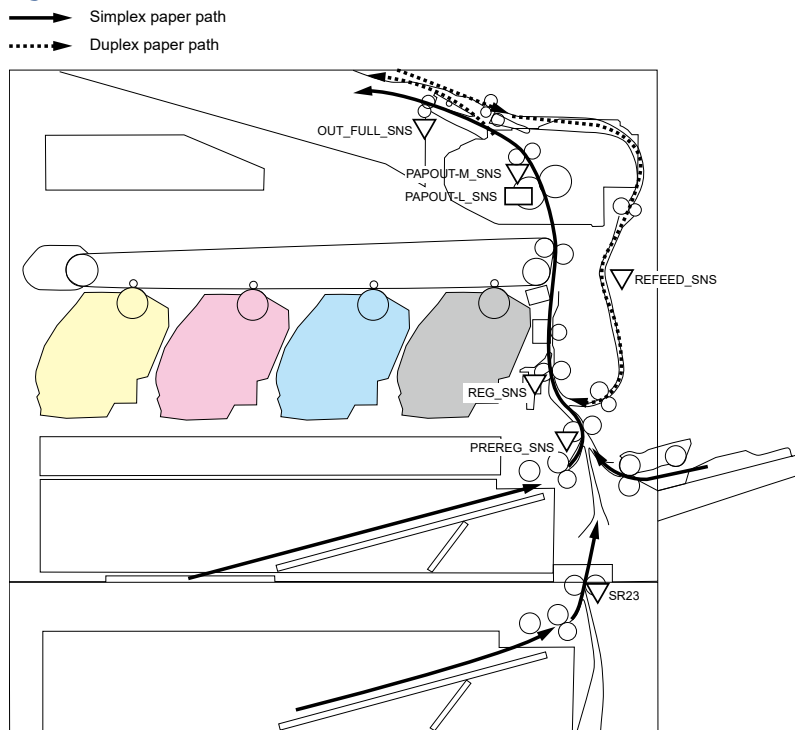
The printer uses the following sensors to detect the presence of paper and to check whether paper is being fed correctly or has jammed.

- Pre-registration sensor (PREREG\_SNS)
- Registration sensor (REG\_SNS)
- Fuser output sensor 1 (PAPOUT-L\_SNS)
- Fuser output sensor 2 (PAPOUT-M\_SNS)
- Fuser loop sensor (LOOP\_SNS)
- FD1 media full sensor (OUT\_FULL\_SNS)
- Duplex feed sensor (REFEED\_SNS)
- Tray 2 feed sensor (TRANS\_SNS) (X654/X677 models models only)
- PF feed sensor (PS23) (550-sheet paper feeder only)
- HCI feed sensor (SR4) (HCI only)

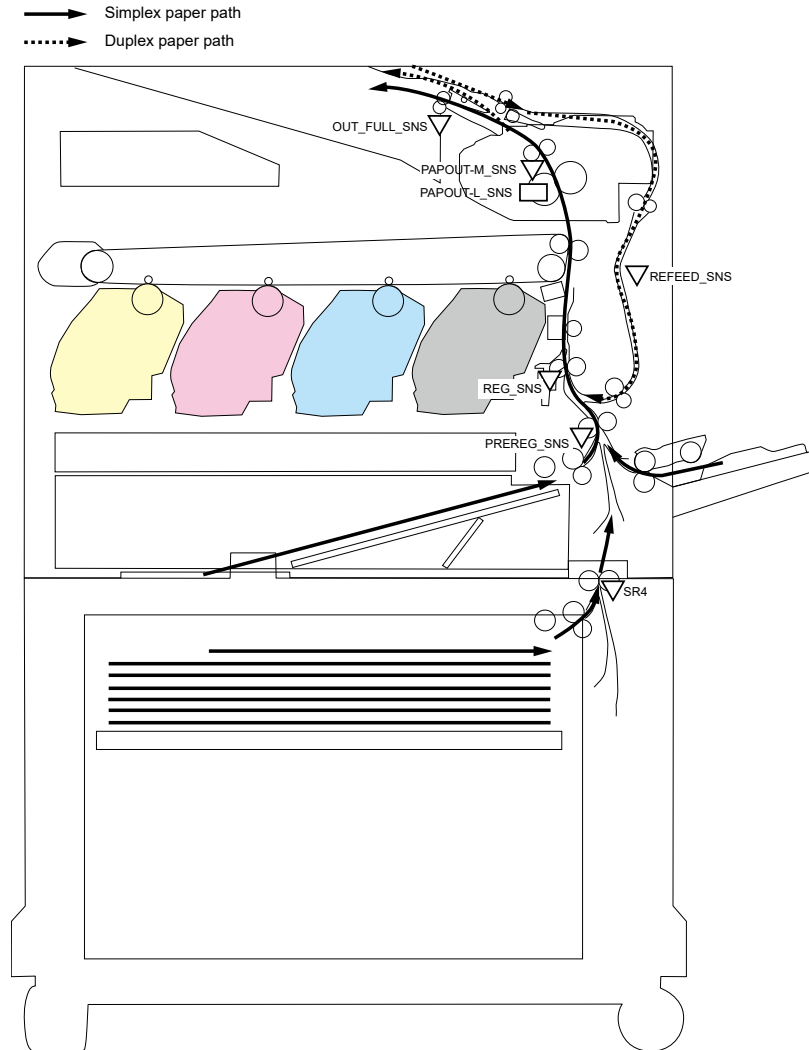
**Figure 3-31 Jam detection sensors (X654/X677 models models)**



**Figure 3-32 Jam detection sensors (6700/6800 models models and 550-sheet paper feeder)**



**Figure 3-33 Jam detection sensors (6700/6800 models models and HCI)**



The printer determines that a jam has occurred if one of these sensors detects paper at an inappropriate time. The DC controller stops the print operation and notifies the formatter.

The printer detects the following jams:

- No pick jam 1
- No pick jam 2
- No pick jam 3
- Pickup stay jam 1
- Fuser delivery delay jam 1
- Fuser delivery delay jam 2
- Fuser delivery stay jam 1
- Fuser delivery stay jam 2
- Residual paper jam 1

- Door open jam 1
- Fuser wrap jam 1
- Fuser wrap jam 2
- Duplex feed delay jam
- Duplex re-pickup delay jam
- Delivery delay jam 1
- Inappropriate to the delivery path jam 2
- Transfer area wrapping jam

## Input devices

Learn about the input devices.

### 550-sheet paper feeder

Learn about the 550-sheet paper feeder (Tray 3).

The 550-sheet paper feeder is installed at bottom of the printer. It picks up the print media and feeds it to the printer. The paper feeder controller controls the operational sequence of the paper feeder.

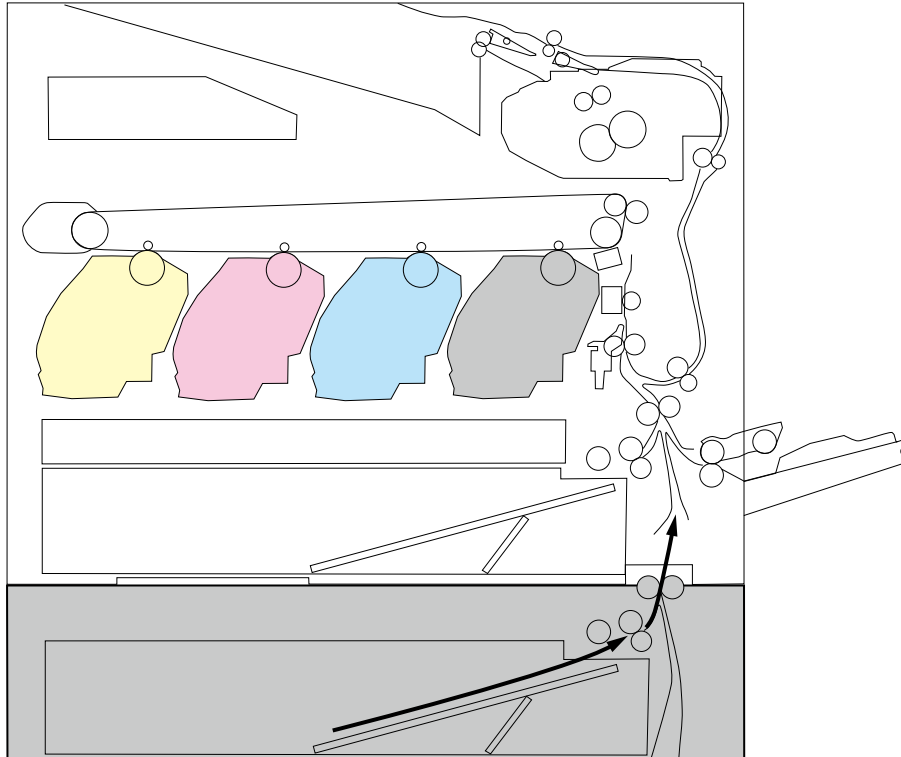
### 550-sheet paper feeder paper path

Learn about the 550-sheet paper feeder paper path.

The figure below shows the 550-sheet paper feeder paper path.



**Figure 3-34 550-sheet paper feeder paper path**

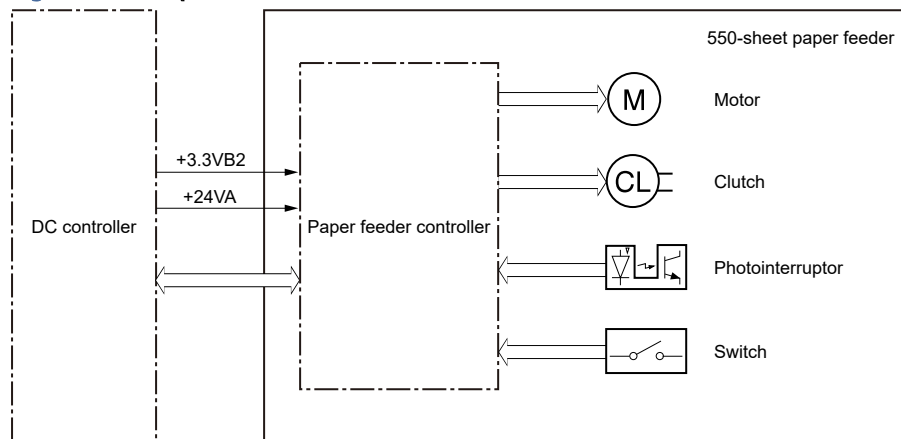


### Paper feeder controller

Learn about the paper feeder controller.

The figure below shows the paper feeder controller block diagram.

**Figure 3-35 Paper feeder controller**

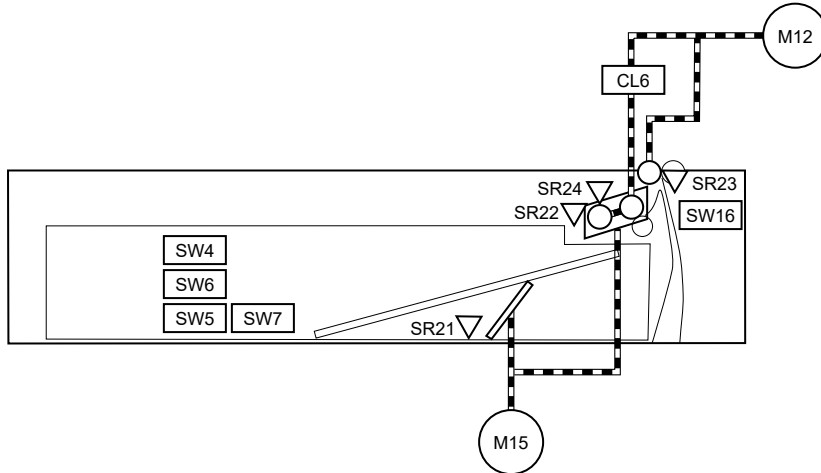


### 550-sheet paper feeder electrical components

Learn about the 550-sheet paper feeder electrical components.

The figure below shows the paper feeder electrical components. The table in this section describes the paper feeder electrical components.

**Figure 3-36 Paper feeder electrical components**



**Table 3-20 Electrical component list, paper feeder**

Component type	Abbreviation	Component name
Motor	M12	Paper feeder feed motor
Motor	M15	Paper feeder lifter motor
Clutch	CL6	Paper feeder pickup clutch
Switch	SW4	Paper feeder media size switch 1
Switch	SW5	Paper feeder media size switch 2
Switch	SW6	Paper feeder media size switch 3
Switch	SW7	Paper feeder media size switch 4
Switch	SW16	Paper feeder door switch
Photo interrupter	SR21	Paper feeder lifter motor rotation sensor
Photo interrupter	SR22	Paper feeder media out sensor
Photo interrupter	SR23	Paper feeder feed sensor
Photo interrupter	SR24	Paper feeder media surface sensor

### 550-sheet paper feeder motor control

The 550-sheet paper feeder has two motors for the paper-feed and cassette lift-up.

The table below describes which components the paper feeder motors drive.

**Table 3-21 Paper feeder motors**

Abbreviation	Component	Drives	Failure detection
M12	Paper feeder feed motor	Paper feeder cassette pickup roller Paper feeder cassette feed roller Paper feeder feed roller	No
M15	Paper feeder lifter motor	Paper feeder cassette lifter drive assembly	No

## 550-sheet paper feeder other functions

Learn about the other paper feeder pickup and feed functions.

The paper feeder has the following pickup and feed functions.

- Cassette lift-up control
- Cassette presence detection
- Cassette media size detection
- Cassette media stack surface detection
- Cassette media out detection
- Cassette media level detection
- Multiple-feed prevention
- Automatic delivery

## 550-sheet feeder jam detection

Learn about the 550-sheet feeder jam detection function.

The paper feeder uses the following sensor to detect the presence of paper and to check whether paper is being fed correctly or has jammed.

- Paper feeder feed sensor (SR23)

The printer determines that a jam has occurred if the sensor detects paper at an inappropriate time.

## High capacity input (HCI) paper feeder

Learn about the HCI.

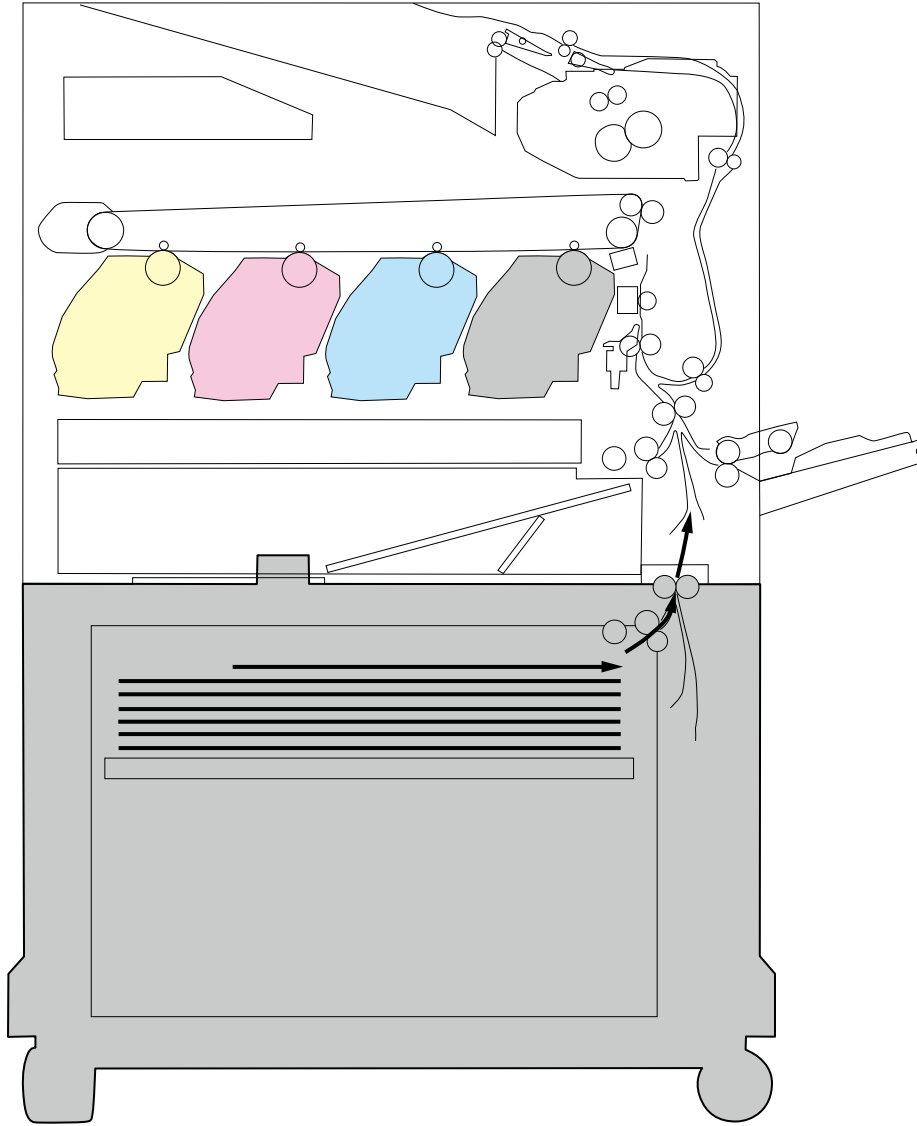
The HCI is optionally installed at bottom of the printer. It picks up the print media and feeds it to the printer. The HCI controller controls the operational sequence of the HCI.

### HCI paper path

Learn about the HCI paper path.

The figure below shows the HCI paper path.

**Figure 3-37 HCI paper path**

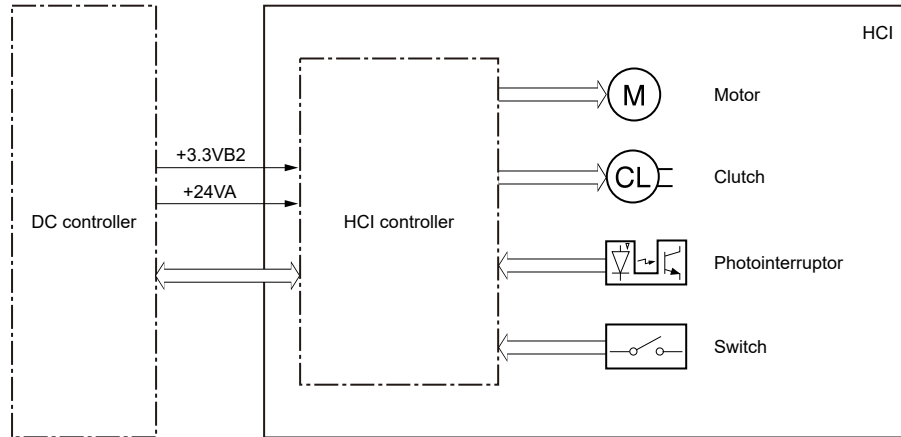


### HCI controller

Learn about the HCI controller.

The figure below shows the HCI controller block diagram.

**Figure 3-38 HCl controller**

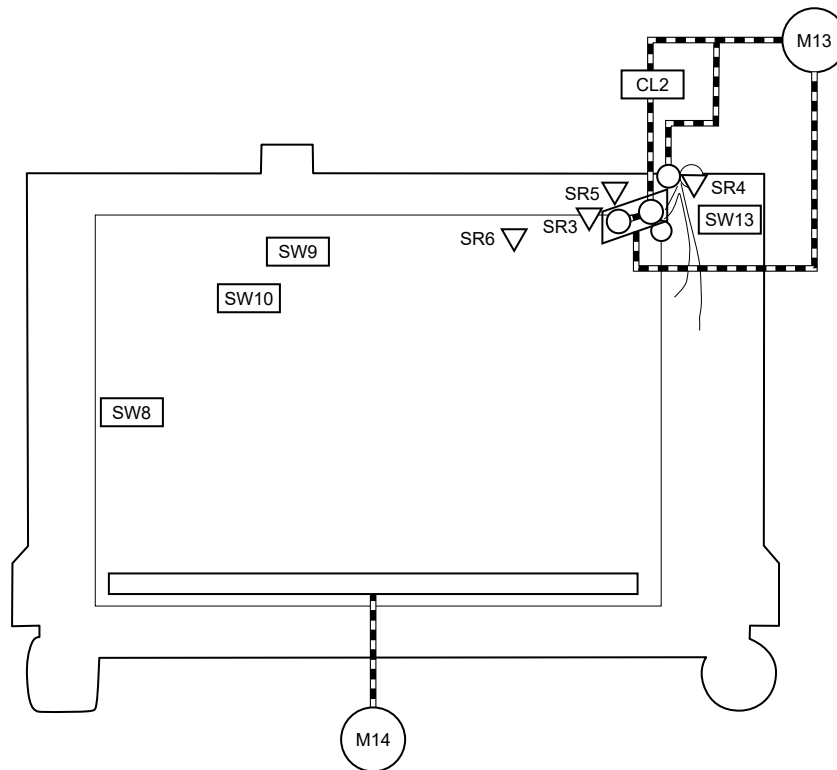


## HCl electrical components

Learn about the HCl electrical components.

The figure below shows the HCl electrical components. The table in this section describes the HCl electrical components.

**Figure 3-39 HCl electrical components**



**Table 3-22 Electrical component list, HCl**

Component type	Abbreviation	Component name
Motor	M13	HCl feed motor
Motor	M14	HCl lifter motor

**Table 3-22 Electrical component list, HCI (continued)**

Component type	Abbreviation	Component name
Clutch	CL2	HCI pickup clutch
Switch	SW8	HCI cassette lifting plate position switch
Switch	SW9	HCI cassette media size switch 1
Switch	SW10	HCI cassette media size switch 2
Switch	SW13	HCI door switch
Photo interrupter	SR3	HCI cassette media out sensor
Photo interrupter	SR4	HCI feed sensor
Photo interrupter	SR5	HCI cassette media surface sensor
Photo interrupter	SR6	HCI cassette pickup rotation sensor

## HCI motor control

The HCI has two motors for the paper-feed and cassette lift-up.

The table below describes which components the HCI motors drive.

**Table 3-23 Paper feeder motors**

Abbreviation	Component	Drives	Failure detection
M13	HCI feed motor	HCI cassette pickup roller HCI cassette feed roller HCI feed roller	No
M14	HCI lifter motor	HCI cassette lifter drive assembly	No

## HCI other functions

Learn about the other HCI pickup and feed functions.

The HCI has the following pickup and feed functions.

- Cassette lift-up control
- Cassette presence detection
- Cassette media size detection
- Cassette media stack surface detection
- Cassette media out detection
- Cassette multiple-feed prevention
- Automatic delivery

## HCI jam detection

Learn about the HCI jam detection function.

The HCI uses the following sensor to detect the presence of paper and to check whether paper is being fed correctly or has jammed.

- HCI feed sensor (SR4)

The printer determines that a jam has occurred if the sensor detects paper at an inappropriate time.

## Output devices

Learn about the output devices.

### 3-bin stapler-stacker

Learn about the 3-bin stapler-stacker.

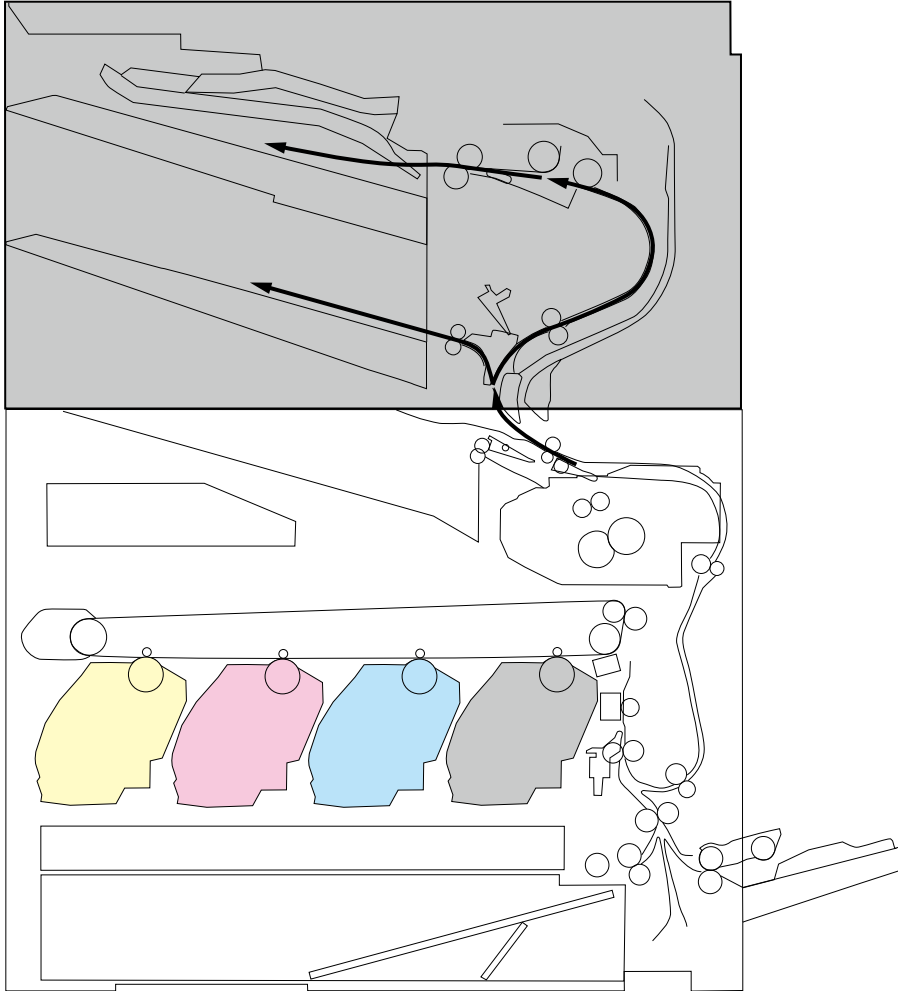
The 3-bin stapler-stacker is installed on the upper side of the printer. It delivers the print media to the output bin after the staple process. The unit's controller controls the operational sequence of the paper feeder.

### 3-bin stapler-stacker paper path

Learn about the 3-bin stapler-stacker paper path.

The figure below shows the 3-bin stapler-stacker paper path.

**Figure 3-40 3-bin stapler-stacker paper path**



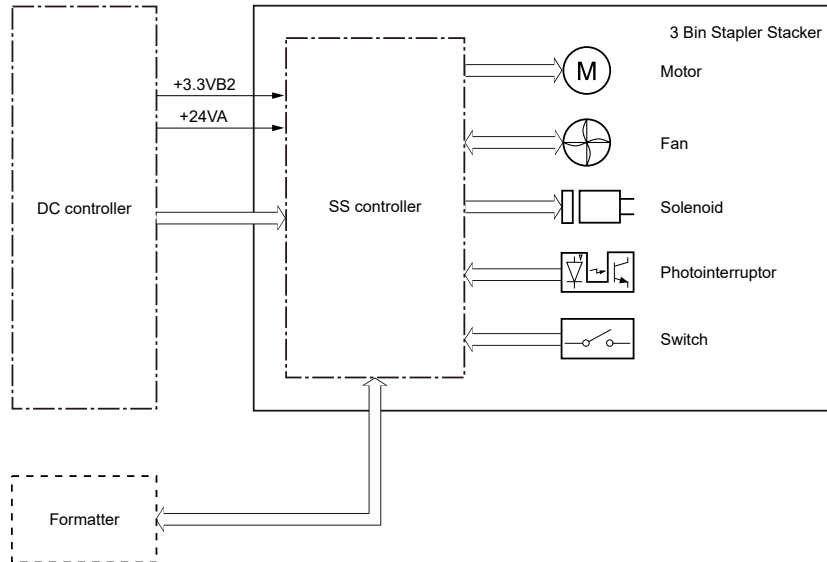
### **3-bin stapler-stacker controller**

Learn about the 3-bin stapler-stacker controller.

The figure below shows the 3-bin stapler-stacker controller block diagram.



**Figure 3-41 3-bin stapler-stacker controller**

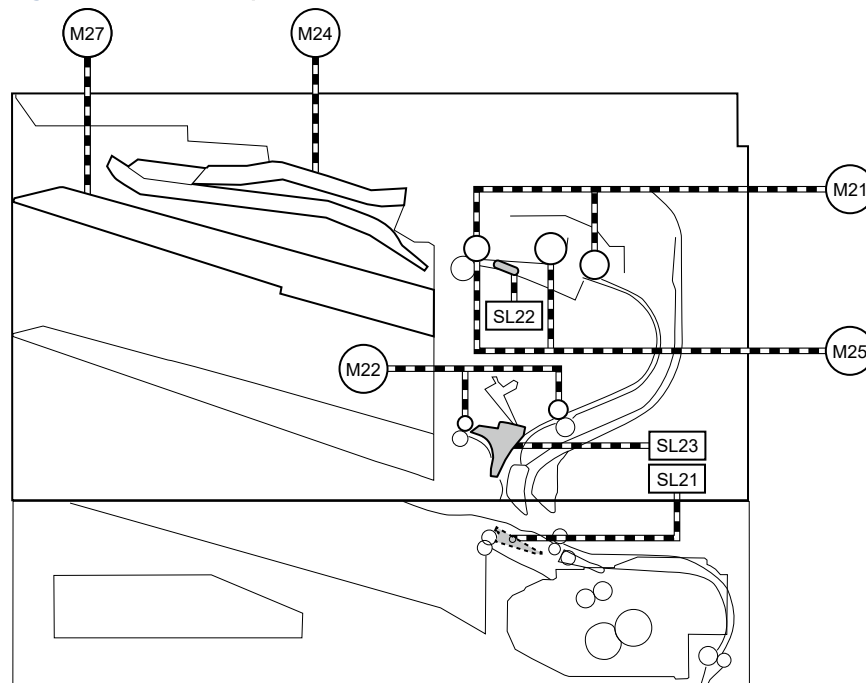


### 3-bin stapler-stacker electrical components

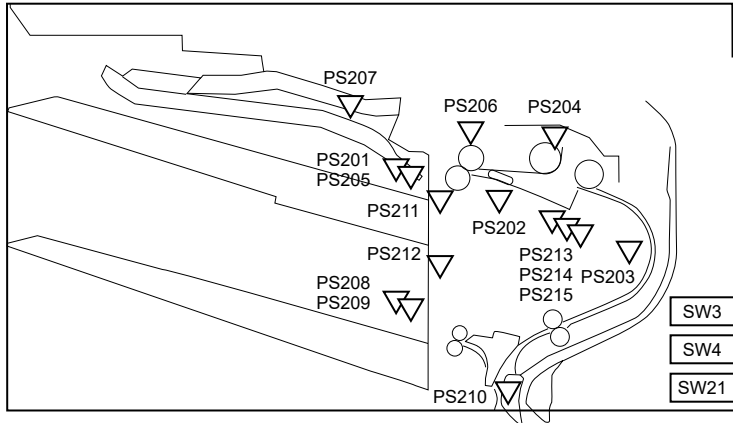
Learn about the 3-bin stapler-stacker electrical components.

The figures below show the 3-bin stapler-stacker electrical components. The table in this section describes the 3-bin stapler-stacker electrical components.

**Figure 3-42 3-bin stapler-stacker motors and solenoids**



**Figure 3-43 3-bin stapler-stacker sensors and switches**



**Table 3-24 Electrical component list, 3-bin stapler-stacker**

Component type	Abbreviation	Component name
Motor	M21	Stapler-stacker output motor
Motor	M22	Stapler-stacker feed motor
Motor	M24	Jogger motor
Motor	M25	Y alignment motor
Motor	M26	Stapler motor
Motor	M27	Lifter motor
Fan	FAN21	Stapler-stacker fan
Solenoid	SL21	Inlet flapper solenoid
Solenoid	SL22	Stamp solenoid
Solenoid	SL23	Output bin 2 flapper solenoid
Photo interrupter	PS201	Bin 1 media presence sensor
Photo interrupter	PS202	Stapler-stacker exit sensor
Photo interrupter	PS203	Staple inlet sensor
Photo interrupter	PS204	Y alignment home position sensor
Photo interrupter	PS205	Bin 1 media full sensor 1
Photo interrupter	PS206	Alienation home position sensor
Photo interrupter	PS207	Jogger home position sensor
Photo interrupter	PS208	Bin 2 media presence sensor
Photo interrupter	PS209	Bin 2 media full sensor
Photo interrupter	PS210	Stapler-stacker inlet sensor
Photo interrupter	PS211	Bin 1 upper limit sensor
Photo interrupter	PS212	Bin 1 lower limit sensor
Photo interrupter	PS213	Staple low sensor
Photo interrupter	PS214	Staple ready sensor

**Table 3-24 Electrical component list, 3-bin stapler-stacker (continued)**

Component type	Abbreviation	Component name
Photo interrupter	PS215	Staple home position sensor
Switch	SW3	Stapler-stacker door switch
Switch	SW4	Staple door switch
Switch	SW21	Interlock switch

### 3-bin stapler-stacker motor control

The 3-bin stapler-stacker has six motors for paper feed, paper alignment, output bin lift up/down, and staple functions.

The table below describes which components the 3-bin stapler-stacker motors drive.

**Table 3-25 Paper feeder motors**

Abbreviation	Component	Drives	Failure detection
M21	Stapler-stacker output motor	Output bin 1 delivery roller Output bin 1 exit feed roller	No
M22	Stapler-stacker feed motor	Output bin 2 delivery roller Output bin 2 inlet feed roller	No
M24	Jogger motor	Jogger guide	Yes
M25	Y alignment motor	Alignment roller Engages/disengages the output bin 1 delivery roller	Yes
M26	Staple motor	Staple	Yes
M27	Lifter motor	Output bin 1 lifter	No

### 3-bin stapler-stacker fan control

The 3-bin stapler-stacker has one fan.

The table below describes the stapler-stacker fan functions.

**Table 3-26 3-bin stapler-stacker fan**

Abbreviation	Component	Cooling area	Type	Speed	Failure detection
FAN21	Stapler-stacker fan	Stapler-stacker interior	Intake	Full/low	Yes

### 3-bin stapler-stacker other functions

Learn about the other 3-bin stapler-stacker delivery functions.

The 3-bin stapler-stacker has the following delivery functions.

- Mailbox mode

- Staple control
- Automatic delivery

### 3-bin stapler-stacker jam detection

Learn about the 3-bin stapler-stacker jam detection function.

The 3-bin stapler-stacker uses the following sensors to detect the presence of paper and to check whether paper is being fed correctly or has jammed.

- Stapler-stacker inlet sensor (PS210)
- Staple inlet sensor (PS203)
- Stapler-stacker exit sensor (PS202)

The printer determines that a jam has occurred if the sensors detect paper at an inappropriate time. The stapler-stacker detects the following jams.

- Residual paper jam
- Feed delay jam
- Feed stay jam

### Floor-standing stapler-stacker

Learn about the floor-standing stapler-stacker.

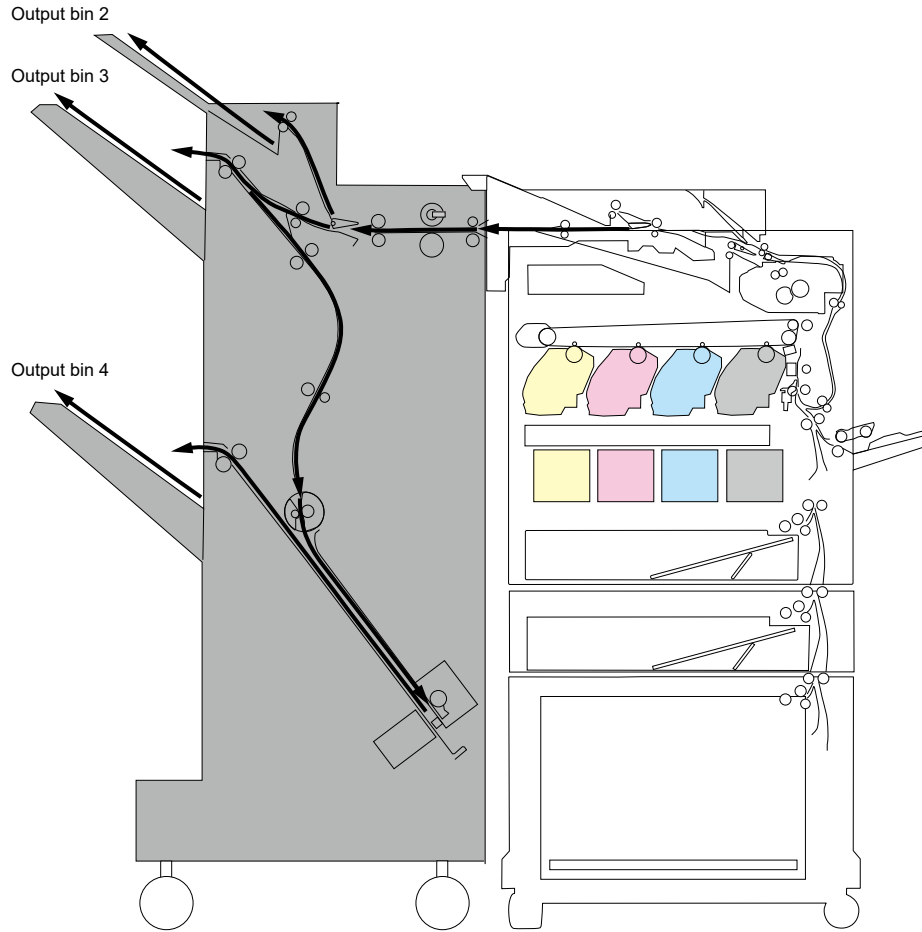
The floor-standing stapler-stacker is installed on the left side of the printer, and it delivers print media to each output bin. The floor-standing stapler-stacker can perform punch processing and staple processing on print media. The floor-standing stapler-stacker controller controls the operation sequence of the floor-standing stapler-stacker.

### Floor-standing stapler-stacker paper path

Learn about the floor-standing stapler-stacker paper path.

The figure below shows the floor-standing stapler-stacker paper path.

**Figure 3-44 Floor-standing stapler-stacker paper path**

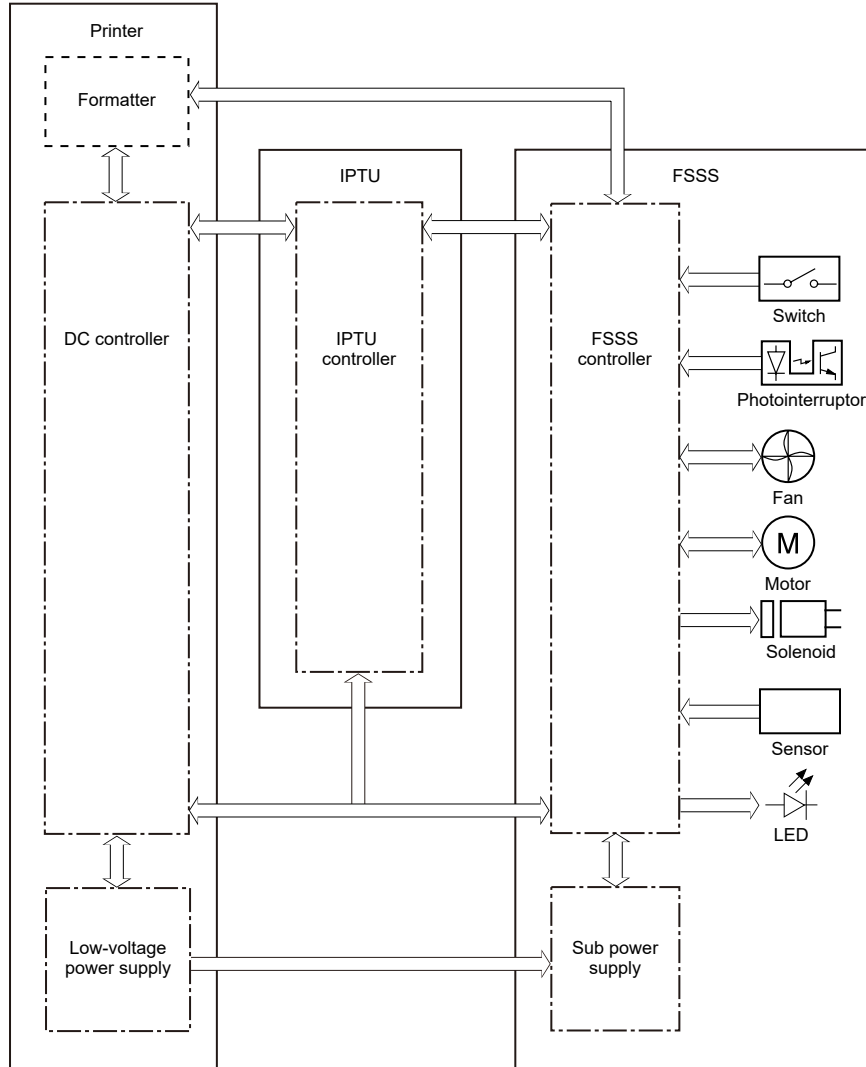


### **Floor-standing stapler-stacker controller**

Learn about the floor-standing stapler-stacker controller.

The figure below shows the floor-standing stapler-stacker controller block diagram.

**Figure 3-45 Floor-standing stapler-stacker controller**

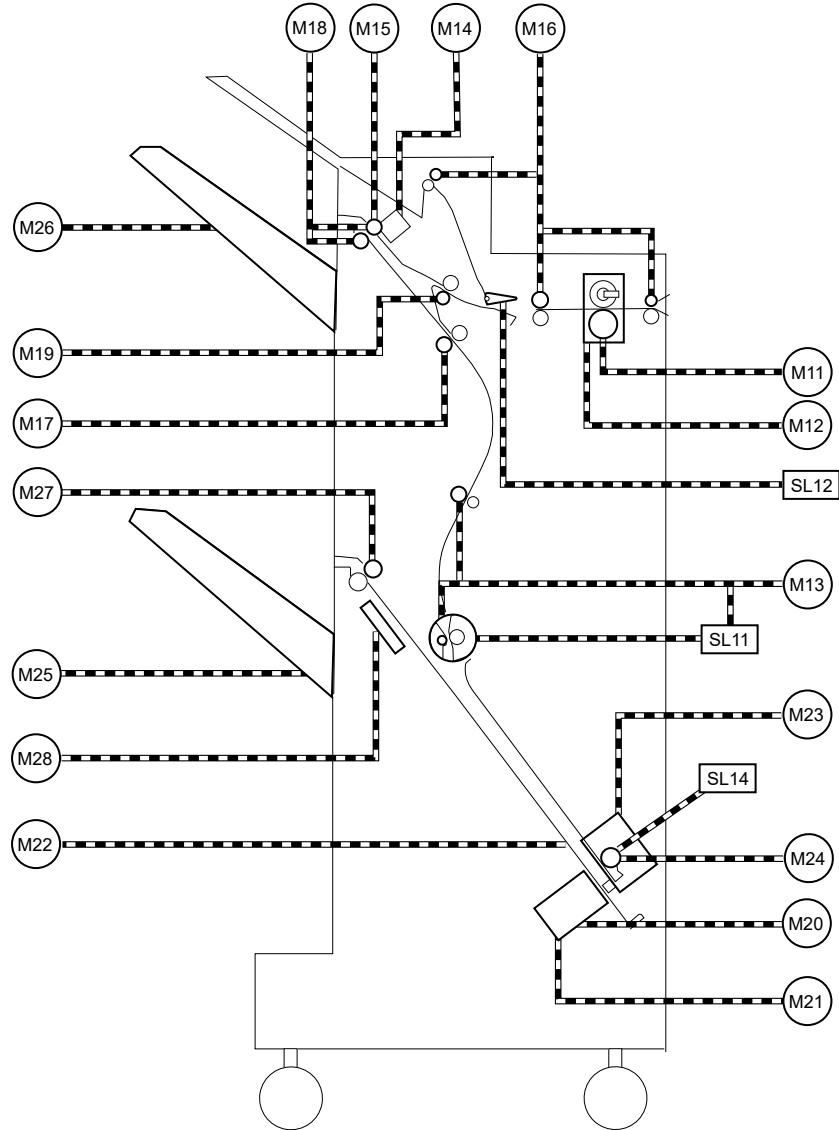


### Floor-standing stapler-stacker electrical components

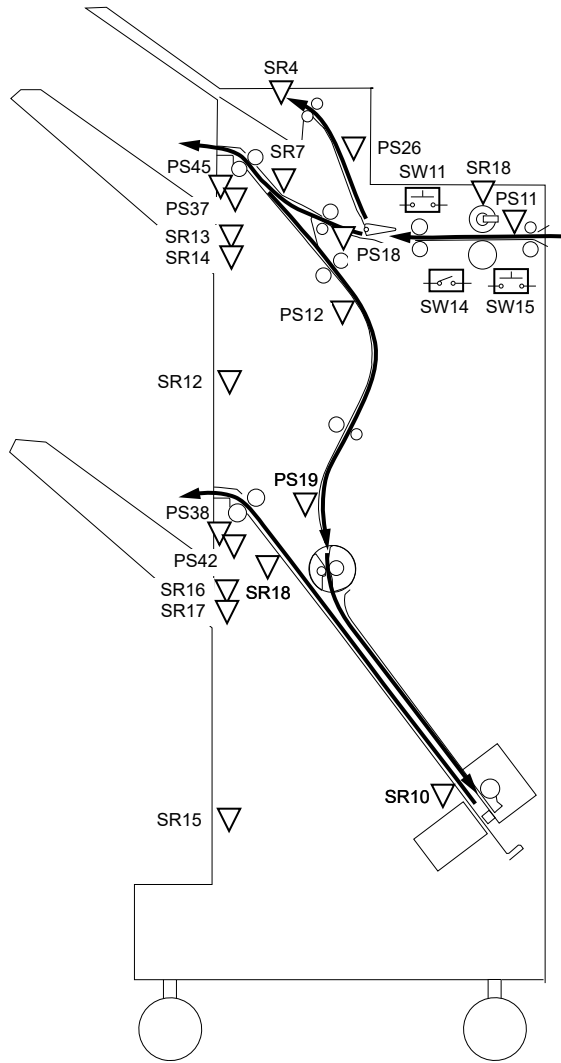
Learn about the floor-standing stapler-stacker electrical components.

The figures below show the floor-standing stapler-stacker electrical components. The table in this section describes the floor-standing stapler-stacker electrical components.

**Figure 3-46 Floor-standing stapler-stacker motors and solenoids**



**Figure 3-47** Floor-standing stapler-stacker sensors and switches



**Table 3-27** Electrical component list, floor-standing stapler-stacker

Component type	Abbreviation	Component name
Motor	M11	Punch motor
Motor	M12	Punch shift motor
Motor	M13	Intermediate feed motor
Motor	M14	Bin 3 shift motor
Motor	M15	Bin 3 alienation motor
Motor	M16	MBM feed motor
Motor	M17	Internal output motor
Motor	M18	Switchback motor
Motor	M19	Buffer front motor
Motor	M20	Staple motor
Motor	M21	Stapler shift motor



**Table 3-27 Electrical component list, floor-standing stapler-stacker (continued)**

Component type	Abbreviation	Component name
Motor	M22	Jogger motor
Motor	M23	Trailing edge assist motor
Motor	M24	Y alignment motor
Motor	M25	Bin 4 lift up motor
Motor	M26	Bin 3 lift up motor
Motor	M28	Bin 4 output motor
Motor	M27	Stacking guide motor motor
Fan	FAN11	Sub power fan
Solenoid	SL	Stage inlet drum drive solenoid
Solenoid	SL	MBM flapper solenoid
Solenoid	SL	Y alignment alienation solenoid
Switch	SW11	Punch door switch (push type)
Switch	SW14	Front door switch (lever type)
Switch	SW15	Front door switch (push type)
Photo interrupter	SR2	Punch home position sensor
Photo interrupter	SR3	Punch shift home position sensor
Photo interrupter	SR4	Bin 2 media full sensor
Photo interrupter	SR5	Bin 3 shift roller alienation home position sensor
Photo interrupter	SR6	Bin 3 shift roller home position sensor
Photo interrupter	SR7	Bin 3 exit sensor
Photo interrupter	SR8	Jogger home position sensor
Photo interrupter	SR9	Staple shift home position sensor
Photo interrupter	SR10	Staple tray media presence sensor
Photo interrupter	SR11	Trailing edge assist home position sensor
Photo interrupter	SR12	Bin 3 lower limit sensor
Photo interrupter	SR13	Bin 3 upper limit sensor
Photo interrupter	SR14	Bin 3 media presence sensor
Photo interrupter	SR15	Bin 4 lower limit sensor
Photo interrupter	SR16	Bin 4 upper limit sensor
Photo interrupter	SR17	Bin 4 media presence sensor
Photo interrupter	SR18	Stapler-stacker exit sensor
Photo interrupter	SR19	Stacking guide home position sensor
Photo interrupter	SR22	Bin 4 output roller alienation home position sensor
Photo interrupter	PS12	Switchback inlet sensor (PCA mounted type)

**Table 3-27 Electrical component list, floor-standing stapler-stacker (continued)**

Component type	Abbreviation	Component name
Photo interrupter	PS18	Punch side registration sensor
Photo interrupter	PS18	Bin 3 inlet sensor (PCA mounted type)
Photo interrupter	PS19	Staple inlet sensor (PCA mounted type)
Photo interrupter	PS26	MBM inlet sensor (PCA mounted type)
Photo interrupter	PS27	Punch inlet roller rotation sensor
Photo interrupter	PS30	Staple home position sensor
Photo interrupter	PS31	Staple low sensor
Photo interrupter	PS32	Staple ready sensor
Photo interrupter	PS38	Bin 4 media full sensor 2
Photo interrupter	PS45	Bin 3 media full sensor 2
Sensor	PS11	Punch inlet sensor
Sensor	PS14	Chad full sensor
Sensor	PS37	Bin 3 media full sensor 1
Sensor	PS42	Bin 4 media full sensor 1
LED	PS13	Chad full sensor
LED	PS17	Punch side registration sensor
LED	PS36	Bin 3 media full sensor 1
LED	PS43	Bin 4 media full sensor 1

## Floor-standing stapler-stacker motor control

The floor-standing stapler-stacker has 18 motors for the paper feed, paper alignment, output bin lift up/down, and staple functions.

The table below describes which components the floor-standing stapler-stacker motors drive.

**Table 3-28 Floor-standing stapler-stacker motors**

Abbreviation	Component	Drives	Failure detection
M11	Punch motor	Punch assembly	No
M12	Punch shift motor	Move the punch assembly	No
M13	Intermediate feed motor	Intermediate feed roller and drum ass'y	No
M14	Bin 3 shift motor	Move in the direction of the width of output bin 3 delivery roller	No
M15	Bin 3 alienation motor	Disengage the output bin 3 delivery roller	No
M16	MBM feed motor	Punch inlet roller, punch exit roller Output bin 2 delivery roller	No
M17	Internal output roller	Inner output roller	No

**Table 3-28 Floor-standing stapler-stacker motors (continued)**

Abbreviation	Component	Drives	Failure detection
M18	Switchback motor	Output bin 3 switchback roller Output bin 3 delivery roller	No
M19	Buffer front motor	Buffer front roller	No
M20	Staple motor	Built-in motor of staple ass'y	Yes
M21	Stapler shift motor	Moving the stapler in the feed direction	No
M22	Jogger motor	Move in the direction of the width of jogger	Yes
M23	Trailing edge assist motor	Trailing edge assist ass'y	No
M24	Y alignment motor	Alignment roller	Yes
M25	Bin 4 lift up motor	Lift up/down the output bin 4	No
M26	Bin 3 lift up motor	Lift up/down the output bin 3	No
M27	Bin 4 output motor	Output bin 4 delivery roller Disengage the output bin 4 delivery roller	No
M28	Stacking guide motor	Stacking guide	No

## Floor-standing stapler-stacker fan control

The floor-standing stapler-stacker has one fan.

The floor-standing stapler-stacker has a fan that prevents the temperature from rising in the sub power supply area. The table below describes the floor-standing stapler-stacker fan functions.

**Table 3-29 Floor-standing stapler-stacker fans**

Abbreviation	Component	Cooling area	Type	Speed	Failure detection
FAN11	Sub power supply fan	Sub power supply	Intake	Full	Yes

## Floor-standing stapler-stacker other functions

Learn about the other floor-standing stapler-stacker delivery functions.

The floor-standing stapler-stacker has the following delivery functions.

- Stack mode
- Punch mode
- Job offset mode
- Staple mode
- Automatic delivery

## 550-sheet feeder jam detection

Learn about the 550-sheet feeder jam detection function.

The paper feeder uses the following sensor to detect the presence of paper and to check whether paper is being fed correctly or has jammed.

- Paper feeder feed sensor (SR23)

The printer determines that a jam has occurred if the sensor detects paper at an inappropriate time.

---

## 4 Solve problems

Learn about solving printer problems.

### How to search for printer documentation

The CPMD, error codes, and other support documentation for each printer is available on the HP portals.

For HP internal access to WISE, go to [WISE](#).


For HP channel partners access WISE, see [Accessing WISE for HP channel partners \(HP Partner Portal\) on page 131](#) or [Accessing WISE for HP channel partners \(CSDP\) on page 130](#).

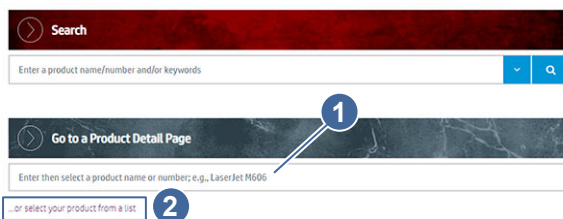
WISE is available to call agents, service technicians, and HP internal users. The level of detail available depends on your access credentials. To learn how to find support content in WISE, [watch the video here](#).

### How to search WISE for printer information and documentation

These instructions are for HP internal use by call agents, service technicians, and other internal users.

To learn how to find support content in WISE, watch the video here: [Finding Error Code and Control Panel Message Document in WISE](#).

 **TIP:** The Product Detail Page (PDP) is available from the WISE home page. Enter, and then select a product name or number in the **Go to a Product Detail Page** area (callout 1), or select the **...or select your product from a list** item (callout 2) on the WISE home page.



The screenshot shows a search bar with a magnifying glass icon and the word 'Search'. Below it is a text input field with the placeholder text 'Enter a product name/number and/or keywords'. To the right of this field are a dropdown arrow and a search icon. Below the search bar is another section with a magnifying glass icon and the text 'Go to a Product Detail Page'. Below this is another text input field with the placeholder text 'Enter then select a product name or number; e.g., LaserJet M606'. Below this field is a link that says '...or select your product from a list'. A blue circle with the number '1' has an arrow pointing to the 'Go to a Product Detail Page' section. A blue circle with the number '2' has an arrow pointing to the '...or select your product from a list' link.

Many types of printer documentation and information are available on WISE. This section details methods for finding error code descriptions and solutions.

 **TIP:** To view a list of control panel message documents (CPMD) per printer, search for the following topic in **WISE**: HP LaserJet, OfficeJet, PageWide, ScanJet Enterprise - Control panel message document (CPMD) list or click the link below.

- [HP LaserJet, HP OfficeJet, HP PageWide, HP ScanJet - Control panel messages document \(CPMD\), Service manual, and Service cost data list](#)

Use one of the following methods to search for CPMD error code information.

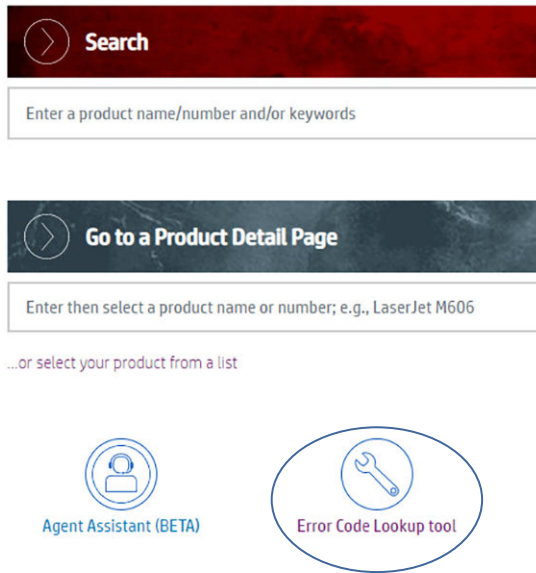
- [Method 1: Use the WISE home page Error Code Lookup tool on page 125](#)
- [Method 2: Search for error codes using the WISE search function on page 126](#)
- [Method 3: Search for error codes using the Product Detail Page on page 128](#)

## Method 1: Use the WISE home page Error Code Lookup tool

Use the WISE Error Code Lookup tool to find error code troubleshooting procedures using the following steps.

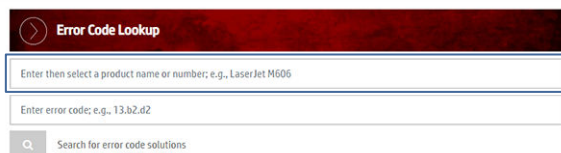
1. On the WISE home page, click the **Error Code Lookup tool** icon.

**Figure 4-1 WISE Error Code Lookup tool icon**



2. Enter a printer model number (for example, M606) in the **Error Code Lookup** dialog box.

**Figure 4-2 WISE Error Code Lookup tool dialog box**

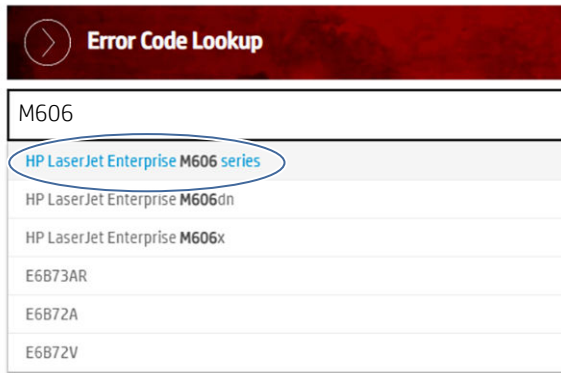


3. A drop-down list appears. Click on the full printer series name (for example, HP LaserJet Enterprise M606 series) in the list.



**NOTE:** Selecting the **series** item from the drop-down list is recommended for the most accurate search return.

**Figure 4-3 WISE Error Code Lookup tool drop-down list**



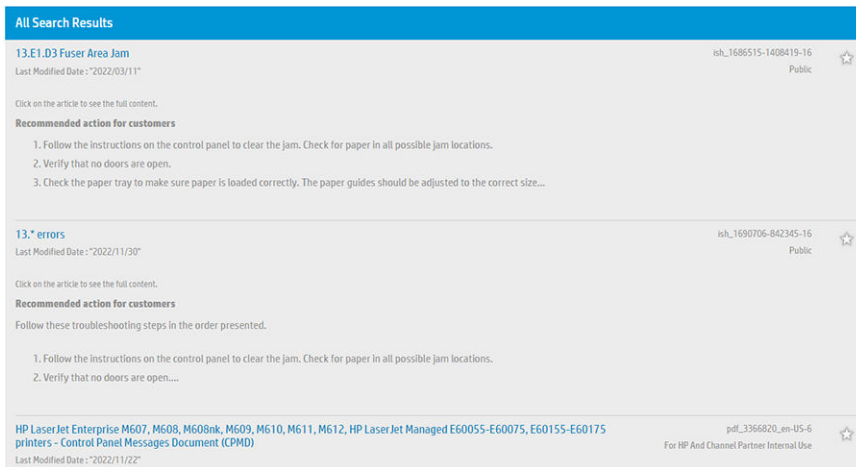
4. Type the error code (for example, 13.b2.d2) in the **Error Code Lookup** keyword field, and then select the search icon.

**Figure 4-4 WISE Error Code Lookup tool search**



5. The error code troubleshooting content displays in the **All Search Results** area.

**Figure 4-5 WISE Search results**

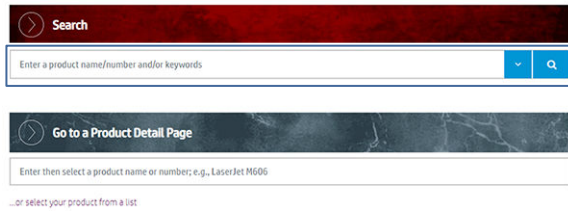


## Method 2: Search for error codes using the WISE search function

Use the WISE search function to find error code troubleshooting procedures using the following steps.

1. On the WISE home page, enter a printer model number (for example, M606) in the **Search** dialog box.

**Figure 4-6 WISE Search dialog box**

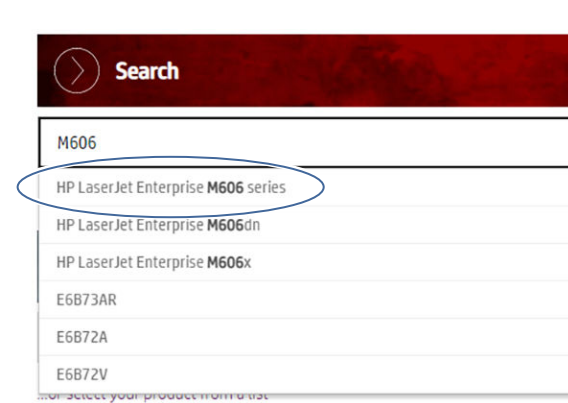


2. A drop-down list appears. Click on the full printer series name (for example, HP LaserJet Enterprise M606 series) in the list.



**NOTE:** Selecting the **series** item from the drop-down list is recommended for the most accurate search return.

**Figure 4-7 WISE Search drop-down list**



3. Type the error code (for example, 13.E1.D3) in the **Search** keyword field, and then select the search icon.

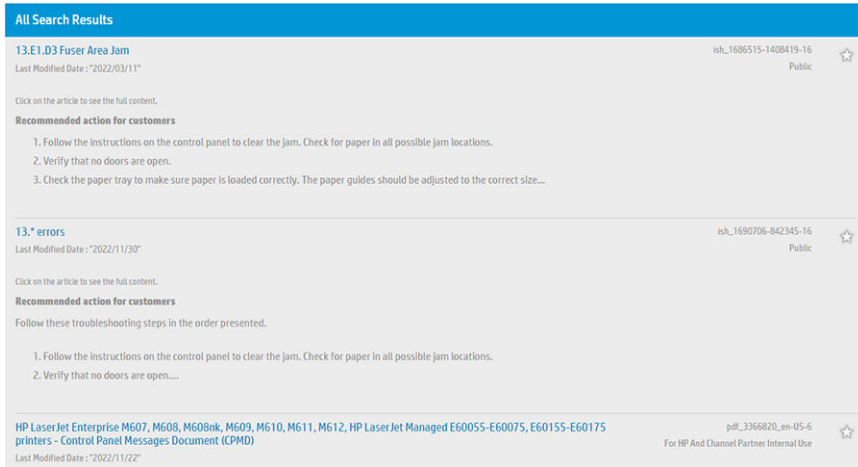
**Figure 4-8 WISE Search**



4. The error code troubleshooting content displays in the **All Search Results** area.




**Figure 4-9 WISE Search results**



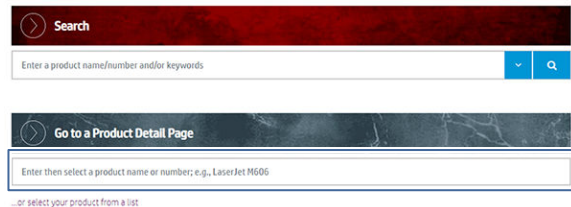
### Method 3: Search for error codes using the Product Detail Page

Use the WISE Product Detail Page (PDP) to find error code troubleshooting procedures using the following steps.

1. On the WISE home page, enter a printer model number (for example, M606) in the **Go to a Product Detail page** dialog box.

 **TIP:** To find a PDP from a list of products by product type, select the **...or select your product from a list** item just below the dialog box.

**Figure 4-10 WISE PDP dialog box**



2. A drop-down list appears. Click on the full printer series name (for example, HP LaserJet Enterprise M606 series) in the list.


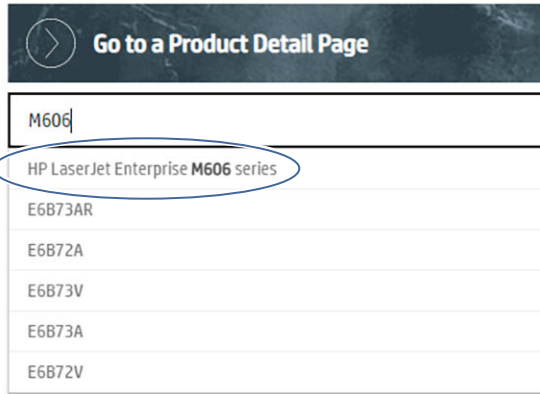
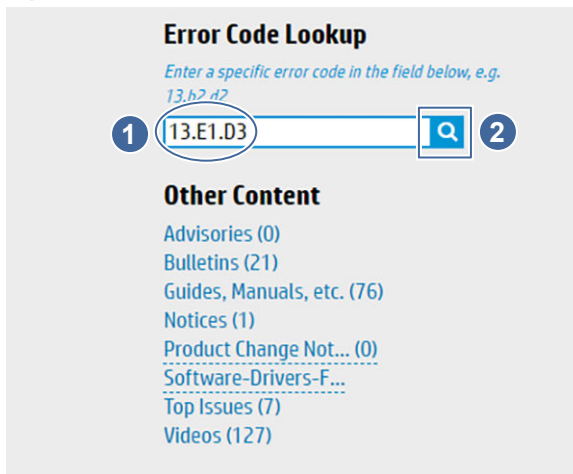
 **NOTE:** Selecting the **series** item from the drop-down list is recommended for the most accurate search return.

Figure 4-11 WISE PDP drop-down list



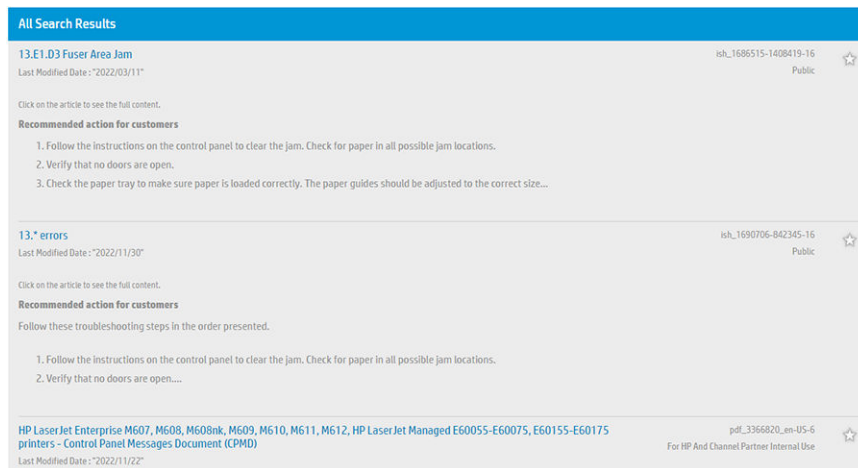
3. Type the error code (for example, 13.E1.D3) in the **Error Code Lookup** field, and then select the search icon.

Figure 4-12 WISE PDP search




4. The error code troubleshooting content displays in the **All Search Results** area.

Figure 4-13 WISE PDP search results



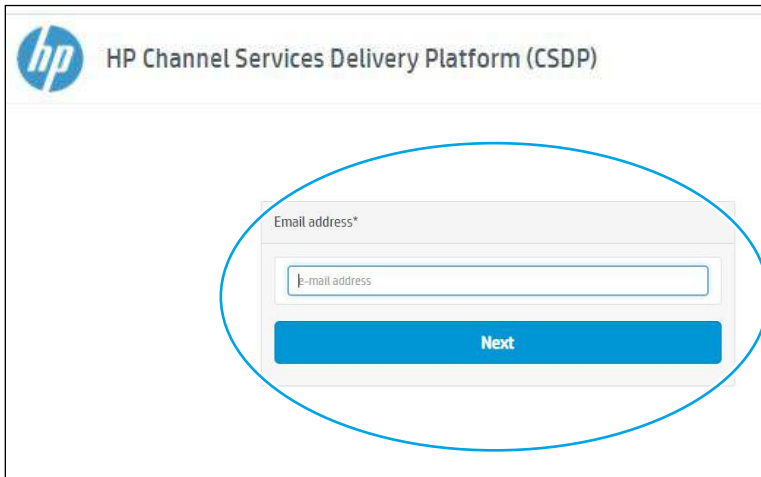
## Accessing WISE for HP channel partners (CSDP)

Learn how to access WISE by accessing the HP Channel Services Delivery Platform (CSDP) if you are an HP Channel Partner.

 **IMPORTANT:** A Partner Admin must request access, via the CSDP portal, to create a new user before you can sign into the CSDP portal.

1. Sign-in to the CSDP portal (click [csdp.hp.com](https://csdp.hp.com) to access the sign-in page).

Figure 4-14 CSDP sign-in page



2. On the CSDP home page, click the **Knowledge and Training** item.


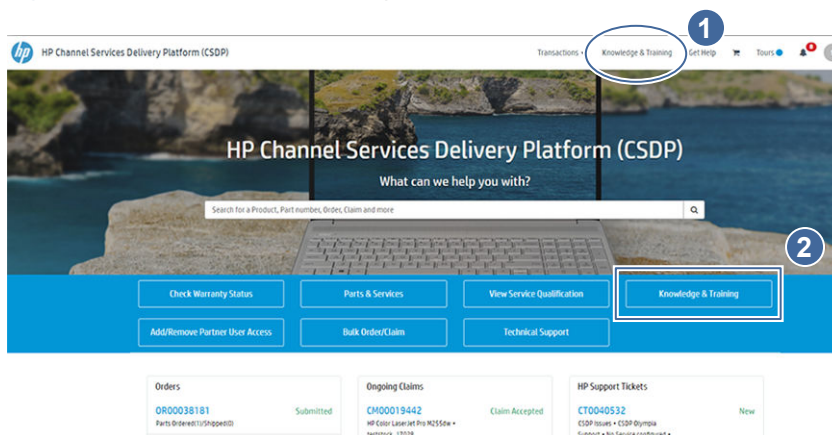
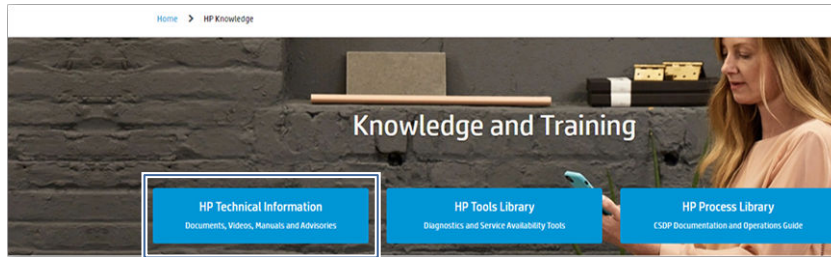
 **TIP:** Use the **Knowledge and Training** item at the top of the CSDP home page (callout 1), or the **Knowledge and Training** action icon (callout 2).

Figure 4-15 CSDP portal home page



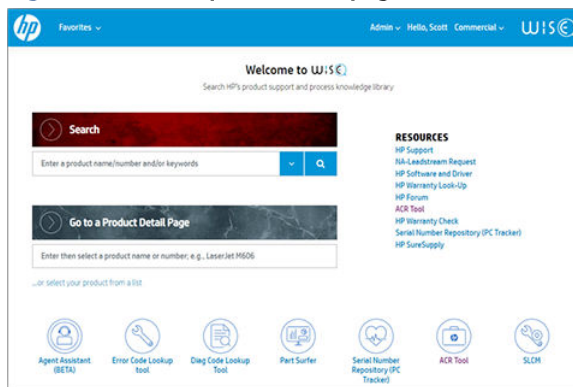
3. Select **HP Technical Documentation** on the **Knowledge and Training** page to open the WISE portal home page.

**Figure 4-16** CSDP portal HP Knowledge and Training page




4. Use the WISE portal to search for printer information.

**Figure 4-17** WISE portal home page



## Accessing WISE for HP channel partners (HP Partner Portal)

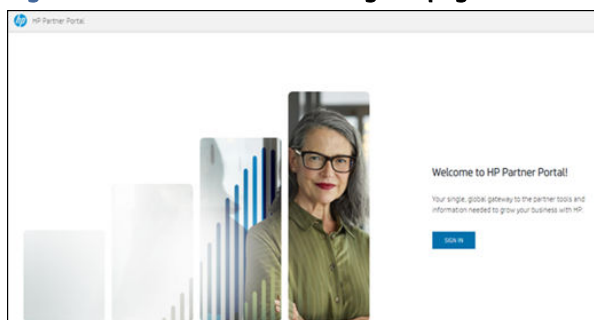
Learn how to access WISE by accessing the HP Partner Portal if you are an HP Channel Partner.

 **NOTE:** If this is your first visit to the HP Partner Portal, you will be asked to create an account. Follow the setup directions using your HP Partner credentials.

 [View a video of how to access WISE for HP channel partners](#)

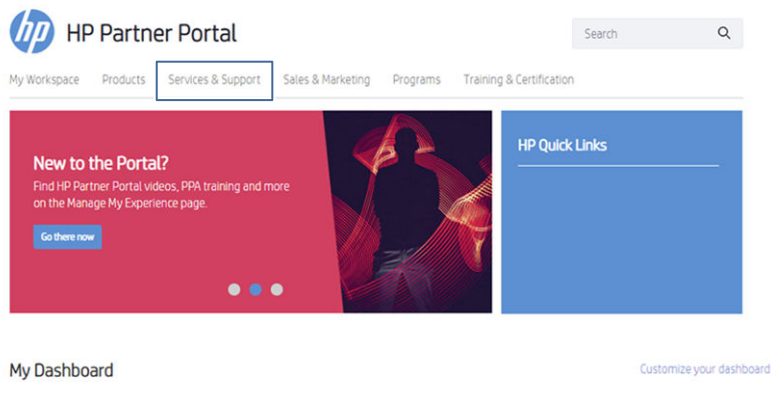
1. Sign-in to the HP Partner Portal (click <https://partner.hp.com> to access the sign-in page).

**Figure 4-18** HP Partner Portal sign-in page



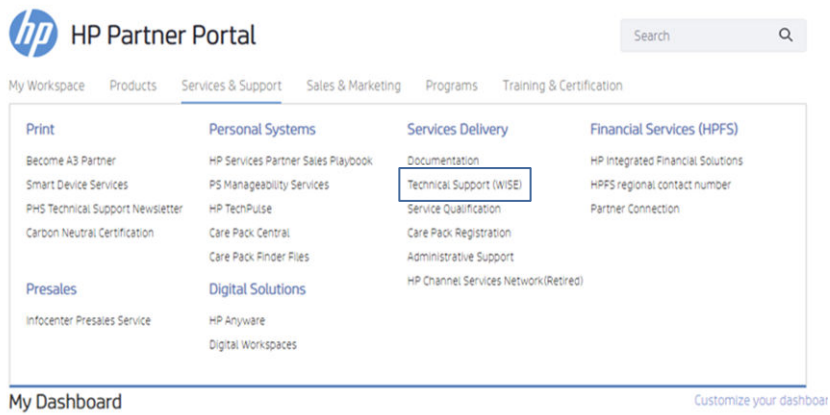
2. On the HP Partner Portal home page, click the **Services & Support** item.

**Figure 4-19 HP Partner Portal home page**



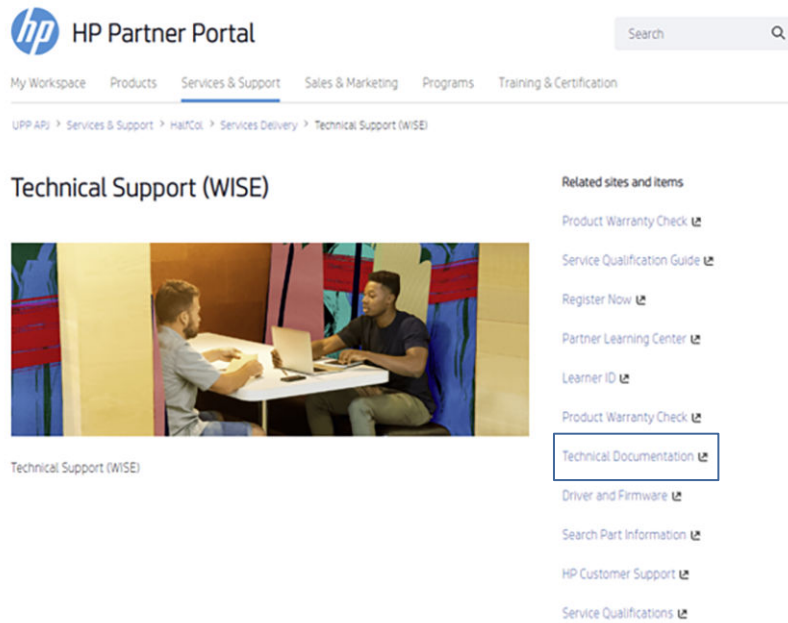
3. Select the **Technical Support (WISE)** item.

**Figure 4-20 HP Partner Portal Service & Support page**



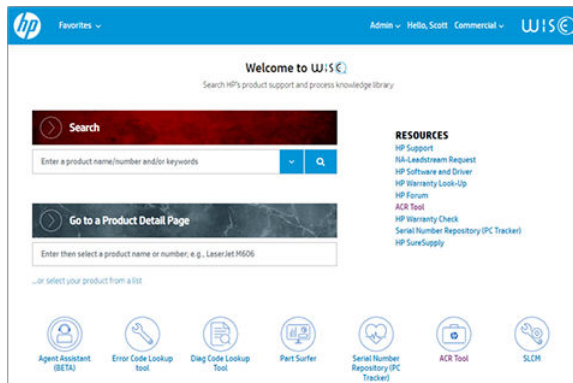
4. Select the **Technical Documentation** item.

**Figure 4-21 HP Partner Portal Technical Support (WISE)page**



5. Use the WISE portal to search for printer information.

**Figure 4-22 WISE portal home page**



## Determine the problem source

When the printer malfunctions or encounters an unexpected situation, the printer control panel alerts the user to the situation.

This section contains a pre-troubleshooting checklist and a troubleshooting flow chart to filter out many possible causes of the problem.

- Use the pre-troubleshooting check list to gather information about the problem from the customer.
- Use the troubleshooting flowchart to pinpoint the root cause of hardware malfunctions. The flowchart guides you to the section of this chapter that contains steps for correcting the malfunction.

Before beginning any troubleshooting procedure, check the following issues:

- Are supply items within their rated life?
- Does the configuration page reveal any configuration errors?



**NOTE:** The customer is responsible for checking supplies and for using supplies that are in good condition.

## Pre-troubleshooting checklist

The following table includes basic questions to ask the customer to quickly help define the problem(s).

**Table 4-1 Pre-troubleshooting checklist**

General topic	Questions
Environment	<ul style="list-style-type: none"> <li>• Is the printer installed on a solid, level surface (+/- 1°)?</li> <li>• Is the power-supply voltage within <math>\pm 10</math> volts of the specified power source?</li> <li>• Is the power-supply plug inserted in the printer and the wall outlet (not a surge protector)?</li> <li>• Is the operating environment within the specified parameters?</li> <li>• Is the printer exposed to ammonia gas, such as that produced by diazo copiers or office cleaning materials?  <b>NOTE:</b> Diazo copiers produce ammonia gas as part of the copying processes. Ammonia gas (from cleaning supplies or a diazo copier) can have an adverse effect on some printer components (for example, the toner cartridge or cartridges OPC).</li> <li>• Is the printer exposed to direct sunlight?</li> <li>• Is the printer exposed to an air conditioning or heating vent that can cause temperature fluctuations?</li> </ul>
Media	<ul style="list-style-type: none"> <li>• Does the customer use only supported media?</li> <li>• Is the media in good condition (no curls, folds, or distortion)?</li> <li>• Is the media stored correctly and within environmental limits?</li> </ul>
Input trays	<ul style="list-style-type: none"> <li>• Is the amount of media in the tray within specifications?</li> <li>• Is the media correctly placed in the tray?</li> <li>• Are the paper guides aligned with the stack (no gaps in the stack or excessive pressure causing the stack to bow)?</li> <li>• Is the tray (or trays) correctly installed in the printer?</li> </ul>
Toner cartridge	<ul style="list-style-type: none"> <li>• Is the toner cartridge (or cartridges) installed correctly?</li> </ul> <p><b>NOTE:</b> If country/region specific toner cartridges are available for the printer, make sure the correct cartridge is installed.</p>
Transfer unit and fuser	<ul style="list-style-type: none"> <li>• Are the transfer unit and fuser installed correctly?</li> </ul> <p><b>NOTE:</b> For printers with an intermediate transfer belt (ITB), is the ITB installed correctly and fully seated. If a replacement ITB was installed, was all of the packing materials removed?</p>
Covers	<ul style="list-style-type: none"> <li>• Is the toner cartridge door closed?</li> </ul>





**Table 4-2 Troubleshooting flowchart (continued)**

Step	Question		Action
	Yes ↓	No →	<p>After the errors have been corrected, go to step 3.</p> <p>Use the control panel message document (CPMD) section in this manual to correct any displayed error messages.</p>
<p><b>3</b></p> <p><b>Event log</b></p>	<p>Open the <b>Troubleshooting</b> menu and print an event log to see the history of errors with this printer.</p> <p>Does the event log print?</p>		
	Yes ↓	No →	<p>If the event log does not print, check for error messages.</p> <p>If paper jams inside the printer, see the jams section of the printer service manual.</p> <p>If error messages display on the control panel when trying to print an event log, see the control panel message document (CPMD) section of this manual.</p> <p>After successfully printing and evaluating the event log, see step 4.</p>
<p><b>4</b></p> <p><b>Information pages</b></p>	<p>Open the <b>Reports</b> menu and print the configuration pages to verify that all the accessories are installed.</p> <p>Are all the accessories installed?</p>		
	Yes ↓	No →	<p>If accessories that are installed are not listed on the configuration page, remove the accessory and reinstall it.</p> <p>Make sure that the most recent firmware is installed. See the firmware upgrade section of this manual for more information.</p> <p>After evaluating the configuration pages, see step 5.</p>
<p><b>5</b></p> <p><b>Print quality</b></p>	<p>Does the print quality meet the customer's requirements?</p>		
	Yes ↓	No →	<p>Compare the images with the sample defects in the Image-quality troubleshooting section of this manual.</p> <p>Solve print-quality and copy-quality issues as needed.</p> <p>After the print quality is acceptable, see step 6.</p>
<p><b>6</b></p> <p><b>Interface</b></p>	<p>Can the customer print successfully from the host computer?</p>		

**Table 4-2 Troubleshooting flowchart (continued)**

Step	Question	Action
	<p>Yes. This is the end of the troubleshooting process.</p> <p>No →</p>	<p>Verify that all I/O cables are connected correctly and that a valid IP address is listed on the HP Jetdirect configuration page.</p> <p>If error messages display on the control panel or appear in the event log, see the control-panel message document (CPMD) section of this manual.</p> <p>When the customer can print from the host computer, this is the end of the troubleshooting process.</p>

## Firmware upgrades

Learn about printer firmware upgrades.

To download the most recent firmware upgrade for the printer, go to:

- In the US, go to <http://www.hp.com/support/colorlj6700> or <http://www.hp.com/support/colorlj6800MFP> or <http://www.hp.com/support/colorlj6801MFP> or <http://www.hp.com/support/colorlj654> or <http://www.hp.com/support/colorljX677MFP>.

- a. Select **Get drivers, Software, and Firmware**, and then select the appropriate product by name.



**NOTE:** More than one printer model might be listed. Make sure to select the correct model so that the upgraded firmware supports all of the printer functions.

- b. Select the driver language and operating system.
- c. Locate the firmware download, and then select **Download**.

- Outside the U.S., go to [www.hp.com/support](http://www.hp.com/support).

- Select your country/region.
- Select **Drivers & Downloads**.
- Enter the product name in the **Find my product** dialogue box, and then select **Go**.



**TIP:** Click on the **How do I find my product name/number?** link to see a short video on identifying the printer's name and number.

- Select the appropriate product by name.




**NOTE:** More than one printer model might be listed. Make sure to select the correct model so that the upgraded firmware supports all of the printer functions.

- Select the driver language and operating system.
- Locate the firmware download, and then select **Download**.

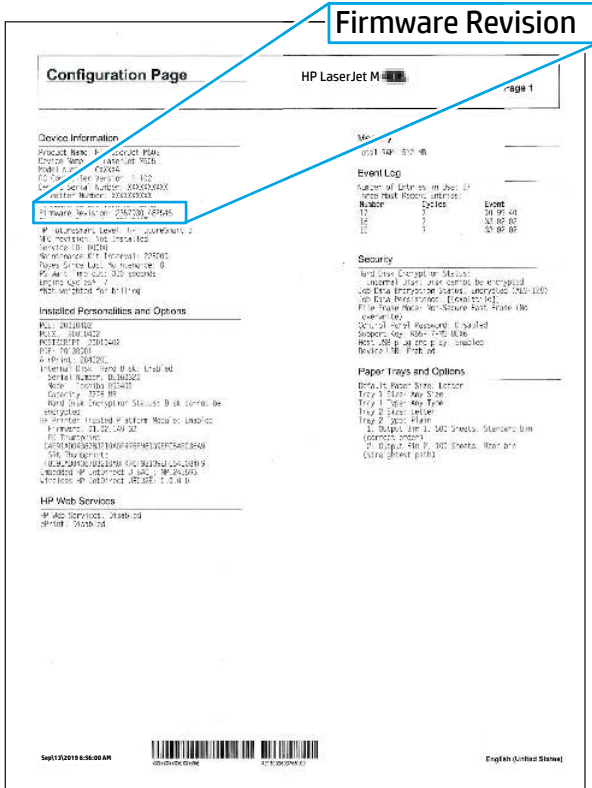
## Determine the installed revision of firmware

Learn about how to determine the version of installed printer firmware.

Print a configuration page to determine the installed revision of firmware.

1. From the **Home** screen on the printer control panel, scroll to and touch the **Reports** button.
2. Open the **Configuration/Status pages** menu.
3. Touch **Configuration Page** to select it.
4. Touch the print icon  to print the pages.
5. Find the firmware revision on the configuration page.

**Figure 4-23 Configuration page firmware version**



## HP Embedded Web Server

Learn how to perform a firmware upgrade using the HP Embedded Web Server.




**NOTE:** The printer should be at the **Ready** state.

The firmware update might take 10 minutes or longer based on the input/output (I/O) transfer rates and the time it takes for the printer to reinitialize.

1. Open an Internet browser window.
2. Enter the printer IP address in the URL line.
3. Select the **Firmware Upgrade** link from the **General** tab or from the **Troubleshooting** tab.

4. Browse to the location that the firmware upgrade file was downloaded to, and then select the firmware file. The file has a .bdl file extension. Select the **Install** button to perform the upgrade.

---

 **NOTE:** Do not close the browser window OR interrupt communication until the HP Embedded Web Server (EWS) displays the confirmation page.

---

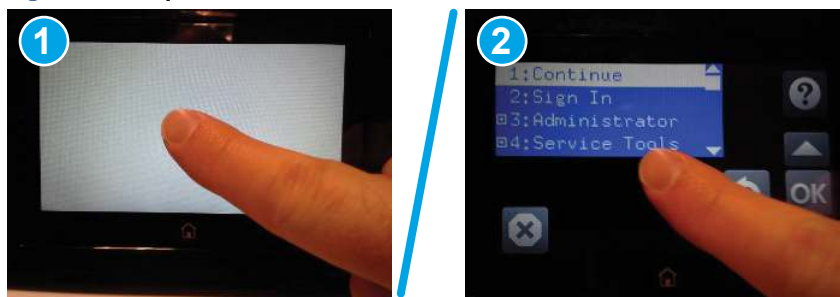
5. After the printer reinitializes, print a configuration page and verify that the latest firmware version has been installed.

## USB flash drive firmware (Pre-boot menu)

Learn how to perform a USB flash drive firmware (Pre-boot menu) update from the control panel.

1. Copy the .bdl file to a portable USB flash drive.
2. Touch the middle of the control panel display when you see the **1/8** under the logo.

**Figure 4-24** Open the Pre-boot menu



3. Use the arrow buttons to highlight **+3 Administrator**, and then touch the **OK** button.
4. Use the arrow buttons to highlight **+1 Download**, and then touch the **OK** button.
5. Insert the USB flash drive with the .bdl file on it into the USB port on the printer.


---

 **NOTE:** If the error message **No USB Thumbdrive Files Found** displays on the control panel display, try using a different portable storage device.

---

6. Use the arrow buttons to highlight **USB Thumbdrive**, and then touch the **OK** button.
7. Use the arrow buttons to highlight the .bdl file, and then touch the **OK** button.

---

 **NOTE:** The upgrade process can take 10 minutes or longer to complete.

---

 **TIP:** If there is more than one .bdl file on the storage device, make sure to select the correct file for this printer.

---

8. When the message **Complete** displays on the control panel display, touch the down arrow **▼** button several times until the message **Continue** displays.
9. Touch the **OK** button to begin the upgrade. When the upgrade is complete, the printer will initialize to the **Ready** state.
10. When the upgrade process is complete, print a configuration page and verify that the upgrade firmware version was installed.

## USB flash drive firmware (control panel menu)

Learn how to perform a USB flash drive firmware (control panel menu) update from the control panel.

1. Copy the .bdl file to a portable USB flash drive.
2. Turn the printer on, and then wait until it reaches the **Ready** state.
3. From the **Home** screen on the printer control panel, scroll to and touch the **Support Tools** button.
4. Open the **Maintenance** menu.
5. Touch the **USB Firmware Upgrade** button.
6. Insert the USB flash drive with the .bdl file on it into the USB port on the printer.
7. Touch the .bdl file, and then touch the **Upgrade** button.



---

**TIP:** If there is more than one .bdl file on the storage device, make sure to select the correct file for this printer.

---

8. Select one of the following options:

- **Upgrade**



---

**NOTE:** The upgrade process can take 10 minutes or longer to complete.

---

- **Re-install**
- **Downgrade**

9. When the upgrade is complete, the printer will initialize to the **Ready** state.
10. When the upgrade process is complete, print a configuration page and verify that the upgrade firmware version was installed.

## Comprehensive list of troubleshooting tools

Learn about the printer troubleshooting tools.

### Engine test

Learn about troubleshooting the printer using the engine test diagnostic.

When the engine test is performed, a test page with lines prints if the engine is functioning correctly.



---

**NOTE:** Depending on printer models, either a simplex engine test page, a duplex engine test page, or both simplex and duplex engine test pages might be available.

---

Use a small pointed object to depress and hold the engine test button (location varies depending on the printer model). An engine test page prints. The test page can use only Tray 2 as the paper source, so make sure that paper is loaded in Tray 2.

Possible engine test pages (printer dependent)

- A series of lines parallel to the **short** end of the page.
- A series of lines parallel to the **long** end of the page.

**Figure 4-25 Engine test button**



## Control panel checks

Learn about control panel troubleshooting.

The printer includes a diagnostic test mode for the touchscreen control panels.

### Touchscreen diagnostic mode

Learn about touchscreen diagnostic mode.

Use the diagnostics in this section to test the control-panel hardware and embedded firmware. These tests are useful for checking control-panel functionality independent of the printer control-panel system diagnostics.

1. Locate the diagnostic-tests access button on the back of the control panel, and then press the button.

**Figure 4-26 Diagnostic-tests access button — 8-inch control panel**



**Figure 4-27** Diagnostic-tests access button — 10-inch control panel



2. Observe the control panel screen as it cycles through the following colors:
  - Red
  - Green
  - Blue
  - Black
  - White

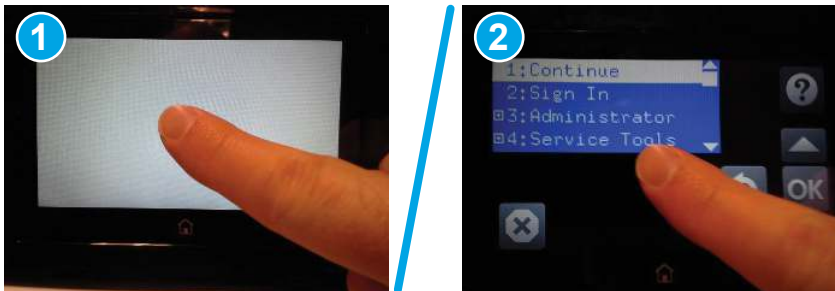
### Open the control panel system diagnostic tests

Learn about accessing the control panel system diagnostics tests from a touchscreen control panel.

Use the following procedure to open the control panel system diagnostics tests.

1. Turn the printer power off, and then on again.
2. Touch the middle of the control panel display when you see the 1/8 under the logo.

**Figure 4-28** Open the Pre-boot menu



3. On the Pre-boot menu screen, use the following buttons to navigate the tests.

Figure 4-29 Pre-boot menu

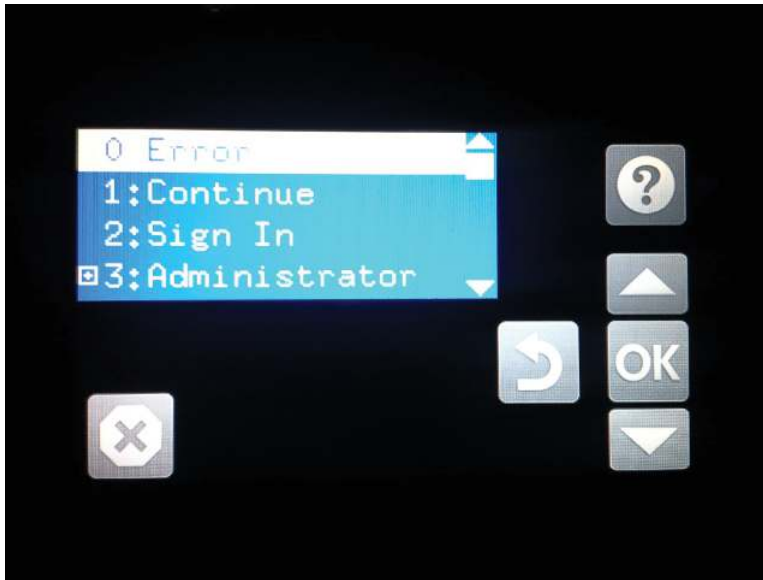








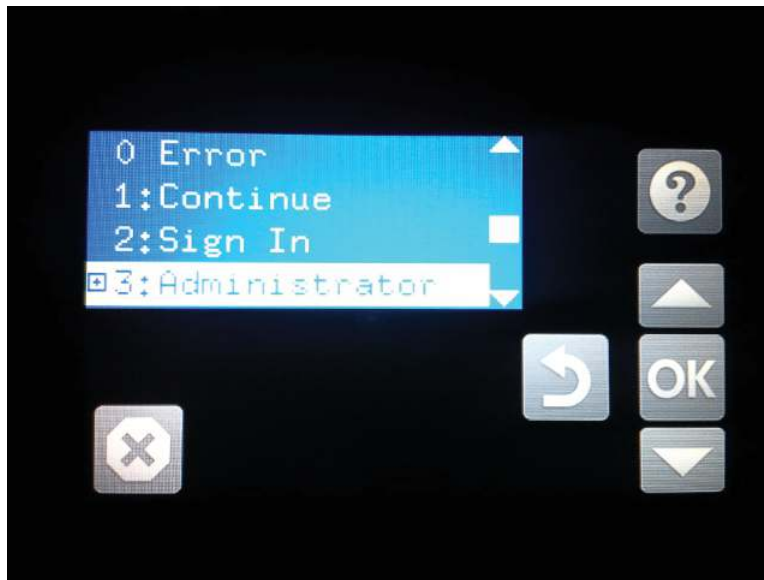
Table 4-3 Pre-boot menu button descriptions

Button	Description
	Use this button to see more information about a selected item.
	Use this button to scroll up through menu items.
	Use this button to select a highlighted menu item.
	Use this button to scroll down through menu items.
	Use this button to go back to the previous menu.
	Not used.



- Use the **down arrow ▼** button to scroll to **+3 Administration**, and then press the **OK** button to select it.

**Figure 4-30** Access the administration menu



- Use the **down arrow ▼** button to scroll to **+E CP Diagnostics**, and then press the **OK** button to select it.

---

 **NOTE:** An administrator password might be required to continue.

---

**Figure 4-31** Access the diagnostics menu



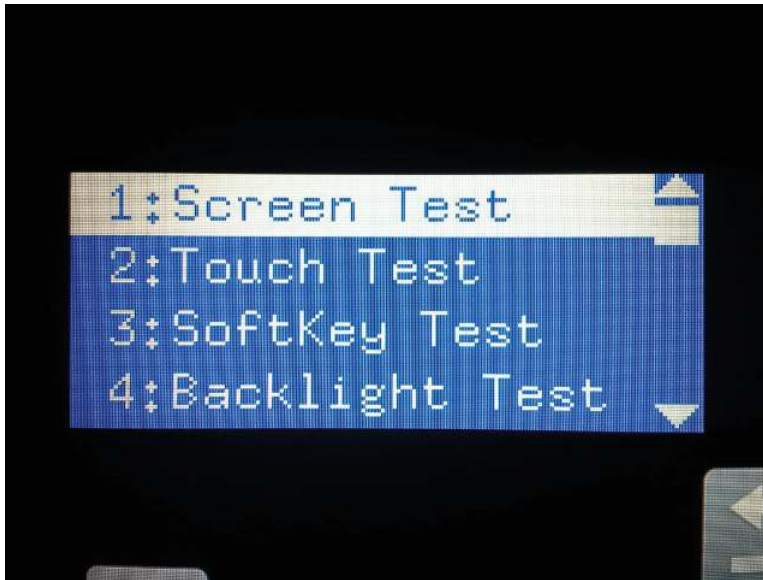
### Screen test

Learn about the control panel system diagnostic screen test.

- Open the control panel system diagnostic tests.

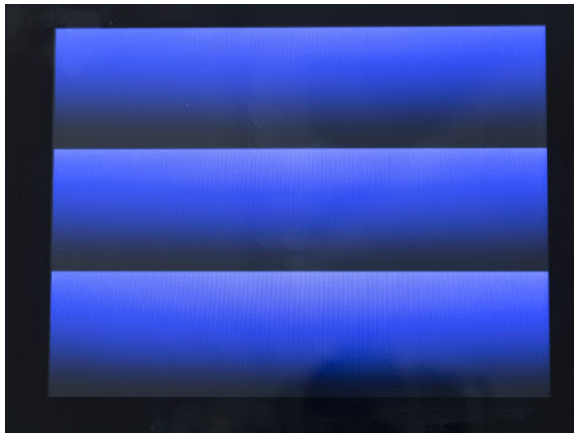
- With **1 Screen Test** highlighted, press the **OK** button to select it.

**Figure 4-32** Open the screen test



The blue horizontal gradient screen appears.

**Figure 4-33** Blue horizontal gradient screen

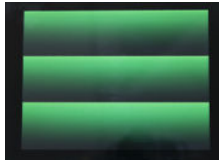


- Touch the touchscreen to scroll through the remaining touchscreen test screens.

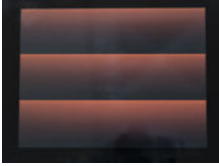

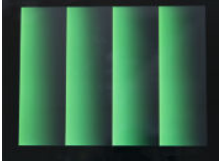
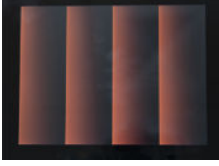


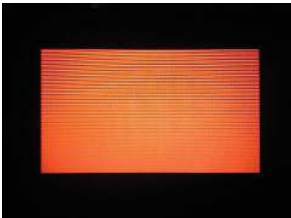


**NOTE:** Touch the **Home** button to exit the test.


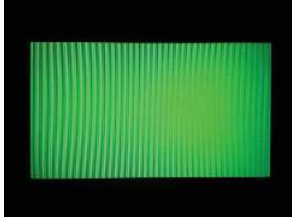




**Table 4-4** Touchscreen test screens

Screen	Description
	Green horizontal gradient

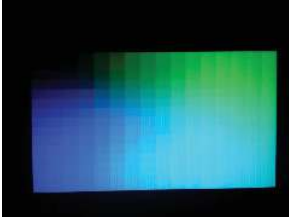
**Table 4-4 Touchscreen test screens (continued)**

Screen	Description
	Red horizontal gradient
	Blue vertical gradient
	Green vertical gradient
	Red vertical gradient
	Blue with horizontal interlaced
	Green with horizontal interlaced
	Red with horizontal interlaced

**Table 4-4 Touchscreen test screens (continued)**

Screen	Description
 A rectangular screen with a black border. The background is a solid blue color with a fine, vertical, wavy interlaced pattern.	Blue with vertical interlaced
 A rectangular screen with a black border. The background is a solid green color with a fine, vertical, wavy interlaced pattern.	Green with vertical interlaced
 A rectangular screen with a black border. The background is a solid red color with a fine, vertical, wavy interlaced pattern.	Red with vertical interlaced
 A rectangular screen with a black border. In the center is a bright white square, surrounded by a thin, glowing white border.	Black with white center
 A rectangular screen with a black border. The background is a solid white color. In the center is a solid black square.	White with black center
 A rectangular screen with a black border. The background is a checkerboard pattern of alternating black and white squares.	Checkerboard

**Table 4-4 Touchscreen test screens (continued)**

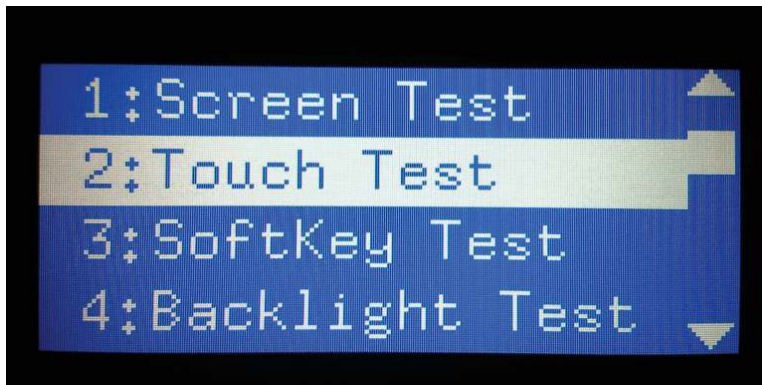
Screen	Description
	Multicolor stripes
	Blue green grid meshing

## Touch test

Learn about the control panel system diagnostic touch test.

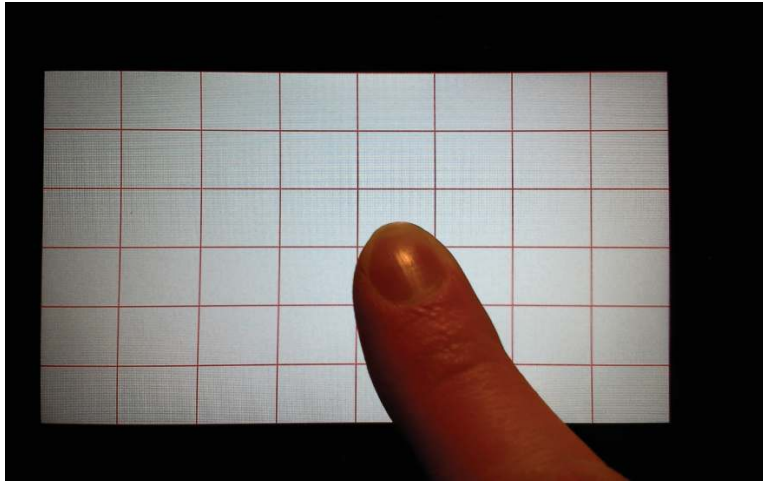
1. Open the control panel system diagnostic tests.
2. Use the **down arrow ▼** button to scroll to **2 Touch Test**, and then press the **OK** button to select it.

**Figure 4-34 Open the touch test**



3. Use your finger to touch the white grid on the display.

**Figure 4-35** Touch the white grid



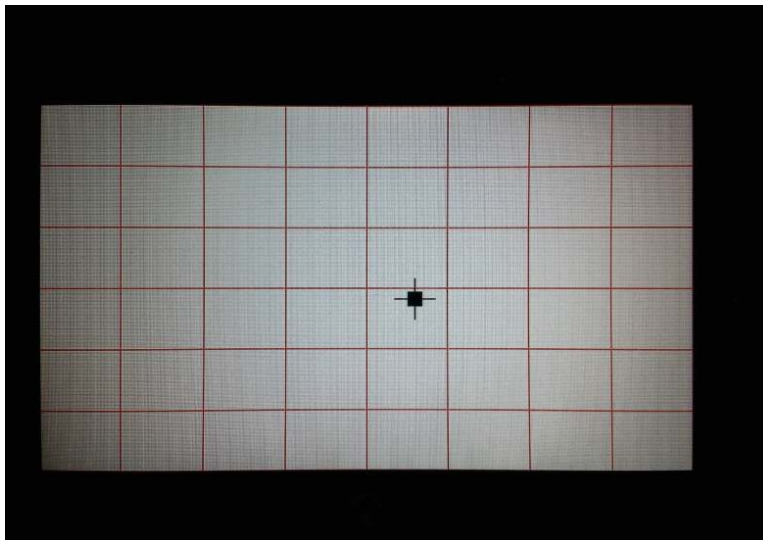
A mark appears on the grid where it was touched.

---

 **NOTE:** Touch the [Home](#) button to exit the test.

---

**Figure 4-36** Verify the mark



## SoftKey test

Learn about the control panel system diagnostic SoftKey test.

1. Open the control panel system diagnostic tests.

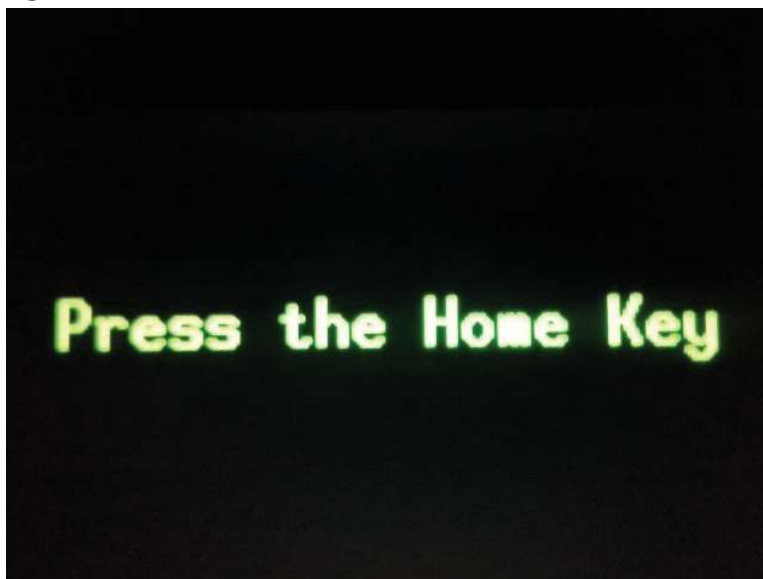
- Use the **down arrow ▼** button to scroll to **3 SoftKey Test**, and then press the **OK** button to select it.

**Figure 4-37** Open the softkey test




- When prompted, touch the **Home** button.

**Figure 4-38** Touch the **Home** button



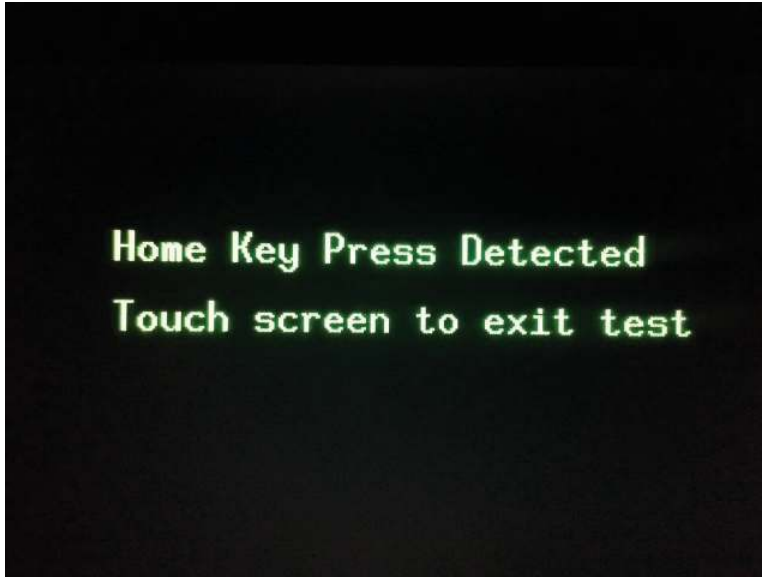
If the test is successful, the following screen appears on the display.

---

 **NOTE:** Touch the screen to exit the test.

---

Figure 4-39 Successful test



## Backlight test

Learn about the control panel system diagnostic backlight test.

1. Open the control panel system diagnostic tests.
2. Use the **down arrow ▼** button to scroll to **4 Backlight Test**, and then press the **OK** button to select it.  
After selecting the **4 Backlight Test**, the screen automatically dims, and then returns to full brightness.


 **NOTE:** Touch any key to exit the test.

Figure 4-40 Open the backlight test




## Sound test

Learn about the control panel system diagnostic sound test.



1. Open the control panel system diagnostic tests.
  2. Use the **down arrow ▼** button to scroll to **5 Sound Test**, and then press the **OK** button to select it.
- After selecting the **5 Sound Test**, the printer emits a series of audible tones.

---

 **NOTE:** Touch any key to exit the test.

---


**Figure 4-41** Open the sound test



### Keyboard test (flow models only)

Learn about the control panel system diagnostic keyboard test.

---

 **IMPORTANT:** The control-panel system diagnostic tests include a **6 Keyboard Test** item. This test is not valid for printers that do **not** have a pull out keyboard installed, even though this option is present in the control-panel system diagnostic tests menu.

If the **6 Keyboard Test** is opened on a non-flow printer, the printer power must be turned off to exit the test.

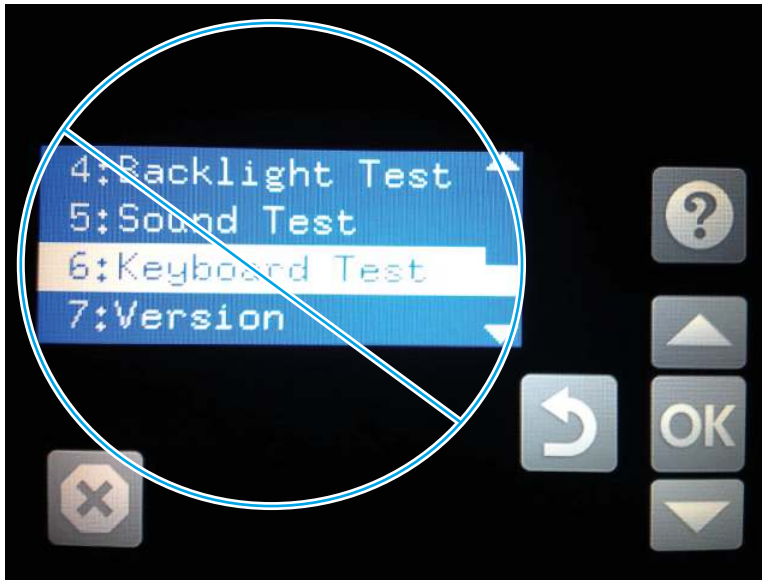
**HP does not recommend** turning the printer power off during the control-panel system diagnostic tests.

---

1. Open the control panel system diagnostic tests..

2. Use the **down arrow ▼** button to scroll to **6 Keyboard Test**, and then press the **OK** button to select it.

**Figure 4-42** Open the keyboard test



3. When prompted, touch the H key on the keyboard or the Home button to exit the test.

## Version

Learn about the control panel system diagnostic version information.

1. Open the control panel system diagnostic tests.
2. Use the **down arrow ▼** button to scroll to **7 Version**, and then press the **OK** button to select it.


---

 **NOTE:** Touch any key to exit the test.

---

Select **7 Version** to view the following types of information:

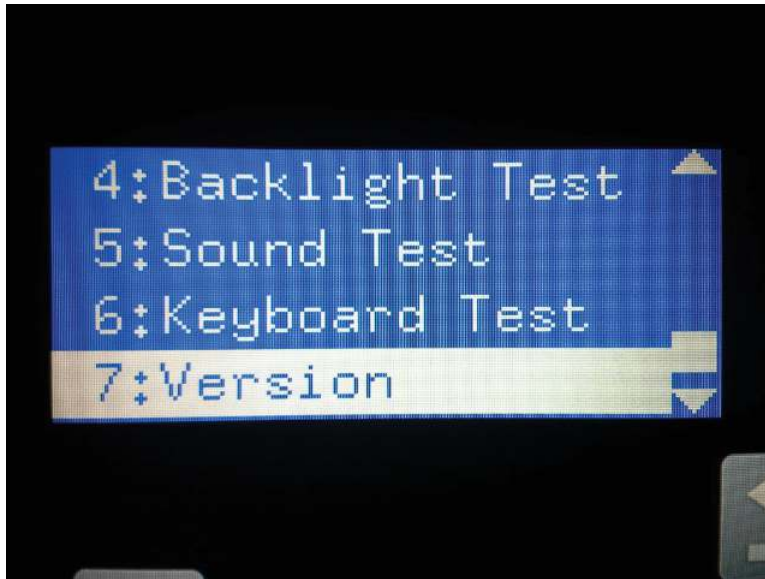
---

 **NOTE:** The following types of information are for the control panel only, not the printer.

---

- Panel ID
- Hardware (version)
- Firmware (version)
- KB Hw (version)
- KB Firm (version)
- LCD Vendor
- Touch Controller Version

**Figure 4-43** Open the version information



### Control panel diagnostic flowcharts

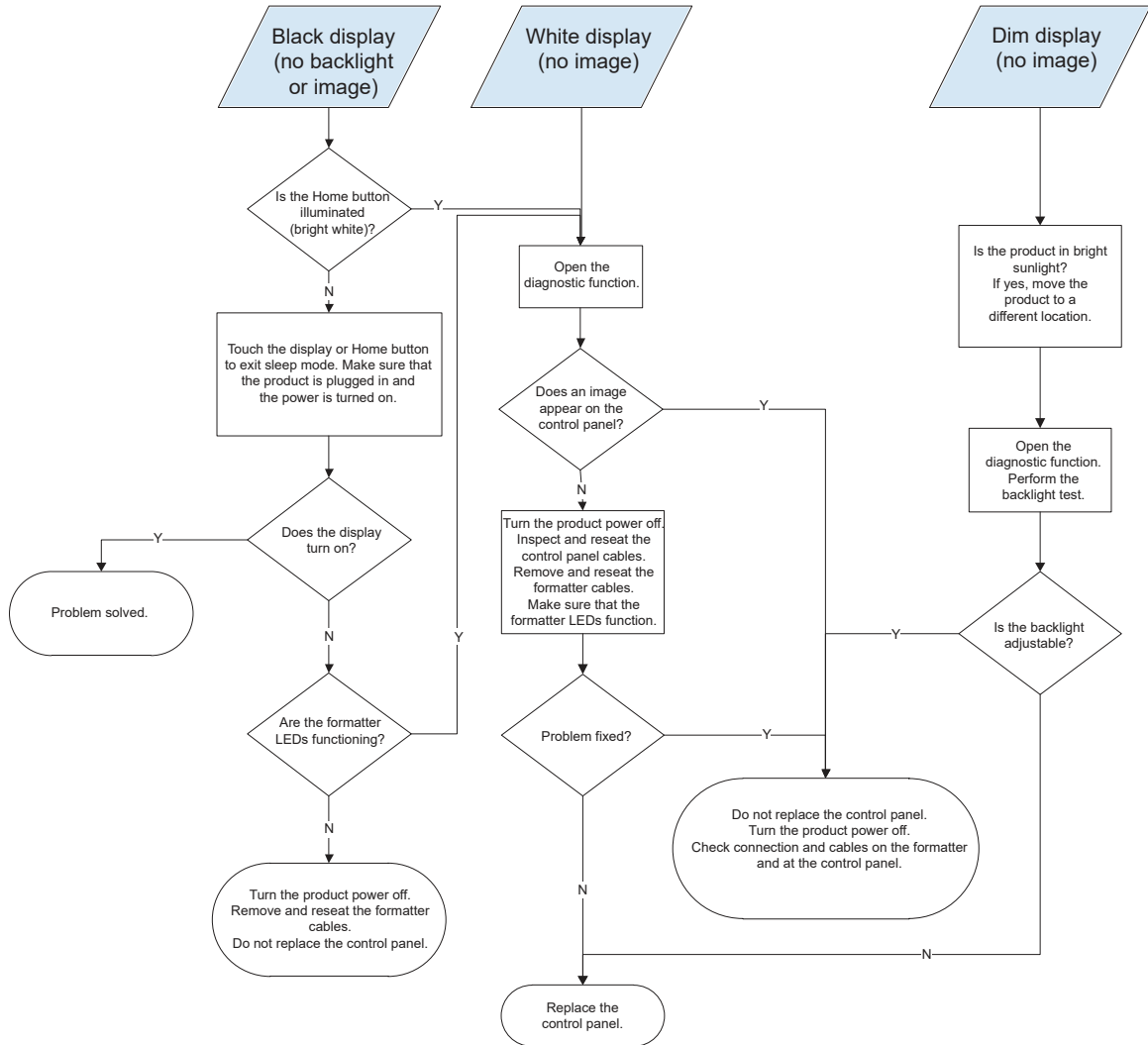
Use the flowcharts in this section to troubleshoot the following control panel problems.

- Touchscreen is blank, white, or dim (no image).
- Touchscreen is slow to respond or requires multiple presses to respond.
- Touchscreen has an unresponsive zone.
- No control panel sound.
- Home button is unresponsive.
- Hardware integration pocket (HIP) is not functioning (control panel functional).

### Touchscreen black, white, or dim (no image)

To open the diagnostic function, press the button on the back of the control panel.

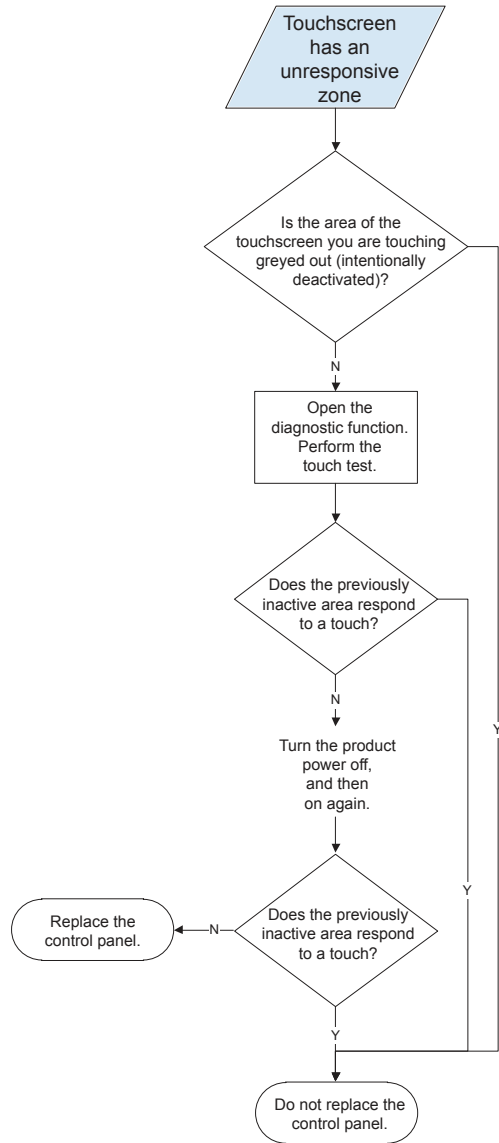
**Figure 4-44 Touchscreen blank, white, or dim (no image)**



**Touchscreen has an unresponsive zone**

To open the diagnostic function, press the button on the back of the control panel.

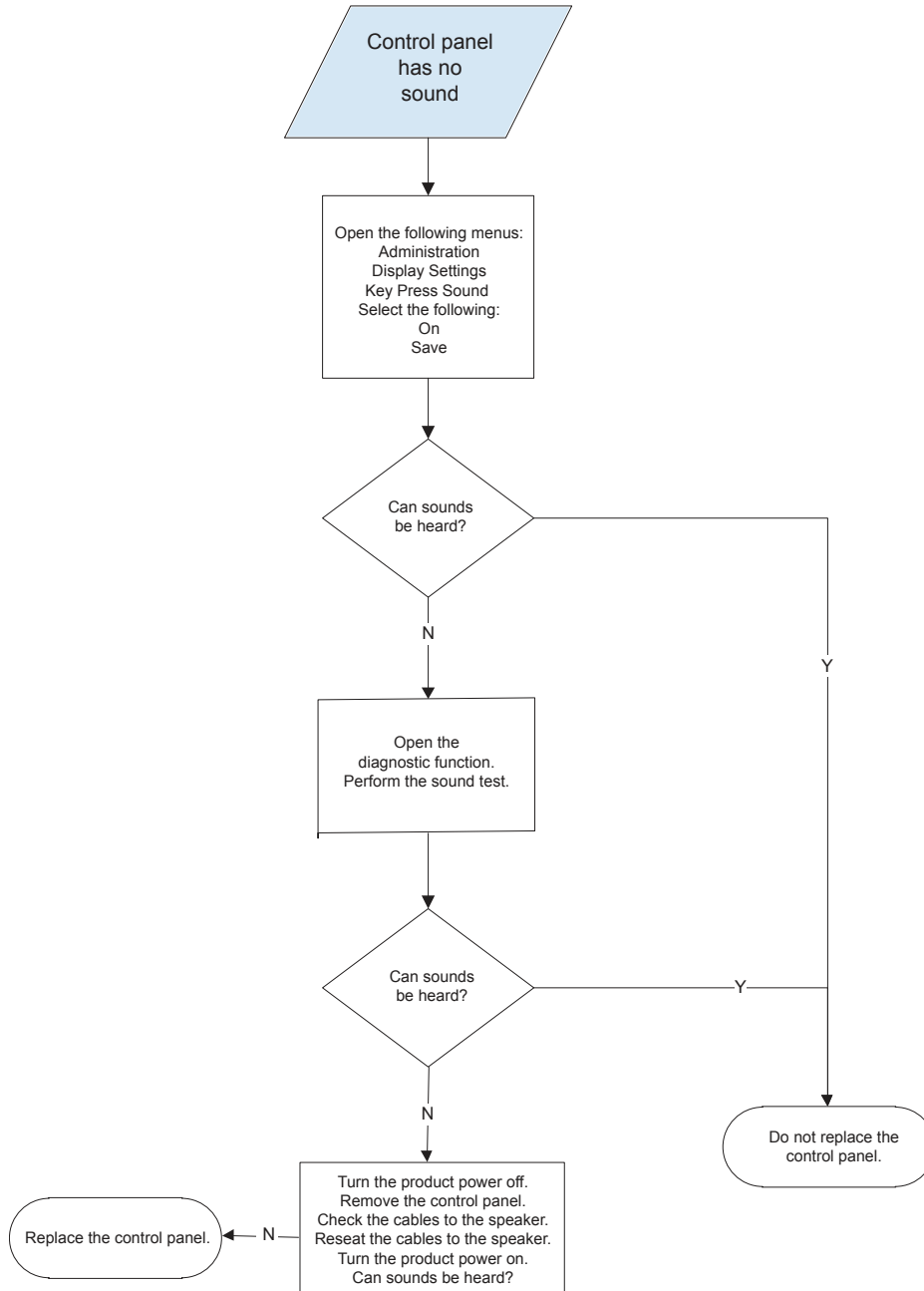
**Figure 4-45 Touchscreen has an unresponsive zone**



### No control panel sound

To open the diagnostic function, press the button on the back of the control panel.

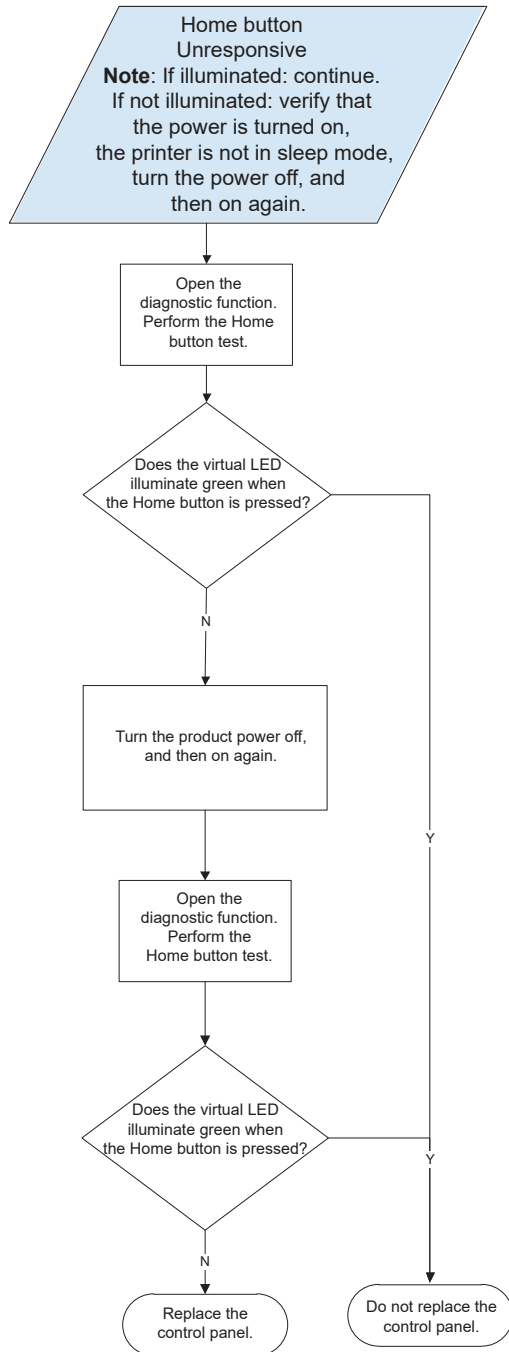
**Figure 4-46 No control panel sound**



**Home button is unresponsive**

To open the diagnostic function, press the button on the back of the control panel.

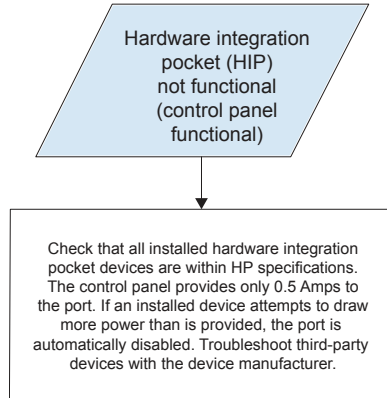
**Figure 4-47 Home button is unresponsive**



**Hardware integration pocket (HIP) is not functioning (control panel functional)**

Review the following information when the HIP is not functioning, but the control panel is functional.


**Figure 4-48 Hardware integration pocket (HIP) is not functioning (control panel functional)**



## Print menu (SFP) and Copy/Print menu (MFP)

Learn about the control-panel **Print** menu (SFP) and the **Copy/Print** menu (MFP).

**To display:** At the printer control panel, select the **Settings** menu, and then select the **Print** menu (SFP) or the **Copy/Print** menu (MFP).

**To print:** At the printer control panel, touch (MFP) or use the arrow buttons (SFP) to select the printer icon . For the SFP, press the **OK** button to print the pages.

In the following table, asterisks (\*) indicate the factory default setting.

**Table 4-5 Print menu (SFP) or Copy/Print menu (MFP)**

First level	Second level	Third level	Fourth Level	Values	Description
Copy Settings	Image preview			Make optional	Use this menu to configure how <b>Copy</b> behaves.
MFP				Require preview	
				Disable preview	
Copy Settings	Copies			1-9999	Configure the default options for copy jobs. If the user does not specify the job options when creating the job, the default options are used.
MFP				Default = 1	



**Table 4-5 Print menu (SFP) or Copy/Print menu (MFP) (continued)**

First level	Second level	Third level	Fourth Level	Values	Description
Copy Settings MFP	Sides	Original Sides		1-sided	Use to indicate whether the original document is printed on one or both sides. For example, select <b>Original Sides 1-sided</b> and <b>Output Sides 2-sided</b> when the original is printed on one side, but you want to make two-sided copies.  Select <b>Flip pages up</b> to print the pages with long edge of the in the landscape orientation.
				2-sided	
				Flip pages up	
Copy Settings MFP	Sides	Output Sides		1-sided	Use to indicate whether the copies should be printed on one or both sides. For example, select <b>Original Sides 1-sided</b> and <b>Output Sides 2-sided</b> when the original is printed on one side, but you want to make two-sided copies.  Select <b>Flip pages up</b> to print the pages with long edge of the in the landscape orientation.
				2-sided	
				Flip pages up	
Copy Settings MFP	Watermark	Watermark Type		None*	Use to set a text watermark.
				Text	
Copy Settings MFP	Watermark	Watermark Text		Draft	Select a predefined text watermark.
				Confidential	
				Secret	
				Top Secret	
				Urgent	
Copy Settings MFP	Watermark	Text Font		Letter Gothic*	Select the font of the text watermark.
				Antique Olive	
				New Century Schoolbook Roman	
				Garamond Antiqua	

**Table 4-5 Print menu (SFP) or Copy/Print menu (MFP) (continued)**

First level	Second level	Third level	Fourth Level	Values	Description
Copy Settings	Watermark	Text Size		30 point	Select the font point size of the text watermark.
MFP				40 point*	
				60 point	
Copy Settings	Watermark	Darkness		1 - (Lighter)	Select the darkness of the text watermark.
MFP				2	
				3*	
				4	
				5 - (Darker)	
Copy Settings	Stamps	Stamp Content		User-defined value	Use to set a stamp in any or all the following locations in the document: <ul style="list-style-type: none"> <li>• Top Left</li> <li>• Top Center</li> <li>• Top Right</li> <li>• Bottom Left</li> <li>• Bottom Center</li> <li>• Bottom Right</li> </ul>
MFP				None*	
				IP address	
				User name	
				Product information	
				Page number	
				Date and time	
Copy Settings	Stamps	Text Font		Letter Gothic*	Select the font of the stamp.
MFP				Antique Olive	
				New Century Schoolbook Roman	
				Garamond Antiqua	
Copy Settings	Stamps	Text Size		8 point	Select the font point size of the stamp.
MFP				12 point*	
				20 point	
Copy Settings	Stamps	White background		Disabled*	Select the check box to enable a white background for the stamp.
MFP				Enabled	

**Table 4-5 Print menu (SFP) or Copy/Print menu (MFP) (continued)**

First level	Second level	Third level	Fourth Level	Values	Description
Copy Settings  MFP	Scan Mode			Standard document*	Use to indicate the type of original document to be scanned.
				Prompt for additional pages	
				Book 2-sided ID	Select <b>Prompt for additional pages</b> to copy or scan an original document that has more pages than the document feeder can accommodate at one time, or to scan originals of different sizes that cannot be scanned together, and then combine these separate scan jobs into a single job.
Copy Settings  MFP	Reduce/Enlarge			Automatic*	Scale the size of the document up or down.
				Include margins	
				Manual Default=100	To reduce the image, select a scaling percentage that is less than 100. To enlarge the image, select a scaling percentage that is greater than 100.  When <b>Include margins</b> is enabled, the printer reduces the image slightly to fit the entire scanned image within the printable area on the page.

**Table 4-5 Print menu (SFP) or Copy/Print menu (MFP) (continued)**

First level	Second level	Third level	Fourth Level	Values	Description
Copy Settings	Original Size			Automatically detect*	Specify the size of the original document.
MFP				Letter (8.5x11)	
				Mixed Letter/Legal	
				Legal (8.5x14)	
				Executive (7.25x10.5)	
				Statement (5.5x8.5)	
				Oficio (8.5x13)	
				4x6	
				5x7	
				5x8	
				A4 (210x297 mm)	
				A5 (148x210 mm)	
				A6 (105x148 mm)	
				RA4 (215x305 mm)	
				B5 (182x257 mm)	
				B6 (128x182 mm)	
				10x15cm	
				16K (195x270 mm)	
				16K (184x260 mm)	
				16K (197x273 mm)	
				DPostcard JIS (148x200 mm)	
				Oficio (216x340 mm)	

**Table 4-5 Print menu (SFP) or Copy/Print menu (MFP) (continued)**

First level	Second level	Third level	Fourth Level	Values	Description
Copy Settings	Paper Selection		Paper Size	Match original size*	Select the size of paper to use when printing or making copies.
MFP				Letter (8.5x11)	
				Legal (8.5x14)	
				Executive (7.25x10.5)	
				Statement (5.5x8.5)	
				Oficio (8.5x13)	
				3x5	
				4x6	
				5x7	
				5x8	
				A4 (210x297 mm)	
				A5 (148x210 mm)	
				A6 (105x148 mm)	
				RA4 (215x305 mm)	
				B5 (182x257 mm)	
				B6 (128x182 mm)	
				10x15cm	
				16K (195x270 mm)	
				16K (184x260 mm)	
				16K (197x273 mm)	
				Postcard JIS (100x148 mm)	
				DPostcard JIS (148x200 mm)	
				Envelope #9	
				Envelope #10	
				Envelope Monarch	
				Envelope #10	
				Envelope B5	
				Envelope C5	
				Envelope C6	
				Envelope DL	
				Custom	
				Oficio (216x340 mm)	

**Table 4-5 Print menu (SFP) or Copy/Print menu (MFP) (continued)**

First level	Second level	Third level	Fourth Level	Values	Description
Copy Settings	Paper Selection		Paper Type	Any Type	Select the type of paper to use when printing or making copies.
MFP				Plain*	
				Light 60-74g	
				Intermediate 85-95g	
				Mid-Weight 96-110g	
				Heavy 111-130g	
				Extra Heavy 131-175g	
				Cardstock 176-220g	
				Mono Transparency	
				Labels	
				Letterhead	
				Envelope	
				Preprinted	
				Prepunched	
				Colored	
				Bond	
				Recycled	
				Rough	
				HP EcoFFICIENT	
				Light Bond	
Copy Settings	Paper Selection		Paper Tray	Automatically detect*	Select which tray to use when printing or making copies.
MFP				Manually Feed	
				Tray 1	
				Tray 2	
Copy Settings	Booklet	Booklet Format		Enabled	Select to have Booklet Format off or on.
MFP				Disabled*	
Copy Settings	Booklet	Booklet Format	Borders on each page	Enabled	Select to have borders printed on the page.
MFP				Disabled*	
Copy Settings	Content Orientation			Portrait*	Specify the way the content of the original document is placed on the page.
MFP				Landscape	
Copy Settings	Pages per Sheet			One*	Select how many pages to print on one sheet.
MFP				Two	
				Four	

**Table 4-5 Print menu (SFP) or Copy/Print menu (MFP) (continued)**

First level	Second level	Third level	Fourth Level	Values	Description
Copy Settings MFP	Page Order			Right, then down	Select to print the pages in rows or columns.
				Down, then right	
Copy Settings MFP	Add page borders			Enabled	Select the <a href="#">Add page borders</a> checkbox to add borders to the pages.
				Disabled*	
Copy Settings MFP	Image Adjustment	Darkness		1 - (Lighter)	Adjust to increase or decrease the amount of white and black in the colors.
				2	
				3	
				4	
				5*	
				6	
				7	
				8	
				9 - (Darker)	
Copy Settings MFP	Image Adjustment	Contrast		1 - (Less)	Adjust to increase or decrease the difference between the lightest and darkest color on the page.
				2	
				3	
				4	
				5*	
				6	
				7	
				8	
				9 - (More)	
Copy Settings MFP	Image Adjustment	Background Cleanup		1 - (Normal)	Adjust if you are having trouble copying a faint image.
				2	
				3*	
				4	
				5*	
				6	
				7	
				8	
				9 - (Cleaner)	

**Table 4-5 Print menu (SFP) or Copy/Print menu (MFP) (continued)**

First level	Second level	Third level	Fourth Level	Values	Description
Copy Settings MFP	Image Adjustment	Sharpness		1 - (Less) 2 3* 4 5 - (More)	Adjust to sharpen or soften the image.
Copy Settings MFP	Optimize Text/ Picture			Text Mixed* Printed picture Photograph	Select to optimize for the output of a particular type of content.
Copy Settings MFP	Edge-to-Edge			Normal (recommended) Edge-to-Edge output	When the Edge-to-Edge feature is enabled, the product minimizes margins and prints as close to the edge of the paper as possible.
Copy Settings MFP	Erase Edges	Use inches		Enabled* Disabled	Use the Erase Edges feature to remove blemishes, such as dark borders or staple marks, by cleaning the edges of the scanned image.  Disabling Use inches changes the measurements to millimeters.
Copy Settings MFP	Erase Edges	Front Side		Specify a different width for each edge Apply same width to all edges* All edges value Default = 0.00	Sets the width of the edge to clean.
Copy Settings MFP	Erase Edges	Back Side		Specify a different width for each edge Apply same width to all edges Mirror front side*	Sets the width of the edge to clean.



**Table 4-5 Print menu (SFP) or Copy/Print menu (MFP) (continued)**

First level	Second level	Third level	Fourth Level	Values	Description
Copy Settings MFP	Collate			Collate on*	When <b>Collate on</b> is selected, each set of copied pages are assembled in the same order as the original document.
				Collate off	
Copy Settings MFP	Multi-feed Detection			Disabled	Use this feature to detect when multiple pages are fed simultaneously into the ADF (automatic document feeder) or sheet-feed scanner.
				Enabled*	
Copy Settings MFP					
Enable Print from USB Drive				Enabled	Enables the printer to open a file from a USB drive.
				Disabled*	
Manage Stored Jobs	Job Sort Order			Job Name*	This option allows you list the jobs either alphabetically or chronologically.
				Date*	
Manage Stored Jobs	Retain Temporary Jobs			Do not retain	Sets which temporary jobs will be retained in the event of a printer reboot.
				Personal jobs only	
				All temporary jobs	
Manage Stored Jobs	Temporary Job Storage Limit			1-300	Configure global settings for jobs that are stored in the printer memory.  The <b>Temporary Job Storage Limit</b> feature specifies the number of temporary jobs that can be stored on the printer. The maximum allowed value is 300.
				Default = 32	
Manage Stored Jobs	Temporary Job Storage Retention			Off	Configure global settings for temporary jobs that are stored in the printer memory.
				30 minutes	
				1 hour	
				4 hours	The <b>Temporary Stored Job Retention</b> feature specifies the amount of time temporary jobs can be stored on the printer.
				1 day	
				1 week	
				4 weeks	
3 days					

**Table 4-5 Print menu (SFP) or Copy/Print menu (MFP) (continued)**

First level	Second level	Third level	Fourth Level	Values	Description
Manage Stored Jobs	Standard Stored Job Retention			Off	Configure global settings for jobs that are stored in the printer memory.  The <a href="#">Standard Stored Job Retention</a> feature specifies the amount of time jobs can be stored on the printer.
				30 minutes	
				1 hour	
				4 hours	
				1 day	
				1 week	
				4 weeks	
				3 days	
Default Print Options	Number of Copies			Range: 1-32000 Default = 1	Sets the default number of copies for a copy job. This default applies when the <a href="#">Copy</a> function or the <a href="#">Quick Copy</a> function is initiated from the printer Home screen.
Default Print Options	Paper Selection	Paper size Paper type Paper tray		Select from a list of sizes that the printer supports.	Configures the default paper size, type and tray used for print jobs.
Default Print Options	Default Custom Paper Size	X Dimension		Range: 3.00-8.50 inches Default = 8.5 inches	Configures the default paper size that is used when the user selects <b>Custom</b> as the paper size for a print job.
Default Print Options	Default Custom Paper Size	Y Dimension		Range: 5.00-14.00 inches Default = 14 inches	Configures the default paper size that is used when the user selects <b>Custom</b> as the paper size for a print job.
Default Print Options	Default Custom Paper Size	Use Inches		Enabled* Disabled	
Default Print Options	Output Sides			1-sided* 2-sided	Use to indicate whether the original document is printed on one or both sides.
Default Print Options	Edge-to-Edge			Normal (recommended)* Edge-to-Edge output	Use to avoid shadows that can appear along the edges of copies when the original document is printed close to the edges.

**Table 4-5 Print menu (SFP) or Copy/Print menu (MFP) (continued)**

First level	Second level	Third level	Fourth Level	Values	Description
Default Print Options	Resolution			FastRes 1200*	Use to select the level of desired print quality.
				ProRes 1200	
Default Print Options	Resolution	Economode		Enabled	Text is printed using less toner. This setting is useful when you are printing drafts. You can turn on this option independently of other print quality settings.
				Disabled*	
PCL and Postscript Settings	Courier Font			Regular*	Select which version of the Courier font you want to use. The factory default setting is <a href="#">Regular</a> , which uses an average stroke width. The <a href="#">Dark</a> setting can be used if a heavier Courier font is needed.
				Dark	
PCL and Postscript Settings	Wide A4			Enabled	Changes the printable area of A4-size paper. If you enable this option, eighty 10-pitch characters can be printed on a single line of A4 paper.
				Disabled*	
PCL and Postscript Settings	Print PS Errors			Enabled	Use this feature to select whether a PostScript (PS) error page is printed when the printer encounters a PS error.
				Disabled*	
PCL and Postscript Settings	Print PDF Errors			Enabled	Selects whether a PDF error page is printed when the printer encounters a PDF error.
				Disabled*	

**Table 4-5 Print menu (SFP) or Copy/Print menu (MFP) (continued)**

First level	Second level	Third level	Fourth Level	Values	Description
PCL and Postscript Settings	Personality			Automatic*	Configures the default print language or personality for the printer. Normally you should not change the printer language. If you change the setting to a specific printer language, the printer does not automatically switch from one language to another unless specific software commands are sent to it.
				PCL	
				PS	
				PDF	
PCL and Postscript Settings	PCL	Font Settings	Font Source	Internal	Selects the font source for the user-soft default font. The list of available options varies depending on the installed printer options.
				Disk resident*	
PCL and Postscript Settings	PCL	Font Settings	Font Number	Range: 0-110 Default = 0	Specifies the font number for the user-soft default font using the source that is specified in the <a href="#">Font Source</a> menu. The printer assigns a number to each font and lists it on the PCL font list. The font number displays in the Font # column of the printout.
PCL and Postscript Settings	PCL	Font Settings	Font Pitch	Range: 0.44-99.99 Default = 10	If the <a href="#">Font Source</a> option and the <a href="#">Font Number</a> setting indicate a contour font, then use this feature to select a default pitch (for a fixed-spaced font).

**Table 4-5 Print menu (SFP) or Copy/Print menu (MFP) (continued)**

First level	Second level	Third level	Fourth Level	Values	Description
PCL and Postscript Settings	PCL	PCL Settings	Form Length	Range: 5-128 lines Default = 60	Controls the PCL print-command options. PCL is a set of printer commands that HP developed to provide access to printer features.  Use the <a href="#">Form Length</a> feature to select the user soft-default vertical form length.
PCL and Postscript Settings	PCL	PCL Settings	Orientation	Portrait* Landscape	Select the orientation that is most often used for copy or scan originals. Select the <a href="#">Portrait</a> option if the short edge is at the top or select the <a href="#">Landscape</a> option if the long edge is at the top.
PCL and Postscript Settings	PCL	PCL Settings	Symbol Set	Select from a list of symbol sets.	Select any one of several available symbol sets from the control panel. A symbol set is a unique grouping of all the characters in a font. The factory default value for this option is PC-8. Either PC-8 or PC-850 are recommended for line-draw characters.
PCL and Postscript Settings	PCL	PCL Settings	Append CR to LF	Enabled Disabled*	When enabled, this option appends a carriage return to each line feed encountered in backwards-compatible PCL jobs.
PCL and Postscript Settings	PCL	PCL Settings	Suppress Blank Pages	Enabled Disabled*	This option is for users who are generating their own PCL, which could include extra form feeds that would cause blank pages to be printed. When the <a href="#">On</a> option is selected, form feeds are ignored if the page is blank.

**Table 4-5 Print menu (SFP) or Copy/Print menu (MFP) (continued)**

First level	Second level	Third level	Fourth Level	Values	Description
PCL and Postscript Settings	PCL	PCL Settings	Media Source Mapping	Standard* Classic	Use to select and maintain input trays by number when you are not using the printer driver, or when the software program has no option for tray selection. The following options are available:  Standard: Tray numbering is based on newer HP LaserJet models.  Classic: Tray numbering is based on HP LaserJet 4 and older models.
Print Quality	General	Toner Density		A sliding bar appears with the indicator set in the middle between Less and More.	Lighten or darken the print on the page by changing the toner density setting.
Print Quality	General	REt		Disabled Enabled*	Use this setting to enable or disable Resolution Enhancement technology (REt), which produces smoother angles, curves, and edges.
Print Quality	Image Registration	Tray	Tray 1 Tray 2 Tray 3 Tray 4 Tray 5  Depends upon the number of trays installed		Specify tray to be adjusted

**Table 4-5 Print menu (SFP) or Copy/Print menu (MFP) (continued)**

First level	Second level	Third level	Fourth Level	Values	Description
Print Quality	Image Registration	Front-side Horizontal Shift		-5.00 mm to 5.00 mm	Shift the margin alignment to center the image on the page from top to bottom and from left to right. You can also align the image on the front with the image printed on the back.
		Front-side Vertical Shift			The direction that is perpendicular to the way the paper passes through the printer is referred to as X. This is also known as the scan direction. X1 is the scan direction for a single-sided page or for the second side of a two-sided page. X2 is the scan direction for the first side of a two-sided page.
		Back-side Horizontal Shift			The direction that the paper feeds through the printer is referred to as Y. Y1 is the feed direction for a single-sided page or for the second side of a two-sided page. Y2 is the feed direction for the first side of a two-sided page.
		Back-side Vertical Shift			Use the <a href="#">Adjust Tray &lt;X&gt;</a> menu to adjust the registration settings for each tray. Before adjusting these values, print a registration test page. It provides alignment guides in the X and Y directions so you can determine which adjustments are necessary. You can adjust values for X1 Shift, X2 Shift, Y1 Shift, and Y2 Shift.

**Table 4-5 Print menu (SFP) or Copy/Print menu (MFP) (continued)**

First level	Second level	Third level	Fourth Level	Values	Description
Print Quality	Image Registration	Print Test Page			Use the <a href="#">Print Test Page</a> option to print a page to test the image registration. It provides alignment guides in the X and Y directions so you can determine which adjustments are necessary.
Print Quality	Auto Sense Behavior	Tray 1		Sense every page Sense first page Sense transparency only	
Print Quality	Auto Sense Behavior	All Other Trays		Sense first page Sense transparency only	
Print Quality	Adjust Paper types	Select from a list of paper types that the printer supports. The available options are the same for each paper type.	Print mode	Select from a list of paper types Reset Paper Types	Changing the <a href="#">Print mode</a> setting is usually the first thing to try to resolve print-quality problems. Problems can include toner not sticking well to the page, a faint image of the page repeated on the same or following page, incorrect gloss level, and so on.
Print Quality	Adjust Paper types	Select from a list of paper types that the printer supports. The available options are the same for each paper type.	Resistance mode	Normal* Up 1 Up 2	Use this setting to correct print quality problems in low-humidity environments and highly resistive paper.  Use the <a href="#">Up</a> options to solve print quality problems that are related to faded images or scattered toner on certain paper types.  The <a href="#">Up</a> options raise the secondary transfer bias.



**Table 4-5 Print menu (SFP) or Copy/Print menu (MFP) (continued)**

First level	Second level	Third level	Fourth Level	Values	Description
Print Quality	Adjust Paper types	Select from a list of paper types that the printer supports. The available options are the same for each paper type.	Paper curl mode	Normal* Reduced	Use this setting to reduce paper curl in print jobs.
Print Quality	Optimize	Line Detail		Normal* Off Alternate	Use this setting if you have scattered lines in printed pages.
Print Quality	Optimize	Moisture Control		Normal* Alternate	
Print Quality	Optimize	Envelope control		Normal Reduced Temp	
Print Quality	Optimize	Tray 1		Normal Alternate	
Print Quality	Optimize	Background		Normal Alternate	
Print Quality	Optimize	Uniformity Control		Normal Alternate 1 Alternate 2 Alternate 3	
Print Quality	Optimize	Cac03		Off On	
Print Quality	Optimize	Best Normal		Off On	
Print Quality	Optimize	Tracking Control		Off On	
Print Quality	Optimize	Registration		Normal Alternate	
Print Quality	Optimize	Transfer Control		Normal Alternate 1	
Print Quality	Optimize	Moisture Control		Normal Alternate	
Print Quality	Optimize	Reset Optimize		Reset	

**Table 4-5 Print menu (SFP) or Copy/Print menu (MFP) (continued)**

First level	Second level	Third level	Fourth Level	Values	Description
Print Quality	Edge Control			Off Light Normal* Maximum	
Manage Trays	Use Requested Tray			Exclusively* When available	<p>Controls how the printer handles jobs that have specified a specific input tray. Two options are available:</p> <p><b>Exclusively:</b> The printer never selects a different tray when the user has indicated that a specific tray should be used, even if that tray is empty.</p> <p><b>When available:</b> The printer pulls from another tray if the specified tray is empty, even though the specific tray was indicated for the job.</p>
Manage Trays	Manually Feed Prompt			Always prompt* Prompt on mismatch	<p>Indicate whether a prompt should appear when the type or size for a job does not match the specified tray and the printer pulls from the multipurpose tray instead. Two options are available:</p> <p><b>Always:</b> A prompt always displays before using the multipurpose tray.</p> <p><b>Prompt on mismatch:</b> A prompt displays only if the size or type do not match or the tray is empty.</p>

**Table 4-5 Print menu (SFP) or Copy/Print menu (MFP) (continued)**

First level	Second level	Third level	Fourth Level	Values	Description
Manage Trays	Size/Type Prompt			Display* Do not display	<p>Controls whether the tray configuration message displays whenever a tray is closed. Two options are available:</p> <p><b>Display:</b> Shows the tray configuration message when a tray is closed. The user is able to configure the tray settings directly from this message.</p> <p><b>Do not display:</b> Prevents the tray configuration message from automatically appearing.</p>
Manage Trays	Use Another Tray			Allow* Do not allow	<p>Use to turn on or off the control panel prompt to select another tray when the specified tray is empty. Two options are available:</p> <p><b>Allow:</b> When this option is selected the user is prompted to either add paper to the selected tray or to choose a different tray. This is the factory default.</p> <p><b>Do not allow:</b> When this option is selected, the user is not given the option of selecting a different tray. The printer prompts the user to add paper to the tray that was initially selected.</p>

**Table 4-5 Print menu (SFP) or Copy/Print menu (MFP) (continued)**

First level	Second level	Third level	Fourth Level	Values	Description
Manage Trays	Alternative Letterhead Mode			Off* On	Use to load letterhead or preprinted paper into the tray the same way for all print jobs, whether you are printing to one side of the sheet or to both sides of the sheet. When this option is selected, load the paper as you would for printing on both sides. See the user documentation that came with the printer for instructions about loading letterhead for printing on both sides. When this option is selected, the printer speed slows to the speed required for printing on both sides.
Manage Trays	Duplex Blank Pages			Automatic* Always	Controls how the printer handles two-sided jobs (duplexing). Two options are available:  <b>Automatic:</b> Choose this option to skip printing blank sides during a two-sided print job. The printer can print jobs faster when blank sides are skipped.  <b>Always:</b> Choose this option to print all sides of a two-sided job, even if one side is blank. This might be preferable for certain jobs that use paper types such as letterhead or prepunched paper.

Table 4-5 Print menu (SFP) or Copy/Print menu (MFP) (continued)

First level	Second level	Third level	Fourth Level	Values	Description
Manage Trays	Override A4/Letter			Yes*	Prints on letter-size paper when an A4 job is sent but no A4-size paper is loaded in the printer (or to print on A4 paper when a letter-size job is sent but no letter-size paper is loaded). This option will also override A3 with ledger-size paper and ledger with A3-size paper.
				No	

## Defeating interlocks


Learn about defeating printer interlocks.

Different tests can be used to isolate different types of issues. For assembly or noise isolation, run the diagnostic test when the front, right or toner supply (model specific) door is open.

Defeating the door interlocks allows observation of the paper pick operation.

### Defeat the front door interlock

1. Open the front door.
2. Insert a folded piece of paper into the slot.

 **TIP:** Fold a stiff piece of paper, for example a business card or index card, into a strip, and insert the strip into the slot for the door interlock logic switch.

It might be easier to use a small flat-blade screwdriver to defeat the door interlock.

Figure 4-49 Defeat the front door interlock



### Defeat the right door interlock

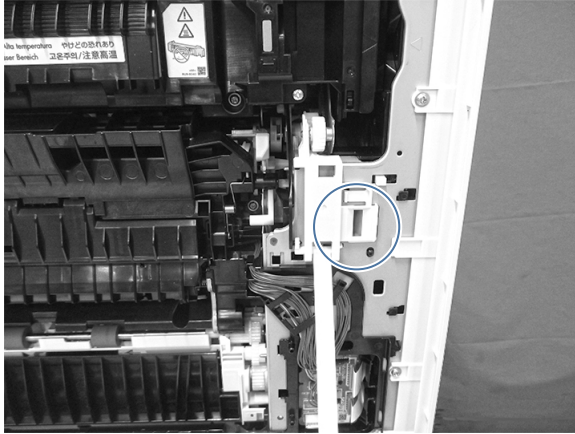
1. Open the right door.

2. Insert a folded piece of paper into the slot.

**TIP:** Fold a stiff piece of paper, for example a business card or index card, into a strip, and insert the strip into the slot for the door interlock logic switch.

It might be easier to use a small flat-blade screwdriver to defeat the door interlock.

**Figure 4-50** Defeat the right door interlock



### Defeat the toner supply door interlock (X654/X677 models)

1. Open the toner supply door.
2. Insert a folded piece of paper into the slot.

**TIP:** Fold a stiff piece of paper, for example a business card or index card, into a strip, and insert the strip into the slot for the door interlock logic switch.

It might be easier to use a small flat-blade screwdriver to defeat the door interlock.

**Figure 4-51** Defeat the toner supply door interlock (X654/X677 models)



## LED diagnostics (formatter)

Learn about troubleshooting the printer using formatter LEDs.

The formatter has two network port LEDs. When the printer is connected to a properly working network through a network cable, the amber LED indicates network activity, and the green LED indicates the link status.

A blinking amber LED indicates network traffic. If the green LED is off, a link has failed. For link failures, check all of the network cable connections.

In addition, try to manually configure the network card link speed setting by using the printer control panel. To change the link speed, complete the following steps.

1. From the [Home](#) screen on the printer control panel, scroll to and touch the [Settings](#) button.
2. Open the following menus:
  - [Networking](#)
  - [Ethernet](#)
  - [Link Speed](#)
3. Touch the desired link speed setting, and then touch the [Done](#) button.

## Scanner tests (MFP)

Learn about troubleshooting the MFP scanner tests.

### Use the scanner tests

The [Scanner Tests](#) screen shows the sensor name, sensor state (active or inactive), and the number of times the sensor has been toggled (activated).

1. From the Home screen on the product control panel, scroll to and select the [Support Tools](#) item.
2. Open the following menus:
  - [Troubleshooting](#)
  - [Diagnostic Tests](#)
  - [Scanner Tests](#)
  - – [Sensors](#)
3. Touch the sensor name on the [Scanner Tests](#) screen to display a sensor location graphic on the control panel display.
4. Activate the desired sensor, and then check the control-panel display to verify the sensor state (active or inactive).
  - The [State](#) virtual LED next to the sensor number and sensor name illuminates green when the sensor is active.
  - The [Toggle](#) virtual LED next to the sensor number and sensor name illuminates green after the sensor is activated and increments by one each time the sensor is interrupted (activated or deactivated).

For example, opening the flatbed cover increments the [Flatbed cover Toggle](#) item count two times—once when the door is opened, and once when the door is closed.
5. Select the [Reset sensors](#) item to reset the [Toggle](#) count item.

-or-

Touch the **Cancel** button to exit the **Scanner Tests** screen, and then touch the **Cancel** button again to return the **Diagnostic Tests** menu.


#### Scanner test sensors

- ADF paper present
- ADF Y (length)
- ADF jam cover
- ADF paper path deskew
- ADF paper path pick success
- Paper path sensor 1 (unreachable)
- Flatbed Y (length)
- Flatbed cover

## Disable cartridge check

Learn about the disable cartridge check troubleshooting diagnostic.

---

 **CAUTION:** Do not perform a disable cartridge check on color printers that use a two-part cartridge design. Doing so might result in toner cross contamination in the supply lines.

---

Use this diagnostic test to print internal pages or send an external job to the printer when a toner cartridge is removed or exchanged. Supply errors are ignored while the printer is in this mode.

When the printer is in this mode, access the troubleshooting menus and print internal pages (the print quality pages will be the most useful). This test can be used to isolate problems, such as noise, and to isolate print-quality problems that are related to a toner cartridge.

---

 **NOTE:** Do not remove or exchange the toner cartridge until after beginning the disable cartridge check diagnostic.

---

1. From the Home screen on the printer control panel, scroll to and touch the **Support Tools** button.
2. Open the following menus:
  - Troubleshooting
  - Diagnostic Tests
  - Disable Cartridge Check

## Print/stop test

Learn about the print/stop test troubleshooting diagnostic.

Use this diagnostic test to isolate the cause of problems such as image-formation defects and jams within the engine.

During this test, stop the paper anywhere along the printer paper path. The test can be programmed to stop printing internal pages or an external print job when the paper reaches a certain position. The test can also be



programmed to stop from 0 to 60,000 ms. If the timer is set to a value that is greater than the job-print time, the printer can recover in one of two ways.

#### Printer recovery (print/stop test)

- After the print job is completed press the **OK** button to return to the **Troubleshooting** menu before the timer times out.
- After the timer times out, touch the **Stop** button. Activate the door switch to restart the engine and return it to a normal state.

#### Common print/stop test timing millisecond (ms) stops

- **600 ms:** The page has passed the registration area and the leading edge is just short of entering the fuser. The image can be seen on the paper but has not fused. If the defect is visible then the cause might be the drum, transfer roller, or a roller prior to, or in, the registration area.
  - **1200 ms:** The leading edge is about 18mm (0.71 in) into the top output bin. The image has gone through the fuser. If the defect was not visible prior to the fuser, and is visible after the fuser, then the fuser it is the likely cause of the print quality defect. Inspect the fuser for damage, debris, or labels stuck to the fuser. Replace the fuser. Discuss media specifications and proper care of the fuser with the customer.
1. From the **Home** screen on the printer control panel, scroll to and touch the **Support Tools** button.
  2. Open the following menus:
    - **Troubleshooting**
    - **Diagnostic Tests**
    - **Print/Stop Test**
  3. Enter a range, and then touch the **OK** button.

## Individual component diagnostics

Learn about printer individual component diagnostics.

### Paper path test

Learn about the paper path test troubleshooting diagnostic.

This diagnostic test generates one or more test pages. Use these pages to isolate the cause of jams.

To isolate a problem, specify which input tray to use, and specify the number of copies to print. Print multiple copies to help isolate intermittent problems. The following options become available after beginning the diagnostic feature:

- **Print Test Page:** Run the paper-path test from the default settings: Tray 2, no duplex, and one copy. To specify other settings, scroll down the menu, and select the setting, and then scroll back up and select **Print Test Page** to start the test.
  - **Source Tray:** Select Tray 1, Tray 2, or the optional tray.
  - **Number of Copies:** Set the numbers of copies to be printed; the choices are 1, 10, 50, 100, or 500.
1. From the **Home** screen on the printer control panel, scroll to and touch the **Support Tools** button.

2. Open the following menus:
  - [Troubleshooting](#)
  - [Diagnostic Tests](#)
  - [Paper Path Test](#)
3. Select the paper path test options for the test.

## Paper path sensors test

Learn about the paper path sensors test troubleshooting diagnostic.

This test displays the status of each paper path sensor and allows viewing of sensor status while printing internal pages.

1. From the [Home](#) screen on the printer control panel, scroll to and touch the [Support Tools](#) button.
2. Open the following menus:
  - [Troubleshooting](#)
  - [Diagnostic Tests](#)
  - [Paper Path Sensors](#)
3. Touch the [Start](#) button to run the test.

## Individual component test

Learn about the individual component test troubleshooting diagnostic.

This test activates individual parts independently to isolate problems.

Each component test can be performed once or repeatedly. If the [Repeat](#) option is enabled from the drop-down menu, the test cycles the component on and off. This process continues for two minutes, and then the test terminates.



---

**NOTE:** The cartridge door interlocks must be defeated to run the component tests. A control panel display prompt appears to indicate removing the toner cartridge, during certain tests.

---

1. From the [Home](#) screen on the printer control panel, scroll to and touch the [Support Tools](#) button.
2. Open the following menus:
  - [Troubleshooting](#)
  - [Diagnostic Tests](#)
  - [Component Test](#)
3. Select the component test options for the test.

## Manual sensor test

Learn about the manual sensor test troubleshooting diagnostic.

The [Manual Sensor Test](#) screen shows the sensor number, sensor name (model specific), sensor state (active or inactive), and the number of times the sensor has been toggled (activated).

1. From the [Home](#) screen on the printer control panel, scroll to and touch the [Support Tools](#) button.
2. Open the following menus:
  - [Troubleshooting](#)
  - [Diagnostic Tests](#)
  - [Manual Sensor Test](#)
3. Activate the desired sensor, and then check the control panel display to verify the sensor state (active or inactive).
  - The [State](#) virtual LED next to the sensor number and sensor name illuminates green when the sensor is active.
  - The [Toggle](#) virtual LED next to the sensor number and sensor name illuminates green after the sensor is activated and increments by one each time the sensor is interrupted (activated or deactivated).

For example, opening a door increments the appropriate sensor item count two times—once when the door is opened, and once when the door is closed.

## Tray/bin manual sensor test

Learn about the tray/bin manual sensor test troubleshooting diagnostic.

The [Tray/Bin Manual Sensor Test](#) screen shows the sensor number, sensor name (model specific), sensor state (active or inactive), and the number of times the sensor has been toggled (activated).

1. From the [Home](#) screen on the printer control panel, scroll to and touch the [Support Tools](#) button.
2. Open the following menus:
  - [Troubleshooting](#)
  - [Diagnostic Tests](#)
  - [Tray/Bin Manual Sensor Test](#)
3. Activate the desired sensor, and then check the control panel display to verify the sensor state (active or inactive).
  - The [State](#) virtual LED next to the sensor number and sensor name illuminates green when the sensor is active.
  - The [Toggle](#) virtual LED next to the sensor number and sensor name illuminates green after the sensor is activated and increments by one each time the sensor is interrupted (activated or deactivated).

For example, opening a door increments the appropriate sensor item count two times—once when the door is opened, and once when the door is closed.

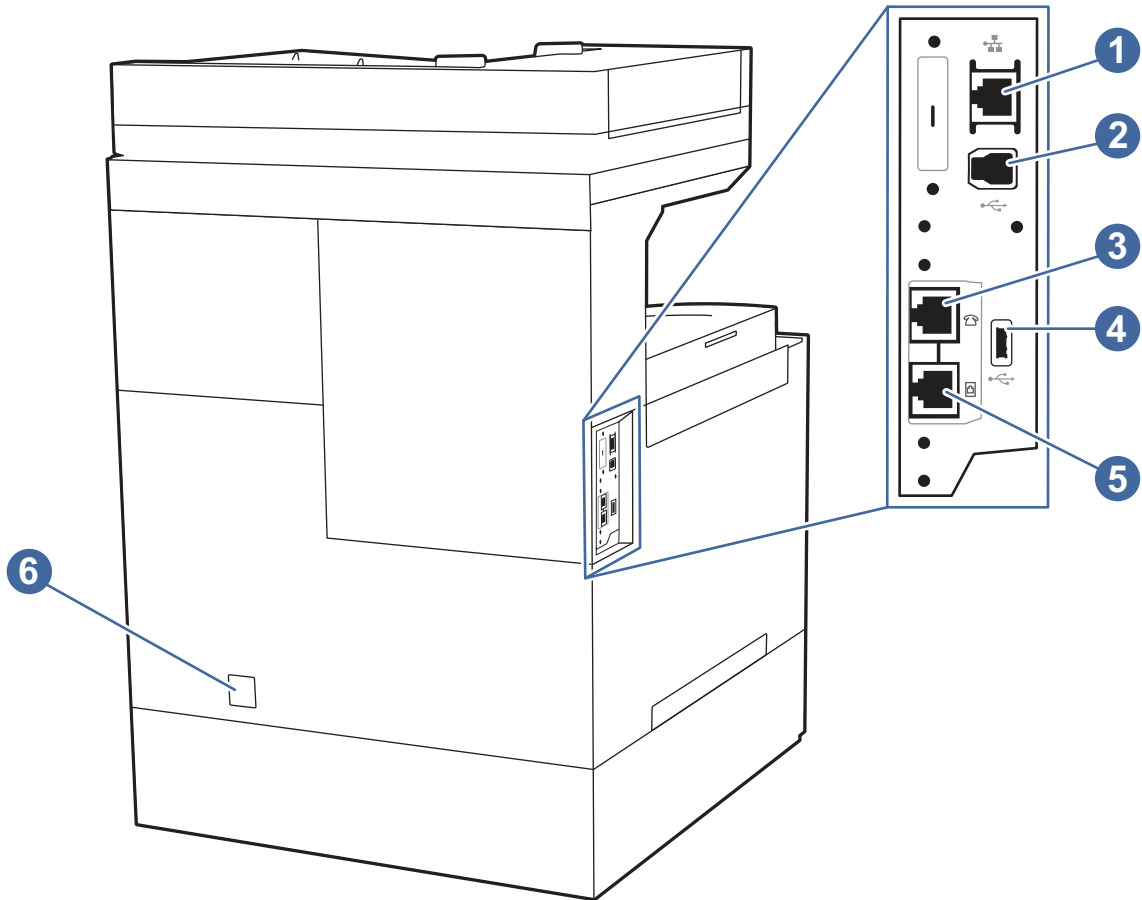
## Diagrams: Block diagrams

View block diagrams for the printer.

## Diagrams: External plug and port locations

View printer external plugs and ports diagrams.

**Figure 4-52 External plug and port locations**



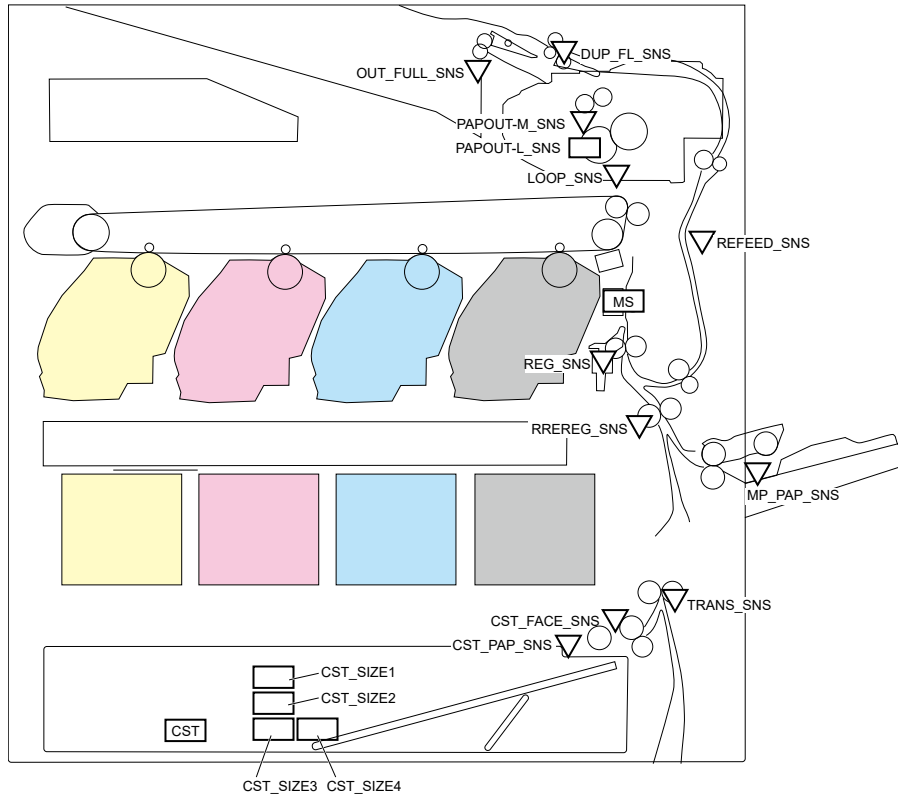
Item	Description
1	Local area network (LAN) Ethernet (RJ-45) network port
2	SuperSpeed USB 3.0 interface port
3	<b>Fax MFP models only:</b> Telephone "line out" port (for attaching an extension phone, answering machine, or other device)  <b>NOTE:</b> This port should remain covered when not in use.
4	SuperSpeed USB 3.0 host port (for job storage and private printing)  <b>NOTE:</b> This port should remain covered when not in use.
5	<b>Fax MFP models only:</b> Fax "line in" port (for attaching the fax phone line to the printer)
6	Power connection

## Sensors and switches

View printer and paper feeder sensor and switch diagrams.

### Sensors and switches, printer base

**Figure 4-53 Sensors and switches, printer base**



**Table 4-6 Sensors and switches, printer base**

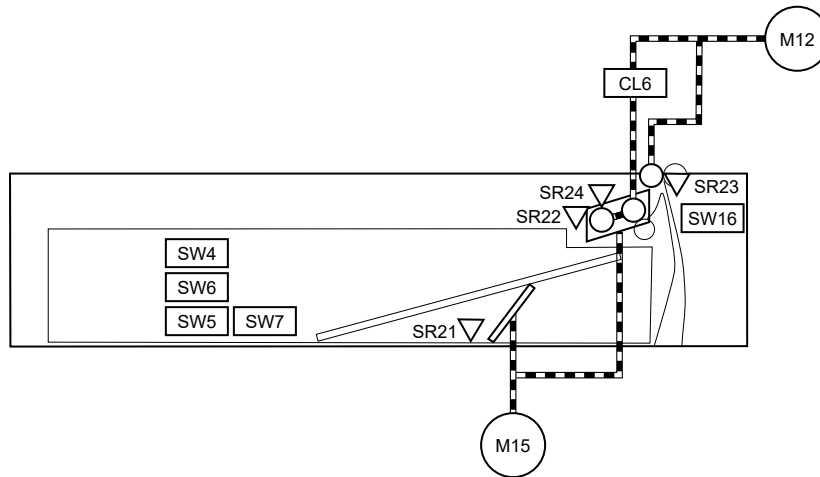
Abbreviation	Component
CST_SIZE1	Tray 2 media size switch 1
CST_SIZE2	Tray 2 media size switch 2
CST_SIZE3	Tray 2 media size switch 3
CST_SIZE4	Tray 2 media size switch 4
DUP_FL_SNS	Duplex flapper position sensor
OUT_FULL_SNS	FD1 media full sensor
CST_PAP_SNS	Tray 2 media out sensor
CST_FACE_SNS	Tray 2 media surface sensor
LOOP_SNS	Fuser loop sensor
REFEED_SNS	Duplex feed sensor
REG_SNS	Registration sensor
RRREG_SNS	Pre-registration sensor
MP_PAP_SNS	Tray 1 media out sensor
PAYOUT-M_SNS	Fuser output sensor 2
TRANS_SNS	Tray 2 feed sensor (X654/X677 models only)
MS (Media sensor PCA)	Media sensor

**Table 4-6** Sensors and switches, printer base (continued)

Abbreviation	Component
PAPOUT-L_SNS	Fuser output sensor 1

## Sensors and switches, 550-sheet paper feeder

**Figure 4-54** Sensors and switches, 550-sheet paper feeder

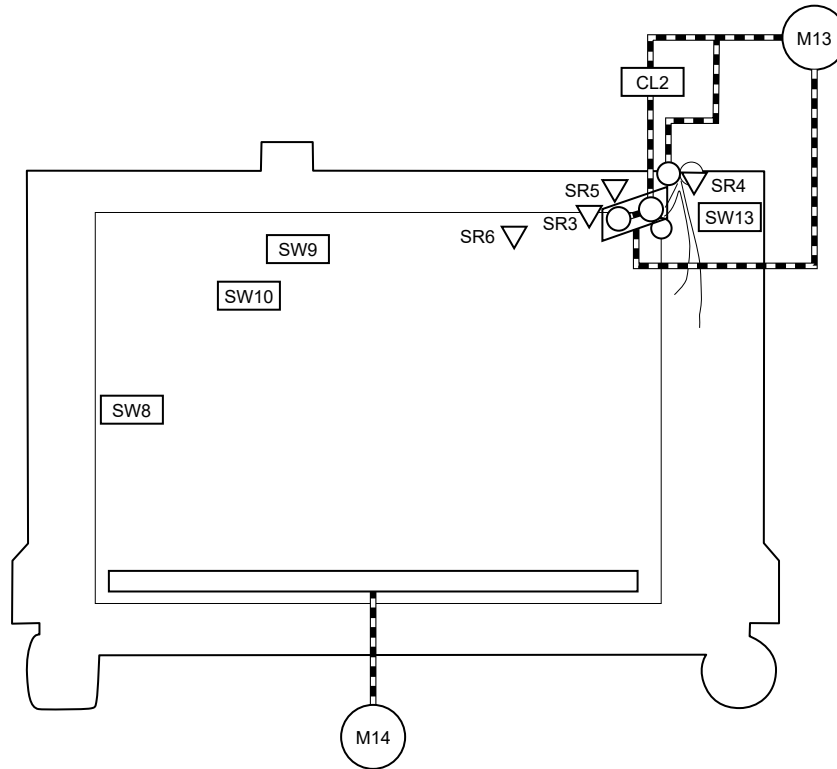


**Table 4-7** Sensors and switches, 550-sheet paper feeder

Abbreviation	Component name
SW4	Paper feeder media size switch 1
SW5	Paper feeder media size switch 2
SW6	Paper feeder media size switch 3
SW7	Paper feeder media size switch 4
SW16	Paper feeder door switch
SR21	Paper feeder lifter motor rotation sensor
SR22	Paper feeder media out sensor
SR23	Paper feeder feed sensor
SR24	Paper feeder media surface sensor

## Sensors and switches, HCI

**Figure 4-55** Sensors and switches, HCI

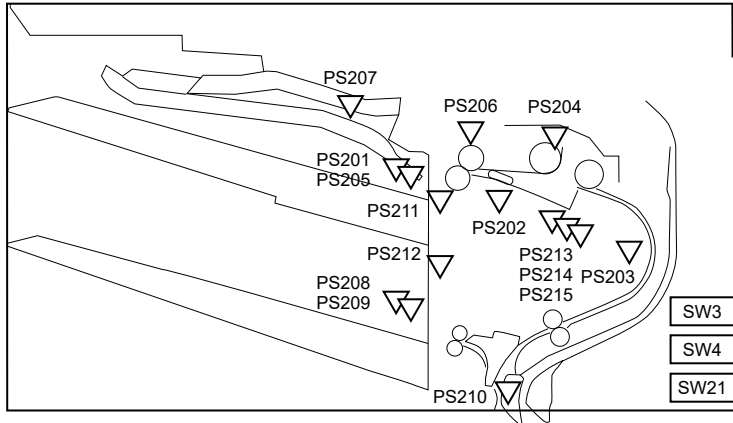


**Table 4-8** Sensors and switches, HCI

Abbreviation	Component name
SW8	HCI cassette lifting plate position switch
SW9	HCI cassette media size switch 1
SW10	HCI cassette media size switch 2
SW13	HCI door switch
SR3	HCI cassette media out sensor
SR4	HCI feed sensor
SR5	HCI cassette media surface sensor
SR6	HCI cassette pickup rotation sensor

### Sensors and switches, 3-bin stapler-stacker

**Figure 4-56 Sensors and switches, 3-bin stapler-stacker**



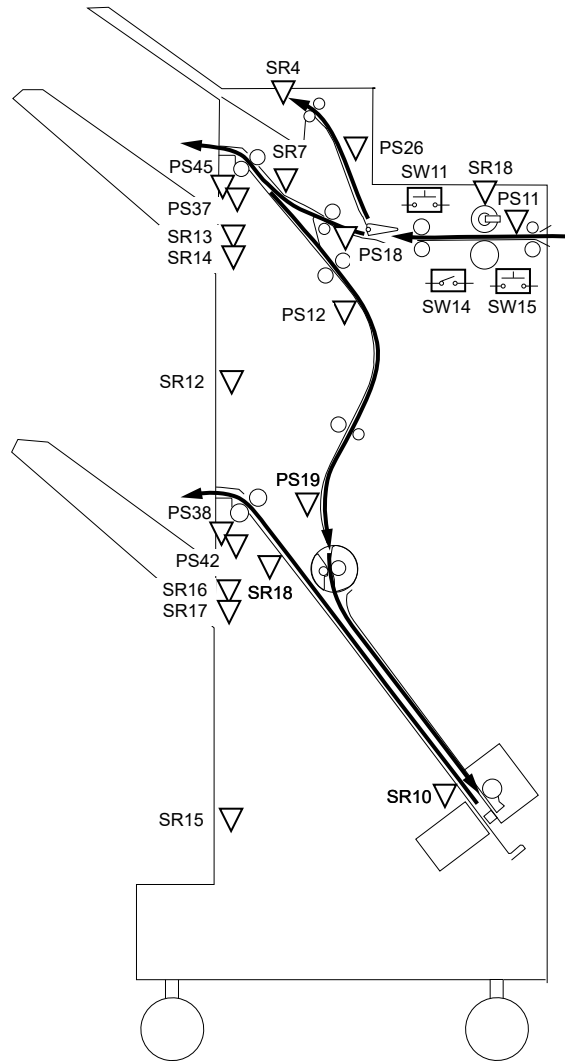
**Table 4-9 Sensors and switches, 3-bin stapler-stacker**

Abbreviation	Component name
PS201	Bin 1 media presence sensor
PS202	Stapler-stacker exit sensor
PS203	Staple inlet sensor
PS204	Y alignment home position sensor
PS205	Bin 1 media full sensor 1
PS206	Alienation home position sensor
PS207	Jogger home position sensor
PS208	Bin 2 media presence sensor
PS209	Bin 2 media full sensor
PS210	Stapler-stacker inlet sensor
PS211	Bin 1 upper limit sensor
PS212	Bin 1 lower limit sensor
PS213	Staple low sensor
PS214	Staple ready sensor
PS215	Staple home position sensor
SW3	Stapler-stacker door switch
SW4	Staple door switch
SW21	Interlock switch

### Sensors and switches, floor-standing stapler-stacker



**Figure 4-57 Sensors and switches, floor-standing stapler-stacker**



**Table 4-10 Sensors and switches, floor-standing stapler-stacker**

Abbreviation	Component name
SW11	Punch door switch (push type)
SW14	Front door switch (lever type)
SW15	Front door switch (push type)
SR2	Punch home position sensor
SR3	Punch shift home position sensor
SR4	Bin 2 media full sensor
SR5	Bin 3 shift roller alienation home position sensor
SR6	Bin 3 shift roller home position sensor
SR7	Bin 3 exit sensor
SR8	Jogger home position sensor
SR9	Staple shift home position sensor

**Table 4-10 Sensors and switches, floor-standing stapler-stacker (continued)**

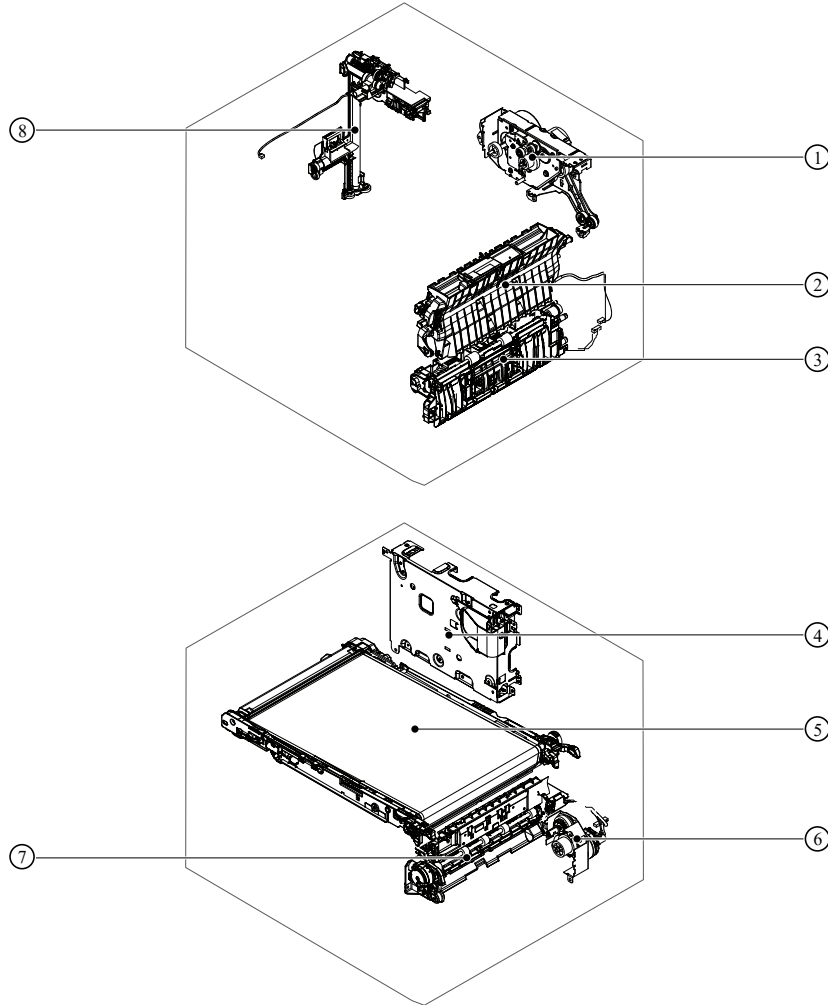
Abbreviation	Component name
SR10	Staple tray media presence sensor
SR11	Trailing edge assist home position sensor
SR12	Bin 3 lower limit sensor
SR13	Bin 3 upper limit sensor
SR14	Bin 3 media presence sensor
SR15	Bin 4 lower limit sensor
SR16	Bin 4 upper limit sensor
SR17	Bin 4 media presence sensor
SR18	Stapler-stacker exit sensor
SR19	Stacking guide home position sensor
SR22	Bin 4 output roller alienation home position sensor
PS12	Switchback inlet sensor (PCA mounted type)
PS18	Punch side registration sensor
PS18	Bin 3 inlet sensor (PCA mounted type)
PS19	Staple inlet sensor (PCA mounted type)
PS26	MBM inlet sensor (PCA mounted type)
PS27	Punch inlet roller rotation sensor
PS30	Staple home position sensor
PS31	Staple low sensor
PS32	Staple ready sensor
PS38	Bin 4 media full sensor 2
PS45	Bin 3 media full sensor 2
PS11	Punch inlet sensor
PS14	Chad full sensor
PS37	Bin 3 media full sensor 1
PS42	Bin 4 media full sensor 1
PS13	Chad full sensor
PS17	Punch side registration sensor
PS36	Bin 3 media full sensor 1
PS43	Bin 4 media full sensor 1

## Diagrams: Major component locations

View printer major component locations diagrams.

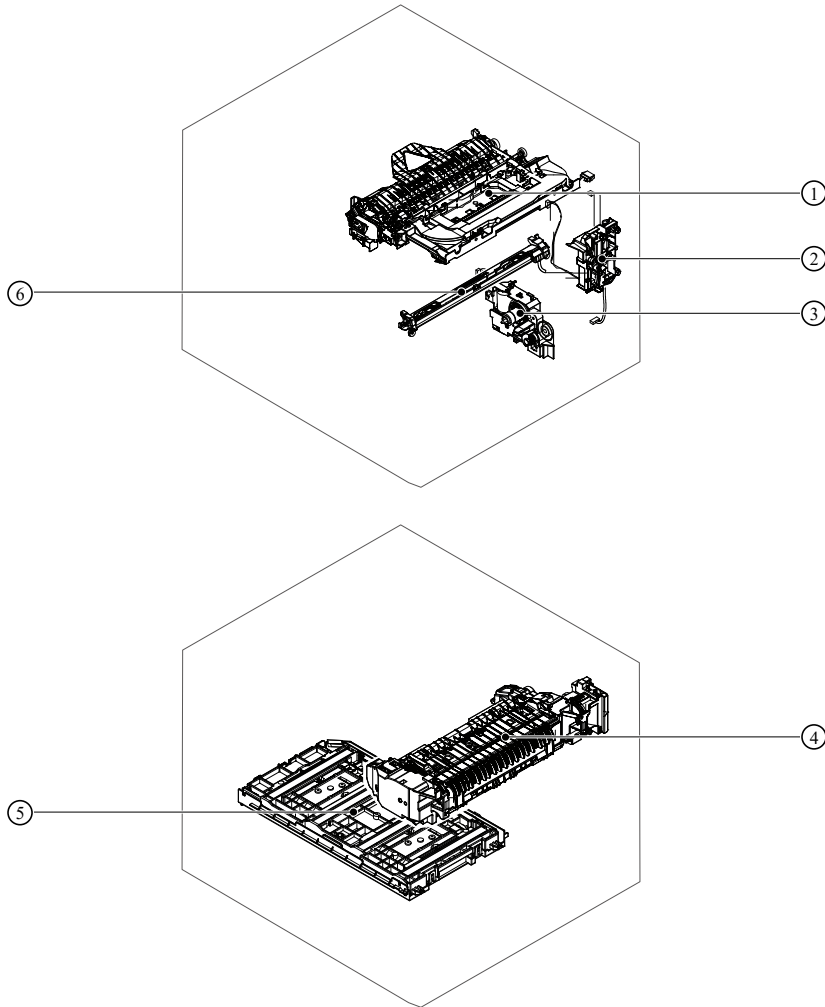
### Major components, printer base

**Figure 4-58 Major components, printer base (1 of 5)**



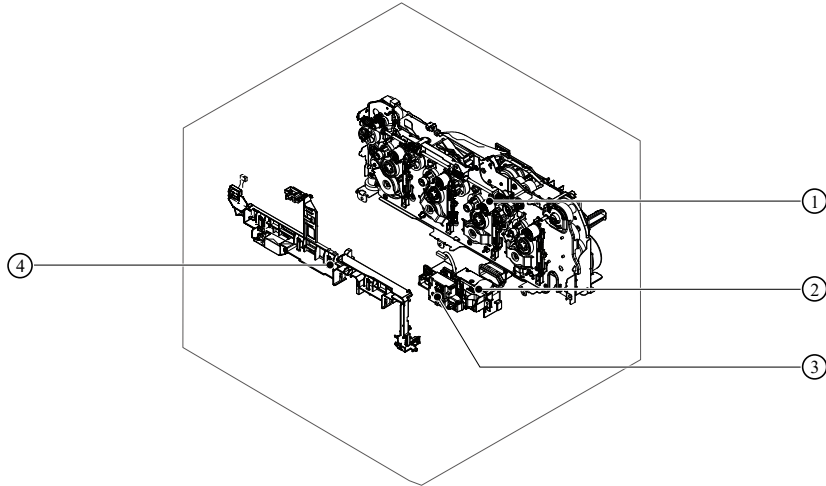
Item	Description	Item	Description
1	Fuser drive assembly	5	Intermediate transfer belt (ITB) assembly
2	Secondary transfer (T2) assembly	6	Pickup drive assembly
3	Pickup assembly	7	Registration assembly
4	Formatter cage assembly	8	Waste toner duct assembly

**Figure 4-59 Major components, printer base (2 of 5)**



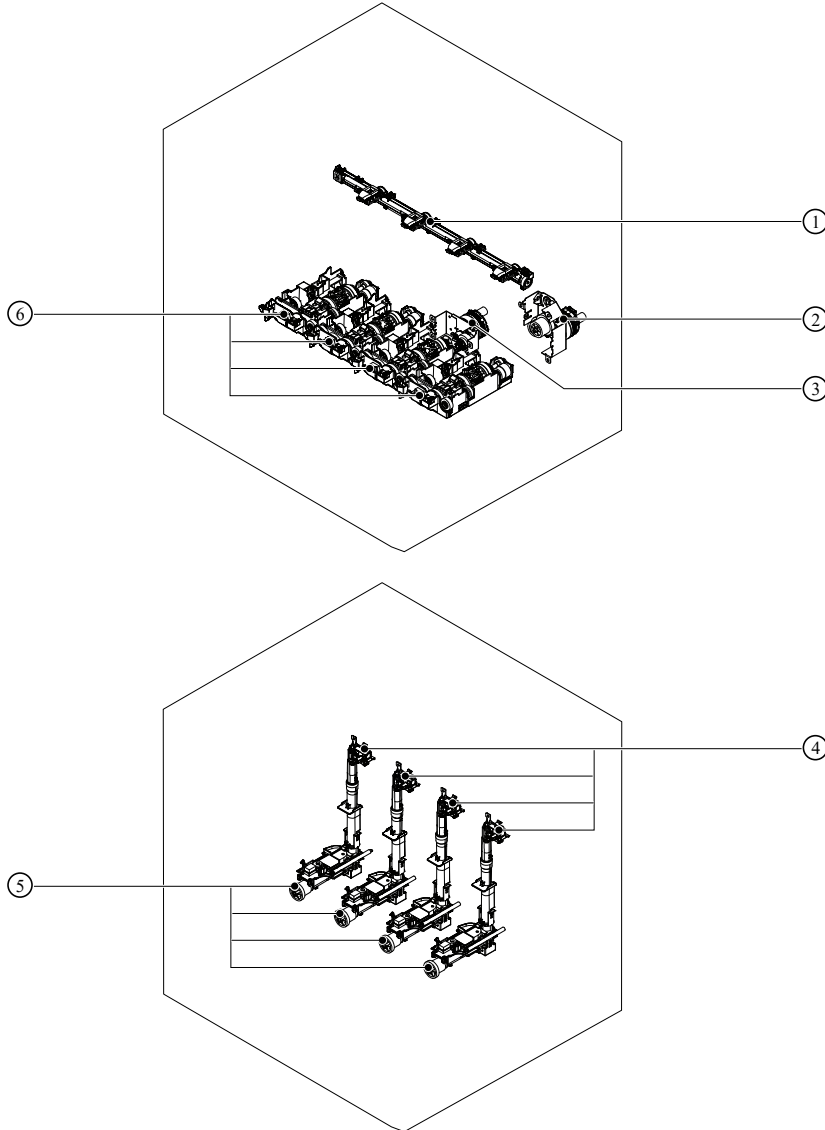
Item	Description	Item	Description
1	Delivery assembly	4	Fuser
2	Interlock assembly	5	Laser scanner assembly
3	Lifter drive assembly	6	Registration density sensor assembly

**Figure 4-60 Major components, printer base (3 of 5)**



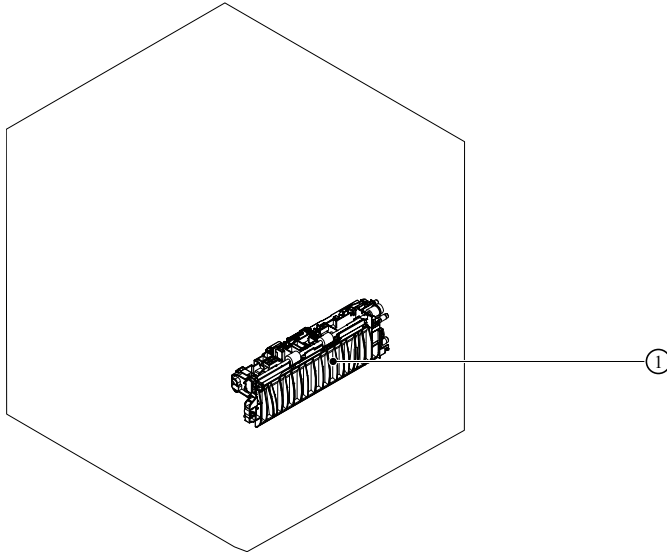
Item	Description	Item	Description
1	Main drive assembly	3	Tray 2 media size detect assembly
2	Auto close assembly	4	Pre-exposure PCA holder assembly

**Figure 4-61 Major components, printer base (4 of 5)**



Item	Description	Item	Description
1	Waste toner feed assembly (X654/X677 models)	4	Toner supply assembly (X654/X677 models)
2	Feed drive assembly (X654/X677 models)	5	Toner supply buffer assembly/intermediate pipe (X654/X677 models)
3	Toner supply motor assembly (X654/X677 models)	6	Toner supply drive assembly (X654/X677 models)

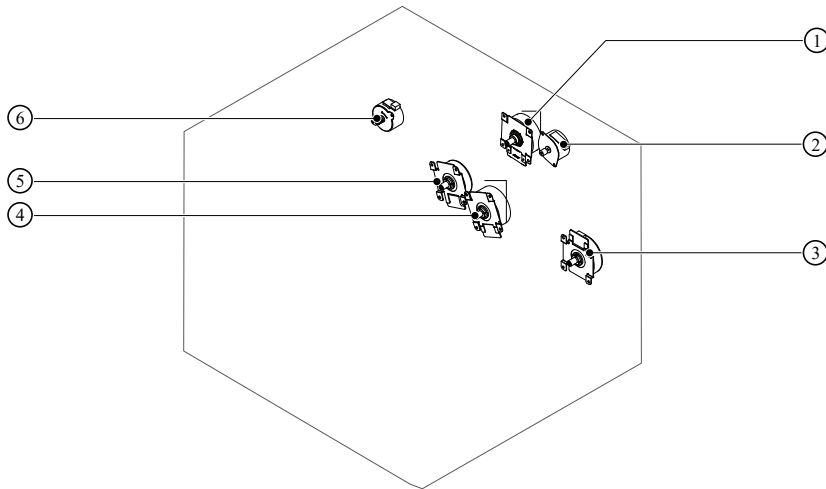
**Figure 4-62 Major components, printer base (5 of 5)**



Item	Description
1	Feed assembly (X654/X677 models)

**Motors, printer base**

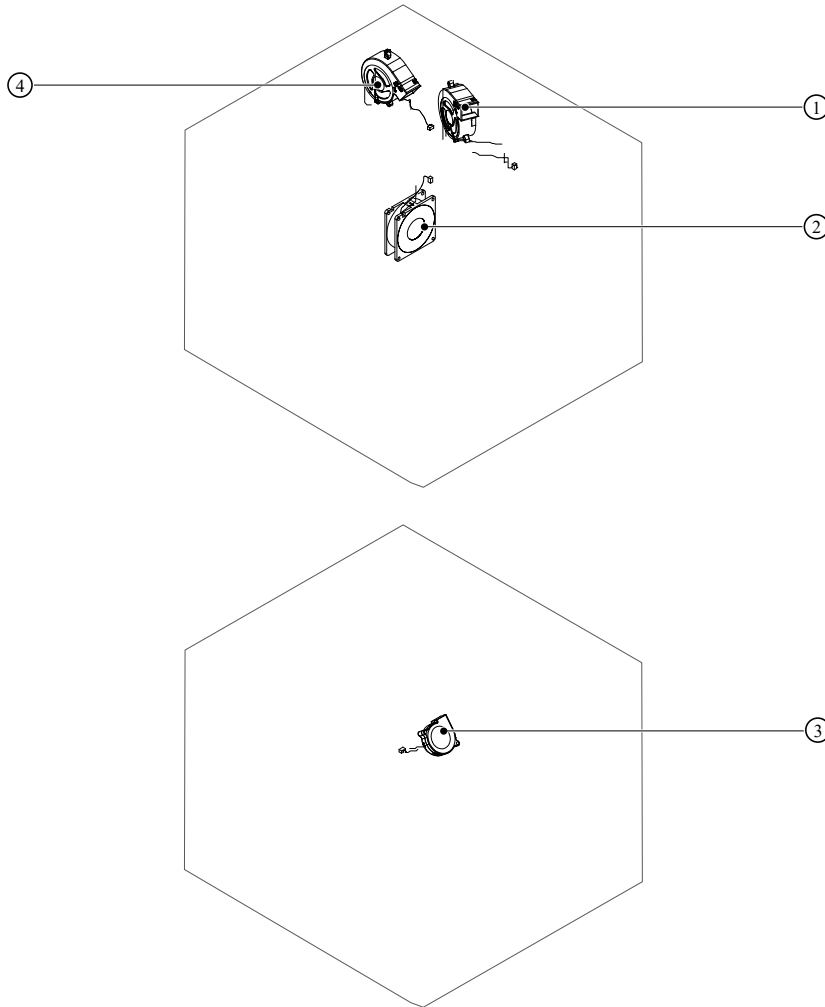
**Figure 4-63 Motors, printer base**



Item	Description	Item	Description
1	Fuser motor	4	Developer motor
2	Duplex motor	5	Drum motor
3	ITB motor	6	Developer alienation motor

**Fans, printer base**

**Figure 4-64 Fans, printer base**

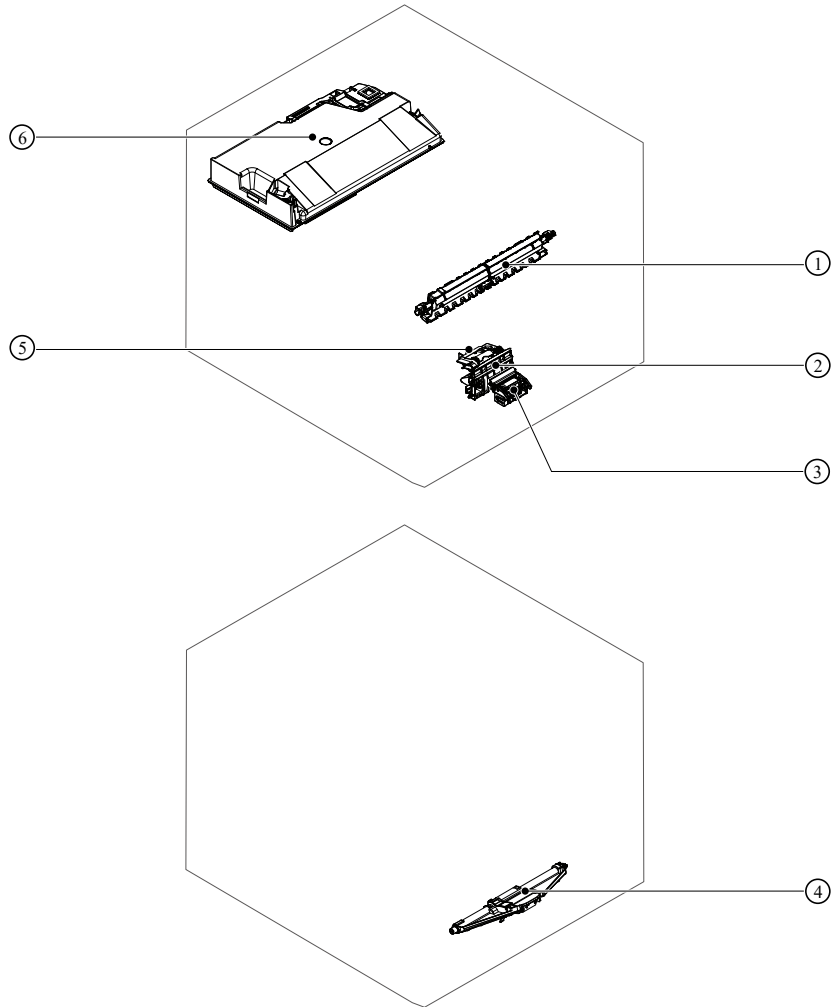


Item	Description	Item	Description
1	Fuser fan	3	Exhaust fan
2	Power supply fan	4	Cartridge fan

**Rollers and toner collection unit, printer base**



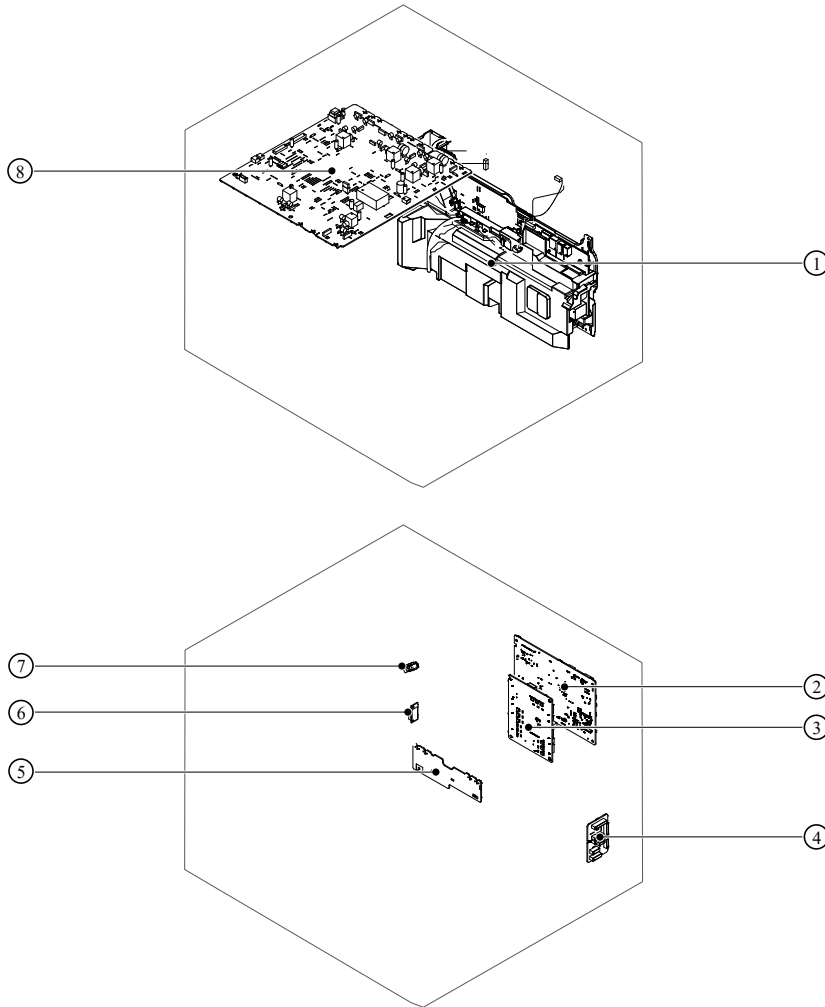
**Figure 4-65** Rollers and toner collection unit, printer base



Item	Description	Item	Description
1	Secondary transfer roller assembly	4	Tray 1 pickup roller assembly
2	Tray 2 separation roller assembly	5	Tray 2 pickup roller assembly
3	Tray 1 separation roller assembly	6	Toner collection unit

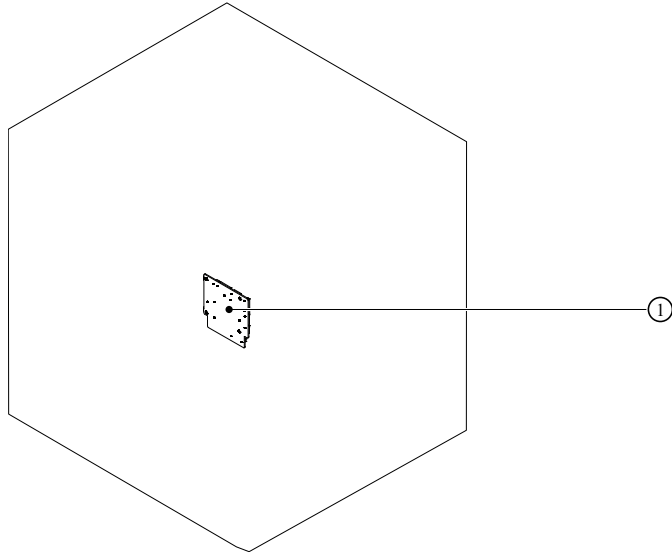
**Printed circuit assemblies, printer base**

**Figure 4-66 Printed circuit assemblies, printer base (1 of 2)**



Item	Description	Item	Description
1	Low-voltage power supply	5	Rear PCA
2	DC controller	6	Environment sensor PCA
3	Drive PCA	7	Drum home position sensor PCA
4	Right PCA	8	High-voltage power supply

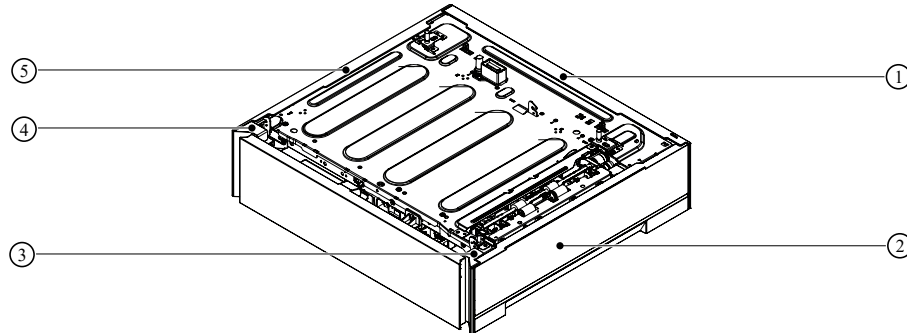
**Figure 4-67** Printed circuit assemblies, printer base (2 of 2)



Item	Description
1	Feed/toner supply controller PCA

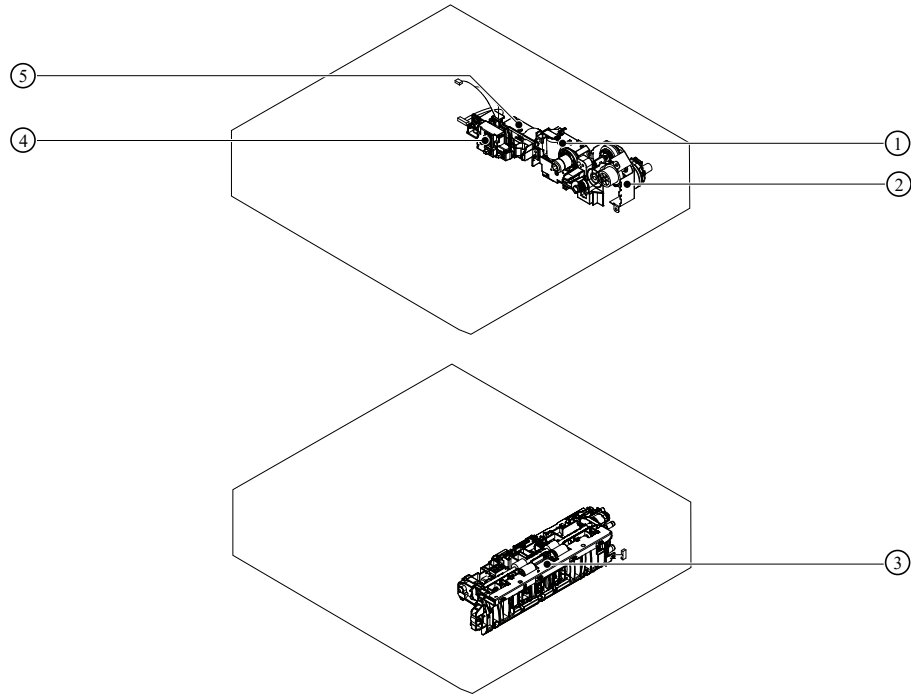
**Major components, 550-sheet paper feeder**

**Figure 4-68** Covers and doors, 550-sheet paper feeder



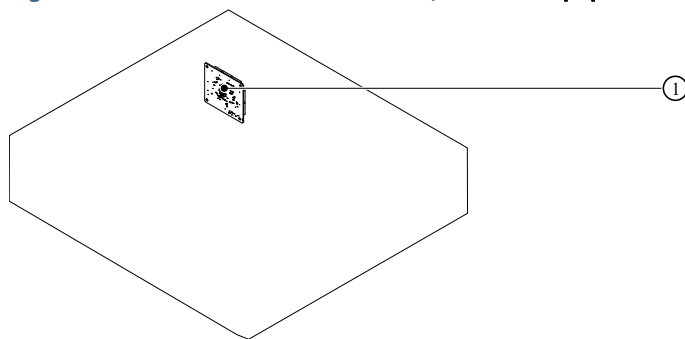
Item	Description	Item	Description
1	Rear cover	4	Front left cover
2	Right door	5	Left cover
3	Front right cover		

**Figure 4-69 Major parts, 550-sheet paper feeder**



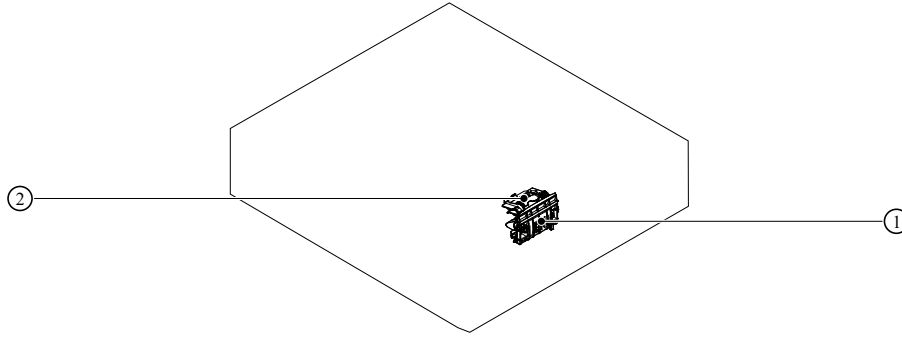
Item	Description	Item	Description
1	Lifter drive assembly	4	Paper feeder cassette media size detect assembly
2	Pickup drive assembly	5	Auto close assembly
3	Pickup assembly		

**Figure 4-70 Printed circuit assemblies, 550-sheet paper feeder**



Item	Description
1	Controller PCA

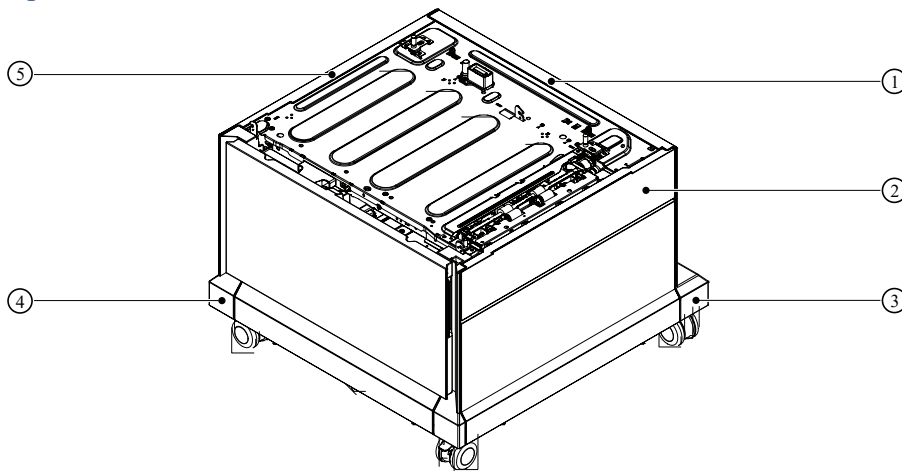
**Figure 4-71** Cassette assemblies, 550-sheet paper feeder



Item	Description	Item	Description
1	Cassette separation roller assembly	2	Cassette pickup roller assembly

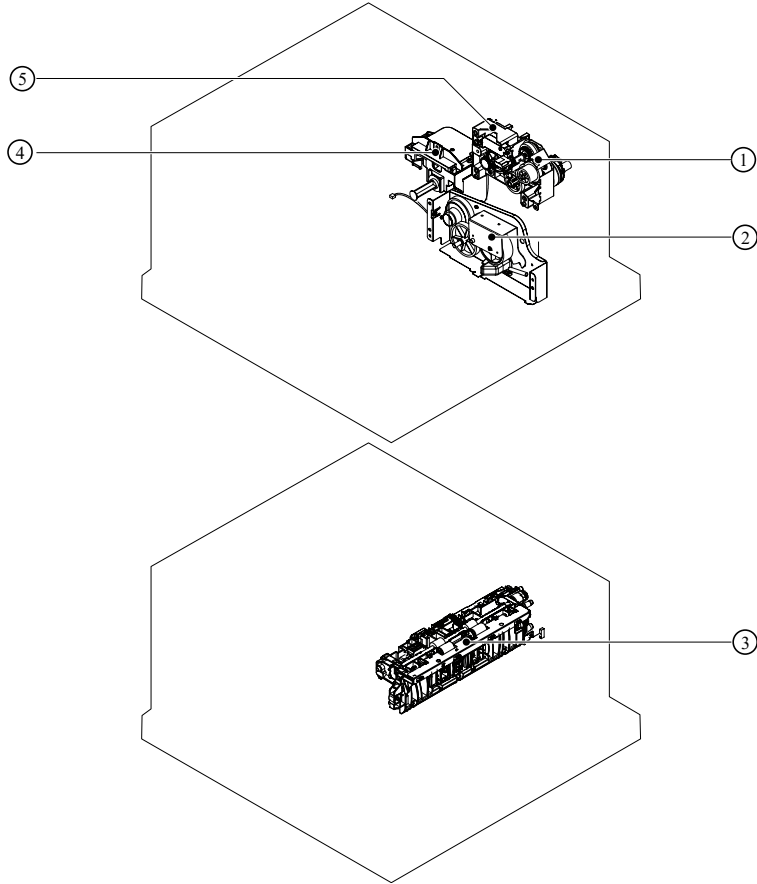
### Major components, HCI

**Figure 4-72** Doors and covers, HCI



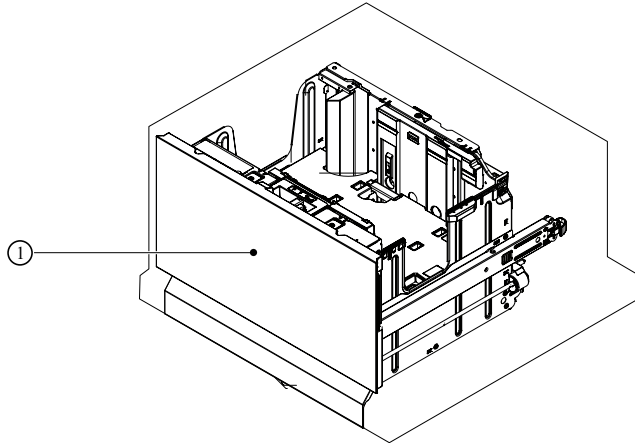
Item	Description	Item	Description
1	Rear cover	4	Front left cover
2	Right door	5	Left cover
3	Rear lower cover		

**Figure 4-73 Main parts, HCI (1 of 2)**



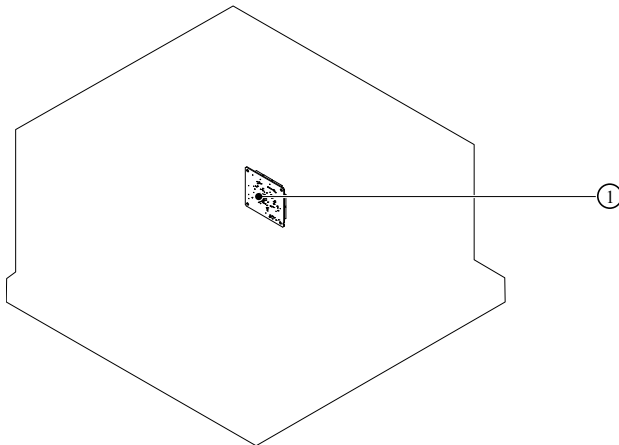
Item	Description	Item	Description
1	Pickup drive assembly	4	Auto close assembly
2	Lifter drive assembly	5	Pickup alienation assembly
3	Pickup assembly		

**Figure 4-74 Main parts, HCI (2 of 2)**



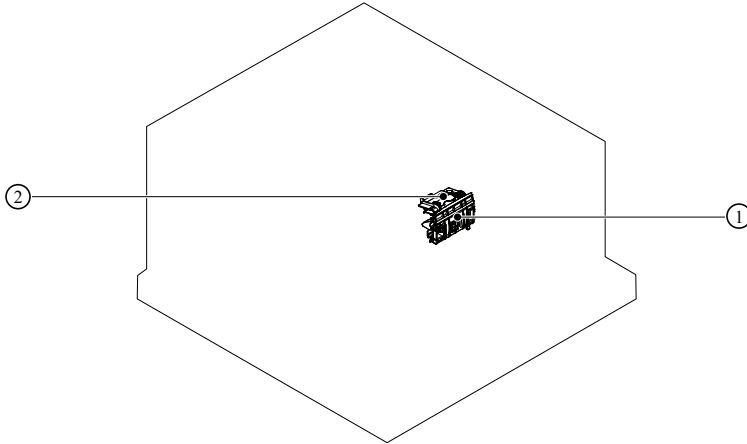
Item	Description
1	Cassette assembly

**Figure 4-75 Printed circuit assemblies, HCI**



Item	Description
1	Controller PCA

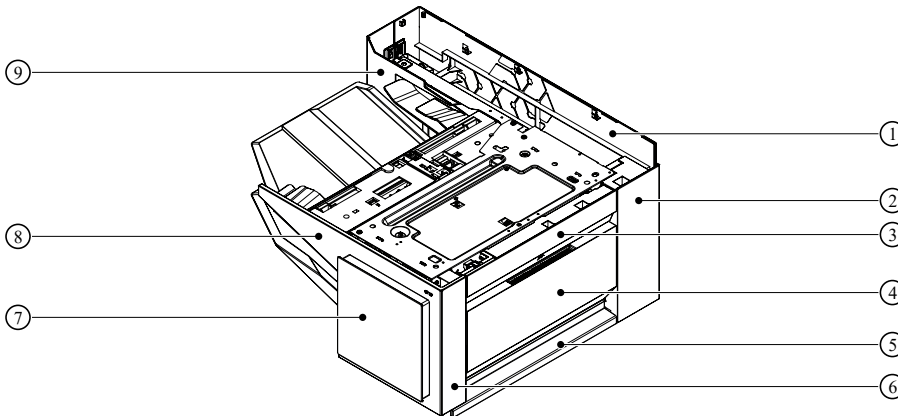
**Figure 4-76** Cassette assemblies, HCI



Item	Description	Item	Description
1	Cassette separation roller assembly	2	Cassette pickup roller assembly

### Major components, 3-bin stapler-stacker

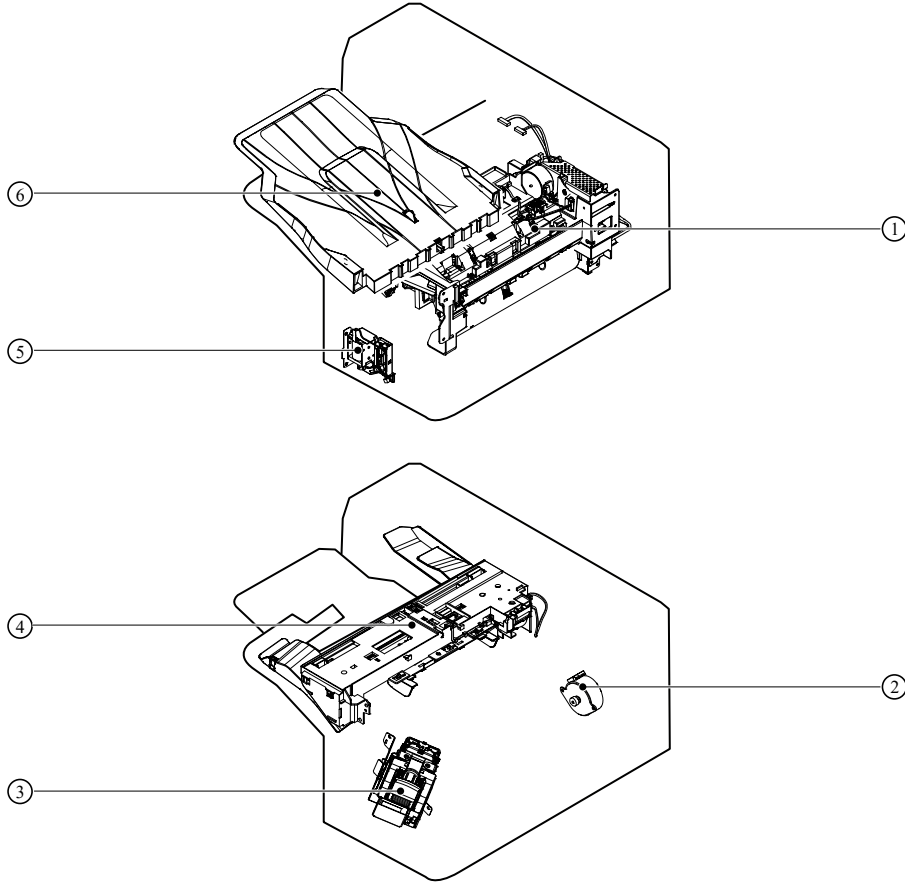
**Figure 4-77** Doors and covers, 3-bin stapler-stacker



Item	Description	Item	Description
1	Rear cover	6	Staple rear cover
2	Right corner cover	7	Staple door
3	Right upper cover	8	Staple cover
4	Stapler-stacker door	9	Rear inner cover
5	Right lower cover		

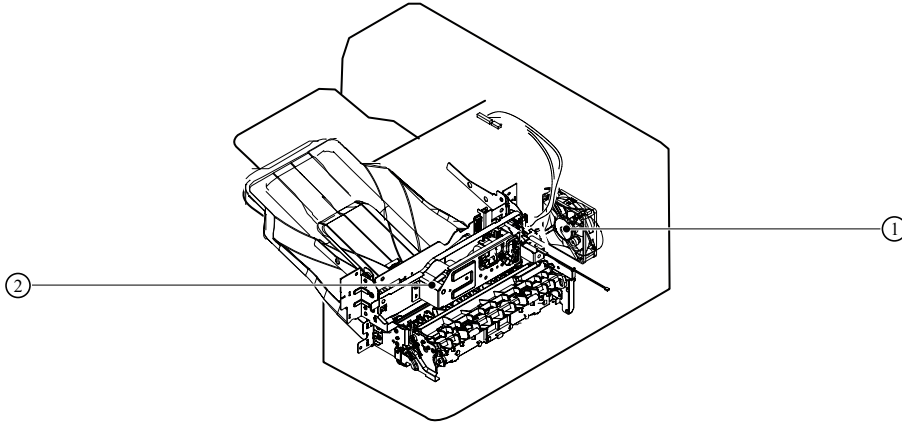


**Figure 4-78 Main parts, 3-bin stapler-stacker (1 of 2)**



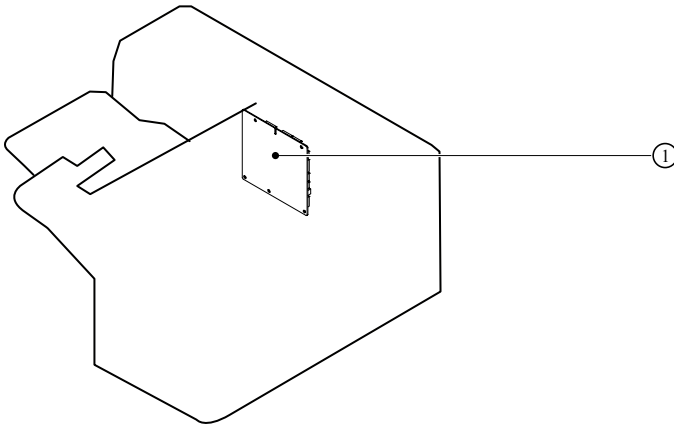
Item	Description	Item	Description
1	Upper feed assembly	4	Jogger assembly
2	Stapler-stacker feed motor	5	Solenoid assembly
3	Stapler assembly	6	Output bin 1 assembly

**Figure 4-79 Main parts, 3-bin stapler-stacker (2 of 2)**



Item	Description	Item	Description
1	MBM fan	2	Lower feed assembly

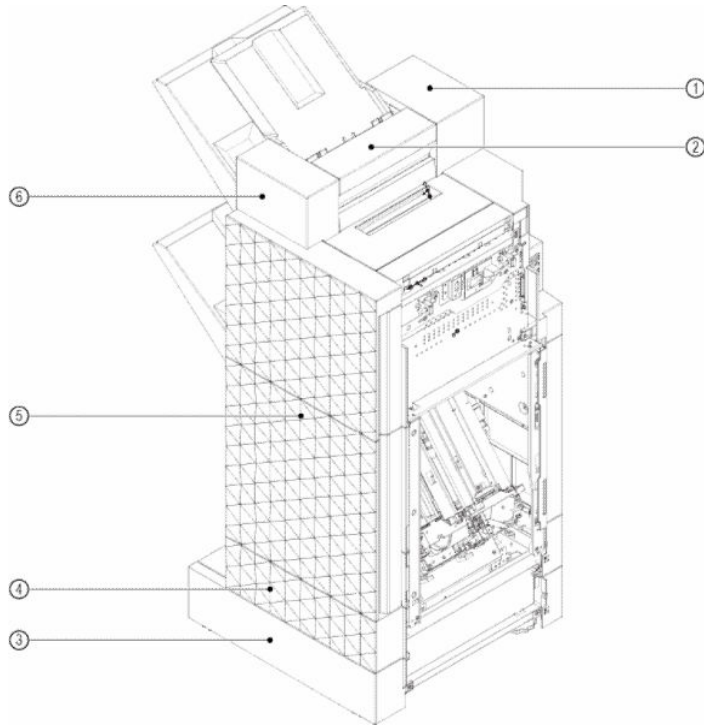
**Figure 4-80 Printed circuit assemblies, 3-bin stapler-stacker**



Item	Description
1	Controller PCA

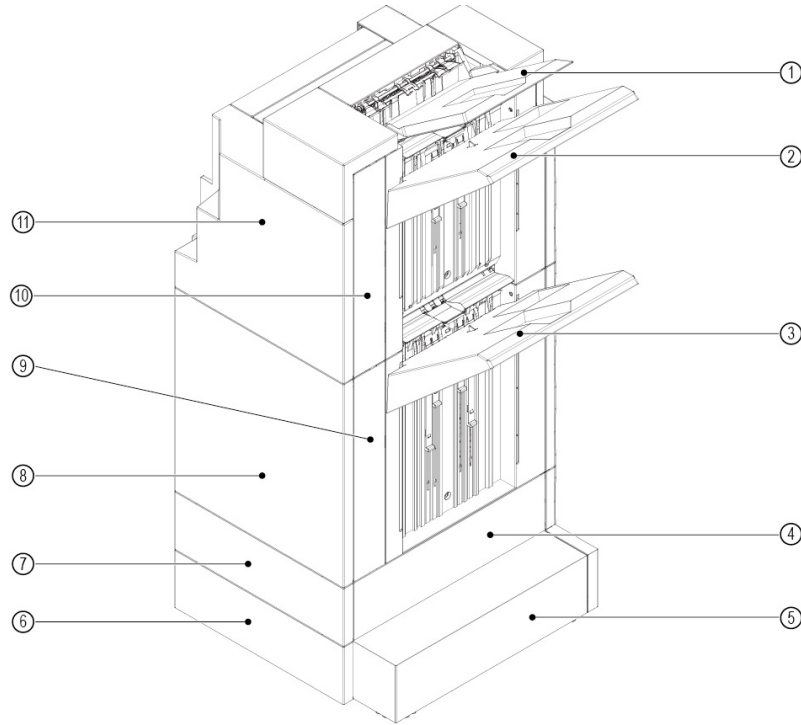
**Major components, floor-standing stapler-stacker**

**Figure 4-81 Covers and doors, floor-standing stapler-stacker (1 of 2)**



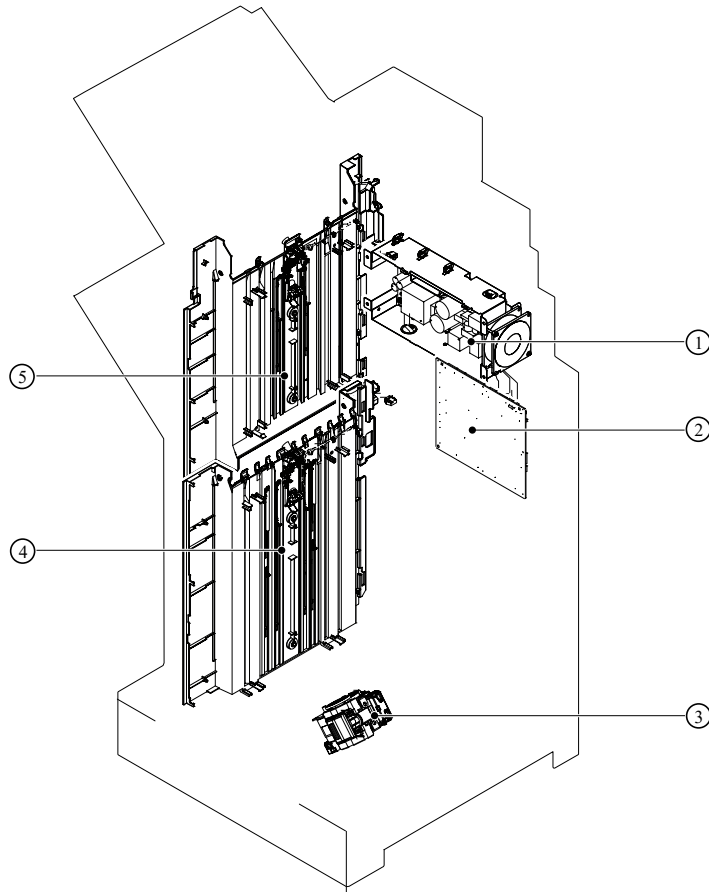
Item	Description	Item	Description
1	MBM rear cover	4	Foot front cover (tall models)
2	MBM top cover	5	Front door
3	Foot front cover	6	MBM front cover

**Figure 4-82 Covers and doors, floor-standing stapler-stacker (2 of 2)**



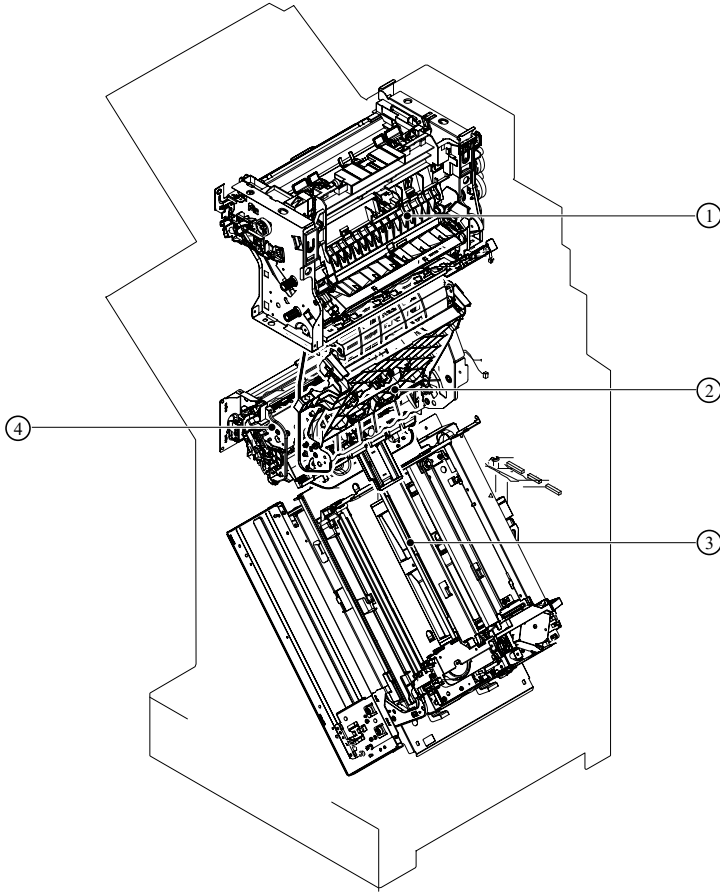
Item	Description	Item	Description
1	MBM tray	7	Foot rear cover (tall models)
2	Upper tray unit	8	Rear cover
3	Lower tray unit	9	Left lower rear cover
4	Foot center cover	10	Left upper rear cover
5	Foot cover	11	Rear upper cover
6	Foot rear cover		

**Figure 4-83 Major components, floor-standing stapler-stacker (1 of 3)**



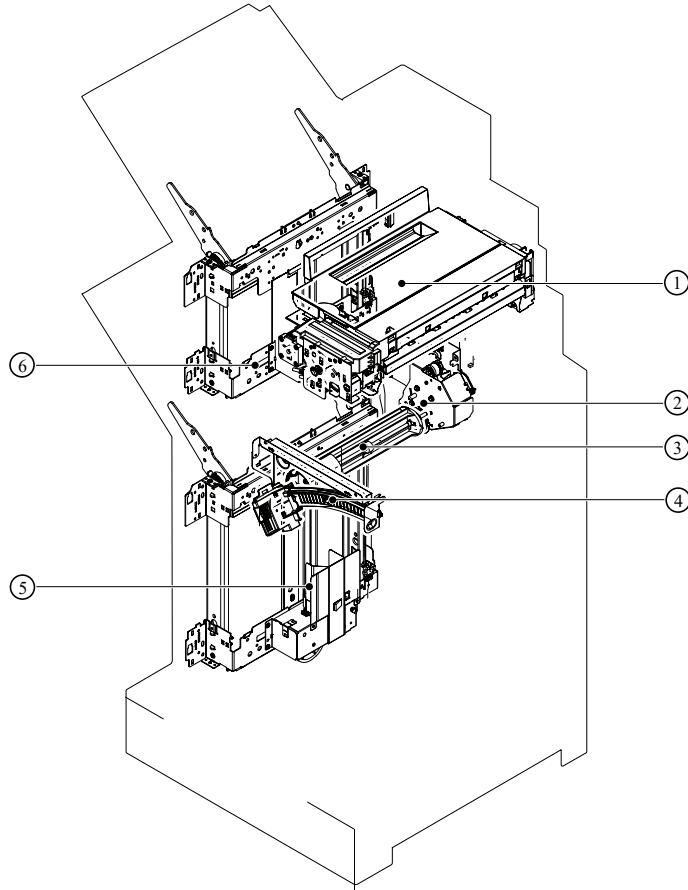
Item	Description	Item	Description
1	Power supply assembly	4	Height wall lower assembly
2	Controller PCA	5	Height wall upper assembly
3	Stapler		

**Figure 4-84 Major components, floor-standing stapler-stacker (2 of 3)**



Item	Description	Item	Description
1	SWB assembly	3	Alignment assembly
2	IMF assembly	4	Delivery assembly

**Figure 4-85 Major components, floor-standing stapler-stacker (3 of 3)**



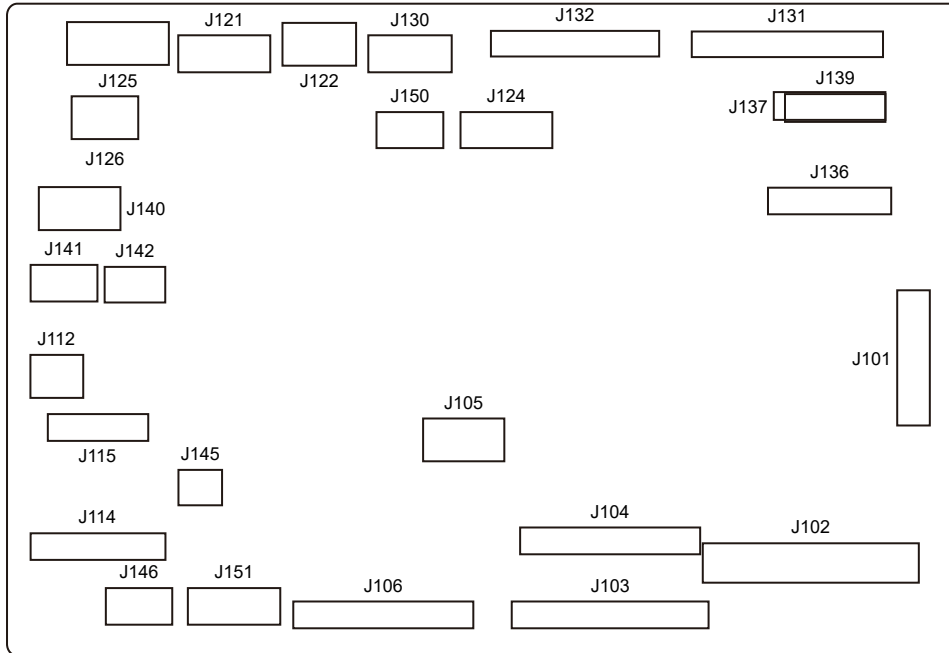
Item	Description	Item	Description
1	Punch assembly	4	Door handle rail assembly
2	Drum drive assembly	5	Lifter base lower assembly
3	Drum assembly	6	Lifter base upper assembly

### Printed circuit assembly (PCA) connector locations

View printed circuit assembly (PCA) diagrams.

### DC controller PCA connections

**Figure 4-86 DC controller PCA connections**

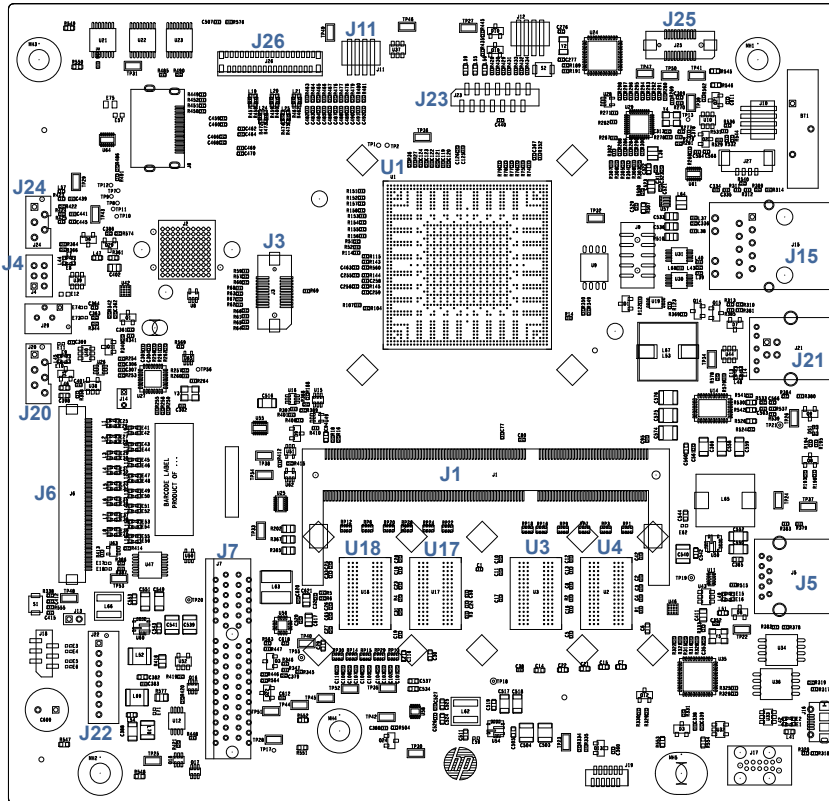


Item	Description	Item	Description
J101	Formatter	J130	Drive PCA
J102	Laser scanner assembly	J131	High-voltage power supply
J103	Drive PCA	J132	High-voltage power supply
J104	Drive PCA	J136	Rear PCA (6700/6800 models)
J105	Formatter	J137	Rear PCA (X654/X677 models)
J106	Low-voltage power supply	139	Rear PCA
J112	Front door switch Right door switch	J140	Not used
J114	Right PCA	J141	Not used
J115	Right PCA	J142	Not used
J121	Duplex flapper solenoid Not use FD1 media full sensor Not use Duplex flapper position sensor	J145	Not used
J122	Duplex motor	J146	Not used
J124	Output accessory (MFP models)	J150	Not used
J125	Fuser	J151	E-label (X654/X677 models)
J126	Fuser		

**Formatter PCA connections**



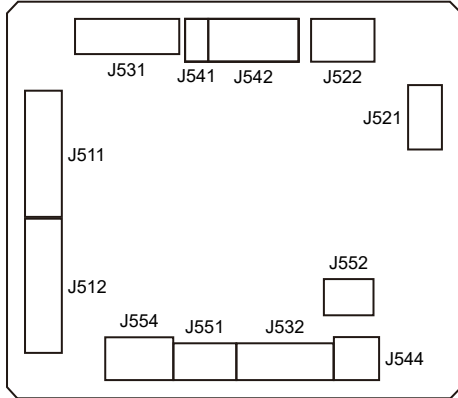
Figure 4-87 Formatter PCA connections



Item	Description	Item	Description
J1	DIMM	J23	WiFi
J3	eMMC	J24	Island of Data (IOD)
J4	USB (walk-up)	J25	Trusted Platform Module (TPM)
J5	USB host	J26	Control panel
J6	Engine VIF	U1	ASIC
J7	HDD riser	U3	Memory
J11	BASH	U4	Memory
J15	LAN	U17	Memory
J20	USB (HIP)	U18	Memory
J21	USB device		

### 550-sheet paper feeder PCA connectors

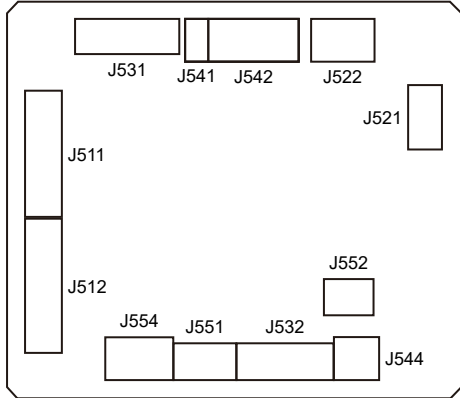
**Figure 4-88 550-sheet paper feeder PCA connectors**



Item	Description	Item	Description
J511	Printer or paper feeder	J541	Media size switch 1 Media size switch 2 Media size switch 3 Media size switch 4
J512	Not used	J542	Not used
J521	Not used	J544	Door switch
J522	Not used	J551	Lifter motor Lifter motor rotation sensor
J531	Feed motor Pickup clutch	J552	Not used
J532	Media out sensor Feed sensor Media surface sensor	J554	Not used

**HCI controller PCA connectors**

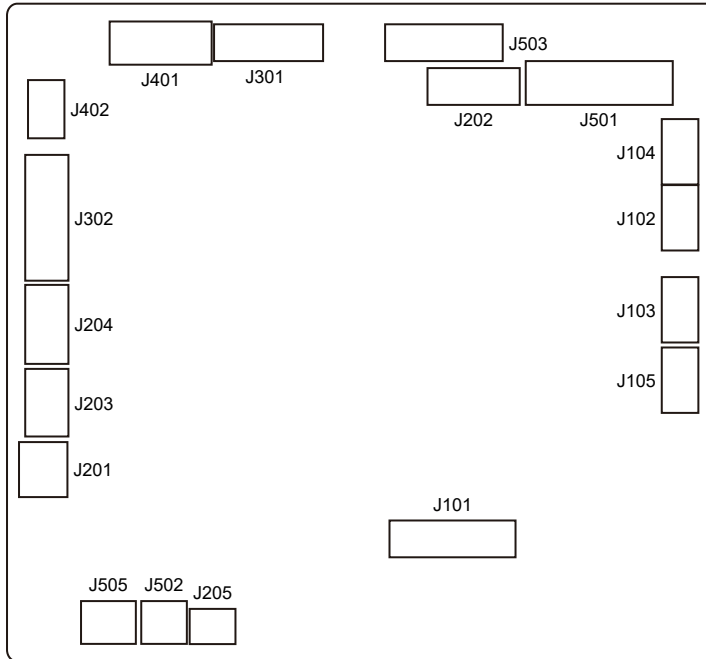
**Figure 4-89 HCI controller PCA connectors**



Item	Description	Item	Description
J511	Printer or paper feeder	J541	Not used
J512	Not used	J542	Media size switch 1 Media size switch 2 Lifting plate position switch
J521	Not used	J544	Door switch
J522	Not used	J551	Not used
J531	Feed motor Pickup clutch	J552	Lifter motor rotation sensor
J532	Media out sensor Feed sensor Media surface sensor	J554	Lifter motor

**3-bin stapler-stacker controller PCA connectors**

**Figure 4-90 3-bin stapler-stacker controller PCA connectors**

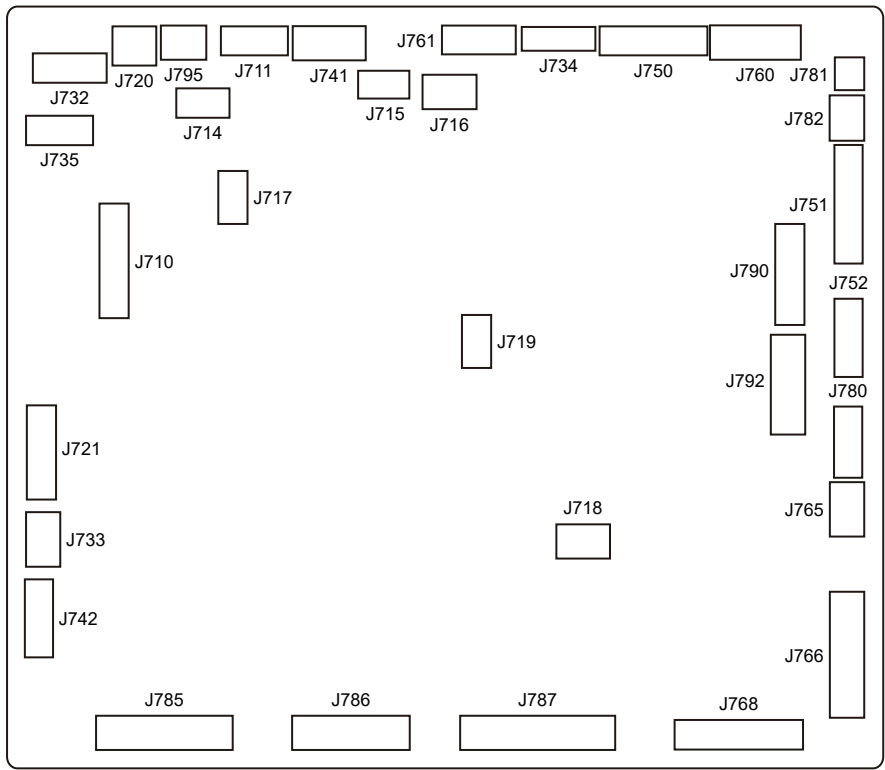


Item	Description	Item	Description
J101	Printer	J205	Staple door switch
J102	Not used	J301	Stapler-stacker output motor Y alignment home position sensor Bin 1 media full sensor 1
J103	Not used	J302	Y alignment motor Alienation home position sensor Stapler-stacker door switch
J104	Not used	J401	Jogger motor Jogger home position sensor
J105	Not used	J402	Stapler-stacker feed motor
J201	Interlock switch	J501	Bin 2 media presence sensor Bin 2 media full sensor Stapler-stacker inlet sensor Bin 2 flapper solenoid
J202	Lifter motor Bin 1 upper limit sensor Bin 1 lower limit sensor SS inlet sensor	J502	Inlet flapper solenoid

Item	Description	Item	Description
J203	Staple motor	J503	Bin 1 media presence sensor Stapler-stacker exit sensor Staple inlet sensor Stamp solenoid
J204	Staple low sensor Staple ready sensor Staple home position sensor	J505	Fan

### Floor-standing stapler-stacker controller PCA connectors

Figure 4-91 Floor-standing stapler-stacker controller PCA connectors



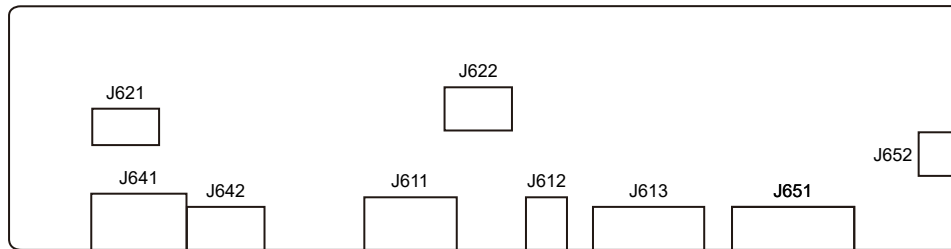
Item	Description	Item	Description
J710	IPTU	J751	Internal output roller Switchback motor
J711	Sub power supply PCA	J752	Buffer front motor
J714	Not used	J760	Bin 3 shift motor Bin 3 alienation motor

<b>Item</b>	<b>Description</b>	<b>Item</b>	<b>Description</b>
J715	Not used	J761	Bin 3 shift roller alienation home position sensor Bin 3 media full sensor 1 Bin 3 shift roller home position sensor
J716	Not used	J765	Bin 3 lift up motor
J717	Not used	J766	Bin 3 lower limit sensor Bin 3 upper limit sensor Bin 3 media full sensor 2 Bin 3 media presence sensor
J718	Not used	J768	Bin 4 lift up motor Bin 4 lower limit sensor Bin 4 upper limit sensor Bin 4 media full sensor 2 Bin 4 media presence sensor
J719	Not used	J780	Intermediate feed motor
J720	Front door switch	J781	Stage inlet drum drive solenoid
J721	Front door sensor Punch door switch Punch inlet sensor Punch shift motor	J782	Staple inlet sensor
J732	Punch home position sensor Punch shift home position sensor Punch side registration sensor (LED)	J785	Trailing edge assist motor Connector PCA
J733	Punch motor	J786	Staple tray media presence sensor Stapler shift motor Jogger motor
J734	Punch side registration sensor	J787	Jogger home position sensor Staple shift home position sensor Staple home position sensor Staple low sensor Staple ready sensor Staple motor

Item	Description	Item	Description
J735	Chad full sensor (LED) Chad full sensor Punch inlet roller rotation sensor	J790	Bin 4 output roller alienation home position sensor Bin 4 media full sensor 1 Stapler-stacker exit sensor Bin 4 output motor
J741	MBM inlet sensor Bin 2 media full sensor	J792	Stacking guide home position sensor Bin 4 media full sensor 1 (LED) Stacking guide motor
J742	MBM feed motor	J795	Sub power fan
J750	MBM flapper solenoid Switchback inlet sensor Bin 3 inlet sensor Bin 3 media full sensor 1 (LED) Bin 3 exit sensor		

## IPTU controller PCA connectors

Figure 4-92 IPTU controller PCA connectors

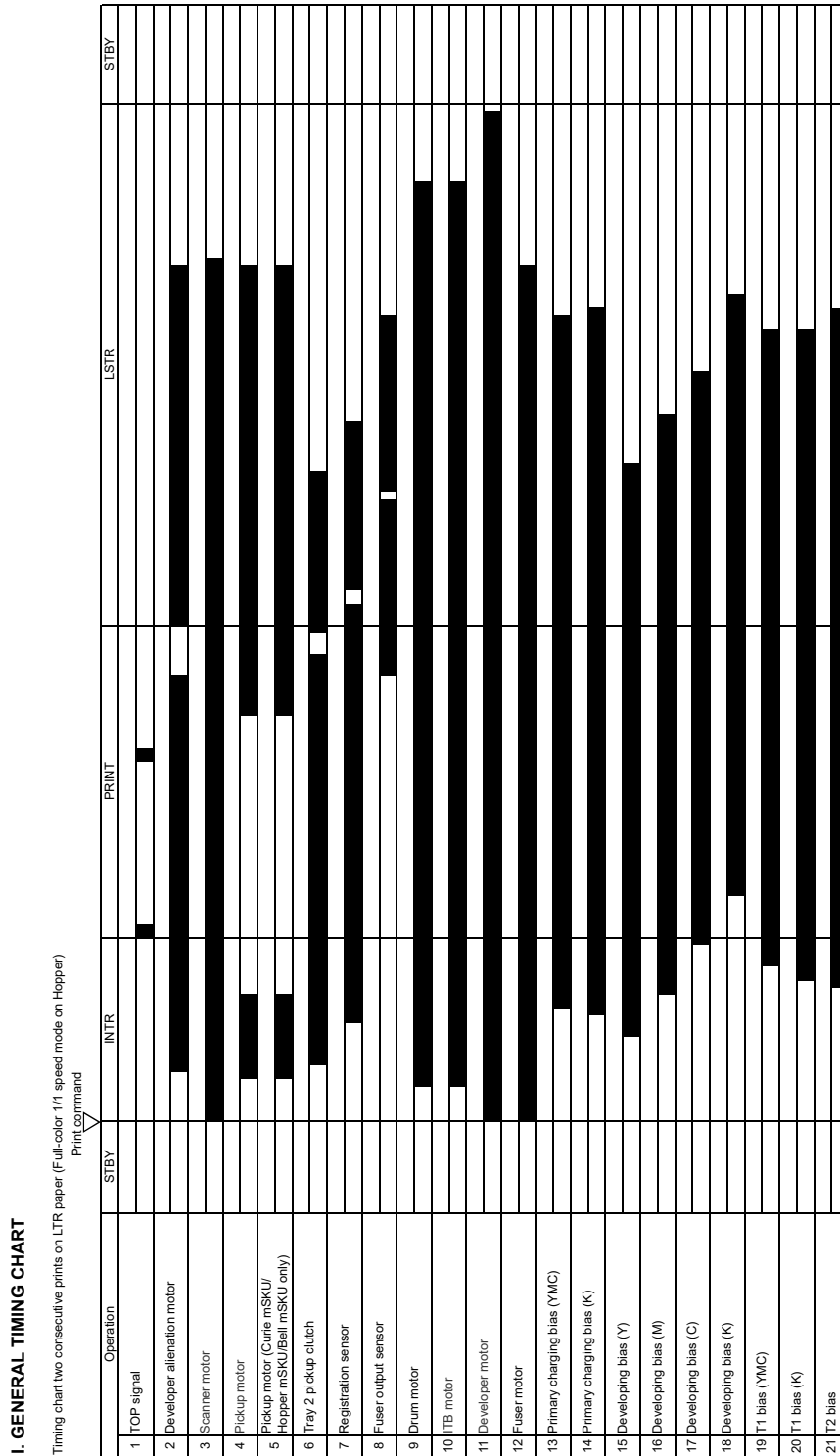


Item	Description	Item	Description
J611	Printer	J641	IPTU feed motor
J612	Floor stand staple stacker	J642	IPTU upper fan IPTU flapper solenoid
J613	Floor stand staple stacker	J651	IPTU inlet sensor IPTU Media full sensor 1 IPTU lower fan
J621	Not used	J652	IPTU door switch
J622	Not used		

## Diagrams: General timing chart

View the printer timing chart diagram.

Figure 4-93 Timing chart



A - 1 - 1

Diagrams: General circuit diagrams

View the printer circuit diagrams.





Figure 4-95 General circuit diagram, base printer (2 of 5)

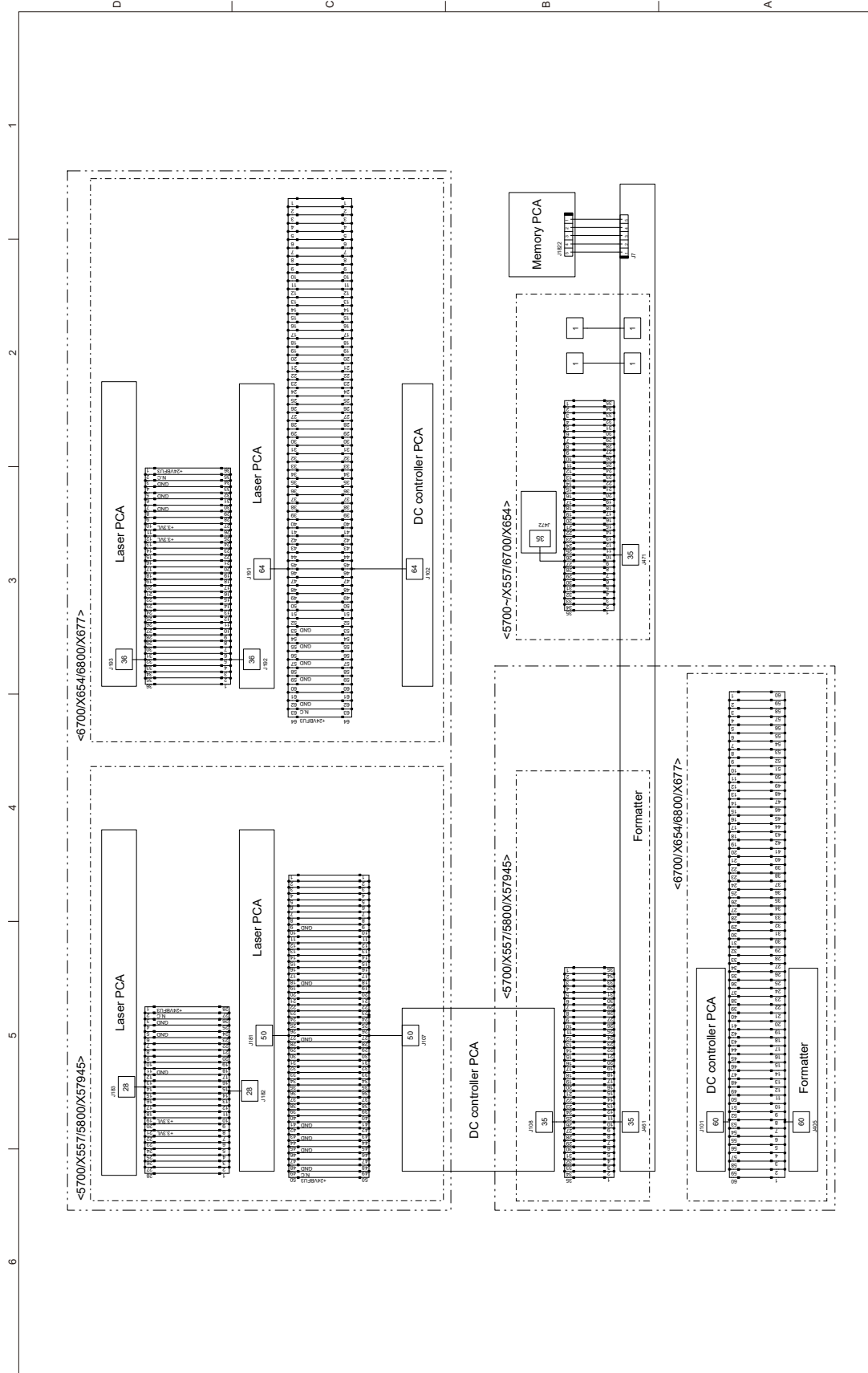


Figure 4-96 General circuit diagram, base printer (3 of 5)

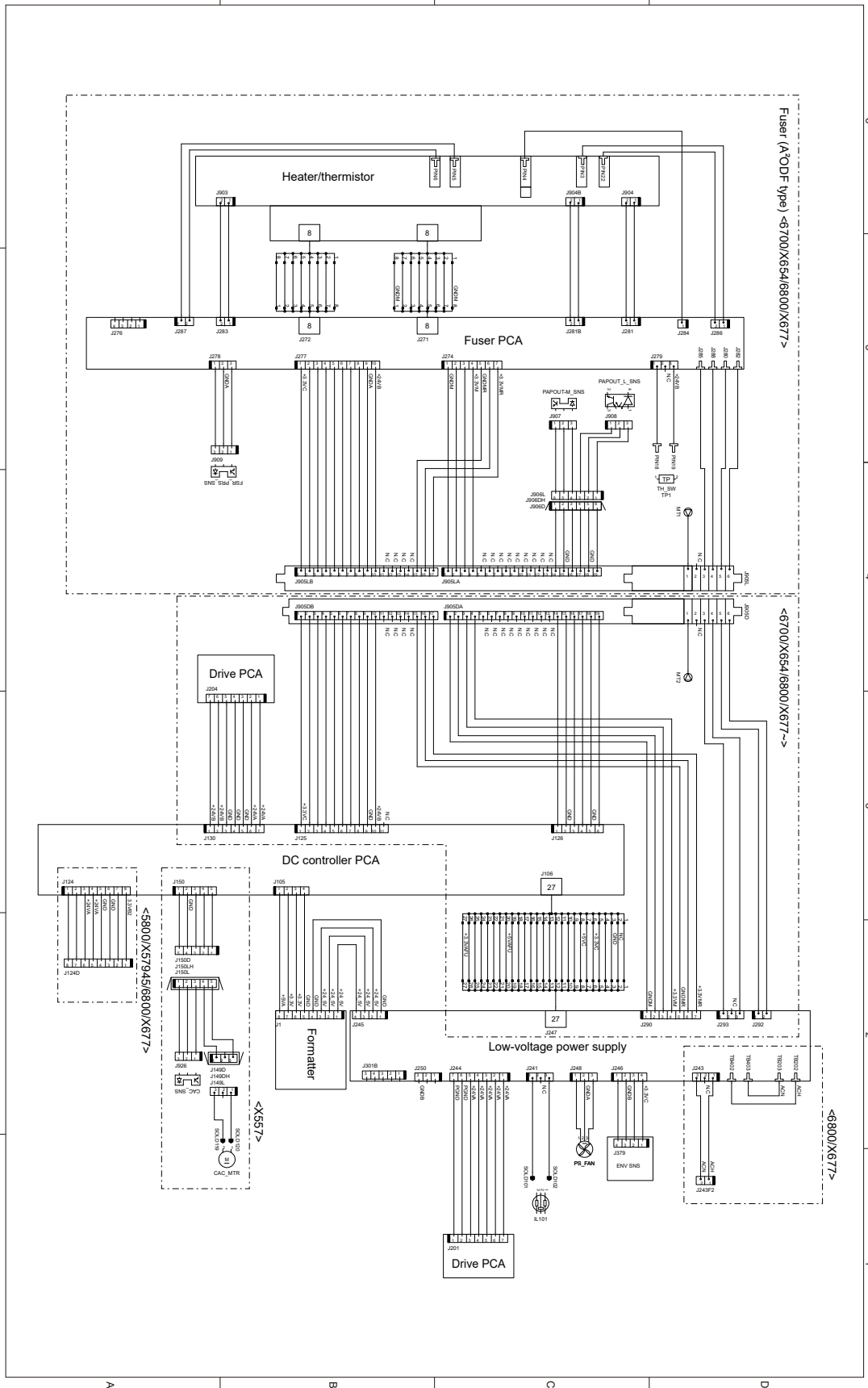






Figure 4-99 General circuit diagram, 550-sheet paper feeder

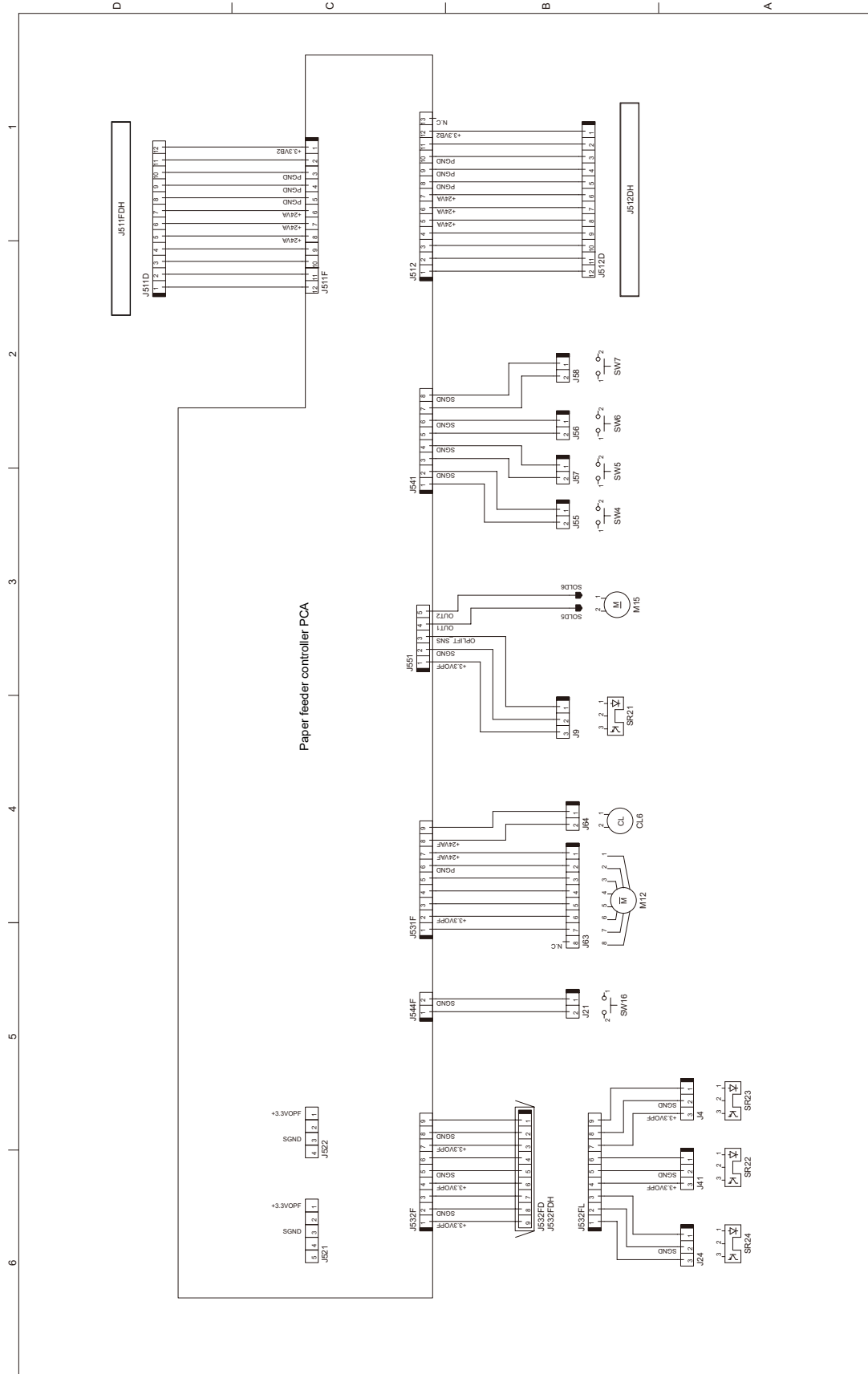


Figure 4-100 General circuit diagram, HCI

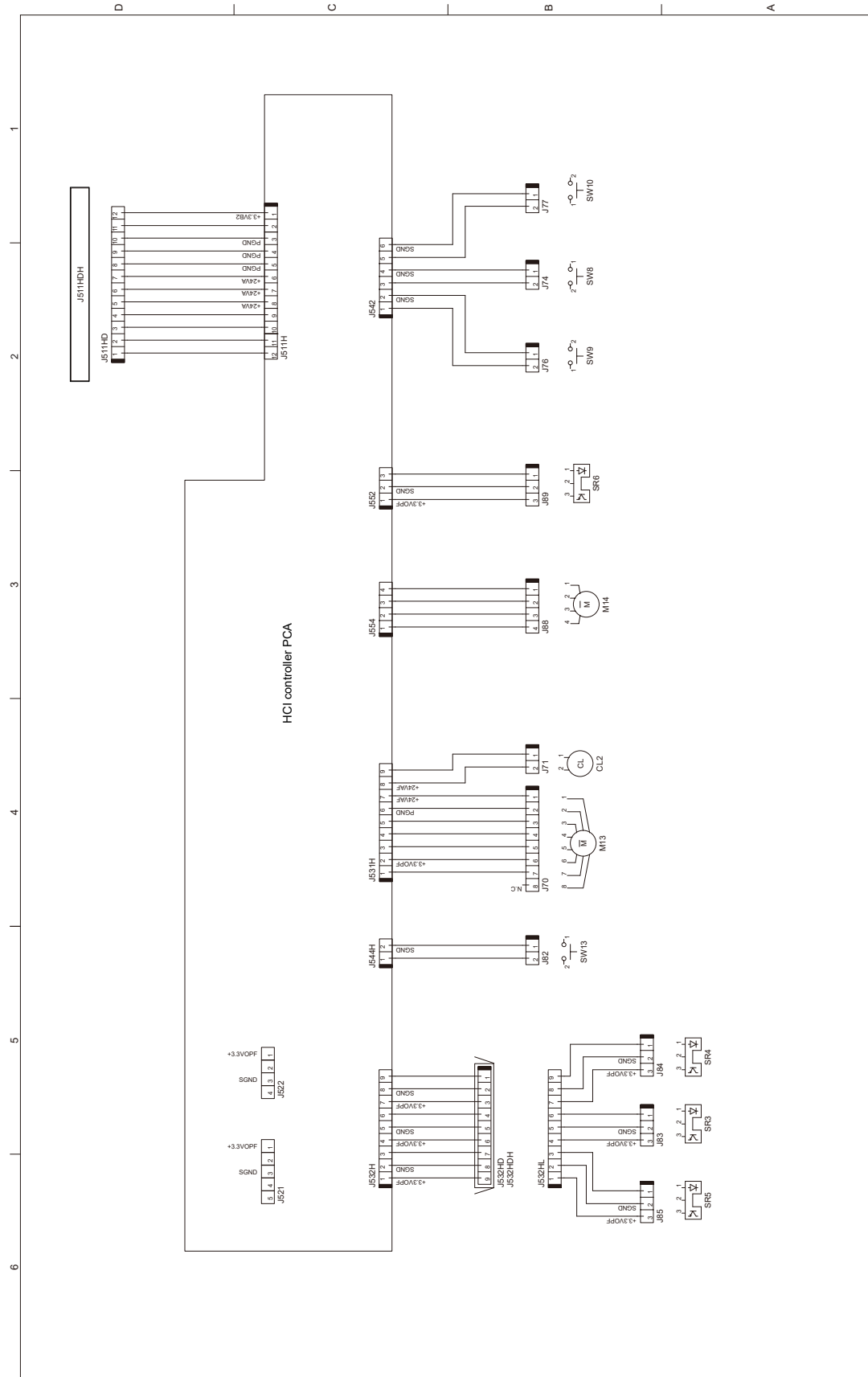
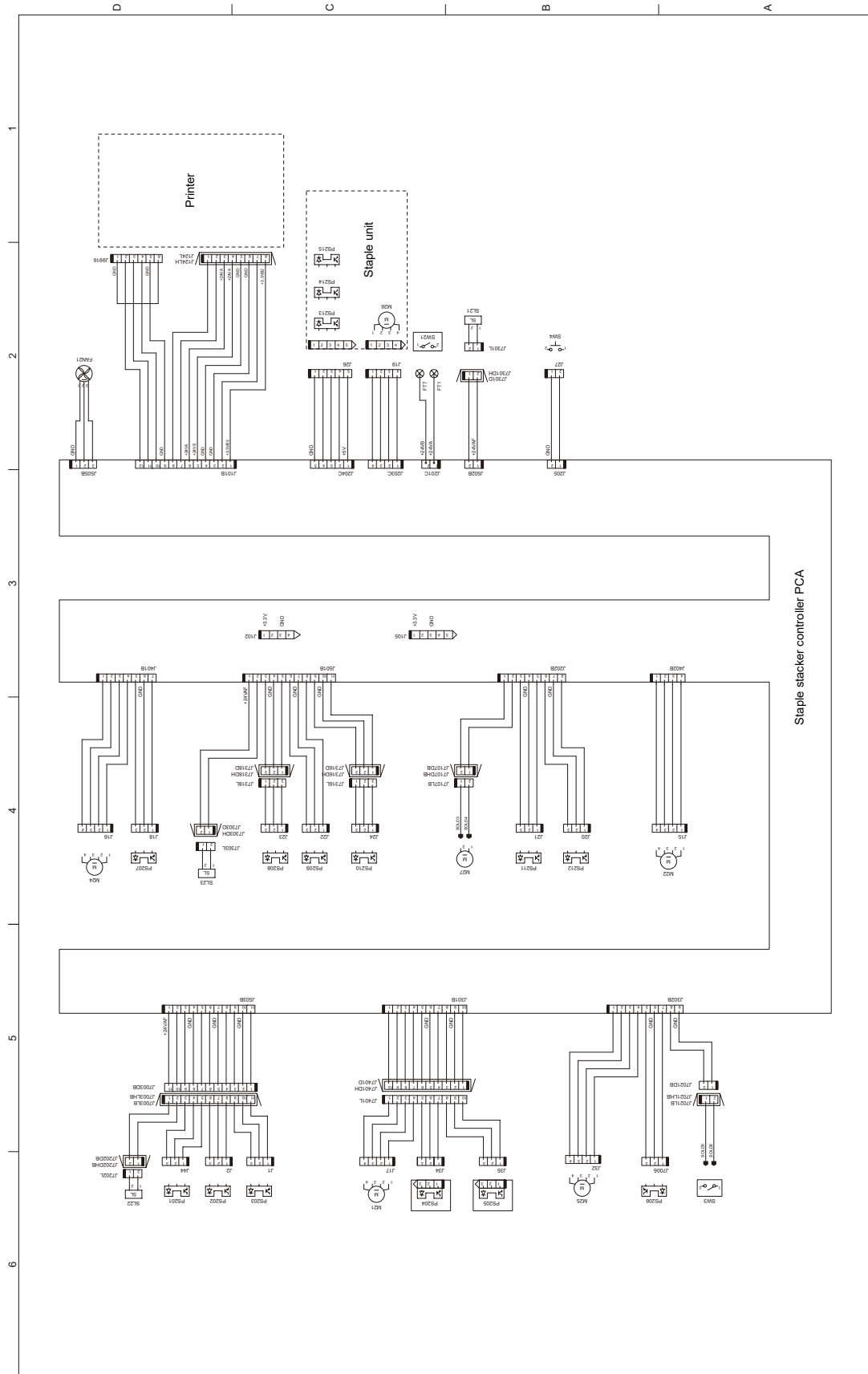


Figure 4-101 General circuit diagram, 3-bin stapler-stacker









## Internal test and information pages

Learn about printer test and information pages.

### Configuration and Jetdirect page


Print and find printer information on configuration and HP embedded Jetdirect information pages.



**NOTE:** Depending on the model, up to three pages print when printing a configuration page. In addition to the main configuration page, the HP embedded Jetdirect configuration and the wireless pages print.

---

Print the configuration page from a touchscreen control panel

1. From the [Home](#) screen on the printer control panel, scroll to and touch the [Reports](#) button.
2. Open the following menus:
  - [Configuration/Status pages](#)
3. Touch [Configuration Page](#) to select it.
4. Touch the print icon  to print the pages.

**Figure 4-104 Configuration page**

**Configuration Page**
HP LaserJet M406
Page 1

**1 Device Information**

Product Name: HP LaserJet M505  
 Device Name: HP LaserJet M505  
 Model Number: Q3XXXX  
 CC Controller Version: 1.102  
 Device Serial Number: XXXXXXXXXX  
 Formatter Number: XXXXXXXXXX  
 Firmware Bundle Version: 361a  
 Firmware Revision: 2337930\_482646  
 Firmware Datecode: 20140617  
 HP FutureSmart Level: HP FutureSmart 3  
 HPic Revision: Not Installed  
 Service ID: 00000  
 Maintenance Kit Interval: 225000  
 Pages Since Last Maintenance: 0  
 PS alert Timeout: 300 seconds  
 Engine Cycles\*: 7  
 \*Not weighted for billing

**2 Installed Personalities and Options**

PCL: 2011940C  
 PCLXL: 2011040C  
 POSTSCRIPT: 2011C402  
 PDI: 20130901  
 AirPrint: 2040201  
 Internal Disk - Hard Disk: Enabled  
 Serial Number: DC160322  
 Model: Toshiba 03040C  
 Capacity: 3275 MB  
 Hard Disk Encryption Status: Disk cannot be encrypted  
 HP Printer Trusted Platform Module: Enabled  
 Firmware: 01.02.149.32  
 iLok Number: 04E91A0436783210A0F476F981396FC54E335A9  
 SRK Thumbprint: 78361A0436783210A0F476F981396FC54E335A9  
 Embedded HP JetDirect J.94C: NP7265E93  
 Wireless HP JetDirect J8932E: 0.0.0.0

**3 HP Web Services**

HP Web Services: Disabled  
 ePrint: Disabled

**4 Memory**

Total RAM: 512 MB

**5 Event Log**

Number of Entries in Use: 17  
 Three Most Recent Entries:

Number	Cycles	Event
17	7	13.05.40
16	7	33.02.02
15	7	33.02.02

**6 Security**

Hard Disk Encryption Status:  
 Internal Disk: Disk cannot be encrypted  
 Job Data Encryption Status: Encrypted (AES-128)  
 Job Data Persistence: [FullWrite]  
 File Erase Mode: Non-Secure Fast Erase (No overwrite)  
 Control Panel Password: Disabled  
 Support Key: RSP 7PMS-UC35  
 Post USB p.up and play: Enabled  
 Device USB: Enabled

**7 Paper Trays and Options**

Default Paper Size: Letter  
 Tray 1 Size: Any Size  
 Tray 1 Type: Any Type  
 Tray 2 Size: Letter  
 Tray 2 Type: Plain  
 1: Output Bin 1, 500 Sheets, Standard bin (correct order)  
 2: Output Bin 2, 100 Sheets, Rear bin (straightest path)

Sep/13/2019 6:56:00 AM
English (United States)

Item	Description	Item	Description
1	Device information	5	Event log
2	Installed personalities and options	6	Security
3	HP Web services	7	Paper trays and options
4	Memory		

Certain information, such as the firmware date codes, the IP address, and the email gateways, is especially helpful while servicing the printer. This information is on the various configuration pages.

**Table 4-11 Important information on the configuration pages**

Type of information	Specific information	Configuration page
Firmware Bundle Version	Firmware information	Main configuration page (Device information)

**Table 4-11 Important information on the configuration pages (continued)**

Type of information	Specific information	Configuration page
Firmware Revision	Firmware information	Main configuration page (Device information)
Firmware Datecode	Firmware information	Main configuration page (Device information)
<b>Accessories and internal storage</b>  All optional devices that are installed on the printer should be listed on the main configuration page.  Separate pages print for the optional paper handling devices and the fax accessory. These pages list more-detailed information for those devices.	Optional installed formatter devices and accessories information	Main configuration page (Installed Personalities and Options)
Memory	Total RAM information	Main configuration page (Memory)
Tray and bin information	Size and type by tray (including installed optional paper feeders) information	Main configuration page (Paper Trays and Options)
Engine cycles, service ID, and cartridge information	Engine information	Main configuration page (Device Information)
Event-log information	Error information	Main configuration page (Event Log)

The second configuration page is the HP embedded Jetdirect page, which contains the following information:

Figure 4-105 HP embedded Jetdirect page

Embedded Jetdirect Page
HP LaserJet M406
Page 1

**1** ----- General Information -----  
Status: I/O Card Initializing  
Model Number: J8932E  
Hardware Address: ECC2:7245593  
Firmware Version: J0:7430315  
Port Config: Unknown  
Auto Negotiation: On  
Manufacturing ID: 0107510700\*\*\*M  
Build Date: 06/16/2014 06:00:50  
MS Registration: Not Registered  
ePrint: Not Applicable  
Email: Not Applicable

**2** ----- Security Settings -----  
IPsec: Disabled  
Secure Web: HTTPS Required  
Cert. Expires: 2009-01-17 02:14 UTC  
SNMP Versions: 1, 2  
SNMP Set Only Name: Not Specified  
SNMP Get Only Name: Not Specified/Default  
Access List: Not Specified  
Admin Password: Not Specified  
Announcement Agent: Success  
FTPS: Disabled

**3** ----- Network Statistics -----  
Total Packets Received: 0  
Unicast Packets Received: 0  
Bad Packets Received: 0  
Framing Errors Received: 0  
Total Packets Transmitted: 0  
Unsendable Packets: 0  
Transmit Collisions: 0  
Transmit Late Collisions: 0  
Last Make: 00000000000000000000000000000000  
00000000000000000000000000000000  
00000000000000000000000000000000

**4** ----- TCP/IP -----  
IPv4: Enabled  
IPv6: Enabled  
Host Name: NP1245593  
IPv4 Domain Name: Not Specified  
IPv6 Domain Name: Not Specified  
Primary DNS Server: Not Specified  
Secondary DNS Server: Not Specified  
DNS(IPv4): Not Specified  
DNS(IPv6): Not Specified  
WINS Server: Not Specified  
TCP Idle Timeout: 90 sec

**5** ----- IPv4 -----  
Status: Initializing  
IP Address: 0.0.0.0  
Subnet Mask: 0.0.0.0  
Default Gateway: 0.0.0.0  
Config By: Not Configured  
BOOTP/DHCP Server: 0.0.0.0  
TFTP Server: 0.0.0.0  
Bonjour Service Name: Not Specified

**6** ----- IPv6 -----  
Status: Ready  
Link Local: Not Configured  
Siteless: Not Configured  
DHCPv6: Not Configured  
Manual: Not Configured


Sep/13/2019 6:56:00 AM
English (United States)

Item	Description
1	General Information indicates the printer status, model number, hardware firmware version, port select, port configuration, auto negotiation, manufacturing identification, and manufactured date.
2	Security Settings information
3	Network Statistics indicates the total packets received, unicast packets received, bad packets received, framing errors received, total packets transmitted, unsendable packets, transmit collisions, and transmit late collisions.
4	TCP/IP information, including the IP address
5	IPv4 information
6	IPv6 information


## Reports menu

Learn about the control-panel [Reports](#) menu.

**To display:** At the printer control panel, select the [Reports](#) menu.

**To print:** At the printer control panel, touch the printer icon .

In the following table, asterisks (\*) indicate the factory default setting.

 **NOTE:** The [View](#) option is control-panel type dependent (might not be available).

**Table 4-12 Reports menu**


First level	Second level	Values	Description
Configuration/Status Pages	Settings Menu Map	Cancel	Shows a map of the entire control panel system and the selected values for each setting.
		View	
		Print	
Configuration/Status Pages	Current Settings Page	Cancel	Shows a summary of the current settings for the printer. This might be helpful if you plan to make changes and need a record of the present configuration.
		View	
		Print	
Configuration/Status Pages	Configuration Page	Cancel	Shows the printer settings and installed accessories.
		View	
		Print	
Configuration/Status Pages	How to Connect Page	Cancel	Shows the network information typically needed to connect the printer to a network.
		View	
		Print	
Configuration/Status Pages	Supplies Status Page	Cancel	Shows the approximate remaining life for the supplies; reports statistics on total number of pages and jobs processed, serial number, page counts, and maintenance information.  HP provides approximations of the remaining life for the supplies as a customer convenience. The actual remaining supply levels might be different than the approximations provided.
		View	
		Print	
Configuration/Status Pages	Usage Page	Cancel	Shows a count of all paper sizes that have passed through the printer; lists whether they were simplex or duplex, and reports the page count.
		View	
		Print	


**Table 4-12 Reports menu (continued)**

First level	Second level	Values	Description
Configuration/Status Pages	File Directory Page	Cancel	Shows the file name and folder name for files that are stored in the printer memory.
		View	
		Print	
Configuration/Status Pages	Web Services Status Page	Cancel	Shows the detected Web Services for the printer.
		View	
		Print	
Fax Reports Fax models only	Fax Activity Log	Cancel	Contains a list of the faxes that have been sent from or received by this printer.
		View	
		Print	
Fax Reports Fax models only	Billing Codes Report	Cancel	Provides a list of billing codes that have been used for outgoing faxes. This report shows how many sent faxes were billed to each code.
		View	
		Print	
Fax Reports Fax models only	Blocked Fax List	Cancel	A list of phone numbers that are blocked from sending faxes to this printer.
		View	
		Print	
Fax Reports Fax models only	Speed Dial List	Cancel	Shows the speed dials that have been set up for this printer.
		View	
		Print	
Fax Reports Fax models only	Fax Call Report	Cancel	A detailed report of the last fax operation, either sent or received.
		View	
		Print	
Other Pages	PCL Font List	Cancel	Prints the available PCL fonts.
		Print	
Other Pages	PS Font List	Cancel	Prints the available PS fonts.
		Print	

## Settings menu

Learn about the control-panel [Settings](#) menu.

 **NOTE:** You can perform basic printer setup by using the [Settings](#) menu. Use the HP Embedded Web Server for more advanced printer setup. To open the HP Embedded Web Server, enter the printer IP address or host name in the address bar of a Web browser.


 **TIP:** If prompted, enter the EWS personal identification number (PIN) from a sticker on the printer (typically located inside the front door or on a toner cartridge tray).



## General menu

Learn about the control-panel [General \(Settings\)](#) menu.

**To display:** At the printer control panel, select the [Settings](#) menu, and then select the [General](#) menu.

**To print:** At the printer control panel, touch (MFP) or use the arrow buttons (SFP) to select the printer icon . For the SFP, press the [OK](#) button to print the pages.

In the following table, asterisks (\*) indicate the factory default setting.

**Table 4-13 General menu**

First level	Second level	Third level	Fourth level	Values	Description
Date/Time Settings	Date/Time Format	Date Format		DD/MMM/YYYY MMM/DD/YYYY YYYY/MMM/DD	Use the <a href="#">Date/Time Settings</a> menu to specify the date and time and to configure date/time settings.
Date/Time Settings	Date/Time Format	Time Format		12 hour (AM/PM) 24 hours	Select the format that the printer uses to show the date and time, for example 12-hour format or 24-hour format.
Date/Time Settings	Date/Time	Time Zone		Select the time zone from a list.	
Date/Time Settings	Date/Time	Date		Select the date from a pop-up calendar.	
Date/Time Settings	Date/Time	Time		Select the time from a pop-up keypad.	
Date/Time Settings	Date/Time	Adjust for Daylight Savings		Checkbox	If you are in an area that uses daylight savings time, select the <a href="#">Adjust for Daylight Savings</a> box.
Energy Settings MFP	Sleep Schedule	A list of scheduled events displays.		+ (Add) Edit Delete	Use to configure the printer to automatically wake up or go to sleep at specific times on specific days. Using this feature saves energy.  <b>NOTE:</b> You must configure the date and time settings before you can use this feature.

**Table 4-13 General menu (continued)**

First level	Second level	Third level	Fourth level	Values	Description
Energy Settings MFP	Sleep Schedule	A list of scheduled events displays.	Event Type	Wake Sleep	Select whether to add or edit a <a href="#">Wake</a> event or a <a href="#">Sleep</a> event, and then select the time and the days for the wake or sleep event.
Energy Settings MFP	Sleep Schedule	A list of scheduled events displays.	Event Time		
Energy Settings MFP	Sleep Schedule	A list of scheduled events displays.	Event Days	Select days of the week from a list.	
Energy Settings MFP	Sleep Timer Settings	Sleep Mode/Auto Off After		Range: 1 to 120 minutes Default = 60 minutes	Set the number of minutes after which the printer enters Sleep or Auto Off mode. Use the arrow buttons on the control panel to increase or decrease the number of minutes.
Energy Settings MFP	Wake/Auto On to These Events			All Events* Network port Power button only	
Energy Settings SFP	Sleep Timer Settings	Sleep/Auto Off Timer		Enabled* Disabled	Enable or disable the printer sleep or auto off function.
Energy Settings SFP	Sleep Timer Settings	Sleep Mode/Auto Off After		Range: 1 to 120 minutes Default = 60 minutes	Set the number of minutes after which the printer enters Sleep or Auto Off mode. Use the arrow buttons on the control panel to increase or decrease the number of minutes.
Display Settings	Display Brightness	A sliding bar displays with the indicator set in the middle. Use the arrow keys to select the desired brightness and then select <a href="#">Done</a> .			Use to specify the intensity of the LCD control panel display.
Display Settings	System Sound			On* Off	Use to enable or disable sounds on the printer.

**Table 4-13 General menu (continued)**

First level	Second level	Third level	Fourth level	Values	Description
Display Settings	Language Settings	Language		Select from a list of languages that the printer supports.	Use to select a different language for control panel messages and specify the default keyboard layout. When you select a new language, the keyboard layout automatically changes to match the factory default for the selected language.
Display Settings		Keyboard Layout		Each language has a default keyboard layout. To change it, select from a list of layouts.	Select the default keyboard layout that matches the language you want to use.
Display Settings	Information Screen			Show connection information* Hide connection information	Use this menu item to display or hide connection information on the Home screen.
Display Settings	Inactivity Timeout			Range: 10-300 seconds Default = 60 seconds	Specifies the amount of time that elapses between any activity on the control panel and when the printer resets to the default settings. When the timeout expires, the control panel display returns to the Home menu, and any user signed in to the printer is signed out.
Display Settings	Clearable Warnings			Display during job* Display until cleared	Use this feature to set the period that a clearable warning displays on the control panel. If the On setting is selected, clearable warnings appear until the Clearable Warnings button is pressed. If the Job setting is selected, clearable warnings stay on the display during the job that generated the warning and disappear from the display when the next job starts.

**Table 4-13 General menu (continued)**

First level	Second level	Third level	Fourth level	Values	Description
Display Settings	Continuable Events			Auto-continue (10 seconds)* Touch OK to continue	Use this option to configure the printer behavior when the printer encounters certain errors. If the <a href="#">Auto-continue (10 seconds)</a> option is selected, the job will continue after 10 seconds. If the <a href="#">Touch OK to continue</a> option is selected, the job will stop and require the user to touch the <a href="#">OK</a> button before continuing.
				Enabled Disabled*	Enables the printer to open a file from a USB drive.
				Off* On Automatic transition Range: 10-300 pages Default = 10 pages	<a href="#">Quiet Mode</a> slows the printer down to reduce the noise the printer makes when printing. <a href="#">Automatic transition</a> allows you to set a predetermined job size of 10 to 999 pages, and print jobs will print in <a href="#">Quiet Mode</a> for all print jobs up to the predetermined page size.

**Table 4-13 General menu (continued)**

First level	Second level	Third level	Fourth level	Values	Description
Jam Recovery				Automatic* Off On	<p>This printer provides a jam recovery feature that reprints jammed pages. Select one of the following options:</p> <p><b>Automatic:</b> The printer attempts to reprint jammed pages when sufficient memory is available. This is the default setting.</p> <p><b>Off:</b> The printer does not attempt to reprint jammed pages. Because no memory is used to store the most recent pages, performance is optimal.</p> <p><b>NOTE:</b> When using this option, if the printer runs out of paper and the job is being printed on both sides, some pages can be lost.</p> <p><b>On:</b> The printer always reprints jammed pages. Additional memory is allocated to store the last few pages printed. This might cause overall performance to suffer.</p>
Auto Recovery				Enabled Disabled*	<p>If <b>Auto Recovery</b> is enabled and an unrecoverable error occurs in the device firmware, the device automatically turns off and turns back on to recover from the error.</p>

**Table 4-13 General menu (continued)**

First level	Second level	Third level	Fourth level	Values	Description
Enable Auto Send				Disabled* Enabled	<p>Browse to the HP Embedded Web Server AutoSend configuration page for advanced set up and the HP online Privacy Statement Information.</p> <p>Use the <a href="#">Enable Auto Send</a> menu to enable or disable the AutoSend feature. The AutoSend feature enables your product to periodically send product configuration information including serial number, event logs, page usage counts and supplies status information to HP web addresses (URLs), or email addresses. Information sent to HP is used to improve products and services, and to monitor the product if you have a relationship with HP that provides you services such as proactive cartridge replacement, pay-per-page contracts, support agreements, or usage tracking.</p>
Hold Off Print Job				Enabled* Disabled	<p>Enable this feature if you want to prevent print jobs from starting while a user is initiating a copy job from the control panel. Held print jobs start printing after the copy job is finished, provided that no other copy job is in the print queue.</p>


**Table 4-13 General menu (continued)**

First level	Second level	Third level	Fourth level	Values	Description
Reset Factory Settings				Address Book (MFP)	Use to restore all printer settings to their factory defaults.
				Copy (MFP)	
				Digital Send (MFP)	
				E-mail (MFP)	
				Fax (MFP)	
				General (MFP)	
				Print (MFP)	
				Security (MFP)	
				Cancel (SFP)	
			Reset (SFP)		

### Scan/Digital Send Settings menu (MFP)

Learn about the control-panel [Scan/Digital Send Settings \(MFP\)](#) menu.

**To display:** At the printer control panel, select the [Settings](#) menu, and then select the [Scan/Digital Send Settings](#) menu.

**To print:** At the printer control panel, touch (MFP) or use the arrow buttons (SFP) to select the printer icon . For the SFP, press the **OK** button to print the pages.

In the following table, asterisks (\*) indicate the factory default setting.

**Table 4-14 Scan/Digital Send Settings menu (MFP)**

First level	Second level	Third level	Fourth level	Values	Description
Scan to Email Settings	E-mail Setup	E-mail Setup Wizard			Use to configure settings that apply to sending documents through email or saving documents to a folder on the network or on a USB multi-drive.
Scan to Network Folder Settings	<b>NOTE:</b> Email Settings only				
Scan to USB Drive Settings					
<b>NOTE:</b> The same options are available for each of these features, except where noted.					The <a href="#">E-mail Setup Wizard</a> feature configures the printer to send scanned images as email attachments. To open the printer HP Embedded Web Server and set up the email notification server, enter the printer IP address into a Web browser.

**Table 4-14 Scan/Digital Send Settings menu (MFP) (continued)**

First level	Second level	Third level	Fourth level	Values	Description
	Default Job Options	Image Preview		<p>Make optional*</p> <p>Require preview</p> <p>Disable preview</p>	<p>Defines the default job options for each function. If you do not specify the job options when creating the job, the default options are used. For complete setup, go to the HP Embedded Web Server by typing the IP address of the printer into a Web browser.</p> <p>Use the <a href="#">Image Preview</a> feature to scan a document and display a preview before completing the job. Select whether this feature is available on the printer.</p> <p><b>Make optional:</b> The feature is optional, depending on the user who is signed in.</p> <p><b>Require preview</b> Previews are required for all users.</p> <p><b>Disable preview:</b> Previews are disabled for all users.</p>
		Default File Name		[Untitled]*	<p>The printer is shipped with a factory default file name of [Untitled] for any scanned files that are sent or saved. Use this feature to specify a different default file name. If you are saving a file to a network folder or USB storage device and a file with the default file name already exists, a number is appended to the file name, for example, [Untitled]001.</p>



**Table 4-14 Scan/Digital Send Settings menu (MFP) (continued)**

First level	Second level	Third level	Fourth level	Values	Description
		Document File Type		Select from a list of file types.	<p><b>PDF</b> provides the best overall image and text quality.</p> <p><b>JPEG</b> is a good choice for most graphics. Most computers have a browser that can view .JPEG files. This file type produces one file per page.</p> <p><b>TIFF</b> is a standard file format that many graphics programs support. This file type produces one file per page.</p> <p><b>MTIFF</b>: stands for multi-page TIFF. This file type saves multiple scanned pages in a single file.</p> <p><b>XPS (XML Paper Specification)</b> creates an XAML file that preserves the original formatting of the document and supports color graphics and embedded fonts.</p> <p><b>PDF/A (Archivable)</b>: provides archivable text and image quality.</p> <p><b>NOTE:</b> OCR file types are not supported on this printer unless attached to DSS.</p>

**Table 4-14 Scan/Digital Send Settings menu (MFP) (continued)**

First level	Second level	Third level	Fourth level	Values	Description
		Optimize Text/ Picture		Mixed* Text Printed picture Photograph	<p>Use to optimize the output for a particular type of content. You can optimize the output for text, printed pictures, or a mixture.</p> <p><b>Mixed:</b> Use to optimize the setting for text and for pictures.</p> <p><b>Text:</b> Use to optimize the text portion of the copy when text and/or pictures are on the original.</p> <p><b>Printed picture:</b> Use for line drawings and preprinted images, such as magazine clippings or pages from books.</p> <p><b>Photograph:</b> Best suited for making copies of printed pictures.</p>
		Quality and File Size		High (large file) Medium* Low (small file)	<p>Use to select the quality for the output. Higher-quality images require a larger file size than lower-quality images. Larger files take more time to send, and some recipients might have trouble receiving larger files.</p>

**Table 4-14 Scan/Digital Send Settings menu (MFP) (continued)**

First level	Second level	Third level	Fourth level	Values	Description
		Original Sides		1-sided 2-sided	Use to describe the layout for each side of the original document. First select whether the original document is printed on one side or both sides. Then touch the <a href="#">Orientation</a> setting to indicate whether the original has portrait or landscape orientation. If it is printed on both sides, also select the 2-sided format that matches the original document.
			Orientation	Automatically detect Portrait* Landscape	For some features to work correctly, you must specify the way the content of the original document is placed on the page. Portrait orientation means the short edge of the page is along the top. Landscape orientation means the long edge of the page is along the top. In the <a href="#">Orientation</a> area, select whether the original document has a portrait or landscape orientation.

**Table 4-14 Scan/Digital Send Settings menu (MFP) (continued)**

First level	Second level	Third level	Fourth level	Values	Description
		Resolution		600 dpi 400 dpi 300 dpi 200 dpi 150 dpi* 75 dpi	Sets the resolution for sent documents. Higher resolution images have more dots per inch (dpi), so they show more detail. Lower resolution images have fewer dots per inch and show less detail, but the file size is smaller. Some file types, for example a file that will be processed with OCR, require a specific resolution. When these file types are selected, the <a href="#">Resolution</a> setting might automatically change to a valid value.
		Content Orientation	Orientation	Auto Detect Portrait* Landscape	For some features to work correctly, you must specify the way the content of the original document is placed on the page. Portrait orientation means the short edge of the page is along the top. Landscape orientation means the long edge of the page is along the top. In the Orientation area, select whether the original document has a portrait or landscape orientation.

**Table 4-14 Scan/Digital Send Settings menu (MFP) (continued)**

First level	Second level	Third level	Fourth level	Values	Description
		Color/Black		Automatically detect color or black*	Use to enable or disable color scanning.
				Automatically detect color or gray	Automatically detect color or black: When pages without color are detected, the printer creates an image of the page in 1-bit black if other settings allow. If the other settings don't allow (File Type, for example), the image is in grayscale.
				Color	
				Black	
				Black/Gray	
					Automatically detect color or gray: When pages without color are detected, the printer creates an image of the page in grayscale. Select this option for the best image quality for non-color pages.
					Color: Scans documents in color.
					Black/Gray: Scans documents in grayscale.
					Black: Scans documents in black and white with a compressed file size.
		Original Size		Select from a list of supported sizes.	Use to describe the page size of the original document.
		Notification		Do not notify*	Configure to receive notification about the status of a sent document.
				Notify when job completes	
				Notify only if job fails	Do not notify: Turns off this feature.
					Notify when job completes: Select to receive notification for this job only.

**Table 4-14 Scan/Digital Send Settings menu (MFP) (continued)**

First level	Second level	Third level	Fourth level	Values	Description
				Print E-mail	<p>Notify only if job fails: Select to receive notification only if the job is not sent successfully.</p> <p>Print: Select to print the notification at this printer.</p>
			Include Thumbnail		<p><b>NOTE:</b> When sending an analog fax, select <b>Include Thumbnail</b> to receive a thumbnail image of the first page of the fax in your notification.</p>
			Notification E-mail address		<p><b>E-mail:</b> Select to receive the notification in an email. Touch the text box following <b>Email Address</b>, and then type the email address for the notification.</p>
		Image Adjustment	Darkness		<p>Use to improve the overall quality of the copy.</p> <p>Adjust the <b>Darkness</b> setting to increase or decrease the amount of white and black in the colors.</p>
			Contrast		<p>Adjust the <b>Contrast</b> setting to increase or decrease the difference between the lightest and darkest color on the page.</p>
			Background Cleanup		<p>Adjust the <b>Background Cleanup</b> setting if you are having trouble copying a faint image.</p>

**Table 4-14 Scan/Digital Send Settings menu (MFP) (continued)**

First level	Second level	Third level	Fourth level	Values	Description
			Sharpness		Adjust the <a href="#">Sharpness</a> setting to clarify or soften the image. For example, increasing the sharpness could make text appear crisper, but decreasing it could make photographs appear smoother.
			Automatic Tone		
			Default		Select this to make the selected <a href="#">Image Adjustment</a> setting the default value.
		Cropping Options		Do not crop* Crop to content Crop to paper	Use this menu item to automatically crop the scan for digital sending. Use the <a href="#">Crop to content</a> option to scan the smallest possible area that has detectable content.
		Erase Edges		Use Inches Back side erase Front side erase	Use this menu item to remove blemishes, such as dark borders or staple marks, by cleaning the specified edges of the scanned image. In each of the text boxes enter the measurements, in millimeters or inches, for how much of the top edge, bottom edge, left edge, and right edge to clean.
		Multi-feed Detection		On* Off	This setting stops the scanning process if it detects multiple-page feeds through the document feeder.
		Blank Page Suppression		Disabled* Enabled	Use to prevent blank pages in the original document from being included in the output document.


**Table 4-14 Scan/Digital Send Settings menu (MFP) (continued)**

First level	Second level	Third level	Fourth level	Values	Description
Digital Send Service Setup	Allow Usage of Digital Sending Software (DSS) Server			Enabled* Disabled	Configure how the printer interacts with the HP Digital Sending Software (DSS) server. HP DSS handles digital sending tasks, such as faxing, emailing, and sending scanned documents to a network folder or USB storage device.  Use the <a href="#">Allow Usage of Digital Sending Software (DSS) Server</a> option to configure the printer to use HP DSS.
	Allow Transfer to New Digital Sending Software (DSS) Server			Enabled* Disabled	Use the <a href="#">Allow Transfer to New Digital Sending Software (DSS) Server</a> option to specify whether DSS management of a printer is transferable to a different DSS.

## Fax menu (MFP)

Learn about the control-panel [Fax menu \(MFP\)](#).

**To display:** At the printer control panel, select the [Settings](#) menu, and then select the [Fax](#) menu.

**To print:** At the printer control panel, touch (MFP) or use the arrow buttons (SFP) to select the printer icon . For the SFP, press the [OK](#) button to print the pages.

In the following table, asterisks (\*) indicate the factory default setting.



**Table 4-15 Fax menu (MFP)**

First level	Second level	Third level	Fourth level	Values	Description
Internal Fax Modem Setup					<p>Configure settings for sending faxes from the printer.</p> <p>Use the <a href="#">Internal Fax Modem Setup</a> feature to set up options for faxing.</p> <p><b>NOTE:</b> To set up LAN fax or Internet fax, use the HP Embedded Web Server. To open the HP Embedded Web Server, type the printer network address into a Web browser. To configure the fax features, select the <b>Fax</b> tab.</p>
Fax Send Settings	Fax Send Setup	Fax Dialing Settings	Fax Dial Volume	Off Low* High	These settings control how the fax modem dials the outgoing fax number when faxes are sent.
Fax Send Settings	Fax Send Setup	Fax Dialing Settings	Dialing Mode	Tone* Pulse	
Fax Send Settings	Fax Send Setup	Fax Dialing Settings	Redial Interval	1 – 5 Minutes Default = 5 minutes	
Fax Send Settings	Fax Send Setup	Fax Dialing Settings	Fax Send Speed	Fast* Medium Slow	
Fax Send Settings	Fax Send Setup	Fax Dialing Settings	Dialing Prefix		
Fax Send Settings	Fax Send Setup	Fax Dialing Settings	Detect Dial Tone		
Fax Send Settings	Fax Send Setup	Fax Dialing Settings	Redial on Error	Range: 0 – 9 Default = 2	
Fax Send Settings	Fax Send Setup	Fax Dialing Settings	Redial on No Answer	Range: 0 – 2 Default = 0	
Fax Send Settings	Fax Send Setup	Fax Dialing Settings	Redial on Busy	Range: 0 – 9 Default = 3	
Fax Send Settings	Fax Send Setup	General Fax Send Settings	Fax Number Confirmation	Enabled Disabled*	If this feature is enabled, you must enter the fax number twice.

**Table 4-15 Fax menu (MFP) (continued)**

First level	Second level	Third level	Fourth level	Values	Description
Fax Send Settings	Fax Send Setup	General Fax Send Settings	PC Fax Send	Enabled* Disabled	Enables users who have the correct driver installed to send faxes through the printer from their computers.
Fax Send Settings	Fax Send Setup	General Fax Send Settings	JBIG Compression	Enabled* Disabled	The JBIG compression reduces fax-transmission time, which can result in lower phone charges. However, using JBIG compression sometimes causes compatibility problems with older fax machines. If this occurs, turn off the JBIG compression.
Fax Send Settings	Fax Send Setup	General Fax Send Settings	Error Correction Mode	Enabled* Disabled	When error-correction mode is enabled and an error occurs during fax transmission, the printer sends or receives the error portion again.
Fax Send Settings	Fax Send Setup	General Fax Send Settings	Fax Header	Prepend* Overlay	Use to prepend or overlay the fax header page.
Fax Send Settings	Fax Send Setup	Billing Codes	Enable Billing Codes	Off On*	When billing codes are enabled, a prompt displays that asks the user to enter the billing code for an outgoing fax. This prompt does not appear if the <a href="#">Allow users to edit billing codes</a> check box is not checked.  You can also use the billing codes report in the <a href="#">Reports</a> menu to view the list of the billing codes that have been used for faxes that have been sent from the printer. The list is grouped by billing code and also shows fax details. This feature can be used for billing or usage tracking.

**Table 4-15 Fax menu (MFP) (continued)**

First level	Second level	Third level	Fourth level	Values	Description
Fax Send Settings	Fax Send Setup	Billing Codes	Default Billing Code		Specify a default billing code for faxing. If you specify a default billing code, this code displays in the <a href="#">Billing Code</a> field when the user sends an outgoing fax. If this field is blank, no default billing code is provided for the user.
Fax Send Settings	Fax Send Setup	Billing Codes	Minimum Length	Range: 1 – 16 Default = 1	Specify the required length of the billing code. Billing codes can be between 1 and 16 characters long.
Fax Send Settings	Fax Send Setup	Billing Codes	Allow users to edit billing codes	Off On*	
Fax Send Settings	Default Job Options	Image Preview		Make optional* Require preview Disable preview	Use the <a href="#">Image Preview</a> feature to scan a document and display a preview before completing the job. Select whether this feature is available on the printer.  <a href="#">Make optional</a> : The feature is optional, depending on the user who is signed in.  <a href="#">Require preview</a> Previews are required for all users.  <a href="#">Disable preview</a> : Previews are disabled for all users.

**Table 4-15 Fax menu (MFP) (continued)**

First level	Second level	Third level	Fourth level	Values	Description
Fax Send Settings	Default Job Options	Resolution		Standard (100 x 200dpi)* Fine (200 x 200dpi) Superfine (300 x 300dpi)	Select the resolution for outgoing faxes. If you increase the resolution, faxes might be clearer but they could transmit more slowly. Some file types, for example a file that will be processed with OCR, require a specific resolution. When these file types are selected, the <a href="#">Resolution</a> setting might be automatically changed to a valid value.
Fax Send Settings	Default Job Options	Original Sides		1-sided* 2-sided Pages flip up	Use to describe the layout for each side of the original document. First select whether the original document is printed on one side or both sides. Then touch the <a href="#">Orientation</a> setting to indicate whether the original has portrait or landscape orientation. If it is printed on both sides, also select the 2-sided format that matches the original document.  If the <a href="#">Pages flip up</a> option is selected, the back side of the page is printed upside-down. This option is for print jobs that are bound along the top edge.

**Table 4-15 Fax menu (MFP) (continued)**

First level	Second level	Third level	Fourth level	Values	Description
Fax Send Settings	Default Job Options	Original Sides	Orientation	Portrait* Landscape	<p>For some features to work correctly, you must specify the way the content of the original document is placed on the page.</p> <p><b>Portrait:</b> This setting means the short edge of the page is along the top.</p> <p><b>Landscape:</b> This setting means the long edge of the page is along the top.</p>
Fax Send Settings	Default Job Options	Notification		Do not notify* Notify when job completes Notify only if job fails	<p>Use to receive notification about the status of a sent document.</p> <p><b>Do not notify:</b> Turns off this feature.</p> <p><b>Notify when job completes:</b> Select to receive notification for this job only.</p> <p><b>Notify only if job fails:</b> Select to receive notification only if the job is not sent successfully.</p>
Fax Send Settings	Default Job Options	Notification		Print E-mail	<p><b>Print:</b> Select to print the notification at this printer.</p> <p><b>E-mail:</b> Select to receive the notification in an email. Touch the text box following <b>Email Address</b>, and then enter the email address for the notification.</p>
Fax Send Settings	Default Job Options	Notification	Include Thumbnail		<p>When sending an analog fax, select <b>Include Thumbnail</b> to receive a thumbnail image of the first page of the fax in your notification.</p>

**Table 4-15 Fax menu (MFP) (continued)**

First level	Second level	Third level	Fourth level	Values	Description
Fax Send Settings	Default Job Options	Notification	Notification E-mail address		Provide the email address that will receive notifications.
Fax Send Settings	Default Job Options	Content Orientation	Orientation	Portrait* Landscape	For some features to work correctly, you must specify the way the content of the original document is placed on the page.  Portrait: This setting means the short edge of the page is along the top.  Landscape: This setting means the long edge of the page is along the top.
Fax Send Settings	Default Job Options	Original Size		Select from a list of sizes that the printer supports.	Use to describe the page size of the original document.
Fax Send Settings	Default Job Options	Image Adjustment	Darkness		Use to improve the overall quality of the copy.  Adjust the Darkness setting to increase or decrease the amount of white and black in the colors.
Fax Send Settings	Default Job Options	Image Adjustment	Contrast		Adjust the Contrast setting to increase or decrease the difference between the lightest and darkest color on the page.
Fax Send Settings	Default Job Options	Image Adjustment	Background Cleanup		Adjust the Background Cleanup setting if you are having trouble copying a faint image.

**Table 4-15 Fax menu (MFP) (continued)**

First level	Second level	Third level	Fourth level	Values	Description
Fax Send Settings	Default Job Options	Image Adjustment	Sharpness		Adjust the <b>Sharpness</b> setting to clarify or soften the image. For example, increasing the sharpness could make text appear crisper, but decreasing it could make photographs appear smoother.
Fax Send Settings	Default Job Options	Image Adjustment	Automatic Tone		The printer automatically adjusts the <b>Darkness, Contrast, and Background Cleanup</b> settings to the most appropriate for the scanned document.
Fax Send Settings	Default Job Options	Optimize Text/ Picture	Manually adjust*	Optimize For Text Printed picture Photograph	<p>Optimizes the output for a particular type of content. You can optimize the output for text, printed pictures, or a mixture.</p> <p><b>Manually adjust:</b> Use to manually optimize the setting for text or for pictures.</p> <p><b>Text:</b> Use to optimize the text portion of the copy where text and/or pictures are on the original.</p> <p><b>Printed picture:</b> Use for line drawings and preprinted images, such as magazine clippings or pages from books.</p> <p><b>Photograph:</b> Best suited for making copies of printed pictures.</p>
Fax Send Settings	Default Job Options	Multi-feed Detection		Disabled Enabled*	This setting stops the scanning process if it detects multiple-page feeds through the document feeder.

**Table 4-15 Fax menu (MFP) (continued)**

First level	Second level	Third level	Fourth level	Values	Description
Fax Send Settings	Default Job Options	Blank Page Suppression		Disabled* Enabled	Prevents blank pages in the original document from being included in the output document.
Fax Receive Settings	Fax Receive Setup	Ringer Volume		Off Low* High	Use to configure settings for receiving faxes.
Fax Receive Settings	Fax Receive Setup	Rings To Answer		Range: 1–6 Default = 1	
Fax Receive Settings	Fax Receive Setup	Fax Send Speed		Fast* Medium Slow	
Fax Receive Settings	Fax Receive Setup	Ring Interval		Range: 220–600 ms Default = 600 ms	
Fax Receive Settings	Fax Receive Setup	Ring Frequency		Range: 1–200 Default = 68hz	
Fax Receive Settings	Fax Printing Schedule			Always store faxes Always print faxes* Use schedule	If you have concerns about the security of private faxes, use this feature to store faxes rather than having them automatically print. Select Incoming Fax Options, and then you can choose to always store faxes, always print them, or you can set up a schedule for each day of the week.
Fax Receive Settings	Fax Printing Schedule	Schedule	Add Edit Delete	Print incoming faxes Store incoming faxes Time Event Days	If you are using a fax printing schedule, use this menu to configure when to print faxes.
		Touch this to set up a fax printing schedule if you selected the Use Fax Printing Schedule option.			



**Table 4-15 Fax menu (MFP) (continued)**

First level	Second level	Third level	Fourth level	Values	Description
Fax Receive Settings	Blocked Fax Numbers	Fax Number to Block			<p>The blocked fax list can contain up to 30 numbers. When the printer receives a call from one of the blocked fax numbers, it deletes the incoming fax. It also logs the blocked fax in the activity log along with job-accounting information.</p> <p>Add blocked numbers: Enter a fax number into the <a href="#">Fax Number to Block</a> field, and then touch the arrow button to add a new number to the blocked fax list.</p> <p>To remove blocked numbers: Select a number and touch the <a href="#">Delete</a> button to delete it from the blocked fax list.</p> <p>To clear all blocked numbers: Touch the <a href="#">Delete All</a> button to clear all of the numbers from the blocked fax list.</p> <p>You can also use the <a href="#">Blocked Fax List</a> report in the <a href="#">Information</a> menu to view the list of the fax numbers that have been blocked on this printer.</p>

**Table 4-15 Fax menu (MFP) (continued)**

First level	Second level	Third level	Fourth level	Values	Description
Fax Receive Settings	Default Job Options	Notification		Do not notify*	Configure to receive notification about the status of a sent document.  <b>Do not notify:</b> Turns off this feature.  <b>Notify when job completes:</b> Select to receive notification for this job only.  <b>Notify only if job fails:</b> Select to receive notification only if the job is not sent successfully.
				Notify when job completes	
				Notify only if job fails	
Fax Receive Settings	Default Job Options			Print	<b>E-mail:</b> Select to receive the notification in an email. Touch the text box following <b>Email Address</b> , and then enter the email address for the notification.
				E-mail*	
Fax Receive Settings	Default Job Options		Include Thumbnail		<b>NOTE:</b> When sending an analog fax, select <b>Include Thumbnail</b> to receive a thumbnail image of the first page of the fax in your notification.
Fax Receive Settings	Default Job Options		Notification E-mail address		
Fax Receive Settings	Default Job Options	Stamp Received Faxes		Enabled	Use this option to add the date, time, sender's phone number, and page number to each page of the faxes that this printer receives.
				Disabled*	
Fax Receive Settings	Default Job Options	Fit to Page		Enabled*	Use to shrink faxes that are larger than Letter-size or A4-size so that they can fit onto a Letter-size or A4-size page. If this feature set to <b>Disabled</b> , faxes larger than Letter or A4 will flow across multiple pages.
				Disabled	


**Table 4-15 Fax menu (MFP) (continued)**

First level	Second level	Third level	Fourth level	Values	Description
Fax Receive Settings	Default Job Options	Paper Selection		Automatic*	Select from a list of the trays.
Fax Receive Settings	Default Job Options	Output sides		1-sided* 2-sided Pages flip up	Use to describe the layout for each side of the original document. First select whether the original document is printed on one side or both sides. Then touch the <a href="#">Orientation</a> setting to indicate whether the original has portrait or landscape orientation. If it is printed on both sides, also select the <a href="#">2-sided</a> format that matches the original document.
Fax Forwarding	Enable Fax Forwarding			Disabled* Enabled	Use to forward received faxes to another fax machine.
Fax Forwarding	Type of Fax Job to Forward			All faxes Sent faxes Received faxes	
Fax Forwarding	Fax Forwarding Number				Enter the fax forwarding number.
Clear Fax Activity Log				Cancel Clear	Clears all events from the <a href="#">Fax Activity Log</a> list.

## Manage Supplies menu

Learn about the control-panel [Manage Supplies](#) menu.

**To display:** At the printer control panel, select the [Settings](#) menu, and then select the [Manage Supplies](#) menu.

**To print:** At the printer control panel, touch (MFP) or use the arrow buttons (SFP) to select the printer icon . For the SFP, press the [OK](#) button to print the pages.

In the following table, asterisks (\*) indicate the factory default setting.

**Table 4-16 Manage Supplies menu**

First level	Second level	Third level	Fourth level	Values	Description
Low Warning Thresholds	Cyan Cartridge			1-100%	Set the estimated percentage at which the printer notifies you when a toner cartridge is very low.
	Magenta Cartridge			Default = 4%	
	Yellow Cartridge				
	Black Cartridge				
Low Warning Thresholds	Document Feeder Kit			1-100%	Set the estimated percentage at which the printer notifies you when the document feeder kit is very low.
	MFP			Default = 10%	
Low Warning Thresholds	Maintenance Kit			1-100%	Set the estimated percentage at which the printer notifies you when the maintenance kit is very low.
	SFP			Default = 10%	
Low Warning Threshold Message				On*	Displays a message on the control panel when a cartridge is very low.
				Off	
Low Behavior				Continue*	Use one of these options to specify the action for the device to take when a supply reaches a low condition.  Stop: Stops the current print job.  Continue: Completes the current print job.
				Stop	
Very Low Behavior	Cyan Cartridge			Stop	Use one or more of these options to specify the action for the device to take when a supply reaches a very low condition.  Stop: Stops the current print job.  Continue: Completes the current print job.  Prompt to continue: Allows the user to decide whether or not to finish printing.
	Magenta Cartridge			Continue*	
	Yellow Cartridge			Prompt to continue	
	Black Cartridge				

**Table 4-16 Manage Supplies menu (continued)**

First level	Second level	Third level	Fourth level	Values	Description
Very Low Behavior	Document Feeder Kit			Stop	Use one or more of these options to specify the action for the device to take when a supply reaches a very low condition.  <b>Stop:</b> Stops the current print job.  <b>Continue:</b> Completes the current print job.  <b>Prompt to continue:</b> Allows the user to decide whether or not to finish printing.
				Continue	
				Prompt to continue*	
Very Low Behavior	Maintenance Kit			Stop	Use one or more of these options to specify the action for the device to take when a supply reaches a very low condition.  <b>Stop:</b> Stops the current print job.  <b>Continue:</b> Completes the current print job.  <b>Prompt to continue:</b> Allows the user to decide whether or not to finish printing.
				Continue	
				Prompt to continue*	
Store Usage Data				On supplies*	<b>Store Usage Data</b> provides a way to suppress the toner cartridges from storing most of the information gathered exclusively for the purpose of understanding the usage of the printer. Select the <b>On supplies</b> setting to store the data on the toner cartridge memory chip. Select the <b>Not on supplies</b> setting to suppress the information from being stored on the memory chip.
				Not on supplies	


**Table 4-16 Manage Supplies menu (continued)**

First level	Second level	Third level	Fourth level	Values	Description
Cartridge Protection				Off* Protect cartridges	Select to permanently protect cartridges so that they can be used only in this product or fleet of products.
Cartridge Policy				Off* Authorized HP	Set <b>Authorized HP</b> to allow only genuine HP cartridges to be used in this printer.
Reset Supplies	Document Feeder Kit MFP Maintenance Kit SFP			Reset Cancel	Select this option if you have installed a new document feeder kit or maintenance kit.

## Networking menu

Learn about the control-panel [Networking](#) menu.

**To display:** At the printer control panel, select the [Settings](#) menu, and then select the [Networking](#) menu.

**To print:** At the printer control panel, touch (MFP) or use the arrow buttons (SFP) to select the printer icon . For the SFP, press the **OK** button to print the pages.

In the following table, asterisks (\*) indicate the factory default setting.

**Table 4-17 Networking menu**

First level	Second level	Third level	Fourth level	Values	Description
Ethernet	Information	Print Security Report		Yes No*	<b>Yes:</b> Prints a page that contains the current security settings on the HP Jetdirect print server.  <b>No:</b> A security settings page is not printed.
Ethernet	TCP/IP	Host Name		Use the arrow buttons to edit the host name.  NPIXXXXXX*	An alphanumeric string, up to 32 characters, used to identify the printer. This name is listed on the HP Jetdirect configuration page. The default host name is NPIxxxxxx, where xxxxxx is the last six digits of the LAN hardware (MAC) address.

**Table 4-17 Networking menu (continued)**

First level	Second level	Third level	Fourth level	Values	Description
Ethernet	TCP/IP	IPv4 Settings	Config Method	<p>Bootp</p> <p>DHCP*</p> <p>Auto IP</p> <p>Manual</p>	<p>Specifies the method that TCP/IPv4 parameters will be configured on the HP Jetdirect print server.</p> <p><b>Bootp</b> (Bootstrap Protocol): Use for automatic configuration from a BootP server.</p> <p><b>DHCP</b> (Dynamic Host Configuration Protocol): Use for automatic configuration from a DHCPv4 server. If selected and a DHCP lease exists, the DHCP Release menu and the DHCP Renew menu are available to set DHCP lease options.</p> <p><b>Auto IP</b>: Use for automatic link-local IPv4 addressing. An address in the form 169.254.x.x is assigned automatically.</p> <p>If you set this option to the <b>Manual</b> setting, use the <b>Manual Settings</b> menu to configure TCP/IPv4 parameters.</p>

**Table 4-17 Networking menu (continued)**

First level	Second level	Third level	Fourth level	Values	Description
Ethernet	TCP/IP	IPv4 Settings	Default IP	Auto IP* Legacy	Specify the IP address to default to when the print server is unable to obtain an IP address from the network during a forced TCP/IP reconfiguration (for example, when manually configured to use BootP or DHCP).  <b>NOTE:</b> This feature assigns a static IP address that might interfere with a managed network.  <b>Auto IP:</b> A link-local IP address 169.254.x.x is set.  <b>Legacy:</b> The address 192.0.0.192 is set, consistent with older HP Jetdirect printers.
Ethernet	TCP/IP	IPv4 Settings	DHCP Release	Yes No*	
Ethernet	TCP/IP	IPv4 Settings	DHCP Renew	Yes No*	
Ethernet	TCP/IP	IPv4 Settings	Primary DNS	Range: 0-255 Default = xxx.xxx.xx.xx	Specify the IP address (n.n.n.n) of a Primary Domain Name System (DNS) Server.
Ethernet	TCP/IP	IPv4 Settings	Secondary DNS	Range: 0-255 Default = 0.0.0.0	Specify the IP address (n.n.n.n) of a Secondary DNS Server.
Ethernet	TCP/IP	IPv6 Settings	Enable	Off On*	Use this item to enable or disable IPv6 operation on the print server.  <b>Off:</b> IPv6 is disabled. <b>On:</b> IPv6 is enabled.
Ethernet	TCP/IP	IPv6 Settings	Address	Manual Settings Enable Address	Use this item to enable and manually configure a TCP/IPv6 address.



**Table 4-17 Networking menu (continued)**

First level	Second level	Third level	Fourth level	Values	Description
Ethernet	TCP/IP	IPv6 Settings	DHCPv6 Policy	Router Specified Router Unavailable* Always	<p><b>Router Specified:</b> The stateful auto-configuration method to be used by the print server is determined by a router. The router specifies whether the print server obtains its address, its configuration information, or both from a DHCPv6 server.</p> <p><b>Router Unavailable:</b> If a router is not available, the print server should attempt to obtain its stateful configuration from a DHCPv6 server.</p> <p><b>Always:</b> Whether a router is available, the print server always attempts to obtain its stateful configuration from a DHCPv6 server.</p>
Ethernet	TCP/IP	IPv6 Settings	Primary DNS	Range: 0-255 Default = xxx.xxx.xx.xx	Specify the IP address (n.n.n.n) of a Primary Domain Name System (DNS) Server.
Ethernet	TCP/IP	IPv6 Settings	Secondary DNS	Range: 0-255 Default = 0.0.0.0	Specify the IP address (n.n.n.n) of a Secondary DNS Server.

**Table 4-17 Networking menu (continued)**

First level	Second level	Third level	Fourth level	Values	Description
Ethernet	TCP/IP	Proxy Server		Select from a provided list.	<p>Specifies the proxy server to be used by embedded applications in the printer. A proxy server is typically used by network clients for Internet access. It caches Web pages, and provides a degree of Internet security for those clients.</p> <p>To specify a proxy server, enter its IPv4 address or fully-qualified domain name. The name can be up to 255 octets.</p> <p>For some networks, you might need to contact your Internet Service Provider (ISP) for the proxy server address.</p>
Ethernet	TCP/IP	Proxy Port		<p>Range: 1-65535</p> <p>Default = 00080</p>	<p>Enter the port number used by the proxy server for client support. The port number identifies the port reserved for proxy activity on your network, and can be a value from 0 to 65535.</p>
Ethernet	TCP/IP	Idle Timeout		<p>Range: 1-3600</p> <p>Default = 0270</p>	<p>The time period, in seconds, after which an idle TCP print data connection is closed (default is 270 seconds, 0 disables the timeout).</p>

**Table 4-17 Networking menu (continued)**

First level	Second level	Third level	Fourth level	Values	Description
I/O Timeout				Range: 5 – 300 sec Default = 10	Use to set the I/O timeout period in seconds. I/O timeout refers to the elapsed time before a print job fails. If the stream of data that the printer receives for a print job gets interrupted, this setting indicates how long the printer will wait before it reports that the job has failed.

## Support Tools menu

Learn about the control-panel [Support Tools](#) menu.



**NOTE:** The [Support Tools](#) sub-menu contains the options for maintaining the printer and troubleshooting printer problems.


## Maintenance menu

Learn about the control-panel [Maintenance](#) menu.

## Backup/Restore menu

Learn about the control-panel [Backup/Restore](#) menu.

**To display:** At the printer control panel, select the [Support Tools](#) menu, select the [Maintenance](#) menu, and then select the [Backup/Restore](#) menu.

**To print:** At the printer control panel, touch (MFP) or use the arrow buttons (SFP) to select the printer icon . For the SFP, press the **OK** button to print the pages.

In the following table, asterisks (\*) indicate the factory default setting.


**Table 4-18 Backup/Restore menu**

First level	Second level	Third level	Values
Back up Data	Enable Scheduled Backups	Backup Time	Enter a time
Back up Data	Enable Scheduled Backups	Days Between Backups	Enter the number of days
Back up Data	Back up Now		
Back up Data	Export Last Backup		
Restore Data			Insert a USB drive that contains the backup file.

## Calibration/Cleaning menu

Learn about the control-panel [Calibration/Cleaning](#) menu .

**To display:** At the printer control panel, select the [Support Tools](#) menu, select the [Maintenance](#) menu, and then select the [Calibration/Cleaning](#) menu.

**To print:** At the printer control panel, touch (MFP) or use the arrow buttons (SFP) to select the printer icon . For the SFP, press the [OK](#) button to print the pages.

In the following table, asterisks (\*) indicate the factory default setting.

**Table 4-19** Calibration/Cleaning menu

First level	Values	Description
Cleaning Page	Automatic Cleaning Interval	Use this menu to configure the settings for the product to automatically print a cleaning page.
	Off*	
	1000 pages	Select a cleaning interval to set the number of pages to be printed before an automatic cleaning page is printed.
	2000 pages	
	5000 pages	
	10000 pages	
	20000 pages	Touch <a href="#">Print</a> to manually print a cleaning page.
	<b>NOTE:</b> Cleaning pages print on the default paper size configured for the printer.	
Quick Calibration	Start	The printer automatically calibrates itself at various times. However, the user can calibrate the printer immediately if the printer experiences problems with print quality. Use this feature to perform a partial calibration. Use this calibration if color density or tone seem incorrect.  Before calibrating, make sure that the <a href="#">Ready</a> indicator displays on the control panel display. If a job is in progress, the calibration occurs when that job is complete.

**Table 4-19 Calibration/Cleaning menu (continued)**

First level	Values	Description
Full Calibration	Start	<p>The printer automatically calibrates itself at various times. However, the user can calibrate the printer immediately if the printer experiences problems with print quality. Use this feature to perform a full calibration, which can take up to three minutes. Use this calibration if the color layers seem to be shifted on the page.</p> <p>Before calibrating, make sure that the <b>Ready</b> indicator displays on the control panel display. If a job is in progress, the calibration occurs when that job is complete.</p>
Power on Calibration	No delay Delay 15 minutes	This feature controls the timing of calibration when the printer wakes up or is turned on.
Calibrate Scanner MFP	Done Start	Touch <b>Start</b> to calibrate the device scanner. Messages on the control panel display will lead you through the calibration process.
Reset Calibration	Reset Cancel	<p>Use this feature to return the product to the factory-set default values for color calibration.</p> <p>Select <b>Reset</b> to reset the color calibration. The printer will restart with the factory-set defaults.</p> <p>Select <b>Cancel</b> to close the menu without resetting the color calibration.</p>

### USB Firmware Upgrade menu

Learn about the control-panel **USB Firmware Upgrade** menu.

**To display:** At the printer control panel, select the **Support Tools** menu, select the **Maintenance** menu, and then select the **USB Firmware Upgrade** menu.

Insert a USB storage device with a firmware upgrade bundle into the USB port, and follow the on-screen instructions.

### Service menu

Learn about the control-panel **Service** menu.

**To display:** At the printer control panel, select the **Support Tools** menu, and then select the **Service** menu.

The [Service](#) menu is locked and requires a personal identification number (PIN) for access. This menu is intended for use by authorized service personnel. See the Service menu section of this manual.




## Troubleshooting menu

Learn about the control-panel [Troubleshooting](#) menu.

**To display:** At the printer control panel, select the [Support Tools](#) menu, and then select the [Troubleshooting](#) menu.

In the following table, asterisks (\*) indicate the factory default setting.

**Table 4-20 Troubleshooting menu**

First level	Second level	Third level	Fourth level	Values	Description
Reports	Configuration/ Status Pages		Settings Menu Map	Select the desired report and then select the print icon  to print the page.	
			Current Settings Page		
			Configuration Page		
			Supplies Status Page		
			Usage Page		
			Paper Path Page		
			File Directory Page		
			Web Services Status Page		
			PCL Font List		
			PS Font List		
			Event Log		
			Warning Log Page		
			T.30 Protocol Trace		
			PQ Troubleshooting Pages		
	Paper Path Test				
Reports	Fax Reports		Fax Activity Log	Select the desired report and then select the print icon  to print the page.	
			Billing Codes Report		
			Blocked Fax List		
			Fax Call Report		
Reports	Other Pages		PCL Font List	Select the desired report and then select the print icon  to print the page.	
			PS Font List		

**Table 4-20 Troubleshooting menu (continued)**

First level	Second level	Third level	Fourth level	Values	Description
Fax Tools Fax models only	Fax T.30 Trace Report			Never automatically print* Print after every fax Print only after fax send jobs Print only after received faxes Print only after fax send errors Print only after fax receive errors Print after any fax error	Use to print or configure the fax T.30 trace report. T.30 is the standard that specifies handshaking, protocols, and error correction between fax machines.
Fax Tools Fax models only	Fax V.34			Enable* Disable	Use to disable V.34 modulations if several fax failures have occurred or if phone line conditions require it.
Fax Tools Fax models only	JBIG Compression			On Off*	
Fax Tools Fax models only	Fax Speaker Mode			Normal* Diagnostic	Used by a technician to evaluate and diagnose fax issues by listening to the sounds of fax modulations
Fax Tools Fax models only	Fax Service Log			Print	The standard fax log includes basic information such as the time and whether the fax was successful. The detailed fax log shows the intermediate results of the redial process not shown in the standard fax log.
Print Quality Pages	PQ Troubleshooting Pages			Print	Use to print pages that help you resolve problems with print quality.

**Table 4-20 Troubleshooting menu (continued)**

First level	Second level	Third level	Fourth level	Values	Description
Event Log					Prints the 50 most recent events in the Event Log. For each event, the printed log shows the error number, page count, error code, and description or personality.
Paper Path Page				Print	Shows how many pages were printed from each tray.
Diagnostic Tests	Disable Cartridge Check			Continue	Use this diagnostic test to print internal pages or send an external job to the printer when the toner cartridge is removed or exchanged. Supply errors are ignored while the printer is in this mode.
Diagnostic Tests	Paper Path Test	Source Tray		Select from a list of the available trays.	Generates a test page for testing paper handling features. You can define the path that is used for the test in order to test specific paper paths
Diagnostic Tests	Paper Path Test	Number of Copies		Range: 1–500 Default = 1	Sets the default number of copies for a copy job. This default applies when the Copy or Quick Copy function is initiated from the printer Home screen. The factory default setting is 1.
Diagnostic Tests	Paper Path Test	Test Duplex Path		Enable Disable*	Prints on both sides of the paper.
Diagnostic Tests	Print/Stop Test				Specify the length of time in milliseconds (0–60,000).
Diagnostic Tests	Paper Path Sensor Test			Select from a list of the printer sensors.	Initiates a test of the paper path sensors.



**Table 4-20 Troubleshooting menu (continued)**

First level	Second level	Third level	Fourth level	Values	Description
Diagnostic Tests	Manual Sensor Test  <b>NOTE:</b> This item appears in the control-panel menus. However, the function is not available for this printer			Select from a list of available components  Reset	Test the printer sensors and switches for correct operation. Each sensor is displayed on the control-panel screen, along with its status. Manually trip each sensor and watch for it to change on the screen. Press the <b>Stop</b> button to abort the test.
Diagnostic Tests	Tray/Bin Manual Sensor Test  <b>NOTE:</b> This item appears in the control-panel menus. However, the function is not available for this printer			Select from a list of available components  Reset	Test the printer sensors and switches for correct operation. Each sensor is displayed on the control-panel screen, along with its status. Manually trip each sensor and watch for it to change on the screen. Press the <b>Stop</b> button to abort the test.
Diagnostic Tests	Component Test  <b>NOTE:</b> This item appears in the control-panel menus. However, the function is not available for this printer			Select from a list of available components.	Use to exercise individual parts independently to isolate noise, leaking, or other issues. To start the test, select one of the components. The test will run the number of times specified by the <b>Repeat</b> option. You might be prompted to remove parts from the printer during the test. Press the <b>Stop</b> button to abort the test.
Diagnostic Tests	Continuous Scan  MFP			2-sided	
Diagnostic Tests	Scanner Tests  MFP			Sensors	
Generate Debug Data				Start	


**Table 4-20 Troubleshooting menu (continued)**

First level	Second level	Third level	Fourth level	Values	Description
Retrieve Diagnostic Data				Create device data file	Create files that contain information about the printer that can help identify the cause of problems.
				Create zipped debug information file	
				Include crash dump files	
				Clean up debug information	
				Send to E-mail	
				Export to USB	
Retrieve Fax Diagnostic Data				Create device data file	Create files that contain information about the printer that can help identify the cause of problems.
				Create zipped debug information file	
				Include crash dump files	
				Clean up debug information	
				Send to E-mail	
				Export to USB	

## Service menu


Learn about the printer [Service](#) menu.

[Service](#) menu access is restricted by using a personal identification number (PIN). Only authorized service people should access the [Service](#) menu. When selecting [Service](#) from the list of menus, the printer prompts the user to enter an eight-digit PIN.

 **NOTE:** The printer automatically exits the [Service](#) menu after about one minute if no items are selected or changed.

### Open the [Service](#) menu from a SFP control panel

1. From the [Home](#) screen on the printer control panel, use the arrow buttons to navigate to [Support Tools](#), and then press the **OK** button.
2. Use the arrow buttons to scroll to [Service](#), and then press the **OK** button.
3. Make sure that [Service Access Code](#) is selected for the [Access Type](#) item.

 **NOTE:** Use the arrow buttons to select and change the [Access Type](#) item if necessary.

4. Enter the following service access PIN for the printer:

- 10670022 (SFP)
- 10680022 (MFP)

## Open the **Service** menu from an MFP control panel

1. From the **Home** screen on the printer control panel, scroll to and touch the **Support Tools** button.
2. Open the following menus:
  - **Service**
3. Make sure that **Service Access Code** is selected for the **Access Type** item.
4. Enter the following service access PIN for the printer:
  - 10670022 (SFP)
  - 10680022 (MFP)

## Service menu table

The following menu items appear in the **Service** menu.

**Table 4-21 Service menu**

First level	Second level	Value	Description
Event Log	Print		Print or view the event log.
Clear Event Log	Clear		Use this item to clear the printer event log.
Cycle Counts	Total Engine Cycles		Set the page count that was stored in NVRAM prior to installing a new formatter.
Cycle Counts	Refurbish Cycle Count		Use this item to record the page count when the printer was refurbished.
Cycle Counts	Document Feeder MFP		Total number of pages since the document feeder kit was replaced.
Cycle Counts	Document Feeder Kit Interval MFP		Use this item to set the interval that causes the printer to prompt the customer to replace document feeder maintenance kit.
Cycle Counts	Clean Rollers Count MFP		Total number of pages since the document feeder rollers were cleaned.
Cycle Counts	Clean Rollers Interval MFP		Use this item to set the interval that causes the printer to prompt the customer to clean the document feeder rollers and separation pad.
Cycle Counts	ADF Count MFP		Set the total pages fed through the document feeder.

**Table 4-21 Service menu (continued)**

First level	Second level	Value	Description
Cycle Counts	Flatbed Count MFP		Set the total pages scanned from the flatbed.
Cycle Counts	ADF Simplex Count MFP		Set the total single-sided pages fed through the document feeder.
Cycle Counts	ADF Duplex Count MFP		Set the total two-sided pages fed through the document feeder.
Cycle Counts	Copy Scan Count MFP		Set the total copy pages that have been scanned.
Cycle Counts	Send Scan Count MFP		Set the number of scanned pages sent to email.
Cycle Counts	Fax Scan Count Fax models only		Set the number of scanned pages that have been faxed.
Cycle Counts	Copy Pages Count MFP		Set the number of scanned pages that have been printed.
Scanner Settings MFP	ADF Settings	Leading edge front Leading edge back Trailing edge front Trailing edge back Left side front Left side back	Set the calibration values. <b>WARNING!</b> Do not change these values unless instructed to do so.
Scanner Settings MFP	Glass Settings	Leading edge glass Left Side Glass	
Serial Number			Set the serial number.
Service ID			Use this item to show the date that the printer was first used on the control panel. This eliminates the need for users to keep paper receipts for proof of warranty.
Cold Reset Paper			When you perform a cold reset, the paper size that is stored in NVRAM is reset to the default factory setting. If you replace a formatter board in a country/region that uses A4 as the standard paper size, use this menu to reset the default paper size to A4. LETTER and A4 are the only available values.

**Table 4-21 Service menu (continued)**

First level	Second level	Value	Description
Low Alerts		Enable Disable	Turn on (or off) low alerts (for supplies).
Reset Low Alerts	<ul style="list-style-type: none"> <li>• Reset to level 1</li> <li>• Reset to level 2</li> <li>• Reset to level 3</li> <li>• Set to non-HP managed mode</li> </ul>		
PTT Test Mode			Test the internal modem for the analog fax accessory.
Fax models only			
PTT Test Mode	Hook Operations	Off Hook	
Fax models only		On Hook	
PTT Test Mode	Generate Random Data	Select a value from the list.	
Fax models only			
PTT Test Mode	Generate DTMF Tone Burst	Select a value from the list.	
Fax models only			
PTT Test Mode	Generate DTMF Continuous Tone	Select a value from the list.	
Fax models only			
PTT Test Mode	Generate Pulse Burst	Select a value from the list.	
Fax models only			
PTT Test Mode	Generate Tone Dial Number	Enter dial number.	
Fax models only			
PTT Test Mode	Generate Pulse Dial Number	Enter dial number.	
Fax models only			
PTT Test Mode	Generate Single Modem Tone	Range: 1100–2100 Hz	
Fax models only		Default = 2100 Hz	
PTT Test Mode	Line Measurements		
Fax models only			
PTT Test Mode	Fax Transmit Signal Loss		
Fax models only			
Test Support	Continuous Scan	2-sided	
	MFP	Save to Disk	
Test Support	Continuous Copy	2-sided	
	MFP	Save to Disk	

**Table 4-21 Service menu (continued)**

First level	Second level	Value	Description
Test Support	Raw Scan	2-sided	
	MFP	Mechanical Calibration	
Test Support	Continuous Print from USB		
Test Support	Automatic Calibrations	Disabled	
	MFP	Enabled*	
Test Support	Runtime Configuration	Standard	
		MFP	StandardEIC
		Workflow	
		WorkflowEIC	
		Reconfigure	

## Printer resets

Learn about the printer resets.

### Restore factory-set defaults from a non-touchscreen control panel

1. From the [Home](#) screen on the printer control panel, use the arrow buttons to navigate to [Settings](#), and then press the [OK](#) button.
2. Use the arrow buttons to scroll to [General](#), and then press the [OK](#) button.
3. Use the arrow buttons to scroll to [Restore Factory Settings](#), and then press the [OK](#) button.
4. A verification message advises that completing the reset function might result in loss of data. Select the [Reset](#) button to complete the process.

### Restore factory-set defaults from a touchscreen control panel

1. From the [Home](#) screen on the printer control panel, scroll to and touch the [Settings](#) button.
2. Open the following menus:
  - [General Settings](#)
  - [Reset Factory Settings](#)
3. A verification message advises that completing the reset function might result in loss of data. Touch the [Reset](#) button to complete the process.

### Restore the Service ID

When replacing the formatter, the Service ID date is lost. Use this menu item to reset the date to the original date that the printer was first used. The date format is YYDDD. Use the following formula to calculate the Service ID.

Calculate the service ID

For the calculation below, the placed-in-service date is 17OCT2002.


1. To calculate YY, subtract 1990 from the calendar year. If the printer was first used in 2002, calculate YY as follows:  $2002 - 1990 = 12$ . YY = 12.
2. Subtract 1 from 10 (October is the tenth month of the year):  $10 - 1 = 9$ .
  - Multiply 9 by 30:  $9 \times 30 = 270$  and add 17 to 270:  $270 + 17 = 287$ . Thus, DDD = 287.
3. In this example the Service ID is 12287.

Convert the Service ID to an actual date

Use the printer Service ID number to determine whether the printer is still under warranty. Use the following formula to convert the Service ID into the actual date the printer was placed-in-service. For the example below, use the Service ID previously calculated (12287).

1. Add 1990 to YY to get the actual year that the printer was installed.
2. Divide DDD by 30. If there is a remainder, add 1 to the result. This is the month.
3. The remainder from the calculation in step 2 is the date.
  - a.  $12 + 1990 = 2002$ , so the year is 2002.
  - b. 287 divided by 30 = 9 with a remainder of 17. Because there is a remainder, add 1 to 9 to get 10, which represents October.
  - c. The remainder in step 2 is 17, so that is the date. The complete date is 17-October-2002.


---

 **NOTE:** A six-day grace period is built into the date system.

---

### Cold reset using the Pre-boot menu from a non-touchscreen control panel

---

 **CAUTION:** This procedure resets all printer configurations and settings to factory defaults (customer configurations and settings are lost).

---

1. Press the **Cancel** button when you see the **1/8** under the logo
2. Use the arrow buttons to highlight **+3:Administrator** item, and then press the **OK** button.
3. Use the arrow buttons to highlight **+8:Startup Options** item, and then press the **OK** button.
4. Use the arrow buttons to highlight **2 Cold Reset** item, and then press the **OK** button.
5. Press the Home button to return to the main Pre-boot menu and highlight the **1:Continue** item, and then press the **OK** button.


---

 **NOTE:** The printer initializes.

---

### Cold reset using the Pre-boot menu from a touchscreen control panel

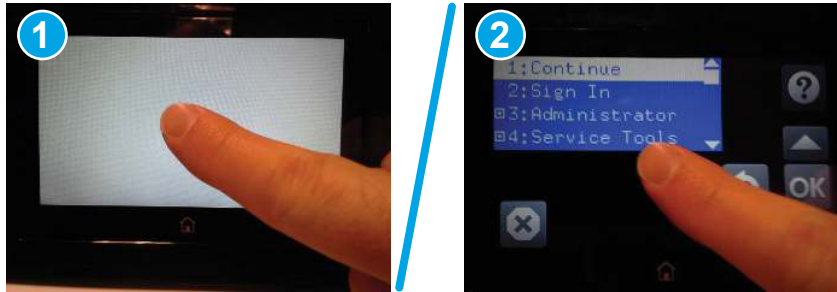
---

 **CAUTION:** This procedure resets all printer configurations and settings to factory defaults (customer configurations and settings are lost).

---

1. Touch the middle of the control-panel display when you see the **1/8** under the logo

**Figure 4-106** Open the Pre-boot menu (MFP)



2. Use the arrow buttons to highlight **+3:Administrator** item, and then press the **OK** button.
3. Use the arrow buttons to highlight **+8:Startup Options** item, and then press the **OK** button.
4. Use the arrow buttons to highlight **2 Cold Reset** item, and then press the **OK** button.
5. Touch the Home button to return to the main Pre-boot menu and highlight the **1:Continue** item, and then press the **OK** button.

---

 **NOTE:** The printer initializes.

---

## Format Disk and Partial Clean functions

Learn about the printer [Format Disk](#) and [Partial Clean](#) functions.

### Active and repository firmware locations

The firmware bundle consists of multiple parts. The main components are the Windows CE Operating System and the printer/peripheral firmware files.


There are two locations/partitions on the hard drive where the firmware components are stored:

- The Active, where the operating system and firmware currently are executing.
- The Repository, the recovery location.

If the Active location is damaged, or a [Partial Clean](#) was performed, the printer automatically copies over the OS and firmware files from the Repository location and the printer recovers.

If both the Active and Repository locations are damaged, or a [Format Disk](#) was performed, then both locations are gone and the error message **99.09.67** displays on the control-panel display. The user must upload the firmware to the printer in order for it to function again.

---

 **CAUTION:** The [Format Disk](#) option performs a disk initialization for the entire disk. The operating system, firmware files, and third party files (among other files) are completely lost. HP does not recommend this action.

---

### Partial Clean

The [Partial Clean](#) option erases all partitions and data on the disk drive, except for the firmware repository where a backup copy of the firmware file is stored. This allows the disk drive to be reformatted without having to download a firmware upgrade file to return the printer to a bootable state.

Characteristics of a [Partial Clean](#)

- Customer-defined settings, third-party solutions, firmware files, and the operating system are deleted.



- Rebooting the printer restores the firmware files from the Repository location, but does not restore any customer-defined settings.
- For previous HP printers, a Hard Disk Initialization is similar to executing the [Partial Clean](#) function for this printer.

**⚠ CAUTION:** HP recommends backing-up printer configuration data before executing a [Partial Clean](#) to retain customer-defined settings (if needed). See the [Backup/Restore](#) item in the [Device Maintenance](#) menu.

#### Reasons for performing [Partial Clean](#)

- The printer continually boots up in an error state.

**📝 NOTE:** Try clearing the error prior to executing a [Partial Clean](#).

- The printer will not respond to commands from the control panel.
- Executing the [Partial Clean](#) function is helpful for troubleshooting hard disk problems.
- To reset the printer by deleting all solutions and customer-defined settings.
- The printer default settings are not properly working.

#### Execute a [Partial Clean](#) from a non-touchscreen control panel

This procedure resets all printer configurations and settings to factory defaults (customer configurations and settings are lost).

1. Press the [Cancel](#) button when you see the [1/8](#) under the logo
2. Use the arrow buttons to highlight [+3:Administrator](#) item, and then press the [OK](#) button.
3. Use the arrow buttons to highlight [Partial Clean](#) item, and then press the [OK](#) button.
4. Press the [OK](#) button again.
5. Press the Home button to return to the main Pre-boot menu and highlight the [Continue](#) item, and then press the [OK](#) button.

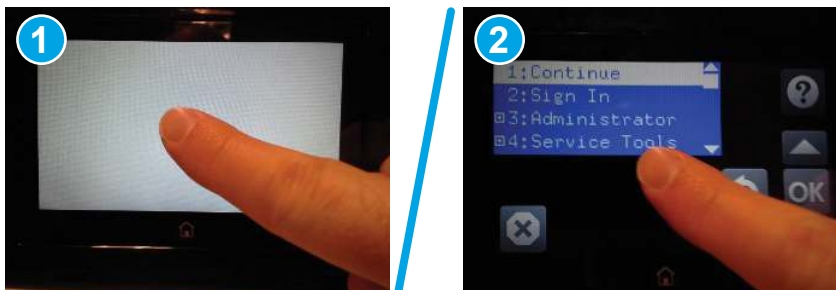
**📝 NOTE:** The printer initializes.

#### Execute a [Partial Clean](#) from a touchscreen control panel

This procedure resets all printer configurations and settings to factory defaults (customer configurations and settings are lost).


1. Touch the middle of the control-panel display when you see the [1/8](#) under the logo

**Figure 4-107 Open the Pre-boot menu (MFP)**



2. Use the arrow buttons to highlight **+3:Administrator** item, and then press the **OK** button.
3. Use the arrow buttons to highlight **Partial Clean** item, and then press the **OK** button.
4. Press the **OK** button again.
5. Touch the Home button to return to the main Pre-boot menu and highlight the **Continue** item, and then press the **OK** button.

---

 **NOTE:** The printer initializes.

---

## Format Disk

The **Format Disk** option erases the entire disk drive.

---


 **CAUTION:** After executing a **Format Disk** option, the printer is not bootable.

---

### Characteristics of a **Format Disk**

- Customer-defined settings, third-party solutions, firmware files, and the operating system are deleted.


---

 **NOTE:** Rebooting the printer *does not* restore the firmware files

---

- Rebooting the printer restores the firmware files from the Repository location, but does not restore any customer-defined settings.
- After executing the **Format Disk** function, the message **99.09.67** displays on the control panel.
- After executing the **Format Disk** function, the printer firmware must be reloaded.

---

 **CAUTION:** HP recommends not using the **Format Disk** option unless an error occurs and the solution in the printer service manual recommends this solution. After executing the **Format Disk** function, the printer is unusable.


HP recommends backing-up printer configuration data before executing a **Format Disk** to retain customer-defined settings (if needed). See the **Backup/Restore** item in the **Device Maintenance** menu.

---

### Reasons for performing **Format Disk**

- The printer continually boots up in an error state.

---

 **NOTE:** Try clearing the error prior to executing a **Format Disk**.

---

- The printer will not respond to commands from the control panel.
- Executing the **Format Disk** function is helpful for troubleshooting hard disk problems.
- To reset the printer by deleting all solutions and customer-defined settings.

### Execute a **Format Disk** from a non-touchscreen control panel

This procedure resets all printer configurations and settings to factory defaults (customer configurations and settings are lost).

1. Press the **Cancel** button when you see the **1/8** under the logo
2. Use the arrow buttons to highlight **+3:Administrator** item, and then press the **OK** button.
3. Use the arrow buttons to highlight **Format Disk** item, and then press the **OK** button.

4. Press the **OK** button again.

---

 **NOTE:** When the **Format Disk** operation is complete, reload the printer firmware.

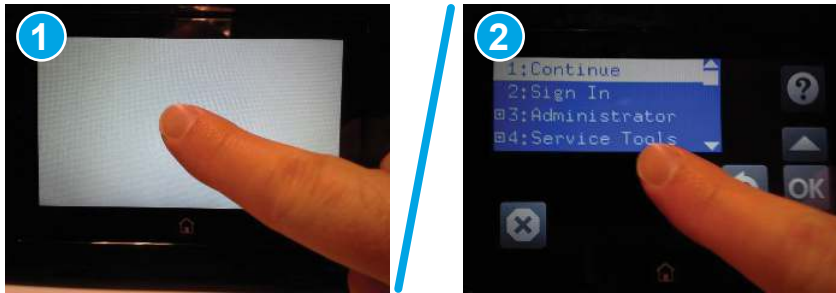
---

Execute a **Format Disk** from a touchscreen control panel

This procedure resets all printer configurations and settings to factory defaults (customer configurations and settings are lost).


1. Touch the middle of the control-panel display when you see the **1/8** under the logo

**Figure 4-108** Open the Pre-boot menu (MFP)



2. Use the arrow buttons to highlight **+3:Administrator** item, and then press the **OK** button.
3. Use the arrow buttons to highlight **Format Disk** item, and then press the **OK** button.
4. Press the **OK** button again.

---

 **NOTE:** When the **Format Disk** operation is complete, reload the printer firmware.

---

## Power on troubleshooting

Learn about power on troubleshooting.

### Power-on checks

Learn about power-on checks.

The basic printer functions should start up when the printer is connected into an electrical outlet and the power switch is pushed to the on position. If the printer does not start, use the information in this section to isolate and solve the problem.

If the control panel display remains blank, random patterns display, or asterisks remain on the control panel display, perform power-on checks to find the cause of the problem.

### Power on troubleshooting overview

Learn about general power on troubleshooting.

During normal operation, a cooling fan begins to spin briefly after the printer power is turned on. Place a hand over the fan intake vents located on the right-side cover. When the fan is correctly operating, air passing into the printer is felt. Lean close to the printer to hear the fan operating. If the fan is operating, the dc side of the power supply is functioning.

After the fan is operating, the main motor turns on (unless the top cover is open, a jam condition is sensed, or the paper-path sensors are damaged). Visually and audibly determine that the main motor is turned on.

If the fan and main motor are operating correctly, the next troubleshooting step is to isolate print engine, formatter, and control panel problems. Perform an engine test. If the formatter is damaged, it might interfere with the engine test. If the engine-test page does not print, try removing the formatter, and then performing the engine test again. If the engine test is then successful, the problem is almost certainly with the formatter, the control panel, or the cable that connects them.

## Troubleshooting power-on or blank control panel problems

If the printer is not powering on correctly, use the following steps to begin troubleshooting the problem.

1. Verify that power is available to the printer. If the printer is plugged into a surge protector or uninterruptible power supply (UPS), remove it. Plug the printer directly into a known operating wall receptacle (make sure that the wall receptacle provides the correct voltage and current for the printer).



---

**NOTE:** Unplug any other devices on the same circuit that the printer is using.

---

2. Try another known operating wall receptacle and a different power cord.
3. To eliminate a thermal switch issue, unplug the power cord and leave it unplugged for over 20 minutes. Re-attach the power cord, and then turn the power on again.
4. During normal operation, a cooling fan or fans begin to spin briefly after the printer power is turned on. Place a hand over the cover vent or vents to feel air passing out of the printer. Lean close to the printer to hear the fan or fans operating. Look for illuminated lights on the control panel and formatter LEDs.



---

**NOTE:** Operational fans, motors, and control-panel lights indicate the following:

---

- AC power is present at the printer.
  - The power supply is providing either or both 24 Vdc and 5 Vdc voltages.
  - The DC controller microprocessor is functioning.
- 
5. If the printer powers on, but the control panel is blank, make sure that the control-panel display wire harness or harnesses and flat flexible cable or cables (FFCs) are connected.



---

**NOTE:** The following conditions indicate that the printer has frozen while in Sleep mode or Sleep delay. Opening a door or pressing a control-panel button should cause the printer to wake up from Sleep mode or Sleep delay.

---

- The control panel home button LED is illuminated
  - The power-switch LED flashes once every three to five seconds
- 

If the control panel is not responding, or if it appears black or blank, try the following:

- a. Turn the printer power off, and then on again.
- b. Verify that the system is correctly functioning by printing a test page. Does the test page print correctly?  
  
Is the printer HP Embedded Web Server (EWS) accessible?
- c. Verify that the control panel is correctly functioning. If it is not, turn the printer off and reseal the control-panel assembly cable connections at the control-panel assembly and the formatter.
- d. Try upgrading the firmware. If the firmware upgrade fails to resolve the problem, and the printer still freezes while in Sleep mode or Sleep delay, elevate the case.

- e. If the error persists and the EWS functions correctly, replace the control-panel assembly.
6. If normal start-up noises are not heard, turn the printer off, and then remove any installed accessories (for example, envelope feeders, paper feeders, or output accessories).
7. Turn the printer on, and then listen for start-up noises. If normal start-up noises are heard, the problem might be with an accessory.
8. Perform an engine test. The engine test procedure varies by printer, so refer to the printer Service Manual to get instructions.
9. If the engine test page prints, the print engine is operating normally. Replace the formatter.

---

 **CAUTION:** Under **NO** circumstances should a formatter from a different printer be installed during the repair or troubleshooting processes. The formatter stores important data specific to the model of printer it is installed in and is not designed to be swapped or repurposed in any way. Return a used formatter to HP.

Issues that can occur from swapping a formatter include:


- Serial number, product number, product name, page count, and supported cartridges information change and might make a product unusable
- 33.02.01 Used board/Disk installed errors

If a used formatter is installed and causes this issue, the **partner** must cover the costs of the repair in the form of a product replacement. **There is no method in the field to recover a printer where a used formatter is installed.**

For more information, see the following topic (c06360930):

- HP internal link: [33.02.01 error or printer name and/or product number changes after replacing the formatter](#)
- HP external partner link: [33.02.01 error or printer name and/or product number changes after replacing the formatter](#)

To access the HP partner link, you must first log in to the HP Partner First Portal and then connect to WISE.

 **NOTE:** If the engine test page does not print, turn the printer off, reconnect the formatter power connector, remove the embedded MultiMedia Card (eMMC), and then try the engine test again. If the page prints, the problem might be the eMMC.

- 
10. If after replacing the formatter or eMMC normal start-up noises are still not heard, replace the DC controller.
  11. If the print engine appears to be correctly operating (the engine test page successfully printed) and the control panel is still blank, replace the power supply.

## Engine diagnostics

Learn about internal engine diagnostics that help in troubleshooting print quality, paper path, noise, assembly, and timing issues.

### Engine test

Learn about troubleshooting the printer using the engine test diagnostic.

When the engine test is performed, a test page with lines prints if the engine is functioning correctly.



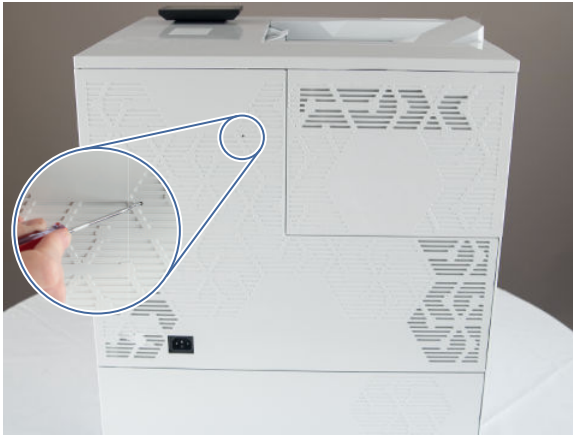
**NOTE:** Depending on printer models, either a simplex engine test page, a duplex engine test page, or both simplex and duplex engine test pages might be available.

Use a small pointed object to depress and hold the engine test button (location varies depending on the printer model). An engine test page prints. The test page can use only Tray 2 as the paper source, so make sure that paper is loaded in Tray 2.

Possible engine test pages (printer dependent)

- A series of lines parallel to the **short** end of the page.
- A series of lines parallel to the **long** end of the page.

**Figure 4-109 Engine test button**



## Defeating interlocks

Learn about defeating printer interlocks.

Different tests can be used to isolate different types of issues. For assembly or noise isolation, run the diagnostic test when the front, right or toner supply (model specific) door is open.

Defeating the door interlocks allows observation of the paper pick operation.

### Defeat the front door interlock

1. Open the front door.
2. Insert a folded piece of paper into the slot.



**TIP:** Fold a stiff piece of paper, for example a business card or index card, into a strip, and insert the strip into the slot for the door interlock logic switch.


It might be easier to use a small flat-blade screwdriver to defeat the door interlock.

**Figure 4-110 Defeat the front door interlock**



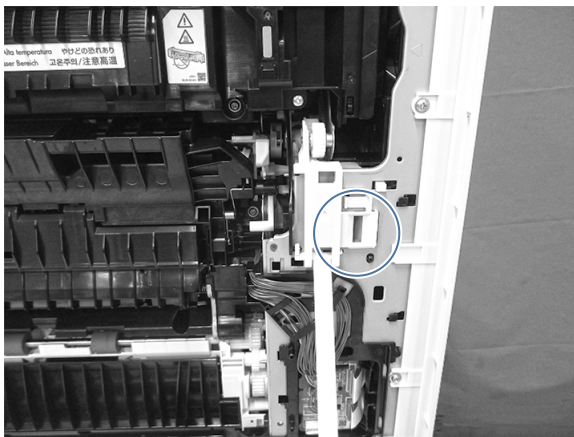
### Defeat the right door interlock

1. Open the right door.
2. Insert a folded piece of paper into the slot.

 **TIP:** Fold a stiff piece of paper, for example a business card or index card, into a strip, and insert the strip into the slot for the door interlock logic switch.


It might be easier to use a small flat-blade screwdriver to defeat the door interlock.

**Figure 4-111 Defeat the right door interlock**



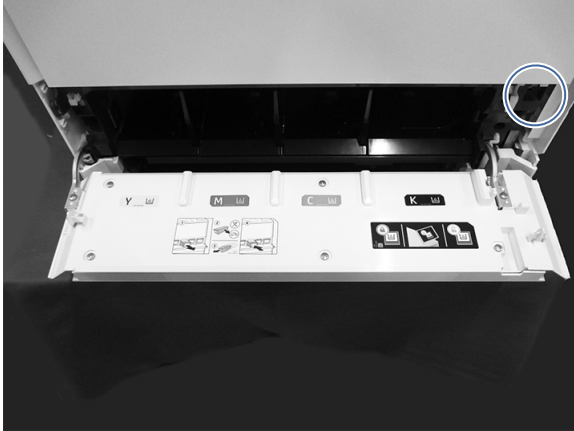
### Defeat the toner supply door interlock (X654/X677 models)

1. Open the toner supply door.
2. Insert a folded piece of paper into the slot.

 **TIP:** Fold a stiff piece of paper, for example a business card or index card, into a strip, and insert the strip into the slot for the door interlock logic switch.

It might be easier to use a small flat-blade screwdriver to defeat the door interlock.

**Figure 4-112 Defeat the toner supply door interlock (X654/X677 models)**



## Disable cartridge check

Learn about the disable cartridge check troubleshooting diagnostic.

**CAUTION:** Do not perform a disable cartridge check on color printers that use a two-part cartridge design. Doing so might result in toner cross contamination in the supply lines.

Use this diagnostic test to print internal pages or send an external job to the printer when a toner cartridge is removed or exchanged. Supply errors are ignored while the printer is in this mode.

When the printer is in this mode, access the troubleshooting menus and print internal pages (the print quality pages will be the most useful). This test can be used to isolate problems, such as noise, and to isolate print-quality problems that are related to a toner cartridge.

**NOTE:** Do not remove or exchange the toner cartridge until after beginning the disable cartridge check diagnostic.

1. From the Home screen on the printer control panel, scroll to and touch the [Support Tools](#) button.
2. Open the following menus:
  - [Troubleshooting](#)
  - [Diagnostic Tests](#)
  - [Disable Cartridge Check](#)

## LED diagnostics (formatter)

Learn about troubleshooting the printer using formatter LEDs.

The formatter has two network port LEDs. When the printer is connected to a properly working network through a network cable, the amber LED indicates network activity, and the green LED indicates the link status.

A blinking amber LED indicates network traffic. If the green LED is off, a link has failed. For link failures, check all of the network cable connections.

In addition, try to manually configure the network card link speed setting by using the printer control panel. To change the link speed, complete the following steps.



1. From the **Home** screen on the printer control panel, scroll to and touch the **Settings** button.
2. Open the following menus:
  - **Networking**
  - **Ethernet**
  - **Link Speed**
3. Touch the desired link speed setting, and then touch the **Done** button.

## Use the solve problems checklist

Learn about using the solve problems checklist.

If the printer is not correctly functioning, complete the steps (in the order given) in the following checklist. If the printer fails a checklist step, follow the corresponding troubleshooting suggestions for that step. If a checklist step resolves the problem, skip the remaining checklist items.

1. If the control panel is blank or black, check the following before proceeding:
  - Check to make sure that the printer is not in Sleep mode (press a button on the control panel).
  - Check the power cable.
  - Check that the power is turned on.
  - Make sure that the line voltage is correct for the printer power configuration. (See the label that is on the back of the printer for voltage requirements.) If a power strip is in use, and its voltage is not within specifications, connect the printer directly into the electrical outlet. If it is already connected into the outlet, try a different outlet.



---

**NOTE:** The following conditions indicate that the printer has frozen while in Sleep mode. Opening a door or pressing a control-panel button causes the printer to wake up from Sleep mode.

- The control panel home button LED is illuminated
  - The power-switch LED flashes once every three to five seconds
- 

If the control panel is not responding, or if it appears black or blank, try the following:

- a. Turn the printer power off, and then on again.
- b. Verify that the system is correctly functioning.



---

**TIP:** The LED on the formatter will blink if the control panel is not detected or the cables are not properly seated.

---

- Try printing from a host computer. Does the printer print a test page?
  - Is the printer HP Embedded Web Server (EWS) accessible?
- c. Verify that the control panel is correctly functioning.
    - i. Turn the power off.
    - ii. Reseat the cable connections on the bottom of the control-panel assembly and the control-panel connectors at the formatter.



- If the page does not print correctly, the problem is with the printer hardware.
  - If the page prints correctly, the printer hardware is working. The problem is with the host computer, with the print driver, or with the program.
5. Print a supplies status page and then check that the maintenance items below are not at their end-of-life.



**NOTE:** HP long-life consumables and maintenance kit life specifications are estimations. Actual individual life/yield during normal use varies depending on usage, environment, media, and other factors. Estimated life is not an implied guarantee or warrantable.

- a. From the **Home** screen on the printer control panel, scroll to and touch the **Reports** button. Open the following menus:
  - i. **Configuration/Status Pages**
  - ii. **Supplies Status Page**
- b. Touch **Supplies Status Page** to select it.



**TIP:** Multiple report pages can be selected, and then printed together.

- c. Touch the **Print** button to print the pages.

If a maintenance item needs to be replaced, order the replacement part.

6. Verify that the correct print driver for this printer is installed. Check the program to make sure that the print driver for this printer is used. The print driver is on the CD that came with the printer, or can be downloaded from this Web site: <http://www.hp.com/support/colorlj6700> or <http://www.hp.com/support/colorlj6800MFP> or <http://www.hp.com/support/colorlj6801MFP> or <http://www.hp.com/support/colorljX654> or <http://www.hp.com/support/colorljX677MFP>.
7. Print a short document from a different program that has worked in the past. If this solution works, the problem is with the program. If this solution does not work (the document does not print), complete these steps:
- a. Try printing the job from another computer that has the printer software installed.
  - b. If the printer is connected to the network, connect the printer directly to a host computer with a USB cable. Redirect the printer to the correct port, or reinstall the software (make sure to select the new connection type).

## Control panel troubleshooting

If the control panel is not responding normally or has display issues, use the following procedures to troubleshoot the issues.

### Control panel system diagnostics

Learn about printer firmware control panel troubleshooting.

Use the diagnostics in this section to test the control panel hardware and display using the printer firmware system diagnostics.

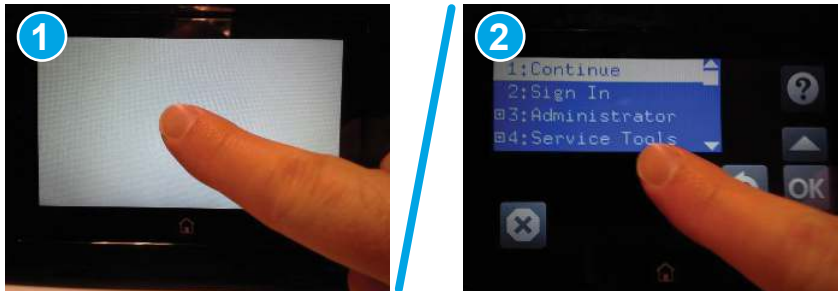
## Open the control panel system diagnostic tests

Learn about accessing the control panel system diagnostics tests from a touchscreen control panel.

Use the following procedure to open the control panel system diagnostics tests.

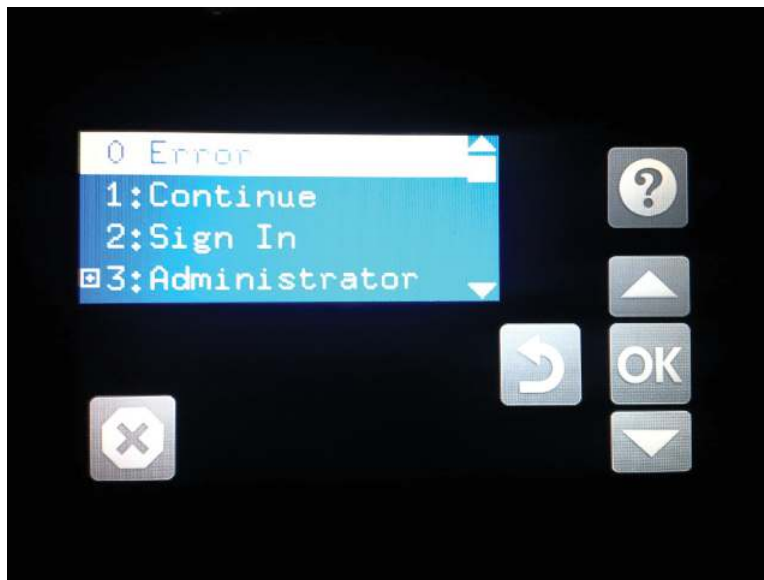
1. Turn the printer power off, and then on again.
2. Touch the middle of the control panel display when you see the 1/8 under the logo.

**Figure 4-113 Open the Pre-boot menu**



3. On the Pre-boot menu screen, use the following buttons to navigate the tests.

**Figure 4-114 Pre-boot menu**



**Table 4-22 Pre-boot menu button descriptions**







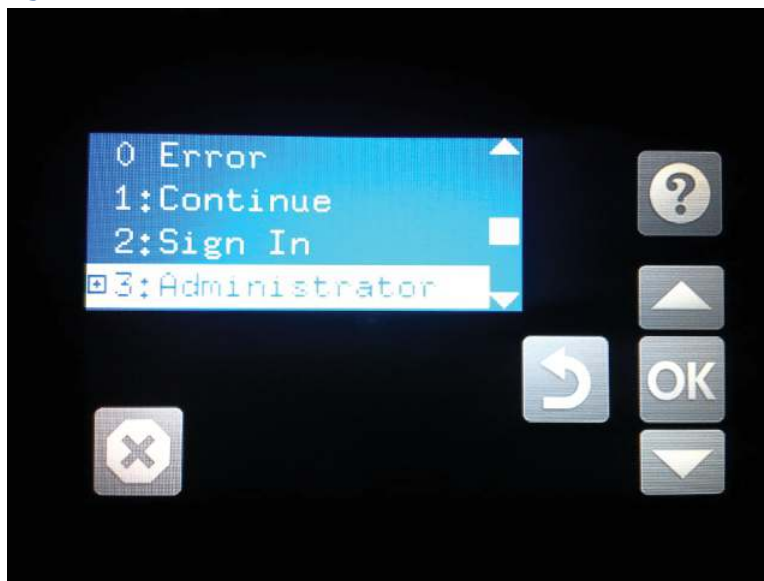
Button	Description
	Use this button to see more information about a selected item.
	Use this button to scroll up through menu items.

Table 4-22 Pre-boot menu button descriptions (continued)

Button	Description
	Use this button to select a highlighted menu item.
	Use this button to scroll down through menu items.
	Use this button to go back to the previous menu.
	Not used.

- Use the **down arrow ▼** button to scroll to **+3 Administration**, and then press the **OK** button to select it.

Figure 4-115 Access the administration menu



- Use the **down arrow ▼** button to scroll to **+E CP Diagnostics**, and then press the **OK** button to select it.

 **NOTE:** An administrator password might be required to continue.

Figure 4-116 Access the diagnostics menu

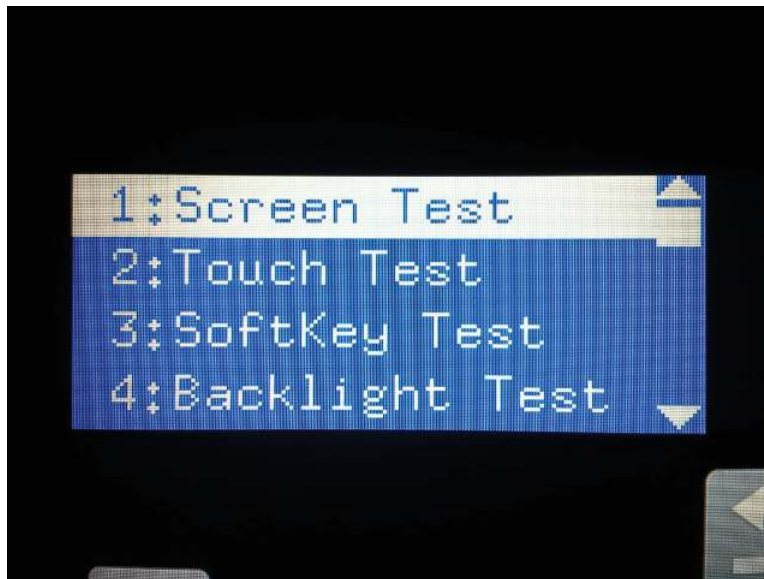


## Screen test

Learn about the control panel system diagnostic screen test.

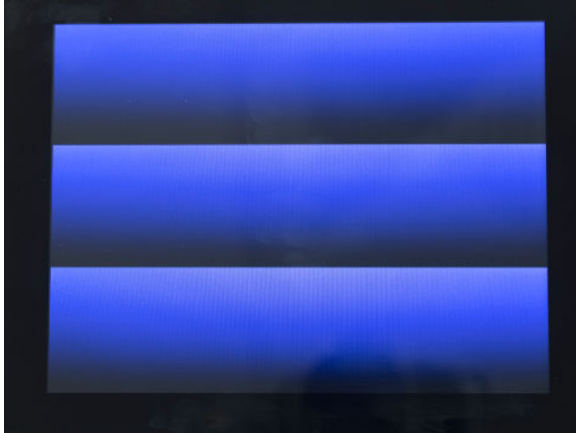
1. Open the control panel system diagnostic tests.
2. With 1 Screen Test highlighted, press the OK button to select it.

Figure 4-117 Open the screen test



The blue horizontal gradient screen appears.

**Figure 4-118 Blue horizontal gradient screen**

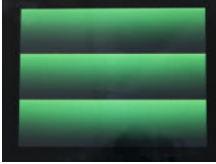
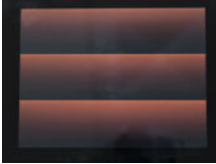

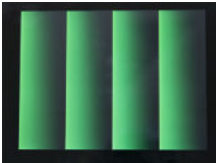
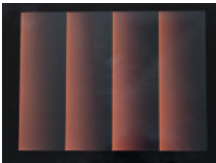


3. Touch the touchscreen to scroll through the remaining touchscreen test screens.



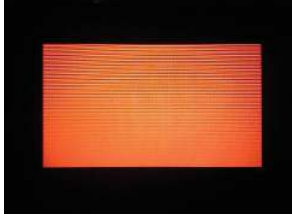

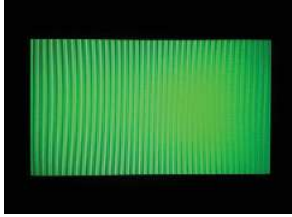
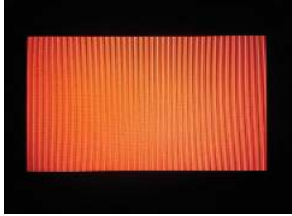


**NOTE:** Touch the [Home](#) button to exit the test.

**Table 4-23 Touchscreen test screens**






Screen	Description
	Green horizontal gradient
	Red horizontal gradient
	Blue vertical gradient
	Green vertical gradient
	Red vertical gradient

**Table 4-23 Touchscreen test screens (continued)**

Screen	Description
 A rectangular test screen with a blue background. It features a pattern of horizontal lines that are slightly wavy and have a subtle gradient from a darker blue at the top to a lighter blue at the bottom.	Blue with horizontal interlaced
 A rectangular test screen with a green background. It features a pattern of horizontal lines that are slightly wavy and have a subtle gradient from a darker green at the top to a lighter green at the bottom.	Green with horizontal interlaced
 A rectangular test screen with a red background. It features a pattern of horizontal lines that are slightly wavy and have a subtle gradient from a darker red at the top to a lighter red at the bottom.	Red with horizontal interlaced
 A rectangular test screen with a blue background. It features a pattern of vertical lines that are slightly wavy and have a subtle gradient from a darker blue on the left to a lighter blue on the right.	Blue with vertical interlaced
 A rectangular test screen with a green background. It features a pattern of vertical lines that are slightly wavy and have a subtle gradient from a darker green on the left to a lighter green on the right.	Green with vertical interlaced
 A rectangular test screen with a red background. It features a pattern of vertical lines that are slightly wavy and have a subtle gradient from a darker red on the left to a lighter red on the right.	Red with vertical interlaced



**Table 4-23 Touchscreen test screens (continued)**

Screen	Description
	Black with white center
	White with black center
	Checkerboard
	Multicolor stripes
	Blue green grid meshing

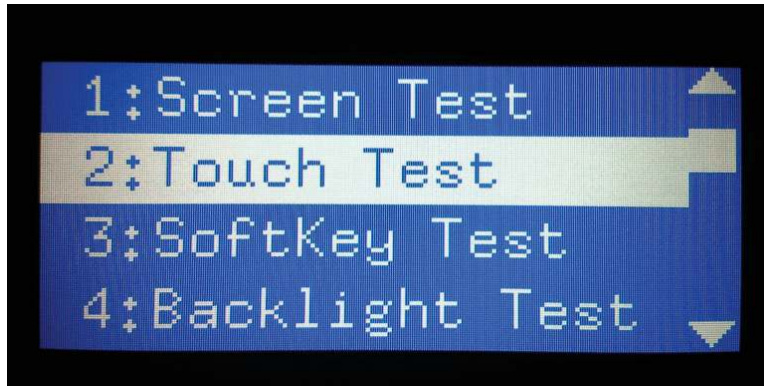
## Touch test

Learn about the control panel system diagnostic touch test.

1. Open the control panel system diagnostic tests.

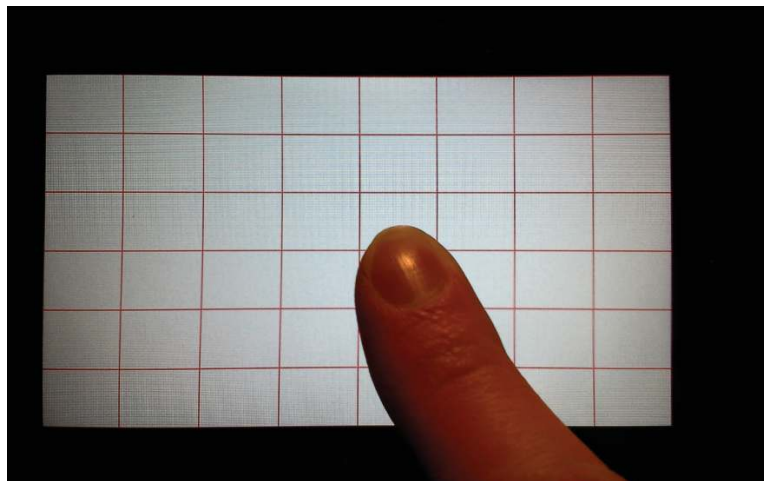
2. Use the **down arrow ▼** button to scroll to **2 Touch Test**, and then press the **OK** button to select it.

**Figure 4-119** Open the touch test



3. Use your finger to touch the white grid on the display.

**Figure 4-120** Touch the white grid



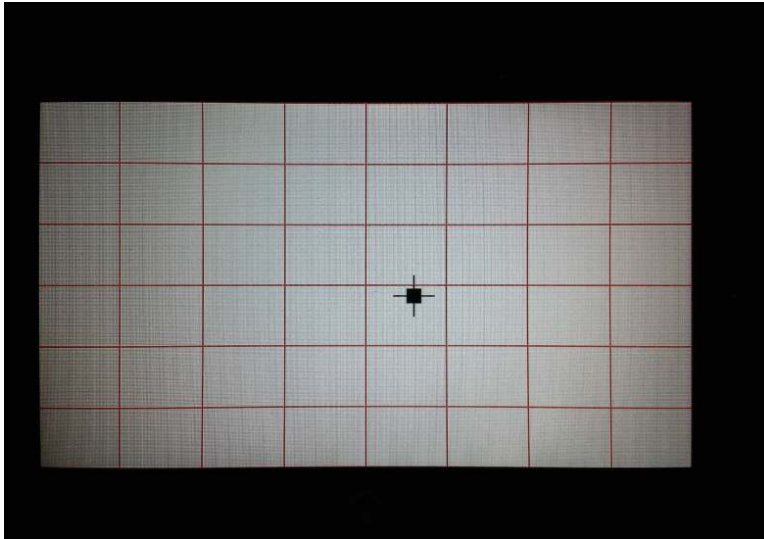
A mark appears on the grid where it was touched.

---

 **NOTE:** Touch the **Home** button to exit the test.

---

**Figure 4-121** Verify the mark



### SoftKey test

Learn about the control panel system diagnostic SoftKey test.

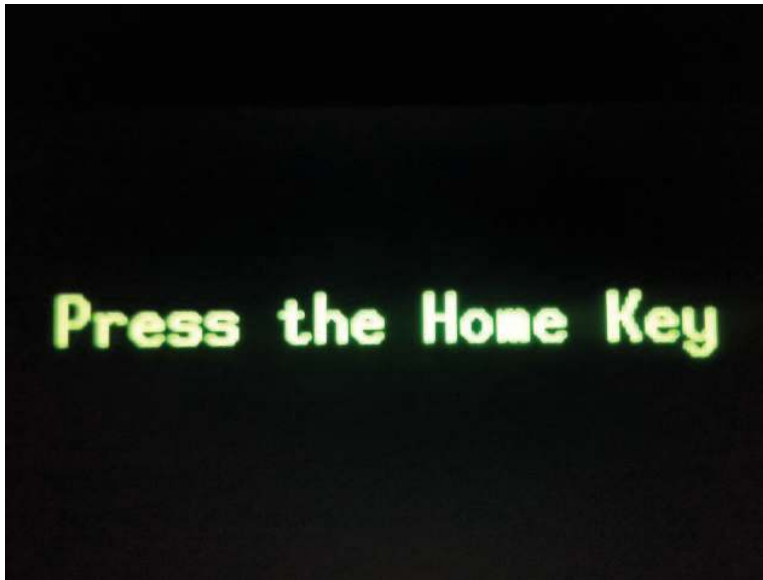
1. Open the control panel system diagnostic tests.
2. Use the **down arrow ▼** button to scroll to **3 SoftKey Test**, and then press the **OK** button to select it.

**Figure 4-122** Open the softkey test




3. When prompted, touch the **Home** button.

**Figure 4-123** Touch the **Home** button



If the test is successful, the following screen appears on the display.

---

 **NOTE:** Touch the screen to exit the test.

---

**Figure 4-124** Successful test



## Backlight test


Learn about the control panel system diagnostic backlight test.

1. Open the control panel system diagnostic tests.

2. Use the **down arrow ▼** button to scroll to **4 Backlight Test**, and then press the **OK** button to select it.

After selecting the **4 Backlight Test**, the screen automatically dims, and then returns to full brightness.

---

 **NOTE:** Touch any key to exit the test.

---

**Figure 4-125** Open the backlight test




## Sound test

Learn about the control panel system diagnostic sound test.

1. Open the control panel system diagnostic tests.
2. Use the **down arrow ▼** button to scroll to **5 Sound Test**, and then press the **OK** button to select it.

After selecting the **5 Sound Test**, the printer emits a series of audible tones.

---

 **NOTE:** Touch any key to exit the test.

---

Figure 4-126 Open the sound test




## Version

Learn about the control panel system diagnostic version information.

1. Open the control panel system diagnostic tests.
2. Use the **down arrow** ▼ button to scroll to **7 Version**, and then press the **OK** button to select it.


---

 **NOTE:** Touch any key to exit the test.

---

Select **7 Version** to view the following types of information:

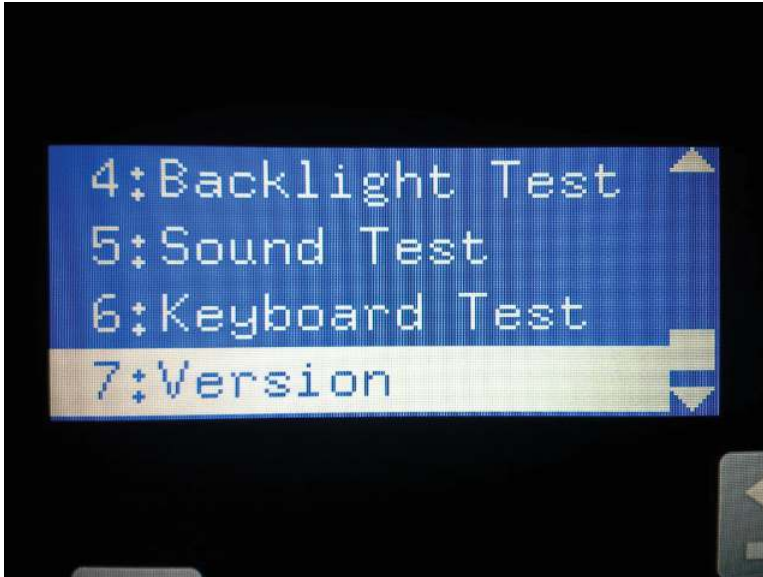
---

 **NOTE:** The following types of information are for the control panel only, not the printer.

---

- Panel ID
- Hardware (version)
- Firmware (version)
- KB Hw (version)
- KB Firm (version)
- LCD Vendor
- Touch Controller Version

Figure 4-127 Open the version information



## How to search for printer documentation

The CPMD, error codes, and other support documentation for each printer is available on the HP portals.

For HP internal access to WISE, go to [WISE](#).


For HP channel partners access WISE, see [Accessing WISE for HP channel partners \(HP Partner Portal\) on page 131](#) or [Accessing WISE for HP channel partners \(CSDP\) on page 130](#).

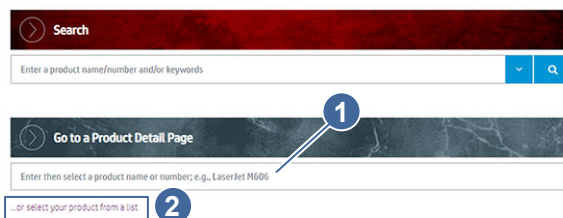
WISE is available to call agents, service technicians, and HP internal users. The level of detail available depends on your access credentials. To learn how to find support content in WISE, [watch the video here](#).

## How to search WISE for printer information and documentation

These instructions are for HP internal use by call agents, service technicians, and other internal users.

To learn how to find support content in WISE, watch the video here: [Finding Error Code and Control Panel Message Document in WISE](#).

 **TIP:** The Product Detail Page (PDP) is available from the WISE home page. Enter, and then select a product name or number in the **Go to a Product Detail Page** area (callout 1), or select the **...or select your product from a list** item (callout 2) on the WISE home page.



Many types of printer documentation and information are available on WISE. This section details methods for finding error code descriptions and solutions.

 **TIP:** To view a list of control panel message documents (CPMD) per printer, search for the following topic in **WISE**: HP LaserJet, OfficeJet, PageWide, ScanJet Enterprise - Control panel message document (CPMD) list or click the link below.

- [HP LaserJet, HP OfficeJet, HP PageWide, HP ScanJet - Control panel messages document \(CPMD\), Service manual, and Service cost data list](#)

Use one of the following methods to search for CPMD error code information.

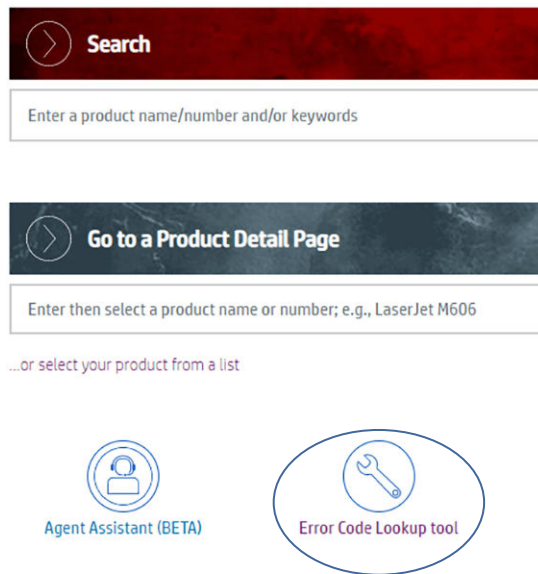
- [Method 1: Use the WISE home page Error Code Lookup tool on page 311](#)
- [Method 2: Search for error codes using the WISE search function on page 312](#)
- [Method 3: Search for error codes using the Product Detail Page on page 314](#)

## Method 1: Use the WISE home page Error Code Lookup tool

Use the WISE Error Code Lookup tool to find error code troubleshooting procedures using the following steps.

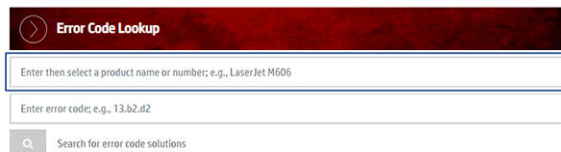
1. On the WISE home page, click the **Error Code Lookup tool** icon.

**Figure 4-128** WISE Error Code Lookup tool icon



2. Enter a printer model number (for example, M606) in the **Error Code Lookup** dialog box.

**Figure 4-129** WISE Error Code Lookup tool dialog box



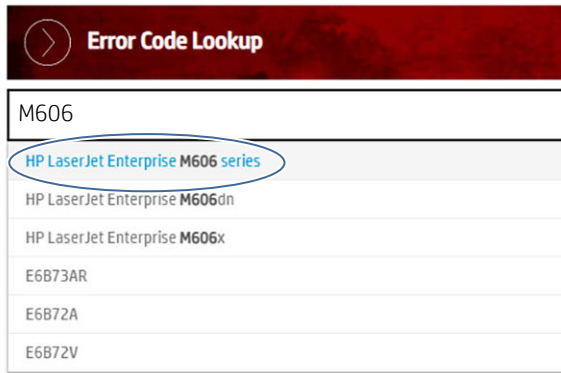
3. A drop-down list appears. Click on the full printer series name (for example, HP LaserJet Enterprise M606 series) in the list.



**NOTE:** Selecting the **series** item from the drop-down list is recommended for the most accurate search return.



**Figure 4-130 WISE Error Code Lookup tool drop-down list**



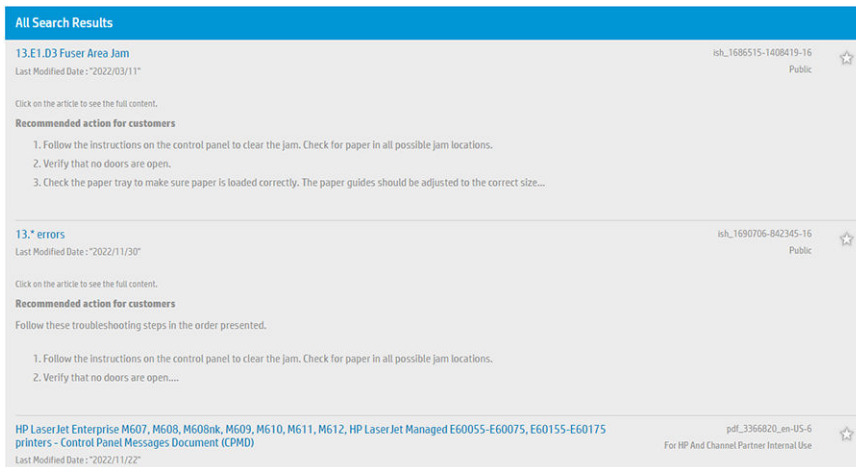
4. Type the error code (for example, 13.b2.d2) in the **Error Code Lookup** keyword field, and then select the search icon.

**Figure 4-131 WISE Error Code Lookup tool search**



5. The error code troubleshooting content displays in the **All Search Results** area.

**Figure 4-132 WISE Search results**

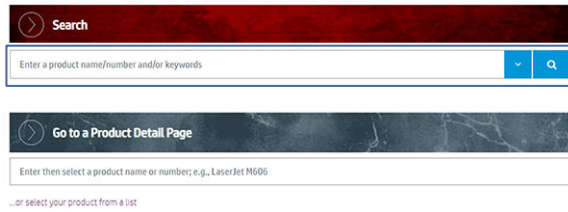


## Method 2: Search for error codes using the WISE search function


Use the WISE search function to find error code troubleshooting procedures using the following steps.

1. On the WISE home page, enter a printer model number (for example, M606) in the **Search** dialog box.

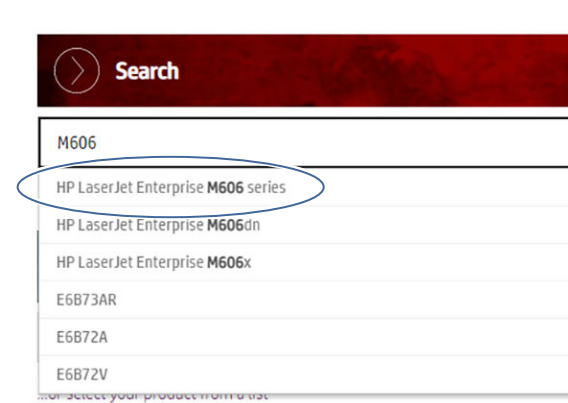
**Figure 4-133 WISE Search dialog box**



2. A drop-down list appears. Click on the full printer series name (for example, HP LaserJet Enterprise M606 series) in the list.

 **NOTE:** Selecting the **series** item from the drop-down list is recommended for the most accurate search return.

**Figure 4-134 WISE Search drop-down list**



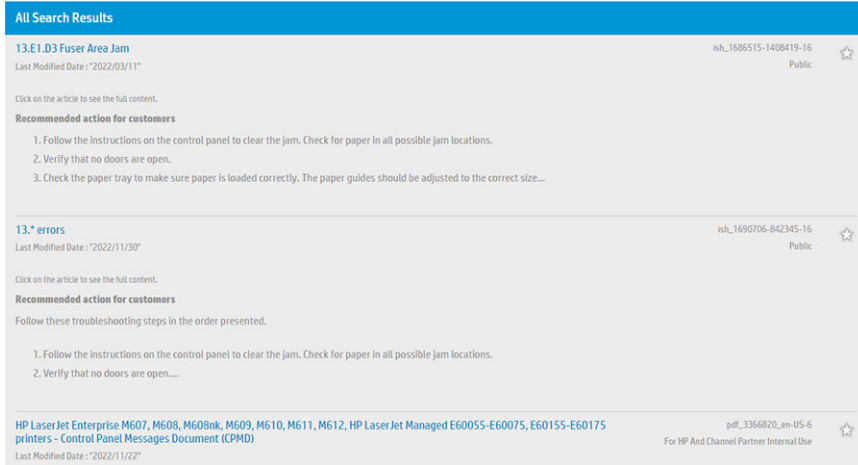
3. Type the error code (for example, 13.E1.D3) in the **Search** keyword field, and then select the search icon.

**Figure 4-135 WISE Search**



4. The error code troubleshooting content displays in the **All Search Results** area.

Figure 4-136 WISE Search results



### Method 3: Search for error codes using the Product Detail Page

Use the WISE Product Detail Page (PDP) to find error code troubleshooting procedures using the following steps.

1. On the WISE home page, enter a printer model number (for example, M606) in the **Go to a Product Detail page** dialog box.


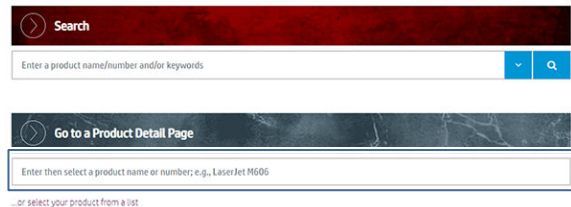
 **TIP:** To find a PDP from a list of products by product type, select the **...or select your product from a list** item just below the dialog box.

Figure 4-137 WISE PDP dialog box



2. A drop-down list appears. Click on the full printer series name (for example, HP LaserJet Enterprise M606 series) in the list.


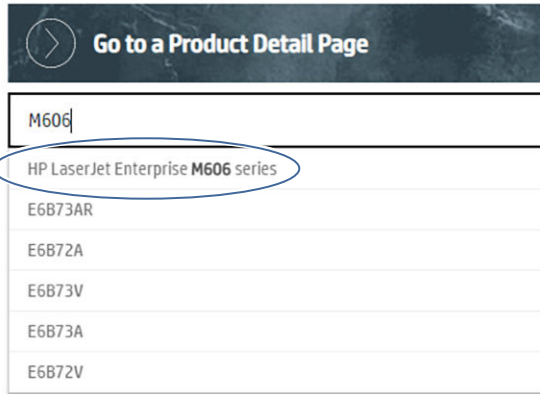
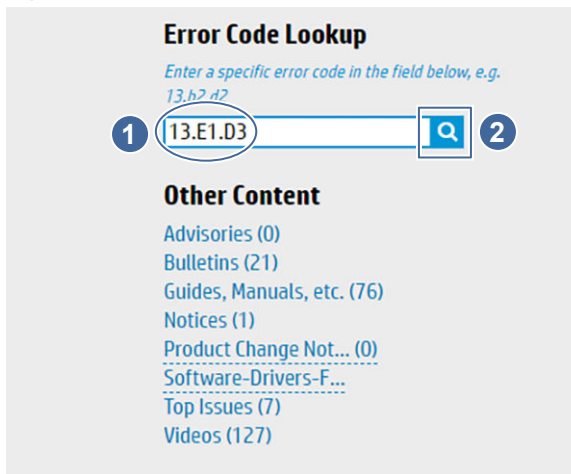
 **NOTE:** Selecting the **series** item from the drop-down list is recommended for the most accurate search return.

Figure 4-138 WISE PDP drop-down list



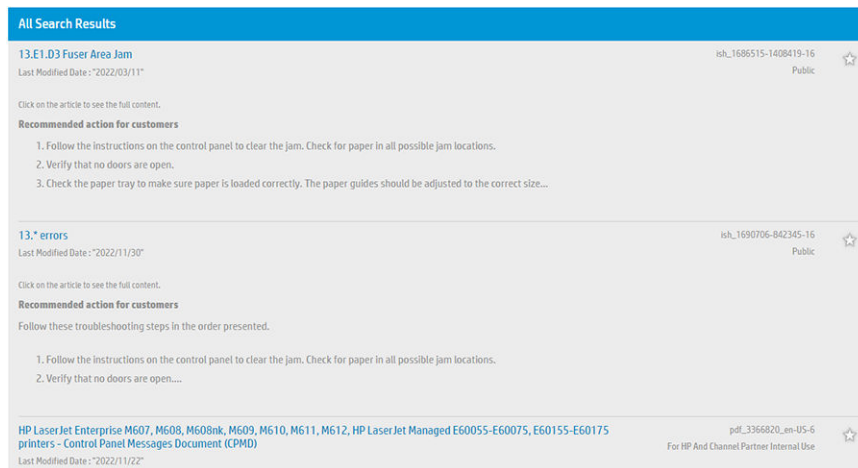
3. Type the error code (for example, 13.E1.D3) in the **Error Code Lookup** field, and then select the search icon.

Figure 4-139 WISE PDP search




4. The error code troubleshooting content displays in the **All Search Results** area.

Figure 4-140 WISE PDP search results



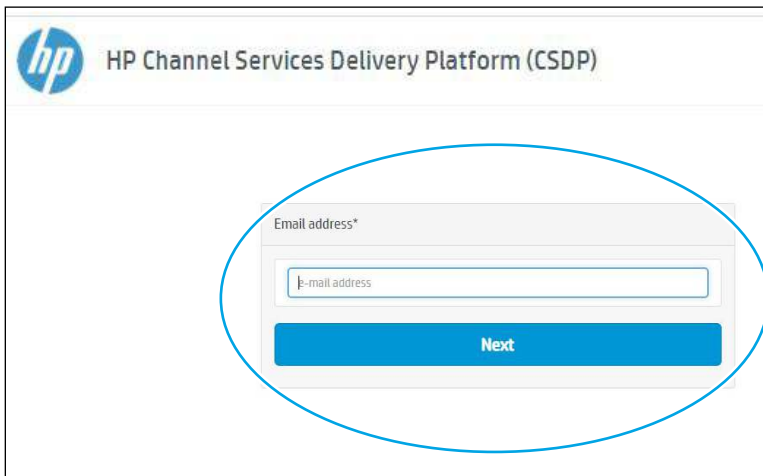
## Accessing WISE for HP channel partners (CSDP)

Learn how to access WISE by accessing the HP Channel Services Delivery Platform (CSDP) if you are an HP Channel Partner.

 **IMPORTANT:** A Partner Admin must requested access, via the CSDP portal, to create a new user before you can sign into the CSDP portal.

1. Sign-in to the CSDP portal (click [csdp.hp.com](https://csdp.hp.com) to access the sign-in page).

Figure 4-141 CSDP sign-in page



2. On the CSDP home page, click the **Knowledge and Training** item.


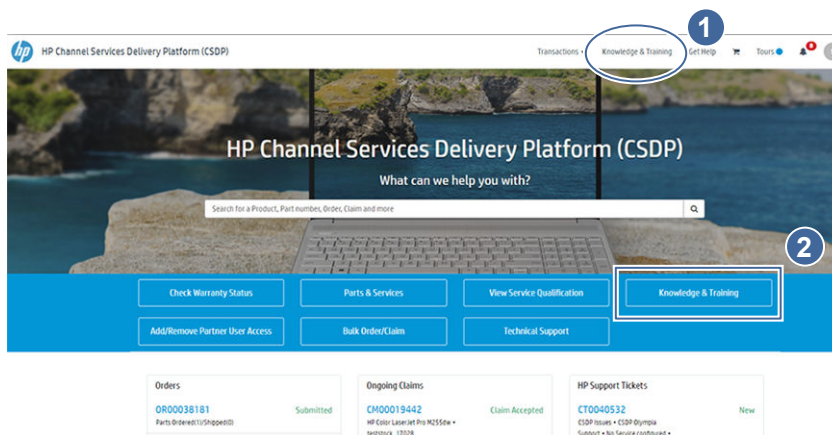
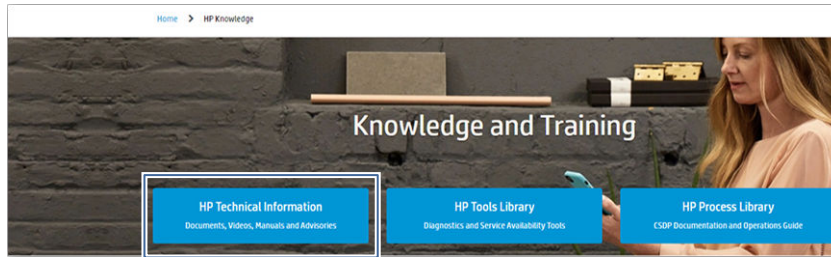
 **TIP:** Use the **Knowledge and Training** item at the top of the CSDP home page (callout 1), or the **Knowledge and Training** action icon (callout 2).

Figure 4-142 CSDP portal home page



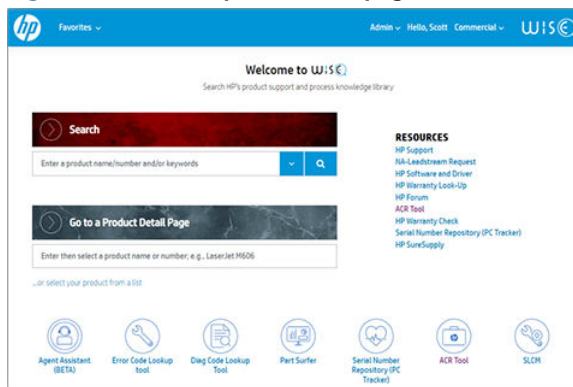
3. Select **HP Technical Documentation** on the **Knowledge and Training** page to open the WISE portal home page.

**Figure 4-143 CSDP portal HP Knowledge and Training page**



4. Use the WISE portal to search for printer information.

**Figure 4-144 WISE portal home page**



## Accessing WISE for HP channel partners (HP Partner Portal)

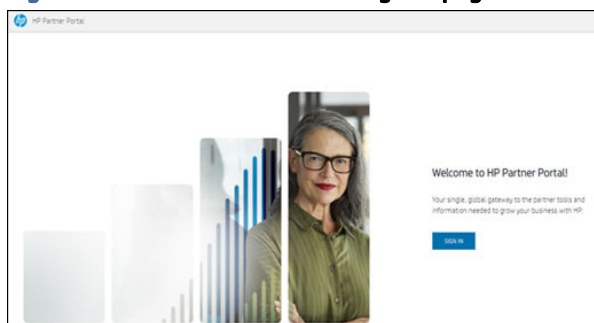
Learn how to access WISE by accessing the HP Partner Portal if you are an HP Channel Partner.

**NOTE:** If this is your first visit to the HP Partner Portal, you will be asked to create an account. Follow the setup directions using your HP Partner credentials.

[View a video of how to access WISE for HP channel partners](#)

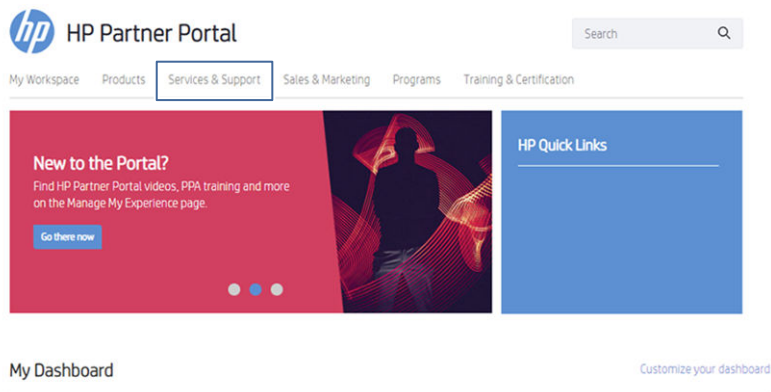
1. Sign-in to the HP Partner Portal (click <https://partner.hp.com> to access the sign-in page).

**Figure 4-145 HP Partner Portal sign-in page**



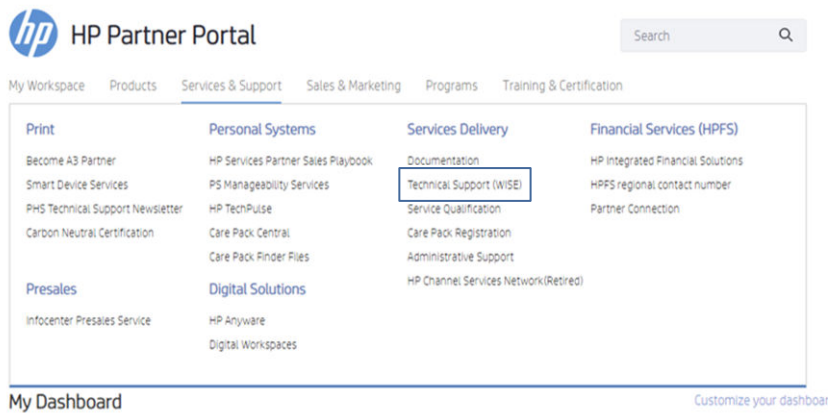
2. On the HP Partner Portal home page, click the **Services & Support** item.

**Figure 4-146 HP Partner Portal home page**



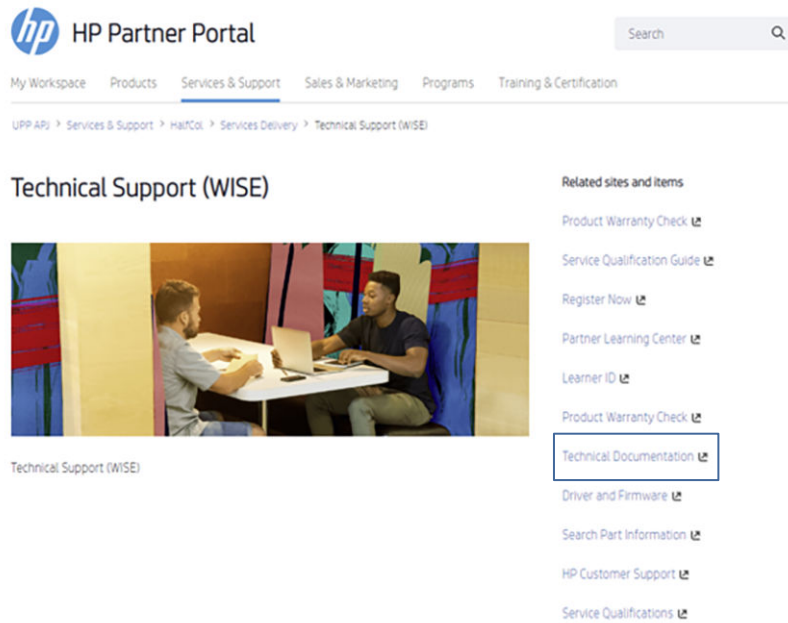
3. Select the **Technical Support (WISE)** item.

**Figure 4-147 HP Partner Portal Service & Support page**



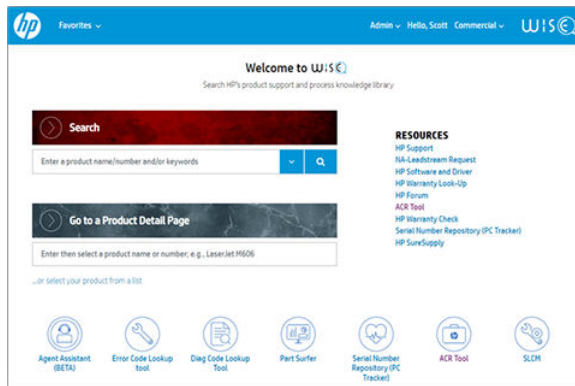
4. Select the **Technical Documentation** item.

**Figure 4-148 HP Partner Portal Technical Support (WISE)page**



5. Use the WISE portal to search for printer information.

**Figure 4-149 WISE portal home page**



## Control panel messages document (CPMD)

Learn about the printer control panel messages document (CPMD).

**NOTE:** A complete CPMD is not included in this service manual. Click on the links below to access a CPMD on the HP Web-based Interactive Search Engine (WISE) site.


[HP Color LaserJet Enterprise 6700, 6701, MFP 6800, 6801 - Control Panel Message Document \(CPMD\)](#)

[HP Color LaserJet Enterprise X654, X65455, X65465, MFP X677, MFP X67755, MFP X67765 - Control Panel Message Document \(CPMD\)](#)



## Print the supplies status page

The supplies status page indicates the cartridge status.

1. From the Home screen on the printer control panel, scroll to and touch the **Reports** menu icon.
2. Touch the **Configuration/Status Pages** menu.
3. Touch **Supplies Status Page**, and then touch the Print icon  to print the page.

## Pre-boot menu options

The **Pre-boot** menus are available prior to the printer initializing.

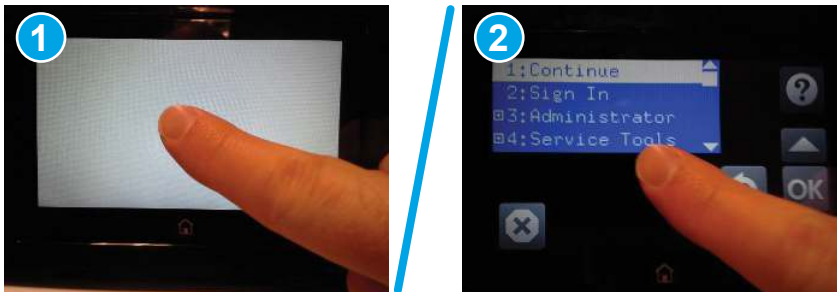
- 
- ⚠ **CAUTION:** The **Format Disk** option performs a disk initialization for the entire disk. The operating system, firmware files, and third party files (among other files) will be completely lost. HP does not recommend this action unless it is specified as a solution in the CPMD.
  - 💡 **TIP:** The **Pre-boot** menu is also remotely accessible by using a telnet network protocol (Remote Admin) to establish an administration connection to the printer.
- 

## Open the Pre-boot menu from a touchscreen control panel

Use the following procedure to open the **Pre-boot** menu from a touchscreen control panel.

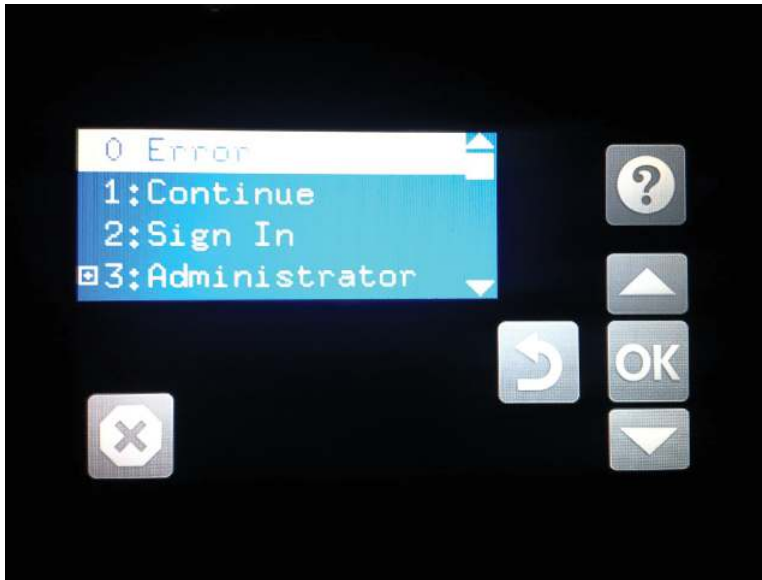
1. Turn the printer on.
2. Touch the middle of the control-panel display when you see the **1/8** under the logo.







**Figure 4-150** Open the Pre-boot menu



3. On the **Pre-boot** menu screen, use the following buttons to navigate the tests.

**Figure 4-151 Pre-boot menu**



Button	Description
	Use this button to see more information about a selected item.
	Use this button to scroll up through menu items.
	Use this button to select a highlighted menu item.
	Use this button to scroll down through menu items.
	Use this button to go back to the previous menu.
	Not used.

4. Use the arrow buttons on the touchscreen to navigate the **Pre-boot** menu.
5. Touch the **OK** button to select a menu item.

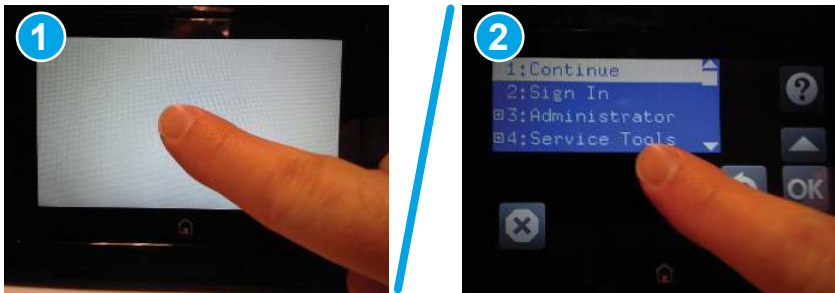
## Cold reset using the Pre-boot menu from a touchscreen control panel

Use the following procedure to perform a cold reset using the **Pre-boot** menu from a touchscreen control panel.

**CAUTION:** This procedure resets all printer configurations and settings to factory defaults (customer configurations and settings are lost).

1. Touch the middle of the control-panel display when you see the **1/8** under the logo.

**Figure 4-152** Open the Pre-boot menu



2. Use the down arrow ▼ button to highlight the **+3:Administrator** item, and then touch the **OK** button.
3. Use the down arrow ▼ button to highlight the **+8:Startup Options** item, and then touch the **OK** button.
4. Use the down arrow ▼ button to highlight the **2 Cold Reset** item, and then touch the **OK** button to select it.
5. Touch the Home button to return to the main **Pre-boot** menu and highlight the **1:Continue** item, and then touch the **OK** button.

**NOTE:** The printer will initialize.

## Remote Admin

Learn about the printer Remote Admin function.

The Remote Admin feature allows remote access the printer **Pre-boot** menu (BIOS environment). The printer functions as a telnet server which uses the telnet networking protocol to transmit text data. Any computer (with telnet installed and enabled) can function as the telnet client to remotely display and interact with the **Pre-boot** menu.

**IMPORTANT:** While the Remote Admin function allows remote access the **Pre-boot** menu, for security reasons the Remote Admin connection must be initiated by a person that is physically present at the printer.

## Required software and network connection


Before using the Remote Admin feature, make sure that the telnet network protocol is installed and enabled on the remote telnet client computer.

**NOTE:** This section describes enabling and configuring the telnet feature for computers using a Windows® operating system.

HP recommends that the telnet client computer be a Windows-based system; however, there are other operating systems that support the telnet network protocol. For information about enabling and configuring the telnet network protocol for other operating systems, see the owner's manual for that operating system.

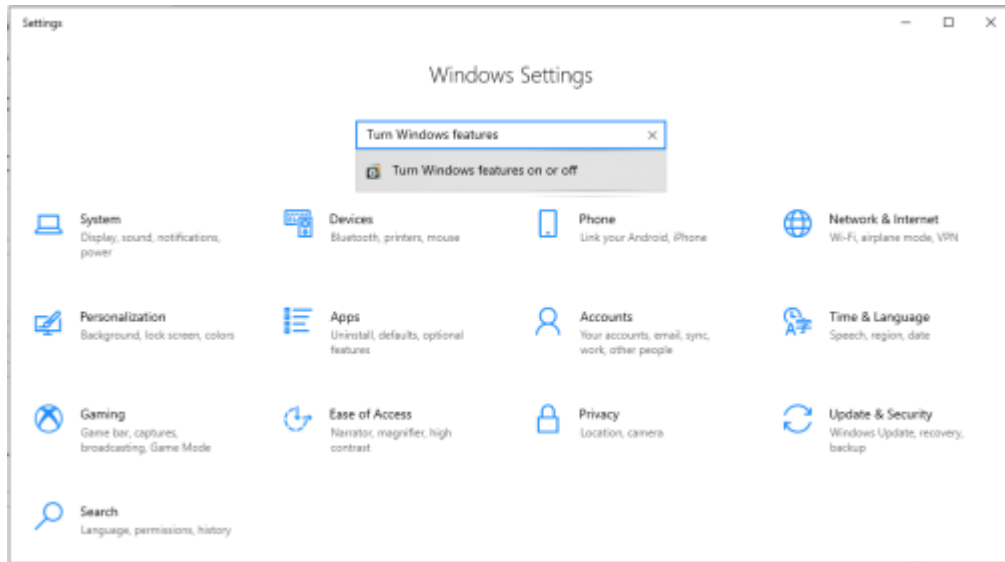
## Enable the Windows telnet client

All computers using the Windows operating system have the telnet client installed, however, the telnet client function might not be enabled by default.


 **NOTE:** The figures and menus in this section are for the Windows 10® operating system. Screens and menu selections might vary slightly for other operating systems.

1. Use the **Start** menu to open the **Windows Settings** dialog box, and then search for **Turn Windows features on or off**. Click the **Turn Windows features on or off** item.

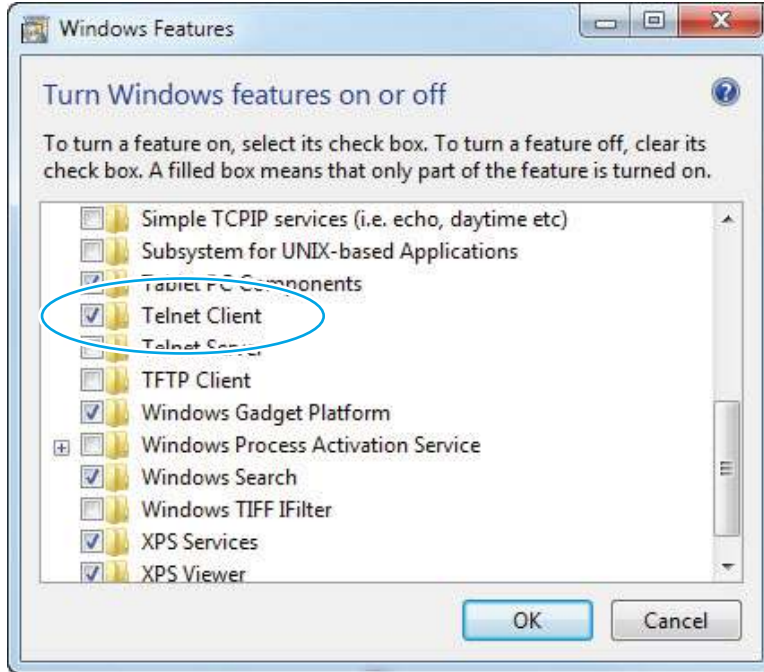
**Figure 4-153** Open Windows Settings



2. In the **Windows Features** box, scroll down to **Telnet Client**. If the check box is not checked, click the box to select it, and then click the **OK** button.

 **TIP:** If the check box is already checked then the telnet client function is already enabled. Click the **Cancel** button.

**Figure 4-154 Enable the telnet client feature**



### Network connection

The remote telnet client computer must have direct network access to the printer for the Remote Admin function to operate. This means that the telnet client computer must be on the same network as the printer.

The Remote Admin function cannot be accessed through a network firewall or other remote access network security programs.

If a private network is not accessible, ask the network administrator to set up a virtual private network (VPN) connection to the network.

### Connect a remote connection

Use the following procedures to connect a remote connection.

### Start the telnet server function at the printer

For security reasons the Remote Admin feature must be initiated by a person that is physically present at the printer. The following steps must be performed by a person that is physically present at the printer.

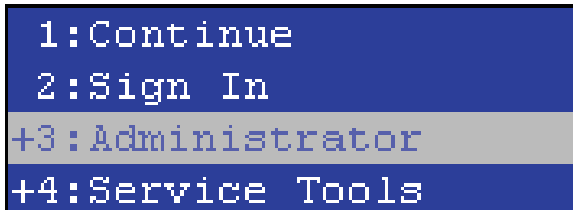


**NOTE:** This person might need to sign in with an administrator or service password depending on how the printer is configured.

1. Turn the printer on.
2. The HP logo displays on the printer control panel. When a  $1/8$  with an underscore displays, touch the middle of the screen to open the **Pre-boot** menu.

3. Use the arrow buttons on the touchscreen to scroll down and highlight the **+3:Administrator** item, and then touch the **OK** button to select it.

**Figure 4-155 Select the +3:Administrator item**



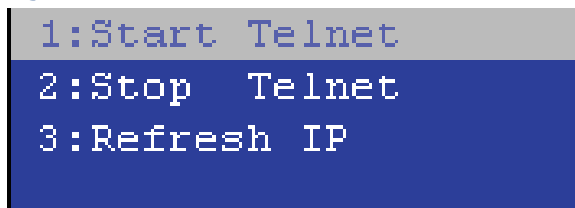
4. Use the arrow buttons on the touchscreen to scroll down and highlight the **+A:Remote Admin** item, and then touch the **OK** button to select it.

**Figure 4-156 Select the +A:Remote Admin item**



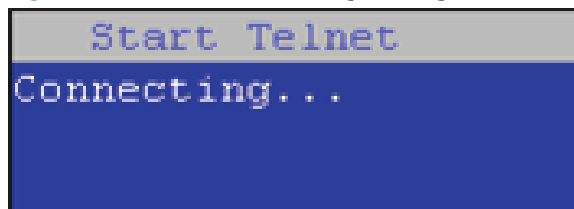
5. Use the arrow buttons on the touchscreen to scroll down and highlight the **1:Start Telnet** item, and then touch the **OK** button to select it.

**Figure 4-157 Select the 1:Start Telnet item**



6. Do one of the following
  - If a connecting message displays briefly, go to vii..

**Figure 4-158 Telnet connecting message**



- If an error message displays, use the steps below to identify the problem.

**Figure 4-159 Telnet error message**

```
Start Telnet
Unable to connect
Contact network
administrator.
```

- a. The printer network cable is not correctly connected.
  - b. The BIOS LAN settings are incorrect.
    - The printer should be configured to use a static IP address, but is configured to use DHCP instead.
    - The printer is configured to use a static IP address, but the IP address is incorrect.
  - c. The printer is correctly configured to use DHCP, but the DHCP server is not turned on or is malfunctioning.
7. When the printer telnet server function is initialized, the following screen appears. Use the information on this screen to connect the remote telnet client computer to the printer.

---

 **NOTE:** The printer is now ready to receive remote telnet client commands.

---

- **IP:** The static or dynamically allocated IP address for the printer.
- **Port:** The standard telnet port (23).
- **Pin:** A randomly generated 4-digit personal identification number (PIN).

**Figure 4-160 Telnet server function initialized**

```
Start Telnet
IP: 16.88.109.66
Port: 23
Pin : 4031
```

#### Start the telnet client function at the remote computer

The following steps establish a Remote Admin connection from a remote computer to the printer.

1. From the **Start** menu open the **Command Prompt** desktop application.

---

 **TIP:** Type `cmd` in the application search dialogue box to find the application.

---

2. From any displayed directory, type `telnet` at the prompt, and then press the **Enter** key.

**Figure 4-161 Start a telnet session**

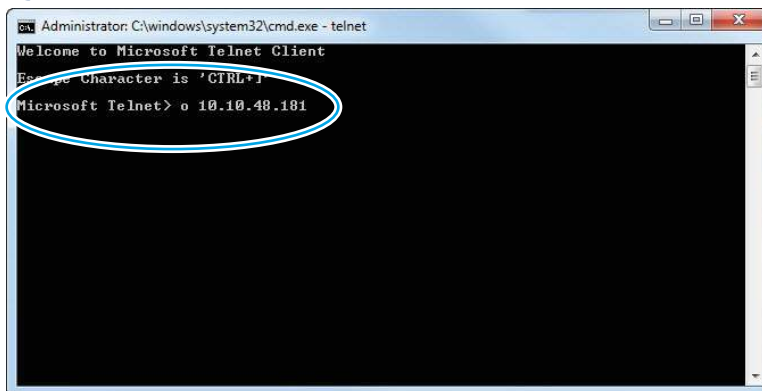


3. Type `<IP ADDRESS>` at the telnet prompt, and then press the **Enter** key.

**NOTE:** For `<IP ADDRESS>`, substitute the IP address that was displayed in step 7 of the "Start the telnet server function at the printer" topic.

**TIP:** If the telnet connection fails to establish a connection, the printer is probably behind a firewall or on a different network than the remote telnet client computer.

**Figure 4-162 Establish a telnet connection**

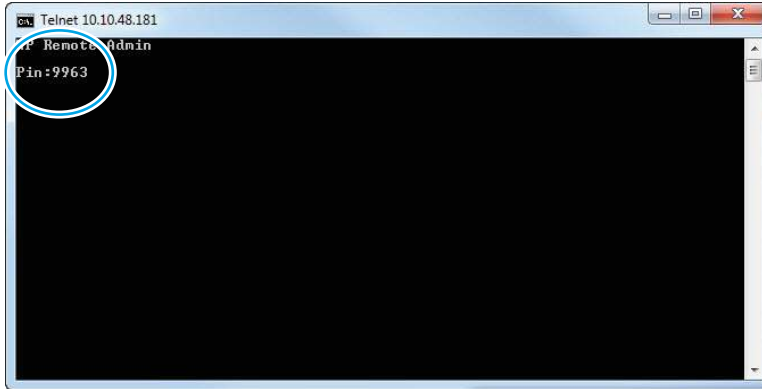


4. Type the PIN that was displayed in step 7 of then "Start the telnet server function at the printer" topic at the prompt, and then press the **Enter** key.


**IMPORTANT:** Make sure to type the PIN correctly. After five incorrect PIN entries, the printer terminates the Remote Admin connection. The Remote Admin feature must be re-initiated at the printer. See the "Start the telnet server function at the printer" topic.



**Figure 4-163 Enter the PIN**

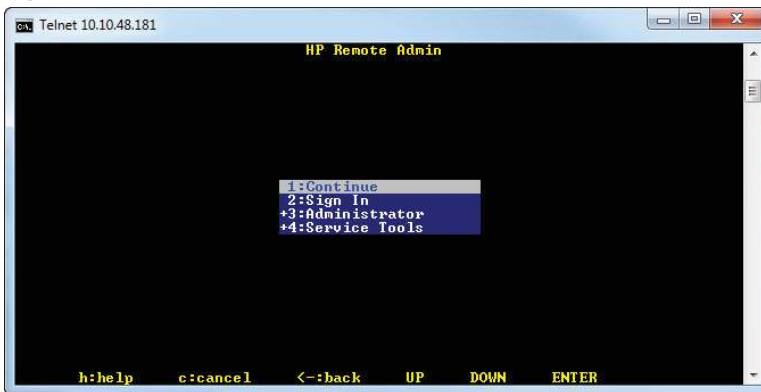


5. The following screen displays when the correct PIN is entered, and the Remote Admin connection is successful. For information about the Pre-boot menu and options, see "Pre-boot menu options" in the printer *Service Manual*.

 **NOTE:** Because a Remote Admin connection is an unsecured telnet network protocol connection, the following Pre-boot menu items are disabled for the remote telnet client computer.


- The **+3:Administrator** menu **4:Change Password** item.
- The **+3:Administrator** menu **5:Clear Password** item.
- The **+3:Administrator** menu **6:Disk Manage** item.

**Figure 4-164 Remote Admin window**



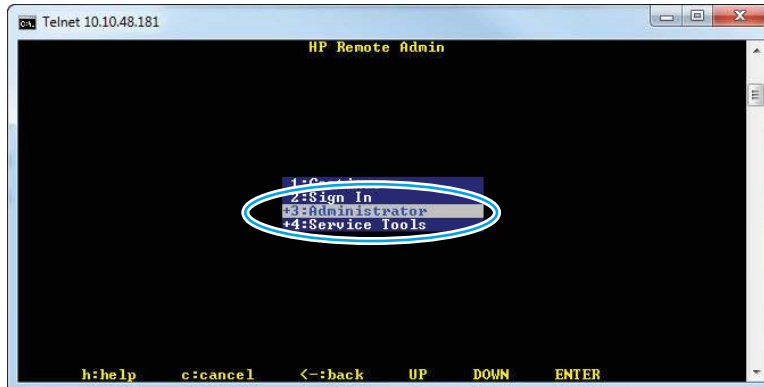
### Disconnect a remote connection

The Remote Admin connection can be terminated from the printer control panel or the remote telnet client computer.

 **NOTE:** The following procedure describes terminating a Remote Admin connection from the remote telnet client computer.

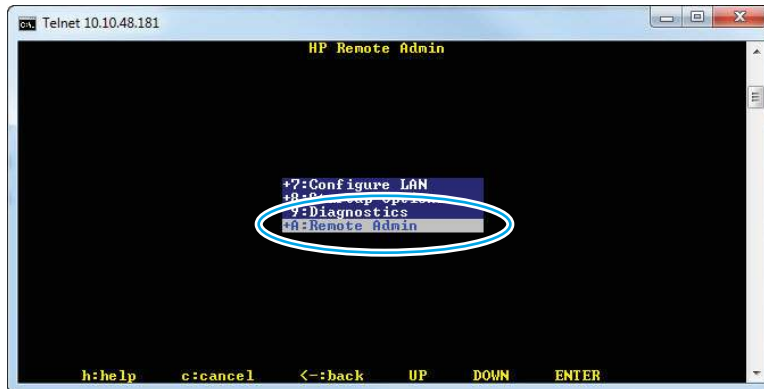
1. From the Pre-boot main menu, use the arrow buttons on the keyboard to scroll down to the **+3:Administrator** item, and then press the **Enter** key.

**Figure 4-165** Access the administrator menu




2. Use the arrow buttons on the keyboard to scroll down to the **+A:Remote Admin** item, and then press the **Enter** key.

**Figure 4-166** Access the remote admin menu

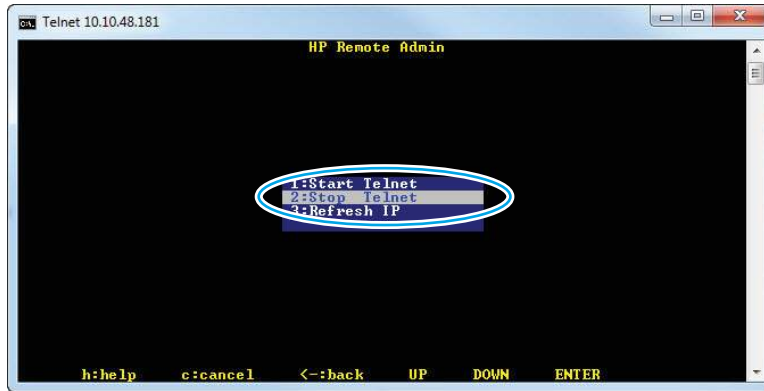


3. Use the arrow buttons on the keyboard to scroll down to the **2:Stop Telnet** item, and then press the **Enter** key. The Remote Admin connection between the printer and the remote telnet client computer terminates.

 **IMPORTANT:** The printer remains in the Pre-boot menu. Have the person that is physically present at the printer do the following:

- Touch the **Home** button to return to the main Pre-boot menu and highlight the **1:Continue** item, and then touch the **OK** button. The printer will continue to initialize.


**Figure 4-167 Terminate the telnet connection**



## Print the event log

Learn how to print the event log.

Print the 50 most recent events in the Event Log. For each event, the printed log shows the error number, page count, error code, and description or personality.

1. From the Home screen on the printer control panel, scroll to and touch the [Troubleshooting](#) menu icon.
2. Touch [Event Log](#).
3. Touch the Print icon  to print the page.

## How to search for printer documentation

The CPMD, error codes, and other support documentation for each printer is available on the HP portals.

For HP internal access to WISE, go to [WISE](#).


For HP channel partners access WISE, see [Accessing WISE for HP channel partners \(HP Partner Portal\)](#) on page 131 or [Accessing WISE for HP channel partners \(CSDP\)](#) on page 130.

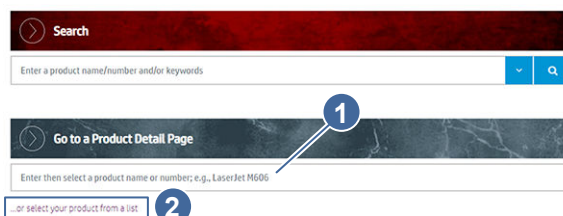
WISE is available to call agents, service technicians, and HP internal users. The level of detail available depends on your access credentials. To learn how to find support content in WISE, [watch the video here](#).

## How to search WISE for printer information and documentation

These instructions are for HP internal use by call agents, service technicians, and other internal users.

To learn how to find support content in WISE, watch the video here: [Finding Error Code and Control Panel Message Document in WISE](#).

 **TIP:** The Product Detail Page (PDP) is available from the WISE home page. Enter, and then select a product name or number in the **Go to a Product Detail Page** area (callout 1), or select the **...or select your product from a list** item (callout 2) on the WISE home page.



Many types of printer documentation and information are available on WISE. This section details methods for finding error code descriptions and solutions.



**TIP:** To view a list of control panel message documents (CPMD) per printer, search for the following topic in **WISE: HP LaserJet, OfficeJet, PageWide, ScanJet Enterprise - Control panel message document (CPMD) list** or click the link below.

- [HP LaserJet, HP OfficeJet, HP PageWide, HP ScanJet - Control panel messages document \(CPMD\), Service manual, and Service cost data list](#)

Use one of the following methods to search for CPMD error code information.

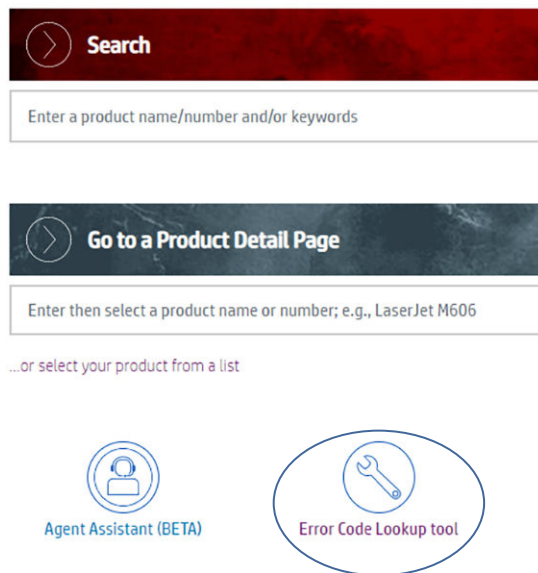
- [Method 1: Use the WISE home page Error Code Lookup tool on page 331](#)
- [Method 2: Search for error codes using the WISE search function on page 332](#)
- [Method 3: Search for error codes using the Product Detail Page on page 334](#)

### Method 1: Use the WISE home page Error Code Lookup tool

Use the WISE Error Code Lookup tool to find error code troubleshooting procedures using the following steps.

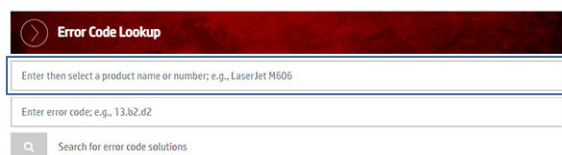
1. On the WISE home page, click the **Error Code Lookup tool** icon.

**Figure 4-168 WISE Error Code Lookup tool icon**



2. Enter a printer model number (for example, M606) in the **Error Code Lookup** dialog box.

**Figure 4-169 WISE Error Code Lookup tool dialog box**

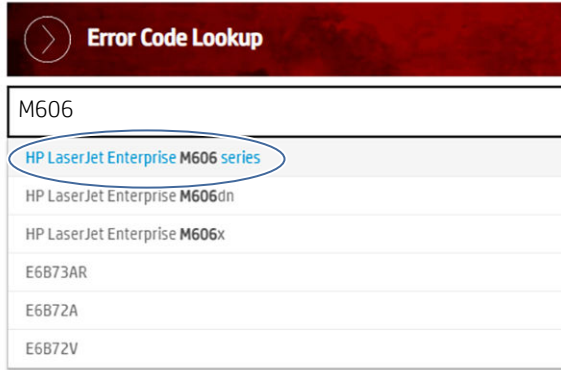


3. A drop-down list appears. Click on the full printer series name (for example, HP LaserJet Enterprise M606 series) in the list.



**NOTE:** Selecting the **series** item from the drop-down list is recommended for the most accurate search return.

**Figure 4-170 WISE Error Code Lookup tool drop-down list**



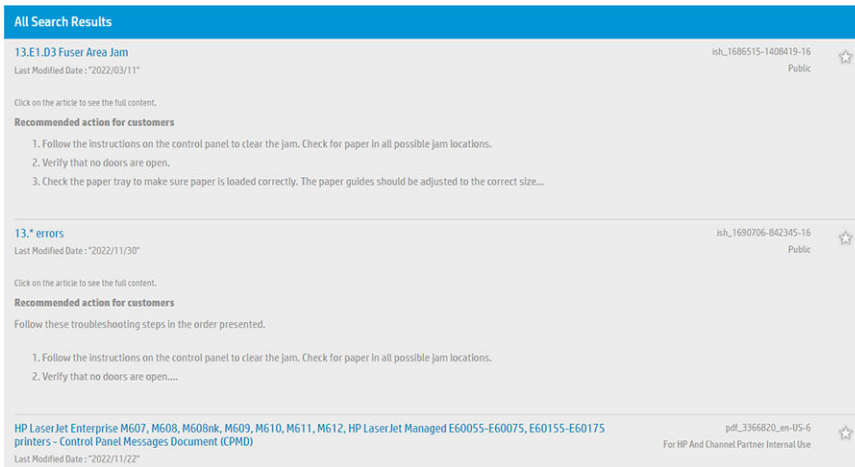
4. Type the error code (for example, 13.b2.d2) in the Error Code Lookup keyword field, and then select the search icon.

**Figure 4-171 WISE Error Code Lookup tool search**



5. The error code troubleshooting content displays in the All Search Results area.

**Figure 4-172 WISE Search results**

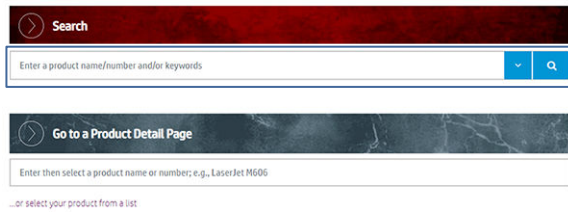


## Method 2: Search for error codes using the WISE search function

Use the WISE search function to find error code troubleshooting procedures using the following steps.

1. On the WISE home page, enter a printer model number (for example, M606) in the **Search** dialog box.

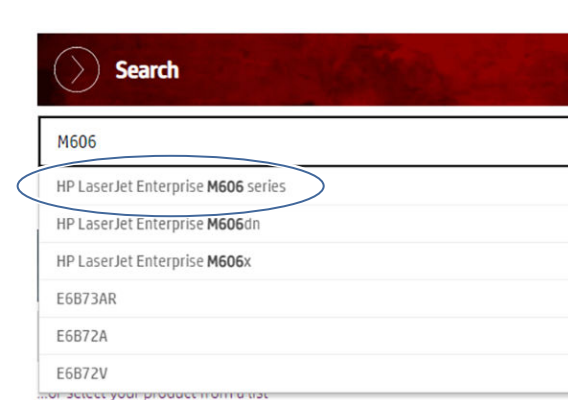
**Figure 4-173 WISE Search dialog box**



2. A drop-down list appears. Click on the full printer series name (for example, HP LaserJet Enterprise M606 series) in the list.

 **NOTE:** Selecting the **series** item from the drop-down list is recommended for the most accurate search return.

**Figure 4-174 WISE Search drop-down list**



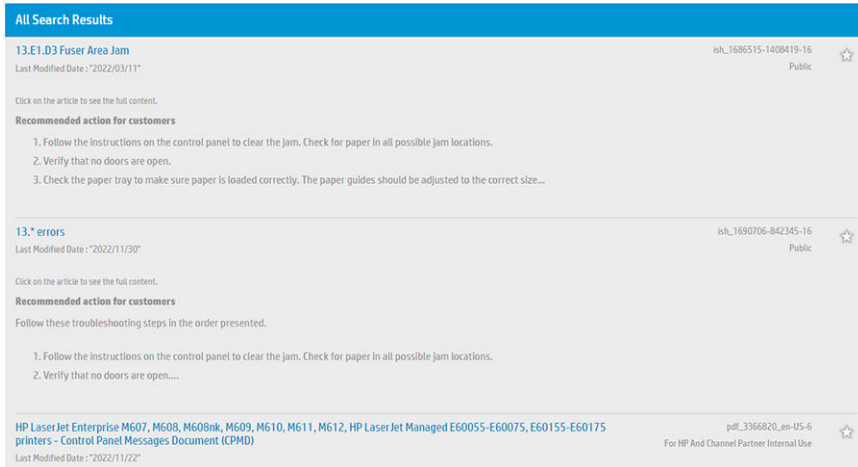
3. Type the error code (for example, 13.E1.D3) in the **Search** keyword field, and then select the search icon.

**Figure 4-175 WISE Search**



4. The error code troubleshooting content displays in the **All Search Results** area.

Figure 4-176 WISE Search results



### Method 3: Search for error codes using the Product Detail Page

Use the WISE Product Detail Page (PDP) to find error code troubleshooting procedures using the following steps.

1. On the WISE home page, enter a printer model number (for example, M606) in the **Go to a Product Detail page** dialog box.


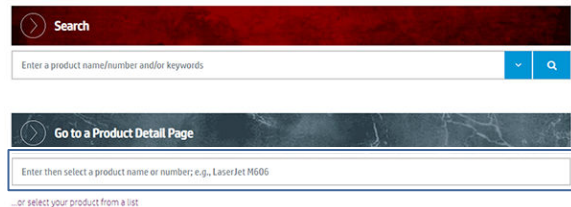
 **TIP:** To find a PDP from a list of products by product type, select the **...or select your product from a list** item just below the dialog box.

Figure 4-177 WISE PDP dialog box



2. A drop-down list appears. Click on the full printer series name (for example, HP LaserJet Enterprise M606 series) in the list.


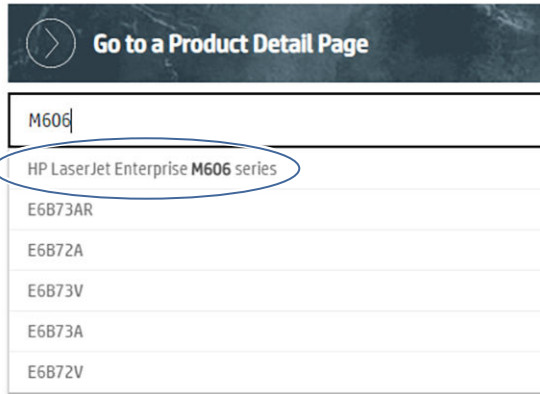
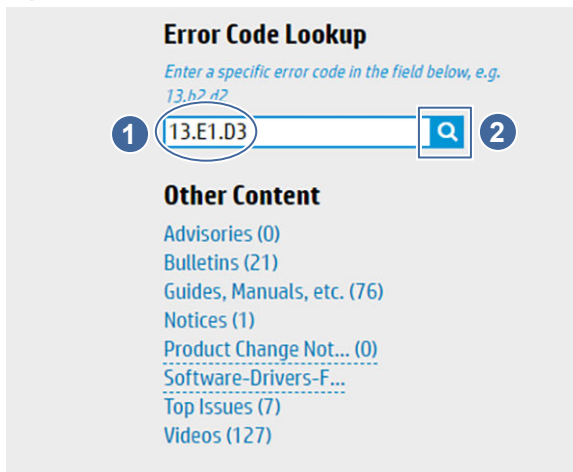
 **NOTE:** Selecting the **series** item from the drop-down list is recommended for the most accurate search return.

Figure 4-178 WISE PDP drop-down list



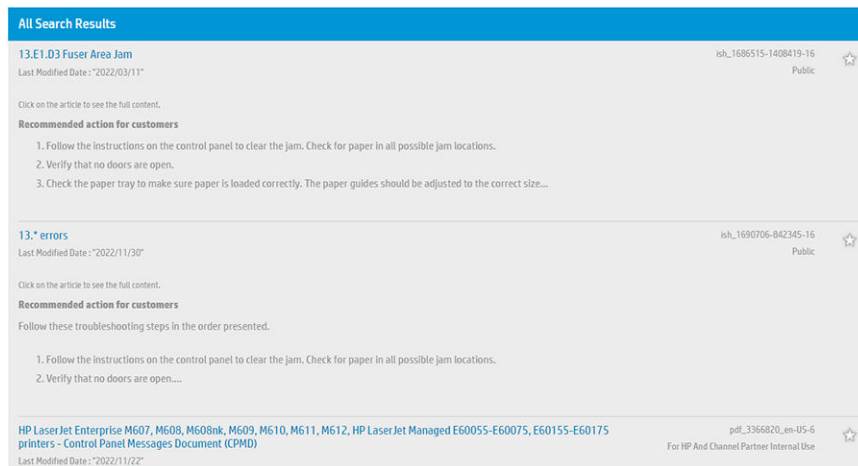
3. Type the error code (for example, 13.E1.D3) in the **Error Code Lookup** field, and then select the search icon.

Figure 4-179 WISE PDP search



4. The error code troubleshooting content displays in the **All Search Results** area.


Figure 4-180 WISE PDP search results





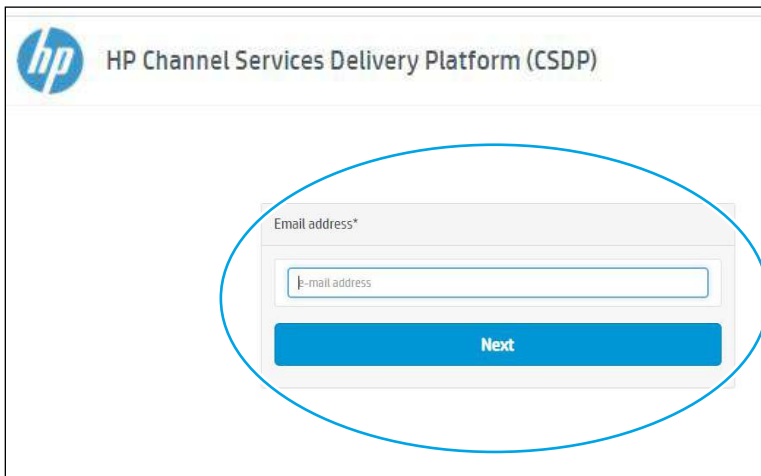
## Accessing WISE for HP channel partners (CSDP)

Learn how to access WISE by accessing the HP Channel Services Delivery Platform (CSDP) if you are an HP Channel Partner.

 **IMPORTANT:** A Partner Admin must request access, via the CSDP portal, to create a new user before you can sign into the CSDP portal.

1. Sign-in to the CSDP portal (click [csdp.hp.com](https://csdp.hp.com) to access the sign-in page).

Figure 4-181 CSDP sign-in page



2. On the CSDP home page, click the **Knowledge and Training** item.


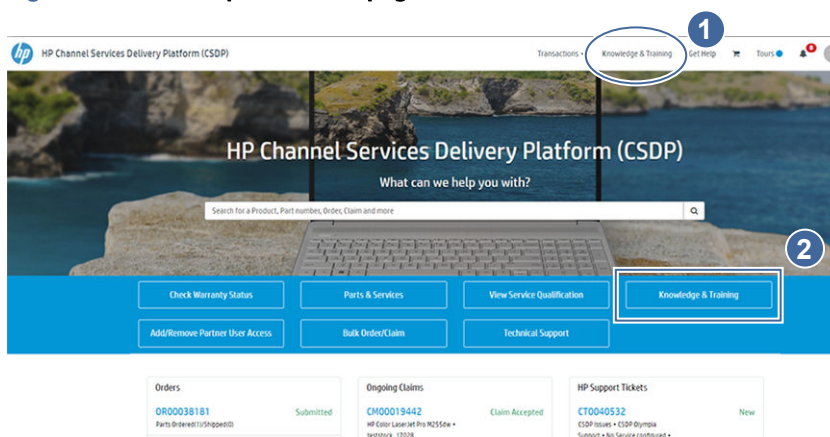
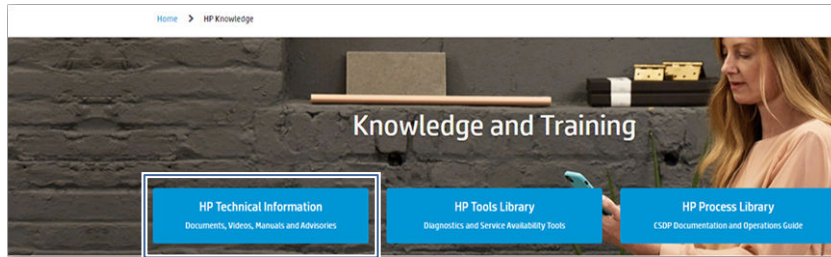
 **TIP:** Use the **Knowledge and Training** item at the top of the CSDP home page (callout 1), or the **Knowledge and Training** action icon (callout 2).

Figure 4-182 CSDP portal home page



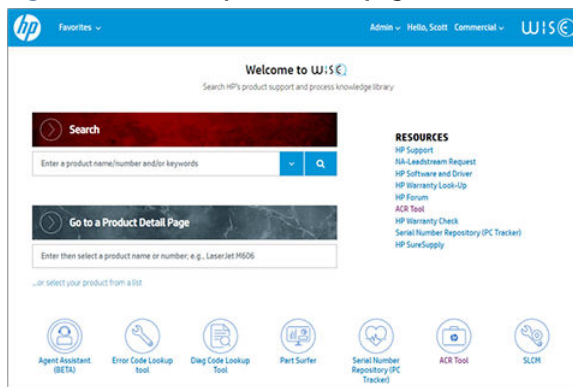
3. Select **HP Technical Documentation** on the **Knowledge and Training** page to open the WISE portal home page.

**Figure 4-183 CSDP portal HP Knowledge and Training page**



4. Use the WISE portal to search for printer information.

**Figure 4-184 WISE portal home page**



## Accessing WISE for HP channel partners (HP Partner Portal)

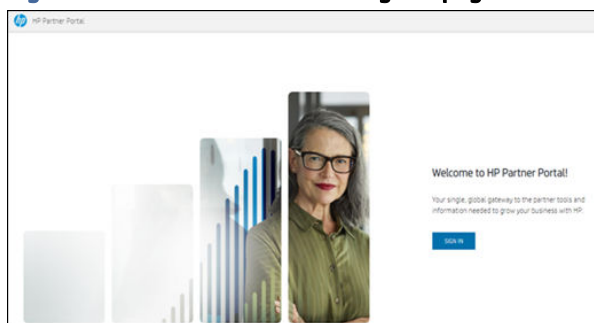
Learn how to access WISE by accessing the HP Partner Portal if you are an HP Channel Partner.

**NOTE:** If this is your first visit to the HP Partner Portal, you will be asked to create an account. Follow the setup directions using your HP Partner credentials.

[View a video of how to access WISE for HP channel partners](#)

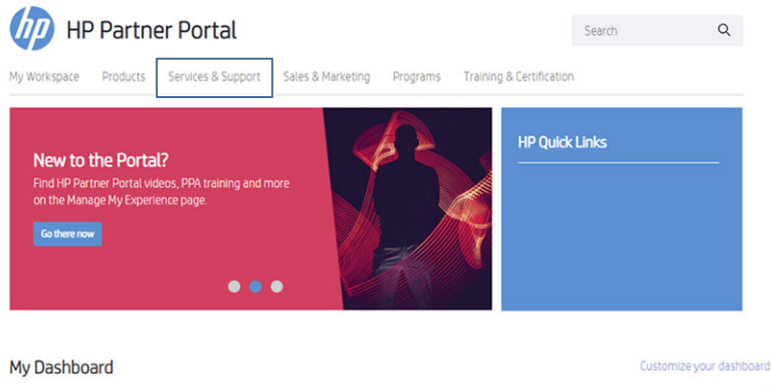
1. Sign-in to the HP Partner Portal (click <https://partner.hp.com> to access the sign-in page).

**Figure 4-185 HP Partner Portal sign-in page**



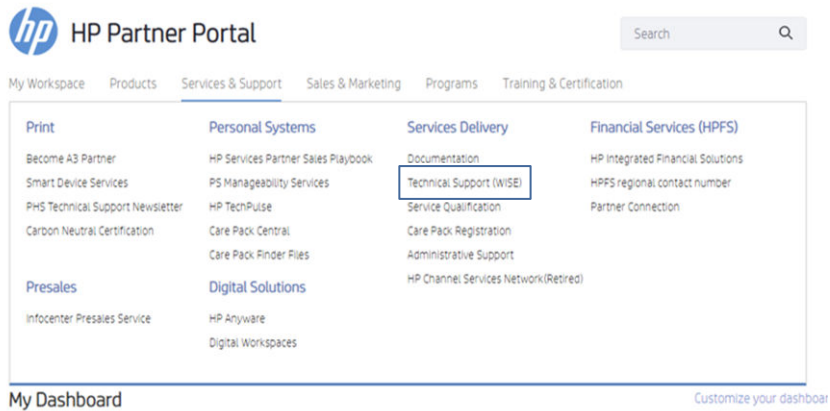
2. On the HP Partner Portal home page, click the **Services & Support** item.

**Figure 4-186 HP Partner Portal home page**



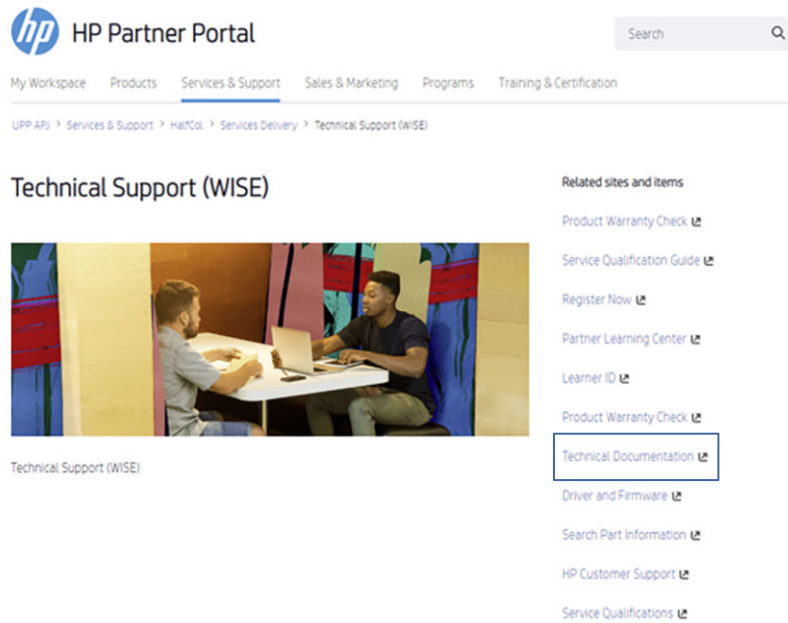
3. Select the **Technical Support (WISE)** item.

**Figure 4-187 HP Partner Portal Service & Support page**



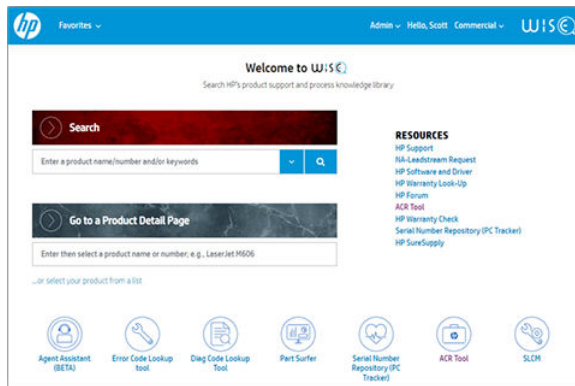
4. Select the **Technical Documentation** item.

**Figure 4-188 HP Partner Portal Technical Support (WISE)page**



5. Use the WISE portal to search for printer information.

**Figure 4-189 WISE portal home page**



## Error-code and control-panel-message troubleshooting overview

This section provides information on error codes and searching for information.

### Error codes (types and structure)

Error codes and control-panel messages display on the printer control panel to indicate the current printer status or situations that might require action. Error codes are numerical, or alphanumeric, and have a set structure with six characters (example: 13.WX.YZ).

- The first two characters are numeric and represent the system component that is causing the error. For example, in error code 10.22.15, **10 = Supplies** for HP LaserJets.
- The remaining four characters (W, X, Y, and Z values) further define the error.

HP LaserJet and HP PageWide Enterprise error codes are documented in the control panel message document (CPMD) for each printer.

The CPMD is a comprehensive list of error codes, diagnostic and troubleshooting steps to clear or resolve the error, and other helpful information such as service mode pins and part numbers.

The CPMD is continually updated and republished with the latest information for the following error codes.

**Table 4-24 ERROR CODES: The first two characters**

Error code	System Component	System Error Description
10.WX.YZ	Supplies (LaserJet)	Supply error or supply memory error.
11.WX.YZ	Real-time clock	Internal error with the clock on the formatter.
13.WX.YZ	Jam (LaserJet)	Paper jam or open door jam error.
15.WX.YZ	Jam (PageWide)	Paper jam or open door jam error.
17.WX.YZ	Supplies (PageWide)	Supply error or supply memory error.
20.WX.YZ	Printer memory	Insufficient memory or buffering error.
21.WX.YZ	Page	Page complexity causing a decompression error when trying to process job.
30.WX.YZ	Scanner	Flatbed scanner error occurring inside the unit.
31.WX.YZ	Document feeder	Document feeder, scanner, or jam error.
32.WX.YZ	Backup, restore, or reset	Backup, restore, or reset notification or error.
33.WX.YZ	Security	Backup, Disk, EFI BIOS, Firmware integrity (SureStart), or Trusted Platform Module (TPM) notification or error.
40.WX.YZ	Input/Output (I/O)	Partition manager, secure erase, or USB accessory error.
41.WX.YZ	Fuser, Laser scanner, or Paper path	Miscellaneous error including general and misprint or mismatch errors typically involving (but not limited to) the fuser, the laser scanner, or the paper path.
42.WX.YZ	Firmware	Firmware failure involving the Event Log, Shell, System Manager, or other component.
44.WX.YZ	Firmware	Firmware failure involving a digital sending component.
45.WX.YZ	OXPd/Web Kit (PageWide)	Informational notifications involving the OXPd Web Kit (communications log).
46.WX.YZ	Engine (LaserJet)	Engine communication error.
47.WX.YZ	Firmware	Job parser or printer calibration error.
48.WX.YZ	Firmware	PJA job accounting, job management, or job pipeline error.
49.WX.YZ	Firmware	Firmware communication error.
50.WX.YZ	Fuser (LaserJet)	Fuser error.
51.WX.YZ	Laser scanner (LaserJet)	Laser scanner beam error.
52.WX.YZ	Laser scanner (LaserJet)	Laser scanner startup error.

**Table 4-24 ERROR CODES: The first two characters (continued)**

Error code	System Component	System Error Description
54.WX.YZ	Sensor	Sensor error (not jam related).
55.WX.YZ	DC controller (LaserJet)	DC controller communication error.
56.WX.YZ	Paper handling (LaserJet)	Paper input/output or accessory error.
57.WX.YZ	Fan	Fan error.
58.WX.YZ	Sensor	Engine sensor failure.
59.WX.YZ	Motor (LaserJet)	Motor error.
60.WX.YZ	Tray motor error (LaserJet)	Tray lifting or pick up error.
61.WX.YZ	Engine (PageWide)	Print engine error with the 8-bit data package.
62.WX.YZ	System (LaserJet) Print bar (PageWide)	LaserJet internal system error. PageWide print system error.
63.WX.YZ	Engine (LaserJet)	General engine error (electrical, communication, etc.).
65.WX.YZ	Connector	Output accessory connection error.
66.WX.YZ	Output accessory	Output accessory error.
67.WX.YZ	Input accessory	Input accessory connection error
69.WX.YZ	Duplexer	Duplexer error.
70.WX.YZ	DC controller (LaserJet)	DC controller firmware error.
76.WX.YZ	DC controller (LaserJet)	Power supply fluctuations causes formatter and DC controller communication issue and results them not to be in synchronization.
80.WX.YZ	Managed device	Embedded Jetdirect error.
81.WX.YZ	Near Field Communication (NFC)	Wireless, Bluetooth or internal EIO error.
82.WX.YZ	Memory (hard disk, EMMC, etc.)	Disk hardware error.
90.WX.YZ	Internal diagnostics	Internal test of systems (i.e. disk, CPB, display) or interconnection error.
98.WX.YZ	Hard disk	Hard disk partition error.
99.WX.YZ	Firmware installer	Remote Firmware Upgrade (RFU), firmware install (engine or accessory), or disk error.

## Solve paper handling problems

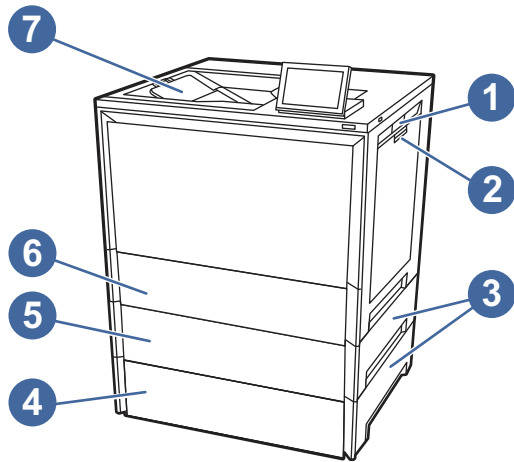
Review the following information to solve paper handling problems.

### Clear paper jams (SFP models)

Use the procedures in this section to clear jammed paper from the printer paper path.

## Paper jam locations

Jams can occur in these locations.



Item	Description
1	Right door and fuser area
2	Tray 1 (multipurpose tray)
3	Tray jam access doors
4	Optional Tray 4
5	Optional Tray 3
6	Tray 2
7	Output bin

## Auto-navigation for clearing paper jams

Learn about printer jam clearing auto-navigation.

The auto-navigation feature assists in clearing jams by providing step-by-step instructions on the control panel.

When you complete a step, the printer displays instructions for the next step until you have completed all steps in the procedure.

## Experiencing frequent or recurring paper jams?

To reduce the number of paper jams, try these solutions.



[View a video that demonstrates how to load paper in a way that reduces the number of paper jams](#)

1. Use only paper that meets HP specifications for this printer.
2. Use paper that is not wrinkled, folded, or damaged. If necessary, use paper from a different package.
3. Use paper that has not previously been printed or copied on.
4. Make sure the tray is not overfilled. If it is, remove the entire stack of paper from the tray, straighten the stack, and then return some of the paper to the tray.

5. Make sure the paper guides in the tray are adjusted correctly for the size of paper. Adjust the guides so they are touching the paper stack without bending it.
6. Make sure that the tray is fully inserted in the printer.
7. If you are printing on heavy, embossed, or perforated paper, use the manual feed feature and feed sheets one at a time.
8. Open the **Trays** menu on the printer control panel. Verify that the tray is configured correctly for the paper type and size.
9. Make sure the printing environment is within recommended specifications.

### 13.B2.D1 jam error in Tray 1 (multipurpose tray)

Use the following procedure to clear paper jams in Tray 1 (multipurpose tray). When a jam occurs, the control panel displays an animation that assists in clearing the jam.

#### Recommended action for customers

When a jam occurs, the control panel displays a message and an animation that assists in clearing the jam.

- **13.B2.D1 Jam in tray 1**

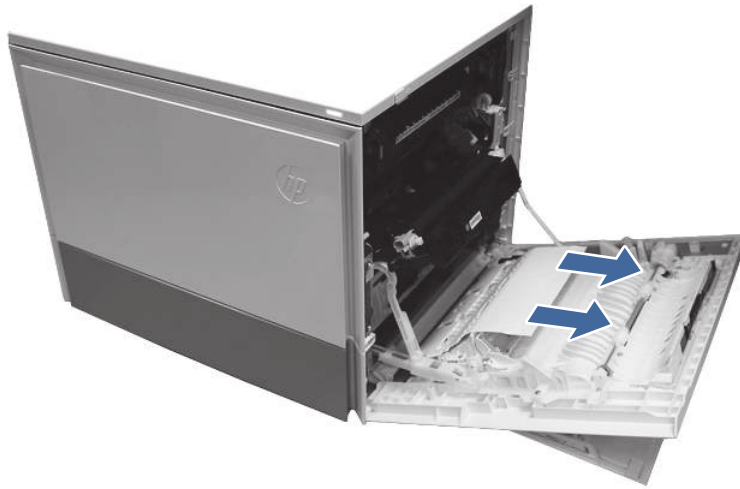
 [View a video of how to clear a jam in Tray 1](#)

1. If you can see the jammed sheet in Tray 1, remove the jammed sheet by gently pulling it straight out.

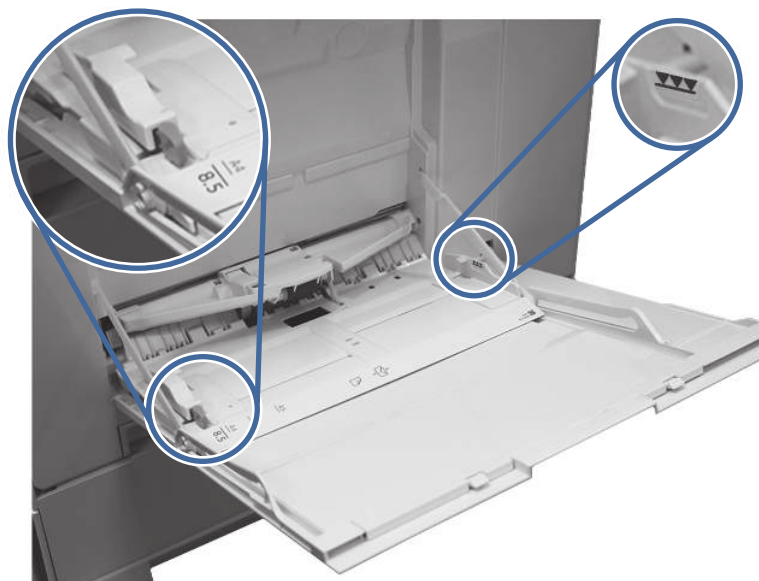




2. Open the right door and remove paper from the area shown.



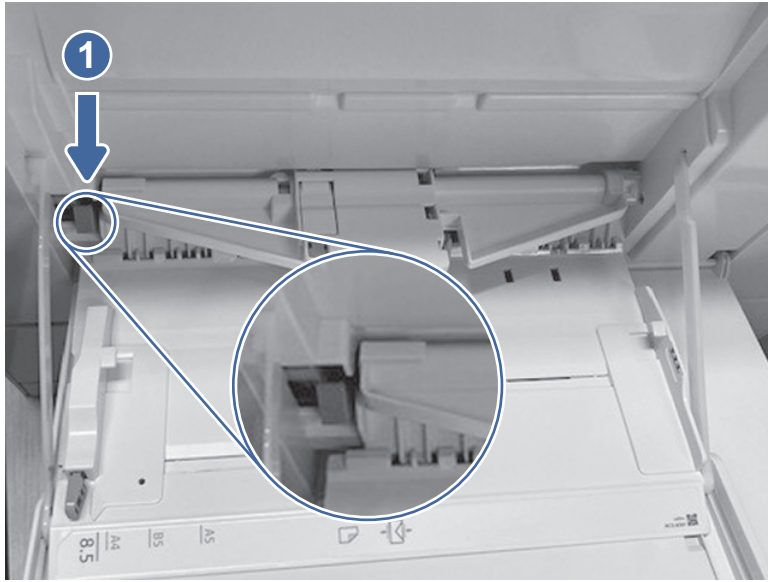
3. Close the right to allow the printer to clear the message.
4. Make sure the type and quality of the paper being used meets the HP specifications for the printer.
5. Make sure the Tray 1 guides are set to the correct paper size and that the paper tray is not overfilled (paper is below the 3 triangles on the right guide).



6. Load the paper back into the tray and restart the print job.
7. If the same jam appears remove and clean the tray 1 pick, feed and separation rollers.

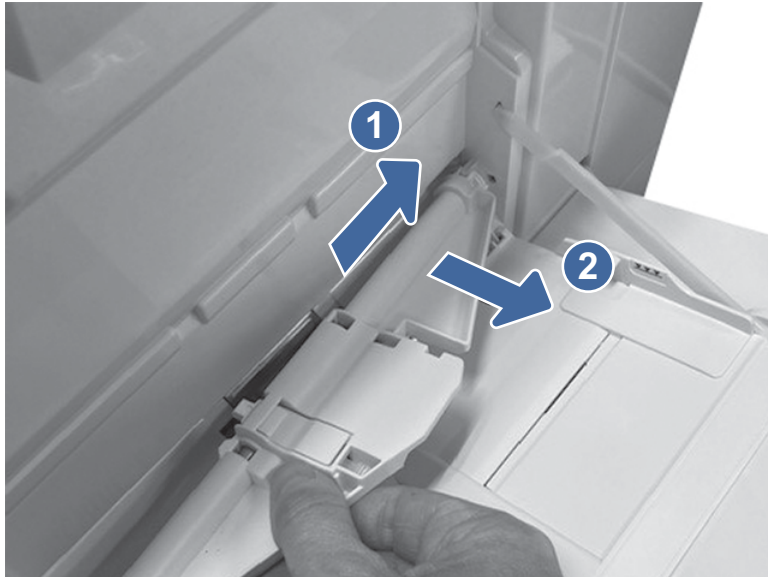
- a. Locate and release the pickup roller assembly release tab.

**Figure 4-190** Locate the pickup roller assembly tab



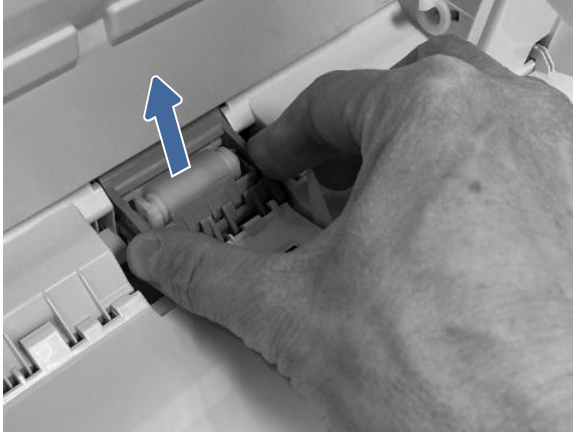
- b. Push the pickup roller assembly to the right and then away from the printer.

**Figure 4-191** Remove the pickup roller assembly



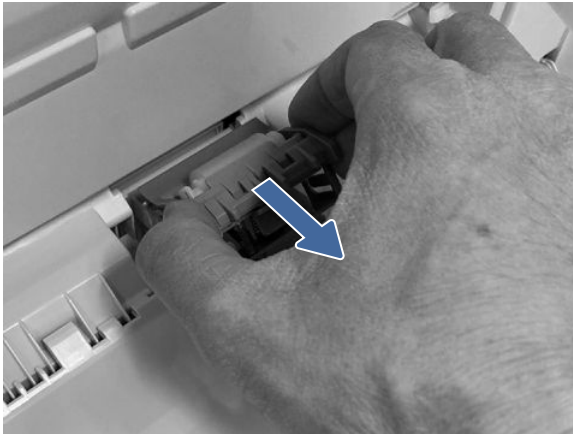
- c. Grasp the left- and right-side of the separation roller assembly, and then lift the assembly up.

**Figure 4-192 Lift the separation roller assembly**



- d. Pull the separation roller assembly straight out to remove it.

**Figure 4-193 Remove the separation roller assembly**



- e. Clean the roller with a dampened lint free cloth.
  - f. Install the rollers back into tray one and test the tray by printing from tray 1.
8. If the error persists, contact your HP-authorized service or support provider, or contact customer support at [www.hp.com/go/contactHP](http://www.hp.com/go/contactHP).

### 13.B2.D2 jam error in Tray 2

Use the following procedure to check for paper in all possible jam locations related to Tray 2. When a jam occurs, the control panel displays an animation that assists in clearing the jam.

#### Recommended action for customers

When a jam occurs, the control panel displays a message and an animation that assists in clearing the jam.

- 13.B2.D2 Paper jam in tray 2

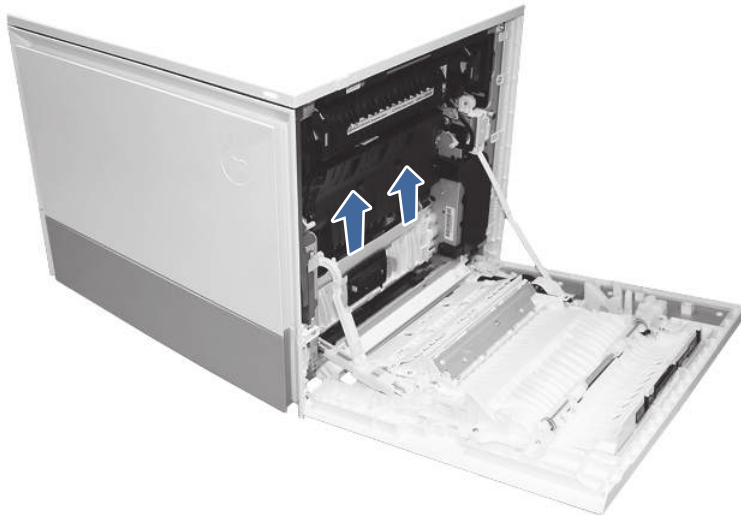


[View a video of how to clear a jam in Tray 2](#)

1. Open the right door.



2. Gently remove any jammed paper.



3. Close the right door to clear the control panel message.

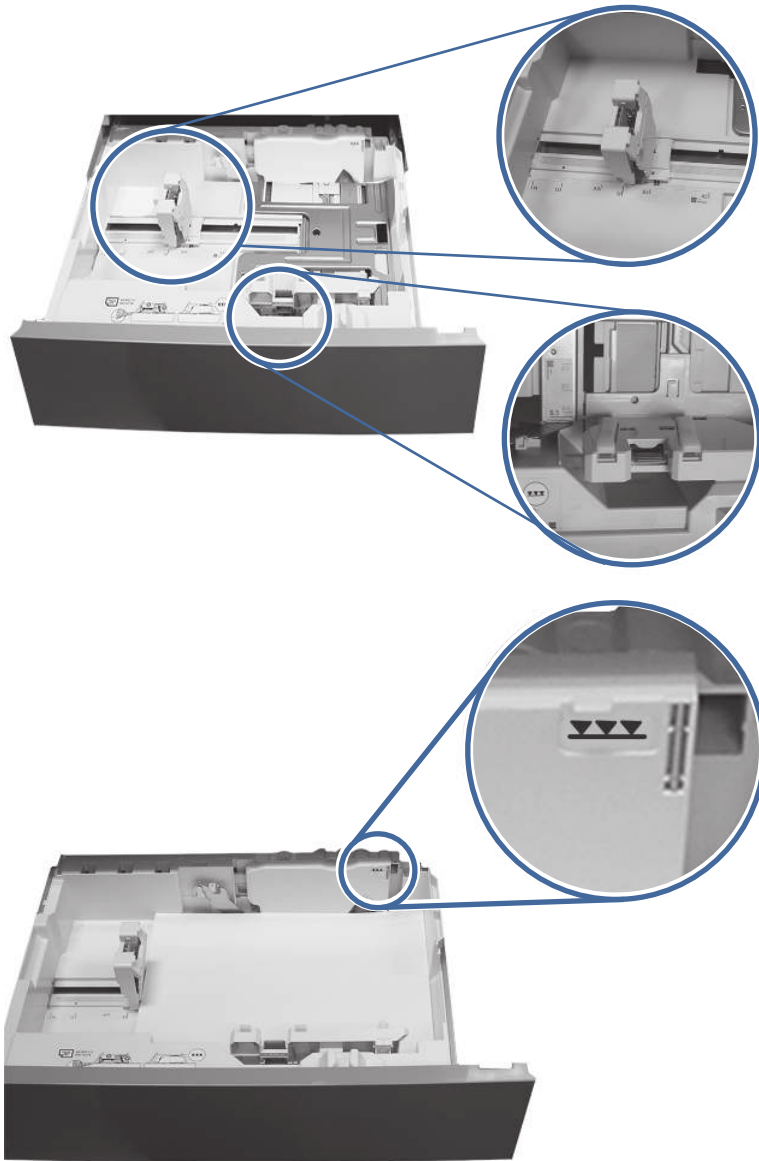
4. Open Tray 2.



5. Remove the paper from the tray and discard any bent, curled, or damaged sheets.



6. Make sure that the tray width and length guides are set to the correct paper size for the paper being installed into the tray and that the tray is not over filled above the fill mark (line below 3 triangles on rear guide).

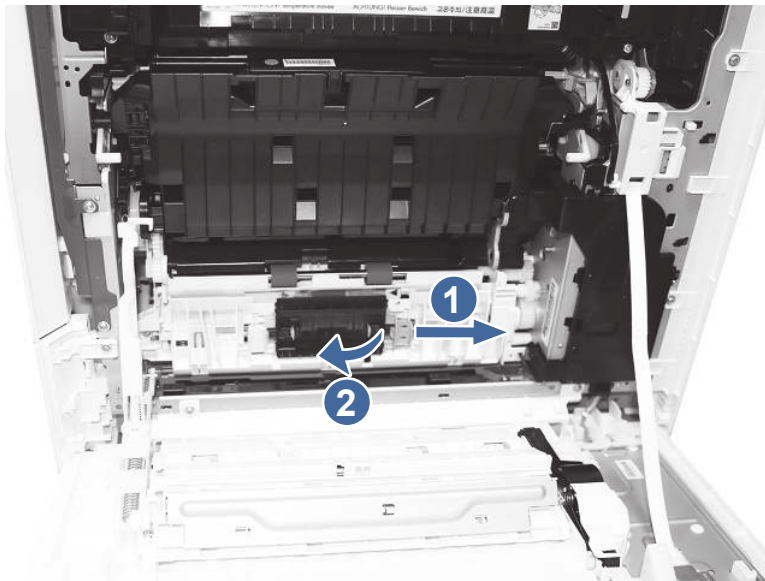


7. Ensure the type and quality of the paper being used meets the HP specifications for the printer.
8. If the error persists, clean the Tray 2 pick, feed, separation rollers.

- a. Open the right door to access the rollers.



- b. Locate and remove the Tray 2 separation roller.




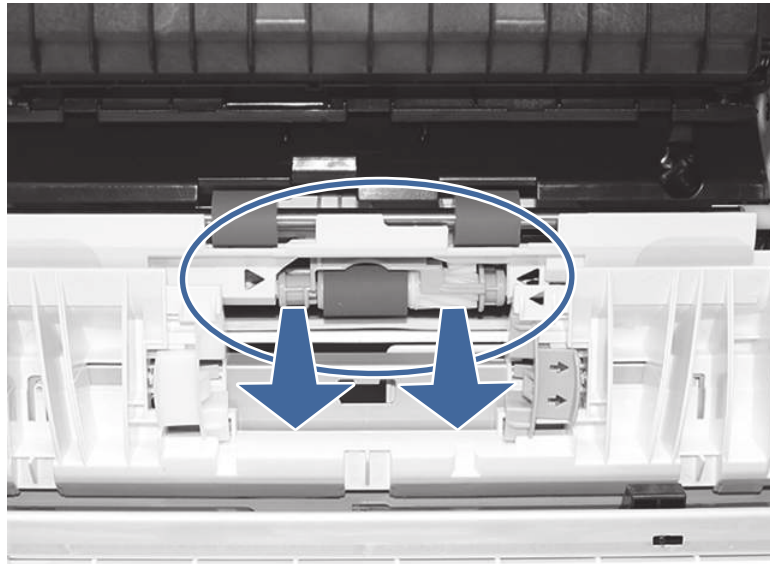
**Call-out 1-** slide blue locking lever

**Call-out 2-** Remove the roller assembly.

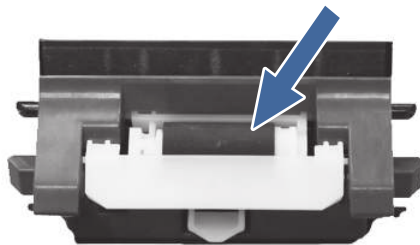
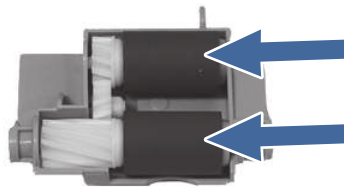
- c. Remove the Tray 2 pick and feed rollers.

To remove the roller assembly, gently pull on the side of the assembly and slide out as shown.

 **NOTE:** Make sure your hands are clean before touching the rollers. Oils or debris from hands can cause paper pickup issues.



- d. Clean the rollers with a dampened lint free cloth.



- e. Reinstall the roller assemblies and close the right door.
  - f. Run a print job from Tray 2.
9. If the error persists, contact your HP-authorized service or support provider, or contact customer support at [www.hp.com/go/contactHP](http://www.hp.com/go/contactHP).

### 13.A3 jam error in Tray 3

Use the following procedure to check for paper in all possible jam locations related to Tray 3. When a jam occurs, the control panel displays an animation that assists in clearing the jam.

#### **Recommended action for customers**

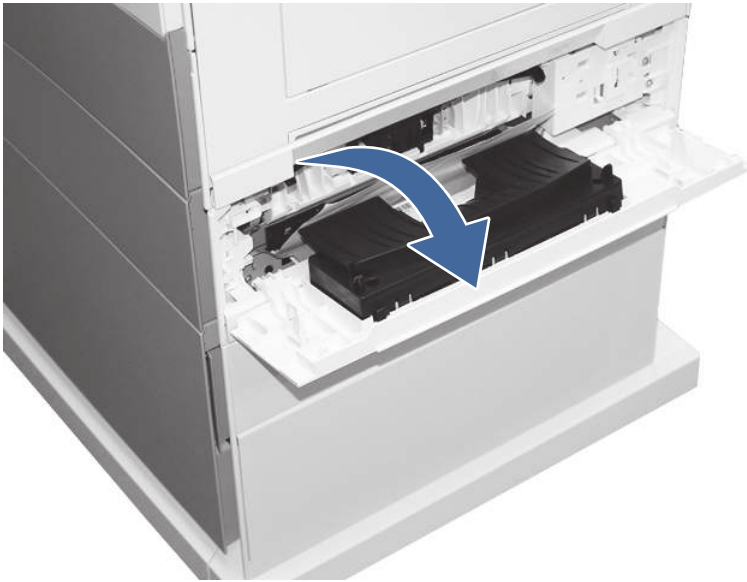
Use the following procedure to check for paper in all possible jam locations related to the 550-sheet trays. When a jam occurs, the control panel displays an animation that assists in clearing the jam.



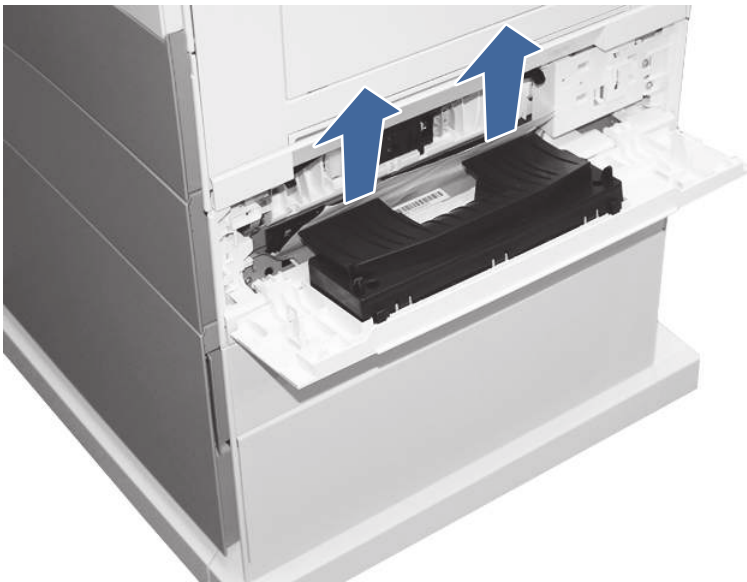
- 13.A3.A3 Jam in tray 3
- 13.A3.D3 Jam in tray 3

 [View a video of how to clear a jam in Tray 3, and the optional trays](#)

1. Open the Tray 3 right side access door.



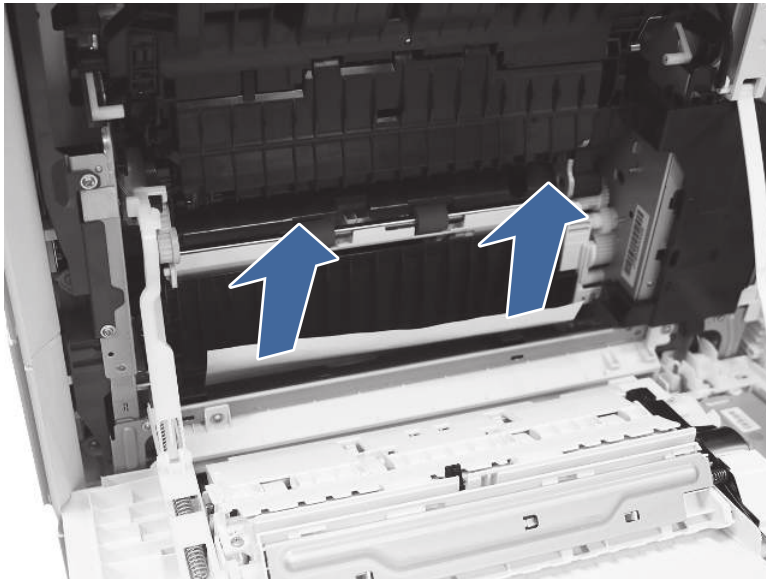
2. Remove any jammed paper found in access area.



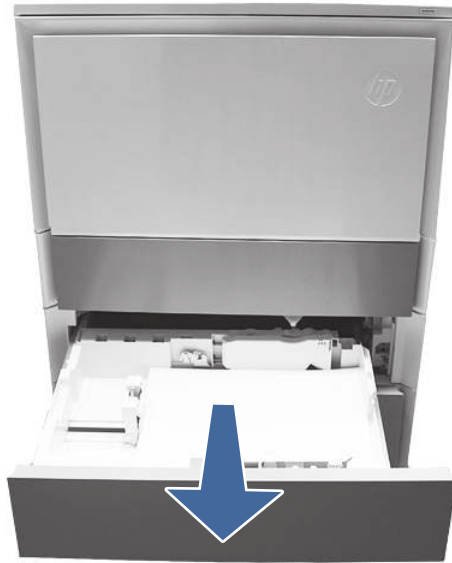
3. Open the right door.



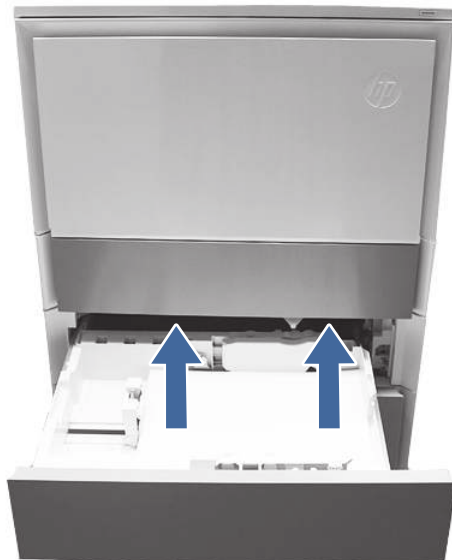
4. Gently remove any jammed paper.



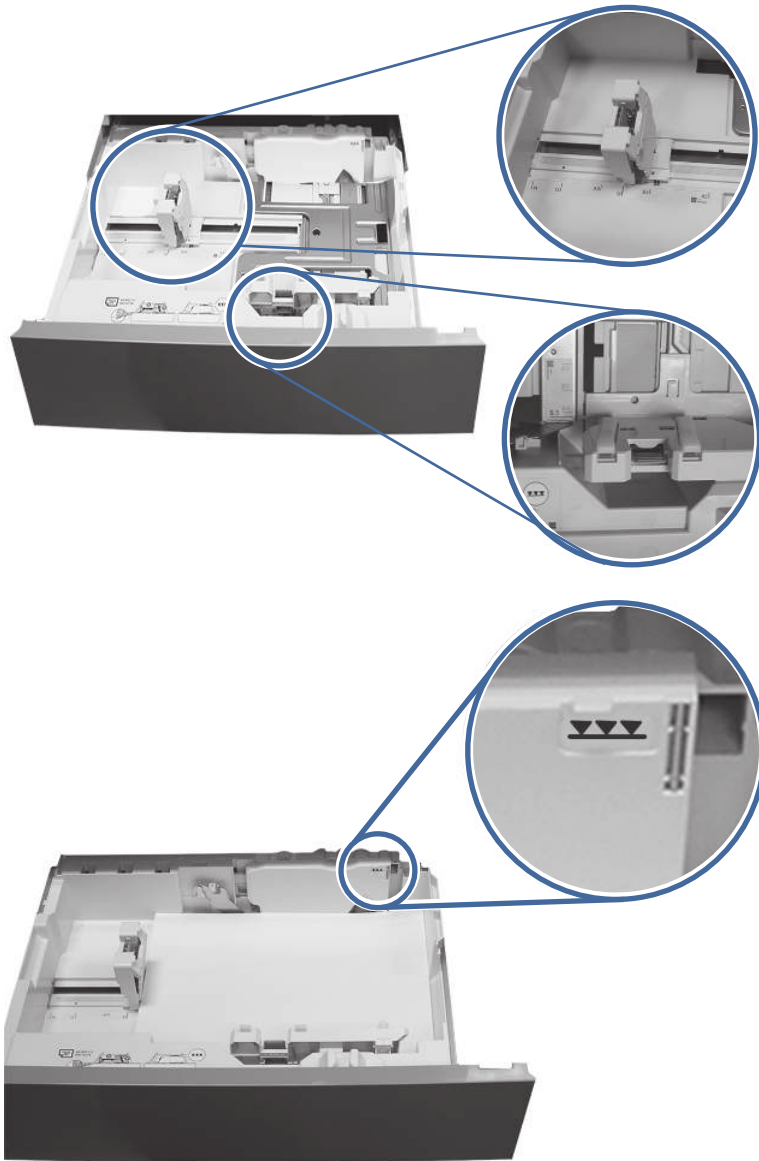
5. Open Tray 3.



6. Remove the paper from the tray and discard any bent, curled, or damaged sheets.

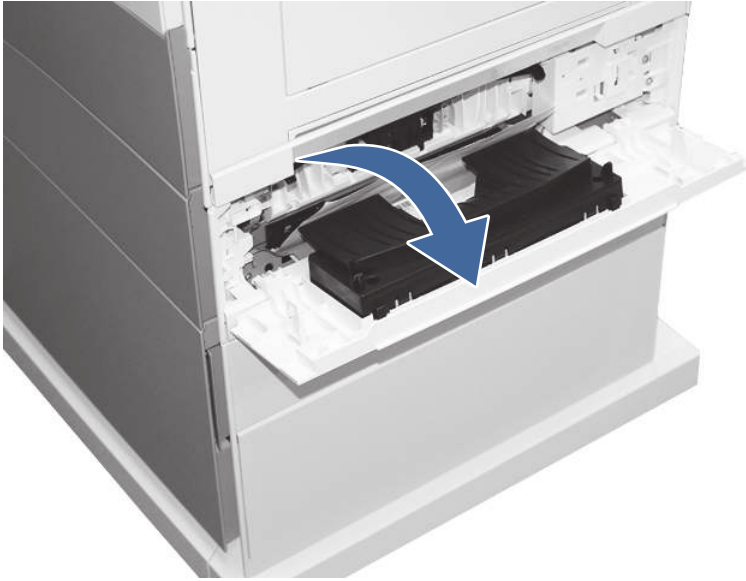


7. Make sure that the tray width and length guides are set to the correct paper size for the paper being installed into the tray and that the tray is not over filled above the fill mark (line below 3 triangles on rear guide).

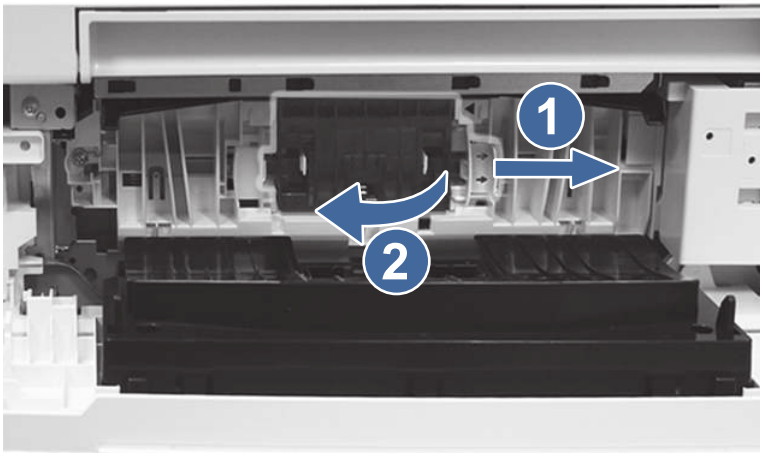


8. Ensure the type and quality of the paper being used meets the HP specifications for the printer.
9. If the error persists, clean the Tray 3 pick, feed, separation rollers.

- a. Open the Tray 3 right door to access the rollers.



- b. Locate and remove the Tray 3 separation roller.



**Call-out 1-** slide blue locking lever

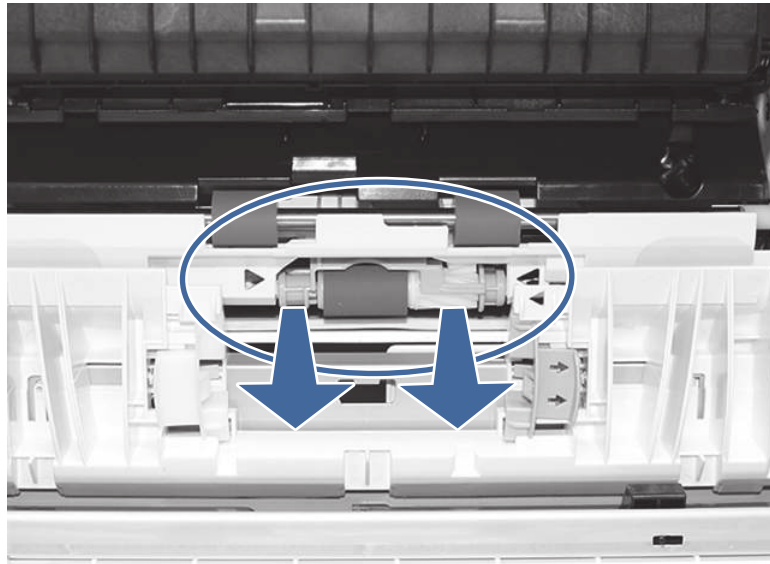
**Call-out 2-** Remove the roller assembly.

- c. Remove the Tray 3 pick and feed rollers.

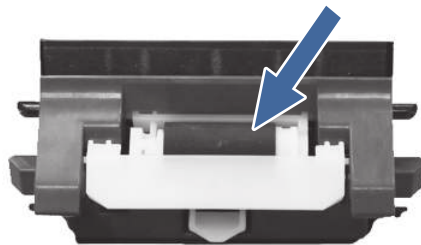
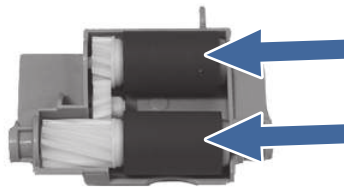
To remove the roller assembly, gently pull on the side of the assembly and slide out as shown.



**NOTE:** Make sure your hands are clean before touching the rollers. Oils or debris from hands can cause paper pickup issues.



- d. Clean the rollers with a dampened lint free cloth.



- e. Reinstall the roller assemblies and close the right door.
  - f. Run a print job from Tray 3.
10. If the error persists, contact your HP-authorized service or support provider, or contact customer support at [www.hp.com/go/contactHP](http://www.hp.com/go/contactHP).

### 13.A4 jam error in Tray 4

Use the following procedure to check for paper in all possible jam locations related to the 550 sheet Tray 4. When a jam occurs, the control panel displays an animation that assists in clearing the jam.

#### **Recommended action for customers**

When a jam occurs, the control panel displays a message and an animation that assists in clearing the jam.

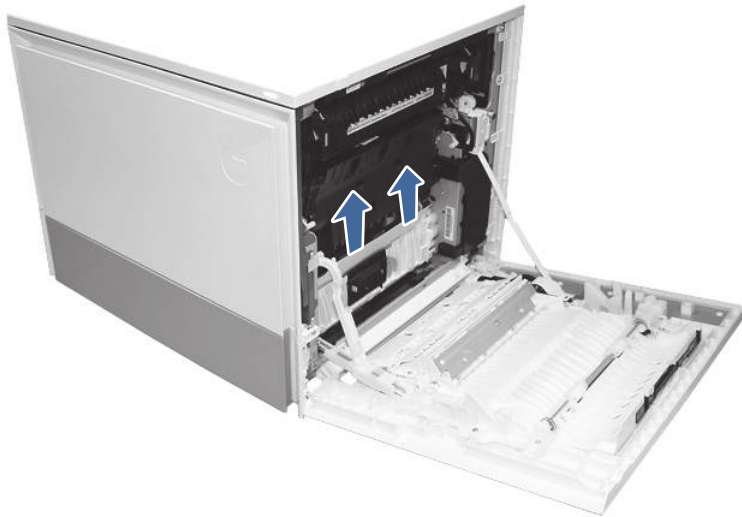
- 13.A4.A4 Paper jam in tray 4
- 13.A4.D4 Paper jam in tray 4

 [View a video of how to clear a jam in Tray 4](#)

1. Open the right door.



2. Gently remove any jammed paper.



3. Open the Tray 4 right access door.

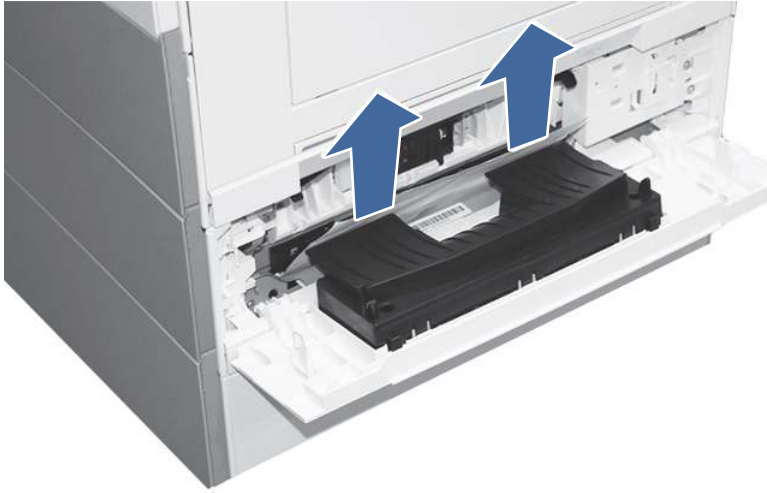


4. Gently remove any jammed paper.

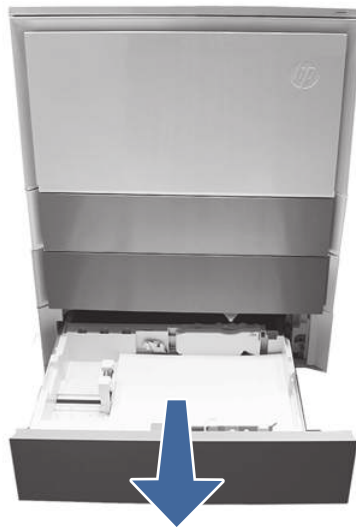




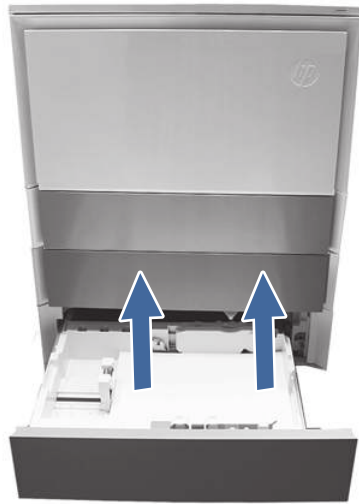
5. Open the Tray 3 access door and gently remove any jammed paper.



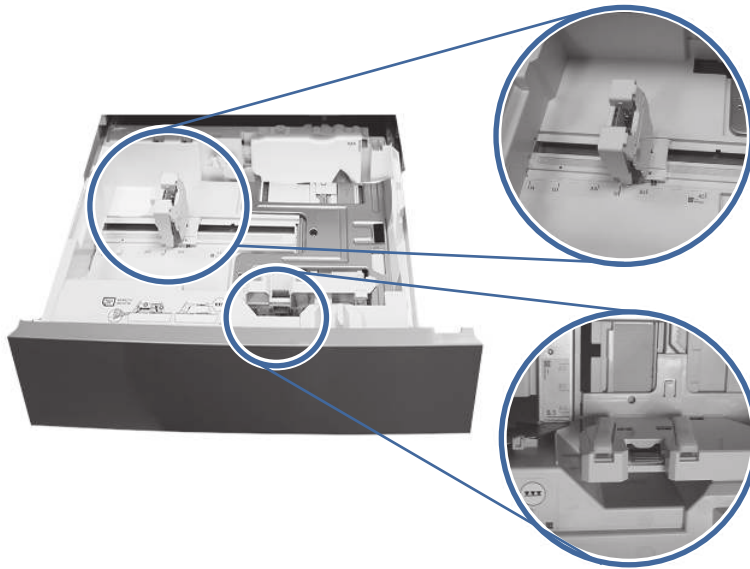
6. Close the right door to clear the control panel message.
7. Open Tray 4.

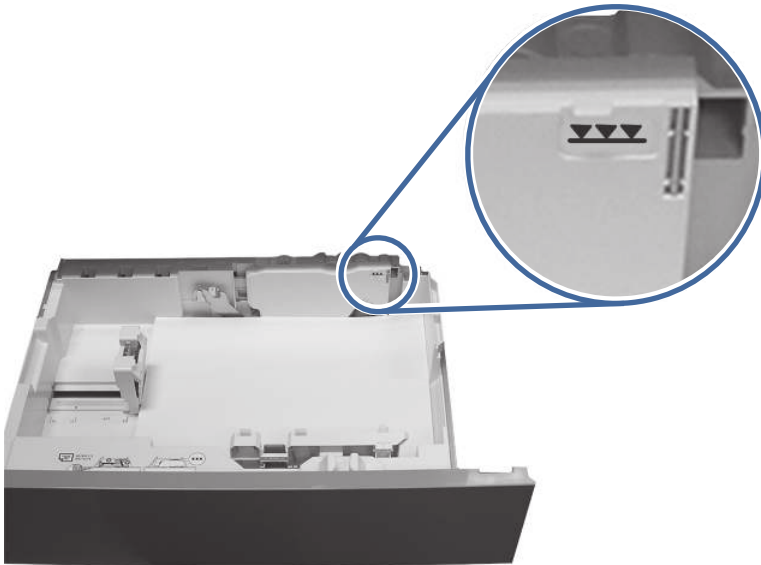


8. Remove the paper from the tray and discard any bent, curled, or damaged sheets.



9. Make sure that the tray width and length guides are set to the correct paper size for the paper being installed into the tray and that the tray is not over filled above the fill mark (line below 3 triangles on rear guide).

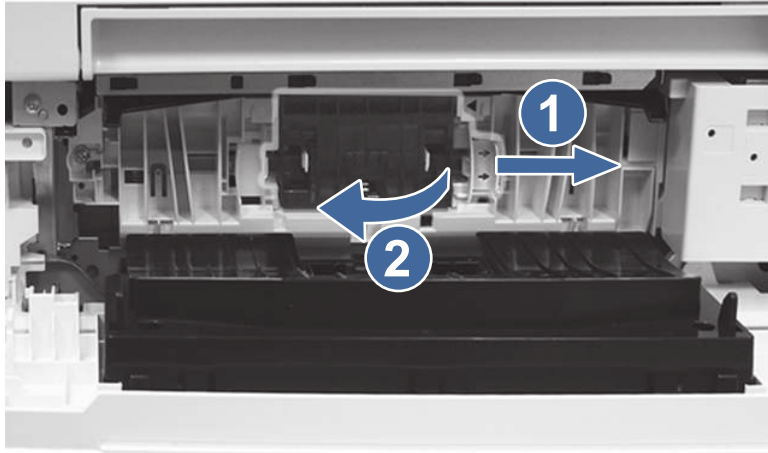




10. Ensure the type and quality of the paper being used meets the HP specifications for the printer.
11. If the error persists, clean the Tray 4 pick, feed, separation rollers.
  - a. Open the Tray 4 door to access the rollers.



- b. Locate and remove the Tray 4 separation roller.




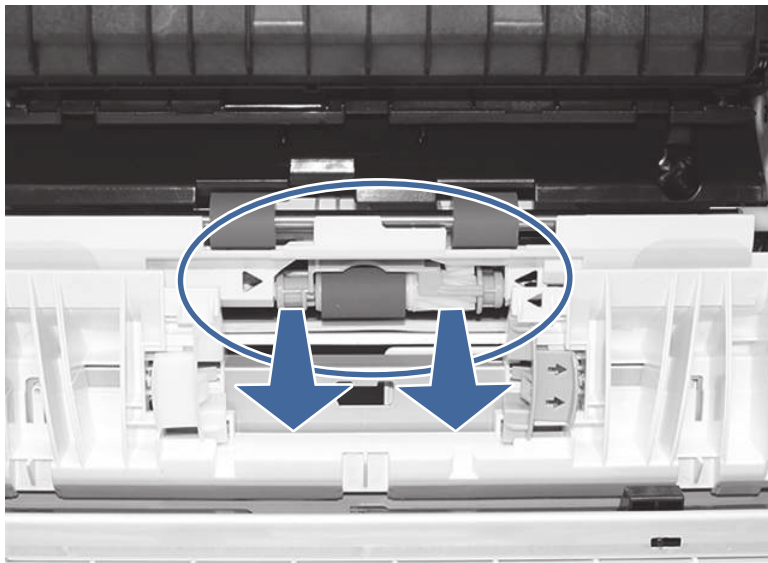
**Call-out 1-** slide blue locking lever

**Call-out 2-** Remove the roller assembly.

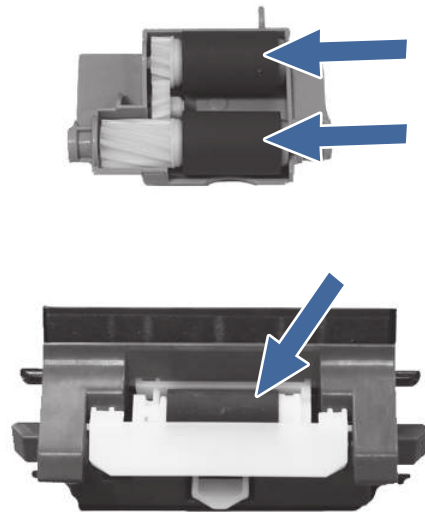
- c. Remove the Tray 4 pick and feed rollers.

To remove the roller assembly, gently pull on to the side of the rollers as shown.

 **NOTE:** Make sure your hands are clean before touching the rollers. Oils or debris from hands can cause paper pickup issues.



- d. Clean the rollers with a dampened lint free cloth.



- e. Reinstall the roller assemblies and close the right door.
- f. Run a print job from Tray 4.

12. If the error persists, contact your HP-authorized service or support provider, or contact customer support at [www.hp.com/go/contactHP](http://www.hp.com/go/contactHP).

### 13.A4 jam error in Tray 4 (2,100 sheet feeder HCI)

Use the following procedure to check for paper in all possible jam locations related to the HCI Tray 4. When a jam occurs, the control panel displays an animation that assists in clearing the jam.

#### Recommended action for customers

When a jam occurs, the control panel displays a message and an animation that assists in clearing the jam.

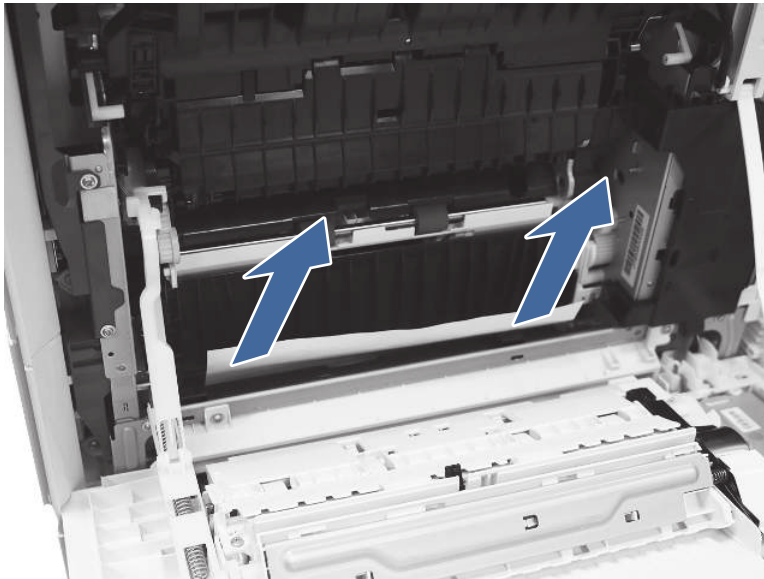
- 13.A4.A4 Paper jam in tray 4
- 13.A4.D4 Paper jam in tray 4

 [View a video of how to clear a jam in the high-capacity input Tray 4](#)

1. Open the printer right door.



2. Gently remove any jammed paper.



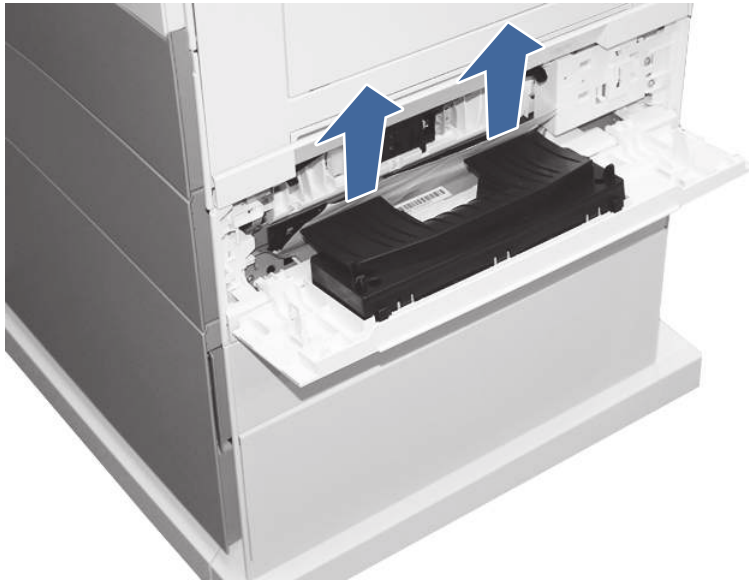
3. Open the Tray 4 right access door.



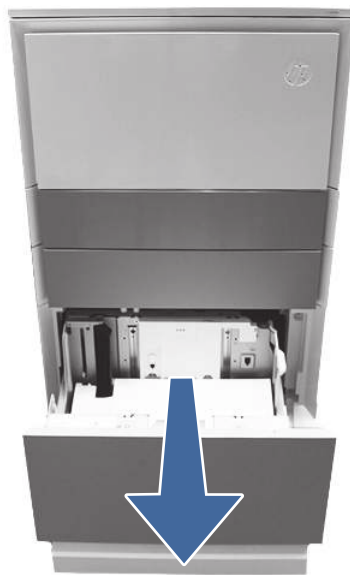
4. Gently remove any jammed paper.



5. Open the Tray 3 access door and gently remove any jammed paper.

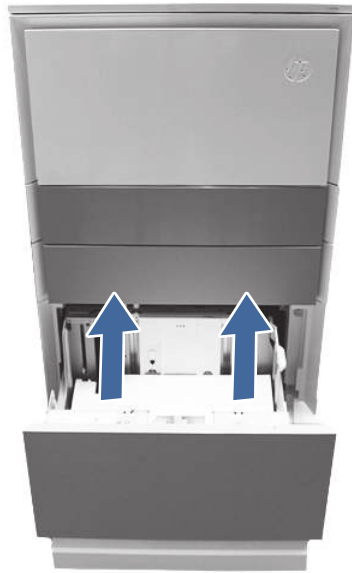


6. Close the right door to clear the control panel message.
7. Open Tray 4.

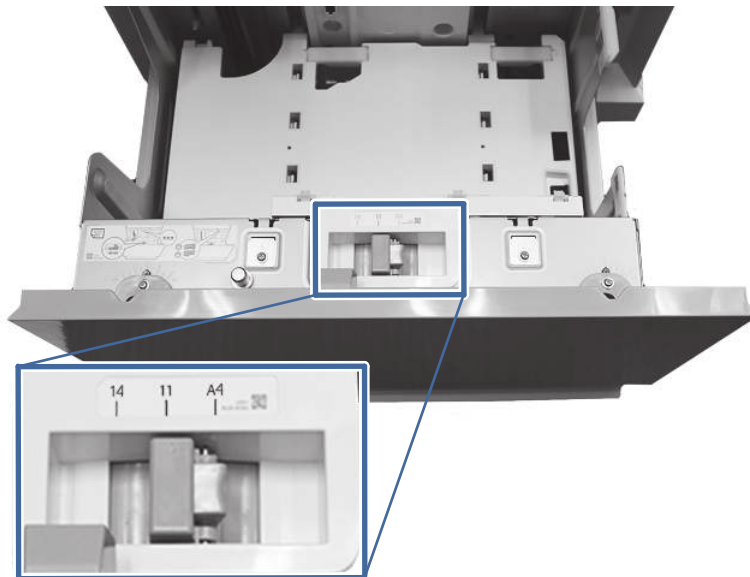


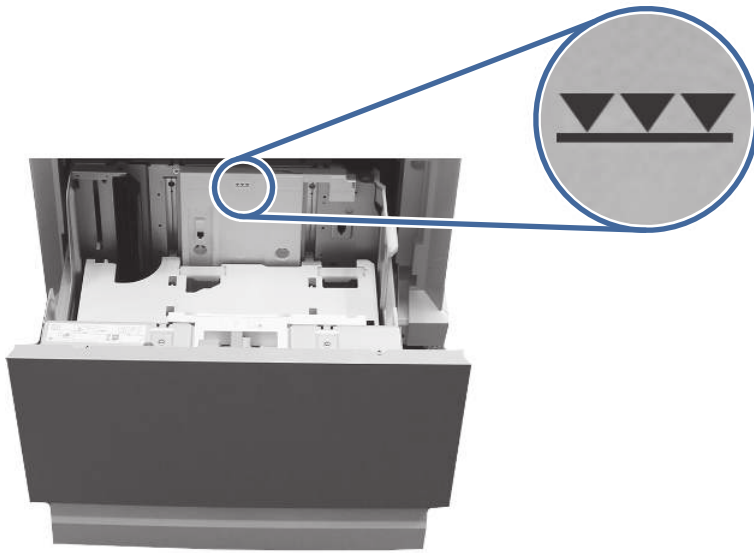


8. Remove the paper from the tray and discard any bent, curled, or damaged sheets.



9. Make sure that the tray width guide is set to the correct paper size for the paper being installed into the tray and that the tray is not over filled above the fill mark (line below 3 triangles on rear guide).

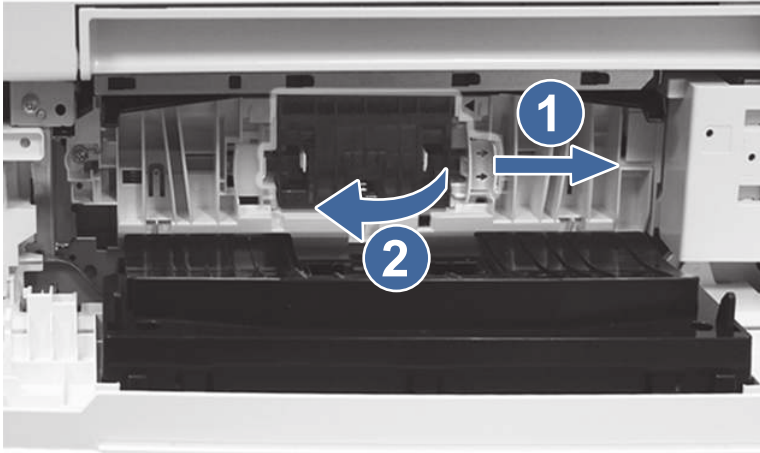




10. Ensure the type and quality of the paper being used meets the HP specifications for the printer.
11. If the error persists, clean the Tray 4 pick, feed, and separation rollers.
  - a. Open the Tray 4 door to access the rollers.



- b. Locate and remove the Tray 4 separation roller.



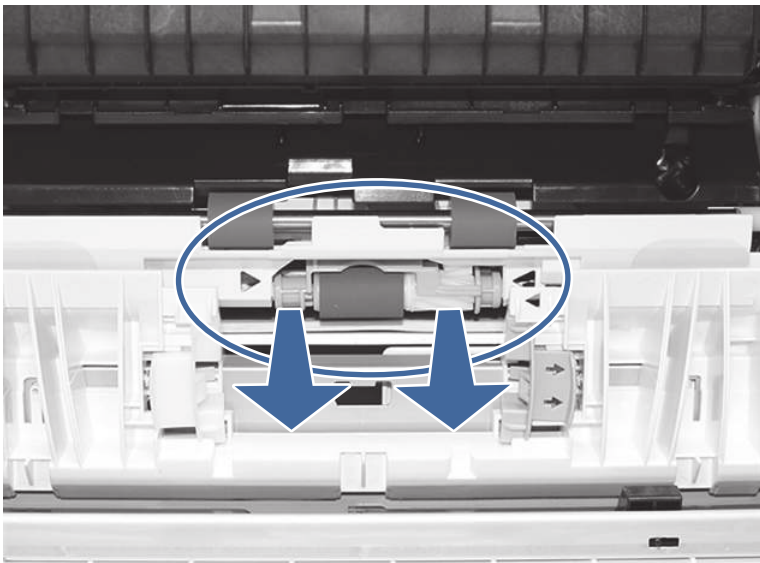
**Call-out 1-** slide locking lever

**Call-out 2-** Remove the roller assembly.

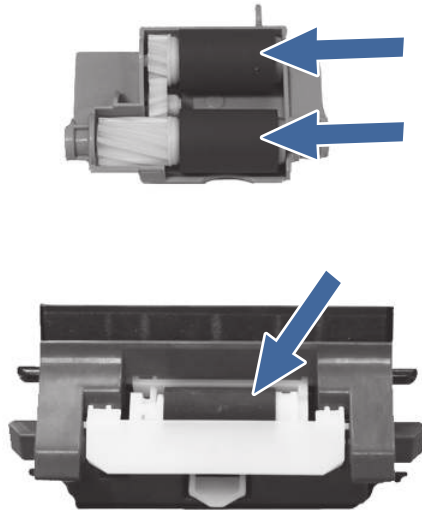
- c. Remove the Tray 4 pick and feed rollers.

To remove the roller assembly, gently pull on to the side of the rollers as shown.

 **NOTE:** Do not touch the rubber part of the rollers with hands. Oils or debris from hands can cause paper pickup issues.



- d. Clean the rollers with a dampened lint free cloth.



- e. Reinstall the roller assemblies and close the right door.
- f. Run a print job from Tray 4.
12. If the error persists, contact your HP-authorized service or support provider, or contact customer support at [www.hp.com/go/contactHP](http://www.hp.com/go/contactHP).

### 13.B2 jam error in right door

Use the following procedure to clear paper jams in the right door and fuser area. When a jam occurs, the control panel displays an animation that assists in clearing the jam.

#### Recommended action for customers

When a jam occurs, the control panel displays a message and an animation that assists in clearing the jam.

- 13.B2.Az Stay jam in right door
- 13.B2.Dz Delay jam in right door
- 13.B2.5z Inappropriate page to the Delivery Path jam
- 13.B2.FF Residual paper jam in right door

z = paper tray. This can be trays 1-5 or "D" for duplex jobs

Or

z = Fuser mode. This can be 0-9 or A-F.



[View a video of how to clear a jam in the right door and fuser area](#)

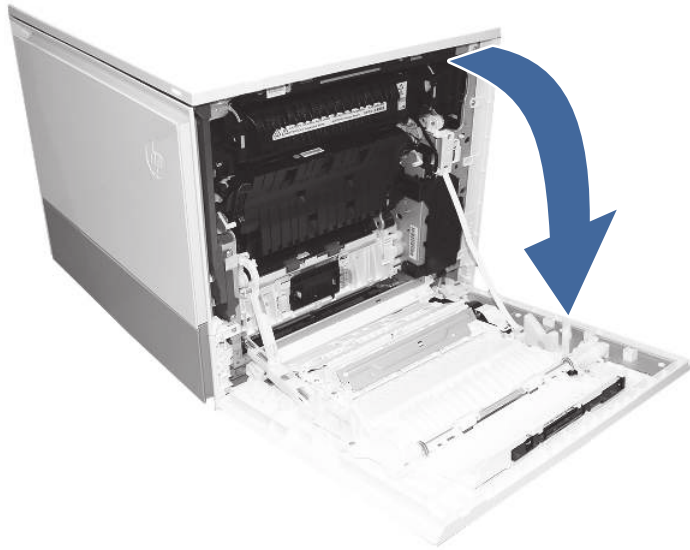


#### CAUTION:

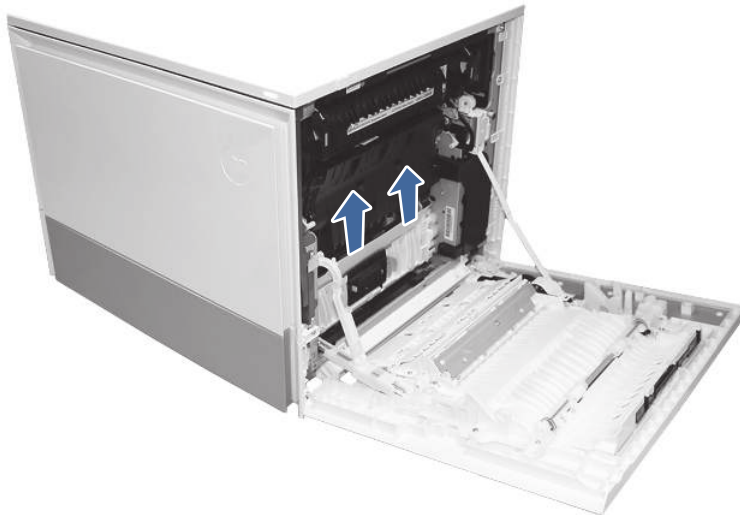


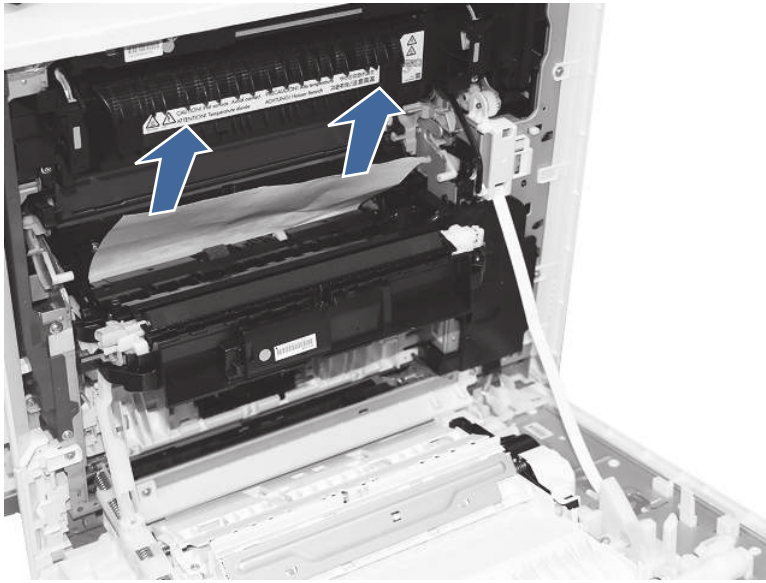
The fuser can be hot while the printer is in use. Wait for the fuser to cool before handling it.

1. Open the right door.

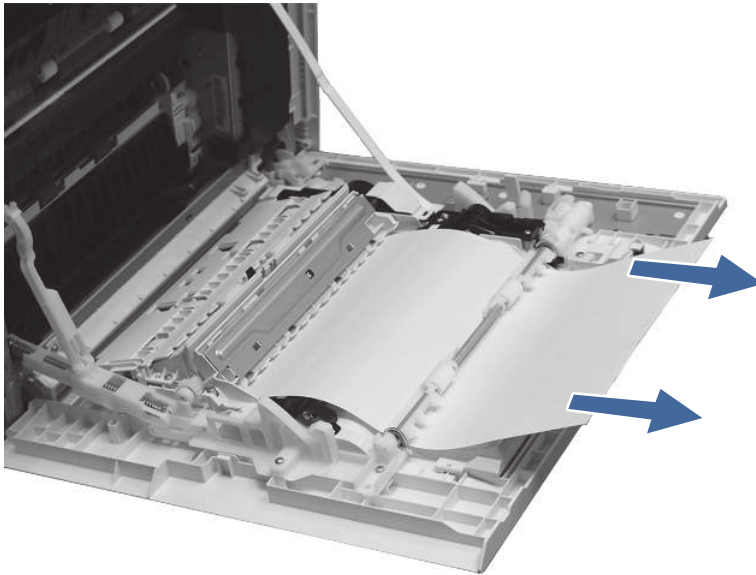


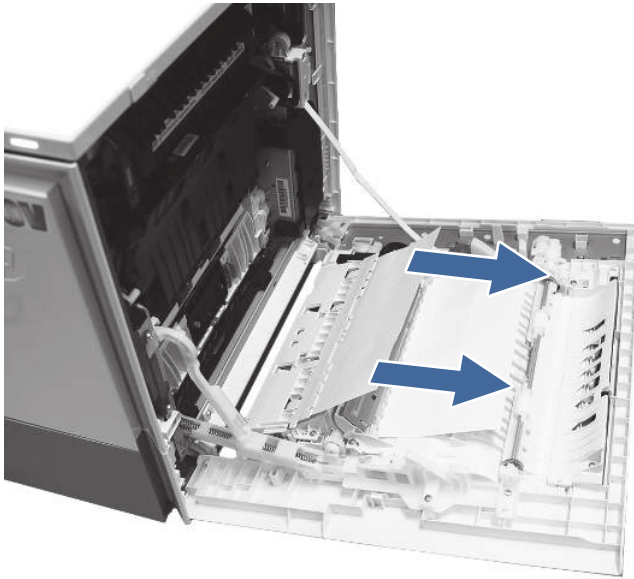
2. Gently remove any jammed paper.






3. Gently remove any jammed paper from the duplexer paper path.





---

 **IMPORTANT:** Make sure the paper being used is not too short for the printer's duplexer requirements.

---

4. Close the right door.
5. Ensure the type and quality of the paper being used meets the HP specifications for the printer.
6. Ensure the paper tray guides are set to the correct size for the paper loaded.
7. If the error persists, contact your HP-authorized service or support provider, or contact customer support at [www.hp.com/go/contactHP](http://www.hp.com/go/contactHP).

### 13.B4 jam errors in the right door

Use the following procedure to clear paper jams in the right door and fuser area. When a jam occurs, the control panel displays an animation that assists in clearing the jam.

#### Recommended action for customers

When a jam occurs, the control panel displays a message and an animation that assists in clearing the jam.

- 13.B4.Cz Jam in right door
- 13.B4.FF Residual paper jam in right door

z = paper tray. This can be trays 1-5 or "D" for duplex print jobs.

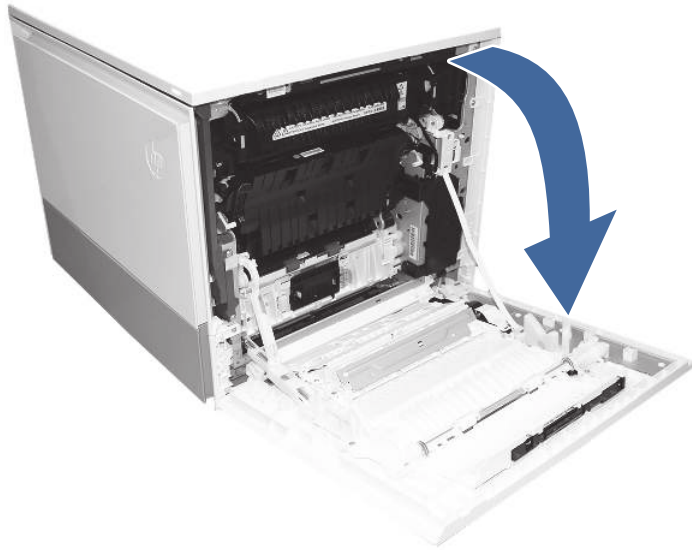
 [View a video of how to clear a jam in the right door and fuser area](#)

---

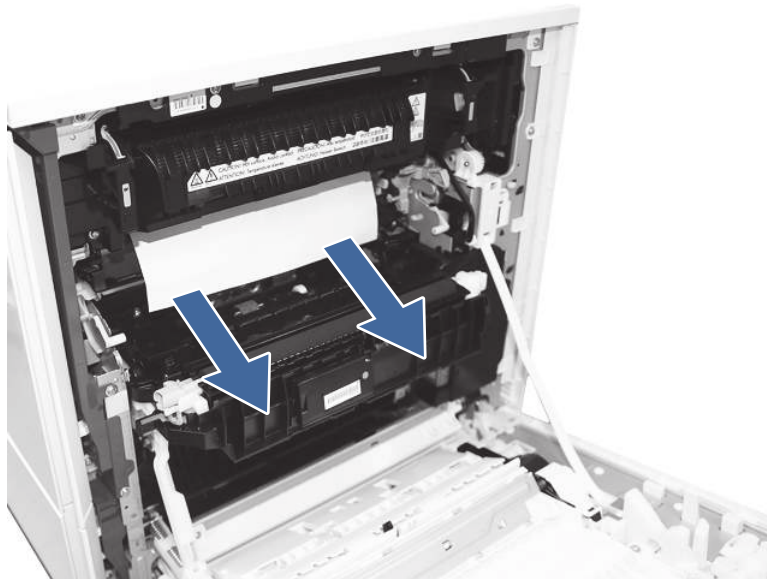
 **CAUTION:**  The fuser can be hot while the printer is in use. Wait for the fuser to cool before handling it.

---

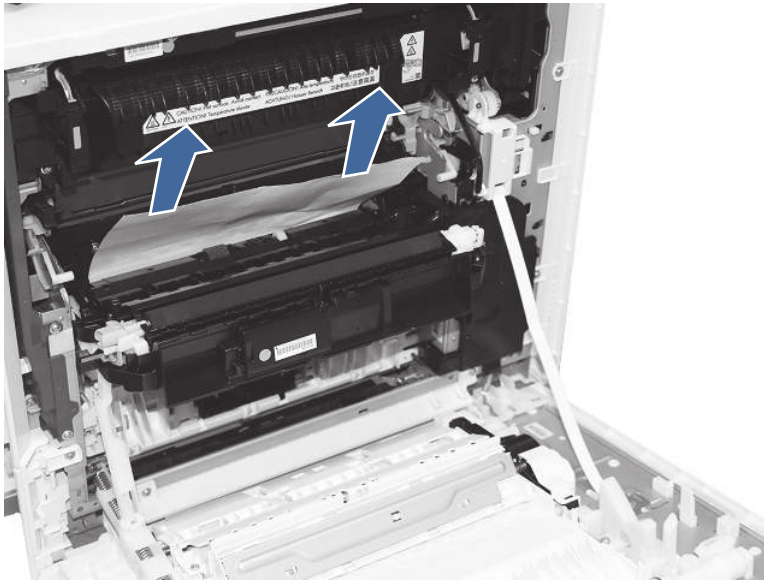
1. Open the right door.



2. Gently remove any jammed paper.







3. Close the right door.
4. Ensure the type and quality of the paper being used meets the HP specifications for the printer.
5. Ensure the paper tray guides are set to the correct size for the paper loaded.
6. If the error persists, contact your HP-authorized service or support provider, or contact customer support at [www.hp.com/go/contactHP](http://www.hp.com/go/contactHP).

### 13.B9 jam errors in the fuser

Use the following procedure to clear paper jams in the right door and fuser area. When a jam occurs, the control panel displays an animation that assists in clearing the jam.

#### Recommended action for customers

When a jam occurs, the control panel displays a message and an animation that assists in clearing the jam.

- 13.B9.yz Jam in right door

y = jam type (A or D)

z = Paper tray. This can be 0-5 or "D" for duplex print jobs.

Or

z = Fuser mode. This can be 0-9 or A-F.

- 13.B9.Cz Jam in right door (Fuser wrap jam)

z = Fuser mode. This can be 0-9 or A-F.

- 13.B9.FF Residual paper jam in right door

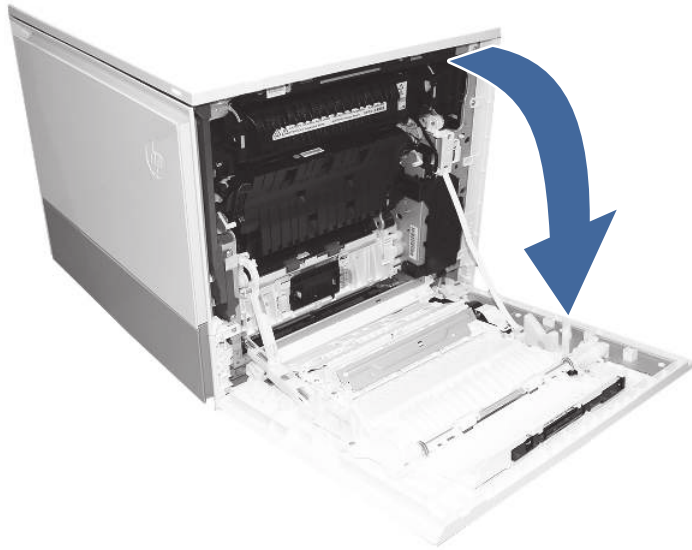


[View a video of how to clear a jam in the right door and fuser area](#)

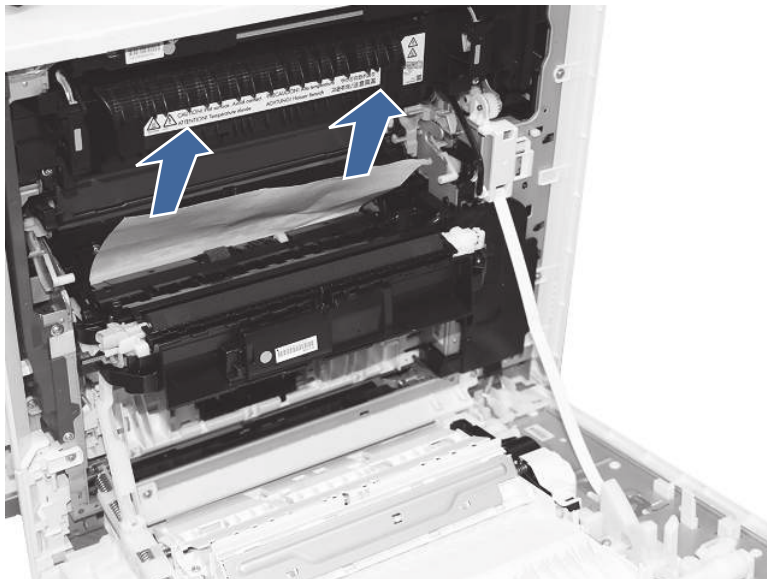


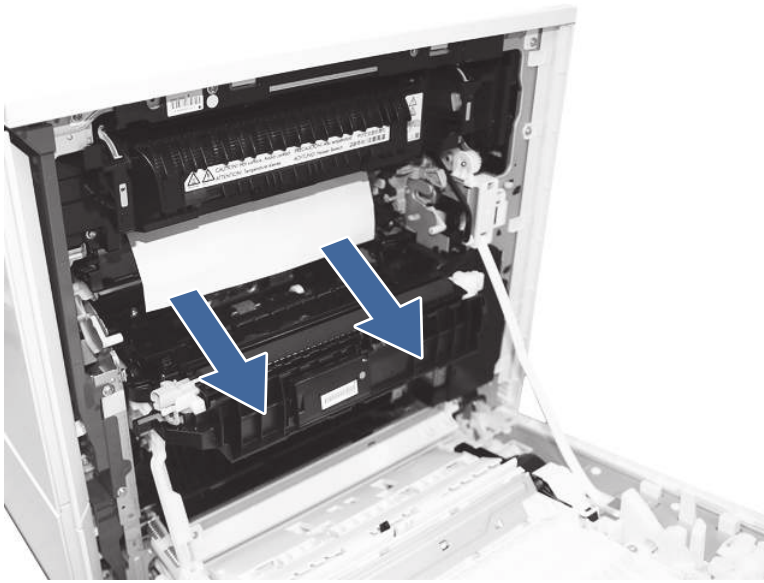
**NOTE:** The fuser is hot while the printer is in use. Wait for the fuser to cool before clearing jams.

1. Open the right door.

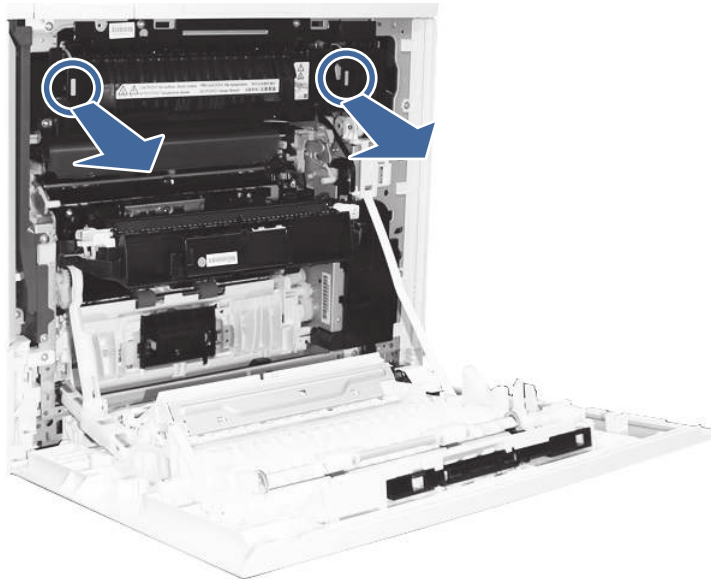


2. Gently remove any jammed paper from the fuser input.

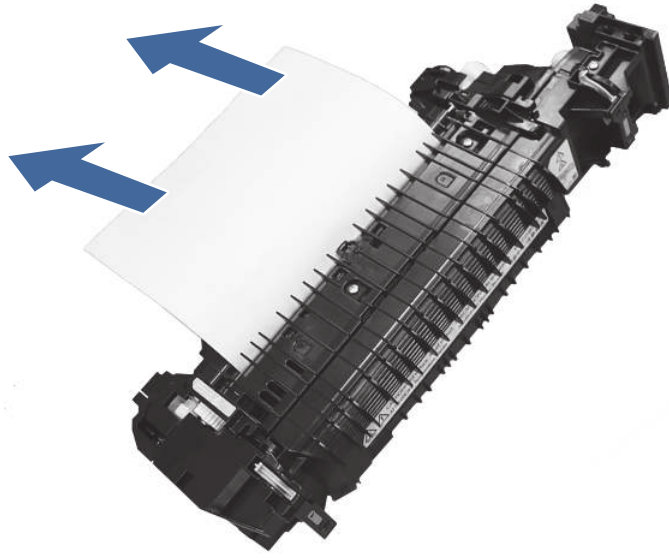




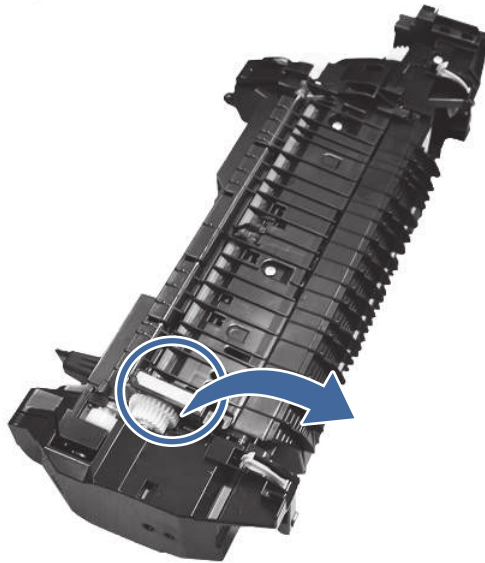
3. Remove the fuser and remove any jammed paper found.
  - a. Squeeze the release levers on the handles (circle call-outs) and then remove the fuser.



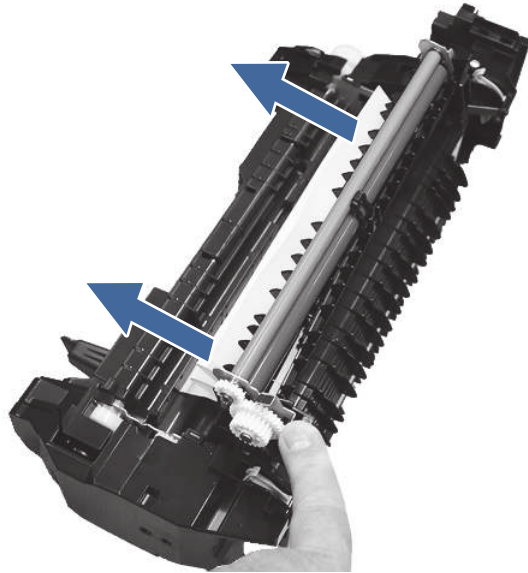
- b. Remove any paper from the exit of the fuser.



- c. Open the fuser access and check for a z-fold paper jam.



- d. Remove jammed paper from fuser.



- e. Reinstall the fuser and close the right door.
4. If the error persists, ensure the type and quality of the paper being used meets the HP specifications for the printer.
  5. If the error persists, contact your HP-authorized service or support provider, or contact customer support at [www.hp.com/go/contactHP](http://www.hp.com/go/contactHP).

### 13.D3 jam errors in the duplexer

Use the following procedure to clear paper jams in the duplexer area. When a jam occurs, the control panel displays an animation that assists in clearing the jam.

#### Recommended action for customers

When a jam occurs, the control panel displays a message and an animation that assists in clearing the jam.

- 13.D3.Dz Duplex delivery delay jam
- 13.D3.FF Residual paper jam in right door

z = Fuser mode. This can be 0-9 or A-F.



[View a video of how to clear a jam in the right door and fuser area](#)

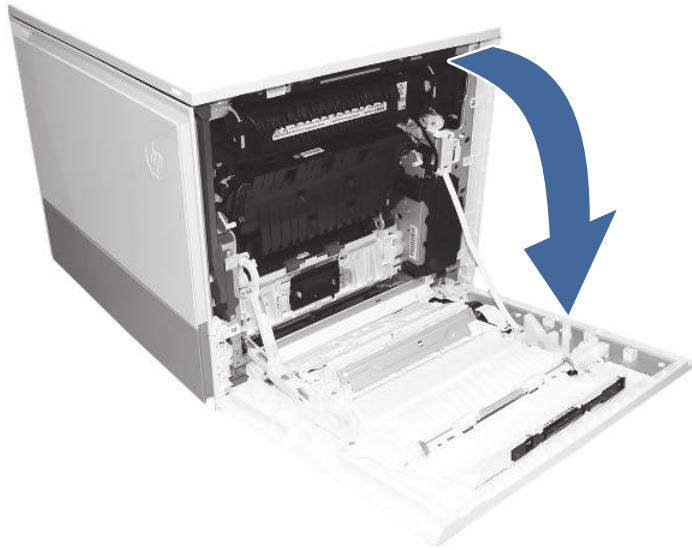


---

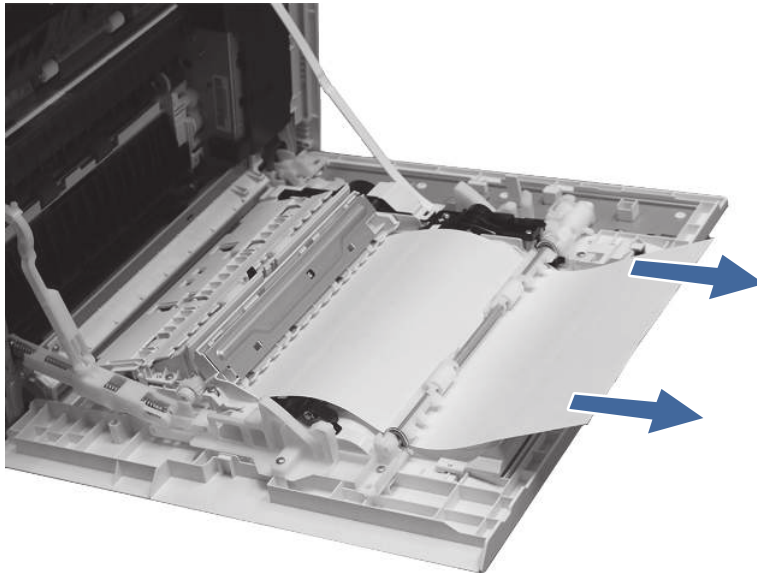
**NOTE:** The fuser is hot while the printer is in use. Wait for the fuser to cool before clearing jams.

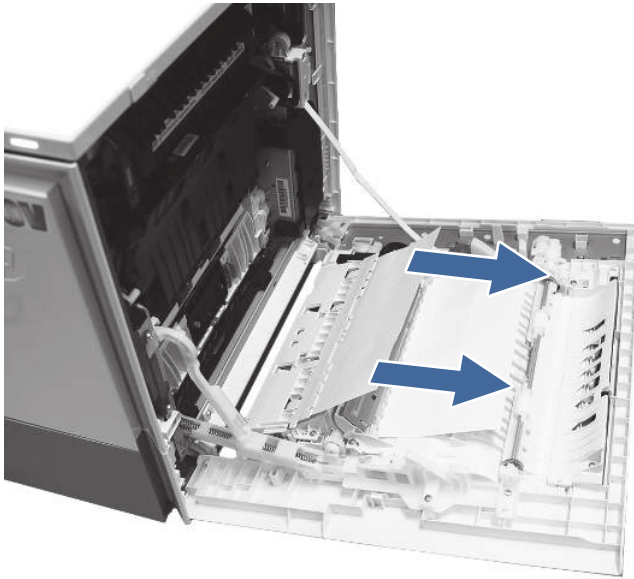
---

1. Open the right door.



2. Gently remove any jammed paper from the duplexer paper path.





3. Close the right door.
4. If the error persists, ensure the type and quality of the paper being used meets the HP specifications for the printer.
5. If the error persists, contact your HP-authorized service or support provider, or contact customer support at [www.hp.com/go/contactHP](http://www.hp.com/go/contactHP).

### 13.E1 jam error in the output bin

Use the following procedure to check for paper in all possible jam locations in the output bin. When a jam occurs, the control panel displays an animation that assists in clearing the jam.

#### Recommended action for customers

When a jam occurs, the control panel displays a message and an animation that assists in clearing the jam.

- 13.E1.Dz Jam in output bin
- 13.E1.FF Residual paper jam in output bin

z = paper type that is being printed on. This can be 0-9 or A-F.

 [View a video of how to clear a jam in the output bin](#)

1. If paper is visible in the output bin, grasp the leading edge and remove it.



2. Ensure the type and quality of the paper being used meets the HP specifications for the printer.
3. If the error persists, contact your HP-authorized service or support provider, or contact customer support at [www.hp.com/go/contactHP](http://www.hp.com/go/contactHP).

## Clear paper jams (MFP models)

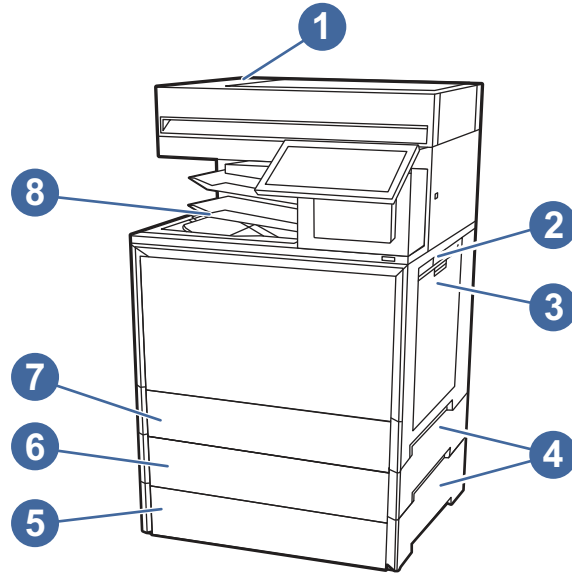
Use the procedures in this section to clear jammed paper from the printer paper path.

### Paper jam locations

Jams can occur in these locations.

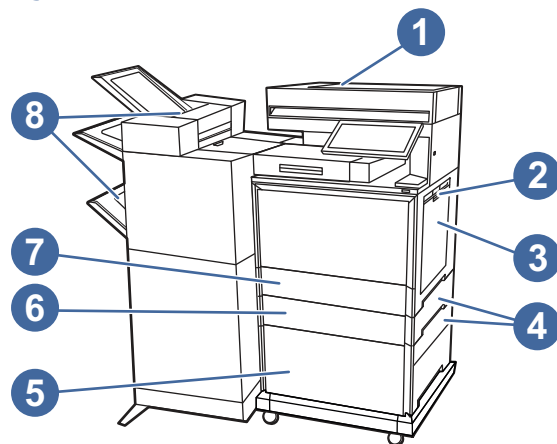


**Figure 4-194 Jam locations - dn, zf, and zfs models**



Item	Description
1	Document feeder
2	Right door and fuser area
3	Tray 1 (multipurpose tray)
4	Tray jam access doors
5	Optional Tray 4
6	Optional Tray 3
7	Tray 2
8	Output bin or finisher output trays

**Figure 4-195 Jam locations - zfw+ model**



Item	Description
1	Document feeder

Item	Description
2	Right door and fuser area
3	Tray 1 (multipurpose tray)
4	Tray jam access doors
5	Tray 4 (high-capacity input tray)
6	Tray 3
7	Tray 2
8	Output bins (floor-standing finisher)

## Auto-navigation for clearing paper jams

Learn about printer jam clearing auto-navigation.

The auto-navigation feature assists in clearing jams by providing step-by-step instructions on the control panel.

When you complete a step, the printer displays instructions for the next step until you have completed all steps in the procedure.

## Experiencing frequent or recurring paper jams?

To reduce the number of paper jams, try these solutions.




[View a video that demonstrates how to load paper in a way that reduces the number of paper jams](#)

1. Use only paper that meets HP specifications for this printer.
2. Use paper that is not wrinkled, folded, or damaged. If necessary, use paper from a different package.
3. Use paper that has not previously been printed or copied on.
4. Make sure the tray is not overfilled. If it is, remove the entire stack of paper from the tray, straighten the stack, and then return some of the paper to the tray.
5. Make sure the paper guides in the tray are adjusted correctly for the size of paper. Adjust the guides so they are touching the paper stack without bending it.
6. Make sure that the tray is fully inserted in the printer.
7. If you are printing on heavy, embossed, or perforated paper, use the manual feed feature and feed sheets one at a time.
8. Open the **Trays** menu on the printer control panel. Verify that the tray is configured correctly for the paper type and size.
9. Make sure the printing environment is within recommended specifications.

## 31.13.yz jam error in the document feeder

The following information describes how to clear paper jams in the document feeder. When a jam occurs, the control panel displays an animation that assists in clearing the jam.

In addition to the instructions provided below

 **NOTE:** The printer model referenced in this video might be different from your printer model, but the steps to clear the jam are the same.

### Recommended action for customers

When a jam occurs, the control panel displays a message and an animation that assists in clearing the jam.

- 31.13.01 Jam in document feeder
- 31.13.02 Jam in document feeder
- 31.13.13 Jam in document feeder

 [View a video of how to clear a jam in the document feeder](#)

1. Remove paper from the exit assembly of the document feeder.



2. Open the document-feeder cover.



3. Remove any jammed paper from the document feeder input area.




4. Lift the document feeder and check the lower side of the feed path.





5. Make sure the guides in the document-feeder input tray are adjusted to the correct size for the document before loading paper.



---

 **NOTE:** To avoid document feeder jams, to copy narrow documents, use the flatbed scanner. Remove all staples and paper clips from original documents. Do not feed damaged or wrinkled paper.

 **NOTE:** Original documents that are printed on heavy, glossy paper can jam more frequently than originals that are printed on plain paper.

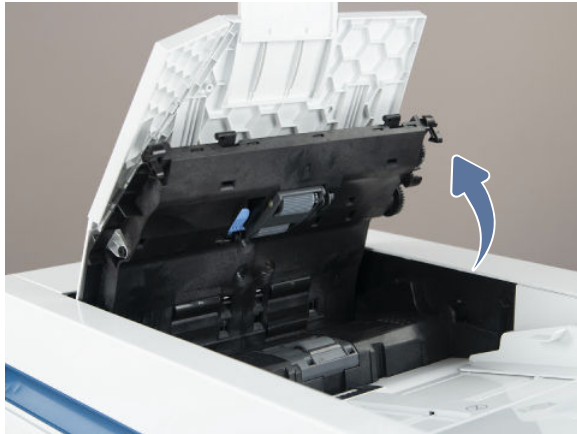
 **IMPORTANT:** Warning: Do not run labels through the automatic document feeder (ADF).

---

6. If the paper continues to jam, remove and clean the document feeder rollers.

- a. Open the document-feeder jam access door.

**Figure 4-196** Open the document-feeder jam access door



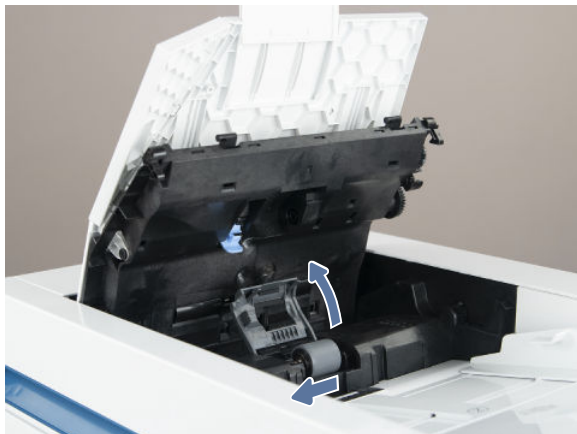
- b. Release the blue locking arm to drop the assembly down. Slide the pickup and feed roller assembly to the left, and then pull it away from the document feeder to remove it.

**Figure 4-197** Release the blue locking arm



- c. Lift the roller cover up and then slide the roller toward the front of the printer to remove it.

**Figure 4-198** Release the separation roller cover



- d. Clean the rollers with a dampened lint free cloth.

- e. Reinstall the rollers in the document feeder and perform a copy job to test.
7. If the error persists, contact your HP-authorized service or support provider, or contact customer support at [www.hp.com/go/contactHP](http://www.hp.com/go/contactHP).

### 13.B2.D1 jam error in Tray 1 (multipurpose tray)

Use the following procedure to clear paper jams in Tray 1 (multipurpose tray). When a jam occurs, the control panel displays an animation that assists in clearing the jam.

#### Recommended action for customers

When a jam occurs, the control panel displays a message and an animation that assists in clearing the jam.

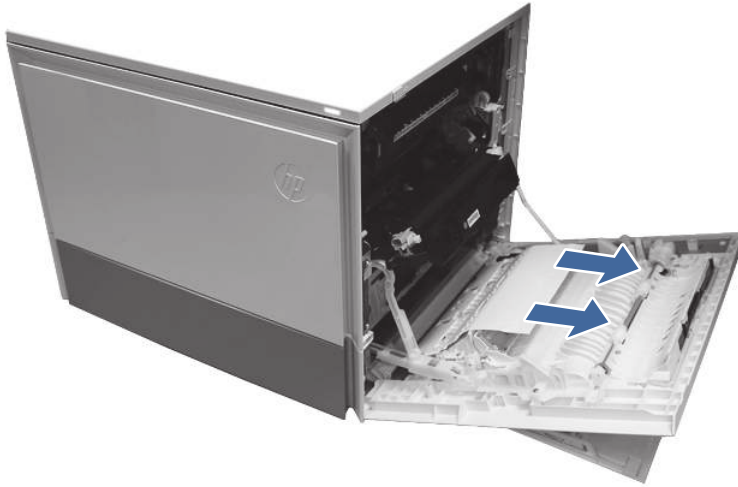
- **13.B2.D1 Jam in tray 1**

 [View a video of how to clear a jam in Tray 1](#)

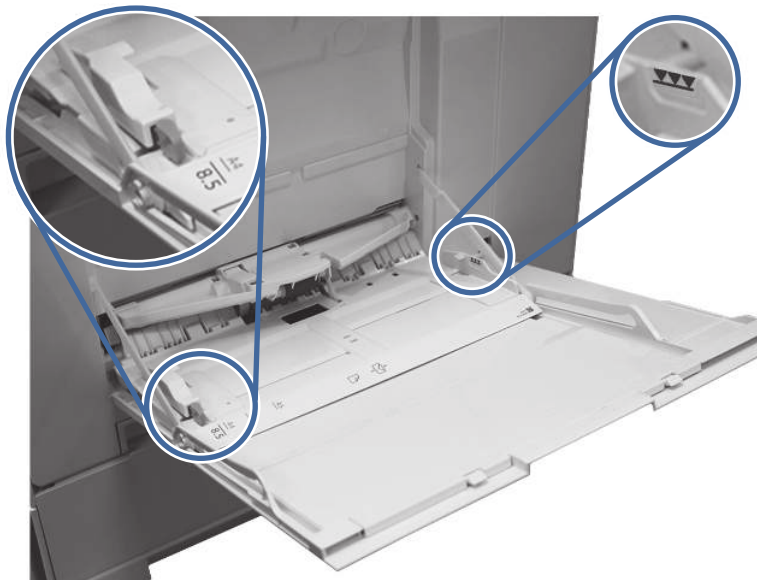
1. If you can see the jammed sheet in Tray 1, remove the jammed sheet by gently pulling it straight out.



2. Open the right door and remove paper from the area shown.



3. Close the right to allow the printer to clear the message.
4. Make sure the type and quality of the paper being used meets the HP specifications for the printer.
5. Make sure the Tray 1 guides are set to the correct paper size and that the paper tray is not overfilled (paper is below the 3 triangles on the right guide).

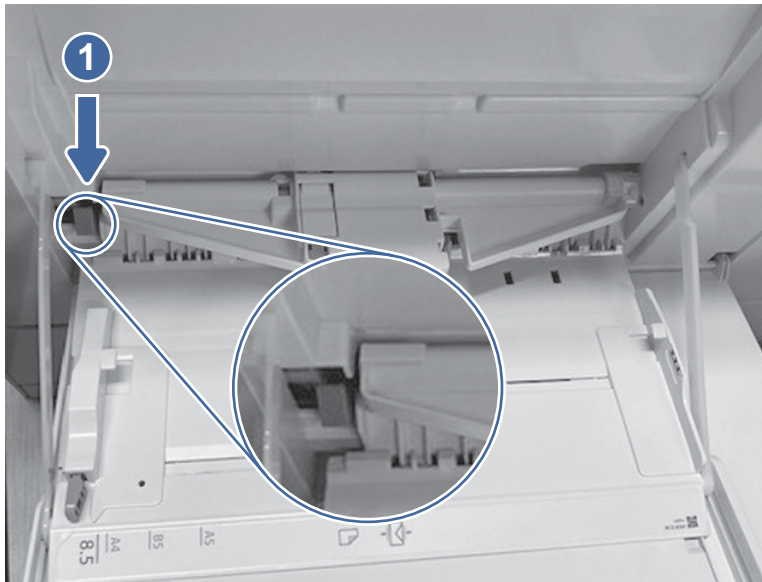


6. Load the paper back into the tray and restart the print job.
7. If the same jam appears remove and clean the tray 1 pick, feed and separation rollers.



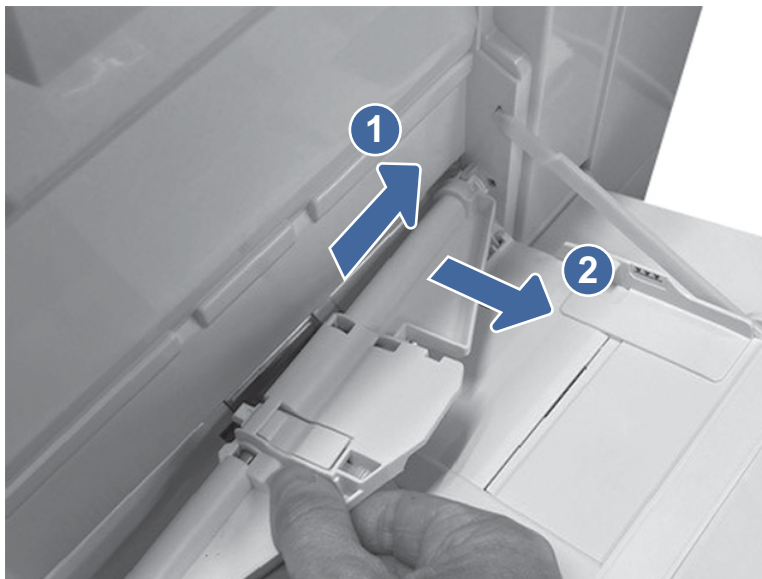
- a. Locate and release the pickup roller assembly release tab.

**Figure 4-199** Locate the pickup roller assembly tab



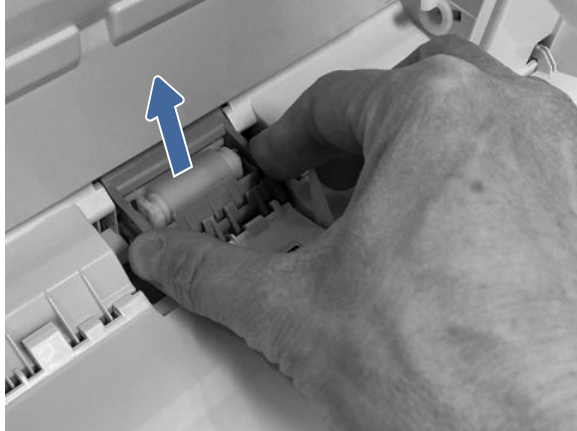
- b. Push the pickup roller assembly to the right and then away from the printer.

**Figure 4-200** Remove the pickup roller assembly



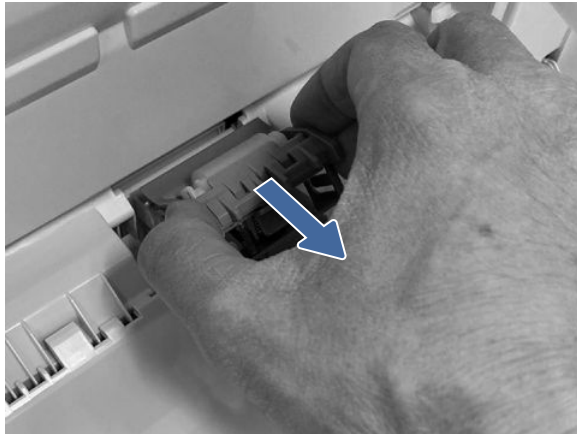
- c. Grasp the left- and right-side of the separation roller assembly, and then lift the assembly up.

**Figure 4-201 Lift the separation roller assembly**



- d. Pull the separation roller assembly straight out to remove it.

**Figure 4-202 Remove the separation roller assembly**



- e. Clean the roller with a dampened lint free cloth.
  - f. Install the rollers back into tray one and test the tray by printing from tray 1.
8. If the error persists, contact your HP-authorized service or support provider, or contact customer support at [www.hp.com/go/contactHP](http://www.hp.com/go/contactHP).

### 13.B2.D2 jam error in Tray 2

Use the following procedure to check for paper in all possible jam locations related to Tray 2. When a jam occurs, the control panel displays an animation that assists in clearing the jam.

#### Recommended action for customers

When a jam occurs, the control panel displays a message and an animation that assists in clearing the jam.

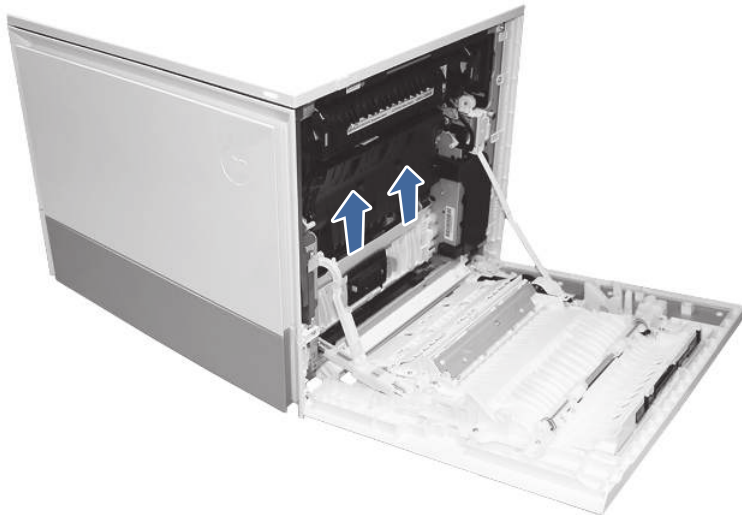
- 13.B2.D2 Paper jam in tray 2

 [View a video of how to clear a jam in Tray 2](#)

1. Open the right door.



2. Gently remove any jammed paper.



3. Close the right door to clear the control panel message.

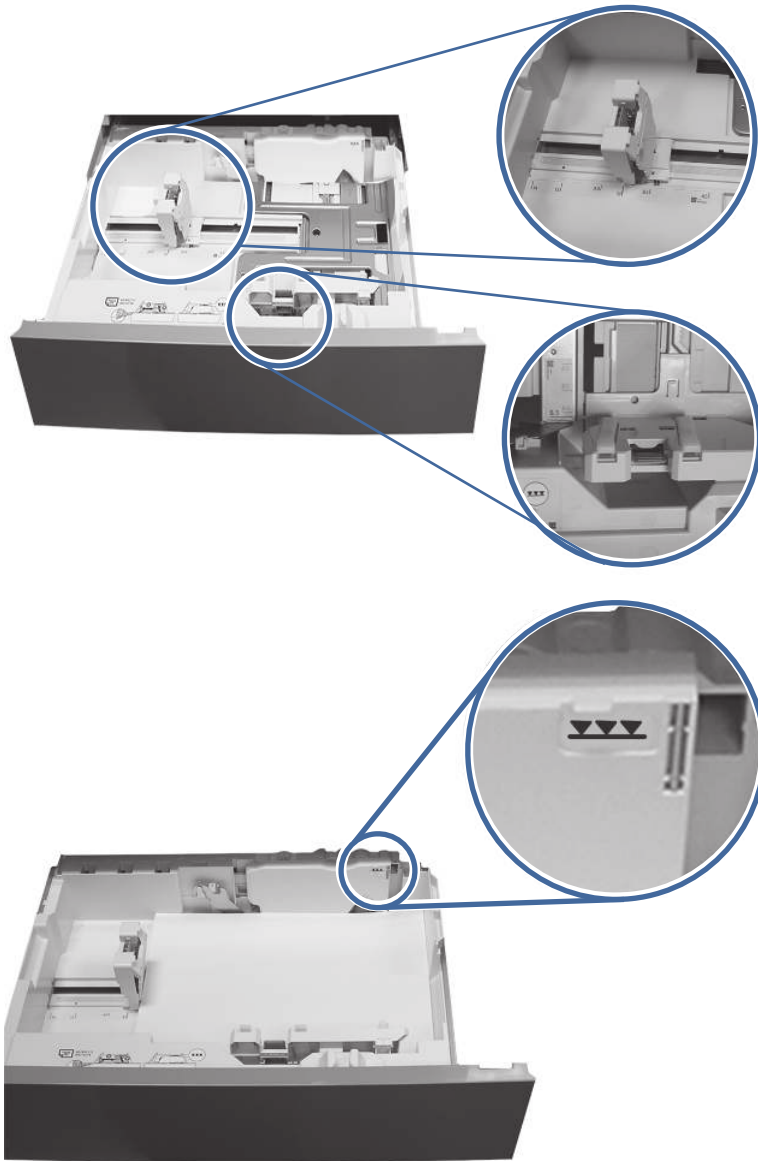
4. Open Tray 2.



5. Remove the paper from the tray and discard any bent, curled, or damaged sheets.



6. Make sure that the tray width and length guides are set to the correct paper size for the paper being installed into the tray and that the tray is not over filled above the fill mark (line below 3 triangles on rear guide).

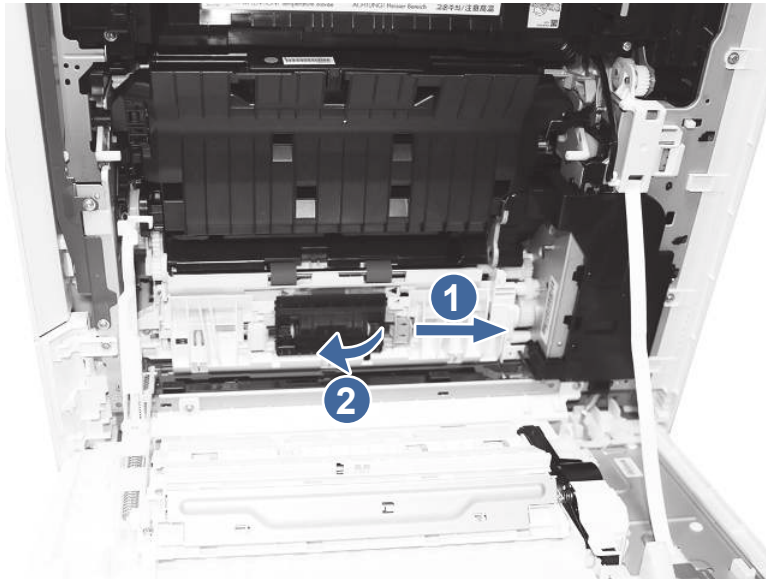


7. Ensure the type and quality of the paper being used meets the HP specifications for the printer.
8. If the error persists, clean the Tray 2 pick, feed, separation rollers.

- a. Open the right door to access the rollers.



- b. Locate and remove the Tray 2 separation roller.



**Call-out 1-** slide blue locking lever

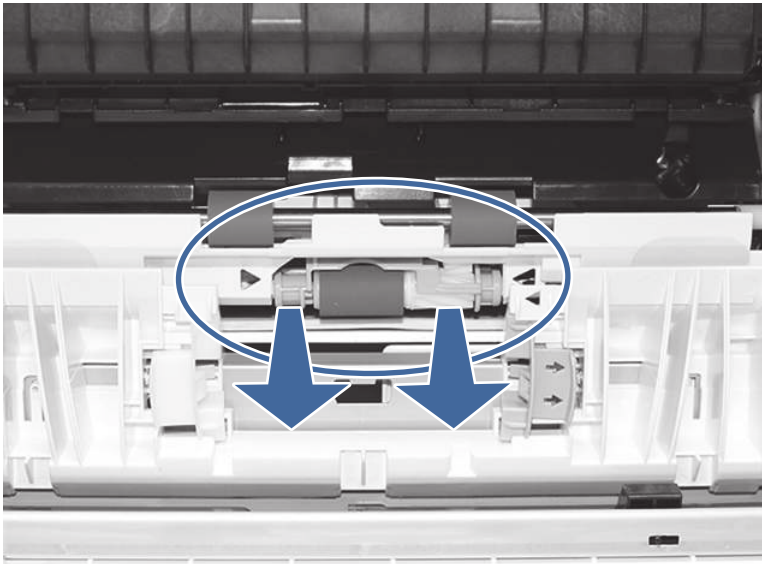
**Call-out 2-** Remove the roller assembly.

- c. Remove the Tray 2 pick and feed rollers.

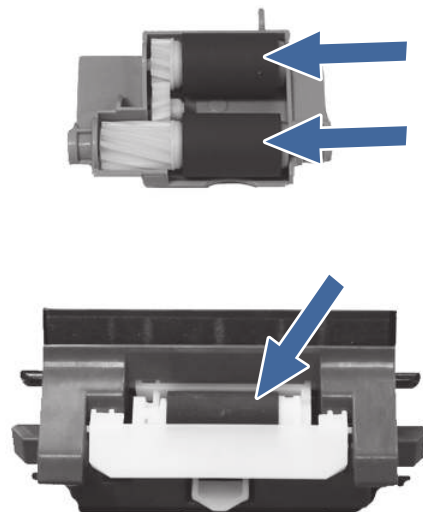
To remove the roller assembly, gently pull on the side of the assembly and slide out as shown.



**NOTE:** Make sure your hands are clean before touching the rollers. Oils or debris from hands can cause paper pickup issues.



- d. Clean the rollers with a dampened lint free cloth.



- e. Reinstall the roller assemblies and close the right door.
- f. Run a print job from Tray 2.
9. If the error persists, contact your HP-authorized service or support provider, or contact customer support at [www.hp.com/go/contactHP](http://www.hp.com/go/contactHP).

### 13.A3 jam error in Tray 3

Use the following procedure to check for paper in all possible jam locations related to Tray 3. When a jam occurs, the control panel displays an animation that assists in clearing the jam.

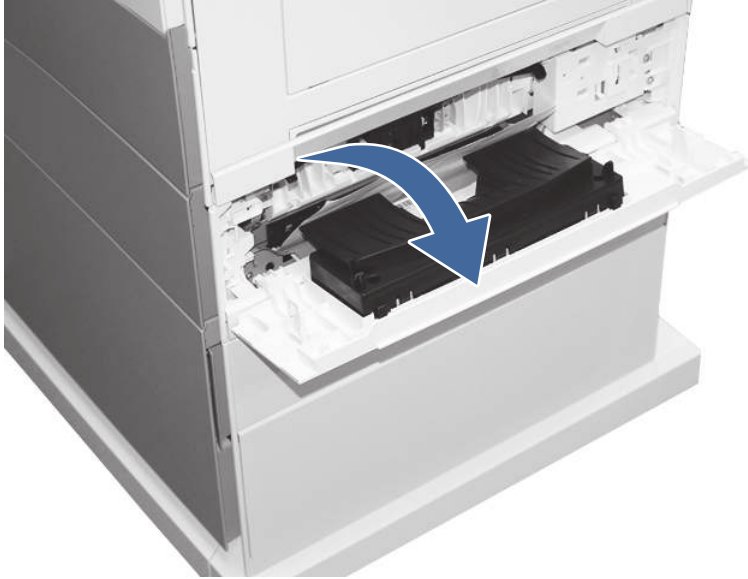
#### **Recommended action for customers**

Use the following procedure to check for paper in all possible jam locations related to the 550-sheet trays. When a jam occurs, the control panel displays an animation that assists in clearing the jam.

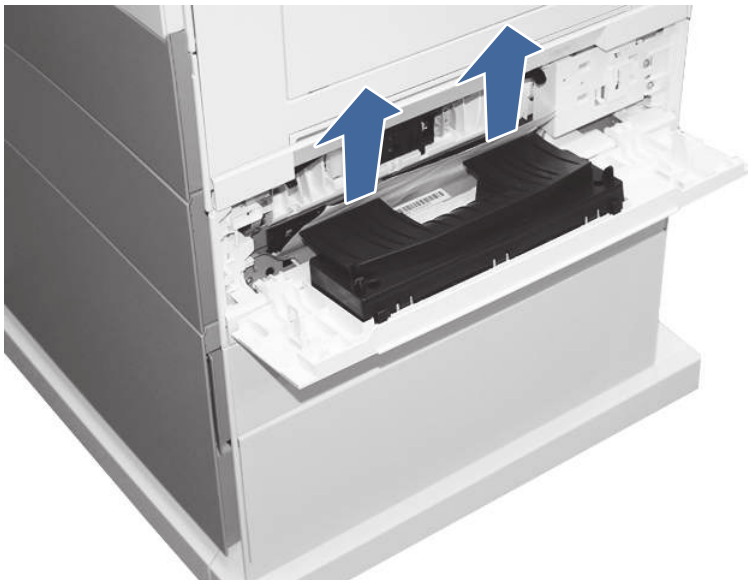
- 13.A3.A3 Jam in tray 3
- 13.A3.D3 Jam in tray 3

 [View a video of how to clear a jam in Tray 3, and the optional trays](#)

1. Open the Tray 3 right side access door.



2. Remove any jammed paper found in access area.

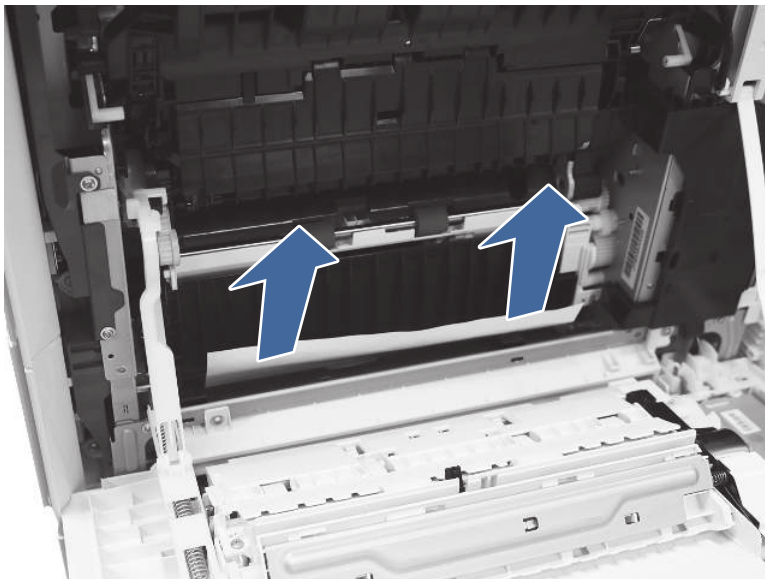




3. Open the right door.



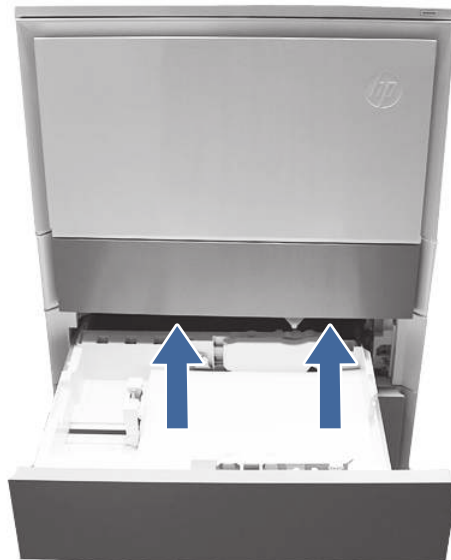
4. Gently remove any jammed paper.



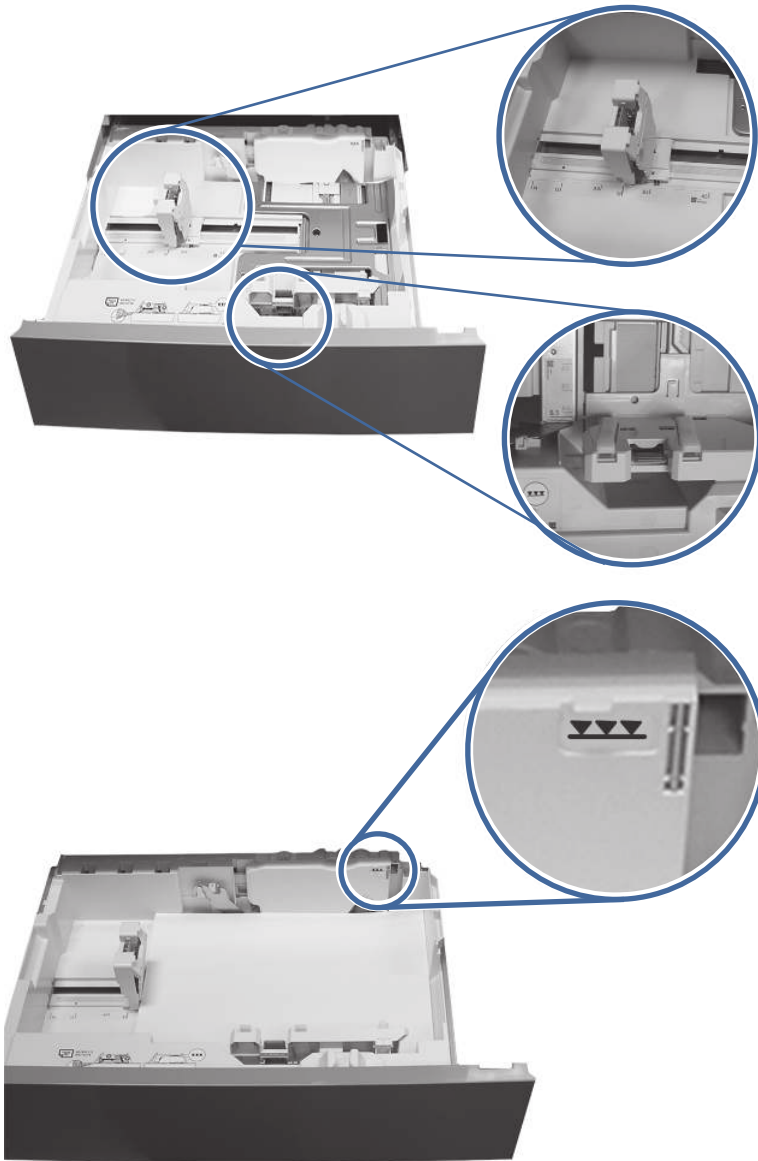
5. Open Tray 3.



6. Remove the paper from the tray and discard any bent, curled, or damaged sheets.

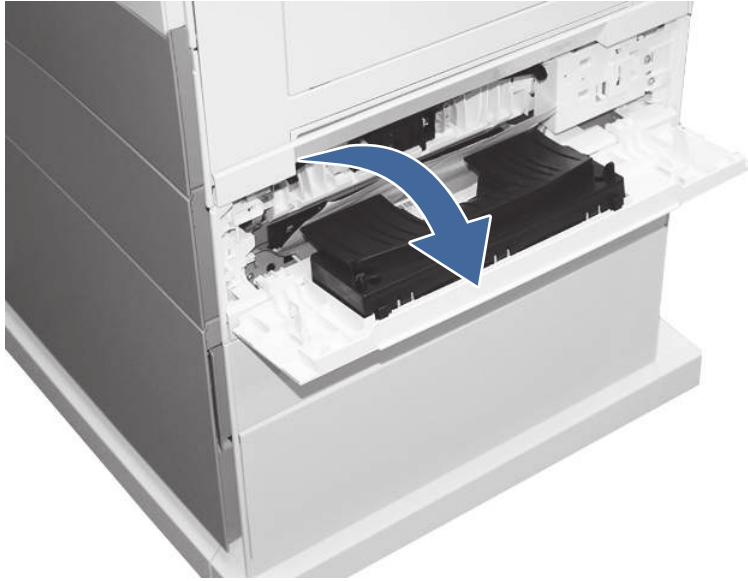


7. Make sure that the tray width and length guides are set to the correct paper size for the paper being installed into the tray and that the tray is not over filled above the fill mark (line below 3 triangles on rear guide).

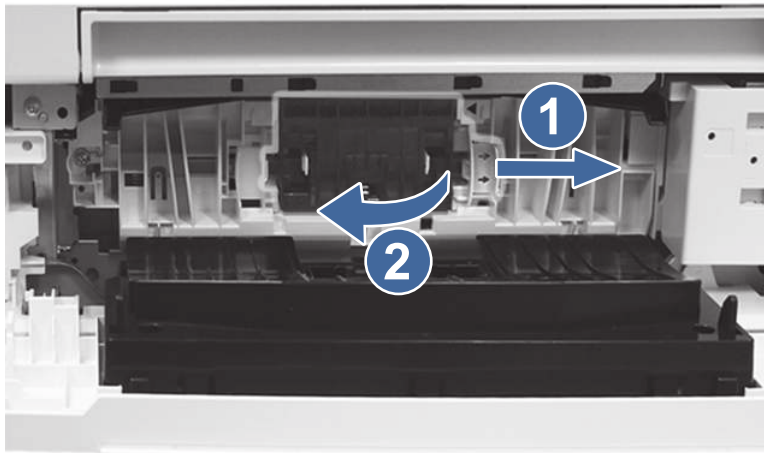


8. Ensure the type and quality of the paper being used meets the HP specifications for the printer.
9. If the error persists, clean the Tray 3 pick, feed, separation rollers.

- a. Open the Tray 3 right door to access the rollers.



- b. Locate and remove the Tray 3 separation roller.




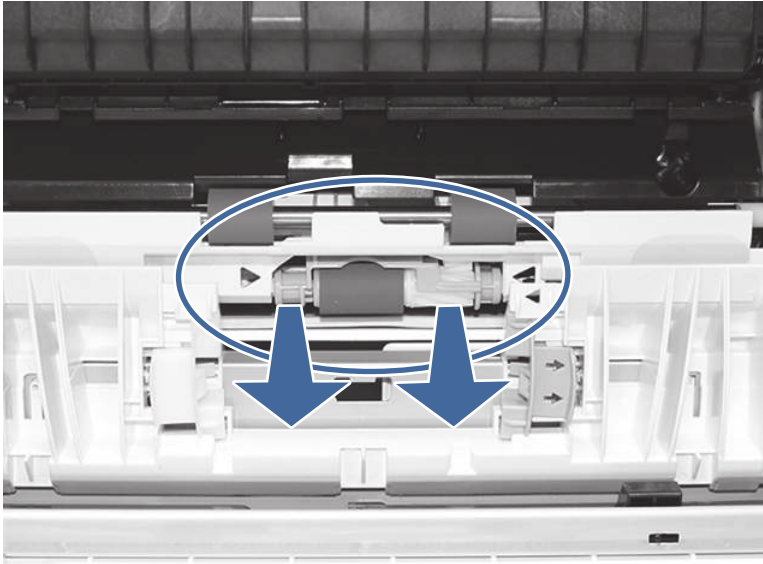
**Call-out 1-** slide blue locking lever

**Call-out 2-** Remove the roller assembly.

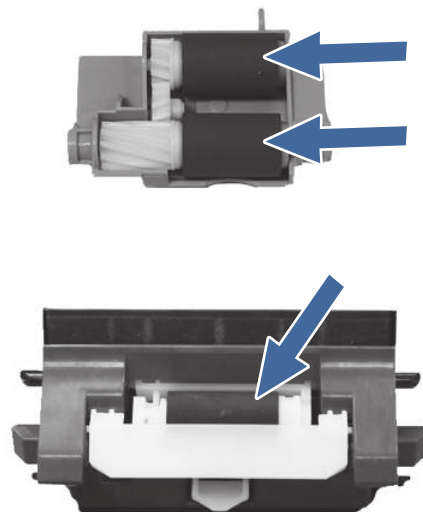
- c. Remove the Tray 3 pick and feed rollers.

To remove the roller assembly, gently pull on the side of the assembly and slide out as shown.

 **NOTE:** Make sure your hands are clean before touching the rollers. Oils or debris from hands can cause paper pickup issues.



- d. Clean the rollers with a dampened lint free cloth.



- e. Reinstall the roller assemblies and close the right door.
  - f. Run a print job from Tray 3.
10. If the error persists, contact your HP-authorized service or support provider, or contact customer support at [www.hp.com/go/contactHP](http://www.hp.com/go/contactHP).

### 13.A4 jam error in Tray 4

Use the following procedure to check for paper in all possible jam locations related to the 550 sheet Tray 4. When a jam occurs, the control panel displays an animation that assists in clearing the jam.

#### **Recommended action for customers**

When a jam occurs, the control panel displays a message and an animation that assists in clearing the jam.

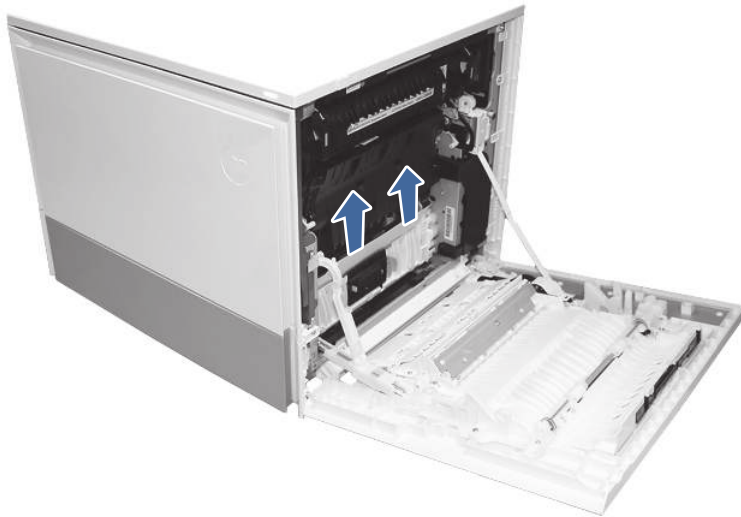
- 13.A4.A4 Paper jam in tray 4
- 13.A4.D4 Paper jam in tray 4

 [View a video of how to clear a jam in Tray 4](#)

1. Open the right door.



2. Gently remove any jammed paper.



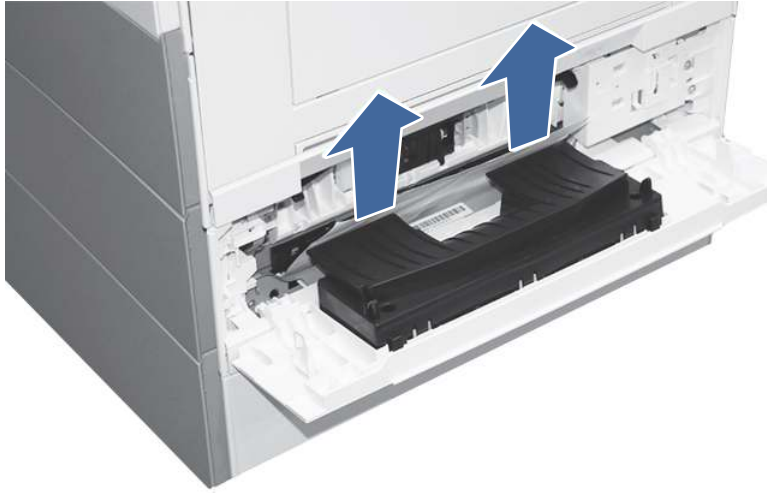
3. Open the Tray 4 right access door.



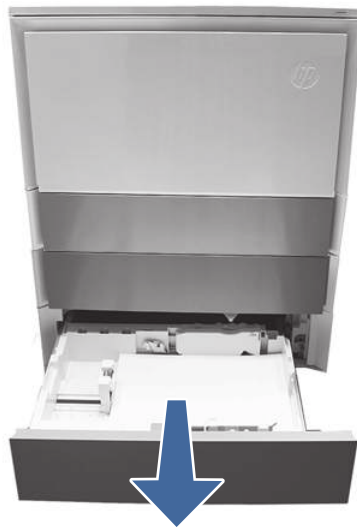
4. Gently remove any jammed paper.



5. Open the Tray 3 access door and gently remove any jammed paper.

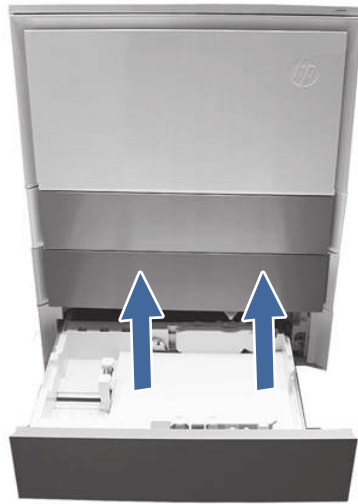


6. Close the right door to clear the control panel message.
7. Open Tray 4.

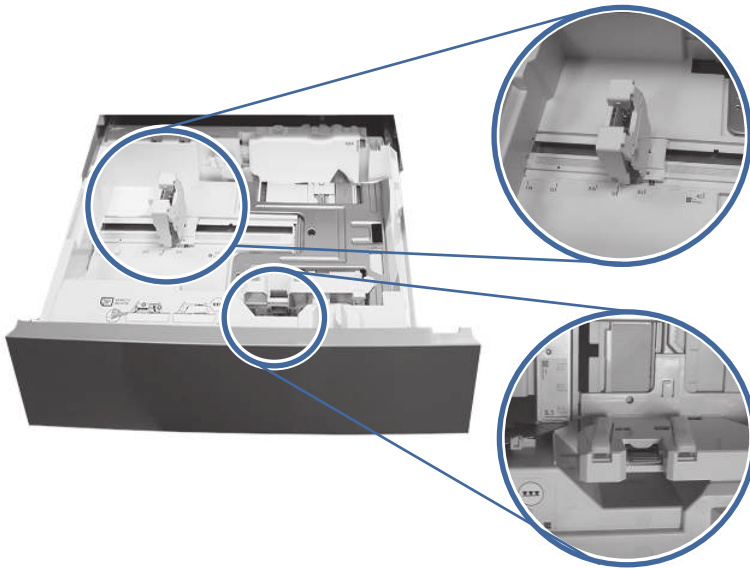


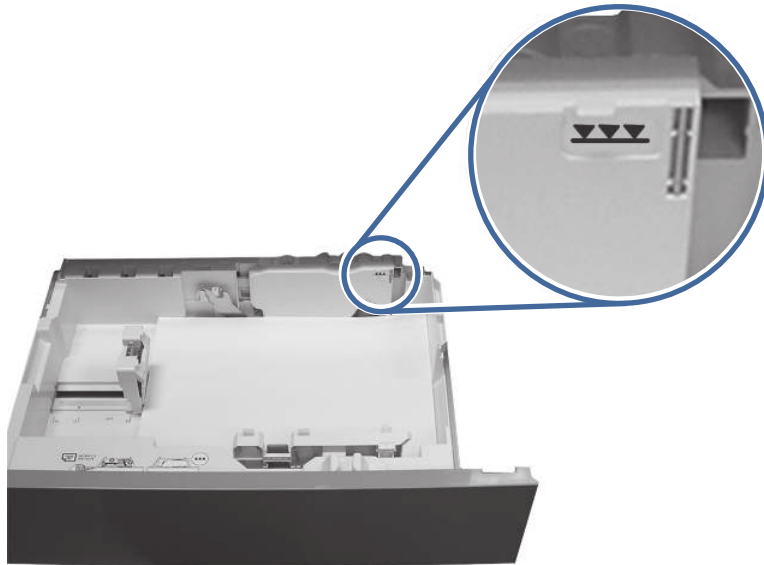


8. Remove the paper from the tray and discard any bent, curled, or damaged sheets.



9. Make sure that the tray width and length guides are set to the correct paper size for the paper being installed into the tray and that the tray is not over filled above the fill mark (line below 3 triangles on rear guide).

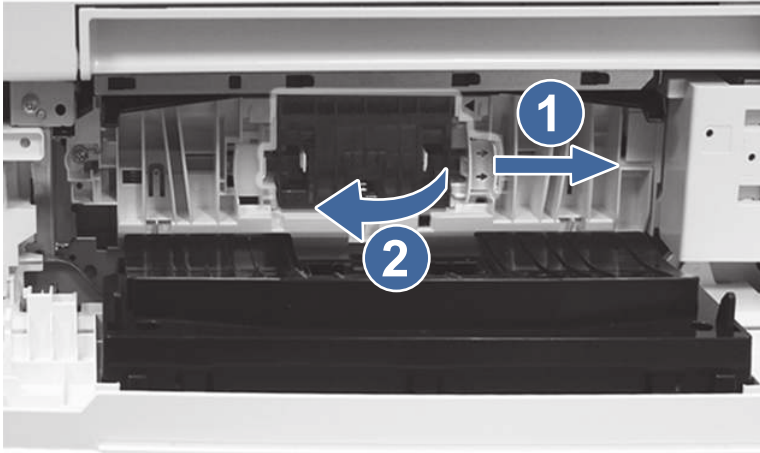




10. Ensure the type and quality of the paper being used meets the HP specifications for the printer.
11. If the error persists, clean the Tray 4 pick, feed, separation rollers.
  - a. Open the Tray 4 door to access the rollers.



- b. Locate and remove the Tray 4 separation roller.




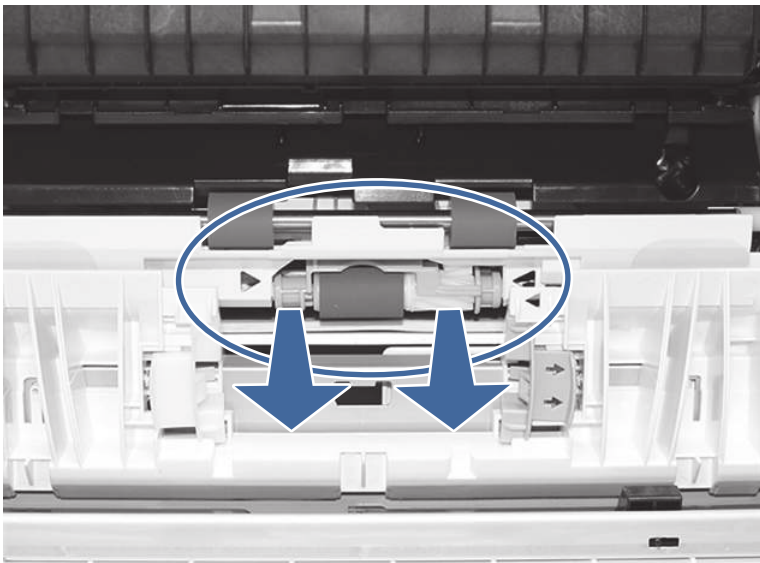
**Call-out 1-** slide blue locking lever

**Call-out 2-** Remove the roller assembly.

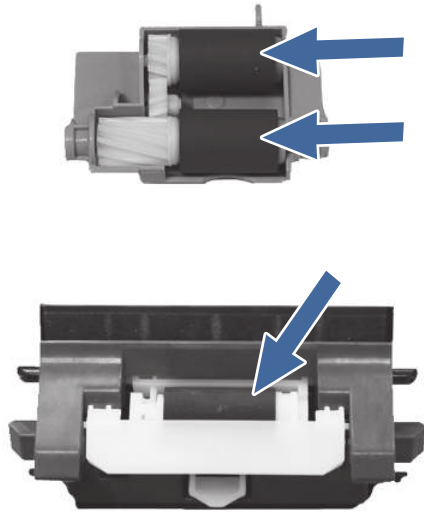
- c. Remove the Tray 4 pick and feed rollers.

To remove the roller assembly, gently pull on to the side of the rollers as shown.

 **NOTE:** Make sure your hands are clean before touching the rollers. Oils or debris from hands can cause paper pickup issues.



- d. Clean the rollers with a dampened lint free cloth.



- e. Reinstall the roller assemblies and close the right door.
  - f. Run a print job from Tray 4.
12. If the error persists, contact your HP-authorized service or support provider, or contact customer support at [www.hp.com/go/contactHP](http://www.hp.com/go/contactHP).

### 13.A4 jam error in Tray 4 (2,100 sheet feeder HCI)

Use the following procedure to check for paper in all possible jam locations related to the HCI Tray 4. When a jam occurs, the control panel displays an animation that assists in clearing the jam.

#### Recommended action for customers

When a jam occurs, the control panel displays a message and an animation that assists in clearing the jam.

- 13.A4.A4 Paper jam in tray 4
- 13.A4.D4 Paper jam in tray 4

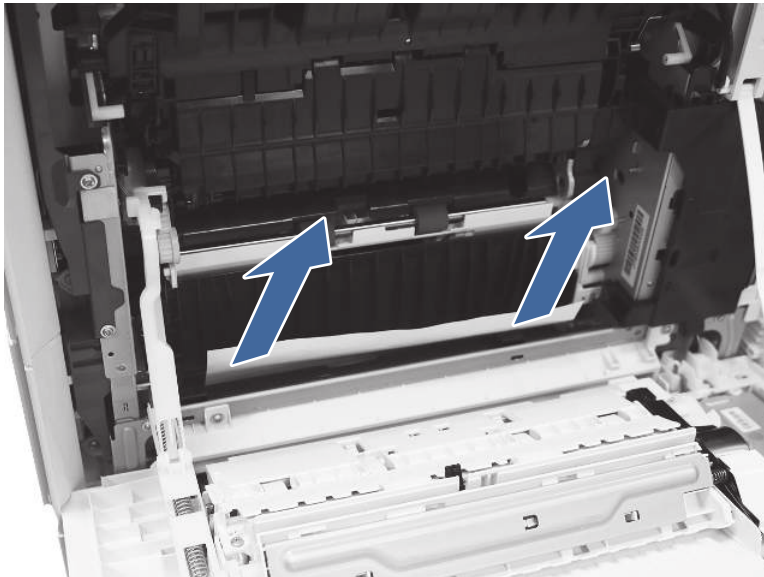


[View a video of how to clear a jam in the high-capacity input Tray 4](#)

1. Open the printer right door.



2. Gently remove any jammed paper.



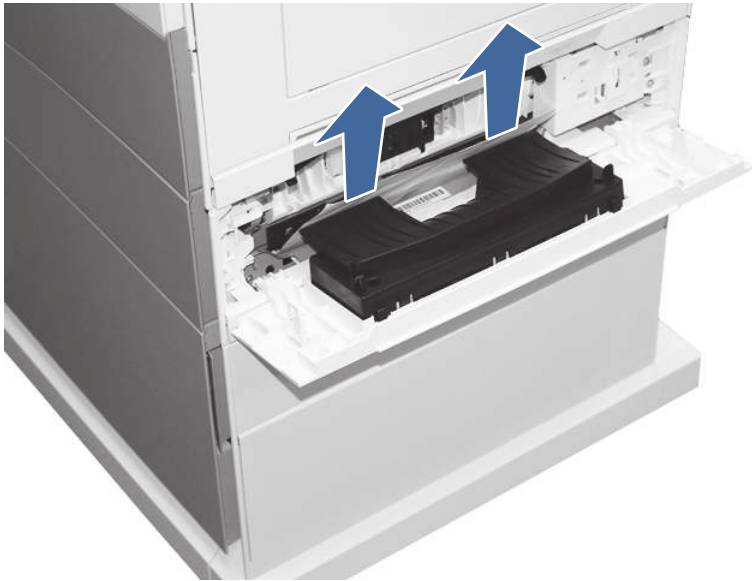
3. Open the Tray 4 right access door.



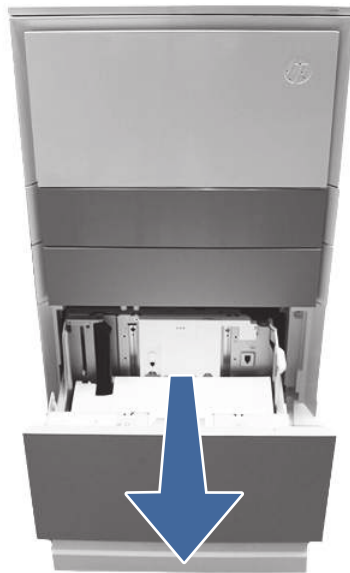
4. Gently remove any jammed paper.



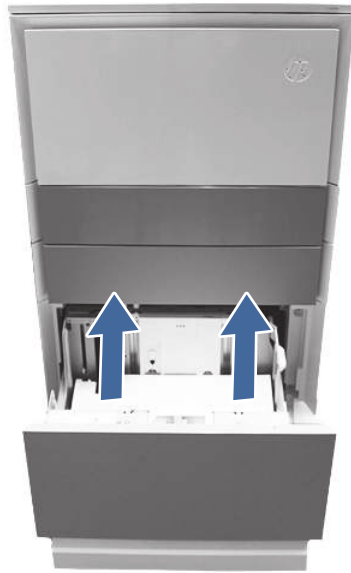
5. Open the Tray 3 access door and gently remove any jammed paper.



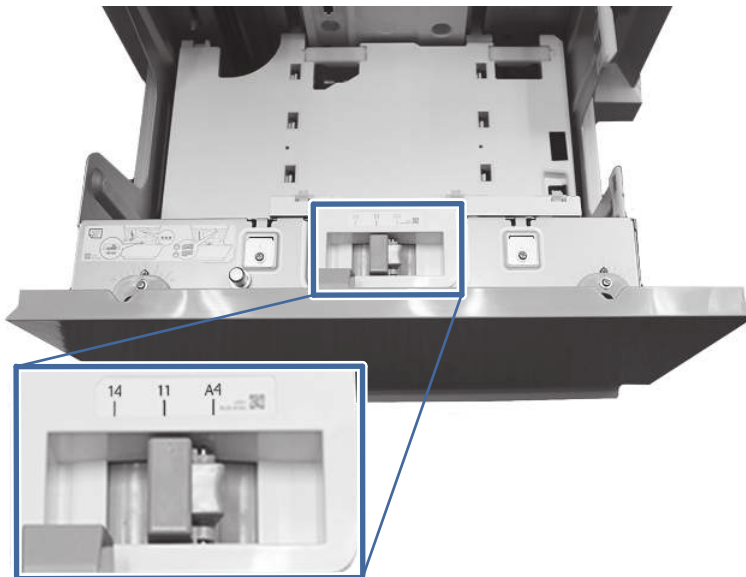
6. Close the right door to clear the control panel message.
7. Open Tray 4.



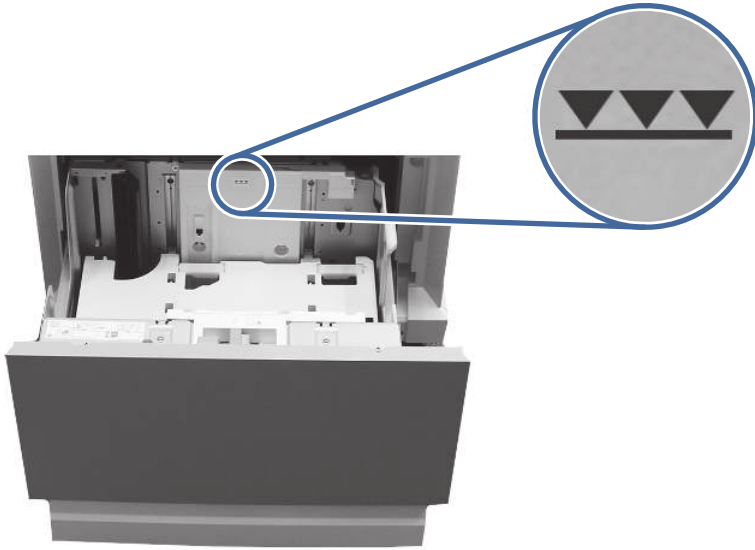
8. Remove the paper from the tray and discard any bent, curled, or damaged sheets.



9. Make sure that the tray width guide is set to the correct paper size for the paper being installed into the tray and that the tray is not over filled above the fill mark (line below 3 triangles on rear guide).



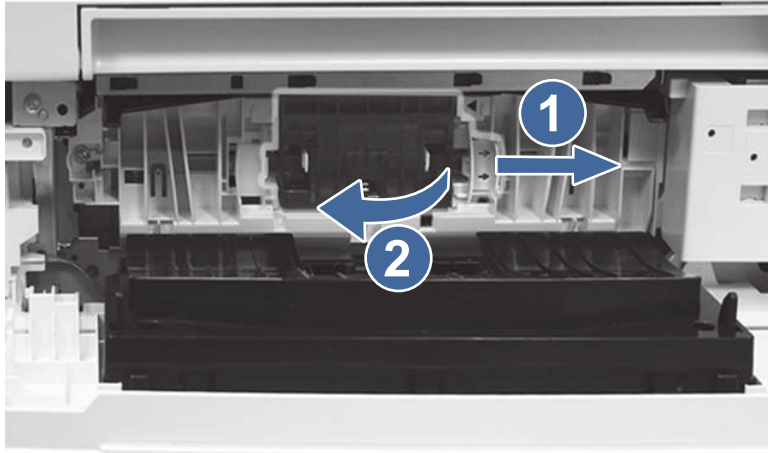




10. Ensure the type and quality of the paper being used meets the HP specifications for the printer.
11. If the error persists, clean the Tray 4 pick, feed, and separation rollers.
  - a. Open the Tray 4 door to access the rollers.



- b. Locate and remove the Tray 4 separation roller.




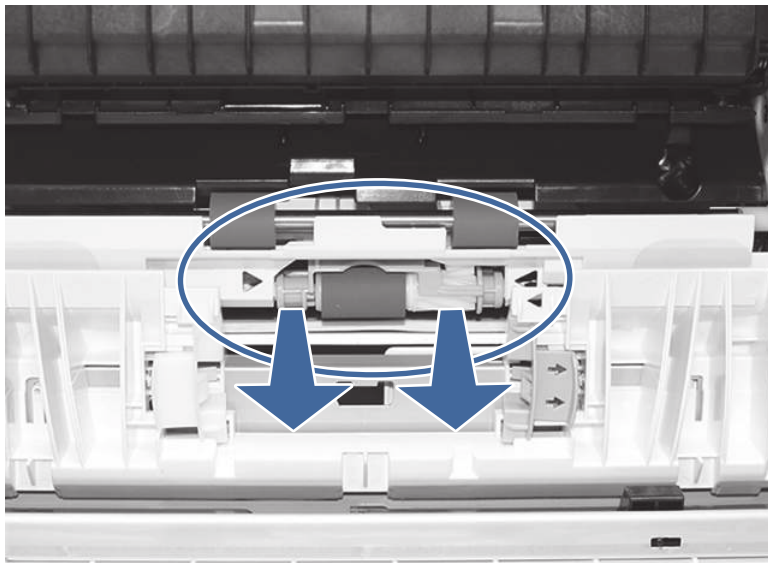
**Call-out 1-** slide locking lever

**Call-out 2-** Remove the roller assembly.

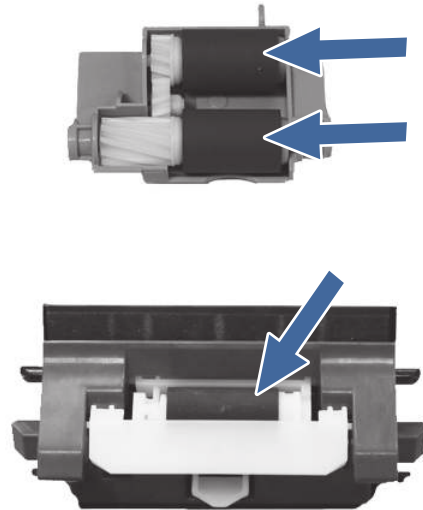
- c. Remove the Tray 4 pick and feed rollers.

To remove the roller assembly, gently pull on to the side of the rollers as shown.

 **NOTE:** Do not touch the rubber part of the rollers with hands. Oils or debris from hands can cause paper pickup issues.



- d. Clean the rollers with a dampened lint free cloth.



- e. Reinstall the roller assemblies and close the right door.  
f. Run a print job from Tray 4.

12. If the error persists, contact your HP-authorized service or support provider, or contact customer support at [www.hp.com/go/contactHP](http://www.hp.com/go/contactHP).

### 13.B2 jam error in right door

Use the following procedure to clear paper jams in the right door and fuser area. When a jam occurs, the control panel displays an animation that assists in clearing the jam.

#### Recommended action for customers

When a jam occurs, the control panel displays a message and an animation that assists in clearing the jam.

- 13.B2.Az Stay jam in right door
- 13.B2.Dz Delay jam in right door
- 13.B2.5z Inappropriate page to the Delivery Path jam
- 13.B2.FF Residual paper jam in right door

z = paper tray. This can be trays 1-5 or "D" for duplex jobs

Or

z = Fuser mode. This can be 0-9 or A-F.



[View a video of how to clear a jam in the right door and fuser area](#)

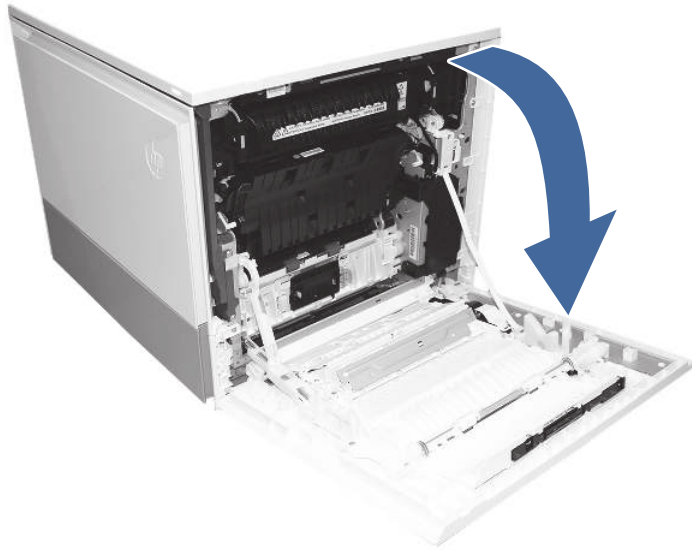


#### CAUTION:

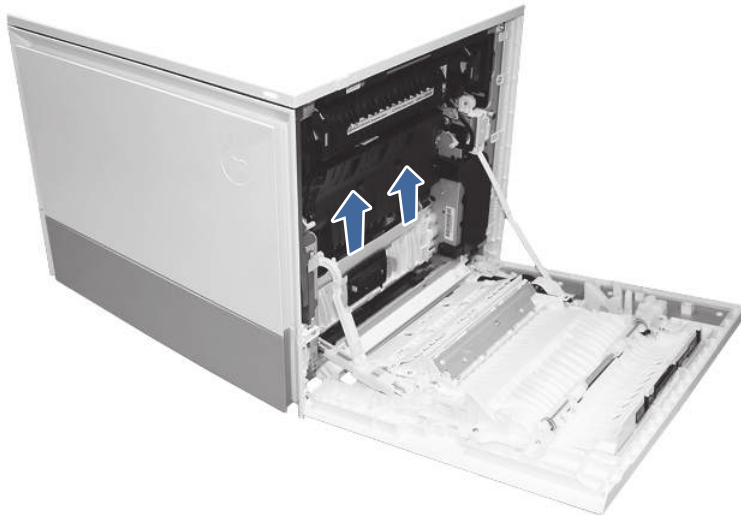


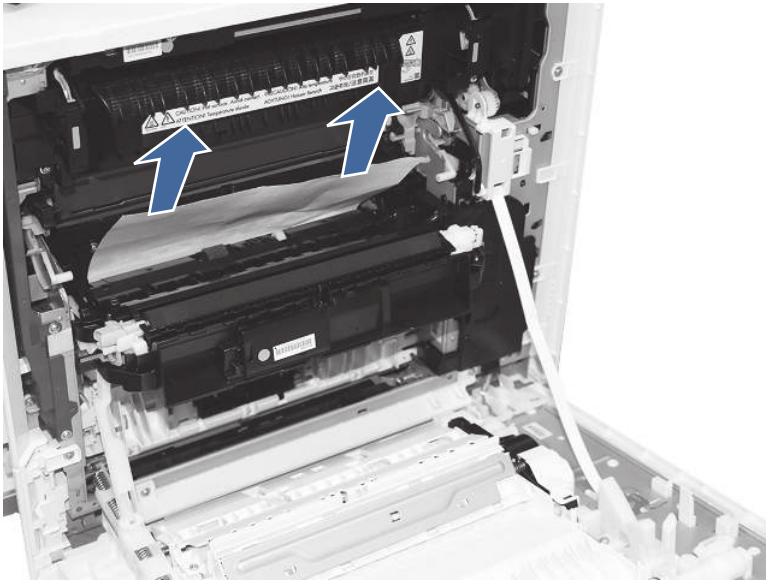
The fuser can be hot while the printer is in use. Wait for the fuser to cool before handling it.

1. Open the right door.

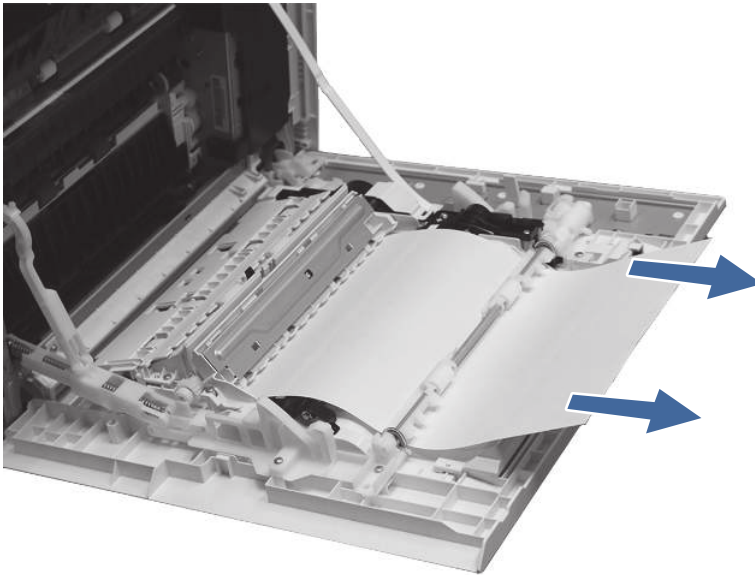


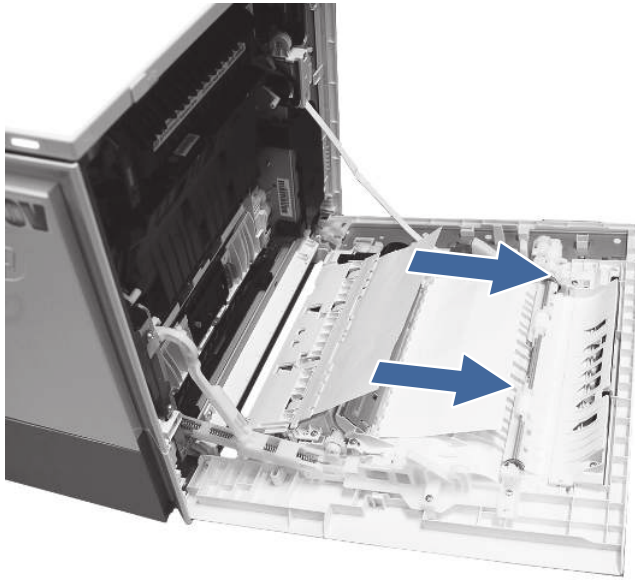
2. Gently remove any jammed paper.






3. Gently remove any jammed paper from the duplexer paper path.





---

 **IMPORTANT:** Make sure the paper being used is not too short for the printer's duplex requirements.

---

4. Close the right door.
5. Ensure the type and quality of the paper being used meets the HP specifications for the printer.
6. Ensure the paper tray guides are set to the correct size for the paper loaded.
7. If the error persists, contact your HP-authorized service or support provider, or contact customer support at [www.hp.com/go/contactHP](http://www.hp.com/go/contactHP).

### 13.B4 jam errors in the right door

Use the following procedure to clear paper jams in the right door and fuser area. When a jam occurs, the control panel displays an animation that assists in clearing the jam.

#### Recommended action for customers


When a jam occurs, the control panel displays a message and an animation that assists in clearing the jam.

- 13.B4.Cz Jam in right door
- 13.B4.FF Residual paper jam in right door

z = paper tray. This can be trays 1-5 or "D" for duplex print jobs.

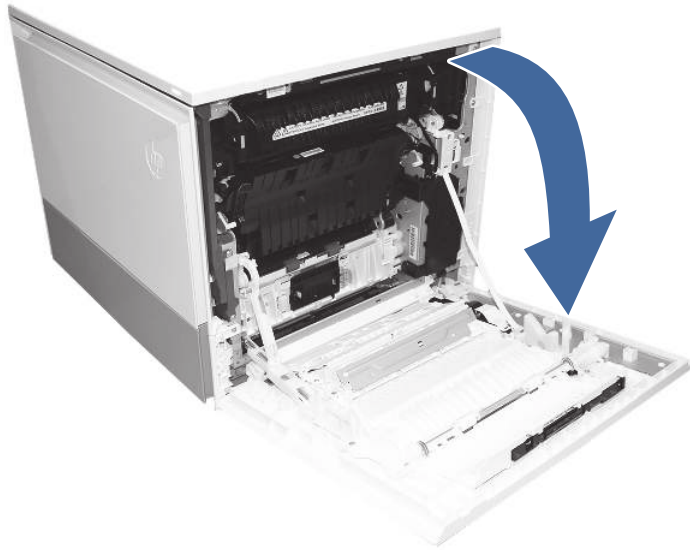
 [View a video of how to clear a jam in the right door and fuser area](#)

---

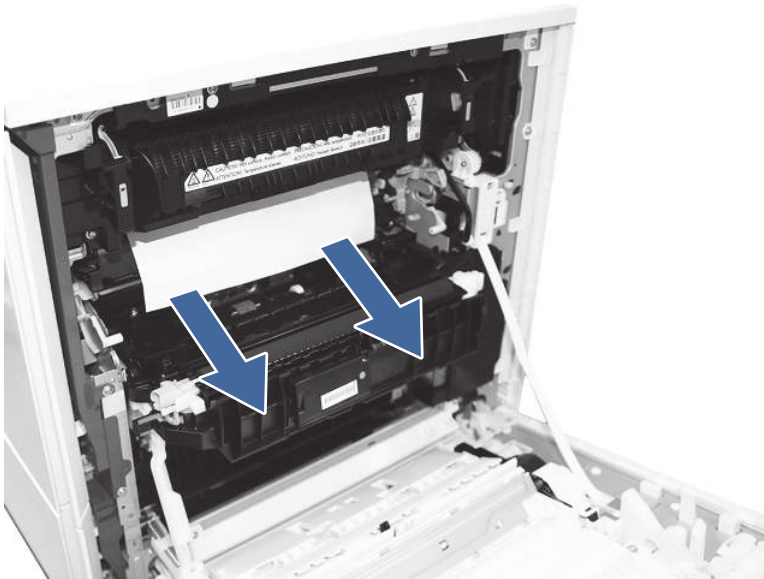
 **CAUTION:**  The fuser can be hot while the printer is in use. Wait for the fuser to cool before handling it.

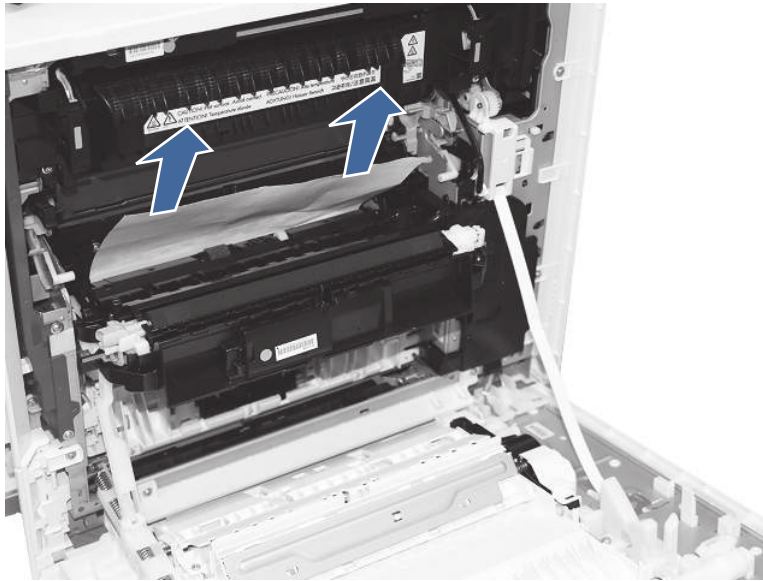
---

1. Open the right door.



2. Gently remove any jammed paper.





3. Close the right door.
4. Ensure the type and quality of the paper being used meets the HP specifications for the printer.
5. Ensure the paper tray guides are set to the correct size for the paper loaded.
6. If the error persists, contact your HP-authorized service or support provider, or contact customer support at [www.hp.com/go/contactHP](http://www.hp.com/go/contactHP).

### 13.B9 jam errors in the fuser

Use the following procedure to clear paper jams in the right door and fuser area. When a jam occurs, the control panel displays an animation that assists in clearing the jam.

#### Recommended action for customers

When a jam occurs, the control panel displays a message and an animation that assists in clearing the jam.

- 13.B9.yz Jam in right door

y = jam type (A or D)

z = Paper tray. This can be 0-5 or "D" for duplex print jobs.

Or

z = Fuser mode. This can be 0-9 or A-F.

- 13.B9.Cz Jam in right door (Fuser wrap jam)

z = Fuser mode. This can be 0-9 or A-F.

- 13.B9.FF Residual paper jam in right door



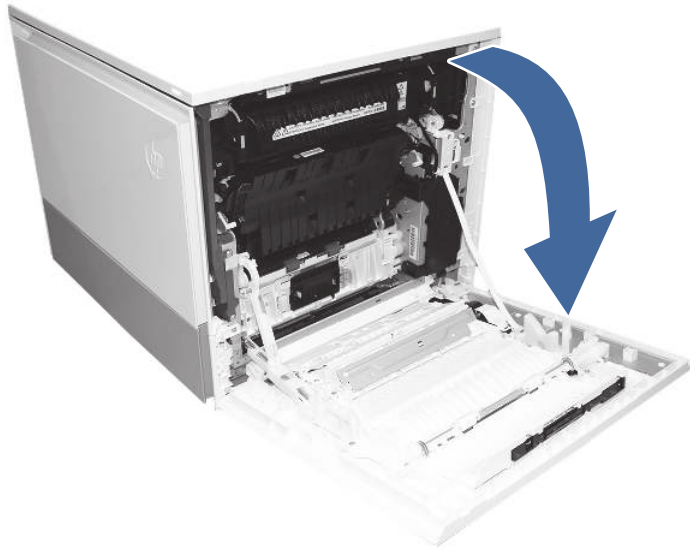
[View a video of how to clear a jam in the right door and fuser area](#)



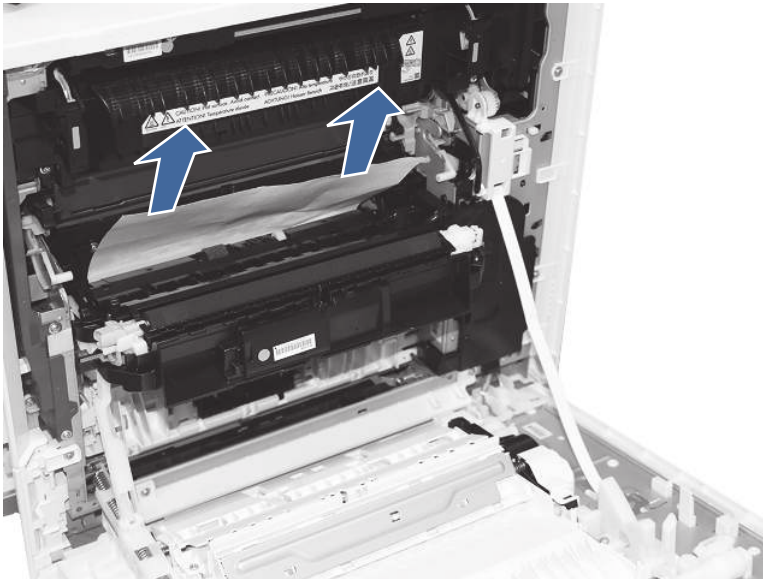
**NOTE:** The fuser is hot while the printer is in use. Wait for the fuser to cool before clearing jams.

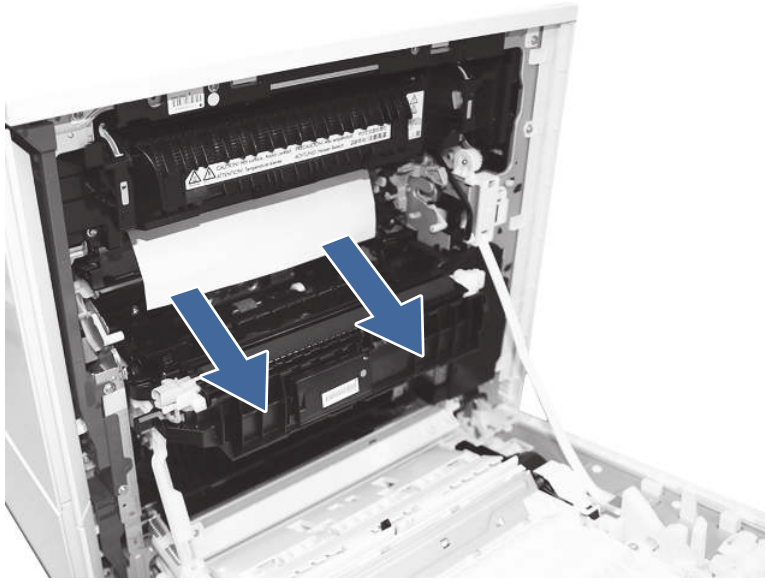


1. Open the right door.

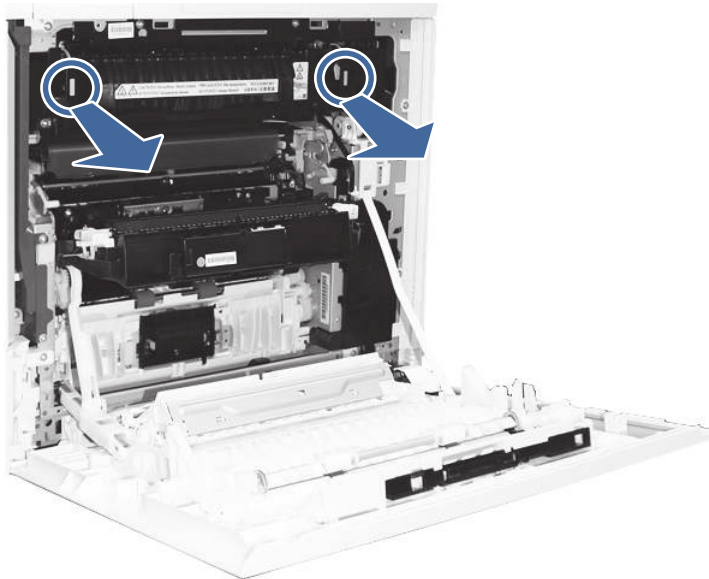


2. Gently remove any jammed paper from the fuser input.

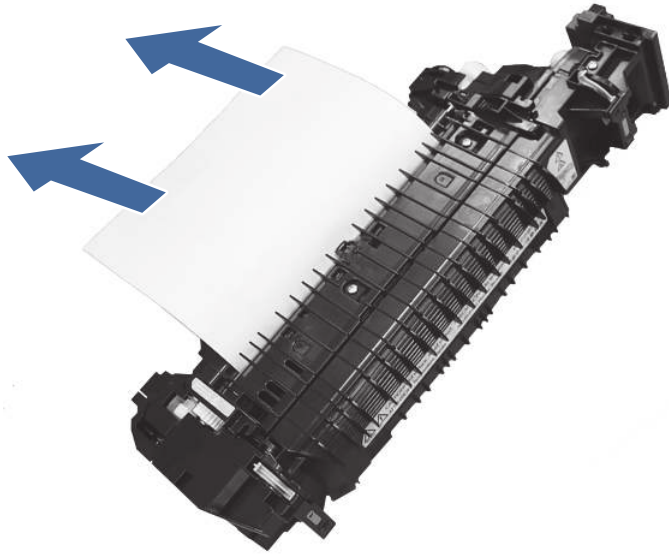




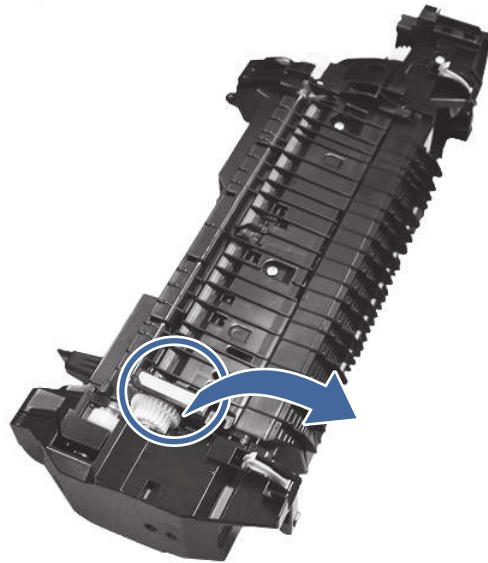
3. Remove the fuser and remove any jammed paper found.
  - a. Squeeze the release levers on the handles (circle call-outs) and then remove the fuser.



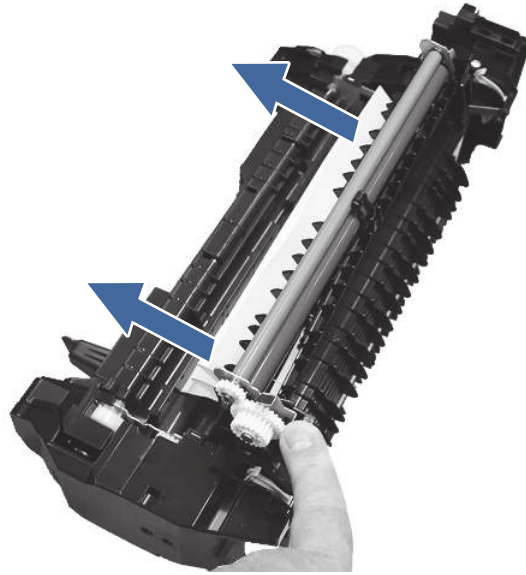
- b. Remove any paper from the exit of the fuser.



- c. Open the fuser access and check for a z-fold paper jam.



- d. Remove jammed paper from fuser.



- e. Reinstall the fuser and close the right door.
4. If the error persists, ensure the type and quality of the paper being used meets the HP specifications for the printer.
  5. If the error persists, contact your HP-authorized service or support provider, or contact customer support at [www.hp.com/go/contactHP](http://www.hp.com/go/contactHP).

### 13.D3 jam errors in the duplexer

Use the following procedure to clear paper jams in the duplexer area. When a jam occurs, the control panel displays an animation that assists in clearing the jam.

#### Recommended action for customers

When a jam occurs, the control panel displays a message and an animation that assists in clearing the jam.

- 13.D3.Dz Duplex delivery delay jam
- 13.D3.FF Residual paper jam in right door

z = Fuser mode. This can be 0-9 or A-F.

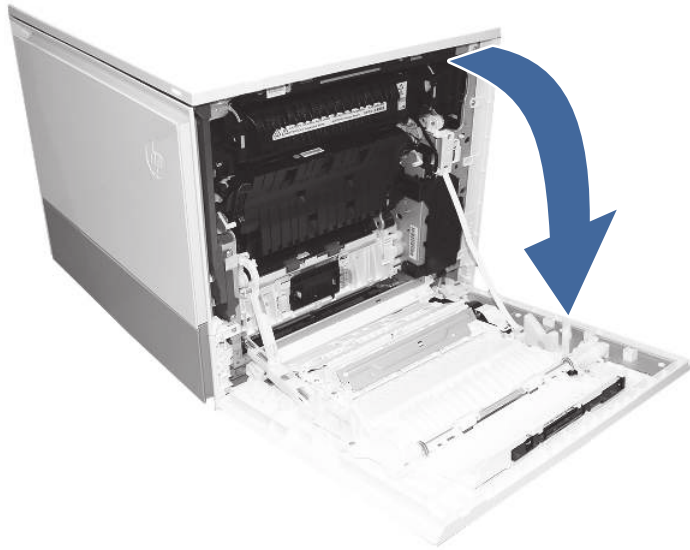


[View a video of how to clear a jam in the right door and fuser area](#)

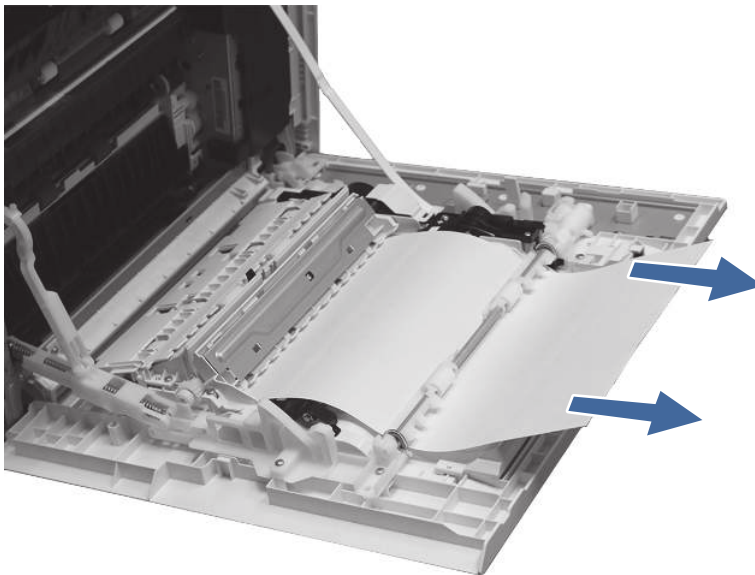


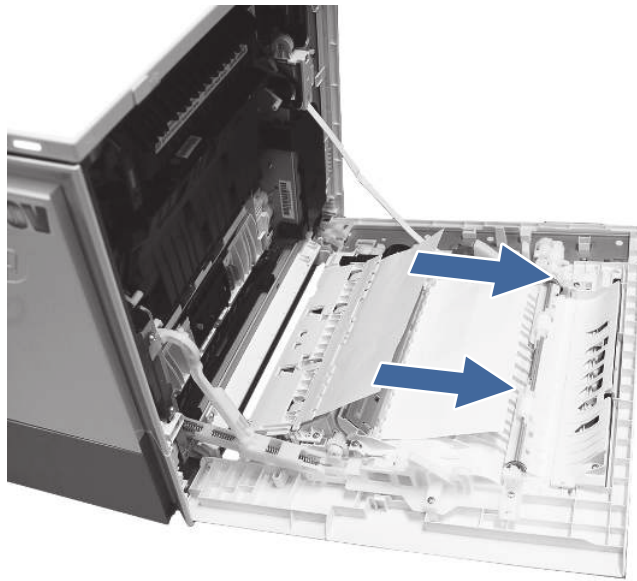
**NOTE:** The fuser is hot while the printer is in use. Wait for the fuser to cool before clearing jams.

1. Open the right door.



2. Gently remove any jammed paper from the duplexer paper path.





3. Close the right door.
4. If the error persists, ensure the type and quality of the paper being used meets the HP specifications for the printer.
5. If the error persists, contact your HP-authorized service or support provider, or contact customer support at [www.hp.com/go/contactHP](http://www.hp.com/go/contactHP).

### 13.E1 jam error in the output bin

Use the following procedure to check for paper in all possible jam locations in the output bin. When a jam occurs, the control panel displays an animation that assists in clearing the jam.

#### Recommended action for customers

When a jam occurs, the control panel displays a message and an animation that assists in clearing the jam.

- 13.E1.Dz Jam in output bin
- 13.E1.FF Residual paper jam in output bin

z = paper type that is being printed on. This can be 0-9 or A-F.

 [View a video of how to clear a jam in the output bin](#)

1. If paper is visible in the output bin, grasp the leading edge and remove it.



2. Ensure the type and quality of the paper being used meets the HP specifications for the printer.
3. If the error persists, contact your HP-authorized service or support provider, or contact customer support at [www.hp.com/go/contactHP](http://www.hp.com/go/contactHP).

### 13.E2 jam error in top cover

Use the following procedure to check for paper in all possible jam locations in the top cover area. When a jam occurs, the control panel displays an animation that assists in clearing the jam.

#### Recommended action for customers

When a jam occurs, the control panel displays a message and an animation that assists in clearing the jam.

- 13.E2.yz Jam in Top cover

y = "A" (stay jam) or "D" (delay jam)

z = 1-4 (output bin page is going to)

**These jams can only be present if the floor standing finisher is installed**



[View a video of how to clear a jam in the output bin](#)

1. Open the printer top access cover.



2. Remove all paper from inside the top cover.







3. Make sure that the floor standing finisher is correctly secured to the printer.
4. Make sure the type and quality of the paper being used meets the HP specifications for the printer.
5. If the error persists, contact your HP-authorized service or support provider, or contact customer support at [www.hp.com/go/contactHP](http://www.hp.com/go/contactHP).

### 13.60 jam errors in the fuser exit area when printing to a stapler/stacker or floor-standing finisher

Use the following procedure to check for paper in all possible jam locations in the fuser exit area when printing to a finisher. When a jam occurs, the control panel displays an animation that assists in clearing the jam.

#### Recommended action for customers

When a jam occurs, the control panel displays a message and an animation that assists in clearing the jam.

- 13.60.51, 13.60.52 Paper too short jam
- 13.60.61, 13.60.62, 13.60.63, 13.60.64 Inter-Page Gap Jam

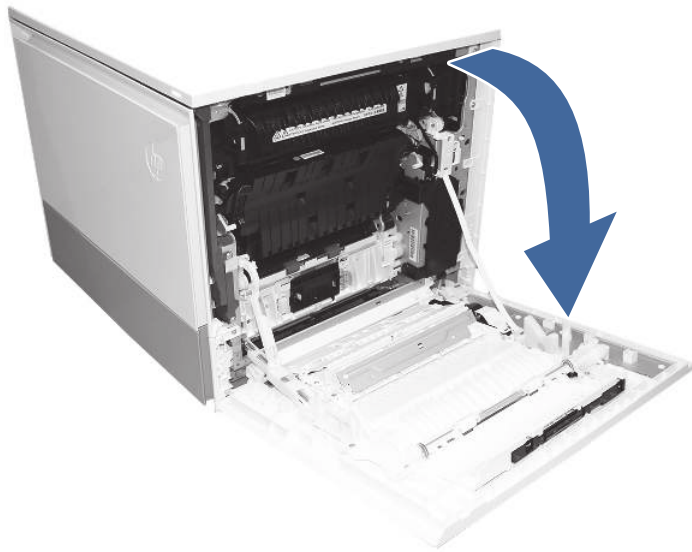
---

 **NOTE:** The images provide do not show any accessories or copy module attached to the printer.

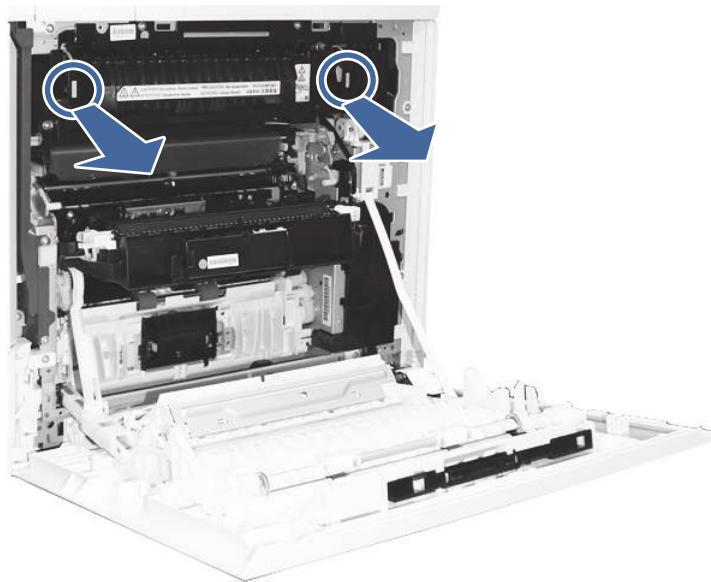
---

 [View a video of how to clear a jam in the output bin](#)

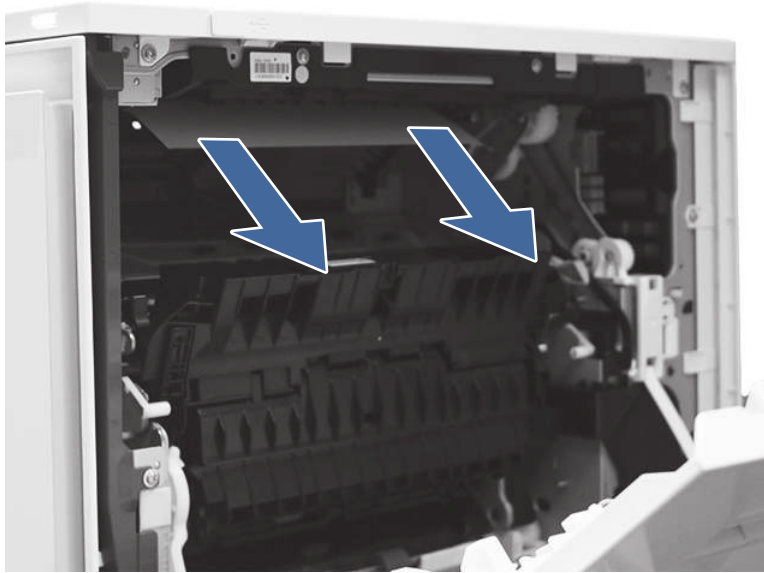
1. Open the right door.



2. Remove the fuser and remove any jammed paper found.
  - a. Squeeze the release levers on the handles (circle call-outs) and then remove the fuser.



- b. Remove any paper jammed in the fuser exit area.



- c. Reinstall the fuser and close the right door.
3. Close right door to allow the printer to clear jam message.
  4. Ensure the type and quality of the paper being used meets the HP specifications for the printer.
  5. If the error persists, contact your HP-authorized service or support provider, or contact customer support at [www.hp.com/go/contactHP](http://www.hp.com/go/contactHP).

### 13.80, 13.83, or 13.84 jam errors in the 3 Bin Stapler/Stacker

Use the following procedure to check for paper in all possible jam locations in the 3-bin stapler/stacker. When a jam occurs, the control panel displays an animation that assists in clearing the jam.

#### Recommended action for customers

When a jam occurs, the control panel displays a message and an animation that assists in clearing the jam.

- 13.80.yz Jam in 3 Bin stapler/stacker
- 13.83.yz Jam in 3 Bin stapler/stacker
- 13.84.yz Jam in 3 Bin stapler/stacker

y = "A" (stay jam), "B" (delay jam) "F" (residual jam)

z = Output destination tray 0-4



[View a video of how to clear a jam in the output bin](#)

1. Remove any paper from the output bins.



2. Clear all paper from upper right door.
  - a. Open the upper right door.



- b. Remove paper from input area inside the door.



- c. Remove paper from upper output area inside the door.

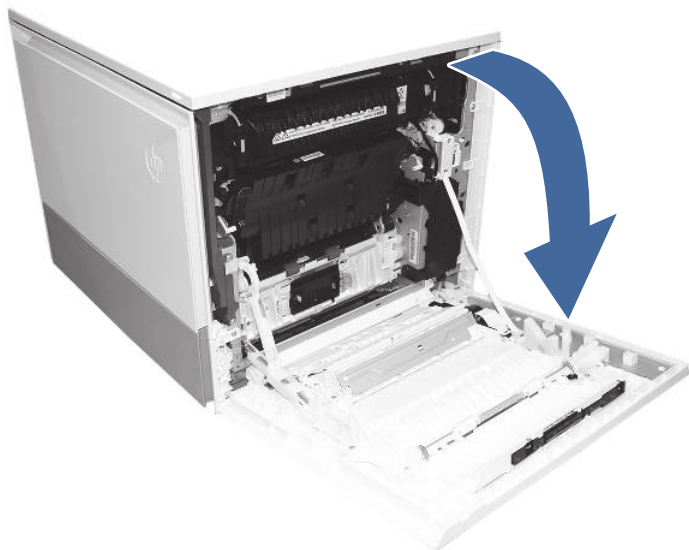


- d. Remove paper from upper standard exit area.



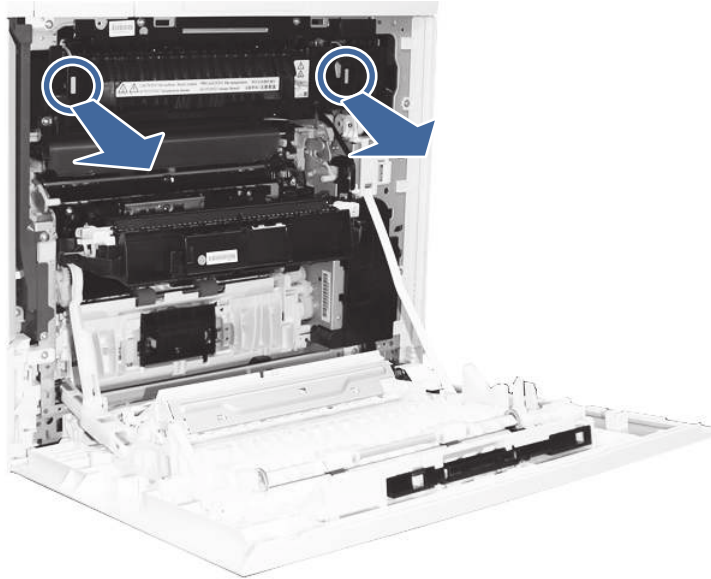
- e. Close the upper right door.

3. Open the right door.

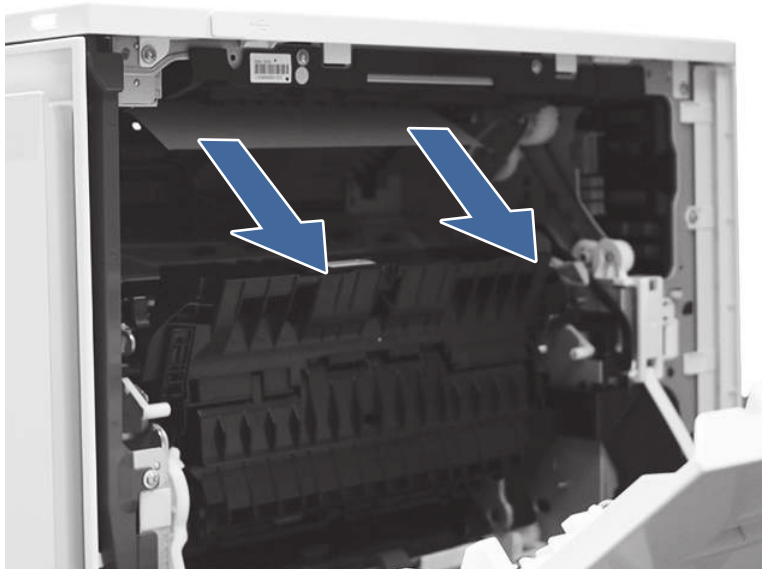


4. Remove the fuser and remove any jammed paper found.

- a. Squeeze the release levers on the handles (circle call-outs) and then remove the fuser.



- b. Remove any paper jammed in the fuser exit area.



- c. Reinstall the fuser and close the right door.
5. Ensure the type and quality of the paper being used meets the HP specifications for the printer.
6. If the error persists, contact your HP-authorized service or support provider, or contact customer support at [www.hp.com/go/contactHP](http://www.hp.com/go/contactHP).

### 13.40 or 13.47 Punch jam error in the Floor-standing finisher

Use the following procedure to check for paper in all possible jam locations in the floor-standing finisher punch area. When a jam occurs, the control panel displays an animation that assists in clearing the jam.

#### Recommended action for customers

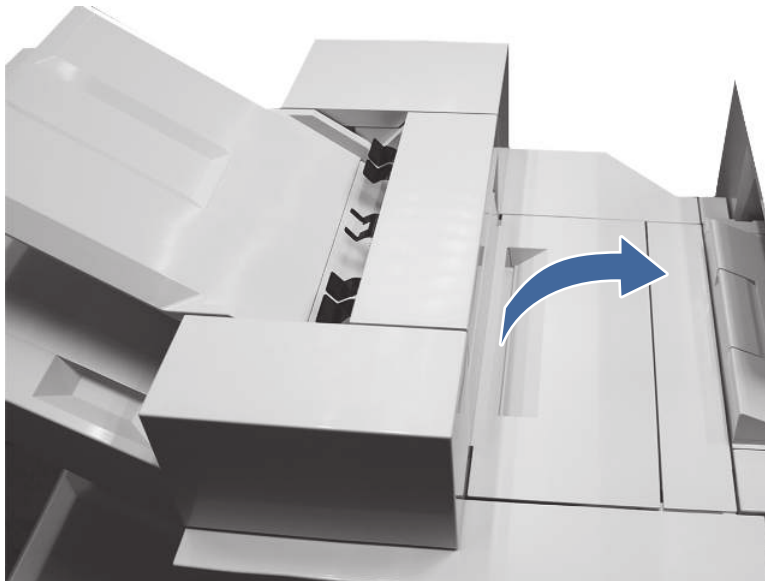
When a jam occurs, the control panel displays a message and an animation that assists in clearing the jam.

- 13.40.yz Punch inlet jam  
y = "A" (stay jam), "D" (delay jam) or "F" (residual jam)  
z = Output destination tray 0, 2-4
- 13.47.4z Punch jam  
z = Output destination tray 2-4



[View a video of how to clear a jam in the floor-standing finisher punch area](#)

1. Open the top left door.



2. Rotate the green dial on the top to the right or left

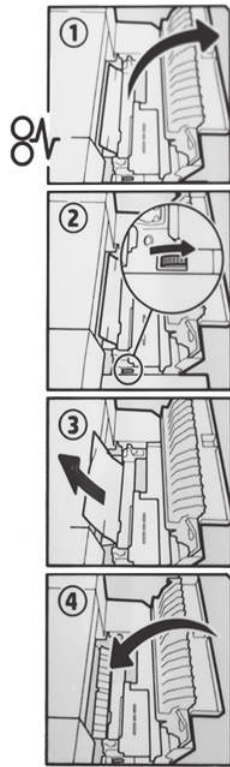


---

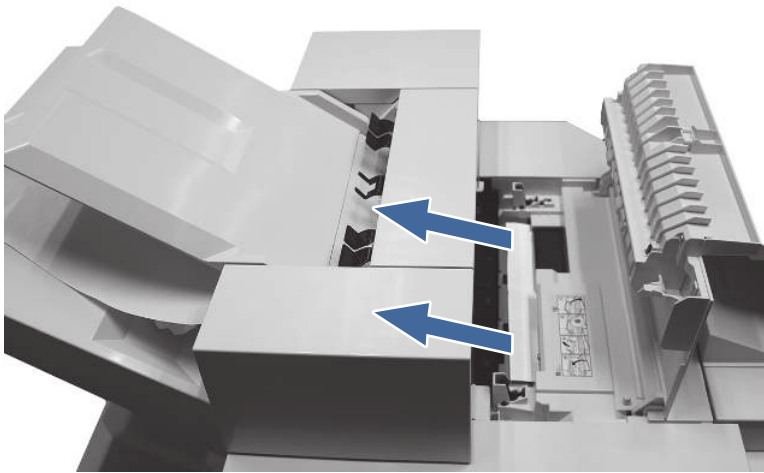
**NOTE:** Use the directions on the inside to assist in clearing the jam.

---





3. Remove paper from the top left door.



4. Close the top left door.
5. Ensure the type and quality of the paper being used meets the HP specifications for the printer.
6. If the error persists, contact your HP-authorized service or support provider, or contact customer support at [www.hp.com/go/contactHP](http://www.hp.com/go/contactHP).

## 13.6, 13.7, or 13.8 jam error in the Floor-standing finisher

Use the following procedure to check for paper in all possible jam locations in the floor-standing finisher. When a jam occurs, the control panel displays an animation that assists in clearing the jam.

### Recommended action for customers

When a jam occurs, the control panel displays a message and an animation that assists in clearing the jam.

- 13.6x.yz Jam in Floor standing stapler/stacker
- 13.7x.yz Jam in Floor standing stapler/stacker
- 13.8x.yz Jam in Floor standing stapler/stacker

x = 0, 1, 3, 4, 5

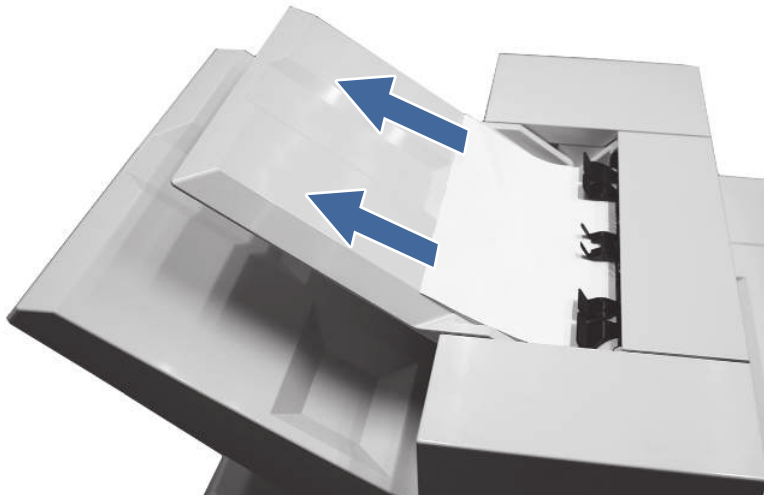
y = "A" (stay jam), "D" (delay jam), "F" (residual jam)

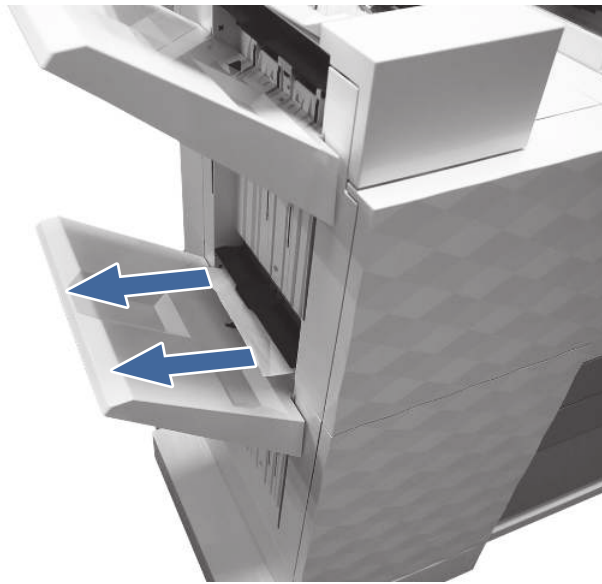
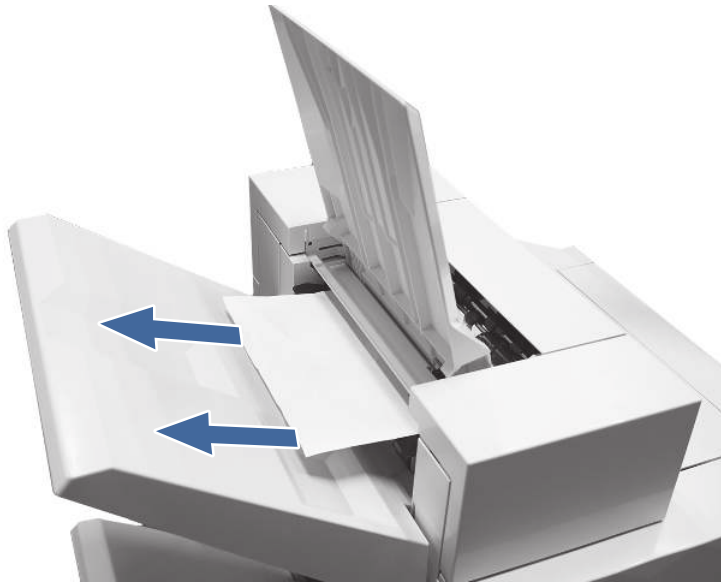
z = Output destination tray 0-4



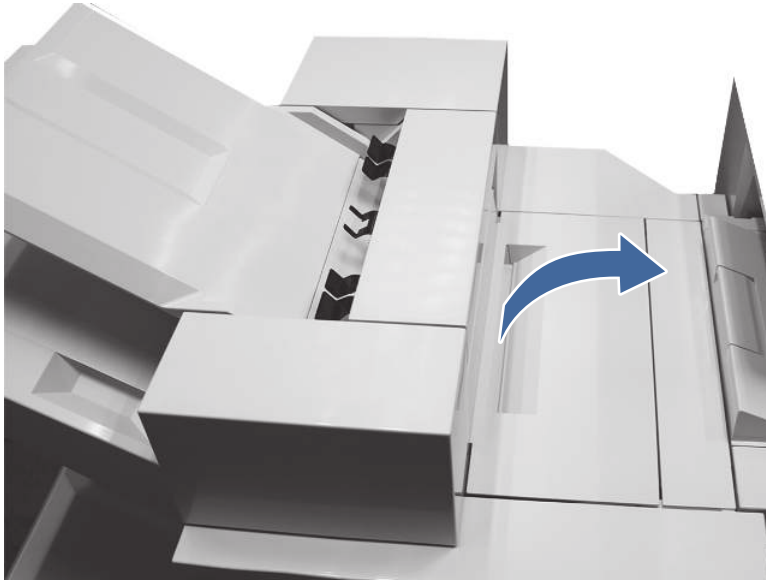
[View a video of how to clear a jam in the floor-standing finisher](#)

1. Remove any paper jams from the output bins by gently grasp the leading edge and remove it.






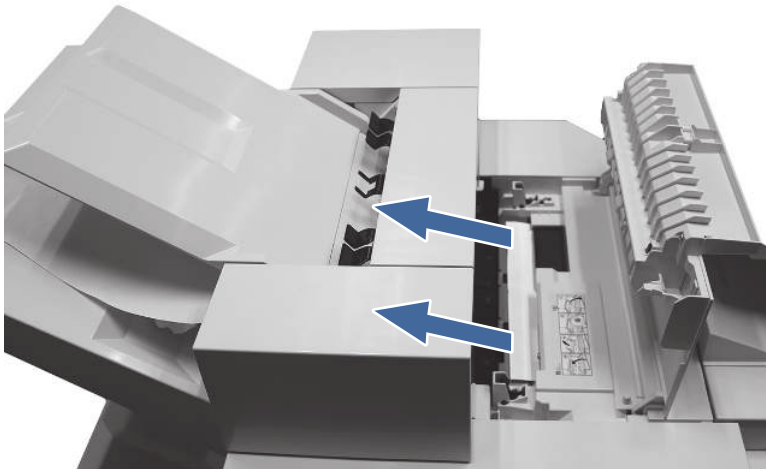
2. Open the top left door.

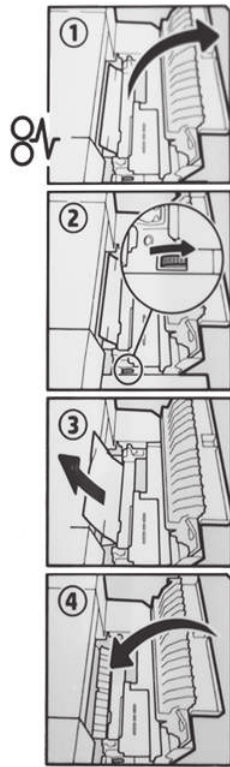


3. Remove paper from the top left door.

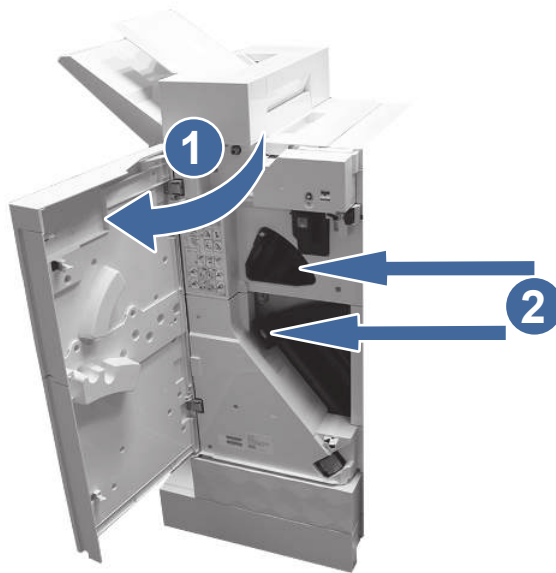
 **NOTE:** Use the directions on the inside to assist in clearing the jam.

---





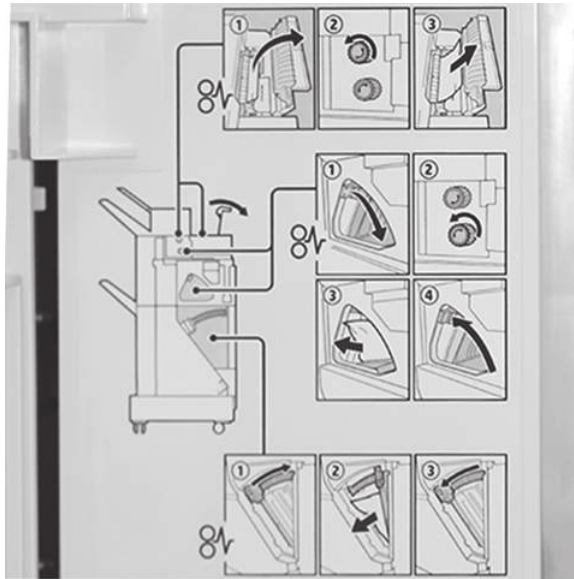
4. Open the front access do to clear any jammed paper.
  - a. Open the front door and check jam access areas.



**Call-out 1:** Open door

**Call-out 2:** Check access areas

- b. Use the directions inside the front access door to help remove the paper.



- 5. Ensure the type and quality of the paper being used meets the HP specifications for the printer.
- 6. If the error persists, contact your HP-authorized service or support provider, or contact customer support at [www.hp.com/go/contactHP](http://www.hp.com/go/contactHP).

## Printer feeds incorrect page size

Review the following information when the printer feeds an incorrect page size.

**Table 4-25 Printer feeds incorrect page size**

Cause	Solution
The correct size paper is not loaded in the tray.	Load the correct size paper in the tray.
The correct size paper is not selected in the software program or printer driver.	Confirm that the settings in the software program and printer driver are correct, because the software program settings override the printer driver and control panel settings, and the printer driver settings override the control panel settings.
The correct size paper for the tray is not selected in the printer control panel.	From the control panel, select the correct size paper for the tray.
The paper size is not configured correctly for the tray.	Print a configuration page to determine the paper size for which the tray is configured.
The guides in the tray are not against the paper.	Verify that the paper guides are touching the paper.

## Printer pulls from incorrect tray

Review the following information when the printer pulls from an incorrect tray.

**Table 4-26 Printer pulls from incorrect tray**

Cause	Solution
A driver for a different printer is in use.	Use a driver for this printer.

**Table 4-26 Printer pulls from incorrect tray (continued)**

Cause	Solution
The specified tray is empty.	Load paper in the specified tray.
The paper size is not configured correctly for the input tray.	Print a configuration page or use the control panel to determine the paper size for which the tray is configured.
The guides in the tray are not against the paper.	Verify that the guides are touching the paper.

## Printer will not duplex or duplexes incorrectly (duplex models)

Review the following information when the printer will not duplex or duplexes incorrectly.

**Table 4-27 Printer will not duplex (print 2-sided jobs) or duplexes incorrectly**

Cause	Solution
The duplex job is trying to use unsupported paper.	Verify that the paper is supported for duplex printing.
The printer driver is not set up for duplex printing.	Set up the printer driver to enable duplex printing.
The first page is printing on the back of preprinted forms or letterhead.	Load preprinted forms and letterhead in Tray 1 with the letterhead or printed side down, with the top of the page leading into the printer. For Tray 2-X, load the paper printed side up with the top of the page toward the right of the printer.
The printer model does not support automatic 2-sided printing.	The printer model does not support automatic 2-sided printing.

## Paper does not feed from Tray 2-X

Review the following information when the paper does not feed from Tray 2-X.

**Table 4-28 Paper does not feed from Tray 2-X**

Cause	Solution
The correct size paper is not loaded.	Load the correct size paper.
The input tray is empty.	Load paper in the input tray.
The correct paper type for the input tray is not selected in the printer control panel.	From the printer control panel, select the correct paper type for the input tray. Trays configured for a paper type with a specific weight range will not match a print job that specifies an exact weight, even if the specified weight is within the weight range.
Paper from a previous jam has not been completely removed.	Open the printer and remove any paper in the paper path. Closely inspect the fuser area for jams.
None of the optional trays appear as input tray options.	The optional trays only display as available if they are installed. Verify that any optional trays are correctly installed. Verify that the printer driver has been configured to recognize the optional trays.
An optional tray is incorrectly installed.	Print a configuration page to confirm that the optional tray is installed. If not, verify that the tray is correctly attached to the printer.
The paper size is not configured correctly for the input tray.	Print a configuration page or use the control panel to determine the paper size for which the tray is configured.
The guides in the tray are not against the paper.	Verify that the guides are touching the paper.

## Output is curled or wrinkled


Review the following information when the output is curled or wrinkled.

**Table 4-29** Output is curled or wrinkled

Cause	Solution
Paper does not meet the specifications for this printer.	Use only paper that meets the HP paper specifications for this printer. Non-recycled, 75 g/m <sup>2</sup> (20 lb) paper is optimal for office use.
The correct paper type for the input tray is not selected in the printer control panel.	From the printer control panel, select the correct paper type for the input tray. Trays configured for a paper type with a specific weight range will not match a print job that specifies an exact weight, even if the specified weight is within the weight range.
Paper is damaged or in poor condition.	Remove paper from the input tray and load paper that is in good condition.
The printer is operating in an excessively humid environment.	Verify that the printing environment is within humidity specifications.
The print job consist of large, solid-filled areas.	Large, solid-filled areas can cause excessive curl. Try using a different pattern.
Paper used was not stored correctly and might have absorbed moisture.	Remove paper and replace it with paper from a fresh, unopened package. Store paper in a plastic bag to protect it from humidity.
Paper has poorly cut edges.	Remove paper, flex it, rotate it 180 degrees or turn it over, and then reload it into the input tray. Do not fan paper. If the problem persists, replace the paper.
The specific paper type was not configured for the tray or selected in the software.	Configure the software for the paper (see the software documentation). Configure the tray for the paper.
The paper has previously been used for a print job.	Do not re-use paper.

## The printer does not pick up paper

If the printer does not pick up paper from the tray, try these solutions.

 **NOTE:** Tray 1 and Tray 2 are optimal for paper pickup when using special paper or media other than 20lb plain paper. For Tray 1 and Tray 2 the printer increases the number of attempts to pick up a page, which increases the reliability of successfully picking the page from the tray and decreases the possibility of a mispick jam.

HP recommends using Tray 1 or Tray 2 if the printer is experiencing excessive or reoccurring jams from trays other than Tray 1 and Tray 2, or for print jobs that require media other than 20lb plain paper.

1. Open the printer and remove any jammed sheets of paper.
2. Load the tray with the correct size of paper for the job.
3. Make sure the paper size and type are set correctly on the printer control panel.
4. Make sure the paper guides in the tray are adjusted correctly for the size of paper. Adjust the guides to the appropriate indentation in the tray.
5. Check the printer control panel to see if the printer is waiting for an acknowledgment to the feed the paper manually prompt. Load paper, and continue.



6. The rollers above the tray might be contaminated. Clean the rollers with a lint-free cloth dampened with warm water.

## The printer picks up multiple sheets of paper

If the printer picks up multiple sheets of paper from the tray, try these solutions.

1. Remove the stack of paper from the tray and flex it, rotate it 180 degrees, and flip it over. *Do not fan the paper.* Return the stack of paper to the tray.
2. Use only paper that meets HP specifications for this printer.
3. Use paper that is not wrinkled, folded, or damaged. If necessary, use paper from a different package.
4. Make sure the tray is not overfilled. If it is, remove the entire stack of paper from the tray, straighten the stack, and then return some of the paper to the tray.
5. Make sure the paper guides in the tray are adjusted correctly for the size of paper. Adjust the guides to the appropriate indentation in the tray.
6. Make sure the printing environment is within recommended specifications.
7. The tray pick and/or feed rollers might be contaminated. Clean the rollers with a lint-free cloth dampened with warm water.

## The document feeder jams, skews, or picks up multiple sheets of paper (MFP)

Learn about MFP document feeder paper handling problems.

Review the following information when the document feeder jams, skews, or picks up multiple sheets of paper.

- Check to see if there are areas on the page that might have had staples removed. This can cause jams and/or mispicks.
- The original might have something on it, such as staples or self-adhesive notes that must be removed.
- Check that all rollers are in place and correctly installed.
- Make sure that the top document-feeder cover is closed.
- The pages might not be placed correctly. Straighten the pages and adjust the paper guides to center the stack.
- The paper guides must be touching the sides of the paper stack to work correctly. Make sure that the paper stack is straight, and the guides are against the paper stack.
- The document feeder input tray or output bin might contain more than the maximum number of pages. Make sure the paper stack fits below the guides in the input tray and remove pages from the output bin.
- Verify that there are no pieces of paper, staples, paper clips, or other debris in the paper path.
- Clean the document-feeder rollers and the separation pad. Use compressed air or a clean, lint-free cloth moistened with warm water. If misfeeds still occur, replace the rollers.
- Use the control panel menus to check the status of the document-feeder kit and replace it if necessary.

## Paper does not feed automatically

Review the following information when the paper does not feed automatically.

**Table 4-30 Paper does not feed automatically**

Cause	Solution
Manual feed is selected in the software program.	Load Tray 1 with paper, or, if the paper is loaded, press the <b>OK</b> button.
The correct size paper is not loaded.	Load the correct size paper.
The input tray is empty.	Load paper into the input tray.
Paper from a previous jam has not been completely removed.	Open the printer and remove any paper in the paper path.
The paper size is not configured correctly for the input tray.	Print a configuration page or use the control panel to determine the paper size for which the tray is configured.
The guides in the tray are not against the paper.	Verify that the rear and width paper guides are touching the paper.

## Image-quality troubleshooting

Learn about image-quality troubleshooting.

Use the information in this topic to troubleshoot and resolve image-quality (what you see on the final printed page) problems including copy-quality, print-quality, and color problems (color printers only).

Various printer hardware problems can cause image-quality defects. This topic is a guide to the steps used to isolate the specific areas of the printer that are causing image-quality defects on the printed page, and to provide solutions to resolve those image-quality defects.

Image-quality problems are defined as:

- **Print-quality (PQ) problems:** PQ problems are associated with the print engine (printer base) of an MFP printer (single function non MFP image-quality problems are always PQ defects). PQ defects appear on pages that are **printed** by the print engine and not fed through an integrated scanner assembly (ISA).
- **Copy-quality (CQ) problems:** CQ problems are associated with the integrated-scanner assembly (ISA) portion of an MFP printer. CQ defects appear on pages that are **copied** using the document feeder or flatbed glass.

If the print defect is already known to be a PQ or CQ problem, skip to the appropriate troubleshooting topic listed below. Otherwise, follow the steps in the next section below to get started troubleshooting image-quality problems.

- **Print-quality (PQ) problems:** See [Print-quality troubleshooting on page 450](#).
- **Copy-quality (CQ) problems:** See [Copy-quality troubleshooting on page 465](#).

### Get started troubleshooting image-quality problems

Print a demonstration page to identify the defect as a PQ (print engine ) or CQ (ISA) problem.



**NOTE:** If the image defect appears on the printed demonstration page, the issue is a print-quality (PQ) problem (associated with the print engine and not the document feeder or flatbed glass) and not a CQ problem.

Make sure that the demonstration page is printed on **plain paper**.

Enterprise printers

1. Select **Reports > Other pages**.
2. Select **Demonstration Page**.

Pro printers

1. At the printer, scroll to or select **Setup**.
2. Go to **Reports**, and then select **Demonstration Page**.

Does the demonstration page show any image-quality defects?

- **Yes:** If defects appear on the printed demonstration page the issue is PQ related. See [Print-quality troubleshooting on page 450](#).
- **No:** If defects does not appear on the printed demonstration page the issue is CQ related. See [Copy-quality troubleshooting on page 465](#).

## Print-quality troubleshooting

Learn about the print-quality troubleshooting.



**NOTE:** Print-quality (PQ) problems are associated with the print engine (printer base) of an MFP printer (single function non MFP image-quality problems are always PQ defects). PQ defects appear on pages that are **printed** by the print engine and not feed through an integrated scanner assembly (ISA).

## Repetitive image defect ruler

Review the following information about a repetitive image defect ruler.

When troubleshooting the source of some print image defects, one solution is to identify if it is a repetitive defect (does the print quality defect appear multiple times on the printed page?). If this is the case, use a ruler to measure occurrences of repetitive image defects to help solve image-quality problems. For more information, see [Using a ruler to measure between repetitive defects](#).

Use a ruler to measure occurrences of repetitive image defects to help solve image-quality problems. Place the ruler next to the first occurrence of the defect on the page. Find the distance between identical defects and use the table below to identify the component that is causing the defect.



**CAUTION:** Do not use solvents or oils to clean rollers. Instead, rub the roller with a lint-free cloth. If dirt is difficult to remove, rub the roller with a lint-free cloth that has been dampened with water.



**NOTE:** The primary charging roller, photosensitive drum, and developer roller cannot be cleaned because they are internal assemblies in the toner cartridge or imaging drum. If one of these assemblies is causing the defect, replace the toner cartridge. The primary fuser sleeve unit or pressure roller cannot be cleaned because they are internal assemblies in the fuser. If one of these assemblies is causing the defect, replace the fuse.



**TIP:** To make a printer specific repetitive defect ruler, use a metric ruler to transfer the measurements in the table below to a transparency or the edge of a piece of paper—clearly label each ruler mark with the associated defective assembly.

**Table 4-31 Repetitive defects**

Assembly	Distance between defects	Notes
Registration roller	44 mm (1.7 in)	Appears as dirt or dirt on the back of the page.
Secondary transfer roller	50 mm (1.97 in)	Appears as dropouts or dirt on the back of the page.
Primary charging roller	26 mm (1 in)	Appears as dropouts.
Photosensitive drum	75 mm (2.95 in)	Appears as dirt or dropouts.
Developer roller	38 mm (1.5 in)	Appears as dropouts.
Fuser film	76 mm (3 in)	Appears as dirt, dropouts, or loose toner.
Pressure roller	79 mm (3.1 in)	Appears as dirt, loose toner, or dirt on the back of the page.

### Use a ruler to measure between repetitive defects

The figures in this section show color repetitive defect pages. However, the process for measuring repetitive defects is valid for mono pages.

1. Identify a repetitive defect on the page.



**TIP:** Print a cleaning page to see if that resolves the defect.

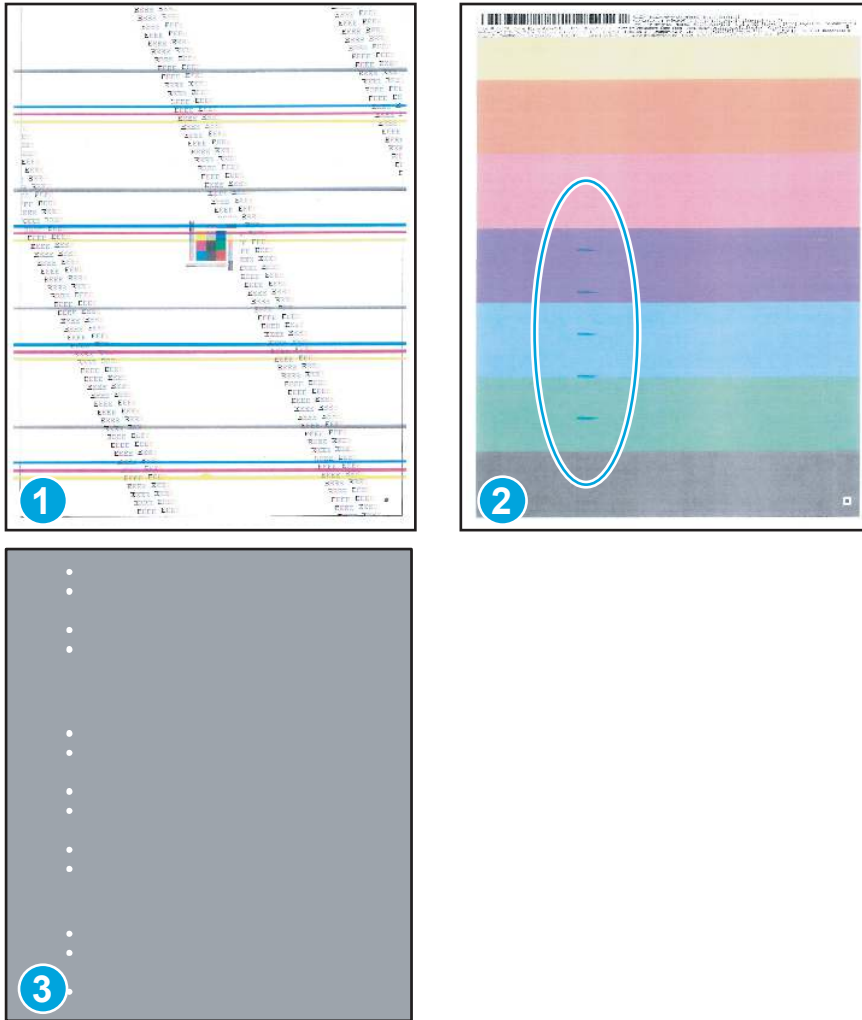


**NOTE:** Some printers allow loading Letter and A4 media in short-edge-first or long-edge-first orientation in the paper trays. When measuring repetitive defects, make sure to place the ruler at the leading edge of the page. This is the edge of the page that feeds into the printer first.

The example pages below show the following types of repetitive defects.

- Lines (callout 1)
- Smudges (callout 2)
- Dots or spots (callout 3)

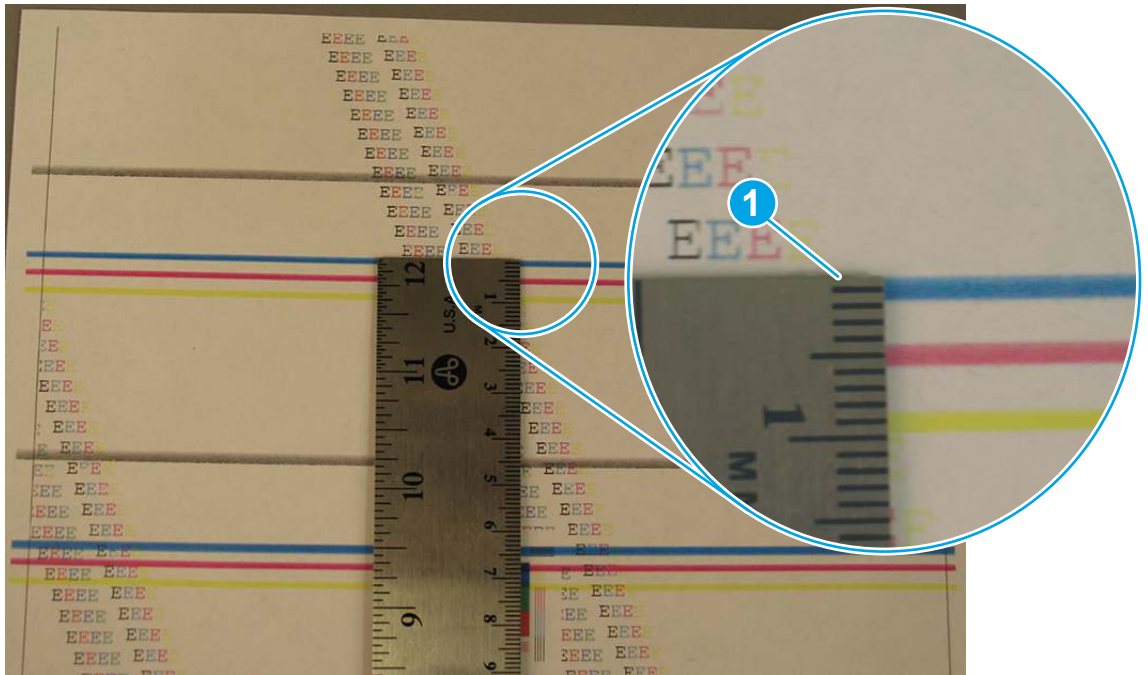
**Figure 4-203** Examples of repetitive defects



 **NOTE:** These are examples only, other types of repetitive defects might appear on a page.

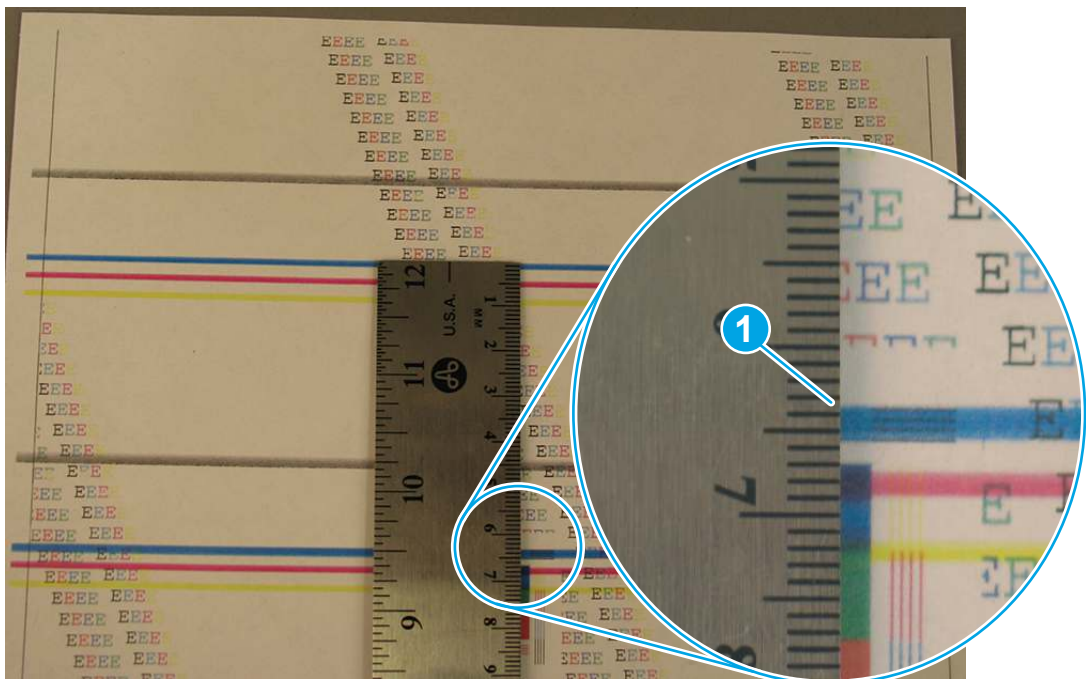
2. Position a metric ruler on the page with the “zero” ruler mark at one occurrence of the defect (callout 1).

**Figure 4-204 Place the ruler on the page**




3. Locate the next occurrence of the defect (callout 1).

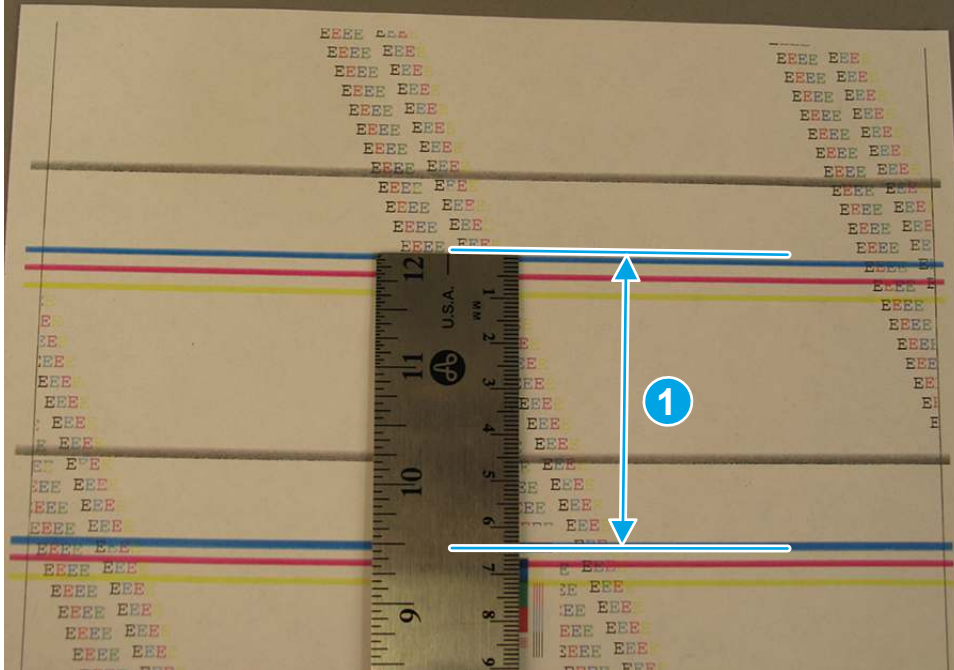
**Figure 4-205 Locate the next repetitive defect**



4. Measure the distance (in millimeters) between the two occurrences (callout 1), and then use the Repetitive defects table to determine the defective assembly.

 **TIP:** Always measure from and to the same point on the defects. For example, if the ruler is “zeroed” at the top edge of a defect, measure to the top edge of the next occurrence of that defect.

**Figure 4-206 Determine the defective assembly**



### Print from a different software program

Try printing from a different software program.

If the page prints correctly, the problem is with the software program from which you were printing.

### Check the paper-type setting for the print job

Check the paper type setting when printing from a software program and the printed pages have smears, fuzzy or dark print, curled paper, scattered dots of toner, loose toner, or small areas of missing toner.

### Check the paper type setting on the control panel

Check the paper type setting on the printer control panel, and change the setting as needed.

1. Open and close the paper tray.
2. Follow the control panel prompts to confirm or modify the paper type and size settings for the tray.
3. Make sure the paper loaded meets specifications.
4. Adjust the humidity and resistance setting on the control panel to match the environment.
  - a. Open the following menus:
    - i. Settings
    - ii. Copy/Print

- iii. Print quality
    - iv. Adjust paper type
  - b. Select the paper type that matches the type loaded in the tray.
  - c. Use the arrows to increase or decrease the humidity and resistance setting.
5. Make sure the driver settings match the control panel settings.

---

 **NOTE:** The print driver settings will override any control panel settings.

---

### Check the paper type setting (Windows)

Check the paper type setting for Windows, and change the setting as needed.

---

 **NOTE:** The print driver settings will override any control panel settings.

---

1. From the software program, select the **Print** option.
2. Select the printer, and then click the **Properties** or **Preferences** button.
3. Click the **Paper/Quality** tab.
4. From the **Paper Type** drop-down list, click the **More...** option.
5. Expand the list of **Type is:** options.
6. Expand the category of paper types that best describes your paper.
7. Select the option for the type of paper you are using, and click the **OK** button.
8. Click the **OK** button to close the **Document Properties** dialog box. In the **Print** dialog box, click the **OK** button to print the job.

### Check the paper type setting (macOS)

Check the paper type setting for macOS, and change the setting as needed.

1. Click the **File** menu, and then click the **Print** option.
2. In the **Printer** menu, select the printer.
3. Click **Show Details** or **Copies & Pages**.
4. Open the menu drop-down list, and then click the **Paper/Quality** menu.
5. Select a type from the **Media Type** drop-down list.
6. Click the **Print** button.

### Check toner-cartridge status

Follow these steps to check the estimated life remaining in the toner cartridges and if applicable, the status of other replaceable maintenance parts.

#### Step one: Print the Supplies Status Page

The supplies status page indicates the cartridge status.

1. From the Home screen on the printer control panel, select the **Reports** menu.



2. Select the [Configuration/Status Pages](#) menu.
3. Select [Supplies Status Page](#), and then select [Print](#) to print the page.

### Step two: Check supplies status

Check the supplies status report as follows.

1. Look at the supplies status report to check the percent of life remaining for the toner cartridges and, if applicable, the status of other replaceable maintenance parts.

Print quality problems can occur when using a toner cartridge that is at its estimated end of life. The supplies status page indicates when a supply level is very low. After an HP supply has reached the very low threshold, HP's premium protection warranty on that supply has ended.

The toner cartridge does not need to be replaced now unless the print quality is no longer acceptable. Consider having a replacement available to install when print quality is no longer acceptable.

If you determine that you need to replace a toner cartridge or other replaceable maintenance parts, the supplies status page lists the genuine HP part numbers.

2. Check to see if you are using a genuine HP cartridge.

A genuine HP toner cartridge has the word "HP" on it, or has the HP logo on it. For more information on identifying HP cartridges go to [www.hp.com/go/learnaboutsupplies](http://www.hp.com/go/learnaboutsupplies).

### Print a cleaning page

Learn how to print a cleaning page.

1. From the [Home](#) screen on the printer control panel, scroll to and touch the [Support Tools](#) button.
2. Open the following menus:
  - [Maintenance](#)
  - [Calibration/Cleaning](#)
3. Touch [Cleaning Page](#), and then touch the [Print](#) button to print the cleaning page.



**NOTE:** A [Cleaning...](#) message displays on the control-panel display. Do not turn the printer off until the cleaning process has finished. When it is finished, discard the printed page.



**TIP:** Use this screen to set up automatic cleaning page intervals if desired.

### Check paper and the printing environment

Use the following information to check the paper selection and the printing environment.

#### Step one: Use paper that meets HP specifications

Some print-quality problems arise from using paper that does not meet HP specifications.

- Always use a paper type and weight that this printer supports.
- Use paper that is of good quality and free of cuts, nicks, tears, spots, loose particles, dust, wrinkles, voids, staples, and curled or bent edges.
- Use paper that has not been previously printed on.
- Use paper that does not contain metallic material, such as glitter.

- Use paper that is designed for use in laser printers. Do not use paper that is designed only for use in Inkjet printers.
- Use paper that is not too rough. Using smoother paper generally results in better print quality.

### Step two: Check the environment

The environment can directly affect print quality and is a common cause of print-quality or paper-feeding issues. Try the following solutions:

- Move the printer away from drafty locations, such as open windows or doors, or air-conditioning vents.
- Make sure the printer is not exposed to temperatures or humidity outside of printer specifications.
- Do not place the printer in a confined space, such as a cabinet.
- Place the printer on a sturdy, level surface.
- Remove anything that is blocking the vents on the printer. The printer requires good air flow on all sides, including the top.
- Protect the printer from airborne debris, dust, steam, grease, or other elements that can leave residue inside the printer.

### Step three: Set the individual tray alignment

Follow these steps when text or images are not centered or aligned correctly on the printed page when printing from specific trays.

1. From the Home screen on the printer control panel, select the **Settings** menu.
2. Select the following menus:
  - a. **Copy/Print or Print**
  - b. **Print Quality**
  - c. **Image Registration**
3. Select **Tray**, and then select the tray to adjust.
4. Select **Print Test Page**, and then follow the instructions on the printed pages.
5. Select **Print Test Page** again to verify the results, and then make further adjustments if necessary.
6. Select **Done** to save the new settings.

### Try a different print driver



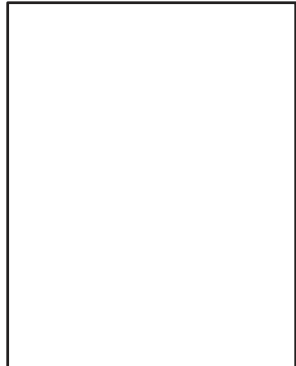


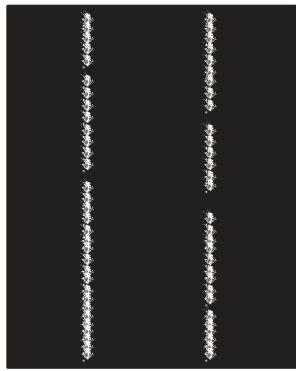
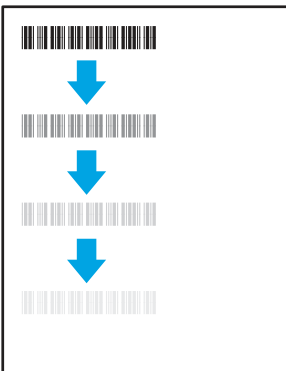


Try a different print driver when printing from a software program and the printed pages have unexpected lines in graphics, missing text, missing graphics, incorrect formatting, or substituted fonts.

Download a different print driver from the HP support Web site: <http://www.hp.com/support/colorlj6700> or <http://www.hp.com/support/colorlj6800MFP> or <http://www.hp.com/support/colorlj6801MFP> or <http://www.hp.com/support/colorljX654> or <http://www.hp.com/support/colorljX677MFP>.

### Troubleshoot image defects

Review examples of image defects and steps to resolve these defects.

**Table 4-32 Image defects table quick reference**

Defect	Defect	Defect
<p data-bbox="248 262 555 289"><a href="#">Table 4-40 Light print on page 463</a></p> 	<p data-bbox="647 262 1023 312"><a href="#">Table 4-38 Gray background or dark print on page 462</a></p> 	<p data-bbox="1046 262 1422 312"><a href="#">Table 4-35 Blank page - No print on page 461</a></p> 
<p data-bbox="248 741 555 768"><a href="#">Table 4-34 Black page on page 460</a></p> 	<p data-bbox="647 741 1015 768"><a href="#">Table 4-33 Banding defects on page 460</a></p> 	<p data-bbox="1046 741 1398 768"><a href="#">Table 4-42 Streak defects on page 464</a></p> 
<p data-bbox="248 1325 600 1375"><a href="#">Table 4-37 Fixing/fuser defects on page 461</a></p> 	<p data-bbox="647 1325 1007 1375"><a href="#">Table 4-39 Image placement defects on page 463</a></p> 	<p data-bbox="1046 1325 1414 1375"><a href="#">Table 4-36 Color plane registrations defects (color models only) on page 461</a></p> 

**Table 4-32 Image defects table quick reference (continued)**



Defect	Defect	Defect
<p data-bbox="274 262 624 289"><a href="#">Table 4-41 Output defects on page 464</a></p> 		


Image defects, no matter the cause, can often be resolved using the same steps. Use the following steps as a starting point for solving image defect issues.

1. Reprint the document. Print quality defects can be intermittent in nature or can go away completely with continued printing.
2. Check the condition of the cartridge or cartridges. If a cartridge is in a **Very Low** state (it has passed the rated life), replace the cartridge.
3. Make sure that the driver and tray print mode settings match the media that is loaded in the tray. Try using a different ream of media or a different tray. Try using a different print mode.
4. Make sure the printer is within the supported operating temperature/humidity range.
5. Make sure that the paper type, size, and weight are supported by the printer. See the printer support page at [support.hp.com](http://support.hp.com) for a list of the supported paper sizes and types for the printer.


 **NOTE:** The term "fusing" refers to the part of the printing process where toner is affixed to paper.

The following examples depict letter-size paper that has passed through the printer with the short edge first.

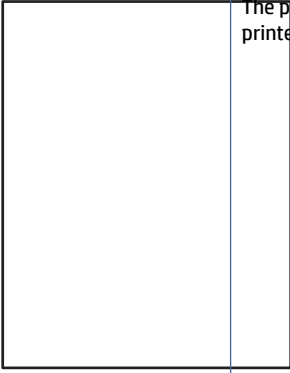
**Table 4-33 Banding defects**

Sample	Description	Possible solutions
	<p>Dark or light lines which repeat down the length of the page, and are wide-pitch and/or impulse bands. They might be sharp or soft in nature. The defect displays only in areas of fill, not in text or sections with no printed content.</p>	<ol style="list-style-type: none"> <li>1. Reprint the document.</li> <li>2. Try printing from another tray.</li> <li>3. Replace the cartridge.</li> <li>4. Use a different paper type.</li> <li>5. <b>Enterprise models only:</b> From the Home screen on the printer control panel, go to the <a href="#">Adjust Paper Types</a> menu, and then choose a print mode that is designed for a slightly heavier media than what you are using. This slows the print speed and might improve the print quality.</li> <li>6. If the issue persists, go to <a href="http://support.hp.com">support.hp.com</a>.</li> </ol>

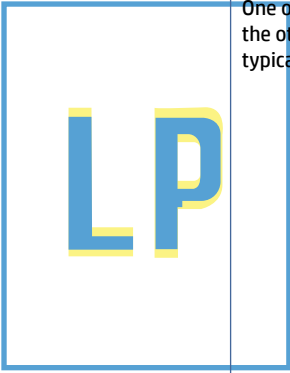
**Table 4-34 Black page**

Sample	Description	Possible solutions
	<p>The entire printed page is black.</p>	<ol style="list-style-type: none"> <li>1. Visually inspect the cartridge to check for damage.</li> <li>2. Make sure that the cartridge is installed correctly.</li> <li>3. Replace the cartridge.</li> <li>4. If the issue persists, go to <a href="http://support.hp.com">support.hp.com</a>.</li> </ol>

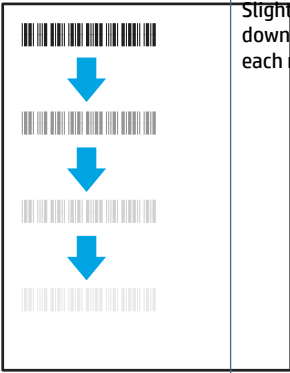
**Table 4-35 Blank page - No print**

Sample	Description	Possible solutions
	The page is completely blank and contains no printed content.	<ol style="list-style-type: none"> <li>1. Make sure that the cartridges are genuine HP cartridges.</li> <li>2. Make sure that the cartridge is installed correctly.</li> <li>3. Print with a different cartridge.</li> <li>4. Check the paper type in the paper tray and adjust the printer settings to match. If necessary, select a lighter paper type.</li> <li>5. If the issue persists, go to <a href="http://support.hp.com">support.hp.com</a>.</li> </ol>

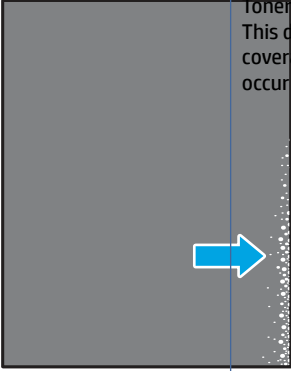
**Table 4-36 Color plane registrations defects (color models only)**

Sample	Description	Possible solutions
	One or more color plane(s) is not aligned with the other color planes. This registration error will typically occur with yellow.	<ol style="list-style-type: none"> <li>1. Reprint the document.</li> <li>2. From the printer control panel, calibrate the printer.</li> <li>3. If a cartridge has reached a <b>Very Low</b> state, or the printed output is severely faded, replace the cartridge.</li> <li>4. From the printer control panel use the <b>Restore Calibration</b> feature to reset the printer's calibration settings to the factory defaults.</li> <li>5. If the issue persists, go to <a href="http://support.hp.com">support.hp.com</a>.</li> </ol>

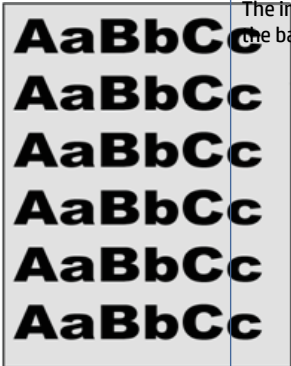
**Table 4-37 Fixing/fuser defects**

Sample	Description	Possible solutions
	Slight shadows or offsets of the image are repeated down the page. The repeated image might fade with each recurrence.	<ol style="list-style-type: none"> <li>1. Reprint the document.</li> <li>2. Check the paper type in the paper tray and adjust the printer settings to match. If necessary, select a lighter paper type.</li> <li>3. If the issue persists, go to <a href="http://support.hp.com">support.hp.com</a>.</li> </ol>

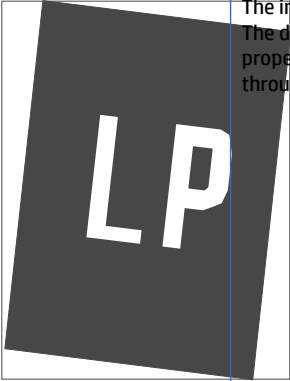
**Table 4-37 Fixing/fuser defects (continued)**

Sample	Description	Possible solutions
	<p>Toner rubs off along either edge of the page. This defect is more common at the edges of high-coverage jobs, and on light media types, but can occur anywhere on the page.</p>	<ol style="list-style-type: none"> <li>1. Reprint the document.</li> <li>2. Check the paper type in the paper tray and adjust the printer settings to match. If necessary, select a heavier paper type.</li> <li>3. <b>Enterprise models only:</b> From the printer control panel, go to the <b>Edge-to-Edge</b> menu and then select <b>Normal</b>. Reprint the document.</li> <li>4. <b>Enterprise models only:</b> From the printer control panel, select <b>Auto Include Margins</b> and then reprint the document.</li> <li>5. If the issue persists, go to <a href="http://support.hp.com">support.hp.com</a>.</li> </ol>

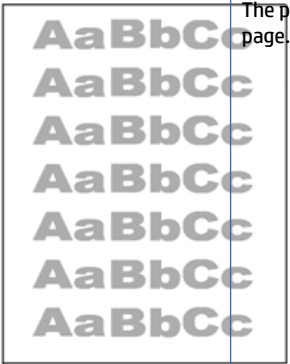
**Table 4-38 Gray background or dark print**

Sample	Description	Possible solutions
	<p>The image or text is darker than expected and/or the background is gray.</p>	<ol style="list-style-type: none"> <li>1. Make sure that the paper in the trays has not already been run through the printer.</li> <li>2. Use a different paper type.</li> <li>3. Reprint the document.</li> <li>4. <b>Mono models only:</b> From the Home screen on the printer control panel, go to the <b>Adjust Toner Density</b> menu, and then adjust the toner density to a lower level.</li> <li>5. Make sure that the printer is within the supported operating temperature and humidity range.</li> <li>6. Replace the cartridge.</li> <li>7. If the issue persists, go to <a href="http://support.hp.com">support.hp.com</a>.</li> </ol>

**Table 4-39 Image placement defects**

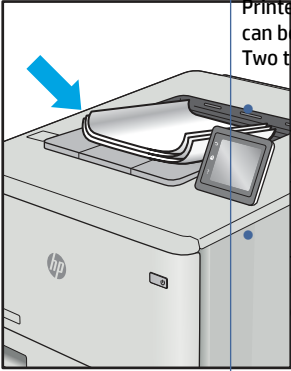
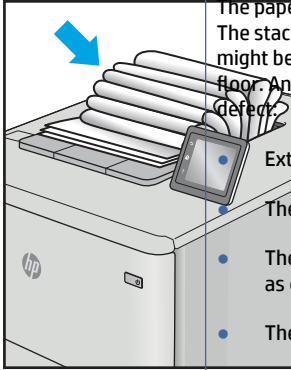
Sample	Description	Possible solutions
	<p>The image is not centered, or is skewed on the page. The defect occurs when the paper is not positioned properly as it is pulled from the tray and moves through the paper path.</p>	<ol style="list-style-type: none"> <li>1. Reprint the document.</li> <li>2. Remove the paper and then reload the tray. Make sure that all the paper edges are even on all sides.</li> <li>3. Make sure that the top of the paper stack is below the tray-full indicator. Do not overfill the tray.</li> <li>4. Make sure that the paper guides are adjusted to the correct size for the paper. Do not adjust the paper guides tightly against the paper stack. Adjust them to the indentations or markings in the tray.</li> <li>5. If the issue persists, go to <a href="http://support.hp.com">support.hp.com</a>.</li> </ol>

**Table 4-40 Light print**

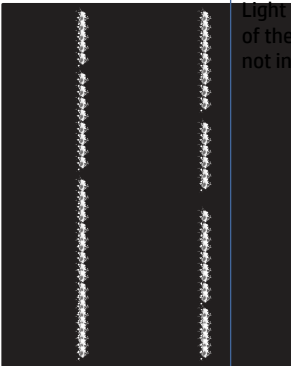
Sample	Description	Possible solutions
	<p>The printed content is light or faded on the entire page.</p>	<ol style="list-style-type: none"> <li>1. Reprint the document.</li> <li>2. Remove the cartridge, and then shake it to redistribute the toner. Reinsert the toner cartridges into the printer and close the cover. For a graphical representation of this procedure, see <i>Replace the toner cartridges</i>.</li> <li>3. <b>Mono models only:</b> Make sure that the EconoMode setting is disabled, both at the printer control panel and in the print driver.</li> <li>4. Make sure that the cartridge is installed correctly.</li> <li>5. Print a Supplies Status Page and check the life and usage of the cartridge.</li> <li>6. Replace the cartridge.</li> <li>7. If the issue persists, go to <a href="http://support.hp.com">support.hp.com</a>.</li> </ol>



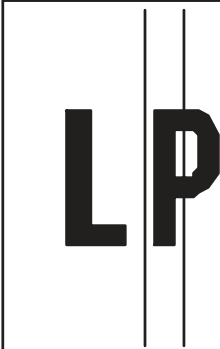
**Table 4-41 Output defects**

Sample	Description	Possible solutions
	<p>Printed pages have curled edges. The curled edge can be along the short or long side of the paper. Two types of curl are possible:</p> <ul style="list-style-type: none"> <li>• <b>Positive curl:</b> The paper curls toward the printed side. The defect occurs in dry environments or when printing high-coverage pages.</li> <li>• <b>Negative curl:</b> The paper curls away from the printed side. The defect occurs in high-humidity environments or when printing low-coverage pages.</li> </ul>	<ol style="list-style-type: none"> <li>1. Reprint the document.</li> <li>2. <b>Positive curl:</b> From the printer control panel, select a heavier paper type. The heavier paper type creates a higher temperature for printing.  <b>Negative curl:</b> From the printer control panel, select a lighter paper type. The lighter paper type creates a lower temperature for printing. Try storing the paper in a dry environment prior to use, or use freshly opened paper.</li> <li>3. Print in duplex mode.</li> <li>4. If the issue persists, go to <a href="http://support.hp.com">support.hp.com</a>.</li> </ol>
	<p>The paper does not stack well in the output tray. The stack might be uneven, skewed, or the pages might be pushed out of the tray and onto the floor. Any of the following conditions can cause this defect:</p> <ul style="list-style-type: none"> <li>• Extreme paper curl</li> <li>• The paper in the tray is wrinkled or deformed</li> <li>• The paper is a non-standard paper type, such as envelopes</li> <li>• The output tray is too full</li> </ul>	<ol style="list-style-type: none"> <li>1. Reprint the document.</li> <li>2. Extend the output bin extension.</li> <li>3. If the defect is caused by extreme paper curl, refer to the troubleshooting steps for "Output curl."</li> <li>4. Use a different paper type.</li> <li>5. Use freshly opened paper.</li> <li>6. Remove the paper from the output tray before the tray gets too full.</li> <li>7. If the issue persists, go to <a href="http://support.hp.com">support.hp.com</a>.</li> </ol>

**Table 4-42 Streak defects**

Sample	Description	Possible solutions
	<p>Light vertical streaks that usually span the length of the page. The defect displays only in areas of fill, not in text or sections with no printed content.</p>	<ol style="list-style-type: none"> <li>1. Reprint the document.</li> <li>2. Remove the cartridge, and then shake it to redistribute the toner. Reinsert the toner cartridges into the printer and close the cover. For a graphical representation of this procedure, see <i>Replace the toner cartridges</i>.</li> <li>3. If the issue persists, go to <a href="http://support.hp.com">support.hp.com</a>.</li> </ol> <p><b>NOTE:</b> Both light and dark vertical streaks can occur when the printing environment is outside the specified range for temperature or humidity. Refer to your printer's environmental specifications for allowable temperature and humidity levels.</p>

**Table 4-42 Streak defects (continued)**

Sample	Description	Possible solutions
	<p>Dark vertical lines which occur down the length of the page. The defect might occur anywhere on the page, in areas of fill or in sections with no printed content. On color models, these lines or streaks will also be visible on the ITB cleaning page.</p>	<ol style="list-style-type: none"> <li>1. Reprint the document.</li> <li>2. Remove the cartridge, and then shake it to redistribute the toner. Reinsert the toner cartridges into the printer and close the cover. For a graphical representation of this procedure, see <i>Replace the toner cartridges</i>.</li> <li>3. Print a cleaning page.</li> <li>4. Check the toner level in the cartridge.</li> <li>5. If the issue persists, go to <a href="http://support.hp.com">support.hp.com</a>.</li> </ol>


## Copy-quality troubleshooting

Learn about copy-quality troubleshooting.

 **NOTE:** Copy-quality (CQ) problems are associated with the integrated-scanner assembly (ISA) portion of an MFP printer. CQ defects appear on pages that are **copied** using the document feeder or flatbed glass.

### Identify the location and type of the CQ problem

Resolving CQ problems involves isolating the defect to the document feeder or flatbed glass. Comparing printed output between the document feeder and the flatbed glass might determine the ISA location that is causing the CQ defect.

 **NOTE:** If a CQ defect appears on printed output from both the document feeder **and** the flatbed glass, carefully inspect the original source for a print-quality (PQ) problem.

#### Document feeder isolation test

1. Mark a printed page in a way that clearly identifies it as the source document used in this isolation procedure.
2. Place the source page in the document feeder, and then make a copy.
3. Mark the copied output page to clearly identify it as output from the document feeder.
4. Compare the original and copied pages. Defects appearing on the copied page are caused by a problem in the document feeder.

#### Flatbed isolation test

1. Mark a printed page in a way that clearly identifies it as the source document used in this isolation procedure.
2. Place the source page on the flatbed glass, and then make a copy.
3. Mark the copied output page to clearly identify it as output from the flatbed.
4. Compare the original and copied pages. Defects appearing on the copied page are caused by a problem in the flatbed.

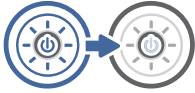
## Check the scanner glass for dirt and smudges

Learn about solving copy-quality debris problems.

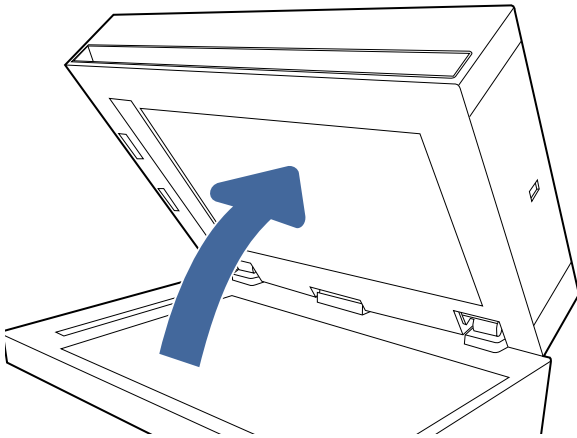
Over time, specks of debris might collect on the scanner glass and document feeder white plastic backing, which might cause print defects. Use the following procedure to clean the scanner if the printed pages have streaks, unwanted lines, black dots, poor print quality, or unclear text.

 [View a video of cleaning the document feeder glass and flatbed glass.](#)

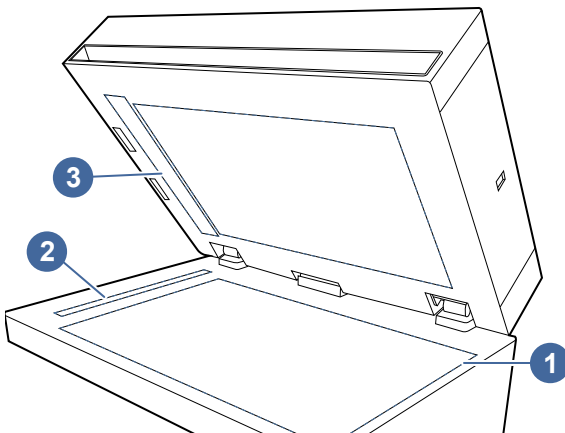
1. Press the power button to turn the printer off, and then disconnect the power cable from the electrical outlet.




2. Open the scanner lid.



3. Clean the scanner glass (callout 1) and the document feeder strips (callout 2, callout 3) with a soft cloth or sponge that has been moistened with nonabrasive glass cleaner.



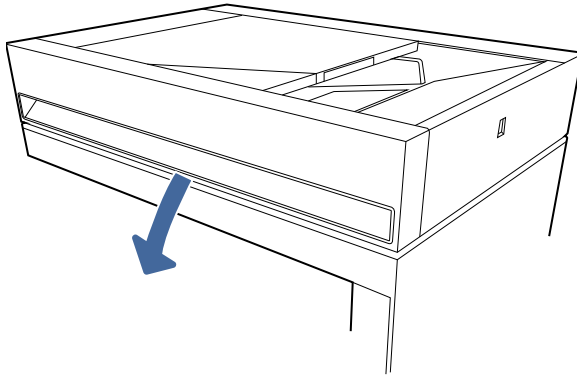
**⚠ CAUTION:** Do not use abrasives, acetone, benzene, ammonia, ethyl alcohol, or carbon tetrachloride on any part of the printer; these can damage the printer. Do not place liquids directly on the glass or platen. They might seep and damage the printer.

 **NOTE:** If you are having trouble with streaks on copies when you are using the document feeder, be sure to clean the small strips of glass on the left side of the scanner (callout 2, callout 3).

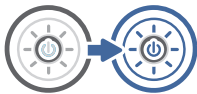
---

4. Dry the glass and white plastic parts with a chamois or a cellulose sponge to prevent spotting.
5. Close the scanner lid.

**Figure 4-207** Close the scanner lid



6. Connect the power cable to an outlet, and then press the power button to turn the printer on.




## Vertical lines, bands, or streaks

Learn about vertical lines, bands, or streaks copy-quality problems.

Vertical lines or streaks appear on copies and/or scans in the same direction that the paper feeds when copying and/or scanning from the document feeder. Lines or streaks might be visible on the front and/or the back side of the page. Copies and/or scans from the flatbed glass look normal. Printouts also look normal.

The line or streak might be black or in color, and can also be present on fax or digital send output (for example, when using [Scan to folder](#) or [Scan to email](#) features).

 **NOTE:** HP has determined that **99%** of all lines and streaks on copies made by feeding the original documents through the document feeder are caused by **debris on the document feeder glass strip**. Even small specks can cause the light reflected off the original to be distorted, resulting in a line, streak, or smudge on copies or scans made from the document feeder.

---

Even if the document feeder glass strip and/or flatbed glass has been wiped clean, the defect might persist. Persistent vertical lines, bands, or streaks when copying from the document feeder might mean that the debris causing the print quality are not readily visible and cannot be removed with a quick cleaning.

Use the procedures below to resolve persistent lines, bands, or streak copy-quality (CQ) problems.


### Locate debris and thoroughly clean the document feeder glass

1. Place a blank sheet of paper in the document feeder and mark an X in the lower right corner as shown.

**Figure 4-208 Load the document feeder**



2. Press the **Start** button to make a copy of the blank page.
3. Place the copied paper face-up on the flatbed glass with the **X** located as shown.

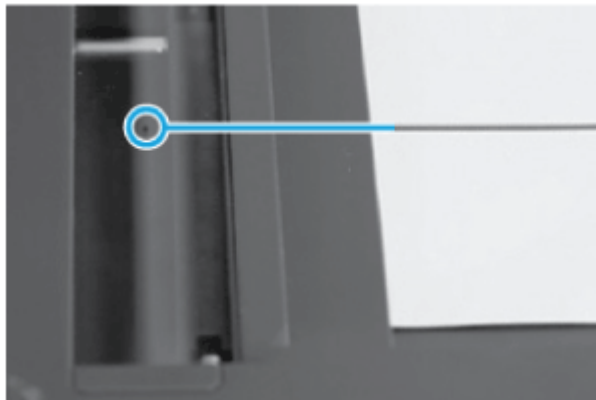
 **NOTE:** Make sure the upper left corner of the copy is aligned with the upper left corner of the flatbed glass.

**Figure 4-209 Place the copy on the flatbed**



4. Follow the line or streak on the paper to the area on the document feeder glass that is causing the CQ problem.

**Figure 4-210 Identify the CQ defect location**



5. Use a fingernail to loosen any stubborn debris.

---

**⚠ WARNING!** Use only a fingernail. Other objects can scratch the document feeder glass.

---

Clean this specific area again (with a lint-free cloth dampened with water), and then dry the glass with a soft, lint-free cloth.

**Figure 4-211 Clean the glass**



6. Make another copy or scan to determine if the defect is gone.

### Clean the duplexer scanner glass (model specific)

---

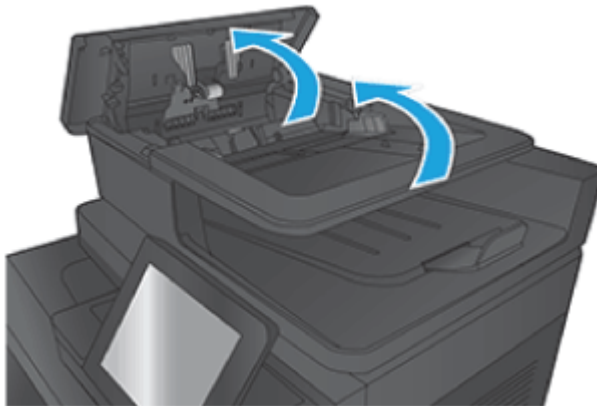
**📝 NOTE:** Not all MFP printers use a background selector for duplex printing.

If a *Side 2 Background Selector* cannot be located for the printer (it might not include one) skip this procedure.

---

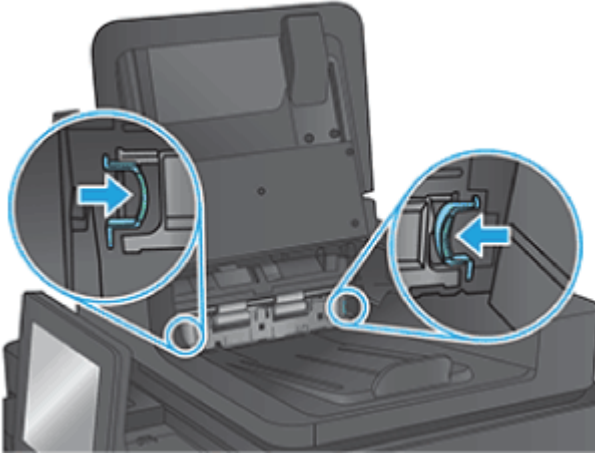
1. Release the latch and open the document feeder jam-access door.

**Figure 4-212 Open the jam-access door**



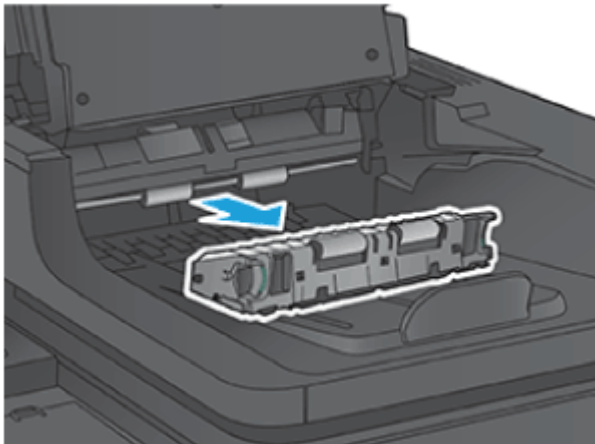
2. Unlock the Side 2 Background Selector by pressing and holding both green tabs inward towards each other.

**Figure 4-213 Release the Side 2 Background Selector**



3. While holding the green tabs, pull out and remove the Side 2 Background Selector.

**Figure 4-214 Remove the Side 2 Background Selector**

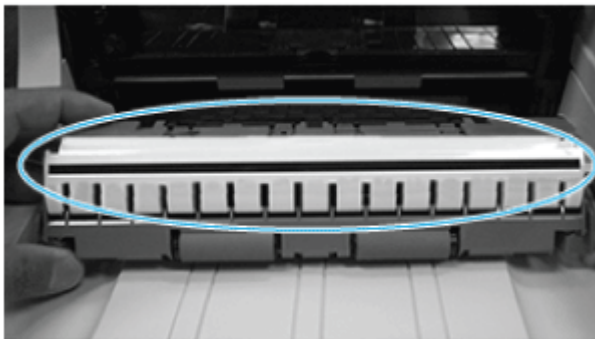


4. Rotate the top to reveal the white and black backside reflector (circled in blue).




**NOTE:** If the white and black areas do not come clean, wipe the surface thoroughly with a damp cloth again. Dry the area with a soft, dry cloth to prevent spotting.

**Figure 4-215 Locate the backside reflector**



5. With the background selector removed from the document feeder, clean the inside of the scan module.
6. In the back area from where the background selector was removed, locate the Side 2 Scan Module glass found under the top area.


---

 **NOTE:** The glass surface of the Side 2 Scan module sits horizontally flat and might not be easily viewable.

---

7. Use a soft, lint-free cloth moistened with water and apply pressure upwards behind the rollers to clean the Side 2 Scan Module Glass, making sure to that the entire width of the glass is cleaned from left to right.

---

 **NOTE:** If needed, lens cleaner or non-abrasive glass cleaner can be applied to the cloth before cleaning the glass. Spray only onto the cloth and not directly onto the glass or device. Do not spray water or glass cleaner on the glass as it can seep under it and possibly damage the printer. Do not use abrasives, acetone, benzene, ethyl alcohol, or carbon tetrachloride on the glass; these can damage it and/or leave residue on the glass resulting in degraded copy/scan quality.

---


8. Reverse the removal steps to reinstall the Side 2 Background Selector.
9. Make another copy or scan to determine if the defect is gone.

## Modify printer settings to improve scan or copy quality

Learn about printer settings to improve scan or copy quality.

Optimize printer settings to potentially improve scan or copy quality.

---

 **IMPORTANT:** The printer settings described in this section are firmware dependent and might not be available for a specific printer (for example, color adjustment settings do not apply to mono printers).

---

### Image Adjustment settings

---

 **NOTE:** [Settings > Print \(SFP\) or Copy/Print \(MFP\) > Image Adjustment > Background Cleanup](#).

---

Use the sliders to perform a [Background Cleanup](#), adjust the image [Darkness](#) as well as changing the [Sharpness](#) and [Contrast](#).

Use this feature to improve the overall quality of the copy (for example, adjusting the [Darkness](#) and [Sharpness](#)). Use the [Background Cleanup](#) setting to remove faint images from the background or to remove a light background color.

- **Darkness:** Adjust this setting to increase or decrease the amount of white and black in the colors.
- **Contrast:** Adjust this setting to increase or decrease the difference between the lightest and darkest color on the page.
- **Background Cleanup:** Adjust this setting if copying a faint image is a problem.
- **Sharpness:** Adjust this setting to clarify or soften the image. Increasing the sharpness might make text appear crisper, but decreasing it would make photographs appear smoother.

### Optimize Text/Picture settings

---

 **NOTE:** [Settings > Scan/Digital Send Settings > Optimize Text/Picture](#).

---



Use to optimize the output for a particular type of content. You can optimize the output for text, printed pictures, or a mixture.

Use this setting to optimize the output for a particular type of content.

- **Mixed:** Use to optimize the setting for text and for pictures.
- **Text:** Use to optimize the text portion of the copy when text and/or pictures are on the original.
- **Printed picture:** Use to optimize line drawing and preprinted images such as magazine clippings or pages from a book. If you see bands of irregular intensity on copies, try selecting **Printed picture** to improve quality.
- **Photographs:** Use to optimize photographic prints.

## Color/Black settings

---

 **NOTE:** Settings > Scan/Digital Send Settings > Color/Black.

---

Use to enable or disable color scanning.(some highlighters will not auto detect as color).


- **Automatically detect color or black:** When pages without color are detected, the printer creates an image of the page in 1-bit black if other settings allow. If the other settings don't allow (File Type, for example), the image is in grayscale.
- **Automatically detect color or gray:** When pages without color are detected, the printer creates an image of the page in grayscale. Select this option for the best image quality for non-color pages.
- **Color:** Scans the documents in color.
- **Black:** Scans documents in black and white with a compressed file size.
- **Black/Gray:** Scans or prints documents in grayscale.

## Light or faint copies (color models)

Learn how to resolve light or faint copy-quality problems.

### Are you attempting to copy or scan highlighted text?

---

 **NOTE:** When digitally sending or copying highlighted images or text objects, the image might appear lighter than expected or does not show up at all with certain brands/types of highlighter pens.

---

Highlighters come in bright, often fluorescent colors. Fluorescent highlighter inks tend to reflect more light than that which is absorbed by the paper source. This reflection might cause the image to not show up as well as non-fluorescent colors depending upon the scanner/MFP being used.

The most common color for highlighters is yellow, but many other colors are also found such as pink, blue, green, orange, and purples. Yellow is often the preferred color to use when making a photocopy as it tends to not produce as much of a shadow on copies or scans.

There are different color and ink properties depending upon the brand of highlighters used. Due to these differences, scanning of the images might vary greatly from not being seen at all to changing colors (for example, orange highlighter might appear brown in the copy or scan or yellow highlighter might appear green).

### Automatic color detect

HP has a feature in all FutureSmart (LaserJet Enterprise Series only) printers which automatically detects color on each page. Depending upon the amount of color information on a page, the scanner might determine the page to be black and white due to a very, very small amount of color which might be considered background artifacts. This helps to reduce the file size of sent files as well as toner usage on a copied page. You might see small highlighted marks on pages print out in black and white or even disappear.

The black and white effect is due to the printer not seeing enough color on the page, in which case the whole image is rendered as a black and white page. The highlighted mark disappearing might be due to the marker characteristics not being detected by the scanner.

## Does the printer have the latest firmware version installed?

No or I don't know.

A Firmware enhancement has been introduced for certain LaserJets to help with the reproduction of highlighted images.

---

 **NOTE:** Some Multifunction Printers (MFPs) using FutureSmart firmware v3.5.3 or later have improved color reproduction of fluorescent highlighters when scanning or copying.

---

Use the following steps to identify the installed firmware version, and then upgrade the firmware if needed.

1. Print a configuration page (from the printer control panel).
2. On the printed configuration page look in the section marked **Device Information**, and then identify the **Firmware Datecode** and **Firmware Revision**.

This is the current version of firmware installed on this printer.

3. In the US, go to <http://www.hp.com/support/colorlj6700> or <http://www.hp.com/support/colorlj6800MFP> or <http://www.hp.com/support/colorlj6801MFP> or <http://www.hp.com/support/colorljX654> or <http://www.hp.com/support/colorljX677MFP>.
  - a. Select **Get drivers, Software, and Firmware**, and then select the appropriate product by name.

---

 **NOTE:** More than one printer model might be listed. Make sure to select the correct model so that the upgraded firmware supports all of the printer functions.

---

- b. Select the driver language and operating system.
  - c. Locate the firmware download. If the firmware version is more recent than the one shown on the printed configuration page, select **Download**.
4. Outside the U.S., go to [www.hp.com/support](http://www.hp.com/support).
    - a. Select your country/region.
    - b. Select **Drivers & Downloads**.
    - c. Enter the product name in the **Find my product** dialogue box, and then select **Go**.


---

 **TIP:** Click on the **How do I find my product name/number?** link to see a short video on identifying the printer name and number.

---

- d. Select the appropriate product by name.

---

 **NOTE:** More than one printer model might be listed. Make sure to select the correct model so that the upgraded firmware supports all of the printer functions.

---

- e. Select the driver language and operating system.
  - f. Locate the firmware download. If the firmware version is more recent than the one shown on the printed configuration page, select **Download**.
5. Perform a firmware upgrade. See the *Firmware upgrades* topic in the product service manual.
  6. When the upgrade process is complete, print a configuration page and verify that the upgrade firmware version was installed.

Yes

These procedures help provide settings which affect the way highlighters are scanned or copied. A firmware enhancement is available for certain printers that helps with the reproduction of highlighted images.

- **Enable Firmware Enhancement**

1. From the Home screen, select the desired scanning application (for example, [Copy](#), [E-Mail](#), [Save to Network Folder](#)).
2. Select [More Options](#) > [Optimize Text/Picture](#) > [Text](#) button (not slider). This enables the improved color reproduction of fluorescent highlighters.



**TIP:** Administrators can set Text as the default setting on the device.

---

- **Alternative Settings**

See [Modify printer settings to improve scan or copy quality on page 471](#) for more information.

## Performance and connectivity troubleshooting

Learn about performance and connectivity troubleshooting.

### Solve fax or email problems

Learn about solving fax and email problems.

Fax or email troubleshooting information is not provided in this service manual. The most current information is available in WISE. Search using model number then use "fax troubleshooting" as the search term.

For HP Channel partners, open the HP Partner First Portal located at <https://partner.hp.com>, and then do the following:

1. Select the **Services & Support** tab, and then select **Technical Support**.
2. Select **Technical Documentation**.
3. You will be taken to the WISE portal.

For HP service personnel, go to one of the following Web-based Interactive Search Engines (WISE) sites:

#### Americas (AMS)

- [WISE - English](#)
- [WISE - Spanish](#)
- [WISE - Portuguese](#)

- [WISE - French](#)

### Asia Pacific / Japan (APJ)

- [WISE - English](#)
- [WISE - Japanese](#)
- [WISE - Korean](#)
- [WISE - Chinese \(simplified\)](#)
- [WISE - Chinese \(traditional\)](#)
- [WISE - Thai](#)

### Europe / Middle East / Africa (EMEA)

- [WISE - English](#)

## Solve performance problems

Review the following information and procedures to solve performance problems.



**NOTE:** Tray 1 and Tray 2 are optimal for paper pickup when using special paper or media other than 75-80gsm (20lb) plain paper. For Tray 1 and Tray 2 the printer increases the number of attempts to pick up a page, which increases the reliability of successfully picking the page from the tray and decreases the possibility of a mis-pick jam.

HP recommends using Tray 1 or Tray 2 if the printer is experiencing excessive or reoccurring jams from trays other than Tray 1 and Tray 2, or for print jobs that require media other than 75-80gsm (20lb) plain paper.

## Factors affecting print performance

Review the following information about factors affecting print performance.

**Table 4-43 Solve performance problems**

Problem	Cause	Solution
Pages print but are totally blank.	The document might contain blank pages.	Check the original document to see if content is present on all of the pages.
Pages print but are totally blank.	The printer might be malfunctioning.	To check the printer, print a Configuration page.
Pages print but are totally blank.	Make sure that the printer is not feeding multiple pages (especially if very thin paper is used).	Make sure that the paper meets HP specifications for this printer.  For a complete list of specific HP-brand paper that this printer supports, go to <a href="http://www.hp.com/support/colorlj6700">http://www.hp.com/support/colorlj6700</a> or <a href="http://www.hp.com/support/colorlj6800MFP">http://www.hp.com/support/colorlj6800MFP</a> or <a href="http://www.hp.com/support/colorlj6801MFP">http://www.hp.com/support/colorlj6801MFP</a> or <a href="http://www.hp.com/support/colorljX654">http://www.hp.com/support/colorljX654</a> or <a href="http://www.hp.com/support/colorljX677MFP">http://www.hp.com/support/colorljX677MFP</a> .
Pages print very slowly.	Heavier paper types can slow the print job.	Print on a different type of paper.

**NOTE:** Some software programs process print jobs slowly.

**Table 4-43 Solve performance problems (continued)**

Problem	Cause	Solution
Pages print very slowly. <b>NOTE:</b> Some software programs process print jobs slowly.	Complex pages can print slowly.	Proper fusing might require a slower print speed to ensure the best print quality.
Pages print very slowly. <b>NOTE:</b> Some software programs process print jobs slowly.	Large batches, narrow paper, and special paper such as gloss, transparency, cardstock, and HP Tough Paper can slow the print job.	Print in smaller batches, on a different type of paper, or on a different size of paper.
Pages did not print.	The printer might not be pulling paper correctly.	Make sure paper is loaded in the tray correctly.
Pages did not print.	The paper is jamming in the printer.	Clear the jam.
Pages did not print.	The USB cable might be defective or incorrectly connected.	<ul style="list-style-type: none"> <li>• Disconnect the USB cable at both ends and reconnect it.</li> <li>• Try printing a job that has printed in the past.</li> <li>• Try using a different USB cable.</li> </ul>
Pages did not print.	Other devices are running on the host computer.	The printer might not share a USB port. If an external hard drive or network switchbox is connected to the same port as the printer, the other device might be interfering with the printer. To connect and use the printer, disconnect the other device or use two USB ports on the host computer.
Pages did not print.	The print job might not have arrived at the printer.	Check the printer status queue. Also, the <a href="#">Printing</a> message should appear on the control panel display.

## Print speeds

Print speed is the number of pages that print in one minute. Print speed depends on different engine-process speeds or operational pauses between printed pages during normal printer operation. Factors that determine the print speed of the printer include the following:

- Page formatting time

The printer must pause for each page to be formatted before it prints. Complex pages take more time to format, resulting in reduced print speed. However, most jobs print at full engine speed.

- Media size

Legal-size media reduces print speed because it is longer than the standard Letter- or A4-size media. A reduce print speed is used when printing on narrow media to prevent the edges of the fuser from overheating.

- Media mode

Some media types require a reduced print speed to achieve maximum print quality on that media. For example, glossy, heavy, and specialty media (for example, envelopes or photos) require a reduced print speed. To maximize the print speed for special media types, make sure that the correct media type in the print driver is selected.

- Printer temperature

To prevent printer damage, print speed is reduced if the printer reaches a specific internal temperature (thermal slow down). The starting temperature of the printer, ambient environment temperature, and the print job size effect the number of pages that can be printed before the printer reduces the print speed. Thermal slow down reduces print speed by printing four pages and then pausing for an amount of time before printing continues.

- Other print speed reduction factors

Other factors (especially during large print jobs) that can cause reduced print speeds include:

- Density control sequence; occurs every 150 pages and takes about 120 seconds

## The printer does not print

If the printer does not print at all, try the following solutions.

1. Make sure the printer is turned on and that the control panel indicates it is ready.
  - If the control panel does not indicate the printer is ready, turn the printer off and then on again.
  - If the control panel indicates the printer is ready, try sending the job again.
2. If the control panel indicates the printer has an error, resolve the error and then try sending the job again.
3. Make sure the cables are all connected correctly. If the printer is connected to a network, check the following items:
  - Check the bottom LED next to the network connection on the printer. If the network is active, the light is green.
  - Make sure that a network cable and not a phone cord is used to connect to the network.
  - Make sure the network router, hub, or switch is turned on and that it is working correctly.
4. Install the HP software for the printer. Using generic printer drivers can cause delays clearing jobs from the print queue.
5. From the list of printers on your computer, right-click the name of this product, click **Properties**, and open the **Ports** tab.
  - If a network cable is used to connect to the network, make sure the printer name listed on the **Ports** tab matches the one on the printer configuration page.
  - If a USB cable is used, and the printer is connected to a wireless network, make sure the box is checked next to **Virtual printer port for USB**.
6. If a personal firewall system on the computer is used, it might be blocking communication with the printer. Try temporarily disabling the firewall to see if it is the source of the problem.
7. If the host computer or the printer is connected to a wireless network, low signal quality or interference might be delaying print jobs.

## The printer prints slowly

If the printer prints, but it seems slow, try the following solutions.

1. Make sure the computer meets the minimum specifications for this printer. For a list of specifications, go to this Web site: <http://www.hp.com/support/colorlj6700> or <http://www.hp.com/support/colorlj6800MFP> or <http://www.hp.com/support/colorlj6801MFP> or <http://www.hp.com/support/colorljX654> or <http://www.hp.com/support/colorljX677MFP>.
2. When the printer is configured to print on some paper types, such as heavy paper, the printer prints more slowly so it can correctly fuse the toner to the paper. If the paper type setting is not correct for the type of paper you are using, change the setting to the correct paper type.
3. If the host computer or the printer is connected to a wireless network, low signal quality or interference might be delaying print jobs.

## Solve connectivity problems

Review the following information and procedures to solve connectivity problems.

### Solve USB connection problems

If you have connected the product directly to a computer, check the cable.

- Verify that the cable is connected to the computer and to the product.
- Verify that the cable is not longer than 2 m (6.65 ft). Try using a shorter cable.
- Verify that the cable is working correctly by connecting it to another product. Replace the cable if necessary.

### Solve wired network problems

Review the following information and procedures to solve wired network problems.

#### Introduction

Learn about solving wired network problems.

Certain types of problems can indicate there is a network communication problem. These problems include the following issues:

- The periodic loss of ability to communicate with the printer
- The printer cannot be found during driver installation
- A periodic failure to print

Check the items in this topic to verify that the printer is communicating with the network. Before beginning, print a configuration page from the printer control panel and locate the printer IP address that is listed on this page.

#### Poor physical connection

Use the following procedure when the printer has a poor physical connection.

1. Verify that the printer is attached to the correct network port using a cable of the correct length.
2. Verify that cable connections are secure.
3. Look at the network port connection on the back of the printer, and verify that the amber activity light and the green link-status light are lit.
4. If the problem continues, try a different cable or port on the hub.

### The computer is using the incorrect IP address for the printer

Use the following procedure when the computer is using the incorrect IP address for the printer.

1. Open the printer properties and click the **Ports** tab. Verify that the current IP address for the printer is selected. The printer IP address is listed on the printer configuration page.
2. If you installed the printer using the HP standard TCP/IP port, select the box labeled **Always print to this printer, even if its IP address changes**.
3. If you installed the printer using a Microsoft standard TCP/IP port, use the hostname instead of the IP address.
4. If the IP address is correct, delete the printer and then add it again.

### The computer is unable to communicate with the printer

Use the following procedure when the computer is unable to communicate with the printer.

1. Test network communication by pinging the network.
  - a. Open a command-line prompt on your computer.
    - For Windows, click **Start**, click **Run**, type `cmd`, and then press **Enter**.
    - For macOS, go to **Applications**, then **Utilities**, and open **Terminal**.
  - b. Type `ping` followed by the IP address for your printer.
  - c. If the window displays round-trip times, the network is working.
2. If the ping command failed, verify that the network hubs are on, and then verify that the network settings, the printer, and the computer are all configured for the same network.

### The printer is using incorrect link and duplex settings for the network

HP recommends leaving these settings in automatic mode (the default setting). If you change these settings, you must also change them for your network.

### New software programs might be causing compatibility problems

Verify that any new software programs are correctly installed and that they use the correct print driver.

### The computer or workstation might be set up incorrectly

Use the following procedure when the computer or workstation might be set up incorrectly.

1. Check the network drivers, print drivers, and the network redirection settings.
2. Verify that the operating system is configured correctly.

### The printer is disabled, or other network settings are incorrect

Use the following procedure when the printer is disabled, or other network settings are incorrect.

1. Review the configuration page to check the status of the network protocol. Enable it if necessary.
2. Reconfigure the network settings if necessary.



---

# 5 Removal and replacement

When servicing the printer, several items must be considered to ensure a successful repair and to avoid damage to the printer or personal injury. Learn about these considerations and find detailed instructions for removing and replacing printer parts.

## 1. Customer self-repair (CSR) A parts and accessories

Customer self-repair (CSR) A parts are parts that a customer replaces without assistance from a field technician. These parts can be replaced without the use of any tools.

### Customer-replaceable units

Learn about customer-replaceable parts removal and replacement.

### Internal parts and assemblies

Learn how to remove and replace the printer internal parts and assemblies.

### Removal and replacement: Toner cartridges (6700/6800 models)

This document provides the procedures to remove and replace the toner cartridges.



[View a video of removing and replacing the toner cartridges.](#)

### Before performing service

**⚠ CAUTION:** To prevent damage to a toner cartridge, do not expose it to light for more than a few minutes. Cover the imaging drum if the toner cartridge must be removed from the printer for an extended period of time.

If toner gets on the skin or clothing, wipe it off with dry tissue paper and wash in cold water. Hot water sets toner and it might be difficult, or impossible, to remove.

Use the table below to identify the correct part number for your printer, and then go to <https://parts.hp.com/hpparts> to order the part.

**Table 5-1 Part information**

Part number	Description
W2130A	HP 213A Black Original LaserJet Toner Cartridge
W2130X	HP 2130X High Yield Black Toner Cartridge
W2130Y	HP 213Y Extra High Yield Black Toner Cartridge

**Table 5-1 Part information (continued)**

<b>Part number</b>	<b>Description</b>
W2130YC	HP W2130YC Black Contract Toner Cartridge
W2131A	HP 213A Cyan Original LaserJet Toner Cartridge
W2131X	HP 2131X High Yield Cyan Toner Cartridge
W2131Y	HP 213Y Extra High Yield Cyan Toner Cartridge
W2131YC	HP W2131YC Cyan Contract Toner Cartridge
W2132A	HP 213A Yellow Original LaserJet Toner
W2132X	HP 2132X High Yield Yellow Toner Cartridge
W2132Y	HP 213Y Extra High Yield Yellow Toner Cartridge
W2132YC	HP W2132YC Yellow Contract Toner Cartridge
W2133A	HP 213A Magenta LaserJet Toner Cartridge
W2133X	HP 2133X High Yield Magenta Toner Cartridge
W2133Y	HP 213Y Extra High Yield Magenta Toner Cartridge
W2133YC	HP W2133YC Magenta Contract Toner Cartridge
W2140Z	HP 214Z Ultra High Yield Black Toner Cartridge (SFP)
W2140ZC	HP W2140ZC Black Contract Toner Cartridge (SFP)
W2141Z	HP 214Z Ultra High Yield Cyan Toner Cartridge (SFP)
W2141ZC	HP W2141ZC Cyan Contract Toner Cartridge (SFP)
W2142Z	HP 214Z Ultra High Yield Yellow Toner Cartridge (SFP)
W2142ZC	HP W2142ZC Yellow Contract Toner Cartridge (SFP)
W2143Z	HP 214Z Ultra High Yield Magenta Toner Cartridge (SFP)
W2143ZC	HP W2143ZC Magenta Contract Toner Cartridge (SFP)
W2170Z	HP 217Z Ultra High Yield Black Toner Cartridge (MFP)
W2170ZC	HP W2170ZC Black Contract Toner Cartridge (MFP)
W2171Z	HP 217Z Ultra High Yield Cyan Toner Cartridge (MFP)
W2171ZC	HP W2171ZC Cyan Contract Toner Cartridge (MFP)
W2172Z	HP 217Z Ultra High Yield Yellow Toner Cartridge (MFP)
W2172ZC	HP W2172ZC Yellow Contract Tone Cartridge (MFP)
W2173Z	HP 217Z Ultra High Yield Magenta Toner Cartridge (MFP)
W2173ZC	HP W2173ZC Magenta Contract Toner Cartridge (MFP)

### Required tools

- No special tools are required to remove or install this assembly.

### After performing service

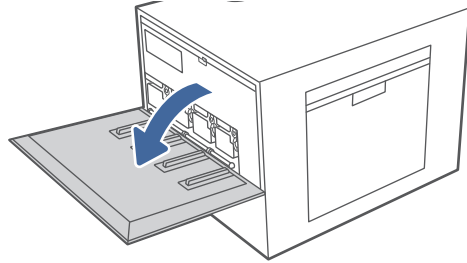
## Post service test

Print any pages necessary to make sure the printer is functioning correctly.

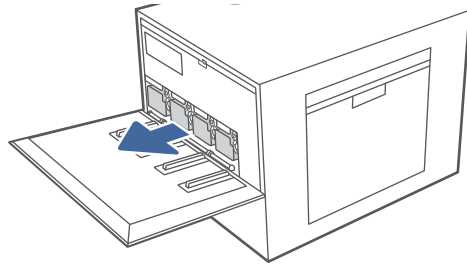
### 1. Remove the toner cartridges (6700/6800 models)

Follow these steps to remove a toner cartridge.

1. Open the front door.



2. Grasp the end of the toner cartridge and pull it straight out of the printer.



### 2. Unpack the replacement assembly

Follow these steps to unpack the replacement assembly.

1. Dispose of the defective part.



**NOTE:** HP recommends responsible disposal of the part.

<http://www8.hp.com/us/en/hp-information/environment/product-recycling.html>

2. Unpack the replacement part from the packaging.

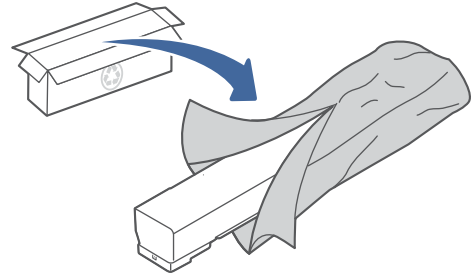


**IMPORTANT:** Make sure that all of the shipping materials (for example shipping tape) are removed from the replacement part prior to installation.

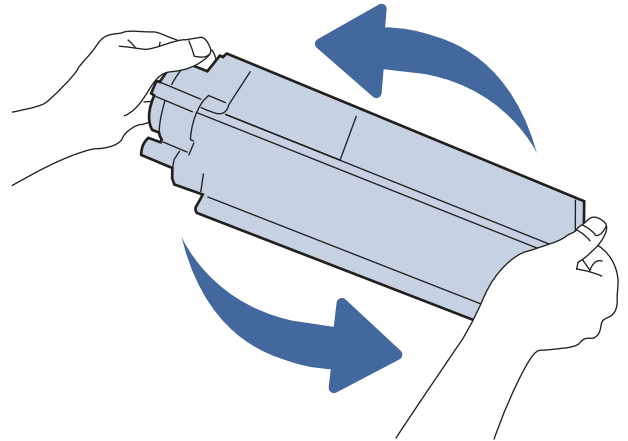
### 3. Install the toner cartridges (6700/6800 models)

Follow these steps to install a toner cartridge.

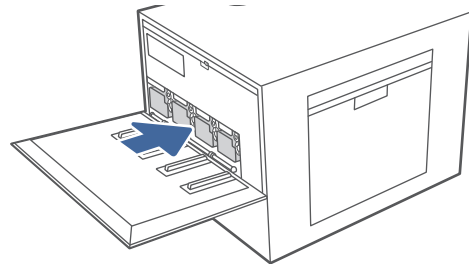
1. Remove the new toner cartridge from its package. Save all packaging for recycling the used toner cartridge.



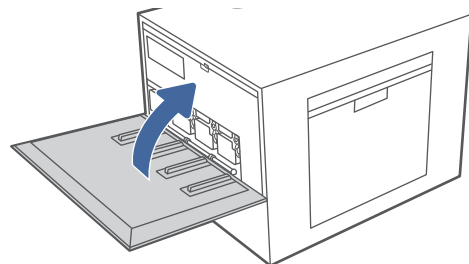
2. Hold both ends of the toner cartridge and rock it back and forth end to end to evenly distribute the toner that is inside.



3. Align the toner cartridge with its slot and insert it into the printer.

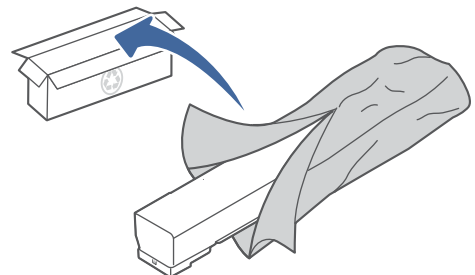


4. Close the front door.



5. Pack the used toner cartridge into the box that the new toner cartridge came in. See the enclosed recycling guide for information about recycling.

In the U.S. and Canada, a pre-paid shipping label is included in the box. In other countries/regions, go to [www.hp.com/recycle](http://www.hp.com/recycle) to print a pre-paid shipping label.



Adhere the pre-paid shipping label to the box, and return the used cartridge to HP for recycling.

## Removal and replacement: Toner cartridges (X654/X677 models)

This document provides the procedures to remove and replace the toner cartridges.

 [View a video of removing and replacing the toner cartridges.](#)

### Before performing service

**CAUTION:** To prevent damage to a toner cartridge, do not expose it to light for more than a few minutes. Cover the imaging drum if the toner cartridge must be removed from the printer for an extended period of time.

If toner gets on the skin or clothing, wipe it off with dry tissue paper and wash in cold water. Hot water sets toner and it might be difficult, or impossible, to remove.

Use the table below to identify the correct part number for your printer, and then go to <https://parts.hp.com/hpparts> to order the part.

**Table 5-2 Part information**

Part number	Description
W9240MC	HP W9240MC Black Mngd LaserJet Toner Cartridge (SFP)
W9241MC	HP W9241MC Cyan Mngd LaserJet Toner Cartridge (SFP)
W9242MC	HP W9242MC Yellow Mngd LaserJet Toner Cartridge (SFP)
W9243MC	HP W9243MC Magenta Mngd LaserJet Toner Cartridge (SFP)
W9250MC	HP W9250MC Black Mngd LaserJet Toner Cartridge (MFP)
W9251MC	HP W9251MC Cyan Mngd LaserJet Toner Cartridge (MFP)
W9252MC	HP W9252MC Yellow Mngd LaserJet Toner Cartridge (MFP)
W9253MC	HP W9253MC Magenta Mngd LaserJet Toner Cartridge (MFP)
W9260MC	HP W9260MC Black Mngd LaserJet Toner Cartridge (SFP)
W9261MC	HP W9261MC Cyan Mngd LaserJet Toner Cartridge (SFP)
W9262MC	HP W9262MC Yellow Mngd LaserJet Toner (SFP)
W9263MC	HP W9263MC Magenta Mngd LaserJet Toner Cartridge (SFP)
W9270MC	HP W9270MC Black Mngd LaserJet Toner Cartridge (MFP)
W9271MC	HP W9271MC Cyan Mngd LaserJet Toner Cartridge (MFP)
W9272MC	HP W9272MC Yellow Mngd LaserJet Toner (MFP)
W9273MC	HP W9273MC Magenta Mngd LaserJet Toner Cartridge (MFP)

### Required tools

- No special tools are required to remove or install this assembly.

### After performing service

- Make sure that the cartridge door is fully closed after replacing a toner cartridge.

## Post service test

Print any pages necessary to make sure the printer is functioning correctly.

### 1. Eject the toner cartridges (X654/X677 models)

Follow these steps to eject a toner cartridge.



**NOTE:** Two methods are available to eject a toner cartridge using the control panel.

- Eject a toner cartridge with the printer in the Ready state.  
See [Eject a toner cartridge using the control panel \(Ready state\) on page 485](#).
  - Eject a toner cartridge with the printer in a cartridge low or very low error state.  
See [Eject a toner cartridge using the control panel \(error condition\) on page 486](#).
- 

#### Eject a toner cartridge using the control panel (Ready state)

Use the following steps to eject a toner cartridge when the printer is in the Ready state.


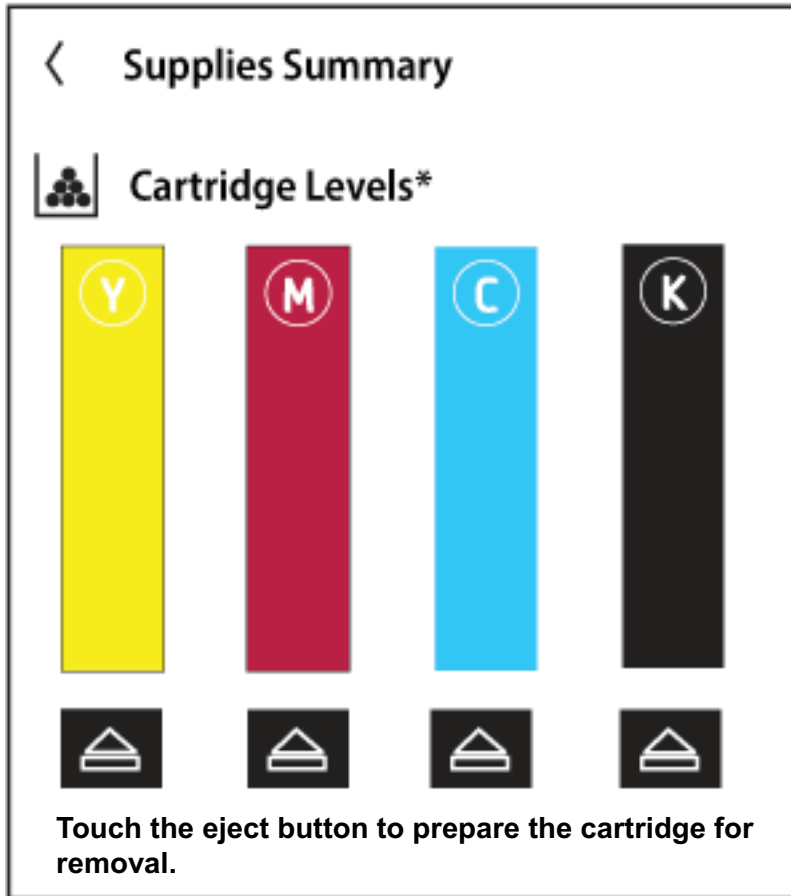
1. From the control panel Home screen, scroll to and select the **Supplies** button.
2. Select the **Eject** button  (located below the **Cartridge Levels** indicators).

Figure 5-1 Eject the toner cartridge (Ready state)



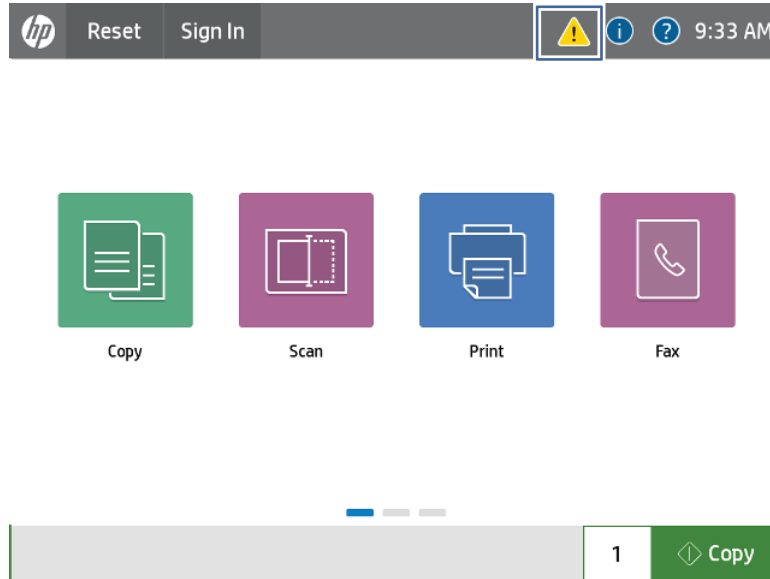
3. A prompt appears on the control-panel display to open the toner cartridge door.

### **Eject a toner cartridge using the control panel (error condition)**

Use the following steps to eject a toner cartridge when the printer is in a cartridge low or very low error state.

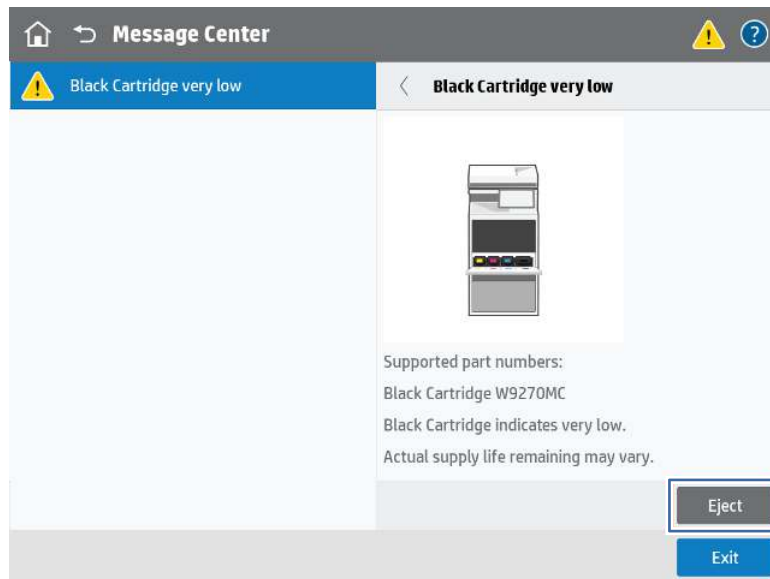
1. On the control panel Home screen, Touch the error icon at the top of the display.

**Figure 5-2 Eject the toner cartridge (error state) (1 of 2)**



2. Touch the **Eject** button at the bottom of the display.


**Figure 5-3 Eject the toner cartridge (error state) (2 of 2)**



3. A prompt appears on the control-panel display to open the toner cartridge door.

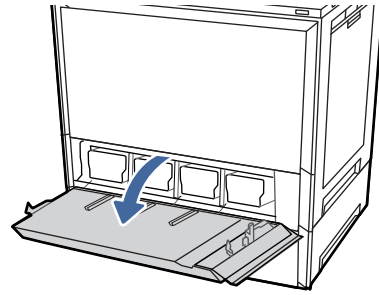
## 2. Remove the toner cartridges (X654/X677 models)

Follow these steps to remove a toner cartridge.

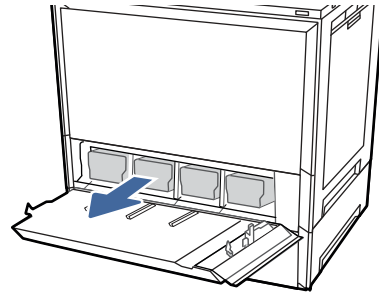
 **NOTE:** The toner cartridges must be released before removing them. See [Eject the toner cartridges \(X654/X677 models\) on page 485](#).



1. Open the toner cartridge door on the front of the printer.



2. Grasp the end of the toner cartridge and pull it straight out of the printer.



### 3. Unpack the replacement assembly

Follow these steps to unpack the replacement assembly.

1. Dispose of the defective part.



**NOTE:** HP recommends responsible disposal of the part.

<http://www8.hp.com/us/en/hp-information/environment/product-recycling.html>

2. Unpack the replacement part from the packaging.

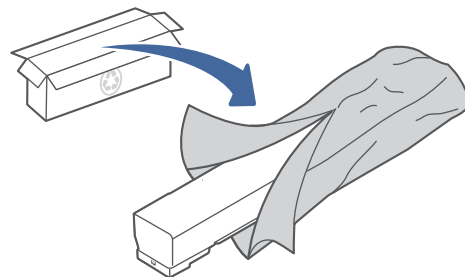


**IMPORTANT:** Make sure that all of the shipping materials (for example shipping tape) are removed from the replacement part prior to installation.

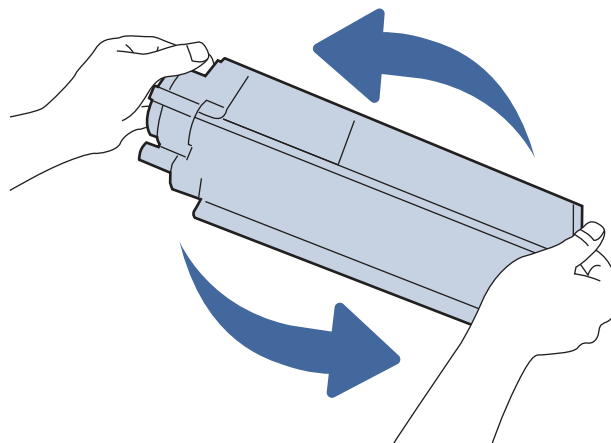
### 4. Install the toner cartridges (X654/X677 models)

Follow these steps to install a toner cartridge.

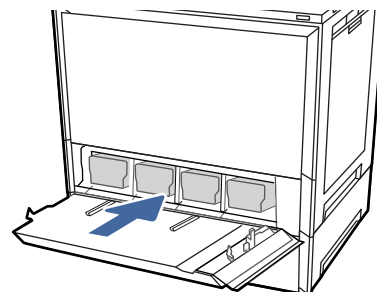
1. Remove the new toner cartridge from its package. Save all packaging for recycling the used toner cartridge.



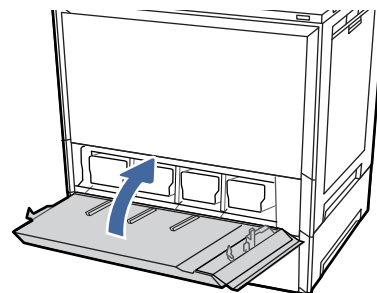
2. Hold both ends of the toner cartridge and rock it to evenly distribute the toner that is inside.



3. Align the toner cartridge with its slot and insert it into the printer.



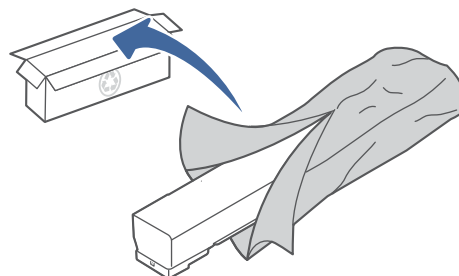
4. Close the toner cartridge door.



5. Pack the used toner cartridge into the box that the new toner cartridge came in. See the enclosed recycling guide for information about recycling.

In the U.S. and Canada, a pre-paid shipping label is included in the box. In other countries/regions, go to [www.hp.com/recycle](http://www.hp.com/recycle) to print a pre-paid shipping label.

Adhere the pre-paid shipping label to the box, and return the used cartridge to HP for recycling.



### Removal and replacement: Imaging drums (X654/X677 models)

This document provides the procedures to remove and replace the imaging drums.



[View a video of removing and replacing the image drums.](#)

## Before performing service

- ⚠ **CAUTION:** To prevent damage to an imaging drum, do not expose it to light for more than a few minutes. Cover the green imaging drum if it must be removed from the printer for an extended period of time.

If toner gets on the skin or clothing, wipe it off with dry tissue paper and wash in cold water. Hot water sets toner and it might be difficult, or impossible, to remove.

Use the table below to identify the correct part number for your printer, and then go to <https://parts.hp.com/hpparts> to order the part.

**Table 5-3** Part information

Part number	Description
W9280MC	HP W9280MC Black Mngd Imaging Drum
W9281MC	HP W9281MC Cyan Mngd Imaging Drum
W9282MC	HP W9282MC Yellow Mngd Imaging Drum
W9283MC	HP W9283MC Magenta Mngd Imaging Drum

## Required tools

- No special tools are required to remove or install this assembly.

## After performing service

- Make sure that the cartridge door is fully closed after replacing an image drum.

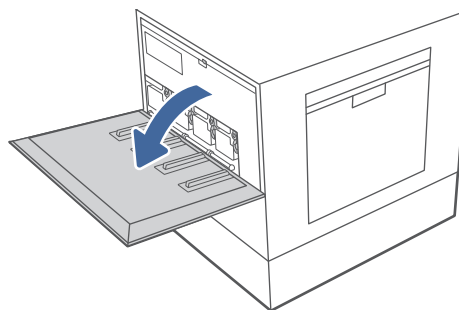
## Post service test

Print any pages necessary to make sure the printer is functioning correctly.

### 1. Remove the imaging drums (X654/X677 models)

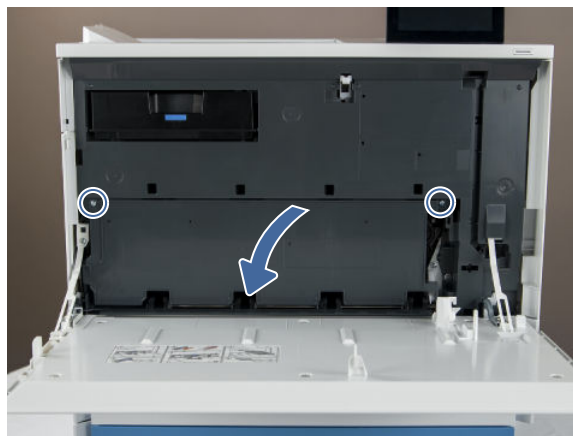
Follow these steps to remove an imaging drum.

1. Open the front door.

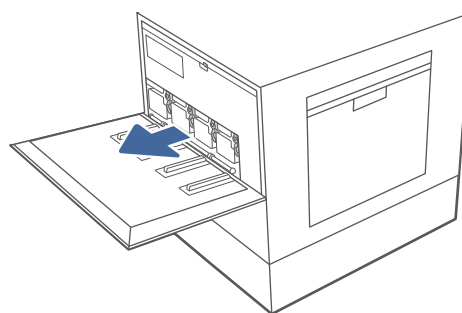


**NOTE:** If necessary, remove two screws holding the imaging drum access cover in place, and then lower the cover to access the imaging drums. See the figure below.

Figure 5-4 Remove two screws, open the cover



2. Grasp the end of the imaging drum cartridge and pull it straight out of the printer.



## 2. Unpack the replacement assembly

Follow these steps to unpack the replacement assembly.

1. Dispose of the defective part.



**NOTE:** HP recommends responsible disposal of the part.

<http://www8.hp.com/us/en/hp-information/environment/product-recycling.html>

2. Unpack the replacement part from the packaging.



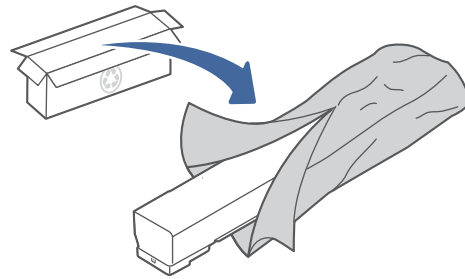
**IMPORTANT:** Make sure that all of the shipping materials (for example shipping tape) are removed from the replacement part prior to installation.

## 3. Install the imaging drums (X654/X677 models)

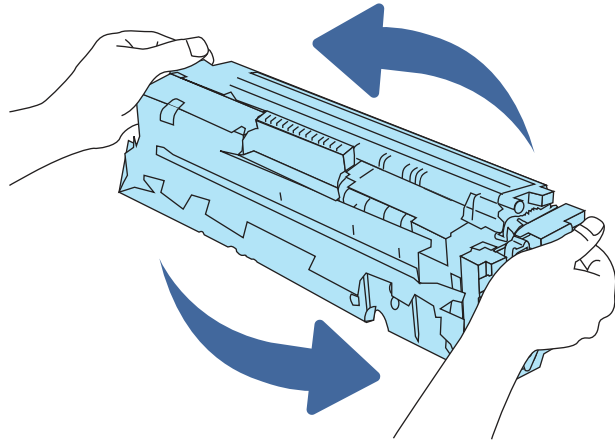
Follow these steps to install an imaging drum.

1. Remove the new imaging drum from its package. Save all packaging for recycling the used imaging drum.

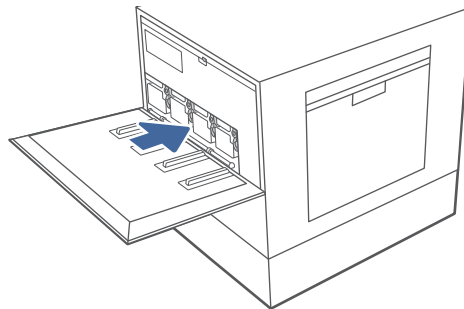
**CAUTION:** To prevent damage to the imaging drum, do not expose it to light for more than a few minutes. Cover the imaging drum if it must be removed from the printer for an extended period of time. Do not touch the blue imaging drum.



2. Hold both ends of the imaging drum and rock it back and forth end to end to evenly distribute the toner that is inside.



3. Align the imaging drum with its slot and insert it into the printer.

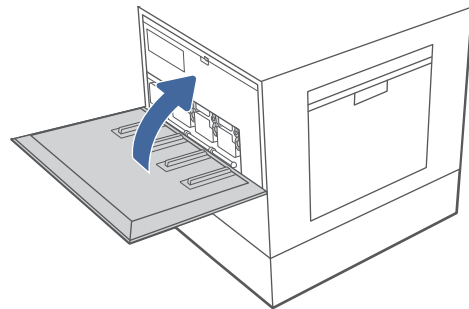


**NOTE:** If necessary, close the imaging drum access cover, and then install the two screws to secure the cover. See the figure below.

Figure 5-5 Close the cover, install two screws



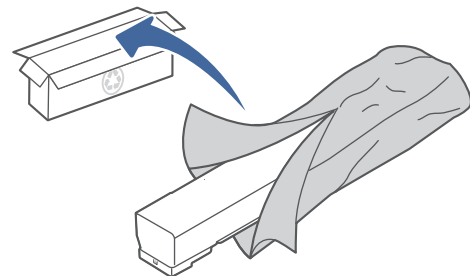
4. Close the front door.



5. Pack the used imaging drum into the box that the new imaging drum came in. See the enclosed recycling guide for information about recycling.

In the U.S. and Canada, a pre-paid shipping label is included in the box. In other countries/regions, go to [www.hp.com/recycle](http://www.hp.com/recycle) to print a pre-paid shipping label.

Adhere the pre-paid shipping label to the box, and return the used imaging drum to HP for recycling.



### Removal and replacement: Toner collection unit (TCU)

Learn about removing and replacing the toner collection unit (TCU).

 [View a video of removing and replacing the TCU.](#)

### Before performing service

Use the table below to identify the correct part number for your printer, and then go to <https://parts.hp.com/hpparts> to order the part.

Table 5-4 Part information

Part number	Part description
527F9A	HP LaserJet Toner collection unit (TCU) with instruction guide

## Required tools

- No special tools are required to remove or install this assembly.

## After performing service

Make sure that the front door is fully closed after replacing the TCU.

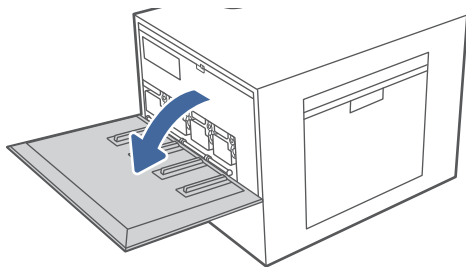
## Post service test

No post service test is available for this assembly.

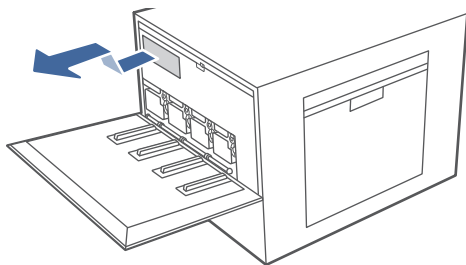
### 1. Remove the toner collection unit (TCU)

Follow these steps to remove the toner collection unit (TCU).

1. Open the front door.



2. Lift the TCU slightly and then pull it out of the printer.



---

**NOTE:** Maintain the position of the TCU as you pull it out from the printer. This will ensure that you do not spill any waste toner in the printer. Place the unit into the clear plastic bag the new TCU was packaged in.

---

### 2. Unpack the replacement assembly

Follow these steps to unpack the replacement assembly.

1. Dispose of the defective part.




---

**NOTE:** HP recommends responsible disposal of the part.

<http://www8.hp.com/us/en/hp-information/environment/product-recycling.html>

---

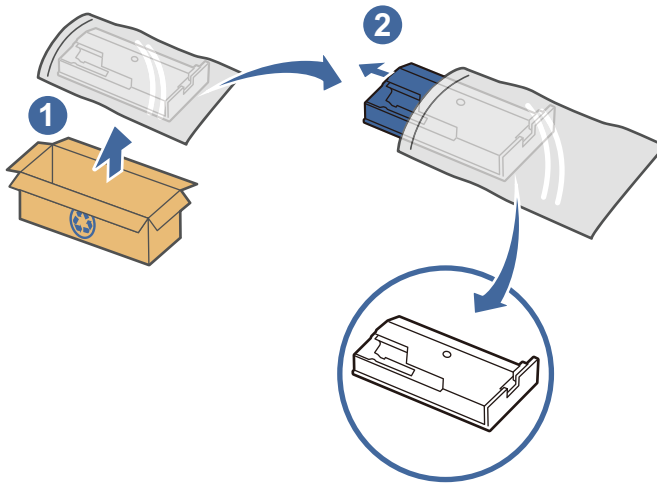
2. Unpack the replacement part from the packaging.

 **IMPORTANT:** Make sure that all of the shipping materials (for example shipping tape) are removed from the replacement part prior to installation.

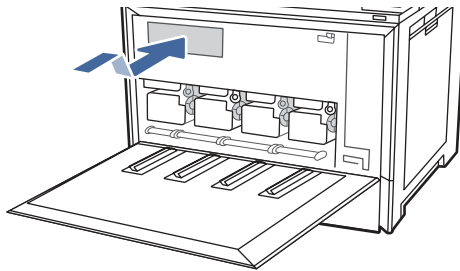
### 3. Install the TCU

Follow these steps to install the toner collection unit (TCU).

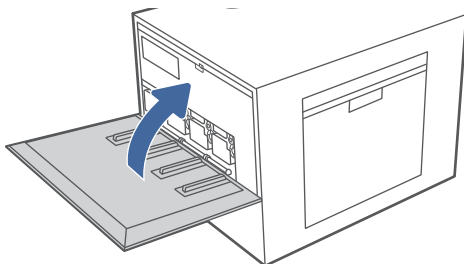
1. Remove the new TCU from its package. Save all packaging for recycling the used TCU.



2. Install the new TCU by inserting it into the printer, and then lifting slightly to make sure it pushes all the way in.



3. Close the front door.

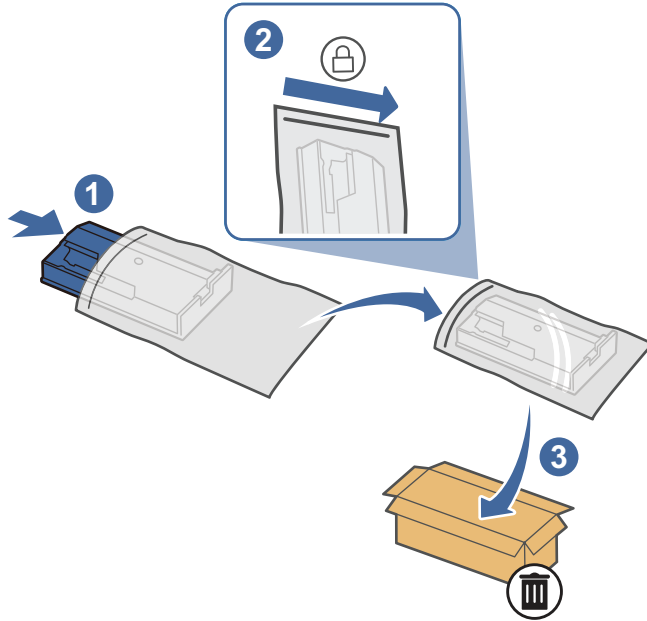




4. Pack the used TCU into the box that the new TCU came in. See the enclosed recycling guide for information about recycling.

In the U.S. and Canada, a pre-paid shipping label is included in the box. In other countries/regions, go to [www.hp.com/recycle](http://www.hp.com/recycle) to print a pre-paid shipping label.

Adhere the pre-paid shipping label to the box, and return the used TCU to HP for recycling.



### Removal and replacement: 3-bin stapler-stacker staple cartridge (3-bin stapler-stacker)

Learn about removing and replacing the 3-bin stapler/stacker staple cartridge.

 [View a video of removing and replacing the staple cartridge.](#)

### Before performing service

Use the table below to identify the correct part number for your printer, and then go to <https://parts.hp.com/hpparts> to order the part.

**Table 5-5 Part information**

Part number	Part description
J8J96AJ8J96A	HP Staple Cartridge Refill for the floor-standing finisher or 3-bin stapler-stacker

### Required tools

- No special tools are required to remove or install this assembly.

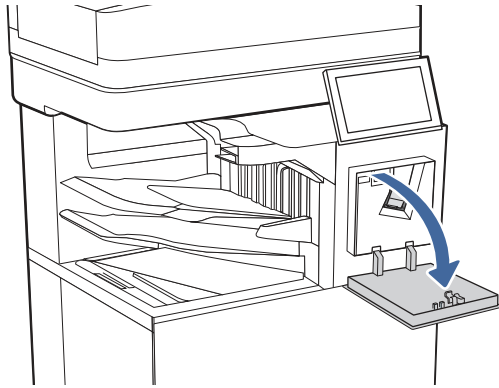
### Post service test

Use the stapler to staple two pages together.

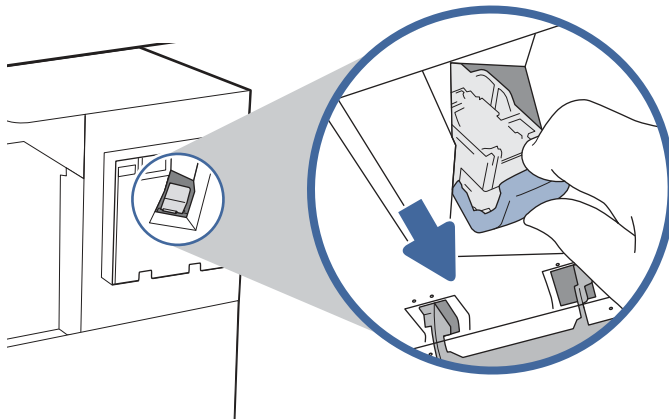
## 1. Remove the staple cartridge (3-bin stapler-stacker)

Follow these steps to remove the 3-bin stapler-stacker staple cartridge.

1. Open the 3-bin stapler-stacker staple door.



2. Pull down the colored handle on the staple carriage, and then pull the staple carriage straight out.



## 2. Unpack the replacement assembly

Follow these steps to unpack the replacement assembly.

1. Dispose of the defective part.



**NOTE:** HP recommends responsible disposal of the part.

<http://www8.hp.com/us/en/hp-information/environment/product-recycling.html>

2. Unpack the replacement part from the packaging.



**IMPORTANT:** Make sure that all of the shipping materials (for example shipping tape) are removed from the replacement part prior to installation.


## 3. Install the staple cartridge (3-bin stapler-stacker)

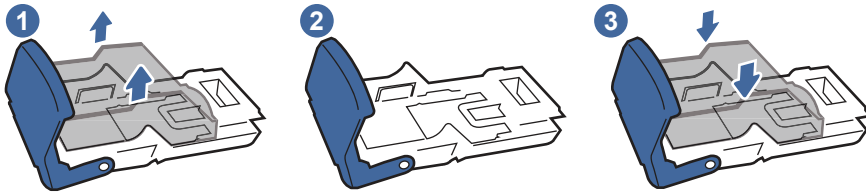
Follow these steps to install the 3-bin stapler-stacker staple cartridge.



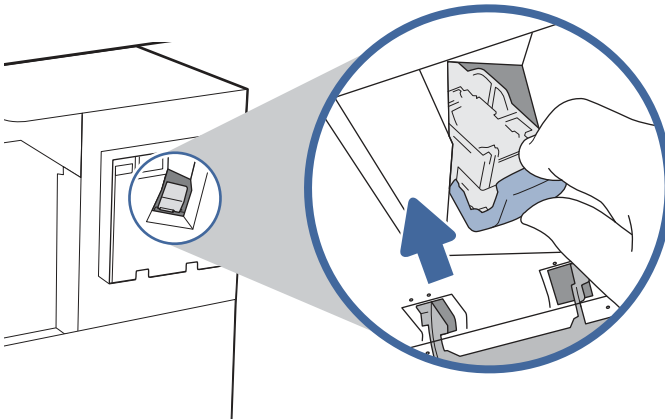
**NOTE:** Do not dispose of the staple carriage. The carriage is not an orderable or replaceable part. If the carriage is disposed of, the entire staple cartridge assembly will need to be replaced.

1. Remove the staple cartridge from the carrier/sled and replace it with the new staple cartridge.

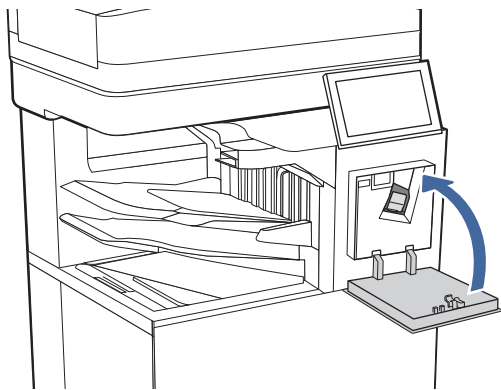
 **NOTE:** Do not dispose of the staple carrier/sled. The sled is not an orderable or replaceable part.



2. Reinstall the staple carriage into the stapler by pressing the colored handle inward until it snaps into place.



3. Close the 3-bin stapler-stacker staple door.



### Removal and replacement: Finisher staple cartridge (floor-standing stapler-stacker)

Learn about removing and replacing the floor-standing finisher staple cartridge.

 [View a video of removing and replacing the staple cartridge.](#)

### Before performing service

Use the table below to identify the correct part number for your printer, and then go to <https://parts.hp.com/hpparts> to order the part.

**Table 5-6 Part information**

Part number	Part description
J8J96A	HP Staple Cartridge Refill (3-bin SS)

## Required tools

- No special tools are required to remove or install this assembly.

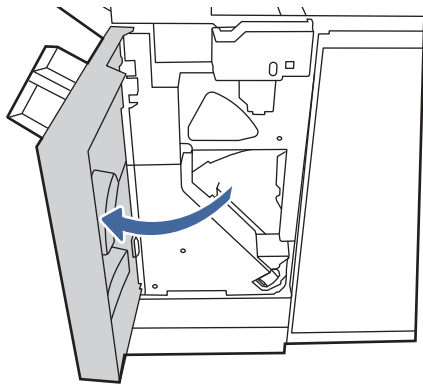
## Post service test

Use the stapler to staple two pages together.

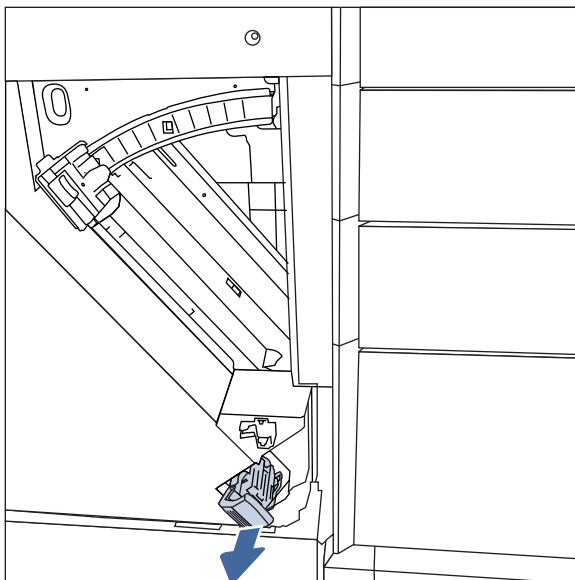
### 1. Remove the staple cartridge (floor-standing finisher)

Follow these steps to remove the floor-standing finisher staple cartridge.

1. Open the finisher door.




2. Pull down the colored handle on the staple carriage, and then pull the staple carriage straight out.



## 2. Unpack the replacement assembly


Follow these steps to unpack the replacement assembly.

1. Dispose of the defective part.

 **NOTE:** HP recommends responsible disposal of the part.


<http://www8.hp.com/us/en/hp-information/environment/product-recycling.html>

2. Unpack the replacement part from the packaging.

 **IMPORTANT:** Make sure that all of the shipping materials (for example shipping tape) are removed from the replacement part prior to installation.

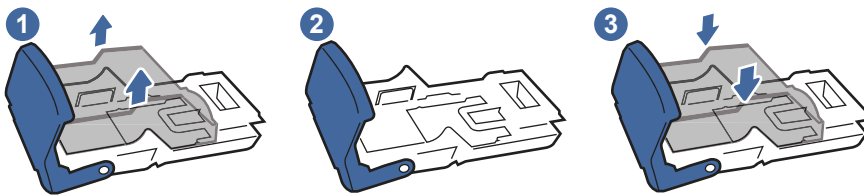
## 3. Install the staple cartridge (floor-standing finisher)

Follow these steps to install the floor-standing finisher staple cartridge.

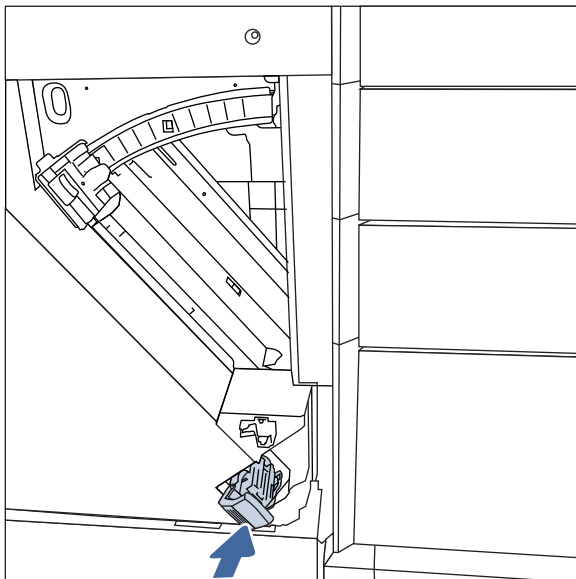
 **NOTE:** Do not dispose of the staple carriage. The carriage is not an orderable or replaceable part. If the carriage is disposed of, the entire staple cartridge assembly will need to be replaced.

1. Remove the staple cartridge from the carrier/sled and replace it with the new staple cartridge.

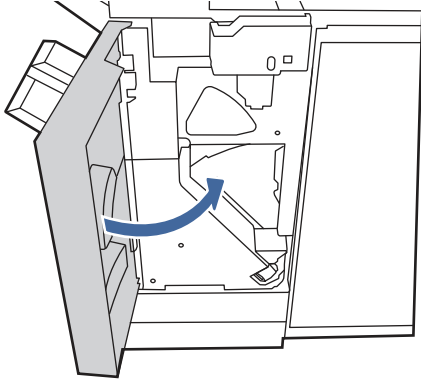
 **NOTE:** Do not dispose of the staple carrier/sled. The sled is not an orderable or replaceable part.



2. Reinstall the staple cartridge into the stapler by pressing the colored handle inward until it snaps into place.



3. Close the finisher door.



### Removal and replacement: Convenience staple cartridge (convenience stapler models)

Learn about removing and replacing the convenience stapler staple cartridge.



[View a video of removing and replacing the staple cartridge.](#)

### Before performing service

Use the table below to identify the correct part number for your printer, and then go to <https://parts.hp.com/hpparts> to order the part.

**Table 5-7 Part information**

Part number	Part description
Q7432A	HP Staple Cartridge Pack for the convenience stapler

### Required tools

- No special tools are required to remove or install this assembly.

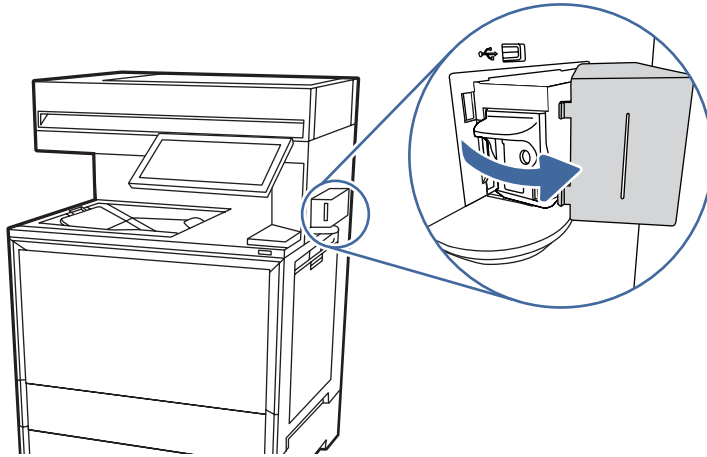
### Post service test

Use the stapler to staple two pages together.

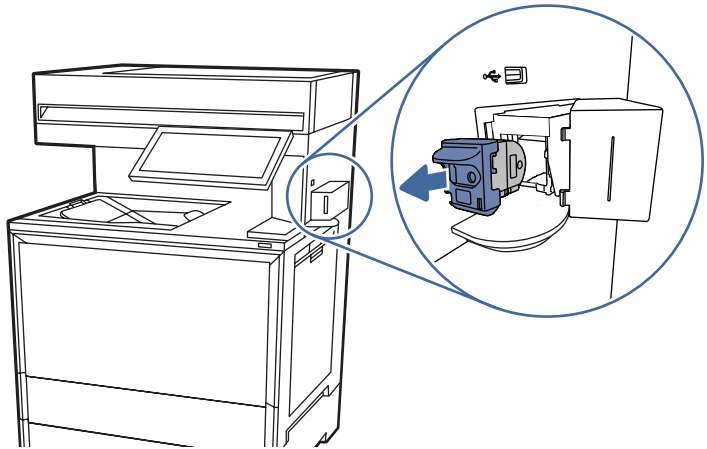
### 1. Remove the staple cartridge (convenience stapler)

Follow these steps to remove the convenience stapler staple cartridge.

1. Open the stapler door.




2. Pull the staple carriage straight out.



## 2. Unpack the replacement assembly


Follow these steps to unpack the replacement assembly.

1. Dispose of the defective part.

 **NOTE:** HP recommends responsible disposal of the part.

<http://www8.hp.com/us/en/hp-information/environment/product-recycling.html>

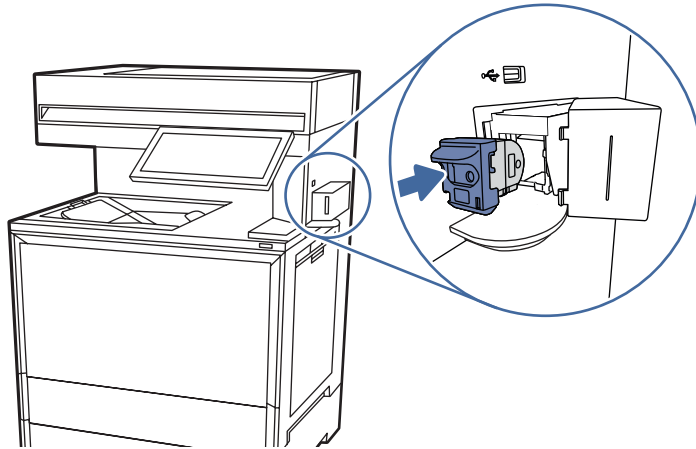
2. Unpack the replacement part from the packaging.

 **IMPORTANT:** Make sure that all of the shipping materials (for example shipping tape) are removed from the replacement part prior to installation.

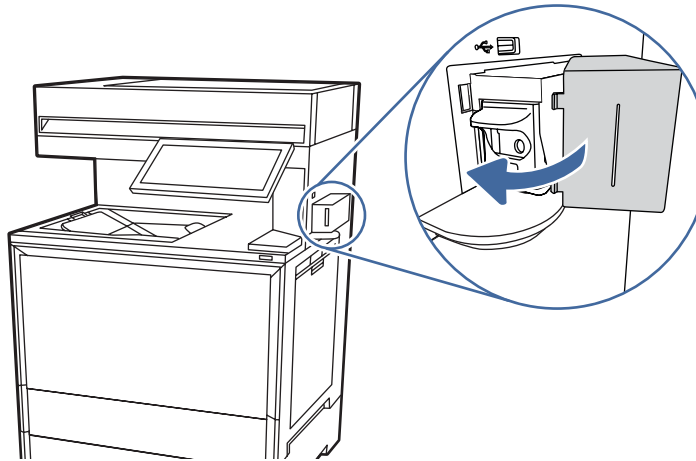
## 3. Install the staple cartridge (convenience stapler)

Follow these steps to install the convenience stapler staple cartridge.

1. Insert the new staple carriage into the stapler.



2. Close the stapler door.



### Removal and replacement: Fuser

This document provides the procedures to remove and replace the fuser.


 [View a video to remove and replace the fuser](#)

Mean time to repair: 5 minutes

Service level: Basic

### Before performing service

---

 **WARNING!** The fuser is hot. Wait at least 30 minutes after turning the printer power off before removing the fuser.

---

Use the table below to identify the correct part number for your printer. To order the part, go to [www.hp.com/buy/parts](http://www.hp.com/buy/parts).



**Table 5-8 Part information**

Part number	Part description
527G2A	HP LaserJet 110V Enhanced Fuser Kit (6700/6800 models)
527G3A	HP LaserJet 220V Enhanced Fuser Kit (6700/6800 models)
527G4MC	HP LaserJet Mngd 110V Enhanced Fuser Kit (X654/X677 models)
527G5MC	HP LaserJet Mngd 220V Enhanced Fuser Kit (X654/X677 models)

## Required tools

No special tools are required to remove or install this assembly.

## After performing service

Make sure that the right door is fully closed after replacing the fuser.

## Post service test

Print a configuration page to make sure that the printer is functioning correctly.

### 1. Remove the fuser

Follow these steps to remove the fuser.

1. Open the right door.

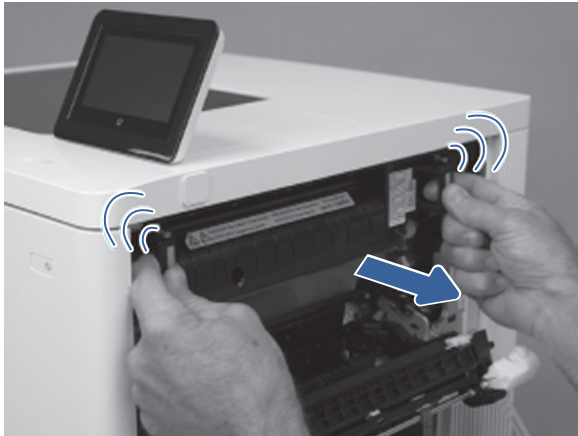
**⚠ CAUTION:** The fuser is hot. Wait at least 10 minutes after turning the printer power off before removing the fuser.

**Figure 5-6 Open the right door**



2. Squeeze the release levers on the handles (circle callouts), and then remove the fuser.

**Figure 5-7 Remove the fuser**



## 2. Unpack the replacement assembly

Follow these steps to unpack the replacement assembly.

1. Dispose of the defective part.



**NOTE:** HP recommends responsible disposal of the part.

<http://www8.hp.com/us/en/hp-information/environment/product-recycling.html>

2. Unpack the replacement part from the packaging.



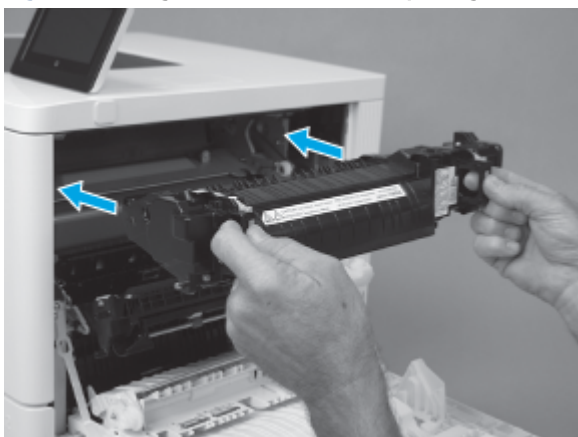
**IMPORTANT:** Make sure that all of the shipping materials (for example shipping tape) are removed from the replacement part prior to installation.

## 3. Install the fuser

Follow these steps to install the fuser.

1. Align the fuser with the opening in the printer.

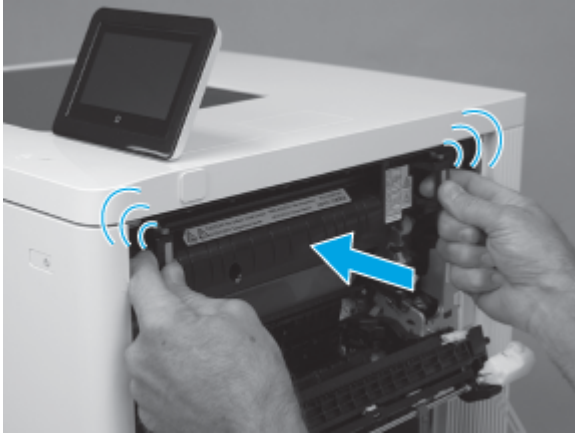
**Figure 5-8 Align the fuser with the opening**



- Slide the fuser into the printer, push in to install it, and then make sure that it is fully seated.

 **TIP:** When the fuser is fully seated, the release levers on the handles make an audible click.

**Figure 5-9** Install the fuser



- Close the right door.

### Removal and replacement: Image transfer belt (ITB)

This document provides instructions about removing and replacing the image transfer belt (ITB) assembly.

 [View a video demonstration of removing and replacing the image transfer belt.](#)

Mean time to repair: 5 minutes

Service level: Basic

### Before performing service

To order a replacement assembly, use the table below to identify the correct part number for your printer. To order the part, go to [www.hp.com/buy/parts](http://www.hp.com/buy/parts)

**Table 5-9** Part information

Part number	Part description
527G9A	HP LaserJet Image Transfer Belt Kit (6700/6800 models)
527H0MC	HP LaserJet Mngd Image Transfer Belt (X654/X677 models)

### Required tools

No special tools are required to remove or install this assembly.

### After performing service

Make sure that the right door is fully closed after replacing the ITB.

### Post service test

Print a configuration page to make sure that the printer is functioning correctly.

## 1. Remove the ITB

Follow these steps to remove the ITB.

1. Open the right door.

**Figure 5-10** Open the right door



2. Hold the two side levers and pull out the ITB assembly.

---

**CAUTION:** Do not touch the gray plastic belt. Skin oils and fingerprints on the belt can cause print-quality problems.

---

**Figure 5-11** Release the ITB



## 2. Unpack the replacement assembly

Follow these steps to unpack the replacement assembly.

1. Dispose of the defective part.

---

**NOTE:** HP recommends responsible disposal of the part.

<http://www8.hp.com/us/en/hp-information/environment/product-recycling.html>

---

2. Unpack the replacement part from the packaging.

---

**IMPORTANT:** Make sure that all of the shipping materials (for example shipping tape) are removed from the replacement part prior to installation.

---

### 3. Install the ITB

Follow these steps to install the ITB.

1. Hold the ITB by the edges (do not touch the gray plastic belt).
2. Align the ITB with the slots in the printer, and then carefully push it into the printer.
3. Continue to carefully push the ITB into the printer until it is fully installed.
4. Close the right door.



**TIP:** The right door should close easily if the ITB assembly is correctly installed.

### Removal and replacement: Secondary transfer roller

Learn about removing and replacing the secondary transfer roller.



[View a video of removing and replacing the T2 roller.](#)

### Before performing service

Use the table below to identify the correct part number for your printer, and then go to <https://parts.hp.com/hpparts> to order the part.

**Table 5-10** Part information

Part number	Part description
527H1MC	HP LaserJet Managed Trans Roller Kit

### Required tools

- No special tools are required to remove or install this assembly.

### After performing service

Make sure that the right door is fully closed after replacing the roller.

### Post service test

Print any pages necessary to make sure the printer is functioning correctly.

#### 1. Remove the secondary transfer roller

Follow these steps to remove the secondary transfer roller.

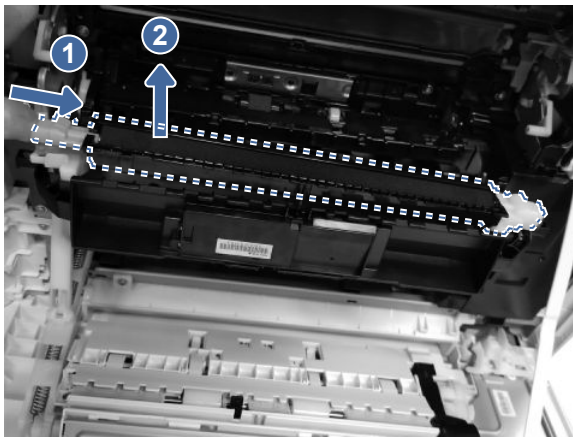
1. Open the right door.

**Figure 5-12 Open the right door**



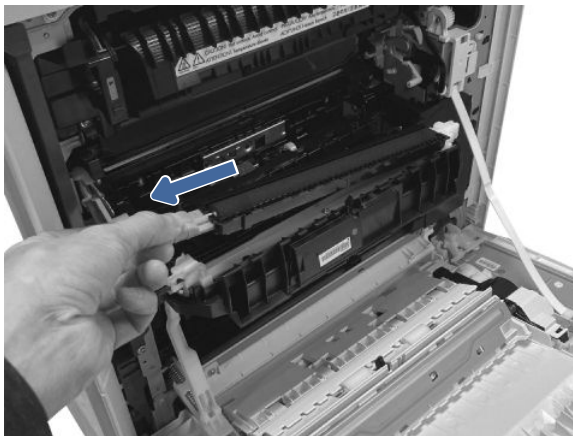
2. Push the blue left end (callout 1) of the roller assembly to the right, and then lift that end of the secondary transfer roller (callout 2).

**Figure 5-13 Release the left end of the secondary transfer roller**



3. With the left end of the roller lifted up, pull the roller to the left and out of the printer. Take care in removing the right end of the roller from its holder.


**Figure 5-14 Remove the secondary transfer roller**



## 2. Unpack the replacement assembly


Follow these steps to unpack the replacement assembly.

1. Dispose of the defective part.

 **NOTE:** HP recommends responsible disposal of the part.

<http://www8.hp.com/us/en/hp-information/environment/product-recycling.html>


2. Unpack the replacement part from the packaging.

 **IMPORTANT:** Make sure that all of the shipping materials (for example shipping tape) are removed from the replacement part prior to installation.

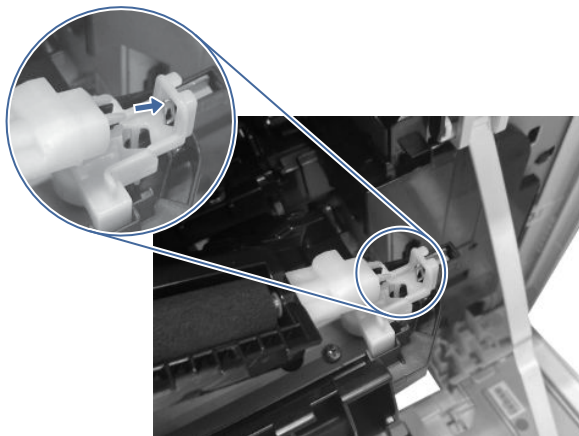
## 3. Install the secondary transfer roller

Follow these steps to install the secondary transfer roller.

1. Carefully align and insert the right end of the replacement roller into the holder

 **IMPORTANT:** Make sure that right end of the roller assembly is fully seated in the holder.

**Figure 5-15** Install right end of the secondary transfer roller



2. Push down on the blue left end until the roller snaps into place.

**Figure 5-16** Secure the secondary transfer roller



3. Close the right door.

### Removal and replacement: Document feeder rollers (MFP models)

Learn about removing and replacing the document feeder rollers.



[View a video of removing and replacing the document feeder rollers.](#)

### Before performing service

Use the table below to identify the correct part number for your printer, and then go to <https://parts.hp.com/hpparts> to order the part.

**Table 5-11 Part information**

Part number	Part description
6H122A	ADF Pick/Sep Roller Kit (6xxx Series)
6M1P3A	ADF Pick/Sep Roller Kit (Flow 6xxx Series)

### Required tools

- No special tools are required to remove or install this assembly.

### Post service test

Use the document feeder to copy a page, and then verify that the document correctly copies, scans, or prints.

#### 1. Remove the ADF pickup and feed roller assembly

Follow these steps to remove the ADF pickup and feed roller assembly.

1. Open the document-feeder jam access door.

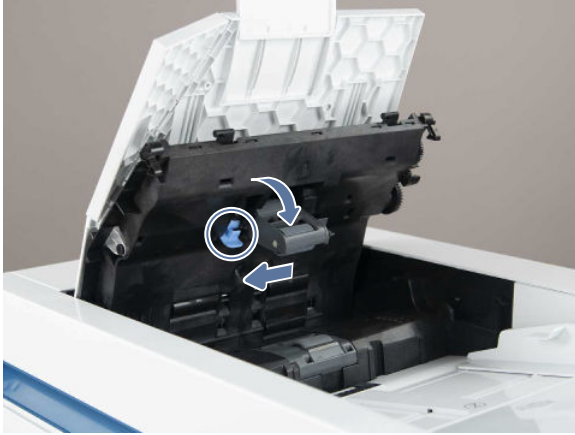
**Figure 5-17 Open the document-feeder jam access door**





2. Release the blue locking arm to drop the assembly down. Slide the pickup and feed roller assembly to the left, and then pull it away from the document feeder to remove it.

**Figure 5-18** Release the blue locking arm

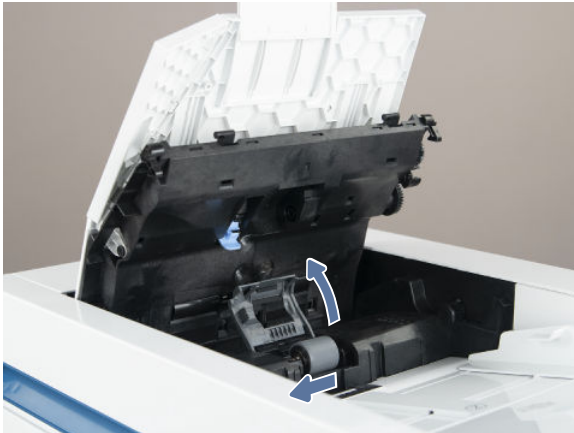


## 2. Remove the ADF separation roller

Follow these steps to remove the ADF separation roller.

- Lift the roller cover up and then slide the roller toward the front of the printer to remove it.

**Figure 5-19** Release the separation roller cover



## 3. Unpack the replacement assembly

Follow these steps to unpack the replacement assembly.

1. Dispose of the defective part.



**NOTE:** HP recommends responsible disposal of the part.

<http://www8.hp.com/us/en/hp-information/environment/product-recycling.html>

2. Unpack the replacement part from the packaging.



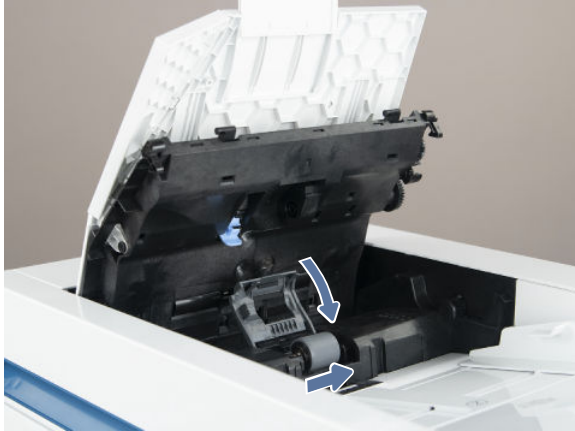
**IMPORTANT:** Make sure that all of the shipping materials (for example shipping tape) are removed from the replacement part prior to installation.

#### 4. Install the ADF separation roller

Follow these steps to install the ADF separation roller.

- Lower the separation roller into the document feeder, slide it to the right to install it, and then bring the cover down over the roller and snap it into place.

**Figure 5-20** Install the ADF separation roller

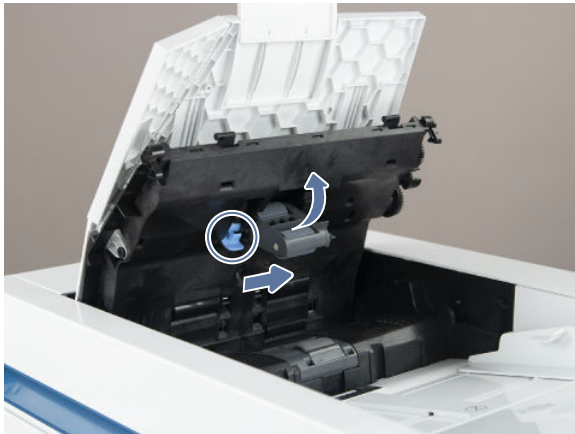


#### 5. Install the ADF pickup and feed roller assembly

Follow these steps to install the pickup and feed roller assembly.

- Position the pickup and feed roller assembly in the document feeder, slide the assembly to the right to seat it in the ADF, and then push the lever up to lock the roller assembly in place.

**Figure 5-21** Install the ADF pickup and feed roller assembly



#### Installation: Keyboard overlay (Flow MFP models)

Learn about installing a keyboard overlay.

#### Introduction

 [View a video of how to install the keyboard overlay.](#)

#### Before performing service

**Turn the printer power off**

- Disconnect the power cable.

---

**⚠ WARNING!** To avoid damage to the printer, turn the printer off, wait 30 seconds, and then remove the power cord before attempting to service the printer.

---

Use the table below to identify the correct part number for your printer, and then go to <https://parts.hp.com/hpparts> to order the part.

**Table 5-12 Part information**

Part number	Part description
A7W12A	Keyboard Overlay Kit - Chinese
A7W13A	Keyboard Overlay Kit - (DN/FR-Swiss/GN)
A7W14A	HP LaserJet Swedish Overlay Keyboard

## Required tools

- No special tools are required to install this assembly.

## After performing service

### Turn the printer power on

- Connect the power cable.
- Use the power switch to turn the power on.

## Post service test

Print any pages necessary to make sure the printer is functioning correctly.

### 1. Install the keyboard overlay (Flow MFP models)

Follow these steps to install the keyboard overlay.

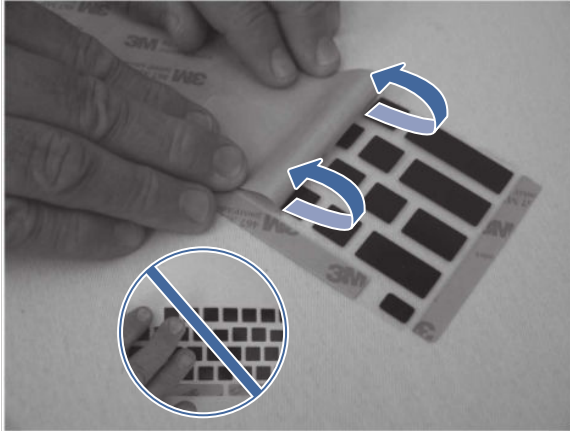
1. Carefully peel the backing from the control panel overlay.

---

**⚠ CAUTION:** Do not touch the adhesive squares and be careful so that the adhesive squares do not come off with the backing.

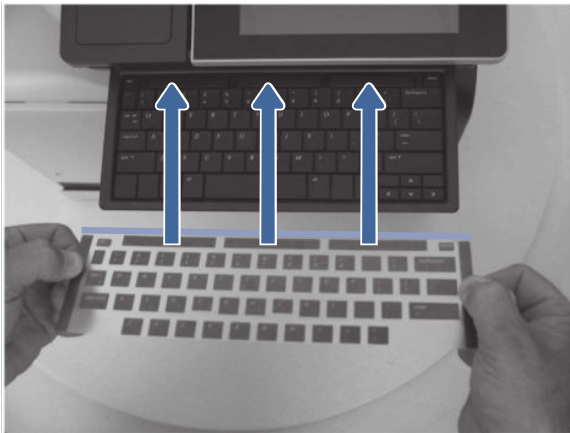
---

**Figure 5-22 Remove the backing**



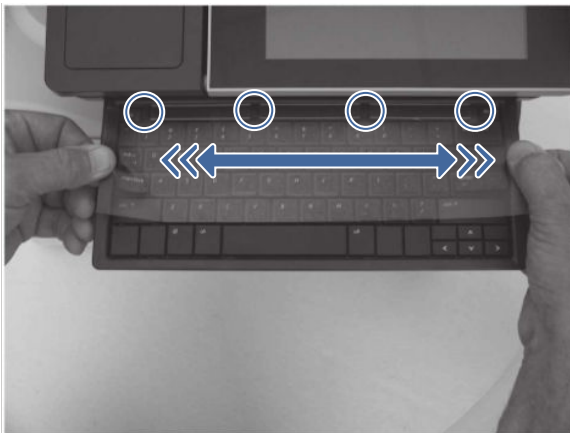
2. Position the keyboard overlay on the keyboard by aligning the upper edge of the overlay with the top edge of the keyboard.

**Figure 5-23 Position the keyboard overlay top edge**



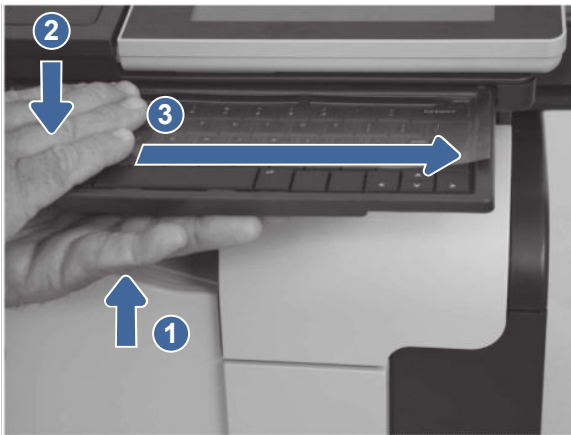
3. With the top edge positioned, align the side edges of the overlay with the keyboard edges.

**Figure 5-24 Position the keyboard overlay side edges**



4. Place one hand under the keyboard and press upward (callout 1). Place the other hand on top of the keyboard overlay and press downward (callout 2). Continue to press while sliding both hands to the right (callout 3) to adhere the overlay to the keyboard.

**Figure 5-25** Apply the keyboard overlay



5. Carefully remove the protective top sheet from the keyboard overlay.

**Figure 5-26** Apply the keyboard overlay

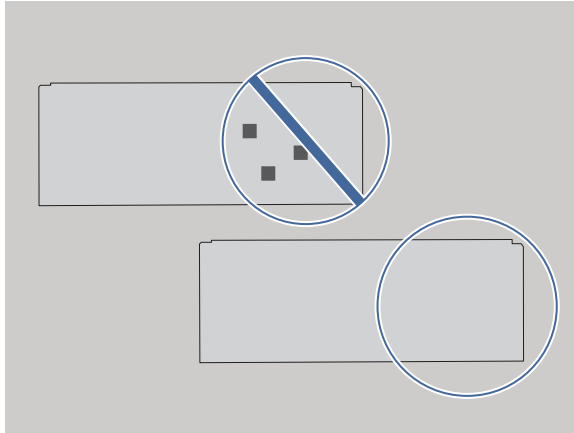


---

**⚠ CAUTION:** Make sure that the adhesive squares do not come off of the keyboard with the protective sheet.

---

**Figure 5-27** Ensure that the squares do not stick to the top sheet



### Removal and replacement: Tray 1 pickup and separation rollers

Learn about removing and replacing the Tray 1 rollers.



[View a video of removing and replacing the Tray 1 rollers.](#)

### Before performing service

If the part is damaged and cannot be cleaned, use the table below to identify the correct part number for your printer. To order the part, go to [www.hp.com/buy/parts](http://www.hp.com/buy/parts).

**Table 5-13** Part information

Part number	Part description
527H3A	HP LaserJet MP Tray Roller Kit

### Required tools

- No special tools are required to remove or install this assembly.

### Post service test

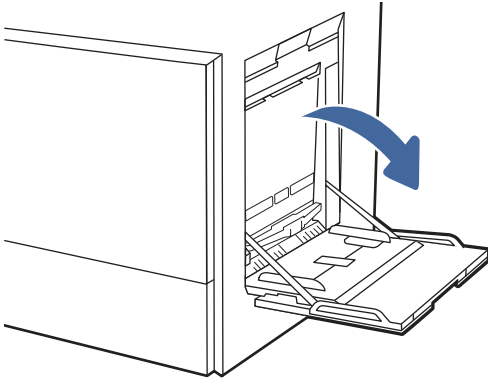
Print any pages necessary to make sure the printer is functioning correctly.

#### 1. Remove the Tray 1 pickup roller

Follow these steps to remove and replace the Tray 1 pickup roller.

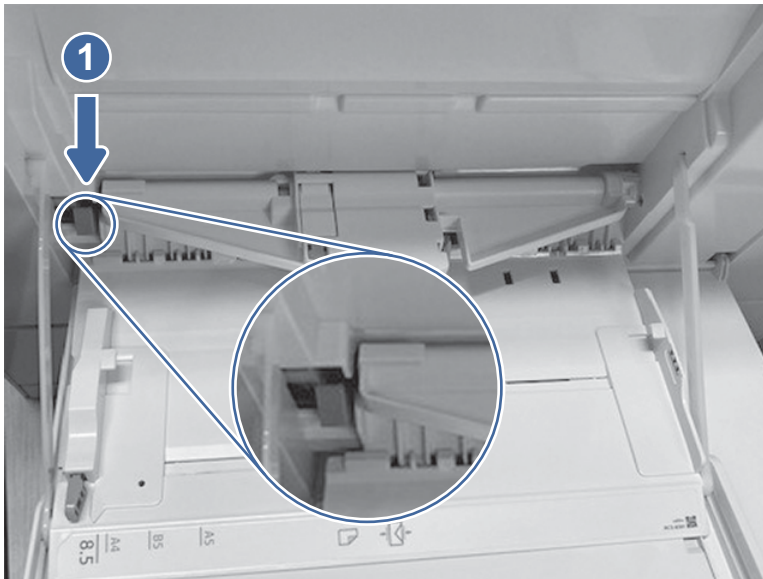
1. On the right side of the printer, release the lower of the two latches to open Tray 1.

**Figure 5-28 Open Tray 1**



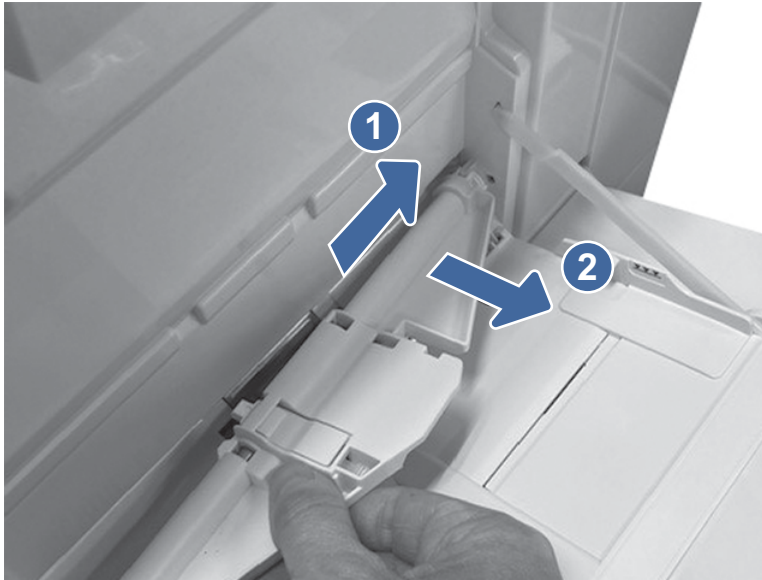
2. Locate and release the blue pickup roller assembly release tab (callout 1).

**Figure 5-29 Locate the pickup roller assembly tab**



3. Push the pickup roller assembly to the right and then away from the printer.


**Figure 5-30** Remove the pickup roller assembly



## 2. Remove the Tray 1 separation roller

Follow these steps to remove and replace the Tray 1 separation roller.

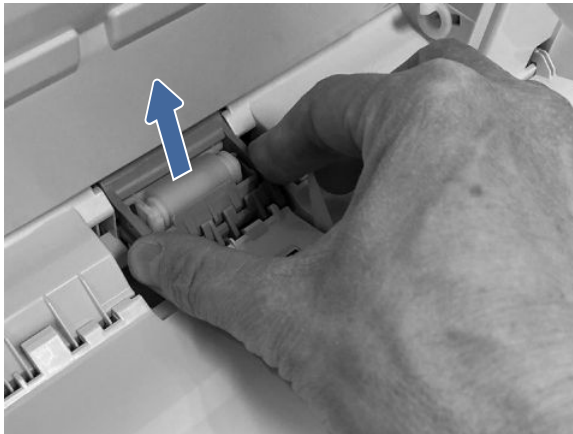
---

 **NOTE:** Even if you want to replace only the separation roller, you must first remove the pickup roller assembly.

---

1. Grasp the left- and right-side of the separation roller assembly, and then lift the assembly up.

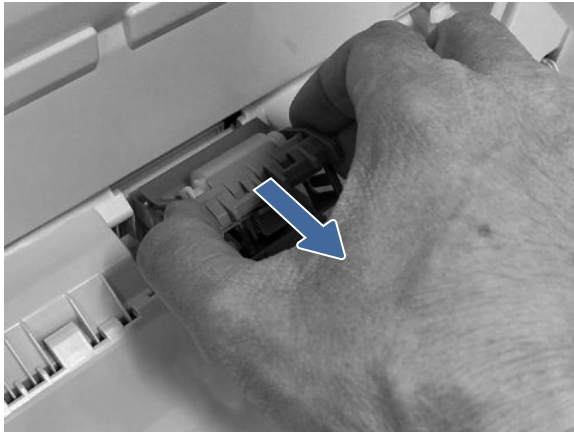
**Figure 5-31** Lift the separation roller assembly





2. Pull the separation roller assembly straight out to remove it.

**Figure 5-32 Remove the separation roller assembly**



### 3. Unpack the replacement assembly

Follow these steps to unpack the replacement assembly.

1. Dispose of the defective part.



**NOTE:** HP recommends responsible disposal of the part.

<http://www8.hp.com/us/en/hp-information/environment/product-recycling.html>

---

2. Unpack the replacement part from the packaging.



**IMPORTANT:** Make sure that all of the shipping materials (for example shipping tape) are removed from the replacement part prior to installation.

---

### 4. Install the Tray 1 separation roller

Follow these steps to install the Tray 1 separation roller.

- ⚠ CAUTION:** Do not touch the spongy portion of the roller. Skin oils on the roller can cause paper-handling and print-quality problems. HP recommends using disposable gloves or thoroughly washing your hands before handling the assembly.
-

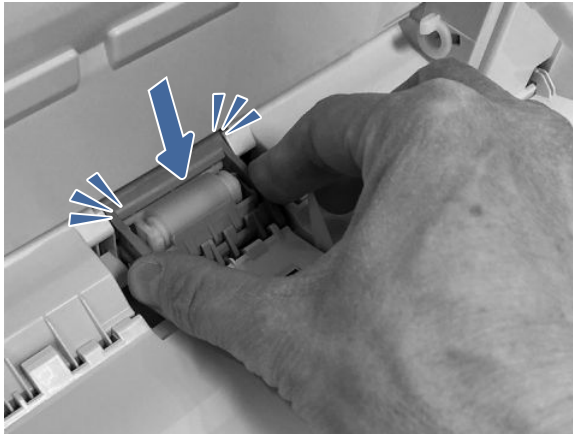
1. Insert the separation roller assembly into the printer.

**Figure 5-33** Insert the separation roller assembly



2. Push down on the Tray 1 separation roller until it snaps into place.

**Figure 5-34** Secure the separation roller assembly



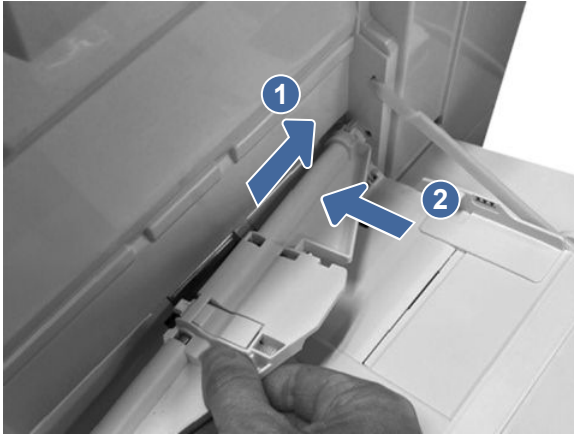
## 5. Install the Tray 1 pickup roller

Follow these steps to install the Tray 1 pickup roller.

- 
- ⚠ CAUTION:** Do not touch the spongy portion of the roller. Skin oils on the roller can cause paper-handling and print-quality problems. HP recommends using disposable gloves or thoroughly washing your hands before handling the assembly.
-

- Insert the keyed right end of the pickup roller assembly into the provided slot, and then rotate the left end into place to install it.

**Figure 5-35** Install the pickup roller assembly



### Removal and replacement: Tray 2 paper pickup roller and separation roller assemblies

Learn about removing and replacing the Tray 2 rollers.

 [View a video of removing and replacing the Tray 2 rollers.](#)

### Before performing service

If the part is damaged and cannot be cleaned, use the table below to identify the correct part number for your printer. To order the part, go to [www.hp.com/buy/parts](http://www.hp.com/buy/parts).

**Table 5-14** Part information

Part number	Part description
527H2A	HP LaserJet Tray 2-x Roller Kit

### Required tools

- No special tools are required to remove or install this assembly.

### Post service test

Print any pages necessary to make sure the printer is functioning correctly.

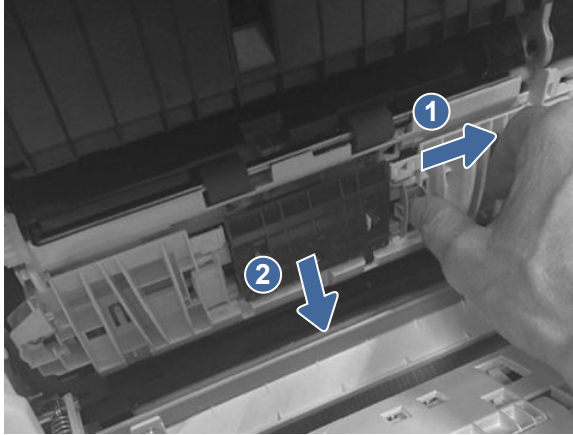
#### 1. Remove the Tray 2 separation roller assembly

Learn about removing the Tray 2 separation roller assembly.

1. Depending on the printer model, perform one of the following steps.
  - 6700/6800 models: Open the right door.
  - X654/X677 models: Open the lower right door.

2. Slide the blue lever (callout 1) to the right, and then remove the separation roller assembly (callout 2) by pulling it out from the printer.

**Figure 5-36 Remove the separation roller assembly**



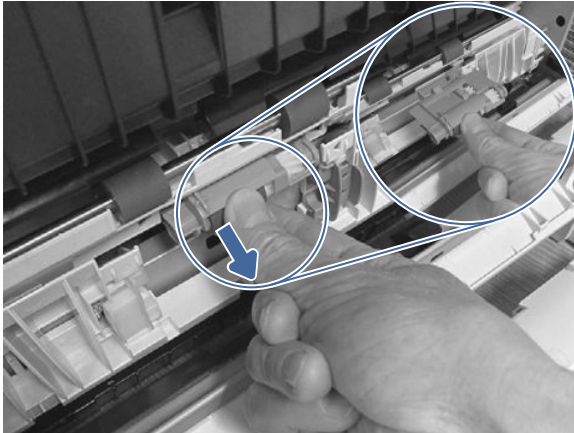
## 2. Remove the Tray 2 paper pickup roller assembly


Learn about removing the Tray 2 pickup rollers.

 **NOTE:** Even if you want to replace only the pickup roller assembly, you must first remove the separation roller assembly.

- Locate the pickup roller assembly, and then pull it away from the printer to remove it.

**Figure 5-37 Remove the pickup roller assembly**




 **NOTE:** As the roller assembly can be hard to grip, you might need to reach under and behind the rollers to securely grip it.

## 3. Unpack the replacement assembly

Follow these steps to unpack the replacement assembly.


1. Dispose of the defective part.

 **NOTE:** HP recommends responsible disposal of the part.

<http://www8.hp.com/us/en/hp-information/environment/product-recycling.html>

2. Unpack the replacement part from the packaging.

---


 **IMPORTANT:** Make sure that all of the shipping materials (for example shipping tape) are removed from the replacement part prior to installation.

---

#### 4. Install the Tray 2 paper pickup roller assembly

Learn about installing the Tray 2 pickup roller assembly.

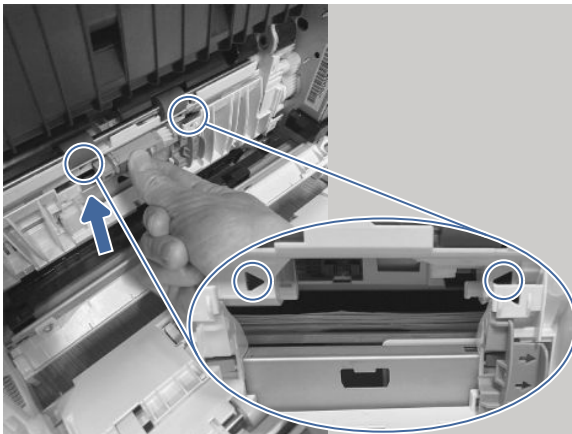
---

 **CAUTION:** Do not touch the spongy portion of the roller. Skin oils on the roller can cause paper-handling and print-quality problems. HP recommends using disposable gloves or thoroughly washing your hands before handling the assembly.

---

- Position the pickup roller assembly in the printer in the correct orientation, and then press the assembly into place.


**Figure 5-38** Install the pickup roller assembly



#### 5. Install the Tray 2 separation roller assembly

Learn about installing the Tray 2 separation roller assembly.

---

 **CAUTION:** Do not touch the spongy portion of the roller. Skin oils on the roller can cause paper-handling and print-quality problems. HP recommends using disposable gloves or thoroughly washing your hands before handling the assembly.

---

- Insert the separation roller assembly into the printer to install it.

**Figure 5-39** Install the separation roller assembly



## 2. Customer self-repair (CSR) B parts and accessories

Customer self-repair (CSR) B parts are parts that a customer replaces without assistance from a field technician. These parts might require the use of tools.

### Customer-replaceable units

Learn about customer-replaceable parts removal and replacement.

### Internal parts and assemblies

Learn how to remove and replace the printer internal parts and assemblies.

### Removal and replacement: Keyboard (Flow MFP models)

Learn about removing and replacing the keyboard.


#### Introduction

 [View a video of how to remove and replace the keyboard.](#)

#### Before performing service

##### Turn the printer power off

- Disconnect the power cable.

 **WARNING!** To avoid damage to the printer, turn the printer off, wait 30 seconds, and then remove the power cord before attempting to service the printer.

Use the table below to identify the correct part number for your printer, and then go to <https://parts.hp.com/hpparts> to order the part.

**Table 5-15** Part information

Part number	Part description
1M0Q2A	HP LaserJet Workflow Keyboard

## Required tools

- Use the reversible screwdriver, the bracket, and the two screws included in the kit.

## After performing service

### Turn the printer power on

- Connect the power cable.
- Use the power switch to turn the power on.

## Post service test

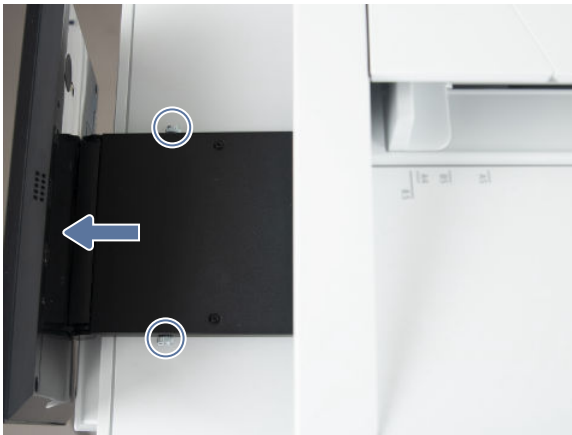
Print any pages necessary to make sure the printer is functioning correctly.

### 1. Remove the control panel (MFP)

Follow these steps to remove the control panel.

- Pull the control panel out and tilt it up, and then remove the two thumbscrews on the control panel arm. Remove the control panel by pulling it away from the printer.

**Figure 5-40** Remove two thumbscrews

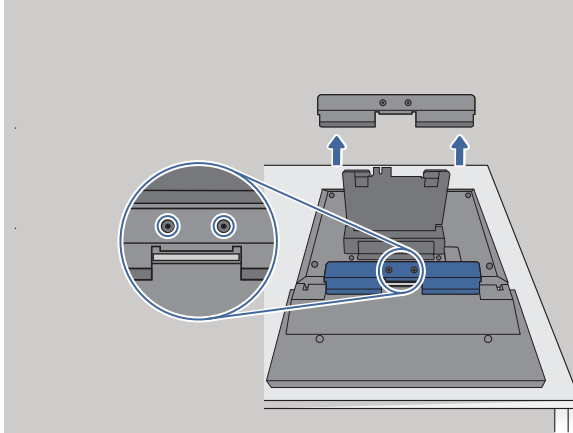


### 2. Remove the keyboard (MFP models)

Follow these steps to remove the keyboard.

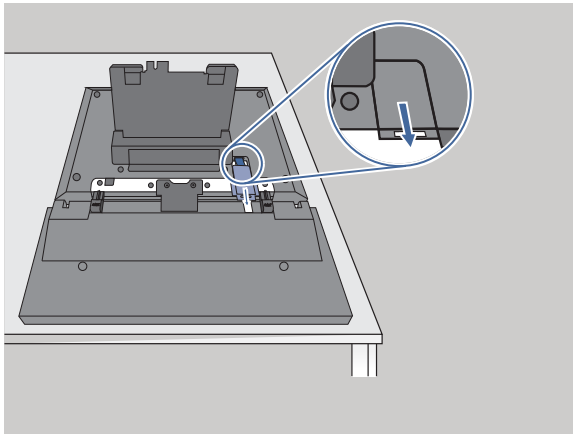
1. On the back of the control panel, remove two screws, and then remove the bracket from the assembly.

**Figure 5-41 Remove the bracket**



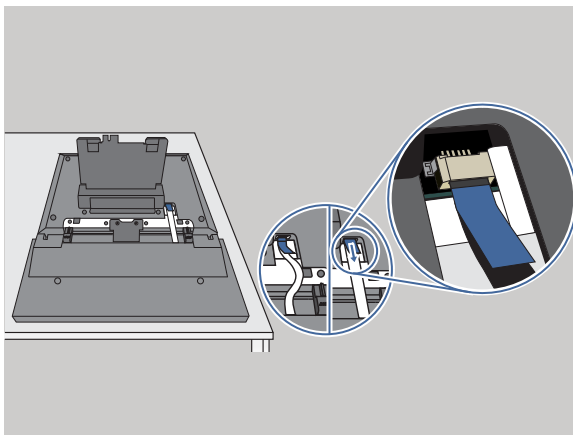
2. Remove the flat flexible cable (FFC) connector cover.

**Figure 5-42 Remove the FFC connector cover**



3. Use the pull tab to disconnect the FFC from the connector in the control panel.

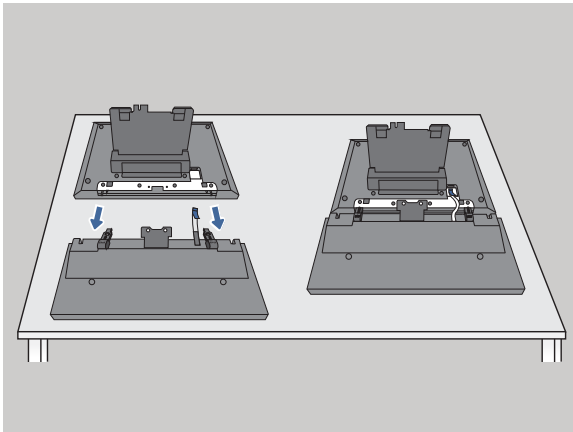
**Figure 5-43 Disconnect the keyboard FFC**





4. Pull the keyboard away from the control panel.

**Figure 5-44 Remove the keyboard**



### 3. Unpack the replacement assembly

Follow these steps to unpack the replacement assembly.

1. Dispose of the defective part.



**NOTE:** HP recommends responsible disposal of the part.

<http://www8.hp.com/us/en/hp-information/environment/product-recycling.html>

2. Unpack the replacement part from the packaging.



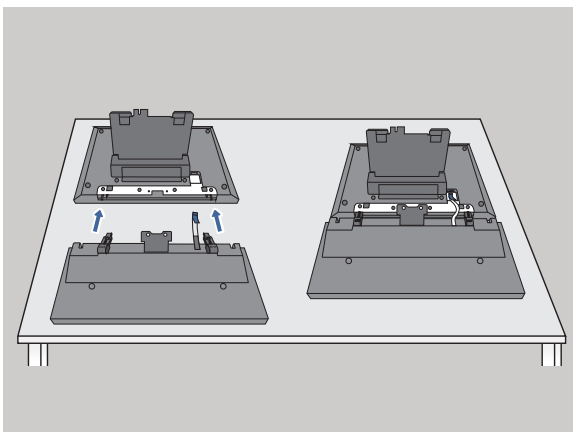
**IMPORTANT:** Make sure that all of the shipping materials (for example shipping tape) are removed from the replacement part prior to installation.

### 4. Install the keyboard (MFP models)

Follow these steps to install the keyboard.

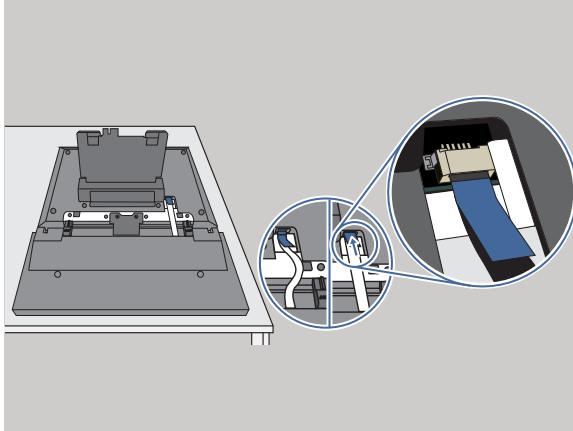
1. Align the back of the keyboard with the back of the control panel and then join them by connecting the hinges.

**Figure 5-45 Connect the keyboard to the control panel**



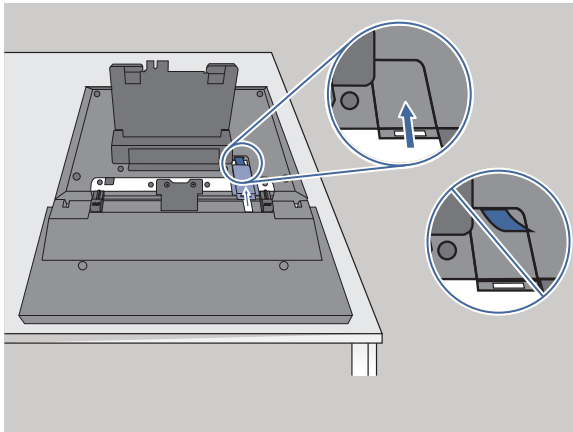
2. Connect the keyboard flat flexible cable (FFC) with the connector in the control panel.

**Figure 5-46** Connect the keyboard FFC



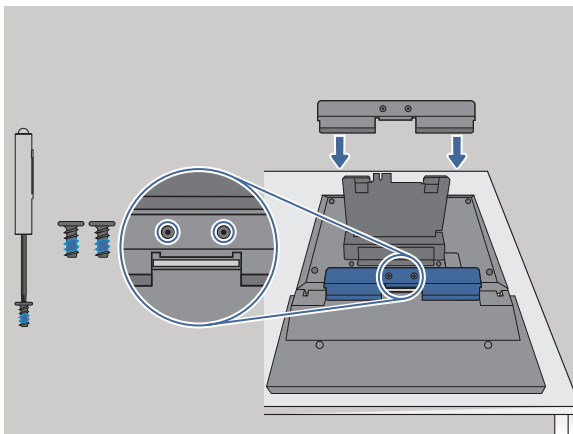
3. Install the FFC cover. Make sure that the FFC pull tab does not stick out after the cover is installed.

**Figure 5-47** Install the FFC cover



4. Use the reversible screwdriver to install the two bracket screws to attach the bracket to the control panel.

**Figure 5-48** Install the bracket

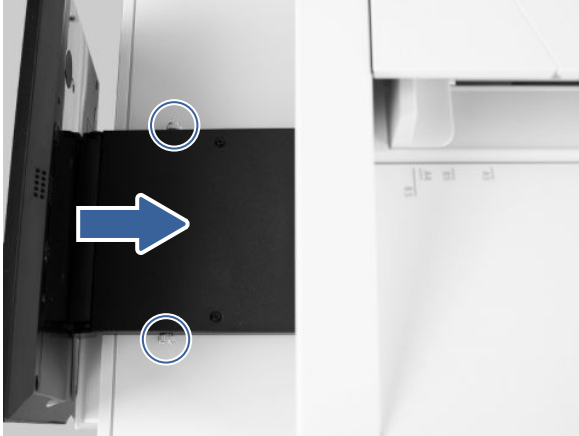


## 5. Install the control panel (MFP models)

Follow these steps to install the control panel.

- Slide the control panel into the control panel arm, and then install the two thumbscrews on the control panel arm.

**Figure 5-49** Install the control panel



### Removal and replacement: Hard-disk drive (HDD)

This document provides the procedures to remove and replace the hard-disk drive (HDD).

 [View a video demonstration of removing and replacing the hard-disk drive.](#)


Mean time to repair: 10 minutes


Service level: Basic

#### Before performing service

##### Turn the printer power off

- Disconnect the power cable.

 **WARNING!** To avoid damage to the printer, turn the printer off, wait 30 seconds, and then remove the power cord before attempting to service the printer.

 **IMPORTANT:** Do not replace the formatter, DC controller, and eMMC PCA or hard-disk drive simultaneously during a single printer servicing. Doing so might cause the printer to become unstable or inoperable.

Use the table below to identify the correct part number for your printer. To order the part, go to [www.hp.com/buy/parts](http://www.hp.com/buy/parts).

**Table 5-16** Part information

Part number	Part description
L41606-011	HDD, 500GB 5400RPM SED
L42243-021	HDD, 500GB 5400RPM FIPS/CCC OPAL2 7MM
6HN31A	HP 500GB CCC FIPS TAA Hard Disk Drive
9EQ11A	HP 500GB CCC FIPS Hard Disk Drive

## Required tools

- #2 Phillips screwdriver with a magnetic tip and a 152 mm (6 in) shaft length

## After performing service

Make sure that the formatter cover is fully seated, and that the screw is fastened.

### Turn the printer power on

- Connect the power cable.
- Use the power switch to turn the power on.

## Post service test


Print a configuration page to make sure that the printer is functioning correctly.

### 1. Remove the formatter cover

Follow these steps to remove the formatter cover.

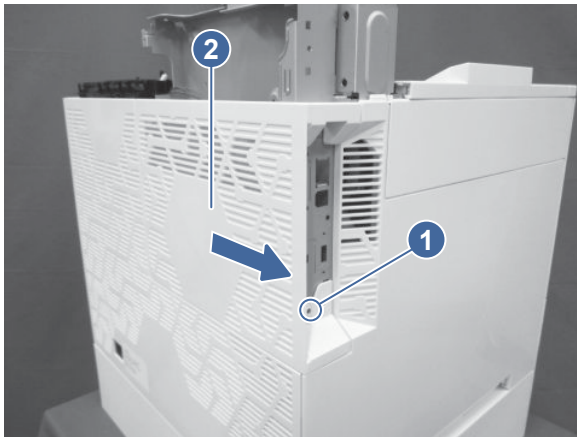
- Remove one screw (callout 1), and then slide the formatter cover (callout 2) away from the printer to remove it.

---

 **TIP:** Reverse the removal steps to install the assembly.

---

**Figure 5-50** Remove the formatter cover



### 2. Remove the hard-disk drive (HDD)

Follow these steps to remove the hard-disk drive (HDD).

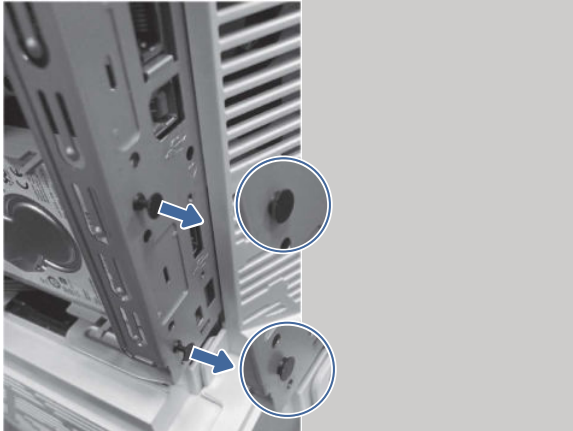
---

 **CAUTION:**  ESD sensitive part.

---

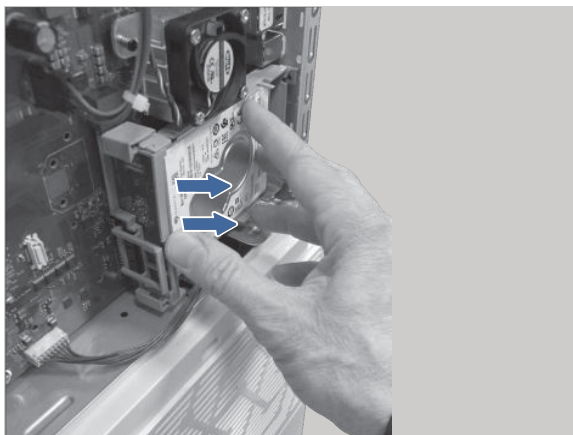
1. Release two pins from the formatter faceplate.

**Figure 5-51 Release two pins**



2. On the left side of the HDD, release the connector from the formatter, and then pull the HDD away from the formatter.

**Figure 5-52 Release the HDD**



### 3. Unpack the replacement assembly

Follow these steps to unpack the replacement assembly.

1. Dispose of the defective part.



**NOTE:** HP recommends responsible disposal of the part.

<http://www8.hp.com/us/en/hp-information/environment/product-recycling.html>

2. Unpack the replacement part from the packaging.



**IMPORTANT:** Make sure that all of the shipping materials (for example shipping tape) are removed from the replacement part prior to installation.

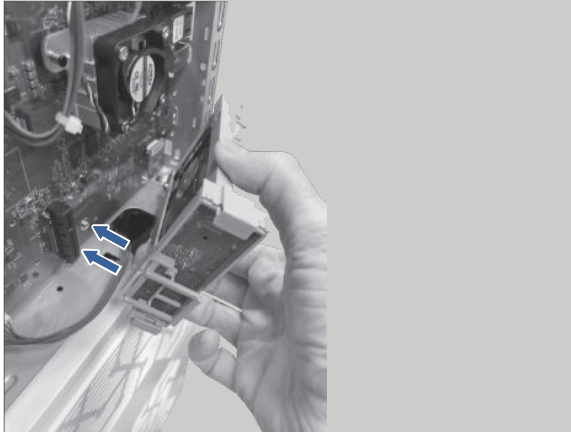
### 4. Install the hard-disk drive (HDD)

Follow these steps to install the hard-disk drive (HDD).

 **CAUTION:**  ESD sensitive part.

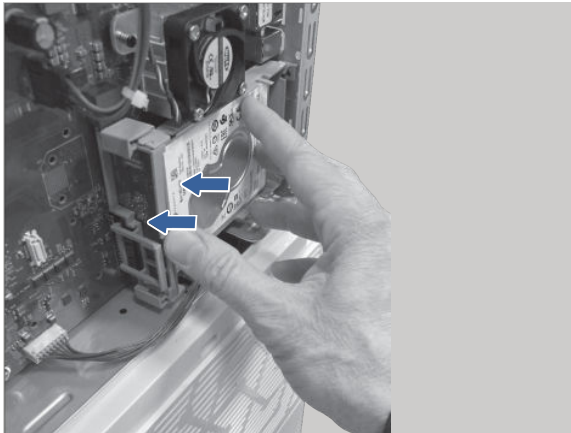
1. Align the connectors on the left side of the HDD with the connector on the formatter.

**Figure 5-53** Align the connectors



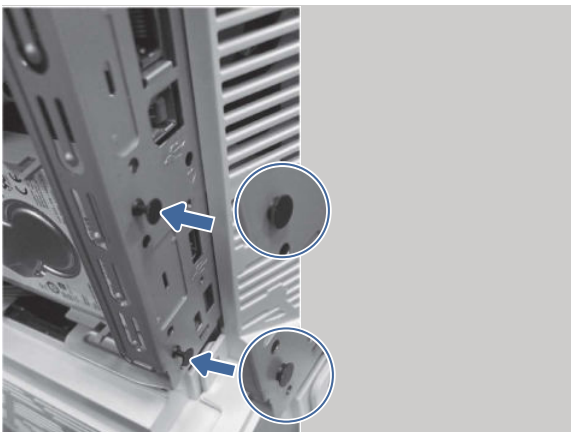
2. Press the connectors together to seat the HDD on the formatter.

**Figure 5-54** Install the HDD



3. Install the two pins through the formatter plate to secure the HDD.

**Figure 5-55** Install two pins

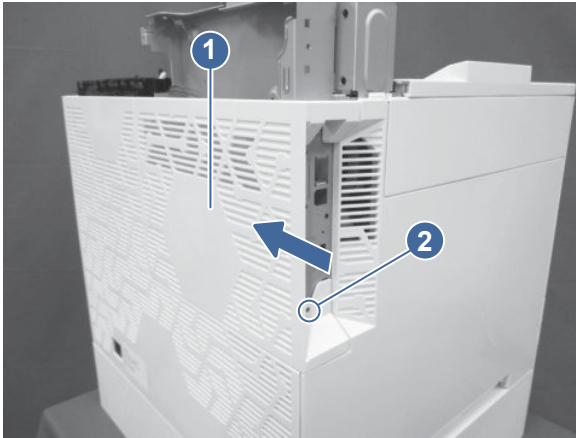


## 5. Install the formatter cover

Follow these steps to install the formatter cover.

- Slide the cover (callout 1) onto the printer, and then install one screw (callout 2) to secure it.

**Figure 5-56** Install the cover



## Removal and replacement: Dual in-line memory module (DIMM) (SFP models)

Learn about removing and replacing the dual in-line memory module (DIMM).

 [View a video demonstration of removing and replacing the DIMM.](#)

### Before performing service

#### Turn the printer power off

- Disconnect the power cable.

**⚠ WARNING!** To avoid damage to the printer, turn the printer off, wait 30 seconds, and then remove the power cord before attempting to service the printer.

Use the table below to identify the correct part number for your printer, and then go to <https://parts.hp.com/hpparts> to order the part.

**Table 5-17** Part information

Part number	Part description
6QY68A	HP 4GB DDR3Lx64 204-pin 933MHz DIMM
1M8J1A	HP 4GB DDR3Lx64 204-pin 933MHz DIMM TAA

### Required tools

- #2 Phillips screwdriver with a magnetic tip and a 152 mm (6 in) shaft length

### After performing service

#### Turn the printer power on

- Connect the power cable.

- Use the power switch to turn the power on.

## Post service test


No post service test is available for this assembly.

### 1. Remove the formatter cover

Follow these steps to remove the formatter cover.

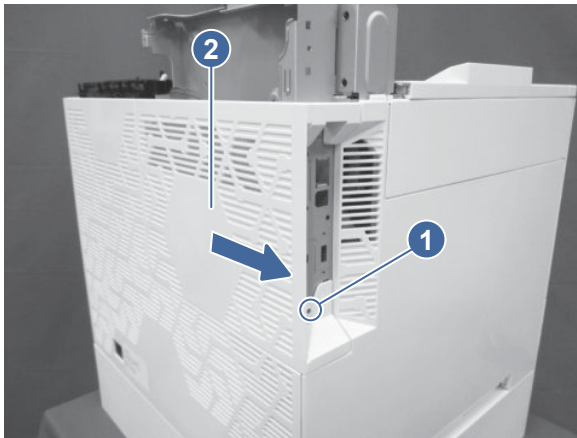
- Remove one screw (callout 1), and then slide the formatter cover (callout 2) away from the printer to remove it.

---

 **TIP:** Reverse the removal steps to install the assembly.

---

**Figure 5-57 Remove the formatter cover**



### 2. Remove the dual in-line memory module (DIMM)

Follow these steps to remove the DIMM.

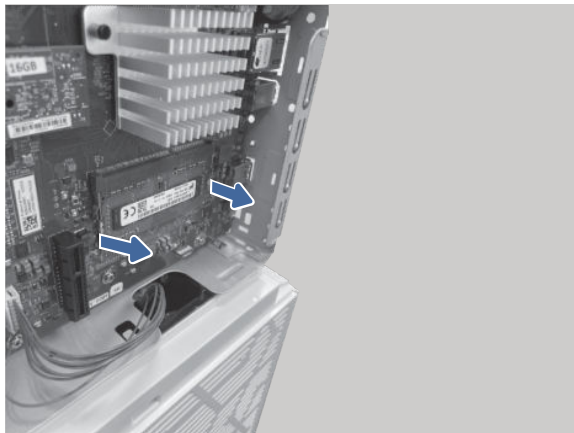
---

 **CAUTION:**  ESD sensitive part.

---

1. Pull the bottom edge of the DIMM away from the formatter to loosen the connector at the top of the DIMM.

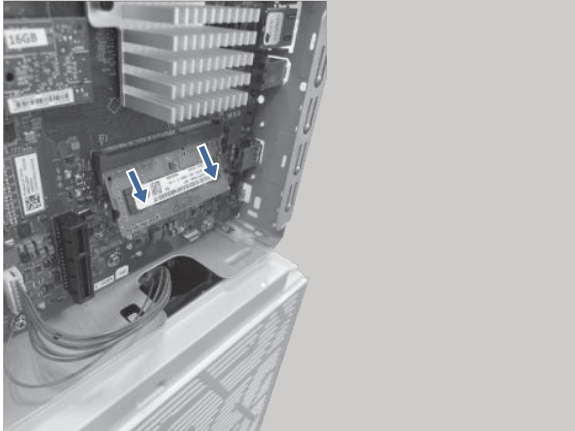
**Figure 5-58 Pull the bottom edge of the DIMM**





2. Pull down on the DIMM to remove it from the formatter.

**Figure 5-59 Remove the DIMM**



### 3. Unpack the replacement assembly

Follow these steps to unpack the replacement assembly.

1. Dispose of the defective part.



**NOTE:** HP recommends responsible disposal of the part.

<http://www8.hp.com/us/en/hp-information/environment/product-recycling.html>

2. Unpack the replacement part from the packaging.



**IMPORTANT:** Make sure that all of the shipping materials (for example shipping tape) are removed from the replacement part prior to installation.

### 4. Install the DIMM

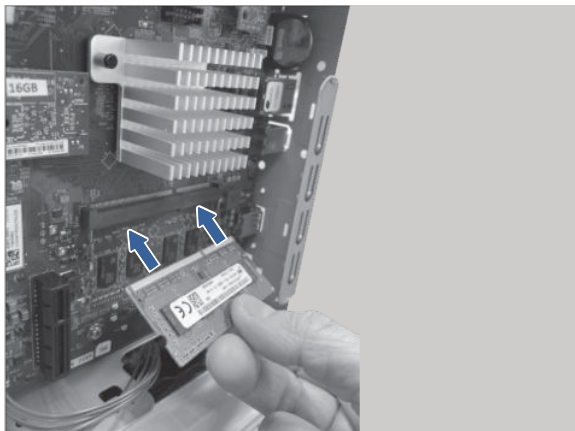
Follow these steps to install the DIMM.



**CAUTION:**  ESD sensitive part.

1. Align the connector edge on the DIMM with the slot on the formatter.

**Figure 5-60 Align the DIMM**



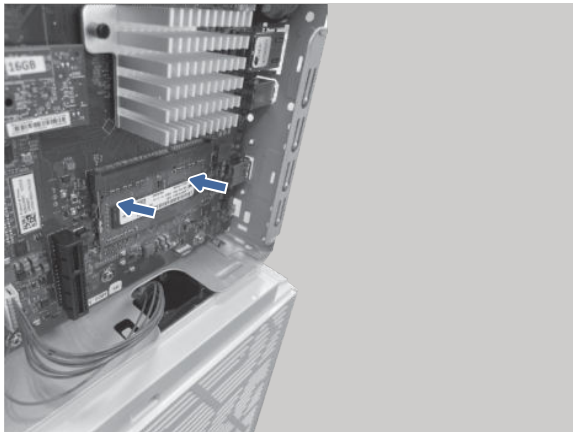
2. Gently insert the top edge of the DIMM up into the formatter slot.

**Figure 5-61** Insert the top edge into the formatter



3. Press the bottom edge of the DIMM against the formatter to seat it firmly in the formatter slot.

**Figure 5-62** Install the DIMM

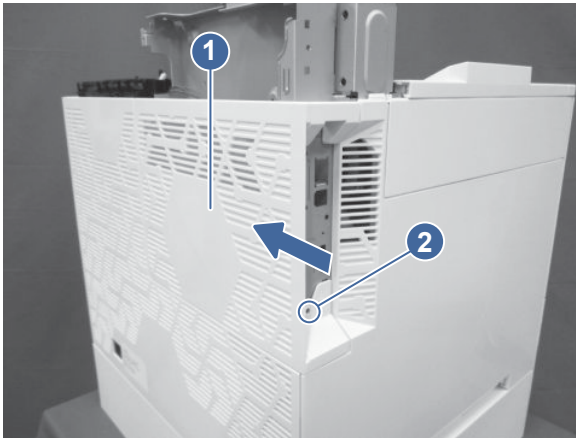


## 5. Install the formatter cover

Follow these steps to install the formatter cover.

- Slide the cover (callout 1) onto the printer, and then install one screw (callout 2) to secure it.

**Figure 5-63 Install the cover**



### Removal and replacement: Fax PCA (fax models)

Learn about removing and replacing the fax PCA.

 [View a video demonstration of removing and replacing the fax PCA.](#)

### Before performing service

#### Turn the printer power off

- Disconnect the power cable.

**⚠ WARNING!** To avoid damage to the printer, turn the printer off, wait 30 seconds, and then remove the power cord before attempting to service the printer.

If the part is damaged and cannot be cleaned, use the table below to identify the correct part number for your printer. To order the part, go to [www.hp.com/buy/parts](http://www.hp.com/buy/parts).

**Table 5-18 Part information**

Part number	Part description
B5L53-67901	Analog Fax Accessory 600

### Required tools

- No special tools are required to remove or install this assembly.

### After performing service

#### Turn the printer power on

- Connect the power cable.
- Use the power switch to turn the power on.

### Post service test


If possible, send and receive a fax from the printer.

### 1. Remove the formatter cover

Follow these steps to remove the formatter cover.

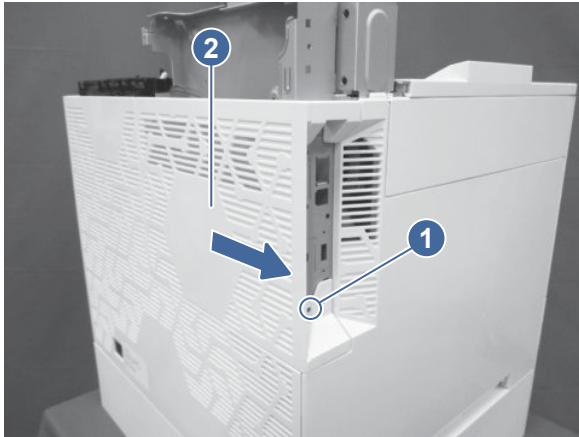
- Remove one screw (callout 1), and then slide the formatter cover (callout 2) away from the printer to remove it.

---

 **TIP:** Reverse the removal steps to install the assembly.

---

**Figure 5-64 Remove the formatter cover**



### 2. Remove the fax PCA (fax MFP models)

Follow these steps to remove the fax PCA.

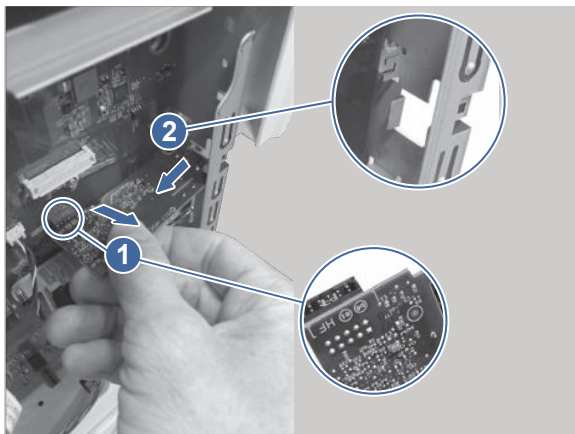
---

 **CAUTION:**  ESD sensitive part.

---

- Rotate end left end of the fax PCA away from the formatter (callout 1) to disconnect the connector, and then slide the card away from the formatter faceplate (callout 2) to remove it.

**Figure 5-65 Remove the fax PCA**




### 3. Unpack the replacement assembly

Follow these steps to unpack the replacement assembly.

1. Dispose of the defective part.

---


 **NOTE:** HP recommends responsible disposal of the part.

<http://www8.hp.com/us/en/hp-information/environment/product-recycling.html>

---

2. Unpack the replacement part from the packaging.

---

 **IMPORTANT:** Make sure that all of the shipping materials (for example shipping tape) are removed from the replacement part prior to installation.

---

#### 4. Install the fax PCA (fax MFP models)

Follow these steps to install the fax PCA.

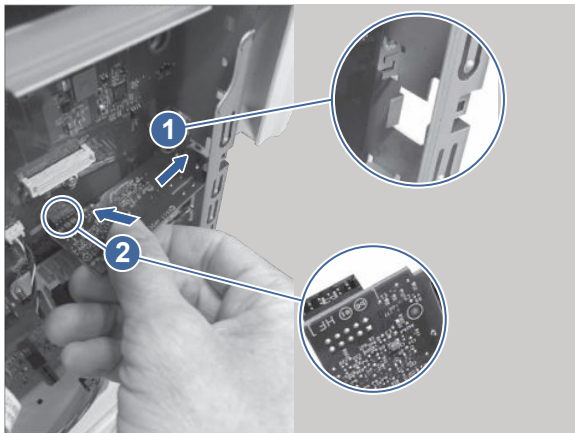
---

 **CAUTION:**  ESD sensitive part.

---

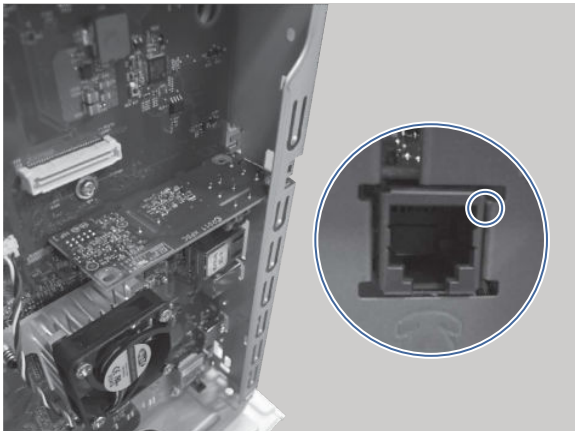
1. Align the fax port with the cut-out in the formatter faceplate, and then align the connector on the back of the card with the formatter connector. Press the connectors together to seat the card on the formatter.

**Figure 5-66** Align the fax PCA



2. When installed, the port on the card should sit securely in the faceplate cut-out.

**Figure 5-67** Check the fax PCA port

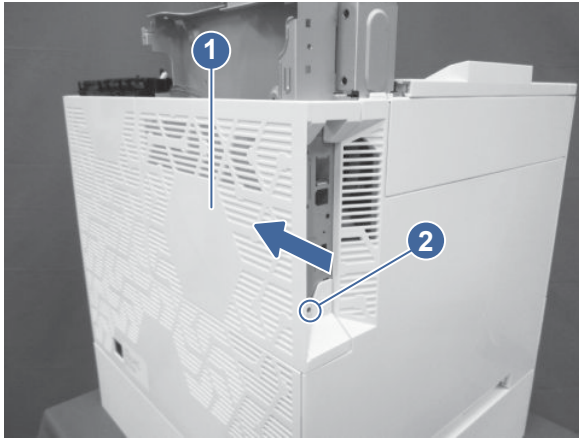


## 5. Install the formatter cover

Follow these steps to install the formatter cover.

- Slide the cover (callout 1) onto the printer, and then install one screw (callout 2) to secure it.

**Figure 5-68** Install the cover



### Removal and replacement: Workflow accelerator

Learn about removing and replacing the workflow accelerator card.



[View a video demonstration of removing and replacing the workflow accelerator.](#)

### Before performing service

#### Turn the printer power off

- Disconnect the power cable.

**⚠ WARNING!** To avoid damage to the printer, turn the printer off, wait 30 seconds, and then remove the power cord before attempting to service the printer.

If the part is damaged and cannot be cleaned, use the table below to identify the correct part number for your printer. To order the part, go to [www.hp.com/buy/parts](http://www.hp.com/buy/parts).

**Table 5-19** Part information

Part number	Part description
1M0Q5A	HP LaserJet Workflow Accelerator Card

### Required tools

- #2 Phillips screwdriver with a magnetic tip and a 152 mm (6 in) shaft length

### After performing service

#### Turn the printer power on

- Connect the power cable.
- Use the power switch to turn the power on.

## Post service test


Print any pages necessary to make sure the printer is functioning correctly.

### 1. Remove the formatter cover

Follow these steps to remove the formatter cover.

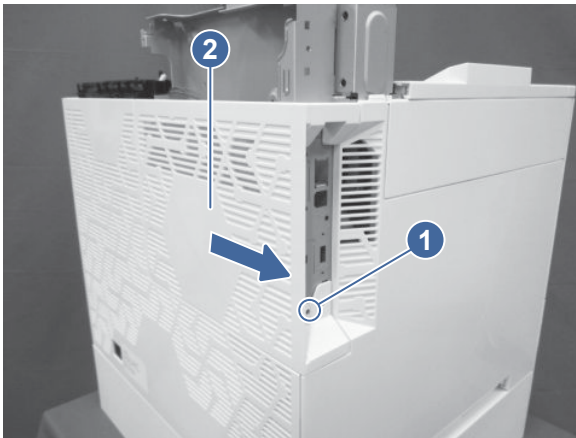
- Remove one screw (callout 1), and then slide the formatter cover (callout 2) away from the printer to remove it.

---

 **TIP:** Reverse the removal steps to install the assembly.

---

**Figure 5-69** Remove the formatter cover



### 2. Remove the workflow accelerator

Follow these steps to remove the workflow accelerator.

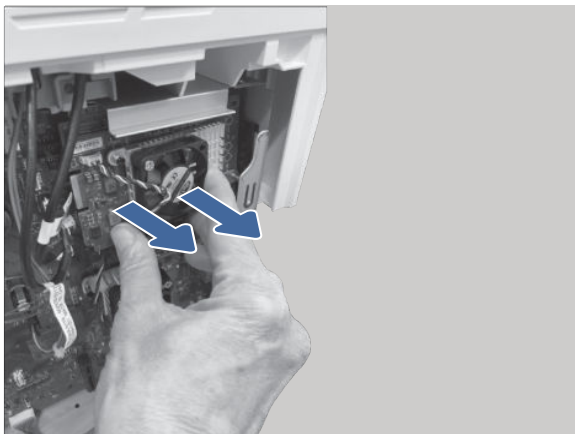
---

 **CAUTION:**  ESD sensitive part.

---

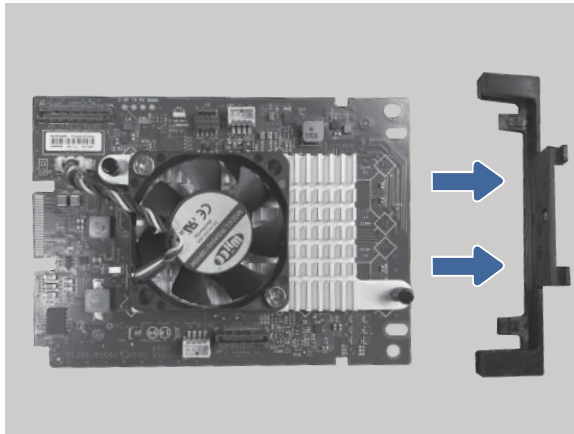
1. Pull the card away from the formatter to disconnect the connector and remove the card.

**Figure 5-70** Remove the card



2. Remove the bracket from the workflow accelerator card.


**Figure 5-71 Remove the bracket**



### 3. Unpack the replacement assembly


Follow these steps to unpack the replacement assembly.

1. Dispose of the defective part.

 **NOTE:** HP recommends responsible disposal of the part.

<http://www8.hp.com/us/en/hp-information/environment/product-recycling.html>

2. Unpack the replacement part from the packaging.

 **IMPORTANT:** Make sure that all of the shipping materials (for example shipping tape) are removed from the replacement part prior to installation.

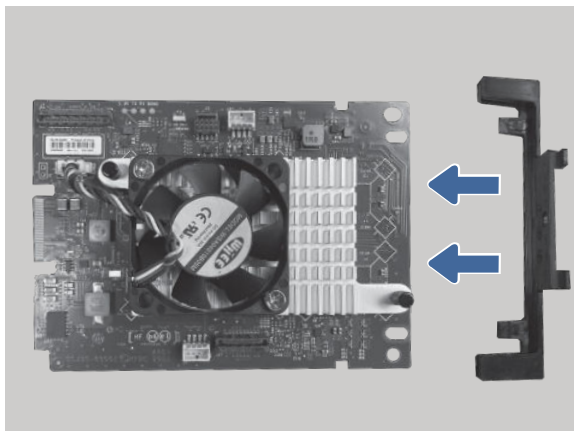
### 4. Install the workflow accelerator

Follow these steps to install the workflow accelerator.

 **CAUTION:**  ESD sensitive part.

1. Slide the bracket onto the accelerator card.

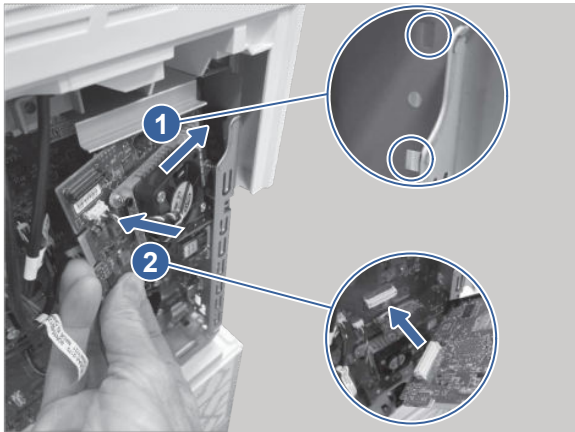
**Figure 5-72 Attach the bracket**





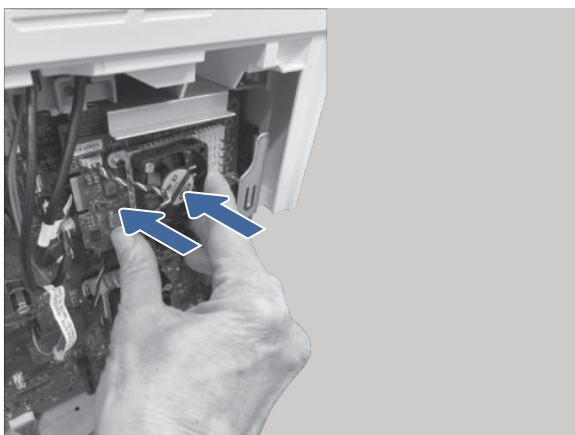
2. Push the right edge of the card into the faceplate slots, and then align the connector on the back of the card with the formatter connector.

**Figure 5-73 Align the connectors**



3. Press the connectors together to seat the card on the formatter.

**Figure 5-74 Connect the connectors**

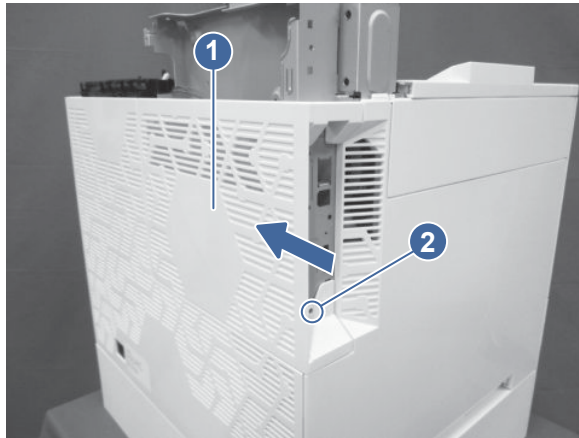


## 5. Install the formatter cover

Follow these steps to install the formatter cover.

- Slide the cover (callout 1) onto the printer, and then install one screw (callout 2) to secure it.

**Figure 5-75 Install the cover**



### Removal and replacement: USB expansion kit

Learn about removing and replacing the USB expansion kit.

 [View a video demonstration of removing and replacing the USB expansion kit.](#)

### Before performing service

#### Turn the printer power off

- Disconnect the power cable.

**⚠ WARNING!** To avoid damage to the printer, turn the printer off, wait 30 seconds, and then remove the power cord before attempting to service the printer.

If the part is damaged and cannot be cleaned, use the table below to identify the correct part number for your printer. To order the part, go to [www.hp.com/buy/parts](http://www.hp.com/buy/parts).

**Table 5-20 Part information**

Part number	Part description
4XN67A	HP Internal USB Expansion Kit

### Required tools

- #2 Phillips screwdriver with a magnetic tip and a 152 mm (6 in) shaft length

### After performing service

#### Turn the printer power on

- Connect the power cable.
- Use the power switch to turn the power on.

### Post service test


Print any pages necessary to make sure the printer is functioning correctly.

## 1. Remove the formatter cover

Follow these steps to remove the formatter cover.

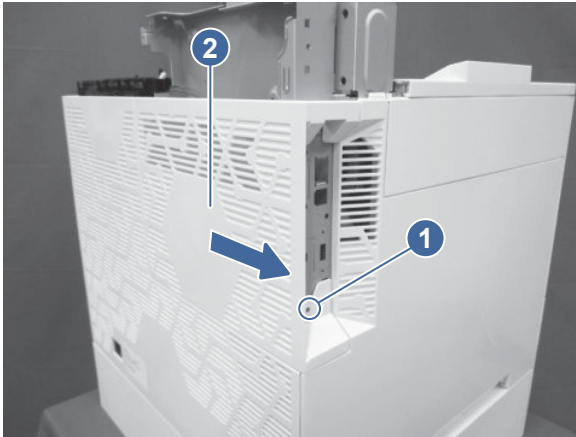
- Remove one screw (callout 1), and then slide the formatter cover (callout 2) away from the printer to remove it.

---

 **TIP:** Reverse the removal steps to install the assembly.

---

**Figure 5-76** Remove the formatter cover



## 2. Remove the internal USB ports

Learn how to remove the internal USB ports.

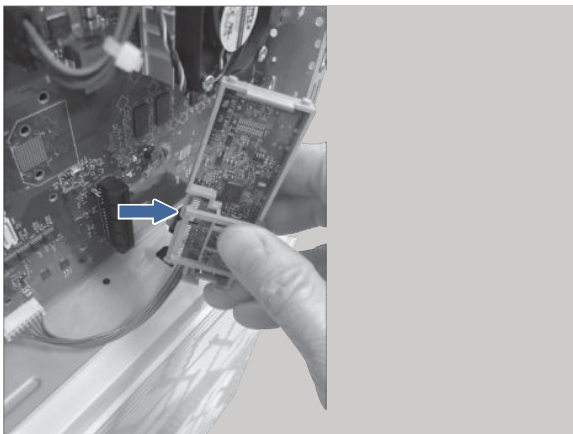
---

 **CAUTION:**  ESD sensitive part.

---

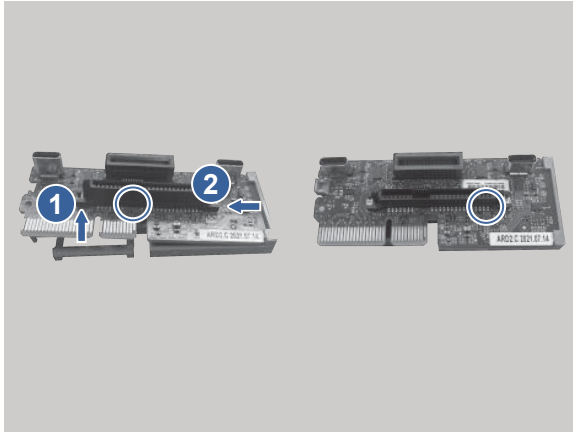
1. Pull the card away from the formatter to disconnect the connector.

**Figure 5-77** Remove the USB ports card



2. Pull the free end of the card away from the bracket, and then pull the captive end of the card out of the bracket.

**Figure 5-78 Remove the bracket**



### 3. Unpack the replacement assembly

Follow these steps to unpack the replacement assembly.

1. Dispose of the defective part.



**NOTE:** HP recommends responsible disposal of the part.

<http://www8.hp.com/us/en/hp-information/environment/product-recycling.html>

2. Unpack the replacement part from the packaging.



**IMPORTANT:** Make sure that all of the shipping materials (for example shipping tape) are removed from the replacement part prior to installation.

### 4. Install the internal USB ports

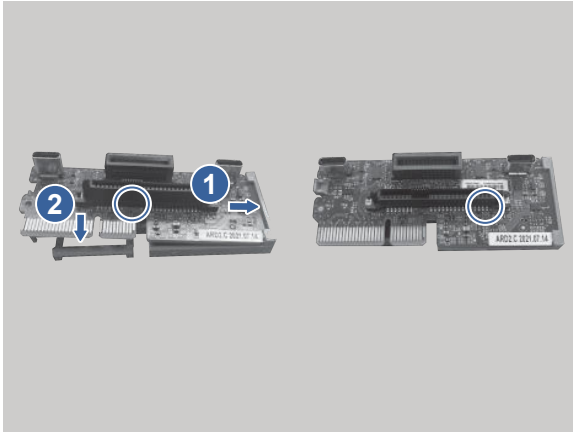
Learn how to install the internal USB ports.



**CAUTION:**  ESD sensitive part.

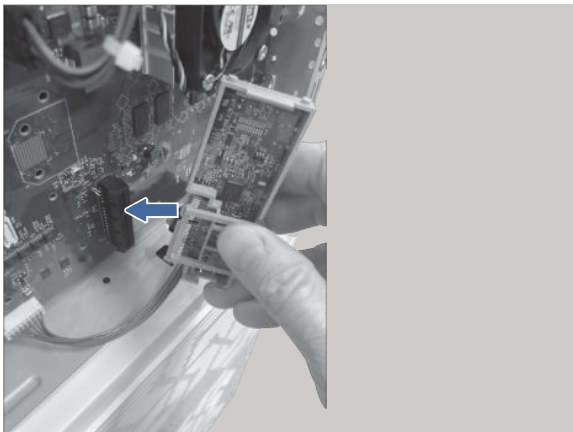
1. Push the short edge of the card into the bracket, and then press the card into the bracket until it is firmly seated.

**Figure 5-79 Attach the bracket**



2. Align the connector on the card with the formatter connector, and then press the connectors together to seat the card on the formatter.

**Figure 5-80 Install the card on the formatter**



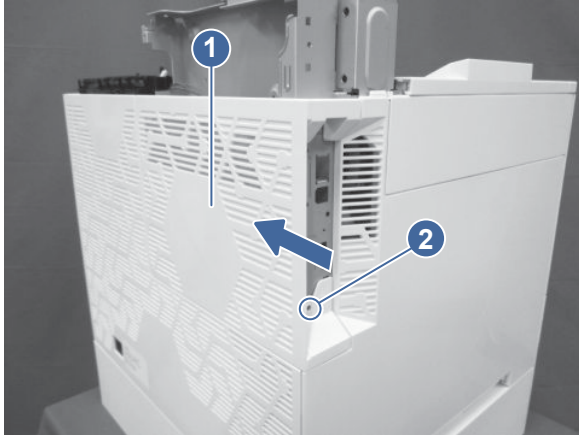
3. Install the formatter cover.

## 5. Install the formatter cover

Follow these steps to install the formatter cover.

- Slide the cover (callout 1) onto the printer, and then install one screw (callout 2) to secure it.

**Figure 5-81 Install the cover**



## Removal and replacement: Solid state drive (SSD)

Learn about removing and replacing the solid state drive.



[View a video demonstration of removing and replacing the SSD.](#)

### Before performing service

#### Turn the printer power off

- Disconnect the power cable.

**⚠ WARNING!** To avoid damage to the printer, turn the printer off, wait 30 seconds, and then remove the power cord before attempting to service the printer.

If the part is damaged and cannot be cleaned, use the table below to identify the correct part number for your printer. To order the part, go to [www.hp.com/buy/parts](http://www.hp.com/buy/parts).

**Table 5-21 Part information**

Part number	Part description
1M0Q4A	HP LaserJet Secure Solid State Drive

### Required tools

- #2 Phillips screwdriver with a magnetic tip and a 152 mm (6 in) shaft length

### After performing service

#### Turn the printer power on

- Connect the power cable.
- Use the power switch to turn the power on.

### Post service test


Print any pages necessary to make sure the printer is functioning correctly.

## 1. Remove the formatter cover

Follow these steps to remove the formatter cover.

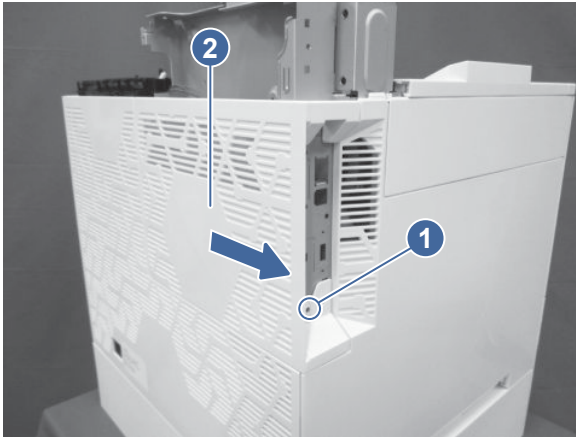
- Remove one screw (callout 1), and then slide the formatter cover (callout 2) away from the printer to remove it.

---

 **TIP:** Reverse the removal steps to install the assembly.

---

**Figure 5-82 Remove the formatter cover**



## 2. Unpack the replacement assembly

Follow these steps to unpack the replacement assembly.

1. Dispose of the defective part.



**NOTE:** HP recommends responsible disposal of the part.

<http://www8.hp.com/us/en/hp-information/environment/product-recycling.html>

---

2. Unpack the replacement part from the packaging.



**IMPORTANT:** Make sure that all of the shipping materials (for example shipping tape) are removed from the replacement part prior to installation.

---

## 3. Install the SSD card only

Learn how to install the SSD card.



**CAUTION:**  ESD sensitive part.

---

1. Place one end of the riser PCA into the cradle, and then press the other end of the card into the cradle.

**Figure 5-83 Install PCA in cradle**



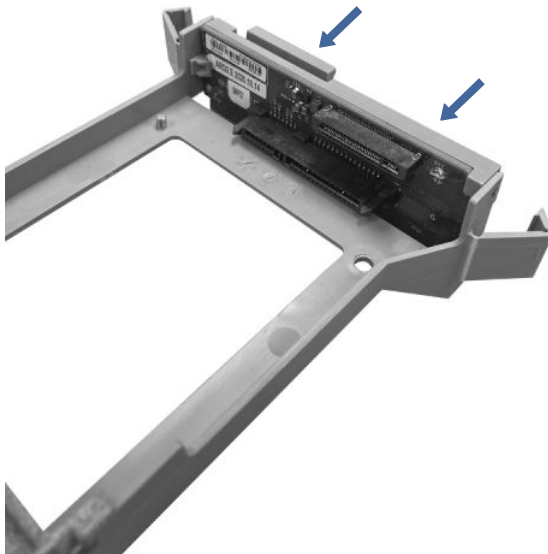
2. Verify that the PCA is properly installed by listening for a click when it is pressed into place. Also verify that the PCA is underneath the two indicated tabs at the end.

**Figure 5-84 Verify PCA installation**



3. Position the PCA cradle on the bracket.

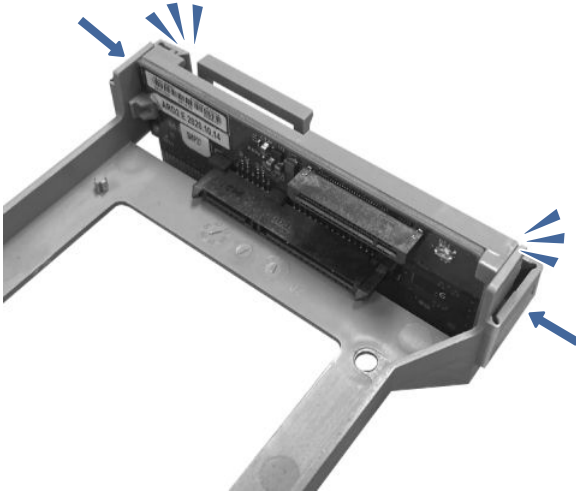
**Figure 5-85 Position the PCA cradle**





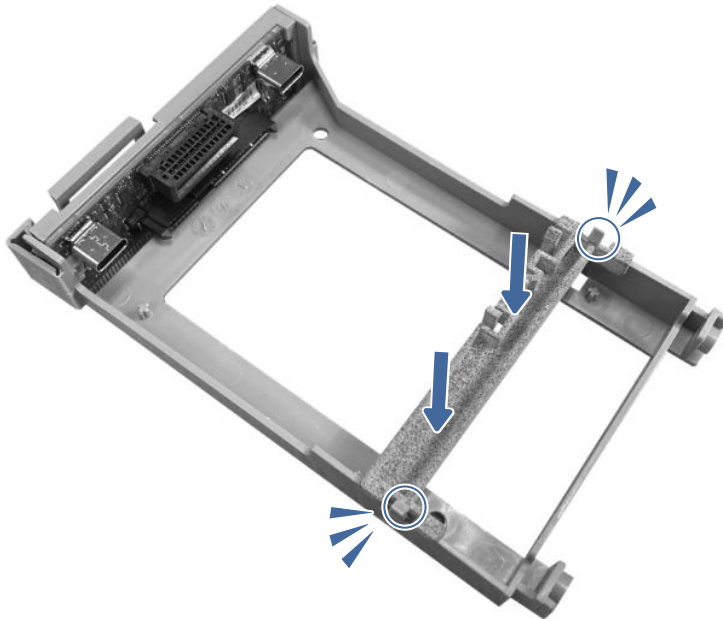
4. Close two clips at the end of the bracket to secure the PCA cradle.

**Figure 5-86 Close the clips**



5. Install the support cross member onto the bracket.

**Figure 5-87 Install the cross member**



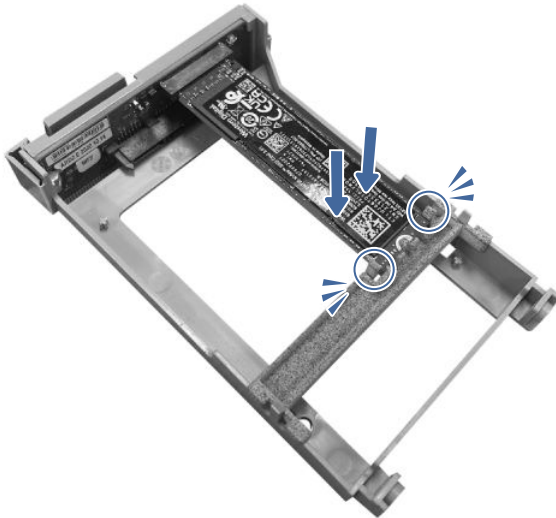
6. Align the SSD card with the connector on the PCA. Note how the end of the SSD is keyed so that it can be installed one way only.

**Figure 5-88** Align the SSD card



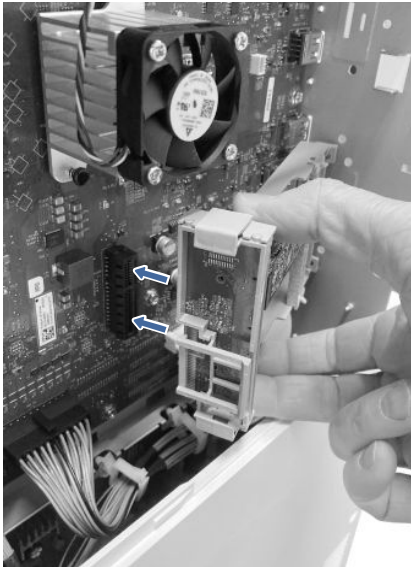
7. Seat the SSD in the PCA connector, and then snap the other end of the SSD on the cross member.

**Figure 5-89** Secure the SSD on the cross member



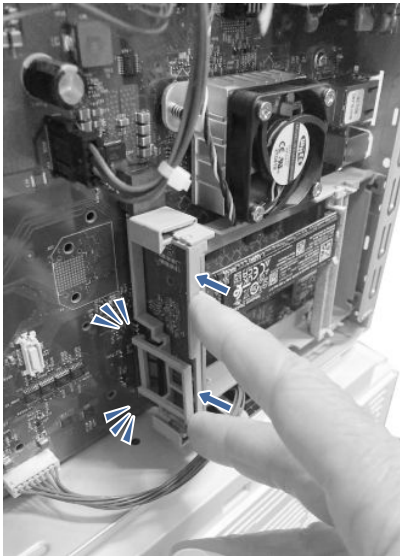
8. Align the bracket assembly with the formatter connector.

**Figure 5-90** Align the bracket assembly



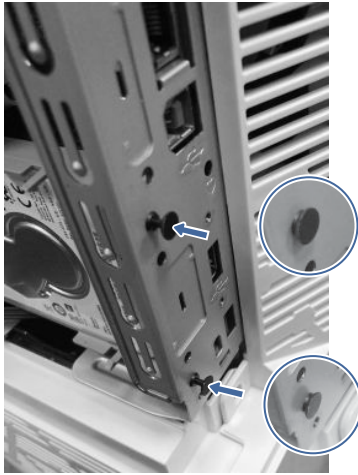
9. Press the bracket assembly to firmly seat it in the formatter connector.

**Figure 5-91** Install the bracket assembly



10. Install two pins to secure the bracket assembly to the formatter faceplate.

**Figure 5-92 Install two pins**



#### 4. Install the SSD card with the HDD

Learn how to install the SSD card with an HDD.

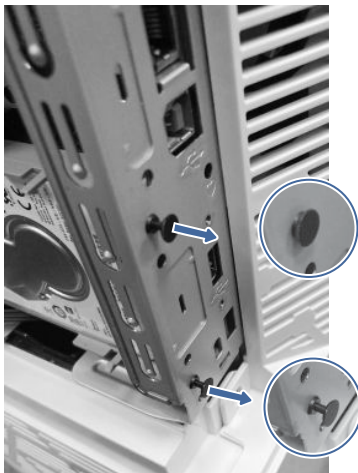
---

 **CAUTION:**  ESD sensitive part.

---

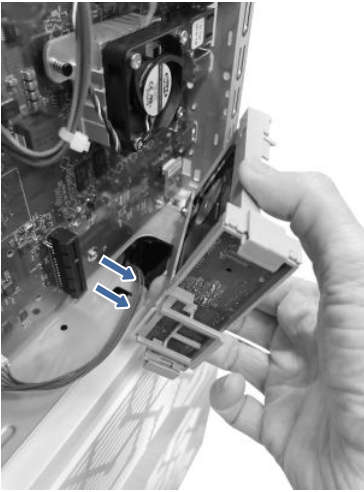
1. Release two pins from the formatter faceplate.

**Figure 5-93 Release two pins**



2. Remove the HDD assembly

**Figure 5-94 Remove the HDD**



3. Open two clips on the HDD bracket.

**Figure 5-95 Open two clips**



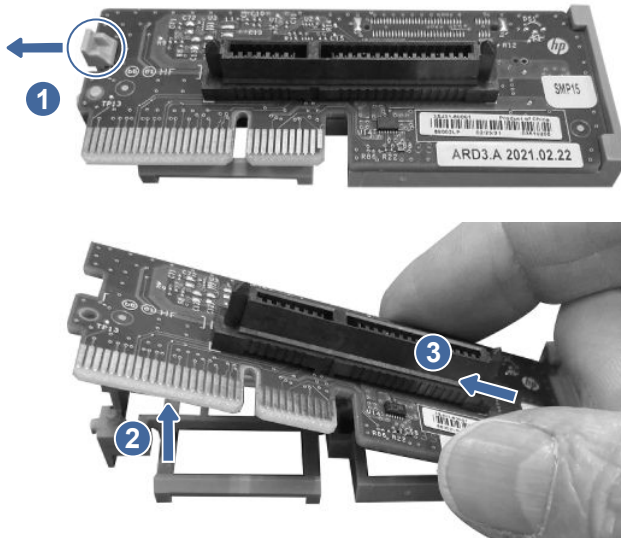
4. Remove the PCA cradle from the HDD bracket.

**Figure 5-96 Remove the PCA cradle**



5. Release one tab (callout 1), raise the end of the PCA up and off the cradle (callout 2), and then remove the PCA from the cradle (callout 3).

**Figure 5-97 Remove the PCA from the holder**

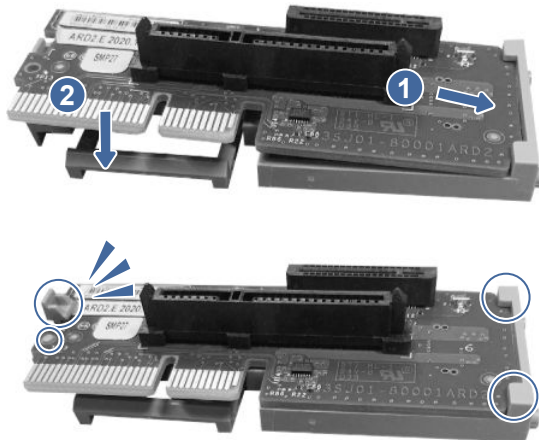


6. Place one end of the new PCA on the cradle (callout 1), and then rotate the other end down onto the cradle (callout 2). Make sure to orientate the PCA on the cradle as shown. Push down on the PCA to install it on the cradle (an audible click is heard when it snaps into place).



**NOTE:** Make sure that the PCA is firmly seated under the clips on the cradle.

**Figure 5-98** Install the PCA in the cradle



7. Align the PCA cradle with the bracket.

**Figure 5-99** Align the PCA cradle



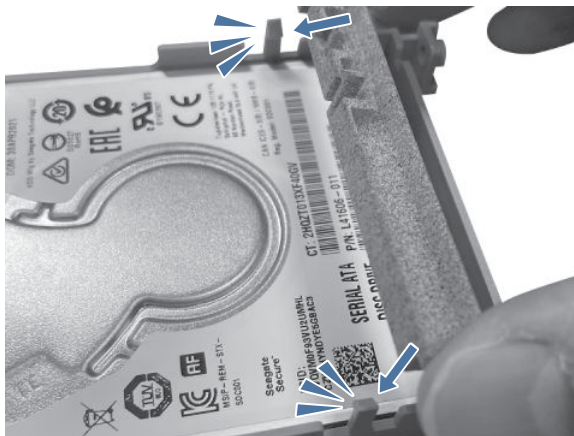
8. Close two clips to secure the PCA cradle to the bracket.

**Figure 5-100 Close two clips**



9. Install the support cross member onto the bracket.

**Figure 5-101 Install the support cross member**





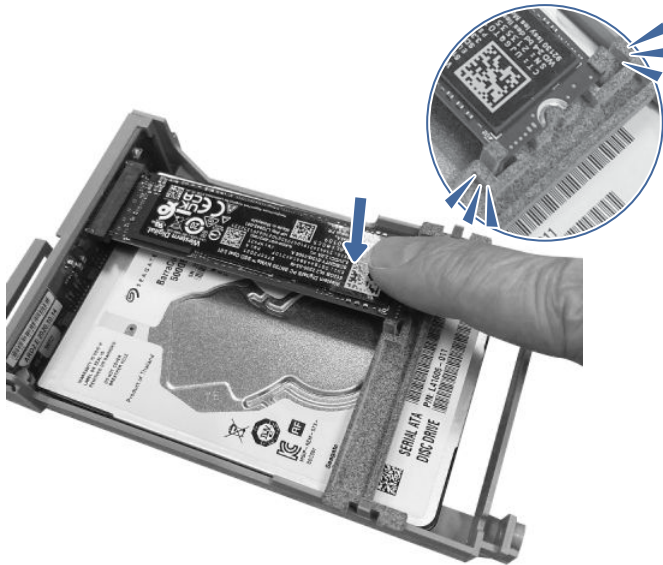
10. Align the SSD card with the PCA connector. Note how the end of the SSD is keyed so that it can be installed one way only.

**Figure 5-102** Align the SSD card



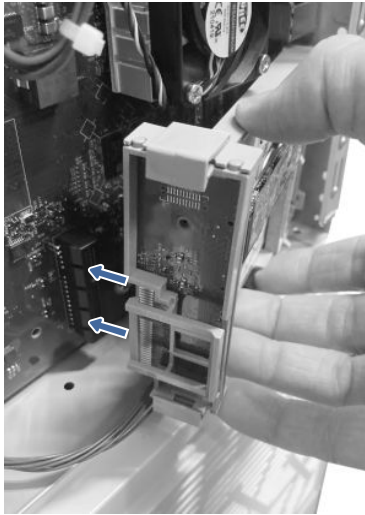
11. Seat the SSD in the PCA connector, and then snap the other end of the SSD on the cross member.

**Figure 5-103** Secure the SSD on the cross member



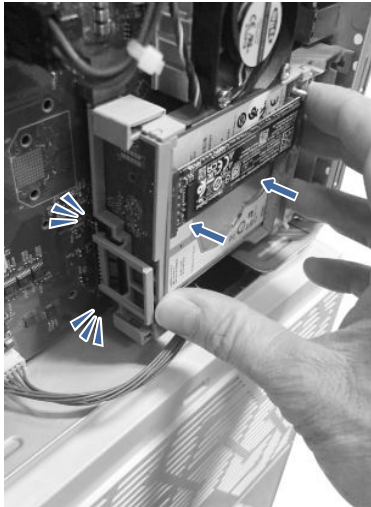
12. Align the bracket assembly with the formatter connector.

**Figure 5-104** Align the bracket assembly



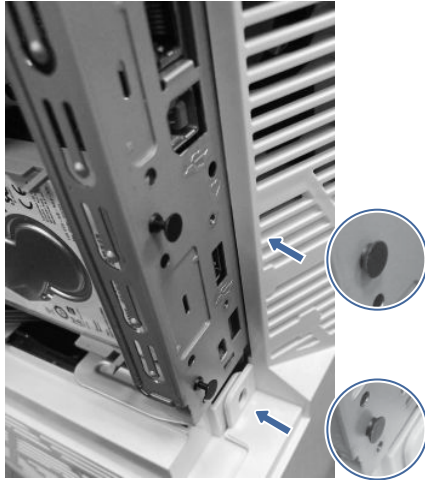
13. Press the bracket assembly to firmly seat it in the formatter connector.

**Figure 5-105** Install the bracket assembly



14. Install two pins to secure the bracket assembly to the formatter faceplate.

**Figure 5-106** Install two pins



## 5. Install the SSD card with USB

Learn how to install the SSD card with a USB card.

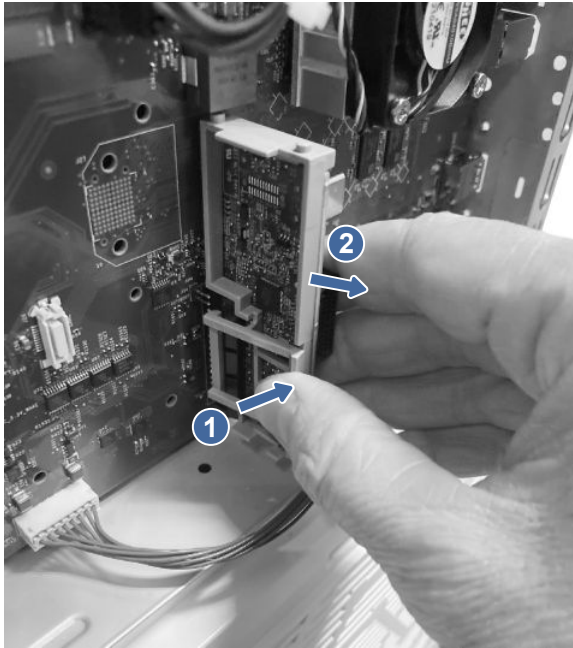
---

 **CAUTION:**  ESD sensitive part.

---

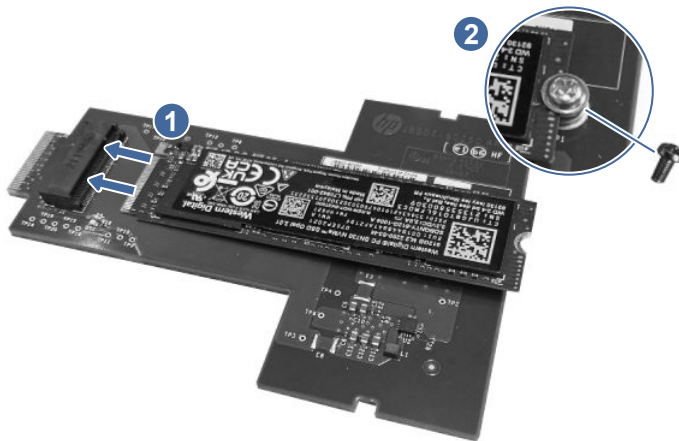
1. Remove the USB PCA from the formatter connector.

**Figure 5-107 Remove the USB PCA**



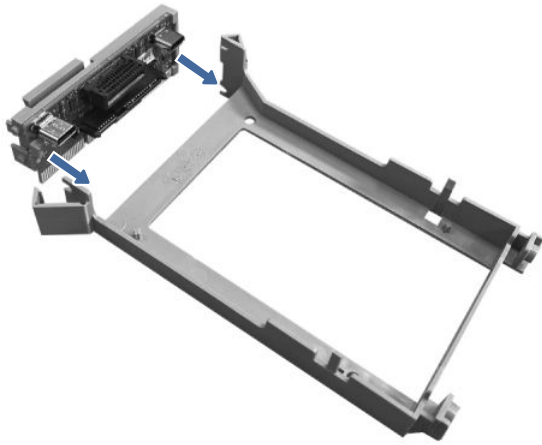
2. Install the SSD card on the board.

**Figure 5-108 Install the SSD card**



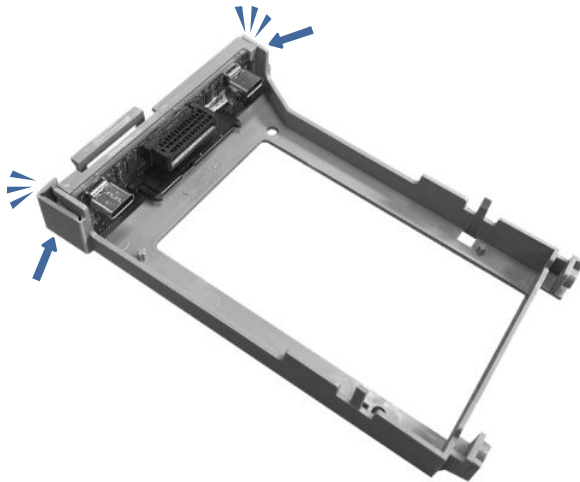
3. Position the PCA cradle on the bracket.

**Figure 5-109 Position the PCA cradle**



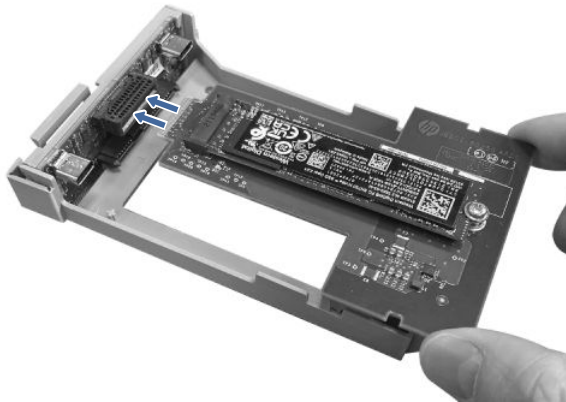
4. Close two clips to secure the PCA cradle to the bracket.

**Figure 5-110 Close two clips**



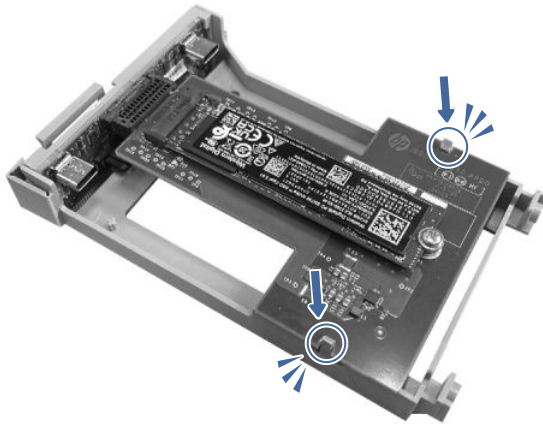
5. Insert the board into the PCA connector.

**Figure 5-111** Insert the board



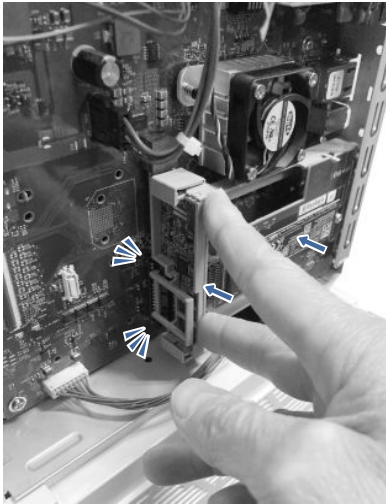
6. Secure the board to the bracket (an audible click is heard when it snaps into place).

**Figure 5-112** Secure the board to the bracket



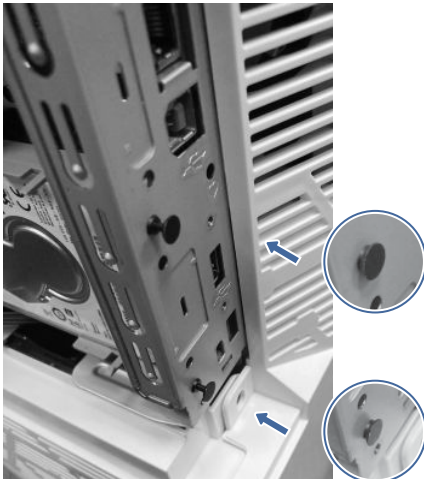
7. Align the bracket assembly with the formatter connector, and then press the bracket assembly to firmly seat it in the formatter connector.

**Figure 5-113 Install the bracket assembly**



8. Install two pins to secure the bracket assembly to the formatter faceplate.

**Figure 5-114 Install two pins**

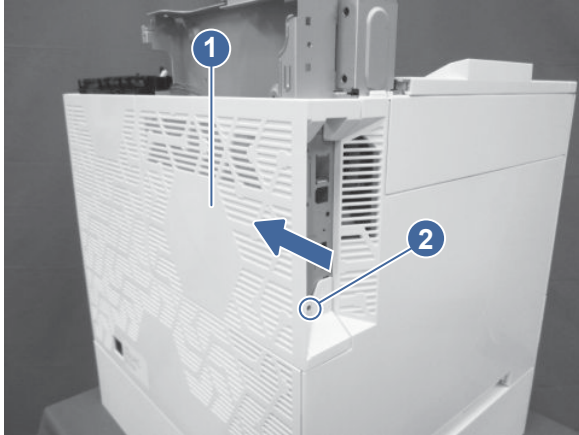


## 6. Install the formatter cover

Follow these steps to install the formatter cover.

- Slide the cover (callout 1) onto the printer, and then install one screw (callout 2) to secure it.

**Figure 5-115 Install the cover**



### Installation: Near field communication (NFC) PCA

Learn about removing and replacing the NFC PCA.



[View a video demonstration of removing and replacing the NFC PCA.](#)

### Before performing service

#### Turn the printer power off

- Disconnect the power cable.

**⚠ WARNING!** To avoid damage to the printer, turn the printer off, wait 30 seconds, and then remove the power cord before attempting to service the printer.

If the part is damaged and cannot be cleaned, use the table below to identify the correct part number for your printer. To order the part, go to [www.hp.com/buy/parts](http://www.hp.com/buy/parts).

**Table 5-22 Part information**

Part number	Part description
1M0Q3A	HP JetDirect 3200w BLE/Wireless accessory
3JN69A	HP JetDirect 3100w BLE/NFC/Wireless accessory

### Required tools

- #2 Phillips screwdriver with a magnetic tip and a 152 mm (6 in) shaft length

### After performing service

#### Turn the printer power on

- Connect the power cable.
- Use the power switch to turn the power on.

### Post service test



Print any pages necessary to make sure the printer is functioning correctly.

## 1. Remove the HIP cover

Follow these steps to remove the HIP cover.

1. Use a small flat-blade screwdriver to release the tabs on the HIP cover.

**Figure 5-116** Release the cover



2. Rotate the cover up and off of the printer to remove it.

**Figure 5-117** Remove the cover



## 2. Install the wireless print server with NFC

Learn how to install the wireless print server with NFC.

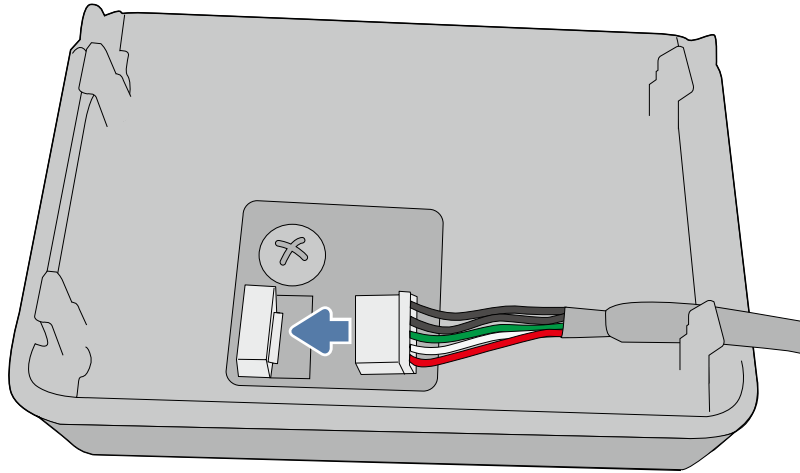
---

 **CAUTION:**  ESD sensitive part.

---

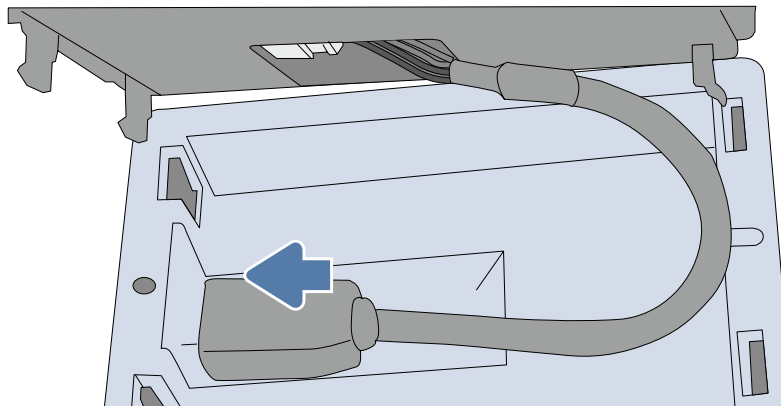
1. Connect the USB cable to the print server.

**Figure 5-118** Connect the USB cable to the print server



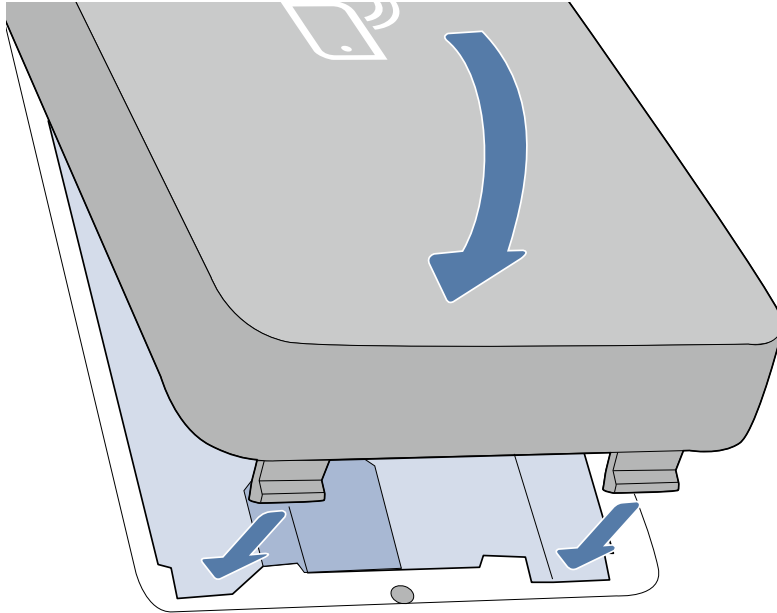
2. Connect the USB cable to the HIP port.

**Figure 5-119** Connect the USB cable to the HIP port



3. Install the printer server in the HIP cavity.

**Figure 5-120 Install the printer server**



### Removal and replacement: embedded MultiMedia Card (eMMC) (SFP models)

Learn about removing and replacing the embedded MultiMedia Card (eMMC).

 [View a video demonstration of removing and replacing the eMMC.](#)

### Before performing service

#### Turn the printer power off

- Disconnect the power cable.

---

**⚠ WARNING!** To avoid damage to the printer, turn the printer off, wait 30 seconds, and then remove the power cord before attempting to service the printer.

---

**⚠ CAUTION:** To prevent damage to a toner cartridge, do not expose it to light for more than a few minutes. Cover the green imaging drum if the toner cartridge must be removed from the printer for an extended period of time.

If toner gets on the skin or clothing, wipe it off with dry tissue paper and wash in cold water. Hot water sets toner and it might be difficult, or impossible, to remove.

---

Use the table below to identify the correct part number for your printer, and then go to <https://parts.hp.com/hpparts> to order the part.

**Table 5-23 Part information**

Part number	Part description
B5L32-60002	eMMC 16GB

## Required tools

- No special tools are required to remove or install this assembly.

## After performing service

### Turn the printer power on

- Connect the power cable.
- Use the power switch to turn the power on.


## Post service test

Print any pages necessary to make sure the printer is functioning correctly.

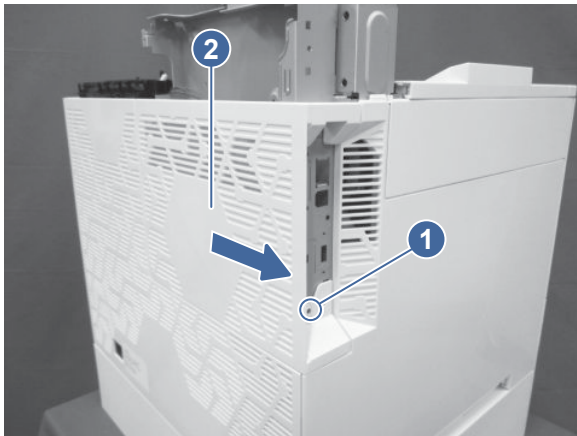
### 1. Remove the formatter cover

Follow these steps to remove the formatter cover.

- Remove one screw (callout 1), and then slide the formatter cover (callout 2) away from the printer to remove it.

 **TIP:** Reverse the removal steps to install the assembly.

**Figure 5-121 Remove the formatter cover**



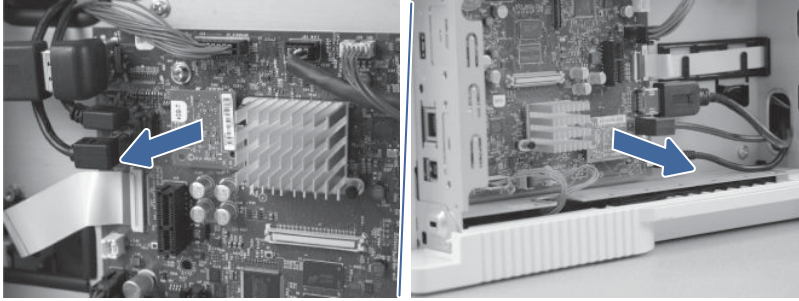
### 2. Remove the embedded MultiMedia Card (eMMC)

Follow these steps to remove the eMMC.

 **CAUTION:**  ESD sensitive part.

- Locate the eMMC component on the formatter, and then pull it straight off of the formatter to remove it.

**Figure 5-122 Remove the eMMC (SFP/MFP)**



### 3. Unpack the replacement assembly

Follow these steps to unpack the replacement assembly.

1. Dispose of the defective part.



**NOTE:** HP recommends responsible disposal of the part.

<http://www8.hp.com/us/en/hp-information/environment/product-recycling.html>

2. Unpack the replacement part from the packaging.



**IMPORTANT:** Make sure that all of the shipping materials (for example shipping tape) are removed from the replacement part prior to installation.

### 4. Install the eMMC

Follow these steps to install the eMMC.



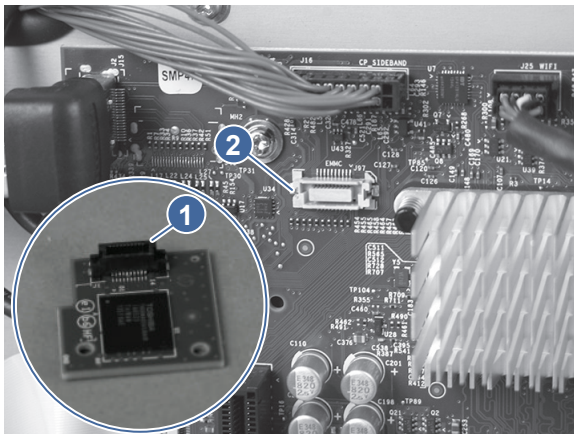
**CAUTION:**  ESD sensitive part.

1. Align the connector on the replacement eMMC (callout 1) with the connector on the formatter (callout 2), and then push the eMMC onto the formatter to install it.



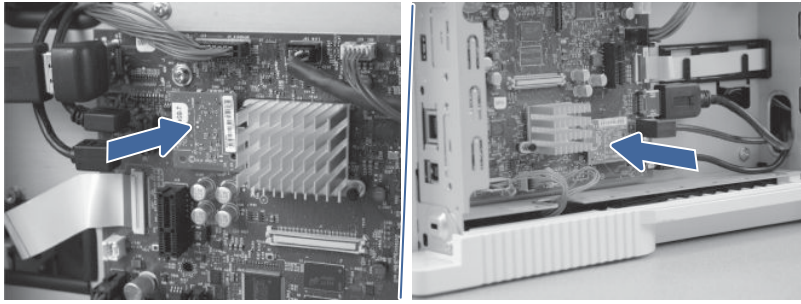
**NOTE:** The eMMC can only be installed in one direction on the formatter

**Figure 5-123 Install the eMMC**



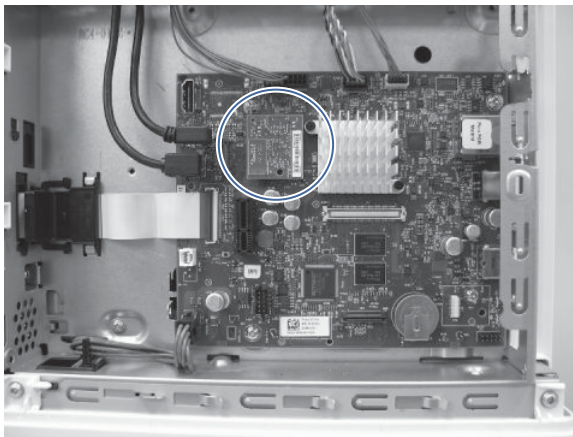
2. Push in on the eMMC to install it in the connector.

**Figure 5-124 Install the eMMC (SFP/MFP)**



3. Verify that the eMMC is fully seated in the connector.

**Figure 5-125 Verify the installation**

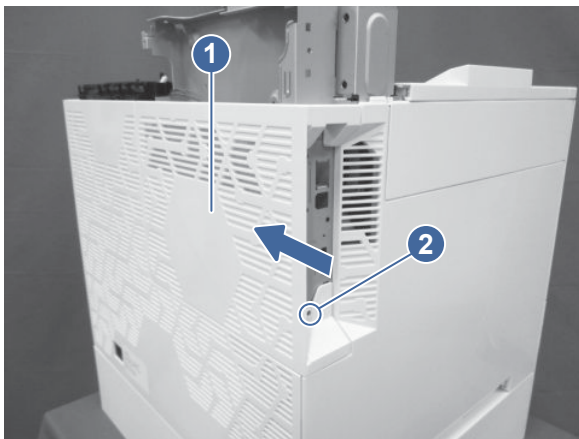


## 5. Install the formatter cover

Follow these steps to install the formatter cover.

- Slide the cover (callout 1) onto the printer, and then install one screw (callout 2) to secure it.

**Figure 5-126 Install the cover**



## 3. Document feeder / scanner

Learn about document feeder and scanner parts removal and replacement.

### Field-replaceable units (FRUs)

Learn about FRU parts removal and replacement.

### Internal parts and assemblies

Learn how to remove and replace the printer internal parts and assemblies.

### Removal and replacement: Scanner control board (SCB) (MFP models)

This document provides the procedures to remove and replace the scanner control board (SCB).

Mean time to repair: 10 minutes

Service level: Intermediate

#### Before performing service

##### Turn the printer power off

- Disconnect the power cable.

---

**⚠ WARNING!** To avoid damage to the printer, turn the printer off, wait 30 seconds, and then remove the power cord before attempting to service the printer.

---

Use the table below to identify the correct part number for your printer. To order the part, go to [www.hp.com/buy/parts](http://www.hp.com/buy/parts).

**Table 5-24 Part information**

Part number	Part description
5851-8961	Scanner control interconnect board (SCIB) (6xxxx Series)

#### Required tools

- #2 Phillips screwdriver with a magnetic tip and a 152 mm (6 in) shaft length

#### After performing service

##### Turn the printer power on

- Connect the power cable.
- Use the power switch to turn the power on.

#### Post service test


No post service test is available for this assembly.

### 1. Remove the formatter cover

Follow these steps to remove the formatter cover.

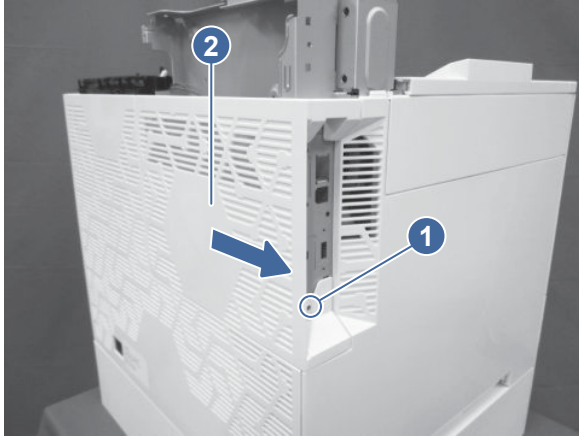
- Remove one screw (callout 1), and then slide the formatter cover (callout 2) away from the printer to remove it.

---

 **TIP:** Reverse the removal steps to install the assembly.

---


**Figure 5-127 Remove the formatter cover**



## 2. Remove the rear cover

Follow these steps to remove the rear cover.

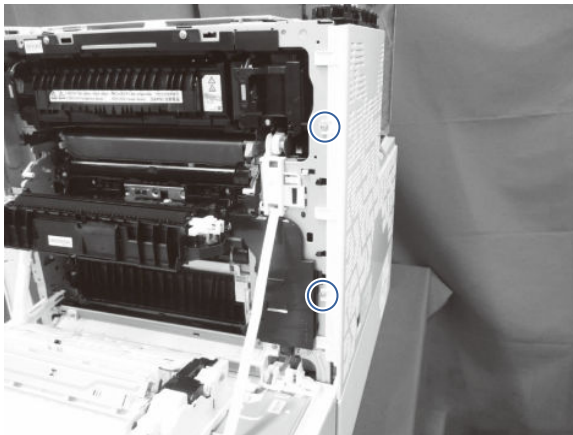
---

 **NOTE:** The figures below show some assemblies (for example the top cover and formatter) removed that might still be installed on the printer. However, the steps to remove the cover are correct.

---

1. Open the right door, and remove two screws.

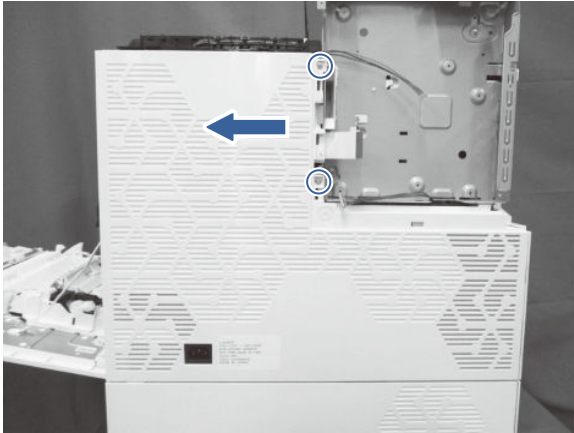
**Figure 5-128 Remove two screws**






2. At the back of the printer, remove two screws, and then slide the rear cover as indicated to remove it.

**Figure 5-129 Remove the rear cover**



### 3. Remove the rear upper cover (MFP models)

Follow these steps to remove the rear upper cover.

 **NOTE:** The task below shows the rear upper cover on a 6800zfs model. The cover on your model might look different, but the process is the same.

- Remove one screw, pry the right side away from printer, and then pull the cover in the direction indicated.


**Figure 5-130 Remove the cover**



### 4. Remove the document feeder

Follow these steps to remove the document feeder.

1. Remove two screws (callout 1).

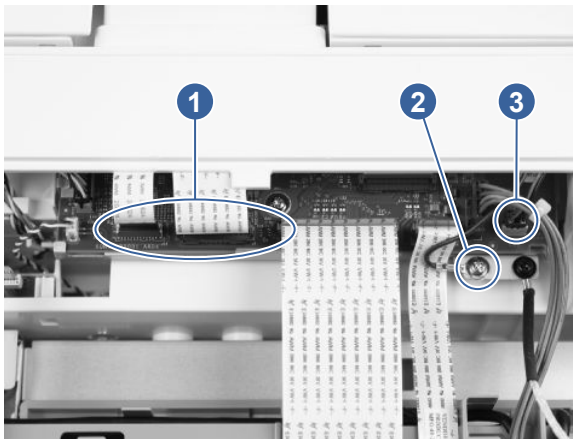
 **TIP:** These are self-tapping screws for plastic. When reinstalling, rotate the screw counterclockwise to align it with the existing thread pattern, and then carefully turn it clockwise to tighten. Do not overtighten. This will prevent stripping the threads inside the screw hole.

**Figure 5-131 Remove two screws**



2. Disconnect one flat cable (callout 1), remove one ground screw (callout 2) to release the grounding cable, and then disconnect the indicated connectors (callout 3) on the scanner control board.

**Figure 5-132 Disconnect the flat cable, ground cable, and connectors**



3. Tilt the document feeder back until it stops, and then lift it off of the scanner until it stops.
4. Support the document feeder, and then use a small flat-blade screwdriver to release two tabs on the document feeder hinges.

**Figure 5-133 Release two tabs**



5. Lift the document feeder up to remove it.



**NOTE:** While removing the document feeder, carefully pass the cables through the cable channel in the scanner bed.

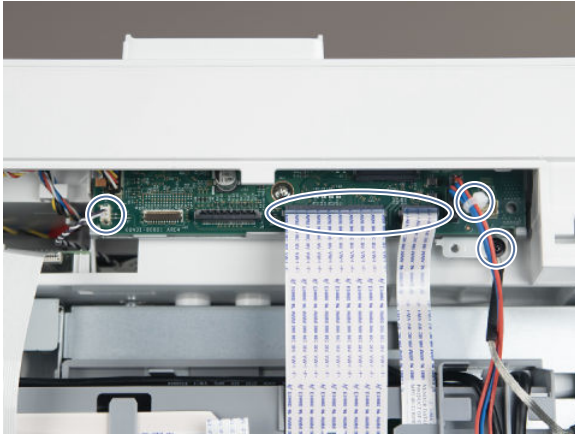
---

## 5. Remove the flatbed scanner assembly

Follow these steps to remove the sub-scanner assembly (SSA).

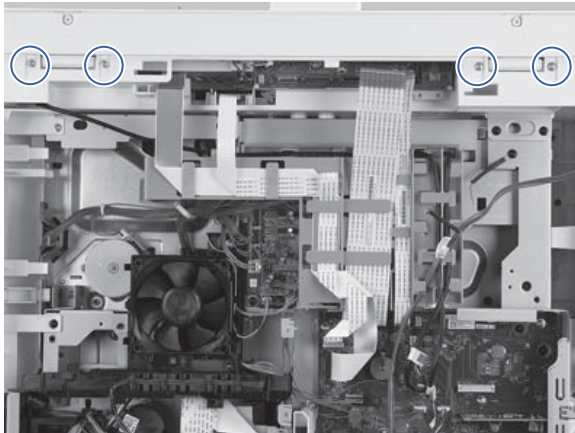
1. On the SCB, disconnect the cables indicated below.

**Figure 5-134 Disconnect SCB connectors**



2. Remove four screws.

**Figure 5-135 Remove four screws**



3. Pull the scan unit up to remove it from the printer.



**NOTE:** Carefully ensure that the cables do not catch on the cable guides as you lift the assembly.

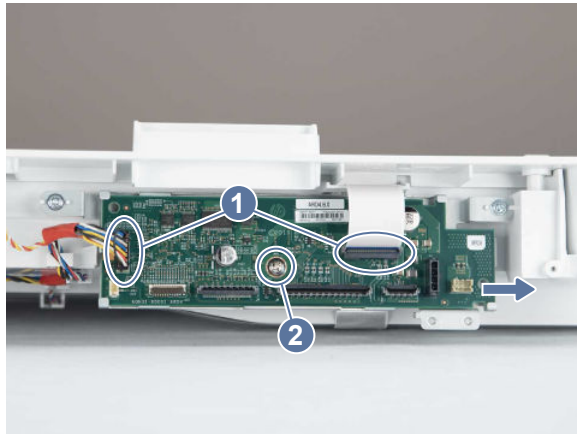
---

## 6. Remove the scanner control board (SCB)

Follow these steps to remove the scanner control board (SCB).

- On the SCB, disconnect two connectors (callout 1), and then remove one screw (callout 2). Slide the SCB to the right, and then remove it from the integrated scanner assembly.

**Figure 5-136 Disconnect connectors**



## 7. Unpack the replacement assembly

Follow these steps to unpack the replacement assembly.

1. Dispose of the defective part.




**NOTE:** HP recommends responsible disposal of the defective part.

<http://www8.hp.com/us/en/hp-information/environment/product-recycling.html>

2. Unpack the replacement part from the packaging.



**CAUTION:**  Some parts are sensitive to electrostatic discharge (ESD). Always perform service work at an ESD-protected workstation or mat. If an ESD workstation or mat is not available, touch the sheet-metal chassis to provide a static ground before touching an ESD-sensitive assembly. Protect the ESD-sensitive assemblies by placing them in ESD pouches when they are out of the printer.



**IMPORTANT:** Make sure that all of the shipping materials (for example shipping tape) are removed from the replacement part prior to installation.



**NOTE:** If the replacement part is a roller or pad, avoid touching the spongy part of it. Skin oils on the roller or pad can cause paper pickup and/or print-quality problems. HP recommends using disposable gloves when handling rollers or pads or washing your hands before touching rollers or pads.

3. To install an assembly, reverse the removal steps.



**NOTE:** When applicable, special installation instructions are provided for an assembly at the end of the removal procedure. Always completely read the removal instructions and follow all special installation instructions.

## Removal and replacement: White backing (MFP models)

Learn about removing and replacing the document feeder white backing.

### Before performing service

**Turn the printer power off**

- Disconnect the power cable.

**⚠ WARNING!** To avoid damage to the printer, turn the printer off, wait 30 seconds, and then remove the power cord before attempting to service the printer.

Use the table below to identify the correct part number for your printer, and then go to <https://parts.hp.com/hpparts> to order the part.

**Table 5-25 Part information**

Part number	Part description
5851-8850	ADF white backing kit (6800/X677 models)

## Required tools

- No special tools are required to remove or install this assembly.

## After performing service

### Turn the printer power on

- Connect the power cable.
- Use the power switch to turn the power on.

## Post service test

Print any pages necessary to make sure the printer is functioning correctly.

## 1. Unpack the replacement assembly


Follow these steps to unpack the replacement assembly.

1. Dispose of the defective part.

**📄 NOTE:** HP recommends responsible disposal of the defective part.

<http://www8.hp.com/us/en/hp-information/environment/product-recycling.html>

2. Unpack the replacement part from the packaging.

**⚠ CAUTION:**  Some parts are sensitive to electrostatic discharge (ESD). Always perform service work at an ESD-protected workstation or mat. If an ESD workstation or mat is not available, touch the sheet-metal chassis to provide a static ground before touching an ESD-sensitive assembly. Protect the ESD-sensitive assemblies by placing them in ESD pouches when they are out of the printer.

**📄 IMPORTANT:** Make sure that all of the shipping materials (for example shipping tape) are removed from the replacement part prior to installation.

**📄 NOTE:** If the replacement part is a roller or pad, avoid touching the spongy part of it. Skin oils on the roller or pad can cause paper pickup and/or print-quality problems. HP recommends using disposable gloves when handling rollers or pads or washing your hands before touching rollers or pads.

3. To install an assembly, reverse the removal steps.



**NOTE:** When applicable, special installation instructions are provided for an assembly at the end of the removal procedure. Always completely read the removal instructions and follow all special installation instructions.

## Whole-unit replacement (WUR)

Learn about WUR parts removal and replacement.

### Automatic document feeder (WUR)

Learn about automatic document feeder whole-unit replacement.

### Removal and replacement: Document feeder (MFP models)

This document provides the procedures to remove and replace the document feeder (MFP).

Mean time to repair: 20 minutes

Service level: Intermediate

### Before performing service

#### Turn the printer power off

- Disconnect the power cable.

**⚠ WARNING!** To avoid damage to the printer, turn the printer off, wait 30 seconds, and then remove the power cord before attempting to service the printer.

Use the table below to identify the correct part number for your printer. To order the part, go to [www.hp.com/buy/parts](http://www.hp.com/buy/parts).

**Table 5-26** Part information

Part number	Part description
J1H98-60037	ADF WUR (6xxx Series Non-Workflow)
J1H98-60038	ADF WUR (6xxx Series Workflow)

### Required tools

- #2 Phillips screwdriver with a magnetic tip.
- Small flat-blade screwdriver.

### After performing service

#### Turn the printer power on

- Connect the power cable.
- Use the power switch to turn the power on.


### Post service test

Use the document feeder to make a copy to make sure that it is properly functioning.

## 1. Remove the formatter cover

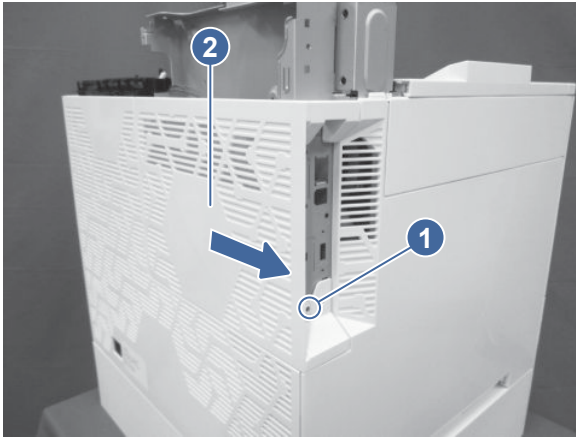
Follow these steps to remove the formatter cover.

- Remove one screw (callout 1), and then slide the formatter cover (callout 2) away from the printer to remove it.

 **TIP:** Reverse the removal steps to install the assembly.


---

**Figure 5-137** Remove the formatter cover



## 2. Remove the rear cover

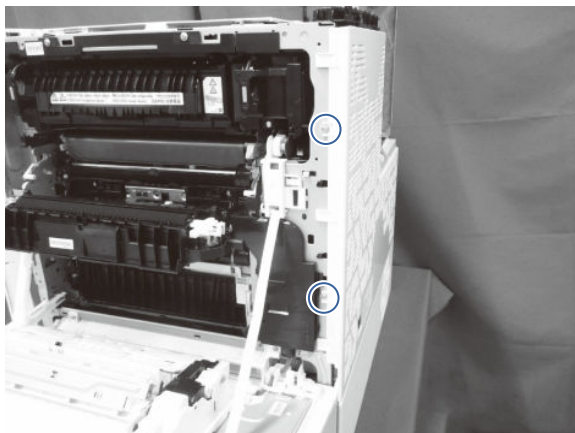
Follow these steps to remove the rear cover.

 **NOTE:** The figures below show some assemblies (for example the top cover and formatter) removed that might still be installed on the printer. However, the steps to remove the cover are correct.

---

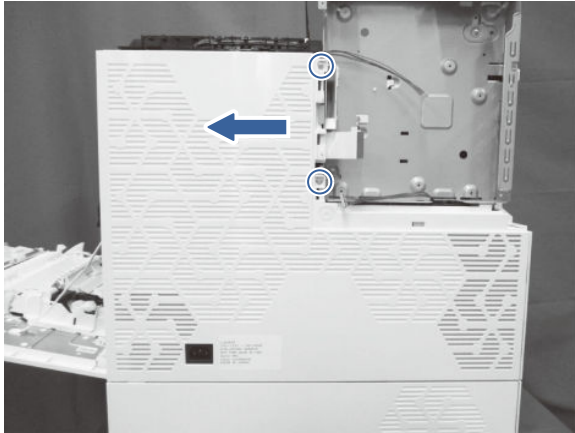
1. Open the right door, and remove two screws.

**Figure 5-138** Remove two screws




2. At the back of the printer, remove two screws, and then slide the rear cover as indicated to remove it.

**Figure 5-139 Remove the rear cover**



### 3. Remove the rear upper cover (MFP models)

Follow these steps to remove the rear upper cover.

 **NOTE:** The task below shows the rear upper cover on a 6800zfs model. The cover on your model might look different, but the process is the same.

- Remove one screw, pry the right side away from printer, and then pull the cover in the direction indicated.


**Figure 5-140 Remove the cover**



### 4. Remove the document feeder

Follow these steps to remove the document feeder.

1. Remove two screws (callout 1).

 **TIP:** These are self-tapping screws for plastic. When reinstalling, rotate the screw counterclockwise to align it with the existing thread pattern, and then carefully turn it clockwise to tighten. Do not overtighten. This will prevent stripping the threads inside the screw hole.

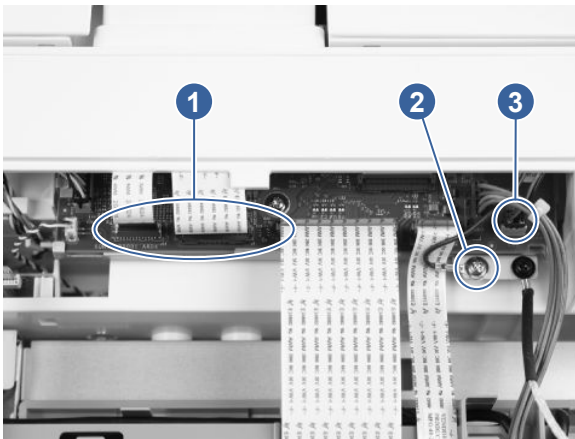


**Figure 5-141 Remove two screws**



2. Disconnect one flat cable (callout 1), remove one ground screw (callout 2) to release the grounding cable, and then disconnect the indicated connectors (callout 3) on the scanner control board.

**Figure 5-142 Disconnect the flat cable, ground cable, and connectors**




3. Tilt the document feeder back until it stops, and then lift it off of the scanner until it stops.
4. Support the document feeder, and then use a small flat-blade screwdriver to release two tabs on the document feeder hinges.

**Figure 5-143 Release two tabs**



5. Lift the document feeder up to remove it.

---

 **NOTE:** While removing the document feeder, carefully pass the cables through the cable channel in the scanner bed.

---

## 5. Unpack the replacement assembly

Follow these steps to unpack the replacement assembly.

1. Dispose of the defective part.

---



 **NOTE:** HP recommends responsible disposal of the defective part.


<http://www8.hp.com/us/en/hp-information/environment/product-recycling.html>


---

2. Unpack the replacement part from the packaging.

---

 **CAUTION:**  Some parts are sensitive to electrostatic discharge (ESD). Always perform service work at an ESD-protected workstation or mat. If an ESD workstation or mat is not available, touch the sheet-metal chassis to provide a static ground before touching an ESD-sensitive assembly. Protect the ESD-sensitive assemblies by placing them in ESD pouches when they are out of the printer.


 **IMPORTANT:** Make sure that all of the shipping materials (for example shipping tape) are removed from the replacement part prior to installation.

 **NOTE:** If the replacement part is a roller or pad, avoid touching the spongy part of it. Skin oils on the roller or pad can cause paper pickup and/or print-quality problems. HP recommends using disposable gloves when handling rollers or pads or washing your hands before touching rollers or pads.

---

3. To install an assembly, reverse the removal steps.

---

 **NOTE:** When applicable, special installation instructions are provided for an assembly at the end of the removal procedure. Always completely read the removal instructions and follow all special installation instructions.

---

## Integrated scanner assembly (WUR)

Learn about integrated scanner assembly (ISA) whole-unit replacement.

## Removal and replacement: Flatbed scanner assembly (MFP models)

Learn how to remove and replace the sub-scanner assembly (SSA).

Mean time to repair: 22 minutes


Service level: Medium

### Before performing service

#### Turn the printer power off


- Disconnect the power cable.

---

 **WARNING!** To avoid damage to the printer, turn the printer off, wait 30 seconds, and then remove the power cord before attempting to service the printer.

---

Use the table below to identify the correct part number for your printer. To order the part, go to [www.hp.com/buy/parts](http://www.hp.com/buy/parts).

 **NOTE:** The integrated scanner assembly (ISA) includes the sub-scanner assembly (SSA) and the automatic document feeder (ADF).

**Table 5-27 Part information**

Part number	Part description
6QN35-67006	Flatbed scanner (6xxx Series)

## Required tools

- Small flat-blade screwdriver
- #2 Phillips screwdriver with a magnetic tip and a 152 mm (6 in) shaft length

## After performing service

### Turn the printer power on

- Connect the power cable.
- Use the power switch to turn the power on.

### Post service test


Make sure that the printer initializes to a **Ready** state.

Print any pages necessary to make sure the printer is functioning correctly.

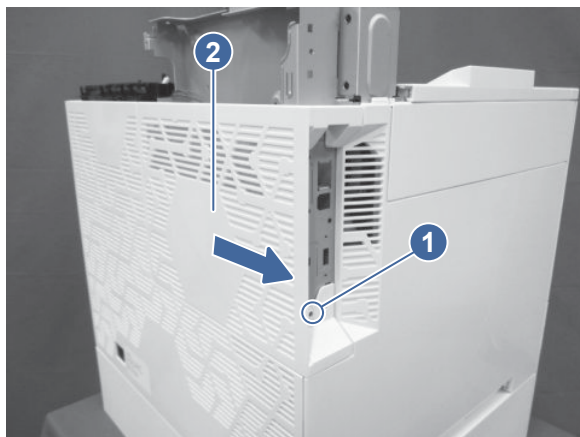
## 1. Remove the formatter cover

Follow these steps to remove the formatter cover.

- Remove one screw (callout 1), and then slide the formatter cover (callout 2) away from the printer to remove it.

 **TIP:** Reverse the removal steps to install the assembly.


**Figure 5-144 Remove the formatter cover**



## 2. Remove the rear cover

Follow these steps to remove the rear cover.

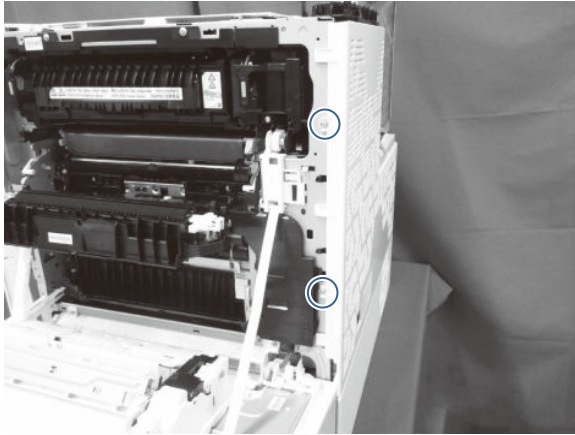
---

 **NOTE:** The figures below show some assemblies (for example the top cover and formatter) removed that might still be installed on the printer. However, the steps to remove the cover are correct.

---

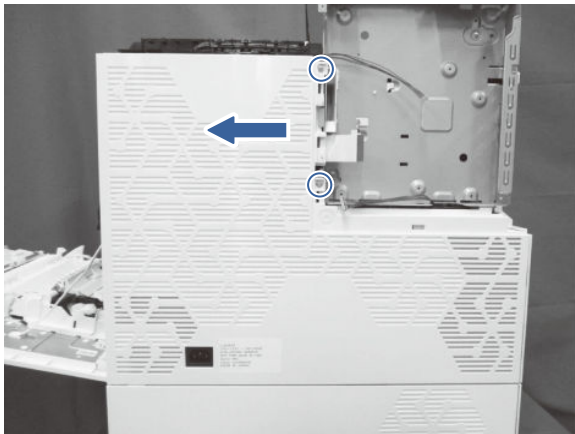
1. Open the right door, and remove two screws.

**Figure 5-145 Remove two screws**



2. At the back of the printer, remove two screws, and then slide the rear cover as indicated to remove it.


**Figure 5-146 Remove the rear cover**



## 3. Remove the rear upper cover (MFP models)

Follow these steps to remove the rear upper cover.

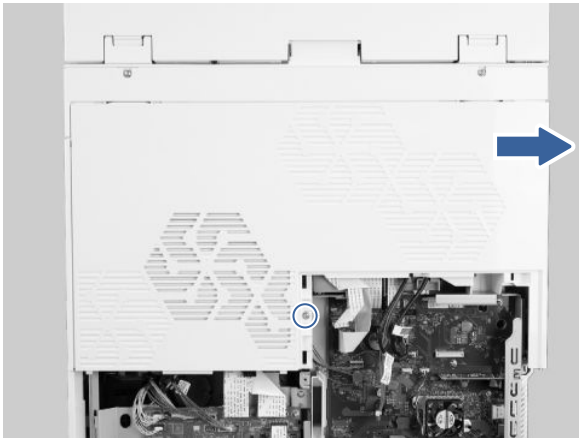
---

 **NOTE:** The task below shows the rear upper cover on a 6800zfs model. The cover on your model might look different, but the process is the same.

---

- Remove one screw, pry the right side away from printer, and then pull the cover in the direction indicated.


**Figure 5-147** Remove the cover



#### 4. Remove the document feeder

Follow these steps to remove the document feeder.

1. Remove two screws (callout 1).

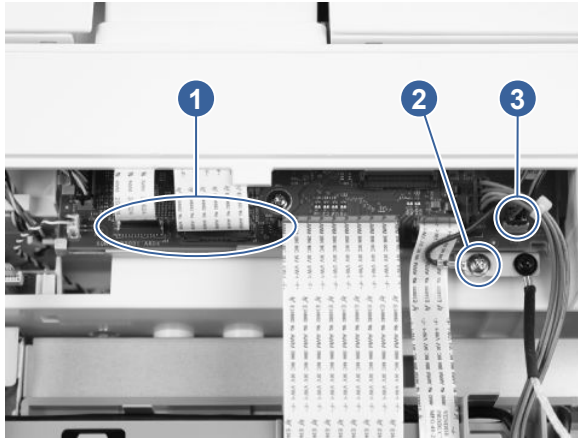
 **TIP:** These are self-tapping screws for plastic. When reinstalling, rotate the screw counterclockwise to align it with the existing thread pattern, and then carefully turn it clockwise to tighten. Do not overtighten. This will prevent stripping the threads inside the screw hole.

**Figure 5-148** Remove two screws



2. Disconnect one flat cable (callout 1), remove one ground screw (callout 2) to release the grounding cable, and then disconnect the indicated connectors (callout 3) on the scanner control board.

**Figure 5-149 Disconnect the flat cable, ground cable, and connectors**




3. Tilt the document feeder back until it stops, and then lift it off of the scanner until it stops.
4. Support the document feeder, and then use a small flat-blade screwdriver to release two tabs on the document feeder hinges.

**Figure 5-150 Release two tabs**



5. Lift the document feeder up to remove it.

---

 **NOTE:** While removing the document feeder, carefully pass the cables through the cable channel in the scanner bed.

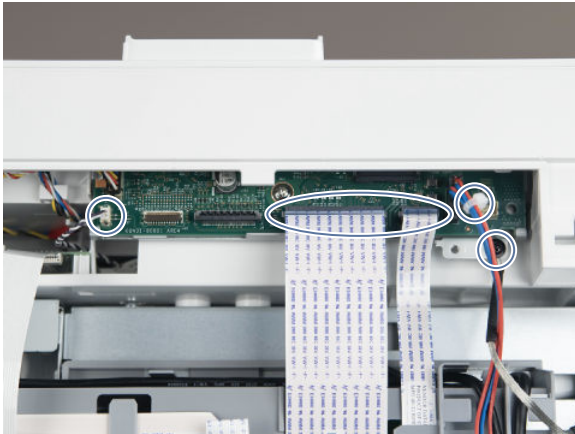
---

## 5. Remove the flatbed scanner assembly

Follow these steps to remove the sub-scanner assembly (SSA).

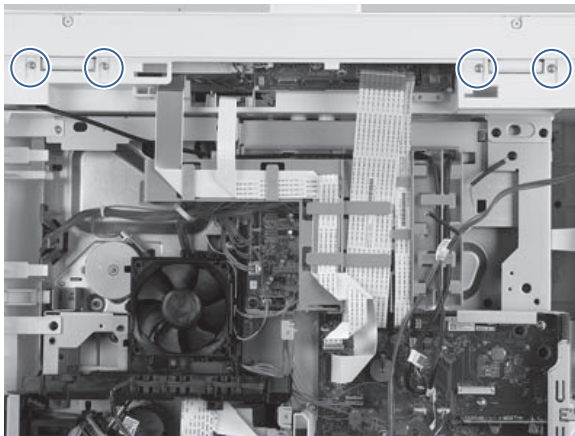
1. On the SCB, disconnect the cables indicated below.

**Figure 5-151 Disconnect SCB connectors**



2. Remove four screws.

**Figure 5-152 Remove four screws**



3. Pull the scan unit up to remove it from the printer.



**NOTE:** Carefully ensure that the cables do not catch on the cable guides as you lift the assembly.

## 6. Unpack the replacement assembly

Follow these steps to unpack the replacement assembly.

1. Dispose of the defective part.





**NOTE:** HP recommends responsible disposal of the defective part.


<http://www8.hp.com/us/en/hp-information/environment/product-recycling.html>

2. Unpack the replacement part from the packaging.



**CAUTION:**  Some parts are sensitive to electrostatic discharge (ESD). Always perform service work at an ESD-protected workstation or mat. If an ESD workstation or mat is not available, touch the sheet-metal chassis to provide a static ground before touching an ESD-sensitive assembly. Protect the ESD-sensitive assemblies by placing them in ESD pouches when they are out of the printer.


 **IMPORTANT:** Make sure that all of the shipping materials (for example shipping tape) are removed from the replacement part prior to installation.

 **NOTE:** If the replacement part is a roller or pad, avoid touching the spongy part of it. Skin oils on the roller or pad can cause paper pickup and/or print-quality problems. HP recommends using disposable gloves when handling rollers or pads or washing your hands before touching rollers or pads.

---

3. To install an assembly, reverse the removal steps.

---

 **NOTE:** When applicable, special installation instructions are provided for an assembly at the end of the removal procedure. Always completely read the removal instructions and follow all special installation instructions.

---

## 4. Removal and replacement: Internal parts and assemblies (base printer)

Learn how to remove and replace the base printer internal parts and assemblies.

### Field-replaceable units (FRUs)

Learn about FRU parts removal and replacement.

### Covers, panels, and doors

Learn about covers, panels, and doors removal and replacement.


### Removal and replacement: Formatter cover

Learn about removing and replacing the formatter cover.

#### Before performing service

##### Turn the printer power off

- Disconnect the power cable.

 **WARNING!** To avoid damage to the printer, turn the printer off, wait 30 seconds, and then remove the power cord before attempting to service the printer.

---

Use the table below to identify the correct part number for your printer, and then go to <https://parts.hp.com/hpparts> to order the part.

**Table 5-28 Part information**

Part number	Part description
RM2-4480-000CN	Formatter cover assembly(all models)
RM2-4530-000CN	Formatter cover assembly(Sub-cover MFP models only)

#### Required tools

- #2 Phillips screwdriver with a magnetic tip and a 152 mm (6 in) shaft length

#### After performing service



### Turn the printer power on

- Connect the power cable.
- Use the power switch to turn the power on.


### Post service test

No post service test is available for this assembly.

#### 1. Remove the formatter cover

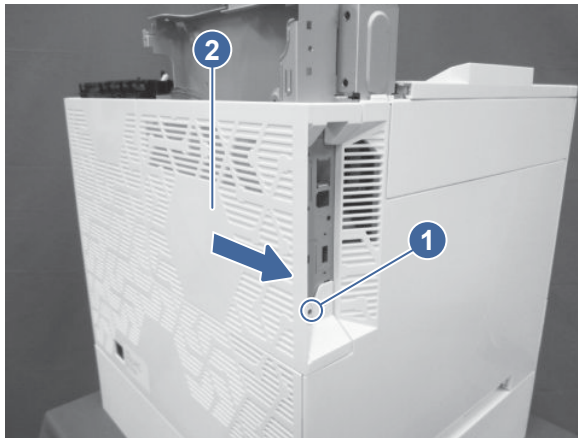
Follow these steps to remove the formatter cover.

- Remove one screw (callout 1), and then slide the formatter cover (callout 2) away from the printer to remove it.

 **TIP:** Reverse the removal steps to install the assembly.

---

**Figure 5-153** Remove the formatter cover



#### 2. Unpack the replacement assembly

Follow these steps to unpack the replacement assembly.



1. Dispose of the defective part.


 **NOTE:** HP recommends responsible disposal of the defective part.


<http://www8.hp.com/us/en/hp-information/environment/product-recycling.html>

---

2. Unpack the replacement part from the packaging.


 **CAUTION:**  Some parts are sensitive to electrostatic discharge (ESD). Always perform service work at an ESD-protected workstation or mat. If an ESD workstation or mat is not available, touch the sheet-metal chassis to provide a static ground before touching an ESD-sensitive assembly. Protect the ESD-sensitive assemblies by placing them in ESD pouches when they are out of the printer.

 **IMPORTANT:** Make sure that all of the shipping materials (for example shipping tape) are removed from the replacement part prior to installation.

 **NOTE:** If the replacement part is a roller or pad, avoid touching the spongy part of it. Skin oils on the roller or pad can cause paper pickup and/or print-quality problems. HP recommends using disposable gloves when handling rollers or pads or washing your hands before touching rollers or pads.

---

3. To install an assembly, reverse the removal steps.

 **NOTE:** When applicable, special installation instructions are provided for an assembly at the end of the removal procedure. Always completely read the removal instructions and follow all special installation instructions.

---


## Removal and replacement: Front door

Learn about removing and replacing the front door.

### Before performing service

#### Turn the printer power off

- Disconnect the power cable.

 **WARNING!** To avoid damage to the printer, turn the printer off, wait 30 seconds, and then remove the power cord before attempting to service the printer.

---

Use the table below to identify the correct part number for your printer, and then go to <https://parts.hp.com/hpparts> to order the part.

**Table 5-29** Part information

Part number	Part description
RM2-4473-000CN	Front door assembly (5700/5800 models)
RM2-4479-000CN	Front door assembly (X57945/X654/X677 models)
RM2-4533-000CN	Front door assembly (X557/6700/6800 models)

### Required tools

- #2 Phillips screwdriver with a magnetic tip and a 152 mm (6 in) shaft length

### After performing service

#### Turn the printer power on

- Connect the power cable.
- Use the power switch to turn the power on.

### Post service test

Make sure that the front door correctly opens and closes.

## 1. Remove Tray 2

Follow these steps to remove Tray 2.

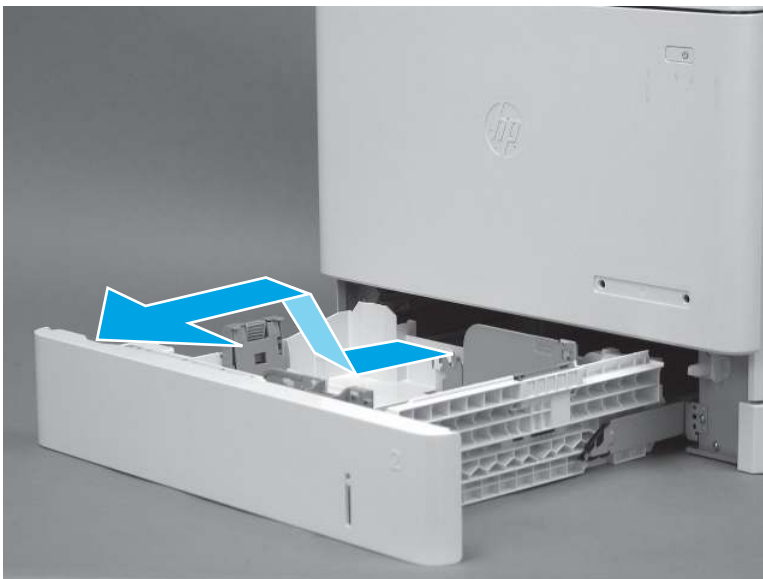
1. Pull the tray out until it stops.

**Figure 5-154 Pull the tray out**



2. Lift the front of the tray, and then pull it out of the printer to remove it.

**Figure 5-155 Remove the tray**



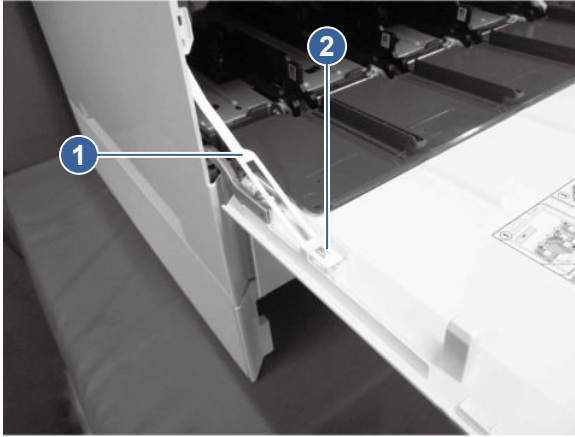
## 2. Remove the front door

Follow these steps to remove the front door.

1. Open the front door.

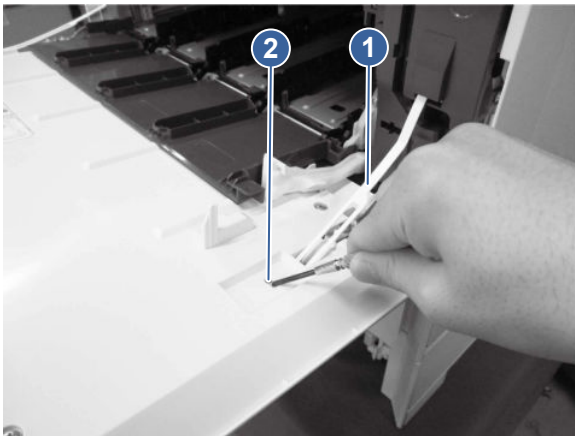
2. At the left side of the door, release the link arm (callout 1) from the clip (callout 2) on the front-door assembly.

**Figure 5-156 Release the left link arm**



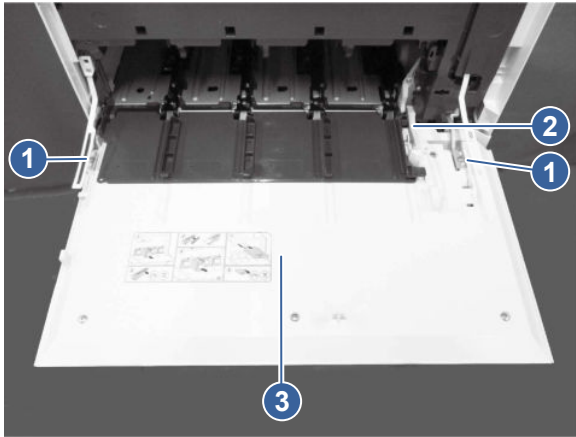
3. At the right side of the door, release the link arm (callout 1) from the clip (callout 2) on the front-door assembly.

**Figure 5-157 Release the right link arm**



4. Remove two screws (callout 1), release the link lever (callout 2) from the front door assembly (callout 3), and then remove the front door.


**Figure 5-158 Remove the door**



### 3. Unpack the replacement assembly



Follow these steps to unpack the replacement assembly.


1. Dispose of the defective part.


 **NOTE:** HP recommends responsible disposal of the defective part.

<http://www8.hp.com/us/en/hp-information/environment/product-recycling.html>


2. Unpack the replacement part from the packaging.

 **CAUTION:**  Some parts are sensitive to electrostatic discharge (ESD). Always perform service work at an ESD-protected workstation or mat. If an ESD workstation or mat is not available, touch the sheet-metal chassis to provide a static ground before touching an ESD-sensitive assembly. Protect the ESD-sensitive assemblies by placing them in ESD pouches when they are out of the printer.

 **IMPORTANT:** Make sure that all of the shipping materials (for example shipping tape) are removed from the replacement part prior to installation.

 **NOTE:** If the replacement part is a roller or pad, avoid touching the spongy part of it. Skin oils on the roller or pad can cause paper pickup and/or print-quality problems. HP recommends using disposable gloves when handling rollers or pads or washing your hands before touching rollers or pads.

3. To install an assembly, reverse the removal steps.

 **NOTE:** When applicable, special installation instructions are provided for an assembly at the end of the removal procedure. Always completely read the removal instructions and follow all special installation instructions.

### Removal and replacement: Toner cartridge access door (X654/X677 models)

Learn about removing and replacing the toner cartridge access door.

#### Before performing service

##### Turn the printer power off

- Disconnect the power cable.

---

**⚠ WARNING!** To avoid damage to the printer, turn the printer off, wait 30 seconds, and then remove the power cord before attempting to service the printer.

---

**⚠ CAUTION:** To prevent damage to a toner cartridge, do not expose it to light for more than a few minutes. Cover the green imaging drum if the toner cartridge must be removed from the printer for an extended period of time.

If toner gets on the skin or clothing, wipe it off with dry tissue paper and wash in cold water. Hot water sets toner and it might be difficult, or impossible, to remove.

---

Use the table below to identify the correct part number for your printer, and then go to <https://parts.hp.com/hpparts> to order the part.

**Table 5-30 Part information**

Part number	Part description
RM2-3678-000CN	Toner supply door assembly

## Required tools

- #2 Phillips screwdriver with a magnetic tip and a 152 mm (6 in) shaft length

## After performing service

### Turn the printer power on

- Connect the power cable.
- Use the power switch to turn the power on.

## Post service test

Make sure that the toner-cartridge door correctly opens and closes.

## 1. Remove Tray 2

Follow these steps to remove Tray 2.

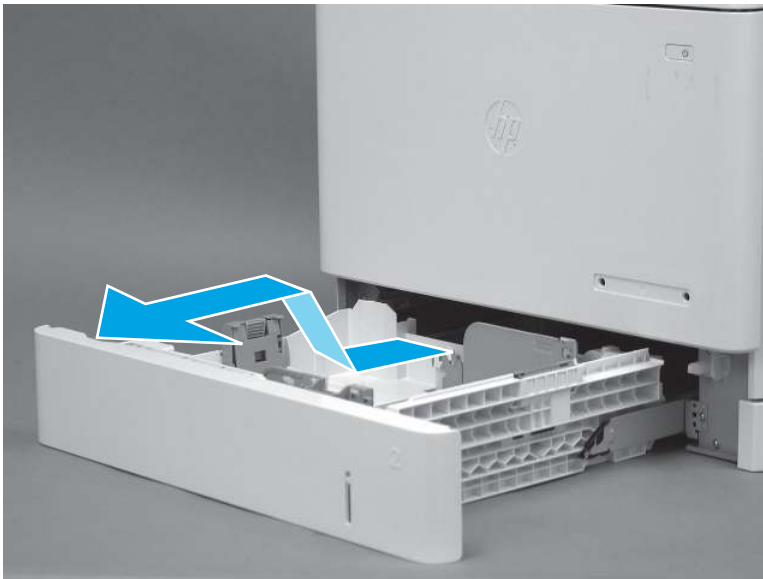
1. Pull the tray out until it stops.

**Figure 5-159 Pull the tray out**



2. Lift the front of the tray, and then pull it out of the printer to remove it.

**Figure 5-160 Remove the tray**



## 2. Remove the cartridge access door (X654/X677 models)

Follow these steps to remove the cartridge access door.

1. Open the cartridge door.

2. At the right- and left-side of the door, remove two screws, and then remove the door.

**Figure 5-161 Remove the door**



### 3. Unpack the replacement assembly



Follow these steps to unpack the replacement assembly.


1. Dispose of the defective part.


 **NOTE:** HP recommends responsible disposal of the defective part.

<http://www8.hp.com/us/en/hp-information/environment/product-recycling.html>


2. Unpack the replacement part from the packaging.

 **CAUTION:**  Some parts are sensitive to electrostatic discharge (ESD). Always perform service work at an ESD-protected workstation or mat. If an ESD workstation or mat is not available, touch the sheet-metal chassis to provide a static ground before touching an ESD-sensitive assembly. Protect the ESD-sensitive assemblies by placing them in ESD pouches when they are out of the printer.

 **IMPORTANT:** Make sure that all of the shipping materials (for example shipping tape) are removed from the replacement part prior to installation.

 **NOTE:** If the replacement part is a roller or pad, avoid touching the spongy part of it. Skin oils on the roller or pad can cause paper pickup and/or print-quality problems. HP recommends using disposable gloves when handling rollers or pads or washing your hands before touching rollers or pads.

3. To install an assembly, reverse the removal steps.

 **NOTE:** When applicable, special installation instructions are provided for an assembly at the end of the removal procedure. Always completely read the removal instructions and follow all special installation instructions.

### Removal and replacement: Rear cover

Learn about removing and replacing the rear cover.

#### Before performing service

Turn the printer power off



- Disconnect the power cable.

**⚠ WARNING!** To avoid damage to the printer, turn the printer off, wait 30 seconds, and then remove the power cord before attempting to service the printer.

Use the table below to identify the correct part number for your printer, and then go to <https://parts.hp.com/hpparts> to order the part.

**Table 5-31 Part information**

Part number	Part description
RC5-9168-000CN	Cover, rear (all models)
RC5-9409-000CN	Cover, rear lower (X57945/X654/X677 models)

## Required tools

- #2 Phillips screwdriver with a magnetic tip and a 152 mm (6 in) shaft length

## After performing service

### Turn the printer power on

- Connect the power cable.
- Use the power switch to turn the power on.

## Post service test

No post service test is available for this assembly.

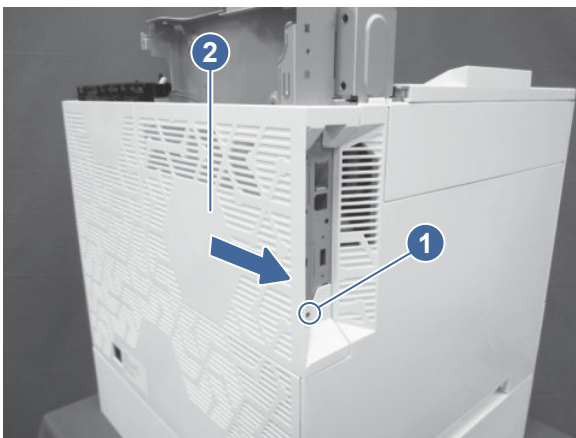
### 1. Remove the formatter cover

Follow these steps to remove the formatter cover.

- Remove one screw (callout 1), and then slide the formatter cover (callout 2) away from the printer to remove it.

**💡 TIP:** Reverse the removal steps to install the assembly.

**Figure 5-162 Remove the formatter cover**



## 2. Remove the rear cover

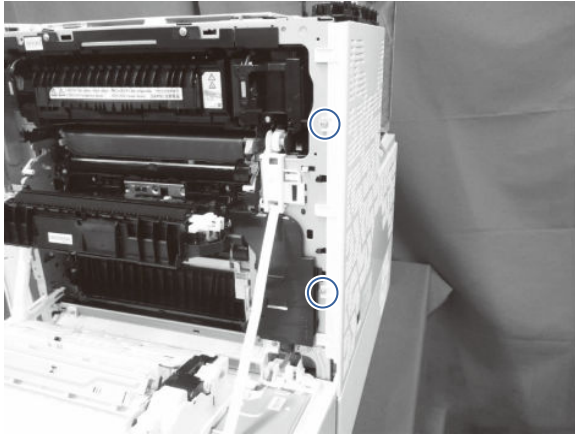
Follow these steps to remove the rear cover.



**NOTE:** The figures below show some assemblies (for example the top cover and formatter) removed that might still be installed on the printer. However, the steps to remove the cover are correct.

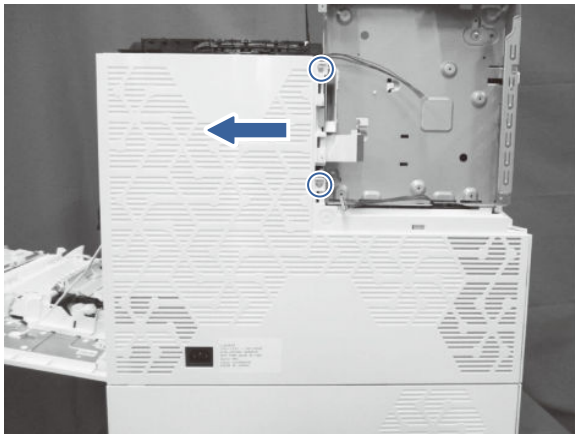
1. Open the right door, and remove two screws.

**Figure 5-163 Remove two screws**



2. At the back of the printer, remove two screws, and then slide the rear cover as indicated to remove it.

**Figure 5-164 Remove the rear cover**



## 3. Unpack the replacement assembly

Follow these steps to unpack the replacement assembly.



1. Dispose of the defective part.





**NOTE:** HP recommends responsible disposal of the defective part.

<http://www8.hp.com/us/en/hp-information/environment/product-recycling.html>


2. Unpack the replacement part from the packaging.

 **CAUTION:**  Some parts are sensitive to electrostatic discharge (ESD). Always perform service work at an ESD-protected workstation or mat. If an ESD workstation or mat is not available, touch the sheet-metal chassis to provide a static ground before touching an ESD-sensitive assembly. Protect the ESD-sensitive assemblies by placing them in ESD pouches when they are out of the printer.

 **IMPORTANT:** Make sure that all of the shipping materials (for example shipping tape) are removed from the replacement part prior to installation.

 **NOTE:** If the replacement part is a roller or pad, avoid touching the spongy part of it. Skin oils on the roller or pad can cause paper pickup and/or print-quality problems. HP recommends using disposable gloves when handling rollers or pads or washing your hands before touching rollers or pads.

3. To install an assembly, reverse the removal steps.

 **NOTE:** When applicable, special installation instructions are provided for an assembly at the end of the removal procedure. Always completely read the removal instructions and follow all special installation instructions.


### Removal and replacement: Rear upper cover (MFP models)

Learn about removing and replacing the rear upper cover.

#### Before performing service

##### Turn the printer power off

- Disconnect the power cable.

 **WARNING!** To avoid damage to the printer, turn the printer off, wait 30 seconds, and then remove the power cord before attempting to service the printer.

Use the table below to identify the correct part number for your printer, and then go to <https://parts.hp.com/hpparts> to order the part.

**Table 5-32** Part information

Part number	Part description
RC6-1305-000CN	Cover, rear upper

#### Required tools

- #2 Phillips screwdriver with a magnetic tip and a 152 mm (6 in) shaft length

#### After performing service

##### Turn the printer power on

- Connect the power cable.
- Use the power switch to turn the power on.

#### Post service test


No post service test is available for this assembly.

## 1. Remove the formatter cover

Follow these steps to remove the formatter cover.

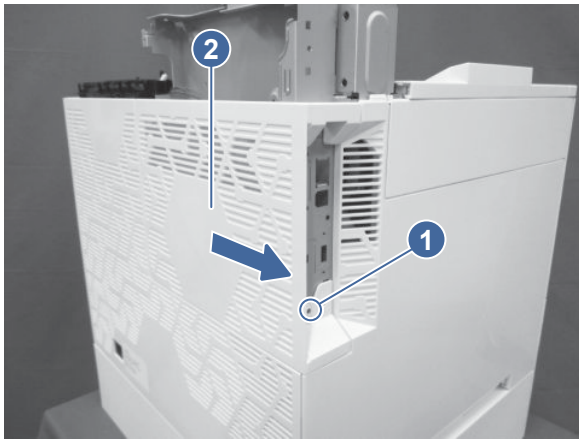
- Remove one screw (callout 1), and then slide the formatter cover (callout 2) away from the printer to remove it.

---

 **TIP:** Reverse the removal steps to install the assembly.

---


**Figure 5-165 Remove the formatter cover**



## 2. Remove the rear cover

Follow these steps to remove the rear cover.

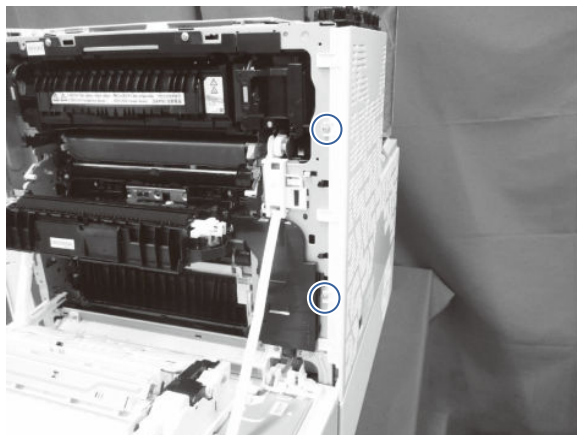
---

 **NOTE:** The figures below show some assemblies (for example the top cover and formatter) removed that might still be installed on the printer. However, the steps to remove the cover are correct.

---

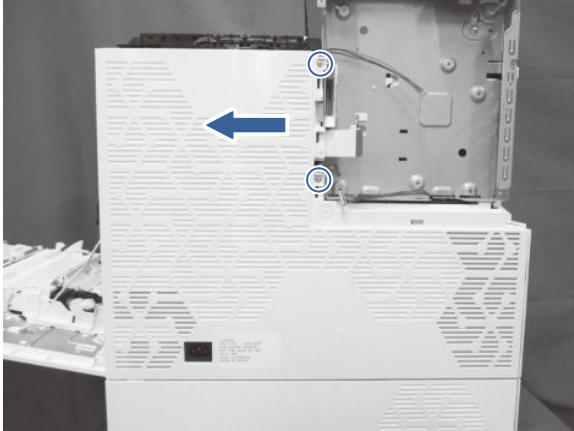
1. Open the right door, and remove two screws.

**Figure 5-166 Remove two screws**




2. At the back of the printer, remove two screws, and then slide the rear cover as indicated to remove it.

**Figure 5-167 Remove the rear cover**



### 3. Remove the rear upper cover (MFP models)

Follow these steps to remove the rear upper cover.

 **NOTE:** The task below shows the rear upper cover on a 6800zfs model. The cover on your model might look different, but the process is the same.

- Remove one screw, pry the right side away from printer, and then pull the cover in the direction indicated.

**Figure 5-168 Remove the cover**



### 4. Unpack the replacement assembly



Follow these steps to unpack the replacement assembly.


1. Dispose of the defective part.


 **NOTE:** HP recommends responsible disposal of the defective part.

<http://www8.hp.com/us/en/hp-information/environment/product-recycling.html>


## 2. Unpack the replacement part from the packaging.

 **CAUTION:**  Some parts are sensitive to electrostatic discharge (ESD). Always perform service work at an ESD-protected workstation or mat. If an ESD workstation or mat is not available, touch the sheet-metal chassis to provide a static ground before touching an ESD-sensitive assembly. Protect the ESD-sensitive assemblies by placing them in ESD pouches when they are out of the printer.

 **IMPORTANT:** Make sure that all of the shipping materials (for example shipping tape) are removed from the replacement part prior to installation.

 **NOTE:** If the replacement part is a roller or pad, avoid touching the spongy part of it. Skin oils on the roller or pad can cause paper pickup and/or print-quality problems. HP recommends using disposable gloves when handling rollers or pads or washing your hands before touching rollers or pads.

## 3. To install an assembly, reverse the removal steps.

 **NOTE:** When applicable, special installation instructions are provided for an assembly at the end of the removal procedure. Always completely read the removal instructions and follow all special installation instructions.


### Removal and replacement: Left upper cover (MFP models)

Learn about removing and replacing the left upper cover.

#### Before performing service

##### Turn the printer power off

- Disconnect the power cable.

 **WARNING!** To avoid damage to the printer, turn the printer off, wait 30 seconds, and then remove the power cord before attempting to service the printer.

Use the table below to identify the correct part number for your printer, and then go to <https://parts.hp.com/hpparts> to order the part.

**Table 5-33** Part information

Part number	Part description
RC5-9204-000CN	Cover, left upper

#### Required tools

- Small flat-blade screwdriver

#### After performing service

##### Turn the printer power on

- Connect the power cable.
- Use the power switch to turn the power on.

#### Post service test

No post service test is available for this assembly.

### 1. Remove the left upper cover (MFP models)

Follow these steps to remove the left upper cover.

1. Open the front door.

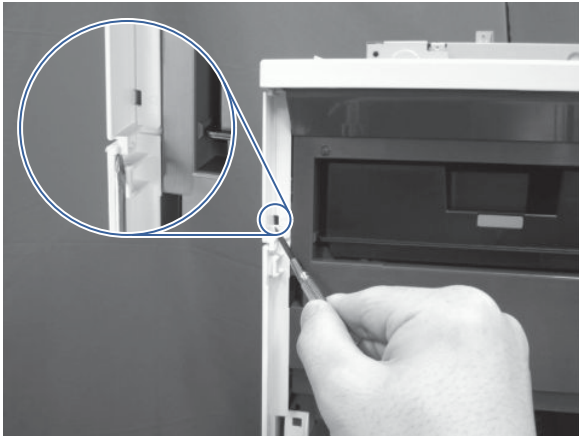
---

**⚠ CAUTION:** If the cover is being removed to gain access to the main drive assembly, make sure that the front door remains open. This keeps the main drive properly aligned.

---

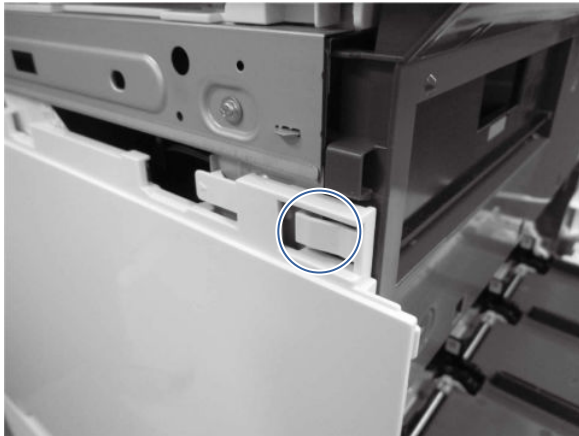
2. At the left side of the printer, insert the small flat-blade screwdriver into the slot to release one tab (callout 1).

**Figure 5-169 Use a screwdriver to release the tab**



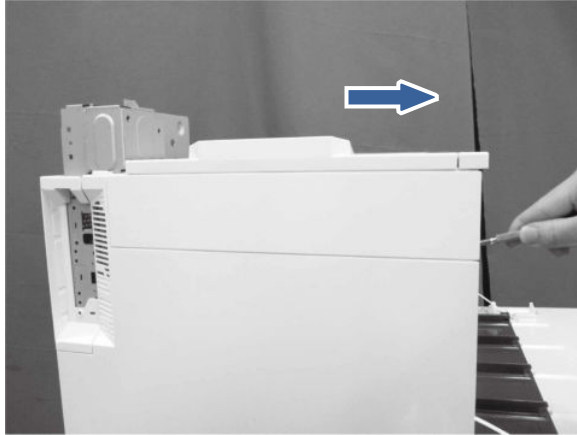
3. Toward the front of the printer, release another tab.

**Figure 5-170 Release the tab**



4. Rotate the cover up to remove it.


**Figure 5-171 Remove the left upper cover**



## 2. Unpack the replacement assembly



Follow these steps to unpack the replacement assembly.


1. Dispose of the defective part.


 **NOTE:** HP recommends responsible disposal of the defective part.

<http://www8.hp.com/us/en/hp-information/environment/product-recycling.html>


2. Unpack the replacement part from the packaging.

 **CAUTION:**  Some parts are sensitive to electrostatic discharge (ESD). Always perform service work at an ESD-protected workstation or mat. If an ESD workstation or mat is not available, touch the sheet-metal chassis to provide a static ground before touching an ESD-sensitive assembly. Protect the ESD-sensitive assemblies by placing them in ESD pouches when they are out of the printer.

 **IMPORTANT:** Make sure that all of the shipping materials (for example shipping tape) are removed from the replacement part prior to installation.

 **NOTE:** If the replacement part is a roller or pad, avoid touching the spongy part of it. Skin oils on the roller or pad can cause paper pickup and/or print-quality problems. HP recommends using disposable gloves when handling rollers or pads or washing your hands before touching rollers or pads.

3. To install an assembly, reverse the removal steps.

 **NOTE:** When applicable, special installation instructions are provided for an assembly at the end of the removal procedure. Always completely read the removal instructions and follow all special installation instructions.

## Removal and replacement: Left cover

Learn about removing and replacing the left cover.

### Before performing service

**Turn the printer power off**



- Disconnect the power cable.

---

**⚠ WARNING!** To avoid damage to the printer, turn the printer off, wait 30 seconds, and then remove the power cord before attempting to service the printer.

---

Use the table below to identify the correct part number for your printer, and then go to <https://parts.hp.com/hpparts> to order the part.

**Table 5-34** Part information

Part number	Part description
RM2-4535-000CN	Left cover assembly

## Required tools

- #2 Phillips screwdriver with a magnetic tip and a 152 mm (6 in) shaft length

## After performing service

### Turn the printer power on

- Connect the power cable.
- Use the power switch to turn the power on.

## Post service test

No post service test is available for this assembly.

### 1. Remove the formatter cover

Follow these steps to remove the formatter cover.

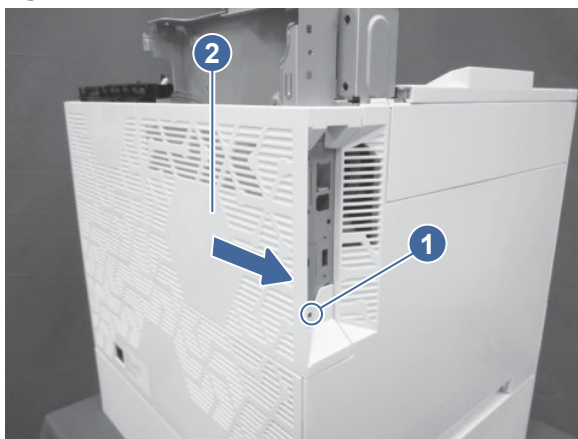
- Remove one screw (callout 1), and then slide the formatter cover (callout 2) away from the printer to remove it.

---

**💡 TIP:** Reverse the removal steps to install the assembly.

---

**Figure 5-172** Remove the formatter cover



## 2. Remove the left upper cover (MFP models)

Follow these steps to remove the left upper cover.

1. Open the front door.

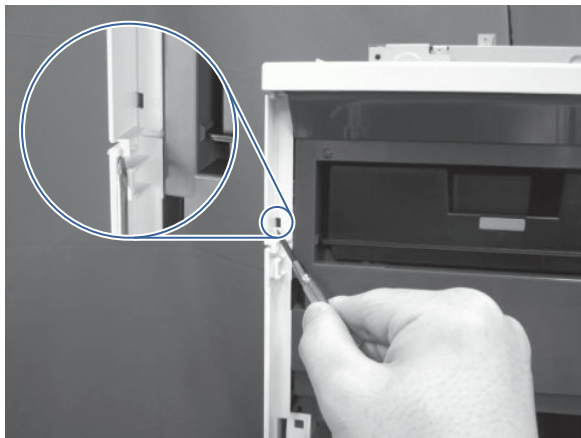
---

**⚠ CAUTION:** If the cover is being removed to gain access to the main drive assembly, make sure that the front door remains open. This keeps the main drive properly aligned.

---

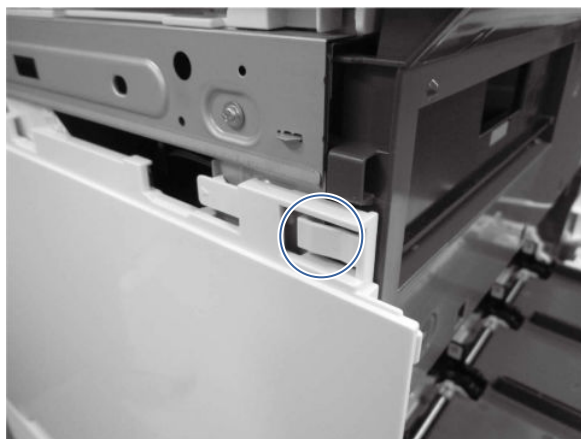
2. At the left side of the printer, insert the small flat-blade screwdriver into the slot to release one tab (callout 1).

**Figure 5-173 Use a screwdriver to release the tab**



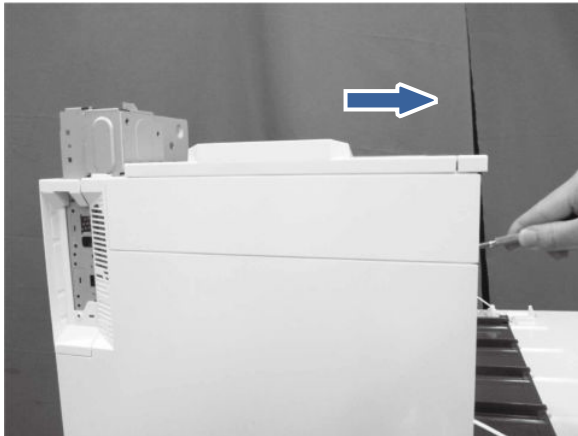
3. Toward the front of the printer, release another tab.

**Figure 5-174 Release the tab**



4. Rotate the cover up to remove it.

**Figure 5-175 Remove the left upper cover**

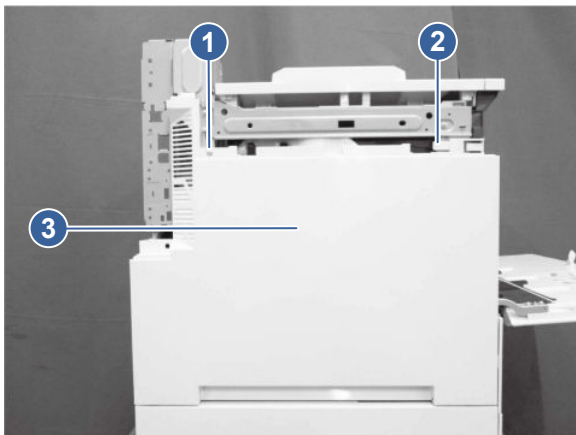


### 3. Remove the left cover

Follow these steps to remove the left cover.

- At the left side of the printer, remove one screw (callout 1), release one tab (callout 2), and then slide the cover (callout 3) toward the rear of the printer to release it.

**Figure 5-176 Remove the left cover**



### 4. Unpack the replacement assembly

Follow these steps to unpack the replacement assembly.



1. Dispose of the defective part.





**NOTE:** HP recommends responsible disposal of the defective part.

<http://www8.hp.com/us/en/hp-information/environment/product-recycling.html>


## 2. Unpack the replacement part from the packaging.

 **CAUTION:**  Some parts are sensitive to electrostatic discharge (ESD). Always perform service work at an ESD-protected workstation or mat. If an ESD workstation or mat is not available, touch the sheet-metal chassis to provide a static ground before touching an ESD-sensitive assembly. Protect the ESD-sensitive assemblies by placing them in ESD pouches when they are out of the printer.

 **IMPORTANT:** Make sure that all of the shipping materials (for example shipping tape) are removed from the replacement part prior to installation.

 **NOTE:** If the replacement part is a roller or pad, avoid touching the spongy part of it. Skin oils on the roller or pad can cause paper pickup and/or print-quality problems. HP recommends using disposable gloves when handling rollers or pads or washing your hands before touching rollers or pads.

## 3. To install an assembly, reverse the removal steps.

 **NOTE:** When applicable, special installation instructions are provided for an assembly at the end of the removal procedure. Always completely read the removal instructions and follow all special installation instructions.


### Removal and replacement: Left handle

Learn about removing and replacing the left handle.

#### Before performing service

##### Turn the printer power off

- Disconnect the power cable.

 **WARNING!** To avoid damage to the printer, turn the printer off, wait 30 seconds, and then remove the power cord before attempting to service the printer.

Use the table below to identify the correct part number for your printer, and then go to <https://parts.hp.com/hpparts> to order the part.

**Table 5-35** Part information

Part number	Part description
RC5-9165-000CN	Handle, left

#### Required tools

- #2 Phillips screwdriver with a magnetic tip and a 152 mm (6 in) shaft length

#### After performing service

##### Turn the printer power on

- Connect the power cable.
- Use the power switch to turn the power on.

#### Post service test


No post service test is available for this assembly.

## 1. Remove the formatter cover

Follow these steps to remove the formatter cover.

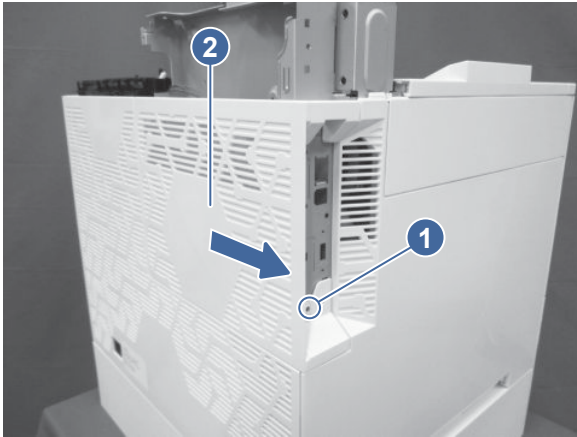
- Remove one screw (callout 1), and then slide the formatter cover (callout 2) away from the printer to remove it.

---

 **TIP:** Reverse the removal steps to install the assembly.

---

**Figure 5-177** Remove the formatter cover




## 2. Remove the left upper cover (MFP models)

Follow these steps to remove the left upper cover.

1. Open the front door.

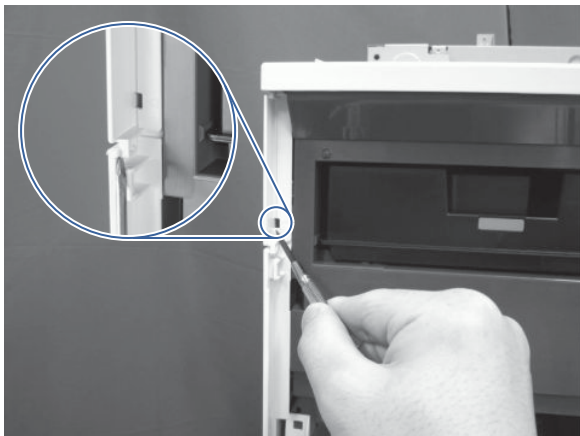
---

 **CAUTION:** If the cover is being removed to gain access to the main drive assembly, make sure that the front door remains open. This keeps the main drive properly aligned.

---

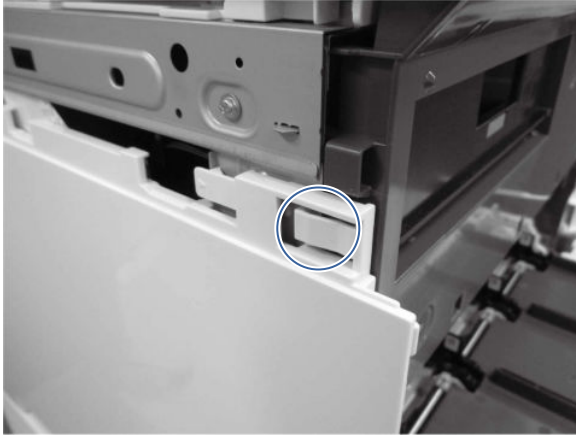
2. At the left side of the printer, insert the small flat-blade screwdriver into the slot to release one tab (callout 1).

**Figure 5-178** Use a screwdriver to release the tab



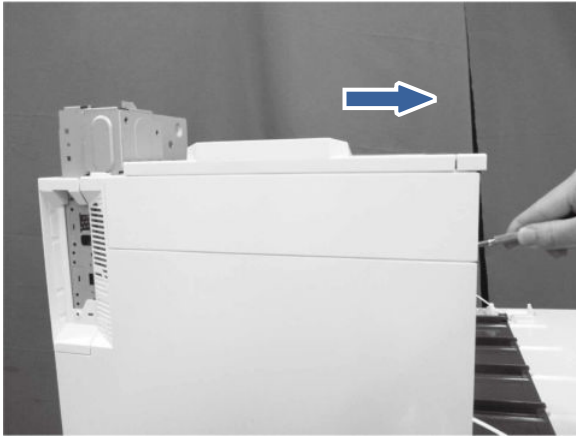
3. Toward the front of the printer, release another tab.

**Figure 5-179 Release the tab**



4. Rotate the cover up to remove it.

**Figure 5-180 Remove the left upper cover**

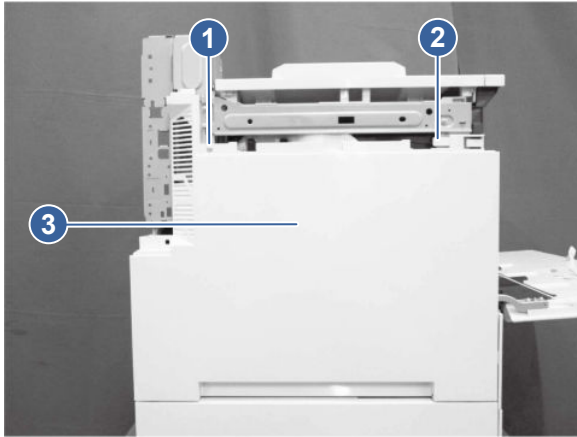


### **3. Remove the left cover**

Follow these steps to remove the left cover.

- At the left side of the printer, remove one screw (callout 1), release one tab (callout 2), and then slide the cover (callout 3) toward the rear of the printer to release it.

**Figure 5-181** Remove the left cover

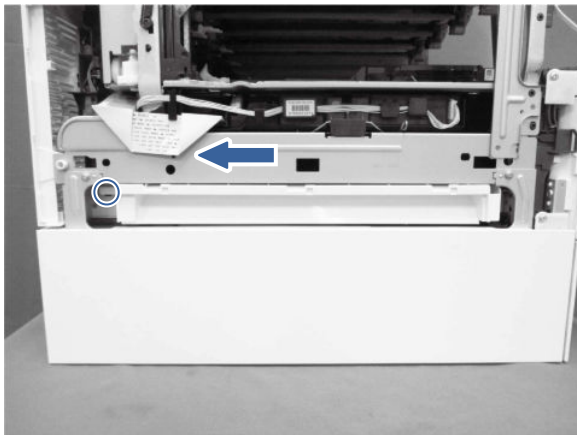


#### 4. Remove the left handle

Follow these steps to remove the left handle.

- At the left side of the printer, release one tab, and then slide the handle as indicated to release it.

**Figure 5-182** Remove the handle



#### 5. Unpack the replacement assembly

Follow these steps to unpack the replacement assembly.



1. Dispose of the defective part.





**NOTE:** HP recommends responsible disposal of the defective part.

<http://www8.hp.com/us/en/hp-information/environment/product-recycling.html>


## 2. Unpack the replacement part from the packaging.

 **CAUTION:**  Some parts are sensitive to electrostatic discharge (ESD). Always perform service work at an ESD-protected workstation or mat. If an ESD workstation or mat is not available, touch the sheet-metal chassis to provide a static ground before touching an ESD-sensitive assembly. Protect the ESD-sensitive assemblies by placing them in ESD pouches when they are out of the printer.

 **IMPORTANT:** Make sure that all of the shipping materials (for example shipping tape) are removed from the replacement part prior to installation.

 **NOTE:** If the replacement part is a roller or pad, avoid touching the spongy part of it. Skin oils on the roller or pad can cause paper pickup and/or print-quality problems. HP recommends using disposable gloves when handling rollers or pads or washing your hands before touching rollers or pads.

## 3. To install an assembly, reverse the removal steps.

 **NOTE:** When applicable, special installation instructions are provided for an assembly at the end of the removal procedure. Always completely read the removal instructions and follow all special installation instructions.


### Removal and replacement: Front left cover

Learn about removing and replacing the front left cover.

#### Before performing service

##### Turn the printer power off

- Disconnect the power cable.

 **WARNING!** To avoid damage to the printer, turn the printer off, wait 30 seconds, and then remove the power cord before attempting to service the printer.

Use the table below to identify the correct part number for your printer, and then go to <https://parts.hp.com/hpparts> to order the part.

**Table 5-36** Part information

Part number	Part description
RC5-9198-000CN	Cover, front left

#### Required tools

- No special tools are required to remove or install this assembly.

#### After performing service

##### Turn the printer power on

- Connect the power cable.
- Use the power switch to turn the power on.

#### Post service test



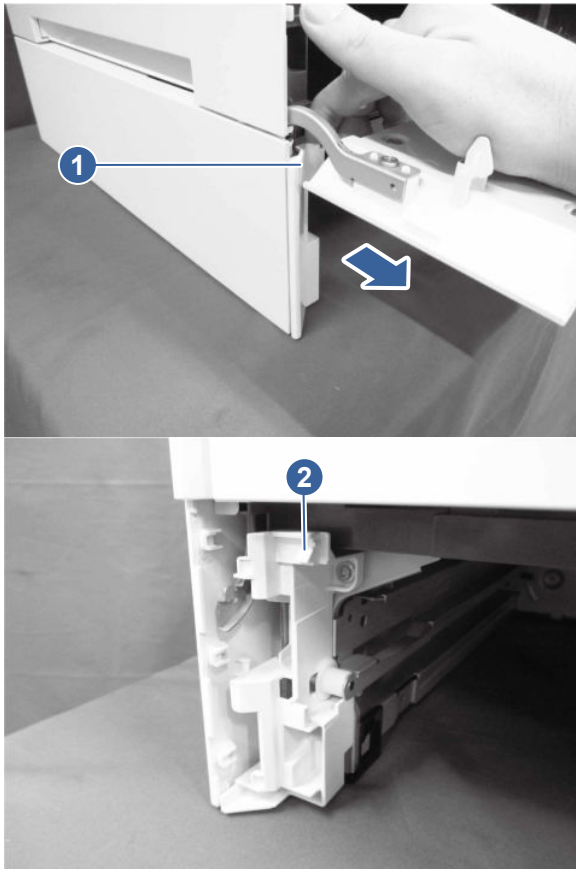
No post service test is available for this assembly.

## 1. Remove the front left cover

Follow these steps to remove the front left cover.

1. Perform one of the following steps.
  - **6700/6800 models:** Open the front door.
  - **X654/X677 models:** Open the toner cartridge access door.
2. Pull the top part of the front left cover (callout 1) in the direction indicated, release one tab (callout 2), and then slide the cover upward to release it.

**Figure 5-183** Remove the cover



## 2. Unpack the replacement assembly

Follow these steps to unpack the replacement assembly.



1. Dispose of the defective part.





**NOTE:** HP recommends responsible disposal of the defective part.

<http://www8.hp.com/us/en/hp-information/environment/product-recycling.html>


## 2. Unpack the replacement part from the packaging.

 **CAUTION:**  Some parts are sensitive to electrostatic discharge (ESD). Always perform service work at an ESD-protected workstation or mat. If an ESD workstation or mat is not available, touch the sheet-metal chassis to provide a static ground before touching an ESD-sensitive assembly. Protect the ESD-sensitive assemblies by placing them in ESD pouches when they are out of the printer.

 **IMPORTANT:** Make sure that all of the shipping materials (for example shipping tape) are removed from the replacement part prior to installation.

 **NOTE:** If the replacement part is a roller or pad, avoid touching the spongy part of it. Skin oils on the roller or pad can cause paper pickup and/or print-quality problems. HP recommends using disposable gloves when handling rollers or pads or washing your hands before touching rollers or pads.

## 3. To install an assembly, reverse the removal steps.

 **NOTE:** When applicable, special installation instructions are provided for an assembly at the end of the removal procedure. Always completely read the removal instructions and follow all special installation instructions.


### Removal and replacement: Front right cover

Learn about removing and replacing the front right cover.

#### Before performing service

##### Turn the printer power off

- Disconnect the power cable.

 **WARNING!** To avoid damage to the printer, turn the printer off, wait 30 seconds, and then remove the power cord before attempting to service the printer.

Use the table below to identify the correct part number for your printer, and then go to <https://parts.hp.com/hpparts> to order the part.

**Table 5-37** Part information

Part number	Part description
RC5-9199-000CN	Cover, front right

#### Required tools

- No special tools are required to remove or install this assembly.

#### After performing service

##### Turn the printer power on

- Connect the power cable.
- Use the power switch to turn the power on.

#### Post service test

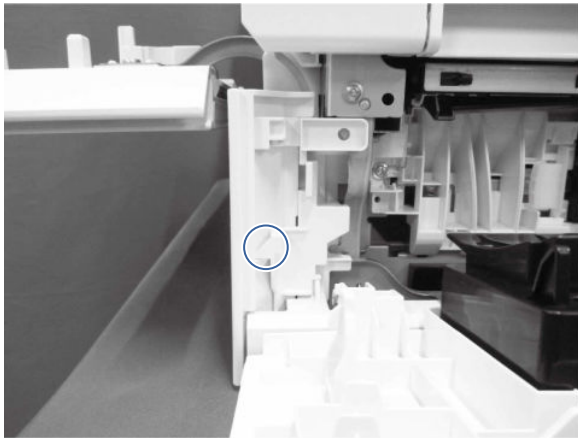
No post service test is available for this assembly.

## 1. Remove the front right cover

Follow these steps to remove the front right cover.

1. Perform one of the following steps.
  - **6700/6800 models:** Open the front door.
  - **X654/X677 models:** Open the toner cartridge access door.
2. Perform one of the following steps.
  - **6700/6800 models:** Open the right door.
  - **X654/X677 models:** Open the right lower door.
3. Release one tab, and then slide the front right cover upward to remove it.

**Figure 5-184** Remove the front right cover



## 2. Unpack the replacement assembly

Follow these steps to unpack the replacement assembly.

1. Dispose of the defective part.




**NOTE:** HP recommends responsible disposal of the defective part.

<http://www8.hp.com/us/en/hp-information/environment/product-recycling.html>


2. Unpack the replacement part from the packaging.



**CAUTION:**  Some parts are sensitive to electrostatic discharge (ESD). Always perform service work at an ESD-protected workstation or mat. If an ESD workstation or mat is not available, touch the sheet-metal chassis to provide a static ground before touching an ESD-sensitive assembly. Protect the ESD-sensitive assemblies by placing them in ESD pouches when they are out of the printer.




**IMPORTANT:** Make sure that all of the shipping materials (for example shipping tape) are removed from the replacement part prior to installation.

 **NOTE:** If the replacement part is a roller or pad, avoid touching the spongy part of it. Skin oils on the roller or pad can cause paper pickup and/or print-quality problems. HP recommends using disposable gloves when handling rollers or pads or washing your hands before touching rollers or pads.

---

3. To install an assembly, reverse the removal steps.

 **NOTE:** When applicable, special installation instructions are provided for an assembly at the end of the removal procedure. Always completely read the removal instructions and follow all special installation instructions.

---


## Removal and replacement: Right door

Learn about removing and replacing the right door.

### Before performing service

#### Turn the printer power off

- Disconnect the power cable.

 **WARNING!** To avoid damage to the printer, turn the printer off, wait 30 seconds, and then remove the power cord before attempting to service the printer.

---

Use the table below to identify the correct part number for your printer, and then go to <https://parts.hp.com/hpparts> to order the part.

**Table 5-38** Part information

Part number	Part description
RM2-3665-000CN	Right door (6700/6800/X654/X677)

### Required tools

- Small flat-blade screwdriver
- #2 Phillips screwdriver with a magnetic tip and a 152 mm (6 in) shaft length

### After performing service

#### Turn the printer power on

- Connect the power cable.
- Use the power switch to turn the power on.

### Post service test

No post service test is available for this assembly.

## 1. Remove the right door

Follow these steps to remove the right door.

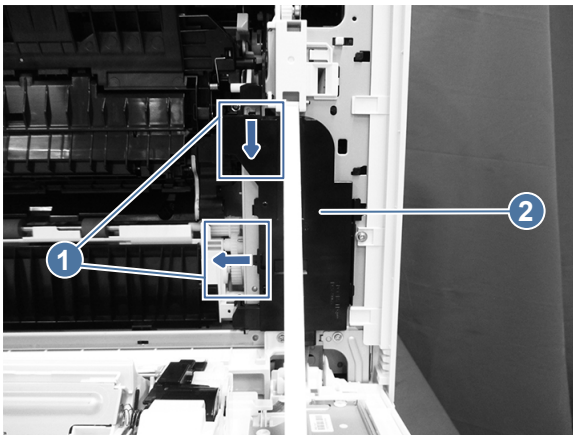
1. Open the right door.

**Figure 5-185** Open the right door



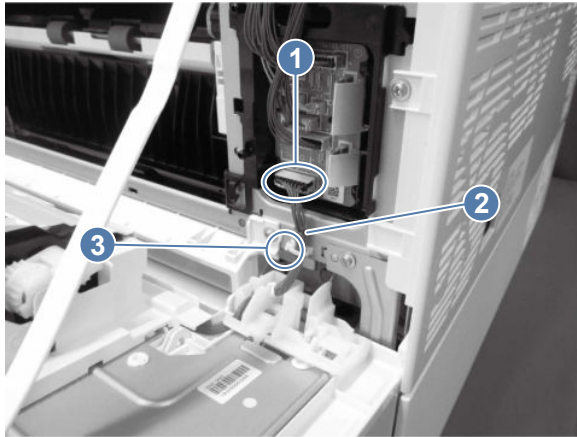
2. Perform one of the following steps.
  - **6700/6800 models:** Open the right door.
  - **X654/X677 models:** Open the right lower door.
3. **6700/6800 models:** Remove the front right cover.
4. Release two tabs (callout 1), and then remove the PCA cover (callout 2).

**Figure 5-186** Remove the PCA cover



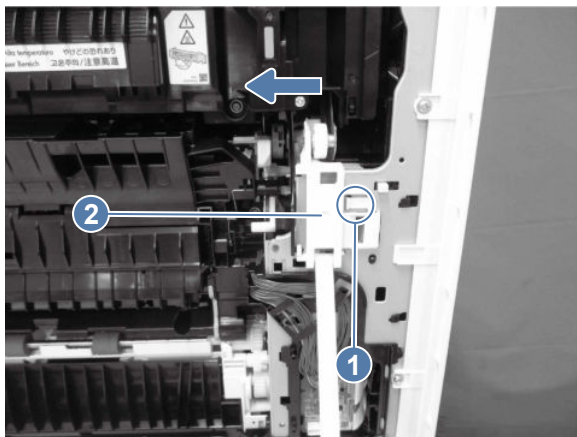
5. Disconnect one connector (callout 1), and then release the cable (callout 2) from the cable clamp (callout 3).

**Figure 5-187 Disconnect one connector**



6. Release one tab (callout 1), slide the link arm (callout 2) in the direction indicated, and then remove it.

**Figure 5-188 Remove the link arm**



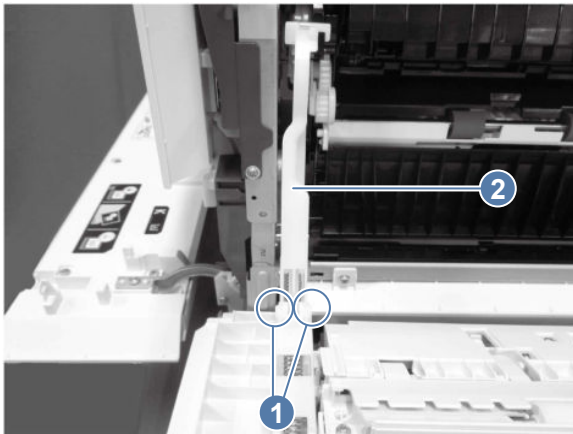
7. Close the front door a little, and then disconnect the joint that connects the two link arms.

**Figure 5-189 Disconnect the link arms**



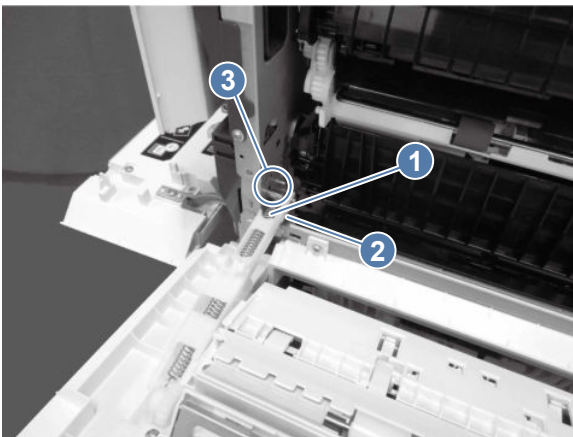
8. Release two bosses (callout 1), and then remove the link arm (callout 2).

**Figure 5-190 Remove the link arm**



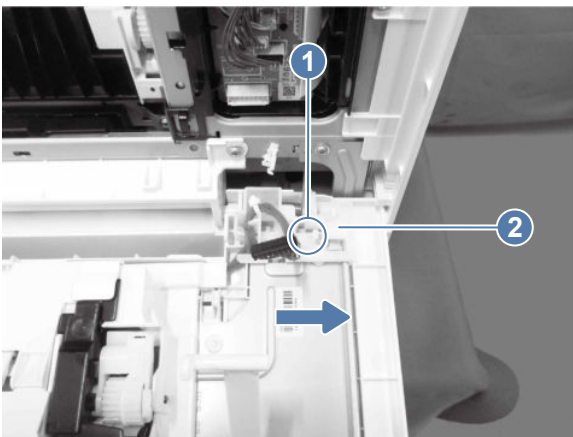
9. Close the front door a little, and then remove the spring (callout 1) from the link arm (callout 2) and from the shaft (callout 3).

**Figure 5-191 Remove the spring**



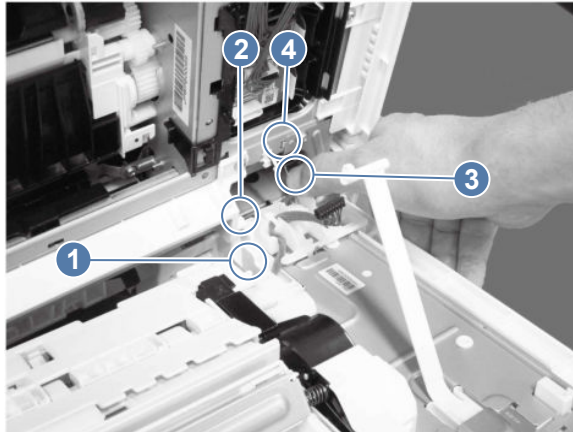
10. Release one tab (callout 1), slide the cable holder (callout 2) in the direction indicated, and then remove it.

**Figure 5-192 Remove the cable holder**



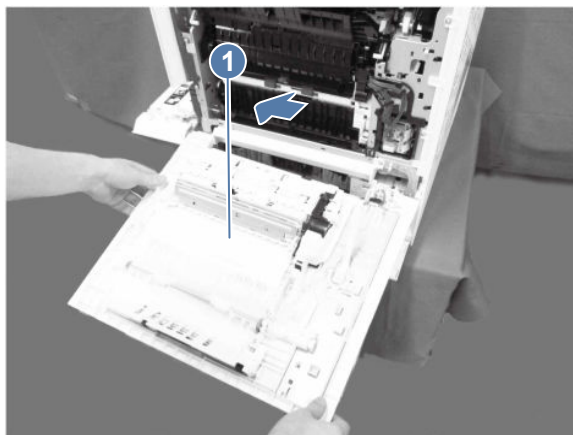
11. Remove the right door (callout 1) from the shaft (callout 2), and then unhook one spring (callout 3) from the frame (callout 4).

**Figure 5-193 Remove the door from the shaft**



12. Slide the right door (callout 1) in the direction indicated to remove it.

**Figure 5-194 Remove the door**



## 2. Unpack the replacement assembly

Follow these steps to unpack the replacement assembly.

1. Dispose of the defective part.




**NOTE:** HP recommends responsible disposal of the defective part.

<http://www8.hp.com/us/en/hp-information/environment/product-recycling.html>

2. Unpack the replacement part from the packaging.




**CAUTION:**  Some parts are sensitive to electrostatic discharge (ESD). Always perform service work at an ESD-protected workstation or mat. If an ESD workstation or mat is not available, touch the sheet-metal chassis to provide a static ground before touching an ESD-sensitive assembly. Protect the ESD-sensitive assemblies by placing them in ESD pouches when they are out of the printer.



**IMPORTANT:** Make sure that all of the shipping materials (for example shipping tape) are removed from the replacement part prior to installation.




 **NOTE:** If the replacement part is a roller or pad, avoid touching the spongy part of it. Skin oils on the roller or pad can cause paper pickup and/or print-quality problems. HP recommends using disposable gloves when handling rollers or pads or washing your hands before touching rollers or pads.

---

3. To install an assembly, reverse the removal steps.

---

 **NOTE:** When applicable, special installation instructions are provided for an assembly at the end of the removal procedure. Always completely read the removal instructions and follow all special installation instructions.

---


### Removal and replacement: Right lower door (X654/X677 models)

Learn about removing and replacing the right lower door.

#### Before performing service

##### Turn the printer power off

- Disconnect the power cable.

 **WARNING!** To avoid damage to the printer, turn the printer off, wait 30 seconds, and then remove the power cord before attempting to service the printer.

---

Use the table below to identify the correct part number for your printer, and then go to <https://parts.hp.com/hpparts> to order the part.

**Table 5-39** Part information

Part number	Part description
RM3-0004-000CN	Right lower door assembly

#### Required tools

- Small flat-blade screwdriver
- #2 Phillips screwdriver with a magnetic tip and a 152 mm (6 in) shaft length

#### After performing service

##### Turn the printer power on

- Connect the power cable.
- Use the power switch to turn the power on.

#### Post service test

No post service test is available for this assembly.

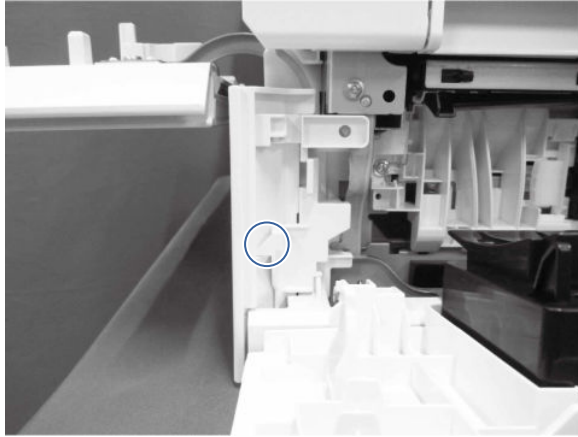
### 1. Remove the front right cover

Follow these steps to remove the front right cover.

1. Perform one of the following steps.
  - **6700/6800 models:** Open the front door.

- **X654/X677 models:** Open the toner cartridge access door.
2. Perform one of the following steps.
    - **6700/6800 models:** Open the right door.
    - **X654/X677 models:** Open the right lower door.
  3. Release one tab, and then slide the front right cover upward to remove it.

**Figure 5-195 Remove the front right cover**

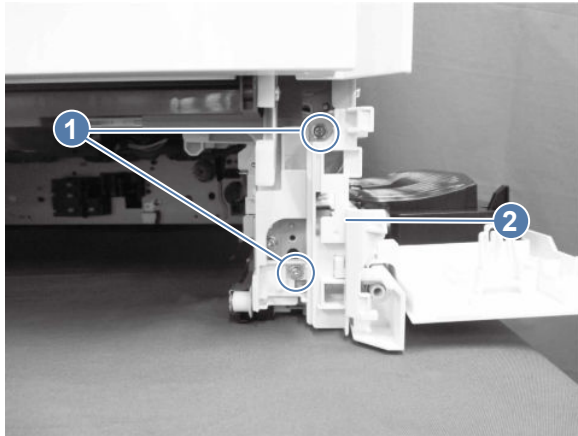


## 2. Remove the right lower door (X654/X677 models)

Follow these steps to remove the right lower door.

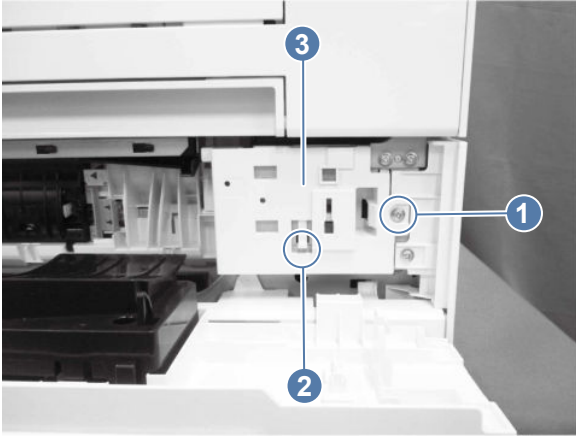
1. Remove two screws (callout 1), and then remove the base frame (callout 2).

**Figure 5-196 Remove the base frame**



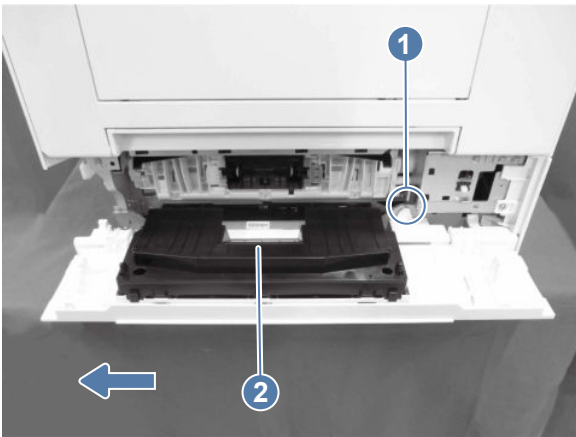
2. Remove one screw (callout 1), release one tab (callout 2), and then slide the rear inner cover (callout 3) downward to remove it.

**Figure 5-197 Remove the rear inner cover**



3. Release one tab (callout 1), and then slide the right lower door assembly (callout 2) in the direction indicated to remove it.

**Figure 5-198 Remove the right lower door assembly**



### 3. Unpack the replacement assembly

Follow these steps to unpack the replacement assembly.

1. Dispose of the defective part.





**NOTE:** HP recommends responsible disposal of the defective part.


<http://www8.hp.com/us/en/hp-information/environment/product-recycling.html>

2. Unpack the replacement part from the packaging.



**CAUTION:**  Some parts are sensitive to electrostatic discharge (ESD). Always perform service work at an ESD-protected workstation or mat. If an ESD workstation or mat is not available, touch the sheet-metal chassis to provide a static ground before touching an ESD-sensitive assembly. Protect the ESD-sensitive assemblies by placing them in ESD pouches when they are out of the printer.


 **IMPORTANT:** Make sure that all of the shipping materials (for example shipping tape) are removed from the replacement part prior to installation.

 **NOTE:** If the replacement part is a roller or pad, avoid touching the spongy part of it. Skin oils on the roller or pad can cause paper pickup and/or print-quality problems. HP recommends using disposable gloves when handling rollers or pads or washing your hands before touching rollers or pads.

---

3. To install an assembly, reverse the removal steps.

---

 **NOTE:** When applicable, special installation instructions are provided for an assembly at the end of the removal procedure. Always completely read the removal instructions and follow all special installation instructions.

---


## Removal and replacement: Rear lower cover (X654/X677 models)

Learn about removing and replacing the rear lower cover.

### Before performing service

#### Turn the printer power off

- Disconnect the power cable.

 **WARNING!** To avoid damage to the printer, turn the printer off, wait 30 seconds, and then remove the power cord before attempting to service the printer.

---

Use the table below to identify the correct part number for your printer, and then go to <https://parts.hp.com/hpparts> to order the part.

Table 5-40 Part information

Part number	Part description
RC5-9409-000CN	Cover, rear lower

### Required tools

- Small flat-blade screwdriver
- #2 Phillips screwdriver with a magnetic tip and a 152 mm (6 in) shaft length

### After performing service

#### Turn the printer power on

- Connect the power cable.
- Use the power switch to turn the power on.

### Post service test

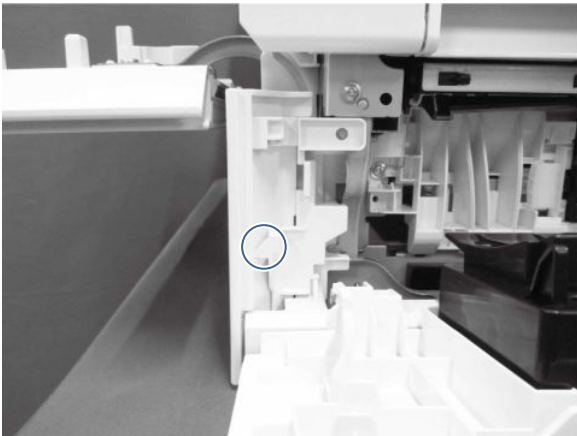
No post service test is available for this assembly.

## 1. Remove the front right cover

Follow these steps to remove the front right cover.

1. Perform one of the following steps.
  - **6700/6800 models:** Open the front door.
  - **X654/X677 models:** Open the toner cartridge access door.
2. Perform one of the following steps.
  - **6700/6800 models:** Open the right door.
  - **X654/X677 models:** Open the right lower door.
3. Release one tab, and then slide the front right cover upward to remove it.

**Figure 5-199 Remove the front right cover**

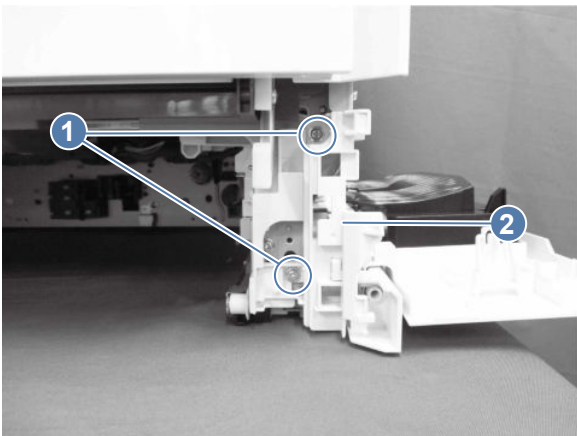


## 2. Remove the right lower door (X654/X677 models)

Follow these steps to remove the right lower door.

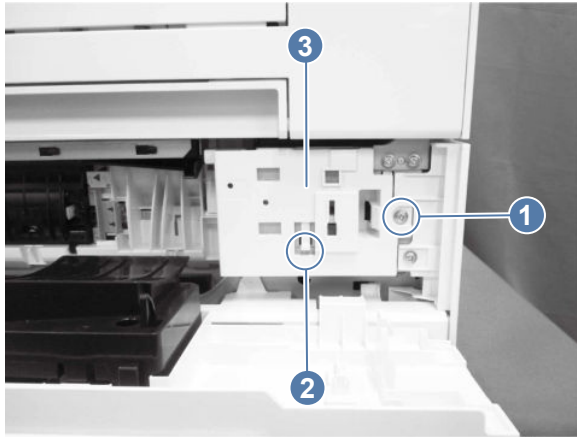
1. Remove two screws (callout 1), and then remove the base frame (callout 2).

**Figure 5-200 Remove the base frame**



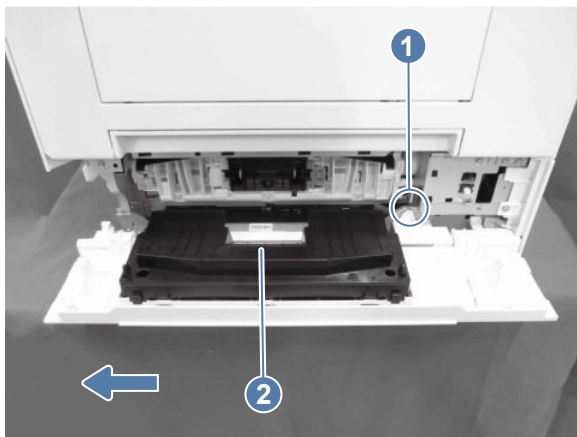
2. Remove one screw (callout 1), release one tab (callout 2), and then slide the rear inner cover (callout 3) downward to remove it.

**Figure 5-201 Remove the rear inner cover**



3. Release one tab (callout 1), and then slide the right lower door assembly (callout 2) in the direction indicated to remove it.

**Figure 5-202 Remove the right lower door assembly**

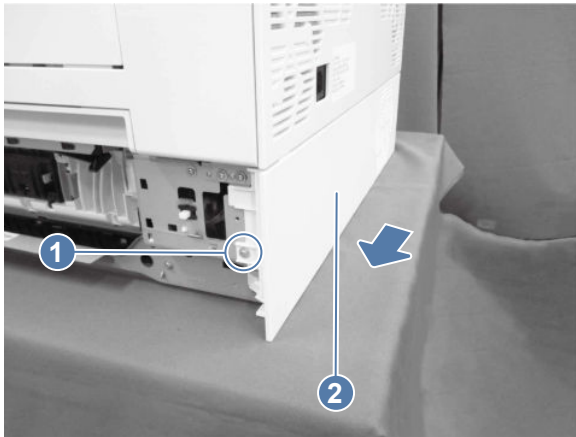


### 3. Remove the rear lower cover (X654/X677 models)

Follow these steps to remove the rear lower cover.

- Remove one screw (callout 1), slide the rear lower cover (callout 2) in the direction indicated below, and then remove it.

**Figure 5-203 Remove the rear lower cover**



#### 4. Unpack the replacement assembly

Follow these steps to unpack the replacement assembly.

1. Dispose of the defective part.

---



 **NOTE:** HP recommends responsible disposal of the defective part.


<http://www8.hp.com/us/en/hp-information/environment/product-recycling.html>


---

2. Unpack the replacement part from the packaging.

---

 **CAUTION:**  Some parts are sensitive to electrostatic discharge (ESD). Always perform service work at an ESD-protected workstation or mat. If an ESD workstation or mat is not available, touch the sheet-metal chassis to provide a static ground before touching an ESD-sensitive assembly. Protect the ESD-sensitive assemblies by placing them in ESD pouches when they are out of the printer.


 **IMPORTANT:** Make sure that all of the shipping materials (for example shipping tape) are removed from the replacement part prior to installation.

 **NOTE:** If the replacement part is a roller or pad, avoid touching the spongy part of it. Skin oils on the roller or pad can cause paper pickup and/or print-quality problems. HP recommends using disposable gloves when handling rollers or pads or washing your hands before touching rollers or pads.

---

3. To install an assembly, reverse the removal steps.

---

 **NOTE:** When applicable, special installation instructions are provided for an assembly at the end of the removal procedure. Always completely read the removal instructions and follow all special installation instructions.

---

#### Removal and replacement: Left lower cover (X654/X677 models)

Learn about removing and replacing the left lower cover.

##### Before performing service

**Turn the printer power off**

- Disconnect the power cable.

**⚠ WARNING!** To avoid damage to the printer, turn the printer off, wait 30 seconds, and then remove the power cord before attempting to service the printer.

Use the table below to identify the correct part number for your printer, and then go to <https://parts.hp.com/hpparts> to order the part.

**Table 5-41 Part information**

Part number	Part description
RC5-9408-000CN	Left lower cover

## Required tools

- Small flat-blade screwdriver
- #2 Phillips screwdriver with a magnetic tip and a 152 mm (6 in) shaft length

## After performing service

### Turn the printer power on

- Connect the power cable.
- Use the power switch to turn the power on.

## Post service test

No post service test is available for this assembly.

## 1. Remove the front right cover

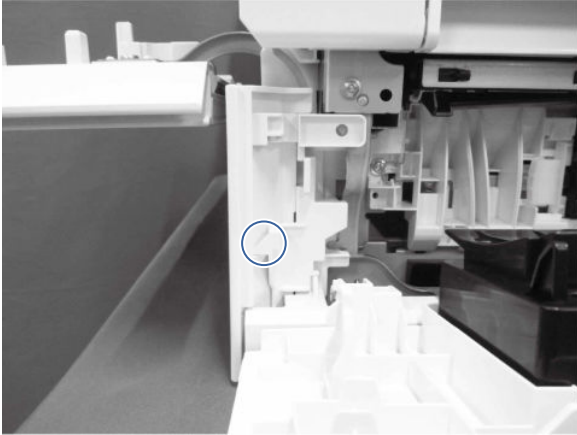
Follow these steps to remove the front right cover.

1. Perform one of the following steps.
  - **6700/6800 models:** Open the front door.
  - **X654/X677 models:** Open the toner cartridge access door.
2. Perform one of the following steps.
  - **6700/6800 models:** Open the right door.
  - **X654/X677 models:** Open the right lower door.



3. Release one tab, and then slide the front right cover upward to remove it.

**Figure 5-204 Remove the front right cover**

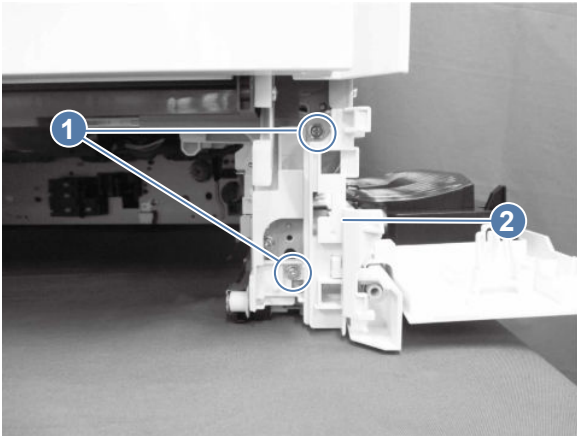


## 2. Remove the right lower door (X654/X677 models)

Follow these steps to remove the right lower door.

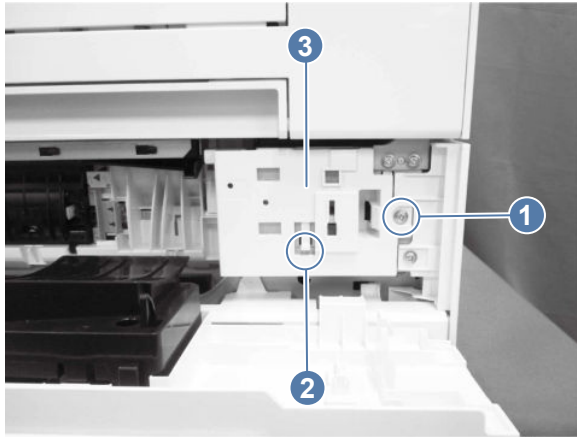
1. Remove two screws (callout 1), and then remove the base frame (callout 2).

**Figure 5-205 Remove the base frame**



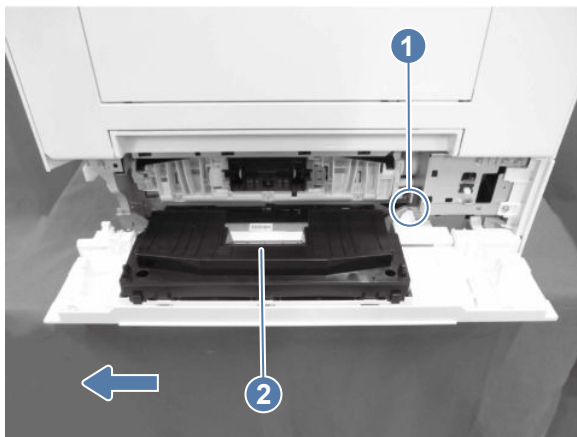
2. Remove one screw (callout 1), release one tab (callout 2), and then slide the rear inner cover (callout 3) downward to remove it.

**Figure 5-206 Remove the rear inner cover**



3. Release one tab (callout 1), and then slide the right lower door assembly (callout 2) in the direction indicated to remove it.

**Figure 5-207 Remove the right lower door assembly**

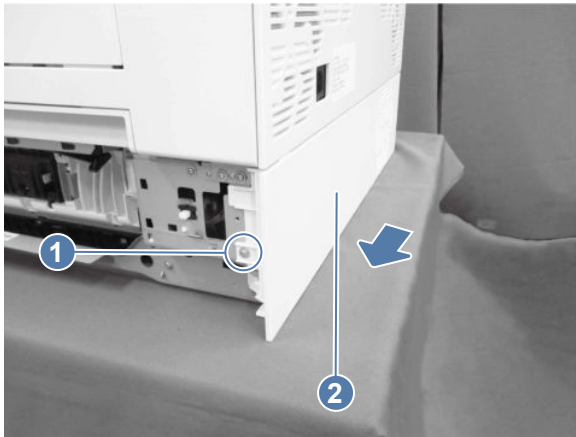


### 3. Remove the rear lower cover (X654/X677 models)

Follow these steps to remove the rear lower cover.

- Remove one screw (callout 1), slide the rear lower cover (callout 2) in the direction indicated below, and then remove it.

**Figure 5-208 Remove the rear lower cover**



#### 4. Remove the left lower cover (X654/X677 models)

Follow these steps to remove the left lower cover.

- Slide the left lower cover in the direction indicated, and then remove it.

**Figure 5-209 Remove the left lower cover**



#### 5. Unpack the replacement assembly

Follow these steps to unpack the replacement assembly.



1. Dispose of the defective part.





**NOTE:** HP recommends responsible disposal of the defective part.

<http://www8.hp.com/us/en/hp-information/environment/product-recycling.html>


## 2. Unpack the replacement part from the packaging.

 **CAUTION:**  Some parts are sensitive to electrostatic discharge (ESD). Always perform service work at an ESD-protected workstation or mat. If an ESD workstation or mat is not available, touch the sheet-metal chassis to provide a static ground before touching an ESD-sensitive assembly. Protect the ESD-sensitive assemblies by placing them in ESD pouches when they are out of the printer.

 **IMPORTANT:** Make sure that all of the shipping materials (for example shipping tape) are removed from the replacement part prior to installation.

 **NOTE:** If the replacement part is a roller or pad, avoid touching the spongy part of it. Skin oils on the roller or pad can cause paper pickup and/or print-quality problems. HP recommends using disposable gloves when handling rollers or pads or washing your hands before touching rollers or pads.

## 3. To install an assembly, reverse the removal steps.

 **NOTE:** When applicable, special installation instructions are provided for an assembly at the end of the removal procedure. Always completely read the removal instructions and follow all special installation instructions.


### Removal and replacement: Output bin

Learn about removing and replacing the output bin.

#### Before performing service

##### Turn the printer power off

- Disconnect the power cable.

 **WARNING!** To avoid damage to the printer, turn the printer off, wait 30 seconds, and then remove the power cord before attempting to service the printer.

Use the table below to identify the correct part number for your printer, and then go to <https://parts.hp.com/hpparts> to order the part.

**Table 5-42** Part information

Part number	Part description
RM2-4471-000CN	Face down tray assembly

#### Required tools

- Small flat-blade screwdriver
- #2 Phillips screwdriver with a magnetic tip and a 152 mm (6 in) shaft length

#### After performing service

##### Turn the printer power on

- Connect the power cable.
- Use the power switch to turn the power on.

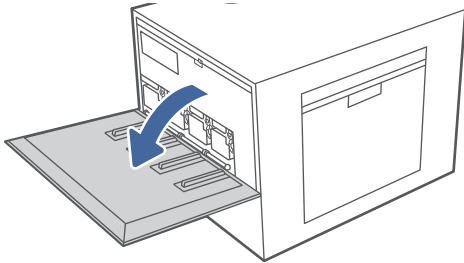
## Post service test

No post service test is available for this assembly.

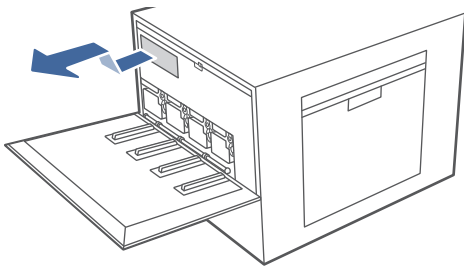
### 1. Remove the toner collection unit (TCU)

Follow these steps to remove the toner collection unit (TCU).


1. Open the front door.



2. Lift the TCU slightly and then pull it out of the printer.



---

 **NOTE:** Maintain the position of the TCU as you pull it out from the printer. This will ensure that you do not spill any waste toner in the printer. Place the unit into the clear plastic bag the new TCU was packaged in.


---

### 2. Remove the left upper cover (MFP models)

Follow these steps to remove the left upper cover.

1. Open the front door.

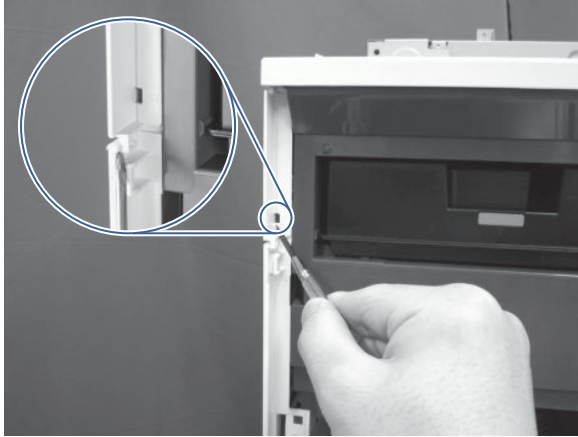
---

 **CAUTION:** If the cover is being removed to gain access to the main drive assembly, make sure that the front door remains open. This keeps the main drive properly aligned.

---

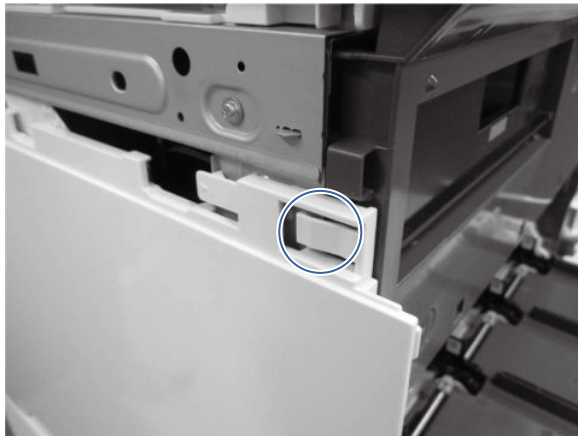
2. At the left side of the printer, insert the small flat-blade screwdriver into the slot to release one tab (callout 1).

**Figure 5-210 Use a screwdriver to release the tab**



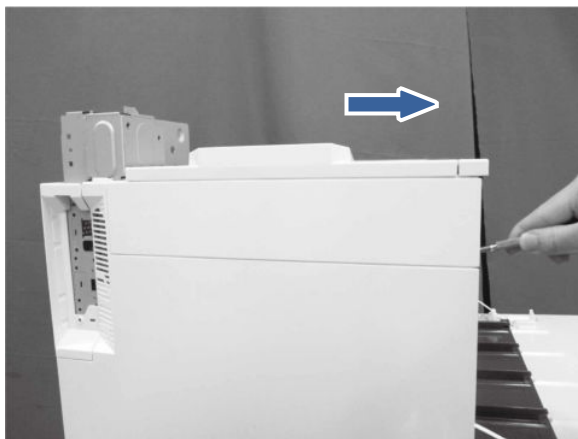
3. Toward the front of the printer, release another tab.

**Figure 5-211 Release the tab**



4. Rotate the cover up to remove it.

**Figure 5-212 Remove the left upper cover**

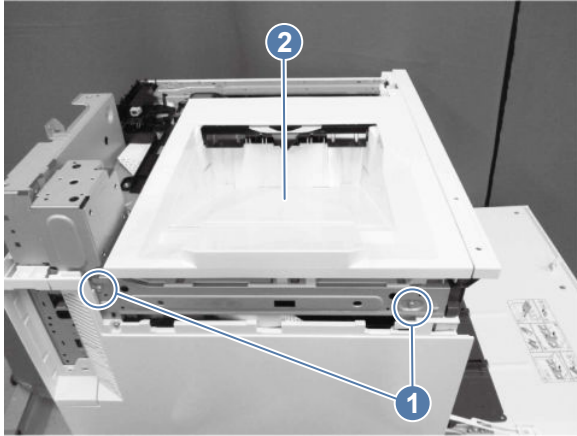


### 3. Remove the output bin

Follow these steps to remove the output bin.

- Remove two screws (callout 1), and then slide the output tray (callout 2) towards the front (SFP models) or left (MFP models) to remove it.

**Figure 5-213** Remove the output bin



### 4. Unpack the replacement assembly

Follow these steps to unpack the replacement assembly.

1. Dispose of the defective part.




**NOTE:** HP recommends responsible disposal of the defective part.

<http://www8.hp.com/us/en/hp-information/environment/product-recycling.html>

2. Unpack the replacement part from the packaging.



**CAUTION:**  Some parts are sensitive to electrostatic discharge (ESD). Always perform service work at an ESD-protected workstation or mat. If an ESD workstation or mat is not available, touch the sheet-metal chassis to provide a static ground before touching an ESD-sensitive assembly. Protect the ESD-sensitive assemblies by placing them in ESD pouches when they are out of the printer.



**IMPORTANT:** Make sure that all of the shipping materials (for example shipping tape) are removed from the replacement part prior to installation.



**NOTE:** If the replacement part is a roller or pad, avoid touching the spongy part of it. Skin oils on the roller or pad can cause paper pickup and/or print-quality problems. HP recommends using disposable gloves when handling rollers or pads or washing your hands before touching rollers or pads.

3. To install an assembly, reverse the removal steps.



**NOTE:** When applicable, special installation instructions are provided for an assembly at the end of the removal procedure. Always completely read the removal instructions and follow all special installation instructions.

### Removal and replacement: Right handle

Learn about removing and replacing the right handle.

## Before performing service

### Turn the printer power off

- Disconnect the power cable.

**⚠ WARNING!** To avoid damage to the printer, turn the printer off, wait 30 seconds, and then remove the power cord before attempting to service the printer.

Use the table below to identify the correct part number for your printer, and then go to <https://parts.hp.com/hpparts> to order the part.

**Table 5-43** Part information

Part number	Part description
RC5-8516-000CN	Handle, right door lower

## Required tools

- #2 Phillips screwdriver with a magnetic tip and a 152 mm (6 in) shaft length

## After performing service

### Turn the printer power on

- Connect the power cable.
- Use the power switch to turn the power on.

## Post service test

No post service test is available for this assembly.

### 1. Remove the right door

Follow these steps to remove the right door.



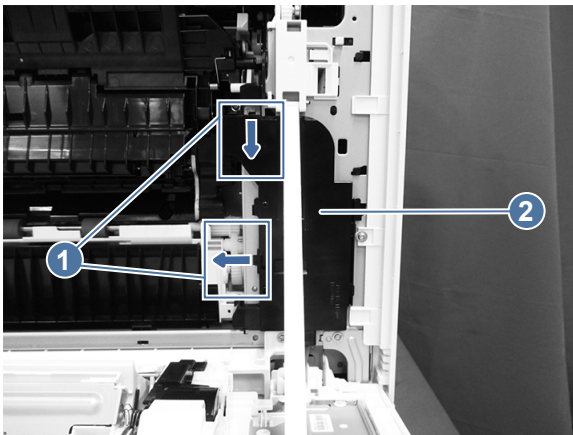
1. Open the right door.

**Figure 5-214** Open the right door



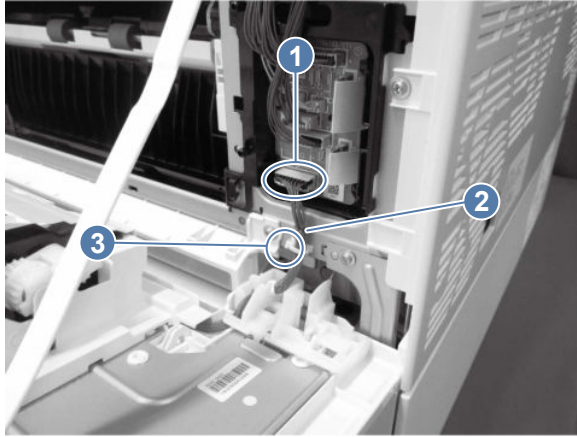
2. Perform one of the following steps.
  - **6700/6800 models:** Open the right door.
  - **X654/X677 models:** Open the right lower door.
3. **6700/6800 models:** Remove the front right cover.
4. Release two tabs (callout 1), and then remove the PCA cover (callout 2).

**Figure 5-215** Remove the PCA cover



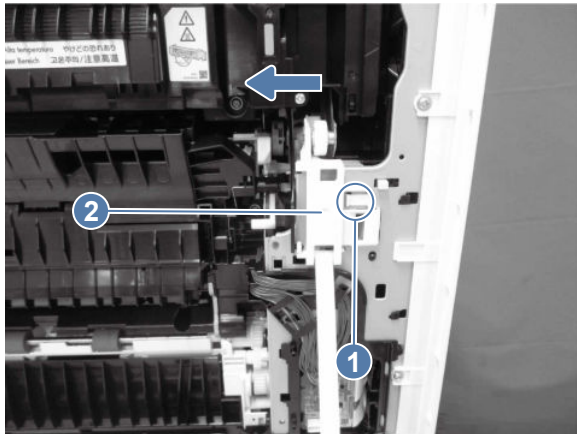
5. Disconnect one connector (callout 1), and then release the cable (callout 2) from the cable clamp (callout 3).

**Figure 5-216 Disconnect one connector**



6. Release one tab (callout 1), slide the link arm (callout 2) in the direction indicated, and then remove it.

**Figure 5-217 Remove the link arm**



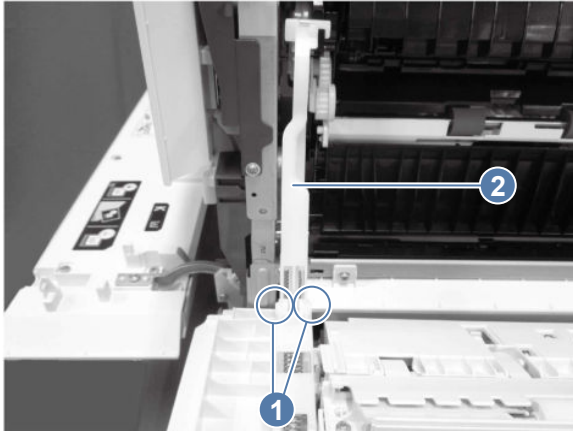
7. Close the front door a little, and then disconnect the joint that connects the two link arms.

**Figure 5-218 Disconnect the link arms**



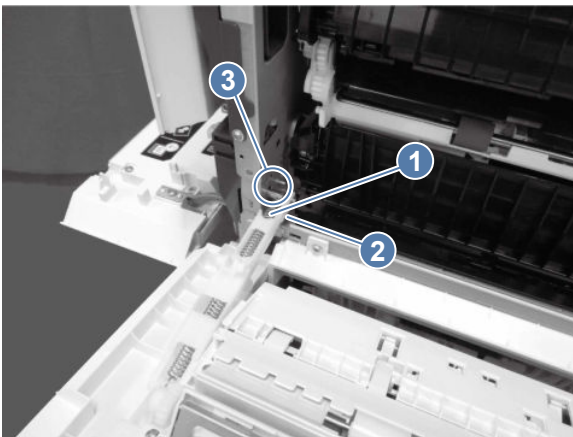
8. Release two bosses (callout 1), and then remove the link arm (callout 2).

**Figure 5-219 Remove the link arm**



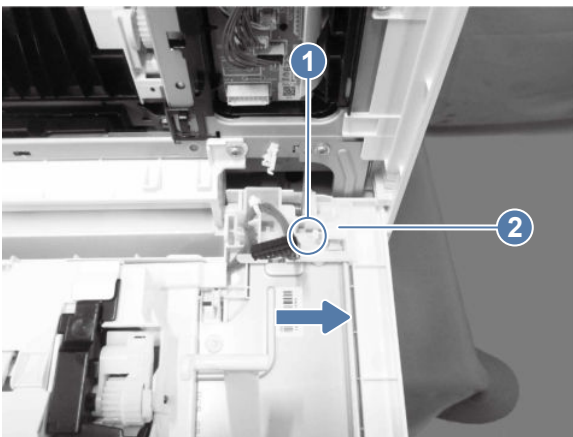
9. Close the front door a little, and then remove the spring (callout 1) from the link arm (callout 2) and from the shaft (callout 3).

**Figure 5-220 Remove the spring**



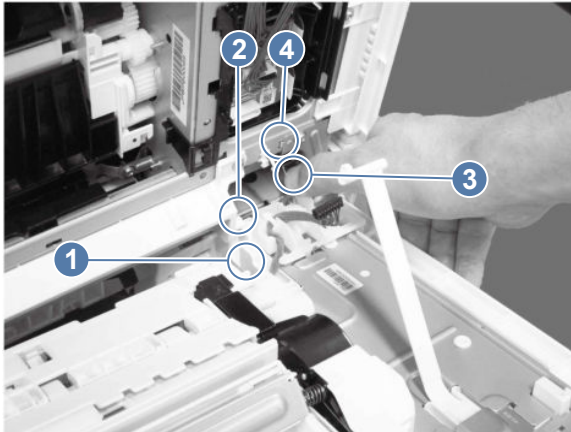
10. Release one tab (callout 1), slide the cable holder (callout 2) in the direction indicated, and then remove it.

**Figure 5-221 Remove the cable holder**



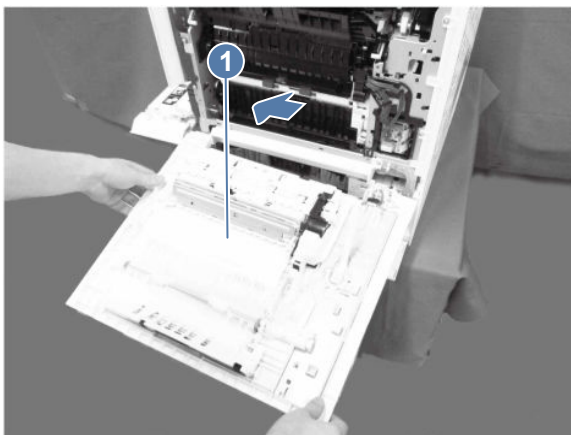
11. Remove the right door (callout 1) from the shaft (callout 2), and then unhook one spring (callout 3) from the frame (callout 4).

**Figure 5-222 Remove the door from the shaft**



12. Slide the right door (callout 1) in the direction indicated to remove it.

**Figure 5-223 Remove the door**

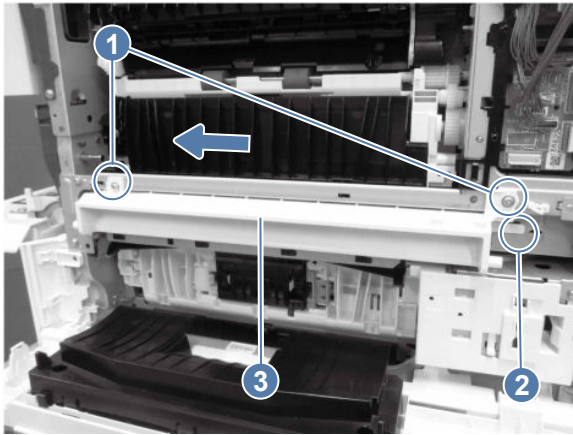


## 2. Remove the right handle

Follow these steps to remove the right handle.

- Remove two screws (callout 1), release one tab (callout 2), and then slide the right handle (callout 3) in the direction indicated to remove it.

Figure 5-224 Remove the handle



### 3. Unpack the replacement assembly

Follow these steps to unpack the replacement assembly.

1. Dispose of the defective part.




**NOTE:** HP recommends responsible disposal of the defective part.

<http://www8.hp.com/us/en/hp-information/environment/product-recycling.html>

2. Unpack the replacement part from the packaging.



**CAUTION:**  Some parts are sensitive to electrostatic discharge (ESD). Always perform service work at an ESD-protected workstation or mat. If an ESD workstation or mat is not available, touch the sheet-metal chassis to provide a static ground before touching an ESD-sensitive assembly. Protect the ESD-sensitive assemblies by placing them in ESD pouches when they are out of the printer.



**IMPORTANT:** Make sure that all of the shipping materials (for example shipping tape) are removed from the replacement part prior to installation.



**NOTE:** If the replacement part is a roller or pad, avoid touching the spongy part of it. Skin oils on the roller or pad can cause paper pickup and/or print-quality problems. HP recommends using disposable gloves when handling rollers or pads or washing your hands before touching rollers or pads.

3. To install an assembly, reverse the removal steps.



**NOTE:** When applicable, special installation instructions are provided for an assembly at the end of the removal procedure. Always completely read the removal instructions and follow all special installation instructions.

### Removal and replacement: Top cover (SFP models)

Learn about removing and replacing the top cover.

#### Before performing service

Turn the printer power off

- Disconnect the power cable.

**⚠ WARNING!** To avoid damage to the printer, turn the printer off, wait 30 seconds, and then remove the power cord before attempting to service the printer.

Use the table below to identify the correct part number for your printer, and then go to <https://parts.hp.com/hpparts> to order the part.

**Table 5-44 Part information**

Part number	Part description
RM2-4517-000CN	Top cover assembly

## Required tools

- Small flat-blade screwdriver
- #2 Phillips screwdriver with a magnetic tip and a 152 mm (6 in) shaft length

## After performing service

### Turn the printer power on

- Connect the power cable.
- Use the power switch to turn the power on.

## Post service test

No post service test is available for this assembly.

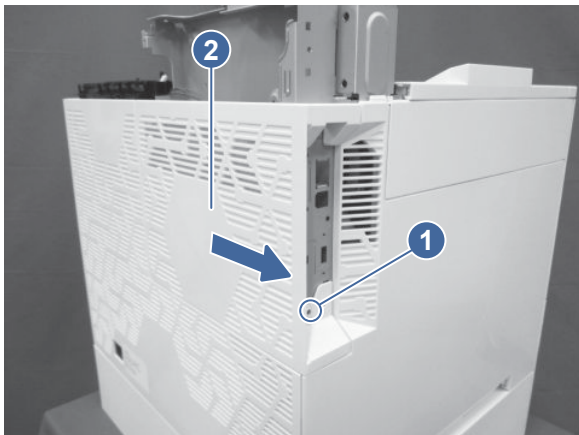
### 1. Remove the formatter cover

Follow these steps to remove the formatter cover.

- Remove one screw (callout 1), and then slide the formatter cover (callout 2) away from the printer to remove it.

**💡 TIP:** Reverse the removal steps to install the assembly.

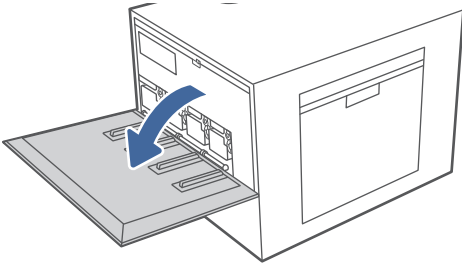
**Figure 5-225 Remove the formatter cover**



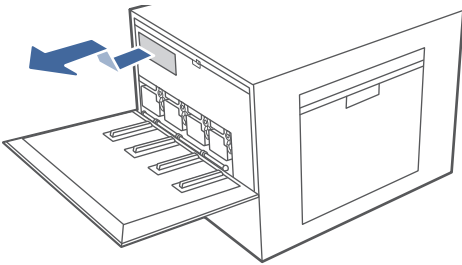
## 2. Remove the toner collection unit (TCU)

Follow these steps to remove the toner collection unit (TCU).


1. Open the front door.



2. Lift the TCU slightly and then pull it out of the printer.



---

 **NOTE:** Maintain the position of the TCU as you pull it out from the printer. This will ensure that you do not spill any waste toner in the printer. Place the unit into the clear plastic bag the new TCU was packaged in.

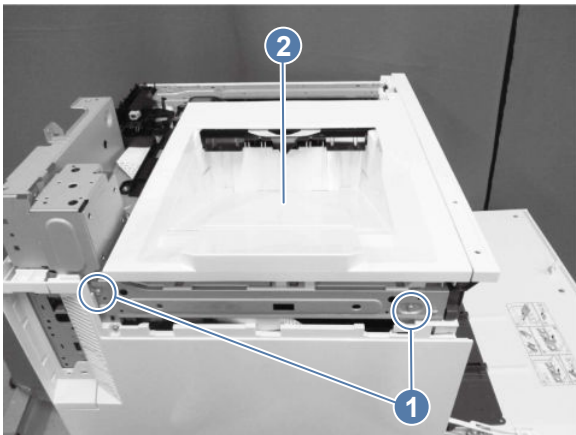
---

## 3. Remove the output bin

Follow these steps to remove the output bin.

- Remove two screws (callout 1), and then slide the output tray (callout 2) towards the front (SFP models) or left (MFP models) to remove it.

**Figure 5-226** Remove the output bin

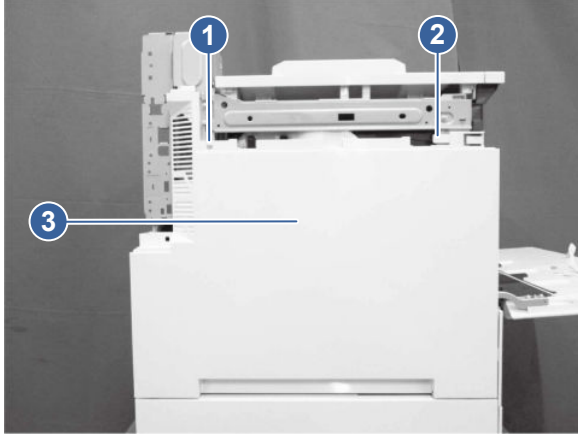


#### 4. Remove the left cover

Follow these steps to remove the left cover.


- At the left side of the printer, remove one screw (callout 1), release one tab (callout 2), and then slide the cover (callout 3) toward the rear of the printer to release it.

**Figure 5-227 Remove the left cover**



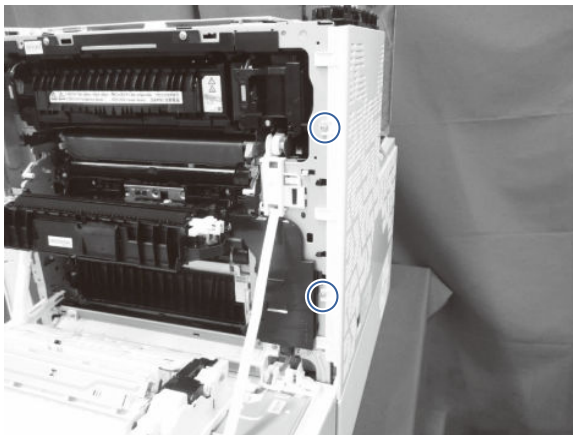
#### 5. Remove the rear cover

Follow these steps to remove the rear cover.

 **NOTE:** The figures below show some assemblies (for example the top cover and formatter) removed that might still be installed on the printer. However, the steps to remove the cover are correct.

1. Open the right door, and remove two screws.

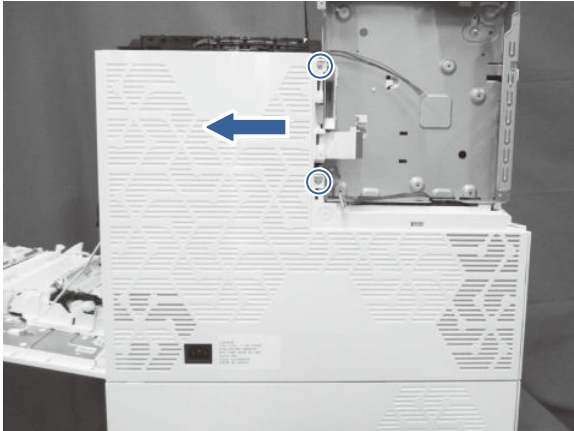
**Figure 5-228 Remove two screws**





2. At the back of the printer, remove two screws, and then slide the rear cover as indicated to remove it.

**Figure 5-229 Remove the rear cover**

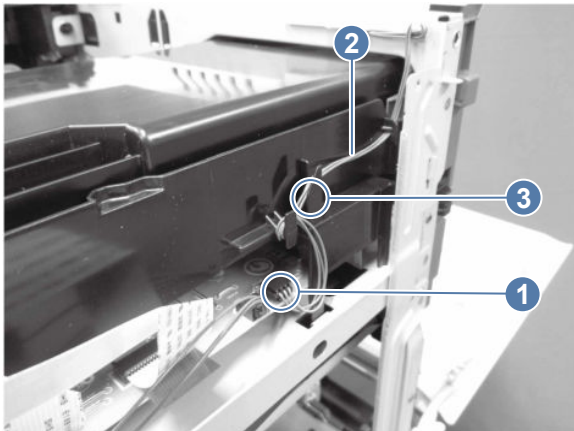


## 6. Remove the top cover (SFP models)

Follow these steps to remove the top cover.

1. Disconnect one connector (callout 1), and then release the cable (callout 2) from the cable guide (callout 3).

**Figure 5-230 Disconnect the connector**



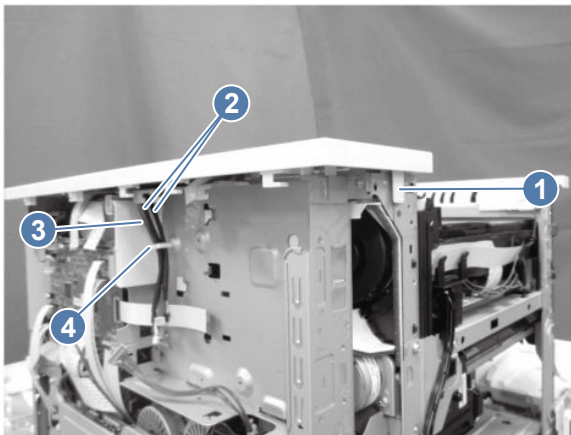
2. Remove two screws.

**Figure 5-231 Remove two screws**



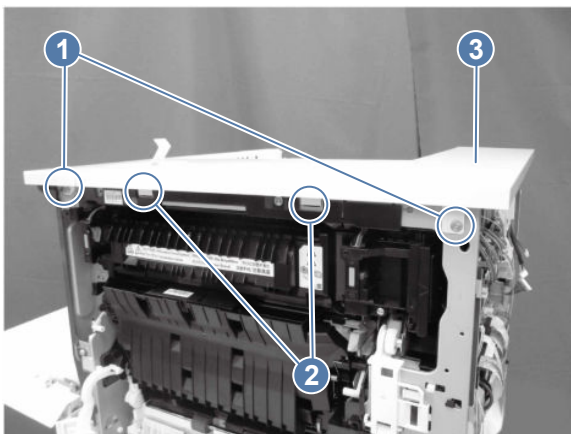
3. Release one tab (callout 1), release two USB cables (callout 2) and another cable (callout 3) from the cable clamp (callout 4).

**Figure 5-232 Release one tab**



4. Remove two screws (callout 1), release two tabs (callout 2), and then remove the top cover (callout 3).


**Figure 5-233 Remove the cover**



## 7. Unpack the replacement assembly



Follow these steps to unpack the replacement assembly.


1. Dispose of the defective part.


 **NOTE:** HP recommends responsible disposal of the defective part.

<http://www8.hp.com/us/en/hp-information/environment/product-recycling.html>


2. Unpack the replacement part from the packaging.

 **CAUTION:**  Some parts are sensitive to electrostatic discharge (ESD). Always perform service work at an ESD-protected workstation or mat. If an ESD workstation or mat is not available, touch the sheet-metal chassis to provide a static ground before touching an ESD-sensitive assembly. Protect the ESD-sensitive assemblies by placing them in ESD pouches when they are out of the printer.

 **IMPORTANT:** Make sure that all of the shipping materials (for example shipping tape) are removed from the replacement part prior to installation.

 **NOTE:** If the replacement part is a roller or pad, avoid touching the spongy part of it. Skin oils on the roller or pad can cause paper pickup and/or print-quality problems. HP recommends using disposable gloves when handling rollers or pads or washing your hands before touching rollers or pads.

3. To install an assembly, reverse the removal steps.

 **NOTE:** When applicable, special installation instructions are provided for an assembly at the end of the removal procedure. Always completely read the removal instructions and follow all special installation instructions.


### Removal and replacement: Top cover (MFP models)

Learn about removing and replacing the top cover.

#### Before performing service

##### Turn the printer power off

- Disconnect the power cable.

 **WARNING!** To avoid damage to the printer, turn the printer off, wait 30 seconds, and then remove the power cord before attempting to service the printer.

Use the table below to identify the correct part number for your printer, and then go to <https://parts.hp.com/hpparts> to order the part.

**Table 5-45** Part information

Part number	Part description
RCS-9172-000CN	Cover, top assembly

#### Required tools

- Small flat-blade screwdriver
- #2 Phillips screwdriver with a magnetic tip and a 152 mm (6 in) shaft length

## After performing service

### Turn the printer power on

- Connect the power cable.
- Use the power switch to turn the power on.

### Post service test

No post service test is available for this assembly.

## 1. Remove the left upper cover (MFP models)

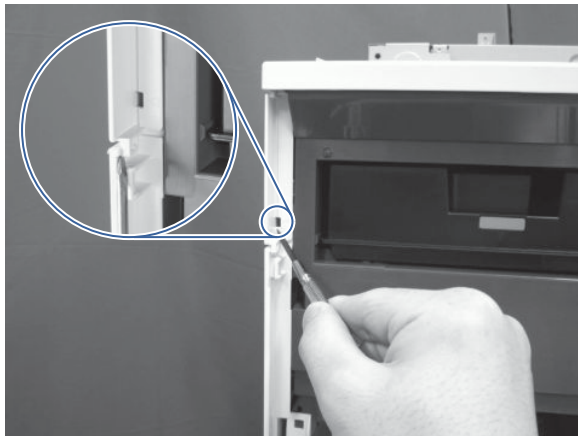
Follow these steps to remove the left upper cover.

1. Open the front door.

**⚠ CAUTION:** If the cover is being removed to gain access to the main drive assembly, make sure that the front door remains open. This keeps the main drive properly aligned.

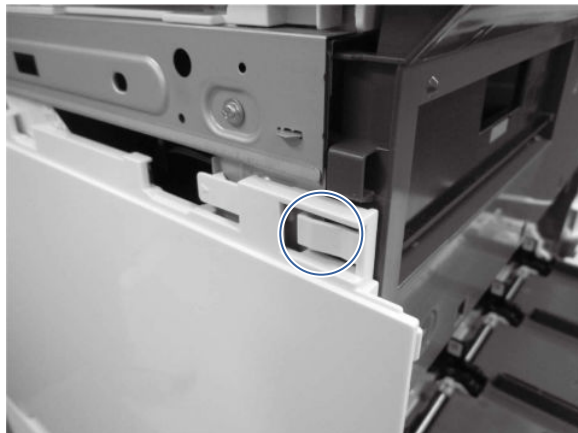
2. At the left side of the printer, insert the small flat-blade screwdriver into the slot to release one tab (callout 1).

**Figure 5-234** Use a screwdriver to release the tab



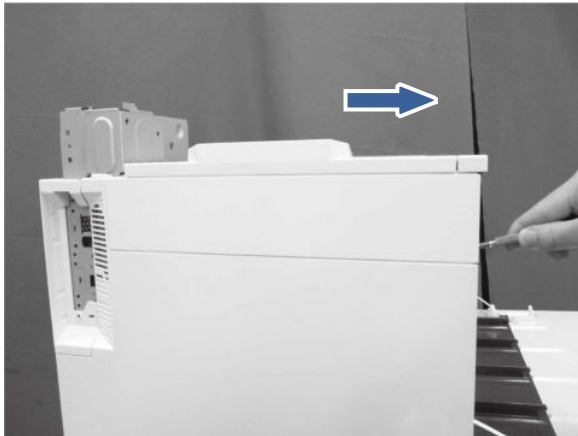
3. Toward the front of the printer, release another tab.

**Figure 5-235** Release the tab



4. Rotate the cover up to remove it.

**Figure 5-236 Remove the left upper cover**

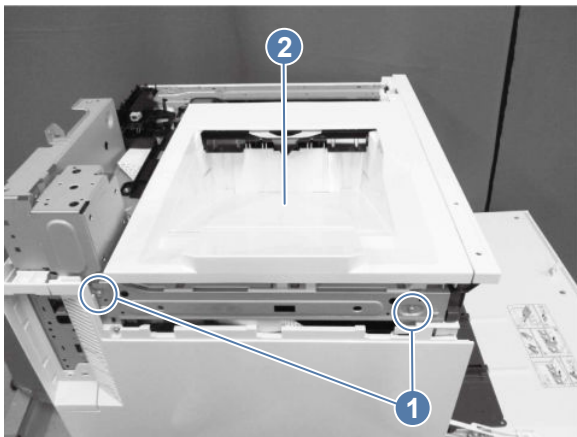


## 2. Remove the output bin

Follow these steps to remove the output bin.

- Remove two screws (callout 1), and then slide the output tray (callout 2) towards the front (SFP models) or left (MFP models) to remove it.

**Figure 5-237 Remove the output bin**

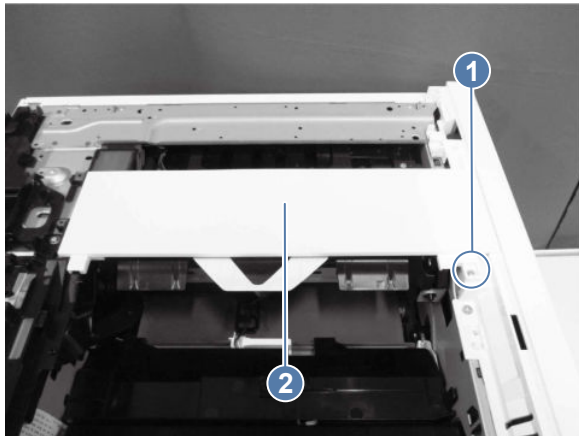


## 3. Remove the top cover (MFP models)

Follow these steps to remove the top cover.

- Remove one screw (callout 1), and then remove the top cover (callout 2).


**Figure 5-238 Remove the top cover**



#### 4. Unpack the replacement assembly



Follow these steps to unpack the replacement assembly.


1. Dispose of the defective part.


 **NOTE:** HP recommends responsible disposal of the defective part.

<http://www8.hp.com/us/en/hp-information/environment/product-recycling.html>


2. Unpack the replacement part from the packaging.

 **CAUTION:**  Some parts are sensitive to electrostatic discharge (ESD). Always perform service work at an ESD-protected workstation or mat. If an ESD workstation or mat is not available, touch the sheet-metal chassis to provide a static ground before touching an ESD-sensitive assembly. Protect the ESD-sensitive assemblies by placing them in ESD pouches when they are out of the printer.

 **IMPORTANT:** Make sure that all of the shipping materials (for example shipping tape) are removed from the replacement part prior to installation.

 **NOTE:** If the replacement part is a roller or pad, avoid touching the spongy part of it. Skin oils on the roller or pad can cause paper pickup and/or print-quality problems. HP recommends using disposable gloves when handling rollers or pads or washing your hands before touching rollers or pads.

3. To install an assembly, reverse the removal steps.

 **NOTE:** When applicable, special installation instructions are provided for an assembly at the end of the removal procedure. Always completely read the removal instructions and follow all special installation instructions.

#### Removal and replacement: Top front cover (MFP models)

Learn about removing and replacing the top front cover.

##### Before performing service

Turn the printer power off

- Disconnect the power cable.

**⚠ WARNING!** To avoid damage to the printer, turn the printer off, wait 30 seconds, and then remove the power cord before attempting to service the printer.

Use the table below to identify the correct part number for your printer, and then go to <https://parts.hp.com/hpparts> to order the part.

**Table 5-46** Part information

Part number	Part description
RM2-4518-000CN	Top front cover assembly

## Required tools

- Small flat-blade screwdriver
- #2 Phillips screwdriver with a magnetic tip and a 152 mm (6 in) shaft length

## After performing service

### Turn the printer power on

- Connect the power cable.
- Use the power switch to turn the power on.

## Post service test

No post service test is available for this assembly.

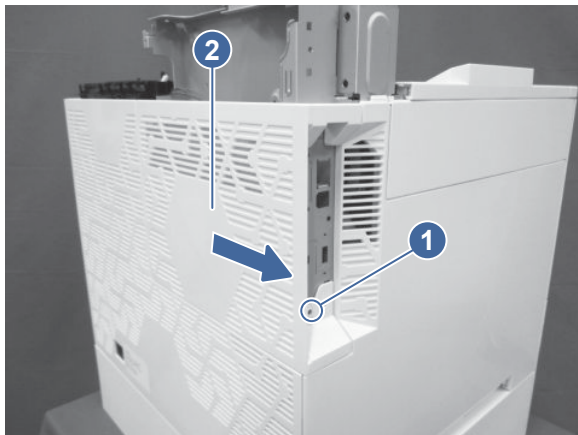
### 1. Remove the formatter cover

Follow these steps to remove the formatter cover.

- Remove one screw (callout 1), and then slide the formatter cover (callout 2) away from the printer to remove it.

**💡 TIP:** Reverse the removal steps to install the assembly.

**Figure 5-239** Remove the formatter cover



## 2. Remove the left upper cover (MFP models)

Follow these steps to remove the left upper cover.

1. Open the front door.

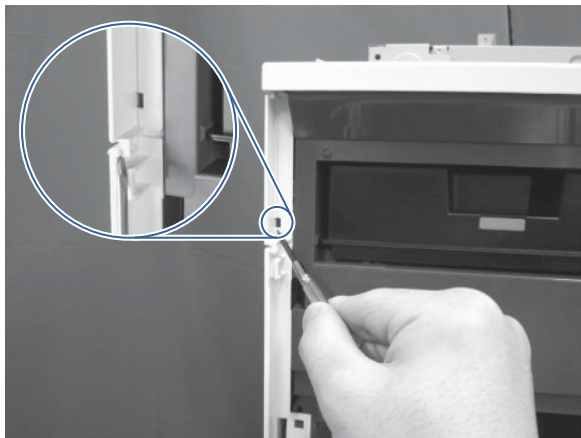
---

**⚠ CAUTION:** If the cover is being removed to gain access to the main drive assembly, make sure that the front door remains open. This keeps the main drive properly aligned.

---

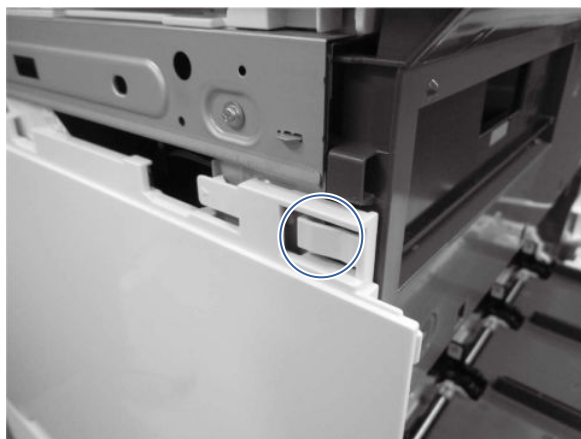
2. At the left side of the printer, insert the small flat-blade screwdriver into the slot to release one tab (callout 1).

**Figure 5-240 Use a screwdriver to release the tab**



3. Toward the front of the printer, release another tab.

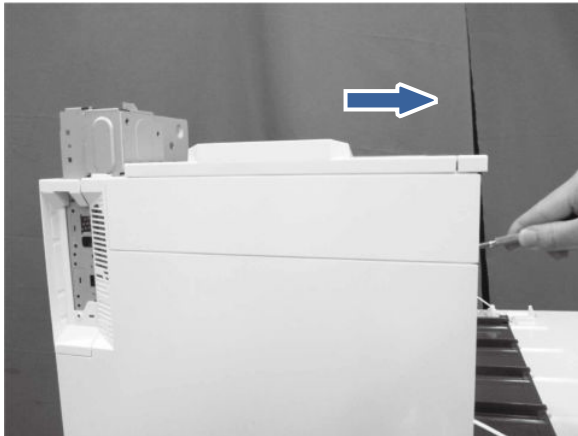
**Figure 5-241 Release the tab**





4. Rotate the cover up to remove it.

**Figure 5-242 Remove the left upper cover**

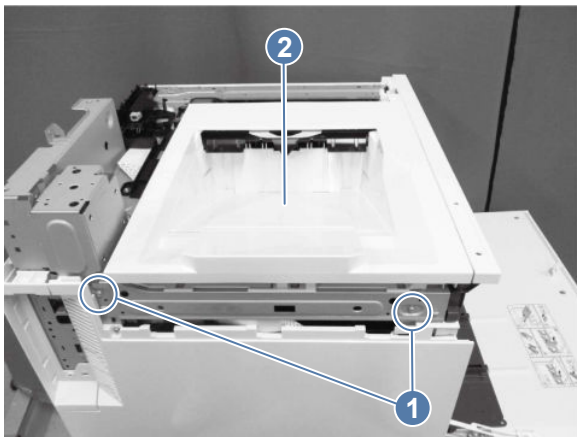


### 3. Remove the output bin

Follow these steps to remove the output bin.

- Remove two screws (callout 1), and then slide the output tray (callout 2) towards the front (SFP models) or left (MFP models) to remove it.

**Figure 5-243 Remove the output bin**

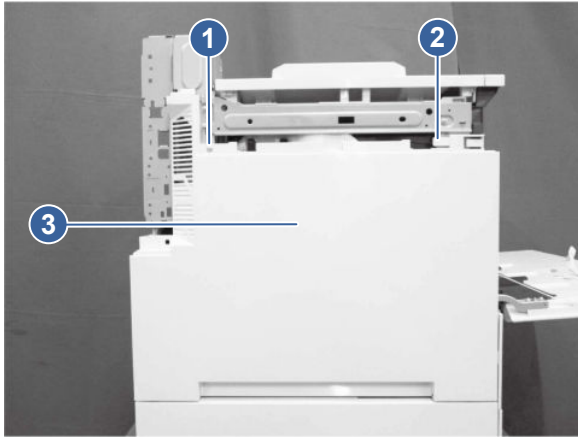


### 4. Remove the left cover

Follow these steps to remove the left cover.

- At the left side of the printer, remove one screw (callout 1), release one tab (callout 2), and then slide the cover (callout 3) toward the rear of the printer to release it.

**Figure 5-244 Remove the left cover**

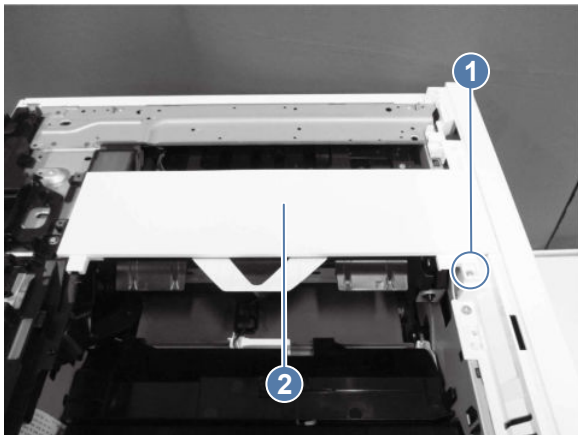


#### 5. Remove the top cover (MFP models)

Follow these steps to remove the top cover.

- Remove one screw (callout 1), and then remove the top cover (callout 2).

**Figure 5-245 Remove the top cover**

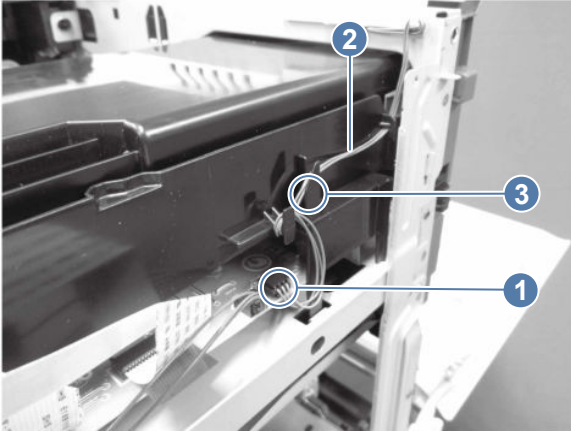


#### 6. Remove the top front cover (MFP models)

Follow these steps to remove the top front cover.

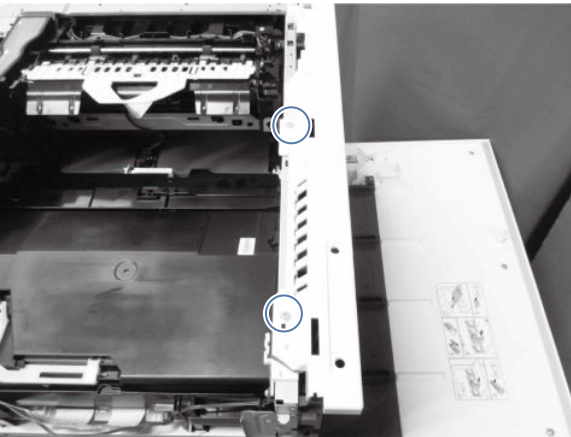
1. Disconnect one connector (callout 1), and then release the cable (callout 2) from the cable guide (callout 3).

**Figure 5-246** Disconnect one connector and release the cable



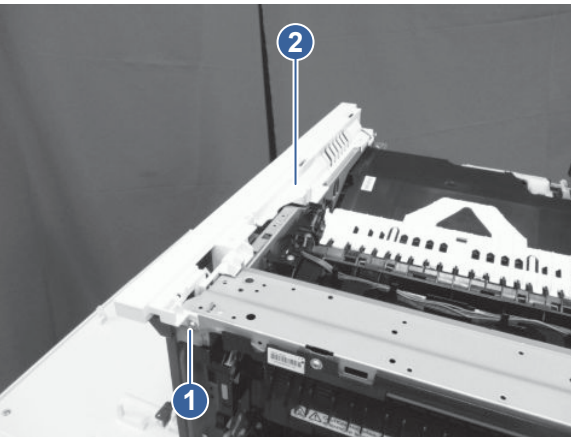
2. Remove two screws.

**Figure 5-247** Remove two screws



3. Remove one screw (callout 1), hold up the top front cover (callout 2), and then remove it.


**Figure 5-248** Remove the top front cover



## 7. Unpack the replacement assembly



Follow these steps to unpack the replacement assembly.


1. Dispose of the defective part.


 **NOTE:** HP recommends responsible disposal of the defective part.

<http://www8.hp.com/us/en/hp-information/environment/product-recycling.html>


2. Unpack the replacement part from the packaging.

 **CAUTION:**  Some parts are sensitive to electrostatic discharge (ESD). Always perform service work at an ESD-protected workstation or mat. If an ESD workstation or mat is not available, touch the sheet-metal chassis to provide a static ground before touching an ESD-sensitive assembly. Protect the ESD-sensitive assemblies by placing them in ESD pouches when they are out of the printer.

 **IMPORTANT:** Make sure that all of the shipping materials (for example shipping tape) are removed from the replacement part prior to installation.

 **NOTE:** If the replacement part is a roller or pad, avoid touching the spongy part of it. Skin oils on the roller or pad can cause paper pickup and/or print-quality problems. HP recommends using disposable gloves when handling rollers or pads or washing your hands before touching rollers or pads.

3. To install an assembly, reverse the removal steps.

 **NOTE:** When applicable, special installation instructions are provided for an assembly at the end of the removal procedure. Always completely read the removal instructions and follow all special installation instructions.


### Removal and replacement: Hardware Integration Pocket (HIP) cover

Learn about removing and replacing the Hardware Integration Pocket (HIP) cover.

#### Before performing service

##### Turn the printer power off

- Disconnect the power cable.

 **WARNING!** To avoid damage to the printer, turn the printer off, wait 30 seconds, and then remove the power cord before attempting to service the printer.

Use the table below to identify the correct part number for your printer, and then go to <https://parts.hp.com/hpparts> to order the part.

Table 5-47 Part information

Part number	Part description
RC4-0213-000CN	Cover, Hardware integration pocket (HIP)

#### Required tools

- Small flat-blade screwdriver

#### After performing service

### Turn the printer power on

- Connect the power cable.
- Use the power switch to turn the power on.

### Post service test

No post service test is available for this assembly.

#### 1. Remove the HIP cover

Follow these steps to remove the HIP cover.

1. Use a small flat-blade screwdriver to release the tabs on the HIP cover.

**Figure 5-249** Release the cover



2. Rotate the cover up and off of the printer to remove it.

**Figure 5-250** Remove the cover



#### 2. Unpack the replacement assembly



Follow these steps to unpack the replacement assembly.


1. Dispose of the defective part.


---

 **NOTE:** HP recommends responsible disposal of the defective part.


2. Unpack the replacement part from the packaging.

 **CAUTION:**  Some parts are sensitive to electrostatic discharge (ESD). Always perform service work at an ESD-protected workstation or mat. If an ESD workstation or mat is not available, touch the sheet-metal chassis to provide a static ground before touching an ESD-sensitive assembly. Protect the ESD-sensitive assemblies by placing them in ESD pouches when they are out of the printer.

 **IMPORTANT:** Make sure that all of the shipping materials (for example shipping tape) are removed from the replacement part prior to installation.

 **NOTE:** If the replacement part is a roller or pad, avoid touching the spongy part of it. Skin oils on the roller or pad can cause paper pickup and/or print-quality problems. HP recommends using disposable gloves when handling rollers or pads or washing your hands before touching rollers or pads.

3. To install an assembly, reverse the removal steps.

 **NOTE:** When applicable, special installation instructions are provided for an assembly at the end of the removal procedure. Always completely read the removal instructions and follow all special installation instructions.


### Removal and replacement: Control panel (SFP models)

Learn about removing and replacing the control panel.

#### Before performing service

##### Turn the printer power off

- Disconnect the power cable.

 **WARNING!** To avoid damage to the printer, turn the printer off, wait 30 seconds, and then remove the power cord before attempting to service the printer.

Use the table below to identify the correct part number for your printer, and then go to <https://parts.hp.com/hpparts> to order the part.

**Table 5-48** Part information

Part number	Part description
6QN28-67001	Control panel 10.9 cm (4.3 in)

#### Required tools

- #2 Phillips screwdriver with a magnetic tip and a 152 mm (6 in) shaft length

#### After performing service

##### Turn the printer power on

- Connect the power cable.
- Use the power switch to turn the power on.

## Post service test

No post service test is available for this assembly.

### 1. Remove the control panel (SFP)

Follow these steps to remove the control panel.

1. Tilt the control panel up.

**Figure 5-251** Remove one screw



2. Pull up the control panel cover. A small flat blade screwdriver might be helpful with this.

**Figure 5-252** Remove the control panel cover



3. Remove one screw.

**Figure 5-253 Remove one screw**



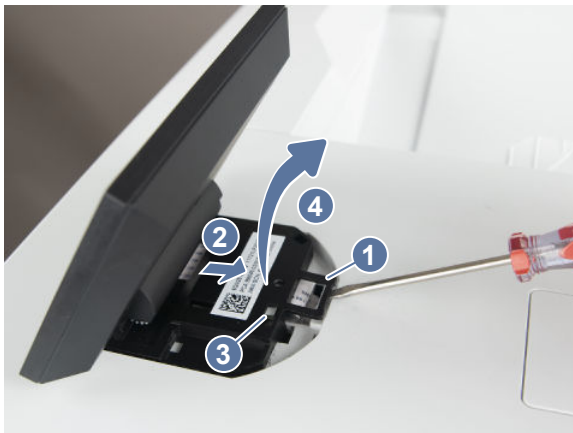
4. Use a small flat blade screwdriver to pry and hold one tab (callout 1), push the assembly (callout 2) to the rear of the printer to release another tab (callout 3), and then lift the control panel up (callout 4), slightly and gently.

---

**⚠ CAUTION:** The control panel is still attached to the printer. Do not attempt to completely remove the control panel.

---

**Figure 5-254 Release the tabs**





5. Disconnect one FFC, and then remove the control panel.

**Figure 5-255 Remove the control panel**




## 2. Unpack the replacement assembly

Follow these steps to unpack the replacement assembly.

1. Dispose of the defective part.

---



 **NOTE:** HP recommends responsible disposal of the defective part.


<http://www8.hp.com/us/en/hp-information/environment/product-recycling.html>


---

2. Unpack the replacement part from the packaging.

---

 **CAUTION:**  Some parts are sensitive to electrostatic discharge (ESD). Always perform service work at an ESD-protected workstation or mat. If an ESD workstation or mat is not available, touch the sheet-metal chassis to provide a static ground before touching an ESD-sensitive assembly. Protect the ESD-sensitive assemblies by placing them in ESD pouches when they are out of the printer.


 **IMPORTANT:** Make sure that all of the shipping materials (for example shipping tape) are removed from the replacement part prior to installation.

 **NOTE:** If the replacement part is a roller or pad, avoid touching the spongy part of it. Skin oils on the roller or pad can cause paper pickup and/or print-quality problems. HP recommends using disposable gloves when handling rollers or pads or washing your hands before touching rollers or pads.

---

3. To install an assembly, reverse the removal steps.

---

 **NOTE:** When applicable, special installation instructions are provided for an assembly at the end of the removal procedure. Always completely read the removal instructions and follow all special installation instructions.

---

## Removal and replacement: Control panel (MFP models)

Learn about removing and replacing the control panel.

 [View a video demonstration of removing and replacing the control panel.](#)

### Before performing service

**Turn the printer power off**

- Disconnect the power cable.

**⚠ WARNING!** To avoid damage to the printer, turn the printer off, wait 30 seconds, and then remove the power cord before attempting to service the printer.

Use the table below to identify the correct part number for your printer, and then go to <https://parts.hp.com/hpparts> to order the part.

**Table 5-49 Part information**

Part number	Part description
6QN37-67001	Control panel 23.3 cm (8 in)
6QN35-67003	Control panel 25.6 cm (10.1 in)

## Required tools

- #2 Phillips screwdriver with a magnetic tip and a 152 mm (6 in) shaft length

## After performing service

### Turn the printer power on

- Connect the power cable.
- Use the power switch to turn the power on.

## Post service test

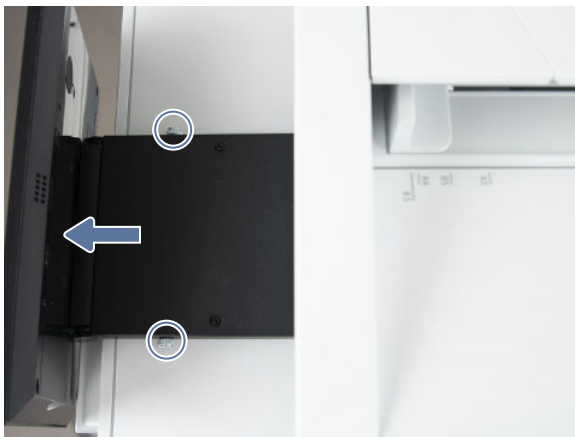
No post service test is available for this assembly.

### 1. Remove the control panel (MFP)

Follow these steps to remove the control panel.

- Pull the control panel out and tilt it up, and then remove the two thumbscrews on the control panel arm. Remove the control panel by pulling it away from the printer.

**Figure 5-256 Remove two thumbscrews**




### 2. Unpack the replacement assembly

Follow these steps to unpack the replacement assembly.

1. Dispose of the defective part.

---



 **NOTE:** HP recommends responsible disposal of the defective part.


<http://www8.hp.com/us/en/hp-information/environment/product-recycling.html>


---

2. Unpack the replacement part from the packaging.

---

 **CAUTION:**  Some parts are sensitive to electrostatic discharge (ESD). Always perform service work at an ESD-protected workstation or mat. If an ESD workstation or mat is not available, touch the sheet-metal chassis to provide a static ground before touching an ESD-sensitive assembly. Protect the ESD-sensitive assemblies by placing them in ESD pouches when they are out of the printer.


 **IMPORTANT:** Make sure that all of the shipping materials (for example shipping tape) are removed from the replacement part prior to installation.

 **NOTE:** If the replacement part is a roller or pad, avoid touching the spongy part of it. Skin oils on the roller or pad can cause paper pickup and/or print-quality problems. HP recommends using disposable gloves when handling rollers or pads or washing your hands before touching rollers or pads.

---

3. To install an assembly, reverse the removal steps.

---

 **NOTE:** When applicable, special installation instructions are provided for an assembly at the end of the removal procedure. Always completely read the removal instructions and follow all special installation instructions.

---

## Internal parts and assemblies

Learn how to remove and replace the printer internal parts and assemblies.

### Removal and replacement: Toner cartridges (manual unlock) (X654/X677 models)

Learn how to manually unlock the toner cartridges so that they can be removed to service other assemblies.

---

 **NOTE:** This procedure describes manually unlocking the cartridges when the printer is not functioning.


To remove the cartridges by using the control-panel ejection method when the printer is operational, see the CSR instructions.

---

 [View a video of removing and replacing the toner cartridges \(manual unlock\).](#)

### Before performing service

---

 **CAUTION:** To prevent damage to a toner cartridge, do not expose it to light for more than a few minutes. Cover the imaging drum if the toner cartridge must be removed from the printer for an extended period of time.

If toner gets on the skin or clothing, wipe it off with dry tissue paper and wash in cold water. Hot water sets toner and it might be difficult, or impossible, to remove.

---

### Required tools

- Tool with a  $\leq 3\text{mm}$  point and  $< 120\text{mm}$  length

### After performing service

- No post service test is available for this assembly.

## Post service test

Print any pages necessary to make sure the printer is functioning correctly.

### 1. Remove Tray 2

Follow these steps to remove Tray 2.

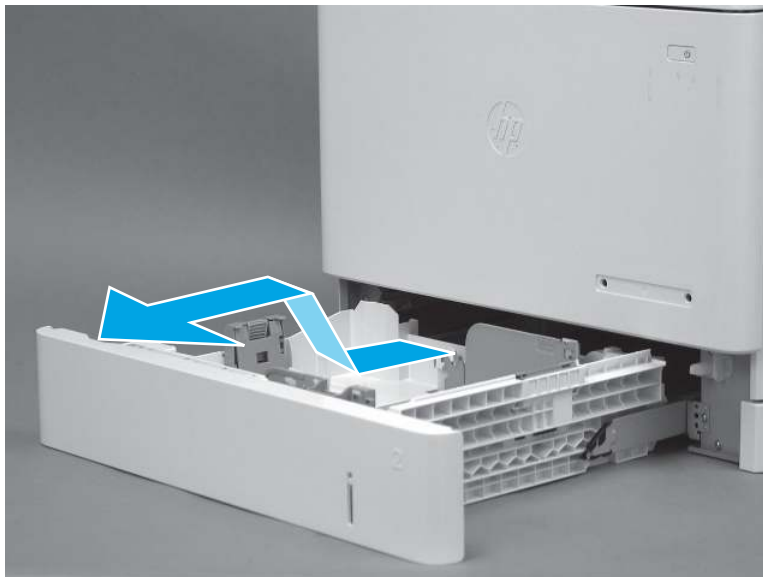
1. Pull the tray out until it stops.

**Figure 5-257 Pull the tray out**



2. Lift the front of the tray, and then pull it out of the printer to remove it.

**Figure 5-258 Remove the tray**

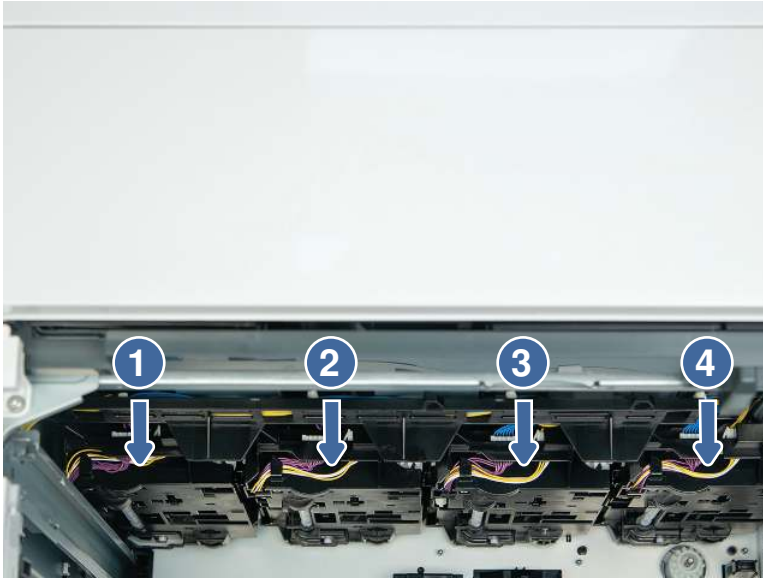


## 2. Manually unlock the toner cartridges (X654/X677 models)

Follow these steps to manually unlock the toner cartridges.

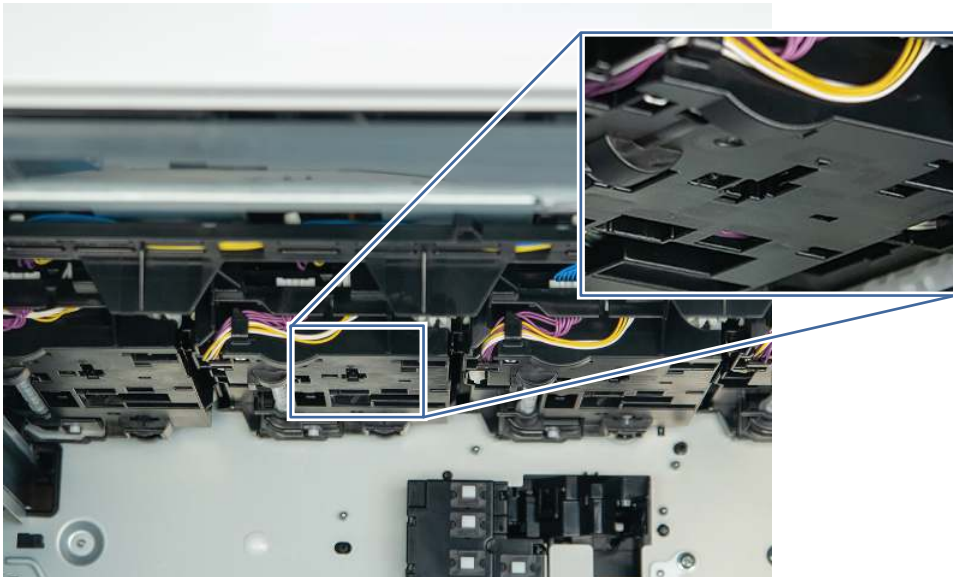
1. Locate the four toner cartridge drive units inside the Tray 2 cavity.

**Figure 5-259** Locate the drive units




2. Locate the cartridge lock mechanism on one of the drive units.

**Figure 5-260** Cartridge lock mechanism



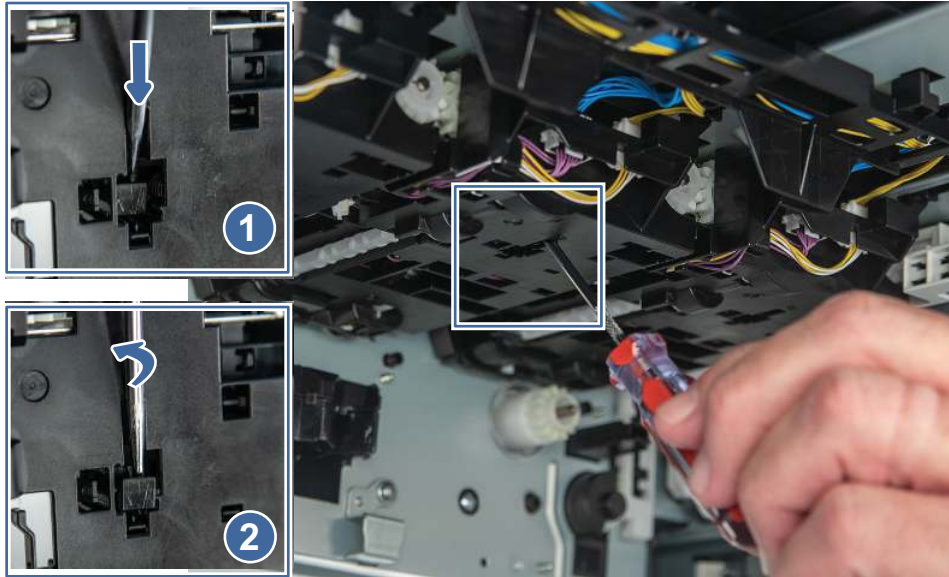
3. Open the cartridge door. Use a tool with a less-than 3mm tip (and less than 120mm in length) to release the lock mechanism.
  - a. Place the tip of the tool in the opening and under the lock mechanism (callout 1)

- b. Rotate the tool to release the lock mechanism (callout 2).

 **NOTE:** When the lock mechanism is released, the corresponding toner cartridge extends out of the printer.

- c. Repeat these steps for each drive unit.

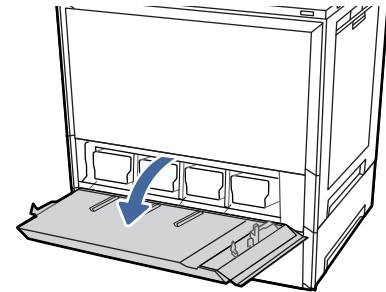
**Figure 5-261** Release the lock mechanism



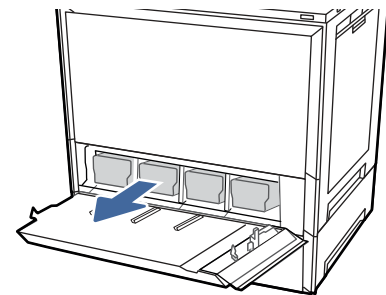
### 3. Remove the toner cartridges (X654/X677 models)

Follow these steps to remove a toner cartridges.

- 1. If the toner cartridge door is not open, open it now.



- 2. Grasp the end of the toner cartridge and pull it straight out of the printer.



## Removal and replacement: Secondary transfer assembly

Learn about removing and replacing the secondary transfer assembly.

### Before performing service

#### Turn the printer power off

- Disconnect the power cable.

**⚠ WARNING!** To avoid damage to the printer, turn the printer off, wait 30 seconds, and then remove the power cord before attempting to service the printer.

Use the table below to identify the correct part number for your printer, and then go to <https://parts.hp.com/hpparts> to order the part.

**Table 5-50** Part information

Part number	Part description
RM2-3586-000CN	Secondary transfer assembly (5700/6700)
RM2-3628-000CN	Secondary transfer assembly (5800/6800/X557/X57945)
RM2-3629-000CN	Secondary transfer assembly (X654/X677)

### Required tools

- No special tools are required to remove or install this assembly.

### After performing service

#### Turn the printer power on

- Connect the power cable.
- Use the power switch to turn the power on.

### Post service test

Print any pages necessary to make sure the printer is functioning correctly.

## 1. Remove the secondary transfer assembly

Follow these steps to remove the secondary transfer assembly.

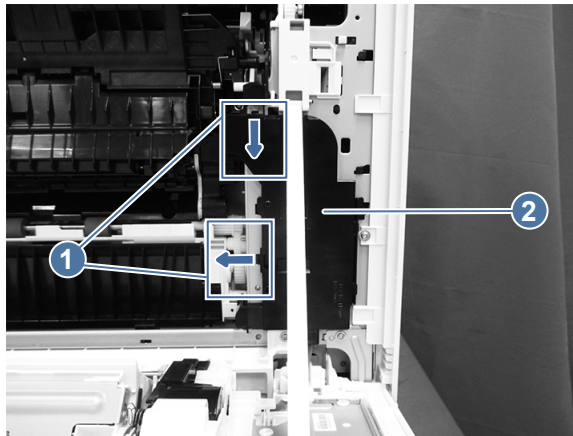
1. Open the right door.

**Figure 5-262 Open the right door**




2. Release two tabs (callout 1), and then remove the PCA cover (callout 2).

**Figure 5-263 Remove the PCA cover**



3. Disconnect one connector (callout 1), and then release the cable (callout 2) from the cable guide (callout 3).

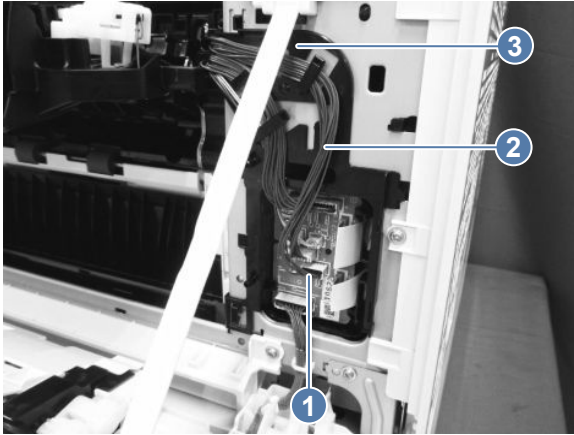
---

 **Reinstallation tip:** When reinstalled, make sure the cable is correctly routed through the cable guide.

---

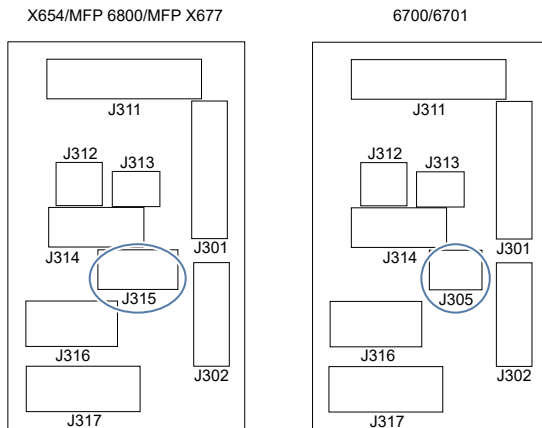


**Figure 5-264 Release the cable**



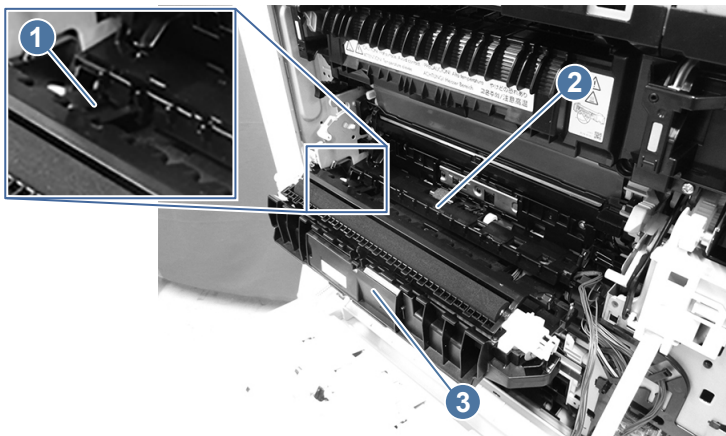
4. Perform one of the following steps.
  - **X654/6800/X677 models:** Disconnect the J315 formatter connector.
  - **6700 models:** Disconnect the J305 formatter connector.

**Figure 5-265 Disconnect a formatter connector**




5. Release one tab (callout 1), and then lift up the registration assembly (callout 2) off the secondary transfer assembly (callout 3)

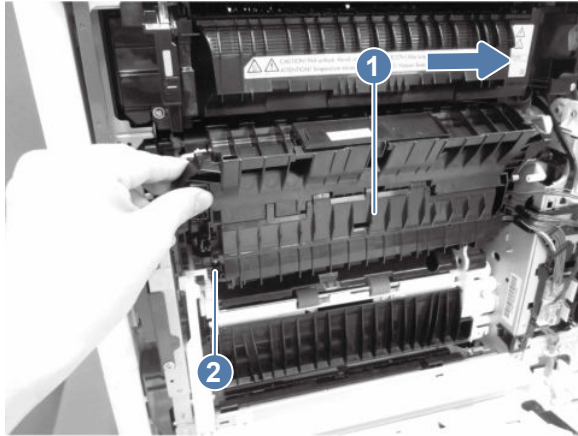
**Figure 5-266 Release the tab**




6. Close the secondary transfer assembly until it is only slightly open. Slide the assembly (callout 1) in the direction indicated below, and then dislodge the hinge pin (callout 2) from the holder to remove the assembly.

 **Reinstallation tip:** Before removing the assembly, take note of where the assembly hinge pins fit into the holes provided in the printer.

**Figure 5-267 Remove the secondary transfer assembly**




 **Reinstallation tip:** On the assembly right side, make sure that the wire is nested in the plastic sleeve. Slide the wire sleeve into its place, depressing the spring, and then twist the left side of the assembly into place and allow the spring pressure to nest the hinge pin in its hole.

## 2. Unpack the replacement assembly



Follow these steps to unpack the replacement assembly.


1. Dispose of the defective part.


 **NOTE:** HP recommends responsible disposal of the defective part.

<http://www8.hp.com/us/en/hp-information/environment/product-recycling.html>

2. Unpack the replacement part from the packaging.

 **CAUTION:**  Some parts are sensitive to electrostatic discharge (ESD). Always perform service work at an ESD-protected workstation or mat. If an ESD workstation or mat is not available, touch the sheet-metal chassis to provide a static ground before touching an ESD-sensitive assembly. Protect the ESD-sensitive assemblies by placing them in ESD pouches when they are out of the printer.

 **IMPORTANT:** Make sure that all of the shipping materials (for example shipping tape) are removed from the replacement part prior to installation.

 **NOTE:** If the replacement part is a roller or pad, avoid touching the spongy part of it. Skin oils on the roller or pad can cause paper pickup and/or print-quality problems. HP recommends using disposable gloves when handling rollers or pads or washing your hands before touching rollers or pads.

3. To install an assembly, reverse the removal steps.



**NOTE:** When applicable, special installation instructions are provided for an assembly at the end of the removal procedure. Always completely read the removal instructions and follow all special installation instructions.

## Removal and replacement: Registration density sensor assembly

Learn about removing and replacing the registration density sensor assembly.

### Before performing service

#### Turn the printer power off

- Disconnect the power cable.

**⚠ WARNING!** To avoid damage to the printer, turn the printer off, wait 30 seconds, and then remove the power cord before attempting to service the printer.

Use the table below to identify the correct part number for your printer, and then go to <https://parts.hp.com/hpparts> to order the part.

**Table 5-51** Part information

Part number	Part description
RM2-4492-000CN	Density detect assembly

### Required tools

- #2 Phillips screwdriver with a magnetic tip and a 152 mm (6 in) shaft length

### After performing service

#### Turn the printer power on

- Connect the power cable.
- Use the power switch to turn the power on.

### Post service test

Print any pages necessary to make sure the printer is functioning correctly.

## 1. Remove the ITB

Follow these steps to remove the ITB.

1. Open the right door.

**Figure 5-268** Open the right door



2. Hold the two side levers and pull out the ITB assembly.

**CAUTION:** Do not touch the gray plastic belt. Skin oils and fingerprints on the belt can cause print-quality problems.

**Figure 5-269** Release the ITB



## 2. Remove the secondary transfer assembly

Follow these steps to remove the secondary transfer assembly.

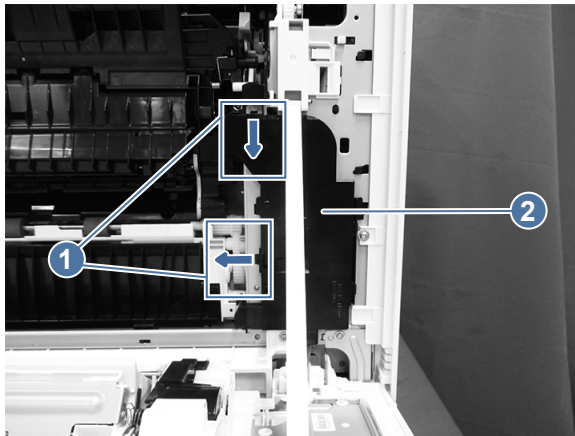
1. Open the right door.

**Figure 5-270 Open the right door**




2. Release two tabs (callout 1), and then remove the PCA cover (callout 2).

**Figure 5-271 Remove the PCA cover**



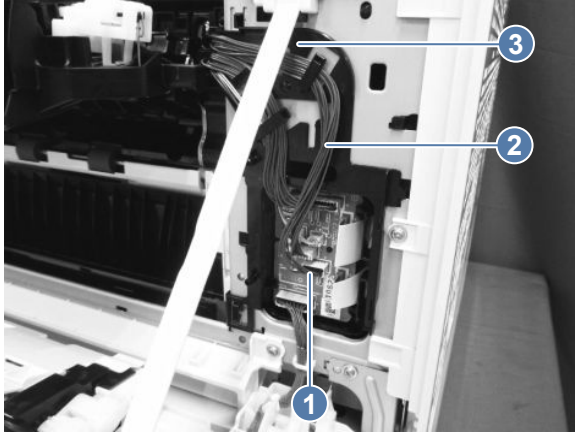
3. Disconnect one connector (callout 1), and then release the cable (callout 2) from the cable guide (callout 3).

---

 **Reinstallation tip:** When reinstalled, make sure the cable is correctly routed through the cable guide.

---

**Figure 5-272 Release the cable**



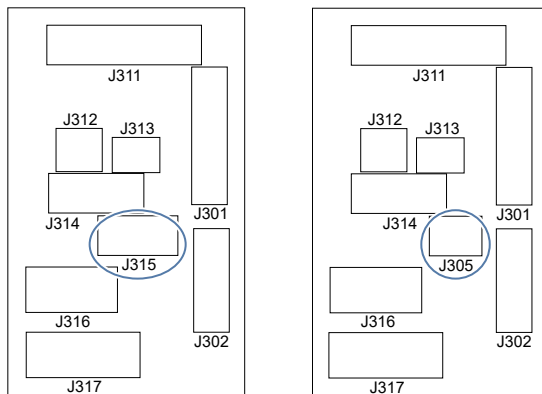
4. Perform one of the following steps.

- **X654/6800/X677 models:** Disconnect the J315 formatter connector.
- **6700 models:** Disconnect the J305 formatter connector.

**Figure 5-273 Disconnect a formatter connector**

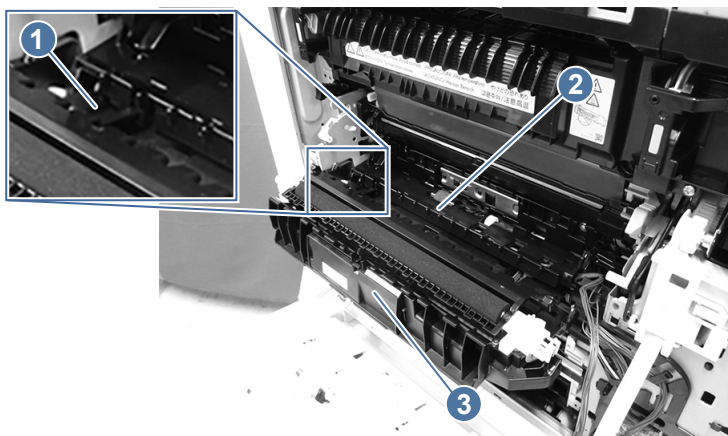
X654/MFP 6800/MFP X677

6700/6701




5. Release one tab (callout 1), and then lift up the registration assembly (callout 2) off the secondary transfer assembly (callout 3)

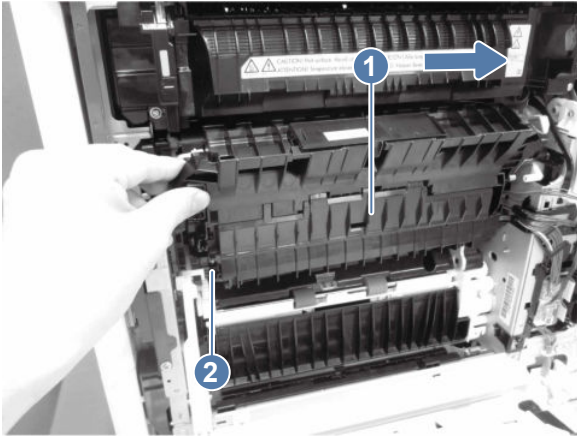
**Figure 5-274 Release the tab**




6. Close the secondary transfer assembly until it is only slightly open. Slide the assembly (callout 1) in the direction indicated below, and then dislodge the hinge pin (callout 2) from the holder to remove the assembly.

 **Reinstallation tip:** Before removing the assembly, take note of where the assembly hinge pins fit into the holes provided in the printer.

**Figure 5-275** Remove the secondary transfer assembly



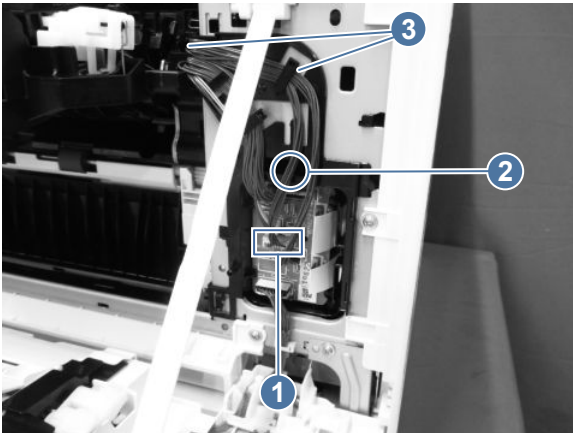
 **Reinstallation tip:** On the assembly right side, make sure that the wire is nested in the plastic sleeve. Slide the wire sleeve into its place, depressing the spring, and then twist the left side of the assembly into place and allow the spring pressure to nest the hinge pin in its hole.

### 3. Remove the registration density sensor


Follow these steps to remove the registration density sensor.

1. Disconnect one connector (J314; callout 1), and then release the cable (callout 2) from the cable guides (callout 3).

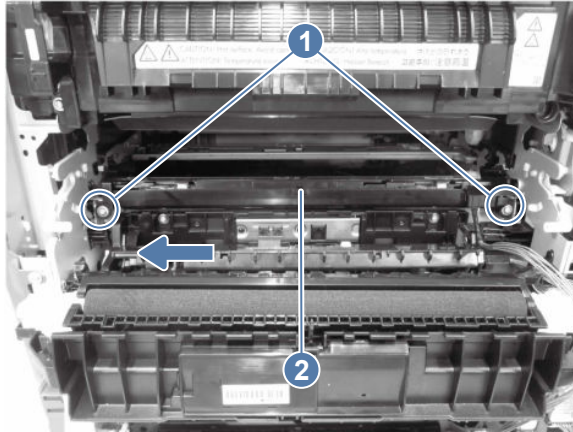
**Figure 5-276** Disconnect one connector



2. Remove two screws (callout 1). Pull out the registration density sensor assembly (callout 2) slightly towards you, and then move the registration density sensor assembly in the direction indicated below. Carefully pull out the right side first to remove the registration density sensor assembly.

 **NOTE:** The shaft on the left side of the assembly is long and can break. Make sure to pivot the right side of the assembly out first to ensure that the shaft does not break. When installing a registration density sensor assembly, insert the shaft on the left side first, and then pivot the right side into the printer.

**Figure 5-277 Release the assembly**



#### 4. Unpack the replacement assembly



Follow these steps to unpack the replacement assembly.


1. Dispose of the defective part.


 **NOTE:** HP recommends responsible disposal of the defective part.

<http://www8.hp.com/us/en/hp-information/environment/product-recycling.html>


2. Unpack the replacement part from the packaging.

 **CAUTION:**  Some parts are sensitive to electrostatic discharge (ESD). Always perform service work at an ESD-protected workstation or mat. If an ESD workstation or mat is not available, touch the sheet-metal chassis to provide a static ground before touching an ESD-sensitive assembly. Protect the ESD-sensitive assemblies by placing them in ESD pouches when they are out of the printer.

 **IMPORTANT:** Make sure that all of the shipping materials (for example shipping tape) are removed from the replacement part prior to installation.

 **NOTE:** If the replacement part is a roller or pad, avoid touching the spongy part of it. Skin oils on the roller or pad can cause paper pickup and/or print-quality problems. HP recommends using disposable gloves when handling rollers or pads or washing your hands before touching rollers or pads.

3. To install an assembly, reverse the removal steps.

 **NOTE:** When applicable, special installation instructions are provided for an assembly at the end of the removal procedure. Always completely read the removal instructions and follow all special installation instructions.



## Removal and replacement: Registration assembly

Learn about removing and replacing the registration assembly.

### Before performing service

#### Turn the printer power off

- Disconnect the power cable.

**⚠ WARNING!** To avoid damage to the printer, turn the printer off, wait 30 seconds, and then remove the power cord before attempting to service the printer.

If the part is damaged and cannot be cleaned, use the table below to identify the correct part number for your printer. To order the part, go to [www.hp.com/buy/parts](http://www.hp.com/buy/parts).

**Table 5-52** Part information

Part number	Part description
RM2-4458-000CN	Registration assembly

### Required tools

- #2 Phillips screwdriver with a magnetic tip and a 152 mm (6 in) shaft length

### After performing service

#### Turn the printer power on

- Connect the power cable.
- Use the power switch to turn the power on.

### Post service test

Print any pages necessary to make sure the printer is functioning correctly.

#### 1. Remove the secondary transfer assembly

Follow these steps to remove the secondary transfer assembly.

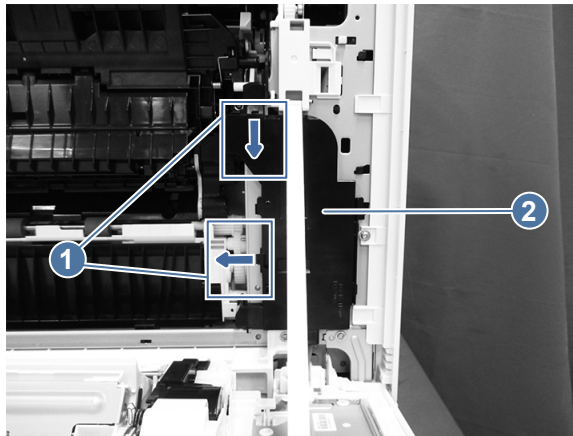
1. Open the right door.

**Figure 5-278 Open the right door**




2. Release two tabs (callout 1), and then remove the PCA cover (callout 2).

**Figure 5-279 Remove the PCA cover**



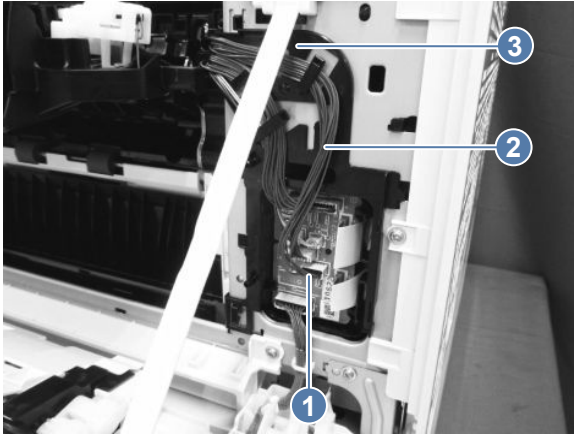
3. Disconnect one connector (callout 1), and then release the cable (callout 2) from the cable guide (callout 3).

---

 **Reinstallation tip:** When reinstalled, make sure the cable is correctly routed through the cable guide.

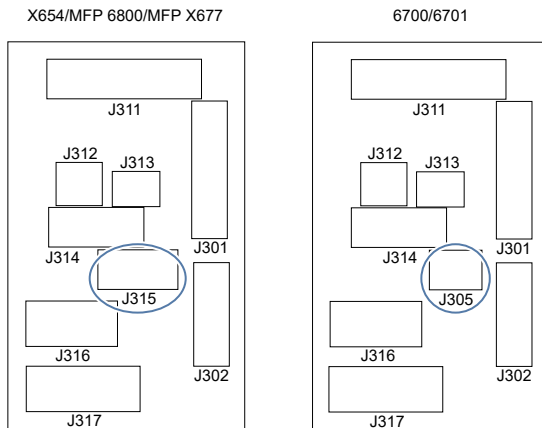
---

**Figure 5-280 Release the cable**



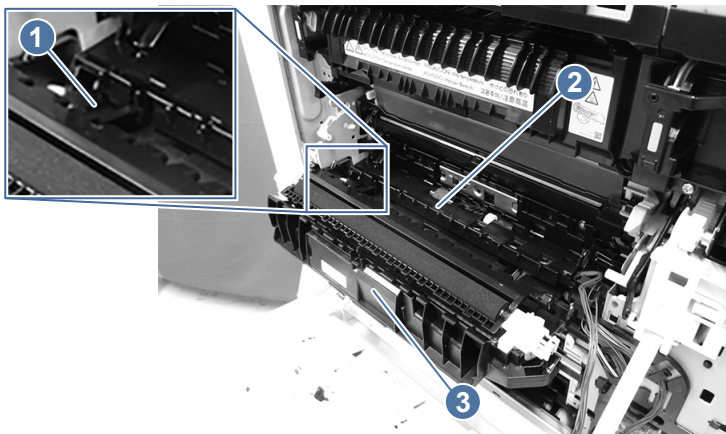
4. Perform one of the following steps.
  - **X654/6800/X677 models:** Disconnect the J315 formatter connector.
  - **6700 models:** Disconnect the J305 formatter connector.

**Figure 5-281 Disconnect a formatter connector**




5. Release one tab (callout 1), and then lift up the registration assembly (callout 2) off the secondary transfer assembly (callout 3)

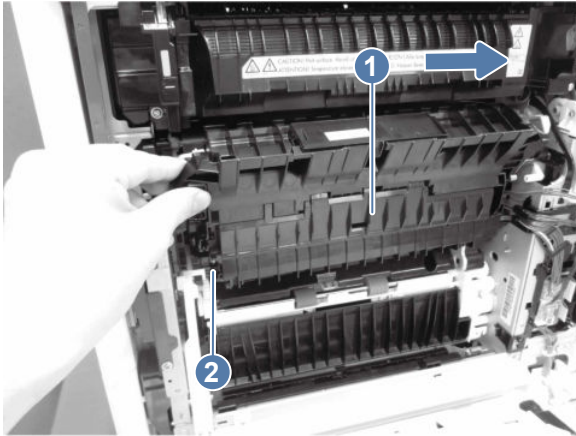
**Figure 5-282 Release the tab**




6. Close the secondary transfer assembly until it is only slightly open. Slide the assembly (callout 1) in the direction indicated below, and then dislodge the hinge pin (callout 2) from the holder to remove the assembly.

 **Reinstallation tip:** Before removing the assembly, take note of where the assembly hinge pins fit into the holes provided in the printer.

**Figure 5-283 Remove the secondary transfer assembly**



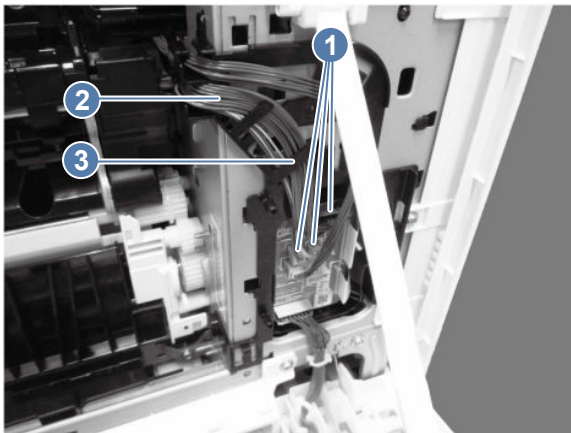
 **Reinstallation tip:** On the assembly right side, make sure that the wire is nested in the plastic sleeve. Slide the wire sleeve into its place, depressing the spring, and then twist the left side of the assembly into place and allow the spring pressure to nest the hinge pin in its hole.

## 2. Remove the registration assembly

Follow these steps to remove the registration assembly.

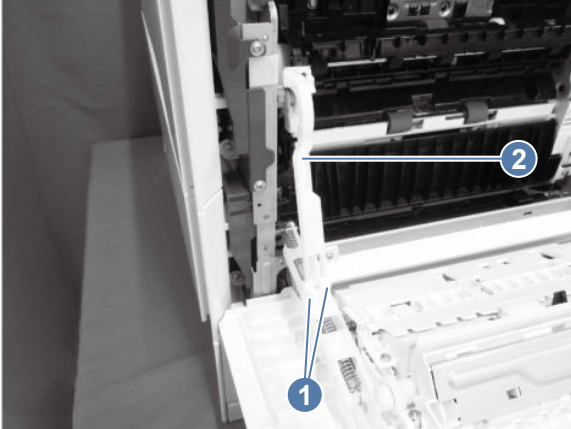
1. Disconnect three connectors (callout 1), and then release the cable (callout 2) from the cable guide (callout 3).

**Figure 5-284 Release the connectors**



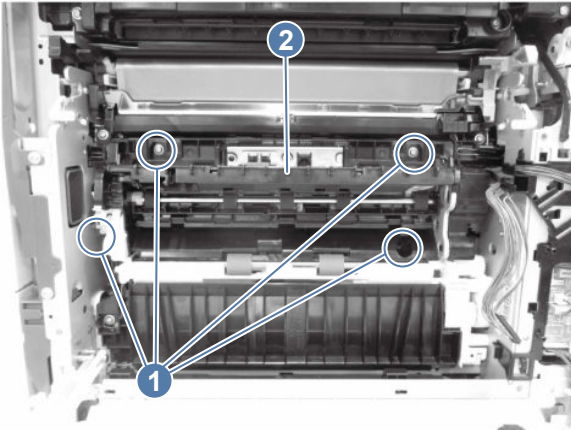
2. Release two bosses (callout 1), and then release the link arm (callout 2) from the door.

**Figure 5-285 Release the link arm**



3. Remove four screws (callout 1), and then remove the registration assembly (callout 2).

**Figure 5-286 Remove the registration assembly**



### 3. Unpack the replacement assembly

Follow these steps to unpack the replacement assembly.

1. Dispose of the defective part.




**NOTE:** HP recommends responsible disposal of the defective part.

<http://www8.hp.com/us/en/hp-information/environment/product-recycling.html>


2. Unpack the replacement part from the packaging.



**CAUTION:**  Some parts are sensitive to electrostatic discharge (ESD). Always perform service work at an ESD-protected workstation or mat. If an ESD workstation or mat is not available, touch the sheet-metal chassis to provide a static ground before touching an ESD-sensitive assembly. Protect the ESD-sensitive assemblies by placing them in ESD pouches when they are out of the printer.




**IMPORTANT:** Make sure that all of the shipping materials (for example shipping tape) are removed from the replacement part prior to installation.

 **NOTE:** If the replacement part is a roller or pad, avoid touching the spongy part of it. Skin oils on the roller or pad can cause paper pickup and/or print-quality problems. HP recommends using disposable gloves when handling rollers or pads or washing your hands before touching rollers or pads.

---

3. To install an assembly, reverse the removal steps.

 **NOTE:** When applicable, special installation instructions are provided for an assembly at the end of the removal procedure. Always completely read the removal instructions and follow all special installation instructions.

---

## Removal and replacement: Paper pickup assembly (6700/6800 models)

Learn about removing and replacing the paper pickup assembly.




[View a video demonstration of removing and replacing the paper pickup assembly.](#)

### Before performing service

#### Turn the printer power off

- Disconnect the power cable.

 **WARNING!** To avoid damage to the printer, turn the printer off, wait 30 seconds, and then remove the power cord before attempting to service the printer.

---

If the part is damaged and cannot be cleaned, use the table below to identify the correct part number for your printer. To order the part, go to [www.hp.com/buy/parts](http://www.hp.com/buy/parts).

**Table 5-53 Part information**

Part number	Part description
RM2-3508-000CN	Paper pickup assembly (6700/6800 models)

### Required tools

- #2 Phillips screwdriver with a magnetic tip and a 152 mm (6 in) shaft length

### After performing service

#### Turn the printer power on

- Connect the power cable.
- Use the power switch to turn the power on.

### Post service test

Print any pages necessary to make sure the printer is functioning correctly.

## 1. Remove the secondary transfer assembly

Follow these steps to remove the secondary transfer assembly.

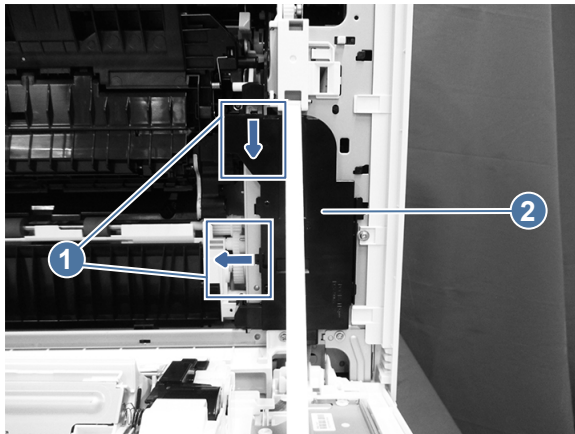
1. Open the right door.

**Figure 5-287** Open the right door




2. Release two tabs (callout 1), and then remove the PCA cover (callout 2).

**Figure 5-288** Remove the PCA cover



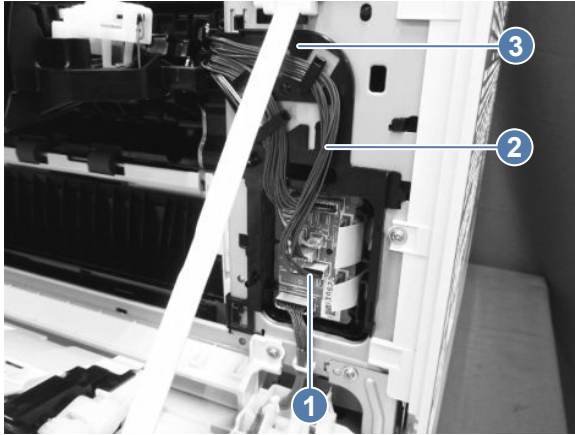
3. Disconnect one connector (callout 1), and then release the cable (callout 2) from the cable guide (callout 3).

---

 **Reinstallation tip:** When reinstalled, make sure the cable is correctly routed through the cable guide.

---

**Figure 5-289 Release the cable**

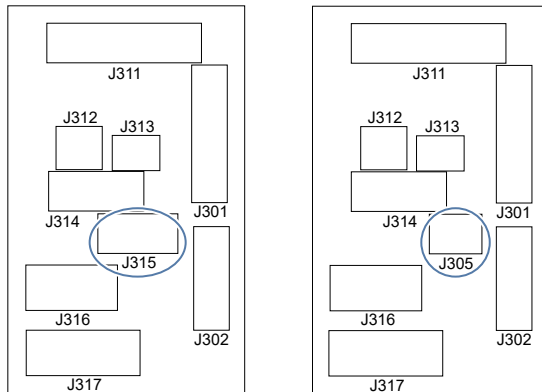


4. Perform one of the following steps.
  - **X654/6800/X677 models:** Disconnect the J315 formatter connector.
  - **6700 models:** Disconnect the J305 formatter connector.

**Figure 5-290 Disconnect a formatter connector**

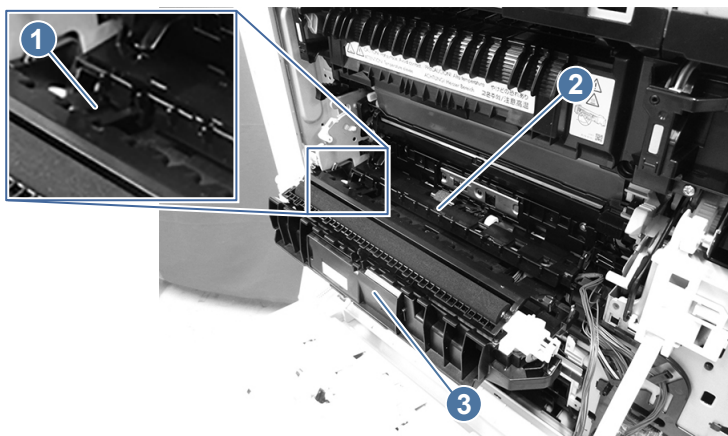
X654/MFP 6800/MFP X677

6700/6701




5. Release one tab (callout 1), and then lift up the registration assembly (callout 2) off the secondary transfer assembly (callout 3)

**Figure 5-291 Release the tab**

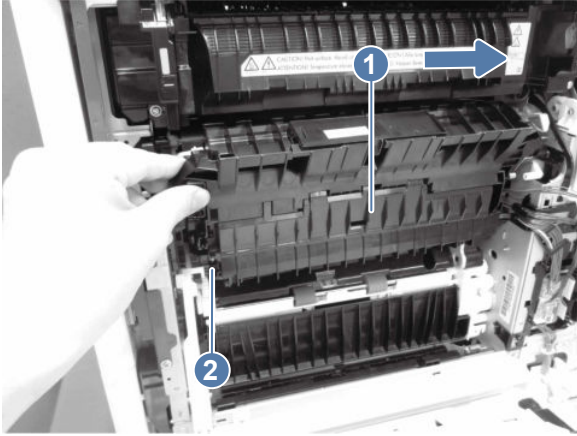





6. Close the secondary transfer assembly until it is only slightly open. Slide the assembly (callout 1) in the direction indicated below, and then dislodge the hinge pin (callout 2) from the holder to remove the assembly.

 **Reinstallation tip:** Before removing the assembly, take note of where the assembly hinge pins fit into the holes provided in the printer.

**Figure 5-292 Remove the secondary transfer assembly**



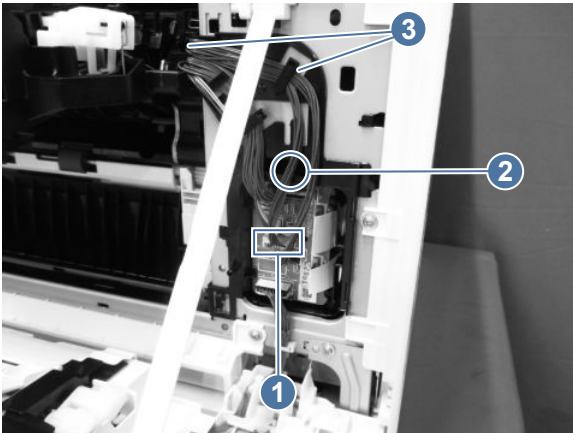
 **Reinstallation tip:** On the assembly right side, make sure that the wire is nested in the plastic sleeve. Slide the wire sleeve into its place, depressing the spring, and then twist the left side of the assembly into place and allow the spring pressure to nest the hinge pin in its hole.

## 2. Remove the registration density sensor


Follow these steps to remove the registration density sensor.

1. Disconnect one connector (J314; callout 1), and then release the cable (callout 2) from the cable guides (callout 3).

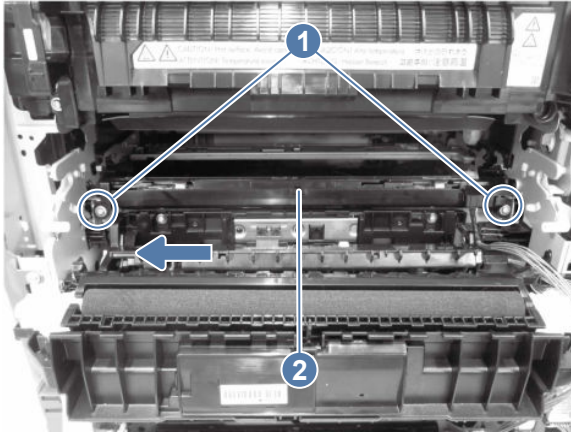
**Figure 5-293 Disconnect one connector**



2. Remove two screws (callout 1). Pull out the registration density sensor assembly (callout 2) slightly towards you, and then move the registration density sensor assembly in the direction indicated below. Carefully pull out the right side first to remove the registration density sensor assembly.

 **NOTE:** The shaft on the left side of the assembly is long and can break. Make sure to pivot the right side of the assembly out first to ensure that the shaft does not break. When installing a registration density sensor assembly, insert the shaft on the left side first, and then pivot the right side into the printer.

**Figure 5-294 Release the assembly**

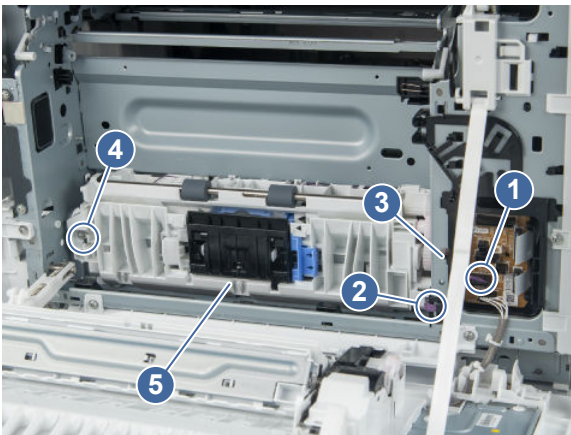



### 3. Remove the paper pickup assembly (6700/6800 models)

Follow these steps to remove the paper pickup assembly.

1. Disconnect one connector (callout 1), release the cable (callout 2) from the cable guide (callout 3), remove one screw (callout 4), and then remove the pickup assembly (callout 5).

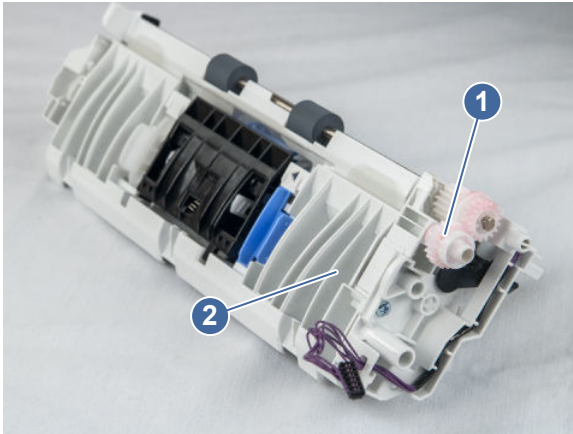
**Figure 5-295 Remove the pickup assembly**



 **Reinstallation tip:** When reinstalling, there are two holes. The screw goes in the upper hole where it comes into contact with the grounding wire.

2. Remove the gear (callout 1) from the assembly (callout 2).

**Figure 5-296 Remove the gear**



#### 4. Unpack the replacement assembly

Follow these steps to unpack the replacement assembly.

1. Dispose of the defective part.




**NOTE:** HP recommends responsible disposal of the defective part.

<http://www8.hp.com/us/en/hp-information/environment/product-recycling.html>

2. Unpack the replacement part from the packaging.



**CAUTION:**  Some parts are sensitive to electrostatic discharge (ESD). Always perform service work at an ESD-protected workstation or mat. If an ESD workstation or mat is not available, touch the sheet-metal chassis to provide a static ground before touching an ESD-sensitive assembly. Protect the ESD-sensitive assemblies by placing them in ESD pouches when they are out of the printer.



**IMPORTANT:** Make sure that all of the shipping materials (for example shipping tape) are removed from the replacement part prior to installation.



**NOTE:** If the replacement part is a roller or pad, avoid touching the spongy part of it. Skin oils on the roller or pad can cause paper pickup and/or print-quality problems. HP recommends using disposable gloves when handling rollers or pads or washing your hands before touching rollers or pads.

3. To install an assembly, reverse the removal steps.



**NOTE:** When applicable, special installation instructions are provided for an assembly at the end of the removal procedure. Always completely read the removal instructions and follow all special installation instructions.

#### Removal and replacement: Paper pickup assembly (X654/X677 models)

Learn about removing and replacing the paper pickup assembly.

#### Before performing service

##### Turn the printer power off

- Disconnect the power cable.

**⚠ WARNING!** To avoid damage to the printer, turn the printer off, wait 30 seconds, and then remove the power cord before attempting to service the printer.

If the part is damaged and cannot be cleaned, use the table below to identify the correct part number for your printer. To order the part, go to [www.hp.com/buy/parts](http://www.hp.com/buy/parts).

**Table 5-54 Part information**

Part number	Part description
RM2-3509-000CN	Paper pickup assembly (X654/X677 models)

## Required tools

- #2 Phillips screwdriver with a magnetic tip and a 152 mm (6 in) shaft length

## After performing service

### Turn the printer power on

- Connect the power cable.
- Use the power switch to turn the power on.

## Post service test

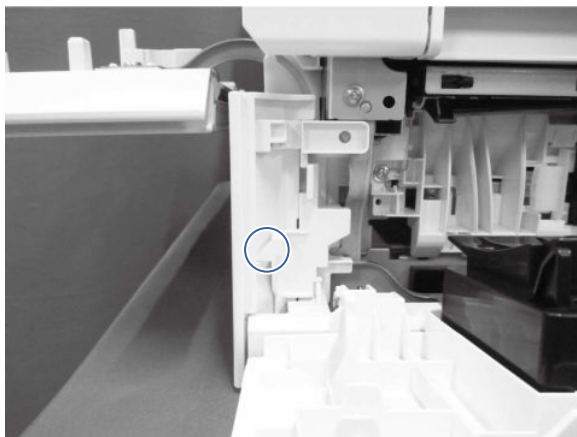
Print any pages necessary to make sure the printer is functioning correctly.

### 1. Remove the front right cover

Follow these steps to remove the front right cover.

1. Open the toner cartridge access door.
2. Open the right lower door.
3. Release one tab, and then slide the front right cover upward to remove it.

**Figure 5-297 Remove the front right cover**

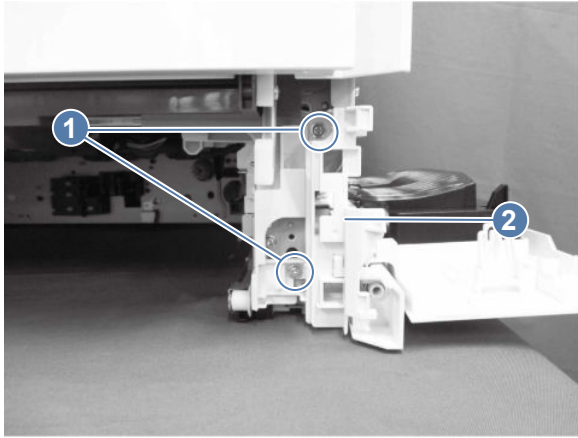


## 2. Remove the right lower door (X654/X677 models)

Follow these steps to remove the right lower door.

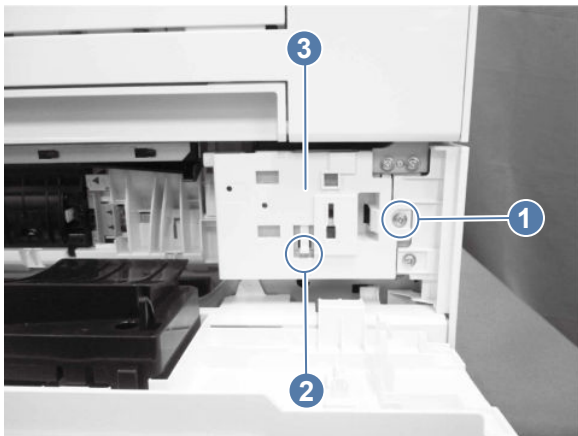
1. Remove two screws (callout 1), and then remove the base frame (callout 2).

**Figure 5-298 Remove the base frame**



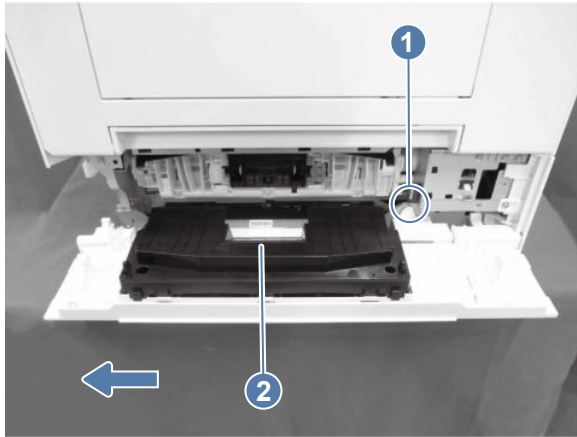
2. Remove one screw (callout 1), release one tab (callout 2), and then slide the rear inner cover (callout 3) downward to remove it.

**Figure 5-299 Remove the rear inner cover**



3. Release one tab (callout 1), and then slide the right lower door assembly (callout 2) in the direction indicated to remove it.

**Figure 5-300 Remove the right lower door assembly**

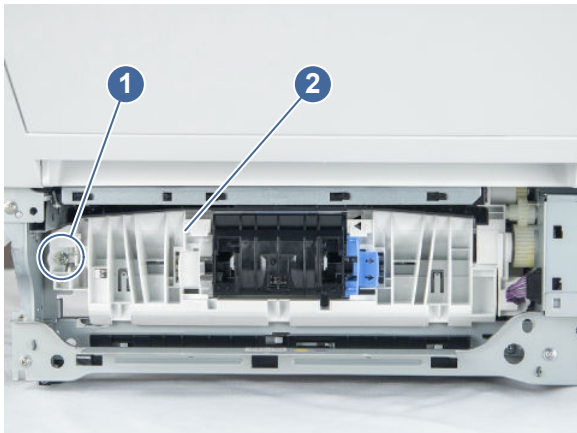


### 3. Remove the paper pickup assembly (X654/X677 models)


Follow these steps to remove the paper pickup assembly.

1. Remove one screw (callout 1), and then remove the pickup assembly (callout 2).

**Figure 5-301 Remove the pickup assembly**



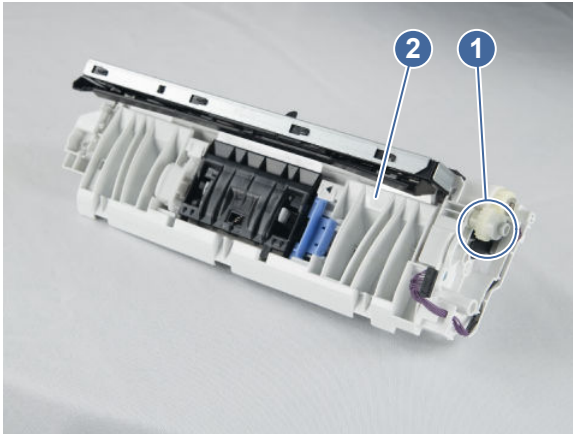
---

 **Reinstallation tip:** When reinstalling, there are two holes. The screw goes in the upper hole where it comes into contact with the grounding wire.

---

2. Remove the gear (callout 1) from the pickup assembly (callout 2).

**Figure 5-302 Remove the gear**



#### 4. Unpack the replacement assembly

Follow these steps to unpack the replacement assembly.

1. Dispose of the defective part.

---



 **NOTE:** HP recommends responsible disposal of the defective part.


<http://www8.hp.com/us/en/hp-information/environment/product-recycling.html>


---

2. Unpack the replacement part from the packaging.

---

 **CAUTION:**  Some parts are sensitive to electrostatic discharge (ESD). Always perform service work at an ESD-protected workstation or mat. If an ESD workstation or mat is not available, touch the sheet-metal chassis to provide a static ground before touching an ESD-sensitive assembly. Protect the ESD-sensitive assemblies by placing them in ESD pouches when they are out of the printer.


 **IMPORTANT:** Make sure that all of the shipping materials (for example shipping tape) are removed from the replacement part prior to installation.

 **NOTE:** If the replacement part is a roller or pad, avoid touching the spongy part of it. Skin oils on the roller or pad can cause paper pickup and/or print-quality problems. HP recommends using disposable gloves when handling rollers or pads or washing your hands before touching rollers or pads.

---

3. To install an assembly, reverse the removal steps.

---

 **NOTE:** When applicable, special installation instructions are provided for an assembly at the end of the removal procedure. Always completely read the removal instructions and follow all special installation instructions.

---

#### Removal and replacement: Delivery assembly

Learn about removing and replacing the delivery assembly.

#### Before performing service

**Turn the printer power off**

- Disconnect the power cable.

---

**⚠ WARNING!** To avoid damage to the printer, turn the printer off, wait 30 seconds, and then remove the power cord before attempting to service the printer.

---

If the part is damaged and cannot be cleaned, use the table below to identify the correct part number for your printer. To order the part, go to [www.hp.com/buy/parts](http://www.hp.com/buy/parts).

**Table 5-55 Part information**

Part number	Part description
RM2-3555-000CN	Paper delivery assembly (6700/X654)
RM2-3556-000CN	Paper delivery assembly (6800/X677)

## Required tools

- #2 Phillips screwdriver with a magnetic tip and a 152 mm (6 in) shaft length

## After performing service

### Turn the printer power on

- Connect the power cable.
- Use the power switch to turn the power on.

## Post service test

Print any pages necessary to make sure the printer is functioning correctly.

## 1. Remove the fuser

Follow these steps to remove the fuser.

1. Open the right door.

---

**⚠ CAUTION:** The fuser is hot. Wait at least 10 minutes after turning the printer power off before removing the fuser.

---

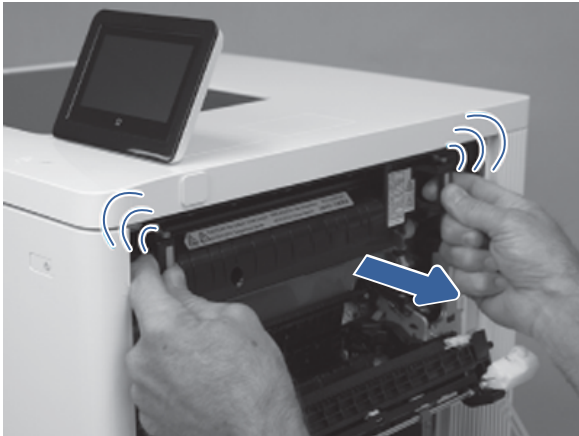
**Figure 5-303 Open the right door**





2. Squeeze the release levers on the handles (circle callouts), and then remove the fuser.

**Figure 5-304 Remove the fuser**

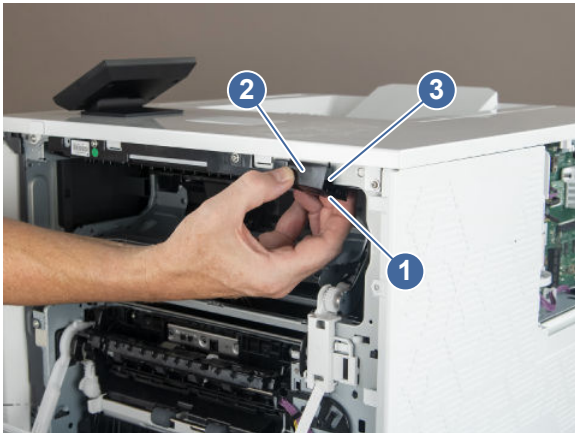


## 2. Remove the delivery assembly

Follow these steps to remove the delivery assembly.

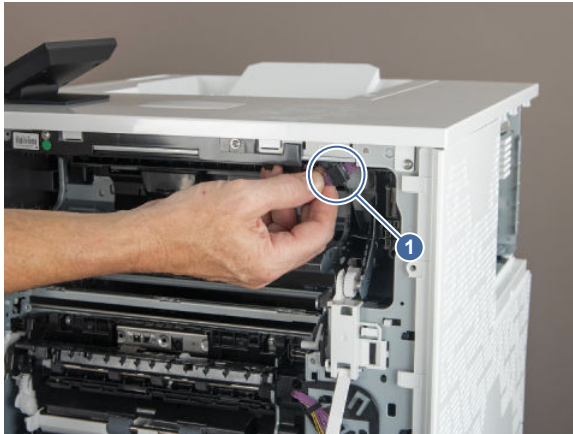
1. Pull the lever (callout 1) at the back of the cable cover (callout 2) to release one tab (callout 3), and then remove the cable cover.

**Figure 5-305 Remove the cable cover**



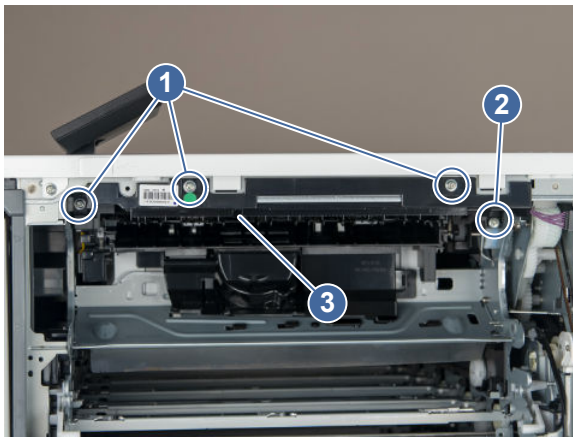
2. Disconnect one connector (callout 1).


**Figure 5-306 Disconnect one connector**



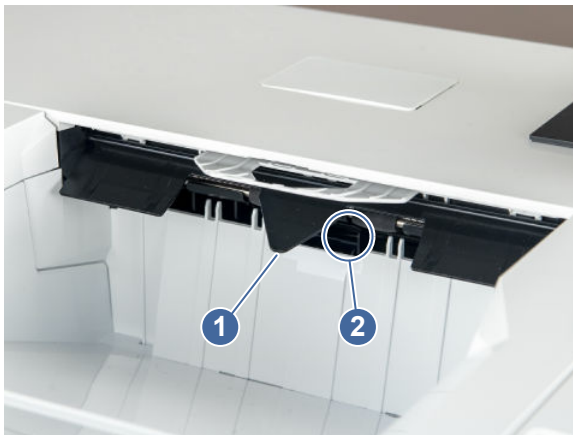
3. Remove three screws (callout 1), remove one binding screw (callout 2), and then pull out the delivery assembly (callout 3) away from the printer.

**Figure 5-307 Remove the delivery assembly**



 **Reinstallation tip:** When reinstalling, lift the flag (callout 1) to prevent the flag from entering the duct (callout 2)


**Figure 5-308 Lift the flag**



### 3. Unpack the replacement assembly



Follow these steps to unpack the replacement assembly.


1. Dispose of the defective part.


 **NOTE:** HP recommends responsible disposal of the defective part.

<http://www8.hp.com/us/en/hp-information/environment/product-recycling.html>


2. Unpack the replacement part from the packaging.

 **CAUTION:**  Some parts are sensitive to electrostatic discharge (ESD). Always perform service work at an ESD-protected workstation or mat. If an ESD workstation or mat is not available, touch the sheet-metal chassis to provide a static ground before touching an ESD-sensitive assembly. Protect the ESD-sensitive assemblies by placing them in ESD pouches when they are out of the printer.

 **IMPORTANT:** Make sure that all of the shipping materials (for example shipping tape) are removed from the replacement part prior to installation.

 **NOTE:** If the replacement part is a roller or pad, avoid touching the spongy part of it. Skin oils on the roller or pad can cause paper pickup and/or print-quality problems. HP recommends using disposable gloves when handling rollers or pads or washing your hands before touching rollers or pads.

3. To install an assembly, reverse the removal steps.

 **NOTE:** When applicable, special installation instructions are provided for an assembly at the end of the removal procedure. Always completely read the removal instructions and follow all special installation instructions.

### Removal and replacement: Laser scanner assembly

This document provides the procedures to remove and replace the laser scanner assembly.


Mean time to repair: 25 minutes

Service level: Intermediate

#### Before performing service

##### Turn the printer power off

- Disconnect the power cable.

 **WARNING!** To avoid damage to the printer, turn the printer off, wait 30 seconds, and then remove the power cord before attempting to service the printer.

Use the table below to identify the correct part number for your printer, and then go to <https://parts.hp.com/hpparts> to order the part.

**Table 5-56** Part information

Part number	Part description
RM2-3822-000CN	Laser scanner assembly (5700, 55745, 5800, 57945)
RM2-3787-000CN	Laser scanner assembly (6700, 654, 6800, 677)

## Required tools

- #2 Phillips screwdriver with a magnetic tip

## After performing service

Make sure that all of the connectors on the HVPS are fully seated.

Make sure that all of the connectors on the LVPS are fully seated.

Make sure that all of the connectors on the formatter are fully seated.

Make sure that the formatter cover is fully seated.

## Turn the printer power on

- Connect the power cable.
- Use the power switch to turn the power on.

## Post service test


Print a configuration page to make sure that the printer is functioning correctly.

### 1. Remove the formatter cover

Follow these steps to remove the formatter cover.

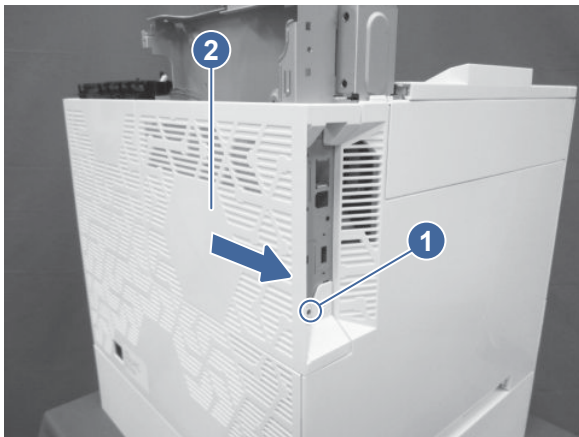
- Remove one screw (callout 1), and then slide the formatter cover (callout 2) away from the printer to remove it.

---

 **TIP:** Reverse the removal steps to install the assembly.

---

**Figure 5-309** Remove the formatter cover




### 2. Remove the left upper cover (MFP models)

Follow these steps to remove the left upper cover.

1. Open the front door.

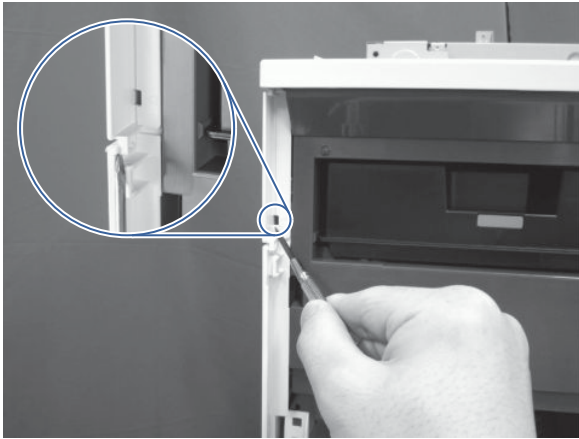
---

 **CAUTION:** If the cover is being removed to gain access to the main drive assembly, make sure that the front door remains open. This keeps the main drive properly aligned.

---

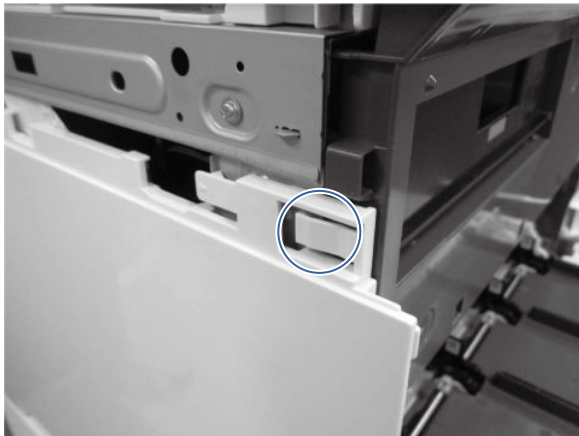
2. At the left side of the printer, insert the small flat-blade screwdriver into the slot to release one tab (callout 1).

**Figure 5-310 Use a screwdriver to release the tab**



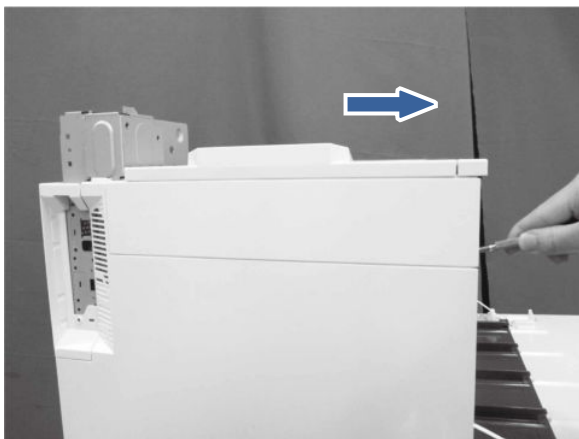
3. Toward the front of the printer, release another tab.

**Figure 5-311 Release the tab**



4. Rotate the cover up to remove it.

**Figure 5-312 Remove the left upper cover**

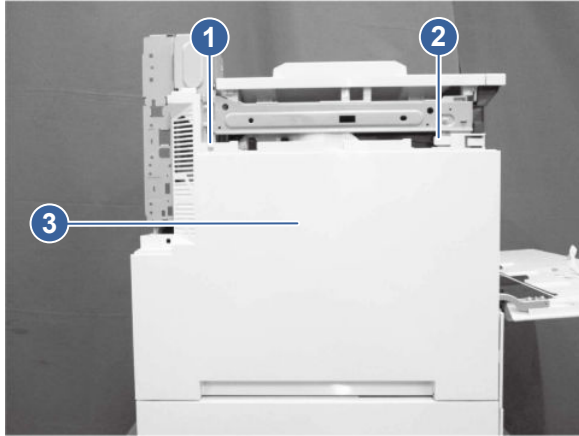


### 3. Remove the left cover

Follow these steps to remove the left cover.

- At the left side of the printer, remove one screw (callout 1), release one tab (callout 2), and then slide the cover (callout 3) toward the rear of the printer to release it.

**Figure 5-313 Remove the left cover**

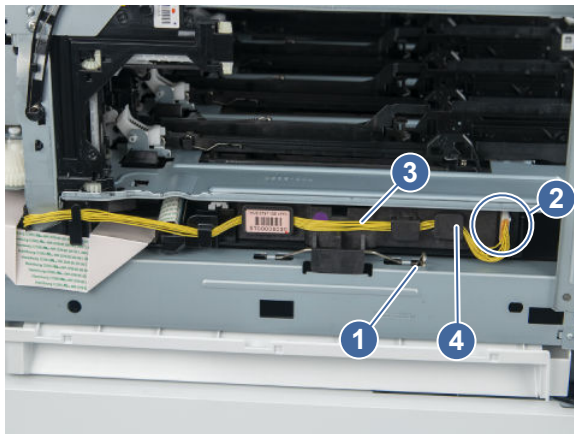


### 4. Remove the laser scanner assembly

Follow these steps to remove the laser scanner assembly.

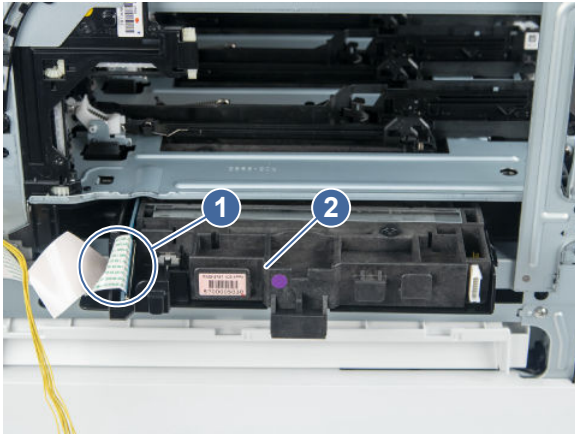
1. Unhook the spring (callout 1), disconnect one connector (callout 2), release the cable (callout 3) from the laser scanner assembly (callout 4), and then pull out the laser scanner assembly slightly.

**Figure 5-314 Unhook the spring**



2. Disconnect the FFC (callout 1), and then pull the laser scanner assembly (callout 2) out of the printer.

**Figure 5-315 Remove the assembly**



## 5. Unpack the replacement assembly

Follow these steps to unpack the replacement assembly.

1. Dispose of the defective part.




**NOTE:** HP recommends responsible disposal of the defective part.

<http://www8.hp.com/us/en/hp-information/environment/product-recycling.html>

2. Unpack the replacement part from the packaging.



**CAUTION:**  Some parts are sensitive to electrostatic discharge (ESD). Always perform service work at an ESD-protected workstation or mat. If an ESD workstation or mat is not available, touch the sheet-metal chassis to provide a static ground before touching an ESD-sensitive assembly. Protect the ESD-sensitive assemblies by placing them in ESD pouches when they are out of the printer.



**IMPORTANT:** Make sure that all of the shipping materials (for example shipping tape) are removed from the replacement part prior to installation.



**NOTE:** If the replacement part is a roller or pad, avoid touching the spongy part of it. Skin oils on the roller or pad can cause paper pickup and/or print-quality problems. HP recommends using disposable gloves when handling rollers or pads or washing your hands before touching rollers or pads.

3. To install an assembly, reverse the removal steps.



**NOTE:** When applicable, special installation instructions are provided for an assembly at the end of the removal procedure. Always completely read the removal instructions and follow all special installation instructions.

## Removal and replacement: DC controller (DCC)

This document provides the procedures to remove and replace the DC controller (DCC).


Mean time to repair: 30 minutes


Service level: Intermediate

### Before performing service

## Turn the printer power off

- Disconnect the power cable.

 **WARNING!** To avoid damage to the printer, turn the printer off, wait 30 seconds, and then remove the power cord before attempting to service the printer.

 **IMPORTANT:** Do not replace the formatter, DC controller, and eMMC PCA or hard-disk drive simultaneously during a single printer servicing. Doing so might cause the printer to become unstable or inoperable.

Use the table below to identify the correct part number for your printer, and then go to <https://parts.hp.com/hpparts> to order the part.

**Table 5-57 Part information**

Part number	Part description
RM3-7753-000CN	DC controller PCA (6700)
RM3-7754-000CN	DC controller PCA (6800)
RM3-7757-000CN	DC controller PCA (X654)
RM3-7758-000CN	DC controller PCA (X677)

## Required tools

- #2 Phillips screwdriver with a magnetic tip

## After performing service

Make sure that all of the connectors on the DC controller are fully seated.

Make sure that the formatter cover is fully seated, and that the thumbscrews are finger tight after replacing it.

## Turn the printer power on

- Connect the power cable.
- Use the power switch to turn the power on.


## Post service test

Print a configuration page to make sure that the printer is functioning correctly.

### 1. Remove the formatter cover

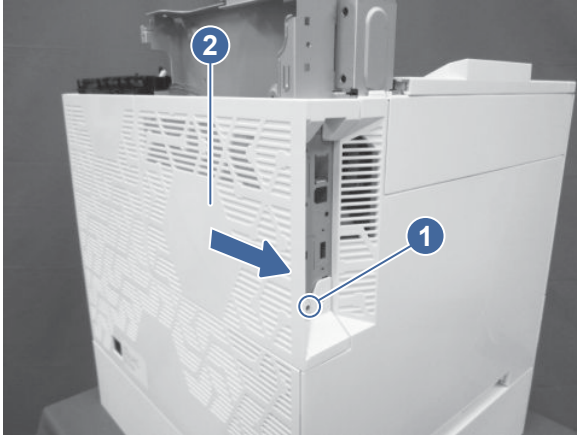
Follow these steps to remove the formatter cover.

- Remove one screw (callout 1), and then slide the formatter cover (callout 2) away from the printer to remove it.

 **TIP:** Reverse the removal steps to install the assembly.



**Figure 5-316 Remove the formatter cover**



## 2. Remove the rear cover

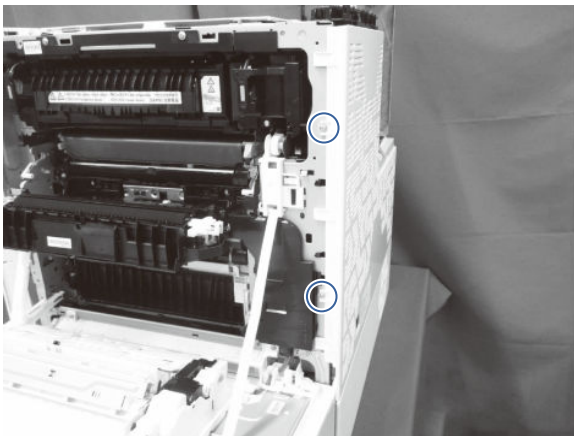
Follow these steps to remove the rear cover.



**NOTE:** The figures below show some assemblies (for example the top cover and formatter) removed that might still be installed on the printer. However, the steps to remove the cover are correct.

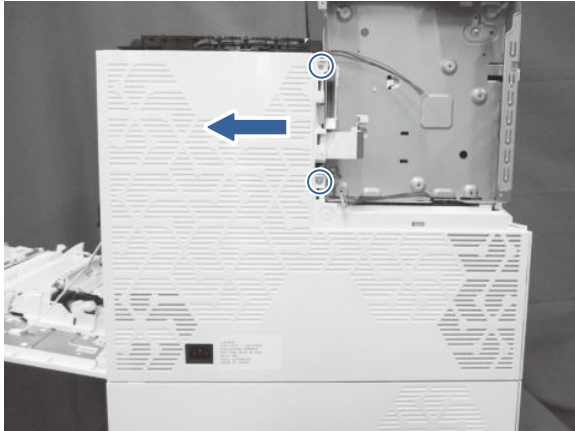
1. Open the right door, and remove two screws.

**Figure 5-317 Remove two screws**



2. At the back of the printer, remove two screws, and then slide the rear cover as indicated to remove it.


**Figure 5-318 Remove the rear cover**



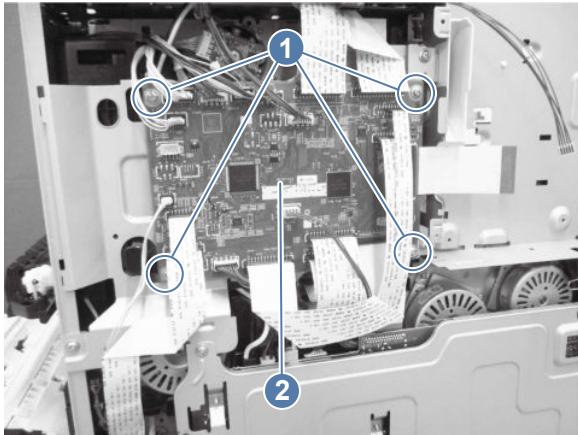
### 3. Remove the DC controller

Follow these steps to remove the DC controller.

- Disconnect all of the connectors on the DC controller, remove four screws (callout 1), and then remove the DC controller (callout 2).

 **IMPORTANT:** Some of the flat flexible cable (FFC) connectors use hinged retainers to secure them to the DC controller. The hinged retainers must be opened to release the FFCs.

**Figure 5-319 Remove the DC controller**



### 4. Unpack the replacement assembly

Follow these steps to unpack the replacement assembly.



1. Dispose of the defective part.


 **NOTE:** HP recommends responsible disposal of the defective part.


<http://www8.hp.com/us/en/hp-information/environment/product-recycling.html>

2. Unpack the replacement part from the packaging.

---


 **CAUTION:**  Some parts are sensitive to electrostatic discharge (ESD). Always perform service work at an ESD-protected workstation or mat. If an ESD workstation or mat is not available, touch the sheet-metal chassis to provide a static ground before touching an ESD-sensitive assembly. Protect the ESD-sensitive assemblies by placing them in ESD pouches when they are out of the printer.

 **IMPORTANT:** Make sure that all of the shipping materials (for example shipping tape) are removed from the replacement part prior to installation.

 **NOTE:** If the replacement part is a roller or pad, avoid touching the spongy part of it. Skin oils on the roller or pad can cause paper pickup and/or print-quality problems. HP recommends using disposable gloves when handling rollers or pads or washing your hands before touching rollers or pads.

---

3. To install an assembly, reverse the removal steps.

 **NOTE:** When applicable, special installation instructions are provided for an assembly at the end of the removal procedure. Always completely read the removal instructions and follow all special installation instructions.

---

### Removal and replacement: Formatter

This document provides the procedures to remove and replace the formatter.

Mean time to repair: 10 minutes


Service level: Intermediate

### Before performing service


#### Turn the printer power off

- Disconnect the power cable.

---

 **WARNING!** To avoid damage to the printer, turn the printer off, wait 30 seconds, and then remove the power cord before attempting to service the printer.


---

 **CAUTION:** Under **NO** circumstances should a formatter from a different printer be installed during the repair or troubleshooting processes. The formatter stores important data specific to the model of printer it is installed in and is not designed to be swapped or re-purposed in any way. Return a used formatter to HP.

Issues that can occur from swapping a formatter include:

- Serial number, product number, product name, page count, and supported cartridges information change and might make a product unusable.
- 33.02.01 Used board/Disk installed errors.

If a used formatter is installed and causes this issue, the partner must cover the costs of the repair in the form of a product replacement. **There is no method in the field to recover a printer where a used formatter is installed.**

 **IMPORTANT:** Do not replace the formatter, DC controller, and hard-disk drive simultaneously during a single printer servicing. Doing so might cause the printer to become unstable or inoperable.

---

Use the table below to identify the correct part number for your printer, and then go to <https://parts.hp.com/hpparts> to order the part.

**Table 5-58 Part information**

Part number	Part description
6QN27-67002	Formatter (57xx / X55xxx)
6QN27-67004	Formatter (57xx / X55xxx) (China/India)
6QN29-67002	Formatter (58xx / X57xxx)
6QN29-67004	Formatter (58xx / X57xxx) (China/India)
6QN32-67002	Formatter (67xx / X65xxx)
6QN32-67004	Formatter (67xx / X65xxx) (China/India)
6QN35-67002	Formatter (68xx / X67xxx)
6QN35-67005	Formatter (68xx / X67xxx) (China/India)

## Required tools

- #2 Phillips screwdriver with a magnetic tip

## After performing service

Make sure that all of the connectors on the formatter are fully seated.

Make sure that the formatter cover is fully seated.

### Turn the printer power on

- Connect the power cable.
- Use the power switch to turn the power on.

## Post service test


Print a configuration page to make sure that the printer is functioning correctly.

### 1. Remove the formatter cover

Follow these steps to remove the formatter cover.

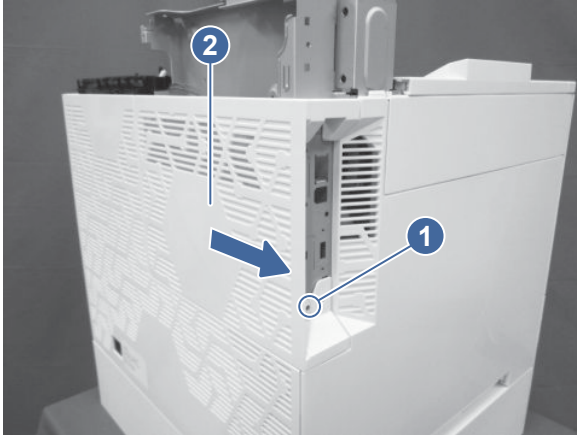
- Remove one screw (callout 1), and then slide the formatter cover (callout 2) away from the printer to remove it.

---

 **TIP:** Reverse the removal steps to install the assembly.

---


**Figure 5-320 Remove the formatter cover**



## 2. Remove the formatter

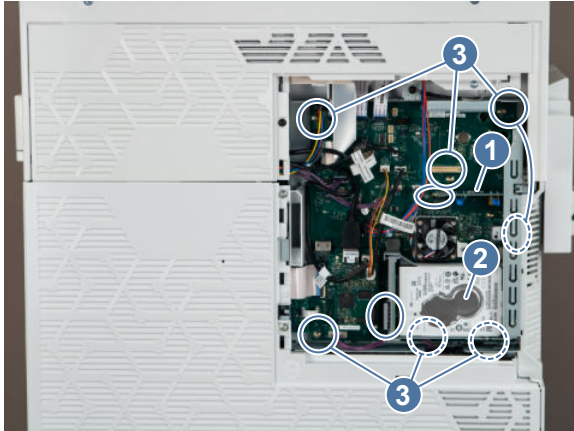
Follow these steps to remove the formatter.

1. Disconnect all of the connectors on the formatter.

 **IMPORTANT:** Some of the flat flexible cable (FFC) connectors use hinged retainers to secure them to the DC controller. The hinged retainers must be opened to release the FFCs.

2. Remove the fax PCA (callout 1) and the hard disk drive (HDD) (callout 2), and then remove seven screws (callout 3) to remove the formatter.

**Figure 5-321 Remove the formatter**



## 3. Unpack the replacement assembly



Follow these steps to unpack the replacement assembly.


1. Dispose of the defective part.


 **NOTE:** HP recommends responsible disposal of the defective part.

<http://www8.hp.com/us/en/hp-information/environment/product-recycling.html>


## 2. Unpack the replacement part from the packaging.

 **CAUTION:**  Some parts are sensitive to electrostatic discharge (ESD). Always perform service work at an ESD-protected workstation or mat. If an ESD workstation or mat is not available, touch the sheet-metal chassis to provide a static ground before touching an ESD-sensitive assembly. Protect the ESD-sensitive assemblies by placing them in ESD pouches when they are out of the printer.

 **IMPORTANT:** Make sure that all of the shipping materials (for example shipping tape) are removed from the replacement part prior to installation.

 **NOTE:** If the replacement part is a roller or pad, avoid touching the spongy part of it. Skin oils on the roller or pad can cause paper pickup and/or print-quality problems. HP recommends using disposable gloves when handling rollers or pads or washing your hands before touching rollers or pads.

## 3. To install an assembly, reverse the removal steps.

 **NOTE:** When applicable, special installation instructions are provided for an assembly at the end of the removal procedure. Always completely read the removal instructions and follow all special installation instructions.


### Removal and replacement: Formatter cage assembly (SFP models)

Learn about removing and replacing the formatter cage assembly for SFP models.

#### Before performing service

##### Turn the printer power off

- Disconnect the power cable.

 **WARNING!** To avoid damage to the printer, turn the printer off, wait 30 seconds, and then remove the power cord before attempting to service the printer.

If the part is damaged and cannot be cleaned, use the table below to identify the correct part number for your printer. To order the part, go to [www.hp.com/buy/parts](http://www.hp.com/buy/parts).

**Table 5-59** Part information

Part number	Part description
RM2-4520-000CN	Formatter cage assembly (SFP)

#### Required tools

- #2 Phillips screwdriver with a magnetic tip and a 152 mm (6 in) shaft length

#### After performing service

##### Turn the printer power on

- Connect the power cable.
- Use the power switch to turn the power on.


#### Post service test

Print any pages necessary to make sure the printer is functioning correctly.

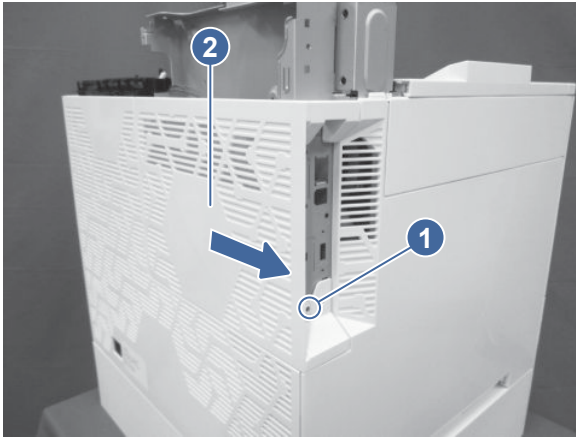
## 1. Remove the formatter cover

Follow these steps to remove the formatter cover.

- Remove one screw (callout 1), and then slide the formatter cover (callout 2) away from the printer to remove it.

 **TIP:** Reverse the removal steps to install the assembly.


**Figure 5-322** Remove the formatter cover



## 2. Remove the formatter

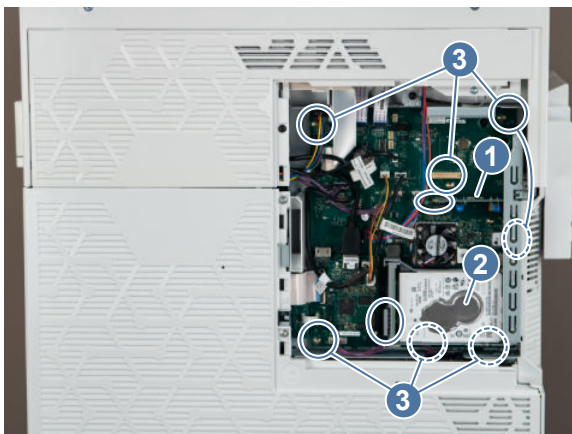
Follow these steps to remove the formatter.

1. Disconnect all of the connectors on the formatter.

 **IMPORTANT:** Some of the flat flexible cable (FFC) connectors use hinged retainers to secure them to the DC controller. The hinged retainers must be opened to release the FFCs.


2. Remove the fax PCA (callout 1) and the hard disk drive (HDD) (callout 2), and then remove seven screws (callout 3) to remove the formatter.

**Figure 5-323** Remove the formatter



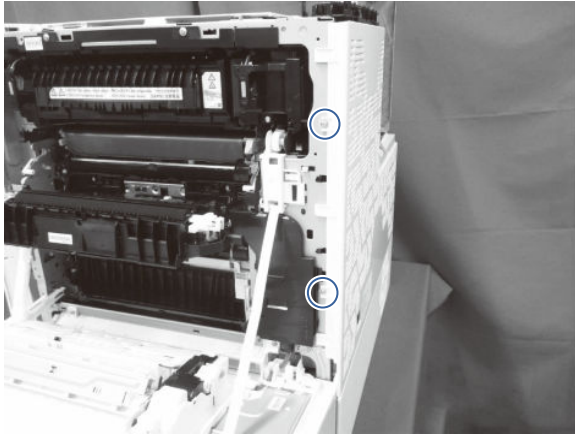
### 3. Remove the rear cover

Follow these steps to remove the rear cover.

 **NOTE:** The figures below show some assemblies (for example the top cover and formatter) removed that might still be installed on the printer. However, the steps to remove the cover are correct.

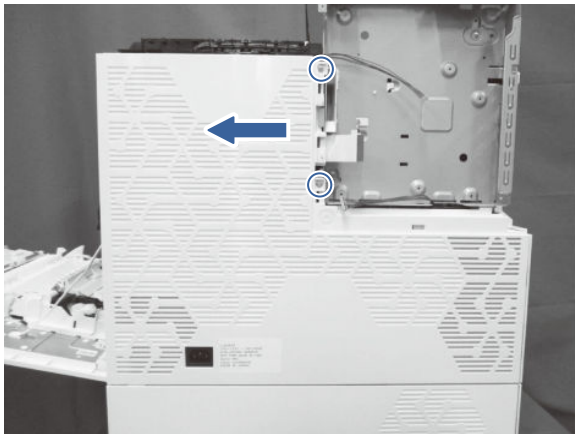
1. Open the right door, and remove two screws.

**Figure 5-324 Remove two screws**



2. At the back of the printer, remove two screws, and then slide the rear cover as indicated to remove it.


**Figure 5-325 Remove the rear cover**



### 4. Remove the formatter cage (SFP models)

Follow these steps to remove the formatter cage.

1. Disconnect all the connectors on the DC controller PCA.

 **IMPORTANT:** Some of the flat flexible cable (FFC) connectors use hinged retainers to secure them to the DC controller. The hinged retainers must be opened to release the FFCs.

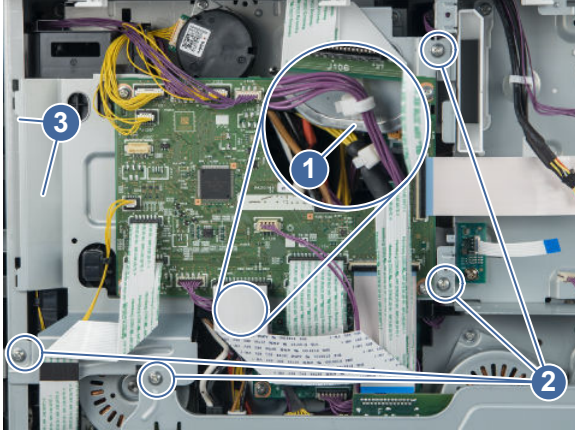


2. Remove the cable clamp (callout 1), remove four screws (callout 2), and then slide the DC controller stay (callout 3) out to remove it.



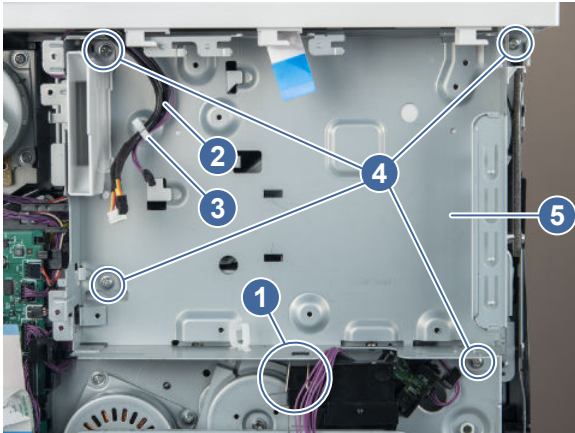
**NOTE:** Be careful not to drop any of the screws into the low-voltage power supply assembly below the DC controller.

**Figure 5-326** Remove the DC controller stay



3. Unhook one spring (callout 1), release the cable (callout 2) from the cable clamp (callout 3), remove four screws (callout 4), and then remove the formatter cage (callout 5).

**Figure 5-327** Remove the formatter cage

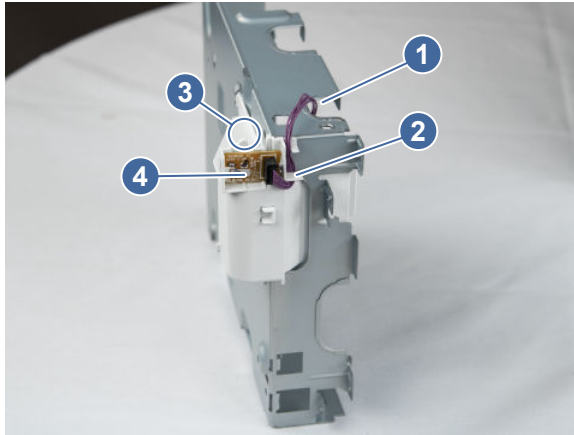


4. **For a replacement formatter cage only:** Release the cable (callout 1) from the cable guide (callout 2), release one tab (callout 3), and then remove the memory PCA (callout 4) from the formatter cage (callout 5).



**NOTE:** Install the PCA on the replacement formatter cage.

**Figure 5-328 Remove the memory PCA**



## 5. Unpack the replacement assembly

Follow these steps to unpack the replacement assembly.

1. Dispose of the defective part.




**NOTE:** HP recommends responsible disposal of the defective part.

<http://www8.hp.com/us/en/hp-information/environment/product-recycling.html>

2. Unpack the replacement part from the packaging.



**CAUTION:**  Some parts are sensitive to electrostatic discharge (ESD). Always perform service work at an ESD-protected workstation or mat. If an ESD workstation or mat is not available, touch the sheet-metal chassis to provide a static ground before touching an ESD-sensitive assembly. Protect the ESD-sensitive assemblies by placing them in ESD pouches when they are out of the printer.



**IMPORTANT:** Make sure that all of the shipping materials (for example shipping tape) are removed from the replacement part prior to installation.



**NOTE:** If the replacement part is a roller or pad, avoid touching the spongy part of it. Skin oils on the roller or pad can cause paper pickup and/or print-quality problems. HP recommends using disposable gloves when handling rollers or pads or washing your hands before touching rollers or pads.

3. To install an assembly, reverse the removal steps.



**NOTE:** When applicable, special installation instructions are provided for an assembly at the end of the removal procedure. Always completely read the removal instructions and follow all special installation instructions.

## Removal and replacement: Formatter cage assembly (MFP) models

Learn about removing and replacing the formatter cage assembly for MFP models.

### Before performing service

**Turn the printer power off**

- Disconnect the power cable.

---

**⚠ WARNING!** To avoid damage to the printer, turn the printer off, wait 30 seconds, and then remove the power cord before attempting to service the printer.

---

If the part is damaged and cannot be cleaned, use the table below to identify the correct part number for your printer. To order the part, go to [www.hp.com/buy/parts](http://www.hp.com/buy/parts).

**Table 5-60** Part information

Part number	Part description
RM2-4521-000CN	Formatter cage assembly (MFP)

## Required tools

- #2 Phillips screwdriver with a magnetic tip and a 152 mm (6 in) shaft length

## After performing service

### Turn the printer power on

- Connect the power cable.
- Use the power switch to turn the power on.

## Post service test

Print any pages necessary to make sure the printer is functioning correctly.

### 1. Remove the formatter cover

Follow these steps to remove the formatter cover.

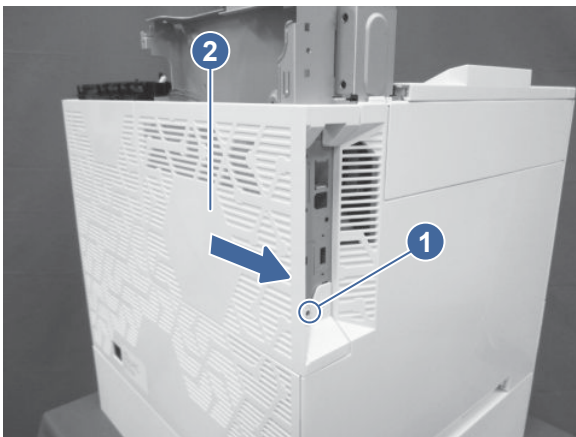
- Remove one screw (callout 1), and then slide the formatter cover (callout 2) away from the printer to remove it.

---

**💡 TIP:** Reverse the removal steps to install the assembly.

---


**Figure 5-329** Remove the formatter cover



## 2. Remove the formatter

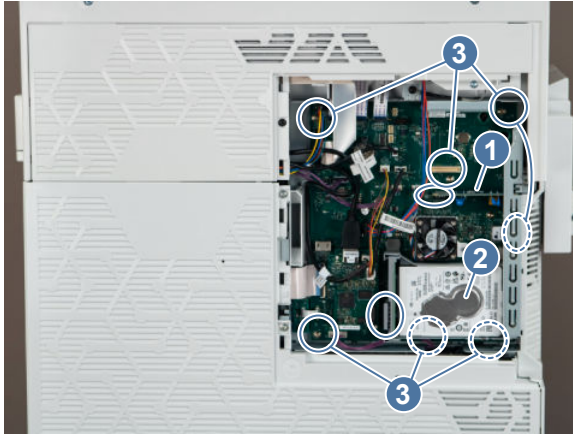
Follow these steps to remove the formatter.

1. Disconnect all of the connectors on the formatter.

 **IMPORTANT:** Some of the flat flexible cable (FFC) connectors use hinged retainers to secure them to the DC controller. The hinged retainers must be opened to release the FFCs.


2. Remove the fax PCA (callout 1) and the hard disk drive (HDD) (callout 2), and then remove seven screws (callout 3) to remove the formatter.

**Figure 5-330 Remove the formatter**



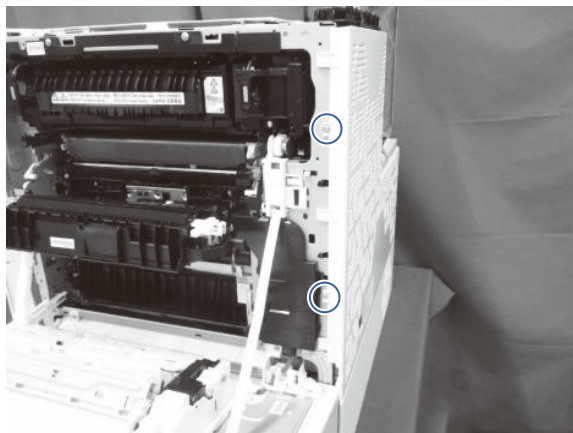
## 3. Remove the rear cover

Follow these steps to remove the rear cover.

 **NOTE:** The figures below show some assemblies (for example the top cover and formatter) removed that might still be installed on the printer. However, the steps to remove the cover are correct.

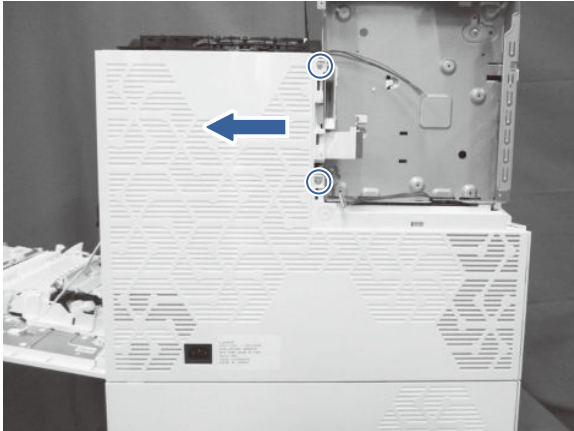
1. Open the right door, and remove two screws.

**Figure 5-331 Remove two screws**



2. At the back of the printer, remove two screws, and then slide the rear cover as indicated to remove it.

**Figure 5-332 Remove the rear cover**

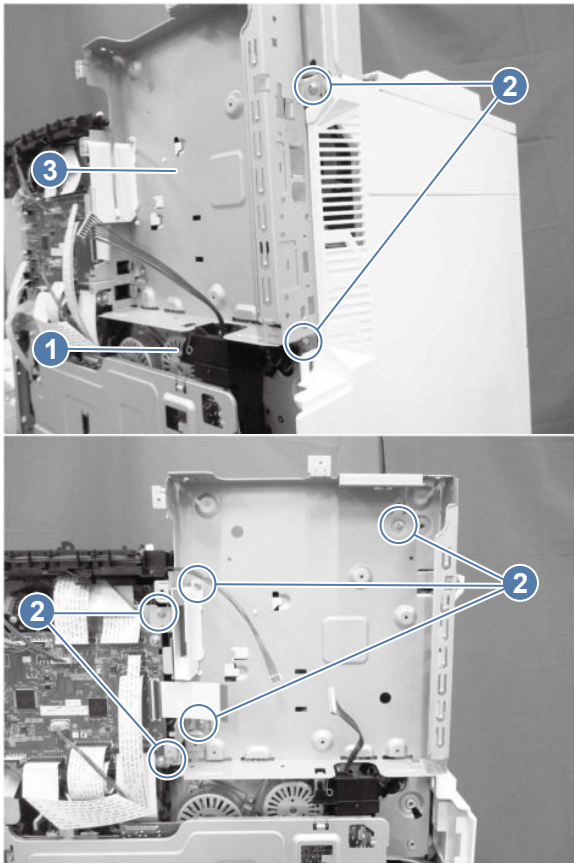


#### 4. Remove the formatter cage (MFP models)

Follow these steps to remove the formatter cage.


1. Unhook one spring (callout 1), remove seven screws (callout 2), and then remove the formatter cage (callout 3).

**Figure 5-333 Remove the formatter cage**



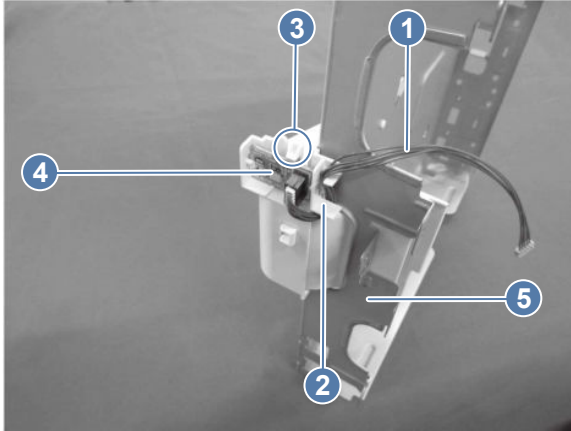
2. **For a replacement formatter cage only:** Release the cable (callout 1) from the cable guide (callout 2), release one tab (callout 3), and then remove the memory PCA (callout 4) from the formatter cage (callout 5).

---

 **NOTE:** Install the PCA on the replacement formatter cage.

---

**Figure 5-334 Remove the memory PCA**




## 5. Unpack the replacement assembly

Follow these steps to unpack the replacement assembly.

1. Dispose of the defective part.



---


 **NOTE:** HP recommends responsible disposal of the defective part.


<http://www8.hp.com/us/en/hp-information/environment/product-recycling.html>

---

2. Unpack the replacement part from the packaging.

 **CAUTION:**  Some parts are sensitive to electrostatic discharge (ESD). Always perform service work at an ESD-protected workstation or mat. If an ESD workstation or mat is not available, touch the sheet-metal chassis to provide a static ground before touching an ESD-sensitive assembly. Protect the ESD-sensitive assemblies by placing them in ESD pouches when they are out of the printer.


 **IMPORTANT:** Make sure that all of the shipping materials (for example shipping tape) are removed from the replacement part prior to installation.

 **NOTE:** If the replacement part is a roller or pad, avoid touching the spongy part of it. Skin oils on the roller or pad can cause paper pickup and/or print-quality problems. HP recommends using disposable gloves when handling rollers or pads or washing your hands before touching rollers or pads.

---

3. To install an assembly, reverse the removal steps.

---

 **NOTE:** When applicable, special installation instructions are provided for an assembly at the end of the removal procedure. Always completely read the removal instructions and follow all special installation instructions.

---

## Removal and replacement: Feed drive assembly (X654/X677 models)

Learn about removing and replacing the feed drive assembly.

## Before performing service

### Turn the printer power off

- Disconnect the power cable.

---

**⚠ WARNING!** To avoid damage to the printer, turn the printer off, wait 30 seconds, and then remove the power cord before attempting to service the printer.

---

If the part is damaged and cannot be cleaned, use the table below to identify the correct part number for your printer. To order the part, go to [www.hp.com/buy/parts](http://www.hp.com/buy/parts).

**Table 5-61** Part information

Part number	Part description
RM2-3702-000CN	Paper pickup drive assembly (X57945)
RM2-3683-000CN	Paper pickup drive assembly (X654/X677)

## Required tools

- #2 Phillips screwdriver with a magnetic tip and a 152 mm (6 in) shaft length

## After performing service

### Turn the printer power on

- Connect the power cable.
- Use the power switch to turn the power on.

## Post service test

Print any pages necessary to make sure the printer is functioning correctly.

### 1. Remove the formatter cover

Follow these steps to remove the formatter cover.

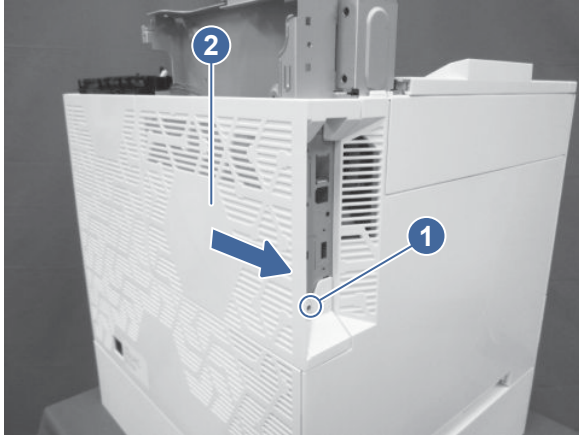
- Remove one screw (callout 1), and then slide the formatter cover (callout 2) away from the printer to remove it.

---

**💡 TIP:** Reverse the removal steps to install the assembly.


---

**Figure 5-335 Remove the formatter cover**



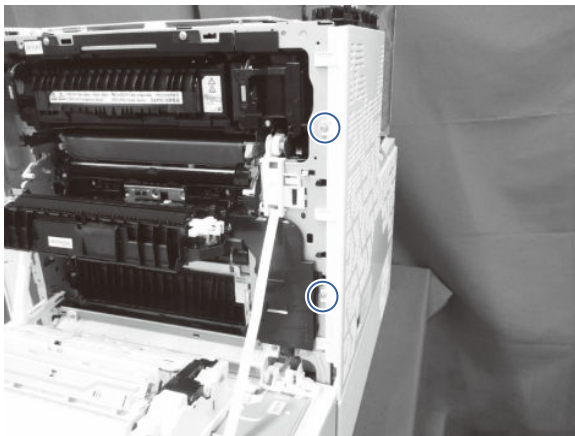
## 2. Remove the rear cover

Follow these steps to remove the rear cover.

 **NOTE:** The figures below show some assemblies (for example the top cover and formatter) removed that might still be installed on the printer. However, the steps to remove the cover are correct.

1. Open the right door, and remove two screws.

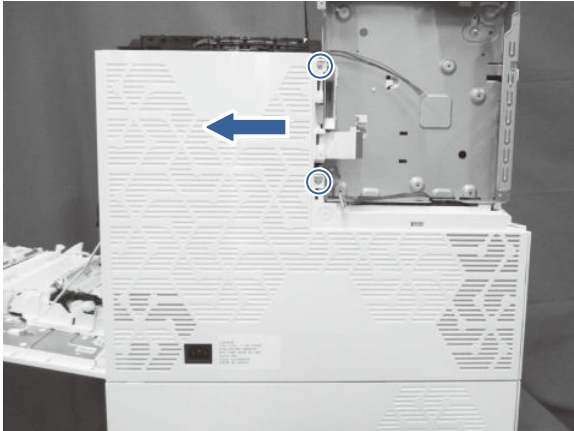
**Figure 5-336 Remove two screws**





2. At the back of the printer, remove two screws, and then slide the rear cover as indicated to remove it.

**Figure 5-337 Remove the rear cover**




### 3. Remove the low-voltage power supply (LVPS)

Follow these steps to remove the low-voltage power supply (LVPS).

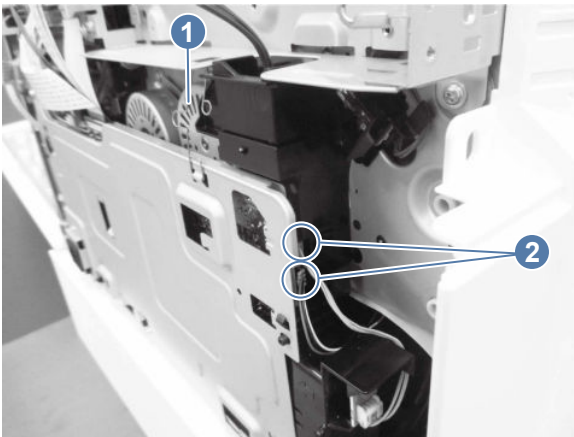
1. Unhook one spring (callout 1), and then disconnect two connectors (callout 2).

---

 **NOTE:** Unhook the spring from the formatter cage, not the low-voltage power supply. The spring should remain attached to the LVPS.


---

**Figure 5-338 Unhook the spring and disconnect two connectors**



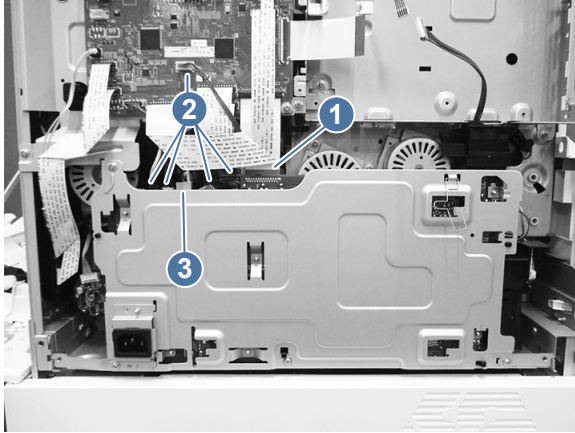
2. Remove the FFC (callout 1), and then disconnect five connectors (callout 2).

---


 **NOTE:** **MFP only:** Disconnect one additional connector (callout 3).

---

**Figure 5-339 Disconnect the LVPS connectors**

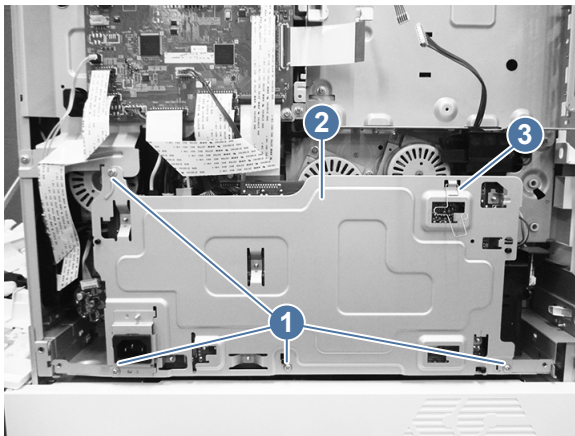



3. Remove four screws (callout 1), and then remove the low-voltage power supply assembly (callout 2).

 **NOTE:** The black ducting in the lower right corner can stick during the removal process.

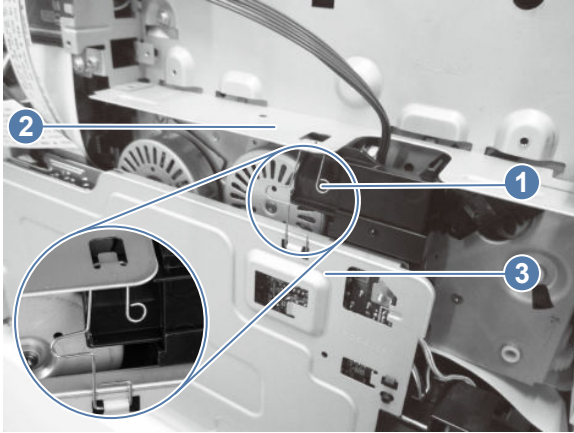
**Replacement LVPS only:** Remove the spring (callout 3), and then install it on the replacement LVPS.

**Figure 5-340 Remove the LVPS**



 **Reinstallation tip:** When reinstalling the LVPS, make sure that the spring (callout 1) is attached to both the formatter cage (callout 2) and the LVPS (callout 3).

**Figure 5-341 Reinstalling the LVPS**

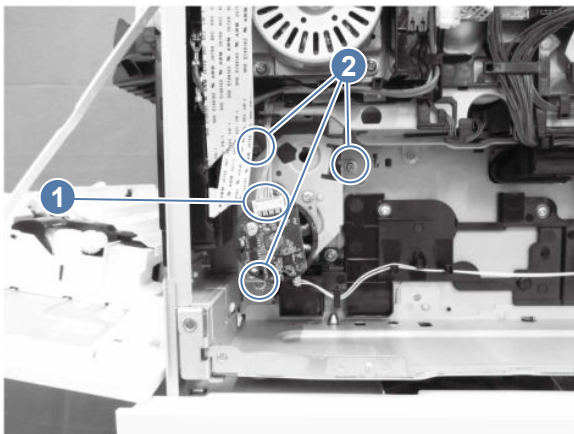


**4. Remove the feed drive assembly (X654/X677 models)**

Follow these steps to remove the feed drive assembly.

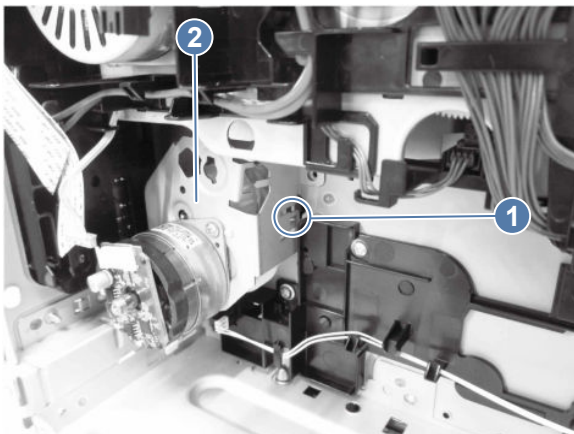
1. Disconnect one connector (callout 1), and then remove three screws (callout 2).

**Figure 5-342 Disconnect connector, remove 3 screws**



2. Release one tab (callout 1), and then remove the feed drive assembly (callout 2).


**Figure 5-343 Remove the feed drive assembly**



## 5. Unpack the replacement assembly



Follow these steps to unpack the replacement assembly.


1. Dispose of the defective part.


 **NOTE:** HP recommends responsible disposal of the defective part.

<http://www8.hp.com/us/en/hp-information/environment/product-recycling.html>


2. Unpack the replacement part from the packaging.

 **CAUTION:**  Some parts are sensitive to electrostatic discharge (ESD). Always perform service work at an ESD-protected workstation or mat. If an ESD workstation or mat is not available, touch the sheet-metal chassis to provide a static ground before touching an ESD-sensitive assembly. Protect the ESD-sensitive assemblies by placing them in ESD pouches when they are out of the printer.

 **IMPORTANT:** Make sure that all of the shipping materials (for example shipping tape) are removed from the replacement part prior to installation.

 **NOTE:** If the replacement part is a roller or pad, avoid touching the spongy part of it. Skin oils on the roller or pad can cause paper pickup and/or print-quality problems. HP recommends using disposable gloves when handling rollers or pads or washing your hands before touching rollers or pads.

3. To install an assembly, reverse the removal steps.

 **NOTE:** When applicable, special installation instructions are provided for an assembly at the end of the removal procedure. Always completely read the removal instructions and follow all special installation instructions.


### Removal and replacement: Pickup drive assembly (6700/6800 models)

Learn about removing and replacing the pickup drive assembly.

#### Before performing service

##### Turn the printer power off

- Disconnect the power cable.

 **WARNING!** To avoid damage to the printer, turn the printer off, wait 30 seconds, and then remove the power cord before attempting to service the printer.

If the part is damaged and cannot be cleaned, use the table below to identify the correct part number for your printer. To order the part, go to [www.hp.com/buy/parts](http://www.hp.com/buy/parts).

Table 5-62 Part information

Part number	Part description
RM2-3681-000CN	Paper pickup drive assembly (5700/X557/5800)
RM2-3682-000CN	Paper pickup drive assembly (6700/6800)

#### Required tools

- #2 Phillips screwdriver with a magnetic tip and a 152 mm (6 in) shaft length

## After performing service

### Turn the printer power on

- Connect the power cable.
- Use the power switch to turn the power on.

### Post service test


Print any pages necessary to make sure the printer is functioning correctly.

#### 1. Remove the formatter cover

Follow these steps to remove the formatter cover.

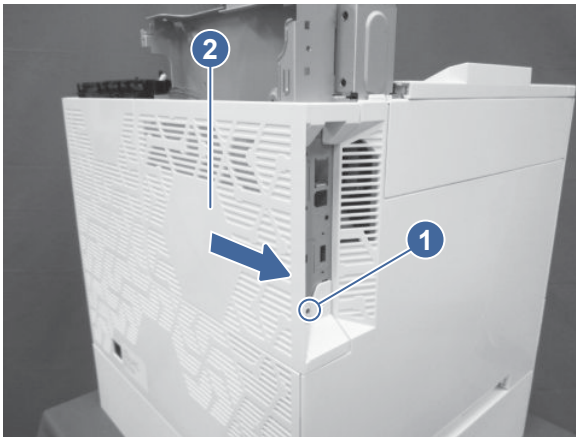
- Remove one screw (callout 1), and then slide the formatter cover (callout 2) away from the printer to remove it.

---

 **TIP:** Reverse the removal steps to install the assembly.

---


**Figure 5-344** Remove the formatter cover



#### 2. Remove the rear cover

Follow these steps to remove the rear cover.

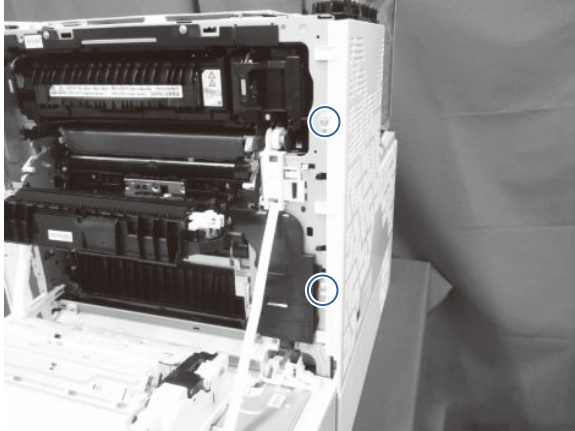
---

 **NOTE:** The figures below show some assemblies (for example the top cover and formatter) removed that might still be installed on the printer. However, the steps to remove the cover are correct.

---

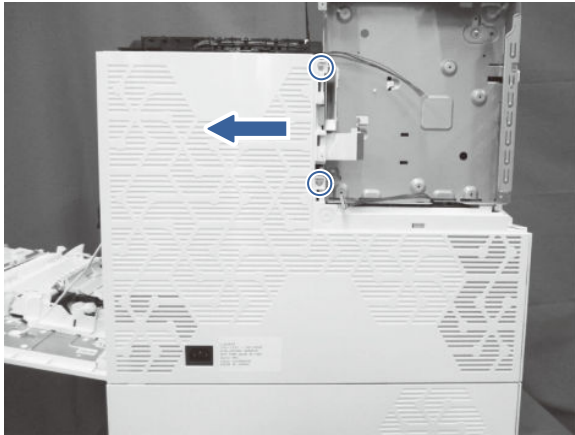
1. Open the right door, and remove two screws.

**Figure 5-345 Remove two screws**



2. At the back of the printer, remove two screws, and then slide the rear cover as indicated to remove it.

**Figure 5-346 Remove the rear cover**



### 3. Remove the low-voltage power supply (LVPS)

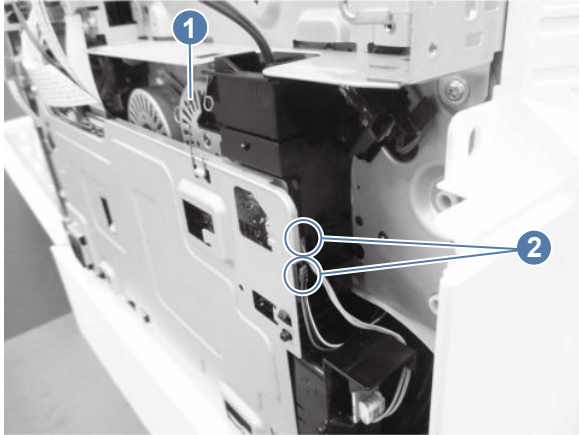
Follow these steps to remove the low-voltage power supply (LVPS).

1. Unhook one spring (callout 1), and then disconnect two connectors (callout 2).




**NOTE:** Unhook the spring from the formatter cage, not the low-voltage power supply. The spring should remain attached to the LVPS.

**Figure 5-347 Unhook the spring and disconnect two connectors**



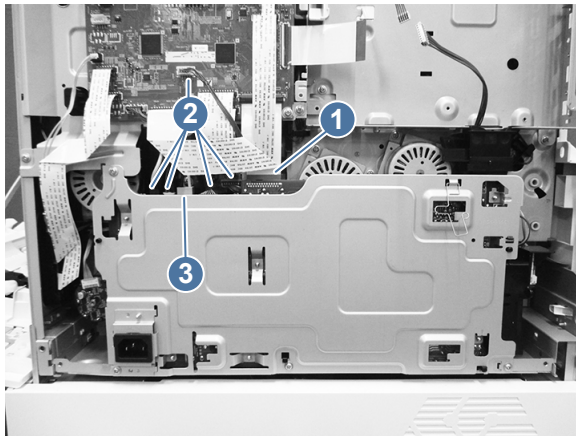
2. Remove the FFC (callout 1), and then disconnect five connectors (callout 2).

---

 **NOTE:** MFP only: Disconnect one additional connector (callout 3).


---

**Figure 5-348 Disconnect the LVPS connectors**



3. Remove four screws (callout 1), and then remove the low-voltage power supply assembly (callout 2).

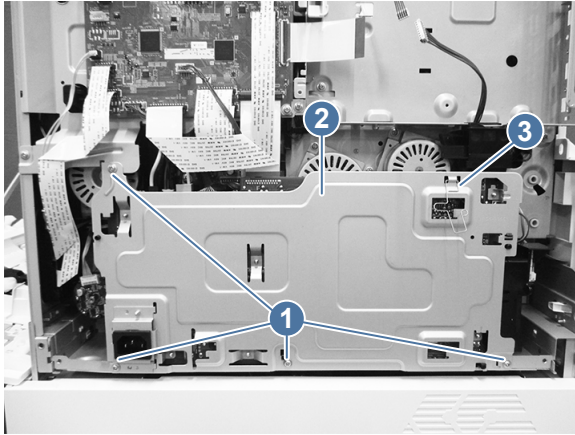
---

 **NOTE:** The black ducting in the lower right corner can stick during the removal process.

**Replacement LVPS only:** Remove the spring (callout 3), and then install it on the replacement LVPS.

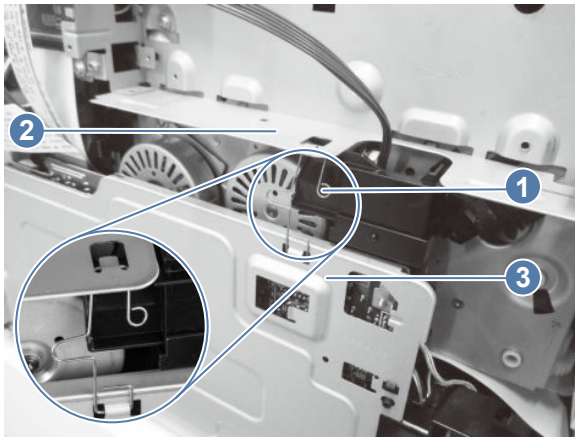
---

**Figure 5-349 Remove the LVPS**



**Reinstallation tip:** When reinstalling the LVPS, make sure that the spring (callout 1) is attached to both the formatter cage (callout 2) and the LVPS (callout 3).

**Figure 5-350 Reinstalling the LVPS**

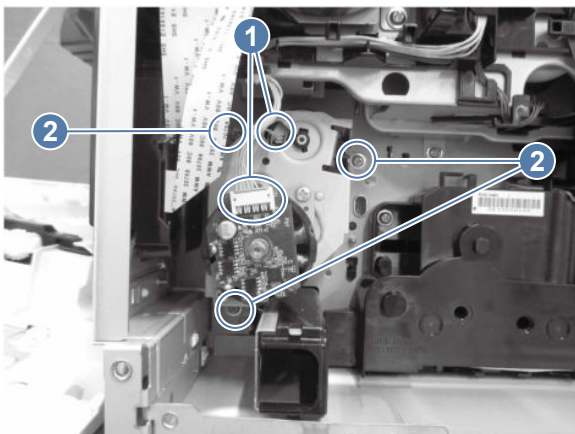


#### 4. Remove the pickup drive assembly (6700/6800 models)

Follow these steps to remove the pickup drive assembly.

1. Disconnect two connectors (callout 1), and then remove three screws (callout 2).

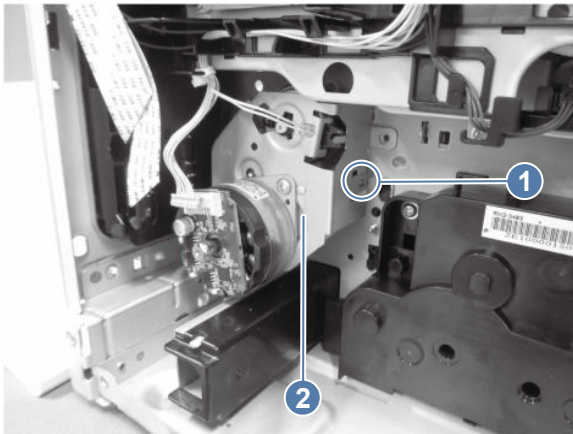
**Figure 5-351 Disconnect two connectors, remove three screws**





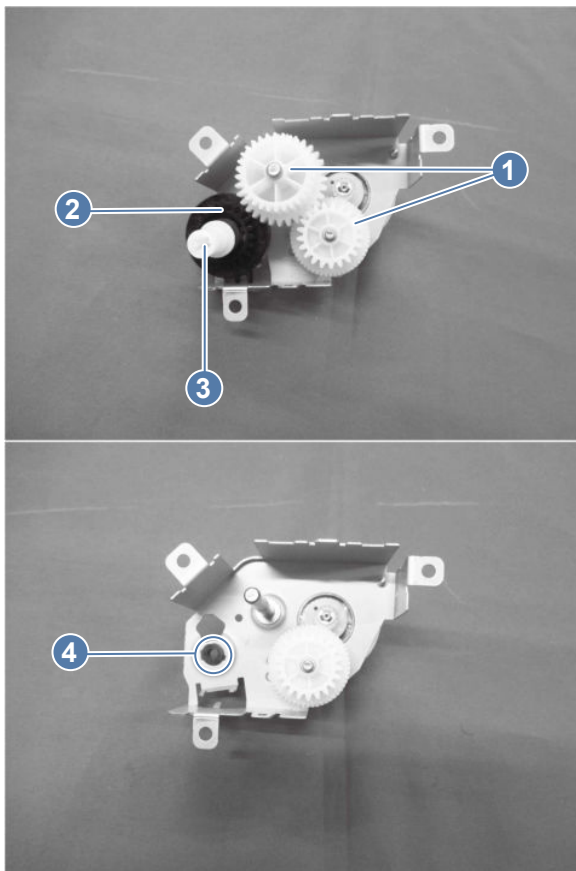
2. Release one tab (callout 1), and then remove the pickup drive assembly (callout 2).

**Figure 5-352 Remove the pickup drive assembly**



**Reinstallation tip:** The indicated gears (callout 1), clutch (callout 2), shaft (callout 3), and bushing (callout 4) are not fixed to the assembly plate. Ensure that these components do not fall apart when installing or removing the paper pickup drive assembly.


**Figure 5-353 Do not lose unfastened components**



## 5. Unpack the replacement assembly



Follow these steps to unpack the replacement assembly.


1. Dispose of the defective part.


 **NOTE:** HP recommends responsible disposal of the defective part.

<http://www8.hp.com/us/en/hp-information/environment/product-recycling.html>


2. Unpack the replacement part from the packaging.

 **CAUTION:**  Some parts are sensitive to electrostatic discharge (ESD). Always perform service work at an ESD-protected workstation or mat. If an ESD workstation or mat is not available, touch the sheet-metal chassis to provide a static ground before touching an ESD-sensitive assembly. Protect the ESD-sensitive assemblies by placing them in ESD pouches when they are out of the printer.

 **IMPORTANT:** Make sure that all of the shipping materials (for example shipping tape) are removed from the replacement part prior to installation.

 **NOTE:** If the replacement part is a roller or pad, avoid touching the spongy part of it. Skin oils on the roller or pad can cause paper pickup and/or print-quality problems. HP recommends using disposable gloves when handling rollers or pads or washing your hands before touching rollers or pads.

3. To install an assembly, reverse the removal steps.

 **NOTE:** When applicable, special installation instructions are provided for an assembly at the end of the removal procedure. Always completely read the removal instructions and follow all special installation instructions.


## Removal and replacement: Pickup drive assembly (X654/X677 models)

Learn about removing and replacing the pickup drive assembly.

### Before performing service

#### Turn the printer power off

- Disconnect the power cable.

 **WARNING!** To avoid damage to the printer, turn the printer off, wait 30 seconds, and then remove the power cord before attempting to service the printer.

If the part is damaged and cannot be cleaned, use the table below to identify the correct part number for your printer. To order the part, go to [www.hp.com/buy/parts](http://www.hp.com/buy/parts).

**Table 5-63 Part information**

Part number	Part description
RM2-3683-000CN	Paper pickup drive assembly (X654/X677)
RM2-3702-000CN	Paper pickup drive assembly (X57945)

### Required tools

- #2 Phillips screwdriver with a magnetic tip and a 152 mm (6 in) shaft length

### After performing service

#### Turn the printer power on

- Connect the power cable.
- Use the power switch to turn the power on.

## Post service test

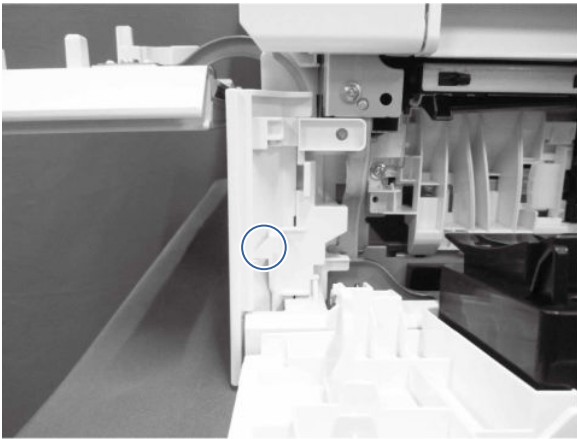
Print any pages necessary to make sure the printer is functioning correctly.

### 1. Remove the front right cover

Follow these steps to remove the front right cover.

1. Open the toner cartridge access door.
2. Open the right lower door.
3. Release one tab, and then slide the front right cover upward to remove it.

**Figure 5-354** Remove the front right cover

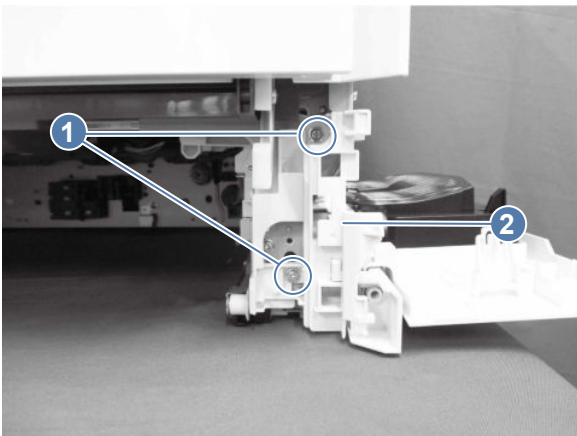


### 2. Remove the right lower door (X654/X677 models)

Follow these steps to remove the right lower door.

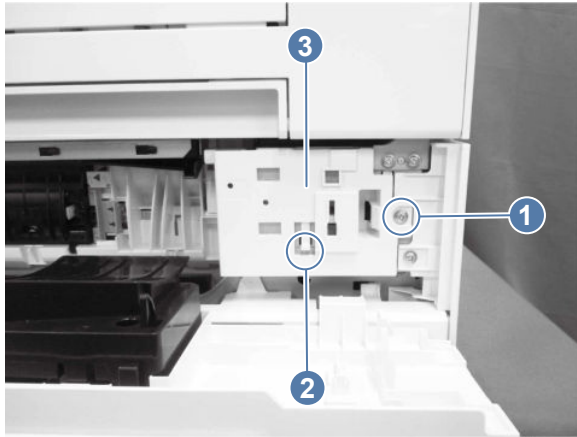
1. Remove two screws (callout 1), and then remove the base frame (callout 2).

**Figure 5-355** Remove the base frame



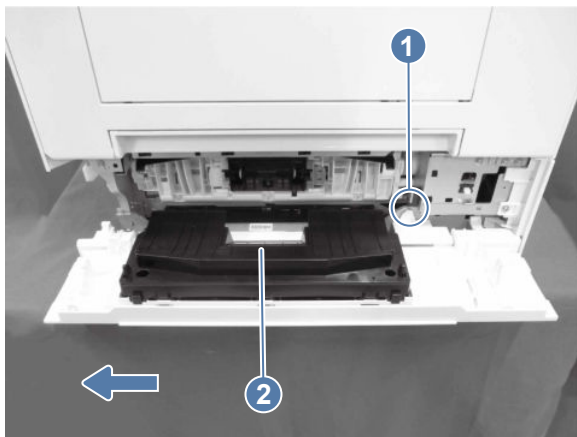
2. Remove one screw (callout 1), release one tab (callout 2), and then slide the rear inner cover (callout 3) downward to remove it.

**Figure 5-356 Remove the rear inner cover**



3. Release one tab (callout 1), and then slide the right lower door assembly (callout 2) in the direction indicated to remove it.

**Figure 5-357 Remove the right lower door assembly**

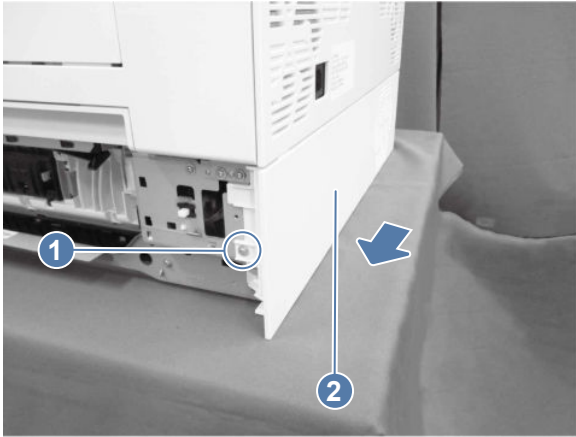


### 3. Remove the rear lower cover (X654/X677 models)

Follow these steps to remove the rear lower cover.

- Remove one screw (callout 1), slide the rear lower cover (callout 2) in the direction indicated below, and then remove it.

**Figure 5-358 Remove the rear lower cover**

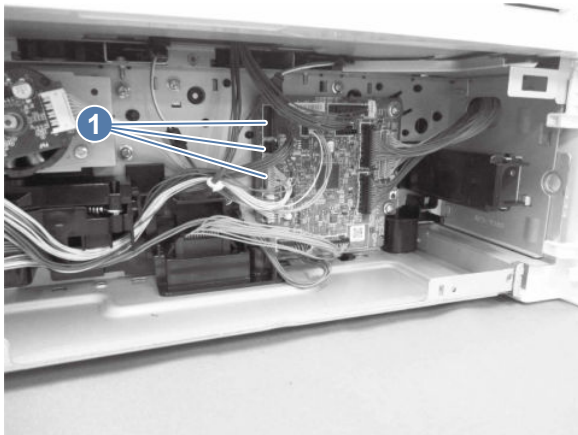


#### 4. Remove the pickup drive assembly (X654/X677 models)

Follow these steps to remove the pickup drive assembly.

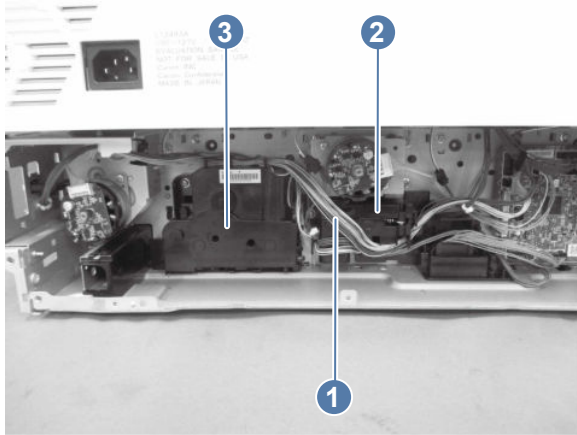
1. Disconnect three connectors (callout 1).

**Figure 5-359 Disconnect three connectors**



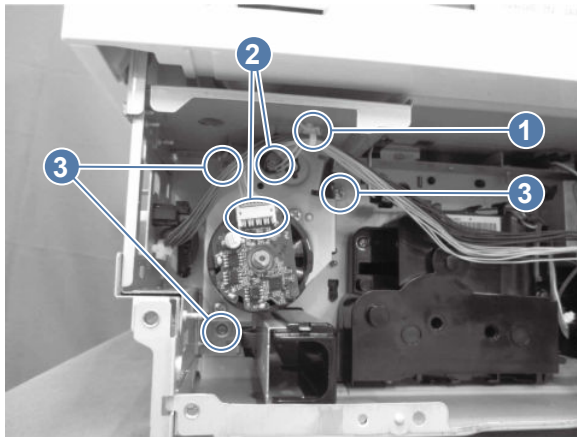
2. Release the cable (callout 1) from the auto close assembly (callout 2) and the lifter drive assembly (callout 3).

**Figure 5-360 Release the cable**



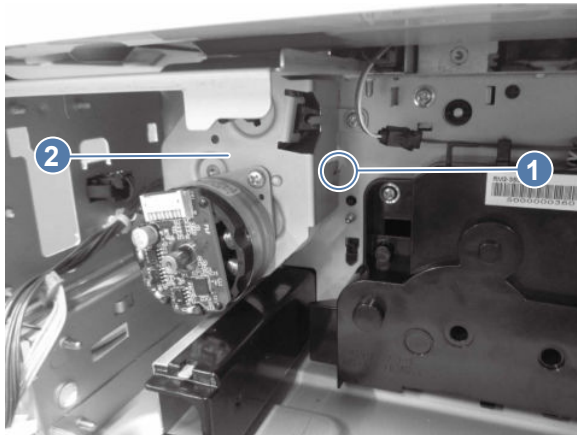
3. Remove the cable clamp (callout 1), disconnect two connectors (callout 2), and then remove three screws (callout 3).

**Figure 5-361 Remove the cable clamp**



4. Release one tab (callout 1), and then remove the pickup drive assembly (callout 2).

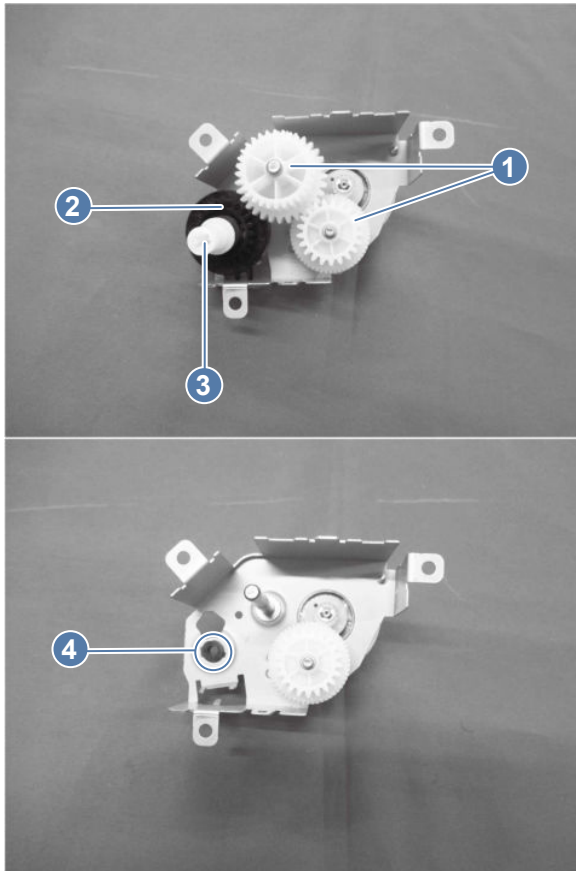
**Figure 5-362 Remove the pickup drive assembly**



---

**Reinstallation tip:** The indicated gears (callout 1), clutch (callout 2), shaft (callout 3), and bushing (callout 4) are not fixed to the assembly plate. Ensure that these components do not fall apart when installing or removing the paper pickup drive assembly.

**Figure 5-363 Do not lose unfastened components**



---

## 5. Unpack the replacement assembly

Follow these steps to unpack the replacement assembly.

1. Dispose of the defective part.

---



 **NOTE:** HP recommends responsible disposal of the defective part.


<http://www8.hp.com/us/en/hp-information/environment/product-recycling.html>


---

2. Unpack the replacement part from the packaging.

---


 **CAUTION:**  Some parts are sensitive to electrostatic discharge (ESD). Always perform service work at an ESD-protected workstation or mat. If an ESD workstation or mat is not available, touch the sheet-metal chassis to provide a static ground before touching an ESD-sensitive assembly. Protect the ESD-sensitive assemblies by placing them in ESD pouches when they are out of the printer.

 **IMPORTANT:** Make sure that all of the shipping materials (for example shipping tape) are removed from the replacement part prior to installation.

 **NOTE:** If the replacement part is a roller or pad, avoid touching the spongy part of it. Skin oils on the roller or pad can cause paper pickup and/or print-quality problems. HP recommends using disposable gloves when handling rollers or pads or washing your hands before touching rollers or pads.

---

3. To install an assembly, reverse the removal steps.

 **NOTE:** When applicable, special installation instructions are provided for an assembly at the end of the removal procedure. Always completely read the removal instructions and follow all special installation instructions.

---


## Removal and replacement: Toner supply motor assembly (X654/X677 models)

Learn about removing and replacing the toner supply motor assembly.

### Before performing service

#### Turn the printer power off

- Disconnect the power cable.

 **WARNING!** To avoid damage to the printer, turn the printer off, wait 30 seconds, and then remove the power cord before attempting to service the printer.

---

If the part is damaged and cannot be cleaned, use the table below to identify the correct part number for your printer. To order the part, go to [www.hp.com/buy/parts](http://www.hp.com/buy/parts).

**Table 5-64** Part information

Part number	Part description
RM2-3612-000CN	Toner supply drive motor assembly (X654/X677 models)

### Required tools

- #2 Phillips screwdriver with a magnetic tip and a 152 mm (6 in) shaft length

### After performing service

#### Turn the printer power on

- Connect the power cable.
- Use the power switch to turn the power on.

### Post service test

Print any pages necessary to make sure the printer is functioning correctly.

## 1. Remove the front right cover

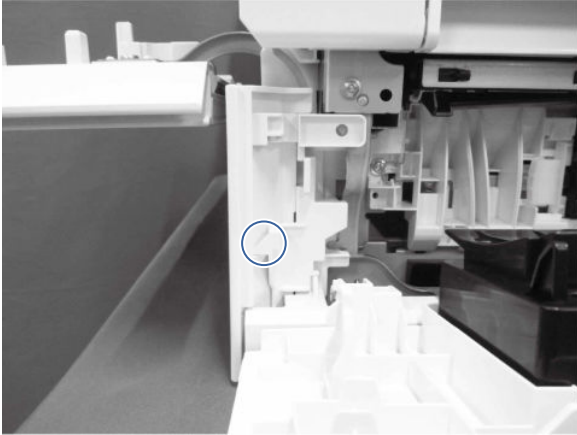
Follow these steps to remove the front right cover.

1. Open the toner cartridge access door.
2. Open the right lower door.



3. Release one tab, and then slide the front right cover upward to remove it.

**Figure 5-364 Remove the front right cover**

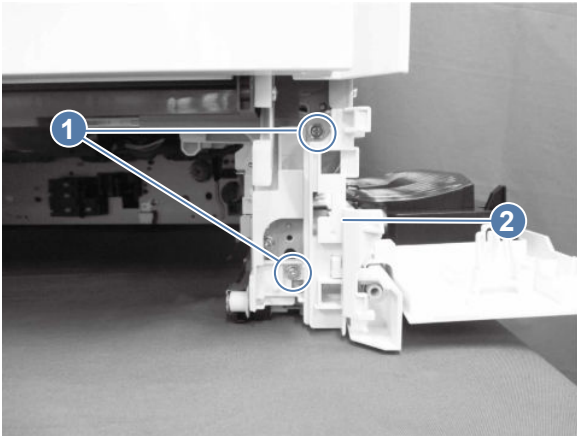


## 2. Remove the right lower door (X654/X677 models)

Follow these steps to remove the right lower door.

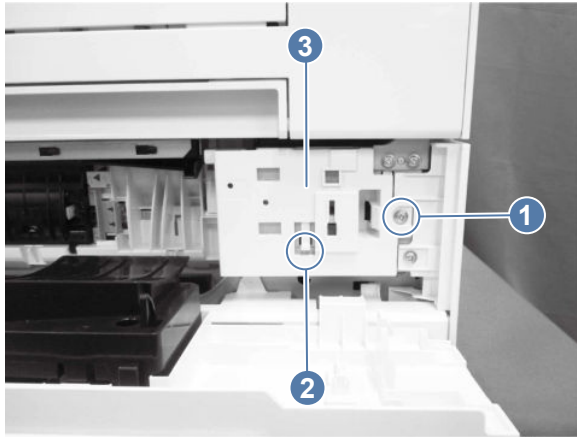
1. Remove two screws (callout 1), and then remove the base frame (callout 2).

**Figure 5-365 Remove the base frame**



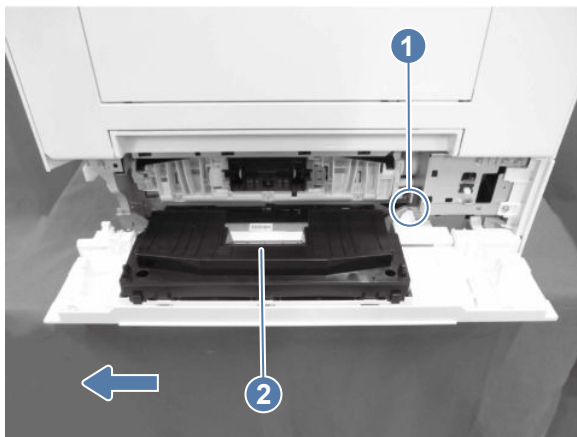
2. Remove one screw (callout 1), release one tab (callout 2), and then slide the rear inner cover (callout 3) downward to remove it.

**Figure 5-366 Remove the rear inner cover**



3. Release one tab (callout 1), and then slide the right lower door assembly (callout 2) in the direction indicated to remove it.

**Figure 5-367 Remove the right lower door assembly**

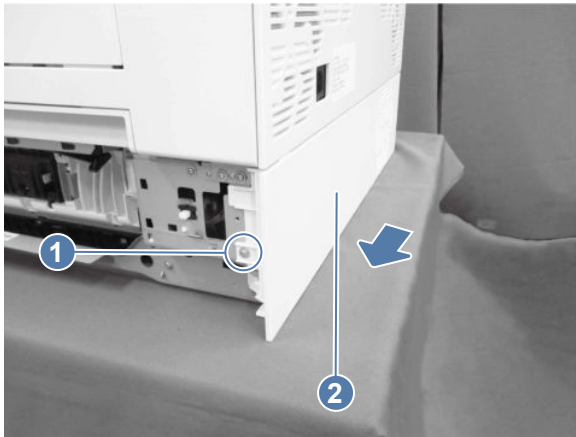


### 3. Remove the rear lower cover (X654/X677 models)

Follow these steps to remove the rear lower cover.

- Remove one screw (callout 1), slide the rear lower cover (callout 2) in the direction indicated below, and then remove it.

**Figure 5-368 Remove the rear lower cover**

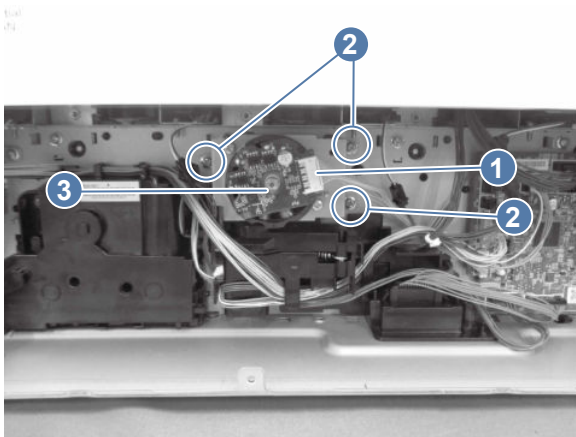


#### 4. Remove the toner supply motor assembly (X654/X677 models)

Follow these steps to remove the toner supply motor assembly.

- Disconnect one connector (callout 1), remove three screws (callout 2), and then remove the toner supply motor assembly (callout 3).

**Figure 5-369 Remove the assembly**



#### 5. Unpack the replacement assembly

Follow these steps to unpack the replacement assembly.





1. Dispose of the defective part.




**NOTE:** HP recommends responsible disposal of the defective part.

<http://www8.hp.com/us/en/hp-information/environment/product-recycling.html>

## 2. Unpack the replacement part from the packaging.

-  **CAUTION:**  Some parts are sensitive to electrostatic discharge (ESD). Always perform service work at an ESD-protected workstation or mat. If an ESD workstation or mat is not available, touch the sheet-metal chassis to provide a static ground before touching an ESD-sensitive assembly. Protect the ESD-sensitive assemblies by placing them in ESD pouches when they are out of the printer.
-  **IMPORTANT:** Make sure that all of the shipping materials (for example shipping tape) are removed from the replacement part prior to installation.
-  **NOTE:** If the replacement part is a roller or pad, avoid touching the spongy part of it. Skin oils on the roller or pad can cause paper pickup and/or print-quality problems. HP recommends using disposable gloves when handling rollers or pads or washing your hands before touching rollers or pads.

## 3. To install an assembly, reverse the removal steps.

-  **NOTE:** When applicable, special installation instructions are provided for an assembly at the end of the removal procedure. Always completely read the removal instructions and follow all special installation instructions.

### Removal and replacement: Lifter drive assembly (6700/6800 models)


Learn about removing and replacing the lifter drive assembly.

 [View a video demonstration of removing and replacing the lifter drive assembly.](#)

#### Before performing service

##### Turn the printer power off

- Disconnect the power cable.

 **WARNING!** To avoid damage to the printer, turn the printer off, wait 30 seconds, and then remove the power cord before attempting to service the printer.

If the part is damaged and cannot be cleaned, use the table below to identify the correct part number for your printer. To order the part, go to [www.hp.com/buy/parts](http://www.hp.com/buy/parts).

**Table 5-65 Part information**

Part number	Part description
RM2-3493-000CN	Lifter drive assembly (5700/5800)
RM2-3500-000CN	Lifter drive assembly (X557/6700/6800)

#### Required tools

- #2 Phillips screwdriver with a magnetic tip and a 152 mm (6 in) shaft length

#### After performing service

##### Turn the printer power on

- Connect the power cable.
- Use the power switch to turn the power on.

## Post service test


Print any pages necessary to make sure the printer is functioning correctly.

### 1. Remove the formatter cover

Follow these steps to remove the formatter cover.

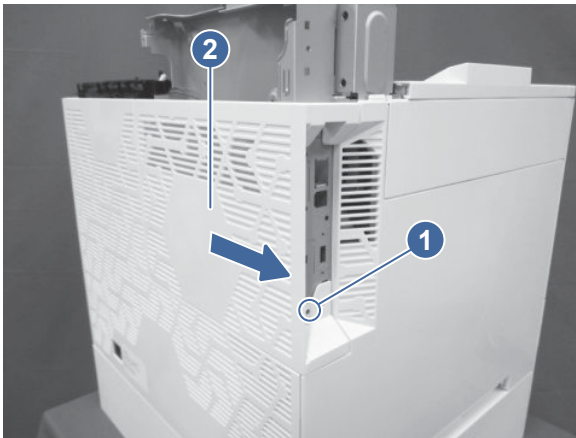
- Remove one screw (callout 1), and then slide the formatter cover (callout 2) away from the printer to remove it.

---

 **TIP:** Reverse the removal steps to install the assembly.

---


**Figure 5-370** Remove the formatter cover



### 2. Remove the rear cover

Follow these steps to remove the rear cover.

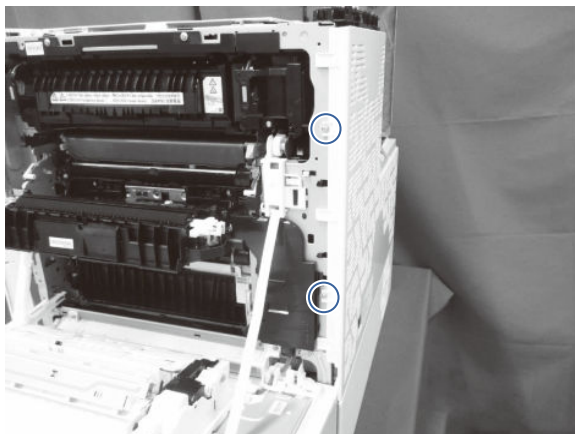
---

 **NOTE:** The figures below show some assemblies (for example the top cover and formatter) removed that might still be installed on the printer. However, the steps to remove the cover are correct.

---

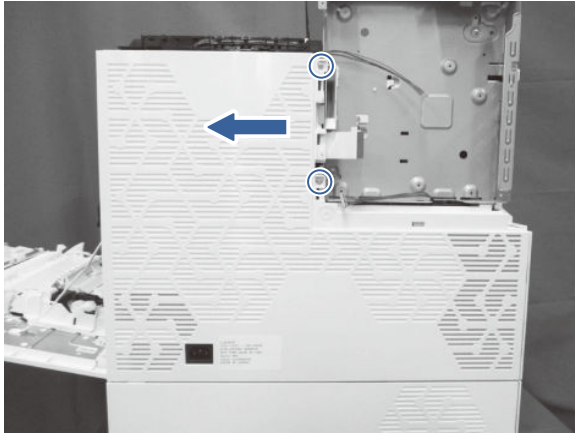
1. Open the right door, and remove two screws.

**Figure 5-371** Remove two screws



2. At the back of the printer, remove two screws, and then slide the rear cover as indicated to remove it.

**Figure 5-372 Remove the rear cover**




### 3. Remove the low-voltage power supply (LVPS)

Follow these steps to remove the low-voltage power supply (LVPS).

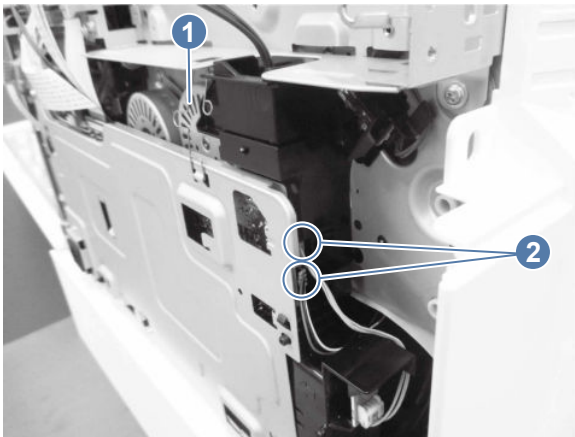
1. Unhook one spring (callout 1), and then disconnect two connectors (callout 2).

---

 **NOTE:** Unhook the spring from the formatter cage, not the low-voltage power supply. The spring should remain attached to the LVPS.


---

**Figure 5-373 Unhook the spring and disconnect two connectors**



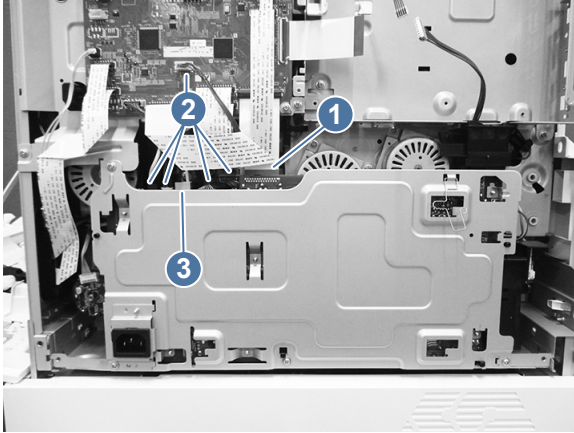
2. Remove the FFC (callout 1), and then disconnect five connectors (callout 2).

---

 **NOTE: MFP only:** Disconnect one additional connector (callout 3).

---

**Figure 5-374 Disconnect the LVPS connectors**



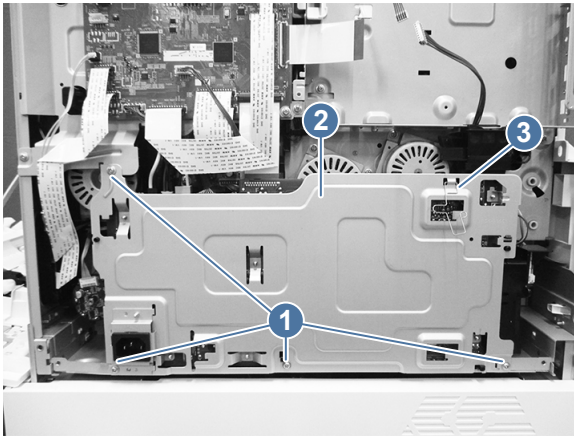
3. Remove four screws (callout 1), and then remove the low-voltage power supply assembly (callout 2).



**NOTE:** The black ducting in the lower right corner can stick during the removal process.

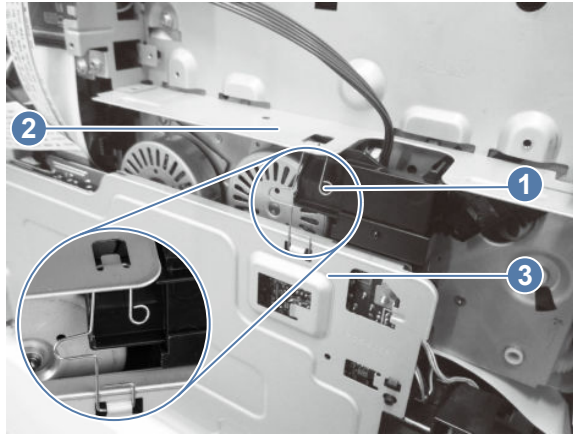
**Replacement LVPS only:** Remove the spring (callout 3), and then install it on the replacement LVPS.

**Figure 5-375 Remove the LVPS**



**Reinstallation tip:** When reinstalling the LVPS, make sure that the spring (callout 1) is attached to both the formatter cage (callout 2) and the LVPS (callout 3).

**Figure 5-376 Reinstalling the LVPS**

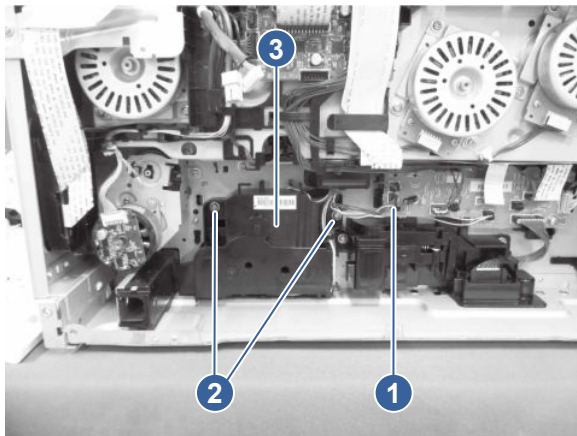


#### 4. Remove the lifter drive assembly (6700/6800 models)

Follow these steps to remove the lifter drive assembly.

- Disconnect one connector (callout 1), remove two screws (callout 2), and then remove the lifter drive assembly (callout 3).

**Figure 5-377 Remove the assembly**



#### 5. Unpack the replacement assembly

Follow these steps to unpack the replacement assembly.

1. Dispose of the defective part.




**NOTE:** HP recommends responsible disposal of the defective part.


<http://www8.hp.com/us/en/hp-information/environment/product-recycling.html>


2. Unpack the replacement part from the packaging.



**CAUTION:**  Some parts are sensitive to electrostatic discharge (ESD). Always perform service work at an ESD-protected workstation or mat. If an ESD workstation or mat is not available, touch the sheet-metal chassis to provide a static ground before touching an ESD-sensitive assembly. Protect the ESD-sensitive assemblies by placing them in ESD pouches when they are out of the printer.




 **IMPORTANT:** Make sure that all of the shipping materials (for example shipping tape) are removed from the replacement part prior to installation.

 **NOTE:** If the replacement part is a roller or pad, avoid touching the spongy part of it. Skin oils on the roller or pad can cause paper pickup and/or print-quality problems. HP recommends using disposable gloves when handling rollers or pads or washing your hands before touching rollers or pads.

---

3. To install an assembly, reverse the removal steps.

 **NOTE:** When applicable, special installation instructions are provided for an assembly at the end of the removal procedure. Always completely read the removal instructions and follow all special installation instructions.

---


## Removal and replacement: Lifter drive assembly (X654/X677 models)

Learn about removing and replacing the lifter drive assembly.

### Before performing service

#### Turn the printer power off

- Disconnect the power cable.

 **WARNING!** To avoid damage to the printer, turn the printer off, wait 30 seconds, and then remove the power cord before attempting to service the printer.

---

If the part is damaged and cannot be cleaned, use the table below to identify the correct part number for your printer. To order the part, go to [www.hp.com/buy/parts](http://www.hp.com/buy/parts).

Table 5-66 Part information

Part number	Part description
RM2-3501-000CN	Lifter drive assembly (X57945/X654/X677)

### Required tools

- #2 Phillips screwdriver with a magnetic tip and a 152 mm (6 in) shaft length

### After performing service

#### Turn the printer power on

- Connect the power cable.
- Use the power switch to turn the power on.

### Post service test

Print any pages necessary to make sure the printer is functioning correctly.

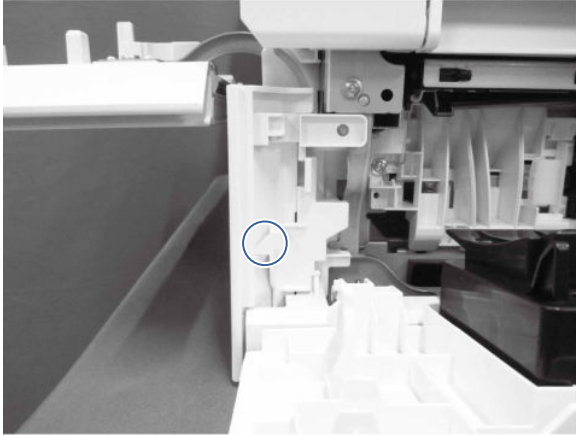
## 1. Remove the front right cover

Follow these steps to remove the front right cover.

1. Open the toner cartridge access door.
2. Open the right lower door.

3. Release one tab, and then slide the front right cover upward to remove it.

**Figure 5-378 Remove the front right cover**

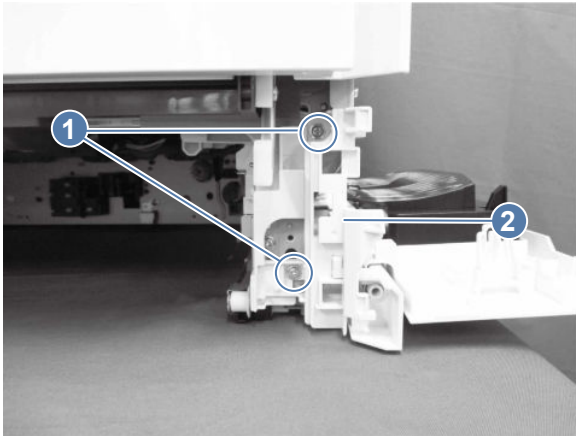


## 2. Remove the right lower door (X654/X677 models)

Follow these steps to remove the right lower door.

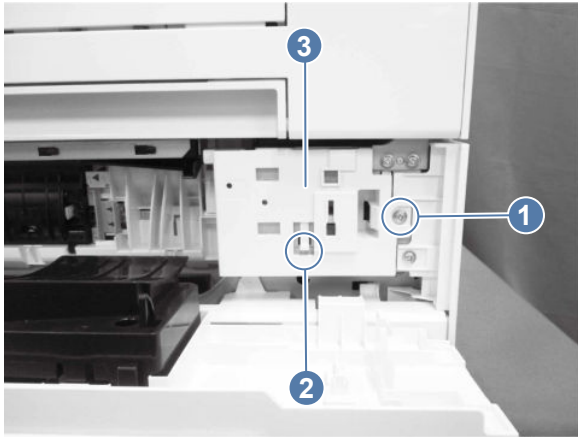
1. Remove two screws (callout 1), and then remove the base frame (callout 2).

**Figure 5-379 Remove the base frame**



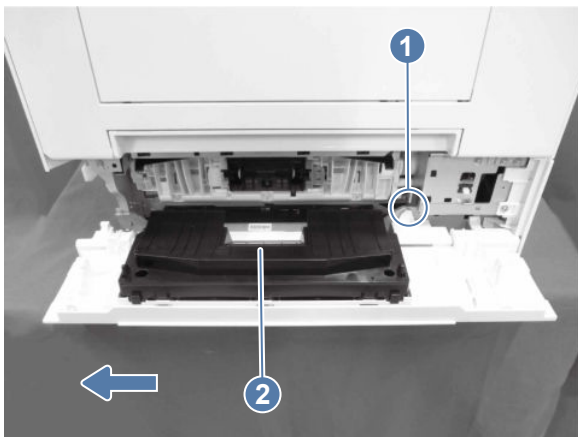
2. Remove one screw (callout 1), release one tab (callout 2), and then slide the rear inner cover (callout 3) downward to remove it.

**Figure 5-380 Remove the rear inner cover**



3. Release one tab (callout 1), and then slide the right lower door assembly (callout 2) in the direction indicated to remove it.

**Figure 5-381 Remove the right lower door assembly**

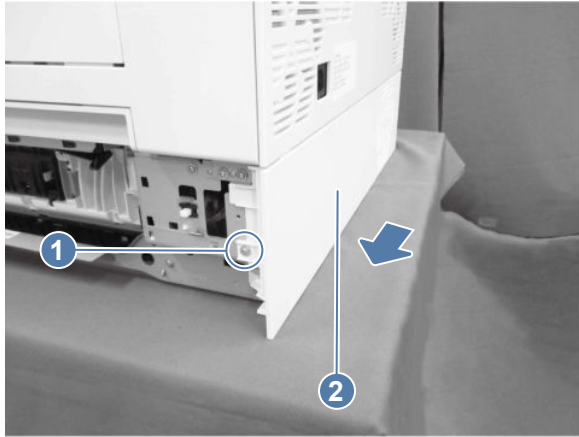


### 3. Remove the rear lower cover (X654/X677 models)

Follow these steps to remove the rear lower cover.

- Remove one screw (callout 1), slide the rear lower cover (callout 2) in the direction indicated below, and then remove it.

**Figure 5-382 Remove the rear lower cover**

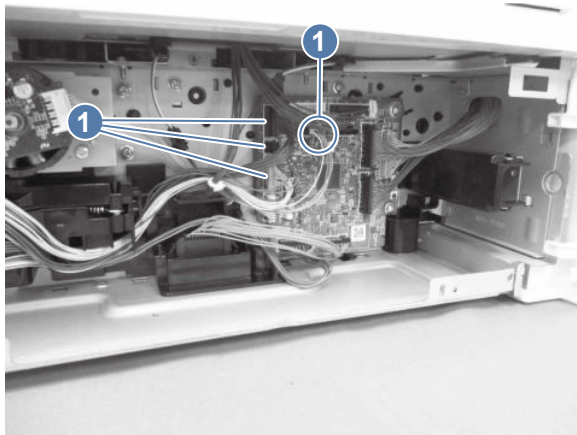


#### 4. Remove the lifter drive assembly (X654/X677 models)

Follow these steps to remove the lifter drive assembly.

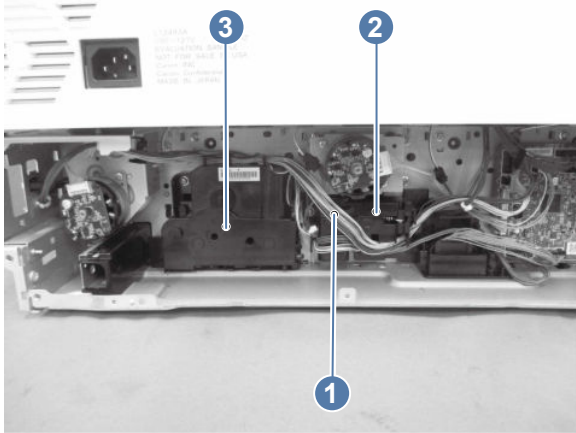
1. Disconnect four connectors (callout 1).

**Figure 5-383 Disconnect four connectors**



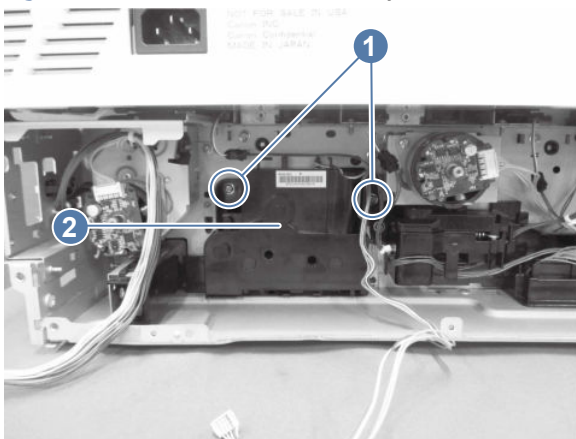
2. Release the cable (callout 1) from the auto close assembly (callout 2) and from the lifter drive assembly (callout 3).

**Figure 5-384 Release the cable**



3. Remove two screws (callout 1), and then remove the lifter drive assembly (callout 2).

**Figure 5-385 Remove the assembly**



## 5. Unpack the replacement assembly

Follow these steps to unpack the replacement assembly.

1. Dispose of the defective part.




**NOTE:** HP recommends responsible disposal of the defective part.

<http://www8.hp.com/us/en/hp-information/environment/product-recycling.html>


2. Unpack the replacement part from the packaging.



**CAUTION:**  Some parts are sensitive to electrostatic discharge (ESD). Always perform service work at an ESD-protected workstation or mat. If an ESD workstation or mat is not available, touch the sheet-metal chassis to provide a static ground before touching an ESD-sensitive assembly. Protect the ESD-sensitive assemblies by placing them in ESD pouches when they are out of the printer.




**IMPORTANT:** Make sure that all of the shipping materials (for example shipping tape) are removed from the replacement part prior to installation.

 **NOTE:** If the replacement part is a roller or pad, avoid touching the spongy part of it. Skin oils on the roller or pad can cause paper pickup and/or print-quality problems. HP recommends using disposable gloves when handling rollers or pads or washing your hands before touching rollers or pads.

---

3. To install an assembly, reverse the removal steps.

 **NOTE:** When applicable, special installation instructions are provided for an assembly at the end of the removal procedure. Always completely read the removal instructions and follow all special installation instructions.

---


## Removal and replacement: Auto close assembly (6700/6800 models)

Learn about removing and replacing the auto close assembly.

### Before performing service

#### Turn the printer power off

- Disconnect the power cable.

 **WARNING!** To avoid damage to the printer, turn the printer off, wait 30 seconds, and then remove the power cord before attempting to service the printer.

---

If the part is damaged and cannot be cleaned, use the table below to identify the correct part number for your printer. To order the part, go to [www.hp.com/buy/parts](http://www.hp.com/buy/parts).

**Table 5-67** Part information

Part number	Part description
RM2-3559-000CN	Auto close assembly

### Required tools

- #2 Phillips screwdriver with a magnetic tip and a 152 mm (6 in) shaft length

### After performing service

#### Turn the printer power on

- Connect the power cable.
- Use the power switch to turn the power on.


### Post service test

No post service test is available for this assembly.

## 1. Remove the formatter cover

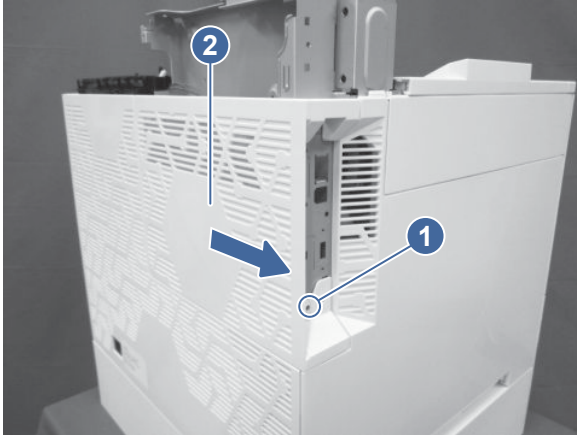
Follow these steps to remove the formatter cover.

- Remove one screw (callout 1), and then slide the formatter cover (callout 2) away from the printer to remove it.

 **TIP:** Reverse the removal steps to install the assembly.

---


**Figure 5-386 Remove the formatter cover**



## 2. Remove the rear cover

Follow these steps to remove the rear cover.

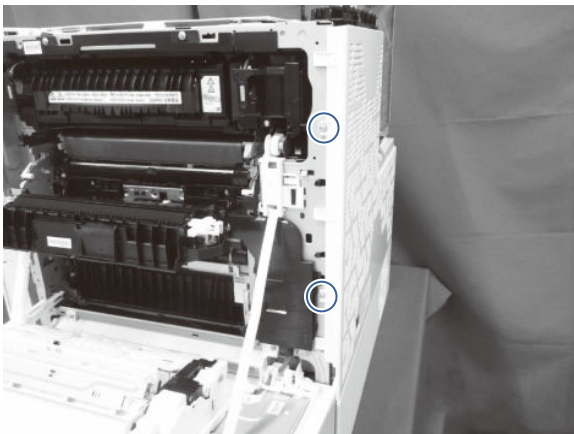
---

 **NOTE:** The figures below show some assemblies (for example the top cover and formatter) removed that might still be installed on the printer. However, the steps to remove the cover are correct.

---

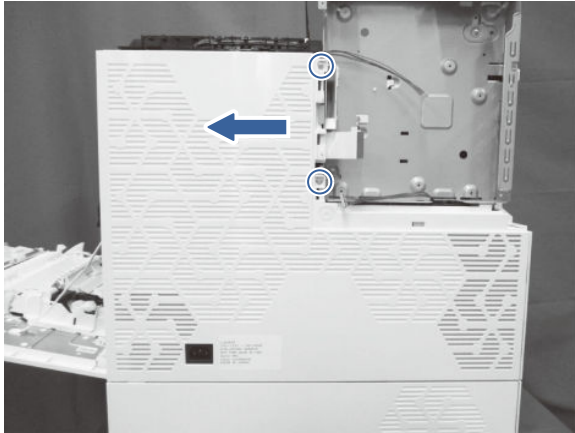
1. Open the right door, and remove two screws.

**Figure 5-387 Remove two screws**



2. At the back of the printer, remove two screws, and then slide the rear cover as indicated to remove it.

**Figure 5-388 Remove the rear cover**




### 3. Remove the low-voltage power supply (LVPS)

Follow these steps to remove the low-voltage power supply (LVPS).

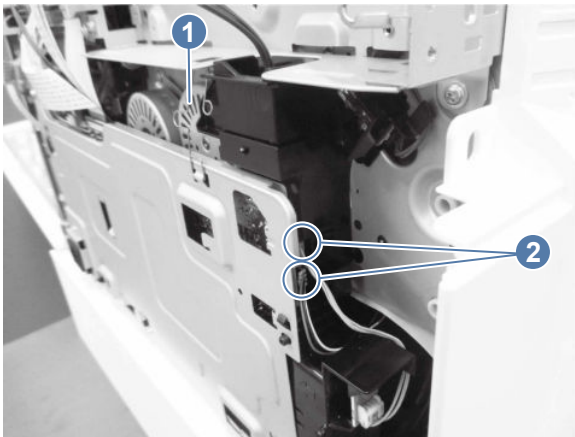
1. Unhook one spring (callout 1), and then disconnect two connectors (callout 2).

---

 **NOTE:** Unhook the spring from the formatter cage, not the low-voltage power supply. The spring should remain attached to the LVPS.


---

**Figure 5-389 Unhook the spring and disconnect two connectors**



2. Remove the FFC (callout 1), and then disconnect five connectors (callout 2).

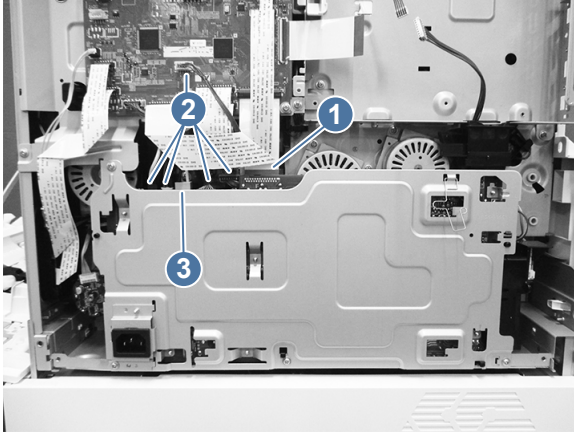
---

 **NOTE: MFP only:** Disconnect one additional connector (callout 3).

---



**Figure 5-390 Disconnect the LVPS connectors**



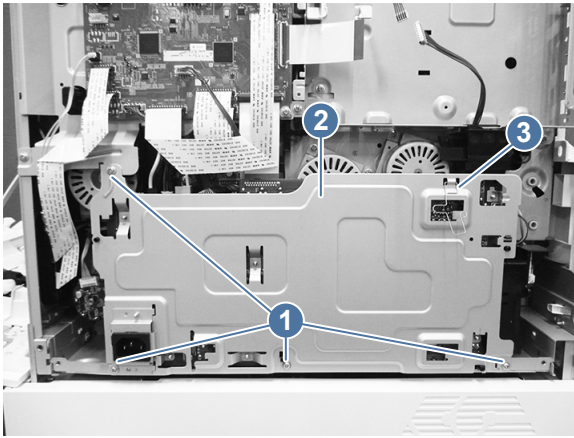
3. Remove four screws (callout 1), and then remove the low-voltage power supply assembly (callout 2).



**NOTE:** The black ducting in the lower right corner can stick during the removal process.

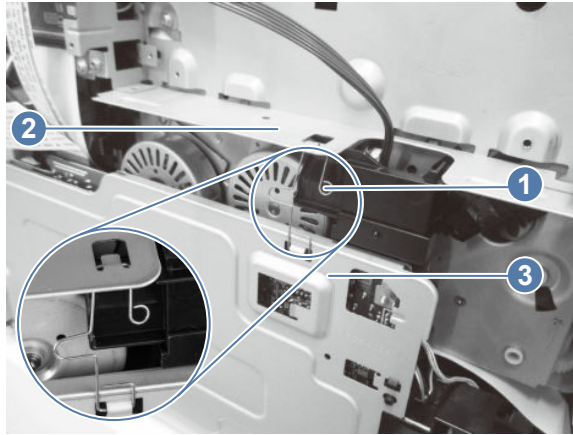
**Replacement LVPS only:** Remove the spring (callout 3), and then install it on the replacement LVPS.

**Figure 5-391 Remove the LVPS**



**Reinstallation tip:** When reinstalling the LVPS, make sure that the spring (callout 1) is attached to both the formatter cage (callout 2) and the LVPS (callout 3).

**Figure 5-392 Reinstalling the LVPS**

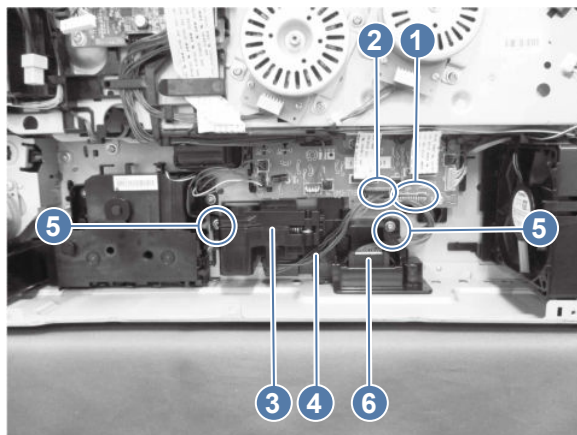


#### 4. Remove the auto close assembly (6700/6800 models)

Follow these steps to remove the auto close assembly.

- Disconnect one connector (callout 1), disconnect one connector (callout 2), release the cables (callout 3) from the auto close assembly (callout 4), remove two screws (callout 5), remove the auto close assembly, and then remove the drawer connector (callout 6) from the auto close assembly.

**Figure 5-393 Remove the auto close assembly**



#### 5. Unpack the replacement assembly

Follow these steps to unpack the replacement assembly.

1. Dispose of the defective part.





**NOTE:** HP recommends responsible disposal of the defective part.


<http://www8.hp.com/us/en/hp-information/environment/product-recycling.html>

2. Unpack the replacement part from the packaging.




**CAUTION:**  Some parts are sensitive to electrostatic discharge (ESD). Always perform service work at an ESD-protected workstation or mat. If an ESD workstation or mat is not available, touch the sheet-metal chassis to provide a static ground before touching an ESD-sensitive assembly. Protect the ESD-sensitive assemblies by placing them in ESD pouches when they are out of the printer.

 **IMPORTANT:** Make sure that all of the shipping materials (for example shipping tape) are removed from the replacement part prior to installation.

 **NOTE:** If the replacement part is a roller or pad, avoid touching the spongy part of it. Skin oils on the roller or pad can cause paper pickup and/or print-quality problems. HP recommends using disposable gloves when handling rollers or pads or washing your hands before touching rollers or pads.

---

3. To install an assembly, reverse the removal steps.

 **NOTE:** When applicable, special installation instructions are provided for an assembly at the end of the removal procedure. Always completely read the removal instructions and follow all special installation instructions.

---


### Removal and replacement: Auto close assembly (X654/X677 models)

Learn about removing and replacing the auto close assembly.

#### Before performing service

##### Turn the printer power off

- Disconnect the power cable.

 **WARNING!** To avoid damage to the printer, turn the printer off, wait 30 seconds, and then remove the power cord before attempting to service the printer.

---

If the part is damaged and cannot be cleaned, use the table below to identify the correct part number for your printer. To order the part, go to [www.hp.com/buy/parts](http://www.hp.com/buy/parts).

**Table 5-68** Part information

Part number	Part description
RM2-3559-000CN	Auto close assembly

#### Required tools

- #2 Phillips screwdriver with a magnetic tip and a 152 mm (6 in) shaft length

#### After performing service

##### Turn the printer power on

- Connect the power cable.
- Use the power switch to turn the power on.

#### Post service test

No post service test is available for this assembly.

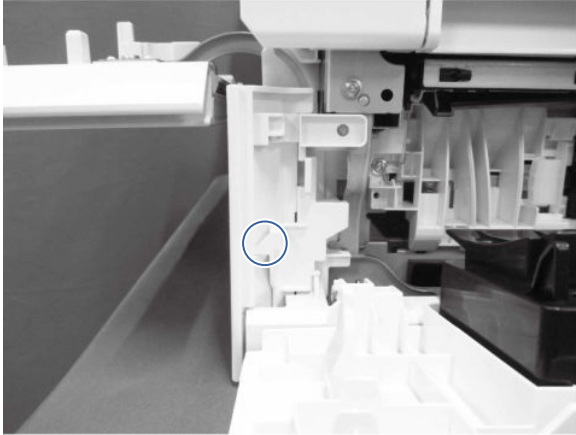
### 1. Remove the front right cover

Follow these steps to remove the front right cover.

1. Open the toner cartridge access door.
2. Open the right lower door.

3. Release one tab, and then slide the front right cover upward to remove it.

**Figure 5-394 Remove the front right cover**

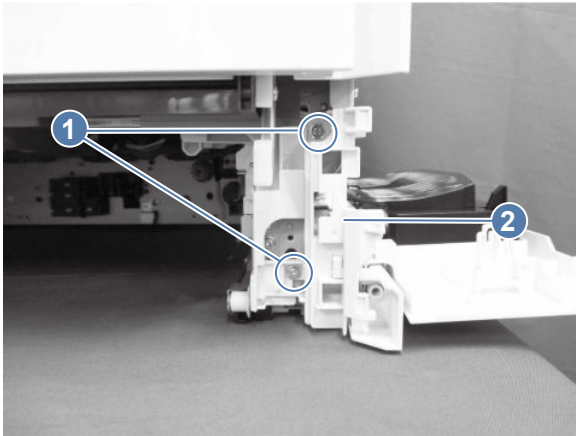


## 2. Remove the right lower door (X654/X677 models)

Follow these steps to remove the right lower door.

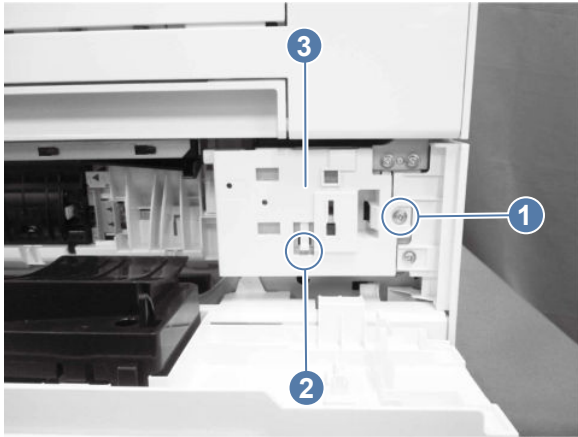
1. Remove two screws (callout 1), and then remove the base frame (callout 2).

**Figure 5-395 Remove the base frame**



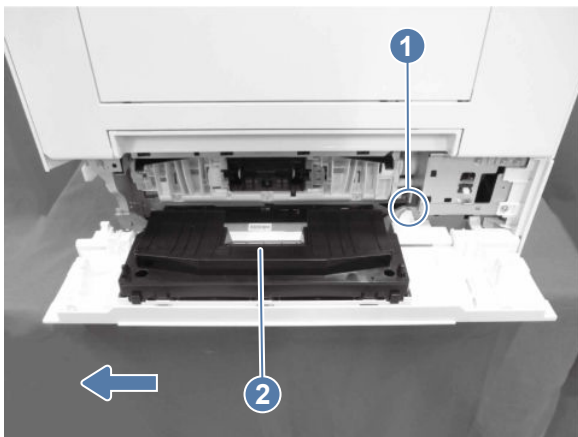
2. Remove one screw (callout 1), release one tab (callout 2), and then slide the rear inner cover (callout 3) downward to remove it.

**Figure 5-396 Remove the rear inner cover**



3. Release one tab (callout 1), and then slide the right lower door assembly (callout 2) in the direction indicated to remove it.

**Figure 5-397 Remove the right lower door assembly**

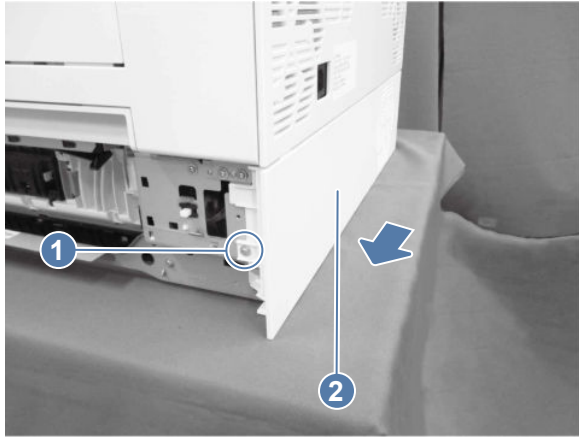


### 3. Remove the rear lower cover (X654/X677 models)

Follow these steps to remove the rear lower cover.

- Remove one screw (callout 1), slide the rear lower cover (callout 2) in the direction indicated below, and then remove it.

**Figure 5-398 Remove the rear lower cover**

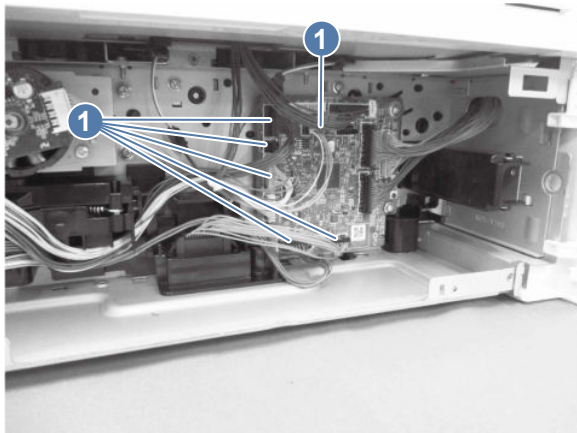


#### 4. Remove the auto close assembly (X654/X677 models)

Follow these steps to remove the auto close assembly.

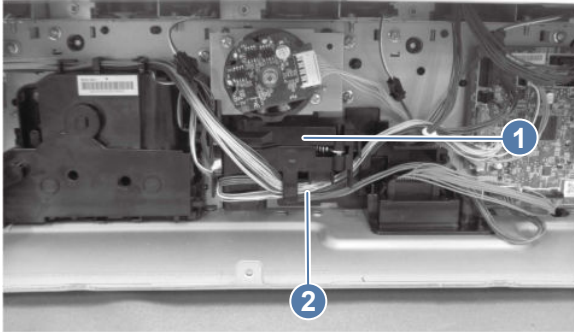
1. Disconnect six connectors (callout 1).

**Figure 5-399 Disconnect six connectors**



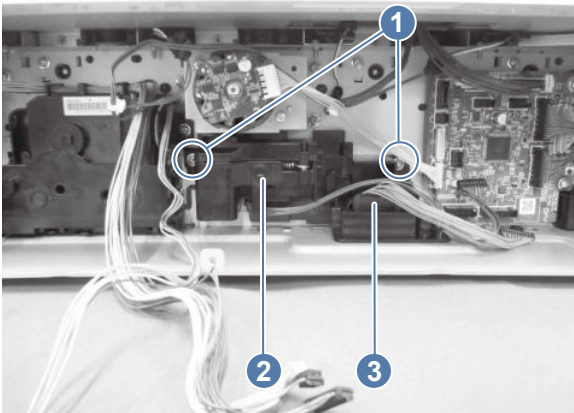
2. Release the cables (callout 1) from the auto close assembly (callout 2).

**Figure 5-400 Release the cable**



3. Remove two screws (callout 1), remove the auto close assembly (callout 2), and then remove the drawer connector (callout 3) from the auto close assembly.

**Figure 5-401 Remove the auto close assembly**



## 5. Unpack the replacement assembly

Follow these steps to unpack the replacement assembly.

1. Dispose of the defective part.




**NOTE:** HP recommends responsible disposal of the defective part.

<http://www8.hp.com/us/en/hp-information/environment/product-recycling.html>


2. Unpack the replacement part from the packaging.



**CAUTION:**  Some parts are sensitive to electrostatic discharge (ESD). Always perform service work at an ESD-protected workstation or mat. If an ESD workstation or mat is not available, touch the sheet-metal chassis to provide a static ground before touching an ESD-sensitive assembly. Protect the ESD-sensitive assemblies by placing them in ESD pouches when they are out of the printer.




**IMPORTANT:** Make sure that all of the shipping materials (for example shipping tape) are removed from the replacement part prior to installation.

 **NOTE:** If the replacement part is a roller or pad, avoid touching the spongy part of it. Skin oils on the roller or pad can cause paper pickup and/or print-quality problems. HP recommends using disposable gloves when handling rollers or pads or washing your hands before touching rollers or pads.

---

3. To install an assembly, reverse the removal steps.

 **NOTE:** When applicable, special installation instructions are provided for an assembly at the end of the removal procedure. Always completely read the removal instructions and follow all special installation instructions.

---


## Removal and replacement: Tray 2 media size detect assembly (6700/6800 models)

Learn about removing and replacing the Tray 2 media size detect assembly.

### Before performing service

#### Turn the printer power off

- Disconnect the power cable.

 **WARNING!** To avoid damage to the printer, turn the printer off, wait 30 seconds, and then remove the power cord before attempting to service the printer.

---

If the part is damaged and cannot be cleaned, use the table below to identify the correct part number for your printer. To order the part, go to [www.hp.com/buy/parts](http://www.hp.com/buy/parts).

**Table 5-69** Part information

Part number	Part description
RM2-3585-000CN	Size detect assembly (6700/6800)
RM2-3634-000CN	Size detect assembly (5700/X557)
RM2-3614-000CN	Size detect assembly (5800)

### Required tools

- #2 Phillips screwdriver with a magnetic tip and a 152 mm (6 in) shaft length

### After performing service

#### Turn the printer power on

- Connect the power cable.
- Use the power switch to turn the power on.

### Post service test


No post service test is available for this assembly.

## 1. Remove the formatter cover

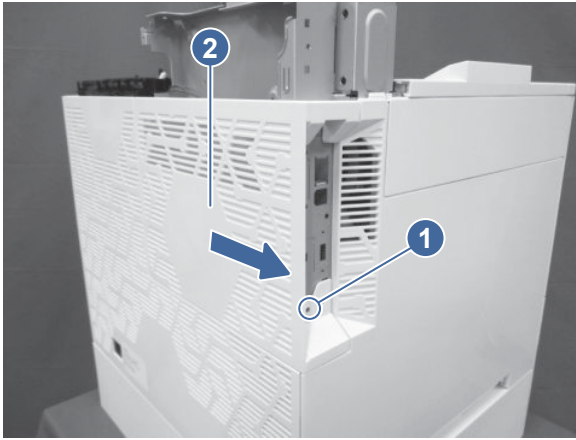
Follow these steps to remove the formatter cover.



- Remove one screw (callout 1), and then slide the formatter cover (callout 2) away from the printer to remove it.


 **TIP:** Reverse the removal steps to install the assembly.

**Figure 5-402 Remove the formatter cover**



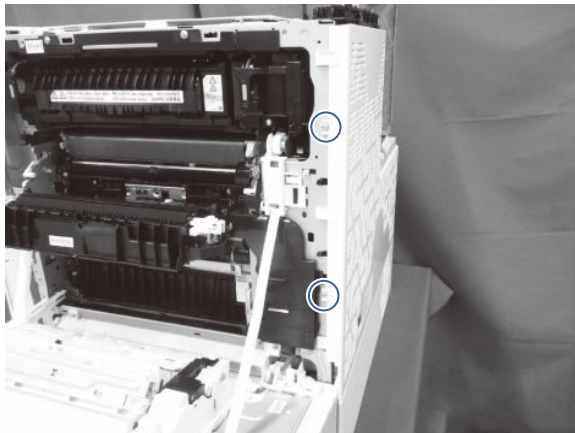
## 2. Remove the rear cover

Follow these steps to remove the rear cover.

 **NOTE:** The figures below show some assemblies (for example the top cover and formatter) removed that might still be installed on the printer. However, the steps to remove the cover are correct.

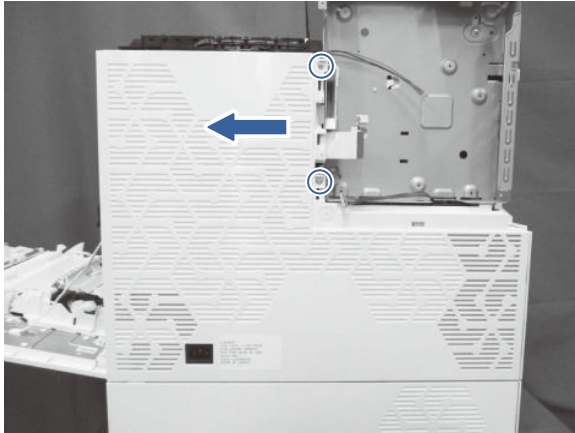
1. Open the right door, and remove two screws.

**Figure 5-403 Remove two screws**



2. At the back of the printer, remove two screws, and then slide the rear cover as indicated to remove it.

**Figure 5-404 Remove the rear cover**




### 3. Remove the low-voltage power supply (LVPS)

Follow these steps to remove the low-voltage power supply (LVPS).

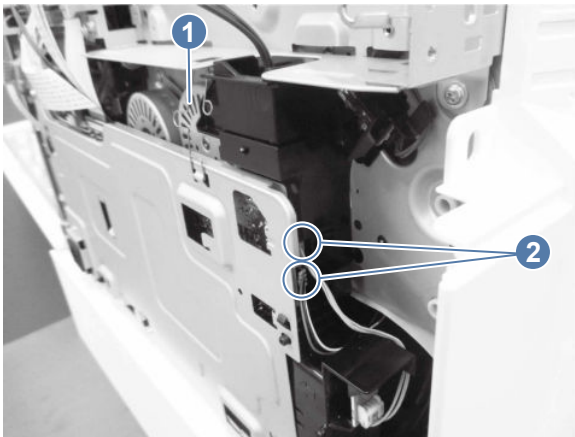
1. Unhook one spring (callout 1), and then disconnect two connectors (callout 2).

---

 **NOTE:** Unhook the spring from the formatter cage, not the low-voltage power supply. The spring should remain attached to the LVPS.


---

**Figure 5-405 Unhook the spring and disconnect two connectors**



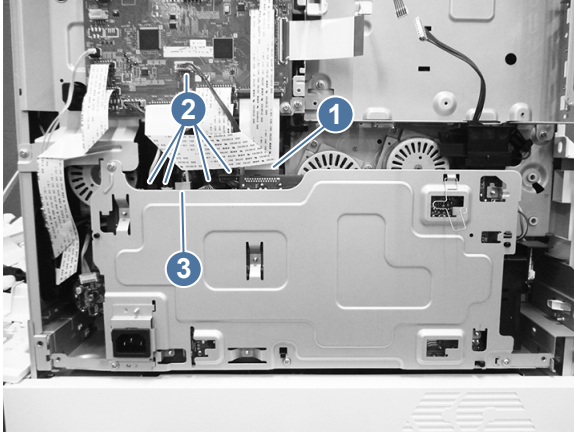
2. Remove the FFC (callout 1), and then disconnect five connectors (callout 2).

---


 **NOTE: MFP only:** Disconnect one additional connector (callout 3).

---

**Figure 5-406 Disconnect the LVPS connectors**

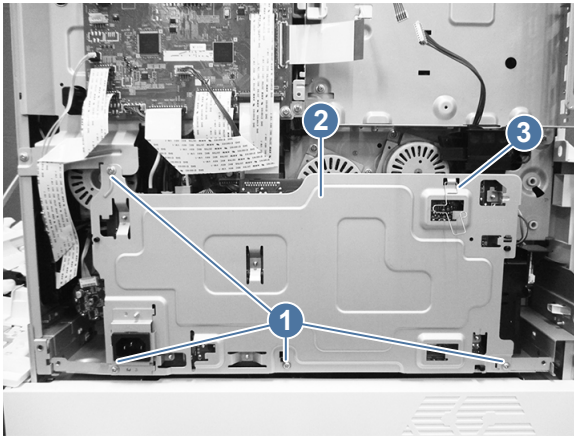



3. Remove four screws (callout 1), and then remove the low-voltage power supply assembly (callout 2).

 **NOTE:** The black ducting in the lower right corner can stick during the removal process.

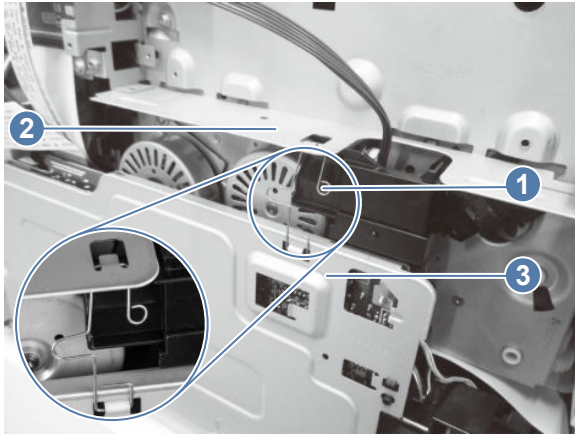
**Replacement LVPS only:** Remove the spring (callout 3), and then install it on the replacement LVPS.

**Figure 5-407 Remove the LVPS**



 **Reinstallation tip:** When reinstalling the LVPS, make sure that the spring (callout 1) is attached to both the formatter cage (callout 2) and the LVPS (callout 3).

**Figure 5-408 Reinstalling the LVPS**

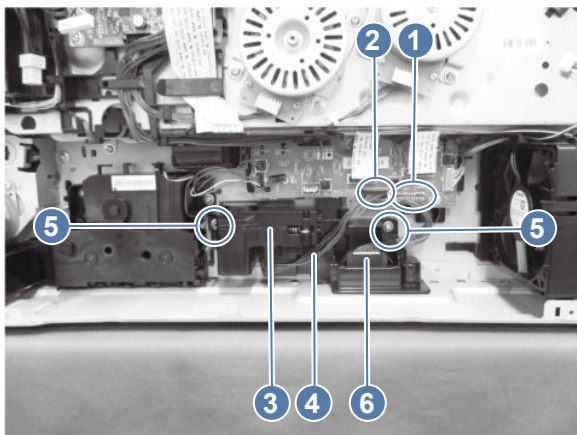


**4. Remove the auto close assembly (6700/6800 models)**

Follow these steps to remove the auto close assembly.

- Disconnect one connector (callout 1), disconnect one connector (callout 2), release the cables (callout 3) from the auto close assembly (callout 4), remove two screws (callout 5), remove the auto close assembly, and then remove the drawer connector (callout 6) from the auto close assembly.

**Figure 5-409 Remove the auto close assembly**

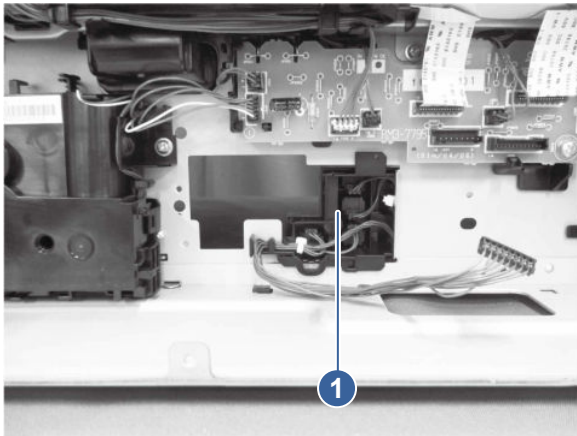


**5. Remove the Tray 2 media size detect assembly (6700/6800 models)**

Follow these steps to remove the Tray 2 media size detect assembly.

- Pull out the Tray 2 media size detect assembly (callout 1) toward you.

**Figure 5-410 Remove the Tray 2 media size detect assembly**




## 6. Unpack the replacement assembly

Follow these steps to unpack the replacement assembly.

1. Dispose of the defective part.

---



 **NOTE:** HP recommends responsible disposal of the defective part.


<http://www8.hp.com/us/en/hp-information/environment/product-recycling.html>


---

2. Unpack the replacement part from the packaging.

---

 **CAUTION:**  Some parts are sensitive to electrostatic discharge (ESD). Always perform service work at an ESD-protected workstation or mat. If an ESD workstation or mat is not available, touch the sheet-metal chassis to provide a static ground before touching an ESD-sensitive assembly. Protect the ESD-sensitive assemblies by placing them in ESD pouches when they are out of the printer.


 **IMPORTANT:** Make sure that all of the shipping materials (for example shipping tape) are removed from the replacement part prior to installation.

 **NOTE:** If the replacement part is a roller or pad, avoid touching the spongy part of it. Skin oils on the roller or pad can cause paper pickup and/or print-quality problems. HP recommends using disposable gloves when handling rollers or pads or washing your hands before touching rollers or pads.

---

3. To install an assembly, reverse the removal steps.

---

 **NOTE:** When applicable, special installation instructions are provided for an assembly at the end of the removal procedure. Always completely read the removal instructions and follow all special installation instructions.

---

## Removal and replacement: Tray 2 media size detect assembly (X654/X677 models)

Learn about removing and replacing the Tray 2 media size detect assembly.

### Before performing service

**Turn the printer power off**

- Disconnect the power cable.

**⚠ WARNING!** To avoid damage to the printer, turn the printer off, wait 30 seconds, and then remove the power cord before attempting to service the printer.

If the part is damaged and cannot be cleaned, use the table below to identify the correct part number for your printer. To order the part, go to [www.hp.com/buy/parts](http://www.hp.com/buy/parts).

**Table 5-70 Part information**

Part number	Part description
RM2-3614-000CN	Size detect assembly (X654/X677 models)

## Required tools

- #2 Phillips screwdriver with a magnetic tip and a 152 mm (6 in) shaft length

## After performing service

### Turn the printer power on

- Connect the power cable.
- Use the power switch to turn the power on.

## Post service test

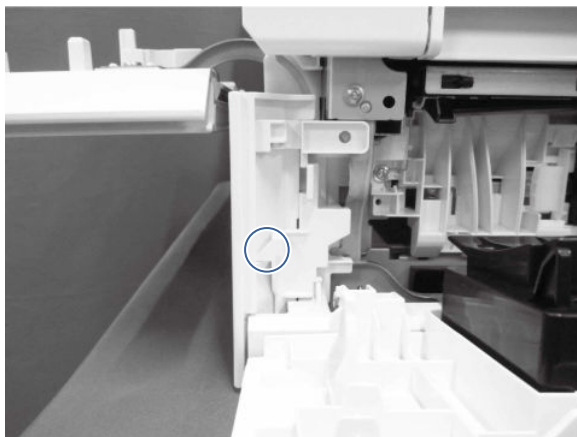
No post service test is available for this assembly.

### 1. Remove the front right cover

Follow these steps to remove the front right cover.

1. Open the toner cartridge access door.
2. Open the right lower door.
3. Release one tab, and then slide the front right cover upward to remove it.

**Figure 5-411 Remove the front right cover**

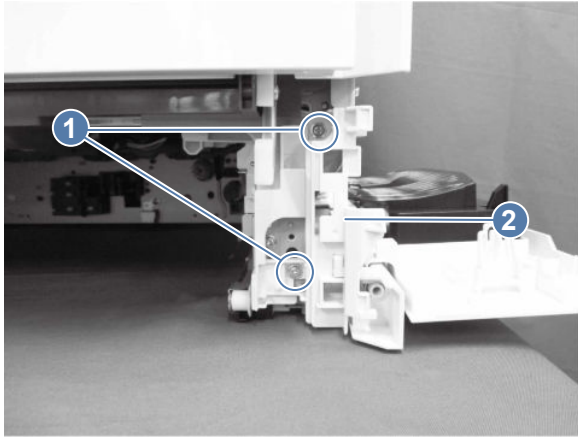


## 2. Remove the right lower door (X654/X677 models)

Follow these steps to remove the right lower door.

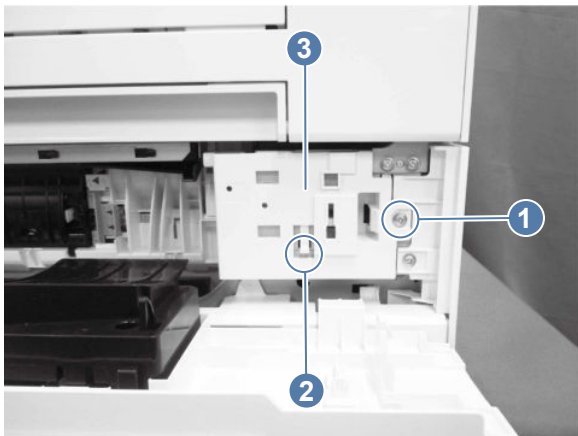
1. Remove two screws (callout 1), and then remove the base frame (callout 2).

**Figure 5-412 Remove the base frame**



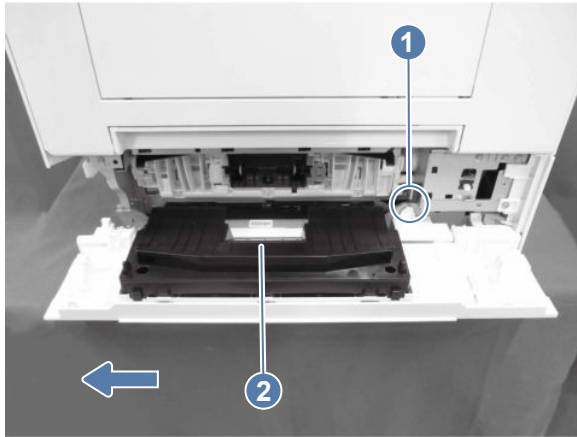
2. Remove one screw (callout 1), release one tab (callout 2), and then slide the rear inner cover (callout 3) downward to remove it.

**Figure 5-413 Remove the rear inner cover**



3. Release one tab (callout 1), and then slide the right lower door assembly (callout 2) in the direction indicated to remove it.

**Figure 5-414 Remove the right lower door assembly**

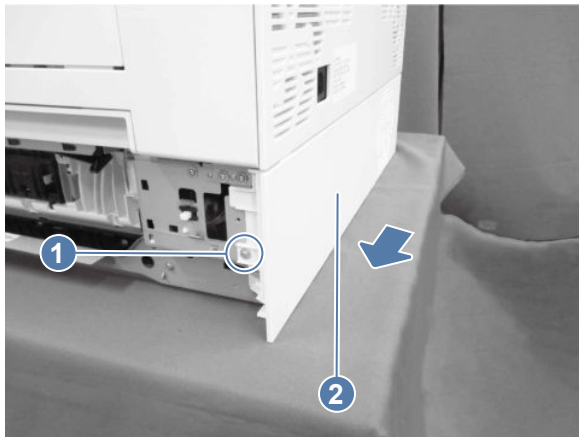


### 3. Remove the rear lower cover (X654/X677 models)

Follow these steps to remove the rear lower cover.

- Remove one screw (callout 1), slide the rear lower cover (callout 2) in the direction indicated below, and then remove it.

**Figure 5-415 Remove the rear lower cover**



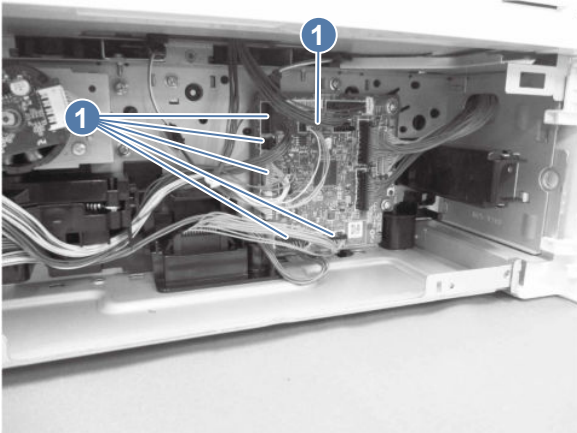
### 4. Remove the auto close assembly (X654/X677 models)

Follow these steps to remove the auto close assembly.



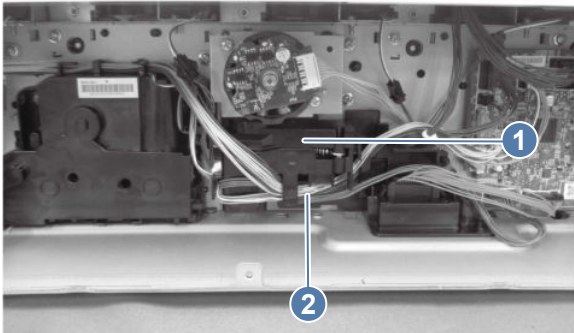
1. Disconnect six connectors (callout 1).

**Figure 5-416 Disconnect six connectors**



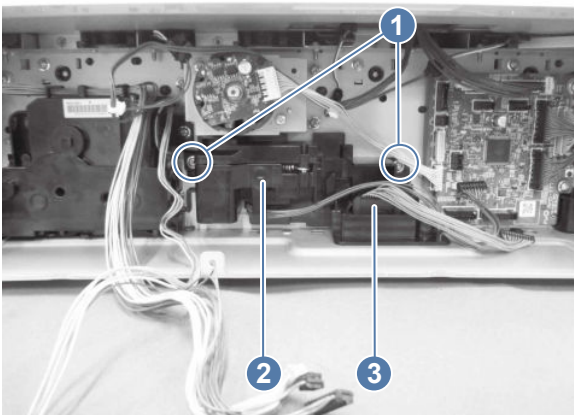
2. Release the cables (callout 1) from the auto close assembly (callout 2).

**Figure 5-417 Release the cable**



3. Remove two screws (callout 1), remove the auto close assembly (callout 2), and then remove the drawer connector (callout 3) from the auto close assembly.

**Figure 5-418 Remove the auto close assembly**

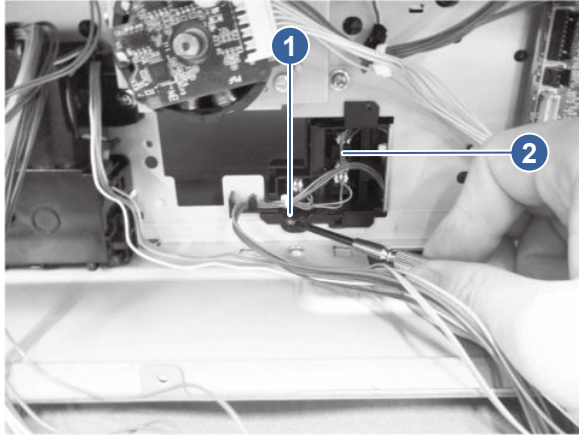


## 5. Remove the Tray 2 media size detect assembly (X654/X677 models)

Follow these steps to remove the Tray 2 media size detect assembly.

- Release one tab (callout 1), and then pull out the Tray 2 media size detect assembly (callout 2) toward you.

**Figure 5-419** Remove the Tray 2 media size detect assembly



## 6. Unpack the replacement assembly



Follow these steps to unpack the replacement assembly.


1. Dispose of the defective part.


 **NOTE:** HP recommends responsible disposal of the defective part.

<http://www8.hp.com/us/en/hp-information/environment/product-recycling.html>


2. Unpack the replacement part from the packaging.

 **CAUTION:**  Some parts are sensitive to electrostatic discharge (ESD). Always perform service work at an ESD-protected workstation or mat. If an ESD workstation or mat is not available, touch the sheet-metal chassis to provide a static ground before touching an ESD-sensitive assembly. Protect the ESD-sensitive assemblies by placing them in ESD pouches when they are out of the printer.

 **IMPORTANT:** Make sure that all of the shipping materials (for example shipping tape) are removed from the replacement part prior to installation.

 **NOTE:** If the replacement part is a roller or pad, avoid touching the spongy part of it. Skin oils on the roller or pad can cause paper pickup and/or print-quality problems. HP recommends using disposable gloves when handling rollers or pads or washing your hands before touching rollers or pads.

3. To install an assembly, reverse the removal steps.

 **NOTE:** When applicable, special installation instructions are provided for an assembly at the end of the removal procedure. Always completely read the removal instructions and follow all special installation instructions.

## Removal and replacement: Fuser drive assembly

Learn about removing and replacing the fuser drive assembly.



[View a video demonstration of removing and replacing the fuser drive assembly.](#)

## Before performing service

### Turn the printer power off

- Disconnect the power cable.

---

**⚠ WARNING!** To avoid damage to the printer, turn the printer off, wait 30 seconds, and then remove the power cord before attempting to service the printer.

---

If the part is damaged and cannot be cleaned, use the table below to identify the correct part number for your printer. To order the part, go to [www.hp.com/buy/parts](http://www.hp.com/buy/parts).

**Table 5-71** Part information

Part number	Part description
RM2-4485-000CN	Fixing drive assembly (5700/X577/5800/X57945)
RM2-4487-000CN	Fixing drive assembly (6700/X654/6800/X677)

## Required tools

- #2 Phillips screwdriver with a magnetic tip and a 152 mm (6 in) shaft length

## After performing service

### Turn the printer power on

- Connect the power cable.
- Use the power switch to turn the power on.

## Post service test

Print any pages necessary to make sure the printer is functioning correctly.

### 1. Remove the fuser

Follow these steps to remove the fuser.

1. Open the right door.

---

**⚠ CAUTION:** The fuser is hot. Wait at least 10 minutes after turning the printer power off before removing the fuser.

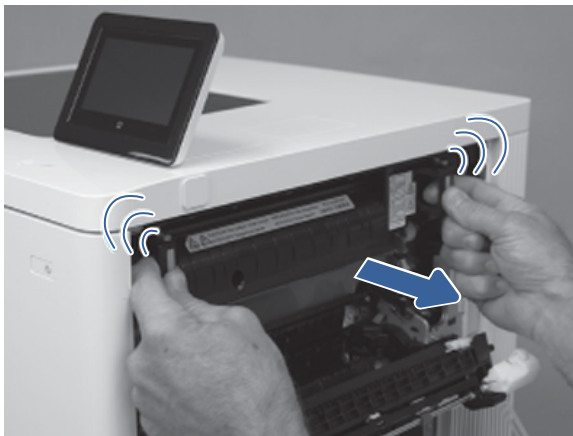
---

**Figure 5-420 Open the right door**



2. Squeeze the release levers on the handles (circle callouts), and then remove the fuser.

**Figure 5-421 Remove the fuser**




## 2. Remove the formatter cover

Follow these steps to remove the formatter cover.

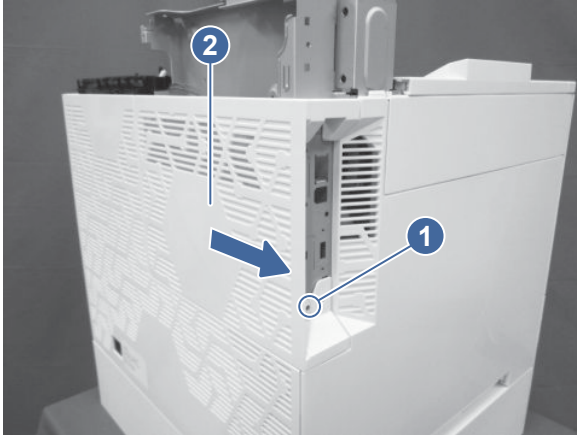
- Remove one screw (callout 1), and then slide the formatter cover (callout 2) away from the printer to remove it.

---

 **TIP:** Reverse the removal steps to install the assembly.

---


**Figure 5-422 Remove the formatter cover**



### 3. Remove the rear cover

Follow these steps to remove the rear cover.

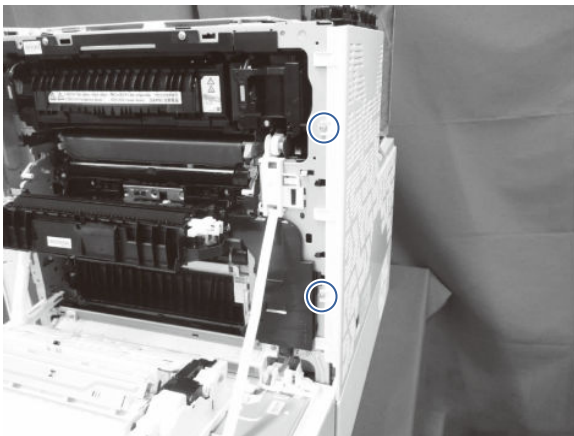
---

 **NOTE:** The figures below show some assemblies (for example the top cover and formatter) removed that might still be installed on the printer. However, the steps to remove the cover are correct.

---

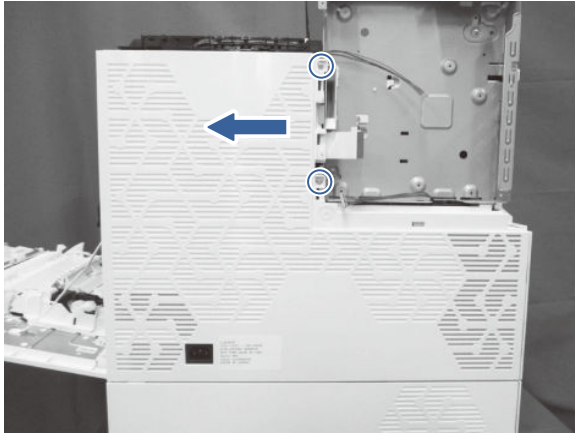
1. Open the right door, and remove two screws.

**Figure 5-423 Remove two screws**



2. At the back of the printer, remove two screws, and then slide the rear cover as indicated to remove it.

**Figure 5-424 Remove the rear cover**




#### 4. Remove the low-voltage power supply (LVPS)

Follow these steps to remove the low-voltage power supply (LVPS).

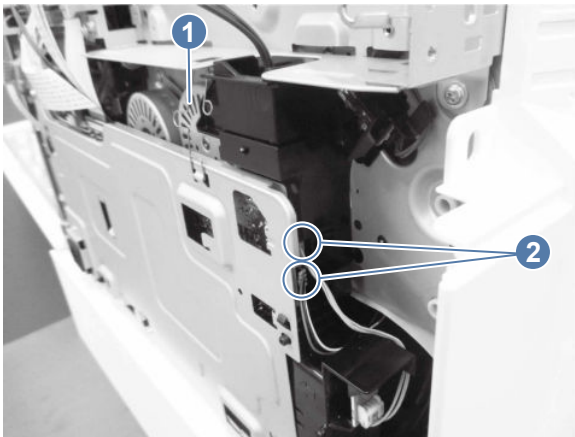
1. Unhook one spring (callout 1), and then disconnect two connectors (callout 2).

---

 **NOTE:** Unhook the spring from the formatter cage, not the low-voltage power supply. The spring should remain attached to the LVPS.


---

**Figure 5-425 Unhook the spring and disconnect two connectors**



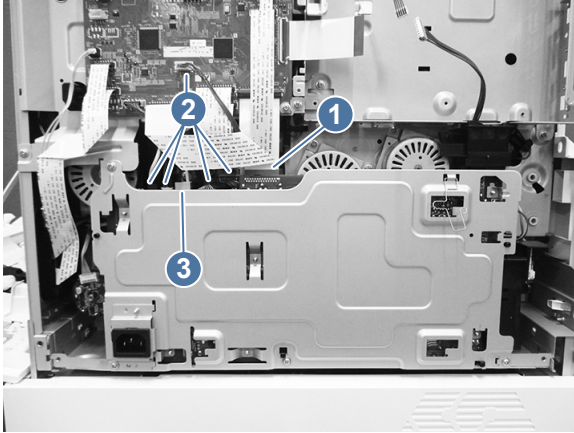
2. Remove the FFC (callout 1), and then disconnect five connectors (callout 2).

---

 **NOTE: MFP only:** Disconnect one additional connector (callout 3).

---

**Figure 5-426 Disconnect the LVPS connectors**

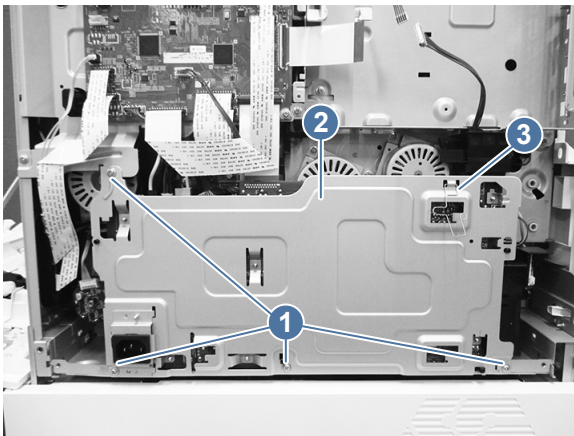



3. Remove four screws (callout 1), and then remove the low-voltage power supply assembly (callout 2).

 **NOTE:** The black ducting in the lower right corner can stick during the removal process.

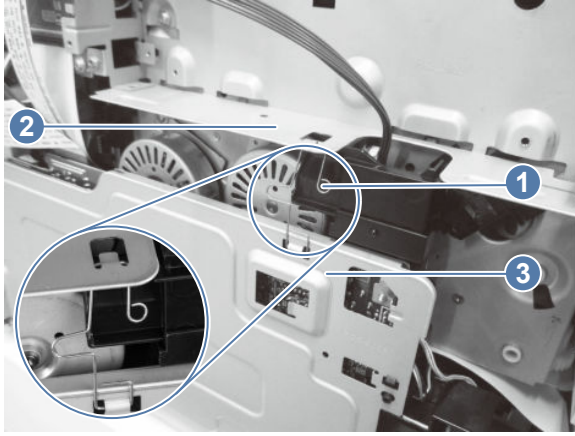
**Replacement LVPS only:** Remove the spring (callout 3), and then install it on the replacement LVPS.

**Figure 5-427 Remove the LVPS**



 **Reinstallation tip:** When reinstalling the LVPS, make sure that the spring (callout 1) is attached to both the formatter cage (callout 2) and the LVPS (callout 3).

**Figure 5-428 Reinstalling the LVPS**

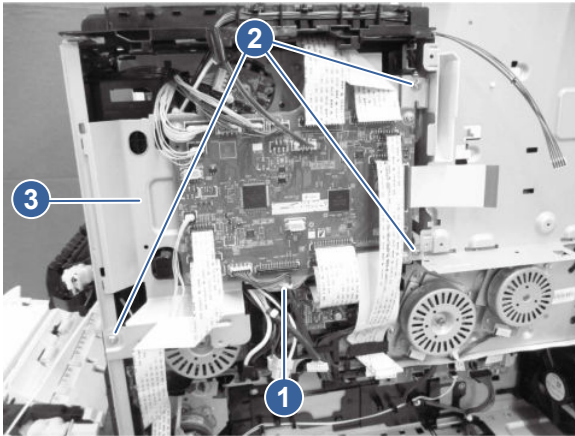


## 5. Remove the fuser drive assembly

Follow these steps to remove the fuser drive assembly.

1. Disconnect all the connectors on the DC controller PCA, remove the cable clamp (callout 1), remove three screws (callout 2), slide the DC controller stay (callout 3) out to remove it.

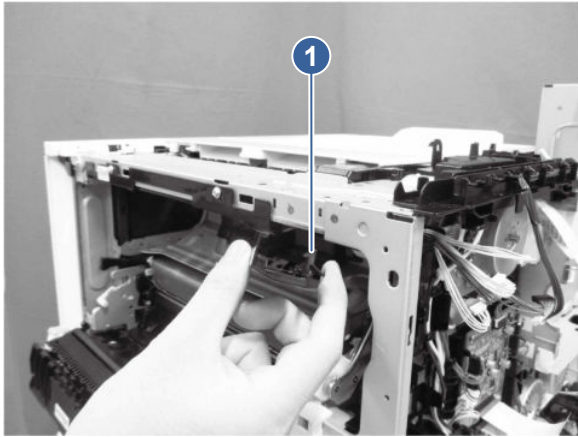
**Figure 5-429 Remove the DC controller stay**





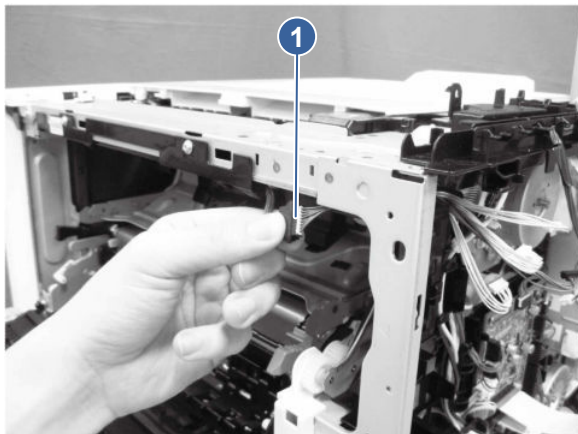
2. Pull the lever (callout 1) of the cable cover (callout 2), release one tab (callout 3), and then remove the cable cover.

**Figure 5-430 Remove the cable cover**



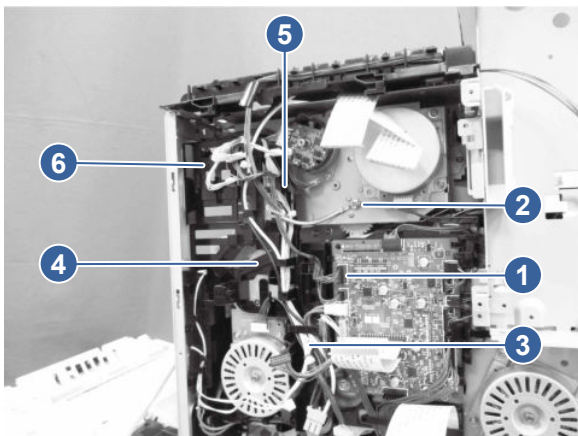
3. Disconnect one connector (callout 1).

**Figure 5-431 Disconnect one connector**



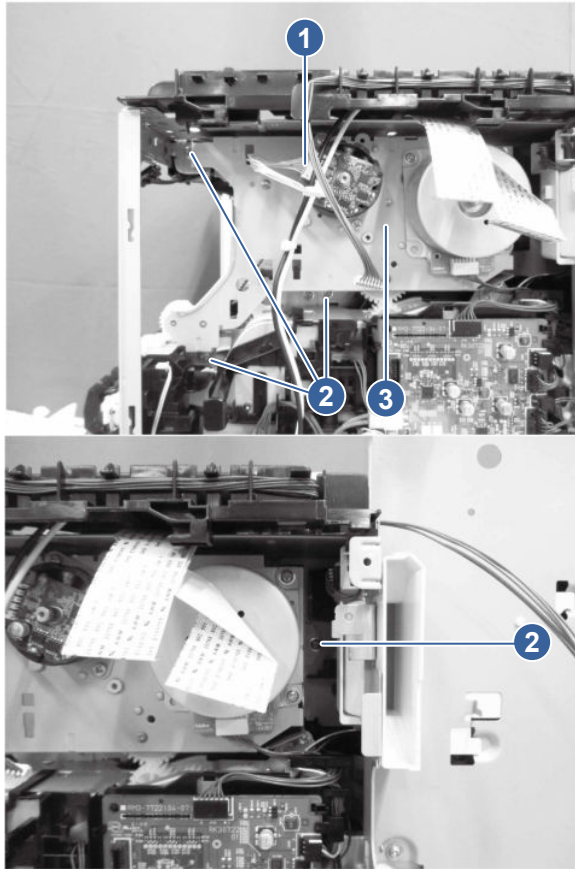
4. Disconnect one connector (callout 1), remove one screw (callout 2), release the cable (callout 3) from the cable guide (callout 4), release one tab (callout 5), and then slide the connector cover (callout 6) upward to remove it.

**Figure 5-432 Remove the connector cover**



5. Disconnect two connectors (callout 1), remove four screws (callout 2), and then remove the fuser drive assembly (callout 3).

**Figure 5-433 Remove the assembly**



## 6. Unpack the replacement assembly

Follow these steps to unpack the replacement assembly.

1. Dispose of the defective part.




**NOTE:** HP recommends responsible disposal of the defective part.

<http://www8.hp.com/us/en/hp-information/environment/product-recycling.html>

2. Unpack the replacement part from the packaging.



**CAUTION:**  Some parts are sensitive to electrostatic discharge (ESD). Always perform service work at an ESD-protected workstation or mat. If an ESD workstation or mat is not available, touch the sheet-metal chassis to provide a static ground before touching an ESD-sensitive assembly. Protect the ESD-sensitive assemblies by placing them in ESD pouches when they are out of the printer.



**IMPORTANT:** Make sure that all of the shipping materials (for example shipping tape) are removed from the replacement part prior to installation.



**NOTE:** If the replacement part is a roller or pad, avoid touching the spongy part of it. Skin oils on the roller or pad can cause paper pickup and/or print-quality problems. HP recommends using disposable gloves when handling rollers or pads or washing your hands before touching rollers or pads.

3. To install an assembly, reverse the removal steps.



**NOTE:** When applicable, special installation instructions are provided for an assembly at the end of the removal procedure. Always completely read the removal instructions and follow all special installation instructions.

## Removal and replacement: Main-drive assembly

Learn about removing and replacing the main drive assembly.



[View a video demonstration of removing and replacing the main drive assembly.](#)

### Before performing service

#### Turn the printer power off

- Disconnect the power cable.



**WARNING!** To avoid damage to the printer, turn the printer off, wait 30 seconds, and then remove the power cord before attempting to service the printer.

If the part is damaged and cannot be cleaned, use the table below to identify the correct part number for your printer. To order the part, go to [www.hp.com/buy/parts](http://www.hp.com/buy/parts).

**Table 5-72** Part information

Part number	Part description
RM2-3506-000CN	Main drive assembly (5700/5800)
RM2-3504-000CN	Main drive assembly (X557/6700/6800)
RM2-3497-000CN	Main drive assembly (X57945/X654/X677)

### Required tools

- #2 Phillips screwdriver with a magnetic tip and a 152 mm (6 in) shaft length

### After performing service

#### Turn the printer power on

- Connect the power cable.
- Use the power switch to turn the power on.

### Post service test

Print any pages necessary to make sure the printer is functioning correctly.

## 1. Remove the fuser

Follow these steps to remove the fuser.

1. Open the right door.



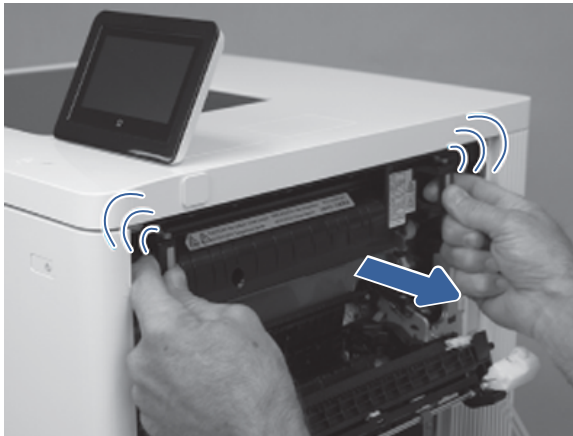
**CAUTION:** The fuser is hot. Wait at least 10 minutes after turning the printer power off before removing the fuser.

**Figure 5-434** Open the right door



2. Squeeze the release levers on the handles (circle callouts), and then remove the fuser.

**Figure 5-435** Remove the fuser




## 2. Remove the formatter cover

Follow these steps to remove the formatter cover.

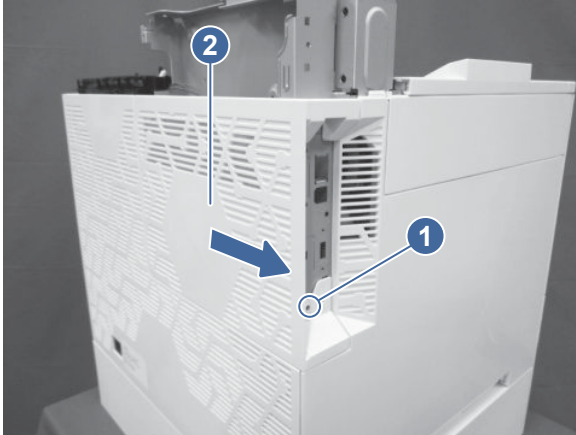
- Remove one screw (callout 1), and then slide the formatter cover (callout 2) away from the printer to remove it.

---

 **TIP:** Reverse the removal steps to install the assembly.

---


**Figure 5-436 Remove the formatter cover**



### 3. Remove the formatter

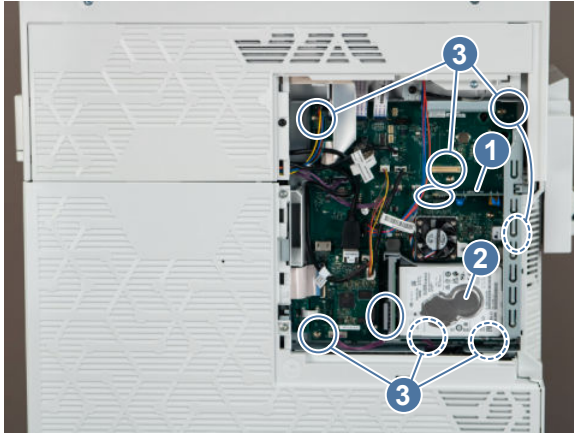
Follow these steps to remove the formatter.

1. Disconnect all of the connectors on the formatter.

 **IMPORTANT:** Some of the flat flexible cable (FFC) connectors use hinged retainers to secure them to the DC controller. The hinged retainers must be opened to release the FFCs.

2. Remove the fax PCA (callout 1) and the hard disk drive (HDD) (callout 2), and then remove seven screws (callout 3) to remove the formatter.


**Figure 5-437 Remove the formatter**



### 4. Remove the left upper cover (MFP models)

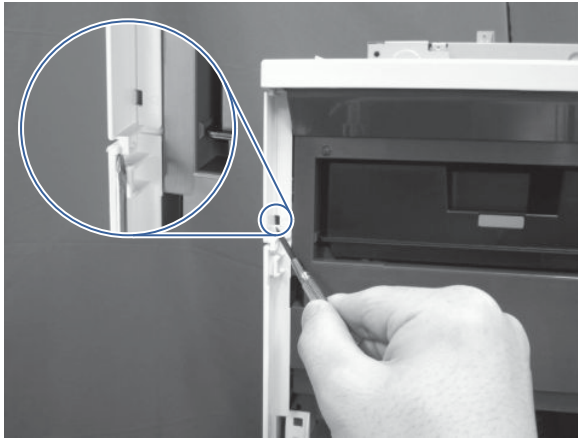
Follow these steps to remove the left upper cover.

1. Open the front door.

 **CAUTION:** If the cover is being removed to gain access to the main drive assembly, make sure that the front door remains open. This keeps the main drive properly aligned.

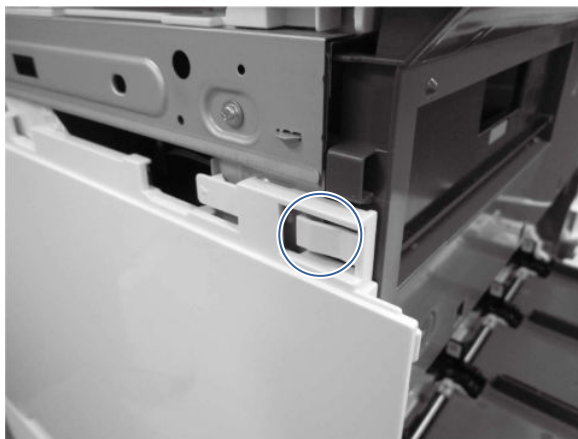
2. At the left side of the printer, insert the small flat-blade screwdriver into the slot to release one tab (callout 1).

**Figure 5-438 Use a screwdriver to release the tab**



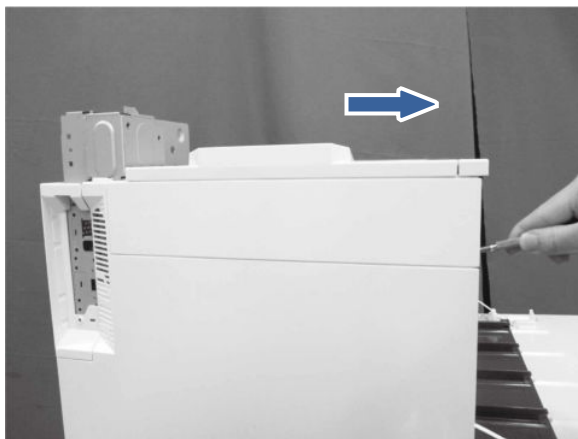
3. Toward the front of the printer, release another tab.

**Figure 5-439 Release the tab**




4. Rotate the cover up to remove it.

**Figure 5-440 Remove the left upper cover**



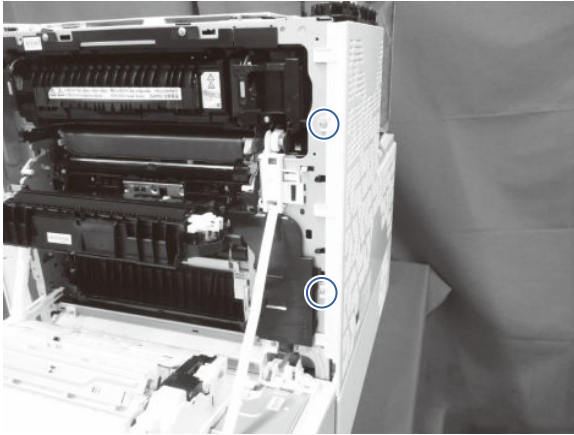
## 5. Remove the rear cover

Follow these steps to remove the rear cover.

 **NOTE:** The figures below show some assemblies (for example the top cover and formatter) removed that might still be installed on the printer. However, the steps to remove the cover are correct.

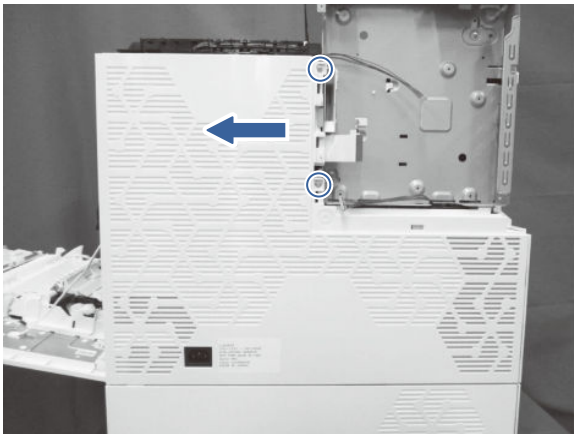
1. Open the right door, and remove two screws.

**Figure 5-441 Remove two screws**



2. At the back of the printer, remove two screws, and then slide the rear cover as indicated to remove it.


**Figure 5-442 Remove the rear cover**



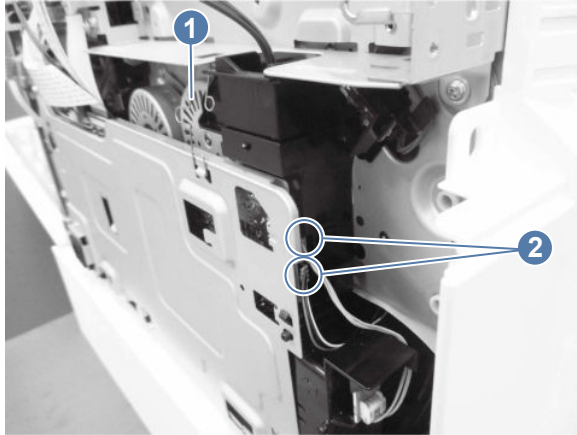
## 6. Remove the low-voltage power supply (LVPS)

Follow these steps to remove the low-voltage power supply (LVPS).

1. Unhook one spring (callout 1), and then disconnect two connectors (callout 2).

 **NOTE:** Unhook the spring from the formatter cage, not the low-voltage power supply. The spring should remain attached to the LVPS.

**Figure 5-443 Unhook the spring and disconnect two connectors**

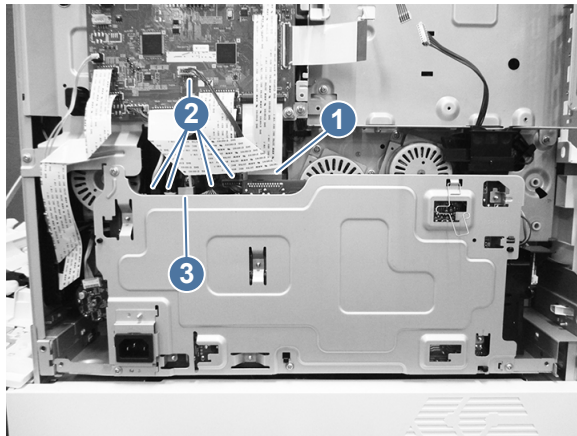


2. Remove the FFC (callout 1), and then disconnect five connectors (callout 2).



**NOTE: MFP only:** Disconnect one additional connector (callout 3).

**Figure 5-444 Disconnect the LVPS connectors**



3. Remove four screws (callout 1), and then remove the low-voltage power supply assembly (callout 2).

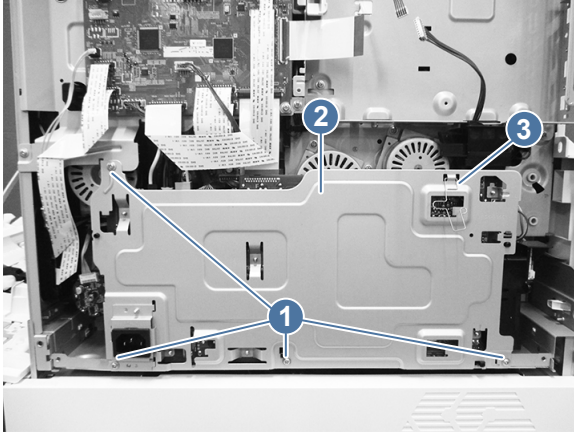



**NOTE:** The black ducting in the lower right corner can stick during the removal process.

**Replacement LVPS only:** Remove the spring (callout 3), and then install it on the replacement LVPS.

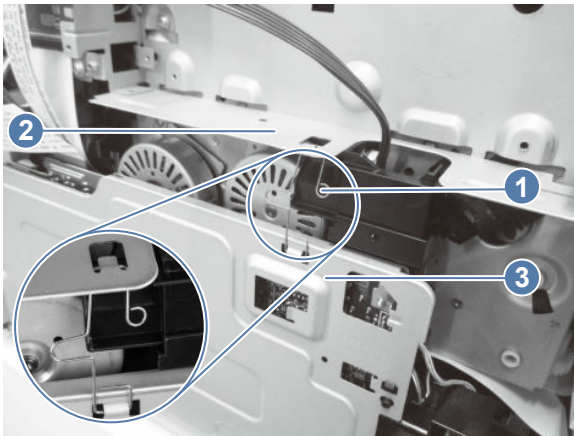


**Figure 5-445 Remove the LVPS**



 **Reinstallation tip:** When reinstalling the LVPS, make sure that the spring (callout 1) is attached to both the formatter cage (callout 2) and the LVPS (callout 3).


**Figure 5-446 Reinstalling the LVPS**



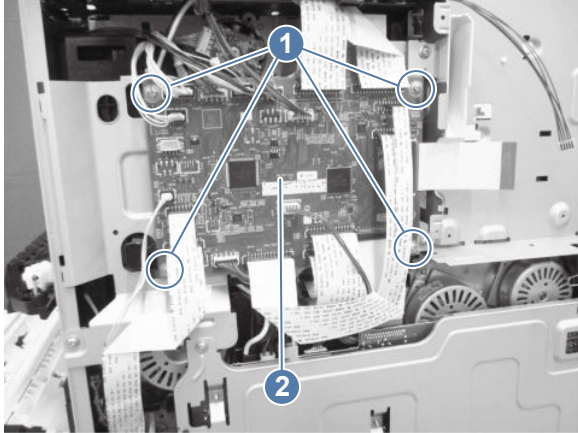
## 7. Remove the DC controller

Follow these steps to remove the DC controller.

- Disconnect all of the connectors on the DC controller, remove four screws (callout 1), and then remove the DC controller (callout 2).

 **IMPORTANT:** Some of the flat flexible cable (FFC) connectors use hinged retainers to secure them to the DC controller. The hinged retainers must be opened to release the FFCs.


**Figure 5-447 Remove the DC controller**



### 8. Remove the formatter cage (SFP models)

Follow these steps to remove the formatter cage.

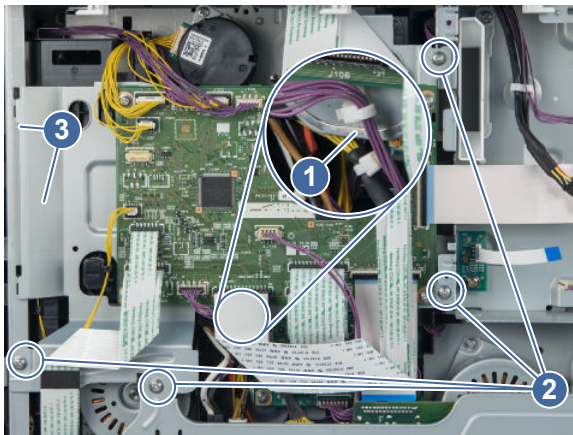
1. Disconnect all the connectors on the DC controller PCA.

 **IMPORTANT:** Some of the flat flexible cable (FFC) connectors use hinged retainers to secure them to the DC controller. The hinged retainers must be opened to release the FFCs.

2. Remove the cable clamp (callout 1), remove four screws (callout 2), and then slide the DC controller stay (callout 3) out to remove it.

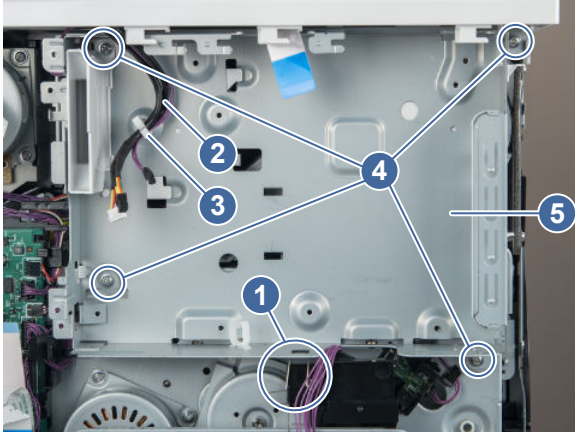
 **NOTE:** Be careful not to drop any of the screws into the low-voltage power supply assembly below the DC controller.

**Figure 5-448 Remove the DC controller stay**




3. Unhook one spring (callout 1), release the cable (callout 2) from the cable clamp (callout 3), remove four screws (callout 4), and then remove the formatter cage (callout 5).

**Figure 5-449 Remove the formatter cage**



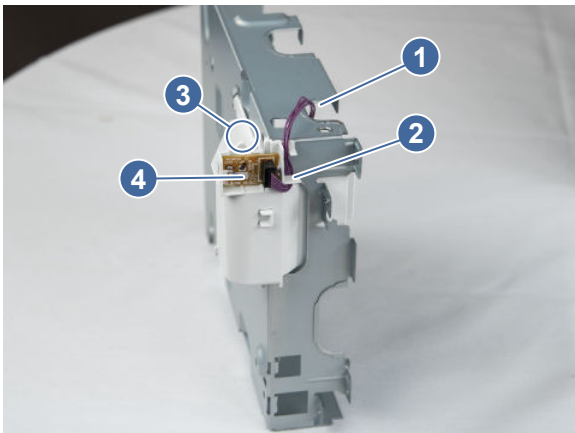
4. **For a replacement formatter cage only:** Release the cable (callout 1) from the cable guide (callout 2), release one tab (callout 3), and then remove the memory PCA (callout 4) from the formatter cage (callout 5).

---

 **NOTE:** Install the PCA on the replacement formatter cage.

---

**Figure 5-450 Remove the memory PCA**

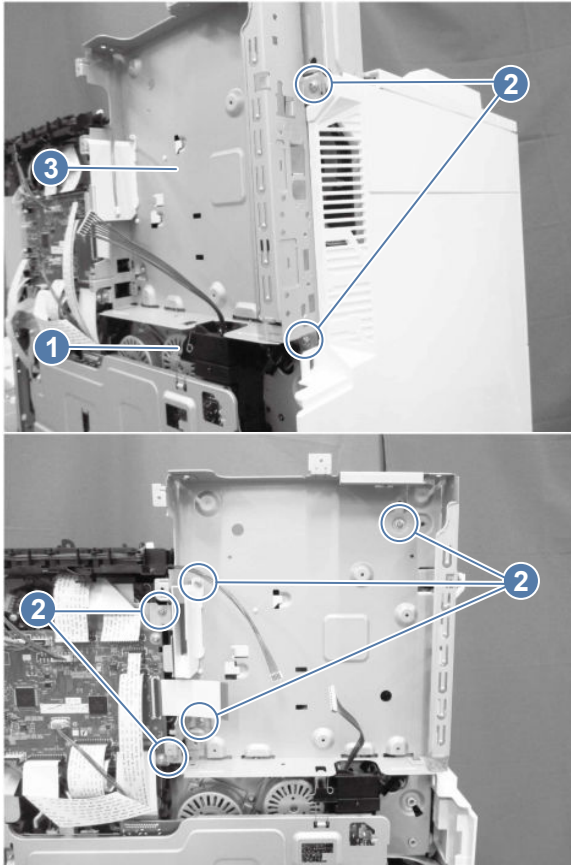


## 9. Remove the formatter cage (MFP models)


Follow these steps to remove the formatter cage.

1. Unhook one spring (callout 1), remove seven screws (callout 2), and then remove the formatter cage (callout 3).

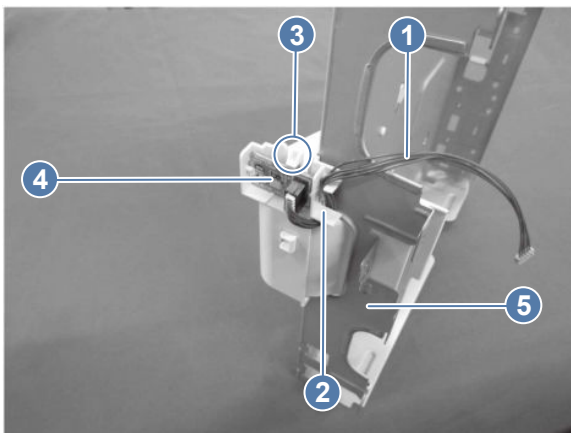
**Figure 5-451 Remove the formatter cage**



2. **For a replacement formatter cage only:** Release the cable (callout 1) from the cable guide (callout 2), release one tab (callout 3), and then remove the memory PCA (callout 4) from the formatter cage (callout 5).

 **NOTE:** Install the PCA on the replacement formatter cage.

**Figure 5-452 Remove the memory PCA**

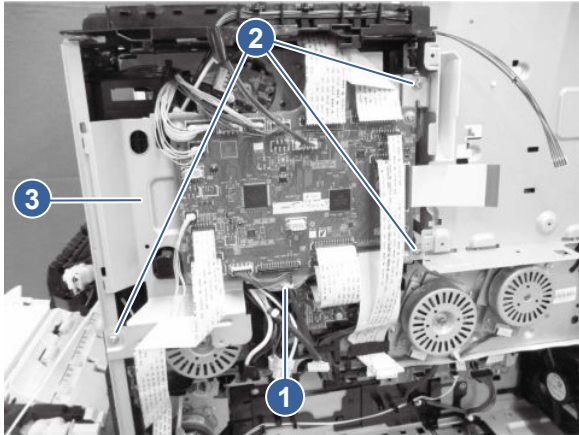


## 10. Remove the drive PCA

Follow these steps to remove the drive PCA.

1. Disconnect all the connectors on the DC controller PCA, remove the cable clamp (callout 1), remove three screws (callout 2), and then slide the DC controller stay (callout 3) out to remove it.

**Figure 5-453** Remove the DC controller stay



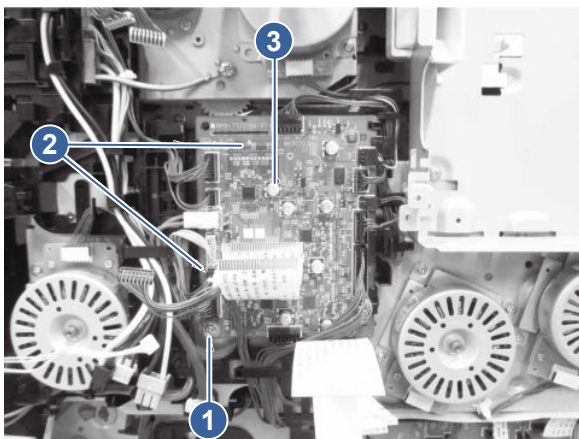
2. Disconnect all the connectors on the drive PCA, remove one screw (callout 1), release two tabs (callout 2), and then remove the drive PCA (callout 3).

---

 **IMPORTANT:** Some of these wires are very tightly connected. Take care when disconnecting them.

---


**Figure 5-454** Remove the drive PCA



## 11. Remove the main-drive assembly

Follow these steps to remove the main-drive assembly.

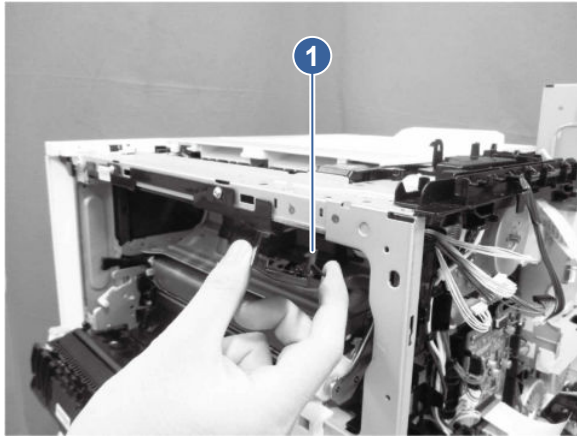
---

 **NOTE:** Make sure that the front door is closed when performing this procedure.


---

1. Pull the lever (callout 1) of the cable cover (callout 2), release one tab (callout 3), and then remove the cable cover.

**Figure 5-455 Remove the cable cover**



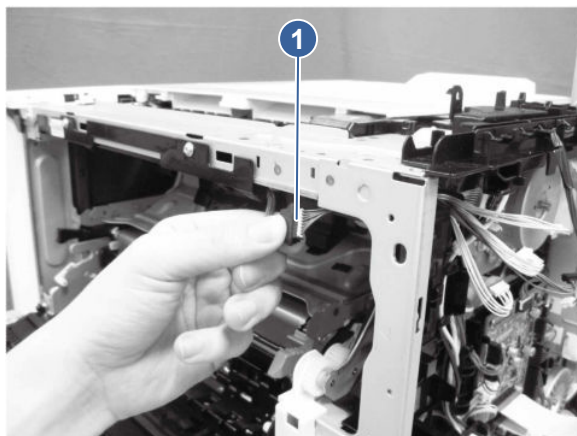
---

 **Reinstallation tip:** When reinstalling, align the pegs in the holes, and then set the cover against the frame and rotate it up and into position.

---

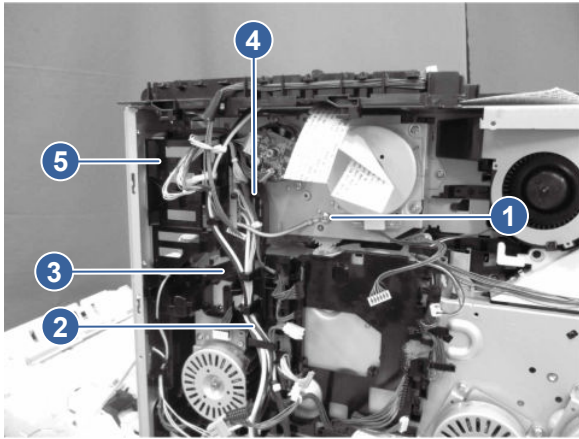
2. Disconnect one connector (callout 1).

**Figure 5-456 Disconnect one connector**



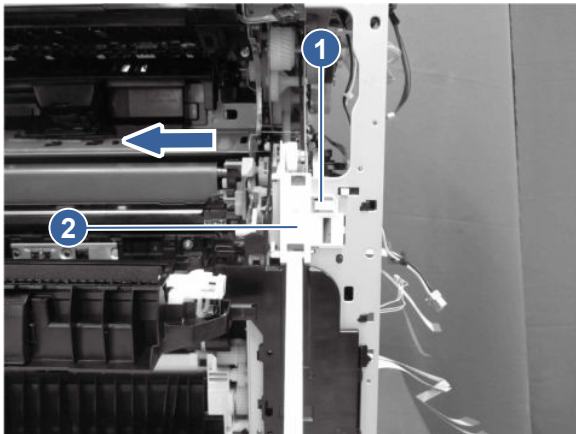
3. Remove one screw (callout 1), release the cable (callout 2) from the cable guide (callout 3), release one tab (callout 4), and then slide the connector cover (callout 5) upward to remove it.

**Figure 5-457 Remove the connector cover**




4. Release one tab (callout 1), and then slide the link cover (callout 2) in the direction indicated to remove it.


**Figure 5-458 Remove the link cover**



5. Close the right door a little, and then release the link arm (callout 1) from the coupling (callout 2).

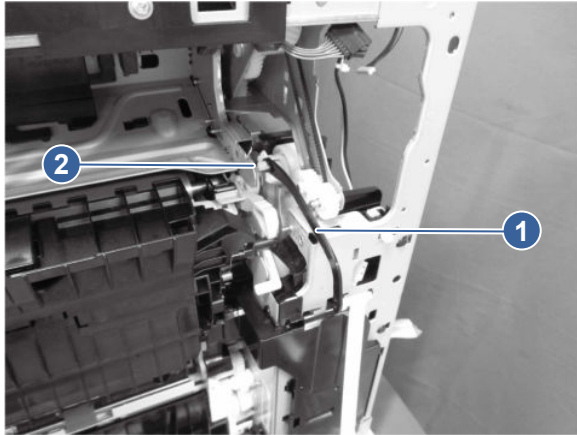
---

 **NOTE:** This is a keyed connection. When disconnecting, make sure to line up the peg with the socket so that you do not strip the peg.

 **Reinstallation tip:** If the black link arm disconnects from the white link arm below it, it might be helpful for reinstallation purposes to reattach the two link arms.

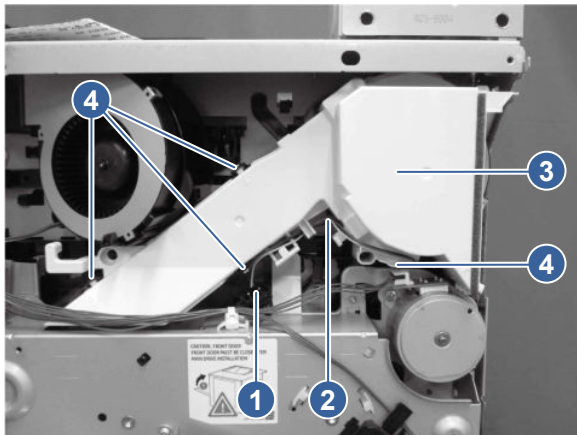
---

**Figure 5-459 Release the link arm**




6. Disconnect one connector (callout 1), release the cable (callout 2) from the fan cover (callout 3), release four tabs (callout 4), and then remove the fan cover.

**Figure 5-460 Remove the fan cover**



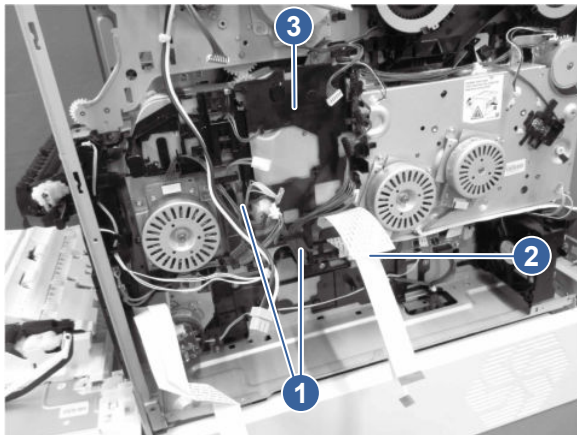
---

 **Reinstallation tip:** When reinstalling this cover, seat the right side pegs into the chassis slots first.

---

7. Release the cables (callout 1) and the remove FFC (callout 2) from the cable guide (callout 3).


**Figure 5-461 Release the cables**






8. Remove seven screws (callout 1), release one tab (callout 2), and then remove the main drive assembly (callout 3).

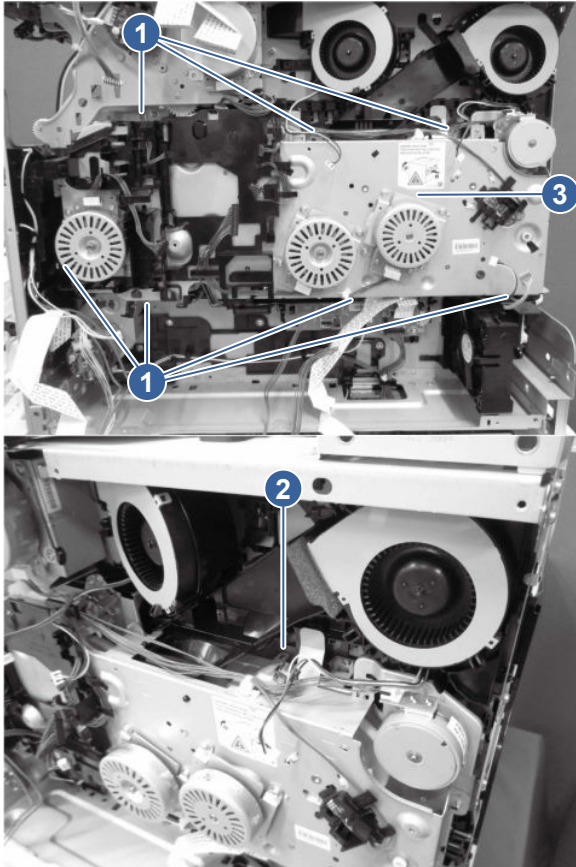
---

 **NOTE:** All seven screws are on sheet metal tabs on the assembly.

 **NOTE:** Ensure that the screws do not fall into the assembly.

---

**Figure 5-462 Remove the main drive assembly**




9. **Special installation instructions for a main drive assembly (replacement unit and serviced unit)**

- **Replacement unit:** A replacement unit is a new assembly that installs in place of a discarded in-service unit.
- **In-service unit:** An in-service unit is an existing assembly that has been removed for repair or to gain access to other assemblies.

---

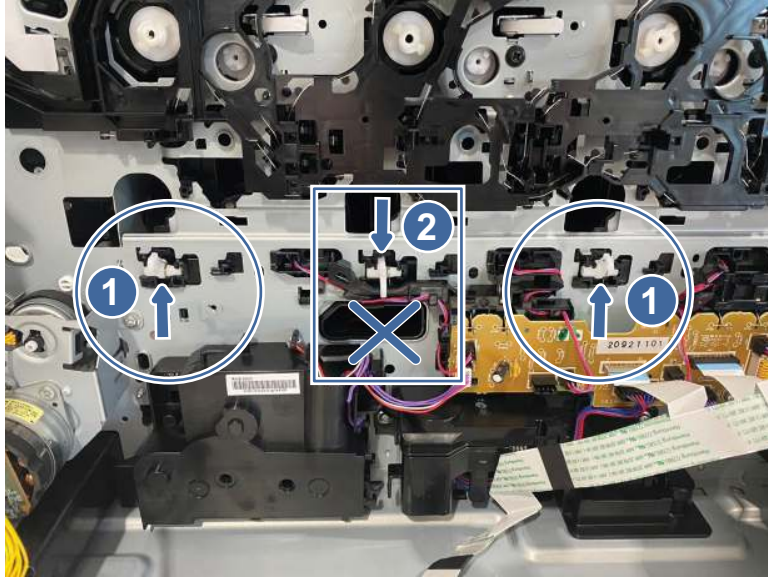
 **CAUTION:** When the main drive assembly is installed (replacement units and service units), the front door **must** be closed.


 **IMPORTANT:** If you are installing a new main drive assembly (replacement unit), you **do not** need to perform the alignment steps below. New assemblies are **already** aligned.

---

- a. **Replacement unit and in-service unit:** On the printer engine, be careful to **not** depress the levers located behind the main drive assembly (when it is installed).
  - **Callout 1:** Levers in the correct raised position.
  - **Callout 2:** Lever in the incorrect depressed position.

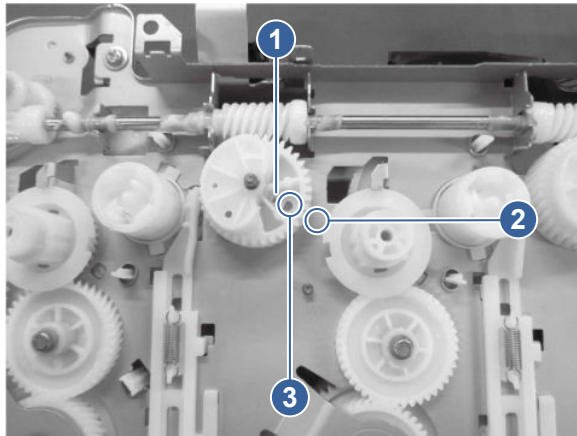
**Figure 5-463** Correct and incorrect lever positions



 **NOTE:** For a replacement unit install, skip the remaining alignment steps which are for in-service units only.

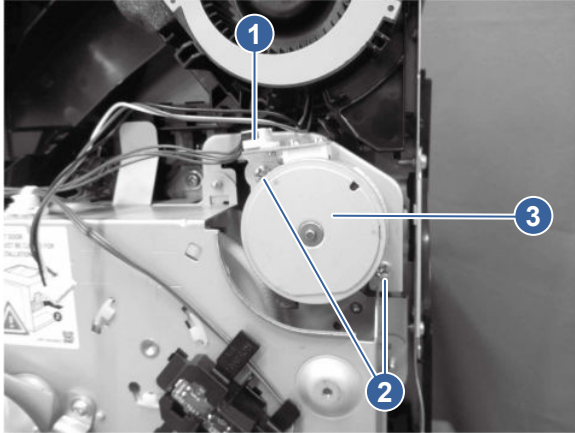
- b. **In-service unit:** There are four gears on the main drive assembly that need to be lined up correctly in order to successfully reinstall the main drive. For each gear, the triangle (callout 1) on the inside of the gear should line up with the triangle (callout 2) stamped on the sheet metal chassis. Also, the hole (callout 3) in the gear should line up with a hole in the chassis.

**Figure 5-464** Correct gear alignment



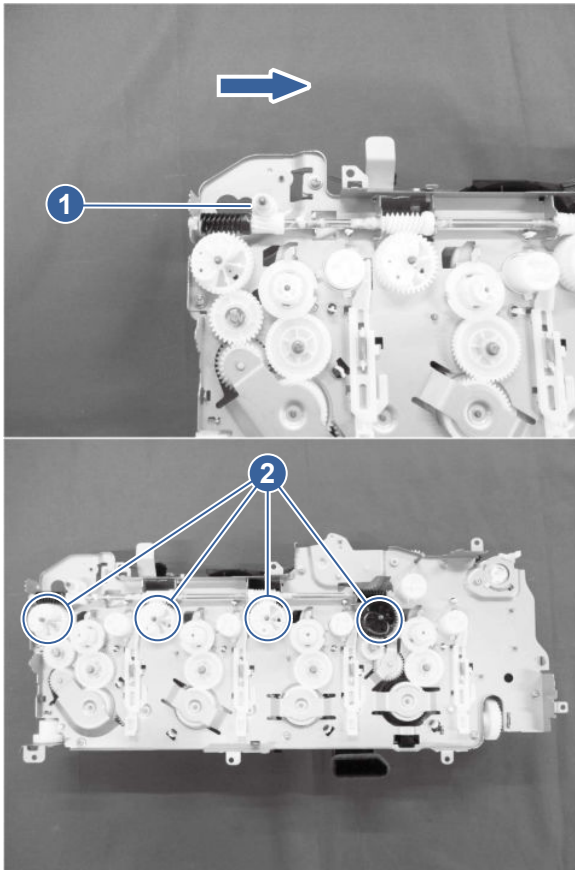
- c. **In-service unit:** In order to realign the four gears, you must remove the motor that locks the gear auger above the four gears. To do this, disconnect one connector (callout 1), remove two screws (callout 2), and then remove the motor (callout 3).

**Figure 5-465 Remove the motor**



- d. **In-service unit:** To realign the four gears, turn the gear (callout 1) in the direction indicated. By turning that gear, the four gears (callout 2) that need to be in phase turn in tandem. Turn the four gears to the correct phase position.


**Figure 5-466 Align the gears**



## 12. Unpack the replacement assembly



Follow these steps to unpack the replacement assembly.


1. Dispose of the defective part.


 **NOTE:** HP recommends responsible disposal of the defective part.

<http://www8.hp.com/us/en/hp-information/environment/product-recycling.html>


2. Unpack the replacement part from the packaging.

 **CAUTION:**  Some parts are sensitive to electrostatic discharge (ESD). Always perform service work at an ESD-protected workstation or mat. If an ESD workstation or mat is not available, touch the sheet-metal chassis to provide a static ground before touching an ESD-sensitive assembly. Protect the ESD-sensitive assemblies by placing them in ESD pouches when they are out of the printer.

 **IMPORTANT:** Make sure that all of the shipping materials (for example shipping tape) are removed from the replacement part prior to installation.

 **NOTE:** If the replacement part is a roller or pad, avoid touching the spongy part of it. Skin oils on the roller or pad can cause paper pickup and/or print-quality problems. HP recommends using disposable gloves when handling rollers or pads or washing your hands before touching rollers or pads.

3. To install an assembly, reverse the removal steps.

 **NOTE:** When applicable, special installation instructions are provided for an assembly at the end of the removal procedure. Always completely read the removal instructions and follow all special installation instructions.


## Removal and replacement: Interlock assembly

Learn about removing and replacing the interlock assembly.

### Before performing service

#### Turn the printer power off

- Disconnect the power cable.

 **WARNING!** To avoid damage to the printer, turn the printer off, wait 30 seconds, and then remove the power cord before attempting to service the printer.

If the part is damaged and cannot be cleaned, use the table below to identify the correct part number for your printer. To order the part, go to [www.hp.com/buy/parts](http://www.hp.com/buy/parts).

**Table 5-73 Part information**

Part number	Part description
RM2-3675-000CN	Interlock assembly (5700/X557/5800/X57945)
RM2-3676-000CN	Interlock assembly (6700/X654/6800/X677)

### Required tools

- #2 Phillips screwdriver with a magnetic tip and a 152 mm (6 in) shaft length

### After performing service

#### Turn the printer power on

- Connect the power cable.
- Use the power switch to turn the power on.

## Post service test

Print any pages necessary to make sure the printer is functioning correctly.

### 1. Remove the fuser

Follow these steps to remove the fuser.

1. Open the right door.

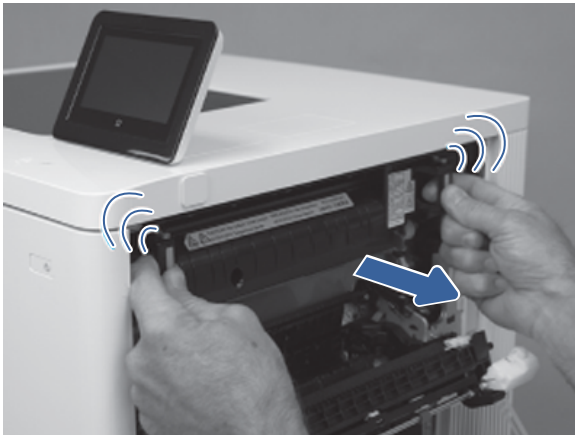
**⚠ CAUTION:** The fuser is hot. Wait at least 10 minutes after turning the printer power off before removing the fuser.

**Figure 5-467** Open the right door



2. Squeeze the release levers on the handles (circle callouts), and then remove the fuser.


**Figure 5-468** Remove the fuser



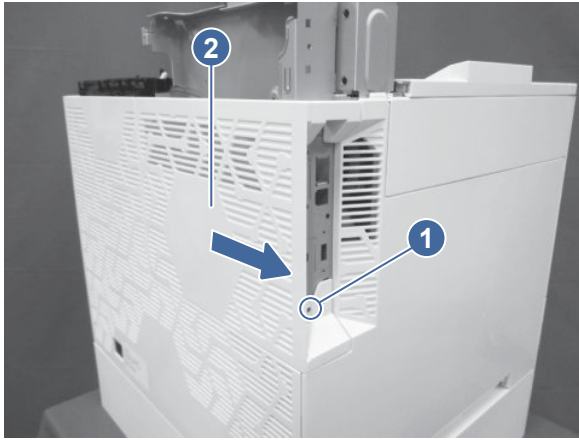
### 2. Remove the formatter cover

Follow these steps to remove the formatter cover.

- Remove one screw (callout 1), and then slide the formatter cover (callout 2) away from the printer to remove it.

 **TIP:** Reverse the removal steps to install the assembly.


**Figure 5-469 Remove the formatter cover**



### 3. Remove the formatter

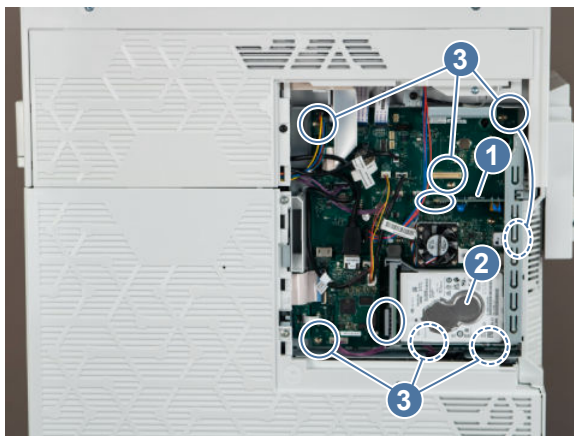
Follow these steps to remove the formatter.

1. Disconnect all of the connectors on the formatter.

 **IMPORTANT:** Some of the flat flexible cable (FFC) connectors use hinged retainers to secure them to the DC controller. The hinged retainers must be opened to release the FFCs.

2. Remove the fax PCA (callout 1) and the hard disk drive (HDD) (callout 2), and then remove seven screws (callout 3) to remove the formatter.

**Figure 5-470 Remove the formatter**



### 4. Remove the left upper cover (MFP models)

Follow these steps to remove the left upper cover.

1. Open the front door.

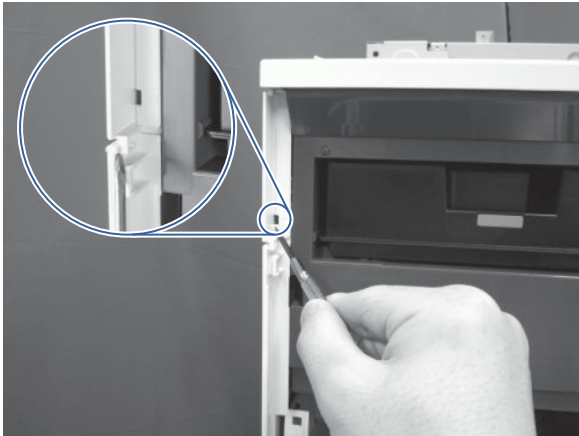
---

**⚠ CAUTION:** If the cover is being removed to gain access to the main drive assembly, make sure that the front door remains open. This keeps the main drive properly aligned.

---

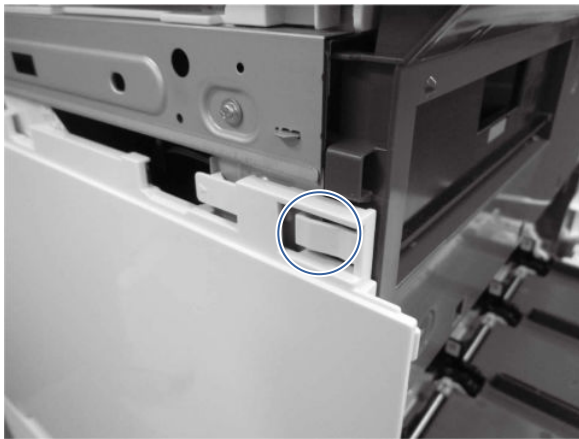
2. At the left side of the printer, insert the small flat-blade screwdriver into the slot to release one tab (callout 1).

**Figure 5-471 Use a screwdriver to release the tab**



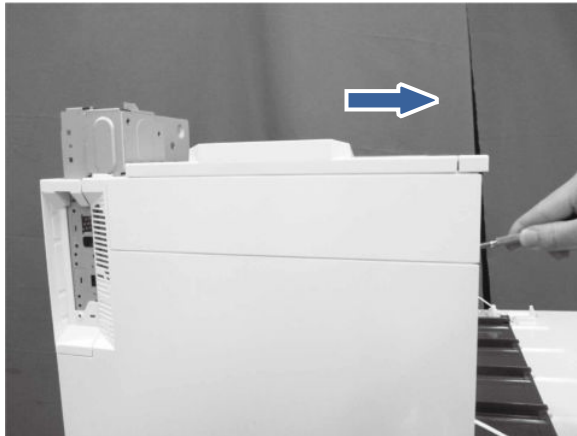
3. Toward the front of the printer, release another tab.

**Figure 5-472 Release the tab**



4. Rotate the cover up to remove it.

**Figure 5-473 Remove the left upper cover**

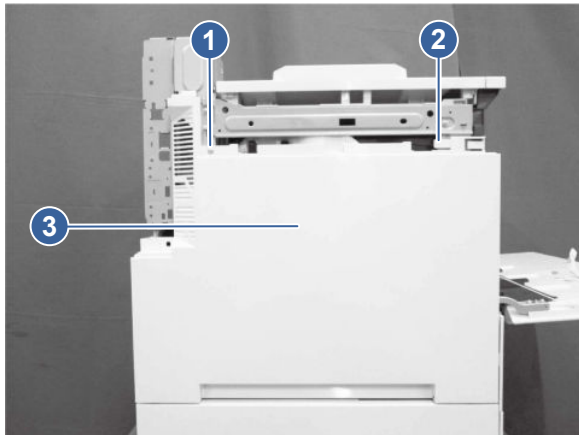


#### 5. Remove the left cover

Follow these steps to remove the left cover.

- At the left side of the printer, remove one screw (callout 1), release one tab (callout 2), and then slide the cover (callout 3) toward the rear of the printer to release it.


**Figure 5-474 Remove the left cover**



#### 6. Remove the rear cover

Follow these steps to remove the rear cover.

---

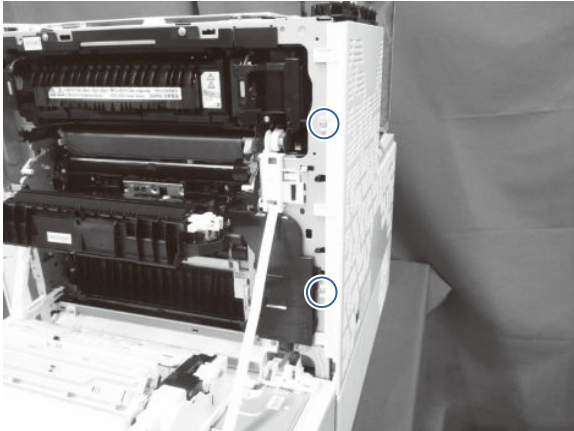
 **NOTE:** The figures below show some assemblies (for example the top cover and formatter) removed that might still be installed on the printer. However, the steps to remove the cover are correct.

---



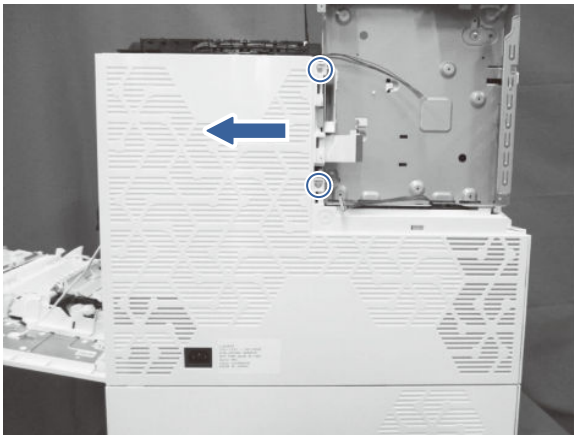
1. Open the right door, and remove two screws.

**Figure 5-475 Remove two screws**



2. At the back of the printer, remove two screws, and then slide the rear cover as indicated to remove it.

**Figure 5-476 Remove the rear cover**




## 7. Remove the low-voltage power supply (LVPS)

Follow these steps to remove the low-voltage power supply (LVPS).

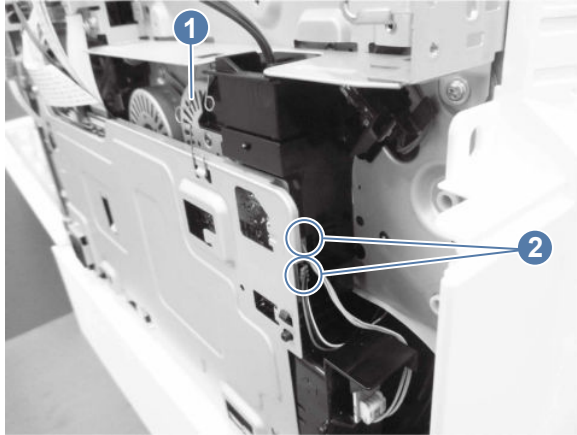
1. Unhook one spring (callout 1), and then disconnect two connectors (callout 2).

---

 **NOTE:** Unhook the spring from the formatter cage, not the low-voltage power supply. The spring should remain attached to the LVPS.

---

**Figure 5-477 Unhook the spring and disconnect two connectors**

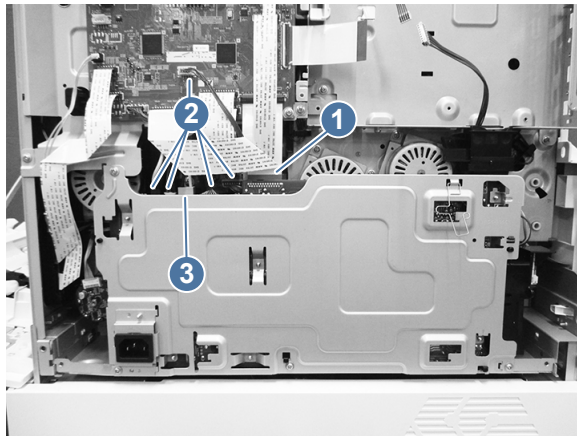


2. Remove the FFC (callout 1), and then disconnect five connectors (callout 2).



**NOTE: MFP only:** Disconnect one additional connector (callout 3).

**Figure 5-478 Disconnect the LVPS connectors**



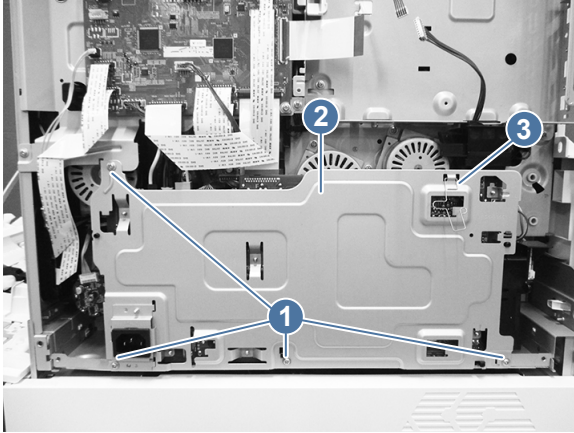
3. Remove four screws (callout 1), and then remove the low-voltage power supply assembly (callout 2).




**NOTE:** The black ducting in the lower right corner can stick during the removal process.

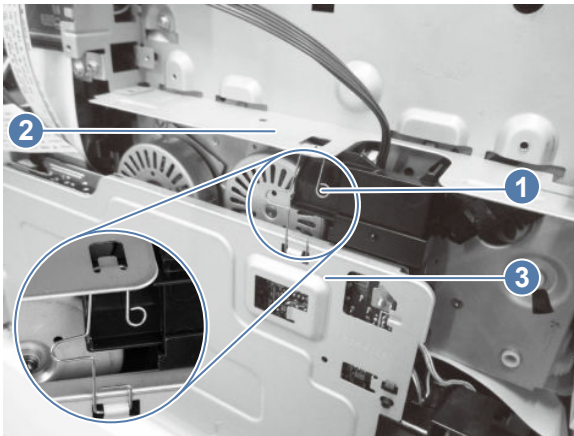
**Replacement LVPS only:** Remove the spring (callout 3), and then install it on the replacement LVPS.

**Figure 5-479 Remove the LVPS**



 **Reinstallation tip:** When reinstalling the LVPS, make sure that the spring (callout 1) is attached to both the formatter cage (callout 2) and the LVPS (callout 3).


**Figure 5-480 Reinstalling the LVPS**



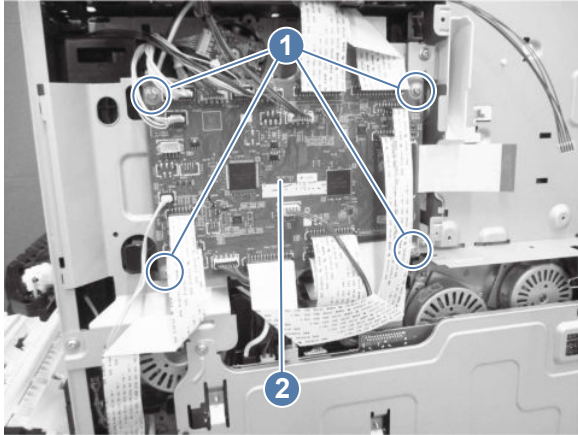
## 8. Remove the DC controller

Follow these steps to remove the DC controller.

- Disconnect all of the connectors on the DC controller, remove four screws (callout 1), and then remove the DC controller (callout 2).

 **IMPORTANT:** Some of the flat flexible cable (FFC) connectors use hinged retainers to secure them to the DC controller. The hinged retainers must be opened to release the FFCs.


**Figure 5-481 Remove the DC controller**




### 9. Remove the formatter cage (SFP models)

Follow these steps to remove the formatter cage.

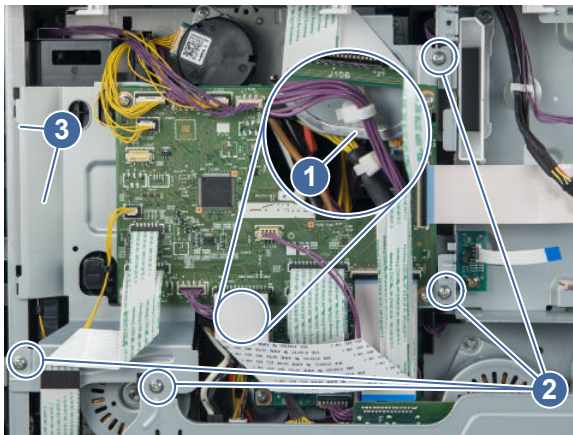
1. Disconnect all the connectors on the DC controller PCA.

 **IMPORTANT:** Some of the flat flexible cable (FFC) connectors use hinged retainers to secure them to the DC controller. The hinged retainers must be opened to release the FFCs.

2. Remove the cable clamp (callout 1), remove four screws (callout 2), and then slide the DC controller stay (callout 3) out to remove it.

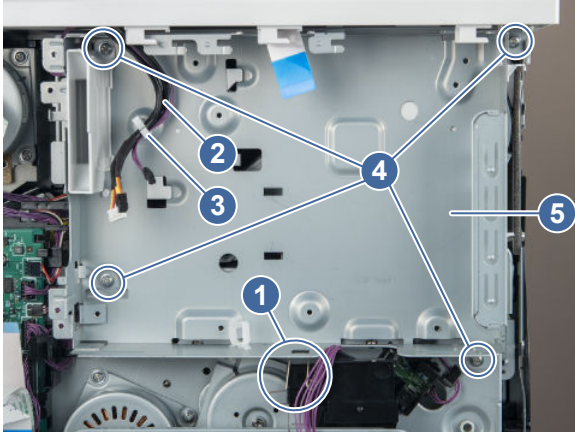
 **NOTE:** Be careful not to drop any of the screws into the low-voltage power supply assembly below the DC controller.

**Figure 5-482 Remove the DC controller stay**




3. Unhook one spring (callout 1), release the cable (callout 2) from the cable clamp (callout 3), remove four screws (callout 4), and then remove the formatter cage (callout 5).

**Figure 5-483 Remove the formatter cage**



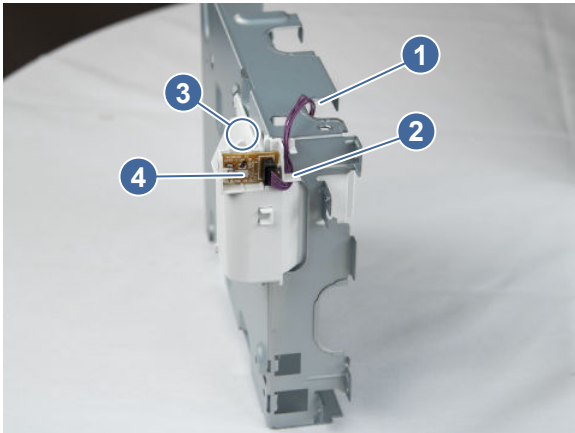
4. **For a replacement formatter cage only:** Release the cable (callout 1) from the cable guide (callout 2), release one tab (callout 3), and then remove the memory PCA (callout 4) from the formatter cage (callout 5).

---

 **NOTE:** Install the PCA on the replacement formatter cage.

---

**Figure 5-484 Remove the memory PCA**

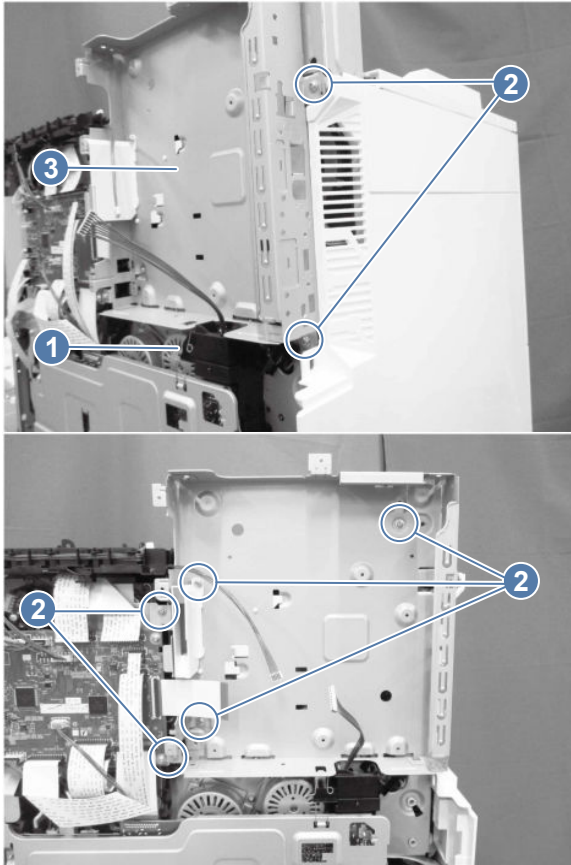


## 10. Remove the formatter cage (MFP models)


Follow these steps to remove the formatter cage.

1. Unhook one spring (callout 1), remove seven screws (callout 2), and then remove the formatter cage (callout 3).

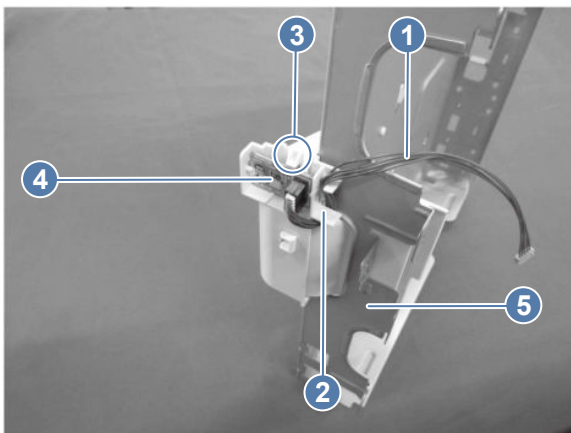
**Figure 5-485 Remove the formatter cage**



2. **For a replacement formatter cage only:** Release the cable (callout 1) from the cable guide (callout 2), release one tab (callout 3), and then remove the memory PCA (callout 4) from the formatter cage (callout 5).

 **NOTE:** Install the PCA on the replacement formatter cage.

**Figure 5-486 Remove the memory PCA**

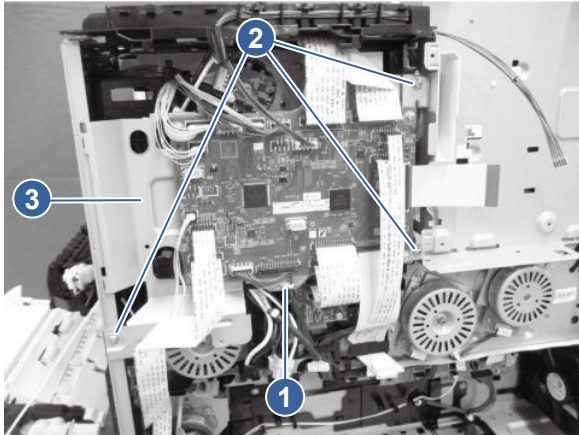


## 11. Remove the drive PCA

Follow these steps to remove the drive PCA.

1. Disconnect all the connectors on the DC controller PCA, remove the cable clamp (callout 1), remove three screws (callout 2), and then slide the DC controller stay (callout 3) out to remove it.

**Figure 5-487** Remove the DC controller stay



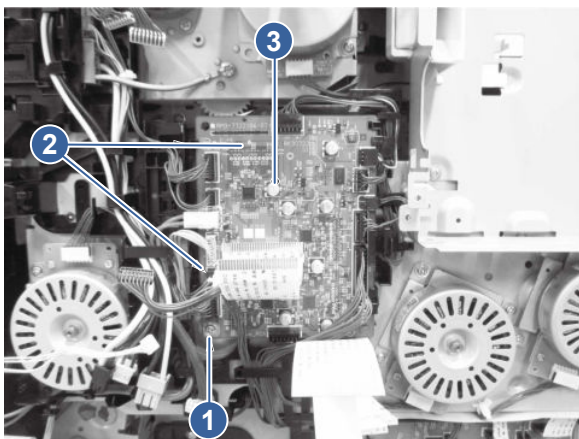
2. Disconnect all the connectors on the drive PCA, remove one screw (callout 1), release two tabs (callout 2), and then remove the drive PCA (callout 3).

---

 **IMPORTANT:** Some of these wires are very tightly connected. Take care when disconnecting them.

---


**Figure 5-488** Remove the drive PCA



## 12. Remove the main-drive assembly

Follow these steps to remove the main-drive assembly.

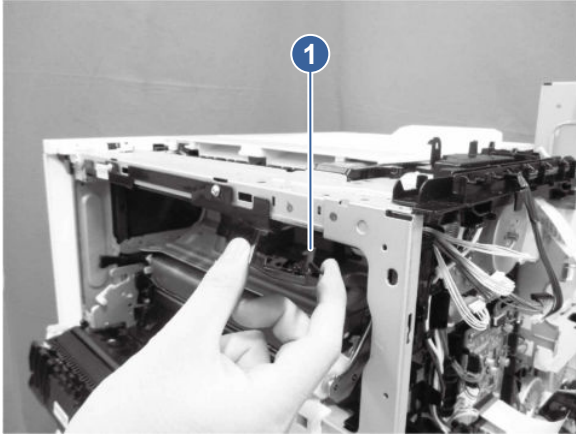
---

 **NOTE:** Make sure that the front door is closed when performing this procedure.


---

1. Pull the lever (callout 1) of the cable cover (callout 2), release one tab (callout 3), and then remove the cable cover.

**Figure 5-489 Remove the cable cover**



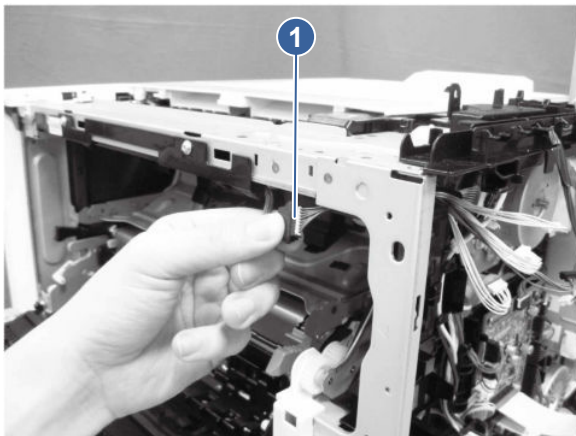
---

 **Reinstallation tip:** When reinstalling, align the pegs in the holes, and then set the cover against the frame and rotate it up and into position.

---

2. Disconnect one connector (callout 1).

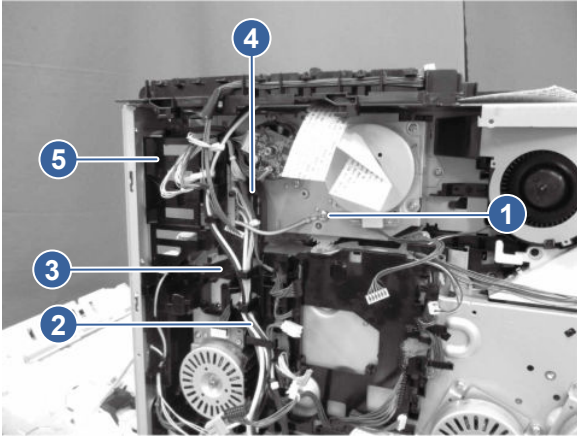
**Figure 5-490 Disconnect one connector**





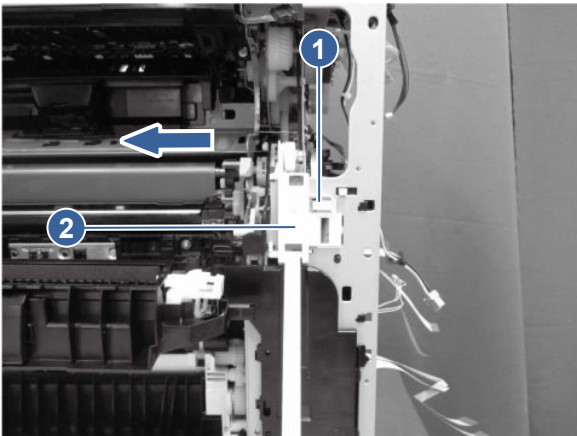
3. Remove one screw (callout 1), release the cable (callout 2) from the cable guide (callout 3), release one tab (callout 4), and then slide the connector cover (callout 5) upward to remove it.

**Figure 5-491 Remove the connector cover**



4. Release one tab (callout 1), and then slide the link cover (callout 2) in the direction indicated to remove it.

**Figure 5-492 Remove the link cover**



5. Close the right door a little, and then release the link arm (callout 1) from the coupling (callout 2).

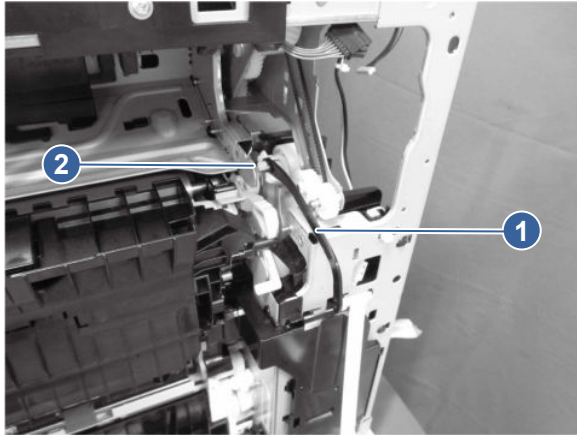


**NOTE:** This is a keyed connection. When disconnecting, make sure to line up the peg with the socket so that you do not strip the peg.



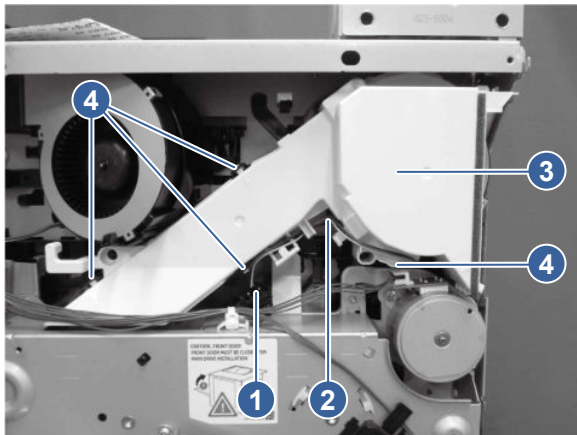
**Reinstallation tip:** If the black link arm disconnects from the white link arm below it, it might be helpful for reinstallation purposes to reattach the two link arms.

**Figure 5-493 Release the link arm**




6. Disconnect one connector (callout 1), release the cable (callout 2) from the fan cover (callout 3), release four tabs (callout 4), and then remove the fan cover.

**Figure 5-494 Remove the fan cover**



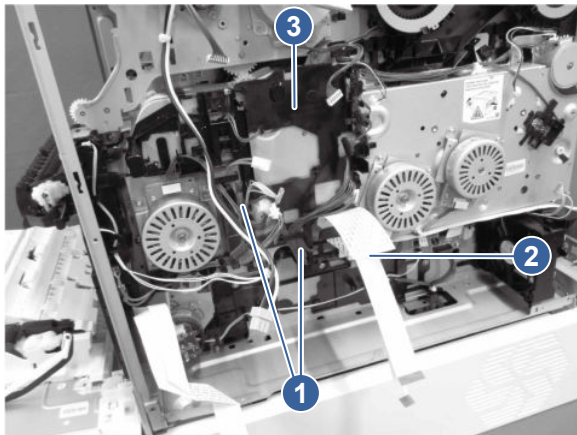
---

 **Reinstallation tip:** When reinstalling this cover, seat the right side pegs into the chassis slots first.

---


7. Release the cables (callout 1) and the remove FFC (callout 2) from the cable guide (callout 3).

**Figure 5-495 Release the cables**



8. Remove seven screws (callout 1), release one tab (callout 2), and then remove the main drive assembly (callout 3).

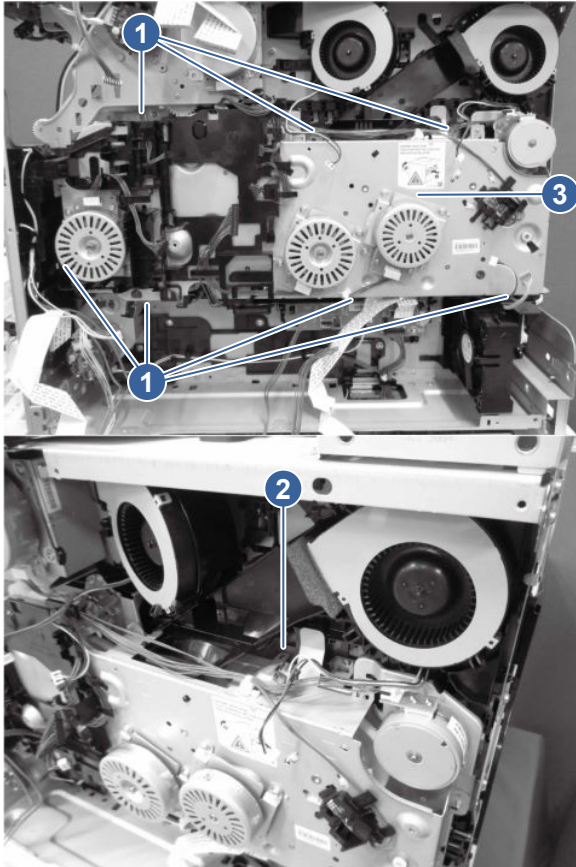
---

 **NOTE:** All seven screws are on sheet metal tabs on the assembly.

 **NOTE:** Ensure that the screws do not fall into the assembly.

---

**Figure 5-496 Remove the main drive assembly**




9. **Special installation instructions for a main drive assembly (replacement unit and serviced unit)**

- **Replacement unit:** A replacement unit is a new assembly that installs in place of a discarded in-service unit.
- **In-service unit:** An in-service unit is an existing assembly that has been removed for repair or to gain access to other assemblies.

---

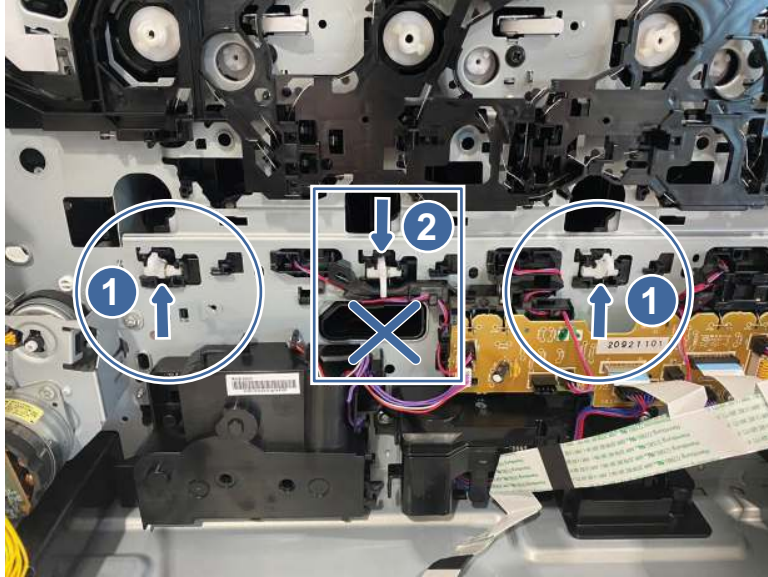
 **CAUTION:** When the main drive assembly is installed (replacement units and service units), the front door **must** be closed.


 **IMPORTANT:** If you are installing a new main drive assembly (replacement unit), you **do not** need to perform the alignment steps below. New assemblies are **already** aligned.

---

- a. **Replacement unit and in-service unit:** On the printer engine, be careful to **not** depress the levers located behind the main drive assembly (when it is installed).
  - **Callout 1:** Levers in the correct raised position.
  - **Callout 2:** Lever in the incorrect depressed position.

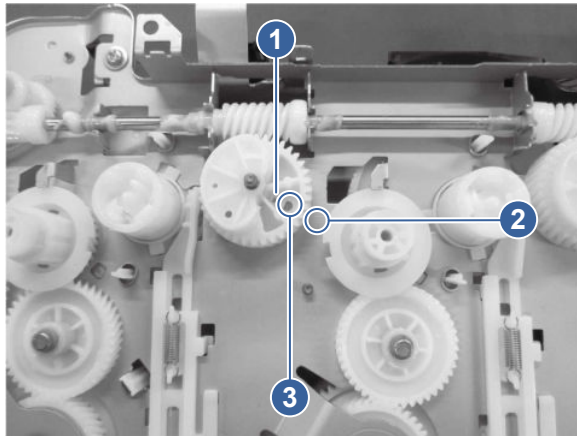
**Figure 5-497** Correct and incorrect lever positions



 **NOTE:** For a replacement unit install, skip the remaining alignment steps which are for in-service units only.

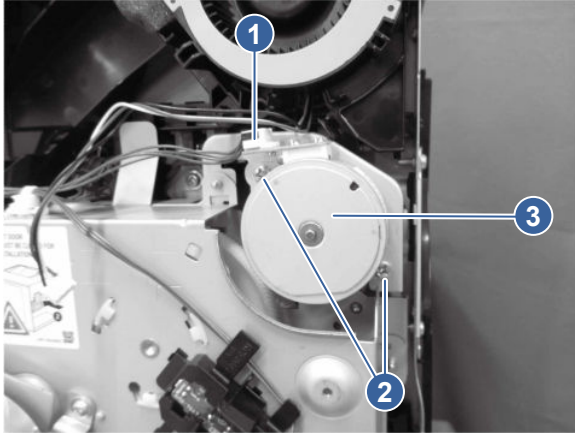
- b. **In-service unit:** There are four gears on the main drive assembly that need to be lined up correctly in order to successfully reinstall the main drive. For each gear, the triangle (callout 1) on the inside of the gear should line up with the triangle (callout 2) stamped on the sheet metal chassis. Also, the hole (callout 3) in the gear should line up with a hole in the chassis.

**Figure 5-498** Correct gear alignment



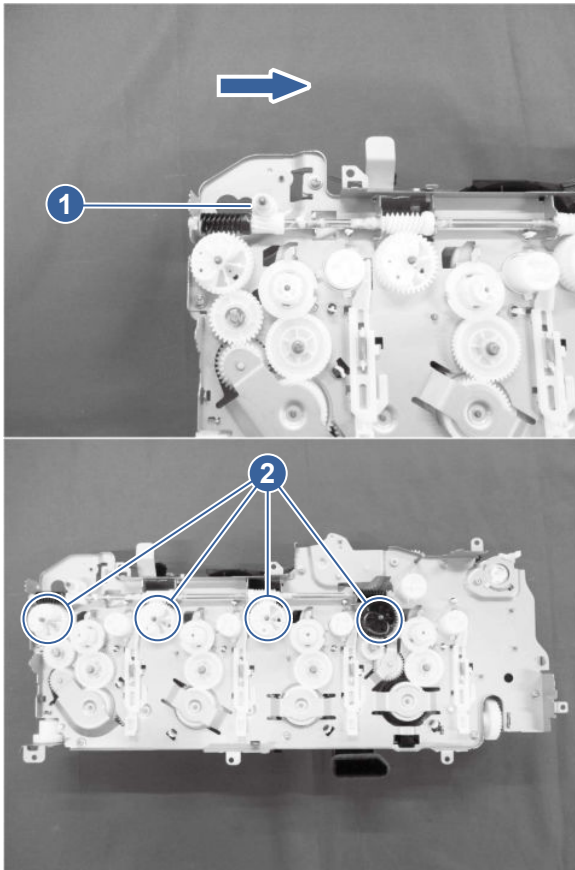
- c. **In-service unit:** In order to realign the four gears, you must remove the motor that locks the gear auger above the four gears. To do this, disconnect one connector (callout 1), remove two screws (callout 2), and then remove the motor (callout 3).

**Figure 5-499 Remove the motor**



- d. **In-service unit:** To realign the four gears, turn the gear (callout 1) in the direction indicated. By turning that gear, the four gears (callout 2) that need to be in phase turn in tandem. Turn the four gears to the correct phase position.

**Figure 5-500 Align the gears**

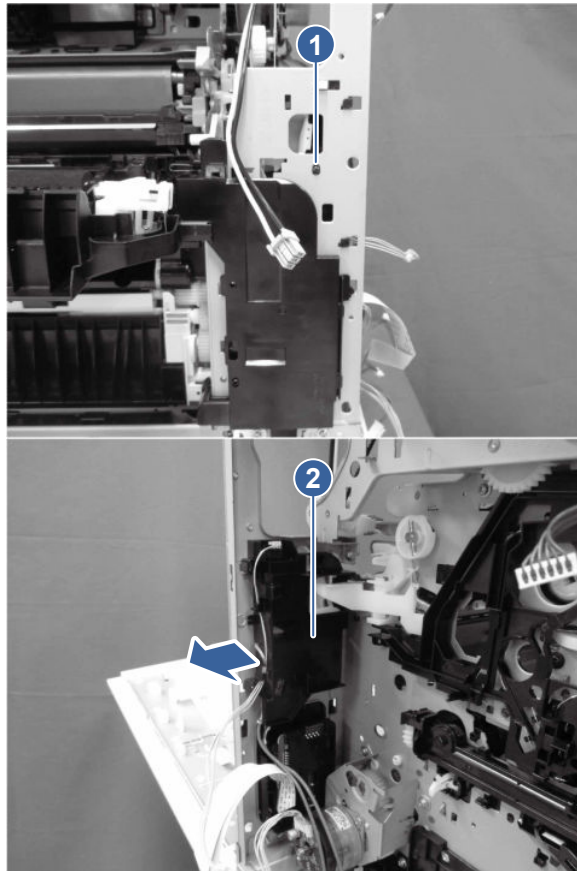


### 13. Remove the interlock assembly

Follow these steps to remove the interlock assembly.

- At the right side of the printer, release one boss (callout 1), and then slide the interlock assembly (callout 2) in the direction indicated to remove it.

**Figure 5-501** Remove the interlock assembly



#### 14. Unpack the replacement assembly



Follow these steps to unpack the replacement assembly.


1. Dispose of the defective part.


 **NOTE:** HP recommends responsible disposal of the defective part.

<http://www8.hp.com/us/en/hp-information/environment/product-recycling.html>

2. Unpack the replacement part from the packaging.

 **CAUTION:**  Some parts are sensitive to electrostatic discharge (ESD). Always perform service work at an ESD-protected workstation or mat. If an ESD workstation or mat is not available, touch the sheet-metal chassis to provide a static ground before touching an ESD-sensitive assembly. Protect the ESD-sensitive assemblies by placing them in ESD pouches when they are out of the printer.

 **IMPORTANT:** Make sure that all of the shipping materials (for example shipping tape) are removed from the replacement part prior to installation.

 **NOTE:** If the replacement part is a roller or pad, avoid touching the spongy part of it. Skin oils on the roller or pad can cause paper pickup and/or print-quality problems. HP recommends using disposable gloves when handling rollers or pads or washing your hands before touching rollers or pads.

3. To install an assembly, reverse the removal steps.



**NOTE:** When applicable, special installation instructions are provided for an assembly at the end of the removal procedure. Always completely read the removal instructions and follow all special installation instructions.

## Removal and replacement: Waste toner duct assembly (X654/X677 models)

Learn about removing and replacing the waste toner duct assembly.

### Before performing service

#### Turn the printer power off

- Disconnect the power cable.

**⚠ WARNING!** To avoid damage to the printer, turn the printer off, wait 30 seconds, and then remove the power cord before attempting to service the printer.

If the part is damaged and cannot be cleaned, use the table below to identify the correct part number for your printer. To order the part, go to [www.hp.com/buy/parts](http://www.hp.com/buy/parts).

**Table 5-74** Part information

Part number	Part description
RM2-3590-000CN	Waste toner duct assembly (X654/X677 models)

### Required tools

- #2 Phillips screwdriver with a magnetic tip and a 152 mm (6 in) shaft length

### After performing service

#### Turn the printer power on

- Connect the power cable.
- Use the power switch to turn the power on.

### Post service test

Print any pages necessary to make sure the printer is functioning correctly.

## 1. Remove the fuser

Follow these steps to remove the fuser.

1. Open the right door.



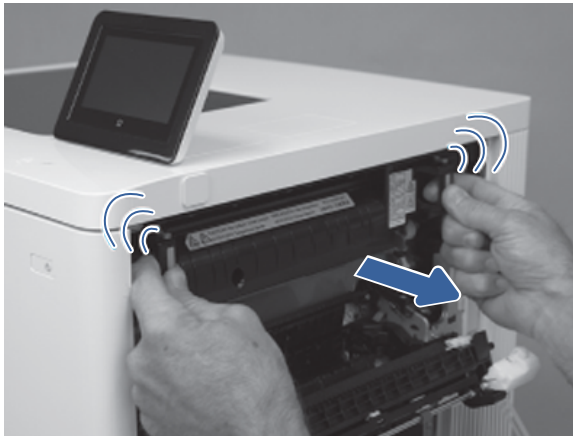
**CAUTION:** The fuser is hot. Wait at least 10 minutes after turning the printer power off before removing the fuser.

**Figure 5-502 Open the right door**



2. Squeeze the release levers on the handles (circle callouts), and then remove the fuser.


**Figure 5-503 Remove the fuser**



## 2. Unseat the ITB

Follow these steps to unseat the ITB.

1. Open the right door (if it is not already open).
2. Grasp the two levers on the ITB, and then slightly pull it out of the printer to unseat and disengage it.

 **Reinstallation tip:** During Reinstallation of the target part, do not reseat the ITB too early in the process. The ITB must remain disengaged to make sure that the gear is correctly aligned.

**A 46.00.0x error occurs if the ITB if the procedure is completed with the ITB seated.**



**Figure 5-504 Disengage the ITB**




### 3. Remove the formatter cover

Follow these steps to remove the formatter cover.

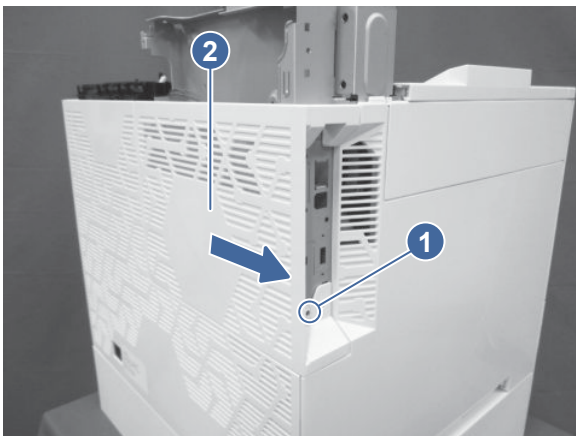
- Remove one screw (callout 1), and then slide the formatter cover (callout 2) away from the printer to remove it.

---

 **TIP:** Reverse the removal steps to install the assembly.

---

**Figure 5-505 Remove the formatter cover**




### 4. Remove the formatter

Follow these steps to remove the formatter.

1. Disconnect all of the connectors on the formatter.

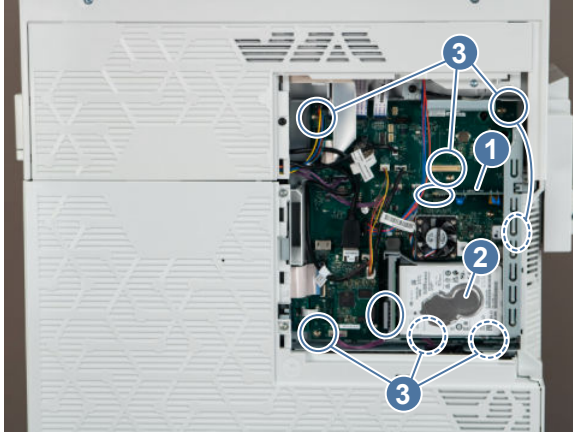
---

 **IMPORTANT:** Some of the flat flexible cable (FFC) connectors use hinged retainers to secure them to the DC controller. The hinged retainers must be opened to release the FFCs.

---

2. Remove the fax PCA (callout 1) and the hard disk drive (HDD) (callout 2), and then remove seven screws (callout 3) to remove the formatter.

**Figure 5-506 Remove the formatter**



### 5. Remove the left upper cover (MFP models)

Follow these steps to remove the left upper cover.

1. Open the front door.

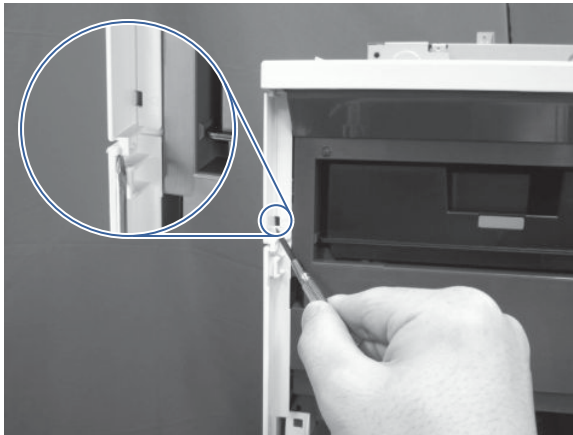
---

**CAUTION:** If the cover is being removed to gain access to the main drive assembly, make sure that the front door remains open. This keeps the main drive properly aligned.

---

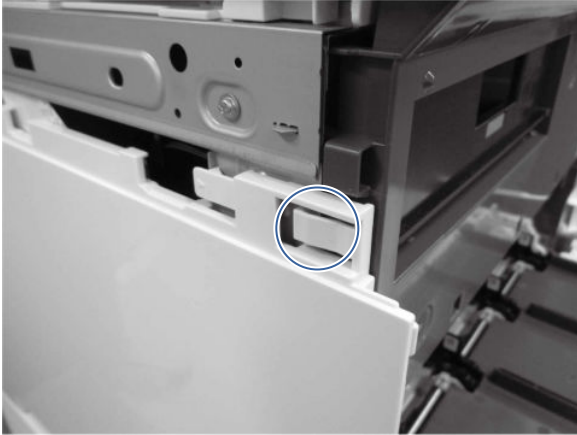
2. At the left side of the printer, insert the small flat-blade screwdriver into the slot to release one tab (callout 1).

**Figure 5-507 Use a screwdriver to release the tab**



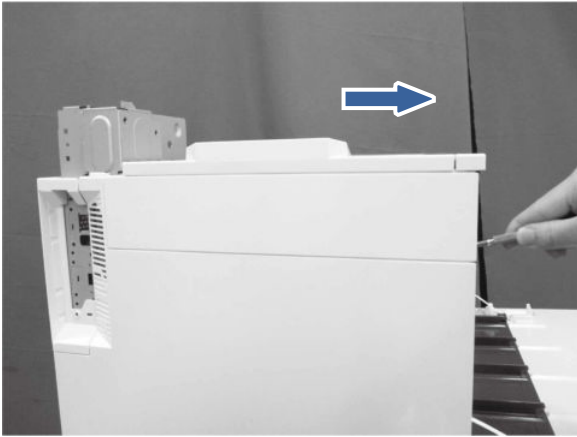
3. Toward the front of the printer, release another tab.

**Figure 5-508 Release the tab**



4. Rotate the cover up to remove it.

**Figure 5-509 Remove the left upper cover**

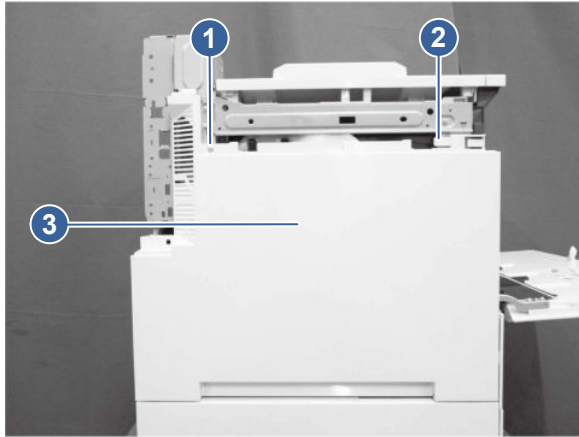


## 6. Remove the left cover

Follow these steps to remove the left cover.

- At the left side of the printer, remove one screw (callout 1), release one tab (callout 2), and then slide the cover (callout 3) toward the rear of the printer to release it.


**Figure 5-510 Remove the left cover**



## 7. Remove the rear cover

Follow these steps to remove the rear cover.

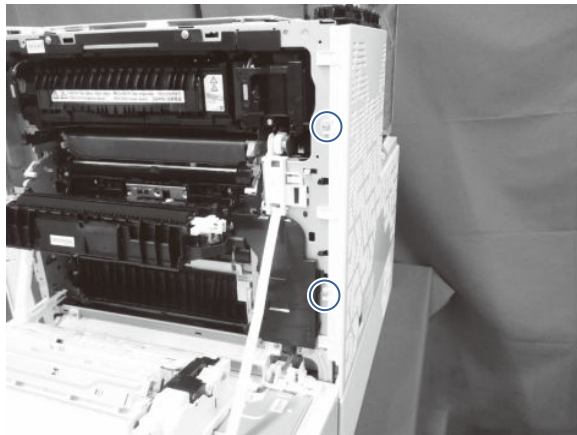
---

 **NOTE:** The figures below show some assemblies (for example the top cover and formatter) removed that might still be installed on the printer. However, the steps to remove the cover are correct.

---

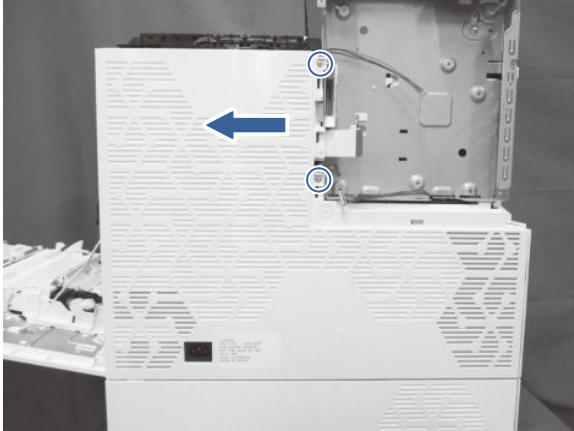
1. Open the right door, and remove two screws.

**Figure 5-511 Remove two screws**



2. At the back of the printer, remove two screws, and then slide the rear cover as indicated to remove it.

**Figure 5-512 Remove the rear cover**




### 8. Remove the low-voltage power supply (LVPS)

Follow these steps to remove the low-voltage power supply (LVPS).

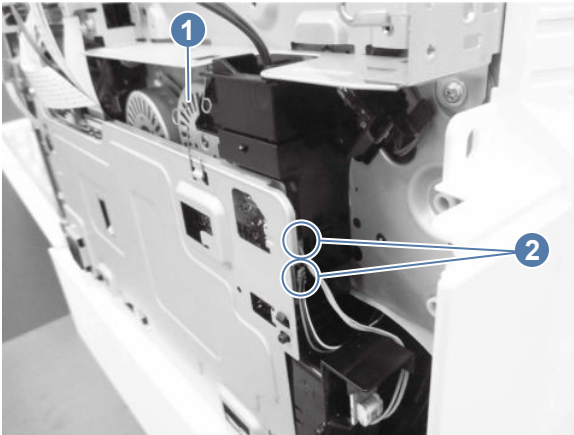
1. Unhook one spring (callout 1), and then disconnect two connectors (callout 2).

---

 **NOTE:** Unhook the spring from the formatter cage, not the low-voltage power supply. The spring should remain attached to the LVPS.


---

**Figure 5-513 Unhook the spring and disconnect two connectors**



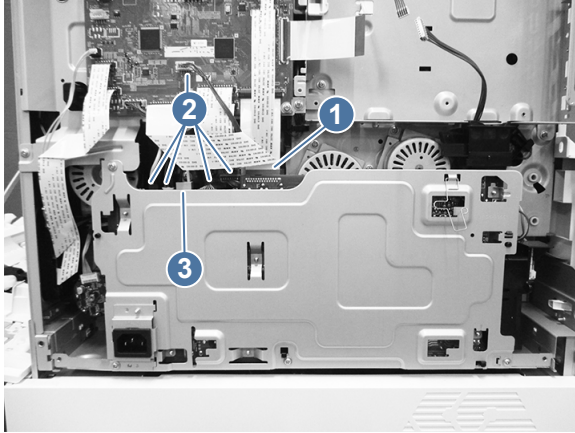
2. Remove the FFC (callout 1), and then disconnect five connectors (callout 2).

---


 **NOTE:** **MFP only:** Disconnect one additional connector (callout 3).

---

**Figure 5-514 Disconnect the LVPS connectors**

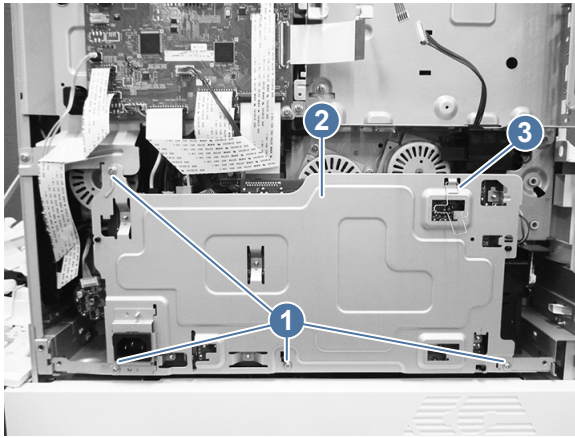



3. Remove four screws (callout 1), and then remove the low-voltage power supply assembly (callout 2).

 **NOTE:** The black ducting in the lower right corner can stick during the removal process.

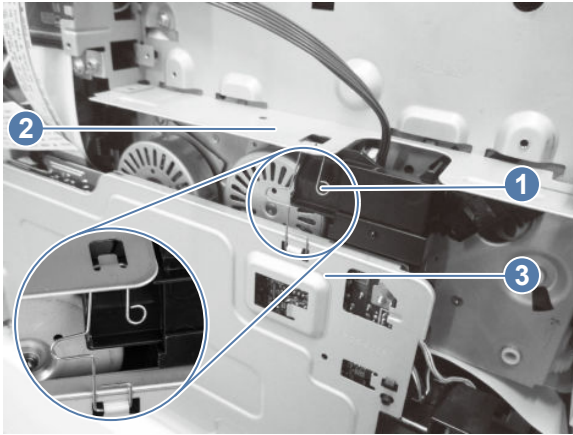
**Replacement LVPS only:** Remove the spring (callout 3), and then install it on the replacement LVPS.

**Figure 5-515 Remove the LVPS**



 **Reinstallation tip:** When reinstalling the LVPS, make sure that the spring (callout 1) is attached to both the formatter cage (callout 2) and the LVPS (callout 3).


**Figure 5-516 Reinstalling the LVPS**



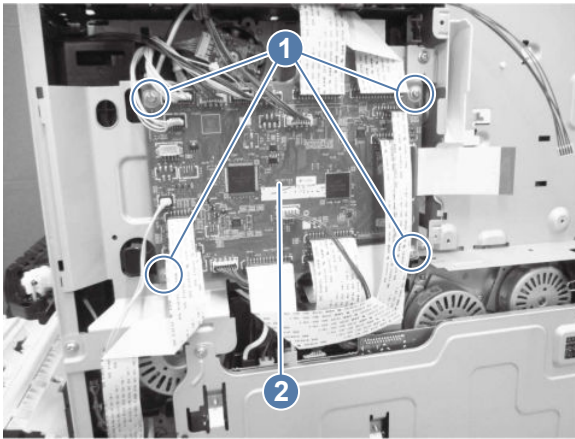
## 9. Remove the DC controller

Follow these steps to remove the DC controller.

- Disconnect all of the connectors on the DC controller, remove four screws (callout 1), and then remove the DC controller (callout 2).

 **IMPORTANT:** Some of the flat flexible cable (FFC) connectors use hinged retainers to secure them to the DC controller. The hinged retainers must be opened to release the FFCs.


**Figure 5-517 Remove the DC controller**




## 10. Remove the formatter cage (SFP models)

Follow these steps to remove the formatter cage.

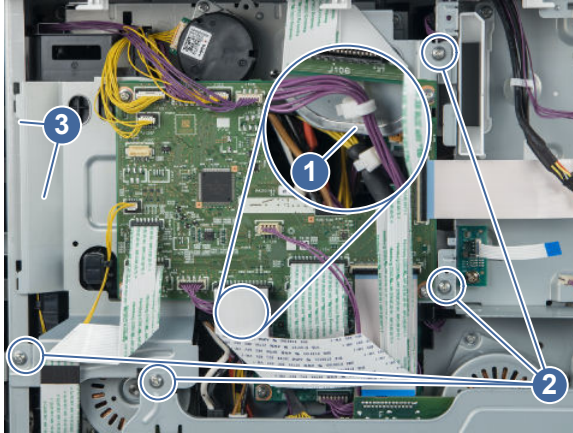
1. Disconnect all the connectors on the DC controller PCA.

 **IMPORTANT:** Some of the flat flexible cable (FFC) connectors use hinged retainers to secure them to the DC controller. The hinged retainers must be opened to release the FFCs.

2. Remove the cable clamp (callout 1), remove four screws (callout 2), and then slide the DC controller stay (callout 3) out to remove it.

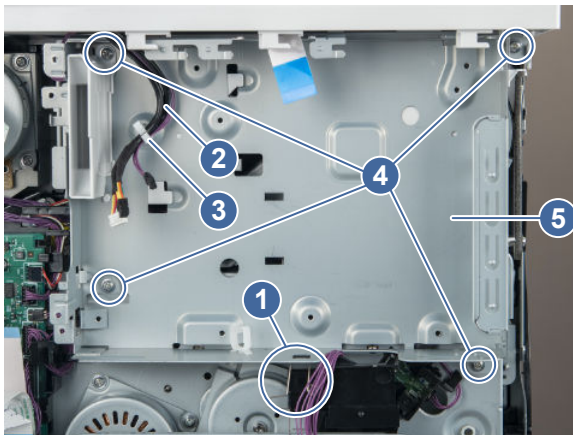
 **NOTE:** Be careful not to drop any of the screws into the low-voltage power supply assembly below the DC controller.

**Figure 5-518 Remove the DC controller stay**




3. Unhook one spring (callout 1), release the cable (callout 2) from the cable clamp (callout 3), remove four screws (callout 4), and then remove the formatter cage (callout 5).

**Figure 5-519 Remove the formatter cage**



4. **For a replacement formatter cage only:** Release the cable (callout 1) from the cable guide (callout 2), release one tab (callout 3), and then remove the memory PCA (callout 4) from the formatter cage (callout 5).

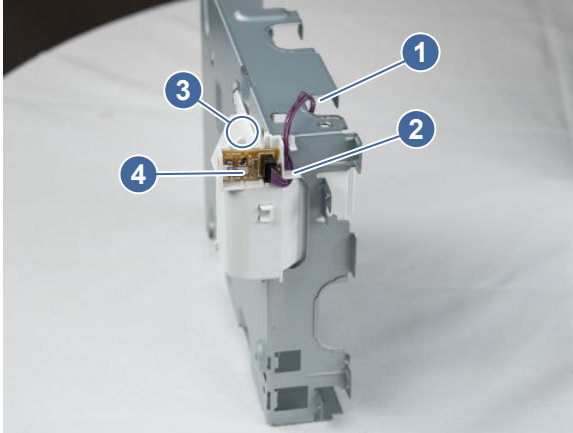
---

 **NOTE:** Install the PCA on the replacement formatter cage.

---



**Figure 5-520 Remove the memory PCA**

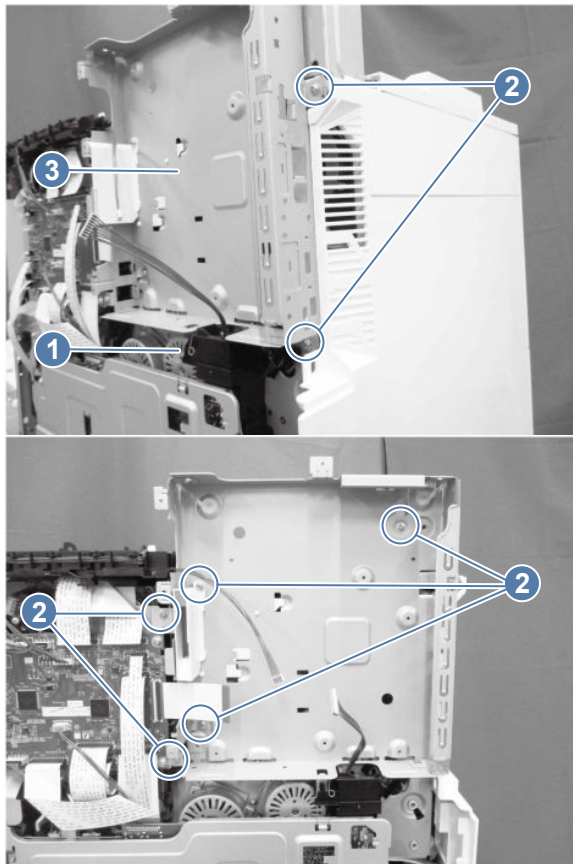


### 11. Remove the formatter cage (MFP models)

Follow these steps to remove the formatter cage.


1. Unhook one spring (callout 1), remove seven screws (callout 2), and then remove the formatter cage (callout 3).

**Figure 5-521 Remove the formatter cage**



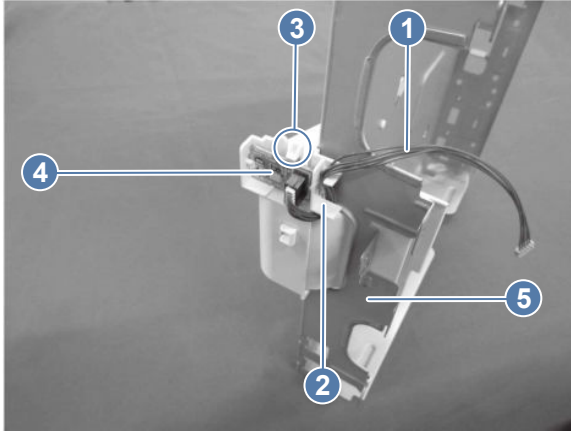
2. **For a replacement formatter cage only:** Release the cable (callout 1) from the cable guide (callout 2), release one tab (callout 3), and then remove the memory PCA (callout 4) from the formatter cage (callout 5).

---

 **NOTE:** Install the PCA on the replacement formatter cage.

---

**Figure 5-522 Remove the memory PCA**

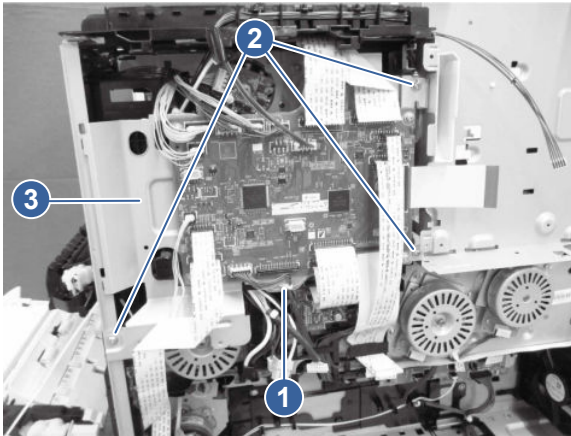


## 12. Remove the drive PCA

Follow these steps to remove the drive PCA.


1. Disconnect all the connectors on the DC controller PCA, remove the cable clamp (callout 1), remove three screws (callout 2), and then slide the DC controller stay (callout 3) out to remove it.

**Figure 5-523 Remove the DC controller stay**



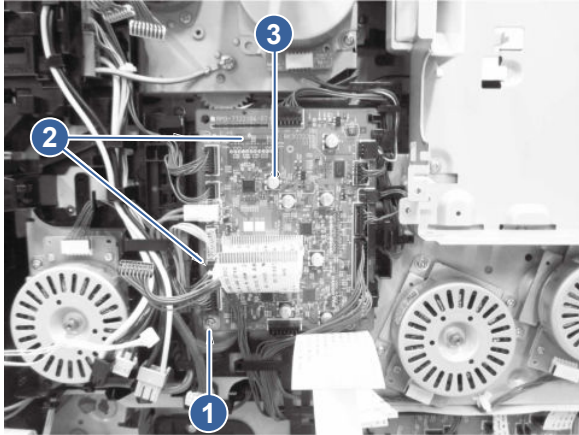
2. Disconnect all the connectors on the drive PCA, remove one screw (callout 1), release two tabs (callout 2), and then remove the drive PCA (callout 3).

---

 **IMPORTANT:** Some of these wires are very tightly connected. Take care when disconnecting them.

---


**Figure 5-524 Remove the drive PCA**



### 13. Remove the main-drive assembly

Follow these steps to remove the main-drive assembly.

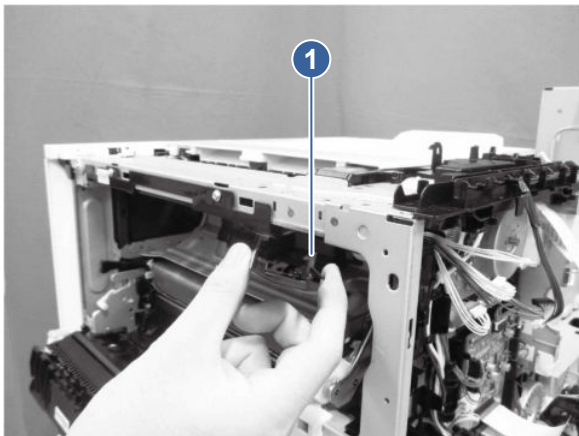
---

 **NOTE:** Make sure that the front door is closed when performing this procedure.


---

1. Pull the lever (callout 1) of the cable cover (callout 2), release one tab (callout 3), and then remove the cable cover.

**Figure 5-525 Remove the cable cover**



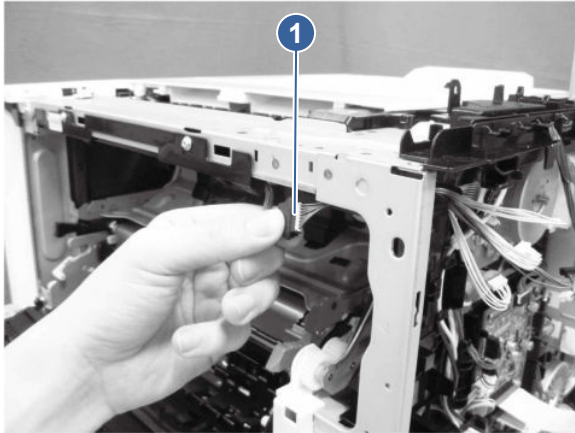
---

 **Reinstallation tip:** When reinstalling, align the pegs in the holes, and then set the cover against the frame and rotate it up and into position.

---

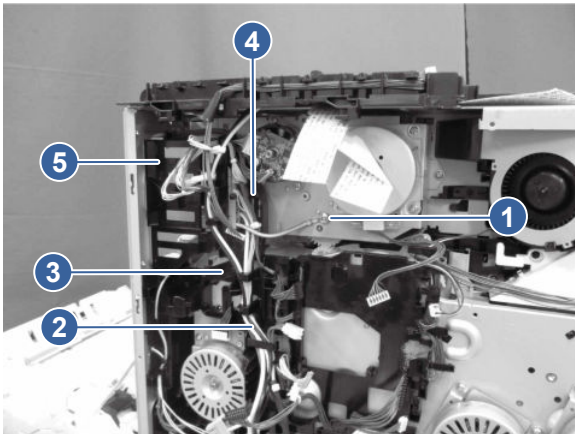
2. Disconnect one connector (callout 1).

**Figure 5-526 Disconnect one connector**



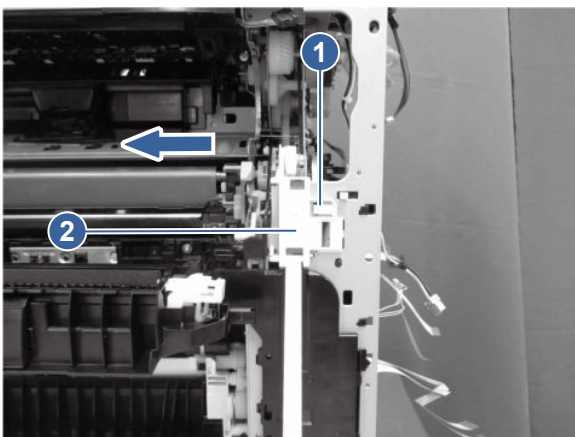
3. Remove one screw (callout 1), release the cable (callout 2) from the cable guide (callout 3), release one tab (callout 4), and then slide the connector cover (callout 5) upward to remove it.

**Figure 5-527 Remove the connector cover**





4. Release one tab (callout 1), and then slide the link cover (callout 2) in the direction indicated to remove it.

**Figure 5-528 Remove the link cover**

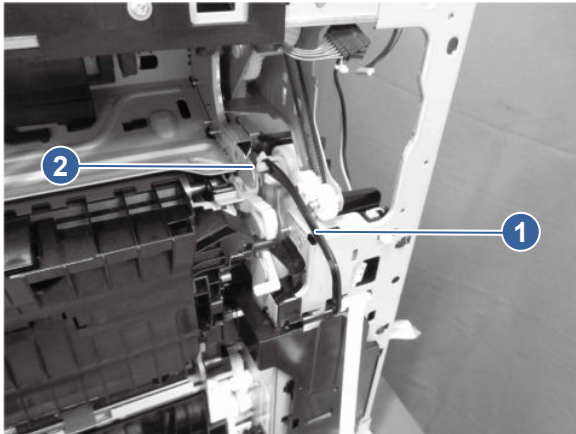


5. Close the right door a little, and then release the link arm (callout 1) from the coupling (callout 2).

 **NOTE:** This is a keyed connection. When disconnecting, make sure to line up the peg with the socket so that you do not strip the peg.

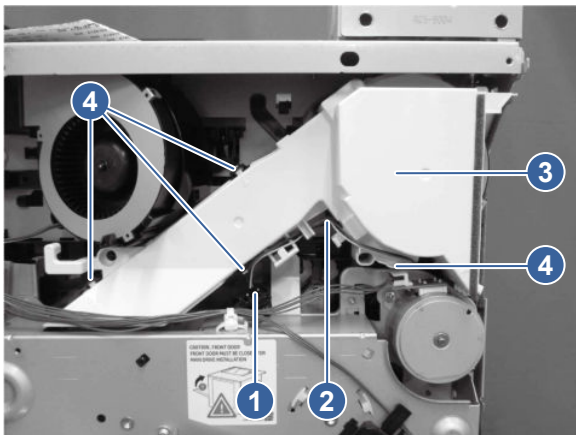
 **Reinstallation tip:** If the black link arm disconnects from the white link arm below it, it might be helpful for reinstallation purposes to reattach the two link arms.


**Figure 5-529 Release the link arm**



6. Disconnect one connector (callout 1), release the cable (callout 2) from the fan cover (callout 3), release four tabs (callout 4), and then remove the fan cover.

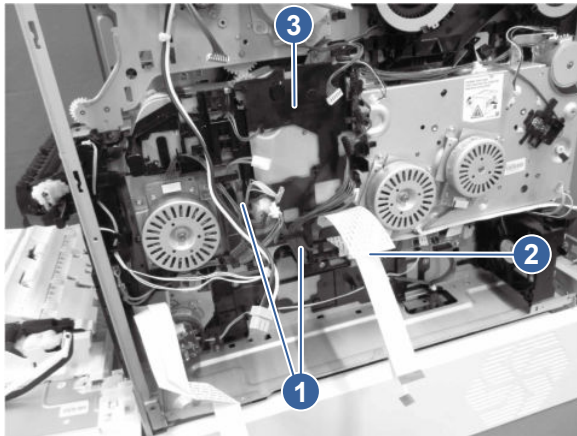
**Figure 5-530 Remove the fan cover**



 **Reinstallation tip:** When reinstalling this cover, seat the right side pegs into the chassis slots first.


7. Release the cables (callout 1) and the remove FFC (callout 2) from the cable guide (callout 3).

**Figure 5-531 Release the cables**



8. Remove seven screws (callout 1), release one tab (callout 2), and then remove the main drive assembly (callout 3).

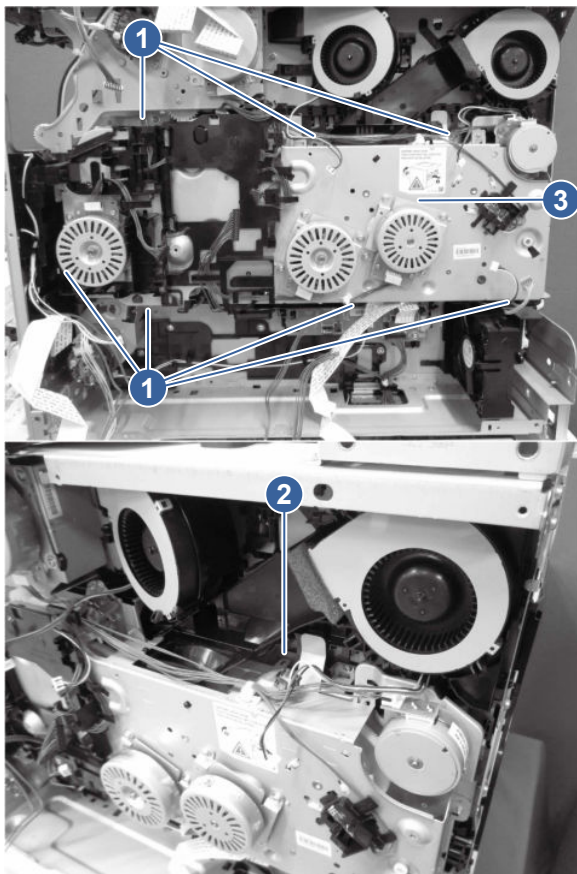
---

 **NOTE:** All seven screws are on sheet metal tabs on the assembly.

 **NOTE:** Ensure that the screws do not fall into the assembly.

---

**Figure 5-532 Remove the main drive assembly**



9. **Special installation instructions for a main drive assembly (replacement unit and serviced unit)**

- **Replacement unit:** A replacement unit is a new assembly that installs in place of a discarded in-service unit.
- **In-service unit:** An in-service unit is a existing assembly that has been removed for repair or to gain access to other assemblies.

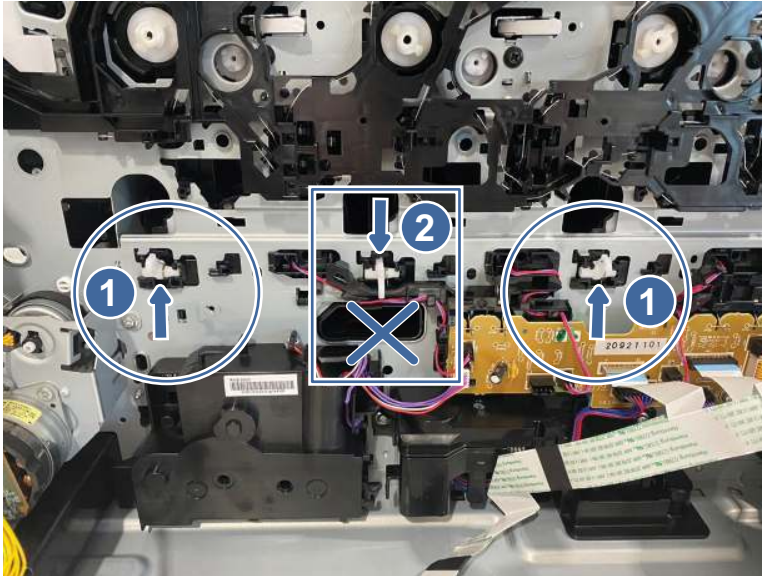
**CAUTION:** When the main drive assembly is installed (replacement units and service units), the front door **must** be closed.

**IMPORTANT:** If you are installing a new main drive assembly (replacement unit), you **do not** need to perform the alignment steps below. New assemblies are **already** aligned.

a. **Replacement unit and in-service unit:** On the printer engine, be careful to **not** depress the levers located behind the main drive assembly (when it is installed).

- **Callout 1:** Levers in the correct raised position.
- **Callout 2:** Lever in the incorrect depressed position.

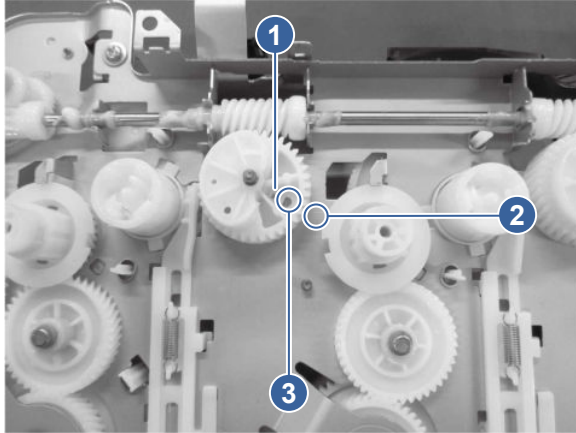
**Figure 5-533** Correct and incorrect lever positions



**NOTE:** For a replacement unit install, skip the remaining alignment steps which are for in-service units only.

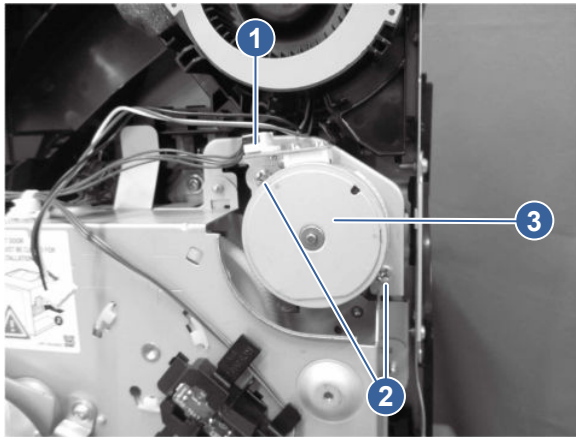
b. **In-service unit:** There are four gears on the main drive assembly that need to be lined up correctly in order to successfully reinstall the main drive. For each gear, the triangle (callout 1) on the inside of the gear should line up with the triangle (callout 2) stamped on the sheet metal chassis. Also, the hole (callout 3) in the gear should line up with a hole in the chassis.

**Figure 5-534 Correct gear alignment**



- c. **In-service unit:** In order to realign the four gears, you must remove the motor that locks the gear auger above the four gears. To do this, disconnect one connector (callout 1), remove two screws (callout 2), and then remove the motor (callout 3).

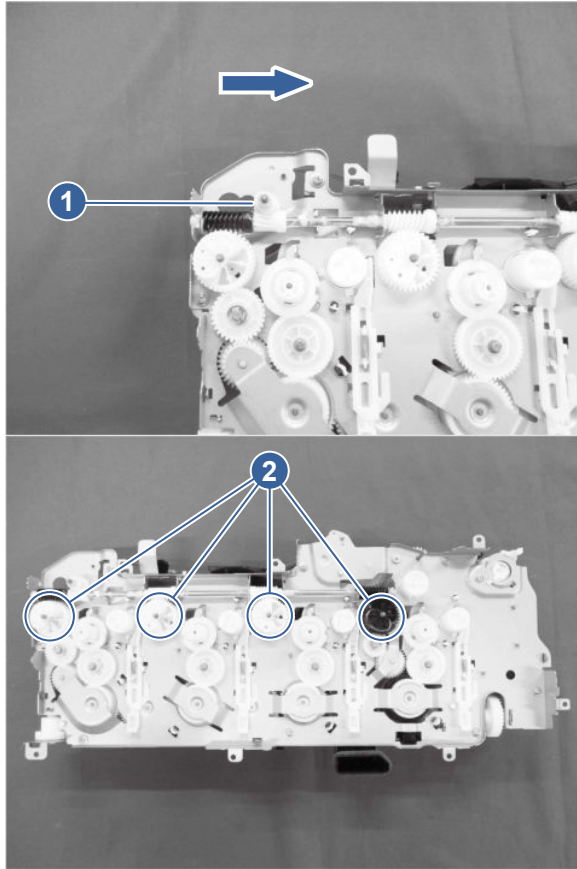
**Figure 5-535 Remove the motor**



- d. **In-service unit:** To realign the four gears, turn the gear (callout 1) in the direction indicated. By turning that gear, the four gears (callout 2) that need to be in phase turn in tandem. Turn the four gears to the correct phase position.



**Figure 5-536 Align the gears**

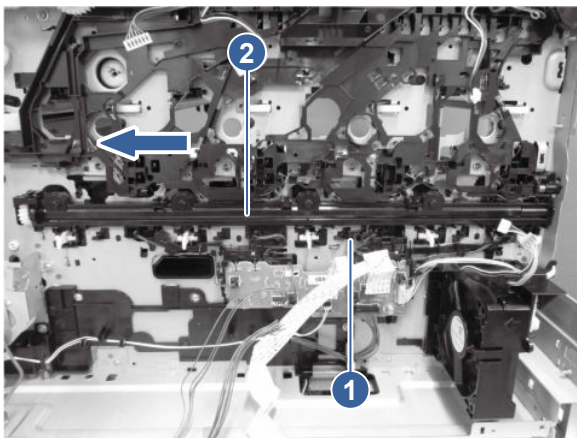


**14. Remove the waste toner duct assembly (X654/X677 models)**

Follow these steps to remove the waste toner duct assembly.

- Release one tab (callout 1), slide the waste toner duct assembly (callout 2) in the direction indicated, and then pull the waste toner duct assembly away from the printer.


**Figure 5-537 Remove the waste toner duct assembly**



**15. Unpack the replacement assembly**



Follow these steps to unpack the replacement assembly.


1. Dispose of the defective part.


 **NOTE:** HP recommends responsible disposal of the defective part.

<http://www8.hp.com/us/en/hp-information/environment/product-recycling.html>


2. Unpack the replacement part from the packaging.

 **CAUTION:**  Some parts are sensitive to electrostatic discharge (ESD). Always perform service work at an ESD-protected workstation or mat. If an ESD workstation or mat is not available, touch the sheet-metal chassis to provide a static ground before touching an ESD-sensitive assembly. Protect the ESD-sensitive assemblies by placing them in ESD pouches when they are out of the printer.

 **IMPORTANT:** Make sure that all of the shipping materials (for example shipping tape) are removed from the replacement part prior to installation.

 **NOTE:** If the replacement part is a roller or pad, avoid touching the spongy part of it. Skin oils on the roller or pad can cause paper pickup and/or print-quality problems. HP recommends using disposable gloves when handling rollers or pads or washing your hands before touching rollers or pads.

3. To install an assembly, reverse the removal steps.

 **NOTE:** When applicable, special installation instructions are provided for an assembly at the end of the removal procedure. Always completely read the removal instructions and follow all special installation instructions.


## Removal and replacement: Waste toner duct assembly (6700/6800 models)

Learn about removing and replacing the waste toner duct assembly.

### Before performing service

#### Turn the printer power off

- Disconnect the power cable.

 **WARNING!** To avoid damage to the printer, turn the printer off, wait 30 seconds, and then remove the power cord before attempting to service the printer.

If the part is damaged and cannot be cleaned, use the table below to identify the correct part number for your printer. To order the part, go to [www.hp.com/buy/parts](http://www.hp.com/buy/parts).

**Table 5-75 Part information**

Part number	Part description
RM2-3517-000CN	Waste toner duct assembly (5700/5800)
RM2-3518-000CN	Waste toner duct assembly (X557/6700/6800)

### Required tools

- #2 Phillips screwdriver with a magnetic tip and a 152 mm (6 in) shaft length

### After performing service

#### Turn the printer power on

- Connect the power cable.
- Use the power switch to turn the power on.

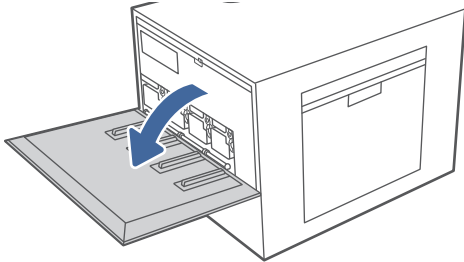
## Post service test

Print any pages necessary to make sure the printer is functioning correctly.

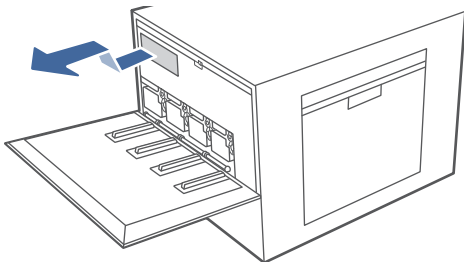
### 1. Remove the toner collection unit (TCU)

Follow these steps to remove the toner collection unit (TCU).

1. Open the front door.



2. Lift the TCU slightly and then pull it out of the printer.



---

**NOTE:** Maintain the position of the TCU as you pull it out from the printer. This will ensure that you do not spill any waste toner in the printer. Place the unit into the clear plastic bag the new TCU was packaged in.

---

### 2. Unseat the ITB

Follow these steps to unseat the ITB.

1. Open the right door (if it is not already open).
2. Grasp the two levers on the ITB, and then slightly pull it out of the printer to unseat and disengage it.



---

**Reinstallation tip:** During Reinstallation of the target part, do not reseat the ITB too early in the process. The ITB must remain disengaged to make sure that the gear is correctly aligned.

---

A **46.00.0x** error occurs if the ITB if the procedure is completed with the ITB seated.

---

**Figure 5-538 Disengage the ITB**




### 3. Remove the formatter cover

Follow these steps to remove the formatter cover.

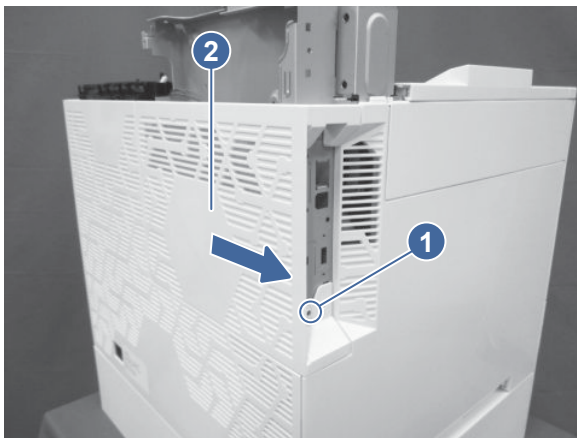
- Remove one screw (callout 1), and then slide the formatter cover (callout 2) away from the printer to remove it.

---

 **TIP:** Reverse the removal steps to install the assembly.

---

**Figure 5-539 Remove the formatter cover**




### 4. Remove the left upper cover (MFP models)

Follow these steps to remove the left upper cover.

1. Open the front door.

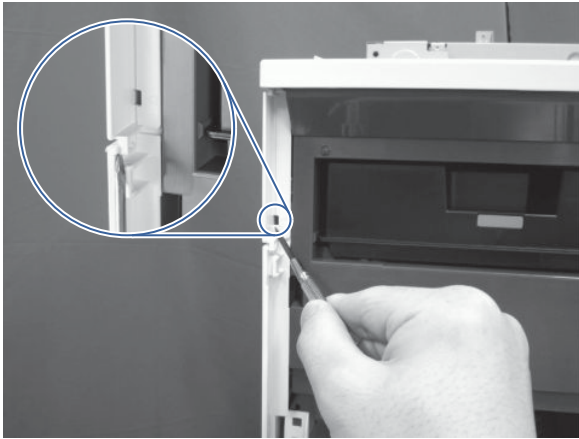
---

 **CAUTION:** If the cover is being removed to gain access to the main drive assembly, make sure that the front door remains open. This keeps the main drive properly aligned.

---

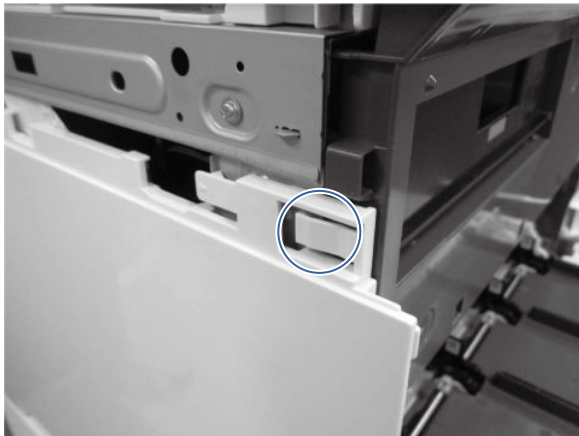
2. At the left side of the printer, insert the small flat-blade screwdriver into the slot to release one tab (callout 1).

**Figure 5-540 Use a screwdriver to release the tab**



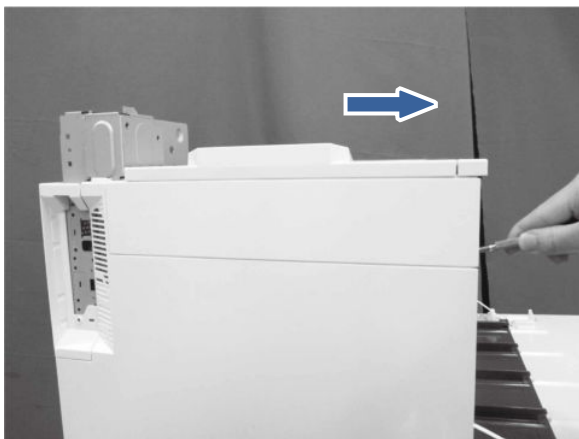
3. Toward the front of the printer, release another tab.

**Figure 5-541 Release the tab**



4. Rotate the cover up to remove it.

**Figure 5-542 Remove the left upper cover**

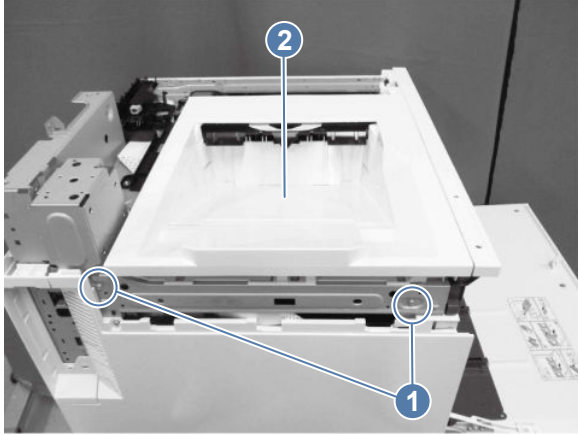


## 5. Remove the output bin

Follow these steps to remove the output bin.

- Remove two screws (callout 1), and then slide the output tray (callout 2) towards the front (SFP models) or left (MFP models) to remove it.

**Figure 5-543 Remove the output bin**

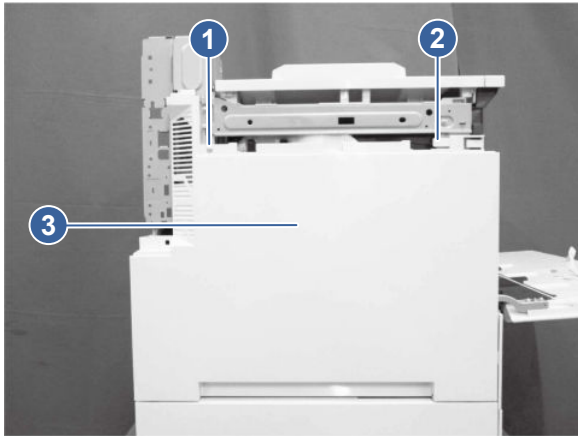


## 6. Remove the left cover

Follow these steps to remove the left cover.

- At the left side of the printer, remove one screw (callout 1), release one tab (callout 2), and then slide the cover (callout 3) toward the rear of the printer to release it.

**Figure 5-544 Remove the left cover**

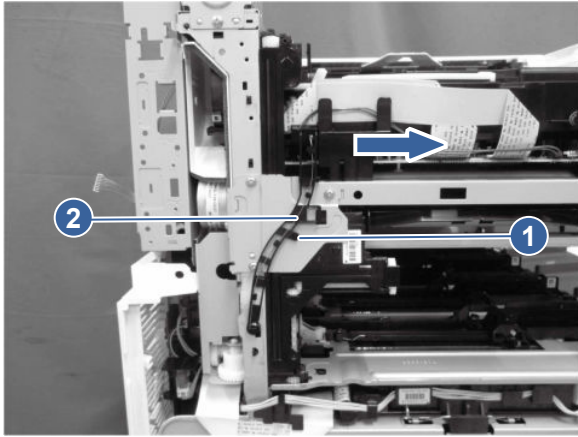


## 7. Remove the waste toner duct assembly (6700/6800 models)

Follow these steps to remove the waste toner duct assembly.

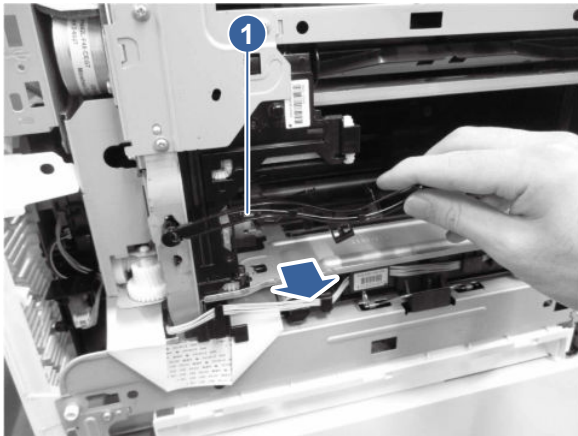
1. Release one tab (callout 1), pull the upper part of the contact holder (callout 2) forward, slide the contact holder in the direction indicated, and then rotate the contact holder.

**Figure 5-545 Slide the contact holder**



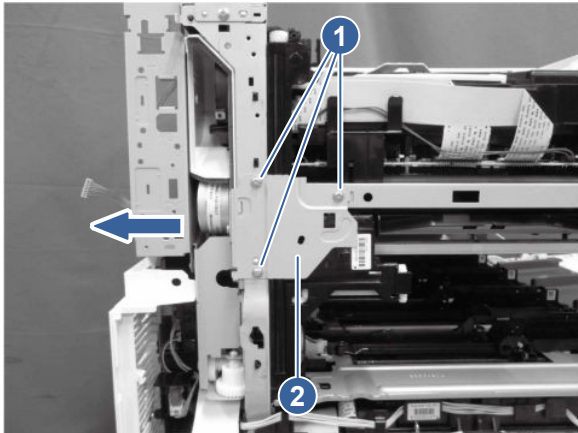
2. Slide the contact holder (callout 1) in the direction indicated to remove it.

**Figure 5-546 Remove the contact holder**



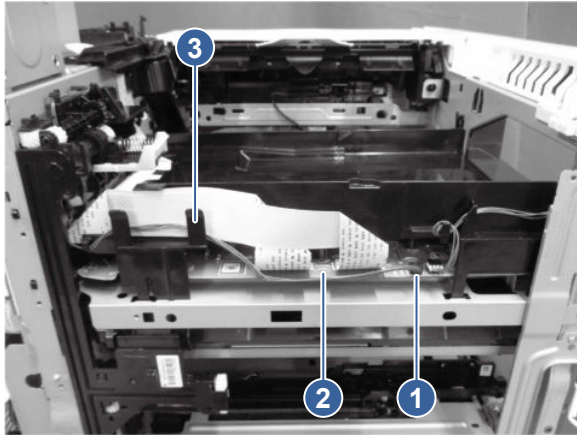
3. Remove three screws (callout 1), and then slide the support plate (callout 2) in the direction indicated to remove it.

**Figure 5-547 Remove the support plate**



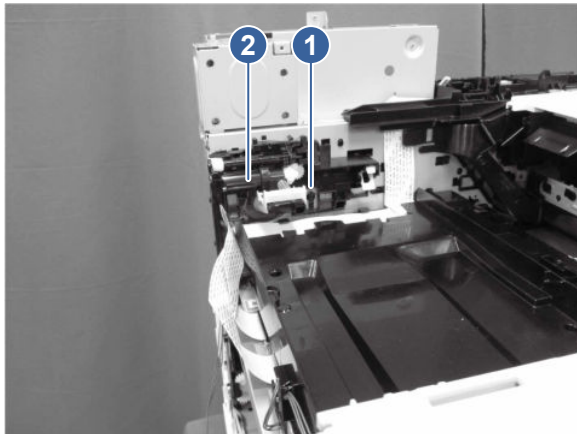
4. Disconnect one connector (callout 1), and then release the cable (callout 2) from the cable guide (callout 3).

**Figure 5-548 Disconnect one connector**



5. Release one tab (callout 1), and then slide the waste toner duct assembly (callout 2) upward to remove it.

**Figure 5-549 Remove the waste toner duct assembly**



## 8. Unpack the replacement assembly

Follow these steps to unpack the replacement assembly.

1. Dispose of the defective part.




**NOTE:** HP recommends responsible disposal of the defective part.

<http://www8.hp.com/us/en/hp-information/environment/product-recycling.html>

2. Unpack the replacement part from the packaging.




**CAUTION:**  Some parts are sensitive to electrostatic discharge (ESD). Always perform service work at an ESD-protected workstation or mat. If an ESD workstation or mat is not available, touch the sheet-metal chassis to provide a static ground before touching an ESD-sensitive assembly. Protect the ESD-sensitive assemblies by placing them in ESD pouches when they are out of the printer.



**IMPORTANT:** Make sure that all of the shipping materials (for example shipping tape) are removed from the replacement part prior to installation.




 **NOTE:** If the replacement part is a roller or pad, avoid touching the spongy part of it. Skin oils on the roller or pad can cause paper pickup and/or print-quality problems. HP recommends using disposable gloves when handling rollers or pads or washing your hands before touching rollers or pads.

---

3. To install an assembly, reverse the removal steps.

---

 **NOTE:** When applicable, special installation instructions are provided for an assembly at the end of the removal procedure. Always completely read the removal instructions and follow all special installation instructions.

---


### Removal and replacement: Pre-exposure PCA holder assembly (6700/6800 models)

Learn about removing and replacing the pre-exposure PCA holder assembly.

#### Before performing service

##### Turn the printer power off

- Disconnect the power cable.

 **WARNING!** To avoid damage to the printer, turn the printer off, wait 30 seconds, and then remove the power cord before attempting to service the printer.

---

If the part is damaged and cannot be cleaned, use the table below to identify the correct part number for your printer. To order the part, go to [www.hp.com/buy/parts](http://www.hp.com/buy/parts).

**Table 5-76** Part information

Part number	Part description
RM2-3565-000CN	Pre-exposure PCA holder (6700/6800 models)

#### Required tools

- #2 Phillips screwdriver with a magnetic tip and a 152 mm (6 in) shaft length

#### After performing service

##### Turn the printer power on

- Connect the power cable.
- Use the power switch to turn the power on.

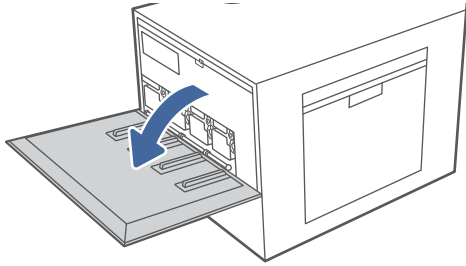
#### Post service test

No post service test is available for this assembly.

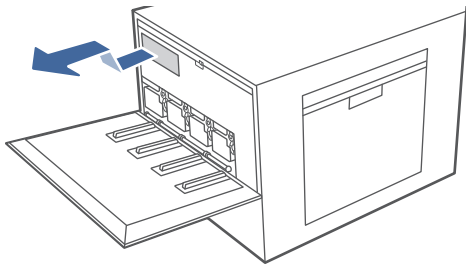
### 1. Remove the toner collection unit (TCU)

Follow these steps to remove the toner collection unit (TCU).


1. Open the front door.



2. Lift the TCU slightly and then pull it out of the printer.



---

 **NOTE:** Maintain the position of the TCU as you pull it out from the printer. This will ensure that you do not spill any waste toner in the printer. Place the unit into the clear plastic bag the new TCU was packaged in.


---

## 2. Remove the fuser

Follow these steps to remove the fuser.

1. Open the right door.

---

 **CAUTION:** The fuser is hot. Wait at least 10 minutes after turning the printer power off before removing the fuser.

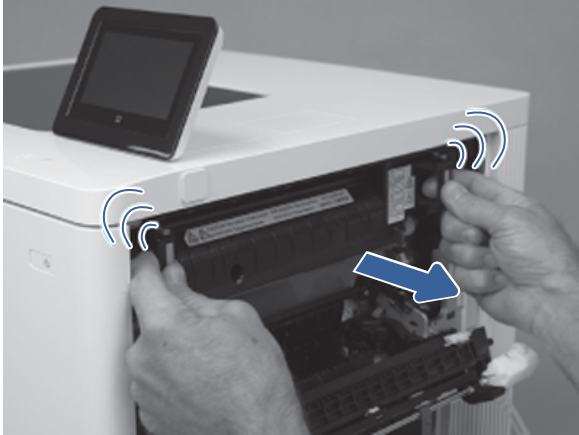
---

**Figure 5-550** Open the right door



2. Squeeze the release levers on the handles (circle callouts), and then remove the fuser.

**Figure 5-551 Remove the fuser**




### 3. Remove the formatter cover

Follow these steps to remove the formatter cover.

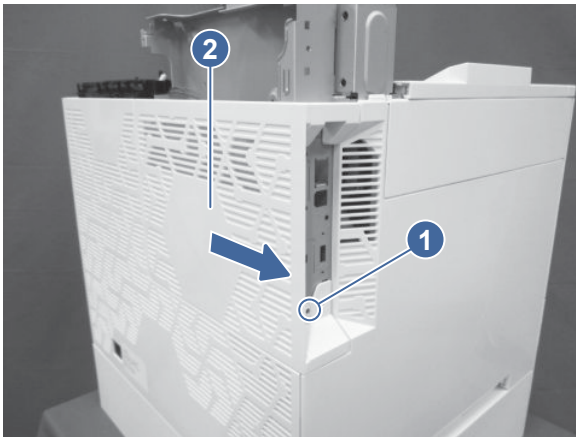
- Remove one screw (callout 1), and then slide the formatter cover (callout 2) away from the printer to remove it.

---

 **TIP:** Reverse the removal steps to install the assembly.

---

**Figure 5-552 Remove the formatter cover**



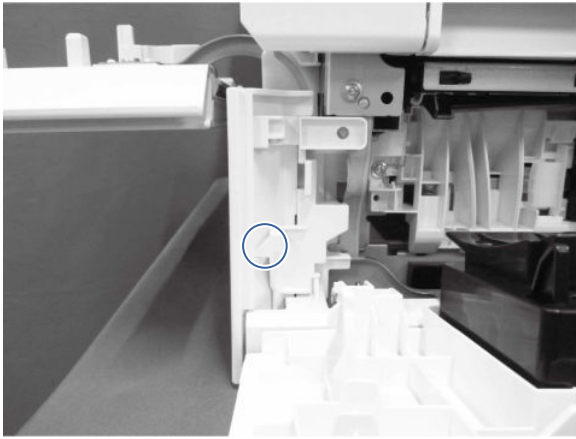
### 4. Remove the front right cover

Follow these steps to remove the front right cover.

1. Perform one of the following steps.
  - **6700/6800 models:** Open the front door.
  - **X654/X677 models:** Open the toner cartridge access door.
2. Perform one of the following steps.
  - **6700/6800 models:** Open the right door.

- **X654/X677 models:** Open the right lower door.
3. Release one tab, and then slide the front right cover upward to remove it.

**Figure 5-553 Remove the front right cover**



### 5. Remove the left upper cover (MFP models)

Follow these steps to remove the left upper cover.

1. Open the front door.

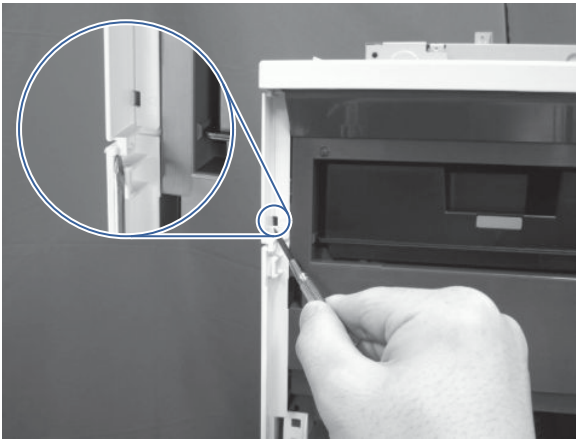
---

**⚠ CAUTION:** If the cover is being removed to gain access to the main drive assembly, make sure that the front door remains open. This keeps the main drive properly aligned.

---

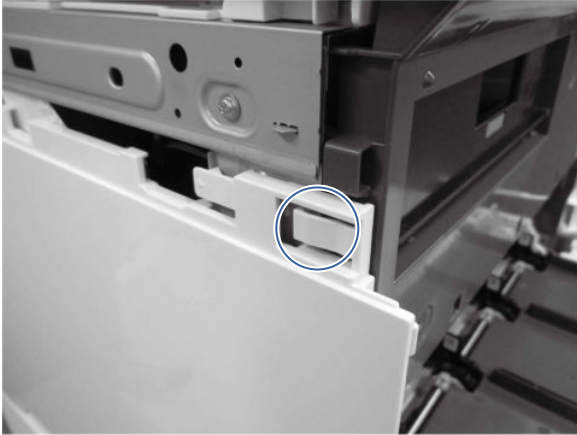
2. At the left side of the printer, insert the small flat-blade screwdriver into the slot to release one tab (callout 1).

**Figure 5-554 Use a screwdriver to release the tab**



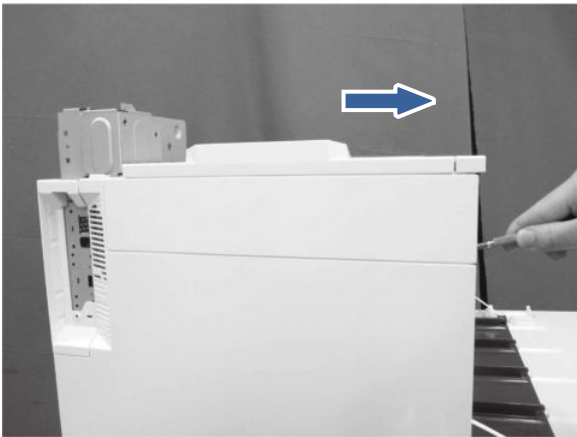
3. Toward the front of the printer, release another tab.

**Figure 5-555 Release the tab**



4. Rotate the cover up to remove it.

**Figure 5-556 Remove the left upper cover**

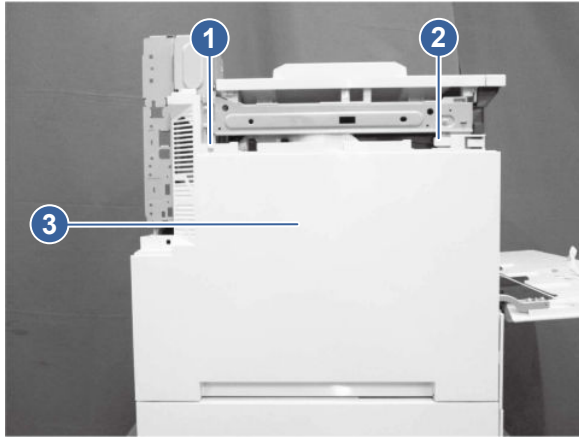


## 6. Remove the left cover

Follow these steps to remove the left cover.

- At the left side of the printer, remove one screw (callout 1), release one tab (callout 2), and then slide the cover (callout 3) toward the rear of the printer to release it.

**Figure 5-557 Remove the left cover**

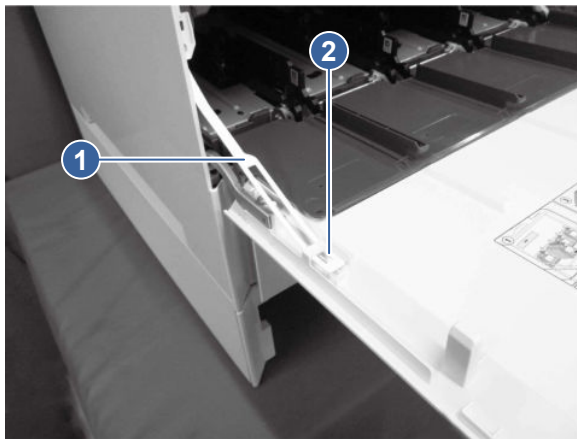


## 7. Remove the front door

Follow these steps to remove the front door.

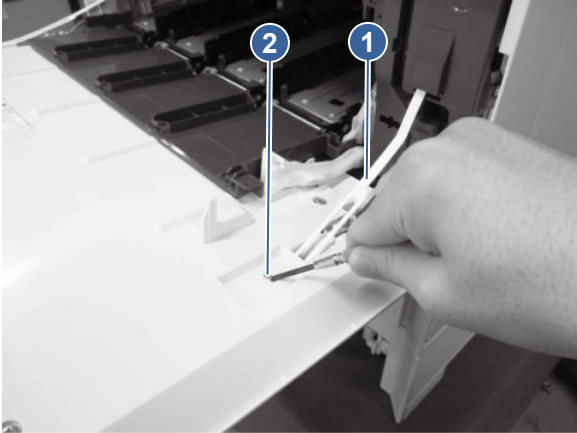
1. Open the front door.
2. At the left side of the door, release the link arm (callout 1) from the clip (callout 2) on the front-door assembly.

**Figure 5-558 Release the left link arm**



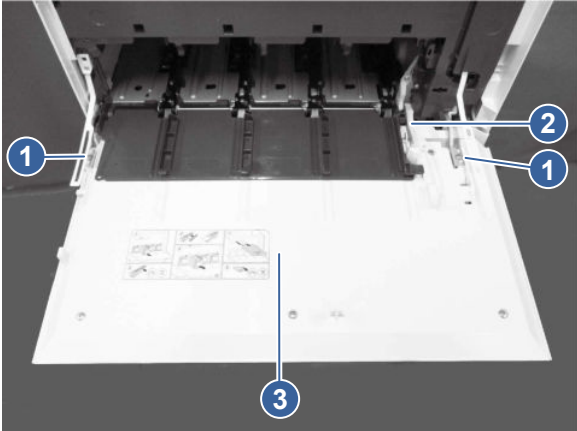
3. At the right side of the door, release the link arm (callout 1) from the clip (callout 2) on the front-door assembly.

**Figure 5-559 Release the right link arm**



4. Remove two screws (callout 1), release the link lever (callout 2) from the front door assembly (callout 3), and then remove the front door.

**Figure 5-560 Remove the door**

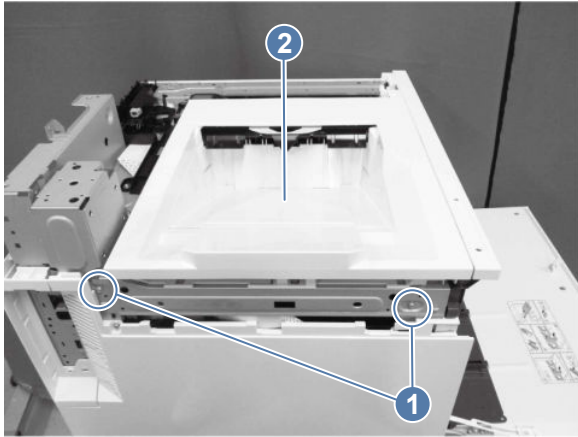


#### **8. Remove the output bin**

Follow these steps to remove the output bin.

- Remove two screws (callout 1), and then slide the output tray (callout 2) towards the front (SFP models) or left (MFP models) to remove it.

**Figure 5-561 Remove the output bin**

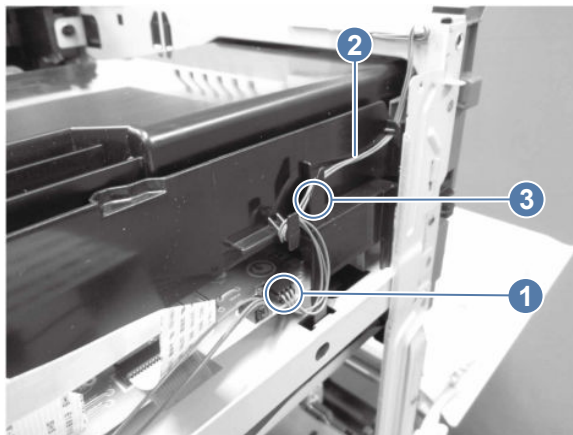


### 9. Remove the top cover (SFP models)

Follow these steps to remove the top cover.

1. Disconnect one connector (callout 1), and then release the cable (callout 2) from the cable guide (callout 3).

**Figure 5-562 Disconnect the connector**





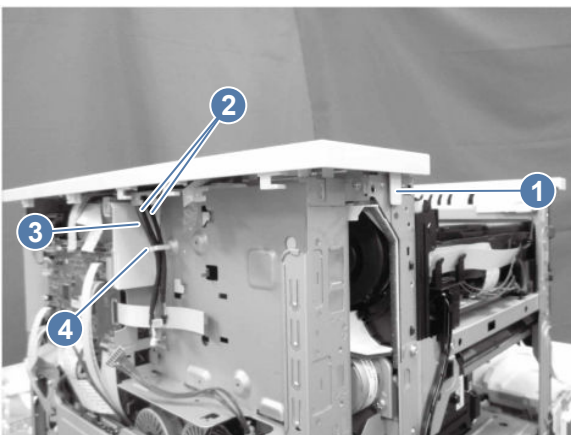
2. Remove two screws.

**Figure 5-563 Remove two screws**



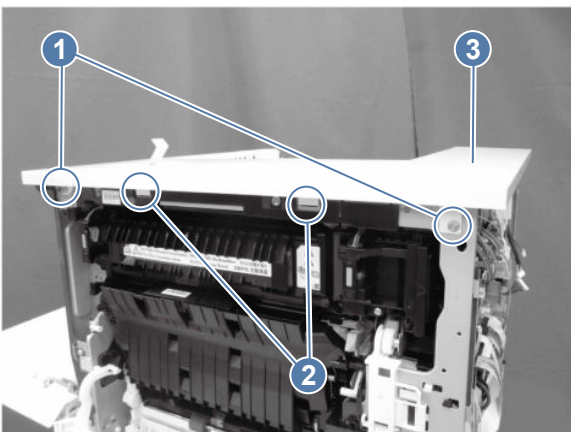
3. Release one tab (callout 1), release two USB cables (callout 2) and another cable (callout 3) from the cable clamp (callout 4).

**Figure 5-564 Release one tab**



4. Remove two screws (callout 1), release two tabs (callout 2), and then remove the top cover (callout 3).

**Figure 5-565 Remove the cover**

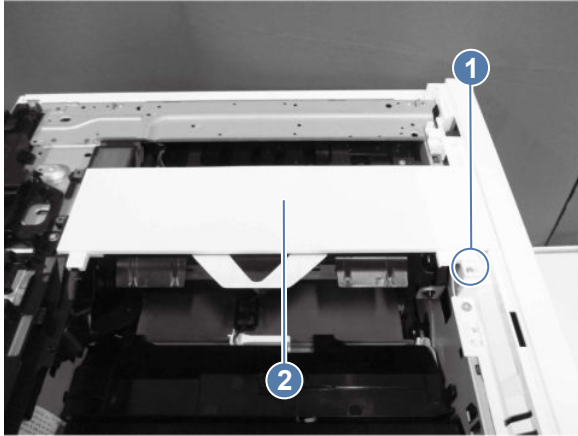


## 10. Remove the top cover (MFP models)

Follow these steps to remove the top cover.

- Remove one screw (callout 1), and then remove the top cover (callout 2).

**Figure 5-566** Remove the top cover

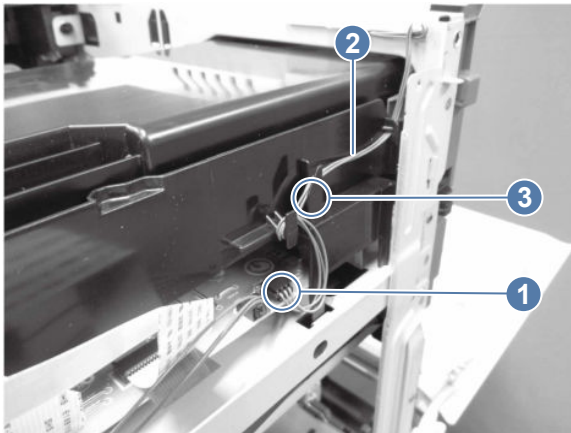


## 11. Remove the top front cover (MFP models)

Follow these steps to remove the top front cover.

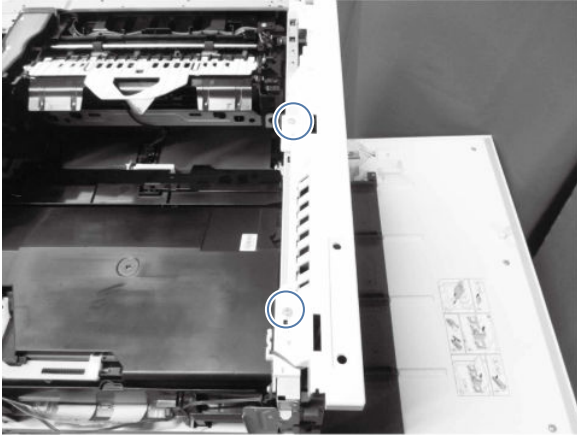
1. Disconnect one connector (callout 1), and then release the cable (callout 2) from the cable guide (callout 3).

**Figure 5-567** Disconnect one connector and release the cable



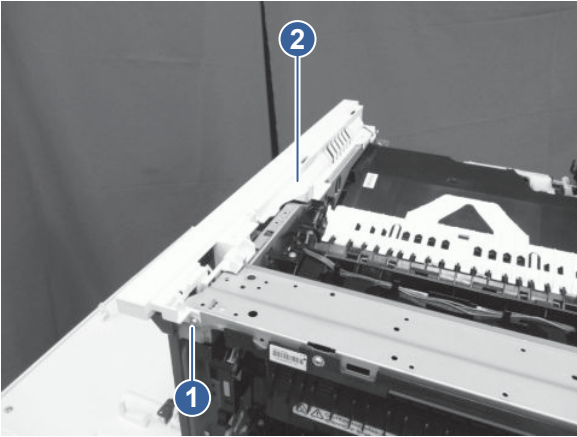
2. Remove two screws.

**Figure 5-568 Remove two screws**



3. Remove one screw (callout 1), hold up the top front cover (callout 2), and then remove it.

**Figure 5-569 Remove the top front cover**

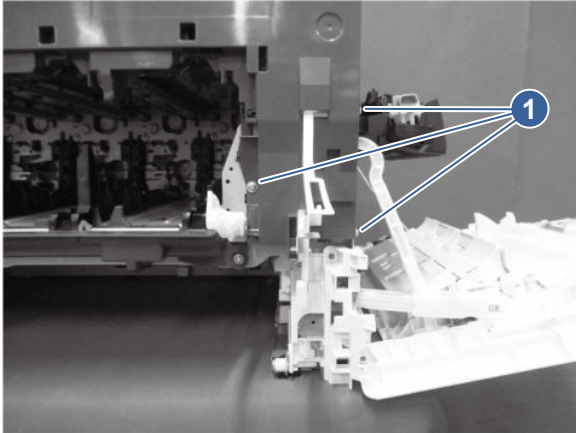


## 12. Remove the pre-exposure PCA holder assembly (6700/6800 models)

Follow these steps to remove the pre-exposure PCA holder assembly.

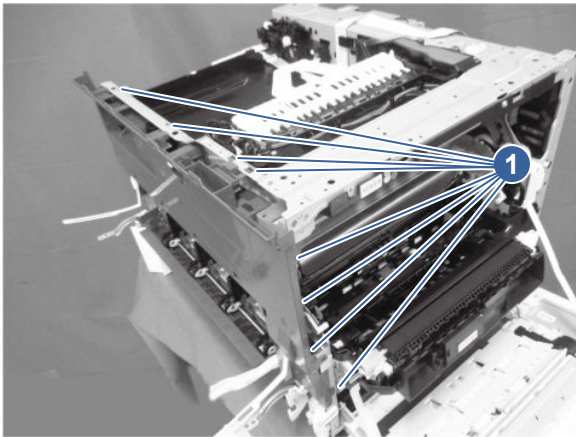
1. Remove three screws (callout 1).

**Figure 5-570 Remove three screws**



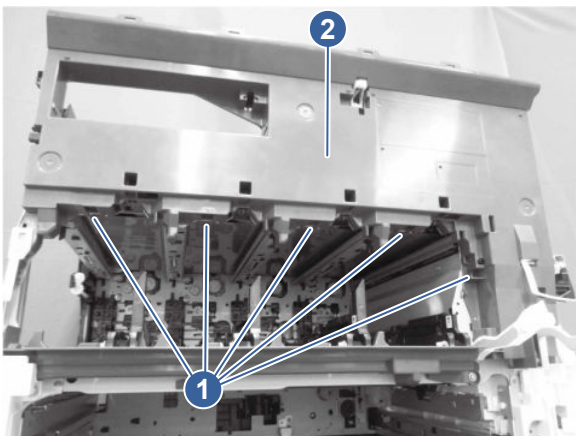
2. Release eight tabs (callout 1).

**Figure 5-571 Release eight tabs**



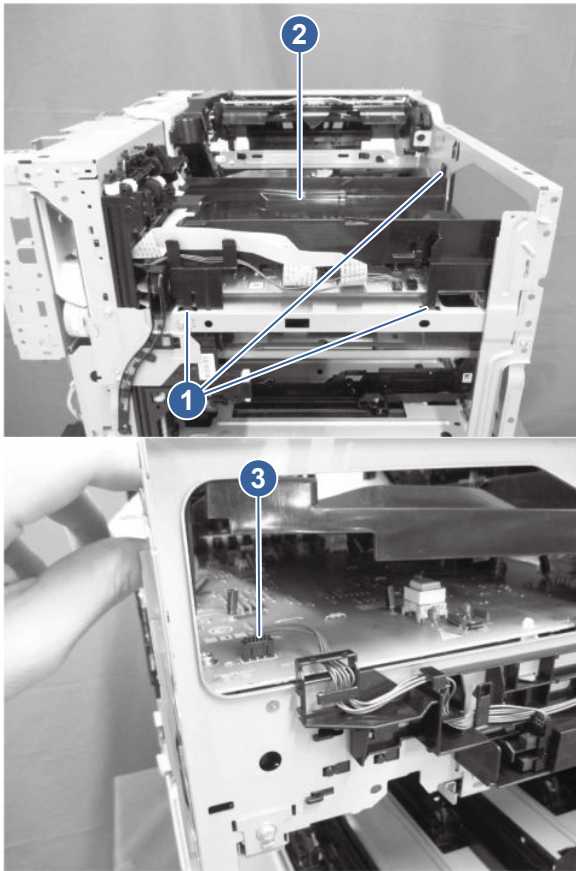
3. Release five tabs (callout 1), and then remove the front inner cover (callout 2).

**Figure 5-572 Remove the front inner cover**



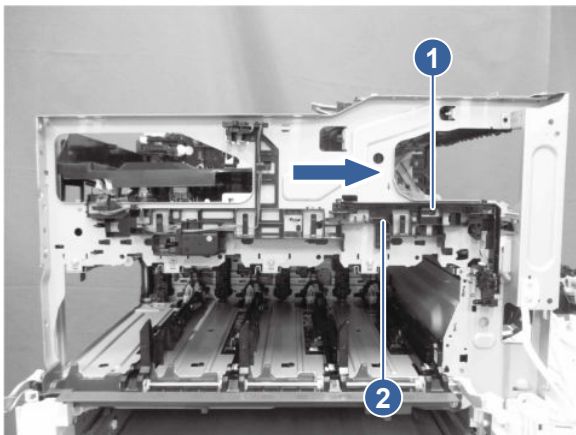
4. Release three tabs (callout 1), hold up the high-voltage PCA cover (callout 2), and then disconnect one connector (callout 3).

**Figure 5-573 Release three tabs**



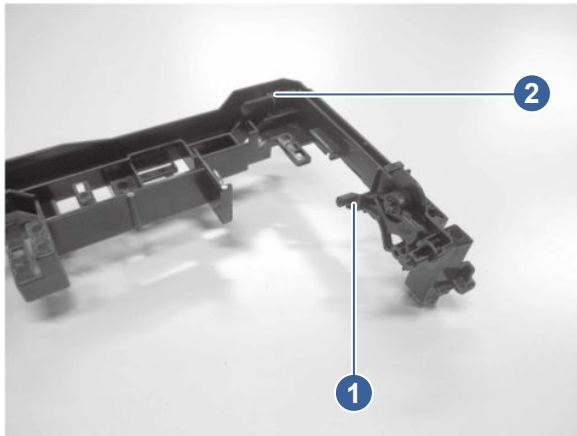
5. Release one tab (callout 1), and then slide the pre-exposure PCA holder assembly (callout 2) in the direction indicated to remove it.

**Figure 5-574 Remove the pre-exposure PCA holder assembly**



6. Remove the link lever (callout 1) from the pre-exposure PCA holder assembly (callout 2).

**Figure 5-575 Remove the link lever**



### 13. Unpack the replacement assembly



Follow these steps to unpack the replacement assembly.


1. Dispose of the defective part.


 **NOTE:** HP recommends responsible disposal of the defective part.

<http://www8.hp.com/us/en/hp-information/environment/product-recycling.html>


2. Unpack the replacement part from the packaging.

 **CAUTION:**  Some parts are sensitive to electrostatic discharge (ESD). Always perform service work at an ESD-protected workstation or mat. If an ESD workstation or mat is not available, touch the sheet-metal chassis to provide a static ground before touching an ESD-sensitive assembly. Protect the ESD-sensitive assemblies by placing them in ESD pouches when they are out of the printer.

 **IMPORTANT:** Make sure that all of the shipping materials (for example shipping tape) are removed from the replacement part prior to installation.

 **NOTE:** If the replacement part is a roller or pad, avoid touching the spongy part of it. Skin oils on the roller or pad can cause paper pickup and/or print-quality problems. HP recommends using disposable gloves when handling rollers or pads or washing your hands before touching rollers or pads.

3. To install an assembly, reverse the removal steps.

 **NOTE:** When applicable, special installation instructions are provided for an assembly at the end of the removal procedure. Always completely read the removal instructions and follow all special installation instructions.

### Removal and replacement: Pre-exposure PCA holder assembly (X654/X677 models)

Learn about removing and replacing the pre-exposure PCA holder assembly.

#### Before performing service

Turn the printer power off

- Disconnect the power cable.

**⚠ WARNING!** To avoid damage to the printer, turn the printer off, wait 30 seconds, and then remove the power cord before attempting to service the printer.

If the part is damaged and cannot be cleaned, use the table below to identify the correct part number for your printer. To order the part, go to [www.hp.com/buy/parts](http://www.hp.com/buy/parts).

**Table 5-77** Part information

Part number	Part description
RM2-3673-000CN	Pre-exposure PCA holder (X654/X677 models)

## Required tools

- #2 Phillips screwdriver with a magnetic tip and a 152 mm (6 in) shaft length

## After performing service

### Turn the printer power on

- Connect the power cable.
- Use the power switch to turn the power on.

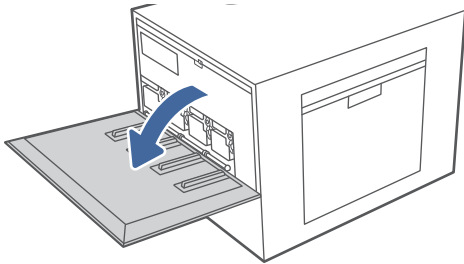
## Post service test

No post service test is available for this assembly.

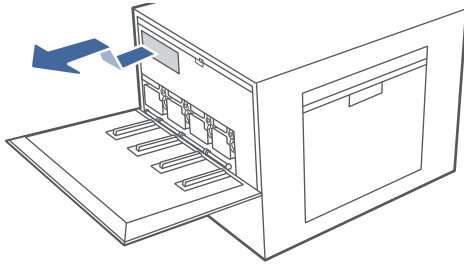
### 1. Remove the toner collection unit (TCU)

Follow these steps to remove the toner collection unit (TCU).


1. Open the front door.



2. Lift the TCU slightly and then pull it out of the printer.



---

 **NOTE:** Maintain the position of the TCU as you pull it out from the printer. This will ensure that you do not spill any waste toner in the printer. Place the unit into the clear plastic bag the new TCU was packaged in.


---

## 2. Remove the fuser

Follow these steps to remove the fuser.

1. Open the right door.

---

 **CAUTION:** The fuser is hot. Wait at least 10 minutes after turning the printer power off before removing the fuser.

---

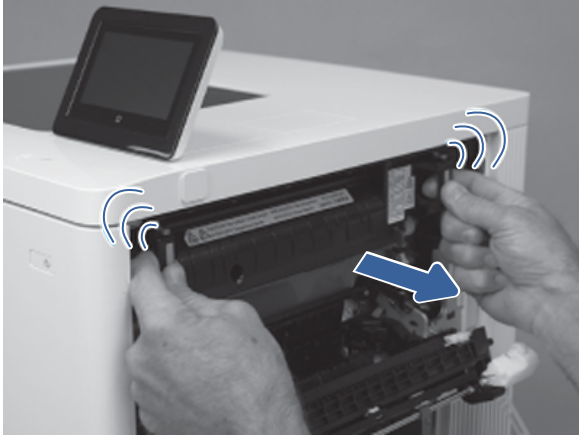
**Figure 5-576** Open the right door





2. Squeeze the release levers on the handles (circle callouts), and then remove the fuser.

**Figure 5-577 Remove the fuser**




### 3. Remove the formatter cover

Follow these steps to remove the formatter cover.

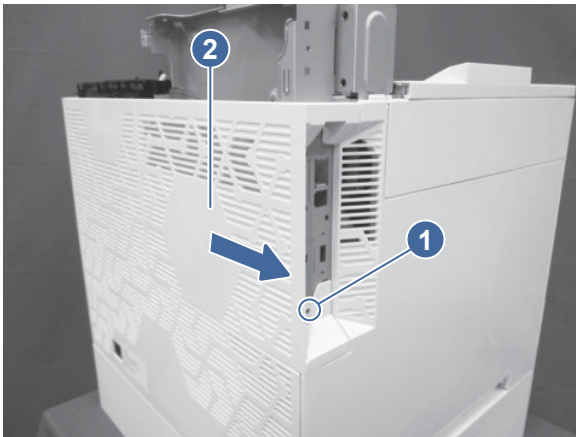
- Remove one screw (callout 1), and then slide the formatter cover (callout 2) away from the printer to remove it.

---

 **TIP:** Reverse the removal steps to install the assembly.

---

**Figure 5-578 Remove the formatter cover**



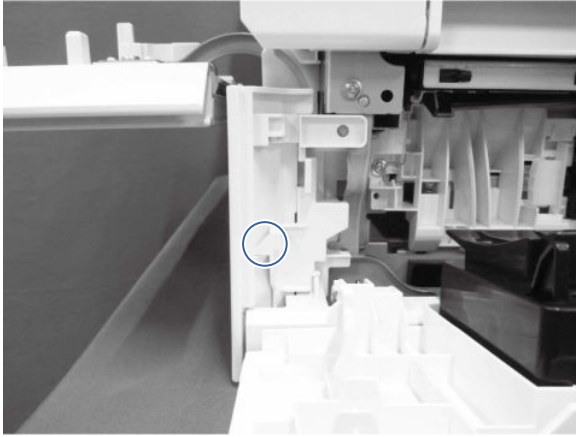
### 4. Remove the front right cover

Follow these steps to remove the front right cover.

1. Perform one of the following steps.
  - **6700/6800 models:** Open the front door.
  - **X654/X677 models:** Open the toner cartridge access door.
2. Perform one of the following steps.
  - **6700/6800 models:** Open the right door.

- **X654/X677 models:** Open the right lower door.
3. Release one tab, and then slide the front right cover upward to remove it.

**Figure 5-579 Remove the front right cover**



### 5. Remove the left upper cover (MFP models)

Follow these steps to remove the left upper cover.

1. Open the front door.

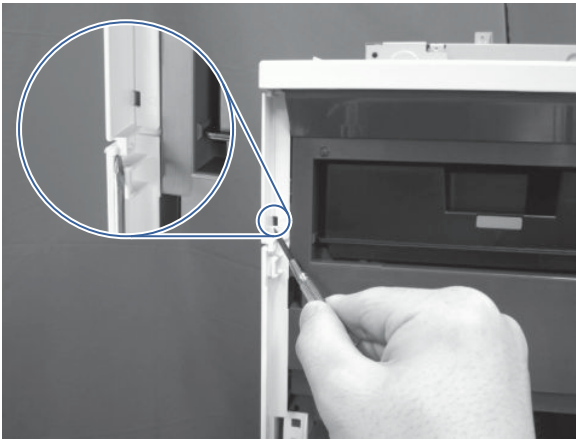
---

**⚠ CAUTION:** If the cover is being removed to gain access to the main drive assembly, make sure that the front door remains open. This keeps the main drive properly aligned.

---

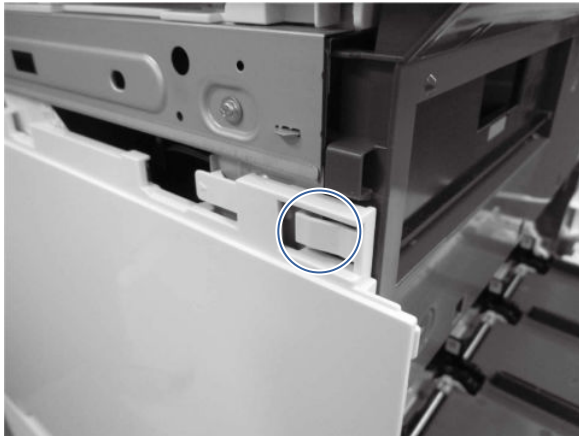
2. At the left side of the printer, insert the small flat-blade screwdriver into the slot to release one tab (callout 1).

**Figure 5-580 Use a screwdriver to release the tab**



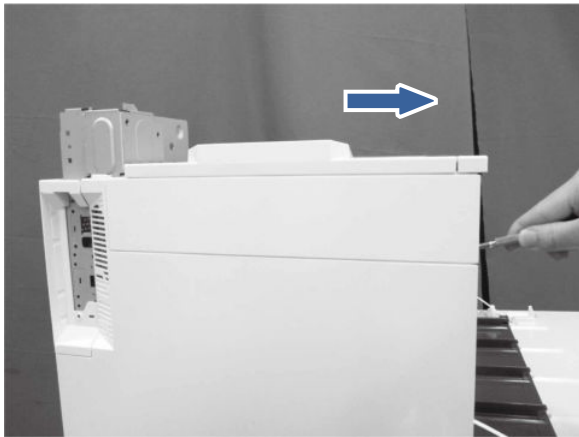
3. Toward the front of the printer, release another tab.

**Figure 5-581 Release the tab**



4. Rotate the cover up to remove it.

**Figure 5-582 Remove the left upper cover**

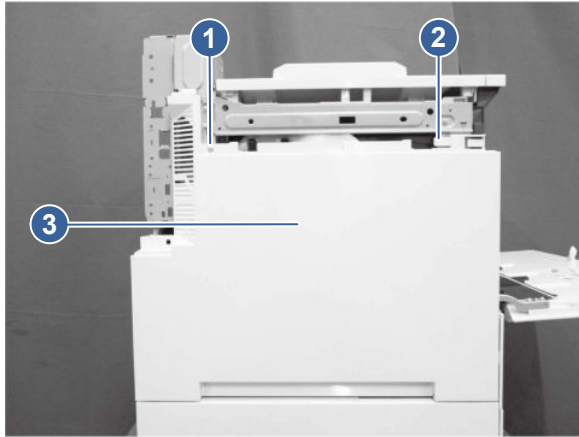


## 6. Remove the left cover

Follow these steps to remove the left cover.

- At the left side of the printer, remove one screw (callout 1), release one tab (callout 2), and then slide the cover (callout 3) toward the rear of the printer to release it.

**Figure 5-583 Remove the left cover**

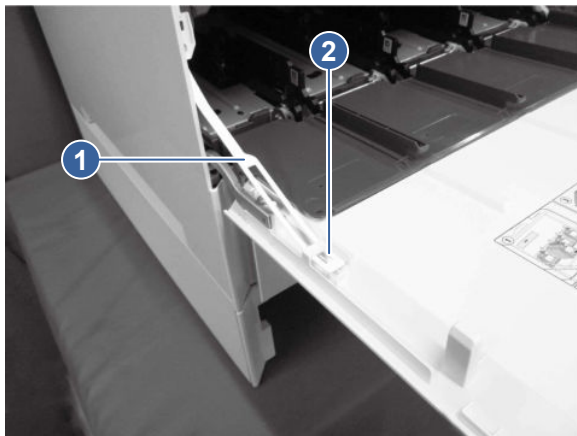


## 7. Remove the front door

Follow these steps to remove the front door.

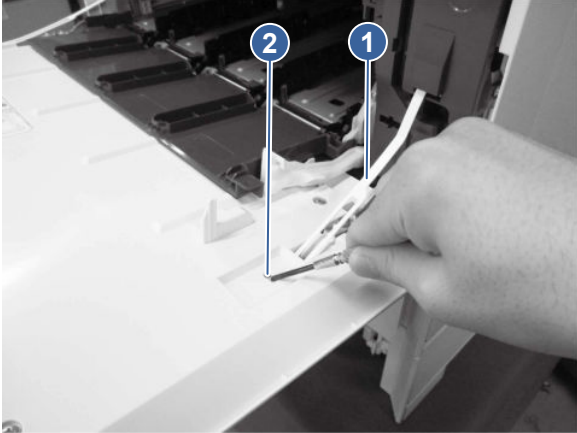
1. Open the front door.
2. At the left side of the door, release the link arm (callout 1) from the clip (callout 2) on the front-door assembly.

**Figure 5-584 Release the left link arm**



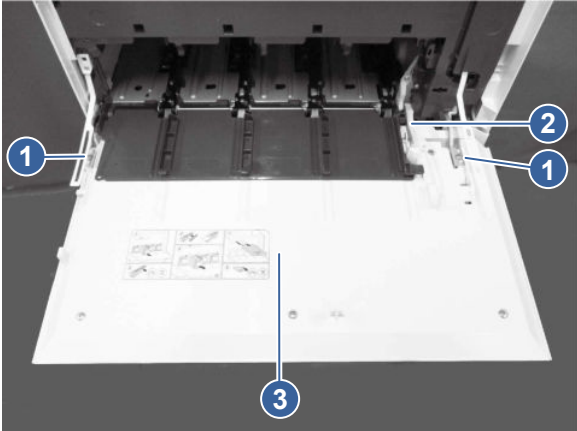
3. At the right side of the door, release the link arm (callout 1) from the clip (callout 2) on the front-door assembly.

**Figure 5-585 Release the right link arm**



4. Remove two screws (callout 1), release the link lever (callout 2) from the front door assembly (callout 3), and then remove the front door.

**Figure 5-586 Remove the door**

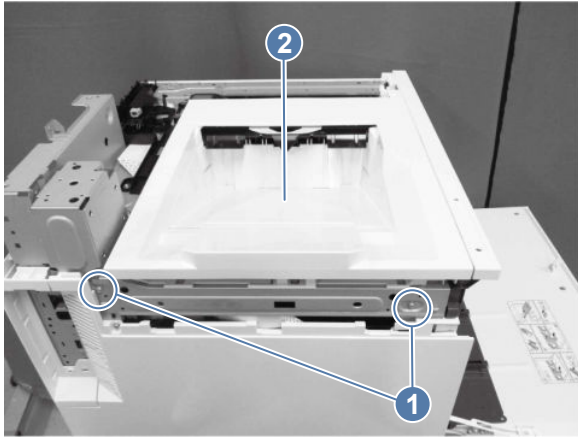


#### **8. Remove the output bin**

Follow these steps to remove the output bin.

- Remove two screws (callout 1), and then slide the output tray (callout 2) towards the front (SFP models) or left (MFP models) to remove it.

**Figure 5-587 Remove the output bin**

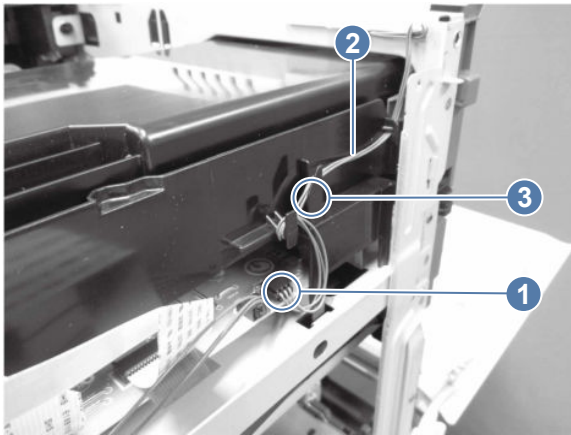


### 9. Remove the top cover (SFP models)

Follow these steps to remove the top cover.

1. Disconnect one connector (callout 1), and then release the cable (callout 2) from the cable guide (callout 3).

**Figure 5-588 Disconnect the connector**



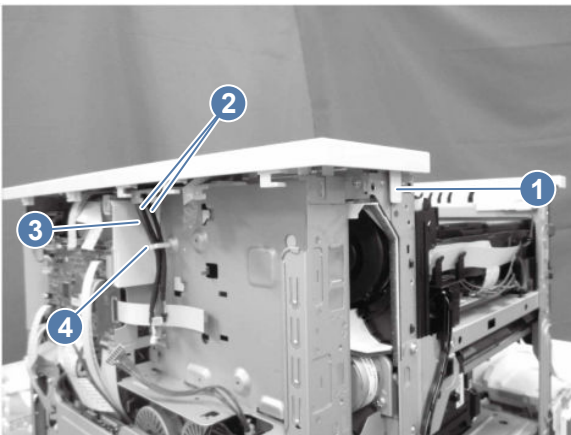
2. Remove two screws.

**Figure 5-589 Remove two screws**



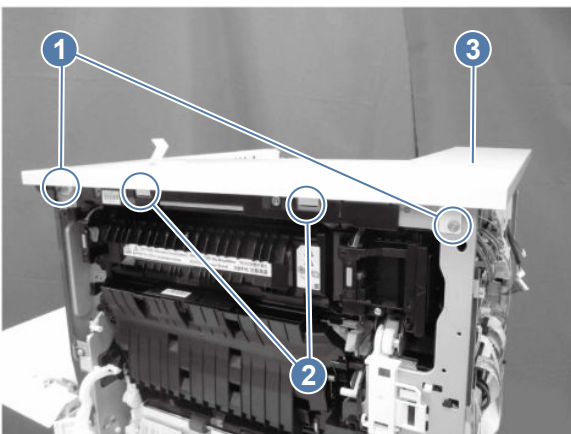
3. Release one tab (callout 1), release two USB cables (callout 2) and another cable (callout 3) from the cable clamp (callout 4).

**Figure 5-590 Release one tab**



4. Remove two screws (callout 1), release two tabs (callout 2), and then remove the top cover (callout 3).

**Figure 5-591 Remove the cover**

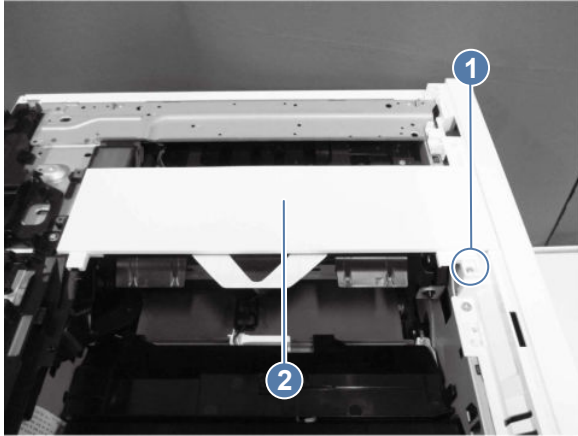


## 10. Remove the top cover (MFP models)

Follow these steps to remove the top cover.

- Remove one screw (callout 1), and then remove the top cover (callout 2).

**Figure 5-592 Remove the top cover**

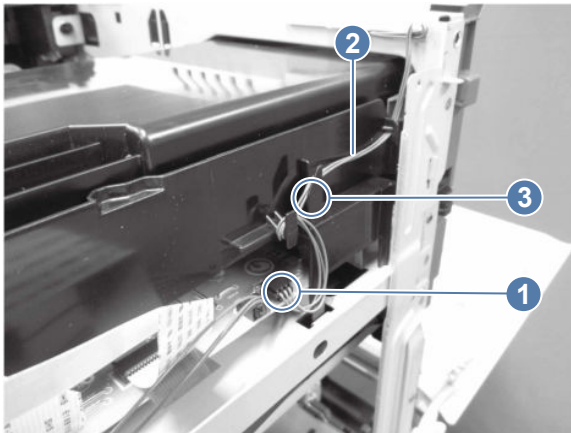


## 11. Remove the top front cover (MFP models)

Follow these steps to remove the top front cover.

1. Disconnect one connector (callout 1), and then release the cable (callout 2) from the cable guide (callout 3).

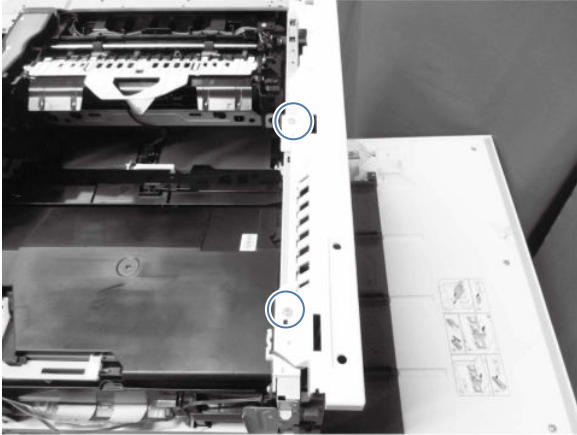
**Figure 5-593 Disconnect one connector and release the cable**





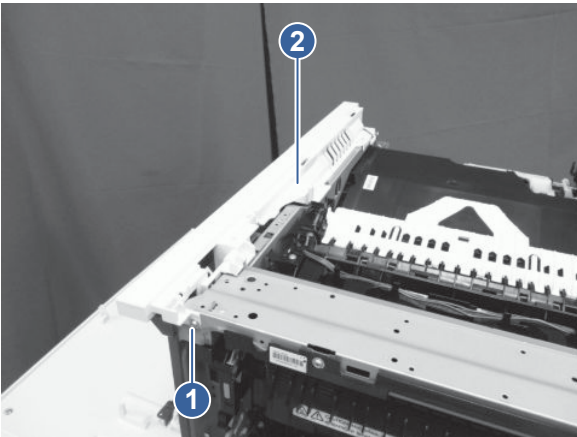
2. Remove two screws.

**Figure 5-594 Remove two screws**



3. Remove one screw (callout 1), hold up the top front cover (callout 2), and then remove it.

**Figure 5-595 Remove the top front cover**

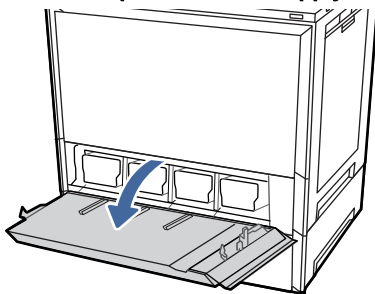


## 12. Remove the pre-exposure PCA holder assembly (X654/X677 models)

Follow these steps to remove the pre-exposure PCA holder assembly.

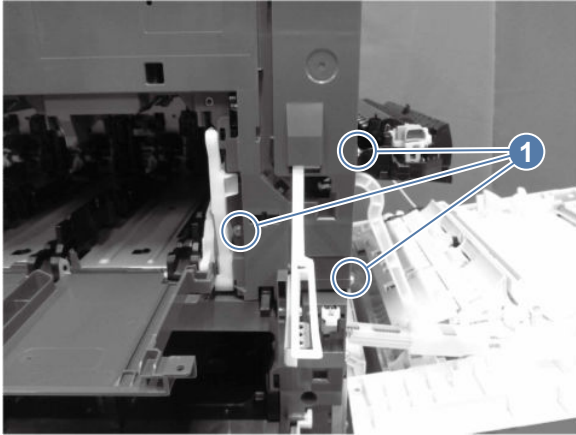
1. Open the toner supply door.

**Figure 5-596 Open the toner supply door**



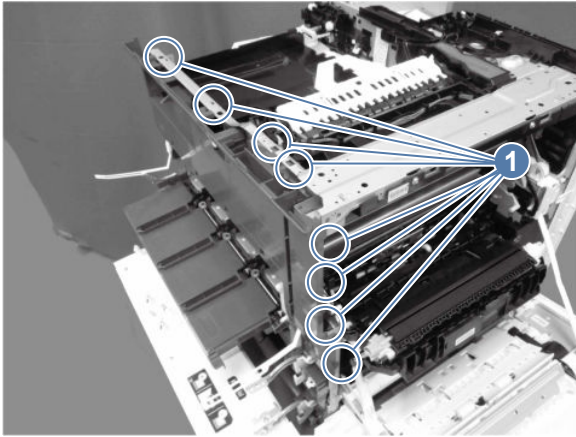
2. Remove three screws (callout 1).

**Figure 5-597 Remove three screws**



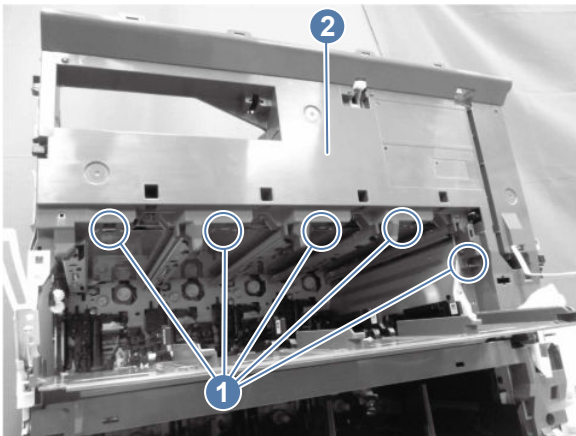
3. Release eight tabs (callout 1).

**Figure 5-598 Release eight tabs**



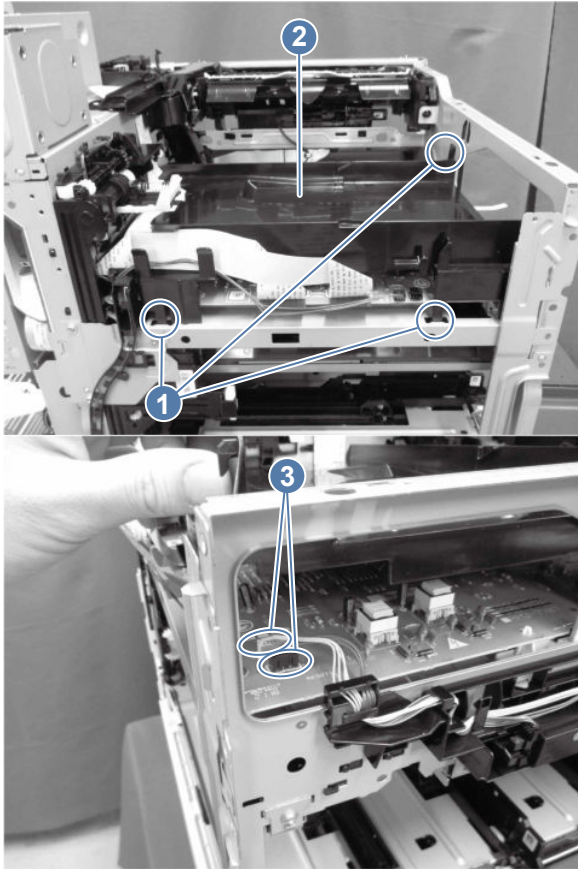
4. Release five tabs (callout 1), and then remove the front inner cover (callout 2).

**Figure 5-599 Remove the front inner cover**



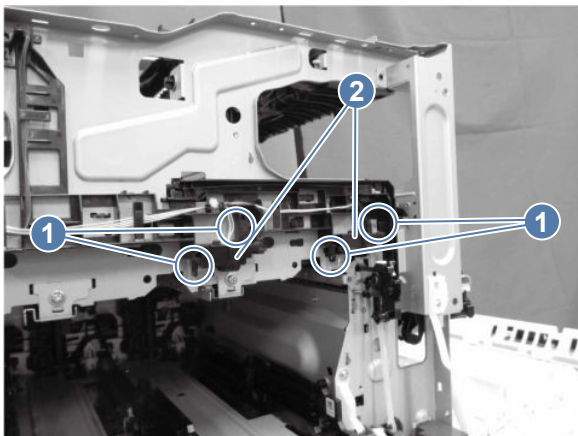
5. Release three tabs (callout 1), hold up the high-voltage PCA cover (callout 2), and then disconnect two connectors (callout 3).

**Figure 5-600 Release three tabs**



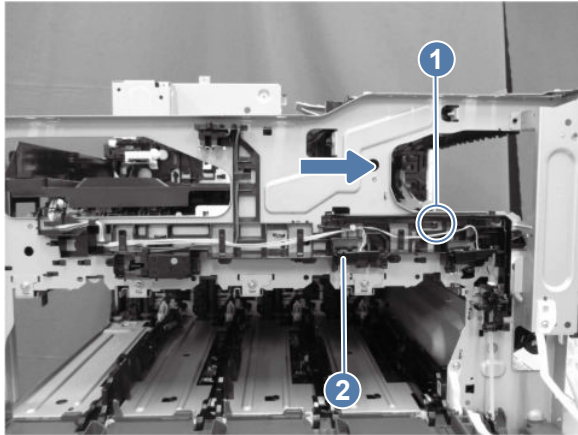
6. Release four tabs (callout 1), and then slide the pre-exposure PCA holder assembly (callout 2) upward.

**Figure 5-601 Release four tabs**



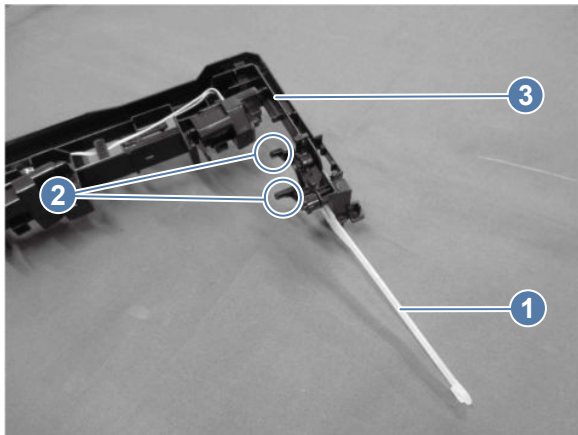
7. Release one tab (callout 1), and then slide the pre-exposure PCA holder assembly (callout 2) in the direction indicated to remove it.

**Figure 5-602 Remove the pre-exposure PCA holder assembly**



8. Remove the link arm (callout 1) and two link levers (callout 2) from the pre-exposure PCA holder assembly (callout 3).

**Figure 5-603 Remove the link arm and two link levers**



### 13. Unpack the replacement assembly

Follow these steps to unpack the replacement assembly.

1. Dispose of the defective part.





**NOTE:** HP recommends responsible disposal of the defective part.


<http://www8.hp.com/us/en/hp-information/environment/product-recycling.html>

2. Unpack the replacement part from the packaging.




**CAUTION:**  Some parts are sensitive to electrostatic discharge (ESD). Always perform service work at an ESD-protected workstation or mat. If an ESD workstation or mat is not available, touch the sheet-metal chassis to provide a static ground before touching an ESD-sensitive assembly. Protect the ESD-sensitive assemblies by placing them in ESD pouches when they are out of the printer.

 **IMPORTANT:** Make sure that all of the shipping materials (for example shipping tape) are removed from the replacement part prior to installation.

 **NOTE:** If the replacement part is a roller or pad, avoid touching the spongy part of it. Skin oils on the roller or pad can cause paper pickup and/or print-quality problems. HP recommends using disposable gloves when handling rollers or pads or washing your hands before touching rollers or pads.

---

3. To install an assembly, reverse the removal steps.

 **NOTE:** When applicable, special installation instructions are provided for an assembly at the end of the removal procedure. Always completely read the removal instructions and follow all special installation instructions.

---


## Removal and replacement: Toner supply drive assembly (X654/X677 models)

Learn about removing and replacing the toner supply drive assembly.

### Before performing service

#### Turn the printer power off

- Disconnect the power cable.

 **WARNING!** To avoid damage to the printer, turn the printer off, wait 30 seconds, and then remove the power cord before attempting to service the printer.

---

If the part is damaged and cannot be cleaned, use the table below to identify the correct part number for your printer. To order the part, go to [www.hp.com/buy/parts](http://www.hp.com/buy/parts).

**Table 5-78** Part information

Part number	Part description
RM2-3607-000CN	Toner supply drive assembly
RM2-3608-000CN	Toner supply drive assembly
RM2-3609-000CN	Toner supply drive assembly

### Required tools

- #2 Phillips screwdriver with a magnetic tip and a 152 mm (6 in) shaft length

### After performing service

#### Turn the printer power on

- Connect the power cable.
- Use the power switch to turn the power on.

### Post service test

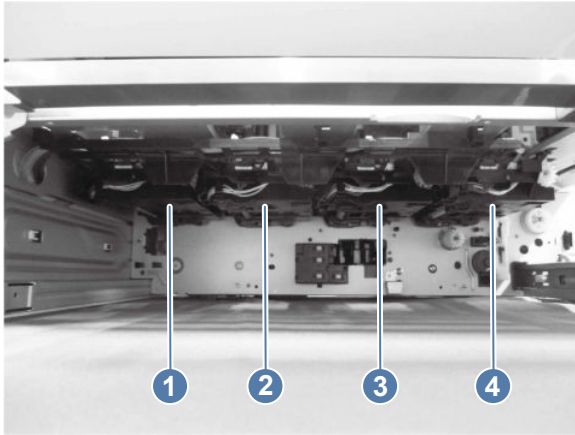
Print any pages necessary to make sure the printer is functioning correctly.

## 1. Remove the toner supply drive assembly (X654/X677 models)

Follow these steps to remove the toner supply drive assembly.

Since the disassembly procedures of the following four toner supply drive assemblies are similar, the disassembly procedure of the 1st toner supply drive assembly (callout 1) is shown below as an example.

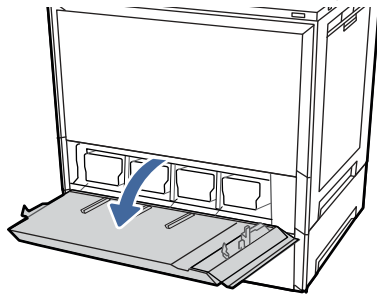
**Figure 5-604 Toner supply drive assemblies**



- First toner supply drive assembly (callout 1)
- Second toner supply drive assembly (callout 2)
- Third toner supply drive assembly (callout 3)
- Fourth toner supply drive assembly (callout 4)

1. Open the toner supply door.

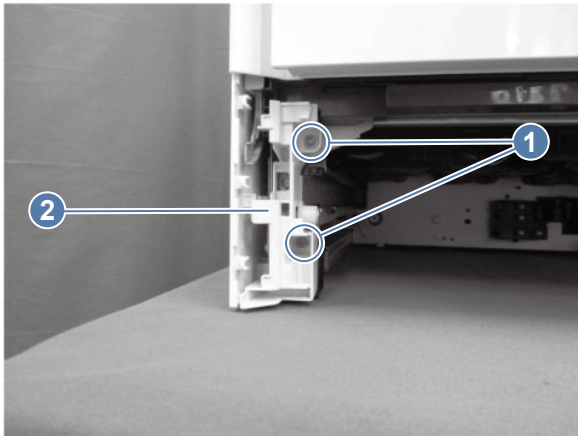
**Figure 5-605 Open the toner supply door**



2. Remove the front left cover.

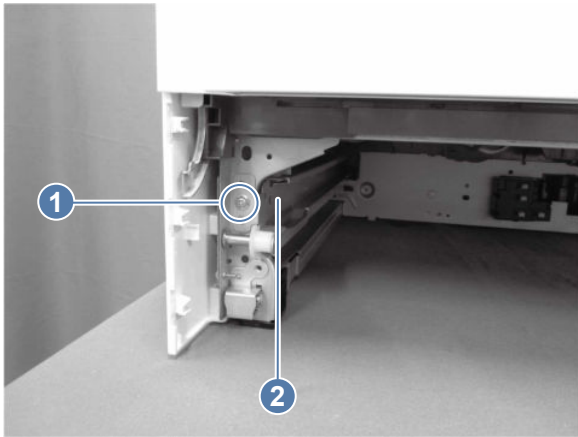
3. Remove two screws (callout 1), and then remove the base frame (callout 2).

**Figure 5-606 Remove the base frame**



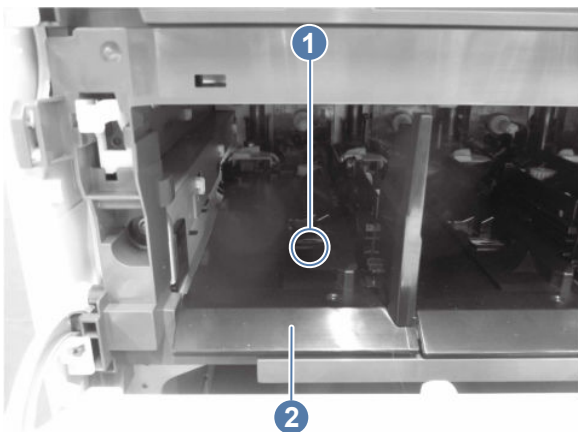
4. Remove one screw (callout 1), and then remove the cassette rail assembly (callout 2).

**Figure 5-607 Remove the cassette rail assembly**



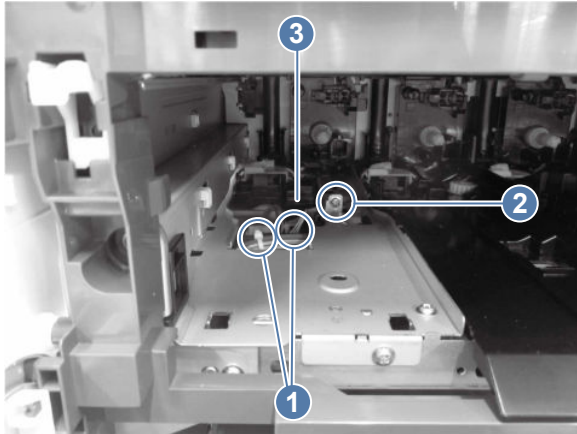
5. Release one tab (callout 1), and then slide the toner cartridge rail assembly (callout 2) towards the front to remove it.

**Figure 5-608 Remove the toner cartridge rail assembly**



6. Disconnect two connectors (callout 1), remove one screw (callout 2), slide the toner supply drive assembly (callout 3) towards the front, and then slide the toner supply drive assembly downward to remove it.

**Figure 5-609 Remove the toner supply drive assembly**




7. For reinstallation of the toner supply drive assembly, keep the following tips in mind.

---

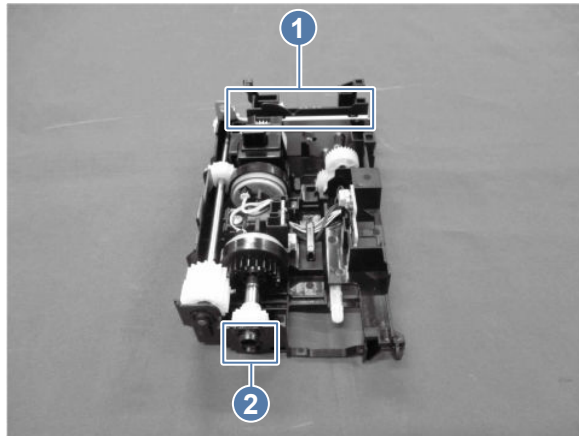
 **Reinstallation tip:** Since a toner supply drive assembly can be installed in another station, be careful not to mix. The exception is assemblies 2 and 4, which are the same.

---


 **Reinstallation tip:** On the first toner supply drive assembly, there are no gears (callout 1) and no coupling (callout 2).

---

**Figure 5-610 First toner supply drive assembly**



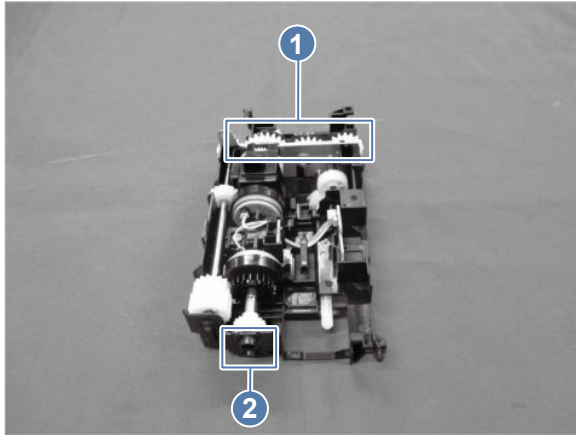
---

 **Reinstallation tip:** On the second and fourth toner supply drive assemblies, there are 3 gears (callout 1) and no coupling (callout 2).

---

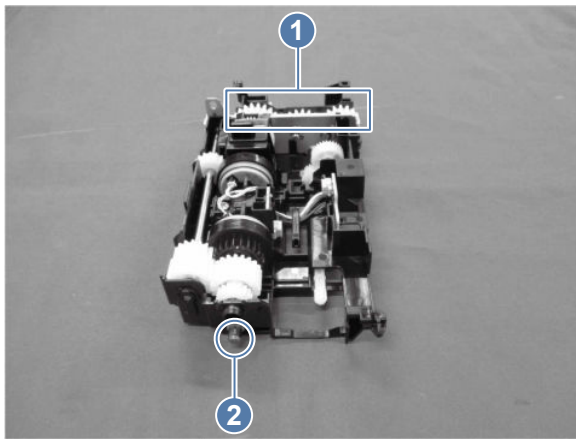


**Figure 5-611** Second and fourth toner supply drive assemblies



**Reinstallation tip:** On the third toner supply drive assembly, there are three gears (callout 1) and a coupling (callout 2).

**Figure 5-612** Third toner supply drive assembly



## 2. Unpack the replacement assembly

Follow these steps to unpack the replacement assembly.

1. Dispose of the defective part.




**NOTE:** HP recommends responsible disposal of the defective part.

<http://www8.hp.com/us/en/hp-information/environment/product-recycling.html>


2. Unpack the replacement part from the packaging.



**CAUTION:**  Some parts are sensitive to electrostatic discharge (ESD). Always perform service work at an ESD-protected workstation or mat. If an ESD workstation or mat is not available, touch the sheet-metal chassis to provide a static ground before touching an ESD-sensitive assembly. Protect the ESD-sensitive assemblies by placing them in ESD pouches when they are out of the printer.




**IMPORTANT:** Make sure that all of the shipping materials (for example shipping tape) are removed from the replacement part prior to installation.

 **NOTE:** If the replacement part is a roller or pad, avoid touching the spongy part of it. Skin oils on the roller or pad can cause paper pickup and/or print-quality problems. HP recommends using disposable gloves when handling rollers or pads or washing your hands before touching rollers or pads.

---

3. To install an assembly, reverse the removal steps.

 **NOTE:** When applicable, special installation instructions are provided for an assembly at the end of the removal procedure. Always completely read the removal instructions and follow all special installation instructions.

---


## Removal and replacement: Toner supply assembly (X654/X677 models)

Learn about removing and replacing the toner supply assembly.

### Before performing service

#### Turn the printer power off

- Disconnect the power cable.

 **WARNING!** To avoid damage to the printer, turn the printer off, wait 30 seconds, and then remove the power cord before attempting to service the printer.

---

If the part is damaged and cannot be cleaned, use the table below to identify the correct part number for your printer. To order the part, go to [www.hp.com/buy/parts](http://www.hp.com/buy/parts).

**Table 5-79** Part information

Part number	Part description
RM3-0846-000CN	HP Toner supply service kit

### Required tools

- #2 Phillips screwdriver with a magnetic tip and a 152 mm (6 in) shaft length

### After performing service

#### Turn the printer power on


- Connect the power cable.
- Use the power switch to turn the power on.

### Post service test

Print any pages necessary to make sure the printer is functioning correctly.

## 1. Remove the toner supply assembly (X654/X677 models)

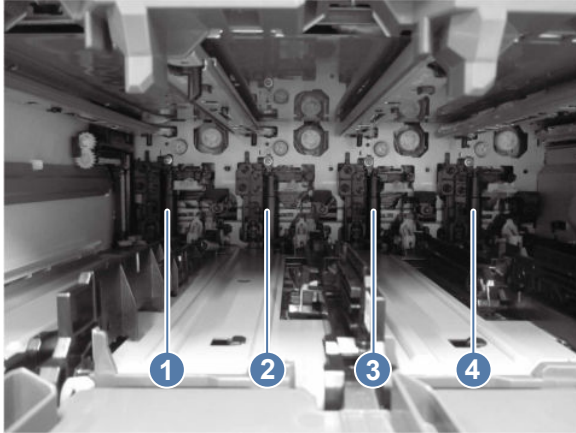
Follow these steps to remove the toner supply assembly.

 **NOTE:** When replacing the toner supply assembly, always replace the toner supply buffer assembly/intermediate pipe at the same time.

---

Since the disassembly procedures of the following four toner supply assemblies are similar, the disassembly procedure of the first toner supply assembly (callout 1) is shown below as an example.

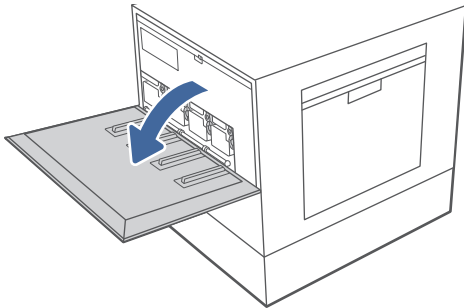
**Figure 5-613 Toner supply assemblies**



- First toner supply assembly (callout 1)
- Second toner supply assembly (callout 2)
- Third toner supply assembly (callout 3)
- Fourth toner supply assembly (callout 4)

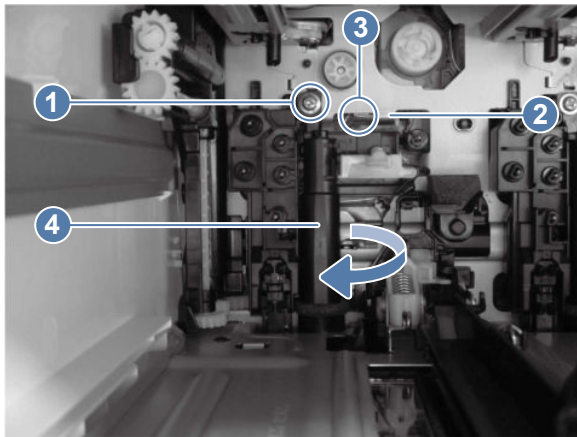
1. Open the front door.

**Figure 5-614 Open the front door**



2. Remove one screw (callout 1), hold the handle (callout 2), and then release one tab (callout 3). Rotate the toner supply assembly (callout 4) in the direction indicated, and then slide the assembly upward to remove it.

Figure 5-615 Remove the assembly



## 2. Unpack the replacement assembly

Follow these steps to unpack the replacement assembly.

1. Dispose of the defective part.




**NOTE:** HP recommends responsible disposal of the defective part.

<http://www8.hp.com/us/en/hp-information/environment/product-recycling.html>

2. Unpack the replacement part from the packaging.



**CAUTION:**  Some parts are sensitive to electrostatic discharge (ESD). Always perform service work at an ESD-protected workstation or mat. If an ESD workstation or mat is not available, touch the sheet-metal chassis to provide a static ground before touching an ESD-sensitive assembly. Protect the ESD-sensitive assemblies by placing them in ESD pouches when they are out of the printer.



**IMPORTANT:** Make sure that all of the shipping materials (for example shipping tape) are removed from the replacement part prior to installation.



**NOTE:** If the replacement part is a roller or pad, avoid touching the spongy part of it. Skin oils on the roller or pad can cause paper pickup and/or print-quality problems. HP recommends using disposable gloves when handling rollers or pads or washing your hands before touching rollers or pads.

3. To install an assembly, reverse the removal steps.



**NOTE:** When applicable, special installation instructions are provided for an assembly at the end of the removal procedure. Always completely read the removal instructions and follow all special installation instructions.

## Removal and replacement: Toner supply buffer assembly/intermediate pipe (X654/X677 models)

Learn about removing and replacing the toner supply buffer assembly/intermediate pipe.

### Before performing service

Turn the printer power off

- Disconnect the power cable.

**⚠ WARNING!** To avoid damage to the printer, turn the printer off, wait 30 seconds, and then remove the power cord before attempting to service the printer.

If the part is damaged and cannot be cleaned, use the table below to identify the correct part number for your printer. To order the part, go to [www.hp.com/buy/parts](http://www.hp.com/buy/parts).

**Table 5-80** Part information

Part number	Part description
RM3-0846-000CN	HP Toner supply service kit

## Required tools

- #2 Phillips screwdriver with a magnetic tip and a 152 mm (6 in) shaft length

## After performing service

### Turn the printer power on

- Connect the power cable.
- Use the power switch to turn the power on.

## Post service test

Print any pages necessary to make sure the printer is functioning correctly.

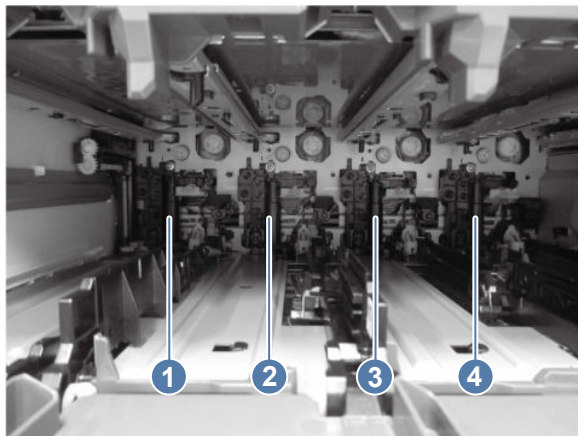
### 1. Remove the toner supply assembly (X654/X677 models)

Follow these steps to remove the toner supply assembly.

**NOTE:** When replacing the toner supply assembly, always replace the toner supply buffer assembly/intermediate pipe at the same time.

Since the disassembly procedures of the following four toner supply assemblies are similar, the disassembly procedure of the first toner supply assembly (callout 1) is shown below as an example.

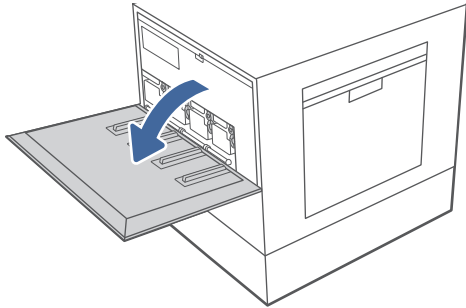
**Figure 5-616** Toner supply assemblies



- First toner supply assembly (callout 1)

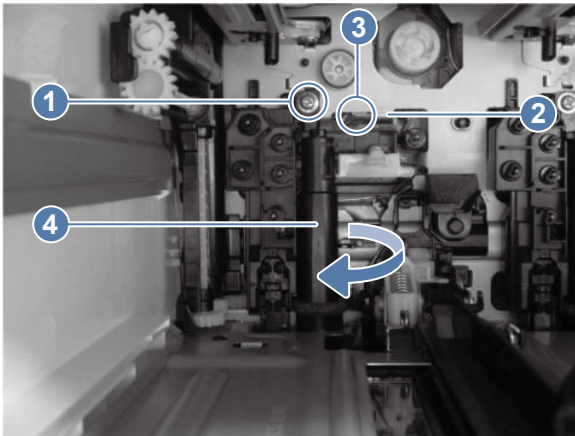
- Second toner supply assembly (callout 2)
  - Third toner supply assembly (callout 3)
  - Fourth toner supply assembly (callout 4)
1. Open the front door.

**Figure 5-617 Open the front door**



2. Remove one screw (callout 1), hold the handle (callout 2), and then release one tab (callout 3). Rotate the toner supply assembly (callout 4) in the direction indicated, and then slide the assembly upward to remove it.

**Figure 5-618 Remove the assembly**

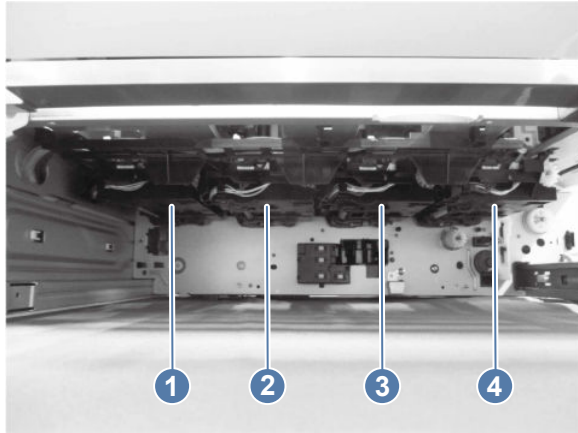


## 2. Remove the toner supply drive assembly (X654/X677 models)

Follow these steps to remove the toner supply drive assembly.

Since the disassembly procedures of the following four toner supply drive assemblies are similar, the disassembly procedure of the 1st toner supply drive assembly (callout 1) is shown below as an example.

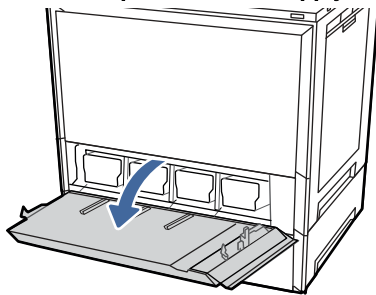
**Figure 5-619 Toner supply drive assemblies**



- First toner supply drive assembly (callout 1)
- Second toner supply drive assembly (callout 2)
- Third toner supply drive assembly (callout 3)
- Fourth toner supply drive assembly (callout 4)

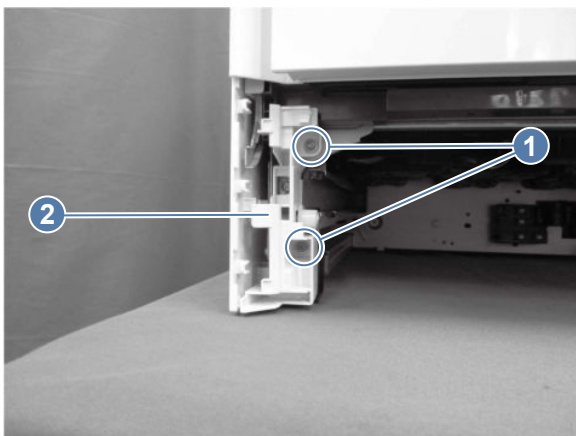
1. Open the toner supply door.

**Figure 5-620 Open the toner supply door**



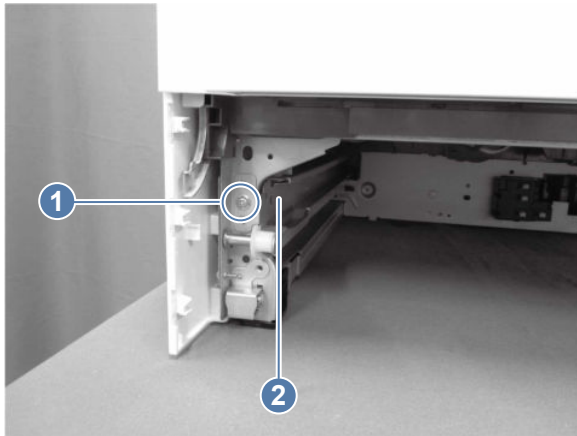
2. Remove the front left cover.
3. Remove two screws (callout 1), and then remove the base frame (callout 2).

**Figure 5-621 Remove the base frame**



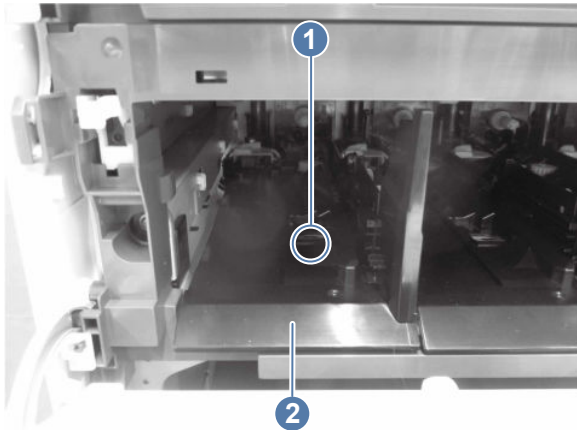
4. Remove one screw (callout 1), and then remove the cassette rail assembly (callout 2).

**Figure 5-622 Remove the cassette rail assembly**



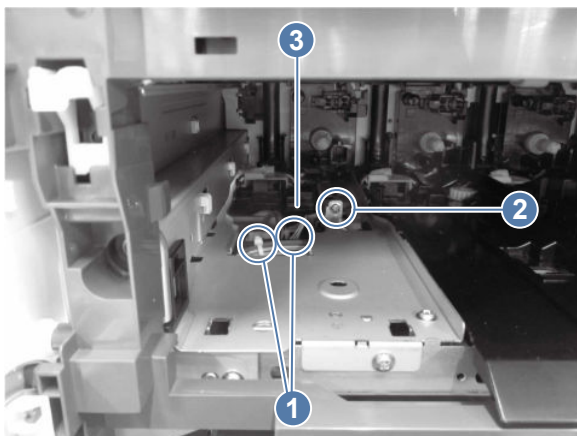
5. Release one tab (callout 1), and then slide the toner cartridge rail assembly (callout 2) towards the front to remove it.

**Figure 5-623 Remove the toner cartridge rail assembly**



6. Disconnect two connectors (callout 1), remove one screw (callout 2), slide the toner supply drive assembly (callout 3) towards the front, and then slide the toner supply drive assembly downward to remove it.


**Figure 5-624 Remove the toner supply drive assembly**






7. For reinstallation of the toner supply drive assembly, keep the following tips in mind.

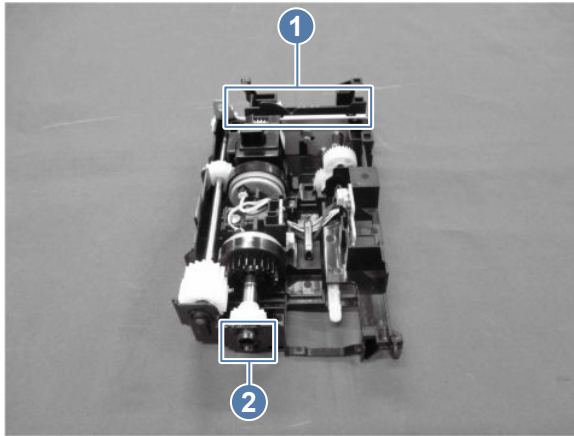
---

 **Reinstallation tip:** Since a toner supply drive assembly can be installed in another station, be careful not to mix. The exception is assemblies 2 and 4, which are the same.


---

 **Reinstallation tip:** On the first toner supply drive assembly, there are no gears (callout 1) and no coupling (callout 2).

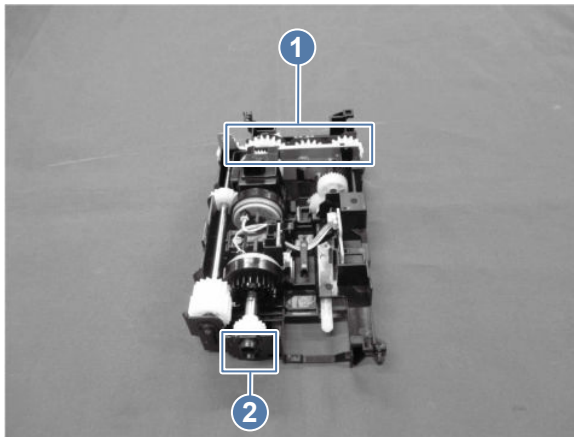
**Figure 5-625** First toner supply drive assembly




---

 **Reinstallation tip:** On the second and fourth toner supply drive assemblies, there are 3 gears (callout 1) and no coupling (callout 2).

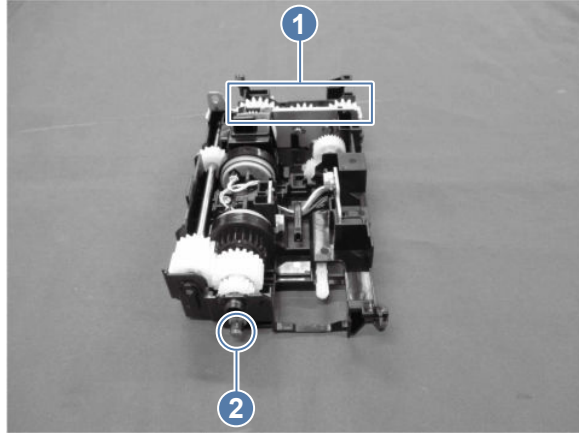
**Figure 5-626** Second and fourth toner supply drive assemblies



---

 **Reinstallation tip:** On the third toner supply drive assembly, there are three gears (callout 1) and a coupling (callout 2).

**Figure 5-627 Third toner supply drive assembly**



### 3. Remove the toner supply buffer assembly/intermediate pipe (X654/X677 models)

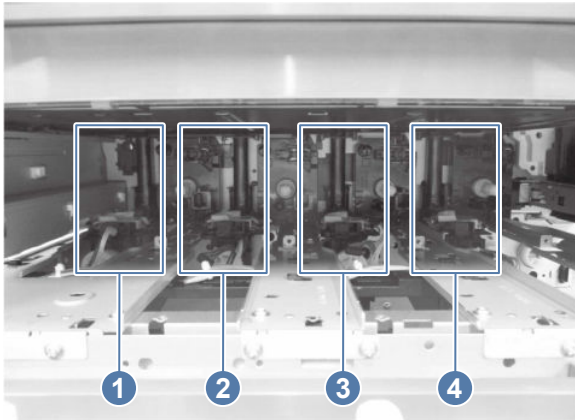
Follow these steps to remove the toner supply buffer assembly/intermediate pipe.



**NOTE:** When replacing toner supply buffer assembly/intermediate pipe, always replace the toner supply assembly at the same time.

Since the disassembly procedures of the following four toner supply buffer assemblies are similar, the disassembly procedure of the first toner supply buffer assembly (callout 1) is shown below as an example.

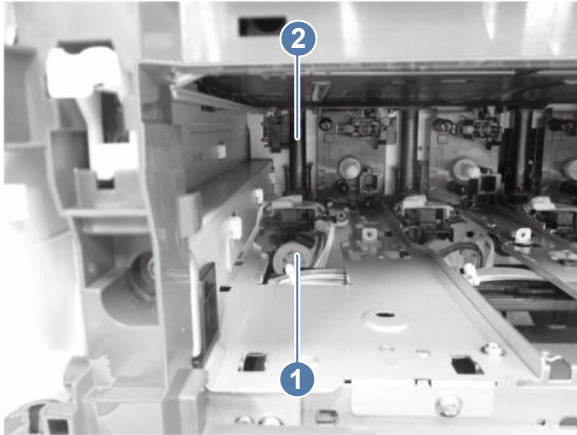
**Figure 5-628 Toner supply buffer assemblies**



- First toner supply buffer assembly (callout 1)
- Second toner supply buffer assembly (callout 2)
- Third toner supply buffer assembly (callout 3)
- Fourth toner supply buffer assembly (callout 4)

- Slide the toner supply buffer assembly (callout 1) forward, and then slide the toner supply buffer assembly (callout 1) and the intermediate pipe (callout 2) downward to remove them together.

**Figure 5-629 Remove the assembly**



#### 4. Unpack the replacement assembly

Follow these steps to unpack the replacement assembly.

1. Dispose of the defective part.

---



 **NOTE:** HP recommends responsible disposal of the defective part.


<http://www8.hp.com/us/en/hp-information/environment/product-recycling.html>


---

2. Unpack the replacement part from the packaging.

---

 **CAUTION:**  Some parts are sensitive to electrostatic discharge (ESD). Always perform service work at an ESD-protected workstation or mat. If an ESD workstation or mat is not available, touch the sheet-metal chassis to provide a static ground before touching an ESD-sensitive assembly. Protect the ESD-sensitive assemblies by placing them in ESD pouches when they are out of the printer.


 **IMPORTANT:** Make sure that all of the shipping materials (for example shipping tape) are removed from the replacement part prior to installation.

 **NOTE:** If the replacement part is a roller or pad, avoid touching the spongy part of it. Skin oils on the roller or pad can cause paper pickup and/or print-quality problems. HP recommends using disposable gloves when handling rollers or pads or washing your hands before touching rollers or pads.

---

3. To install an assembly, reverse the removal steps.

---

 **NOTE:** When applicable, special installation instructions are provided for an assembly at the end of the removal procedure. Always completely read the removal instructions and follow all special installation instructions.

---

#### Removal and replacement: Feed assembly (X654/X677 models)

Learn about removing and replacing the feed assembly.

#### Before performing service

##### Turn the printer power off

- Disconnect the power cable.

**⚠ WARNING!** To avoid damage to the printer, turn the printer off, wait 30 seconds, and then remove the power cord before attempting to service the printer.

If the part is damaged and cannot be cleaned, use the table below to identify the correct part number for your printer. To order the part, go to [www.hp.com/buy/parts](http://www.hp.com/buy/parts).

**Table 5-81 Part information**

Part number	Part description
RM2-3479-000CN	Paper feed assembly

## Required tools

- #2 Phillips screwdriver with a magnetic tip and a 152 mm (6 in) shaft length

## After performing service

### Turn the printer power on

- Connect the power cable.
- Use the power switch to turn the power on.

## Post service test

Print any pages necessary to make sure the printer is functioning correctly.

### 1. Remove the secondary transfer assembly

Follow these steps to remove the secondary transfer assembly.

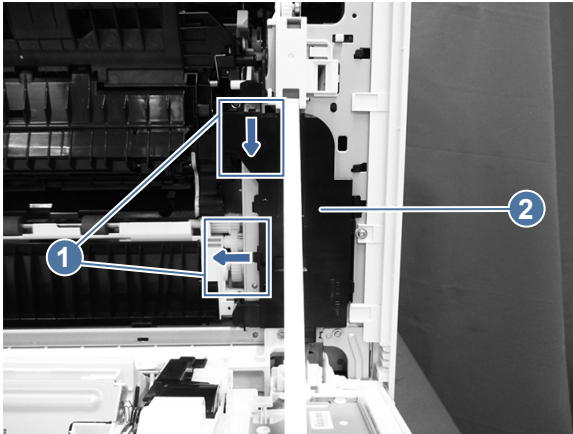
1. Open the right door.

**Figure 5-630 Open the right door**



2. Release two tabs (callout 1), and then remove the PCA cover (callout 2).

**Figure 5-631 Remove the PCA cover**

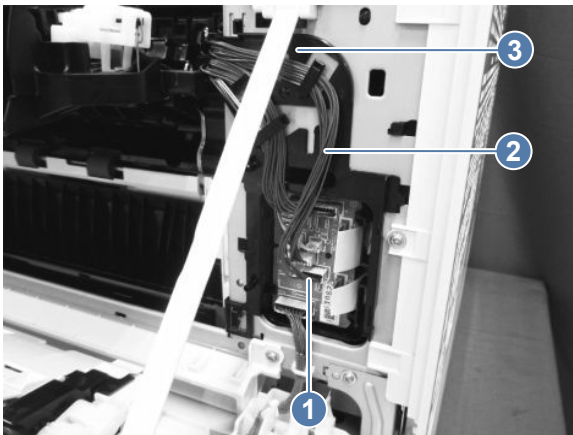


3. Disconnect one connector (callout 1), and then release the cable (callout 2) from the cable guide (callout 3).



**Reinstallation tip:** When reinstalled, make sure the cable is correctly routed through the cable guide.

**Figure 5-632 Release the cable**

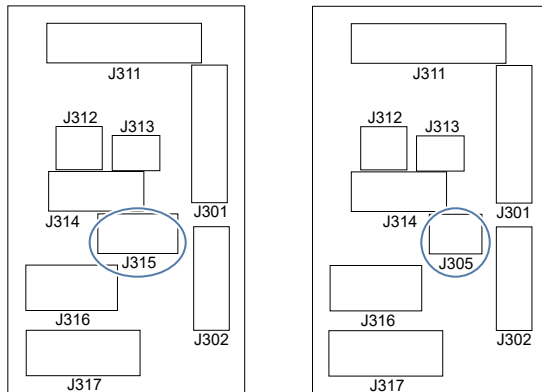


4. Perform one of the following steps.
  - **X654/6800/X677 models:** Disconnect the J315 formatter connector.
  - **6700 models:** Disconnect the J305 formatter connector.

**Figure 5-633 Disconnect a formatter connector**

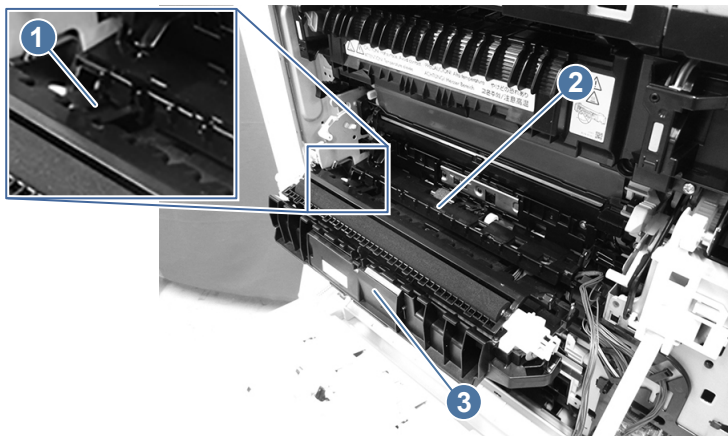
X654/MFP 6800/MFP X677

6700/6701




5. Release one tab (callout 1), and then lift up the registration assembly (callout 2) off the secondary transfer assembly (callout 3)

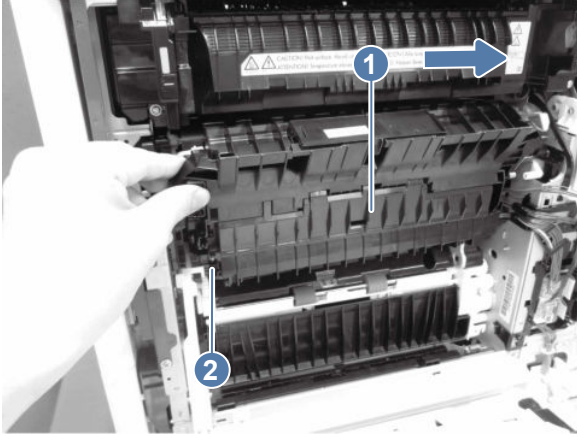
**Figure 5-634 Release the tab**



6. Close the secondary transfer assembly until it is only slightly open. Slide the assembly (callout 1) in the direction indicated below, and then dislodge the hinge pin (callout 2) from the holder to remove the assembly.

 **Reinstallation tip:** Before removing the assembly, take note of where the assembly hinge pins fit into the holes provided in the printer.

**Figure 5-635 Remove the secondary transfer assembly**



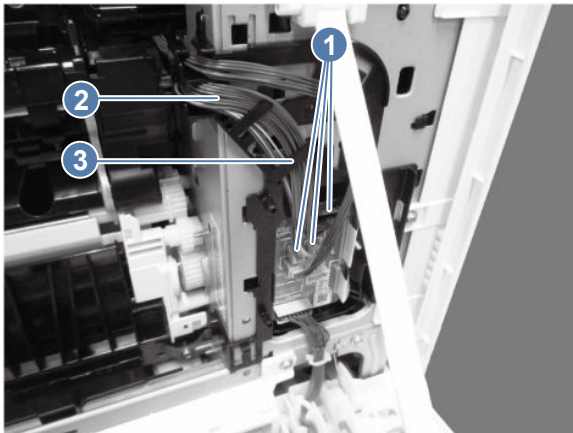
**Reinstallation tip:** On the assembly right side, make sure that the wire is nested in the plastic sleeve. Slide the wire sleeve into its place, depressing the spring, and then twist the left side of the assembly into place and allow the spring pressure to nest the hinge pin in its hole.

## 2. Remove the registration assembly

Follow these steps to remove the registration assembly.

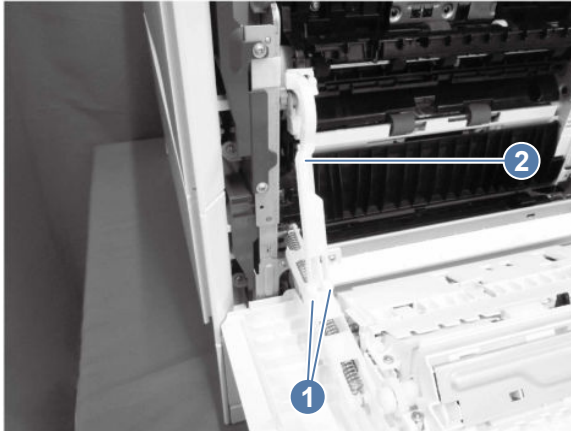
1. Disconnect three connectors (callout 1), and then release the cable (callout 2) from the cable guide (callout 3).

**Figure 5-636 Release the connectors**



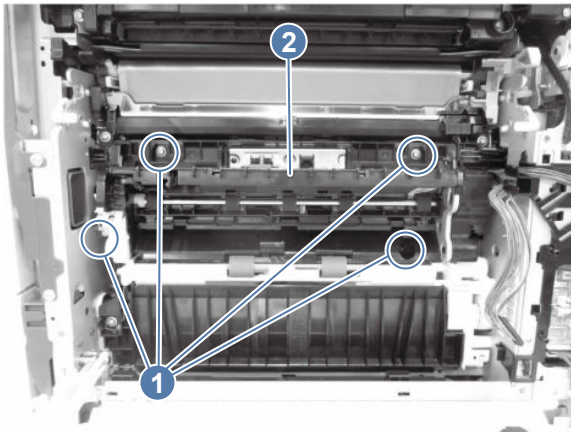
2. Release two bosses (callout 1), and then release the link arm (callout 2) from the door.

**Figure 5-637 Release the link arm**



3. Remove four screws (callout 1), and then remove the registration assembly (callout 2).

**Figure 5-638 Remove the registration assembly**



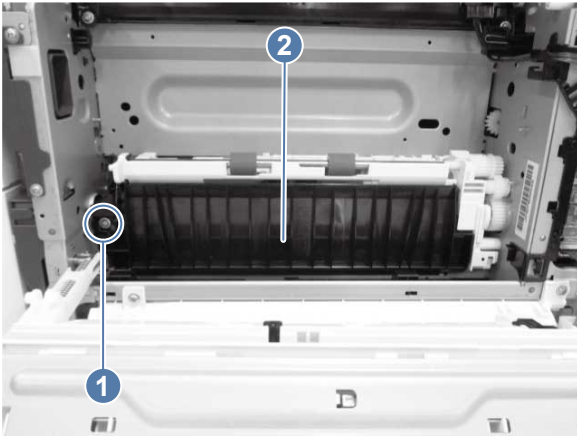
### 3. Remove the feed assembly (X654/X677 models)

Follow these steps to remove the feed assembly.



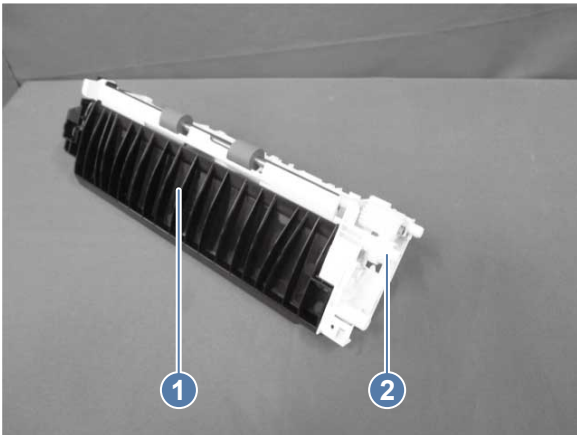
1. Remove one screw (callout 1), and then remove the feed assembly (callout 2).

**Figure 5-639 Remove the feed assembly**



2. Remove the gear (callout 1) from the feed assembly (callout 2).

**Figure 5-640 Remove the gear**



#### 4. Unpack the replacement assembly

Follow these steps to unpack the replacement assembly.

1. Dispose of the defective part.




**NOTE:** HP recommends responsible disposal of the defective part.

<http://www8.hp.com/us/en/hp-information/environment/product-recycling.html>


2. Unpack the replacement part from the packaging.



**CAUTION:**  Some parts are sensitive to electrostatic discharge (ESD). Always perform service work at an ESD-protected workstation or mat. If an ESD workstation or mat is not available, touch the sheet-metal chassis to provide a static ground before touching an ESD-sensitive assembly. Protect the ESD-sensitive assemblies by placing them in ESD pouches when they are out of the printer.




**IMPORTANT:** Make sure that all of the shipping materials (for example shipping tape) are removed from the replacement part prior to installation.

 **NOTE:** If the replacement part is a roller or pad, avoid touching the spongy part of it. Skin oils on the roller or pad can cause paper pickup and/or print-quality problems. HP recommends using disposable gloves when handling rollers or pads or washing your hands before touching rollers or pads.

---

3. To install an assembly, reverse the removal steps.

 **NOTE:** When applicable, special installation instructions are provided for an assembly at the end of the removal procedure. Always completely read the removal instructions and follow all special installation instructions.

---

## Removal and replacement: Low-voltage power supply (LVPS)

This document provides the procedures to remove and replace the low-voltage power supply (LVPS).


Mean time to repair: 25 minutes

Service level: Intermediate

### Before performing service

#### Turn the printer power off

- Disconnect the power cable.

 **WARNING!** To avoid damage to the printer, turn the printer off, wait 30 seconds, and then remove the power cord before attempting to service the printer.

---

Use the table below to identify the correct part number for your printer, and then go to <https://parts.hp.com/hpparts> to order the part.

**Table 5-82 LVPS part numbers**

Part number	Part description
RM3-7724-000CN	LVPS (110-127V) (5700/X557)
RM3-7725-000CN	LVPS (220-240V) (5700/X557)
RM3-7726-000CN	LVPS (110-127V) (6700/X654)
RM3-7727-000CN	LVPS (220-240V) (6700/X654)
RM3-7728-000CN	LVPS (110-127V) (6800/X677)
RM3-7729-000CN	LVPS (220-240V) (6800/X677)
RM3-9012-000CN	LVPS (110-127V) (5800/X57945)
RM3-9013-000CN	LVPS (220-240V) (5800/X57945)

### Required tools

- #2 Phillips screwdriver with a magnetic tip

### After performing service

Make sure that all of the connectors on the LVPS are fully seated.

Make sure that all of the connectors on the formatter are fully seated.

Make sure that the formatter cover is fully seated.

### Turn the printer power on

- Connect the power cable.
- Use the power switch to turn the power on.

### Post service test


Print a configuration page to make sure that the printer is functioning correctly.

## 1. Remove the formatter cover

Follow these steps to remove the formatter cover.

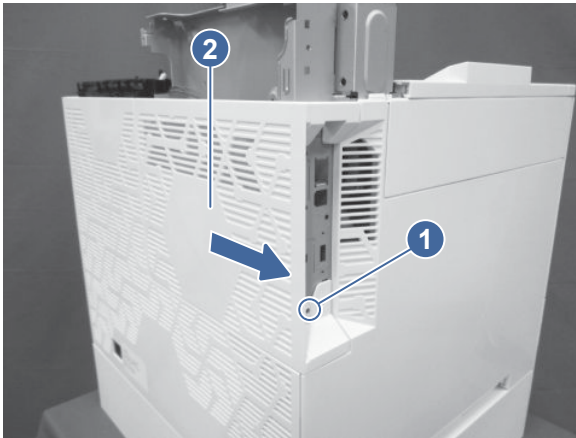
- Remove one screw (callout 1), and then slide the formatter cover (callout 2) away from the printer to remove it.

---

 **TIP:** Reverse the removal steps to install the assembly.

---


**Figure 5-641** Remove the formatter cover



## 2. Remove the rear cover

Follow these steps to remove the rear cover.

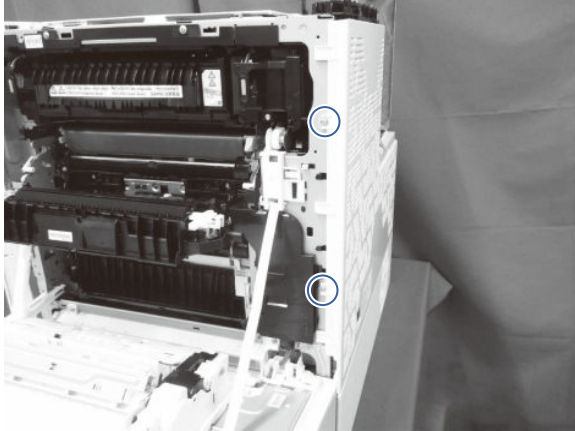
---

 **NOTE:** The figures below show some assemblies (for example the top cover and formatter) removed that might still be installed on the printer. However, the steps to remove the cover are correct.

---

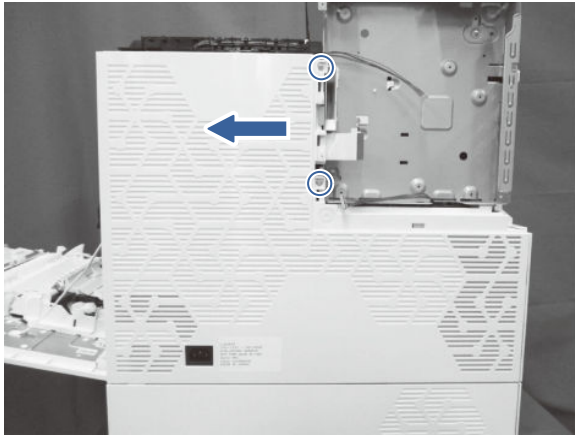
1. Open the right door, and remove two screws.

**Figure 5-642 Remove two screws**



2. At the back of the printer, remove two screws, and then slide the rear cover as indicated to remove it.

**Figure 5-643 Remove the rear cover**



### 3. Remove the low-voltage power supply (LVPS)

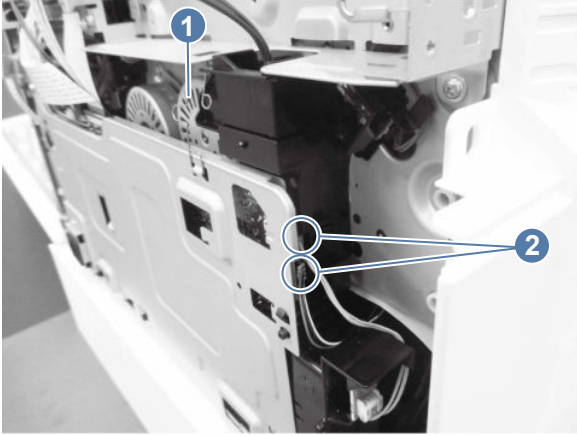
Follow these steps to remove the low-voltage power supply (LVPS).

1. Unhook one spring (callout 1), and then disconnect two connectors (callout 2).




**NOTE:** Unhook the spring from the formatter cage, not the low-voltage power supply. The spring should remain attached to the LVPS.

**Figure 5-644 Unhook the spring and disconnect two connectors**



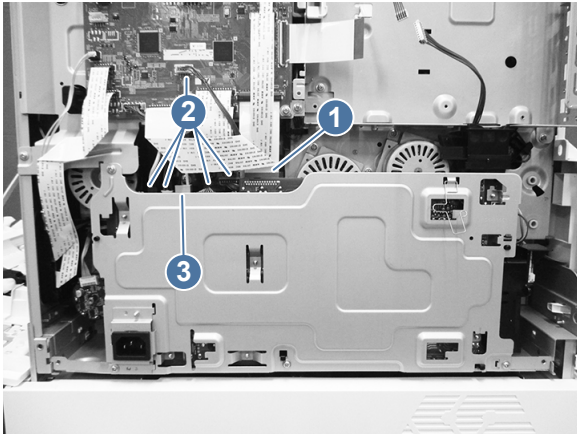
2. Remove the FFC (callout 1), and then disconnect five connectors (callout 2).

---

 **NOTE:** MFP only: Disconnect one additional connector (callout 3).

---

**Figure 5-645 Disconnect the LVPS connectors**



3. Remove four screws (callout 1), and then remove the low-voltage power supply assembly (callout 2).

---

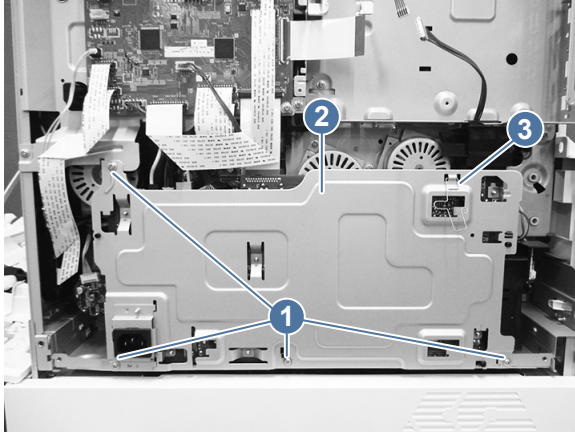
 **NOTE:** The black ducting in the lower right corner can stick during the removal process.


---

**Replacement LVPS only:** Remove the spring (callout 3), and then install it on the replacement LVPS.

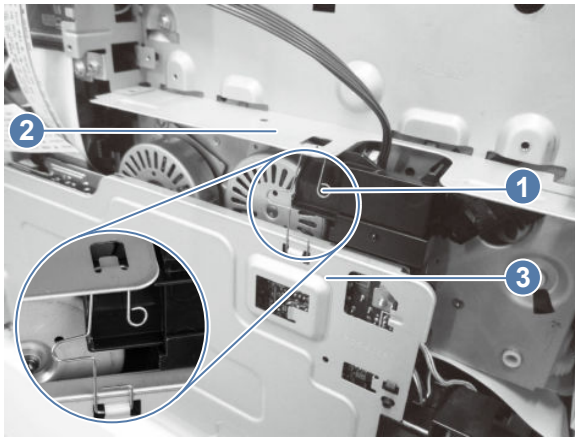
---

**Figure 5-646 Remove the LVPS**



 **Reinstallation tip:** When reinstalling the LVPS, make sure that the spring (callout 1) is attached to both the formatter cage (callout 2) and the LVPS (callout 3).

**Figure 5-647 Reinstalling the LVPS**



#### 4. Unpack the replacement assembly



Follow these steps to unpack the replacement assembly.


1. Dispose of the defective part.


 **NOTE:** HP recommends responsible disposal of the defective part.

<http://www8.hp.com/us/en/hp-information/environment/product-recycling.html>

2. Unpack the replacement part from the packaging.

 **CAUTION:**  Some parts are sensitive to electrostatic discharge (ESD). Always perform service work at an ESD-protected workstation or mat. If an ESD workstation or mat is not available, touch the sheet-metal chassis to provide a static ground before touching an ESD-sensitive assembly. Protect the ESD-sensitive assemblies by placing them in ESD pouches when they are out of the printer.


 **IMPORTANT:** Make sure that all of the shipping materials (for example shipping tape) are removed from the replacement part prior to installation.

 **NOTE:** If the replacement part is a roller or pad, avoid touching the spongy part of it. Skin oils on the roller or pad can cause paper pickup and/or print-quality problems. HP recommends using disposable gloves when handling rollers or pads or washing your hands before touching rollers or pads.

---

3. To install an assembly, reverse the removal steps.

---

 **NOTE:** When applicable, special installation instructions are provided for an assembly at the end of the removal procedure. Always completely read the removal instructions and follow all special installation instructions.

---

## Removal and replacement: High-voltage power supply (HVPS)


Learn about removing and replacing the high-voltage power supply PCA.

 [View a video demonstration of removing and replacing the HVPS.](#)

### Before performing service

#### Turn the printer power off

- Disconnect the power cable.

 **WARNING!** To avoid damage to the printer, turn the printer off, wait 30 seconds, and then remove the power cord before attempting to service the printer.

---

If the part is damaged and cannot be cleaned, use the table below to identify the correct part number for your printer. To order the part, go to [www.hp.com/buy/parts](http://www.hp.com/buy/parts).

**Table 5-83** Part information

Part number	Part description
RM3-9040-000CN	HV power supply PCA (5700/X557/5800)
RM3-9041-000CN	HV power supply PCA (6700/6800)
RM3-9042-000CN	HV power supply PCA (X57945)
RM3-9043-000CN	HV power supply PCA (X654/X677)

### Required tools

- #2 Phillips screwdriver with a magnetic tip and a 152 mm (6 in) shaft length

### After performing service

#### Turn the printer power on

- Connect the power cable.
- Use the power switch to turn the power on.

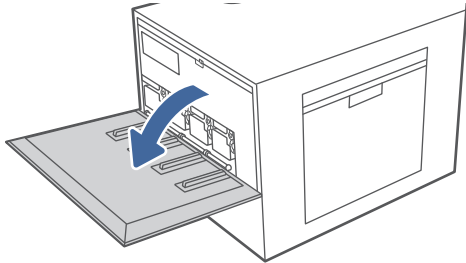
### Post service test

Print any pages necessary to make sure the printer is functioning correctly.

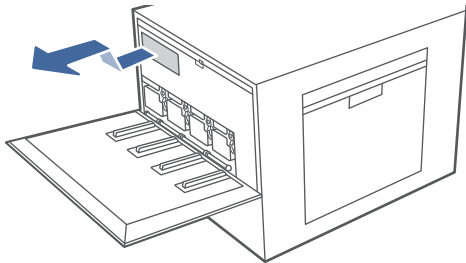
## 1. Remove the toner collection unit (TCU)

Follow these steps to remove the toner collection unit (TCU).


1. Open the front door.



2. Lift the TCU slightly and then pull it out of the printer.



---

 **NOTE:** Maintain the position of the TCU as you pull it out from the printer. This will ensure that you do not spill any waste toner in the printer. Place the unit into the clear plastic bag the new TCU was packaged in.


---

## 2. Remove the formatter cover

Follow these steps to remove the formatter cover.

- Remove one screw (callout 1), and then slide the formatter cover (callout 2) away from the printer to remove it.

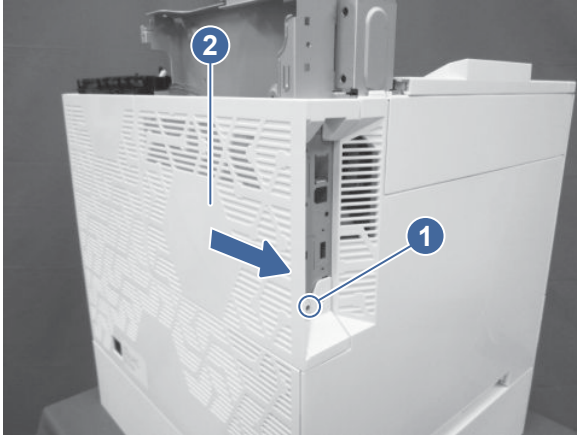
---

 **TIP:** Reverse the removal steps to install the assembly.

---



**Figure 5-648 Remove the formatter cover**



### 3. Remove the left upper cover (MFP models)

Follow these steps to remove the left upper cover.

1. Open the front door.

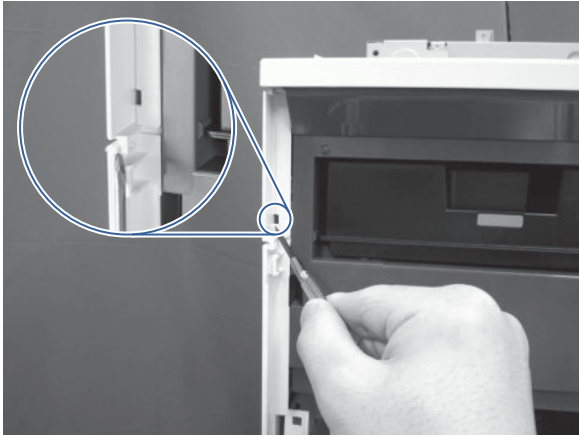
---

**⚠ CAUTION:** If the cover is being removed to gain access to the main drive assembly, make sure that the front door remains open. This keeps the main drive properly aligned.

---

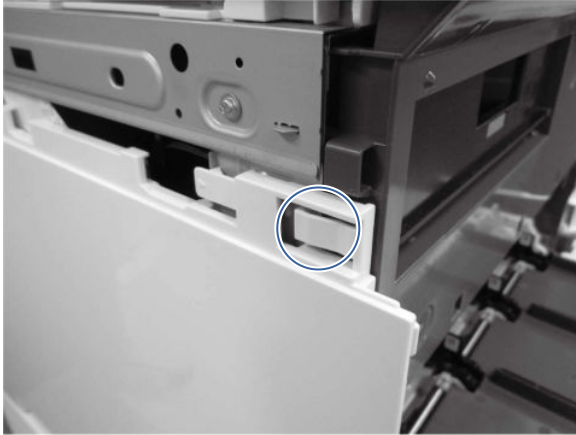
2. At the left side of the printer, insert the small flat-blade screwdriver into the slot to release one tab (callout 1).

**Figure 5-649 Use a screwdriver to release the tab**



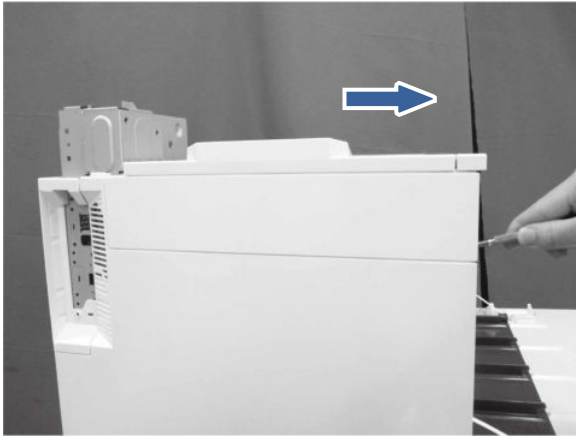
3. Toward the front of the printer, release another tab.

**Figure 5-650 Release the tab**



4. Rotate the cover up to remove it.

**Figure 5-651 Remove the left upper cover**

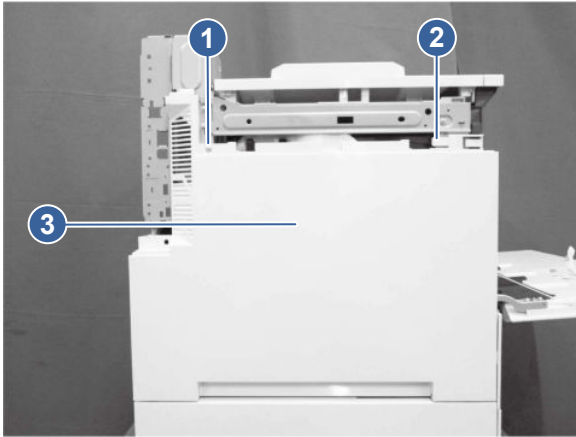


#### **4. Remove the left cover**

Follow these steps to remove the left cover.

- At the left side of the printer, remove one screw (callout 1), release one tab (callout 2), and then slide the cover (callout 3) toward the rear of the printer to release it.

**Figure 5-652 Remove the left cover**

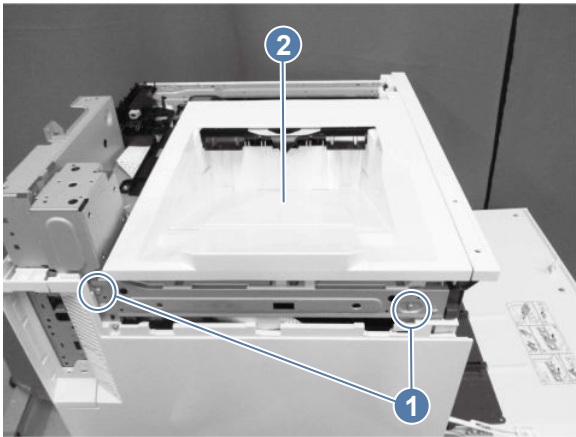


### 5. Remove the output bin

Follow these steps to remove the output bin.

- Remove two screws (callout 1), and then slide the output tray (callout 2) towards the front (SFP models) or left (MFP models) to remove it.

**Figure 5-653 Remove the output bin**

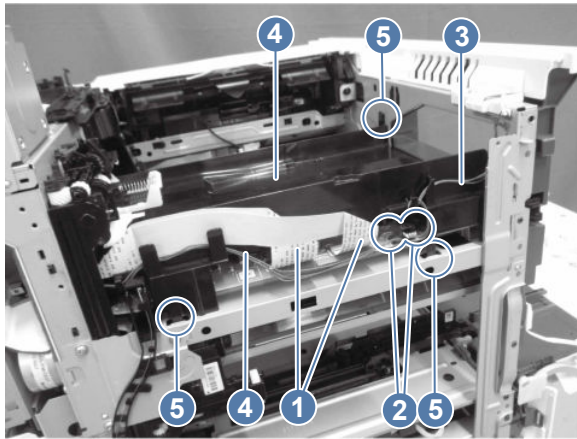



### 6. Remove the high-voltage power supply (HVPS)

Follow these steps to remove the high-voltage power supply (HVPS).

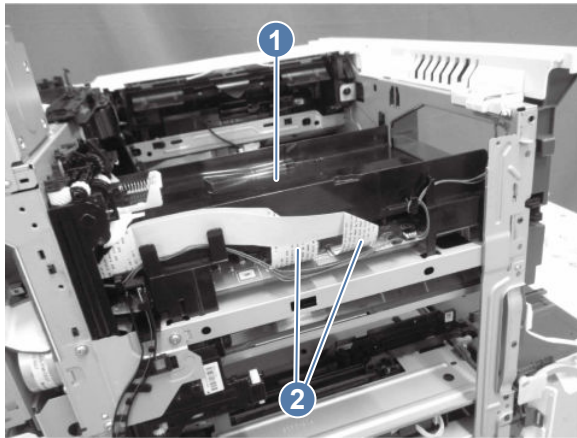
1. Remove two FFCs (callout 1) and disconnect two connectors (callout 2). Remove the FFC (callout 1) and cable (callout 4) from the high-voltage PCA cover (callout 3), release three tabs (callout 5), and then remove the high-voltage PCA cover.

**Figure 5-654 Remove the high-voltage PCA cover**



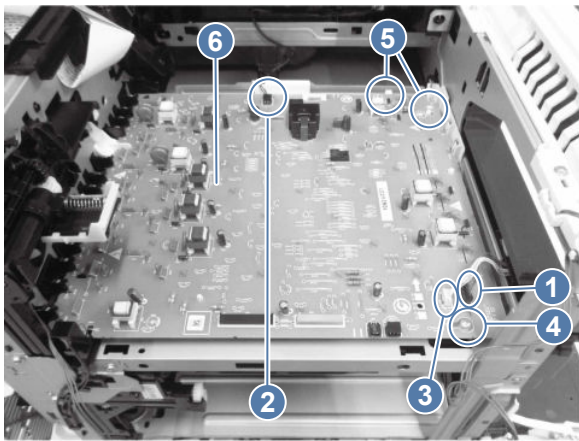
 **Reinstallation tip:** The FFC (callout 2) is attached to the high-voltage PCA cover (callout 1) by double sided tape. When removing the FFC from the high-voltage PCA cover, take care not to damage the FFC.

**Figure 5-655 Use caution with the taped FFC**




2. Disconnect two connector (callout 1/2). Disconnect one connector (callout 3) (X654/X677 models only). Remove one screw (callout 4), release two tabs (callout 5), and then remove the high-voltage power supply assembly (callout 6).

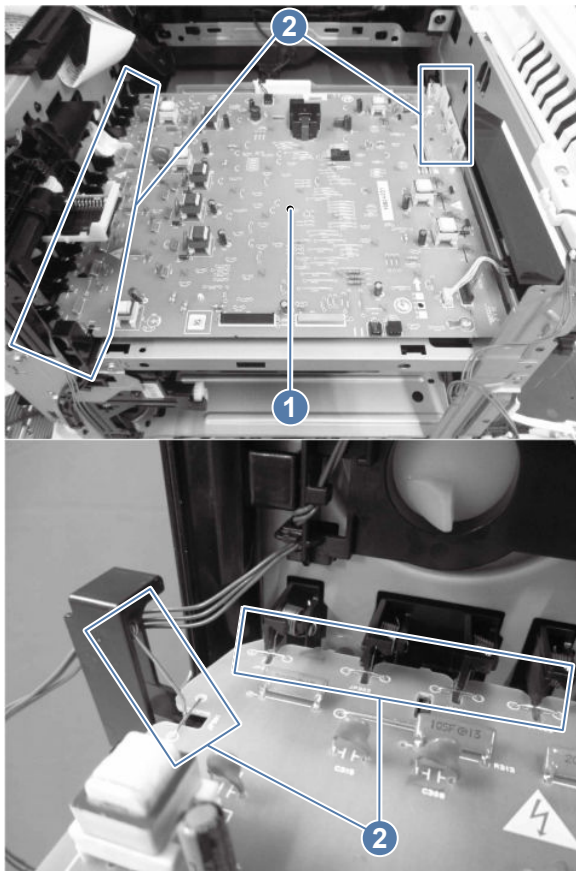
**Figure 5-656 Remove the HVPS**




3. For reinstallation of the HVPS, keep the following tips in mind.

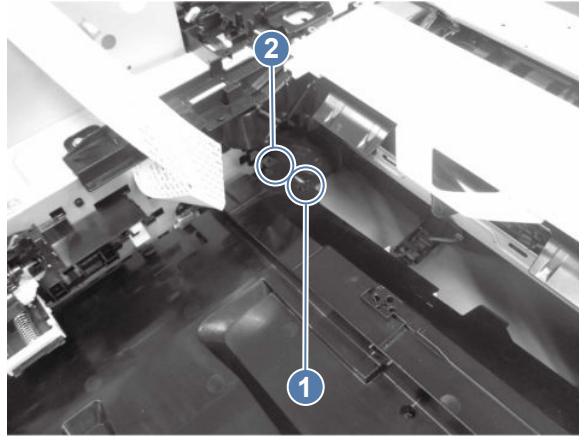
 **Reinstallation tip:** When installing the high-voltage power supply PCA (callout 1), confirm that the contact springs (callout 2) are in the correct position (so that the PCA engages with the spring).

**Figure 5-657 Verify that the contact springs are in the correct position**



- 
-  **Reinstallation tip:** When installing the high-voltage PCA cover, confirm that the contact spring (callout 1) is in the contact holder (callout 2).

**Figure 5-658** Verify that the contact spring is in the holder



---

## 7. Unpack the replacement assembly



Follow these steps to unpack the replacement assembly.


1. Dispose of the defective part.


 **NOTE:** HP recommends responsible disposal of the defective part.

<http://www8.hp.com/us/en/hp-information/environment/product-recycling.html>


2. Unpack the replacement part from the packaging.

 **CAUTION:**  Some parts are sensitive to electrostatic discharge (ESD). Always perform service work at an ESD-protected workstation or mat. If an ESD workstation or mat is not available, touch the sheet-metal chassis to provide a static ground before touching an ESD-sensitive assembly. Protect the ESD-sensitive assemblies by placing them in ESD pouches when they are out of the printer.

 **IMPORTANT:** Make sure that all of the shipping materials (for example shipping tape) are removed from the replacement part prior to installation.

 **NOTE:** If the replacement part is a roller or pad, avoid touching the spongy part of it. Skin oils on the roller or pad can cause paper pickup and/or print-quality problems. HP recommends using disposable gloves when handling rollers or pads or washing your hands before touching rollers or pads.

3. To install an assembly, reverse the removal steps.

 **NOTE:** When applicable, special installation instructions are provided for an assembly at the end of the removal procedure. Always completely read the removal instructions and follow all special installation instructions.

---

## Removal and replacement: Drive PCA

Learn about removing and replacing the drive PCA.


 [View a video demonstration of removing and replacing the drive PCA.](#)

## Before performing service

## Turn the printer power off

- Disconnect the power cable.

---

 **WARNING!** To avoid damage to the printer, turn the printer off, wait 30 seconds, and then remove the power cord before attempting to service the printer.

---

If the part is damaged and cannot be cleaned, use the table below to identify the correct part number for your printer. To order the part, go to [www.hp.com/buy/parts](http://www.hp.com/buy/parts).

**Table 5-84** Part information

Part number	Part description
RM3-7722-000CN	Driver PCA (6700/V654/6800/X677)
RM3-7723-000CN	Driver PCA (5700/X557/5800/X57945)

## Required tools

- #2 Phillips screwdriver with a magnetic tip and a 152 mm (6 in) shaft length

## After performing service

### Turn the printer power on

- Connect the power cable.
- Use the power switch to turn the power on.

## Post service test


Print any pages necessary to make sure the printer is functioning correctly.

### 1. Remove the formatter cover

Follow these steps to remove the formatter cover.

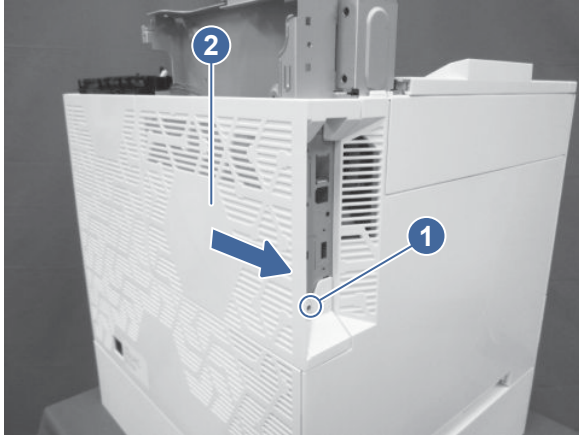
- Remove one screw (callout 1), and then slide the formatter cover (callout 2) away from the printer to remove it.

---

 **TIP:** Reverse the removal steps to install the assembly.


---

**Figure 5-659 Remove the formatter cover**



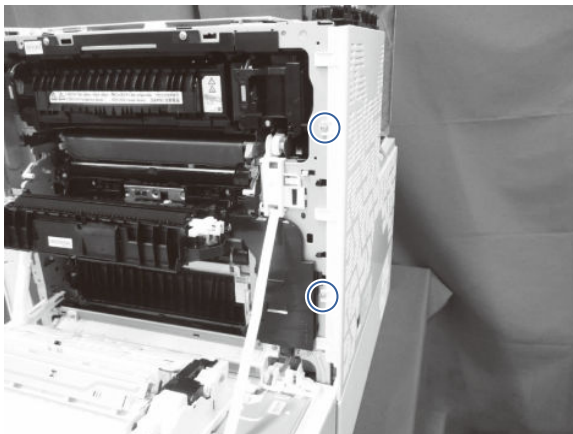
## 2. Remove the rear cover

Follow these steps to remove the rear cover.

 **NOTE:** The figures below show some assemblies (for example the top cover and formatter) removed that might still be installed on the printer. However, the steps to remove the cover are correct.

1. Open the right door, and remove two screws.

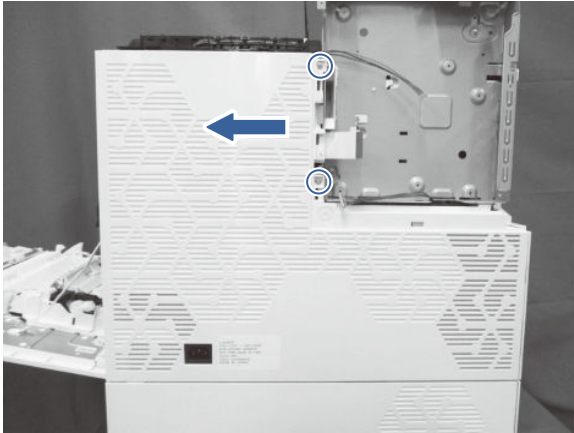
**Figure 5-660 Remove two screws**





2. At the back of the printer, remove two screws, and then slide the rear cover as indicated to remove it.

**Figure 5-661 Remove the rear cover**




### 3. Remove the low-voltage power supply (LVPS)

Follow these steps to remove the low-voltage power supply (LVPS).

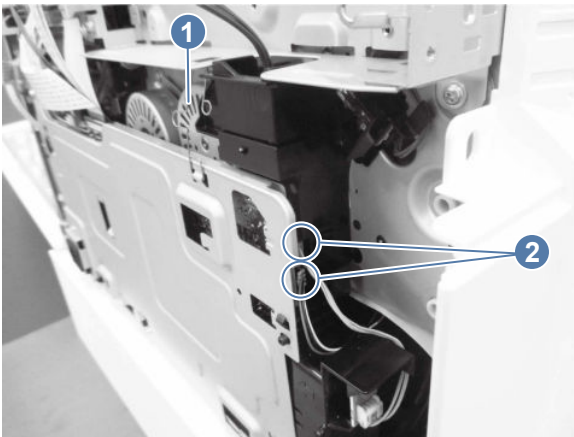
1. Unhook one spring (callout 1), and then disconnect two connectors (callout 2).

---

 **NOTE:** Unhook the spring from the formatter cage, not the low-voltage power supply. The spring should remain attached to the LVPS.


---

**Figure 5-662 Unhook the spring and disconnect two connectors**



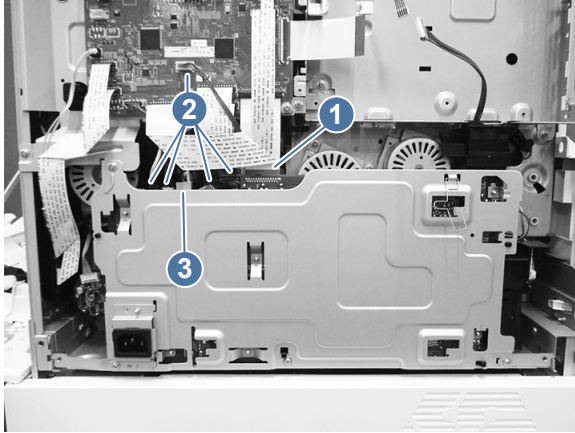
2. Remove the FFC (callout 1), and then disconnect five connectors (callout 2).

---


 **NOTE:** **MFP only:** Disconnect one additional connector (callout 3).

---

**Figure 5-663 Disconnect the LVPS connectors**

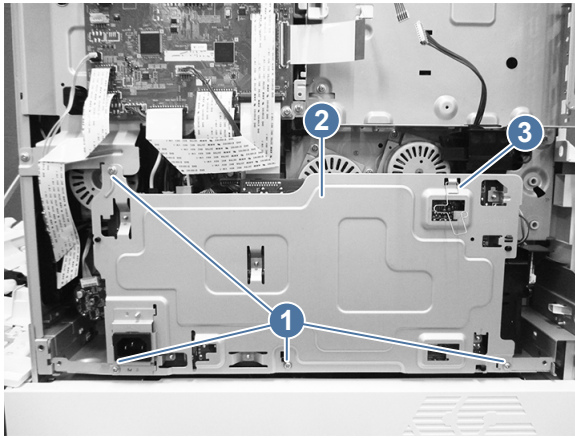



3. Remove four screws (callout 1), and then remove the low-voltage power supply assembly (callout 2).

 **NOTE:** The black ducting in the lower right corner can stick during the removal process.

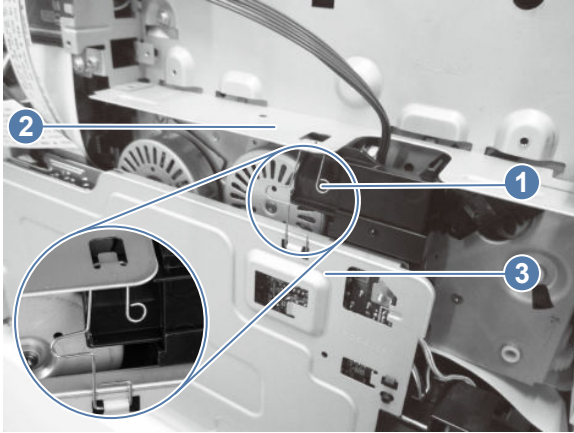
**Replacement LVPS only:** Remove the spring (callout 3), and then install it on the replacement LVPS.

**Figure 5-664 Remove the LVPS**



 **Reinstallation tip:** When reinstalling the LVPS, make sure that the spring (callout 1) is attached to both the formatter cage (callout 2) and the LVPS (callout 3).

**Figure 5-665 Reinstalling the LVPS**

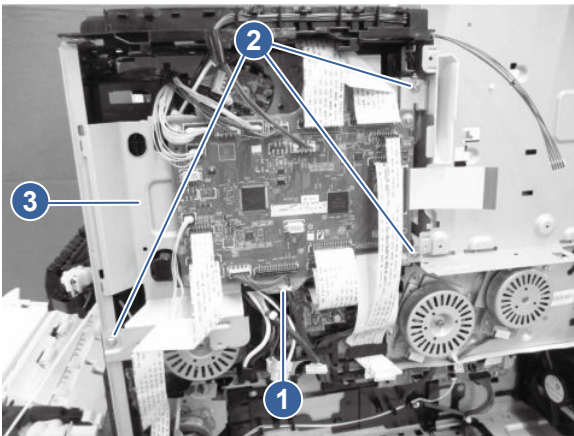


#### 4. Remove the drive PCA

Follow these steps to remove the drive PCA.

1. Disconnect all the connectors on the DC controller PCA, remove the cable clamp (callout 1), remove three screws (callout 2), and then slide the DC controller stay (callout 3) out to remove it.

**Figure 5-666 Remove the DC controller stay**

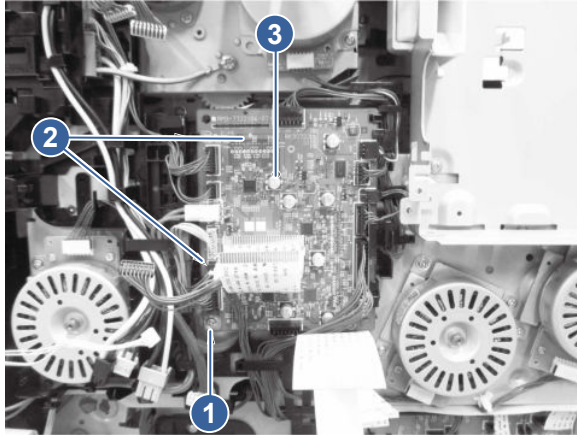


2. Disconnect all the connectors on the drive PCA, remove one screw (callout 1), release two tabs (callout 2), and then remove the drive PCA (callout 3).



**IMPORTANT:** Some of these wires are very tightly connected. Take care when disconnecting them.

Figure 5-667 Remove the drive PCA



## 5. Unpack the replacement assembly

Follow these steps to unpack the replacement assembly.

1. Dispose of the defective part.




**NOTE:** HP recommends responsible disposal of the defective part.

<http://www8.hp.com/us/en/hp-information/environment/product-recycling.html>

2. Unpack the replacement part from the packaging.



**CAUTION:**  Some parts are sensitive to electrostatic discharge (ESD). Always perform service work at an ESD-protected workstation or mat. If an ESD workstation or mat is not available, touch the sheet-metal chassis to provide a static ground before touching an ESD-sensitive assembly. Protect the ESD-sensitive assemblies by placing them in ESD pouches when they are out of the printer.



**IMPORTANT:** Make sure that all of the shipping materials (for example shipping tape) are removed from the replacement part prior to installation.



**NOTE:** If the replacement part is a roller or pad, avoid touching the spongy part of it. Skin oils on the roller or pad can cause paper pickup and/or print-quality problems. HP recommends using disposable gloves when handling rollers or pads or washing your hands before touching rollers or pads.

3. To install an assembly, reverse the removal steps.



**NOTE:** When applicable, special installation instructions are provided for an assembly at the end of the removal procedure. Always completely read the removal instructions and follow all special installation instructions.

### Removal and replacement: Feed/toner supply controller PCA (X654/X677 models)

Learn about removing and replacing the feed/toner supply controller PCA.

#### Before performing service

Turn the printer power off

- Disconnect the power cable.

**⚠ WARNING!** To avoid damage to the printer, turn the printer off, wait 30 seconds, and then remove the power cord before attempting to service the printer.

If the part is damaged and cannot be cleaned, use the table below to identify the correct part number for your printer. To order the part, go to [www.hp.com/buy/parts](http://www.hp.com/buy/parts).

**Table 5-85** Part information

Part number	Part description
RM3-7771-000CN	Toner supply PCA (X654/X677 models)

## Required tools

- #2 Phillips screwdriver with a magnetic tip and a 152 mm (6 in) shaft length

## After performing service

### Turn the printer power on

- Connect the power cable.
- Use the power switch to turn the power on.

## Post service test

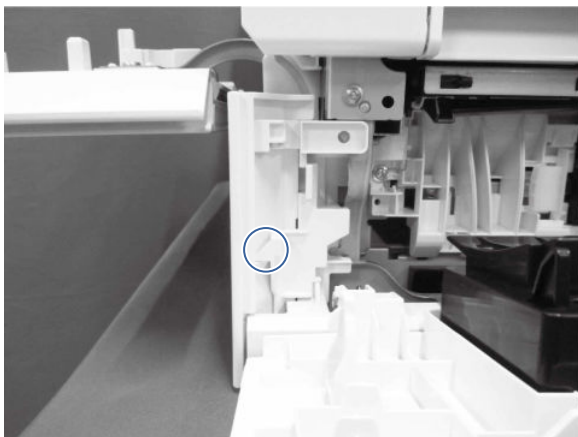
Print any pages necessary to make sure the printer is functioning correctly.

### 1. Remove the front right cover

Follow these steps to remove the front right cover.

1. Open the toner cartridge access door.
2. Open the right lower door.
3. Release one tab, and then slide the front right cover upward to remove it.

**Figure 5-668** Remove the front right cover

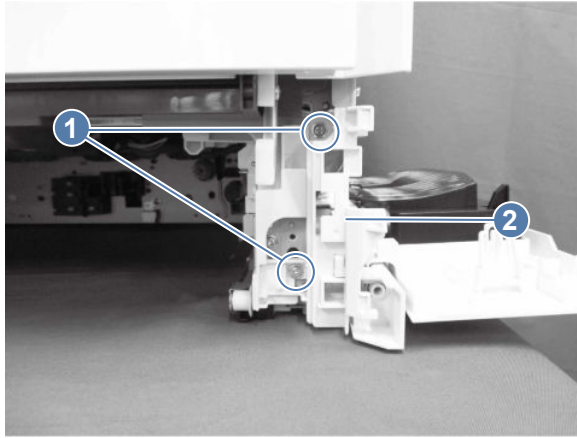


## 2. Remove the right lower door (X654/X677 models)

Follow these steps to remove the right lower door.

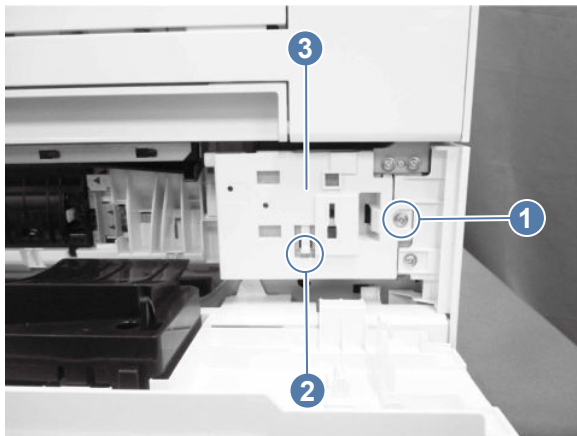
1. Remove two screws (callout 1), and then remove the base frame (callout 2).

**Figure 5-669 Remove the base frame**



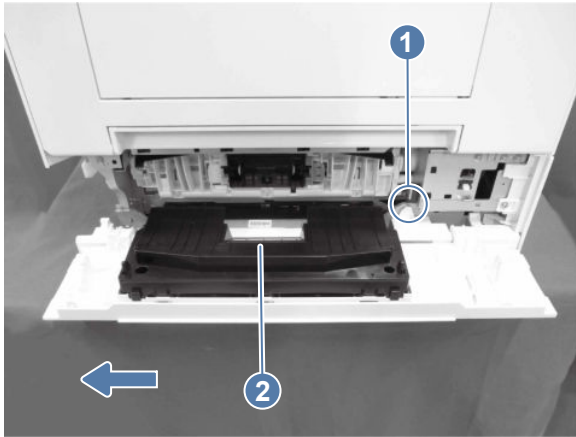
2. Remove one screw (callout 1), release one tab (callout 2), and then slide the rear inner cover (callout 3) downward to remove it.

**Figure 5-670 Remove the rear inner cover**



3. Release one tab (callout 1), and then slide the right lower door assembly (callout 2) in the direction indicated to remove it.

**Figure 5-671 Remove the right lower door assembly**

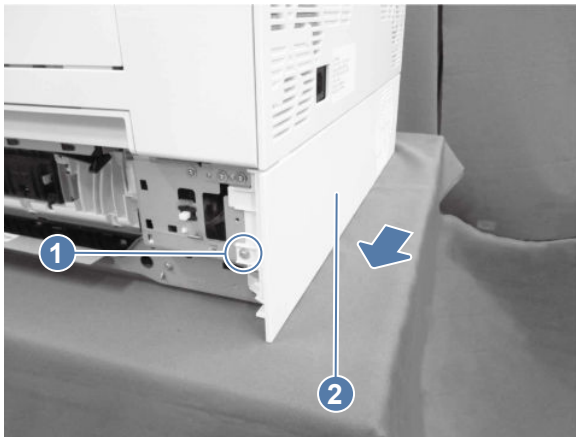


### 3. Remove the rear lower cover (X654/X677 models)

Follow these steps to remove the rear lower cover.

- Remove one screw (callout 1), slide the rear lower cover (callout 2) in the direction indicated below, and then remove it.

**Figure 5-672 Remove the rear lower cover**

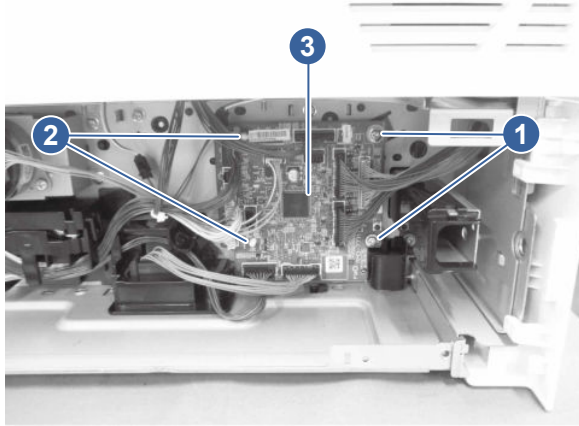


### 4. Remove the feed/toner supply controller PCA (X654/X677 models)

Follow these steps to remove the feed/toner supply controller PCA.

- Disconnect all the connectors on the feed/toner supply controller PCA. Remove two screws (callout 1), remove two PCA spacers (callout 2), and then remove the feed/toner supply controller PCA (callout 3).

**Figure 5-673 Remove the feed/toner supply controller PCA**



## 5. Unpack the replacement assembly

Follow these steps to unpack the replacement assembly.

1. Dispose of the defective part.




**NOTE:** HP recommends responsible disposal of the defective part.

<http://www8.hp.com/us/en/hp-information/environment/product-recycling.html>

2. Unpack the replacement part from the packaging.



**CAUTION:**  Some parts are sensitive to electrostatic discharge (ESD). Always perform service work at an ESD-protected workstation or mat. If an ESD workstation or mat is not available, touch the sheet-metal chassis to provide a static ground before touching an ESD-sensitive assembly. Protect the ESD-sensitive assemblies by placing them in ESD pouches when they are out of the printer.



**IMPORTANT:** Make sure that all of the shipping materials (for example shipping tape) are removed from the replacement part prior to installation.



**NOTE:** If the replacement part is a roller or pad, avoid touching the spongy part of it. Skin oils on the roller or pad can cause paper pickup and/or print-quality problems. HP recommends using disposable gloves when handling rollers or pads or washing your hands before touching rollers or pads.

3. To install an assembly, reverse the removal steps.



**NOTE:** When applicable, special installation instructions are provided for an assembly at the end of the removal procedure. Always completely read the removal instructions and follow all special installation instructions.

## Removal and replacement: Right PCA

Learn about removing and replacing the right PCA.

### Before performing service

Turn the printer power off



- Disconnect the power cable.

**⚠ WARNING!** To avoid damage to the printer, turn the printer off, wait 30 seconds, and then remove the power cord before attempting to service the printer.

If the part is damaged and cannot be cleaned, use the table below to identify the correct part number for your printer. To order the part, go to [www.hp.com/buy/parts](http://www.hp.com/buy/parts).

**Table 5-86 Part information**

Part number	Part description
RM3-7740-000CN	Right PCA (5700)
RM3-7790-000CN	Right PCA (X557/5800)
RM3-7791-000CN	Right PCA (X57945)
RM3-7792-000CN	Right PCA (6700)
RM3-7793-000CN	Right PCA (6800)
RM3-7794-000CN	Right PCA (X654/X677)

## Required tools

- #2 Phillips screwdriver with a magnetic tip and a 152 mm (6 in) shaft length

## After performing service

### Turn the printer power on

- Connect the power cable.
- Use the power switch to turn the power on.

## Post service test

Print any pages necessary to make sure the printer is functioning correctly.

### 1. Remove the right PCA

Follow these steps to remove the right PCA.

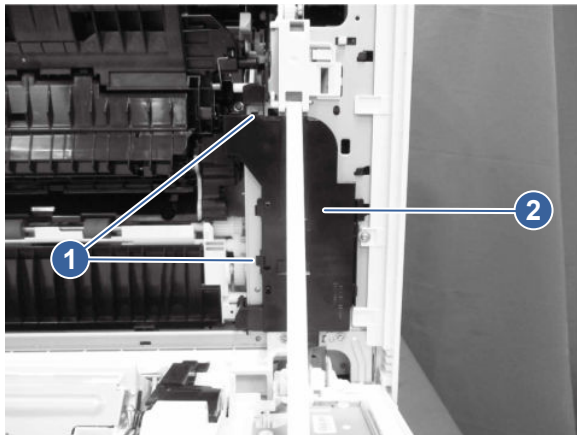
1. Open the right door.

**Figure 5-674** Open the right door



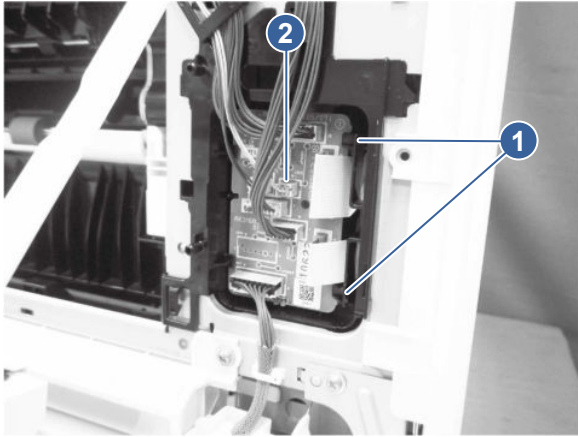
2. Release two tabs (callout 1), and then remove the PCA cover (callout 2).

**Figure 5-675** Remove the PCA cover



3. Disconnect all the connectors on the right PCA, release two tabs (callout 1), and then remove the right PCA (callout 2).

**Figure 5-676 Remove the right PCA**



---

**CAUTION:** The FFCs are tightly packed and can be difficult to remove. A solution is to remove the FFCs from the rear of the unit, remove the PCA, and then remove the FFCs to reinstall them on the back. This option should be used *only* if needed and to ensure that the FFCs are not damaged.

---

## 2. Unpack the replacement assembly

Follow these steps to unpack the replacement assembly.

1. Dispose of the defective part.

---


**NOTE:** HP recommends responsible disposal of the defective part.


<http://www8.hp.com/us/en/hp-information/environment/product-recycling.html>


---

2. Unpack the replacement part from the packaging.

---

**CAUTION:**  Some parts are sensitive to electrostatic discharge (ESD). Always perform service work at an ESD-protected workstation or mat. If an ESD workstation or mat is not available, touch the sheet-metal chassis to provide a static ground before touching an ESD-sensitive assembly. Protect the ESD-sensitive assemblies by placing them in ESD pouches when they are out of the printer.


**IMPORTANT:**  Make sure that all of the shipping materials (for example shipping tape) are removed from the replacement part prior to installation.

**NOTE:**  If the replacement part is a roller or pad, avoid touching the spongy part of it. Skin oils on the roller or pad can cause paper pickup and/or print-quality problems. HP recommends using disposable gloves when handling rollers or pads or washing your hands before touching rollers or pads.

---

3. To install an assembly, reverse the removal steps.

---

**NOTE:**  When applicable, special installation instructions are provided for an assembly at the end of the removal procedure. Always completely read the removal instructions and follow all special installation instructions.

---

## Removal and replacement: Rear PCA

Learn about removing and replacing the rear PCA.



[View a video demonstration of removing and replacing the rear PCA.](#)

## Before performing service

### Turn the printer power off

- Disconnect the power cable.

**⚠ WARNING!** To avoid damage to the printer, turn the printer off, wait 30 seconds, and then remove the power cord before attempting to service the printer.

If the part is damaged and cannot be cleaned, use the table below to identify the correct part number for your printer. To order the part, go to [www.hp.com/buy/parts](http://www.hp.com/buy/parts).

**Table 5-87** Part information

Part number	Part description
RM3-9044-000CN	Rear PCA (5700/5800)
RM3-9045-000CN	Rear PCA (X557/6700/6800)
RM3-9046-000CN	Rear PCA (X57945/X654/X677)

## Required tools

- #2 Phillips screwdriver with a magnetic tip and a 152 mm (6 in) shaft length

## After performing service

### Turn the printer power on

- Connect the power cable.
- Use the power switch to turn the power on.

## Post service test

Print any pages necessary to make sure the printer is functioning correctly.

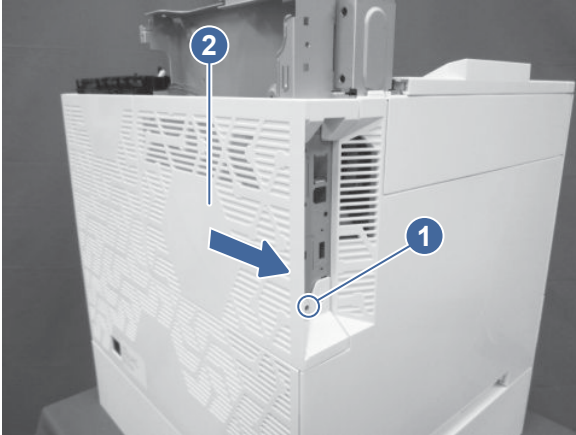
### 1. Remove the formatter cover

Follow these steps to remove the formatter cover.

- Remove one screw (callout 1), and then slide the formatter cover (callout 2) away from the printer to remove it.

**💡 TIP:** Reverse the removal steps to install the assembly.

**Figure 5-677 Remove the formatter cover**



## 2. Remove the rear cover

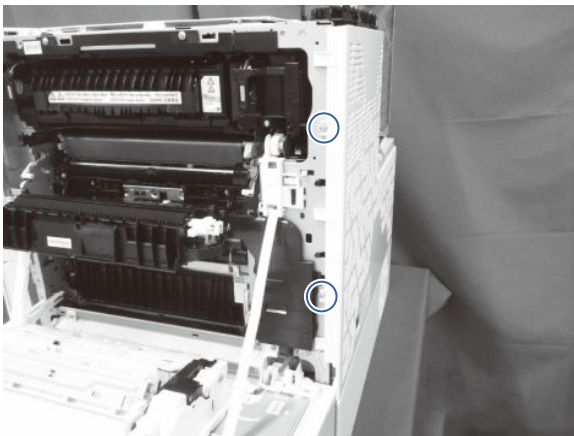
Follow these steps to remove the rear cover.



**NOTE:** The figures below show some assemblies (for example the top cover and formatter) removed that might still be installed on the printer. However, the steps to remove the cover are correct.

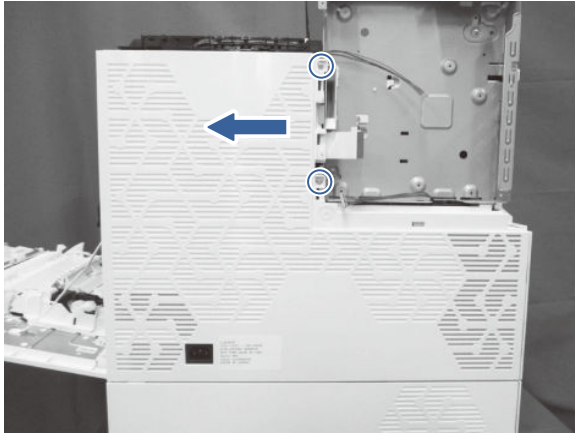
1. Open the right door, and remove two screws.

**Figure 5-678 Remove two screws**



2. At the back of the printer, remove two screws, and then slide the rear cover as indicated to remove it.

**Figure 5-679 Remove the rear cover**




### 3. Remove the low-voltage power supply (LVPS)

Follow these steps to remove the low-voltage power supply (LVPS).

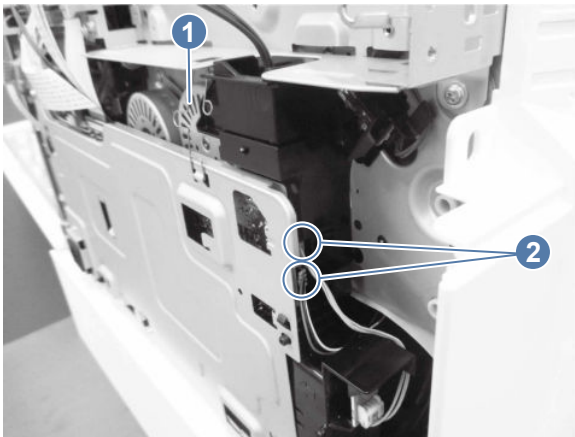
1. Unhook one spring (callout 1), and then disconnect two connectors (callout 2).

---

 **NOTE:** Unhook the spring from the formatter cage, not the low-voltage power supply. The spring should remain attached to the LVPS.


---

**Figure 5-680 Unhook the spring and disconnect two connectors**



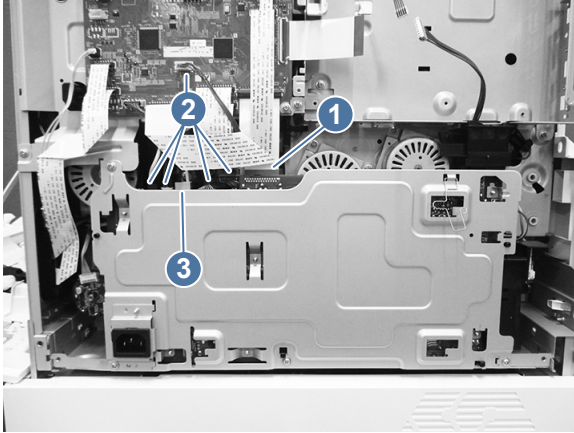
2. Remove the FFC (callout 1), and then disconnect five connectors (callout 2).

---

 **NOTE: MFP only:** Disconnect one additional connector (callout 3).

---

**Figure 5-681 Disconnect the LVPS connectors**

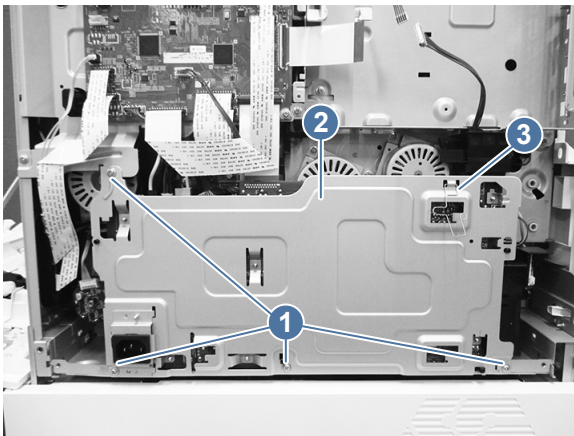



3. Remove four screws (callout 1), and then remove the low-voltage power supply assembly (callout 2).

 **NOTE:** The black ducting in the lower right corner can stick during the removal process.

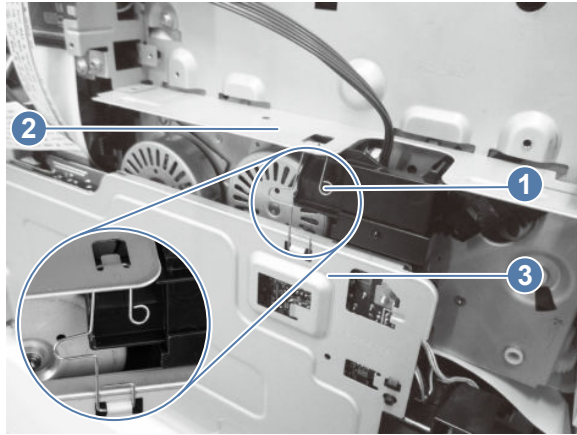
**Replacement LVPS only:** Remove the spring (callout 3), and then install it on the replacement LVPS.

**Figure 5-682 Remove the LVPS**



 **Reinstallation tip:** When reinstalling the LVPS, make sure that the spring (callout 1) is attached to both the formatter cage (callout 2) and the LVPS (callout 3).


**Figure 5-683 Reinstalling the LVPS**



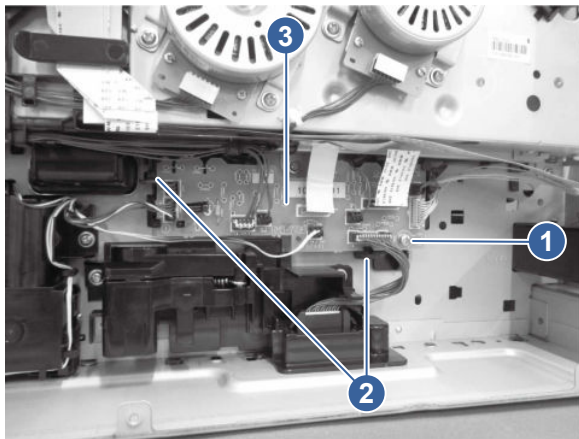
#### 4. Remove the rear PCA


Follow these steps to remove the rear PCA.

- Disconnect all the connectors on the rear PCA, remove one screw (callout 1), release two tabs (callout 2), and then remove the rear PCA (callout 3).

 **NOTE:** Grounding wires are mounted on the top of this PCA. Use care when removing it. Pull the bottom part out first, and then slide the assembly down to cleanly release from the spring wires at the top.

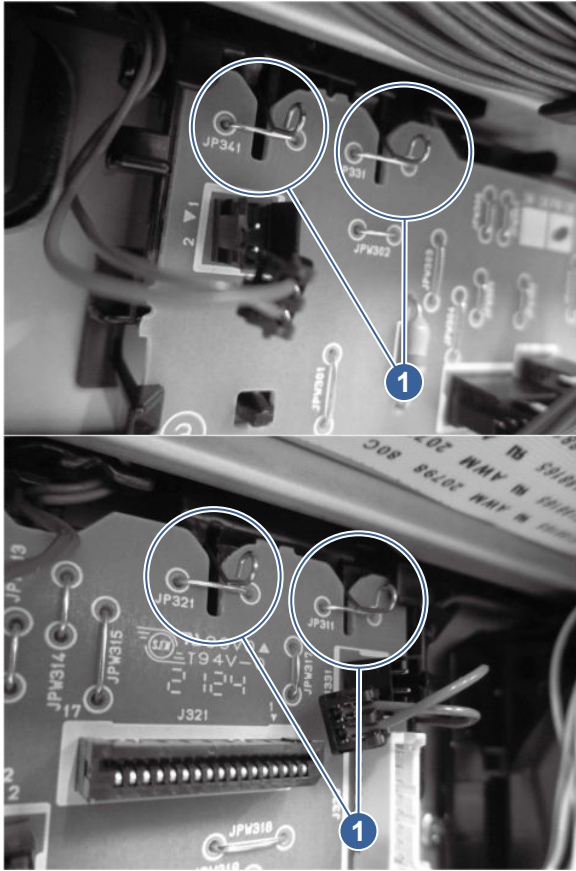
**Figure 5-684 Remove the rear PCA**



 **Reinstallation tip:** When installing the rear PCA, confirm that each contact spring (callout 1) is in the correct position (so that the PCA engages with the springs).



**Figure 5-685** Correct spring position



## 5. Unpack the replacement assembly



Follow these steps to unpack the replacement assembly.


1. Dispose of the defective part.


 **NOTE:** HP recommends responsible disposal of the defective part.

<http://www8.hp.com/us/en/hp-information/environment/product-recycling.html>

2. Unpack the replacement part from the packaging.


 **CAUTION:**  Some parts are sensitive to electrostatic discharge (ESD). Always perform service work at an ESD-protected workstation or mat. If an ESD workstation or mat is not available, touch the sheet-metal chassis to provide a static ground before touching an ESD-sensitive assembly. Protect the ESD-sensitive assemblies by placing them in ESD pouches when they are out of the printer.

 **IMPORTANT:** Make sure that all of the shipping materials (for example shipping tape) are removed from the replacement part prior to installation.

 **NOTE:** If the replacement part is a roller or pad, avoid touching the spongy part of it. Skin oils on the roller or pad can cause paper pickup and/or print-quality problems. HP recommends using disposable gloves when handling rollers or pads or washing your hands before touching rollers or pads.

3. To install an assembly, reverse the removal steps.

---

 **NOTE:** When applicable, special installation instructions are provided for an assembly at the end of the removal procedure. Always completely read the removal instructions and follow all special installation instructions.

---

## Removal and replacement: Environmental sensor PCA


Learn about removing and replacing the environmental sensor PCA.

### Before performing service

#### Turn the printer power off

- Disconnect the power cable.

---

 **WARNING!** To avoid damage to the printer, turn the printer off, wait 30 seconds, and then remove the power cord before attempting to service the printer.

---

If the part is damaged and cannot be cleaned, use the table below to identify the correct part number for your printer. To order the part, go to [www.hp.com/buy/parts](http://www.hp.com/buy/parts).

**Table 5-88** Part information

Part number	Part description
WP2-5473-000CN	Sensor, humidity HSU-08FDB2A

### Required tools

- #2 Phillips screwdriver with a magnetic tip and a 152 mm (6 in) shaft length

### After performing service

#### Turn the printer power on

- Connect the power cable.
- Use the power switch to turn the power on.

### Post service test


Print any pages necessary to make sure the printer is functioning correctly.

## 1. Remove the formatter cover

Follow these steps to remove the formatter cover.

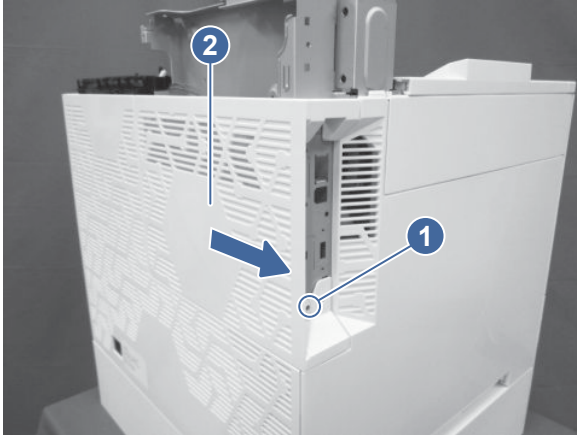
- Remove one screw (callout 1), and then slide the formatter cover (callout 2) away from the printer to remove it.

---

 **TIP:** Reverse the removal steps to install the assembly.

---


**Figure 5-686 Remove the formatter cover**



## 2. Remove the rear cover

Follow these steps to remove the rear cover.

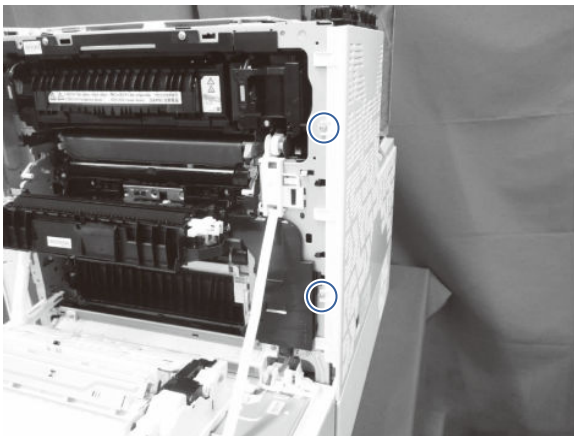
---

 **NOTE:** The figures below show some assemblies (for example the top cover and formatter) removed that might still be installed on the printer. However, the steps to remove the cover are correct.

---

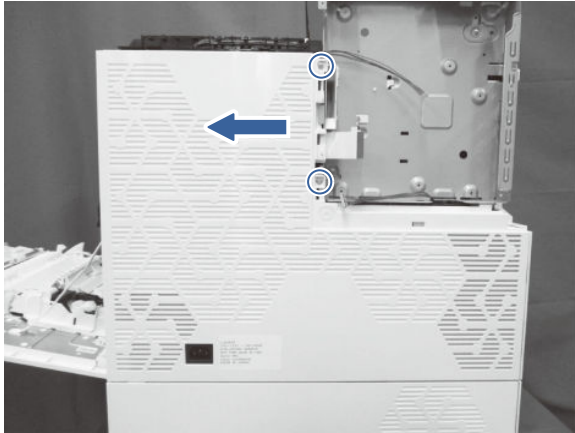
1. Open the right door, and remove two screws.

**Figure 5-687 Remove two screws**



2. At the back of the printer, remove two screws, and then slide the rear cover as indicated to remove it.

**Figure 5-688 Remove the rear cover**

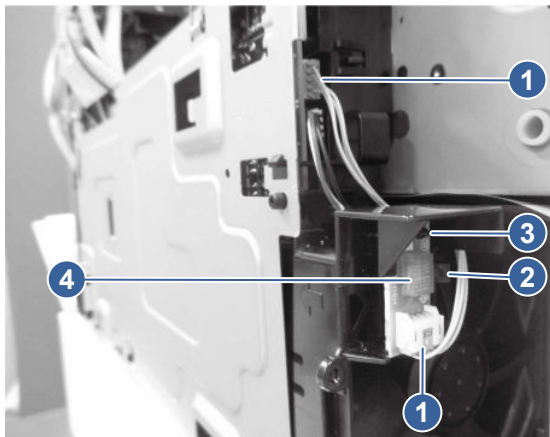


### 3. Remove the environmental sensor PCA

Follow these steps to remove the environmental sensor PCA.

- Disconnect one connector (callout 1), release one tab (callout 2), release one boss (callout 3), and then remove the environmental sensor PCA (callout 4).

**Figure 5-689 Remove the environmental sensor PCA**



### 4. Unpack the replacement assembly

Follow these steps to unpack the replacement assembly.

1. Dispose of the defective part.






**NOTE:** HP recommends responsible disposal of the defective part.


<http://www8.hp.com/us/en/hp-information/environment/product-recycling.html>

2. Unpack the replacement part from the packaging.

---


 **CAUTION:**  Some parts are sensitive to electrostatic discharge (ESD). Always perform service work at an ESD-protected workstation or mat. If an ESD workstation or mat is not available, touch the sheet-metal chassis to provide a static ground before touching an ESD-sensitive assembly. Protect the ESD-sensitive assemblies by placing them in ESD pouches when they are out of the printer.

 **IMPORTANT:** Make sure that all of the shipping materials (for example shipping tape) are removed from the replacement part prior to installation.

 **NOTE:** If the replacement part is a roller or pad, avoid touching the spongy part of it. Skin oils on the roller or pad can cause paper pickup and/or print-quality problems. HP recommends using disposable gloves when handling rollers or pads or washing your hands before touching rollers or pads.

---

3. To install an assembly, reverse the removal steps.

 **NOTE:** When applicable, special installation instructions are provided for an assembly at the end of the removal procedure. Always completely read the removal instructions and follow all special installation instructions.

---

### Removal and replacement: Drum home position PCA


Learn about removing and replacing the drum home position sensor PCA.

#### Before performing service

##### Turn the printer power off

- Disconnect the power cable.

---

 **WARNING!** To avoid damage to the printer, turn the printer off, wait 30 seconds, and then remove the power cord before attempting to service the printer.

---

If the part is damaged and cannot be cleaned, use the table below to identify the correct part number for your printer. To order the part, go to [www.hp.com/buy/parts](http://www.hp.com/buy/parts).

**Table 5-89** Part information

Part number	Part description
RM3-7647-000CN	Drum position sensor PCA

#### Required tools

- #2 Phillips screwdriver with a magnetic tip and a 152 mm (6 in) shaft length

#### After performing service

##### Turn the printer power on

- Connect the power cable.
- Use the power switch to turn the power on.

#### Post service test


Print any pages necessary to make sure the printer is functioning correctly.

## 1. Remove the formatter cover

Follow these steps to remove the formatter cover.

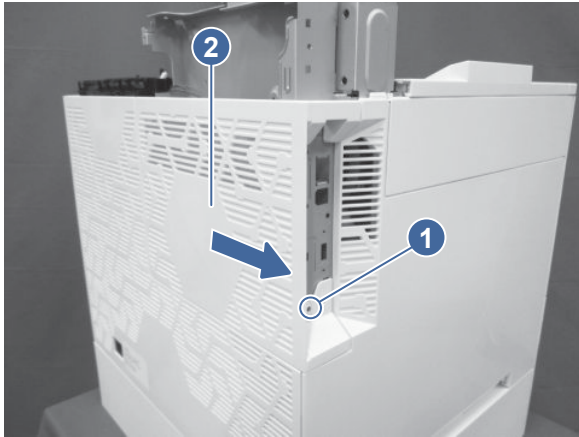
- Remove one screw (callout 1), and then slide the formatter cover (callout 2) away from the printer to remove it.

---

 **TIP:** Reverse the removal steps to install the assembly.

---


**Figure 5-690 Remove the formatter cover**



## 2. Remove the rear cover

Follow these steps to remove the rear cover.

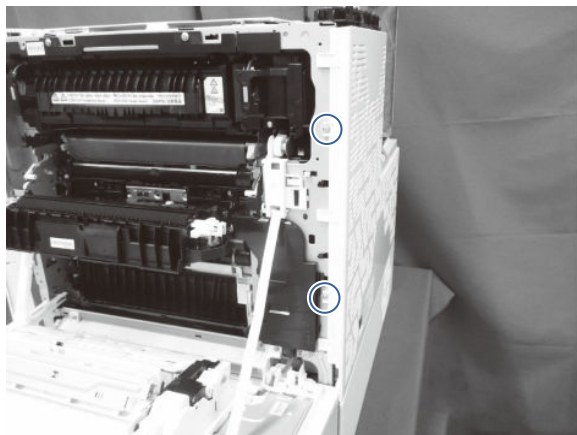
---

 **NOTE:** The figures below show some assemblies (for example the top cover and formatter) removed that might still be installed on the printer. However, the steps to remove the cover are correct.

---

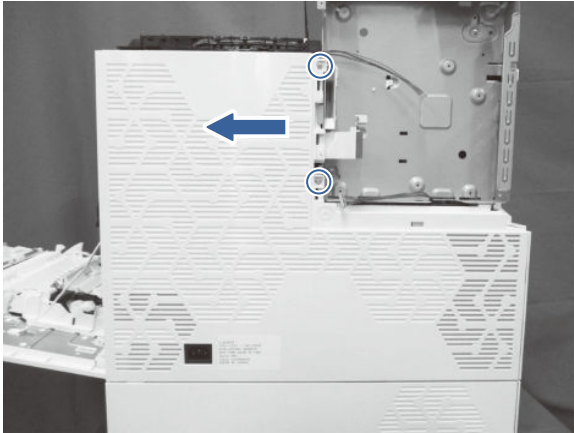
1. Open the right door, and remove two screws.

**Figure 5-691 Remove two screws**



2. At the back of the printer, remove two screws, and then slide the rear cover as indicated to remove it.

**Figure 5-692 Remove the rear cover**




### 3. Remove the low-voltage power supply (LVPS)

Follow these steps to remove the low-voltage power supply (LVPS).

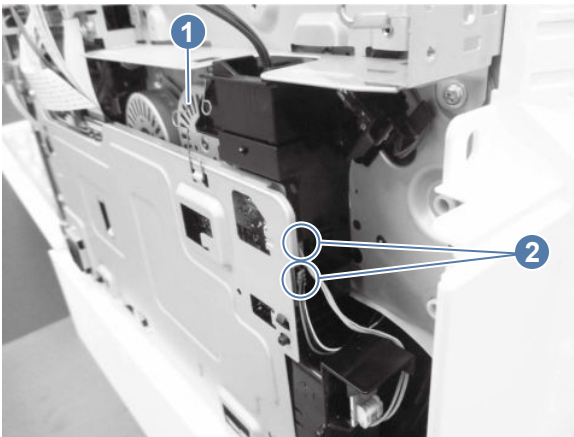
1. Unhook one spring (callout 1), and then disconnect two connectors (callout 2).

---

 **NOTE:** Unhook the spring from the formatter cage, not the low-voltage power supply. The spring should remain attached to the LVPS.


---

**Figure 5-693 Unhook the spring and disconnect two connectors**



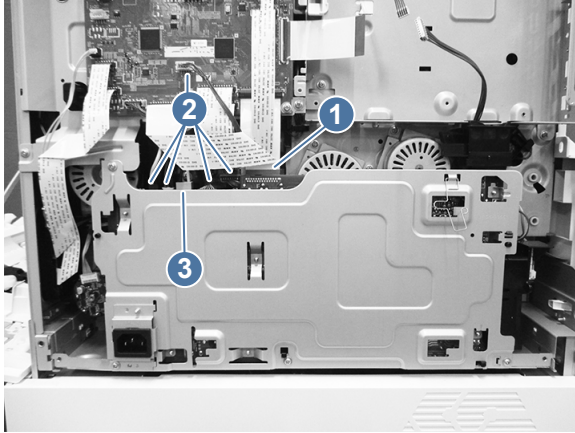
2. Remove the FFC (callout 1), and then disconnect five connectors (callout 2).

---


 **NOTE:** **MFP only:** Disconnect one additional connector (callout 3).

---

**Figure 5-694 Disconnect the LVPS connectors**

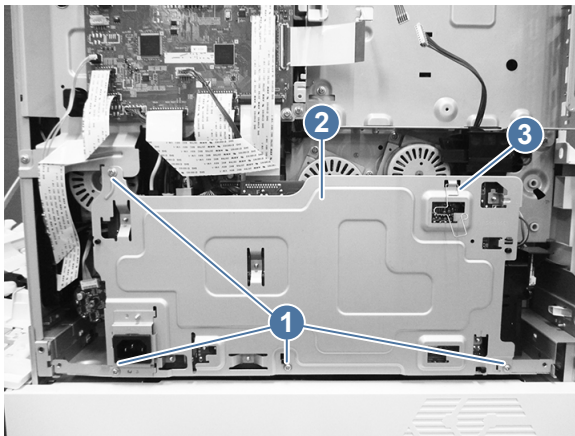



3. Remove four screws (callout 1), and then remove the low-voltage power supply assembly (callout 2).

 **NOTE:** The black ducting in the lower right corner can stick during the removal process.

**Replacement LVPS only:** Remove the spring (callout 3), and then install it on the replacement LVPS.

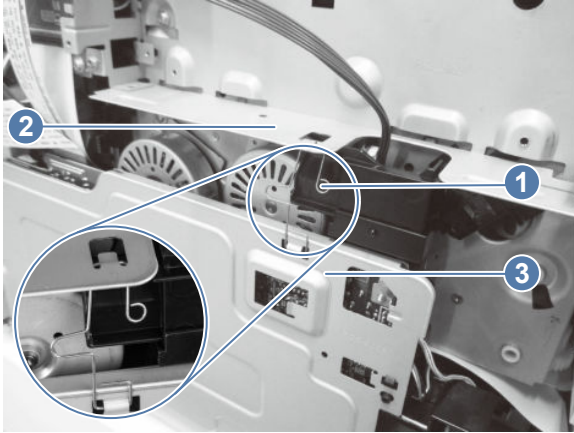
**Figure 5-695 Remove the LVPS**



 **Reinstallation tip:** When reinstalling the LVPS, make sure that the spring (callout 1) is attached to both the formatter cage (callout 2) and the LVPS (callout 3).



**Figure 5-696 Reinstalling the LVPS**

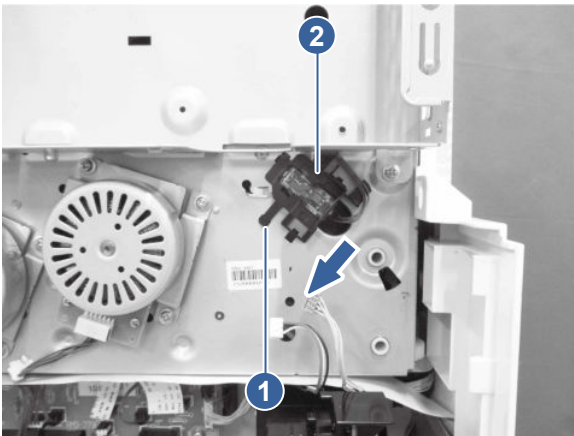


#### 4. Remove the drum home position sensor PCA

Follow these steps to remove the drum home position sensor PCA.

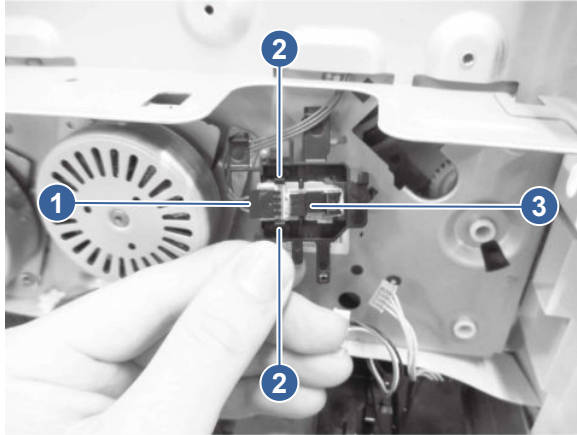
1. Release one tab (callout 1), and then slide the PCA holder (callout 2) in the direction indicated to remove it.

**Figure 5-697 Remove the PCA holder**



2. Disconnect one connector (callout 1), release two tabs (callout 2), and then remove the drum home position sensor PCA (callout 3).

**Figure 5-698 Remove the drum home position sensor PCA**



## 5. Unpack the replacement assembly

Follow these steps to unpack the replacement assembly.

1. Dispose of the defective part.




**NOTE:** HP recommends responsible disposal of the defective part.

<http://www8.hp.com/us/en/hp-information/environment/product-recycling.html>

2. Unpack the replacement part from the packaging.



**CAUTION:**  Some parts are sensitive to electrostatic discharge (ESD). Always perform service work at an ESD-protected workstation or mat. If an ESD workstation or mat is not available, touch the sheet-metal chassis to provide a static ground before touching an ESD-sensitive assembly. Protect the ESD-sensitive assemblies by placing them in ESD pouches when they are out of the printer.



**IMPORTANT:** Make sure that all of the shipping materials (for example shipping tape) are removed from the replacement part prior to installation.



**NOTE:** If the replacement part is a roller or pad, avoid touching the spongy part of it. Skin oils on the roller or pad can cause paper pickup and/or print-quality problems. HP recommends using disposable gloves when handling rollers or pads or washing your hands before touching rollers or pads.

3. To install an assembly, reverse the removal steps.



**NOTE:** When applicable, special installation instructions are provided for an assembly at the end of the removal procedure. Always completely read the removal instructions and follow all special installation instructions.

## Removal and replacement: Drum motor

Learn about removing and replacing the drum motor.

### Before performing service

Turn the printer power off

- Disconnect the power cable.

---

**⚠ WARNING!** To avoid damage to the printer, turn the printer off, wait 30 seconds, and then remove the power cord before attempting to service the printer.

---

If the part is damaged and cannot be cleaned, use the table below to identify the correct part number for your printer. To order the part, go to [www.hp.com/buy/parts](http://www.hp.com/buy/parts).

**Table 5-90** Part information

Part number	Part description
RM3-7788-000CN	Drum motor assembly

## Required tools

- #2 Phillips screwdriver with a magnetic tip and a 152 mm (6 in) shaft length

## After performing service

### Turn the printer power on

- Connect the power cable.
- Use the power switch to turn the power on.

## Post service test

Print any pages necessary to make sure the printer is functioning correctly.

### 1. Remove the formatter cover

Follow these steps to remove the formatter cover.

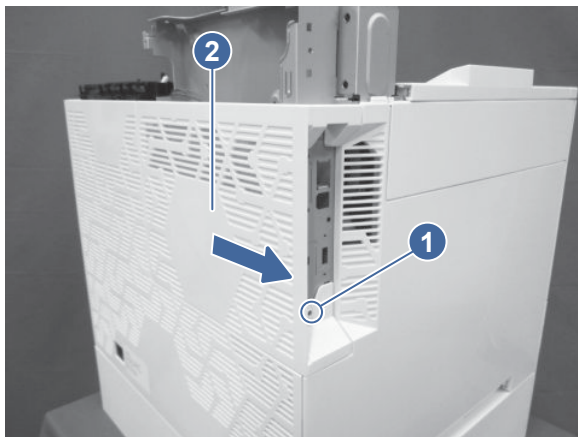
- Remove one screw (callout 1), and then slide the formatter cover (callout 2) away from the printer to remove it.

---

**💡 TIP:** Reverse the removal steps to install the assembly.


---

**Figure 5-699** Remove the formatter cover



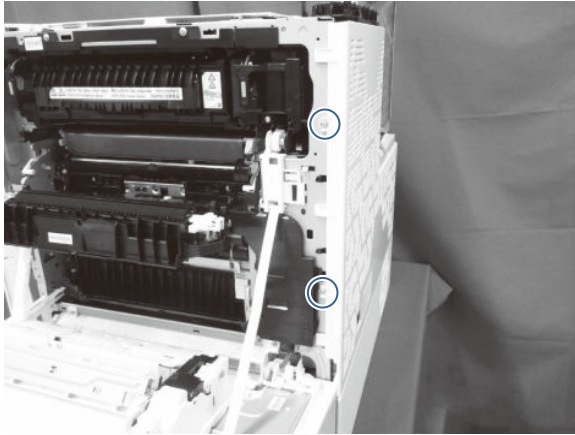
## 2. Remove the rear cover

Follow these steps to remove the rear cover.

 **NOTE:** The figures below show some assemblies (for example the top cover and formatter) removed that might still be installed on the printer. However, the steps to remove the cover are correct.

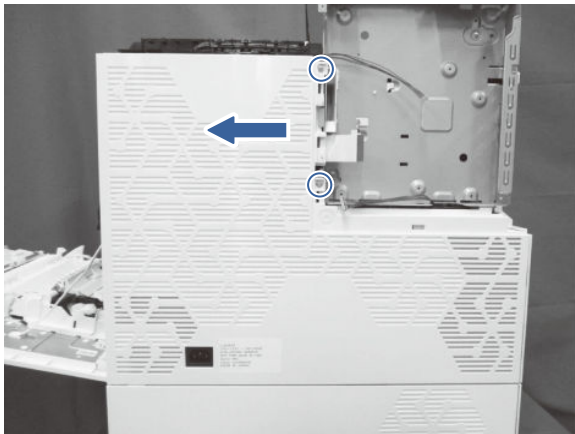
1. Open the right door, and remove two screws.

**Figure 5-700 Remove two screws**



2. At the back of the printer, remove two screws, and then slide the rear cover as indicated to remove it.


**Figure 5-701 Remove the rear cover**



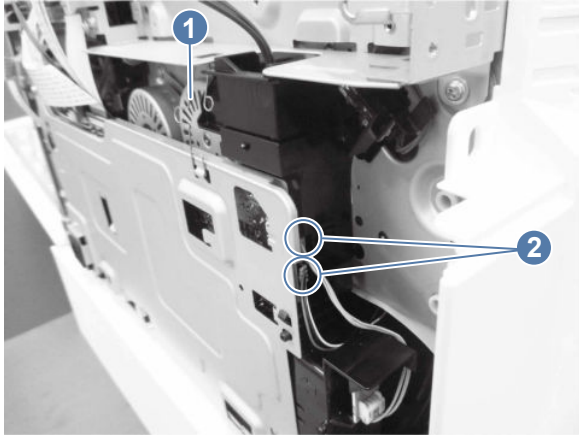
## 3. Remove the low-voltage power supply (LVPS)

Follow these steps to remove the low-voltage power supply (LVPS).


1. Unhook one spring (callout 1), and then disconnect two connectors (callout 2).

 **NOTE:** Unhook the spring from the formatter cage, not the low-voltage power supply. The spring should remain attached to the LVPS.

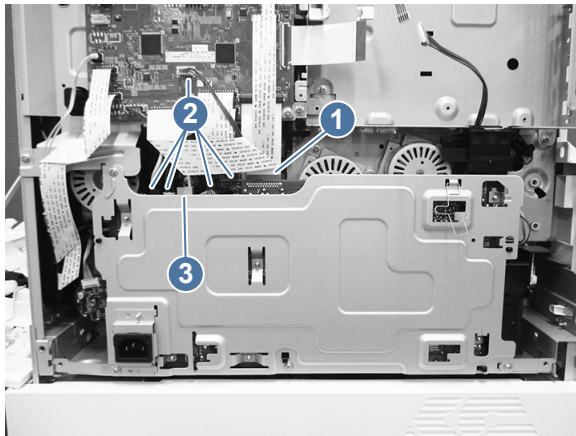
**Figure 5-702 Unhook the spring and disconnect two connectors**



2. Remove the FFC (callout 1), and then disconnect five connectors (callout 2).

 **NOTE:** MFP only: Disconnect one additional connector (callout 3).

**Figure 5-703 Disconnect the LVPS connectors**

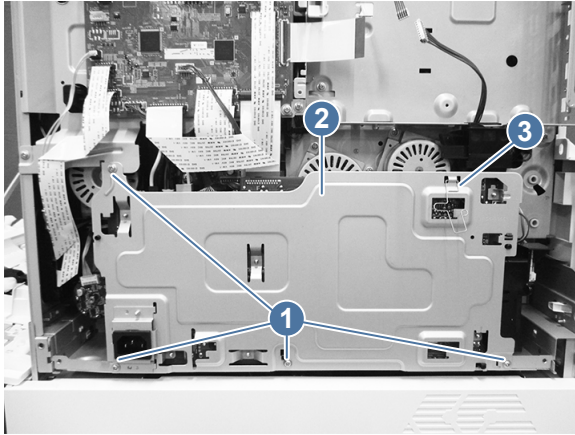



3. Remove four screws (callout 1), and then remove the low-voltage power supply assembly (callout 2).

 **NOTE:** The black ducting in the lower right corner can stick during the removal process.

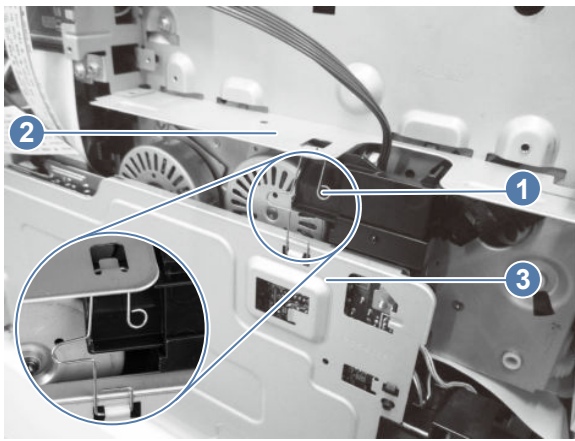
**Replacement LVPS only:** Remove the spring (callout 3), and then install it on the replacement LVPS.

**Figure 5-704 Remove the LVPS**



 **Reinstallation tip:** When reinstalling the LVPS, make sure that the spring (callout 1) is attached to both the formatter cage (callout 2) and the LVPS (callout 3).

**Figure 5-705 Reinstalling the LVPS**

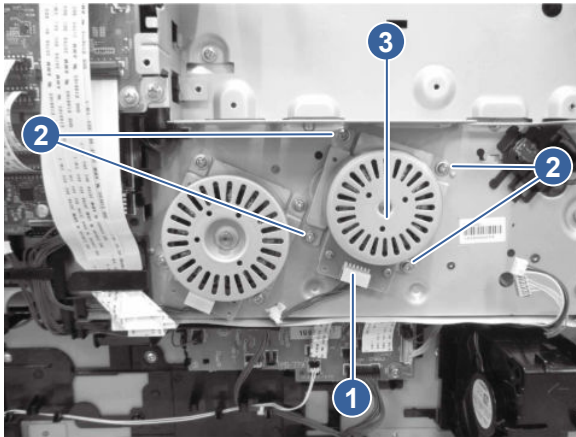


#### 4. Remove the drum motor

Follow these steps to remove the drum motor.

- Disconnect one connector (callout 1), remove four screws (callout 2), and then remove the drum motor (callout 3).

**Figure 5-706 Remove the motor**



## 5. Unpack the replacement assembly

Follow these steps to unpack the replacement assembly.

1. Dispose of the defective part.

---



 **NOTE:** HP recommends responsible disposal of the defective part.


<http://www8.hp.com/us/en/hp-information/environment/product-recycling.html>


---

2. Unpack the replacement part from the packaging.

---

 **CAUTION:**  Some parts are sensitive to electrostatic discharge (ESD). Always perform service work at an ESD-protected workstation or mat. If an ESD workstation or mat is not available, touch the sheet-metal chassis to provide a static ground before touching an ESD-sensitive assembly. Protect the ESD-sensitive assemblies by placing them in ESD pouches when they are out of the printer.


 **IMPORTANT:** Make sure that all of the shipping materials (for example shipping tape) are removed from the replacement part prior to installation.

 **NOTE:** If the replacement part is a roller or pad, avoid touching the spongy part of it. Skin oils on the roller or pad can cause paper pickup and/or print-quality problems. HP recommends using disposable gloves when handling rollers or pads or washing your hands before touching rollers or pads.

---

3. To install an assembly, reverse the removal steps.

---

 **NOTE:** When applicable, special installation instructions are provided for an assembly at the end of the removal procedure. Always completely read the removal instructions and follow all special installation instructions.

---

## Removal and replacement: Developer motor

Learn about removing and replacing the developer motor.

### Before performing service

**Turn the printer power off**

- Disconnect the power cable.

---

**⚠ WARNING!** To avoid damage to the printer, turn the printer off, wait 30 seconds, and then remove the power cord before attempting to service the printer.

---

If the part is damaged and cannot be cleaned, use the table below to identify the correct part number for your printer. To order the part, go to [www.hp.com/buy/parts](http://www.hp.com/buy/parts).

**Table 5-91 Part information**

Part number	Part description
RM2-3625-000CN	Developing motor assembly

## Required tools

- #2 Phillips screwdriver with a magnetic tip and a 152 mm (6 in) shaft length

## After performing service

### Turn the printer power on

- Connect the power cable.
- Use the power switch to turn the power on.

## Post service test

Print any pages necessary to make sure the printer is functioning correctly.

### 1. Remove the formatter cover

Follow these steps to remove the formatter cover.

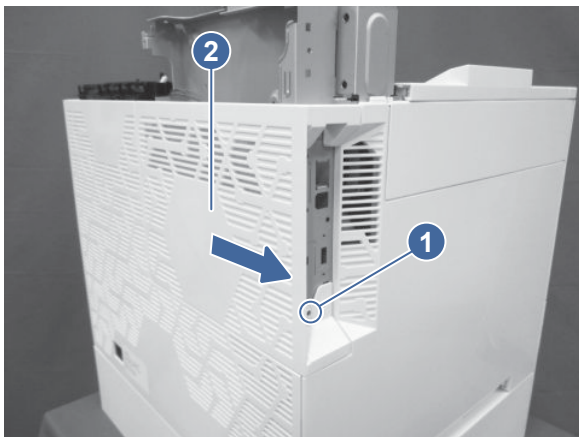
- Remove one screw (callout 1), and then slide the formatter cover (callout 2) away from the printer to remove it.

---

**💡 TIP:** Reverse the removal steps to install the assembly.

---


**Figure 5-707 Remove the formatter cover**





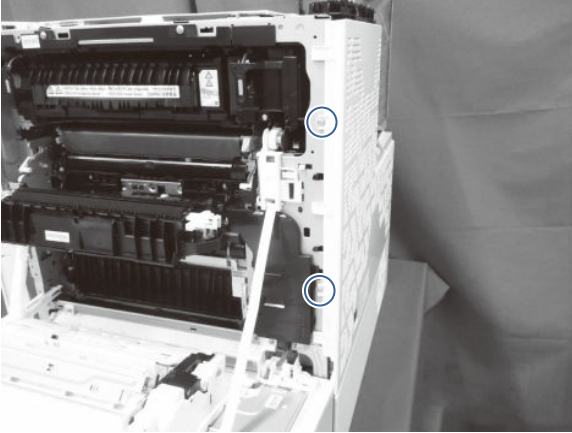
## 2. Remove the rear cover

Follow these steps to remove the rear cover.

 **NOTE:** The figures below show some assemblies (for example the top cover and formatter) removed that might still be installed on the printer. However, the steps to remove the cover are correct.

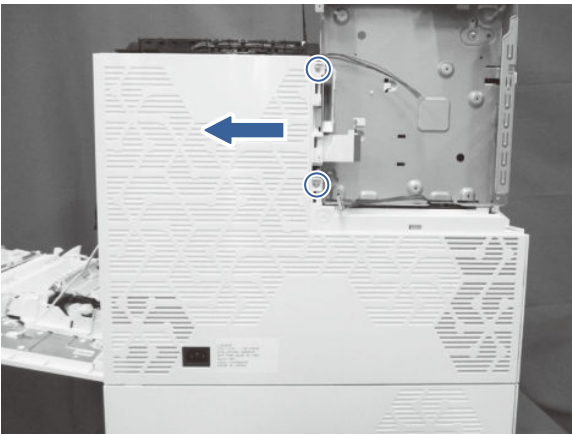
1. Open the right door, and remove two screws.

**Figure 5-708 Remove two screws**



2. At the back of the printer, remove two screws, and then slide the rear cover as indicated to remove it.


**Figure 5-709 Remove the rear cover**



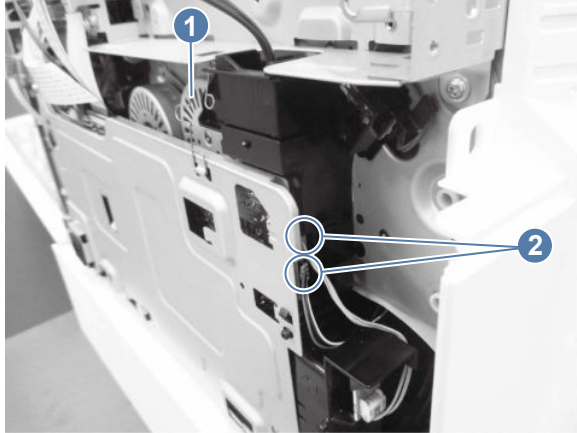
## 3. Remove the low-voltage power supply (LVPS)

Follow these steps to remove the low-voltage power supply (LVPS).

1. Unhook one spring (callout 1), and then disconnect two connectors (callout 2).


 **NOTE:** Unhook the spring from the formatter cage, not the low-voltage power supply. The spring should remain attached to the LVPS.

**Figure 5-710 Unhook the spring and disconnect two connectors**



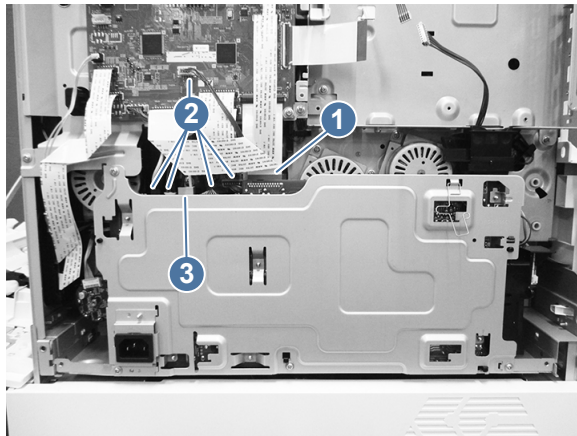
2. Remove the FFC (callout 1), and then disconnect five connectors (callout 2).

---

 **NOTE:** MFP only: Disconnect one additional connector (callout 3).

---

**Figure 5-711 Disconnect the LVPS connectors**



3. Remove four screws (callout 1), and then remove the low-voltage power supply assembly (callout 2).

---

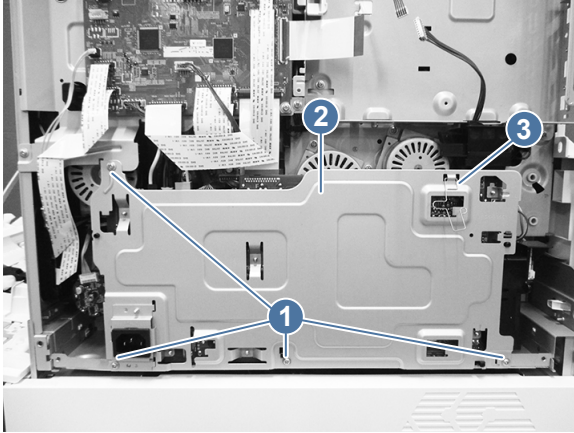
 **NOTE:** The black ducting in the lower right corner can stick during the removal process.


---

**Replacement LVPS only:** Remove the spring (callout 3), and then install it on the replacement LVPS.

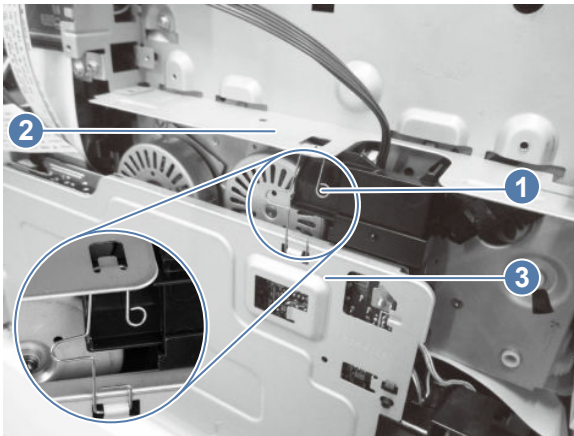
---

**Figure 5-712 Remove the LVPS**



 **Reinstallation tip:** When reinstalling the LVPS, make sure that the spring (callout 1) is attached to both the formatter cage (callout 2) and the LVPS (callout 3).

**Figure 5-713 Reinstalling the LVPS**

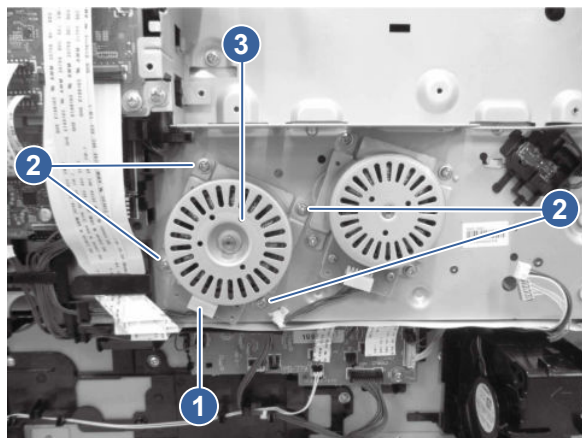


#### 4. Remove the developer motor

Follow these steps to remove the developer motor.

- Disconnect one connector (callout 1), remove four screws (callout 2), and then remove the motor (callout 3).

**Figure 5-714 Remove the motor**



## 5. Unpack the replacement assembly



Follow these steps to unpack the replacement assembly.


1. Dispose of the defective part.


 **NOTE:** HP recommends responsible disposal of the defective part.

<http://www8.hp.com/us/en/hp-information/environment/product-recycling.html>


2. Unpack the replacement part from the packaging.

 **CAUTION:**  Some parts are sensitive to electrostatic discharge (ESD). Always perform service work at an ESD-protected workstation or mat. If an ESD workstation or mat is not available, touch the sheet-metal chassis to provide a static ground before touching an ESD-sensitive assembly. Protect the ESD-sensitive assemblies by placing them in ESD pouches when they are out of the printer.

 **IMPORTANT:** Make sure that all of the shipping materials (for example shipping tape) are removed from the replacement part prior to installation.

 **NOTE:** If the replacement part is a roller or pad, avoid touching the spongy part of it. Skin oils on the roller or pad can cause paper pickup and/or print-quality problems. HP recommends using disposable gloves when handling rollers or pads or washing your hands before touching rollers or pads.

3. To install an assembly, reverse the removal steps.

 **NOTE:** When applicable, special installation instructions are provided for an assembly at the end of the removal procedure. Always completely read the removal instructions and follow all special installation instructions.

## Removal and replacement: Image transfer belt (ITB) motor

Learn about removing and replacing the ITB motor.

### Before performing service

Turn the printer power off

- Disconnect the power cable.

---

**⚠ WARNING!** To avoid damage to the printer, turn the printer off, wait 30 seconds, and then remove the power cord before attempting to service the printer.

---

If the part is damaged and cannot be cleaned, use the table below to identify the correct part number for your printer. To order the part, go to [www.hp.com/buy/parts](http://www.hp.com/buy/parts).

**Table 5-92** Part information

Part number	Part description
RM3-7797-000CN	ITB motor assembly

## Required tools

- #2 Phillips screwdriver with a magnetic tip and a 152 mm (6 in) shaft length

## After performing service

### Turn the printer power on

- Connect the power cable.
- Use the power switch to turn the power on.

## Post service test

Print any pages necessary to make sure the printer is functioning correctly.

### 1. Remove the formatter cover

Follow these steps to remove the formatter cover.

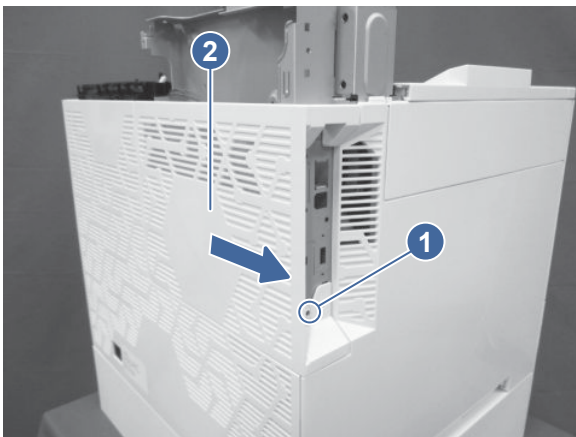
- Remove one screw (callout 1), and then slide the formatter cover (callout 2) away from the printer to remove it.

---

**💡 TIP:** Reverse the removal steps to install the assembly.


---

**Figure 5-715** Remove the formatter cover



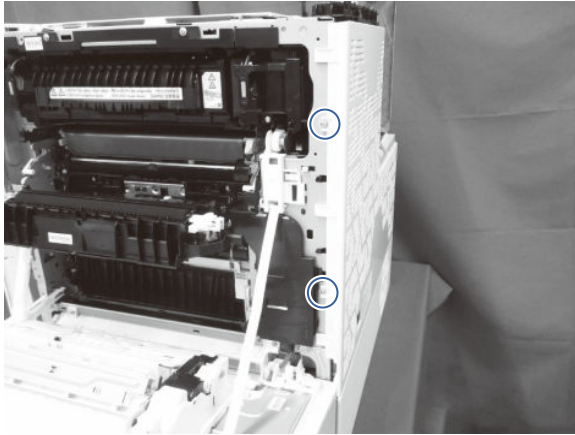
## 2. Remove the rear cover

Follow these steps to remove the rear cover.

 **NOTE:** The figures below show some assemblies (for example the top cover and formatter) removed that might still be installed on the printer. However, the steps to remove the cover are correct.

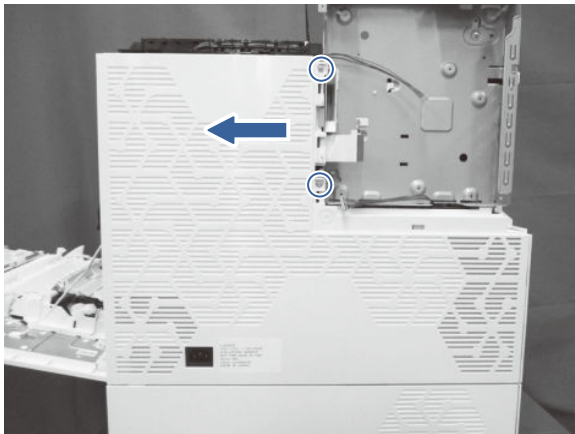
1. Open the right door, and remove two screws.

**Figure 5-716 Remove two screws**



2. At the back of the printer, remove two screws, and then slide the rear cover as indicated to remove it.


**Figure 5-717 Remove the rear cover**



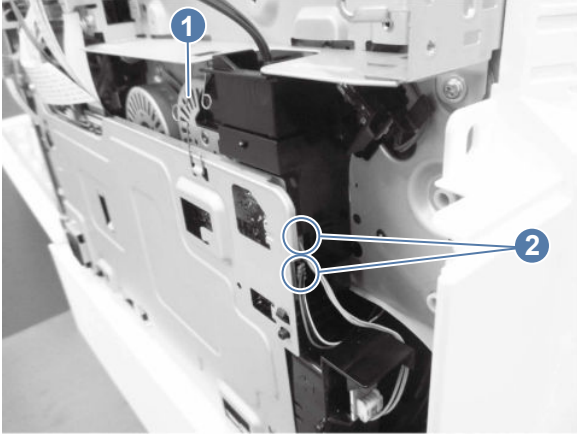
## 3. Remove the low-voltage power supply (LVPS)

Follow these steps to remove the low-voltage power supply (LVPS).

1. Unhook one spring (callout 1), and then disconnect two connectors (callout 2).


 **NOTE:** Unhook the spring from the formatter cage, not the low-voltage power supply. The spring should remain attached to the LVPS.

**Figure 5-718 Unhook the spring and disconnect two connectors**



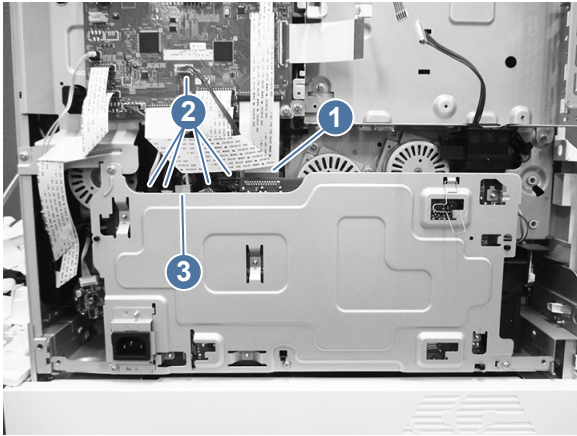
2. Remove the FFC (callout 1), and then disconnect five connectors (callout 2).

---

 **NOTE:** MFP only: Disconnect one additional connector (callout 3).

---

**Figure 5-719 Disconnect the LVPS connectors**



3. Remove four screws (callout 1), and then remove the low-voltage power supply assembly (callout 2).

---

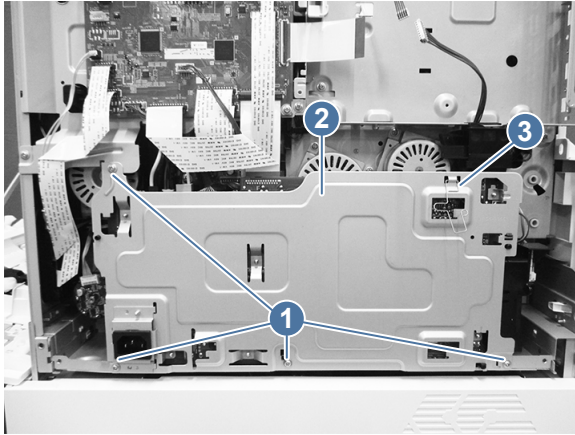
 **NOTE:** The black ducting in the lower right corner can stick during the removal process.


---

**Replacement LVPS only:** Remove the spring (callout 3), and then install it on the replacement LVPS.

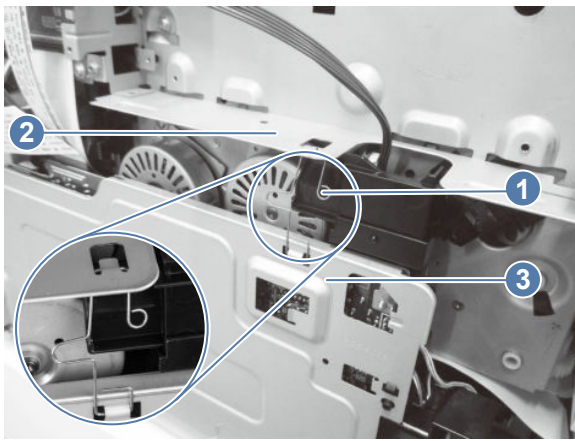
---

**Figure 5-720 Remove the LVPS**



 **Reinstallation tip:** When reinstalling the LVPS, make sure that the spring (callout 1) is attached to both the formatter cage (callout 2) and the LVPS (callout 3).

**Figure 5-721 Reinstalling the LVPS**



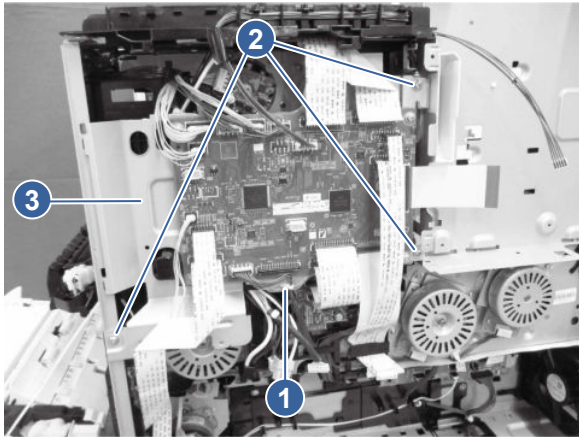
#### 4. Remove the image transfer belt (ITB) motor

Follow these steps to remove the image transfer belt (ITB) motor.



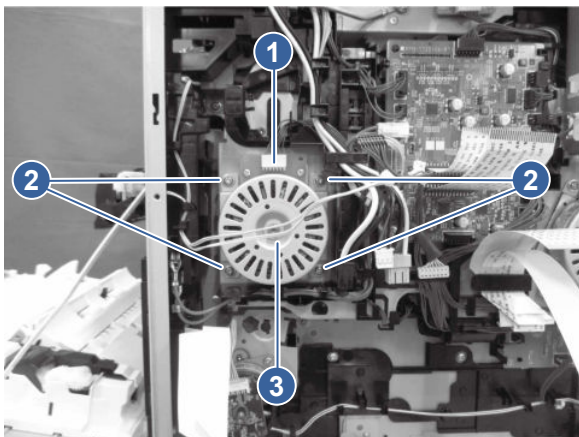
1. Disconnect all the connectors on the DC controller PCA, remove the cable clamp (callout 1), remove three screws (callout 2), slide the DC controller stay (callout 3) out to remove it.

**Figure 5-722 Remove the DC controller stay**



2. Disconnect one connector (callout 1), remove four screws (callout 2), and then remove the motor (callout 3).

**Figure 5-723 Remove the motor**



## 5. Unpack the replacement assembly

Follow these steps to unpack the replacement assembly.

1. Dispose of the defective part.





**NOTE:** HP recommends responsible disposal of the defective part.


<http://www8.hp.com/us/en/hp-information/environment/product-recycling.html>

2. Unpack the replacement part from the packaging.



**CAUTION:**  Some parts are sensitive to electrostatic discharge (ESD). Always perform service work at an ESD-protected workstation or mat. If an ESD workstation or mat is not available, touch the sheet-metal chassis to provide a static ground before touching an ESD-sensitive assembly. Protect the ESD-sensitive assemblies by placing them in ESD pouches when they are out of the printer.


 **IMPORTANT:** Make sure that all of the shipping materials (for example shipping tape) are removed from the replacement part prior to installation.

 **NOTE:** If the replacement part is a roller or pad, avoid touching the spongy part of it. Skin oils on the roller or pad can cause paper pickup and/or print-quality problems. HP recommends using disposable gloves when handling rollers or pads or washing your hands before touching rollers or pads.

---

3. To install an assembly, reverse the removal steps.

---

 **NOTE:** When applicable, special installation instructions are provided for an assembly at the end of the removal procedure. Always completely read the removal instructions and follow all special installation instructions.

---


## Removal and replacement: Developer alienation motor

Learn about removing and replacing developer alienation motor.

### Before performing service

#### Turn the printer power off

- Disconnect the power cable.

 **WARNING!** To avoid damage to the printer, turn the printer off, wait 30 seconds, and then remove the power cord before attempting to service the printer.

---

If the part is damaged and cannot be cleaned, use the table below to identify the correct part number for your printer. To order the part, go to [www.hp.com/buy/parts](http://www.hp.com/buy/parts).

**Table 5-93** Part information

Part number	Part description
RK2-6027-000CN	Motor, stepping (Developer alienation motor)

### Required tools

- #2 Phillips screwdriver with a magnetic tip and a 152 mm (6 in) shaft length

### After performing service

#### Turn the printer power on

- Connect the power cable.
- Use the power switch to turn the power on.


### Post service test

Print any pages necessary to make sure the printer is functioning correctly.

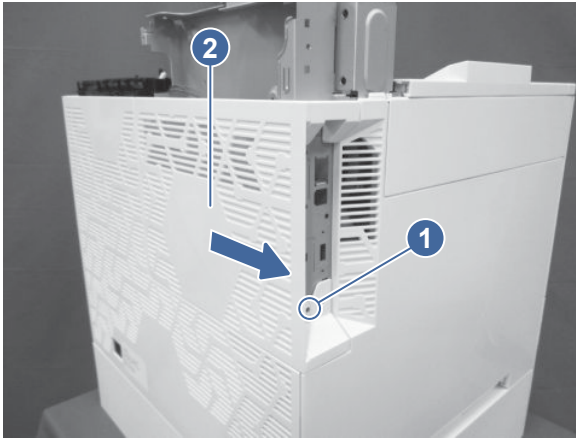
## 1. Remove the formatter cover

Follow these steps to remove the formatter cover.

- Remove one screw (callout 1), and then slide the formatter cover (callout 2) away from the printer to remove it.

 **TIP:** Reverse the removal steps to install the assembly.


**Figure 5-724** Remove the formatter cover



## 2. Remove the formatter

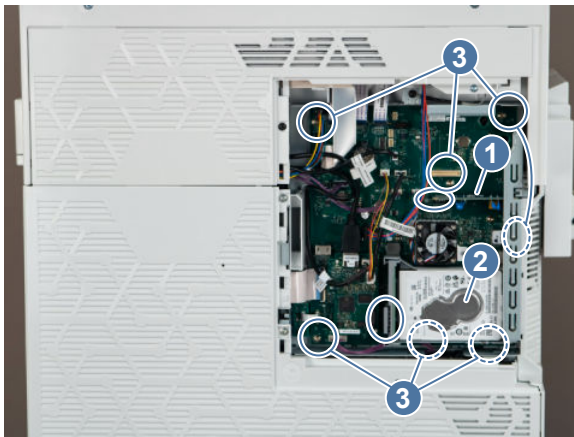
Follow these steps to remove the formatter.

1. Disconnect all of the connectors on the formatter.

 **IMPORTANT:** Some of the flat flexible cable (FFC) connectors use hinged retainers to secure them to the DC controller. The hinged retainers must be opened to release the FFCs.

2. Remove the fax PCA (callout 1) and the hard disk drive (HDD) (callout 2), and then remove seven screws (callout 3) to remove the formatter.

**Figure 5-725** Remove the formatter



## 3. Remove the left upper cover (MFP models)

Follow these steps to remove the left upper cover.

1. Open the front door.

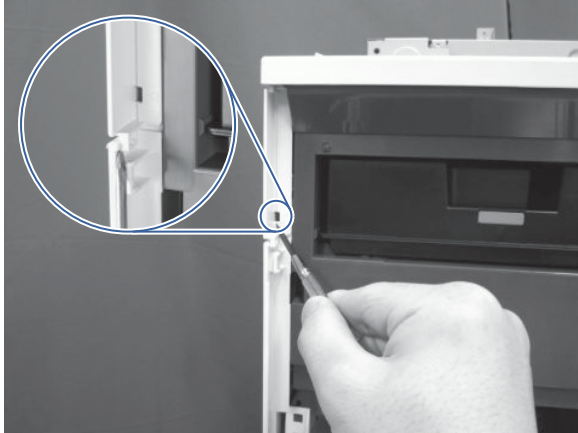
---

**⚠ CAUTION:** If the cover is being removed to gain access to the main drive assembly, make sure that the front door remains open. This keeps the main drive properly aligned.

---

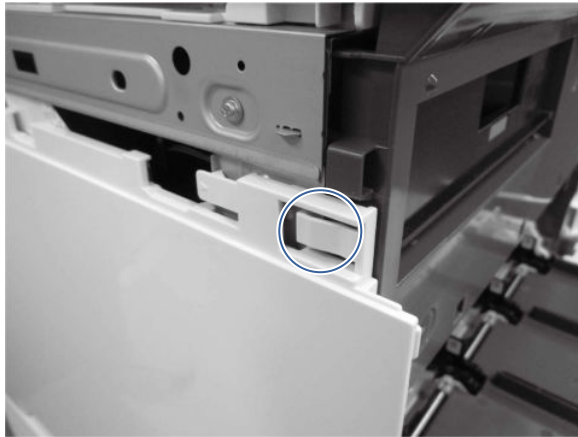
2. At the left side of the printer, insert the small flat-blade screwdriver into the slot to release one tab (callout 1).

**Figure 5-726 Use a screwdriver to release the tab**



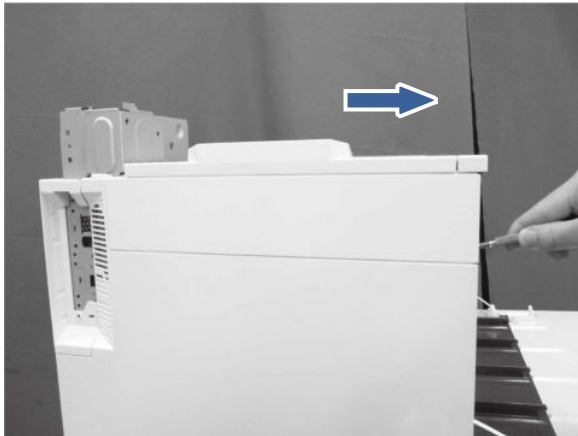
3. Toward the front of the printer, release another tab.

**Figure 5-727 Release the tab**



4. Rotate the cover up to remove it.

**Figure 5-728 Remove the left upper cover**

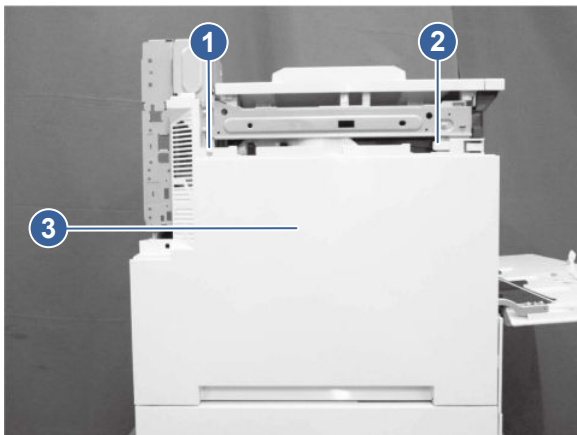


#### 4. Remove the left cover

Follow these steps to remove the left cover.

- At the left side of the printer, remove one screw (callout 1), release one tab (callout 2), and then slide the cover (callout 3) toward the rear of the printer to release it.


**Figure 5-729 Remove the left cover**



#### 5. Remove the rear cover

Follow these steps to remove the rear cover.

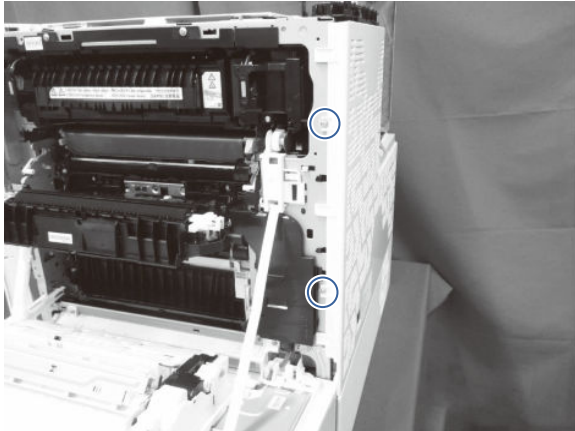
---

 **NOTE:** The figures below show some assemblies (for example the top cover and formatter) removed that might still be installed on the printer. However, the steps to remove the cover are correct.

---

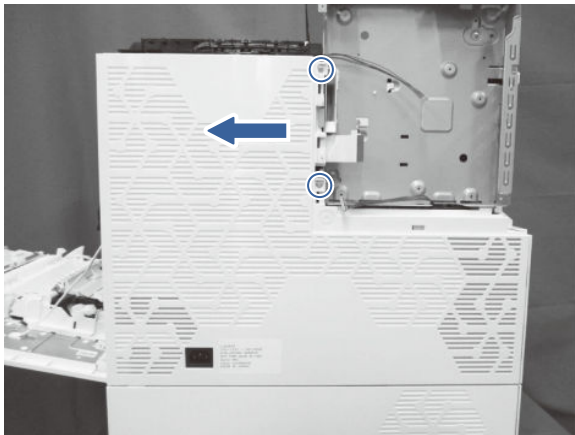
1. Open the right door, and remove two screws.

**Figure 5-730 Remove two screws**



2. At the back of the printer, remove two screws, and then slide the rear cover as indicated to remove it.


**Figure 5-731 Remove the rear cover**



## 6. Remove the formatter cage (SFP models)

Follow these steps to remove the formatter cage.

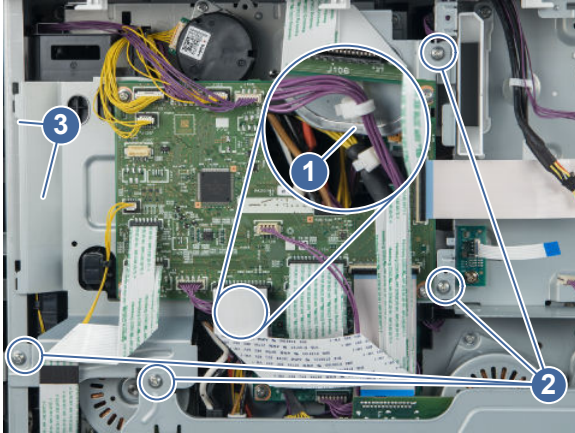
1. Disconnect all the connectors on the DC controller PCA.

 **IMPORTANT:** Some of the flat flexible cable (FFC) connectors use hinged retainers to secure them to the DC controller. The hinged retainers must be opened to release the FFCs.

2. Remove the cable clamp (callout 1), remove four screws (callout 2), and then slide the DC controller stay (callout 3) out to remove it.

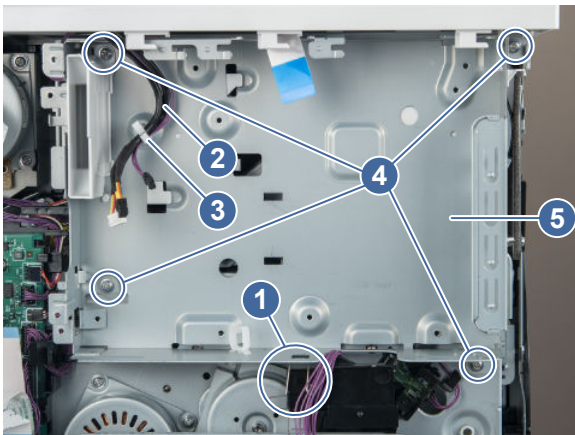
 **NOTE:** Be careful not to drop any of the screws into the low-voltage power supply assembly below the DC controller.

**Figure 5-732 Remove the DC controller stay**



3. Unhook one spring (callout 1), release the cable (callout 2) from the cable clamp (callout 3), remove four screws (callout 4), and then remove the formatter cage (callout 5).

**Figure 5-733 Remove the formatter cage**

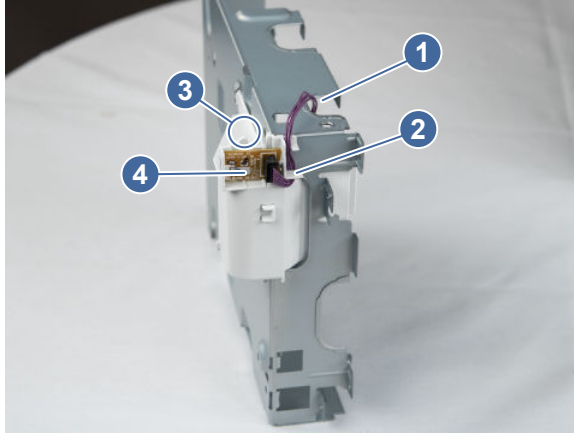


4. **For a replacement formatter cage only:** Release the cable (callout 1) from the cable guide (callout 2), release one tab (callout 3), and then remove the memory PCA (callout 4) from the formatter cage (callout 5).



**NOTE:** Install the PCA on the replacement formatter cage.

**Figure 5-734 Remove the memory PCA**

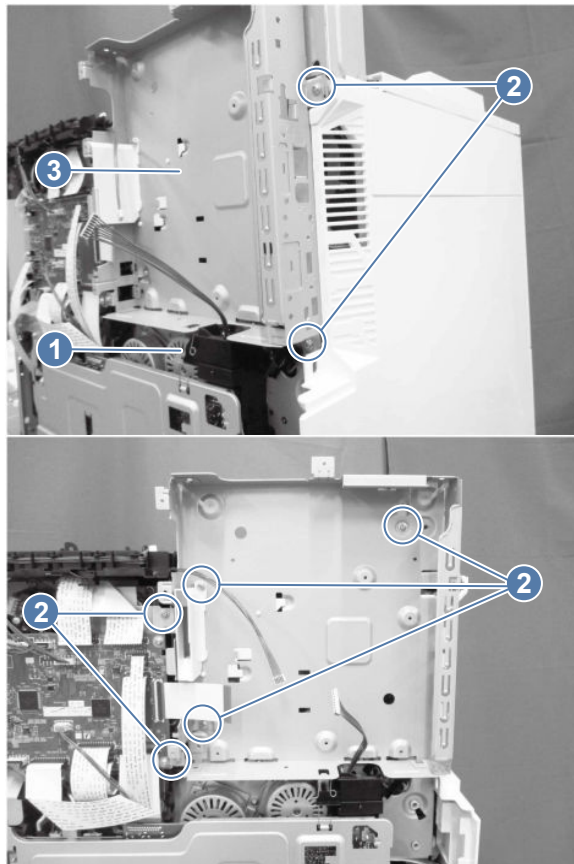


### 7. Remove the formatter cage (MFP models)

Follow these steps to remove the formatter cage.

1. Unhook one spring (callout 1), remove seven screws (callout 2), and then remove the formatter cage (callout 3).


**Figure 5-735 Remove the formatter cage**





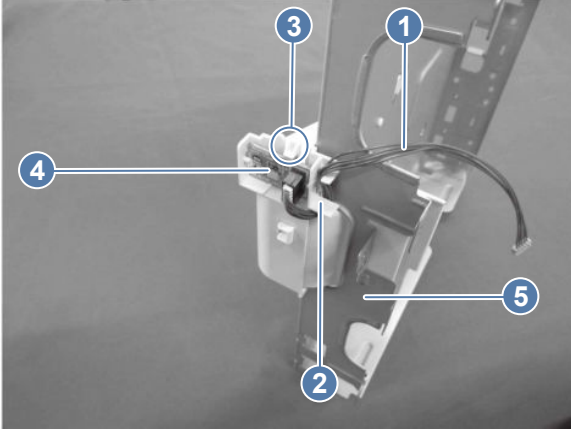
2. **For a replacement formatter cage only:** Release the cable (callout 1) from the cable guide (callout 2), release one tab (callout 3), and then remove the memory PCA (callout 4) from the formatter cage (callout 5).

---

 **NOTE:** Install the PCA on the replacement formatter cage.

---

**Figure 5-736** Remove the memory PCA

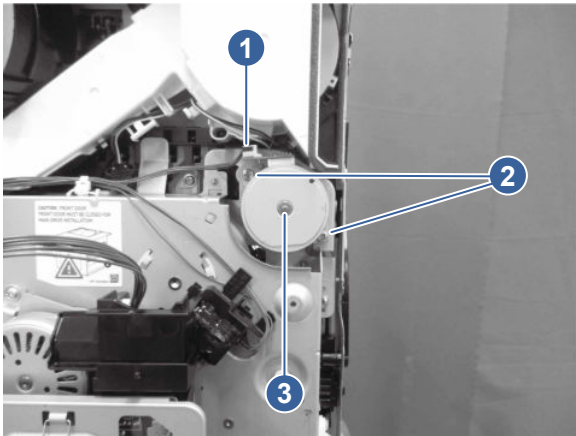


## 8. Remove the developer alienation motor

Follow these steps to remove the developer alienation motor.

- Disconnect one connector (callout 1), remove two screws (callout 2), and then remove the motor (callout 3).

**Figure 5-737** Remove the motor



## 9. Unpack the replacement assembly

Follow these steps to unpack the replacement assembly.

1. Dispose of the defective part.

---



 **NOTE:** HP recommends responsible disposal of the defective part.


---


<http://www8.hp.com/us/en/hp-information/environment/product-recycling.html>

---


## 2. Unpack the replacement part from the packaging.

 **CAUTION:**  Some parts are sensitive to electrostatic discharge (ESD). Always perform service work at an ESD-protected workstation or mat. If an ESD workstation or mat is not available, touch the sheet-metal chassis to provide a static ground before touching an ESD-sensitive assembly. Protect the ESD-sensitive assemblies by placing them in ESD pouches when they are out of the printer.

 **IMPORTANT:** Make sure that all of the shipping materials (for example shipping tape) are removed from the replacement part prior to installation.

 **NOTE:** If the replacement part is a roller or pad, avoid touching the spongy part of it. Skin oils on the roller or pad can cause paper pickup and/or print-quality problems. HP recommends using disposable gloves when handling rollers or pads or washing your hands before touching rollers or pads.

## 3. To install an assembly, reverse the removal steps.

 **NOTE:** When applicable, special installation instructions are provided for an assembly at the end of the removal procedure. Always completely read the removal instructions and follow all special installation instructions.


### Removal and replacement: Fuser motor

Learn about removing and replacing the fuser motor.

#### Before performing service

##### Turn the printer power off

- Disconnect the power cable.

 **WARNING!** To avoid damage to the printer, turn the printer off, wait 30 seconds, and then remove the power cord before attempting to service the printer.

If the part is damaged and cannot be cleaned, use the table below to identify the correct part number for your printer. To order the part, go to [www.hp.com/buy/parts](http://www.hp.com/buy/parts).

**Table 5-94** Part information

Part number	Part description
RM2-4488-000CN	Fixing motor assembly (Fuser motor)

#### Required tools

- #2 Phillips screwdriver with a magnetic tip and a 152 mm (6 in) shaft length

#### After performing service

##### Turn the printer power on

- Connect the power cable.
- Use the power switch to turn the power on.

#### Post service test


Print any pages necessary to make sure the printer is functioning correctly.

## 1. Remove the formatter cover

Follow these steps to remove the formatter cover.

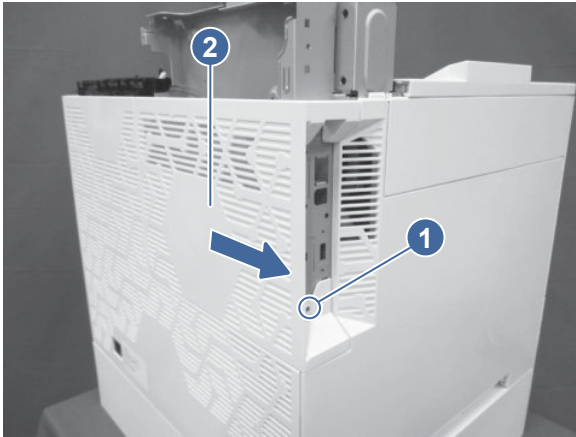
- Remove one screw (callout 1), and then slide the formatter cover (callout 2) away from the printer to remove it.

---

 **TIP:** Reverse the removal steps to install the assembly.

---


**Figure 5-738** Remove the formatter cover



## 2. Remove the rear cover

Follow these steps to remove the rear cover.

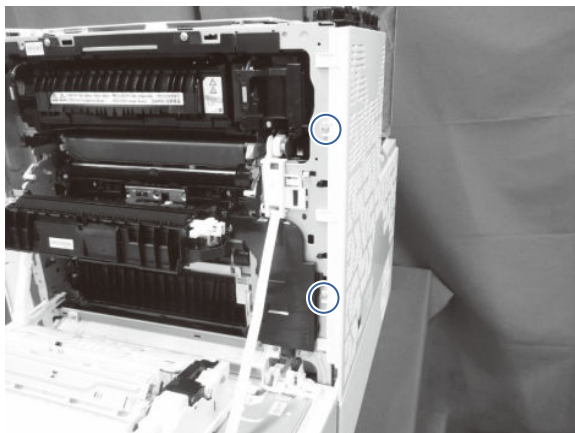
---

 **NOTE:** The figures below show some assemblies (for example the top cover and formatter) removed that might still be installed on the printer. However, the steps to remove the cover are correct.

---

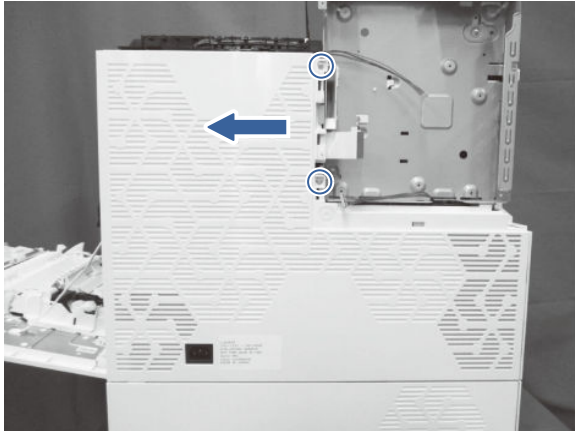
1. Open the right door, and remove two screws.

**Figure 5-739** Remove two screws



2. At the back of the printer, remove two screws, and then slide the rear cover as indicated to remove it.

**Figure 5-740 Remove the rear cover**




### 3. Remove the low-voltage power supply (LVPS)

Follow these steps to remove the low-voltage power supply (LVPS).

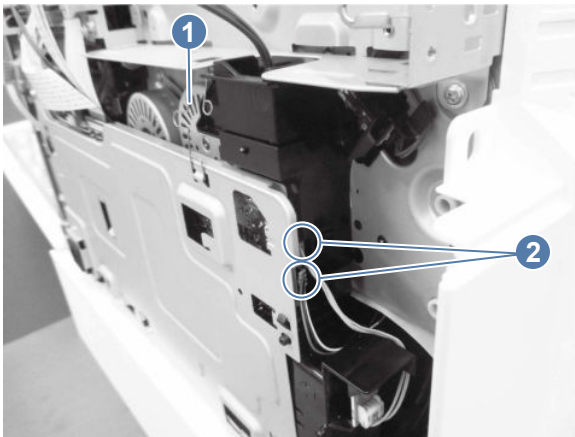
1. Unhook one spring (callout 1), and then disconnect two connectors (callout 2).

---

 **NOTE:** Unhook the spring from the formatter cage, not the low-voltage power supply. The spring should remain attached to the LVPS.


---

**Figure 5-741 Unhook the spring and disconnect two connectors**



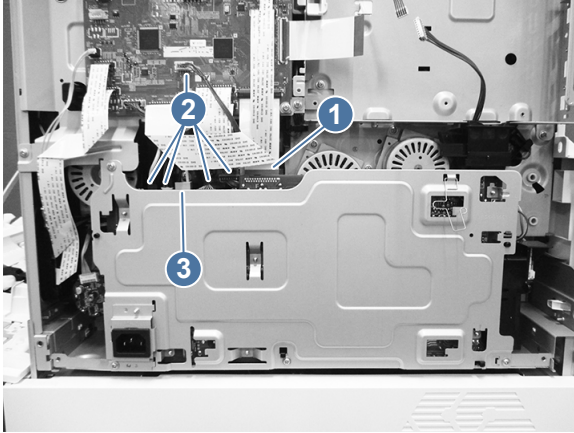
2. Remove the FFC (callout 1), and then disconnect five connectors (callout 2).

---

 **NOTE: MFP only:** Disconnect one additional connector (callout 3).

---

**Figure 5-742 Disconnect the LVPS connectors**

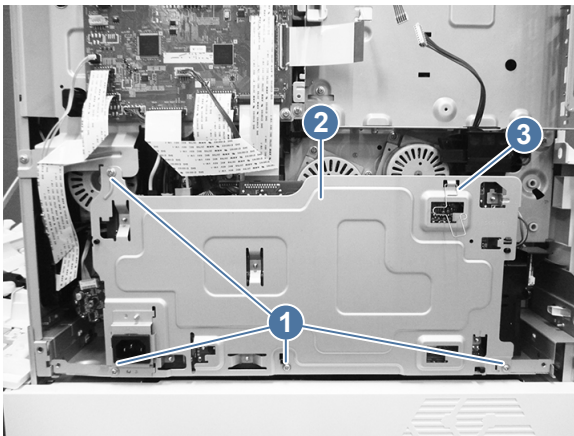



3. Remove four screws (callout 1), and then remove the low-voltage power supply assembly (callout 2).

 **NOTE:** The black ducting in the lower right corner can stick during the removal process.

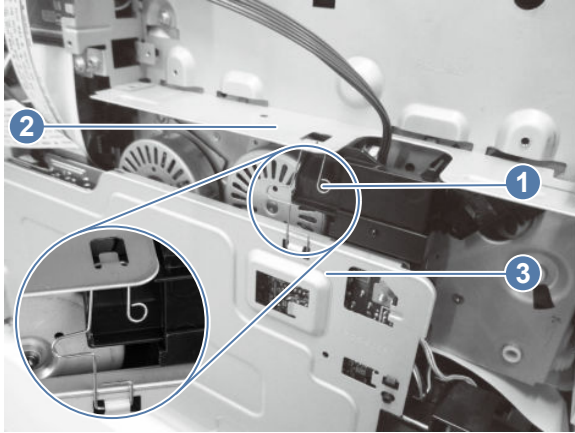
**Replacement LVPS only:** Remove the spring (callout 3), and then install it on the replacement LVPS.

**Figure 5-743 Remove the LVPS**



 **Reinstallation tip:** When reinstalling the LVPS, make sure that the spring (callout 1) is attached to both the formatter cage (callout 2) and the LVPS (callout 3).

**Figure 5-744 Reinstalling the LVPS**

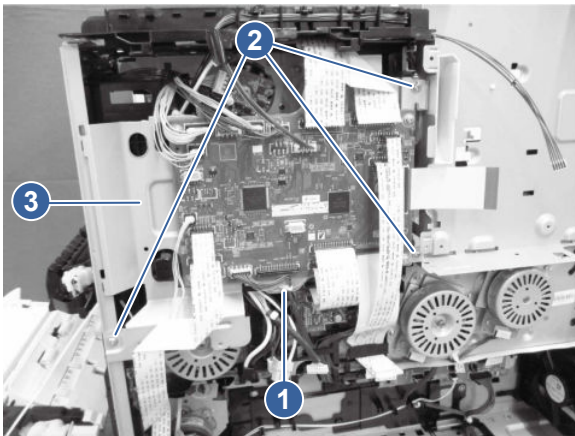


#### 4. Remove the fuser motor

Follow these steps to remove the fuser motor.

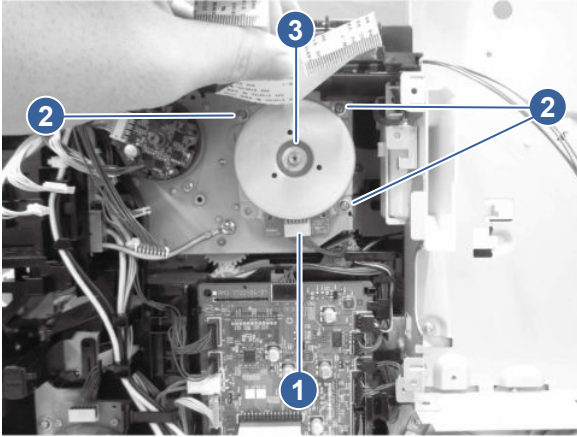
1. Disconnect all the connectors on the DC controller PCA, remove the cable clamp (callout 1), remove three screws (callout 2), slide the DC controller stay (callout 3) out to remove it.

**Figure 5-745 Remove the DC controller stay**



2. Disconnect one connector (callout 1), remove three screws (callout 2), and then remove the motor (callout 3).

Figure 5-746 Remove the motor




## 5. Unpack the replacement assembly

Follow these steps to unpack the replacement assembly.

1. Dispose of the defective part.

---



 **NOTE:** HP recommends responsible disposal of the defective part.


<http://www8.hp.com/us/en/hp-information/environment/product-recycling.html>


---

2. Unpack the replacement part from the packaging.

---

 **CAUTION:**  Some parts are sensitive to electrostatic discharge (ESD). Always perform service work at an ESD-protected workstation or mat. If an ESD workstation or mat is not available, touch the sheet-metal chassis to provide a static ground before touching an ESD-sensitive assembly. Protect the ESD-sensitive assemblies by placing them in ESD pouches when they are out of the printer.


 **IMPORTANT:** Make sure that all of the shipping materials (for example shipping tape) are removed from the replacement part prior to installation.

 **NOTE:** If the replacement part is a roller or pad, avoid touching the spongy part of it. Skin oils on the roller or pad can cause paper pickup and/or print-quality problems. HP recommends using disposable gloves when handling rollers or pads or washing your hands before touching rollers or pads.

---

3. To install an assembly, reverse the removal steps.

---

 **NOTE:** When applicable, special installation instructions are provided for an assembly at the end of the removal procedure. Always completely read the removal instructions and follow all special installation instructions.

---

## Removal and replacement: Duplex motor

Learn about removing and replacing the duplex motor.

### Before performing service

#### Turn the printer power off

- Disconnect the power cable.

**⚠ WARNING!** To avoid damage to the printer, turn the printer off, wait 30 seconds, and then remove the power cord before attempting to service the printer.

If the part is damaged and cannot be cleaned, use the table below to identify the correct part number for your printer. To order the part, go to [www.hp.com/buy/parts](http://www.hp.com/buy/parts).

**Table 5-95 Part information**

Part number	Part description
RK2-7751-000CN	Motor, stepping (Duplex motor; 5700/X557/5800/X57945)
RM2-4489-000CN	Motor assembly (Duplex motor; 6700/X654/6800/X677)

## Required tools

- #2 Phillips screwdriver with a magnetic tip and a 152 mm (6 in) shaft length

## After performing service

### Turn the printer power on

- Connect the power cable.
- Use the power switch to turn the power on.

## Post service test

Print any pages necessary to make sure the printer is functioning correctly.

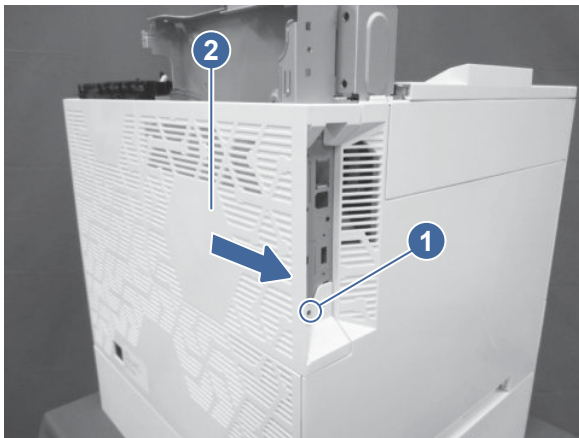
### 1. Remove the formatter cover

Follow these steps to remove the formatter cover.

- Remove one screw (callout 1), and then slide the formatter cover (callout 2) away from the printer to remove it.

**💡 TIP:** Reverse the removal steps to install the assembly.


**Figure 5-747 Remove the formatter cover**





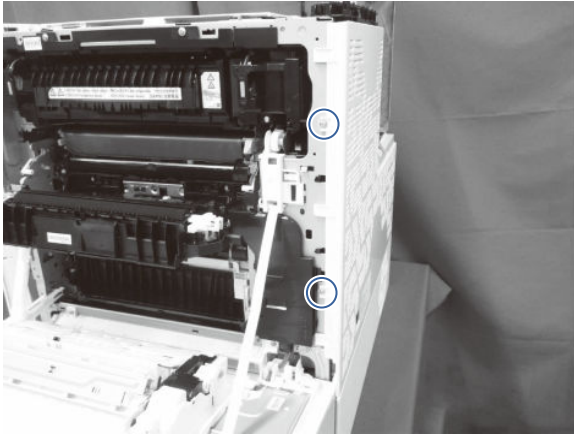
## 2. Remove the rear cover

Follow these steps to remove the rear cover.

 **NOTE:** The figures below show some assemblies (for example the top cover and formatter) removed that might still be installed on the printer. However, the steps to remove the cover are correct.

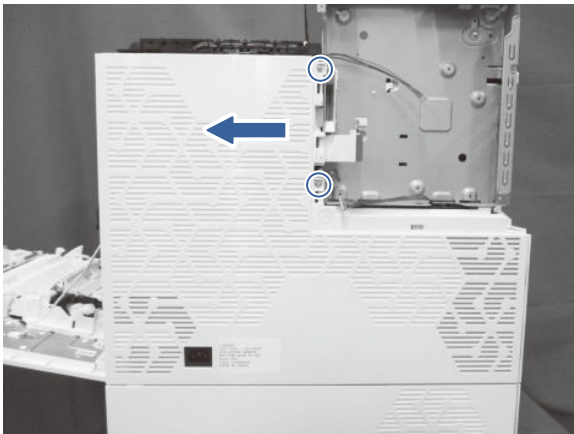
1. Open the right door, and remove two screws.

**Figure 5-748 Remove two screws**



2. At the back of the printer, remove two screws, and then slide the rear cover as indicated to remove it.


**Figure 5-749 Remove the rear cover**



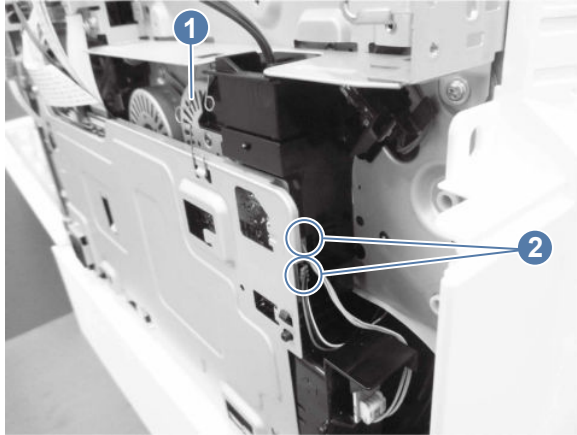
## 3. Remove the low-voltage power supply (LVPS)

Follow these steps to remove the low-voltage power supply (LVPS).

1. Unhook one spring (callout 1), and then disconnect two connectors (callout 2).

 **NOTE:** Unhook the spring from the formatter cage, not the low-voltage power supply. The spring should remain attached to the LVPS.

**Figure 5-750 Unhook the spring and disconnect two connectors**

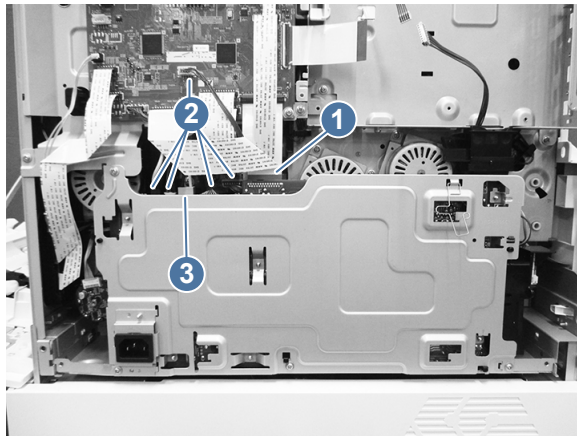


2. Remove the FFC (callout 1), and then disconnect five connectors (callout 2).



**NOTE: MFP only:** Disconnect one additional connector (callout 3).

**Figure 5-751 Disconnect the LVPS connectors**



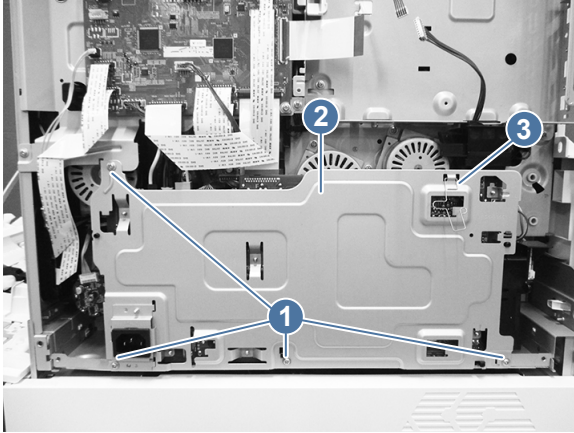
3. Remove four screws (callout 1), and then remove the low-voltage power supply assembly (callout 2).




**NOTE:** The black ducting in the lower right corner can stick during the removal process.

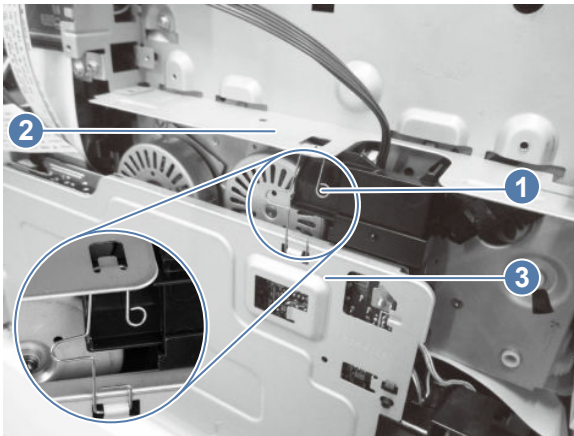
**Replacement LVPS only:** Remove the spring (callout 3), and then install it on the replacement LVPS.

**Figure 5-752 Remove the LVPS**



 **Reinstallation tip:** When reinstalling the LVPS, make sure that the spring (callout 1) is attached to both the formatter cage (callout 2) and the LVPS (callout 3).

**Figure 5-753 Reinstalling the LVPS**

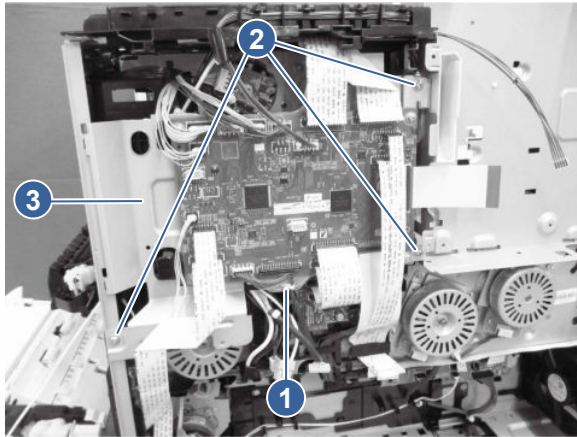


#### 4. Remove the duplex motor

Follow these steps to remove the duplex motor.

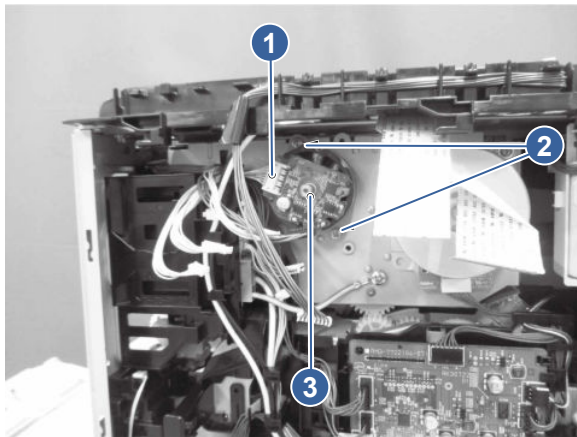
1. Disconnect all the connectors on the DC controller PCA, remove the cable clamp (callout 1), remove three screws (callout 2), slide the DC controller stay (callout 3) out to remove it.

**Figure 5-754 Remove the DC controller stay**



2. Disconnect one connector (callout 1), remove three screws (callout 2), and then remove the motor (callout 3).

**Figure 5-755 Remove the motor**



## 5. Unpack the replacement assembly

Follow these steps to unpack the replacement assembly.

1. Dispose of the defective part.





**NOTE:** HP recommends responsible disposal of the defective part.


<http://www8.hp.com/us/en/hp-information/environment/product-recycling.html>

2. Unpack the replacement part from the packaging.




**CAUTION:**  Some parts are sensitive to electrostatic discharge (ESD). Always perform service work at an ESD-protected workstation or mat. If an ESD workstation or mat is not available, touch the sheet-metal chassis to provide a static ground before touching an ESD-sensitive assembly. Protect the ESD-sensitive assemblies by placing them in ESD pouches when they are out of the printer.

 **IMPORTANT:** Make sure that all of the shipping materials (for example shipping tape) are removed from the replacement part prior to installation.

 **NOTE:** If the replacement part is a roller or pad, avoid touching the spongy part of it. Skin oils on the roller or pad can cause paper pickup and/or print-quality problems. HP recommends using disposable gloves when handling rollers or pads or washing your hands before touching rollers or pads.

---

3. To install an assembly, reverse the removal steps.

 **NOTE:** When applicable, special installation instructions are provided for an assembly at the end of the removal procedure. Always completely read the removal instructions and follow all special installation instructions.

---


## Removal and replacement: Power-supply fan

Learn about removing and replacing power supply fan.

### Before performing service

#### Turn the printer power off

- Disconnect the power cable.

 **WARNING!** To avoid damage to the printer, turn the printer off, wait 30 seconds, and then remove the power cord before attempting to service the printer.

---

If the part is damaged and cannot be cleaned, use the table below to identify the correct part number for your printer. To order the part, go to [www.hp.com/buy/parts](http://www.hp.com/buy/parts).

**Table 5-96** Part information

Part number	Part description
RK3-2277-000CN	Fan (Power supply fan)

### Required tools

- #2 Phillips screwdriver with a magnetic tip and a 152 mm (6 in) shaft length

### After performing service

#### Turn the printer power on

- Connect the power cable.
- Use the power switch to turn the power on.

### Post service test


Print any pages necessary to make sure the printer is functioning correctly.

## 1. Remove the formatter cover

Follow these steps to remove the formatter cover.

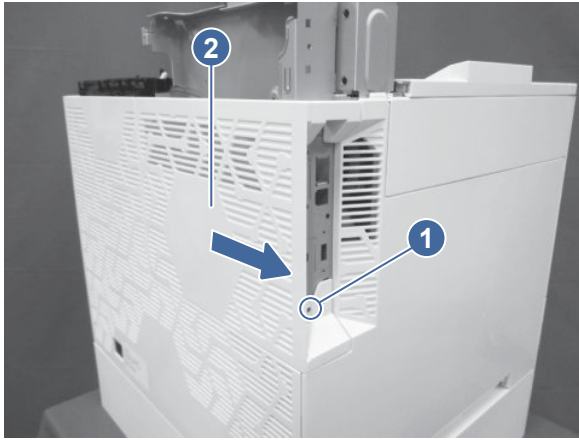
- Remove one screw (callout 1), and then slide the formatter cover (callout 2) away from the printer to remove it.

---

 **TIP:** Reverse the removal steps to install the assembly.

---


**Figure 5-756 Remove the formatter cover**



## 2. Remove the rear cover

Follow these steps to remove the rear cover.

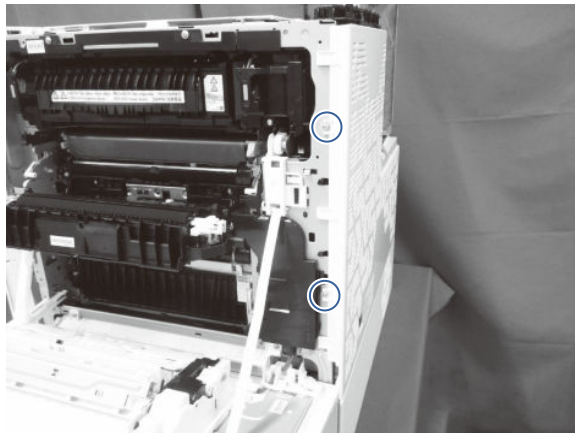
---

 **NOTE:** The figures below show some assemblies (for example the top cover and formatter) removed that might still be installed on the printer. However, the steps to remove the cover are correct.

---

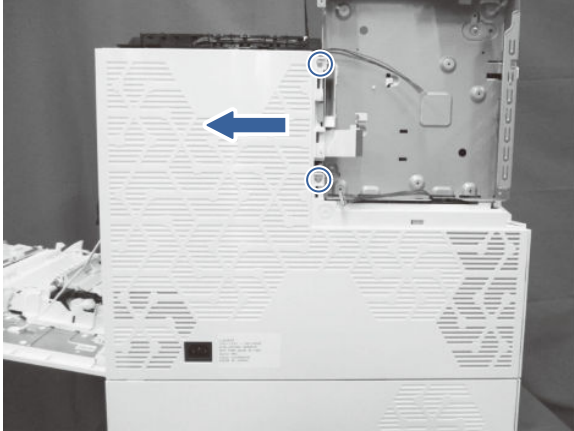
1. Open the right door, and remove two screws.

**Figure 5-757 Remove two screws**



2. At the back of the printer, remove two screws, and then slide the rear cover as indicated to remove it.

**Figure 5-758 Remove the rear cover**




### 3. Remove the low-voltage power supply (LVPS)

Follow these steps to remove the low-voltage power supply (LVPS).

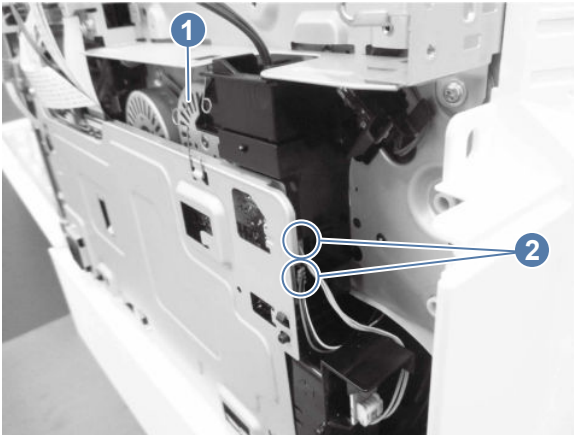
1. Unhook one spring (callout 1), and then disconnect two connectors (callout 2).

---

 **NOTE:** Unhook the spring from the formatter cage, not the low-voltage power supply. The spring should remain attached to the LVPS.


---

**Figure 5-759 Unhook the spring and disconnect two connectors**



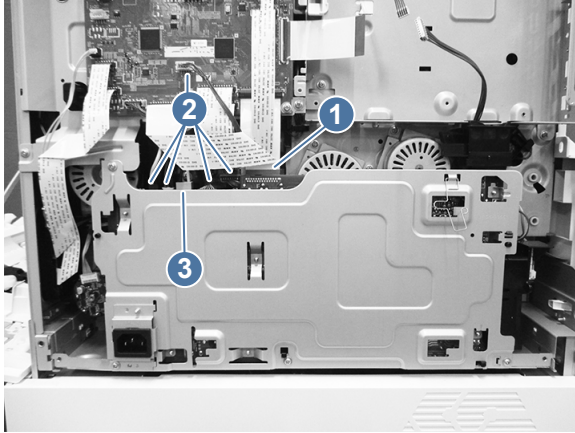
2. Remove the FFC (callout 1), and then disconnect five connectors (callout 2).

---


 **NOTE:** **MFP only:** Disconnect one additional connector (callout 3).

---

**Figure 5-760 Disconnect the LVPS connectors**

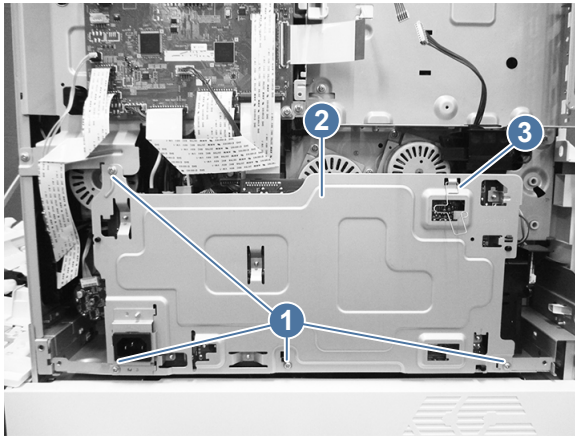



3. Remove four screws (callout 1), and then remove the low-voltage power supply assembly (callout 2).

 **NOTE:** The black ducting in the lower right corner can stick during the removal process.

**Replacement LVPS only:** Remove the spring (callout 3), and then install it on the replacement LVPS.

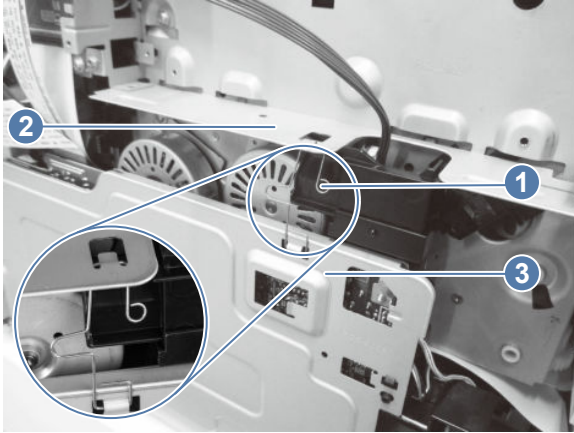
**Figure 5-761 Remove the LVPS**



 **Reinstallation tip:** When reinstalling the LVPS, make sure that the spring (callout 1) is attached to both the formatter cage (callout 2) and the LVPS (callout 3).




**Figure 5-762 Reinstalling the LVPS**



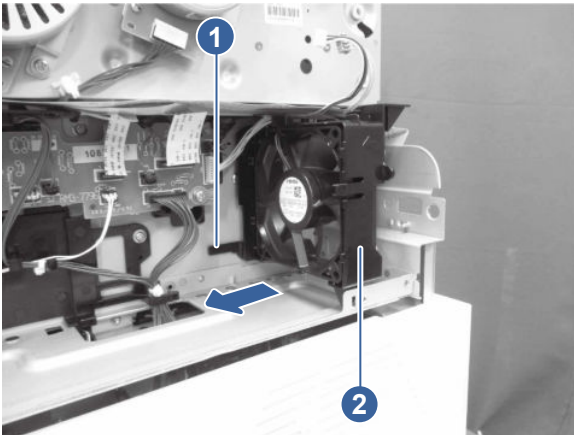
#### 4. Remove the power supply fan

Follow these steps to remove the power supply fan.

1. Release one tab (callout 1), and then slide the fan holder (callout 2) in the direction indicated to remove it.

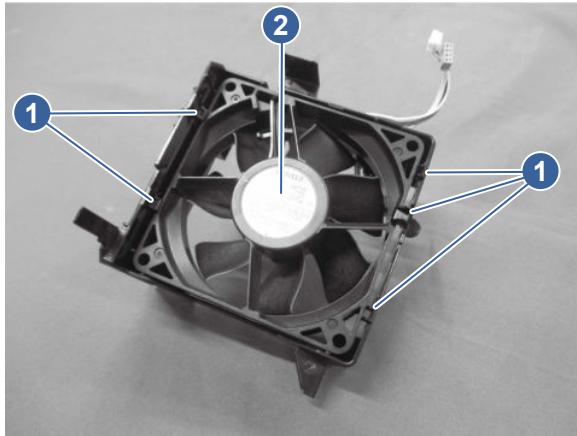
 **NOTE:** Take care not to pull any cables as you remove this assembly.

**Figure 5-763 Remove the fan holder**



2. Release five tabs (callout 1), and then remove the power supply fan (callout 2).

**Figure 5-764 Release the fan**



## 5. Unpack the replacement assembly

Follow these steps to unpack the replacement assembly.

1. Dispose of the defective part.

---



 **NOTE:** HP recommends responsible disposal of the defective part.


<http://www8.hp.com/us/en/hp-information/environment/product-recycling.html>


---

2. Unpack the replacement part from the packaging.

---

 **CAUTION:**  Some parts are sensitive to electrostatic discharge (ESD). Always perform service work at an ESD-protected workstation or mat. If an ESD workstation or mat is not available, touch the sheet-metal chassis to provide a static ground before touching an ESD-sensitive assembly. Protect the ESD-sensitive assemblies by placing them in ESD pouches when they are out of the printer.


 **IMPORTANT:** Make sure that all of the shipping materials (for example shipping tape) are removed from the replacement part prior to installation.

 **NOTE:** If the replacement part is a roller or pad, avoid touching the spongy part of it. Skin oils on the roller or pad can cause paper pickup and/or print-quality problems. HP recommends using disposable gloves when handling rollers or pads or washing your hands before touching rollers or pads.

---

3. To install an assembly, reverse the removal steps.

---

 **NOTE:** When applicable, special installation instructions are provided for an assembly at the end of the removal procedure. Always completely read the removal instructions and follow all special installation instructions.

---

## Removal and replacement: Cartridge fan

Learn about removing and replacing the cartridge fan.

### Before performing service

Turn the printer power off

- Disconnect the power cable.

---

**⚠ WARNING!** To avoid damage to the printer, turn the printer off, wait 30 seconds, and then remove the power cord before attempting to service the printer.

---

If the part is damaged and cannot be cleaned, use the table below to identify the correct part number for your printer. To order the part, go to [www.hp.com/buy/parts](http://www.hp.com/buy/parts).

**Table 5-97** Part information

Part number	Part description
RK3-0762-000CN	Fan (Cartridge fan; X57945/6700/X654/6800/X677)
RK3-1637-000CN	Fan (Cartridge fan; 5700/X557/5800)

## Required tools

- #2 Phillips screwdriver with a magnetic tip and a 152 mm (6 in) shaft length

## After performing service

### Turn the printer power on

- Connect the power cable.
- Use the power switch to turn the power on.

## Post service test

Print any pages necessary to make sure the printer is functioning correctly.

### 1. Remove the formatter cover

Follow these steps to remove the formatter cover.

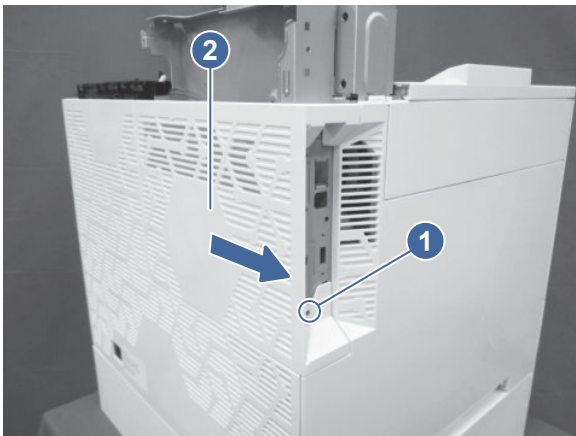
- Remove one screw (callout 1), and then slide the formatter cover (callout 2) away from the printer to remove it.

---

**💡 TIP:** Reverse the removal steps to install the assembly.


---

**Figure 5-765** Remove the formatter cover



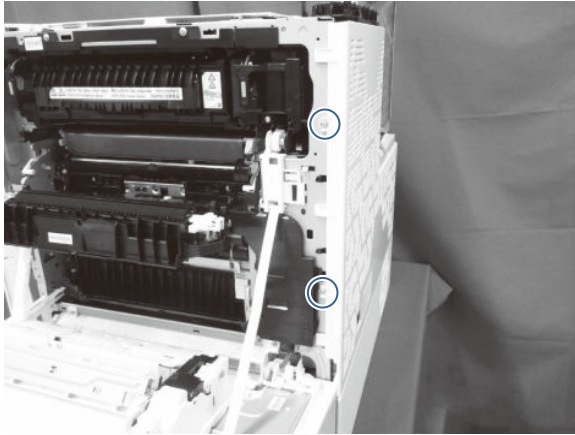
## 2. Remove the rear cover

Follow these steps to remove the rear cover.

 **NOTE:** The figures below show some assemblies (for example the top cover and formatter) removed that might still be installed on the printer. However, the steps to remove the cover are correct.

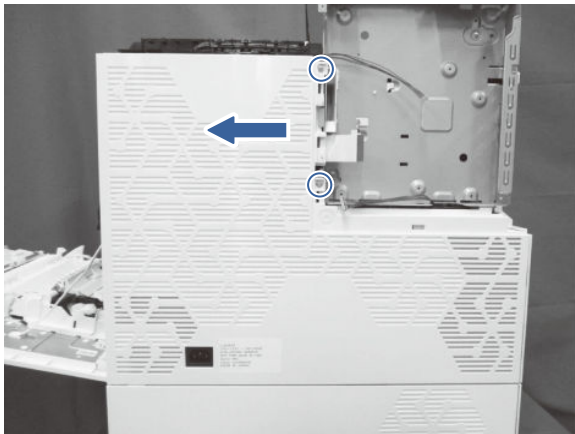
1. Open the right door, and remove two screws.

**Figure 5-766 Remove two screws**



2. At the back of the printer, remove two screws, and then slide the rear cover as indicated to remove it.


**Figure 5-767 Remove the rear cover**



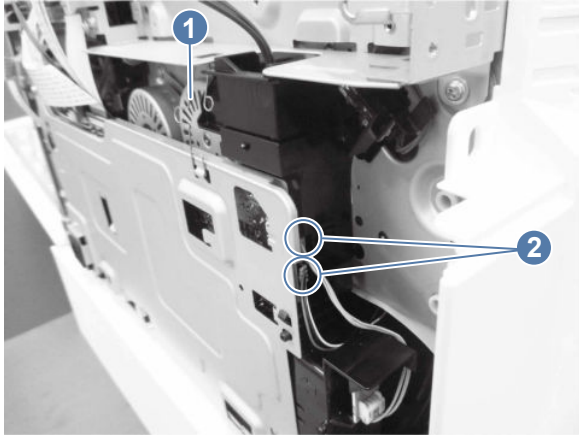
## 3. Remove the low-voltage power supply (LVPS)

Follow these steps to remove the low-voltage power supply (LVPS).

1. Unhook one spring (callout 1), and then disconnect two connectors (callout 2).

 **NOTE:** Unhook the spring from the formatter cage, not the low-voltage power supply. The spring should remain attached to the LVPS.

**Figure 5-768 Unhook the spring and disconnect two connectors**

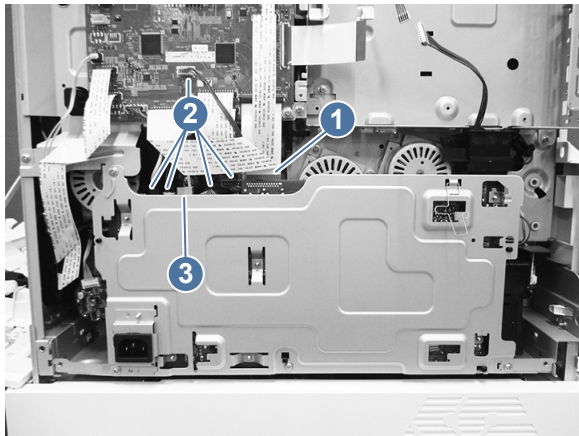


2. Remove the FFC (callout 1), and then disconnect five connectors (callout 2).



**NOTE:** MFP only: Disconnect one additional connector (callout 3).

**Figure 5-769 Disconnect the LVPS connectors**



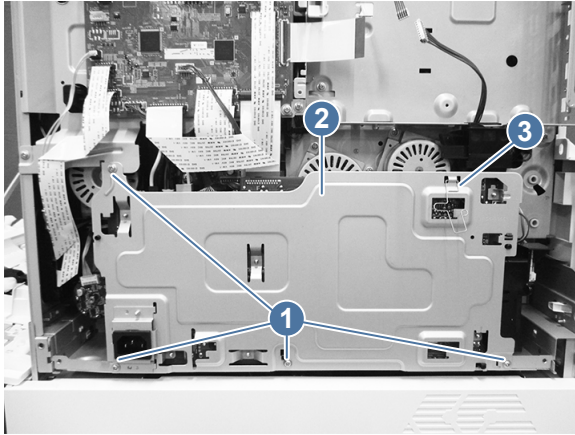
3. Remove four screws (callout 1), and then remove the low-voltage power supply assembly (callout 2).




**NOTE:** The black ducting in the lower right corner can stick during the removal process.

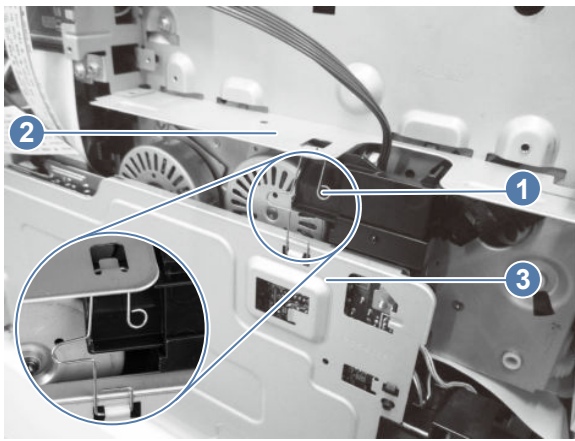
**Replacement LVPS only:** Remove the spring (callout 3), and then install it on the replacement LVPS.

**Figure 5-770 Remove the LVPS**



 **Reinstallation tip:** When reinstalling the LVPS, make sure that the spring (callout 1) is attached to both the formatter cage (callout 2) and the LVPS (callout 3).

**Figure 5-771 Reinstalling the LVPS**

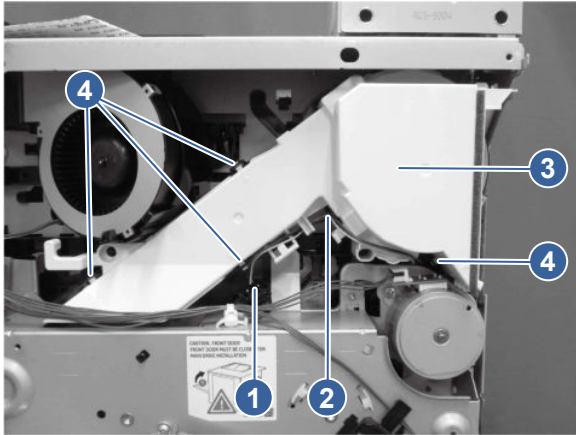


#### 4. Remove the cartridge fan

Follow these steps to remove the cartridge fan.

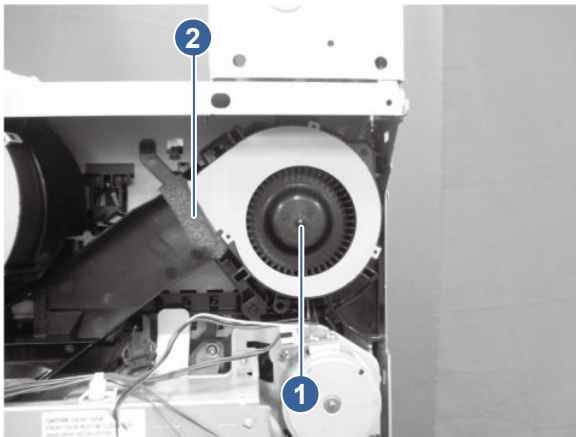
1. Disconnect one connector (callout 1), release the cable (callout 2) from the fan cover (callout 3), release four tabs (callout 4), and then remove the fan cover.

**Figure 5-772 Remove the fan cover**



2. Pull out the cartridge fan (callout 1) toward you, and then remove the sponge (callout 2) from the cartridge fan.

**Figure 5-773 Remove the fan sponge**



## 5. Unpack the replacement assembly

Follow these steps to unpack the replacement assembly.

1. Dispose of the defective part.





**NOTE:** HP recommends responsible disposal of the defective part.


<http://www8.hp.com/us/en/hp-information/environment/product-recycling.html>

2. Unpack the replacement part from the packaging.



**CAUTION:**  Some parts are sensitive to electrostatic discharge (ESD). Always perform service work at an ESD-protected workstation or mat. If an ESD workstation or mat is not available, touch the sheet-metal chassis to provide a static ground before touching an ESD-sensitive assembly. Protect the ESD-sensitive assemblies by placing them in ESD pouches when they are out of the printer.


 **IMPORTANT:** Make sure that all of the shipping materials (for example shipping tape) are removed from the replacement part prior to installation.

 **NOTE:** If the replacement part is a roller or pad, avoid touching the spongy part of it. Skin oils on the roller or pad can cause paper pickup and/or print-quality problems. HP recommends using disposable gloves when handling rollers or pads or washing your hands before touching rollers or pads.

---

3. To install an assembly, reverse the removal steps.

---

 **NOTE:** When applicable, special installation instructions are provided for an assembly at the end of the removal procedure. Always completely read the removal instructions and follow all special installation instructions.

---

## Removal and replacement: Fuser fan

Learn about removing and replacing the fuser fan.




[View a video demonstration of removing and replacing the fuser fan.](#)

### Before performing service

#### Turn the printer power off

- Disconnect the power cable.

 **WARNING!** To avoid damage to the printer, turn the printer off, wait 30 seconds, and then remove the power cord before attempting to service the printer.

---

If the part is damaged and cannot be cleaned, use the table below to identify the correct part number for your printer. To order the part, go to [www.hp.com/buy/parts](http://www.hp.com/buy/parts).

**Table 5-98** Part information

Part number	Part description
RK3-0762-000CN	Fan (Fuser fan)

### Required tools

- #2 Phillips screwdriver with a magnetic tip and a 152 mm (6 in) shaft length

### After performing service

#### Turn the printer power on

- Connect the power cable.
- Use the power switch to turn the power on.

### Post service test


Print any pages necessary to make sure the printer is functioning correctly.

## 1. Remove the formatter cover

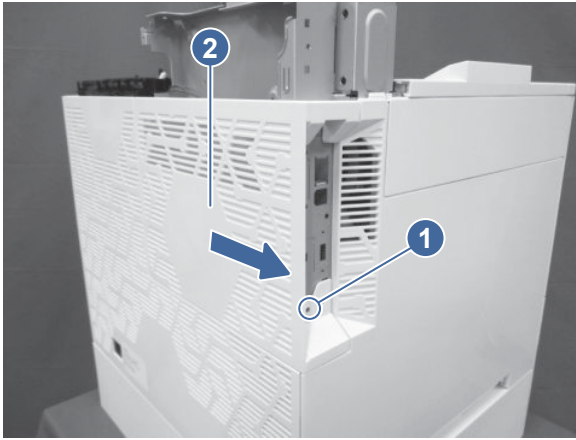
Follow these steps to remove the formatter cover.



- Remove one screw (callout 1), and then slide the formatter cover (callout 2) away from the printer to remove it.

 **TIP:** Reverse the removal steps to install the assembly.


**Figure 5-774** Remove the formatter cover



## 2. Remove the formatter

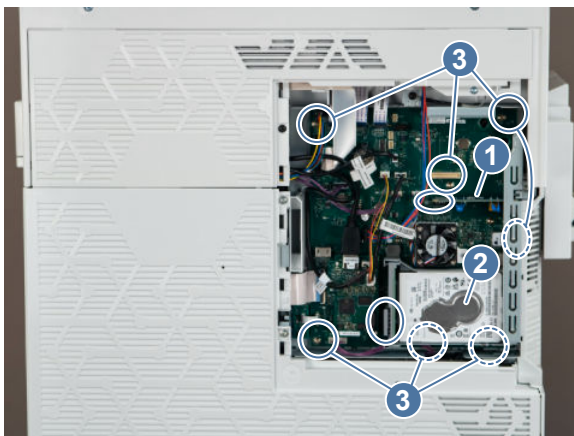
Follow these steps to remove the formatter.

1. Disconnect all of the connectors on the formatter.

 **IMPORTANT:** Some of the flat flexible cable (FFC) connectors use hinged retainers to secure them to the DC controller. The hinged retainers must be opened to release the FFCs.


2. Remove the fax PCA (callout 1) and the hard disk drive (HDD) (callout 2), and then remove seven screws (callout 3) to remove the formatter.

**Figure 5-775** Remove the formatter



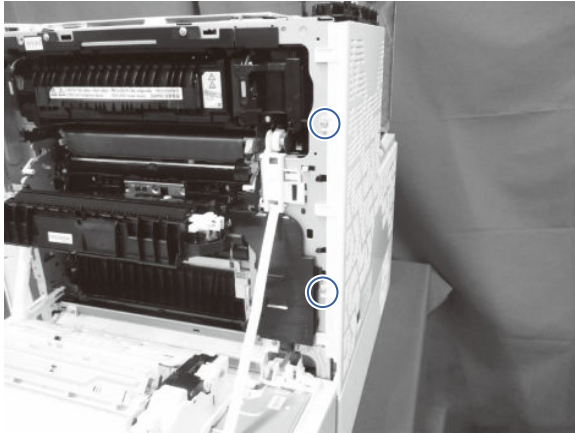
## 3. Remove the rear cover

Follow these steps to remove the rear cover.

 **NOTE:** The figures below show some assemblies (for example the top cover and formatter) removed that might still be installed on the printer. However, the steps to remove the cover are correct.

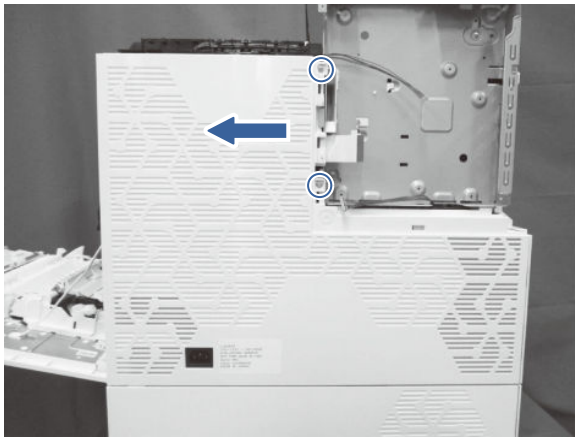
1. Open the right door, and remove two screws.

**Figure 5-776 Remove two screws**



2. At the back of the printer, remove two screws, and then slide the rear cover as indicated to remove it.

**Figure 5-777 Remove the rear cover**




#### 4. Remove the formatter cage (SFP models)

Follow these steps to remove the formatter cage.

1. Disconnect all the connectors on the DC controller PCA.

---

 **IMPORTANT:** Some of the flat flexible cable (FFC) connectors use hinged retainers to secure them to the DC controller. The hinged retainers must be opened to release the FFCs.

---

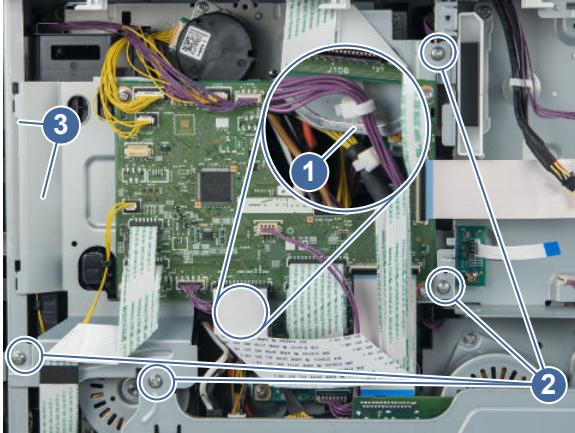
2. Remove the cable clamp (callout 1), remove four screws (callout 2), and then slide the DC controller stay (callout 3) out to remove it.

---

 **NOTE:** Be careful not to drop any of the screws into the low-voltage power supply assembly below the DC controller.

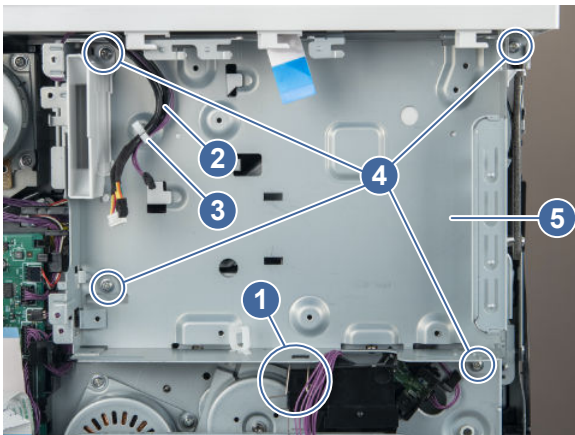
---

**Figure 5-778 Remove the DC controller stay**



3. Unhook one spring (callout 1), release the cable (callout 2) from the cable clamp (callout 3), remove four screws (callout 4), and then remove the formatter cage (callout 5).

**Figure 5-779 Remove the formatter cage**

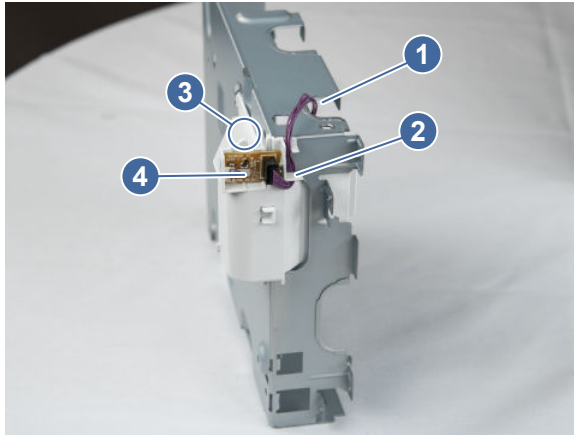


4. **For a replacement formatter cage only:** Release the cable (callout 1) from the cable guide (callout 2), release one tab (callout 3), and then remove the memory PCA (callout 4) from the formatter cage (callout 5).



**NOTE:** Install the PCA on the replacement formatter cage.

**Figure 5-780 Remove the memory PCA**

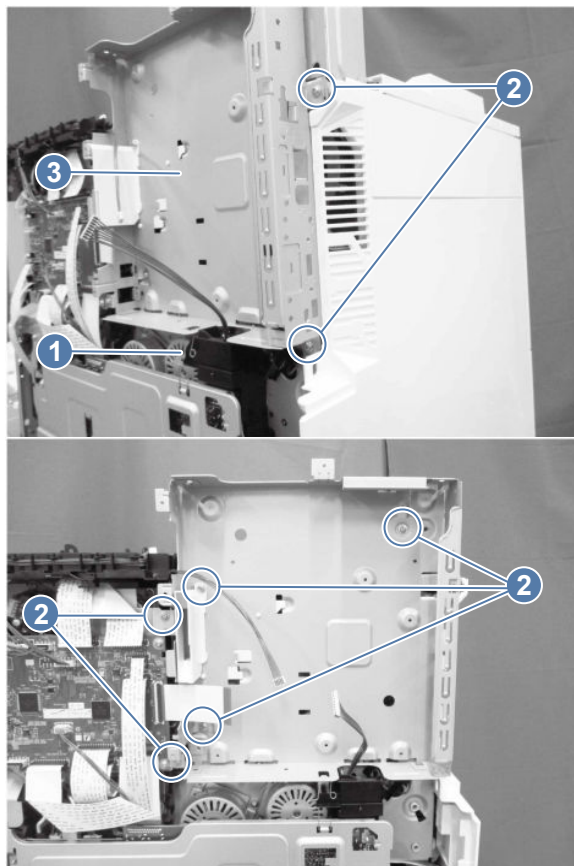


### 5. Remove the formatter cage (MFP models)


Follow these steps to remove the formatter cage.

1. Unhook one spring (callout 1), remove seven screws (callout 2), and then remove the formatter cage (callout 3).

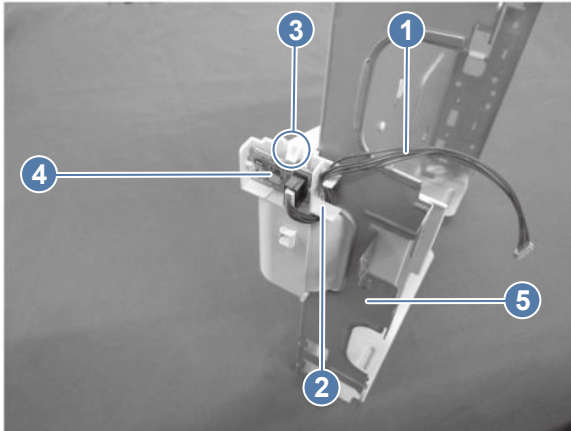
**Figure 5-781 Remove the formatter cage**



2. **For a replacement formatter cage only:** Release the cable (callout 1) from the cable guide (callout 2), release one tab (callout 3), and then remove the memory PCA (callout 4) from the formatter cage (callout 5).

 **NOTE:** Install the PCA on the replacement formatter cage.

**Figure 5-782 Remove the memory PCA**

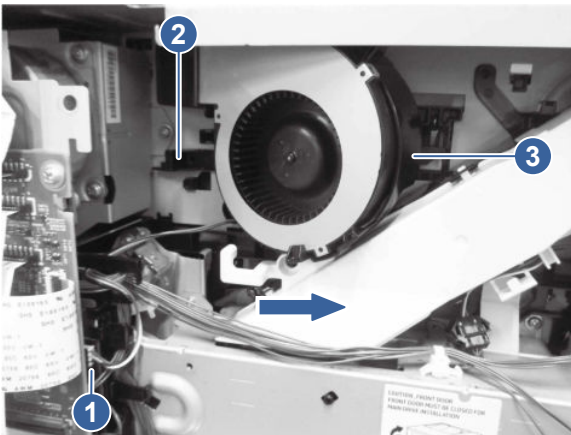


## 6. Remove the fuser fan

Follow these steps to remove the fuser fan.

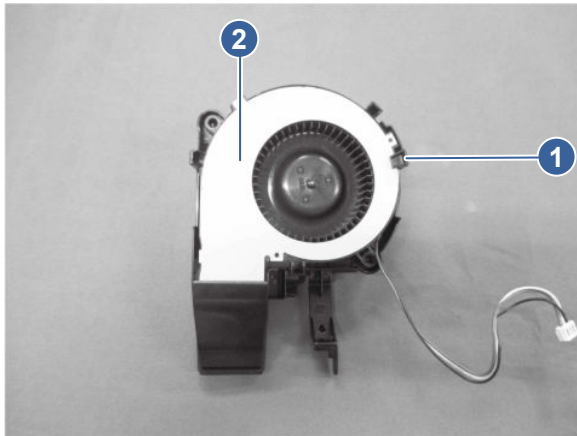
1. Disconnect one connector (callout 1), release one tab (callout 2), slide the fan holder (callout 3) in the direction indicated, and then pull the fan holder (callout 3) out of the printer.

**Figure 5-783 Remove the fan holder**



2. Release one tab (callout 1), and then remove the fuser fan (callout 2).

**Figure 5-784 Remove the fan from the holder**



## 7. Unpack the replacement assembly



Follow these steps to unpack the replacement assembly.


1. Dispose of the defective part.


 **NOTE:** HP recommends responsible disposal of the defective part.

<http://www8.hp.com/us/en/hp-information/environment/product-recycling.html>


2. Unpack the replacement part from the packaging.

 **CAUTION:**  Some parts are sensitive to electrostatic discharge (ESD). Always perform service work at an ESD-protected workstation or mat. If an ESD workstation or mat is not available, touch the sheet-metal chassis to provide a static ground before touching an ESD-sensitive assembly. Protect the ESD-sensitive assemblies by placing them in ESD pouches when they are out of the printer.

 **IMPORTANT:** Make sure that all of the shipping materials (for example shipping tape) are removed from the replacement part prior to installation.

 **NOTE:** If the replacement part is a roller or pad, avoid touching the spongy part of it. Skin oils on the roller or pad can cause paper pickup and/or print-quality problems. HP recommends using disposable gloves when handling rollers or pads or washing your hands before touching rollers or pads.

3. To install an assembly, reverse the removal steps.

 **NOTE:** When applicable, special installation instructions are provided for an assembly at the end of the removal procedure. Always completely read the removal instructions and follow all special installation instructions.

## Removal and replacement: Exhaust fan

Learn about removing and replacing the exhaust fan.

### Before performing service

Turn the printer power off

- Disconnect the power cable.

---

**⚠ WARNING!** To avoid damage to the printer, turn the printer off, wait 30 seconds, and then remove the power cord before attempting to service the printer.

---

If the part is damaged and cannot be cleaned, use the table below to identify the correct part number for your printer. To order the part, go to [www.hp.com/buy/parts](http://www.hp.com/buy/parts).

**Table 5-99** Part information

Part number	Part description
RK3-0760-000CN	Fan (Exhaust fan)

## Required tools

- #2 Phillips screwdriver with a magnetic tip and a 152 mm (6 in) shaft length

## After performing service

### Turn the printer power on

- Connect the power cable.
- Use the power switch to turn the power on.

## Post service test

Print any pages necessary to make sure the printer is functioning correctly.

### 1. Remove the fuser

Follow these steps to remove the fuser.

1. Open the right door.

---

**⚠ CAUTION:** The fuser is hot. Wait at least 10 minutes after turning the printer power off before removing the fuser.

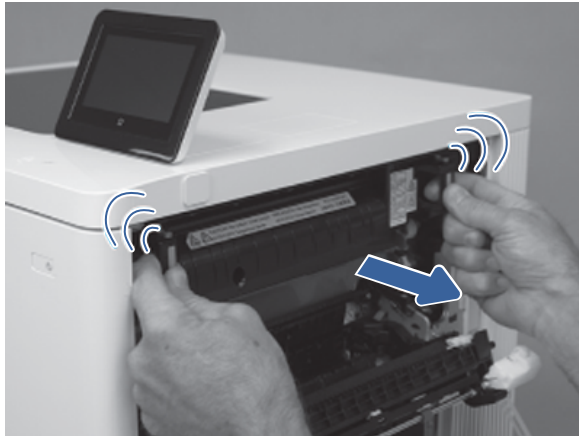
---

**Figure 5-785** Open the right door



2. Squeeze the release levers on the handles (circle callouts), and then remove the fuser.

**Figure 5-786 Remove the fuser**

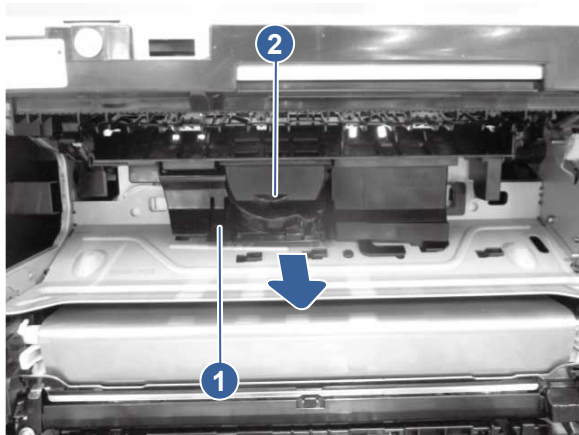


## 2. Remove the exhaust fan

Follow these steps to remove the exhaust fan.

1. Release one tab (callout 1), slide the fan duct assembly (callout 2) in the direction indicated, and then remove it.

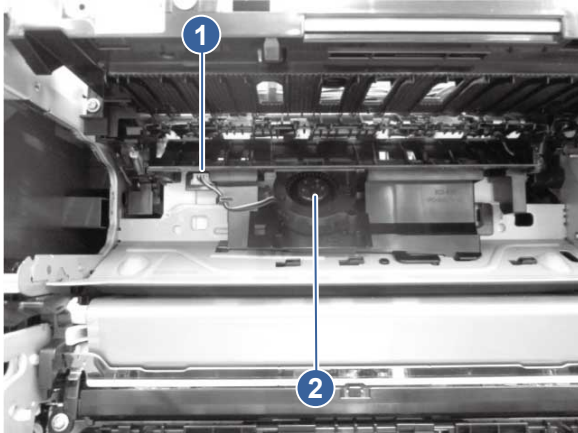
**Figure 5-787 Remove the fan duct assembly**





2. Disconnect one connector (callout 1), and then remove the exhaust fan (callout 2).

**Figure 5-788 Remove the fan**



### 3. Unpack the replacement assembly

Follow these steps to unpack the replacement assembly.

1. Dispose of the defective part.




**NOTE:** HP recommends responsible disposal of the defective part.

<http://www8.hp.com/us/en/hp-information/environment/product-recycling.html>

2. Unpack the replacement part from the packaging.



**CAUTION:**  Some parts are sensitive to electrostatic discharge (ESD). Always perform service work at an ESD-protected workstation or mat. If an ESD workstation or mat is not available, touch the sheet-metal chassis to provide a static ground before touching an ESD-sensitive assembly. Protect the ESD-sensitive assemblies by placing them in ESD pouches when they are out of the printer.



**IMPORTANT:** Make sure that all of the shipping materials (for example shipping tape) are removed from the replacement part prior to installation.



**NOTE:** If the replacement part is a roller or pad, avoid touching the spongy part of it. Skin oils on the roller or pad can cause paper pickup and/or print-quality problems. HP recommends using disposable gloves when handling rollers or pads or washing your hands before touching rollers or pads.

3. To install an assembly, reverse the removal steps.



**NOTE:** When applicable, special installation instructions are provided for an assembly at the end of the removal procedure. Always completely read the removal instructions and follow all special installation instructions.

## 5. Input device - 550-sheet paper feeder

Learn how to remove and replace the 550-sheet paper feeder parts and assemblies.

### Field-replaceable units (FRUs)

Learn about FRU parts removal and replacement.

## Covers, panels, and doors

Learn about covers, panels, and doors removal and replacement.

### Removal and replacement: Front left cover (550-sheet paper feeder)

Learn about removing and replacing the paper feeder left cover.

#### Before performing service

##### Turn the printer power off

- Disconnect the power cable.

**⚠ WARNING!** To avoid damage to the printer, turn the printer off, wait 30 seconds, and then remove the power cord before attempting to service the printer.

Use the table below to identify the correct part number for your printer, and then go to <https://parts.hp.com/hpparts> to order the part.

**Table 5-100** Part information

Part number	Part description
RC5-9200-000CN	Cover, front left (1x550-sheet paper feeder)

#### Required tools

- No special tools are required to remove or install this assembly.

#### After performing service

##### Turn the printer power on

- Connect the power cable.
- Use the power switch to turn the power on.

#### Post service test

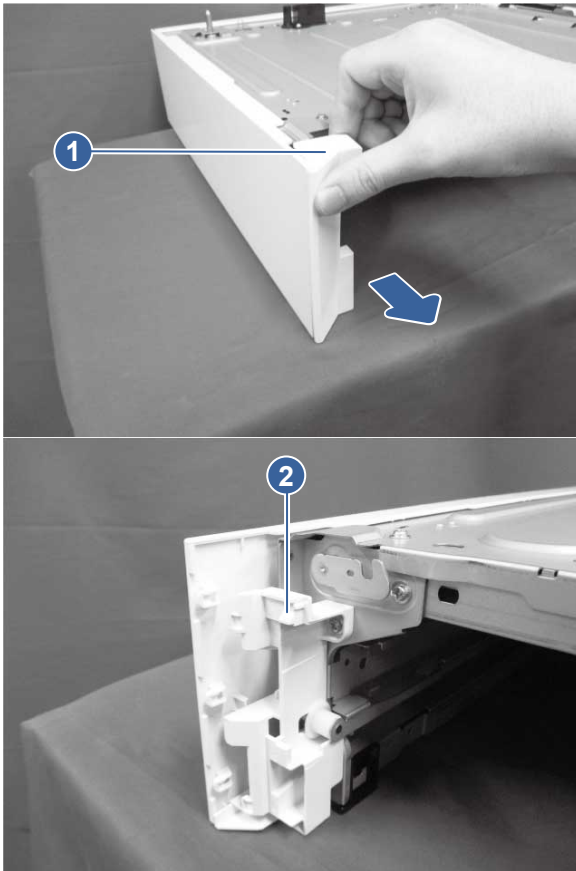
No post service test is available for this assembly.

### 1. Remove the front left cover (550-sheet paper feeder)

Follow these steps to remove the 550-sheet tray front left cover.

- Flex the upper part of the front left cover (callout 1) in the direction indicated, release one tab (callout 2), and then slide the front left cover upward to remove it.

**Figure 5-789 Remove the front left cover (550-sheet paper feeder)**



## 2. Unpack the replacement assembly

Follow these steps to unpack the replacement assembly.

1. Dispose of the defective part.




**NOTE:** HP recommends responsible disposal of the defective part.

<http://www8.hp.com/us/en/hp-information/environment/product-recycling.html>

2. Unpack the replacement part from the packaging.



**CAUTION:**  Some parts are sensitive to electrostatic discharge (ESD). Always perform service work at an ESD-protected workstation or mat. If an ESD workstation or mat is not available, touch the sheet-metal chassis to provide a static ground before touching an ESD-sensitive assembly. Protect the ESD-sensitive assemblies by placing them in ESD pouches when they are out of the printer.



**IMPORTANT:** Make sure that all of the shipping materials (for example shipping tape) are removed from the replacement part prior to installation.



**NOTE:** If the replacement part is a roller or pad, avoid touching the spongy part of it. Skin oils on the roller or pad can cause paper pickup and/or print-quality problems. HP recommends using disposable gloves when handling rollers or pads or washing your hands before touching rollers or pads.

3. To install an assembly, reverse the removal steps.



**NOTE:** When applicable, special installation instructions are provided for an assembly at the end of the removal procedure. Always completely read the removal instructions and follow all special installation instructions.

## Removal and replacement: Front right cover (550-sheet paper feeder)

Learn about removing and replacing the paper feeder front right cover.

### Before performing service

#### Turn the printer power off

- Disconnect the power cable.

**⚠ WARNING!** To avoid damage to the printer, turn the printer off, wait 30 seconds, and then remove the power cord before attempting to service the printer.

Use the table below to identify the correct part number for your printer, and then go to <https://parts.hp.com/hpparts> to order the part.

**Table 5-101** Part information

Part number	Part description
RCS-9201-000CN	Cover, front right (1x550-sheet paper feeder)

### Required tools

- No special tools are required to remove or install this assembly.

### After performing service

#### Turn the printer power on

- Connect the power cable.
- Use the power switch to turn the power on.

### Post service test

No post service test is available for this assembly.

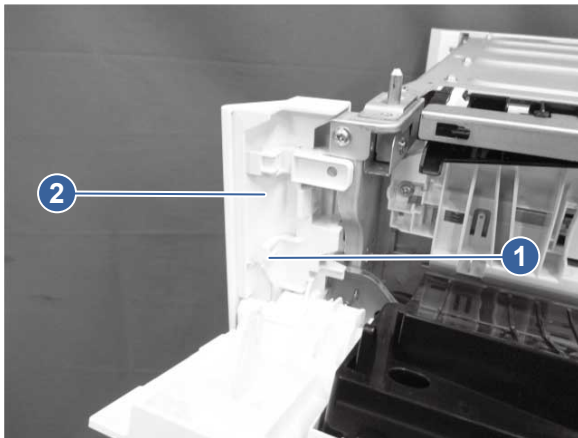
## 1. Remove the front right cover (550-sheet paper feeder)

Follow these steps to remove the 550-sheet tray front right cover.

1. Open the paper feeder right door.

2. Release one tab (callout 1), and then slide the front right cover (callout 2) upward to remove it.

**Figure 5-790 Remove the front right cover (550-sheet paper feeder)**



## 2. Unpack the replacement assembly

Follow these steps to unpack the replacement assembly.

1. Dispose of the defective part.

---



 **NOTE:** HP recommends responsible disposal of the defective part.


<http://www8.hp.com/us/en/hp-information/environment/product-recycling.html>


---

2. Unpack the replacement part from the packaging.

---

 **CAUTION:**  Some parts are sensitive to electrostatic discharge (ESD). Always perform service work at an ESD-protected workstation or mat. If an ESD workstation or mat is not available, touch the sheet-metal chassis to provide a static ground before touching an ESD-sensitive assembly. Protect the ESD-sensitive assemblies by placing them in ESD pouches when they are out of the printer.


 **IMPORTANT:** Make sure that all of the shipping materials (for example shipping tape) are removed from the replacement part prior to installation.

 **NOTE:** If the replacement part is a roller or pad, avoid touching the spongy part of it. Skin oils on the roller or pad can cause paper pickup and/or print-quality problems. HP recommends using disposable gloves when handling rollers or pads or washing your hands before touching rollers or pads.

---

3. To install an assembly, reverse the removal steps.

---

 **NOTE:** When applicable, special installation instructions are provided for an assembly at the end of the removal procedure. Always completely read the removal instructions and follow all special installation instructions.

---

## Removal and replacement: Right door (550-sheet paper feeder)

Learn about removing and replacing the paper right door.

### Before performing service

**Turn the printer power off**

- Disconnect the power cable.

**⚠ WARNING!** To avoid damage to the printer, turn the printer off, wait 30 seconds, and then remove the power cord before attempting to service the printer.

Use the table below to identify the correct part number for your printer, and then go to <https://parts.hp.com/hpparts> to order the part.

**Table 5-102 Part information**

Part number	Part description
RM3-0004-000CN	Right door assembly (1x550-sheet paper feeder)

## Required tools

- No special tools are required to remove or install this assembly.

## After performing service

### Turn the printer power on

- Connect the power cable.
- Use the power switch to turn the power on.

## Post service test

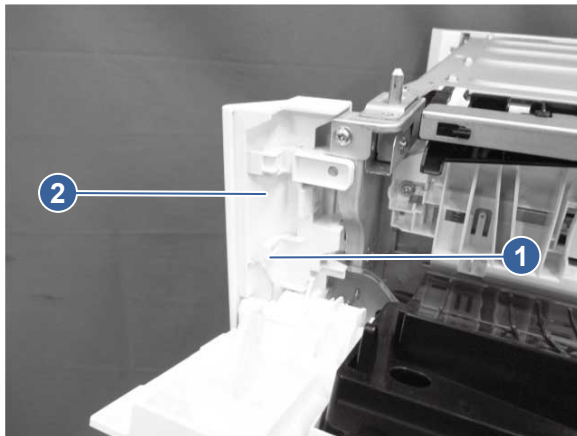
No post service test is available for this assembly.

### 1. Remove the front right cover (550-sheet paper feeder)

Follow these steps to remove the 550-sheet tray front right cover.

1. Open the paper feeder right door.
2. Release one tab (callout 1), and then slide the front right cover (callout 2) upward to remove it.

**Figure 5-791 Remove the front right cover (550-sheet paper feeder)**

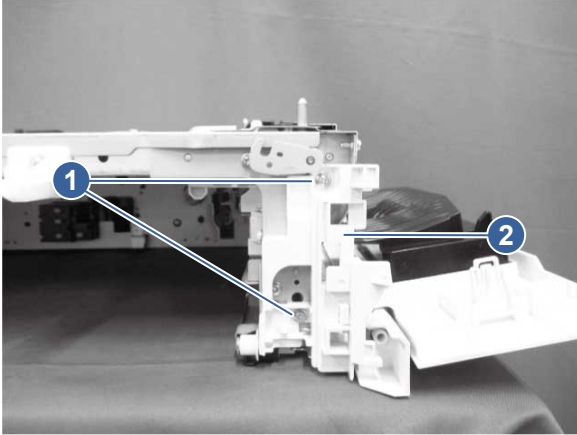


### 2. Remove the right door (550-sheet paper feeder)

Follow these steps to remove the 550-sheet tray right door.

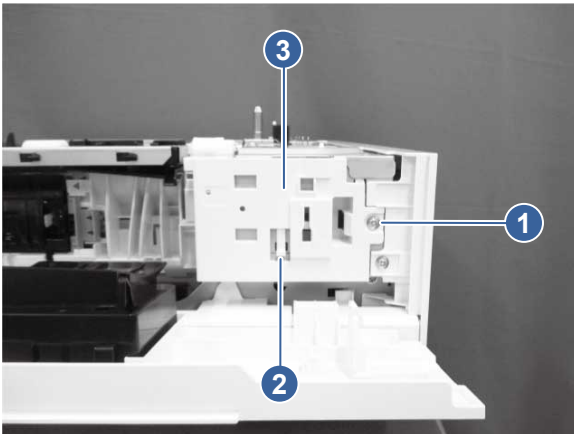
1. Remove two screws (callout 1), and then remove the base frame (callout 2).

**Figure 5-792 Remove the base frame**



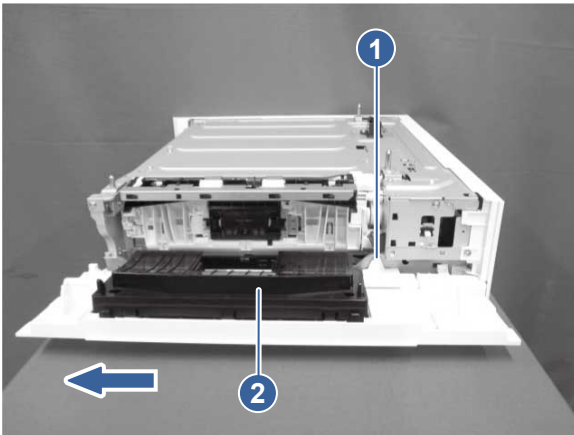
2. Remove one screw (callout 1), release one tab (callout 2), and then slide the rear inner cover (callout 3) downward to remove it.

**Figure 5-793 Remove the rear inner cover**



3. Release one tab (callout 1), and then slide the right door assembly (callout 2) in the direction indicated to remove it.


**Figure 5-794 Remove the right door (550-sheet paper feeder)**



### 3. Unpack the replacement assembly



Follow these steps to unpack the replacement assembly.


1. Dispose of the defective part.


 **NOTE:** HP recommends responsible disposal of the defective part.

<http://www8.hp.com/us/en/hp-information/environment/product-recycling.html>


2. Unpack the replacement part from the packaging.

 **CAUTION:**  Some parts are sensitive to electrostatic discharge (ESD). Always perform service work at an ESD-protected workstation or mat. If an ESD workstation or mat is not available, touch the sheet-metal chassis to provide a static ground before touching an ESD-sensitive assembly. Protect the ESD-sensitive assemblies by placing them in ESD pouches when they are out of the printer.

 **IMPORTANT:** Make sure that all of the shipping materials (for example shipping tape) are removed from the replacement part prior to installation.

 **NOTE:** If the replacement part is a roller or pad, avoid touching the spongy part of it. Skin oils on the roller or pad can cause paper pickup and/or print-quality problems. HP recommends using disposable gloves when handling rollers or pads or washing your hands before touching rollers or pads.

3. To install an assembly, reverse the removal steps.

 **NOTE:** When applicable, special installation instructions are provided for an assembly at the end of the removal procedure. Always completely read the removal instructions and follow all special installation instructions.


#### Removal and replacement: Rear cover (550-sheet paper feeder)

Learn about removing and replacing the paper feeder rear cover.

#### Before performing service

##### Turn the printer power off

- Disconnect the power cable.

 **WARNING!** To avoid damage to the printer, turn the printer off, wait 30 seconds, and then remove the power cord before attempting to service the printer.

Use the table below to identify the correct part number for your printer, and then go to <https://parts.hp.com/hpparts> to order the part.

**Table 5-103** Part information

Part number	Part description
RC5-9409-000CN	Cover, rear (1x550-sheet paper feeder)

#### Required tools

- No special tools are required to remove or install this assembly.

#### After performing service



### Turn the printer power on

- Connect the power cable.
- Use the power switch to turn the power on.

### Post service test

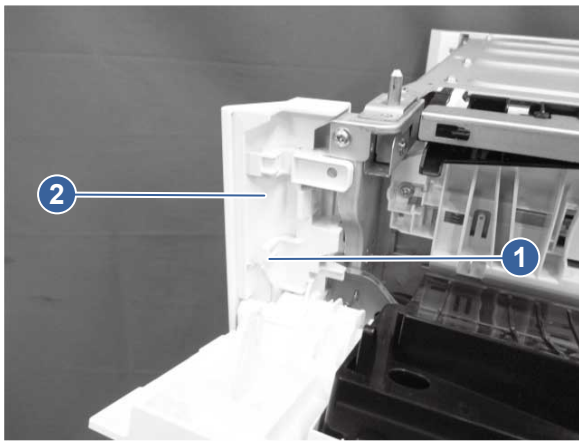
No post service test is available for this assembly.

#### 1. Remove the front right cover (550-sheet paper feeder)

Follow these steps to remove the 550-sheet tray front right cover.

1. Open the paper feeder right door.
2. Release one tab (callout 1), and then slide the front right cover (callout 2) upward to remove it.

**Figure 5-795 Remove the front right cover (550-sheet paper feeder)**

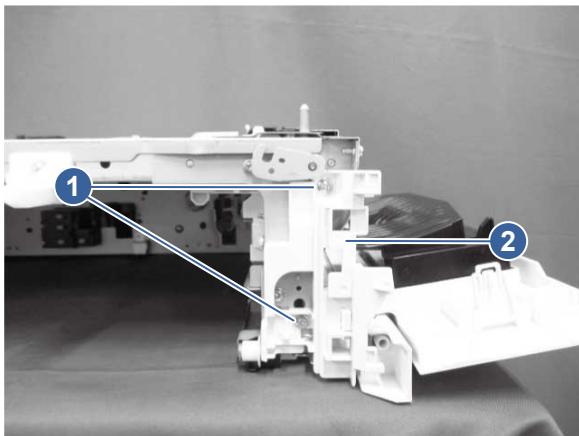


#### 2. Remove the right door (550-sheet paper feeder)

Follow these steps to remove the 550-sheet tray right door.

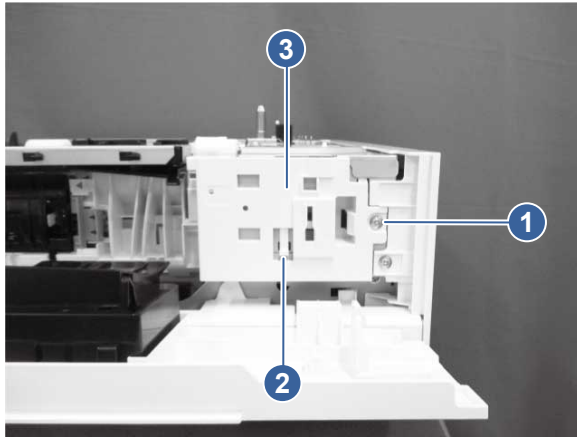
1. Remove two screws (callout 1), and then remove the base frame (callout 2).

**Figure 5-796 Remove the base frame**



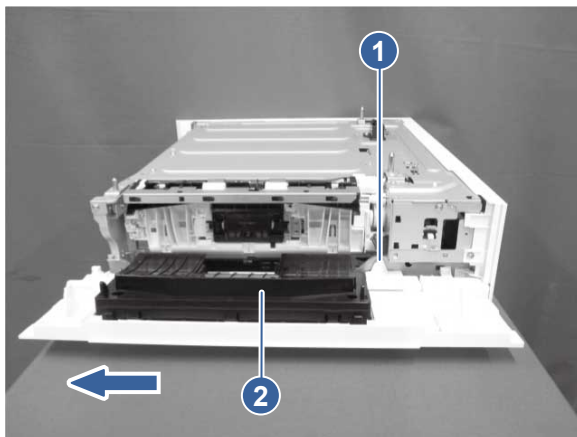
2. Remove one screw (callout 1), release one tab (callout 2), and then slide the rear inner cover (callout 3) downward to remove it.

**Figure 5-797 Remove the rear inner cover**



3. Release one tab (callout 1), and then slide the right door assembly (callout 2) in the direction indicated to remove it.

**Figure 5-798 Remove the right door (550-sheet paper feeder)**

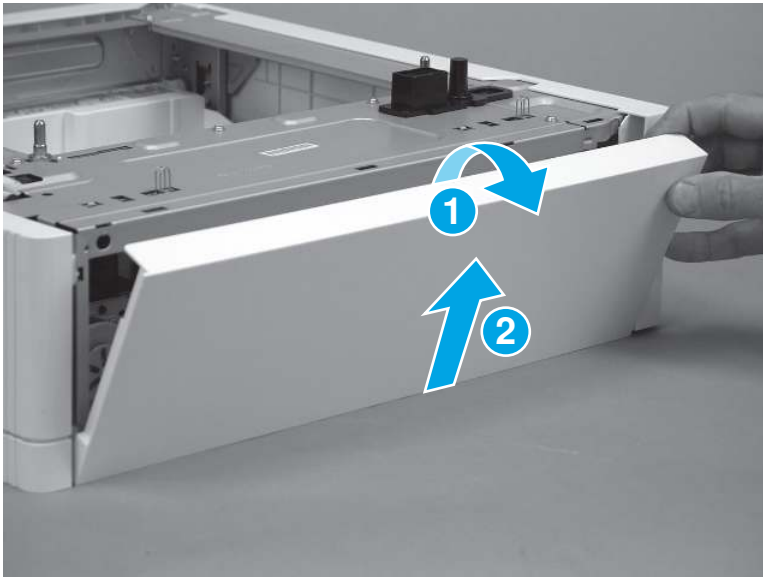


### 3. Remove the rear cover (550-sheet paper feeder)

Follow these steps to remove the 550-sheet tray rear cover.

- Remove one screw (callout 1), and then slide the rear cover (callout 2) in the direction indicated to remove it.

**Figure 5-799 Remove the rear cover (550-sheet paper feeder)**



#### 4. Unpack the replacement assembly

Follow these steps to unpack the replacement assembly.

1. Dispose of the defective part.




**NOTE:** HP recommends responsible disposal of the defective part.

<http://www8.hp.com/us/en/hp-information/environment/product-recycling.html>

2. Unpack the replacement part from the packaging.



**CAUTION:**  Some parts are sensitive to electrostatic discharge (ESD). Always perform service work at an ESD-protected workstation or mat. If an ESD workstation or mat is not available, touch the sheet-metal chassis to provide a static ground before touching an ESD-sensitive assembly. Protect the ESD-sensitive assemblies by placing them in ESD pouches when they are out of the printer.



**IMPORTANT:** Make sure that all of the shipping materials (for example shipping tape) are removed from the replacement part prior to installation.



**NOTE:** If the replacement part is a roller or pad, avoid touching the spongy part of it. Skin oils on the roller or pad can cause paper pickup and/or print-quality problems. HP recommends using disposable gloves when handling rollers or pads or washing your hands before touching rollers or pads.

3. To install an assembly, reverse the removal steps.



**NOTE:** When applicable, special installation instructions are provided for an assembly at the end of the removal procedure. Always completely read the removal instructions and follow all special installation instructions.

#### Removal and replacement: Left cover (550-sheet paper feeder)

Learn about removing and replacing the paper feeder left cover.

## Before performing service

### Turn the printer power off

- Disconnect the power cable.

**⚠ WARNING!** To avoid damage to the printer, turn the printer off, wait 30 seconds, and then remove the power cord before attempting to service the printer.

Use the table below to identify the correct part number for your printer, and then go to <https://parts.hp.com/hpparts> to order the part.

**Table 5-104** Part information

Part number	Part description
RC5-9408-000CN	Cover, left (1x550-sheet paper feeder)

## Required tools

- No special tools are required to remove or install this assembly.

## After performing service

### Turn the printer power on

- Connect the power cable.
- Use the power switch to turn the power on.

## Post service test

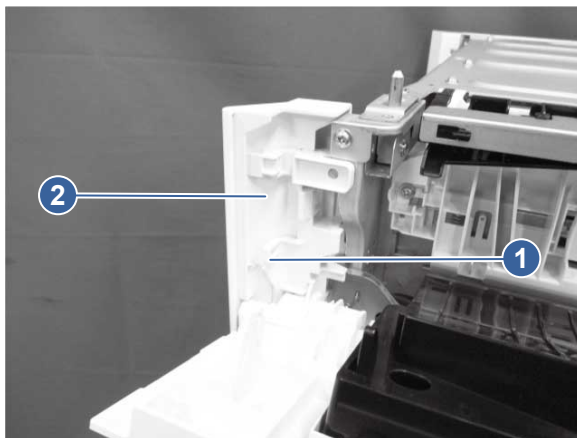
No post service test is available for this assembly.

### 1. Remove the front right cover (550-sheet paper feeder)

Follow these steps to remove the 550-sheet tray front right cover.

1. Open the paper feeder right door.
2. Release one tab (callout 1), and then slide the front right cover (callout 2) upward to remove it.

**Figure 5-800** Remove the front right cover (550-sheet paper feeder)

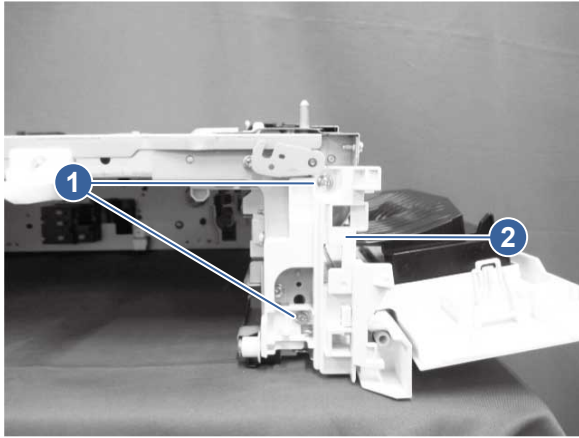


## 2. Remove the right door (550-sheet paper feeder)

Follow these steps to remove the 550-sheet tray right door.

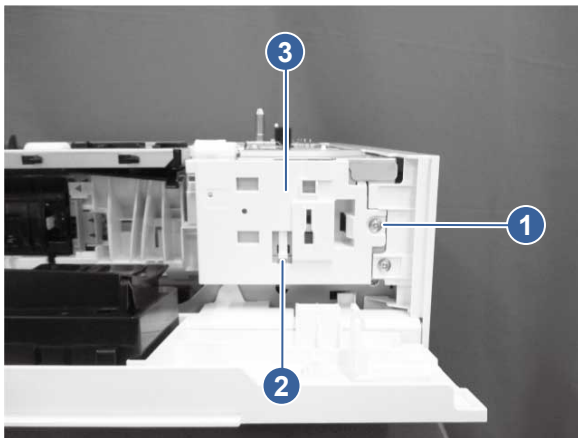
1. Remove two screws (callout 1), and then remove the base frame (callout 2).

**Figure 5-801 Remove the base frame**



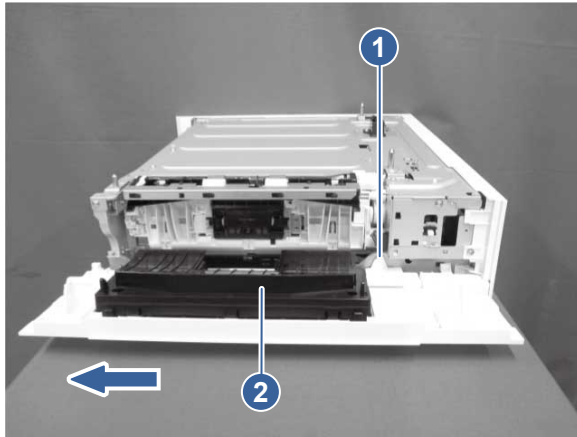
2. Remove one screw (callout 1), release one tab (callout 2), and then slide the rear inner cover (callout 3) downward to remove it.

**Figure 5-802 Remove the rear inner cover**



3. Release one tab (callout 1), and then slide the right door assembly (callout 2) in the direction indicated to remove it.

**Figure 5-803 Remove the right door (550-sheet paper feeder)**

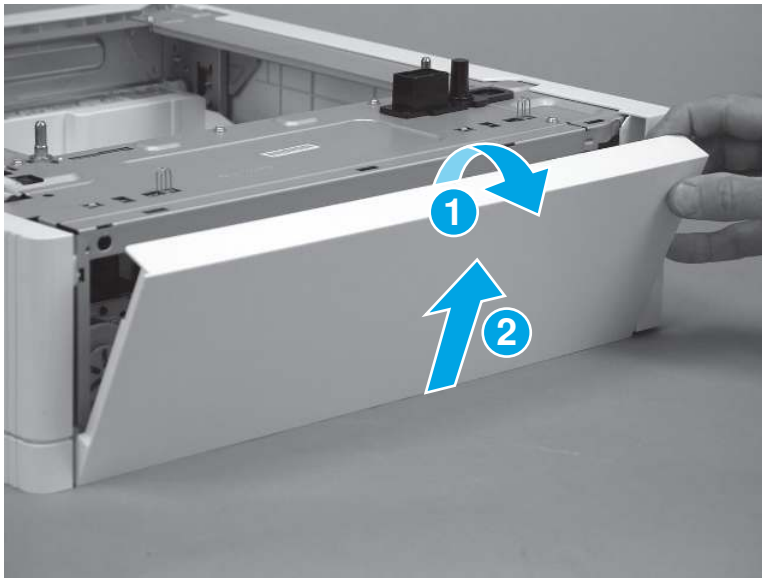


### 3. Remove the rear cover (550-sheet paper feeder)

Follow these steps to remove the 550-sheet tray rear cover.

- Remove one screw (callout 1), and then slide the rear cover (callout 2) in the direction indicated to remove it.

**Figure 5-804 Remove the rear cover (550-sheet paper feeder)**

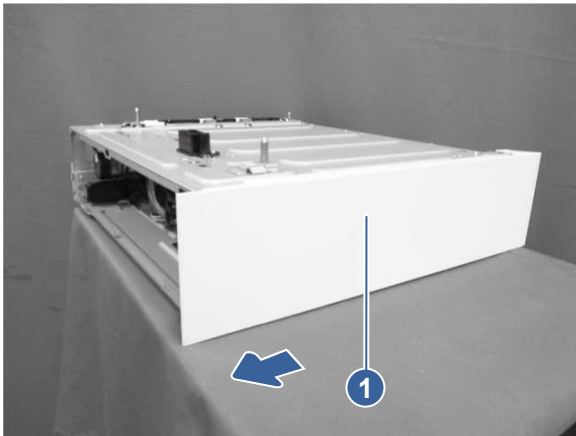


### 4. Remove the left cover (550-sheet paper feeder)

Follow these steps to remove the 550-sheet tray left cover.

- Slide the left cover (callout 1) in the direction indicated to remove it.

**Figure 5-805 Remove the left cover**



## 5. Unpack the replacement assembly

Follow these steps to unpack the replacement assembly.

1. Dispose of the defective part.

---



 **NOTE:** HP recommends responsible disposal of the defective part.


<http://www8.hp.com/us/en/hp-information/environment/product-recycling.html>


---

2. Unpack the replacement part from the packaging.

---

 **CAUTION:**  Some parts are sensitive to electrostatic discharge (ESD). Always perform service work at an ESD-protected workstation or mat. If an ESD workstation or mat is not available, touch the sheet-metal chassis to provide a static ground before touching an ESD-sensitive assembly. Protect the ESD-sensitive assemblies by placing them in ESD pouches when they are out of the printer.


 **IMPORTANT:** Make sure that all of the shipping materials (for example shipping tape) are removed from the replacement part prior to installation.

 **NOTE:** If the replacement part is a roller or pad, avoid touching the spongy part of it. Skin oils on the roller or pad can cause paper pickup and/or print-quality problems. HP recommends using disposable gloves when handling rollers or pads or washing your hands before touching rollers or pads.

---

3. To install an assembly, reverse the removal steps.

---

 **NOTE:** When applicable, special installation instructions are provided for an assembly at the end of the removal procedure. Always completely read the removal instructions and follow all special installation instructions.

---

## Internal parts and assemblies

Learn how to remove and replace the printer internal parts and assemblies.

### Removal and replacement: Pickup assembly (550-sheet paper feeder)

Learn about removing and replacing the paper feeder pickup assembly.

## Before performing service

## Turn the printer power off

- Disconnect the power cable.

**⚠ WARNING!** To avoid damage to the printer, turn the printer off, wait 30 seconds, and then remove the power cord before attempting to service the printer.

Use the table below to identify the correct part number for your printer, and then go to <https://parts.hp.com/hpparts> to order the part.

**Table 5-105** Part information

Part number	Part description
RM2-3617-000CN	Paper pickup drive assembly (1x550-sheet paper feeder)

## Required tools

- #2 Phillips screwdriver with a magnetic tip and a 152 mm (6 in) shaft length
- Small flat-blade screwdriver

## After performing service

### Turn the printer power on

- Connect the power cable.
- Use the power switch to turn the power on.

## Post service test

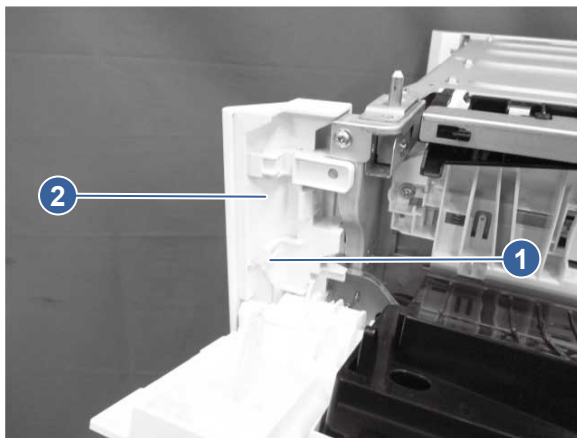
Print any pages necessary to make sure the printer is functioning correctly.

### 1. Remove the front right cover (550-sheet paper feeder)

Follow these steps to remove the 550-sheet tray front right cover.

1. Open the paper feeder right door.
2. Release one tab (callout 1), and then slide the front right cover (callout 2) upward to remove it.

**Figure 5-806** Remove the front right cover (550-sheet paper feeder)



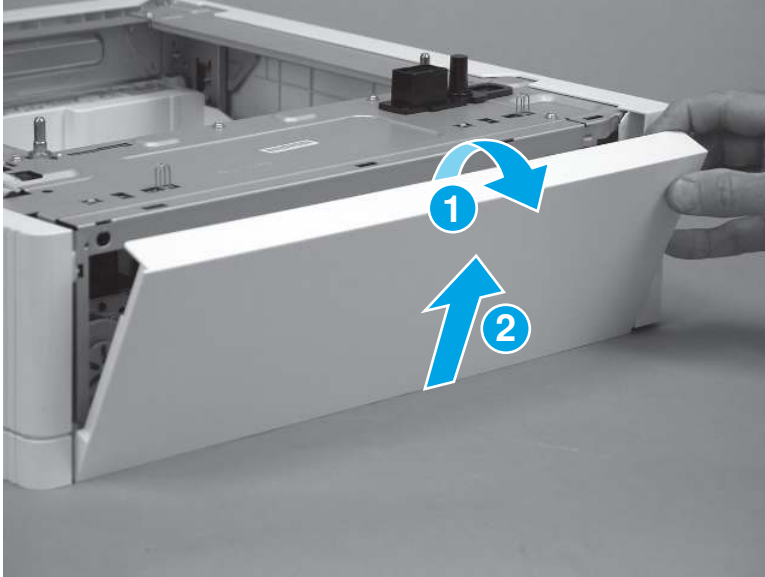


## 2. Remove the rear cover (550-sheet paper feeder)

Follow these steps to remove the 550-sheet tray rear cover.

- Remove one screw (callout 1), and then slide the rear cover (callout 2) in the direction indicated to remove it.

**Figure 5-807** Remove the rear cover (550-sheet paper feeder)

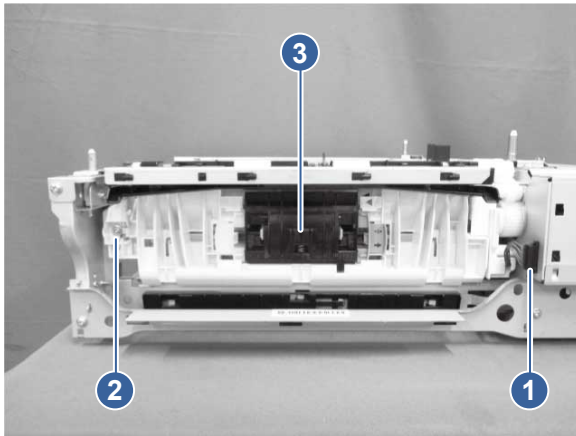


## 3. Remove the paper pickup assembly (550-sheet paper feeder)

Follow these steps to remove the paper pickup assembly.

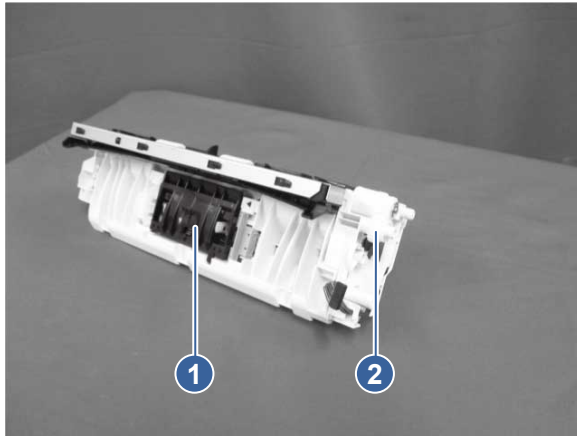
1. Disconnect one connector (callout 1), remove one screw (callout 2), and then remove the pickup assembly (callout 3).

**Figure 5-808** Remove the assembly



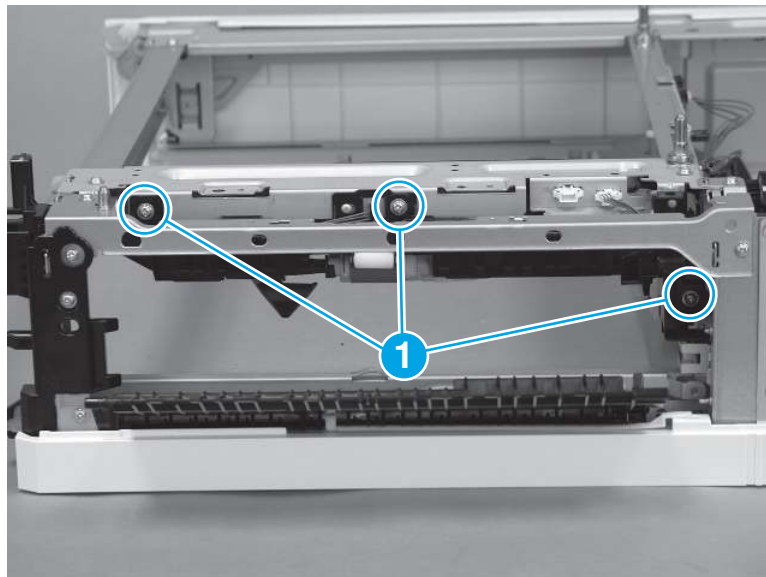
2. Remove the gear (callout 1) from the pickup assembly (callout 2).

**Figure 5-809 Disconnect one connector**



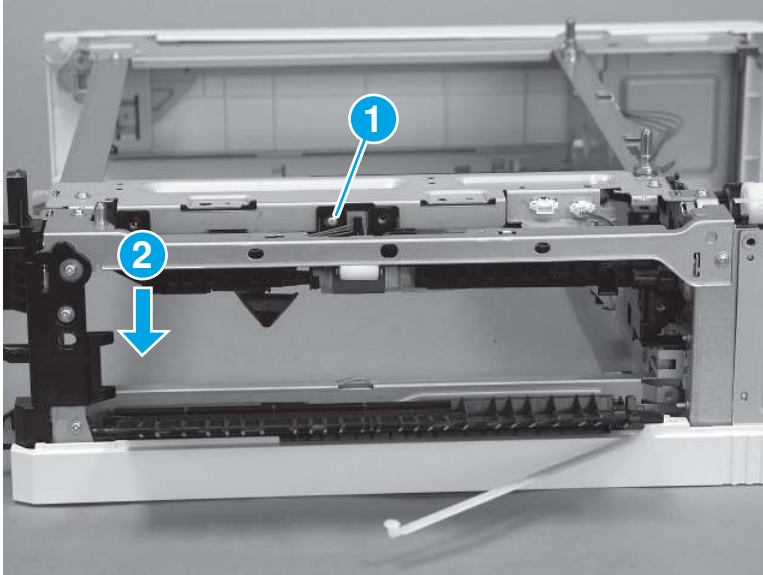
3. Remove three screws (callout 1).

**Figure 5-810 Remove three screws**



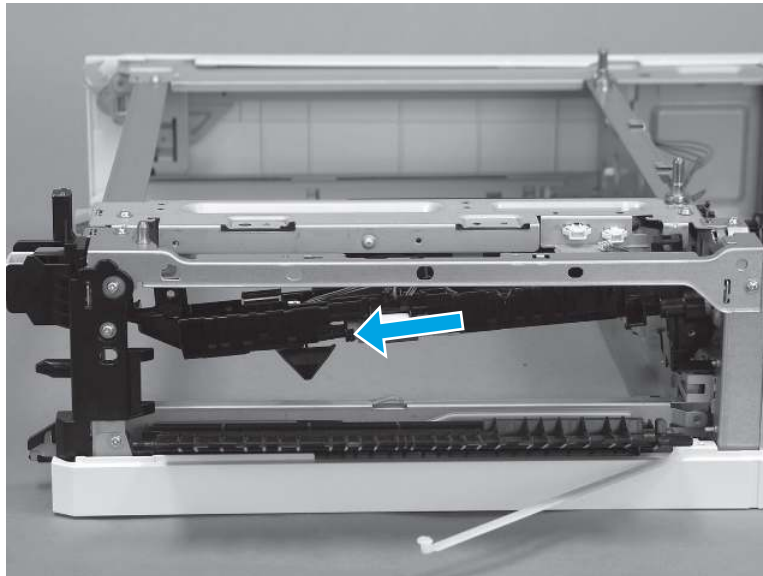
4. Release one alignment pins (callout 1), and then lower the left end of the assembly (callout 2)—the end near the tray cavity.

**Figure 5-811 Lower the end of the assembly**



5. Slide the paper pickup assembly to the left to release it from the drive gear on the lifter drive assembly.

**Figure 5-812 Release the assembly from the drive gear**



#### 4. Unpack the replacement assembly

Follow these steps to unpack the replacement assembly.





1. Dispose of the defective part.




**NOTE:** HP recommends responsible disposal of the defective part.

<http://www8.hp.com/us/en/hp-information/environment/product-recycling.html>

## 2. Unpack the replacement part from the packaging.

-  **CAUTION:**  Some parts are sensitive to electrostatic discharge (ESD). Always perform service work at an ESD-protected workstation or mat. If an ESD workstation or mat is not available, touch the sheet-metal chassis to provide a static ground before touching an ESD-sensitive assembly. Protect the ESD-sensitive assemblies by placing them in ESD pouches when they are out of the printer.
-  **IMPORTANT:** Make sure that all of the shipping materials (for example shipping tape) are removed from the replacement part prior to installation.
-  **NOTE:** If the replacement part is a roller or pad, avoid touching the spongy part of it. Skin oils on the roller or pad can cause paper pickup and/or print-quality problems. HP recommends using disposable gloves when handling rollers or pads or washing your hands before touching rollers or pads.

## 3. To install an assembly, reverse the removal steps.

-  **NOTE:** When applicable, special installation instructions are provided for an assembly at the end of the removal procedure. Always completely read the removal instructions and follow all special installation instructions.

### Removal and replacement: Lifter drive assembly (550-sheet paper feeder)

Learn about removing and replacing the paper feeder lifter drive assembly.




[View a video demonstration of removing and replacing the lifter drive assembly.](#)

### Before performing service

#### Turn the printer power off

- Disconnect the power cable.

 **WARNING!** To avoid damage to the printer, turn the printer off, wait 30 seconds, and then remove the power cord before attempting to service the printer.

Use the table below to identify the correct part number for your printer, and then go to <https://parts.hp.com/hpparts> to order the part.

**Table 5-106** Part information

Part number	Part description
RM2-3501-000CN	Lifter drive assembly (1x550-sheet paper feeder)

### Required tools

- #2 Phillips screwdriver with a magnetic tip and a 152 mm (6 in) shaft length
- Small flat-blade screwdriver

### After performing service

#### Turn the printer power on

- Connect the power cable.

- Use the power switch to turn the power on.

## Post service test

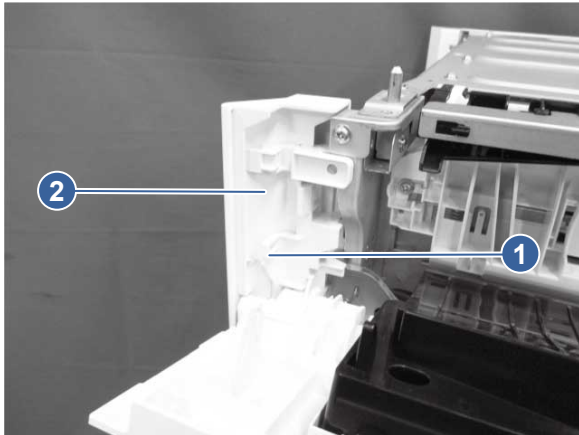
Print any pages necessary to make sure the printer is functioning correctly.

### 1. Remove the front right cover (550-sheet paper feeder)

Follow these steps to remove the 550-sheet tray front right cover.

1. Open the paper feeder right door.
2. Release one tab (callout 1), and then slide the front right cover (callout 2) upward to remove it.

**Figure 5-813** Remove the front right cover (550-sheet paper feeder)

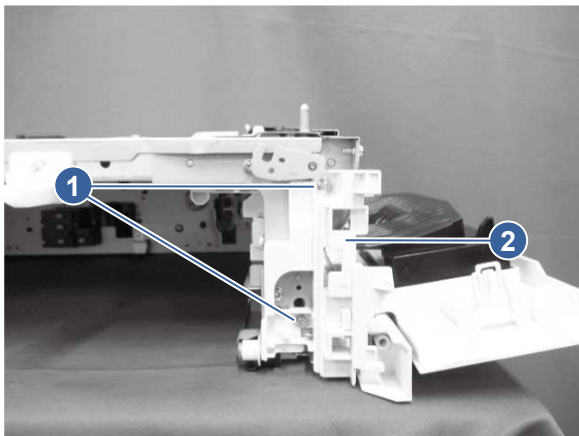


### 2. Remove the right door (550-sheet paper feeder)

Follow these steps to remove the 550-sheet tray right door.

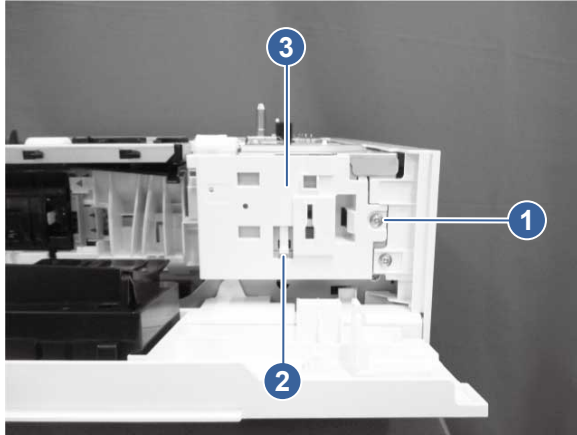
1. Remove two screws (callout 1), and then remove the base frame (callout 2).

**Figure 5-814** Remove the base frame



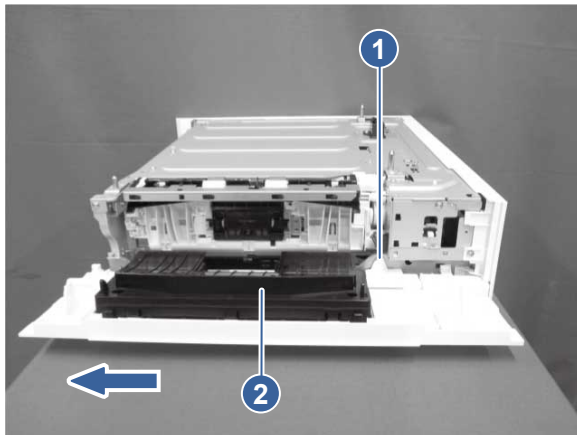
2. Remove one screw (callout 1), release one tab (callout 2), and then slide the rear inner cover (callout 3) downward to remove it.

**Figure 5-815 Remove the rear inner cover**



3. Release one tab (callout 1), and then slide the right door assembly (callout 2) in the direction indicated to remove it.

**Figure 5-816 Remove the right door (550-sheet paper feeder)**

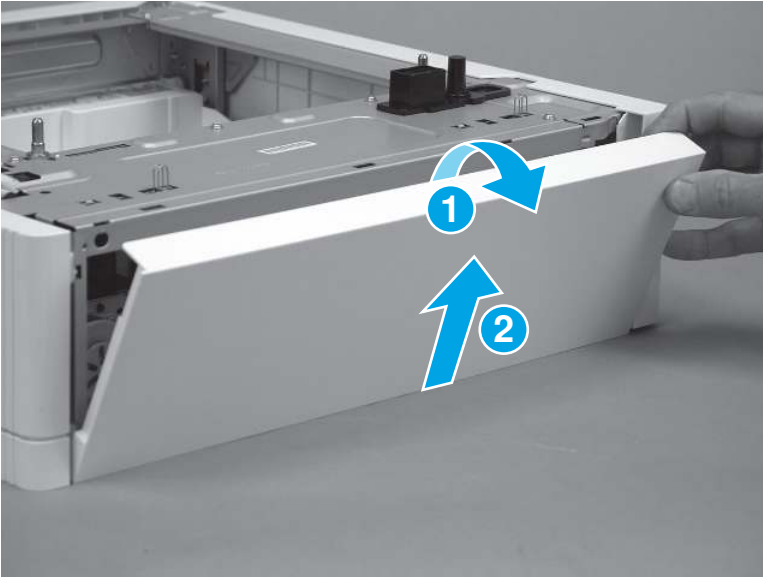


### 3. Remove the rear cover (550-sheet paper feeder)

Follow these steps to remove the 550-sheet tray rear cover.

- Remove one screw (callout 1), and then slide the rear cover (callout 2) in the direction indicated to remove it.

**Figure 5-817 Remove the rear cover (550-sheet paper feeder)**

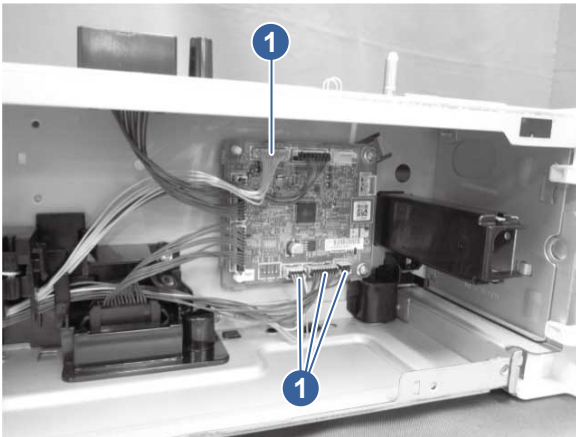


#### 4. Remove the lifter drive assembly (550-sheet paper feeder)

Follow these steps to remove the lifter drive assembly.

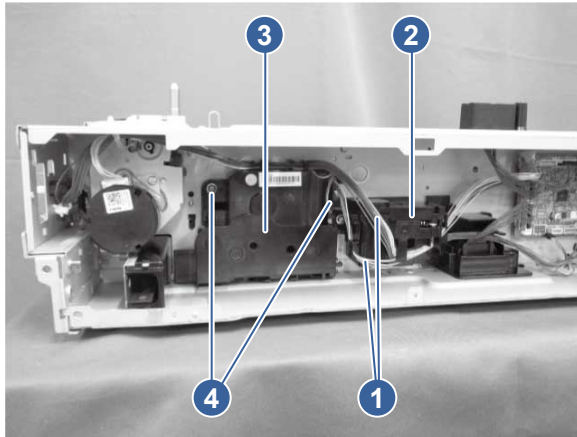
1. Disconnect four connectors (callout 1).

**Figure 5-818 Disconnect four connectors**



2. Release cables (callout 1) from the auto close assembly (callout 2) and the lifter drive assembly (callout 3). Remove two screws (callout 4), and then remove the lifter drive assembly.

**Figure 5-819 Remove the lifter drive assembly (550-sheet paper feeder)**



## 5. Unpack the replacement assembly

Follow these steps to unpack the replacement assembly.

1. Dispose of the defective part.




**NOTE:** HP recommends responsible disposal of the defective part.

<http://www8.hp.com/us/en/hp-information/environment/product-recycling.html>

2. Unpack the replacement part from the packaging.



**CAUTION:**  Some parts are sensitive to electrostatic discharge (ESD). Always perform service work at an ESD-protected workstation or mat. If an ESD workstation or mat is not available, touch the sheet-metal chassis to provide a static ground before touching an ESD-sensitive assembly. Protect the ESD-sensitive assemblies by placing them in ESD pouches when they are out of the printer.



**IMPORTANT:** Make sure that all of the shipping materials (for example shipping tape) are removed from the replacement part prior to installation.



**NOTE:** If the replacement part is a roller or pad, avoid touching the spongy part of it. Skin oils on the roller or pad can cause paper pickup and/or print-quality problems. HP recommends using disposable gloves when handling rollers or pads or washing your hands before touching rollers or pads.

3. To install an assembly, reverse the removal steps.



**NOTE:** When applicable, special installation instructions are provided for an assembly at the end of the removal procedure. Always completely read the removal instructions and follow all special installation instructions.

## Removal and replacement: Pickup drive assembly (550-sheet paper feeder)

Learn about removing and replacing the paper feeder pickup drive assembly.



[View a video demonstration of removing and replacing the pickup drive assembly.](#)

## Before performing service



## Turn the printer power off

- Disconnect the power cable.

**⚠ WARNING!** To avoid damage to the printer, turn the printer off, wait 30 seconds, and then remove the power cord before attempting to service the printer.

Use the table below to identify the correct part number for your printer, and then go to <https://parts.hp.com/hpparts> to order the part.

**Table 5-107** Part information

Part number	Part description
RM2-3617-000CN	Paper pickup drive assembly (1x550-sheet paper feeder)

## Required tools

- #2 Phillips screwdriver with a magnetic tip and a 152 mm (6 in) shaft length
- Small flat-blade screwdriver

## After performing service

### Turn the printer power on

- Connect the power cable.
- Use the power switch to turn the power on.

## Post service test

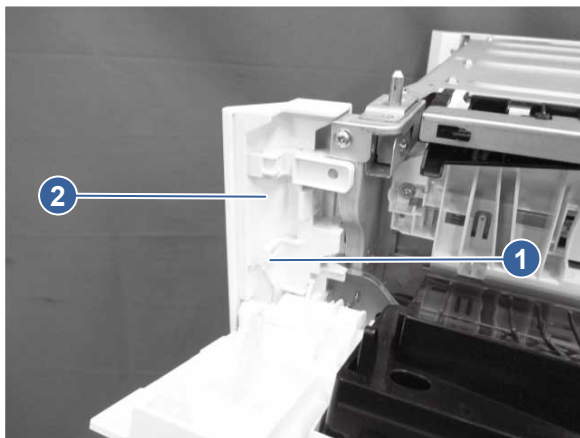
Print any pages necessary to make sure the printer is functioning correctly.

### 1. Remove the front right cover (550-sheet paper feeder)

Follow these steps to remove the 550-sheet tray front right cover.

1. Open the paper feeder right door.
2. Release one tab (callout 1), and then slide the front right cover (callout 2) upward to remove it.

**Figure 5-820** Remove the front right cover (550-sheet paper feeder)

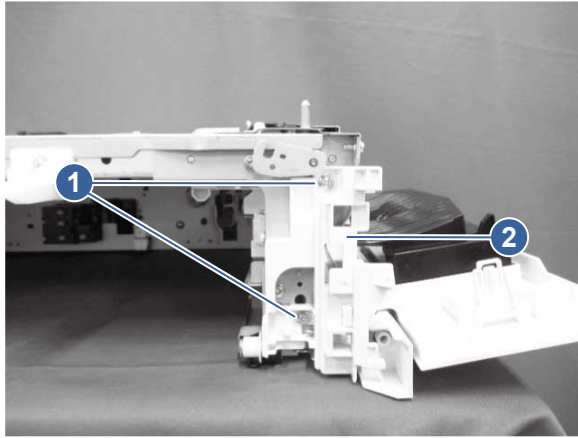


## 2. Remove the right door (550-sheet paper feeder)

Follow these steps to remove the 550-sheet tray right door.

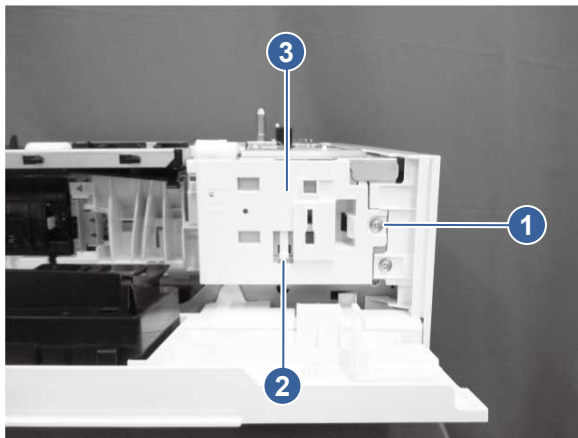
1. Remove two screws (callout 1), and then remove the base frame (callout 2).

**Figure 5-821 Remove the base frame**



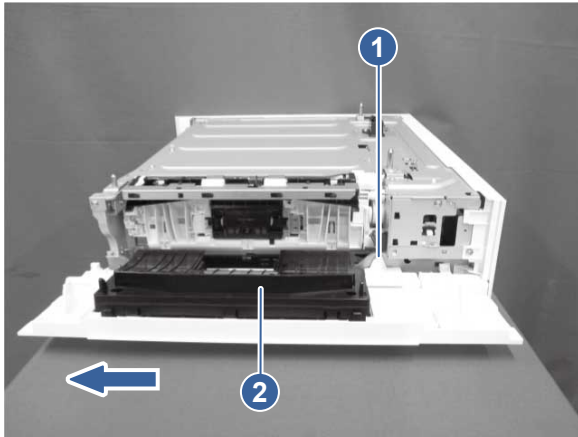
2. Remove one screw (callout 1), release one tab (callout 2), and then slide the rear inner cover (callout 3) downward to remove it.

**Figure 5-822 Remove the rear inner cover**



3. Release one tab (callout 1), and then slide the right door assembly (callout 2) in the direction indicated to remove it.

**Figure 5-823 Remove the right door (550-sheet paper feeder)**

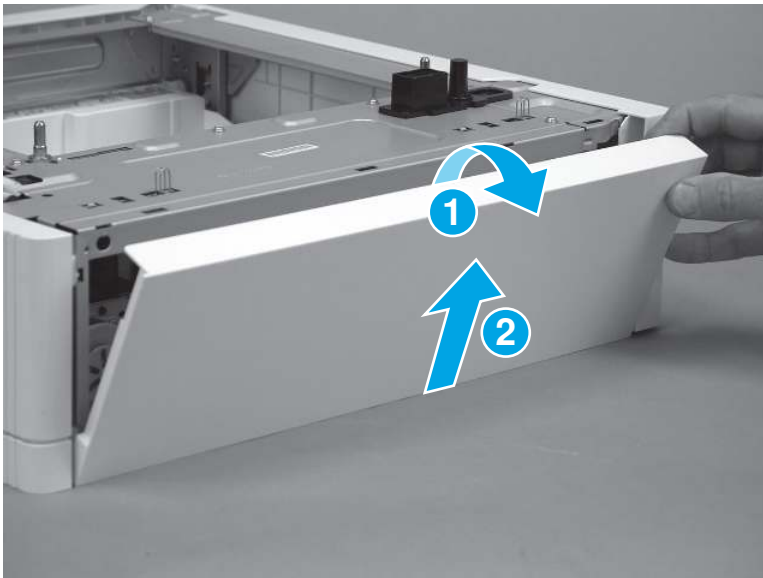


### 3. Remove the rear cover (550-sheet paper feeder)

Follow these steps to remove the 550-sheet tray rear cover.

- Remove one screw (callout 1), and then slide the rear cover (callout 2) in the direction indicated to remove it.

**Figure 5-824 Remove the rear cover (550-sheet paper feeder)**

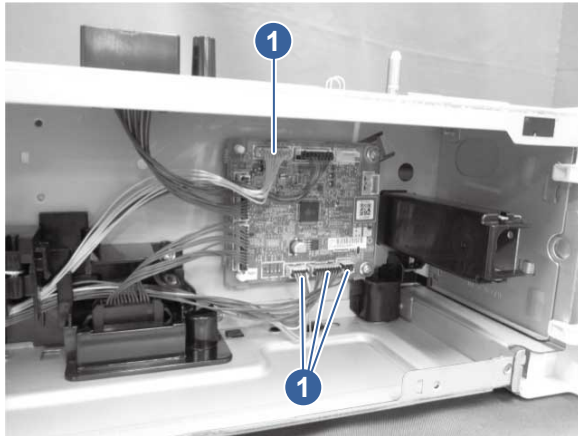


### 4. Remove the pickup drive assembly (550-sheet paper feeder)

Follow these steps to remove the pickup drive assembly.

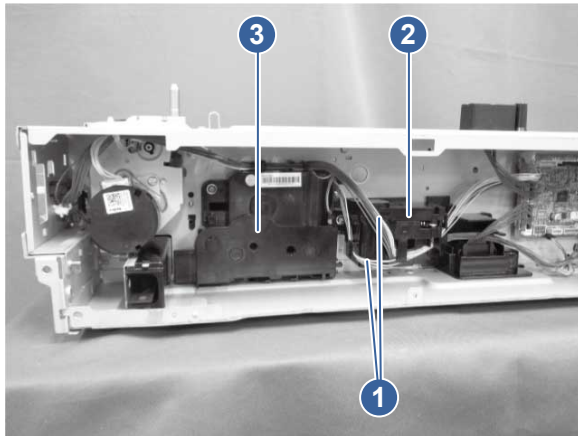
1. Disconnect four connectors (callout 1).

**Figure 5-825 Disconnect four connectors**



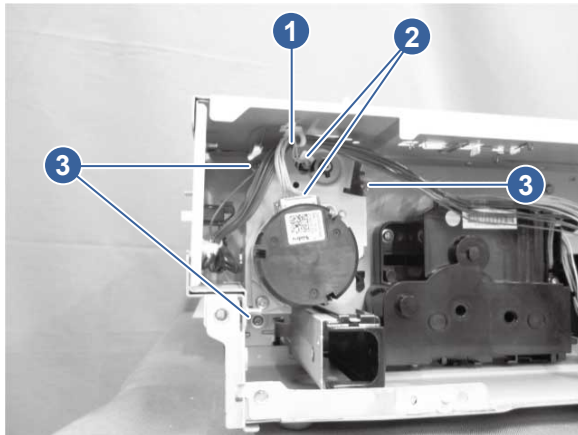
2. Release the cables (callout 1) from the auto close assembly (callout 2) and the lifter drive assembly (callout 3).

**Figure 5-826 Release the cables**



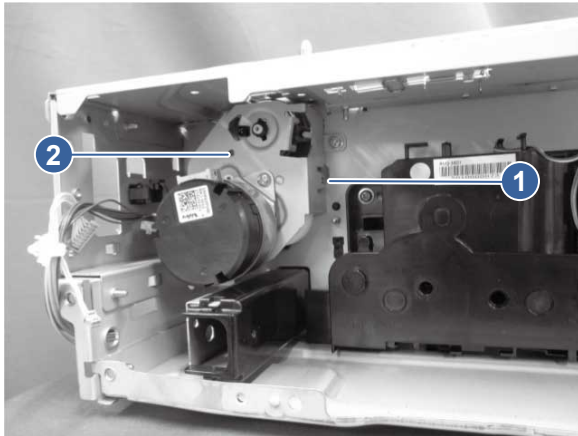
3. Remove the cable clamp (callout 1), disconnect two connectors (callout 2), and then remove three screws (callout 3).

**Figure 5-827 Remove the cable clamp**



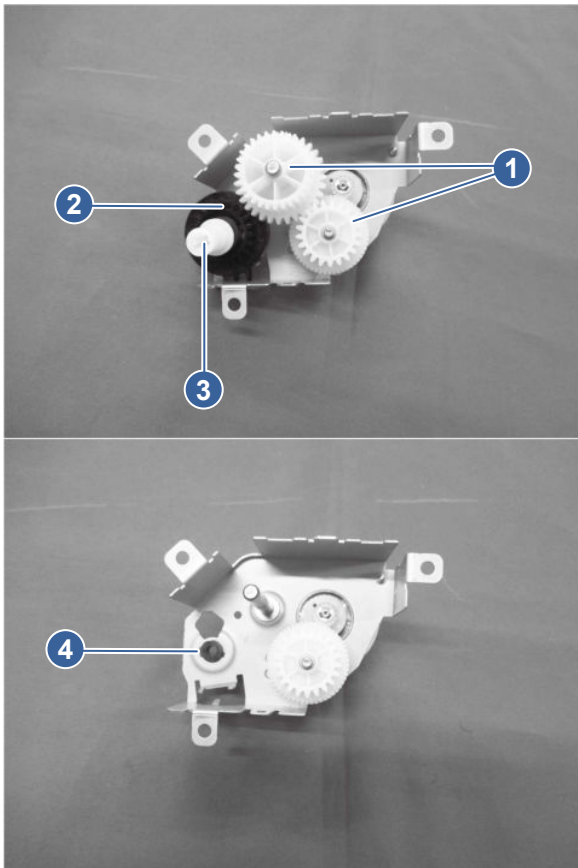
4. Release one tab (callout 1), and then remove the pickup drive assembly (callout 2).

**Figure 5-828 Remove the pickup drive assembly (550-sheet paper feeder)**



**Reinstallation tip:** The indicated gears (callout 1), clutch (callout 2), shaft (callout 3), and bushing (callout 4) are not fixed to the assembly plate. Ensure that these components do not fall apart when installing or removing the paper pickup drive assembly.


**Figure 5-829 Do not lose unfastened components**



## 5. Unpack the replacement assembly



Follow these steps to unpack the replacement assembly.


1. Dispose of the defective part.


 **NOTE:** HP recommends responsible disposal of the defective part.

<http://www8.hp.com/us/en/hp-information/environment/product-recycling.html>


2. Unpack the replacement part from the packaging.

 **CAUTION:**  Some parts are sensitive to electrostatic discharge (ESD). Always perform service work at an ESD-protected workstation or mat. If an ESD workstation or mat is not available, touch the sheet-metal chassis to provide a static ground before touching an ESD-sensitive assembly. Protect the ESD-sensitive assemblies by placing them in ESD pouches when they are out of the printer.

 **IMPORTANT:** Make sure that all of the shipping materials (for example shipping tape) are removed from the replacement part prior to installation.

 **NOTE:** If the replacement part is a roller or pad, avoid touching the spongy part of it. Skin oils on the roller or pad can cause paper pickup and/or print-quality problems. HP recommends using disposable gloves when handling rollers or pads or washing your hands before touching rollers or pads.

3. To install an assembly, reverse the removal steps.

 **NOTE:** When applicable, special installation instructions are provided for an assembly at the end of the removal procedure. Always completely read the removal instructions and follow all special installation instructions.

## Removal and replacement: Auto close assembly (550-sheet paper feeder)


Learn about removing and replacing the paper feeder auto close assembly.

 [View a video demonstration of removing and replacing the auto close assembly.](#)

### Before performing service

#### Turn the printer power off

- Disconnect the power cable.

 **WARNING!** To avoid damage to the printer, turn the printer off, wait 30 seconds, and then remove the power cord before attempting to service the printer.

Use the table below to identify the correct part number for your printer, and then go to <https://parts.hp.com/hpparts> to order the part.

**Table 5-108** Part information

Part number	Part description
RM2-3559-000CN	Auto close assembly (1x550-sheet paper feeder)

### Required tools

- #2 Phillips screwdriver with a magnetic tip and a 152 mm (6 in) shaft length

### After performing service

### Turn the printer power on

- Connect the power cable.
- Use the power switch to turn the power on.

### Post service test

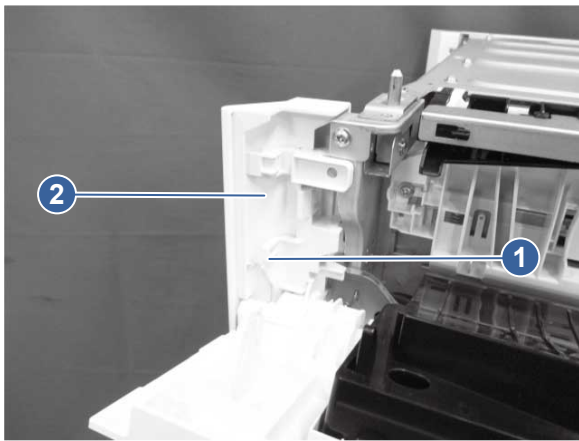
No post service test is available for this assembly.

#### 1. Remove the front right cover (550-sheet paper feeder)

Follow these steps to remove the 550-sheet tray front right cover.

1. Open the paper feeder right door.
2. Release one tab (callout 1), and then slide the front right cover (callout 2) upward to remove it.

**Figure 5-830 Remove the front right cover (550-sheet paper feeder)**

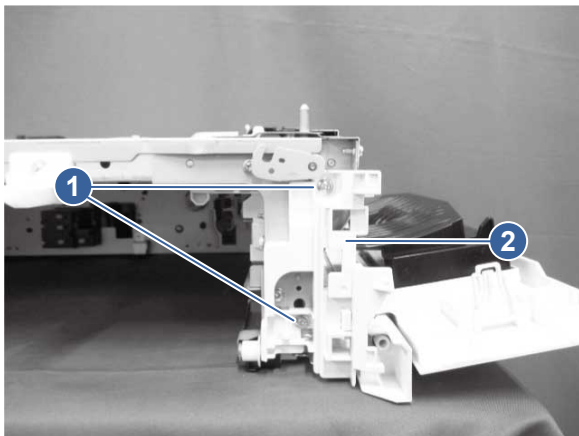


#### 2. Remove the right door (550-sheet paper feeder)

Follow these steps to remove the 550-sheet tray right door.

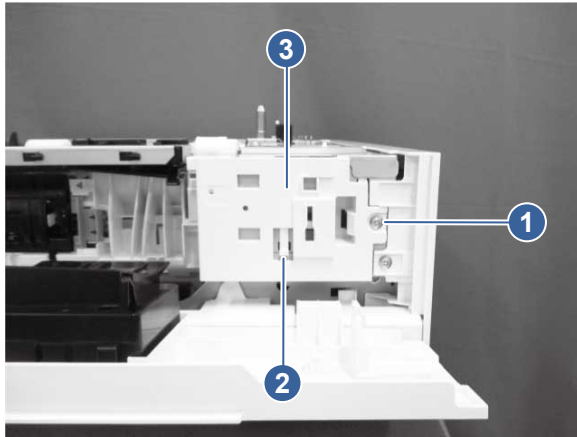
1. Remove two screws (callout 1), and then remove the base frame (callout 2).

**Figure 5-831 Remove the base frame**



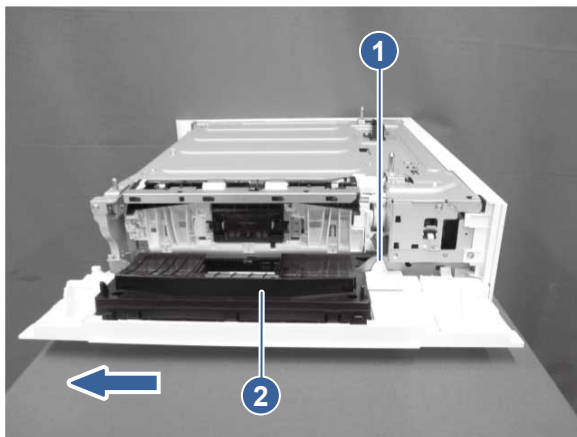
2. Remove one screw (callout 1), release one tab (callout 2), and then slide the rear inner cover (callout 3) downward to remove it.

**Figure 5-832 Remove the rear inner cover**



3. Release one tab (callout 1), and then slide the right door assembly (callout 2) in the direction indicated to remove it.

**Figure 5-833 Remove the right door (550-sheet paper feeder)**



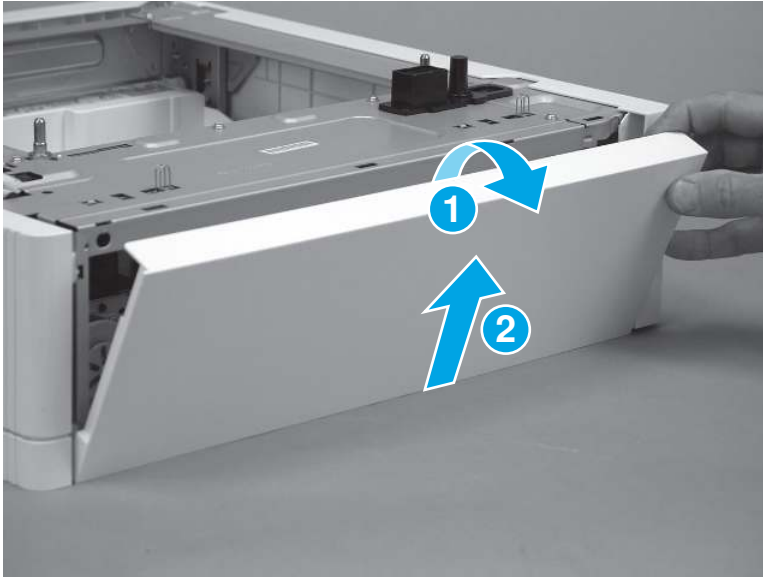
### 3. Remove the rear cover (550-sheet paper feeder)

Follow these steps to remove the 550-sheet tray rear cover.



- Remove one screw (callout 1), and then slide the rear cover (callout 2) in the direction indicated to remove it.

**Figure 5-834 Remove the rear cover (550-sheet paper feeder)**

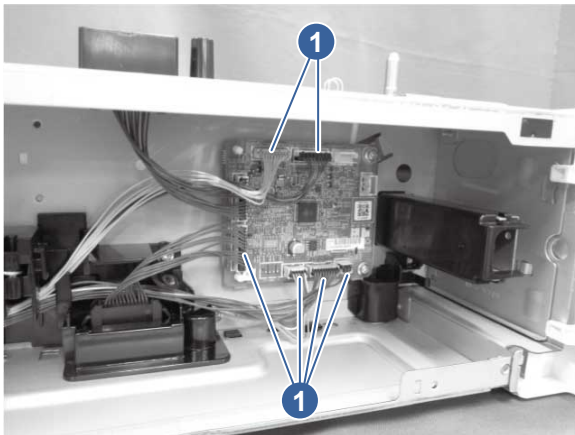


#### 4. Remove the auto close assembly (550-sheet paper feeder)

Follow these steps to remove the auto close assembly.

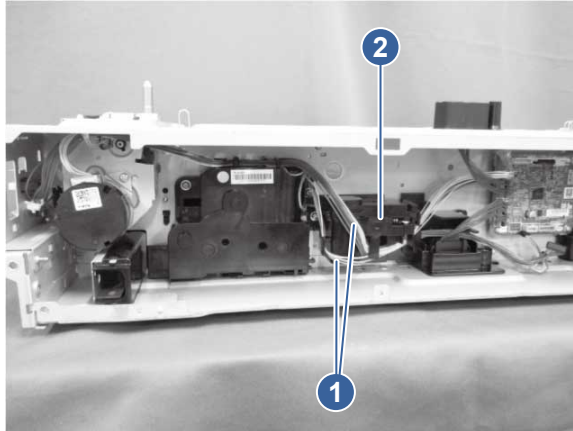
1. Disconnect six connectors (callout 1).

**Figure 5-835 Disconnect six connectors**



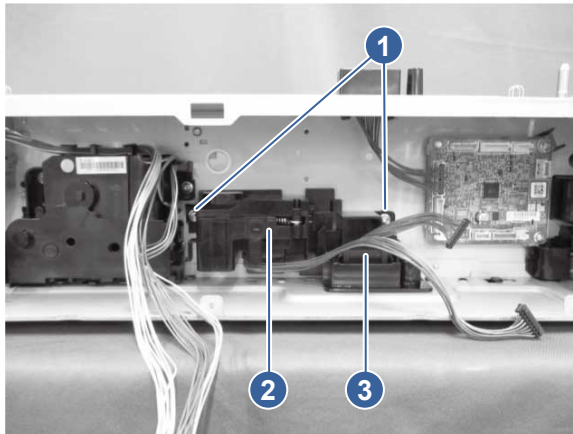
2. Release the cables (callout 1) from the auto close assembly (callout 2).

**Figure 5-836 Release the cables**



3. Remove two screws (callout 1), remove the auto close assembly (callout 2), and then remove the drawer connector (callout 3) from the auto close assembly.

**Figure 5-837 Remove the assembly**



## 5. Unpack the replacement assembly

Follow these steps to unpack the replacement assembly.

1. Dispose of the defective part.




**NOTE:** HP recommends responsible disposal of the defective part.

<http://www8.hp.com/us/en/hp-information/environment/product-recycling.html>


2. Unpack the replacement part from the packaging.



**CAUTION:**  Some parts are sensitive to electrostatic discharge (ESD). Always perform service work at an ESD-protected workstation or mat. If an ESD workstation or mat is not available, touch the sheet-metal chassis to provide a static ground before touching an ESD-sensitive assembly. Protect the ESD-sensitive assemblies by placing them in ESD pouches when they are out of the printer.




**IMPORTANT:** Make sure that all of the shipping materials (for example shipping tape) are removed from the replacement part prior to installation.

 **NOTE:** If the replacement part is a roller or pad, avoid touching the spongy part of it. Skin oils on the roller or pad can cause paper pickup and/or print-quality problems. HP recommends using disposable gloves when handling rollers or pads or washing your hands before touching rollers or pads.

---

3. To install an assembly, reverse the removal steps.

 **NOTE:** When applicable, special installation instructions are provided for an assembly at the end of the removal procedure. Always completely read the removal instructions and follow all special installation instructions.

---

## Removal and replacement: Media size detection assembly (550-sheet paper feeder)


Learn about removing and replacing the paper feeder media size detection assembly.

 [View a video demonstration of removing and replacing the media size detection assembly.](#)

### Before performing service

#### Turn the printer power off

- Disconnect the power cable.

 **WARNING!** To avoid damage to the printer, turn the printer off, wait 30 seconds, and then remove the power cord before attempting to service the printer.

---

Use the table below to identify the correct part number for your printer, and then go to <https://parts.hp.com/hpparts> to order the part.

**Table 5-109 Part information**

Part number	Part description
RM2-3614-000CN	Size detect assembly (1x550-sheet paper feeder)

### Required tools

- No special tools are required to remove or install this assembly.

### After performing service

#### Turn the printer power on

- Connect the power cable.
- Use the power switch to turn the power on.

### Post service test

No post service test is available for this assembly.

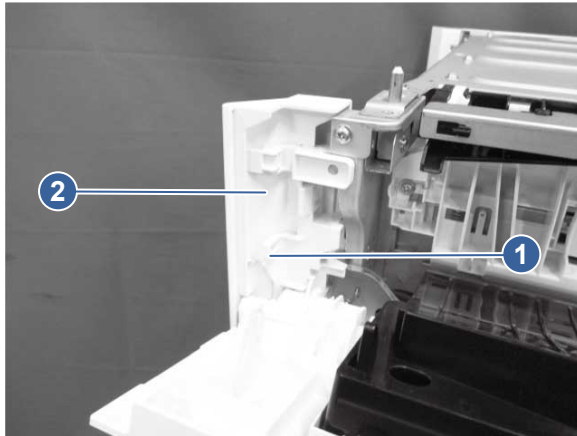
## 1. Remove the front right cover (550-sheet paper feeder)

Follow these steps to remove the 550-sheet tray front right cover.

1. Open the paper feeder right door.

2. Release one tab (callout 1), and then slide the front right cover (callout 2) upward to remove it.

**Figure 5-838 Remove the front right cover (550-sheet paper feeder)**

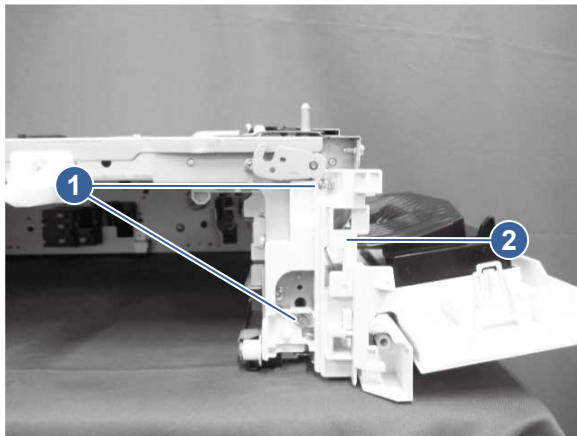


## 2. Remove the right door (550-sheet paper feeder)

Follow these steps to remove the 550-sheet tray right door.

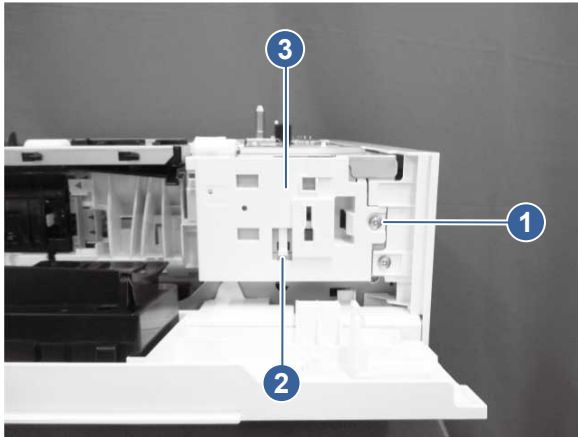
1. Remove two screws (callout 1), and then remove the base frame (callout 2).

**Figure 5-839 Remove the base frame**



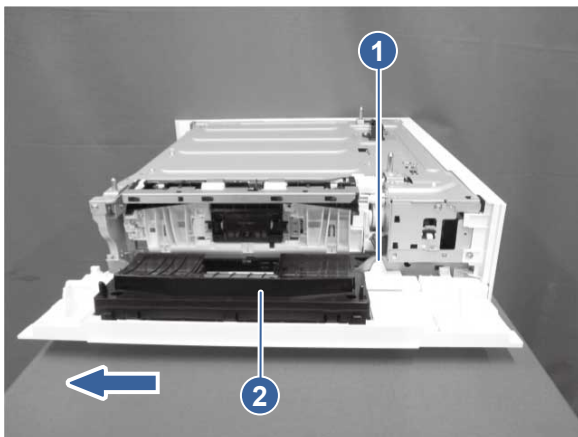
2. Remove one screw (callout 1), release one tab (callout 2), and then slide the rear inner cover (callout 3) downward to remove it.

**Figure 5-840 Remove the rear inner cover**



3. Release one tab (callout 1), and then slide the right door assembly (callout 2) in the direction indicated to remove it.

**Figure 5-841 Remove the right door (550-sheet paper feeder)**

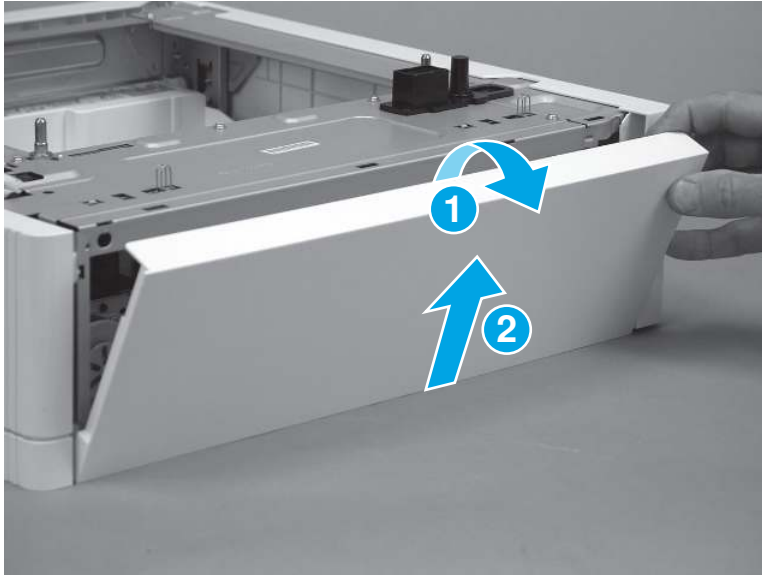


### 3. Remove the rear cover (550-sheet paper feeder)

Follow these steps to remove the 550-sheet tray rear cover.

- Remove one screw (callout 1), and then slide the rear cover (callout 2) in the direction indicated to remove it.

**Figure 5-842 Remove the rear cover (550-sheet paper feeder)**

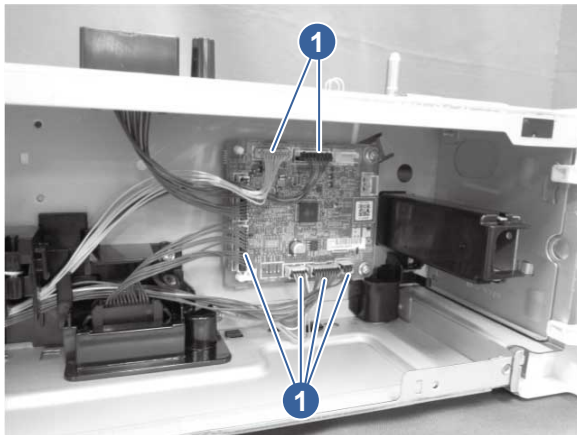


#### 4. Remove the auto close assembly (550-sheet paper feeder)

Follow these steps to remove the auto close assembly.

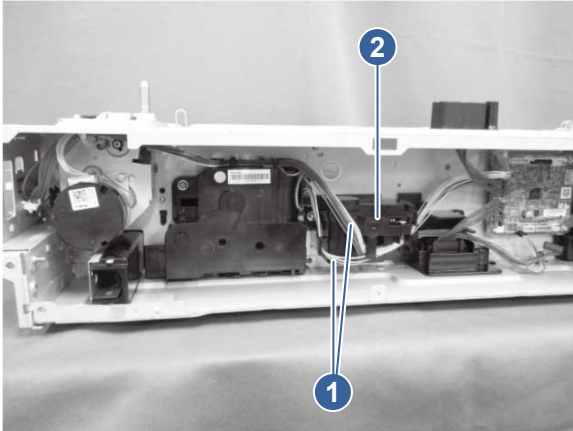
1. Disconnect six connectors (callout 1).

**Figure 5-843 Disconnect six connectors**



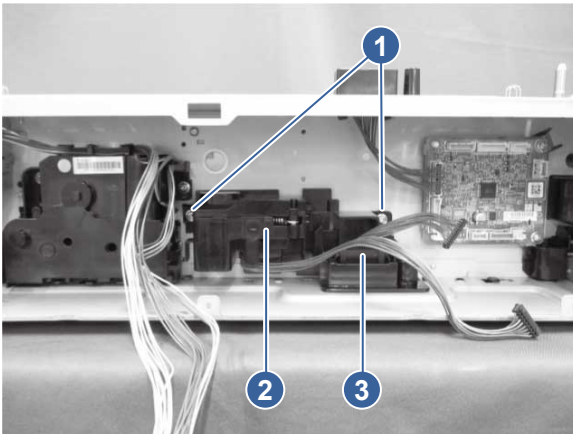
2. Release the cables (callout 1) from the auto close assembly (callout 2).

**Figure 5-844 Release the cables**



3. Remove two screws (callout 1), remove the auto close assembly (callout 2), and then remove the drawer connector (callout 3) from the auto close assembly.

**Figure 5-845 Remove the assembly**

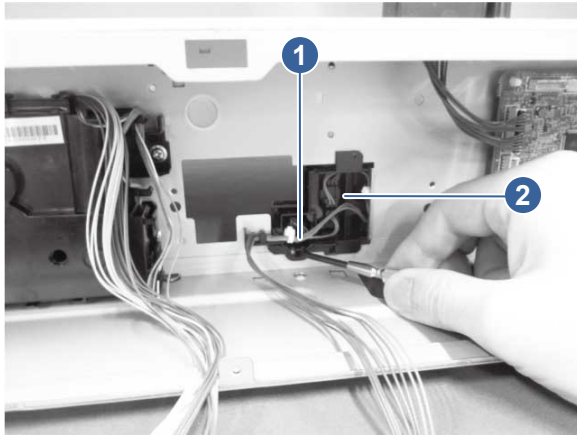


## 5. Remove the media size detection assembly (550-sheet paper feeder)

Follow these steps to remove the media size detection assembly.

- Release one tab (callout 1), and then pull the media size detect assembly (callout 2) toward you to remove it.

**Figure 5-846 Release one tab**



## 6. Unpack the replacement assembly

Follow these steps to unpack the replacement assembly.

1. Dispose of the defective part.

---



 **NOTE:** HP recommends responsible disposal of the defective part.


<http://www8.hp.com/us/en/hp-information/environment/product-recycling.html>


---

2. Unpack the replacement part from the packaging.

---

 **CAUTION:**  Some parts are sensitive to electrostatic discharge (ESD). Always perform service work at an ESD-protected workstation or mat. If an ESD workstation or mat is not available, touch the sheet-metal chassis to provide a static ground before touching an ESD-sensitive assembly. Protect the ESD-sensitive assemblies by placing them in ESD pouches when they are out of the printer.


 **IMPORTANT:** Make sure that all of the shipping materials (for example shipping tape) are removed from the replacement part prior to installation.

 **NOTE:** If the replacement part is a roller or pad, avoid touching the spongy part of it. Skin oils on the roller or pad can cause paper pickup and/or print-quality problems. HP recommends using disposable gloves when handling rollers or pads or washing your hands before touching rollers or pads.

---

3. To install an assembly, reverse the removal steps.

---

 **NOTE:** When applicable, special installation instructions are provided for an assembly at the end of the removal procedure. Always completely read the removal instructions and follow all special installation instructions.

---

## Removal and replacement: Controller PCA (550-sheet paper feeder)

Learn about removing and replacing the paper-feeder controller PCA.

### Before performing service

Turn the printer power off



- Disconnect the power cable.

**⚠ WARNING!** To avoid damage to the printer, turn the printer off, wait 30 seconds, and then remove the power cord before attempting to service the printer.

Use the table below to identify the correct part number for your printer, and then go to <https://parts.hp.com/hpparts> to order the part.

**Table 5-110 Part information**

Part number	Part description
RM3-8051-000CN	Paper feeder controller PCA (1x550-sheet paper feeder)

## Required tools

- #2 Phillips screwdriver with a magnetic tip and a 152 mm (6 in) shaft length

## After performing service

### Turn the printer power on

- Connect the power cable.
- Use the power switch to turn the power on.

## Post service test

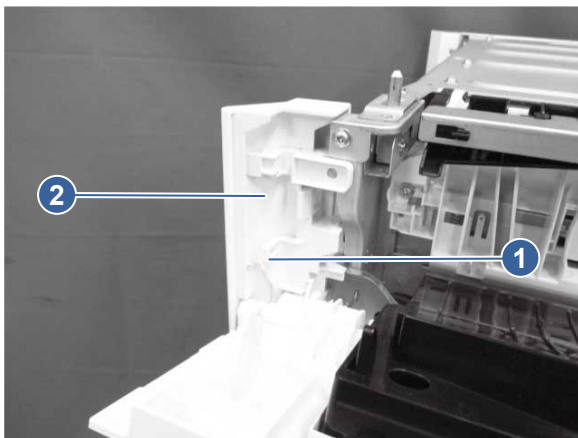
Print any pages necessary to make sure the printer is functioning correctly.

### 1. Remove the front right cover (550-sheet paper feeder)

Follow these steps to remove the 550-sheet tray front right cover.

1. Open the paper feeder right door.
2. Release one tab (callout 1), and then slide the front right cover (callout 2) upward to remove it.

**Figure 5-847 Remove the front right cover (550-sheet paper feeder)**

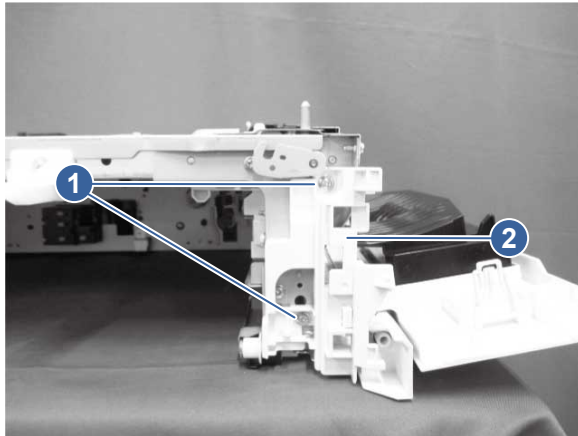


### 2. Remove the right door (550-sheet paper feeder)

Follow these steps to remove the 550-sheet tray right door.

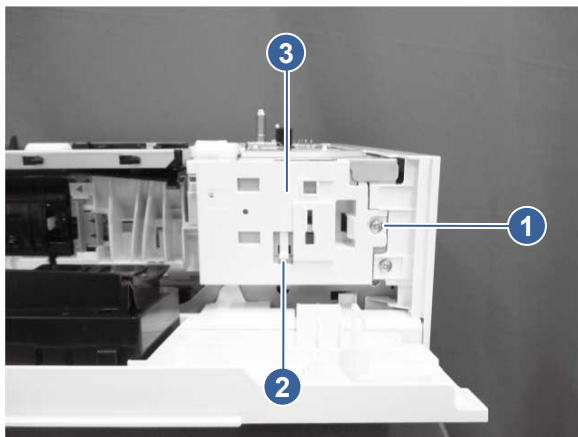
1. Remove two screws (callout 1), and then remove the base frame (callout 2).

**Figure 5-848 Remove the base frame**



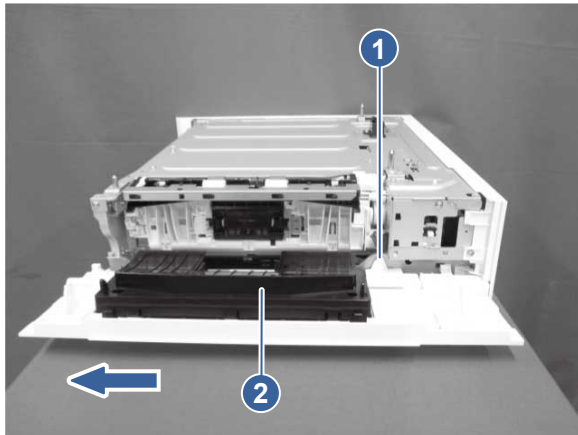
2. Remove one screw (callout 1), release one tab (callout 2), and then slide the rear inner cover (callout 3) downward to remove it.

**Figure 5-849 Remove the rear inner cover**



3. Release one tab (callout 1), and then slide the right door assembly (callout 2) in the direction indicated to remove it.

**Figure 5-850 Remove the right door (550-sheet paper feeder)**

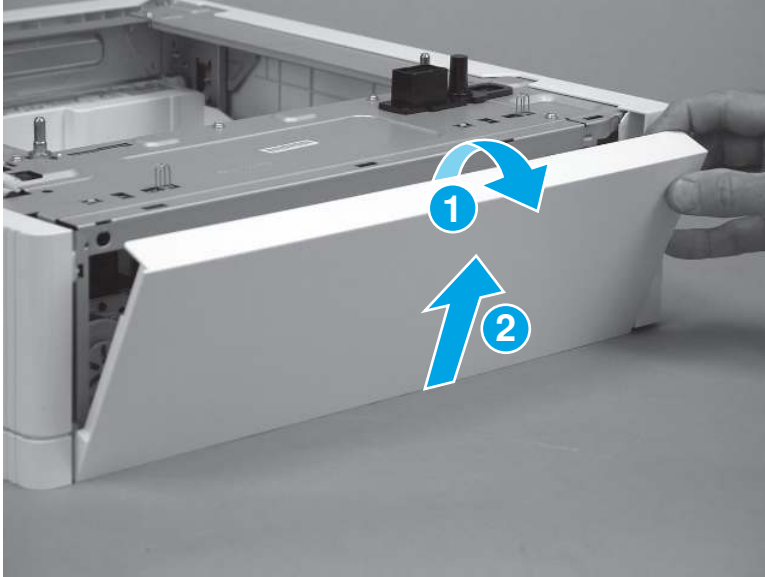


### 3. Remove the rear cover (550-sheet paper feeder)

Follow these steps to remove the 550-sheet tray rear cover.

- Remove one screw (callout 1), and then slide the rear cover (callout 2) in the direction indicated to remove it.

**Figure 5-851** Remove the rear cover (550-sheet paper feeder)

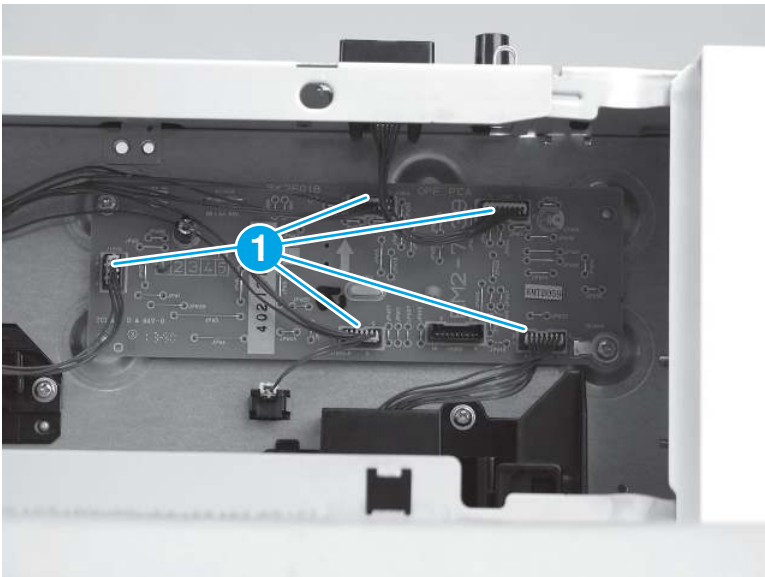


### 4. Remove the controller PCA (550-sheet paper feeder)

Follow these steps to remove the controller PCA.

- Disconnect all the connectors on the paper feeder controller PCA, remove two screws (callout 1), remove two PCA spacers (callout 2), and then remove the paper feeder controller PCA (callout 3).


**Figure 5-852** Remove the controller PCA (550-sheet paper feeder)



## 5. Unpack the replacement assembly



Follow these steps to unpack the replacement assembly.


1. Dispose of the defective part.


 **NOTE:** HP recommends responsible disposal of the defective part.

<http://www8.hp.com/us/en/hp-information/environment/product-recycling.html>


2. Unpack the replacement part from the packaging.

 **CAUTION:**  Some parts are sensitive to electrostatic discharge (ESD). Always perform service work at an ESD-protected workstation or mat. If an ESD workstation or mat is not available, touch the sheet-metal chassis to provide a static ground before touching an ESD-sensitive assembly. Protect the ESD-sensitive assemblies by placing them in ESD pouches when they are out of the printer.

 **IMPORTANT:** Make sure that all of the shipping materials (for example shipping tape) are removed from the replacement part prior to installation.

 **NOTE:** If the replacement part is a roller or pad, avoid touching the spongy part of it. Skin oils on the roller or pad can cause paper pickup and/or print-quality problems. HP recommends using disposable gloves when handling rollers or pads or washing your hands before touching rollers or pads.

3. To install an assembly, reverse the removal steps.

 **NOTE:** When applicable, special installation instructions are provided for an assembly at the end of the removal procedure. Always completely read the removal instructions and follow all special installation instructions.


### Removal and replacement: Separation roller assembly (550-sheet paper feeder)

Learn about removing and replacing the paper feeder separation roller assembly.

#### Before performing service

##### Turn the printer power off

- Disconnect the power cable.

 **WARNING!** To avoid damage to the printer, turn the printer off, wait 30 seconds, and then remove the power cord before attempting to service the printer.

If the part is damaged and cannot be cleaned, use the table below to identify the correct part number for your printer. To order the part, go to [www.hp.com/buy/parts](http://www.hp.com/buy/parts).

**Table 5-111** Part information

Part number	Part description
527H2A	HP LaserJet Tray 2-x Roller Kit (1x550-sheet paper feeder)

#### Required tools

- No special tools are required to remove or install this assembly.

#### After performing service

### Turn the printer power on

- Connect the power cable.
- Use the power switch to turn the power on.

### Post service test

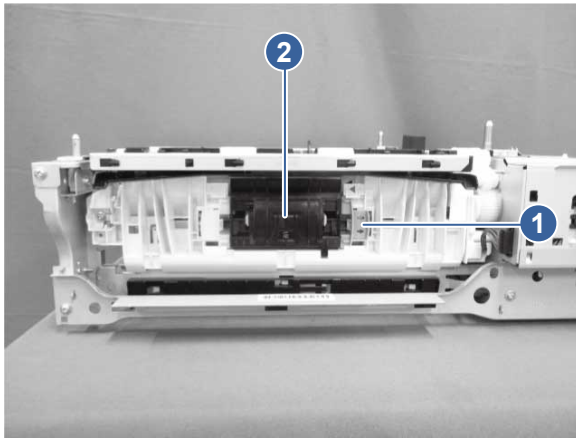
Print any pages necessary to make sure the printer is functioning correctly.

#### 1. Remove the separation roller assembly (550-sheet paper feeder)

Learn about removing the 550-sheet paper feeder separation roller assembly.

1. Open the right door.
2. Slide the lever (callout 1) to the right, and then remove the roller assembly (callout 2) by pulling it out from the printer.

**Figure 5-853** Remove the roller assembly



#### 2. Unpack the replacement assembly

Follow these steps to unpack the replacement assembly.

1. Dispose of the defective part.

---



 **NOTE:** HP recommends responsible disposal of the defective part.


<http://www8.hp.com/us/en/hp-information/environment/product-recycling.html>


---

2. Unpack the replacement part from the packaging.

---


 **CAUTION:**  Some parts are sensitive to electrostatic discharge (ESD). Always perform service work at an ESD-protected workstation or mat. If an ESD workstation or mat is not available, touch the sheet-metal chassis to provide a static ground before touching an ESD-sensitive assembly. Protect the ESD-sensitive assemblies by placing them in ESD pouches when they are out of the printer.

 **IMPORTANT:** Make sure that all of the shipping materials (for example shipping tape) are removed from the replacement part prior to installation.

 **NOTE:** If the replacement part is a roller or pad, avoid touching the spongy part of it. Skin oils on the roller or pad can cause paper pickup and/or print-quality problems. HP recommends using disposable gloves when handling rollers or pads or washing your hands before touching rollers or pads.

---

3. To install an assembly, reverse the removal steps.

 **NOTE:** When applicable, special installation instructions are provided for an assembly at the end of the removal procedure. Always completely read the removal instructions and follow all special installation instructions.

---


## Removal and replacement: Pickup roller assembly (550-sheet paper feeder)

Learn about removing and replacing the paper feeder pickup roller assembly.

### Before performing service

#### Turn the printer power off

- Disconnect the power cable.

 **WARNING!** To avoid damage to the printer, turn the printer off, wait 30 seconds, and then remove the power cord before attempting to service the printer.

---

If the part is damaged and cannot be cleaned, use the table below to identify the correct part number for your printer. To order the part, go to [www.hp.com/buy/parts](http://www.hp.com/buy/parts).

**Table 5-112** Part information

Part number	Part description
527H2A	HP LaserJet Tray 2-x Roller Kit

### Required tools

- No special tools are required to remove or install this assembly.

### After performing service

#### Turn the printer power on

- Connect the power cable.
- Use the power switch to turn the power on.

### Post service test

Print any pages necessary to make sure the printer is functioning correctly.

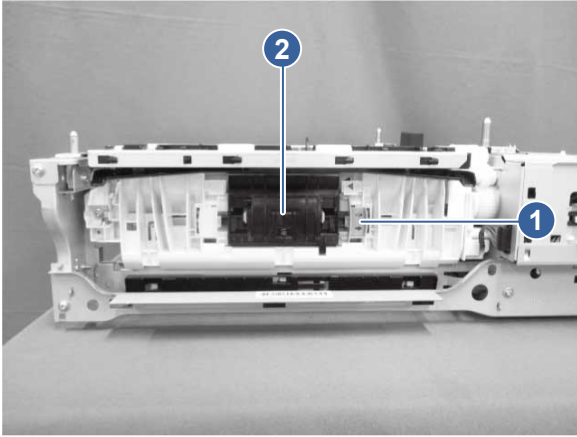
## 1. Remove the separation roller assembly (550-sheet paper feeder)

Learn about removing the 550-sheet paper feeder separation roller assembly.

1. Open the right door.

2. Slide the lever (callout 1) to the right, and then remove the roller assembly (callout 2) by pulling it out from the printer.

**Figure 5-854 Remove the roller assembly**



## 2. Remove the paper pickup roller assembly (550-sheet paper feeder)

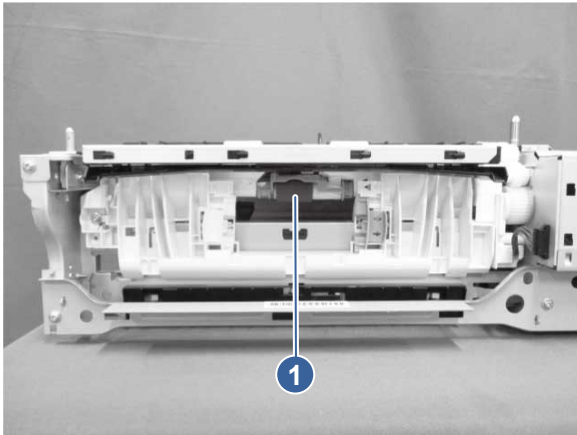
Learn about removing the 550-sheet paper feeder pickup rollers.



**NOTE:** Even if you want to replace only the pickup roller assembly, you must first remove the separation roller assembly.

- Locate the pickup roller assembly (callout 1) and then pull it away from the printer to remove it.

**Figure 5-855 Remove the pickup roller assembly**



## 3. Unpack the replacement assembly

Follow these steps to unpack the replacement assembly.



1. Dispose of the defective part.





**NOTE:** HP recommends responsible disposal of the defective part.

<http://www8.hp.com/us/en/hp-information/environment/product-recycling.html>


## 2. Unpack the replacement part from the packaging.

 **CAUTION:**  Some parts are sensitive to electrostatic discharge (ESD). Always perform service work at an ESD-protected workstation or mat. If an ESD workstation or mat is not available, touch the sheet-metal chassis to provide a static ground before touching an ESD-sensitive assembly. Protect the ESD-sensitive assemblies by placing them in ESD pouches when they are out of the printer.

 **IMPORTANT:** Make sure that all of the shipping materials (for example shipping tape) are removed from the replacement part prior to installation.

 **NOTE:** If the replacement part is a roller or pad, avoid touching the spongy part of it. Skin oils on the roller or pad can cause paper pickup and/or print-quality problems. HP recommends using disposable gloves when handling rollers or pads or washing your hands before touching rollers or pads.

## 3. To install an assembly, reverse the removal steps.

 **NOTE:** When applicable, special installation instructions are provided for an assembly at the end of the removal procedure. Always completely read the removal instructions and follow all special installation instructions.

# 6. Removal and replacement: 2,100-sheet paper deck

Learn how to remove and replace the 2,100-sheet paper deck parts and assemblies.

## Field-replaceable units (FRUs)

Learn about FRU parts removal and replacement.

## Covers, panels, and doors

Learn about covers, panels, and doors removal and replacement.


## Removal and replacement: Right door (HCI)

Learn about removing and replacing the HCI right door.

### Before performing service

#### Turn the printer power off

- Disconnect the power cable.

 **WARNING!** To avoid damage to the printer, turn the printer off, wait 30 seconds, and then remove the power cord before attempting to service the printer.

Use the table below to identify the correct part number for your printer, and then go to <https://parts.hp.com/hpparts> to order the part.

**Table 5-113** Part information

Part number	Part description
RM3-0035-000CN	Right door assembly (2,100-sheet paper deck HCI)

### Required tools



- No special tools are required to remove or install this assembly.

## After performing service

### Turn the printer power on

- Connect the power cable.
- Use the power switch to turn the power on.

### Post service test

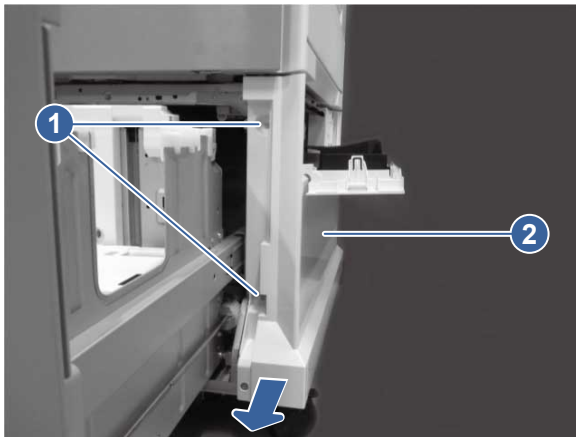
No post service test is available for this assembly.

## 1. Remove the right door (HCI)

Follow these steps to remove the HCI right door.

1. Open the HCI tray, and then open the right door.
2. Remove two screws (callout 1), and then slide the right door (callout 2) in the direction indicated to remove it.

**Figure 5-856 Remove the right door (HCI)**



## 2. Unpack the replacement assembly

Follow these steps to unpack the replacement assembly.

1. Dispose of the defective part.




**NOTE:** HP recommends responsible disposal of the defective part.

<http://www8.hp.com/us/en/hp-information/environment/product-recycling.html>


2. Unpack the replacement part from the packaging.



**CAUTION:**  Some parts are sensitive to electrostatic discharge (ESD). Always perform service work at an ESD-protected workstation or mat. If an ESD workstation or mat is not available, touch the sheet-metal chassis to provide a static ground before touching an ESD-sensitive assembly. Protect the ESD-sensitive assemblies by placing them in ESD pouches when they are out of the printer.




**IMPORTANT:** Make sure that all of the shipping materials (for example shipping tape) are removed from the replacement part prior to installation.

 **NOTE:** If the replacement part is a roller or pad, avoid touching the spongy part of it. Skin oils on the roller or pad can cause paper pickup and/or print-quality problems. HP recommends using disposable gloves when handling rollers or pads or washing your hands before touching rollers or pads.

---

3. To install an assembly, reverse the removal steps.

 **NOTE:** When applicable, special installation instructions are provided for an assembly at the end of the removal procedure. Always completely read the removal instructions and follow all special installation instructions.

---


## Removal and replacement: Front left cover/left cover (HCI)

Learn about removing and replacing the HCI front left cover/left cover.

### Before performing service

#### Turn the printer power off

- Disconnect the power cable.

 **WARNING!** To avoid damage to the printer, turn the printer off, wait 30 seconds, and then remove the power cord before attempting to service the printer.

---

Use the table below to identify the correct part number for your printer, and then go to <https://parts.hp.com/hpparts> to order the part.

**Table 5-114** Part information

Part number	Part description
RC5-9696-000CN	Cover, front left (2,100-sheet paper deck HCI)
RC5-9692-000CN	Cover, left (2,100-sheet paper deck HCI)

### Required tools

- No special tools are required to remove or install this assembly.

### After performing service

#### Turn the printer power on

- Connect the power cable.
- Use the power switch to turn the power on.

### Post service test

No post service test is available for this assembly.

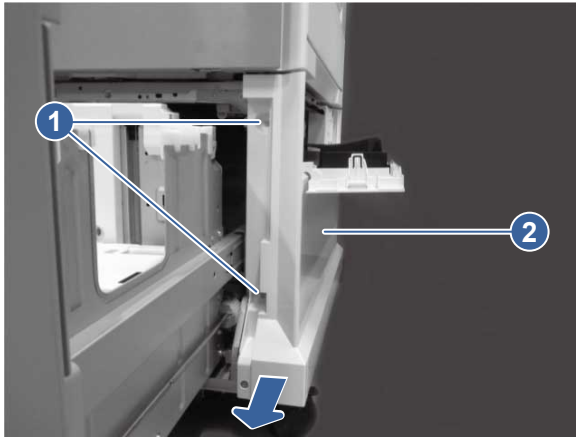
## 1. Remove the right door (HCI)

Follow these steps to remove the HCI right door.

1. Open the HCI tray, and then open the right door.

2. Remove two screws (callout 1), and then slide the right door (callout 2) in the direction indicated to remove it.

**Figure 5-857 Remove the right door (HCI)**

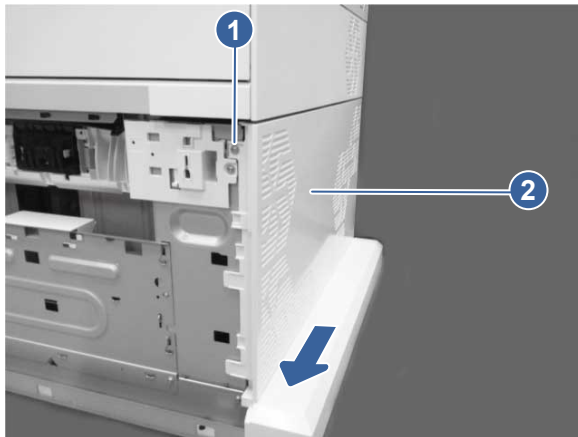


### 2. Remove the rear cover (HCI)

Follow these steps to remove the HCI rear cover.

- Remove one screw (callout 1), and then slide the rear cover (callout 2) in the direction indicated to remove it.

**Figure 5-858 Remove the rear cover (HCI)**

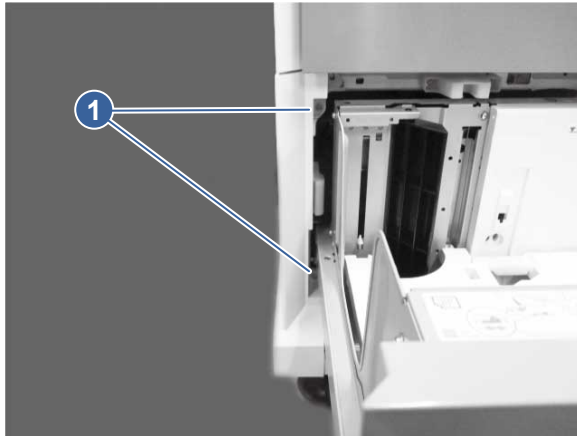


### 3. Remove the front left cover/left cover (HCI)

Follow these steps to remove the HCI front left cover/left cover.

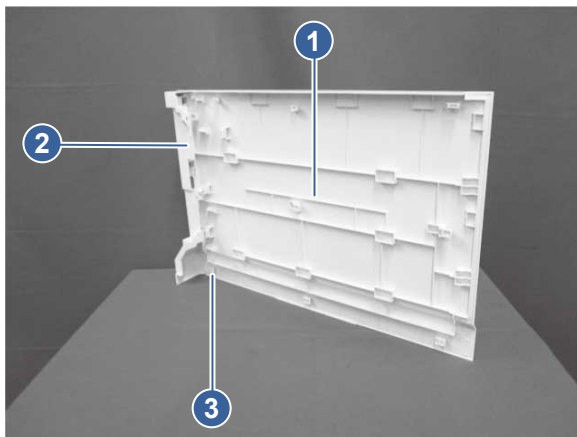
1. Remove two screws (callout 1).

**Figure 5-859 Remove two screws**



2. Remove the left cover (callout 1) together with the front left cover (callout 2). Release one tab (callout 3), and then slide the front left cover upward to remove it from the left cover.

**Figure 5-860 Remove the front left cover from the left cover (HCI)**



#### 4. Unpack the replacement assembly

Follow these steps to unpack the replacement assembly.

1. Dispose of the defective part.




**NOTE:** HP recommends responsible disposal of the defective part.

<http://www8.hp.com/us/en/hp-information/environment/product-recycling.html>


2. Unpack the replacement part from the packaging.



**CAUTION:**  Some parts are sensitive to electrostatic discharge (ESD). Always perform service work at an ESD-protected workstation or mat. If an ESD workstation or mat is not available, touch the sheet-metal chassis to provide a static ground before touching an ESD-sensitive assembly. Protect the ESD-sensitive assemblies by placing them in ESD pouches when they are out of the printer.




**IMPORTANT:** Make sure that all of the shipping materials (for example shipping tape) are removed from the replacement part prior to installation.

 **NOTE:** If the replacement part is a roller or pad, avoid touching the spongy part of it. Skin oils on the roller or pad can cause paper pickup and/or print-quality problems. HP recommends using disposable gloves when handling rollers or pads or washing your hands before touching rollers or pads.

---

3. To install an assembly, reverse the removal steps.

---

 **NOTE:** When applicable, special installation instructions are provided for an assembly at the end of the removal procedure. Always completely read the removal instructions and follow all special installation instructions.

---


## Removal and replacement: Rear cover (HCI)

Learn about removing and replacing the HCI rear cover.

### Before performing service

#### Turn the printer power off

- Disconnect the power cable.

 **WARNING!** To avoid damage to the printer, turn the printer off, wait 30 seconds, and then remove the power cord before attempting to service the printer.

---

Use the table below to identify the correct part number for your printer, and then go to <https://parts.hp.com/hpparts> to order the part.

**Table 5-115** Part information

Part number	Part description
RC5-9693-000CN	Cover, rear (2,100-sheet paper deck HCI)

### Required tools

- No special tools are required to remove or install this assembly.

### After performing service

#### Turn the printer power on

- Connect the power cable.
- Use the power switch to turn the power on.

### Post service test

No post service test is available for this assembly.

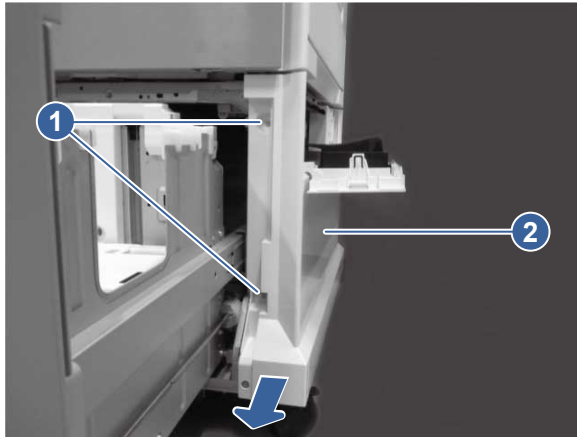
## 1. Remove the right door (HCI)

Follow these steps to remove the HCI right door.

1. Open the HCI tray, and then open the right door.

2. Remove two screws (callout 1), and then slide the right door (callout 2) in the direction indicated to remove it.

**Figure 5-861 Remove the right door (HCI)**

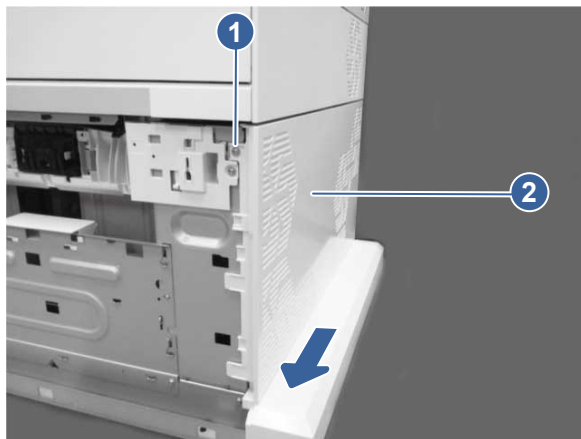


### 2. Remove the rear cover (HCI)

Follow these steps to remove the HCI rear cover.

- Remove one screw (callout 1), and then slide the rear cover (callout 2) in the direction indicated to remove it.

**Figure 5-862 Remove the rear cover (HCI)**



### 3. Unpack the replacement assembly

Follow these steps to unpack the replacement assembly.


1. Dispose of the defective part.





**NOTE:** HP recommends responsible disposal of the defective part.

<http://www8.hp.com/us/en/hp-information/environment/product-recycling.html>


2. Unpack the replacement part from the packaging.

**CAUTION:**  Some parts are sensitive to electrostatic discharge (ESD). Always perform service work at an ESD-protected workstation or mat. If an ESD workstation or mat is not available, touch the sheet-metal chassis to provide a static ground before touching an ESD-sensitive assembly. Protect the ESD-sensitive assemblies by placing them in ESD pouches when they are out of the printer.

**IMPORTANT:**  Make sure that all of the shipping materials (for example shipping tape) are removed from the replacement part prior to installation.

**NOTE:**  If the replacement part is a roller or pad, avoid touching the spongy part of it. Skin oils on the roller or pad can cause paper pickup and/or print-quality problems. HP recommends using disposable gloves when handling rollers or pads or washing your hands before touching rollers or pads.

3. To install an assembly, reverse the removal steps.

**NOTE:**  When applicable, special installation instructions are provided for an assembly at the end of the removal procedure. Always completely read the removal instructions and follow all special installation instructions.


### Removal and replacement: Rear lower cover (HCI)

Learn about removing and replacing the HCI rear lower cover.

#### Before performing service

##### Turn the printer power off

- Disconnect the power cable.

**WARNING!**  To avoid damage to the printer, turn the printer off, wait 30 seconds, and then remove the power cord before attempting to service the printer.

Use the table below to identify the correct part number for your printer, and then go to <https://parts.hp.com/hpparts> to order the part.

**Table 5-116** Part information

Part number	Part description
RCS-9695-000CN	Cover, rear lower (2,100-sheet paper deck HCI)

#### Required tools

- No special tools are required to remove or install this assembly.

#### After performing service

##### Turn the printer power on

- Connect the power cable.
- Use the power switch to turn the power on.

#### Post service test

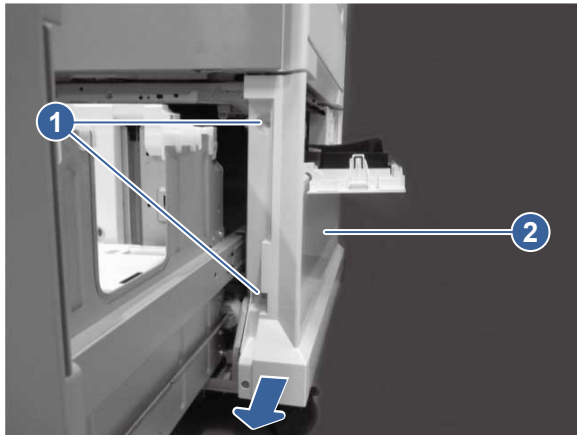
No post service test is available for this assembly.

### 1. Remove the right door (HCI)

Follow these steps to remove the HCI right door.

1. Open the HCI tray, and then open the right door.
2. Remove two screws (callout 1), and then slide the right door (callout 2) in the direction indicated to remove it.

**Figure 5-863 Remove the right door (HCI)**

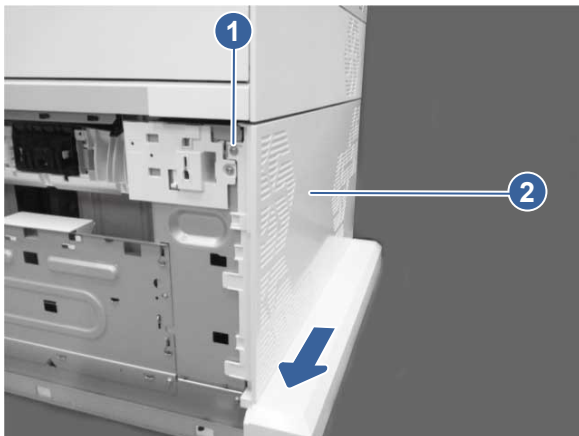


### 2. Remove the rear cover (HCI)

Follow these steps to remove the HCI rear cover.

- Remove one screw (callout 1), and then slide the rear cover (callout 2) in the direction indicated to remove it.

**Figure 5-864 Remove the rear cover (HCI)**



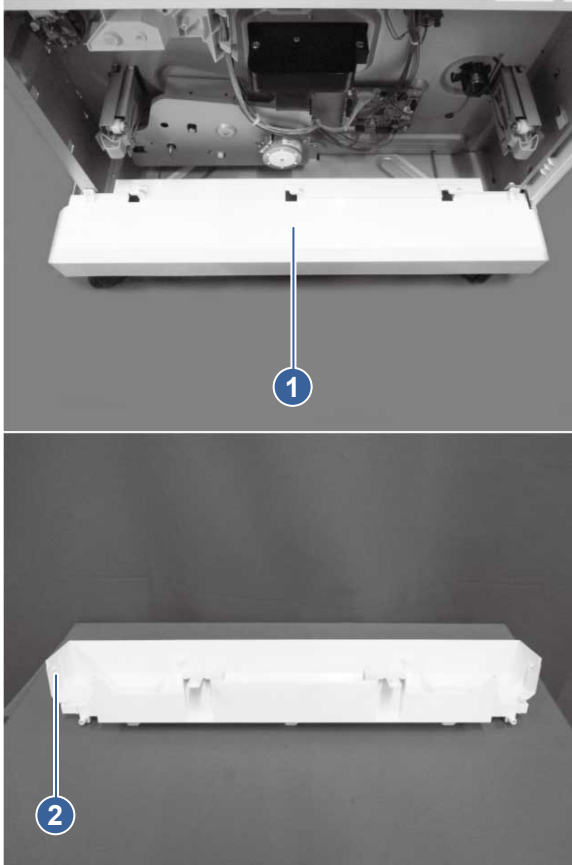
### 3. Remove the rear lower cover (HCI)

Follow these steps to remove the HCI rear lower cover.



- Bend the left edge of the rear lower cover (callout 1), release one tab (callout 2), and then pull the rear lower cover toward you from the left end of it to remove it.

**Figure 5-865 Remove the rear lower cover (HCI)**



#### 4. Unpack the replacement assembly

Follow these steps to unpack the replacement assembly.

1. Dispose of the defective part.




**NOTE:** HP recommends responsible disposal of the defective part.

<http://www8.hp.com/us/en/hp-information/environment/product-recycling.html>

2. Unpack the replacement part from the packaging.



**CAUTION:**  Some parts are sensitive to electrostatic discharge (ESD). Always perform service work at an ESD-protected workstation or mat. If an ESD workstation or mat is not available, touch the sheet-metal chassis to provide a static ground before touching an ESD-sensitive assembly. Protect the ESD-sensitive assemblies by placing them in ESD pouches when they are out of the printer.



**IMPORTANT:** Make sure that all of the shipping materials (for example shipping tape) are removed from the replacement part prior to installation.



**NOTE:** If the replacement part is a roller or pad, avoid touching the spongy part of it. Skin oils on the roller or pad can cause paper pickup and/or print-quality problems. HP recommends using disposable gloves when handling rollers or pads or washing your hands before touching rollers or pads.

3. To install an assembly, reverse the removal steps.



**NOTE:** When applicable, special installation instructions are provided for an assembly at the end of the removal procedure. Always completely read the removal instructions and follow all special installation instructions.

## Internal parts and assemblies

Learn how to remove and replace the printer internal parts and assemblies.

### Removal and replacement: Cassette assembly (HCI)

Learn about removing and replacing the HCI cassette.

#### Before performing service

##### Turn the printer power off

- Disconnect the power cable.

**⚠ WARNING!** To avoid damage to the printer, turn the printer off, wait 30 seconds, and then remove the power cord before attempting to service the printer.

Use the table below to identify the correct part number for your printer, and then go to <https://parts.hp.com/hpparts> to order the part.

**Table 5-117** Part information

Part number	Part description
RM3-0023-000CN	Tray assembly (2,100-sheet paper deck HCI)

#### Required tools

- #2 Phillips screwdriver with a magnetic tip and a 152 mm (6 in) shaft length
- Small flat-blade screwdriver

#### After performing service

##### Turn the printer power on

- Connect the power cable.
- Use the power switch to turn the power on.

#### Post service test

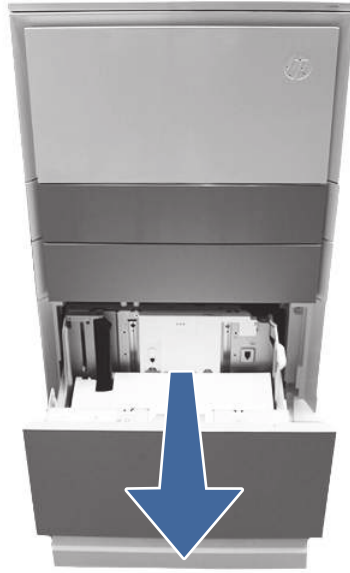
Print any pages necessary to make sure the printer is functioning correctly.

### 1. Remove the cassette (HCI)

Follow these steps to remove the HCI cassette.

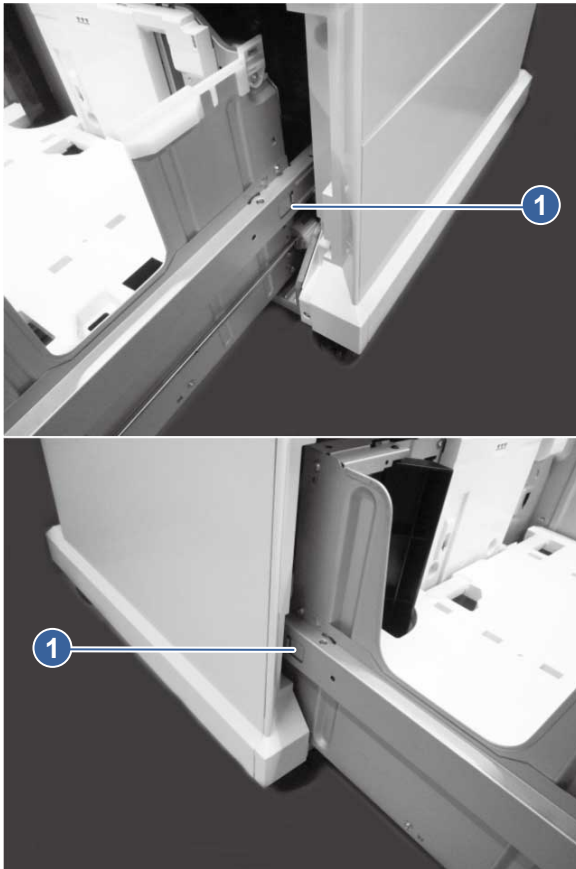
1. Open the HCI cassette assembly.

**Figure 5-866** Open the HCI cassette



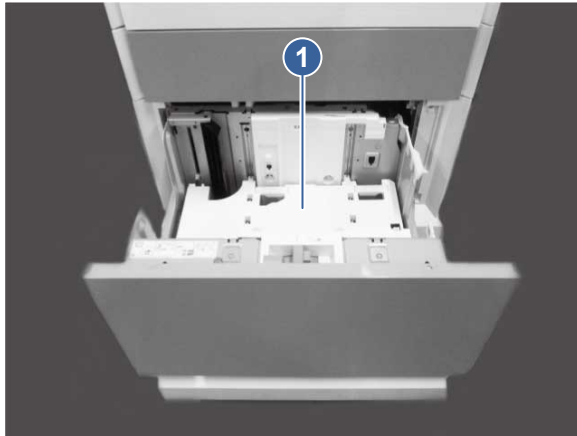
2. Press the left and right release levers (callout 1).

**Figure 5-867** Press the release levers



3. Pull the HCI cassette assembly (callout 1) out of the HCI chassis.

**Figure 5-868 Remove the tray cassette (HCI)**



## 2. Unpack the replacement assembly

Follow these steps to unpack the replacement assembly.

1. Dispose of the defective part.

---



 **NOTE:** HP recommends responsible disposal of the defective part.


<http://www8.hp.com/us/en/hp-information/environment/product-recycling.html>


---

2. Unpack the replacement part from the packaging.

---

 **CAUTION:**  Some parts are sensitive to electrostatic discharge (ESD). Always perform service work at an ESD-protected workstation or mat. If an ESD workstation or mat is not available, touch the sheet-metal chassis to provide a static ground before touching an ESD-sensitive assembly. Protect the ESD-sensitive assemblies by placing them in ESD pouches when they are out of the printer.


 **IMPORTANT:** Make sure that all of the shipping materials (for example shipping tape) are removed from the replacement part prior to installation.

 **NOTE:** If the replacement part is a roller or pad, avoid touching the spongy part of it. Skin oils on the roller or pad can cause paper pickup and/or print-quality problems. HP recommends using disposable gloves when handling rollers or pads or washing your hands before touching rollers or pads.

---

3. To install an assembly, reverse the removal steps.

---

 **NOTE:** When applicable, special installation instructions are provided for an assembly at the end of the removal procedure. Always completely read the removal instructions and follow all special installation instructions.

---

## Removal and replacement: Pickup assembly (HCI)

Learn about removing and replacing the HCI paper pickup assembly.

### Before performing service

Turn the printer power off

- Disconnect the power cable.

**⚠ WARNING!** To avoid damage to the printer, turn the printer off, wait 30 seconds, and then remove the power cord before attempting to service the printer.

Use the table below to identify the correct part number for your printer, and then go to <https://parts.hp.com/hpparts> to order the part.

**Table 5-118 Part information**

Part number	Part description
RM2-3509-000CN	Paper pickup assembly (2,100-sheet paper deck HCI)

## Required tools

- #2 Phillips screwdriver with a magnetic tip and a 152 mm (6 in) shaft length
- Small flat-blade screwdriver

## After performing service

### Turn the printer power on

- Connect the power cable.
- Use the power switch to turn the power on.

## Post service test

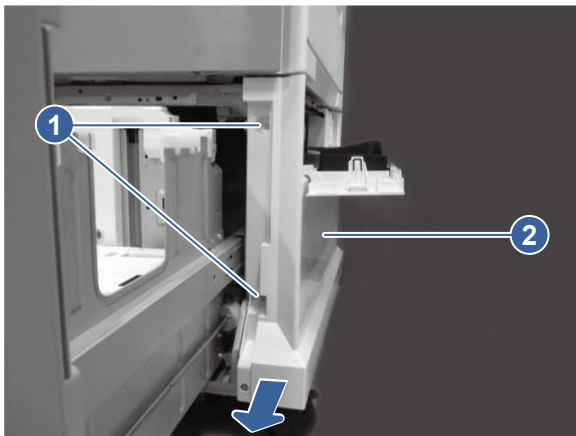
Print any pages necessary to make sure the printer is functioning correctly.

### 1. Remove the right door (HCI)

Follow these steps to remove the HCI right door.

1. Open the HCI tray, and then open the right door.
2. Remove two screws (callout 1), and then slide the right door (callout 2) in the direction indicated to remove it.

**Figure 5-869 Remove the right door (HCI)**

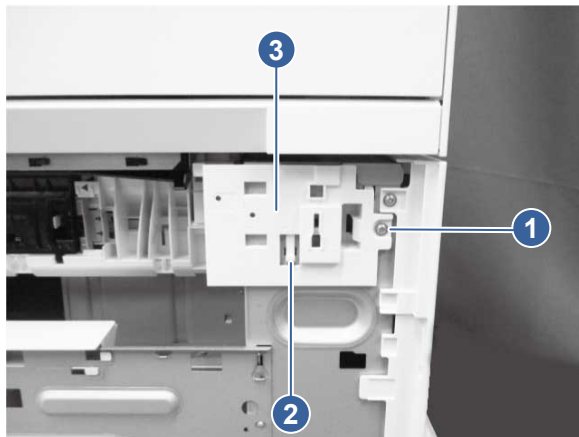


## 2. Remove the paper pickup assembly (HCI)

Follow these steps to remove the HCI paper pickup assembly.

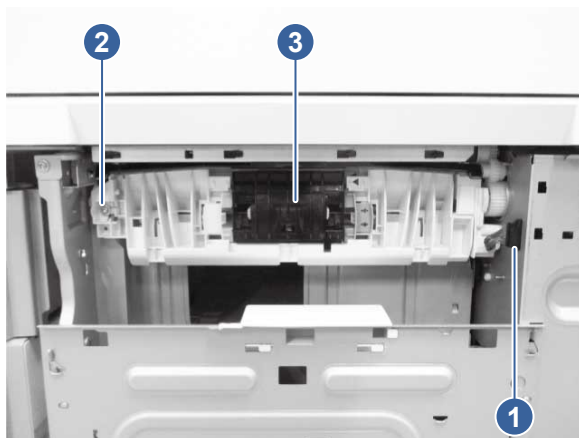
1. Remove one screw (callout 1), release one tab (callout 2), and then slide the inner cover (callout 3) downward to remove it.

**Figure 5-870 Remove the inner cover**



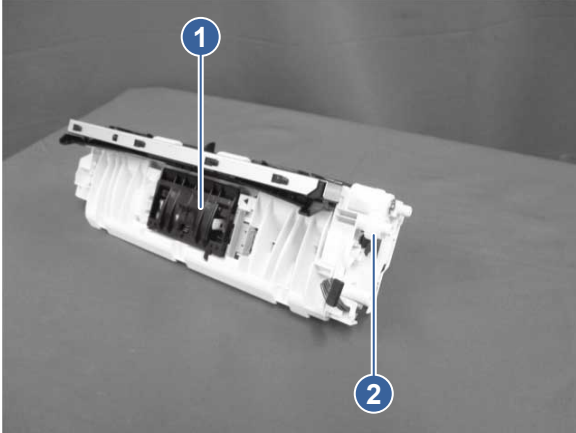
2. Disconnect one connector (callout 1), remove one screw (callout 2), and then remove the pickup assembly (callout 3).

**Figure 5-871 Remove the pickup assembly (HCI)**



3. Remove the gear (callout 2) from the pickup assembly (callout 1).

**Figure 5-872 Remove the gear**




### 3. Unpack the replacement assembly

Follow these steps to unpack the replacement assembly.

1. Dispose of the defective part.

---



 **NOTE:** HP recommends responsible disposal of the defective part.


<http://www8.hp.com/us/en/hp-information/environment/product-recycling.html>


---

2. Unpack the replacement part from the packaging.

---

 **CAUTION:**  Some parts are sensitive to electrostatic discharge (ESD). Always perform service work at an ESD-protected workstation or mat. If an ESD workstation or mat is not available, touch the sheet-metal chassis to provide a static ground before touching an ESD-sensitive assembly. Protect the ESD-sensitive assemblies by placing them in ESD pouches when they are out of the printer.


 **IMPORTANT:** Make sure that all of the shipping materials (for example shipping tape) are removed from the replacement part prior to installation.

 **NOTE:** If the replacement part is a roller or pad, avoid touching the spongy part of it. Skin oils on the roller or pad can cause paper pickup and/or print-quality problems. HP recommends using disposable gloves when handling rollers or pads or washing your hands before touching rollers or pads.

---

3. To install an assembly, reverse the removal steps.

---

 **NOTE:** When applicable, special installation instructions are provided for an assembly at the end of the removal procedure. Always completely read the removal instructions and follow all special installation instructions.

---

### Removal and replacement: Auto close assembly (HCI)

Learn about removing and replacing the HCI auto close assembly.

#### Before performing service

**Turn the printer power off**

- Disconnect the power cable.

**⚠ WARNING!** To avoid damage to the printer, turn the printer off, wait 30 seconds, and then remove the power cord before attempting to service the printer.

Use the table below to identify the correct part number for your printer, and then go to <https://parts.hp.com/hpparts> to order the part.

**Table 5-119 Part information**

Part number	Part description
RM2-0918-000CN	Auto close assembly (2,100-sheet paper deck HCI)

## Required tools

- #2 Phillips screwdriver with a magnetic tip and a 152 mm (6 in) shaft length

## After performing service

### Turn the printer power on

- Connect the power cable.
- Use the power switch to turn the power on.

## Post service test

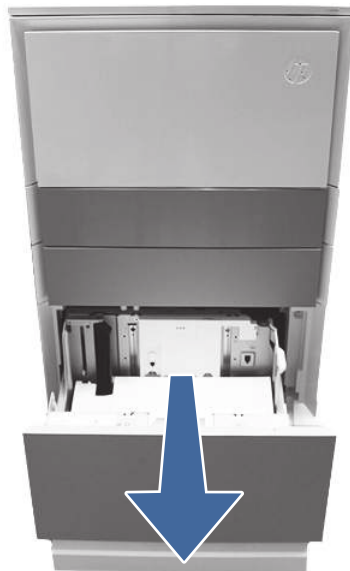
No post service test is available for this assembly.

### 1. Remove the cassette (HCI)

Follow these steps to remove the HCI cassette.

1. Open the HCI cassette assembly.

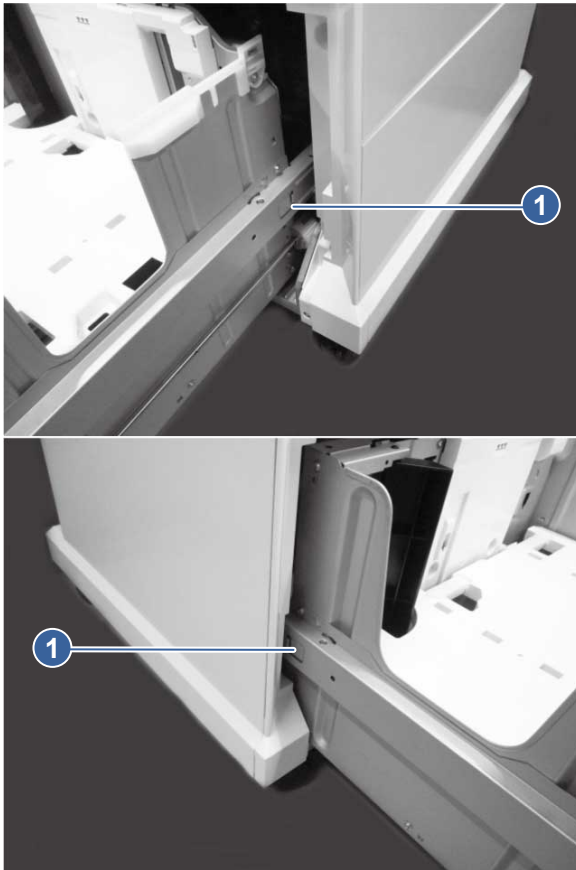
**Figure 5-873 Open the HCI cassette**





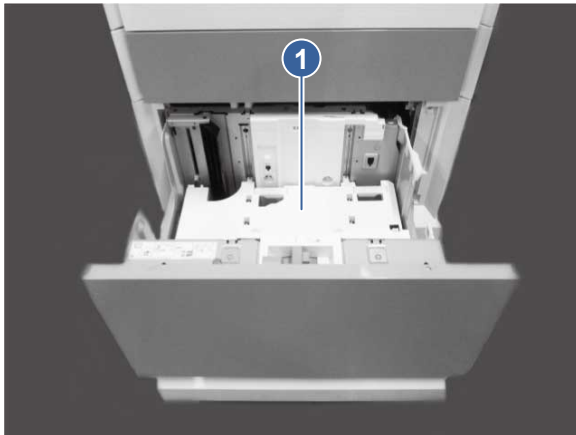
2. Press the left and right release levers (callout 1).

**Figure 5-874 Press the release levers**



3. Pull the HCI cassette assembly (callout 1) out of the HCI chassis.

**Figure 5-875 Remove the tray cassette (HCI)**

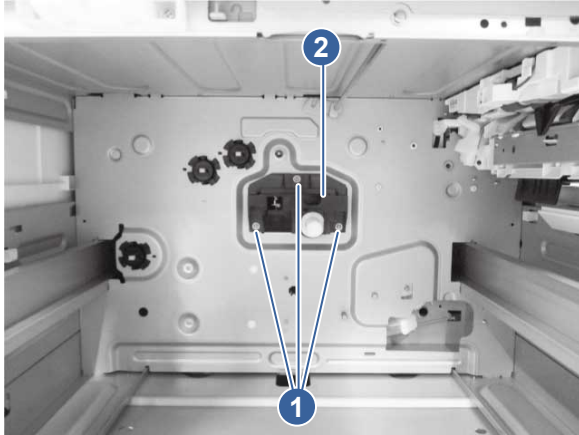


## 2. Remove the auto close assembly (HCI)

Follow these steps to remove the HCI auto close assembly.

- Remove three screws (callout 1), and then remove the auto close assembly (callout 2).

**Figure 5-876 Remove the auto close assembly (HCI)**



### 3. Unpack the replacement assembly



Follow these steps to unpack the replacement assembly.


1. Dispose of the defective part.


 **NOTE:** HP recommends responsible disposal of the defective part.

<http://www8.hp.com/us/en/hp-information/environment/product-recycling.html>


2. Unpack the replacement part from the packaging.

 **CAUTION:**  Some parts are sensitive to electrostatic discharge (ESD). Always perform service work at an ESD-protected workstation or mat. If an ESD workstation or mat is not available, touch the sheet-metal chassis to provide a static ground before touching an ESD-sensitive assembly. Protect the ESD-sensitive assemblies by placing them in ESD pouches when they are out of the printer.

 **IMPORTANT:** Make sure that all of the shipping materials (for example shipping tape) are removed from the replacement part prior to installation.

 **NOTE:** If the replacement part is a roller or pad, avoid touching the spongy part of it. Skin oils on the roller or pad can cause paper pickup and/or print-quality problems. HP recommends using disposable gloves when handling rollers or pads or washing your hands before touching rollers or pads.

3. To install an assembly, reverse the removal steps.

 **NOTE:** When applicable, special installation instructions are provided for an assembly at the end of the removal procedure. Always completely read the removal instructions and follow all special installation instructions.

### Removal and replacement: Lifter drive assembly (HCI)

Learn about removing and replacing the HCI lifter drive assembly.

#### Before performing service

**Turn the printer power off**

- Disconnect the power cable.

**⚠ WARNING!** To avoid damage to the printer, turn the printer off, wait 30 seconds, and then remove the power cord before attempting to service the printer.

Use the table below to identify the correct part number for your printer, and then go to <https://parts.hp.com/hpparts> to order the part.

**Table 5-120 Part information**

Part number	Part description
RM3-0021-000CN	Lifter drive assembly (2,100-sheet paper deck HCI)

## Required tools

- #2 Phillips screwdriver with a magnetic tip and a 152 mm (6 in) shaft length
- Small flat-blade screwdriver

## After performing service

### Turn the printer power on

- Connect the power cable.
- Use the power switch to turn the power on.

## Post service test

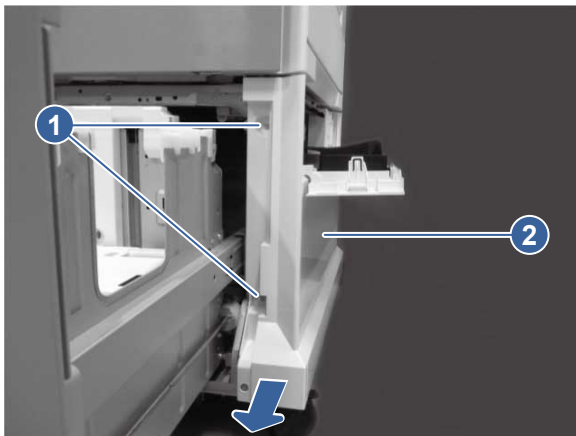
Print any pages necessary to make sure the printer is functioning correctly.

### 1. Remove the right door (HCI)

Follow these steps to remove the HCI right door.

1. Open the HCI tray, and then open the right door.
2. Remove two screws (callout 1), and then slide the right door (callout 2) in the direction indicated to remove it.

**Figure 5-877 Remove the right door (HCI)**

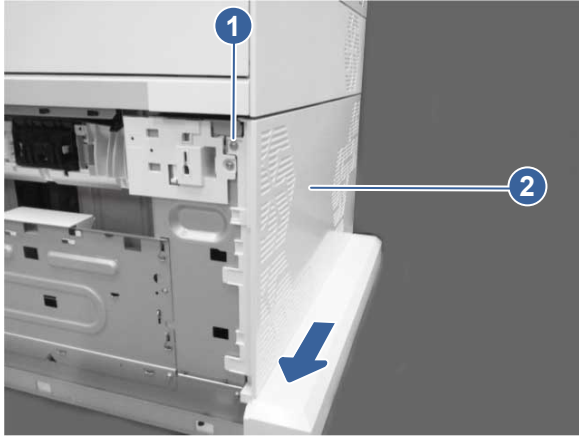


## 2. Remove the rear cover (HCI)

Follow these steps to remove the HCI rear cover.

- Remove one screw (callout 1), and then slide the rear cover (callout 2) in the direction indicated to remove it.

**Figure 5-878 Remove the rear cover (HCI)**

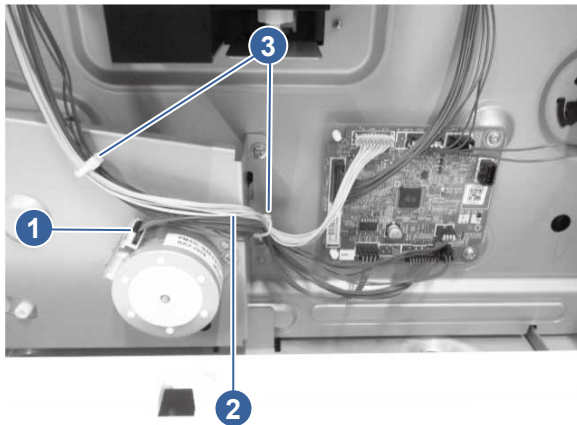


## 3. Remove the lifter drive assembly (HCI)

Follow these steps to remove the HCI lifter drive assembly.

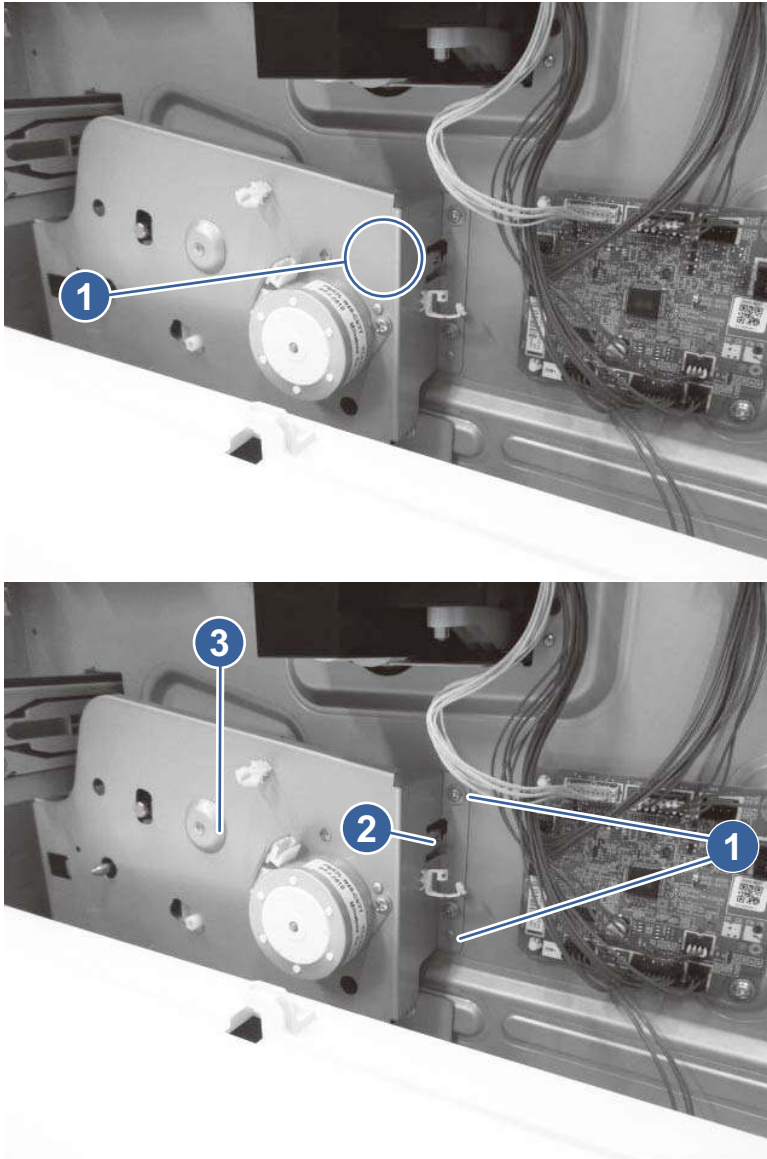
1. Disconnect one connector (callout 1), release the cable (callout 2) from the cable clamps (callout 3).

**Figure 5-879 Disconnect one connector**



2. Remove three screws (callout 1), release one tab (callout 2), and then remove the lifter drive assembly (callout 3).

**Figure 5-880 Remove the lifter drive assembly (HCI)**



#### 4. Unpack the replacement assembly

Follow these steps to unpack the replacement assembly.



1. Dispose of the defective part.





**NOTE:** HP recommends responsible disposal of the defective part.

<http://www8.hp.com/us/en/hp-information/environment/product-recycling.html>


## 2. Unpack the replacement part from the packaging.

 **CAUTION:**  Some parts are sensitive to electrostatic discharge (ESD). Always perform service work at an ESD-protected workstation or mat. If an ESD workstation or mat is not available, touch the sheet-metal chassis to provide a static ground before touching an ESD-sensitive assembly. Protect the ESD-sensitive assemblies by placing them in ESD pouches when they are out of the printer.

 **IMPORTANT:** Make sure that all of the shipping materials (for example shipping tape) are removed from the replacement part prior to installation.

 **NOTE:** If the replacement part is a roller or pad, avoid touching the spongy part of it. Skin oils on the roller or pad can cause paper pickup and/or print-quality problems. HP recommends using disposable gloves when handling rollers or pads or washing your hands before touching rollers or pads.

## 3. To install an assembly, reverse the removal steps.

 **NOTE:** When applicable, special installation instructions are provided for an assembly at the end of the removal procedure. Always completely read the removal instructions and follow all special installation instructions.


### Removal and replacement: Pickup alienation assembly (HCI)

Learn about removing and replacing the HCI pickup alienation assembly.

#### Before performing service

##### Turn the printer power off

- Disconnect the power cable.

 **WARNING!** To avoid damage to the printer, turn the printer off, wait 30 seconds, and then remove the power cord before attempting to service the printer.

Use the table below to identify the correct part number for your printer, and then go to <https://parts.hp.com/hpparts> to order the part.

**Table 5-121** Part information

Part number	Part description
RM3-0022-000CN	Pickup estrangement assembly (2,100-sheet paper deck HCI)

#### Required tools

- No special tools are required to remove or install this assembly.

#### After performing service

##### Turn the printer power on

- Connect the power cable.
- Use the power switch to turn the power on.

#### Post service test

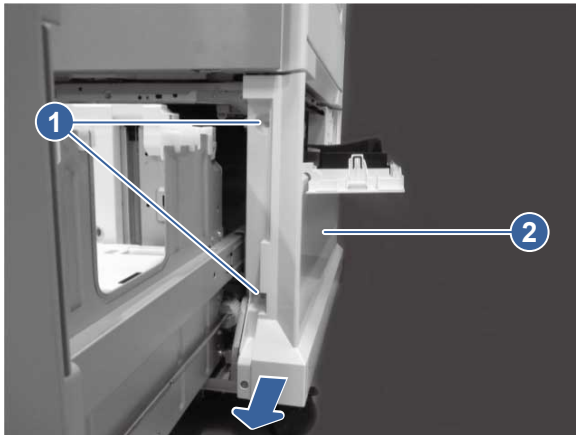
No post service test is available for this assembly.

### 1. Remove the right door (HCI)

Follow these steps to remove the HCI right door.

1. Open the HCI tray, and then open the right door.
2. Remove two screws (callout 1), and then slide the right door (callout 2) in the direction indicated to remove it.

**Figure 5-881 Remove the right door (HCI)**

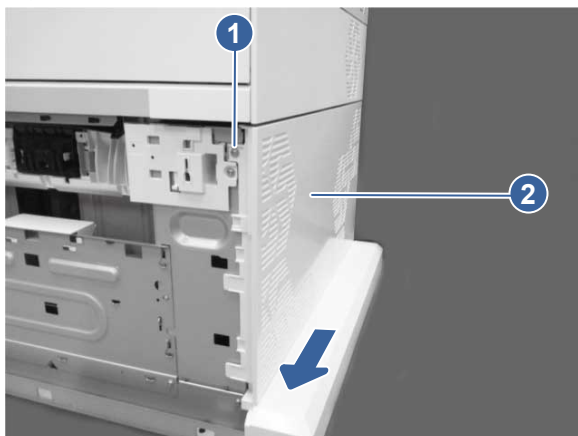


### 2. Remove the rear cover (HCI)

Follow these steps to remove the HCI rear cover.

- Remove one screw (callout 1), and then slide the rear cover (callout 2) in the direction indicated to remove it.

**Figure 5-882 Remove the rear cover (HCI)**

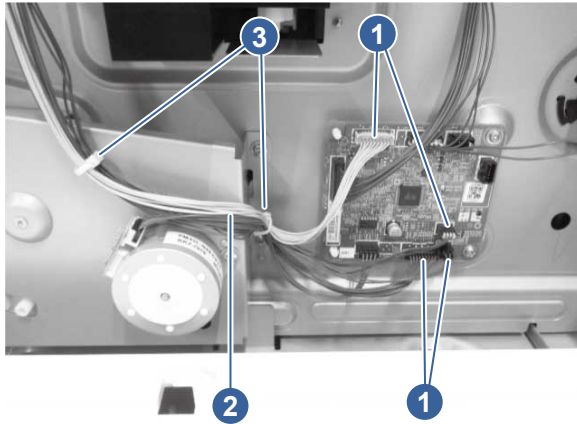


### 3. Remove the pickup alienation assembly (HCI)

Follow these steps to remove the HCI pickup alienation assembly.

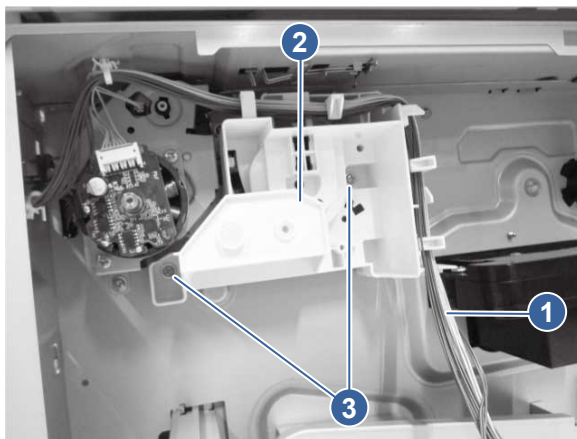
1. Disconnect four connectors (callout 1), and then release the cable (callout 2) from the cable clamps (callout 3).


**Figure 5-883 Disconnect four connectors**



2. Release the cable (callout 1) from the pickup alienation assembly (callout 2), remove two screws (callout 3), and then remove the pickup alienation assembly.

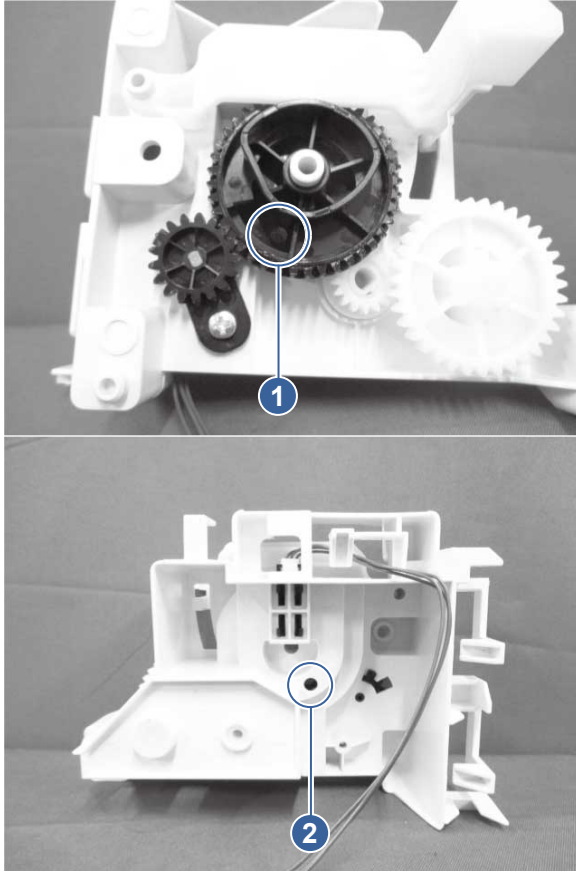
**Figure 5-884 Remove the pickup alienation assembly (HCI)**



 **Reinstallation tip:** When reassembling the pickup alienation assembly, line up the hole (callout 1) in the gear overlaps the position of the hole (callout 2) in the pickup alienation assembly.



**Figure 5-885** Align hole in gear with hole in chassis



#### 4. Unpack the replacement assembly



Follow these steps to unpack the replacement assembly.


1. Dispose of the defective part.


 **NOTE:** HP recommends responsible disposal of the defective part.

<http://www8.hp.com/us/en/hp-information/environment/product-recycling.html>

2. Unpack the replacement part from the packaging.

 **CAUTION:**  Some parts are sensitive to electrostatic discharge (ESD). Always perform service work at an ESD-protected workstation or mat. If an ESD workstation or mat is not available, touch the sheet-metal chassis to provide a static ground before touching an ESD-sensitive assembly. Protect the ESD-sensitive assemblies by placing them in ESD pouches when they are out of the printer.

 **IMPORTANT:** Make sure that all of the shipping materials (for example shipping tape) are removed from the replacement part prior to installation.

 **NOTE:** If the replacement part is a roller or pad, avoid touching the spongy part of it. Skin oils on the roller or pad can cause paper pickup and/or print-quality problems. HP recommends using disposable gloves when handling rollers or pads or washing your hands before touching rollers or pads.

3. To install an assembly, reverse the removal steps.



**NOTE:** When applicable, special installation instructions are provided for an assembly at the end of the removal procedure. Always completely read the removal instructions and follow all special installation instructions.

## Removal and replacement: Pickup drive assembly (HCI)

Learn about removing and replacing the HCI pickup drive assembly.



[View a video demonstration of removing and replacing the pickup drive assembly.](#)

### Before performing service

#### Turn the printer power off

- Disconnect the power cable.



**WARNING!** To avoid damage to the printer, turn the printer off, wait 30 seconds, and then remove the power cord before attempting to service the printer.

Use the table below to identify the correct part number for your printer, and then go to <https://parts.hp.com/hpparts> to order the part.

**Table 5-122** Part information

Part number	Part description
RM2-3617-000CN	Paper pickup drive assembly (2,100-sheet paper deck HCI)

### Required tools

- #2 Phillips screwdriver with a magnetic tip and a 152 mm (6 in) shaft length
- Small flat-blade screwdriver

### After performing service

#### Turn the printer power on

- Connect the power cable.
- Use the power switch to turn the power on.

### Post service test

Print any pages necessary to make sure the printer is functioning correctly.

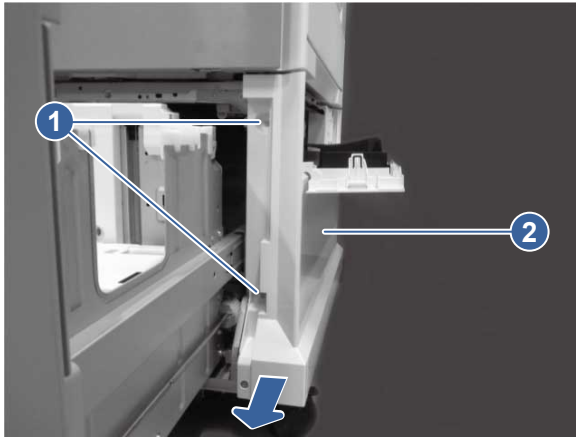
## 1. Remove the right door (HCI)

Follow these steps to remove the HCI right door.

1. Open the HCI tray, and then open the right door.

2. Remove two screws (callout 1), and then slide the right door (callout 2) in the direction indicated to remove it.

**Figure 5-886 Remove the right door (HCI)**

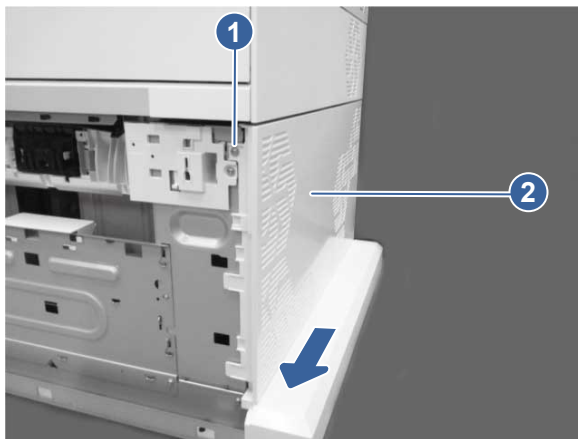


### 2. Remove the rear cover (HCI)

Follow these steps to remove the HCI rear cover.

- Remove one screw (callout 1), and then slide the rear cover (callout 2) in the direction indicated to remove it.

**Figure 5-887 Remove the rear cover (HCI)**

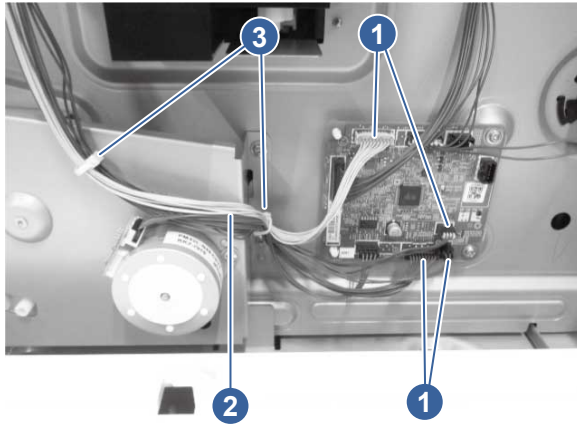


### 3. Remove the pickup alienation assembly (HCI)

Follow these steps to remove the HCI pickup alienation assembly.

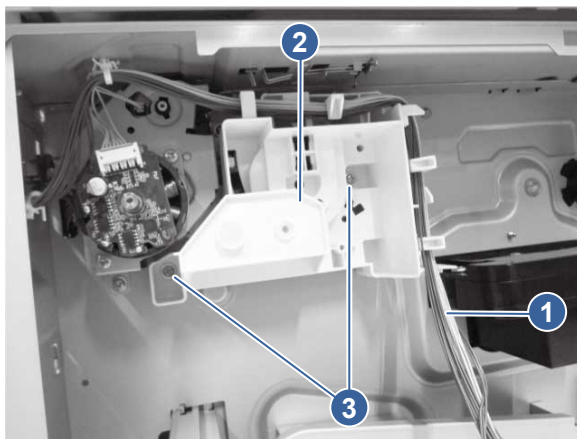
1. Disconnect four connectors (callout 1), and then release the cable (callout 2) from the cable clamps (callout 3).


**Figure 5-888 Disconnect four connectors**



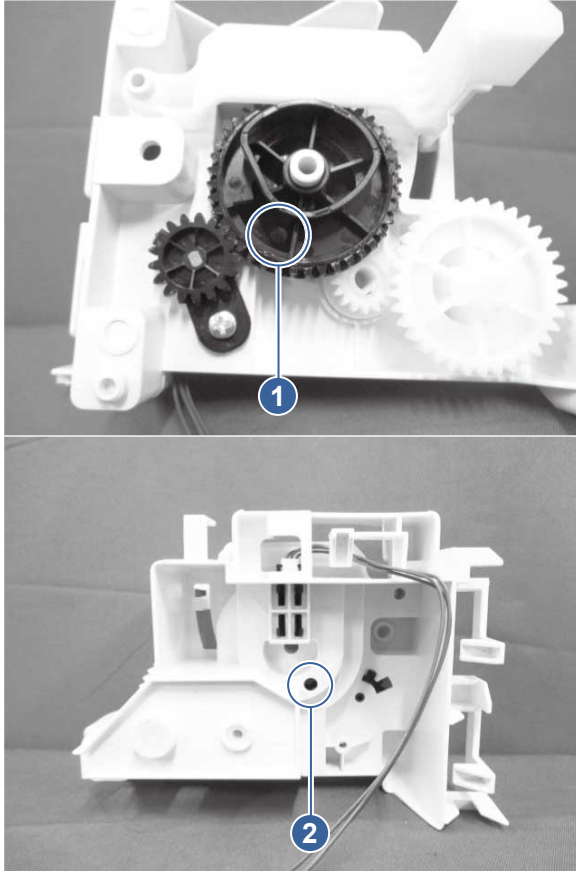
2. Release the cable (callout 1) from the pickup alienation assembly (callout 2), remove two screws (callout 3), and then remove the pickup alienation assembly.

**Figure 5-889 Remove the pickup alienation assembly (HCI)**



 **Reinstallation tip:** When reassembling the pickup alienation assembly, line up the hole (callout 1) in the gear overlaps the position of the hole (callout 2) in the pickup alienation assembly.

**Figure 5-890** Align hole in gear with hole in chassis

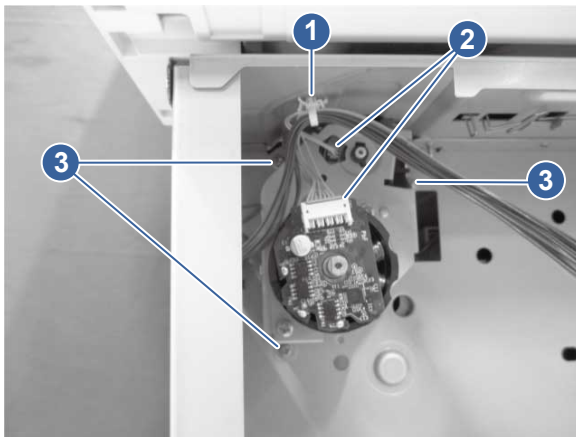


#### 4. Remove the pickup drive assembly (HCI)

Follow these steps to remove the HCI pickup drive assembly.

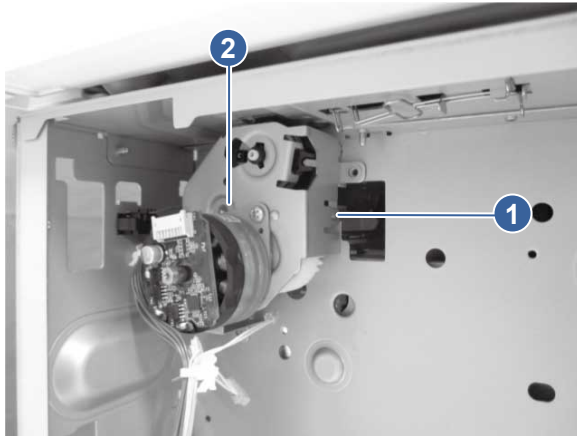
1. Remove the cable clamp (callout 1), disconnect two connectors (callout 2), and then remove three screws (callout 3).

**Figure 5-891** Disconnect connectors and remove screws



2. Release one tab (callout 1), and then remove the pickup drive assembly (callout 2).

**Figure 5-892 Remove the pickup drive assembly (HCI)**



## 5. Unpack the replacement assembly



Follow these steps to unpack the replacement assembly.


1. Dispose of the defective part.


 **NOTE:** HP recommends responsible disposal of the defective part.

<http://www8.hp.com/us/en/hp-information/environment/product-recycling.html>


2. Unpack the replacement part from the packaging.

 **CAUTION:**  Some parts are sensitive to electrostatic discharge (ESD). Always perform service work at an ESD-protected workstation or mat. If an ESD workstation or mat is not available, touch the sheet-metal chassis to provide a static ground before touching an ESD-sensitive assembly. Protect the ESD-sensitive assemblies by placing them in ESD pouches when they are out of the printer.

 **IMPORTANT:** Make sure that all of the shipping materials (for example shipping tape) are removed from the replacement part prior to installation.

 **NOTE:** If the replacement part is a roller or pad, avoid touching the spongy part of it. Skin oils on the roller or pad can cause paper pickup and/or print-quality problems. HP recommends using disposable gloves when handling rollers or pads or washing your hands before touching rollers or pads.

3. To install an assembly, reverse the removal steps.

 **NOTE:** When applicable, special installation instructions are provided for an assembly at the end of the removal procedure. Always completely read the removal instructions and follow all special installation instructions.

## Removal and replacement: Controller PCA (HCI)

Learn about removing and replacing the HCI controller PCA.

### Before performing service

Turn the printer power off

- Disconnect the power cable.

**⚠ WARNING!** To avoid damage to the printer, turn the printer off, wait 30 seconds, and then remove the power cord before attempting to service the printer.

Use the table below to identify the correct part number for your printer, and then go to <https://parts.hp.com/hpparts> to order the part.

**Table 5-123 Part information**

Part number	Part description
RM3-8071-000CN	HCI controller PCA (2,100-sheet paper deck HCI)

## Required tools

- #2 Phillips screwdriver with a magnetic tip and a 152 mm (6 in) shaft length

## After performing service

### Turn the printer power on

- Connect the power cable.
- Use the power switch to turn the power on.

## Post service test

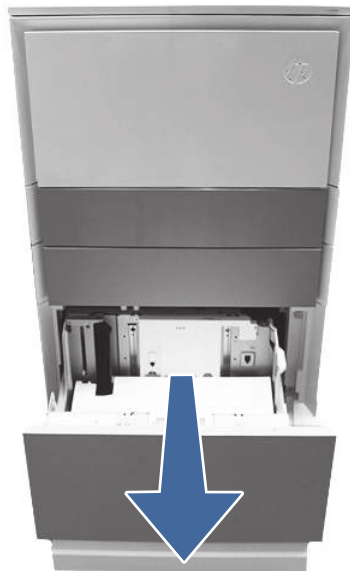
Print any pages necessary to make sure the printer is functioning correctly.

### 1. Remove the cassette (HCI)

Follow these steps to remove the HCI cassette.

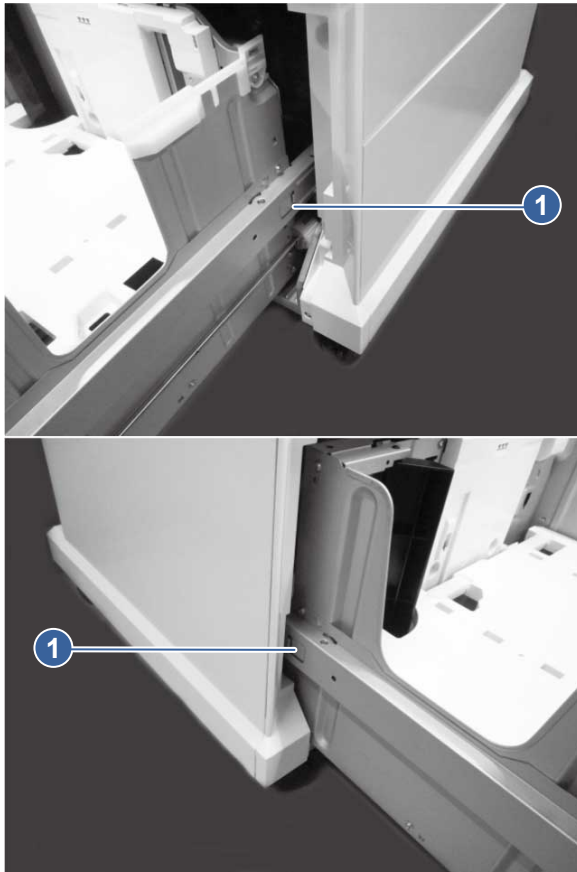
1. Open the HCI cassette assembly.

**Figure 5-893 Open the HCI cassette**



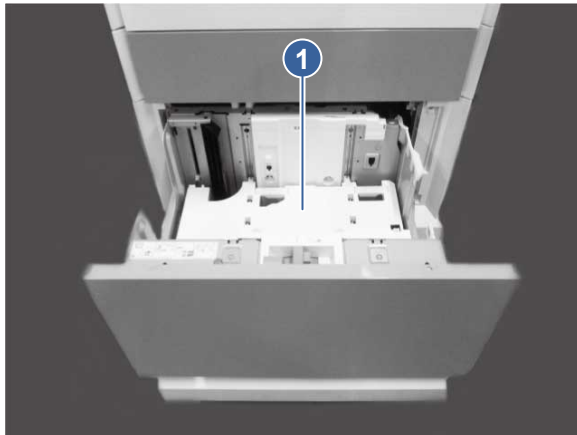
2. Press the left and right release levers (callout 1).

**Figure 5-894 Press the release levers**



3. Pull the HCI cassette assembly (callout 1) out of the HCI chassis.

**Figure 5-895 Remove the tray cassette (HCI)**



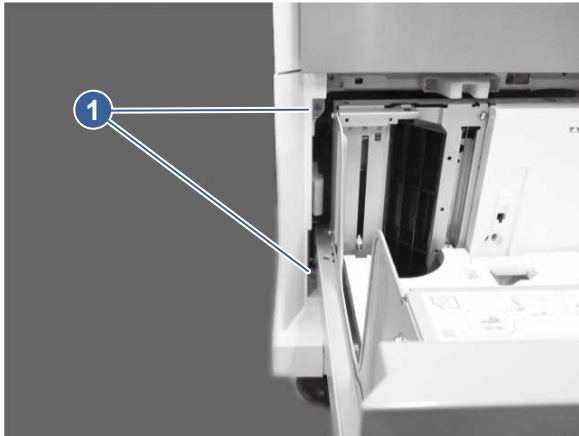
## 2. Remove the front left cover/left cover (HCI)

Follow these steps to remove the HCI front left cover/left cover.



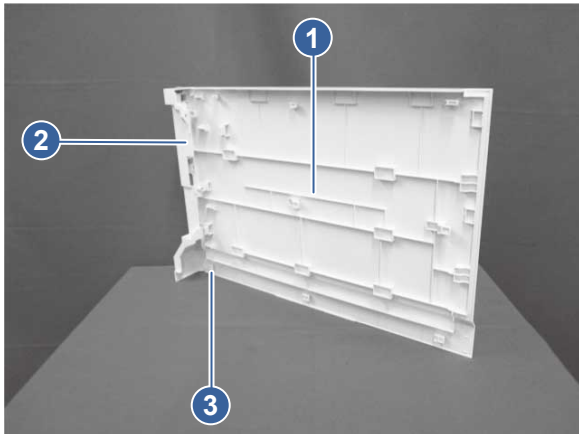
1. Remove two screws (callout 1).

**Figure 5-896 Remove two screws**



2. Remove the left cover (callout 1) together with the front left cover (callout 2). Release one tab (callout 3), and then slide the front left cover upward to remove it from the left cover.

**Figure 5-897 Remove the front left cover from the left cover (HCI)**

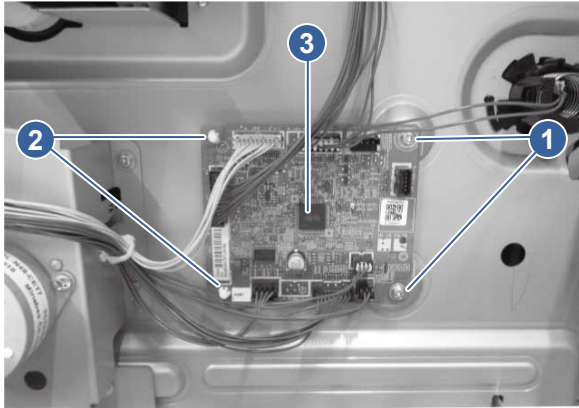


### 3. Remove the controller PCA (HCI)

Follow these steps to remove the HCI controller PCA.

- Disconnect all the connectors on the HCI controller PCA. Remove two screws (callout 1), remove two PCA spacers (callout 2), and then remove the HCI controller PCA (callout 3).

**Figure 5-898 Remove the controller PCA (HCI)**



#### 4. Unpack the replacement assembly



Follow these steps to unpack the replacement assembly.


1. Dispose of the defective part.


 **NOTE:** HP recommends responsible disposal of the defective part.

<http://www8.hp.com/us/en/hp-information/environment/product-recycling.html>


2. Unpack the replacement part from the packaging.

 **CAUTION:**  Some parts are sensitive to electrostatic discharge (ESD). Always perform service work at an ESD-protected workstation or mat. If an ESD workstation or mat is not available, touch the sheet-metal chassis to provide a static ground before touching an ESD-sensitive assembly. Protect the ESD-sensitive assemblies by placing them in ESD pouches when they are out of the printer.

 **IMPORTANT:** Make sure that all of the shipping materials (for example shipping tape) are removed from the replacement part prior to installation.

 **NOTE:** If the replacement part is a roller or pad, avoid touching the spongy part of it. Skin oils on the roller or pad can cause paper pickup and/or print-quality problems. HP recommends using disposable gloves when handling rollers or pads or washing your hands before touching rollers or pads.

3. To install an assembly, reverse the removal steps.

 **NOTE:** When applicable, special installation instructions are provided for an assembly at the end of the removal procedure. Always completely read the removal instructions and follow all special installation instructions.

#### Removal and replacement: Separation roller assembly (HCI)

Learn about removing and replacing the HCI separation roller assembly.

##### Before performing service

Turn the printer power off

- Disconnect the power cable.

**⚠ WARNING!** To avoid damage to the printer, turn the printer off, wait 30 seconds, and then remove the power cord before attempting to service the printer.

If the part is damaged and cannot be cleaned, use the table below to identify the correct part number for your printer. To order the part, go to [www.hp.com/buy/parts](http://www.hp.com/buy/parts).

**Table 5-124 Part information**

Part number	Part description
527H2A	HP LaserJet Tray 2-x Roller Kit (2,100-sheet paper deck HCI)

## Required tools

- No special tools are required to remove or install this assembly.

## After performing service

### Turn the printer power on

- Connect the power cable.
- Use the power switch to turn the power on.

## Post service test

Print any pages necessary to make sure the printer is functioning correctly.

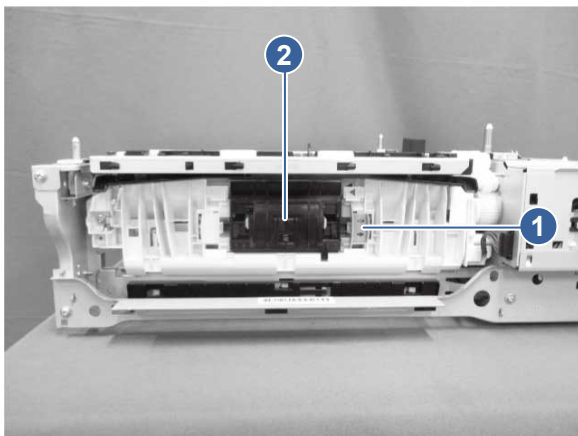
### 1. Remove the separation roller assembly (HCI)

Learn about removing the HCI separation roller assembly.

**NOTE:** The 550-sheet paper feeder is shown in the graphics below. The steps for the HCI rollers are the same.

1. Open the right door.
2. Slide the lever (callout 1) to the right, and then remove the roller assembly (callout 2) by pulling it out from the printer.


**Figure 5-899 Remove the roller assembly**



## 2. Unpack the replacement assembly



Follow these steps to unpack the replacement assembly.


1. Dispose of the defective part.


 **NOTE:** HP recommends responsible disposal of the defective part.

<http://www8.hp.com/us/en/hp-information/environment/product-recycling.html>


2. Unpack the replacement part from the packaging.

 **CAUTION:**  Some parts are sensitive to electrostatic discharge (ESD). Always perform service work at an ESD-protected workstation or mat. If an ESD workstation or mat is not available, touch the sheet-metal chassis to provide a static ground before touching an ESD-sensitive assembly. Protect the ESD-sensitive assemblies by placing them in ESD pouches when they are out of the printer.

 **IMPORTANT:** Make sure that all of the shipping materials (for example shipping tape) are removed from the replacement part prior to installation.

 **NOTE:** If the replacement part is a roller or pad, avoid touching the spongy part of it. Skin oils on the roller or pad can cause paper pickup and/or print-quality problems. HP recommends using disposable gloves when handling rollers or pads or washing your hands before touching rollers or pads.

3. To install an assembly, reverse the removal steps.

 **NOTE:** When applicable, special installation instructions are provided for an assembly at the end of the removal procedure. Always completely read the removal instructions and follow all special installation instructions.


### Removal and replacement: Pickup roller assembly (HCI)

Learn about removing and replacing the HCI pickup roller assembly.

#### Before performing service

##### Turn the printer power off

- Disconnect the power cable.

 **WARNING!** To avoid damage to the printer, turn the printer off, wait 30 seconds, and then remove the power cord before attempting to service the printer.

If the part is damaged and cannot be cleaned, use the table below to identify the correct part number for your printer. To order the part, go to [www.hp.com/buy/parts](http://www.hp.com/buy/parts).

**Table 5-125** Part information

Part number	Part description
527H2A	HP LaserJet Tray 2-x Roller Kit (2,100-sheet paper deck HCI)

#### Required tools

- No special tools are required to remove or install this assembly.

#### After performing service

### Turn the printer power on

- Connect the power cable.
- Use the power switch to turn the power on.

### Post service test

Print any pages necessary to make sure the printer is functioning correctly.

#### 1. Remove the separation roller assembly (HCI)

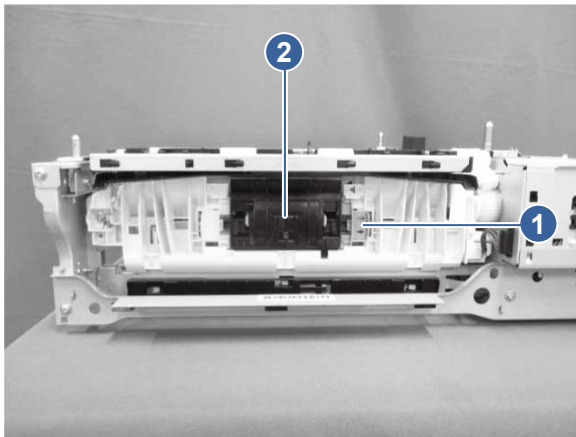
Learn about removing the HCI separation roller assembly.



**NOTE:** The 550-sheet paper feeder is shown in the graphics below. The steps for the HCI rollers are the same.

1. Open the right door.
2. Slide the lever (callout 1) to the right, and then remove the roller assembly (callout 2) by pulling it out from the printer.

**Figure 5-900 Remove the roller assembly**



#### 2. Remove the paper pickup roller assembly (HCI)

Learn about removing the HCI pickup rollers.



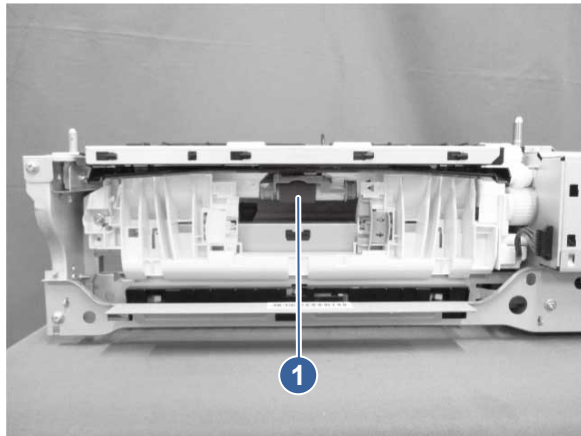
**NOTE:** Even if you want to replace only the pickup roller assembly, you must first remove the separation roller assembly.



**NOTE:** The 550-sheet paper feeder is shown in the graphics below. The steps for the HCI rollers are the same.

- Locate the pickup roller assembly (callout 1) and then pull it away from the printer to remove it.

**Figure 5-901 Remove the pickup roller assembly**




### 3. Unpack the replacement assembly

Follow these steps to unpack the replacement assembly.

1. Dispose of the defective part.

---



 **NOTE:** HP recommends responsible disposal of the defective part.


<http://www8.hp.com/us/en/hp-information/environment/product-recycling.html>


---

2. Unpack the replacement part from the packaging.

---

 **CAUTION:**  Some parts are sensitive to electrostatic discharge (ESD). Always perform service work at an ESD-protected workstation or mat. If an ESD workstation or mat is not available, touch the sheet-metal chassis to provide a static ground before touching an ESD-sensitive assembly. Protect the ESD-sensitive assemblies by placing them in ESD pouches when they are out of the printer.


 **IMPORTANT:** Make sure that all of the shipping materials (for example shipping tape) are removed from the replacement part prior to installation.

 **NOTE:** If the replacement part is a roller or pad, avoid touching the spongy part of it. Skin oils on the roller or pad can cause paper pickup and/or print-quality problems. HP recommends using disposable gloves when handling rollers or pads or washing your hands before touching rollers or pads.

---

3. To install an assembly, reverse the removal steps.

---

 **NOTE:** When applicable, special installation instructions are provided for an assembly at the end of the removal procedure. Always completely read the removal instructions and follow all special installation instructions.

---

## 7. Output device - 3-bin staple stacker multi-bin mailbox

Learn how to remove and replace the 3-bin staple stacker multi-bin mailbox parts and assemblies.

### Field-replaceable units (FRUs)

Learn about FRU parts removal and replacement.

## Covers, panels, and doors

Learn about covers, panels, and doors removal and replacement.

### Removal and replacement: Rear cover (3-bin stapler-stacker)

Learn about removing and replacing the rear cover.

#### Before performing service

##### Turn the printer power off

- Disconnect the power cable.

**⚠ WARNING!** To avoid damage to the printer, turn the printer off, wait 30 seconds, and then remove the power cord before attempting to service the printer.

Use the table below to identify the correct part number for your printer, and then go to <https://parts.hp.com/hpparts> to order the part.

**Table 5-126** Part information

Part number	Part description
RC6-1305-000CN	Cover, rear (3-bin SS)

#### Required tools

- No special tools are required to remove or install this assembly.

#### After performing service

##### Turn the printer power on

- Connect the power cable.
- Use the power switch to turn the power on.

#### Post service test

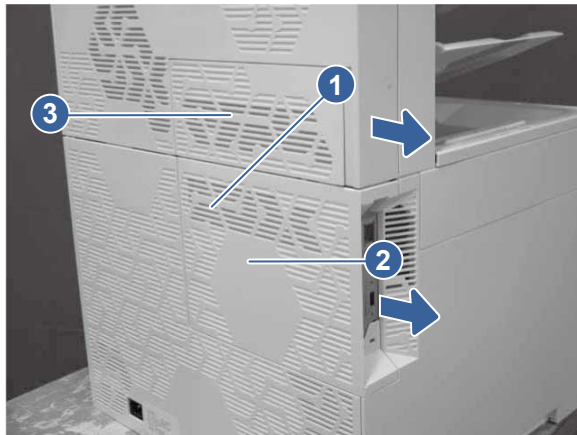
No post service test is available for this assembly.

### 1. Remove the rear cover (3-bin stapler-stacker)

Learn about removing the 3-bin stapler-stacker rear cover.

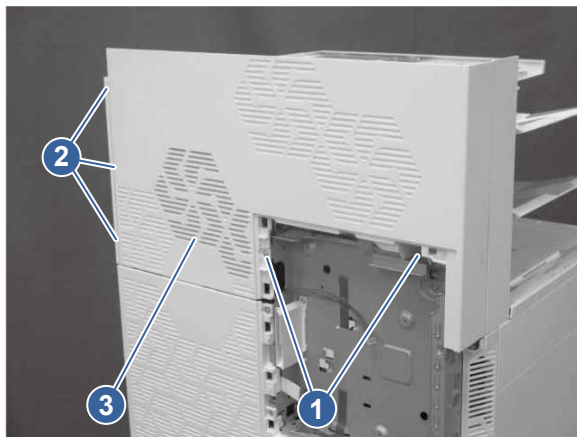
1. Remove the printer formatter cover by removing one screw (callout 1) and then sliding the cover (callout 2) in the direction indicated. Slide the 3-bin stapler-stacker formatter cover assembly (callout 3) in the direction indicated to remove it.

**Figure 5-902 Remove the 3-bin stapler-stacker formatter cover**



2. Remove two screws (callout 1), release three tabs (callout 2), and then remove the rear cover (callout 3).

**Figure 5-903 Remove the rear cover**



## 2. Unpack the replacement assembly

Follow these steps to unpack the replacement assembly.

1. Dispose of the defective part.




**NOTE:** HP recommends responsible disposal of the defective part.


<http://www8.hp.com/us/en/hp-information/environment/product-recycling.html>


2. Unpack the replacement part from the packaging.



**CAUTION:**  Some parts are sensitive to electrostatic discharge (ESD). Always perform service work at an ESD-protected workstation or mat. If an ESD workstation or mat is not available, touch the sheet-metal chassis to provide a static ground before touching an ESD-sensitive assembly. Protect the ESD-sensitive assemblies by placing them in ESD pouches when they are out of the printer.




 **IMPORTANT:** Make sure that all of the shipping materials (for example shipping tape) are removed from the replacement part prior to installation.

 **NOTE:** If the replacement part is a roller or pad, avoid touching the spongy part of it. Skin oils on the roller or pad can cause paper pickup and/or print-quality problems. HP recommends using disposable gloves when handling rollers or pads or washing your hands before touching rollers or pads.

---

3. To install an assembly, reverse the removal steps.

 **NOTE:** When applicable, special installation instructions are provided for an assembly at the end of the removal procedure. Always completely read the removal instructions and follow all special installation instructions.

---


## Removal and replacement: Staple cover and staple door (3-bin stapler-stacker)

Learn about removing and replacing the staple cover and door.

### Before performing service

#### Turn the printer power off

- Disconnect the power cable.

 **WARNING!** To avoid damage to the printer, turn the printer off, wait 30 seconds, and then remove the power cord before attempting to service the printer.

---

Use the table below to identify the correct part number for your printer, and then go to <https://parts.hp.com/hpparts> to order the part.

**Table 5-127** Part information

Part number	Part description
RM3-0483-000CN	Staple cover assembly (3-bin SS)
RM3-0484-000CN	Staple door assembly (3-bin SS)

### Required tools

- No special tools are required to remove or install this assembly.

### After performing service

#### Turn the printer power on

- Connect the power cable.
- Use the power switch to turn the power on.

### Post service test

No post service test is available for this assembly.

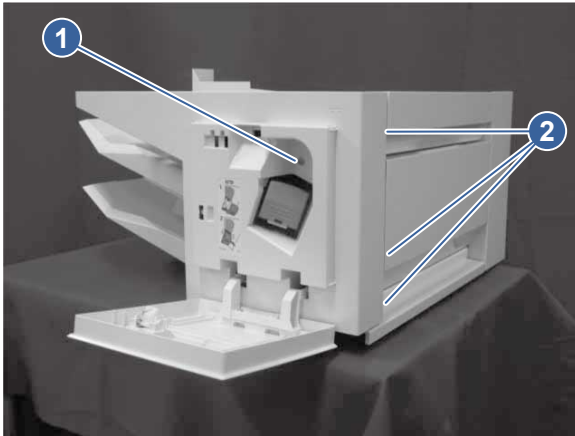
## 1. Remove the staple cover and staple door (3-bin stapler-stacker)

Learn about removing the 3-bin stapler-stacker staple cover and staple door.

1. Open the stapler-stacker door assembly and the stapler door.

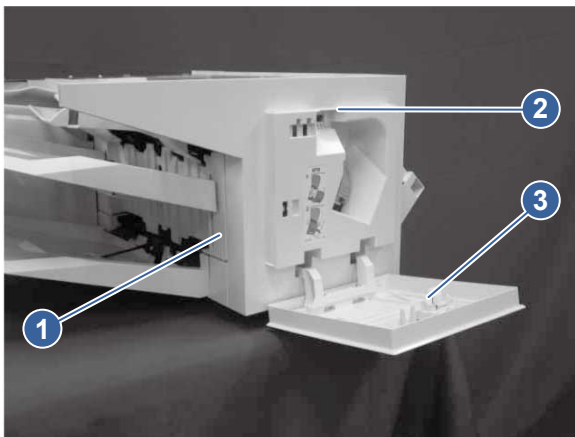
2. Remove one screw (callout 1), and then release three tabs (callout 2).

**Figure 5-904 Remove one screw**



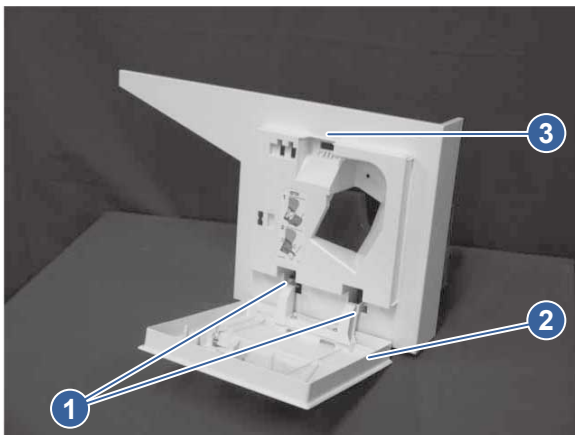
3. Release one tab (callout 1), and then remove the staple cover (callout 2) and the staple door (callout 3) together.

**Figure 5-905 Release one tab**



4. Remove two shafts (callout 1), and then remove the staple door (callout 2) from the staple cover (callout 3).


**Figure 5-906 Remove the staple door from the staple cover**



## 2. Unpack the replacement assembly



Follow these steps to unpack the replacement assembly.


1. Dispose of the defective part.


 **NOTE:** HP recommends responsible disposal of the defective part.

<http://www8.hp.com/us/en/hp-information/environment/product-recycling.html>


2. Unpack the replacement part from the packaging.

 **CAUTION:**  Some parts are sensitive to electrostatic discharge (ESD). Always perform service work at an ESD-protected workstation or mat. If an ESD workstation or mat is not available, touch the sheet-metal chassis to provide a static ground before touching an ESD-sensitive assembly. Protect the ESD-sensitive assemblies by placing them in ESD pouches when they are out of the printer.

 **IMPORTANT:** Make sure that all of the shipping materials (for example shipping tape) are removed from the replacement part prior to installation.

 **NOTE:** If the replacement part is a roller or pad, avoid touching the spongy part of it. Skin oils on the roller or pad can cause paper pickup and/or print-quality problems. HP recommends using disposable gloves when handling rollers or pads or washing your hands before touching rollers or pads.

3. To install an assembly, reverse the removal steps.

 **NOTE:** When applicable, special installation instructions are provided for an assembly at the end of the removal procedure. Always completely read the removal instructions and follow all special installation instructions.


### Removal and replacement: Right upper cover (3-bin stapler-stacker)

Learn about removing and replacing the right upper cover.

#### Before performing service

##### Turn the printer power off

- Disconnect the power cable.

 **WARNING!** To avoid damage to the printer, turn the printer off, wait 30 seconds, and then remove the power cord before attempting to service the printer.

Use the table below to identify the correct part number for your printer, and then go to <https://parts.hp.com/hpparts> to order the part.

**Table 5-128** Part information

Part number	Part description
RC6-1308-000CN	Cover, right upper (3-bin SS)

#### Required tools

- No special tools are required to remove or install this assembly.

#### After performing service

### Turn the printer power on

- Connect the power cable.
- Use the power switch to turn the power on.

### Post service test

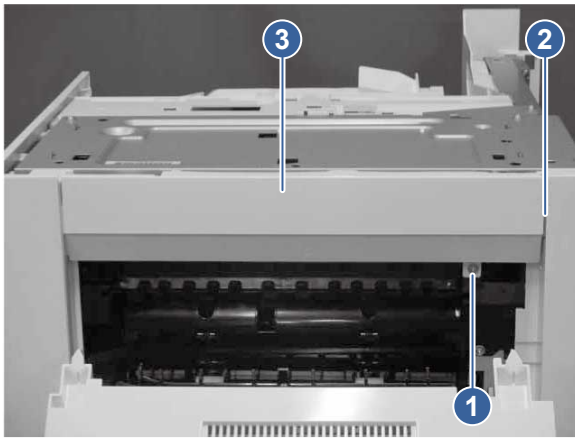
No post service test is available for this assembly.

## 1. Remove the right upper cover (3-bin stapler-stacker)

Learn about removing the 3-bin stapler-stacker right upper cover.

1. Open the stapler-stacker door assembly.
2. Remove one screw (callout 1), release one tab (callout 2), and then remove the right upper cover (callout 3).

**Figure 5-907** Remove the 3-bin stapler-stacker right upper cover



## 2. Unpack the replacement assembly

Follow these steps to unpack the replacement assembly.

1. Dispose of the defective part.




**NOTE:** HP recommends responsible disposal of the defective part.

<http://www8.hp.com/us/en/hp-information/environment/product-recycling.html>


2. Unpack the replacement part from the packaging.



**CAUTION:**  Some parts are sensitive to electrostatic discharge (ESD). Always perform service work at an ESD-protected workstation or mat. If an ESD workstation or mat is not available, touch the sheet-metal chassis to provide a static ground before touching an ESD-sensitive assembly. Protect the ESD-sensitive assemblies by placing them in ESD pouches when they are out of the printer.




**IMPORTANT:** Make sure that all of the shipping materials (for example shipping tape) are removed from the replacement part prior to installation.

 **NOTE:** If the replacement part is a roller or pad, avoid touching the spongy part of it. Skin oils on the roller or pad can cause paper pickup and/or print-quality problems. HP recommends using disposable gloves when handling rollers or pads or washing your hands before touching rollers or pads.

---

3. To install an assembly, reverse the removal steps.

---

 **NOTE:** When applicable, special installation instructions are provided for an assembly at the end of the removal procedure. Always completely read the removal instructions and follow all special installation instructions.

---


### Removal and replacement: Right corner cover (3-bin stapler-stacker)

Learn about removing and replacing the right corner cover.

#### Before performing service

##### Turn the printer power off

- Disconnect the power cable.

 **WARNING!** To avoid damage to the printer, turn the printer off, wait 30 seconds, and then remove the power cord before attempting to service the printer.

---

Use the table below to identify the correct part number for your printer, and then go to <https://parts.hp.com/hpparts> to order the part.

**Table 5-129** Part information

Part number	Part description
RC6-1307-000CN	RC6-1307-000CN (3-bin SS)

#### Required tools

- No special tools are required to remove or install this assembly.

#### After performing service

##### Turn the printer power on

- Connect the power cable.
- Use the power switch to turn the power on.

#### Post service test

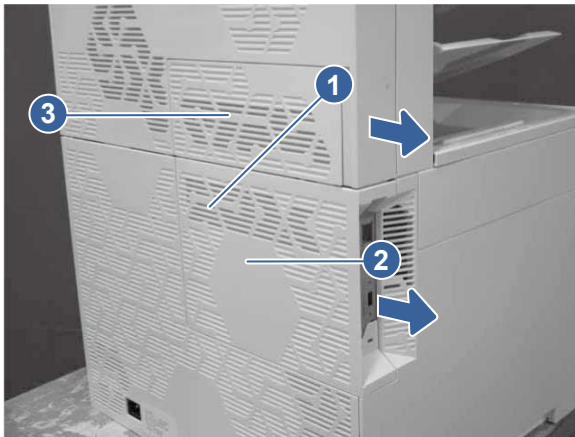
No post service test is available for this assembly.

### 1. Remove the rear cover (3-bin stapler-stacker)

Learn about removing the 3-bin stapler-stacker rear cover.

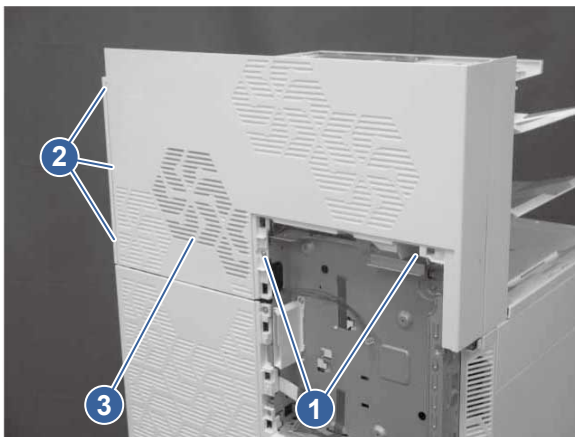
1. Remove the printer formatter cover by removing one screw (callout 1) and then sliding the cover (callout 2) in the direction indicated. Slide the 3-bin stapler-stacker formatter cover assembly (callout 3) in the direction indicated to remove it.

**Figure 5-908 Remove the 3-bin stapler-stacker formatter cover**



2. Remove two screws (callout 1), release three tabs (callout 2), and then remove the rear cover (callout 3).

**Figure 5-909 Remove the rear cover**



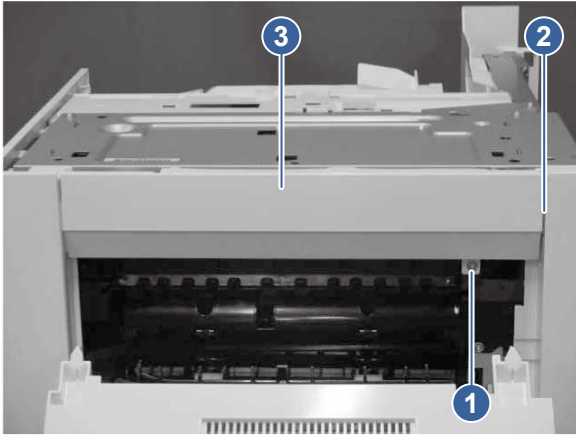
## 2. Remove the right upper cover (3-bin stapler-stacker)

Learn about removing the 3-bin stapler-stacker right upper cover.

1. Open the stapler-stacker door assembly.

2. Remove one screw (callout 1), release one tab (callout 2), and then remove the right upper cover (callout 3).

**Figure 5-910 Remove the 3-bin stapler-stacker right upper cover**

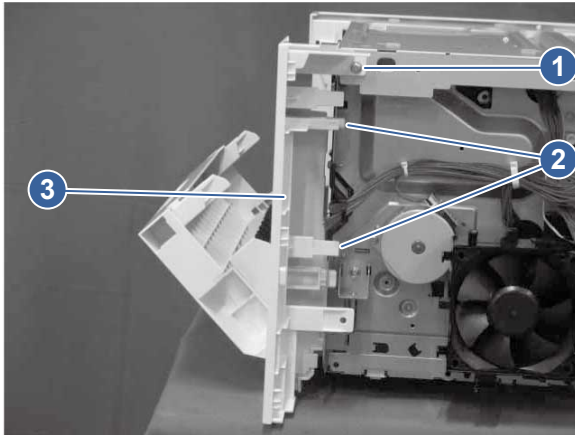


### 3. Remove the right corner cover (3-bin stapler-stacker)

Learn about removing the 3-bin stapler-stacker right corner cover.

- Remove one screw (callout 1), release two tabs (callout 2), and then remove the right corner cover (callout 3).

**Figure 5-911 Remove the right corner cover**



### 4. Unpack the replacement assembly

Follow these steps to unpack the replacement assembly.



1. Dispose of the defective part.





**NOTE:** HP recommends responsible disposal of the defective part.

<http://www8.hp.com/us/en/hp-information/environment/product-recycling.html>


## 2. Unpack the replacement part from the packaging.

 **CAUTION:**  Some parts are sensitive to electrostatic discharge (ESD). Always perform service work at an ESD-protected workstation or mat. If an ESD workstation or mat is not available, touch the sheet-metal chassis to provide a static ground before touching an ESD-sensitive assembly. Protect the ESD-sensitive assemblies by placing them in ESD pouches when they are out of the printer.

 **IMPORTANT:** Make sure that all of the shipping materials (for example shipping tape) are removed from the replacement part prior to installation.

 **NOTE:** If the replacement part is a roller or pad, avoid touching the spongy part of it. Skin oils on the roller or pad can cause paper pickup and/or print-quality problems. HP recommends using disposable gloves when handling rollers or pads or washing your hands before touching rollers or pads.

## 3. To install an assembly, reverse the removal steps.

 **NOTE:** When applicable, special installation instructions are provided for an assembly at the end of the removal procedure. Always completely read the removal instructions and follow all special installation instructions.


### Removal and replacement: Right lower cover (3-bin stapler-stacker)

Learn about removing and replacing the right lower cover.

#### Before performing service

##### Turn the printer power off

- Disconnect the power cable.

 **WARNING!** To avoid damage to the printer, turn the printer off, wait 30 seconds, and then remove the power cord before attempting to service the printer.

Use the table below to identify the correct part number for your printer, and then go to <https://parts.hp.com/hpparts> to order the part.

**Table 5-130** Part information

Part number	Part description
RC6-1309-000CN	Cover, right lower (3-bin SS)

#### Required tools

- No special tools are required to remove or install this assembly.

#### After performing service

##### Turn the printer power on

- Connect the power cable.
- Use the power switch to turn the power on.

#### Post service test



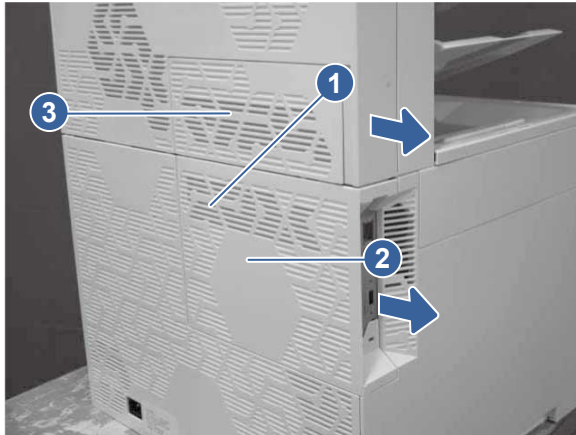
No post service test is available for this assembly.

### 1. Remove the rear cover (3-bin stapler-stacker)

Learn about removing the 3-bin stapler-stacker rear cover.

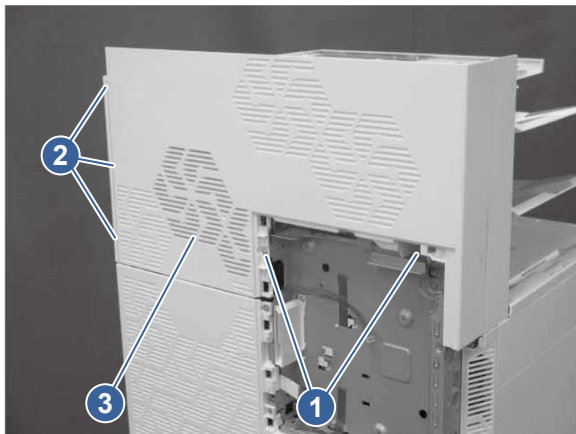
1. Remove the printer formatter cover by removing one screw (callout 1) and then sliding the cover (callout 2) in the direction indicated. Slide the 3-bin stapler-stacker formatter cover assembly (callout 3) in the direction indicated to remove it.

**Figure 5-912 Remove the 3-bin stapler-stacker formatter cover**



2. Remove two screws (callout 1), release three tabs (callout 2), and then remove the rear cover (callout 3).

**Figure 5-913 Remove the rear cover**



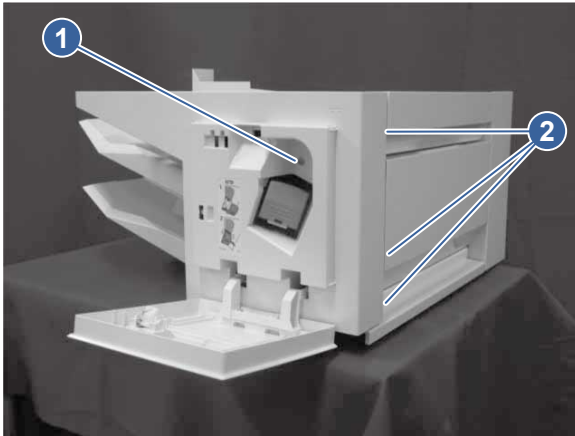
### 2. Remove the staple cover and staple door (3-bin stapler-stacker)

Learn about removing the 3-bin stapler-stacker staple cover and staple door.

1. Open the stapler-stacker door assembly and the stapler door.

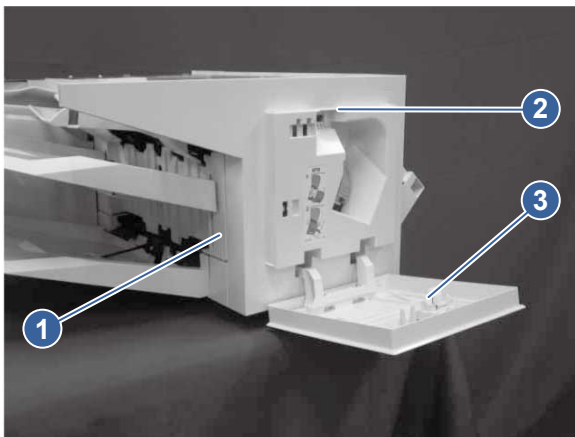
2. Remove one screw (callout 1), and then release three tabs (callout 2).

**Figure 5-914 Remove one screw**



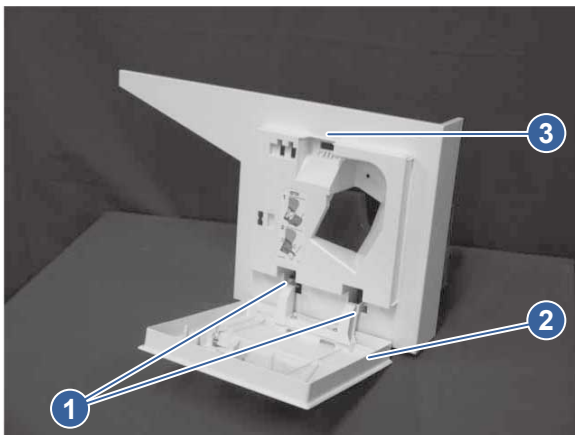
3. Release one tab (callout 1), and then remove the staple cover (callout 2) and the staple door (callout 3) together.

**Figure 5-915 Release one tab**



4. Remove two shafts (callout 1), and then remove the staple door (callout 2) from the staple cover (callout 3).

**Figure 5-916 Remove the staple door from the staple cover**

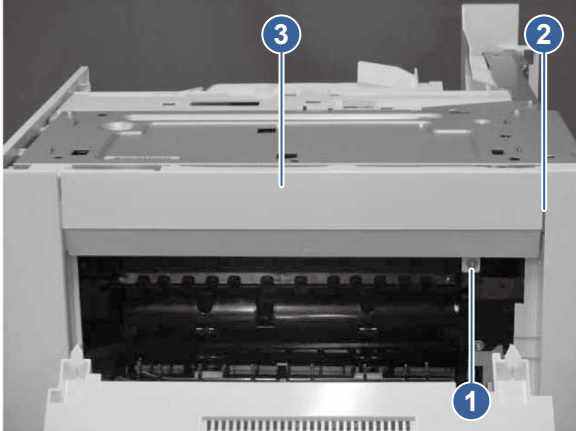


### 3. Remove the right upper cover (3-bin stapler-stacker)

Learn about removing the 3-bin stapler-stacker right upper cover.

1. Open the stapler-stacker door assembly.
2. Remove one screw (callout 1), release one tab (callout 2), and then remove the right upper cover (callout 3).

**Figure 5-917 Remove the 3-bin stapler-stacker right upper cover**

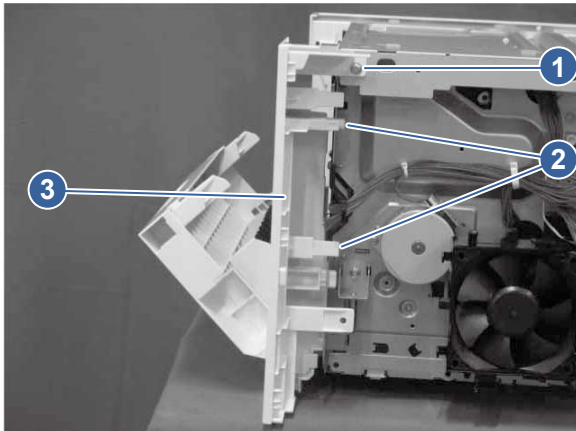


### 4. Remove the right corner cover (3-bin stapler-stacker)

Learn about removing the 3-bin stapler-stacker right corner cover.

- Remove one screw (callout 1), release two tabs (callout 2), and then remove the right corner cover (callout 3).

**Figure 5-918 Remove the right corner cover**

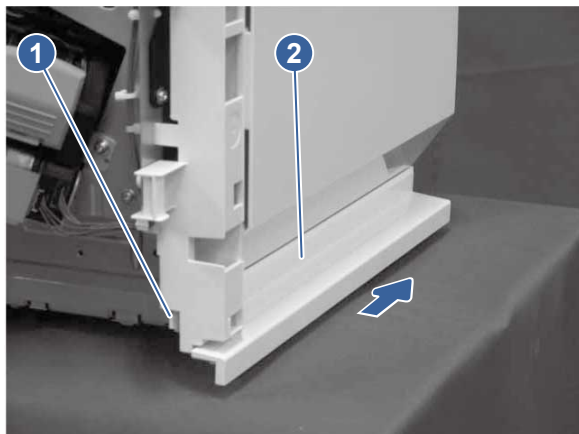


### 5. Remove the right lower cover (3-bin stapler-stacker)

Learn about removing the 3-bin stapler-stacker right lower cover.

- Release one tab (callout 1), and then slide the right lower cover (callout 2) in the direction indicated to remove it.


**Figure 5-919 Remove the right lower cover**



## 6. Unpack the replacement assembly



Follow these steps to unpack the replacement assembly.


1. Dispose of the defective part.


 **NOTE:** HP recommends responsible disposal of the defective part.

<http://www8.hp.com/us/en/hp-information/environment/product-recycling.html>


2. Unpack the replacement part from the packaging.

 **CAUTION:**  Some parts are sensitive to electrostatic discharge (ESD). Always perform service work at an ESD-protected workstation or mat. If an ESD workstation or mat is not available, touch the sheet-metal chassis to provide a static ground before touching an ESD-sensitive assembly. Protect the ESD-sensitive assemblies by placing them in ESD pouches when they are out of the printer.

 **IMPORTANT:** Make sure that all of the shipping materials (for example shipping tape) are removed from the replacement part prior to installation.

 **NOTE:** If the replacement part is a roller or pad, avoid touching the spongy part of it. Skin oils on the roller or pad can cause paper pickup and/or print-quality problems. HP recommends using disposable gloves when handling rollers or pads or washing your hands before touching rollers or pads.

3. To install an assembly, reverse the removal steps.

 **NOTE:** When applicable, special installation instructions are provided for an assembly at the end of the removal procedure. Always completely read the removal instructions and follow all special installation instructions.

## Removal and replacement: Rear inner cover (3-bin stapler-stacker)

Learn about removing and replacing the rear inner cover.

### Before performing service

**Turn the printer power off**

- Disconnect the power cable.

**⚠ WARNING!** To avoid damage to the printer, turn the printer off, wait 30 seconds, and then remove the power cord before attempting to service the printer.

Use the table below to identify the correct part number for your printer, and then go to <https://parts.hp.com/hpparts> to order the part.

**Table 5-131 Part information**

Part number	Part description
RM3-0485-000CN	Rear inner cover assembly (3-bin SS)

## Required tools

- No special tools are required to remove or install this assembly.

## After performing service

### Turn the printer power on

- Connect the power cable.
- Use the power switch to turn the power on.

## Post service test

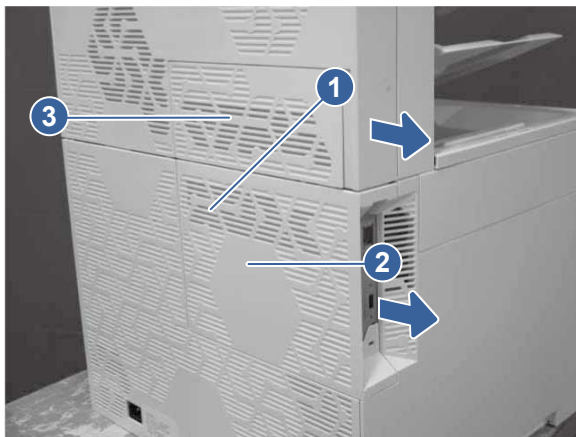
No post service test is available for this assembly.

### 1. Remove the rear cover (3-bin stapler-stacker)

Learn about removing the 3-bin stapler-stacker rear cover.

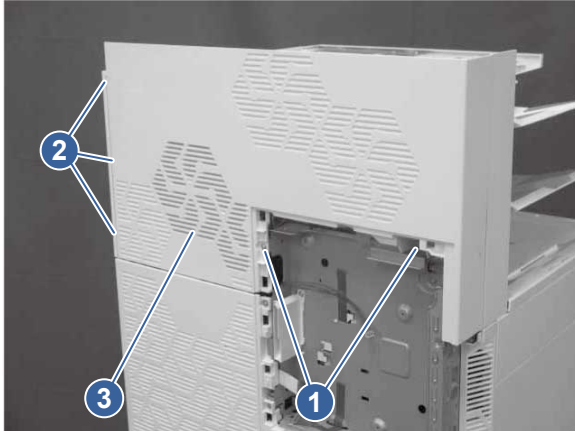
1. Remove the printer formatter cover by removing one screw (callout 1) and then sliding the cover (callout 2) in the direction indicated. Slide the 3-bin stapler-stacker formatter cover assembly (callout 3) in the direction indicated to remove it.

**Figure 5-920 Remove the 3-bin stapler-stacker formatter cover**



2. Remove two screws (callout 1), release three tabs (callout 2), and then remove the rear cover (callout 3).

**Figure 5-921 Remove the rear cover**

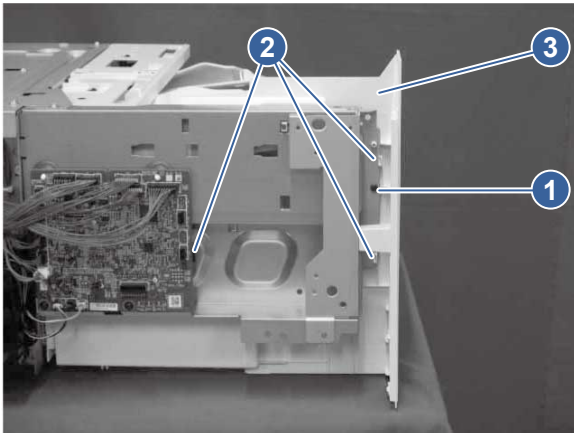


### 2. Remove the rear inner cover (3-bin stapler-stacker)

Learn about removing the 3-bin stapler-stacker rear inner cover.

- Remove one screw (callout 1) release three tabs (callout 2), and then remove the rear inner cover (callout 3).

**Figure 5-922 Remove the rear inner cover**



### 3. Unpack the replacement assembly

Follow these steps to unpack the replacement assembly.

1. Dispose of the defective part.






**NOTE:** HP recommends responsible disposal of the defective part.


<http://www8.hp.com/us/en/hp-information/environment/product-recycling.html>

2. Unpack the replacement part from the packaging.

---


 **CAUTION:**  Some parts are sensitive to electrostatic discharge (ESD). Always perform service work at an ESD-protected workstation or mat. If an ESD workstation or mat is not available, touch the sheet-metal chassis to provide a static ground before touching an ESD-sensitive assembly. Protect the ESD-sensitive assemblies by placing them in ESD pouches when they are out of the printer.

 **IMPORTANT:** Make sure that all of the shipping materials (for example shipping tape) are removed from the replacement part prior to installation.

 **NOTE:** If the replacement part is a roller or pad, avoid touching the spongy part of it. Skin oils on the roller or pad can cause paper pickup and/or print-quality problems. HP recommends using disposable gloves when handling rollers or pads or washing your hands before touching rollers or pads.

---

3. To install an assembly, reverse the removal steps.

 **NOTE:** When applicable, special installation instructions are provided for an assembly at the end of the removal procedure. Always completely read the removal instructions and follow all special installation instructions.

---

### Removal and replacement: Stapler-stacker door assembly (3-bin stapler-stacker)


Learn about removing and replacing the stapler-stacker door.

#### Before performing service

##### Turn the printer power off

- Disconnect the power cable.

---

 **WARNING!** To avoid damage to the printer, turn the printer off, wait 30 seconds, and then remove the power cord before attempting to service the printer.

---

Use the table below to identify the correct part number for your printer, and then go to <https://parts.hp.com/hpparts> to order the part.

**Table 5-132** Part information

Part number	Part description
RM2-4167-000CN	Right door assembly (3-bin SS)

#### Required tools

- No special tools are required to remove or install this assembly.

#### After performing service

##### Turn the printer power on

- Connect the power cable.
- Use the power switch to turn the power on.

#### Post service test

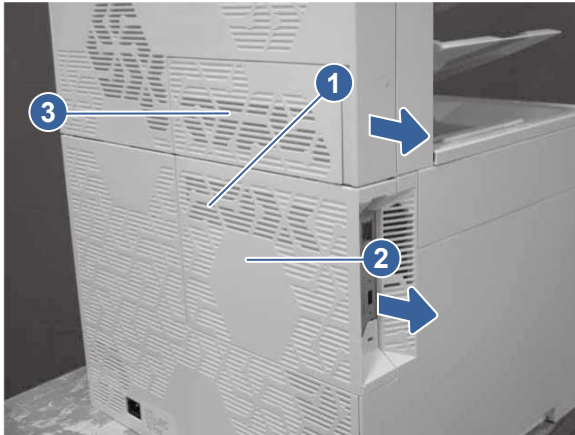
No post service test is available for this assembly.

## 1. Remove the rear cover (3-bin stapler-stacker)

Learn about removing the 3-bin stapler-stacker rear cover.

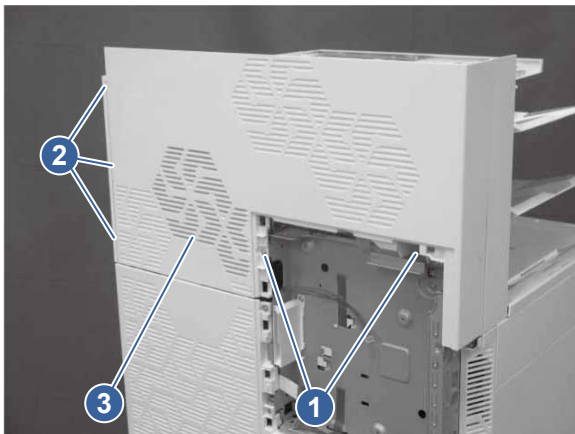
1. Remove the printer formatter cover by removing one screw (callout 1) and then sliding the cover (callout 2) in the direction indicated. Slide the 3-bin stapler-stacker formatter cover assembly (callout 3) in the direction indicated to remove it.

**Figure 5-923 Remove the 3-bin stapler-stacker formatter cover**



2. Remove two screws (callout 1), release three tabs (callout 2), and then remove the rear cover (callout 3).

**Figure 5-924 Remove the rear cover**



## 2. Remove the staple cover and staple door (3-bin stapler-stacker)

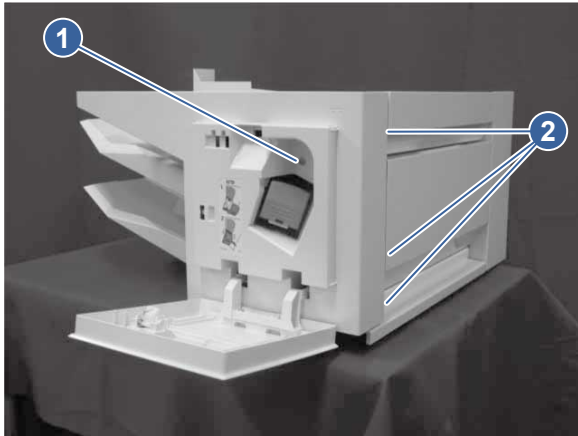
Learn about removing the 3-bin stapler-stacker staple cover and staple door.

1. Open the stapler-stacker door assembly and the stapler door.



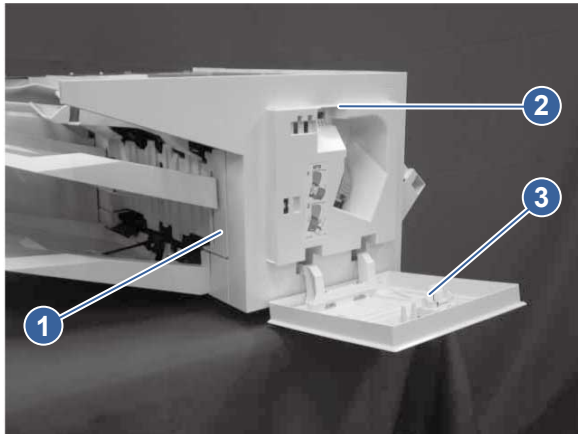
2. Remove one screw (callout 1), and then release three tabs (callout 2).

**Figure 5-925 Remove one screw**



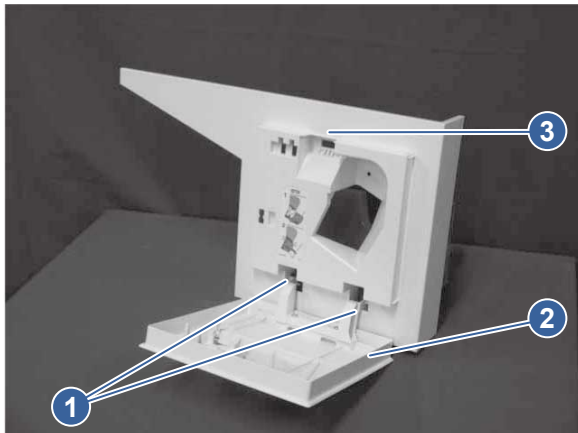
3. Release one tab (callout 1), and then remove the staple cover (callout 2) and the staple door (callout 3) together.

**Figure 5-926 Release one tab**



4. Remove two shafts (callout 1), and then remove the staple door (callout 2) from the staple cover (callout 3).

**Figure 5-927 Remove the staple door from the staple cover**

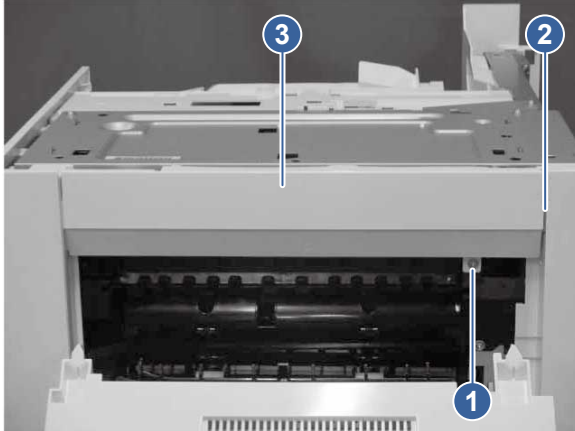


### 3. Remove the right upper cover (3-bin stapler-stacker)

Learn about removing the 3-bin stapler-stacker right upper cover.

1. Open the stapler-stacker door assembly.
2. Remove one screw (callout 1), release one tab (callout 2), and then remove the right upper cover (callout 3).

**Figure 5-928** Remove the 3-bin stapler-stacker right upper cover

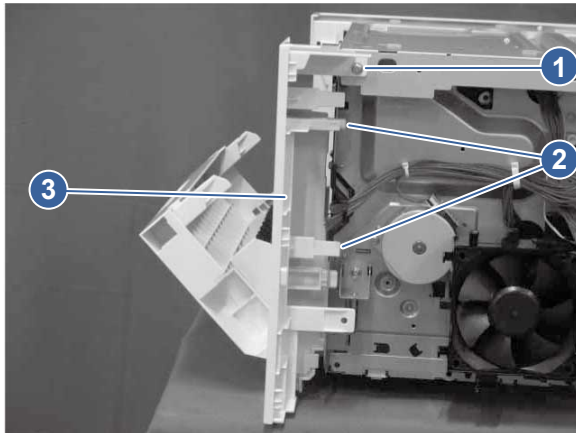


### 4. Remove the right corner cover (3-bin stapler-stacker)

Learn about removing the 3-bin stapler-stacker right corner cover.

- Remove one screw (callout 1), release two tabs (callout 2), and then remove the right corner cover (callout 3).

**Figure 5-929** Remove the right corner cover

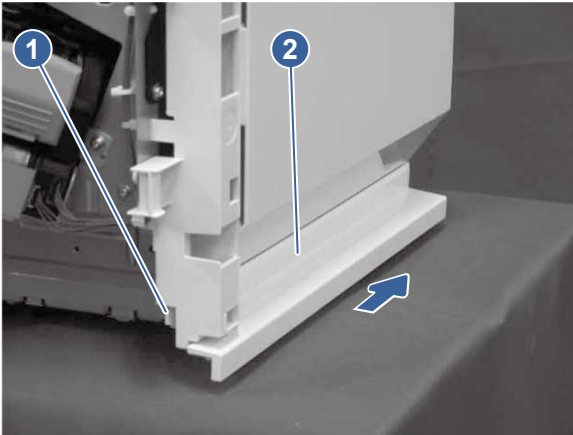


### 5. Remove the right lower cover (3-bin stapler-stacker)

Learn about removing the 3-bin stapler-stacker right lower cover.

- Release one tab (callout 1), and then slide the right lower cover (callout 2) in the direction indicated to remove it.

**Figure 5-930 Remove the right lower cover**

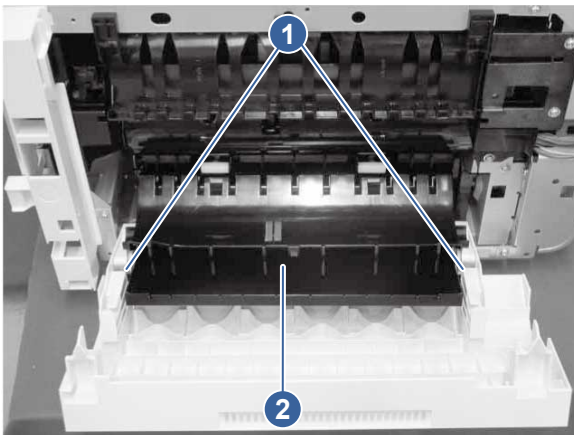


## 6. Remove the stapler-stacker door assembly (3-bin stapler-stacker)

Learn about removing the 3-bin stapler-stacker door assembly.

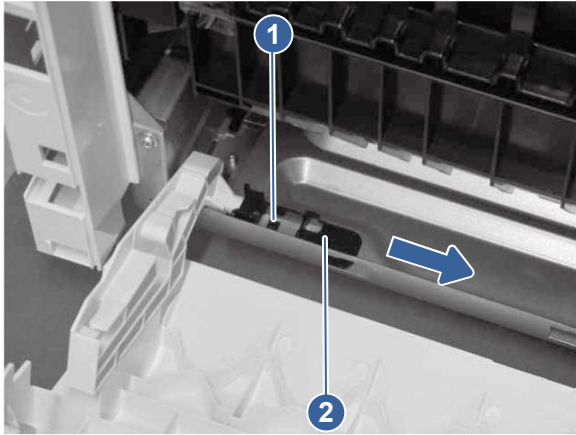
1. Remove two shafts (callout 1), and then open the feed guide (callout 2).

**Figure 5-931 Remove two shafts**



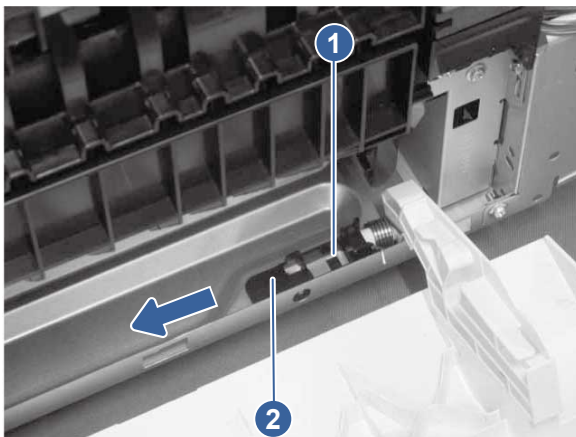
2. Release one tab (callout 1), and then slide the left bushing (callout 2) in the direction indicated to remove it.

**Figure 5-932 Remove the left bushing**



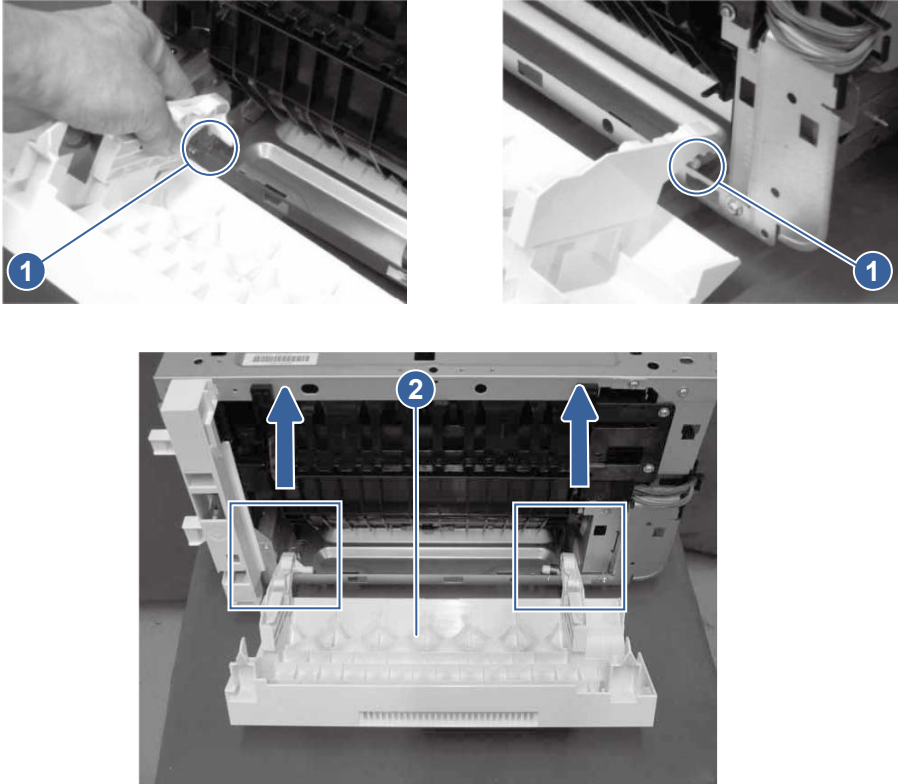
3. Release one tab (callout 1), and then slide the right bushing (callout 2) in the direction indicated to remove it.

**Figure 5-933 Remove the right bushing**



4. Remove right and left shafts (callout 1), and then remove the stapler-stacker door assembly (callout 2).


**Figure 5-934 Remove the stapler-stacker door assembly**



## 7. Unpack the replacement assembly



Follow these steps to unpack the replacement assembly.


1. Dispose of the defective part.


 **NOTE:** HP recommends responsible disposal of the defective part.

<http://www8.hp.com/us/en/hp-information/environment/product-recycling.html>


2. Unpack the replacement part from the packaging.

 **CAUTION:**  Some parts are sensitive to electrostatic discharge (ESD). Always perform service work at an ESD-protected workstation or mat. If an ESD workstation or mat is not available, touch the sheet-metal chassis to provide a static ground before touching an ESD-sensitive assembly. Protect the ESD-sensitive assemblies by placing them in ESD pouches when they are out of the printer.

 **IMPORTANT:** Make sure that all of the shipping materials (for example shipping tape) are removed from the replacement part prior to installation.

 **NOTE:** If the replacement part is a roller or pad, avoid touching the spongy part of it. Skin oils on the roller or pad can cause paper pickup and/or print-quality problems. HP recommends using disposable gloves when handling rollers or pads or washing your hands before touching rollers or pads.

3. To install an assembly, reverse the removal steps.

 **NOTE:** When applicable, special installation instructions are provided for an assembly at the end of the removal procedure. Always completely read the removal instructions and follow all special installation instructions.


## Removal and replacement: Stacking wall assembly (3-bin stapler-stacker)

Learn about removing and replacing the stacking wall.

### Before performing service

#### Turn the printer power off

- Disconnect the power cable.

 **WARNING!** To avoid damage to the printer, turn the printer off, wait 30 seconds, and then remove the power cord before attempting to service the printer.

Use the table below to identify the correct part number for your printer, and then go to <https://parts.hp.com/hpparts> to order the part.

**Table 5-133** Part information

Part number	Part description
RM3-0480-000CN	Stacking wall assembly (3-bin SS)

### Required tools

- No special tools are required to remove or install this assembly.

### After performing service

#### Turn the printer power on

- Connect the power cable.
- Use the power switch to turn the power on.

### Post service test

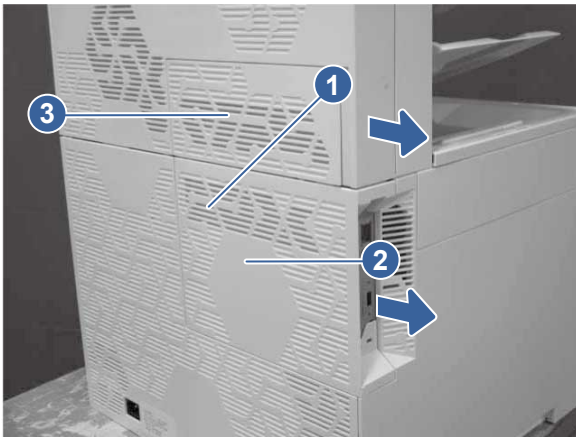
No post service test is available for this assembly.

## 1. Remove the rear cover (3-bin stapler-stacker)

Learn about removing the 3-bin stapler-stacker rear cover.

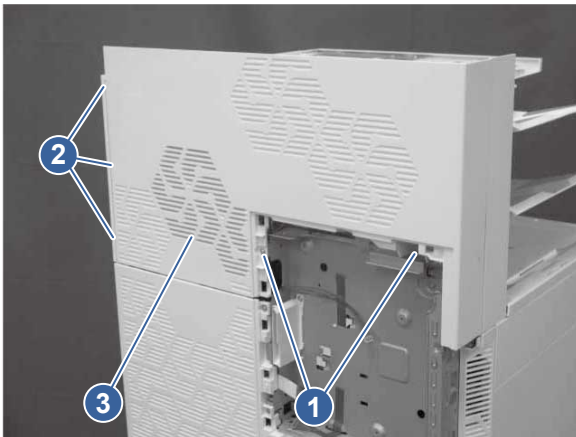
1. Remove the printer formatter cover by removing one screw (callout 1) and then sliding the cover (callout 2) in the direction indicated. Slide the 3-bin stapler-stacker formatter cover assembly (callout 3) in the direction indicated to remove it.

**Figure 5-935 Remove the 3-bin stapler-stacker formatter cover**



2. Remove two screws (callout 1), release three tabs (callout 2), and then remove the rear cover (callout 3).

**Figure 5-936 Remove the rear cover**



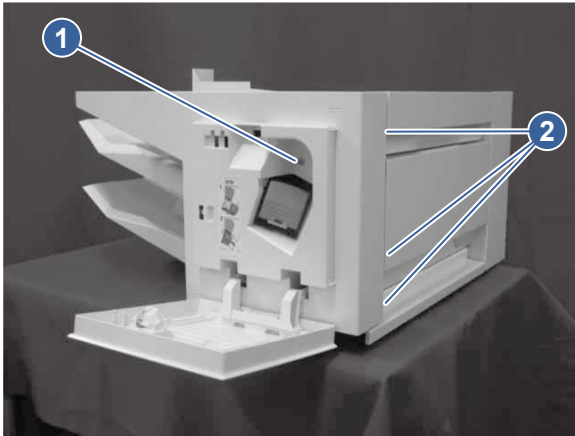
## 2. Remove the staple cover and staple door (3-bin stapler-stacker)

Learn about removing the 3-bin stapler-stacker staple cover and staple door.

1. Open the stapler-stacker door assembly and the stapler door.

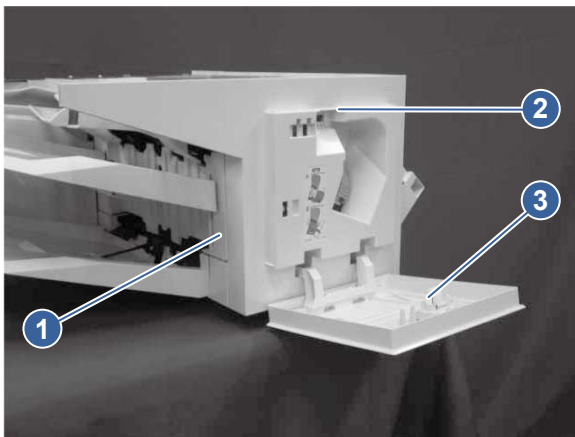
2. Remove one screw (callout 1), and then release three tabs (callout 2).

**Figure 5-937 Remove one screw**



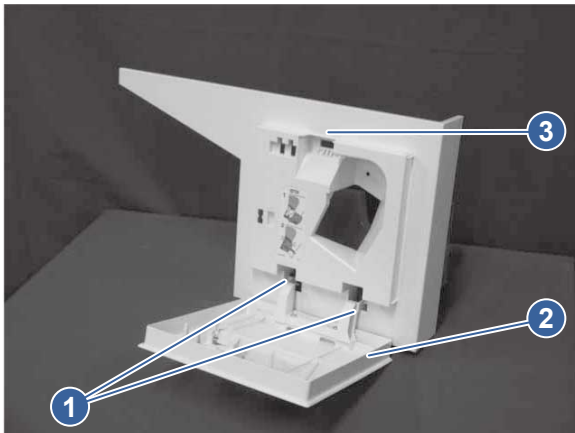
3. Release one tab (callout 1), and then remove the staple cover (callout 2) and the staple door (callout 3) together.

**Figure 5-938 Release one tab**



4. Remove two shafts (callout 1), and then remove the staple door (callout 2) from the staple cover (callout 3).

**Figure 5-939 Remove the staple door from the staple cover**



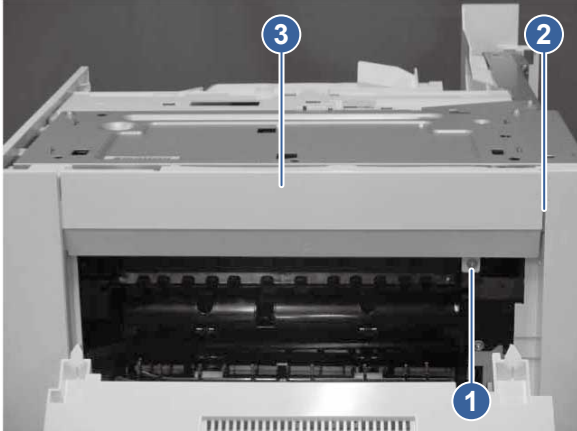


### 3. Remove the right upper cover (3-bin stapler-stacker)

Learn about removing the 3-bin stapler-stacker right upper cover.

1. Open the stapler-stacker door assembly.
2. Remove one screw (callout 1), release one tab (callout 2), and then remove the right upper cover (callout 3).

**Figure 5-940 Remove the 3-bin stapler-stacker right upper cover**

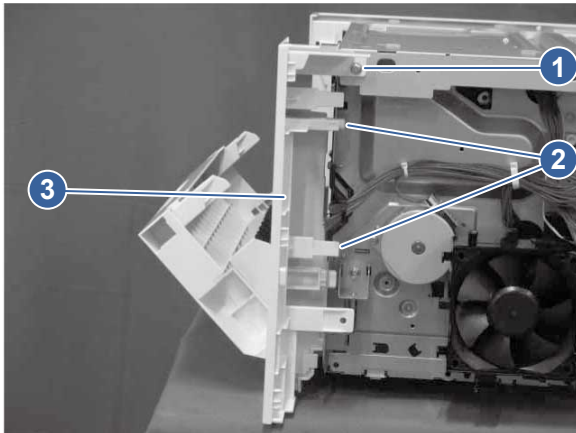


### 4. Remove the right corner cover (3-bin stapler-stacker)

Learn about removing the 3-bin stapler-stacker right corner cover.

- Remove one screw (callout 1), release two tabs (callout 2), and then remove the right corner cover (callout 3).

**Figure 5-941 Remove the right corner cover**

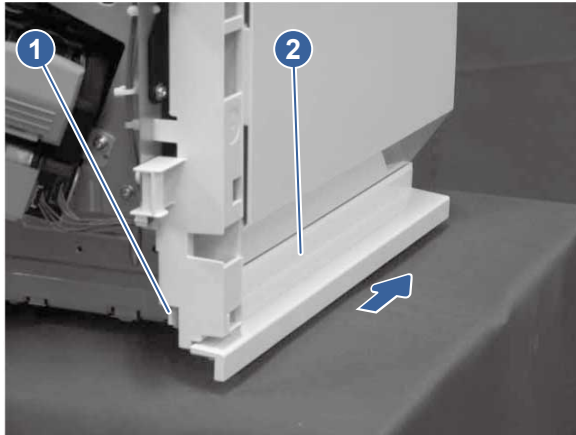


### 5. Remove the right lower cover (3-bin stapler-stacker)

Learn about removing the 3-bin stapler-stacker right lower cover.

- Release one tab (callout 1), and then slide the right lower cover (callout 2) in the direction indicated to remove it.

**Figure 5-942 Remove the right lower cover**

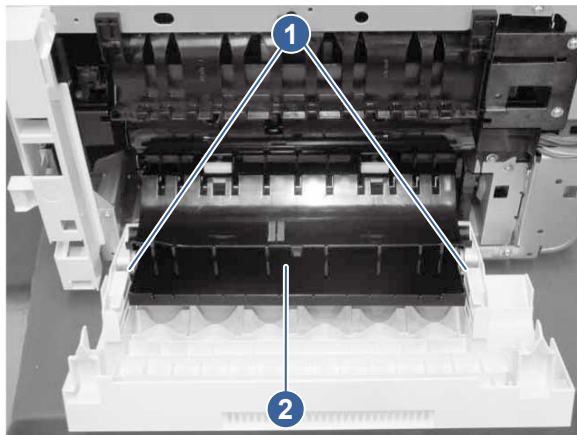


#### 6. Remove the stapler-stacker door assembly (3-bin stapler-stacker)

Learn about removing the 3-bin stapler-stacker door assembly.

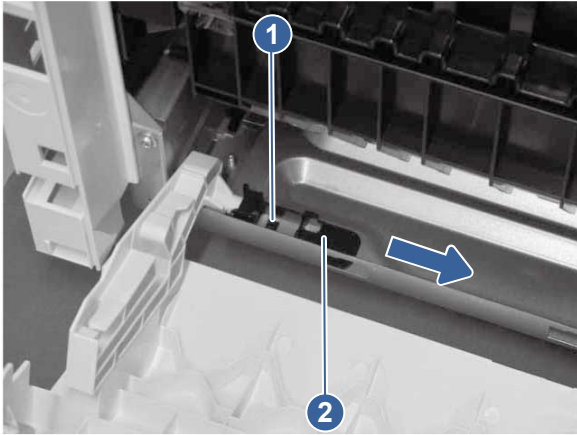
1. Remove two shafts (callout 1), and then open the feed guide (callout 2).

**Figure 5-943 Remove two shafts**



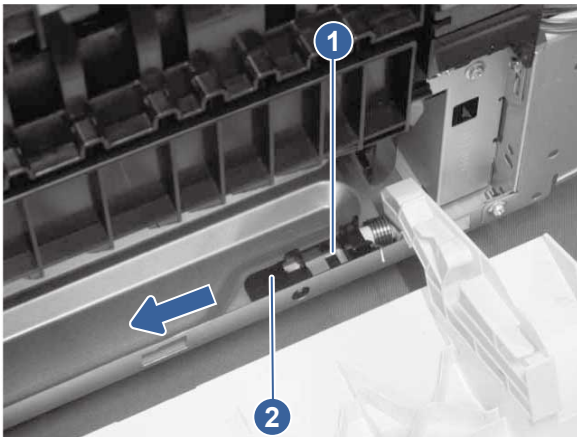
2. Release one tab (callout 1), and then slide the left bushing (callout 2) in the direction indicated to remove it.

**Figure 5-944 Remove the left bushing**



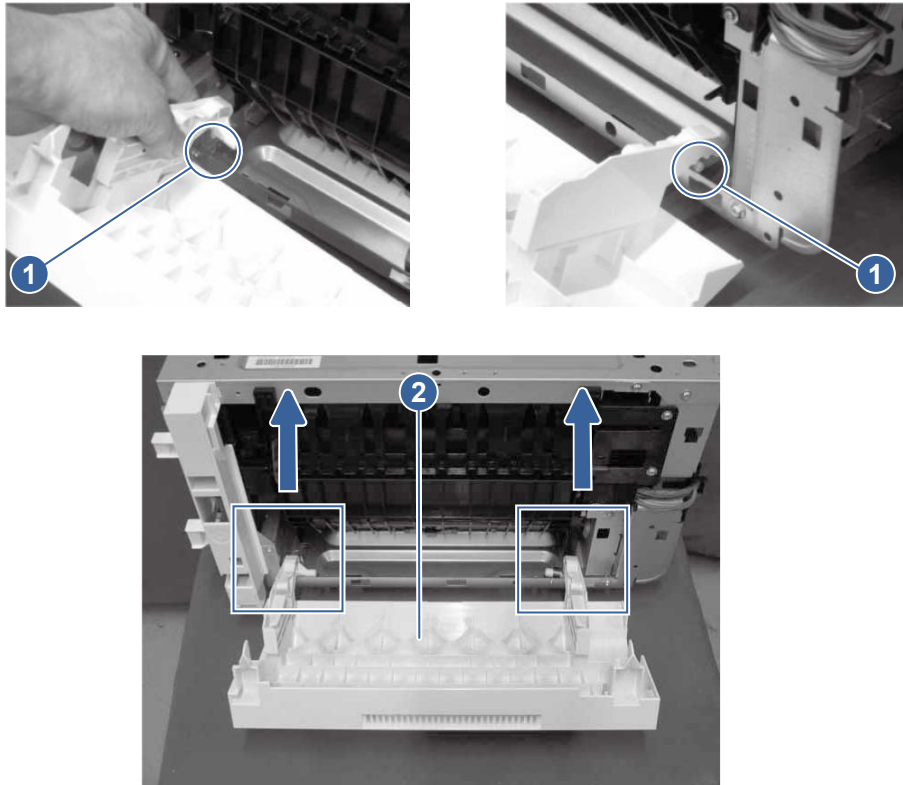
3. Release one tab (callout 1), and then slide the right bushing (callout 2) in the direction indicated to remove it.

**Figure 5-945 Remove the right bushing**



4. Remove right and left shafts (callout 1), and then remove the stapler-stacker door assembly (callout 2).

**Figure 5-946 Remove the stapler-stacker door assembly**

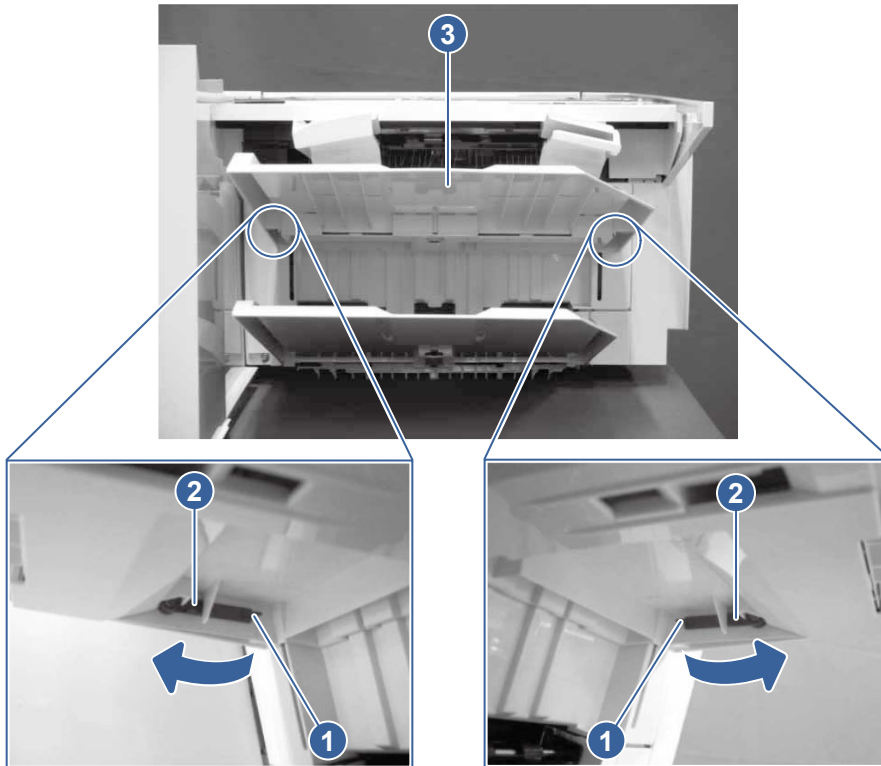


#### **7. Remove the output bin 1 assembly (3-bin stapler-stacker)**

Learn about removing the 3-bin stapler-stacker output bin 1 assembly.

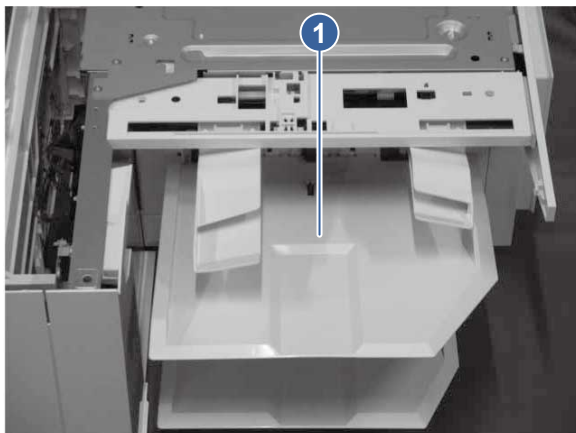
1. Release one boss (callout 1), rotate the pin (callout 2) in the direction indicated, and then remove the pin.

**Figure 5-947 Remove the pin**



2. Remove the output bin 1 assembly (callout 1).

**Figure 5-948 Remove the output bin**

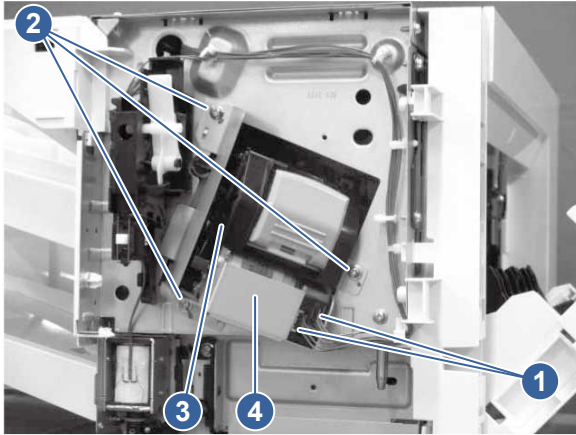


## 8. Remove the stapler assembly (3-bin stapler-stacker)

Learn about removing the 3-bin stapler-stacker stapler assembly.

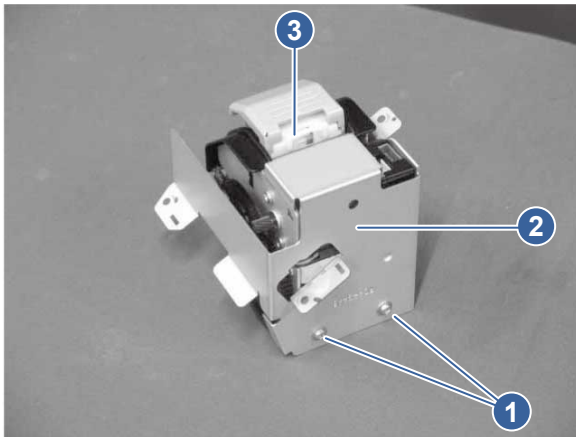
1. Disconnect two connectors (callout 1), remove three screws (callout 2), and then remove the stapler assembly (callout 3) and the plate (callout 4) together.

**Figure 5-949 Remove the stapler assembly and the plate**



2. Remove two screws (callout 1), and then remove the plate (callout 2) from the stapler assembly (callout 3).

**Figure 5-950 Remove the plate from the stapler assembly**

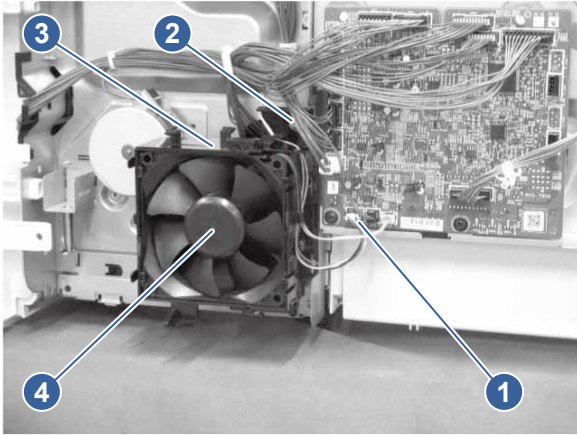


## 9. Remove the MBM fan (3-bin stapler-stacker)

Learn about removing the 3-bin stapler-stacker mailbox/booklet-maker fan.

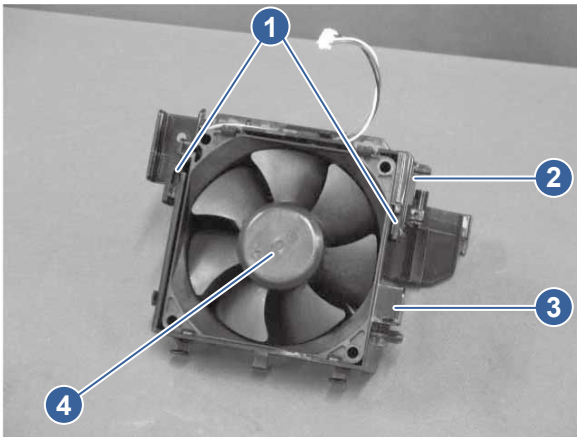
1. Disconnect one connector (callout 1), remove one screw (callout 2), and then remove the fan holder (callout 3) together with the fan (callout 4).

**Figure 5-951 Remove the fan holder and fan**



2. Release two tabs (callout 1), remove the duct 1 (callout 2) and the duct 2 (callout 3), and then remove the MBM fan (callout 4) from the holder.

**Figure 5-952 Remove the fan from the holder**

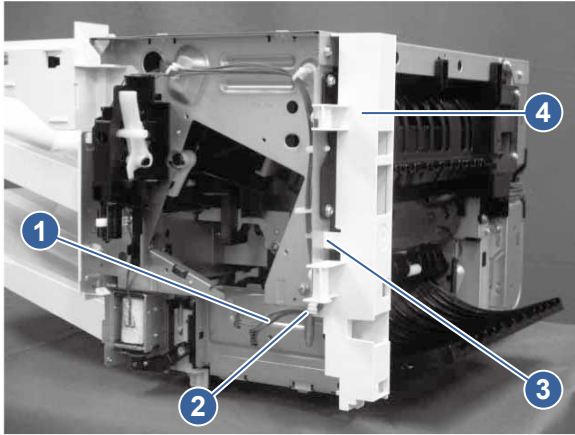


## 10. Remove the upper feed assembly (3-bin stapler-stacker)

Learn about removing the 3-bin stapler-stacker upper feed assembly.

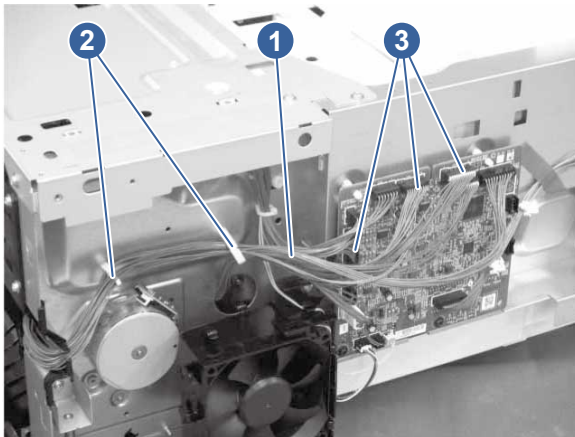
1. Release the cable (callout 1) from cable guide (callout 2), release one tab (callout 3), and then remove the inner cover (callout 4).

**Figure 5-953 Remove the inner cover**



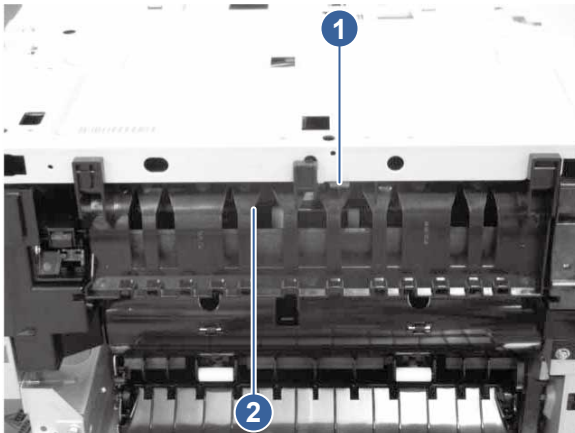
2. Release the cable (callout 1) from cable clamps (callout 2), and then disconnect three connectors (callout 3).

**Figure 5-954 Release the cable**



3. Release one tab (callout 1), and then remove the guide (callout 2).

**Figure 5-955 Remove the guide**

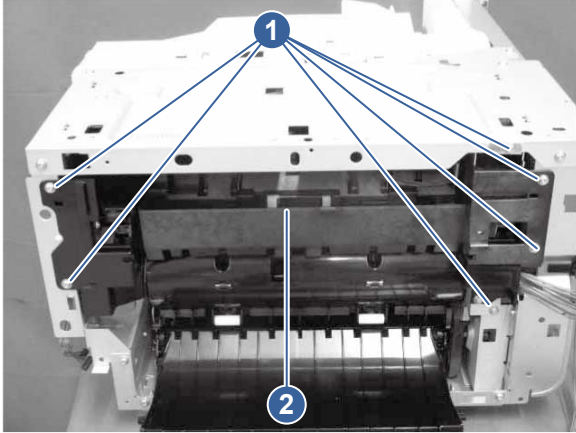




4. Remove six screws (callout 1), and then remove the upper feed assembly (callout 2).

**⚠ CAUTION:** Be sure that the paper guides extend into the tray area when reinstalling the upper feed assembly. The guides can be damaged if they are trapped behind the in-cave frame when the assembly is seated in the frame.

**Figure 5-956 Remove the upper feed assembly**

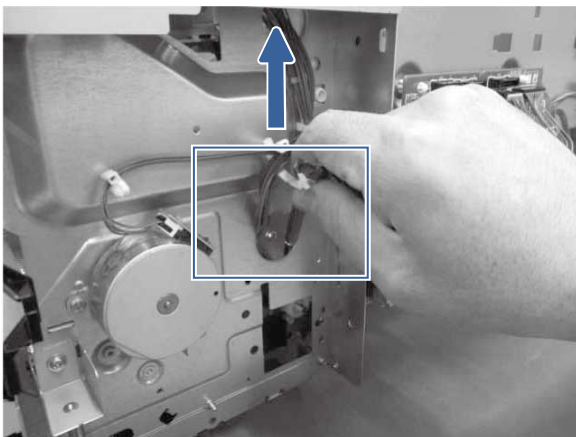
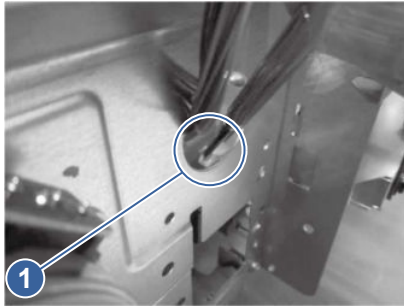


### 11. Remove the stacking wall assembly (3-bin stapler-stacker)

Learn about removing the 3-bin stapler-stacker stacking wall assembly.

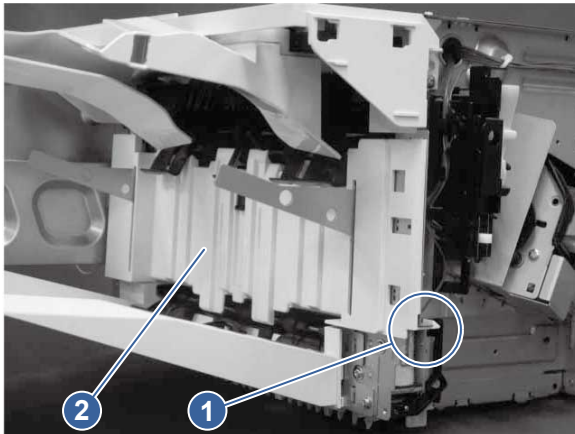
1. Release one tab (callout 1).

**Figure 5-957 Release one tab**



2. Release one tab (callout 1), and then remove the stacking wall assembly (callout 2).

**Figure 5-958 Remove the stacking wall assembly**



## 12. Unpack the replacement assembly

Follow these steps to unpack the replacement assembly.

1. Dispose of the defective part.

---



 **NOTE:** HP recommends responsible disposal of the defective part.


<http://www8.hp.com/us/en/hp-information/environment/product-recycling.html>


---

2. Unpack the replacement part from the packaging.

---

 **CAUTION:**  Some parts are sensitive to electrostatic discharge (ESD). Always perform service work at an ESD-protected workstation or mat. If an ESD workstation or mat is not available, touch the sheet-metal chassis to provide a static ground before touching an ESD-sensitive assembly. Protect the ESD-sensitive assemblies by placing them in ESD pouches when they are out of the printer.


 **IMPORTANT:** Make sure that all of the shipping materials (for example shipping tape) are removed from the replacement part prior to installation.

 **NOTE:** If the replacement part is a roller or pad, avoid touching the spongy part of it. Skin oils on the roller or pad can cause paper pickup and/or print-quality problems. HP recommends using disposable gloves when handling rollers or pads or washing your hands before touching rollers or pads.

---

3. To install an assembly, reverse the removal steps.

---

 **NOTE:** When applicable, special installation instructions are provided for an assembly at the end of the removal procedure. Always completely read the removal instructions and follow all special installation instructions.

---

## Internal parts and assemblies

Learn how to remove and replace the printer internal parts and assemblies.

### Removal and replacement: Stapler assembly (3-bin stapler-stacker)

Learn about removing and replacing the stapler assembly.

### Before performing service

## Turn the printer power off

- Disconnect the power cable.

**⚠ WARNING!** To avoid damage to the printer, turn the printer off, wait 30 seconds, and then remove the power cord before attempting to service the printer.

Use the table below to identify the correct part number for your printer, and then go to <https://parts.hp.com/hpparts> to order the part.

**Table 5-134** Part information

Part number	Part description
RK2-8148-000CN	Stapler assembly (3-bin SS)

## Required tools

- #2 Phillips screwdriver with a magnetic tip and a 152 mm (6 in) shaft length
- Small flat-blade screwdriver

## After performing service

### Turn the printer power on

- Connect the power cable.
- Use the power switch to turn the power on.

## Post service test

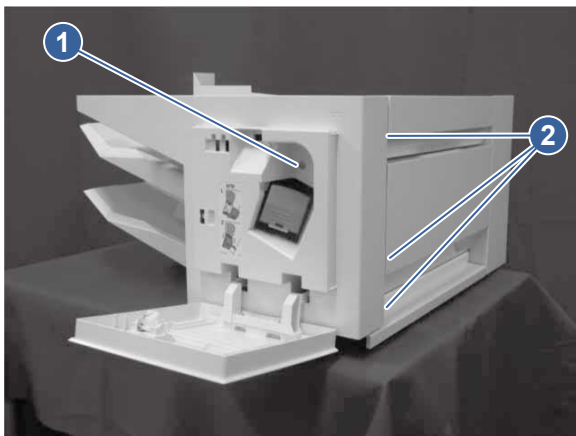
Print any pages necessary to make sure the printer is functioning correctly.

### 1. Remove the staple cover and staple door (3-bin stapler-stacker)

Learn about removing the 3-bin stapler-stacker staple cover and staple door.

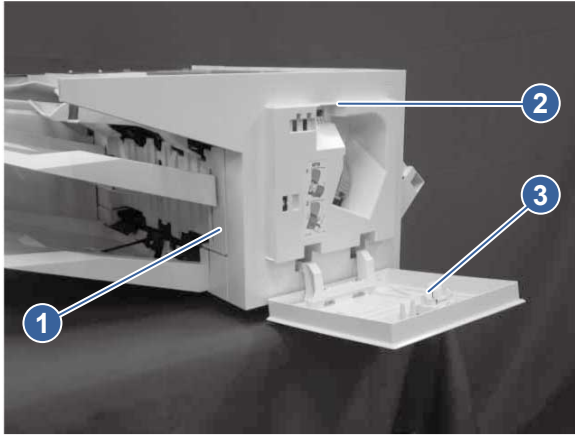
1. Open the stapler-stacker door assembly and the stapler door.
2. Remove one screw (callout 1), and then release three tabs (callout 2).

**Figure 5-959** Remove one screw



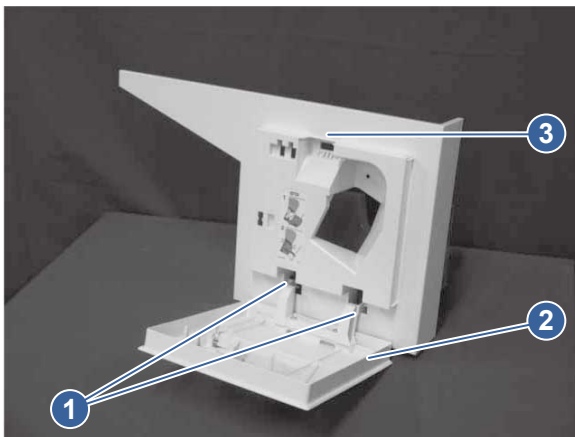
3. Release one tab (callout 1), and then remove the staple cover (callout 2) and the staple door (callout 3) together.

**Figure 5-960 Release one tab**



4. Remove two shafts (callout 1), and then remove the staple door (callout 2) from the staple cover (callout 3).

**Figure 5-961 Remove the staple door from the staple cover**

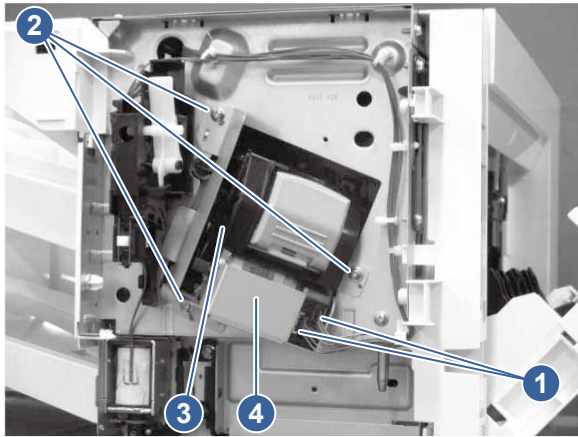


## 2. Remove the stapler assembly (3-bin stapler-stacker)

Learn about removing the 3-bin stapler-stacker stapler assembly.

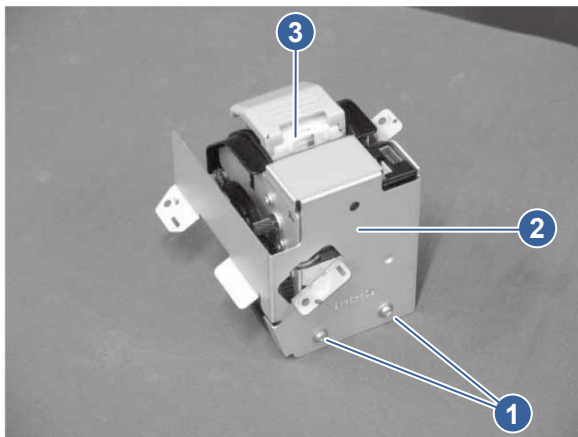
1. Disconnect two connectors (callout 1), remove three screws (callout 2), and then remove the stapler assembly (callout 3) and the plate (callout 4) together.

**Figure 5-962 Remove the stapler assembly and the plate**



2. Remove two screws (callout 1), and then remove the plate (callout 2) from the stapler assembly (callout 3).

**Figure 5-963 Remove the plate from the stapler assembly**



### 3. Unpack the replacement assembly

Follow these steps to unpack the replacement assembly.

1. Dispose of the defective part.





**NOTE:** HP recommends responsible disposal of the defective part.


<http://www8.hp.com/us/en/hp-information/environment/product-recycling.html>

2. Unpack the replacement part from the packaging.



**CAUTION:**  Some parts are sensitive to electrostatic discharge (ESD). Always perform service work at an ESD-protected workstation or mat. If an ESD workstation or mat is not available, touch the sheet-metal chassis to provide a static ground before touching an ESD-sensitive assembly. Protect the ESD-sensitive assemblies by placing them in ESD pouches when they are out of the printer.


 **IMPORTANT:** Make sure that all of the shipping materials (for example shipping tape) are removed from the replacement part prior to installation.

 **NOTE:** If the replacement part is a roller or pad, avoid touching the spongy part of it. Skin oils on the roller or pad can cause paper pickup and/or print-quality problems. HP recommends using disposable gloves when handling rollers or pads or washing your hands before touching rollers or pads.

---

3. To install an assembly, reverse the removal steps.

---

 **NOTE:** When applicable, special installation instructions are provided for an assembly at the end of the removal procedure. Always completely read the removal instructions and follow all special installation instructions.

---


## Removal and replacement: Jogger assembly (3-bin stapler-stacker)

Learn about removing and replacing the jogger assembly.

### Before performing service

#### Turn the printer power off

- Disconnect the power cable.

 **WARNING!** To avoid damage to the printer, turn the printer off, wait 30 seconds, and then remove the power cord before attempting to service the printer.

---

Use the table below to identify the correct part number for your printer, and then go to <https://parts.hp.com/hpparts> to order the part.

**Table 5-135** Part information

Part number	Part description
RM3-0481-000CN	Jog assembly (3-bin SS)

### Required tools

- #2 Phillips screwdriver with a magnetic tip and a 152 mm (6 in) shaft length
- Small flat-blade screwdriver

### After performing service

#### Turn the printer power on

- Connect the power cable.
- Use the power switch to turn the power on.

### Post service test

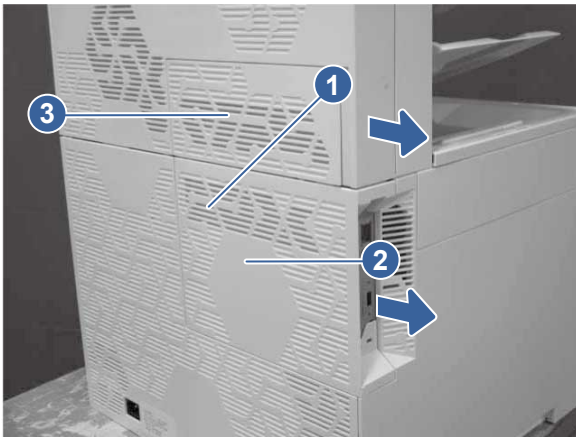
Print any pages necessary to make sure the printer is functioning correctly.

## 1. Remove the rear cover (3-bin stapler-stacker)

Learn about removing the 3-bin stapler-stacker rear cover.

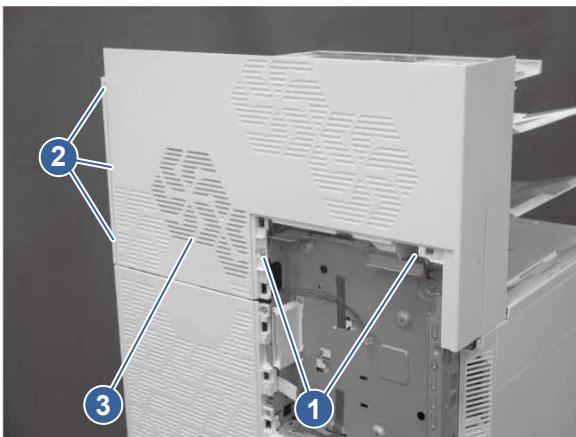
1. Remove the printer formatter cover by removing one screw (callout 1) and then sliding the cover (callout 2) in the direction indicated. Slide the 3-bin stapler-stacker formatter cover assembly (callout 3) in the direction indicated to remove it.

**Figure 5-964 Remove the 3-bin stapler-stacker formatter cover**



2. Remove two screws (callout 1), release three tabs (callout 2), and then remove the rear cover (callout 3).

**Figure 5-965 Remove the rear cover**



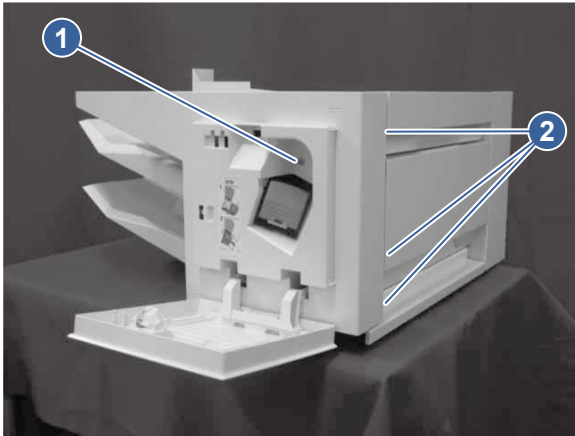
## 2. Remove the staple cover and staple door (3-bin stapler-stacker)

Learn about removing the 3-bin stapler-stacker staple cover and staple door.

1. Open the stapler-stacker door assembly and the stapler door.

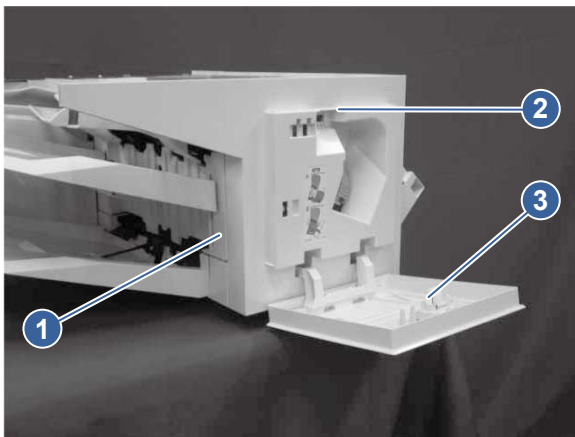
2. Remove one screw (callout 1), and then release three tabs (callout 2).

**Figure 5-966 Remove one screw**



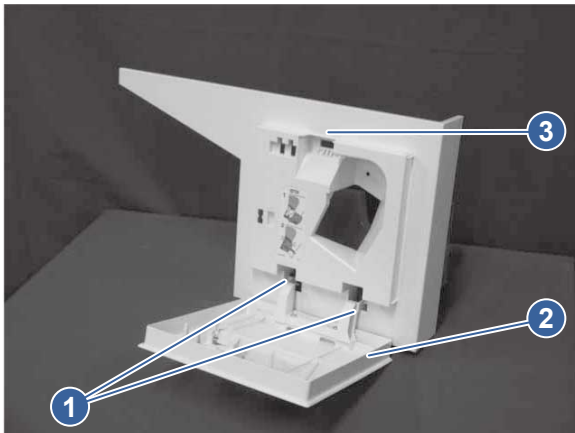
3. Release one tab (callout 1), and then remove the staple cover (callout 2) and the staple door (callout 3) together.

**Figure 5-967 Release one tab**



4. Remove two shafts (callout 1), and then remove the staple door (callout 2) from the staple cover (callout 3).

**Figure 5-968 Remove the staple door from the staple cover**



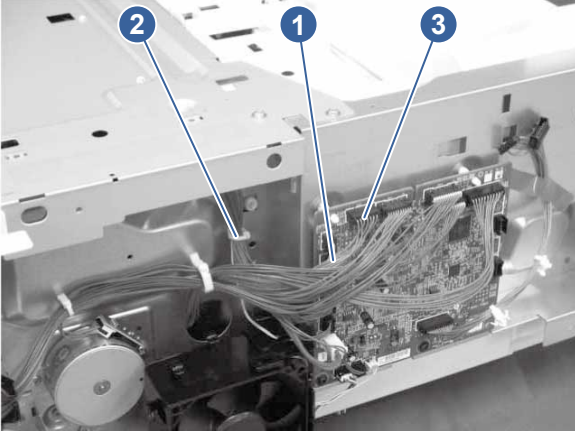


### 3. Remove the jogger assembly (3-bin stapler-stacker)

Learn about removing the 3-bin stapler-stacker jogger assembly.

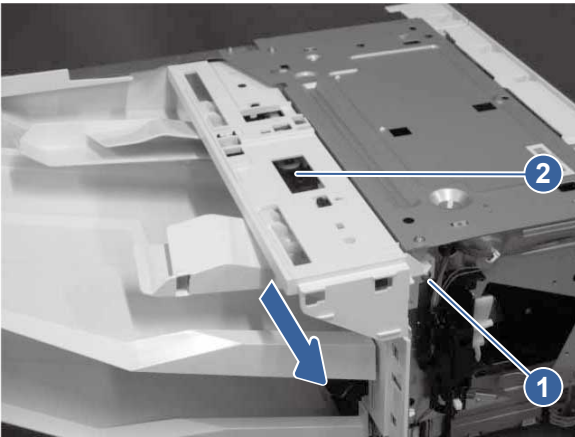
1. Release the cable (callout 1) from the cable clamp (callout 2), and then disconnect one connector (callout 3).

**Figure 5-969** Release the cable



2. Remove one screw (callout 1), and then slide the jogger assembly (callout 2) in the direction indicated to remove it.

**Figure 5-970** Remove the jogger assembly



### 4. Unpack the replacement assembly

Follow these steps to unpack the replacement assembly.



1. Dispose of the defective part.





**NOTE:** HP recommends responsible disposal of the defective part.

<http://www8.hp.com/us/en/hp-information/environment/product-recycling.html>


## 2. Unpack the replacement part from the packaging.

 **CAUTION:**  Some parts are sensitive to electrostatic discharge (ESD). Always perform service work at an ESD-protected workstation or mat. If an ESD workstation or mat is not available, touch the sheet-metal chassis to provide a static ground before touching an ESD-sensitive assembly. Protect the ESD-sensitive assemblies by placing them in ESD pouches when they are out of the printer.

 **IMPORTANT:** Make sure that all of the shipping materials (for example shipping tape) are removed from the replacement part prior to installation.

 **NOTE:** If the replacement part is a roller or pad, avoid touching the spongy part of it. Skin oils on the roller or pad can cause paper pickup and/or print-quality problems. HP recommends using disposable gloves when handling rollers or pads or washing your hands before touching rollers or pads.

## 3. To install an assembly, reverse the removal steps.

 **NOTE:** When applicable, special installation instructions are provided for an assembly at the end of the removal procedure. Always completely read the removal instructions and follow all special installation instructions.


### Removal and replacement: Output bin 1 (3-bin stapler-stacker)

Learn about removing and replacing output bin 1.

#### Before performing service

##### Turn the printer power off

- Disconnect the power cable.

 **WARNING!** To avoid damage to the printer, turn the printer off, wait 30 seconds, and then remove the power cord before attempting to service the printer.

Use the table below to identify the correct part number for your printer, and then go to <https://parts.hp.com/hpparts> to order the part.

**Table 5-136** Part information

Part number	Part description
RM2-4173-000CN	Tray assembly (3-bin SS)

#### Required tools

- #2 Phillips screwdriver with a magnetic tip and a 152 mm (6 in) shaft length
- Small flat-blade screwdriver

#### After performing service

##### Turn the printer power on

- Connect the power cable.
- Use the power switch to turn the power on.

## Post service test

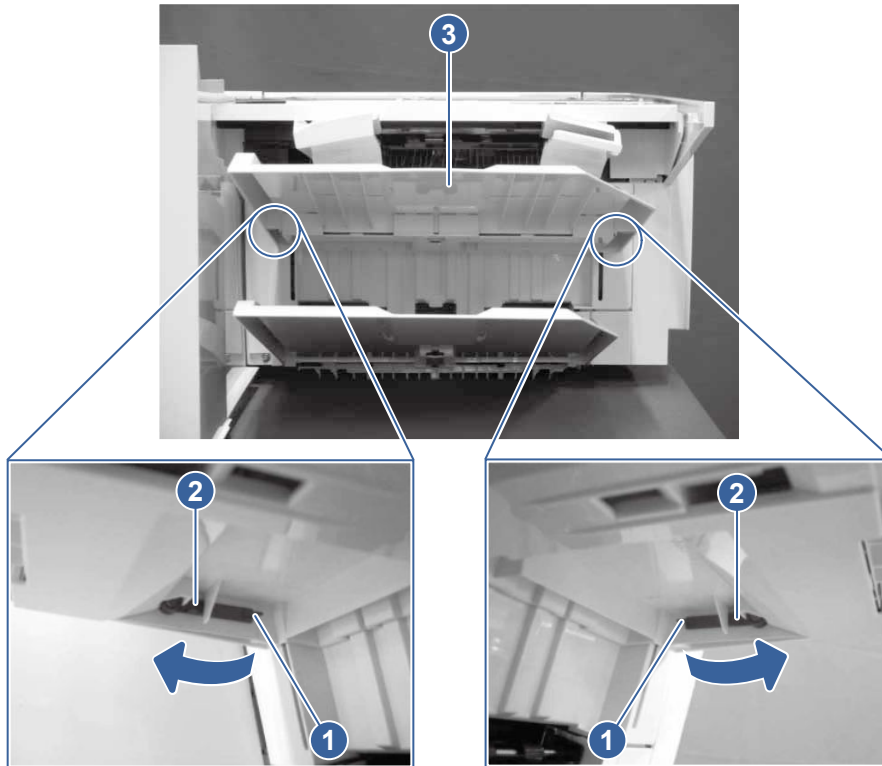
Print any pages necessary to make sure the printer is functioning correctly.

### 1. Remove the output bin 1 assembly (3-bin stapler-stacker)

Learn about removing the 3-bin stapler-stacker output bin 1 assembly.

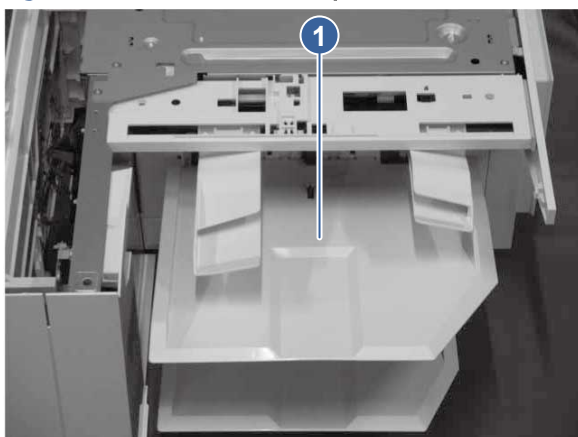
1. Release one boss (callout 1), rotate the pin (callout 2) in the direction indicated, and then remove the pin.

**Figure 5-971 Remove the pin**



2. Remove the output bin 1 assembly (callout 1).


**Figure 5-972 Remove the output bin**



## 2. Unpack the replacement assembly



Follow these steps to unpack the replacement assembly.


1. Dispose of the defective part.


 **NOTE:** HP recommends responsible disposal of the defective part.

<http://www8.hp.com/us/en/hp-information/environment/product-recycling.html>


2. Unpack the replacement part from the packaging.

 **CAUTION:**  Some parts are sensitive to electrostatic discharge (ESD). Always perform service work at an ESD-protected workstation or mat. If an ESD workstation or mat is not available, touch the sheet-metal chassis to provide a static ground before touching an ESD-sensitive assembly. Protect the ESD-sensitive assemblies by placing them in ESD pouches when they are out of the printer.

 **IMPORTANT:** Make sure that all of the shipping materials (for example shipping tape) are removed from the replacement part prior to installation.

 **NOTE:** If the replacement part is a roller or pad, avoid touching the spongy part of it. Skin oils on the roller or pad can cause paper pickup and/or print-quality problems. HP recommends using disposable gloves when handling rollers or pads or washing your hands before touching rollers or pads.

3. To install an assembly, reverse the removal steps.

 **NOTE:** When applicable, special installation instructions are provided for an assembly at the end of the removal procedure. Always completely read the removal instructions and follow all special installation instructions.

### Removal and replacement: Upper feed assembly (3-bin stapler-stacker)


Learn about removing and replacing the upper feed assembly.

 [View a video demonstration of removing and replacing the upper feed assembly.](#)

### Before performing service

#### Turn the printer power off

- Disconnect the power cable.

 **WARNING!** To avoid damage to the printer, turn the printer off, wait 30 seconds, and then remove the power cord before attempting to service the printer.

Use the table below to identify the correct part number for your printer, and then go to <https://parts.hp.com/hpparts> to order the part.

**Table 5-137** Part information

Part number	Part description
RM2-4169-000CN	Upper paper feed assembly (3-bin SS)

### Required tools

- #2 Phillips screwdriver with a magnetic tip and a 152 mm (6 in) shaft length
- Small flat-blade screwdriver

### After performing service

#### Turn the printer power on

- Connect the power cable.
- Use the power switch to turn the power on.

### Post service test

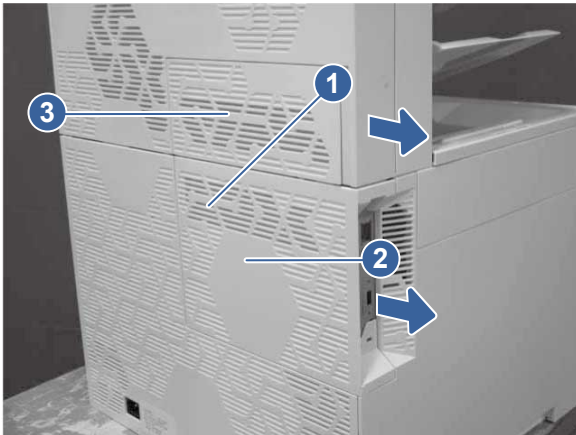
Print any pages necessary to make sure the printer is functioning correctly.

#### 1. Remove the rear cover (3-bin stapler-stacker)

Learn about removing the 3-bin stapler-stacker rear cover.

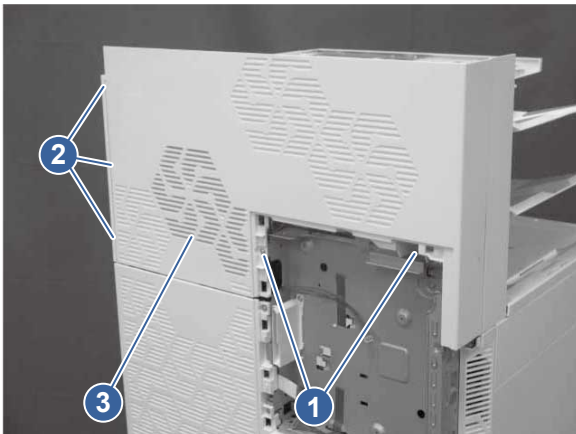
1. Remove the printer formatter cover by removing one screw (callout 1) and then sliding the cover (callout 2) in the direction indicated. Slide the 3-bin stapler-stacker formatter cover assembly (callout 3) in the direction indicated to remove it.

**Figure 5-973 Remove the 3-bin stapler-stacker formatter cover**



2. Remove two screws (callout 1), release three tabs (callout 2), and then remove the rear cover (callout 3).

**Figure 5-974 Remove the rear cover**

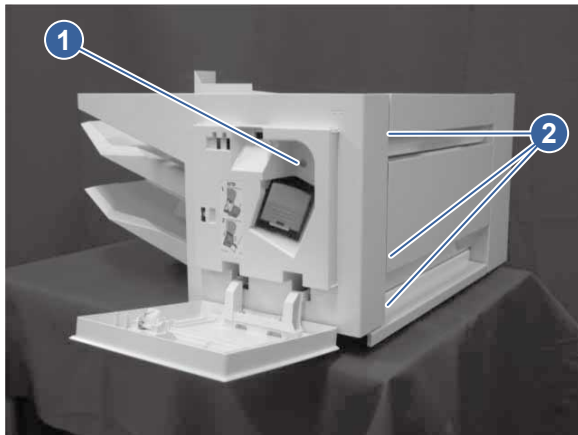


## 2. Remove the staple cover and staple door (3-bin stapler-stacker)

Learn about removing the 3-bin stapler-stacker staple cover and staple door.

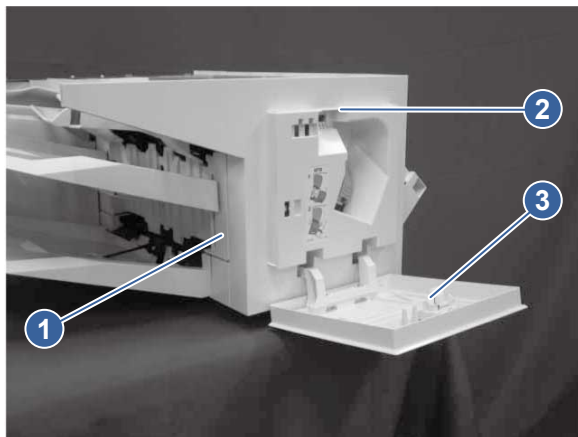
1. Open the stapler-stacker door assembly and the stapler door.
2. Remove one screw (callout 1), and then release three tabs (callout 2).

**Figure 5-975 Remove one screw**



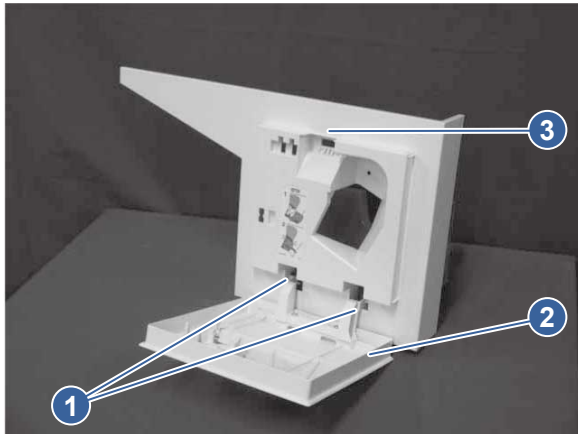
3. Release one tab (callout 1), and then remove the staple cover (callout 2) and the staple door (callout 3) together.

**Figure 5-976 Release one tab**



4. Remove two shafts (callout 1), and then remove the staple door (callout 2) from the staple cover (callout 3).

**Figure 5-977 Remove the staple door from the staple cover**

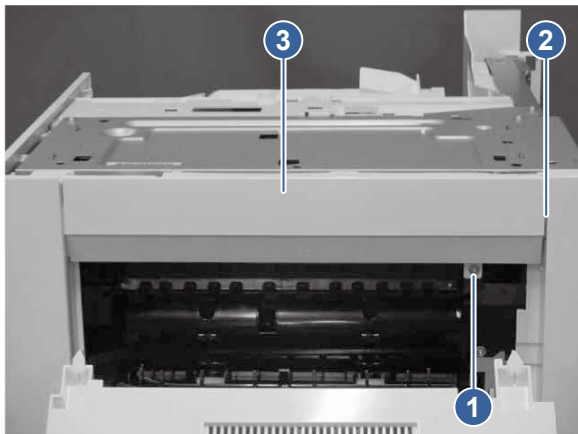


### 3. Remove the right upper cover (3-bin stapler-stacker)

Learn about removing the 3-bin stapler-stacker right upper cover.

1. Open the stapler-stacker door assembly.
2. Remove one screw (callout 1), release one tab (callout 2), and then remove the right upper cover (callout 3).

**Figure 5-978 Remove the 3-bin stapler-stacker right upper cover**

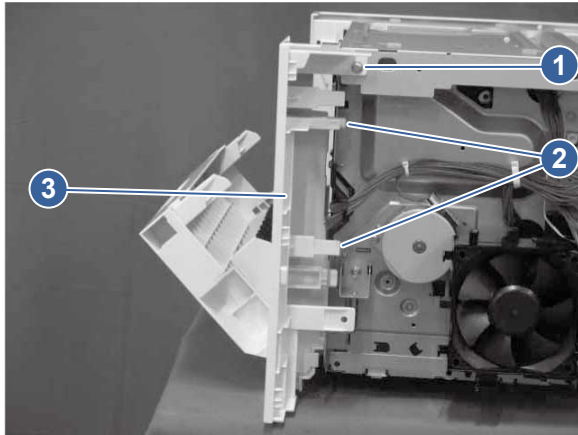


### 4. Remove the right corner cover (3-bin stapler-stacker)

Learn about removing the 3-bin stapler-stacker right corner cover.

- Remove one screw (callout 1), release two tabs (callout 2), and then remove the right corner cover (callout 3).

**Figure 5-979 Remove the right corner cover**

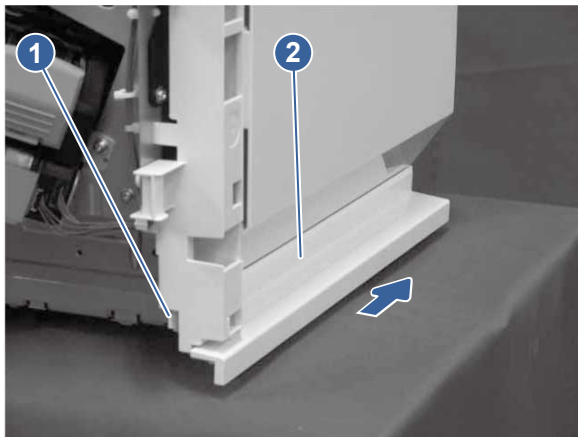


#### 5. Remove the right lower cover (3-bin stapler-stacker)

Learn about removing the 3-bin stapler-stacker right lower cover.

- Release one tab (callout 1), and then slide the right lower cover (callout 2) in the direction indicated to remove it.

**Figure 5-980 Remove the right lower cover**



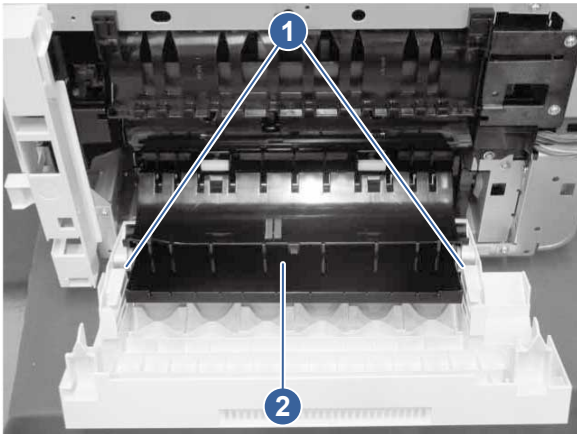
#### 6. Remove the stapler-stacker door assembly (3-bin stapler-stacker)

Learn about removing the 3-bin stapler-stacker door assembly.



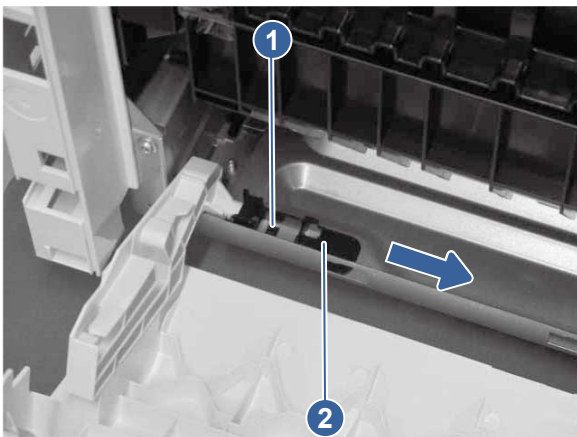
1. Remove two shafts (callout 1), and then open the feed guide (callout 2).

**Figure 5-981 Remove two shafts**



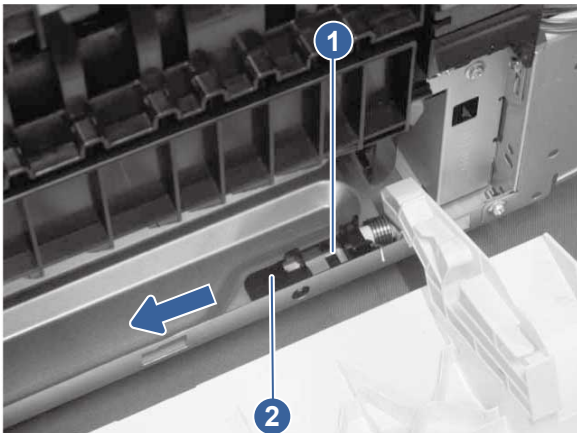
2. Release one tab (callout 1), and then slide the left bushing (callout 2) in the direction indicated to remove it.

**Figure 5-982 Remove the left bushing**



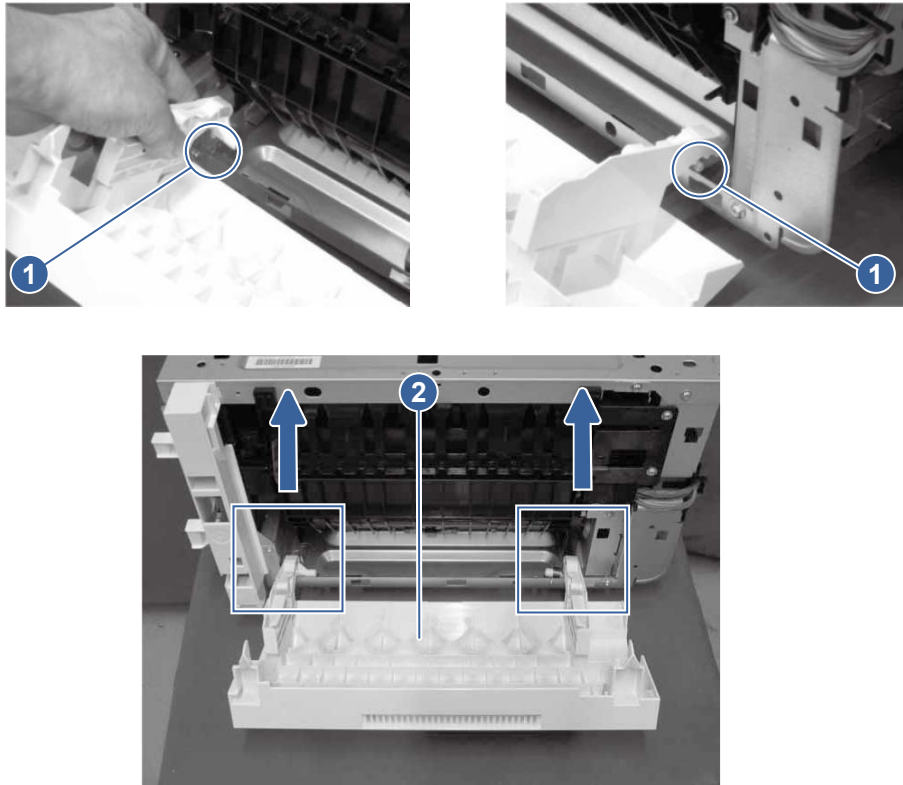
3. Release one tab (callout 1), and then slide the right bushing (callout 2) in the direction indicated to remove it.

**Figure 5-983 Remove the right bushing**



4. Remove right and left shafts (callout 1), and then remove the stapler-stacker door assembly (callout 2).

**Figure 5-984 Remove the stapler-stacker door assembly**

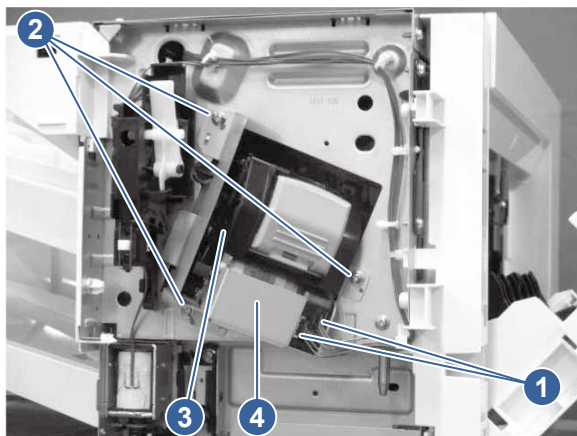


### 7. Remove the stapler assembly (3-bin stapler-stacker)

Learn about removing the 3-bin stapler-stacker stapler assembly.

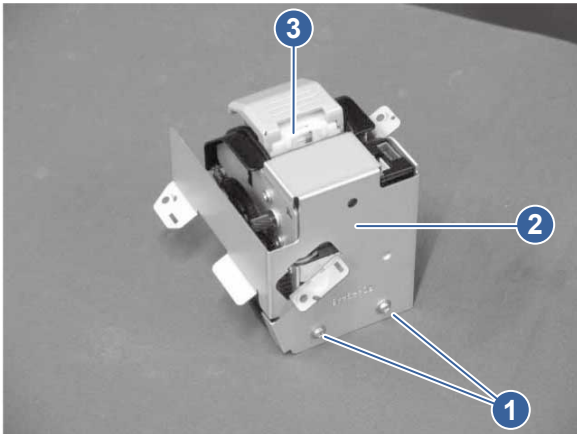
1. Disconnect two connectors (callout 1), remove three screws (callout 2), and then remove the stapler assembly (callout 3) and the plate (callout 4) together.

**Figure 5-985 Remove the stapler assembly and the plate**



2. Remove two screws (callout 1), and then remove the plate (callout 2) from the stapler assembly (callout 3).

**Figure 5-986 Remove the plate from the stapler assembly**

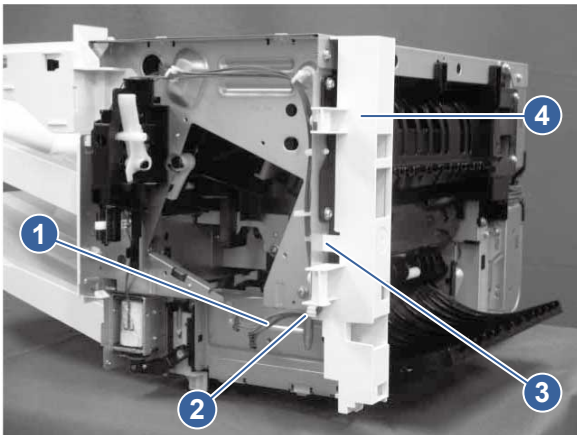


### 8. Remove the upper feed assembly (3-bin stapler-stacker)

Learn about removing the 3-bin stapler-stacker upper feed assembly.

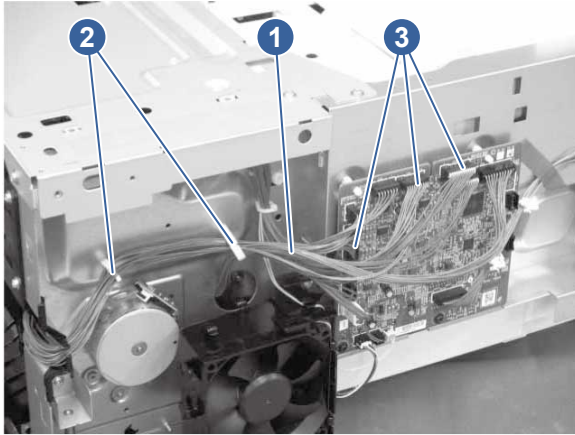
1. Release the cable (callout 1) from cable guide (callout 2), release one tab (callout 3), and then remove the inner cover (callout 4).

**Figure 5-987 Remove the inner cover**



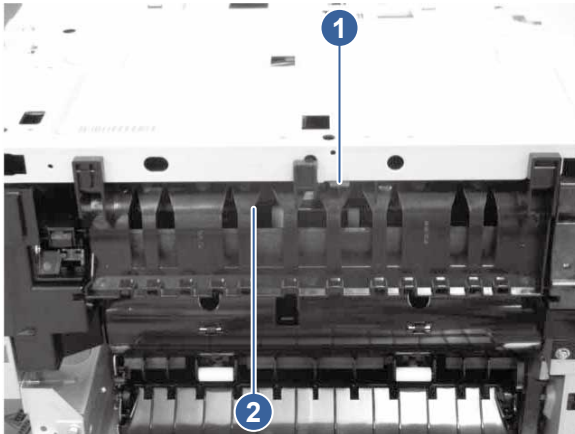
2. Release the cable (callout 1) from cable clamps (callout 2), and then disconnect three connectors (callout 3).

**Figure 5-988 Release the cable**



3. Release one tab (callout 1), and then remove the guide (callout 2).

**Figure 5-989 Remove the guide**



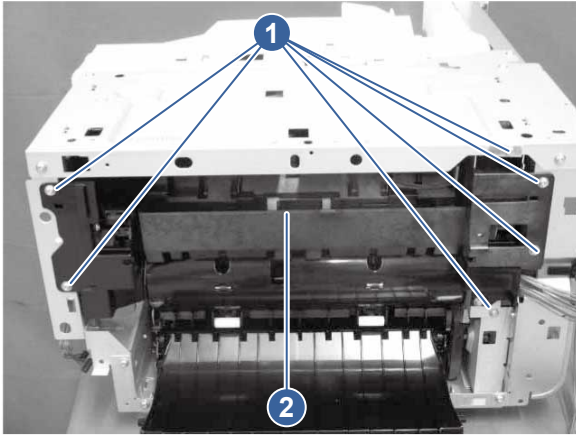
4. Remove six screws (callout 1), and then remove the upper feed assembly (callout 2).

---

**⚠ CAUTION:** Be sure that the paper guides extend into the tray area when reinstalling the upper feed assembly. The guides can be damaged if they are trapped behind the in-cave frame when the assembly is seated in the frame.

---

**Figure 5-990 Remove the upper feed assembly**



## 9. Unpack the replacement assembly

Follow these steps to unpack the replacement assembly.

1. Dispose of the defective part.




**NOTE:** HP recommends responsible disposal of the defective part.

<http://www8.hp.com/us/en/hp-information/environment/product-recycling.html>

2. Unpack the replacement part from the packaging.



**CAUTION:**  Some parts are sensitive to electrostatic discharge (ESD). Always perform service work at an ESD-protected workstation or mat. If an ESD workstation or mat is not available, touch the sheet-metal chassis to provide a static ground before touching an ESD-sensitive assembly. Protect the ESD-sensitive assemblies by placing them in ESD pouches when they are out of the printer.



**IMPORTANT:** Make sure that all of the shipping materials (for example shipping tape) are removed from the replacement part prior to installation.



**NOTE:** If the replacement part is a roller or pad, avoid touching the spongy part of it. Skin oils on the roller or pad can cause paper pickup and/or print-quality problems. HP recommends using disposable gloves when handling rollers or pads or washing your hands before touching rollers or pads.

3. To install an assembly, reverse the removal steps.



**NOTE:** When applicable, special installation instructions are provided for an assembly at the end of the removal procedure. Always completely read the removal instructions and follow all special installation instructions.

## Removal and replacement: Lower feed assembly (3-bin stapler-stacker)

Learn about removing and replacing the lower feed assembly.



[View a video demonstration of removing and replacing the lower feed assembly.](#)

## Before performing service

**Turn the printer power off**

- Disconnect the power cable.

**⚠ WARNING!** To avoid damage to the printer, turn the printer off, wait 30 seconds, and then remove the power cord before attempting to service the printer.

Use the table below to identify the correct part number for your printer, and then go to <https://parts.hp.com/hpparts> to order the part.

**Table 5-138 Part information**

Part number	Part description
RM2-4168-000CN	Lower paper feed assembly (3-bin SS)

## Required tools

- #2 Phillips screwdriver with a magnetic tip and a 152 mm (6 in) shaft length
- Small flat-blade screwdriver

## After performing service

### Turn the printer power on

- Connect the power cable.
- Use the power switch to turn the power on.

## Post service test

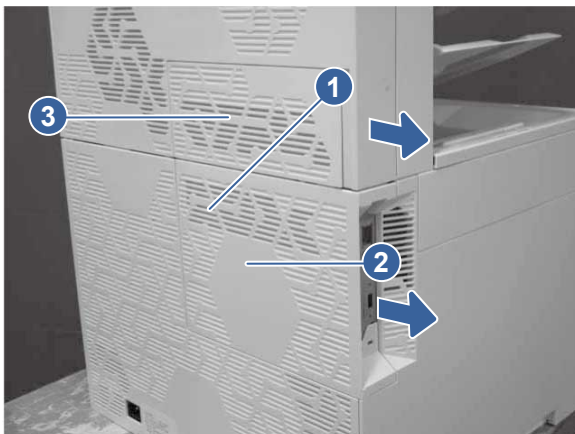
Print any pages necessary to make sure the printer is functioning correctly.

### 1. Remove the rear cover (3-bin stapler-stacker)

Learn about removing the 3-bin stapler-stacker rear cover.

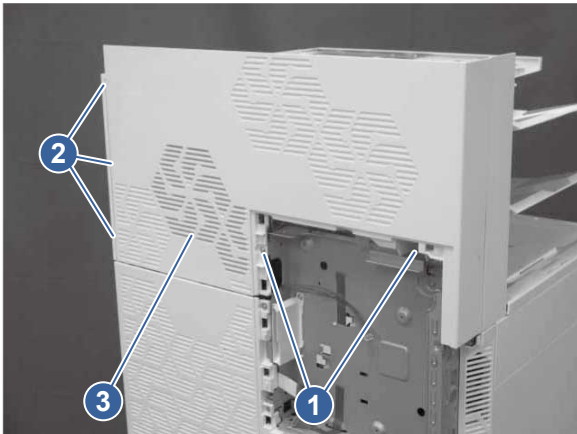
1. Remove the printer formatter cover by removing one screw (callout 1) and then sliding the cover (callout 2) in the direction indicated. Slide the 3-bin stapler-stacker formatter cover assembly (callout 3) in the direction indicated to remove it.

**Figure 5-991 Remove the 3-bin stapler-stacker formatter cover**



2. Remove two screws (callout 1), release three tabs (callout 2), and then remove the rear cover (callout 3).

**Figure 5-992 Remove the rear cover**

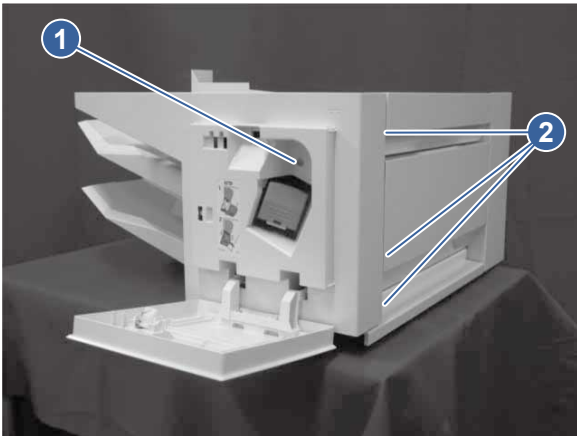


## 2. Remove the staple cover and staple door (3-bin stapler-stacker)

Learn about removing the 3-bin stapler-stacker staple cover and staple door.

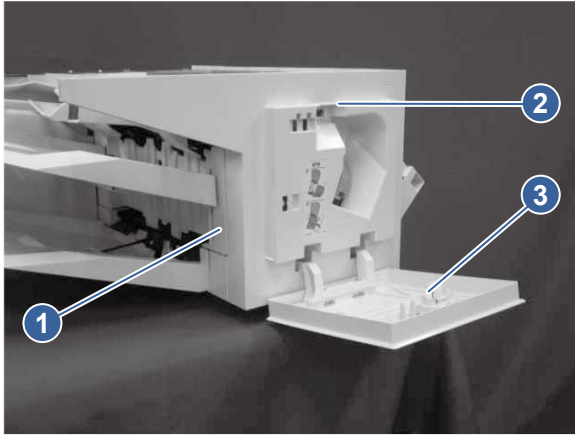
1. Open the stapler-stacker door assembly and the stapler door.
2. Remove one screw (callout 1), and then release three tabs (callout 2).

**Figure 5-993 Remove one screw**



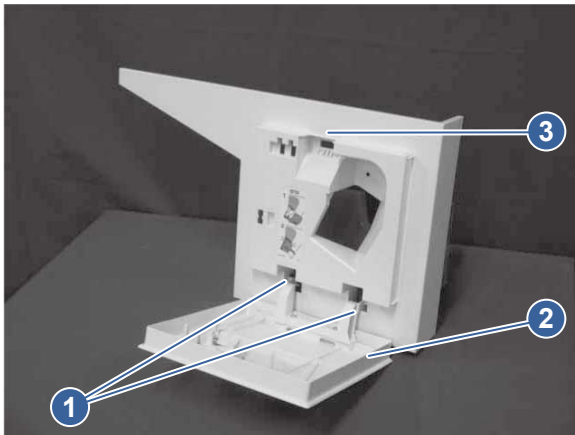
3. Release one tab (callout 1), and then remove the staple cover (callout 2) and the staple door (callout 3) together.

**Figure 5-994 Release one tab**



4. Remove two shafts (callout 1), and then remove the staple door (callout 2) from the staple cover (callout 3).

**Figure 5-995 Remove the staple door from the staple cover**



### 3. Remove the right upper cover (3-bin stapler-stacker)

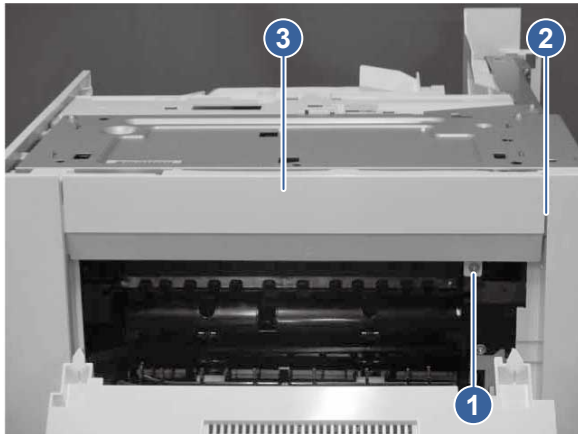
Learn about removing the 3-bin stapler-stacker right upper cover.

1. Open the stapler-stacker door assembly.



2. Remove one screw (callout 1), release one tab (callout 2), and then remove the right upper cover (callout 3).

**Figure 5-996 Remove the 3-bin stapler-stacker right upper cover**

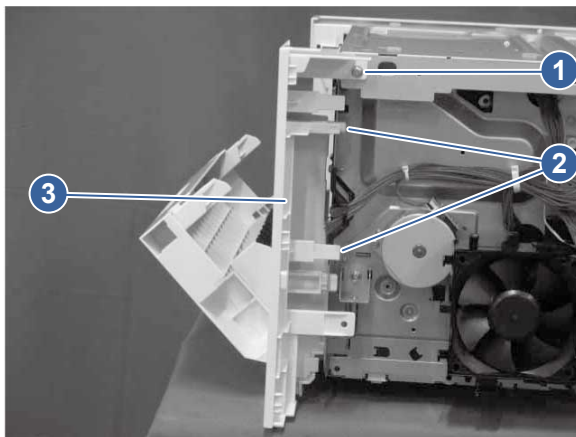


#### 4. Remove the right corner cover (3-bin stapler-stacker)

Learn about removing the 3-bin stapler-stacker right corner cover.

- Remove one screw (callout 1), release two tabs (callout 2), and then remove the right corner cover (callout 3).

**Figure 5-997 Remove the right corner cover**

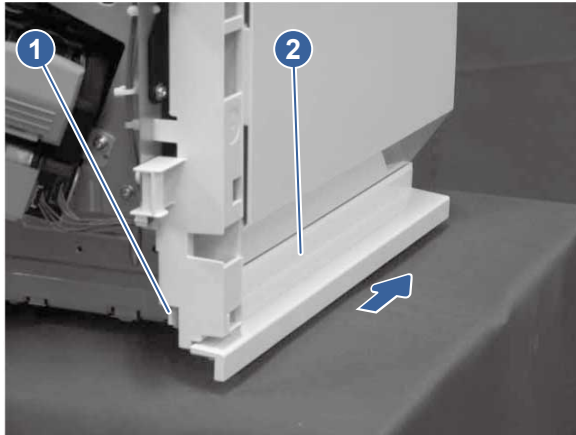


#### 5. Remove the right lower cover (3-bin stapler-stacker)

Learn about removing the 3-bin stapler-stacker right lower cover.

- Release one tab (callout 1), and then slide the right lower cover (callout 2) in the direction indicated to remove it.

**Figure 5-998 Remove the right lower cover**

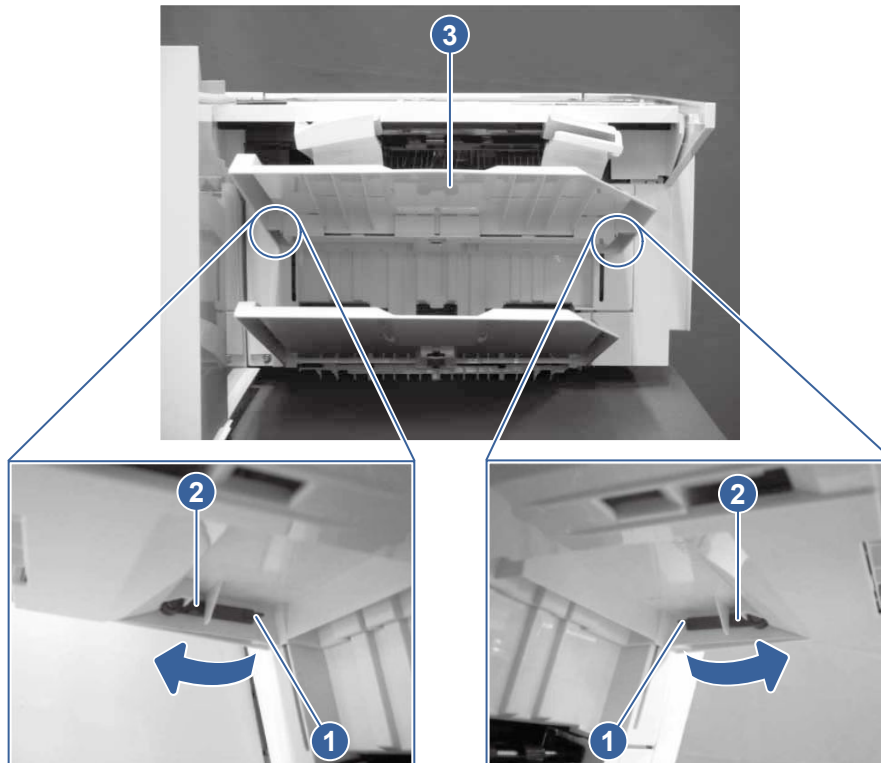


#### 6. Remove the output bin 1 assembly (3-bin stapler-stacker)

Learn about removing the 3-bin stapler-stacker output bin 1 assembly.

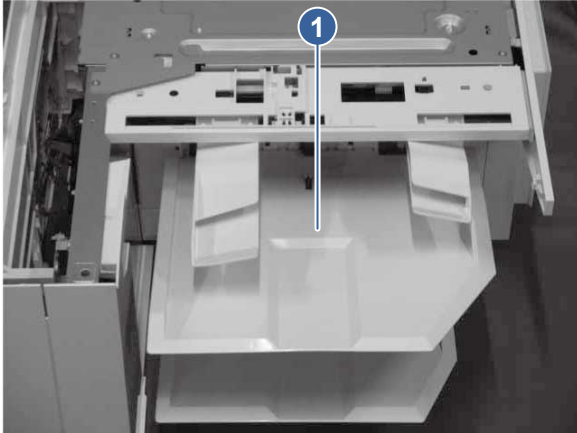
1. Release one boss (callout 1), rotate the pin (callout 2) in the direction indicated, and then remove the pin.

**Figure 5-999 Remove the pin**



2. Remove the output bin 1 assembly (callout 1).

**Figure 5-1000 Remove the output bin**

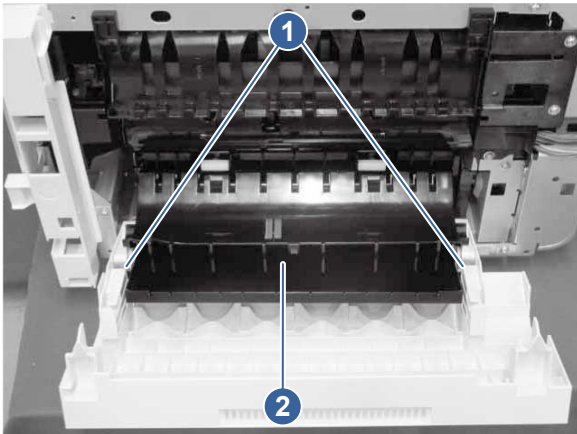


### 7. Remove the stapler-stacker door assembly (3-bin stapler-stacker)

Learn about removing the 3-bin stapler-stacker door assembly.

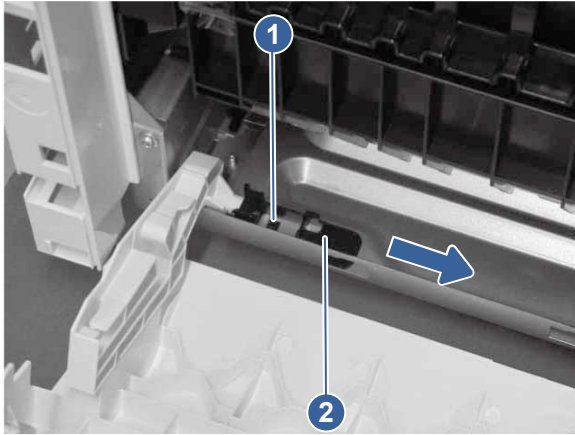
1. Remove two shafts (callout 1), and then open the feed guide (callout 2).

**Figure 5-1001 Remove two shafts**



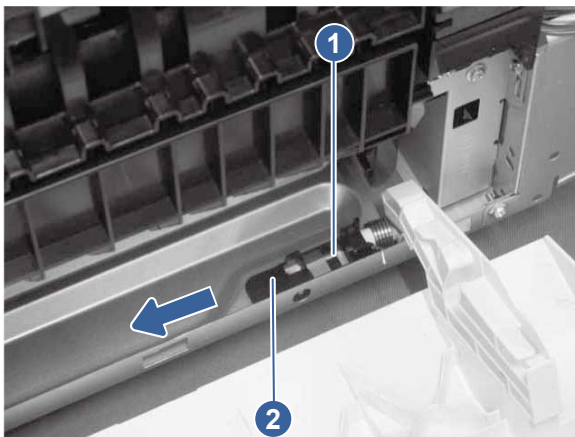
2. Release one tab (callout 1), and then slide the left bushing (callout 2) in the direction indicated to remove it.

**Figure 5-1002 Remove the left bushing**



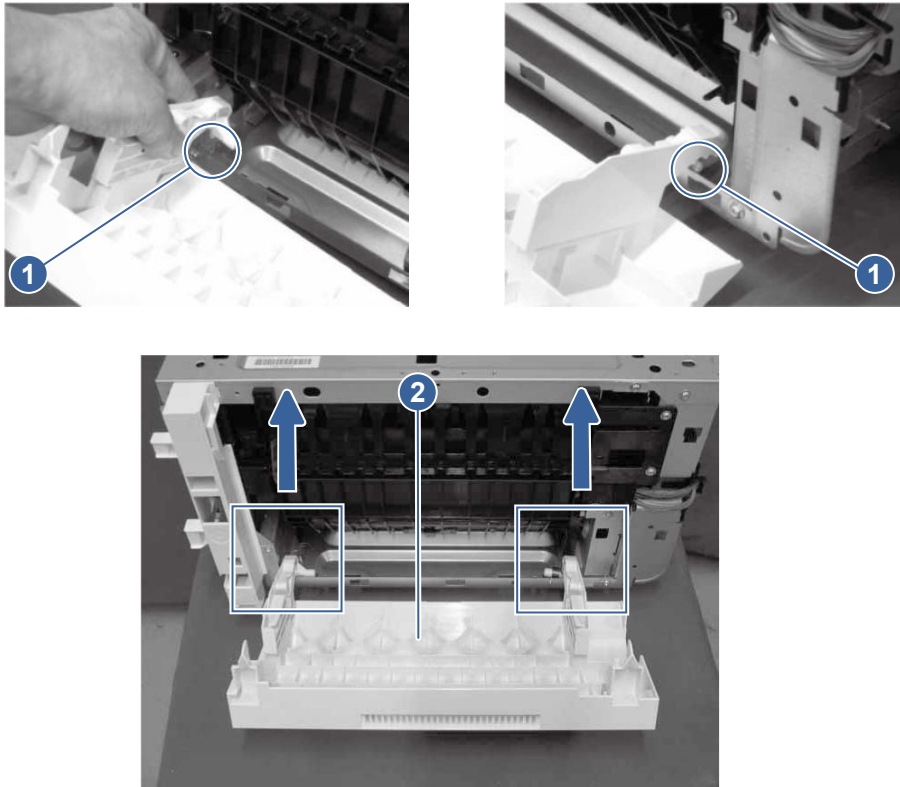
3. Release one tab (callout 1), and then slide the right bushing (callout 2) in the direction indicated to remove it.

**Figure 5-1003 Remove the right bushing**



4. Remove right and left shafts (callout 1), and then remove the stapler-stacker door assembly (callout 2).

**Figure 5-1004 Remove the stapler-stacker door assembly**

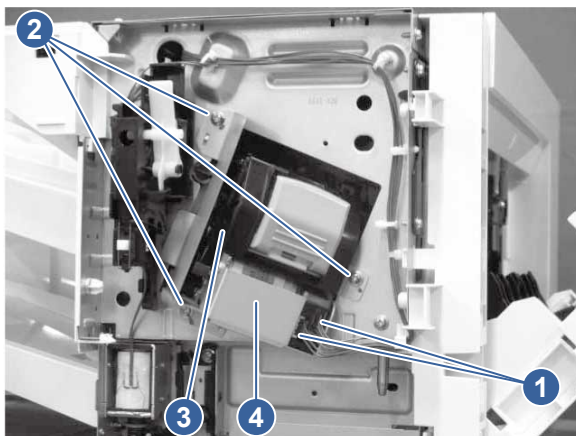


### 8. Remove the stapler assembly (3-bin stapler-stacker)

Learn about removing the 3-bin stapler-stacker stapler assembly.

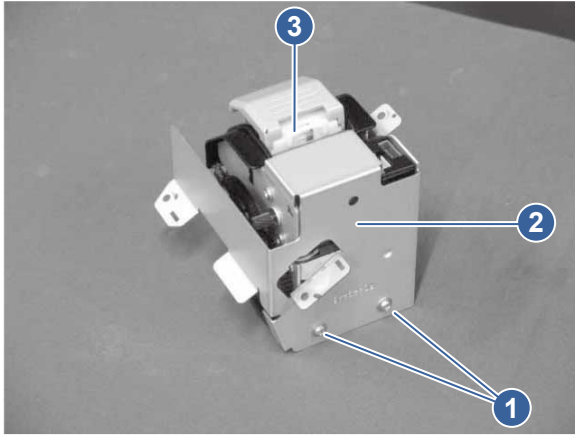
1. Disconnect two connectors (callout 1), remove three screws (callout 2), and then remove the stapler assembly (callout 3) and the plate (callout 4) together.

**Figure 5-1005 Remove the stapler assembly and the plate**



2. Remove two screws (callout 1), and then remove the plate (callout 2) from the stapler assembly (callout 3).

**Figure 5-1006 Remove the plate from the stapler assembly**

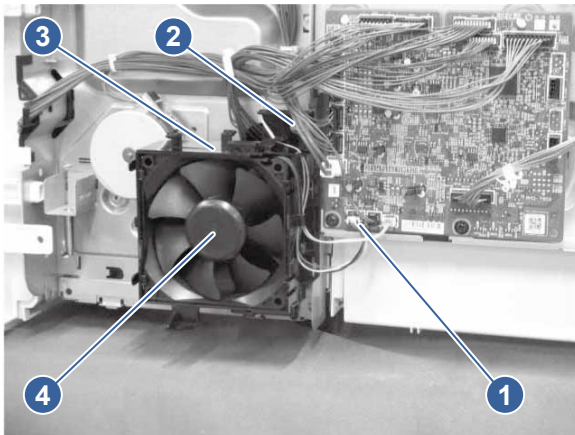


### 9. Remove the MBM fan (3-bin stapler-stacker)

Learn about removing the 3-bin stapler-stacker mailbox/booklet-maker fan.

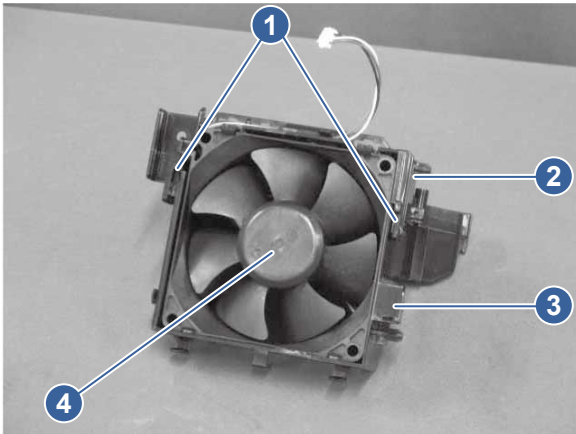
1. Disconnect one connector (callout 1), remove one screw (callout 2), and then remove the fan holder (callout 3) together with the fan (callout 4).

**Figure 5-1007 Remove the fan holder and fan**



2. Release two tabs (callout 1), remove the duct 1 (callout 2) and the duct 2 (callout 3), and then remove the MBM fan (callout 4) from the holder.

**Figure 5-1008 Remove the fan from the holder**

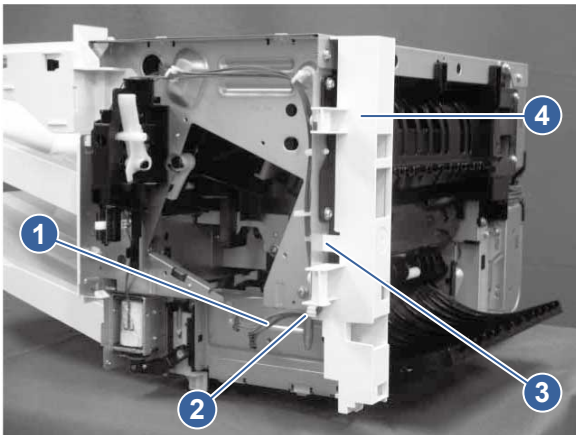


#### 10. Remove the upper feed assembly (3-bin stapler-stacker)

Learn about removing the 3-bin stapler-stacker upper feed assembly.

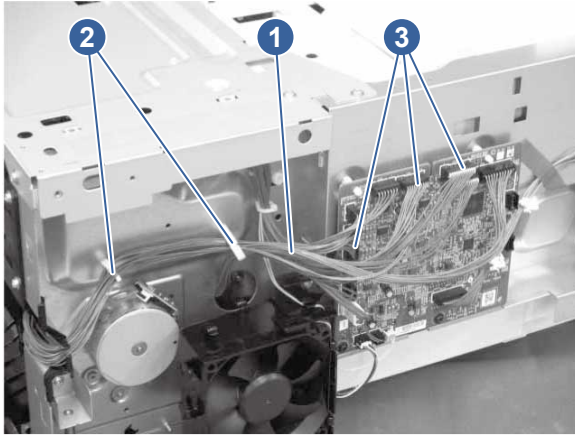
1. Release the cable (callout 1) from cable guide (callout 2), release one tab (callout 3), and then remove the inner cover (callout 4).

**Figure 5-1009 Remove the inner cover**



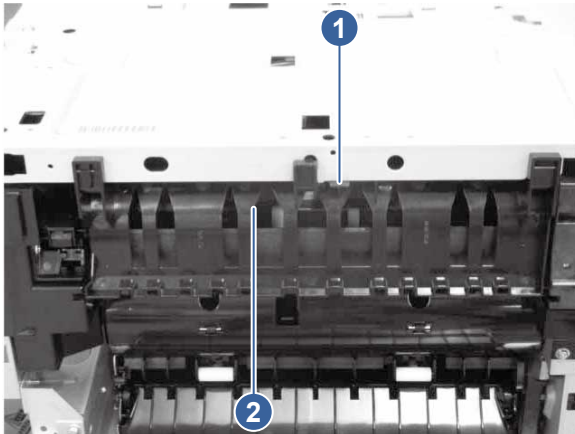
2. Release the cable (callout 1) from cable clamps (callout 2), and then disconnect three connectors (callout 3).

**Figure 5-1010 Release the cable**



3. Release one tab (callout 1), and then remove the guide (callout 2).

**Figure 5-1011 Remove the guide**



4. Remove six screws (callout 1), and then remove the upper feed assembly (callout 2).

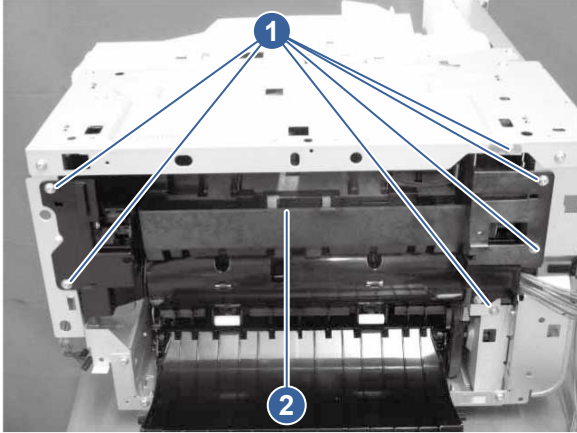
---

**⚠ CAUTION:** Be sure that the paper guides extend into the tray area when reinstalling the upper feed assembly. The guides can be damaged if they are trapped behind the in-cave frame when the assembly is seated in the frame.

---



**Figure 5-1012 Remove the upper feed assembly**

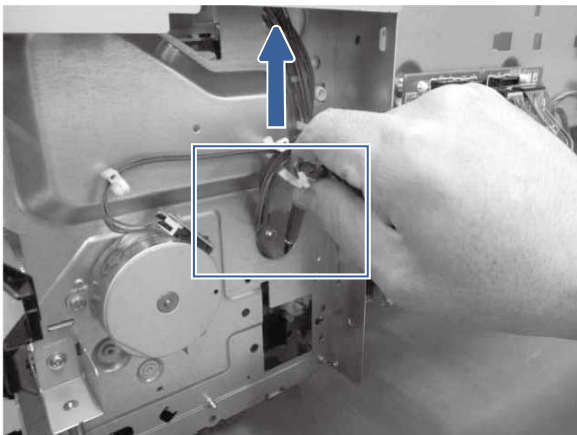
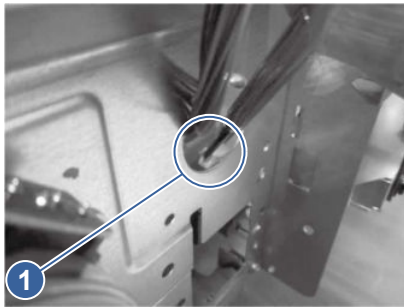


**11. Remove the stacking wall assembly (3-bin stapler-stacker)**

Learn about removing the 3-bin stapler-stacker stacking wall assembly.

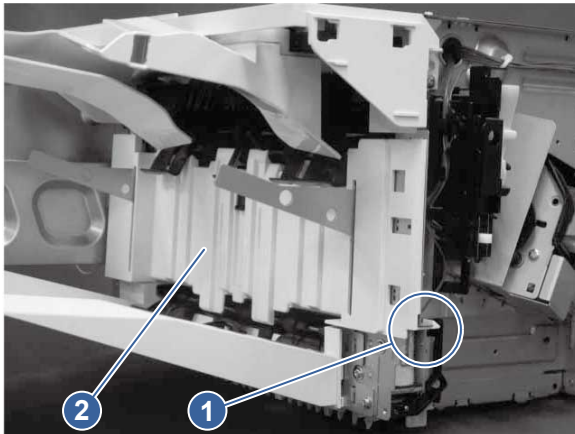
1. Release one tab (callout 1).

**Figure 5-1013 Release one tab**



2. Release one tab (callout 1), and then remove the stacking wall assembly (callout 2).

**Figure 5-1014 Remove the stacking wall assembly**

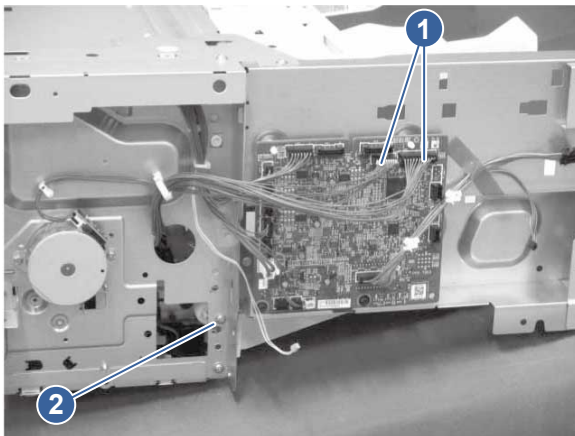


## 12. Remove the lower feed assembly (3-bin stapler-stacker)

Learn about removing the 3-bin stapler-stacker lower feed assembly.

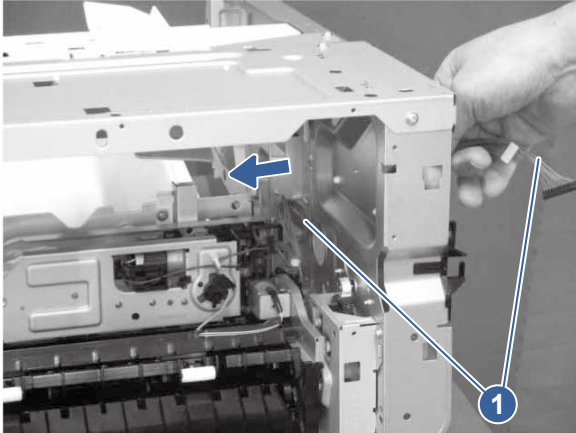
1. Disconnect two connectors (callout 1), and then remove one screw (callout 2).

**Figure 5-1015 Disconnect two connectors**



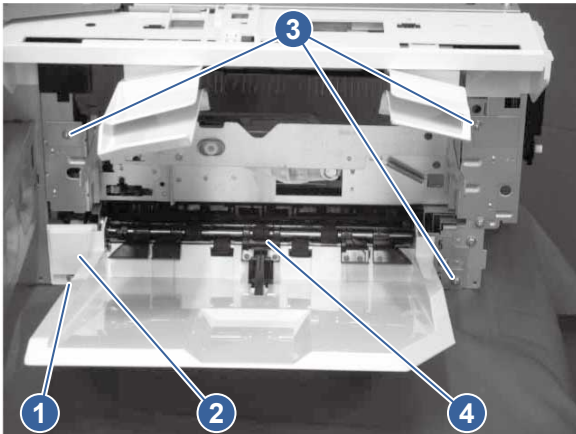
2. Remove the cable (callout 1) by pulling it through the chassis.

**Figure 5-1016 Remove the cable**



3. Remove one screw (callout 1), remove the cover (callout 2), remove three screws (callout 3), and then remove the lower feed assembly (callout 4).

**Figure 5-1017 Remove the lower feed assembly**



### 13. Unpack the replacement assembly

Follow these steps to unpack the replacement assembly.

1. Dispose of the defective part.




**NOTE:** HP recommends responsible disposal of the defective part.

<http://www8.hp.com/us/en/hp-information/environment/product-recycling.html>


2. Unpack the replacement part from the packaging.



**CAUTION:**  Some parts are sensitive to electrostatic discharge (ESD). Always perform service work at an ESD-protected workstation or mat. If an ESD workstation or mat is not available, touch the sheet-metal chassis to provide a static ground before touching an ESD-sensitive assembly. Protect the ESD-sensitive assemblies by placing them in ESD pouches when they are out of the printer.




**IMPORTANT:** Make sure that all of the shipping materials (for example shipping tape) are removed from the replacement part prior to installation.

 **NOTE:** If the replacement part is a roller or pad, avoid touching the spongy part of it. Skin oils on the roller or pad can cause paper pickup and/or print-quality problems. HP recommends using disposable gloves when handling rollers or pads or washing your hands before touching rollers or pads.

---

3. To install an assembly, reverse the removal steps.

 **NOTE:** When applicable, special installation instructions are provided for an assembly at the end of the removal procedure. Always completely read the removal instructions and follow all special installation instructions.

---

## Removal and replacement: Solenoid assembly (3-bin stapler-stacker)

Learn about removing and replacing the solenoid assembly.




[View a video demonstration of removing and replacing the solenoid assembly.](#)

### Before performing service

#### Turn the printer power off

- Disconnect the power cable.

 **WARNING!** To avoid damage to the printer, turn the printer off, wait 30 seconds, and then remove the power cord before attempting to service the printer.

---

Use the table below to identify the correct part number for your printer, and then go to <https://parts.hp.com/hpparts> to order the part.

**Table 5-139** Part information

Part number	Part description
RM2-1040-010CN	Solenoid assembly (3-bin SS)

### Required tools

- #2 Phillips screwdriver with a magnetic tip and a 152 mm (6 in) shaft length
- Small flat-blade screwdriver

### After performing service

#### Turn the printer power on

- Connect the power cable.
- Use the power switch to turn the power on.

### Post service test

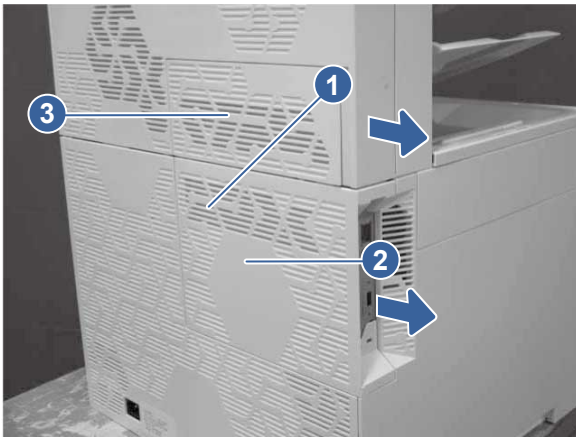
Print any pages necessary to make sure the printer is functioning correctly.

## 1. Remove the rear cover (3-bin stapler-stacker)

Learn about removing the 3-bin stapler-stacker rear cover.

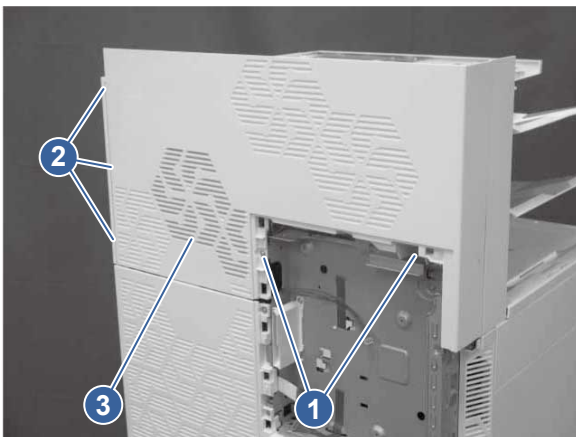
1. Remove the printer formatter cover by removing one screw (callout 1) and then sliding the cover (callout 2) in the direction indicated. Slide the 3-bin stapler-stacker formatter cover assembly (callout 3) in the direction indicated to remove it.

**Figure 5-1018 Remove the 3-bin stapler-stacker formatter cover**



2. Remove two screws (callout 1), release three tabs (callout 2), and then remove the rear cover (callout 3).

**Figure 5-1019 Remove the rear cover**



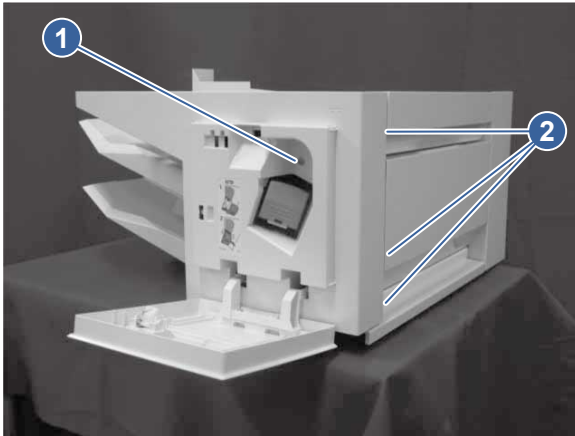
## 2. Remove the staple cover and staple door (3-bin stapler-stacker)

Learn about removing the 3-bin stapler-stacker staple cover and staple door.

1. Open the stapler-stacker door assembly and the stapler door.

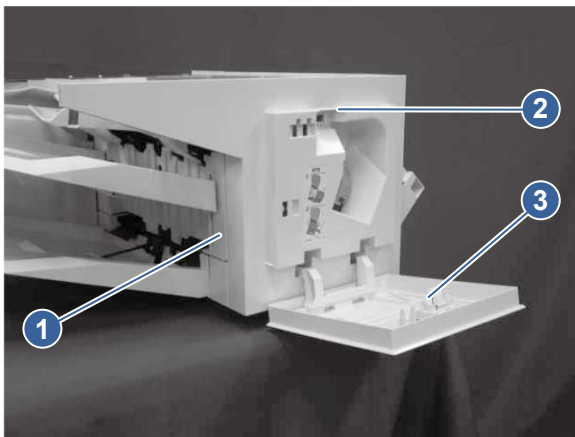
2. Remove one screw (callout 1), and then release three tabs (callout 2).

**Figure 5-1020 Remove one screw**



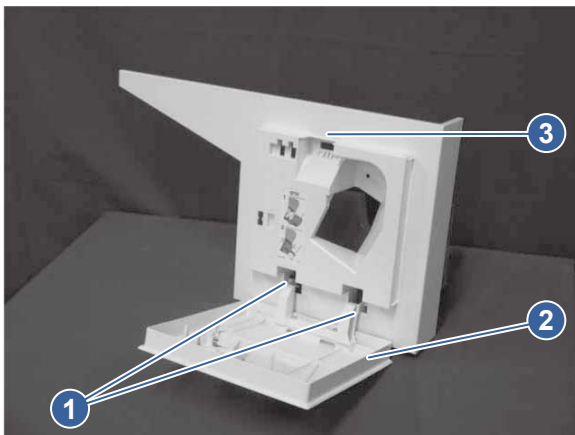
3. Release one tab (callout 1), and then remove the staple cover (callout 2) and the staple door (callout 3) together.

**Figure 5-1021 Release one tab**



4. Remove two shafts (callout 1), and then remove the staple door (callout 2) from the staple cover (callout 3).

**Figure 5-1022 Remove the staple door from the staple cover**

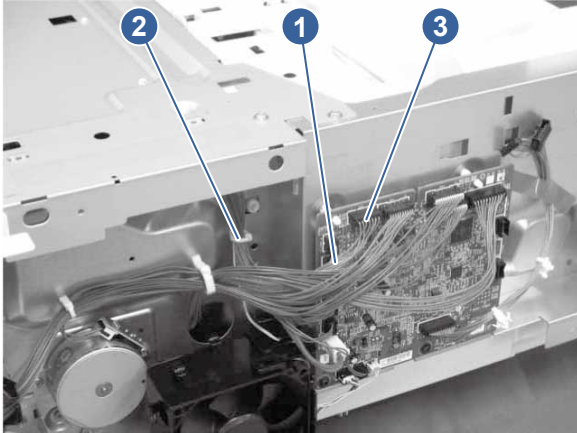


### 3. Remove the jogger assembly (3-bin stapler-stacker)

Learn about removing the 3-bin stapler-stacker jogger assembly.

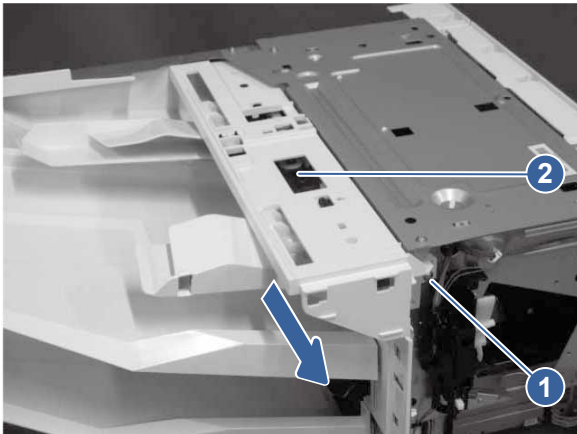
1. Release the cable (callout 1) from the cable clamp (callout 2), and then disconnect one connector (callout 3).

**Figure 5-1023 Release the cable**



2. Remove one screw (callout 1), and then slide the jogger assembly (callout 2) in the direction indicated to remove it.

**Figure 5-1024 Remove the jogger assembly**

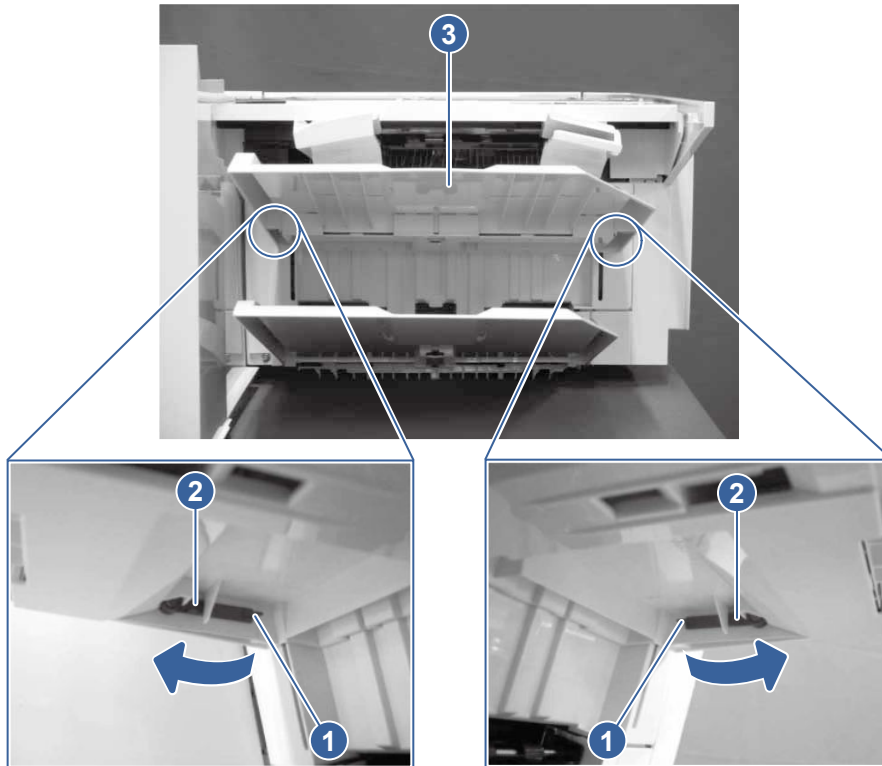


### 4. Remove the output bin 1 assembly (3-bin stapler-stacker)

Learn about removing the 3-bin stapler-stacker output bin 1 assembly.

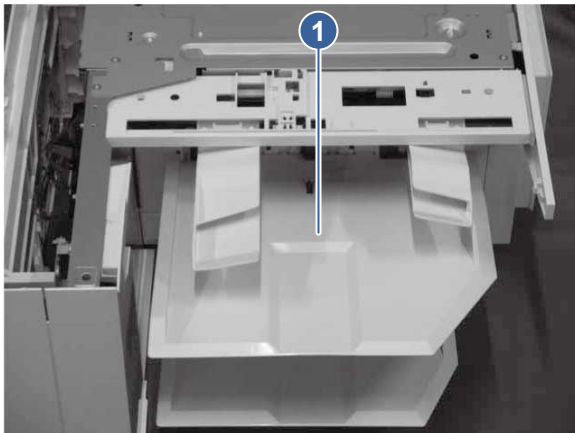
1. Release one boss (callout 1), rotate the pin (callout 2) in the direction indicated, and then remove the pin.

**Figure 5-1025 Remove the pin**



2. Remove the output bin 1 assembly (callout 1).

**Figure 5-1026 Remove the output bin**



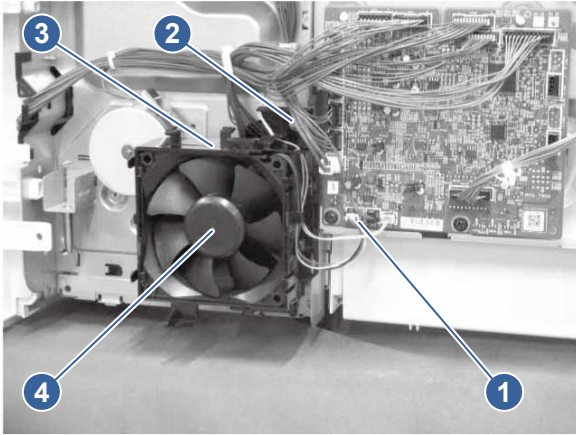
## 5. Remove the MBM fan (3-bin stapler-stacker)

Learn about removing the 3-bin stapler-stacker mailbox/booklet-maker fan.



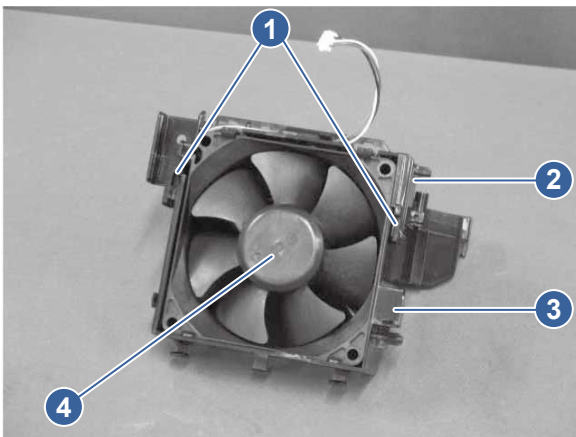
1. Disconnect one connector (callout 1), remove one screw (callout 2), and then remove the fan holder (callout 3) together with the fan (callout 4).

**Figure 5-1027 Remove the fan holder and fan**



2. Release two tabs (callout 1), remove the duct 1 (callout 2) and the duct 2 (callout 3), and then remove the MBM fan (callout 4) from the holder.

**Figure 5-1028 Remove the fan from the holder**

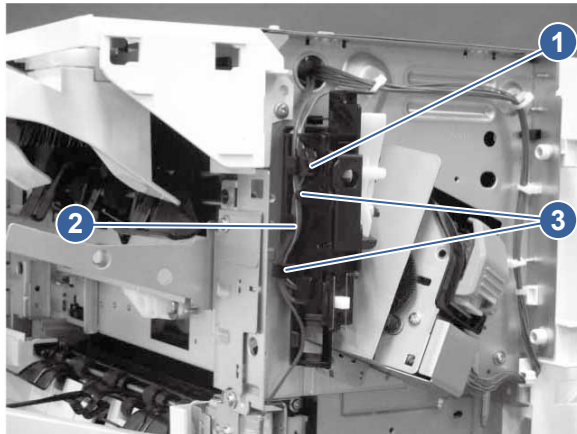


#### 6. Remove the solenoid assembly (3-bin stapler-stacker)

Learn about removing the 3-bin stapler-stacker solenoid assembly.

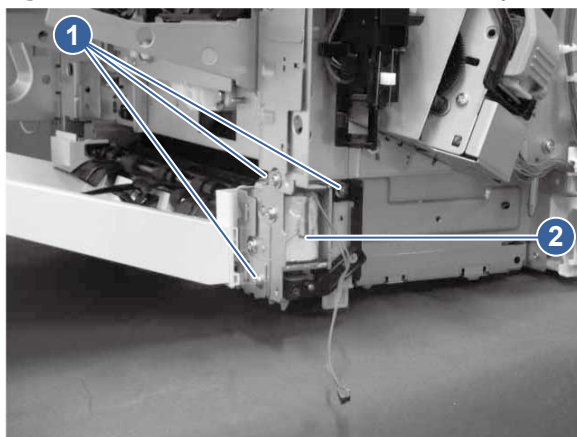
1. Disconnect one connector (callout 1), and then release the cable (callout 2) from the cable stoppers (callout 3).

**Figure 5-1029 Release the cable**



2. Remove three screws (callout 1), and then remove the solenoid assembly (callout 2).

**Figure 5-1030 Remove the solenoid assembly**



## 7. Unpack the replacement assembly

Follow these steps to unpack the replacement assembly.

1. Dispose of the defective part.




**NOTE:** HP recommends responsible disposal of the defective part.

<http://www8.hp.com/us/en/hp-information/environment/product-recycling.html>


2. Unpack the replacement part from the packaging.



**CAUTION:**  Some parts are sensitive to electrostatic discharge (ESD). Always perform service work at an ESD-protected workstation or mat. If an ESD workstation or mat is not available, touch the sheet-metal chassis to provide a static ground before touching an ESD-sensitive assembly. Protect the ESD-sensitive assemblies by placing them in ESD pouches when they are out of the printer.




**IMPORTANT:** Make sure that all of the shipping materials (for example shipping tape) are removed from the replacement part prior to installation.

 **NOTE:** If the replacement part is a roller or pad, avoid touching the spongy part of it. Skin oils on the roller or pad can cause paper pickup and/or print-quality problems. HP recommends using disposable gloves when handling rollers or pads or washing your hands before touching rollers or pads.

---

3. To install an assembly, reverse the removal steps.

---

 **NOTE:** When applicable, special installation instructions are provided for an assembly at the end of the removal procedure. Always completely read the removal instructions and follow all special installation instructions.

---


## Removal and replacement: MBM fan (3-bin stapler-stacker)

Learn about removing and replacing the 3-bin stapler-stacker mailbox/booklet-maker fan.

### Before performing service

#### Turn the printer power off

- Disconnect the power cable.

 **WARNING!** To avoid damage to the printer, turn the printer off, wait 30 seconds, and then remove the power cord before attempting to service the printer.

---

Use the table below to identify the correct part number for your printer, and then go to <https://parts.hp.com/hpparts> to order the part.

**Table 5-140** Part information

Part number	Part description
RK2-8153-000CN	Fan (3-bin SS)

### Required tools

- #2 Phillips screwdriver with a magnetic tip and a 152 mm (6 in) shaft length
- Small flat-blade screwdriver

### After performing service

#### Turn the printer power on

- Connect the power cable.
- Use the power switch to turn the power on.

### Post service test

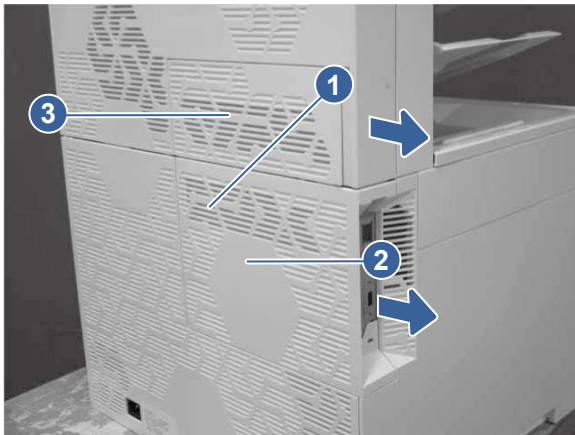
Print any pages necessary to make sure the printer is functioning correctly.

## 1. Remove the rear cover (3-bin stapler-stacker)

Learn about removing the 3-bin stapler-stacker rear cover.

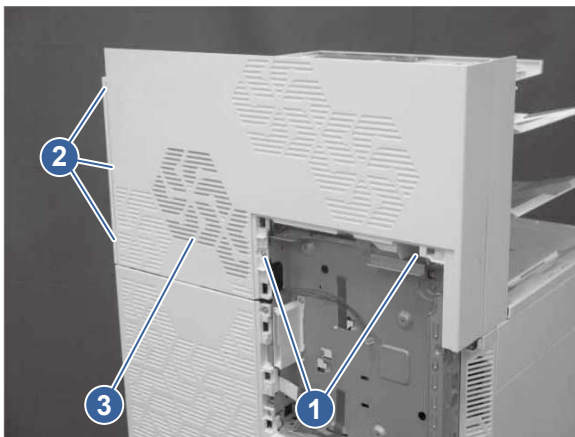
1. Remove the printer formatter cover by removing one screw (callout 1) and then sliding the cover (callout 2) in the direction indicated. Slide the 3-bin stapler-stacker formatter cover assembly (callout 3) in the direction indicated to remove it.

**Figure 5-1031 Remove the 3-bin stapler-stacker formatter cover**



2. Remove two screws (callout 1), release three tabs (callout 2), and then remove the rear cover (callout 3).

**Figure 5-1032 Remove the rear cover**

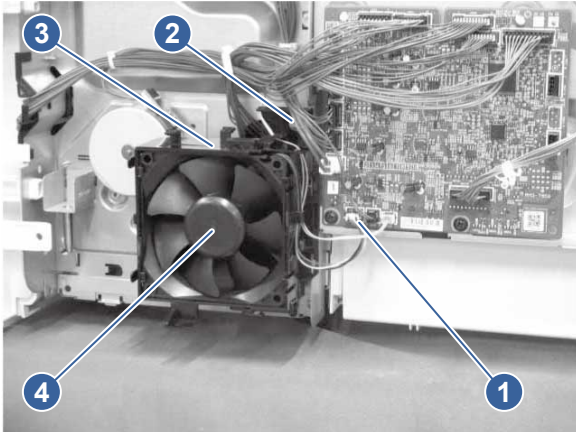


## 2. Remove the MBM fan (3-bin stapler-stacker)

Learn about removing the 3-bin stapler-stacker mailbox/booklet-maker fan.

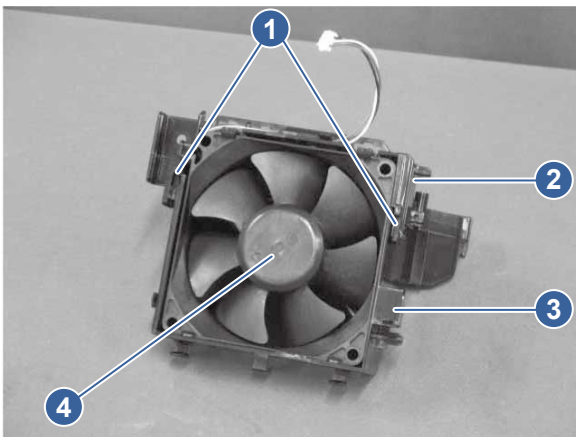
1. Disconnect one connector (callout 1), remove one screw (callout 2), and then remove the fan holder (callout 3) together with the fan (callout 4).

**Figure 5-1033 Remove the fan holder and fan**



2. Release two tabs (callout 1), remove the duct 1 (callout 2) and the duct 2 (callout 3), and then remove the MBM fan (callout 4) from the holder.

**Figure 5-1034 Remove the fan from the holder**



### 3. Unpack the replacement assembly

Follow these steps to unpack the replacement assembly.

1. Dispose of the defective part.





**NOTE:** HP recommends responsible disposal of the defective part.


<http://www8.hp.com/us/en/hp-information/environment/product-recycling.html>

2. Unpack the replacement part from the packaging.



**CAUTION:**  Some parts are sensitive to electrostatic discharge (ESD). Always perform service work at an ESD-protected workstation or mat. If an ESD workstation or mat is not available, touch the sheet-metal chassis to provide a static ground before touching an ESD-sensitive assembly. Protect the ESD-sensitive assemblies by placing them in ESD pouches when they are out of the printer.


 **IMPORTANT:** Make sure that all of the shipping materials (for example shipping tape) are removed from the replacement part prior to installation.

 **NOTE:** If the replacement part is a roller or pad, avoid touching the spongy part of it. Skin oils on the roller or pad can cause paper pickup and/or print-quality problems. HP recommends using disposable gloves when handling rollers or pads or washing your hands before touching rollers or pads.

---

3. To install an assembly, reverse the removal steps.

---

 **NOTE:** When applicable, special installation instructions are provided for an assembly at the end of the removal procedure. Always completely read the removal instructions and follow all special installation instructions.

---


## Removal and replacement: Stapler-stacker feed motor (3-bin stapler-stacker)

Learn about removing and replacing the feed motor.

### Before performing service

#### Turn the printer power off

- Disconnect the power cable.

 **WARNING!** To avoid damage to the printer, turn the printer off, wait 30 seconds, and then remove the power cord before attempting to service the printer.

---

Use the table below to identify the correct part number for your printer, and then go to <https://parts.hp.com/hpparts> to order the part.

**Table 5-141** Part information

Part number	Part description
RK2-8149-000CN	Motor, stepping DC (3-bin SS)

### Required tools

- #2 Phillips screwdriver with a magnetic tip and a 152 mm (6 in) shaft length
- Small flat-blade screwdriver

### After performing service

#### Turn the printer power on

- Connect the power cable.
- Use the power switch to turn the power on.

### Post service test

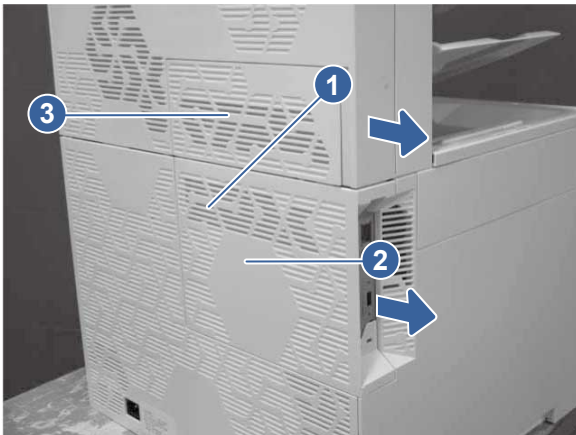
Print any pages necessary to make sure the printer is functioning correctly.

## 1. Remove the rear cover (3-bin stapler-stacker)

Learn about removing the 3-bin stapler-stacker rear cover.

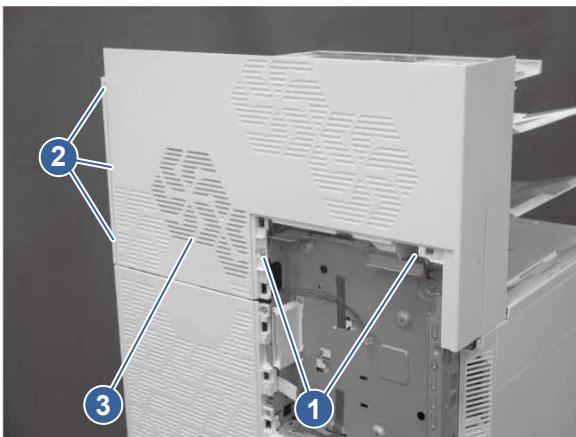
1. Remove the printer formatter cover by removing one screw (callout 1) and then sliding the cover (callout 2) in the direction indicated. Slide the 3-bin stapler-stacker formatter cover assembly (callout 3) in the direction indicated to remove it.

**Figure 5-1035 Remove the 3-bin stapler-stacker formatter cover**



2. Remove two screws (callout 1), release three tabs (callout 2), and then remove the rear cover (callout 3).

**Figure 5-1036 Remove the rear cover**

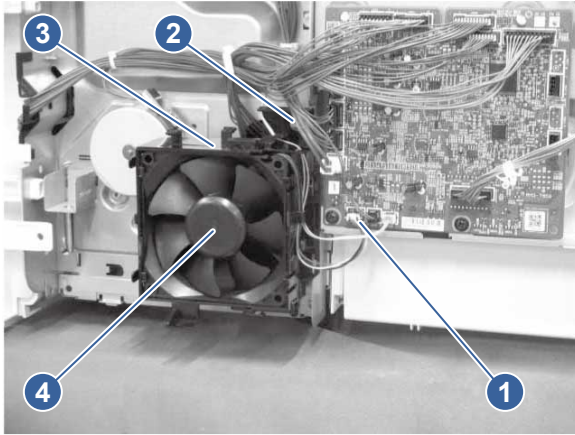


## 2. Remove the MBM fan (3-bin stapler-stacker)

Learn about removing the 3-bin stapler-stacker mailbox/booklet-maker fan.

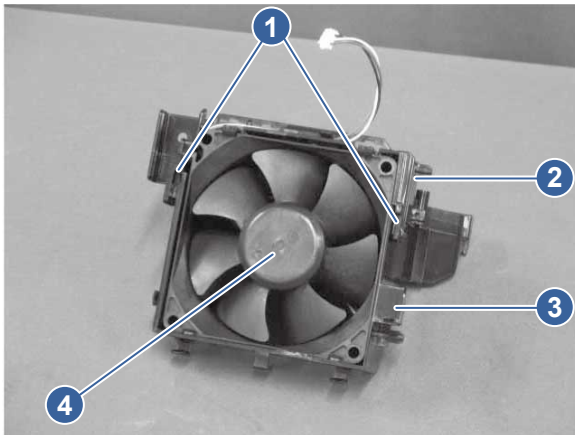
1. Disconnect one connector (callout 1), remove one screw (callout 2), and then remove the fan holder (callout 3) together with the fan (callout 4).

**Figure 5-1037 Remove the fan holder and fan**



2. Release two tabs (callout 1), remove the duct 1 (callout 2) and the duct 2 (callout 3), and then remove the MBM fan (callout 4) from the holder.

**Figure 5-1038 Remove the fan from the holder**



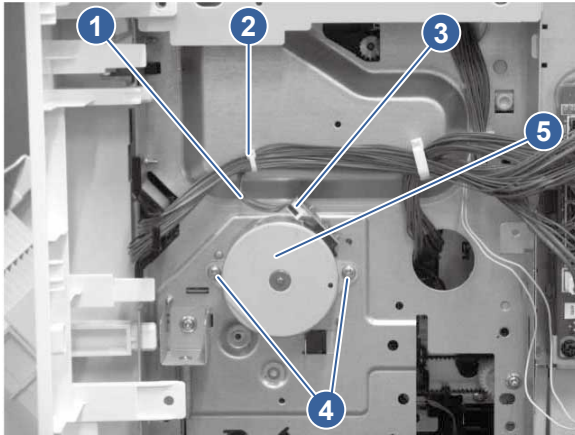
### 3. Remove the feed motor (3-bin stapler-stacker)

Learn about removing the 3-bin stapler-stacker feed motor.



- Release the cable (callout 1) from the cable clamp (callout 2), disconnect one connector (callout 3), remove two screws (callout 4), and then remove the stapler-stacker feed motor (callout 5).

**Figure 5-1039 Remove the feed motor**



#### 4. Unpack the replacement assembly

Follow these steps to unpack the replacement assembly.

1. Dispose of the defective part.

---



 **NOTE:** HP recommends responsible disposal of the defective part.


<http://www8.hp.com/us/en/hp-information/environment/product-recycling.html>


---

2. Unpack the replacement part from the packaging.

---

 **CAUTION:**  Some parts are sensitive to electrostatic discharge (ESD). Always perform service work at an ESD-protected workstation or mat. If an ESD workstation or mat is not available, touch the sheet-metal chassis to provide a static ground before touching an ESD-sensitive assembly. Protect the ESD-sensitive assemblies by placing them in ESD pouches when they are out of the printer.


 **IMPORTANT:** Make sure that all of the shipping materials (for example shipping tape) are removed from the replacement part prior to installation.

 **NOTE:** If the replacement part is a roller or pad, avoid touching the spongy part of it. Skin oils on the roller or pad can cause paper pickup and/or print-quality problems. HP recommends using disposable gloves when handling rollers or pads or washing your hands before touching rollers or pads.

---

3. To install an assembly, reverse the removal steps.

---

 **NOTE:** When applicable, special installation instructions are provided for an assembly at the end of the removal procedure. Always completely read the removal instructions and follow all special installation instructions.

---

#### Removal and replacement: Controller PCA (3-bin stapler-stacker)

Learn about removing and replacing the 3-bin stapler-stacker controller PCA.

#### Before performing service

**Turn the printer power off**

- Disconnect the power cable.

**⚠ WARNING!** To avoid damage to the printer, turn the printer off, wait 30 seconds, and then remove the power cord before attempting to service the printer.

Use the table below to identify the correct part number for your printer, and then go to <https://parts.hp.com/hpparts> to order the part.

**Table 5-142 Part information**

Part number	Part description
RM3-7950-000CN	Staple stacker PCA (3-bin SS)

## Required tools

- #2 Phillips screwdriver with a magnetic tip and a 152 mm (6 in) shaft length
- Small flat-blade screwdriver

## After performing service

### Turn the printer power on

- Connect the power cable.
- Use the power switch to turn the power on.

## Post service test

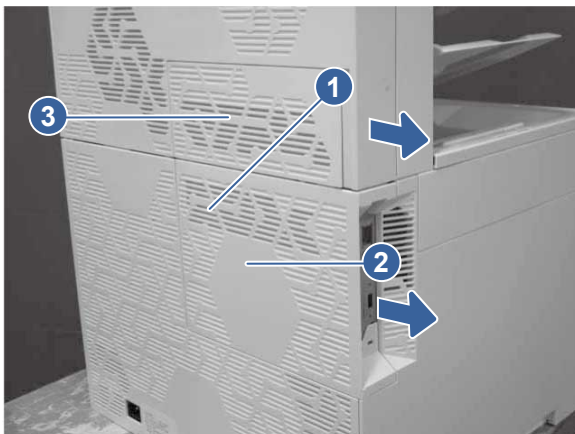
Print any pages necessary to make sure the printer is functioning correctly.

### 1. Remove the rear cover (3-bin stapler-stacker)

Learn about removing the 3-bin stapler-stacker rear cover.

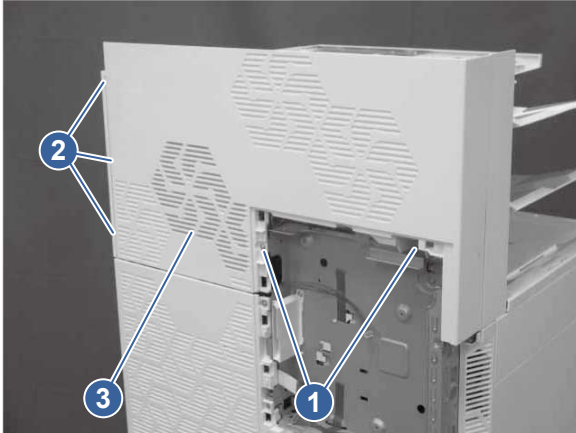
1. Remove the printer formatter cover by removing one screw (callout 1) and then sliding the cover (callout 2) in the direction indicated. Slide the 3-bin stapler-stacker formatter cover assembly (callout 3) in the direction indicated to remove it.

**Figure 5-1040 Remove the 3-bin stapler-stacker formatter cover**



2. Remove two screws (callout 1), release three tabs (callout 2), and then remove the rear cover (callout 3).

**Figure 5-1041 Remove the rear cover**

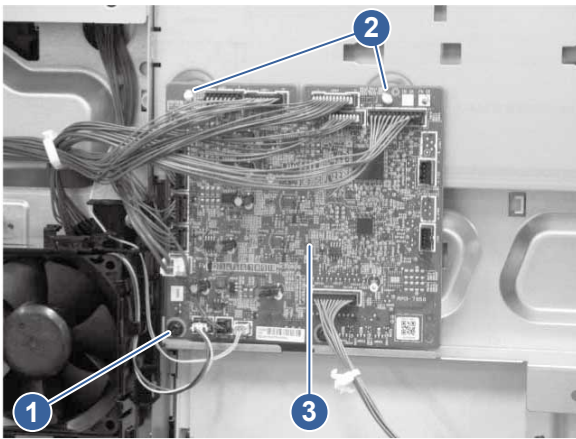


## 2. Remove the controller PCA (3-bin stapler-stacker)

Learn about removing the 3-bin stapler-stacker controller PCA.

1. Disconnect all the connectors on the controller PCA.
2. Remove one screw (callout 1), release two tabs (callout 2), and then remove the controller PCA (callout 3).

**Figure 5-1042 Remove the controller PCA**



## 3. Unpack the replacement assembly

Follow these steps to unpack the replacement assembly.

1. Dispose of the defective part.






**NOTE:** HP recommends responsible disposal of the defective part.


<http://www8.hp.com/us/en/hp-information/environment/product-recycling.html>

2. Unpack the replacement part from the packaging.

---


 **CAUTION:**  Some parts are sensitive to electrostatic discharge (ESD). Always perform service work at an ESD-protected workstation or mat. If an ESD workstation or mat is not available, touch the sheet-metal chassis to provide a static ground before touching an ESD-sensitive assembly. Protect the ESD-sensitive assemblies by placing them in ESD pouches when they are out of the printer.

 **IMPORTANT:** Make sure that all of the shipping materials (for example shipping tape) are removed from the replacement part prior to installation.

 **NOTE:** If the replacement part is a roller or pad, avoid touching the spongy part of it. Skin oils on the roller or pad can cause paper pickup and/or print-quality problems. HP recommends using disposable gloves when handling rollers or pads or washing your hands before touching rollers or pads.

---

3. To install an assembly, reverse the removal steps.

 **NOTE:** When applicable, special installation instructions are provided for an assembly at the end of the removal procedure. Always completely read the removal instructions and follow all special installation instructions.

---

## 8. Output device - floor-standing staple stacker

Learn how to remove and replace the floor-standing staple stacker parts and assemblies.

### Field-replaceable units (FRUs)

Learn about FRU parts removal and replacement.

### Covers, panels, and doors

Learn about covers, panels, and doors removal and replacement.

### Removal and replacement: Front door (floor-standing stapler-stacker)


Learn about removing and replacing the floor-standing stapler-stacker front door.

#### Before performing service

##### Turn the printer power off

- Disconnect the power cable.

---

 **WARNING!** To avoid damage to the printer, turn the printer off, wait 30 seconds, and then remove the power cord before attempting to service the printer.

---

Use the table below to identify the correct part number for your printer, and then go to <https://parts.hp.com/hpparts> to order the part.

**Table 5-143** Part information

Part number	Part description
RM2-3857-000CN	Front cover assembly (FSSS)

#### Required tools

- #2 Phillips screwdriver with a magnetic tip and a 152 mm (6 in) shaft length
- Small flat-blade screwdriver

### After performing service

#### Turn the printer power on

- Connect the power cable.
- Use the power switch to turn the power on.

### Post service test

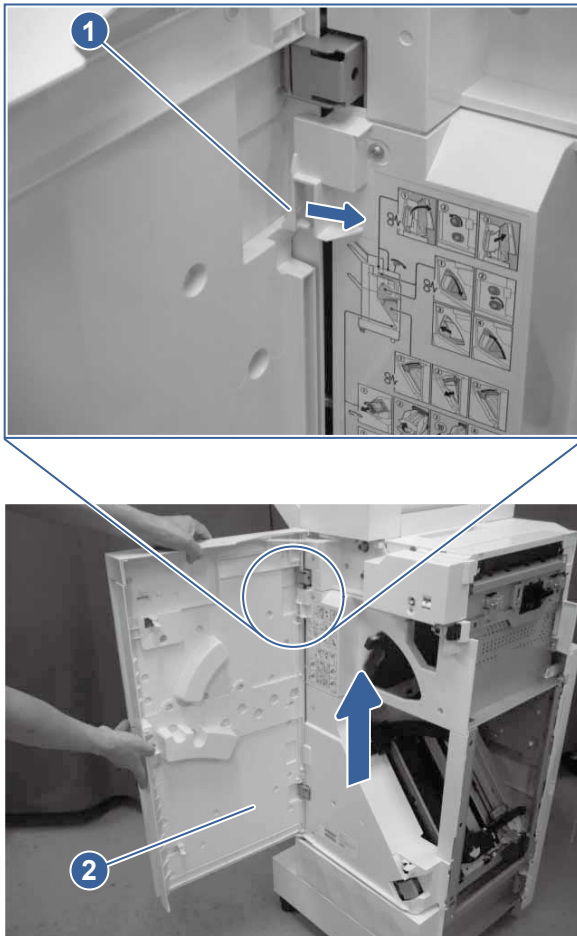
Print any pages necessary to make sure the printer is functioning correctly.

#### 1. Remove the front door assembly (floor-standing stapler-stacker)

Learn about removing the floor-standing stapler-stacker front door assembly.

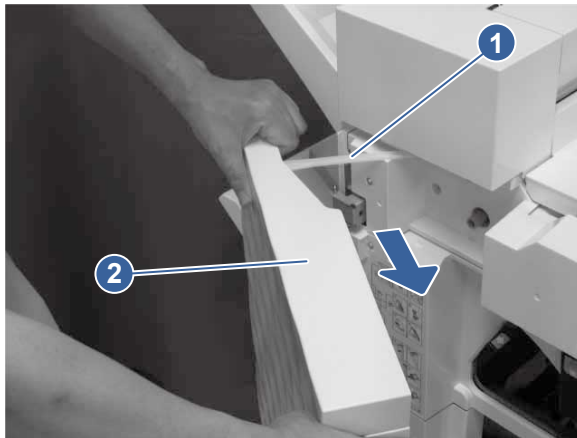
1. Open the front door.
2. Push the stopper (callout 1) in the direction indicated, and then pull up the front door assembly (callout 2) to remove it.

**Figure 5-1043** Remove the front door assembly



3. Remove the hinge (callout 1) from the front door assembly (callout 2).

**Figure 5-1044 Remove the hinge**



## 2. Unpack the replacement assembly



Follow these steps to unpack the replacement assembly.


1. Dispose of the defective part.


 **NOTE:** HP recommends responsible disposal of the defective part.

<http://www8.hp.com/us/en/hp-information/environment/product-recycling.html>


2. Unpack the replacement part from the packaging.

 **CAUTION:**  Some parts are sensitive to electrostatic discharge (ESD). Always perform service work at an ESD-protected workstation or mat. If an ESD workstation or mat is not available, touch the sheet-metal chassis to provide a static ground before touching an ESD-sensitive assembly. Protect the ESD-sensitive assemblies by placing them in ESD pouches when they are out of the printer.

 **IMPORTANT:** Make sure that all of the shipping materials (for example shipping tape) are removed from the replacement part prior to installation.

 **NOTE:** If the replacement part is a roller or pad, avoid touching the spongy part of it. Skin oils on the roller or pad can cause paper pickup and/or print-quality problems. HP recommends using disposable gloves when handling rollers or pads or washing your hands before touching rollers or pads.

3. To install an assembly, reverse the removal steps.

 **NOTE:** When applicable, special installation instructions are provided for an assembly at the end of the removal procedure. Always completely read the removal instructions and follow all special installation instructions.

## Removal and replacement: Upper and lower output bins (floor-standing stapler-stacker)

Learn about removing and replacing the floor-standing stapler-stacker upper and lower output bins.

 [View a video demonstration of removing and replacing the upper and lower output bins.](#)

## Before performing service

## Turn the printer power off

- Disconnect the power cable.

**⚠ WARNING!** To avoid damage to the printer, turn the printer off, wait 30 seconds, and then remove the power cord before attempting to service the printer.

Use the table below to identify the correct part number for your printer, and then go to <https://parts.hp.com/hpparts> to order the part.

**Table 5-144 Part information**

Part number	Part description
RM2-3837-000CN	Tray assembly (FSSS)

## Required tools

- #2 Phillips screwdriver with a magnetic tip and a 152 mm (6 in) shaft length
- Small flat-blade screwdriver

## After performing service

### Turn the printer power on

- Connect the power cable.
- Use the power switch to turn the power on.

## Post service test

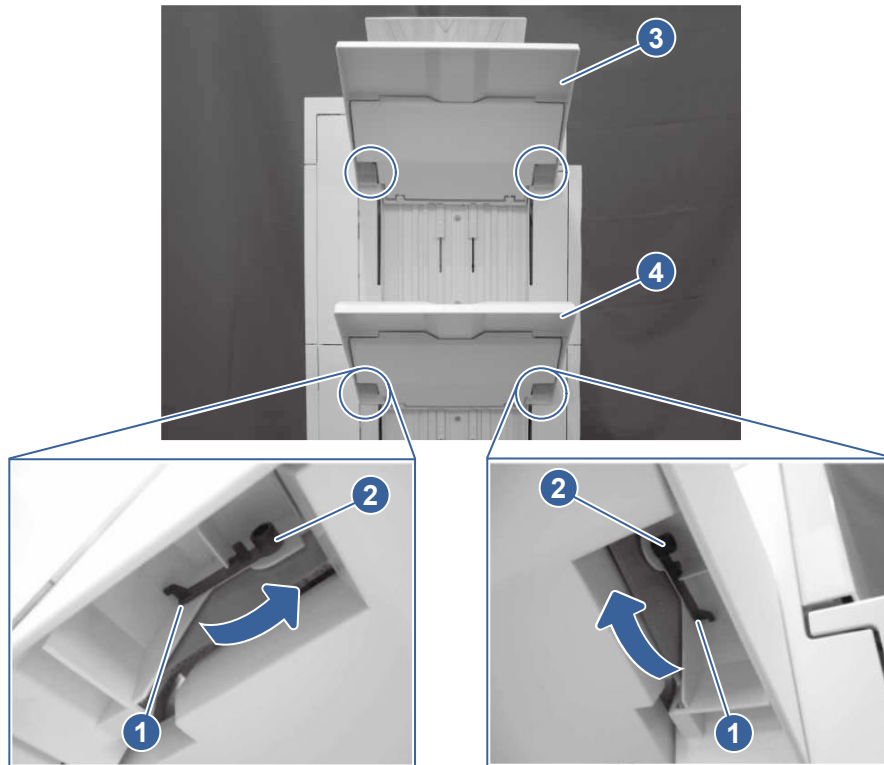
Print any pages necessary to make sure the printer is functioning correctly.

### 1. Remove the output bins (floor-standing stapler-stacker)

Learn about removing the floor-standing stapler-stacker output bins.

- Release one boss (callout 1), rotate the pin (callout 2) in the direction indicated, and then remove the pin. Remove either the upper bin (callout 3) or the lower bin (callout 4) with this process.

Figure 5-1045 Remove either bin



## 2. Unpack the replacement assembly

Follow these steps to unpack the replacement assembly.

1. Dispose of the defective part.




**NOTE:** HP recommends responsible disposal of the defective part.

<http://www8.hp.com/us/en/hp-information/environment/product-recycling.html>

2. Unpack the replacement part from the packaging.



**CAUTION:**  Some parts are sensitive to electrostatic discharge (ESD). Always perform service work at an ESD-protected workstation or mat. If an ESD workstation or mat is not available, touch the sheet-metal chassis to provide a static ground before touching an ESD-sensitive assembly. Protect the ESD-sensitive assemblies by placing them in ESD pouches when they are out of the printer.



**IMPORTANT:** Make sure that all of the shipping materials (for example shipping tape) are removed from the replacement part prior to installation.



**NOTE:** If the replacement part is a roller or pad, avoid touching the spongy part of it. Skin oils on the roller or pad can cause paper pickup and/or print-quality problems. HP recommends using disposable gloves when handling rollers or pads or washing your hands before touching rollers or pads.



3. To install an assembly, reverse the removal steps.



**NOTE:** When applicable, special installation instructions are provided for an assembly at the end of the removal procedure. Always completely read the removal instructions and follow all special installation instructions.

### Removal and replacement: Left upper rear cover (floor-standing stapler-stacker)

Learn about removing and replacing the floor-standing stapler-stacker left upper rear cover.

#### Before performing service

##### Turn the printer power off

- Disconnect the power cable.

**⚠ WARNING!** To avoid damage to the printer, turn the printer off, wait 30 seconds, and then remove the power cord before attempting to service the printer.

Use the table below to identify the correct part number for your printer, and then go to <https://parts.hp.com/hpparts> to order the part.

**Table 5-145** Part information

Part number	Part description
RC6-0213-000CN	Cover, rear left (FSSS)

#### Required tools

- #2 Phillips screwdriver with a magnetic tip and a 152 mm (6 in) shaft length
- Small flat-blade screwdriver

#### After performing service

##### Turn the printer power on

- Connect the power cable.
- Use the power switch to turn the power on.

#### Post service test

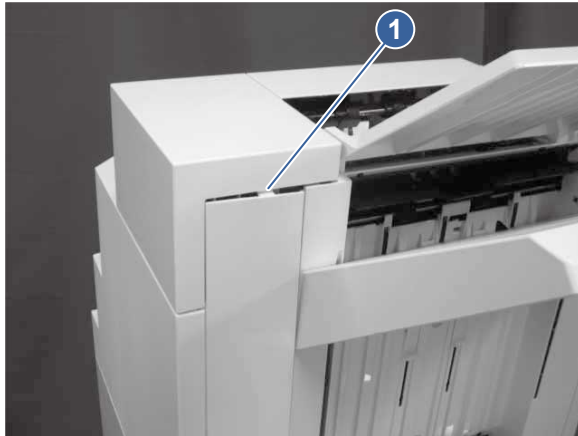
Print any pages necessary to make sure the printer is functioning correctly.

### 1. Remove the left upper rear cover (floor-standing stapler-stacker)

Learn about removing the floor-standing stapler-stacker left upper rear cover.

1. Release one tab (callout 1).

**Figure 5-1046 Release one tab**



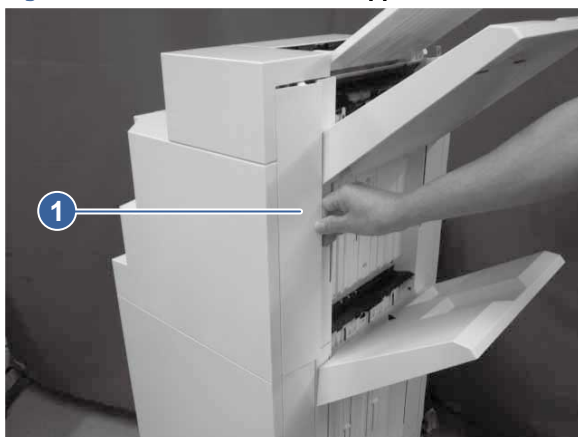
2. Release one boss (callout 1).

**Figure 5-1047 Release one boss**



3. Pull up the left upper rear cover (callout 1) to remove it.

**Figure 5-1048 Remove the left upper rear cover**



## 2. Unpack the replacement assembly

Follow these steps to unpack the replacement assembly.

1. Dispose of the defective part.




**NOTE:** HP recommends responsible disposal of the defective part.

<http://www8.hp.com/us/en/hp-information/environment/product-recycling.html>

2. Unpack the replacement part from the packaging.



**CAUTION:**  Some parts are sensitive to electrostatic discharge (ESD). Always perform service work at an ESD-protected workstation or mat. If an ESD workstation or mat is not available, touch the sheet-metal chassis to provide a static ground before touching an ESD-sensitive assembly. Protect the ESD-sensitive assemblies by placing them in ESD pouches when they are out of the printer.



**IMPORTANT:** Make sure that all of the shipping materials (for example shipping tape) are removed from the replacement part prior to installation.



**NOTE:** If the replacement part is a roller or pad, avoid touching the spongy part of it. Skin oils on the roller or pad can cause paper pickup and/or print-quality problems. HP recommends using disposable gloves when handling rollers or pads or washing your hands before touching rollers or pads.

3. To install an assembly, reverse the removal steps.



**NOTE:** When applicable, special installation instructions are provided for an assembly at the end of the removal procedure. Always completely read the removal instructions and follow all special installation instructions.

### Removal and replacement: Left lower rear cover (floor-standing stapler-stacker)

Learn about removing and replacing the floor-standing stapler-stacker left lower rear cover.



[View a video demonstration of removing and replacing the left lower rear cover.](#)

### Before performing service

#### Turn the printer power off

- Disconnect the power cable.



**WARNING!** To avoid damage to the printer, turn the printer off, wait 30 seconds, and then remove the power cord before attempting to service the printer.

Use the table below to identify the correct part number for your printer, and then go to <https://parts.hp.com/hpparts> to order the part.

**Table 5-146** Part information

Part number	Part description
RC6-0213-000CN	Cover, rear left (FSSS)

### Required tools

- #2 Phillips screwdriver with a magnetic tip and a 152 mm (6 in) shaft length
- Small flat-blade screwdriver

### After performing service

#### Turn the printer power on

- Connect the power cable.
- Use the power switch to turn the power on.

#### Post service test

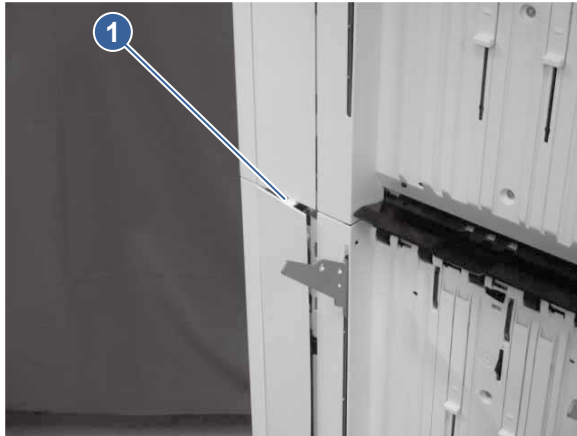
Print any pages necessary to make sure the printer is functioning correctly.

### 1. Remove the left lower rear cover (floor-standing stapler-stacker)

Learn about removing the floor-standing stapler-stacker left lower rear cover.

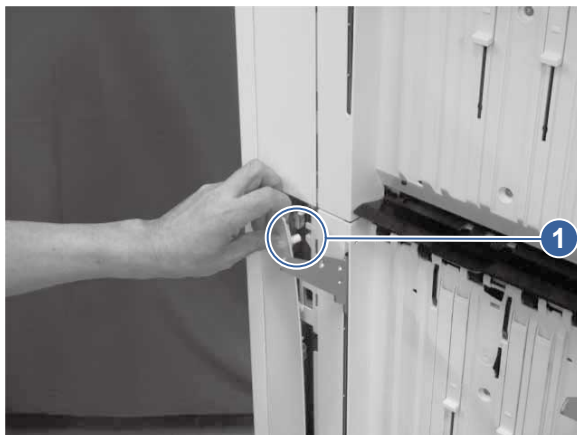
1. Release one tab (callout 1).

**Figure 5-1049 Release one tab**



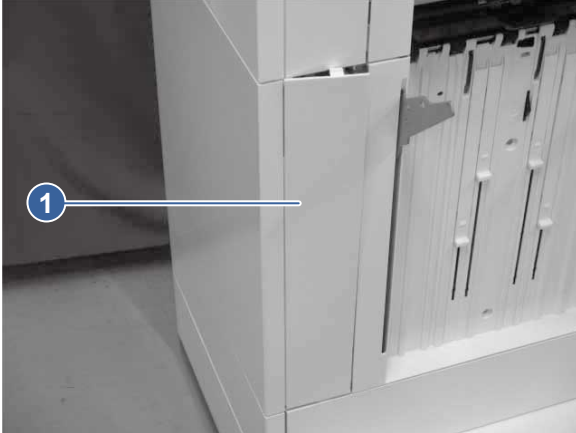
2. Release one boss (callout 1).

**Figure 5-1050 Release one boss**



3. Pull up the left lower rear cover (callout 1) to remove it.

**Figure 5-1051 Remove the left lower rear cover**



## 2. Unpack the replacement assembly

Follow these steps to unpack the replacement assembly.

1. Dispose of the defective part.




**NOTE:** HP recommends responsible disposal of the defective part.

<http://www8.hp.com/us/en/hp-information/environment/product-recycling.html>

2. Unpack the replacement part from the packaging.



**CAUTION:**  Some parts are sensitive to electrostatic discharge (ESD). Always perform service work at an ESD-protected workstation or mat. If an ESD workstation or mat is not available, touch the sheet-metal chassis to provide a static ground before touching an ESD-sensitive assembly. Protect the ESD-sensitive assemblies by placing them in ESD pouches when they are out of the printer.



**IMPORTANT:** Make sure that all of the shipping materials (for example shipping tape) are removed from the replacement part prior to installation.



**NOTE:** If the replacement part is a roller or pad, avoid touching the spongy part of it. Skin oils on the roller or pad can cause paper pickup and/or print-quality problems. HP recommends using disposable gloves when handling rollers or pads or washing your hands before touching rollers or pads.

3. To install an assembly, reverse the removal steps.



**NOTE:** When applicable, special installation instructions are provided for an assembly at the end of the removal procedure. Always completely read the removal instructions and follow all special installation instructions.

## Removal and replacement: Rear cover (floor-standing stapler-stacker)

Learn about removing and replacing the floor-standing stapler-stacker rear cover.

### Before performing service

#### Turn the printer power off

- Disconnect the power cable.

**⚠ WARNING!** To avoid damage to the printer, turn the printer off, wait 30 seconds, and then remove the power cord before attempting to service the printer.

Use the table below to identify the correct part number for your printer, and then go to <https://parts.hp.com/hpparts> to order the part.

**Table 5-147 Part information**

Part number	Part description
RC5-0223-000CN	Cover, rear (FSSS)

## Required tools

- #2 Phillips screwdriver with a magnetic tip and a 152 mm (6 in) shaft length
- Small flat-blade screwdriver

## After performing service

### Turn the printer power on

- Connect the power cable.
- Use the power switch to turn the power on.

## Post service test

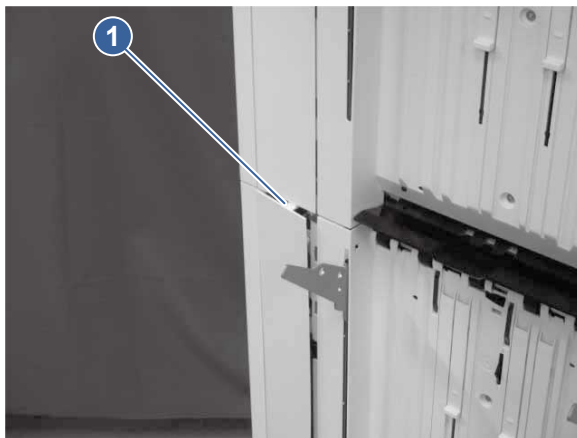
Print any pages necessary to make sure the printer is functioning correctly.

### 1. Remove the left lower rear cover (floor-standing stapler-stacker)

Learn about removing the floor-standing stapler-stacker left lower rear cover.

1. Release one tab (callout 1).

**Figure 5-1052 Release one tab**



2. Release one boss (callout 1).

**Figure 5-1053 Release one boss**



3. Pull up the left lower rear cover (callout 1) to remove it.

**Figure 5-1054 Remove the left lower rear cover**

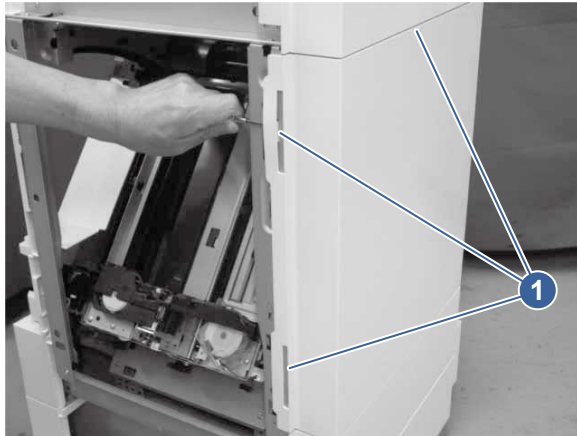


## 2. Remove the rear cover (floor-standing stapler-stacker)

Learn about removing the floor-standing stapler-stacker rear cover.

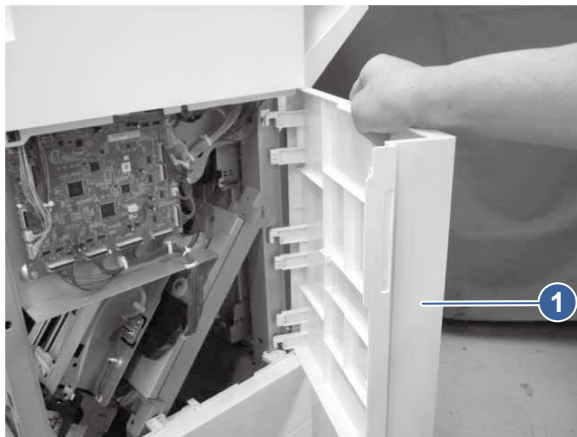
1. Release three tabs (callout 1).

**Figure 5-1055 Release three tabs**



2. Remove the rear cover (callout 1).

**Figure 5-1056 Remove the rear cover**



### 3. Unpack the replacement assembly

Follow these steps to unpack the replacement assembly.

1. Dispose of the defective part.




**NOTE:** HP recommends responsible disposal of the defective part.

<http://www8.hp.com/us/en/hp-information/environment/product-recycling.html>

2. Unpack the replacement part from the packaging.




**CAUTION:**  Some parts are sensitive to electrostatic discharge (ESD). Always perform service work at an ESD-protected workstation or mat. If an ESD workstation or mat is not available, touch the sheet-metal chassis to provide a static ground before touching an ESD-sensitive assembly. Protect the ESD-sensitive assemblies by placing them in ESD pouches when they are out of the printer.




**IMPORTANT:** Make sure that all of the shipping materials (for example shipping tape) are removed from the replacement part prior to installation.



 **NOTE:** If the replacement part is a roller or pad, avoid touching the spongy part of it. Skin oils on the roller or pad can cause paper pickup and/or print-quality problems. HP recommends using disposable gloves when handling rollers or pads or washing your hands before touching rollers or pads.

---

3. To install an assembly, reverse the removal steps.

 **NOTE:** When applicable, special installation instructions are provided for an assembly at the end of the removal procedure. Always completely read the removal instructions and follow all special installation instructions.

---


## Removal and replacement: Rear upper cover (floor-standing stapler-stacker)

Learn about removing and replacing the floor-standing stapler-stacker rear upper cover.

### Before performing service

#### Turn the printer power off

- Disconnect the power cable.

 **WARNING!** To avoid damage to the printer, turn the printer off, wait 30 seconds, and then remove the power cord before attempting to service the printer.

---

Use the table below to identify the correct part number for your printer, and then go to <https://parts.hp.com/hpparts> to order the part.

**Table 5-148** Part information

Part number	Part description
RM2-3864-000CN	Rear upper cover assembly (FSSS)

### Required tools

- #2 Phillips screwdriver with a magnetic tip and a 152 mm (6 in) shaft length
- Small flat-blade screwdriver

### After performing service

#### Turn the printer power on

- Connect the power cable.
- Use the power switch to turn the power on.

### Post service test

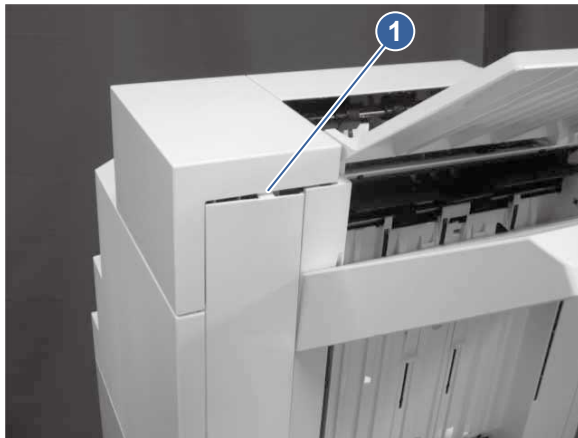
Print any pages necessary to make sure the printer is functioning correctly.

## 1. Remove the left upper rear cover (floor-standing stapler-stacker)

Learn about removing the floor-standing stapler-stacker left upper rear cover.

1. Release one tab (callout 1).

**Figure 5-1057 Release one tab**



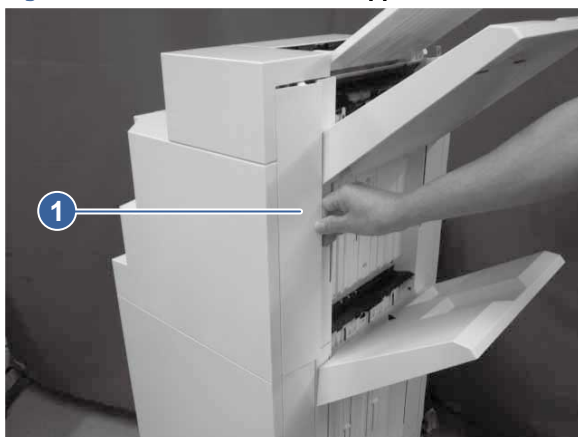
2. Release one boss (callout 1).

**Figure 5-1058 Release one boss**



3. Pull up the left upper rear cover (callout 1) to remove it.

**Figure 5-1059 Remove the left upper rear cover**

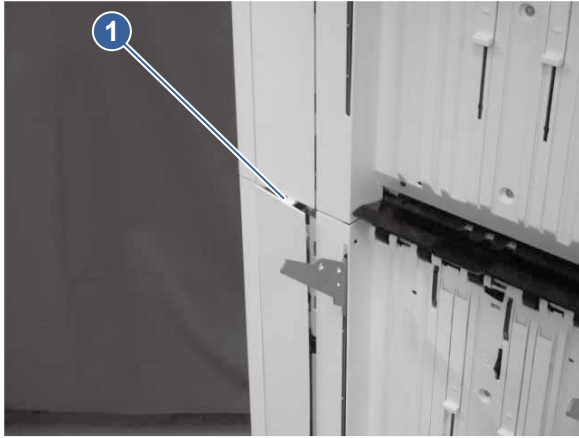


## 2. Remove the left lower rear cover (floor-standing stapler-stacker)

Learn about removing the floor-standing stapler-stacker left lower rear cover.

1. Release one tab (callout 1).

**Figure 5-1060 Release one tab**



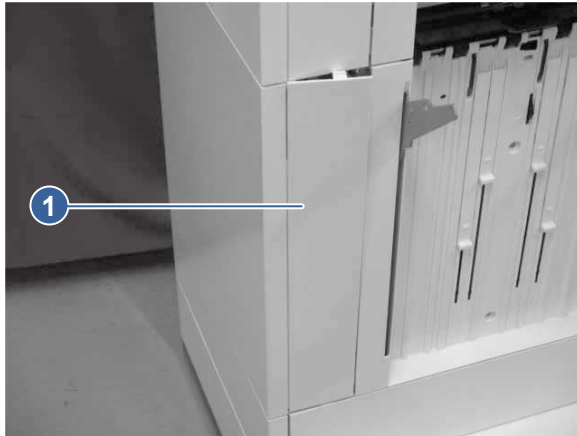
2. Release one boss (callout 1).

**Figure 5-1061 Release one boss**



3. Pull up the left lower rear cover (callout 1) to remove it.

**Figure 5-1062 Remove the left lower rear cover**

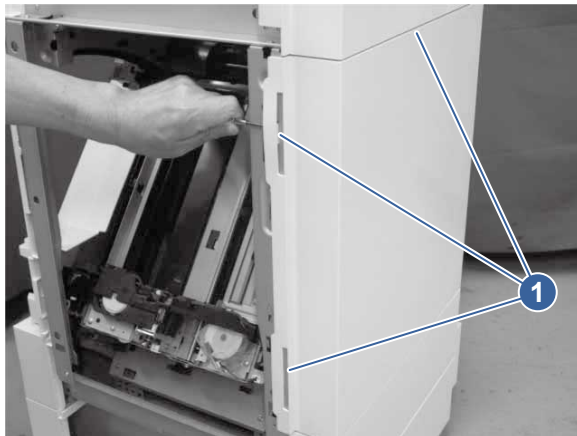


### 3. Remove the rear cover (floor-standing stapler-stacker)

Learn about removing the floor-standing stapler-stacker rear cover.

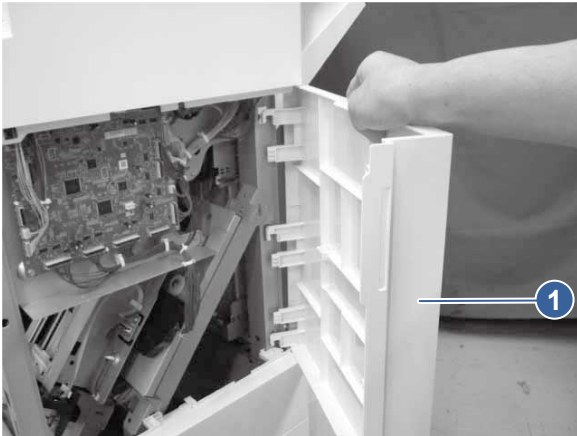
1. Release three tabs (callout 1).

**Figure 5-1063 Release three tabs**



2. Remove the rear cover (callout 1).

**Figure 5-1064 Remove the rear cover**

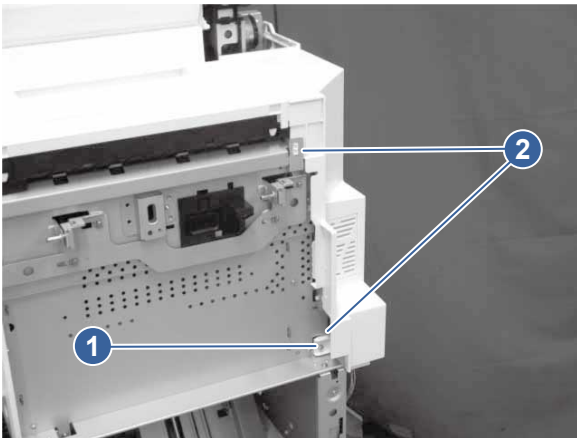


#### 4. Remove the rear upper cover (floor-standing stapler-stacker)

Learn about removing the floor-standing stapler-stacker rear upper cover.

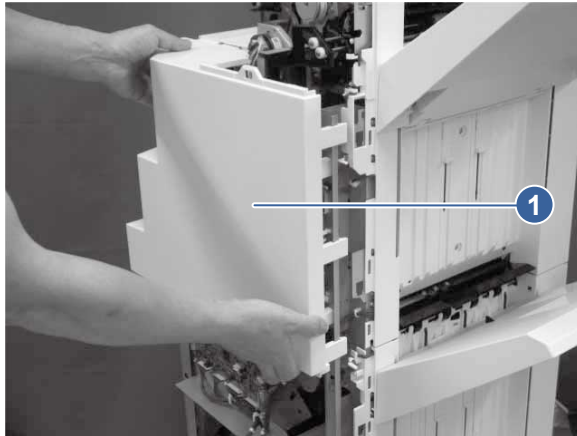
1. Remove one screw (callout 1), and then release two tabs (callout 2).

**Figure 5-1065 Remove one screw and release two tabs**



2. Remove the rear upper cover (callout 1).

**Figure 5-1066 Remove the rear upper cover**



## 5. Unpack the replacement assembly

Follow these steps to unpack the replacement assembly.

1. Dispose of the defective part.

---



 **NOTE:** HP recommends responsible disposal of the defective part.


<http://www8.hp.com/us/en/hp-information/environment/product-recycling.html>


---

2. Unpack the replacement part from the packaging.

---

 **CAUTION:**  Some parts are sensitive to electrostatic discharge (ESD). Always perform service work at an ESD-protected workstation or mat. If an ESD workstation or mat is not available, touch the sheet-metal chassis to provide a static ground before touching an ESD-sensitive assembly. Protect the ESD-sensitive assemblies by placing them in ESD pouches when they are out of the printer.


 **IMPORTANT:** Make sure that all of the shipping materials (for example shipping tape) are removed from the replacement part prior to installation.

 **NOTE:** If the replacement part is a roller or pad, avoid touching the spongy part of it. Skin oils on the roller or pad can cause paper pickup and/or print-quality problems. HP recommends using disposable gloves when handling rollers or pads or washing your hands before touching rollers or pads.

---

3. To install an assembly, reverse the removal steps.

---

 **NOTE:** When applicable, special installation instructions are provided for an assembly at the end of the removal procedure. Always completely read the removal instructions and follow all special installation instructions.

---

## Removal and replacement: MBM front cover (floor-standing stapler-stacker)

Learn about removing and replacing the floor-standing stapler-stacker mailbox/booklet-maker front cover.

### Before performing service

**Turn the printer power off**

- Disconnect the power cable.

**⚠ WARNING!** To avoid damage to the printer, turn the printer off, wait 30 seconds, and then remove the power cord before attempting to service the printer.

Use the table below to identify the correct part number for your printer, and then go to <https://parts.hp.com/hpparts> to order the part.

**Table 5-149 Part information**

Part number	Part description
RC6-0214-000CN	Cover, MBM front (FSSS)

## Required tools

- #2 Phillips screwdriver with a magnetic tip and a 152 mm (6 in) shaft length
- Small flat-blade screwdriver

## After performing service

### Turn the printer power on

- Connect the power cable.
- Use the power switch to turn the power on.

## Post service test

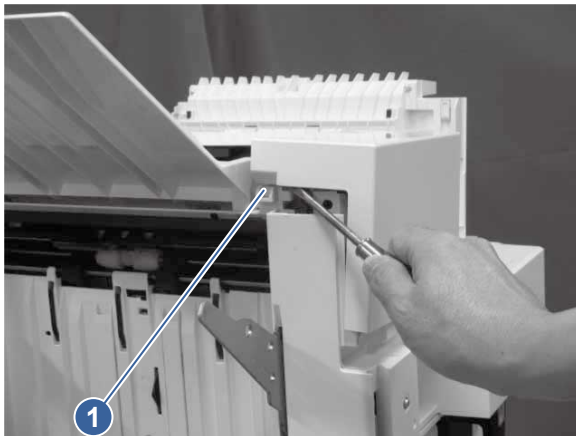
Print any pages necessary to make sure the printer is functioning correctly.

### 1. Remove the MBM front cover (floor-standing stapler-stacker)

Learn about removing the floor-standing stapler-stacker mailbox/booklet-maker front cover.

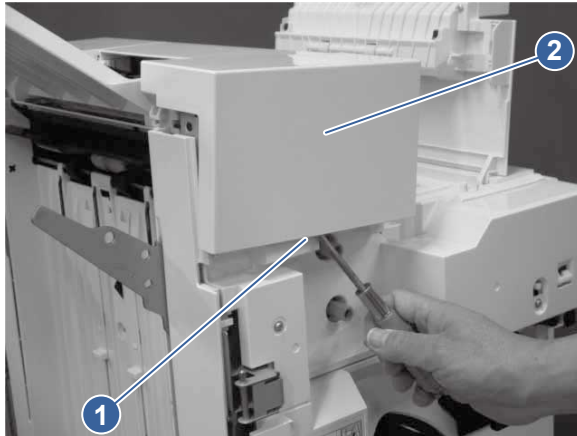
1. Release one tab (callout 1).

**Figure 5-1067 Release one tab**



2. Release one tab (callout 1), and then remove the MBM front cover (callout 2).

**Figure 5-1068 Remove the MBM front cover**



## 2. Unpack the replacement assembly



Follow these steps to unpack the replacement assembly.


1. Dispose of the defective part.


 **NOTE:** HP recommends responsible disposal of the defective part.

<http://www8.hp.com/us/en/hp-information/environment/product-recycling.html>


2. Unpack the replacement part from the packaging.

 **CAUTION:**  Some parts are sensitive to electrostatic discharge (ESD). Always perform service work at an ESD-protected workstation or mat. If an ESD workstation or mat is not available, touch the sheet-metal chassis to provide a static ground before touching an ESD-sensitive assembly. Protect the ESD-sensitive assemblies by placing them in ESD pouches when they are out of the printer.

 **IMPORTANT:** Make sure that all of the shipping materials (for example shipping tape) are removed from the replacement part prior to installation.

 **NOTE:** If the replacement part is a roller or pad, avoid touching the spongy part of it. Skin oils on the roller or pad can cause paper pickup and/or print-quality problems. HP recommends using disposable gloves when handling rollers or pads or washing your hands before touching rollers or pads.

3. To install an assembly, reverse the removal steps.

 **NOTE:** When applicable, special installation instructions are provided for an assembly at the end of the removal procedure. Always completely read the removal instructions and follow all special installation instructions.

## Removal and replacement: MBM rear cover (floor-standing stapler-stacker)

Learn about removing and replacing the floor-standing stapler-stacker mailbox/booklet-maker rear cover.

### Before performing service

Turn the printer power off



- Disconnect the power cable.

**⚠ WARNING!** To avoid damage to the printer, turn the printer off, wait 30 seconds, and then remove the power cord before attempting to service the printer.

Use the table below to identify the correct part number for your printer, and then go to <https://parts.hp.com/hpparts> to order the part.

**Table 5-150 Part information**

Part number	Part description
RCS-0215-000CN	Cover, MBM rear (FSSS)

## Required tools

- #2 Phillips screwdriver with a magnetic tip and a 152 mm (6 in) shaft length
- Small flat-blade screwdriver

## After performing service

### Turn the printer power on

- Connect the power cable.
- Use the power switch to turn the power on.

## Post service test

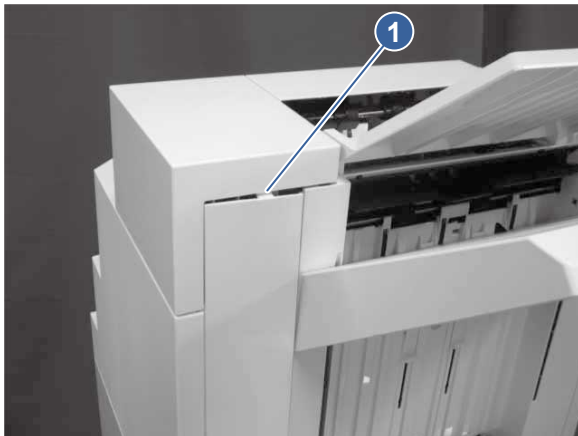
Print any pages necessary to make sure the printer is functioning correctly.

### 1. Remove the left upper rear cover (floor-standing stapler-stacker)

Learn about removing the floor-standing stapler-stacker left upper rear cover.

1. Release one tab (callout 1).

**Figure 5-1069 Release one tab**



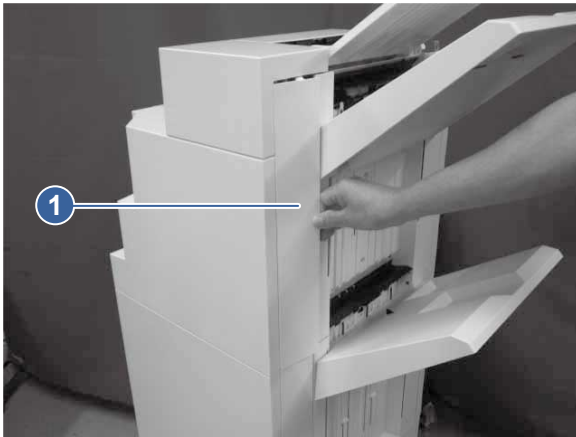
2. Release one boss (callout 1).

**Figure 5-1070 Release one boss**



3. Pull up the left upper rear cover (callout 1) to remove it.

**Figure 5-1071 Remove the left upper rear cover**



## **2. Remove the MBM rear cover (floor-standing stapler-stacker)**

Learn about removing the floor-standing stapler-stacker mailbox/booklet-maker rear cover.

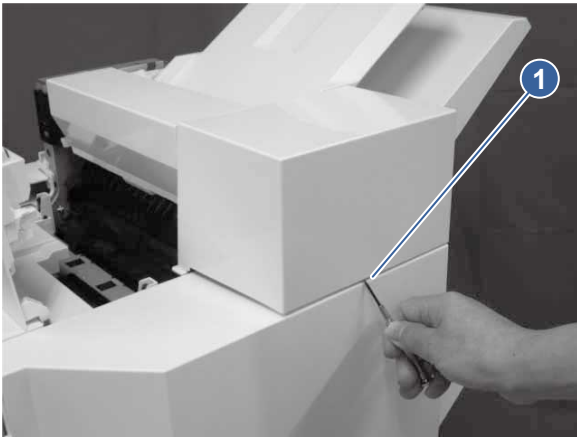
1. On the inside of the cover, release one tab (callout 1).

**Figure 5-1072 Release one tab**



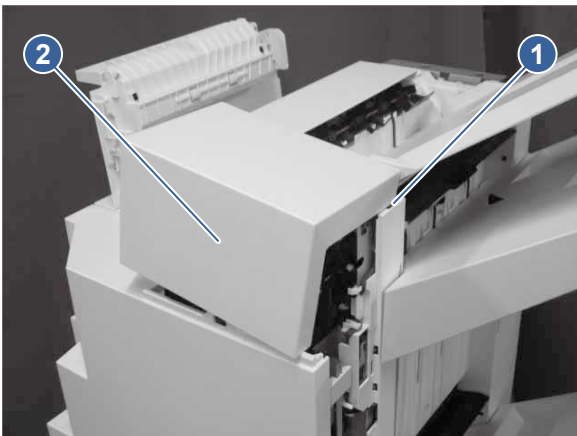
2. Release another tab (callout 1).

**Figure 5-1073 Release another tab**



3. Release another tab (callout 1), and then remove the MBM rear cover (callout 2).


**Figure 5-1074 Remove the MBM rear cover**



### 3. Unpack the replacement assembly



Follow these steps to unpack the replacement assembly.


1. Dispose of the defective part.


 **NOTE:** HP recommends responsible disposal of the defective part.

<http://www8.hp.com/us/en/hp-information/environment/product-recycling.html>


2. Unpack the replacement part from the packaging.

 **CAUTION:**  Some parts are sensitive to electrostatic discharge (ESD). Always perform service work at an ESD-protected workstation or mat. If an ESD workstation or mat is not available, touch the sheet-metal chassis to provide a static ground before touching an ESD-sensitive assembly. Protect the ESD-sensitive assemblies by placing them in ESD pouches when they are out of the printer.

 **IMPORTANT:** Make sure that all of the shipping materials (for example shipping tape) are removed from the replacement part prior to installation.

 **NOTE:** If the replacement part is a roller or pad, avoid touching the spongy part of it. Skin oils on the roller or pad can cause paper pickup and/or print-quality problems. HP recommends using disposable gloves when handling rollers or pads or washing your hands before touching rollers or pads.

3. To install an assembly, reverse the removal steps.

 **NOTE:** When applicable, special installation instructions are provided for an assembly at the end of the removal procedure. Always completely read the removal instructions and follow all special installation instructions.


### Removal and replacement: MBM top cover (floor-standing stapler-stacker)

Learn about removing and replacing the floor-standing stapler-stacker mailbox/booklet-maker top cover.

#### Before performing service

##### Turn the printer power off

- Disconnect the power cable.

 **WARNING!** To avoid damage to the printer, turn the printer off, wait 30 seconds, and then remove the power cord before attempting to service the printer.

Use the table below to identify the correct part number for your printer, and then go to <https://parts.hp.com/hpparts> to order the part.

**Table 5-151** Part information

Part number	Part description
RM2-3863-000CN	MBM cover assembly (FSSS)

#### Required tools

- #2 Phillips screwdriver with a magnetic tip and a 152 mm (6 in) shaft length
- Small flat-blade screwdriver

## After performing service

### Turn the printer power on

- Connect the power cable.
- Use the power switch to turn the power on.

### Post service test

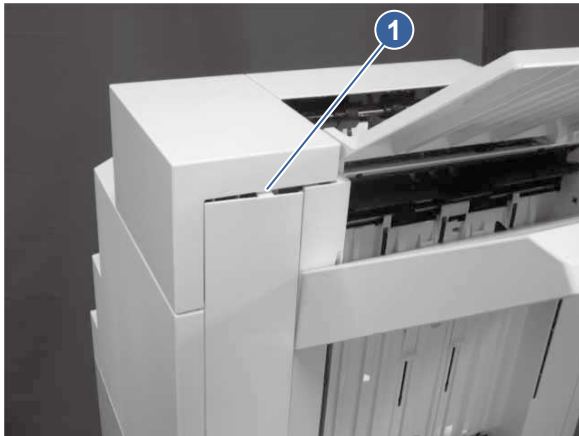
Print any pages necessary to make sure the printer is functioning correctly.

#### 1. Remove the left upper rear cover (floor-standing stapler-stacker)

Learn about removing the floor-standing stapler-stacker left upper rear cover.

1. Release one tab (callout 1).

**Figure 5-1075** Release one tab



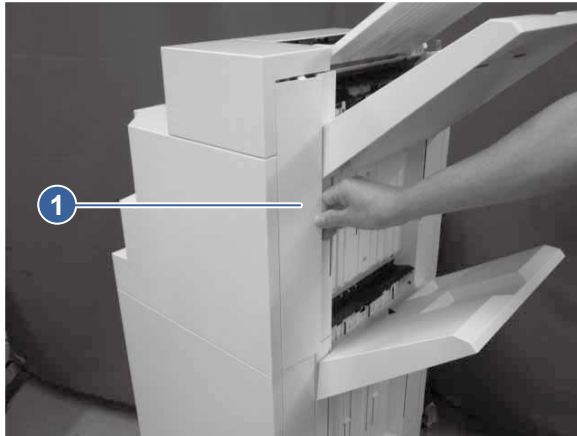
2. Release one boss (callout 1).

**Figure 5-1076** Release one boss



3. Pull up the left upper rear cover (callout 1) to remove it.

**Figure 5-1077 Remove the left upper rear cover**

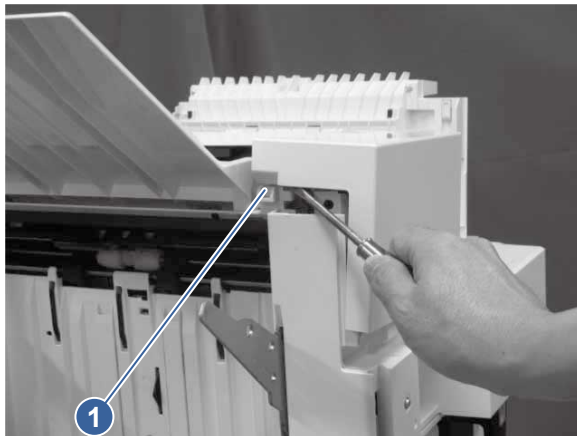


## 2. Remove the MBM front cover (floor-standing stapler-stacker)

Learn about removing the floor-standing stapler-stacker mailbox/booklet-maker front cover.

1. Release one tab (callout 1).

**Figure 5-1078 Release one tab**



2. Release one tab (callout 1), and then remove the MBM front cover (callout 2).

**Figure 5-1079 Remove the MBM front cover**



### 3. Remove the MBM rear cover (floor-standing stapler-stacker)

Learn about removing the floor-standing stapler-stacker mailbox/booklet-maker rear cover.

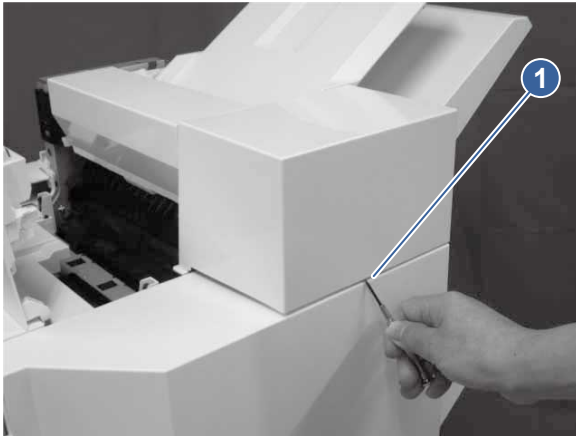
1. On the inside of the cover, release one tab (callout 1).

**Figure 5-1080 Release one tab**



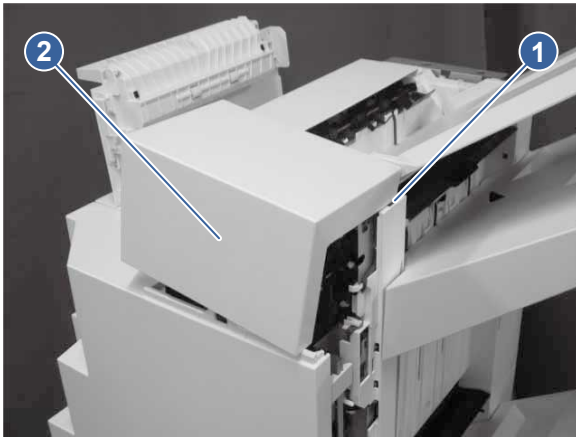
2. Release another tab (callout 1).

**Figure 5-1081 Release another tab**



3. Release another tab (callout 1), and then remove the MBM rear cover (callout 2).

**Figure 5-1082 Remove the MBM rear cover**



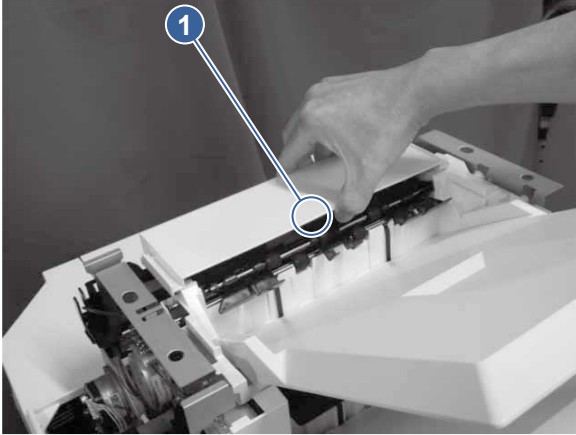
#### **4. Remove the MBM top cover (floor-standing stapler-stacker)**

Learn about removing the floor-standing stapler-stacker mailbox/booklet-maker top cover.



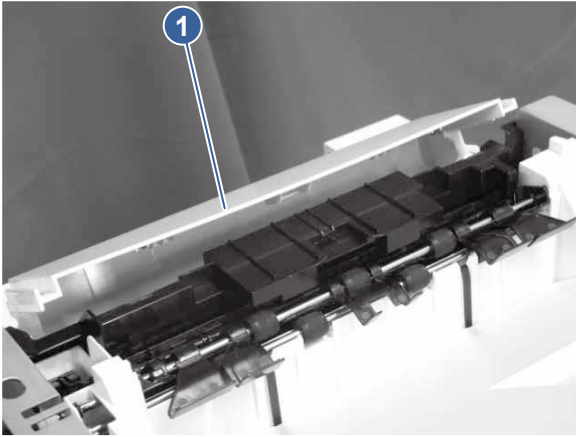
1. Release one tab (callout 1).

**Figure 5-1083 Release one tab**



2. Remove the MBM top cover (callout 1).

**Figure 5-1084 Remove the MBM top cover**



## 5. Unpack the replacement assembly

Follow these steps to unpack the replacement assembly.

1. Dispose of the defective part.




**NOTE:** HP recommends responsible disposal of the defective part.

<http://www8.hp.com/us/en/hp-information/environment/product-recycling.html>


2. Unpack the replacement part from the packaging.



**CAUTION:**  Some parts are sensitive to electrostatic discharge (ESD). Always perform service work at an ESD-protected workstation or mat. If an ESD workstation or mat is not available, touch the sheet-metal chassis to provide a static ground before touching an ESD-sensitive assembly. Protect the ESD-sensitive assemblies by placing them in ESD pouches when they are out of the printer.




**IMPORTANT:** Make sure that all of the shipping materials (for example shipping tape) are removed from the replacement part prior to installation.

 **NOTE:** If the replacement part is a roller or pad, avoid touching the spongy part of it. Skin oils on the roller or pad can cause paper pickup and/or print-quality problems. HP recommends using disposable gloves when handling rollers or pads or washing your hands before touching rollers or pads.

---

3. To install an assembly, reverse the removal steps.

 **NOTE:** When applicable, special installation instructions are provided for an assembly at the end of the removal procedure. Always completely read the removal instructions and follow all special installation instructions.

---


## Removal and replacement: MBM output bin (floor-standing stapler-stacker)

Learn about removing and replacing the floor-standing stapler-stacker mailbox/booklet-maker output bin.

### Before performing service

#### Turn the printer power off

- Disconnect the power cable.

 **WARNING!** To avoid damage to the printer, turn the printer off, wait 30 seconds, and then remove the power cord before attempting to service the printer.

---

Use the table below to identify the correct part number for your printer, and then go to <https://parts.hp.com/hpparts> to order the part.

**Table 5-152** Part information

Part number	Part description
RC6-0513-000CN	Tray, MBM (FSSS)

### Required tools

- #2 Phillips screwdriver with a magnetic tip and a 152 mm (6 in) shaft length
- Small flat-blade screwdriver

### After performing service

#### Turn the printer power on

- Connect the power cable.
- Use the power switch to turn the power on.

### Post service test

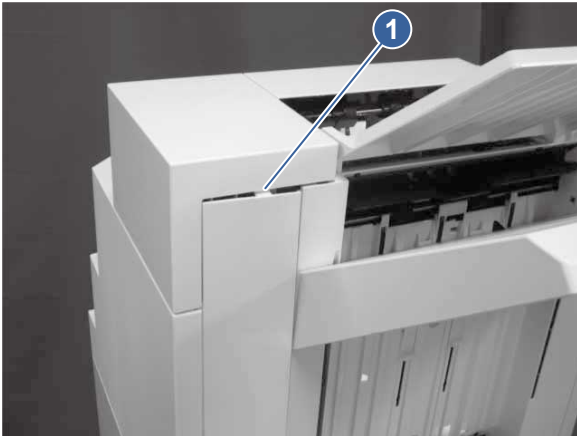
Print any pages necessary to make sure the printer is functioning correctly.

## 1. Remove the left upper rear cover (floor-standing stapler-stacker)

Learn about removing the floor-standing stapler-stacker left upper rear cover.

1. Release one tab (callout 1).

**Figure 5-1085 Release one tab**



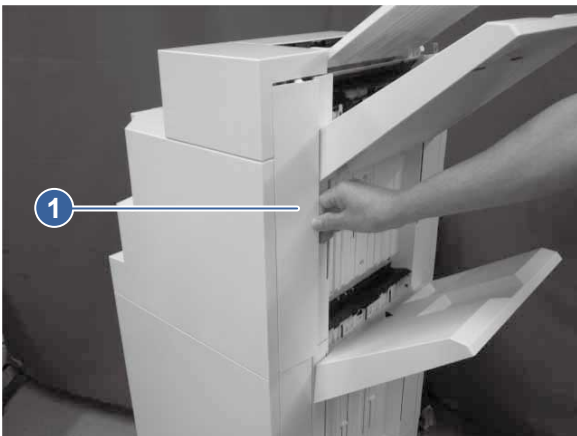
2. Release one boss (callout 1).

**Figure 5-1086 Release one boss**



3. Pull up the left upper rear cover (callout 1) to remove it.

**Figure 5-1087 Remove the left upper rear cover**

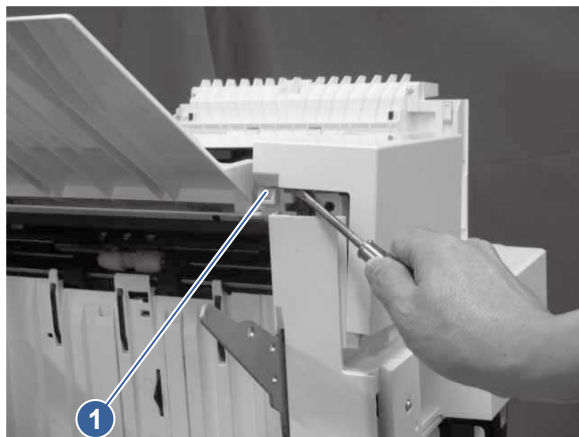


## 2. Remove the MBM front cover (floor-standing stapler-stacker)

Learn about removing the floor-standing stapler-stacker mailbox/booklet-maker front cover.

1. Release one tab (callout 1).

**Figure 5-1088 Release one tab**



2. Release one tab (callout 1), and then remove the MBM front cover (callout 2).

**Figure 5-1089 Remove the MBM front cover**



## 3. Remove the MBM rear cover (floor-standing stapler-stacker)

Learn about removing the floor-standing stapler-stacker mailbox/booklet-maker rear cover.

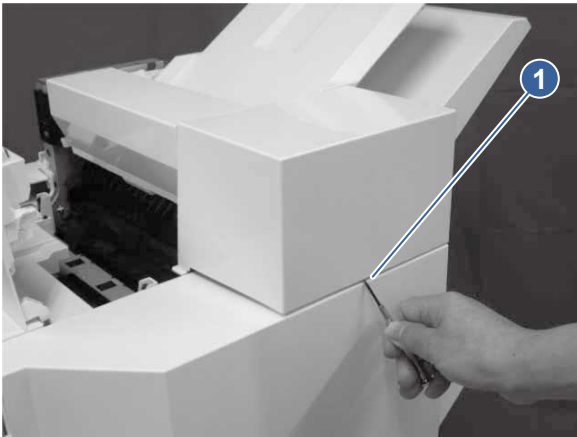
1. On the inside of the cover, release one tab (callout 1).

**Figure 5-1090 Release one tab**



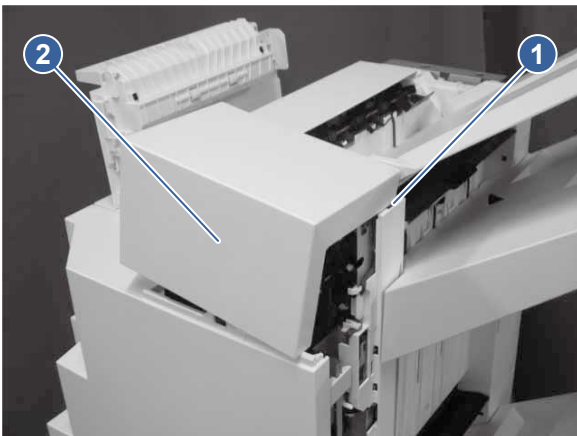
2. Release another tab (callout 1).

**Figure 5-1091 Release another tab**



3. Release another tab (callout 1), and then remove the MBM rear cover (callout 2).

**Figure 5-1092 Remove the MBM rear cover**

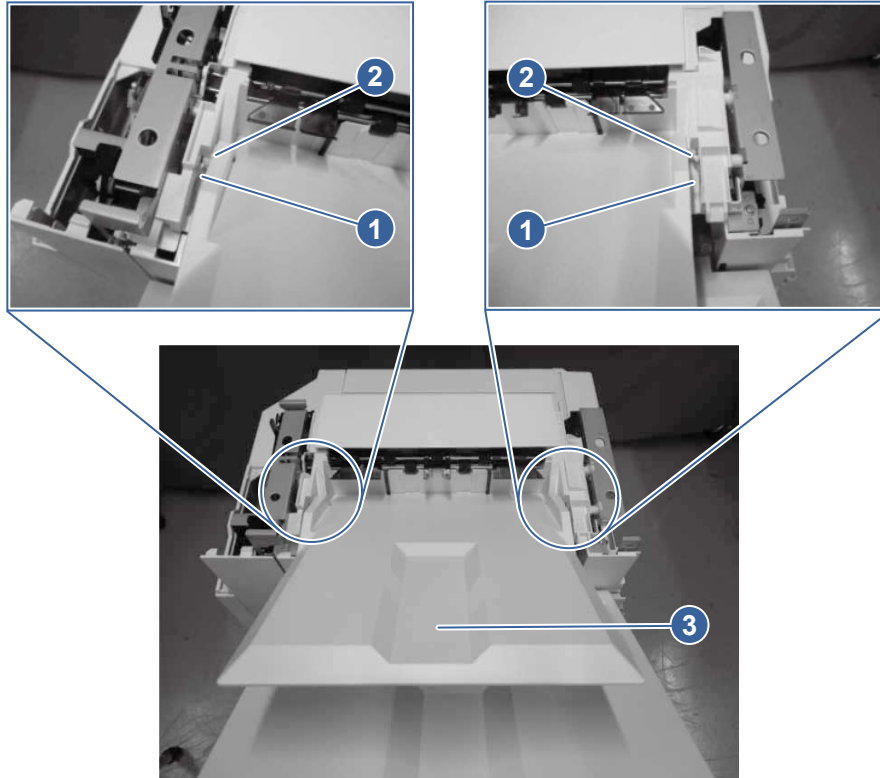


#### 4. Remove the MBM output bin (floor-standing stapler-stacker)

Learn about removing the floor-standing stapler-stacker mailbox/booklet-maker output bin.

- Press the left and right stoppers (callout 1) to remove the shaft (callout 2), and then remove the MBM output bin (callout 3).


**Figure 5-1093** Remove the MBM output bin



#### 5. Unpack the replacement assembly



Follow these steps to unpack the replacement assembly.


1. Dispose of the defective part.


 **NOTE:** HP recommends responsible disposal of the defective part.

<http://www8.hp.com/us/en/hp-information/environment/product-recycling.html>

2. Unpack the replacement part from the packaging.

 **CAUTION:**  Some parts are sensitive to electrostatic discharge (ESD). Always perform service work at an ESD-protected workstation or mat. If an ESD workstation or mat is not available, touch the sheet-metal chassis to provide a static ground before touching an ESD-sensitive assembly. Protect the ESD-sensitive assemblies by placing them in ESD pouches when they are out of the printer.

 **IMPORTANT:** Make sure that all of the shipping materials (for example shipping tape) are removed from the replacement part prior to installation.

 **NOTE:** If the replacement part is a roller or pad, avoid touching the spongy part of it. Skin oils on the roller or pad can cause paper pickup and/or print-quality problems. HP recommends using disposable gloves when handling rollers or pads or washing your hands before touching rollers or pads.

3. To install an assembly, reverse the removal steps.



**NOTE:** When applicable, special installation instructions are provided for an assembly at the end of the removal procedure. Always completely read the removal instructions and follow all special installation instructions.

### Removal and replacement: Front inner upper cover (floor-standing stapler-stacker)

Learn about removing and replacing the floor-standing stapler-stacker front inner upper cover.

#### Before performing service

##### Turn the printer power off

- Disconnect the power cable.

**⚠ WARNING!** To avoid damage to the printer, turn the printer off, wait 30 seconds, and then remove the power cord before attempting to service the printer.

Use the table below to identify the correct part number for your printer, and then go to <https://parts.hp.com/hpparts> to order the part.

**Table 5-153** Part information

Part number	Part description
RC6-0186-000CN	Cover, front inner upper (FSSS)

#### Required tools

- #2 Phillips screwdriver with a magnetic tip and a 152 mm (6 in) shaft length
- Small flat-blade screwdriver

#### After performing service

##### Turn the printer power on

- Connect the power cable.
- Use the power switch to turn the power on.

#### Post service test

Print any pages necessary to make sure the printer is functioning correctly.

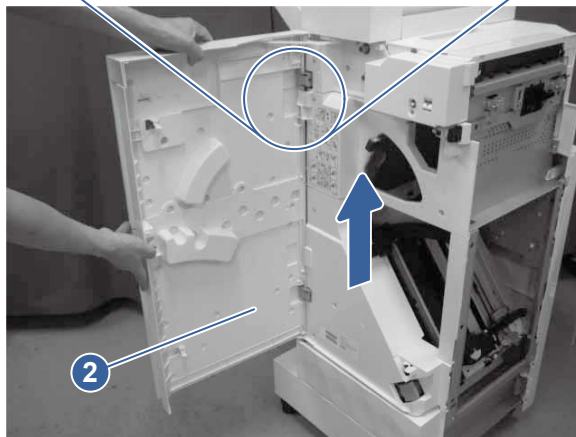
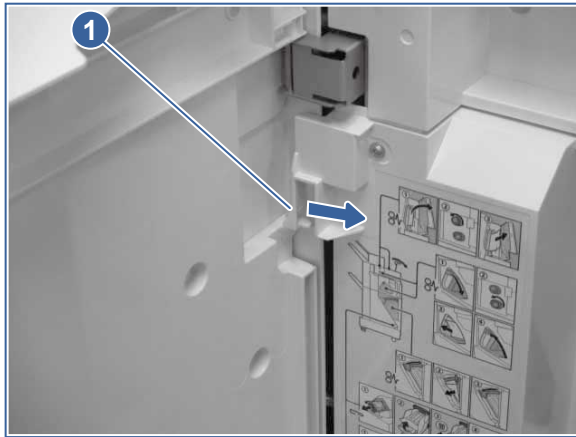
### 1. Remove the front door assembly (floor-standing stapler-stacker)

Learn about removing the floor-standing stapler-stacker front door assembly.

1. Open the front door.

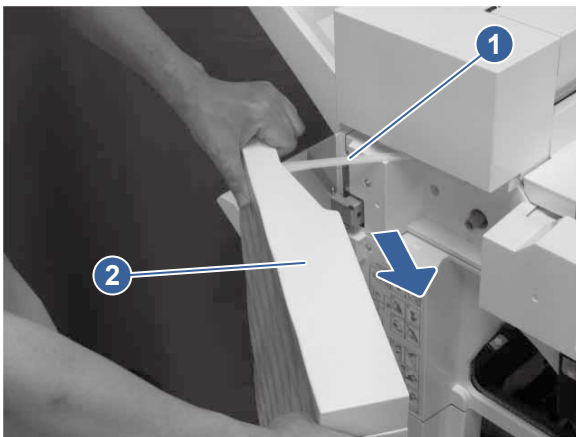
2. Push the stopper (callout 1) in the direction indicated, and then pull up the front door assembly (callout 2) to remove it.

**Figure 5-1094 Remove the front door assembly**



3. Remove the hinge (callout 1) from the front door assembly (callout 2).

**Figure 5-1095 Remove the hinge**



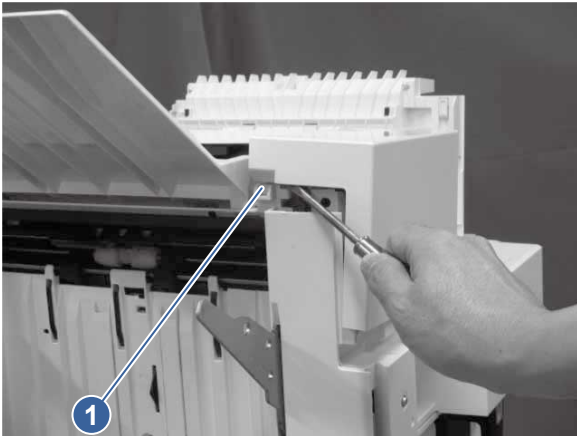
## 2. Remove the MBM front cover (floor-standing stapler-stacker)

Learn about removing the floor-standing stapler-stacker mailbox/booklet-maker front cover.



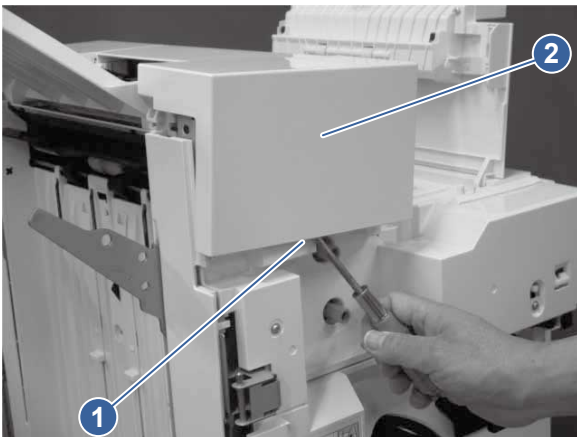
1. Release one tab (callout 1).

**Figure 5-1096 Release one tab**



2. Release one tab (callout 1), and then remove the MBM front cover (callout 2).

**Figure 5-1097 Remove the MBM front cover**

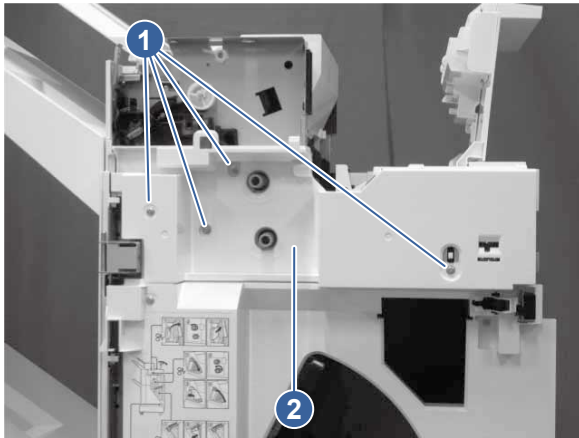


3. Remove the front inner upper cover (floor-standing stapler-stacker)

Learn about removing the floor-standing stapler-stacker front inner upper cover.

- Remove four screws (callout 1), and then remove the front inner upper cover (callout 2).

**Figure 5-1098 Remove the front inner upper cover**



#### 4. Unpack the replacement assembly



Follow these steps to unpack the replacement assembly.


1. Dispose of the defective part.


 **NOTE:** HP recommends responsible disposal of the defective part.

<http://www8.hp.com/us/en/hp-information/environment/product-recycling.html>


2. Unpack the replacement part from the packaging.

 **CAUTION:**  Some parts are sensitive to electrostatic discharge (ESD). Always perform service work at an ESD-protected workstation or mat. If an ESD workstation or mat is not available, touch the sheet-metal chassis to provide a static ground before touching an ESD-sensitive assembly. Protect the ESD-sensitive assemblies by placing them in ESD pouches when they are out of the printer.

 **IMPORTANT:** Make sure that all of the shipping materials (for example shipping tape) are removed from the replacement part prior to installation.

 **NOTE:** If the replacement part is a roller or pad, avoid touching the spongy part of it. Skin oils on the roller or pad can cause paper pickup and/or print-quality problems. HP recommends using disposable gloves when handling rollers or pads or washing your hands before touching rollers or pads.

3. To install an assembly, reverse the removal steps.

 **NOTE:** When applicable, special installation instructions are provided for an assembly at the end of the removal procedure. Always completely read the removal instructions and follow all special installation instructions.

#### Removal and replacement: Front inner lower cover (floor-standing stapler-stacker)

Learn about removing and replacing the floor-standing stapler-stacker front inner lower cover.

##### Before performing service

Turn the printer power off

- Disconnect the power cable.

**⚠ WARNING!** To avoid damage to the printer, turn the printer off, wait 30 seconds, and then remove the power cord before attempting to service the printer.

Use the table below to identify the correct part number for your printer, and then go to <https://parts.hp.com/hpparts> to order the part.

**Table 5-154 Part information**

Part number	Part description
RM2-3862-000CN	Lower front inner cover assembly (FSSS)

## Required tools

- #2 Phillips screwdriver with a magnetic tip and a 152 mm (6 in) shaft length
- Small flat-blade screwdriver

## After performing service

### Turn the printer power on

- Connect the power cable.
- Use the power switch to turn the power on.

## Post service test

Print any pages necessary to make sure the printer is functioning correctly.

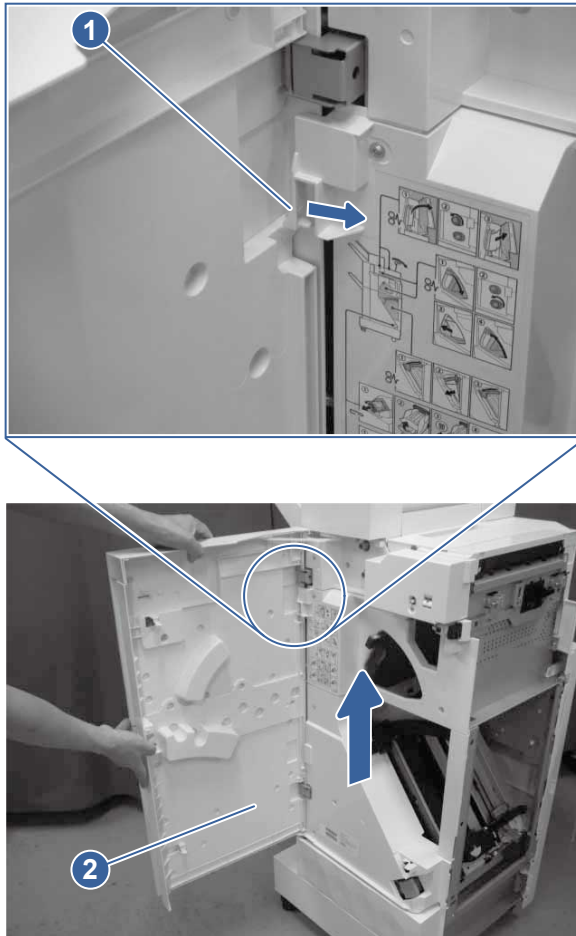
### 1. Remove the front door assembly (floor-standing stapler-stacker)

Learn about removing the floor-standing stapler-stacker front door assembly.

1. Open the front door.

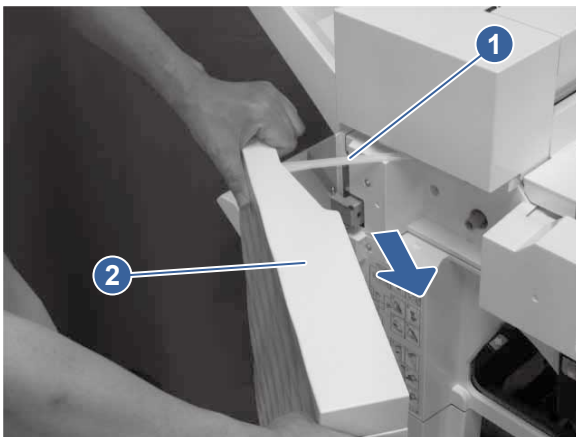
2. Push the stopper (callout 1) in the direction indicated, and then pull up the front door assembly (callout 2) to remove it.

**Figure 5-1099 Remove the front door assembly**



3. Remove the hinge (callout 1) from the front door assembly (callout 2).

**Figure 5-1100 Remove the hinge**

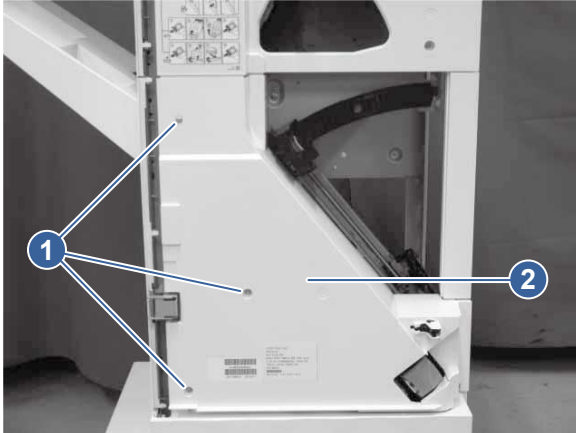


## 2. Remove the front inner lower cover (floor-standing stapler-stacker)

Learn about removing the floor-standing stapler-stacker front inner lower cover.

- Remove three screws (callout 1), and then remove the front inner lower cover (callout 2).

**Figure 5-1101 Remove the front inner lower cover**




### 3. Unpack the replacement assembly

Follow these steps to unpack the replacement assembly.

1. Dispose of the defective part.

---



 **NOTE:** HP recommends responsible disposal of the defective part.


<http://www8.hp.com/us/en/hp-information/environment/product-recycling.html>


---

2. Unpack the replacement part from the packaging.

---

 **CAUTION:**  Some parts are sensitive to electrostatic discharge (ESD). Always perform service work at an ESD-protected workstation or mat. If an ESD workstation or mat is not available, touch the sheet-metal chassis to provide a static ground before touching an ESD-sensitive assembly. Protect the ESD-sensitive assemblies by placing them in ESD pouches when they are out of the printer.


 **IMPORTANT:** Make sure that all of the shipping materials (for example shipping tape) are removed from the replacement part prior to installation.

 **NOTE:** If the replacement part is a roller or pad, avoid touching the spongy part of it. Skin oils on the roller or pad can cause paper pickup and/or print-quality problems. HP recommends using disposable gloves when handling rollers or pads or washing your hands before touching rollers or pads.

---

3. To install an assembly, reverse the removal steps.

---

 **NOTE:** When applicable, special installation instructions are provided for an assembly at the end of the removal procedure. Always completely read the removal instructions and follow all special installation instructions.

---

### Removal and replacement: Front inner cover (floor-standing stapler-stacker)

Learn about removing and replacing the floor-standing stapler-stacker front inner cover.

#### Before performing service

**Turn the printer power off**

- Disconnect the power cable.

**⚠ WARNING!** To avoid damage to the printer, turn the printer off, wait 30 seconds, and then remove the power cord before attempting to service the printer.

Use the table below to identify the correct part number for your printer, and then go to <https://parts.hp.com/hpparts> to order the part.

**Table 5-155 Part information**

Part number	Part description
RM2-3861-000CN	Front inner cover assembly (FSSS)

### Required tools

- #2 Phillips screwdriver with a magnetic tip and a 152 mm (6 in) shaft length
- Small flat-blade screwdriver

### After performing service

#### Turn the printer power on

- Connect the power cable.
- Use the power switch to turn the power on.

### Post service test

Print any pages necessary to make sure the printer is functioning correctly.

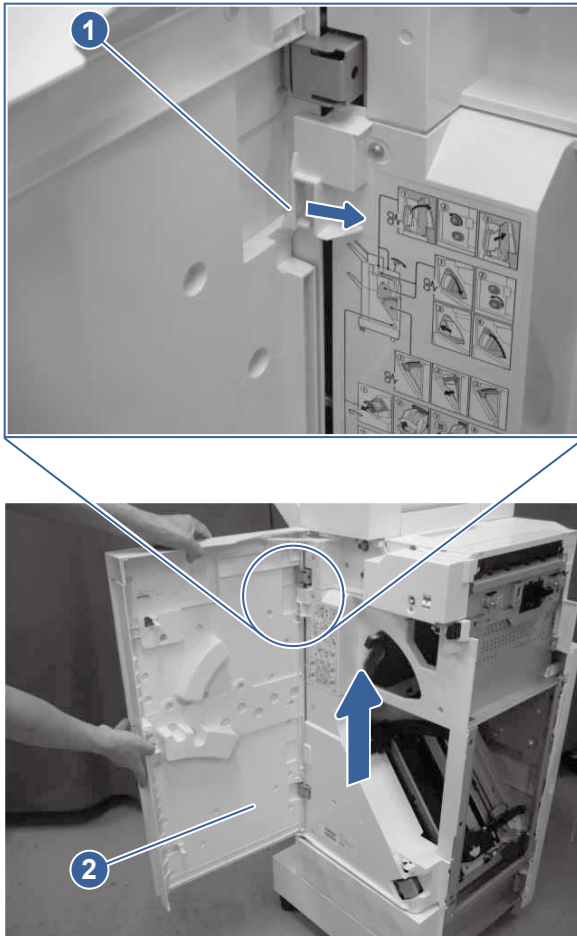
#### 1. Remove the front door assembly (floor-standing stapler-stacker)

Learn about removing the floor-standing stapler-stacker front door assembly.

1. Open the front door.

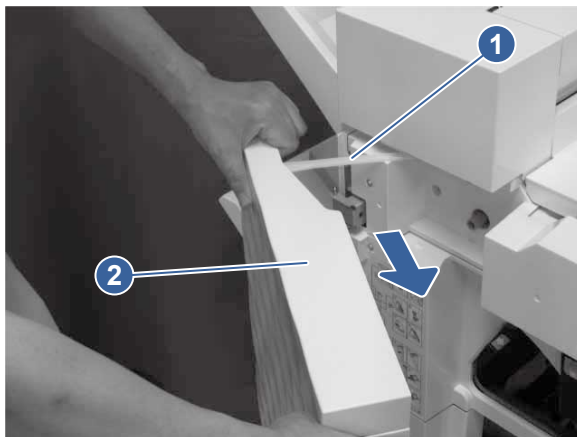
2. Push the stopper (callout 1) in the direction indicated, and then pull up the front door assembly (callout 2) to remove it.

**Figure 5-1102 Remove the front door assembly**



3. Remove the hinge (callout 1) from the front door assembly (callout 2).

**Figure 5-1103 Remove the hinge**

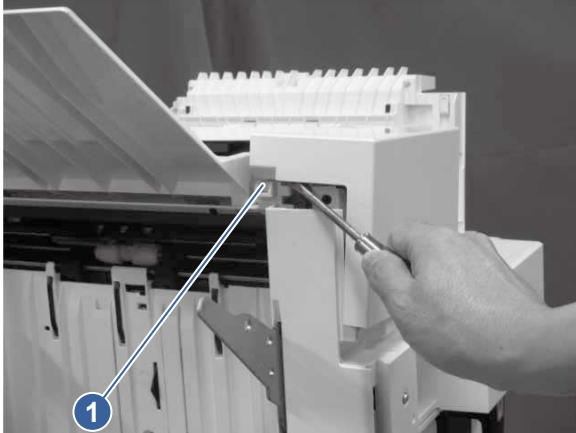


## 2. Remove the MBM front cover (floor-standing stapler-stacker)

Learn about removing the floor-standing stapler-stacker mailbox/booklet-maker front cover.

1. Release one tab (callout 1).

**Figure 5-1104 Release one tab**



2. Release one tab (callout 1), and then remove the MBM front cover (callout 2).

**Figure 5-1105 Remove the MBM front cover**



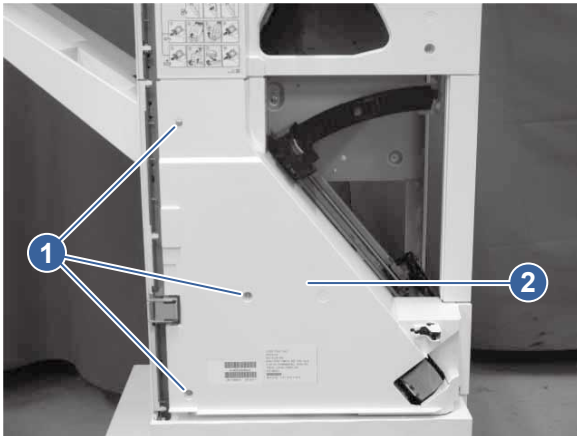
3. Remove the front inner lower cover (floor-standing stapler-stacker)

Learn about removing the floor-standing stapler-stacker front inner lower cover.



- Remove three screws (callout 1), and then remove the front inner lower cover (callout 2).

**Figure 5-1106 Remove the front inner lower cover**

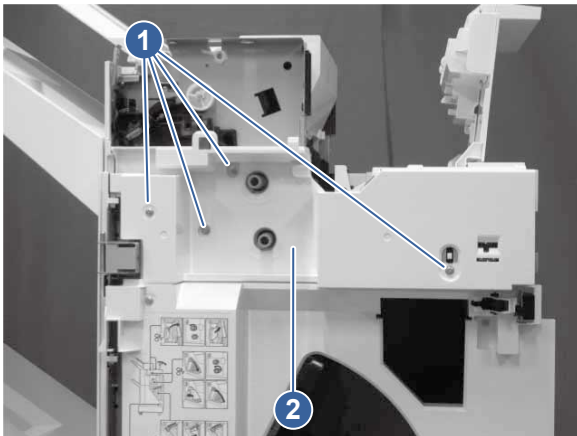


#### 4. Remove the front inner upper cover (floor-standing stapler-stacker)

Learn about removing the floor-standing stapler-stacker front inner upper cover.

- Remove four screws (callout 1), and then remove the front inner upper cover (callout 2).

**Figure 5-1107 Remove the front inner upper cover**

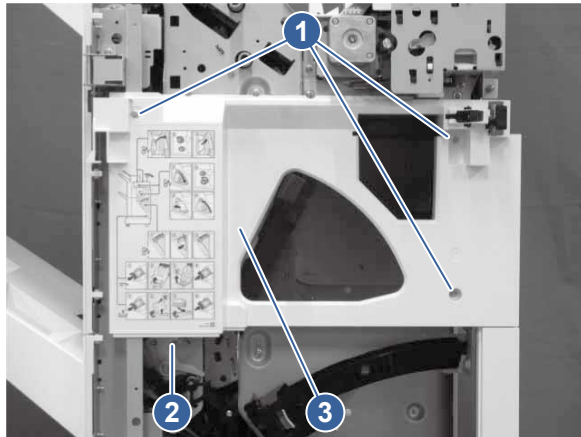


#### 5. Remove the front inner cover (floor-standing stapler-stacker)

Learn about removing the floor-standing stapler-stacker front inner cover.

- Remove three screws (callout 1), release one tab (callout 2), and then remove the front inner cover (callout 3).

**Figure 5-1108 Remove the front inner cover**



## 6. Unpack the replacement assembly



Follow these steps to unpack the replacement assembly.


1. Dispose of the defective part.


 **NOTE:** HP recommends responsible disposal of the defective part.

<http://www8.hp.com/us/en/hp-information/environment/product-recycling.html>


2. Unpack the replacement part from the packaging.

 **CAUTION:**  Some parts are sensitive to electrostatic discharge (ESD). Always perform service work at an ESD-protected workstation or mat. If an ESD workstation or mat is not available, touch the sheet-metal chassis to provide a static ground before touching an ESD-sensitive assembly. Protect the ESD-sensitive assemblies by placing them in ESD pouches when they are out of the printer.

 **IMPORTANT:** Make sure that all of the shipping materials (for example shipping tape) are removed from the replacement part prior to installation.

 **NOTE:** If the replacement part is a roller or pad, avoid touching the spongy part of it. Skin oils on the roller or pad can cause paper pickup and/or print-quality problems. HP recommends using disposable gloves when handling rollers or pads or washing your hands before touching rollers or pads.

3. To install an assembly, reverse the removal steps.

 **NOTE:** When applicable, special installation instructions are provided for an assembly at the end of the removal procedure. Always completely read the removal instructions and follow all special installation instructions.

## Removal and replacement: Foot front cover (tall model only) (floor-standing stapler-stacker)

Learn about removing and replacing the floor-standing stapler-stacker foot front cover (tall finishers).

### Before performing service

**Turn the printer power off**

- Disconnect the power cable.

**⚠ WARNING!** To avoid damage to the printer, turn the printer off, wait 30 seconds, and then remove the power cord before attempting to service the printer.

Use the table below to identify the correct part number for your printer, and then go to <https://parts.hp.com/hpparts> to order the part.

**Table 5-156 Part information**

Part number	Part description
RC6-0226-000CN	Cover, foot front (tall model) (FSSS)

## Required tools

- #2 Phillips screwdriver with a magnetic tip and a 152 mm (6 in) shaft length
- Small flat-blade screwdriver

## After performing service

### Turn the printer power on

- Connect the power cable.
- Use the power switch to turn the power on.

## Post service test

Print any pages necessary to make sure the printer is functioning correctly.

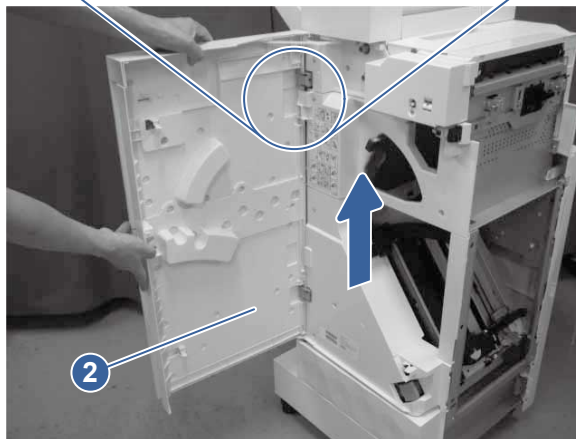
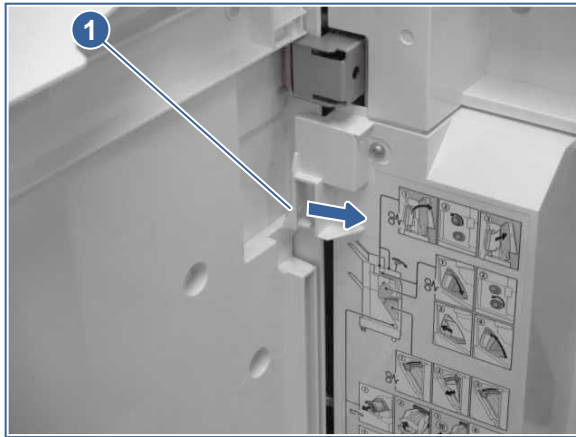
### 1. Remove the front door assembly (floor-standing stapler-stacker)

Learn about removing the floor-standing stapler-stacker front door assembly.

1. Open the front door.

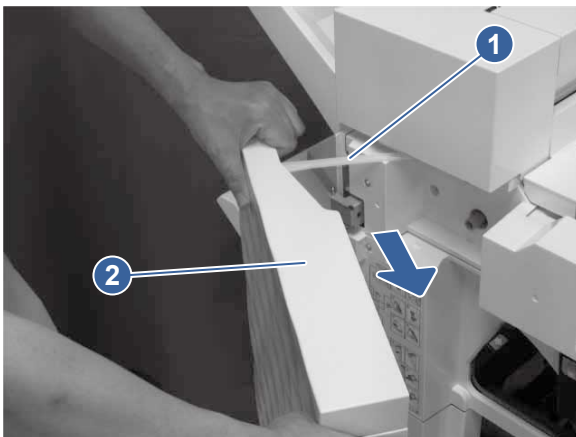
2. Push the stopper (callout 1) in the direction indicated, and then pull up the front door assembly (callout 2) to remove it.

**Figure 5-1109 Remove the front door assembly**



3. Remove the hinge (callout 1) from the front door assembly (callout 2).

**Figure 5-1110 Remove the hinge**

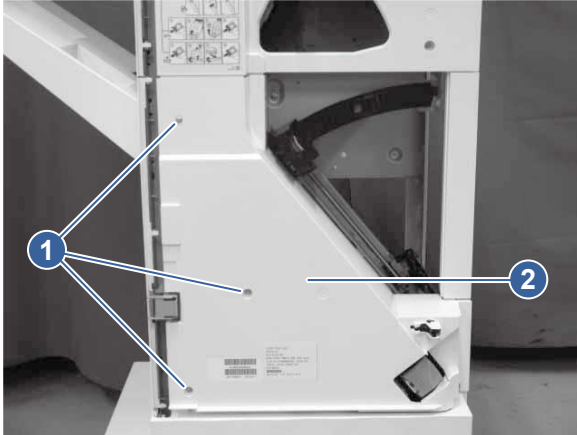


## 2. Remove the front inner lower cover (floor-standing stapler-stacker)

Learn about removing the floor-standing stapler-stacker front inner lower cover.

- Remove three screws (callout 1), and then remove the front inner lower cover (callout 2).

**Figure 5-1111 Remove the front inner lower cover**

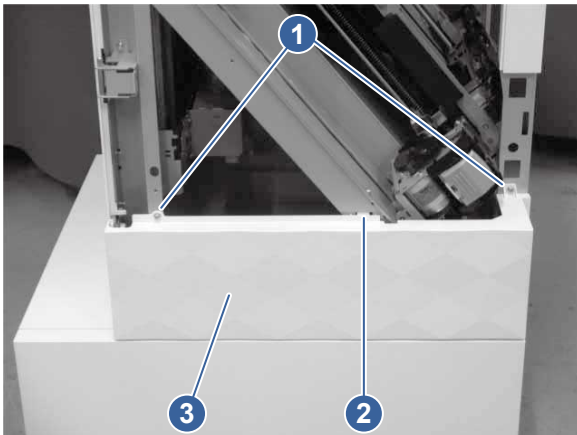


### 3. Remove the foot front cover (tall floor-standing stapler-stacker)

Learn about removing the tall floor-standing stapler-stacker foot front cover.

- Remove two screws (callout 1), release one tab (callout 2), and then remove the foot front cover (callout 3).

**Figure 5-1112 Remove the foot front cover (tall finisher)**



### 4. Unpack the replacement assembly

Follow these steps to unpack the replacement assembly.



1. Dispose of the defective part.





**NOTE:** HP recommends responsible disposal of the defective part.

<http://www8.hp.com/us/en/hp-information/environment/product-recycling.html>


## 2. Unpack the replacement part from the packaging.

 **CAUTION:**  Some parts are sensitive to electrostatic discharge (ESD). Always perform service work at an ESD-protected workstation or mat. If an ESD workstation or mat is not available, touch the sheet-metal chassis to provide a static ground before touching an ESD-sensitive assembly. Protect the ESD-sensitive assemblies by placing them in ESD pouches when they are out of the printer.

 **IMPORTANT:** Make sure that all of the shipping materials (for example shipping tape) are removed from the replacement part prior to installation.

 **NOTE:** If the replacement part is a roller or pad, avoid touching the spongy part of it. Skin oils on the roller or pad can cause paper pickup and/or print-quality problems. HP recommends using disposable gloves when handling rollers or pads or washing your hands before touching rollers or pads.

## 3. To install an assembly, reverse the removal steps.

 **NOTE:** When applicable, special installation instructions are provided for an assembly at the end of the removal procedure. Always completely read the removal instructions and follow all special installation instructions.


### Removal and replacement: Foot front cover (floor-standing stapler-stacker)

Learn about removing and replacing the floor-standing stapler-stacker foot front cover (regular-size finishers).

#### Before performing service

##### Turn the printer power off

- Disconnect the power cable.

 **WARNING!** To avoid damage to the printer, turn the printer off, wait 30 seconds, and then remove the power cord before attempting to service the printer.

Use the table below to identify the correct part number for your printer, and then go to <https://parts.hp.com/hpparts> to order the part.

**Table 5-157** Part information

Part number	Part description
RC6-0220-000CN	Cover, foot front (FSSS)

#### Required tools

- #2 Phillips screwdriver with a magnetic tip and a 152 mm (6 in) shaft length
- Small flat-blade screwdriver

#### After performing service

##### Turn the printer power on

- Connect the power cable.
- Use the power switch to turn the power on.

## Post service test

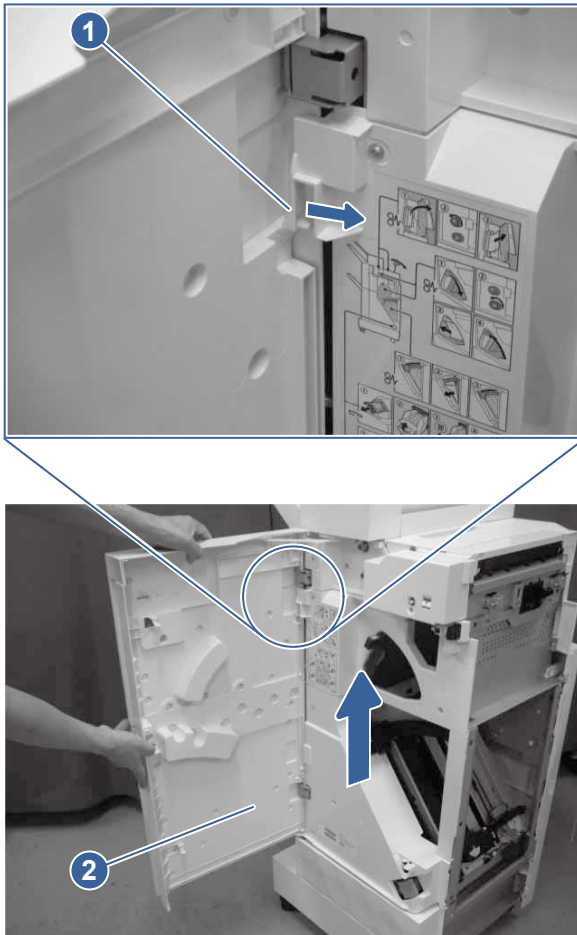
Print any pages necessary to make sure the printer is functioning correctly.

### 1. Remove the front door assembly (floor-standing stapler-stacker)

Learn about removing the floor-standing stapler-stacker front door assembly.

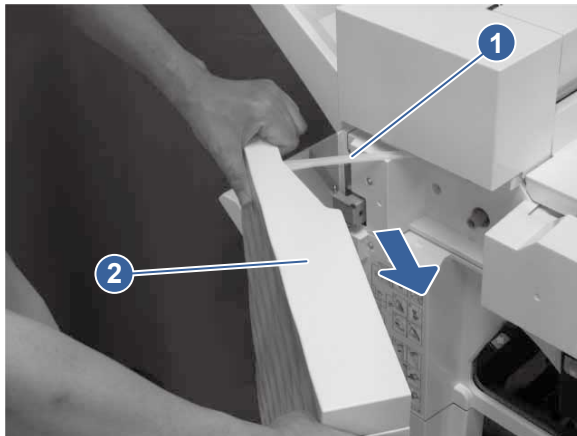
1. Open the front door.
2. Push the stopper (callout 1) in the direction indicated, and then pull up the front door assembly (callout 2) to remove it.

**Figure 5-1113 Remove the front door assembly**



3. Remove the hinge (callout 1) from the front door assembly (callout 2).

**Figure 5-1114 Remove the hinge**

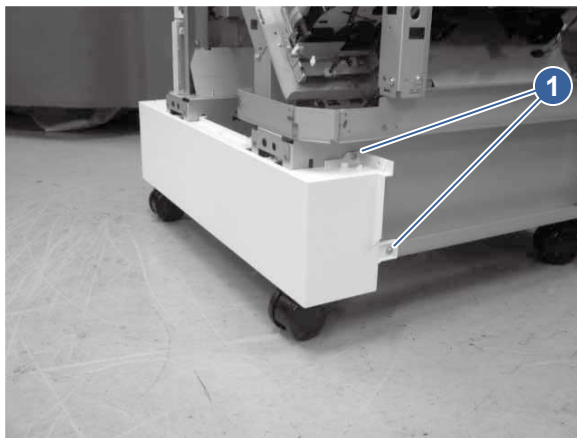


## 2. Remove the foot front cover (standard floor-standing stapler-stacker)

Learn about removing the standard floor-standing stapler-stacker foot front cover.

1. Remove two screws (callout 1).

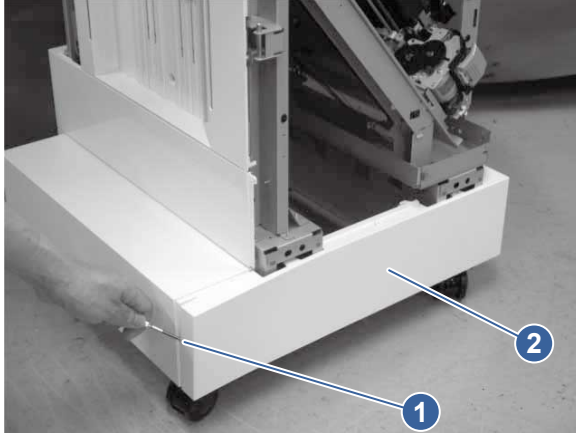
**Figure 5-1115 Remove two screws**





2. Release one tab (callout 1), and then remove the foot front cover (callout 2).

**Figure 5-1116 Remove the foot front cover (standard finisher)**



### 3. Unpack the replacement assembly

Follow these steps to unpack the replacement assembly.

1. Dispose of the defective part.




**NOTE:** HP recommends responsible disposal of the defective part.

<http://www8.hp.com/us/en/hp-information/environment/product-recycling.html>

2. Unpack the replacement part from the packaging.



**CAUTION:**  Some parts are sensitive to electrostatic discharge (ESD). Always perform service work at an ESD-protected workstation or mat. If an ESD workstation or mat is not available, touch the sheet-metal chassis to provide a static ground before touching an ESD-sensitive assembly. Protect the ESD-sensitive assemblies by placing them in ESD pouches when they are out of the printer.



**IMPORTANT:** Make sure that all of the shipping materials (for example shipping tape) are removed from the replacement part prior to installation.



**NOTE:** If the replacement part is a roller or pad, avoid touching the spongy part of it. Skin oils on the roller or pad can cause paper pickup and/or print-quality problems. HP recommends using disposable gloves when handling rollers or pads or washing your hands before touching rollers or pads.

3. To install an assembly, reverse the removal steps.



**NOTE:** When applicable, special installation instructions are provided for an assembly at the end of the removal procedure. Always completely read the removal instructions and follow all special installation instructions.

### Removal and replacement: Foot rear cover (floor-standing stapler-stacker)

Learn about removing and replacing the floor-standing stapler-stacker foot rear cover.

#### Before performing service

##### Turn the printer power off

- Disconnect the power cable.

**⚠ WARNING!** To avoid damage to the printer, turn the printer off, wait 30 seconds, and then remove the power cord before attempting to service the printer.

Use the table below to identify the correct part number for your printer, and then go to <https://parts.hp.com/hpparts> to order the part.

**Table 5-158 Part information**

Part number	Part description
RC6-0222-000CN	Cover, foot rear (FSSS)

## Required tools

- #2 Phillips screwdriver with a magnetic tip and a 152 mm (6 in) shaft length
- Small flat-blade screwdriver

## After performing service

### Turn the printer power on

- Connect the power cable.
- Use the power switch to turn the power on.

## Post service test

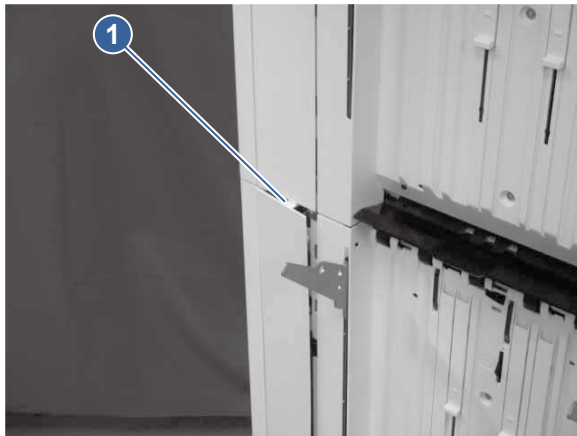
Print any pages necessary to make sure the printer is functioning correctly.

### 1. Remove the left lower rear cover (floor-standing stapler-stacker)

Learn about removing the floor-standing stapler-stacker left lower rear cover.

1. Release one tab (callout 1).

**Figure 5-1117 Release one tab**



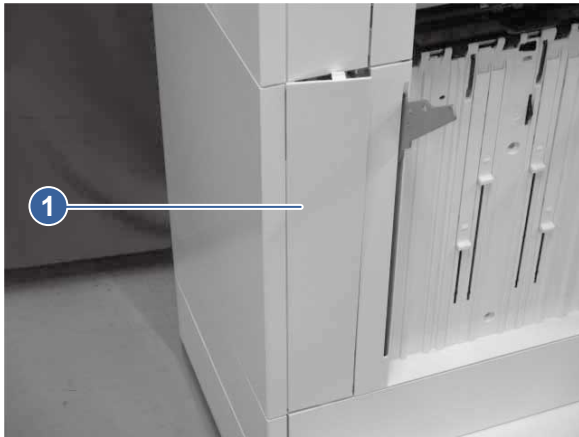
2. Release one boss (callout 1).

**Figure 5-1118 Release one boss**



3. Pull up the left lower rear cover (callout 1) to remove it.

**Figure 5-1119 Remove the left lower rear cover**

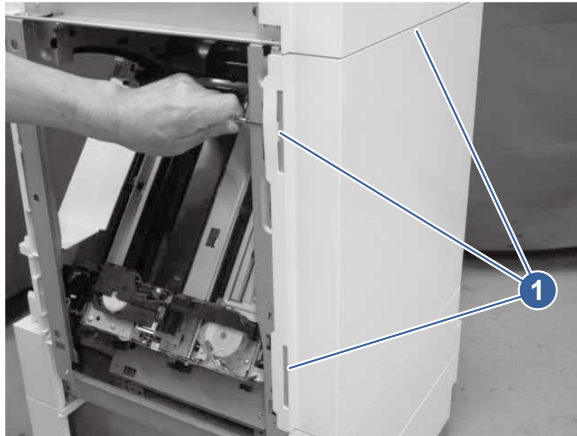


## 2. Remove the rear cover (floor-standing stapler-stacker)

Learn about removing the floor-standing stapler-stacker rear cover.

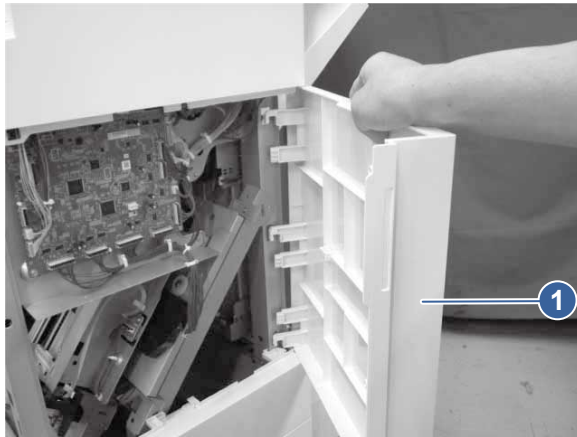
1. Release three tabs (callout 1).

**Figure 5-1120 Release three tabs**



2. Remove the rear cover (callout 1).

**Figure 5-1121 Remove the rear cover**

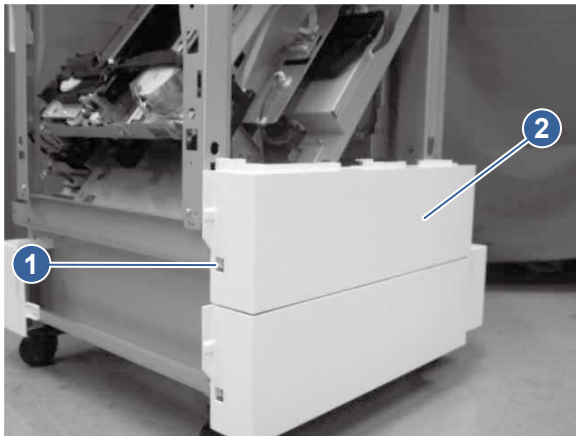


### **3. Remove the foot rear cover (floor-standing stapler-stacker)**

Learn about removing the floor-standing stapler-stacker foot rear cover.

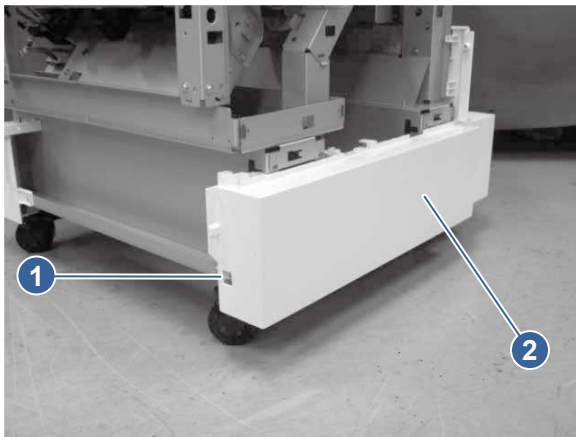
1. **Tall finishers only:** Remove one screw (callout 1), and then remove the tall foot rear cover (callout 2).

**Figure 5-1122 Remove the tall finisher cover**



2. Remove one screw (callout 1), and then remove the foot rear cover (callout 1).

**Figure 5-1123 Remove the foot rear cover**



#### 4. **Unpack the replacement assembly**

Follow these steps to unpack the replacement assembly.

1. Dispose of the defective part.




**NOTE:** HP recommends responsible disposal of the defective part.

<http://www8.hp.com/us/en/hp-information/environment/product-recycling.html>


2. Unpack the replacement part from the packaging.



**CAUTION:**  Some parts are sensitive to electrostatic discharge (ESD). Always perform service work at an ESD-protected workstation or mat. If an ESD workstation or mat is not available, touch the sheet-metal chassis to provide a static ground before touching an ESD-sensitive assembly. Protect the ESD-sensitive assemblies by placing them in ESD pouches when they are out of the printer.




**IMPORTANT:** Make sure that all of the shipping materials (for example shipping tape) are removed from the replacement part prior to installation.

 **NOTE:** If the replacement part is a roller or pad, avoid touching the spongy part of it. Skin oils on the roller or pad can cause paper pickup and/or print-quality problems. HP recommends using disposable gloves when handling rollers or pads or washing your hands before touching rollers or pads.

---

3. To install an assembly, reverse the removal steps.

 **NOTE:** When applicable, special installation instructions are provided for an assembly at the end of the removal procedure. Always completely read the removal instructions and follow all special installation instructions.

---


## Removal and replacement: Foot center cover (floor-standing stapler-stacker)

Learn about removing and replacing the floor-standing stapler-stacker foot center cover.

### Before performing service

#### Turn the printer power off

- Disconnect the power cable.

 **WARNING!** To avoid damage to the printer, turn the printer off, wait 30 seconds, and then remove the power cord before attempting to service the printer.

---

Use the table below to identify the correct part number for your printer, and then go to <https://parts.hp.com/hpparts> to order the part.

**Table 5-159** Part information

Part number	Part description
RC6-0227-000CN	Cover, foot center (FSSS)

### Required tools

- #2 Phillips screwdriver with a magnetic tip and a 152 mm (6 in) shaft length
- Small flat-blade screwdriver

### After performing service

#### Turn the printer power on

- Connect the power cable.
- Use the power switch to turn the power on.

### Post service test

Print any pages necessary to make sure the printer is functioning correctly.

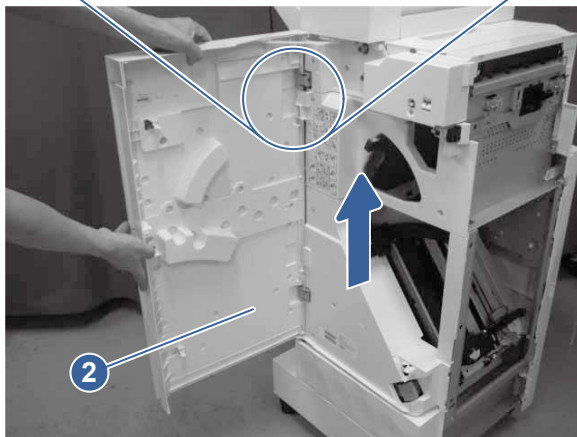
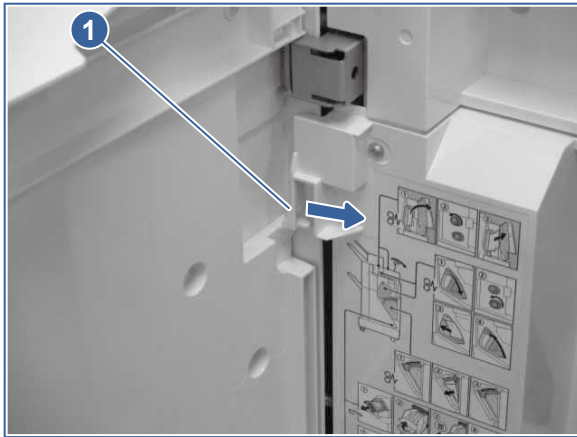
## 1. Remove the front door assembly (floor-standing stapler-stacker)

Learn about removing the floor-standing stapler-stacker front door assembly.

1. Open the front door.

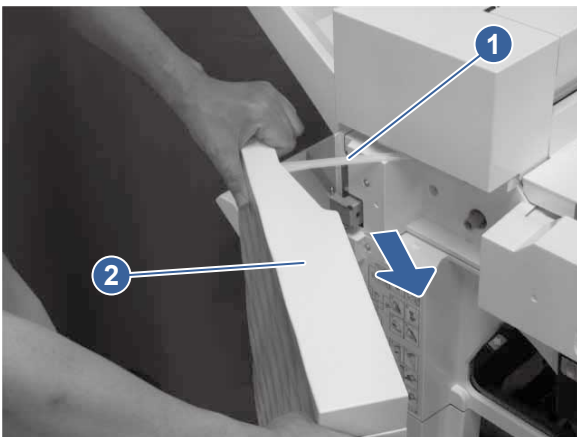
2. Push the stopper (callout 1) in the direction indicated, and then pull up the front door assembly (callout 2) to remove it.

**Figure 5-1124 Remove the front door assembly**



3. Remove the hinge (callout 1) from the front door assembly (callout 2).

**Figure 5-1125 Remove the hinge**

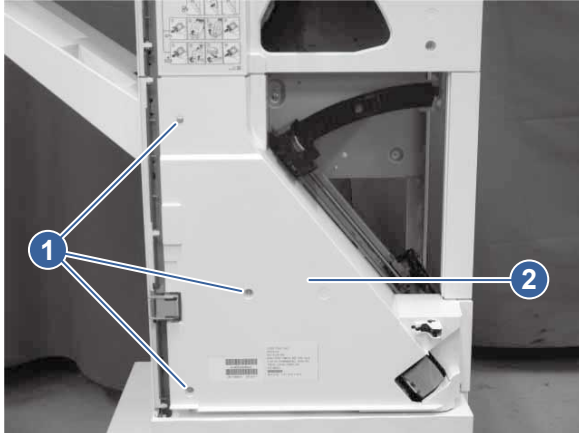


## **2. Remove the front inner lower cover (floor-standing stapler-stacker)**

Learn about removing the floor-standing stapler-stacker front inner lower cover.

- Remove three screws (callout 1), and then remove the front inner lower cover (callout 2).

**Figure 5-1126 Remove the front inner lower cover**

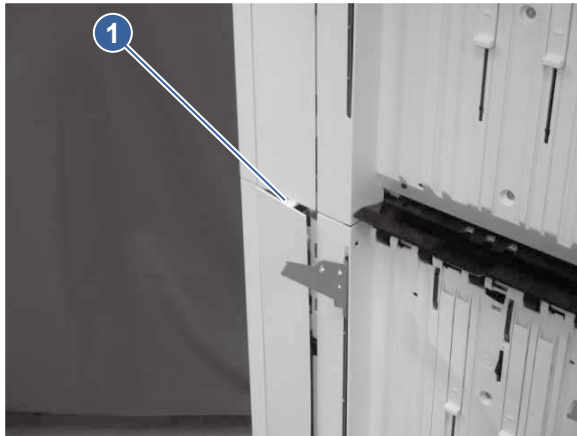


### 3. Remove the left lower rear cover (floor-standing stapler-stacker)

Learn about removing the floor-standing stapler-stacker left lower rear cover.

1. Release one tab (callout 1).

**Figure 5-1127 Release one tab**





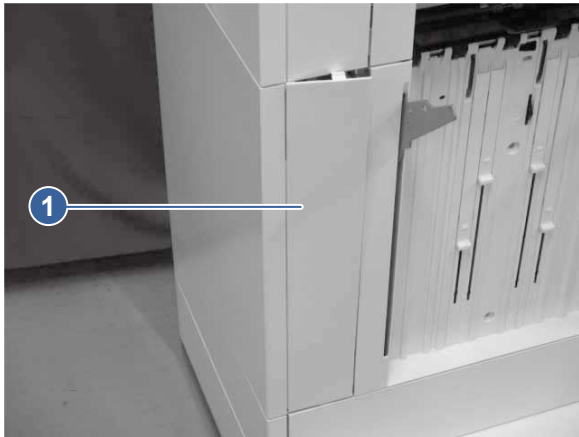
2. Release one boss (callout 1).

**Figure 5-1128 Release one boss**



3. Pull up the left lower rear cover (callout 1) to remove it.

**Figure 5-1129 Remove the left lower rear cover**

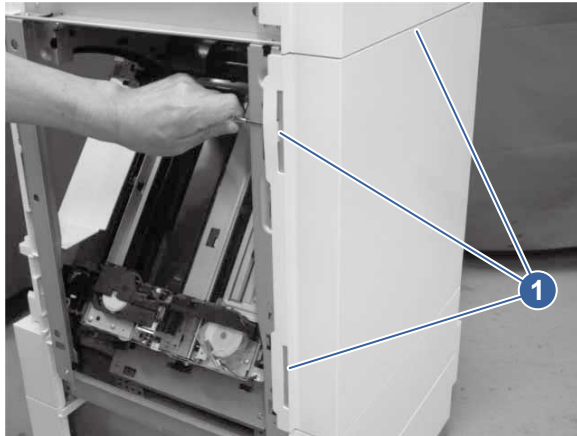


#### **4. Remove the rear cover (floor-standing stapler-stacker)**

Learn about removing the floor-standing stapler-stacker rear cover.

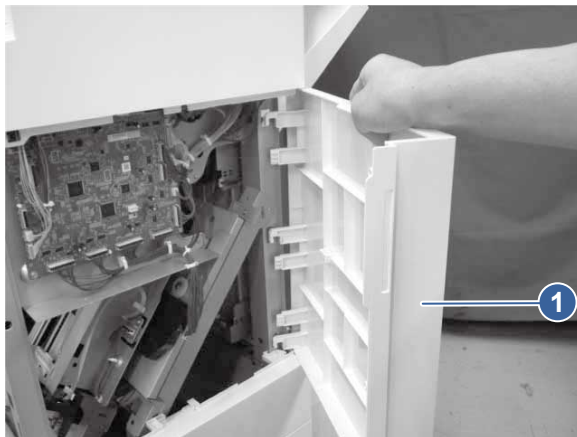
1. Release three tabs (callout 1).

**Figure 5-1130 Release three tabs**



2. Remove the rear cover (callout 1).

**Figure 5-1131 Remove the rear cover**

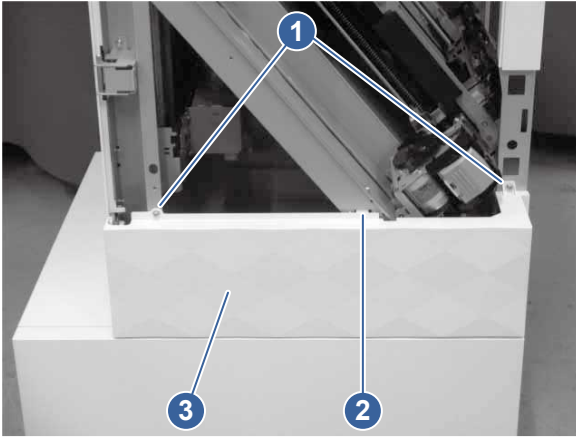


#### **5. Remove the foot front cover (tall floor-standing stapler-stacker)**

Learn about removing the tall floor-standing stapler-stacker foot front cover.

- Remove two screws (callout 1), release one tab (callout 2), and then remove the foot front cover (callout 3).

**Figure 5-1132 Remove the foot front cover (tall finisher)**

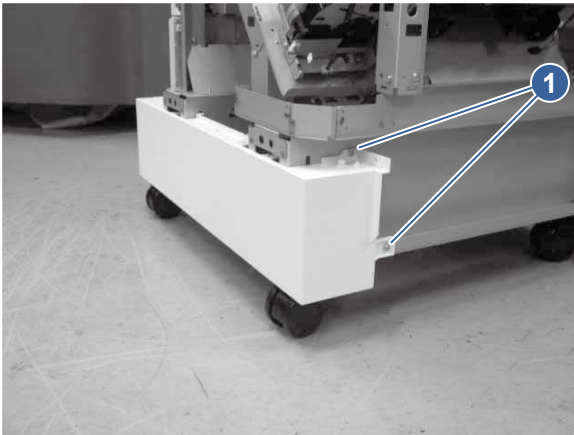


#### 6. Remove the foot front cover (standard floor-standing stapler-stacker)

Learn about removing the standard floor-standing stapler-stacker foot front cover.

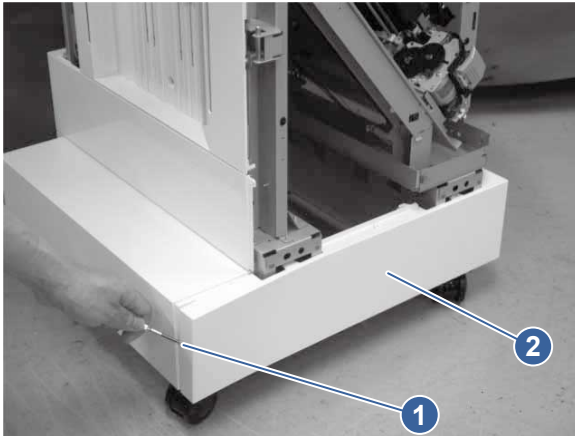
1. Remove two screws (callout 1).

**Figure 5-1133 Remove two screws**



2. Release one tab (callout 1), and then remove the foot front cover (callout 2).

**Figure 5-1134 Remove the foot front cover (standard finisher)**

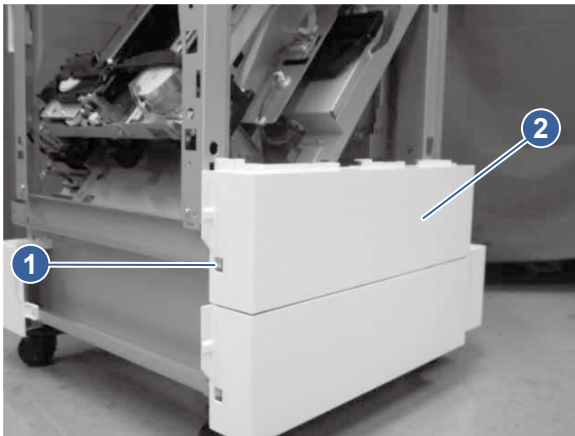


### 7. Remove the foot rear cover (floor-standing stapler-stacker)

Learn about removing the floor-standing stapler-stacker foot rear cover.

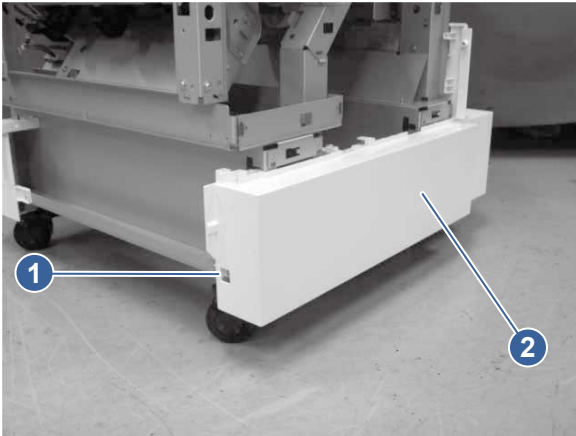
1. **Tall finishers only:** Remove one screw (callout 1), and then remove the tall foot rear cover (callout 2).

**Figure 5-1135 Remove the tall finisher cover**



2. Remove one screw (callout 1), and then remove the foot rear cover (callout 2).

**Figure 5-1136 Remove the foot rear cover**

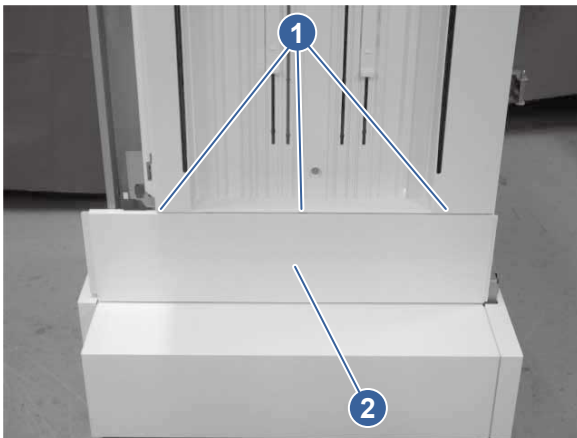


### 8. Remove the foot center cover (floor-standing stapler-stacker)

Learn about removing the floor-standing stapler-stacker foot center cover.

- Release three tabs (callout 1), and then remove the foot center cover (callout 2).

**Figure 5-1137 Remove the foot center cover**



### 9. Unpack the replacement assembly

Follow these steps to unpack the replacement assembly.

1. Dispose of the defective part.

---



 **NOTE:** HP recommends responsible disposal of the defective part.


<http://www8.hp.com/us/en/hp-information/environment/product-recycling.html>


---

2. Unpack the replacement part from the packaging.

---

 **CAUTION:**  Some parts are sensitive to electrostatic discharge (ESD). Always perform service work at an ESD-protected workstation or mat. If an ESD workstation or mat is not available, touch the sheet-metal chassis to provide a static ground before touching an ESD-sensitive assembly. Protect the ESD-sensitive assemblies by placing them in ESD pouches when they are out of the printer.


 **IMPORTANT:** Make sure that all of the shipping materials (for example shipping tape) are removed from the replacement part prior to installation.

 **NOTE:** If the replacement part is a roller or pad, avoid touching the spongy part of it. Skin oils on the roller or pad can cause paper pickup and/or print-quality problems. HP recommends using disposable gloves when handling rollers or pads or washing your hands before touching rollers or pads.

---

3. To install an assembly, reverse the removal steps.

---

 **NOTE:** When applicable, special installation instructions are provided for an assembly at the end of the removal procedure. Always completely read the removal instructions and follow all special installation instructions.

---

## Removal and replacement: Foot cover (floor-standing stapler-stacker)

Learn about removing and replacing the floor-standing stapler-stacker foot cover.




[View a video demonstration of removing and replacing the foot cover.](#)

### Before performing service

#### Turn the printer power off

- Disconnect the power cable.

 **WARNING!** To avoid damage to the printer, turn the printer off, wait 30 seconds, and then remove the power cord before attempting to service the printer.

---

Use the table below to identify the correct part number for your printer, and then go to <https://parts.hp.com/hpparts> to order the part.

**Table 5-160** Part information

Part number	Part description
RC6-0229-000CN	Cover, foot (FSSS)

### Required tools

- #2 Phillips screwdriver with a magnetic tip and a 152 mm (6 in) shaft length
- Small flat-blade screwdriver

### After performing service

#### Turn the printer power on

- Connect the power cable.
- Use the power switch to turn the power on.

### Post service test

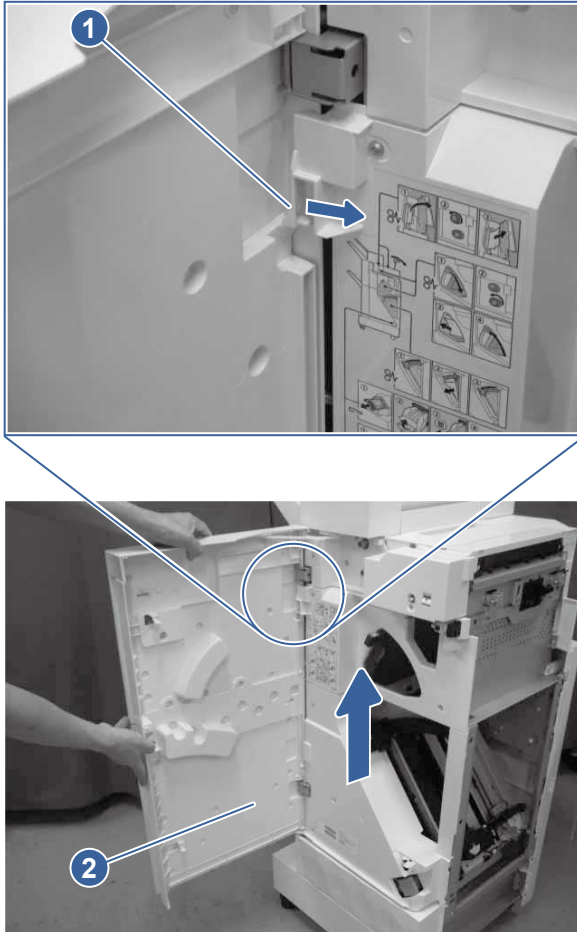
Print any pages necessary to make sure the printer is functioning correctly.

## 1. Remove the front door assembly (floor-standing stapler-stacker)

Learn about removing the floor-standing stapler-stacker front door assembly.

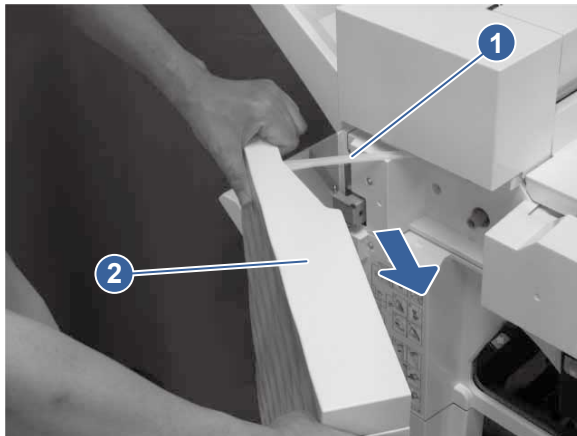
1. Open the front door.
2. Push the stopper (callout 1) in the direction indicated, and then pull up the front door assembly (callout 2) to remove it.

**Figure 5-1138 Remove the front door assembly**



3. Remove the hinge (callout 1) from the front door assembly (callout 2).

**Figure 5-1139 Remove the hinge**

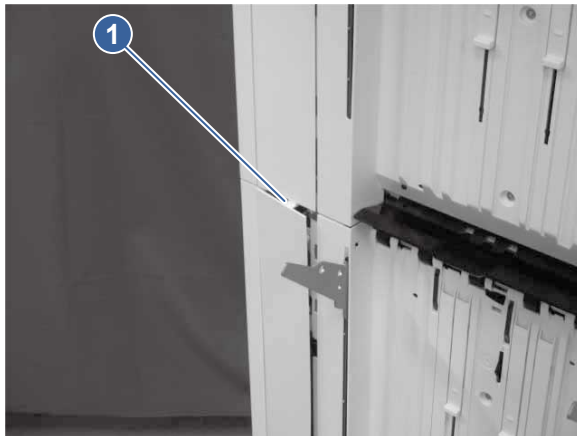


## 2. Remove the left lower rear cover (floor-standing stapler-stacker)

Learn about removing the floor-standing stapler-stacker left lower rear cover.

1. Release one tab (callout 1).

**Figure 5-1140 Release one tab**





2. Release one boss (callout 1).

**Figure 5-1141 Release one boss**



3. Pull up the left lower rear cover (callout 1) to remove it.

**Figure 5-1142 Remove the left lower rear cover**

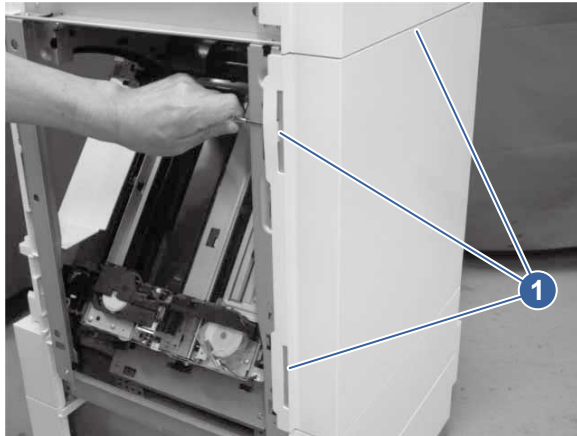


### 3. Remove the rear cover (floor-standing stapler-stacker)

Learn about removing the floor-standing stapler-stacker rear cover.

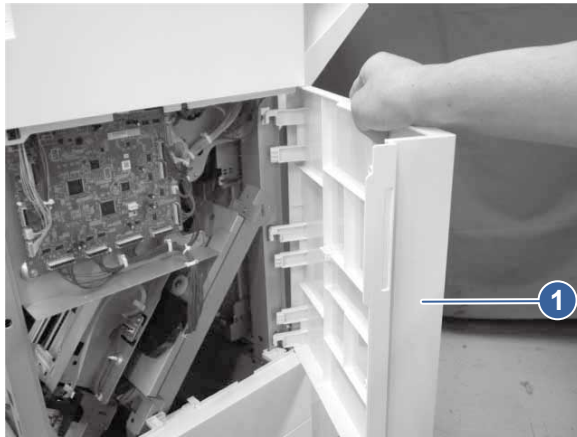
1. Release three tabs (callout 1).

**Figure 5-1143 Release three tabs**



2. Remove the rear cover (callout 1).

**Figure 5-1144 Remove the rear cover**

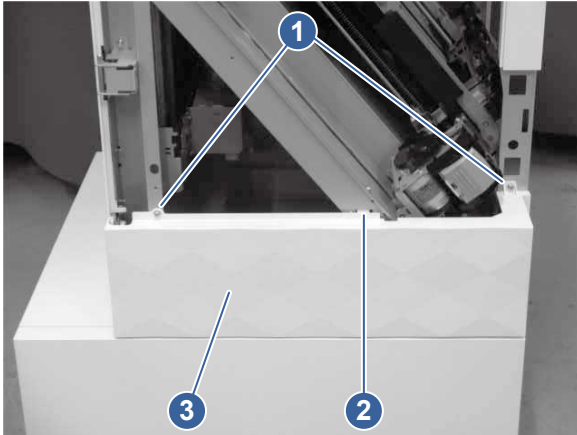


#### **4. Remove the foot front cover (tall floor-standing stapler-stacker)**

Learn about removing the tall floor-standing stapler-stacker foot front cover.

- Remove two screws (callout 1), release one tab (callout 2), and then remove the foot front cover (callout 3).

**Figure 5-1145 Remove the foot front cover (tall finisher)**

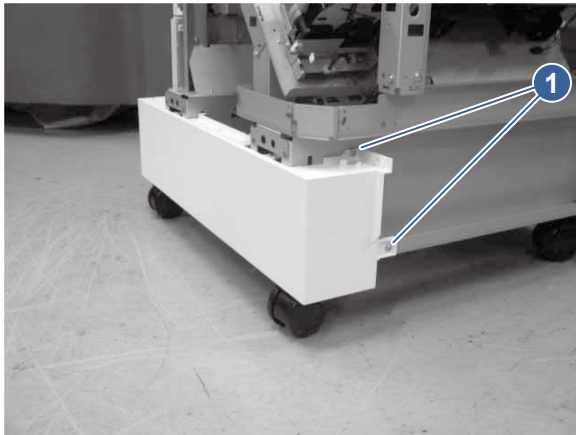


#### 5. Remove the foot front cover (standard floor-standing stapler-stacker)

Learn about removing the standard floor-standing stapler-stacker foot front cover.

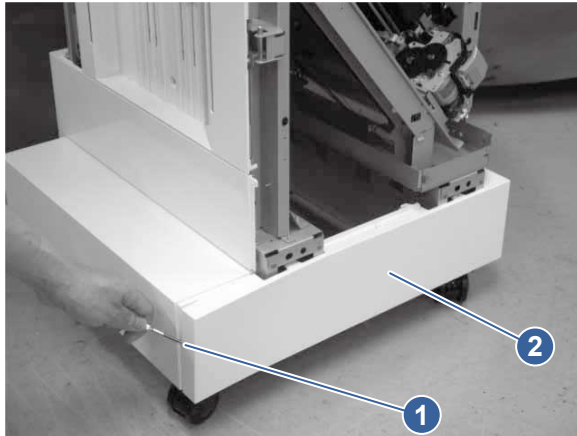
1. Remove two screws (callout 1).

**Figure 5-1146 Remove two screws**



2. Release one tab (callout 1), and then remove the foot front cover (callout 2).

**Figure 5-1147 Remove the foot front cover (standard finisher)**

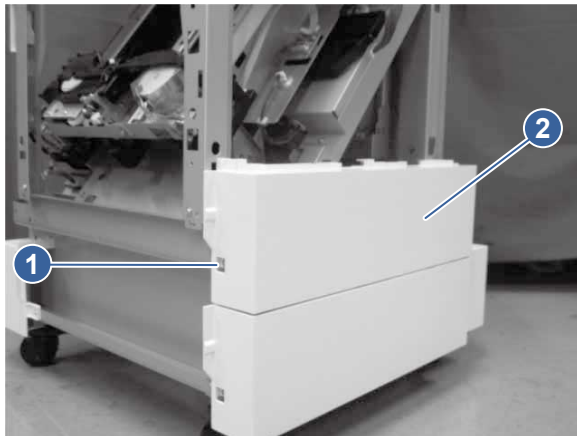


#### 6. Remove the foot rear cover (floor-standing stapler-stacker)

Learn about removing the floor-standing stapler-stacker foot rear cover.

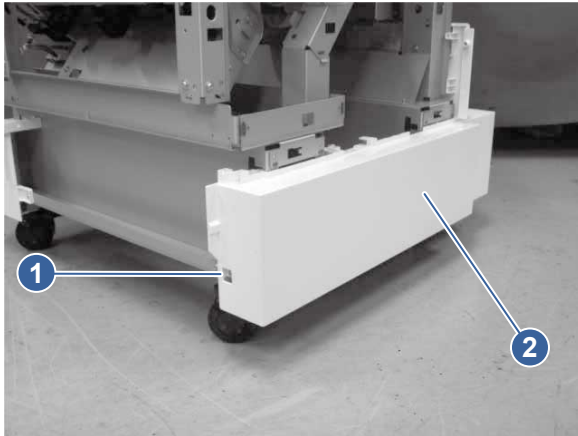
1. **Tall finishers only:** Remove one screw (callout 1), and then remove the tall foot rear cover (callout 2).

**Figure 5-1148 Remove the tall finisher cover**



2. Remove one screw (callout 1), and then remove the foot rear cover (callout 2).

**Figure 5-1149 Remove the foot rear cover**

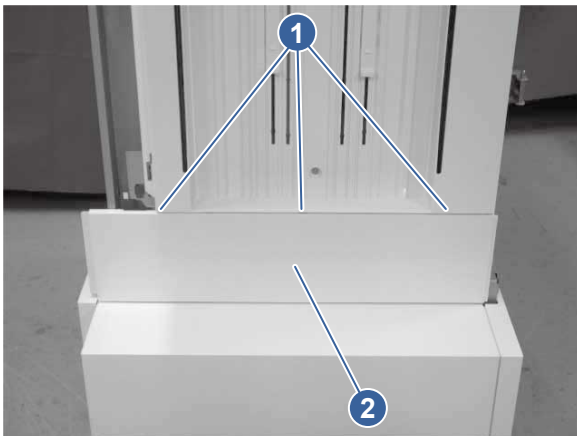


### 7. Remove the foot center cover (floor-standing stapler-stacker)

Learn about removing the floor-standing stapler-stacker foot center cover.

- Release three tabs (callout 1), and then remove the foot center cover (callout 2).

**Figure 5-1150 Remove the foot center cover**

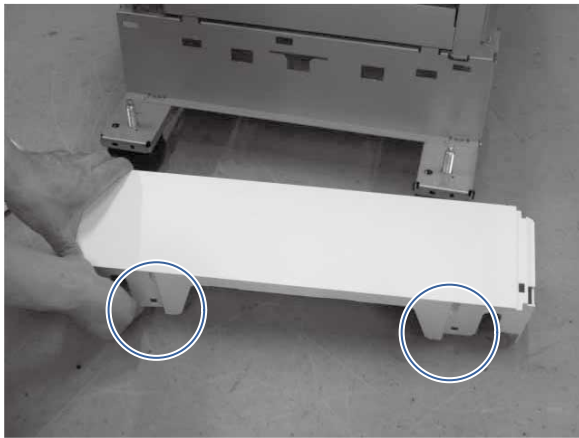
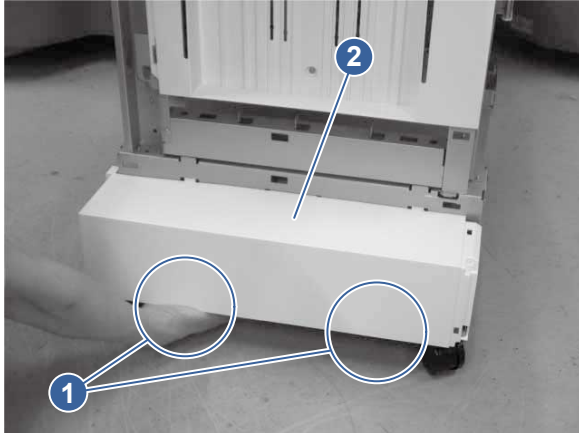


### 8. Remove the foot cover (floor-standing stapler-stacker)

Learn about removing the floor-standing stapler-stacker foot cover.

- Release two tabs (callout 1), and then remove the foot cover (callout 2).


**Figure 5-1151 Remove the foot cover**



## 9. Unpack the replacement assembly



Follow these steps to unpack the replacement assembly.


1. Dispose of the defective part.


 **NOTE:** HP recommends responsible disposal of the defective part.

<http://www8.hp.com/us/en/hp-information/environment/product-recycling.html>

2. Unpack the replacement part from the packaging.

 **CAUTION:**  Some parts are sensitive to electrostatic discharge (ESD). Always perform service work at an ESD-protected workstation or mat. If an ESD workstation or mat is not available, touch the sheet-metal chassis to provide a static ground before touching an ESD-sensitive assembly. Protect the ESD-sensitive assemblies by placing them in ESD pouches when they are out of the printer.

 **IMPORTANT:** Make sure that all of the shipping materials (for example shipping tape) are removed from the replacement part prior to installation.

 **NOTE:** If the replacement part is a roller or pad, avoid touching the spongy part of it. Skin oils on the roller or pad can cause paper pickup and/or print-quality problems. HP recommends using disposable gloves when handling rollers or pads or washing your hands before touching rollers or pads.

3. To install an assembly, reverse the removal steps.



**NOTE:** When applicable, special installation instructions are provided for an assembly at the end of the removal procedure. Always completely read the removal instructions and follow all special installation instructions.

## Internal parts and assemblies

Learn how to remove and replace the printer internal parts and assemblies.

### Removal and replacement: Stapler (floor-standing stapler-stacker)

Learn about removing and replacing the floor-standing stapler-stacker stapler assembly.

#### Before performing service

##### Turn the printer power off

- Disconnect the power cable.

**⚠ WARNING!** To avoid damage to the printer, turn the printer off, wait 30 seconds, and then remove the power cord before attempting to service the printer.

Use the table below to identify the correct part number for your printer, and then go to <https://parts.hp.com/hpparts> to order the part.

**Table 5-161 Part information**

Part number	Part description
RK2-8148-000CN	Stapler assembly (FSSS)

#### Required tools

- #2 Phillips screwdriver with a magnetic tip and a 152 mm (6 in) shaft length
- Small flat-blade screwdriver

#### After performing service

##### Turn the printer power on

- Connect the power cable.
- Use the power switch to turn the power on.

#### Post service test

Print any pages necessary to make sure the printer is functioning correctly.

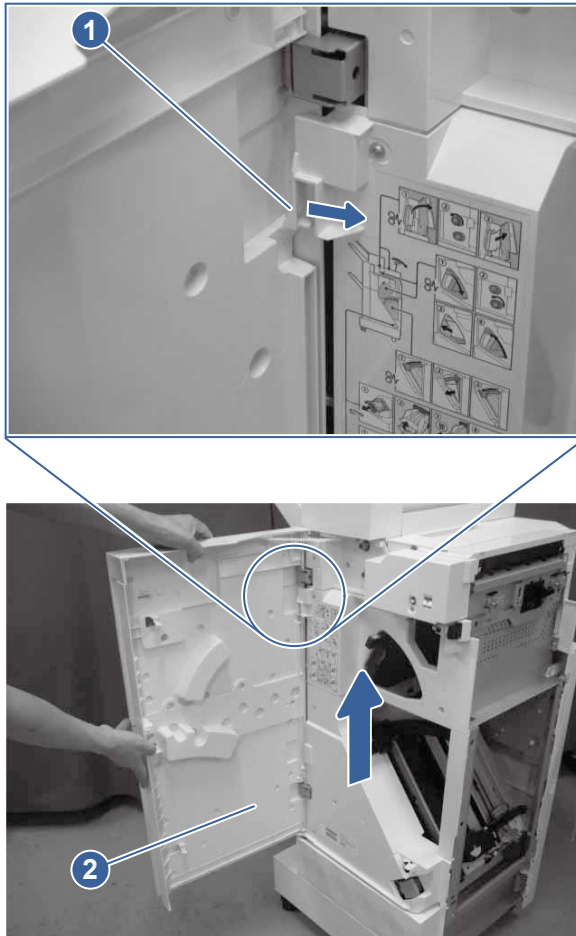
### 1. Remove the front door assembly (floor-standing stapler-stacker)

Learn about removing the floor-standing stapler-stacker front door assembly.

1. Open the front door.

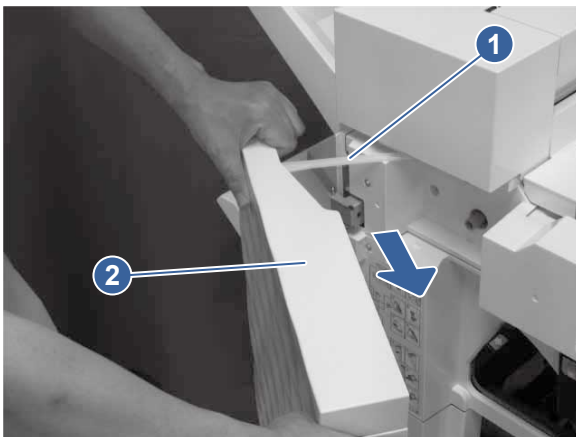
2. Push the stopper (callout 1) in the direction indicated, and then pull up the front door assembly (callout 2) to remove it.

**Figure 5-1152 Remove the front door assembly**



3. Remove the hinge (callout 1) from the front door assembly (callout 2).

**Figure 5-1153 Remove the hinge**



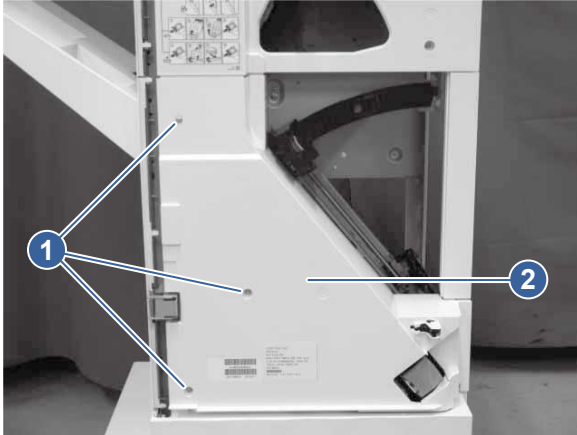
## 2. Remove the front inner lower cover (floor-standing stapler-stacker)

Learn about removing the floor-standing stapler-stacker front inner lower cover.



- Remove three screws (callout 1), and then remove the front inner lower cover (callout 2).

**Figure 5-1154 Remove the front inner lower cover**

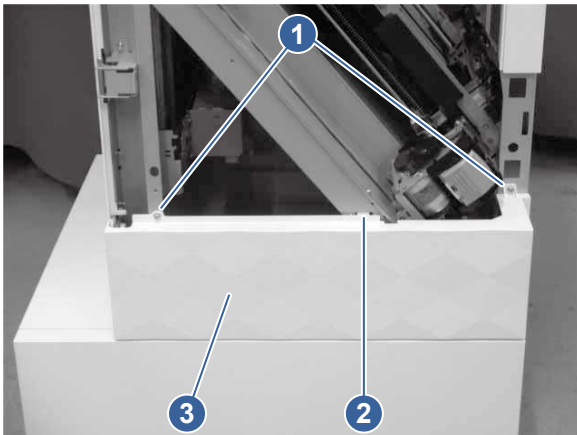


### 3. Remove the foot front cover (tall floor-standing stapler-stacker)

Learn about removing the tall floor-standing stapler-stacker foot front cover.

- Remove two screws (callout 1), release one tab (callout 2), and then remove the foot front cover (callout 3).

**Figure 5-1155 Remove the foot front cover (tall finisher)**

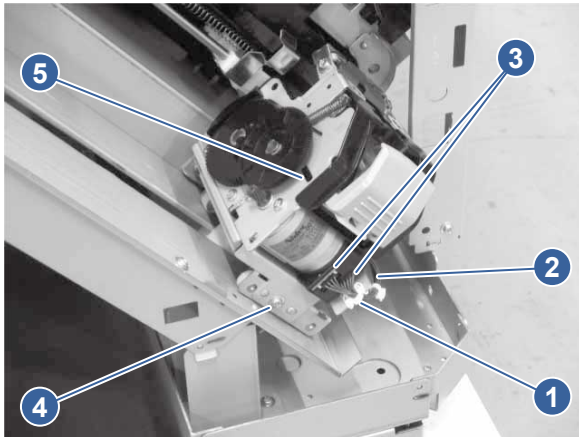


### 4. Remove the stapler (floor-standing stapler-stacker)

Learn about removing the floor-standing stapler-stacker stapler assembly.

- Release the cable (callout 1) from the cable clamp (callout 2), disconnect two connectors (callout 3), remove one screw (callout 4), and then remove the stapler (callout 5).

**Figure 5-1156 Remove the stapler**



## 5. Unpack the replacement assembly

Follow these steps to unpack the replacement assembly.

1. Dispose of the defective part.



---


 **NOTE:** HP recommends responsible disposal of the defective part.


<http://www8.hp.com/us/en/hp-information/environment/product-recycling.html>

---

2. Unpack the replacement part from the packaging.


 **CAUTION:**  Some parts are sensitive to electrostatic discharge (ESD). Always perform service work at an ESD-protected workstation or mat. If an ESD workstation or mat is not available, touch the sheet-metal chassis to provide a static ground before touching an ESD-sensitive assembly. Protect the ESD-sensitive assemblies by placing them in ESD pouches when they are out of the printer.

 **IMPORTANT:** Make sure that all of the shipping materials (for example shipping tape) are removed from the replacement part prior to installation.

 **NOTE:** If the replacement part is a roller or pad, avoid touching the spongy part of it. Skin oils on the roller or pad can cause paper pickup and/or print-quality problems. HP recommends using disposable gloves when handling rollers or pads or washing your hands before touching rollers or pads.

---

3. To install an assembly, reverse the removal steps.

 **NOTE:** When applicable, special installation instructions are provided for an assembly at the end of the removal procedure. Always completely read the removal instructions and follow all special installation instructions.

---

## Removal and replacement: Controller PCA (floor-standing stapler-stacker)

Learn about removing and replacing the floor-standing stapler-stacker controller PCA.

### Before performing service

**Turn the printer power off**

- Disconnect the power cable.

**⚠ WARNING!** To avoid damage to the printer, turn the printer off, wait 30 seconds, and then remove the power cord before attempting to service the printer.

Use the table below to identify the correct part number for your printer, and then go to <https://parts.hp.com/hpparts> to order the part.

**Table 5-162 Part information**

Part number	Part description
RM3-7931-000CN	Staple stacker PCA (FSSS)

## Required tools

- #2 Phillips screwdriver with a magnetic tip and a 152 mm (6 in) shaft length
- Small flat-blade screwdriver

## After performing service

### Turn the printer power on

- Connect the power cable.
- Use the power switch to turn the power on.

## Post service test

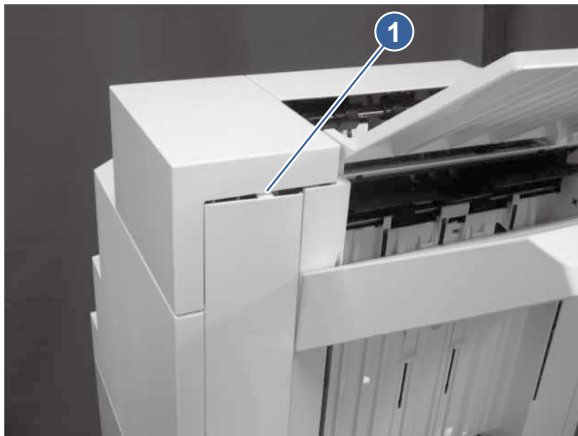
Print any pages necessary to make sure the printer is functioning correctly.

### 1. Remove the left upper rear cover (floor-standing stapler-stacker)

Learn about removing the floor-standing stapler-stacker left upper rear cover.

1. Release one tab (callout 1).

**Figure 5-1157 Release one tab**



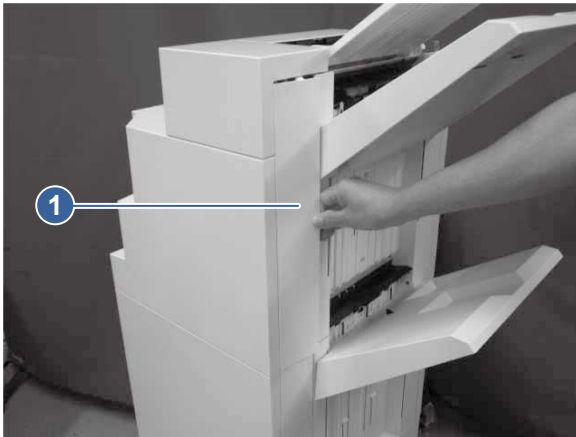
2. Release one boss (callout 1).

**Figure 5-1158 Release one boss**



3. Pull up the left upper rear cover (callout 1) to remove it.

**Figure 5-1159 Remove the left upper rear cover**

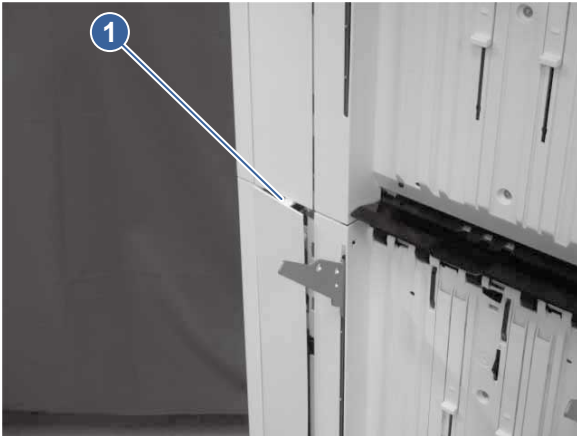


## **2. Remove the left lower rear cover (floor-standing stapler-stacker)**

Learn about removing the floor-standing stapler-stacker left lower rear cover.

1. Release one tab (callout 1).

**Figure 5-1160 Release one tab**



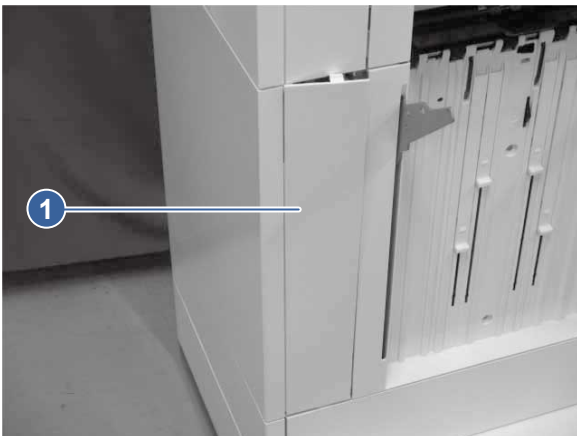
2. Release one boss (callout 1).

**Figure 5-1161 Release one boss**



3. Pull up the left lower rear cover (callout 1) to remove it.

**Figure 5-1162 Remove the left lower rear cover**

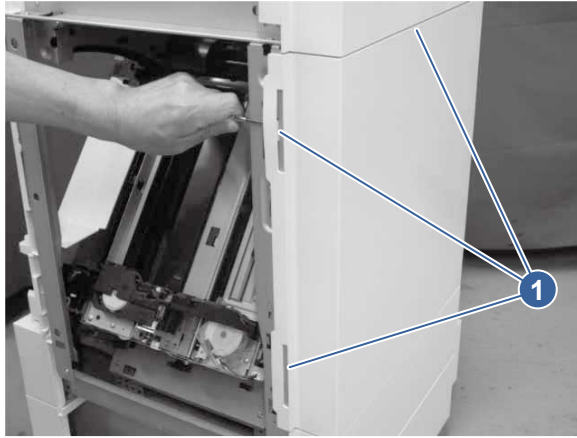


### 3. Remove the rear cover (floor-standing stapler-stacker)

Learn about removing the floor-standing stapler-stacker rear cover.

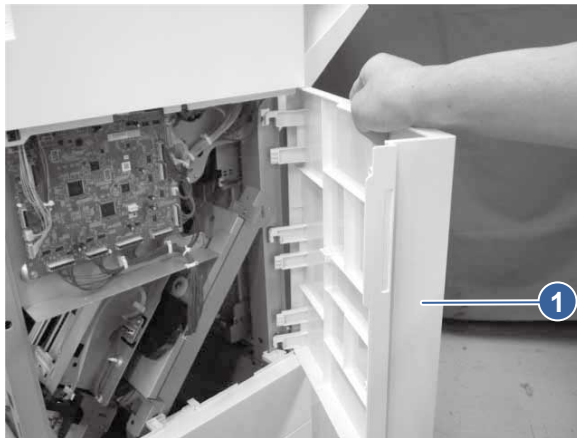
1. Release three tabs (callout 1).

**Figure 5-1163 Release three tabs**



2. Remove the rear cover (callout 1).

**Figure 5-1164 Remove the rear cover**

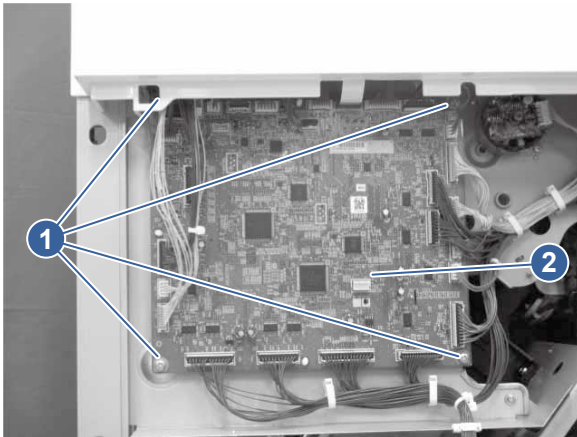


### 4. Remove the controller PCA (floor-standing stapler-stacker)

Learn about removing the floor-standing stapler-stacker controller PCA.

- Disconnect all the connectors on the controller PCA, remove four screws (callout 1), and then remove the controller PCA (callout 2).

**Figure 5-1165 Remove the controller PCA**



## 5. Unpack the replacement assembly



Follow these steps to unpack the replacement assembly.


1. Dispose of the defective part.


 **NOTE:** HP recommends responsible disposal of the defective part.

<http://www8.hp.com/us/en/hp-information/environment/product-recycling.html>


2. Unpack the replacement part from the packaging.

 **CAUTION:**  Some parts are sensitive to electrostatic discharge (ESD). Always perform service work at an ESD-protected workstation or mat. If an ESD workstation or mat is not available, touch the sheet-metal chassis to provide a static ground before touching an ESD-sensitive assembly. Protect the ESD-sensitive assemblies by placing them in ESD pouches when they are out of the printer.

 **IMPORTANT:** Make sure that all of the shipping materials (for example shipping tape) are removed from the replacement part prior to installation.

 **NOTE:** If the replacement part is a roller or pad, avoid touching the spongy part of it. Skin oils on the roller or pad can cause paper pickup and/or print-quality problems. HP recommends using disposable gloves when handling rollers or pads or washing your hands before touching rollers or pads.

3. To install an assembly, reverse the removal steps.

 **NOTE:** When applicable, special installation instructions are provided for an assembly at the end of the removal procedure. Always completely read the removal instructions and follow all special installation instructions.

## Removal and replacement: Power supply assembly (floor-standing stapler-stacker)

Learn about removing and replacing the floor-standing stapler-stacker power supply assembly.

### Before performing service

#### Turn the printer power off

- Disconnect the power cable.

**⚠ WARNING!** To avoid damage to the printer, turn the printer off, wait 30 seconds, and then remove the power cord before attempting to service the printer.

Use the table below to identify the correct part number for your printer, and then go to <https://parts.hp.com/hpparts> to order the part.

**Table 5-163 Part information**

Part number	Part description
RM2-3854-000CN	Sub power supply assembly (FSSS)

## Required tools

- #2 Phillips screwdriver with a magnetic tip and a 152 mm (6 in) shaft length
- Small flat-blade screwdriver

## After performing service

### Turn the printer power on

- Connect the power cable.
- Use the power switch to turn the power on.

## Post service test

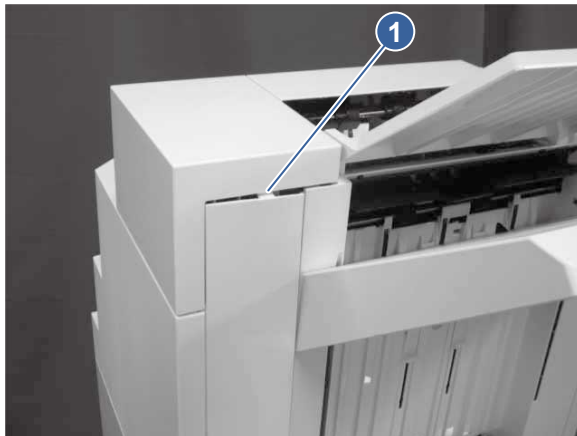
Print any pages necessary to make sure the printer is functioning correctly.

### 1. Remove the left upper rear cover (floor-standing stapler-stacker)

Learn about removing the floor-standing stapler-stacker left upper rear cover.

1. Release one tab (callout 1).

**Figure 5-1166 Release one tab**





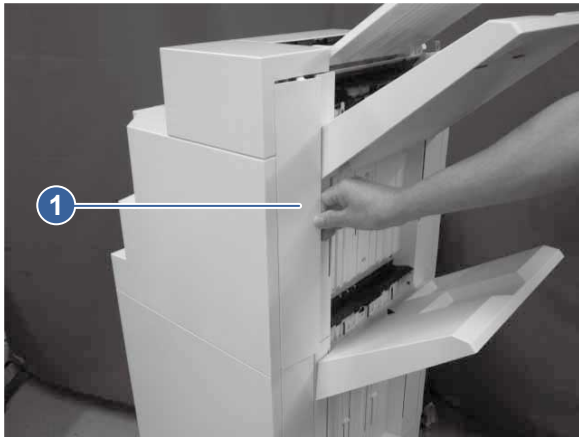
2. Release one boss (callout 1).

**Figure 5-1167 Release one boss**



3. Pull up the left upper rear cover (callout 1) to remove it.

**Figure 5-1168 Remove the left upper rear cover**

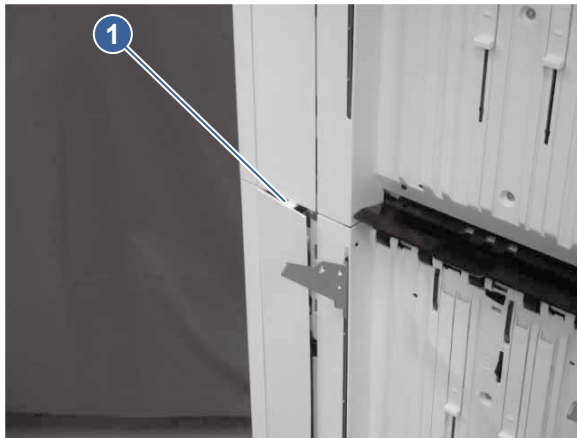


## **2. Remove the left lower rear cover (floor-standing stapler-stacker)**

Learn about removing the floor-standing stapler-stacker left lower rear cover.

1. Release one tab (callout 1).

**Figure 5-1169 Release one tab**



2. Release one boss (callout 1).

**Figure 5-1170 Release one boss**



3. Pull up the left lower rear cover (callout 1) to remove it.

**Figure 5-1171 Remove the left lower rear cover**

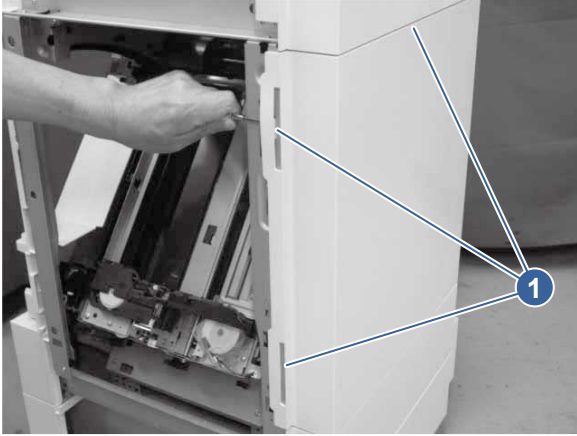


### 3. Remove the rear cover (floor-standing stapler-stacker)

Learn about removing the floor-standing stapler-stacker rear cover.

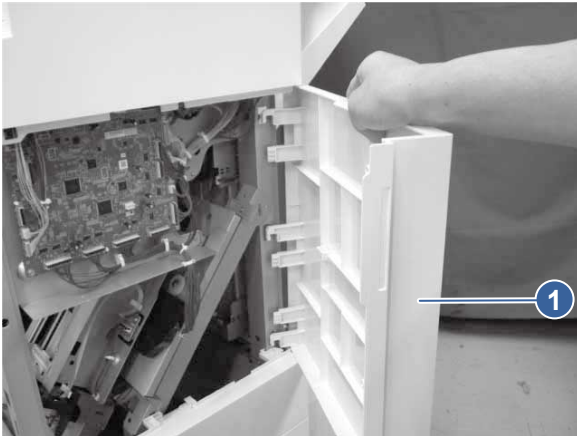
1. Release three tabs (callout 1).

**Figure 5-1172** Release three tabs



2. Remove the rear cover (callout 1).

**Figure 5-1173** Remove the rear cover

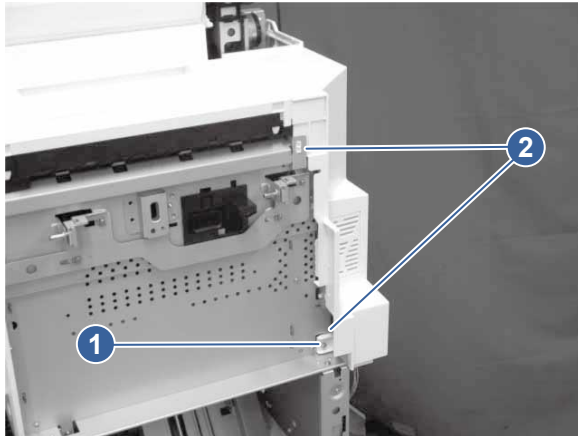


### 4. Remove the rear upper cover (floor-standing stapler-stacker)

Learn about removing the floor-standing stapler-stacker rear upper cover.

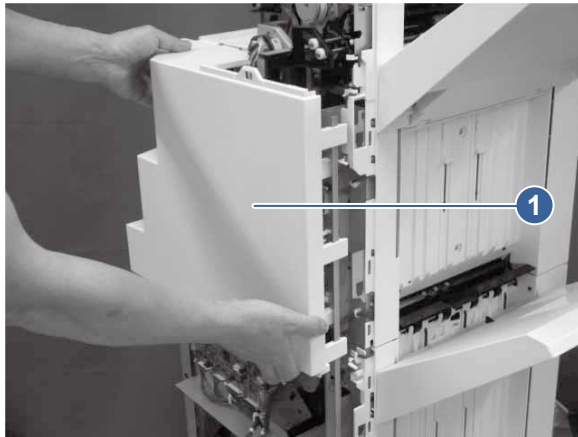
1. Remove one screw (callout 1), and then release two tabs (callout 2).

**Figure 5-1174 Remove one screw and release two tabs**



2. Remove the rear upper cover (callout 1).

**Figure 5-1175 Remove the rear upper cover**

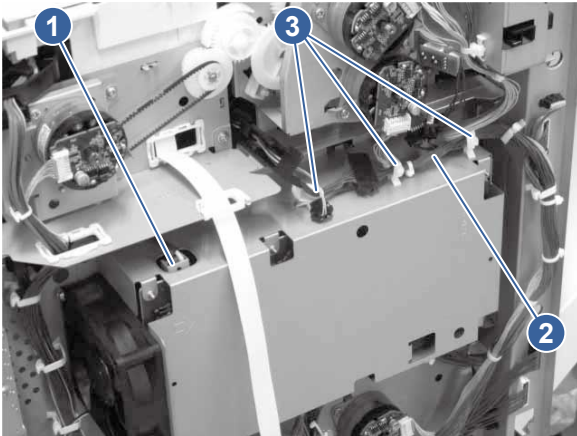


#### **5. Remove the power supply assembly (floor-standing stapler-stacker)**

Learn about removing the floor-standing stapler-stacker power supply assembly.

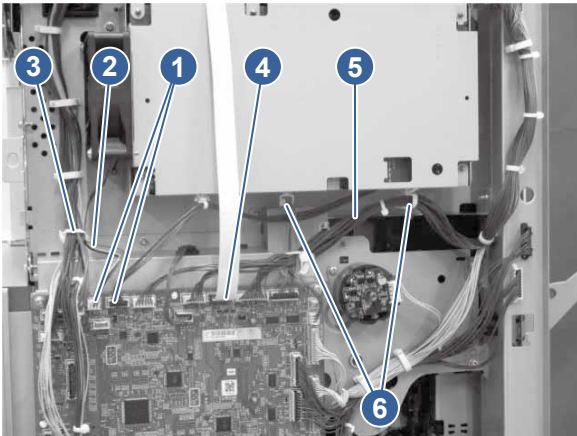
1. Disconnect one connector (callout 1), and then release the cable (callout 2) from cable clamps (callout 3).

**Figure 5-1176 Release the cable**



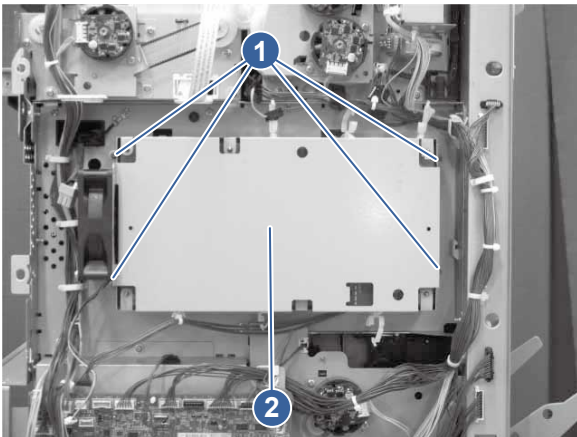
2. Disconnect two connectors (callout 1), release the cable (callout 2) from the cable clamp (callout 3), remove the FFC (callout 4), and then release the cable (callout 5) from the cable clamps (callout 6).

**Figure 5-1177 Disconnect two connectors**



3. Remove four screws (callout 1), and then remove the power supply assembly (callout 2).


**Figure 5-1178 Remove the power supply assembly**



## 6. Unpack the replacement assembly



Follow these steps to unpack the replacement assembly.


1. Dispose of the defective part.


 **NOTE:** HP recommends responsible disposal of the defective part.

<http://www8.hp.com/us/en/hp-information/environment/product-recycling.html>


2. Unpack the replacement part from the packaging.

 **CAUTION:**  Some parts are sensitive to electrostatic discharge (ESD). Always perform service work at an ESD-protected workstation or mat. If an ESD workstation or mat is not available, touch the sheet-metal chassis to provide a static ground before touching an ESD-sensitive assembly. Protect the ESD-sensitive assemblies by placing them in ESD pouches when they are out of the printer.

 **IMPORTANT:** Make sure that all of the shipping materials (for example shipping tape) are removed from the replacement part prior to installation.

 **NOTE:** If the replacement part is a roller or pad, avoid touching the spongy part of it. Skin oils on the roller or pad can cause paper pickup and/or print-quality problems. HP recommends using disposable gloves when handling rollers or pads or washing your hands before touching rollers or pads.

3. To install an assembly, reverse the removal steps.

 **NOTE:** When applicable, special installation instructions are provided for an assembly at the end of the removal procedure. Always completely read the removal instructions and follow all special installation instructions.


### Removal and replacement: Height wall upper assembly (floor-standing stapler-stacker)

Learn about removing and replacing the floor-standing stapler-stacker upper height wall.

#### Before performing service

##### Turn the printer power off

- Disconnect the power cable.

 **WARNING!** To avoid damage to the printer, turn the printer off, wait 30 seconds, and then remove the power cord before attempting to service the printer.

Use the table below to identify the correct part number for your printer, and then go to <https://parts.hp.com/hpparts> to order the part.

**Table 5-164** Part information

Part number	Part description
RM2-3845-000CN	Height wall upper assembly (FSSS)

#### Required tools

- #2 Phillips screwdriver with a magnetic tip and a 152 mm (6 in) shaft length
- Small flat-blade screwdriver

## After performing service

### Turn the printer power on

- Connect the power cable.
- Use the power switch to turn the power on.

### Post service test

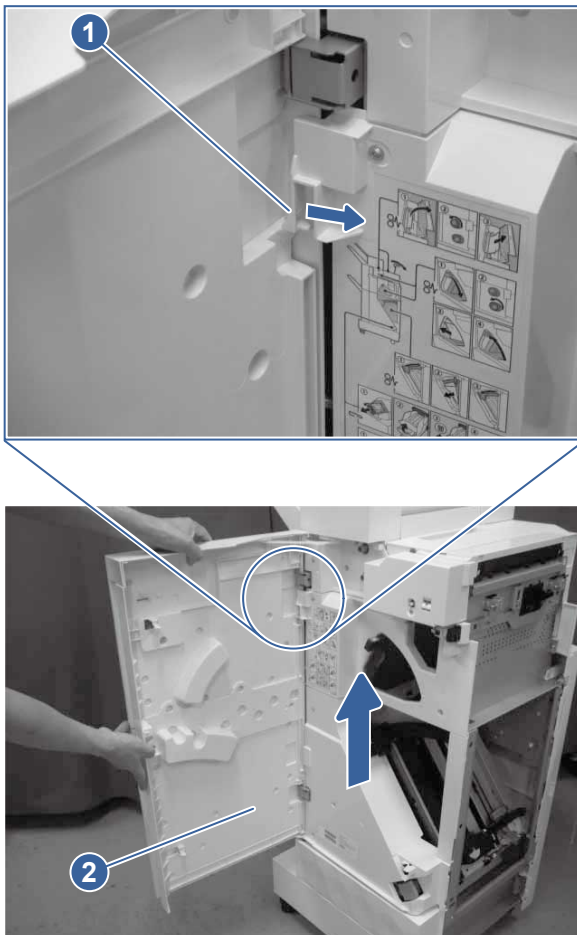
Print any pages necessary to make sure the printer is functioning correctly.

#### 1. Remove the front door assembly (floor-standing stapler-stacker)

Learn about removing the floor-standing stapler-stacker front door assembly.

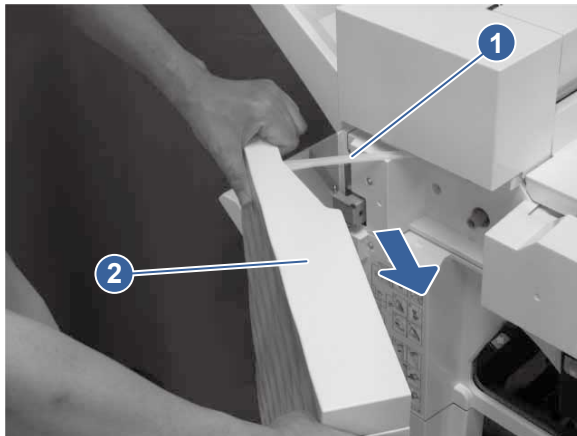
1. Open the front door.
2. Push the stopper (callout 1) in the direction indicated, and then pull up the front door assembly (callout 2) to remove it.

**Figure 5-1179** Remove the front door assembly



3. Remove the hinge (callout 1) from the front door assembly (callout 2).

**Figure 5-1180 Remove the hinge**

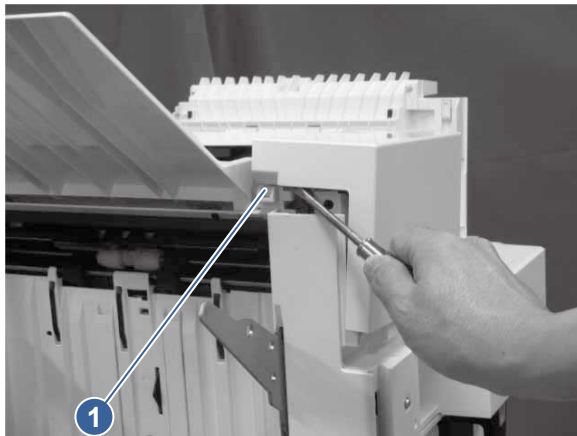


## 2. Remove the MBM front cover (floor-standing stapler-stacker)

Learn about removing the floor-standing stapler-stacker mailbox/booklet-maker front cover.

1. Release one tab (callout 1).

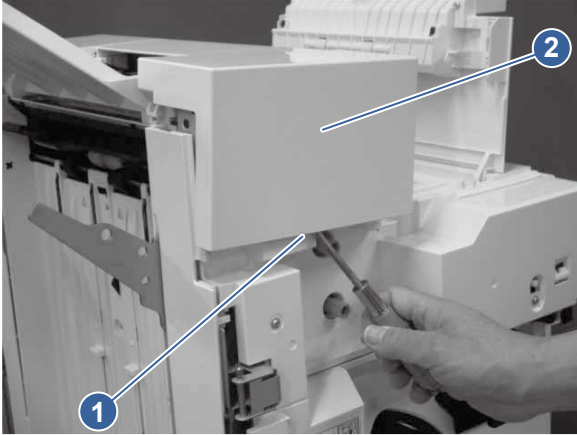
**Figure 5-1181 Release one tab**





2. Release one tab (callout 1), and then remove the MBM front cover (callout 2).

**Figure 5-1182 Remove the MBM front cover**

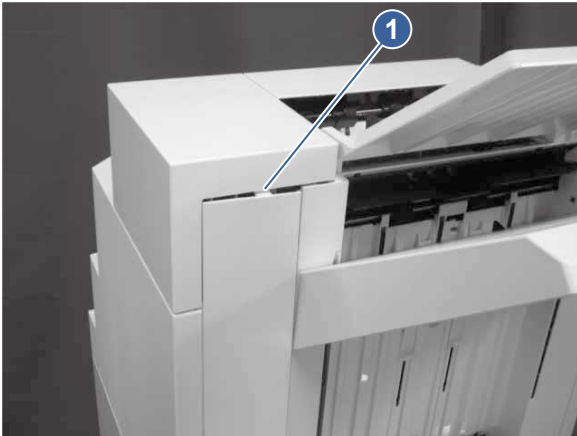


### 3. Remove the left upper rear cover (floor-standing stapler-stacker)

Learn about removing the floor-standing stapler-stacker left upper rear cover.

1. Release one tab (callout 1).

**Figure 5-1183 Release one tab**



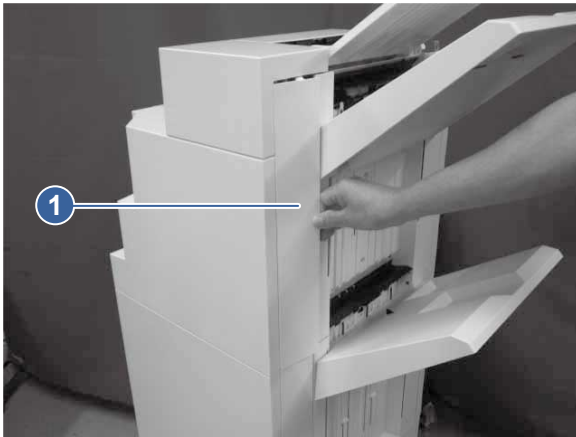
2. Release one boss (callout 1).

**Figure 5-1184 Release one boss**



3. Pull up the left upper rear cover (callout 1) to remove it.

**Figure 5-1185 Remove the left upper rear cover**

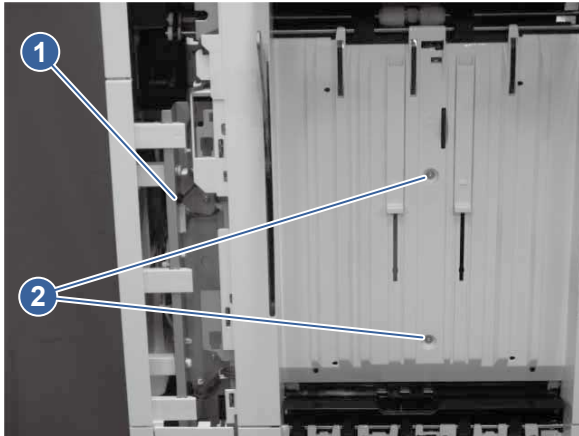


#### **4. Remove the upper height wall assembly (floor-standing stapler-stacker)**

Learn about removing the floor-standing stapler-stacker upper height wall assembly.

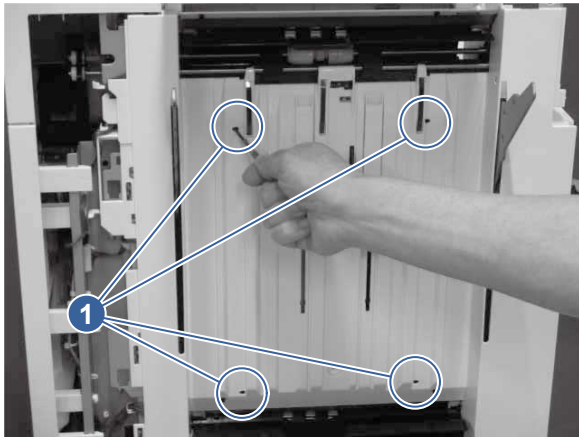
1. Disconnect one connector (callout 1), and then remove two screws (callout 2).

**Figure 5-1186 Disconnect one connector**

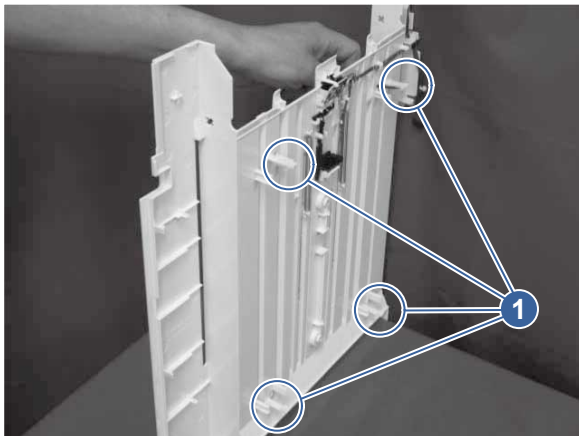


2. Release four inner tabs (callout 1) with a pointed tool.

**Figure 5-1187 Release four inner tabs**

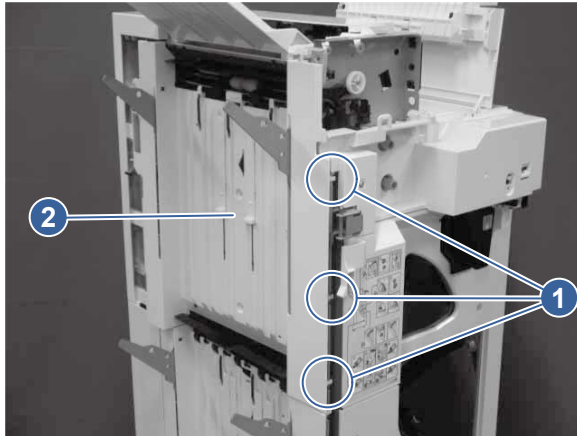


**Figure 5-1188 The four tabs viewed from the other side of the assembly**



3. Release three tabs (callout 1), and then remove the height wall upper assembly (callout 2).

**Figure 5-1189 Remove the upper height wall assembly**



## 5. Unpack the replacement assembly



Follow these steps to unpack the replacement assembly.


1. Dispose of the defective part.


 **NOTE:** HP recommends responsible disposal of the defective part.

<http://www8.hp.com/us/en/hp-information/environment/product-recycling.html>


2. Unpack the replacement part from the packaging.

 **CAUTION:**  Some parts are sensitive to electrostatic discharge (ESD). Always perform service work at an ESD-protected workstation or mat. If an ESD workstation or mat is not available, touch the sheet-metal chassis to provide a static ground before touching an ESD-sensitive assembly. Protect the ESD-sensitive assemblies by placing them in ESD pouches when they are out of the printer.

 **IMPORTANT:** Make sure that all of the shipping materials (for example shipping tape) are removed from the replacement part prior to installation.

 **NOTE:** If the replacement part is a roller or pad, avoid touching the spongy part of it. Skin oils on the roller or pad can cause paper pickup and/or print-quality problems. HP recommends using disposable gloves when handling rollers or pads or washing your hands before touching rollers or pads.

3. To install an assembly, reverse the removal steps.

 **NOTE:** When applicable, special installation instructions are provided for an assembly at the end of the removal procedure. Always completely read the removal instructions and follow all special installation instructions.

## Removal and replacement: Height wall lower assembly (floor-standing stapler-stacker)

Learn about removing and replacing the floor-standing stapler-stacker lower height wall.

### Before performing service

Turn the printer power off

- Disconnect the power cable.

**⚠ WARNING!** To avoid damage to the printer, turn the printer off, wait 30 seconds, and then remove the power cord before attempting to service the printer.

Use the table below to identify the correct part number for your printer, and then go to <https://parts.hp.com/hpparts> to order the part.

**Table 5-165 Part information**

Part number	Part description
RM2-3844-000CN	Height wall lower assembly (FSSS)

## Required tools

- #2 Phillips screwdriver with a magnetic tip and a 152 mm (6 in) shaft length
- Small flat-blade screwdriver

## After performing service

### Turn the printer power on

- Connect the power cable.
- Use the power switch to turn the power on.

## Post service test

Print any pages necessary to make sure the printer is functioning correctly.

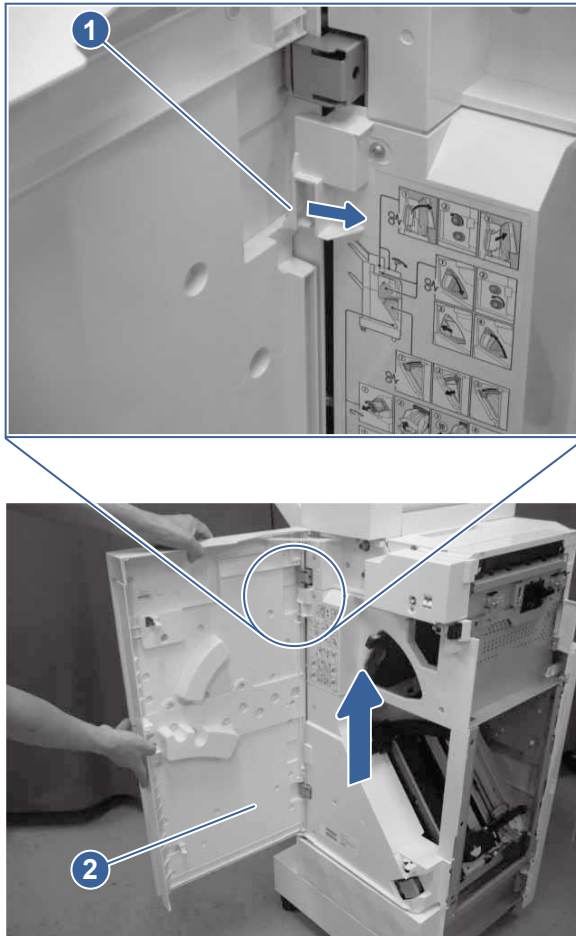
### 1. Remove the front door assembly (floor-standing stapler-stacker)

Learn about removing the floor-standing stapler-stacker front door assembly.

1. Open the front door.

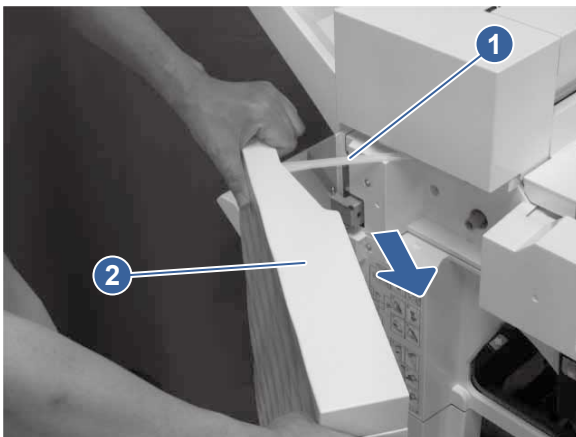
2. Push the stopper (callout 1) in the direction indicated, and then pull up the front door assembly (callout 2) to remove it.

**Figure 5-1190 Remove the front door assembly**



3. Remove the hinge (callout 1) from the front door assembly (callout 2).

**Figure 5-1191 Remove the hinge**

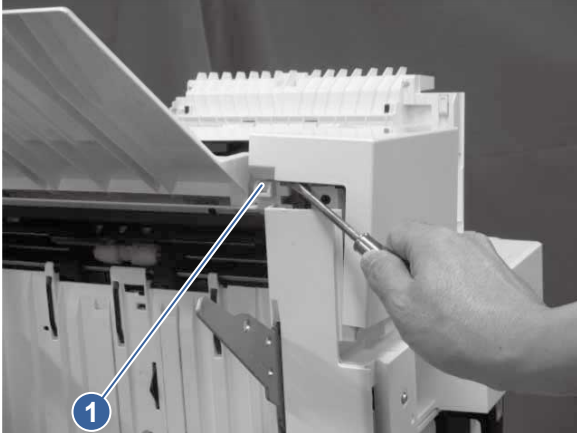


## 2. Remove the MBM front cover (floor-standing stapler-stacker)

Learn about removing the floor-standing stapler-stacker mailbox/booklet-maker front cover.

1. Release one tab (callout 1).

**Figure 5-1192 Release one tab**



2. Release one tab (callout 1), and then remove the MBM front cover (callout 2).

**Figure 5-1193 Remove the MBM front cover**

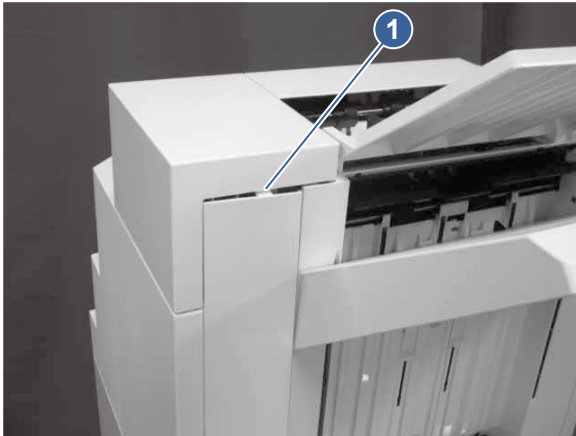


3. Remove the left upper rear cover (floor-standing stapler-stacker)

Learn about removing the floor-standing stapler-stacker left upper rear cover.

1. Release one tab (callout 1).

**Figure 5-1194 Release one tab**



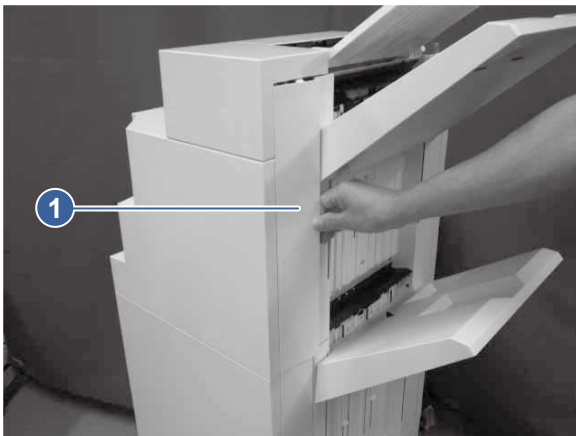
2. Release one boss (callout 1).

**Figure 5-1195 Release one boss**



3. Pull up the left upper rear cover (callout 1) to remove it.

**Figure 5-1196 Remove the left upper rear cover**



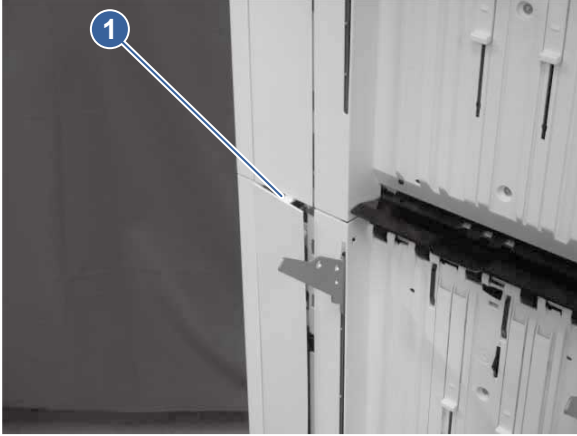


#### 4. Remove the left lower rear cover (floor-standing stapler-stacker)

Learn about removing the floor-standing stapler-stacker left lower rear cover.

1. Release one tab (callout 1).

**Figure 5-1197 Release one tab**



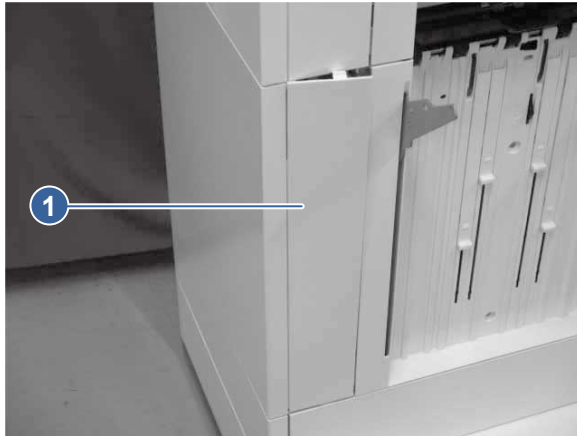
2. Release one boss (callout 1).

**Figure 5-1198 Release one boss**



3. Pull up the left lower rear cover (callout 1) to remove it.

**Figure 5-1199 Remove the left lower rear cover**

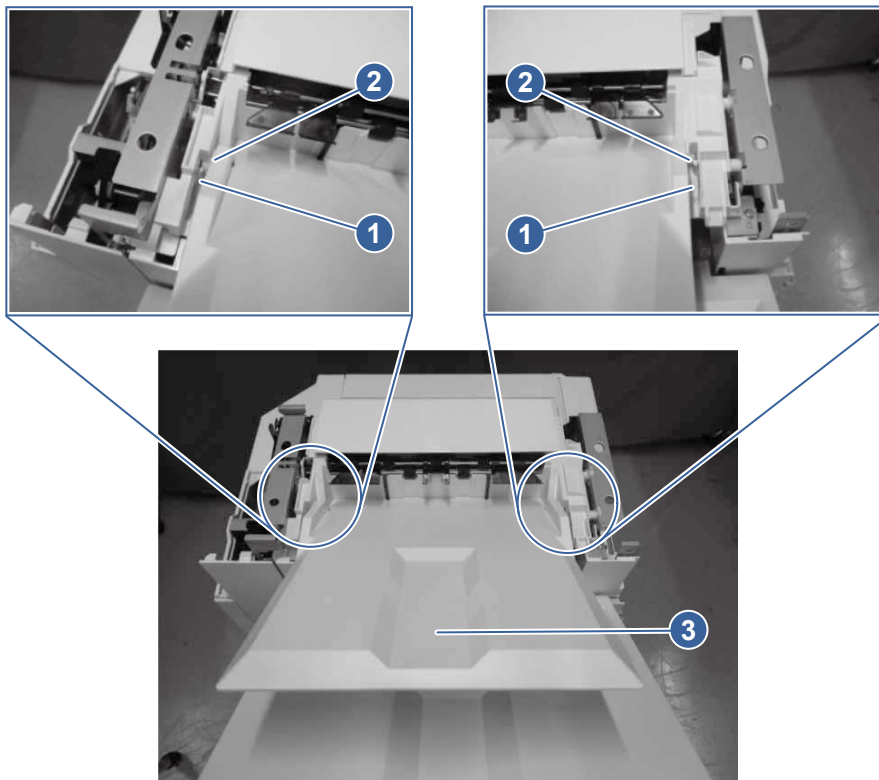


### 5. Remove the MBM output bin (floor-standing stapler-stacker)

Learn about removing the floor-standing stapler-stacker mailbox/booklet-maker output bin.

- Press the left and right stoppers (callout 1) to remove the shaft (callout 2), and then remove the MBM output bin (callout 3).

**Figure 5-1200 Remove the MBM output bin**

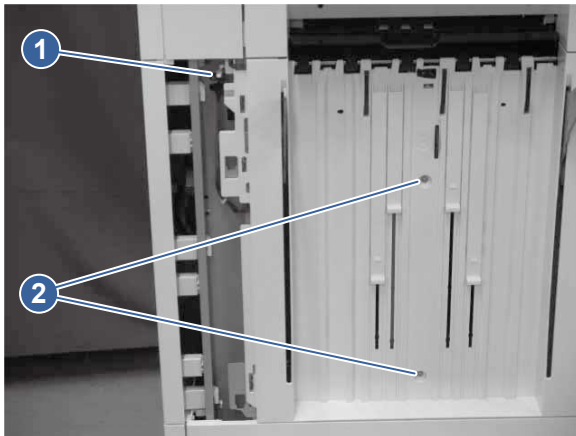


### 6. Remove the lower height wall (floor-standing stapler-stacker)

Learn about removing the floor-standing stapler-stacker lower height wall.

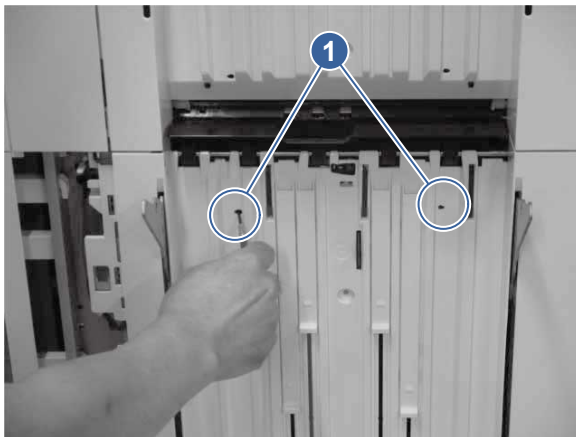
1. Disconnect one connector (callout 1), and then remove two screws (callout 2).

**Figure 5-1201 Disconnect one connector**

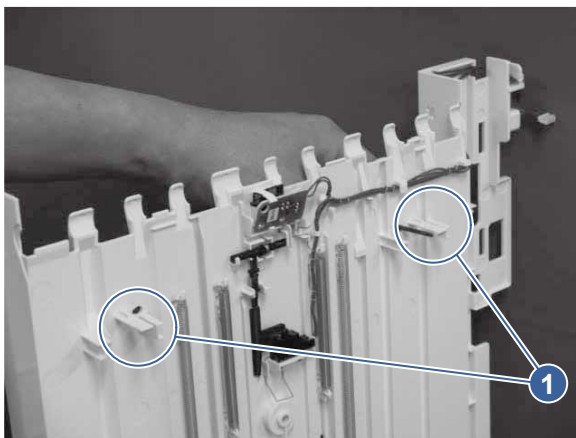


2. Release two inner tabs (callout 1) with a pointed tool.

**Figure 5-1202 Release two inner tabs**

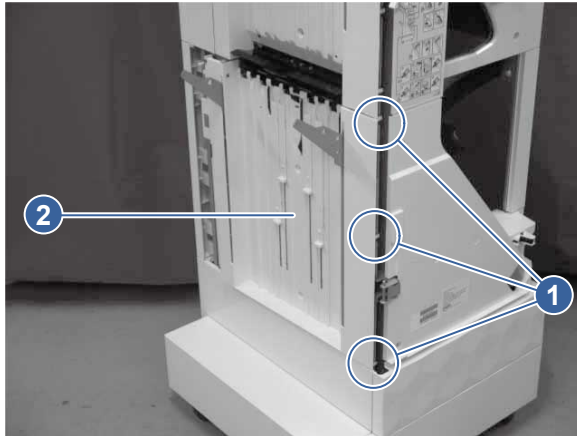


**Figure 5-1203 The two tabs viewed from the other side of the assembly**



3. Release three tabs (callout 1), and then remove the lower height wall assembly (callout 2).

**Figure 5-1204 Remove the lower height wall assembly**



## 7. Unpack the replacement assembly



Follow these steps to unpack the replacement assembly.


1. Dispose of the defective part.


 **NOTE:** HP recommends responsible disposal of the defective part.

<http://www8.hp.com/us/en/hp-information/environment/product-recycling.html>


2. Unpack the replacement part from the packaging.

 **CAUTION:**  Some parts are sensitive to electrostatic discharge (ESD). Always perform service work at an ESD-protected workstation or mat. If an ESD workstation or mat is not available, touch the sheet-metal chassis to provide a static ground before touching an ESD-sensitive assembly. Protect the ESD-sensitive assemblies by placing them in ESD pouches when they are out of the printer.

 **IMPORTANT:** Make sure that all of the shipping materials (for example shipping tape) are removed from the replacement part prior to installation.

 **NOTE:** If the replacement part is a roller or pad, avoid touching the spongy part of it. Skin oils on the roller or pad can cause paper pickup and/or print-quality problems. HP recommends using disposable gloves when handling rollers or pads or washing your hands before touching rollers or pads.

3. To install an assembly, reverse the removal steps.

 **NOTE:** When applicable, special installation instructions are provided for an assembly at the end of the removal procedure. Always completely read the removal instructions and follow all special installation instructions.

## Removal and replacement: Lifter base upper assembly (floor-standing stapler-stacker)

Learn about removing and replacing the floor-standing stapler-stacker upper lifter base.

### Before performing service

Turn the printer power off

- Disconnect the power cable.

**⚠ WARNING!** To avoid damage to the printer, turn the printer off, wait 30 seconds, and then remove the power cord before attempting to service the printer.

Use the table below to identify the correct part number for your printer, and then go to <https://parts.hp.com/hpparts> to order the part.

**Table 5-166 Part information**

Part number	Part description
RM2-3843-000CN	Lifter base upper assembly (FSSS)

## Required tools

- #2 Phillips screwdriver with a magnetic tip and a 152 mm (6 in) shaft length
- Small flat-blade screwdriver

## After performing service

### Turn the printer power on

- Connect the power cable.
- Use the power switch to turn the power on.

## Post service test

Print any pages necessary to make sure the printer is functioning correctly.

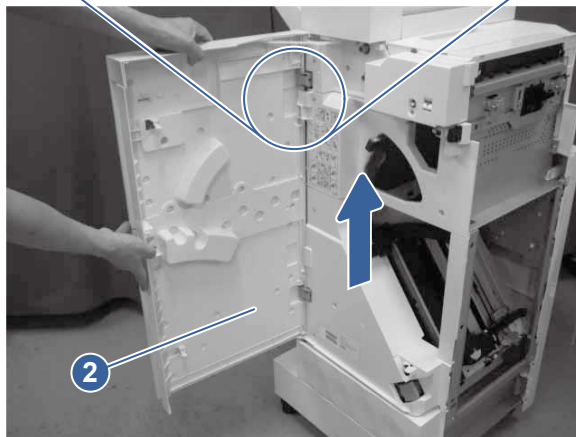
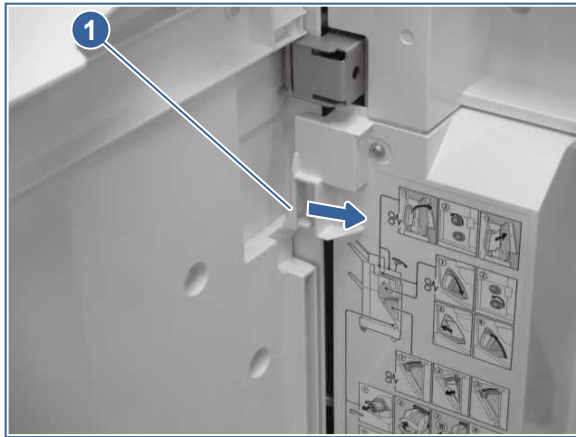
### 1. Remove the front door assembly (floor-standing stapler-stacker)

Learn about removing the floor-standing stapler-stacker front door assembly.

1. Open the front door.

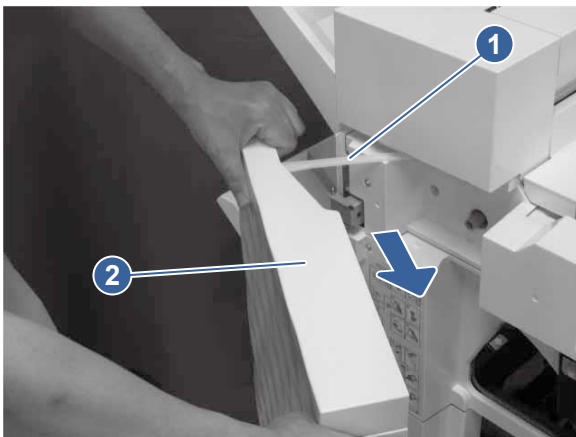
2. Push the stopper (callout 1) in the direction indicated, and then pull up the front door assembly (callout 2) to remove it.

**Figure 5-1205 Remove the front door assembly**



3. Remove the hinge (callout 1) from the front door assembly (callout 2).

**Figure 5-1206 Remove the hinge**

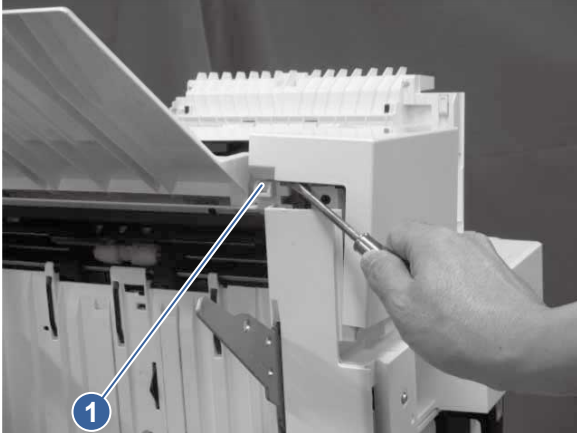


## 2. Remove the MBM front cover (floor-standing stapler-stacker)

Learn about removing the floor-standing stapler-stacker mailbox/booklet-maker front cover.

1. Release one tab (callout 1).

**Figure 5-1207 Release one tab**



2. Release one tab (callout 1), and then remove the MBM front cover (callout 2).

**Figure 5-1208 Remove the MBM front cover**

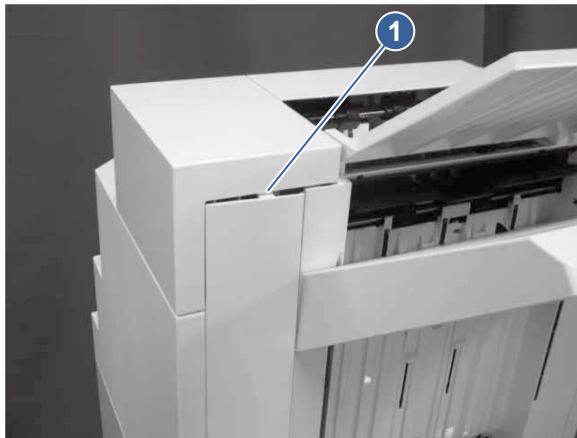


3. Remove the left upper rear cover (floor-standing stapler-stacker)

Learn about removing the floor-standing stapler-stacker left upper rear cover.

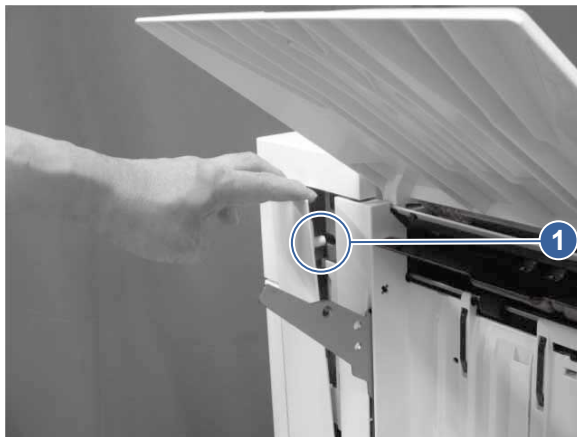
1. Release one tab (callout 1).

**Figure 5-1209 Release one tab**



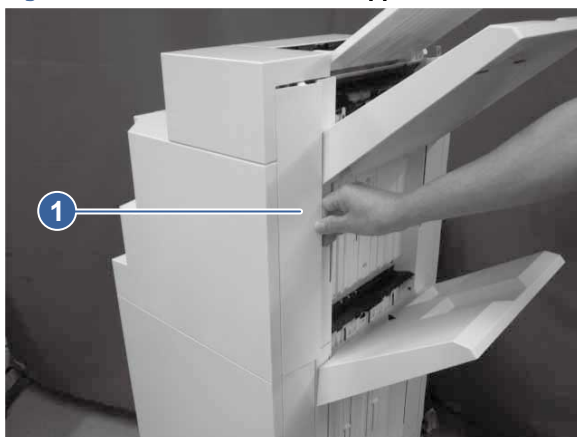
2. Release one boss (callout 1).

**Figure 5-1210 Release one boss**



3. Pull up the left upper rear cover (callout 1) to remove it.

**Figure 5-1211 Remove the left upper rear cover**



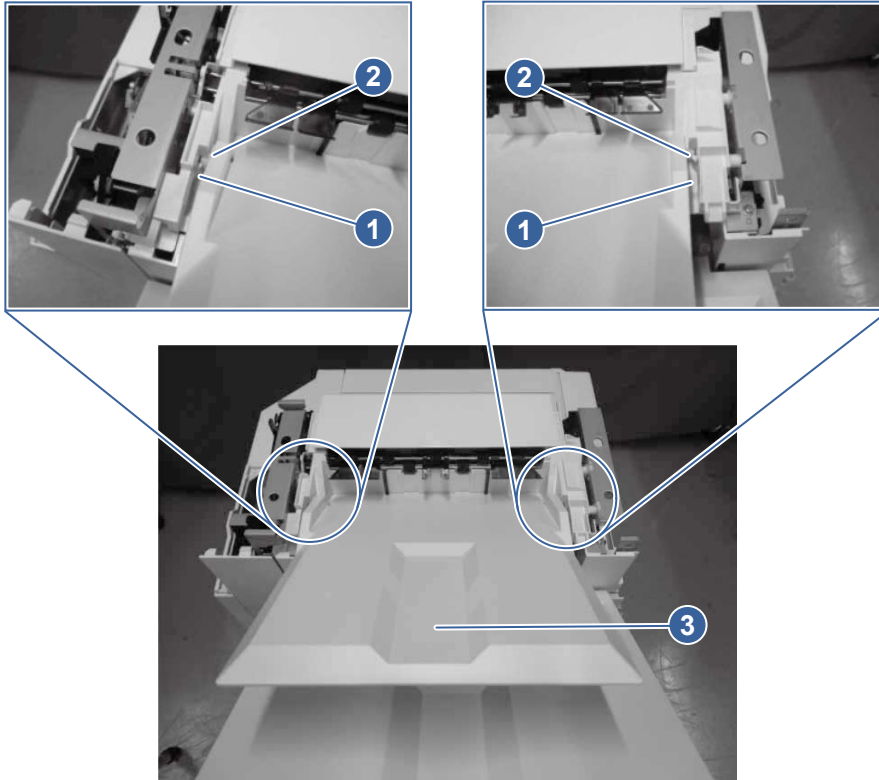


#### 4. Remove the MBM output bin (floor-standing stapler-stacker)

Learn about removing the floor-standing stapler-stacker mailbox/booklet-maker output bin.

- Press the left and right stoppers (callout 1) to remove the shaft (callout 2), and then remove the MBM output bin (callout 3).

**Figure 5-1212 Remove the MBM output bin**

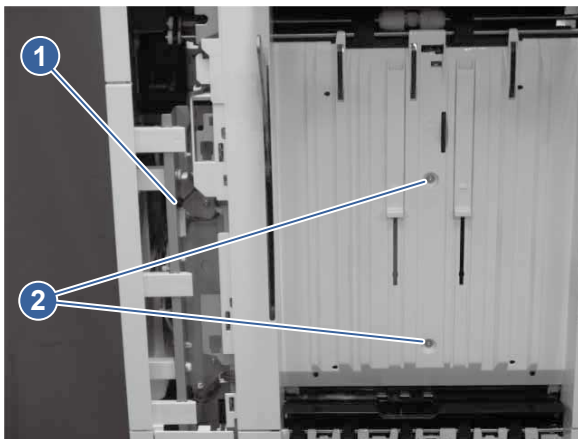


#### 5. Remove the upper height wall assembly (floor-standing stapler-stacker)

Learn about removing the floor-standing stapler-stacker upper height wall assembly.

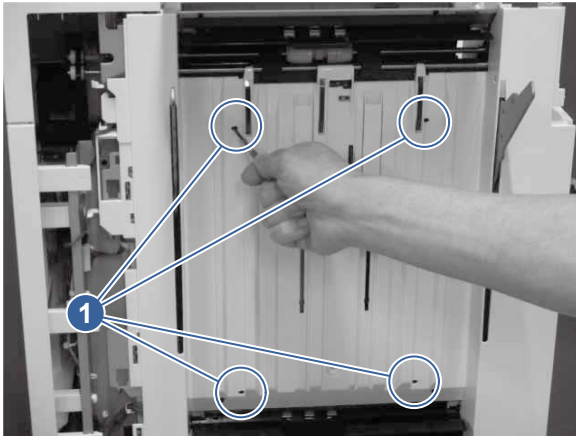
1. Disconnect one connector (callout 1), and then remove two screws (callout 2).

**Figure 5-1213 Disconnect one connector**

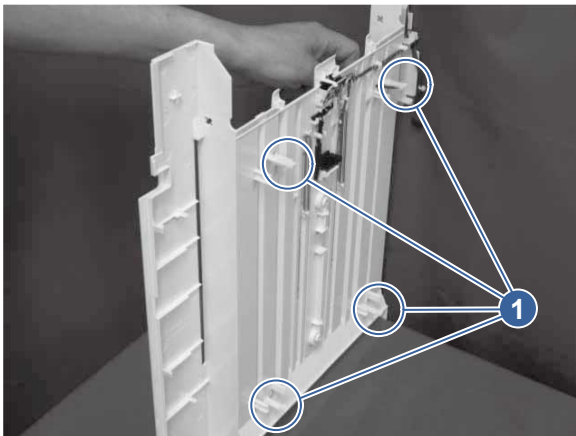


2. Release four inner tabs (callout 1) with a pointed tool.

**Figure 5-1214 Release four inner tabs**

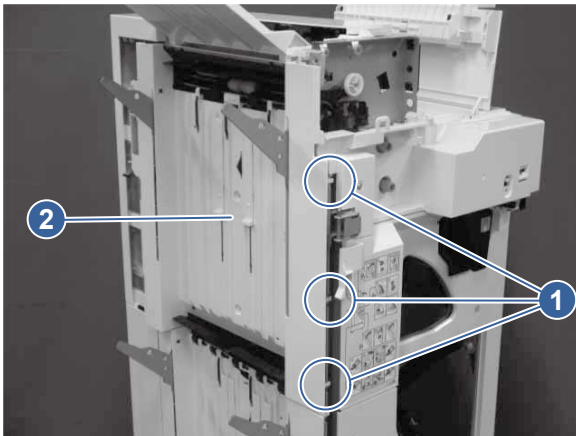


**Figure 5-1215 The four tabs viewed from the other side of the assembly**



3. Release three tabs (callout 1), and then remove the height wall upper assembly (callout 2).

**Figure 5-1216 Remove the upper height wall assembly**

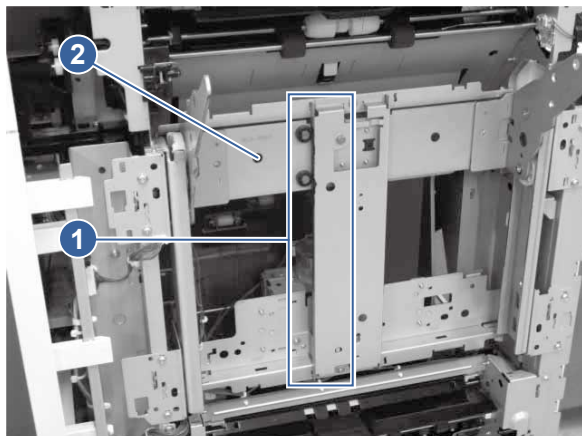


## 6. Remove the upper lifter base assembly (floor-standing stapler-stacker)

Learn about removing the floor-standing stapler-stacker upper lifter base assembly.

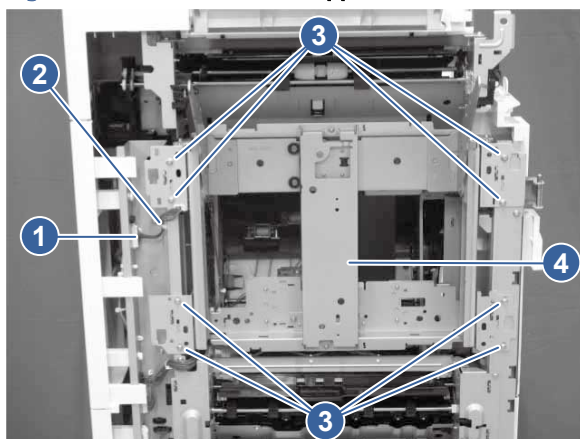
Do not touch the center (callout 1) of the upper lifter base assembly (callout 2) because grease is applied to the center.

**Figure 5-1217 Avoid touching the center**



- Disconnect one connector (callout 1), release the cable clamp (callout 2), remove eight screws (callout 3), and then remove the upper lifter base assembly (callout 4).

**Figure 5-1218 Remove the upper lifter base assembly**



## 7. Unpack the replacement assembly

Follow these steps to unpack the replacement assembly.

1. Dispose of the defective part.





**NOTE:** HP recommends responsible disposal of the defective part.


<http://www8.hp.com/us/en/hp-information/environment/product-recycling.html>

2. Unpack the replacement part from the packaging.



**CAUTION:**  Some parts are sensitive to electrostatic discharge (ESD). Always perform service work at an ESD-protected workstation or mat. If an ESD workstation or mat is not available, touch the sheet-metal chassis to provide a static ground before touching an ESD-sensitive assembly. Protect the ESD-sensitive assemblies by placing them in ESD pouches when they are out of the printer.


 **IMPORTANT:** Make sure that all of the shipping materials (for example shipping tape) are removed from the replacement part prior to installation.

 **NOTE:** If the replacement part is a roller or pad, avoid touching the spongy part of it. Skin oils on the roller or pad can cause paper pickup and/or print-quality problems. HP recommends using disposable gloves when handling rollers or pads or washing your hands before touching rollers or pads.

---

3. To install an assembly, reverse the removal steps.

---

 **NOTE:** When applicable, special installation instructions are provided for an assembly at the end of the removal procedure. Always completely read the removal instructions and follow all special installation instructions.

---


## Removal and replacement: Lifter base lower assembly (floor-standing stapler-stacker)

Learn about removing and replacing the floor-standing stapler-stacker lower lifter base.

### Before performing service

#### Turn the printer power off

- Disconnect the power cable.

 **WARNING!** To avoid damage to the printer, turn the printer off, wait 30 seconds, and then remove the power cord before attempting to service the printer.

---

Use the table below to identify the correct part number for your printer, and then go to <https://parts.hp.com/hpparts> to order the part.

**Table 5-167** Part information

Part number	Part description
RM2-3842-000CN	Lifter base lower assembly (FSSS)

### Required tools

- #2 Phillips screwdriver with a magnetic tip and a 152 mm (6 in) shaft length
- Small flat-blade screwdriver

### After performing service

#### Turn the printer power on

- Connect the power cable.
- Use the power switch to turn the power on.

### Post service test

Print any pages necessary to make sure the printer is functioning correctly.

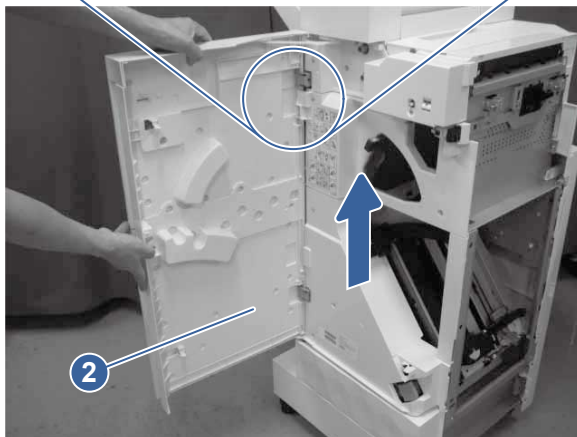
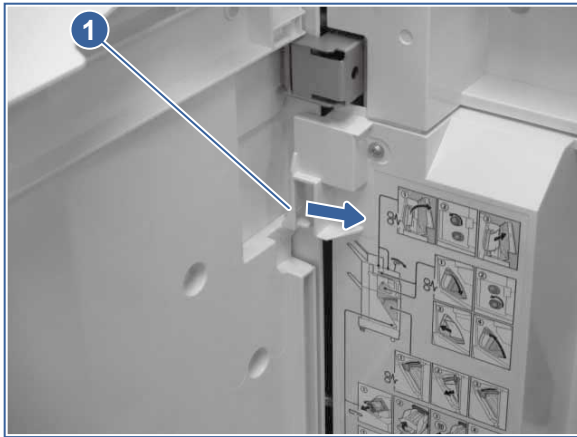
## 1. Remove the front door assembly (floor-standing stapler-stacker)

Learn about removing the floor-standing stapler-stacker front door assembly.

1. Open the front door.

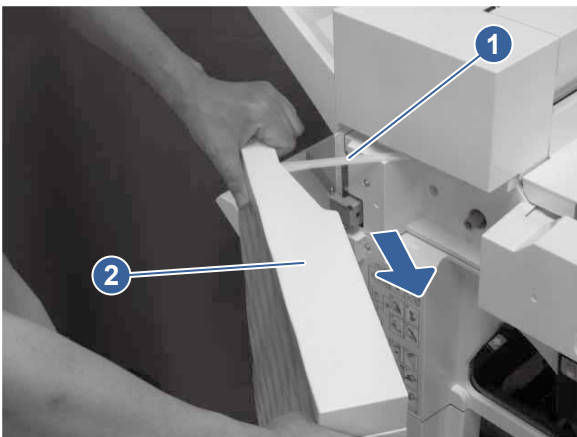
2. Push the stopper (callout 1) in the direction indicated, and then pull up the front door assembly (callout 2) to remove it.

**Figure 5-1219 Remove the front door assembly**



3. Remove the hinge (callout 1) from the front door assembly (callout 2).

**Figure 5-1220 Remove the hinge**

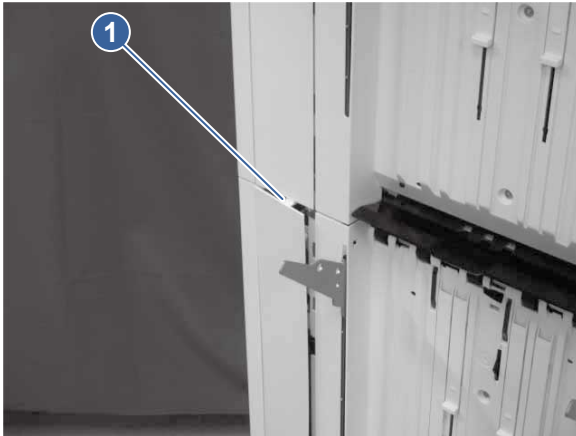


## 2. Remove the left lower rear cover (floor-standing stapler-stacker)

Learn about removing the floor-standing stapler-stacker left lower rear cover.

1. Release one tab (callout 1).

**Figure 5-1221 Release one tab**



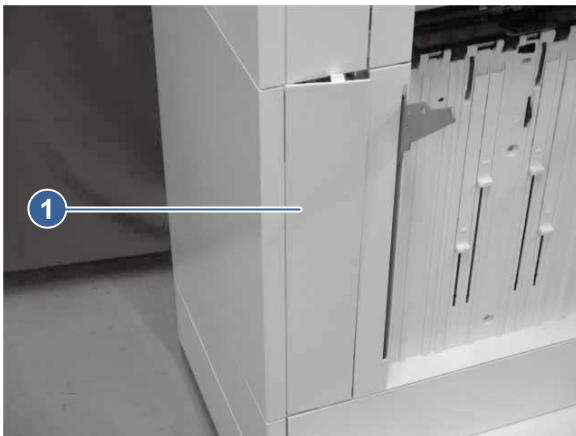
2. Release one boss (callout 1).

**Figure 5-1222 Release one boss**



3. Pull up the left lower rear cover (callout 1) to remove it.

**Figure 5-1223 Remove the left lower rear cover**

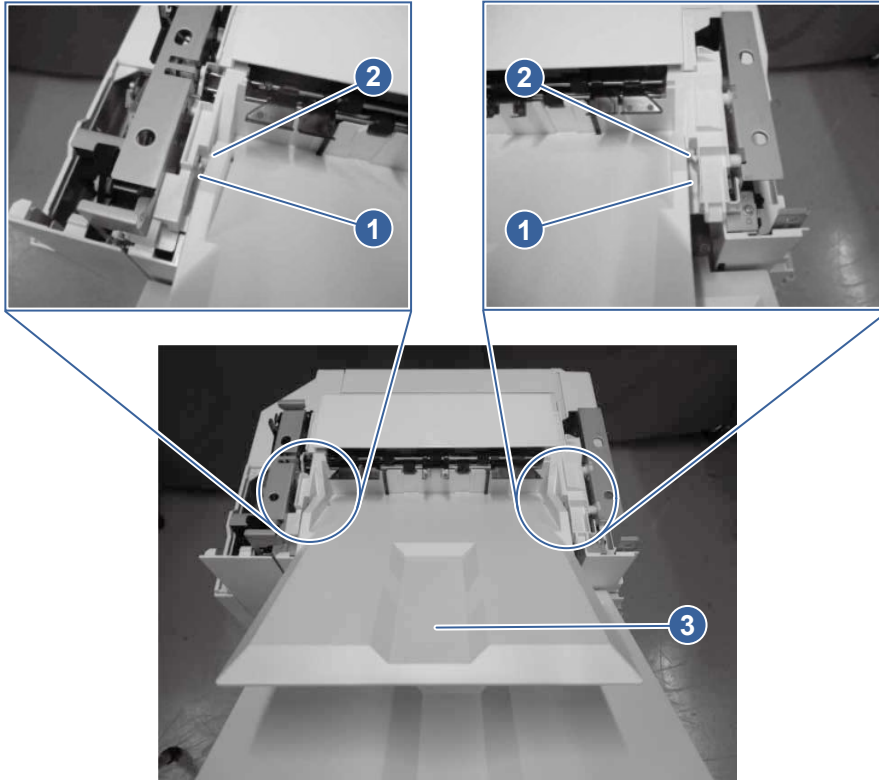


### 3. Remove the MBM output bin (floor-standing stapler-stacker)

Learn about removing the floor-standing stapler-stacker mailbox/booklet-maker output bin.

- Press the left and right stoppers (callout 1) to remove the shaft (callout 2), and then remove the MBM output bin (callout 3).

**Figure 5-1224** Remove the MBM output bin

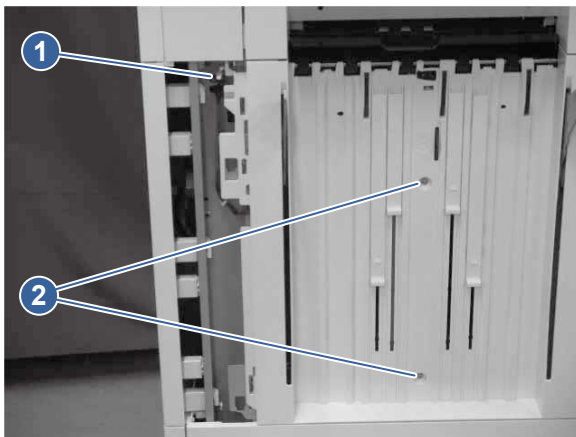


### 4. Remove the lower height wall (floor-standing stapler-stacker)

Learn about removing the floor-standing stapler-stacker lower height wall.

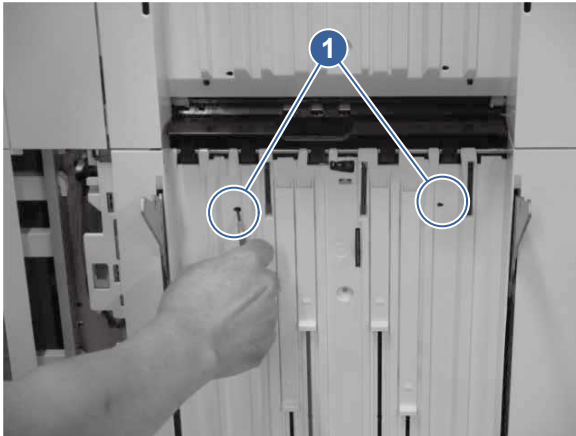
1. Disconnect one connector (callout 1), and then remove two screws (callout 2).

**Figure 5-1225** Disconnect one connector

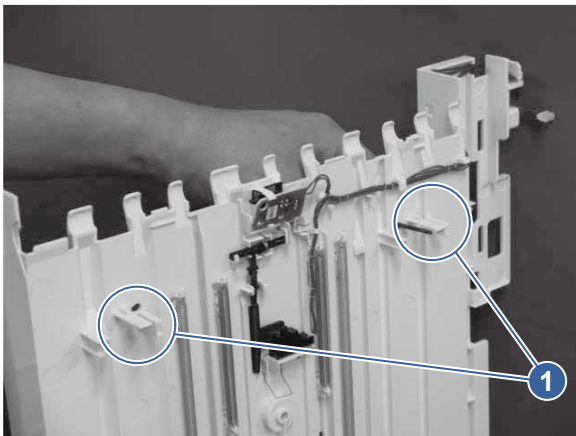


2. Release two inner tabs (callout 1) with a pointed tool.

**Figure 5-1226 Release two inner tabs**

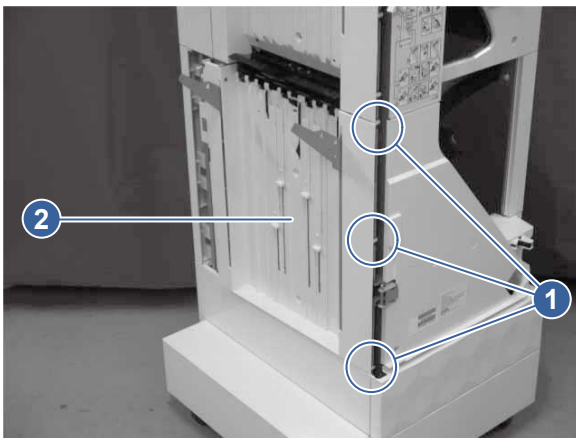


**Figure 5-1227 The two tabs viewed from the other side of the assembly**



3. Release three tabs (callout 1), and then remove the lower height wall assembly (callout 2).

**Figure 5-1228 Remove the lower height wall assembly**



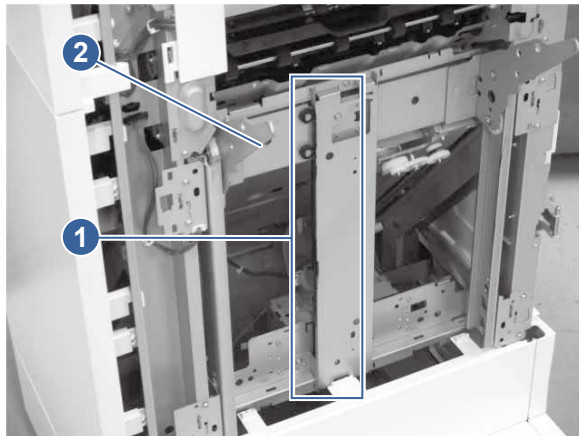
## 5. Remove the lower lifter base assembly (floor-standing stapler-stacker)

Learn about removing the floor-standing stapler-stacker lower lifter base assembly.



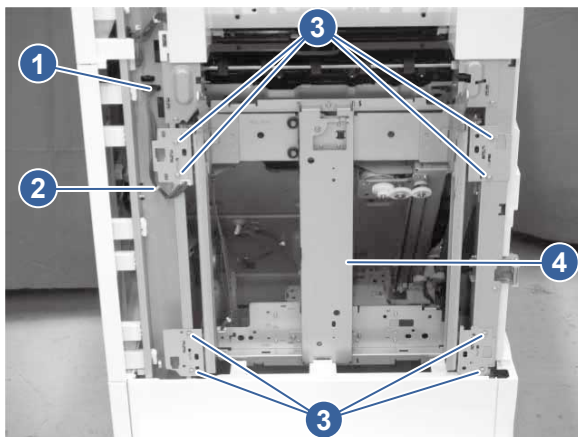
Do not touch the center (callout 1) of the lower lifter base assembly (callout 2) because grease is applied to the center.

**Figure 5-1229 Avoid touching the center**



- Disconnect one connector (callout 1), release the cable clamp (callout 2), remove eight screws (callout 3), and then remove the lower lifter base assembly (callout 4).

**Figure 5-1230 Remove the lower lifter base assembly**



## 6. Unpack the replacement assembly

Follow these steps to unpack the replacement assembly.

1. Dispose of the defective part.





**NOTE:** HP recommends responsible disposal of the defective part.


<http://www8.hp.com/us/en/hp-information/environment/product-recycling.html>

2. Unpack the replacement part from the packaging.



**CAUTION:**  Some parts are sensitive to electrostatic discharge (ESD). Always perform service work at an ESD-protected workstation or mat. If an ESD workstation or mat is not available, touch the sheet-metal chassis to provide a static ground before touching an ESD-sensitive assembly. Protect the ESD-sensitive assemblies by placing them in ESD pouches when they are out of the printer.


 **IMPORTANT:** Make sure that all of the shipping materials (for example shipping tape) are removed from the replacement part prior to installation.

 **NOTE:** If the replacement part is a roller or pad, avoid touching the spongy part of it. Skin oils on the roller or pad can cause paper pickup and/or print-quality problems. HP recommends using disposable gloves when handling rollers or pads or washing your hands before touching rollers or pads.

---

3. To install an assembly, reverse the removal steps.

---

 **NOTE:** When applicable, special installation instructions are provided for an assembly at the end of the removal procedure. Always completely read the removal instructions and follow all special installation instructions.

---

## Removal and replacement: Delivery assembly (floor-standing stapler-stacker)

Learn about removing and replacing the floor-standing stapler-stacker delivery assembly.




[View a video demonstration of removing and replacing the delivery assembly.](#)

### Before performing service

#### Turn the printer power off

- Disconnect the power cable.

 **WARNING!** To avoid damage to the printer, turn the printer off, wait 30 seconds, and then remove the power cord before attempting to service the printer.

---

Use the table below to identify the correct part number for your printer, and then go to <https://parts.hp.com/hpparts> to order the part.

**Table 5-168** Part information

Part number	Part description
RM2-3836-000CN	Paper delivery assembly (FSSS)

### Required tools

- #2 Phillips screwdriver with a magnetic tip and a 152 mm (6 in) shaft length
- Small flat-blade screwdriver

### After performing service

#### Turn the printer power on

- Connect the power cable.
- Use the power switch to turn the power on.

### Post service test

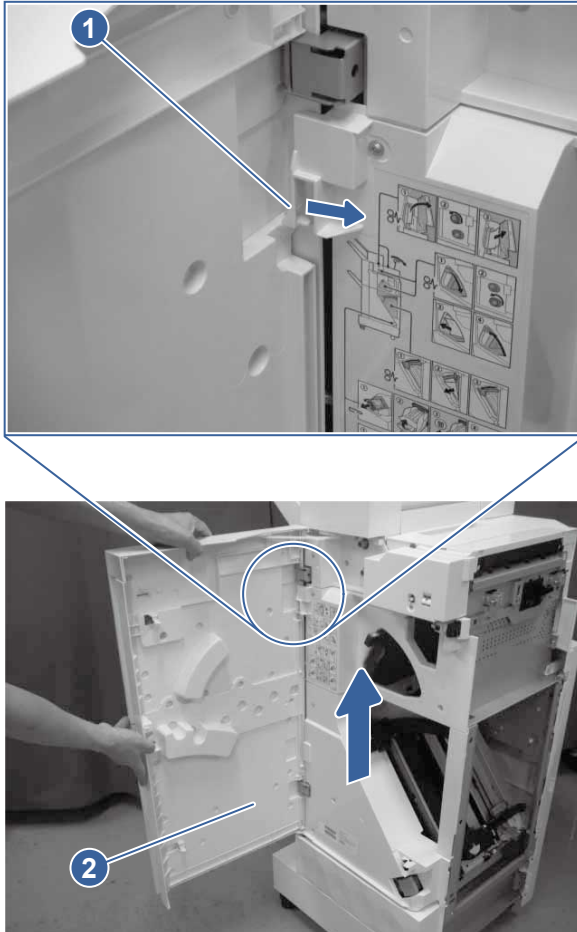
Print any pages necessary to make sure the printer is functioning correctly.

## 1. Remove the front door assembly (floor-standing stapler-stacker)

Learn about removing the floor-standing stapler-stacker front door assembly.

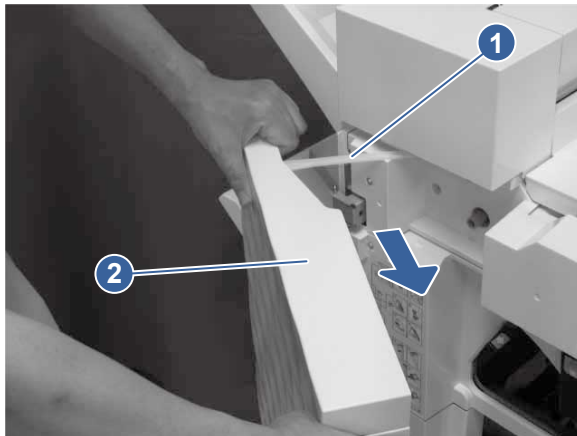
1. Open the front door.
2. Push the stopper (callout 1) in the direction indicated, and then pull up the front door assembly (callout 2) to remove it.

**Figure 5-1231 Remove the front door assembly**



3. Remove the hinge (callout 1) from the front door assembly (callout 2).

**Figure 5-1232 Remove the hinge**

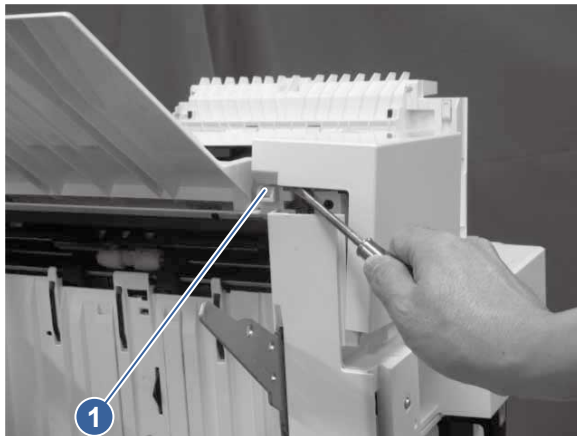


## 2. Remove the MBM front cover (floor-standing stapler-stacker)

Learn about removing the floor-standing stapler-stacker mailbox/booklet-maker front cover.

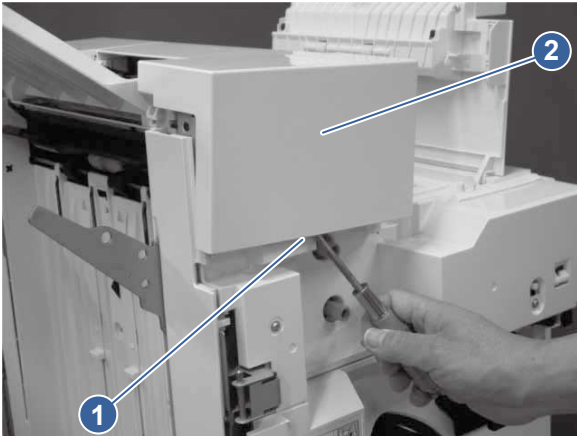
1. Release one tab (callout 1).

**Figure 5-1233 Release one tab**



2. Release one tab (callout 1), and then remove the MBM front cover (callout 2).

**Figure 5-1234 Remove the MBM front cover**

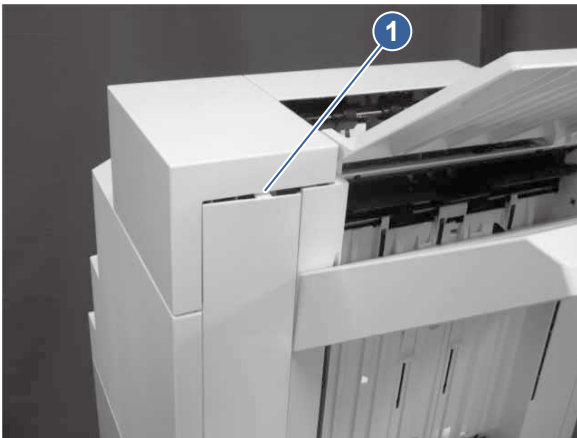


### **3. Remove the left upper rear cover (floor-standing stapler-stacker)**

Learn about removing the floor-standing stapler-stacker left upper rear cover.

1. Release one tab (callout 1).

**Figure 5-1235 Release one tab**



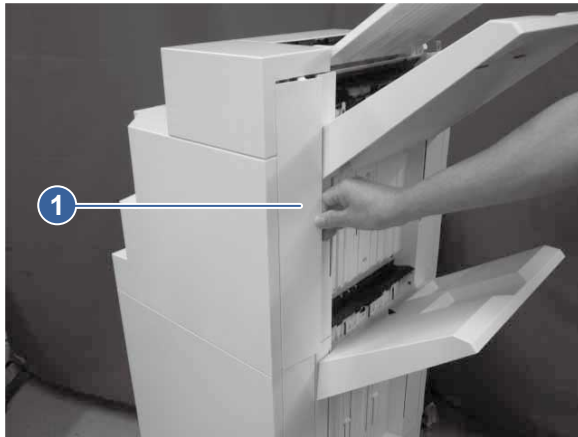
2. Release one boss (callout 1).

**Figure 5-1236 Release one boss**



3. Pull up the left upper rear cover (callout 1) to remove it.

**Figure 5-1237 Remove the left upper rear cover**

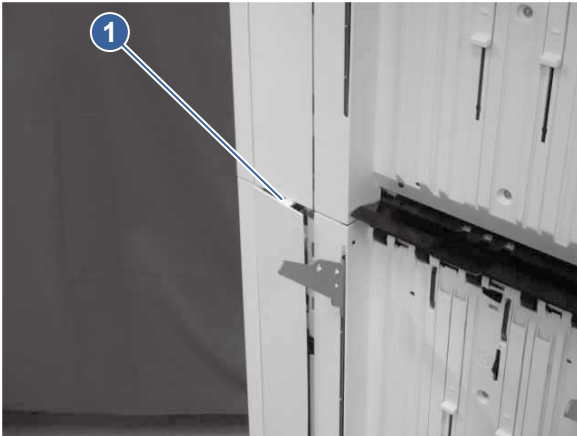


#### **4. Remove the left lower rear cover (floor-standing stapler-stacker)**

Learn about removing the floor-standing stapler-stacker left lower rear cover.

1. Release one tab (callout 1).

**Figure 5-1238 Release one tab**



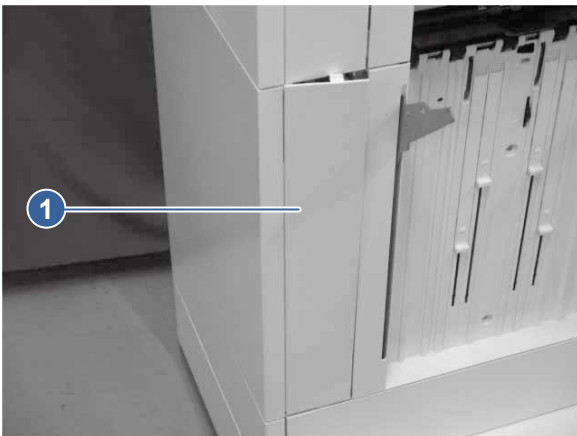
2. Release one boss (callout 1).

**Figure 5-1239 Release one boss**



3. Pull up the left lower rear cover (callout 1) to remove it.

**Figure 5-1240 Remove the left lower rear cover**

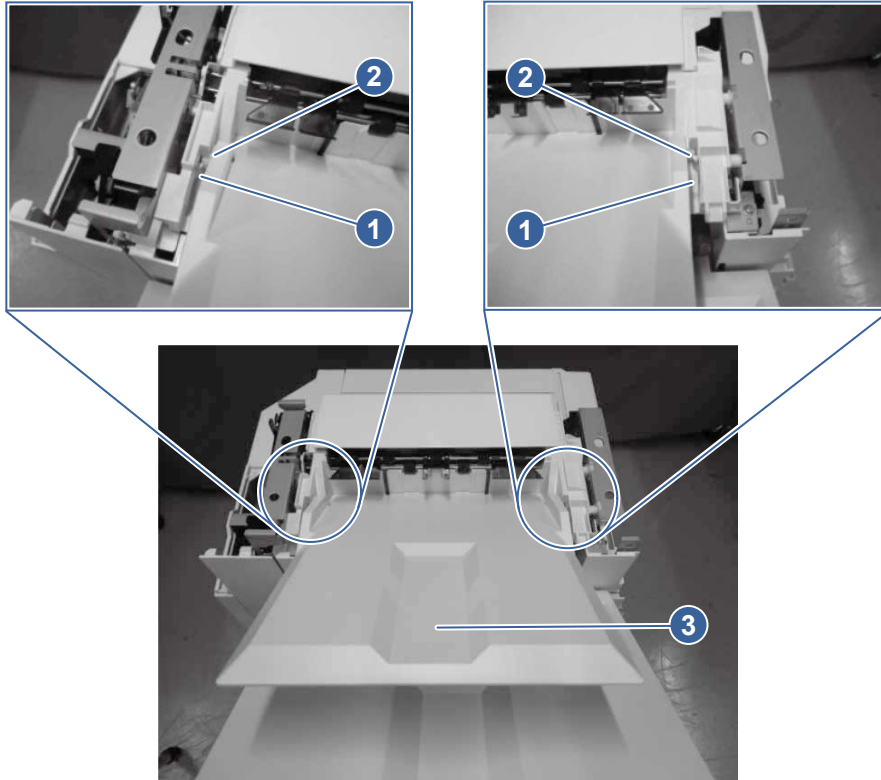


## 5. Remove the MBM output bin (floor-standing stapler-stacker)

Learn about removing the floor-standing stapler-stacker mailbox/booklet-maker output bin.

- Press the left and right stoppers (callout 1) to remove the shaft (callout 2), and then remove the MBM output bin (callout 3).

**Figure 5-1241 Remove the MBM output bin**

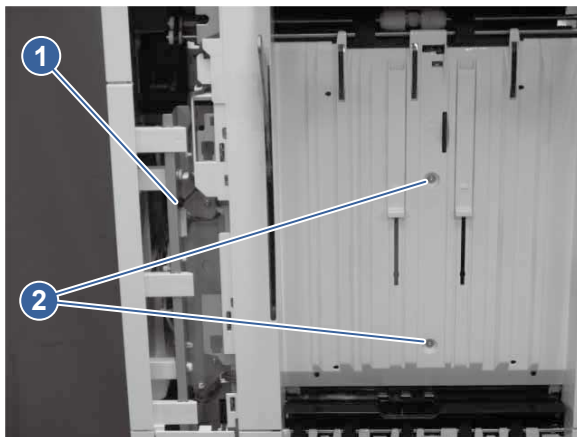


## 6. Remove the upper height wall assembly (floor-standing stapler-stacker)

Learn about removing the floor-standing stapler-stacker upper height wall assembly.

1. Disconnect one connector (callout 1), and then remove two screws (callout 2).

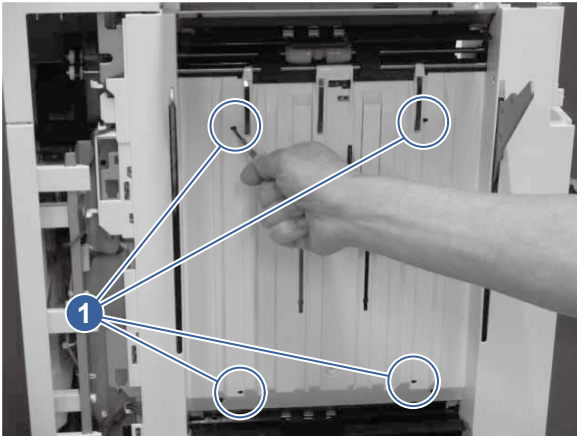
**Figure 5-1242 Disconnect one connector**



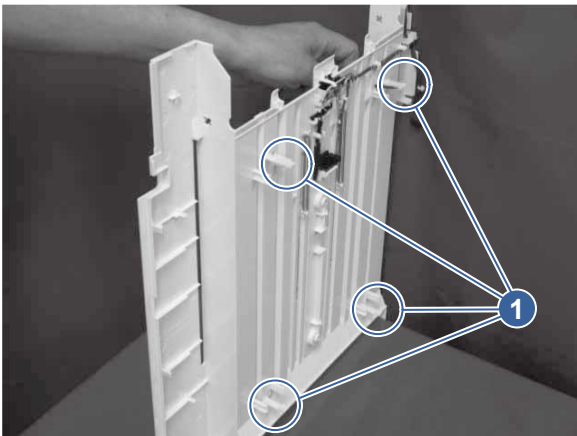


2. Release four inner tabs (callout 1) with a pointed tool.

**Figure 5-1243 Release four inner tabs**

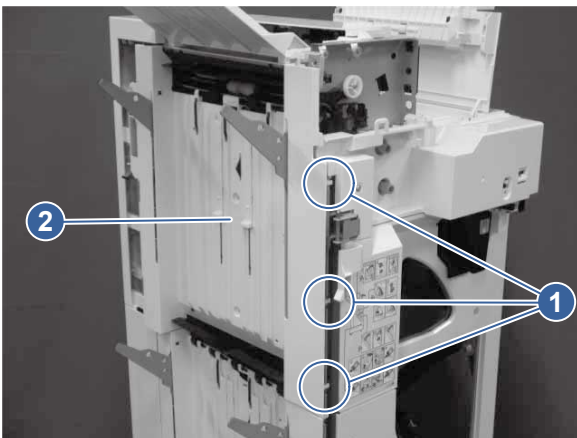


**Figure 5-1244 The four tabs viewed from the other side of the assembly**



3. Release three tabs (callout 1), and then remove the height wall upper assembly (callout 2).

**Figure 5-1245 Remove the upper height wall assembly**

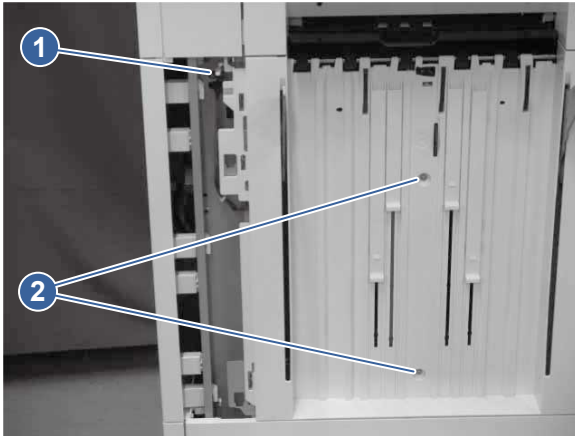


## 7. Remove the lower height wall (floor-standing stapler-stacker)

Learn about removing the floor-standing stapler-stacker lower height wall.

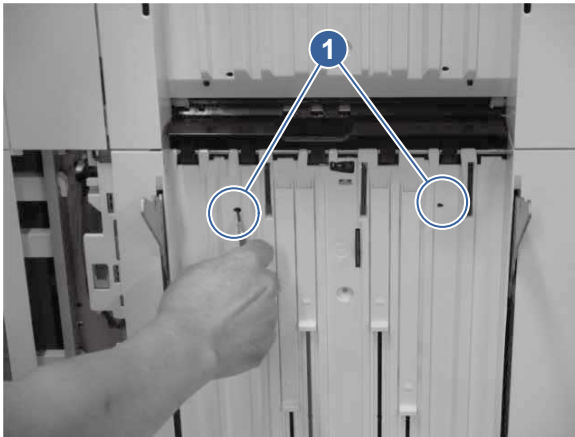
1. Disconnect one connector (callout 1), and then remove two screws (callout 2).

**Figure 5-1246 Disconnect one connector**

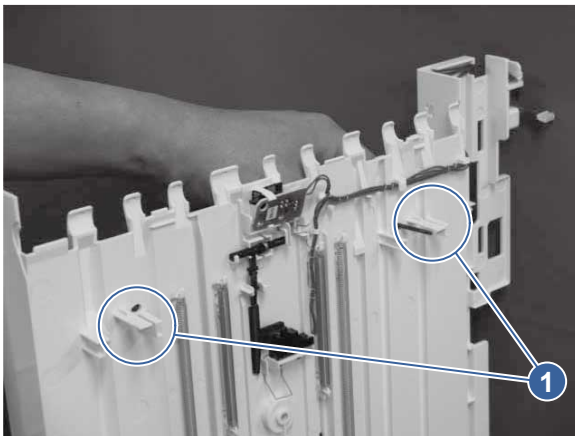


2. Release two inner tabs (callout 1) with a pointed tool.

**Figure 5-1247 Release two inner tabs**

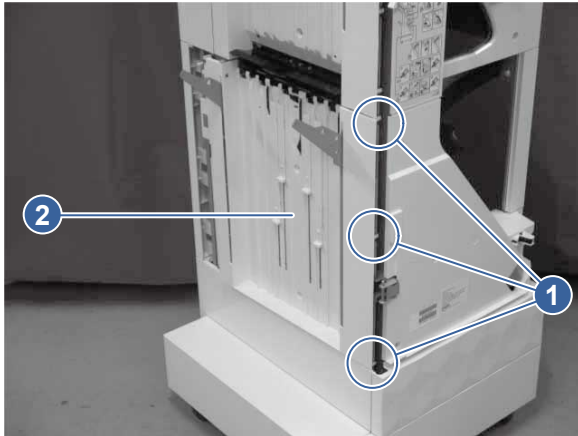


**Figure 5-1248 The two tabs viewed from the other side of the assembly**



3. Release three tabs (callout 1), and then remove the lower height wall assembly (callout 2).

**Figure 5-1249 Remove the lower height wall assembly**

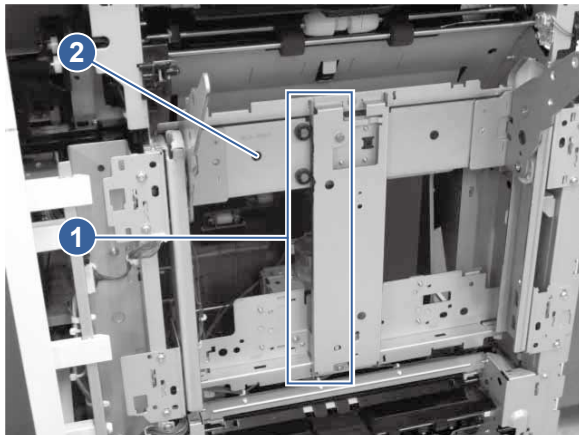


### 8. Remove the upper lifter base assembly (floor-standing stapler-stacker)

Learn about removing the floor-standing stapler-stacker upper lifter base assembly.

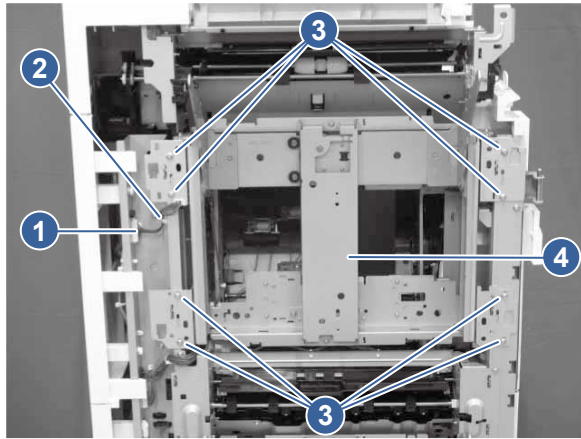
Do not touch the center (callout 1) of the upper lifter base assembly (callout 2) because grease is applied to the center.

**Figure 5-1250 Avoid touching the center**



- Disconnect one connector (callout 1), release the cable clamp (callout 2), remove eight screws (callout 3), and then remove the upper lifter base assembly (callout 4).

**Figure 5-1251 Remove the upper lifter base assembly**

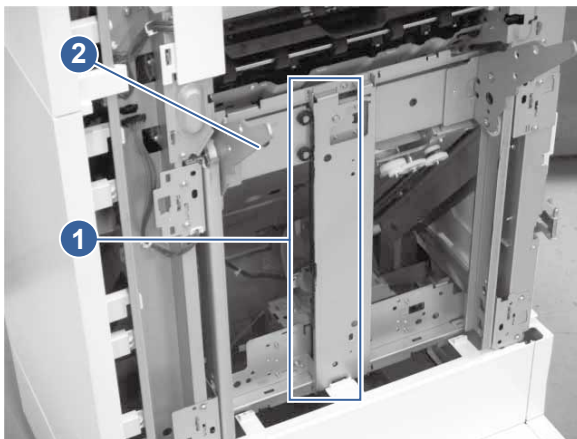


### 9. Remove the lower lifter base assembly (floor-standing stapler-stacker)

Learn about removing the floor-standing stapler-stacker lower lifter base assembly.

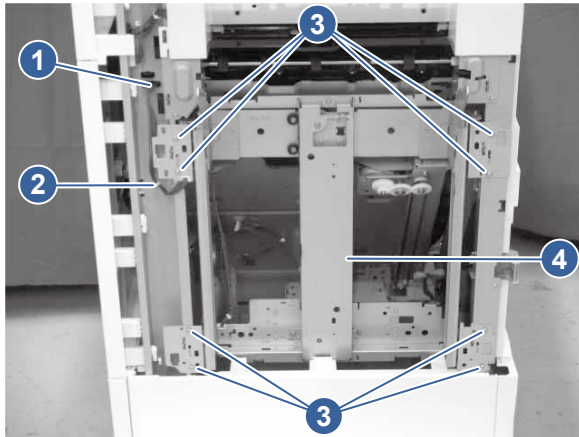
Do not touch the center (callout 1) of the lower lifter base assembly (callout 2) because grease is applied to the center.

**Figure 5-1252 Avoid touching the center**



- Disconnect one connector (callout 1), release the cable clamp (callout 2), remove eight screws (callout 3), and then remove the lower lifter base assembly (callout 4).

**Figure 5-1253 Remove the lower lifter base assembly**

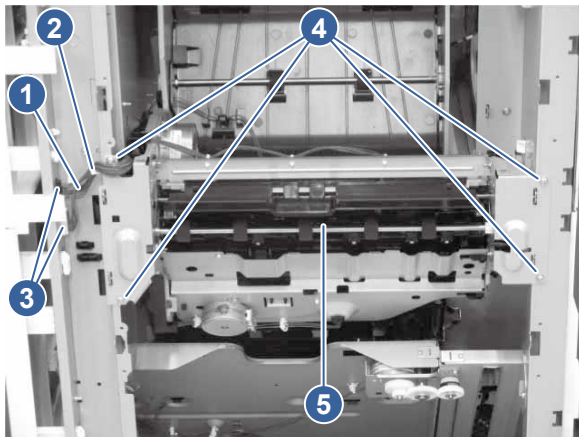


## 10. Remove the delivery assembly (floor-standing stapler-stacker)

Learn about removing the floor-standing stapler-stacker delivery assembly.

- Release the cable (callout 1) from the cable clamp (callout 2), disconnect two connectors (callout 3), remove four screws (callout 4), and then remove the delivery assembly (callout 5).

**Figure 5-1254 Remove the delivery assembly**



## 11. Unpack the replacement assembly

Follow these steps to unpack the replacement assembly.



1. Dispose of the defective part.





**NOTE:** HP recommends responsible disposal of the defective part.

<http://www8.hp.com/us/en/hp-information/environment/product-recycling.html>


## 2. Unpack the replacement part from the packaging.

 **CAUTION:**  Some parts are sensitive to electrostatic discharge (ESD). Always perform service work at an ESD-protected workstation or mat. If an ESD workstation or mat is not available, touch the sheet-metal chassis to provide a static ground before touching an ESD-sensitive assembly. Protect the ESD-sensitive assemblies by placing them in ESD pouches when they are out of the printer.

 **IMPORTANT:** Make sure that all of the shipping materials (for example shipping tape) are removed from the replacement part prior to installation.

 **NOTE:** If the replacement part is a roller or pad, avoid touching the spongy part of it. Skin oils on the roller or pad can cause paper pickup and/or print-quality problems. HP recommends using disposable gloves when handling rollers or pads or washing your hands before touching rollers or pads.

## 3. To install an assembly, reverse the removal steps.

 **NOTE:** When applicable, special installation instructions are provided for an assembly at the end of the removal procedure. Always completely read the removal instructions and follow all special installation instructions.

### Removal and replacement: Punch assembly (floor-standing stapler-stacker)

Learn about removing and replacing the floor-standing stapler-stacker punch assembly.




[View a video demonstration of removing and replacing the punch assembly.](#)

### Before performing service

#### Turn the printer power off

- Disconnect the power cable.

 **WARNING!** To avoid damage to the printer, turn the printer off, wait 30 seconds, and then remove the power cord before attempting to service the printer.

Use the table below to identify the correct part number for your printer, and then go to <https://parts.hp.com/hpparts> to order the part.

**Table 5-169** Part information

Part number	Part description
RM2-3834-000CN	Punch assembly (FSSS)

### Required tools

- #2 Phillips screwdriver with a magnetic tip and a 152 mm (6 in) shaft length
- Small flat-blade screwdriver

### After performing service

#### Turn the printer power on

- Connect the power cable.

- Use the power switch to turn the power on.

## Post service test

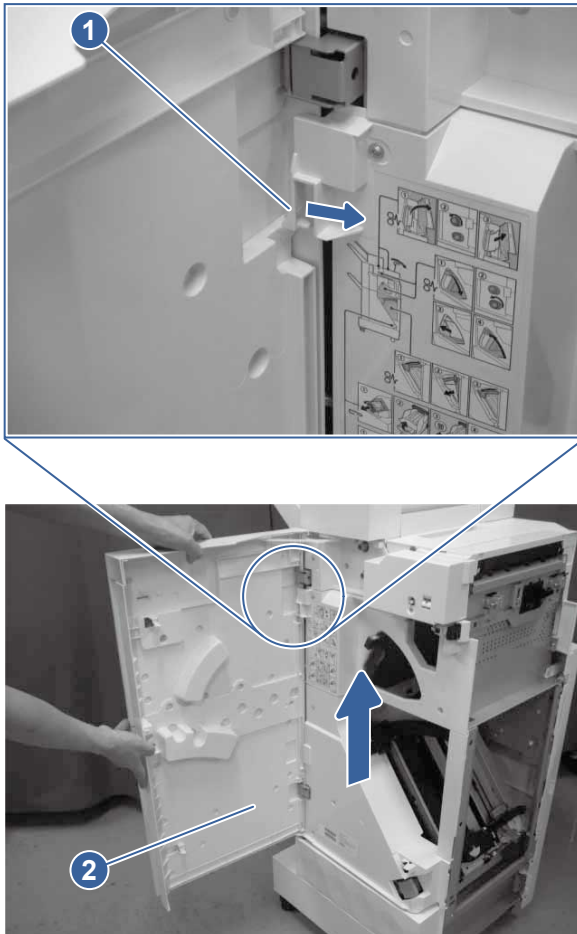
Print any pages necessary to make sure the printer is functioning correctly.

### 1. Remove the front door assembly (floor-standing stapler-stacker)

Learn about removing the floor-standing stapler-stacker front door assembly.

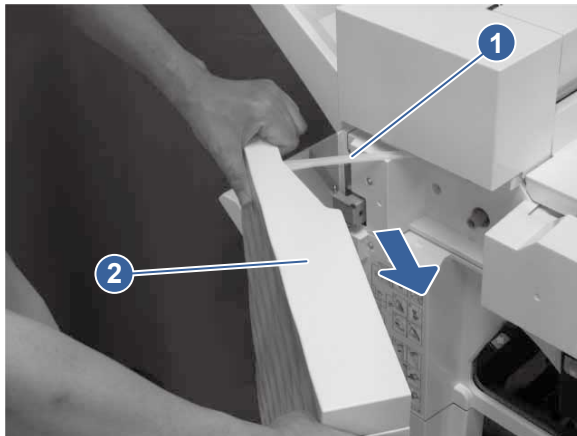
1. Open the front door.
2. Push the stopper (callout 1) in the direction indicated, and then pull up the front door assembly (callout 2) to remove it.

**Figure 5-1255** Remove the front door assembly



3. Remove the hinge (callout 1) from the front door assembly (callout 2).

**Figure 5-1256 Remove the hinge**

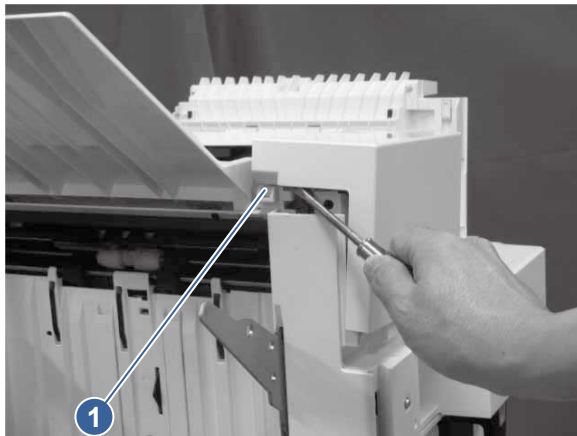


## 2. Remove the MBM front cover (floor-standing stapler-stacker)

Learn about removing the floor-standing stapler-stacker mailbox/booklet-maker front cover.

1. Release one tab (callout 1).

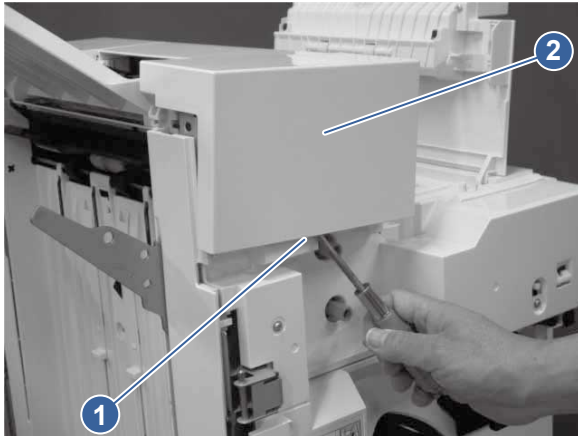
**Figure 5-1257 Release one tab**





2. Release one tab (callout 1), and then remove the MBM front cover (callout 2).

**Figure 5-1258 Remove the MBM front cover**

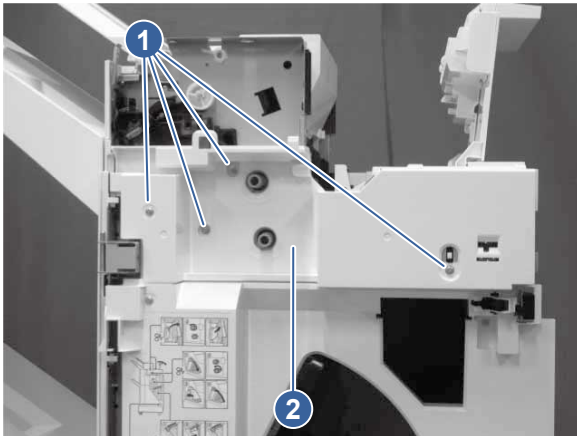


### 3. Remove the front inner upper cover (floor-standing stapler-stacker)

Learn about removing the floor-standing stapler-stacker front inner upper cover.

- Remove four screws (callout 1), and then remove the front inner upper cover (callout 2).

**Figure 5-1259 Remove the front inner upper cover**

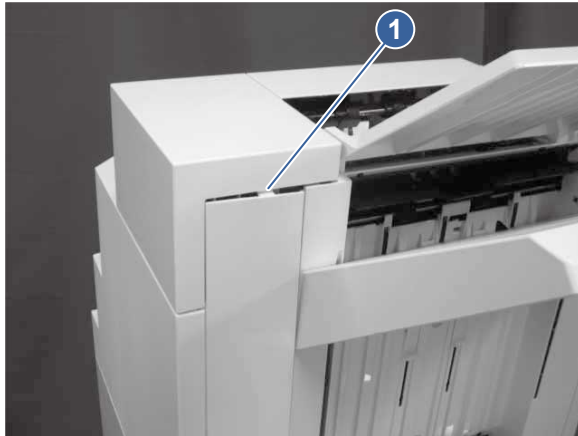


### 4. Remove the left upper rear cover (floor-standing stapler-stacker)

Learn about removing the floor-standing stapler-stacker left upper rear cover.

1. Release one tab (callout 1).

**Figure 5-1260 Release one tab**



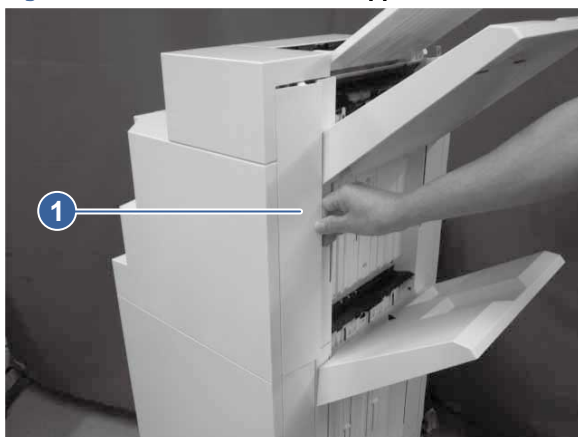
2. Release one boss (callout 1).

**Figure 5-1261 Release one boss**



3. Pull up the left upper rear cover (callout 1) to remove it.

**Figure 5-1262 Remove the left upper rear cover**

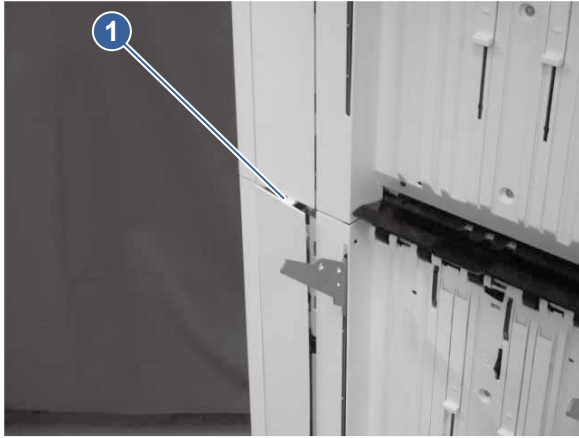


## 5. Remove the left lower rear cover (floor-standing stapler-stacker)

Learn about removing the floor-standing stapler-stacker left lower rear cover.

1. Release one tab (callout 1).

**Figure 5-1263 Release one tab**



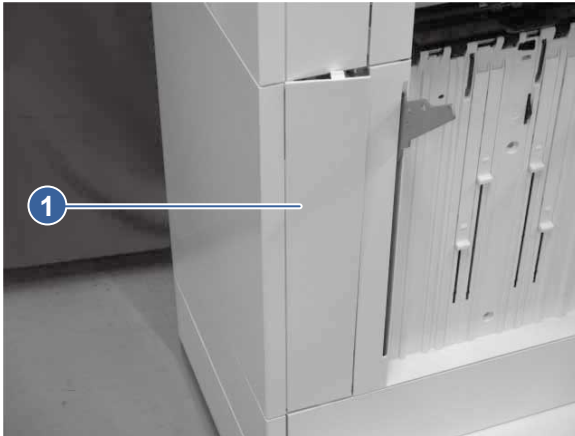
2. Release one boss (callout 1).

**Figure 5-1264 Release one boss**



3. Pull up the left lower rear cover (callout 1) to remove it.

**Figure 5-1265 Remove the left lower rear cover**



#### **6. Remove the MBM rear cover (floor-standing stapler-stacker)**

Learn about removing the floor-standing stapler-stacker mailbox/booklet-maker rear cover.

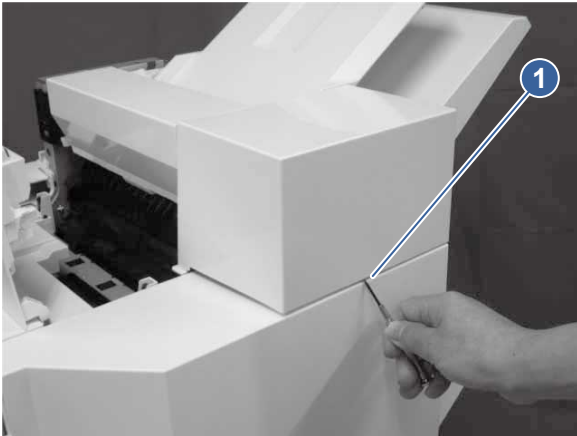
1. On the inside of the cover, release one tab (callout 1).

**Figure 5-1266 Release one tab**



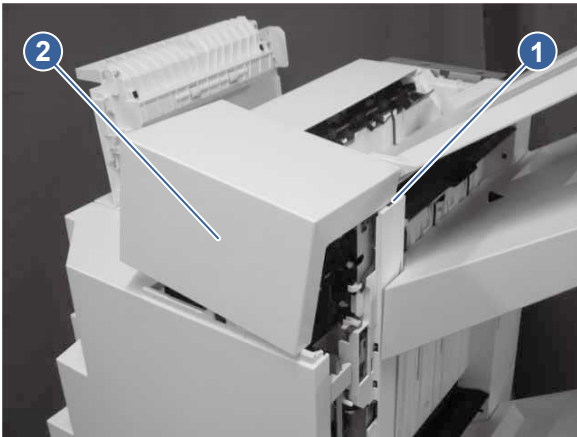
2. Release another tab (callout 1).

**Figure 5-1267 Release another tab**



3. Release another tab (callout 1), and then remove the MBM rear cover (callout 2).

**Figure 5-1268 Remove the MBM rear cover**

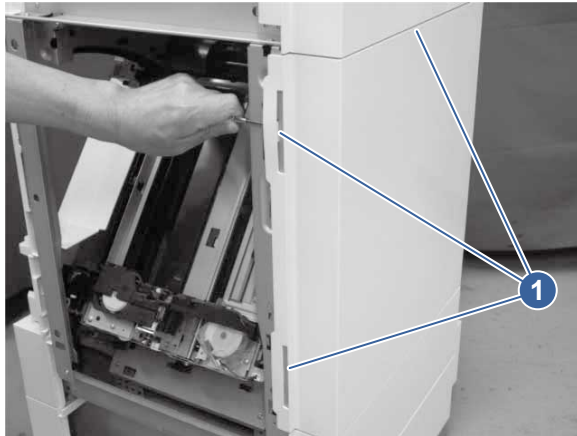


## 7. Remove the rear cover (floor-standing stapler-stacker)

Learn about removing the floor-standing stapler-stacker rear cover.

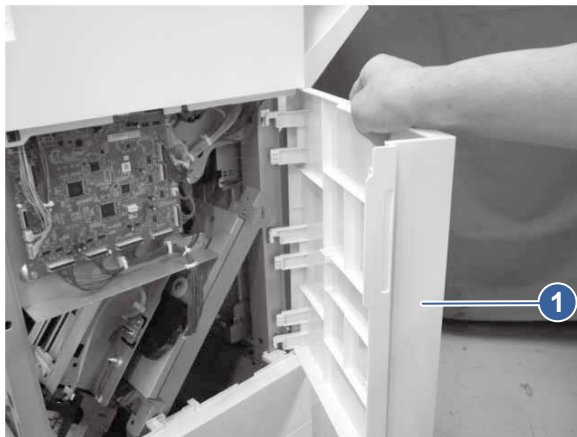
1. Release three tabs (callout 1).

**Figure 5-1269 Release three tabs**



2. Remove the rear cover (callout 1).

**Figure 5-1270 Remove the rear cover**

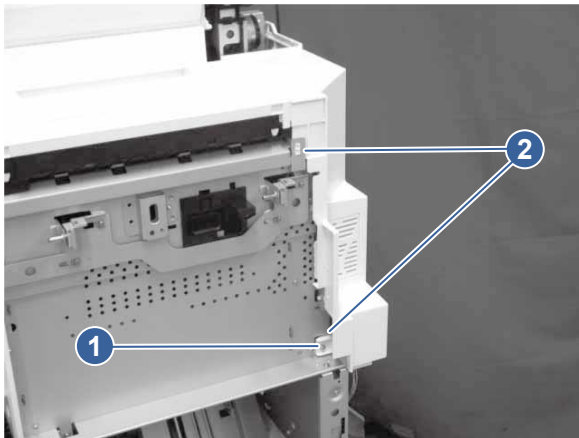


#### **8. Remove the rear upper cover (floor-standing stapler-stacker)**

Learn about removing the floor-standing stapler-stacker rear upper cover.

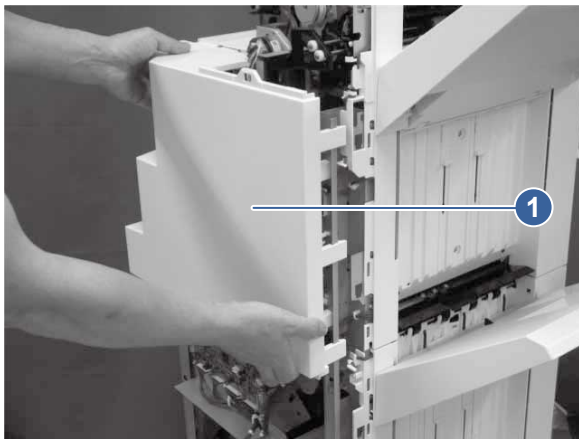
1. Remove one screw (callout 1), and then release two tabs (callout 2).

**Figure 5-1271 Remove one screw and release two tabs**



2. Remove the rear upper cover (callout 1).

**Figure 5-1272 Remove the rear upper cover**

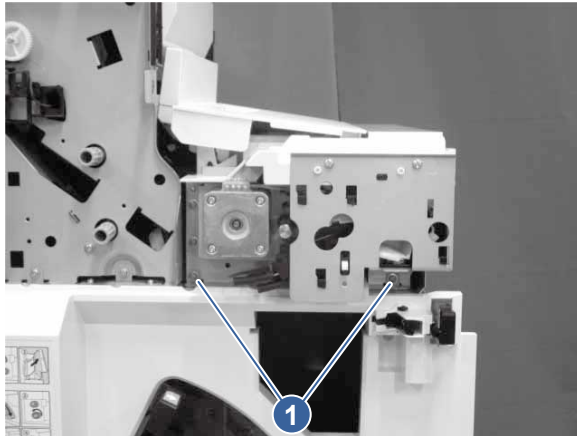


## 9. Remove the punch assembly (floor-standing stapler-stacker)

Learn about removing the floor-standing stapler-stacker punch assembly.

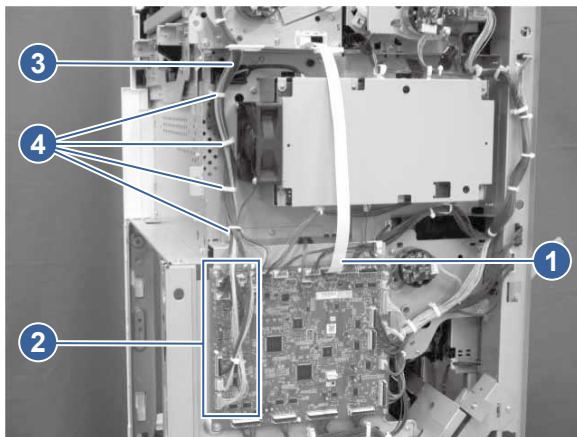
1. Remove two screws (callout 1).

**Figure 5-1273 Remove two screws**



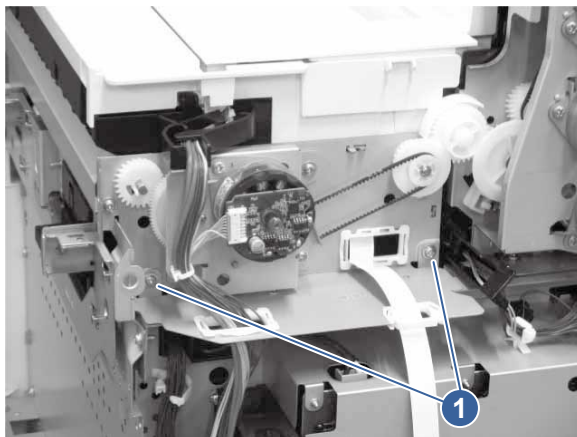
2. Remove one FFC (callout 1), disconnect seven connectors (callout 2), and then release the cable (callout 3) from the cable clamps (callout 4).

**Figure 5-1274 Remove one FFC**



3. Remove two screws (callout 1).

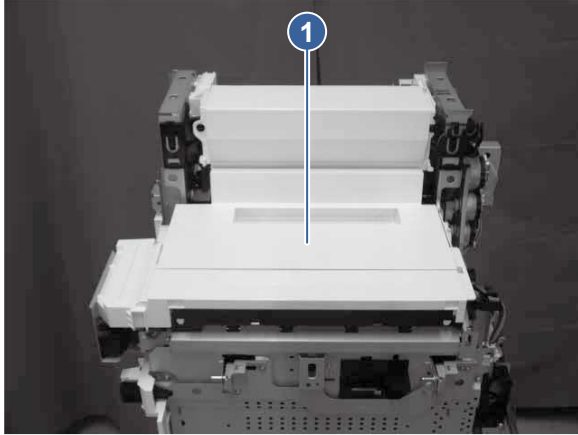
**Figure 5-1275 Remove two screws**





4. Remove the punch assembly (callout 1).

**Figure 5-1276 Remove the punch assembly**




## 10. Unpack the replacement assembly

Follow these steps to unpack the replacement assembly.

1. Dispose of the defective part.

---



 **NOTE:** HP recommends responsible disposal of the defective part.


<http://www8.hp.com/us/en/hp-information/environment/product-recycling.html>


---

2. Unpack the replacement part from the packaging.

---

 **CAUTION:**  Some parts are sensitive to electrostatic discharge (ESD). Always perform service work at an ESD-protected workstation or mat. If an ESD workstation or mat is not available, touch the sheet-metal chassis to provide a static ground before touching an ESD-sensitive assembly. Protect the ESD-sensitive assemblies by placing them in ESD pouches when they are out of the printer.


 **IMPORTANT:** Make sure that all of the shipping materials (for example shipping tape) are removed from the replacement part prior to installation.

 **NOTE:** If the replacement part is a roller or pad, avoid touching the spongy part of it. Skin oils on the roller or pad can cause paper pickup and/or print-quality problems. HP recommends using disposable gloves when handling rollers or pads or washing your hands before touching rollers or pads.

---

3. To install an assembly, reverse the removal steps.

---

 **NOTE:** When applicable, special installation instructions are provided for an assembly at the end of the removal procedure. Always completely read the removal instructions and follow all special installation instructions.

---

## Removal and replacement: SWB assembly (floor-standing stapler-stacker)

Learn about removing and replacing the floor-standing stapler-stacker SWB assembly.

 [View a video demonstration of removing and replacing the SWB assembly.](#)

## Before performing service

### Turn the printer power off

- Disconnect the power cable.

**⚠ WARNING!** To avoid damage to the printer, turn the printer off, wait 30 seconds, and then remove the power cord before attempting to service the printer.

Use the table below to identify the correct part number for your printer, and then go to <https://parts.hp.com/hpparts> to order the part.

**Table 5-170** Part information

Part number	Part description
RM2-3867-000CN	Switch back assembly (FSSS)

### Required tools

- #2 Phillips screwdriver with a magnetic tip and a 152 mm (6 in) shaft length
- Small flat-blade screwdriver

### After performing service

#### Turn the printer power on

- Connect the power cable.
- Use the power switch to turn the power on.

### Post service test

Print any pages necessary to make sure the printer is functioning correctly.

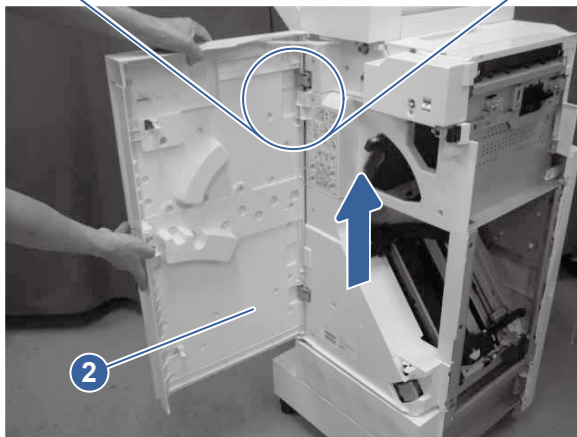
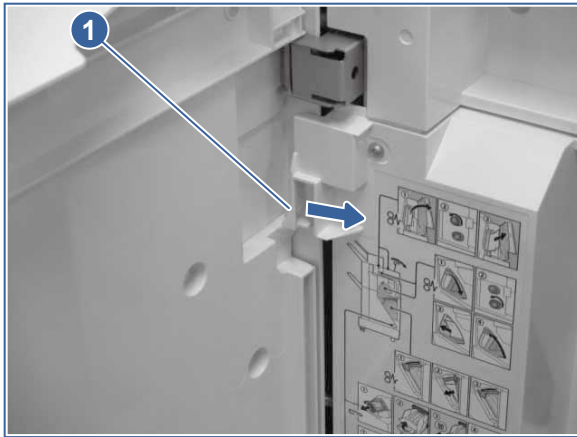
#### 1. Remove the front door assembly (floor-standing stapler-stacker)

Learn about removing the floor-standing stapler-stacker front door assembly.

1. Open the front door.

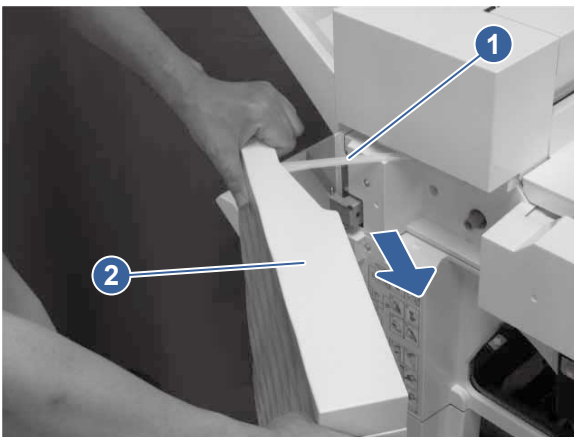
2. Push the stopper (callout 1) in the direction indicated, and then pull up the front door assembly (callout 2) to remove it.

**Figure 5-1277 Remove the front door assembly**



3. Remove the hinge (callout 1) from the front door assembly (callout 2).

**Figure 5-1278 Remove the hinge**

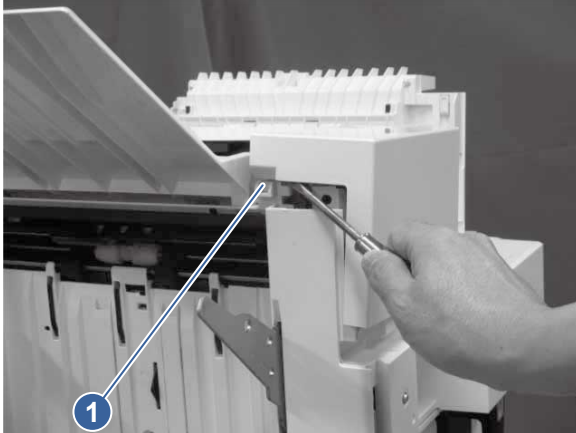


## 2. Remove the MBM front cover (floor-standing stapler-stacker)

Learn about removing the floor-standing stapler-stacker mailbox/booklet-maker front cover.

1. Release one tab (callout 1).

**Figure 5-1279 Release one tab**



2. Release one tab (callout 1), and then remove the MBM front cover (callout 2).

**Figure 5-1280 Remove the MBM front cover**

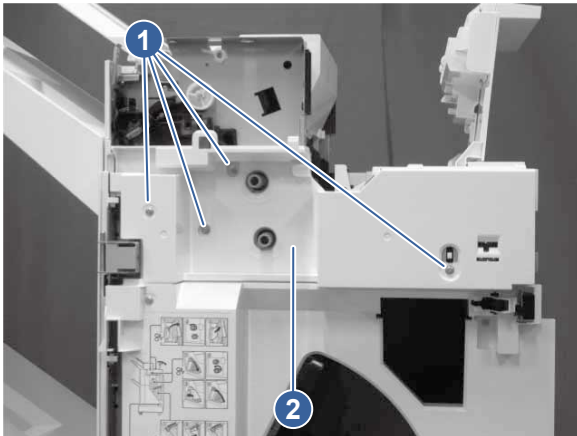


### **3. Remove the front inner upper cover (floor-standing stapler-stacker)**

Learn about removing the floor-standing stapler-stacker front inner upper cover.

- Remove four screws (callout 1), and then remove the front inner upper cover (callout 2).

**Figure 5-1281 Remove the front inner upper cover**

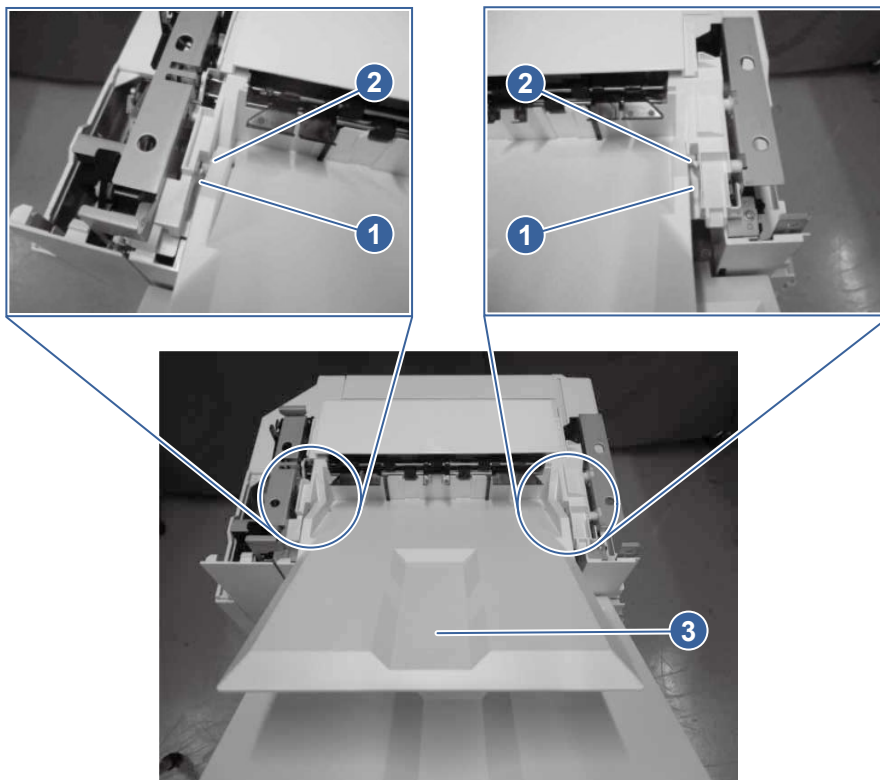


#### 4. Remove the MBM output bin (floor-standing stapler-stacker)

Learn about removing the floor-standing stapler-stacker mailbox/booklet-maker output bin.

- Press the left and right stoppers (callout 1) to remove the shaft (callout 2), and then remove the MBM output bin (callout 3).

**Figure 5-1282 Remove the MBM output bin**

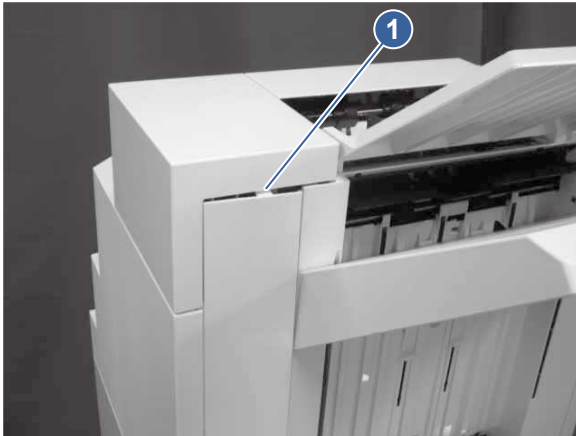


#### 5. Remove the left upper rear cover (floor-standing stapler-stacker)

Learn about removing the floor-standing stapler-stacker left upper rear cover.

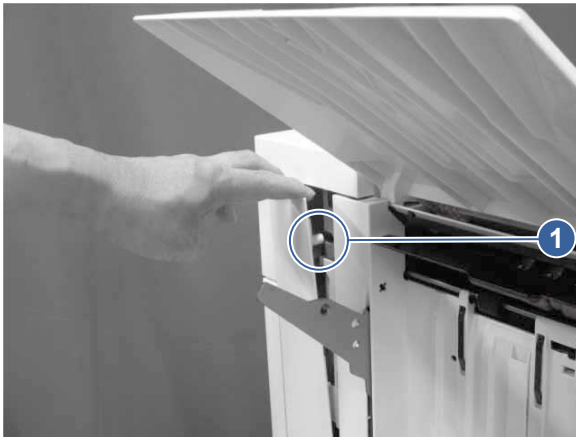
1. Release one tab (callout 1).

**Figure 5-1283 Release one tab**



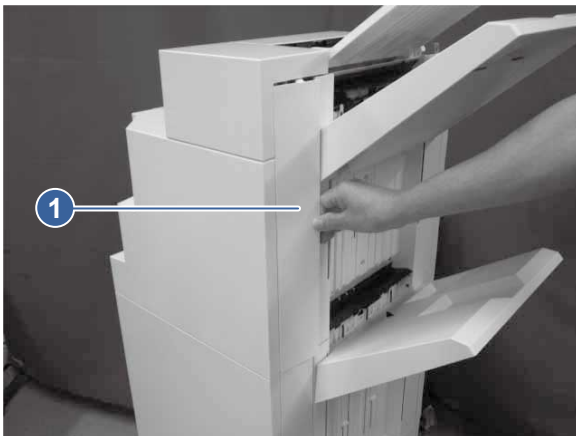
2. Release one boss (callout 1).

**Figure 5-1284 Release one boss**



3. Pull up the left upper rear cover (callout 1) to remove it.

**Figure 5-1285 Remove the left upper rear cover**

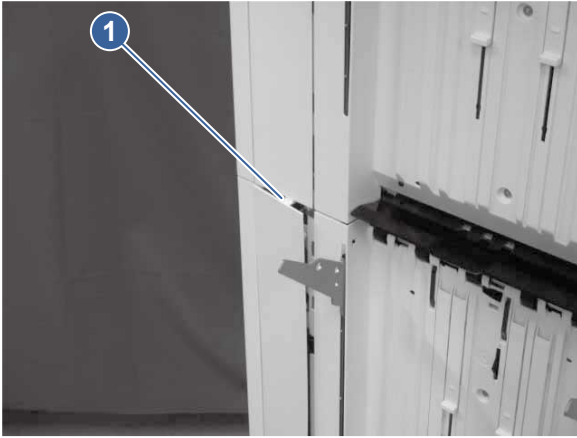


## 6. Remove the left lower rear cover (floor-standing stapler-stacker)

Learn about removing the floor-standing stapler-stacker left lower rear cover.

1. Release one tab (callout 1).

**Figure 5-1286 Release one tab**



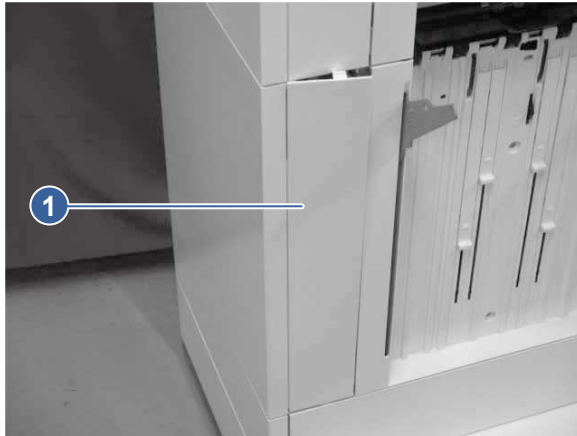
2. Release one boss (callout 1).

**Figure 5-1287 Release one boss**



3. Pull up the left lower rear cover (callout 1) to remove it.

**Figure 5-1288 Remove the left lower rear cover**



### 7. Remove the MBM rear cover (floor-standing stapler-stacker)

Learn about removing the floor-standing stapler-stacker mailbox/booklet-maker rear cover.

1. On the inside of the cover, release one tab (callout 1).

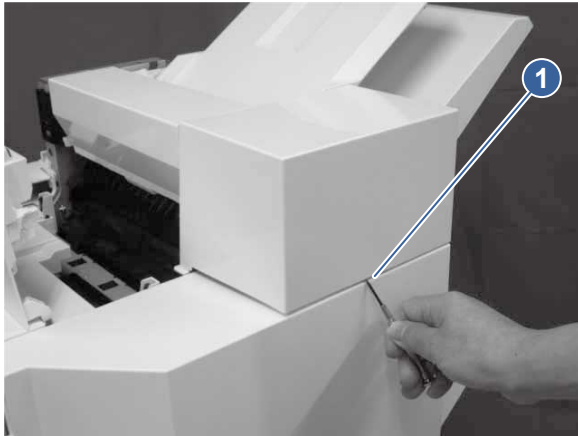
**Figure 5-1289 Release one tab**





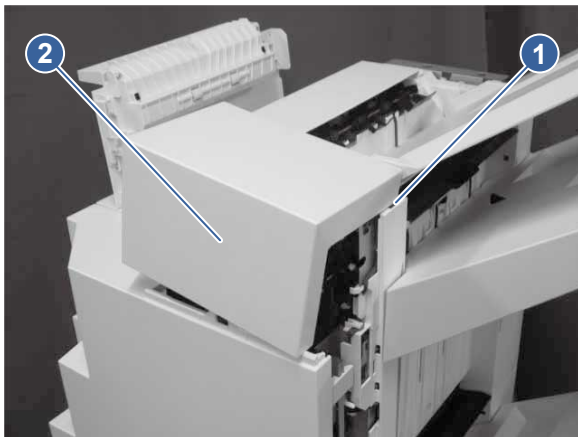
2. Release another tab (callout 1).

**Figure 5-1290 Release another tab**



3. Release another tab (callout 1), and then remove the MBM rear cover (callout 2).

**Figure 5-1291 Remove the MBM rear cover**

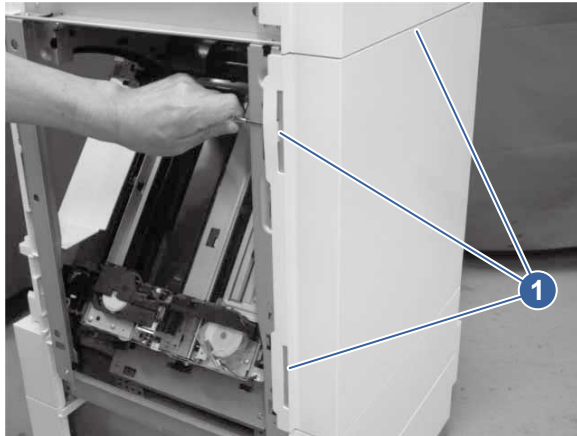


#### **8. Remove the rear cover (floor-standing stapler-stacker)**

Learn about removing the floor-standing stapler-stacker rear cover.

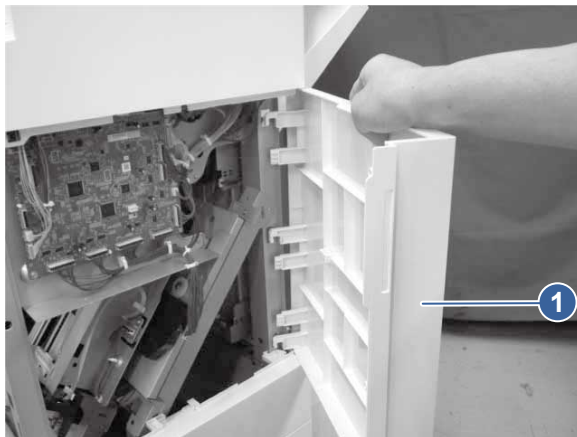
1. Release three tabs (callout 1).

**Figure 5-1292 Release three tabs**



2. Remove the rear cover (callout 1).

**Figure 5-1293 Remove the rear cover**

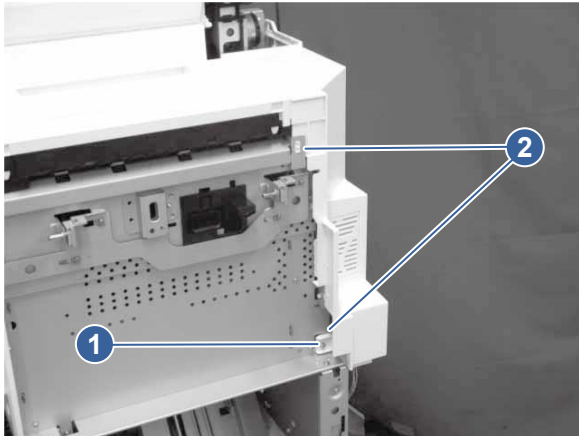


### **9. Remove the rear upper cover (floor-standing stapler-stacker)**

Learn about removing the floor-standing stapler-stacker rear upper cover.

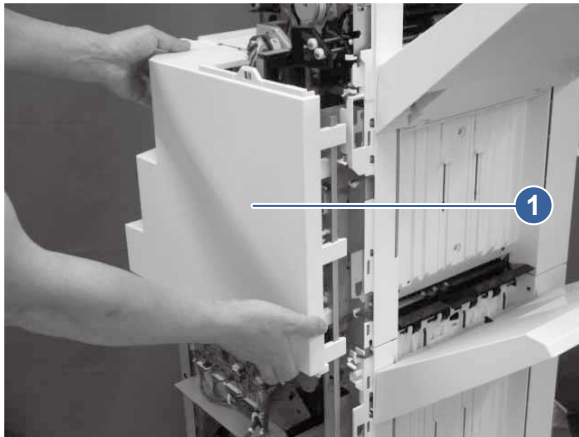
1. Remove one screw (callout 1), and then release two tabs (callout 2).

**Figure 5-1294 Remove one screw and release two tabs**



2. Remove the rear upper cover (callout 1).

**Figure 5-1295 Remove the rear upper cover**

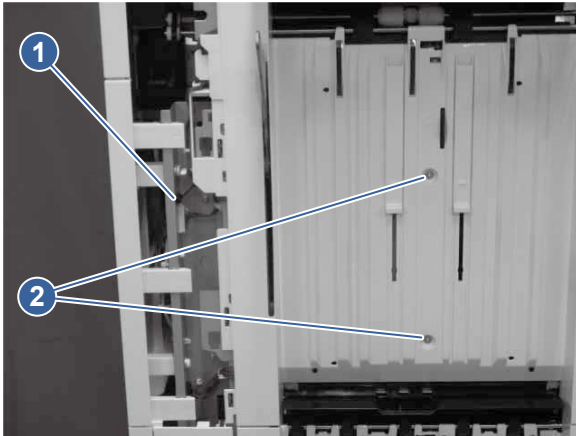


## 10. Remove the upper height wall assembly (floor-standing stapler-stacker)

Learn about removing the floor-standing stapler-stacker upper height wall assembly.

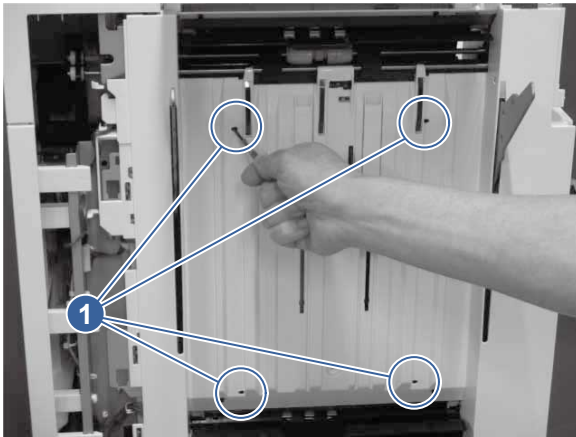
1. Disconnect one connector (callout 1), and then remove two screws (callout 2).

**Figure 5-1296 Disconnect one connector**

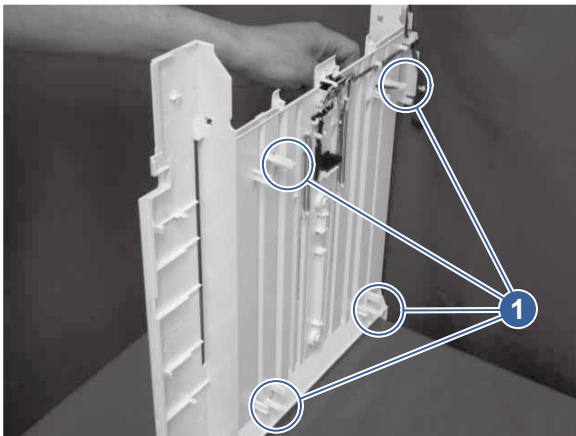


2. Release four inner tabs (callout 1) with a pointed tool.

**Figure 5-1297 Release four inner tabs**

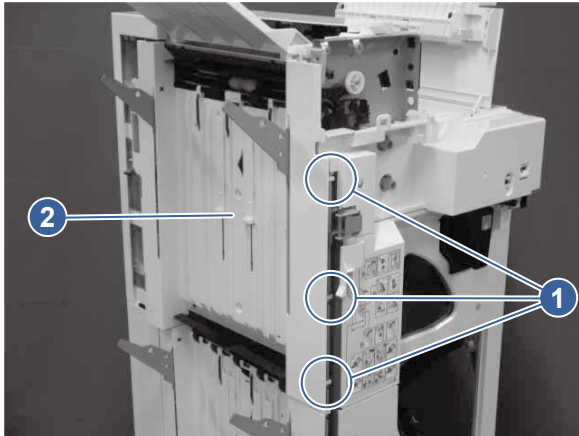


**Figure 5-1298 The four tabs viewed from the other side of the assembly**



3. Release three tabs (callout 1), and then remove the height wall upper assembly (callout 2).

**Figure 5-1299 Remove the upper height wall assembly**

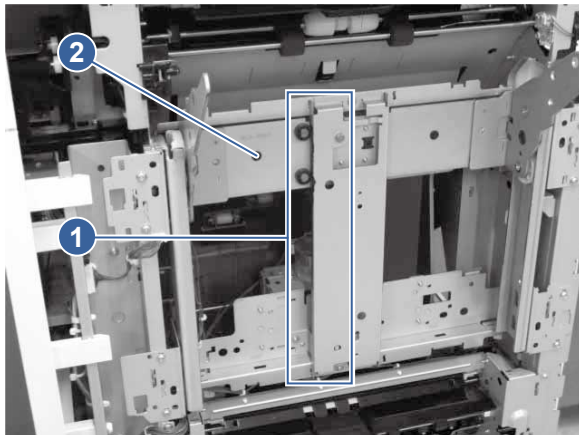


### 11. Remove the upper lifter base assembly (floor-standing stapler-stacker)

Learn about removing the floor-standing stapler-stacker upper lifter base assembly.

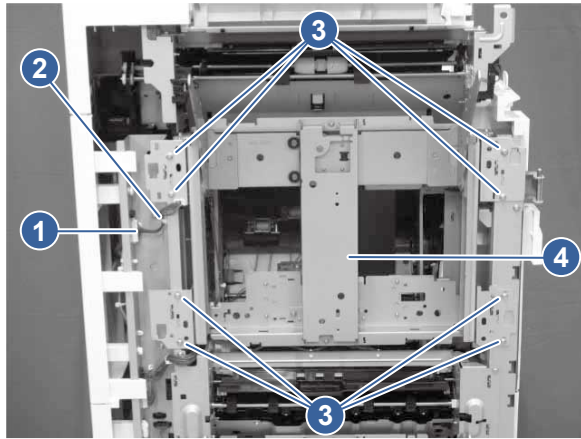
Do not touch the center (callout 1) of the upper lifter base assembly (callout 2) because grease is applied to the center.

**Figure 5-1300 Avoid touching the center**



- Disconnect one connector (callout 1), release the cable clamp (callout 2), remove eight screws (callout 3), and then remove the upper lifter base assembly (callout 4).

**Figure 5-1301 Remove the upper lifter base assembly**

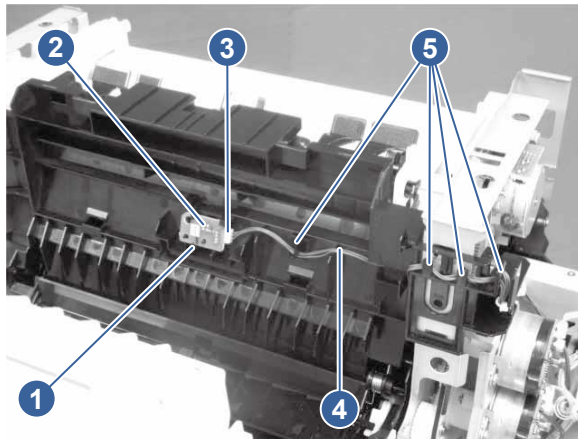


## 12. Remove the SWB assembly (floor-standing stapler-stacker)

Learn about removing the floor-standing stapler-stacker SWB assembly.

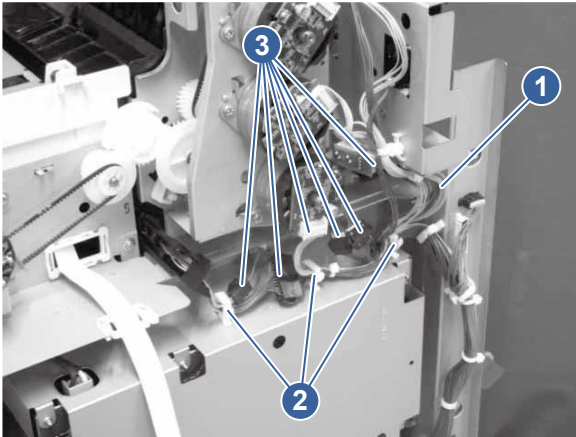
1. Release one tab (callout 1), remove the sensor PCA (callout 2), disconnect one connector (callout 1), and then release the cable (callout 4) from the cable clamps (callout 5).

**Figure 5-1302 Release one tab**



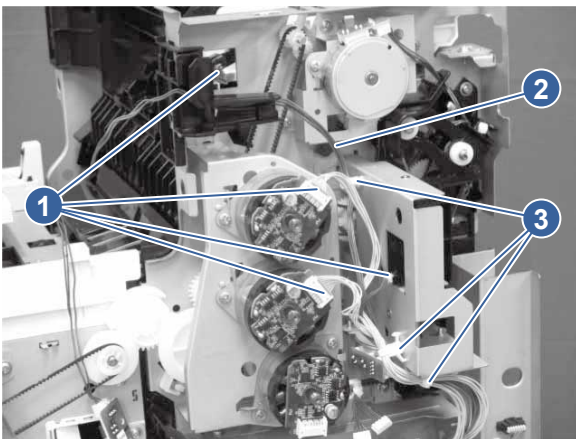
2. Release the cable (callout 1) from the cable clamps (callout 2), and then disconnect six connectors (callout 3).

**Figure 5-1303 Release the cable**



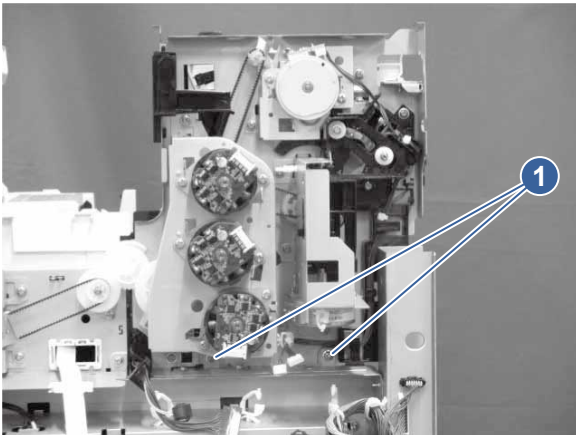
3. Disconnect four connectors (callout 1), and then release the cable (callout 2) from the cable clamps (callout 3).

**Figure 5-1304 Disconnect four connectors**



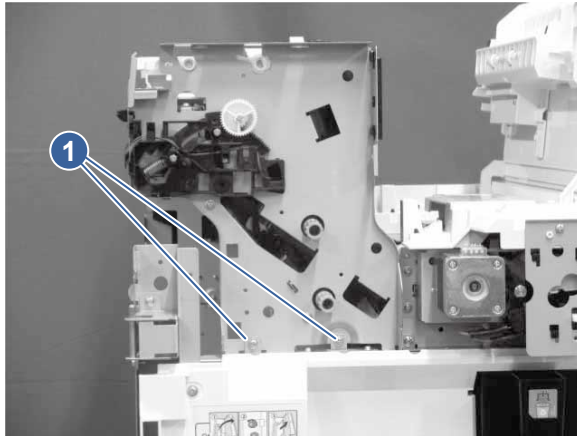
4. Remove two screws (callout 1).

**Figure 5-1305 Remove two screws**



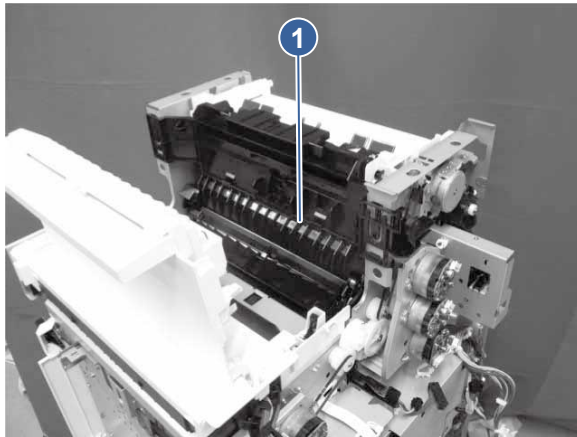
5. Remove two screws (callout 1).

**Figure 5-1306 Remove two screws**



6. Remove the SWB assembly (callout 1).

**Figure 5-1307 Remove the SWB assembly**



### 13. Unpack the replacement assembly

Follow these steps to unpack the replacement assembly.

1. Dispose of the defective part.




**NOTE:** HP recommends responsible disposal of the defective part.

<http://www8.hp.com/us/en/hp-information/environment/product-recycling.html>

2. Unpack the replacement part from the packaging.




**CAUTION:**  Some parts are sensitive to electrostatic discharge (ESD). Always perform service work at an ESD-protected workstation or mat. If an ESD workstation or mat is not available, touch the sheet-metal chassis to provide a static ground before touching an ESD-sensitive assembly. Protect the ESD-sensitive assemblies by placing them in ESD pouches when they are out of the printer.




**IMPORTANT:** Make sure that all of the shipping materials (for example shipping tape) are removed from the replacement part prior to installation.



 **NOTE:** If the replacement part is a roller or pad, avoid touching the spongy part of it. Skin oils on the roller or pad can cause paper pickup and/or print-quality problems. HP recommends using disposable gloves when handling rollers or pads or washing your hands before touching rollers or pads.

3. To install an assembly, reverse the removal steps.

 **NOTE:** When applicable, special installation instructions are provided for an assembly at the end of the removal procedure. Always completely read the removal instructions and follow all special installation instructions.


## Removal and replacement: Drum assembly/door handle rail assembly (floor-standing stapler-stacker)

Learn about removing and replacing the floor-standing stapler-stacker drum assembly and door handle rail assembly.

### Before performing service

#### Turn the printer power off

- Disconnect the power cable.

 **WARNING!** To avoid damage to the printer, turn the printer off, wait 30 seconds, and then remove the power cord before attempting to service the printer.

Use the table below to identify the correct part number for your printer, and then go to <https://parts.hp.com/hpparts> to order the part.

**Table 5-171 Part information**

Part number	Part description
RM2-3848-000CN	Drum assembly (FSSS)
RM2-3849-000CN	Door handle rail assembly (FSSS)

### Required tools

- #2 Phillips screwdriver with a magnetic tip and a 152 mm (6 in) shaft length
- Small flat-blade screwdriver

### After performing service

#### Turn the printer power on

- Connect the power cable.
- Use the power switch to turn the power on.

### Post service test

Print any pages necessary to make sure the printer is functioning correctly.

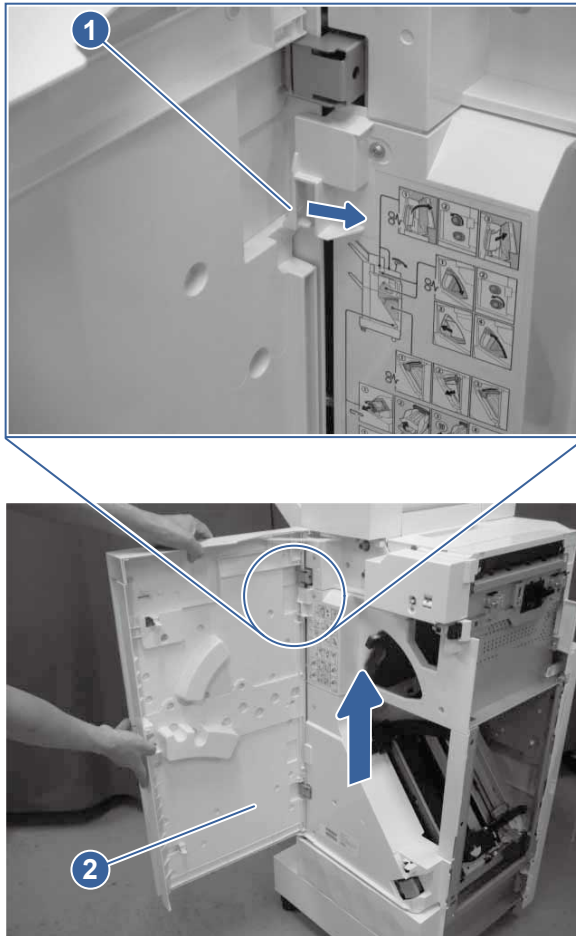
#### 1. Remove the front door assembly (floor-standing stapler-stacker)

Learn about removing the floor-standing stapler-stacker front door assembly.

1. Open the front door.

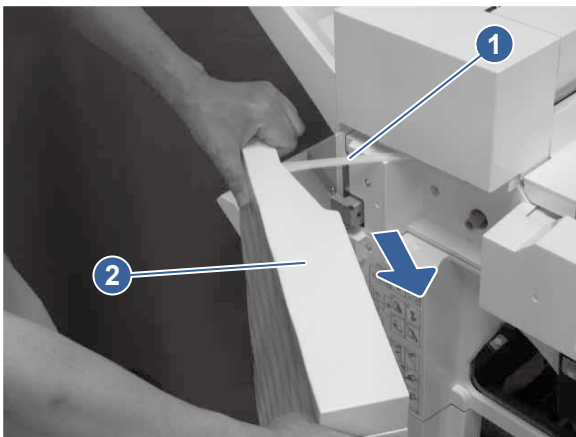
2. Push the stopper (callout 1) in the direction indicated, and then pull up the front door assembly (callout 2) to remove it.

**Figure 5-1308 Remove the front door assembly**



3. Remove the hinge (callout 1) from the front door assembly (callout 2).

**Figure 5-1309 Remove the hinge**

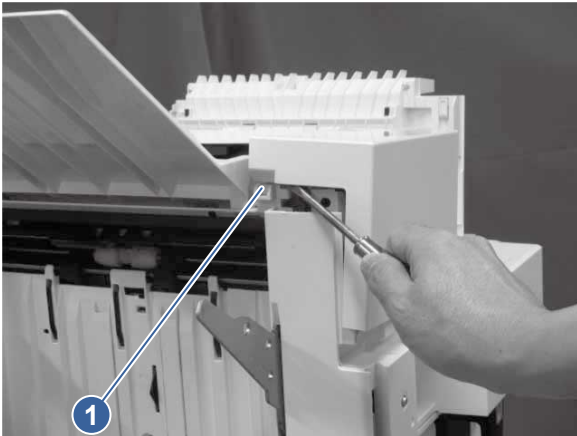


## 2. Remove the MBM front cover (floor-standing stapler-stacker)

Learn about removing the floor-standing stapler-stacker mailbox/booklet-maker front cover.

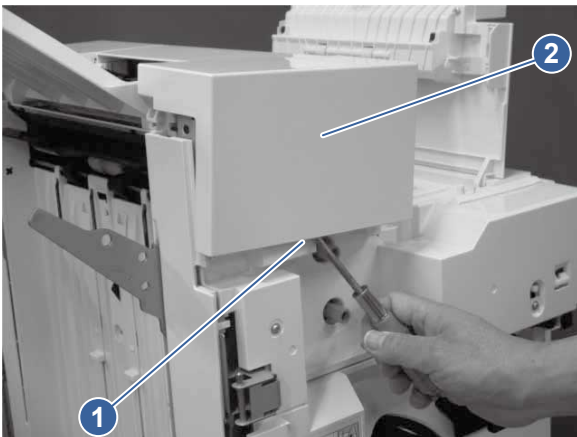
1. Release one tab (callout 1).

**Figure 5-1310 Release one tab**



2. Release one tab (callout 1), and then remove the MBM front cover (callout 2).

**Figure 5-1311 Remove the MBM front cover**

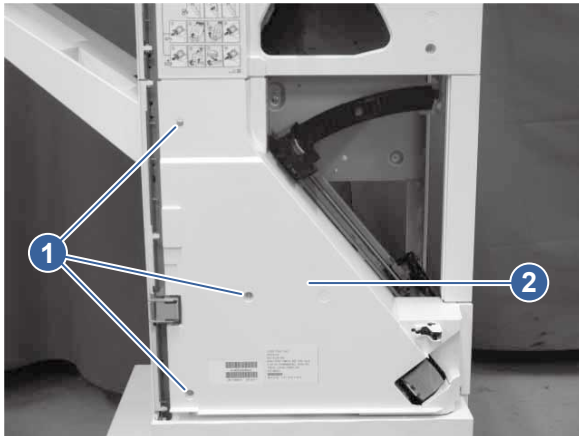


3. Remove the front inner lower cover (floor-standing stapler-stacker)

Learn about removing the floor-standing stapler-stacker front inner lower cover.

- Remove three screws (callout 1), and then remove the front inner lower cover (callout 2).

**Figure 5-1312 Remove the front inner lower cover**

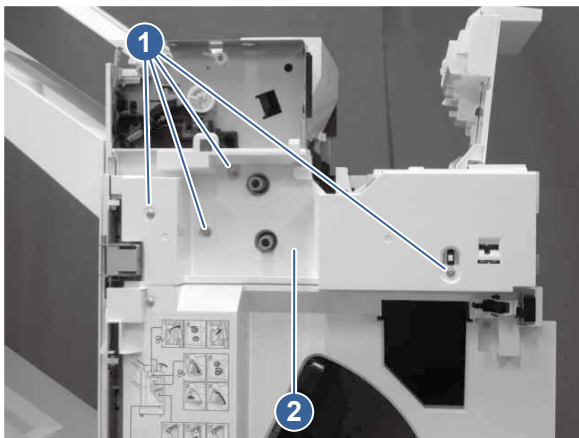


#### 4. Remove the front inner upper cover (floor-standing stapler-stacker)

Learn about removing the floor-standing stapler-stacker front inner upper cover.

- Remove four screws (callout 1), and then remove the front inner upper cover (callout 2).

**Figure 5-1313 Remove the front inner upper cover**

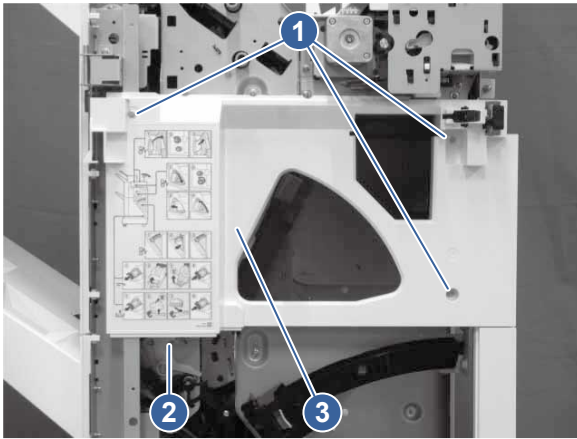


#### 5. Remove the front inner cover (floor-standing stapler-stacker)

Learn about removing the floor-standing stapler-stacker front inner cover.

- Remove three screws (callout 1), release one tab (callout 2), and then remove the front inner cover (callout 3).

**Figure 5-1314 Remove the front inner cover**

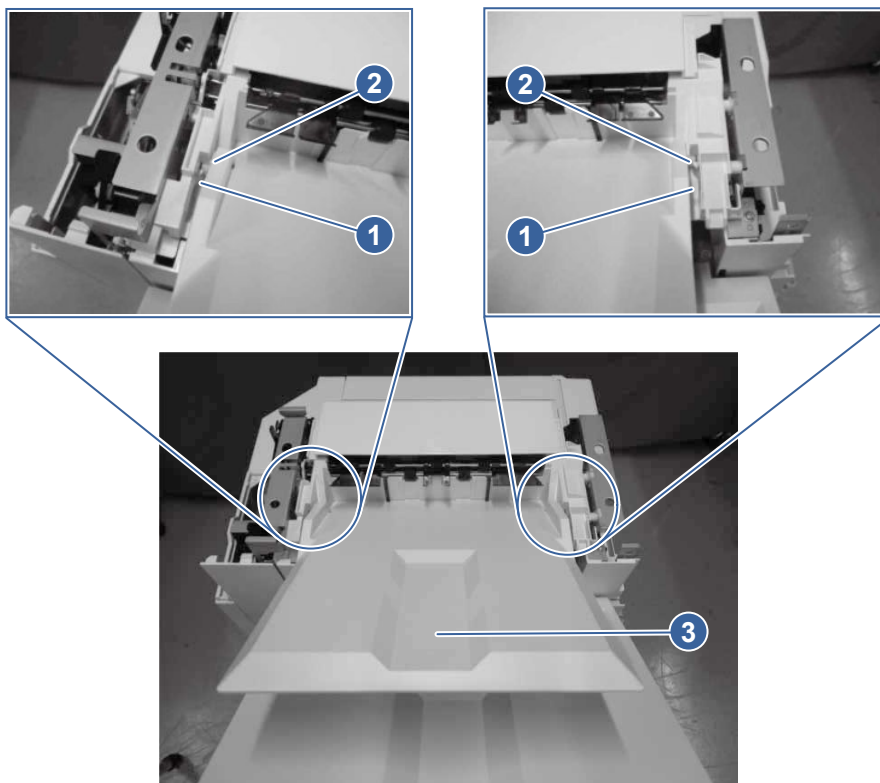


## 6. Remove the MBM output bin (floor-standing stapler-stacker)

Learn about removing the floor-standing stapler-stacker mailbox/booklet-maker output bin.

- Press the left and right stoppers (callout 1) to remove the shaft (callout 2), and then remove the MBM output bin (callout 3).

**Figure 5-1315 Remove the MBM output bin**

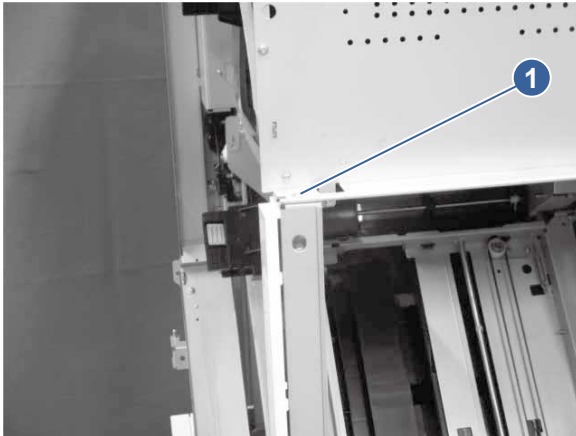


## 7. Remove the drum assembly/door handle rail assembly (floor-standing stapler-stacker)

Learn about removing the floor-standing stapler-stacker drum assembly and door handle rail assembly.

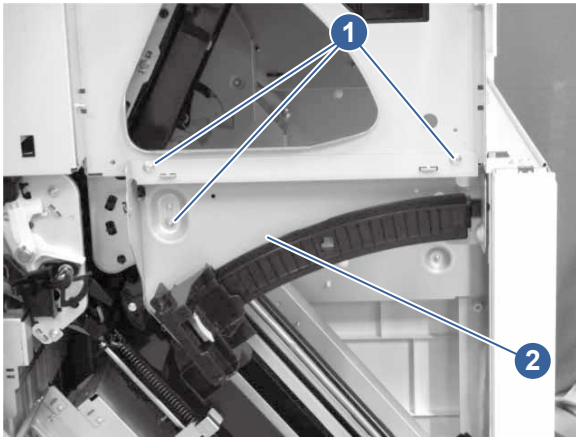
1. Remove one screw (callout 1).

**Figure 5-1316 Remove one screw**



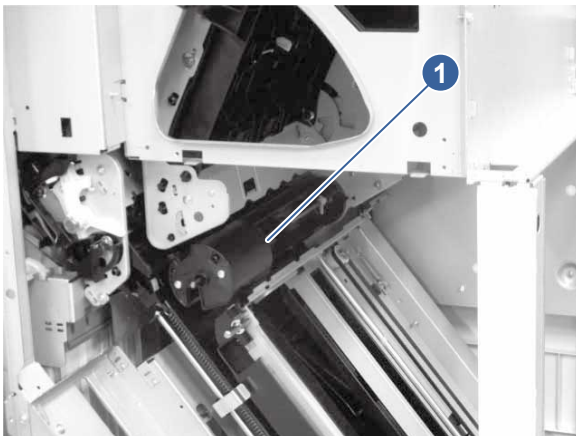
2. Remove three screws (callout 1), and then remove the door handle rail assembly (callout 2).


**Figure 5-1317 Remove the door handle rail assembly**



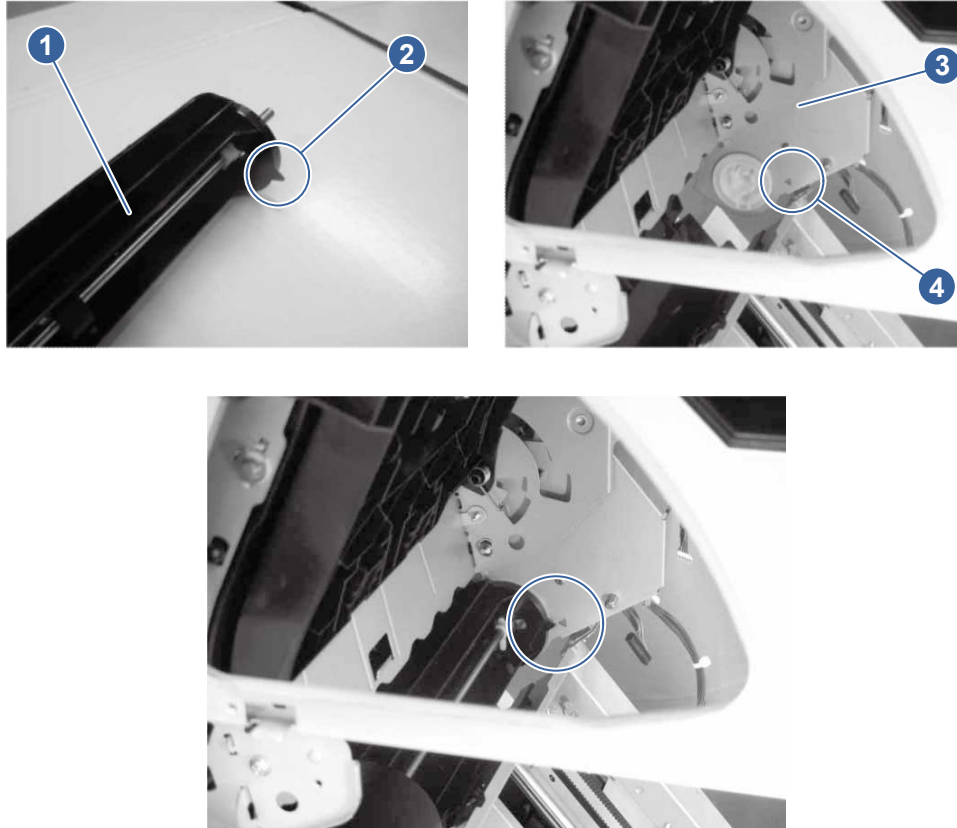
3. Remove the drum assembly (callout 1).

**Figure 5-1318 Remove the drum assembly**



 **Reinstallation tip:** When installing the drum assembly, align the projection (callout 1) on the drum assembly (callout 2) with the mark (callout 3) on the sheet metal (callout 4).

**Figure 5-1319** Align the drum




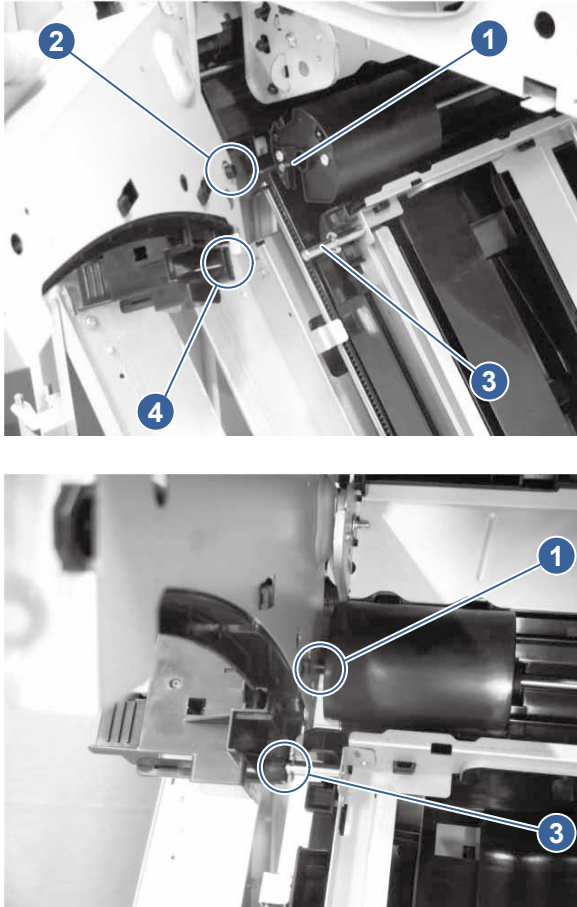
 **Reinstallation tip:** When installing the door handle rail assembly and drum assembly, the shaft (callout 1) of drum assembly is inserted into the hole (callout 2) of the door handle rail assembly, and the shaft (callout 3) is inserted into the hole (callout 4) of the door handle rail assembly.

Figure 5-1320 Lining up the shafts



## 8. Unpack the replacement assembly

Follow these steps to unpack the replacement assembly.

1. Dispose of the defective part.




**NOTE:** HP recommends responsible disposal of the defective part.

<http://www8.hp.com/us/en/hp-information/environment/product-recycling.html>

2. Unpack the replacement part from the packaging.



**CAUTION:**  Some parts are sensitive to electrostatic discharge (ESD). Always perform service work at an ESD-protected workstation or mat. If an ESD workstation or mat is not available, touch the sheet-metal chassis to provide a static ground before touching an ESD-sensitive assembly. Protect the ESD-sensitive assemblies by placing them in ESD pouches when they are out of the printer.



**IMPORTANT:** Make sure that all of the shipping materials (for example shipping tape) are removed from the replacement part prior to installation.



**NOTE:** If the replacement part is a roller or pad, avoid touching the spongy part of it. Skin oils on the roller or pad can cause paper pickup and/or print-quality problems. HP recommends using disposable gloves when handling rollers or pads or washing your hands before touching rollers or pads.



3. To install an assembly, reverse the removal steps.



**NOTE:** When applicable, special installation instructions are provided for an assembly at the end of the removal procedure. Always completely read the removal instructions and follow all special installation instructions.

### Removal and replacement: Drum drive assembly (floor-standing stapler-stacker)

Learn about removing and replacing the floor-standing stapler-stacker drum drive assembly.

#### Before performing service

##### Turn the printer power off

- Disconnect the power cable.

**⚠ WARNING!** To avoid damage to the printer, turn the printer off, wait 30 seconds, and then remove the power cord before attempting to service the printer.

Use the table below to identify the correct part number for your printer, and then go to <https://parts.hp.com/hpparts> to order the part.

**Table 5-172 Part information**

Part number	Part description
RM2-3847-000CN	Drum drive assembly (FSSS)

#### Required tools

- #2 Phillips screwdriver with a magnetic tip and a 152 mm (6 in) shaft length
- Small flat-blade screwdriver

#### After performing service

##### Turn the printer power on

- Connect the power cable.
- Use the power switch to turn the power on.

#### Post service test

Print any pages necessary to make sure the printer is functioning correctly.

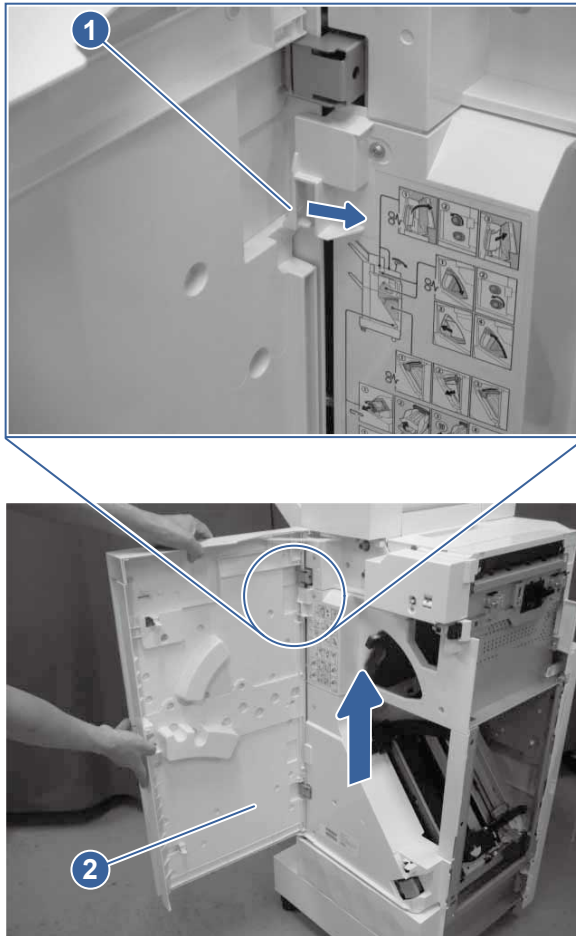
### 1. Remove the front door assembly (floor-standing stapler-stacker)

Learn about removing the floor-standing stapler-stacker front door assembly.

1. Open the front door.

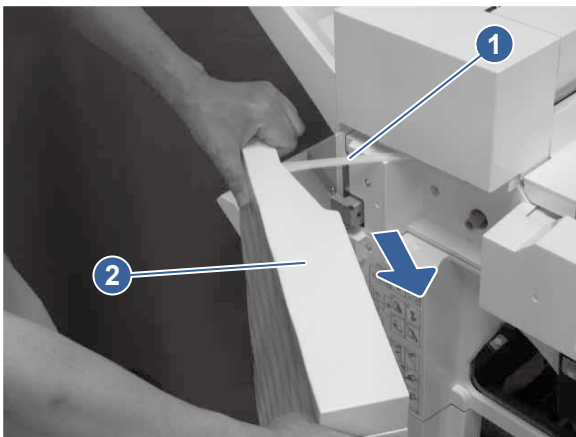
2. Push the stopper (callout 1) in the direction indicated, and then pull up the front door assembly (callout 2) to remove it.

**Figure 5-1321 Remove the front door assembly**



3. Remove the hinge (callout 1) from the front door assembly (callout 2).

**Figure 5-1322 Remove the hinge**

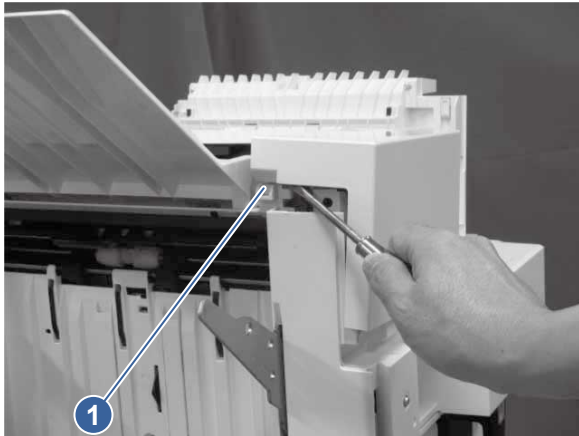


## 2. Remove the MBM front cover (floor-standing stapler-stacker)

Learn about removing the floor-standing stapler-stacker mailbox/booklet-maker front cover.

1. Release one tab (callout 1).

**Figure 5-1323 Release one tab**



2. Release one tab (callout 1), and then remove the MBM front cover (callout 2).

**Figure 5-1324 Remove the MBM front cover**

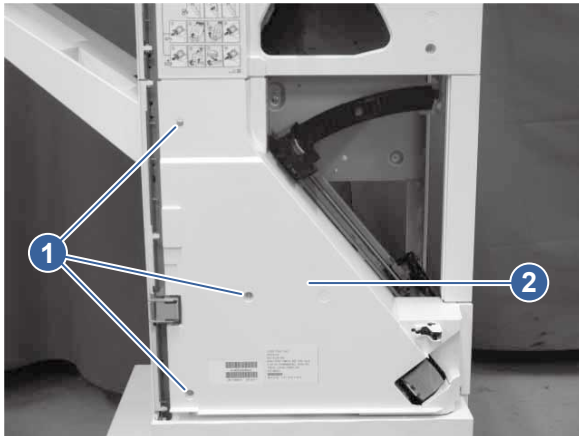


3. Remove the front inner lower cover (floor-standing stapler-stacker)

Learn about removing the floor-standing stapler-stacker front inner lower cover.

- Remove three screws (callout 1), and then remove the front inner lower cover (callout 2).

**Figure 5-1325 Remove the front inner lower cover**

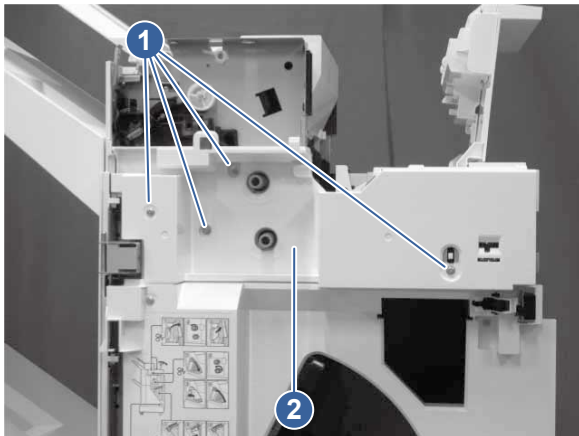


#### 4. Remove the front inner upper cover (floor-standing stapler-stacker)

Learn about removing the floor-standing stapler-stacker front inner upper cover.

- Remove four screws (callout 1), and then remove the front inner upper cover (callout 2).

**Figure 5-1326 Remove the front inner upper cover**

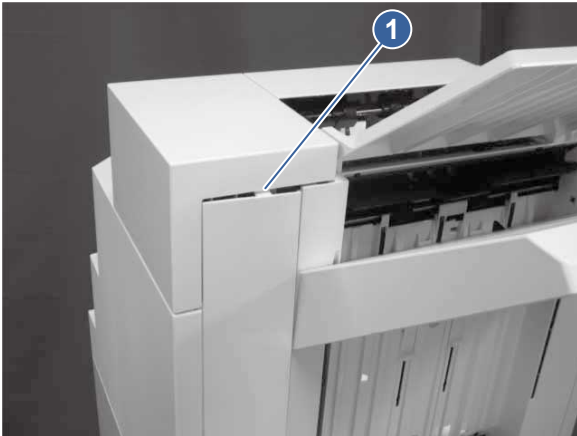


#### 5. Remove the left upper rear cover (floor-standing stapler-stacker)

Learn about removing the floor-standing stapler-stacker left upper rear cover.

1. Release one tab (callout 1).

**Figure 5-1327 Release one tab**



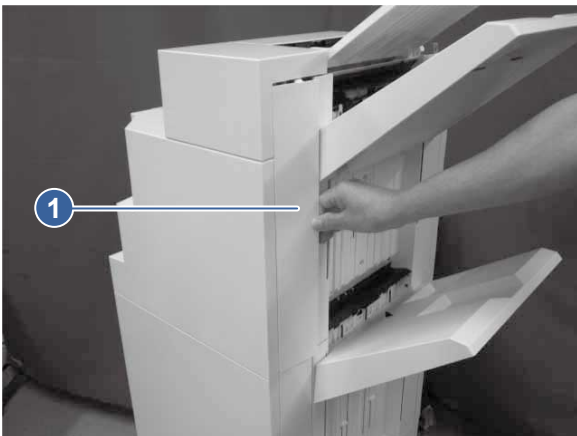
2. Release one boss (callout 1).

**Figure 5-1328 Release one boss**



3. Pull up the left upper rear cover (callout 1) to remove it.

**Figure 5-1329 Remove the left upper rear cover**

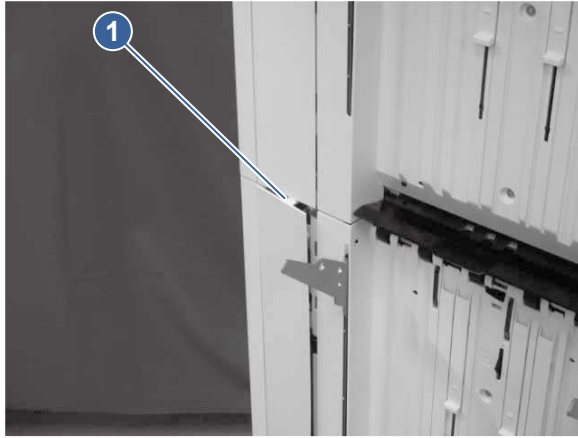


## 6. Remove the left lower rear cover (floor-standing stapler-stacker)

Learn about removing the floor-standing stapler-stacker left lower rear cover.

1. Release one tab (callout 1).

**Figure 5-1330 Release one tab**



2. Release one boss (callout 1).

**Figure 5-1331 Release one boss**



3. Pull up the left lower rear cover (callout 1) to remove it.

**Figure 5-1332 Remove the left lower rear cover**

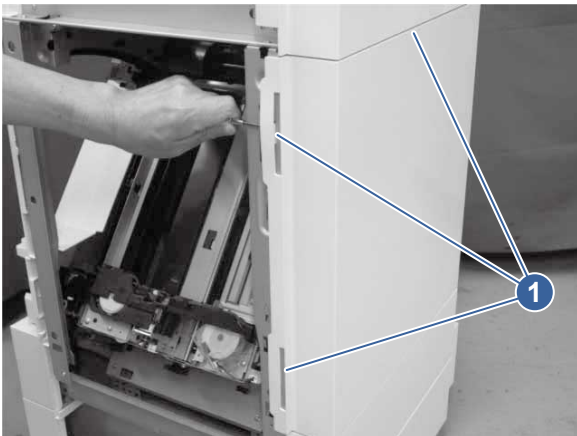


### 7. Remove the rear cover (floor-standing stapler-stacker)

Learn about removing the floor-standing stapler-stacker rear cover.

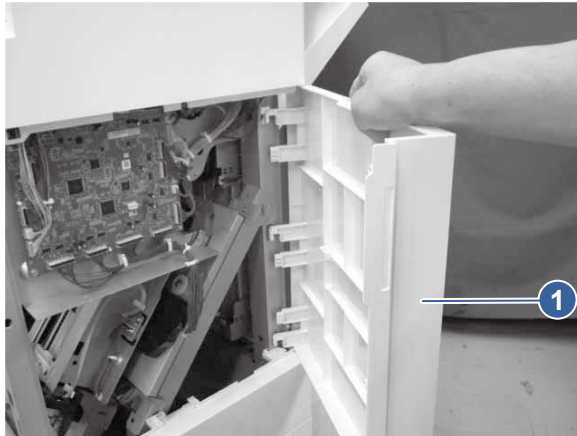
1. Release three tabs (callout 1).

**Figure 5-1333 Release three tabs**



2. Remove the rear cover (callout 1).

**Figure 5-1334 Remove the rear cover**

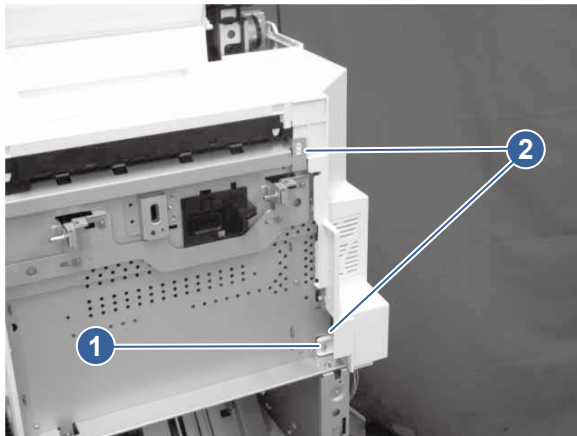


### **8. Remove the rear upper cover (floor-standing stapler-stacker)**

Learn about removing the floor-standing stapler-stacker rear upper cover.

1. Remove one screw (callout 1), and then release two tabs (callout 2).

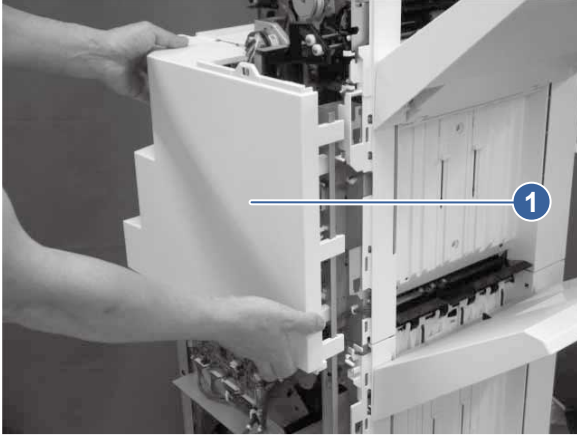
**Figure 5-1335 Remove one screw and release two tabs**





2. Remove the rear upper cover (callout 1).

**Figure 5-1336 Remove the rear upper cover**

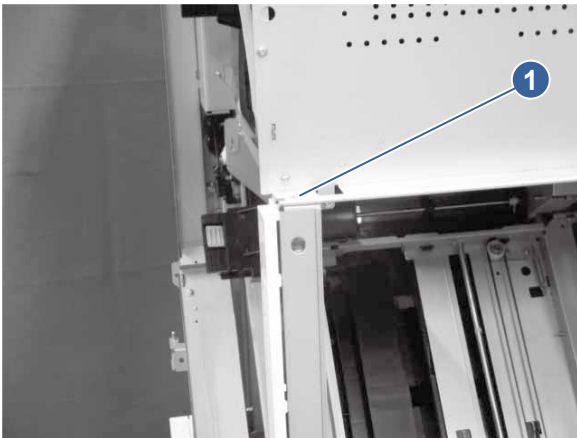


### 9. Remove the drum assembly/door handle rail assembly (floor-standing stapler-stacker)

Learn about removing the floor-standing stapler-stacker drum assembly and door handle rail assembly.

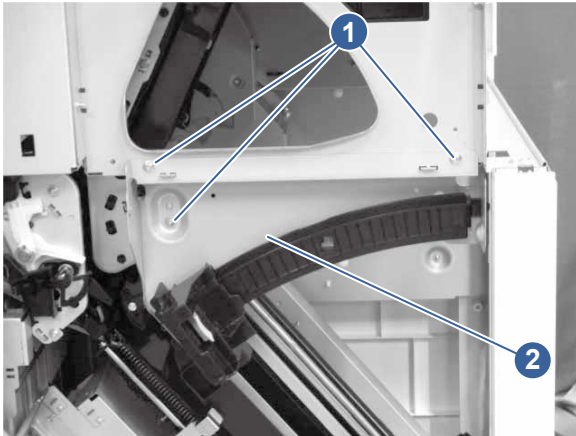
1. Remove one screw (callout 1).

**Figure 5-1337 Remove one screw**



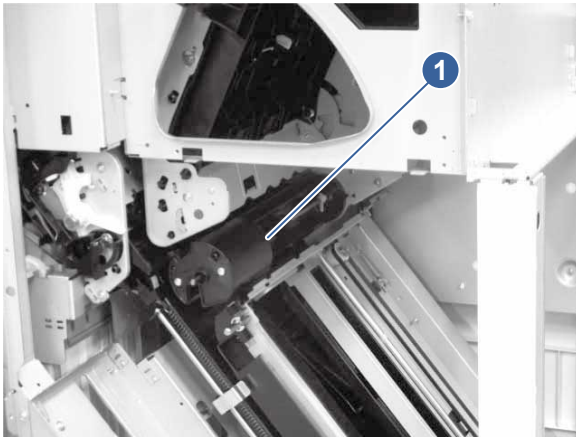
2. Remove three screws (callout 1), and then remove the door handle rail assembly (callout 2).

**Figure 5-1338 Remove the door handle rail assembly**




3. Remove the drum assembly (callout 1).

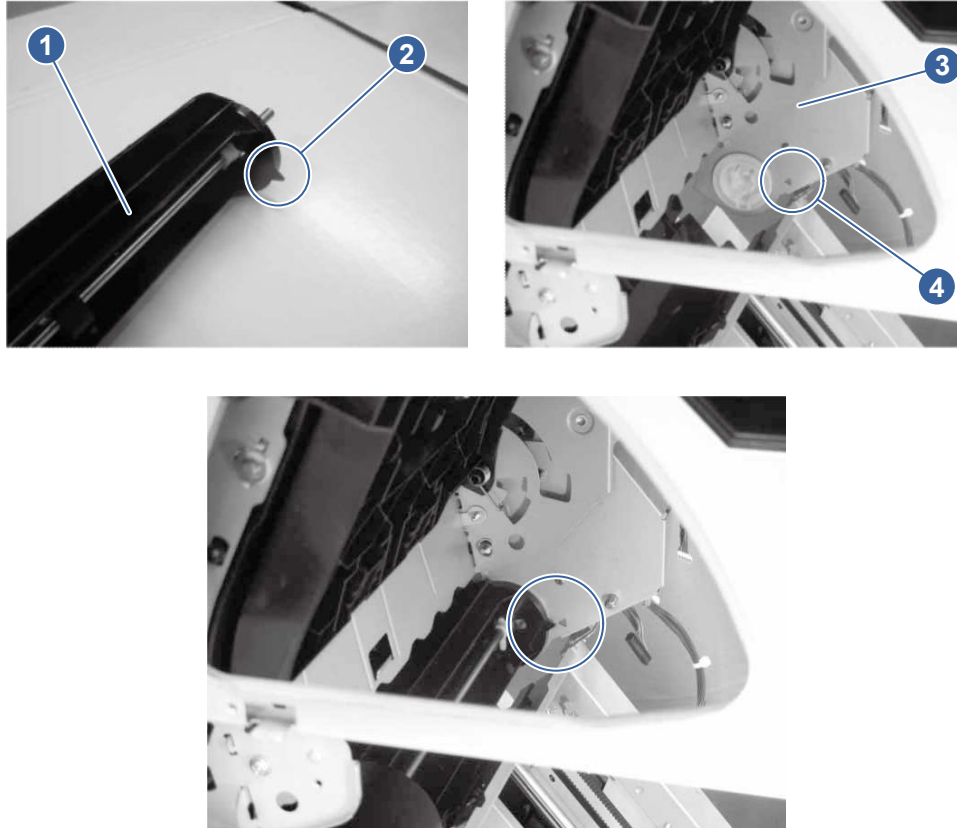
**Figure 5-1339 Remove the drum assembly**




---

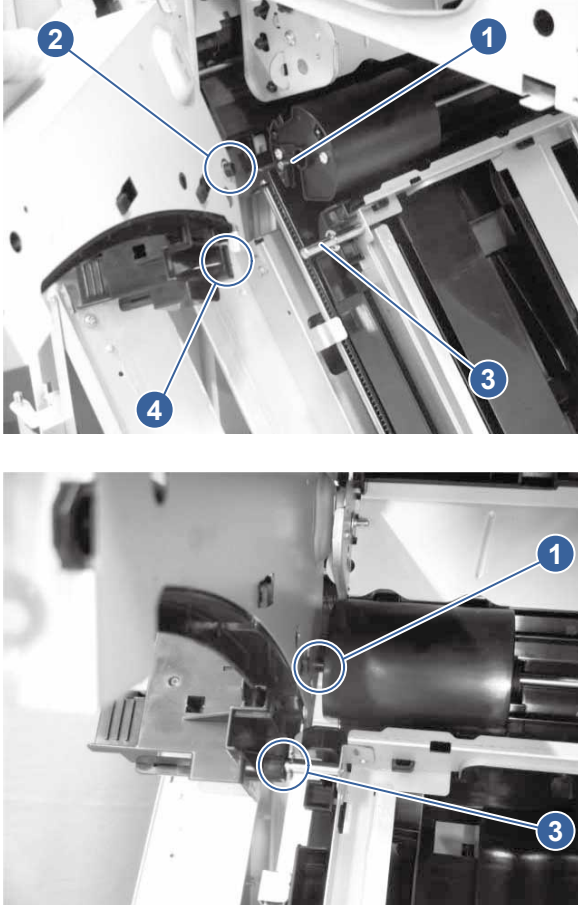
 **Reinstallation tip:** When installing the drum assembly, align the projection (callout 1) on the drum assembly (callout 2) with the mark (callout 3) on the sheet metal (callout 4).

**Figure 5-1340** Align the drum



 **Reinstallation tip:** When installing the door handle rail assembly and drum assembly, the shaft (callout 1) of drum assembly is inserted into the hole (callout 2) of the door handle rail assembly, and the shaft (callout 3) is inserted into the hole (callout 4) of the door handle rail assembly.

**Figure 5-1341 Lining up the shafts**

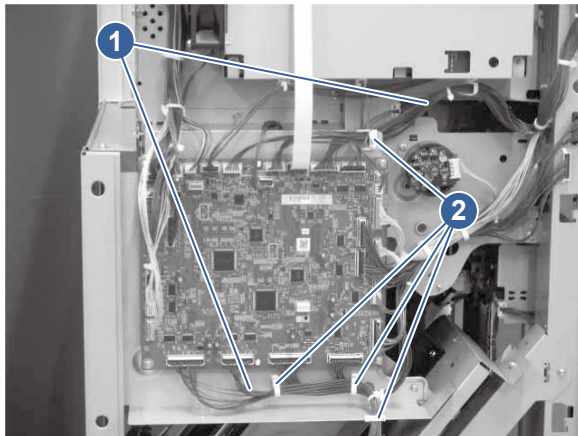


## 10. Remove the drum drive assembly (floor-standing stapler-stacker)

Learn about removing the floor-standing stapler-stacker drum drive assembly.

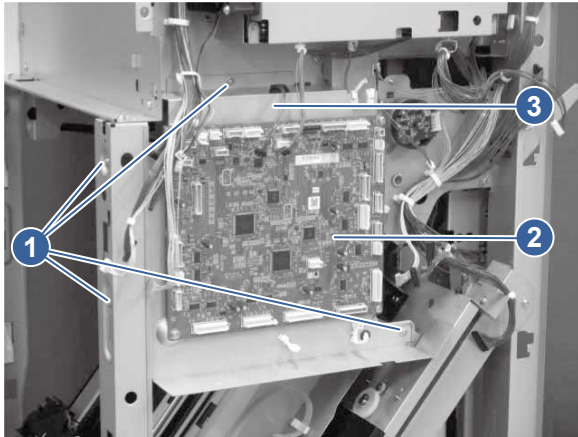
1. Disconnect all the connectors on the controller PCA, and then release the cables (callout 1) from the cable clamps (callout 2).

**Figure 5-1342 Release the cables**



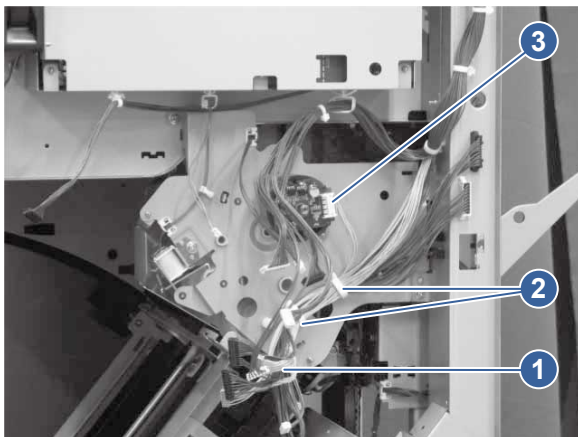
2. Remove four screws (callout 1), and then remove the controller PCA (callout 2) and the plate (callout 3) together.

**Figure 5-1343 Remove the controller PCA and the plate together**



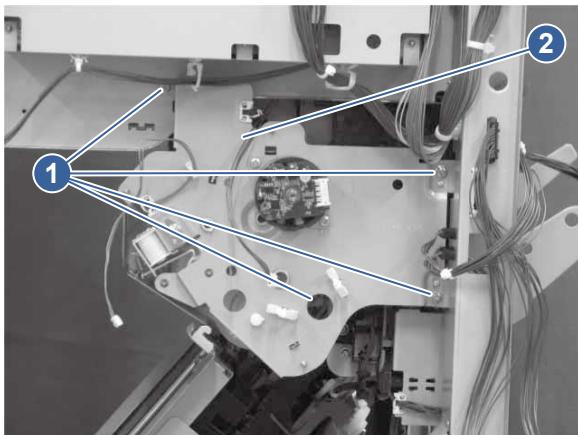
3. Release the cable (callout 1) from the cable clamps (callout 2), and then disconnect one connector (callout 3).

**Figure 5-1344 Release the cable**



4. Remove four screws (callout 1), and then remove the drum drive assembly (callout 2).


**Figure 5-1345 Remove the drum drive assembly**



## 11. Unpack the replacement assembly



Follow these steps to unpack the replacement assembly.


1. Dispose of the defective part.


 **NOTE:** HP recommends responsible disposal of the defective part.

<http://www8.hp.com/us/en/hp-information/environment/product-recycling.html>


2. Unpack the replacement part from the packaging.

 **CAUTION:**  Some parts are sensitive to electrostatic discharge (ESD). Always perform service work at an ESD-protected workstation or mat. If an ESD workstation or mat is not available, touch the sheet-metal chassis to provide a static ground before touching an ESD-sensitive assembly. Protect the ESD-sensitive assemblies by placing them in ESD pouches when they are out of the printer.

 **IMPORTANT:** Make sure that all of the shipping materials (for example shipping tape) are removed from the replacement part prior to installation.

 **NOTE:** If the replacement part is a roller or pad, avoid touching the spongy part of it. Skin oils on the roller or pad can cause paper pickup and/or print-quality problems. HP recommends using disposable gloves when handling rollers or pads or washing your hands before touching rollers or pads.

3. To install an assembly, reverse the removal steps.

 **NOTE:** When applicable, special installation instructions are provided for an assembly at the end of the removal procedure. Always completely read the removal instructions and follow all special installation instructions.

### Removal and replacement: IMF assembly (floor-standing stapler-stacker)


Learn about removing and replacing the floor-standing stapler-stacker IMF assembly.

 [View a video demonstration of removing and replacing the IMF assembly.](#)

### Before performing service

#### Turn the printer power off

- Disconnect the power cable.

 **WARNING!** To avoid damage to the printer, turn the printer off, wait 30 seconds, and then remove the power cord before attempting to service the printer.

Use the table below to identify the correct part number for your printer, and then go to <https://parts.hp.com/hpparts> to order the part.

**Table 5-173** Part information

Part number	Part description
RM2-3839-000CN	IMF assembly (FSSS)

### Required tools

- #2 Phillips screwdriver with a magnetic tip and a 152 mm (6 in) shaft length
- Small flat-blade screwdriver

### After performing service

#### Turn the printer power on

- Connect the power cable.
- Use the power switch to turn the power on.

### Post service test

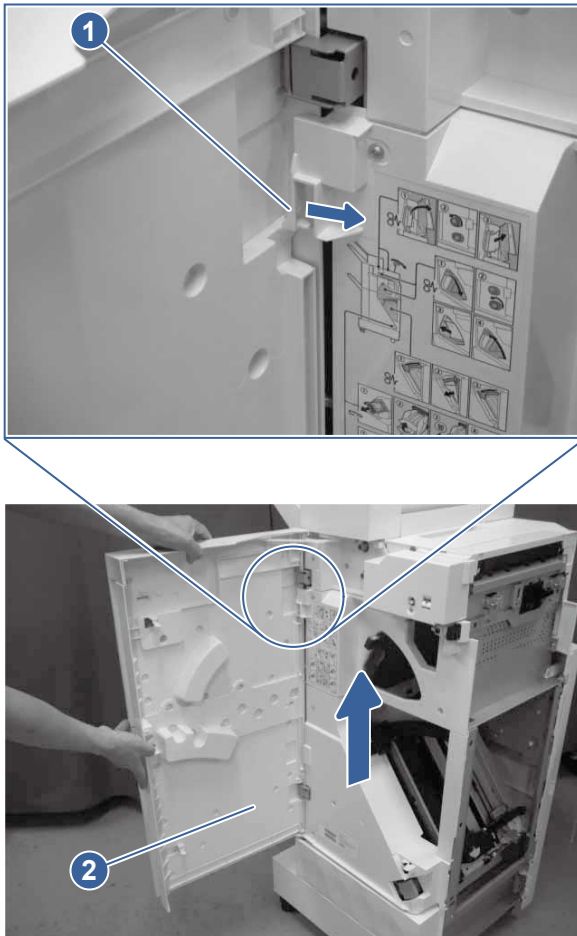
Print any pages necessary to make sure the printer is functioning correctly.

#### 1. Remove the front door assembly (floor-standing stapler-stacker)

Learn about removing the floor-standing stapler-stacker front door assembly.

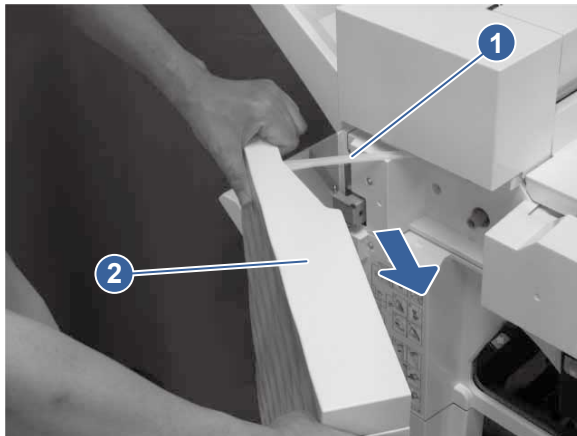
1. Open the front door.
2. Push the stopper (callout 1) in the direction indicated, and then pull up the front door assembly (callout 2) to remove it.

**Figure 5-1346** Remove the front door assembly



3. Remove the hinge (callout 1) from the front door assembly (callout 2).

**Figure 5-1347 Remove the hinge**

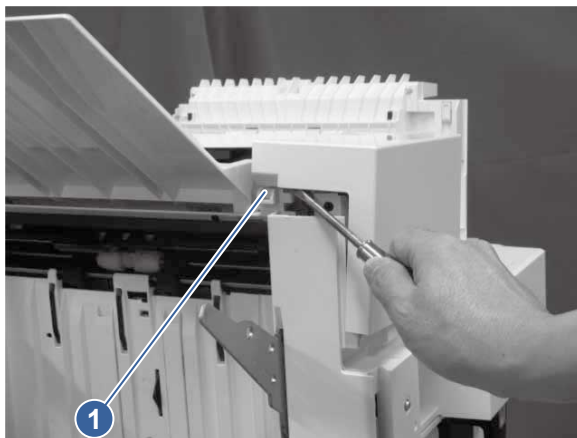


## 2. Remove the MBM front cover (floor-standing stapler-stacker)

Learn about removing the floor-standing stapler-stacker mailbox/booklet-maker front cover.

1. Release one tab (callout 1).

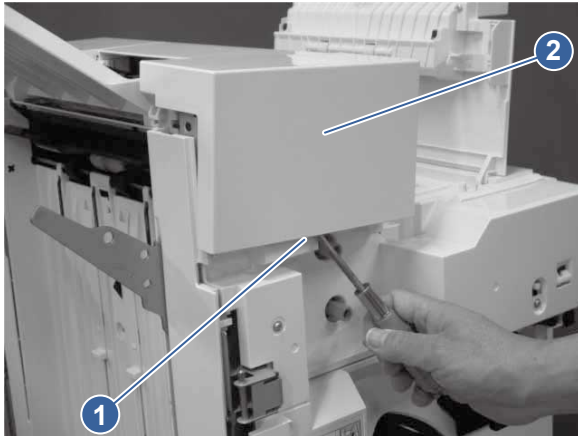
**Figure 5-1348 Release one tab**





2. Release one tab (callout 1), and then remove the MBM front cover (callout 2).

**Figure 5-1349 Remove the MBM front cover**

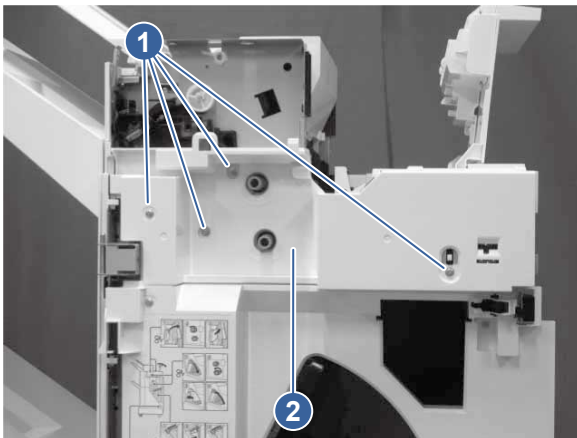


### 3. Remove the front inner upper cover (floor-standing stapler-stacker)

Learn about removing the floor-standing stapler-stacker front inner upper cover.

- Remove four screws (callout 1), and then remove the front inner upper cover (callout 2).

**Figure 5-1350 Remove the front inner upper cover**

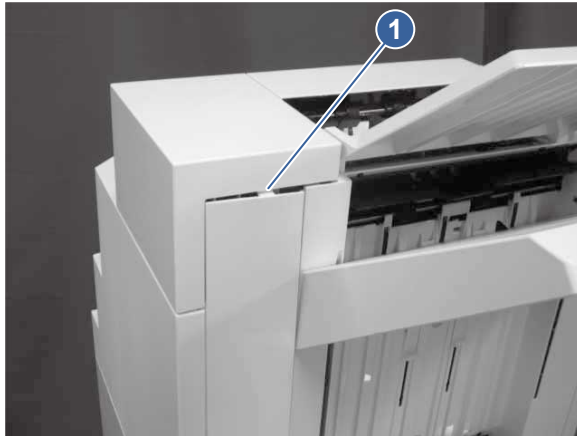


### 4. Remove the left upper rear cover (floor-standing stapler-stacker)

Learn about removing the floor-standing stapler-stacker left upper rear cover.

1. Release one tab (callout 1).

**Figure 5-1351 Release one tab**



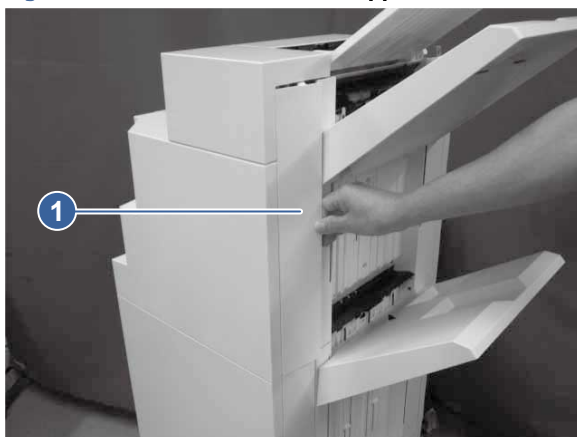
2. Release one boss (callout 1).

**Figure 5-1352 Release one boss**



3. Pull up the left upper rear cover (callout 1) to remove it.

**Figure 5-1353 Remove the left upper rear cover**



## 5. Remove the MBM rear cover (floor-standing stapler-stacker)

Learn about removing the floor-standing stapler-stacker mailbox/booklet-maker rear cover.

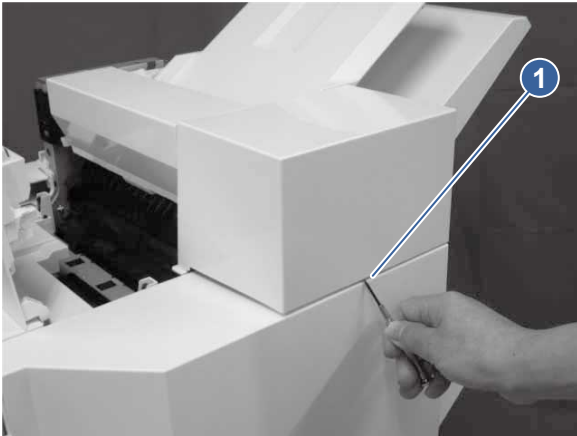
1. On the inside of the cover, release one tab (callout 1).

**Figure 5-1354** Release one tab



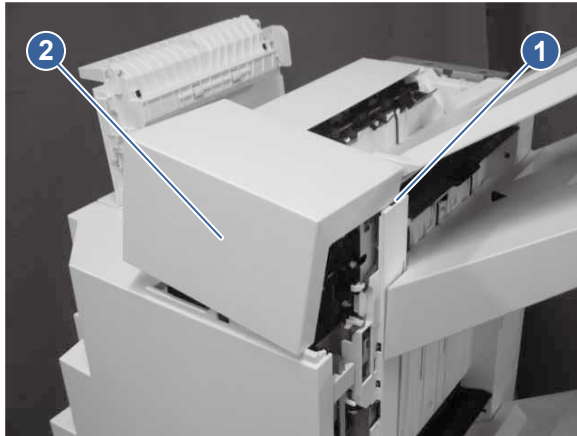
2. Release another tab (callout 1).

**Figure 5-1355** Release another tab



3. Release another tab (callout 1), and then remove the MBM rear cover (callout 2).

**Figure 5-1356 Remove the MBM rear cover**

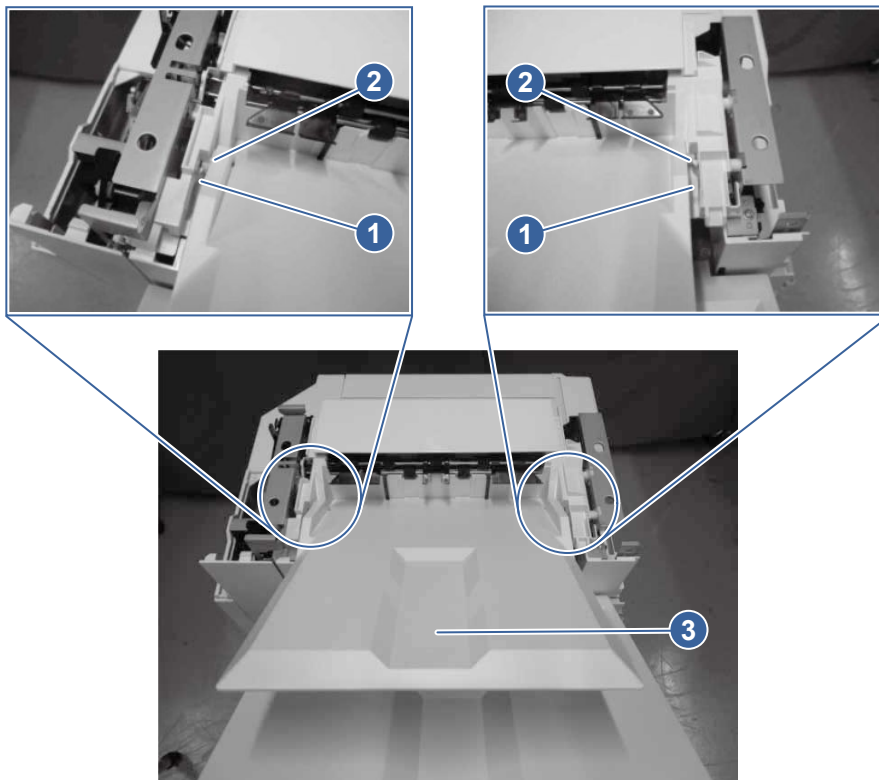


### 6. Remove the MBM output bin (floor-standing stapler-stacker)

Learn about removing the floor-standing stapler-stacker mailbox/booklet-maker output bin.

- Press the left and right stoppers (callout 1) to remove the shaft (callout 2), and then remove the MBM output bin (callout 3).

**Figure 5-1357 Remove the MBM output bin**

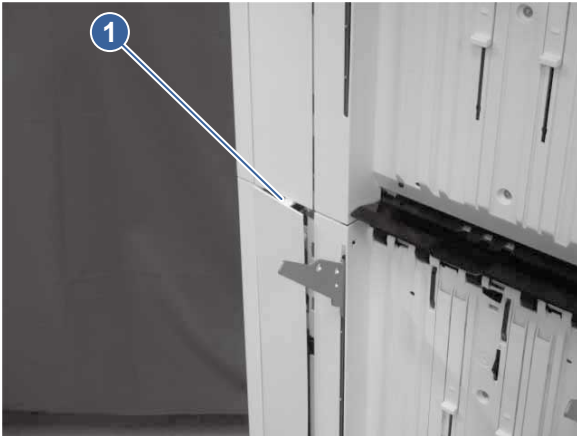


### 7. Remove the left lower rear cover (floor-standing stapler-stacker)

Learn about removing the floor-standing stapler-stacker left lower rear cover.

1. Release one tab (callout 1).

**Figure 5-1358 Release one tab**



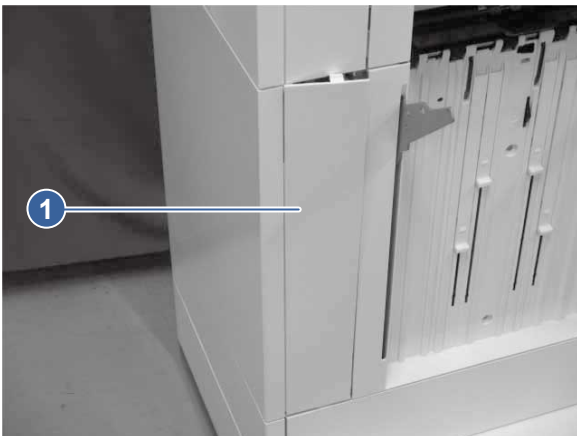
2. Release one boss (callout 1).

**Figure 5-1359 Release one boss**



3. Pull up the left lower rear cover (callout 1) to remove it.

**Figure 5-1360 Remove the left lower rear cover**

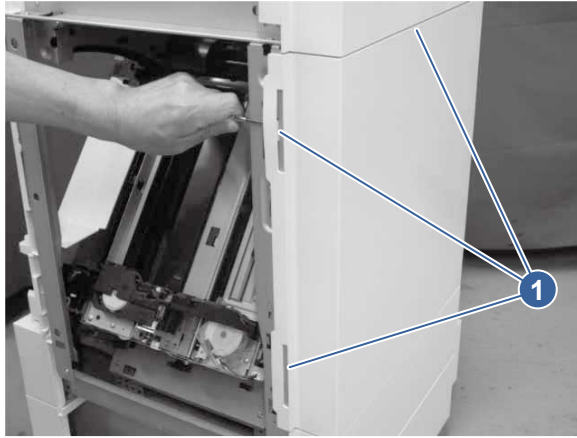


## 8. Remove the rear cover (floor-standing stapler-stacker)

Learn about removing the floor-standing stapler-stacker rear cover.

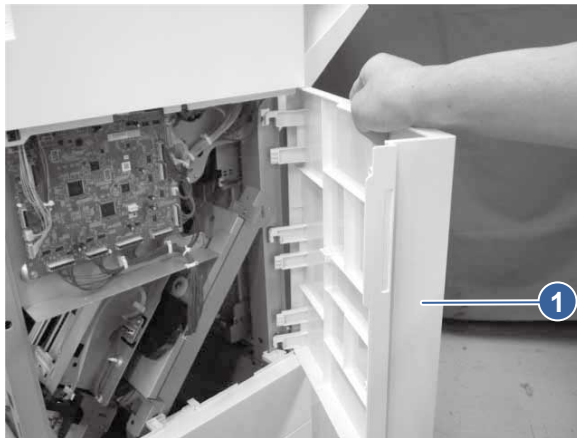
1. Release three tabs (callout 1).

**Figure 5-1361 Release three tabs**



2. Remove the rear cover (callout 1).

**Figure 5-1362 Remove the rear cover**

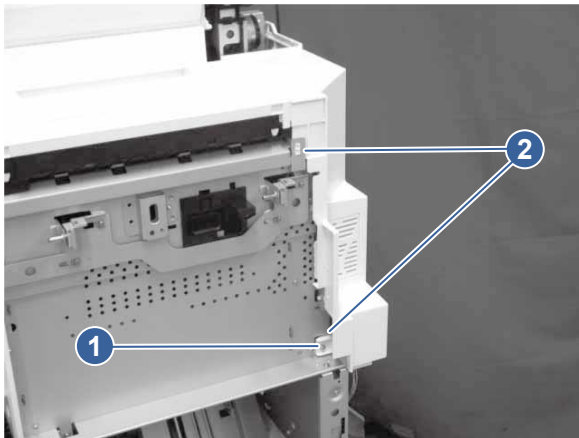


## 9. Remove the rear upper cover (floor-standing stapler-stacker)

Learn about removing the floor-standing stapler-stacker rear upper cover.

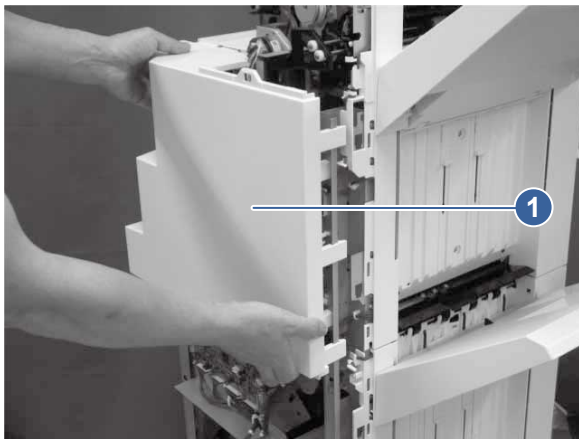
1. Remove one screw (callout 1), and then release two tabs (callout 2).

**Figure 5-1363 Remove one screw and release two tabs**



2. Remove the rear upper cover (callout 1).

**Figure 5-1364 Remove the rear upper cover**

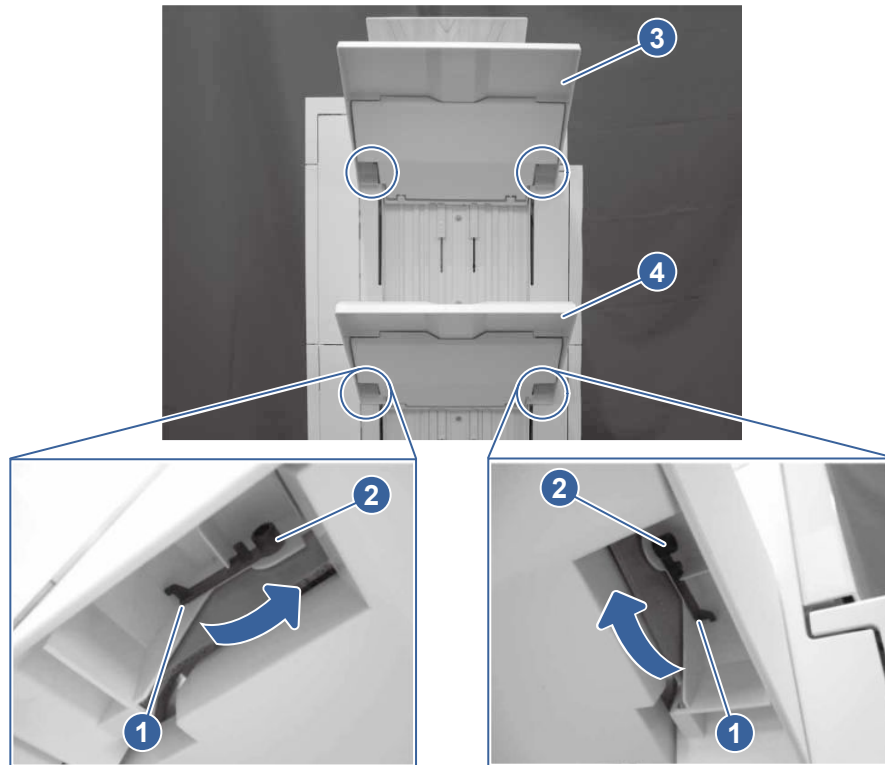


#### 10. Remove the output bins (floor-standing stapler-stacker)

Learn about removing the floor-standing stapler-stacker output bins.

- Release one boss (callout 1), rotate the pin (callout 2) in the direction indicated, and then remove the pin. Remove either the upper bin (callout 3) or the lower bin (callout 4) with this process.

**Figure 5-1365 Remove either bin**

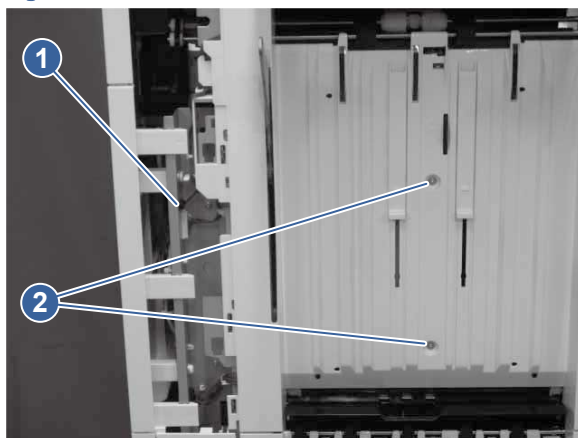


### 11. Remove the upper height wall assembly (floor-standing stapler-stacker)

Learn about removing the floor-standing stapler-stacker upper height wall assembly.

1. Disconnect one connector (callout 1), and then remove two screws (callout 2).

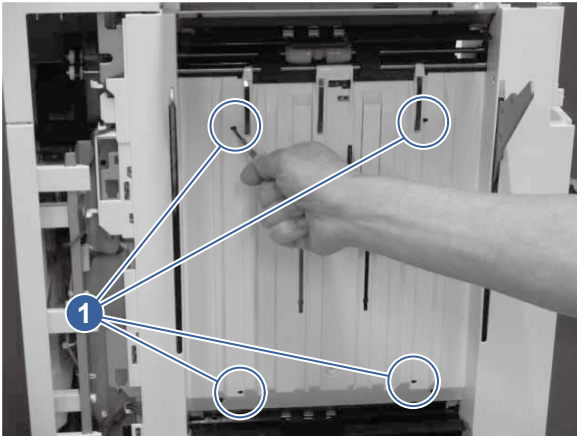
**Figure 5-1366 Disconnect one connector**



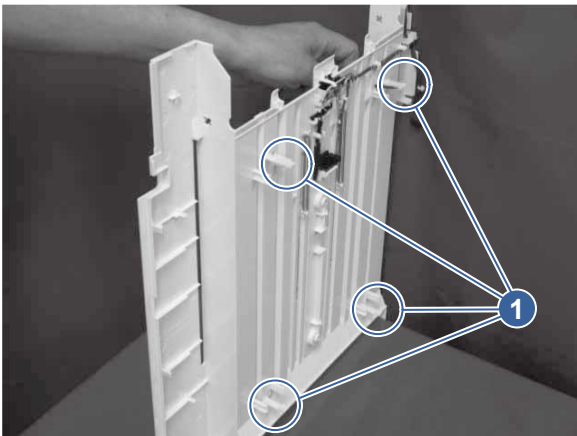


2. Release four inner tabs (callout 1) with a pointed tool.

**Figure 5-1367 Release four inner tabs**

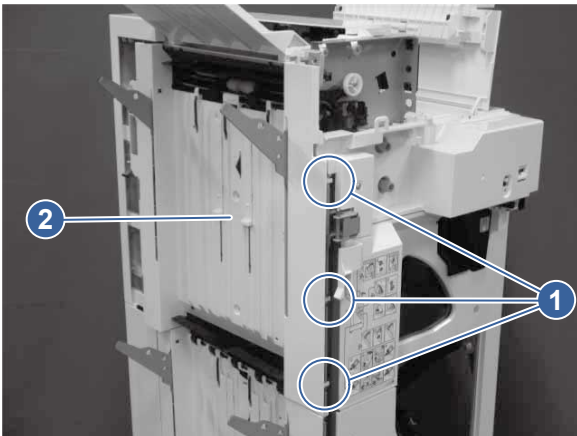


**Figure 5-1368 The four tabs viewed from the other side of the assembly**



3. Release three tabs (callout 1), and then remove the height wall upper assembly (callout 2).

**Figure 5-1369 Remove the upper height wall assembly**

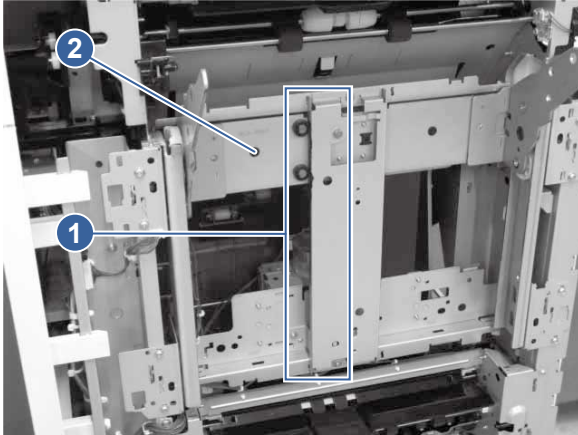


## 12. Remove the upper lifter base assembly (floor-standing stapler-stacker)

Learn about removing the floor-standing stapler-stacker upper lifter base assembly.

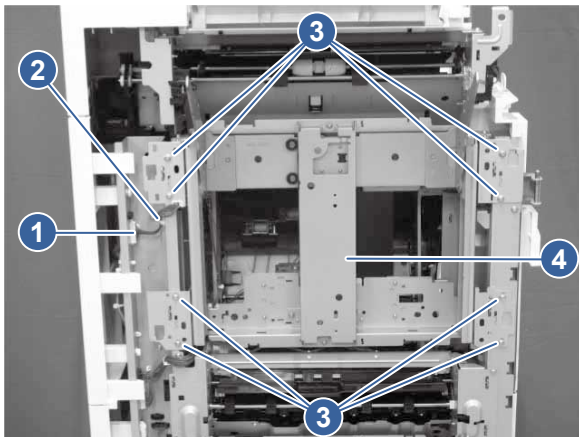
Do not touch the center (callout 1) of the upper lifter base assembly (callout 2) because grease is applied to the center.

**Figure 5-1370 Avoid touching the center**



- Disconnect one connector (callout 1), release the cable clamp (callout 2), remove eight screws (callout 3), and then remove the upper lifter base assembly (callout 4).

**Figure 5-1371 Remove the upper lifter base assembly**

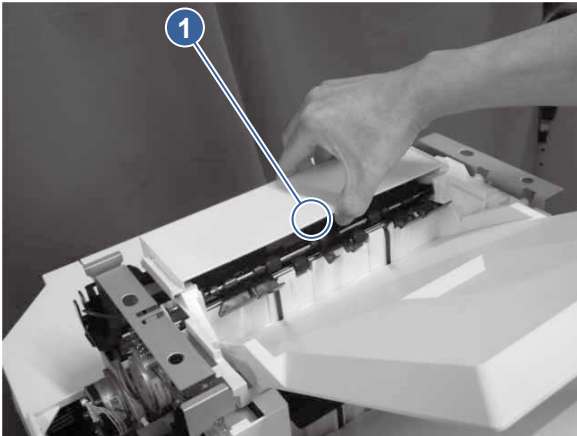


### 13. Remove the MBM top cover (floor-standing stapler-stacker)

Learn about removing the floor-standing stapler-stacker mailbox/booklet-maker top cover.

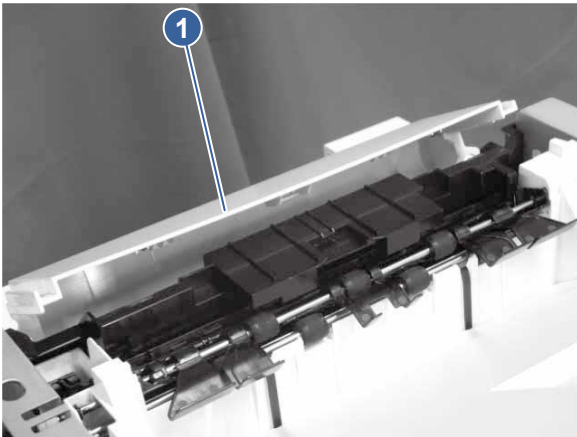
1. Release one tab (callout 1).

**Figure 5-1372 Release one tab**



2. Remove the MBM top cover (callout 1).

**Figure 5-1373 Remove the MBM top cover**

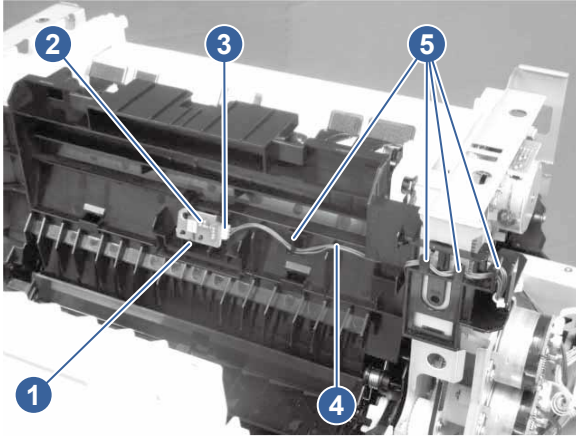


#### **14. Remove the SWB assembly (floor-standing stapler-stacker)**

Learn about removing the floor-standing stapler-stacker SWB assembly.

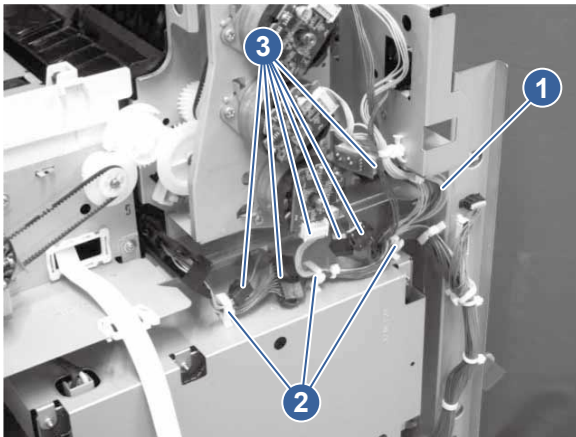
1. Release one tab (callout 1), remove the sensor PCA (callout 2), disconnect one connector (callout 1), and then release the cable (callout 4) from the cable clamps (callout 5).

**Figure 5-1374 Release one tab**



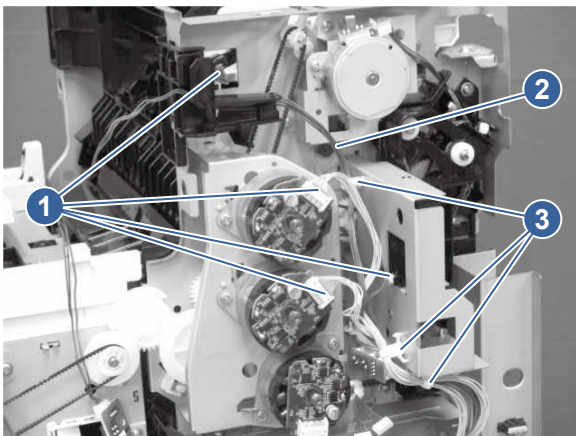
2. Release the cable (callout 1) from the cable clamps (callout 2), and then disconnect six connectors (callout 3).

**Figure 5-1375 Release the cable**



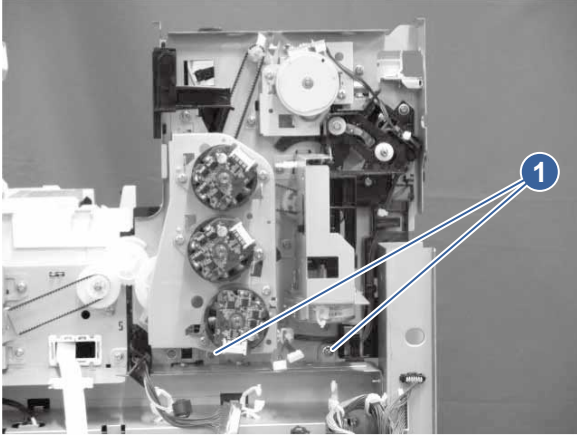
3. Disconnect four connectors (callout 1), and then release the cable (callout 2) from the cable clamps (callout 3).

**Figure 5-1376 Disconnect four connectors**



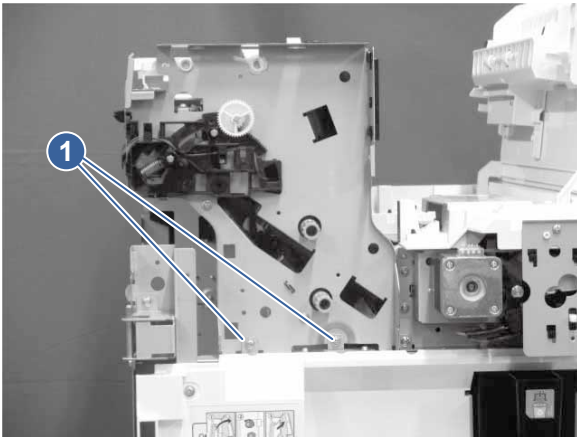
4. Remove two screws (callout 1).

**Figure 5-1377 Remove two screws**



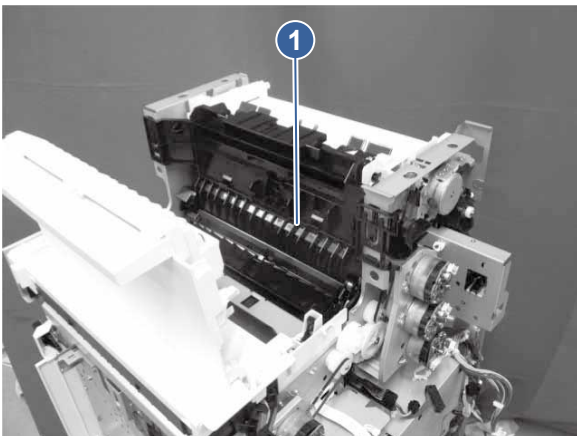
5. Remove two screws (callout 1).

**Figure 5-1378 Remove two screws**



6. Remove the SWB assembly (callout 1).

**Figure 5-1379 Remove the SWB assembly**

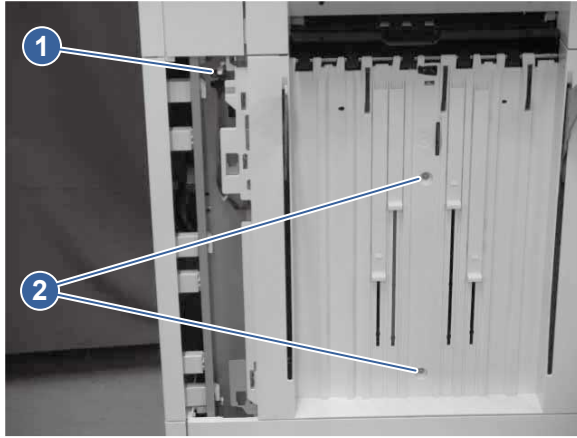


## 15. Remove the lower height wall (floor-standing stapler-stacker)

Learn about removing the floor-standing stapler-stacker lower height wall.

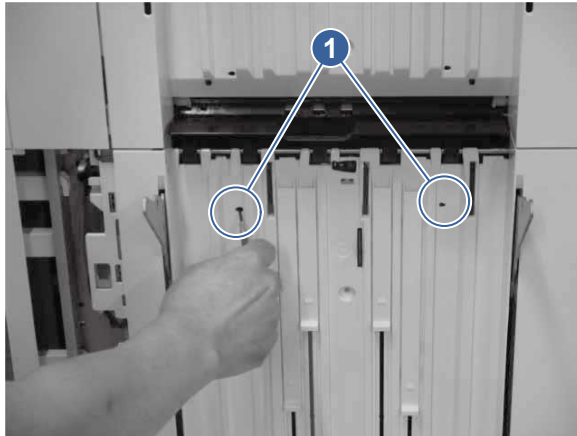
1. Disconnect one connector (callout 1), and then remove two screws (callout 2).

**Figure 5-1380 Disconnect one connector**

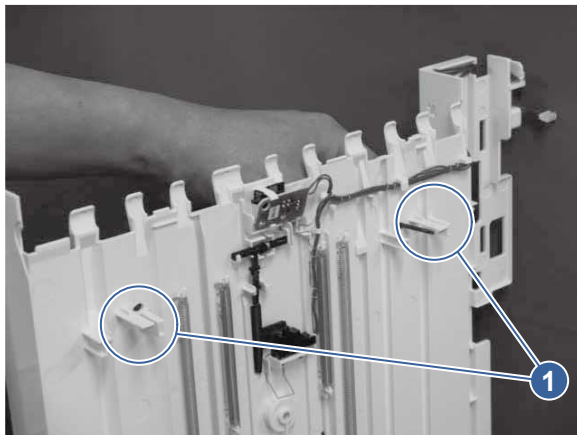


2. Release two inner tabs (callout 1) with a pointed tool.

**Figure 5-1381 Release two inner tabs**

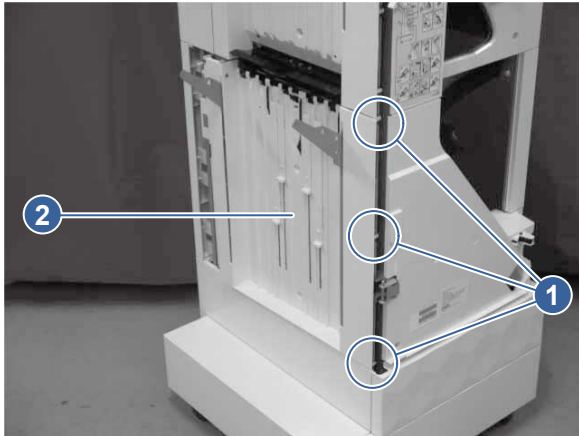


**Figure 5-1382 The two tabs viewed from the other side of the assembly**



3. Release three tabs (callout 1), and then remove the lower height wall assembly (callout 2).

**Figure 5-1383 Remove the lower height wall assembly**

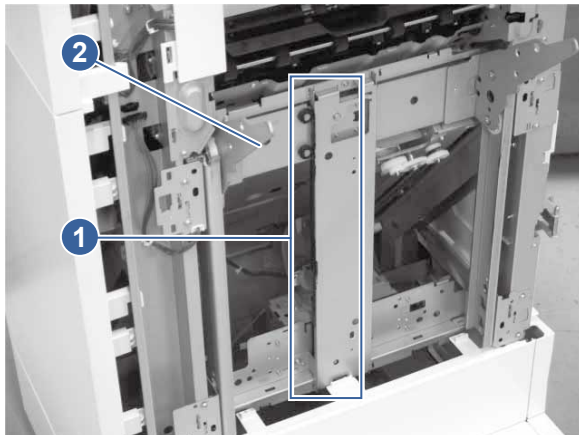


### 16. Remove the lower lifter base assembly (floor-standing stapler-stacker)

Learn about removing the floor-standing stapler-stacker lower lifter base assembly.

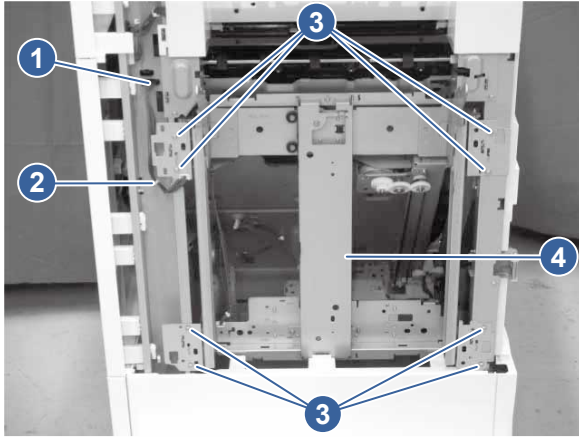
Do not touch the center (callout 1) of the lower lifter base assembly (callout 2) because grease is applied to the center.

**Figure 5-1384 Avoid touching the center**



- Disconnect one connector (callout 1), release the cable clamp (callout 2), remove eight screws (callout 3), and then remove the lower lifter base assembly (callout 4).

**Figure 5-1385 Remove the lower lifter base assembly**

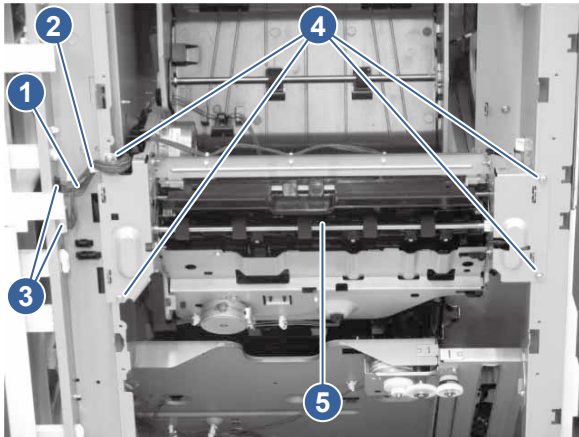


### 17. Remove the delivery assembly (floor-standing stapler-stacker)

Learn about removing the floor-standing stapler-stacker delivery assembly.

- Release the cable (callout 1) from the cable clamp (callout 2), disconnect two connectors (callout 3), remove four screws (callout 4), and then remove the delivery assembly (callout 5).

**Figure 5-1386 Remove the delivery assembly**



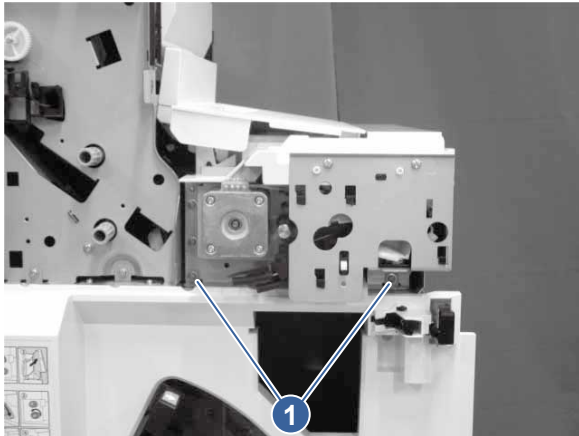
### 18. Remove the punch assembly (floor-standing stapler-stacker)

Learn about removing the floor-standing stapler-stacker punch assembly.



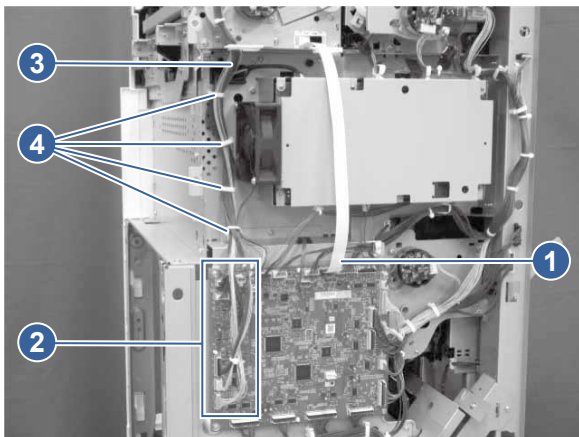
1. Remove two screws (callout 1).

**Figure 5-1387 Remove two screws**



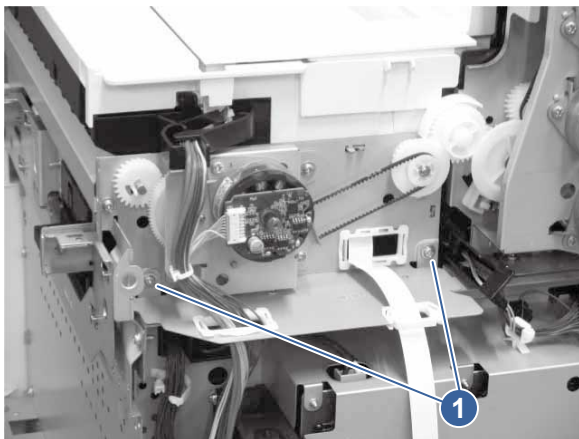
2. Remove one FFC (callout 1), disconnect seven connectors (callout 2), and then release the cable (callout 3) from the cable clamps (callout 4).

**Figure 5-1388 Remove one FFC**



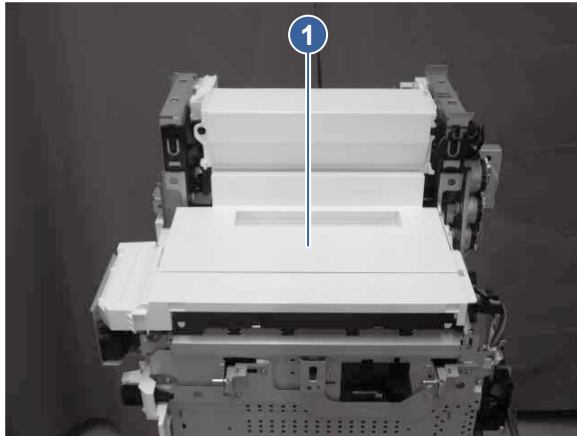
3. Remove two screws (callout 1).

**Figure 5-1389 Remove two screws**



4. Remove the punch assembly (callout 1).

**Figure 5-1390 Remove the punch assembly**

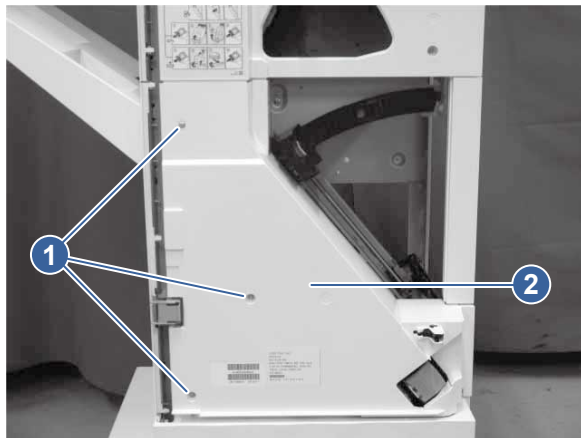


#### 19. Remove the front inner lower cover (floor-standing stapler-stacker)

Learn about removing the floor-standing stapler-stacker front inner lower cover.

- Remove three screws (callout 1), and then remove the front inner lower cover (callout 2).

**Figure 5-1391 Remove the front inner lower cover**

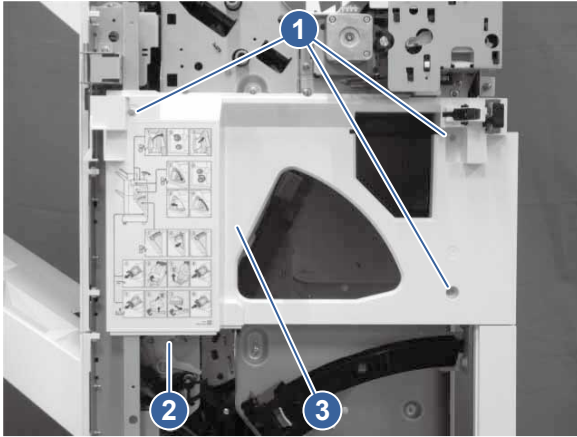


#### 20. Remove the front inner cover (floor-standing stapler-stacker)

Learn about removing the floor-standing stapler-stacker front inner cover.

- Remove three screws (callout 1), release one tab (callout 2), and then remove the front inner cover (callout 3).

**Figure 5-1392 Remove the front inner cover**

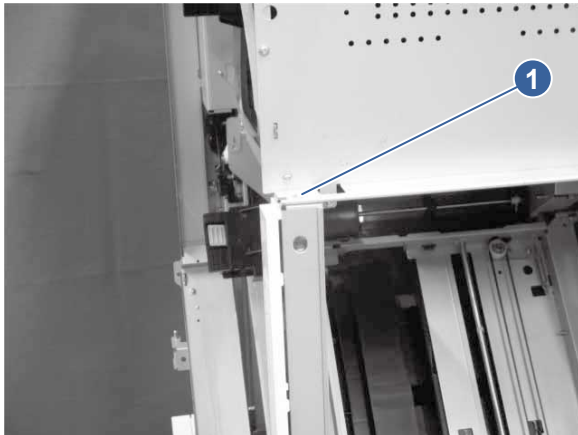


## 21. Remove the drum assembly/door handle rail assembly (floor-standing stapler-stacker)

Learn about removing the floor-standing stapler-stacker drum assembly and door handle rail assembly.

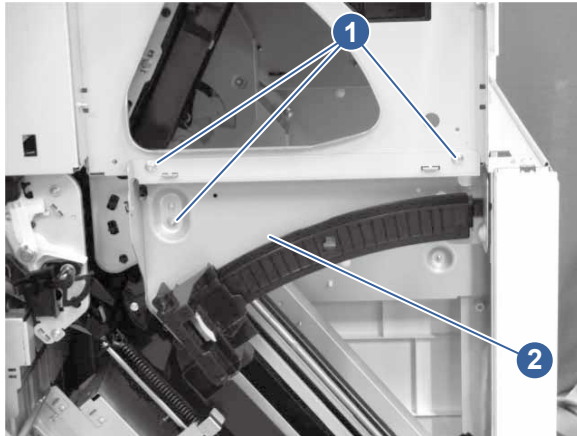
1. Remove one screw (callout 1).

**Figure 5-1393 Remove one screw**



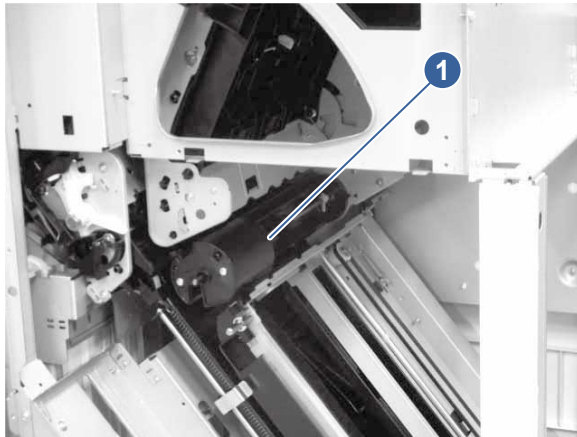
2. Remove three screws (callout 1), and then remove the door handle rail assembly (callout 2).

**Figure 5-1394 Remove the door handle rail assembly**




3. Remove the drum assembly (callout 1).

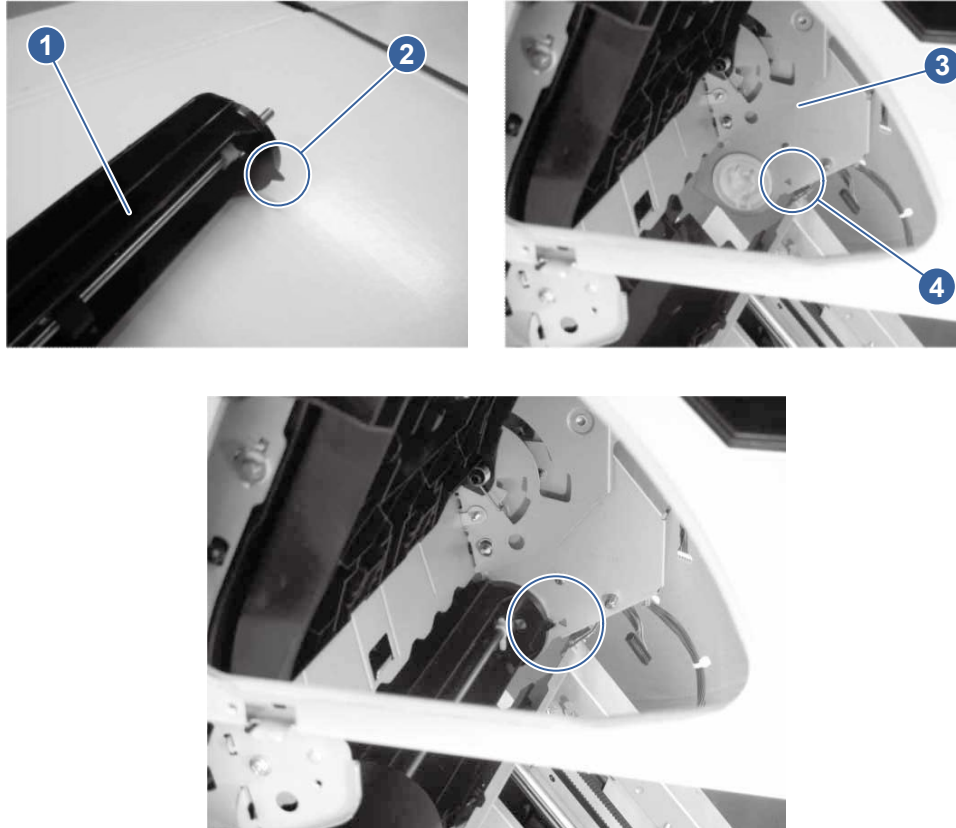
**Figure 5-1395 Remove the drum assembly**




---

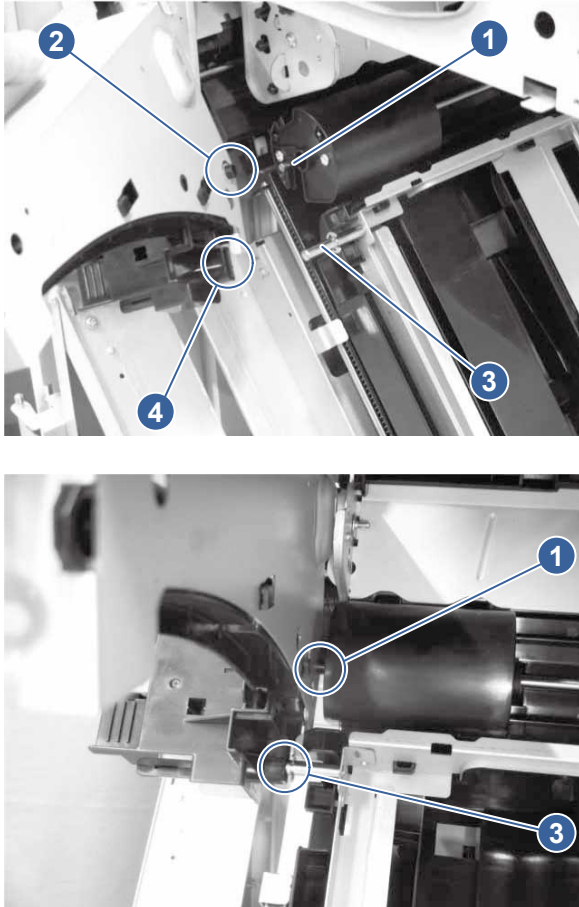
 **Reinstallation tip:** When installing the drum assembly, align the projection (callout 1) on the drum assembly (callout 2) with the mark (callout 3) on the sheet metal (callout 4).

**Figure 5-1396** Align the drum



 **Reinstallation tip:** When installing the door handle rail assembly and drum assembly, the shaft (callout 1) of drum assembly is inserted into the hole (callout 2) of the door handle rail assembly, and the shaft (callout 3) is inserted into the hole (callout 4) of the door handle rail assembly.

**Figure 5-1397 Lining up the shafts**

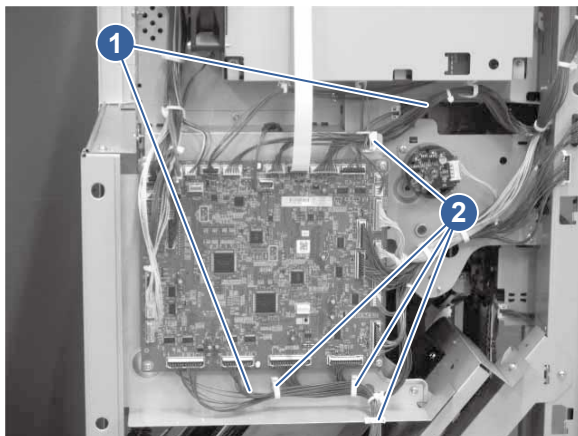


## 22. Remove the drum drive assembly (floor-standing stapler-stacker)

Learn about removing the floor-standing stapler-stacker drum drive assembly.

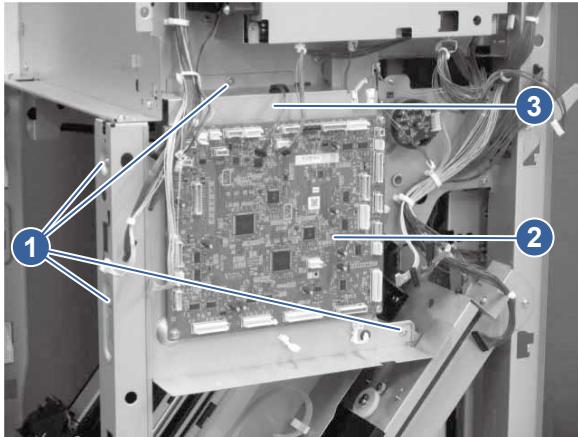
1. Disconnect all the connectors on the controller PCA, and then release the cables (callout 1) from the cable clamps (callout 2).

**Figure 5-1398 Release the cables**



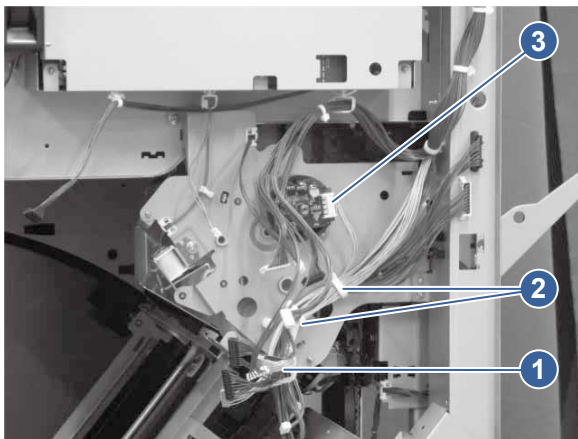
2. Remove four screws (callout 1), and then remove the controller PCA (callout 2) and the plate (callout 3) together.

**Figure 5-1399 Remove the controller PCA and the plate together**



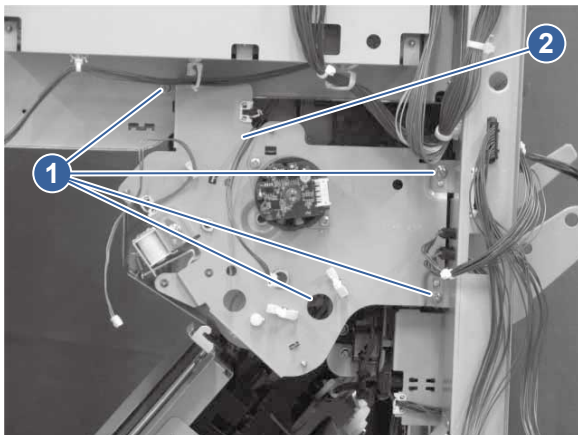
3. Release the cable (callout 1) from the cable clamps (callout 2), and then disconnect one connector (callout 3).

**Figure 5-1400 Release the cable**



4. Remove four screws (callout 1), and then remove the drum drive assembly (callout 2).

**Figure 5-1401 Remove the drum drive assembly**

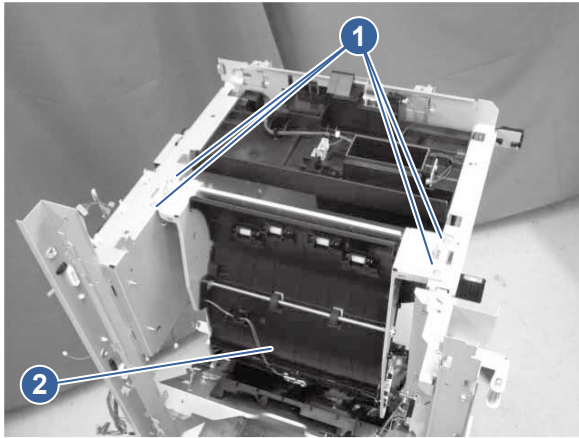


## 23. Remove the IMF assembly (floor-standing stapler-stacker)

Learn about removing the floor-standing stapler-stacker IMF assembly.

- Remove two screws (callout 1), and then remove the IMF assembly (callout 2).

Figure 5-1402 Remove the IMF assembly



## 24. Unpack the replacement assembly



Follow these steps to unpack the replacement assembly.


1. Dispose of the defective part.


 **NOTE:** HP recommends responsible disposal of the defective part.

<http://www8.hp.com/us/en/hp-information/environment/product-recycling.html>


2. Unpack the replacement part from the packaging.

 **CAUTION:**  Some parts are sensitive to electrostatic discharge (ESD). Always perform service work at an ESD-protected workstation or mat. If an ESD workstation or mat is not available, touch the sheet-metal chassis to provide a static ground before touching an ESD-sensitive assembly. Protect the ESD-sensitive assemblies by placing them in ESD pouches when they are out of the printer.

 **IMPORTANT:** Make sure that all of the shipping materials (for example shipping tape) are removed from the replacement part prior to installation.

 **NOTE:** If the replacement part is a roller or pad, avoid touching the spongy part of it. Skin oils on the roller or pad can cause paper pickup and/or print-quality problems. HP recommends using disposable gloves when handling rollers or pads or washing your hands before touching rollers or pads.

3. To install an assembly, reverse the removal steps.

 **NOTE:** When applicable, special installation instructions are provided for an assembly at the end of the removal procedure. Always completely read the removal instructions and follow all special installation instructions.

## Removal and replacement: Alignment assembly (floor-standing stapler-stacker)

Learn about removing and replacing the floor-standing stapler-stacker alignment assembly.

 [View a video demonstration of removing and replacing the alignment assembly.](#)



## Before performing service

### Turn the printer power off

- Disconnect the power cable.

**⚠ WARNING!** To avoid damage to the printer, turn the printer off, wait 30 seconds, and then remove the power cord before attempting to service the printer.

Use the table below to identify the correct part number for your printer, and then go to <https://parts.hp.com/hpparts> to order the part.

**Table 5-174 Part information**

Part number	Part description
RM2-3833-000CN	Alignment assembly (FSSS)

## Required tools

- #2 Phillips screwdriver with a magnetic tip and a 152 mm (6 in) shaft length
- Small flat-blade screwdriver

## After performing service

### Turn the printer power on

- Connect the power cable.
- Use the power switch to turn the power on.

## Post service test

Print any pages necessary to make sure the printer is functioning correctly.

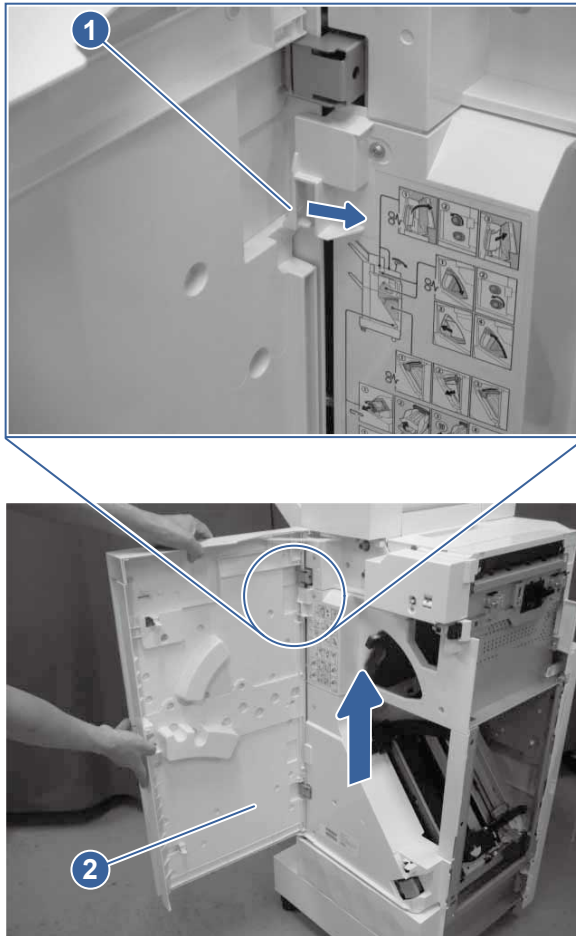
### 1. Remove the front door assembly (floor-standing stapler-stacker)

Learn about removing the floor-standing stapler-stacker front door assembly.

1. Open the front door.

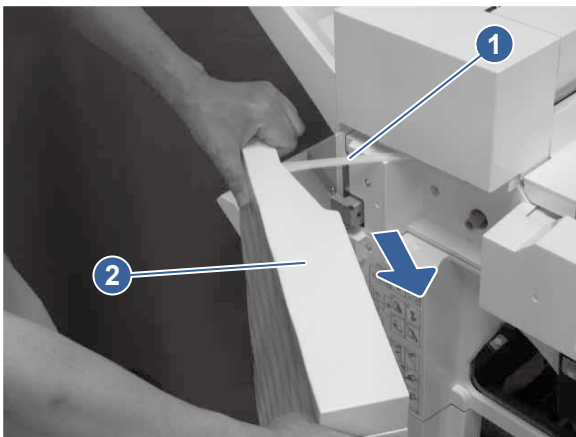
2. Push the stopper (callout 1) in the direction indicated, and then pull up the front door assembly (callout 2) to remove it.

**Figure 5-1403 Remove the front door assembly**



3. Remove the hinge (callout 1) from the front door assembly (callout 2).

**Figure 5-1404 Remove the hinge**

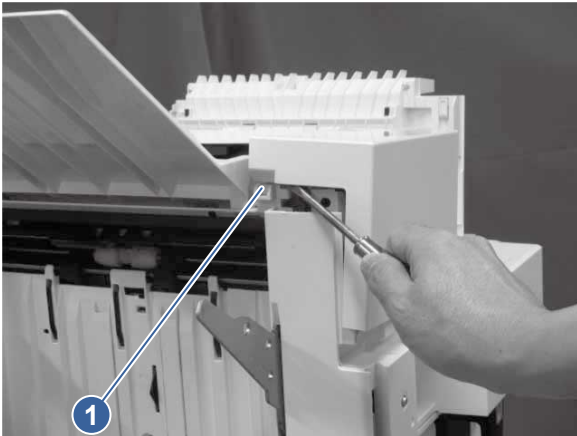


## 2. Remove the MBM front cover (floor-standing stapler-stacker)

Learn about removing the floor-standing stapler-stacker mailbox/booklet-maker front cover.

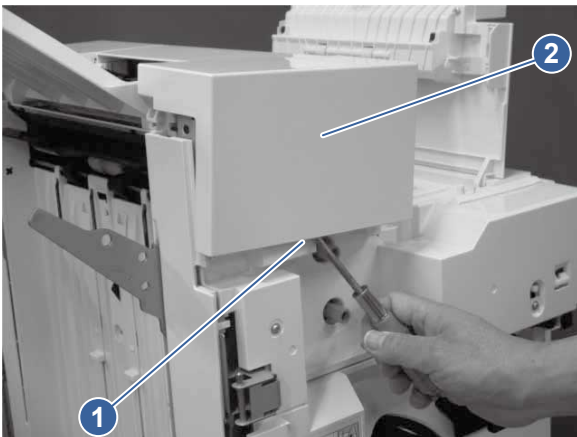
1. Release one tab (callout 1).

**Figure 5-1405 Release one tab**



2. Release one tab (callout 1), and then remove the MBM front cover (callout 2).

**Figure 5-1406 Remove the MBM front cover**

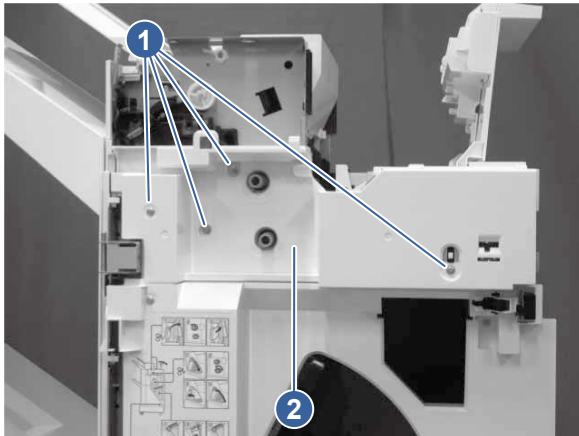


3. Remove the front inner upper cover (floor-standing stapler-stacker)

Learn about removing the floor-standing stapler-stacker front inner upper cover.

- Remove four screws (callout 1), and then remove the front inner upper cover (callout 2).

**Figure 5-1407 Remove the front inner upper cover**

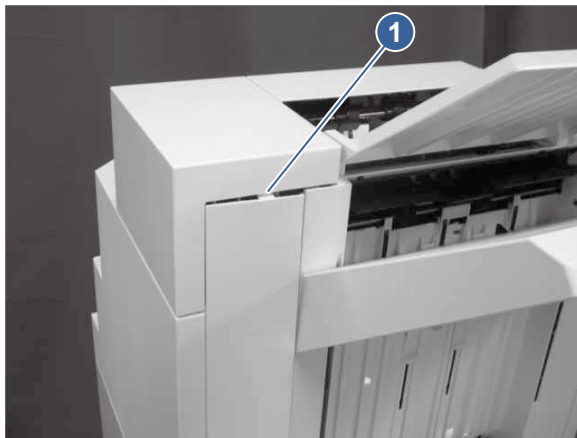


#### **4. Remove the left upper rear cover (floor-standing stapler-stacker)**

Learn about removing the floor-standing stapler-stacker left upper rear cover.

1. Release one tab (callout 1).

**Figure 5-1408 Release one tab**



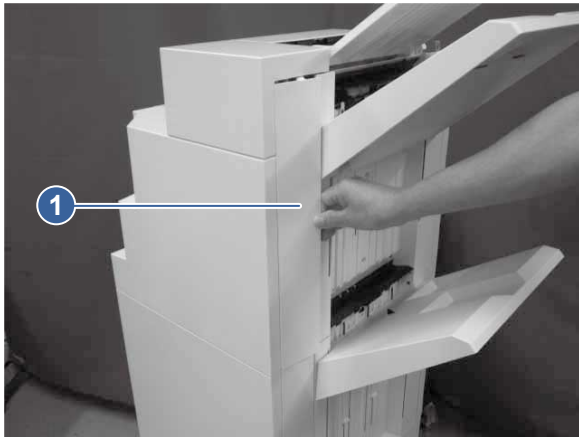
2. Release one boss (callout 1).

**Figure 5-1409 Release one boss**



3. Pull up the left upper rear cover (callout 1) to remove it.

**Figure 5-1410 Remove the left upper rear cover**



#### **5. Remove the MBM rear cover (floor-standing stapler-stacker)**

Learn about removing the floor-standing stapler-stacker mailbox/booklet-maker rear cover.

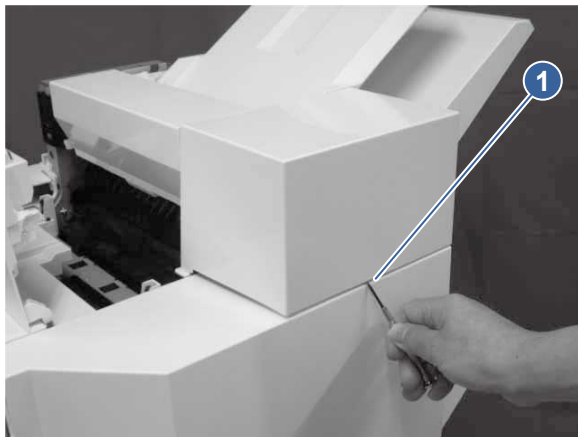
1. On the inside of the cover, release one tab (callout 1).

**Figure 5-1411 Release one tab**



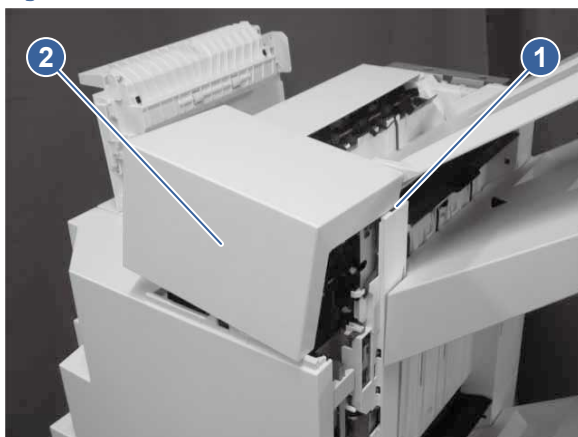
2. Release another tab (callout 1).

**Figure 5-1412 Release another tab**



3. Release another tab (callout 1), and then remove the MBM rear cover (callout 2).

**Figure 5-1413 Remove the MBM rear cover**

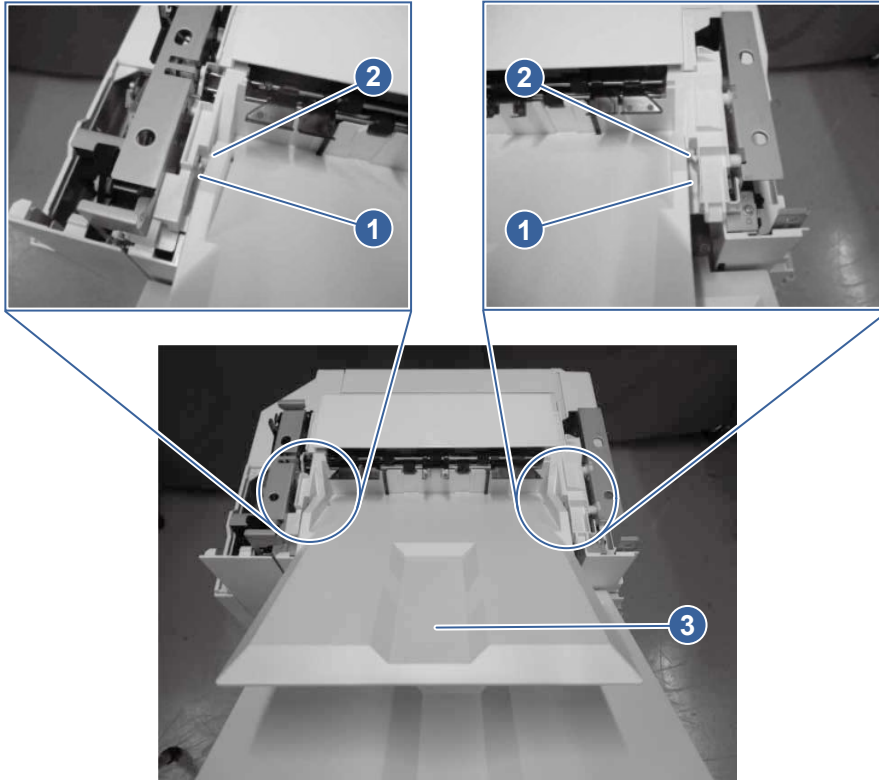


## 6. Remove the MBM output bin (floor-standing stapler-stacker)

Learn about removing the floor-standing stapler-stacker mailbox/booklet-maker output bin.

- Press the left and right stoppers (callout 1) to remove the shaft (callout 2), and then remove the MBM output bin (callout 3).

**Figure 5-1414** Remove the MBM output bin

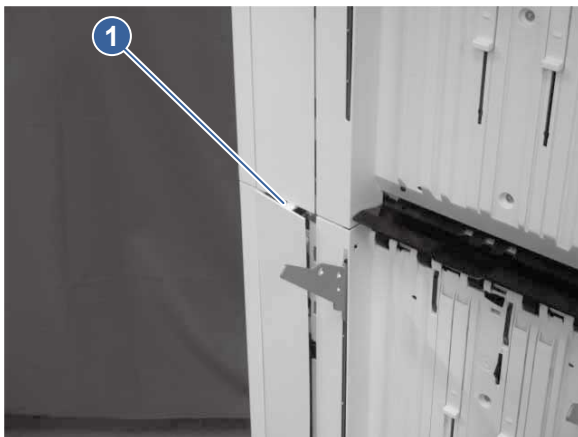


## 7. Remove the left lower rear cover (floor-standing stapler-stacker)

Learn about removing the floor-standing stapler-stacker left lower rear cover.

1. Release one tab (callout 1).

**Figure 5-1415** Release one tab



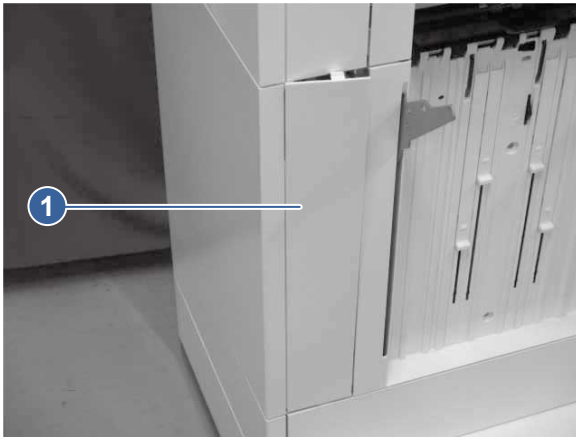
2. Release one boss (callout 1).

**Figure 5-1416 Release one boss**



3. Pull up the left lower rear cover (callout 1) to remove it.

**Figure 5-1417 Remove the left lower rear cover**



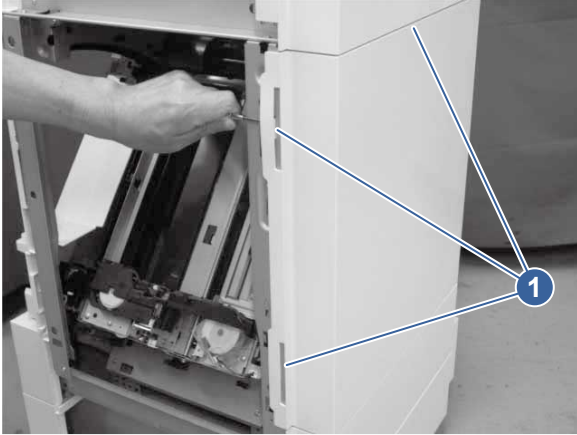
## **8. Remove the rear cover (floor-standing stapler-stacker)**

Learn about removing the floor-standing stapler-stacker rear cover.



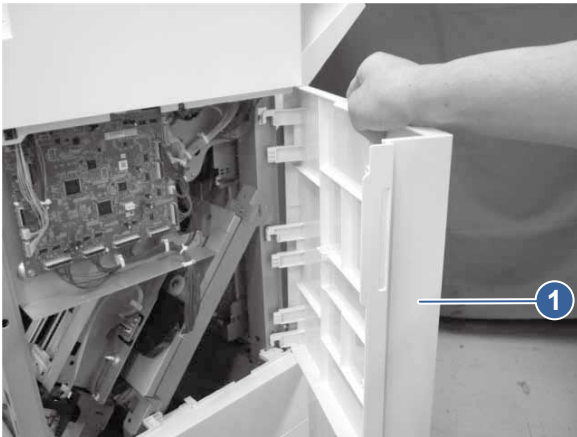
1. Release three tabs (callout 1).

**Figure 5-1418 Release three tabs**



2. Remove the rear cover (callout 1).

**Figure 5-1419 Remove the rear cover**

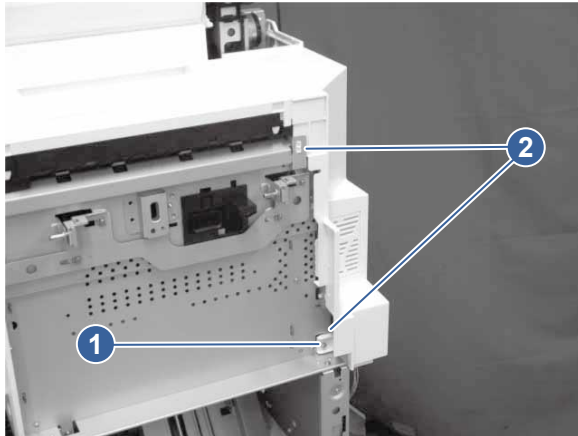


## 9. Remove the rear upper cover (floor-standing stapler-stacker)

Learn about removing the floor-standing stapler-stacker rear upper cover.

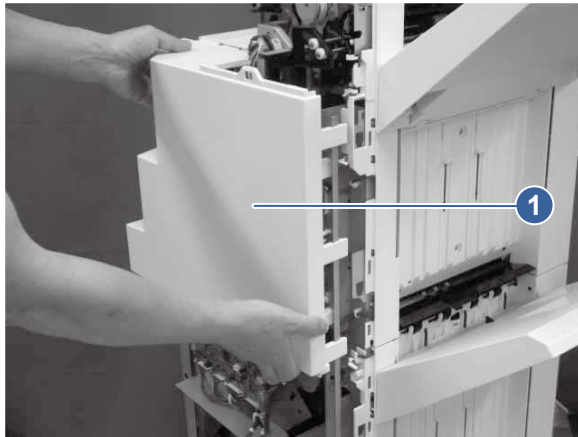
1. Remove one screw (callout 1), and then release two tabs (callout 2).

**Figure 5-1420 Remove one screw and release two tabs**



2. Remove the rear upper cover (callout 1).

**Figure 5-1421 Remove the rear upper cover**

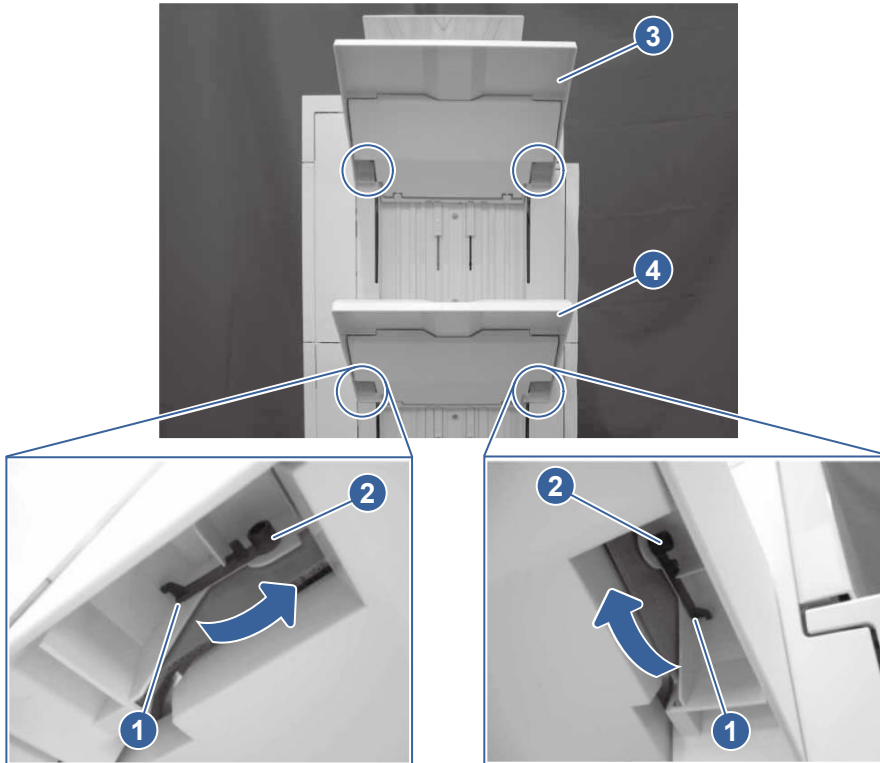


## 10. Remove the output bins (floor-standing stapler-stacker)

Learn about removing the floor-standing stapler-stacker output bins.

- Release one boss (callout 1), rotate the pin (callout 2) in the direction indicated, and then remove the pin. Remove either the upper bin (callout 3) or the lower bin (callout 4) with this process.

**Figure 5-1422 Remove either bin**

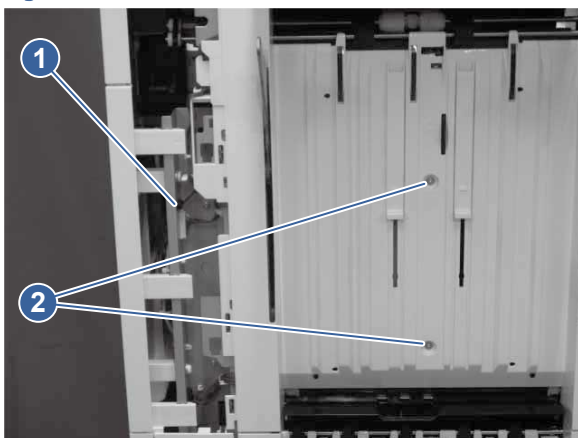


### 11. Remove the upper height wall assembly (floor-standing stapler-stacker)

Learn about removing the floor-standing stapler-stacker upper height wall assembly.

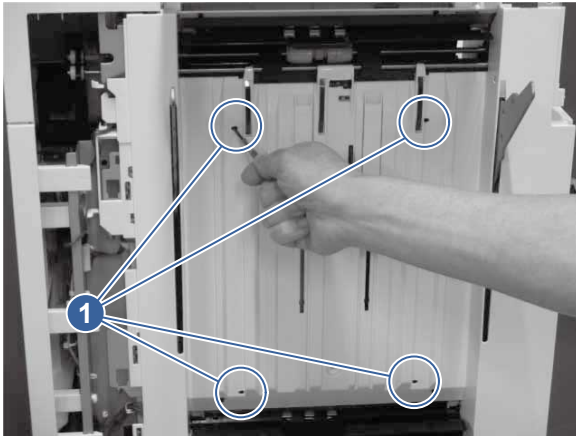
1. Disconnect one connector (callout 1), and then remove two screws (callout 2).

**Figure 5-1423 Disconnect one connector**

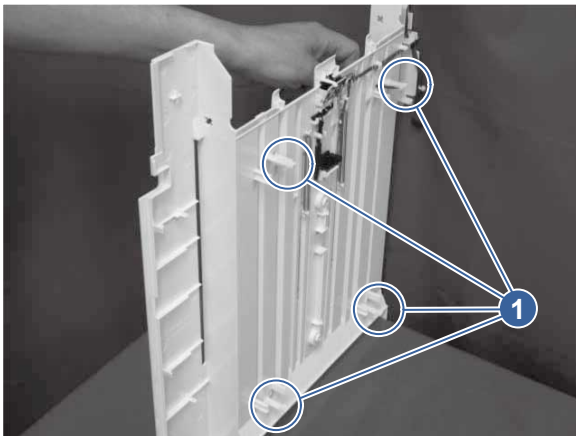


2. Release four inner tabs (callout 1) with a pointed tool.

**Figure 5-1424 Release four inner tabs**

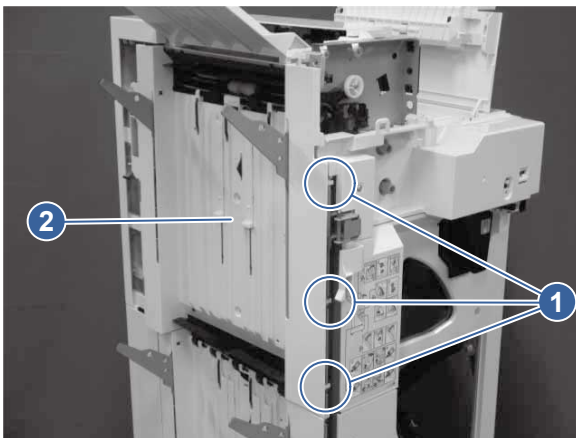


**Figure 5-1425 The four tabs viewed from the other side of the assembly**



3. Release three tabs (callout 1), and then remove the height wall upper assembly (callout 2).

**Figure 5-1426 Remove the upper height wall assembly**

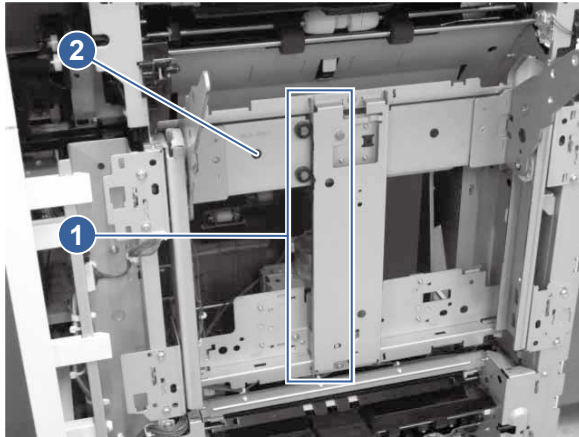


## 12. Remove the upper lifter base assembly (floor-standing stapler-stacker)

Learn about removing the floor-standing stapler-stacker upper lifter base assembly.

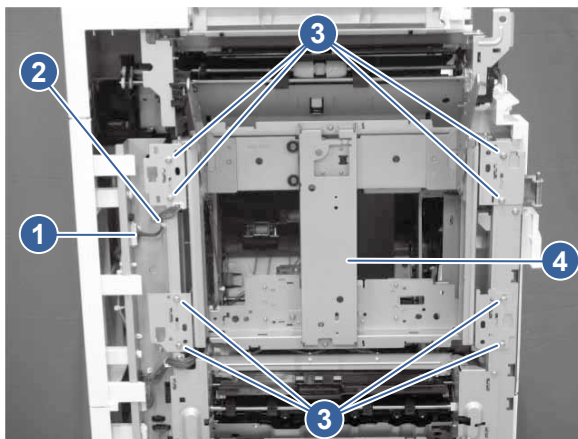
Do not touch the center (callout 1) of the upper lifter base assembly (callout 2) because grease is applied to the center.

**Figure 5-1427 Avoid touching the center**



- Disconnect one connector (callout 1), release the cable clamp (callout 2), remove eight screws (callout 3), and then remove the upper lifter base assembly (callout 4).

**Figure 5-1428 Remove the upper lifter base assembly**

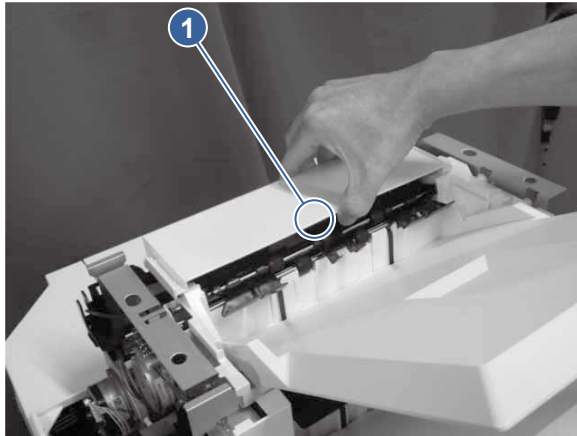


### 13. Remove the MBM top cover (floor-standing stapler-stacker)

Learn about removing the floor-standing stapler-stacker mailbox/booklet-maker top cover.

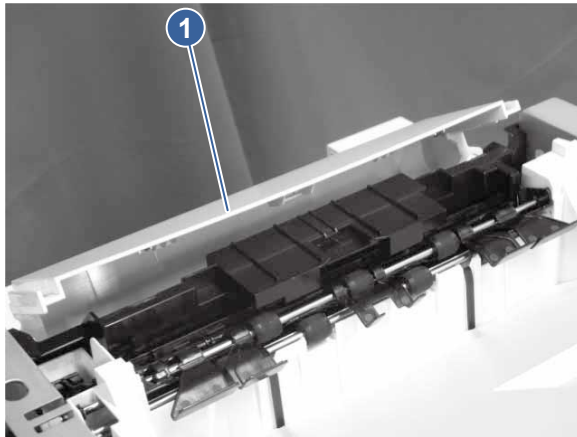
1. Release one tab (callout 1).

**Figure 5-1429 Release one tab**



2. Remove the MBM top cover (callout 1).

**Figure 5-1430 Remove the MBM top cover**

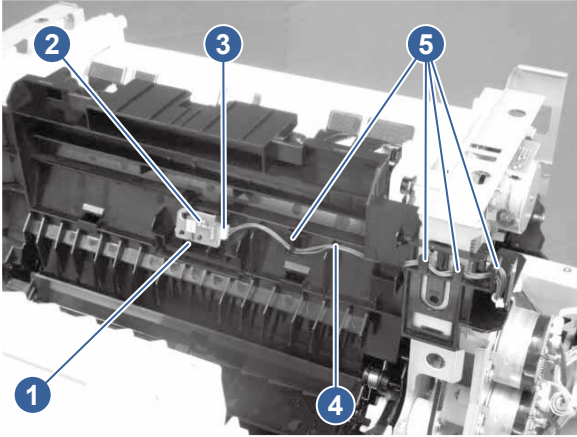


#### **14. Remove the SWB assembly (floor-standing stapler-stacker)**

Learn about removing the floor-standing stapler-stacker SWB assembly.

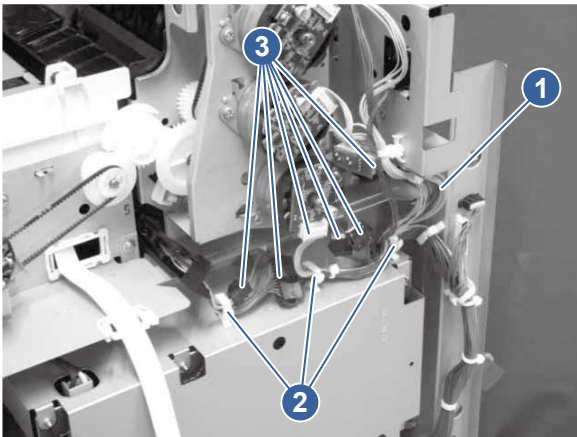
1. Release one tab (callout 1), remove the sensor PCA (callout 2), disconnect one connector (callout 1), and then release the cable (callout 4) from the cable clamps (callout 5).

**Figure 5-1431 Release one tab**



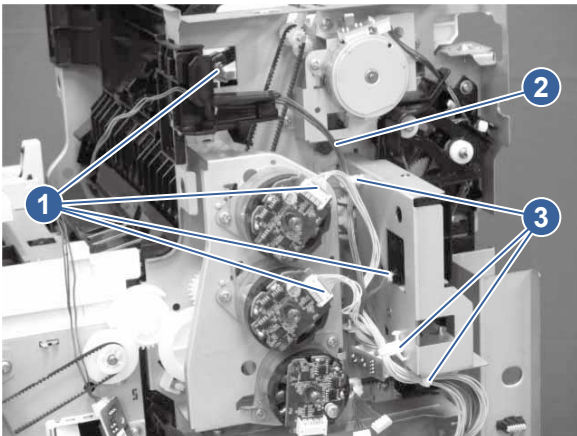
2. Release the cable (callout 1) from the cable clamps (callout 2), and then disconnect six connectors (callout 3).

**Figure 5-1432 Release the cable**



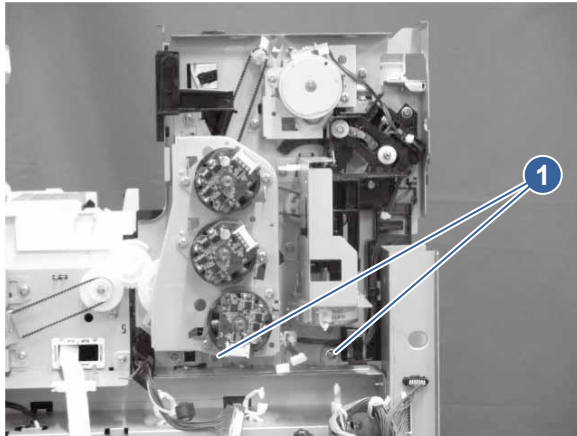
3. Disconnect four connectors (callout 1), and then release the cable (callout 2) from the cable clamps (callout 3).

**Figure 5-1433 Disconnect four connectors**



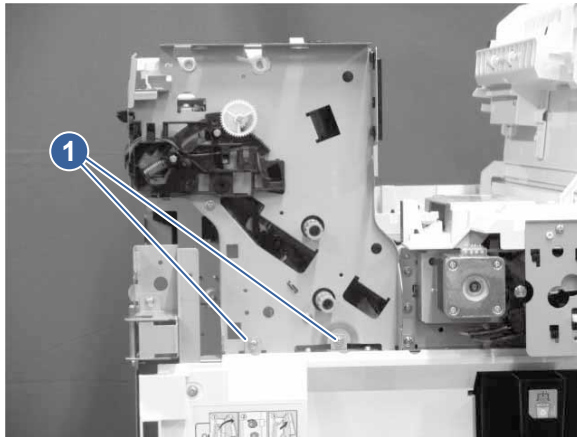
4. Remove two screws (callout 1).

**Figure 5-1434 Remove two screws**



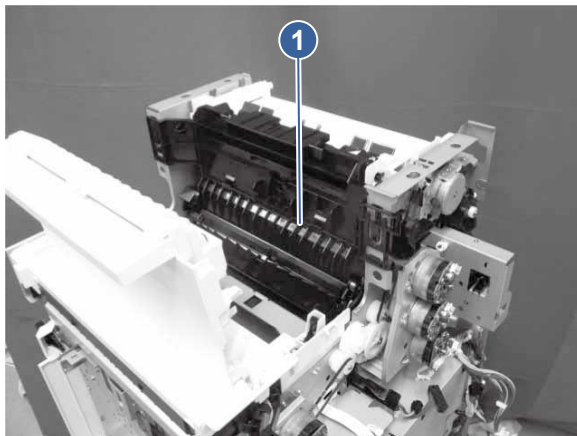
5. Remove two screws (callout 1).

**Figure 5-1435 Remove two screws**



6. Remove the SWB assembly (callout 1).

**Figure 5-1436 Remove the SWB assembly**



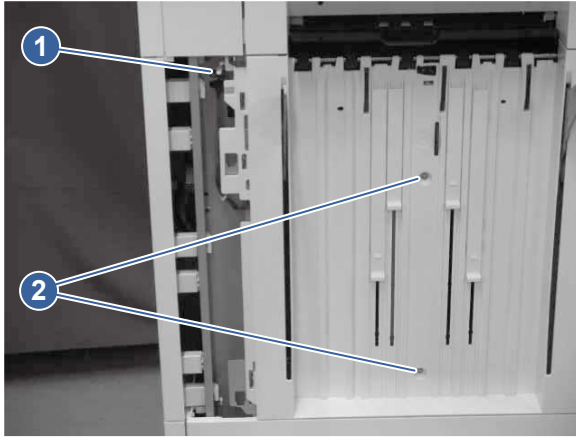


## 15. Remove the lower height wall (floor-standing stapler-stacker)

Learn about removing the floor-standing stapler-stacker lower height wall.

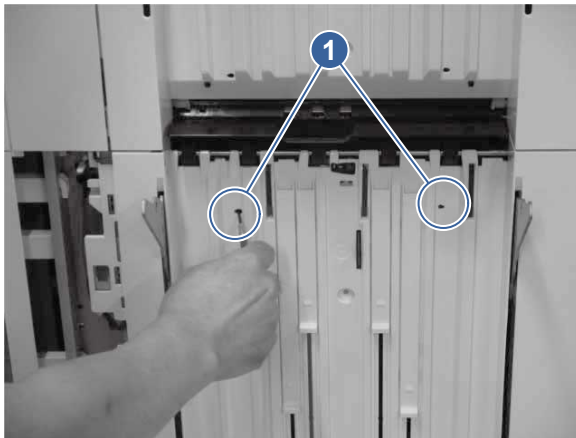
1. Disconnect one connector (callout 1), and then remove two screws (callout 2).

**Figure 5-1437 Disconnect one connector**

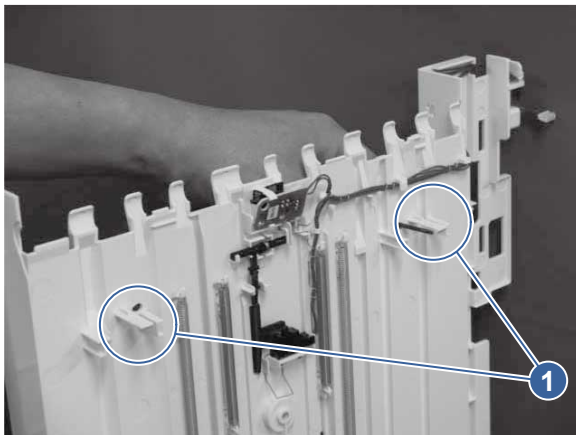


2. Release two inner tabs (callout 1) with a pointed tool.

**Figure 5-1438 Release two inner tabs**

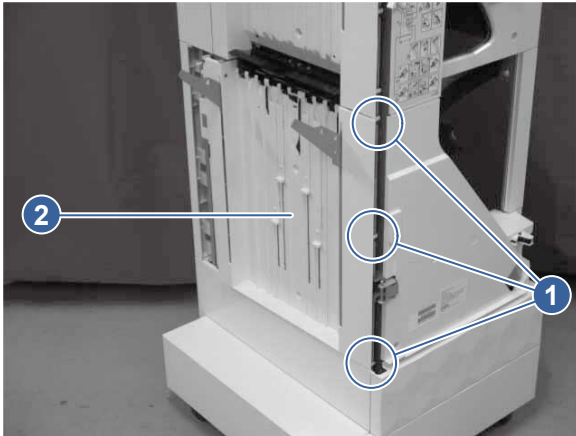


**Figure 5-1439 The two tabs viewed from the other side of the assembly**



3. Release three tabs (callout 1), and then remove the lower height wall assembly (callout 2).

**Figure 5-1440 Remove the lower height wall assembly**

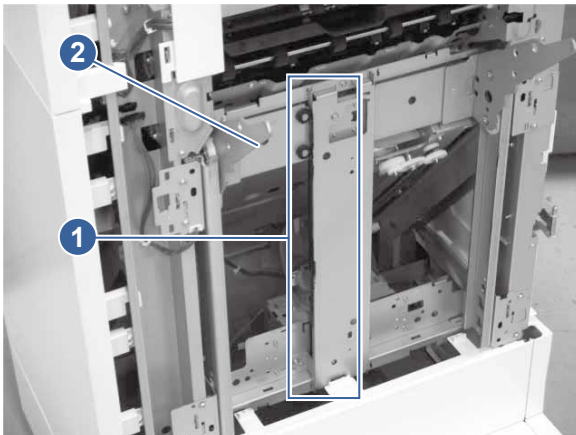


### 16. Remove the lower lifter base assembly (floor-standing stapler-stacker)

Learn about removing the floor-standing stapler-stacker lower lifter base assembly.

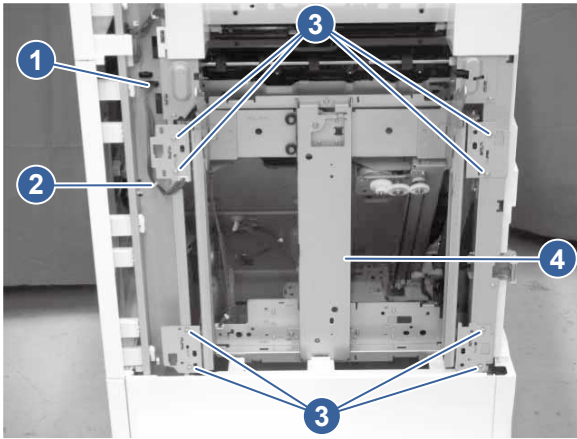
Do not touch the center (callout 1) of the lower lifter base assembly (callout 2) because grease is applied to the center.

**Figure 5-1441 Avoid touching the center**



- Disconnect one connector (callout 1), release the cable clamp (callout 2), remove eight screws (callout 3), and then remove the lower lifter base assembly (callout 4).

**Figure 5-1442 Remove the lower lifter base assembly**

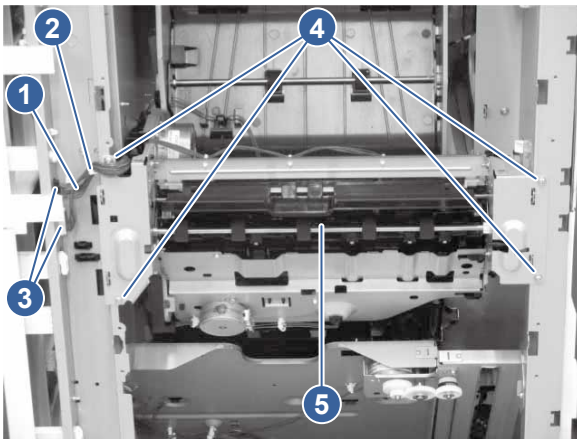


### 17. Remove the delivery assembly (floor-standing stapler-stacker)

Learn about removing the floor-standing stapler-stacker delivery assembly.

- Release the cable (callout 1) from the cable clamp (callout 2), disconnect two connectors (callout 3), remove four screws (callout 4), and then remove the delivery assembly (callout 5).

**Figure 5-1443 Remove the delivery assembly**

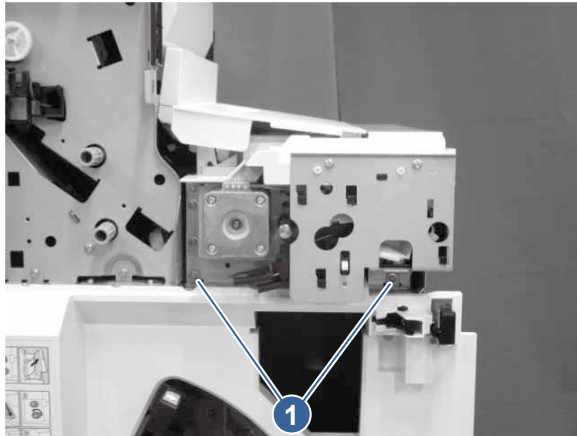


### 18. Remove the punch assembly (floor-standing stapler-stacker)

Learn about removing the floor-standing stapler-stacker punch assembly.

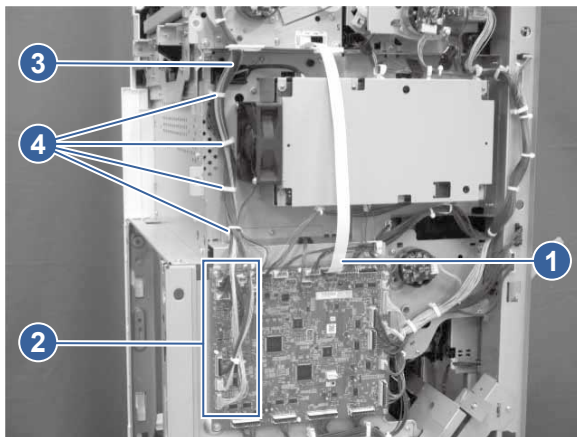
1. Remove two screws (callout 1).

**Figure 5-1444 Remove two screws**



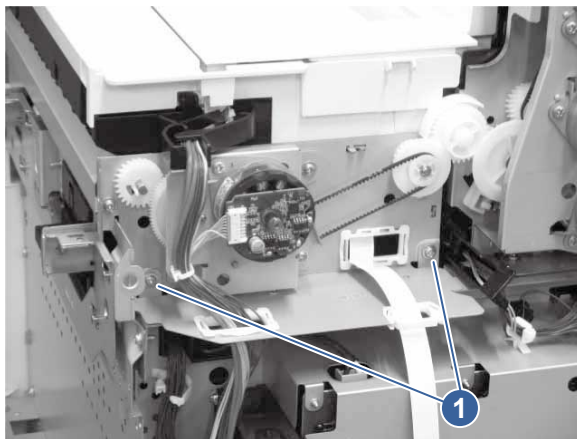
2. Remove one FFC (callout 1), disconnect seven connectors (callout 2), and then release the cable (callout 3) from the cable clamps (callout 4).

**Figure 5-1445 Remove one FFC**



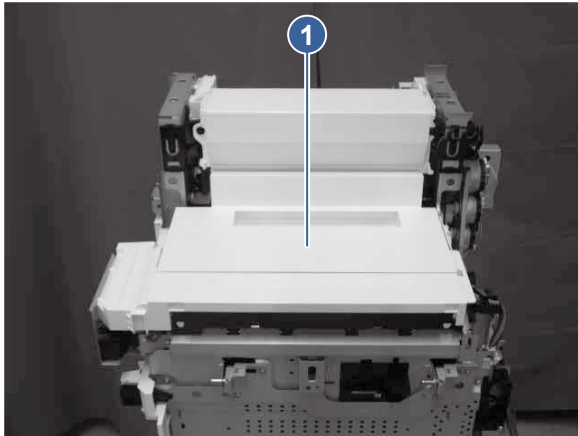
3. Remove two screws (callout 1).

**Figure 5-1446 Remove two screws**



4. Remove the punch assembly (callout 1).

**Figure 5-1447 Remove the punch assembly**

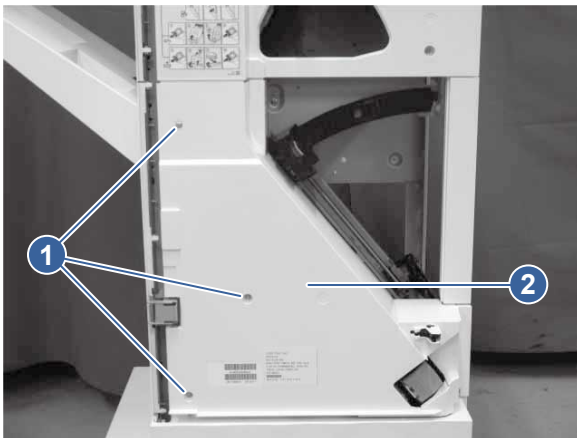


#### 19. Remove the front inner lower cover (floor-standing stapler-stacker)

Learn about removing the floor-standing stapler-stacker front inner lower cover.

- Remove three screws (callout 1), and then remove the front inner lower cover (callout 2).

**Figure 5-1448 Remove the front inner lower cover**

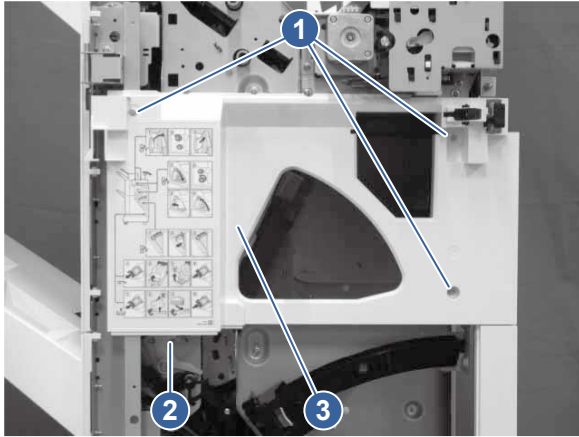


#### 20. Remove the front inner cover (floor-standing stapler-stacker)

Learn about removing the floor-standing stapler-stacker front inner cover.

- Remove three screws (callout 1), release one tab (callout 2), and then remove the front inner cover (callout 3).

**Figure 5-1449 Remove the front inner cover**

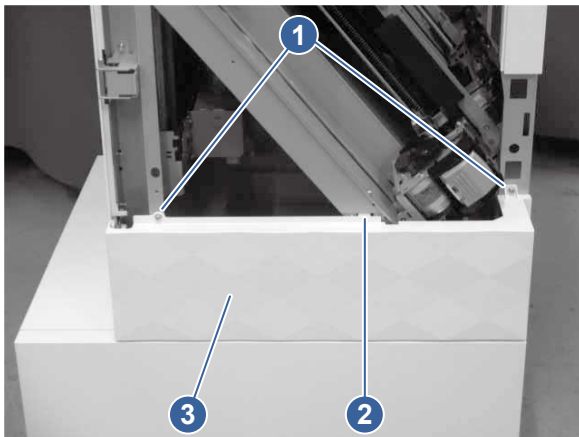


## 21. Remove the foot front cover (tall floor-standing stapler-stacker)

Learn about removing the tall floor-standing stapler-stacker foot front cover.

- Remove two screws (callout 1), release one tab (callout 2), and then remove the foot front cover (callout 3).

**Figure 5-1450 Remove the foot front cover (tall finisher)**

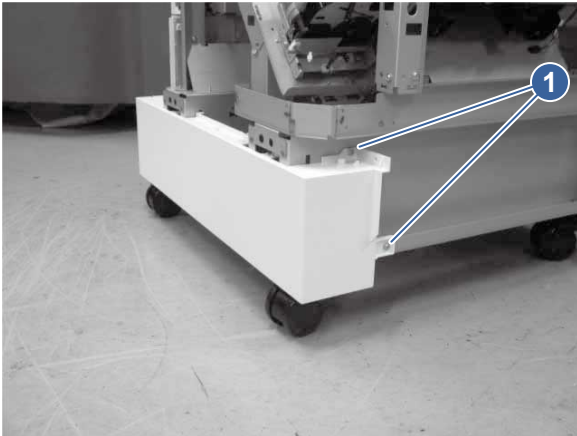


## 22. Remove the foot front cover (standard floor-standing stapler-stacker)

Learn about removing the standard floor-standing stapler-stacker foot front cover.

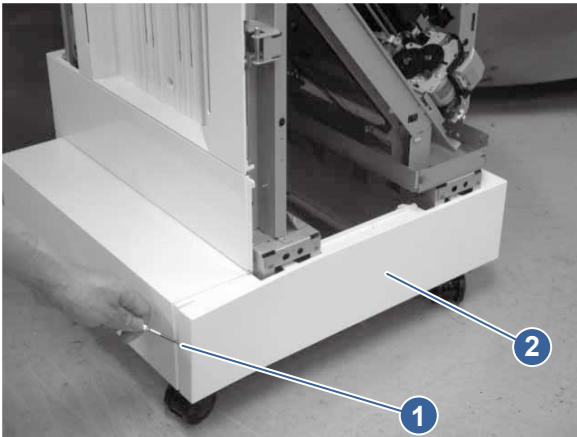
1. Remove two screws (callout 1).

**Figure 5-1451 Remove two screws**



2. Release one tab (callout 1), and then remove the foot front cover (callout 2).

**Figure 5-1452 Remove the foot front cover (standard finisher)**

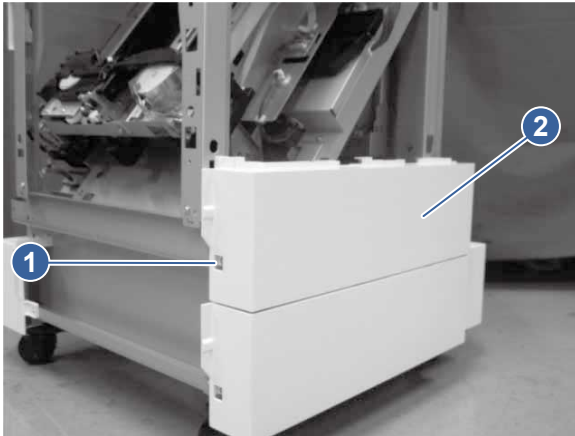


**23. Remove the foot rear cover (floor-standing stapler-stacker)**

Learn about removing the floor-standing stapler-stacker foot rear cover.

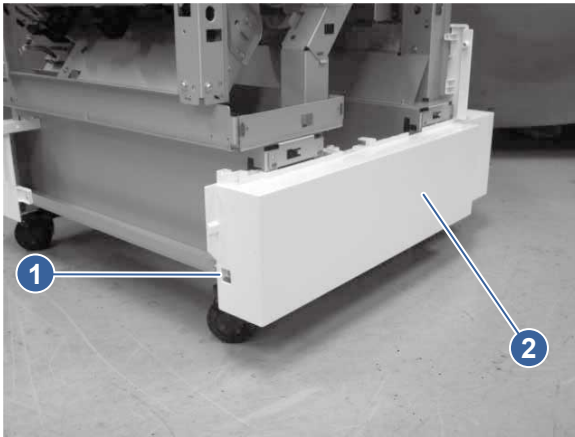
1. **Tall finishers only:** Remove one screw (callout 1), and then remove the tall foot rear cover (callout 2).

**Figure 5-1453 Remove the tall finisher cover**



2. Remove one screw (callout 1), and then remove the foot rear cover (callout 1).

**Figure 5-1454 Remove the foot rear cover**



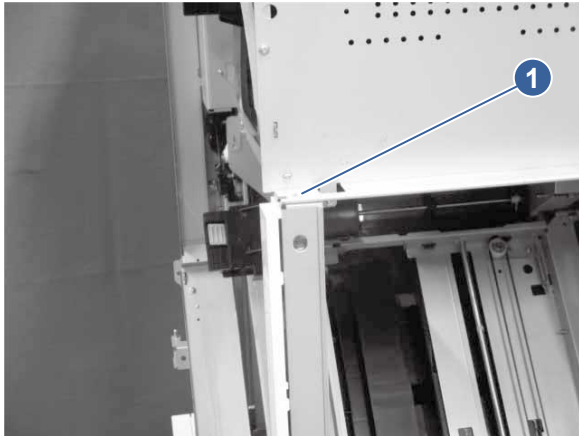
#### 24. Remove the drum assembly/door handle rail assembly (floor-standing stapler-stacker)

Learn about removing the floor-standing stapler-stacker drum assembly and door handle rail assembly.



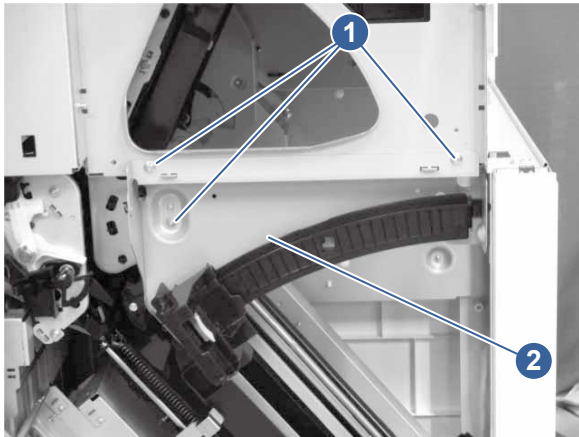
1. Remove one screw (callout 1).

**Figure 5-1455 Remove one screw**



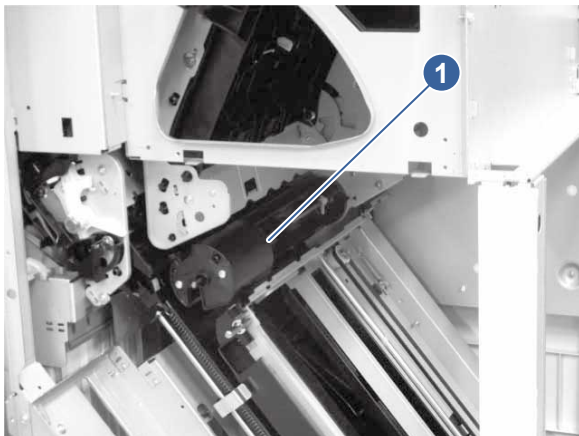
2. Remove three screws (callout 1), and then remove the door handle rail assembly (callout 2).

**Figure 5-1456 Remove the door handle rail assembly**




3. Remove the drum assembly (callout 1).

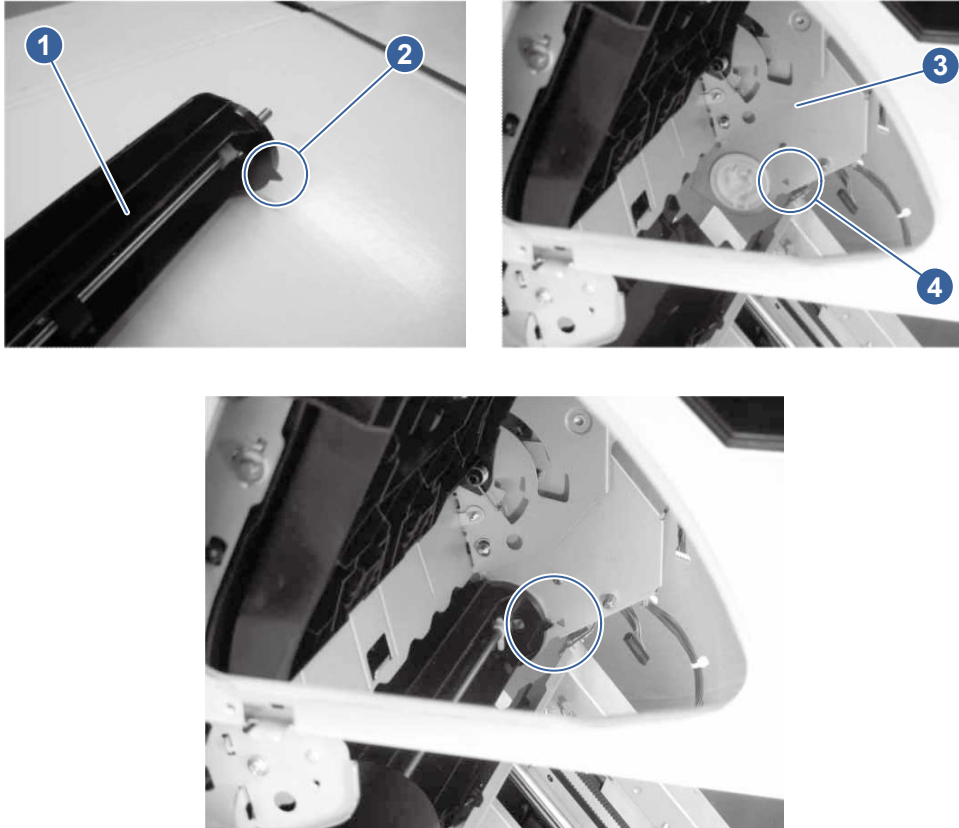
**Figure 5-1457 Remove the drum assembly**




---

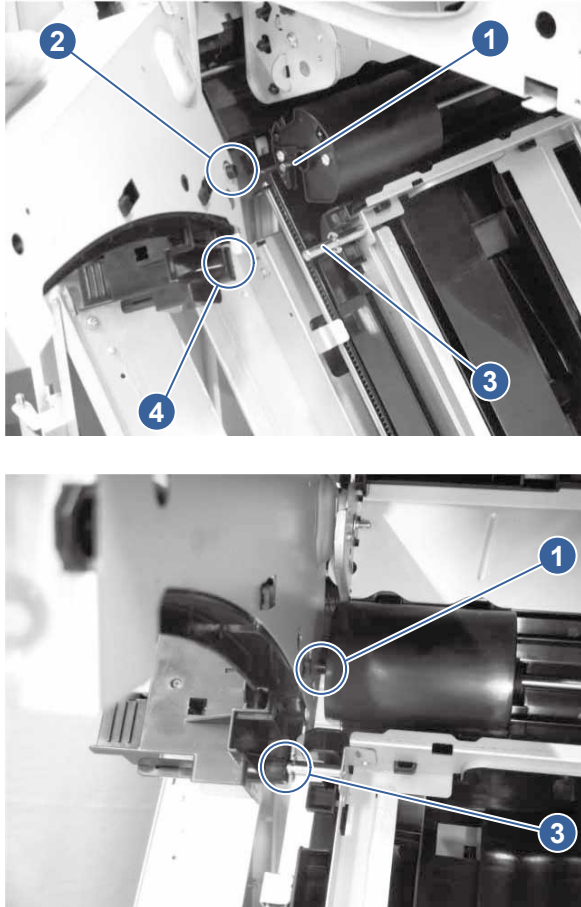
 **Reinstallation tip:** When installing the drum assembly, align the projection (callout 1) on the drum assembly (callout 2) with the mark (callout 3) on the sheet metal (callout 4).

**Figure 5-1458** Align the drum



 **Reinstallation tip:** When installing the door handle rail assembly and drum assembly, the shaft (callout 1) of drum assembly is inserted into the hole (callout 2) of the door handle rail assembly, and the shaft (callout 3) is inserted into the hole (callout 4) of the door handle rail assembly.

**Figure 5-1459 Lining up the shafts**

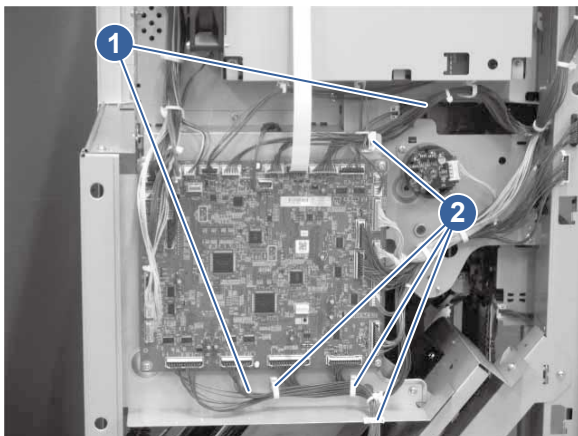


## 25. Remove the alignment assembly (floor-standing stapler-stacker)

Learn about removing the floor-standing stapler-stacker alignment assembly.

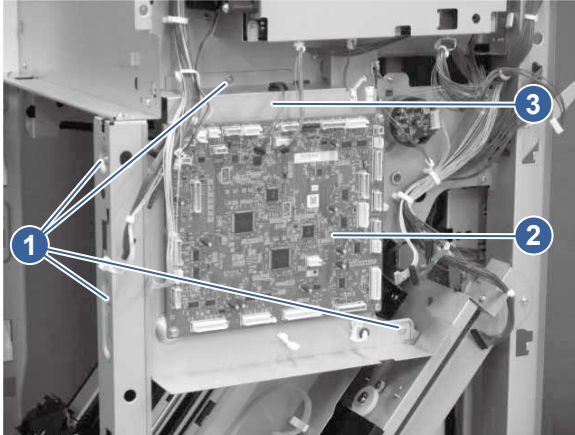
1. Disconnect all the connectors on the controller PCA, and then release the cables (callout 1) from the cable clamps (callout 2).

**Figure 5-1460 Release the cables**



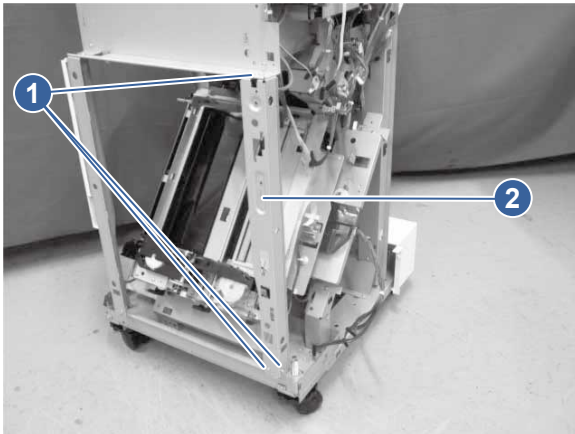
2. Remove four screws (callout 1), and then remove the controller PCA (callout 2) and the plate (callout 3) together.

**Figure 5-1461 Remove the controller PCA and the plate together**



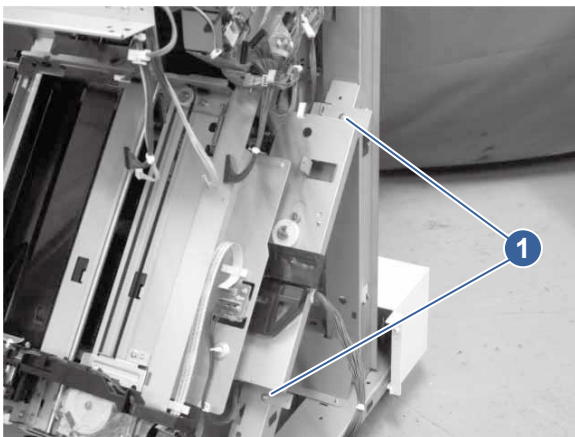
3. Remove three screws (callout 1), and then remove the prop (callout 2).

**Figure 5-1462 Remove three screws**



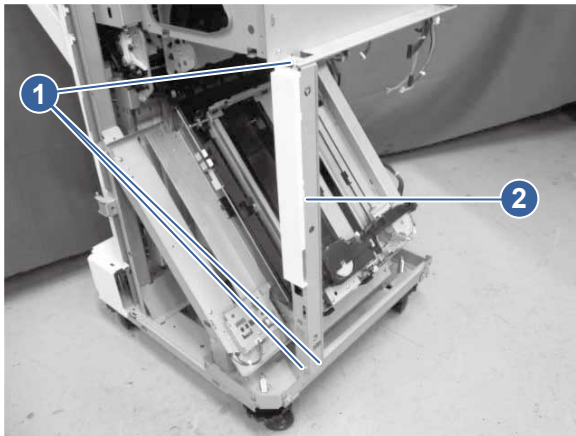
4. Remove two screws (callout 1).

**Figure 5-1463 Remove two screws**



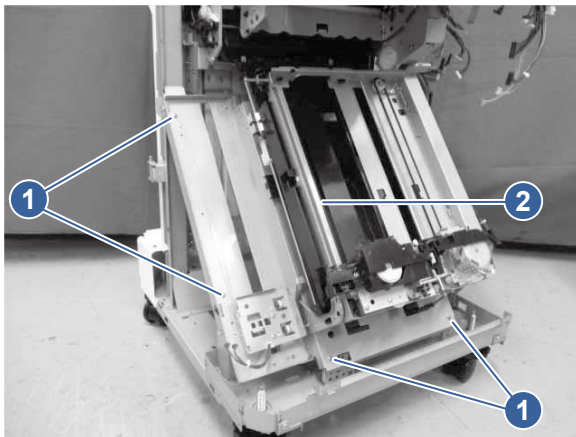
5. Remove three screws (callout 1), and then remove the prop (callout 2).

**Figure 5-1464 Remove three screws**



6. Remove four screws (callout 1), and then remove the alignment assembly (callout 2).

**Figure 5-1465 Remove the alignment assembly**



## 26. Unpack the replacement assembly

Follow these steps to unpack the replacement assembly.

1. Dispose of the defective part.




**NOTE:** HP recommends responsible disposal of the defective part.

<http://www8.hp.com/us/en/hp-information/environment/product-recycling.html>


2. Unpack the replacement part from the packaging.



**CAUTION:**  Some parts are sensitive to electrostatic discharge (ESD). Always perform service work at an ESD-protected workstation or mat. If an ESD workstation or mat is not available, touch the sheet-metal chassis to provide a static ground before touching an ESD-sensitive assembly. Protect the ESD-sensitive assemblies by placing them in ESD pouches when they are out of the printer.




**IMPORTANT:** Make sure that all of the shipping materials (for example shipping tape) are removed from the replacement part prior to installation.

 **NOTE:** If the replacement part is a roller or pad, avoid touching the spongy part of it. Skin oils on the roller or pad can cause paper pickup and/or print-quality problems. HP recommends using disposable gloves when handling rollers or pads or washing your hands before touching rollers or pads.

---

**3.** To install an assembly, reverse the removal steps.

---

 **NOTE:** When applicable, special installation instructions are provided for an assembly at the end of the removal procedure. Always completely read the removal instructions and follow all special installation instructions.

---

---

## 6 Parts and diagrams

Printer parts information including exploded assembly diagrams and part number lists.

### Document feeder / scanner

Learn about the integrated scanner assembly (ISA) parts and assemblies.



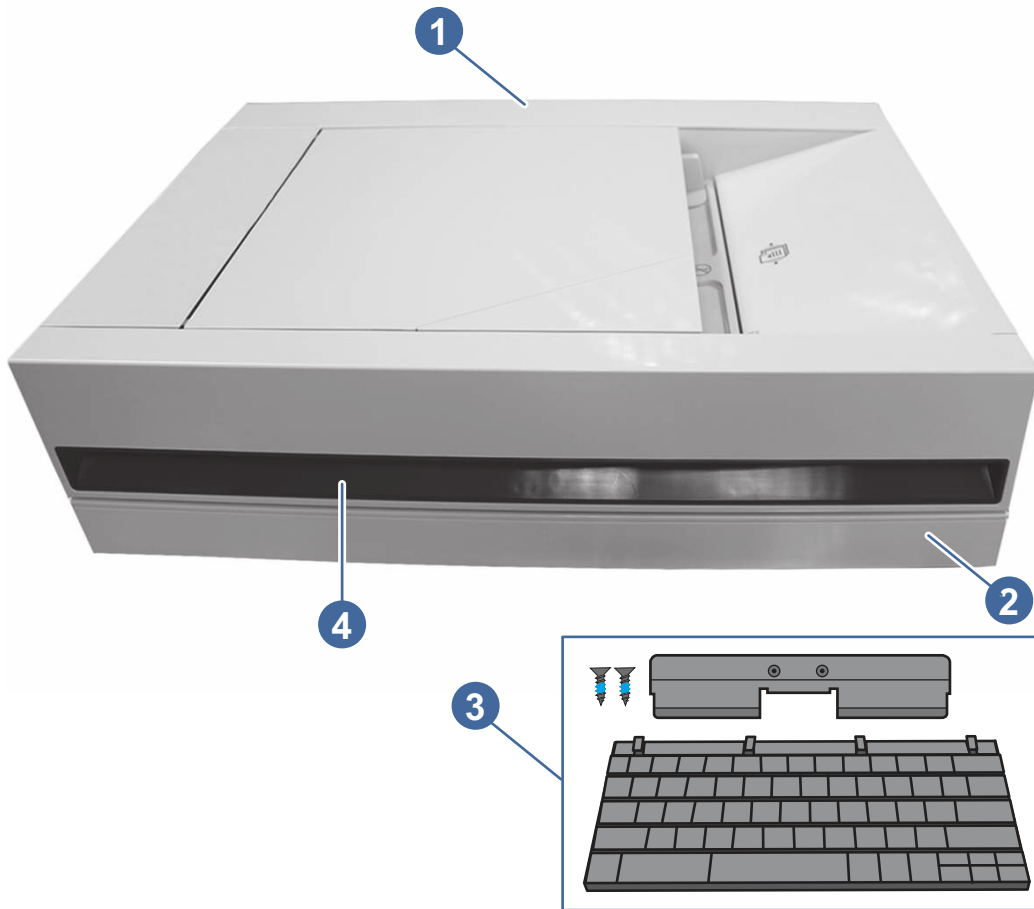
**NOTE:** This section is for MFP printers only.

---

### Integrated scanner assembly

Parts diagram and part list for the integrated scanner assembly (ISA).

**Figure 6-1 Integrated scanner assembly**



**Table 6-1 Integrated scanner assembly**

Ref No	Part number	Description	Qty
1	J1H98-60037	ADF WUR (6xxx Series Non-Workflow)	1
1	J1H98-60038	ADF WUR (6xxx Series Workflow)	1
2	6QN35-67006	Flatbed scanner	1
3	1MQ2A	HP LaserJet Workflow Keyboard	
4	5851-8688	Handle (Lunar Grey Dark/ Cement Dark)	1
4	5851-8689	Handle (Lunar Comet Red Dark)	1
4	5851-8690	Handle (Lunar Cosmic Green Dark)	1
4	5851-8691	Handle (Lunar Constellation Yellow)	1
4	5851-8692	Handle (Lunar Aurora Purple Dark)	1
4	5851-8693	Handle (OOV white)	1



**Table 6-1 Integrated scanner assembly (continued)**

Ref No	Part number	Description	Qty
Not shown	5851-8849	ADF damper	1
Not shown	5851-8842	ADF hinge kit (6xxx Series)	1
Not shown	5851-8850	ADF white backing kit	1
Not shown	6H122A	ADF Pick/Sep Roller Kit (6xxx Series)	1
Not shown	6M1P3A	ADF Pick/Sep Roller Kit (Flow 6xxx Series)	1
Not shown	5851-8844	ADF roller cover (6xxx Series)	1
Not shown	A7W12A	Keyboard Overlay Kit - Chinese	1
Not shown	A7W13A	Keyboard Overlay Kit - (DN/FR-Swiss/GN)	1
Not shown	A7W14A	HP LaserJet Swedish Overlay Keyboard	1

## Base printer

Learn about the printer engine parts and assemblies.

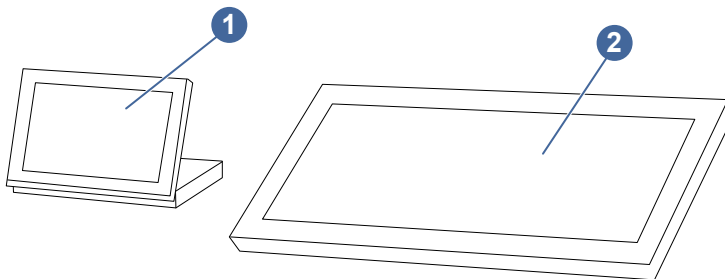
## Control panels

Parts diagrams and part lists for the control panels.

### Control panels

Parts diagrams and parts lists for the printer control panels.

**Figure 6-2 Control panels**



**Table 6-2 Control panels**

Ref No	Part number	Description	Qty
1	6QN28-67001	Control panel 10.9 cm (4.3 in)	1
2	6QN35-67003	Control panel 25.6 cm (10.1 in)	1

**Table 6-2 Control panels (continued)**

<b>Ref No</b>	<b>Part number</b>	<b>Description</b>	<b>Qty</b>
2	6QN37-67001	Control panel 23.3 cm (8 in)	

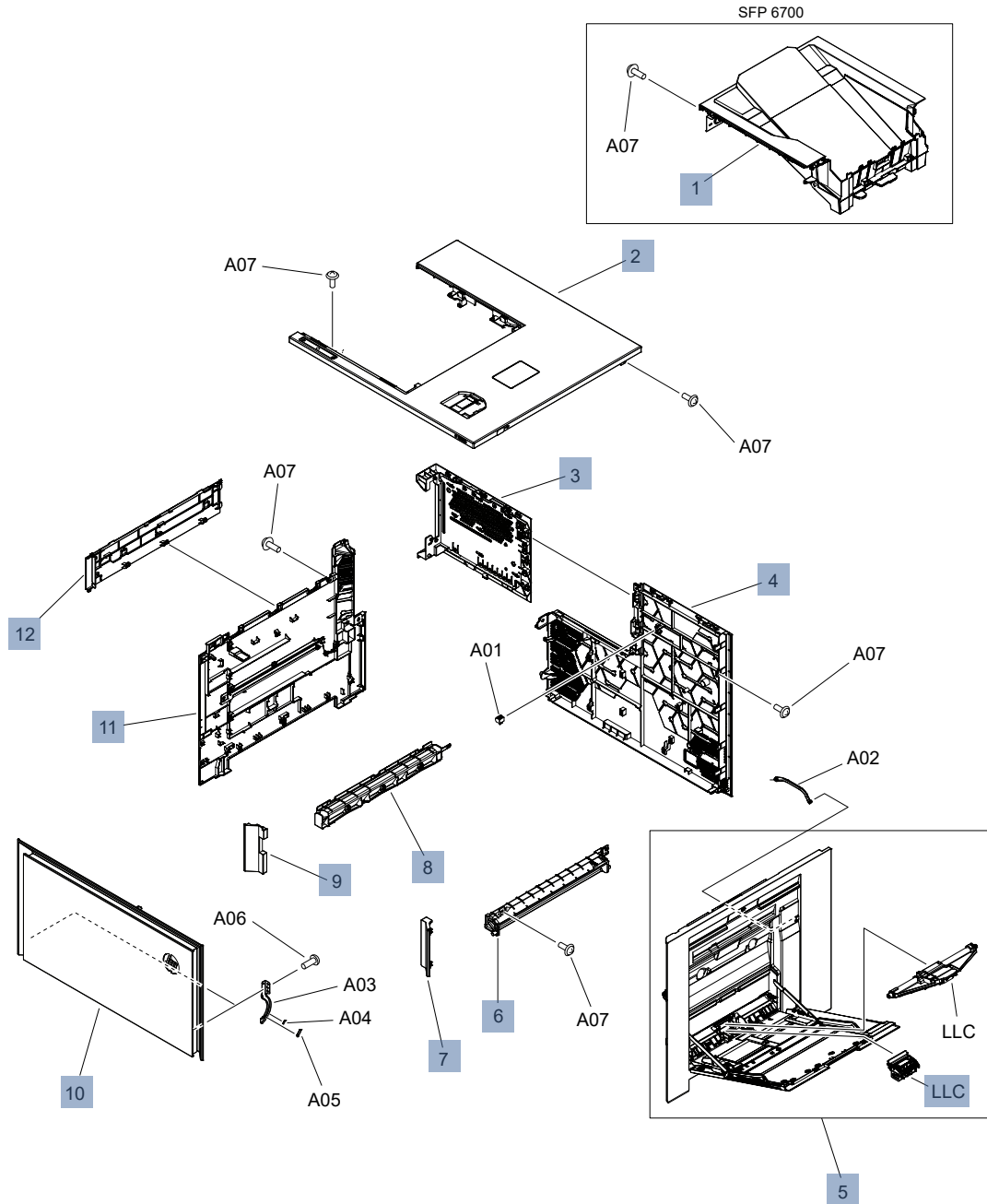
## Covers, panels, and doors

Parts diagrams and part lists for the covers, panels, and doors.

### Parts and diagrams: Covers 6700 models

Parts diagram and parts list for the SFP printer covers.

Figure 6-3 Covers 6700 models



**Table 6-3 Covers 6700 models**

<b>Key No</b>	<b>Part number</b>	<b>Qty</b>	<b>Description</b>
1	RM2-4471-000CN	1	Face down tray assembly
2	RM2-4517-000CN	1	Cover, top assembly
3	RM2-4480-000CN	1	Formatter cover assembly
4	RC5-9168-000CN	1	Cover, rear lower
5	RM2-3665-000CN	1	Right lower door assembly
6	RC5-8516-000CN	1	Handle, right door lower
7	RC5-9199-000CN	1	Cover, front right
8	RC5-9165-000CN	1	Handle, left
9	RC5-9198-000CN	1	Cover, front left
10	RM2-4533-000CN	1	Front door assembly
11	RM2-4535-000CN	1	Left cover assembly
12	RC5-9204-000CN	1	Cover, left upper
LLC	527H3A	1	HP LaserJet MP Tray Roller Kit
Not shown	RC4-0213-000CN	1	Cover, Hardware integration pocket (HIP)

## Parts and diagrams: Covers X654 models

Parts diagram and parts list for the SFP printer covers.

Figure 6-4 Covers X654 models

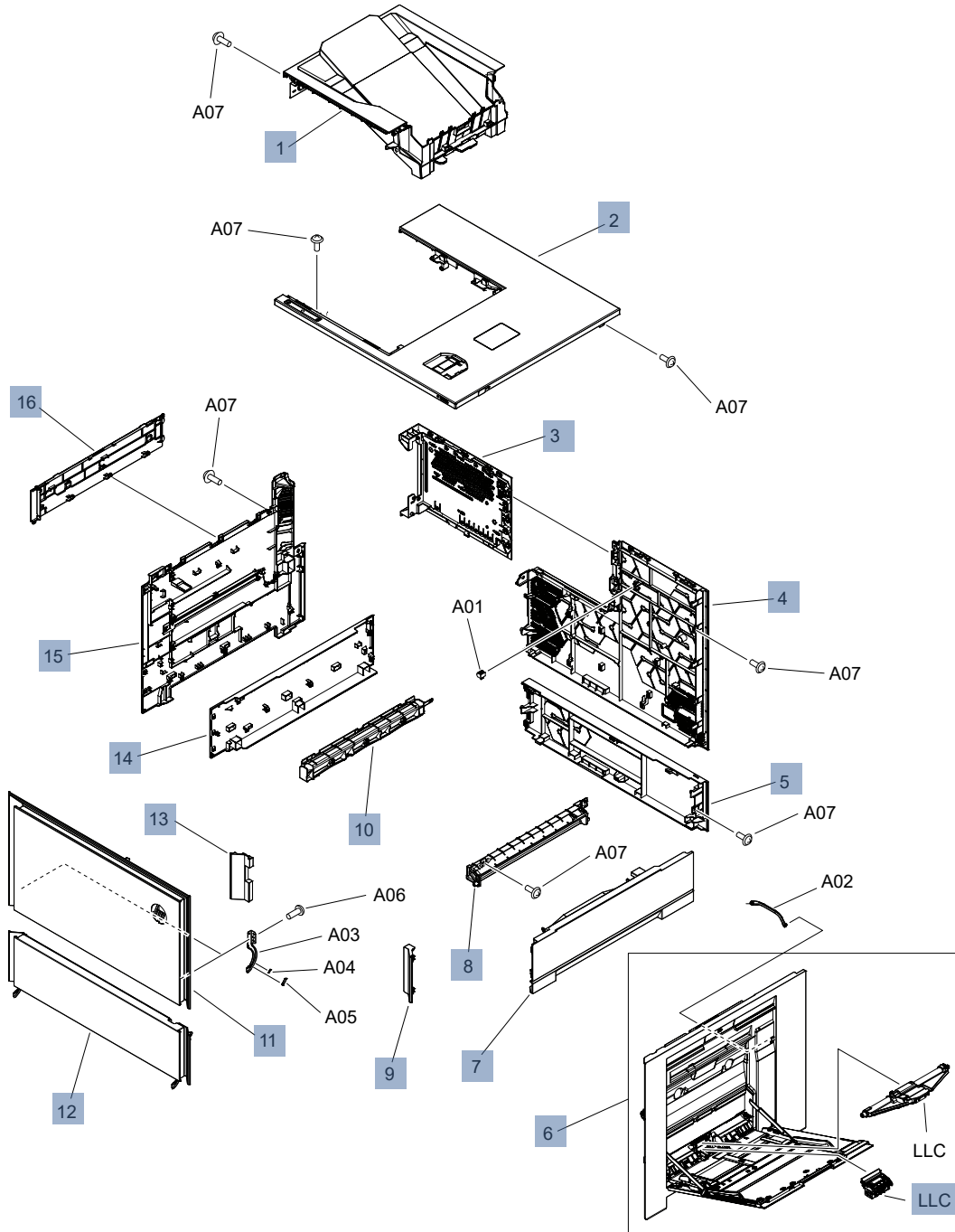


Table 6-4 Covers X654 models

Key No	Part number	Qty	Description
1	RM2-4471-000CN	1	Face down tray assembly

**Table 6-4 Covers X654 models (continued)**

<b>Key No</b>	<b>Part number</b>	<b>Qty</b>	<b>Description</b>
2	RM2-4517-000CN	1	Cover, top assembly
3	RM2-4480-000CN	1	Formatter cover assembly
4	RC5-9168-000CN	1	Cover, rear lower
5	RC5-9409-000CN		Cover, rear lower
6	RM2-3665-000CN	1	Right lower door assembly
7	RM3-0004-000CN	1	Right lower door assembly
8	RC5-8516-000CN	1	Handle, right door lower
9	RC5-9199-000CN	1	Cover, front right
10	RC5-9165-000CN	1	Handle, left
11	RM2-4479-000CN	1	Front door assembly
12	RM2-3678-000CN	1	Toner supply door assembly
13	RC5-9198-000CN	1	Cover, front left
14	RC5-9408-000CN	1	Left lower cover
15	RM2-4535-000CN	1	Left cover assembly
16	RC5-9204-000CN	1	Cover, left upper
LLC	527H3A	1	HP LaserJet MP Tray Roller Kit
Not shown	RC4-0213-000CN	1	Cover, Hardware integration pocket (HIP)

## Parts and diagrams: Covers 6800 models

Parts diagram and parts list for the MFP printer covers.

Figure 6-5 Covers 6800 models

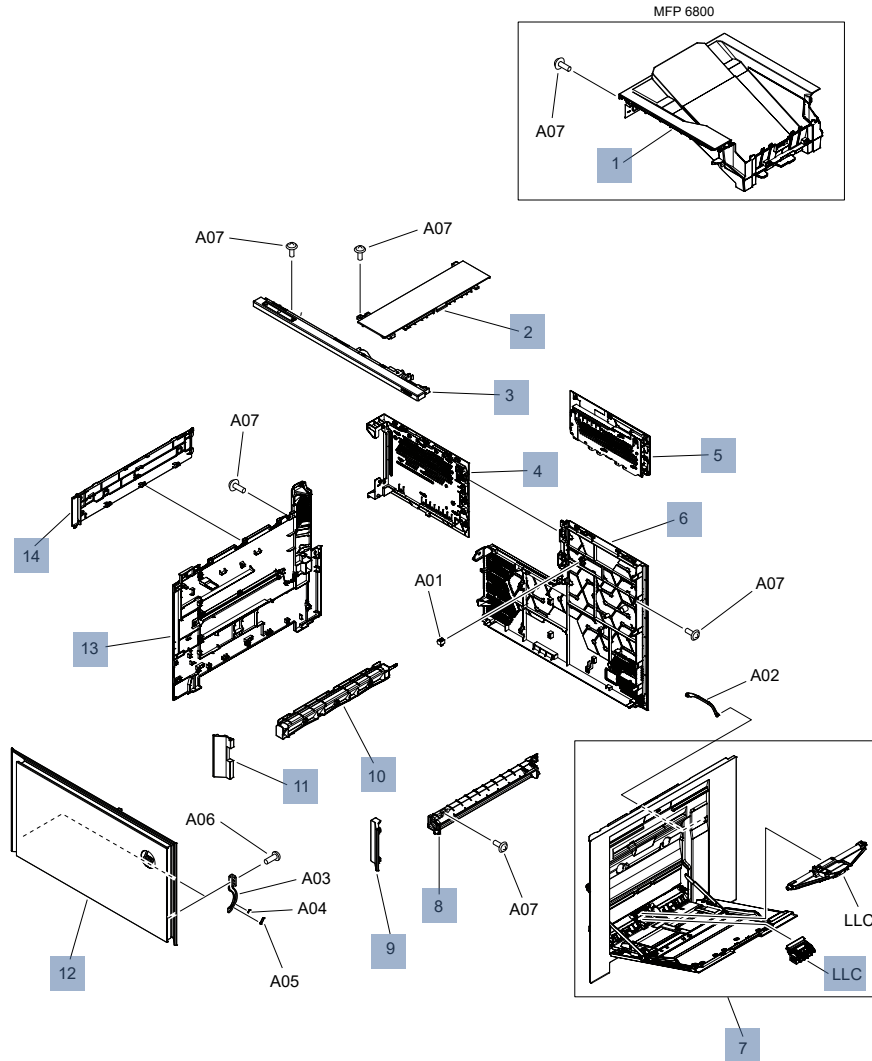


Table 6-5 Covers 6800 models

Key No	Part number	Qty	Description
1	RM2-4471-000CN	1	Face down tray assembly
2	RC5-9172-000CN	1	Cover, top assembly
3	RM2-4518-000CN	1	Top front cover assembly
4	RM2-4480-000CN	1	Formatter cover assembly
5	RM2-4530-000CN	1	Formatter cover assembly
6	RC5-9168-000CN	1	Cover, rear lower
7	RM2-3665-000CN	1	Right lower door assembly

**Table 6-5 Covers 6800 models (continued)**

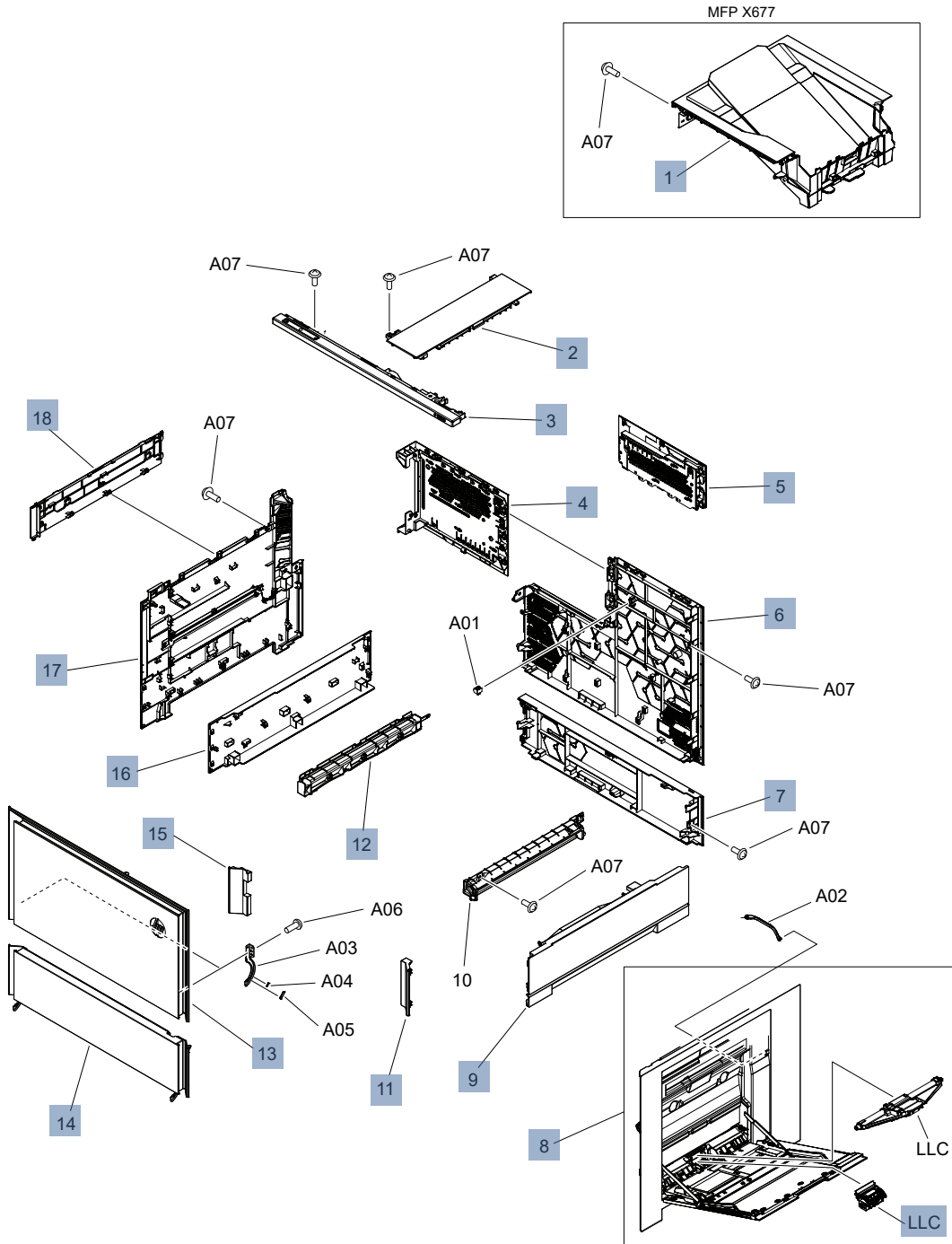
<b>Key No</b>	<b>Part number</b>	<b>Qty</b>	<b>Description</b>
8	RC5-8516-000CN	1	Handle, right door lower
9	RC5-9199-000CN	1	Cover, front right
10	RC5-9165-000CN	1	Handle, left
11	RC5-9198-000CN	1	Cover, front left
12	RM2-4533-000CN	1	Front door assembly
13	RM2-4535-000CN	1	Left cover assembly
14	RC5-9204-000CN	1	Cover, left upper
LLC	527H3A	1	HP LaserJet MP Tray Roller Kit
Not shown	RC4-0213-000CN	1	Cover, Hardware integration pocket (HIP)



## Parts and diagrams: Covers X677 models

Parts diagram and parts list for the MFP printer covers.

Figure 6-6 Covers X677 models



**Table 6-6 Covers X677 models**

Key No	Part number	Qty	Description
1	RM2-4471-000CN	1	Face down tray assembly
2	RC5-9172-000CN	1	Cover, top assembly
3	RM2-4518-000CN	1	Top front cover assembly
4	RM2-4480-000CN	1	Formatter cover assembly
5	RM2-4530-000CN	1	Formatter cover assembly
6	RC5-9168-000CN	1	Cover, rear lower
7	RC5-9409-000CN	1	Cover, rear lower
8	RM2-3665-000CN	1	Right lower door assembly
9	RM3-0004-000CN	1	Right lower door assembly
10	RC5-8516-000CN	1	Handle, right door lower
11	RC5-9199-000CN	1	Cover, front right
12	RC5-9165-000CN	1	Handle, left
13	RM2-4479-000CN	1	Front door assembly
14	RM2-3678-000CN	1	Toner supply door assembly
15	RC5-9198-000CN	1	Cover, front left
16	RC5-9408-000CN	1	Left lower cover
17	RM2-4535-000CN	1	Left cover assembly
18	RC5-9204-000CN	1	Cover, left upper
LLC	527H3A	1	HP LaserJet MP Tray Roller Kit
Not shown	RC4-0213-000CN	1	Cover, Hardware integration pocket (HIP)

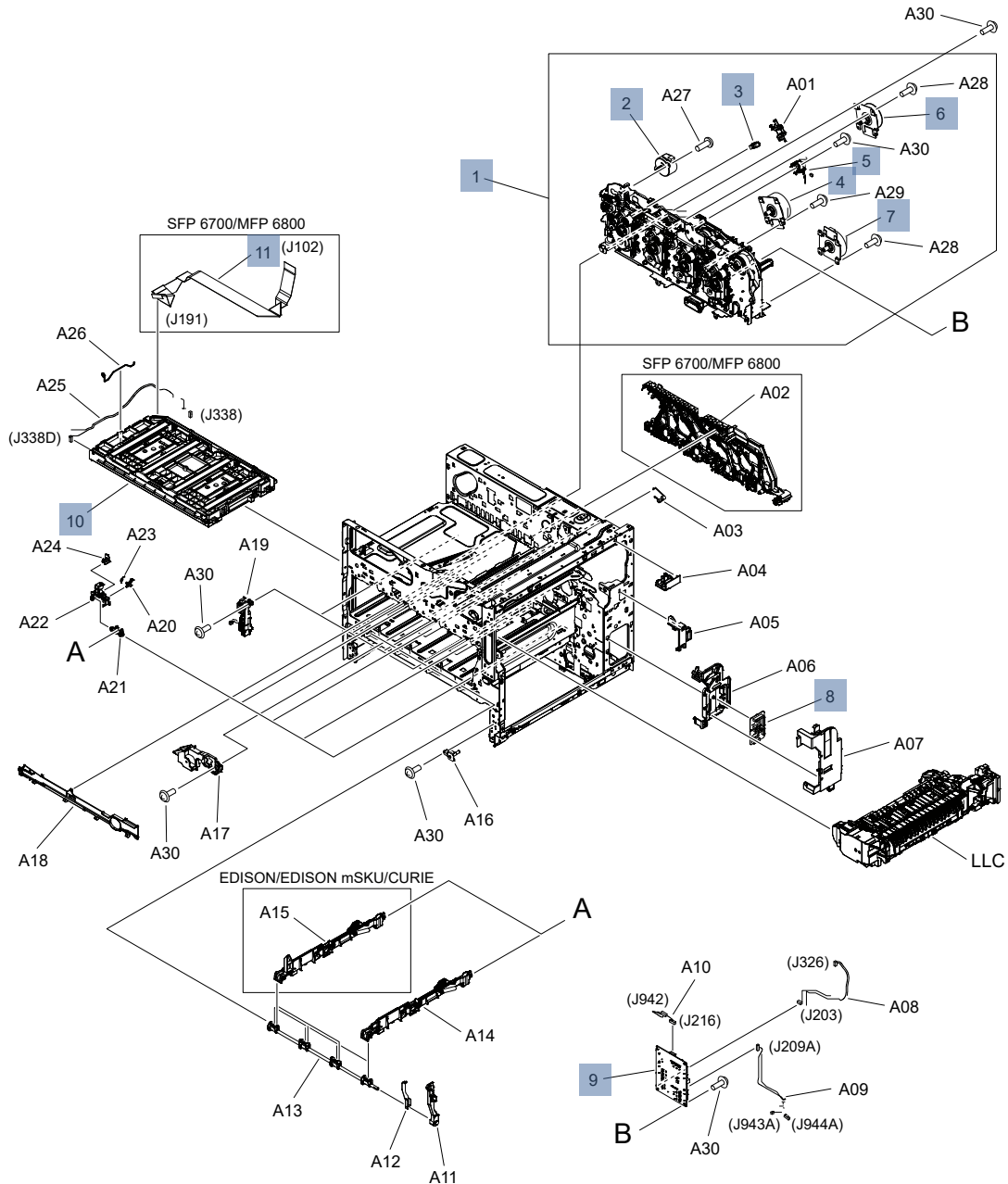
# Internal parts and assemblies

Parts diagrams and part lists for the internal parts and assemblies.

## Parts and diagrams: Internal assemblies (1 of 7) 6700/6800 models

Parts diagram and parts list for the internal printer assemblies.

Figure 6-7 Internal assemblies (1 of 7) 6700/6800 models



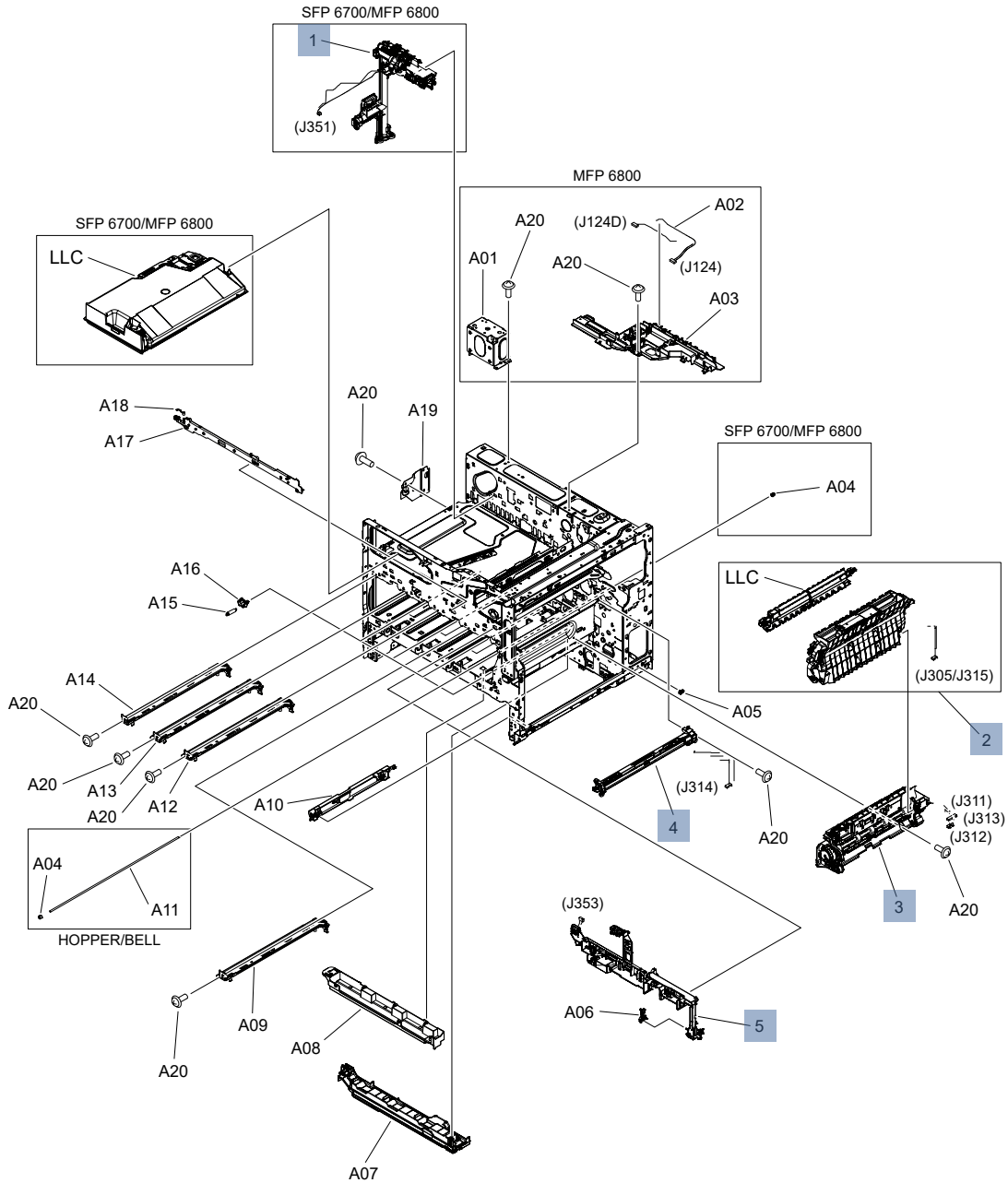
**Table 6-7 Internal assemblies (1 of 7) 6700/6800 models**

<b>Ref No</b>	<b>Part number</b>	<b>Qty</b>	<b>Description</b>
1	RM2-3504-000CN		Main drive assembly
2	RM2-3625-000CN	1	Developing motor assembly
3	RM3-7647-000CN	1	Drum position sensor PCA
4	RM3-7788-000CN	1	Drum motor assembly
5	RM2-7360-000CN	1	T1 solenoid assembly
6	RK2-6027-000CN	1	Motor, stepping
7	RM3-7797-000CN	1	ITB motor assembly
8	RM3-7792-000CN	1	Right PCA
8	RM3-7792-000CN	1	Right PCA
9	RM3-7722-000CN	1	Driver PCA
10	RM2-3787-000CN	1	Laser scanner assembly
11	RK3-0825-000CN	1	Cable, flat SCN

## Parts and diagrams: Internal assemblies (2 of 7) 6700/6800 models

Parts diagram and parts list for the internal printer assemblies.

**Figure 6-8 Internal assemblies (2 of 7) 6700/6800 models**



**Table 6-8 Internal assemblies (2 of 7) 6700/6800 models**

Ref No	Part number	Qty	Description
1	RM2-3518-000CN	1	Waste toner duct assembly
2	RM2-3586-000CN	1	Secondary transfer assembly 6700
2	RM2-3628-000CN	1	Secondary transfer assembly 6800

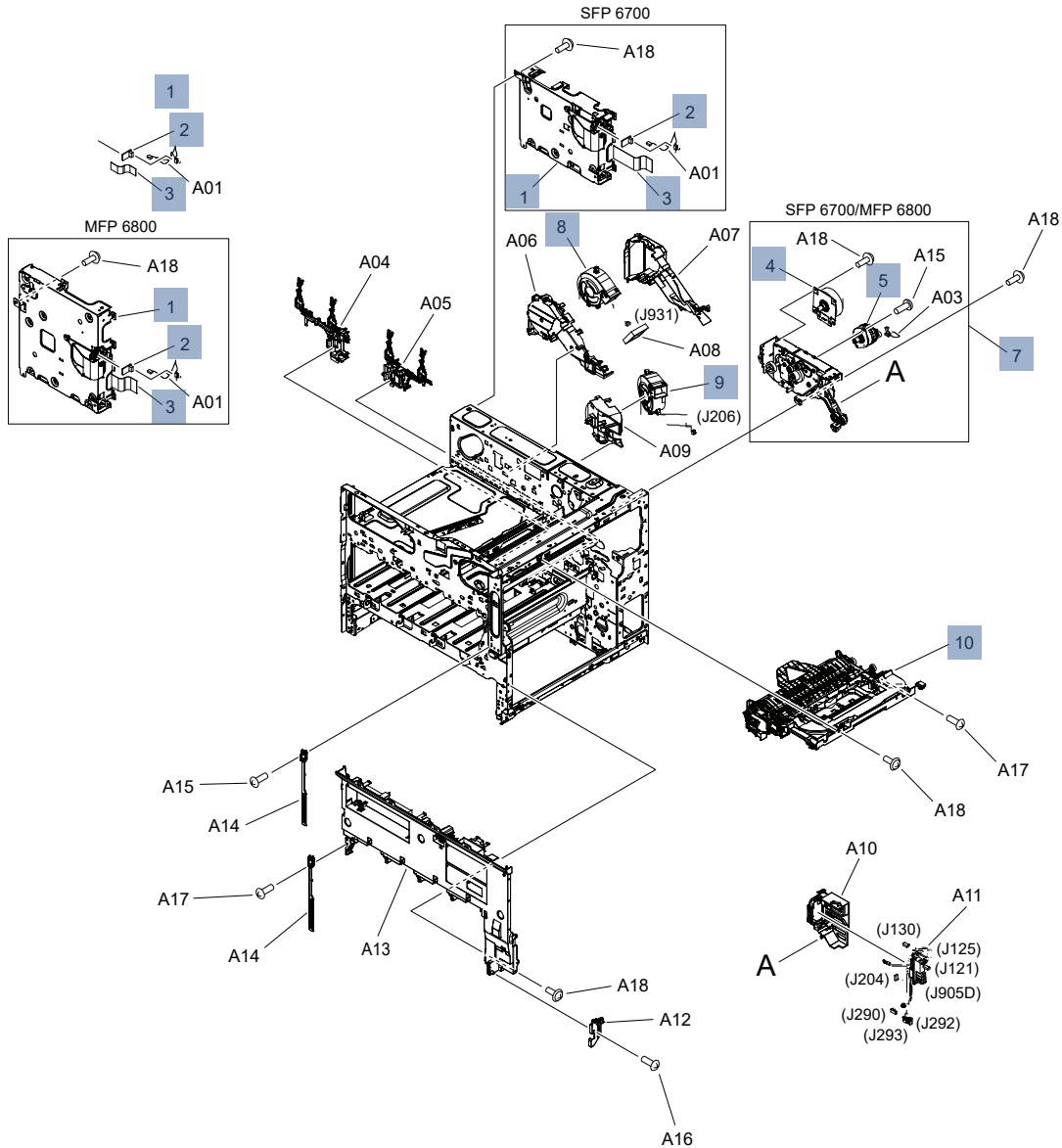
**Table 6-8 Internal assemblies (2 of 7) 6700/6800 models (continued)**

<b>Ref No</b>	<b>Part number</b>	<b>Qty</b>	<b>Description</b>
3	RM2-4458-000CN	1	Registration assembly
4	RM2-4492-000CN	1	Density detect assembly
5	RM2-3565-000CN	1	Pre-exposure PCA holder
Not shown as Ref No	527F9A	1	HP LaserJet Toner Collection Unit

## Parts and diagrams: Internal assemblies (3 of 7) 6700/6800 models

Parts diagram and parts list for the internal printer assemblies.

**Figure 6-9 Internal assemblies (3 of 7) 6700/6800 models**



**Table 6-9 Internal assemblies (3 of 7) 6700/6800 models**

Ref No	Part number	Qty	Description
1	RM2-4520-000CN	1	Formatter cage assembly (6700)
1	RM2-4521-000CN	1	Formatter cage assembly (MFP 6800)
2	RM2-7138-000CN	1	Memory PC board assembly
3	RK3-0817-000CN	1	Cable, flat FMTR
3	RK3-0837-000	1	CABLE, FLAT, FMTR

**Table 6-9 Internal assemblies (3 of 7) 6700/6800 models (continued)**

Ref No	Part number	Qty	Description
4	RM2-4488-000CN	1	Fixing motor assembly
5	RM2-4489-000CN	1	Motor assembly
7	RM2-4487-000CN	1	Fixing drive assembly
8	RK3-0762-000CN	1	Fan
9	RK3-0762-000CN	1	Fan
10	RM2-3555-000CN	1	Paper delivery assembly (6700)
10	RM2-3556-000CN	1	Paper delivery assembly (MFP 6800)
10	RM2-3556-000CN	1	Paper delivery assembly (MFP 6800)
Not shown as Ref No	1MQ0A	1	HP MFP Analog Fax 702 Accessory
Not shown as Ref No	1MQ1A	1	HP MFP Analog Fax 703 Accessory
Not shown as Ref No	1MQ3A	1	HP JetDirect 3200w BLE/Wireless accessory
Not shown as Ref No	1MQ4A	1	HP LaserJet Secure Solid State Drive
Not shown as Ref No	1MQ5A	1	HP LaserJet Workflow Accelerator Card
Not shown as Ref No	1M8JA	1	HP 4GB DDR3Lx64 204-pin 933MHz DIMM
Not shown as Ref No	1M8J1A	1	HP 4GB DDR3Lx64 204-pin 933MHz DIMM TAA
Not shown as Ref No	3JN69A	1	HP JetDirect 3100w BLE/NFC/Wireless accessory
Not shown as Ref No	527G0A	1	HP LaserJet 110V Fuser Kit
Not shown as Ref No	527G1A	1	HP LaserJet 220V Fuser Kit
Not shown as Ref No	527G2A	1	HP LaserJet 110V Enhanced Fuser Kit
Not shown as Ref No	527G3A	1	HP LaserJet 220V Enhanced Fuser Kit
Not shown as Ref No	527G6A	1	HP LaserJet 110V Enhanced Fuser Kit
Not shown as Ref No	527G7A	1	HP LaserJet 220V Enhanced Fuser Kit
Not shown as Ref No	6HN31A	1	HP 500GB CCC FIPS TAA Hard Disk Drive
Not shown as Ref No	6QY68A	1	HP 2GB DDR3Lx32 120-pin 933MHz DIMM



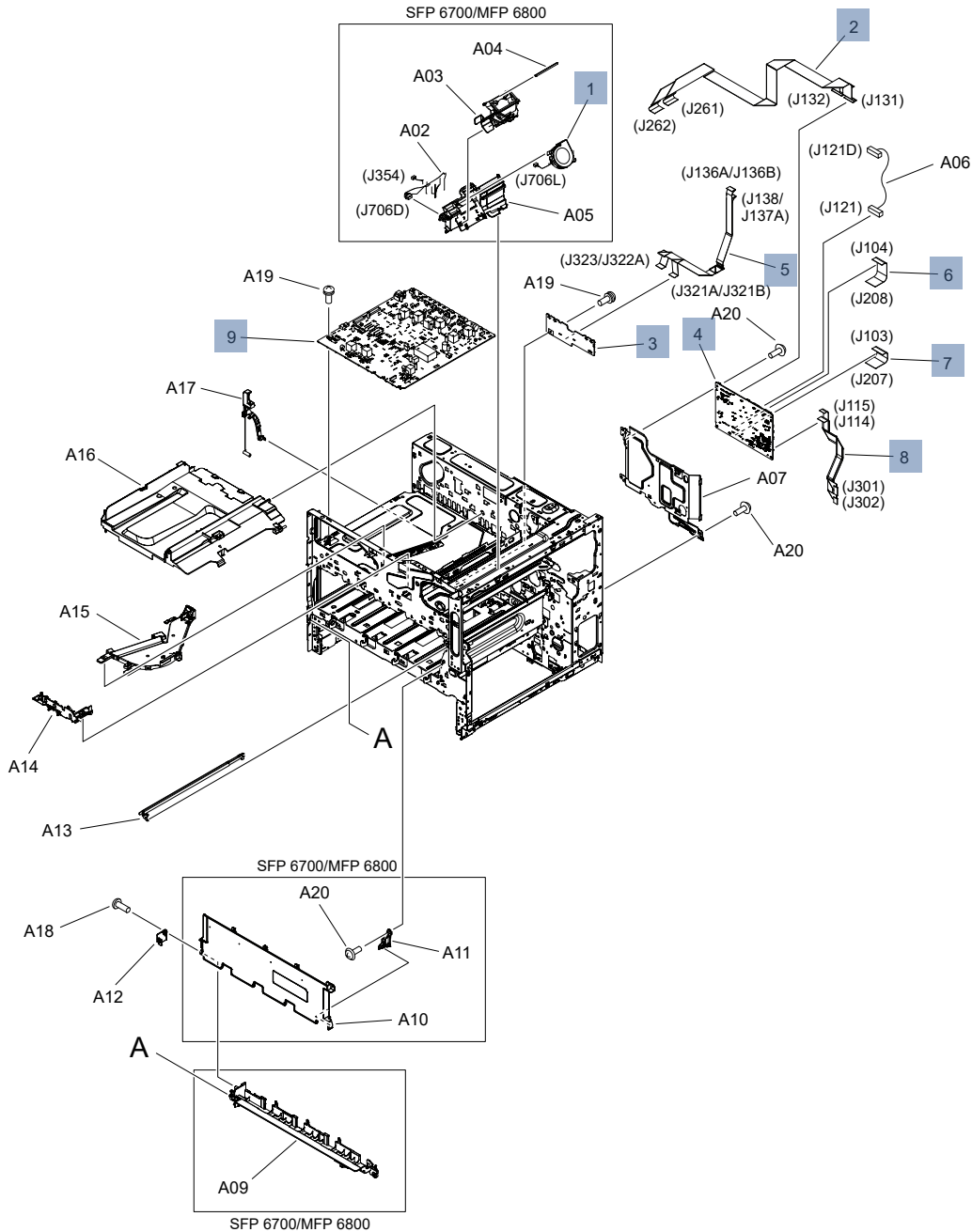
**Table 6-9 Internal assemblies (3 of 7) 6700/6800 models (continued)**

<b>Ref No</b>	<b>Part number</b>	<b>Qty</b>	<b>Description</b>
Not shown as Ref No	9EQ11A	1	HP 500GB CCC FIPS Hard Disk Drive
Not shown as Ref No	B5L32-60002	1	eMMC 16GB
Not shown as Ref No	B5L32-67001	1	eMMC 32GB
Not shown as Ref No	L41606-011	1	HP Removable Hard Drive Enclosure
Not shown as Ref No	NA	1	HDD, 500GB 5400RPM FIPS/CCC OPAL2 7MM

## Parts and diagrams: Internal assemblies (4 of 7) 6700/6800 models

Parts diagram and parts list for the internal printer assemblies.

**Figure 6-10 Internal assemblies (4 of 7) 6700/6800 models**



**Table 6-10 Internal assemblies (4 of 7) 6700/6800 models**

Ref No	Part number	Qty	Description
1	RK3-0760-000CN	1	Fan
2	RK3-1509-000CN	1	Cable, flat HVT

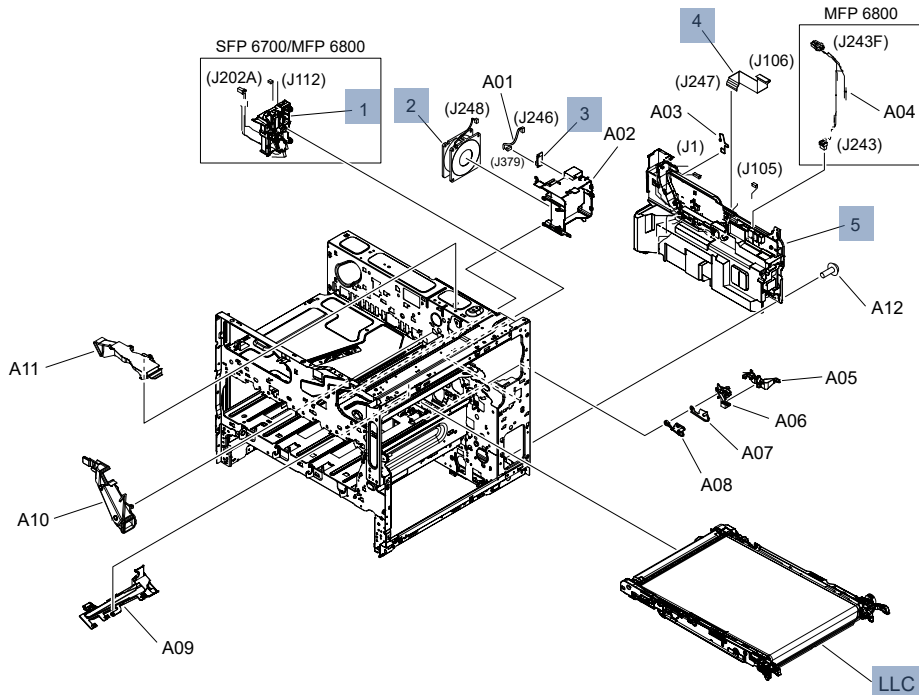
**Table 6-10 Internal assemblies (4 of 7) 6700/6800 models (continued)**

<b>Ref No</b>	<b>Part number</b>	<b>Qty</b>	<b>Description</b>
3	RM3-9045-000CN	1	Rear PCA
4	RM3-7753-000CN	1	DC controller PCA
4	RM3-7754-000CN	1	DC controller PCA
5	RK3-1692-000CN	1	Cable, flat rear
6	RK3-0821-000CN	1	Cable, flat drive
7	RK3-0819-000CN	1	Cable, flat drive
8	RK3-1694-000CN	1	Cable, flat right
9	RM3-9041-000CN	1	HV power supply PCA
Not shown	6QN32-67002	1	Formatter (67xx / X65xxx)
Not shown	6QN32-67004	1	Formatter (67xx / X65xxx) (China/India)
Not shown	6QN35-67002	1	Formatter (68xx / X67xxx)
Not shown	6QN35-67005	1	Formatter (68xx / X67xxx) (China/India)

## Parts and diagrams: Internal assemblies (5 of 7) 6700/6800 models

Parts diagram and parts list for the internal printer assemblies.

**Figure 6-11 Internal assemblies (5 of 7) 6700/6800 models**



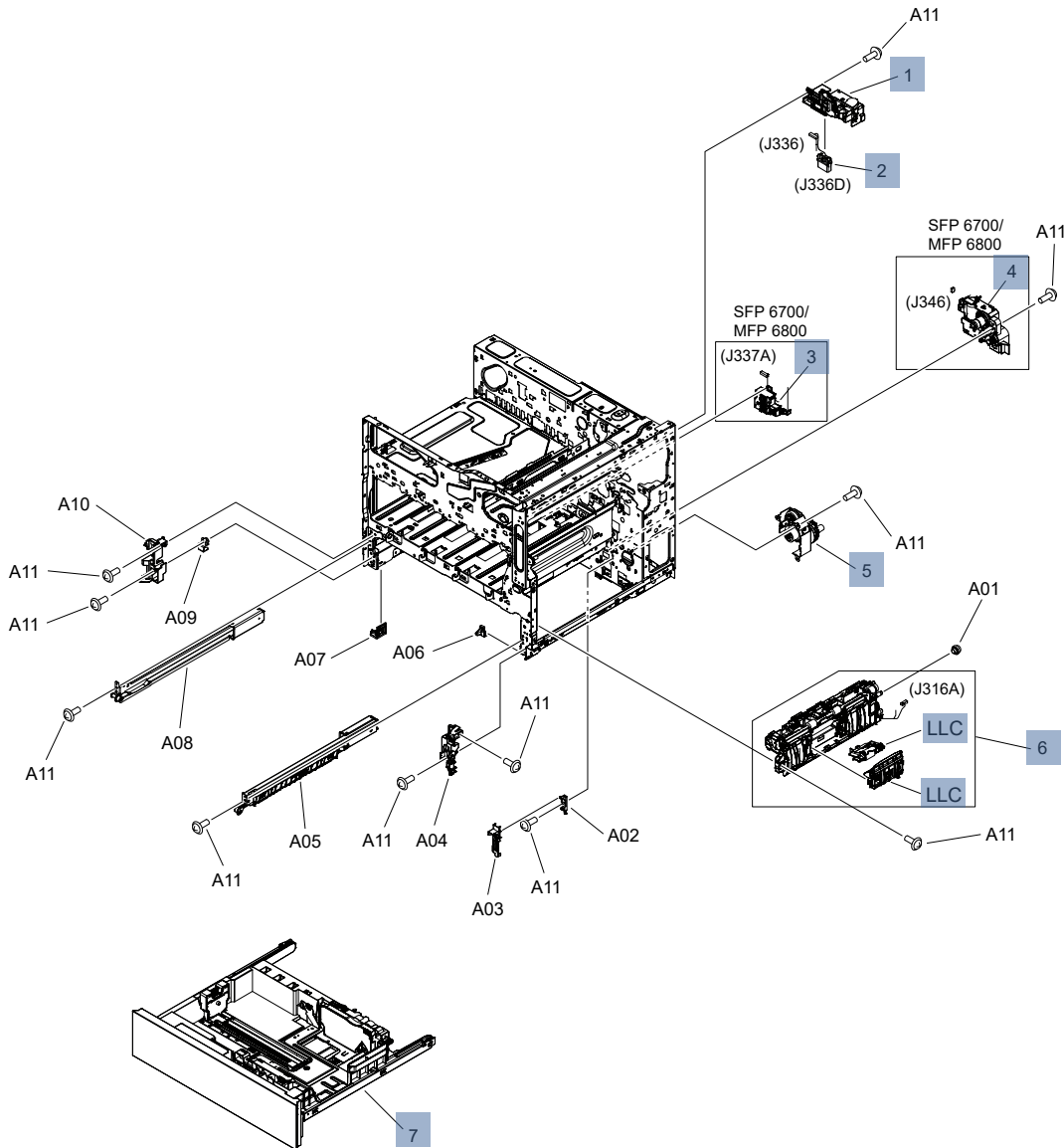
**Table 6-11 Internal assemblies (5 of 7) 6700/6800 models**

Ref No	Part number	Qty	Description
1	RM2-3676-000CN	1	Interlock assembly
2	RK3-2277-000CN	1	Fan
3	WP2-5473-000CN	1	Sensor, humidity HSU-08FDB2A
4	RK3-0827-000CN	1	Cable, flat LVPS
5	RM3-7726-000CN	1	LVPS (110-127V) (6700)
5	RM3-7727-000CN	1	LVPS (220-240V) (6700)
5	RM3-7728-000CN	1	LVPS (110-127V) (MFP 6800)
5	RM3-7729-000CN	1	LVPS (220-240V) (MFP 6800)
LLC	527G8A	1	HP LaserJet Image Transfer Belt
LLC	527G9A	1	HP LaserJet Image Transfer Belt Kit

## Parts and diagrams: Internal assemblies (6 of 7) 6700/6800 models

Parts diagram and parts list for the internal printer assemblies.

**Figure 6-12 Internal assemblies (6 of 7) 6700/6800 models**



**Table 6-12 Internal assemblies (6 of 7) 6700/6800 models**

Ref No	Part number	Qty	Description
1	RM2-3559-000CN	1	Auto close assembly
2	RM3-8001-000CN	1	Drawer cable assembly
3	RM2-3585-000CN	1	Size detect assembly
4	RM2-3500-000CN	1	Lifter drive assembly
5	RM2-3682-000CN	1	Paper pickup drive assembly

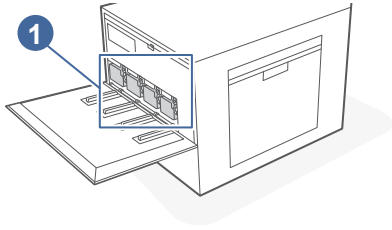
**Table 6-12 Internal assemblies (6 of 7) 6700/6800 models (continued)**

<b>Ref No</b>	<b>Part number</b>	<b>Qty</b>	<b>Description</b>
6	RM2-3508-000CN	1	Paper pickup assembly
7	RM2-3616-000CN	1	Cassette assembly
LLC	527H2A	1	HP LaserJet Tray 2-x Roller Kit

## Parts and diagrams: Internal assemblies (7 of 7) 6700/6800 models

Parts diagram and parts list for the internal printer assemblies.

**Figure 6-13 Internal assemblies (7 of 7) 6700/6800 models**



**Table 6-13 Internal assemblies (7 of 7) 6700/6800 models**

Ref No	Part number	Qty	Description
1	W2130A	1	HP 213A Black Original LaserJet Toner Cartridge
1	W2130X	1	HP 2130X High Yield Black Toner Cartridge
1	W2130Y	1	HP 213Y Extra High Yield Black Toner Cartridge
1	W2130YC	1	HP W2130YC Black Contract Toner Cartridge
1	W2131A	1	HP 213A Cyan Original LaserJet Toner Cartridge
1	W2131X	1	HP 2131X High Yield Cyan Toner Cartridge
1	W2131Y	1	HP 213Y Extra High Yield Cyan Toner Cartridge
1	W2131YC	1	HP W2131YC Cyan Contract Toner Cartridge
1	W2132A	1	HP 213A Yellow Original LaserJet Toner
1	W2132X	1	HP 2132X High Yield Yellow Toner Cartridge
1	W2132Y	1	HP 213Y Extra High Yield Yellow Toner Cartridge
1	W2132YC	1	HP W2132YC Yellow Contract Toner Cartridge
1	W2133A	1	HP 213A Magenta LaserJet Toner Cartridge
1	W2133X	1	HP 2133X High Yield Magenta Toner Cartridge
1	W2133Y	1	HP 213Y Extra High Yield Magenta Toner Cartridge
1	W2133YC	1	HP W2133YC Magenta Contract Toner Cartridge
1	W2140Z	1	HP 214Z Ultra High Yield Black Toner Cartridge (SFP)
1	W2140ZC	1	HP W2140ZC Black Contract Toner Cartridge (SFP)
1	W2141Z	1	HP 214Z Ultra High Yield Cyan Toner Cartridge (SFP)
1	W2141ZC	1	HP W2141ZC Cyan Contract Toner Cartridge (SFP)
1	W2142Z	1	HP 214Z Ultra High Yield Yellow Toner Cartridge (SFP)

**Table 6-13 Internal assemblies (7 of 7) 6700/6800 models (continued)**

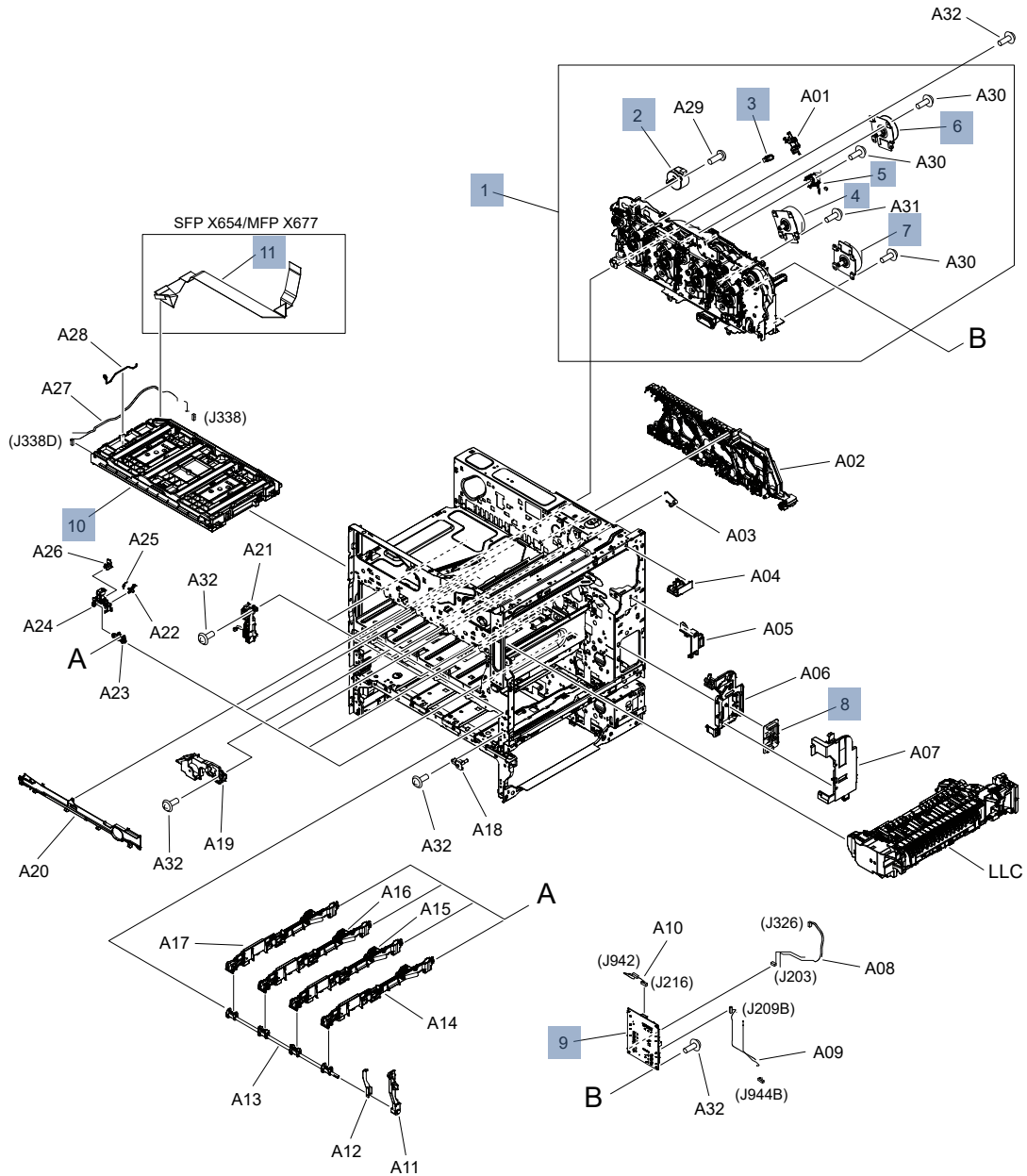
<b>Ref No</b>	<b>Part number</b>	<b>Qty</b>	<b>Description</b>
1	W2142ZC	1	HP W2142ZC Yellow Contract Toner Cartridge (SFP)
1	W2143Z	1	HP 214Z Ultra High Yield Magenta Toner Cartridge (SFP)
1	W2143ZC	1	HP W2143ZC Magenta Contract Toner Cartridge (SFP)
1	W2170Z	1	HP 217Z Ultra High Yield Black Toner Cartridge (MFP)
1	W2170ZC	1	HP W2170ZC Black Contract Toner Cartridge (MFP)
1	W2171Z	1	HP 217Z Ultra High Yield Cyan Toner Cartridge (MFP)
1	W2171ZC	1	HP W2171ZC Cyan Contract Toner Cartridge (MFP)
1	W2172Z	1	HP 217Z Ultra High Yield Yellow Toner Cartridge (MFP)
1	W2172ZC	1	HP W2172ZC Yellow Contract Tone Cartridge (MFP)
1	W2173Z	1	HP 217Z Ultra High Yield Magenta Toner Cartridge (MFP)
1	W2173ZC	1	HP W2173ZC Magenta Contract Toner Cartridge (MFP)



## Parts and diagrams: Internal assemblies (1 of 9) X654/X677 models

Parts diagram and parts list for the internal printer assemblies.

**Figure 6-14** Internal assemblies (1 of 9) X654/X677 models



**Table 6-14** Internal assemblies (1 of 9) X654/X677 models

Ref No	Part number	Qty	Description
1	RM2-3497-000CN		Main drive assembly
2	RM2-3625-000CN	1	Developing motor assembly
3	RM3-7647-000CN	1	Drum position sensor PCA

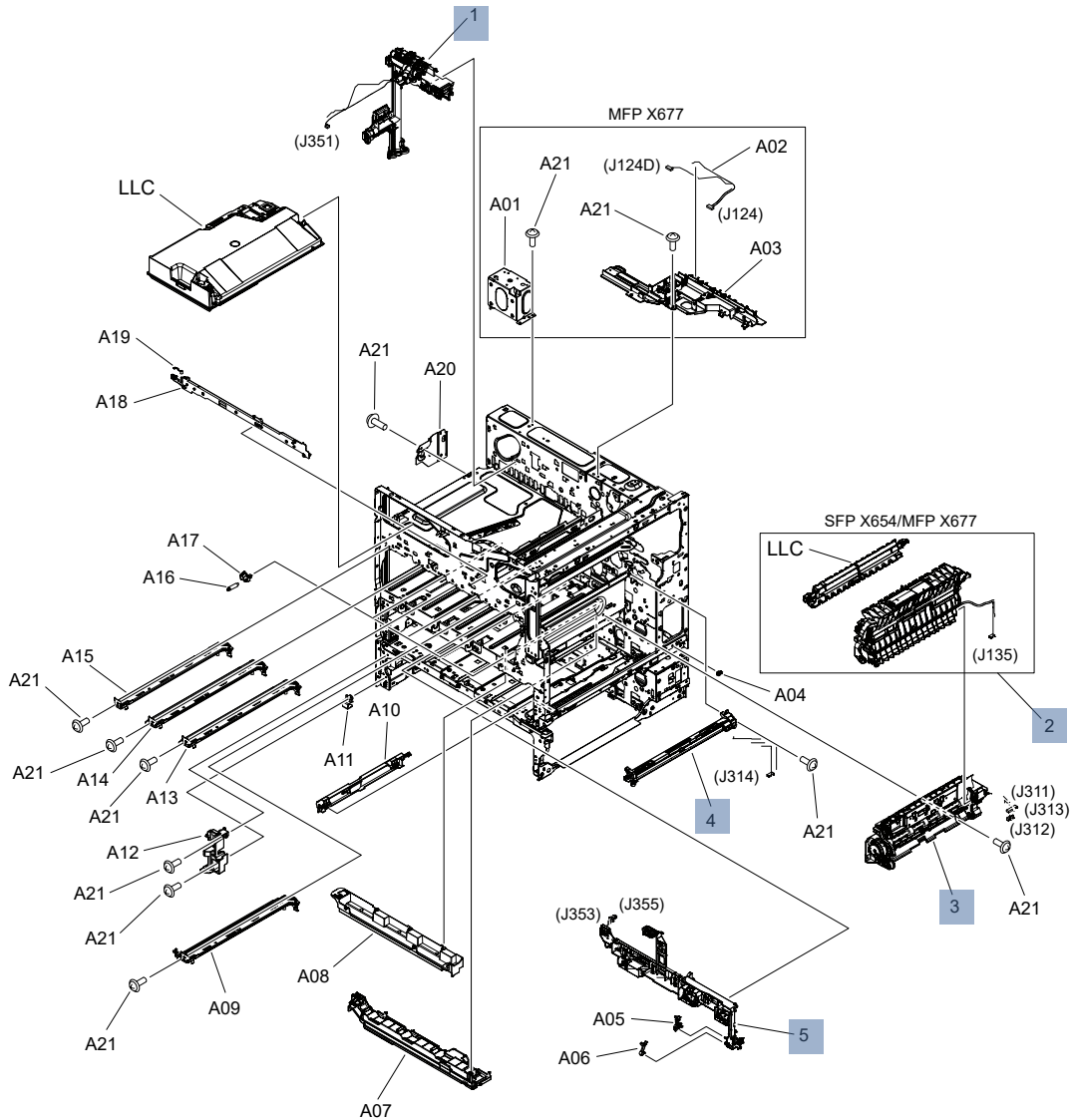
**Table 6-14 Internal assemblies (1 of 9) X654/X677 models (continued)**

<b>Ref No</b>	<b>Part number</b>	<b>Qty</b>	<b>Description</b>
4	RM3-7788-000CN	1	Drum motor assembly
5	RM2-7360-000CN	1	T1 solenoid assembly
6	RK2-6027-000CN	1	Motor, stepping
7	RM3-7797-000CN	1	ITB motor assembly
8	RM3-7794-000CN	1	Right PCA
9	RM3-7722-000CN	1	Driver PCA
10	RM2-3787-000CN	1	Laser scanner assembly
11	RK3-0825-000CN	1	Cable, flat SCN

## Parts and diagrams: Internal assemblies (2 of 9) X654/X677 models

Parts diagram and parts list for the internal printer assemblies.

**Figure 6-15 Internal assemblies (2 of 9) X654/X677 models**



**Table 6-15 Internal assemblies (2 of 9) X654/X677 models**

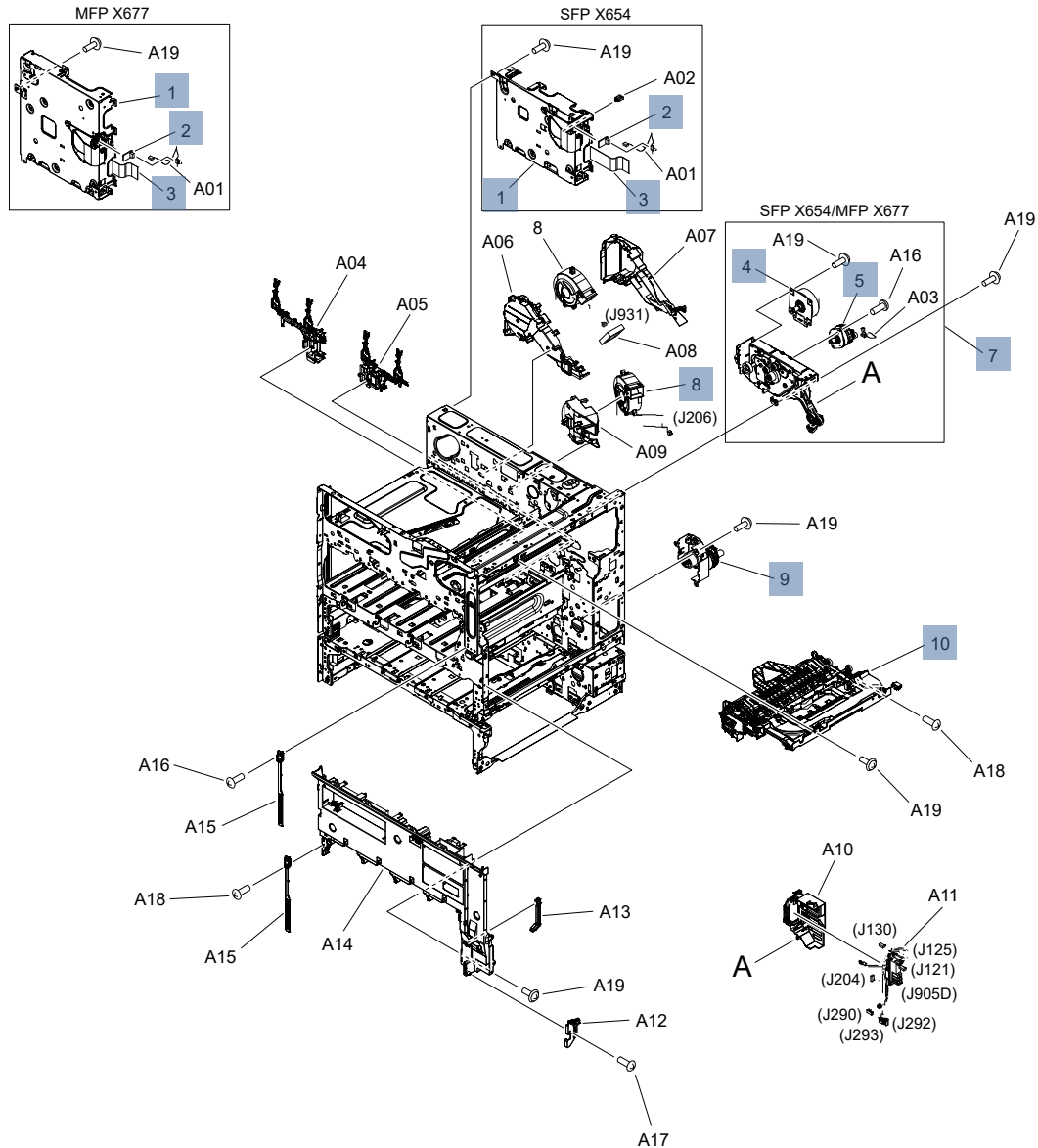
Ref No	Part number	Qty	Description
1	RM2-3590-000CN	1	Waste toner duct assembly
2	RM2-3629-000CN	1	Secondary transfer assembly 6700
3	RM2-4458-000CN	1	Registration assembly
4	RM2-4492-000CN	1	Density detect assembly
5	RM2-3673-000CN	1	Pre-exposure PCA holder
Not shown	527F9A	1	HP LaserJet Toner collection unit (TCU)



## Parts and diagrams: Internal assemblies (3 of 9)X654/X677 models

Parts diagram and parts list for the internal printer assemblies.

**Figure 6-16 Internal assemblies (3 of 9)X654/X677 models**



**Table 6-16 Internal assemblies (3 of 9) X654/X677 models**

Ref No	Part number	Qty	Description
1	RM2-4521-000CN	1	Formatter cage assembly
2	RM2-7138-000CN	1	Memory PC board assembly
3	RK3-0817-000CN	1	Cable, flat FMTR (X654)
3	RK3-0847-000CN	1	Cable, flat FMTR (X677)
4	RM2-4488-000CN	1	Fixing motor assembly

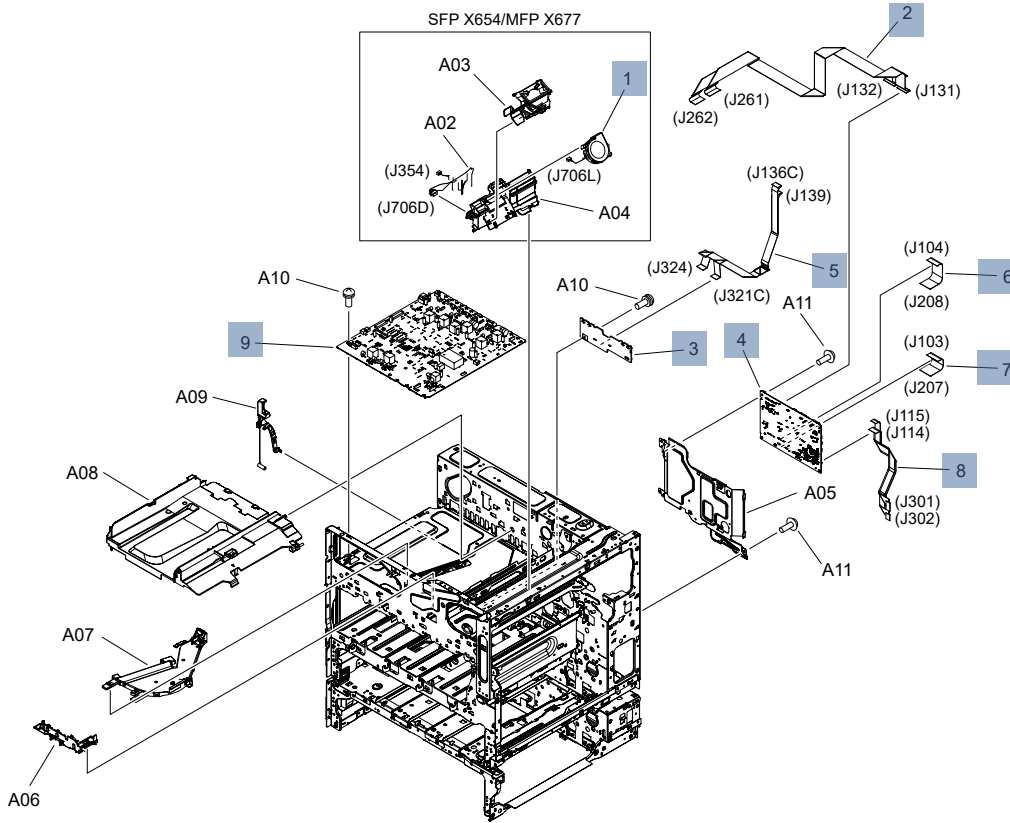
**Table 6-16 Internal assemblies (3 of 9) X654/X677 models (continued)**

Ref No	Part number	Qty	Description
5	RM2-4489-000CN	1	Motor assembly
7	RM2-4487-000CN	1	Fixing drive assembly
8	RK3-0762-000CN	2	Fan
9	RM2-3683-000CN	1	Paper pickup drive assembly
10	RM2-3555-000CN	1	Paper delivery assembly (MFP X677)
10	RM2-3556-000CN	1	Paper delivery assembly (MFP X677)
Not shown	1M0Q0A	1	HP MFP Analog Fax 702 Accessory
Not shown	1M0Q1A	1	HP MFP Analog Fax 703 Accessory
Not shown	1M0Q3A	1	HP JetDirect 3200w BLE/Wireless accessory
Not shown as Ref No	1M0Q4A	1	HP LaserJet Secure Solid State Drive
Not shown	1M0Q5A	1	HP LaserJet Workflow Accelerator Card
Not shown	1M8J0A	1	HP 4GB DDR3Lx64 204-pin 933MHz DIMM
Not shown	1M8J1A	1	HP 4GB DDR3Lx64 204-pin 933MHz DIMM TAA
Not shown	3JN69A	1	HP JetDirect 3100w BLE/NFC/Wireless accessory
Not shown	527G0A	1	HP LaserJet 110V Fuser Kit
Not shown	527G1A	1	HP LaserJet 220V Fuser Kit
Not shown	527G2A	1	HP LaserJet 110V Enhanced Fuser Kit
Not shown	527G3A	1	HP LaserJet 220V Enhanced Fuser Kit
Not shown	527G4MC	1	HP LaserJet Mngd 110V Enhanced Fuser Kit
Not shown	527G5MC	1	HP LaserJet Mngd 220V Enhanced Fuser Kit
Not shown	527G6A	1	HP LaserJet 110V Enhanced Fuser Kit
Not shown	527G7A	1	HP LaserJet 220V Enhanced Fuser Kit
Not shown	6HN31A	1	HP 500GB CCC FIPS TAA Hard Disk Drive
Not shown	6QY68A	1	HP 2GB DDR3Lx32 120-pin 933MHz DIMM
Not shown	9EQ11A	1	HP 500GB CCC FIPS Hard Disk Drive
Not shown	B5L32-60002	1	eMMC 16GB
Not shown	B5L32-67001	1	eMMC 32GB
Not shown	L41606-011	1	HP Removable Hard Drive Enclosure
Not shown	NA	1	HDD, 500GB 5400RPM FIPS/CCC OPAL2 7MM

## Parts and diagrams: Internal assemblies (4 of 9)X654/X677 models

Parts diagram and parts list for the internal printer assemblies.

**Figure 6-17 Internal assemblies (4 of 9) X654/X677 models**



**Table 6-17 Internal assemblies (4 of 9) X654/X677 models**

Ref No	Part number	Qty	Description
1	RK3-0760-000CN	1	Fan
2	RK3-1509-000CN	1	Cable, flat HVT
3	RM3-9046-000CN	1	Rear PCA
4	RM3-7758-000CN	1	DC controller PCA
5	RK3-1693-000CN	1	Cable, flat rear
6	RK3-0821-000CN	1	Cable, flat drive
7	RK3-0819-000CN	1	Cable, flat drive
8	RK3-1694-000CN	1	Cable, flat right
9	RM3-9043-000CN	1	HV power supply PCA
Not shown	6QN32-67002	1	Formatter (67xx / X65xxx)
Not shown	6QN32-67004	1	Formatter (67xx / X65xxx) (China/India)
Not shown	6QN35-67002	1	Formatter (68xx / X67xxx)

**Table 6-17 Internal assemblies (4 of 9) X654/X677 models (continued)**

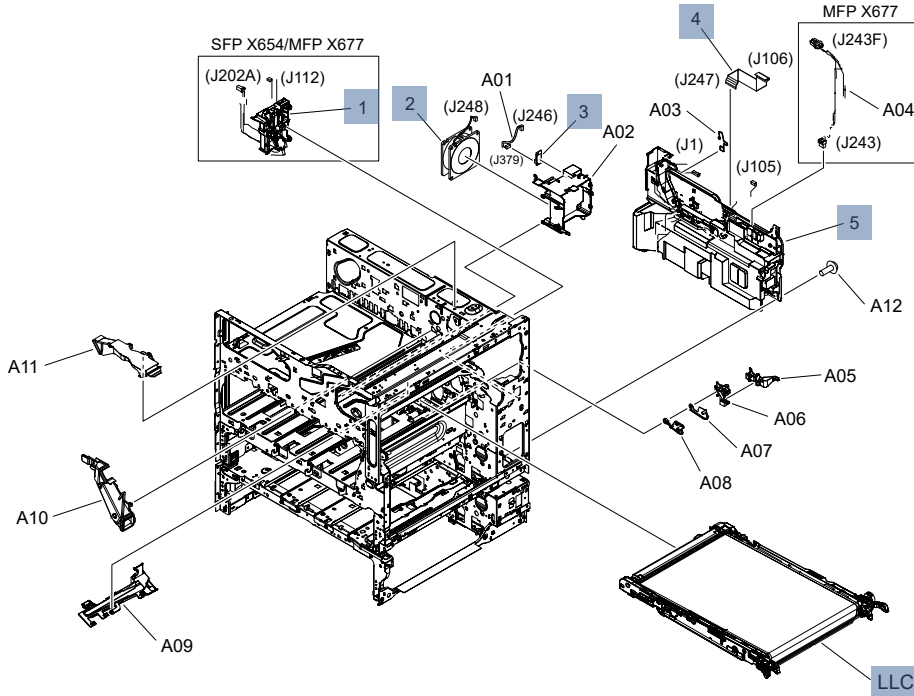
<b>Ref No</b>	<b>Part number</b>	<b>Qty</b>	<b>Description</b>
Not shown	6QN35-67005	1	Formatter (68xx / X67xxx) (China/India)



## Parts and diagrams: Internal assemblies (5 of 9)X654/X677 models

Parts diagram and parts list for the internal printer assemblies.

**Figure 6-18 Internal assemblies (5 of 9)X654/X677 models**



**Table 6-18 Internal assemblies (5 of 9) X654/X677 models**

Ref No	Part number	Qty	Description
1	RM2-3676-000CN	1	Interlock assembly
2	RK3-2277-000CN	1	Fan
3	WP2-5473-000CN	1	Sensor, humidity HSU-08FDB2A
4	RK3-0827-000CN	1	Cable, flat LVPS
5	RM3-7726-000CN	1	LVPS (110-127V) (X654)
5	RM3-7727-000CN	1	LVPS (220-240V)(X654)
5	RM3-7728-000CN	1	LVPS (110-127V)(MFP X677)
5	RM3-7729-000CN	1	LVPS (220-240V)(MFP X677)
LLC	527H0MC	1	HP LaserJet Mngd Image Transfer Belt
LLC	527H1MC	1	HP LaserJet Managed Trans Roller Kit



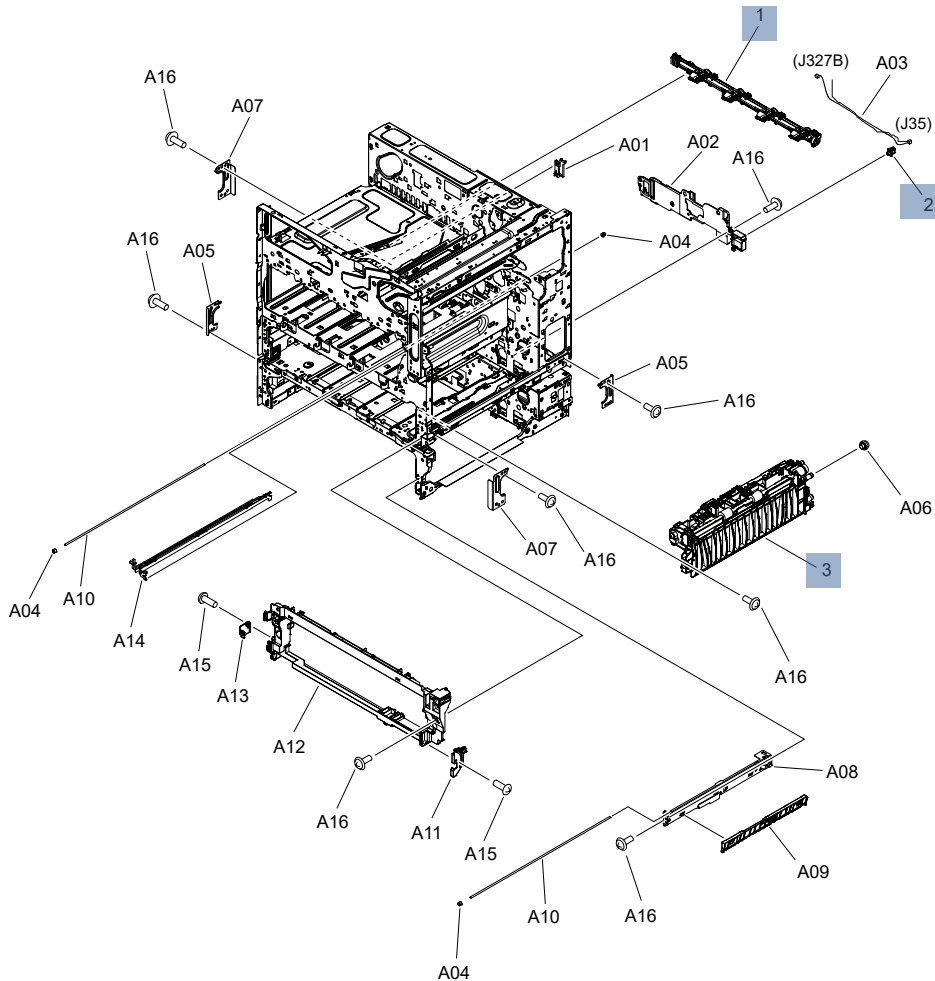
**Table 6-19 Internal assemblies (6 of 9) X654/X677 models (continued)**

<b>Ref No</b>	<b>Part number</b>	<b>Qty</b>	<b>Description</b>
2	RM2-3559-000CN	1	Auto close assembly
3	RM3-8038-000CN	1	Drawer cable assembly
4	RM2-3614-000CN	1	Size detect assembly
5	RM2-3501-000CN	1	Lifter drive assembly
6	RM2-3612-000CN	1	Toner supply drive motor assembly
7	RM2-3617-000CN	1	Paper pickup drive assembly
8	5851-7005	1	Assy-USB A F Panel Mount To WTB 335mm
9	RM2-3509-000CN	1	Paper pickup assembly
10	RM2-3616-000CN	1	Cassette assembly
LLC	527H2A	1	HP LaserJet Tray 2-x Roller Kit

## Parts and diagrams: Internal assemblies (7 of 9) X654/X677 models

Parts diagram and parts list for the internal printer assemblies.

**Figure 6-20** Internal assemblies (7 of 9) X654/X677 models



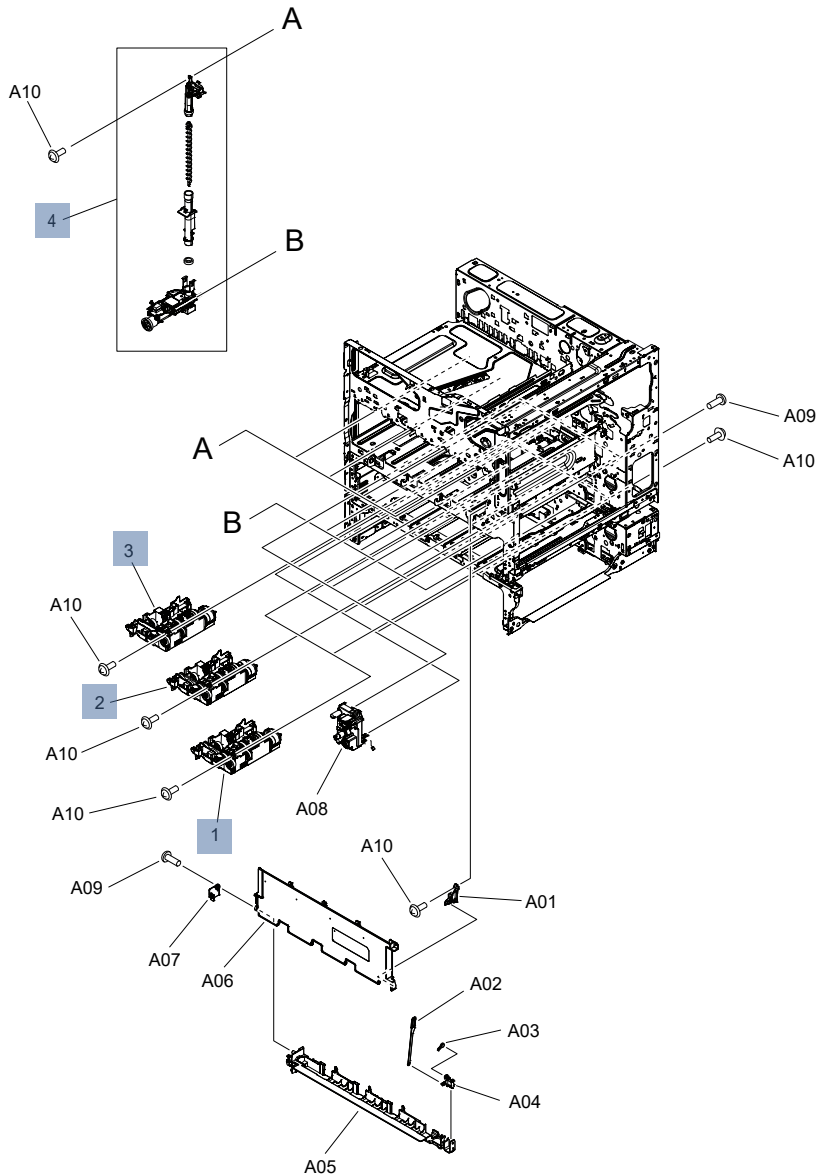
**Table 6-20** Internal assemblies (7 of 9) X654/X677 models

Ref No	Part number	Qty	Description
1	RM2-3601-000CN	1	Waste toner carry assembly
2	5851-7005	1	Assy-USB A F Panel Mount To WTB 335mm
3	RM2-3479-000CN	1	Paper feed assembly

## Parts and diagrams: Internal assemblies (8 of 9) X654/X677 models

Parts diagram and parts list for the internal printer assemblies.

**Figure 6-21** Internal assemblies (8 of 9) X654/X677 models



**Table 6-21** Internal assemblies (8 of 9) X654/X677 models

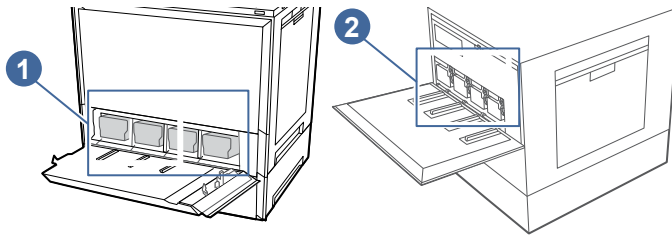
Ref No	Part number	Qty	Description
1	RM2-3609-000CN	2	Toner supply drive assembly
2	RM2-3608-000CN	1	Toner supply drive assembly
3	RM2-3607-000CN	1	Toner supply drive assembly
4	RM3-0846-000CN	1	HP Toner supply service kit
Not shown	5851-8886	1	Kit-Inline Scan Bar (Mngd)



## Parts and diagrams: Internal assemblies (9 of 9) X654/X677 models

Parts diagram and parts list for the internal printer assemblies.

**Figure 6-22 Internal assemblies (9 of 9) X654/X677 models**



**Table 6-22 Internal assemblies (9 of 9) X654/X677 models**

Ref No	Part number	Qty	Description
1	W9240MC	2	HP W9240MC Black Mngd LaserJet Toner Cartridge (SFP)
1	W9241MC	1	HP W9241MC Cyan Mngd LaserJet Toner Cartridge (SFP)
1	W9242MC	1	HP W9242MC Yellow Mngd LaserJet Toner Cartridge (SFP)
1	W9243MC	1	HP W9243MC Magenta Mngd LaserJet Toner Cartridge (SFP)
1	W9250MC	1	HP W9250MC Black Mngd LaserJet Toner Cartridge (MFP)
1	W9251MC	1	HP W9251MC Cyan Mngd LaserJet Toner Cartridge (MFP)
1	W9252MC	1	HP W9252MC Yellow Mngd LaserJet Toner Cartridge (MFP)
1	W9253MC	1	HP W9253MC Magenta Mngd LaserJet Toner Cartridge (MFP)
1	W9260MC	1	HP W9260MC Black Mngd LaserJet Toner Cartridge (SFP)
1	W9261MC	1	HP W9261MC Cyan Mngd LaserJet Toner Cartridge (SFP)
1	W9262MC	1	HP W9262MC Yellow Mngd LaserJet Toner (SFP)
1	W9263MC	1	HP W9263MC Magenta Mngd LaserJet Toner Cartridge (SFP)
1	W9270MC	1	HP W9270MC Black Mngd LaserJet Toner Cartridge (MFP)
1	W9271MC	1	HP W9271MC Cyan Mngd LaserJet Toner Cartridge (MFP)
1	W9272MC	1	HP W9272MC Yellow Mngd LaserJet Toner (MFP)
1	W9273MC	1	HP W9273MC Magenta Mngd LaserJet Toner Cartridge (MFP)

**Table 6-22 Internal assemblies (9 of 9) X654/X677 models (continued)**

Ref No	Part number	Qty	Description
2	W9280MC	1	HP W9280MC Black Mngd Imaging Drum
2	W9281MC	1	HP W9281MC Cyan Mngd Imaging Drum
2	W9282MC	1	HP W9282MC Yellow Mngd Imaging Drum
2	W9283MC	1	HP W9283MC Magenta Mngd Imaging Drum

## Input devices

Learn about the input devices.

### Input device - 550-sheet paper feeder

Learn about the 550-sheet paper feeder parts and assemblies.

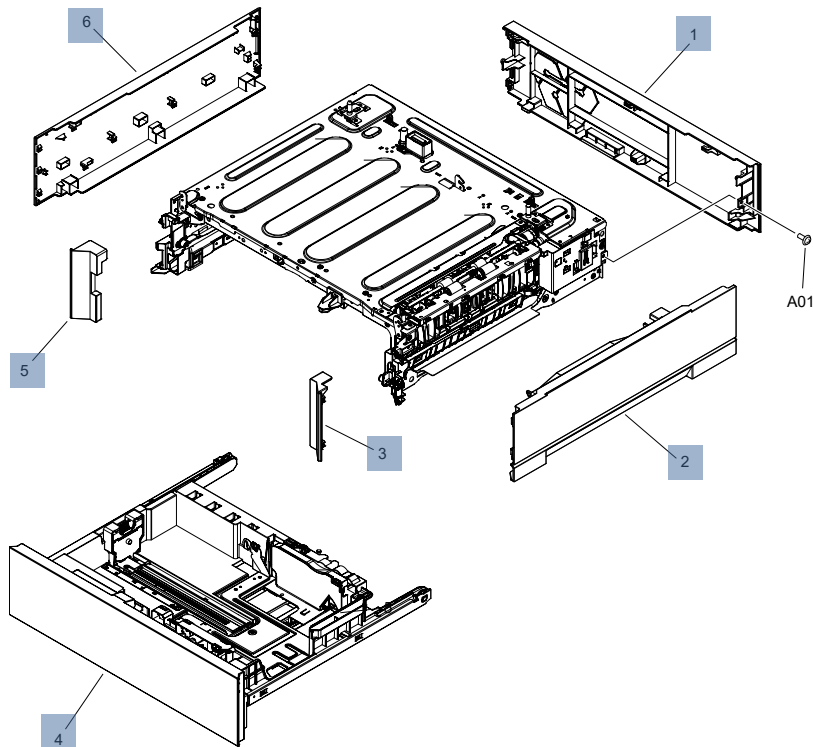
#### Covers, panels, and doors

Parts diagrams and part lists for the covers, panels, and doors.

#### Covers, panels, and doors (550-sheet paper feeder)

Parts diagram and part list for the 550-sheet paper feeder covers, panels, and doors.

**Figure 6-23 550-sheet paper feeder covers, panels, and doors**





**Table 6-23 550-sheet paper feeder covers, panels, and doors**

Ref No	Part number	Description	Qty
1	RC5-9409-000CN	Cover, rear lower	1
2	RM3-0004-000CN	Right lower door assembly	1
3	RC5-9201-000CN	Cover, front right	1
4	RM2-3640-000CN	Cassette assembly	1
5	RC5-9200-000CN	Cover, front left	1
6	RC5-9408-000CN	Cover, left	1

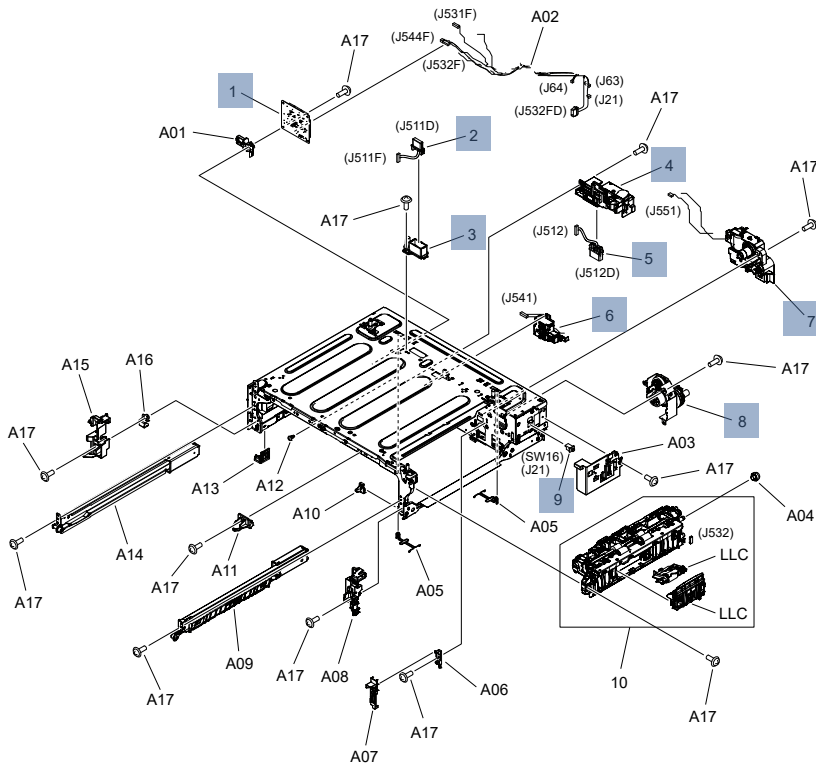
## Internal parts and assemblies

Parts diagrams and part lists for the internal parts and assemblies.

### Internal parts and assemblies (550-sheet paper feeder)

Parts diagram and part list for the 550-sheet paper feeder main body.

**Figure 6-24 550-sheet paper feeder internal parts and assemblies**



**Table 6-24 550-sheet paper feeder internal parts and assemblies**

<b>Ref No</b>	<b>Part number</b>	<b>Description</b>	<b>Qty</b>
1	RM3-8051-000CN	Paper feeder controller PCA	1
2	RM3-8058-000CN	Drawer upper cable assembly	1
3	RC5-9398-000CN	Holder, drawer connector upper	1
4	RM2-3559-000CN	Auto close assembly	2
5	RM3-8059-000CN	Drawer lower cable assembly	1
6	RM2-3614-000CN	Size detect assembly	1
7	RM2-3501-000CN	Lifter drive assembly	1
8	RM2-3617-000CN	Paper pickup drive assembly	1
9	5851-7005	Assy-USB A F Panel Mount To WTB 335mm	1
9	RM2-3509-000CN	Paper pickup assembly	1
Not shown as Ref No	6QN57A	550-sheet paper feeder (tray)	1

# Input device - 2,100-sheet high capacity input (HCI) paper feeder

Learn about the 2,100-sheet paper feeder parts and assemblies.

## Parts and diagrams: HCI covers

Parts diagram and parts list for the HCI covers.

Figure 6-25 HCI Covers

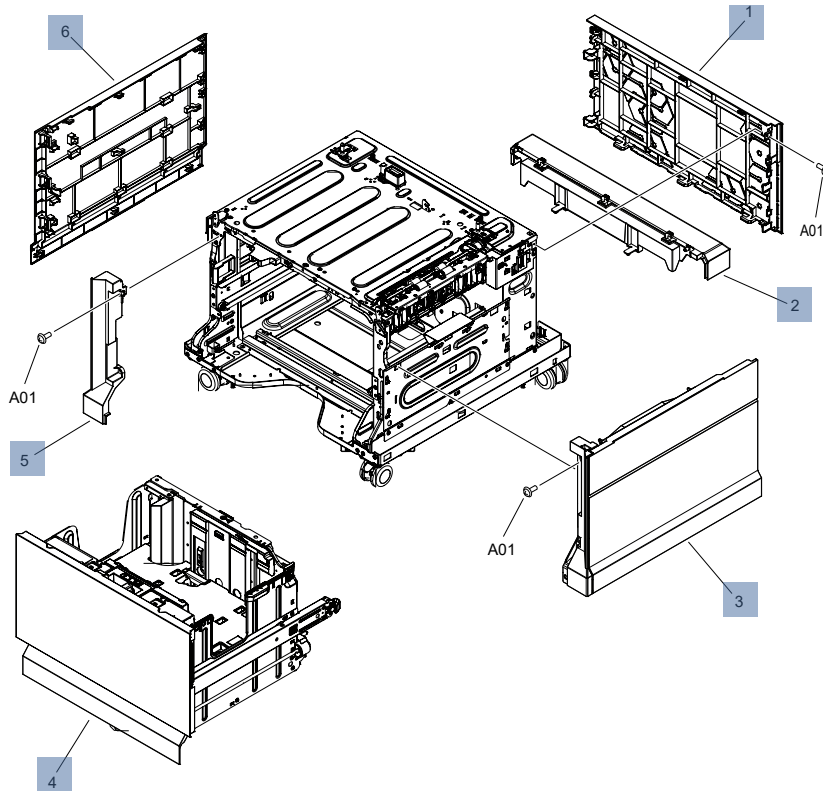


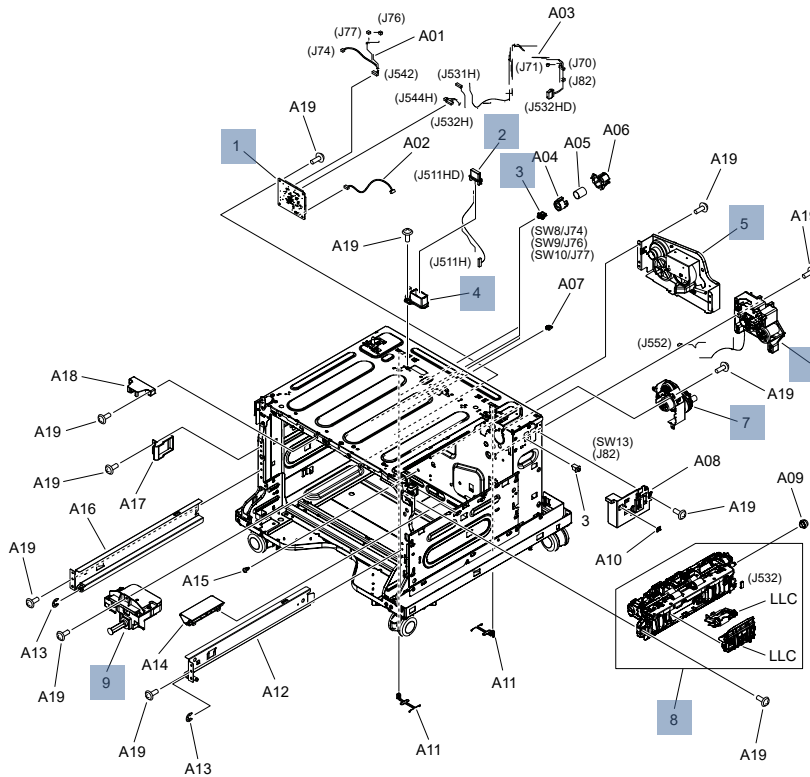
Table 6-25 HCI Covers

Key No	Part number	Qty	Description
1	RC5-9693-000CN	1	Cover, rear
2	RC5-9695-000CN	1	Cover, rear lower
3	RM3-0035-000CN	1	Right door assembly
4	RM3-0023-000CN	1	Tray assembly
5	RC5-9696-000CN	1	Cover, front left
6	RC5-9692-000CN	1	Cover, left

## Parts and diagrams: HCI main body

Parts diagram and parts list for the HCI main body.

**Figure 6-26** HCI main body



**Table 6-26** HCI main body

Key No	Part number	Qty	Description
1	RM3-8071-000CN	1	HCI controller PCA
2	RM3-8079-000CN	1	Drawer cable assembly
3	WC2-5806-000CN	1	Button switch
4	RC5-9398-000CN	1	Holder, drawer connector upper
5	RM3-0021-000CN	1	Lifter drive assembly
6	RM3-0022-000CN	1	Pick estrangement assembly
7	RM2-3617-000CN	1	Paper pickup drive assembly
8	RM2-3509-000CN	1	Paper pickup assembly
9	RM2-0918-000CN	1	Auto close assembly
Not shown as Ref No	6QN57A	1	2,100-sheet HCI feeder/stand

# Output devices

Learn about the output devices.

## Output device - Floor stand staple stacker (FSSS)

Learn about the FSSS output device.

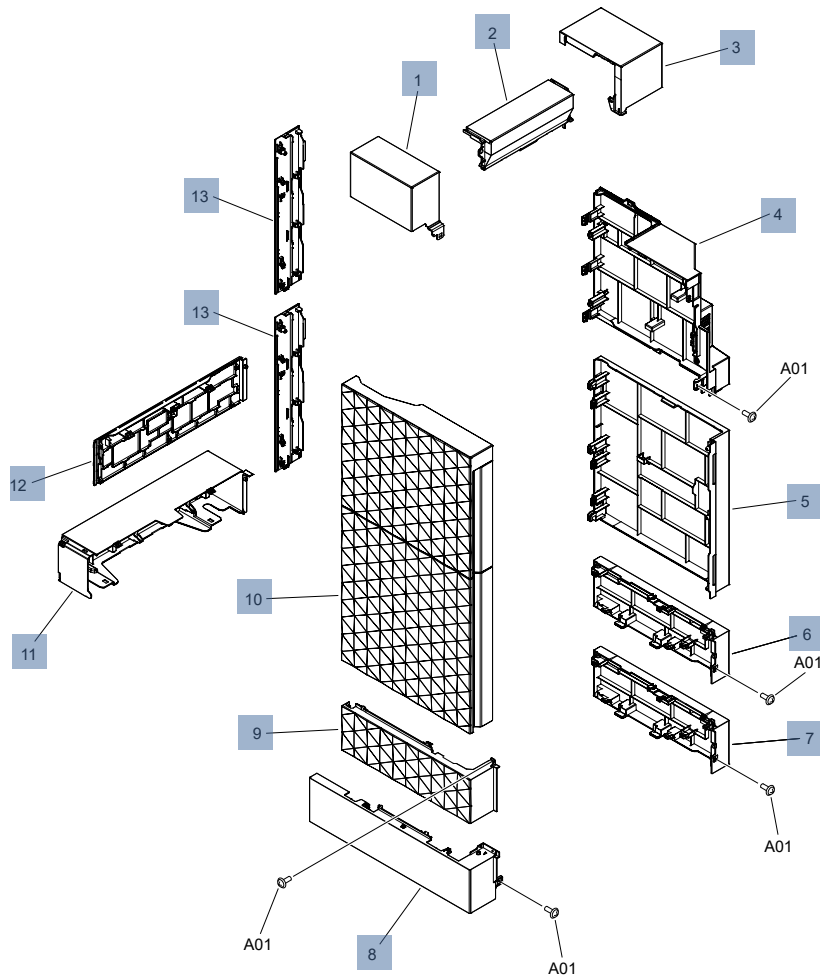
### Covers, panels, and doors

Parts diagrams and part lists for the covers, panels, and doors.

#### Parts and diagrams: Floor stand staple stacker (FSSS) covers 6800/X677 models

Parts diagram and parts list for the FSSS covers.

**Figure 6-27 Floor stand staple stacker covers 6800/X677 models**



**Table 6-27 Floor stand staple stacker covers 6800/X677 models**

Key No	Part number	Qty	Description
1	RC6-0214-000CN	1	Cover, MBM front

**Table 6-27 Floor stand staple stacker covers 6800/X677 models (continued)**

<b>Key No</b>	<b>Part number</b>	<b>Qty</b>	<b>Description</b>
2	RM2-3863-000CN	1	MBM cover assembly
3	RC5-0215-000CN	1	Cover, MBM rear
4	RM2-3864-000CN	1	Rear upper cover assembly
5	RC5-0223-000CN	1	Cover, rear
6	RC6-0222-000CN	1	Cover, foot rear
7	RC6-0222-000CN	1	Cover, foot rear
8	RC6-0226-000CN	1	Cover, foot front (tall model)
9	RC6-0220-000CN	1	Cover, foot front
10	RM2-3857-000CN	1	Front cover assembly
11	RC6-0229-000CN	1	Cover, foot
12	RC6-0227-000CN	1	Cover, foot center
13	RC6-0213-000CN	1	Cover, rear left

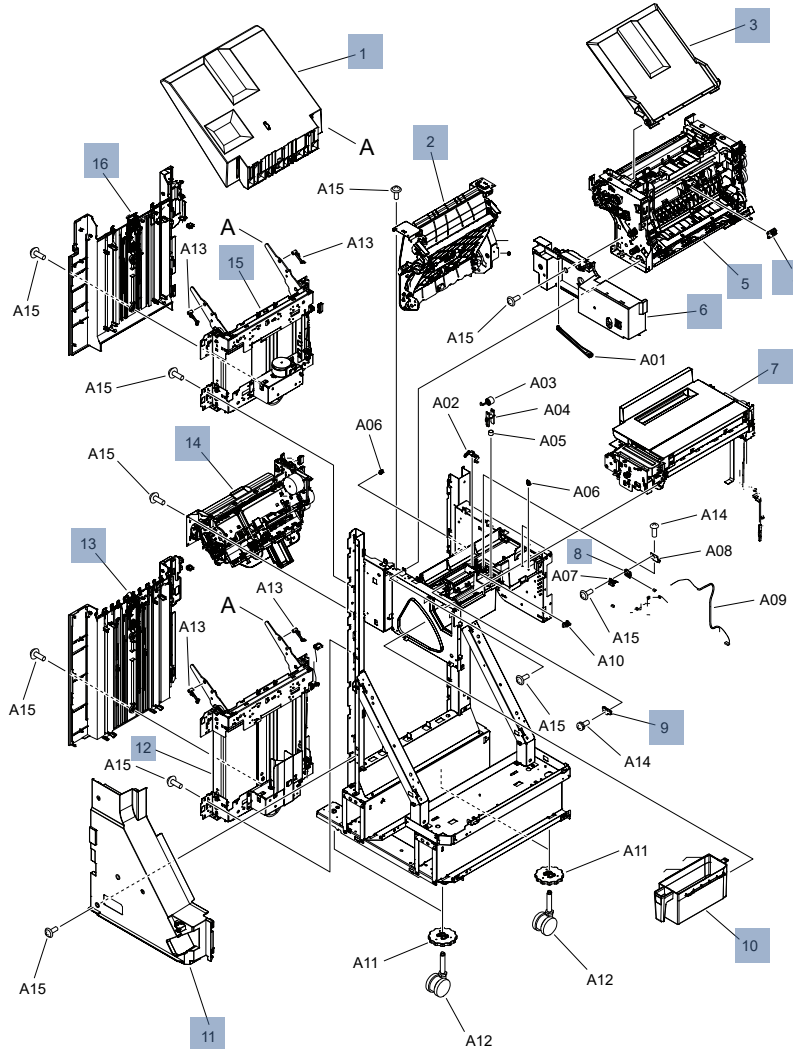
## Internal parts and assemblies

Parts diagrams and part lists for the internal parts and assemblies.

### Parts and diagrams: Floor stand staple stacker (FSSS) main body 6800/X677 models (1 of 2)

Parts diagram and parts list for the FSSS printer covers.

**Figure 6-28** Floor stand staple stacker main body 6800/X677 models



**Table 6-28** Floor stand staple stacker main body 6800/X677 models

Key No	Part number	Qty	Description
1	RM2-3837-000CN	1	Tray assembly
2	RM2-3834-000CN	1	Punch assembly
3	RC6-0513-000CN	1	Tray, MBM
4	RM3-7934-000CN	1	Sensor PCA
5	RM2-3867-000CN	1	Switch back assembly

**Table 6-28 Floor stand staple stacker main body 6800/X677 models (continued)**

<b>Key No</b>	<b>Part number</b>	<b>Qty</b>	<b>Description</b>
6	RC6-0186-000CN	1	Cover, front inner upper
7	RM2-3839-000CN	1	IMF assembly
8	RM3-7937-000CN	1	LED PCA
9	RM3-7738-000CN	1	Sensor PCA
10	RM2-3865-000CN	1	Punch box assembly
11	RM2-3862-000CN	1	Lower front inner cover assembly
12	RM2-3842-000CN	1	Lifter base lower assembly
13	RM2-3844-000CN	1	Height wall lower assembly
14	RM2-3836-000CN	1	Paper delivery assembly
15	RM2-3843-000CN	1	Lifter base upper assembly
16	RM2-3845-000CN	1	Height wall upper assembly



Parts and diagrams: Floor stand staple stacker (FSSS) main body 6800/X677 models (2 of 2)

Parts diagram and parts list for the FSSS printer covers.

Figure 6-29 Floor stand staple stacker main body 6800/X677 models

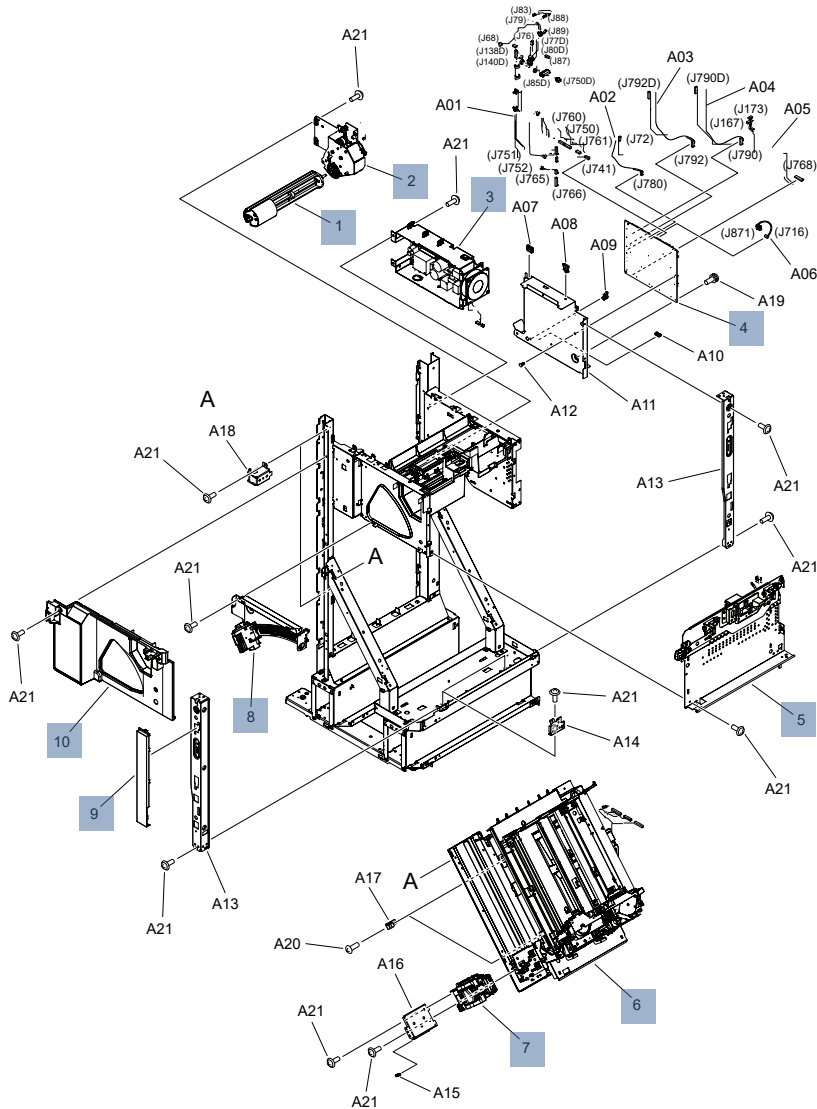


Table 6-29 Floor stand staple stacker main body 6800/X677 models

Key No	Part number	Qty	Description
1	RM2-3848-000CN	1	Drum assembly
2	RM2-3847-000CN	1	Drum drive assembly
3	RM2-3854-000CN	1	Sub power supply assembly
4	RM3-7931-000CN	1	Staple stacker PCA
5	RM2-3866-000CN	1	Side plate assembly right
6	RM2-3833-000CN	1	Alignment assembly

**Table 6-29 Floor stand staple stacker main body 6800/X677 models (continued)**

Key No	Part number	Qty	Description
7	RK2-8148-000CN	1	Stapler assembly
8	RM2-3849-000CN	1	Door handle rail assembly
9	RC6-2402-000CN	1	Cover, front inner right lower
10	RM2-3861-000CN	1	Front inner cover assembly

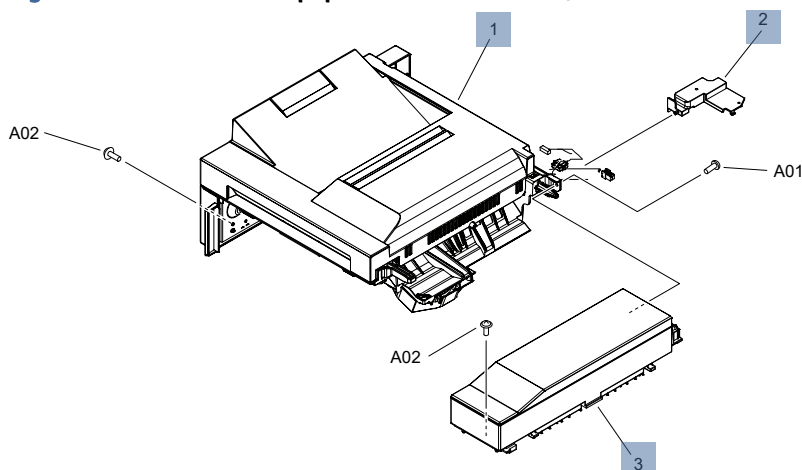
## Output device - Intermediate paper transfer unit (IPTU)

Learn about the IPTU output device.

### Parts and diagrams: Intermediate paper transfer unit 6800/X677 models

Parts diagram and parts list for the MFP printer covers.

**Figure 6-30 Intermediate paper transfer unit 6800/X677 models**



**Table 6-30 Intermediate paper transfer unit 6800/X677 models**

Key No	Part number	Qty	Description
1	RM2-3858-000CN	1	Paper feed assembly
2	RC6-2406-000CN	1	Cover, harness
3	RM2-3859-000CN	1	Connecting assembly

## Output device - 3-bin staple stacker

Learn about the 3-bin staple stacker output device.

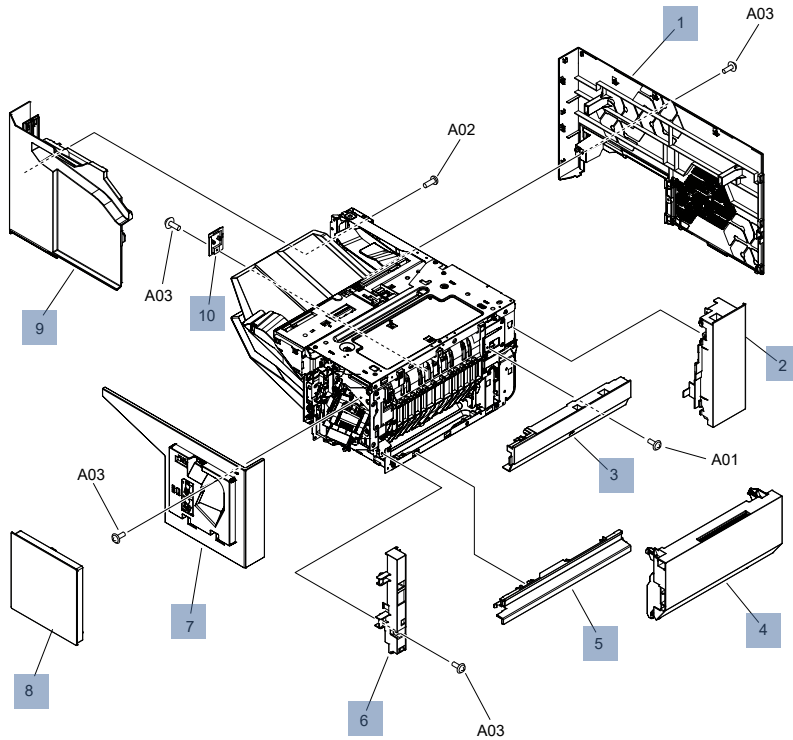
## Covers, panels, and doors

Parts diagrams and part lists for the covers, panels, and doors.

### Parts and diagrams: 3 bin staple stacker covers 6800/X677 models

Parts diagram and parts list for the MFP printer covers.

**Figure 6-31 3 bin staple stacker covers 6800/X677 models**



**Table 6-31 3 bin staple stacker covers 6800/X677 models**

Key No	Part number	Qty	Description
1	RC6-1305-000CN	1	Cover, rear
2	RC6-1307-000CN	1	Cover, corner right
3	RC6-1308-000CN	1	Cover, right upper
4	RM2-4167-000CN	1	Right door assembly
5	RC6-1309-000CN	1	Cover, right lower
6	RC6-1310-000CN	1	Cover, stapler rear
7	RM3-0483-000CN	1	Staple cover assembly
8	RM3-0484-000CN	1	Staple door assembly
9	RM3-0485-000CN	1	Rear inner cover assembly
10	RC6-2356-000CN	1	Cover, left front

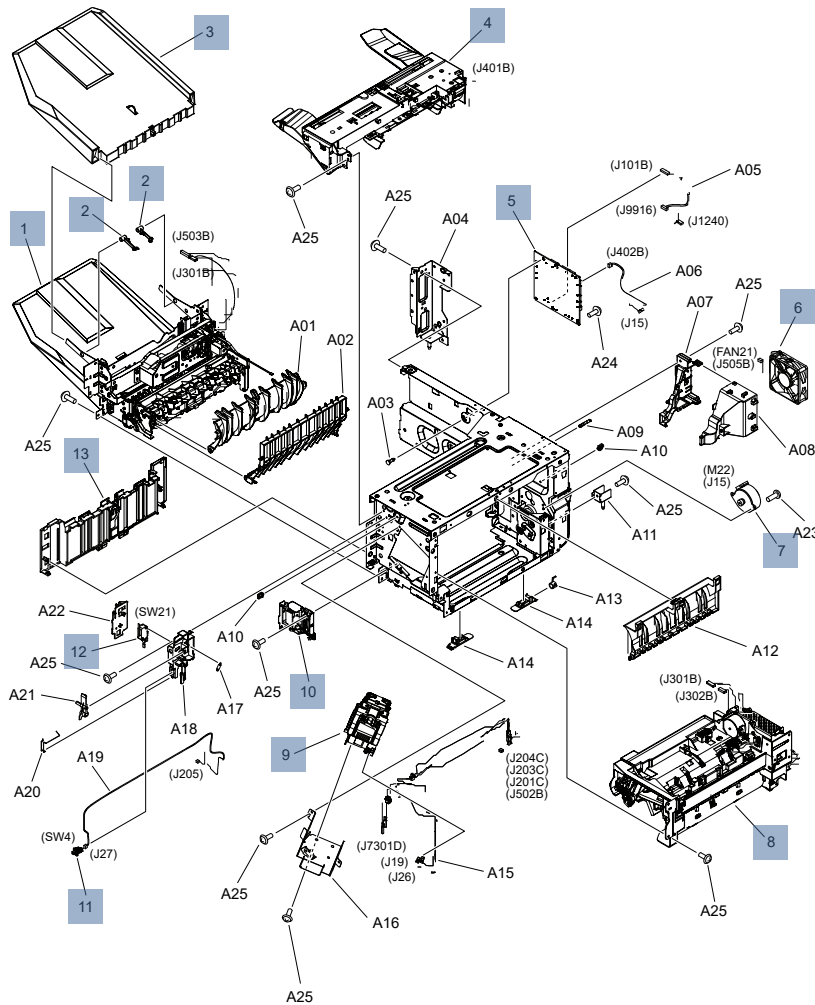
## Internal parts and assemblies

Parts diagrams and part lists for the internal parts and assemblies.

### Parts and diagrams: 3 bin staple stacker main body 6800/X677 models

Parts diagram and parts list for the MFP printer covers.

**Figure 6-32 3 bin staple stacker main body 6800/X677 models**



**Table 6-32 3 bin staple stacker main body 6800/X677 models**

Key No	Part number	Qty	Description
1	RM2-4168-000CN	1	Lower paper feed assembly
2	RC5-0353-000CN	1	Pin, tray fixed
3	RM2-4173-000CN	1	Tray assembly
4	RM3-0481-000CN	1	Jog assembly
5	RM3-7950-000CN	1	Staple stacker PCA
6	RK2-8153-000CN	1	Fan

**Table 6-32 3 bin staple stacker main body 6800/X677 models (continued)**

<b>Key No</b>	<b>Part number</b>	<b>Qty</b>	<b>Description</b>
7	RK2-8149-000CN	1	Motor, stepping DC
8	RM2-4169-000CN	1	Upper paper feed assembly
9	RK2-8148-000CN	1	Stapler assembly
10	RM2-1040-010CN	1	Solenoid assembly
11	5851-7005	1	Assy-USB A F Panel Mount To WTB 335mm
12	WC4-5136-000CN	1	Microswitch
13	RM3-0480-000CN	1	Stacking wall assembly

# Alphabetical parts list

**Table 6-33 Alphabetical parts list**

Description	Part number	Table and page
2,100-sheet HCI feeder/stand	6QN57A	<a href="#">HCI main body on page 1435</a>
550-sheet paper feeder (tray)	6QN57A	<a href="#">550-sheet paper feeder internal parts and assemblies on page 1433</a>
ADF Pick/Sep Roller Kit (6xxx Series)	6H122A	<a href="#">Integrated scanner assembly on page 1391</a>
ADF Pick/Sep Roller Kit (Flow 6xxx Series)	6M1P3A	<a href="#">Integrated scanner assembly on page 1391</a>
ADF WUR (6xxx Series Non-Workflow)	J1H98-60037	<a href="#">Integrated scanner assembly on page 1391</a>
ADF WUR (6xxx Series Workflow)	J1H98-60038	<a href="#">Integrated scanner assembly on page 1391</a>
ADF damper	5851-8849	<a href="#">Integrated scanner assembly on page 1391</a>
ADF hinge kit (6xxx Series)	5851-8842	<a href="#">Integrated scanner assembly on page 1391</a>
ADF roller cover (6xxx Series)	5851-8844	<a href="#">Integrated scanner assembly on page 1391</a>
ADF white backing kit	5851-8850	<a href="#">Integrated scanner assembly on page 1391</a>
Alignment assembly	RM2-3833-000CN	<a href="#">Floor stand staple stacker main body 6800/X677 models on page 1440</a>
Assy-USB A F Panel Mount To WTB 335mm	5851-7005	<a href="#">Internal assemblies (6 of 9) X654/X677 models on page 1425</a>
Assy-USB A F Panel Mount To WTB 335mm	5851-7005	<a href="#">Internal assemblies (7 of 9) X654/X677 models on page 1427</a>
Assy-USB A F Panel Mount To WTB 335mm	5851-7005	<a href="#">550-sheet paper feeder internal parts and assemblies on page 1433</a>
Assy-USB A F Panel Mount To WTB 335mm	5851-7005	<a href="#">3 bin staple stacker main body 6800/X677 models on page 1443</a>
Auto close assembly	RM2-0918-000CN	<a href="#">HCI main body on page 1435</a>
Auto close assembly	RM2-3559-000CN	<a href="#">Internal assemblies (6 of 7) 6700/6800 models on page 1412</a>
Auto close assembly	RM2-3559-000CN	<a href="#">Internal assemblies (6 of 9) X654/X677 models on page 1425</a>
Auto close assembly	RM2-3559-000CN	<a href="#">550-sheet paper feeder internal parts and assemblies on page 1433</a>

**Table 6-33** Alphabetical parts list (continued)

<b>Description</b>	<b>Part number</b>	<b>Table and page</b>
Button switch	WC2-5806-000CN	<a href="#">HCI main body on page 1435</a>
CABLE, FLAT, FMTR	RK3-0837-000	<a href="#">Internal assemblies (3 of 7) 6700/6800 models on page 1406</a>
Cable, flat FMTR	RK3-0817-000CN	<a href="#">Internal assemblies (3 of 7) 6700/6800 models on page 1406</a>
Cable, flat FMTR	RK3-0817-000CN	<a href="#">Internal assemblies (3 of 9) X654/X677 models on page 1420</a>
Cable, flat FMTR	RK3-0847-000CN	<a href="#">Internal assemblies (3 of 9) X654/X677 models on page 1420</a>
Cable, flat HVT	RK3-1509-000CN	<a href="#">Internal assemblies (4 of 7) 6700/6800 models on page 1409</a>
Cable, flat HVT	RK3-1509-000CN	<a href="#">Internal assemblies (4 of 9) X654/X677 models on page 1422</a>
Cable, flat LVPS	RK3-0827-000CN	<a href="#">Internal assemblies (5 of 7) 6700/6800 models on page 1411</a>
Cable, flat LVPS	RK3-0827-000CN	<a href="#">Internal assemblies (5 of 9) X654/X677 models on page 1424</a>
Cable, flat SCN	RK3-0825-000CN	<a href="#">Internal assemblies (1 of 7) 6700/6800 models on page 1403</a>
Cable, flat SCN	RK3-0825-000CN	<a href="#">Internal assemblies (1 of 9) X654/X677 models on page 1416</a>
Cable, flat drive	RK3-0819-000CN	<a href="#">Internal assemblies (4 of 7) 6700/6800 models on page 1409</a>
Cable, flat drive	RK3-0819-000CN	<a href="#">Internal assemblies (4 of 9) X654/X677 models on page 1422</a>
Cable, flat drive	RK3-0821-000CN	<a href="#">Internal assemblies (4 of 7) 6700/6800 models on page 1409</a>
Cable, flat drive	RK3-0821-000CN	<a href="#">Internal assemblies (4 of 9) X654/X677 models on page 1422</a>
Cable, flat rear	RK3-1692-000CN	<a href="#">Internal assemblies (4 of 7) 6700/6800 models on page 1409</a>
Cable, flat rear	RK3-1693-000CN	<a href="#">Internal assemblies (4 of 9) X654/X677 models on page 1422</a>

**Table 6-33 Alphabetical parts list (continued)**

<b>Description</b>	<b>Part number</b>	<b>Table and page</b>
Cable, flat right	RK3-1694-000CN	<a href="#">Internal assemblies (4 of 7) 6700/6800 models on page 1409</a>
Cable, flat right	RK3-1694-000CN	<a href="#">Internal assemblies (4 of 9) X654/X677 models on page 1422</a>
Cassette assembly	RM2-3616-000CN	<a href="#">Internal assemblies (6 of 7) 6700/6800 models on page 1412</a>
Cassette assembly	RM2-3616-000CN	<a href="#">Internal assemblies (6 of 9) X654/X677 models on page 1425</a>
Cassette assembly	RM2-3640-000CN	<a href="#">550-sheet paper feeder covers, panels, and doors on page 1432</a>
Connecting assembly	RM2-3859-000CN	<a href="#">Intermediate paper transfer unit 6800/X677 models on page 1441</a>
Control panel 10.9 cm 4.3 in	6QN28-67001	<a href="#">Control panels on page 1392</a>
Control panel 23.3 cm 8 in	6QN37-67001	<a href="#">Control panels on page 1392</a>
Control panel 25.6 cm 10.1 in	6QN35-67003	<a href="#">Control panels on page 1392</a>
Cover, Hardware integration pocket (HIP)	RC4-0213-000CN	<a href="#">Covers 6700 models on page 1395</a>
Cover, Hardware integration pocket (HIP)	RC4-0213-000CN	<a href="#">Covers X654 models on page 1396</a>
Cover, Hardware integration pocket (HIP)	RC4-0213-000CN	<a href="#">Covers 6800 models on page 1398</a>
Cover, Hardware integration pocket (HIP)	RC4-0213-000CN	<a href="#">Covers X677 models on page 1401</a>
Cover, MBM front	RC6-0214-000CN	<a href="#">Floor stand staple stacker covers 6800/X677 models on page 1436</a>
Cover, MBM rear	RC5-0215-000CN	<a href="#">Floor stand staple stacker covers 6800/X677 models on page 1436</a>
Cover, corner right	RC6-1307-000CN	<a href="#">3 bin staple stacker covers 6800/X677 models on page 1442</a>
Cover, foot	RC6-0229-000CN	<a href="#">Floor stand staple stacker covers 6800/X677 models on page 1436</a>
Cover, foot center	RC6-0227-000CN	<a href="#">Floor stand staple stacker covers 6800/X677 models on page 1436</a>
Cover, foot front	RC6-0220-000CN	<a href="#">Floor stand staple stacker covers 6800/X677 models on page 1436</a>



**Table 6-33 Alphabetical parts list (continued)**

<b>Description</b>	<b>Part number</b>	<b>Table and page</b>
Cover, foot front (tall model)	RC6-0226-000CN	<a href="#">Floor stand staple stacker covers 6800/X677 models on page 1436</a>
Cover, foot rear	RC6-0222-000CN	<a href="#">Floor stand staple stacker covers 6800/X677 models on page 1436</a>
Cover, foot rear	RC6-0222-000CN	<a href="#">Floor stand staple stacker covers 6800/X677 models on page 1436</a>
Cover, front inner right lower	RC6-2402-000CN	<a href="#">Floor stand staple stacker main body 6800/X677 models on page 1440</a>
Cover, front inner upper	RC6-0186-000CN	<a href="#">Floor stand staple stacker main body 6800/X677 models on page 1438</a>
Cover, front left	RC5-9198-000CN	<a href="#">Covers 6700 models on page 1395</a>
Cover, front left	RC5-9198-000CN	<a href="#">Covers X654 models on page 1396</a>
Cover, front left	RC5-9198-000CN	<a href="#">Covers 6800 models on page 1398</a>
Cover, front left	RC5-9198-000CN	<a href="#">Covers X677 models on page 1401</a>
Cover, front left	RC5-9200-000CN	<a href="#">550-sheet paper feeder covers, panels, and doors on page 1432</a>
Cover, front left	RC5-9696-000CN	<a href="#">HCI Covers on page 1434</a>
Cover, front right	RC5-9199-000CN	<a href="#">Covers 6700 models on page 1395</a>
Cover, front right	RC5-9199-000CN	<a href="#">Covers X654 models on page 1396</a>
Cover, front right	RC5-9199-000CN	<a href="#">Covers 6800 models on page 1398</a>
Cover, front right	RC5-9199-000CN	<a href="#">Covers X677 models on page 1401</a>
Cover, front right	RC5-9201-000CN	<a href="#">550-sheet paper feeder covers, panels, and doors on page 1432</a>
Cover, harness	RC6-2406-000CN	<a href="#">Intermediate paper transfer unit 6800/X677 models on page 1441</a>
Cover, left	RC5-9408-000CN	<a href="#">550-sheet paper feeder covers, panels, and doors on page 1432</a>
Cover, left	RC5-9692-000CN	<a href="#">HCI Covers on page 1434</a>
Cover, left front	RC6-2356-000CN	<a href="#">3 bin staple stacker covers 6800/X677 models on page 1442</a>
Cover, left upper	RC5-9204-000CN	<a href="#">Covers 6700 models on page 1395</a>

**Table 6-33 Alphabetical parts list (continued)**

<b>Description</b>	<b>Part number</b>	<b>Table and page</b>
Cover, left upper	RC5-9204-000CN	<a href="#">Covers X654 models on page 1396</a>
Cover, left upper	RC5-9204-000CN	<a href="#">Covers 6800 models on page 1398</a>
Cover, left upper	RC5-9204-000CN	<a href="#">Covers X677 models on page 1401</a>
Cover, rear	RC5-0223-000CN	<a href="#">Floor stand staple stacker covers 6800/X677 models on page 1436</a>
Cover, rear	RC5-9693-000CN	<a href="#">HCI Covers on page 1434</a>
Cover, rear	RC6-1305-000CN	<a href="#">3 bin staple stacker covers 6800/X677 models on page 1442</a>
Cover, rear left	RC6-0213-000CN	<a href="#">Floor stand staple stacker covers 6800/X677 models on page 1436</a>
Cover, rear lower	RC5-9168-000CN	<a href="#">Covers 6700 models on page 1395</a>
Cover, rear lower	RC5-9168-000CN	<a href="#">Covers X654 models on page 1396</a>
Cover, rear lower	RC5-9168-000CN	<a href="#">Covers 6800 models on page 1398</a>
Cover, rear lower	RC5-9168-000CN	<a href="#">Covers X677 models on page 1401</a>
Cover, rear lower	RC5-9409-000CN	<a href="#">Covers X654 models on page 1396</a>
Cover, rear lower	RC5-9409-000CN	<a href="#">Covers X677 models on page 1401</a>
Cover, rear lower	RC5-9409-000CN	<a href="#">550-sheet paper feeder covers, panels, and doors on page 1432</a>
Cover, rear lower	RC5-9695-000CN	<a href="#">HCI Covers on page 1434</a>
Cover, right lower	RC6-1309-000CN	<a href="#">3 bin staple stacker covers 6800/X677 models on page 1442</a>
Cover, right upper	RC6-1308-000CN	<a href="#">3 bin staple stacker covers 6800/X677 models on page 1442</a>
Cover, stapler rear	RC6-1310-000CN	<a href="#">3 bin staple stacker covers 6800/X677 models on page 1442</a>
Cover, top assembly	RC5-9172-000CN	<a href="#">Covers 6800 models on page 1398</a>
Cover, top assembly	RC5-9172-000CN	<a href="#">Covers X677 models on page 1401</a>
Cover, top assembly	RM2-4517-000CN	<a href="#">Covers 6700 models on page 1395</a>
Cover, top assembly	RM2-4517-000CN	<a href="#">Covers X654 models on page 1396</a>

**Table 6-33 Alphabetical parts list (continued)**

<b>Description</b>	<b>Part number</b>	<b>Table and page</b>
DC controller PCA	RM3-7753-000CN	<a href="#">Internal assemblies (4 of 7) 6700/6800 models on page 1409</a>
DC controller PCA	RM3-7754-000CN	<a href="#">Internal assemblies (4 of 7) 6700/6800 models on page 1409</a>
DC controller PCA	RM3-7758-000CN	<a href="#">Internal assemblies (4 of 9) X654/X677 models on page 1422</a>
Density detect assembly	RM2-4492-000CN	<a href="#">Internal assemblies (2 of 7) 6700/6800 models on page 1404</a>
Density detect assembly	RM2-4492-000CN	<a href="#">Internal assemblies (2 of 9) X654/X677 models on page 1418</a>
Developing motor assembly	RM2-3625-000CN	<a href="#">Internal assemblies (1 of 7) 6700/6800 models on page 1403</a>
Developing motor assembly	RM2-3625-000CN	<a href="#">Internal assemblies (1 of 9) X654/X677 models on page 1416</a>
Door handle rail assembly	RM2-3849-000CN	<a href="#">Floor stand staple stacker main body 6800/X677 models on page 1440</a>
Drawer cable assembly	RM3-8001-000CN	<a href="#">Internal assemblies (6 of 7) 6700/6800 models on page 1412</a>
Drawer cable assembly	RM3-8038-000CN	<a href="#">Internal assemblies (6 of 9) X654/X677 models on page 1425</a>
Drawer cable assembly	RM3-8079-000CN	<a href="#">HCI main body on page 1435</a>
Drawer lower cable assembly	RM3-8059-000CN	<a href="#">550-sheet paper feeder internal parts and assemblies on page 1433</a>
Drawer upper cable assembly	RM3-8058-000CN	<a href="#">550-sheet paper feeder internal parts and assemblies on page 1433</a>
Driver PCA	RM3-7722-000CN	<a href="#">Internal assemblies (1 of 7) 6700/6800 models on page 1403</a>
Driver PCA	RM3-7722-000CN	<a href="#">Internal assemblies (1 of 9) X654/X677 models on page 1416</a>
Drum assembly	RM2-3848-000CN	<a href="#">Floor stand staple stacker main body 6800/X677 models on page 1440</a>
Drum drive assembly	RM2-3847-000CN	<a href="#">Floor stand staple stacker main body 6800/X677 models on page 1440</a>

**Table 6-33 Alphabetical parts list (continued)**

<b>Description</b>	<b>Part number</b>	<b>Table and page</b>
Drum motor assembly	RM3-7788-000CN	<a href="#">Internal assemblies (1 of 7) 6700/6800 models on page 1403</a>
Drum motor assembly	RM3-7788-000CN	<a href="#">Internal assemblies (1 of 9) X654/X677 models on page 1416</a>
Drum position sensor PCA	RM3-7647-000CN	<a href="#">Internal assemblies (1 of 7) 6700/6800 models on page 1403</a>
Drum position sensor PCA	RM3-7647-000CN	<a href="#">Internal assemblies (1 of 9) X654/X677 models on page 1416</a>
Face down tray assembly	RM2-4471-000CN	<a href="#">Covers 6700 models on page 1395</a>
Face down tray assembly	RM2-4471-000CN	<a href="#">Covers X654 models on page 1396</a>
Face down tray assembly	RM2-4471-000CN	<a href="#">Covers 6800 models on page 1398</a>
Face down tray assembly	RM2-4471-000CN	<a href="#">Covers X677 models on page 1401</a>
Fan	RK2-8153-000CN	<a href="#">3 bin staple stacker main body 6800/X677 models on page 1443</a>
Fan	RK3-0760-000CN	<a href="#">Internal assemblies (4 of 7) 6700/6800 models on page 1409</a>
Fan	RK3-0760-000CN	<a href="#">Internal assemblies (4 of 9) X654/X677 models on page 1422</a>
Fan	RK3-0762-000CN	<a href="#">Internal assemblies (3 of 7) 6700/6800 models on page 1406</a>
Fan	RK3-0762-000CN	<a href="#">Internal assemblies (3 of 7) 6700/6800 models on page 1406</a>
Fan	RK3-0762-000CN	<a href="#">Internal assemblies (3 of 9) X654/X677 models on page 1420</a>
Fan	RK3-2277-000CN	<a href="#">Internal assemblies (5 of 7) 6700/6800 models on page 1411</a>
Fan	RK3-2277-000CN	<a href="#">Internal assemblies (5 of 9) X654/X677 models on page 1424</a>
Fixing drive assembly	RM2-4487-000CN	<a href="#">Internal assemblies (3 of 7) 6700/6800 models on page 1406</a>

**Table 6-33 Alphabetical parts list (continued)**

<b>Description</b>	<b>Part number</b>	<b>Table and page</b>
Fixing drive assembly	RM2-4487-000CN	<a href="#">Internal assemblies (3 of 9) X654/X677 models on page 1420</a>
Fixing motor assembly	RM2-4488-000CN	<a href="#">Internal assemblies (3 of 7) 6700/6800 models on page 1406</a>
Fixing motor assembly	RM2-4488-000CN	<a href="#">Internal assemblies (3 of 9) X654/X677 models on page 1420</a>
Flatbed scanner	6QN35-67006	<a href="#">Integrated scanner assembly on page 1391</a>
Formatter (67xx / X65xxx)	6QN32-67002	<a href="#">Internal assemblies (4 of 7) 6700/6800 models on page 1409</a>
Formatter (67xx / X65xxx)	6QN32-67002	<a href="#">Internal assemblies (4 of 9) X654/X677 models on page 1422</a>
Formatter (67xx / X65xxx) (China/India)	6QN32-67004	<a href="#">Internal assemblies (4 of 7) 6700/6800 models on page 1409</a>
Formatter (67xx / X65xxx) (China/India)	6QN32-67004	<a href="#">Internal assemblies (4 of 9) X654/X677 models on page 1422</a>
Formatter (68xx / X67xxx)	6QN35-67002	<a href="#">Internal assemblies (4 of 7) 6700/6800 models on page 1409</a>
Formatter (68xx / X67xxx)	6QN35-67002	<a href="#">Internal assemblies (4 of 9) X654/X677 models on page 1422</a>
Formatter (68xx / X67xxx) (China/India)	6QN35-67005	<a href="#">Internal assemblies (4 of 7) 6700/6800 models on page 1409</a>
Formatter (68xx / X67xxx) (China/India)	6QN35-67005	<a href="#">Internal assemblies (4 of 9) X654/X677 models on page 1422</a>
Formatter cage assembly	RM2-4520-000CN	<a href="#">Internal assemblies (3 of 7) 6700/6800 models on page 1406</a>
Formatter cage assembly	RM2-4521-000CN	<a href="#">Internal assemblies (3 of 7) 6700/6800 models on page 1406</a>
Formatter cage assembly	RM2-4521-000CN	<a href="#">Internal assemblies (3 of 9) X654/X677 models on page 1420</a>
Formatter cover assembly	RM2-4480-000CN	<a href="#">Covers 6700 models on page 1395</a>
Formatter cover assembly	RM2-4480-000CN	<a href="#">Covers X654 models on page 1396</a>

**Table 6-33 Alphabetical parts list (continued)**

<b>Description</b>	<b>Part number</b>	<b>Table and page</b>
Formatter cover assembly	RM2-4480-000CN	<a href="#">Covers 6800 models on page 1398</a>
Formatter cover assembly	RM2-4480-000CN	<a href="#">Covers X677 models on page 1401</a>
Formatter cover assembly	RM2-4530-000CN	<a href="#">Covers 6800 models on page 1398</a>
Formatter cover assembly	RM2-4530-000CN	<a href="#">Covers X677 models on page 1401</a>
Front cover assembly	RM2-3857-000CN	<a href="#">Floor stand staple stacker covers 6800/X677 models on page 1436</a>
Front door assembly	RM2-4479-000CN	<a href="#">Covers X654 models on page 1396</a>
Front door assembly	RM2-4479-000CN	<a href="#">Covers X677 models on page 1401</a>
Front door assembly	RM2-4533-000CN	<a href="#">Covers 6700 models on page 1395</a>
Front door assembly	RM2-4533-000CN	<a href="#">Covers 6800 models on page 1398</a>
Front inner cover assembly	RM2-3861-000CN	<a href="#">Floor stand staple stacker main body 6800/X677 models on page 1440</a>
HCI controller PCA	RM3-8071-000CN	<a href="#">HCI main body on page 1435</a>
HDD, 500GB 5400RPM FIPS/CCC OPAL2 7MM	NA	<a href="#">Internal assemblies (3 of 7) 6700/6800 models on page 1406</a>
HDD, 500GB 5400RPM FIPS/CCC OPAL2 7MM	NA	<a href="#">Internal assemblies (3 of 9) X654/X677 models on page 1420</a>
HP 2130X High Yield Black Toner Cartridge	W2130X	<a href="#">Internal assemblies (7 of 7) 6700/6800 models on page 1414</a>
HP 2131X High Yield Cyan Toner Cartridge	W2131X	<a href="#">Internal assemblies (7 of 7) 6700/6800 models on page 1414</a>
HP 2132X High Yield Yellow Toner Cartridge	W2132X	<a href="#">Internal assemblies (7 of 7) 6700/6800 models on page 1414</a>
HP 2133X High Yield Magenta Toner Cartridge	W2133X	<a href="#">Internal assemblies (7 of 7) 6700/6800 models on page 1414</a>
HP 213A Black Original LaserJet Toner Cartridge	W2130A	<a href="#">Internal assemblies (7 of 7) 6700/6800 models on page 1414</a>
HP 213A Cyan Original LaserJet Toner Cartridge	W2131A	<a href="#">Internal assemblies (7 of 7) 6700/6800 models on page 1414</a>

**Table 6-33 Alphabetical parts list (continued)**

Description	Part number	Table and page
HP 213A Magenta LaserJet Toner Cartridge	W2133A	<a href="#">Internal assemblies (7 of 7) 6700/6800 models on page 1414</a>
HP 213A Yellow Original LaserJet Toner	W2132A	<a href="#">Internal assemblies (7 of 7) 6700/6800 models on page 1414</a>
HP 213Y Extra High Yield Black Toner Cartridge	W2130Y	<a href="#">Internal assemblies (7 of 7) 6700/6800 models on page 1414</a>
HP 213Y Extra High Yield Cyan Toner Cartridge	W2131Y	<a href="#">Internal assemblies (7 of 7) 6700/6800 models on page 1414</a>
HP 213Y Extra High Yield Magenta Toner Cartridge	W2133Y	<a href="#">Internal assemblies (7 of 7) 6700/6800 models on page 1414</a>
HP 213Y Extra High Yield Yellow Toner Cartridge	W2132Y	<a href="#">Internal assemblies (7 of 7) 6700/6800 models on page 1414</a>
HP 214Z Ultra High Yield Black Toner Cartridge (SFP)	W2140Z	<a href="#">Internal assemblies (7 of 7) 6700/6800 models on page 1414</a>
HP 214Z Ultra High Yield Cyan Toner Cartridge (SFP)	W2141Z	<a href="#">Internal assemblies (7 of 7) 6700/6800 models on page 1414</a>
HP 214Z Ultra High Yield Magenta Toner Cartridge (SFP)	W2143Z	<a href="#">Internal assemblies (7 of 7) 6700/6800 models on page 1414</a>
HP 214Z Ultra High Yield Yellow Toner Cartridge (SFP)	W2142Z	<a href="#">Internal assemblies (7 of 7) 6700/6800 models on page 1414</a>
HP 217Z Ultra High Yield Black Toner Cartridge (MFP)	W2170Z	<a href="#">Internal assemblies (7 of 7) 6700/6800 models on page 1414</a>
HP 217Z Ultra High Yield Cyan Toner Cartridge (MFP)	W2171Z	<a href="#">Internal assemblies (7 of 7) 6700/6800 models on page 1414</a>
HP 217Z Ultra High Yield Magenta Toner Cartridge (MFP)	W2173Z	<a href="#">Internal assemblies (7 of 7) 6700/6800 models on page 1414</a>
HP 217Z Ultra High Yield Yellow Toner Cartridge (MFP)	W2172Z	<a href="#">Internal assemblies (7 of 7) 6700/6800 models on page 1414</a>
HP 2GB DDR3Lx32 120-pin 933MHz DIMM	6QY68A	<a href="#">Internal assemblies (3 of 7) 6700/6800 models on page 1406</a>
HP 2GB DDR3Lx32 120-pin 933MHz DIMM	6QY68A	<a href="#">Internal assemblies (3 of 9) X654/X677 models on page 1420</a>

**Table 6-33 Alphabetical parts list (continued)**

Description	Part number	Table and page
HP 4GB DDR3Lx64 204-pin 933MHz DIMM	1M8J0A	<a href="#">Internal assemblies (3 of 7) 6700/6800 models on page 1406</a>
HP 4GB DDR3Lx64 204-pin 933MHz DIMM	1M8J0A	<a href="#">Internal assemblies (3 of 9) X654/X677 models on page 1420</a>
HP 4GB DDR3Lx64 204-pin 933MHz DIMM TAA	1M8J1A	<a href="#">Internal assemblies (3 of 7) 6700/6800 models on page 1406</a>
HP 4GB DDR3Lx64 204-pin 933MHz DIMM TAA	1M8J1A	<a href="#">Internal assemblies (3 of 9) X654/X677 models on page 1420</a>
HP 500GB CCC FIPS Hard Disk Drive	9EQ11A	<a href="#">Internal assemblies (3 of 7) 6700/6800 models on page 1406</a>
HP 500GB CCC FIPS Hard Disk Drive	9EQ11A	<a href="#">Internal assemblies (3 of 9) X654/X677 models on page 1420</a>
HP 500GB CCC FIPS TAA Hard Disk Drive	6HN31A	<a href="#">Internal assemblies (3 of 7) 6700/6800 models on page 1406</a>
HP 500GB CCC FIPS TAA Hard Disk Drive	6HN31A	<a href="#">Internal assemblies (3 of 9) X654/X677 models on page 1420</a>
HP JetDirect 3100w BLE/NFC/Wireless accessory	3JN69A	<a href="#">Internal assemblies (3 of 7) 6700/6800 models on page 1406</a>
HP JetDirect 3100w BLE/NFC/Wireless accessory	3JN69A	<a href="#">Internal assemblies (3 of 9) X654/X677 models on page 1420</a>
HP JetDirect 3200w BLE/Wireless accessory	1M0Q3A	<a href="#">Internal assemblies (3 of 7) 6700/6800 models on page 1406</a>
HP JetDirect 3200w BLE/Wireless accessory	1M0Q3A	<a href="#">Internal assemblies (3 of 9) X654/X677 models on page 1420</a>
HP LaserJet 110V Enhanced Fuser Kit	527G2A	<a href="#">Internal assemblies (3 of 7) 6700/6800 models on page 1406</a>
HP LaserJet 110V Enhanced Fuser Kit	527G2A	<a href="#">Internal assemblies (3 of 9) X654/X677 models on page 1420</a>
HP LaserJet 110V Enhanced Fuser Kit	527G6A	<a href="#">Internal assemblies (3 of 7) 6700/6800 models on page 1406</a>
HP LaserJet 110V Enhanced Fuser Kit	527G6A	<a href="#">Internal assemblies (3 of 9) X654/X677 models on page 1420</a>



**Table 6-33 Alphabetical parts list (continued)**

<b>Description</b>	<b>Part number</b>	<b>Table and page</b>
HP LaserJet 110V Fuser Kit	527G0A	<a href="#">Internal assemblies (3 of 7) 6700/6800 models on page 1406</a>
HP LaserJet 110V Fuser Kit	527G0A	<a href="#">Internal assemblies (3 of 9) X654/X677 models on page 1420</a>
HP LaserJet 220V Enhanced Fuser Kit	527G3A	<a href="#">Internal assemblies (3 of 7) 6700/6800 models on page 1406</a>
HP LaserJet 220V Enhanced Fuser Kit	527G3A	<a href="#">Internal assemblies (3 of 9) X654/X677 models on page 1420</a>
HP LaserJet 220V Enhanced Fuser Kit	527G7A	<a href="#">Internal assemblies (3 of 7) 6700/6800 models on page 1406</a>
HP LaserJet 220V Enhanced Fuser Kit	527G7A	<a href="#">Internal assemblies (3 of 9) X654/X677 models on page 1420</a>
HP LaserJet 220V Fuser Kit	527G1A	<a href="#">Internal assemblies (3 of 7) 6700/6800 models on page 1406</a>
HP LaserJet 220V Fuser Kit	527G1A	<a href="#">Internal assemblies (3 of 9) X654/X677 models on page 1420</a>
HP LaserJet Image Transfer Belt	527G8A	<a href="#">Internal assemblies (5 of 7) 6700/6800 models on page 1411</a>
HP LaserJet Image Transfer Belt Kit	527G9A	<a href="#">Internal assemblies (5 of 7) 6700/6800 models on page 1411</a>
HP LaserJet MP Tray Roller Kit	527H3A	<a href="#">Covers 6700 models on page 1395</a>
HP LaserJet MP Tray Roller Kit	527H3A	<a href="#">Covers X654 models on page 1396</a>
HP LaserJet MP Tray Roller Kit	527H3A	<a href="#">Covers 6800 models on page 1398</a>
HP LaserJet MP Tray Roller Kit	527H3A	<a href="#">Covers X677 models on page 1401</a>
HP LaserJet Managed Trans Roller Kit	527H1MC	<a href="#">Internal assemblies (5 of 9) X654/X677 models on page 1424</a>
HP LaserJet Mngd 110V Enhanced Fuser Kit	527G4MC	<a href="#">Internal assemblies (3 of 9) X654/X677 models on page 1420</a>
HP LaserJet Mngd 220V Enhanced Fuser Kit	527G5MC	<a href="#">Internal assemblies (3 of 9) X654/X677 models on page 1420</a>

**Table 6-33 Alphabetical parts list (continued)**

<b>Description</b>	<b>Part number</b>	<b>Table and page</b>
HP LaserJet Mngd Image Transfer Belt	527H0MC	<a href="#">Internal assemblies (5 of 9) X654/X677 models on page 1424</a>
HP LaserJet Secure Solid State Drive	1MQ4A	<a href="#">Internal assemblies (3 of 7) 6700/6800 models on page 1406</a>
HP LaserJet Secure Solid State Drive	1MQ4A	<a href="#">Internal assemblies (3 of 9) X654/X677 models on page 1420</a>
HP LaserJet Swedish Overlay Keyboard	A7W14A	<a href="#">Integrated scanner assembly on page 1391</a>
HP LaserJet Toner Collection Unit	527F9A	<a href="#">Internal assemblies (2 of 7) 6700/6800 models on page 1404</a>
HP LaserJet Toner collection unit (TCU)	527F9A	<a href="#">Internal assemblies (2 of 9) X654/X677 models on page 1418</a>
HP LaserJet Tray 2-x Roller Kit	527H2A	<a href="#">Internal assemblies (6 of 7) 6700/6800 models on page 1412</a>
HP LaserJet Tray 2-x Roller Kit	527H2A	<a href="#">Internal assemblies (6 of 9) X654/X677 models on page 1425</a>
HP LaserJet Workflow Accelerator Card	1MQ5A	<a href="#">Internal assemblies (3 of 7) 6700/6800 models on page 1406</a>
HP LaserJet Workflow Accelerator Card	1MQ5A	<a href="#">Internal assemblies (3 of 9) X654/X677 models on page 1420</a>
HP LaserJet Workflow Keyboard	1MQ2A	<a href="#">Integrated scanner assembly on page 1391</a>
HP MFP Analog Fax 702 Accessory	1MQ0A	<a href="#">Internal assemblies (3 of 7) 6700/6800 models on page 1406</a>
HP MFP Analog Fax 702 Accessory	1MQ0A	<a href="#">Internal assemblies (3 of 9) X654/X677 models on page 1420</a>
HP MFP Analog Fax 703 Accessory	1MQ1A	<a href="#">Internal assemblies (3 of 7) 6700/6800 models on page 1406</a>
HP MFP Analog Fax 703 Accessory	1MQ1A	<a href="#">Internal assemblies (3 of 9) X654/X677 models on page 1420</a>
HP Removable Hard Drive Enclosure	L41606-011	<a href="#">Internal assemblies (3 of 7) 6700/6800 models on page 1406</a>
HP Removable Hard Drive Enclosure	L41606-011	<a href="#">Internal assemblies (3 of 9) X654/X677 models on page 1420</a>

**Table 6-33 Alphabetical parts list (continued)**

Description	Part number	Table and page
HP Toner supply service kit	RM3-0846-000CN	<a href="#">Internal assemblies (8 of 9) X654/X677 models on page 1428</a>
HP W2130YC Black Contract Toner Cartridge	W2130YC	<a href="#">Internal assemblies (7 of 7) 6700/6800 models on page 1414</a>
HP W2131YC Cyan Contract Toner Cartridge	W2131YC	<a href="#">Internal assemblies (7 of 7) 6700/6800 models on page 1414</a>
HP W2132YC Yellow Contract Toner Cartridge	W2132YC	<a href="#">Internal assemblies (7 of 7) 6700/6800 models on page 1414</a>
HP W2133YC Magenta Contract Toner Cartridge	W2133YC	<a href="#">Internal assemblies (7 of 7) 6700/6800 models on page 1414</a>
HP W2140ZC Black Contract Toner Cartridge (SFP)	W2140ZC	<a href="#">Internal assemblies (7 of 7) 6700/6800 models on page 1414</a>
HP W2141ZC Cyan Contract Toner Cartridge (SFP)	W2141ZC	<a href="#">Internal assemblies (7 of 7) 6700/6800 models on page 1414</a>
HP W2142ZC Yellow Contract Toner Cartridge (SFP)	W2142ZC	<a href="#">Internal assemblies (7 of 7) 6700/6800 models on page 1414</a>
HP W2143ZC Magenta Contract Toner Cartridge (SFP)	W2143ZC	<a href="#">Internal assemblies (7 of 7) 6700/6800 models on page 1414</a>
HP W2170ZC Black Contract Toner Cartridge (MFP)	W2170ZC	<a href="#">Internal assemblies (7 of 7) 6700/6800 models on page 1414</a>
HP W2171ZC Cyan Contract Toner Cartridge (MFP)	W2171ZC	<a href="#">Internal assemblies (7 of 7) 6700/6800 models on page 1414</a>
HP W2172ZC Yellow Contract Tone Cartridge (MFP)	W2172ZC	<a href="#">Internal assemblies (7 of 7) 6700/6800 models on page 1414</a>
HP W2173ZC Magenta Contract Toner Cartridge (MFP)	W2173ZC	<a href="#">Internal assemblies (7 of 7) 6700/6800 models on page 1414</a>
HP W9240MC Black Mngd LaserJet Toner Cartridge (SFP)	W9240MC	<a href="#">Internal assemblies (9 of 9) X654/X677 models on page 1430</a>
HP W9241MC Cyan Mngd LaserJet Toner Cartridge (SFP)	W9241MC	<a href="#">Internal assemblies (9 of 9) X654/X677 models on page 1430</a>
HP W9242MC Yellow Mngd LaserJet Toner Cartridge (SFP)	W9242MC	<a href="#">Internal assemblies (9 of 9) X654/X677 models on page 1430</a>

**Table 6-33 Alphabetical parts list (continued)**

<b>Description</b>	<b>Part number</b>	<b>Table and page</b>
HP W9243MC Magenta Mngd LaserJet Toner Cartridge (SFP)	W9243MC	<a href="#">Internal assemblies (9 of 9) X654/X677 models on page 1430</a>
HP W9250MC Black Mngd LaserJet Toner Cartridge (MFP)	W9250MC	<a href="#">Internal assemblies (9 of 9) X654/X677 models on page 1430</a>
HP W9251MC Cyan Mngd LaserJet Toner Cartridge (MFP)	W9251MC	<a href="#">Internal assemblies (9 of 9) X654/X677 models on page 1430</a>
HP W9252MC Yellow Mngd LaserJet Toner Cartridge (MFP)	W9252MC	<a href="#">Internal assemblies (9 of 9) X654/X677 models on page 1430</a>
HP W9253MC Magenta Mngd LaserJet Toner Cartridge (MFP)	W9253MC	<a href="#">Internal assemblies (9 of 9) X654/X677 models on page 1430</a>
HP W9260MC Black Mngd LaserJet Toner Cartridge (SFP)	W9260MC	<a href="#">Internal assemblies (9 of 9) X654/X677 models on page 1430</a>
HP W9261MC Cyan Mngd LaserJet Toner Cartridge (SFP)	W9261MC	<a href="#">Internal assemblies (9 of 9) X654/X677 models on page 1430</a>
HP W9262MC Yellow Mngd LaserJet Toner (SFP)	W9262MC	<a href="#">Internal assemblies (9 of 9) X654/X677 models on page 1430</a>
HP W9263MC Magenta Mngd LaserJet Toner Cartridge (SFP)	W9263MC	<a href="#">Internal assemblies (9 of 9) X654/X677 models on page 1430</a>
HP W9270MC Black Mngd LaserJet Toner Cartridge (MFP)	W9270MC	<a href="#">Internal assemblies (9 of 9) X654/X677 models on page 1430</a>
HP W9271MC Cyan Mngd LaserJet Toner Cartridge (MFP)	W9271MC	<a href="#">Internal assemblies (9 of 9) X654/X677 models on page 1430</a>
HP W9272MC Yellow Mngd LaserJet Toner (MFP)	W9272MC	<a href="#">Internal assemblies (9 of 9) X654/X677 models on page 1430</a>
HP W9273MC Magenta Mngd LaserJet Toner Cartridge (MFP)	W9273MC	<a href="#">Internal assemblies (9 of 9) X654/X677 models on page 1430</a>
HP W9280MC Black Mngd Imaging Drum	W9280MC	<a href="#">Internal assemblies (9 of 9) X654/X677 models on page 1430</a>
HP W9281MC Cyan Mngd Imaging Drum	W9281MC	<a href="#">Internal assemblies (9 of 9) X654/X677 models on page 1430</a>
HP W9282MC Yellow Mngd Imaging Drum	W9282MC	<a href="#">Internal assemblies (9 of 9) X654/X677 models on page 1430</a>

**Table 6-33 Alphabetical parts list (continued)**

Description	Part number	Table and page
HP W9283MC Magenta Mngd Imaging Drum	W9283MC	<a href="#">Internal assemblies (9 of 9) X654/X677 models on page 1430</a>
HV power supply PCA	RM3-9041-000CN	<a href="#">Internal assemblies (4 of 7) 6700/6800 models on page 1409</a>
HV power supply PCA	RM3-9043-000CN	<a href="#">Internal assemblies (4 of 9) X654/X677 models on page 1422</a>
Handle (Lunar Aurora Purple Dark)	5851-8692	<a href="#">Integrated scanner assembly on page 1391</a>
Handle (Lunar Comet Red Dark)	5851-8689	<a href="#">Integrated scanner assembly on page 1391</a>
Handle (Lunar Constellation Yellow)	5851-8691	<a href="#">Integrated scanner assembly on page 1391</a>
Handle (Lunar Cosmic Green Dark)	5851-8690	<a href="#">Integrated scanner assembly on page 1391</a>
Handle (Lunar Grey Dark/ Cement Dark)	5851-8688	<a href="#">Integrated scanner assembly on page 1391</a>
Handle (OOV white)	5851-8693	<a href="#">Integrated scanner assembly on page 1391</a>
Handle, left	RC5-9165-000CN	<a href="#">Covers 6700 models on page 1395</a>
Handle, left	RC5-9165-000CN	<a href="#">Covers X654 models on page 1396</a>
Handle, left	RC5-9165-000CN	<a href="#">Covers 6800 models on page 1398</a>
Handle, left	RC5-9165-000CN	<a href="#">Covers X677 models on page 1401</a>
Handle, right door lower	RC5-8516-000CN	<a href="#">Covers 6700 models on page 1395</a>
Handle, right door lower	RC5-8516-000CN	<a href="#">Covers X654 models on page 1396</a>
Handle, right door lower	RC5-8516-000CN	<a href="#">Covers 6800 models on page 1398</a>
Handle, right door lower	RC5-8516-000CN	<a href="#">Covers X677 models on page 1401</a>
Height wall lower assembly	RM2-3844-000CN	<a href="#">Floor stand staple stacker main body 6800/X677 models on page 1438</a>
Height wall upper assembly	RM2-3845-000CN	<a href="#">Floor stand staple stacker main body 6800/X677 models on page 1438</a>
Holder, drawer connector upper	RC5-9398-000CN	<a href="#">550-sheet paper feeder internal parts and assemblies on page 1433</a>

**Table 6-33 Alphabetical parts list (continued)**

<b>Description</b>	<b>Part number</b>	<b>Table and page</b>
Holder, drawer connector upper	RC5-9398-000CN	<a href="#">HCI main body on page 1435</a>
IMF assembly	RM2-3839-000CN	<a href="#">Floor stand staple stacker main body 6800/X677 models on page 1438</a>
ITB motor assembly	RM3-7797-000CN	<a href="#">Internal assemblies (1 of 7) 6700/6800 models on page 1403</a>
ITB motor assembly	RM3-7797-000CN	<a href="#">Internal assemblies (1 of 9) X654/X677 models on page 1416</a>
Interlock assembly	RM2-3676-000CN	<a href="#">Internal assemblies (5 of 7) 6700/6800 models on page 1411</a>
Interlock assembly	RM2-3676-000CN	<a href="#">Internal assemblies (5 of 9) X654/X677 models on page 1424</a>
Jog assembly	RM3-0481-000CN	<a href="#">3 bin staple stacker main body 6800/X677 models on page 1443</a>
Keyboard Overlay Kit - (DN/FR-Swiss/GN)	A7W13A	<a href="#">Integrated scanner assembly on page 1391</a>
Keyboard Overlay Kit - Chinese	A7W12A	<a href="#">Integrated scanner assembly on page 1391</a>
Kit-Inline Scan Bar (Mngd)	5851-8886	<a href="#">Internal assemblies (8 of 9) X654/X677 models on page 1428</a>
LED PCA	RM3-7937-000CN	<a href="#">Floor stand staple stacker main body 6800/X677 models on page 1438</a>
LVPS (110-127V)	RM3-7726-000CN	<a href="#">Internal assemblies (5 of 7) 6700/6800 models on page 1411</a>
LVPS (110-127V)	RM3-7726-000CN	<a href="#">Internal assemblies (5 of 9) X654/X677 models on page 1424</a>
LVPS (110-127V)	RM3-7728-000CN	<a href="#">Internal assemblies (5 of 7) 6700/6800 models on page 1411</a>
LVPS (110-127V)	RM3-7728-000CN	<a href="#">Internal assemblies (5 of 9) X654/X677 models on page 1424</a>
LVPS (220-240V)	RM3-7727-000CN	<a href="#">Internal assemblies (5 of 7) 6700/6800 models on page 1411</a>
LVPS (220-240V)	RM3-7727-000CN	<a href="#">Internal assemblies (5 of 9) X654/X677 models on page 1424</a>

**Table 6-33 Alphabetical parts list (continued)**

<b>Description</b>	<b>Part number</b>	<b>Table and page</b>
LVPS (220-240V)	RM3-7729-000CN	<a href="#">Internal assemblies (5 of 7) 6700/6800 models on page 1411</a>
LVPS (220-240V)	RM3-7729-000CN	<a href="#">Internal assemblies (5 of 9) X654/X677 models on page 1424</a>
Laser scanner assembly	RM2-3787-000CN	<a href="#">Internal assemblies (1 of 7) 6700/6800 models on page 1403</a>
Laser scanner assembly	RM2-3787-000CN	<a href="#">Internal assemblies (1 of 9) X654/X677 models on page 1416</a>
Left cover assembly	RM2-4535-000CN	<a href="#">Covers 6700 models on page 1395</a>
Left cover assembly	RM2-4535-000CN	<a href="#">Covers X654 models on page 1396</a>
Left cover assembly	RM2-4535-000CN	<a href="#">Covers 6800 models on page 1398</a>
Left cover assembly	RM2-4535-000CN	<a href="#">Covers X677 models on page 1401</a>
Left lower cover	RC5-9408-000CN	<a href="#">Covers X654 models on page 1396</a>
Left lower cover	RC5-9408-000CN	<a href="#">Covers X677 models on page 1401</a>
Lifter base lower assembly	RM2-3842-000CN	<a href="#">Floor stand staple stacker main body 6800/X677 models on page 1438</a>
Lifter base upper assembly	RM2-3843-000CN	<a href="#">Floor stand staple stacker main body 6800/X677 models on page 1438</a>
Lifter drive assembly	RM2-3500-000CN	<a href="#">Internal assemblies (6 of 7) 6700/6800 models on page 1412</a>
Lifter drive assembly	RM2-3501-000CN	<a href="#">Internal assemblies (6 of 9) X654/X677 models on page 1425</a>
Lifter drive assembly	RM2-3501-000CN	<a href="#">550-sheet paper feeder internal parts and assemblies on page 1433</a>
Lifter drive assembly	RM3-0021-000CN	<a href="#">HCI main body on page 1435</a>
Lower front inner cover assembly	RM2-3862-000CN	<a href="#">Floor stand staple stacker main body 6800/X677 models on page 1438</a>
Lower paper feed assembly	RM2-4168-000CN	<a href="#">3 bin staple stacker main body 6800/X677 models on page 1443</a>

**Table 6-33 Alphabetical parts list (continued)**

<b>Description</b>	<b>Part number</b>	<b>Table and page</b>
MBM cover assembly	RM2-3863-000CN	<a href="#">Floor stand staple stacker covers 6800/X677 models on page 1436</a>
Main drive assembly	RM2-3497-000CN	<a href="#">Internal assemblies (1 of 9) X654/X677 models on page 1416</a>
Main drive assembly	RM2-3504-000CN	<a href="#">Internal assemblies (1 of 7) 6700/6800 models on page 1403</a>
Memory PC board assembly	RM2-7138-000CN	<a href="#">Internal assemblies (3 of 7) 6700/6800 models on page 1406</a>
Memory PC board assembly	RM2-7138-000CN	<a href="#">Internal assemblies (3 of 9) X654/X677 models on page 1420</a>
Microswitch	WC4-5136-000CN	<a href="#">3 bin staple stacker main body 6800/X677 models on page 1443</a>
Motor assembly	RM2-4489-000CN	<a href="#">Internal assemblies (3 of 7) 6700/6800 models on page 1406</a>
Motor assembly	RM2-4489-000CN	<a href="#">Internal assemblies (3 of 9) X654/X677 models on page 1420</a>
Motor, stepping	RK2-6027-000CN	<a href="#">Internal assemblies (1 of 7) 6700/6800 models on page 1403</a>
Motor, stepping	RK2-6027-000CN	<a href="#">Internal assemblies (1 of 9) X654/X677 models on page 1416</a>
Motor, stepping DC	RK2-8149-000CN	<a href="#">3 bin staple stacker main body 6800/X677 models on page 1443</a>
Paper delivery assembly	RM2-3555-000CN	<a href="#">Internal assemblies (3 of 7) 6700/6800 models on page 1406</a>
Paper delivery assembly	RM2-3555-000CN	<a href="#">Internal assemblies (3 of 9) X654/X677 models on page 1420</a>
Paper delivery assembly	RM2-3556-000CN	<a href="#">Internal assemblies (3 of 7) 6700/6800 models on page 1406</a>
Paper delivery assembly	RM2-3556-000CN	<a href="#">Internal assemblies (3 of 7) 6700/6800 models on page 1406</a>
Paper delivery assembly	RM2-3556-000CN	<a href="#">Internal assemblies (3 of 9) X654/X677 models on page 1420</a>



**Table 6-33 Alphabetical parts list (continued)**

<b>Description</b>	<b>Part number</b>	<b>Table and page</b>
Paper delivery assembly	RM2-3836-000CN	<a href="#">Floor stand staple stacker main body 6800/X677 models on page 1438</a>
Paper feed assembly	RM2-3479-000CN	<a href="#">Internal assemblies (7 of 9) X654/X677 models on page 1427</a>
Paper feed assembly	RM2-3858-000CN	<a href="#">Intermediate paper transfer unit 6800/X677 models on page 1441</a>
Paper feeder controller PCA	RM3-8051-000CN	<a href="#">550-sheet paper feeder internal parts and assemblies on page 1433</a>
Paper pickup assembly	RM2-3508-000CN	<a href="#">Internal assemblies (6 of 7) 6700/6800 models on page 1412</a>
Paper pickup assembly	RM2-3509-000CN	<a href="#">Internal assemblies (6 of 9) X654/X677 models on page 1425</a>
Paper pickup assembly	RM2-3509-000CN	<a href="#">550-sheet paper feeder internal parts and assemblies on page 1433</a>
Paper pickup assembly	RM2-3509-000CN	<a href="#">HCI main body on page 1435</a>
Paper pickup drive assembly	RM2-3617-000CN	<a href="#">Internal assemblies (6 of 9) X654/X677 models on page 1425</a>
Paper pickup drive assembly	RM2-3617-000CN	<a href="#">550-sheet paper feeder internal parts and assemblies on page 1433</a>
Paper pickup drive assembly	RM2-3617-000CN	<a href="#">HCI main body on page 1435</a>
Paper pickup drive assembly	RM2-3682-000CN	<a href="#">Internal assemblies (6 of 7) 6700/6800 models on page 1412</a>
Paper pickup drive assembly	RM2-3683-000CN	<a href="#">Internal assemblies (3 of 9) X654/X677 models on page 1420</a>
Pick estrangement assembly	RM3-0022-000CN	<a href="#">HCI main body on page 1435</a>
Pin, tray fixed	RC5-0353-000CN	<a href="#">3 bin staple stacker main body 6800/X677 models on page 1443</a>
Pre-exposure PCA holder	RM2-3565-000CN	<a href="#">Internal assemblies (2 of 7) 6700/6800 models on page 1404</a>
Pre-exposure PCA holder	RM2-3673-000CN	<a href="#">Internal assemblies (2 of 9) X654/X677 models on page 1418</a>
Punch assembly	RM2-3834-000CN	<a href="#">Floor stand staple stacker main body 6800/X677 models on page 1438</a>

**Table 6-33 Alphabetical parts list (continued)**

<b>Description</b>	<b>Part number</b>	<b>Table and page</b>
Punch box assembly	RM2-3865-000CN	<a href="#">Floor stand staple stacker main body 6800/X677 models on page 1438</a>
Rear PCA	RM3-9045-000CN	<a href="#">Internal assemblies (4 of 7) 6700/6800 models on page 1409</a>
Rear PCA	RM3-9046-000CN	<a href="#">Internal assemblies (4 of 9) X654/X677 models on page 1422</a>
Rear inner cover assembly	RM3-0485-000CN	<a href="#">3 bin staple stacker covers 6800/X677 models on page 1442</a>
Rear upper cover assembly	RM2-3864-000CN	<a href="#">Floor stand staple stacker covers 6800/X677 models on page 1436</a>
Registration assembly	RM2-4458-000CN	<a href="#">Internal assemblies (2 of 7) 6700/6800 models on page 1404</a>
Registration assembly	RM2-4458-000CN	<a href="#">Internal assemblies (2 of 9) X654/X677 models on page 1418</a>
Right PCA	RM3-7792-000CN	<a href="#">Internal assemblies (1 of 7) 6700/6800 models on page 1403</a>
Right PCA	RM3-7792-000CN	<a href="#">Internal assemblies (1 of 7) 6700/6800 models on page 1403</a>
Right PCA	RM3-7794-000CN	<a href="#">Internal assemblies (1 of 9) X654/X677 models on page 1416</a>
Right door assembly	RM2-4167-000CN	<a href="#">3 bin staple stacker covers 6800/X677 models on page 1442</a>
Right door assembly	RM3-0035-000CN	<a href="#">HCl Covers on page 1434</a>
Right lower door assembly	RM2-3665-000CN	<a href="#">Covers 6700 models on page 1395</a>
Right lower door assembly	RM2-3665-000CN	<a href="#">Covers X654 models on page 1396</a>
Right lower door assembly	RM2-3665-000CN	<a href="#">Covers 6800 models on page 1398</a>
Right lower door assembly	RM2-3665-000CN	<a href="#">Covers X677 models on page 1401</a>
Right lower door assembly	RM3-0004-000CN	<a href="#">Covers X654 models on page 1396</a>
Right lower door assembly	RM3-0004-000CN	<a href="#">Covers X677 models on page 1401</a>
Right lower door assembly	RM3-0004-000CN	<a href="#">550-sheet paper feeder covers, panels, and doors on page 1432</a>

**Table 6-33 Alphabetical parts list (continued)**

<b>Description</b>	<b>Part number</b>	<b>Table and page</b>
Secondary transfer assembly	RM2-3586-000CN	<a href="#">Internal assemblies (2 of 7) 6700/6800 models on page 1404</a>
Secondary transfer assembly	RM2-3628-000CN	<a href="#">Internal assemblies (2 of 7) 6700/6800 models on page 1404</a>
Secondary transfer assembly	RM2-3629-000CN	<a href="#">Internal assemblies (2 of 9) X654/X677 models on page 1418</a>
Sensor PCA	RM3-7738-000CN	<a href="#">Floor stand staple stacker main body 6800/X677 models on page 1438</a>
Sensor PCA	RM3-7934-000CN	<a href="#">Floor stand staple stacker main body 6800/X677 models on page 1438</a>
Sensor, humidity HSU-08FDB2A	WP2-5473-000CN	<a href="#">Internal assemblies (5 of 7) 6700/6800 models on page 1411</a>
Sensor, humidity HSU-08FDB2A	WP2-5473-000CN	<a href="#">Internal assemblies (5 of 9) X654/X677 models on page 1424</a>
Side plate assembly right	RM2-3866-000CN	<a href="#">Floor stand staple stacker main body 6800/X677 models on page 1440</a>
Size detect assembly	RM2-3585-000CN	<a href="#">Internal assemblies (6 of 7) 6700/6800 models on page 1412</a>
Size detect assembly	RM2-3614-000CN	<a href="#">Internal assemblies (6 of 9) X654/X677 models on page 1425</a>
Size detect assembly	RM2-3614-000CN	<a href="#">550-sheet paper feeder internal parts and assemblies on page 1433</a>
Solenoid assembly	RM2-1040-010CN	<a href="#">3 bin staple stacker main body 6800/X677 models on page 1443</a>
Stacking wall assembly	RM3-0480-000CN	<a href="#">3 bin staple stacker main body 6800/X677 models on page 1443</a>
Staple cover assembly	RM3-0483-000CN	<a href="#">3 bin staple stacker covers 6800/X677 models on page 1442</a>
Staple door assembly	RM3-0484-000CN	<a href="#">3 bin staple stacker covers 6800/X677 models on page 1442</a>
Staple stacker PCA	RM3-7931-000CN	<a href="#">Floor stand staple stacker main body 6800/X677 models on page 1440</a>
Staple stacker PCA	RM3-7950-000CN	<a href="#">3 bin staple stacker main body 6800/X677 models on page 1443</a>

**Table 6-33 Alphabetical parts list (continued)**

<b>Description</b>	<b>Part number</b>	<b>Table and page</b>
Stapler assembly	RK2-8148-000CN	<a href="#">Floor stand staple stacker main body 6800/X677 models on page 1440</a>
Stapler assembly	RK2-8148-000CN	<a href="#">3 bin staple stacker main body 6800/X677 models on page 1443</a>
Sub power supply assembly	RM2-3854-000CN	<a href="#">Floor stand staple stacker main body 6800/X677 models on page 1440</a>
Switch back assembly	RM2-3867-000CN	<a href="#">Floor stand staple stacker main body 6800/X677 models on page 1438</a>
T1 solenoid assembly	RM2-7360-000CN	<a href="#">Internal assemblies (1 of 7) 6700/6800 models on page 1403</a>
T1 solenoid assembly	RM2-7360-000CN	<a href="#">Internal assemblies (1 of 9) X654/X677 models on page 1416</a>
Toner supply PCA	RM3-7771-000CN	<a href="#">Internal assemblies (6 of 9) X654/X677 models on page 1425</a>
Toner supply door assembly	RM2-3678-000CN	<a href="#">Covers X654 models on page 1396</a>
Toner supply door assembly	RM2-3678-000CN	<a href="#">Covers X677 models on page 1401</a>
Toner supply drive assembly	RM2-3607-000CN	<a href="#">Internal assemblies (8 of 9) X654/X677 models on page 1428</a>
Toner supply drive assembly	RM2-3608-000CN	<a href="#">Internal assemblies (8 of 9) X654/X677 models on page 1428</a>
Toner supply drive assembly	RM2-3609-000CN	<a href="#">Internal assemblies (8 of 9) X654/X677 models on page 1428</a>
Toner supply drive motor assembly	RM2-3612-000CN	<a href="#">Internal assemblies (6 of 9) X654/X677 models on page 1425</a>
Top front cover assembly	RM2-4518-000CN	<a href="#">Covers 6800 models on page 1398</a>
Top front cover assembly	RM2-4518-000CN	<a href="#">Covers X677 models on page 1401</a>
Tray assembly	RM2-3837-000CN	<a href="#">Floor stand staple stacker main body 6800/X677 models on page 1438</a>
Tray assembly	RM2-4173-000CN	<a href="#">3 bin staple stacker main body 6800/X677 models on page 1443</a>
Tray assembly	RM3-0023-000CN	<a href="#">HCI Covers on page 1434</a>

**Table 6-33 Alphabetical parts list (continued)**

<b>Description</b>	<b>Part number</b>	<b>Table and page</b>
Tray, MBM	RC6-0513-000CN	<a href="#">Floor stand staple stacker main body 6800/X677 models on page 1438</a>
Upper paper feed assembly	RM2-4169-000CN	<a href="#">3 bin staple stacker main body 6800/X677 models on page 1443</a>
Waste toner carry assembly	RM2-3601-000CN	<a href="#">Internal assemblies (7 of 9) X654/X677 models on page 1427</a>
Waste toner duct assembly	RM2-3518-000CN	<a href="#">Internal assemblies (2 of 7) 6700/6800 models on page 1404</a>
Waste toner duct assembly	RM2-3590-000CN	<a href="#">Internal assemblies (2 of 9) X654/X677 models on page 1418</a>
eMMC 16GB	B5L32-60002	<a href="#">Internal assemblies (3 of 7) 6700/6800 models on page 1406</a>
eMMC 16GB	B5L32-60002	<a href="#">Internal assemblies (3 of 9) X654/X677 models on page 1420</a>
eMMC 32GB	B5L32-67001	<a href="#">Internal assemblies (3 of 7) 6700/6800 models on page 1406</a>
eMMC 32GB	B5L32-67001	<a href="#">Internal assemblies (3 of 9) X654/X677 models on page 1420</a>

# Numerical parts list

**Table 6-34 Numerical parts list**

Part number	Description	Table and page
1M0Q0A	HP MFP Analog Fax 702 Accessory	<a href="#">Internal assemblies (3 of 7) 6700/6800 models on page 1406</a>
1M0Q0A	HP MFP Analog Fax 702 Accessory	<a href="#">Internal assemblies (3 of 9) X654/X677 models on page 1420</a>
1M0Q1A	HP MFP Analog Fax 703 Accessory	<a href="#">Internal assemblies (3 of 7) 6700/6800 models on page 1406</a>
1M0Q1A	HP MFP Analog Fax 703 Accessory	<a href="#">Internal assemblies (3 of 9) X654/X677 models on page 1420</a>
1M0Q2A	HP LaserJet Workflow Keyboard	<a href="#">Integrated scanner assembly on page 1391</a>
1M0Q3A	HP JetDirect 3200w BLE/Wireless accessory	<a href="#">Internal assemblies (3 of 7) 6700/6800 models on page 1406</a>
1M0Q3A	HP JetDirect 3200w BLE/Wireless accessory	<a href="#">Internal assemblies (3 of 9) X654/X677 models on page 1420</a>
1M0Q4A	HP LaserJet Secure Solid State Drive	<a href="#">Internal assemblies (3 of 7) 6700/6800 models on page 1406</a>
1M0Q4A	HP LaserJet Secure Solid State Drive	<a href="#">Internal assemblies (3 of 9) X654/X677 models on page 1420</a>
1M0Q5A	HP LaserJet Workflow Accelerator Card	<a href="#">Internal assemblies (3 of 7) 6700/6800 models on page 1406</a>
1M0Q5A	HP LaserJet Workflow Accelerator Card	<a href="#">Internal assemblies (3 of 9) X654/X677 models on page 1420</a>
1M8J0A	HP 4GB DDR3Lx64 204-pin 933MHz DIMM	<a href="#">Internal assemblies (3 of 7) 6700/6800 models on page 1406</a>
1M8J0A	HP 4GB DDR3Lx64 204-pin 933MHz DIMM	<a href="#">Internal assemblies (3 of 9) X654/X677 models on page 1420</a>
1M8J1A	HP 4GB DDR3Lx64 204-pin 933MHz DIMM TAA	<a href="#">Internal assemblies (3 of 7) 6700/6800 models on page 1406</a>
1M8J1A	HP 4GB DDR3Lx64 204-pin 933MHz DIMM TAA	<a href="#">Internal assemblies (3 of 9) X654/X677 models on page 1420</a>
3JN69A	HP JetDirect 3100w BLE/NFC/Wireless accessory	<a href="#">Internal assemblies (3 of 7) 6700/6800 models on page 1406</a>

**Table 6-34 Numerical parts list (continued)**

<b>Part number</b>	<b>Description</b>	<b>Table and page</b>
3JN69A	HP JetDirect 3100w BLE/NFC/Wireless accessory	<a href="#">Internal assemblies (3 of 9) X654/X677 models on page 1420</a>
527F9A	HP LaserJet Toner Collection Unit	<a href="#">Internal assemblies (2 of 7) 6700/6800 models on page 1404</a>
527F9A	HP LaserJet Toner collection unit (TCU)	<a href="#">Internal assemblies (2 of 9) X654/X677 models on page 1418</a>
527G0A	HP LaserJet 110V Fuser Kit	<a href="#">Internal assemblies (3 of 7) 6700/6800 models on page 1406</a>
527G0A	HP LaserJet 110V Fuser Kit	<a href="#">Internal assemblies (3 of 9) X654/X677 models on page 1420</a>
527G1A	HP LaserJet 220V Fuser Kit	<a href="#">Internal assemblies (3 of 7) 6700/6800 models on page 1406</a>
527G1A	HP LaserJet 220V Fuser Kit	<a href="#">Internal assemblies (3 of 9) X654/X677 models on page 1420</a>
527G2A	HP LaserJet 110V Enhanced Fuser Kit	<a href="#">Internal assemblies (3 of 7) 6700/6800 models on page 1406</a>
527G2A	HP LaserJet 110V Enhanced Fuser Kit	<a href="#">Internal assemblies (3 of 9) X654/X677 models on page 1420</a>
527G3A	HP LaserJet 220V Enhanced Fuser Kit	<a href="#">Internal assemblies (3 of 7) 6700/6800 models on page 1406</a>
527G3A	HP LaserJet 220V Enhanced Fuser Kit	<a href="#">Internal assemblies (3 of 9) X654/X677 models on page 1420</a>
527G4MC	HP LaserJet Mngd 110V Enhanced Fuser Kit	<a href="#">Internal assemblies (3 of 9) X654/X677 models on page 1420</a>
527G5MC	HP LaserJet Mngd 220V Enhanced Fuser Kit	<a href="#">Internal assemblies (3 of 9) X654/X677 models on page 1420</a>
527G6A	HP LaserJet 110V Enhanced Fuser Kit	<a href="#">Internal assemblies (3 of 7) 6700/6800 models on page 1406</a>
527G6A	HP LaserJet 110V Enhanced Fuser Kit	<a href="#">Internal assemblies (3 of 9) X654/X677 models on page 1420</a>
527G7A	HP LaserJet 220V Enhanced Fuser Kit	<a href="#">Internal assemblies (3 of 7) 6700/6800 models on page 1406</a>

**Table 6-34 Numerical parts list (continued)**

<b>Part number</b>	<b>Description</b>	<b>Table and page</b>
527G7A	HP LaserJet 220V Enhanced Fuser Kit	<a href="#">Internal assemblies (3 of 9) X654/X677 models on page 1420</a>
527G8A	HP LaserJet Image Transfer Belt	<a href="#">Internal assemblies (5 of 7) 6700/6800 models on page 1411</a>
527G9A	HP LaserJet Image Transfer Belt Kit	<a href="#">Internal assemblies (5 of 7) 6700/6800 models on page 1411</a>
527H0MC	HP LaserJet Mngd Image Transfer Belt	<a href="#">Internal assemblies (5 of 9) X654/X677 models on page 1424</a>
527H1MC	HP LaserJet Managed Trans Roller Kit	<a href="#">Internal assemblies (5 of 9) X654/X677 models on page 1424</a>
527H2A	HP LaserJet Tray 2-x Roller Kit	<a href="#">Internal assemblies (6 of 7) 6700/6800 models on page 1412</a>
527H2A	HP LaserJet Tray 2-x Roller Kit	<a href="#">Internal assemblies (6 of 9) X654/X677 models on page 1425</a>
527H3A	HP LaserJet MP Tray Roller Kit	<a href="#">Covers 6700 models on page 1395</a>
527H3A	HP LaserJet MP Tray Roller Kit	<a href="#">Covers X654 models on page 1396</a>
527H3A	HP LaserJet MP Tray Roller Kit	<a href="#">Covers 6800 models on page 1398</a>
527H3A	HP LaserJet MP Tray Roller Kit	<a href="#">Covers X677 models on page 1401</a>
5851-7005	Assy-USB A F Panel Mount To WTB 335mm	<a href="#">Internal assemblies (6 of 9) X654/X677 models on page 1425</a>
5851-7005	Assy-USB A F Panel Mount To WTB 335mm	<a href="#">Internal assemblies (7 of 9) X654/X677 models on page 1427</a>
5851-7005	Assy-USB A F Panel Mount To WTB 335mm	<a href="#">550-sheet paper feeder internal parts and assemblies on page 1433</a>
5851-7005	Assy-USB A F Panel Mount To WTB 335mm	<a href="#">3 bin staple stacker main body 6800/X677 models on page 1443</a>
5851-8688	Handle (Lunar Grey Dark/ Cement Dark)	<a href="#">Integrated scanner assembly on page 1391</a>
5851-8689	Handle (Lunar Comet Red Dark)	<a href="#">Integrated scanner assembly on page 1391</a>
5851-8690	Handle (Lunar Cosmic Green Dark)	<a href="#">Integrated scanner assembly on page 1391</a>



**Table 6-34 Numerical parts list (continued)**

<b>Part number</b>	<b>Description</b>	<b>Table and page</b>
5851-8691	Handle (Lunar Constellation Yellow)	<a href="#">Integrated scanner assembly on page 1391</a>
5851-8692	Handle (Lunar Aurora Purple Dark)	<a href="#">Integrated scanner assembly on page 1391</a>
5851-8693	Handle (OOV white)	<a href="#">Integrated scanner assembly on page 1391</a>
5851-8842	ADF hinge kit (6xxx Series)	<a href="#">Integrated scanner assembly on page 1391</a>
5851-8844	ADF roller cover (6xxx Series)	<a href="#">Integrated scanner assembly on page 1391</a>
5851-8849	ADF damper	<a href="#">Integrated scanner assembly on page 1391</a>
5851-8850	ADF white backing kit	<a href="#">Integrated scanner assembly on page 1391</a>
5851-8886	Kit-Inline Scan Bar (Mngd)	<a href="#">Internal assemblies (8 of 9) X654/X677 models on page 1428</a>
6H122A	ADF Pick/Sep Roller Kit (6xxx Series)	<a href="#">Integrated scanner assembly on page 1391</a>
6HN31A	HP 500GB CCC FIPS TAA Hard Disk Drive	<a href="#">Internal assemblies (3 of 7) 6700/6800 models on page 1406</a>
6HN31A	HP 500GB CCC FIPS TAA Hard Disk Drive	<a href="#">Internal assemblies (3 of 9) X654/X677 models on page 1420</a>
6M1P3A	ADF Pick/Sep Roller Kit (Flow 6xxx Series)	<a href="#">Integrated scanner assembly on page 1391</a>
6QN28-67001	Control panel 10.9 cm 4.3 in	<a href="#">Control panels on page 1392</a>
6QN32-67002	Formatter (67xx / X65xxx)	<a href="#">Internal assemblies (4 of 7) 6700/6800 models on page 1409</a>
6QN32-67002	Formatter (67xx / X65xxx)	<a href="#">Internal assemblies (4 of 9) X654/X677 models on page 1422</a>
6QN32-67004	Formatter (67xx / X65xxx) (China/India)	<a href="#">Internal assemblies (4 of 7) 6700/6800 models on page 1409</a>
6QN32-67004	Formatter (67xx / X65xxx) (China/India)	<a href="#">Internal assemblies (4 of 9) X654/X677 models on page 1422</a>
6QN35-67002	Formatter (68xx / X67xxx)	<a href="#">Internal assemblies (4 of 7) 6700/6800 models on page 1409</a>
6QN35-67002	Formatter (68xx / X67xxx)	<a href="#">Internal assemblies (4 of 9) X654/X677 models on page 1422</a>
6QN35-67003	Control panel 25.6 cm 10.1 in	<a href="#">Control panels on page 1392</a>

**Table 6-34 Numerical parts list (continued)**

<b>Part number</b>	<b>Description</b>	<b>Table and page</b>
6QN35-67005	Formatter (68xx / X67xxx) (China/India)	<a href="#">Internal assemblies (4 of 7) 6700/6800 models on page 1409</a>
6QN35-67005	Formatter (68xx / X67xxx) (China/India)	<a href="#">Internal assemblies (4 of 9) X654/X677 models on page 1422</a>
6QN35-67006	Flatbed scanner	<a href="#">Integrated scanner assembly on page 1391</a>
6QN37-67001	Control panel 23.3 cm 8 in	<a href="#">Control panels on page 1392</a>
6QN57A	2,100-sheet HCI feeder/stand	<a href="#">HCI main body on page 1435</a>
6QN57A	550-sheet paper feeder (tray)	<a href="#">550-sheet paper feeder internal parts and assemblies on page 1433</a>
6QY68A	HP 2GB DDR3Lx32 120-pin 933MHz DIMM	<a href="#">Internal assemblies (3 of 7) 6700/6800 models on page 1406</a>
6QY68A	HP 2GB DDR3Lx32 120-pin 933MHz DIMM	<a href="#">Internal assemblies (3 of 9) X654/X677 models on page 1420</a>
9EQ11A	HP 500GB CCC FIPS Hard Disk Drive	<a href="#">Internal assemblies (3 of 7) 6700/6800 models on page 1406</a>
9EQ11A	HP 500GB CCC FIPS Hard Disk Drive	<a href="#">Internal assemblies (3 of 9) X654/X677 models on page 1420</a>
A7W12A	Keyboard Overlay Kit - Chinese	<a href="#">Integrated scanner assembly on page 1391</a>
A7W13A	Keyboard Overlay Kit - (DN/FR-Swiss/GN)	<a href="#">Integrated scanner assembly on page 1391</a>
A7W14A	HP LaserJet Swedish Overlay Keyboard	<a href="#">Integrated scanner assembly on page 1391</a>
B5L32-60002	eMMC 16GB	<a href="#">Internal assemblies (3 of 7) 6700/6800 models on page 1406</a>
B5L32-60002	eMMC 16GB	<a href="#">Internal assemblies (3 of 9) X654/X677 models on page 1420</a>
B5L32-67001	eMMC 32GB	<a href="#">Internal assemblies (3 of 7) 6700/6800 models on page 1406</a>
B5L32-67001	eMMC 32GB	<a href="#">Internal assemblies (3 of 9) X654/X677 models on page 1420</a>
J1H98-60037	ADF WUR (6xxx Series Non-Workflow)	<a href="#">Integrated scanner assembly on page 1391</a>
J1H98-60038	ADF WUR (6xxx Series Workflow)	<a href="#">Integrated scanner assembly on page 1391</a>

**Table 6-34 Numerical parts list (continued)**

<b>Part number</b>	<b>Description</b>	<b>Table and page</b>
L41606-011	HP Removable Hard Drive Enclosure	<a href="#">Internal assemblies (3 of 7) 6700/6800 models on page 1406</a>
L41606-011	HP Removable Hard Drive Enclosure	<a href="#">Internal assemblies (3 of 9) X654/X677 models on page 1420</a>
NA	HDD, 500GB 5400RPM FIPS/CCC OPAL2 7MM	<a href="#">Internal assemblies (3 of 7) 6700/6800 models on page 1406</a>
NA	HDD, 500GB 5400RPM FIPS/CCC OPAL2 7MM	<a href="#">Internal assemblies (3 of 9) X654/X677 models on page 1420</a>
RC4-0213-000CN	Cover, Hardware integration pocket (HIP)	<a href="#">Covers 6700 models on page 1395</a>
RC4-0213-000CN	Cover, Hardware integration pocket (HIP)	<a href="#">Covers X654 models on page 1396</a>
RC4-0213-000CN	Cover, Hardware integration pocket (HIP)	<a href="#">Covers 6800 models on page 1398</a>
RC4-0213-000CN	Cover, Hardware integration pocket (HIP)	<a href="#">Covers X677 models on page 1401</a>
RC5-0215-000CN	Cover, MBM rear	<a href="#">Floor stand staple stacker covers 6800/X677 models on page 1436</a>
RC5-0223-000CN	Cover, rear	<a href="#">Floor stand staple stacker covers 6800/X677 models on page 1436</a>
RC5-0353-000CN	Pin, tray fixed	<a href="#">3 bin staple stacker main body 6800/X677 models on page 1443</a>
RC5-8516-000CN	Handle, right door lower	<a href="#">Covers 6700 models on page 1395</a>
RC5-8516-000CN	Handle, right door lower	<a href="#">Covers X654 models on page 1396</a>
RC5-8516-000CN	Handle, right door lower	<a href="#">Covers 6800 models on page 1398</a>
RC5-8516-000CN	Handle, right door lower	<a href="#">Covers X677 models on page 1401</a>
RC5-9165-000CN	Handle, left	<a href="#">Covers 6700 models on page 1395</a>
RC5-9165-000CN	Handle, left	<a href="#">Covers X654 models on page 1396</a>
RC5-9165-000CN	Handle, left	<a href="#">Covers 6800 models on page 1398</a>
RC5-9165-000CN	Handle, left	<a href="#">Covers X677 models on page 1401</a>
RC5-9168-000CN	Cover, rear lower	<a href="#">Covers 6700 models on page 1395</a>

**Table 6-34 Numerical parts list (continued)**

<b>Part number</b>	<b>Description</b>	<b>Table and page</b>
RC5-9168-000CN	Cover, rear lower	<a href="#">Covers X654 models on page 1396</a>
RC5-9168-000CN	Cover, rear lower	<a href="#">Covers 6800 models on page 1398</a>
RC5-9168-000CN	Cover, rear lower	<a href="#">Covers X677 models on page 1401</a>
RC5-9172-000CN	Cover, top assembly	<a href="#">Covers 6800 models on page 1398</a>
RC5-9172-000CN	Cover, top assembly	<a href="#">Covers X677 models on page 1401</a>
RC5-9198-000CN	Cover, front left	<a href="#">Covers 6700 models on page 1395</a>
RC5-9198-000CN	Cover, front left	<a href="#">Covers X654 models on page 1396</a>
RC5-9198-000CN	Cover, front left	<a href="#">Covers 6800 models on page 1398</a>
RC5-9198-000CN	Cover, front left	<a href="#">Covers X677 models on page 1401</a>
RC5-9199-000CN	Cover, front right	<a href="#">Covers 6700 models on page 1395</a>
RC5-9199-000CN	Cover, front right	<a href="#">Covers X654 models on page 1396</a>
RC5-9199-000CN	Cover, front right	<a href="#">Covers 6800 models on page 1398</a>
RC5-9199-000CN	Cover, front right	<a href="#">Covers X677 models on page 1401</a>
RC5-9200-000CN	Cover, front left	<a href="#">550-sheet paper feeder covers, panels, and doors on page 1432</a>
RC5-9201-000CN	Cover, front right	<a href="#">550-sheet paper feeder covers, panels, and doors on page 1432</a>
RC5-9204-000CN	Cover, left upper	<a href="#">Covers 6700 models on page 1395</a>
RC5-9204-000CN	Cover, left upper	<a href="#">Covers X654 models on page 1396</a>
RC5-9204-000CN	Cover, left upper	<a href="#">Covers 6800 models on page 1398</a>
RC5-9204-000CN	Cover, left upper	<a href="#">Covers X677 models on page 1401</a>
RC5-9398-000CN	Holder, drawer connector upper	<a href="#">550-sheet paper feeder internal parts and assemblies on page 1433</a>
RC5-9398-000CN	Holder, drawer connector upper	<a href="#">HCI main body on page 1435</a>
RC5-9408-000CN	Cover, left	<a href="#">550-sheet paper feeder covers, panels, and doors on page 1432</a>

**Table 6-34 Numerical parts list (continued)**

<b>Part number</b>	<b>Description</b>	<b>Table and page</b>
RC5-9408-000CN	Left lower cover	<a href="#">Covers X654 models on page 1396</a>
RC5-9408-000CN	Left lower cover	<a href="#">Covers X677 models on page 1401</a>
RC5-9409-000CN	Cover, rear lower	<a href="#">Covers X654 models on page 1396</a>
RC5-9409-000CN	Cover, rear lower	<a href="#">Covers X677 models on page 1401</a>
RC5-9409-000CN	Cover, rear lower	<a href="#">550-sheet paper feeder covers, panels, and doors on page 1432</a>
RC5-9692-000CN	Cover, left	<a href="#">HCI Covers on page 1434</a>
RC5-9693-000CN	Cover, rear	<a href="#">HCI Covers on page 1434</a>
RC5-9695-000CN	Cover, rear lower	<a href="#">HCI Covers on page 1434</a>
RC5-9696-000CN	Cover, front left	<a href="#">HCI Covers on page 1434</a>
RC6-0186-000CN	Cover, front inner upper	<a href="#">Floor stand staple stacker main body 6800/X677 models on page 1438</a>
RC6-0213-000CN	Cover, rear left	<a href="#">Floor stand staple stacker covers 6800/X677 models on page 1436</a>
RC6-0214-000CN	Cover, MBM front	<a href="#">Floor stand staple stacker covers 6800/X677 models on page 1436</a>
RC6-0220-000CN	Cover, foot front	<a href="#">Floor stand staple stacker covers 6800/X677 models on page 1436</a>
RC6-0222-000CN	Cover, foot rear	<a href="#">Floor stand staple stacker covers 6800/X677 models on page 1436</a>
RC6-0222-000CN	Cover, foot rear	<a href="#">Floor stand staple stacker covers 6800/X677 models on page 1436</a>
RC6-0226-000CN	Cover, foot front (tall model)	<a href="#">Floor stand staple stacker covers 6800/X677 models on page 1436</a>
RC6-0227-000CN	Cover, foot center	<a href="#">Floor stand staple stacker covers 6800/X677 models on page 1436</a>
RC6-0229-000CN	Cover, foot	<a href="#">Floor stand staple stacker covers 6800/X677 models on page 1436</a>
RC6-0513-000CN	Tray, MBM	<a href="#">Floor stand staple stacker main body 6800/X677 models on page 1438</a>
RC6-1305-000CN	Cover, rear	<a href="#">3 bin staple stacker covers 6800/X677 models on page 1442</a>

**Table 6-34 Numerical parts list (continued)**

<b>Part number</b>	<b>Description</b>	<b>Table and page</b>
RC6-1307-000CN	Cover, corner right	<a href="#">3 bin staple stacker covers 6800/X677 models on page 1442</a>
RC6-1308-000CN	Cover, right upper	<a href="#">3 bin staple stacker covers 6800/X677 models on page 1442</a>
RC6-1309-000CN	Cover, right lower	<a href="#">3 bin staple stacker covers 6800/X677 models on page 1442</a>
RC6-1310-000CN	Cover, stapler rear	<a href="#">3 bin staple stacker covers 6800/X677 models on page 1442</a>
RC6-2356-000CN	Cover, left front	<a href="#">3 bin staple stacker covers 6800/X677 models on page 1442</a>
RC6-2402-000CN	Cover, front inner right lower	<a href="#">Floor stand staple stacker main body 6800/X677 models on page 1440</a>
RC6-2406-000CN	Cover, harness	<a href="#">Intermediate paper transfer unit 6800/X677 models on page 1441</a>
RK2-6027-000CN	Motor, stepping	<a href="#">Internal assemblies (1 of 7) 6700/6800 models on page 1403</a>
RK2-6027-000CN	Motor, stepping	<a href="#">Internal assemblies (1 of 9) X654/X677 models on page 1416</a>
RK2-8148-000CN	Stapler assembly	<a href="#">Floor stand staple stacker main body 6800/X677 models on page 1440</a>
RK2-8148-000CN	Stapler assembly	<a href="#">3 bin staple stacker main body 6800/X677 models on page 1443</a>
RK2-8149-000CN	Motor, stepping DC	<a href="#">3 bin staple stacker main body 6800/X677 models on page 1443</a>
RK2-8153-000CN	Fan	<a href="#">3 bin staple stacker main body 6800/X677 models on page 1443</a>
RK3-0760-000CN	Fan	<a href="#">Internal assemblies (4 of 7) 6700/6800 models on page 1409</a>
RK3-0760-000CN	Fan	<a href="#">Internal assemblies (4 of 9) X654/X677 models on page 1422</a>
RK3-0762-000CN	Fan	<a href="#">Internal assemblies (3 of 7) 6700/6800 models on page 1406</a>
RK3-0762-000CN	Fan	<a href="#">Internal assemblies (3 of 7) 6700/6800 models on page 1406</a>
RK3-0762-000CN	Fan	<a href="#">Internal assemblies (3 of 9) X654/X677 models on page 1420</a>

**Table 6-34 Numerical parts list (continued)**

<b>Part number</b>	<b>Description</b>	<b>Table and page</b>
RK3-0817-000CN	Cable, flat FMTR	<a href="#">Internal assemblies (3 of 7) 6700/6800 models on page 1406</a>
RK3-0817-000CN	Cable, flat FMTR	<a href="#">Internal assemblies (3 of 9) X654/X677 models on page 1420</a>
RK3-0819-000CN	Cable, flat drive	<a href="#">Internal assemblies (4 of 7) 6700/6800 models on page 1409</a>
RK3-0819-000CN	Cable, flat drive	<a href="#">Internal assemblies (4 of 9) X654/X677 models on page 1422</a>
RK3-0821-000CN	Cable, flat drive	<a href="#">Internal assemblies (4 of 7) 6700/6800 models on page 1409</a>
RK3-0821-000CN	Cable, flat drive	<a href="#">Internal assemblies (4 of 9) X654/X677 models on page 1422</a>
RK3-0825-000CN	Cable, flat SCN	<a href="#">Internal assemblies (1 of 7) 6700/6800 models on page 1403</a>
RK3-0825-000CN	Cable, flat SCN	<a href="#">Internal assemblies (1 of 9) X654/X677 models on page 1416</a>
RK3-0827-000CN	Cable, flat LVPS	<a href="#">Internal assemblies (5 of 7) 6700/6800 models on page 1411</a>
RK3-0827-000CN	Cable, flat LVPS	<a href="#">Internal assemblies (5 of 9) X654/X677 models on page 1424</a>
RK3-0837-000	CABLE, FLAT, FMTR	<a href="#">Internal assemblies (3 of 7) 6700/6800 models on page 1406</a>
RK3-0847-000CN	Cable, flat FMTR	<a href="#">Internal assemblies (3 of 9) X654/X677 models on page 1420</a>
RK3-1509-000CN	Cable, flat HVT	<a href="#">Internal assemblies (4 of 7) 6700/6800 models on page 1409</a>
RK3-1509-000CN	Cable, flat HVT	<a href="#">Internal assemblies (4 of 9) X654/X677 models on page 1422</a>
RK3-1692-000CN	Cable, flat rear	<a href="#">Internal assemblies (4 of 7) 6700/6800 models on page 1409</a>
RK3-1693-000CN	Cable, flat rear	<a href="#">Internal assemblies (4 of 9) X654/X677 models on page 1422</a>

**Table 6-34 Numerical parts list (continued)**

<b>Part number</b>	<b>Description</b>	<b>Table and page</b>
RK3-1694-000CN	Cable, flat right	<a href="#">Internal assemblies (4 of 9) 6700/6800 models on page 1409</a>
RK3-1694-000CN	Cable, flat right	<a href="#">Internal assemblies (4 of 9) X654/X677 models on page 1422</a>
RK3-2277-000CN	Fan	<a href="#">Internal assemblies (5 of 7) 6700/6800 models on page 1411</a>
RK3-2277-000CN	Fan	<a href="#">Internal assemblies (5 of 9) X654/X677 models on page 1424</a>
RM2-0918-000CN	Auto close assembly	<a href="#">HCI main body on page 1435</a>
RM2-1040-010CN	Solenoid assembly	<a href="#">3 bin staple stacker main body 6800/X677 models on page 1443</a>
RM2-3479-000CN	Paper feed assembly	<a href="#">Internal assemblies (7 of 9) X654/X677 models on page 1427</a>
RM2-3497-000CN	Main drive assembly	<a href="#">Internal assemblies (1 of 9) X654/X677 models on page 1416</a>
RM2-3500-000CN	Lifter drive assembly	<a href="#">Internal assemblies (6 of 7) 6700/6800 models on page 1412</a>
RM2-3501-000CN	Lifter drive assembly	<a href="#">Internal assemblies (6 of 9) X654/X677 models on page 1425</a>
RM2-3501-000CN	Lifter drive assembly	<a href="#">550-sheet paper feeder internal parts and assemblies on page 1433</a>
RM2-3504-000CN	Main drive assembly	<a href="#">Internal assemblies (1 of 7) 6700/6800 models on page 1403</a>
RM2-3508-000CN	Paper pickup assembly	<a href="#">Internal assemblies (6 of 7) 6700/6800 models on page 1412</a>
RM2-3509-000CN	Paper pickup assembly	<a href="#">Internal assemblies (6 of 9) X654/X677 models on page 1425</a>
RM2-3509-000CN	Paper pickup assembly	<a href="#">550-sheet paper feeder internal parts and assemblies on page 1433</a>
RM2-3509-000CN	Paper pickup assembly	<a href="#">HCI main body on page 1435</a>
RM2-3518-000CN	Waste toner duct assembly	<a href="#">Internal assemblies (2 of 7) 6700/6800 models on page 1404</a>



**Table 6-34 Numerical parts list (continued)**

<b>Part number</b>	<b>Description</b>	<b>Table and page</b>
RM2-3555-000CN	Paper delivery assembly	<a href="#">Internal assemblies (3 of 7) 6700/6800 models on page 1406</a>
RM2-3555-000CN	Paper delivery assembly	<a href="#">Internal assemblies (3 of 9) X654/X677 models on page 1420</a>
RM2-3556-000CN	Paper delivery assembly	<a href="#">Internal assemblies (3 of 7) 6700/6800 models on page 1406</a>
RM2-3556-000CN	Paper delivery assembly	<a href="#">Internal assemblies (3 of 7) 6700/6800 models on page 1406</a>
RM2-3556-000CN	Paper delivery assembly	<a href="#">Internal assemblies (3 of 9) X654/X677 models on page 1420</a>
RM2-3559-000CN	Auto close assembly	<a href="#">Internal assemblies (6 of 7) 6700/6800 models on page 1412</a>
RM2-3559-000CN	Auto close assembly	<a href="#">Internal assemblies (6 of 9) X654/X677 models on page 1425</a>
RM2-3559-000CN	Auto close assembly	<a href="#">550-sheet paper feeder internal parts and assemblies on page 1433</a>
RM2-3565-000CN	Pre-exposure PCA holder	<a href="#">Internal assemblies (2 of 7) 6700/6800 models on page 1404</a>
RM2-3585-000CN	Size detect assembly	<a href="#">Internal assemblies (6 of 7) 6700/6800 models on page 1412</a>
RM2-3586-000CN	Secondary transfer assembly	<a href="#">Internal assemblies (2 of 7) 6700/6800 models on page 1404</a>
RM2-3590-000CN	Waste toner duct assembly	<a href="#">Internal assemblies (2 of 9) X654/X677 models on page 1418</a>
RM2-3601-000CN	Waste toner carry assembly	<a href="#">Internal assemblies (7 of 9) X654/X677 models on page 1427</a>
RM2-3607-000CN	Toner supply drive assembly	<a href="#">Internal assemblies (8 of 9) X654/X677 models on page 1428</a>
RM2-3608-000CN	Toner supply drive assembly	<a href="#">Internal assemblies (8 of 9) X654/X677 models on page 1428</a>
RM2-3609-000CN	Toner supply drive assembly	<a href="#">Internal assemblies (8 of 9) X654/X677 models on page 1428</a>

**Table 6-34 Numerical parts list (continued)**

<b>Part number</b>	<b>Description</b>	<b>Table and page</b>
RM2-3612-000CN	Toner supply drive motor assembly	<a href="#">Internal assemblies (6 of 9) X654/X677 models on page 1425</a>
RM2-3614-000CN	Size detect assembly	<a href="#">Internal assemblies (6 of 9) X654/X677 models on page 1425</a>
RM2-3614-000CN	Size detect assembly	<a href="#">550-sheet paper feeder internal parts and assemblies on page 1433</a>
RM2-3616-000CN	Cassette assembly	<a href="#">Internal assemblies (6 of 7) 6700/6800 models on page 1412</a>
RM2-3616-000CN	Cassette assembly	<a href="#">Internal assemblies (6 of 9) X654/X677 models on page 1425</a>
RM2-3617-000CN	Paper pickup drive assembly	<a href="#">Internal assemblies (6 of 9) X654/X677 models on page 1425</a>
RM2-3617-000CN	Paper pickup drive assembly	<a href="#">550-sheet paper feeder internal parts and assemblies on page 1433</a>
RM2-3617-000CN	Paper pickup drive assembly	<a href="#">HCI main body on page 1435</a>
RM2-3625-000CN	Developing motor assembly	<a href="#">Internal assemblies (1 of 7) 6700/6800 models on page 1403</a>
RM2-3625-000CN	Developing motor assembly	<a href="#">Internal assemblies (1 of 9) X654/X677 models on page 1416</a>
RM2-3628-000CN	Secondary transfer assembly	<a href="#">Internal assemblies (2 of 7) 6700/6800 models on page 1404</a>
RM2-3629-000CN	Secondary transfer assembly	<a href="#">Internal assemblies (2 of 9) X654/X677 models on page 1418</a>
RM2-3640-000CN	Cassette assembly	<a href="#">550-sheet paper feeder covers, panels, and doors on page 1432</a>
RM2-3665-000CN	Right lower door assembly	<a href="#">Covers 6700 models on page 1395</a>
RM2-3665-000CN	Right lower door assembly	<a href="#">Covers X654 models on page 1396</a>
RM2-3665-000CN	Right lower door assembly	<a href="#">Covers 6800 models on page 1398</a>
RM2-3665-000CN	Right lower door assembly	<a href="#">Covers X677 models on page 1401</a>
RM2-3673-000CN	Pre-exposure PCA holder	<a href="#">Internal assemblies (2 of 9) X654/X677 models on page 1418</a>

**Table 6-34 Numerical parts list (continued)**

<b>Part number</b>	<b>Description</b>	<b>Table and page</b>
RM2-3676-000CN	Interlock assembly	<a href="#">Internal assemblies (5 of 7) 6700/6800 models on page 1411</a>
RM2-3676-000CN	Interlock assembly	<a href="#">Internal assemblies (5 of 9) X654/X677 models on page 1424</a>
RM2-3678-000CN	Toner supply door assembly	<a href="#">Covers X654 models on page 1396</a>
RM2-3678-000CN	Toner supply door assembly	<a href="#">Covers X677 models on page 1401</a>
RM2-3682-000CN	Paper pickup drive assembly	<a href="#">Internal assemblies (6 of 7) 6700/6800 models on page 1412</a>
RM2-3683-000CN	Paper pickup drive assembly	<a href="#">Internal assemblies (3 of 9) X654/X677 models on page 1420</a>
RM2-3787-000CN	Laser scanner assembly	<a href="#">Internal assemblies (1 of 7) 6700/6800 models on page 1403</a>
RM2-3787-000CN	Laser scanner assembly	<a href="#">Internal assemblies (1 of 9) X654/X677 models on page 1416</a>
RM2-3833-000CN	Alignment assembly	<a href="#">Floor stand staple stacker main body 6800/X677 models on page 1440</a>
RM2-3834-000CN	Punch assembly	<a href="#">Floor stand staple stacker main body 6800/X677 models on page 1438</a>
RM2-3836-000CN	Paper delivery assembly	<a href="#">Floor stand staple stacker main body 6800/X677 models on page 1438</a>
RM2-3837-000CN	Tray assembly	<a href="#">Floor stand staple stacker main body 6800/X677 models on page 1438</a>
RM2-3839-000CN	IMF assembly	<a href="#">Floor stand staple stacker main body 6800/X677 models on page 1438</a>
RM2-3842-000CN	Lifter base lower assembly	<a href="#">Floor stand staple stacker main body 6800/X677 models on page 1438</a>
RM2-3843-000CN	Lifter base upper assembly	<a href="#">Floor stand staple stacker main body 6800/X677 models on page 1438</a>
RM2-3844-000CN	Height wall lower assembly	<a href="#">Floor stand staple stacker main body 6800/X677 models on page 1438</a>
RM2-3845-000CN	Height wall upper assembly	<a href="#">Floor stand staple stacker main body 6800/X677 models on page 1438</a>

**Table 6-34 Numerical parts list (continued)**

<b>Part number</b>	<b>Description</b>	<b>Table and page</b>
RM2-3847-000CN	Drum drive assembly	<a href="#">Floor stand staple stacker main body 6800/X677 models on page 1440</a>
RM2-3848-000CN	Drum assembly	<a href="#">Floor stand staple stacker main body 6800/X677 models on page 1440</a>
RM2-3849-000CN	Door handle rail assembly	<a href="#">Floor stand staple stacker main body 6800/X677 models on page 1440</a>
RM2-3854-000CN	Sub power supply assembly	<a href="#">Floor stand staple stacker main body 6800/X677 models on page 1440</a>
RM2-3857-000CN	Front cover assembly	<a href="#">Floor stand staple stacker covers 6800/X677 models on page 1436</a>
RM2-3858-000CN	Paper feed assembly	<a href="#">Intermediate paper transfer unit 6800/X677 models on page 1441</a>
RM2-3859-000CN	Connecting assembly	<a href="#">Intermediate paper transfer unit 6800/X677 models on page 1441</a>
RM2-3861-000CN	Front inner cover assembly	<a href="#">Floor stand staple stacker main body 6800/X677 models on page 1440</a>
RM2-3862-000CN	Lower front inner cover assembly	<a href="#">Floor stand staple stacker main body 6800/X677 models on page 1438</a>
RM2-3863-000CN	MBM cover assembly	<a href="#">Floor stand staple stacker covers 6800/X677 models on page 1436</a>
RM2-3864-000CN	Rear upper cover assembly	<a href="#">Floor stand staple stacker covers 6800/X677 models on page 1436</a>
RM2-3865-000CN	Punch box assembly	<a href="#">Floor stand staple stacker main body 6800/X677 models on page 1438</a>
RM2-3866-000CN	Side plate assembly right	<a href="#">Floor stand staple stacker main body 6800/X677 models on page 1440</a>
RM2-3867-000CN	Switch back assembly	<a href="#">Floor stand staple stacker main body 6800/X677 models on page 1438</a>
RM2-4167-000CN	Right door assembly	<a href="#">3 bin staple stacker covers 6800/X677 models on page 1442</a>
RM2-4168-000CN	Lower paper feed assembly	<a href="#">3 bin staple stacker main body 6800/X677 models on page 1443</a>
RM2-4169-000CN	Upper paper feed assembly	<a href="#">3 bin staple stacker main body 6800/X677 models on page 1443</a>

**Table 6-34 Numerical parts list (continued)**

<b>Part number</b>	<b>Description</b>	<b>Table and page</b>
RM2-4173-000CN	Tray assembly	<a href="#">3 bin staple stacker main body 6800/X677 models on page 1443</a>
RM2-4458-000CN	Registration assembly	<a href="#">Internal assemblies (2 of 7) 6700/6800 models on page 1404</a>
RM2-4458-000CN	Registration assembly	<a href="#">Internal assemblies (2 of 9) X654/X677 models on page 1418</a>
RM2-4471-000CN	Face down tray assembly	<a href="#">Covers 6700 models on page 1395</a>
RM2-4471-000CN	Face down tray assembly	<a href="#">Covers X654 models on page 1396</a>
RM2-4471-000CN	Face down tray assembly	<a href="#">Covers 6800 models on page 1398</a>
RM2-4471-000CN	Face down tray assembly	<a href="#">Covers X677 models on page 1401</a>
RM2-4479-000CN	Front door assembly	<a href="#">Covers X654 models on page 1396</a>
RM2-4479-000CN	Front door assembly	<a href="#">Covers X677 models on page 1401</a>
RM2-4480-000CN	Formatter cover assembly	<a href="#">Covers 6700 models on page 1395</a>
RM2-4480-000CN	Formatter cover assembly	<a href="#">Covers X654 models on page 1396</a>
RM2-4480-000CN	Formatter cover assembly	<a href="#">Covers 6800 models on page 1398</a>
RM2-4480-000CN	Formatter cover assembly	<a href="#">Covers X677 models on page 1401</a>
RM2-4487-000CN	Fixing drive assembly	<a href="#">Internal assemblies (3 of 7) 6700/6800 models on page 1406</a>
RM2-4487-000CN	Fixing drive assembly	<a href="#">Internal assemblies (3 of 9) X654/X677 models on page 1420</a>
RM2-4488-000CN	Fixing motor assembly	<a href="#">Internal assemblies (3 of 7) 6700/6800 models on page 1406</a>
RM2-4488-000CN	Fixing motor assembly	<a href="#">Internal assemblies (3 of 9) X654/X677 models on page 1420</a>
RM2-4489-000CN	Motor assembly	<a href="#">Internal assemblies (3 of 7) 6700/6800 models on page 1406</a>
RM2-4489-000CN	Motor assembly	<a href="#">Internal assemblies (3 of 9) X654/X677 models on page 1420</a>

**Table 6-34 Numerical parts list (continued)**

<b>Part number</b>	<b>Description</b>	<b>Table and page</b>
RM2-4492-000CN	Density detect assembly	<a href="#">Internal assemblies (2 of 7) 6700/6800 models on page 1404</a>
RM2-4492-000CN	Density detect assembly	<a href="#">Internal assemblies (2 of 9) X654/X677 models on page 1418</a>
RM2-4517-000CN	Cover, top assembly	<a href="#">Covers 6700 models on page 1395</a>
RM2-4517-000CN	Cover, top assembly	<a href="#">Covers X654 models on page 1396</a>
RM2-4518-000CN	Top front cover assembly	<a href="#">Covers 6800 models on page 1398</a>
RM2-4518-000CN	Top front cover assembly	<a href="#">Covers X677 models on page 1401</a>
RM2-4520-000CN	Formatter cage assembly	<a href="#">Internal assemblies (3 of 7) 6700/6800 models on page 1406</a>
RM2-4521-000CN	Formatter cage assembly	<a href="#">Internal assemblies (3 of 7) 6700/6800 models on page 1406</a>
RM2-4521-000CN	Formatter cage assembly	<a href="#">Internal assemblies (3 of 9) X654/X677 models on page 1420</a>
RM2-4530-000CN	Formatter cover assembly	<a href="#">Covers 6800 models on page 1398</a>
RM2-4530-000CN	Formatter cover assembly	<a href="#">Covers X677 models on page 1401</a>
RM2-4533-000CN	Front door assembly	<a href="#">Covers 6700 models on page 1395</a>
RM2-4533-000CN	Front door assembly	<a href="#">Covers 6800 models on page 1398</a>
RM2-4535-000CN	Left cover assembly	<a href="#">Covers 6700 models on page 1395</a>
RM2-4535-000CN	Left cover assembly	<a href="#">Covers X654 models on page 1396</a>
RM2-4535-000CN	Left cover assembly	<a href="#">Covers 6800 models on page 1398</a>
RM2-4535-000CN	Left cover assembly	<a href="#">Covers X677 models on page 1401</a>
RM2-7138-000CN	Memory PC board assembly	<a href="#">Internal assemblies (3 of 7) 6700/6800 models on page 1406</a>
RM2-7138-000CN	Memory PC board assembly	<a href="#">Internal assemblies (3 of 9) X654/X677 models on page 1420</a>

**Table 6-34 Numerical parts list (continued)**

<b>Part number</b>	<b>Description</b>	<b>Table and page</b>
RM2-7360-000CN	T1 solenoid assembly	<a href="#">Internal assemblies (1 of 7) 6700/6800 models on page 1403</a>
RM2-7360-000CN	T1 solenoid assembly	<a href="#">Internal assemblies (1 of 9) X654/X677 models on page 1416</a>
RM3-0004-000CN	Right lower door assembly	<a href="#">Covers X654 models on page 1396</a>
RM3-0004-000CN	Right lower door assembly	<a href="#">Covers X677 models on page 1401</a>
RM3-0004-000CN	Right lower door assembly	<a href="#">550-sheet paper feeder covers, panels, and doors on page 1432</a>
RM3-0021-000CN	Lifter drive assembly	<a href="#">HCI main body on page 1435</a>
RM3-0022-000CN	Pick estrangement assembly	<a href="#">HCI main body on page 1435</a>
RM3-0023-000CN	Tray assembly	<a href="#">HCI Covers on page 1434</a>
RM3-0035-000CN	Right door assembly	<a href="#">HCI Covers on page 1434</a>
RM3-0480-000CN	Stacking wall assembly	<a href="#">3 bin staple stacker main body 6800/X677 models on page 1443</a>
RM3-0481-000CN	Jog assembly	<a href="#">3 bin staple stacker main body 6800/X677 models on page 1443</a>
RM3-0483-000CN	Staple cover assembly	<a href="#">3 bin staple stacker covers 6800/X677 models on page 1442</a>
RM3-0484-000CN	Staple door assembly	<a href="#">3 bin staple stacker covers 6800/X677 models on page 1442</a>
RM3-0485-000CN	Rear inner cover assembly	<a href="#">3 bin staple stacker covers 6800/X677 models on page 1442</a>
RM3-0846-000CN	HP Toner supply service kit	<a href="#">Internal assemblies (8 of 9) X654/X677 models on page 1428</a>
RM3-7647-000CN	Drum position sensor PCA	<a href="#">Internal assemblies (1 of 7) 6700/6800 models on page 1403</a>
RM3-7647-000CN	Drum position sensor PCA	<a href="#">Internal assemblies (1 of 9) X654/X677 models on page 1416</a>
RM3-7722-000CN	Driver PCA	<a href="#">Internal assemblies (1 of 7) 6700/6800 models on page 1403</a>
RM3-7722-000CN	Driver PCA	<a href="#">Internal assemblies (1 of 9) X654/X677 models on page 1416</a>
RM3-7726-000CN	LVPS (110-127V)	<a href="#">Internal assemblies (5 of 7) 6700/6800 models on page 1411</a>

**Table 6-34 Numerical parts list (continued)**

<b>Part number</b>	<b>Description</b>	<b>Table and page</b>
RM3-7726-000CN	LVPS (110-127V)	<a href="#">Internal assemblies (5 of 9) X654/X677 models on page 1424</a>
RM3-7727-000CN	LVPS (220-240V)	<a href="#">Internal assemblies (5 of 7) 6700/6800 models on page 1411</a>
RM3-7727-000CN	LVPS (220-240V)	<a href="#">Internal assemblies (5 of 9) X654/X677 models on page 1424</a>
RM3-7728-000CN	LVPS (110-127V)	<a href="#">Internal assemblies (5 of 7) 6700/6800 models on page 1411</a>
RM3-7728-000CN	LVPS (110-127V)	<a href="#">Internal assemblies (5 of 9) X654/X677 models on page 1424</a>
RM3-7729-000CN	LVPS (220-240V)	<a href="#">Internal assemblies (5 of 7) 6700/6800 models on page 1411</a>
RM3-7729-000CN	LVPS (220-240V)	<a href="#">Internal assemblies (5 of 9) X654/X677 models on page 1424</a>
RM3-7738-000CN	Sensor PCA	<a href="#">Floor stand staple stacker main body 6800/X677 models on page 1438</a>
RM3-7753-000CN	DC controller PCA	<a href="#">Internal assemblies (4 of 7) 6700/6800 models on page 1409</a>
RM3-7754-000CN	DC controller PCA	<a href="#">Internal assemblies (4 of 7) 6700/6800 models on page 1409</a>
RM3-7758-000CN	DC controller PCA	<a href="#">Internal assemblies (4 of 9) X654/X677 models on page 1422</a>
RM3-7771-000CN	Toner supply PCA	<a href="#">Internal assemblies (6 of 9) X654/X677 models on page 1425</a>
RM3-7788-000CN	Drum motor assembly	<a href="#">Internal assemblies (1 of 7) 6700/6800 models on page 1403</a>
RM3-7788-000CN	Drum motor assembly	<a href="#">Internal assemblies (1 of 9) X654/X677 models on page 1416</a>
RM3-7792-000CN	Right PCA	<a href="#">Internal assemblies (1 of 7) 6700/6800 models on page 1403</a>
RM3-7792-000CN	Right PCA	<a href="#">Internal assemblies (1 of 7) 6700/6800 models on page 1403</a>



**Table 6-34 Numerical parts list (continued)**

<b>Part number</b>	<b>Description</b>	<b>Table and page</b>
RM3-7794-000CN	Right PCA	<a href="#">Internal assemblies (1 of 9) X654/X677 models on page 1416</a>
RM3-7797-000CN	ITB motor assembly	<a href="#">Internal assemblies (1 of 7) 6700/6800 models on page 1403</a>
RM3-7797-000CN	ITB motor assembly	<a href="#">Internal assemblies (1 of 9) X654/X677 models on page 1416</a>
RM3-7931-000CN	Staple stacker PCA	<a href="#">Floor stand staple stacker main body 6800/X677 models on page 1440</a>
RM3-7934-000CN	Sensor PCA	<a href="#">Floor stand staple stacker main body 6800/X677 models on page 1438</a>
RM3-7937-000CN	LED PCA	<a href="#">Floor stand staple stacker main body 6800/X677 models on page 1438</a>
RM3-7950-000CN	Staple stacker PCA	<a href="#">3 bin staple stacker main body 6800/X677 models on page 1443</a>
RM3-8001-000CN	Drawer cable assembly	<a href="#">Internal assemblies (6 of 7) 6700/6800 models on page 1412</a>
RM3-8038-000CN	Drawer cable assembly	<a href="#">Internal assemblies (6 of 9) X654/X677 models on page 1425</a>
RM3-8051-000CN	Paper feeder controller PCA	<a href="#">550-sheet paper feeder internal parts and assemblies on page 1433</a>
RM3-8058-000CN	Drawer upper cable assembly	<a href="#">550-sheet paper feeder internal parts and assemblies on page 1433</a>
RM3-8059-000CN	Drawer lower cable assembly	<a href="#">550-sheet paper feeder internal parts and assemblies on page 1433</a>
RM3-8071-000CN	HCI controller PCA	<a href="#">HCI main body on page 1435</a>
RM3-8079-000CN	Drawer cable assembly	<a href="#">HCI main body on page 1435</a>
RM3-9041-000CN	HV power supply PCA	<a href="#">Internal assemblies (4 of 7) 6700/6800 models on page 1409</a>
RM3-9043-000CN	HV power supply PCA	<a href="#">Internal assemblies (4 of 9) X654/X677 models on page 1422</a>
RM3-9045-000CN	Rear PCA	<a href="#">Internal assemblies (4 of 7) 6700/6800 models on page 1409</a>

**Table 6-34 Numerical parts list (continued)**

<b>Part number</b>	<b>Description</b>	<b>Table and page</b>
RM3-9046-000CN	Rear PCA	<a href="#">Internal assemblies (4 of 9) X654/X677 models on page 1422</a>
W2130A	HP 213A Black Original LaserJet Toner Cartridge	<a href="#">Internal assemblies (7 of 7) 6700/6800 models on page 1414</a>
W2130X	HP 2130X High Yield Black Toner Cartridge	<a href="#">Internal assemblies (7 of 7) 6700/6800 models on page 1414</a>
W2130Y	HP 213Y Extra High Yield Black Toner Cartridge	<a href="#">Internal assemblies (7 of 7) 6700/6800 models on page 1414</a>
W2130YC	HP W2130YC Black Contract Toner Cartridge	<a href="#">Internal assemblies (7 of 7) 6700/6800 models on page 1414</a>
W2131A	HP 213A Cyan Original LaserJet Toner Cartridge	<a href="#">Internal assemblies (7 of 7) 6700/6800 models on page 1414</a>
W2131X	HP 2131X High Yield Cyan Toner Cartridge	<a href="#">Internal assemblies (7 of 7) 6700/6800 models on page 1414</a>
W2131Y	HP 213Y Extra High Yield Cyan Toner Cartridge	<a href="#">Internal assemblies (7 of 7) 6700/6800 models on page 1414</a>
W2131YC	HP W2131YC Cyan Contract Toner Cartridge	<a href="#">Internal assemblies (7 of 7) 6700/6800 models on page 1414</a>
W2132A	HP 213A Yellow Original LaserJet Toner	<a href="#">Internal assemblies (7 of 7) 6700/6800 models on page 1414</a>
W2132X	HP 2132X High Yield Yellow Toner Cartridge	<a href="#">Internal assemblies (7 of 7) 6700/6800 models on page 1414</a>
W2132Y	HP 213Y Extra High Yield Yellow Toner Cartridge	<a href="#">Internal assemblies (7 of 7) 6700/6800 models on page 1414</a>
W2132YC	HP W2132YC Yellow Contract Toner Cartridge	<a href="#">Internal assemblies (7 of 7) 6700/6800 models on page 1414</a>
W2133A	HP 213A Magenta LaserJet Toner Cartridge	<a href="#">Internal assemblies (7 of 7) 6700/6800 models on page 1414</a>
W2133X	HP 2133X High Yield Magenta Toner Cartridge	<a href="#">Internal assemblies (7 of 7) 6700/6800 models on page 1414</a>
W2133Y	HP 213Y Extra High Yield Magenta Toner Cartridge	<a href="#">Internal assemblies (7 of 7) 6700/6800 models on page 1414</a>

**Table 6-34 Numerical parts list (continued)**

<b>Part number</b>	<b>Description</b>	<b>Table and page</b>
W2133YC	HP W2133YC Magenta Contract Toner Cartridge	<a href="#">Internal assemblies (7 of 7) 6700/6800 models on page 1414</a>
W2140Z	HP 214Z Ultra High Yield Black Toner Cartridge (SFP)	<a href="#">Internal assemblies (7 of 7) 6700/6800 models on page 1414</a>
W2140ZC	HP W2140ZC Black Contract Toner Cartridge (SFP)	<a href="#">Internal assemblies (7 of 7) 6700/6800 models on page 1414</a>
W2141Z	HP 214Z Ultra High Yield Cyan Toner Cartridge (SFP)	<a href="#">Internal assemblies (7 of 7) 6700/6800 models on page 1414</a>
W2141ZC	HP W2141ZC Cyan Contract Toner Cartridge (SFP)	<a href="#">Internal assemblies (7 of 7) 6700/6800 models on page 1414</a>
W2142Z	HP 214Z Ultra High Yield Yellow Toner Cartridge (SFP)	<a href="#">Internal assemblies (7 of 7) 6700/6800 models on page 1414</a>
W2142ZC	HP W2142ZC Yellow Contract Toner Cartridge (SFP)	<a href="#">Internal assemblies (7 of 7) 6700/6800 models on page 1414</a>
W2143Z	HP 214Z Ultra High Yield Magenta Toner Cartridge (SFP)	<a href="#">Internal assemblies (7 of 7) 6700/6800 models on page 1414</a>
W2143ZC	HP W2143ZC Magenta Contract Toner Cartridge (SFP)	<a href="#">Internal assemblies (7 of 7) 6700/6800 models on page 1414</a>
W2170Z	HP 217Z Ultra High Yield Black Toner Cartridge (MFP)	<a href="#">Internal assemblies (7 of 7) 6700/6800 models on page 1414</a>
W2170ZC	HP W2170ZC Black Contract Toner Cartridge (MFP)	<a href="#">Internal assemblies (7 of 7) 6700/6800 models on page 1414</a>
W2171Z	HP 217Z Ultra High Yield Cyan Toner Cartridge (MFP)	<a href="#">Internal assemblies (7 of 7) 6700/6800 models on page 1414</a>
W2171ZC	HP W2171ZC Cyan Contract Toner Cartridge (MFP)	<a href="#">Internal assemblies (7 of 7) 6700/6800 models on page 1414</a>
W2172Z	HP 217Z Ultra High Yield Yellow Toner Cartridge (MFP)	<a href="#">Internal assemblies (7 of 7) 6700/6800 models on page 1414</a>
W2172ZC	HP W2172ZC Yellow Contract Tone Cartridge (MFP)	<a href="#">Internal assemblies (7 of 7) 6700/6800 models on page 1414</a>
W2173Z	HP 217Z Ultra High Yield Magenta Toner Cartridge (MFP)	<a href="#">Internal assemblies (7 of 7) 6700/6800 models on page 1414</a>

**Table 6-34 Numerical parts list (continued)**

<b>Part number</b>	<b>Description</b>	<b>Table and page</b>
W2173ZC	HP W2173ZC Magenta Contract Toner Cartridge (MFP)	<a href="#">Internal assemblies (7 of 7) 6700/6800 models on page 1414</a>
W9240MC	HP W9240MC Black Mngd LaserJet Toner Cartridge (SFP)	<a href="#">Internal assemblies (9 of 9) X654/X677 models on page 1430</a>
W9241MC	HP W9241MC Cyan Mngd LaserJet Toner Cartridge (SFP)	<a href="#">Internal assemblies (9 of 9) X654/X677 models on page 1430</a>
W9242MC	HP W9242MC Yellow Mngd LaserJet Toner Cartridge (SFP)	<a href="#">Internal assemblies (9 of 9) X654/X677 models on page 1430</a>
W9243MC	HP W9243MC Magenta Mngd LaserJet Toner Cartridge (SFP)	<a href="#">Internal assemblies (9 of 9) X654/X677 models on page 1430</a>
W9250MC	HP W9250MC Black Mngd LaserJet Toner Cartridge (MFP)	<a href="#">Internal assemblies (9 of 9) X654/X677 models on page 1430</a>
W9251MC	HP W9251MC Cyan Mngd LaserJet Toner Cartridge (MFP)	<a href="#">Internal assemblies (9 of 9) X654/X677 models on page 1430</a>
W9252MC	HP W9252MC Yellow Mngd LaserJet Toner Cartridge (MFP)	<a href="#">Internal assemblies (9 of 9) X654/X677 models on page 1430</a>
W9253MC	HP W9253MC Magenta Mngd LaserJet Toner Cartridge (MFP)	<a href="#">Internal assemblies (9 of 9) X654/X677 models on page 1430</a>
W9260MC	HP W9260MC Black Mngd LaserJet Toner Cartridge (SFP)	<a href="#">Internal assemblies (9 of 9) X654/X677 models on page 1430</a>
W9261MC	HP W9261MC Cyan Mngd LaserJet Toner Cartridge (SFP)	<a href="#">Internal assemblies (9 of 9) X654/X677 models on page 1430</a>
W9262MC	HP W9262MC Yellow Mngd LaserJet Toner (SFP)	<a href="#">Internal assemblies (9 of 9) X654/X677 models on page 1430</a>
W9263MC	HP W9263MC Magenta Mngd LaserJet Toner Cartridge (SFP)	<a href="#">Internal assemblies (9 of 9) X654/X677 models on page 1430</a>
W9270MC	HP W9270MC Black Mngd LaserJet Toner Cartridge (MFP)	<a href="#">Internal assemblies (9 of 9) X654/X677 models on page 1430</a>
W9271MC	HP W9271MC Cyan Mngd LaserJet Toner Cartridge (MFP)	<a href="#">Internal assemblies (9 of 9) X654/X677 models on page 1430</a>
W9272MC	HP W9272MC Yellow Mngd LaserJet Toner (MFP)	<a href="#">Internal assemblies (9 of 9) X654/X677 models on page 1430</a>

**Table 6-34 Numerical parts list (continued)**

<b>Part number</b>	<b>Description</b>	<b>Table and page</b>
W9273MC	HP W9273MC Magenta Mngd LaserJet Toner Cartridge (MFP)	<a href="#">Internal assemblies (9 of 9) X654/X677 models on page 1430</a>
W9280MC	HP W9280MC Black Mngd Imaging Drum	<a href="#">Internal assemblies (9 of 9) X654/X677 models on page 1430</a>
W9281MC	HP W9281MC Cyan Mngd Imaging Drum	<a href="#">Internal assemblies (9 of 9) X654/X677 models on page 1430</a>
W9282MC	HP W9282MC Yellow Mngd Imaging Drum	<a href="#">Internal assemblies (9 of 9) X654/X677 models on page 1430</a>
W9283MC	HP W9283MC Magenta Mngd Imaging Drum	<a href="#">Internal assemblies (9 of 9) X654/X677 models on page 1430</a>
WC2-5806-000CN	Button switch	<a href="#">HCI main body on page 1435</a>
WC4-5136-000CN	Microswitch	<a href="#">3 bin staple stacker main body 6800/X677 models on page 1443</a>
WP2-5473-000CN	Sensor, humidity HSU-08FDB2A	<a href="#">Internal assemblies (5 of 7) 6700/6800 models on page 1411</a>
WP2-5473-000CN	Sensor, humidity HSU-08FDB2A	<a href="#">Internal assemblies (5 of 9) X654/X677 models on page 1424</a>

# A Certificate of Volatility

Review the certificates of volatility for the printer.

## Certificate of Volatility

Review the certificates of volatility for the printers.

**Figure A-1 Certificate of Volatility SFP (1 of 2)**

Hewlett-Packard Certificate of Volatility				
Model(s): HP Color LaserJet Enterprise X65455/65 and 6700/01	Part Number(s): X654dn=6QQ00A X65455dn=49L02A X65465dn=49L04A 6700dn=6QN33A 6701dn=58M42A		Address: Hewlett Packard Company 11311 Chinden Blvd Boise, ID 83714	
Volatile Memory				
Does the device contain volatile memory (Memory whose contents are lost when power is removed)? <input checked="" type="checkbox"/> Yes <input type="checkbox"/> No If Yes please describe the type, size, function, and steps to clear the memory below				
Type (SRAM, DRAM, etc): DRAM	Size: 2GB	User Modifiable: <input type="checkbox"/> Yes <input checked="" type="checkbox"/> No	Function: Temporary storage for system operation and print buffer	Steps to clear memory: When the printer is powered off the memory is erased
Non-Volatile Memory				
Does the device contain non-volatile memory (Memory whose contents are retained when power is removed)? <input checked="" type="checkbox"/> Yes <input type="checkbox"/> No If Yes please describe the type, size, function, and steps to clear the memory below				
Type (Flash, EEPROM, etc): EEPROM	Size: 32KB	User Modifiable: <input type="checkbox"/> Yes <input checked="" type="checkbox"/> No	Function: Store customer setting data for backup /restore	Steps to clear memory: There are no steps to clear this data
Type (Flash, EEPROM, etc): SPI	Size: 4MB	User Modifiable: <input type="checkbox"/> Yes <input checked="" type="checkbox"/> No	Function: BIOS	Steps to clear memory: There are no steps to clear this data
Mass Storage				
Does the device contain mass storage memory (Hard Disk Drive, Tape Backup)? <input checked="" type="checkbox"/> Yes <input type="checkbox"/> No If Yes please describe the type, size, function, and steps to clear the memory below				
Type (HDD, Tape, etc.): eMMC	Size: 16GB	User Modifiable: <input checked="" type="checkbox"/> Yes <input type="checkbox"/> No	Function: Stores data, OS, applications, digitally signed firmware images, persistent data, and temporary data for processing system functions	Steps to clear memory: Firmware update  or  Initiate a non-secure fast erase from the EWS
USB				
Does the item accept USB input and if so, for what purpose (i.e. Print Jobs, device firmware updates, scan upload)? <input checked="" type="checkbox"/> Yes <input type="checkbox"/> No If Yes please describe below				
Explanation: Print Jobs and device firmware updates				
Can any data other than scan upload be sent to the USB device? <input type="checkbox"/> Yes <input checked="" type="checkbox"/> No If Yes please describe below				
Explanation:				

**Figure A-2 Certificate of Volatility SFP (2 of 2)**

RF/RFID			
Does the item use RF or RFID for receive or transmit of any data including remote diagnostics? (e.g. Cellular phone, Bluetooth) <input type="checkbox"/> Yes <input checked="" type="checkbox"/> No If Yes please describe below			
Purpose:			
Frequency:		Bandwidth:	
Modulation:		Effective Radiate Power (ERP):	
Specifications:			
Other Transmission Capabilities			
Does the device employ any other methods of non-wired access to transmit or receive any data whatsoever (e.g. anything other than standard hard wired TCP/IP, direct USB, or parallel connections)? <input type="checkbox"/> Yes <input checked="" type="checkbox"/> No If Yes please describe below:			
Purpose:			
Frequency:		Bandwidth:	
Modulation:		Effective Radiate Power (ERP):	
Specifications:			
Other Capabilities			
Does the device employ any other method of communications such as a Modem to transmit or receive any data whatsoever? <input type="checkbox"/> Yes <input checked="" type="checkbox"/> No If Yes please describe below:			
Purpose:			
Specifications:			
Author Information			
Name	Title	Email	Business Unit
	System Engineer	Technical.Marketing@hp.com	IPG
Date Prepared: 11/07/2022			

**Figure A-3 Certificate of Volatility MFP (1 of 2)**

Hewlett-Packard Certificate of Volatility					
Model(s): HP Color LaserJet Enterprise X67755/65 and 6800/01	Part Number(s): X677dn=6QQ01A X677zs=6QQ02A X677s=76H08A X677z=76H09A X677z+=6QQ03A+632P2A X67755dn=49K86A X67765dn=49K90A X67755zs=49K87A X67765zs=49K91A X67755z+=49K88A+632P2A X67765z+=49K92A+632P2A 6800dn=6QN35A 6800zf=6QN36A 6800zfs=6QN37A 6800zfw+=6QN38A+632P1A 6801zfs=76H10A 6801zfw+=76H11A+632P1A			Address: Hewlett Packard Company 11311 Chinden Blvd Boise, ID 83714	
Volatile Memory					
Does the device contain volatile memory (Memory whose contents are lost when power is removed)? <input checked="" type="checkbox"/> Yes <input type="checkbox"/> No If Yes please describe the type, size, function, and steps to clear the memory below					
Type (SRAM, DRAM, etc): DRAM	Size: 6GB	User Modifiable: <input type="checkbox"/> Yes <input checked="" type="checkbox"/> No	Function: Temporary storage for system operation and print buffer	Steps to clear memory: When the printer is powered off the memory is erased	
Non-Volatile Memory					
Does the device contain non-volatile memory (Memory whose contents are retained when power is removed)? <input checked="" type="checkbox"/> Yes <input type="checkbox"/> No If Yes please describe the type, size, function, and steps to clear the memory below					
Type (Flash, EEPROM, etc): EEPROM	Size: 32KB	User Modifiable: <input type="checkbox"/> Yes <input checked="" type="checkbox"/> No	Function: Store customer setting data for backup /restore	Steps to clear memory: There are no steps to clear this data	
Type (Flash, EEPROM, etc): SPI	Size: 4MB	User Modifiable: <input type="checkbox"/> Yes <input checked="" type="checkbox"/> No	Function: BIOS	Steps to clear memory: There are no steps to clear this data	
Mass Storage					
Does the device contain mass storage memory (Hard Disk Drive, Tape Backup)? <input checked="" type="checkbox"/> Yes <input type="checkbox"/> No If Yes please describe the type, size, function, and steps to clear the memory below					
Type (HDD, Tape, etc.): HDD	Size: 500GB	User Modifiable: <input checked="" type="checkbox"/> Yes <input type="checkbox"/> No	Function: Stores data, OS, applications, digitally signed firmware images, persistent data, and temporary data for processing system functions	Steps to clear memory: Firmware update  or  Initiate a non-secure fast erase from the EWS	
USB					
Does the item accept USB input and if so, for what purpose (i.e. Print Jobs, device firmware updates, scan upload)? <input checked="" type="checkbox"/> Yes <input type="checkbox"/> No If Yes please describe below					
Explanation: Print Jobs, scan upload, and device firmware updates					
Can any data other than scan upload be sent to the USB device? <input type="checkbox"/> Yes <input checked="" type="checkbox"/> No If Yes please describe below					
Explanation:					



**Figure A-4 Certificate of Volatility MFP (2 of 2)**

RF/RFID			
Does the item use RF or RFID for receive or transmit of any data including remote diagnostics? (e.g. Cellular phone, Bluetooth) <input type="checkbox"/> Yes <input checked="" type="checkbox"/> No If Yes please describe below			
Purpose:			
Frequency:		Bandwidth:	
Modulation:		Effective Radiate Power (ERP):	
Specifications:			
Other Transmission Capabilities			
Does the device employ any other methods of non-wired access to transmit or receive any data whatsoever (e.g. anything other than standard hard wired TCP/IP, direct USB, or parallel connections)? <input type="checkbox"/> Yes <input checked="" type="checkbox"/> No If Yes please describe below:			
Purpose:			
Frequency:		Bandwidth:	
Modulation:		Effective Radiate Power (ERP):	
Specifications:			
Other Capabilities			
Does the device employ any other method of communications such as a Modem to transmit or receive any data whatsoever? <input type="checkbox"/> Yes <input checked="" type="checkbox"/> No If Yes please describe below:			
Purpose:			
Specifications:			
Author Information			
Name	Title	Email	Business Unit
	System Engineer	Technical.Marketing@hp.com	IPG
Date Prepared: 11/07/2022			

---

# Glossary of terms

## **802.11**

802.11 is a set of standards for wireless local area network (WLAN) communication, developed by the IEEE LAN/MAN Standards Committee (IEEE 802).

## **802.11b/g/n**

802.11b/g/n can share the same hardware and use the 2.4 GHz band. 802.11b supports bandwidth up to 11 Mbps, 802.11n supports bandwidth up to 150 Mbps. 802.11b/g/n devices might occasionally suffer interferences from microwave ovens, cordless telephones, and Bluetooth devices.

## **AC**

An electric current that reverses its direction many times a second at regular intervals. For example, the 110V line current found in a typical US electrical wall receptacle.

## **AC Control Module (PageWide)**

The AC Control Module controls the heating elements in the airflow assembly. Functions include voltage monitoring (ensuring correct operation in a low-quality-power environment), isolation (low voltage heater control signals are isolated from the high voltage AC power for safety), AC switching (power is switched on/off to the heater), and heating element configuration (heating element configuration is changed between series and parallel for temperature predictability).

## **ADF**

An Automatic Document Feeder (ADF) is a device that automatically feeds an original sheet (or multiple sheets) of paper into the image scanner. The document feeder is a component of the integrated scanner assembly (ADF and image scanner).

## **Airflow System (PageWide)**

The airflow system conditions the printed pages to avoid page curling due to the ink on the page. The airflow system functionally consists of a fan and heating elements. The pressurized air is blown on the page through the nozzles that are placed on the paper path of the airflow system between print and eject zone.

## **BOOTP**

Bootstrap Protocol. A network protocol used by a network client to obtain its IP address automatically. This is usually done in the bootstrap process of computers or operating systems running on them. The BOOTP servers assigns an IP address from a pool of addresses to each client. BOOTP enables “diskless workstation” computers to obtain an IP address prior to loading any advanced operating system.

## **CCD**

A Charged Coupled Device (CCD) is the scanner module which enables a scan job. A CCD locking mechanism is used to hold the CCD module to prevent any damage when the printer is moved.

**CIS**

A Contact Image Sensor (CIS) scanner captures an image using the printer's optical path. Red, green, and blue LEDs sequentially illuminate a small strip of the document (often called a raster line), and the optical system captures each color in a single row of Charged Coupled Device (CCD) sensors that cover the entire page width.

**Collation**

Collation is a process of printing a multiple-copy job in sets. When collation is selected, the device prints an entire set before printing additional copies.

**Control Panel**

The control panel is a flat, typically vertical panel or screen where the user can control and/or monitor the printer. The control panel is found on the front of the printer.

**Coverage**

Coverage is the printing term used for a toner usage measurement on printing. For example, 5% coverage means that an A4 sided paper has about 5% image or text on it. If the paper or original has complicated images or a large amount of text, the coverage will be higher and at the same time, a toner usage will be as much as the coverage.

**DC**

An electric current flowing in one direction only. Typically, a low voltage load current supplied to an electrical assembly.

**DCC**

The DC controller (DCC) controls the operation of the printer sub-systems and electrical components. The DCC sends out various signals to operate motors, solenoids, and other printer components based on the print command and image data that the host computer sends the formatter.

**Default**

The value or setting that is in effect when a printer is unboxed, reset, or initialized.

**DHCP**

Dynamic Host Configuration Protocol (DHCP) is a client-server networking protocol. A DHCP server provides configuration parameters specific to the DHCP client host requesting, generally, information required by the client host to participate on an IP network. The DHCP also provides a mechanism for allocation of IP addresses to client hosts.

**Digital Send Software**

Digital send software allows a multi-function printer (MFP) to scan and send information quickly and securely to email, network folders, other printers, and fax services.

**DIMM**

A Dual Inline Memory Module (DIMM) is a small circuit board that holds memory. The DIMM stores all data within the printer, such as printing data and received fax data.

**DPI**

Dots Per Inch (DPI) is a measurement of resolution that is used for scanning and printing. Generally, higher DPI results in a higher resolution (more visible detail in the image and a larger file size).

**Duplex**

A mechanism that automatically turns over a sheet of paper so that the printer can print (or scan) on both sides of the paper. A printer equipped with a duplex unit can print on both sides of the paper during one print cycle.

**Duty Cycle**

Duty cycle is the page quantity which does not affect printer performance for a month. Generally, the printer has the lifespan limitation such as pages per year. The lifespan means the average capacity of print-outs, usually within the warranty period. For example, if the duty cycle is 48,000 pages per month the printer limit is 2,400 pages a day (assuming 20 working days/month).

**Dynamic Security**

Dynamic Security is a toner cartridge design and process for authenticating genuine HP supplies. HP printers use toner cartridges that have security chips or electronic circuitry. Cartridges using a non-HP chip, or modified chip, or non-HP circuitry might not work (now or in the future).

**e-Duplex**

Single-pass electronic duplex (e-Duplex) printer use two separate scan modules to scan the front-side and back-side of an e-duplex copy job page in a single pass through the document feeder.

**EMC**

EMC is a measure of a device's ability to operate as intended in its shared operating environment while, at the same time, not affecting the ability of other equipment within the same environment to operate as intended.

**EMI**

EMI is the electromagnetic energy which affects the functioning of an electronic device. Electronic devices (like printers) are a source of EMI. Because it is rare for electronics to operate in isolation, products are generally engineered to function in the presence of some amount of EMI.

**eMMC**

An embedded Multi-Media Card is a compact memory device consisting of NAND flash memory and a simple storage controller.

**Emulation**

Emulation is a technique of one machine obtaining the same results as another. An emulator duplicates the functions of one system with a different system, so that the second system behaves like the first system. Emulation focuses on exact reproduction of external behavior. This is different from simulation, which concerns an abstract model of the system being simulated, often considering its internal state.

**EPS**

Encapsulated PostScript (EPS) is a PostScript (PS) code file which is used for storing font and vector graphic image information.

**ESD**

An electrostatic discharge (ESD) is a sudden flow of electricity between two electrically charged objects caused by contact, an electrical short, or dielectric breakdown. Discharge of built up static electricity.

**Ethernet**

Ethernet is a frame-based computer networking technology for local area networks (LANs). It defines wiring and signaling for the physical layer, and frame formats and protocols for the media access control (MAC)/data link layer of the OSI model. Ethernet is mostly standardized as IEEE 802.3. Ethernet has become the most widespread LAN technology in use during the 1990s to present.

**Ferrite**

A ferrite is used to reduce the amount of radio frequency noise (or interference) in a wire or cable. A ferrite enables proper EMC/EMI performance for regulatory purposes.

**FFC**

Flat Flexible Cables (FFCs) are designed for Printed Circuit Assembly (PCA) to PCA connections (for example, connecting a fax PCA to the formatter).

**FIH**

A Foreign Interface Harness (FIH) is a port that enables HP multifunction printers (MFPs) to use third-party devices to extend the capabilities of the MFP.

**Firmware**

The formatter stores the printer firmware. A remote firmware upgrade process is used to overwrite and upgrade the firmware.

**Flash memory**

Flash memory is non-volatile, meaning it retains stored data even when the power is turned off.

**Flow integrated scanner assembly**

A printer scanner assembly that includes a slide-out external physical keyboard.

**Formatter (LaserJet)**

The formatter controls printer functions like receiving and processes print data, developing and coordinating data placement and timing with the DC controller PCA, storing font and customer configuration information, communicating with the host computer, and monitoring control panel functions and relaying printer status information through the control panel.

**FTP**

FTP stands for File Transfer Protocol. FTP is a protocol designed for transferring files over the Internet. Files stored on an FTP server can be accessed using an FTP client, such as a web browser, FTP software program, or a command line interface.

**Fuser Unit**

The fuser unit is part of a laser printer that adheres the toner onto the printed page. It consists of a heat roller and a pressure roller. After toner is transferred onto the paper, the fuser unit applies heat and pressure to make sure that the toner stays on the paper permanently (which is why paper is warm when it comes out of a laser printer).

**Gateway**

A connection between computer networks, or between a computer network and a telephone line. A gateway is used to connect two different computer networks, especially a connection to the Internet.

**Grayscale**

Shades of gray that represent light and dark portions of a color image printed in monochrome. Colors are represented by a range of gray shades from white to black.

**Halftone**

Halftone is a way of reproducing a photograph or other image in which the various tones of gray or color are produced by variously sized dots of ink or toner. Halftone simulates grayscale by varying the number of dots. Highly colored areas consist of a large number of dots, while lighter areas consist of a smaller number of dots.

**HDD**

A Hard-Disk Drive (HDD) (commonly referred to as a hard drive or hard disk) is a non-volatile storage device which stores digitally-encoded data on rapidly rotating platters with magnetic surfaces.

**IEEE**

The Institute of Electrical and Electronics Engineers (IEEE) is an international non-profit, professional organization for the advancement of technology related to electricity.

**Image scanner**

The image scanner (or Sub Scanner Assembly) contains the components to digitally scan an original source document. The image scanner is a component of the integrated scanner assembly (ADF and image scanner).

**IP address**

An Internet Protocol (IP) address is a unique number that a device uses in order to identify and communicate with other devices on a network utilizing the Internet Protocol standard.

**IPM**

The Images Per Minute (IPM) is a method of measuring the speed of a printer. An IPM rate indicates the number of single-sided sheets a printer can complete in one minute.

**IPP**

The Internet Printing Protocol (IPP) defines a standard protocol for printing and managing print jobs, media size, resolution, etc. IPP can be used locally, or over the internet to reach hundreds of printers. IPP also supports access control, authentication, and encryption, making it a capable and secure printing solution.

**ISA**

The Integrated Scanner Assembly (ISA) includes the document feeder and image scanner.

**ISO**

The International Organization for Standardization (ISO) is an international standard-setting body composed of representatives from national standards bodies. It produces world-wide industrial and commercial standards.

**JBIG**

Joint Bi-level Image Experts Group (JBIG) is an image compression standard with no loss of accuracy or quality. It was designed for compression of binary images, particularly for faxes, but can also be used for other images.

**JPEG**

Joint Photographic Experts Group (JPEG) is a commonly used standard method of loss compression for photographic images. It is the format used for storing and transmitting photographs on the World Wide Web.

**LDAP**

The Lightweight Directory Access Protocol (LDAP) is a networking protocol for querying and modifying directory services running over TCP/IP.

**LED**

A Light-Emitting Diode (LED) is a semiconductor device that can indicate the status of a printer (formatter LEDs) or a component in a contact image sensor (CIS) scanner that helps capture an image.

**LEDM**

Low end data model (LEDM) provides one consistent data representation method and defines the dynamic and capabilities tickets shared between clients and devices, as well as the access protocol, event, security, and discovery methods.

**LPDC**

Late point differentiation configuration (LPDC) allows the channel partner to configure the speed to the printer depending on the customer's order. LPDC configuration is stored on the Trusted Platform Module (TPM).

**LVPS - SMPS**

Low Voltage Power Supplies (LVPS) and Switching Mode Power Supplies (SMPS) supply direct current (DC) voltages to various printer components and assemblies.

**MAC address**

Media Access Control (MAC) address is a unique identifier associated with a network adapter. MAC address is a unique 48-bit identifier usually written as 12 hexadecimal characters grouped in pairs (for example, 00-00-0c-34-11-4e). This address is usually hard-coded into a Network Interface Card (NIC) by the manufacturer and used as an aid for routers trying to locate machines on a large network.

**MEt**

HP Memory Enhancement technology (MEt) effectively doubles the standard memory through a variety of font- and data-compression methods. MEt is available only in Printer Command Language (PCL) mode; it is not functional when printing in PostScript (PS) mode.

**MFP**

A Multi Function Printer (MFP) is a printer that incorporates multiple functionalities in a single physical body. For example, an MFP printer can scan, digitally send, fax, copy, and print.

**MHV**

Miniature High Voltage (MHV) is designed for high voltage applications of BNC connectors (DC voltage between 500 V and 5 kV).

**Modem**

A device that modulates a carrier signal to encode digital information, and also demodulates such a carrier signal to decode transmitted information.

**MPCA (PageWide)**

The MPCA integrates both formatter (LaserJet) and engine control electronics (DC controller) into a single assembly. The Main PCA (MPCA) controls printer functions like receiving and processes print data, developing and coordinating data placement, storing font and customer configuration information, communicating with the host computer, and monitoring control panel functions and relaying printer status information through the control panel.

**NAND**

NAND is not an acronym (the term is short for **NOT AND** a Boolean operator and logic gate). NAND (flash) memory is non-volatile, meaning it retains stored data even when the power is turned off.

**NVRAM**

Nonvolatile random access memory (NVRAM) is used to store I/O and information about the print environment configuration (stored data even when the power is turned off).

**OPC**

Organic Photo Conductor (OPC) is a mechanism that makes a virtual image for print using a laser beam emitted from a laser printer. It is usually green or rust colored and has a cylinder shape. An imaging unit containing a drum slowly wears the drum surface during its usage in the printer, and it should be replaced appropriately due to wear from contact with the cartridge development brush, cleaning mechanism, and paper.

**Originals**

The first example of something, such as a document, photograph, or text which is copied, reproduced, or translated to produce additional copies. The original itself is not copied or derived from something else.

**PCA**

Printed Circuit Assembly (PCA). Once the printed circuit board (PCB) is complete, electronic components must be assembled to form a functional printed circuit assembly or PCA.

**PCL**

Printer Command Language (PCL) is a Page Description Language (PDL) developed by HP as a printer protocol. PCL has become an industry standard. Originally developed for early Inkjet printers, PCL has been released in varying levels for thermal, dot matrix printers and laser printers.

**PDF**

Portable Document Format (PDF) is a proprietary file format developed by Adobe Systems. A PDF represents two dimension documents in a device independent and resolution independent format.

**PJL**

Printer job language (PJL) is an integral part of printer configuration, in addition to the standard PCL and PostScript (PS). With standard cabling, the printer can use PJL to perform a variety of functions like dynamic I/O switching, context-sensitive switching, and isolation of print environment settings from one print job to the next.

**PML**

Printer management language (PML) allows remote configuration of the printer and status read-back from the printer through the I/O ports.

**PostScript (PS)**

PostScript (PS) is a Page Description Language (PDL) and programming language used primarily in electronic and desktop publishing. PostScript is run in an interpreter to generate an image.

**PPM**

Pages Per Minute (PPM) is a method of measurement for determining how fast a printer works, meaning the number of pages a printer can produce in one minute.

**Print Media**

Media like paper, envelopes, labels, and transparencies which can be used in a printer, scanner, fax, or copier.

**Printer Driver**

A program used to send commands and transfer data from the computer to the printer.

**Printhead (PageWide)**

The printhead converts the digital firing instructions from the printer electronics into properly formed and timed microscopic drops of the four ink colors.

**Printhead Wiper (PageWide)**

The printhead wiper system keeps the printhead nozzles firing correctly throughout the life of the printer as it performs the wiping and capping functions. The wiping function cleans the nozzles of ink residue and particulates. The capping function keeps the nozzles moist during storage and when the printer is idle.

**Protocol**

A convention or standard that controls or enables the connection, communication, and data transfer between two computing endpoints.



**RAM**

Random Access Memory (RAM) is the printer memory device where the data in current use is kept so it can be quickly retrieved by the device's processor. This memory is an important factor in avoiding errors and printing documents properly. Printer memory is used to store, and process print jobs as they are sent to the printer from a computer. After printing, the job is cleared from the memory to make room for more print jobs. Printer memory is directly linked to two print characteristics: speed and print quality. More memory allows you to print faster and print larger, high-quality graphics.

**REDI sensor**

An optical reflective edge detection interrupter (REDI) sensor. Usually used in conjunction with mirrors to sense the presence or absence of paper in the paper path. These sensors are carefully aligned and calibrated at the factory, so care must be taken when servicing these sensors.

**Resolution**

The sharpness of an image is measured in Dots Per Inch (DPI). The higher the DPI, the greater the resolution.

**SCB**

The Scanner Control Board (SCB) controls the functions of the image scanner components in the Sub Scanner Assembly (SSA).

**Service fluid and aerosol management systems (PageWide)**

There are two types of service fluid, shipping fluid and ink. The service fluid management system is contained entirely within the duplex module. Service fluid is discharged as droplets from the printhead, and then collected in a container inside the duplex module. Some of the droplets are called aerosol because they are lighter than air. Aerosol can float inside the printer and collect on the lens of optical sensors, producing false failures. The aerosol management system transports the aerosol and collects it in a safe place. Aerosol management consists of an aerosol fan, mounted on the rear wall of the air flow assembly, which creates air flow that pulls the aerosol through the holes in the platen and into the aerosol filter inside the duplex module.

**SFP**

A single-function printer only processes print jobs sent from a host computer or from an USB port on the printer.

**SMB**

Server Message Block (SMB) is a network protocol mainly applied to share files, printers, serial ports, and miscellaneous communications between nodes on a network. SMB also provides an authenticated inter-process communication mechanism.

**SMTP**

Simple Mail Transfer Protocol (SMTP) is the standard for email transmissions across the internet. SMTP is a relatively simple, text-based protocol, where one or more recipient of a message is specified, and the message text is transferred. It is a client server protocol where the client transmits an email message to the server.

**SODIMM**

Small outline dual in-line memory module (SODIMM) is a thin profile memory storage device (a smaller alternative to a standard DIMM device).

**SSA**

The Sub-Scanner Assembly is the image scanner component of the Integrated Scanner Assembly (ISA, which includes the document feeder and the image scanner).

**Subnet Mask**

The subnet mask is used in conjunction with the network address to determine which part of the address is the network address and which part is the host address.

## **TCP/IP**

The Transmission Control Protocol (TCP) and the Internet Protocol (IP) are the set of communications protocols that implement the protocol stack on which the internet and most commercial networks run.

## **TIFF**

Tagged Image File Format (TIFF) is a variable-resolution bit mapped image format. TIFF describes image data that typically come from scanners. TIFF images use tags, keywords defining the characteristics of the image that is included in the file. This flexible and platform-independent format can be used for pictures that have been made by various image processing applications.


## **Toner Cartridge**

A bottle or container that holds toner, which is used in a machine like a printer. Toner is a powder used in laser printers and photocopiers. The toner forms the text and images on printed paper. Toner can be fused by a combination of heat/pressure from the fuser, causing it to bind the fibers in the paper.

## **TPM**

The HP Trusted Platform Module (TPM) is a security accessory for printers. The TPM strengthens protection of encrypted credentials and data stored on your printer. Certificate private keys are both generated by and protected by the TPM. Once installed, the printer and the TPM are sealed, and the printer owns the TPM. The TPM may not be moved to another device without losing its ownership from the original printer. Installing a TPM accessory might necessitate a firmware upgrade. The TPM prevents the printer from starting if the TPM is missing. If the TPM is removed from the printer, a control-panel error message appears indicating that the TPM is missing.

---

 **NOTE:** The TPM is not a service part for some printer models. Check the printer service manual to determine if the TPM is a replaceable service part.

---

## **TWAIN**

An industry standard for scanners and software. By using a TWAIN compliant scanner with TWAIN-compliant software, a scan can be initiated from the program. TWAIN is an image capture API for Microsoft Windows and Apple Macintosh operating systems.

## **URL**

Uniform Resource Locator (URL) is the global address of documents and resources on the internet. The first part of the address indicates what protocol to use. The second part specifies the IP address or the domain name where the resource is located.

## **USB**

Universal Serial Bus (USB) is a standard that was developed by the USB Implementers Forum, Inc., to connect computers and peripherals. Unlike the parallel port, USB is designed to concurrently connect a single computer USB port to multiple peripherals.

## **Walk-up USB**

Some printers support direct printing from a USB flash drive (the walk-up USB port is usually near the control panel).

## **Watermark**

A watermark is a recognizable image or pattern in paper that appears lighter when viewed by transmitted light. Watermarks were first introduced in Bologna, Italy in 1282. Watermarks have been used by paper makers to identify their product, and also on postage stamps, currency, and other government documents to discourage counterfeiting.

## **XPS**

XML Paper Specification (XPS) is a specification for a Page Description Language (PDL) and a new document format developed by Microsoft. This has benefits for portable document and electronic documents. It is an XML-based specification based on a new print path and vector-based, device-independent document format.

**ZIF Connector**

Zero insertion force (ZIF) connectors use a mechanical locking method to secure Flat Flexible Cables (FFCs) to a Printed Circuit Assembly (PCA).

# Index

## Symbols/Numerics

- 10/100/1000 functions
  - theory of operations 60
- 2,100-sheet paper feeder HCI
  - parts and diagrams 1434
- 3 bin staple stacker covers MFP
  - parts 1442
- 3 bin staple stacker main body MFP
  - parts 1443
- 3-bin staple stacker output devices
  - parts and diagrams 1441
- 3-bin stapler-stacker
  - controller 110
  - delivery functions, other 110
  - electrical components 112
  - fan control 110
  - jam detection 110
  - motor control 110, 114
  - other functions 114
  - output accessories 110
  - paper path 110
- 550-sheet paper feeder
  - controller 103
  - electrical components 103, 104
  - input accessories 103
  - jam detection 103
  - motor control 103, 105
  - other functions 106
  - paper path 103, 110
  - parts and diagrams 1431
  - parts, main body 1432
  - pickup and feed functions, other 103
- 550-sheet paper feeder covers, panels, and doors
  - whole unit replacement 1431
- 550-sheet paper feeder paper path
  - theory of operation 103, 110
- 550-sheet tray
  - jams 383
- 550-sheet trays
  - jams 341

76.00.24 341

## A

- accessories, input
  - 550-sheet paper feeder 103
  - HCI 106
- accessories, output
  - 3-bin stapler-stacker 110
  - floor-standing stapler-stacker 115
- acoustic specifications 30
- assemblies 2,100-sheet paper deck
  - remove and replace 1031
- assemblies 3-bin staple stacker
  - multi-bin mailbox
    - remove and replace 1069, 1155
- assemblies 550-sheet paper feeder
  - remove and replace 984
- assemblies base printer, remove and replace 591
- auto on / auto off mode
  - setup and operation 57
- automatic document feeder
  - whole-unit replacement 581

## B

- backup error
  - 32.WX.YZ error 340
  - reset error 340
  - restore error 340
- Backup/Restore (Maintenance) menu
  - control-panel menu 274
- base printer
  - configuration 10
  - information 3
  - parts and diagrams 1392
  - specifications 14
- basic printer operation 55
- bin, output
  - locating MFP managed 7
  - locating MFP transactional 5
  - locating SFP managed 3

- locating SFP transactional 3
- blank pages
  - troubleshooting 475

## C

- cables
  - USB, troubleshooting 475
- Calibrate/Cleaning menu, control panel 274
- Calibrate/Cleaning menu, control-panel menu 275
- calibration
  - operations 91
- calibration, color
  - theory 78
- calibration)
  - operation 91
- cartridge
  - developing unit engagement and disengagement 78
  - eject 485
  - life detection 78
  - manually unlock 668
  - memory chip 78
  - presence detection 78
  - remove 482, 487
  - remove (manually unlocked) 669
  - replacing 482, 488
  - toner level detection 78
- caution iv
- certificate of volatility 1493
- Channel partners
  - WISE v
- checklists
  - pre-troubleshooting 133, 134
- circuit base printer, diagrams 223
- circuit diagrams
  - high-voltage power supply 62, 71
  - low-voltage power supply 62
- cleaning page 274, 275

- print 456
  - clutches
    - theory of operation 62
  - cold rest
    - reset 285
  - color self calibration
    - theory 78
  - component diagnostics
    - solve problems 184
  - components
    - DC controller 62
    - engine-control unit 62
    - fuser control 72
    - intermediate transfer belt (ITB) 78, 89
    - low-voltage power supply 68
    - pickup, feed, and delivery 92
    - secondary transfer roller assembly 91
    - toner cartridge 78
  - configuration
    - base printer 10
    - printer 1
  - configuration page
    - determine installed firmware 137
    - find information 234
    - solve problems 234
  - configurations, 6700/X654/X65455/X65465 11
  - configurations, 6800/X677/X67755/X67765 12
  - connectivity and performance
    - troubleshooting 474
  - connector error
    - 65.WX.YZ error 341
  - connector locations
    - external plug and port diagrams 186
    - printed circuit assembly diagrams 214
  - control panel 60
    - locating MFP managed 7
    - locating MFP transactional 5
    - locating SFP managed 3
    - locating SFP transactional 3
    - parts 1392
    - solve problems 141, 298
  - control panel diagnostic
    - flowcharts 154
  - control panel messages 319
  - control panel, system diagnostics
    - solve problems 298
  - control panels
    - parts and diagrams 1392
  - control-panel menu
    - Maintenance 274
  - control-panel menu)
    - Service (Maintenance) 276
    - Troubleshooting (Maintenance) 277
    - USB Firmware Upgrade (Maintenance) 276
  - controller
    - 550-sheet paper feeder 103
    - floor-standing stapler-stacker 110, 115
    - HCI 106
  - conventions used iv
  - cooling
    - areas and fans 62, 68
  - copy-quality problems
    - light or faint copies 472
    - modify printer settings to improve scan or copy quality 471
    - vertical lines, bands, or streaks 467
  - copy-quality troubleshooting 465
  - Copy/Print (Settings) menu (MFP)
    - control-panel menu 159
  - CoV
    - certificate of volatility 1493
  - covers
    - remove and replace parts 591, 985, 1031, 1070, 1155
  - covers MFP
    - parts 1398, 1400
  - covers SFP
    - parts 1394, 1396
  - covers, panels, and doors
    - parts and diagrams 1394, 1431, 1436, 1442
  - CPMD 319
  - customer self-repair (CSR) A parts and accessories 480
  - customer self-repair (CSR) B parts and accessories 525
  - customer-replaceable units
    - remove and replace parts 480, 525
- D**
- DC controller
    - components 62
    - fans 62, 68
    - motors 62, 66
    - theory of operation 62
  - DC controller communication error
    - 55.WX.YZ error 341
  - DC controller firmware error
    - 70.WX.YZ error 341
  - DC motors 62, 66
  - defeating
    - interlocks 292
  - defeating interlocks
    - solve problems 180, 293
  - definitions and terms
    - glossary 1497
  - delivery functions, other
    - 3-bin stapler-stacker 110
    - floor-standing stapler-stacker 115
  - determine problem source 133
  - development
    - image formation 84
  - development process 78, 80
  - devices, input
    - information 31
  - devices, output
    - information 33
  - diagnostics
    - component, solve problems 184
    - engine 292
  - diagram
    - 3-bin stapler-stacker 33
    - floor-standing stapler-stacker 34
    - IPTU 37
  - diagrams, block
    - solve problems 186
  - diagrams, external plug and port
    - locations 186
  - diagrams, general circuit base printer 223
  - diagrams, major component
    - locations 193
  - diagrams, printed circuit assembly
    - connector locations 214
  - diagrams, sensors and
    - switches 187
  - diagrams, timing chart 222
  - digital sending error (firmware)
    - 44.WX.YZ error 340
  - dimensions, printer 23, 24, 27
  - disable cartridge check
    - solve problems 183, 295
  - document feeder
    - jams 383, 385
    - locating MFP managed 7
    - locating MFP transactional 5
    - locating SFP managed 3

- paper-feeding problems (MFP) 448
- remove and replace parts 574
- whole unit replacement 1390
- document feeder / scanner
  - information, configurations, and specifications 1
  - parts and diagrams 1390
  - theory of operations 54
- document feeder and scanner
  - information 1
- document feeder error
  - 31.WX.YZ error 340
- doors
  - parts and diagrams 1394, 1431, 1436, 1442
  - remove and replace parts 591, 985, 1031, 1070, 1155
- drum
  - remove 490
  - replacing 491
- drum cleaning 78, 80
- duplexer
  - jams 341, 383
- duplexer error
  - 69.WX.YZ error 341
- duplexing unit
  - motors 62, 66

**E**

- easy-access USB port
  - locating MFP managed 7
  - locating MFP transactional 5
  - locating SFP managed 3
- eject
  - toner cartridges 485
- electrical components
  - 550-sheet paper feeder 103
  - floor-standing stapler-stacker 117
  - HCI 106
- electrical specifications 30
- email problems
  - get help from WISE 474
- Embedded Jetdirect error
  - 80.WX.YZ error 341
- engine
  - diagnostics 292
  - test page 292
- engine error (LaserJet)
  - 46.WX.YZ error 340
  - 63.WX.YZ error 341
- engine error (PageWide)
  - 61.WX.YZ error 341

- engine FRUs, internal
  - parts and diagrams 1402, 1432, 1438, 1443
- engine laser scanner system
  - laser scanner safety 79
- engine test
  - solve problems 140, 292
- engine-control unit
  - components 62
- engine, printer
  - parts and diagrams 1392
- event log 330
- event log error (firmware)
  - 42.WX.YZ error 340
- exhaust fans 62, 68
- external plug and port diagrams
  - locations 186

**F**

- factory settings
  - reset 285, 287
- failure detection
  - laser/scanner 78
  - motors 62, 66
- faint copies
  - copy-quality problems 472
- fan control
  - 3-bin stapler-stacker 110
  - floor-standing stapler-stacker 115
- fan error
  - 58.WX.YZ error 341
- fans
  - DC controller 62, 68
  - exhaust 62, 68
  - intake 62, 68
  - theory of operation 62
- Fax (Settings) menu (MFP)
  - control-panel menu 255
- fax functions
  - theory of operations 60
- fax ports
  - locating MFP 10
- fax problems
  - get help from WISE 474
- field-replaceable units
  - covers, panels, and doors 591, 985, 1031, 1070, 1155
  - remove and replace parts 574, 591, 984, 1031, 1069, 1155
- firmware
  - determine the installed version 137
  - theory of operations 61

- firmware communication error
  - 49.WX.YZ error 340
- firmware install error
  - 99.WX.YZ error 341
- hard disk error 341
- remote firmware upgrade
  - error 341
- firmware locations
  - active and repository 287
- firmware upgrade
  - firmware version
    - determine 137
- firmware upgrade)
  - embedded web server 137
  - USB flash drive, control panel 137
  - USB flash drive, pre-boot menu 137
- firmware, upgrade
  - downloading 137
- firmware, version determine
  - find information 137
- firmware, version determining 137
- flash memory
  - theory of operations 61
- flatbed
  - scanning and image capture MFP only 55
- Floor stand staple stacker covers
  - MFP
    - parts 1436
- Floor stand staple stacker main body
  - MFP
    - parts 1438, 1440
- floor stand staple stacker output
  - devices
    - parts and diagrams 1436
- floor-standing stapler-stacker
  - controller 115
  - delivery functions, other 115
  - electrical components 117
  - fan control 115
  - jam detection 115
  - motor control 115, 121, 122
  - other functions 122
  - output accessories 115
  - paper path 115
- floor-standing stapler-stacker paper
  - path
    - theory of operation 115
- flowcharts
  - troubleshooting 133, 135
- format disk
  - solve problems 287

- formatter
    - locating MFP 10
  - formatter control system 57
  - front door
    - locating MFP managed 7
    - locating MFP transactional 5
    - locating SFP managed 3
    - locating SFP transactional 3
  - FRUs
    - remove and replace parts 574, 591, 984, 1031, 1069, 1155
  - FRUS, internal
    - parts and diagrams 1402, 1432, 1438, 1443
  - functions
    - fuser control 72
    - low-voltage power supply 68, 70
    - toner cartridge 89
  - fuser
    - jams 374, 376, 380, 383, 421, 423, 427
  - fuser control
    - fuser control functions 78
    - theory of operation 72
  - fuser control functions
    - fuser control 78
  - fuser error
    - 41.WX.YZ error 340
    - laser scanner error 340
    - paper path error 340
  - fuser error (LaserJet)
    - 50.WX.YZ error 340
  - fuser heater
    - protection 77
  - fusing
    - image formation 86
  - fusing process 78, 80
- G**
- General (Settings) menu
    - control-panel menu 240
  - glossary
    - terms and definitions 1497
- H**
- hard disk partition error
    - 98.WX.YZ error 341
  - hardware integration pocket (HIP)
    - locating SFP managed 3
  - hardware integration pocket (HIP) is not functioning 154, 158
  - HCI
    - controller 106
    - electrical components 106, 108
    - input accessories 106
    - jam detection 106
    - motor control 106, 109
    - other functions 109
    - paper path 106
    - pickup and feed functions, other 106
    - HCI covers
      - parts 1434
    - HCI main body
      - parts 1435
    - HCI paper path
      - theory of operation 106
    - high-voltage power supply (HVPS)
      - operations 62, 71
    - home button is unresponsive 154, 157
    - HP internal users
      - WISE v
    - HVPS (high-voltage power supply)
      - operations 62, 71
- I**
- I/O functions
    - theory of operations 60
  - image capture system
    - scanning MFP only 55
  - image defects, repetitive ruler 450
  - image formation development
    - theory of operation 84
  - image formation fusing
    - theory of operation 86
  - image formation ITB cleaning
    - theory of operation 86
  - image formation laser-beam exposure
    - theory of operation 83
  - image formation pre-exposure
    - theory of operation 82
  - image formation primary charging
    - theory of operation 83
  - image formation primary transfer
    - theory of operation 84
  - image formation secondary transfer
    - theory of operation 85
  - image formation separation
    - theory of operation 85
  - image quality
    - check toner-cartridge status 455
  - image-formation process
    - development process 78, 80
    - drum cleaning 78, 80
    - fusing process 78, 80
    - laser-beam exposure 78, 80
    - primary charging 78, 80
    - primary transfer process 78, 80
    - secondary transfer process 78, 80
    - separation process 78, 80
  - image-information system 78
  - image-quality troubleshooting 449
  - imaging drums
    - remove 490
    - replacing 491
  - individual component test
    - solve problems 185
  - information
    - document feeder and scanner 1
    - input devices 31
    - output devices 33
    - printer 1
    - printer base 3
  - information pages
    - configuration page 234
    - Jetdirect page 234
  - information, configurations, and specifications
    - ADF / scanner 1
    - document feeder / scanner 1
    - scanner / document feeder 1
  - initial rotation period 55, 56
  - input accessory error
    - 67.WX.YZ error 341
  - input devices
    - information 31
    - parts and diagrams 1431
    - remove and replace, 2,100-sheet paper deck 1031
    - remove and replace, 550-sheet paper feeder 984
  - input, 2,100-sheet paper feeder HCI
    - parts and diagrams 1434
  - input, 550-sheet paper feeder
    - parts and diagrams 1431
  - input/output error
    - 40.WX.YZ error 340
  - input/output functions
    - theory of operations 60
  - install
    - tray 1 pickup roller 521
  - installation
    - printer 39
  - installation, base printer 41
  - installation, document feeder / scanner 39
  - intake fans 62, 68

- integrated scanner assembly (ISA)
    - ISA
      - whole-unit replacement, integrated scanner assembly 585
      - whole-unit replacement 585
  - interface ports
    - locating MFP 10
    - locating SFP 4
  - interlocks
    - defeating 292
  - Intermediate paper transfer unit MFP
    - parts 1441
  - intermediate paper transport unit
    - output devices
      - parts and diagrams 1441
  - intermediate transfer belt (ITB)
    - components 78, 89
    - operations 78, 89
  - internal assemblies (1 of 7), parts 1402
  - internal assemblies (1 of 9), parts 1416
  - internal assemblies (2 of 7), parts 1404
  - internal assemblies (2 of 9), parts 1418
  - internal assemblies (3 of 7), parts 1406
  - Internal assemblies (3 of 9), parts 1420
  - internal assemblies (4 of 7), parts 1409
  - Internal assemblies (4 of 9), parts 1422
  - internal assemblies (5 of 7), parts 1411
  - Internal assemblies (5 of 9), parts 1424
  - internal assemblies (6 of 7), parts 1412
  - internal assemblies (6 of 9), parts 1425
  - internal assemblies (7 of 7), parts 1414
  - internal assemblies (7 of 9), parts 1427
  - internal assemblies (8 of 9), parts 1428
  - internal assemblies (9 of 9), parts 1430
  - internal assemblies 2,100-sheet paper deck 1031
  - internal assemblies 3-bin staple stacker multi-bin mailbox 1069, 1155
  - internal assemblies 550-sheet paper feeder 984
  - internal assemblies base printer 591
  - internal diagnostics error
    - 90.WX.YZ error 341
    - video display error 341
  - internal parts 2,100-sheet paper deck
    - remove and replace 1031
  - internal parts 3-bin staple stacker multi-bin mailbox
    - remove and replace 1069, 1155
  - internal parts 550-sheet paper feeder
    - remove and replace 984
  - internal parts and assemblies
    - parts and diagrams 1402, 1432, 1438, 1443
  - internal parts and assemblies, remove and replace 480, 525, 574, 666, 998, 1041, 1105, 1230
  - internal parts base printer, remove and replace 591
  - internal test and information pages
    - solve problems 234
  - ITB (intermediate transfer belt)
    - operation 78, 89
  - ITB cleaning
    - image formation 86
- J**
- jam detection
    - 3-bin stapler-stacker 110, 115
    - 550-sheet feeder 106, 123
    - 550-sheet paper feeder 103
    - floor-standing stapler-stacker 115
    - HCI 106, 110
  - jam error (LaserJet)
    - 13.WX.YZ error 340
  - jam error (PageWide)
    - 13.WX.YZ error 340
  - jams
    - 3-bin stapler-stacker 115
    - 550-sheet feeder 106, 123
    - 550-sheet tray 383
    - 550-sheet trays 341
    - auto-navigation 342, 385
    - causes of 342, 385
    - document feeder 383, 385
  - duplexer 341, 383
  - fuser 374, 376, 380, 383, 421, 423, 427
  - HCI 110
  - in right door 371, 418
  - locations 341, 342, 383
  - output bin 341, 382, 383, 429, 430, 432, 434, 438, 441
  - Tray 1 341, 383
  - Tray 2 341, 346, 383, 393
  - Tray 4 357, 364, 404, 411
- Jetdirect page
  - solve problems 234
- job accounting error (firmware)
    - 48.WX.YZ error 340
  - job management error (firmware) 340
  - job pipeline error (firmware) 340
  - job parser error (firmware)
    - 47.WX.YZ error 340
  - printer calibration error 340
- K**
- keyboard 60
- L**
- laser scanner
    - failure detection 79
  - laser scanner error (LaserJet)
    - 51.WX.YZ error 340
    - 52.WX.YZ error 340
  - laser scanner functions
    - failure detection 79
  - laser scanner safety
    - engine laser scanner system 79
  - laser-beam exposure 78, 80
  - image formation 83
  - laser/scanner
    - failure detection 78
    - operations 78
  - last rotation period 55, 56
  - latent image formation 78, 80
  - light copies
    - copy-quality problems 472
  - lines, bands, streaks
    - copy-quality problems 467
  - link speed, change 181, 295
  - low-voltage power supply
    - functions 70
    - over-current/over-voltage protection 70
    - safety 70
    - theory of operation 68



- voltage descriptions 69
- low-voltage power supply (HVPS)
  - operations 62
- LVPS (low-voltage power supply)
  - operations 62

## M

- maintenance
  - printer 39
  - maintenance, base printer 41
  - maintenance, document feeder / scanner 39
- major component diagrams
  - locations 193
- major component locations
  - diagrams 193
- Manage Supplies (Settings) menu
  - control-panel menu 266
- manual sensor test, tray/bin
  - solve problems 186
- manual sensor tests
  - solve problem 185
- memory
  - included 14, 16, 17, 20
  - toner cartridge 78
- Memory Enhancement technology
  - theory of operations 61
- Memory Enhancement technology (MEt) 57
- memory error
  - 82.WX.YZ error 341
  - EMMC error 341
  - hard disk error 341
- memory functions
  - theory of operations 61
- menu, control panel
  - Backup/Restore (Maintenance) menu 274
  - Backup/Restore menu 274
  - Calibrate/Cleaning menu 274, 275
  - Copy/Print (Settings) menu (MFP) 159
  - Fax (Settings) menu (MFP) 255
  - General (Settings) menu 240
  - Manage Supplies (Settings) menu) 266
  - Networking (Settings) menu 269
  - Print (Settings) menu (SFP) 159
  - Reports menu 238
  - Scan/Digital Send (Settings) menu (MFP) 246

- Service (Maintenance) menu 276
- Service menu 274
- Settings menu 239
- Support Tools menu 274
- Troubleshooting (Maintenance) menu 277
- USB Firmware Upgrade (Maintenance) menu 276
- USB Firmware Upgrade menu 274
- menus control panel, control panel Calibrate/Cleaning) 274
- menus, control panel Calibrate/Cleaning 275
- motor control
  - 3-bin stapler-stacker 110, 114
  - 550-sheet paper feeder 103, 105
  - floor-standing stapler-stacker 115, 121, 122
  - HCI 106, 109
- motor error (LaserJet) 59.WX.YZ error 341
- motors
  - DC controller 62, 66
  - failure detection 62, 66
  - pickup, feed, and delivery system 92, 96
  - stepping 62, 66
  - theory of operation 62
- movement of paper through printer
  - See pickup, feed, and delivery

## N

- Near Field Communication error
  - 81.WX.YZ error 341
  - Bluetooth error 341
  - external I/O card error 341
  - internal EIO error 341
  - wireless error 341
- network port
  - locating SFP 4
- Networking (Settings) menu
  - control-panel menu 269
- networks
  - supported 14, 16, 17, 20
- no control panel sound 154, 156
- note iv
- NVRAM
  - theory of operations 61

## O

- on/off button
  - locating MFP managed 7
  - locating MFP transactional 5
  - locating SFP managed 3
  - locating SFP transactional 3
- operating-environment range
  - printer 30
- operation
  - Sleep delay 57
  - Sleep mode 57
- operation sequence 55, 56
- operations
  - laser/scanner 78
  - toner cartridge memory 78
- other functions
  - floor-standing stapler-stacker 122
  - other functions, 3-bin stapler-stacker
    - theory of operation 114
  - other functions, 550-sheet paper feeder
    - theory of operation 106
  - other functions, HCI
    - theory of operation 109
- output accessory error 66.WX.YZ error 341
- output bin
  - clear jams 341, 382, 383, 429, 430, 434, 438, 441
  - locating MFP managed 7
  - locating SFP managed 3
  - locating SFP transactional 3
- output bin, base printer
  - locating MFP transactional 5
- output bin, finisher
  - locating MFP transactional 5
- output device, 3-bin staple stacker
  - parts and diagrams 1441
- output device, floor stand staple stacker
  - parts and diagrams 1436
- output device, intermediate paper transport unit
  - parts and diagrams 1441
- output devices
  - information 33
  - parts and diagrams 1436
  - remove and replace, 3-bin staple stacker multi-bin mailbox 1069, 1155

- over-current/over-voltage protection
  - low-voltage power supply 70
- OXPd/Web kit error
  - 45.WX.YZ error 340
- P**
- page error
  - 21.WX.YZ error 340
- pages
  - blank 475
  - not printing 475
  - printing slowly 475
- pages per minute 14, 16, 17, 20
- panels
  - parts and diagrams 1394, 1431, 1436, 1442
  - remove and replace parts 591, 985, 1031, 1070, 1155
- paper
  - jams 341, 342, 383, 385
  - selecting 456
- paper feeder, 2,100-sheet HCI
  - parts and diagrams 1434
- paper feeder, 550-sheet
  - parts and diagrams 1431
  - parts, main body 1432
  - whole unit replacement part 1431
- paper handling
  - solve problems 341
- paper handling error (LaserJet)
  - 56.WX.YZ error 341
- paper jams
  - 550-sheet tray 383
  - 550-sheet trays 341
  - document feeder 383, 385
  - duplexer 341, 383
  - fuser 374, 376, 380, 383, 421, 423, 427
  - locations 341, 342, 383
  - output bin 341, 382, 383, 429, 430, 432, 434, 438, 441
  - right door 371, 418
  - Stapler stacker 432
  - Tray 1 341, 383
  - Tray 2 341, 346, 383, 393
  - Tray 4 357, 364, 404, 411
- paper movement
  - operation 92
- paper path
  - 3-bin stapler-stacker 110
  - 550-sheet paper feeder 103
  - floor-standing stapler-stacker 115
  - HCI 106
  - printer 92
- paper path sensors test (not available for this printer)
  - solve problems 185
- paper path test
  - solve problems 184
- partial clean (disk)
  - solve problems 287
- parts
  - 3 bin staple stacker covers MFP 1442
  - 3 bin staple stacker main body MFP 1443
  - 550-sheet paper feeder covers, panels, and doors 1431
  - 550-sheet paper feeder main body 1432
  - control panel 1392
  - covers MFP 1398, 1400
  - covers SFP 1394, 1396
  - document feeder and scanner whole units 1390
  - Floor stand staple stacker covers MFP 1436
  - Floor stand staple stacker main body MFP 1438, 1440
  - HCI covers 1434
  - HCI main body 1435
  - Intermediate paper transfer unit MFP 1441
- parts and diagrams
  - 2,100-sheet paper feeder HCI 1434
  - 550-sheet paper feeder 1431
  - ADF / scanner 1390
  - base printer 1392
  - control panels 1392
  - covers, panels, and doors 1394, 1431, 1436, 1442
  - document feeder / scanner 1390
  - doors 1394, 1431, 1436, 1442
  - engine, printer 1392
  - f3-bin staple stacker output device 1441
  - floor stand staple stacker output device 1436
  - input devices 1431
  - intermediate paper transport unit output device 1441
  - internal parts and assemblies 1402, 1432, 1438, 1443
  - output devices 1436
  - panels 1394, 1431, 1436, 1442
  - scanner / document feeder 1390
  - parts internal 2,100-sheet paper deck
    - remove and replace 1031
  - parts internal 3-bin staple stacker multi-bin mailbox
    - remove and replace 1069, 1155
  - parts internal 550-sheet paper feeder
    - remove and replace 984
  - parts internal base printer, remove and replace 591
  - parts, internal assemblies (1 of 7) 1402
  - parts, internal assemblies (1 of 9) 1416
  - parts, internal assemblies (2 of 7) 1404
  - parts, internal assemblies (2 of 9) 1418
  - parts, internal assemblies (3 of 7) 1406
  - parts, Internal assemblies (3 of 9) 1420
  - parts, internal assemblies (4 of 7) 1409
  - parts, Internal assemblies (4 of 9) 1422
  - parts, internal assemblies (5 of 7) 1411
  - parts, Internal assemblies (5 of 9) 1424
  - parts, internal assemblies (6 of 7) 1412
  - parts, internal assemblies (6 of 9) 1425
  - parts, internal assemblies (7 of 7) 1414
  - parts, internal assemblies (7 of 9) 1427
  - parts, internal assemblies (8 of 9) 1428
  - parts, internal assemblies (9 of 9) 1430
  - performance and connectivity troubleshooting 474
  - periods of the operation sequence 55, 56

- personal identification number (PIN)
    - service menu 281
  - pickup and feed functions, other
    - 550-sheet paper feeder 103
    - HCI 106
  - pickup, feed, and delivery
    - components 92
    - overview 92
  - PJL (printer job language) 57, 59
  - PML (printer management language) 57
  - power
    - consumption 30
  - power connection
    - locating SFP 4
  - power management
    - theory of operation 58
  - power on troubleshooting 290
  - power on troubleshooting
    - overview 290
  - power switch
    - locating SFP transactional 3
  - power-on checks
    - troubleshooting process 290
  - pre-boot menu options 320
  - pre-exposure
    - image formation 82
  - pre-troubleshooting checklist 133, 134
  - primary charging
    - image formation 83
  - primary charging process 78, 80
  - Print (Settings) menu (SFP)
    - control-panel menu 159
  - print a cleaning page 456
  - print bar error (PageWide)
    - 62.WX.YZ error 341
  - print-quality troubleshooting 450
  - print/stop test
    - solve problems 183
  - printed circuit assembly diagrams
    - connector locations 214
  - printer
    - information, configuration, and specifications 1
    - installation and maintenance 39
    - operating-environment range 30
    - resets 285
    - space requirements 30
  - printer engine
    - parts and diagrams 1392
  - printer information, configuration, and specifications
    - document feeder and scanner specifications 1
    - document feeder and scanner views 1
  - printer installation and maintenance
    - base printer 41
    - document feeder / scanner 39
  - printer job language (PJL) 57, 59
  - printer management language (PML) 57
  - printer memory error
    - 20.WX.YZ error 340
  - printer resets
    - solve problems 285
  - printer settings
    - copy-quality problems 471
  - printer, base
    - configuration 10
    - information 3
    - specifications 14
  - printing
    - period in operation sequence 55, 56
    - troubleshooting 475
  - Process Cleaning Page 274, 275
  - protection
    - fuser heater 77
- R**
- RAM
    - theory of operations 61
  - real-time clock error
    - 11.WX.YZ error 340
  - removal and replacement 480
  - remove
    - imaging drums 490
    - toner cartridges 482, 487
    - toner cartridges (manually unlocked) 669
    - tray 1 pickup roller 517
  - remove and replace
    - 2,100-sheet paper deck, internal parts and assemblies 1031
    - 3-bin staple stacker multi-bin mailbox, internal parts and assemblies 1069, 1155
    - 550-sheet paper feeder, internal parts and assemblies 984
  - remove and replace parts
    - automatic document feeder, whole-unit replacement 581
    - covers, panels, and doors 591, 985, 1031, 1070, 1155
    - customer-replaceable units 480, 525
    - document feeder / scanner 574
    - field-replaceable units 574, 591, 984, 1031, 1069, 1155
    - integrated scanner assembly (ISA), whole-unit replacement 585
    - whole-unit replacement 581
  - remove and replace, internal parts and assemblies 480, 525, 574, 666, 998, 1041, 1105, 1230
  - remove and replace, internal parts and assemblies base printer 591
  - repetitive image defect ruler 450
  - replacing
    - imaging drums 491
    - toner cartridges 482, 488
  - reports
    - event log 330
    - supplies status page 320
  - Reports menu
    - control-panel menu 238
  - resets
    - printer 285
  - revision history iii
  - right door
    - locating MFP managed 7
    - locating MFP transactional 5
    - locating SFP managed 3
    - locating SFP transactional 3
  - Right door
    - jams 371, 418
  - roller, tray 1 pickup
    - install 521
    - remove 517
- S**
- safety
    - low-voltage power supply 70
  - scan or copy quality improvement
    - copy-quality problems 471
  - Scan/Digital Send (Settings) menu (MFP)
    - control-panel menu 246
  - scanner
    - remove and replace parts 574
  - scanner and document feeder
    - information 1
  - scanner error
    - 30.WX.YZ error 340

- scanner tests (MFP)
  - solve problems 182
  - troubleshooting 182
- scanner, image
  - whole unit replacement
    - part 1390
- scanner/document feeder
  - information, configurations, and specifications 1
  - parts and diagrams 1390
  - theory of operations 54
- scanning
  - image capture MFP only 55
- secondary transfer
  - image formation 85
- secondary transfer assembly
  - operation 91
- secondary transfer processes 78, 80
- secondary transfer roller assembly
  - components 91
  - operations 91
- secondary transfer roller assembly)
  - operation 91
- security
  - dynamic security 78
- security error
  - 33.WX.YZ error 340
- sensor error
  - 54.WX.YZ error 341
  - 58.WX.YZ error 341
- sensors
  - pickup, feed, and delivery
    - system 92, 94
  - theory of operation 62
- sensors and switches diagrams
  - 3-bin stapler-stacker 187
  - 550-sheet paper feeder 187
  - base printer 187
  - floor-standing stapler-stacker 187
  - HCI 187
- separation
  - image formation 85
- separation process 78, 80
- Service (Maintenance) menu
  - control-panel menu 276
- service and support
  - WISE v
- service ID
  - restore 285
- service menu
  - personal identification number (PIN) 281
  - solve problems 281
- Settings (Copy/Print, MFP) menu
  - control-panel menu 159
- Settings (Fax) menu (MFP)
  - control-panel menu 255
- Settings (General) menu
  - control-panel menu 240
- Settings (Manage Supplies) menu)
  - control-panel menu 266
- Settings (Networking) menu
  - control-panel menu 269
- Settings (Print, SFP) menu
  - control-panel menu 159
- Settings (Scan/Digital Send) menu (MFP)
  - control-panel menu 246
- Settings menu
  - control-panel menu 239
- sleep delay
  - operation 57
- sleep mode
  - operation 57
- sleep settings 57
- solenoids
  - pickup, feed, and delivery
    - system 92, 96
  - theory of operation 62
- solve connectivity problems 478
- solve performance problems 475
  - factors affecting print
    - performance 475
    - print speeds 476
    - printer does not print 477
    - printer prints slowly 477
- solve problems
  - circuit diagrams 223
  - configuration page 234
  - control panel 141, 298
  - control panel messages 319
  - copy-quality
    - troubleshooting 465
  - CPMD 319
  - defeating interlocks 180, 293
  - diagrams, block 186
  - disable cartridge check 183, 295
  - engine test 140, 292
  - external plug and port location
    - diagrams 186
  - firmware upgrade 137
  - firmware, determine
    - version 137
  - format disk and partial clean
    - functions 287
  - image-quality
    - troubleshooting 449
- individual component
  - diagnostics 184
- individual component test 185
- internal test and information
  - pages 234
- LED diagnostics 181, 295
- link speed 181, 295
- major component locations
  - diagrams 193
- manual sensor test 185
- output is curled or
  - wrinkled 341, 447
- paper does not feed
  - automatically 341, 449
- paper does not feed from Tray 2-X 341, 446
- paper handling 341
- paper path sensors test (not available for this printer) 185
- paper path test 184
- performance and connectivity
  - troubleshooting 474
- power-on checks 290
- print-quality
  - troubleshooting 450
- print/stop test 183
- printed circuit assembly
  - connector location
    - diagrams 214
- printer does not pick up
  - paper 341
- printer does not pick up paper or misfeeds 341
- printer feeds incorrect page size 341, 445
- printer picks up multiple sheets of paper 341
- printer pulls from incorrect tray 341, 445
- printer resets 285
- printer will not duplex or duplexes incorrectly 341, 446
- scanner tests (MFP) 182
- sensors and switches
  - diagrams 187
- service menu 281
- system diagnostics, control panel 298
- timing chart diagrams 222
- tray/bin manual sensor
  - test 186
- troubleshooting tools 140

- solving
  - direct-connect problems 478
- space requirements
  - printer 30
- specifications
  - base printer 14
  - electrical and acoustic 30
  - printer 1
- specifications, document feeder and scanner
  - printer information, configuration, and specifications 1
- standby period 55, 56
- stapler
  - locating MFP managed 7
  - locating MFP transactional 5
- Stapler stacker
  - clear jams 432
- stepping motors 62, 66
- supplies
  - eject toner cartridges 485
  - remove imaging drums 490
  - remove toner cartridges 482, 487
  - remove toner cartridges (manually unlocked) 669
  - replacing imaging drums 491
  - replacing toner cartridges 482, 488
  - unlock manually the toner cartridges 668
- supplies error (LaserJet)
  - 10.WX.YZ error 340
- supplies error (PageWide)
  - 17.WX.YZ error 340
- supplies status page 320
- Support Tools menu
  - control-panel menu 274
- switches
  - pickup, feed, and delivery system 92, 94
  - theory of operation 62
- system error (LaserJet)
  - 62.WX.YZ error 341

**T**

- terms and definitions
  - glossary 1497
- tests
  - disable cartridge check 292
  - engine 292
- theory of operation 54
- 3-bin stapler-stacker other
  - functions 114
- 550-sheet paper feeder other
  - functions 106
- 550-sheet paper feeder paper
  - path 103, 110
- clutches 62
- DC controller 62
- fans 62
- floor-standing stapler-stacker
  - paper path 115
- fuser control 72
- HCI other functions 109
- HCI paper path 106
- image formation
  - development 84
- image formation fusing 86
- image formation ITB
  - cleaning 86
- image formation laser-beam
  - exposure 83
- image formation pre-exposure 82
- image formation primary
  - charging 83
- image formation primary
  - transfer 84
- image formation secondary
  - transfer 85
- image formation separation 85
- low-voltage power supply 68
- motors 62
- scanning and image capture 55
- sensors 62
- solenoids 62
- switches 62
- toner cartridges 87
- theory of operations
  - 10/100/1000 functions 60
  - ADF / scanner 54
  - base printer 55
  - document feeder / scanner 54
  - fax functions 60
  - firmware 61
  - flash memory 61
  - I/O functions 60
  - input devices 103
  - input/output functions 60
  - Memory Enhancement technology 61
  - memory functions 61
  - NVRAM 61
  - output devices 110
  - printer, base 55
  - RAM 61
- scanner / document feeder 54
  - USB functions 60
  - USB hosts functions 60
  - wireless functions 60
- timing chart, diagrams 222
- tip iv
- toner
  - image formation, use during 78, 80
- toner cartridge
  - developing unit engagement and disengagement 78
  - diagnostic test 292
  - functions 89
  - life detection 78
  - memory chip 78
  - presence detection 78
  - toner level detection 78
- toner cartridges 78
  - components 78
  - eject 485
  - error conditions 78
  - manually unlock 668
  - operations 78
  - remove 482, 487
  - remove (manually unlocked) 669
  - replacing 482, 488
  - theory of operation 87
- touchscreen blank, white, or dim (no image) 154
- touchscreen control panel 60
- touchscreen has an unresponsive zone 154, 155
- transfer processes 78, 80
- transfer unit
  - operation 78, 89
- tray
  - location assemblies, 550-sheet paper feeder 31
  - location assemblies, HCI paper feeder 32
- Tray 1
  - jams 341, 383
  - locating MFP managed 7
  - locating MFP transactional 5
  - locating SFP managed 3
  - locating SFP transactional 3
- tray 1 pickup roller
  - install 521
  - remove 517
- Tray 2
  - jams 341, 346, 383, 393
  - locating MFP managed 7
  - locating MFP transactional 5

- locating SFP managed 3
- locating SFP transactional 3
- Tray 3
  - locating MFP managed 7
  - locating MFP transactional 5
  - locating SFP managed 3
- Tray 4
  - jams 357, 364, 404, 411
  - locating MFP managed 7
  - locating MFP transactional 5
- tray motor error (LaserJet)
  - 60.WX.YZ error 341
- tray/bin, manual sensor test
  - solve problems 186
- trays
  - capacity 14, 16, 17, 20
  - included 14, 16, 17, 20
  - locating MFP managed 7
  - locating MFP transactional 5
  - locating SFP managed 3
  - locating SFP transactional 3
- troubleshooting
  - blank pages 475
  - check toner-cartridge
    - status 455
  - checklist 133, 134
  - control panel 141, 298
  - defeating interlocks 180, 293
  - direct-connect problems 478
  - disable cartridge check 183, 295
  - engine test 140, 292
  - event log 330
  - flowchart 133, 135
  - format disk and partial clean
    - functions 287
  - individual component test 185
  - jams 341, 342, 383, 385
  - LED diagnostics 181, 295
  - link speed 181, 295
  - manual sensor test 185
  - network problems 478
  - pages not printing 475
  - pages printing slowly 475
  - paper path sensors test (not available for this printer) 185
  - paper path test 184
  - print/stop test 183
  - printer resets 285
  - scanner tests (MFP) 182
  - service menu 281
  - supplies status page 320
  - system diagnostics, control panel 298
  - tray/bin manual sensor
    - test 186
  - USB cables 475
  - wired network 478
- Troubleshooting (Maintenance)
  - menu
    - control-panel menu 277
- troubleshooting process
  - power on 290
  - power subsystem 290
  - power-on checks 290
- troubleshooting process overview
  - power on 290
- troubleshooting tools
  - control panel messages 319
  - copy-quality
    - troubleshooting 465
  - CPMD 319
  - determine the problem
    - source 133
  - diagrams, block 186
  - firmware upgrade 137
  - image-quality
    - troubleshooting 449
  - individual component
    - diagnostics 184
  - performance and connectivity
    - troubleshooting 474
  - print-quality
    - troubleshooting 450
  - solve problems 140
- U**
  - unlock, manually
    - toner cartridges 668
  - upgrade, product firmware 137
  - USB Firmware Upgrade (Maintenance) menu
    - control-panel menu 276
  - USB functions
    - theory of operations 60
  - USB hosts functions
    - theory of operations 60
  - USB port
    - locating SFP transactional 3
    - troubleshooting 475
- V**
  - vertical lines, bands, or streaks
    - copy-quality problems 467
  - views, document feeder and scanner
    - printer information, configuration, and specifications 1
- voltage descriptions
  - low-voltage power supply 69
- W**
  - waiting period 55, 56
  - warning iv
  - Web-based Interactive Search Engine (WISE)
    - HP internal users and Channel partners v
  - weight, printer 23, 24, 27
  - whole-unit replacement
    - automatic document
      - feeder 581
    - integrated scanner assembly (ISA) 585
    - remove and replace parts 581
  - wireless functions
    - theory of operations 60
  - WISE
    - email problems 474
    - fax problems 474
    - HP internal users and Channel partners v
  - WUR
    - automatic document
      - feeder 581
    - integrated scanner assembly (ISA) 585
    - remove and replace parts 581