Solve problems

To use the information in this chapter, you should have a basic understanding of the HP LaserJet printing process. Explanations of each mechanical assembly, the printer systems, and the basic theory of operation are contained in the English-language service manual. Do not perform any of these troubleshooting processes unless you understand the function of each product component.

- [Solve problems checklist](#)
- [Menu map](#)
- [Troubleshooting process](#)
- [Tools for troubleshooting](#)
- [Clear jams](#)
- [Solve paper-handling problems](#)
- [Use manual print modes](#)
- [Solve image-quality problems](#)
- [Clean the product](#)
- [Solve performance problems](#)
- [Solve connectivity problems](#)
- [Service mode functions](#)
- [Preboot menu options](#)
- [Product updates](#)

Solve problems checklist

If the product is not responding correctly, complete the steps in the following checklist, in order. If the product does not pass a step, follow the corresponding troubleshooting suggestions. If a step resolves the problem, you can stop without performing the other steps on the checklist.

1. Make sure that the control-panel display shows one of the following messages: **Ready**, **Paused**, or **SLEEP MODE ON**. If no lights are illuminated or the display does not say **Ready**, **Paused**, or **Sleep Mode**, use the Power-on checks section in the product service manual to troubleshoot the problem.
2. Check the cables.
 - a. Check the cable connection between the product and the computer or network port. Make sure that the connection is secure.
 - b. Make sure that the cable itself is not faulty by using a different cable, if possible.
 - c. Check the network connection.
3. Ensure that the print media that you are using meets specifications.
4. Print a configuration page. If the product is connected to a network, an HP Jetdirect page also prints.
 - a. If the pages do not print, check that at least one tray contains print media.
 - b. If the page jams in the product, see the jams section.
5. If the configuration page prints, check the following items.
 - a. If the page prints correctly, the product hardware is working. The problem is with the computer you are using, with the printer driver, or with the program.
 - b. If the page does not print correctly, the problem is with the product hardware.
6. Does the image quality meet the user's requirements? If yes, see step 7. If no, check the following items:
 - Print the print-quality (PQ) troubleshooting pages.
 - Solve the print-quality problems, and then see step 7.
7. At the computer, check to see if the print queue is stopped, paused, or set to print offline.

Windows: Click **Start**, click **Settings**, and then click **Printers** or **Printers and Faxes**. Double-click the **HP Color LaserJet CP5525n**, **HP Color LaserJet CP5525dn**, or **HP Color LaserJet CP5525xh** item depending on the product model installed.





-or-

Mac OS X: Open **Printer Setup Utility**, and then double-click the line for the **HP Color LaserJet CP5525n**, **HP Color LaserJet CP5525dn**, or **HP Color LaserJet CP5525xh** item depending on the product model installed.

8. Verify that you have installed the HP Color LaserJet Enterprise CP5520 Printer Series printer driver. Check the program to make sure that you are using the HP Color LaserJet Enterprise CP5520 Printer Series printer driver.
9. Print a short document from a different program that has worked in the past. If this solution works, the problem is with the program that you are using. If this solution does not work (the document does not print) complete these steps:
 - a. Try printing the job from another computer that has the product software installed.
 - b. If you connected the product to the network, connect the product directly to a computer with a USB cable. Redirect the product to the correct port, or reinstall the software, and select the new connection type that you are using.

Menu map



Print the menu maps

1. At the control panel, press the Home button .
2. Open the following menus:
 - **Administration**
 - **Reports**
 - **Configuration/Status Pages**
3. Use the **Down** arrow button  to highlight the **Administration Menu Map** item, and then press the OK button to select it.
4. Use the **Up** arrow button  to highlight the **Print** item, and then press the OK button.
5. Press the Home button  or Back button  to exit the menus.

Current settings pages

Printing the current settings pages provides a map of the user configurable settings that might be helpful in the troubleshooting process.

Print the current settings pages

1. At the control panel, press the Home button .
2. Open the following menus:
 - **Administration**
 - **Reports**
 - **Configuration/Status Pages**
3. Use the **Down** arrow button  to highlight the **Current Settings Page** item, and then press the OK button to select it.



4. Use the **Up** arrow button ▲ to highlight the **Print** item, and then press the OK button
5. Press the Home button 🏠 or Back button ↶ to exit the menus.

Control panel menus

To use all of the capabilities of this product, a firmware upgrade might be required. HP recommends that you periodically go to www.hp.com/go/ljcp5520series_software to see if a new version of firmware is available.

 **NOTE:** Print a configuration page to determine the version of firmware currently installed in this product.

Navigate the control-panel menus

- Press the Home button  to access the menus.
- Use the up arrow button  and down arrow button  to highlight a desired menu item.
- Press the OK button to select the menu item.

Sign In menu

Table 1 Sign In menu

First level	Second level	Values
User Access Code	Access Code	
Administrator Access Code	Access Code	
Service Access Code	Access Code	

Retrieve Job From USB menu

Use the **Retrieve Job From USB** menu to view listings of jobs stored on an external USB memory device.

Table 2 Retrieve Job From USB menu

First level	Second level	Values
Retrieve Job From USB		OK
		Cancel
	Select a File or Folder	Select from the provided list.

Retrieve Job From Device Memory menu

Use the **Retrieve Job From Device Memory** menu to view listings of jobs stored on the internal product memory.

Table 3 Retrieve Job From Device Memory menu

First level	Second level	Third level	Values
Retrieve Job From Device Memory	All Jobs (No PIN) NOTE: Individual job names also appear.	Print	Range: 1 – 9999 Default = 1
		Delete	Select from the provided list.

Supplies menu

In the following table, asterisks (*) indicate the factory default setting.

Table 4 Supplies menu

First level	Second level	Third level	Fourth level	Values	
Manage Supplies	Supplies Status	Supply Settings	Black Cartridge	Very Low Settings	Stop
					Prompt to continue*
	Continue				
	Color Cartridges	Very Low Settings	Low Threshold Settings	Cyan Cartridge	1-100%
					Magenta Cartridge
	Yellow Cartridge				
	Fuser	Very Low Settings	Low Threshold Settings	Transfer Kit	Stop
					Prompt to continue*
	Continue				
	Transfer Kit	Very Low Settings	Low Threshold Settings	Transfer Kit	1-100%
					Prompt to continue*
	Continue				

Table 4 Supplies menu (continued)

First level	Second level	Third level	Fourth level	Values
			Low Threshold Settings	1-100%
		Color/Black Mix		Auto*
				Mostly Color Pages
				Mostly Black Pages
	Supply Messages	Low Message		On*
				Off
		Level Gauge		On*
				Off
Black Cartridge				
OK: - Status				
Cyan Cartridge				
OK: - Status				
Magenta Cartridge OK: - Status				
Yellow Cartridge				
OK: - Status				
Toner Collection Unit OK: - Status				
Transfer Kit OK: - Status				
Fuser OK: - Status				

Trays menu

In the following table, asterisks (*) indicate the factory default setting.

Table 5 Trays menu

First level	Second level	Values
Manage Trays	Use Requested Tray	Exclusively*
		First
	Manually Feed Prompt	Always*
		Unless loaded
	Size/Type Prompt	Display*
		Do not display
	Use another tray	Enabled*
		Disabled
	Alternative Letterhead Mode	Disabled*
		Enabled
Blank Pages	Auto*	
	Yes	
Override A4/Letter	Yes*	
	No	
Tray 1 Size		Select from a provided list.
Tray 1 Type		Select from a provided list.
Tray 2 Size		Select from a provided list.
Tray 2 Type		Select from a provided list.
Tray 3 Size		Select from a provided list.
Tray 3 Type		Select from a provided list.
Tray 4 Size		Select from a provided list.
Tray 4 Type		Select from a provided list.
Tray 5 Size		Select from a provided list.
Tray 5 Type		Select from a provided list.
Tray 6 Size		Select from a provided list.
Tray 6 Type		Select from a provided list.

Administration menu

Reports menu

Table 6 Reports menu

First level	Second level	Third level	Values
Configuration/Status Pages	Print		
		Administration Menu Map	
		Configuration Page	
		Supplies Status Page	
		Usage Page	
		Paper Path Page	
		File Directory Page	
		Current Settings Page	
		Color Usage Job Log	
	Other Pages	Print	
		Demonstration Page	
		RGB Samples	
		CMYK Samples	
		PCL Font List	
		PS Font List	

General Settings menu

In the following table, asterisks (*) indicate the factory default setting.

Table 7 General Settings menu

First level	Second level	Third level	Fourth level	Values	
Date/Time Settings	Date/Time Format	Date Format		DD/MMM/YYYY	
				MMM/DD/YYYY*	
				YYYY/MMM/DD	
		Date/Time	Date	Time Format	12 hour (AM/PM)*
					24 hours
				Time	
			Time Zone		

Table 7 General Settings menu (continued)

First level	Second level	Third level	Fourth level	Values
		Adjust for Daylight Savings		On Off*
Energy Settings	Sleep Delay			15* Range: 1 – 120 minutes
	Optimum Speed/ Energy Usage			Faster First Page* Save Energy Save More Energy Save Most Energy
Print Quality	Adjust Color	Highlights	Cyan Density Magenta Density Yellow Density Black Density	-5 to 5 Default = 0
		Midtones	Cyan Density Magenta Density Yellow Density Black Density	-5 to 5 Default = 0
		Shadows	Cyan Density Magenta Density Yellow Density Black Density	-5 to 5 Default = 0
		Restore Color Values		
	Image Registration	Adjust Tray <X>	Print Test Page	
			X1 Shift Y1 Shift X2 Shift Y2 Shift	-5.00 mm to 5.00 mm Default = 0
	Auto Sense Mode	Tray 1 Sensing		Full sensing Expanded sensing* Transparency Only
		Tray X Sensing		Expanded sensing* Transparency Only

Table 7 General Settings menu (continued)

First level	Second level	Third level	Fourth level	Values
	Adjust Paper Types	Select from a list of paper types that the product supports. The available options are the same for each paper type.	Print Mode	Select from a list of print modes. Default = Auto Sense Mode
			Resistance Mode	Normal* Up Down
			Humidity Mode	Normal* High
			Fuser Temp Mode	Normal* Up Down
			Paper Curl Mode	Normal* Reduced
	Optimize	Normal Paper		Standard* Smooth
		Light Media		Normal* Smooth
		Heavy Paper		Standard* Smooth
		Envelope Control		Normal* Alternate 1 Alternate 2
		Environment		Normal* Low Temp
		Line Voltage		Normal* Low Voltage
		Tray 1		Normal* Alternate
		Cleaning Control		Normal* Alternate

Table 7 General Settings menu (continued)

First level	Second level	Third level	Fourth level	Values
		Background		Normal* Alternate 1 Alternate 2 Alternate 3
		Media Temp		Normal* Alternate
		Uniformity Control		Normal* Alternate 1 Alternate 2 Alternate 3
		Pre-Rotation		Normal* Alternate 1 Alternate 2 Alternate 3
		Registration		Normal* Alternate
		Transfer Control		Normal* Alternate 1 Alternate 2 Alternate 3
		Moisture Control		Normal* Alternate
		Restore Optimize		
	Edge Control			Off Light Normal* Maximum
Jam Recovery				Auto* Off On

Table 7 General Settings menu (continued)

First level	Second level	Third level	Fourth level	Values
Manage Stored Jobs	Quick Copy Job Storage Limit			1-300
				Default = 32
	Quick Copy Job Held Timeout			Off*
				1 hour
				4 Hours
				1 Day
				1 Week
	Default Folder Name for Stored Jobs			Select from a list of folder names.
				Public*
	Sort Stored Jobs By			Job Name*
				Date
Restore Factory Settings	Reset			All
				Calibration
				General
				Print
				Security
Restrict Color				Enable
				Disable
				Color if Allowed*

Retrieve From USB Settings menu

Table 8 Retrieve From USB Settings menu

First level	Second level	Values
Retrieve From USB Settings	Access Code	Enable*
		Disable

Print Settings menu

In the following table, asterisks (*) indicate the factory default setting.

Table 9 Print Settings menu

First level	Second level	Values
Manual Feed		Enabled
		Disabled*
Courier Font		Regular*
		Dark
Wide A4		Enabled
		Disabled*
Print PS Errors		Enabled
		Disabled*
Print PDF Errors		Enabled
		Disabled*
Personality		Auto*
		PCL
		POSTSCRIPT
		PDF
PCL	Form Length	Range: 5 – 128
		Default = 60
	Orientation	Portrait*
		Landscape
	Font Source	Internal*
		Soft
		USB <X>
	Font Number	Range: 0 – 999
		Default = 0

Table 9 Print Settings menu (continued)

First level	Second level	Values
	Font Pitch	Range: 0.44 – 99.99 Default = 10
	Font Point Size	Range: 4.00 – 999.75 Default = 12.00
	Symbol Set	Select from a list of symbol sets.
	Append CR to LF	No* Yes
	Suppress Blank Pages	No* Yes
	Media Source Mapping	Standard* Classic

Print Options menu

In the following table, asterisks (*) indicate the factory default setting.

Table 10 Print Options menu

First level	Second level	Values
Number of Copies		Default = 1
Default Paper Size		Select from a list of sizes that the product supports.
Default Custom Paper Size	Inches	X Dimension Range: 2.99 – 12.28 Default = 12.28
		Y Dimension Range: 5.00 – 18.50 Default = 18.5
	MM	X Dimension Range: 76 – 312 Default = 312
		Y Dimension Range: 127 – 470 Default = 470
Sides		1-sided* 2-sided

Table 10 Print Options menu (continued)

First level	Second level	Values
Two-Sided Format		Book-style*
		Flip-style
Enable Edge to Edge Overrides		Enabled
		Disabled*

Display Settings menu

In the following table, asterisks (*) indicate the factory default setting.

Table 11 Display Settings menu

First level	Second level	Values
Display Brightness		Range: -10 to 10 Default = 0
Language		Select from a list of languages that the product supports.
Show IP address		Display* Hide
Sleep Mode		Disabled Use sleep delay* User sleep schedule Balance power savings/Wait time
Inactivity Timeout		Range: 10 – 300 seconds Default = 60
Clearable Warnings		On Job*
Continuable Events		Auto continue (10 seconds)* Press OK to continue

Manage Supplies menu

In the following table, asterisks (*) indicate the factory default setting.

Table 12 Manage Supplies menu

First level	Second level	Third level	Fourth level	Values
Supplies Status				
Supply Settings	Black Cartridge	Very Low Settings		Stop
				Prompt to continue*
				Continue
		Low Threshold Settings		1-100%
	Color Cartridges	Very Low Settings		Stop
				Prompt to continue*
				Continue
		Low Threshold Settings	Cyan Cartridge	1-100%
			Magenta Cartridge	
			Yellow Cartridge	
	Fuser	Very Low Settings		Stop
				Prompt to continue*
				Continue
		Low Threshold Settings		1-100%
	Transfer Kit	Very Low Settings		Stop
				Prompt to continue*
				Continue
		Low Threshold Settings		1-100%
	Color/Black Mix			Auto*
				Mostly Color Pages
				Mostly Black Pages
Supply Messages	Low Message			On*
				Off
	Level Gauge			On*
				Off

Table 12 Manage Supplies menu (continued)

First level	Second level	Third level	Fourth level	Values
Reset Supplies	New Fuser Kit			No
				Yes
	New Transfer Kit			No
				Yes

Manage Trays menu

In the following table, asterisks (*) indicate the factory default setting.

Table 13 Manage Trays menu

First level	Values
Use Requested Tray	Exclusively*
	First
Manually Feed Prompt	Always*
	Unless loaded
Size/Type Prompt	Display*
	Do not display
Use another tray	Enabled*
	Disabled
Alternative Letterhead Mode	Disabled*
	Enabled
Blank Pages	Auto*
	Yes
Override A4/Letter	Yes*
	No

Network Settings menu

In the following table, asterisks (*) indicate the factory default setting.

Table 14 Network Settings menu

First level	Values
I/O Timeout	Range: 5 – 300 sec Default = 15
Embedded Jetdirect	See the table that follows for details. These menus have the same structure. If an additional HP Jetdirect network card is installed in the EIO slot, then both menus are available.

Table 15 Embedded Jetdirect

First level	Second level	Third level	Fourth level	Fifth level	Values
Information	Print Sec Report				Yes
					No*
TCP/IP	Enable				On*
					Off
	Host Name				Use the arrow buttons to edit the host name. NPXXXXXX*
	IPv4 Settings	Config Method			Bootp*
					DHCP
					Auto IP
					Manual
		Default IP			Auto IP*
					Legacy
		DHCP Release			Yes
					No*
		DHCP Renew			Yes
					No*
		Primary DNS			Range: 0 – 255 Default = xxx.xxx.xx.xx
		Secondary DNS			Range: 0 – 255 Default = 0.0.0.0

Table 15 Embedded Jetdirect (continued)

First level	Second level	Third level	Fourth level	Fifth level	Values
	IPv6 Settings	Enable			On* Off
		Address	Manual Settings	Enable	On Off*
				Address	Select from a provided list.
		DHCPV6 Policy			Router Specified Router Unavailable* Always
		Primary DNS			Select from a provided list.
		Secondary DNS			Select from a provided list.
		Proxy Server			Select from a provided list.
		Proxy Port			Default = 0080
		Idle Timeout			Default = 0270
Security	Secure Web				HTTPS Required* HTTPS Optional
	IPSEC				Keep Disable*
	802.1x				Reset Keep*
	Reset Security				Yes No*
Diagnostics	Embedded Test	LAN HW Test			Yes No*
		HTTP Test			Yes No*
		SNMP Test			Yes No*

Table 15 Embedded Jetdirect (continued)

First level	Second level	Third level	Fourth level	Fifth level	Values
		Data Path Test			Yes No*
		Select All Tests			Yes No*
		Execution Time			Range: 1 – 60 hours Default = 1
		Execute			Yes No*
	Ping Test	Dest Type			IPv4 IPv6
		Dest IPv4			Range: 0 – 255 Default = 127.0.0.1
		Dest IPv6			Select from a provided list. Default = ::1
		Packet Size			Default = 64
		Timeout			Default = 001
		Count			Default = 004
		Print Results			Yes No*
		Execute			Yes No*
	Ping Results	Packets Sent			Default = 00000
		Packets Received			Default = 00000
		Percent Lost			Default = 000
		RTT Min			Default = 0000
		RTT Max			Default = 0000
		RTT Average			Default = 0000
		Ping In Progress			Yes No*

Table 15 Embedded Jetdirect (continued)

First level	Second level	Third level	Fourth level	Fifth level	Values
		Refresh			Yes No*
Link Speed					Auto* 10T Half 10T Full 100TX Half 100TX Full 100TX Auto 1000TX Full

Troubleshooting menu

In the following table, asterisks (*) indicate the factory default setting.

Table 16 Troubleshooting menu

First level	Second level	Third level	Fourth level	Values
Exit Troubleshooting				
NOTE: This item only displays if you are backing out of the Troubleshooting menu.				
Print Event Log				
View Event Log				
Print Quality Pages	Print PQ Troubleshooting Pages			
	Diagnostics Page			
	Color Band Test	Print Test Page		
		Copies		Range: 1 – 30 Default = 1
Diagnostic Tests	Disable Cartridge Check			
	Paper Path Sensors			Start Test
	Paper Path Test	Print Test Page		Print
		Source		Select from a list of the available trays.

Table 16 Troubleshooting menu (continued)

First level	Second level	Third level	Fourth level	Values
		Test Duplex Path		Off* On
		Number of Copies		Range: 1 – 500 Default = 1
	Manual Sensor Test			Select from a list of the product sensors.
	Tray/Bin Manual Sensor Test			Select from a list of the product sensors.
	Component Test			Select from a list of available components.
		Repeat		Off* On
	Print/Stop Test			
Retrieve Diagnostic Data	Export to USB			
	Diagnostic Files			Device Data File Debug Information File*
	Include Crash Dumps			Off On*
	Cleanup Debug Info			Off On*
General Debug Data				

Device Maintenance menu

Backup/Restore menu

△ **CAUTION:** Data backup and restoration is the responsibility of the customer/administrator of the product. Service personnel should not back up or restore customer data under any circumstances.

In the following table, asterisks (*) indicate the factory default setting.

Table 17 Backup/Restore menu

First level	Second level	Third level	Values
Backup Data	Scheduled Backups	Enable Scheduling	Disabled* Enabled

Table 17 Backup/Restore menu (continued)

First level	Second level	Third level	Values
		Backup Time	Default = current time
		Days Between Backups	Default = 1
	Backup Now		
	Export Last Backup		
Restore Data			Insert a USB drive that contains the backup file.

Calibration/Cleaning menu

In the following table, asterisks (*) indicate the factory default setting.

Table 18 Calibration/Cleaning menu

First level	Second level	Values
Auto Cleaning		Off* On
Cleaning Interval		Select from a list of cleaning intervals.
Auto Cleaning Size		Letter* A4
Print Cleaning Page		
Clean Laser Glass		
Quick Calibration		
Full Calibration		
Delay Calibration at Wake/Power On		Yes* No

USB Firmware Upgrade menu

To display: At the product control panel, select the **Device Maintenance** menu, and then select the **USB Firmware Upgrade** menu.

Insert a USB storage device with a firmware upgrade bundle into the USB port, and follow the on-screen instructions.

Service menu

The personal identification number (PIN; **Service Access Code**) used to access the **Service** menu is 11552010.

In the following table, asterisks (*) indicate the factory default setting.

First level	Second level	Third level	Values
User Access Code			
Administrator Access Code			
Service Access Code	Print Event Log		
	View Event Log		
	Clear Event Log		
	Cycle Counts	Mono Cycle Counts	0* Range: 0 – 9999999
		Color Cycle Count	0* Range: 0 – 9999999
		Refurbish Cycle Count	0* Range: 0 – 9999999
	Serial Number		
	Service ID		20182*
	Cold Reset Paper		Letter* A4
	New Registration Roller		Yes No*
	Media Sensor Value		0* Range: 0 – 4095
	Manual Laser Glass Cleaning		
Test Support	Continuous Print from USB		
	Automatic Calibrations		Disabled Enabled*

Troubleshooting process

When the product malfunctions or encounters an unexpected situation, the product control panel alerts you to the situation. This chapter contains information to help diagnose and solve problems.

- Use the pretroubleshooting checklist to evaluate the source of the problem and to reduce the number of steps that are required to fix the problem.
- Use the troubleshooting flowchart to pinpoint the root cause of hardware malfunctions. The flowchart guides you to the section of this chapter that contains steps for correcting the malfunction.

Before beginning any troubleshooting procedure, check the following issues:

- Are supply items within their rated life?
- Does the configuration page reveal any configuration errors?

 **NOTE:** The customer is responsible for checking supplies and for using supplies that are in good condition.

Determine the problem source

When the product malfunctions or encounters an unexpected situation, the product control panel alerts you to the situation. This section contains a pre-troubleshooting checklist to filter out many possible causes of the problem. A troubleshooting flowchart helps you diagnose the root cause of the problem. The remainder of this chapter provides steps for correcting problems.

Pre-troubleshooting checklist

The following table includes basic questions to ask the customer to quickly help define the problem.

General topic	Questions
Environment	<ul style="list-style-type: none">• Is the product installed on a solid, level surface (+/- 1°)?• Is the power-supply voltage within ± 10 volts of the specified power source?• Is the power-supply plug inserted in the product and the outlet (not a power strip)?• Is the operating environment within the specified parameters?• Is the product exposed to ammonia gas, such as that produced by diazo copiers or office cleaning materials? NOTE: Diazo copiers produce ammonia gas as part of the copying processes. Ammonia gas (from cleaning supplies or a diazo copier) can have an adverse affect on some product components (for example, the print-cartridge OPC).• Is the product exposed to direct sunlight?

General topic	Questions
Media	<ul style="list-style-type: none"> • Does the customer use only supported media? • Is the media in good condition (no curls, folds, or distortion)? • Is the media stored correctly and within environmental limits?
Input trays	<ul style="list-style-type: none"> • Is the amount of media in the tray within specifications? • Is the media correctly placed in the tray? • Are the paper guides aligned with the stack? • Is the cassette correctly installed in the product?
Print cartridges	<ul style="list-style-type: none"> • Is each print cartridge installed correctly? • Are original HP print cartridges installed? • Are the cartridges damaged?
ITB and fuser	<ul style="list-style-type: none"> • Are the ITB and fuser correctly installed? • Is the ITB or fuser damaged?
Doors	<ul style="list-style-type: none"> • Are the right and front doors closed?
Condensation	<ul style="list-style-type: none"> • Does condensation occur following a temperature change (particularly in winter following cold storage)? If so, wipe affected parts dry or leave the product on for 10 to 20 minutes. • Was a print cartridge opened soon after being moved from a cold to a warm room? If so, allow the print cartridge to sit at room temperature for 1 to 2 hours.
Miscellaneous	<ul style="list-style-type: none"> • Check for and remove any non-HP components (for example, print cartridges or memory modules) from the product. • Check to see whether the hardware or software configuration has changed or the problem is not associated with any specific software. • Remove the product from the network and ensure that the failure is associated with the product before beginning troubleshooting. • For any print-quality issues, calibrate the product. See Calibrate the product on page 103.

Troubleshooting flowchart

This flowchart highlights the general processes that you can follow to quickly isolate and solve product hardware problems.

Each row depicts a major troubleshooting step. A “yes” answer to a question allows you to proceed to the next major step. A “no” answer indicates that more testing is needed. Go to the appropriate section in this chapter, and follow the instructions there. After completing the instructions, go to the next major step in this troubleshooting flowchart.

Table 19 Troubleshooting flowchart

1 Power on	Is the product on and does a readable message display?		Follow the power-on troubleshooting checks. See Power subsystem on page 30 .
	Yes ↓	No →	After the control panel display is functional, see step 2.
2 Control panel messages	Does the message Ready display on the control panel?		If an error message displays, see Interpret control-panel, status-alert messages, and event code errors on page 158 .
	Yes ↓	No →	After the errors have been corrected, go to step 3.
3 Event log	Open the Troubleshooting menu and print an event log to see the history of errors with this product. Does the event log print?		If the event log does not print, see Print an event log on page 238 . If paper jams inside the product, see Clear jams on page 240 . If error messages display on the control panel when you try to print an event log, see Print an event log on page 238 .
	Yes ↓	No →	After successfully printing and evaluating the event log, see step 4.
4 Information pages	Open the Reports menu and print the configuration pages to verify that all the accessories are installed. Are all the accessories installed?		If accessories that are installed are not listed on the configuration page, remove the accessory and reinstall it. After evaluating the configuration pages, see step 5.
	Yes ↓	No →	
5 Image quality	Does the print quality meet the customer's requirements?		Compare the images with the sample defects in the image defect tables. See Print quality examples on page 269 .
	Yes ↓	No →	After the print quality is acceptable, see step 6.
6 Interface	Can the customer print successfully from the host computer?		Verify that all I/O cables are connected correctly and that a valid IP address is listed on the Jetdirect configuration page.
	Yes. This is the end of the troubleshooting process.	No →	If error messages display on the control panel, see Print an event log on page 238 . When the customer can print from the host computer, this is the end of the troubleshooting process.

Power subsystem

Power-on checks

The basic product functions should start up when the product is plugged into an electrical outlet and the power switch is pushed to the *on* position. If the product does not start, use the information in this section to isolate and solve the problem.

Power-on troubleshooting overview

Turn on the product power. If the control panel display remains blank, random patterns display, or asterisks remain on the control panel display, perform power-on checks to find the cause of the problem.

During normal operation, the power supply, fuser, and formatter cooling fans begin to spin after the product power is turned on. Place your hand over the holes in the left-side cover, near the formatter. If the fan is operating, you will feel air passing out of the product. You can also lean close to the product and hear the fan operating. You can also place your hand over the hole in the right-front lower corner. If the fan is operating, you should feel air being drawn into the product. When these fans are operational, the DC side of the power supply is functioning correctly.

After the fans are operating, the motor turn on and off (unless the right or front cover is open, a jam condition is sensed, or the paper-path sensors are damaged). You might be able to visually and audibly determine if the motors turn on and off.

If the fans and motors are operating correctly, the next troubleshooting step is to isolate print engine, formatter, and control panel problems. Perform an engine test (see [Engine test button on page 35](#)). If the formatter is damaged, it might interfere with the engine test. If the engine-test page does not print, try removing the formatter and then performing the engine test again. If the engine test is then successful, the problem is almost certainly with the formatter, the control panel, or the cable that connects them.

If the control panel is blank when you turn on the product, check the following items.

1. Make sure that the product is plugged directly into an active electrical outlet (not a power strip) that delivers the correct voltage.
2. Make sure that the power switch is in the *on* position.
3. Make sure that the fans run briefly, which indicates that the power supply is operational.
4. Make sure that the control panel display wire harness is connected.
5. Make sure that the formatter is seated and operating correctly. Turn off the product and remove the formatter. Reinstall the formatter, and then verify that the heartbeat LED is flashing.
6. Remove any HP Jetdirect or other EIO cards, and then try to turn the product on again.

 **NOTE:** If the control panel display is blank, but the cooling fans run after the product power is turned on, try printing an engine-test page to determine whether the problem is with the control-panel display, formatter, or other product components. See [Engine test button on page 35](#).

Power-on timing (approximate)

Power-on timing from boot sequence to the **Ready** state might change as the firmware is upgraded.

- 00.00 seconds; power-button LED illuminates and fans rotate at high speed
- 00.06 seconds; control panel backlight illuminates and engine noises begin
- 00:10 seconds; HP logo appears on the control-panel display, boot sequence count appears on the control-panel display

Boot sequence

- 1/8 = 10 seconds
- 2/8 = 15 seconds

 **NOTE:** Depending on how the product was shut down, the product might stay at this point for several minutes while the Disk Check process completes.

- 7/8 = 45 seconds
- 8/8 = 50 seconds
- 01:30 seconds; fuser fan noise stops and engine noises stop
- 01:50 seconds; product enters the **Ready** state

Tools for troubleshooting

Component diagnostics

LED diagnostics

LED, engine, and individual diagnostics can identify and troubleshoot product problems.

Understand lights on the formatter

Three LEDs on the formatter indicate that the product is functioning correctly.

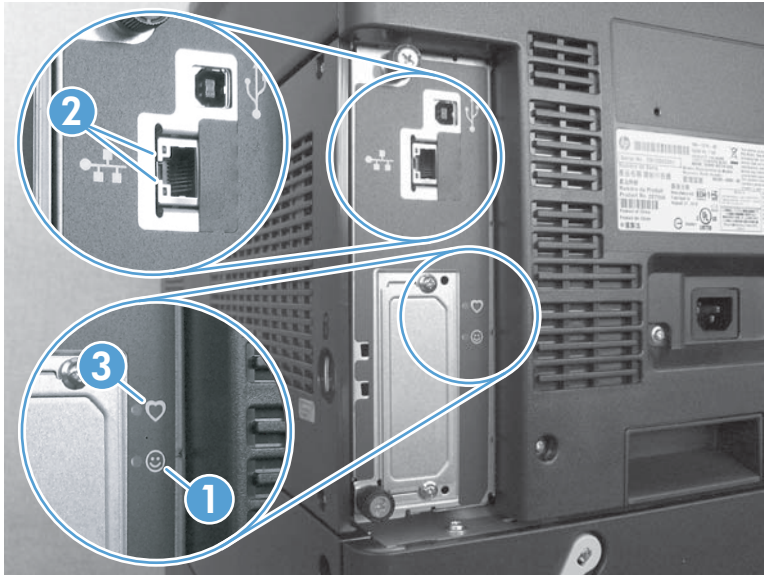



1	Formatter connectivity LED (lit when formatter is correctly seated)
2	HP Jetdirect LEDs
3	Heartbeat LED

HP Jetdirect LEDs

The embedded HP Jetdirect print server has two LEDs. The yellow LED indicates network activity, and the green LED indicates the link status. A blinking yellow LED indicates network traffic. If the green LED is off, a link has failed.

For link failures, check all the network cable connections. In addition, you can try to manually configure the link settings on the embedded print server by using the product control-panel menus.

1. Press the Home button .
2. Press the **Down** arrow  to highlight the **Administration** menu, and then press the OK button.
3. Press the **Down** arrow  to highlight the **Network Settings** menu, and then press the OK button.

4. Press the **Down** arrow ▼ to highlight the **Embedded Jetdirect** option, and then press the OK button.
5. Press the **Down** arrow ▼ to highlight the **Link Speed** menu, and then press the OK button.
6. Select the appropriate link speed, and then press the OK button.

Heartbeat LED

The heartbeat LED indicates that the formatter is functioning correctly. While the product is initializing after you turn it on, the LED blinks on/off, on/off, pauses for a short duration, then repeats the sequence. This sequence continues after the product has finished the initialization sequence.

Engine diagnostics

This section provides an overview of the engine diagnostics that are available in the HP Color LaserJet Enterprise CP5520 Printer Series product. The product contains extensive internal diagnostics that help in troubleshooting print quality, paper path, noise, component, and timing issues.

Defeating interlocks

Different tests can be used to isolate different types of issues. For component or noise isolation, you can run the diagnostic test when the front and right doors are open. To operate the product with the doors open, the door switch levers must be depressed to simulate a closed-door position.

⚠ **WARNING!** Be careful when performing printer diagnostics to avoid risk of injury. Only trained service personnel should open the doors and run the diagnostics with the covers removed. Never touch any of the power supplies when the printer is plugged in or turned on.

Defeat the right-door opening/closing sensor (PS15)

1. Open the right and front doors.

2. Insert a thin piece of paper into the right-door sensor slot (callout 1).

△ **CAUTION:** Using too thick of a piece of paper to activate this sensor might dislodge the photo-interrupter body from its mounting bracket. Make sure you use a thin piece of paper to activate the sensor.

Figure 1 Defeating door interlocks (1 of 2)

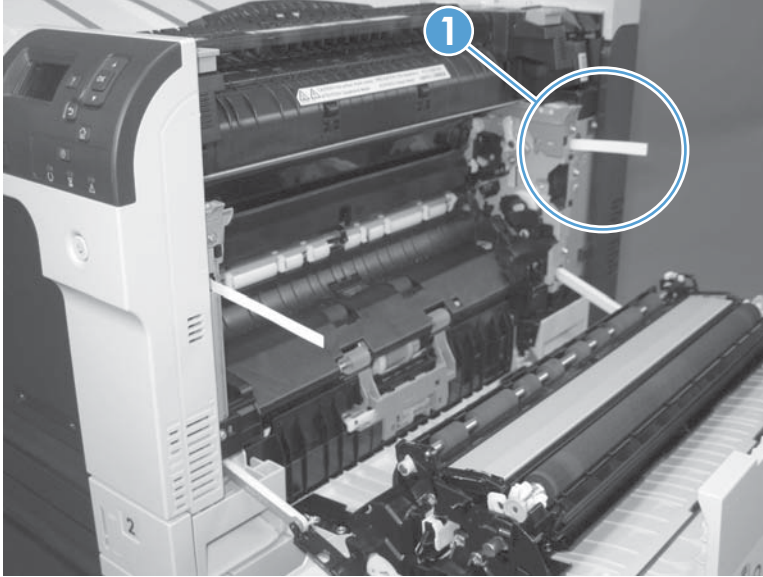

3. Insert a folded piece of paper into the front door switch (callout 2). Wait until the product enters the **Ready** state.

📄 **NOTE:** The paper must be thick enough to depress and hold in place the sensor actuator arm.

Figure 2 Defeating door interlocks (2 of 2)

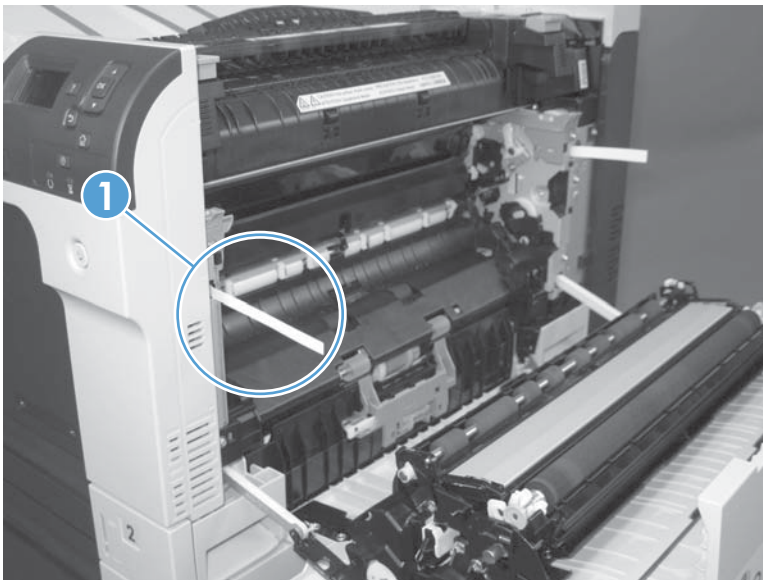

Disable cartridge check

Use this diagnostic test to print internal pages or send an external job to the product when one or more print cartridges are removed or exchanged. Consumable supply errors are ignored while the product is in this mode. When the product is in this mode, you can navigate the troubleshooting menus and print internal pages (the print quality pages will be the most useful). This test can be used isolate problems, such as noise, and to isolate print-quality problems that are related to individual print cartridges.

 **NOTE:** Color cartridges are not keyed and can be interchanged. An error will display on the control panel if a print cartridge is installed in the wrong position. The **Supplies Status** menu will explain which print cartridge is misplaced.

NOTE: Do not remove or exchange print cartridges and image drums until after you start the disable cartridge check diagnostic.

1. Press the Home  button.
2. Open the following menus:
 - **Administration**
 - **Troubleshooting**
 - **Diagnostic Tests**
3. Press the **Down** arrow  to highlight **DISABLE CARTRIDGE CHECK**, and then press the OK button .

To exit this diagnostic test, press the **Stop** button  and then select **EXIT TROUBLESHOOTING**.

Engine test button

1. Turn the product on.
2. Use a fine-point tool, (for example a precision-slotted screwdriver with a 1 mm (0.04 in) blade width) to press the engine test button.

 **NOTE:** Access the engine test button through a hole in the rear cover.

3. An engine test page (lines in each of the print cartridge colors) prints.

Figure 3 Engine test button location





Paper-path test

This diagnostic test generates one or more test pages that you can use to isolate the cause of jams.

To isolate a problem, specify which input tray to use, specify whether to use the duplex path, and specify the number of copies to print. Multiple copies can be printed to help isolate intermittent problems. The following options become available after you start the diagnostic feature:

- **Print Test Page.** Run the paper-path test from the default settings: Tray 2, no duplex, and one copy. To specify other settings, scroll down the menu and select the setting, and then scroll back up and select **Print Test Page** to start the test.
- **Source Tray.** Select Tray 1, Tray 2, or the optional tray.
- **Test Duplex Path.** Enable or disable two-sided printing.

 **NOTE:** Duplex models only.

- **Number of Copies.** Set the numbers of copies to be printed; the choices are 1, 10, 50, 100, or 500.
1. Press the Home  button.
 2. Open the following menus:
 - **Administration**
 - **Troubleshooting**
 - **Diagnostic Tests**
 3. Press the **Down** arrow  to highlight **PAPER PATH TEST**, and then press the OK button.
 4. Select the paper-path test options for the test you want to run.

Manual sensor test

Use this diagnostic test to manually test the product sensors and switches. Each sensor is represented by a letter and number on the control panel display.

1. Press the Home button .
2. Open the following menus:
 - **Administration**
 - **Troubleshooting**
 - **Diagnostic Tests**
3. Press the **Down** arrow  to highlight the **Manual Sensor Test** item, and then press the OK button.

To exit this diagnostic, press the Stop button , and then select **EXIT TROUBLESHOOTING**.



Menus cannot be opened during this test, so the OK button serves the same function as the **Stop** button .

Table 20 Manual sensor diagnostic tests

Sensor or switch name	Sensor or switch number
Front door opening/closing switch	PS14
Right door opening/closing sensor	PS15
A TOP (top of page) sensor	PS5
Fuser loop 1 sensor	PS7
Fuser loop 2 sensor	PS8
Fuser pressure-release sensor	PS9
Fuser output sensor	PS6
Developer alienation sensor	PS11
ITB alienation sensor	SW5

Front-door opening/closing switch (PS14)

 **NOTE:** This switch is also activated by the right door. See [Right-door opening/closing sensor \(PS15\)](#) on page 39. During this test, the right door must remain closed.

1. Open the front-door assembly to disengage the front-door opening/closing switch.
2. Close the front-door assembly, and then check the control panel on the product for sensor response.



 **TIP:** You can leave the front door open and use a folded piece of paper to activate the switch.

Figure 4 Test the front-door opening/closing switch

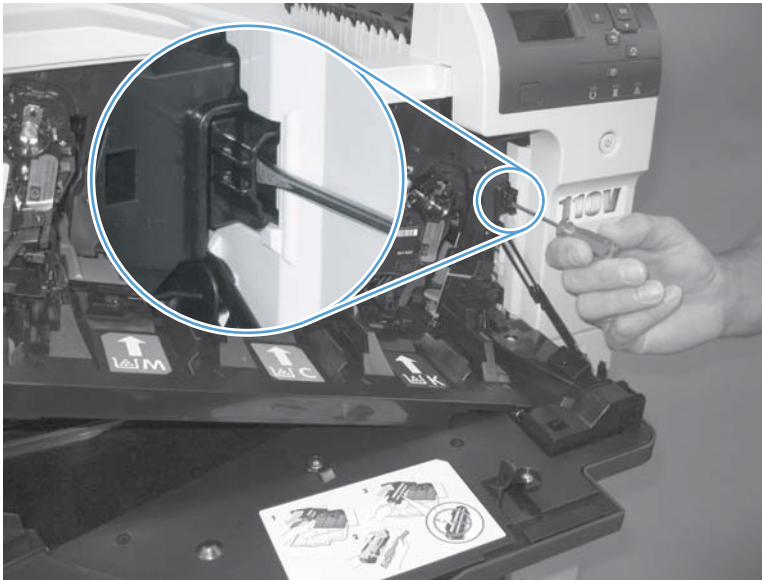

3. Check the control-panel display for sensor response.
4. If there is no response, replace the front-door opening/closing microswitch or the cable.

Right-door opening/closing sensor (PS15)

 **NOTE:** The front-door opening/closing switch (PS14) is also activated by the right door. During this test, the front door must remain closed.

1. Open the right-door assembly to disengage the right-door opening/closing photo-interrupter sensor.
2. Insert a piece of paper (callout 1) to override the front-door opening/closing switch (PS14).

 **NOTE:** The paper must be thick enough to depress and hold in place the sensor actuator arm.

Figure 5 Test the right-door opening/closing switch (1 of 2)



3. Insert a thin piece of paper (callout 1) to activate the right-door opening/closing sensor (PS15).

△ **CAUTION:** Using too thick of a piece of paper to activate this sensor might dislodge the photo-interrupter body from its mounting bracket. Make sure you use a thin piece of paper to activate the sensor.

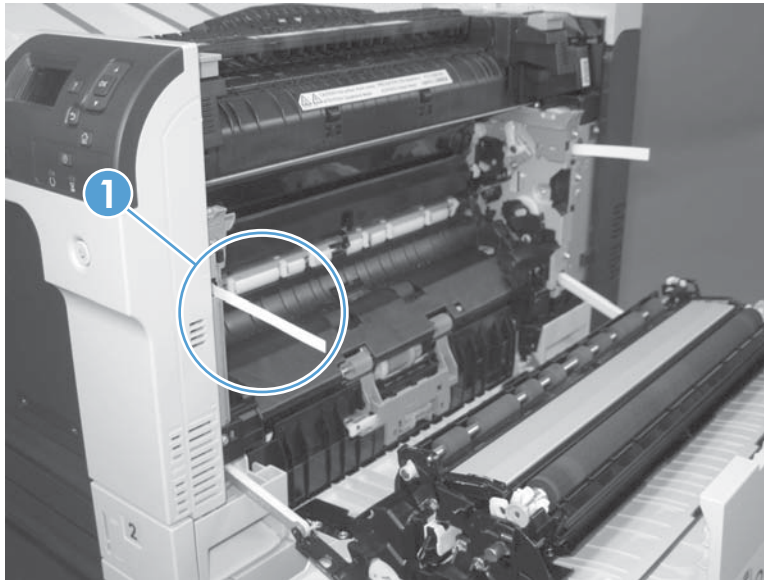
Figure 6 Test the right-door opening/closing switch (2 of 2)

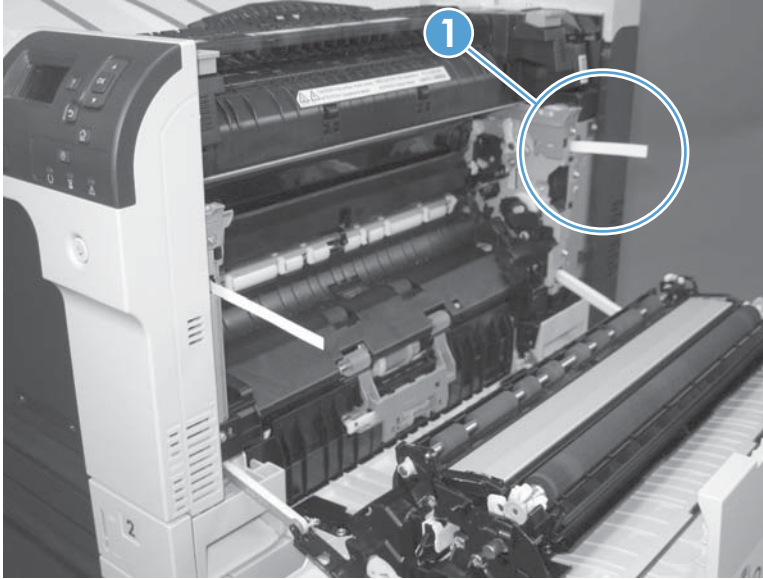

4. If there is no response, replace the right-door sensor.

TOP (top-of-page) sensor (PS5)

1. Open the right door, and then locate the sensor flag (callout 1).

Figure 7 Test the TOP sensor (1 of 2)

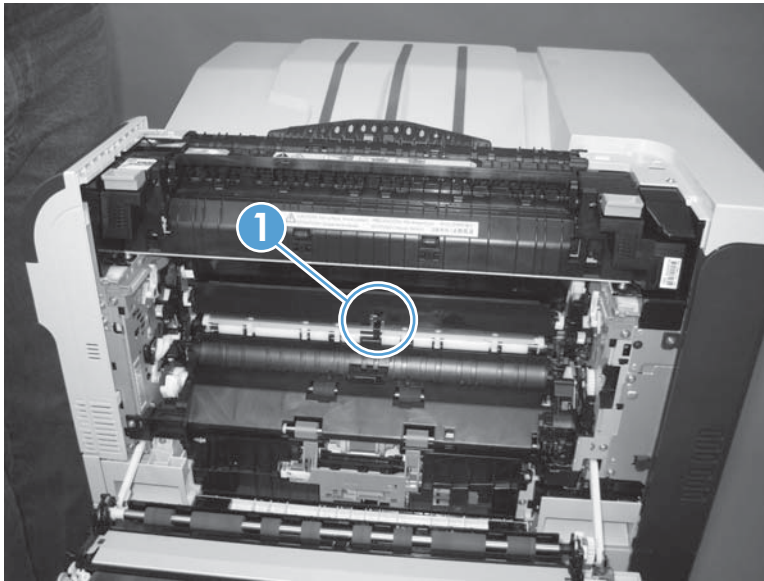

2. Activate the TOP sensor.

Figure 8 Test the TOP sensor (2 of 2)

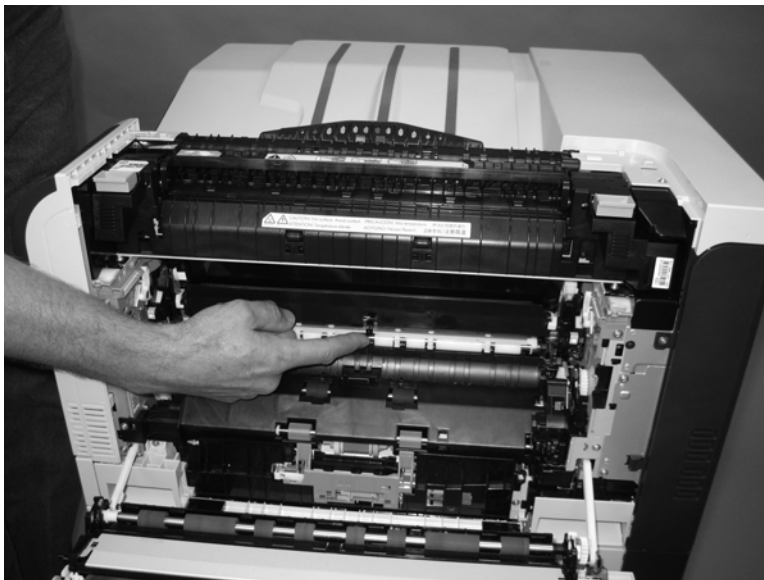

3. Check the control-panel display for sensor response.
4. If there is no response, replace the registration assembly.

Fuser loop sensors 1 and 2 (PS7 and PS8)

1. Open the right door.
2. Slowly insert a piece of paper at the entrance of the fuser to activate the fuser loop sensors 1 and 2 underneath the fuser.

Figure 9 Test the fuser loop sensors

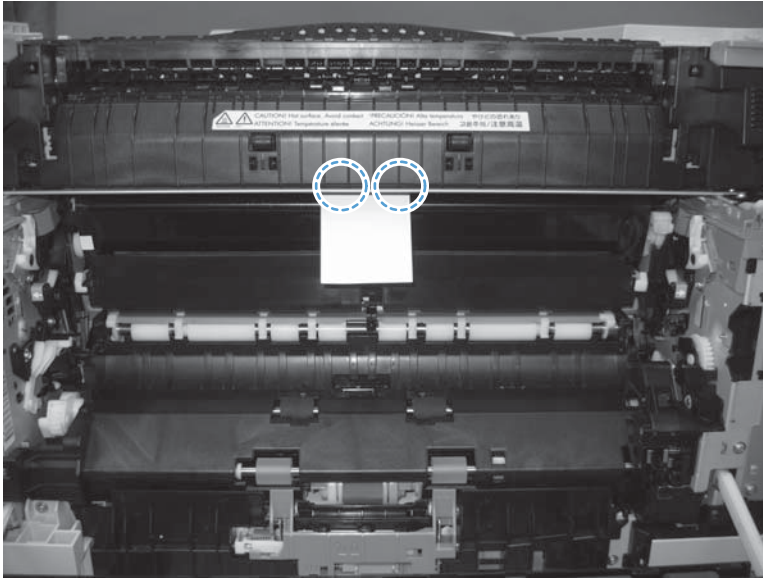

3. Check the control-panel display for a sensor response.
4. If there is no response, replace fuser.

Fuser pressure-release sensor (PS9)

1. Open the right-door assembly.
2. Remove the fuser.
3. Insert a piece of paper as shown to activate the fuser pressure-release sensor.

Figure 10 Test the fuser pressure-release sensor

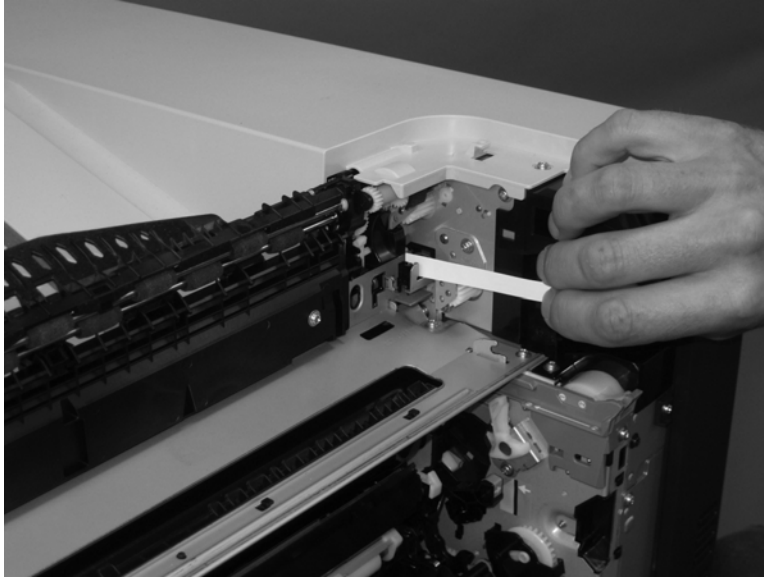

4. Check the control-panel display for sensor response.
5. If there is no response, replace the fuser drive assembly.

Fuser output sensor (PS6)

1. Open the right-door assembly.
2. Open the fuser jam-access flap.

Figure 11 Test the fuser output sensor (1 of 2)

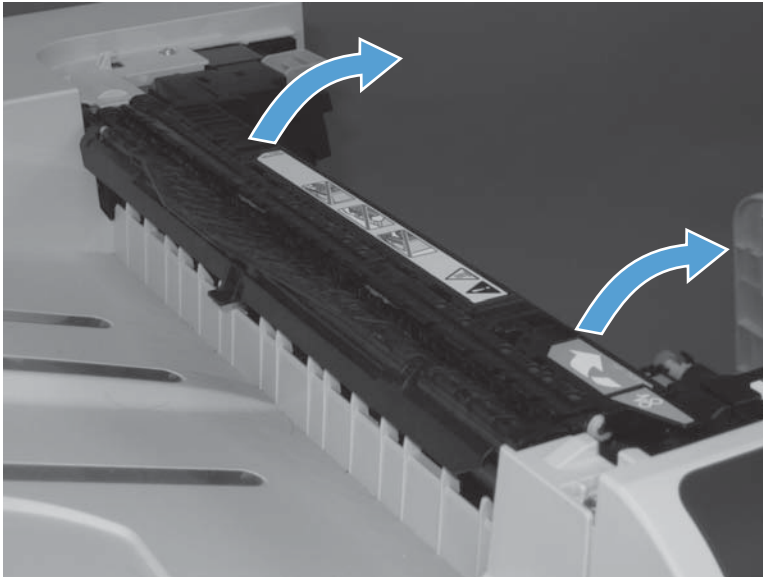

3. Locate the fuser output sensor flag (callout 1), and then activate the sensor flag.

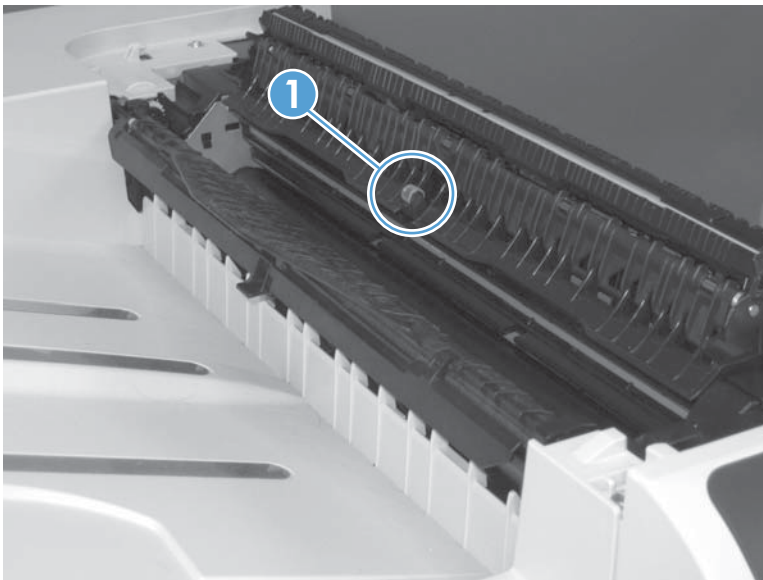

Figure 12 Test the fuser output sensor (2 of 2)



4. Check the control-panel display for a sensor response.
5. If there is no response, replace the fuser.

Developer alienation sensor (PS11)

This sensor is located inside the main-drive assembly and cannot be accessed for direct manual testing. Use the paper path sensor test to test this sensor.

1. Press the Home button .
2. Open the following menus:
 - **Administration**
 - **Troubleshooting**
 - **Diagnostic Tests**
3. Press the **Down** arrow  to highlight the **Paper Path Sensors** item, and then press the OK button.
4. Press the **Down** arrow  to highlight **Start**, and then check the control-panel display for sensor response (watch the developer alienation sensor (PS11) in the list).
5. If there is no response, replace the main drive assembly.

ITB alienation switch (SW5)

1. Remove the toner cartridges and the ITB. Activate the sensor by moving the flag located on the rear ITB guide rail.

Figure 13 Test the ITB alienation switch

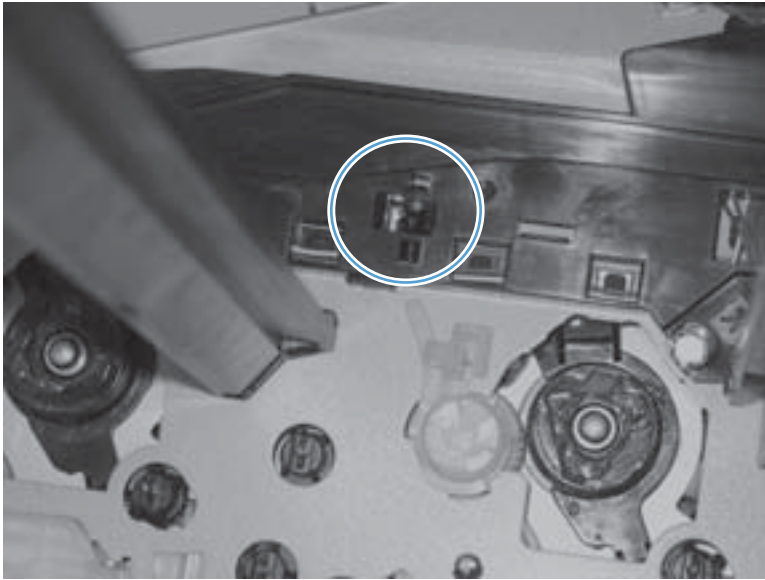

2. Check the control-panel display for sensor response.
3. If there is no response, replace the main drive assembly.

Tray/Bin manual sensor test

Use this test to test the tray and bin sensors and switches manually. The following illustrations and table show the locations of these sensors.

1. Press the Home button .
2. Open the following menus:
 - **Administration**
 - **Troubleshooting**
 - **Diagnostic Tests**
3. Press the **Down** arrow ▼ to highlight the **Tray/Bin Manual Sensor Test** item, and then press the OK button.

Table 21 Tray/Bin manual sensor test

Sensor or switch name	Sensor or switch number
Tray 1 paper sensor	PS2
Tray 2 paper sensor	PS1
Tray 2 paper surface sensor	PS4
Tray 2 paper size switches	SW7 and SW 8
Tray 3 paper sensor	SR3
Tray 3 paper surface sensor	SR2
Tray 3 paper size switches	SW2 and SW3
Tray 3 feed sensor	SR1
Tray 3 door opening/closing sensor	SW1
Tray 4 paper sensor	SR3
Tray 4 paper surface sensor	SR2
Tray 4 paper size switches	SW2 and SW3
Tray 4 feed sensor	SR1
Tray 4 opening/closing sensor ¹	SW1
Tray 5 paper sensor	SR83
Tray 5 paper surface sensor	SR82
Tray 5 paper size switches	SW82 and SW83
Tray 5 feed sensor	SR81
Tray 5 opening/closing sensor ¹	SW1
Tray 6 paper sensor	SR93
Tray 6 paper surface sensor	SR92

Table 21 Tray/Bin manual sensor test (continued)

Sensor or switch name	Sensor or switch number
Tray 6 paper size switches	SW92 and SW93
Tray 6 feed sensor	SR91
Tray 6 opening/closing sensor ¹	SW1
Output bin full sensor	PS10

¹ Tray 4, Tray 5, and Tray 6 use the same opening/closing sensor (SW1) on the right door of the accessory.

Tray 1 paper sensor (PS2)

1. Open Tray 1.
2. Locate the Tray 1 paper-present sensor flag (callout 1), and then toggle the sensor flag to activate the sensor.

Figure 14 Test the Tray 1 paper present sensor

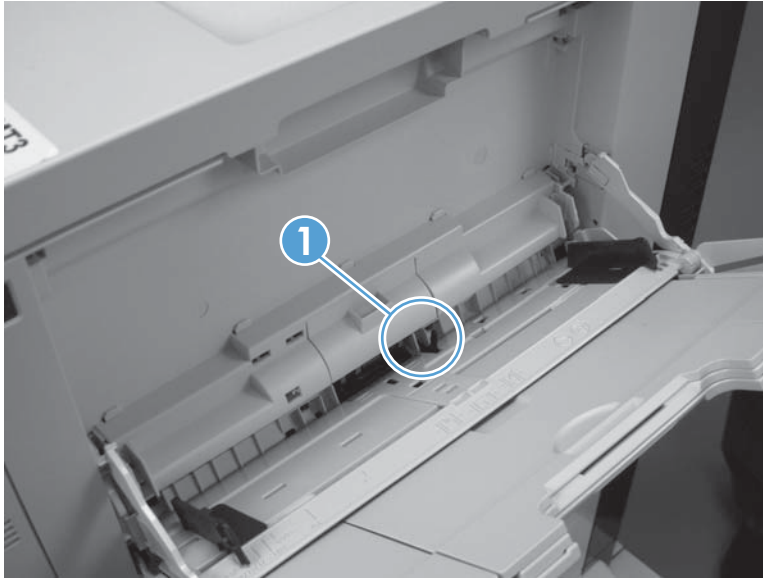

3. Check the control-panel display for sensor response.
4. If there is no response, replace the paper pickup assembly.

Tray 2 paper present sensor (PS1)

1. Remove the tray.
2. In the tray cavity, release the spring loaded tray-present lever to lower the flag (callout 1), and then toggle the flag to activate the sensor.

Figure 15 Test the tray 2 paper sensor

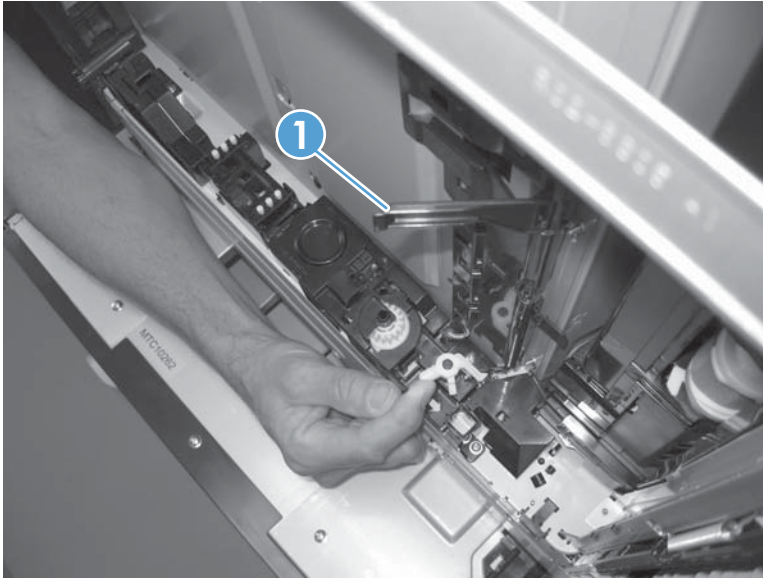

3. Check the control-panel display for sensor response.
4. If there is no response, replace the last paper detect sensor.

Tray 2 paper surface sensor (PS4)

1. Remove the tray.
2. In the tray cavity, insert a slip of paper in the photo sensor receptor and transmitter (callout 1).

Figure 16 Tray 2 paper surface sensor

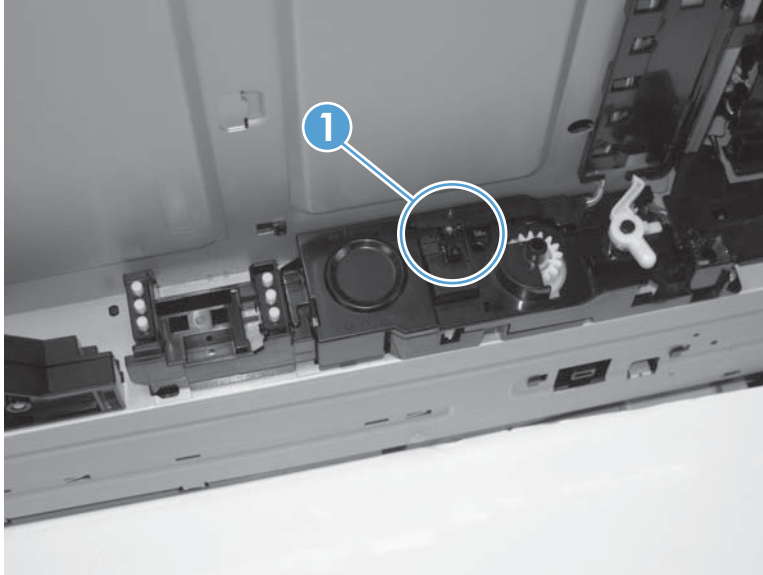

3. Check the control-panel display for sensor response.
4. If there is no response, replace the lifter drive assembly.

Tray 2 paper size switches (SW7 and SW8)

 **NOTE:** These switches also detect cassette presence. If these switches fail, the message **Tray <X> open** could appear on the control-panel display.

1. Remove the tray. From inside the tray cavity, push any of the switch buttons (callout 1).

 **TIP:** You can test these sensors by opening, and then closing the tray.

Figure 17 Test the Tray 2 paper size switches



2. Check the control-panel display for sensor response.
3. If there is no response, replace the lifter assembly.

Tray 3 paper sensor (SR3)

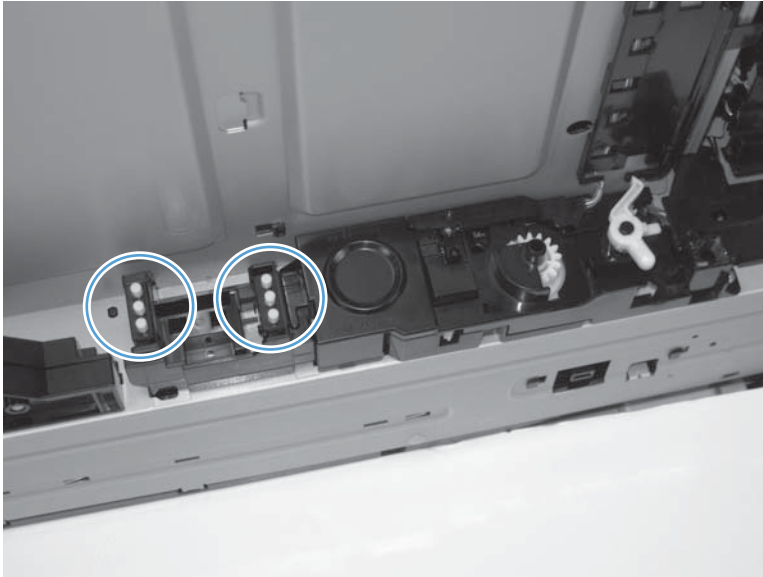
1. Remove the tray.
2. In the tray cavity, release the spring loaded tray-present lever to lower the flag (callout 1), and then toggle the flag to activate the sensor.

Figure 18 Test Tray 3 paper sensor

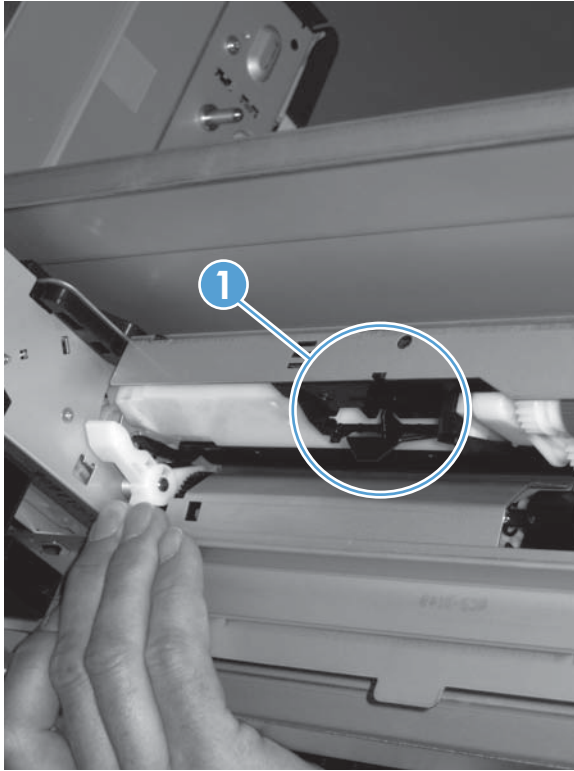

3. Check the control-panel display for sensor response.
4. If there is no response, replace the paper pickup assembly.

Tray 3 paper surface sensor (SR2)

1. Remove the tray.
2. In the tray cavity, release the spring loaded tray-present lever to lower the flag (callout 1), and then toggle the flag to activate the sensor.

Figure 19 Test Tray 3 paper sensor

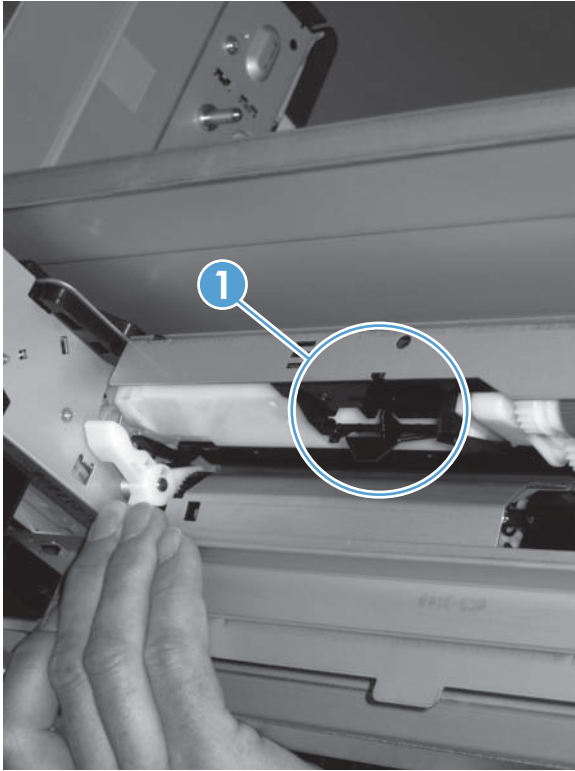

3. Check the control-panel display for sensor response.
4. If there is no response, replace the paper pickup assembly.

Tray 3 paper size sensors (SW2 and SW3)

 **NOTE:** These switches also detect cassette presence. If these switches fail, the message **Tray <X> open** could appear on the control-panel display.

1. Remove the tray. From inside the tray cavity, push any of the switch buttons (callout 1).

 **TIP:** You can test these sensors by opening, and then closing the tray.

Figure 20 Test Tray 3 paper size sensors



2. Check the control-panel display for sensor response.
3. If no response, replace the lifter drive assembly.

Tray 3 feed sensor (SR1)

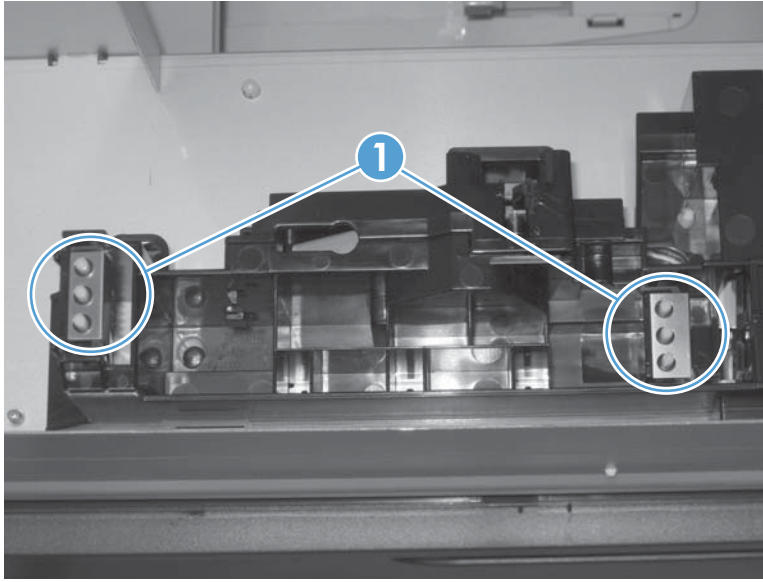
1. Open the paper-feeder door.
2. Insert a piece of paper as shown to activate the feed sensor.

💡 **TIP:** Use stiff paper when performing this test (for example a business card or index card).

Figure 21 Test the Tray 3 feed sensor



3. Check the control-panel display for sensor response.
4. If no response, replace the paper pickup assembly.

Tray 3 door opening/closing sensor (SW1)

1. Open and then close the paper-feeder door to activate the sensor. The tab on the door (callout 1) activates the sensor (callout 2).

Figure 22 Test the Tray 3 door opening/closing sensor

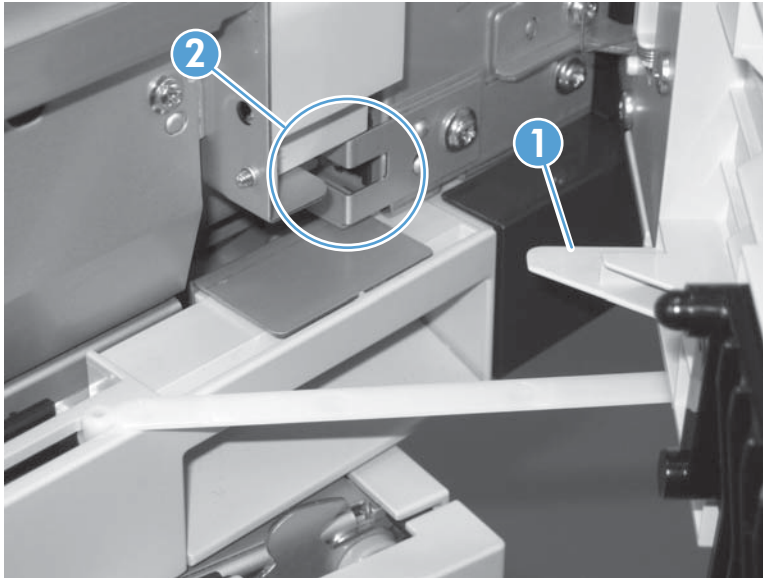

2. Check the control-panel display for sensor response.
3. If no response, replace the button switch.

Tray 4 paper sensor (SR3)

See [Tray 3 paper sensor \(SR3\) on page 53](#).

Tray 4 paper surface sensor (SR2)

See [Tray 3 paper surface sensor \(SR2\) on page 54](#).

Tray 4 paper size sensors (SW2 and SW3)

See [Tray 3 paper size sensors \(SW2 and SW3\) on page 55](#).

Tray 4 feed sensor (SR1)

See [Tray 3 feed sensor \(SR1\) on page 56](#).

Tray 4 door opening/closing door sensor (SW1)

 **NOTE:** Tray 4, Tray 5, and Tray 6 use the same opening/closing door sensor (SW1).

1. Open and then close the paper-feeder door to activate the sensor (the tab on the door (callout 1) activates the sensor (callout 2)).

Figure 23 Test the Tray 4 door opening/closing sensor

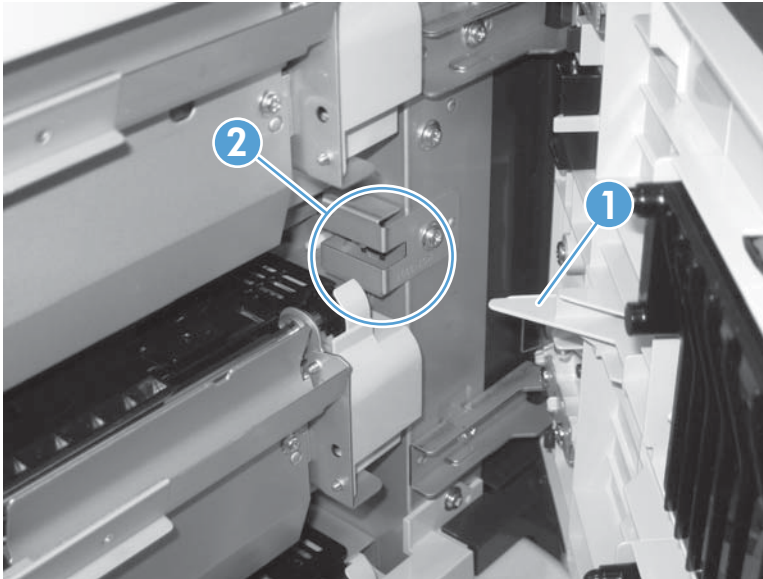

2. Check the control-panel display for sensor response.
3. If no response, replace the button switch.

Tray 5 paper sensor (SR83)

See [Tray 3 paper sensor \(SR3\) on page 53](#).

Tray 5 paper surface sensor (SR82)

See [Tray 3 paper surface sensor \(SR2\) on page 54](#).

Tray 5 paper size sensors (SW82 and SW83)

See [Tray 3 paper size sensors \(SW2 and SW3\) on page 55](#).

Tray 5 feed sensor (SR81)

See [Tray 3 feed sensor \(SR1\) on page 56](#).

Tray 5 door opening/closing sensor (SW1)

See [Tray 4 door opening/closing door sensor \(SW1\) on page 58](#).

Tray 6 paper sensor (SR93)

See [Tray 2 paper present sensor \(PS1\) on page 50](#).

Tray 6 paper surface sensor (SR92)

See [Tray 3 paper surface sensor \(SR2\) on page 54](#).

Tray 6 paper size sensors (SW92 and SW93)

See [Tray 3 paper size sensors \(SW2 and SW3\) on page 55](#).

Tray 6 feed sensor (SR91)

See [Tray 3 feed sensor \(SR1\) on page 56](#).

Tray 6 door opening/closing sensor (SW1)

See [Tray 4 door opening/closing door sensor \(SW1\) on page 58](#).

Output-bin-full sensor (PS10)

1. Locate the output-bin-full sensor flag (callout 1), and then activate the sensor flag.

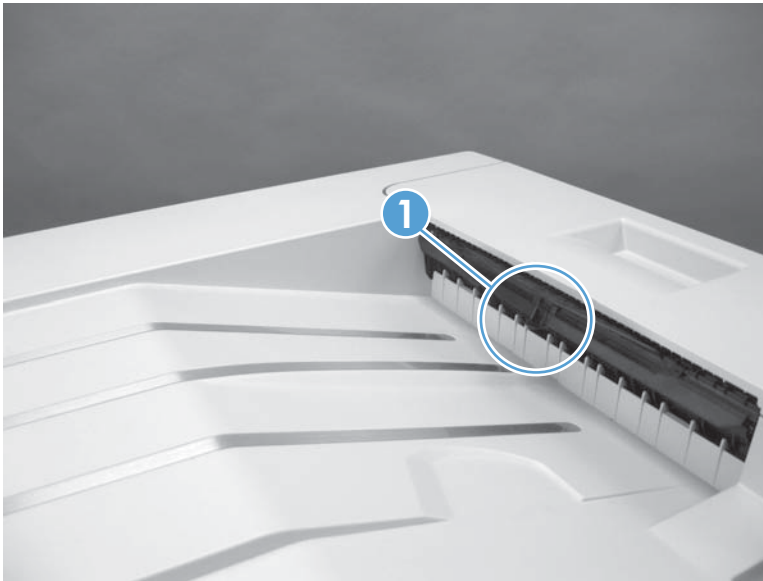

Figure 24 Test the output-bin-full sensor



2. Check the control-panel display for sensor response.
3. If there is no response, examine the flag at the left end of the output bin full sensor flag. If the flag is broken, replace the paper delivery assembly. If the flag is not broken, replace the fuser gear assembly.

Paper-path sensors test

This test displays the status of each paper-path sensor and allows viewing of sensor status while printing internal pages.

1. Press the Home  button.
2. Open the following menus:
 - **Administration**
 - **Troubleshooting**
 - **Diagnostic Tests**
3. Press the **Down** arrow  to highlight the **Paper Path Sensors** option, and then press the OK button.
4. Select **Start Test**. Press the down arrow  to see the test results.

 **NOTE:** Exiting the Paper-path sensor test menu and then reentering it will clear the test values from the previous test.

Viewing the sensor status before you activate the test should show that the sensors PS9, PS11 and SW5 have already been activated. After running the Paper-path sensor test, sensor PS9 does not show any activation status.

Table 22 Paper-path sensors diagnostic tests

Sensor name	Sensor number
TOP (top of page) sensor	PS5
Fuser loop sensor	PS7
Fuser loop sensor	PS8
Fuser delivery sensor	PS6
Output bin full sensor	PS10
Developer alienation	PS11
Fuser pressure-release sensor	PS9
Primary transfer-roller-disengagement sensor	SW5

Print/stop test

Use this diagnostic test to isolate the cause of problems such as image-formation defects and jams within the engine. During this test you can stop the paper anywhere along the product paper path. The test can be programmed to stop printing internal pages or an external print job when the paper reaches a certain position. The test can also be programmed to stop from 0 to 60,000 ms. If the timer is set to a value that is greater than the job-print time, you can recover the product in one of two ways.

- After the print job is completed press the **Stop** button (⊗) to return to the **Diagnostic Tests** menu before the timer times out.
- After the timer times out, press the **Stop** button (⊗). Activate the door switch to restart the engine and return it to a normal state.

When the timer trips, the control panel display shows the message **Printing stopped To continue, press OK**. Pressing the Home button (⏠) will print the previously selected job. If you do not want the previous job to print, press the **Stop** button (⊗) first, and then press the Home button (⏠).

 **NOTE:** Do not try to perform a print/stop test while the product is calibrating, because you will be required to power-cycle the product. If a jam message displays on the control panel during testing, activate the door switch.

Component tests

Component test (special-mode test)

This test activates individual parts independently to isolate problems.

Each component test can be performed once or repeatedly. If you select the **Repeat** option (at the end of the menu), the test cycles the component on and off. This process continues for two minutes, and then the test terminates.

 **NOTE:** The front or side door interlocks must be defeated to run the component tests. Some tests may require that the ITB and print cartridges be removed. The control panel display prompts you to remove some or all cartridges during certain tests.

1. Press the Home button .
2. Open the following menus:
 - **Administration**
 - **Troubleshooting**
 - **Diagnostic Tests**
3. Press the **Down** arrow ▼ to highlight the **Component Test** item, and then press the OK button.
4. Select the component test options for the test you want to run.

Table 23 Component tests (1 of 2)

Component test	Component tested	Comments
Transfer Motors	M1 (ITB motor)	Drives the ITB motor and drum motor together at a specified speed for 5 seconds.
	M2 (drum motor)	
Belt Only	M1 (ITB motor)	Drives ITB drive motor at a specified speed for 5 seconds.
Developer Motors	M1 (ITB motor)	Drives the ITB motor at a specified speed for 5 seconds.
	M3 (developer motor)	Drives the developer motor at a specified speed for 5 seconds (drives 3 times).
Cartridge Motors	M1 (ITB motor)	Drives the ITB motor at a specified speed for 5 seconds.
	M2 (drum motor)	Drives the drum motor at a specified speed for 5 seconds (drives 3 times).
Fuser Motor	M4	Drives the fuser motor at a specified speed for 5 seconds.
Alienation Motor (cartridge)	M6 (developer alienation motor)	Drives the developer disengagement motor and engages or disengages the developer (drives the motor four times). If the home position of the developer is not commanded within 5 seconds, the product brings the developer to its home position.

Table 23 Component tests (1 of 2) (continued)

Component test	Component tested	Comments
ITB Contact/Alienation Motor	M4 (fuser motor)	<p>Drives the fuser motor M4 (drives the motor four times) and the T1 roller disengagement solenoid SL5, and brings the T1 roller to either one of the following states:</p> <ul style="list-style-type: none"> • 4 rollers are disengaged (home position) • Only K T1 roller is engaged or 4 rollers are engaged <p>If home position of the T1 roller is not commanded within 10 seconds, the printer moves the T1 roller to its home position.</p> <p>Additionally, the printer keeps the state of 4 rollers engagement so that the service technician can access and manually clean the dust-proof glass (open the front door and remove the cartridge).</p>
	SL5 (disengagement solenoid)	
Fuser Contact/Alienation Drive	M4 (fuser motor)	Reverses the fuser motor to rotate the fuser pressure release cam and pressurize or depressurize the pressure roller. If home position of the pressure roller is not commanded within 5 seconds, the printer brings the pressure roller to its home position.
Tray<X> Pickup Motor	M5 (pickup motor)	<p>Drives the pickup motor M5, the 500 sheet paper feeder pickup motor M1, and each of the 3x500 paper deck cassette pickup motors, cassette 1 M1, cassette 2 M81, and cassette 3 M91 individually at a specified speed for 5 seconds.</p>
	M1 (Tray 3 pickup motor)	
	M1 (Tray 4 pickup motor)	
	M81 (Tray 5 pickup motor)	
	M91 (Tray 6 pickup motor)	
DuplexerPickup Motor	M8 (duplex pickup motor)	Drives the duplex feed motor at a specified speed for 5 seconds.
Switchback Motor	M7 (duplex reverse motor)	Drives the duplex reverse motor at a specified speed for 5 seconds.

Table 23 Component tests (1 of 2) (continued)

Component test	Component tested	Comments
Tray<X> Pickup Solenoid	SL2 (Tray 1 pickup solenoid)	Drives the Tray 1 pickup solenoid SL2, the Tray 2 cassette pickup solenoid SL1, the 500 sheet feeder pickup solenoid SL1, and each of the 3x500 paper deck cassette solenoids, cassette 1 SL1, cassette 2 SL82, and cassette 3 SL92, individually for 5 seconds.
	SL1 (Tray 2 pickup solenoid)	
	SL1 (Tray 3 pickup solenoid)	
	SL1 (Tray 4 pickup solenoid)	
	SL82 (Tray 5 pickup solenoid)	
	SL92 (Tray 6 pickup solenoid)	
Switchback Flapper Solenoid	SL3 (duplex reverse solenoid)	Drives the duplex reverse solenoid for 10 seconds.

Additional component tests

The following tests are not supported in the firmware. These component tests are accomplished by manipulating or observing the product during operation or when the power is turned on.

Table 24 Component tests (2 of 2)

Component test	Component tested	Comments
Paper Deck Cassette Lifter Motor	M9 (Tray 2 lifter drive assembly)	Open and then close a paper tray. Listen at the back side of the product for the sound of the lift motor for that tray.
	M2 (Tray 3 lifter drive assembly)	
	M2 (Tray 4 lifter drive assembly)	If the lift motor does not make a sound and the paper surface sensor for that tray passes a sensor test (see Tray/Bin manual sensor test on page 47), replace the lifter drive assembly.
	M82 (Tray 5 lifter drive assembly)	
	M92 (Tray 6 lifter drive assembly)	
Power Supply Fan	FM1	<p>Turn the product power off, and then on. Listen at the left-front-lower corner area of the print engine for fan noise while the product initializes.</p> <p>Full/half speed intake fan Cools the following areas:</p> <ul style="list-style-type: none"> • low-voltage power supply area • face-down bin • delivery bin • laser scanner area

Table 24 Component tests (2 of 2) (continued)

Component test	Component tested	Comments
Fuser Fan	FM2	<p>Turn the product power off, and then on. Listen at the front-right-lower corner of the print engine for fan noise while the product initializes.</p> <p>Full speed intake fan Cools the following areas:</p> <ul style="list-style-type: none">• duplex feed• ITB
Formatter Fan	FM3	<p>Turn the product power off, and then on. Listen at the back-lower center area of the rear cover for fan noise while the product initializes.</p> <p>Speed controlled intake fan Cools the following areas:</p> <ul style="list-style-type: none">• DC controller• ICB• formatter <p>NOTE: The formatter controls the speed of this fan depending on product operations.</p>
Laser Scanner Motor	M10 (laser/scanner motor)	Drives the laser/scanner motor at a specified speed for 10 seconds.

Diagrams

Block diagrams

Figure 25 Product cross section

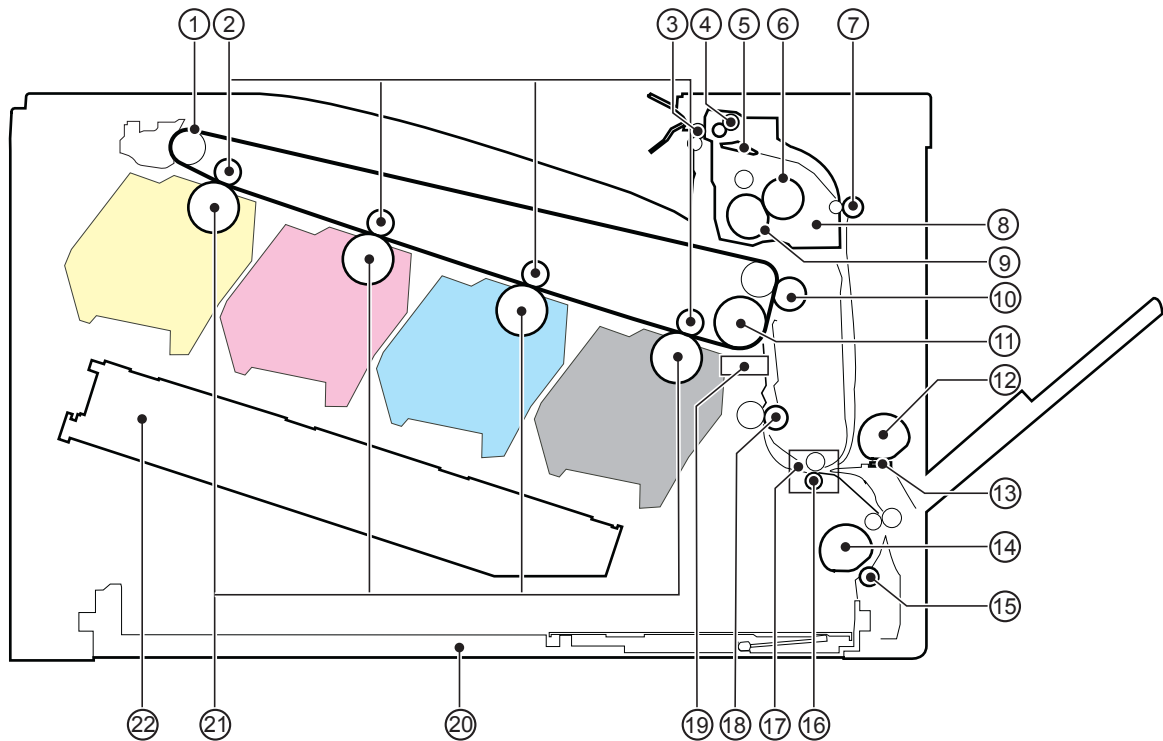

Item	Description	Item	Description
1	ITB	12	MP tray pickup roller
2	Primary transfer roller	13	MP tray separation pad
3	Delivery roller	14	Cassette pickup roller
4	Duplex reverse roller (duplex models only)	15	Cassette separation roller
5	Duplex flapper (duplex models only)	16	Feed roller
6	Pressure roller	17	Media sensor
7	Duplex feed roller (duplex models only)	18	Registration roller
8	IFuser	19	Registration density sensor
9	Fuser sleeve	20	Cassette
10	Secondary transfer roller	21	Photosensitive drum
	ITB drive roller		Laser/scanner assembly

Figure 26 Optional paper feeder (Tray 3) cross section

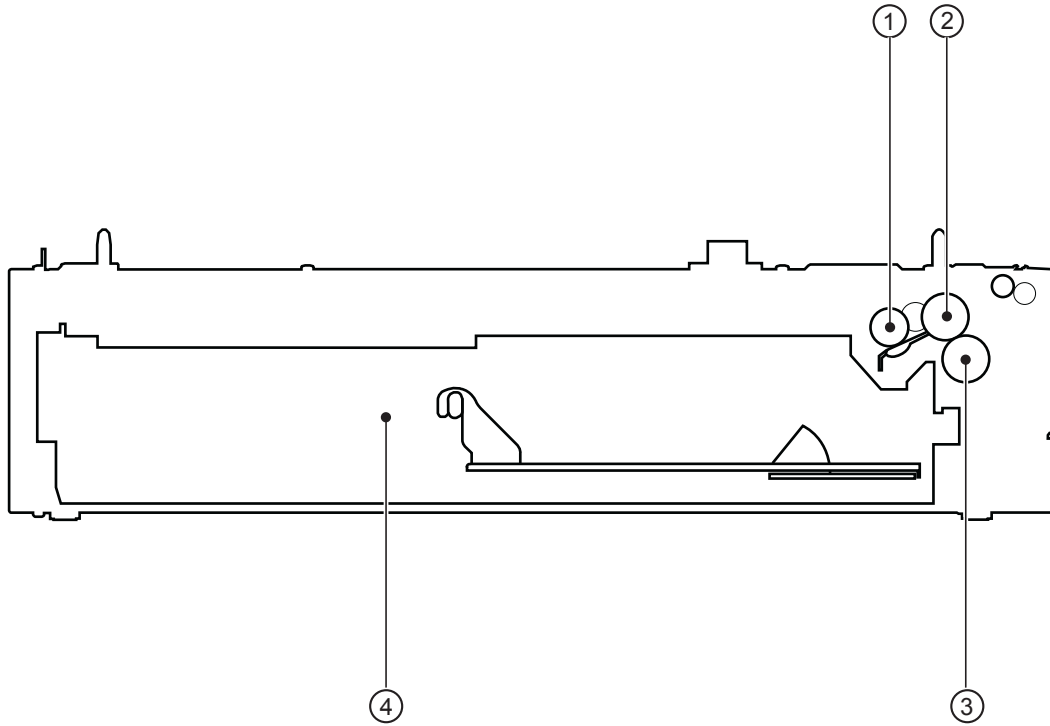

1	Pickup roller
2	Feed roller
3	Separation roller
4	Cassette

Plug/jack locations

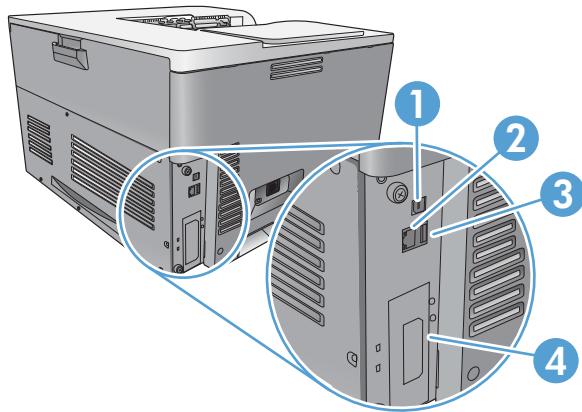

1	Hi-Speed USB 2.0 printing port
2	Local area network (LAN) Ethernet (RJ-45) network port
3	USB port for a third-party device
4	EIO interface expansion slot

Location of connectors

DC controller connections

Figure 27 DC controller connections

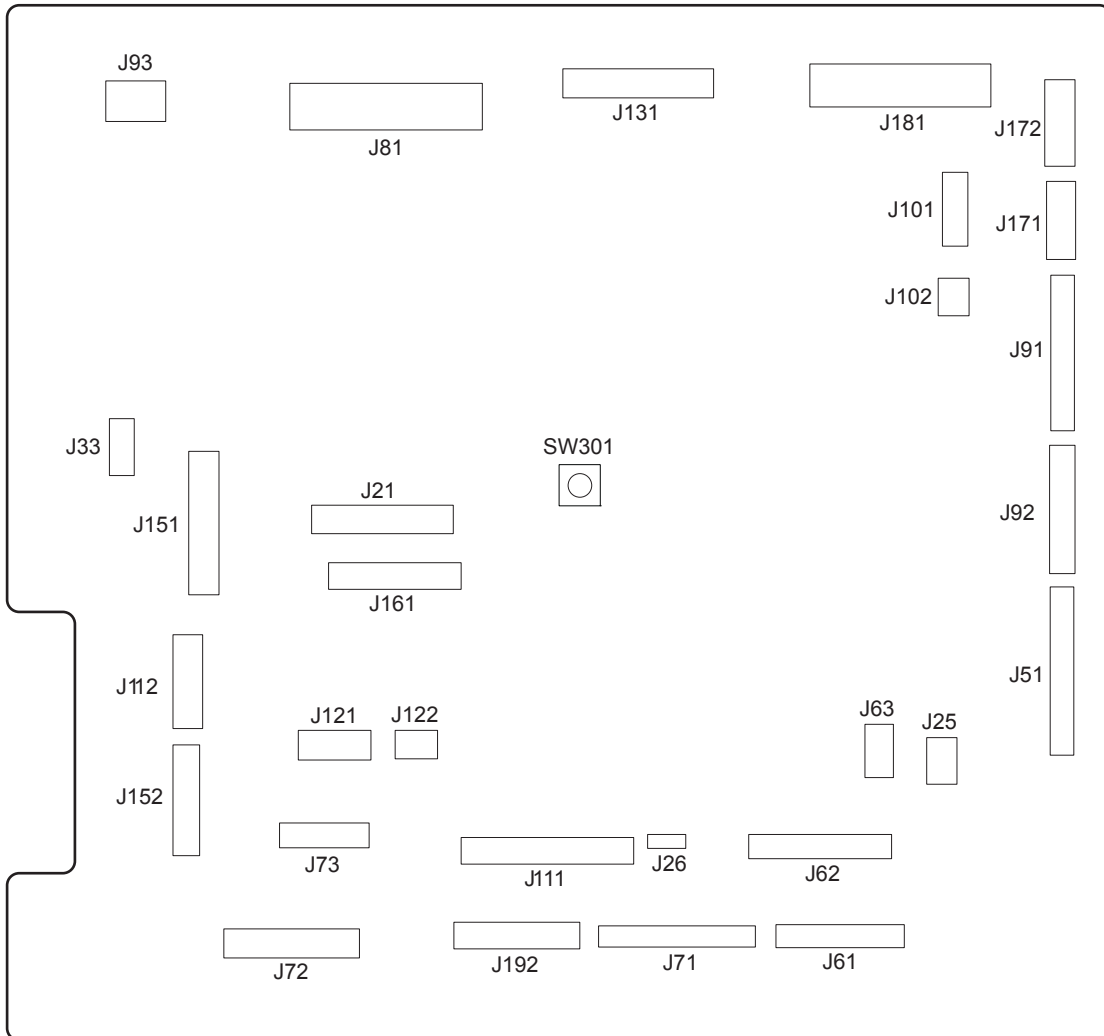

Table 25 DC controller connections

Item	Description	Item	Description	Item	Description
J21	DC controller power	J73	Secondary transfer	J122	Top of page sensor
J25	Low-voltage power supply	J81	ITB motor	J131	Fuser
			Fuser motor		
			Drum motor		
			Developing motor		

Table 25 DC controller connections (continued)

Item	Description	Item	Description	Item	Description
J33	Environment sensor	J91	Duplex reverse solenoid Cassette pickup solenoid Pickup motor Developing disengagement motor	J151	Cassette paper size Cassette paper presence Cassette lifter motor
J51	Formatter	J92	Duplex feed motor Duplex reverse motor	J152	MP tray paper presence MP tray pickup solenoid
J61	Laser scanner	J93	Driver PCA	J161	Cartridge toner level sensors
J62	Laser scanner	J101	Cartridge memory tag (yellow, magenta, cyan)	J171	Cartridge pre-exposure LEDs
J63	Laser scanner motor	J102	Cartridge memory tag (black)	J172	Cartridge pre-exposure LEDs
J71	Developing high-voltage PCA	J111	Registration and density sensor	J181	Cartridge drum home-position sensors Right door switch Primary transfer disengagement solenoid Fuser pressure release Output bin full sensor Toner collection unit full sensor ITB waste toner full sensor
J72	Cartridge primary transfer	J121	Front door switch Fuser fan	J192	Paper feeder

Product connections

Figure 28 Product connections (1 of 6)

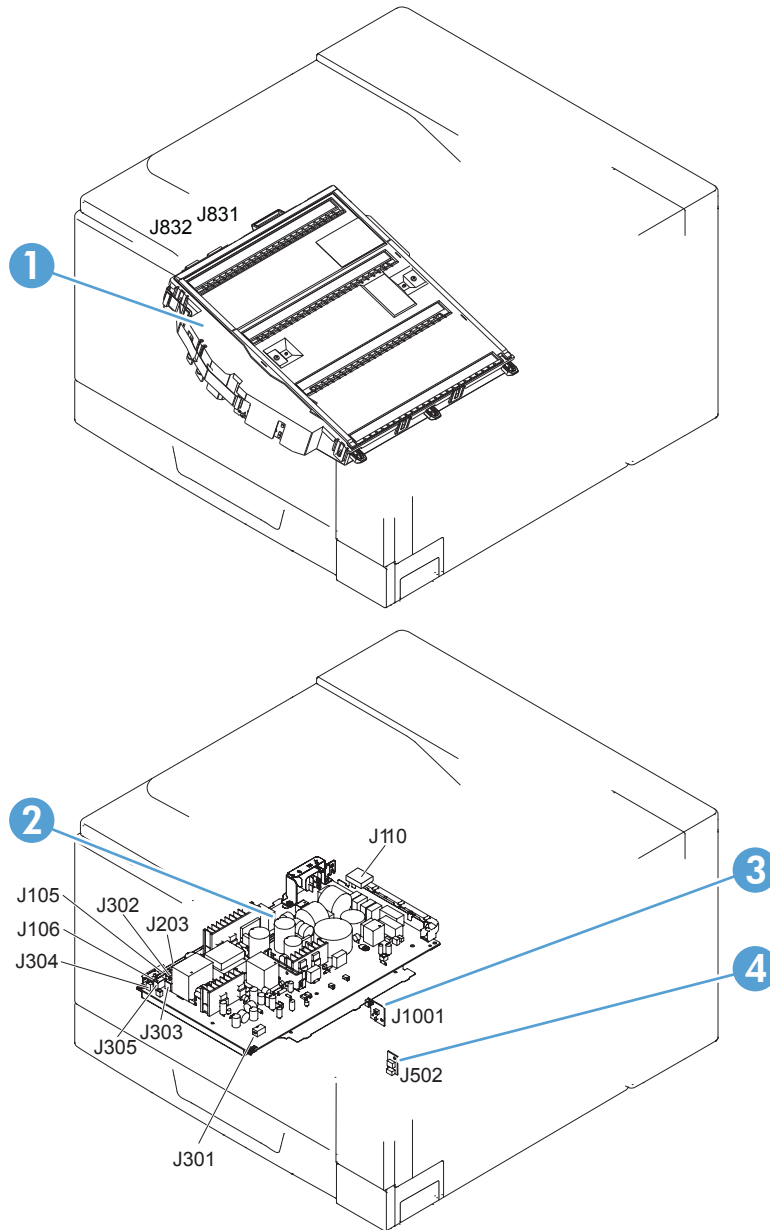

Item	Description
1	Laser scanner unit
2	Low-voltage power supply
3	Power switch PCA
4	Environment sensor

Figure 29 Product connections (2 of 6)

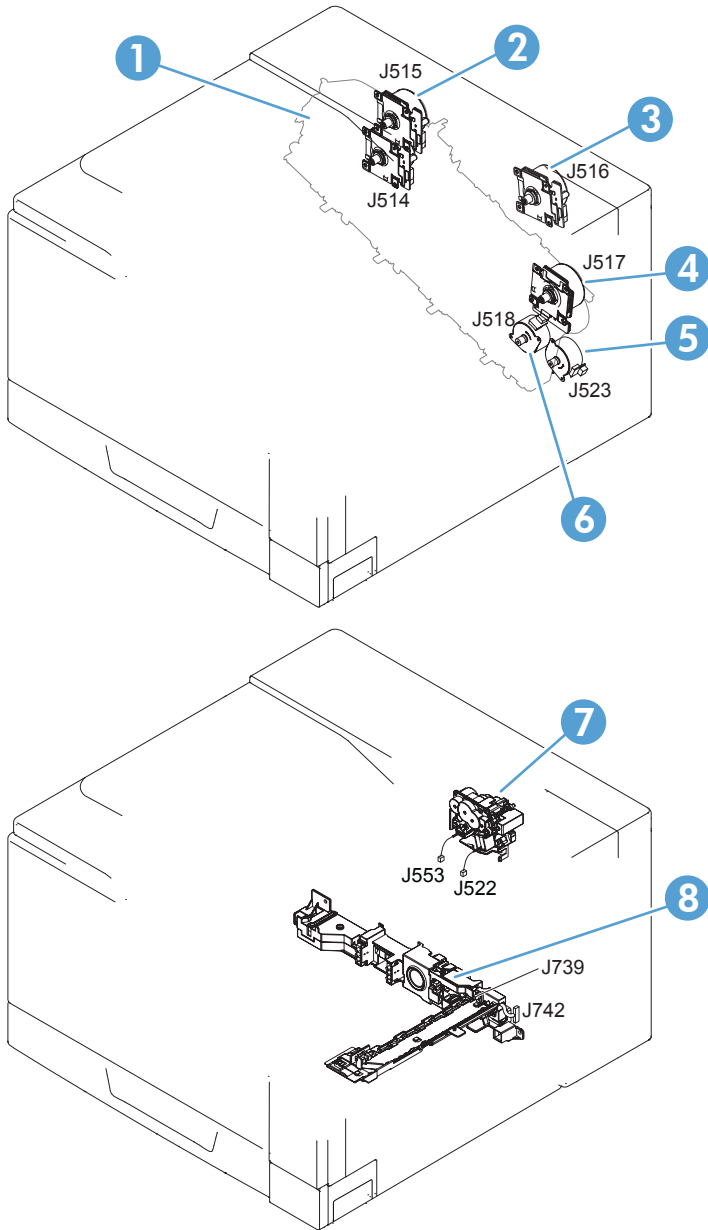

Item	Description
1	Developing motor
2	Drum motor
3	Fuser motor
4	ITB motor
5	Pickup motor
6	Developing disengagement motor

Item	Description
7	Drive unit
8	Lifter drive unit

Figure 30 Product connections (3 of 6)

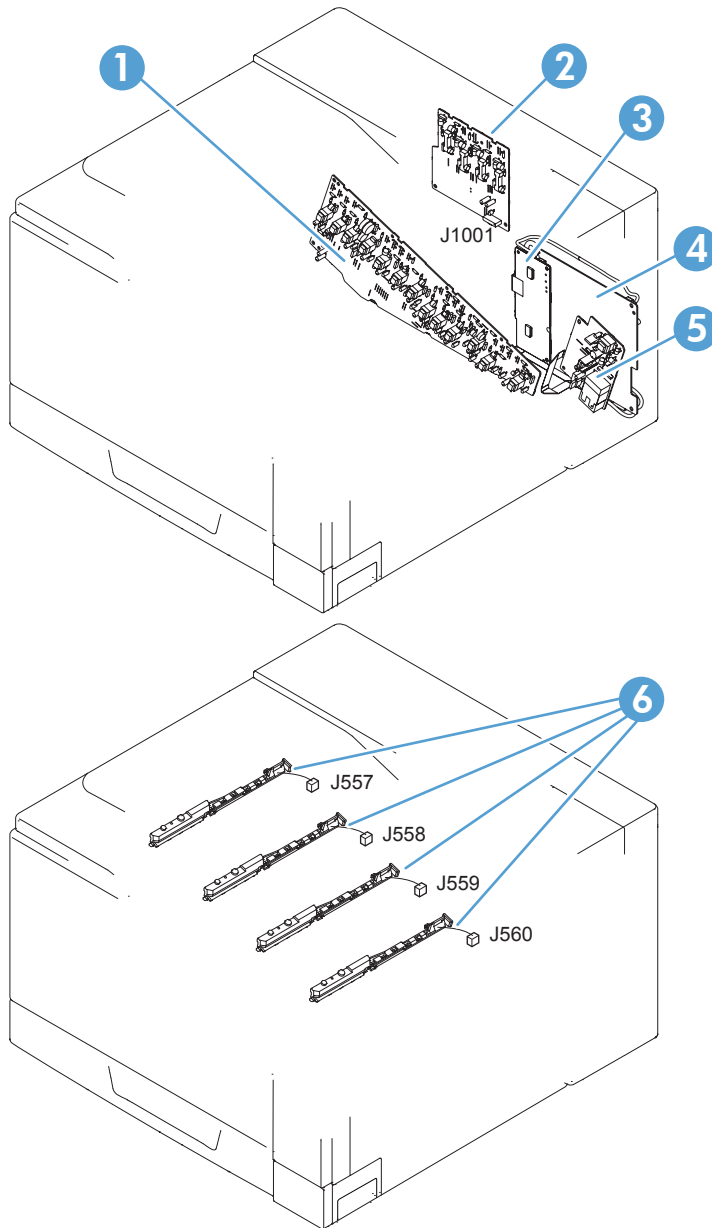

Item	Description
1	High-voltage power supply imaging (developing) PCA
2	High-voltage power supply 1st transfer PCA
3	Driver PCA

Item	Description
4	DC controller PCA
5	High-voltage power supply 2nd transfer PCA
6	Toner remaining detect PCA

Figure 31 Product connections (4 of 6)

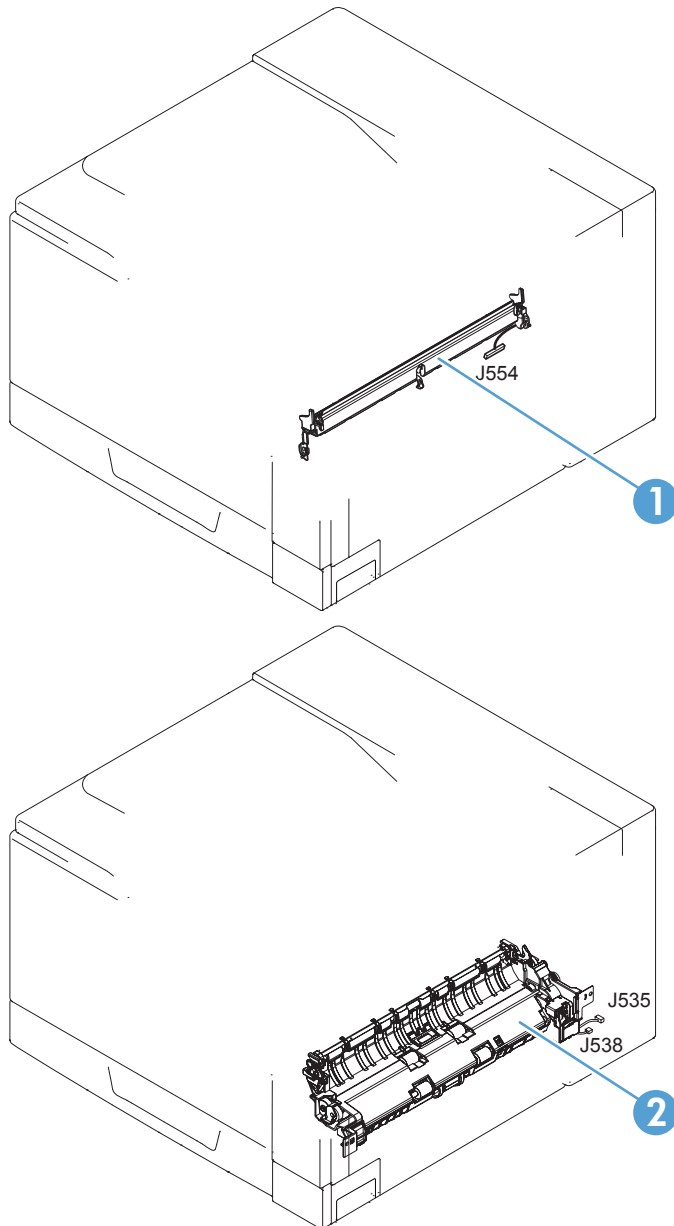

Item	Description
1	Registration sensor assembly
2	Paper pickup drive unit

Figure 32 Product connections (5 of 6)

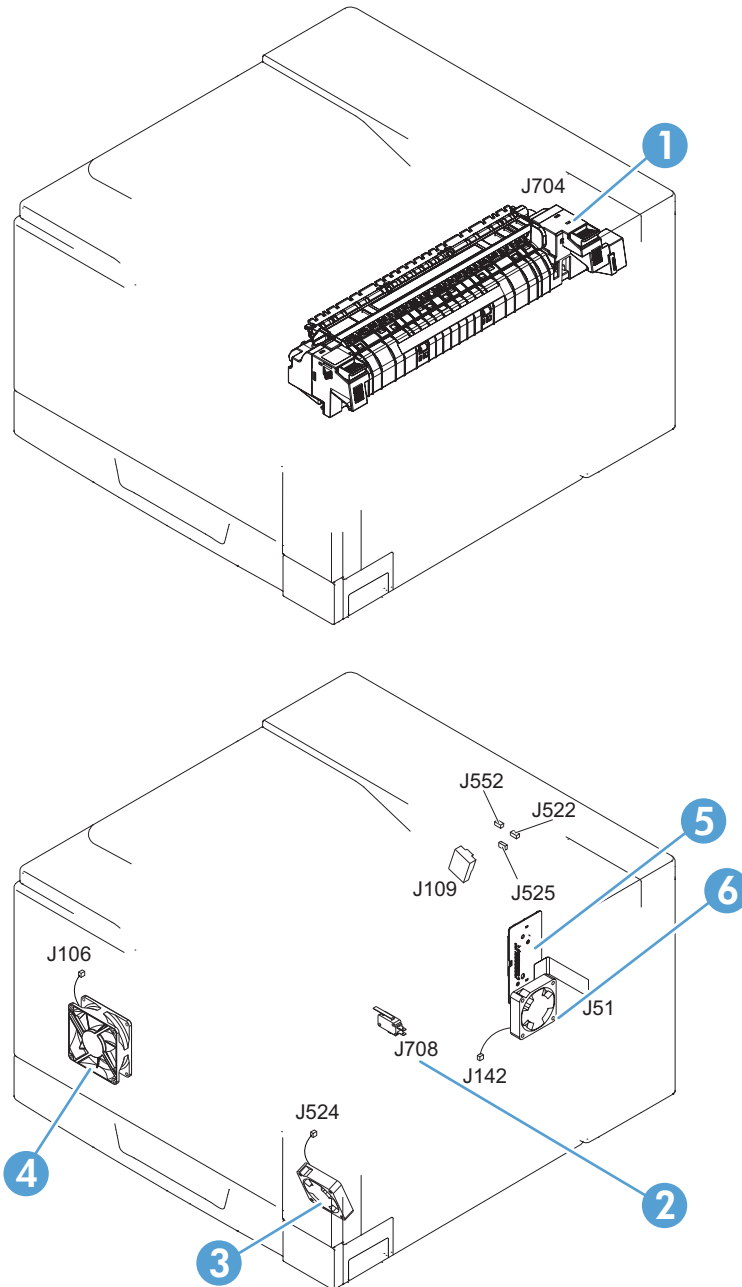

Item	Description
1	Fuser
2	24V interlock switch
3	Fuser fan
4	Power supply fan
5	ICB PCA
6	Formatter fan

Figure 33 Product connections (6 of 6)

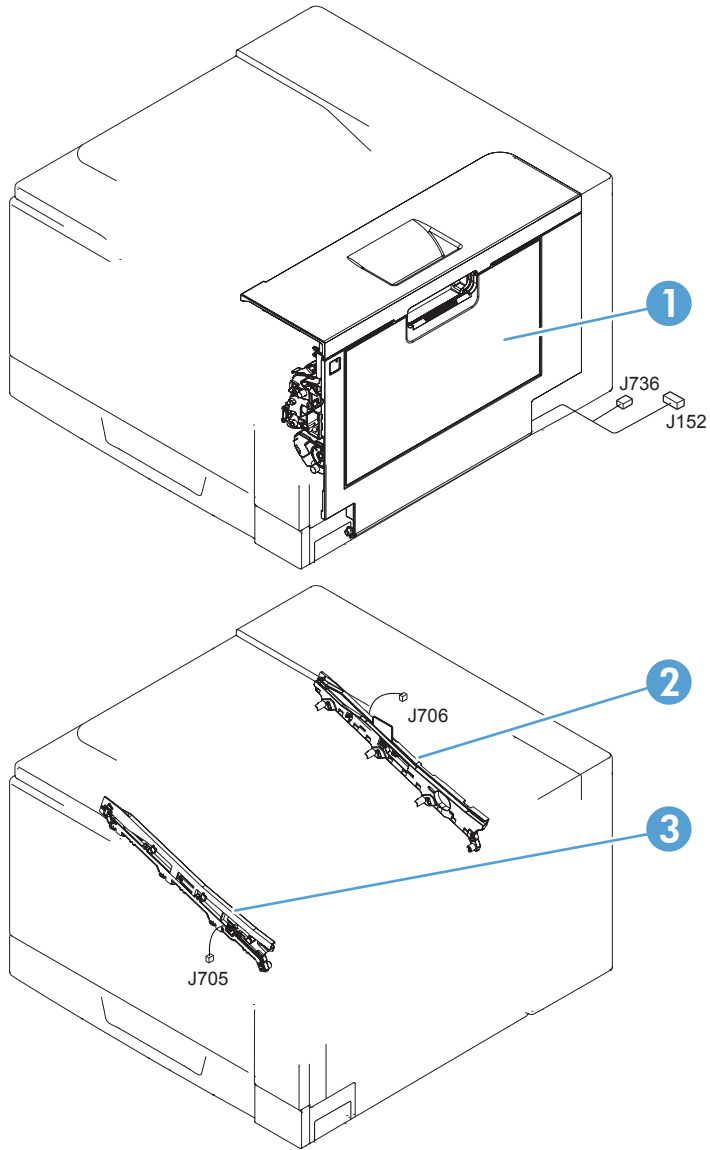

Item	Description
1	Right door assembly
2	ITB rear guide
3	ITB front guide

Figure 34 Paper feeder connections

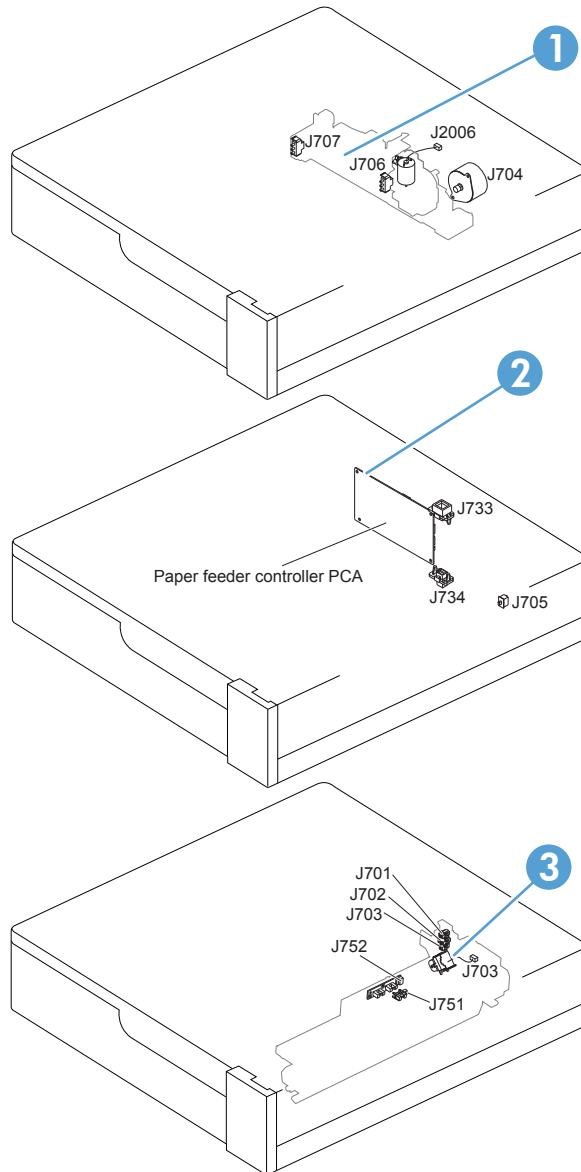

Item	Description
1	Paper feeder lifter-drive assembly
2	Paper feeder PCA
3	Paper feeder paper-pickup assembly

Locations of major components

Figure 35 External component locations

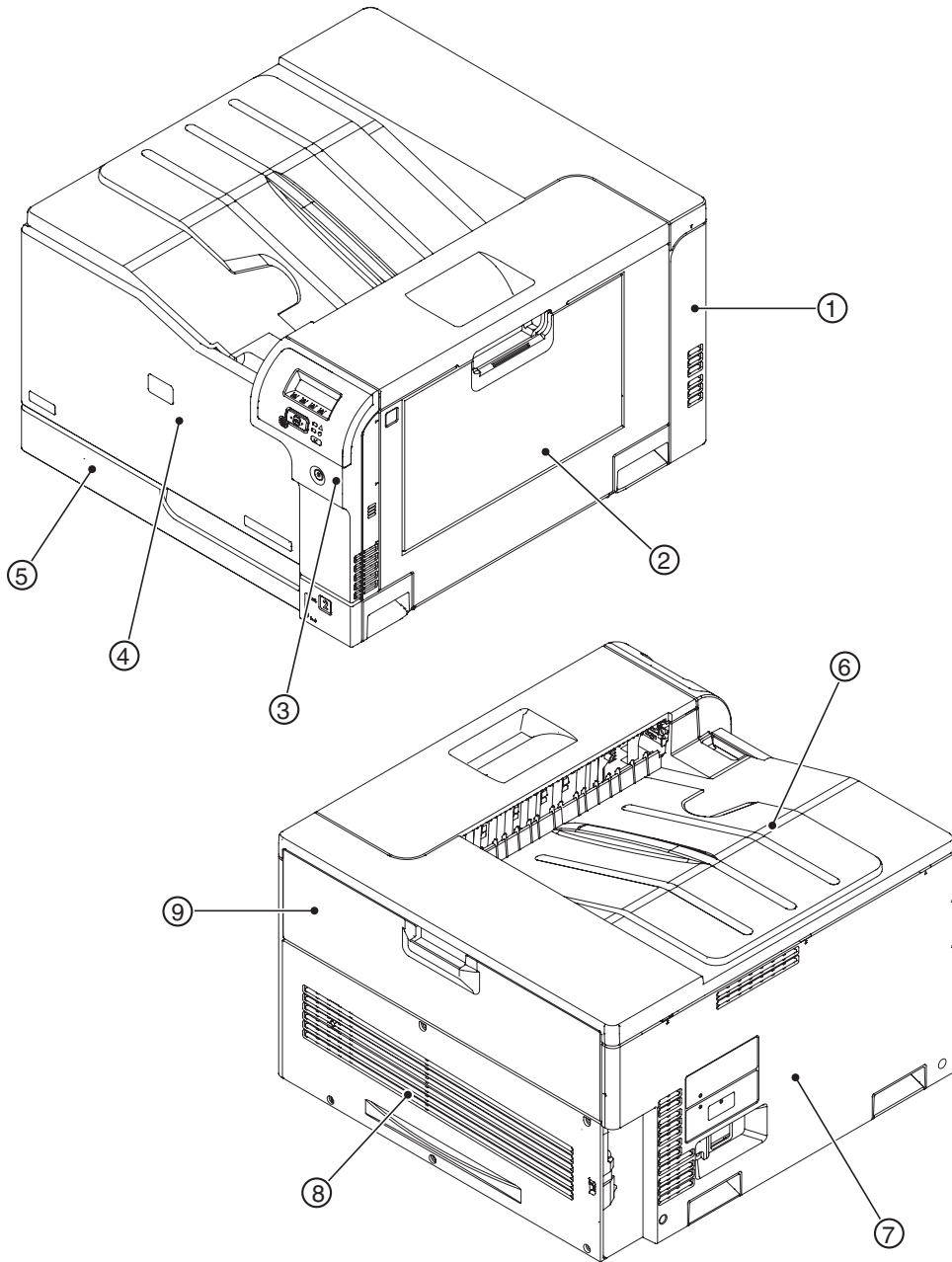

Item	Description	Item	Description
1	Right-rear cover	6	Top cover
2	Right-door assembly	7	Left cover
3	Right-front cover	8	Rear cover
4	Front-door assembly	9	Toner collection unit access-door
5	Cassette (Tray 2)		

Figure 36 Major component locations (1 of 3)

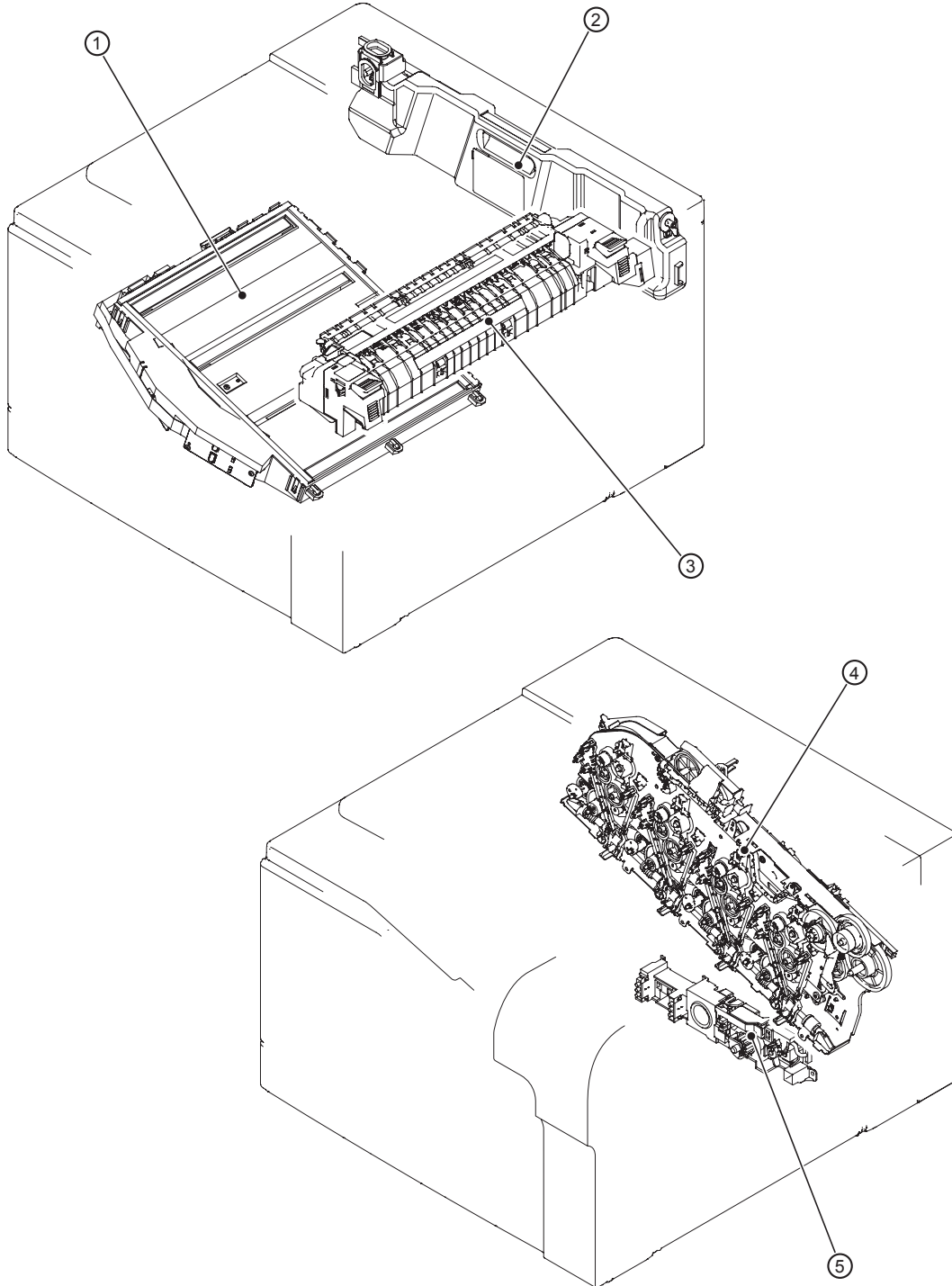

Item	Description
1	Laser scanner unit
2	Toner collection unit
3	Fuser

Item	Description
4	Main drive unit
5	Lifter drive unit

Figure 37 Major component locations (2 of 3)

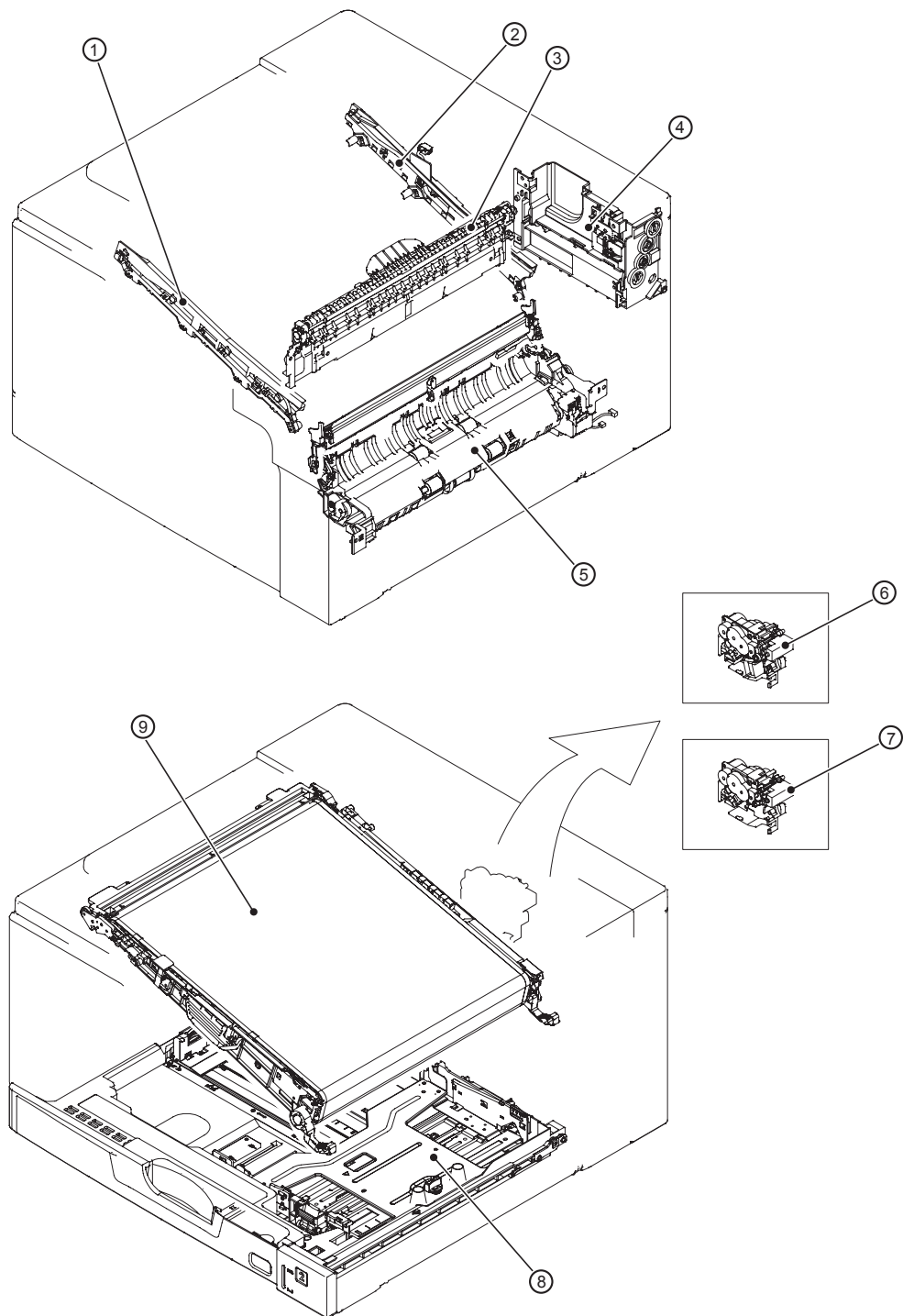

Item	Description	Item	Description
1	ITB front guide unit	6	Duplex drive unit (duplex models only)
2	ITB rear guide unit	7	Delivery drive unit (simplex models only)
3	Delivery unit	8	Cassette (Tray 2)

Item	Description	Item	Description
4	Toner collection unit full sensor	9	ITB unit
5	Cassette pickup drive unit		

Figure 38 Major component locations (3 of 3)

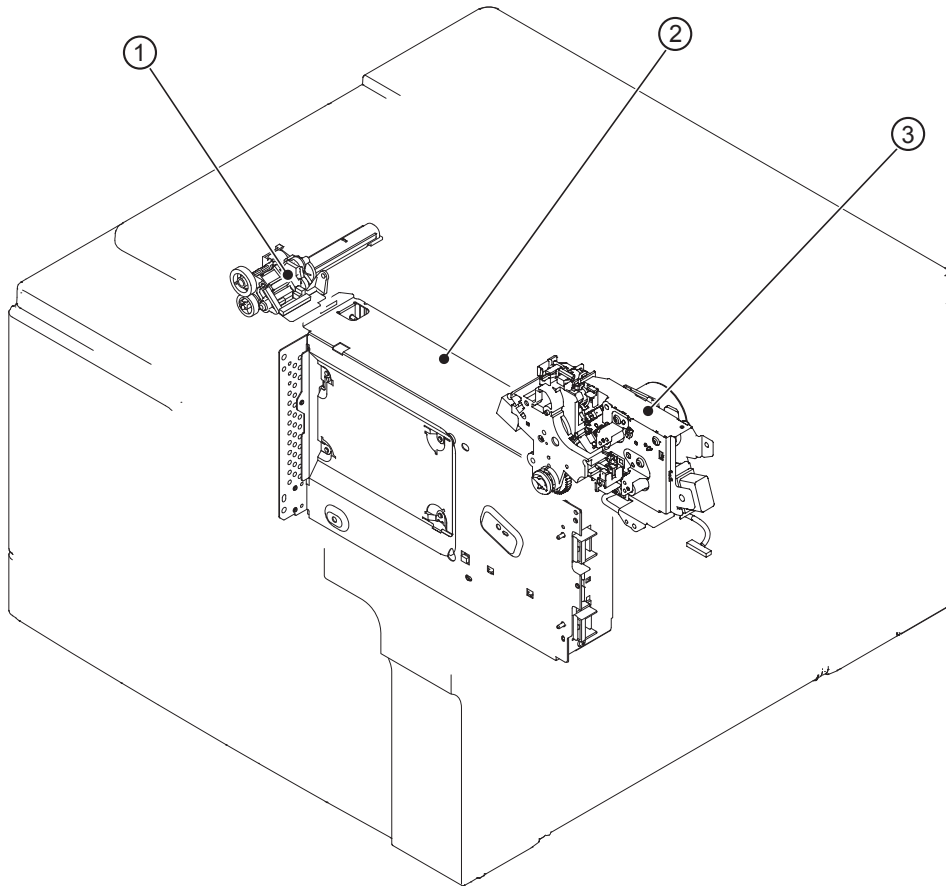

Item	Description
1	Waste toner carrier unit
2	Formatter
3	Fuser drive unit

Figure 39 Motors, fans, and rollers component locations

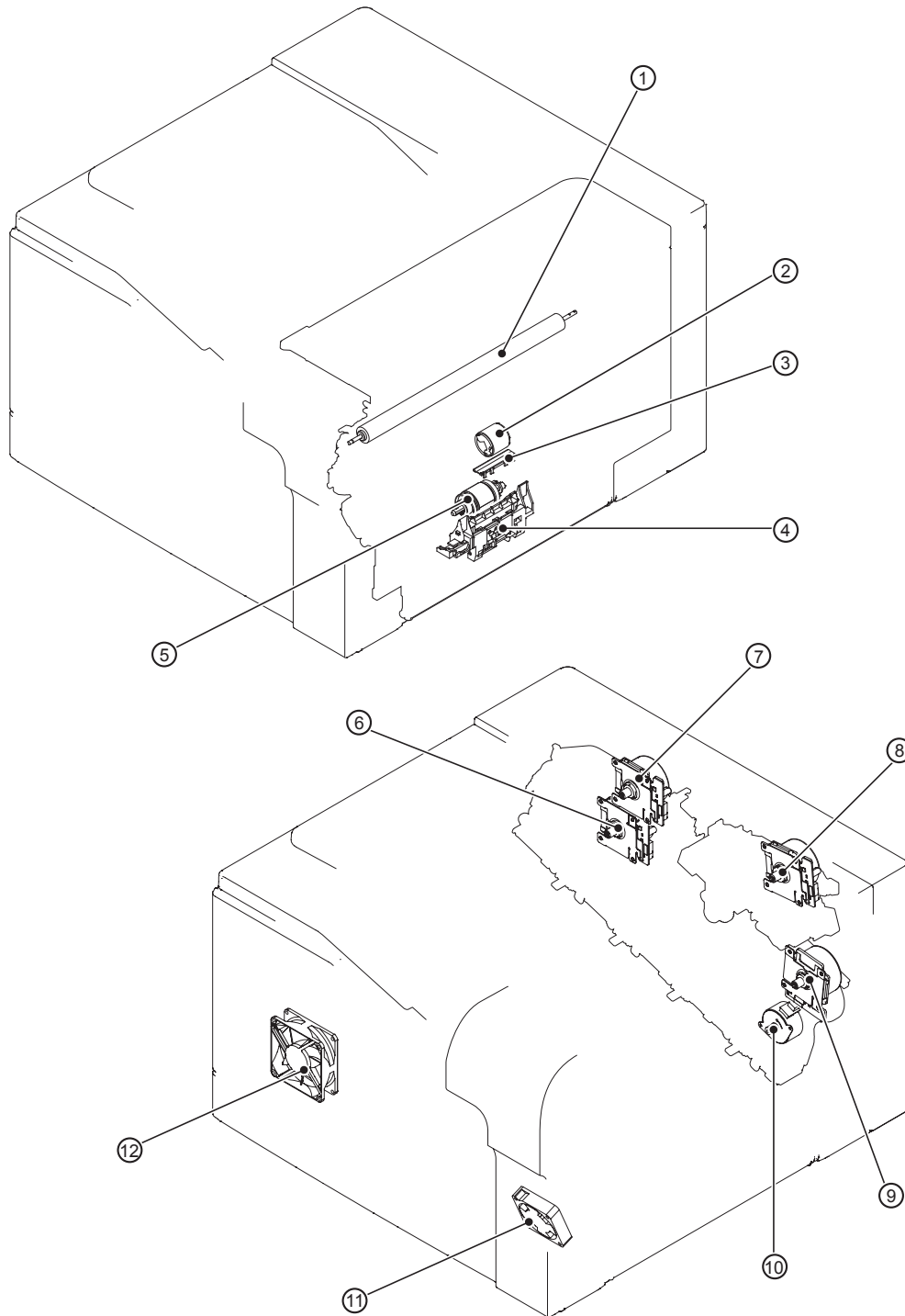

Item	Description	Item	Description
1	Secondary transfer roller unit	7	Drum motor
2	MP tray (Tray 1) pickup roller	8	Fuser motor
3	MP tray (Tray 1) separation pad	9	ITB motor
4	Cassette (Tray 2) separation roller unit	10	Developing disengagement motor

Item	Description	Item	Description
5	Cassette (Tray 2) pickup roller unit	11	Fuser fan
6	Developing motor	12	Power supply fan

Figure 40 PCA component locations

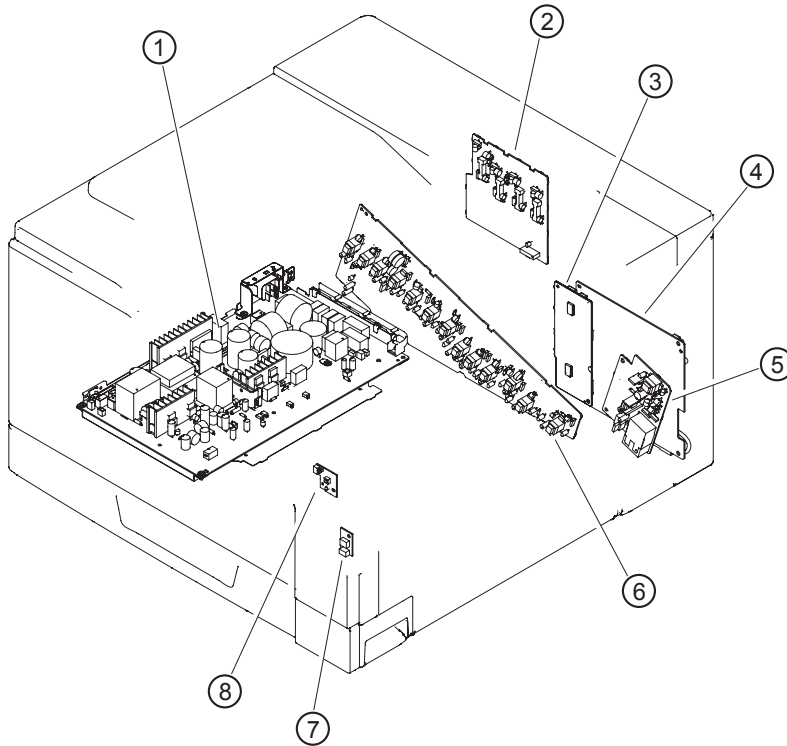

Item	Description	Item	Description
1	Low-voltage power-supply PCA	5	High-voltage power supply 2nd transfer PCA
2	High-voltage power supply 1st transfer PCA	6	High-voltage power supply imaging (development) PCA
3	Driver PCA	7	Environment sensor PCA
4	DC controller PCA	8	Power switch PCA

General timing charts

Figure 41 General timing chart (1 of 2)

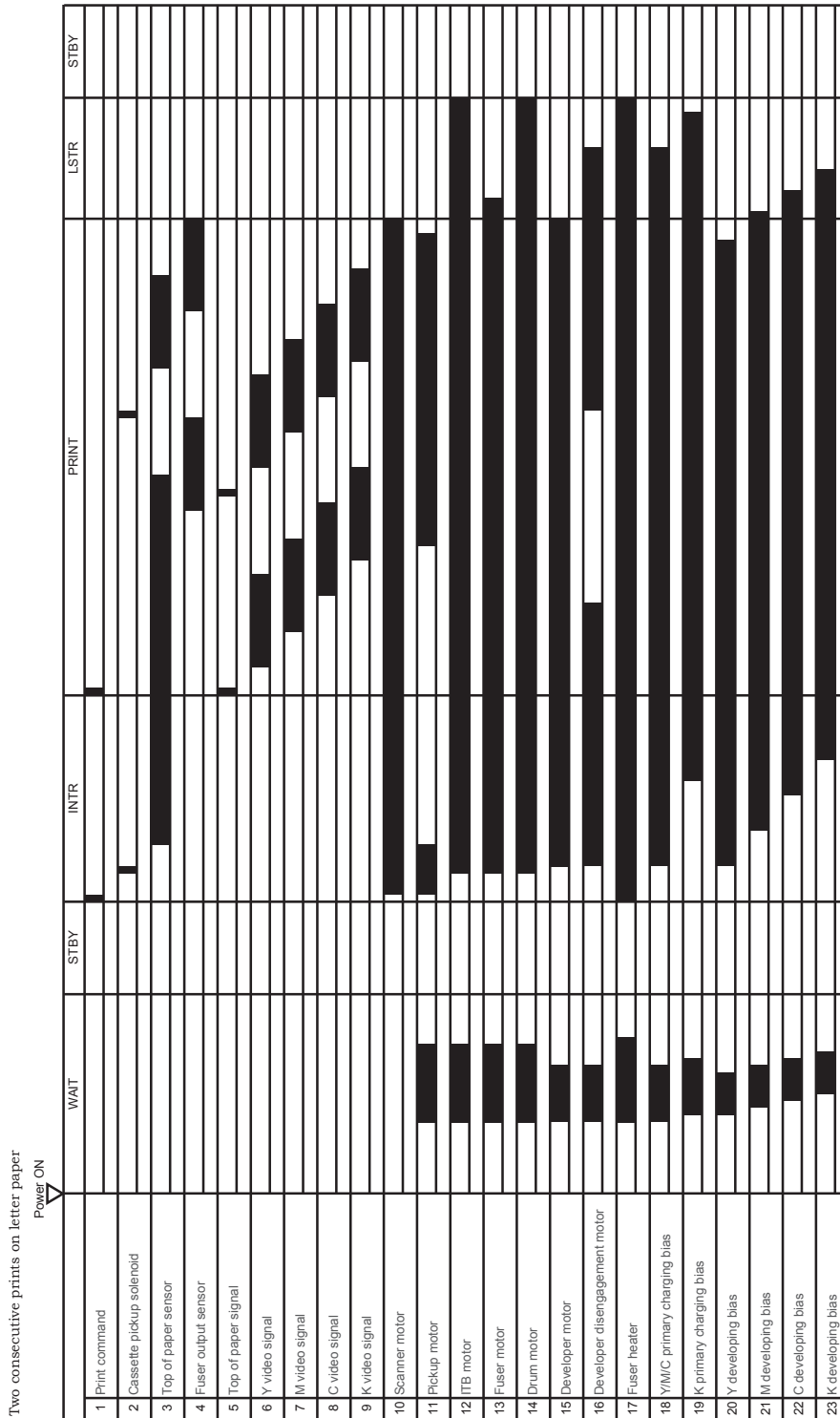
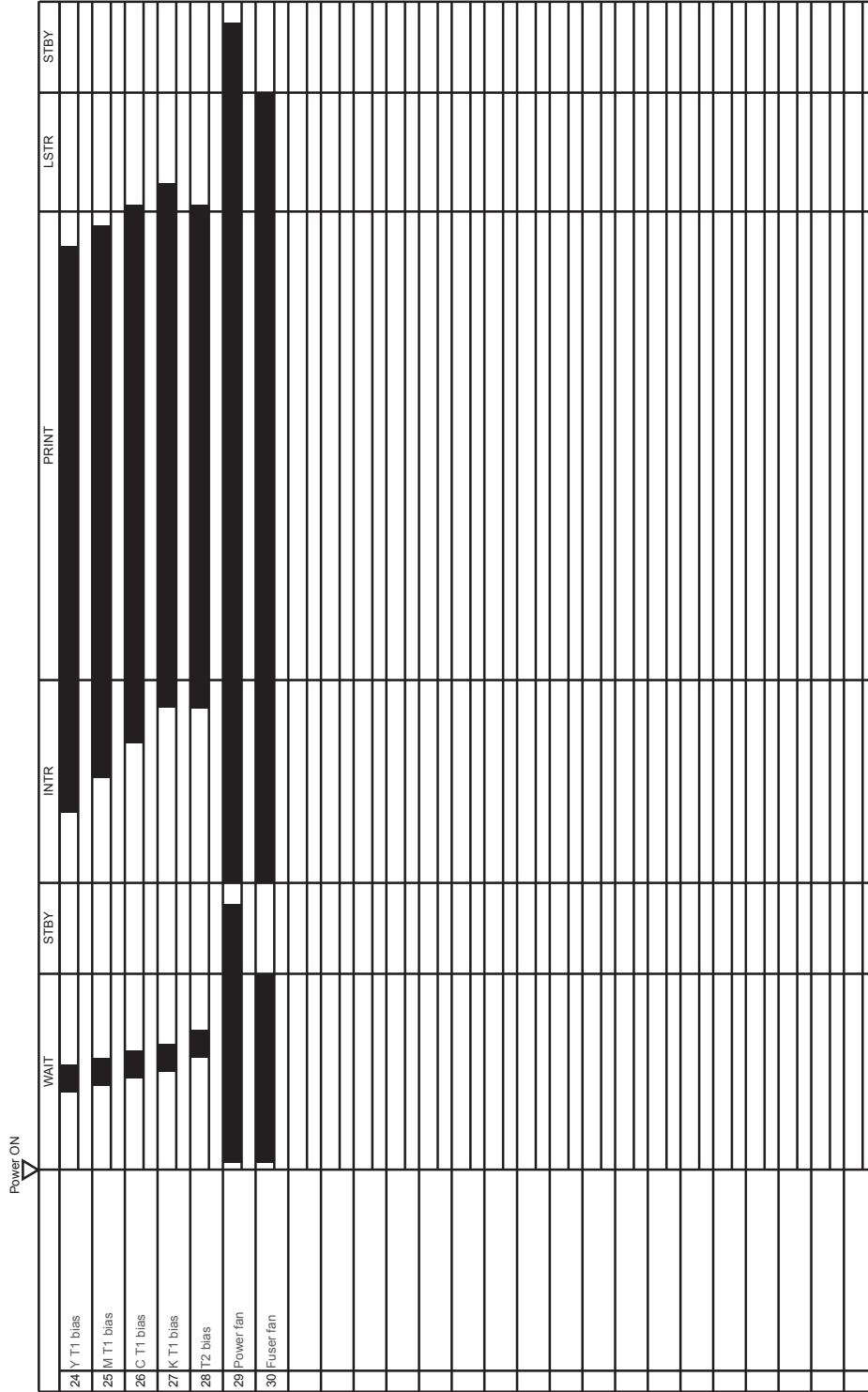



Figure 42 General timing chart (2 of 2)



Internal print-quality test pages

Print-quality-troubleshooting pages

Use the built-in print-quality-troubleshooting pages to help diagnose and solve print-quality problems.

1. Press the Home  button.
2. Open the following menus:
 - **Administration**
 - **Troubleshooting**
 - **Print Quality Pages**
3. Press the **Down** arrow  to highlight the **Print PQ Troubleshooting Pages** item, and then press the OK button to print the pages.

The product returns to the **Ready** state after printing the print-quality-troubleshooting pages. Follow the instructions on the pages that print out.

Figure 47 Print-quality troubleshooting procedure



Figure 48 Yellow print-quality troubleshooting page

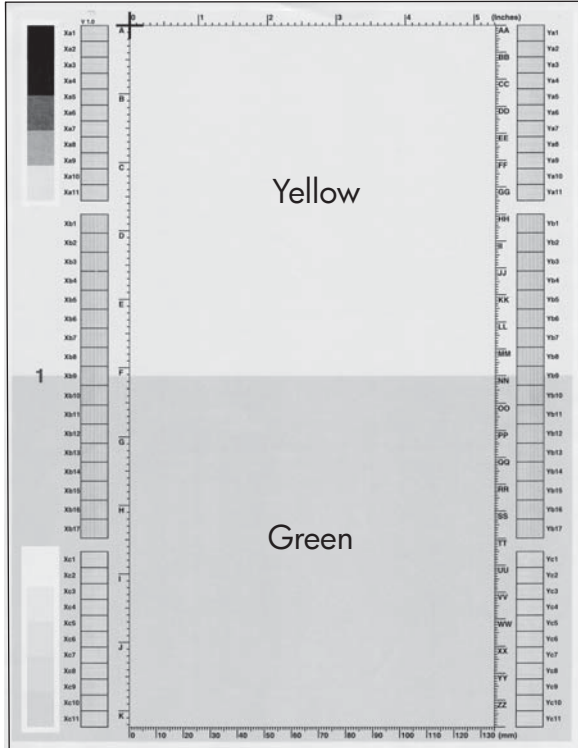
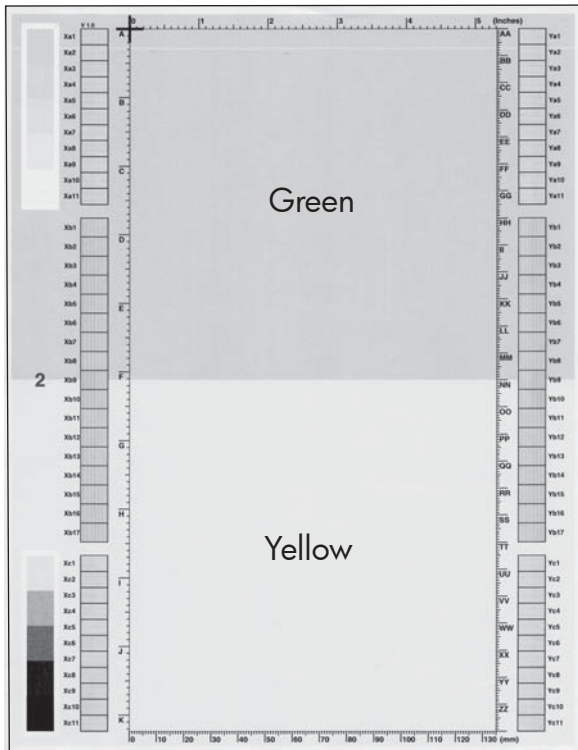
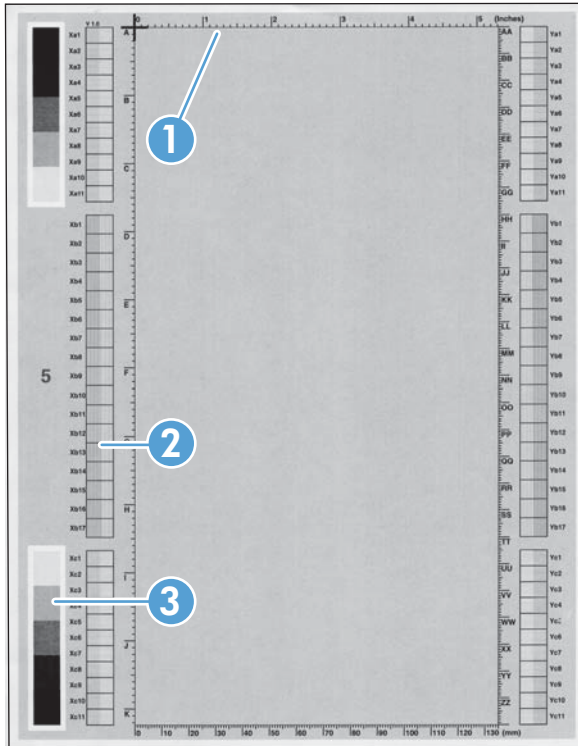

Figure 49 Yellow comparison page



Yellow cannot be easily seen unless combined with cyan, so half of each page is yellow and the other half is an amplified version of yellow problems (green half). Compare the yellow on page one with the corresponding green on page two for defects. You can also check the cyan page for defects.

Figure 50 Black print-quality troubleshooting page





<p>1. Grids</p>	<p>The grids are in inches and millimeters. They are label with letters and numbers so that defects can be described by position and by distance between repeats.</p>
<p>2. Color plane registration (CPR) bars</p>	<p>After printing, the box with no extra color in each area on each page shows how far off the CPR of that color is. Each page has two process direction areas and three scan direction areas that are labeled x and y and 1–11. The page should be fed by the long edge. Each square from the center equals 42 microns.</p>
<p>3. Color ramp patches</p>	<p>Used to detect offset for the OPC or developer in the image drum or offset in the fuser.</p>

 **NOTE:** To get further assistance in print quality troubleshooting, go to www.hp.com/support/ljcp5520series and select PQ Troubleshooting Tools.

Diagnostics page

Use the diagnostics page to evaluate problems with color plane registration, EP parameters, and print quality.

1. Press the Home  button.
2. Open the following menus:
 - **Administration**
 - **Troubleshooting**
 - **Print Quality Pages**
3. Press the **Down** arrow  to highlight the **Diagnostics Page** item, and then press the OK button to print the page.

Diagnostics Page HP Color LaserJet CP5520 Series Page 1

1 Calibration Information

- Last CPR (Engine Cycles): 149
- Last CPR: 11 Oct 2010/20:27
- Last DMax/Dhalf (Engine Cycles): 149
- Last DMax/Dhalf: 11 Oct 2010/19:54
- Model Number: CE7099
- Device Serial Number: ONC882001
- Firmware Datecode: 20100826
- Firmware Revision: 103033_1_104646
- Engine Cycles: 150
- Color Engine Cycles: 85

3 Color Density

	C	M	Y	K
Highlights	0	0	0	0
Midtones	0	0	0	0
Shadows	0	0	0	0

Three Most Recent Event Log Entries

Number	Cycles	Entry
10	0	33.02.01
9	16	10.99.40
8	96	10.99.40

2 Parameters

	A	B	C	D	E	F	G	H	I	J	K	L	M	N	O	P	Q	R	S	T	U	V	W	X	Y	Z	AA	BB	CC	DD	EE	FF	
1	01	00	07	00	00	04	06	0F	00	09	0F	03	09	06	19	07	16	10	10	14	00	0C	15	08	0E	14	21	18	19	20	23	24	
2	28	39	49	59	79	85	92	9F	AB	B0	C5	CA	CE	D0	D0	6F	83	00	00	00	00	00	00	00	00	00	00	00	00	00	00	00	
3	03	00	08	00	00	0C	06	11	00	00	06	00	01	0A	12	02	12	13	15	07	11	06	0F	0A	00	0F	18	20	18	20	19	29	
4	2F	3E	53	60	81	8A	9C	AB	B2	C0	C7	CB	D0	D2	D2	74	B9	00	00	00	00	00	00	00	00	00	00	00	00	00	00	00	
5	00	07	01	00	01	09	01	13	05	01	0C	00	00	01	10	00	10	0C	0E	08	09	0E	11	00	08	0C	10	10	13	18	12	26	
6	26	33	43	54	7A	87	9A	A5	B0	BC	CD	CE	C3	C3	C3	6C	88	00	00	00	00	00	00	00	00	00	00	00	00	00	00	00	
7	05	02	00	01	00	00	00	00	00	00	09	00	01	06	12	06	00	02	11	06	04	05	10	09	08	0C	13	14	16	15	17	15	
8	21	30	3E	4E	6C	78	88	92	90	94	CD	C9	D1	D4	05	5F	AA	00	00	00	00	00	00	00	00	00	00	00	00	00	00	00	
9	00	00	00	00	00	00	00	00	00	00	00	00	00	00	00	00	00	00	00	00	00	00	00	00	00	00	00	00	00	00	00	00	00
10	00	00	00	00	00	00	00	00	00	00	00	00	00	00	00	00	00	00	00	00	00	00	00	00	00	00	00	00	00	00	00	00	00
11	00	00	00	00	00	00	00	00	00	00	00	00	00	00	00	00	00	00	00	00	00	00	00	00	00	00	00	00	00	00	00	00	00
12	00	00	00	00	00	00	00	00	00	00	00	00	00	00	00	00	00	00	00	00	00	00	00	00	00	00	00	00	00	00	00	00	00
13	00	00	00	00	00	00	00	00	00	00	00	00	00	00	00	00	00	00	00	00	00	00	00	00	00	00	00	00	00	00	00	00	00
14	00	00	00	00	00	00	00	00	00	00	00	00	00	00	00	00	00	00	00	00	00	00	00	00	00	00	00	00	00	00	00	00	00
15	00	00	00	00	00	00	00	00	00	00	00	00	00	00	00	00	00	00	00	00	00	00	00	00	00	00	00	00	00	00	00	00	00
16	00	00	00	00	00	00	00	00	00	00	00	00	00	00	00	00	00	00	00	00	00	00	00	00	00	00	00	00	00	00	00	00	00
17	00	00	00	00	00	00	00	00	00	00	00	00	00	00	00	00	00	00	00	00	00	00	00	00	00	00	00	00	00	00	00	00	00
18	00	00	00	00	00	00	00	00	00	00	00	00	00	00	00	00	00	00	00	00	00	00	00	00	00	00	00	00	00	00	00	00	00
19	00	00	00	00	00	00	00	00	00	00	00	00	00	00	00	00	00	00	00	00	00	00	00	00	00	00	00	00	00	00	00	00	00
20	00	30	FF	E8	00	00	00	00	38	00	05	FF	00	FF	E7	00	FF	F2	00	10	00	27	00	00	00	00	00	00	00	00	00	00	00
21	19	14	29	00	04	59	00	00	01	52	00	00	03	67	22	00	03	67	22	00	03	67	22	00	03	67	22	00	03	67	22	00	00
22	7A	67	00	00	03	67	22	00	03	67	22	00	03	67	22	00	03	67	22	00	03	67	22	00	03	67	22	00	03	67	22	00	00
23	03	67	22	00	03	67	22	00	03	67	22	00	03	67	22	00	03	67	22	00	03	67	22	00	03	67	22	00	03	67	22	00	00
24	19	18	00	00	00	00	00	00	00	00	00	00	00	00	00	00	00	00	00	00	00	00	00	00	00	00	00	00	00	00	00	00	00
25	1E	EF	00	00	00	00	00	00	00	00	00	00	00	00	00	00	00	00	00	00	00	00	00	00	00	00	00	00	00	00	00	00	00
26	A5	00	00	00	00	00	00	00	00	00	00	00	00	00	00	00	00	00	00	00	00	00	00	00	00	00	00	00	00	00	00	00	00
27	A5	00	00	00	00	00	00	00	00	00	00	00	00	00	00	00	00	00	00	00	00	00	00	00	00	00	00	00	00	00	00	00	00
28	00	00	00	00	00	00	00	00	00	00	00	00	00	00	00	00	00	00	00	00	00	00	00	00	00	00	00	00	00	00	00	00	00
29	00	00	00	00	00	00	00	00	00	00	00	00	00	00	00	00	00	00	00	00	00	00	00	00	00	00	00	00	00	00	00	00	00
30	64	64	64	64	63	63	63	63	63	63	64	00	00	00	00	00	00	00	00	00	00	00	00	00	00	00	00	00	00	00	00	00	00
31	00	00	00	00	00	00	00	00	00	00	00	00	00	00	00	00	00	00	00	00	00	00	00	00	00	00	00	00	00	00	00	00	00
32	FF	90	00	90	05	FF	F5	FF	6F	00	A3	00	33	FF	AE	00	20	00	93	00	57	FF	02	00	00	00	00	00	00	00	00	00	
33	FF	A5	FF	0C	FF	F0	FF	D1	FF	BE	FF	96	FF	AB	FF	D1	FF	00	03	F6	00	00	00	00	00	00	00	00	00	00	00	00	
34	00	00	00	00	00	00	00	00	00	00	00	00	00	00	00	00	00	00	00	00	00	00	00	00	00	00	00	00	00	00	00	00	00
35	00	00	00	00	00	00	00	00	00	00	00	00	00	00	00	00	00	00	00	00	00	00	00	00	00	00	00	00	00	00	00	00	00
36	00	00	00	00	00	00	00	00	00	00	00	00	00	00	00	00	00	00	00	00	00	00	00	00	00	00	00	00	00	00	00	00	00

4 Barcode: ONC8820012010404310 0027108113409000241081120590060910802514970017300113409



Oct/11/2010 6:14:18 PM English (United States)

1	Calibration information
2	Parameters
3	Color density

4	Color plane registration
5	Primary colors
6	Secondary colors
7	Temperature values (21A)
8	Humidity values (21B)



Clean the paper path

Process a cleaning page

1. Press the Home button .
2. Open the following menus:
 - **Device Maintenance**
 - **Calibration/Cleaning**
3. Press the **Down** arrow  to highlight the **Print Cleaning Page** item, and then press the OK button.
4. The product prints a cleaning page, and then returns to the main menu. Discard the printed page.

Set up an auto cleaning page

Use the procedure in this section to set up an automatic cleaning page.

1. Press the Home button .
2. Open the following menus:
 - **Device Maintenance**
 - **Calibration/Cleaning**
3. Press the **Down** arrow  to highlight the **Auto Cleaning** item, and then select the **Enabled** item. Press the OK button.
4. Press the **Down** arrow  to highlight the **Cleaning Interval** item, and then use the arrow buttons to select an interval. Press the OK button.

 **TIP:** HP recommends processing a cleaning page after every 5000 printed pages.



5. Press the **Down** arrow  to highlight the **Auto Cleaning Size** item, and then use the arrow buttons to select the cleaning page size. Press the OK button.

Configuration page

Depending on the model, up to three pages print when you print a configuration page. In addition to the main configuration page, the embedded Jetdirect configuration pages print.

Configuration page

Use the configuration page to view current product settings, to help troubleshoot product problems, or to verify installation of optional accessories, such as memory (DIMMs), paper trays, and printer languages.

1. Press the Home button .
2. Open the following menus:
 - **Administration**
 - **Reports**
 - **Configuration/Status Pages**
3. Press the **Down** arrow  to highlight the **Configuration Page** item, and then press the OK button.
4. Press the **Up** arrow  to highlight the **Print** item, and then press the OK button.

The message **Submitted to Queue** displays on the control panel until the product finishes printing the configuration page. The product returns to the **Ready** state after printing the configuration page.



NOTE: If the product is configured with EIO cards (for example, an HP Jetdirect Print Server) or an optional hard-disk drive, additional pages will print that provide information about those devices.

Figure 51 Configuration page

Configuration Page
HP Color LaserJet CP5520 Series
Page 1

1 Device Information

Product Name: HP Color LaserJet CP5520 Series
 Device Name: HP Color LaserJet CP5520 Series
 Model Number: CE709V
 DC Controller Version: 4.89
 Optional Trays Version: 3.103
 Device Serial Number: CN1C882001
 Formatter Number: PA0013R
 Firmware Datecode: 20100826
 Firmware Revision: 103033_1_104646
 Service ID: 20266
 PS Wait Time-out: 300 seconds
 Engine Cycles*: 305
 Color Engine Cycles*: 234
 *Not weighted for billing

2 Installed Personalities and Options

PCL: 20010402
 PCLXL: 20010402
 POSTSCRIPT: 20010402
 PDF: 20050131
 Internal Disk: Hard Disk: Enabled
 Serial Number: 5VB1E7M
 Model: HP Secure Hard Disk
 Capacity: 114473 MB
 Hard Disk Encryption Status: Encrypted
 EID: Empty
 Embedded IP JetDirect J8016E: 15.5.176.177
 Custom Color Table: Not Installed

3 Color Density

	C	M	Y	K
Highlights	0	0	0	0
Midtones	0	0	0	0
Shadows	0	0	0	0

4 Calibration Information

Last CPR (Engine Cycles): 298
 Last CPR: 12 Oct 2010/17:54
 Last DMax/DHalf (Engine Cycles): 231
 Last DMax/DHalf: 12 Oct 2010/17:36

5 Memory

Total RAM: 1024 MB

6 Event Log

Number of Entries in Use: 10
 Three Most Recent Entries:

Number	Cycles	Event
10	0	33.02.03
9	16	10.99.40
8	96	10.99.40

7 Security

Hard Disk Encryption Status: Encrypted
 File Erase Mode: Non-Secure Fast Erase (No overwrites)
 Control Panel Password: Disabled
 Support Key: 669X-7043-8200
 Host USB plug and play: Enabled
 Device USB: Enabled

8 Paper Trays and Options

Default Paper Size: Letter
 Tray 1 Size: Any Size
 Tray 1 Type: Any Type
 Tray 2 Size: Letter
 Tray 2 Type: Plain
 Tray 3 Size: Letter =
 Tray 3 Type: Plain
 Tray 4 Size: 11x17
 Tray 4 Type: HP Glossy 130g
 Tray 5 Size: Letter
 Tray 5 Type: Plain
 Tray 6 Size: 11x17
 Tray 6 Type: Plain
 Duplex Unit:

1: Output Bin 1, 300 Sheets, Standard top bin

Oct12/2010 4:00:04 PM

English (United States)

1	Printer information
2	Installed personalities and options
3	Color density
4	Calibration information
5	Memory
6	Event log
7	Security
8	Paper trays and options

HP embedded Jetdirect page

The second configuration page is the HP embedded Jetdirect page, which contains the following information:

Figure 52 HP embedded Jetdirect page

```

Embedded Jetdirect Page      HP Color LaserJet CP5520 Series      Page 1

----- General Information -----
Status: I/O Card Ready
Model Number: J8056
Hardware Address: 1C1CE0E0F3
Firmware Version: V.29.24.FT
JAX: 1C1CE0E0F3
Port Config: 10/10/10
Auto Negotiation: On
Manufacturing ID: S805602000000
Date Manufactured: 07/0610

----- Security Settings -----
802.1X: Not Specified
IPsec: Disabled
Admin Password: Not Specified
Secure web: HTTPS Required
Cert Expires: 2015-07-01 00:00 UTC
SMP Versions: 1.2
SMP Set Only Name: Not Specified/Default
SMP Get Only Name: Not Specified/Default
Access List: Not Specified

----- Network Statistics -----
Total Packets Received: 3963879
Unicast Packets Received: 238035
Bad Packets Received: 96
Framing Errors Received: 0
Total Packets Transmitted: 330675
Unsendable Packets: 0
Transmit Collisions: 0
Transmit Late Collisions: 0

----- TCP/IP -----
IPv6: Enabled
IPv4: Enabled
Host Name: M10E0F63
IPv4 Domain Name: america.hpqcorp.net
IPv6 Domain Name: Not Specified
Primary DNS Server: 16.110.136.51
Secondary DNS Server: 16.110.136.52
DNS(IPv6): Not Specified
DNS(IPv4): Not Specified
WINS Server: 16.232.7.246
Idle Timeout: 270 sec

----- IPv4 -----
Status: IPv4 Ready
IP Address: 15.5.176.177
Subnet Mask: 255.255.252.0
Default Gateway: 15.5.176.1
Config By: DKCP
DKCP Server: 16.232.7.250
TFTP Server: Not Specified
Bonjour Service Name: HP Color LaserJet CP5520 Series (R0E0F3)

----- IPv6 -----
Status: IPv6 Ready
Link-Local: fe80::1ac1:a0ff:fe63:e9f3
Stateless: Not Configured
DKCPv6: Not Configured
Mcast: Not Configured

```

1	HP Jetdirect Configuration indicates the product status, model number, hardware firmware version, port select, port configuration, auto negotiation, manufacturing identification, and manufactured date.
2	Security Settings information
3	Network Statistics indicates the total packets received, unicast packets received, bad packets received, framing errors received, total packets transmitted, unsendable packets, transmit collisions, and transmit late collisions.
4	TCP/IP information, including the IP address
5	IPv4 information
6	IPv6 information

Always make sure the status line under the HP Jetdirect configuration lines indicates "I/O Card Ready".

Finding important information on the configuration pages

Certain information, such as the firmware date codes, the IP address, and the e-mail gateways, is especially helpful while servicing the product. This information is on the various configuration pages.

Table 26 Important information on the configuration pages

Type of information	Specific information	Configuration page
<p>Firmware date codes</p> <p>When you use the remote firmware upgrade procedure, all of these firmware components are upgraded.</p>	DC controller	Look on the main configuration page, under "Device Information."
	Firmware datecode	Look on the main configuration page, under "Device Information."
	Embedded Jetdirect firmware version	Look on the embedded Jetdirect page, under "HP Jetdirect Configuration."
<p>Accessories and internal storage</p> <p>All optional devices that are installed on the product should be listed on the main configuration page.</p> <p>In addition, separate pages print for the optional paper handling devices and the fax accessory. These pages list more-detailed information for those devices.</p>	External disk (optional)	Look on the main configuration page, under "Installed Personalities and Options." Shows model and capacity.
	Embedded HP Jetdirect	Look on the main configuration page, under "Installed Personalities and Options." Shows model and ID.
	Total RAM	Look on the main configuration page, under "Memory."
	Duplex unit	Look on the main configuration page, under "Paper Trays and Options."
Additional 500-sheet feeders	Additional 500-sheet feeders	Look on the main configuration page, under "Paper Trays and Options."
<p>Engine cycles and event logs</p> <p>Total page counts and maintenance kit counts are important for ongoing product maintenance.</p> <p>The configuration page lists only the three most recent errors. To see a list of the 50 most recent errors, print an event log from the Diagnostics menu.</p>	Engine cycles	Look on the main configuration page, under "Device Information."
	Event-log information	Event-log information

Color-band test

The color-band test page shows bands of colors that can indicate whether or not the product is producing colors correctly.

1. Press the Home button .
2. Open the following menus:
 - **Administration**
 - **Troubleshooting**
 - **Print Quality Pages**
3. Press the **Down** arrow ▼ to highlight the **Color Band Test** item, and then press the OK button.
4. Press the **Down** arrow ▼ to highlight the **Print Test Page** item, and then press the OK button.

Print quality troubleshooting tools

Repetitive image-defect ruler

Use a ruler to measure occurrences of repetitive image defects to help solve image quality problems. Place the ruler next to the first occurrence of the defect on the page. Find the distance between identical defects and use the figure below to identify the component that is causing the defect.



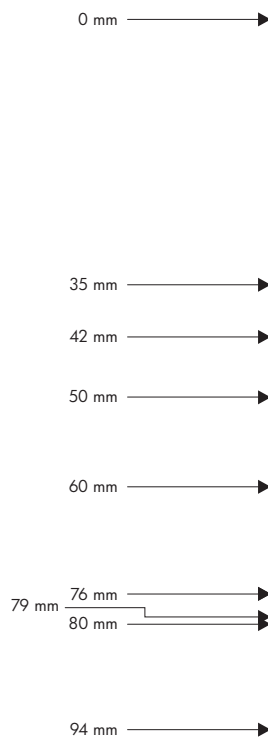

 **NOTE:** When printing this defect ruler, verify that any scaling options in the printer driver are disabled.



Distance between defects	Product components that cause the defect
35 mm	Print cartridge (primary charging roller)
42 mm	Print cartridge (developer roller)
50 mm	Print engine (primary transfer roller)
60 mm	Print engine (secondary transfer roller)
76 mm	Fuser (fuser film)
79 mm	Fuser (pressure roller)
94 mm	Print cartridge (OPC)

Calibrate the product

Calibration is a product function that optimizes print quality. If you experience any image-quality problems, calibrate the product.

1. Press the Home button .
2. Press the **Down** arrow  to highlight the **Device Maintenance** menu, and then press the OK button.
3. Press the **Down** arrow  to highlight the **Calibration/Cleaning** menu, and then press the OK button.
4. Press the **Down** arrow  to highlight the **Full Calibration** or **Quick Calibration** setting, and then press the OK button.
 - **Full Calibration:** takes about 70 seconds and performs color plane registration, environment change control, and Dmax and Dhalf adjustments. Use **Full Calibration** if colors are misaligned or appear blurry. **Full Calibration** runs automatically after a replacement transfer belt (ITB) is installed. **Full Calibration** must be run manually after a laser scanner is replaced.
 - **Quick Calibration:** takes about 45 seconds and performs Dmax and Dhalf adjustments. Use **Quick Calibration** if colors are wrong, highlights are missing, or if colors are too dark or too light.







Control panel menus

To use all of the capabilities of this product, a firmware upgrade might be required. HP recommends that you periodically go to www.hp.com/go/ljcp5520series_software to see if a new version of firmware is available.



NOTE: Print a configuration page to determine the version of firmware currently installed in this product.

Navigate the control-panel menus:

- Press the Home button  to access the menus.
- Press the **Up** arrow button  and **Down** arrow button  to highlight a desired menu item.
- Press the OK button to select the menu item.
- Press the Back arrow button  to navigate backwards in nested menus.
- Press the Home button  again, or the Back arrow button  repeatedly, to exit the menus.

Sign In menu

Table 27 Sign In menu

First level	Second level	Values	Description
User Access Code	Access Code		Access the product with a user-level personal identification number (PIN). NOTE: Some menus or functions might not be available.
Administrator Access Code	Access Code		Access the product with a administrator-level PIN.
Service Access Code	Access Code		Access the product with a technician-level PIN.

Retrieve Job From USB menu

Use the **Retrieve Job From USB** menu to view listings of jobs stored on an external USB memory device.

 **NOTE:** You must enable this feature by using the control-panel menus or the HP Embedded Web Server before it can be used.

To enable this feature by using the control-panel menus, access the **Administration** menu, **Retrieve From USB Settings** sub menu, and then select **Enable**.

Table 28 Retrieve Job From USB menu

First level	Second level	Values	Description
Retrieve Job From USB		OK	Use the Retrieve Job From USB item to view a listing of all jobs stored on a portable storage device.
		Cancel	
	Select a File or Folder	Select from the provided list.	

Retrieve Job From Device Memory menu

Use the **Retrieve Job From Device Memory** menu to view listings of jobs stored on the internal product memory.

Table 29 Retrieve Job From Device Memory menu

First level	Second level	Third level	Values	Description
Retrieve Job From Device Memory	All Jobs (No PIN) NOTE: Individual job names also appear.	Print	Range: 1 – 9999 Default = 1	Use the Retrieve Job From Device Memory item to view a listing of all jobs stored in the product memory.
		Delete	Select from the provided list.	

Supplies menu

In the following table, asterisks (*) indicate the factory default setting.

Table 30 Supplies menu

First level	Second level	Third level	Fourth level	Values	Description
Manage Supplies	Supplies Status				
	Supply Settings	Black Cartridge	Very Low Settings		<p>Stop</p> <p>Prompt to continue*</p> <p>Continue</p> <p>Select what the product should do when the print cartridge is very near the end of its estimated life.</p> <p>Stop: The product stops until you replace the cartridge.</p> <p>Prompt to continue: The product stops until you clear the prompt message. After the prompt message is cleared, there will not be another message indicating that the supply needs to be replaced.</p> <p>Continue: The product provides an alert message, but it continues printing. There will not be another message indicating that the supply needs to be replaced.</p>
			Low Threshold Settings	1-100%	Use the arrow buttons to enter the percentage of estimated cartridge life at which you want the product to alert you that the cartridge is low.

Table 30 Supplies menu (continued)

First level	Second level	Third level	Fourth level	Values	Description
		Color Cartridges	Very Low Settings		<p>Stop</p> <p>Prompt to continue*</p> <p>Continue</p> <p>Select what the product should do when the print cartridge is very near the end of its estimated life.</p> <p>Stop: The product stops until you replace the cartridge.</p> <p>Prompt to continue: The product stops until you clear the prompt message.</p> <p>Continue: The product provides an alert message, but it continues printing.</p>
			Low Threshold Settings	Cyan Cartridge Magenta Cartridge Yellow Cartridge	1-100% Use the arrow buttons to enter the percentage of estimated cartridge life at which you want the product to alert you that the cartridge is low.
		Fuser	Very Low Settings		<p>Stop</p> <p>Prompt to continue*</p> <p>Continue</p> <p>Stop: The product stops until you replace the fuser kit.</p> <p>Prompt to continue: The product stops until you clear the prompt message.</p> <p>Continue: The product provides an alert message, but it continues printing.</p>

Table 30 Supplies menu (continued)

First level	Second level	Third level	Fourth level	Values	Description
			Low Threshold Settings	1-100%	Use the arrow buttons to enter the percentage of estimated cartridge life at which you want the product to alert you that the cartridge is low.
		Transfer Kit	Very Low Settings		<p>Stop</p> <p>Prompt to continue*</p> <p>Continue</p> <p>Stop: The product stops until you replace the transfer kit.</p> <p>Prompt to continue: The product stops until you clear the prompt message.</p> <p>Continue: The product provides an alert message, but it continues printing.</p>
			Low Threshold Settings	1-100%	Use the arrow buttons to enter the percentage of estimated cartridge life at which you want the product to alert you that the cartridge is low.
		Color/Black Mix			<p>Auto*</p> <p>Mostly Color Pages</p> <p>Mostly Black Pages</p> <p>Use this feature to instruct the product when to switch between color and monochrome printing modes for the best overall performance. Select the setting depending on the types of jobs you typically print.</p>

Table 30 Supplies menu (continued)

First level	Second level	Third level	Fourth level	Values	Description
	Supply Messages	Low Message		On* Off	Select how the product displays the supply information. Low Message: Determines whether or not a low supply message is displayed on the control panel.
		Level Gauge		On* Off	LEVEL GAUGE: Determines whether or not a supply level gauge appears on the control panel.
Black Cartridge OK: - Status					Supply status message—no action required.
Cyan Cartridge OK: - Status					Supply status message—no action required.
Magenta Cartridge OK: - Status					Supply status message—no action required.
Yellow Cartridge OK: - Status					Supply status message—no action required.
Toner Collection Unit OK: - Status					Supply status message—no action required.
Transfer Kit OK: - Status					Supply status message—no action required.
Fuser OK: - Status					Supply status message—no action required.

Trays menu

In the following table, asterisks (*) indicate the factory default setting.

Table 31 Trays menu

First level	Second level	Values	Description
Manage Trays	Use Requested Tray	Exclusively* First	Use this feature to control how the product handles jobs that have specified a specific input tray.
	Manually Feed Prompt	Always* Unless loaded	Use this feature to indicate whether a prompt should appear when the type or size for a job does not match the specified tray and the product pulls from the multipurpose tray instead.
	Size/Type Prompt	Display* Do not display	Use this feature to control whether the tray configuration message appears whenever a tray is closed.
	Use another tray	Enabled* Disabled	Use this feature to turn on or off the control-panel prompt to select another tray when the specified tray is empty.
	Alternative Letterhead Mode	Disabled* Enabled	Use this feature so that you can load letterhead or preprinted paper into the tray the same way for all print jobs, whether you are printing to one side of the sheet or to both sides of the sheet.
	Blank Pages	Auto* Yes	Use this feature to control how the product handles two-sided jobs (duplexing). Auto: This option enables Smart Duplexing, which instructs the product not to process blank pages. Yes: This option disables Smart Duplexing and forces the duplexer to flip the sheet of paper even if it is printed on only one side.
	Override A4/Letter	Yes* No	Use this feature to print on letter-size paper when an A4 job is sent but no A4-size paper is loaded in the product (or to print on A4 paper when a letter-size job is sent but no letter-size paper is loaded).

Table 31 Trays menu (continued)

First level	Second level	Values	Description
Tray 1 Size		Select from a provided list.	Allows you to configure the paper size for Tray 1. The default is Any Size . See the product user guide for a complete list of available sizes.
Tray 1 Type		Select from a provided list.	Allows you to configure the paper type for Tray 1. The default is Any Type . See the product user guide for a complete list of available types.
Tray 2 Size		Select from a provided list.	Use this feature to specify the size of paper loaded in the tray.
Tray 2 Type		Select from a provided list.	Use this feature to specify the type of paper loaded in the tray.
Tray 3 Size		Select from a provided list.	Use this feature to specify the size of paper loaded in the tray.
Tray 3 Type		Select from a provided list.	Use this feature to specify the type of paper loaded in the tray.
Tray 4 Size		Select from a provided list.	Use this feature to specify the size of paper loaded in the tray.
Tray 4 Type		Select from a provided list.	Use this feature to specify the type of paper loaded in the tray.
Tray 5 Size		Select from a provided list.	Use this feature to specify the size of paper loaded in the tray.
Tray 5 Type		Select from a provided list.	Use this feature to specify the type of paper loaded in the tray.
Tray 6 Size		Select from a provided list.	Use this feature to specify the size of paper loaded in the tray.
Tray 6 Type		Select from a provided list.	Use this feature to specify the type of paper loaded in the tray.

Administration menu

Reports menu



NOTE: After selecting items from this menu, select **Print** to print the report.

Table 32 Reports menu

First level	Second level	Values	Description
Configuration/Status Pages	Print		Select a report, and then select Print to print the report.

Table 32 Reports menu (continued)

First level	Second level	Values	Description
	Administration Menu Map		Prints the control-panel menu map, which shows the layout of the control-panel menu items.
	Configuration Page		Shows the printer settings and installed accessories.
	Supplies Status Page		Shows the approximate remaining life for the supplies; reports statistics on total number of pages and jobs processed, serial number, page counts, and maintenance information.
	Usage Page		Prints a count of impressions (letter/A4 equivalents that have passed through the product; lists whether they were monochrome, or color; and reports the count).
	Paper Path Page		Prints a count of all paper sizes that have passed through the product by paper size; lists whether they were simplex, duplex, blank page, source, destination, paper type, and print mode usage.
	File Directory Page		Shows the file name and folder name for files that are stored in the product memory.
	Current Settings Page		Shows the products current settings.
	Color Usage Job Log		Shows information about the number of color and black & white pages that each user has printed. It also indicates from which software program each of the jobs was printed.
Other Pages	Print		This menu contains several other product-related reports and pages.
	Demonstration Page		Print the Demo page for an example of high-quality printing from the product.
	RGB Samples		Print the RGB Samples page for a palette of RGB (red, green, blue) color values. Use this page to match colors.
	CMYK Samples		Print the CMYK Samples page for a palette of CMYK (cyan, magenta, yellow, black) color values. Use this page to match colors.
	PCL Font List		Use this feature to print a list of printer control language (PCL) fonts that are currently available to the product.
	PS Font List		Use this feature to print a list of PostScript (PS) fonts that are currently available to the product.

General Settings menu

In the following table, asterisks (*) indicate the factory default setting.

Table 33 General Settings menu

First level	Second level	Third level	Fourth level	Values	Description
Date/Time Settings	Date/Time Format	Date Format		DD/MMM/YYYY	Allows you to choose the order in which the year, month, and day appear in the date.
				MMM/DD/YYYY*	
				YYYY/MMM/DD	
		Time Format		12 hour (AM/PM)*	Time Format
				24 hours	
	Date/Time	Date			Allows you to set the correct date. The range for the year is 2008 to 2037.
		Time			Time
		Time Zone			Allows you to set the correct time zone.
		Adjust for Daylight Savings		On Off*	If you are in an area that observes daylight saving time, select On.
Energy Settings	Sleep Delay			15* Range: 1 – 120 minutes	Reduces power consumption when the product has been inactive for the selected period.

Table 33 General Settings menu (continued)

First level	Second level	Third level	Fourth level	Values	Description
	Optimum Speed/ Energy Usage			Faster First Page*	Controls the fuser cool down behavior.
				Save Energy	Faster First Page: The fuser maintains power and the first page processes faster for any new job that is sent to the product. Save Energy: The fuser reduces power when it is idle. Save More Energy: The fuser reduces more power than the Save Energy option. Save Most Energy: The fuser is turned off and it gradually cools to room temperature. The Save Most Energy option takes the longest time to print the first page.
				Save More Energy	
				Save Most Energy	
Print Quality	Adjust Color	Highlights	Cyan Density	-5 to 5	Adjust the darkness or lightness of highlights on a printed page. Lower values represent lighter highlights on a printed page, and higher values represent darker highlights on a printed page.
			Magenta Density	Default = 0	
			Yellow Density		
			Black Density		
		Midtones	Cyan Density	-5 to 5	Adjust the darkness or lightness of midtones on a printed page. Lower values represent lighter midtones on a printed page, and higher values represent darker midtones on a printed page.
	Magenta Density		Default = 0		
	Yellow Density				
	Black Density				

Table 33 General Settings menu (continued)

First level	Second level	Third level	Fourth level	Values	Description
		Shadows	Cyan Density	-5 to 5	Shadows
			Magenta Density	Default = 0	
			Yellow Density		
			Black Density		
		Restore Color Values			Restore the color settings by resetting the density values of each color.
	Image Registration	Adjust Tray <X>	Print Test Page		Print Test Page
			X1 Shift	-5.00 mm to 5.00 mm	The scan direction is referred to as X. X1 is the scan direction for a single-sided page or for the second side of a two-sided page. X2 is the scan direction for the first side of a two-sided page. The feed direction is referred to as Y. Y1 is the feed direction for a single-sided page or for the second side of a two-sided page. Y2 is the feed direction for the first side of a two-sided page.
			Y1 Shift	Default = 0	
			X2 Shift		
			Y2 Shift		

Table 33 General Settings menu (continued)

First level	Second level	Third level	Fourth level	Values	Description
	Auto Sense Mode	Tray 1 Sensing		Full sensing Expanded sensing* Transparency Only	<p>Sets the sensing option for Tray 1 for paper types using AUTO SENSE mode.</p> <p>When Full sensing is selected, the product senses every page and switches modes accordingly. The product can distinguish light paper, plain paper, heavy paper, glossy paper, tough paper, or transparencies. Using this mode significantly reduces print speed. Use it only when you are printing on mixed paper types.</p> <p>When Expanded sensing is selected, the product senses only the first page and assumes the rest of the pages are the same type. The product can distinguish light paper, plain paper, heavy paper, glossy paper, tough paper, or transparencies.</p> <p>When Transparency Only is selected, the product senses only the first page. The product can distinguish transparencies from other paper types.</p>

Table 33 General Settings menu (continued)

First level	Second level	Third level	Fourth level	Values	Description
		Tray X Sensing		Expanded sensing* Transparency Only	<p>Sets the sensing option for Trays 2-5 for paper types using AUTO SENSE mode.</p> <p>When Expanded sensing is selected, the product senses only the first few pages and assumes the rest of the pages are the same type. The product can distinguish light paper, plain paper, heavy paper, glossy paper, tough paper, or transparencies. The product senses the paper type when you turn it on and after you open and close a tray.</p> <p>When Transparency Only is selected, the product senses only the first page. The product can distinguish transparencies from other paper types.</p>
	Adjust Paper Types	Select from a list of paper types that the product supports. The available options are the same for each paper type.	Print Mode	Select from a list of print modes. Default = Auto Sense Mode	Configure the print mode that is associated with each media type.

Table 33 General Settings menu (continued)

First level	Second level	Third level	Fourth level	Values	Description
			Resistance Mode	Normal* Up Down	Use this setting to correct print quality problems in low-humidity environments and highly resistive paper. The default setting is Normal. Use the Up setting to increase the T2 bias in order to solve print quality problems that are related to poor tonertransfer at the T2 stage. Use the Down setting to decrease the T2 bias in the event that small, "pin-hole" defects occur.
			Humidity Mode	Normal* High	Use this setting to correct print quality problems in high-humidity environments. The default setting is Normal. Use the High setting if you are in a high-humidity environment and you are seeing problems with low toner density on the first page of a job.

Table 33 General Settings menu (continued)

First level	Second level	Third level	Fourth level	Values	Description
			Fuser Temp Mode	Normal* Up Down	If you are seeing a faint image of the page repeated at the bottom of the page or on the following page, you should first make sure the Paper Type and Print Mode settings are correct for the type of paper you are using. If you continue to see ghost images on your print jobs, set this feature to the Up or Down setting. Try the Up setting to improve toner fixing performance. Try the Down setting if you are seeing hot offset issues. Using this mode increases wear on product parts and might also slow down the printing process.
			Paper Curl Mode	Normal* Reduced	If excessive curling of paper occurs in warm, high-humidity environments above 23° C (73° F), set this feature to Reduced. This setting reduces the fuser temperature, increases the gap between pages, and increases the frequency of consumable replacements.
	Optimize	Normal Paper		Standard* Smooth	Set to SMOOTH when printing on smooth paper of normal weight.
		Light Media		Normal* Smooth	Set to SMOOTH when printing on smooth paper of light weight.

Table 33 General Settings menu (continued)

First level	Second level	Third level	Fourth level	Values	Description
		Heavy Paper		Standard* Smooth	Set to SMOOTH when printing on smooth, heavy media types.
		Envelope Control		Normal* Alternate 1 Alternate 2	Set to REDUCED TEMP if envelopes are sticking due to moisture in the envelop adhesive.
		Environment		Normal* Low Temp	Set to LOW TEMP if the product is operating in a low-temperature environment and you are having problems with print quality such as blisters in the printed image.
		Line Voltage		Normal* Low Voltage	Set to LOW VOLTAGE if the product is operating in a low-voltage environment and you are having problems with print quality such as blisters in the printed image.
		Tray 1		Normal* Alternate	Set the mode to ALTERNATE if you are seeing marks on the back side of the paper when printing from Tray 1. This sets the product to initiate a clean sequence every time a job finishes when the product is set for Any Size and Any Type for Tray 1.
		Cleaning Control		Normal* Alternate	Generates and processes a fuser cleaning page for the printer.

Table 33 General Settings menu (continued)

First level	Second level	Third level	Fourth level	Values	Description
		Background		Normal* Alternate 1 Alternate 2 Alternate 3	Set to ALTERNATIVE 1 when a background occurs all over the page. Set to ALTERNATIVE 2 when thin vertical lines appear on the page. Set to ALTERNATIVE 3 when the other alternatives do not correct the problem.
		Media Temp		Normal* Alternate	Set to ALTERNATE if the product is operating in a low-temperature environment and you are having problems with print quality such as blisters in the printed image.
		Uniformity Control		Normal* Alternate 1 Alternate 2 Alternate 3	Set to ALTERNATIVE 1 to improve uniformity on any paper type. Set to ALTERNATIVE 2 to improve uniformity on normal and light paper types. Set to ALTERNATIVE 3 when the other alternatives do not correct the problem.
		Pre-Rotation		Normal* Alternate 1 Alternate 2 Alternate 3	Turn this feature on if horizontal streaks appear on pages. Using this feature increases the first-page-out time by about 3.5 seconds.
		Registration		Normal* Alternate	Set to ALTERNATIVE when color misregistration occurs.

Table 33 General Settings menu (continued)

First level	Second level	Third level	Fourth level	Values	Description
		Transfer Control		Normal* Alternate 1 Alternate 2 Alternate 3	Set to ALTERNATIVE 1 to reduce primary transfer bias and to resolve low density or blotchy images. Set to ALTERNATIVE 2 to resolve ghosting outlines that look like a finger or fingers. Set to ALTERNATIVE 3 when the other alternatives do not correct the problem.
		Moisture Control		Normal* Alternate	Use this setting to correct print quality problems in high-humidity environments. The default setting is Normal. Use the Alternate setting if you are in a high-humidity environment and you are seeing problems with low toner density on the first page of a job.
		Restore Optimize			Allows you to optimize various print modes to address print quality issues.

Table 33 General Settings menu (continued)

First level	Second level	Third level	Fourth level	Values	Description
	Edge Control			Off Light Normal* Maximum	<p>The Edge Control setting determines how edges are rendered. Edge control has two components: adaptive halftoning and trapping. Adaptive halftoning increases edge sharpness. Trapping reduces the effect of color-plane misregistration by overlapping the edges of adjacent objects slightly.</p> <p>Off turns off both trapping and adaptive halftoning.</p> <p>Light sets trapping at a minimal level, and adaptive halftoning is on.</p> <p>Normal is the default trapping setting. Trapping is at a medium level and adaptive halftoning is on.</p> <p>Maximum is the most aggressive trapping setting. Adaptive halftoning is on.</p>
	Jam Recovery			Auto* Off On	<p>Sets whether the product will attempt to reprint pages after a jam. If you select Auto, the product reprints pages if enough memory is available for full-speed two-sided printing.</p>

Table 33 General Settings menu (continued)

First level	Second level	Third level	Fourth level	Values	Description
Manage Stored Jobs	Quick Copy Job Storage Limit			1-300 Default = 32	Allows you to specify the number of Quick Copy jobs that can be stored on the product. The default value is 32. The maximum allowed value is 300.
		Quick Copy Job Held Timeout		Off* 1 hour 4 Hours 1 Day 1 Week	Allows you to set the amount of time that Quick Copy jobs are kept before being automatically deleted from the queue. This menu item only appears when a hard disk is installed.
	Default Folder Name for Stored Jobs			Select from a list of folder names. Public*	use this item to select the default folder name for stored jobs.
	Sort Stored Jobs By			Job Name* Date	use this item to select how stored jobs are listed.

Table 33 General Settings menu (continued)

First level	Second level	Third level	Fourth level	Values	Description
Restore Factory Settings	Reset			All	Allows you to clear the page buffer, remove all perishable personality data, reset the printing environment, and return most settings to factory defaults.
				Calibration	
				General	
				Print	
				Security	
Restrict Color				Enable	This menu item controls the authorization of color printing. DISABLE COLOR: All jobs sent to the product print only in monochrome. ENABLE COLOR: All color pages sent to the product print in color. Color if Allowed: A permissions database is referenced to verify if color pages are printed in color or monochrome.
				Disable	
				Color if Allowed*	

Retrieve From USB Settings menu

Table 34 Retrieve From USB Settings menu

First level	Second level	Values	Description
Retrieve From USB Settings	Access Code	Enable Disable*	Configure this setting to allow Walk-up USB printing at the control panel.

Print Settings menu

In the following table, asterisks (*) indicate the factory default setting.

Table 35 Print Settings menu

First level	Second level	Values	Description
Manual Feed		Enabled Disabled*	Setting this option to On makes Manual Feed the default for jobs that do not select a tray. The Autoselect option in the printer driver overrides this option.
Courier Font		Regular* Dark	Allows you to select a version of the Courier font. The Dark setting is an internal Courier font available on HP LaserJet Series III printers and older.
Wide A4		Enabled Disabled*	Allows you to change the printable area of A4 paper. If you select Disabled, the printable area is seventy-eight 10-pitch characters on a single line. If you select Enabled, the printable area is eighty 10-pitch characters on a single line.
Print PS Errors		Enabled Disabled*	Allows you to select to print PS error pages.
Print PDF Errors		Enabled Disabled*	Allows you to select to print PDF error pages.
Personality		Auto* PCL POSTSCRIPT PDF	Sets the default personality to automatic switching, PCL, PDF, or POSTSCRIPT modes.
PCL	Form Length	Range: 5 – 128 Default = 60	Allows you to set the Form Length

Table 35 Print Settings menu (continued)

First level	Second level	Values	Description
	Orientation	Portrait* Landscape	Allows you to set the default page orientation to portrait or landscape.
	Font Source	Internal* Soft USB <X>	Selects the font source. The default is Internal .
	Font Number	Range: 0 – 999 Default = 0	The product assigns a number to each font and lists the numbers on the PCL font list. The default is 0.
	Font Pitch	Range: 0.44 – 99.99 Default = 10	Selects the font pitch. This item might not appear, depending on the font selected. The default is 10.00.
	Font Point Size	Range: 4.00 – 999.75 Default = 12.00	Selects the font point size. The default is 12.00.
	Symbol Set	Select from a list of symbol sets.	Selects any one of several available symbol sets at the product control panel. A symbol set is a unique grouping of all the characters in a font.
	Append CR to LF	No* Yes	Select Yes to append a carriage return to each line-feed that is encountered in backward-compatible PCL jobs (pure text, no job control). Some environments indicate a new line by only the line-feed control code. Use this option to append the required carriage return to each line feed.

Table 35 Print Settings menu (continued)

First level	Second level	Values	Description
	Suppress Blank Pages	No* Yes	When generating your own PCL, extra form feeds are included that would cause a blank page to be printed. Select Yes for form feeds to be ignored if the page is blank.
	Media Source Mapping	Standard* Classic	The Media Source Mapping command selects an input tray by a number that maps to the various available trays and feeders. The Standard numbering is based on newer HP LaserJet printers with updated changes to the numbering of trays and feeders. The Classic numbering is based on HP LaserJet 4 printers and earlier models.

Print Options menu

In the following table, asterisks (*) indicate the factory default setting.

Table 36 Print Options menu

First level	Second level	Values	Description
Number of Copies		Default = 1	Allows you to set the default number of copies for print jobs. The default number is 1 .
Default Paper Size		Select from a list of sizes that the product supports.	Allows you to set the default paper size.
Default Custom Paper Size	Inches	X Dimension Range: 2.99 – 12.28 Default = 12.28	Allows you to set the default size for any custom print job that does not specify the dimensions (in inches).
		Y Dimension Range: 5.00 – 18.50 Default = 18.5	Allows you to set the default size for any custom print job that does not specify the dimensions (in inches).
	MM	X Dimension Range: 76 – 312 Default = 312	Allows you to set the default size for any custom print job that does not specify the dimensions (in millimeters).

Table 36 Print Options menu (continued)

First level	Second level	Values	Description
	Y Dimension	Range: 127 – 470 Default = 470	Allows you to set the default size for any custom print job that does not specify the dimensions (in millimeters).
Sides		1-sided* 2-sided	Use this feature to indicate whether the original document is printed on one or both sides, and whether the copies should be printed on one or both sides.
Two-Sided Format		Book-style* Flip-style	Allows you to change the binding edge for two-sided printing. NOTE: This menu is available only on models that have automatic duplexing.
Enable Edge to Edge Overrides		Enabled Disabled*	Allows you to set the product to print an A4 job on letter-size paper when no tray is configured for A4 paper, or to print on A4-size paper when no tray is configured for letter paper.

Display Settings menu

In the following table, asterisks (*) indicate the factory default setting.

Table 37 Display Settings menu

First level	Second level	Values	Description
Display Brightness		Range: -10 to 10 Default = 0	Sets the brightness of the control panel display. The default is 0 . This item also controls the viewing angle at which the display is visible.
Language		Select from a list of languages that the product supports.	Sets the language. The default language is ENGLISH .
Show IP address		Display* Hide	Use this feature to display or hide the IP address on the control-panel display.
Sleep Mode		Use sleep delay* User sleep schedule Use Both	The sleep delay setting helps save energy by having the product enter a low-power mode after a certain time of inactivity. The sleep schedule automatically wakes up the product at the start of the workday. The sleep schedule can be configured using the EWS.
Inactivity Timeout		Range: 10 – 300 seconds Default = 60	Idle Timeout: The time period, in seconds, after which an idle TCP print data connection is closed (default is 60 seconds, 0 disables the timeout).
Clearable Warnings		On Job*	Sets whether a warning is cleared on the control panel or when another job is sent. Job: The warning message disappears at the end of the job. On: The warning message remains until you press the OK button.
Continuable Events		Auto continue (10 seconds)* Press OK to continue	Determines product behavior when the system generates an Auto Continuable error. On: Allows the product to continue printing. Off: Stops the product from printing until the error is cleared by the user.

Manage Supplies menu

In the following table, asterisks (*) indicate the factory default setting.

Table 38 Manage Supplies menu

First level	Second level	Third level	Fourth level	Values	Description
Supplies Status					Use the Supplies Status menu to configure how the product reacts when supplies are reaching the end of their estimated life.
Supply Settings	Black Cartridge	Very Low Settings		Stop Prompt to continue* Continue	<p>Select what the product should do when the print cartridge is very near the end of its estimated life.</p> <p>Stop: The product stops until you replace the cartridge.</p> <p>Prompt to continue: The product stops until you clear the prompt message. After the prompt message is cleared, there will not be another message indicating that the supply needs to be replaced.</p> <p>Continue: The product provides an alert message, but it continues printing. There will not be another message indicating that the supply needs to be replaced.</p>
		Low Threshold Settings		1-100%	Set the percentage at which the product notifies you when the supply is very low.

Table 38 Manage Supplies menu (continued)

First level	Second level	Third level	Fourth level	Values	Description
	Color Cartridges	Very Low Settings		Stop Prompt to continue* Continue	<p>Select what the product should do when the print cartridge is very near the end of its estimated life.</p> <p>Stop: The product stops until you replace the cartridge.</p> <p>Prompt to continue: The product stops until you clear the prompt message.</p> <p>Continue: The product provides an alert message, but it continues printing.</p>
		Low Threshold Settings	Cyan Cartridge Magenta Cartridge Yellow Cartridge	1-100%	Set the percentage at which the product notifies you when the supply is very low.
	Fuser	Very Low Settings		Stop Prompt to continue* Continue	<p>Stop: The product stops until you replace the fuser kit.</p> <p>Prompt to continue: The product stops until you clear the prompt message.</p> <p>Continue: The product provides an alert message, but it continues printing.</p>
		Low Threshold Settings		1-100%	Set the percentage at which the product notifies you when the supply is very low.

Table 38 Manage Supplies menu (continued)

First level	Second level	Third level	Fourth level	Values	Description
	Transfer Kit	Very Low Settings		Stop Prompt to continue* Continue	<p>Stop: The product stops until you replace the transfer kit.</p> <p>Prompt to continue: The product stops until you clear the prompt message.</p> <p>Continue: The product provides an alert message, but it continues printing.</p>
		Low Threshold Settings		1-100%	Set the percentage at which the product notifies you when the supply is very low.
	Color/Black Mix			Auto* Mostly Color Pages Mostly Black Pages	<p>These menu selections allow you to balance the trade-off between supply life and performance.</p> <p>Auto: The product software uses an algorithm based on printing data to achieve the best output.</p> <p>Mostly Color Pages: This selection provides the highest performance. If most of the printing is in color, this selection will not negatively affect supply life.</p> <p>Mostly Black Pages: This selection conserves the most supply life and is the best choice if most of the printing is done in black and white.</p>

Table 38 Manage Supplies menu (continued)

First level	Second level	Third level	Fourth level	Values	Description
Supply Messages	Low Message			On*	Select how the product displays the supply information. Low Message: Determines whether or not a low supply message is displayed on the control panel.
				Off	
	Level Gauge			On*	LEVEL GAUGE: Determines whether or not a supply level gauge appears on the control panel.
				Off	
Reset Supplies	New Fuser Kit			No	Use this menu to notify the product that a new fuser kit has been installed.
				Yes	
	New Transfer Kit			No	Use this menu to notify the product that a new transfer kit has been installed.
				Yes	

Manage Trays menu

In the following table, asterisks (*) indicate the factory default setting.

Table 39 Manage Trays menu

First level	Values	Description
Use Requested Tray	Exclusively*	Use Requested Tray handles jobs that have specified a specific input tray. Two options are available: Exclusively: The product never selects a different tray when the user has indicated that a specific tray should be used, even if that tray is empty. First: The product can pull from another tray if the specified tray is empty, even though the user specifically indicated a tray for the job.
	First	

Table 39 Manage Trays menu (continued)

First level	Values	Description
Manually Feed Prompt	Always*	<p>This option controls whether a manual feed message should appear when the type or size for a job does not match the size or type configured for Tray 1. Two options are available:</p> <p>Always: A prompt always appears before printing a manual-feed job.</p> <p>Unless loaded: A message appears only if the multipurpose tray is empty or does not match the size or type of the job.</p>
	Unless loaded	
Size/Type Prompt	Display*	<p>This option controls whether the tray configuration message appears whenever a tray is closed. Two options are available:</p> <p>Display: This option shows the tray configuration message when a tray is closed. You can configure the tray size or type directly from this message.</p> <p>Do not display: This option prevents the tray configuration message from automatically appearing.</p>
	Do not display	
Use another tray	Enabled*	<p>This option turns on or off the control-panel prompt to select another tray when the specified tray is empty.</p>
	Disabled	
Alternative Letterhead Mode	Disabled*	<p>When this option is On you can load letterhead or preprinted paper the same way for every job, whether printing on one or both sides of the page.</p> <p>This option is available only for models that have automatic duplexing.</p>
	Enabled	

Table 39 Manage Trays menu (continued)

First level	Values	Description
Blank Pages	Auto*	This option controls how the product handles two-sided jobs (duplexing). Two options are available: Auto: Enables Smart Duplexing, which instructs the product not to process both sides if the second side is blank. Letterhead and prepunched paper types are exceptions. This can improve print speed. Yes: Disables Smart Duplexing and forces the duplexer to flip the sheet of paper even if it is printed on only one side. This option is available only for models that have automatic duplexing.
	Yes	
Override A4/Letter	Yes*	Allows you to set the product to print an A4 job on letter-size paper when no tray is configured for A4 paper, or to print on A4-size paper when no tray is configured for letter paper.
	No	

Network Settings menu

In the following table, asterisks (*) indicate the factory default setting.

Table 40 Network Settings menu

First level	Values	Description
I/O Timeout	Range: 5 – 300 sec Default = 15	Allows you to set the product I/O Timeout in seconds. The default is 15 seconds. Use this setting to adjust timeout for the best performance. If data from other ports appears in the middle of your print job, increase the timeout value.
Embedded Jetdirect		See the table that follows for details. These menus have the same structure. If an additional HP Jetdirect network card is installed in the EIO slot, then both menus are available.

Table 41 Embedded Jetdirect

First level	Second level	Third level	Fourth level	Fifth level	Values	Description
Information	Print Sec Report				Yes No*	Yes: Prints a page that contains the current security settings on the HP Jetdirect print server. No: A security settings page is not printed.
TCP/IP	Enable				On* Off	On: Enable the TCP/IP protocol. Off: Disable the TCP/IP protocol.
	Host Name				Use the arrow buttons to edit the host name. NPXXXXXX*	An alphanumeric string, up to 32 characters, used to identify the product. This name is listed on the HP Jetdirect configuration page. The default host name is NPxxxxxx, where xxxxxx is the last six digits of the LAN hardware (MAC) address.

Table 41 Embedded Jetdirect (continued)

First level	Second level	Third level	Fourth level	Fifth level	Values	Description
	IPv4 Settings	Config Method			Bootp* DHCP Auto IP Manual	<p>Specifies the method that TCP/IPv4 parameters will be configured on the HP Jetdirect print server.</p> <p>Use Bootp (Bootstrap Protocol) for automatic configuration from a BootP server.</p> <p>Use DHCP (Dynamic Host Configuration Protocol) for automatic configuration from a DHCPv4 server. If selected and a DHCP lease exists, DHCP Release and DHCP Renew menus are available to set DHCP lease options.</p> <p>Use Auto IP for automatic link-local IPv4 addressing. An address in the form 169.254.x.x is assigned automatically.</p>
		Default IP			Auto IP* Legacy	<p>Specify the IP address to default to when the print server is unable to obtain an IP address from the network during a forced TCP/IP reconfiguration (for example, when manually configured to use BootP or DHCP).</p> <p>This feature assigns a static IP address that might interfere with a managed network.</p> <p>Auto IP: A link-local IP address 169.254.x.x is set.</p> <p>Legacy: The address 192.0.0.192 is set, consistent with older HP Jetdirect products.</p>
		DHCP Release			Yes No*	<p>This menu appears if Config Method is set to DHCP and a DHCP lease for the print server exists.</p> <p>No: The current DHCP lease is saved.</p> <p>Yes: The current DHCP lease and the leased IP address are released.</p>

Table 41 Embedded Jetdirect (continued)

First level	Second level	Third level	Fourth level	Fifth level	Values	Description
		DHCP Renew			Yes No*	<p>This menu appears if Config Method is set to DHCP and a DHCP lease for the print server exists.</p> <p>No: The print server does not request to renew the DHCP lease.</p> <p>Yes: The print server requests to renew the current DHCP lease.</p>
		Primary DNS			Range: 0 – 255 Default = xxx.xxx.xx.xx	Specify the IP address (n.n.n.n) of a Primary DNS Server.
		Secondary DNS			Range: 0 – 255 Default = 0.0.0.0	Specify the IP address (n.n.n.n) of a Secondary Domain Name System (DNS) Server.
	IPv6 Settings	Enable			On* Off	<p>Use this item to enable or disable IPv6 operation on the print server.</p> <p>Off: IPv6 is disabled.</p> <p>On: IPv6 is enabled.</p>
		Address	Manual Settings	Enable	On Off*	<p>Use this item to enable and manually configure a TCP/IPv6 address.</p> <p>Enable: Choose On to enable manual configuration, or Off to disable manual configuration. The default is Off.</p>
				Address	Select from a provided list.	Address: Use this item to type a 32 hexadecimal digit IPv6 node address that uses the colon hexadecimal syntax.

Table 41 Embedded Jetdirect (continued)

First level	Second level	Third level	Fourth level	Fifth level	Values	Description
		DHCPV6 Policy			Router Specified Router Unavailable* Always	<p>Router Specified: The stateful auto-configuration method to be used by the print server is determined by a router. The router specifies whether the print server obtains its address, its configuration information, or both from a DHCPv6 server.</p> <p>Router Unavailable: If a router is not available, the print server should attempt to obtain its stateful configuration from a DHCPv6 server.</p> <p>Always: Whether or not a router is available, the print server always attempts to obtain its stateful configuration from a DHCPv6 server.</p>
		Primary DNS			Select from a provided list.	Use this item to specify an IPv6 address for a primary DNS server that the print server should use.
		Secondary DNS			Select from a provided list.	Use this item to specify an IPv6 address for a secondary DNS server that the print server should use.
		Proxy Server			Select from a provided list.	<p>Specifies the proxy server to be used by embedded applications in the product. A proxy server is typically used by network clients for Internet access. It caches Web pages, and provides a degree of Internet security, for those clients.</p> <p>To specify a proxy server, enter its IPv4 address or fully-qualified domain name. The name can be up to 255 octets.</p> <p>For some networks, you might need to contact your Internet Service Provider (ISP) for the proxy server address.</p>

Table 41 Embedded Jetdirect (continued)

First level	Second level	Third level	Fourth level	Fifth level	Values	Description
		Proxy Port			Default = 0080	Type the port number used by the proxy server for client support. The port number identifies the port reserved for proxy activity on your network, and can be a value from 0 to 65535.
		Idle Timeout			Default = 0270	Idle Timeout: The time period, in seconds, after which an idle TCP print data connection is closed (default is 270 seconds, 0 disables the timeout).
Security	Secure Web				HTTPS Required* HTTPS Optional	For configuration management, specify whether the embedded Web server will accept communications using HTTPS (Secure HTTP) only, or both HTTP and HTTPS. HTTPS Required: For secure, encrypted communications, only HTTPS access is accepted. The print server will appear as a secure site. HTTPS Optional: Access using either HTTP or HTTPS is permitted.
		IPSEC			Keep Disable*	Specify the IPsec status on the print server. Keep: IPsec status remains the same as currently configured. Disable: IPsec operation on the print server is disabled.
		802.1x			Reset Keep*	Specify whether the 802.1X settings on the print server are reset to the factory defaults. Reset: The 802.1X settings are reset to the factory defaults. Keep: The current 802.1X settings are maintained.

Table 41 Embedded Jetdirect (continued)

First level	Second level	Third level	Fourth level	Fifth level	Values	Description
	Reset Security				Yes No*	Specify whether the current security settings on the print server will be saved or reset to factory defaults. Yes: Security settings are reset to factory defaults. No: The current security settings are maintained.
Diagnostics	Embedded Test	LAN HW Test			Yes No*	This menu provides tests to help diagnose network hardware or TCP/IP network connection problems. Embedded tests help to identify whether a network fault is internal or external to the product. Use an embedded test to check hardware and communication paths on the print server. After you select and enable a test and set the execution time, you must select Execute to initiate the test. Depending on the execution time, a selected test runs continuously until either the product is turned off, or an error occurs and a diagnostic page is printed. Running this embedded test will erase your TCP/IP configuration. This test performs an internal loopback test. An internal loopback test will send and receive packets only on the internal network hardware. There are no external transmissions on your network. Select Yes to choose this test, or No to not choose it.
		HTTP Test			Yes No*	This test checks operation of HTTP by retrieving predefined pages from the product, and tests the embedded Web server. Select Yes to choose this test, or No to not choose it.

Table 41 Embedded Jetdirect (continued)

First level	Second level	Third level	Fourth level	Fifth level	Values	Description
		SNMP Test			Yes No*	This test checks operation of SNMP communications by accessing predefined SNMP objects on the product. Select Yes to choose this test, or No to not choose it.
		Data Path Test			Yes No*	This test helps to identify data path and corruption problems on an HP postscript level 3 emulation product. It sends a predefined PS file to the product. However, the test is paperless; the file will not print. Select Yes to choose this test, or No to not choose it.
		Select All Tests			Yes No*	Use this item to select all available embedded tests. Select Yes to choose all tests. Select No to select individual tests.
		Execution Time			Range: 1 – 60 hours Default = 1	Use this item to specify the length of time (in hours) that an embedded test will be run. You can select a value from 1 to 60 hours. If you select zero (1), the test runs indefinitely until an error occurs or the product is turned off. Data gathered from the HTTP, SNMP, and Data Path tests is printed after the tests have completed.
		Execute			Yes No*	No: Do not initiate the selected tests. Yes: Initiate the selected tests.
	Ping Test	Dest Type			IPv4 IPv6	This test is used to check network communications. This test sends link-level packets to a remote network host, then waits for an appropriate response. To run a ping test, set the following items: Specify whether the target product is an IPv4 or IPv6 node.

Table 41 Embedded Jetdirect (continued)

First level	Second level	Third level	Fourth level	Fifth level	Values	Description
		Dest IPv4			Range: 0 – 255 Default = 127.0.0.1	Type the IPv4 address.
		Dest IPv6			Select from a provided list. Default = : : 1	Type the IPv6 address.
		Packet Size			Default = 64	Specify the size of each packet, in bytes, to be sent to the remote host. The minimum is 64 (default) and the maximum is 2048.
		Timeout			Default = 001	Specify the length of time, in seconds, to wait for a response from the remote host. The default is 1 and the maximum is 100.
		Count			Default = 004	Specify the number of ping test packets to send for this test. Select a value from 0 to 100. The default is 4. To configure the test to run continuously, select 0.
		Print Results			Yes No*	If the ping test was not set for continuous operation, you can choose to print the test results. Select Yes to print results. If you select No , results are not printed.
		Execute			Yes No*	Specify whether to initiate the ping test. Select Yes to initiate the test, or No to not run the test.
	Ping Results	Packets Sent			Default = 00000	Use this item to view the ping test status and results using the control panel display. You can select the following items: Shows the number of packets (0 - 65535) sent to the remote host since the most recent test was initiated or completed. The default is 0.
		Packets Received			Default = 00000	Shows the number of packets (0 - 65535) received from the remote host since the most recent test was initiated or completed. The default is 0.

Table 41 Embedded Jetdirect (continued)

First level	Second level	Third level	Fourth level	Fifth level	Values	Description
		Percent Lost			Default = 000	Shows the percent (0 to 100) of ping test packets that were sent with no response from the remote host since the most recent test was initiated or completed. The default is 0.
		RTT Min			Default = 0000	Shows the minimum detected roundtrip-time (RTT), from 0 to 4096 milliseconds, for packet transmission and response. The default is 0.
		RTT Max			Default = 0000	Shows the maximum detected roundtrip-time (RTT), from 0 to 4096 milliseconds, for packet transmission and response. The default is 0.
		RTT Average			Default = 0000	Shows the average round-trip-time (RTT), from 0 to 4096 milliseconds, for packet transmission and response. The default is 0.
		Ping In Progress			Yes No*	Shows whether a ping test is in progress. Yes indicates a test in progress, and No indicates that a test completed or was not run.

Table 41 Embedded Jetdirect (continued)

First level	Second level	Third level	Fourth level	Fifth level	Values	Description
		Refresh			Yes No*	When viewing the ping test results, this item updates the ping test data with current results. Select Yes to update the data, or No to maintain the existing data. However, a refresh automatically occurs when the menu times out or you manually return to the main menu.
Link Speed					Auto* 10T Half 10T Full 100TX Half 100TX Full 100TX Auto 1000TX Full	<p>The link speed and communication mode of the print server must match the network. The available settings depend on the product and installed print server. Select one of the following link configuration settings:</p> <p>If you change the link setting, network communications with the print server and network product might be lost.</p> <p>Auto: The print server uses auto-negotiation to configure itself with the highest link speed and communication mode allowed. If auto-negotiation fails, either 100TX Half or 10T Half is set depending on the detected link speed of the hub/switch port. (A 1000T half-duplex selection is not supported.)</p> <p>10T Half: 10 Mbps, half-duplex operation.</p> <p>10T Full: 10 Mbps, full-duplex operation.</p> <p>100TX Half: 100 Mbps, half-duplex operation.</p> <p>100TX Full: 100 Mbps, full-duplex operation.</p> <p>100TX Auto: Limits auto-negotiation to a maximum link speed of 100 Mbps.</p> <p>1000T FULL: 1000 Mbps, full-duplex operation.</p>

Troubleshooting menu

In the following table, asterisks (*) indicate the factory default setting.

Table 42 Troubleshooting menu

First level	Second level	Third level	Fourth level	Values	Description
Exit Troubleshooting					Use this menu to help resolve problems.
NOTE: This item only displays if you are backing out of the Troubleshooting menu.					
Print Event Log					Prints a report containing the last 50 entries in the product's event log, starting with the most recent.
View Event Log					Displays the last 50 events, starting with the most recent.
Print Quality Pages	Print PQ Troubleshooting Pages				Prints a page that includes instructions, pages for each color, a demo page, and a configuration page. These pages can help isolate print-quality problems.
	Diagnostics Page				Prints a page that can assist in diagnosing product problems.
	Color Band Test	Print Test Page			Prints a color band test page that is used to identify arcing in the high-voltage power supply.
		Copies		Range: 1 – 30 Default = 1	Specify how many copies of the internal page are printed.
Diagnostic Tests	Disable Cartridge Check				This item allows you to remove a print cartridge to help determine which cartridge is the source of a problem.

Table 42 Troubleshooting menu (continued)

First level	Second level	Third level	Fourth level	Values	Description
	Paper Path Sensors			Start Test	Performs a test on each of the product's sensors to determine if they are working correctly and displays the status of each sensor.
	Paper Path Test	Print Test Page		Print	<p>Tests the paper-handling features of the product, such as the configuration of the trays.</p> <p>Generates a page for testing the paper-handling features. You must define the path for the test in order to test specific paper paths.</p>
		Source		Select from a list of the available trays.	Specifies whether the test page is printed from all trays or from a specific tray.
		Test Duplex Path		Off* On	<p>Determines whether the duplexer is included in the test.</p> <p>NOTE: This option is available only for models that have an automatic duplexer.</p>
		Number of Copies		Range: 1 – 500 Default = 1	Determines how many pages should be sent from the specified source as part of the test.

Table 42 Troubleshooting menu (continued)

First level	Second level	Third level	Fourth level	Values	Description
	Manual Sensor Test			Select from a list of the product sensors.	<p>Use this feature to exercise individual parts independently to isolate noise, leaking, or other issues.</p> <p>To start the test, select a component. The test runs the number of times specified by the Repeat option.</p> <p>You might be prompted to remove parts from the product during the test. Press the Stop button to abort the test.</p>
	Tray/Bin Manual Sensor Test			Select from a list of the product sensors.	<p>Use this feature to exercise individual parts independently to isolate noise, leaking, or other issues.</p> <p>To start the test, select a component. The test runs the number of times specified by the Repeat option.</p> <p>You might be prompted to remove parts from the product during the test. Press the Stop button to abort the test.</p>

Table 42 Troubleshooting menu (continued)

First level	Second level	Third level	Fourth level	Values	Description
	Component Test			Select from a list of available components.	Use this feature to exercise individual parts independently to isolate noise, leaking, or other issues. To start the test, select a component. The test runs the number of times specified by the Repeat option. You might be prompted to remove parts from the product during the test. Press the Stop button to abort the test.
		Repeat		Off* On	The test will run the number of times specified by the Repeat option.
	Print/Stop Test				Isolates print quality faults more accurately by stopping the product in mid-print cycle, which allows you to see where the image begins to degrade. This causes a jam message that might need to be manually cleared. A service representative should perform this test.
Retrieve Diagnostic Data	Export to USB				Stores product diagnostic data on a portable storage device. This function is for the HP lab use to troubleshoot and diagnose system failures.

Table 42 Troubleshooting menu (continued)

First level	Second level	Third level	Fourth level	Values	Description
	Diagnostic Files			Device Data File Debug Information File*	Choose the diagnostic data type to be saved. This function is for the HP lab use to troubleshoot and diagnose system failures.
	Include Crash Dumps			Off On*	Enable or disable saving product crash data. This function is for the HP lab use to troubleshoot and diagnose system failures.
	Cleanup Debug Info			Off On*	Enable or disable saving product debug data. This function is for the HP lab use to troubleshoot and diagnose system failures.
General Debug Data					This function is for the HP lab use to troubleshoot and diagnose system failures.

Device Maintenance menu

Backup/Restore menu

△ **CAUTION:** Data backup and restoration is the responsibility of the customer/administrator of the product. Service personnel should not back up or restore customer data under any circumstances.

In the following table, asterisks (*) indicate the factory default setting.

Table 43 Backup/Restore menu

First level	Second level	Third level	Values	Description
Backup Data	Scheduled Backups	Enable Scheduling	Disabled* Enabled	This feature allows you to create a backup copy of the products configuration, settings and stored jobs. Restores from backup copy when configuration recovery is necessary.
		Backup Time	Default = current time	Set the time that the scheduled backup executes.
		Days Between Backups	Default = 1	Set the number of days between scheduled backups.
	Backup Now			Use this feature to perform manual backups of the products configuration data to the local drive or the front panel USB port.
	Export Last Backup			Use this feature to export the last performed backup data to the local drive or the front panel USB port.
Restore Data			Insert a USB drive that contains the backup file.	Restore locally saved backups of the systems configuration data from the front panel USB drive.

Calibration/Cleaning menu

In the following table, asterisks (*) indicate the factory default setting.

Table 44 Calibration/Cleaning menu

First level	Second level	Values	Description
Auto Cleaning		Off* On	When auto-cleaning is on, the product prints a cleaning page when the page count reaches the Cleaning Interval setting.
Cleaning Interval		Select from a list of cleaning intervals.	Specify the number of pages that are printed before a cleaning page is automatically printed. This item appears only when the Auto Cleaning option is set to On .
Auto Cleaning Size		Letter* A4	Specify the paper size that is used to print the cleaning page. This item appears only when the Auto Cleaning option is set to On .
Print Cleaning Page			Allows you to create and process a cleaning page for cleaning the pressure roller in the fuser. When the cleaning process runs, a cleaning page is printed. This page can be discarded.
Clean Laser Glass			Use this menu to perform laser glass cleaning tasks.
Quick Calibration			Performs a partial product calibration.

Table 44 Calibration/Cleaning menu (continued)

First level	Second level	Values	Description
Full Calibration			Performs all product calibrations.
Delay Calibration at Wake/Power On		Yes* No	<p>This menu controls the timing of the calibration when the product wakes up or is turned on.</p> <p>Select No to have the product calibrate immediately when it wakes up or is turned on. The product will not print any jobs until it finishes calibrating.</p> <p>Select Yes to enable a product that is asleep to accept print jobs before it calibrates. It may start calibrating before it has printed all the jobs it has received. This option allows quicker printing when coming out of sleep mode or when you turn the product on, but print quality might be reduced.</p> <p>For best results, allow the product to calibrate before printing. Print jobs performed before calibration might not be of the highest quality.</p>

USB Firmware Upgrade menu

To display: At the product control panel, select the **Device Maintenance** menu, and then select the **USB Firmware Upgrade** menu.

Insert a USB storage device with a firmware upgrade bundle into the USB port, and follow the on-screen instructions.

Service menu

The personal identification number (PIN) used to access the **Service** menu is 11552010.

In the following table, asterisks (*) indicate the factory default setting.

First level	Second level	Third level	Values	Description
User Access Code				<p>Access the product with a user-level personal identification number (PIN).</p> <p>NOTE: Some menus or function might not be available.</p>
Administrator Access Code				Access the product with a administrator-level personal identification number (PIN).
Service Access Code	Print Event Log			<p>Access the product with a technician-level personal identification number (PIN).</p> <p>Prints a report containing the last 50 entries in the product's event log, starting with the most recent.</p>
	View Event Log			Displays the last 50 events, starting with the most recent.
	Clear Event Log			Removes all recorded events from the event log.
	Cycle Counts	Mono Cycle Counts	0* Range: 0 – 9999999	Shows the number of mono print cycles.
		Color Cycle Count	0* Range: 0 – 9999999	Shows the number of color print cycles.
		Refurbish Cycle Count	0* Range: 0 – 9999999	Used for setting the page count when the product is refurbished at the factory.
	Serial Number			Use this item to enter the product serial number.
	Service ID		20182*	Use this item to enter the product service ID.

First level	Second level	Third level	Values	Description
	Cold Reset Paper		Letter* A4	Use this item to select the page size used for a cold reset operation.
	New Registration Roller		Yes No*	Use this item to inform the product that a new roller was installed.
	Media Sensor Value		0* Range: 0 – 4095	Use this item to set the media sensor value when the paper pickup assembly is replaced. The media sensor value is located on a label on the paper pickup assembly.
	Manual Laser Glass Cleaning			Use this menu item to manually clean the glass that covers the laser scanner windows. When executed, the shutters open and reveal the laser-scanner glass. You can then clean the glass.

Interpret control-panel, status-alert messages, and event code errors

The control-panel messages indicate the current product status or situations that might require action.

Control-panel messages appear temporarily and might require that you acknowledge the message by pressing the OK button to resume printing or by pressing the **Stop** button to cancel the job. With certain messages, the job might not finish printing or the print quality might be affected. If the message is related to printing and the auto-continue feature is on, the product will attempt to resume printing after the message has appeared for 10 seconds without acknowledgement.

For some messages, restarting the product might fix the problem. If a critical error persists, the product might require service.

10.0X.Y0 Supply memory error

Description

The product cannot read or write to at least one print cartridge memory tag or a memory tag is missing from a print cartridge.

Memory error

- **10.00.00** (event code)

Black print cartridge

- **10.01.00** (event code)

Cyan print cartridge

- **10.02.00** (event code)

Magenta print cartridge

- **10.03.00** (event code)

Yellow print cartridge

E-label missing

- **10.00.10** (event code)

Black print cartridge

- **10.01.10** (event code)

Cyan print cartridge

- **10.021.10** (event code)

Magenta print cartridge

- **10.03.10** (event code)

Yellow print cartridge

Recommended action

1. Remove, and then reinstall the indicated print cartridge.
2. If the error reappears, turn the power off, and then on.
3. Check the cartridge e-label. If it is damaged, replace the cartridge.
4. If the error persists, replace the indicated print cartridge.

10.22.50**Description**

The transfer kit life was reset above the order threshold.

A new ITB was installed.

Recommended action

No action necessary.

10.22.51**Description**

The transfer kit life was reset above the replace threshold.

A new ITB was installed.

Recommended action

No action necessary.

10.22.52**Description**

The transfer kit life was reset above the reset threshold.

A new ITB was installed.

Recommended action

No action necessary.

10.23.50**Description**

The fuser kit life was reset above the order threshold.

A new ITB was installed.

Recommended action

No action necessary.

10.23.51

Description

The fuser kit life was reset above the replace threshold.

A new ITB was installed.

Recommended action

No action necessary.

10.23.52

Description

The fuser kit life was reset above the reset threshold.

A new ITB was installed.

Recommended action

No action necessary.

10.23.70 Printing past very low

Description

The product indicates when fuser kit is very low. The actual remaining fuse kit life might vary.

You do not need to replace the fuser kit at this time unless print quality is no longer acceptable.

△ **CAUTION:** After an HP supply has reached the very low threshold, the HP premium protection warranty ends.

Recommended action

If print quality is no longer acceptable, replace the fuser kit. See the parts chapter in the service manual for the fuser kit part number.

💡 **TIP:** Advise the customer that HP recommends that they have replacement supplies available to install when the print quality is no longer acceptable.

10.XX.34 Used supply in use

Description

The indicated cartridge is used.

- **10.00.34** (event code)
Black print cartridge
- **10.01.34** (event code)
Cyan print cartridge

- **10.02.34** (event code)
Magenta print cartridge
- **10.03.34** (event code)
Yellow print cartridge

Recommended action

If you believe this is a genuine HP supply, go to www.hp.com/go/anticounterfeit.

 **NOTE:** Removing a cartridge from one product and then installing it in a different product (for testing functionality) will cause this event code.

10.XX.40 Genuine HP supplies installed

Description

More than one genuine HP print cartridge has been installed.

- **10.00.40** (event code)
Black print cartridge
- **10.01.40** (event code)
Cyan print cartridge
- **10.02.40** (event code)
Magenta print cartridge
- **10.03.40** (event code)
Yellow print cartridge

Recommended action

No action necessary.

10.XX.41 Unsupported supply in use

Description

The indicated print cartridge is for a different product.

- **10.00.41** (event code)
Black print cartridge
- **10.01.41** (event code)
Cyan print cartridge
- **10.020.41** (event code)

Magenta print cartridge

- **10.03.41** (event code)

Yellow print cartridge

Recommended action

Remove the indicated print cartridge, and then install the correct cartridge for this product.

 **TIP:** See the parts chapter in the service manual for the correct cartridge part number.

10.XX.70 Printing past very low

Description

The product indicates when a supply level is very low. The actual remaining print cartridge life might vary.

You do not need to replace the print cartridge at this time unless print quality is no longer acceptable.

 **CAUTION:** After an HP supply has reached the very low threshold, the HP premium protection warranty ends.

- **10.00.70**10.00.70 (event code)

Black print cartridge

- **10.01.70** (event code)

Cyan print cartridge

- **10.02.70** (event code)

Magenta print cartridge

- **10.03.70** (event code)

Yellow print cartridge

Recommended action

If print quality is no longer acceptable, replace the indicated print cartridge. See the parts chapter in the service manual for the correct cartridge part number.

 **TIP:** Advise the customer that HP recommends that they have replacement supplies available to install when the print quality is no longer acceptable.

10.YY.15 Install <supply>

Description

The indicated supply has been removed or installed incorrectly.

- **10.00.15** (event code)
Black print cartridge
- **10.01.15** (event code)
Cyan print cartridge
- **10.02.15** (event code)
Magenta print cartridge
- **10.03.15** (event code)
Yellow print cartridge
- **10.23.15**
Fuser kit
- **10.31.15**
TCU

Recommended action

Replace or install the indicated supply.

See the parts chapter in the service manual for the correct supply or kit part number.

10.YY.25 Wrong cartridge in <color> slot

Description

The indicated cartridge is installed in the wrong position.

- **10.00.25** (event code)
Black print cartridge
- **10.01.25** (event code)
Cyan print cartridge
- **10.02.25** (event code)
Magenta print cartridge
- **10.03.25** (event code)
Yellow print cartridge

Recommended action

Install the indicated cartridge in the correct position.

From left to right, the correct cartridge order follows:

- Yellow
- Magenta
- Cyan
- Black

10.YY.35 Incompatible <supply>

Description

The indicated supply is not compatible with this product.

- **10.00.35** (event code)
Black print cartridge
- **10.01.35** (event code)
Cyan print cartridge
- **10.02.35** (event code)
Magenta print cartridge
- **10.03.35** (event code)
Yellow print cartridge
- **10.23.35** (event code)
Fuser

Recommended action

△ **CAUTION:** The fuser might be hot. Be careful when removing the fuser.

Install a supply that is designed for this product.

See the parts chapter in the service manual for the correct supply part number.

11.00.YY Internal clock error

Description

The product real time clock has experienced an error.

- 01=dead clock
- 02=dead real time clock

Recommended action

Whenever the product is turned off and then turned on again, set the time and date at the control panel.

If the error persists, you might need to replace the formatter.

13.00.00**Description**

Generic jam event code.

Recommended action

Check the product for a jam. See the clear jams section in the service manual.

13.A3.FF**Description**

Power on jam at the Tray 3 feed sensor.

Recommended action

Check the product for a jam. See the clear jams section in the service manual.

13.D3.DZ**Description**

Late to duplex re-feed jam

Z = fuser mode

Recommended action

Check the product for a jam. See the clear jams section in the service manual.

13.WX.EE**Description**

This jam occurs when a door is opened during printing.

- **13.AA.EE** (event code)
Tray 3, 4, or 5 door open
- **13.AB.EE** (event code)
Tray 4, 5, or 6 door open
- **13.BA.EE** (event code)

Front door open

- **13.BB.EE** (event code)

Right door open

Recommended action

Make sure that the doors are fully closed.

13.WX.FF

Description

Power on residual paper jam

This jam occurs when the paper exists at any of the paper path jam sensors at power on or door close. Due to the current FW timing requirements, the displayed jam code is always 13.FF.FF, only the event log will have 13.WX.FF

- **13.B2.FF** (event code)

Registration sensor - PS5

- **13.B4.FF** (event code)

Loop sensor - PS7 and PS8

- 13.B9.FF (event code)

Fuser output sensor - PS6

- **13.A3.FF** (event code)

Tray 3 feed sensor - SR1

- **13.A4.FF** (event code)

Tray 4 feed sensor - SR1

- **13.A5.FF** (event code)

Tray 5 feed sensor - SR81

- **13.A6.FF** (event code)

Tray 6 feed sensor - SR91

- **13.FF.FF** (event code)

Multiple sensors

Recommended action

Clear the jam. See the clear jams section in the service manual.

13.WX.YZ Fuser area jam

Description

- **13.B9.AZ** (event code)

Stopped at fuser jam

This jam occurs when the paper stays at the fuser output sensor for a designated amount of time after it has reached the fuser output sensor.

Z = fuser mode

- 1 = Normal auto sense
 - 2 = Normal non-auto sense
 - 3 = Light 1 to 3
 - 4 = Heavy 1
 - 5 = Heavy 2
 - 6 = Heavy 3
 - 7 = Glossy 1
 - 8 = Glossy 2
 - 9 = Glossy 3
 - A = Glossy film
 - B = Transparency
 - C = Label
 - D = Envelope 1 to 3
 - E = Rough
 - 0 = Photo 1 to 3
- **13.B9.DZ** (event code)

Z = the source tray number

This jam occurs when the paper does not reach the fuser output sensor in the designated amount of time.

- **13.E1.DZ** (event code)

Z = fuser mode

This jam occurs when the paper stays at the fuser output sensor for a designated amount of time after it has reached the fuser output sensor.

Recommended action

Clear the jam. See the clear jams section in the service manual.

For a 13.B9.DZ jam: Make sure media is within specifications, check for obstructions in the fuser, check that the T2 roller is installed properly.

13.WX.YZ Fuser wrap jam

Description

- **13.B9.CZ** (event code)

Fuser wrap jam

This jam occurs when the paper disappears from the fuser output sensor before a designated amount of time after the paper reached the fuser output sensor (It is determined that the paper is being wrapped around the fuser roller).

Z = fuser mode

- 1 = Normal auto sense
- 2 = Normal non-auto sense
- 3 = Light 1 to 3
- 4 = Heavy 1
- 5 = Heavy 2
- 6 = Heavy 3
- 7 = Glossy 1
- 8 = Glossy 2
- 9 = Glossy 3
- A = Glossy film
- B = Transparency
- C = Label
- D = Envelope 1 to 3
- E = Rough
- 0 = Photo 1 to 3

Recommended action

Clear the jam. See the clear jams section in the service manual.

13.WX.YZ Jam below control panel

Description

- **13.B2.9Z** (event code)
Page at duplex switchback jam.
Z = the source tray number

Recommended action

Check the product for a jam. See the clear jams section in the service manual.

13.WX.YZ Jam in lower right door

Description

- **13.A3.D5** (event code)
Late to path jam from Tray 5

This jam occurs when the paper does not reach the Tray 3 feed sensor (SR1) in designated amount of time after the Tray 5 feed sensor (SR81) sensed the leading edge.
- **13.A4.D5** (event code)
Late to path jam from Tray 5

This jam occurs when the paper does not reach the Tray 4 feed sensor (SR1) in designated amount of time after the Tray 5 feed sensor (SR81) sensed the leading edge.
- **13.A5.A5** (event code)
Stopped at tray path jam, from Tray 5
- **13.A3.D6** (event code)
Late to path jam from Tray 6

This jam occurs when the paper does not reach the Tray 3 feed sensor (SR1) in designated amount of time after the Tray 6 feed sensor (SR91) sensed the leading edge.
- **13.A5.D6** (event code)
Late to path jam from Tray 6

This jam occurs when the paper does not reach the Tray 5 feed sensor (SR81) in designated amount of time after the Tray 6 feed sensor (SR91) sensed the leading edge.

Recommended action

Clear the jam. See the clear jams section in the service manual.

13.WX.YZ Jam in middle right door

Description

- **13.A3.D4** (event code)

Late to path jam from Tray 4

This jam occurs when the paper does not reach the Tray 3 feed sensor (SR1) in designated amount of time after the Tray 4 feed sensor (SR1) sensed the leading edge.

Recommended action

Clear the jam. See the clear jams section in the service manual.

13.WX.YZ Jam in right door

Description

- **13.B2.AZ** (event code)

Stopped at registration jam.

This jam occurs when the media is longer than the longest Universal size, (470 mm; 18.50 in), by 40 mm (1.57 in) or more, and printing from Tray 1.

However, this jam occurs when the media that is longer than the designated length by 40 mm (1.57 in) and more is detected, if the media that is longer than the longest Universal is designated. This jam occurs when the media longer than LEDGER-P by 40 mm (1.57 in) or more is detected at printing from Tray 2 through Tray 6.

Z = the source tray number

- **13.B2.DD** (event code)

Late to registration jam, from duplexer

This jam occurs when the paper does not reach the TOP sensor in designated amount of time after it is reversed at the switchback position.

Z = D for duplexer

- **13.B2.DZ** (event code)

Late to registration jam, from tray <Z>

This jam occurs when the paper does not reach the TOP sensor in the designated amount of time after the Tray 3 feed sensor sensed the leading edge at printing from Tray 3, 4, 5, or 6.

Z = source tray

- **13.B9.DD** (event code)

Late to fuser jam, from duplexer

This jam occurs when the paper does not reach the fuser output sensor in designated amount of time.

Recommended action

Clear the jam. See the clear jams section in the service manual.

13.WX.YZ Jam in Tray 1

Description

- **13.B2.D1** (event code)

Late to registration jam, from Tray 1

This jam occurs when the paper does not reach the TOP sensor in designated amount of time from the start of paper pickup at printing from Tray 1 and duplex printing.

Recommended action

Clear the jam. See the clear jams section in the service manual.

13.WX.YZ Jam in Tray <X>

Description

- **13.B2.D2** (event code)

Misfeed jam from Tray 2

This jam occurs when the paper does not reach the TOP sensor in designated amount of time from the start of paper pick-up at printing from Tray 2 and duplex printing.

- **13.A3.D3** (event code)

Misfeed jam from Tray 3

This jam occurs when the paper does not reach the feed sensor of each tray in designated amount of time after the start of paper pickup.

- **13.A4.D4** (event code)

Misfeed from Tray 4

This jam occurs when the paper does not reach the Tray 3 feed sensor (SR1) in designated amount of time after the Tray 4 feed sensor (SR1) sensed the leading edge.

- **13.A5.D5** (event code)

Misfeed from Tray 5

This jam occurs when the paper does not reach the Tray 3 feed sensor (SR1) in designated amount of time after the Tray 4 feed sensor (SR1) sensed the leading edge.

- **13.A6.D6** (event code)

Misfeed jam from Tray 6

This jam occurs when the paper does not reach the feed sensor of each tray in designated amount of time after the start of paper pickup.

Recommended action

Clear the jam. See the clear jams section in the service manual.

20.00.00 Insufficient memory To continue, press OK

Description

The product has experienced a memory error. You might have tried to transfer too many fonts or macros.

Recommended action

Press the OK button to print the transferred data (some data might be lost), and then simplify the print job or install additional memory.

21.00.00 Page too complex

Description

The page decompression process was too slow for the printer.

Recommended action

Press the OK button to continue printing (some data might be lost).

32.1C.XX

Description

- **32.1C.01** (event code)
NVRAM backup/restore service backup started
- **32.1C.02** (event code)
NVRAM backup/restore service restore started
- **32.1C.03** (event code)
NVRAM backup/restore administrator backup started
- **32.1C.04** (event code)
NVRAM backup/restore administrator restore started
- **32.1C.05** (event code)
Backup/restore complete
- **32.1C.06** (event code)
Data model failed to clone job ticket
- **32.1C.07** (event code)
Backup restore permissions error

- **32.1C.08** (event code)
Not enough disk space to perform backup/restore or network share issue
- **32.1C.09** (event code)
Tried to restore a backup file that was not valid for this product
- **32.1C.0A** (event code)
Backup file is invalid
- **32.1C.0B** (event code)
Backup is from newer version of FW than what is currently on the product
- **32.1C.0C** (event code)
Backup cancelled from the HP Embedded Web Server
- **32.1C.0D** (event code)
Backup/restore failed, auto-reboot failed, or the product might be busy
- **32.1C.0E** (event code)
Backup/restore timeout while communicating with the formatter
- **32.1C.11** (event code)
Backup/restore timeout while communicating with the engine
- **32.1C.12** (event code)
Backup/restore timeout while communicating with the disk
- **32.1C.13** (event code)
Scheduled backup failure
- **32.1C.14** (event code)
NVRAM restore timeout while communicating with the formatter
- **32.1C.17** (event code)
NVRAM restore timeout while communicating with the engine
- **32.1C.1B** (event code)
Backup of print subsystem failed
- **32.1C.1C** (event code)
Backup of networking subsystem failed
- **32.1C.21** (event code)
Restore of print subsystem failed

- **32.1C.22** (event code)
Restore of networking subsystem failed
- **32.1C.24** (event code)
NVRAM backup/restore successful
- **32.1C.28** (event code)
Reset of print subsystem failed
- **32.1C.29** (event code)
Reset of networking subsystem failed
- **32.1C.2B** (event code)
Reset formatter timeout
- **32.1C.2E** (event code)
Reset engine timeout
- **32.1C.2F** (event code)
Reset failure

Recommended action

- **32.1C.01** (event code)
No action necessary
- **32.1C.02** (event code)
No action necessary
- **32.1C.03** (event code)
No action necessary
- **32.1C.04** (event code)
No action necessary
- **32.1C.05** (event code)
No action necessary
- **32.1C.06** (event code)
Retry
- **32.1C.07** (event code)
Retry
- **32.1C.08** (event code)

- Remove stored jobs and retry
- Use larger capacity storage device
- Check network share
- **32.1C.09** (event code)
 - Use a valid backup file
- **32.1C.0A** (event code)
 - Use a valid backup file
 - Reboot and observe state of product
 - Do a partition clean using the **Preboot** menu
- **32.1C.0B** (event code)
 - Use a valid backup file or put correct firmware version on the product
- **32.1C.0C** (event code)
 - No action necessary
- **32.1C.0D** (event code)
 - Reboot and then retry the backup/restore
- **32.1C.0E** (event code)
 - Turn the product off then on and retry
- **32.1C.11** (event code)
 - Turn the product off then on and retry
- **32.1C.12** (event code)
 - Turn the product off then on and retry
- **32.1C.13** (event code)
 - Turn the product off then on and retry
- **32.1C.14** (event code)
 - Turn the product off then on and retry
- **32.1C.17** (event code)
 - Turn the product off then on and retry
- **32.1C.1B** (event code)
 - Turn the product off then on and retry
- **32.1C.1C** (event code)

Turn the product off then on and retry

- **32.1C.21** (event code)

Turn the product off then on and retry

If the error persists, clear the firmware image from the active partition by using the **Partial Clean** item in the **Preboot** menu

- **32.1C.22** (event code)

Turn the product off then on and retry

If the error persists, clear the firmware image from the active partition by using the **Partial Clean** item in the **Preboot** menu

- **32.1C.24** (event code)

Turn the product off then on and retry.

- **32.1C.28** (event code)

Turn the product off then on and retry.

- **32.1C.29** (event code)

Turn the product off then on and retry.

- **32.1C.2B** (event code)

Turn the product off then on and retry.

- **32.1C.2E** (event code)

Turn the product off then on and retry.

- **32.1C.2f** (event code)

Turn the product off then on and retry.

32.21.00

Description

Corrupt firmware in external accessory

Recommended action

Turn the product off, then on, and retry.

If the error persists, clear the firmware image from the active partition by using the **Partial Clean** item in the **Preboot** menu

40.00.01 USB I/O buffer overflow To continue, press OK

Description

The USB buffer has overflowed.

Recommended action

Press the OK button to print the transferred data (some data might be lost).

Check the host configuration.

40.00.02 Embedded I/O buffer overflow To continue, press OK

Description

The product has experienced a JetDirect buffer overflow.

Recommended action

Press the OK button to print the transferred data (some data might be lost).

Check the host configuration.

40.00.03 EIO buffer overflow To continue, press OK

Description

Too much data was sent to the EIO card in the specified slot (x). An incorrect communications protocol might be in use.

Recommended action

Press the OK button to print the transferred data (some data might be lost).

40.00.04 Unsupported USB accessory detected To continue, press OK

Description

The connection between the product and the USB device has been broken.

Recommended action

Press the OK button to clear the error message and continue printing.

Remove, and then reinstall the USB device.

40.00.05 Embedded I/O bad transmission To continue, press OK

Description

The USB device has been removed.

Recommended action

Press the OK button to clear the error message. (Data will be lost.)

Install the USB device.

41.02.00 Error

Description

A beam detected misprint error.

Recommended action

Turn the product off, and then on.

If the error persists, replace the laser/scanner assembly.

41.03.YZ Unexpected size in tray <X>

Description

The product detected a different paper size than expected.

- Y = 0
Size mismatch. Detected media is longer or shorter than expected.
- Y = A
Size mismatch. Detected media too long.
- Y = B
Size mismatch. Detected media too short.
- Z = 1
Source is Tray 1
- Z = 2
Source is Tray 2
- Z = 3
Source is Tray 3
- Z = 4
Source is Tray 4
- Z = 5
Source is Tray 5
- Z = 6
Source is Tray 6

Recommended action

Make sure that the tray is loaded with the correct paper size and that the sliding paper guides are correctly adjusted.

Use the Manual/tray bin sensor test to verify that the cassette media switch is correctly functioning.

If the error persists, replace the lifter assembly.

41.05.YZ Unexpected type in tray <X>

Description

The product detected a different paper type than expected.

- Y = 0 (expected type)
Unknown
- Y = 1 (expected type)
Normal media
- Y = 3 (expected type)
LBP OHT
- Y = 4 (expected type)
Glossy media
- Y = 5 (expected type)
Gloss film
- Y = 6 (expected type)
Non-assured OHT
- Y = 7 (expected type)
Heavy media
- Y = 8 (expected type)
Light media
- Y = 9 (expected type)
Rough media
- Y = A (expected type)
Extra heavy glossy media (glossy media 3)
- Y = B (expected type)
Heavy glossy media (glossy media 2)

- Y = C (expected type)
Heavy media 3
- Y = D (expected type)
Heavy media 2
- Z = 1 (detected type)
Normal media
- Z = 3 (detected type)
LBP OHT
- Z = 4 (detected type)
Glossy media
- Z = 5 (detected type)
Gloss film
- Z = 6 (detected type)
Non-assured OHT
- Z = 7 (detected type)
Heavy media
- Z = 8 (detected type)
Light media
- Z = 9 (detected type)
Rough media
- Z = A (detected type)
Extra heavy glossy media (glossy media 3)
- Z = B (detected type)
Heavy glossy media (glossy media 2)
- Z = C (detected type)
Heavy media 3
- Z = D (detected type)
Heavy media 2

Recommended action

Load the tray with the size and type of paper indicated, or use another tray if available.

If this message appears and the tray is loaded with the correct paper type, check the print driver settings to make sure they match the tray type settings.

Clean the Media Sensor.

If the error persists, replace the paper pickup assembly.

41.07.YZ Error To continue, press OK

Description

A media transportation error has occurred.

- Y = 0
Photo media 1, Photo media 2, Photo media 3, Designated media 2, Designated media 3, or N/A, typed or AutoSense
- Y = 1
AutoSense (Normal): special case distinguished from typed Normal
- Y = 2
Normal: typed (not AutoSense)
- Y = 3
Light media 1, 2, or 3: typed or AutoSense
- Y = 4
Heavy media 1: typed or AutoSense
- Y = 5
Heavy media 2: typed or AutoSense
- Y = 6
Heavy media 3: typed or AutoSense
- Y = 7
Glossy media 1: typed or AutoSense
- Y = 8
Glossy media 2: typed or AutoSense
- Y = 9
Glossy media 3: typed or AutoSense
- Y = A
Glossy film: typed or AutoSense
- Y = B

OHT: typed or AutoSense

- Y = C

Label

- Y = D

Envelope 1, Envelope 2, or Envelope 3

- Y = E

Rough (designated media 1): typed or AutoSense

- Z = 1

Tray 1

- Z = 2

Tray 2

- Z = 3

Tray 3

- Z = 41

Tray 4

- Z = 5

Tray 5

- Z = 6

Tray 6

- Z = D

Duplexer

Recommended action

Turn the product off, and then on.

If the error persists, replace the DC controller PCA.

42.XX.YY

Description

Internal system failure

Recommended action

Turn the product off, then on, and retry.

If the error persists, clear the firmware image from the active partition by using the **Partial Clean** item in the **Preboot** menu.

47.00.XX

Description

Backchannel internal error

Recommended action

Turn the product off, and then on again. Resend the print job.

If the error persists, execute the **Partial Clean** item in the **Preboot** menu.

47.01.XX

Description

Image transformer internal error

Recommended action

Turn the product off, and then on again. Resend the print job.

If the error persists, execute the **Partial Clean** item in the **Preboot** menu.

47.02.XX

Description

Job parser internal error

Recommended action

Turn the product off, and then on again. Resend the print job.

If the error persists, execute the **Partial Clean** item in the **Preboot** menu.

47.03.XX

Description

Print job internal error

Recommended action

Turn the product off, and then on again. Resend the print job.

If the error persists, execute the **Partial Clean** item in the **Preboot** menu.

47.04.XX

Description

Print spooler 9100 internal error

Recommended action

Turn the product off, and then on again. Resend the print job.

If the error persists, execute the **Partial Clean** item in the **Preboot** menu.

47.05.00**Description**

Print spooler framework internal error

Recommended action

Turn the product off, and then on again. Resend the print job.

If the error persists, execute the **Partial Clean** item in the **Preboot** menu.

47.06.XX**Description**

Print App internal error

Recommended action

Turn the product off, and then on again. Resend the print job.

If the error persists, execute the **Partial Clean** item in the **Preboot** menu.

47.WX.YZ Printer calibration error To continue, press OK**Description**

The device is unable to access or implement one of the image patterns files.

Y = calibration type, Z = event

- **47.FC.00** (event code)
Color plane registration (CPR) Image not found at system initialization
- **47.FC.01** (event code)
CPR Store Image failure
- **47.FC.02** (event code)
CPR Image not found
- **47.FC.03** (event code)
CPR Print engine execution failure
- **47.FC.10** (event code)
Consecutive Dmax Dhalf Image not found at system initialization

- **47.FC.11** (event code)
Consecutive Dmax Dhalf Store image failure
- **47.FC.12** (event code)
Consecutive Dmax Dhalf Image not found
- **47.FC.13** (event code)
Consecutive Dmax Dhalf Print engine execution failure
- **47.FC.20** (event code)
Error Diffusion Image not found at system initialization
- **47.FC.21** (event code)
Error Diffusion Store image failure
- **47.FC.22** (event code)
Error Diffusion Image not found
- **47.FC.23**
Error Diffusion Print engine execution failure
- **47.FC.300** (event code)
Drum Speed Adjustment Image not found at system initialization
- **47.FC.31** (event code)
Drum Speed Adjustment Store image failure
- **47.FC.32** (event code)
Drum Speed Adjustment Image not found
- **47.FC.33** (event code)
Drum Speed Adjustment Print engine execution failure
- **47.FC.40** (event code)
Pulse Width Modulation Image not found at system initialization
- **47.FC.41** (event code)
Pulse Width Modulation Store image failure
- **47.FC.42** (event code)
Pulse Width Modulation Image not found
- **47.FC.430** (event code)
Pulse Width Modulation Print engine execution failure

Recommended action

Turn the product off, and then on.

If the error persists, reload the firmware.

50.WX.YZ Fuser error To continue, turn off then on**Description**

The fuser has experienced an error.

W = fuser error code, X = fuser mode, Y = previous printer sleep state, Z = next printer sleep state

Recommended action**W = 1 or W = 2**

Low fuser temperature and fuser warm-up failure

1. Remove and then reseal the fuser. Make sure there is no residual paper in the fuser. Make sure the device is not located in front of a vent or window where cool air may interfere with the ability of the fuser to heat up.
2. Check the product power source. Make sure the power source meets product requirements. Make sure this is the only device using the circuit.
3. Replace the fuser.
4. Check the connector (J704) between the fuser and the printer. If it is damaged, replace the fuser drive assembly or fuser.
5. If the error persists, replace the low-voltage power supply.
6. If this product has been previously serviced, check the connector (J131) on the DC controller PCA and the connectors (J109 and J110) on the power line between the low-voltage power supply assembly and the fuser.

W = 3

High fuser temperature

1. Remove and then reseal the fuser.
2. Check the paper type setting using the product menus and in the printer driver. Make sure that they match and are correct for the type of media being used.
3. Replace the fuser.
4. If the error persists, replace the low-voltage power supply.
5. If this product has been previously serviced, check the connector (J131) on the DC controller PCA.

W = 4

Drive circuit fault

1. Check the power source. Make sure the power source meets product requirements.

 **NOTE:** If the power source does not meet the power frequency requirement of 43 to 67Hz, the fuser temperature control does not work properly and causes this error.

2. If the error persists, replace the low-voltage power supply.
3. If this product has been previously serviced, check the connector (J21) on the DC controller PCA.

W = 7

Fuser pressure-release mechanism failure

1. Remove and then reseal the fuser. Make sure there is no residual paper in the fuser.
2. Check the fuser pressure-release sensor flag. If it is damaged, replace the fuser.
3. Use the sensor test in the Manual sensor test to verify that the fuser pressure-release sensor (PS9) is properly functioning. If it is not, replace the fuser gear assembly.
4. Use the fuser pressure-release drive test in the component test to verify that the fuser motor (M4) is properly functioning. If it is not, replace the fuser motor.
5. If the error persists, replace the low-voltage power supply.
6. If this product has been previously serviced, check the connector (J181) on the DC controller PCA.

W = 8

Low fuser temperature 2

1. Remove and then reseal the fuser. Make sure there is no residual paper in the fuser. Make sure the device is not located in front of a vent or window where cool air may interfere with the ability of the fuser to heat up.
2. Check the product power source. Make sure the power source meets product requirements. Make sure this is the only device using the circuit.
3. Replace the fuser.
4. Check the connector (J704) between the fuser and the printer. If it is damaged, replace the fuser drive assembly or fuser.
5. If the error persists, replace the low-voltage power supply.
6. If this product has been previously serviced, check the connector (J131) on the DC controller PCA and the connectors (J109 and J110) on the power line between the low-voltage power supply assembly and the fuser.

W = 9

High fuser temperature 2

1. Remove and then reseal the fuser.
2. Check the paper type setting using the product menus and in the printer driver. Making sure that they match and are correct for the type of media being used.
3. Replace the fuser.
4. If this product has been previously serviced, check the connector (J131) on the DC controller PCA.

W = A

Low fuser temperature 3

1. Remove and then reseal the fuser. Make sure there is no residual paper in the fuser. Make sure the device is not located in front of a vent or window where cool air may interfere with the ability of the fuser to heat up.
2. Check the product power source. Make sure the power source meets product requirements. Make sure this is the only device using the circuit.
3. Replace the fuser.
4. Check the connector (J704) between the fuser and the printer. If it is damaged, replace the fuser drive assembly or fuser.
5. If this product has been previously serviced, check the connector (J131) on the DC controller PCA and the connectors (J109 and J110) on the power line between the low-voltage power supply assembly and the fuser.

W = B

High fuser temperature 3

1. Remove and then reseal the fuser.
2. Check the paper type setting using the product menus and in the printer driver. Making sure that they match and are correct for the type of media being used.
3. Replace the fuser.
4. Check the connector (J704) between the fuser and the printer. If it is damaged, replace the fuser drive assembly or fuser.
5. If this product has been previously serviced, check the connector (J131) on the DC controller PCA.

51.00.YY Error

Description

Laser/scanner error

- YY = 20
Black laser/scanner error
- YY = 21
Cyan laser/scanner error
- YY = 22
Magenta laser/scanner error
- YY = 23
Yellow laser/scanner error

Recommended action

Turn the product off, and then on.

If the error persists, replace the laser/scanner assembly.

52.XX.00 Error To continue, turn off then on

Description

Laser/scanner error

- XX = 00
laser/scanner motor startup error
- XX = 20
Laser/scanner rotation error

Recommended action

Use the scanner motor (M10) drive test in the component test to test the motor. If the motor does not run, replace the laser/scanner assembly.

 **NOTE:** Listen for a high pitched whine from the motor.

If the laser/scanner assembly has been removed or replaced, check the connectors (J831 and J832) on the laser-driver PCA and the connectors (J61 and J62) on the DC controller PCA.

54.XX.YY Error

Description

A sensor error has occurred.

Recommended action

54.00.03

Environmental sensor failure

1. Turn the product off, and then on.
2. If the error persists, replace the environment sensor assembly.
3. If the environment sensor has been removed or replaced check the connector (J502) on the environment sensor and the connector (J33) on the DC controller PCA.

54.00.06 or 54.00.14 or 54.00.19

Registration density sensor failure

1. Open and close the right door (or turn on and then off the power switch) to perform the color plane registration.
2. If the error persists, replace the registration density sensor assembly.

54.01.05

Media sensor is out of calibration range

1. Turn the product off, and then clean the media sensor with a lint-free cloth. Turn the product on.
2. If the error persists, replace the paper pickup assembly.

54.06.21

Primary laser/scanner beam detect abnormality

1. Turn the product off, and then on.
2. If the error persists, replace the laser/scanner assembly.
3. If the product has had parts removed or replace, check the connector (J61) on the DC controller PCA.

54.11.05 or 54.12.05

Media Sensor is not functioning properly

1. Clean the media sensor with a lint-free cloth and then turn the product off and then on.
2. **54.11.05:** If the error persists replace the paper pickup assembly. The threshold level for the media sensor (**Media Sensor Value**) is located on a label on the paper pickup assembly. Use the **Service** menu to input this value into the product memory after replacing the paper pickup assembly.

-or-

2. **54.12.05:** If the error persists replace the right door assembly.
3. **54.11.05:** If the product has had parts removed or replace check the connector (J542) on the media sensor and the connector (J112) on the DC controller PCA.

-or-

54.12.05: If the product has had parts removed or replace check the connector (J114) on the media sensor and the connector (J152) on the DC controller PCA.

54.0X.07

Drum home position sensor failure

X = 5 black, X = 6 cyan, X = 7 magenta, X = 8 yellow

1. Turn the product off, and then on.
2. If the error persists, replace the main drive assembly.
3. If the product has had parts removed or replace, check the connector (J181) on the DC controller PCA.

54.0X.0B or 54.0X.0C

Density sensor out of range error or Dhalf calibration failure

X = 0 black, X = 1 cyan, X = 2 magenta, X = 3 yellow

1. Check the supplies status page to make sure the toner cartridges are not past their useful life.
2. Check the ITB for damage.
3. Make sure the CPR sensor is not contaminated with toner or paper dust. Clean the sensor with compressed air and soft brush.
4. If error persists, replace the registration sensor assembly.

54.0X.0D or 54.0X.0E

Optical memory element abnormal or CPR sensor out of range

X = 0 black, X = 1 cyan, X = 2 magenta, X = 3 yellow

1. Check the supplies status page to make sure the toner cartridges are not past their useful life.
2. Check the ITB for damage.
3. Make sure the CPR sensor is not contaminated with toner or paper dust. Clean the sensor with compressed air and soft brush.
4. If error persists, replace the registration sensor assembly.

54.0X.0B or 54.0X.0C

Density sensor out of range error or Dhalf calibration failure

X = 0 black, X = 1 cyan, X = 2 magenta, X = 3 yellow

1. Check the supplies status page to make sure the toner cartridges are not past their useful life.
2. Check the ITB for damage.

3. Make sure the CPR sensor is not contaminated with toner or paper dust. Clean the sensor with compressed air and soft brush.
4. If error persists, replace the registration sensor assembly.

54.0X.0D or 54.0X.0E

Optical memory element abnormal or CPR sensor out of range

X = 0 black, X = 1 cyan, X = 2 magenta, X = 3 yellow

1. Check the supplies status page to make sure the toner cartridges are not past their useful life.
2. Check the ITB for damage.
3. Make sure the CPR sensor is not contaminated with toner or paper dust. Clean the sensor with compressed air and soft brush.
4. If error persists, replace the registration sensor assembly.

55.00.YY DC controller error To continue, turn off then on

Description

DC controller PCA error

- **55.00.01** (event code)
DC controller memory error
- **55.00.03** (event code)
DC controller no engine response
- **55.00.04** (event code)
DC controller communications timeout

Recommended action

Turn the product off, and then on.

If the error persists, replace the DC controller PCA.

55.0X.YY DC controller error To continue, turn off then on

Description

DC controller PCA error

- **55.01.06** (event code)
NVRAM memory data error warning
- **55.02.06** (event code)
NVRAM memory access error warning

Recommended action

Turn the product off, and then on.

If the error persists, replace the DC controller PCA.

56.00.YY Error To continue, turn off then on**Description**

Optional paper trays communication error

Recommended action

Turn the product off, and then on.

If the error persists, reseal the optional paper trays (1 x 500-sheet feeder and/or 3 x 500-sheet feeder).

Check the input connectors for damage. If a connector is damaged, replace the connector.

57.00.0Y Error To continue, turn off then on**Description**

Fan error

Recommended action**57.00.01**

Power supply fan (FM1) failure

1. Turn the product off, and then on. Listen for fan noise at the front lower-left corner of the product. If no noise is heard, replace the power supply fan (FM1).
2. If this part has been removed or replaced, check the connector (J21) on the DC controller PCA and the connector (J106) on the low-voltage power supply assembly.

57.00.02

Fuser fan (FM2) failure

1. Turn the product off, and then on. Listen for fan noise at the front lower-right corner of the product. If no noise is heard, replace the fuser fan (FM2).
2. If this part has been removed or replaced, check the connector (J121) on the DC controller PCA and the intermediate connector (J524).

57.00.03

Formatter fan (FM3) failure

1. Turn the product off, and then on. Listen for fan noise at the lower back-center of the product. If no noise is heard, replace the formatter fan (FM3).
2. If this part has been removed or replaced, check the connector (J142) on the intermediate connect board.

59.00.YY Error To continue, turn off then on

Description

Printing error

Recommended action

59.00.30 or 59.00.04

Fuser motor (M4) start up error or fuser motor (M4) rotational error

1. Use the fuser motor (M4) drive test in the component test to verify that the fuser motor is properly functioning. If it is not, replace the fuser motor assembly.
2. If the product has been serviced, check the connector (J516) on the fuser motor and the connector (J81) on the DC controller PCA.

59.00.90 or 59.00.A0

ITB motor (M1) start up error or ITB motor (M1) abnormal rotational error

1. Use the ITB motor (M1) drive test in the component test to verify that the ITB motor is properly functioning. If it is not, replace the ITB motor assembly.
2. If the product has been serviced, check the connector (J517) on the ITB motor and the connector (J81) on the DC controller PCA.

59.00.C0

Developer alienation motor (M6) error

1. Use the developer engagement and disengagement drive test in the component test to verify that the disengagement mechanism is properly functioning. If it is not, replace the ITB motor assembly.
2. Use the sensor test in the Manual sensor test to verify that the developer disengagement sensor (PS11) is properly functioning. If it is not, replace the main drive assembly.
3. If the product has been serviced, check the connector (J518) on the developer disengagement motor, the connector (J1005) on the driver PCA and the connector (J91) on the DC controller PCA.

59.00.F0

T1 alienation mechanism failure

1. Make sure that the ITB is correctly installed.
2. Use the T1 roller alienation switch (SW5) test in the Manual sensor test to verify that the switch is properly functioning. If it is not, replace the main drive assembly.
3. Use the T1 roller engagement and disengagement drive test in the component test to verify that the T1 roller disengagement mechanism is properly functioning. If it is not, replace the fuser drive assembly.
4. If the product has been serviced, check the connector (J181) on the DC controller PCA.

59.0X.50 Error To continue, turn off then on

Description

Motor startup error

X= 5 black, X = 6 cyan, X = 7 magenta, X = 8 yellow

Recommended action

50.05.50

Black image drum start up error (ITB motor; M1)

1. Use the ITB drum motor (M1) drive test in the Component test to verify that the motor is properly functioning. If it is not, replace the ITB motor assembly.
2. If the product has been serviced, check the connector (J517) on the ITB motor and the connector (J81) on the DC controller PCA.

50.06.50 or 50.07.50 or 50.08.50

CMY drum motor (M2) start up error

1. Use the drum motor (M2) drive test in the Component test to verify that the motor is properly functioning. If it is not, replace the drum motor assembly.
2. If the product has been serviced, check the connector (J515) on the drum motor and the connector (J81) on the DC controller PCA.

59.0X.60 Error To continue, turn off then on

Description

Motor rotational error

X= 5 black, X = 6 cyan, X = 7 magenta, X = 8 yellow

Recommended action

50.06.60 or 50.07.60 or 50.08.60

CMY drum motor (M2) rotation error

1. Use the drum motor (M2) drive test in the Component test to verify that the motor is properly functioning. If it is not, replace the drum motor assembly.
2. If the product has been serviced, check the connector (J515) on the drum motor and the connector (J81) on the DC controller PCA.

59.0X.70 Error To continue, turn off then on

Description

Motor abnormal rotation

Recommended action

50.05.70

Black developer motor abnormal start up error (ITB motor; M1)

1. Use the ITB drum motor (M1) drive test in the Component test to verify that the motor is properly functioning. If it is not, replace the ITB motor assembly.
2. If the product has been serviced, check the connector (J517) on the ITB motor and the connector (J81) on the DC controller PCA.

50.06.70 or 50.07.70 or 50.08.70

CMY developer motor (M3) abnormal start up error

1. Use the developer motor (M3) drive test in the Component test to verify that the motor is properly functioning. If it is not, replace the developer motor assembly.
2. If the product has been serviced, check the connector (J514) on the developer motor and the connector (J81) on the DC controller PCA.

59.0X.80 Error To continue, turn off then on

Description

Developer motor failure

Recommended action

50.05.80

Black developer motor failure error (ITB motor; M1)

1. Use the ITB drum motor (M1) drive test in the Component test to verify that the motor is properly functioning. If it is not, replace the ITB motor assembly.
2. If the product has been serviced, check the connector (J517) on the ITB motor and the connector (J81) on the DC controller PCA.

50.06.80 or 50.07.80 or 50.08.80

CMY developer motor (M3) failure error

1. Use the developer motor (M3) drive test in the Component test to verify that the motor is properly functioning. If it is not, replace the developer motor assembly.
2. If the product has been serviced, check the connector (J514) on the developer motor and the connector (J81) on the DC controller PCA.

60.00.0Y Tray <Y> lifting error

Description

Tray lift motors error

Recommended action

60.00.02

Media input Tray 2 lift-up motor (M9) failure

1. Use the Tray 2 paper surface sensor (PS4) test in the Tray/Bin manual sensor test to verify that the sensor is properly functioning. If it is not, replace the lifter drive assembly.
2. Open and close Tray 2 and listen at the back of the product for the sound of the lifer motor (M9) operating. If it does not operate, replace the lifter drive assembly.
3. If the product has been serviced, check the intermediate connector (J742) and the connector (J151) on the DC controller PCA.
4. If the error persists, replace the cassette tray.

60.00.03 or 60.00.04

Media input Tray 3 lift-up motor (M2) failure or media input Tray 4 lift-up motor (M2) failure

1. Use the Tray 3 paper surface sensor (SR2) or Tray 4 paper surface sensor (SR2) test in the Tray/Bin manual sensor test to verify that the sensor is properly functioning. If it is not, replace the lifter drive assembly.

 **NOTE:** Both the Tray 3 and Tray 4 paper surface sensors are designated as SR2. The first one listed in the Tray/Bin manual test is Tray 3, the second one listed is for Tray 4.

2. Open and close Tray 3 or Tray 4 and listen at the back of the product for the sound of the lifer motor (M2) operating. If it does not operate, replace the lifter drive assembly.

 **NOTE:** Both the Tray 3 and Tray 4 lifter motors are designated as M2. Listen for the appropriate motor to operate.

3. If the product has been serviced, check the connector (J2003) on the paper feeder controller PCA, the intermediate connector (J702) and the connector (J2006) on the paper feeder controller PCA.

 **TIP:** Check the connector (J2006) on the paper feeder controller PCA associated with the tray.

4. If the error persists, replace the cassette tray.

60.00.05 or 60.00.05

Media input Tray 5 lift-up motor (M82) failure or media input Tray 6 lift-up motor (M92) failure

1. Use the Tray 5 paper surface sensor (SR82) or Tray 6 paper surface sensor (SR92) test in the Tray/Bin manual sensor test to verify that the sensor is properly functioning. If it is not, replace the lifter drive assembly.
2. Open and close Tray 5 or Tray 6 and listen at the back of the product for the sound of the lifer motor (M82 or M92) operating. If it does not operate, replace the lifter drive assembly.
3. If the product has been serviced, check the connector (J2003) on the paper feeder controller PCA, the intermediate connector (J702) and the connector (J2006) on the paper feeder controller PCA.

 **TIP:** Check the connector (J2006) on the paper feeder controller PCA associated with the tray.

4. If the error persists, replace the cassette tray.

61.00.01

Description

Color table read failure

Recommended action

Turn the product off, and then on.

If the error persists, reload the firmware. If the error still persists, perform a firmware upgrade.

If the firmware upgrade does not resolve the problem, replace the hard disk.

62.00.00 No system To continue, turn off then on

Description

Internal system failure

Recommended action

Turn the product off, and then on.

If the error persists, reload the firmware. If the error still persists, perform a firmware upgrade.

If the firmware upgrade does not resolve the problem, replace the hard disk.

70.00.00 Error To continue, turn off then on

Description

DC controller failure

Recommended action

Turn the product off, and then on.

If the error persists, replace the DC controller.

80.0X.YY Embedded JetDirect error

Description

Embedded HP JetDirect print server critical error

- **80.01.80** (event code)

No heartbeat

- **80.01.81** (event code)

Reclaim timeout

- **80.01.82** (event code)
Invalid data length
- **80.01.8B** (event code)
Invalid max outstanding packet header field
- **80.01.8C** (event code)
Invalid channel mapping response
- **80.03.01** (event code)
No PGP buffers
- **80.03.02** (event code)
Channel table full
- **80.03.03** (event code)
Producer index not reset
- **80.03.04** (event code)
Consumer index not reset
- **80.03.05** (event code)
Queue position size too small
- **80.03.06** (event code)
Transport overflow
- **80.03.07** (event code)
No overflow packets
- **80.03.08** (event code)
Invalid identify response
- **80.03.09** (event code)
Invalid channel map return status
- **80.03.10** (event code)
Invalid reclaim return status
- **80.03.12** (event code)
Datagram invalid buffer
- **80.03.13** (event code)
Max stream channels

- **80.03.14** (event code)
Max datagram channels
- **80.03.15** (event code)
Card reset failed
- **80.03.16** (event code)
Self test failure
- **80.03.17** (event code)
Unknown PGP packet
- **80.03.18** (event code)
Duplicate I/O channel.

Recommended action

Turn the product off, and then on.

If the error persists, replace the formatter.

98.00.01 Corrupt data in firmware volume

Description

Data corruption has occurred in the firmware volume

Recommended action

Turn the product off, and then on.

Use the **Clean Disk** item in the **Preboot** menu.

Reload the firmware.

98.00.02 Corrupt data in solutions volume

Description

Data corruption has occurred in the solutions volume

Recommended action

Turn the product off, and then on.

Use the **Clean Disk** item in the **Preboot** menu.

Reload the firmware.

98.00.03 Corrupt data in configuration volume

Description

Data corruption has occurred in the configuration volume

Recommended action

Turn the product off, and then on.

Use the **Clean Disk** item in the **Preboot** menu.

Reload the firmware.

98.00.04 Corrupt data in job data volume

Description

Data corruption has occurred in the job data volume

Recommended action

Turn the product off, and then on.

Rerun the file erase function.

99.00.01 Upgrade not performed file is corrupt

Description

A remote firmware upgrade (RFU) was not performed.

CRC error in the firmware image (bad image).

Recommended action

Download the RFU file and attempt the upgrade again.

99.00.02 Upgrade not performed timeout during receive

Description

A remote firmware upgrade (RFU) was not performed.

I/O timeout when reading header number and size. Indicates a problem with the network environment, not the device.

Recommended action

The most common cause is an issue with the network environment. Make sure that there is a good connection to the device and attempt the upgrade again, or upgrade using the USB walk-up port.

99.00.03 Upgrade not performed error writing to disk

Description

A remote firmware upgrade (RFU) was not performed.

Disk error. May indicate a problem or a hard disk failure. It might be necessary to check the connection to the hard disk or replace the hard disk.

Recommended action

1. Download the RFU file and attempt the upgrade again.
2. If the error persists, perform the **Clean Disk** process. You will then need to download firmware from the **Preboot** menu.
3. If the error persists, replace the hard disk.

99.00.04 Upgrade not performed timeout during receive

Description

A remote firmware upgrade (RFU) was not performed.

I/O timeout when reading rest of header.

Recommended action

The most common cause is an issue with the network environment. Make sure that there is a good connection to the device and attempt the upgrade again, or upgrade using the USB walk-up port.

99.00.05 Upgrade not performed timeout during receive

Description

A remote firmware upgrade (RFU) was not performed.

I/O timeout when reading image data.

Recommended action

The most common cause is an issue with the network environment. Make sure that there is a good connection to the device and attempt the upgrade again, or upgrade using the USB walk-up port.

99.00.06 Upgrade not performed error reading upgrade

Description

A remote firmware upgrade (RFU) was not performed.

Unexpected read error when reading header number and size.

Recommended action

1. Download the RFU file and attempt the upgrade again.
2. If the error persists, replace the hard disk.

99.00.07 Upgrade not performed error reading upgrade

Description

A remote firmware upgrade (RFU) was not performed.

Unexpected read error when reading rest of header.

Recommended action

1. Download the RFU file and attempt the upgrade again.
2. If the error persists, replace the hard disk.

99.00.08 Upgrade not performed error reading upgrade

Description

A remote firmware upgrade (RFU) was not performed.

Unexpected read error when reading image data.

Recommended action

1. Download the RFU file and attempt the upgrade again.
2. If the error persists, replace the hard disk.

99.00.09 Upgrade canceled by user

Description

A remote firmware upgrade (RFU) was not performed.

The RFU was canceled by the user.

Recommended action

Resend the RFU.

99.00.10 Upgrade canceled by user

Description

A remote firmware upgrade (RFU) was not performed.

Job canceled when reading header number and size.

Recommended action

Resend the RFU.

99.00.11 Upgrade canceled by user

Description

A remote firmware upgrade (RFU) was not performed.

Job canceled when reading rest of header.

Recommended action

Resend the RFU.

99.00.12 Upgrade not performed the file is invalid

Description

A remote firmware upgrade (RFU) was not performed.

Header number is 1 but header size doesn't match version 1 size.

Recommended action

Download the RFU file again. Make sure that you download the file for the correct product model.
Resend the RFU.

99.00.13 Upgrade not performed the file is invalid

Description

A remote firmware upgrade (RFU) was not performed.

Header number is 2 but header size doesn't match version 2 size.

Recommended action

Download the RFU file again. Make sure that you download the file for the correct product model.
Resend the RFU.

99.00.14 Upgrade not performed the file is invalid

Description

A remote firmware upgrade (RFU) was not performed.

The file is invalid.

Recommended action

Download the RFU file again. Make sure that you download the file for the correct product model.
Resend the RFU.

99.00.2X

Description

- **99.00.20** (event log)
The bundle is not for this product
- **99.00.21** (event log)
The bundle is not signed with the correct signature, or the signature is invalid
- **99.00.22** (event log)
The bundle header version is not supported by this firmware
- **99.00.23** (event log)

- The package header version is not supported by this firmware
- **99.00.24** (event log)
 - The format of the bundle is invalid
- **99.00.25** (event log)
 - The format of the package is invalid
- **99.00.26** (event log)
 - A CRC32 check did not pass
- **99.00.27** (event log)
 - An I/O error occurred while downloading the bundle

Recommended action

Download the correct firmware file from www.hp.com/support/cljcp5525 or www.hp.com/go/cljcp5525_firmware, and then resend the firmware upgrade.

99.00.27 only: Turn the product off, and then on again. Resend the firmware upgrade. If the error persists, try the sending the upgrade by another method (USB or Embedded Web Server).

99.09.60 Unsupported disk

Description

Preboot menu error.

The hard disk currently installed is not recognized or supported by the product.

Recommended action

Install the correct hard disk for this product.

99.09.61 Unsupported disk

Description

Preboot menu error.

The installed disk is installed in a product configured for a encrypted hard disk.

Recommended action

Access the **Preboot** menu and then select **Lock Disk** to lock the disk.

99.09.62 Unknown disk

Description

Preboot menu error.

The installed disk was previously locked in another product.

Recommended action

Install a new disk or use the **Preboot** menu to unlock this disk. If the disk is to be reused in a different product, execute the **Clean Disk** procedure from the **Preboot** menu, then reload firmware and lock the disk.

99.09.63 Incorrect disk

Description

A new or blank disk has been installed in a device which previously had an encrypted disk.

Recommended action

Follow the procedure to load firmware on a new hard disk and then lock it to this product.

99.09.64 Disk malfunction

Description

A fatal hard disk failure has occurred.

Recommended action

Replace the hard disk drive.

99.09.65 Disk data error

Description

Disk data corruption has occurred.

Recommended action

Execute the **Clean Disk** procedure from the **Preboot** menu, and then resend the RFU.

99.09.66 No disk data installed

Description

A disk drive is not installed in the product.

Recommended action

Install a compatible hard disk drive.

99.09.67 Disk is not bootable please download firmware

Description

The product has a non-secure disk (solid state disk) installed as the boot disk, and it has been replaced with a new service part. A new firmware image needs to be downloaded to the device.

Recommended action

1. Press any key to continue to the main **Preboot** menu.
2. Press the Help button  to see the help text for the error.
3. Select the Administrator menu.

 **NOTE:** If there is a password assigned to the Administrator, a prompt to enter the password displays.

4. Select the Download item.
5. The user can now download a new firmware bundle to the product.

99.XX.YY

Description

Firmware installation error

Recommended action

Reload the firmware.

<Binname> Full Remove all paper from bin

Description

The specified output bin is full.

Recommended action

Empty the bin to continue printing.

<Supply> almost full

Description

Toner Collection bottle is almost full.

- **10.31.60** (event code)

Toner collection unit

Recommended action

Replace the toner collection unit

<Supply> low OR Supplies low

Description

The product indicates when a supply level, or more than one supply, is low. Actual print cartridge life might vary. You do not need to replace the print cartridge at this time unless print quality is no longer acceptable.

When multiple supplies are low, more than one event code is recorded.

- **10.00.60** (event code)
Black print cartridge
- **10.01.60** (event code)
Cyan print cartridge
- **10.02.60** (event code)
Magenta print cartridge
- **10.03.60** (event code)
Yellow print cartridge
- **10.23.60** (event code)
Fuser Kit
- **10.22.60** (event code)
Transfer kit

Recommended action

If print quality is no longer acceptable, replace the supply.

HP recommends that the customer have a replacement supply available to install when print quality is no longer acceptable.

 **NOTE:** When an HP supply has reached its approximated end of life, the HP Premium Protection Warranty ends.

<Supply>very low OR Supplies very low

Description

The product indicates when a supply level, or more than one supply, is very low. Actual print cartridge life might vary. You do not need to replace the print cartridge at this time unless print quality is no longer acceptable.

When multiple supplies are low, more than one event code is recorded.

- **10.00.70** (event code)
Black print cartridge
- **10.01.70** (event code)
Cyan print cartridge
- **10.02.70** (event code)
Magenta print cartridge

- **10.03.70** (event code)
Yellow print cartridge
- **10.23.70** (event code)
Fuser Kit
- **10.22.70** (event code)
Transfer kit

Recommended action

If print quality is no longer acceptable, replace the supply.

HP recommends that the customer have a replacement supply available to install when print quality is no longer acceptable.

 **NOTE:** When an HP supply has reached its approximated end of life, the HP Premium Protection Warranty ends.

<Tray X> lifting

Description

The product is in the process of lifting paper in the indicated tray.

- X = 2
Tray 2
- X = 3
Tray 3
- X = 4
Tray 4
- X = 5
Tray 5
- X = 6
Tray 6

Recommended action

No action necessary.

[File System] device failure To clear, press OK

Description

The specified device has failed.

Recommended action

Press the OK button to clear the error.

[File System] file operation failed To clear, press OK**Description**

A PJI file system command attempted to perform an illogical operation.

Recommended action

Press the OK button to clear the error.

[File System] file system is full To clear, press OK**Description**

A PJI file system command could not store something on the file system because the file system was full.

Recommended action

Press the OK button to clear the error.

[File System] is not initialized**Description**

This file-storage component must be initialized before use.

Recommended action

Use the HP Embedded Web Server or HP Web Jetadmin to initialize the file system.

[File System] is write protected**Description**

The file system device is protected and no new files can be written to it.

Recommended action

Press the OK button to clear the error.

Accept bad signature**Description**

The product is performing a remote firmware upgrade, and the code signature is invalid.

Recommended action

Download the correct firmware upgrade file for this product, and then reinstall the upgrade. See the product user guide for more information.

Bad optional tray connection

Description

The optional tray is not connected, not connected correctly, or a connection is not working correctly.

Recommended action

1. Turn the product off.
2. Remove and then reinstall the optional tray.
3. Reconnect connectors for the tray.
4. If the problem continues, replace the connector for the tray.

Calibration reset pending

Description

A calibration reset occurs when all jobs are processed.

Recommended action

To begin the reset sooner, cancel all jobs by pressing the **Stop** button ⊗.

Canceling

Description

The product is canceling the current job.

Recommended action

No action is necessary.

Canceling... <jobname>

Description

The product is canceling the current job <jobname>.

Recommended action

No action is necessary.

Checking engine

Description

The product is conducting an internal test.

Recommended action

No action is necessary.

Checking paper path

Description

The product is checking for possible paper jams.

Recommended action

No action is necessary.

Chosen personality not available To continue, press OK

Description

A print job requested a product language (personality) that is not available for this product. The job will not print and will be cleared from memory.

Recommended action

Print the job by using a print driver for a different language, or add the requested language to the product (if possible). To see a list of available personalities, print a configuration page.

Cleaning do not grab paper

Description

The product is performing an automatic cleaning cycle. Printing will continue after the cleaning is complete.

Recommended action

No action is necessary.

Cleaning...

Description

The product is performing an automatic cleaning cycle. Printing will continue after the cleaning is complete.

Recommended action

No action is necessary.

Clearing event log

Description

This message is displayed while the event log is cleared. The product exits the menus when the event log has been cleared.

Recommended action

No action is necessary.

Clearing paper path

Description

The product is attempting to eject jammed paper.

Recommended action

Check progress at the bottom of the display.

Close front door

Description

The front door of the product is open.

Recommended action

Close the door.

Use the switch test in the manual sensor test to verify that the front-door switch is properly functioning. If the switch fails the test, replace the switch.

Check the sensor flag on the front-door assembly. If it is damaged, replace the front-door assembly.

If the product has been recently serviced, check the connector (J708) on the 24V interlock switch and the connector (J121) on the DC controller PCA.

Close lower right door

Description

The 3 x 500-sheet optional paper feeder right door is open.

Recommended action

Close the door.

Use the lower-right door switch (SW1) test in the Tray/Bin manual sensor test to verify that the switch is properly functioning. If the switch fails the test, replace the switch.

Check the sensor flag on the lower-right door assembly. If it is damaged, replace the door assembly.

Close middle right door

Description

The 1 x 500-sheet optional paper feeder right door is open.

Recommended action

Close the door.

Use the right-door switch (SW1) test in the Tray/Bin manual sensor test to verify that the switch is properly functioning. If the switch fails the test, replace the switch.

Check the sensor flag on the right door assembly. If it is damaged, replace the door assembly.

Close right door

Description

The right door of the product is open.

Recommended action

Close the door.

Use the right-door switch (SP15) test in the manual sensor test to verify that the switch is properly functioning. If the switch fails the test, replace the switch.

Check the sensor flag on the right door assembly. If it is damaged, replace the door assembly.

If the product has been recently serviced, check the connector (J708) on the 24V interlock switch and the connector (J181) on the DC controller PCA.

Close upper right door For help press ?

Description

The upper-right door of the product is open.

Recommended action

Close the door.

Use the right-door switch (SP15) test in the manual sensor test to verify that the switch is properly functioning. If the switch fails the test, replace the switch.

Check the sensor flag on the right door assembly. If it is damaged, replace the door assembly.

If the product has been recently serviced, check the connector (J708) on the 24V interlock switch and the connector (J181) on the DC controller PCA.

Cooling device

Description

The product is cooling.

Recommended action

No action is necessary.

Creating cleaning page

Description

A cleaning page is being generated.

Recommended action

No action is necessary.

Data received To print last page, press OK

Description

The product is waiting for the command to print the last page.

Recommended action

Press the OK button to print the last page of the job.

EIO <X> disk initializing

Description

The specified EIO disk device is initializing.

Recommended action

No action is necessary.

EIO <X> disk not functional

Description

The EIO disk in slot <X> is not correctly functioning.

- X = 1
Slot 1
- X = 2
Slot 2

Recommended action

Turn the product off, and then on.

If the error persists, turn the product off, and then remove and reinstall the disk.

EIO <X> disk spinning up

Description

EIO disk device in slot <X> is spinning up its platter. Jobs that require disk access must wait.

- X = 1
Slot 1
- X = 2
Slot 2

Recommended action

No action is necessary.

Event log is empty

Description

No product events are in the log.

Recommended action

No action is necessary.

Expected drive missing

Description

The product cannot find the encrypted hard drive.

Recommended action

Install the encrypted hard drive.

HP Secure Hard Drive disabled

Description

The drive has been encrypted for another product.

Recommended action

Remove the drive or use the Embedded Web Server for more information.

Incompatible <supply>

Description

The indicated supply <supply>is not compatible with this product.

- **10.00.35** (event code)
Black print cartridge
- **10.01.35** (event code)
Cyan print cartridge
- **10.02.35** (event code)
Magenta print cartridge
- **10.03.35** (event code)
Yellow print cartridge
- Fuser kite
10.23.35 (event code)

Recommended action

Replace the supply with one that is designed for this product.

Incompatible supplies

Description

Print cartridges or other supply items are installed that were not designed for this product. The product cannot print with these supplies installed.

Event codes are supply specific.

Recommended action

Press the OK button to identify the incompatible supplies.

Replace the supplies with those that are designed for this product.

Initializing...

Description

The product is starting.

Recommended action

No action necessary.

Install <supply>

Description

A supply item is either not installed or installed incorrectly.

- Black cartridge
10.00.15 (event code)
- Cyan cartridge
10.10.15 (event code)
- Magenta cartridge
10.02.15 (event code)
- Yellow cartridge
10.03.15 (event code)
- Fuser kite
10.23.15 (event code)

Recommended action

Install the supply item or make sure that the installed supply item is fully seated.

Install <supply> Close rear door

Description

The toner collection unit has been removed or has been installed incorrectly.

- Toner collection unit

10.31.15 (event code)

Recommended action

Replace or reinstall the toner collection unit correctly to continue printing.

Install Fuser Unit

Description

The fuser has been removed or installed incorrectly.

Recommended action

△ **CAUTION:** The fuser can be hot while the product is in use. Wait for the fuser to cool before handling it.

1. Open the right door.
2. Install or adjust the fuser.
3. Close the right door.

Install supplies

Description

More than one supply is missing or is installed incorrectly.

Recommended action

Press the OK button to identify the supplies that need to be replaced.

Press the OK button a second time for more information about the specific supply.

Insert the supply or make sure it is correctly installed and fully seated.

Install Transfer Unit

Description

The transfer unit is either not installed or not installed correctly.

Recommended action

1. Open the right door.
2. Install the ITB.

 **NOTE:** If the ITB is already installed, remove it, and then reinstall the ITB.

3. Close the right door.
4. If the error persists, use the ITB alienation sensor switch (SW5) in the manual sensor test to verify that the switch is properly functioning. If it is not, replace the main drive assembly.
5. If the error persists, use the T1 roller engagement and disengagement drive test in the component test to verify that the ITB alienation mechanism is properly functioning. If it is not, replace the fuser drive assembly.
6. If the product was recently serviced, check the connector (J181) on the DC controller PCA.

Internal disk not functional

Description

The internal hard drive is not correctly functioning.

Recommended action

Turn the product off, and then reinstall the hard drive.

If the error persists, replace the internal hard drive.

Internal disk spinning up

Description

Internal disk device is spinning up its platter. Jobs that require disk access must wait.

Recommended action

No action is necessary.

Load Tray <X>: [Type], [Size]

Description

This message appears even though there is media loaded in the tray.

Recommended action

Use the cassette media present sensor test in the Tray/bin manual sensor test to verify that the sensor is correctly functioning.

Make sure that the sensor flag on the media presence sensor is not damaged and moves freely.

Reconnect the corresponding connector:

- MP tray: connector (J736) on the MP tray media out sensor and the connector (J152) on the DC controller PCA.
- Printer cassette: connectors (J739 and J742) on the cassette media out sensor and the connector (J151) on the DC controller PCA.
- 1 X 500-sheet paper feeder cassette: connector (J702D) on the paper feeder cassette media out sensor and the connector (J2003) on the paper feeder controller PCA.
- Paper deck cassette 1: connector (J702D) on the paper deck cassette 1 media out sensor and connector (J2003) on the paper deck controller PCA 1
- Paper deck cassette 2: connector (J802D) on the paper deck cassette 2 media out sensor and connector (J2003B) on the paper deck controller PCA 2.
- Paper deck cassette 3: connector (J902D) on the paper deck cassette 3 media out sensor and connector (J2003C) on the paper deck controller PCA 3.

Load Tray <X>: [Type], [Size] To use another tray, press OK

Description

This message appears when the indicated tray is selected but is not loaded, and other paper trays are available for use. It also appears when the tray is configured for a different paper type or size than the print job requires.

Recommended action

Load the correct paper in the tray.

If prompted, confirm the size and type of paper loaded.

Otherwise, press the OK button to select another tray.

Loading program <XX> Do not power off

Description

Programs and fonts can be stored on the product's file system and are loaded into RAM when the product is turned on. The number <XX> specifies a sequence number indicating the current program being loaded.

Recommended action

No action necessary.

 **NOTE:** Do not turn the product off.

Manually feed output stack Then press OK to print second sides

Description

The product has printed the first side of a manual duplex job and is waiting for the user to insert the output stack to print the second side.

Recommended action

1. Maintaining the same orientation, remove pages from the output bin.
2. Flip document printed side up.
3. Load document in Tray 1.
4. Press the OK button to print the second side of the job.

Manually feed: [Type], [Size]

Description

This message appears when manual feed is selected, Tray 1 is not loaded, and other trays are empty.

Recommended action

Load tray with requested paper.

If paper is already in tray, press the Help button to exit the message and then press the OK button to print.

To use another tray, clear paper from Tray 1, press the Help button to exit the message and then press the OK button.

Manually feed: [Type], [Size] To use another tray, press OK

Description

This message appears when manual feed is selected, Tray 1 is loaded, and other trays are available.

Recommended action

Load tray with requested paper.

If paper is already in tray, press the Help button to exit the message and then press the OK button to print.

To use another tray, clear paper from Tray 1, press the Help button to exit the message and then press the OK button.

Moving solenoid

Description

The solenoid is moving as part of a component test.

Recommended action

To exit press ▼

Moving solenoid and motor

Description

The solenoid and a motor are moving as part of a component test.

Recommended action

To exit press ▼

No job to cancel

Description

You have pressed the stop button but the product is not actively processing any jobs.

Recommended action

No action necessary.

Paused

Description

The product is paused, and there are no error messages pending at the display. The I/O continues receiving data until memory is full.

Recommended action

Press the **Stop** button ⊗.

Performing Color Band Test...

Description

A color-band test is being performed.

Recommended action

No action necessary.

Performing Paper Path Test...

Description

A paper-path test is being performed.

Recommended action

No action necessary.

Please wait...

Description

The product is in the process of clearing data.

Recommended action

No action necessary.

Printing CMYK samples...

Description

The product is printing the CMYK Sample pages.

Recommended action

No action necessary.

Printing Color Usage Log...

Description

The product is printing the Color Usage log.

Recommended action

No action necessary.

Printing Configuration...

Description

The product is printing the Configuration page.

Recommended action

No action necessary.

Printing Demo Page...

Description

The product is printing the Demo page.

Recommended action

No action necessary.

Printing Diagnostics Page...

Description

The product is printing the Diagnostics page.

Recommended action

No action necessary.

Printing Engine Test...

Description

The product is printing an engine test page.

Recommended action

No action necessary.

Printing Event Log...**Description**

The product is printing the Event Log page.

Recommended action

No action necessary.

Printing File Directory...**Description**

The product is printing the File Directory pages.

Recommended action

No action necessary.

Printing Font List...**Description**

The product is printing the Font List pages.

Recommended action

No action necessary.

Printing Fuser Test Page...**Description**

The product is printing the Fuser Test page.

Recommended action

No action necessary.

Printing Help Page...**Description**

The product is printing the Help page.

Recommended action

No action necessary.

Printing Menu Map...

Description

The product is printing the Menu Map pages.

Recommended action

No action necessary.

Printing PQ Troubleshooting...

Description

The product is printing the PQ Troubleshooting pages.

Recommended action

No action necessary.

Printing Registration Page...

Description

The product is printing the Registration pages.

Recommended action

No action necessary.

Printing RGB Samples...

Description

The product is printing the RGB Sample pages.

Recommended action

No action necessary.

Printing stopped

Description

Time has expired on the Print/Stop test.

Recommended action

Press the OK button to continue.

Printing Supplies Status Page...

Description

The product is printing the Supplies Status page.

Recommended action

No action necessary.

Printing Usage Page...**Description**

The product is printing the Usage page.

Recommended action

No action necessary.

Processing duplex job Do not grab paper until job completes**Description**

Paper temporarily comes into the output bin while printing a duplex job.

△ **CAUTION:** Do not grab paper as it temporarily comes into the output bin. The message disappears when the job is finished.

Recommended action

No action necessary.

Processing job from tray <X>... Do not grab paper until job completes**Description**

The product is actively processing a job from the designated tray.

Recommended action

No action necessary.

Processing... <filename>**Description**

The product is currently processing a job but is not yet picking pages. When paper motion begins, this message is replaced by a message that indicates the tray the job is using.

Recommended action

No action necessary.

Processing... copy <X> of <Y>**Description**

The product is currently processing or printing collated copies. The message indicates that copy number <X> of total copies <Y> is currently being processed.

Recommended action

No action necessary.

Ready**Description**

The product is online and ready for data. No status or product attendance messages are pending at the display.

Recommended action

No action necessary.

Ready <IP Address>**Description**

The product is online and ready for data. No status or product attendance messages are pending at the display. The product IP address displays.

Recommended action

No action necessary.

Remove all print cartridges**Description**

The product is testing the transfer unit assembly.

Recommended action

To perform the test, remove all the print cartridges. To cancel the test, press the **Stop** button ⊗.

To exit press ▼

Remove at least one print cartridge**Description**

The product is testing the print-cartridge motor.

Recommended action

To perform the test, remove at least one print cartridge. To cancel the test, press the **Stop** button ⊗.

To exit press ▼

Remove shipping lock from Tray 2**Description**

The Tray 2 shipping lock was not removed before you turned the product on.

Recommended action

Open tray 2, and then remove the shipping lock.

Replace <supply>

Description

This alert appears only if the product is configured to stop when a supply reaches the very low threshold. The product indicates when a supply level is at its estimated end of life. The actual life remaining might be different than estimated.

The supply does not need to be replaced now unless the print quality is no longer acceptable.

HP recommends that the customer have a replacement supply available to install when print quality is no longer acceptable.

The product can be configured to stop when the supply level is very low. The supply might still be able to produce acceptable print quality.

 **NOTE:** When an HP supply has reached its approximated end of life, the HP Premium Protection Warranty on that supply ends.

- **10.00.70** (event code)
Black print cartridge
- **10.01.70** (event code)
Cyan print cartridge
- **10.02.70** (event code)
Magenta print cartridge
- **10.03.70** (event code)
Yellow print cartridge
- **10.23.70** (event code)
Fuser Kit
- **10.31.70** (event code)
Toner collection unit
- **10.22.70** (event code)
Transfer kit

Recommended action

Replace the specified supply.

Or, configure the product to continue printing by using the **Manage Supplies** menu.

Replace supplies

Description

This alert appears only if the product is configured to stop when a supplies reach the very low threshold. Two or more supplies have reached the estimated end of life. The product indicates when a supply level is at its estimated end of life. The actual life remaining might be different than estimated.

The supply does not need to be replaced now unless the print quality is no longer acceptable.

HP recommends that the customer have a replacement supply available to install when print quality is no longer acceptable.

 **NOTE:** When an HP supply has reached its approximated end of life, the HP Premium Protection Warranty on that supply ends.

Recorded event codes depend on which supplies are at the end of life.

- **10.00.70** (event code)
Black print cartridge
- **10.01.70** (event code)
Cyan print cartridge
- **10.02.70** (event code)
Magenta print cartridge
- **10.03.70** (event code)
Yellow print cartridge
- **10.23.70** (event code)
Fuser Kit
- **10.31.70** (event code)
Toner collection unit
- **10.22.70** (event code)
Transfer kit

Recommended action

Press the OK button to find out which supplies need to be replaced.

Or, configure the product to continue printing by using the **Manage Supplies** menu.

Restore Factory Settings

Description

The product is restoring factory settings.

Recommended action

No action necessary.

Restricted from printing in color**Description**

This message displays when color printing is disabled for the product or when it is disabled for a particular user or print job.

Recommended action

To enable color printing for the product, change the **Restrict Color Use** setting in the **Manage Supplies** menu.

Rotating <color> motor**Description**

A component test is in progress. the component selected is the indicated <color> cartridge motor.

<color> =

- Black
- Cyan
- Magenta
- Yellow

Recommended action

Press the **Stop** button ⊗ when ready to stop this test.

To exit press ▼

Rotating motor**Description**

The product is executing a component test and the component selected is a motor.

Recommended action

Press the **Stop** button ⊗ when ready to stop this test.

To exit press ▼

Size mismatch in Tray <X>**Description**

The paper in the listed tray does not match the size specified for that tray.

Recommended action

1. Load the correct paper.
2. Verify the paper is positioned correctly.
3. Close the tray, and then verify that the control panel lists the correct size and type for the specified tray.
4. If necessary, use the control-panel menus to reconfigure the size and type settings for the specified tray.

Sleep mode on

Description

The product is in sleep mode. Pressing a control-panel button, receiving of a print job, or an error condition clears this message.

Recommended action

No action necessary.

Supplies in wrong positions

Description

Two or more print-cartridge slots contain the wrong print cartridge.

From left to right, the print cartridges should be installed in the following order:

- Yellow
- Magenta
- Cyan
- Black

Recommended action

Install the correct cartridge in each slot.

Tray <X> empty: [Type], [Size]

Description

The specified tray is empty and the current job does not need this tray to print.

- X = 1
Tray 1
- X = 2
Tray 2

- X = 3
Tray 3
- X = 4
Tray 4
- X = 5
Tray 5
- X = 6
Tray 6

Recommended action

Refill the tray at a convenient time.

 **NOTE:** This could be a false message. If the tray is loaded without removing the shipping lock, the product does not sense that the paper is loaded. Remove the shipping lock and then load the tray.

Tray <X> open

Description

The specified tray is open or not closed completely.

- X = 2
Tray 2
- X = 3
Tray 3
- X = 4
Tray 4
- X = 5
Tray 5
- X = 6
Tray 6

Recommended action

Close the tray.

 **NOTE:** If this message appears after lifter drive assembly was removed or replaced, make sure that the connector on the assembly is correctly connected and fully seated.

If the error persists, use the Media size switches (SW2,3 - SW82,83 - SW92,93) test in the Tray/Bin manual sensor test to test the switches. If they do not respond, replace associated the lifter drive assembly.

Tray <X> overfilled

Description

The tray is filled above the stack-height mark.

- X = 2
Tray 2
- X = 3
Tray 3
- X = 4
Tray 4
- X = 5
Tray 5
- X = 6
Tray 6

Recommended action

Remove enough paper so that the paper stack does not exceed the limit for the tray.

 **NOTE:** If this message appears after lifter drive assembly was removed or replaced, make sure that the connector on the assembly is correctly connected and fully seated.

Troubleshooting

Description

The product is in the Troubleshooting process.

Recommended action

Press the **Stop** button ⊗.

To exit press ▼

Type mismatch Tray <X>

Description

The specified tray contains a paper type that does not match the configured type.

Recommended action

The specified tray will not be used until this condition is addressed. Printing can continue from other trays.

1. Load the correct paper in the specified tray.
2. At the control panel, verify the type configuration.

Unsupported drive installed To continue, press OK

Description

A non-supported hard drive has been installed. The drive is unusable by this product.

Recommended action

1. Turn the product off.
2. Remove the hard drive.
3. Turn the product on.

Unsupported supply in use OR Unsupported supply installed To continue, press OK

Description

A non-supported supply has been installed.

OR

One of the print cartridges is for a different HP product.

- XX = 00
Black print cartridge
- XX = 01
Cyan print cartridge
- XX = 02
Magenta print cartridge
- XX = 03
Yellow print cartridge

Recommended action

Install the correct supplies for this product. See the parts chapter in the service manual for supply part numbers.

Unsupported tray configuration

Description

The product has too many optional trays installed.

Recommended action

Turn the product off, remove the unsupported trays, and then turn the product on.

Unsupported USB accessory detected Remove USB accessory

Description

A non-supported USB accessory has been installed.

Recommended action

Turn the product off, remove the USB accessory, and then turn the product on.

USB accessory needs too much power Remove USB and turn off then on

Description

A USB accessory is drawing too much electrical current. Printing cannot continue.

Recommended action

Turn the product off, remove the USB accessory, and then turn the product on.

Use a USB accessory that uses less power or that contains its own power supply.

USB accessory not functional

Description

A parameter in the USB accessory is not correctly functioning.

Recommended action

1. Turn the product off.
2. Remove the USB accessory.
3. Insert a replacement USB accessory.

Used supply installed To continue, press OK OR Used supply in use

Description

One of the print cartridges has been previously used.

- XX = 00
Black print cartridge
- XX = 01
Cyan print cartridge
- XX = 02
Magenta print cartridge
- XX = 03
Yellow print cartridge

Recommended action

If you believe you purchased a genuine HP supply, go to www.hp.com/go/anticounterfeit.

Wrong cartridge in <color> slot

Description

The indicated slot for a print cartridge contains a cartridge that is not the correct color.

From left to right, the print cartridges should be installed in the following order:

- Yellow
10.03.25 (event code)
- Magenta
10.02.25 (event code)
- Cyan
10.01.25 (event code)
- Black
10.00.25 (event code)

Recommended action

Remove the print cartridge from that slot, and install a cartridge that is the correct color.

Event-log messages

This section describes messages that only appear in the event log. For additional numeric messages, see the control-panel message section of this manual

Figure 53 Sample event log

Event Log						
HP Color LaserJet CP5520 Series						
Page 1						
Device Information						
Device Serial Number: CN1C88700P						
Number	Date and Time	Cycles	Event	Firmware	Description or Personality	Consecutive Repeats
35	10/13/2010 10:42:09 AM	305	10.23.15	103104_104867	Install Supply	0
34	10/13/2010 10:13:16 AM	17	10.23.15	103104_104867	Install Supply	0
33	10/13/2010 9:18:04 AM	17	10.23.15	103104_104867	Install Supply	0
32	10/13/2010 9:05:14 PM	16	10.23.15	103104_104867	Install Supply	1
31	10/13/2010 11:38:24 AM	16	10.23.15	103104_104867	Install Supply	0
30	10/8/2010 5:30:39 PM	50	32.08.A2	103104_104867	Add Link	0
29	10/8/2010 5:30:39 PM	50	47.04.04	103104_104867	Print spooler 9100 internal error	0
28	10/8/2010 5:24:56 PM	49	10.23.15	103104_104867	Install Supply	1
27	10/8/2010 5:02:28 PM	34	10.23.15	103104_104867	Install Supply	4
26	10/8/2010 4:24:52 PM	34	32.08.A3	103104_104867	Add Link	0
25	10/8/2010 3:06:26 PM	34	32.08.A2	103104_104867	Add Link	0
24	10/8/2010 3:06:26 PM	34	47.04.04	103104_104867	Print spooler 9100 internal error	0
23	10/7/2010 5:17:44 PM	23	13.00.EE	103104_104867	Unknown	0
22	10/7/2010 5:17:03 PM	22	13.00.EE	103104_104867	Unknown	0
21	10/6/2010 4:45:52 PM	20	32.08.A3	103104_104867	Add Link	0
20	10/4/2010 3:00:03 PM	20	10.23.15	103104_104867	Install Supply	0
19	10/2/2010 6:17:04 PM	20	32.08.A2	103104_104867	Add Link	0
18	10/2/2010 6:17:04 PM	20	47.04.04	103104_104867	Print spooler 9100 internal error	0
17	10/2/2010 5:54:32 PM	18	10.22.15	103104_104867	Install Supply	0
16	10/2/2010 3:07:20 PM	18	32.08.A2	103104_104867	Add Link	0
15	10/2/2010 3:07:20 PM	18	47.04.04	103104_104867	Print spooler 9100 internal error	0
14	9/28/2010 5:38:32 PM	18	32.08.A3	103104_104867	Add Link	0
13	9/28/2010 5:35:54 PM	16	32.08.A2	103104_104867	Add Link	0
12	9/28/2010 5:35:53 PM	16	47.04.04	103104_104867	Print spooler 9100 internal error	0
11	9/28/2010 5:21:56 PM	16	10.99.40	103104_104867	Genuine HP supplies installed	0
10	9/28/2010 5:21:55 PM	16	33.01.01	103104_104867	Restore occurred	0
9	9/28/2010 5:21:53 PM	16	33.01.01	103104_104867	Restore occurred	0
8	9/28/2010 5:21:52 PM	16	33.01.01	103104_104867	Restore occurred	0
7	9/28/2010 5:21:48 PM	16	33.01.01	103104_104867	Restore occurred	0
6	9/28/2010 5:21:44 PM	16	33.01.01	103104_104867	Restore occurred	0
5	9/28/2010 5:21:44 PM	16	33.01.01	103104_104867	Restore occurred	0
4	9/28/2010 5:21:25 PM	16	00.00.00	103104_104867	Unknown	2
3	9/28/2010 5:20:38 PM	16	33.01.03	103104_104867	[[cplUsedPartReplaced]]	0
2	9/28/2010 5:20:31 PM	16	99.02.01	103104_104867	Unknown	0
1	9/28/2010 5:19:58 PM	16	99.02.01	103104_104867	Unknown	0



Oct13/2010 12:41:29 PM English (United States)

1	Product information
2	Event number
3	Date and time
4	Engine cycles
5	Event log code
6	Firmware version number
7	Description of personality
8	Consecutive Repeats

Print an event log

 **NOTE:** Printing an event log by using the **Administration** menu shows only a subset of events. To print a complete event log, use the **Service** menu.

Print the event log from the Administration menu

1. Press the Home button .
2. Open the following menus:
 - **Administration**
 - **Troubleshooting**
3. Use the **Down** arrow button  to select the **Print Event Log** item, and then press the OK button.

Print the event log from the Service menu



1. Press the Home button .
2. Open the following menus:
 - **Device Maintenance**
 - **Service**

The PIN required for the **Service** menu is 11552010.
3. Use the **Down** arrow button  to select the **Print Event Log** item, and then press the OK button.

View an event log

 **NOTE:** Viewing an event log by using the **Administration** menu shows only a subset of events. To print a complete event log, use the **Service** menu.

View an event log from the Administration menu

1. Press the Home button .
2. Open the following menus:
 - **Administration**
 - **Troubleshooting**
3. Use the **Down** arrow button  to select the **View Event Log** item, and then press the OK button.

Viewing the event log from the Service menu

1. Press the Home button .
2. Open the following menus:
 - **Device Maintenance**
 - **Service**

The PIN required for the **Service** menu is 11552010.
3. Use the **Down** arrow button  to select the **View Event Log** item, and then press the OK button.

Clear an event log

1. Press the Home button .
2. Open the following menus:
 - **Device Maintenance**
 - **Service**

The PIN required for the **Service** menu is 11552010.
3. Use the **Down** arrow button  to select the **Clear Event Log** item, and then press the OK button.

Clear jams

Common causes of jams

The product is jammed.

Cause	Solution
The paper does not meet specifications.	Use only paper that meets HP specifications. See the product user guide.
A component is installed incorrectly.	Verify that the transfer belt and transfer roller are correctly installed.
You are using paper that has already passed through a printer or copier.	Do not use paper that has been previously printed on or copied.
An input tray is loaded incorrectly.	Remove any excess paper from the input tray. Make sure that the stack is below the maximum stack height mark in the tray.
The paper is skewed.	The input-tray guides are not adjusted correctly. Adjust them so they hold the stack firmly in place without bending it.
The paper is binding or sticking together.	Remove the paper, flex it, rotate it 180°, or flip it over. Reload the paper into the input tray.
The paper is removed before it settles into the output bin.	Reset the product. Wait until the page completely settles in the output bin before removing it.
During two-sided printing, you removed the paper before the second side of the document was printed.	Reset the product and print the document again. Wait until the page completely settles in the output bin before removing it.
The paper is in poor condition.	Replace the paper.
The internal tray rollers are not picking up the paper.	If the paper is heavier than the heaviest supported weight for the tray, it might not be picked from the tray. The rollers are worn. Replace the rollers.
The paper has rough or jagged edges.	Replace the paper.
The paper is perforated or embossed.	Perforated or embossed paper does not separate easily. Feed single sheets from Tray 1.
Paper was not stored correctly.	Replace the paper in the trays. Paper should be stored in the original packaging in a controlled environment.
Not all product packing material was removed.	Verify that the packing tape, cardboard, and plastic shipping locks have been removed from the product.

Jam locations

Use this illustration to identify locations of jams. In addition, instructions appear on the control panel to direct you to the location of jammed paper and how to clear it. Internal areas of the product that might need to be opened to clear jams, have green handles or green labels.

⚠ WARNING! To avoid electrical shock, remove any necklaces, bracelets, or other metal items before reaching into the inside of the product.

📄 NOTE: Sensors in the paper path generate event codes if a jam occurs. For sensor locations, see [Figure 55 Paper path jam sensors on page 242](#). For jam event code information, see [Table 47 Event codes for jams on page 243](#).

Figure 54 Jam locations

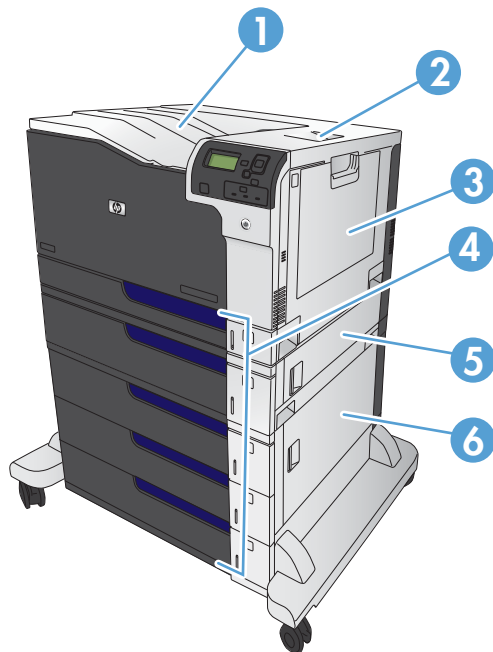

1	Output bin
2	Upper right door
3	Tray 1 area
4	Tray 2, Tray 3, and optional Trays 4, 5, and 6
5	Middle right door
6	Lower right door

Figure 55 Paper path jam sensors

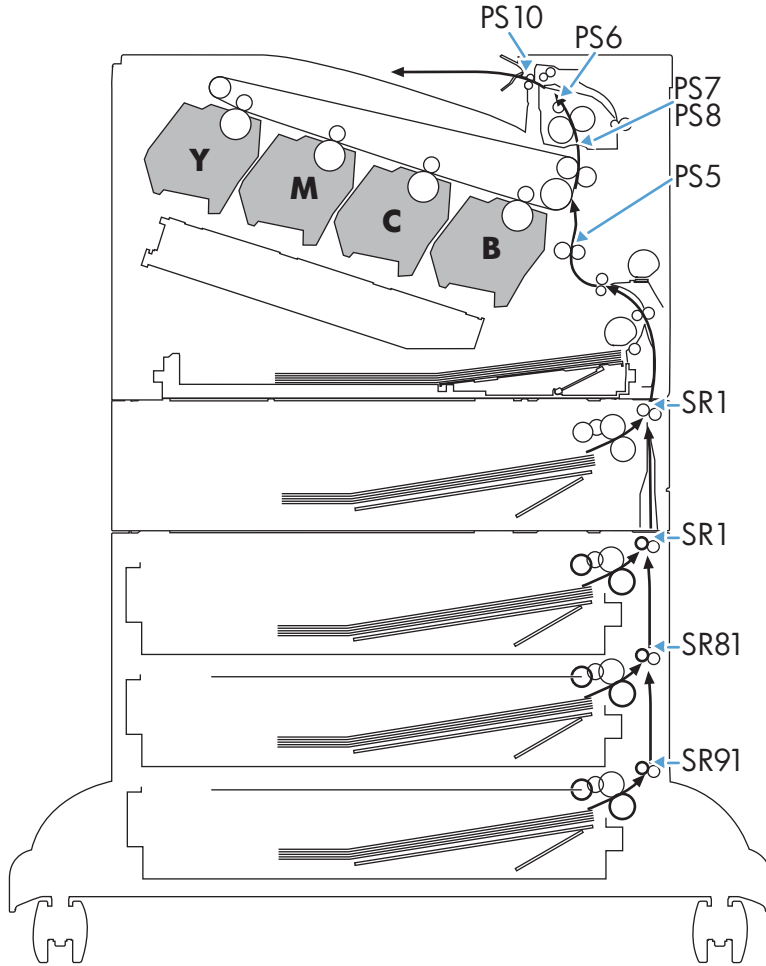

Note: Both the 1 X 500-sheet feeder and the 3 X 500-sheet feeder use a SR1 tray feed sensor.

Table 46 Paper path jam sensors

Sensor	Description
PS5	Registration sensor
PS6	Fuser output sensor
PS7	Loop sensor
PS8	Loop sensor
PS10	Bin full sensor
SR1	Tray 3 feed sensor
SR1	Tray 4 feed sensor
SR81	Tray 5 feed sensor
SR91	Tray 6 feed sensor

Table 47 Event codes for jams

Jam event code	Jammed paper location
13.A3.D3	Leading edge of paper fed from Tray 3 is stopped before SR1
13.A3.D4	Leading edge of paper fed from Tray 4 is stopped before SR1 after passing Tray 4 SR1
13.A3.D5	Leading edge of paper fed from Tray 5 is stopped before SR1 after passing Tray 4 SR1
13.A3.D6	Leading edge of paper fed from Tray 6 is stopped before SR1 after passing Tray 4 SR1
13.A3.FF	At auto-flushing : Paper stays at SR1
13.A4.D4	Leading edge of paper fed from Tray 4 is stopped before Tray 4 SR1
13.A4.D5	Leading edge of paper fed from Tray 5 is stopped before Tray 4 SR1 after passing SR81
13.A4.D6	Leading edge of paper fed from Tray 6 is stopped before Tray 4 SR1 after passing SR81
13.A4.FF	At auto-flushing : Paper stays at Tray 4 SR1
13.A5.D5	Leading edge of paper fed from Tray 5 is stopped before SR81
13.A5.D6	Leading edge of paper fed from Tray 6 is stopped before SR81 after passing SR91
13.A5.FF	At auto-flushing: paper stays at SR81
13.A6.D6	Leading edge of paper fed from Tray 6 is stopped before SR91
13.A6.FF	At auto-flushing : Paper stays at SR91
13.B2.A1	Paper stays at PS5 – media longer than allowed from Tray 1
13.B2.A2	Paper stays at PS5 - media longer than allowed from Tray 2
13.B2.A3	Paper stays at PS5 - media longer than allowed from Tray 3
13.B2.A4	Paper stays at PS5 - media longer than allowed from Tray 4
13.B2.A5	Paper stays at PS5 - media longer than allowed from Tray 5
13.B2.A6	Paper stays at PS5 - media longer than allowed from Tray 6
13.B2.AD	Paper stays at PS5 - media longer than allowed from Duplexer
13.B2.D1	Leading edge of paper fed from Tray 1 is stopped before PS5
13.B2.D2	Leading edge of paper fed from Tray 2 is stopped before PS5
13.B2.D3	Leading edge of paper fed from Tray 3 is stopped before PS5 after passing SR1
13.B2.D4	Leading edge of paper fed from Tray 4 is stopped before PS5 after passing SR1
13.B2.D5	Leading edge of paper fed from Tray 5 is stopped before PS5 after passing SR1
13.B2.D6	Leading edge of paper fed from Tray 6 is stopped before PS5 after passing SR1
13.B2.DD	Duplex re-feed paper is stopped between PS6 and PS5
13.B2.FF	At power on, door close, or auto-flushing: paper stays at PS5
13.B4.FF	At power on, door close, or auto-flushing : paper stays at PS7/PS8

Table 47 Event codes for jams (continued)

Jam event code	Jammed paper location
13.B9.Az	Paper stays at PS6
NOTE: z is the fuser mode, see Fuser modes for jam event codes (Z) on page 244	
13.B9.Cz	Paper is wrapping at fuser
NOTE: z is the fuser mode, see Fuser modes for jam event codes (Z) on page 244	
13.B9.D1	Leading edge of paper is stopped between PS5 and PS6 – fed from tray 1
13.B9.D2	Leading edge of paper is stopped between PS5 and PS6 – fed from Tray 2
13.B9.D3	Leading edge of paper is stopped between PS5 and PS6 – fed from Tray 3
13.B9.D4	Leading edge of paper is stopped between PS5 and PS6 – fed from Tray 4
13.B9.D5	Leading edge of paper is stopped between PS5 and PS6 – fed from Tray 5
13.B9.D6	Leading edge of paper is stopped between PS5 and PS6 – fed from Tray 6
13.B9.DD	Leading edge of paper is stopped between PS5 and PS6 – fed from Duplexer
13.B9.FF	At power on, door close, or auto-flushing: paper stays at PS6
13.E1.Dz	Leading edge of paper is stopped before PS10 after passing PS6
NOTE: z is the fuser mode, see Fuser modes for jam event codes (Z) on page 244	
13.00.EE	Door was opened during printing
13.AA.EE	Tray 3, 4, or 5 right tray access door was opened during print job
13.AB.EE	Tray 4, 5, 6 right tray access door was opened during print job
13.BB.EE	Front door was opened during print job
13.BA.EE	Right door was opened during print job
13.FF.FF	Jams at multiple sensors

Fuser modes for jam event codes (Z)

- 1 = Normal auto sense
- 2 = Normal non-auto sense
- 3 = Light 1 to 3
- 4 = Heavy 1
- 5 = heavy 2
- 6 = Heavy 3

- 7 = Glossy 1
- 8 = Glossy 2
- 9 = Glossy 3
- A = Glossy film
- B = Transparency
- C = Label
- D = Envelope 1 to 3

Clear jams in the upper right door

⚠ **WARNING!** The fuser can be hot while the product is in use. Wait for the fuser to cool before handling it.

1. Open the upper right door.

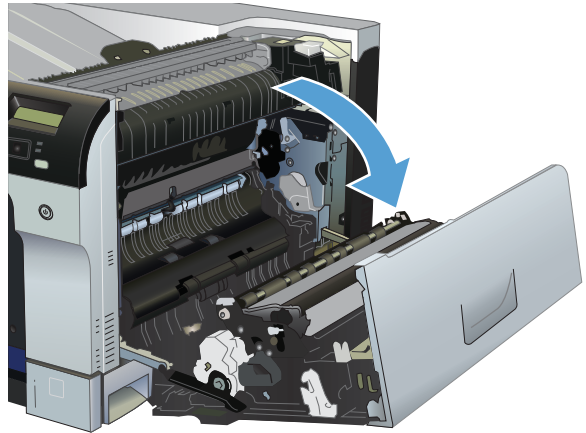

2. Gently pull the paper out of the pickup area.

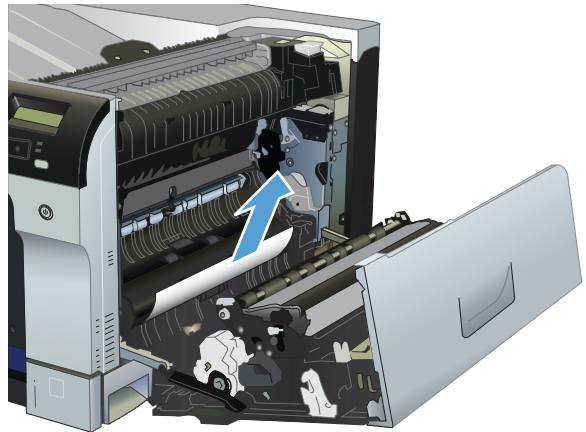

3. If paper is visible entering the bottom of the fuser, gently pull downward to remove it.

CAUTION: Do not touch the transfer roller. Contaminants on the roller can affect print quality.

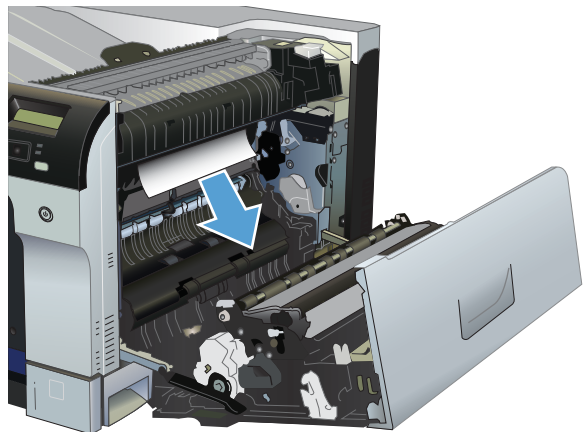

4. Paper could be jammed inside the fuser where it would not be visible. Open the fuser jam access door. If paper is jammed inside the fuser, gently pull it straight up to remove it. If the paper tears, remove all paper fragments.

WARNING! Even if the body of the fuser has cooled, the rollers that are inside could still be hot. Do not touch the fuser rollers until they have cooled.

If no paper is found but the product still reports a jam, remove the fuser to check for jammed paper inside the fuser cavity. Remove any paper, and then reinstall the fuser.

NOTE: Make sure that the fuser is reinstalled correctly before closing the upper right door.

5. Close the upper right door.

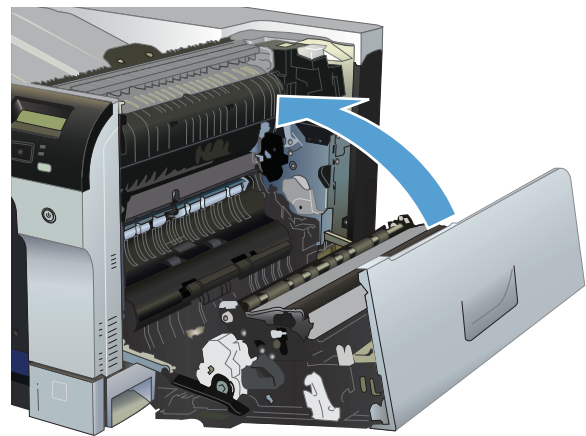
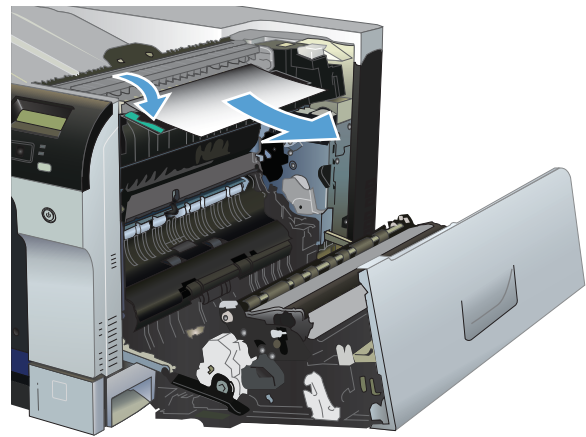

Clear jams in the lower right door

1. Open the lower right door.

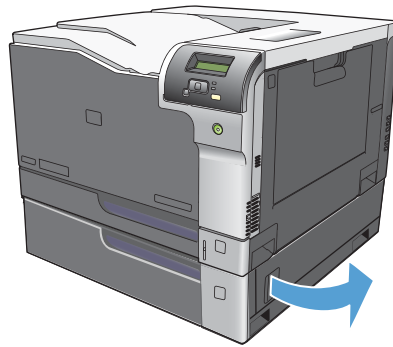

2. If paper is visible, gently pull the jammed paper up or down to remove it.

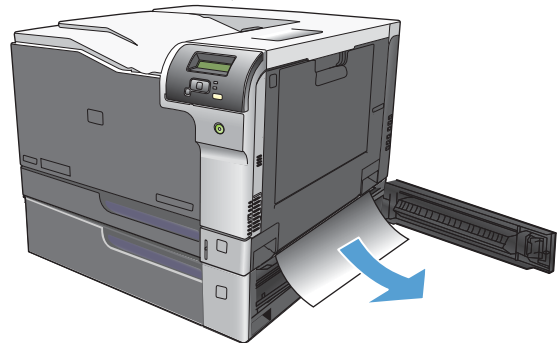
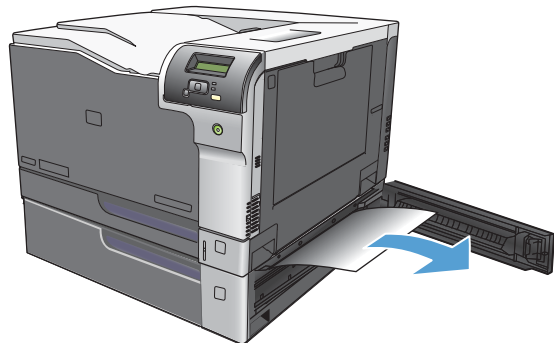

3. Close the lower right door.

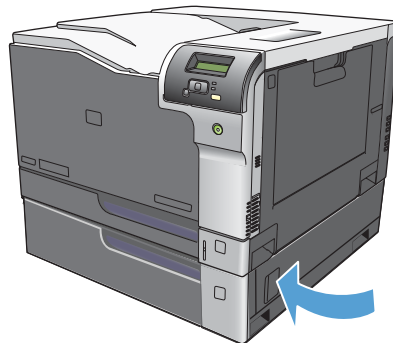

Clear jams in Tray 1

1. If jammed paper is visible in Tray 1, clear the jam by gently pulling the paper straight out. Press the OK button to clear the message.

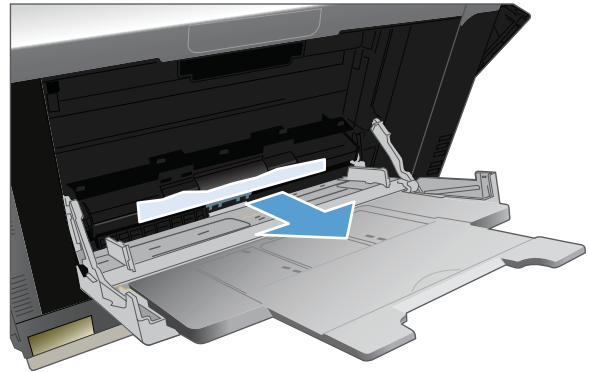

2. If you cannot remove the paper, or if no jammed paper is visible in Tray 1, close Tray 1 and open the upper right door.

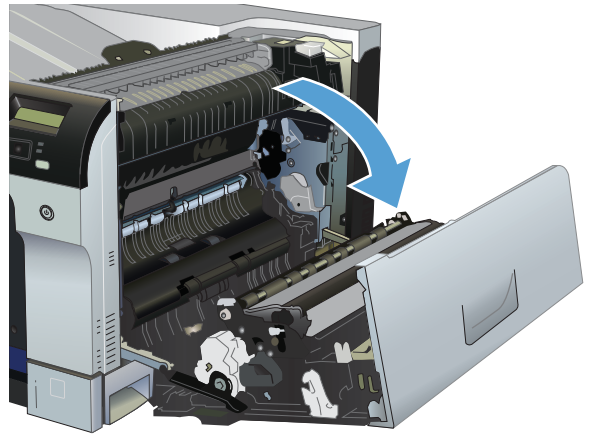

3. Gently pull the paper out of the pick up area.

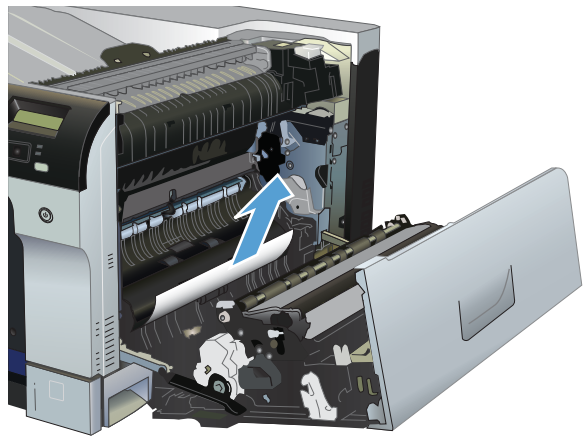

4. Close the upper right door.

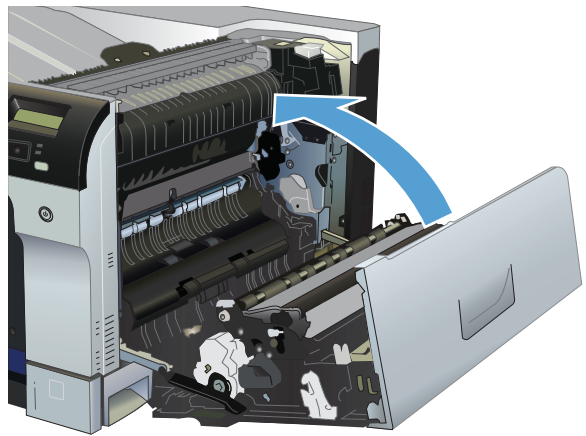

Clear jams from Tray 2, Tray 3, or an optional tray

△ **CAUTION:** Opening a tray when paper is jammed can cause the paper to tear and leave pieces of paper in the tray, which might cause another jam. Be sure to clear jams from the upper and lower right door before opening a tray.

1. Open the tray and make sure that the paper is stacked correctly. Remove any jammed or damaged sheets of paper. To access jammed paper from the tray cavity, remove the tray from the product.

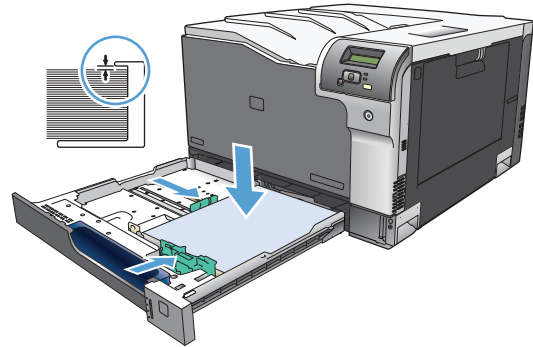

2. Close the tray.

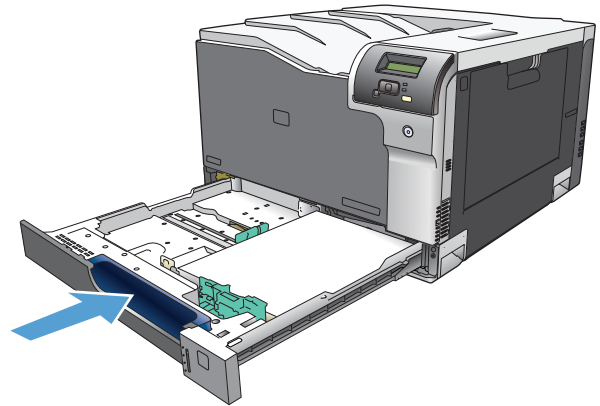

3. If the jam is in Tray 3, you also can open the door on the right side of the tray, remove the jammed paper, and then close the door.

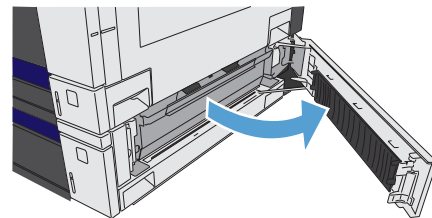

Clear jams in the output bin area

1. If paper is visible from the output bin, grasp the leading edge and remove it.

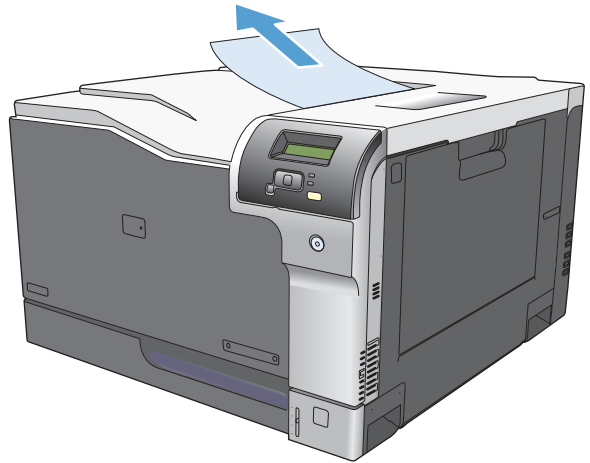

Jam causes and solutions

Jams in the output bin

Table 48 Causes and solutions for delivery delay jam

Cause	Solution
The output-bin full sensor flag is damaged.	Examine the output-bin full sensor flag for damage. If the flag is damaged, replace the paper delivery assembly. See {Xref Error! Target does not exist.}. See Output-bin-full sensor (PS10) on page 60 for troubleshooting information.
Poor contact of the output-bin full sensor connector.	If the product was recently repaired, check and reconnect the connector (J181) on the DC controller PCA and the intermediate connector (J743).
The output bin full sensor (PS10) is defective.	Check the output bin full sensor (PS10) using the manual sensor test. See Output-bin-full sensor (PS10) on page 60 .
Poor contact of the fuser-motor (M4) connector.	Reconnect the connectors of the fuser motor (J516), and the DC controller PCA (J81).
The fuser motor (M4) is defective.	Execute the fuser-motor driving test in the component test (see Component tests on page 61). If the motor is defective, replace the fuser motor (M4). See {Xref Error! Target does not exist.}.

Jams in the fuser and transfer area

Table 49 Causes and solutions for fuser delivery delay jams

Cause	Solution
The fuser-output sensor connector has a poor connection.	Reconnect connector J131 on the DC controller PCA.
The fuser-output sensor (PS6) is defective.	Check the fuser-output sensor (PS6) with the manual sensor test. See Fuser output sensor (PS6) on page 44 . If the sensor is defective, replace the fuser. See {Xref Error! Target does not exist.}.

Table 50 Causes and solutions for wrapping jams

Cause	Solution
The fuser roller or pressure roller is dirty.	Print a cleaning page. See Clean the paper path on page 96 .
The fuser roller or the pressure roller is worn or deformed.	Replace the fuser. See {Xref Error! Target does not exist.}.
The output bin full sensor has a poor connection.	Reconnect the connectors J181 on the DC controller PCA, and the intermediate connector J743).
The output bin full sensor is defective.	Run the manual sensor test to verify the output bin full sensor is functioning properly. See Output-bin-full sensor (PS10) on page 60 . If not, replace the fuser gear assembly. See {Xref Error! Target does not exist.}.

Table 51 Causes and solutions for fuser delivery stationary jams

Cause	Solution
The fuser roller or pressure roller is worn or deformed.	Replace the fuser. See {Xref Error! Target does not exist.} .
The fuser-delivery roller is deformed.	
The gear of the fuser-delivery roller is damaged.	
Poor contact of the fuser-output sensor connector.	Reconnect the fuser-output sensor and connector (J131) on the DC controller PCA.
The fuser-output sensor (PS6) is defective.	Run the manual sensor test to verify that the fuser-output sensor is functioning properly. See Fuser output sensor (PS6) on page 44 . If it is not, replace the. See {Xref Error! Target does not exist.} .

Table 52 Causes and solutions for pickup delay jams Tray 2

Cause	Solution
Poor contact of the pickup motor drive connector.	Reconnect the connector J91 on the DC controller PCA .
The pickup motor is defective.	Execute the Tray 2 pickup motor test in the component test (see Component test (special-mode test) on page 61). If the motor is defective, replace the paper pickup assembly. See {Xref Error! Target does not exist.} .
The pickup roller is worn or deformed.	Replace the pickup roller. See {Xref Error! Target does not exist.} .
The tray 2 separation roller is worn or deformed.	Replace the separation roller. See {Xref Error! Target does not exist.} .
Poor contact of the TOP sensor connector.	Reconnect the TOP sensor and connector (J122) on the DC controller PCA.
The TOP sensor (PS5) is defective.	Run the manual sensor test to verify that the TOP sensor is functioning properly. See TOP (top-of-page) sensor (PS5) on page 41 for information. If it is not, replace the registration sensor assembly. See {Xref Error! Target does not exist.} .
Poor contact of the Tray 2 pickup solenoid drive connector.	Reconnect the pickup solenoid and (J1003) on the DC controller PCA.
The Tray 2 pickup solenoid is defective.	Run the Tray 2 pickup solenoid drive test in the component test (see Component test (special-mode test) on page 61) to verify that the Tray 2 pickup solenoid is functioning properly. If it is not, replace the paper pickup assembly. See {Xref Error! Target does not exist.} .

Jams in the duplex area (duplex models only)

Table 53 Causes and solutions for duplexing reverse jams

Cause	Solution
The duplex reverse roller is worn or deformed.	Replace the fuser. See {Xref Error! Target does not exist.} .
The duplex feed roller is worn or deformed.	Replace the right door. See {Xref Error! Target does not exist.} .

Table 53 Causes and solutions for duplexing reverse jams (continued)

Cause	Solution
Poor contact of the duplex reverse-motor (M7) connector	Reconnect the connectors (J520) on the duplex reverse motor, intermediate connectors (J552L and J552D), connector (J1006) on the driver PCA, and connectors (J93; J92; J91) on the DC controller PCA.
The duplex reverse motor is defective.	Replace the duplex drive assembly. See {Xref Error! Target does not exist.}.

Table 54 Causes and solutions for duplex repick jams

Cause	Solution
The duplex re-pickup sensor lever is set incorrectly or damaged.	Check the sensor lever to make sure it is set correctly. If it is damaged, replace the right door assembly. See {Xref Error! Target does not exist.}.
The spring of the duplex re-pickup sensor lever is unhooked.	Check the spring and place it in correct position.
Poor contact of the duplex reverse solenoid (SL3) connector	Reconnect the intermediate connectors (J522L and J522D), connector (J1005) on the driver PCA, and connectors (J93; J92; J91) on the DC controller PCA.
The duplex reverse solenoid is defective.	Replace the duplex-drive assembly. See {Xref Error! Target does not exist.}.
The duplex flapper is damaged or malfunctioning.	Replace the delivery assembly. See {Xref Error! Target does not exist.}.
The duplex reverse solenoid is defective.	Replace the duplex-drive assembly. See {Xref Error! Target does not exist.}.
The duplex flapper is damaged or malfunctioning.	Replace the paper delivery assembly. See {Xref Error! Target does not exist.}.
The duplex repick roller is worn or damaged.	Replace the registration sensor assembly. See {Xref Error! Target does not exist.}.
The duplex repick clutch is defective.	Run the solenoid drive test in component test (see Component tests on page 61) to verify that the duplex repick clutch is functioning properly. If it is not, replace the duplex drive assembly. See {Xref Error! Target does not exist.}.

Table 55 Causes and solutions for residual media jams

Cause	Solution
Poor contact of the fuser loop-sensor connector and fuser loop sensor 1 and 2.	Reconnect the connectors of the fuser loop sensor 1 and 2 (J13) and the connector (J131) on the DC controller PCA.
The loop sensor is defective.	Run the manual sensor test. See Fuser loop sensors 1 and 2 (PS7 and PS8) on page 42 for information. If the sensor is defective, replace fuser. See {Xref Error! Target does not exist.}.
The spring of the fuser-output-sensor lever is unhooked.	Check the spring of the fuser and right door and place it in the correct position.
The fuser-output sensor lever is damaged.	Replace the sensor (PS6).
Poor contact of the fuser-output sensor connector.	Reconnect connector (J1055) of the fuser-output sensor and connector (J131) on the DC controller PCA.

Table 55 Causes and solutions for residual media jams (continued)

Cause	Solution
The fuser-output sensor is defective.	Run the manual sensor test to make sure the fuser-delivery sensor is functioning properly. See Fuser output sensor (PS6) on page 44 for information. If the sensor is defective, replace the fuser. See {Xref Error! Target does not exist.} .
The duplex pickup sensor lever is damaged.	Replace the right door assembly. See {Xref Error! Target does not exist.} .

 **NOTE:** Even if jammed paper is visible in Tray 1, clear the jam from the inside of the product by opening the right door.

Jams in Tray 1, Tray 2 and internal paper path

Table 56 Causes and solutions for pickup delay jam 1: tray pickup

Cause	Solution
The tray 1 pick up roller or the tray 1 separation pad is worn or deformed.	Replace the tray 1 pickup roller and separation pad. See {Xref Error! Target does not exist.} and {Xref Error! Target does not exist.} . Replace the right door. See {Xref Error! Target does not exist.} .
Poor contact of the tray 1 media-presence-sensor connector	Reconnect the connectors of the tray media-feed sensor intermediate connectors (J531L and J531D), and the connector (J152) on the DC controller.
Poor contact of the TOP sensor connector.	Reconnect the intermediate connector (J554L and J554D) of the TOP sensor and connector (J122) on the DC controller PCA.
The TOP sensor is defective.	Run the manual sensor test to verify that the TOP sensor is functioning properly. If not, replace the registration assembly. See {Xref Error! Target does not exist.} .
Poor contact of the MP-pickup-solenoid drive connector	Reconnect the connector of the tray pickup solenoid intermediate connectors (J530L and J530D), and the connector (J152) on the DC controller PCA.
The MP-pickup solenoid is defective.	Execute the tray-pickup-solenoid driving test in the component test (see Component tests on page 61). If the solenoid is defective, replace the right door assembly. See {Xref Error! Target does not exist.} .
Poor contact of the pickup-motor drive connector (M5)	Reconnect the pickup-motor connector (J523) and connector (J260), intermediate connectors (J535L and J535D), and the connector (J1003) on the DC controller PCA.
The pickup motor is defective.	Execute the pickup-motor driving test in the component test (see Component tests on page 61). If the motor is defective, replace the paper pickup assembly. See {Xref Error! Target does not exist.} .

Table 57 Causes and solutions for pickup stationary jams

Cause	Solution
Multiple feed of media	<p>Replace any worn or deformed parts (tray separation pad, tray feed roller, MP tray pickup roller or MP tray separation pad).</p> <p>Check the separation pad and MP tray separation pad to see if they are firmly seated and coupled with the torque limiter.</p> <p>Replace the separation pad and feed roller for the associated tray.</p> <p>If the MP tray pickup roller is defective, replace the roller. See {Xref Error! Target does not exist.}. If the MP tray separation pad is defective, replace the separation pad assembly. See {Xref Error! Target does not exist.}.</p>
The secondary transfer roller is not set correctly.	Place the secondary-transfer-roller unit in the correct position.
The secondary-transfer roller is worn or deformed.	Replace the secondary-transfer-roller assembly. See {Xref Error! Target does not exist.} .
Poor contact of the drum drive connector	Reconnect the connectors of the ITB motor (J517) and the DC controller PCA (J81).
The drum motor is defective.	Execute the drum motor driving test in the component test (see Component tests on page 61). If the motor is defective, replace the motor.
The ITB does not rotate smoothly.	Replace the ITB. See {Xref Error! Target does not exist.} .

Table 58 Causes and solutions for residual media jams

Cause	Solution
A piece of paper remains at the sensor detecting the jam.	Make sure that all paper, including small bits of paper, are removed from the product when a jam is removed.
The sensor detecting a residual media jam is not working.	<p>Test each sensor using the manual sensor test. See Manual sensor test on page 37 for information. If the sensor does not respond, replace the component indicated:</p> <ul style="list-style-type: none"> • TOP sensor (PS5): Replace the registration sensor assembly. See {Xref Error! Target does not exist.}. • Fuser-output sensor (PS6): Replace the fuser. See {Xref Error! Target does not exist.}. • Fuser loop sensors 1 and 2 (PS7 and PS8): Replace the fuser. See {Xref Error! Target does not exist.}.
If service was recently performed on the product, a sensor connector might be disconnected.	<p>Run the manual sensor tests to verify which sensor detects the media. See Manual sensor test on page 37 or Tray/Bin manual sensor test on page 47 for information. Reconnect the corresponding sensor connector:</p> <ul style="list-style-type: none"> • TOP sensor: Connector (J122) on the DC controller PCA • Fuser-output sensor: Connector (J131) on the DC controller PCA • Fuser Loop sensor 1 or 2: Connector (J131) on the DC controller PCA

Table 59 Causes and solutions for pickup stationary jams

Cause	Solution
Multiple-feed of media	Inspect the pickup rollers and separation rollers (separation pad for tray 1) for the tray experiencing the multi-feed issue. If the rollers or pad are worn or deformed, replace any defective parts.
The TOP sensor lever is incorrectly positioned or damaged	Check the sensor lever to make sure it is correctly positioned . If it is damaged, replace the registration sensor assembly. See {Xref Error! Target does not exist.} .
Poor contact of the TOP sensor connector	Reconnect the TOP sensor and connector (J122) on the DC controller PCA.
The TOP sensor is defective.	Run the manual sensor test to verify that the TOP sensor (PS5) is functioning properly. See TOP (top-of-page) sensor (PS5) on page 41 for information. If it is not, replace the registration sensor assembly. See {Xref Error! Target does not exist.} .

Jams in Tray 3, 4, 5, and 6

Table 60 Causes and solutions for pickup delay and pickup stationary jams

Cause	Solution
The paper-feeder pickup roller is worn or deformed.	Replace the pickup roller. See {Xref Error! Target does not exist.} .
The paper-feeder separation roller is worn or deformed.	Replace the separation roller. See {Xref Error! Target does not exist.} .
The paper-feeder feed roller is worn or deformed.	Replace the feed roller. See {Xref Error! Target does not exist.} .
Poor contact of the paper-feeder media-feed sensor connectorS	
A tray feed sensor is defective.	Run the manual sensor test to verify that the paper-feeder media feed sensor is functioning properly. See Tray/Bin manual sensor test on page 47 for information. If it is not, replace the paper pickup assembly of the specific tray.
Poor contact of a paper-feeder pickup solenoid drive connector	
The paper-feeder pickup solenoid is defective.	Run the solenoid drive test in the component test (see Component tests on page 61) to verify that the paper-feeder pickup solenoid is functioning properly. If it is not, replace the paper pickup assembly of the specific tray.
Poor contact of paper-feeder pickup motor drive connector.	
The paper-feeder pickup motor is defective.	Run the pickup motor drive test in the component test (see Component tests on page 61) to verify that the paper-feeder pickup motor is functioning properly. If it is not, replace the pickup assembly of the specific tray.
Multiple feed of media	If the tray 3 pickup roller, separation roller, or feed roller is worn or deformed, replace any defective parts.
The paper-feeder media-feed sensor lever is set incorrectly or damaged.	Check the sensor lever to make sure it is set correctly. If it is damaged, replace the paper-feeder assembly.

Table 60 Causes and solutions for pickup delay and pickup stationary jams (continued)

Cause	Solution
The spring of the paper-feeder media-feed sensor lever is unhooked.	Check the spring and place it in correct position.
Poor contact of the paper-feeder media-feed sensor connector.	Reconnect the connector (J406) on the connector PCA and connector (J22) of the paper-feeder media feed sensor.
A tray feed sensor is defective.	Run the manual sensor test to verify that the tray feed sensor is functioning properly. See Tray/Bin manual sensor test on page 47 for information. If it is not, replace the pickup assembly of the specific tray.

Table 61 Causes and solutions for residual media jams

Cause	Solution
The sensor that detects residual paper jams is set incorrectly or damaged.	Run the manual sensor test to verify which sensor detects the paper. See Tray/Bin manual sensor test on page 47 for information. Check the sensor lever to make sure it is set correctly. If it is damaged, replace the corresponding pickup assembly.
The spring of the sensor lever that detects residual paper jams is unhooked.	Run the manual sensor test to verify which sensor detects the paper. See Tray/Bin manual sensor test on page 47 for information. Check the spring of the sensor lever to make sure it is set correctly.
Poor contact exists in the sensor that detects residual paper jams.	Run the manual sensor test to verify which sensor detects the paper. See Tray/Bin manual sensor test on page 47 for information. Reconnect the following corresponding sensor connectors:
The sensor that detects residual paper jams is defective.	Run the sensor test in the sensor monitor mode to verify which sensor detects the paper. Replace media feed sensor.

Change jam recovery





This product provides a jam recovery feature that reprints jammed pages. The following options are available:

- **Auto** — The product attempts to reprint jammed pages when enough memory is available. This is the default setting.
- **Off** — The product does not try to reprint jammed pages. Because no memory is used to store the most recent pages, performance is optimal.

 **NOTE:** When using this option, if the product runs out of paper and the job is being printed on both sides, some pages can be lost.

- **On** — The product always reprints jammed pages. Additional memory is allocated to store the last few pages printed. This might cause overall performance to suffer.

Set the jam recovery feature

1. Press the Home button .
2. Open the following menus:
 - **Administration**
 - **General Settings**
 - **Jam Recovery**
3. Press the **Down** arrow or **Up** arrow / button to highlight the appropriate setting, and then press the OK button.
4. Press the Home button  to return to the **Ready** state.

Solve paper-handling problems

Product feeds multiple sheets

Product feeds multiple sheets	
Cause	Solution
The input tray is overfilled. Open the tray and verify that the paper stack is below the maximum stack height mark.	Remove excess paper from the input tray.
Print paper is sticking together.	Remove paper, flex it, rotate it 180 degrees or flip it over, and then reload it into the tray. NOTE: Do not fan paper. Fanning can cause static electricity, which can cause paper to stick together.
Paper does not meet the specifications for this product.	Use only paper that meets HP paper specifications for this product.
Trays are not properly adjusted.	Make sure that the paper guides match the size of paper being used.
Tray 2 feeds multiple sheets.	Make sure Tray 2 is not overfilled. Open the tray and verify that the paper stack is below the maximum stack height mark. Remove paper from Tray 2 to avoid jams.

Product feeds incorrect page size

Product feeds incorrect page size	
Cause	Solution
The correct size paper is not loaded in the tray.	Load the correct size paper in the tray.
The correct size paper is not selected in the software program or printer driver.	Confirm that the settings in the software program and printer driver are correct, because the software program settings override the printer driver and control panel settings, and the printer driver settings override the control panel settings.
The correct size paper for the tray is not selected in the product control panel.	From the control panel, select the correct size paper for the tray.
The paper size is not configured correctly for the tray.	Print a configuration page or use the control panel to determine the paper size for which the tray is configured.
The guides in the tray are not against the paper.	Verify that the paper guides are touching the paper.

Product pulls from incorrect tray

Product pulls from incorrect tray	
Cause	Solution
You are using a driver for a different product.	Use a driver for this product.

Product pulls from incorrect tray

Cause	Solution
The specified tray is empty.	Load paper in the specified tray.
The paper size is not configured correctly for the input tray.	Print a configuration page or use the control panel to determine the paper size for which the tray is configured.
The guides in the tray are not against the paper.	Verify that the guides are touching the paper.

Paper does not feed automatically

Paper does not feed automatically

Cause	Solution
Manual feed is selected in the software program.	Load Tray 1 with paper, or, if the paper is loaded, press the checkmark button  .
The correct size paper is not loaded.	Load the correct size paper.
The input tray is empty.	Load paper into the input tray.
Paper from a previous jam has not been completely removed.	Open the product and remove any paper in the paper path.
The paper size is not configured correctly for the input tray.	Print a configuration page or use the control panel to determine the paper size for which the tray is configured.
The guides in the tray are not against the paper.	Verify that the rear and width paper guides are touching the paper.
The manual-feed prompt is set to ALWAYS . The product always prompts for manual feed, even if the tray is loaded.	Open the tray, reload the media, and then close the tray. Or, change the manual-feed prompt setting to UNLESS LOADED , so that the product prompts for manual feed only when the tray is empty.
The USE REQUESTED TRAY setting on the product is set to EXCLUSIVELY , and the requested tray is empty. The product will not use another tray.	Load the requested tray. Or, change the setting from EXCLUSIVELY to FIRST on the CONFIGURE DEVICE menu. The product can use other trays if no media is loaded in the specified tray.

Paper does not feed from Tray 2, 3, 4, or 5

Paper does not feed from Tray 2, 3, 4, or 5

Cause	Solution
The correct size paper is not loaded.	Load the correct size paper.
The input tray is empty.	Load paper in the input tray.

Paper does not feed from Tray 2, 3, 4, or 5

Cause	Solution
The correct paper type for the input tray is not selected in the product control panel.	From the product control panel, select the correct paper type for the input tray. Trays configured for a paper type with a specific weight range will not match a print job that specifies an exact weight, even if the specified weight is within the weight range.
Paper from a previous jam has not been completely removed.	Open the product and remove any paper in the paper path. Closely inspect the fuser area for jams.
None of the optional trays appear as input tray options.	The optional trays only display as available if they are installed. Verify that any optional trays are correctly installed. Verify that the printer driver has been configured to recognize the optional trays.
An optional tray is incorrectly installed.	Print a configuration page to confirm that the optional tray is installed. If not, verify that the tray is correctly attached to the product.
The paper size is not configured correctly for the input tray.	Print a configuration page or use the control panel to determine the paper size for which the tray is configured.
The guides in the tray are not against the paper.	Verify that the guides are touching the paper.

Transparencies or glossy paper will not feed

Transparencies or glossy paper will not feed

Cause	Solution
The correct paper type is not specified in the software or printer driver.	Verify that the correct paper type is selected in the software or printer driver.
The input tray is overfilled.	Remove excess paper from the input tray. Do not exceed the maximum stack height marks for the tray.
Paper in another input tray is the same size as the transparencies, and the product is defaulting to the other tray.	Make sure that the input tray containing the transparencies or glossy paper is selected in the software program or printer driver. Use the product control panel to configure the tray to the paper type loaded.
The tray containing the transparencies or glossy paper is not configured correctly for type.	Make sure that the input tray containing the transparencies or glossy paper is selected in the software program or printer driver. Use the product control panel to configure the tray to the paper type loaded.
Transparencies or glossy paper might not meet supported paper specifications.	Use only paper that meets the HP paper specifications for this product.
High-humidity environments may cause glossy paper not to feed, or to feed too many sheets.	Avoid printing glossy paper in high humidity conditions. When printing glossy paper, removing the paper from the wrapper and letting it rest for a few hours can improve feeding into the product. However, letting paper rest in humid environments may also cause blisters.

Envelopes jam or will not feed in the product

Envelopes jam or will not feed in the product

Cause	Solution
Envelopes are loaded in an unsupported tray. Only Tray 1 can feed envelopes.	Load envelopes into Tray 1.
Envelopes are curled or damaged.	Try using different envelopes. Store envelopes in a controlled environment.
Envelopes are sealing because the moisture content is too high.	Try using different envelopes. Store envelopes in a controlled environment.
Envelope orientation is incorrect.	Verify that the envelope is loaded correctly.
This product does not support the envelopes being used.	Refer to the <i>HP LaserJet Printer Family Print Media Guide</i> .
Tray 1 is configured for a size other than envelopes.	Configure Tray 1 size for envelopes.

Output is curled or wrinkled

Output is curled or wrinkled

Cause	Solution
Paper does not meet the specifications for this product.	Use only paper that meets the HP paper specifications for this product.
Paper is damaged or in poor condition.	Remove paper from the input tray and load paper that is in good condition.
Product is operating in an excessively humid environment.	Verify that the printing environment is within humidity specifications.
You are printing large, solid-filled areas.	Large, solid-filled areas can cause excessive curl. Try using a different pattern.
Paper used was not stored correctly and might have absorbed moisture.	Remove paper and replace it with paper from a fresh, unopened package.
Paper has poorly cut edges.	Remove paper, flex it, rotate it 180 degrees or turn it over, and then reload it into the input tray. Do not fan paper. If the problem persists, replace the paper.
The specific paper type was not configured for the tray or selected in the software.	Configure the software for the paper (see the software documentation). Configure the tray for the paper.
The paper has previously been used for a print job.	Do not re-use paper.

Use manual print modes

Try the following multi-purpose (MP) modes to see if they solve the image-quality problems. To access the manual print modes, open the following menus:

- **Administration**
- **General Settings**
- **Print Quality**
- **Adjust Paper Types**

Table 62 MP modes under the Adjust Paper Types sub menu

Print Mode	
	<ul style="list-style-type: none">• AUTOSENSE MODE• NORMAL MODE• LIGHT MODE• HEAVY MODE• CARDSTOCK MODE• TRANSPARENCY MODE• TRANSPARENCY MODE 2• ENVELOPE MODE• LABEL MODE• TOUGH MODE• EXTRA TOUGH MODE• HEAVY GLOSSY MODE• X-HVY GLOSSY MODE• ROUGH MODE• CARD GLOSSY MODE• 4MM TRNS MODE• LIGHT ROUGH MODE
RESISTANCE MODE	<p>NOTE: Not all print modes are available for all paper types.</p> <p>Set to Up to resolve print-quality issues caused by poor secondary transfer in low-humidity environments with resistive or rough surface media.</p>

Table 62 MP modes under the Adjust Paper Types sub menu (continued)

HUMIDITY MODE	<p>With glossy film, set to High when the product is in a high-humidity environment and print-quality defects occur on HP Tough Paper or Opaque film.</p> <p>With transparencies, set to High when the product is in a high-humidity environment and print-quality defects occur on color transparencies on the first page of a print job.</p> <p>With all other paper types, set to High when the product is in a high-humidity environment and light density occurs on the first page of a print job.</p>
FUSER TEMP MODE	<p>If you are seeing a faint image of the page repeated at the bottom of the page or on the following page, first make sure the Paper Type and Print Mode settings are correct for the type of paper you are using. If you continue to see ghost images on your print jobs, set the Fuser Temp feature to one of the Alternate settings . Try the ALTERNATE 1 setting first and see if it solves the problem. If you continue to see the problem, try ALTERNATE 2 and then ALTERNATE 3. Using the ALTERNATE 2 and ALTERNATE 3 settings might cause an extra delay between jobs.</p>
PAPER CURL MODE	<p>Use in high-humidity and high-temperature environments. The REDUCED setting decreases fuser temperature and increases the interpage gap.</p>

Table 63 MP modes under the Optimize submenu

NORMAL PAPER	Set to SMOOTH when printing on smooth paper of normal weight.
HEAVY PAPER	Set to SMOOTH when printing on smooth, heavy media types.
LIGHT MEDIA	Set to SMOOTH when printing on smooth, light media types.
ENVELOPE CONTROL	Set to REDUCED TEMP if envelopes are sticking due to moisture in the envelop adhesive.
ENVIRONMENT	Set to LOW TEMP if the product is operating in a low-temperature environment and you are having problems with print quality such as blisters in the printed image.
LINE VOLTAGE	Set to LOW VOLTAGE if the product is operating in a low-voltage environment and you are having problems with print quality such as blisters in the printed image.
TRAY1	Set to ALTERNATE if you are seeing marks on the back side of the paper when printing from Tray 1. This sets the product to initiate a clean sequence every time a job finishes when the product is set for Any Size and Any Type for Tray 1.
BACKGROUND	Set to ALTERNATIVE 1 when a background occurs all over the page. Set to ALTERNATIVE 2 when thin vertical lines appear on the page. Set to ALTERNATIVE 3 when the other alternatives do not correct the problem.

Table 63 MP modes under the Optimize submenu (continued)

CLEANING CONTROL	<p>Changes the control of toner purge. Toner purge is executed with the CRG in contact with the ITB. Toner purge is executed right after this mode is selected at the control panel.</p> <p>ALTERNATIVE 1: Use this option when ITB cleaning failure occurs during lower coverage printing or when abnormal noise occurs from ITB cleaning blade.</p>
MEDIA TEMP	<p>Use ALTERNATIVE 1 to preventing media in the output bin from sticking together.</p>
UNIFORMITY CONTROL	<p>Set to ALTERNATIVE 1 to improve uniformity on any paper type. Set to ALTERNATIVE 2 to improve uniformity on normal and light paper types. Set to ALTERNATIVE 3 when the other alternatives do not correct the problem.</p>
PRE-ROTATION	<p>Set to ALTERNATIVE 1 when horizontal banding occurs with the drum pitch, or when 53 mm band occurs after leaving engine for a long period of time.</p> <p>Set to ALTERNATIVE 2 when the problems like fade finger (trailing edge toner starvation) occur after high coverage continuous printing.</p>
REGISTRATION	<p>Set to ALTERNATIVE when color misregistration occurs.</p>
TRANSFER CONTROL	<p>Set to ALTERNATIVE 1 to reduce primary transfer bias and to resolve low density or blotchy images. Set to ALTERNATIVE 2 to resolve ghosting outlines that look like a finger or fingers. Set to ALTERNATIVE 3 when the other alternatives do not correct the problem.</p>
MOISTURE CONTROL	<p>Set to ALTERNATE when image failure occurs due to water drops.</p>

Solve image-quality problems

Occasionally, you might encounter problems with print quality. The information in the following sections helps you identify and resolve these issues.

Print quality examples





Some print quality problems arise from low or very low cartridges or other supplies. The solution is to replace the low or very low supplies.





Some print quality problems arise from use of inappropriate paper.



- Use paper that meets HP paper specifications.
- The surface of the paper is too rough. Use paper that meets HP paper specifications.
- The printer driver setting or paper tray setting might be incorrect. Be sure that you have configured the paper tray at the product control panel and have also selected the correct driver setting for the paper that you are using.
- The print mode might be set incorrectly, or the paper might not meet recommended specifications.
- The transparencies you are using are not designed for proper toner adhesion. Use only transparencies designed for HP Color LaserJet products.
- The moisture content of the paper is uneven, too high, or too low. Use paper from a different source or from an unopened ream of paper.
- Some areas of the paper reject toner. Use paper from a different source or from an unopened ream of paper.
- The letterhead you are using is printed on rough paper. Use a smoother, xerographic paper. If this solves your problem, consult with the printer of your letterhead to verify that the paper used meets the specifications for this product.
- Several optimize print modes can be used to address print quality issues. See the print modes section of this manual.

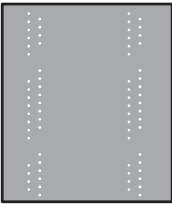

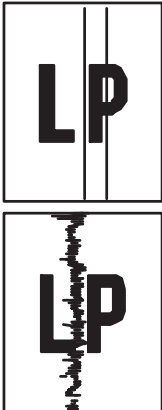
If you are having problems with light streaks in an image, use the **Administration** menu to print the supplies status page. If none of the cartridges has reached its estimated end of life, remove the cartridges from the product, and then reinstall them. The product initiates a cleaning mechanism that might correct the light streaks.



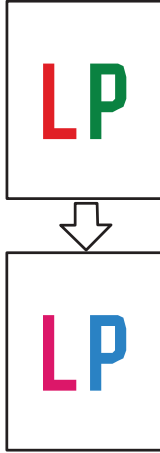

The following examples depict letter-size paper that has passed through the product short-edge first. These examples illustrate problems that would affect all the pages that you print, whether you print in color or in black only. The topics that follow list the typical cause and solution for each of these examples.

Problem	Sample	Cause	Solution
Print is light or faded on entire page.		Poor contacts exist on the ITB unit and the product grounding unit.	Clean the grounding contacts. If the problem remains after cleaning, check the contacts for damage. Replace any deformed or damaged parts.
Print is light or faded in a particular color.		Poor primary transfer bias contacts on the ITB unit and product.	Clean the contacts of the color that produces the light print. If the problem remains after cleaning, check the contacts for damage. Replace any deformed or damaged parts.
Image is too dark.		The registration density (RD) sensor is defective.	Replace the RD sensor.
Page is blank.		The imaging high-voltage power-supply is defective (no developing bias output).	Replace the imaging high-voltage power-supply .
The page is all black or a solid color.		Poor contact exists in the primary charging bias or developing bias contacts between the print cartridge and the product.	Clean each contact of the color that produces the all black or solid color. If the problem remains after cleaning, check the contacts for damage. Replace any deformed or damaged parts. Replace the affected print cartridge.

Problem	Sample	Cause	Solution
White spots appear in an image		Poor conductivity caused by dirt on the static eliminator.	Clean the static eliminator.
		The primary transfer roller is deformed or has deteriorated.	Replace the ITB.
		The secondary transfer roller is deformed or has deteriorated.	Replace the secondary-transfer-roller.
The back of the page is dirty.		The secondary transfer roller is dirty.	Replace the secondary transfer roller.
		The fuser inlet guide or separation guide is dirty.	Clean the dirty parts. If the dirt does not come off, replace the guide.
		The pressure roller is dirty.	Run the cleaning page several times. If the dirt does not come off, install a fuser cleaning kit. If the issue persists, replace the fuser.
Vertical streaks or bands appear on the page.		Scratches are present on the circumference of the photosensitive drum.	Replace the print cartridge of the color that matches the defect.
		Scratches are present on the circumference of the fuser roller.	Replace the fuser.
		Scratches are present on the circumference of the ITB.	Replace the ITB.
		The ITB drive roller is deformed or has deteriorated.	
		The ITB cleaning mechanism is malfunctioning.	
Vertical white lines appear in a particular color.		The laser beam window is dirty.	Execute the Clean Laser Glass item in the Calibration/Cleaning submenu (in the Device Maintenance menu) If the error persists, manually clean the window and remove any foreign substances.
		Scratches are present on the circumference of the developing cylinder or photosensitive drum.	Replace the affected print cartridge. If the problem persists, replace the affected print cartridge.
		The laser/scanner-unit mirror is dirty.	Replace the laser/scanner assembly.

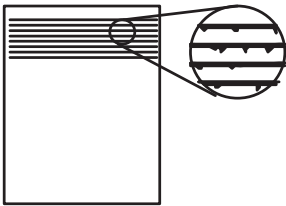
Problem	Sample	Cause	Solution
Vertical white lines appear in all colors.		Horizontal scratches on the fuser roller.	Replace the fuser.
		Scratches are present on the circumference of the ITB.	Replace the affected print cartridge. Replace the ITB.
Horizontal lines appear on the page.		Repetitive horizontal lines appear.	Use the repetitive defects ruler to identify the dirty roller. Clean the roller. If the roller cannot be cleaned, replace the fuser.
		Horizontal scratches are present on the photosensitive drum.	Replace the print cartridge of the color that matches the defect.
		Horizontal scratches are present on the fuser roller.	Replace the fuser.
A horizontal white line appears on the page.		Repetitive horizontal white lines appear.	Use the repetitive defects ruler to identify the dirty roller. Clean the roller. If the roller cannot be cleaned, replace the roller.
		Horizontal scratches are present on the photosensitive drum.	Replace the print cartridge of the color that matches the defect.
		Scratches are present on the circumference of the ITB.	Replace the ITB.
Image in a particular color does not print in the correct color.		Poor contact exists in the primary charging bias or developing bias contacts between the print cartridge and the product.	Clean each contact of the color that produces the missing color. If the problem remains after cleaning, check the contacts for damage. Replace any deformed or damaged parts.
		The print cartridge (primary charging roller, developing roller, or photosensitive drum) is defective.	Replace the print cartridge of the color that matches the defect.
		The imaging high-voltage power-supply is defective (no primary charging bias or developing bias output).	Replace the imaging high-voltage power-supply.
		The laser/scanner unit is defective.	Replace the laser/scanner assembly.

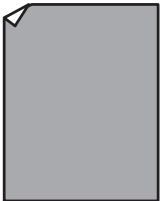
Problem	Sample	Cause	Solution
Dropouts appear.		The secondary transfer roller is deformed or has deteriorated.	Replace the secondary-transfer-roller.
		The primary charging roller, developing roller, or photosensitive drum is deformed or has deteriorated.	Replace the print cartridge of the color that matches the defect.
		The fuser roller is deformed or has deteriorated.	Replace the fuser.
		The transfer 1 high-voltage power-supply PCA is defective (no transfer 1 bias output).	Replace the transfer 1 high-voltage power-supply.
		The transfer 2 high-voltage power-supply PCA is defective (no transfer 2 bias output).	Replace the transfer 2 high-voltage power-supply.
The toner is not fully fused to the paper.		The fuser roller or pressure roller is scarred or deformed.	Replace the fuser.
		The fuser control circuit is defective.	Replace the low-voltage power supply.
		The thermistor is defective.	Replace the fuser.
		The fuser heater is defective.	
Some color is misregistered.		The product is incorrectly calibrated.	Calibrate the product.
		The ITB unit is defective.	If the ITB does not rotate smoothly or a cleaning malfunction occurs (ITB is dirty), replace the ITB.
		The drive gear of the ITB motor is worn or chipped.	Check each drive gear between the ITB drive roller and the ITB motor. If the gear is worn or chipped, replace the drive unit.
		The RD sensor is defective.	Open and close the right door several times to clean the RD sensor. If the problem persists, replace the RD sensor.
		The laser/scanner unit is defective.	Replace the laser/scanner assembly.
		The print cartridge is defective.	Replace the print cartridge of the affected color.

Problem	Sample	Cause	Solution
Toner smears appear on the media.		The product has residual media.	Remove the residual media.
		Poor contact exists in the primary charging bias or developing bias contacts between the print cartridge and the product.	Clean each contact of the color that produces the missing color. If the problem remains after cleaning, check the contacts for damage. Replace any deformed or damaged parts.
		The fuser inlet guide is dirty.	Clean the fuser inlet guide.
The printed page contains misformed characters.		The product is experiencing page skew.	See the "Text or graphics are skewed on the printed page" row in this table.
		The laser/scanner unit is defective.	Replace the laser/scanner assembly.
Text or graphics are skewed on the printed page.		The registration shutter spring is unhooked.	Check the spring and place it in the correct position.
		The registration shutter spring is deformed.	Replace the cassette pickup assembly.
The printed page contains wrinkles or creases.		The roller or media feed guide is dirty.	Clean any dirty components.
		A feed roller is deformed or has deteriorated.	Replace any deformed or deteriorated rollers.
		The paper feed guide is damaged.	Replace the paper-feed-guide unit.
The front of the page is dirty.		The photosensitive drum is dirty.	Replace the print cartridge.
		The fuser roller or pressure roller is dirty.	Execute a cleaning page to clean the contaminate off the fuser. If the dirt does not come off, replace the fuser.
Repetitive horizontal lines		Damaged or dirty roller.	See repetitive image defect ruler. Clean the indicated roller. If the contaminate does not come off, replace appropriate roller or assembly.
			NOTE: Cleaning the fuser with HP tough paper provides better results than with plain paper. You might need to execute the cleaning process several times to remove all contaminates on the fuser.

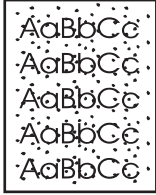
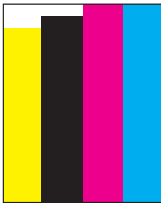
Problem	Sample	Cause	Solution
Pages have flecks of toner		Dirty paper path.	<p>Execute a cleaning page to clean the contaminate off the fuser. The cleaning page may need to be run several time to clean the fuser. Do not replace the fuser.</p> <p>NOTE: Cleaning the fuser with HP tough paper provides better results than with plain paper. You might need to execute the cleaning process several times to remove all contaminates on the fuser. A fuser cleaning kit (CC468-67919) is available.</p>
Pages have one or more skewed color planes (can appear on the right or left side of the page)		Print cartridge incorrectly installed or damaged.	Remove, and then reinstall the print cartridge associated with the defect.

Clean the product

Over time, particles of toner and paper accumulate inside the product. This can cause print-quality problems during printing. Cleaning the product eliminates or reduces these problems.



Clean the paper path and print-cartridge areas every time that you change the print cartridge or whenever print-quality problems occur. As much as possible, keep the product free from dust and debris.

To clean the product exterior, use a soft, water-moistened cloth.

Clean the paper path



 **NOTE:** If you are processing a cleaning page to clean the fuser, repeat the process 1 to 6 times until the paper comes out clean.

Process a cleaning page

1. Press the Home button .
2. Open the following menus:
 - **Device Maintenance**
 - **Calibration/Cleaning**
3. Press the **Down** arrow  to highlight the **Print Cleaning Page** item, and then press the OK button.
4. The product prints a cleaning page, and then returns to the main menu. Discard the printed page.

Set up an auto cleaning page

Use the procedure in this section to set up an automatic cleaning page.

1. Press the Home button .
2. Open the following menus:
 - **Device Maintenance**
 - **Calibration/Cleaning**
3. Press the **Down** arrow  to highlight the **Auto Cleaning** item, and then select the **Enabled** item. Press the OK button.
4. Press the **Down** arrow  to highlight the **Cleaning Interval** item, and then use the arrow buttons to select an interval. Press the OK button.

 **TIP:** HP recommends processing a cleaning page after every 5000 printed pages.

5. Press the **Down** arrow  to highlight the **Auto Cleaning Size** item, and then use the arrow buttons to select the cleaning page size. Press the OK button.

Solve performance problems

Problem	Cause	Solution
Pages print but are totally blank.	The document might contain blank pages.	Check the document that you are printing to see if content appears on all of the pages.
	The product might be malfunctioning.	To check the product, print a Configuration page.
	All of the print cartridges might be very low on toner.	Replace the toner cartridges if a Supplies very low message is displayed.
Pages print very slowly.	Heavier paper types can slow the print job.	Print on a different type of paper. Proper fusing may require a slower print speed to ensure the best print quality.
	Complex pages can print slowly.	Simplify the page.
Pages did not print.	The product might not be pulling paper correctly.	Make sure paper is loaded in the tray correctly.
	The paper is jamming in the product.	Clear the jam. See Clear jams on page 240 .
	The USB cable might be defective or incorrectly connected.	<ul style="list-style-type: none">• Disconnect the USB cable at both ends and reconnect it.• Try printing a job that has printed in the past.• Try using a different USB cable.
	Other devices are running on your computer.	The product might not share a USB port. If you have an external hard drive or network switchbox that is connected to the same port as the product, the other device might be interfering. To connect and use the product, you must disconnect the other device or you must use two USB ports on the computer.

Solve connectivity problems

Solve direct-connect problems

If you have connected the product directly to a computer, check the cable.

- Verify that the cable is connected to the computer and to the product.
- Verify that the cable is not longer than 2 m (6.5 ft). Replace the cable if necessary.
- Verify that the cable is working correctly by connecting it to another product. Replace the cable if necessary.

Solve network problems

Check the following items to verify that the product is communicating with the network. Before beginning, print a configuration page. See [Configuration page on page 97](#).

Problem	Solution
Poor physical connection	<p>Verify that the product is attached to the correct network port using a cable of the correct length.</p> <p>Verify that cable connections are secure.</p> <p>Look at the network port connection on the back of the product, and verify that the amber activity light and the green link-status light are lit.</p> <p>If the problem continues, try a different cable or port on the hub.</p>
The computer is unable to communicate with the product.	<p>Use the command prompt to ping the product from your computer. For example:</p> <pre>ping 192.168.45.39</pre> <p>Verify that the ping displays round-trip times, which indicates that it is working.</p> <p>If the ping command failed, verify that the network hubs are on, and then verify that the network settings, the product, and the computer are all configured for the same network.</p>
Incorrect link and duplex settings	<p>Hewlett-Packard recommends leaving this setting in automatic mode (the default setting). See the user guide.</p>
Incorrect IP address for the product on the computer	<p>Use the correct IP address. The IP address is listed on the configuration page.</p> <p>If the IP address is correct, delete the product and then add it again.</p>
New software programs have caused compatibility problems.	<p>Verify that any new software programs are correctly installed and that they use the correct printer driver.</p>
Your computer or workstation is set up incorrectly.	<p>Check the network drivers, printer drivers, and the network redirection.</p> <p>Verify that the operating system is configured correctly.</p>
The protocol is disabled, or other network settings are incorrect.	<p>Review the configuration page to check the status of the protocol. Enable it if necessary.</p> <p>Reconfigure the network settings if necessary. See the user guide.</p>

Service mode functions

Service menu

The **Service** menu is PIN-protected for added security. Only authorized service people have access to the **Service** menu. When you select **Service** from the list of menus, the product prompts you to enter an eight-digit PIN number (**Service Access Code**). The PIN for the HP Color LaserJet Enterprise CP5520 Printer Series is 11552010.

1. Press the Home  button.
2. Open the following menus:
 - **Device Maintenance**
 - **Service**
 - **Service Access Code**
3. Enter the eight-digit PIN using the arrow buttons.

 **NOTE:** Only the **Service Access Code** can be used to access the **Service** menu. The message **Your user account does not have permission to access the selected item** displays if the correct **Service Access Code** is not used.

4. Press the OK button to enter the PIN and open the **Service** menu.

The following menu items appear in the **Service** menu:

First level	Second level	Third level	Description
User Access Code			Only the Service Access Code can be used to access the Service menu. The message Your user account does not have permission to access the selected item displays if the correct Service Access Code is not used.
Administrator Access Code			Only the Service Access Code can be used to access the Service menu. The message Your user account does not have permission to access the selected item displays if the correct Service Access Code is not used.
Service Access Code	Print Event Log		This item allows access to the Service sub menus.
	View Event Log		Use this item to view the service event log.

First level	Second level	Third level	Description
	Clear Event Log		Use this item to clear (erase) the service event log.
	Cycle Counts	Mono Cycle Counts	Use this item to reset the mono print job page count.
		Color Cycle Count	Use this item to reset the color print job page count.
		Refurbish Cycle Count	Use this item to reset the refurbish print job page count.
	Serial Number		Use this item to reset the product serial number.
	Service ID		Use this item to reset the product service identification number.
	Cold Reset Paper		Use this item to set the cold reset paper size.
	New Registration Roller		Use this item to reset the registration roller page count.
	Media Sensor Value		Use this item to record the media sensor value found on a replacement paper pickup assembly.
	Manual Laser Glass Cleaning		Use this item to execute a manual laser glass cleaning. The laser shutters are moved away from the laser glass windows so that they can be manually cleaned.
Test Support	Continuous Print from USB		Use this item to test print from an external USB.
	Automatic Calibrations		Use this item to enable automatic calibrations.

Product resets

Restore factory-set defaults

1. Press the Home button .
2. Open the following menus:
 - **Administration**
 - **General Settings**
 - **Restore Factory Settings**

3. Press the **Down** arrow button ▼ to highlight the select type of reset from a list, and then press the OK button.
4. Press the **Down** arrow ▼ to highlight the **Reset** item, and then press the OK button.

Restore factory-set defaults values

- **Calibration**

- Persisted calibration engine data
- Engine color density data
- LaserJet engine calibration data

- **General**

- Display and sound settings for the control panel
- Localization settings (for example, clock format and date format)
- Error and warning log behavior
- Default media settings
- Sleep mode and delay setting
- Internal backup file maximum size
- Oxp installer solutions, tasks and pending tasks
- Http job defaults
- Clears the error, warning and info logs
- Supported media types
- Resets JetLink connected external devices

- **Print**

- Print default job, stored job and quick set settings
- Some print job usage data
- Print system configuration settings

- **Security**

- Default Authentication agent
- Authentication agents
- Policy agents
- Color access control

Clean Disk and Partial Clean functions

Active and repository firmware locations

The firmware bundle now consists of multiple parts. The main components are the Windows CE Operating System and the printer/peripheral firmware files.

There are two locations/partitions on the hard drive where the firmware components are stored:

- The Active – where the Operating System and firmware currently are executing
- The Repository – the recovery location

If the Active location is damaged, or a **Partial Clean** was performed, the printer automatically copies over the OS and firmware files from the Repository location and the printer recovers.

If both the Active and Repository locations are damaged, or a **Clean Disk** was performed, then both locations are gone and the error message **99.09.67** appears on the control-panel display. The user must upload the firmware to the printer in order for it to function again

-
- △ **CAUTION:** The **Clean Disk** option performs a disk initialization for the entire disk. The operating system, firmware files, and third party files (among other files) will be completely lost. HP does not recommend this action.
-

Partial Clean

The **Partial Clean** option erases all partitions and data on the disk drive, except for the firmware repository where a backup copy of the firmware file is stored. This allows the disk drive to be reformatted without having to download a firmware upgrade file to return the product to a bootable state.

Characteristics of a **Partial Clean**

- Customer-defined settings, third-party solutions, firmware files, and the operating system are deleted.
- Rebooting the product restores the firmware files from the Repository location, but does not restore any customer-defined settings.
- For previous HP products, a Hard Disk Initialization is similar to executing the **Partial Clean** function for this product.

-
- △ **CAUTION:** HP recommends backing-up product configuration data before executing a **Partial Clean** if you need to retain customer-defined settings. See the **Backup/Restore** item in the **Device Maintenance** menu.
-

Reasons for performing **Partial Clean**

- The product continually boots up in an error state.

📝 **NOTE:** Try clearing the error prior to executing a **Partial Clean**.

- The product will not respond to commands from the control panel.
- Executing the **Partial Clean** function is helpful for troubleshooting hard disk problems.

- To reset the product by deleting all solutions and customer-defined settings.
- The product default settings are not properly working.

Execute a Partial Clean

1. Turn the product on.
2. When the Ready, Data, and Attention LEDs are illuminated solid, press the **Stop** button.
3. Press the **Down** arrow button ▼ to highlight **Administration**, and then press the OK button.
4. Press the **Down** arrow button ▼ to highlight **Partial Clean**, and then press the OK button.
5. Press the OK button again.
6. Press the Back button to highlight **Continue**, and then press the OK button.

 **NOTE:** The product initializes.

Clean Disk

The **Clean Disk** option erases the entire disk drive.

△ **CAUTION:** After executing a **Clean Disk** option, the product is *not* bootable.

Characteristics of a **Partial Clean**

- Customer-defined settings, third-party solutions, firmware files, and the operating system are deleted.

 **NOTE:** Rebooting the product *does not* restore the firmware files.

- Rebooting the product restores the firmware files from the Repository location, but does not restore any customer-defined settings.
- After executing the **Clean Disk** function, the message **99.09.67** displays on the control panel.
- After executing the **Clean Disk** function, the product firmware must be reloaded.

△ **CAUTION:** HP recommends that you do not use the **Clean Disk** option unless an error occurs and the solution in the product service manual recommends this solution. After executing the **Clean Disk** function, the product is unusable.

HP recommends backing-up product configuration data before executing a **Clean Disk** if you need to retain customer-defined settings. See the **Backup/Restore** item in the **Device Maintenance** menu.

Reasons for performing **Clean Disk**

- The product continually boots up in an error state.

 **NOTE:** Try clearing the error prior to executing a **Clean Disk**.

- The product will not respond to commands from the control panel.
- Executing the **Clean Disk** function is helpful for troubleshooting hard disk problems.
- To reset the product by deleting all solutions and customer-defined settings.

Execute a Clean Disk

1. Turn the product on.
2. When the Ready, Data, and Attention LEDs are illuminated solid, press the **Stop** button.
3. Press the **Down** arrow button ▼ to highlight **Administration**, and then press the OK button.
4. Press the **Down** arrow button ▼ to highlight **Clean Disk**, and then press the OK button.
5. Press the OK button again.



NOTE: When the **Clean Disk** operation is complete, you will need to reload the product firmware.

Preboot menu options

If an error occurs while the product is booting, an error message appears on the control-panel display. The user can access the Preboot menus. The Error menu item will not be seen if an error did not occur.

Cold reset using the Preboot menu

1. Turn the product on.
2. Press the **Stop** ⊗ button when the Ready, Data, and Attention LEDs are illuminated solid.
3. Use the **Down** arrow ▼ button to highlight **Administrator**, and then press the OK button.
4. Use the **Down** arrow ▼ button to highlight **Startup Options**, and then press the OK button.
5. Use the **Down** arrow ▼ button to highlight **Cold Reset**, and then press the OK button.
6. Press the Back button twice to highlight **Continue**, and then press the OK button.

 **NOTE:** The product will initialize.

Table 64 Preboot menu options (1 of 5)

Menu option	First level	Second level	Third level	Description
Continue				Selecting the Continue item exits the Preboot menu and continues the normal boot process. If a selection is not made in the initial menu within 30 seconds, the product returns to a normal boot (the same as selecting Continue . If the user navigates to another menu, the timeout does not apply.
Sign In				Enter the Administrator PIN or Service PIN if one is required to access the Preboot menu.

Table 64 Preboot menu options (1 of 5) (continued)

Menu option	First level	Second level	Third level	Description
Administrator				<p>This item navigates to the Administrator sub menus.</p> <p>If authentication is required (and the user is not already signed in) the Sign In displays. The user is required to sign in.</p>
	Download			<p>This item initiates a preboot firmware download process. A USB device interface or a Network connection can be used to download firmware.</p>
		Network		<p>See Product updates on page 292.</p>
		USB <X>		<p>See Product updates on page 292.</p>
	Clean Disk			<p>This item reinitializes the disk and cleans all disk partitions.</p> <p>CAUTION: Selecting the Clean Disk item removes all data.</p> <p>A delete confirmation prompt is not provided.</p> <p>The system is not bootable after this action—a firmware download must be performed to return the system to a bootable state.</p>
	Partial Clean			<p>This item reinitializes the disk (removing all data except the firmware repository where the master firmware bundle is downloaded and saved).</p> <p>CAUTION: Selecting the Partial Clean item removes all data except the firmware repository.</p> <p>A delete confirmation prompt is not provided.</p> <p>This allows user to reformat the disk by removing the firmware image from the active directory without having to download new firmware code (product remains bootable).</p>
	Change Password			<p>Select this item to set or change the administrator password.</p>
	Clear Password			<p>Select the Clear Password item to remove a password from the Administrator menu. Before the password is actually cleared, a message will be shown asking to confirm that the password should be cleared. Press the OK button to confirm the action.</p> <p>When the confirmation prompt appears, press the OK button to clear the password.</p>

Table 65 Preboot menu options (2 of 5)

Menu option	First level	Second level	Third level	Description	
Administrator continued	Manage Disk	Clear Disk		Select the Clear Disk item to enable an external device for job storage. Job storage is normally enabled only for the Boot device. This will be grayed out unless the 99.09.68 error is displayed.	
		Lock Disk		Select the Lock Disk item to lock (mate) a new secure disk to this product. The secure disk already locked to this product will remain accessible to this product. Use this function to have more than one encrypted disk accessible by the product when using them interchangeably. The data stored on the secure disk locked to this product always remains accessible to this product.	
		Leave Unlocked		Select the Leave Unlocked item to use a new secure disk in an unlocked mode for single service event. The secure disk that is already locked to this product will remain accessible to this product and uses the old disk's encryption password with the new disk. The secure disk that is already locked to this product remains accessible to this product.	
		Clear Password		Select the Clear Password item to continue using the non-secure disk and clear the password associated with the yet to be installed secure disk. CAUTION: Data on the missing secure disk will be permanently inaccessible.	
		Retain Password		Select the Retain Password item to use the non-secure disk for this session only, and then search for the missing secure disk in future sessions.	
		Boot Device			
		Secure Erase		Select the Secure Erase item to erase all of the data on the disk and unlock it if required. This might take a long time. NOTE: The system will be unusable until the system files are reinstalled. ATA secure-erase command one pass over write. Erases entire disk including firmware. The disk remains an encrypted disk.	
		Erase and Unlock		Select the Erase and Unlock item to cryptographically erase all data on disk and unlock the disk to allow access to it from any product. NOTE: The system will be unusable until the system files are reinstalled. Erases the crypto key. The disk becomes a non-encrypted disk.	
		Get Status		This item provides disk status information if any is available.	

Table 66 Preboot menu options (3 of 5)

Menu option	First level	Second level	Third level	Description
Administrator continued	Manage Disk continued	Internal Device		Select the Internal Device item to erase the internal device or get status about the internal device.
			Secure Erase	Select the Secure Erase item to erase all of the data on the disk and unlock it if required. This might take a long time. NOTE: The system will be unusable until the system files are reinstalled. ATA secure-erase command one pass over write. Erases the entire disk, including firmware. The disk remains an encrypted disk.
			Erase and Unlock	Select the Erase and Unlock item to cryptographically erase all data on disk and unlock the disk to allow access to it from any product. NOTE: The system will be unusable until the system files are reinstalled. Erases the crypto key. The disk becomes a non-encrypted disk.
			Get Status	This item provides disk status information if any is available.
		External Device	Select the External Device item to erase the internal device or get status about the internal device.	
		Secure Erase	Select the Secure Erase item to erase all of the data on the disk and unlock it if required. This might take a long time. NOTE: The system will be unusable until the system files are reinstalled. ATA secure-erase command one pass over write. Erases the entire disk, including firmware. The disk remains an encrypted disk.	
		Erase and Unlock	Select the Erase and Unlock item to cryptographically erase all data on disk and unlock the disk to allow access to it from any product. NOTE: The system will be unusable until the system files are reinstalled. Erases the crypto key. The disk becomes a non-encrypted disk.	
		Get Status	This item provides disk status information if any is available.	

Table 67 Preboot menu options (4 of 5)

Menu option	First level	Second level	Third level	Description	
Administrator continued	Configure LAN			Select the Configure LAN item to setup the network settings for the PreBoot menu firmware upgrade. The network can be configured obtain the network settings from a DHCP server or as static.	
			DHCP	Use this item for automatic IP address acquisition from the DHCP server.	
			Static	Use this item to manually assign the network addresses.	
				IP Address	Use this item to manually enter the IP addresses.
				Subnet Mask	Use this item to manually enter the subnet mask.
				Default Gateway	Use this item to manually enter the default gateway.
				Save and Exit	Select the Save and Exit item to save the manual settings.

Table 68 Preboot menu options (5 of 5)

Menu option	First level	Second level	Third level	Description
Administrator continued	Startup Options			Select the Startup Options item to specify options that can be set for the next time the product is turned on and initializes to the Ready state.
			Cold Reset	Check the Cold Reset item to clear the IP address and all customer settings (this item also returns all settings to factory defaults). NOTE: Items in the Service menu are not reset.
			First Power	Not currently functional: This item allows the product initialize as if it is the first time it has been turned on. For example, the user is prompted to configure first time settings like Select Date/Time, Select Language, and other settings). Check this item so that it is enabled for the next time the product power is turned on. When the product power is turned on the next time, this item is unchecked so that the pre-configured settings are used during configuration and the first time setting prompt is not used.
			Skip Plug-ins	This item allows the device to be started without loading the third party applications. This means that files including Accessible Architecture on the disk will not be available at bootup. This is useful for troubleshooting problems with the hard disk without having to remove the hard disk. It also applies to flash file system disks on DIMMs. In this case, this function will cause the printer to configure the HP firmware first, followed by the third-party applications. NOTE: The files on the disk will be available after the printer enters the Ready state.
			Skip Cal	Select the Skip Cal item to initialize the product the next time the power is turned on without calibrating.
			Show Revision	Not currently functional: Check the Show Revision item to allow the product to initialize and show the firmware version when the device reaches the Ready state. Once the product power is turned on the next time, the Show Revision item is unchecked so the firmware revision is not shown.
			Lock Service	CAUTION: Select the Lock Service item to lock the Service menu access (both PreBoot and Device Maintenance application). Service personnel must have the Administrator remove the Lock Service setting before they can enter the Service menu.

Table 69 Preboot menu options (5 of 5)

Menu option	First level	Second level	Third level	Description
Administrator	Startup Options	Skip Disk Scan		Check the Skip Disk Scan item to allow the product to initialize without scanning the disk.
continued	continued			If the product is crashing on Step 4/8, checking this item may allow the problem to be isolated.
				Once the device is turned on the next time, the Skip Disk Scan item is unchecked and the disk scan is not skipped.
		Embedded Jetdirect Off		Check the Embedded Jetdirect Off item to disable the embedded Jetdirect. By default this item is unchecked so that Jetdirect is always enabled.
Service Tools				This item requires the Service access code.
	Reset Password			Use this item to clear the Administrator password.
	Subsystems			For manufacturing use only. Do not change these values.

Product updates

To download the most recent firmware upgrade for the product, go to www.hp.com/support/cljcp5525 or www.hp.com/go/cljcp5525_firmware.

Determine the installed revision of firmware

Print a configuration page to determine the installed revision of firmware. See [Configuration page on page 97](#).

On the configuration page, look in the section marked Device Information for the firmware datecode and firmware revision.

Firmware datecode and firmware revision examples

- 20100831 (firmware datecode)
- 103067_104746 (firmware revision)

Perform a firmware upgrade

The firmware bundle is a xxxxxxxx.bdl file. This file requires an interactive upgrade method. You cannot upgrade the printer using the traditional FTP, LPR or Port 9100 methods of upgrading. Use one of the following methods to upgrade the firmware for this product.

Embedded Web Server

1. Open an browser window.
2. Enter the product IP address in the URL line.
3. Select the **Firmware upgrade** link from within the **Troubleshooting** tab.

 **NOTE:** If you get a warning screen, follow the instructions for setting an administrator password from the **Security** tab.

4. Browse to the location that the firmware upgrade file was downloaded to, and then select the firmware file. Select the Install button to perform the upgrade.

 **NOTE:** Do not close the browser window until the Embedded Web Server (EWS) displays the confirmation page.

5. Select **Restart Now** from the EWS confirmation page, or turn the product off, and then on again using the power switch.

USB storage device (Preboot menu)

1. Copy the `xxxxxxxx.bdl` file to a portable USB flash memory storage device (thumb drive).
2. Turn the product on.
3. Press the **Stop** button when the Ready, Data and Attention LEDs illuminate solid.
4. Press the down arrow ▼ button to highlight **Administrator**, and then press the OK button.
5. Press the down arrow ▼ button to highlight **Download**, and then press the OK button.
6. Insert the portable USB storage device with the `xxxxxxxx.bdl` file on it.

 **NOTE:** If the error message **No USB Thumbdrive Files Found** appears on the control-panel display, you might need to connect the storage device to the external USB connection on the formatter.

7. Press the down arrow ▼ button to highlight **USB Thumb Drive**, and then press the OK button.
8. Press the down arrow ▼ button to highlight the `xxxxxxxx.bdl` file, and then press the OK button.

 **NOTE:** The upgrade process can take up to 10 minutes to complete.

 **TIP:** If there is more than one `xxxxxxxx.bdl` file on the storage device, make sure that you select the correct file for this product.

9. When the message **Complete** appears on the control-panel display, press the Back button 3 times.
10. When the message **Continue** appears on the control-panel display, press the OK button. The product will initialize.
11. When the upgrade process is complete, print a configuration page and verify that the upgrade firmware version was installed. See [Configuration page on page 97](#) and [Determine the installed revision of firmware on page 292](#).

USB storage device (control-panel menu)

1. Copy the xxxxxxxx.bdl file to a portable USB flash memory storage device (thumbdrive).
2. Turn the product on, and then wait until it reaches the Ready state.
3. Press the Home button or OK button.
4. Press the down arrow ▼ button to highlight **Device Maintenance**, and then press the OK button.
5. Press the down arrow ▼ button to highlight **USB Firmware Upgrade**, and then press the OK button.
6. Insert the portable USB storage device with the xxxxxxxx.bdl file on it into the USB port on the front of the product, and then press the OK button.
7. Press the down arrow ▼ button to highlight the xxxxxxxx.bdl file, and then press the OK button.

 **TIP:** If there is more than one xxxxxxxx.bdl file on the storage device, make sure that you select the correct file for this product.

8. A prompt to upgrade an older, newer, or reinstall the same version appears. Press the down arrow ▼ button to highlight the desired option, and then press the OK button.

When the upgrade is complete, the product will initialize.

 **NOTE:** The upgrade process can take up to 10 minutes to complete.

9. When the upgrade process is complete, print a configuration page and verify that the upgrade firmware version was installed. See [Configuration page on page 97](#) and [Determine the installed revision of firmware on page 292](#).