



# LASERJET PRO 200 COLOR MFP

## Troubleshooting Manual



M276





# HP LaserJet Pro 200 color MFP M276 Series

Troubleshooting Manual

**Copyright and License**

© 2012 Copyright Hewlett-Packard Development Company, L.P.

Reproduction, adaptation, or translation without prior written permission is prohibited, except as allowed under the copyright laws.

The information contained herein is subject to change without notice.

The only warranties for HP products and services are set forth in the express warranty statements accompanying such products and services. Nothing herein should be construed as constituting an additional warranty. HP shall not be liable for technical or editorial errors or omissions contained herein.

Part number: CF144-90996

Edition 1, 9/2012

**Trademark Credits**

Microsoft®, Windows®, Windows® XP, and Windows Vista® are U.S. registered trademarks of Microsoft Corporation.

ENERGY STAR and the ENERGY STAR mark are registered U.S. marks.

## Conventions used in this guide

---

 **TIP:** Tips provide helpful hints or shortcuts.

 **NOTE:** Notes provide important information to explain a concept or to complete a task.

 **CAUTION:** Cautions indicate procedures that you should follow to avoid losing data or damaging the product.

 **WARNING!** Warnings alert you to specific procedures that you should follow to avoid personal injury, catastrophic loss of data, or extensive damage to the product.

---



---

# Table of contents

<b>1 Theory of operation .....</b>	<b>1</b>
Basic operation .....	2
Major product systems .....	2
Product components .....	3
Sequence of operation .....	4
Engine control system .....	5
DC controller .....	6
Low-voltage power supply .....	7
High-voltage power supply .....	8
Laser/scanner system .....	9
Laser failure detection .....	9
Image-formation system .....	10
Image-formation process .....	10
Latent-image formation stage .....	11
Step 1: primary charging .....	12
Step 2: laser-beam exposure .....	12
Developing stage .....	12
Step 3: development .....	13
Transfer stage .....	14
Step 4: primary transfer .....	14
Step 5: secondary transfer .....	14
Step 6: separation from the ITB .....	15
Fusing stage .....	15
Step 7: fusing .....	15
ITB cleaning stage .....	16
Step 8: ITB cleaning .....	16
Drum cleaning stage .....	17
Step 9: drum cleaning .....	17
Pickup-and-feed system .....	18
Jam detection .....	19
Scanner system (base models) .....	20
Scanner power-on sequence of events .....	20

Copy or scan-to-computer sequence of events .....	21
Fax functions and operation (fax models only) .....	22
Computer and network security features .....	22
PSTN operation .....	22
Receive faxes when you hear fax tones .....	22
Distinctive ring function .....	23
Fax by using Voice over IP services .....	23
The fax subsystem .....	24
Fax card in the fax subsystem .....	24
Safety isolation .....	24
Safety-protection circuitry .....	25
Data path .....	25
Hook state .....	25
Downstream device detection .....	26
Hook switch control .....	26
Ring detect .....	26
Line current control .....	26
Billing- (metering-) tone filters .....	26
Fax page storage in flash memory .....	26
Stored fax pages .....	27
Advantages of flash memory storage .....	27
USB Flash Drive .....	28
<b>2 Solve problems .....</b>	<b>29</b>
Solve problems checklist .....	30
Menu map .....	32
Troubleshooting process .....	32
Pre-troubleshooting checklist .....	32
Power-on checks .....	34
Tools for troubleshooting .....	35
Component diagnostics .....	35
LED diagnostics .....	35
Network LEDs .....	35
Control panel LEDs .....	36
Control-panel diagnostics .....	37
Engine Diagnostics .....	37
Engine test .....	37
Diagrams .....	38
Plug/jack locations .....	38
DC controller PCA .....	39
Locations of major components .....	41



General timing charts .....	43
General circuit diagram .....	44
Internal print-quality test pages .....	44
Interpret the Print Quality Page .....	44
Print a cleaning page .....	45
Print a cleaning page .....	45
Configuration page .....	46
Print a configuration page .....	46
Print-quality troubleshooting tools .....	46
Repetitive image defects .....	46
Calibrate the product to align the colors .....	47
Control panel menus .....	48
Setup Menu .....	48
HP Web Services .....	48
Reports menu .....	49
Self Diagnostics menu .....	50
Fax Setup menu .....	50
System Setup menu .....	53
Service menu .....	57
Network Setup menu .....	59
Quick Forms menu .....	60
Function specific menus .....	61
USB Flash Drive .....	61
Fax Menu .....	61
Copy Menu .....	63
Scan Menu .....	65
Apps .....	66
Interpret control panel messages .....	67
Control panel message types .....	67
Control panel messages .....	67
10.X00Y Supply Error .....	67
49 Error, Turn off then on .....	68
50.x Fuser Error .....	68
51.XX Error .....	68
54.XX Error .....	68
55.X Error .....	69
57 Fan Error, Turn off then on .....	69
59.X Error .....	69
79 Error Turn off then on .....	70
Black Cartridge Low .....	70
Black in wrong position .....	70

Black Very Low .....	70
Cleaning .....	71
Cyan Cartridge Low .....	71
Cyan in wrong position .....	71
Cyan Very Low .....	71
Device error, press OK .....	72
Door open .....	72
Genuine HP supply installed .....	72
Incompatible <color> .....	72
Incorrect supplies .....	72
Install <color> cartridge .....	73
Invalid driver Press [OK] .....	73
Jam in Tray 1, Clear jam and then press OK .....	73
Load tray 1 Press [OK] for available media .....	73
Load Tray 1 <TYPE> <SIZE>, Press OK to use available media .....	73
Load Tray 1, <PLAIN> <SIZE> / Cleaning mode, OK to start .....	73
Magenta Cartridge Low .....	74
Magenta in wrong position .....	74
Magenta Very Low .....	74
Manual Duplex Load Tray 1, Press OK .....	74
Memory is low. Press OK. ....	75
Misprint, Press OK .....	75
Print failure, press OK. If error repeats, turn off then on. ....	75
Rear door open .....	75
Remove shipping lock from <color> cartridge .....	76
Remove shipping locks from cartridges .....	76
Replace <color> .....	76
Supplies low .....	76
Unexpected size in tray 1 Load <size> Press [OK] .....	76
Unsupported <color> Press [OK] to continue .....	77
Used <color> in use .....	77
Used <color> installed, to accept press OK .....	77
Used supplies in use .....	77
Yellow Cartridge Low .....	77
Yellow in wrong position .....	78
Yellow Very Low .....	78
Event-log messages .....	79
Clear jams .....	85
Jam locations .....	85
Clear jams from the document feeder .....	86
Clear jams in the paper input tray .....	87

Clear jams from the output bin .....	89
Clear jams from the rear door .....	89
Solve paper-handling problems .....	91
The product picks up multiple sheets of paper .....	91
The product does not pick up paper .....	91
Solve image quality problems .....	92
Use the correct paper type setting in the printer driver .....	92
Change the paper type setting for Windows .....	92
Change the paper type setting for Mac .....	92
Adjust color settings in the printer driver .....	93
Change the color theme for a print job .....	93
Change the color options .....	94
Use paper that meets HP specifications .....	94
Print a cleaning page .....	95
Calibrate the product to align the colors .....	95
Check the toner cartridges .....	96
Print the Supplies Status page .....	96
Inspect the print cartridge for damage .....	96
Repeating defects .....	97
Use the printer driver that best meets your printing needs .....	97
Solve performance problems .....	99
Factors affecting print performance .....	99
Print speeds .....	100
The product does not print or it prints slowly .....	101
The product does not print .....	101
The product prints slowly .....	102
Solve product connectivity problems .....	103
Solve direct-connect problems .....	103
Solve network problems .....	103
Poor physical connection .....	103
The computer is using the incorrect IP address for the product .....	103
The computer is unable to communicate with the product .....	104
The product is using incorrect link and duplex settings for the network .....	104
New software programs might be causing compatibility problems .....	104
The computer or workstation might be set up incorrectly .....	104
The product is disabled, or other network settings are incorrect .....	104
Solve wireless network problems .....	105
Wireless connectivity checklist .....	105
The control panel displays the message: The wireless feature on this product has been turned off .....	106
The product does not print after the wireless configuration completes .....	106

The product does not print, and the computer has a third-party firewall installed .....	106
The wireless connection does not work after moving the wireless router or product .....	106
Cannot connect more computers to the wireless product .....	107
The wireless product loses communication when connected to a VPN .....	107
The network does not appear in the wireless networks list .....	107
The wireless network is not functioning .....	108
Service mode functions .....	109
Secondary service menu .....	109
Open the secondary service menu .....	109
Secondary service menu structure .....	109
Product resets .....	110
Restore the factory-set defaults .....	111
NVRAM initialization .....	111
Solve fax problems .....	112
Fax troubleshooting checklist .....	112
Solve problems receiving faxes .....	114
The fax does not respond .....	114
The fax has a dedicated phone line .....	114
An answering machine is connected to the product .....	114
A telephone handset is connected to the product .....	115
The Answer Mode setting is set to the Manual setting .....	115
Voice mail is available on the fax line .....	115
The product is connected to a DSL phone service .....	116
The product uses a fax over IP or VoIP phone service .....	116
An error message displays on the control panel .....	117
The No fax detected. message displays .....	117
The Communication error. message displays .....	117
The Fax storage is full. message displays .....	118
The Fax is busy. message displays .....	118
A fax is received but does not print .....	119
The Private Receive feature is on .....	119
Sender receives a busy signal .....	119
A handset is connected to the product .....	119
A phone line splitter is being used .....	119
No dial tone .....	119
Fax cuts off or prints on two pages .....	120
Solve problems sending faxes .....	120
An error message displays on the control panel .....	121
The Communication error. message displays .....	121

No dial tone. ....	121
The Fax is busy. message displays .....	122
The No fax answer. message displays .....	122
Document feeder paper jam .....	123
The Fax storage is full. message displays .....	123
Scanner error .....	123
The control panel displays a Ready message with no attempt to send the fax .	124
The control panel displays the message "Storing page 1" and does not progress beyond that message .....	124
Faxes can be received, but not sent .....	124
Unable to use fax functions from the control panel .....	125
Unable to use speed dials .....	125
Unable to use group dials .....	125
Receive a recorded error message from the phone company when trying to send a fax .....	126
Unable to send a fax when a phone is connected to the product .....	126
Solve fax performance problems .....	127
Faxes are sending slowly .....	127
Fax quality is poor .....	128
Solve DSL problems .....	128
Cannot send or receive a fax on a PBX line .....	128
Product updates .....	128

## **Appendix A Service and support ..... 129**

Hewlett-Packard limited warranty statement .....	130
HP's Premium Protection Warranty: LaserJet print cartridge limited warranty statement .....	132
Data stored on the print cartridge .....	133
End User License Agreement .....	134
OpenSSL .....	136
Customer support .....	136
Repack the product .....	137

## **Appendix B Product specifications ..... 139**

Physical specifications .....	140
Power consumption, electrical specifications, and acoustic emissions .....	140
Environmental specifications .....	140

## **Appendix C Regulatory information ..... 141**

FCC regulations .....	142
Environmental product stewardship program .....	143
Protecting the environment .....	143

Ozone production .....	143
Power consumption .....	143
Paper use .....	143
Plastics .....	143
HP LaserJet print supplies .....	143
Return and recycling instructions .....	144
United States and Puerto Rico .....	144
Multiple returns (more than one cartridge) .....	144
Single returns .....	144
Shipping .....	144
Non-U.S. returns .....	145
Paper .....	145
Material restrictions .....	145
Disposal of waste equipment by users in private households in the European Union .....	146
Chemical substances .....	146
Material Safety Data Sheet (MSDS) .....	146
For more information .....	146
Declaration of conformity .....	147
Declaration of conformity (wireless model) .....	149
Certificate of Volatility .....	151
Safety statements .....	152
Laser safety .....	152
Canadian DOC regulations .....	152
VCCI statement (Japan) .....	152
Power cord instructions .....	152
Power cord statement (Japan) .....	152
EMC statement (Korea) .....	153
Laser statement for Finland .....	153
GS statement (Germany) .....	153
Substances Table (China) .....	154
Restriction on Hazardous Substances statement (Turkey) .....	154
Additional statements for telecom (fax) products .....	155
EU Statement for Telecom Operation .....	155
New Zealand Telecom Statements .....	155
Additional FCC statement for telecom products (US) .....	155
Telephone Consumer Protection Act (US) .....	156
Industry Canada CS-03 requirements .....	156
Additional statements for wireless products .....	158
FCC compliance statement—United States .....	158
Australia statement .....	158
Brazil ANATEL statement .....	158

Canadian statements ..... 158  
European Union regulatory notice ..... 158  
Notice for use in France ..... 159  
Notice for use in Russia ..... 159  
Korean statement ..... 159  
Taiwan statement ..... 160

**Index ..... 161**





---

# List of tables

Table 1-1	Sequence of operation .....	4
Table 2-1	DC controller connectors .....	39
Table 2-2	Major components .....	41
Table 2-3	Repetitive image defects .....	46
Table 2-4	Event-log messages .....	79
Table 2-5	Fax event log codes .....	84
Table 2-6	Secondary service menu .....	109
Table B-1	Physical specifications .....	140
Table B-2	Environmental specifications <sup>1</sup> .....	140



---

# List of figures

Figure 1-1	Product systems .....	2
Figure 1-2	Product components .....	3
Figure 1-3	Engine control system components .....	5
Figure 1-4	DC controller circuit diagram .....	6
Figure 1-5	Low-voltage power supply .....	7
Figure 1-6	High-voltage power supply .....	8
Figure 1-7	Laser/scanner system .....	9
Figure 1-8	Image-formation system .....	10
Figure 1-9	Image-formation process .....	11
Figure 1-10	Primary charging .....	12
Figure 1-11	Laser-beam exposure .....	12
Figure 1-12	Development .....	13
Figure 1-13	Primary transfer .....	14
Figure 1-14	Secondary transfer .....	14
Figure 1-15	Separation from the ITB .....	15
Figure 1-16	Fusing .....	15
Figure 1-17	ITB cleaning .....	16
Figure 1-18	Drum cleaning .....	17
Figure 1-19	Pickup-and-feed system .....	18
Figure 2-1	DC controller connectors .....	39
Figure 2-2	Major components .....	41
Figure 2-3	Timing diagram .....	43
Figure 2-4	Circuit diagram .....	44



---

# 1 Theory of operation

This chapter presents an overview of the major components of the product, and includes a detailed discussion of the image-formation system.

- [Basic operation](#)
- [Engine control system](#)
- [Laser/scanner system](#)
- [Image-formation system](#)
- [Pickup-and-feed system](#)
- [Scanner system \(base models\)](#)
- [Fax functions and operation \(fax models only\)](#)
- [USB Flash Drive](#)

# Basic operation

## Major product systems

The product includes the following systems:

- Engine control system
- Laser/scanner system
- Image-formation system
- Pickup-and-feed system

**Figure 1-1** Product systems

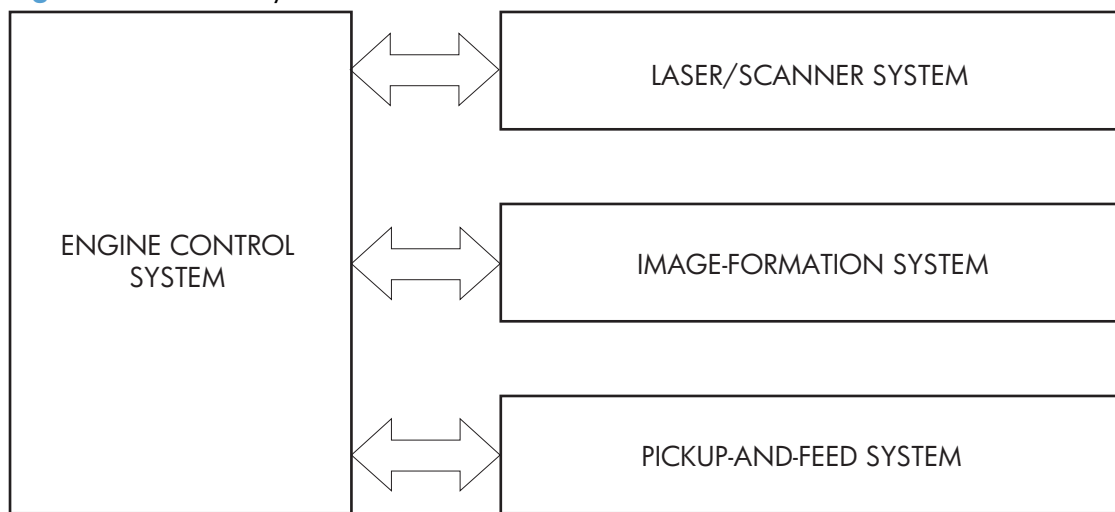

## Product components

Figure 1-2 Product components

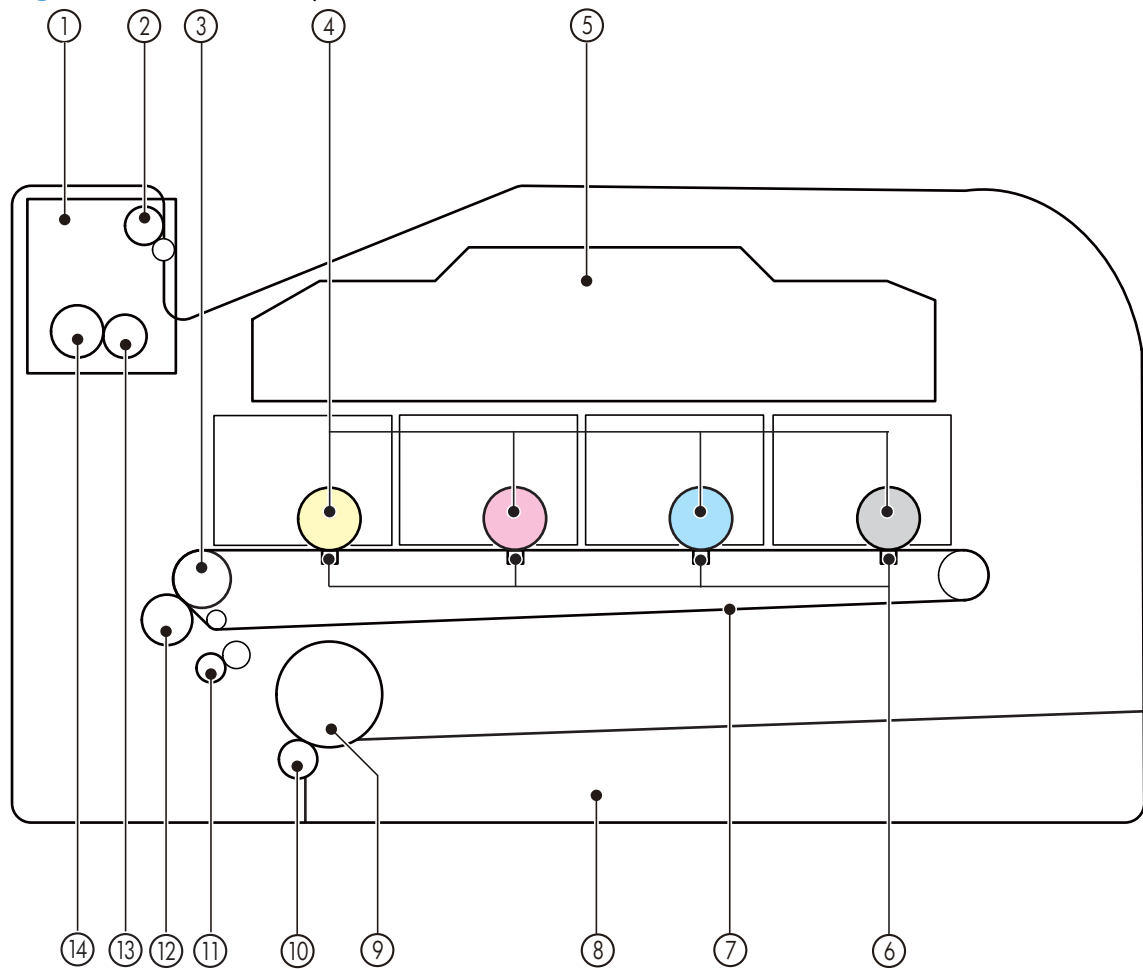

Item	Description	Item	Description
1	Fuser unit	8	Cassette
2	Delivery roller	9	Pickup roller
3	ITB drive roller	10	Separation roller
4	Photosensitive drum	11	Registration roller
5	Laser scanner assembly	12	Secondary transfer roller
6	Transfer pad	13	Fusing film
7	Intermediate transfer belt (ITB)	14	Pressure roller

## Sequence of operation

**Table 1-1 Sequence of operation**

<b>Period</b>	<b>Duration</b>	<b>Purpose</b>	<b>Remarks</b>
WAIT	From the time the power is turned on or the door is closed, until the printer is ready for a print operation	Clears the potential from the drum surface, adjusts the drum phase, and cleans the ITB	Detects the cartridge presence and environment; completes any required calibration (color registration control and image stability)
STBY (Standby period)	From end of the WAIT or LSTR period until either the print command is received from the formatter or the power is turned off	Maintains the printer in readiness for a print command	The printer enters sleep mode when the formatter sends a sleep command, and performs color registration and image stability control when the formatter sends those commands
INTR (Initial rotation)	From the time the print command is received until the media is picked up	Prepares the photosensitive drum for printing	
PRINT	From the end of INTR period until the fuser paper sensor detects the trailing edge of paper	Forms the images on the photosensitive drum and transfers the toner image to the print media	Performs image stabilization at a specified print interval or at specified times
LSTR (Last rotation)	From the end of the PRINT period until the delivery motor stops rotating	Moves the printed sheet out of the printer	The printer enters the INTR period as soon as the formatter sends another print command



# Engine control system

The engine control system coordinates all printer functions and drives the other three systems.

The engine control system contains the DC controller, high-voltage power-supply PCA, low-voltage power-supply unit, and fuser control.

**Figure 1-3** Engine control system components

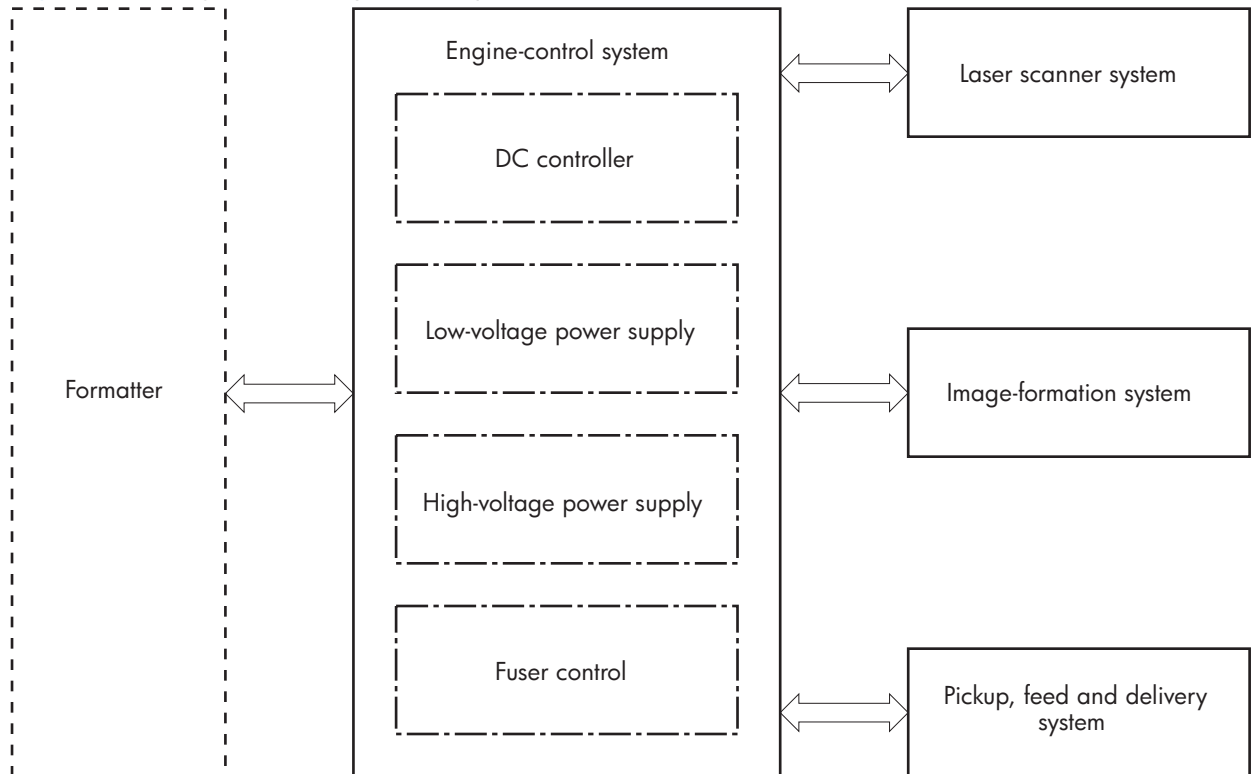

# DC controller

Figure 1-4 DC controller circuit diagram

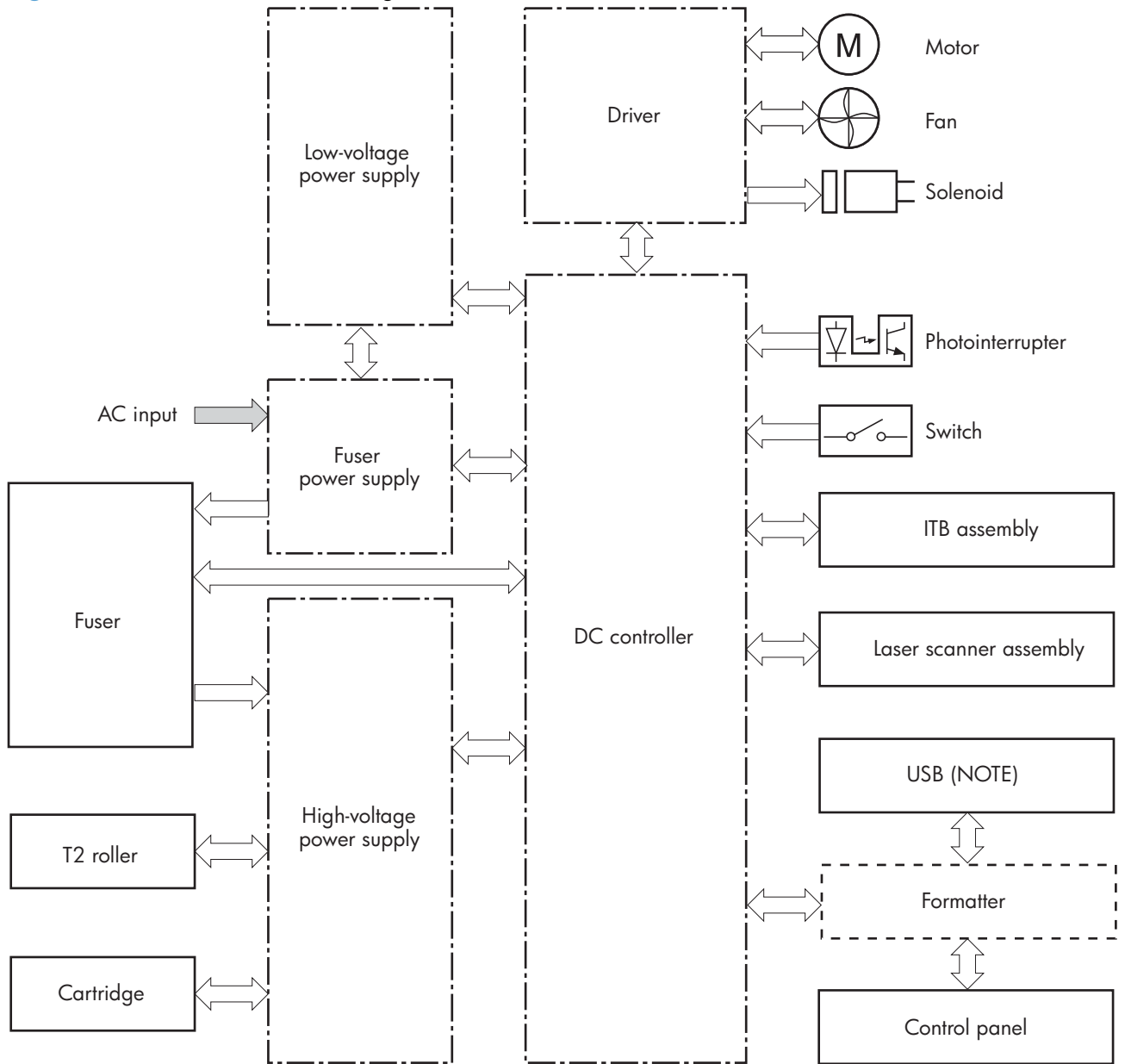

# Low-voltage power supply

**Figure 1-5** Low-voltage power supply

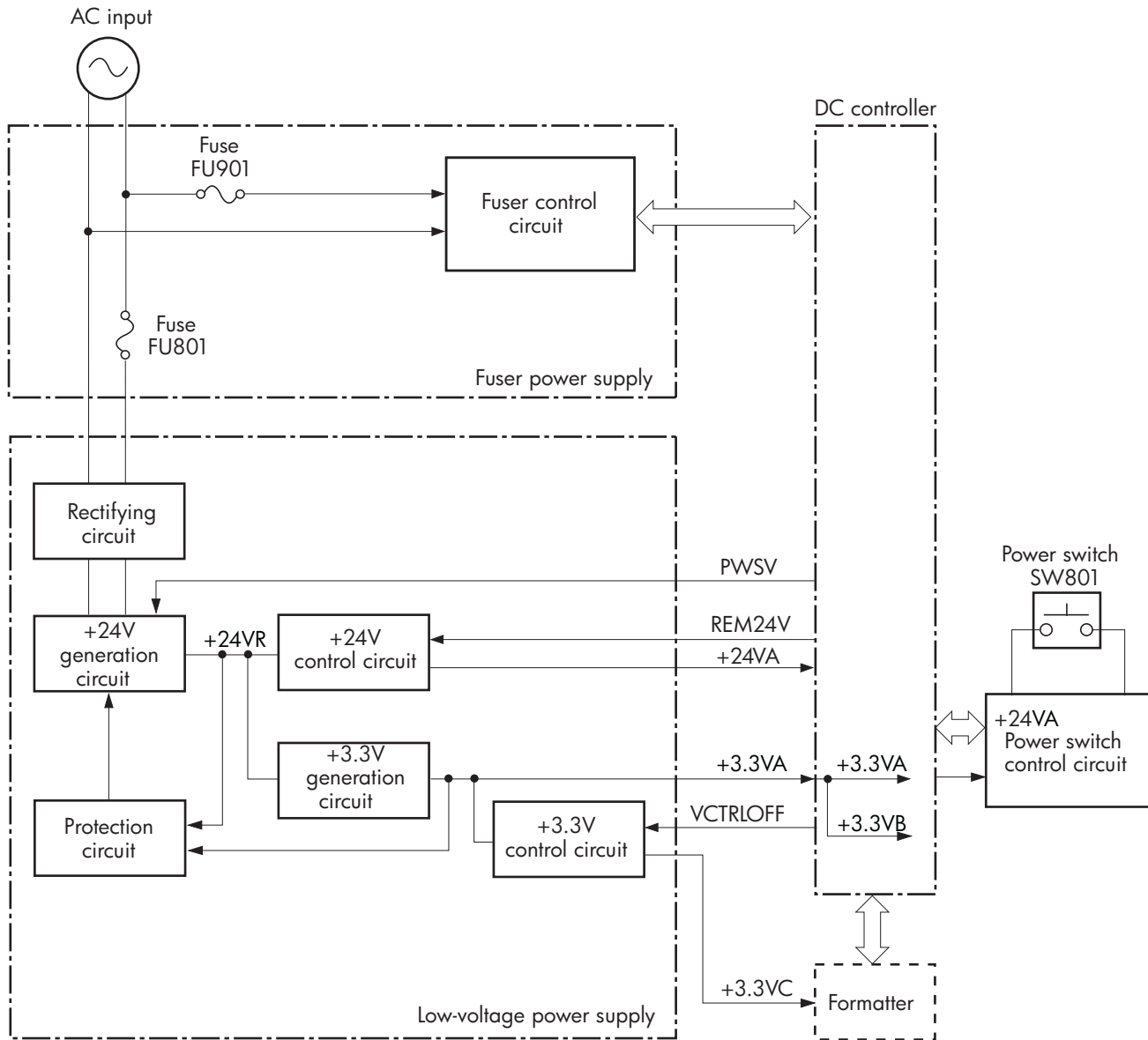

# High-voltage power supply

Figure 1-6 High-voltage power supply

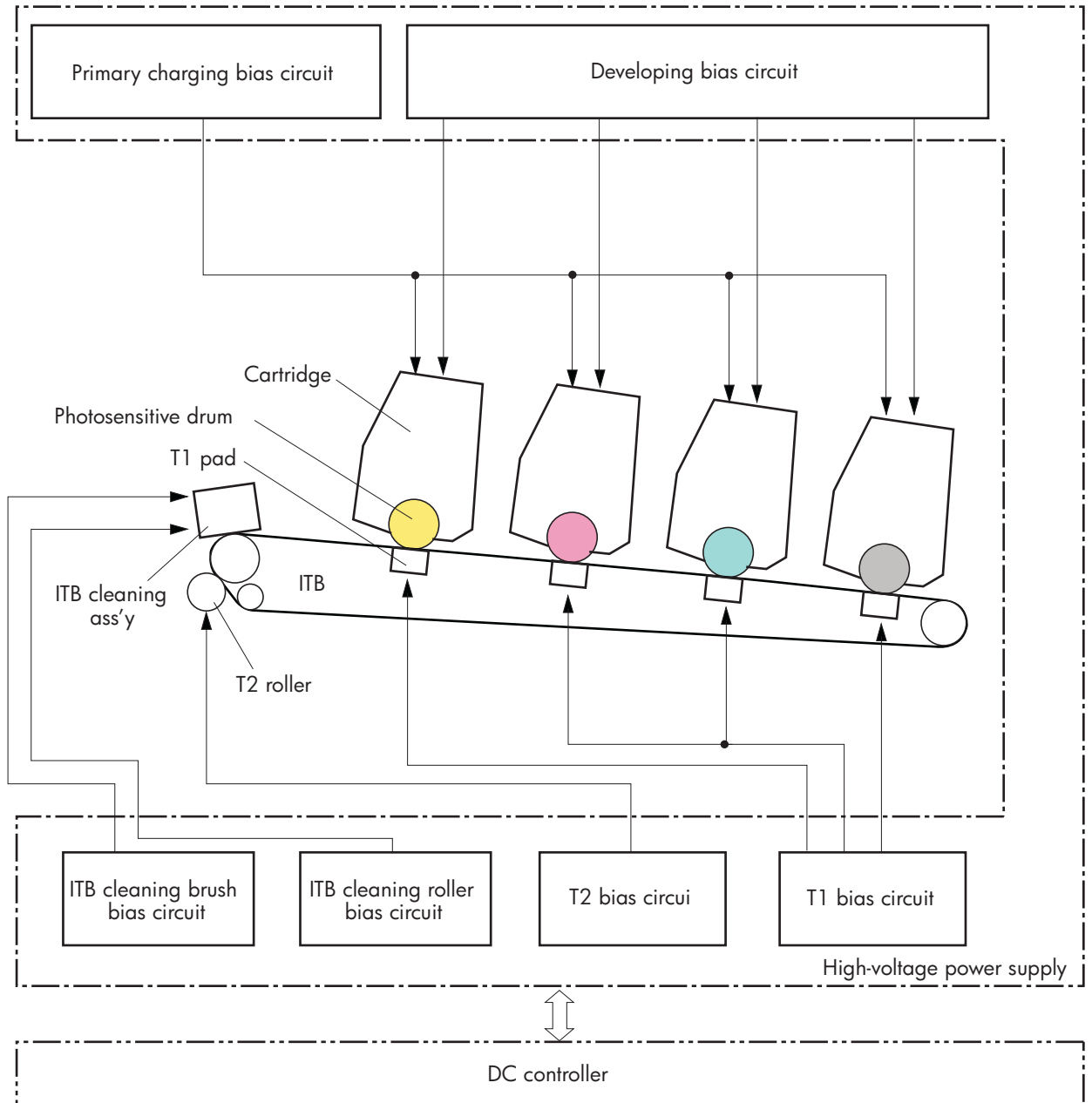

# Laser/scanner system

The formatter sends video signals to the DC controller, which controls the laser/scanner. When the laser/scanner system receives those signals, it converts them to latent images on the photosensitive drum.

**Figure 1-7** Laser/scanner system

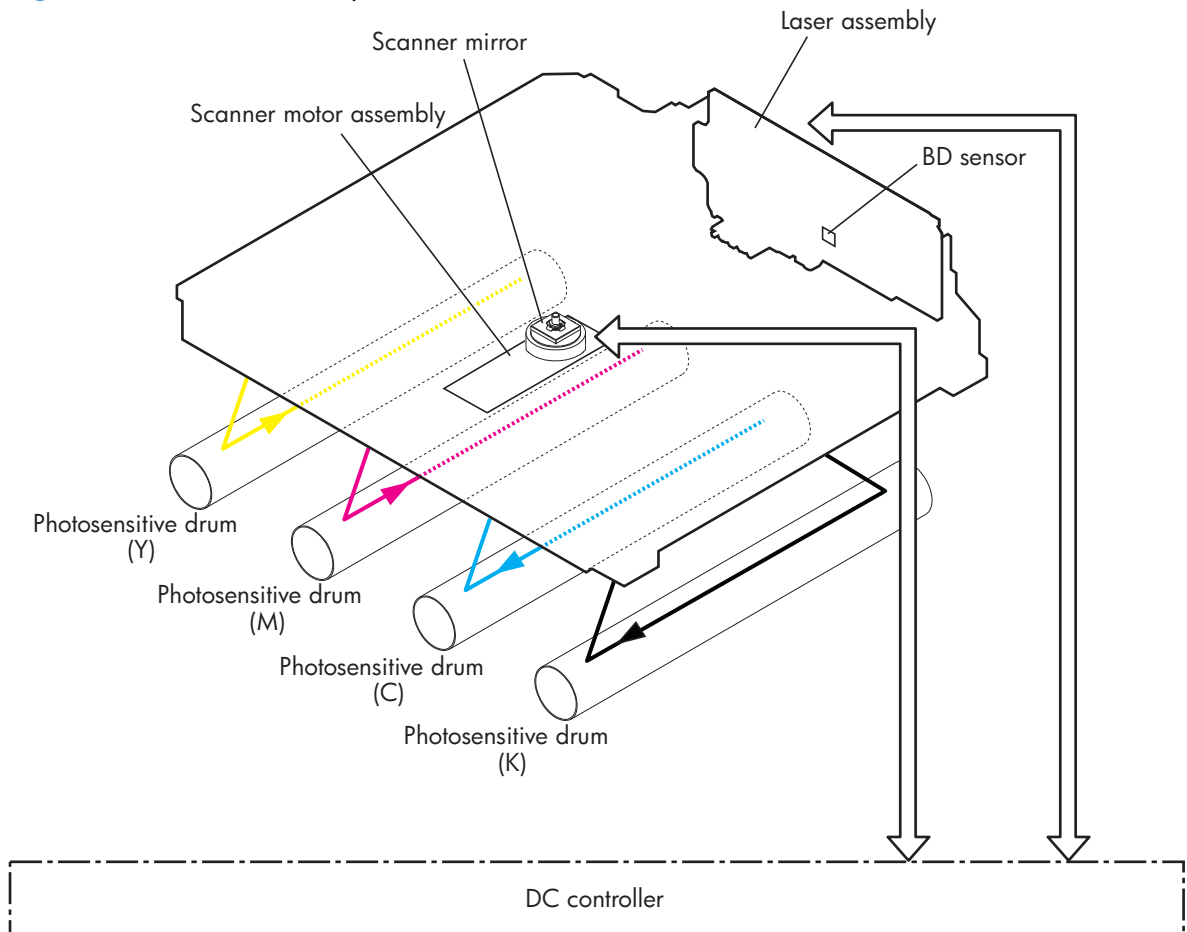

## Laser failure detection

The optical unit failure detection sensor manages the laser/scanner unit failure-detection functions. The DC controller identifies the laser/scanner unit failure and notifies the formatter if the laser/scanner unit encounters the following conditions:

- Scanner motor failure
- BD failure

# Image-formation system

The image-formation system forms a toner image on media. The product includes four toner cartridges that contain the toner. Toner is applied in the following order, using only the colors necessary for a specific image: yellow (Y), magenta (M), cyan (C), and black (K).

**Figure 1-8** Image-formation system

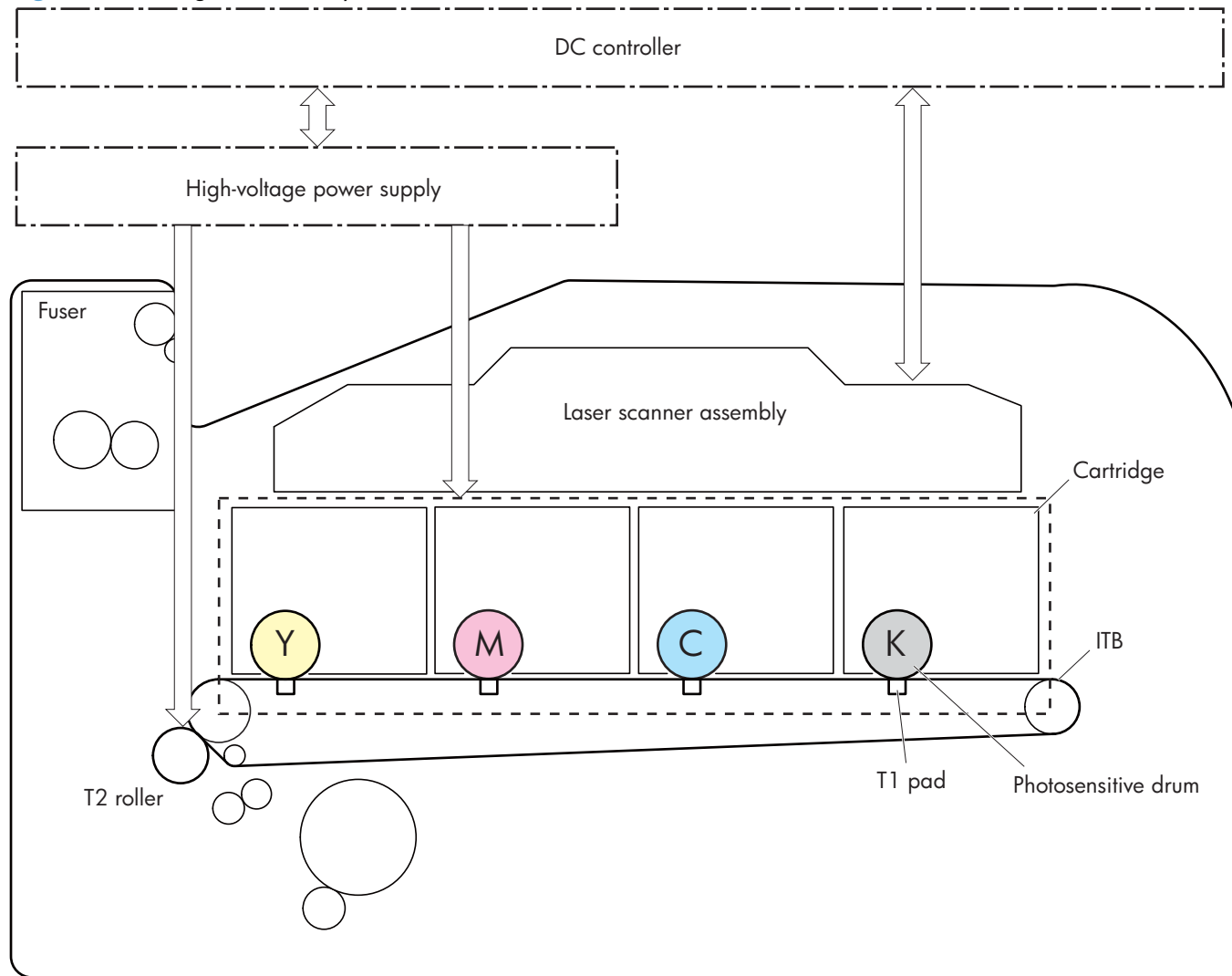

## Image-formation process

Laser printing requires the interaction of several different technologies including electronics, optics, and electrographics to provide a printed page. Each process functions independently and must be coordinated with the other processes. Image formation consists of the following processes:

- Latent-image formation
- Development
- Transfer

- Fuser
- ITB cleaning
- Drum cleaning

These processes are divided into nine steps, which are shown in [Figure 1-9 Image-formation process](#) on page 11 and described in the following sections.

**Figure 1-9** Image-formation process

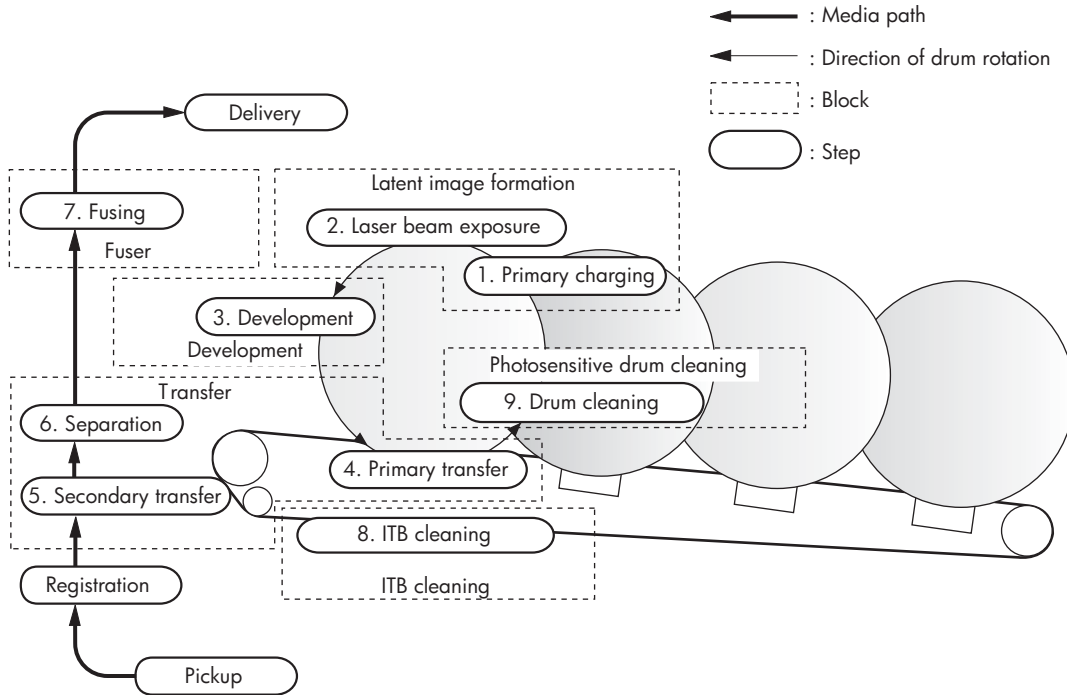

## Latent-image formation stage

During the two steps that comprise this stage, a latent image is formed by applying a negative charge to the photosensitive drum. You cannot see this image on the drum.

## Step 1: primary charging

A high-voltage DC bias is applied to the primary charging roller, which is made of conductive rubber and is in contact with the drum surface. As the roller moves across the drum, it applies the negative charge to that surface.

**Figure 1-10** Primary charging

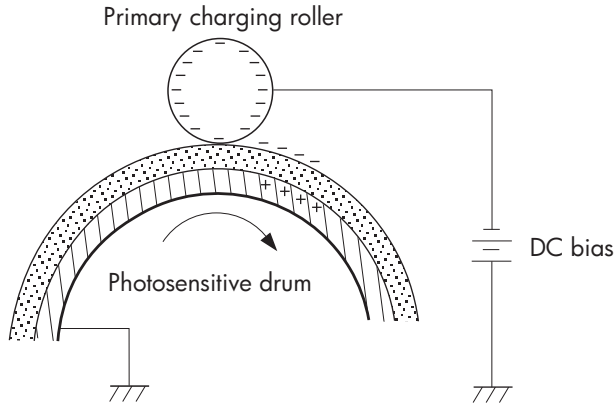

## Step 2: laser-beam exposure

The laser beam scans the photosensitive drum to neutralize the negative charge on portions of the drum surface. An electrostatic latent image is formed where the negative charge was neutralized.

**Figure 1-11** Laser-beam exposure

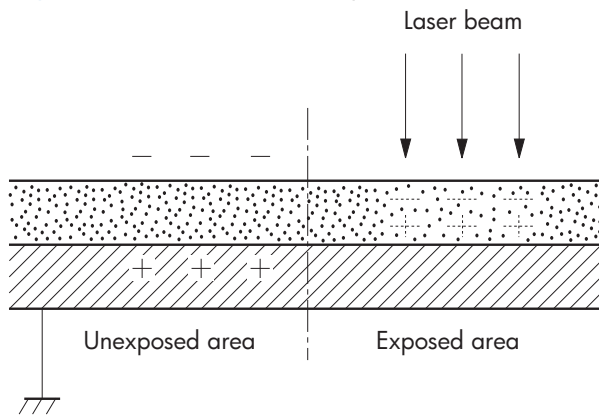

## Developing stage

The developer roller comes in contact with the photosensitive drum and deposits toner on the electrostatic latent image.



### Step 3: development

Toner acquires a negative charge as a result of the friction from the developer roller rotating against the developer blade. When the negatively charged toner comes in contact with the drum, it adheres to the electrostatic latent image. When the toner is on the drum, the image becomes visible.

**Figure 1-12** Development

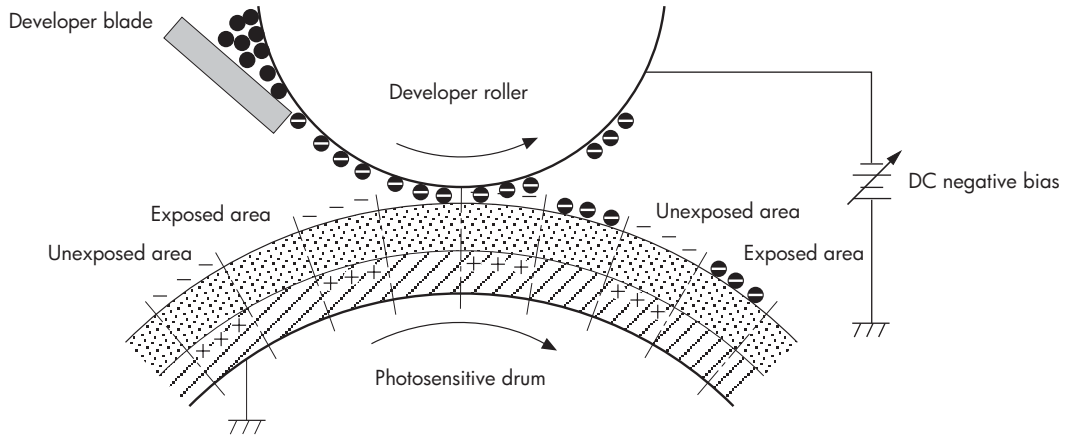

## Transfer stage

### Step 4: primary transfer

The toner image on the photosensitive drum is transferred to the ITB. The DC positive bias is applied to the primary transfer pad. The negatively charged toner transfers to the ITB from the drum surface.

**Figure 1-13** Primary transfer

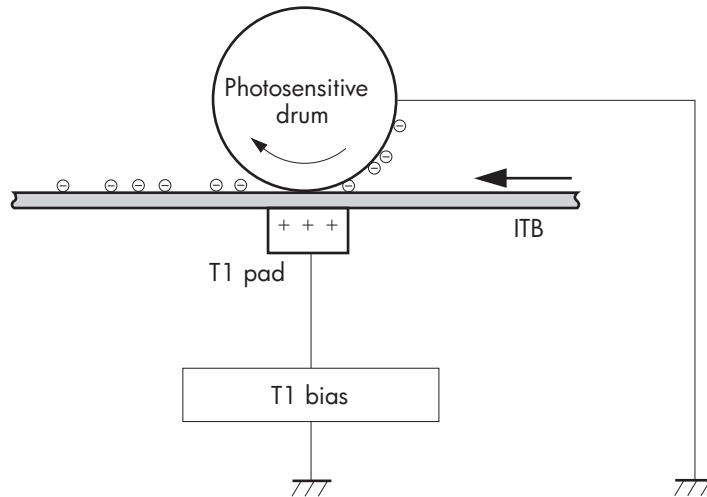

### Step 5: secondary transfer

The toner image on the ITB is transferred to the print media. The DC positive bias is applied to the secondary transfer roller. As the media passes between the secondary transfer roller and the ITB, the toner image is transferred to the media.

**Figure 1-14** Secondary transfer

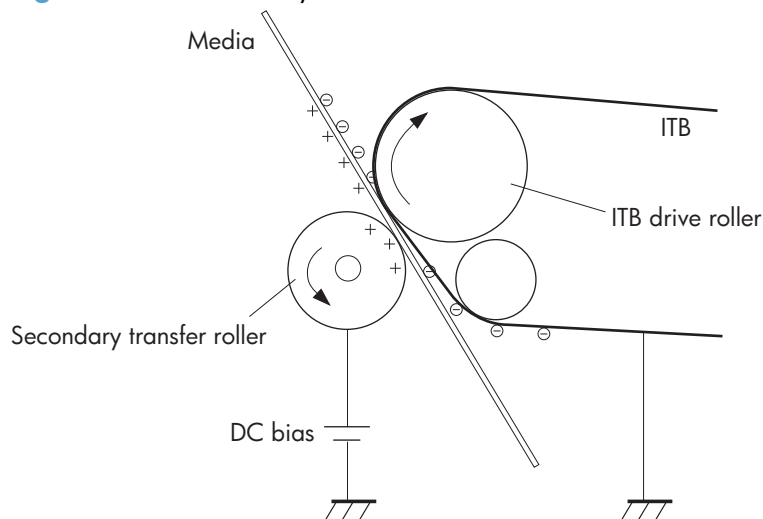

## Step 6: separation from the ITB

The elasticity of the print media and the curvature of the ITB drive roller cause the media to separate from the ITB.

**Figure 1-15** Separation from the ITB

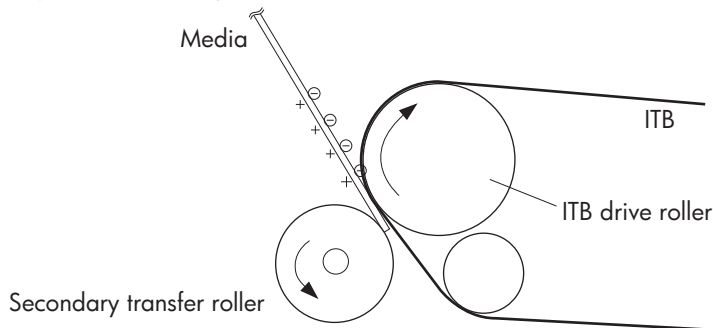

## Fusing stage

Until the fusing stage is complete, the image is not permanently affixed to the print media. The toner can be easily smudged until the heat and pressure of the fusing process fix the image to the sheet.

## Step 7: fusing

The product uses an on-demand fixing method to fix the toner image onto the media. The toner image is permanently affixed to the print media by heat and pressure.

**Figure 1-16** Fusing

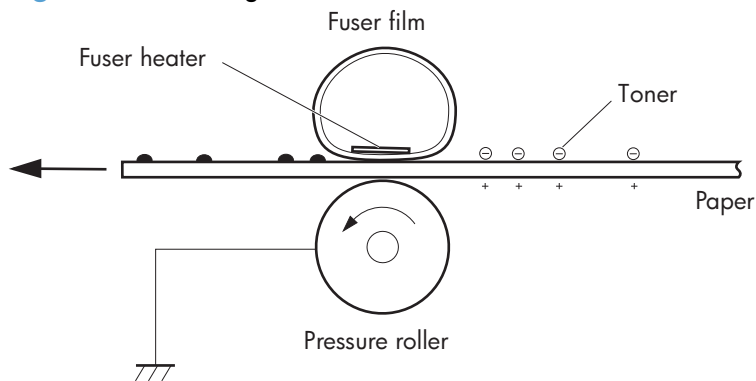

## ITB cleaning stage

### Step 8: ITB cleaning

The ITB cleaning roller and the cleaning brush are applied with the DC positive bias to charge the residual toner positive. Because the primary transfer pad is also applied with the DC positive bias, the positively charged residual toner is reverse-transferred to the photosensitive drum from the ITB surface.

**Figure 1-17** ITB cleaning

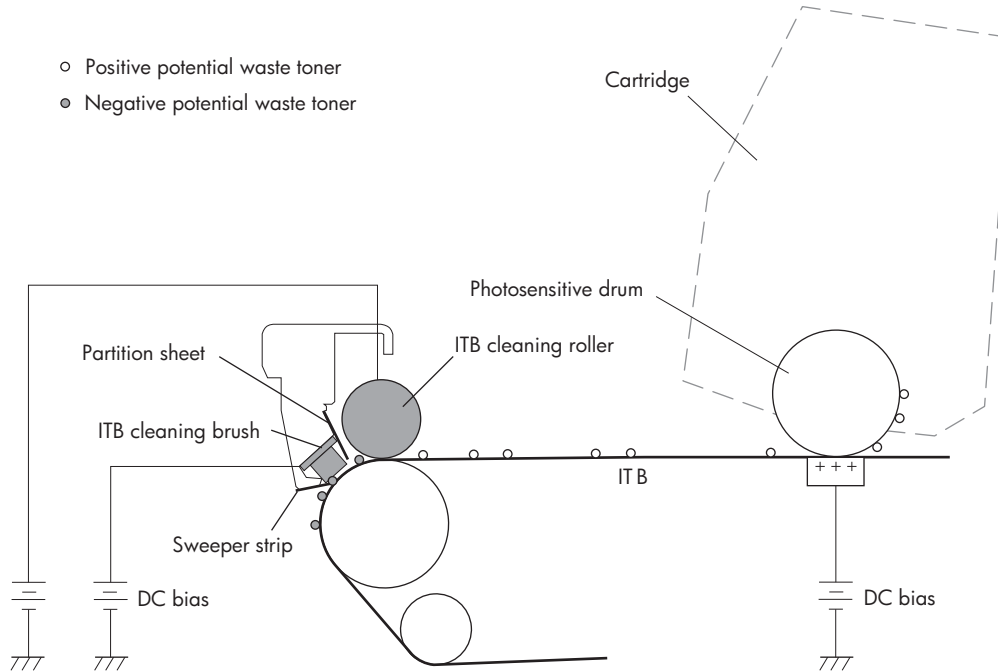

## Drum cleaning stage

Not all of the toner is removed from the photosensitive drum during the transfer stage. During the cleaning stage, the residual, or waste, toner is cleared from the drum surface to prepare the surface for the next latent-image formation.

### Step 9: drum cleaning

The cleaning blade scrapes the residual toner off the surface of the photosensitive drum and deposits it in the waste-toner container. The drum is now clear and is ready for the next image-formation process.

**Figure 1-18** Drum cleaning

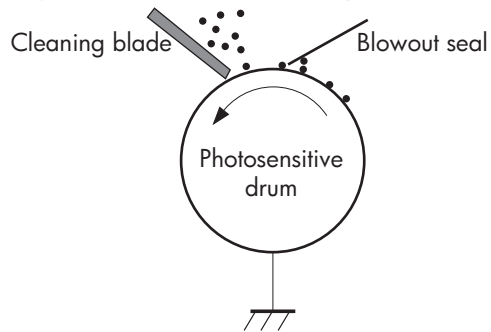

# Pickup-and-feed system

The pickup-and-feed system picks up and feeds the print media. It consists of several types of feed rollers.

**Figure 1-19** Pickup-and-feed system

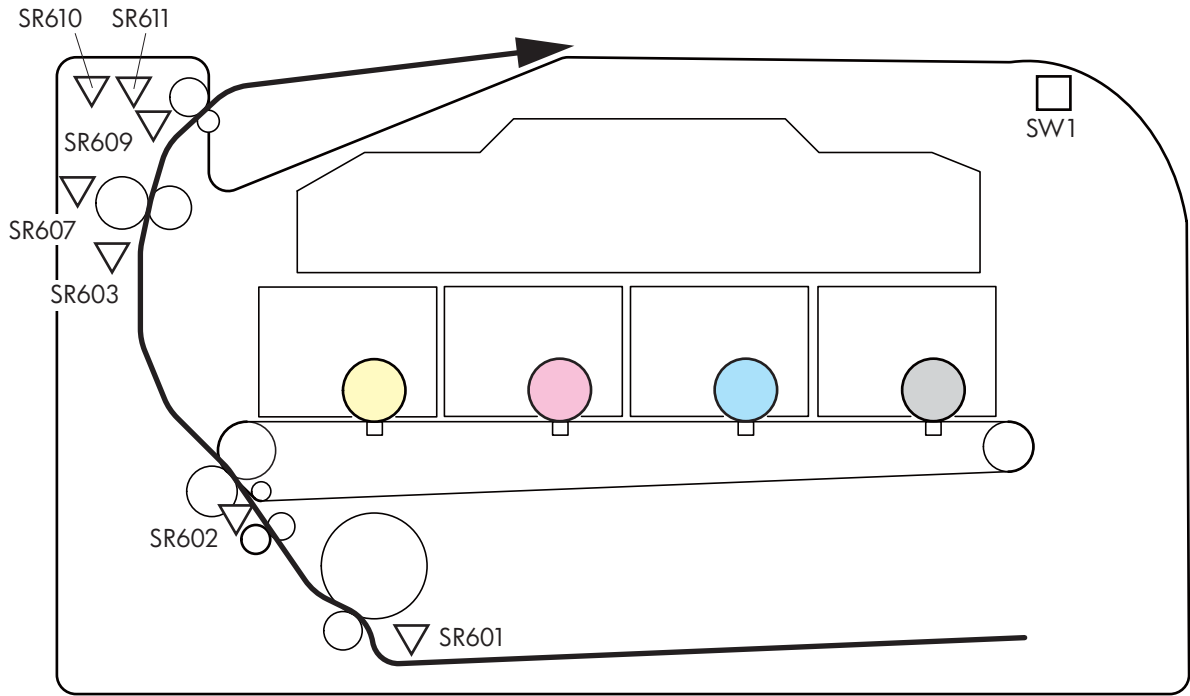

Number	Description	Number	Description
	Cassette paper out sensor	SR601	CASSETTE PAPER OUT signal
	Registration sensor	SR602	REGISTRATION signal
	Loop sensor	SR603	LOOP signal
	Fuser output sensor	SR609	FUSER OUTPUT signal
	Rear door open detection sensor	SR607	REAR DOOR OPEN DETECTION signal
	Paper width sensor (L)	SR610	PAPER WIDTH (L) signal
	Paper width sensor (R)	SR611	PAPER WIDTH (R) signal
	Front door open detection switch	SW1	FRONT DOOR OPEN DETECTION signal

## Jam detection

The product uses the following sensors to detect the presence of media and to check whether media is being fed correctly or has jammed:

- Cassette media-presence sensor
- Top-of-page sensor
- Loop sensor
- Fuser delivery sensor

The product detects the following jams:

- Pickup delay jam
- Pickup stationary jam
- Delivery delay jam
- Delivery stationary jam
- Fixing wrapping jam
- Residual media jam

## Scanner system (base models)

The flatbed image scanner captures an electronic image of the document on the glass. The scanner does this by illuminating the document with LEDs (red, green, and blue) and capturing the image in the image sensor to create an electronic format of the document. The flatbed scanner consists of three main elements

- **CIS scanner.** The CIS (contact image sensor) scanner captures an image using the product's optical path. Red, green, and blue LEDs sequentially illuminate a small strip of the document (often called a raster line), and the optical system captures each color in a single row of CCD sensors that cover the entire page width. Because only one color is captured for each line per exposure, the three colors are recombined electronically to create the full color image. For monochromatic scans or copies, all three LEDs are illuminated to create a white light for the scan so the raster line can be captured in one exposure.
- **Mechanical carriage drive.** The carriage drive moves the CIS scan head along the document length to create the image. In this product, a small DC motor with an optical encoder creates this motion. The speed of the carriage drive is proportional to the scan resolution (300 ppi is much faster than 1200 ppi) and also proportional to the type of scan (color scans are three-times slower than monochromatic scans). A 1200 ppi color scan moves so slowly that the product may appear to not be working, whereas a monochromatic copy scan moves at 50 times that speed and will be somewhat noisy.
- **Image processing system (formatter).** The formatter processes the scanner data into either a copy or a scan to the computer. For copies, the image data is sent directly to the product without being transmitted to the computer. Depending on user selections for the copy settings, the formatter enhances the scanner data significantly before sending it to the product. Image data is captured at 300 ppi for copies and is user selectable for scans to the computer. Each pixel is represented by 8 bits for each of the three colors (256 levels for each color), for a total of 24 bits per pixel (24-bit color).

## Scanner power-on sequence of events

When the product is turned on, it performs the following tests:

- **Motor test.** The product moves the motor left and right to confirm operation. It reports a scanner error 12 if no motion is detected in the motor encoder system.
- **Wall find.** The scan carriage moves slowly to the left while watching an encoder on the carriage motor to determine when the carriage has found the side wall or stop. This enables the product to identify the document origin (position of the original). If the document origin cannot be located, a default position is used instead.
- **LED check.** The product moves the carriage to the white calibration label under the left side of the flatbed image scanner, and it verifies that the minimum and maximum response is acceptable. It reports a scanner error 14 if the response is unacceptable.
- **Home find.** The scan carriage uses the optical scanner to find physical reference features that relate to the document origin at the left side of the image glass. This process ensures accurate location of the first document pixels so that the user documents will have an accurate placement of



the image on scans and copies. It reports a scanner error 6 message if the reference features are not found.

- **Calibration.** This test, also known as scanner color calibration, enables the product to identify the black and white on every pixel in the CCD. Calibration occurs in two major processes: a broad (analog) adjustment of all pixels to bring them into the target output range, and a pixel-by-pixel adjustment (digital) to fine tune the actual black and white response. The calibration process occurs under the left side of flatbed image scanner where there is a special white calibration label.

Calibration is the most important step in creating a high quality image. Calibration problems can include color and brightness inaccuracies, and vertical streaks through the image. The calibration process identifies any bad pixels and enables the image formatter to recreate the lost information from adjacent pixels. Extreme cases of this problem can appear as large vertical streaks or image smears. The user has no control over the calibration process itself or this pixel-replacement process.

## Copy or scan-to-computer sequence of events

To create an accurate rendition of a document, the scanner must be calibrated for the requested operation. If the user selects a scan at 600 ppi color, the flatbed image scanner calibrates for that specific operational mode. Subsequently, the flatbed image scanner automatically re-calibrates for the next requested operation. Calibration does not occur for every new copy request.

Normal sequence of operation for a flatbed copy or scan includes:

1. LEDs illuminate.
2. Carriage motion begins moving the CIS scanner toward the right.
3. Image capture continues for the entire page or length requested in a scan-to-computer operation.
4. Carriage returns to the home position on the left.

# Fax functions and operation (fax models only)

The following sections describe the product fax capabilities.

## Computer and network security features

The product can send and receive fax data over telephone lines that conform to public switch telephone network (PSTN) standards. The secure fax protocols make it impossible for computer viruses to be transferred from the telephone line to a computer or network.

The following product features prevent virus transmission:

- No direct connection exists between the fax line and any devices that are connected to the USB or Ethernet ports.
- The internal firmware cannot be modified through the fax connection.
- All fax communications go through the fax subsystem, which does not use Internet data-exchange protocols.

## PSTN operation

The PSTN operates through a central office (CO) that generates a constant voltage on the TIP and RING wires (48 V, usually). A device goes on-hook by connecting impedance (such as 600 ohms for the U.S.) across the TIP and RING so that a line current can flow. The CO can detect this current and can send impulses like dial tones. The product generates more signaling tones, such as dialing digits, to tell the CO how to connect the call. The product can also detect tones, such as a busy tone from the CO, that tell it how to behave.

When the call is finally connected, the CO behaves like a piece of wire connecting the sender and receiver. This is the period during which all of the fax signaling and data transfer occurs. When a call is completed, the circuit opens again and the line-current flow ceases, removing the CO connection from both the sender and the receiver.

On most phone systems, the TIP and RING signals appear on pins 3 and 4 of the RJ-11 modular jack (the one on the fax card, as defined in the common 6 wire RJ standard). These two signals do not have to be polarized because all of the equipment works with either TIP or RING on one pin and the other signal on the other pin. This means that cables of either polarity can interconnect and still work.

These basic functions of PSTN operation are assumed in the design of the fax subsystem. The product generates and detects the signaling tones, currents, and data signals that are required to transmit and receive faxes using the PSTN.

## Receive faxes when you hear fax tones

In general, incoming faxes to the product are automatically received. However, if other devices are connected to the same phone line, the product might not be set to answer automatically.

If the product is connected to a phone line that receives both fax and phone calls, and you hear fax tones when you answer the extension phone, receive the fax in one of two ways:

- If you are near the product, press **Start Fax** on the control panel.
- Press 1-2-3 in sequence on the extension phone keypad, listen for fax transmission sounds, and then hang up.

 **NOTE:** In order for the 1-2-3 sequence to work, the extension phone setting must be set to **On** in the **Fax Setup** menu.

## Distinctive ring function

Distinctive ring is a service that a telephone company provides. The distinctive ring service allows three phone numbers to be assigned to one phone line. Each phone number has a distinctive ring. The first phone number has a single ring, the second phone number has a double ring, and the third phone number has a triple ring.

 **NOTE:** The product has not been tested with all of the distinctive-ring services that telephone companies provide in all countries/regions. HP does not guarantee that the distinctive-ring function will operate correctly in all countries/regions. Contact the local phone service provider for assistance.

### Set up the distinctive ring function

1. Press **Setup** .
2. Use the arrow buttons to select **Fax Setup**, and then press **Enter**.
3. Use the arrow buttons to select **Basic Setup**, and then press **Enter**.
4. Use the arrow buttons to select **Distinctive Ring**, and then press **Enter**.
5. Use the arrow buttons to select one of the following options:

 **NOTE:** The control-panel display might show some of these options as abbreviations.

- **All Rings** (default setting)
- **Single**
- **Double**
- **Triple**
- **Double and Triple**

Press **Enter** to save the setting.

## Fax by using Voice over IP services

Voice over IP (VoIP) services provide normal telephone service, including long distance service through a broadband Internet connection. These services use packets to break up the voice signal on a telephone line and transmit it digitally to the receiver, where the packets are reassembled. The VoIP

services are often not compatible with fax machines. The VoIP provider must state that the service supports fax over IP services.

Because the installation process varies, the VoIP service provider will have to assist in installing the product fax component.

Although a fax might work on a VoIP network, it can fail when the following events occur:

- Internet traffic becomes heavy and packets are lost.
- Latency (the time it takes for a packet to travel from its point of origin to its point of destination) becomes excessive.

If you experience problems using the fax feature on a VoIP network, ensure that all of the product cables and settings are correct. Configuring the **Fax Speed** setting to **Medium(V.17)** or **Slow(V.29)** can also improve your ability to send a fax over a VoIP network.

If you continue to have problems faxing, contact your VoIP provider.

## The fax subsystem

The formatter, fax card, firmware, and software all contribute to the fax functionality. The designs of the formatter and fax card, along with parameters in the firmware, determine the majority of the regulatory requirements for telephony on the product.

The fax subsystem is designed to support V.34 fax transmission, low speeds (such as V.17 fax), and older fax machines.

## Fax card in the fax subsystem

Two versions of the fax card are used in the product. One is used in the North American, South American, and Asian countries/regions. The other is used primarily in European countries/regions.

The fax card contains the modem chipset (DSP and CODEC) that controls the basic fax functions of tone generation and detection, along with channel control for fax transmissions. The CODEC and its associated circuitry act as the third-generation silicon data access arrangement (DAA) to comply with worldwide regulatory requirements.

The only difference between the two versions is that each version is compliant with the 2/4-wire phone jack system from the respective country/region.

## Safety isolation

The most important function of the fax card is the safety isolation between the high-voltage, transient-prone environment of the telephone network (TNV [telephone network voltage]) and the low-voltage analog and digital circuitry of the formatter (SELV [secondary extra-low voltage]). This safety isolation provides both customer safety and product reliability in the telecom environment.

Any signals that cross the isolation barrier do so magnetically. The breakdown voltage rating of barrier-critical components is greater than 5 kV.

## Safety-protection circuitry

In addition to the safety barrier, the fax card protects against over-voltage and over-current events.

Telephone over-voltage events can be either differential mode or common mode. The event can be transient in nature (a lightning-induced surge or ESD) or continuous (a power line crossed with a phone line). The fax card protection circuitry provides margin against combinations of over-voltage and over-current events.

Common mode protection is provided by the selection of high-voltage-barrier critical components (transformer and relay). The safety barrier of the fax card PCB traces and the clearance between the fax card and surrounding components also contribute to common mode protection.

A voltage suppressor (a crowbar-type thyristor) provides differential protection. This device becomes low impedance at approximately 300 V differential, and crowbars to a low voltage. A series thermal switch works in conjunction with the crowbar for continuous telephone line events, such as crossed power lines.

All communications cross the isolation barrier magnetically. The breakdown voltage rating of barrier-critical components is greater than 5 kV.

## Data path

TIP and RING are the two-wire paths for all signals from the telephone network. All signaling and data information comes across them, including fax tones and fax data.

The telephone network uses DC current to determine the hook state of the telephone, so line current must be present during a call. The silicon DAA provides a DC holding circuit to keep the line current constant during a fax call.

The silicon DAA converts the analog signal to a digital signal for DSP processing, and also converts the digital signal to an analog signal for transmitting data through a telephone line.

The magnetically coupled signals that cross the isolation barrier go through either a transformer or a relay.

The DSP in the fax card communicates with the ASIC in the formatter using the high-speed serial interface.

## Hook state

Another magnetically coupled signal is the control signal that disconnects the downstream telephone devices (such as a phone or answering machine). A control signal originating on the DSP can change the relay state, causing the auxiliary jack (downstream jack) to be disconnected from the telephone circuit.

The product takes control of calls that it recognizes as fax calls. If the product does not directly pick up the call, it monitors incoming calls for the fax tone or for the user to direct it to receive a fax. This idle mode is also called eavesdropping. This mode is active when the product is on-hook but current exists in the downstream phone line because another device is off-hook. During eavesdropping, the receive circuit is enabled but has a different gain from the current that is generated during normal fax transmissions.

The product does not take control of the line unless it detects a fax tone or the user causes it to connect manually. This feature allows the user to make voice calls from a phone that is connected to the product without being cut off if a fax is not being received.

## Downstream device detection

The line voltage monitoring module of the silicon DAA can detect the line state as well as the downstream device. It tells DSP via DIB that an active device (telephone, modem, or answering machine) is connected to the auxiliary port on the product (the right side of the dual RJ-11 jack). The DSP uses the signal to ensure that the product does not go off-hook (and disconnects a downstream call) until it has been authorized to do so (by a manual fax start or the detection of the appropriate tones).

## Hook switch control

In the silicon DAA the CODEC controls the hook switch directly. The CODEC is activated when it receives commands from the DSP. When the circuit is drawing DC current from the central office it is considered off-hook. When no DC current flows the state is considered on-hook.

## Ring detect

Ring detect is performed by the line voltage monitoring module of the silicon DAA, and is a combination of voltage levels and cadence (time on and time off). Both must be present to detect a valid ring. The CODEC works with DSP as well as the firmware to determine if an incoming signal is an answerable ring.

## Line current control

The DC current from the CO needs to have a path to flow from TIP to RING. The DC impedance emulation line modulator and DC terminations modules in the silicon DAA act as a DC holding circuit, and work with the firmware to achieve the voltage-current characteristic between TIP and RING. The impedance (the current-voltage characteristic) changes corresponding to certain special events, such as pulse dialing or when the product goes on-hook.

## Billing- (metering-) tone filters

Switzerland and Germany provide high-frequency AC signals on the phone line in order to bill customers.

A filter in a special fax cable (for certain countries/regions), can filter these signals. Because these billing signals are not used in the U.S., these filters are not present in the U.S. fax cable.

To obtain a special fax cable, contact your local telephone service provider.

## Fax page storage in flash memory

Fax pages are the electronic images of the document page. They can be created in any of three ways: scanned to be sent to another fax machine, generated to be sent by the computer, or received from a fax machine to be printed.

The product stores all fax pages in flash memory automatically. After these pages are written into flash memory, they are stored until the pages are sent to another fax machine, printed on the product, transmitted to the computer, or erased by the user.

These pages are stored in flash memory, which is the nonvolatile memory that can be repeatedly read from, written to, and erased. The product has 8 MB of flash memory, of which 7.5 MB is available for fax storage. The remaining 0.5 MB is used for the file system and reclamation. Adding RAM does not affect the fax page storage because the product does not use RAM for storing fax pages.

## Stored fax pages

The user can reprint stored fax receive pages in case of errors. For a fax send, the product will resend the fax in case of errors. The product will resend stored fax pages after a busy signal, communication error, no answer, or power failure. Other fax devices store fax pages in either normal RAM or short-term RAM. Normal RAM immediately loses its data when power is lost, while short-term RAM loses its data about 60 minutes after power failure. Flash memory maintains its data for years without any applied power.

## Advantages of flash memory storage

Fax pages that are stored in flash memory are persistent. They are not lost as a result of a power failure, no matter how long the power is off. Users can reprint faxes in case the print cartridge runs out of toner or the product experiences other errors while printing faxes.

The product also has scan-ahead functionality that makes use of flash memory. Scan-ahead automatically scans pages into flash memory before a fax job is sent. This allows the sender to pick up the original document immediately after it is scanned, eliminating the need to wait until the fax transmission is complete.

Because fax pages are stored in flash memory rather than RAM, more RAM is available to handle larger and more complicated copy and print jobs.

## USB Flash Drive

This product features printing the following types of files from the USB flash drive.

- PDF
- RGB JPEG

When a USB flash drive is inserted into the front of the product, the control panel will display the USB Flash Drive Menu. The files present on the USB flash drive can be accessed from the control panel using the touch screen. Any RGB jpeg or pdf files on the USB flash drive can be printed directly from the product control panel. Pages also can be scanned and saved to the USB flash drive from the control panel.



---

## 2 Solve problems

- [Solve problems checklist](#)
- [Menu map](#)
- [Troubleshooting process](#)
- [Tools for troubleshooting](#)
- [Clear jams](#)
- [Solve paper-handling problems](#)
- [Solve image quality problems](#)
- [Solve performance problems](#)
- [Solve product connectivity problems](#)
- [Service mode functions](#)
- [Solve fax problems](#)
- [Product updates](#)

# Solve problems checklist

- 1.** Ensure that the product is set up correctly.
  - a.** Press the power button to turn on the product or to deactivate the Auto-Off mode.
  - b.** Check the power-cable connections.
  - c.** Ensure that the line voltage is correct for the product power configuration. (See the label that is on the back of the product for voltage requirements.) If you are using a power strip and its voltage is not within specifications, plug the product directly into the wall. If it is already plugged into the wall, try a different outlet.
- 2.** Check the cable connections.
  - a.** Check the cable connection between the product and the computer. Ensure that the connection is secure.
  - b.** Ensure that the cable itself is not faulty, by using a different cable if possible.
  - c.** Check the network connection: Ensure the network light is lit. The network light is next to the network port on the back of the product.

If the product remains unable to connect to the network, uninstall and then reinstall the product. If the error persists, contact a network administrator.
- 3.** Check to see if any messages appear on the control panel.
- 4.** Ensure that the paper you are using meets specifications.
- 5.** Ensure that the paper is loaded correctly in the input tray.
- 6.** Ensure that the product software is installed correctly.
- 7.** Verify that you have installed the printer driver for this product, and that you are selecting this product from the list of available printers.
- 8.** Print a configuration page.
  - a.** If the page does not print, verify that the input tray contains paper and that the paper is properly loaded.
  - b.** Ensure that the toner cartridge is installed correctly.

- c.** If the page jams in the product, clear the jam.
  - d.** If the print quality is unacceptable, complete the following steps:
    - Verify that the print settings are correct for the paper you are using.
    - Solve print-quality problems.
- 9.** Print a small document from a different program that has printed in the past. If this solution works, then the problem is with the program you are using. If this solution does not work (the document does not print), complete these steps:
- a.** Try printing the job from another computer that has the product software installed.
  - b.** Check the cable connection. Direct the product to the correct port, or reinstall the software, selecting the connection type you are using.

## Menu map

Use the following procedure to print a control-panel menu layout map.

1. From the Home screen, touch the Setup  button.
2. Touch the [Reports](#) button.
3. Touch the [Menu Structure](#) button.

## Troubleshooting process

When the product malfunctions or encounters an unexpected situation, the product control panel alerts you to the situation. This chapter contains information to help diagnose and solve problems.

- Use the pre-troubleshooting checklist to evaluate the source of the problem and to reduce the number of steps that are required to fix the problem.
- Use the troubleshooting flowchart to pinpoint the root cause of the hardware malfunction. The flowchart guides you to the section of this chapter that contains steps for correcting the malfunction.

Before beginning any troubleshooting procedure, check the following issues:

- Are supply items within their rated life?
- Does the configuration page reveal any configuration errors?



**NOTE:** The customer is responsible for checking supplies and for using supplies that are in good condition.

## Pre-troubleshooting checklist

The following table includes basic questions to ask the customer to quickly help define the problem(s).

General topic	Questions
Environment	<ul style="list-style-type: none"><li>• Is the product installed on a solid, level surface (+/- 1°)?</li><li>• Is the power-supply voltage within <math>\pm 10</math> volts of the specified power source?</li><li>• Is the power-supply plug inserted in the product and the outlet?</li><li>• Is the operating environment within the specified parameters?</li><li>• Is the product exposed to ammonia gas, such as that produced by diazo copiers or office cleaning materials? <b>NOTE:</b> Diazo copiers produce ammonia gas as part of the copying processes. Ammonia gas (from cleaning supplies or a diazo copier) can have an adverse affect on some product components (for example, the print-cartridge OPC).</li><li>• Is the product exposed to direct sunlight?</li></ul>

General topic	Questions
Media	<ul style="list-style-type: none"> <li>• Does the customer use only supported media?</li> <li>• Is the media in good condition (no curls, folds, or distortion)?</li> <li>• Is the media stored correctly and within environmental limits?</li> </ul>
Input trays	<ul style="list-style-type: none"> <li>• Is the amount of media in the tray within specifications?</li> <li>• Is the media correctly placed in the tray?</li> <li>• Are the paper guides aligned with the stack?</li> <li>• Is the cassette correctly installed in the product?</li> </ul>
Toner cartridges	<ul style="list-style-type: none"> <li>• Is each toner cartridge installed correctly?</li> </ul>
Transfer unit and fuser	<ul style="list-style-type: none"> <li>• Are the transfer unit and fuser installed correctly?</li> </ul>
Covers	<ul style="list-style-type: none"> <li>• Is the front cover closed?</li> </ul>
Condensation	<ul style="list-style-type: none"> <li>• Does condensation occur following a temperature change (particularly in winter following cold storage)? If so, wipe affected parts dry or leave the product on for 10 to 20 minutes.</li> <li>• Was the toner cartridge opened soon after being moved from a cold to a warm room? If so, allow the toner cartridge to sit at room temperature for 1 to 2 hours.</li> </ul>
Miscellaneous	<ul style="list-style-type: none"> <li>• Check for and remove any non-HP components (toner cartridges, memory modules, and EIO cards) from the product.</li> <li>• If the hardware or software configuration has not changed or the problem is not associated with any specific software, see the complete service manual for this product.</li> <li>• Remove the product from the network and ensure that the failure is associated with the product before beginning troubleshooting.</li> <li>• For any print-quality issues, calibrate the product.</li> </ul>

## Power-on checks

When you turn on the product, if it does not make any sound or if the control-panel display is blank, check the following items:

- Verify that the product is plugged directly into an active electrical outlet that has the correct voltage. Do not plug the product into a surge protector or power strip.
- Press the power button.
- Verify that the formatter is seated and operating correctly.
- Remove any HP Jetdirect accessories or other devices, and then try to turn the product on again.
- Ensure that the control-panel display is connected.
- Check the two fuses on the power supply.
- If necessary, replace the power supply.
- If necessary, replace the DC controller.

# Tools for troubleshooting

## Component diagnostics

### LED diagnostics

#### Network LEDs

The onboard network solution has two network port LEDs. When the product is connected to a properly working network through a network cable, the yellow LED indicates network activity, and the green LED indicates the link status. A blinking yellow LED indicates network traffic. If the green LED is off, a link has failed.

For link failures, check all of the network cable connections. In addition, you can try to manually configure the link settings on the onboard network solution by using the product control-panel menus.

1. Touch the Setup  button.
2. Scroll to and touch the [Network Setup](#) menu.
3. Touch the [Link Speed](#) menu.
4. Select one of the following options.

Setting	Description
<a href="#">Automatic</a>	The print server automatically configures itself for the highest link speed and communication mode allowed on the network.
<a href="#">10T Half</a>	10 megabytes per second (Mbps), half-duplex operation
<a href="#">10T Full</a>	10 Mbps, full-duplex operation
<a href="#">100TX Half</a>	100 Mbps, half-duplex operation
<a href="#">100TX Full</a>	100 Mbps, full-duplex operation

5. Touch the [OK](#) button. The product turns off and then on.

## Control panel LEDs

The state of the Ready light and the Attention light on the product signal the product status. The following table outlines the possible control-panel light states.



**NOTE:** Wireless models have a blue LED that illuminates when the product wireless function is enabled and available.

<b>Product state</b>	<b>Ready light state</b>	<b>Attention light state</b>
Initializing	Blinking	Blinking
Ready	On	Off
Receiving data/processing job or cancelling job	Blinking	Off
Error message	Off	Blinking
Fatal error (49 or 79 error) <sup>1</sup>	On	On





<sup>1</sup> The product restarts after one of these errors occurs.







## Control-panel diagnostics

The product includes diagnostic tests for the control panel.

### Test the control-panel display

1. Touch the Setup  button.
2. Touch the left arrow button , and then quickly touch the Cancel  button.
3. Touch the Setup  button to return to the main menus.
4. Open the [2ndary Service](#) menu.
5. Open the **Display test** menu.

### Test the control-panel buttons

1. Touch the Setup  button.
2. Touch the left arrow button , and then quickly touch the Cancel  button.
3. Touch the Setup  button to return to the main menu.
4. Open the [2ndary Service](#) menu.
5. Open the **Button test** menu.

## Engine Diagnostics

### Engine test

1. With the product off, open the front and rear doors.
2. Turn the power on, and close both doors within ten seconds.
3. An engine test page (a page containing multiple horizontal colored lines) will print.

## Diagrams

### Plug/jack locations

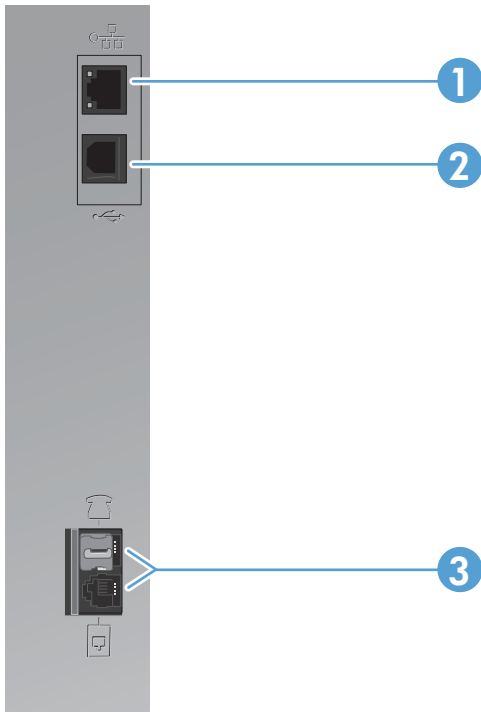

1	Network port
2	Hi-Speed USB 2.0 port
3	Fax ports

## DC controller PCA

**Figure 2-1** DC controller connectors

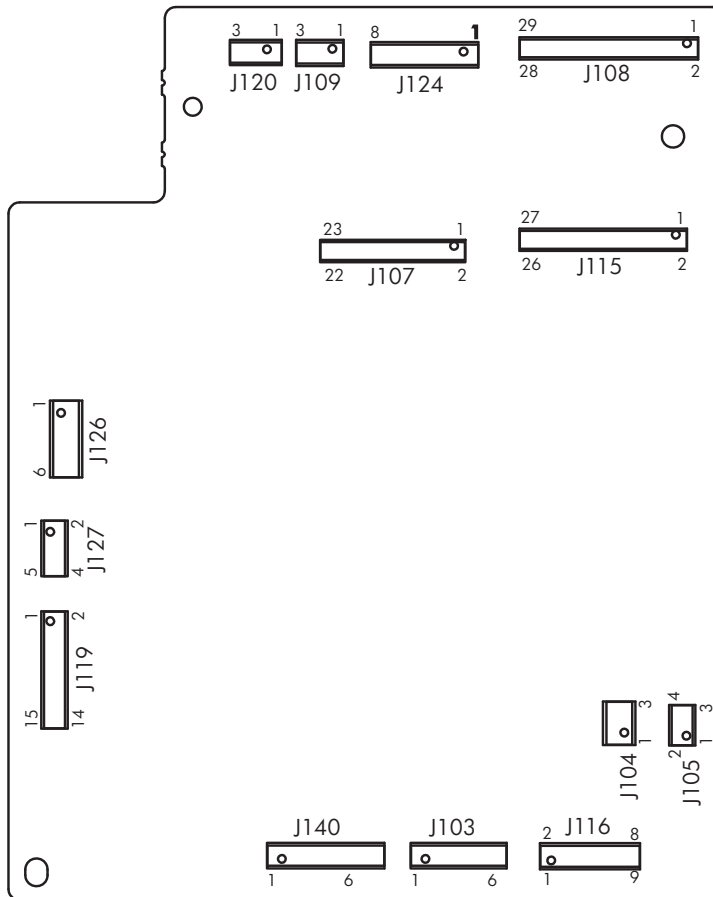

**Table 2-1** DC controller connectors

Item	Description
J103	Low-voltage power supply (+3.3 V)
J104	Thermistor (TH802)
J105	Fuser power supply
J107	Formatter
J108	Laser driver PCA
J109	Scanner motor (M704)
J115	High-voltage power supply
J116	Pickup assembly <ul style="list-style-type: none"> <li>• Loop sensor (SR603)</li> <li>• Top-of-page sensor (SR602)</li> <li>• Cassette media present sensor (SR601)</li> </ul>

**Table 2-1 DC controller connectors (continued)**

<b>Item</b>	<b>Description</b>
J119	ITB assembly density and perimeter sensors
J120	Developing home position sensor (SR606)
J124	Memory tags (e-labels)
J126	IOT
127	Flash
J130	Front door (cartridge access door) switch
J131	Power switch
J140	Motor driver

## Locations of major components

Figure 2-2 Major components

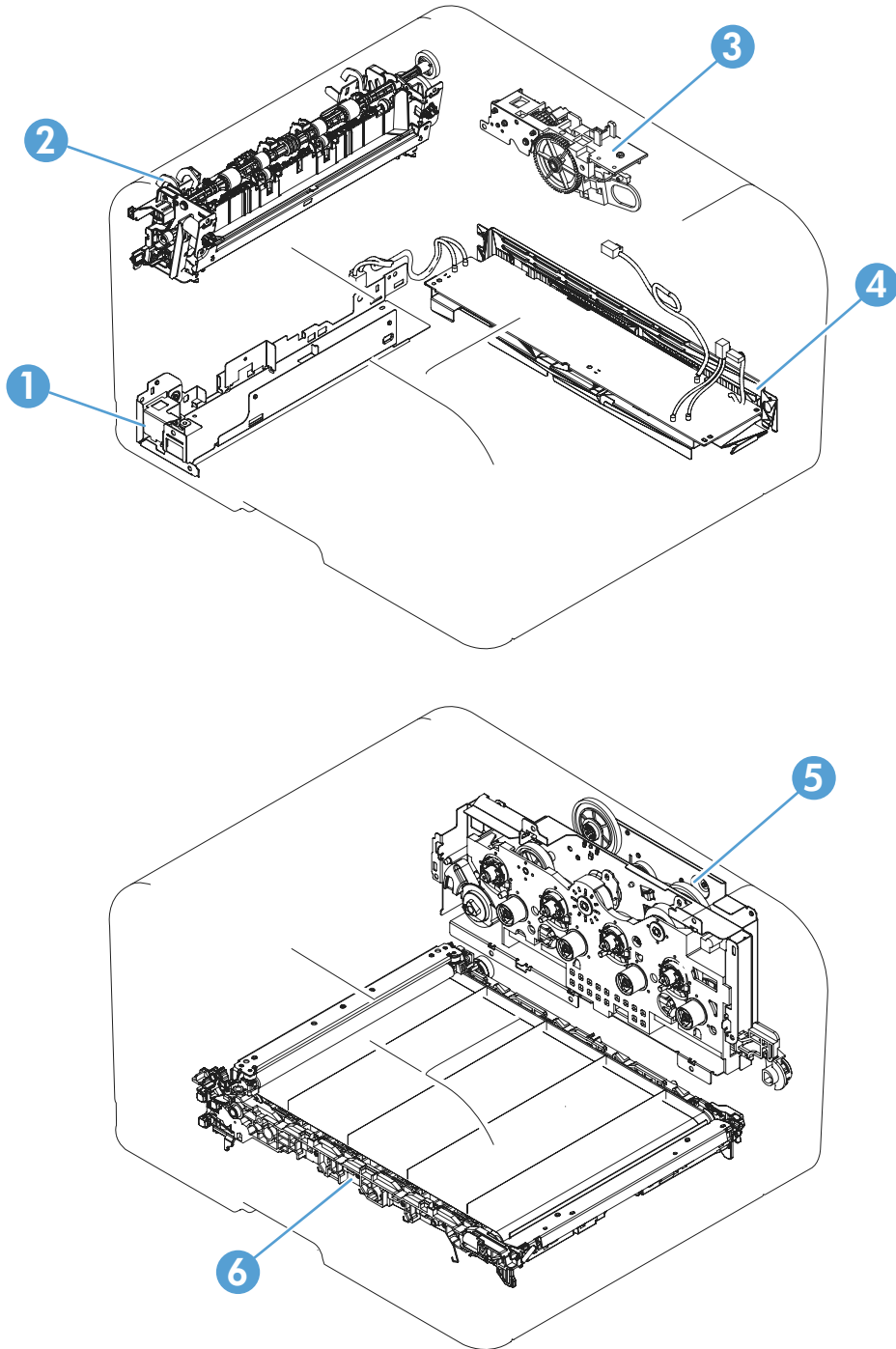

Table 2-2 Major components

Item	Description
1	Fuser power supply

**Table 2-2 Major components (continued)**

<b>Item</b>	<b>Description</b>
2	Fuser assembly
3	Sub-drive assembly
4	Low-voltage power supply
5	Main drive assembly
6	ITB assembly

## General timing charts

The following chart lists the approximate timing for this product, specified in seconds.

**Figure 2-3** Timing diagram

### I. GENERAL TIMING CHART

Two consecutive prints on LTR paper

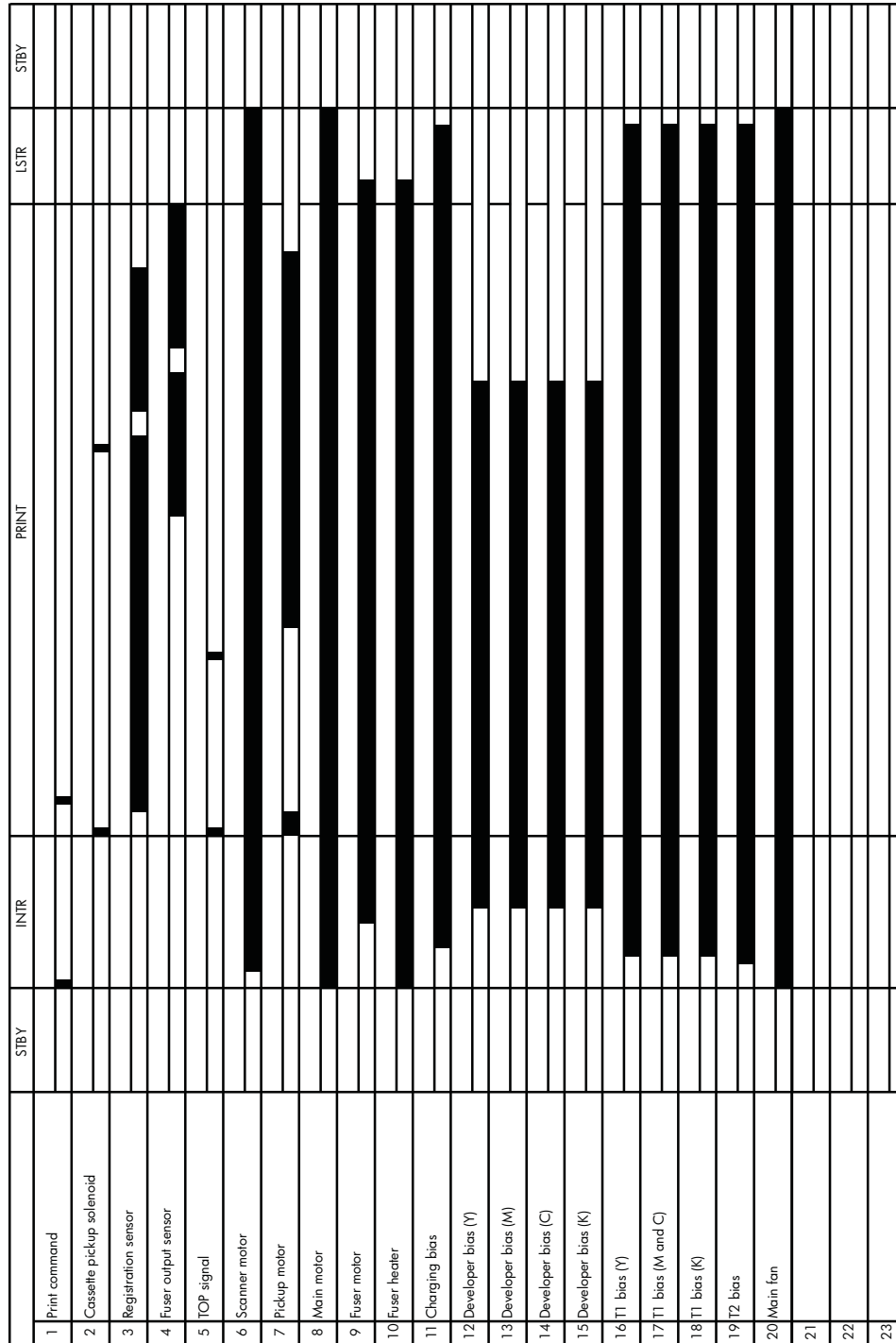

## General circuit diagram

Figure 2-4 Circuit diagram

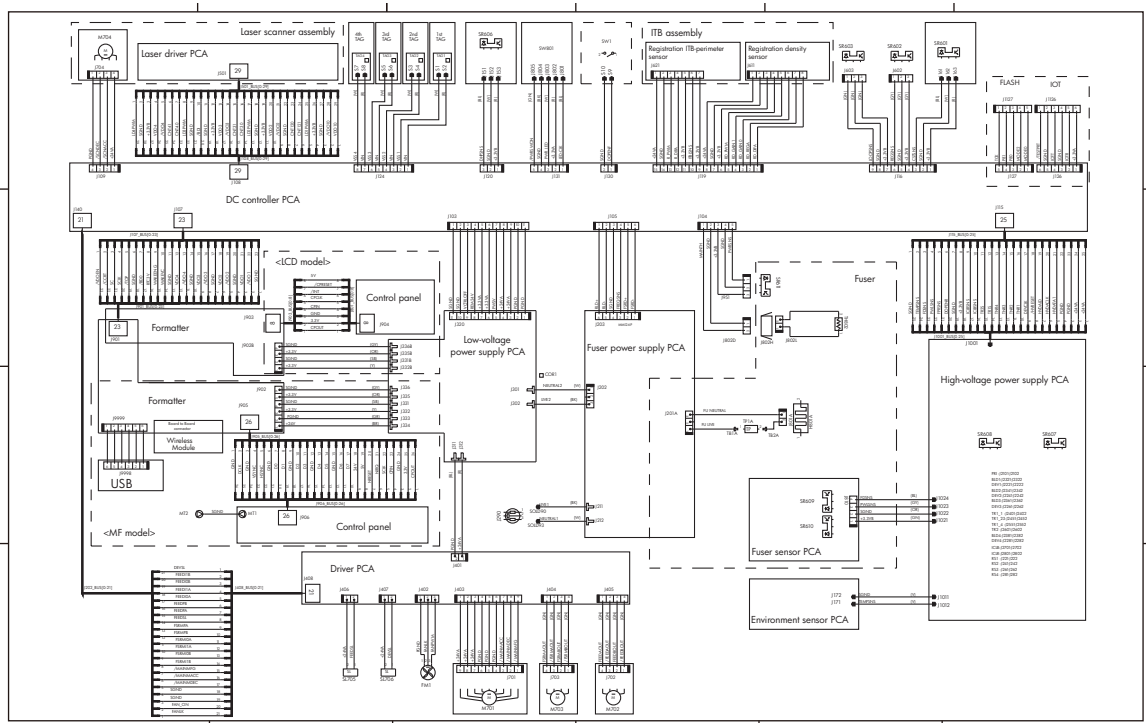

## Internal print-quality test pages

### Interpret the Print Quality Page

1. On the product control panel, open the [Reports](#) menu.
2. Select the [Print Quality Page](#) item to print it.

This page contains five bands of color, which are divided into four groups as indicated in the following illustration. By examining each group, you can isolate the problem to a particular print cartridge.

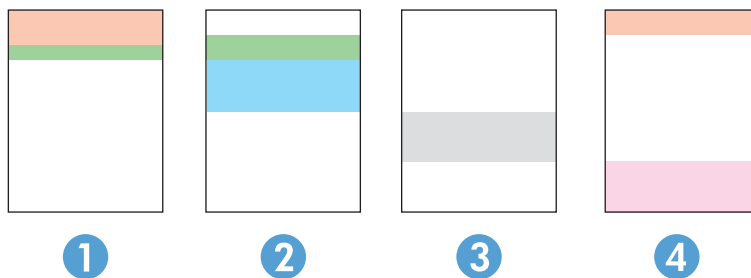

Section	Print-cartridge
1	Yellow
2	Cyan



Section	Print-cartridge
3	Black
4	Magenta

- If dots or streaks appear in only one of the groups, replace the print cartridge that correlates with that group.
- If dots appear in more than one group, print a cleaning page. If this does not solve the problem, determine if the dots are always the same color; for example, if magenta dots appear in all five color bands. If the dots are all the same color, replace that print cartridge.
- If streaks appear in multiple color bands, contact HP. A component other than the print cartridge is probably causing the problem.

## Print a cleaning page

Print a cleaning page to remove dust and excess toner from the paper path if you are having any of the following problems:

- Specks of toner are on the printed pages.
- Toner is smearing on the printed pages.
- Repeated marks occur on the printed pages.

## Print a cleaning page

1. From the Home screen on the product control panel, touch the Setup  button.
2. Touch the **Service** menu.
3. Touch the **Cleaning Page** button.
4. Load plain letter or A4 paper when you are prompted.
5. Touch the **OK** button to begin the cleaning process.
6. The product prints the first side and then prompts you to remove the page from the output bin and reload it in Tray 1, keeping the same orientation (the side with the black stripe should be face-down with the arrow toward the back of the product).
7. Press the **OK** button to continue the cleaning process. Wait until the process is complete. Discard the page that prints.

## Configuration page

### Print a configuration page



**NOTE:** This section applies to the HP LaserJet Pro 200 color M276nw MFP model only.

1. From the Home screen on the product control panel, touch the Setup button.
2. Touch the [Reports](#) button.
3. Touch [Configuration Report](#).

## Print-quality troubleshooting tools

### Repetitive image defects

If the product output has a consistent, repetitive defect, use the table in this section to determine which part needs to be replaced based on the measured distance between the repetitions of the defect.



**NOTE:** The following table replaces the graphical repetitive defect ruler. You can make your own ruler by using these measurements. For the most accurate results, use a metric ruler.

**Table 2-3 Repetitive image defects**

Distance between identical defects	Component	Notes
22.3 mm (0.87 in)	Developer roller (one rotation)	Appears in a single color plane.
26.7 mm (1.05 in)	Charge roller (one rotation)	Appears in a single color plane.
28.5 mm (1.12 in)	RS roller (one rotation)	Appears in a single color plane.
44.0 mm (1.73 in)	Registration roller	
56.5 mm (2.22 in)	Fuser film (one rotation)	Appears in all color planes.
59.7 mm (2.35 in)	Fuser pressure roller (one rotation)	Appears in all color planes.
56.5 mm (2.22 in)	Transfer roller	Appears in all color planes.
69.0 mm (2.71 in)	Cartridge-to-cartridge spacing	Distance between each color image drum
75.8 mm (2.98 in)	Image drum (one rotation)	Appears in a single color plane.
633.6 mm (24.94 in)	ITB	Because the ITB is longer than a page, you might have to look at multiple pages to determine if a repetitive defect is present.

## Calibrate the product to align the colors

If the printed output has colored shadows, blurry graphics, or areas that have poor color, you might need to calibrate the product to align the colors. Print the Diagnostics Page from the Reports menu on the control panel to check the color alignment. If the blocks of color on that page are not aligned with each other, you need to calibrate the product.

1. On the product control panel, open the [System Setup](#) menu.
2. Open the [Print Quality](#) menu, and select the [Color Calibration](#) item.
3. Select the [Calibrate Now](#) option.

# Control panel menus

## Setup Menu

To open this menu, touch the Setup  button. The following sub menus are available:

- HP Web Services
- Reports
- Self Diagnostics
- Fax Setup
- System Setup
- Service
- Network Setup

## HP Web Services

Menu item	Description
Enable Web Services	Use <a href="#">Enable Web Services</a> to set up Web Services on the product.  <b>NOTE:</b> You must be connected to a network to enable HP Web Services.
Proxy Settings	The Proxy Settings sub-menu includes the following: <ul style="list-style-type: none"><li>• <a href="#">Proxy Server</a></li><li>• <a href="#">Proxy Port</a></li><li>• <a href="#">Username</a></li><li>• <a href="#">Password</a></li></ul>

## Reports menu

Menu item	Description
Demo Page	Prints a page that demonstrates print quality
Menu Structure	Prints a control-panel menu layout map.
Configuration Report	Prints a list of the product settings
Supplies Status	Prints the toner cartridge status. Includes the following information: <ul style="list-style-type: none"><li>• Approximate pages remaining</li><li>• Supply level</li><li>• Serial number</li><li>• Number of pages printed</li><li>• First install date</li><li>• Last used date</li></ul>
Network Summary	Displays status for: <ul style="list-style-type: none"><li>• Network hardware configuration</li><li>• Enabled features</li><li>• TCP/IP and SNMP information</li><li>• Network statistics</li><li>• Wireless network configuration (wireless models only)</li></ul>
Usage Page	Displays the number of pages printed, faxed, copied, and scanned by the product
PCL Font List	Prints a list of all installed PCL 5 fonts
PS Font List	Prints a list of all installed PS fonts
PCL6 Font List	Prints a list of all installed PCL 6 fonts
Color Usage Log	Prints information about the color supply usage
Service Page	Prints the service page  The service page includes information about supported paper types, copy settings, and other settings that are not included on the configuration page.
Diagnostics Page	Prints diagnostic information about calibration and color quality
Print Quality Page	Prints a page that helps solve problems with print quality

## Self Diagnostics menu

Menu item	Description
Run Network Test	The network test provides information on the following: <ul style="list-style-type: none"> <li>• Diagnostics summary</li> <li>• Troubleshooting</li> <li>• Configuration summary</li> </ul>
Run Fax Test	Test the product's fax capabilities

## Fax Setup menu

In the following table, items that have an asterisk (\*) indicate the factory default setting.

Menu item	Sub-menu item	Sub-menu item	Description
Fax Set-Up Utility			This is a tool for configuring the fax settings. Follow the on-screen prompts and select the appropriate response for each question.
Basic Setup	Time/Date	(Settings for time format, current time, date format, and current date.)	Sets the time and date setting for the product.
	Fax Header	Enter your fax number.	Sets the identifying information that is sent to the receiving product.
Enter company name.		Identifies the fax sender (optional)	
Answer Mode	Automatic*		Sets the type of answer mode. The following options are available: <ul style="list-style-type: none"> <li>• <b>Automatic:</b> The product automatically answers an incoming call on the configured number of rings.</li> <li>• <b>Manual:</b> The user must touch the <b>Start Fax</b> button or use an extension phone number to make the product answer the incoming call.</li> <li>• <b>TAM:</b> A telephone answering machine (TAM) is attached to the Auxiliary phone port of the product. The product will not pick up any incoming call, but will listen for fax tones after the answering machine has picked up the call.</li> <li>• <b>Fax/Tel:</b> The product must automatically pick up the call and determine if the call is a voice or fax call. If the call is a fax call, the product handles the call as usual. If the call is a voice call, an audible synthesized ring is generated to alert the user of an incoming voice call.</li> </ul>
	Manual		
	TAM		
	Fax/Tel		

Menu item	Sub-menu item	Sub-menu item	Description
	Rings to Answer		Sets the number of rings that must occur before the fax modem answers. The default setting is 5.
	Distinctive Ring	All Rings* Single Double Triple Double and Triple	<p>If you have distinctive ring phone service, use this item to configure how the product responds to incoming calls.</p> <ul style="list-style-type: none"> <li>• <b>All Rings:</b> The product answers any calls that come through the telephone line.</li> <li>• <b>Single:</b> The product answers any calls that produce a single-ring pattern.</li> <li>• <b>Double:</b> The product answers any calls that produce a double-ring pattern.</li> <li>• <b>Triple:</b> The product answers any calls that produce a triple-ring pattern.</li> <li>• <b>Double and Triple:</b> The product answers any calls that produce a double-ring or triple-ring pattern.</li> </ul>
	Dial Prefix	On Off*	Specifies a prefix number that must be dialed when sending faxes from the product. If this feature is turned on, the product prompts you for the number and then it automatically includes that number every time a fax is sent.
Advanced Setup	Fax Resolution	Standard Fine* Superfine Photo	Sets the resolution for sent documents. Higher resolution images have more dots per inch (dpi), so they show more detail. Lower resolution images have fewer dots per inch and show less detail, but the file size is smaller and the fax takes less time to transmit.
	Lighter/Darker		Sets the darkness for outgoing faxes.
	Fit to Page	On* Off	Shrinks incoming faxes that are larger than the paper size set for the tray.
	Glass Size	Letter A4	<p>Sets the default paper size for documents being scanned from the flatbed scanner.</p> <p><b>NOTE:</b> The default setting is determined by the choice of location during the initial product setup.</p>
	Dialing Mode	Tone* Pulse	Sets whether the product should use tone or pulse dialing.
	Redial if Busy	On* Off	Sets whether the product should attempt to redial if the line is busy.
	Redial if No Answer	On Off*	Sets whether the product should attempt to redial if the recipient fax number does not answer.
	Redial if Comm. Error	On* Off	Sets whether the product should attempt to redial the recipient fax number if a communication error occurs.

Menu item	Sub-menu item	Sub-menu item	Description
	Detect Dial Tone	On Off*	Sets whether the product should check for a dial tone before sending a fax.
	Billing Codes	On Off*	Enables the use of billing codes when set to <b>On</b> . A prompt appears for the billing code for an outgoing fax.
	Extension Phone	On* Off	When this feature is enabled, the <b>1-2-3</b> buttons on the extension phone may be pressed to cause the product to answer an incoming fax call.
	Stamp Faxes	On Off*	Sets the product to print the date, time, sender's phone number, and page number on each page of incoming faxes.
	Private Receive	On Off*	Setting <b>Private Receive</b> to <b>On</b> requires you to set a product password. After setting the password, the following options are set: <ul style="list-style-type: none"> <li>• <b>Private Receive</b> is turned on.</li> <li>• All old faxes are deleted from memory.</li> <li>• <b>Fax forwarding</b> is set to <b>Off</b> and is not allowed to be changed.</li> <li>• All incoming faxes are stored in memory.</li> </ul>
	Confirm Fax Number	On Off*	Confirm a fax number by entering it a second time.
	Allow Fax Reprint	On* Off	Sets whether incoming faxes are stored in memory for reprinting later.
	Fax/Tel Ring Time	20 30 40 70	Sets the time, in seconds, after which the product should stop sounding the <b>Fax/Tel</b> audible ring to notify the user of an incoming voice call.
	Fax Speed	Fast(V.34)* Medium(V.17) Slow(V.29)	Sets the allowed fax communication speed.



## System Setup menu

In the following table, items that have an asterisk (\*) indicate the factory default setting.

Menu item	Sub-menu item	Sub-menu item	Description
Language	(List of available control-panel display languages.)		Sets the language in which the control panel displays messages and product reports.
Paper Setup	Default Paper Size	Letter	Sets the size for printing internal reports, faxes, or any print job that does not specify a size.  <b>NOTE:</b> The default setting is determined by the choice of location during the initial product setup.
		A4	
		Legal	
	Default Paper Type	Lists available paper types.	Sets the type for printing internal reports, faxes, or any print job that does not specify a type.
Tray 1		Paper Type	Configures the size and type for the tray.
		Paper Size	
Paper Out Action		Wait forever*	Determines how the product reacts when a print job requires a paper size or type that is unavailable or when the tray is empty. <ul style="list-style-type: none"> <li>• <b>Wait forever:</b> The product waits until you load the correct paper.</li> <li>• <b>Override:</b> Print on a different size paper after a specified delay.</li> <li>• <b>Cancel:</b> Automatically cancel the print job after a specified delay.</li> <li>• If you select either the <b>Override</b> or <b>Cancel</b> item, the control panel prompts you for the number of seconds to delay.</li> </ul>
		Cancel	
		Override	
Print Quality	Color Calibration	Calibrate Now	Performs a full calibration. <ul style="list-style-type: none"> <li>• <b>Calibrate Now:</b> Performs an immediate calibration.</li> <li>• <b>Power-On Calibration:</b> Specify the length of time the product should wait after you turn it on before it calibrates.</li> </ul>
		Power-On Calibration	

Menu item	Sub-menu item	Sub-menu item	Description
Energy Settings	Sleep Delay	Off	Specifies the amount of idle time before the product enters sleep mode.
		1 Minute	
		15 Minutes*	
		30 Minutes	
		1 Hour	
		2 Hours	
	Auto Power Down	Power Down Delay	Set the amount of elapsed time before the product turns itself off. The options are: <ul style="list-style-type: none"> <li>• Never</li> <li>• 30 Minutes</li> <li>• 1 Hour</li> <li>• 2 Hours</li> <li>• 4 Hours</li> <li>• 8 Hours</li> <li>• 24 Hours</li> </ul>
		Wake Events	Select the events that bring the product out of sleep mode. The following events are available for selection: <ul style="list-style-type: none"> <li>• USB Job</li> <li>• LAN Job</li> <li>• Wireless Job</li> <li>• Control Panel Touch</li> <li>• Fax Ring</li> <li>• Paper in ADF</li> <li>• USB Drive Insert</li> </ul>

Menu item	Sub-menu item	Sub-menu item	Description
Supply Settings	Black Cartridge	Very Low Setting	<p><b>Stop:</b> The product stops printing until you replace the print cartridge.</p> <p><b>Prompt*:</b> The product stops printing and prompts you to replace the print cartridge. You can acknowledge the prompt and continue printing.</p> <p><b>Continue:</b> The product alerts you that the print cartridge is very low, but it continues printing.</p>
		Low Threshold	Enter a percentage for the low threshold setting.
	Color Cartridges	Very Low Setting	<p><b>Stop:</b> The product stops printing until you replace the print cartridge.</p> <p><b>Prompt*:</b> The product stops printing and prompts you to replace the print cartridge. You can acknowledge the prompt and continue printing.</p> <p><b>Continue:</b> The product alerts you that the print cartridge is very low, but it continues printing.</p> <p><b>Print Black:</b> When a color print cartridge becomes very low, the product prints in black only to prevent fax interruptions. When you choose to replace the very low print cartridge, color printing resumes automatically. To configure the product to print in color and use the remaining toner in the print cartridge past very low, follow these steps:</p> <p><b>NOTE:</b> <b>Prompt</b> is the default setting, but if you install the fax wizard on your first incoming fax, the setting switches automatically to <b>Print Black</b>.</p> <ol style="list-style-type: none"> <li>1. On the product control panel, touch the Setup  button, and then touch the <b>System Setup</b> button.</li> <li>2. Touch the <b>At Very Low</b> button, and then touch the <b>Color Cartridges</b> button. Touch the <b>Continue</b> button.</li> </ol>
	Low Threshold	Set a low threshold percentage setting for the following colors: <ul style="list-style-type: none"> <li>• Cyan</li> <li>• Magenta</li> <li>• Yellow</li> </ul>	
	Store Usage Data		Select where to store the product's usage data, either on the supplies or not on the supplies.
Volume Settings	Alarm Volume		Set the volume levels for the product. The following options are available for each volume setting: <ul style="list-style-type: none"> <li>• Off</li> <li>• Soft</li> <li>• Medium*</li> <li>• Loud</li> </ul>
	Ring Volume		
	Key-Press Volume		
	Phone Line Volume		

Menu item	Sub-menu item	Sub-menu item	Description
Time/Date	12 Hour		Sets the time and date setting for the product.
	24 Hour		
Administration	Product Security	On	Sets the product-security feature. If you select the On setting, you must set a password.
		Off	
	USB Flash Drive	On*	Enables or disables the USB flash drive.
		Off	
	Disable Fax	Yes	Enable, or disable, faxing to and from the product.
		No*	
	Scan to Network Folder	On*	Enable, or disable, the product's scan to folder capability.
		Off	
	Scan to E-mail	On*	Enable, or disable, the product's scan to email feature.
		Off	
	Color Copy	On*	Enable, or disable, the product's color copying feature.
		Off	
Courier Font	Regular*		Sets Courier font values.
	Dark		

## Service menu

In the following table, items that have an asterisk (\*) indicate the factory default setting.

Menu item	Sub-menu item	Sub-menu item	Description	
Fax Service	Clear Saved Faxes		Clears all faxes in memory.	
	Run Fax Test		Performs a fax test to verify that the phone cord is plugged in the correct outlet and that there is a signal on the phone line. A fax test report is printed indicating the results.	
	Print T.30 Trace	Now		Prints or schedules a report that is used to troubleshoot fax transmission issues.
		Never*		
If Error				
At End of Call				
Error Correction	On*		The error correction mode allows the sending device to re-transmit data if it detects an error signal.	
	Off			
	Fax Service Log		The fax service log prints out the last 40 entries in the fax log.	
Cleaning Page			<p>Cleans the product when specks or other marks appear on printed output. The cleaning process removes dust and excess toner from the paper path.</p> <p>When selected, the product prompts you to load plain Letter or A4 paper in Tray 1. Touch the <b>OK</b> button to begin the cleaning process. Wait until the process completes. Discard the page that prints.</p>	
USB Speed	High*		Sets the USB speed for the USB connection to the computer. For the product to actually operate at high speed, it must have high speed enabled and be connected to an EHCI host controller that is also operating at high speed. This menu item does not reflect the current operating speed of the product.	
	Full			

Menu item	Sub-menu item	Sub-menu item	Description
Less Paper Curl	On Off*		When printed pages are consistently curled, this option sets the product to a mode that reduces curl.
Archive Print	On Off*		When printing pages that will be stored for a long time, this option sets the product to a mode that reduces toner smearing and dusting.
Firmware Datecode			Displays the current firmware datecode
Restore Defaults			Sets all settings to the factory default values
Signature Check	Cancel if Invalid* Prompt if Invalid		Validates HP firmware downloads.
HP Smart Install	On* Off		Enable, or disable, the HP Smart Install feature on the product.
LaserJet Update	Check for Updates Now  Manage Updates	Install Now Remind Me Later Skip this Update Allow Downgrade Check Automatically Prompt Before Install Allow Updates	
SMTP Comm. Report			The <a href="#">SMTP Communication Report</a> contains the SMTP communication to and from the device from the last Scan to E-mail job.

## Network Setup menu

In the following table, items that have an asterisk (\*) indicate the factory default setting.

Menu item	Sub-menu item	Description
Wireless Menu (wireless models only)	Wireless Direct Settings	Manage the product's wireless direct settings.
	Wireless Setup Wizard	Guides you through the steps to set up the product on a wireless network
	Wi-Fi Protected Setup	If your wireless router supports this feature, use this method to set up the product on a wireless network. This is the simplest method.
	Run Network Test	Tests the wireless network and prints a report with the results.
	Turn Wireless On/Off	Enables or disables the wireless network feature.
TCP/IP Config	Automatic*	<b>Automatic:</b> The product automatically configures all the TCP/IP settings via DHCP, BootP or AutoIP.
	Manual	<b>Manual:</b> You can manually configure the IP address, subnet mask, and default gateway. The control panel prompts you to specify values for each address section. As each address is completed, the product prompts for address confirmation before moving to the next one. After all three addresses are set, the network reinitializes.
Network Services	IPv4	Enable or disable the IPv4 and IPv6 protocols. By default, each protocol is enabled.
	IPv6	
Link Speed	Automatic*	Sets the link speed manually if needed.
	10T Full	After setting the link speed, the product automatically restarts.
	10T Half	
	100TX Full	
	100TX Half	
HTTPS Enforcement	Yes	An encrypted communication and secure identification of a network web server. Only enabled if printer is password protected.
	*No	
Restore Defaults		Resets all network configurations to their factory defaults.

## Quick Forms menu

Menu item	Sub-menu item	Description
Notebook Paper	Narrow Rule	Prints pages that have preprinted lines
	Wide Rule	
	Child Rule	
Graph Paper	1/8 inch	Prints pages that have preprinted graph lines
	5 mm	
Checklist	1-Column	Prints pages that have preprinted lines with check boxes
	2-Column	
Music Paper	Portrait	Prints pages that have preprinted lines for writing music
	Landscape	



## Function specific menus

The product features function-specific menus for copying, faxing, scanning, and using a USB flash drive. To open these menus, touch the button for that function on the control panel.

### USB Flash Drive

The following types are supported:

- .PDF
- .JPG

Menu item	Description
Print Documents	<p>Prints documents stored on the USB flash drive. Use the arrow buttons to scroll through the documents. Touch the names of documents to print.</p> <p>Touch the summary screen to change settings such as the number of copies, the paper size, or the paper type.</p> <p>Touch the <a href="#">Print</a> button to print the documents.</p>
View and Print Photos	<p>Previews photos on the USB flash drive. Use the arrow buttons to scroll through the photos. Touch the preview image for each photo to print. Adjust the settings and save the changes as the new default settings. To print the photos, touch the <a href="#">Print</a> button.</p>
Scan to USB Drive	<p>Scans a document and stores it as a .PDF file or .JPEG image on the USB flash drive.</p>

### Fax Menu

To open this menu, touch the [Fax](#) button, and then touch the [Fax Menu](#) button.

Menu item	Sub-menu item	Sub-menu item	Description
Fax Reports	Fax Confirmation	On Every Fax	Sets whether the product prints a confirmation report after a successful fax job.
		On Send Fax Only	
		On Receive Fax Only	
		Never*	
	Include First Page	On*	Sets whether the product includes a thumbnail image of the first page of the fax on the report.
		Off	

Menu item	Sub-menu item	Sub-menu item	Description
	Fax Error Report	On Every Error* On Send Error On Receive Error Never	Sets whether the product prints a report after a failed fax job.
	Print Last Call Report		Prints a detailed report of the last fax operation, either sent or received.
	Fax Activity Log	Print Log Now Auto Log Print	<b>Print Log Now:</b> Prints a list of the faxes that have been sent from or received by this product. <b>Auto Log Print:</b> Automatically prints a report after every fax job.
	Print Phone Book		Prints a list of the speed dials that have been set up for this product.
	Print Junk Fax list		Prints a list of phone numbers that are blocked from sending faxes to this product.
	Print Billing Report		Prints a list of billing codes that have been used for outgoing faxes. This report shows how many sent faxes were billed to each code. This menu item appears only when the billing codes feature is turned on.
	Print All fax Reports		Prints all fax-related reports.
Send Options	Send Fax Later		Allows a fax to be sent at a later time and date.
	Broadcast Fax		Sends a fax to multiple recipients.
	Fax Job Status		Displays pending fax jobs, and allows you to cancel pending fax jobs.
	Fax Resolution	Standard Fine* Superfine Photo	Sets the resolution for sent documents. Higher resolution images have more dots per inch (dpi), so they show more detail. Lower resolution images have fewer dots per inch and show less detail, but the file size is smaller.

Menu item	Sub-menu item	Sub-menu item	Description
Receive Options	Print Private Faxes		Prints stored faxes when the private-receive feature is turned on. The product prompts you for the system password.
	Block Junk Faxes	Add Number	Modifies the junk fax list. The junk fax list can contain up to 30 numbers. When the product receives a call from one of the junk fax numbers, it deletes the incoming fax. It also logs the junk fax in the activity log along with job-accounting information.
		Delete Number	
		Delete All Numbers	
		Print Junk Fax list	
Reprint Faxes		Prints the received faxes stored in available memory. This item is available only if you have turned on the <a href="#">Allow Fax Reprint</a> feature in the <a href="#">Fax Setup</a> menu.	
Forward Fax	On	Off*	Sets product to send all received faxes to another fax machine.
	Polling Receive		Allows the product to call another fax machine that has polling send enabled.
Phone Book Setup	Individual Setup		Edits the fax phone book speed dials and group-dial entries. The product supports up to 120 phone book entries, which can be either individual or group entries.
	Group Setup		
	Delete Entry	Deletes a specific phone book entry	
	Delete All Entries	Deletes all entries in the phone book	
	Print Report Now	Prints a list of all the individual and group dial entries in the phone book	
	Change Defaults		

## Copy Menu

To open this menu, touch the [Copy](#) button, and then touch the [Settings](#) button.



**NOTE:** Settings that you change with this menu expire 2 minutes after the last copy completes.

Menu item	Sub-menu item	Sub-menu item	Description
ID Copy			Copies both sides of identification cards, or other small-size documents, onto the same side of one sheet of paper.
<b>NOTE:</b> This item is available from the main <a href="#">Copy</a> screen. You do not need to touch the <a href="#">Settings</a> button to access it.			
Number of Copies	(1-99)		Specifies the number of copies
Reduce/Enlarge	Original=100% Legal to Letter=78% Legal to A4=83% A4 to Letter=94% Letter to A4=97% Full Page=91% Fit to Page 2 Pages per Sheet 4 Pages per Sheet Custom: 25 to 400%		Specifies the size of the copy.
Lighter/Darker			Specifies the contrast of the copy.
Optimize	Describe Original	Auto Select* Mixed Text Picture	Specifies the type of content in the original document, so the copy is the best match for the original.
Paper	Letter* Legal A4		Specifies the paper size. <b>NOTE:</b> The default paper size setting is determined by the choice of location during the initial product setup.
Multi-Page Copy	Off* On		When this feature is on, the product prompts you to load another page onto the scanner glass or to indicate that the job is complete.
Collation	On* Off		Specifies whether to collate copy jobs.

Menu item	Sub-menu item	Sub-menu item	Description
Draft Mode	Off*		Specifies whether to use draft-quality printing for copies
	On		
Image Adjustment	Lightness		Adjusts the image quality settings for copies
	Contrast		
	Sharpen		
	Background Removal		
	Color Balance		
	Grayness		
Set as New Defaults			Saves any changes you have made to this menu as the new defaults
Restore Defaults			Restores the factory defaults for this menu

## Scan Menu

Menu item	Description
Scan to USB Drive	Scans a document and stores it as a .PDF file or .JPEG image on the USB flash drive.
Scan to Network Folder	Scans a document to a network folder.
Scan to E-mail	Scans a document and sends as an email attachment.

## Apps

Use the [Apps](#) menu to install HP Web Services applications.

# Interpret control panel messages

## Control panel message types

The control panel messages indicate the current product status or situations that might require action.

Alert and warning messages appear temporarily and might require you to acknowledge the messages by touching the **OK** button to resume the job or by touching the **Cancel** **X** button to cancel the job. With certain warnings, the job might not complete or the print quality might be affected. If the alert or warning message is related to printing and the auto-continue feature is on, the product will attempt to resume the printing job after the message has appeared for 10 seconds without acknowledgement.

Critical error messages can indicate some kind of failure. Turning off and then turning on the power might fix the problem. If a critical error persists, the product might require service.

## Control panel messages

### 10.X00Y Supply Error

#### Description

The memory chip for one of the toner cartridges cannot be read or is missing.

- 10.0000 = black memory chip error
- 10.0001 = cyan memory chip error
- 10.0002 = magenta memory chip error
- 10.0003 = yellow memory chip error
- 10.1000 = black memory chip is missing
- 10.1001 = cyan memory chip is missing
- 10.1002 = magenta memory chip is missing
- 10.1003 = yellow memory chip is missing

#### Recommended action

Reinstall the toner cartridge.

Turn the product off and then on.

If the problem is not solved, replace the toner cartridge.

If the problem is still not solved, verify that the connector J124 on the DC controller is firmly seated.

Replace the DC controller.

## 49 Error, Turn off then on

### **Description**

The product experienced an internal error.

### **Recommended action**

Turn the product off, wait at least 30 seconds, and then turn the product on and wait for it to initialize.

If you are using a surge protector, remove it. Plug the product directly into the wall socket. Turn the product power on.

If the message persists, contact HP support.

## 50.x Fuser Error

### **Description**

The product has experienced an error with the fuser.

### **Recommended action**

Turn the product power off, wait at least 30 seconds, and then turn the product power on and wait for it to initialize.

Turn off the product, wait at least 25 minutes, and then turn on the product.

If you are using a surge protector, remove it. Plug the product directly into the wall socket. Turn the product power on.

If the message persists, contact HP support.

## 51.XX Error

### **Description**

The product has experienced an internal hardware error.

### **Recommended action**

Turn the product power off, wait at least 30 seconds, and then turn the product power on and wait for it to initialize.

If you are using a surge protector, remove it. Plug the product directly into the wall socket. Turn the product on.

If the message persists, contact HP support.

## 54.XX Error

### **Description**

The product has experienced an error with one of the internal sensors.



### **Recommended action**

Turn the product power off, wait at least 30 seconds, and then turn the product power on and wait for it to initialize.

If you are using a surge protector, remove it. Plug the product directly into the wall socket. Turn the product power on.

If the message persists, contact HP support.

## **55.X Error**

### **Description**

The product has experienced an internal error.

### **Recommended action**

Turn the product power off, wait at least 30 seconds, and then turn the product power on and wait for it to initialize.

If you are using a surge protector, remove it. Plug the product directly into the wall socket. Turn the product power on.

If the message persists, contact HP support.

## **57 Fan Error, Turn off then on**

### **Description**

The product has experienced a problem with its internal fan.

### **Recommended action**

Turn the product power off, wait at least 30 seconds, and then turn the product power on and wait for it to initialize.

If you are using a surge protector, remove it. Plug the product directly into the wall socket. Turn the product power on.

If the message persists, contact HP support.

## **59.X Error**

### **Description**

The product has experienced a problem with one of the motors.

### **Recommended action**

Turn the product power off, wait at least 30 seconds, and then turn the product power on and wait for it to initialize.

If you are using a surge protector, remove it. Plug the product directly into the wall socket. Turn the product power on.

If the message persists, contact HP support.

## 79 Error Turn off then on

### Description

The product has experienced an internal firmware error.

### Recommended action

Turn the product power off, wait at least 30 seconds, and then turn the product power on and wait for it to initialize.

If you are using a surge protector, remove it. Plug the product directly into the wall socket. Turn the product power on.

If the message persists, contact HP support.

## Black Cartridge Low

### Description

The toner cartridge is nearing the end of its useful life.

### Recommended action

Printing can continue, but consider having a replacement supply on hand.

## Black in wrong position

### Description

The toner cartridge is installed in the incorrect slot.

### Recommended action

Ensure that each toner cartridge is installed in the correct slot. From front to back, the toner cartridges are installed in this order: black, cyan, magenta, and yellow.

## Black Very Low

### Description

The toner cartridge is at the end of its useful life. A customer configurable option on this product is "Prompt to Remind Me in 100 pages, 200 pages, 300 pages, 400 pages, or never." This option is provided as a customer convenience and is not an indication these pages will have acceptable print quality.

### Recommended action

To ensure optimal print quality, HP recommends replacing the toner cartridge at this point. You can continue printing until you notice a decrease in print quality. Actual cartridge life might vary.

Once an HP supply has reached **Very Low**, HP's Premium Protection Warranty on that supply has ended. All print defects or cartridge failures incurred when an HP supply is used in [Continue](#) at very

low mode will not be considered to be defects in materials or workmanship in the supply under the HP Print Cartridge Warranty Statement.

## Cleaning

### Description

The product periodically performs a cleaning procedure to maintain the best print quality.

### Recommended action

Wait for the cleaning process to finish.

## Cyan Cartridge Low

### Description

The toner cartridge is nearing the end of its useful life.

### Recommended action

Printing can continue, but consider having a replacement supply on hand.

## Cyan in wrong position

### Description

The toner cartridge is installed in the incorrect slot.

### Recommended action

Ensure that each toner cartridge is installed in the correct slot. From front to back, the toner cartridges are installed in this order: black, cyan, magenta, and yellow.

## Cyan Very Low

### Description

The toner cartridge is at the end of its useful life. A customer configurable option on this product is "Prompt to Remind Me in 100 pages, 200 pages, 300 pages, 400 pages, or never." This option is provided as a customer convenience and is not an indication these pages will have acceptable print quality.

### Recommended action

To ensure optimal print quality, HP recommends replacing the toner cartridge at this point. You can continue printing until you notice a decrease in print quality. Actual cartridge life might vary.

Once an HP supply has reached **Very Low**, HP's Premium Protection Warranty on that supply has ended. All print defects or cartridge failures incurred when an HP supply is used in [Continue](#) at very low mode will not be considered to be defects in materials or workmanship in the supply under the HP Print Cartridge Warranty Statement.

## Device error, press OK

### Description

An internal error occurred.

### Recommended action

Touch the **OK** button to resume the job.

## Door open

### Description

The product front door is open.

### Recommended action

Close the door.

## Genuine HP supply installed

### Description

A genuine HP supply was installed.

### Recommended action

No action necessary.

## Incompatible <color>

### Description

You have installed a toner cartridge that is intended for use in a different HP product model. The product might not function correctly with this toner cartridge installed.

### Recommended action

Install the correct toner cartridge for this product.

## Incorrect supplies

### Description

More than one toner cartridge is installed in the incorrect slot.

### Recommended action

Be sure that each toner cartridge is in the correct slot. From front to back, the toner cartridges are installed in this order: black, cyan, magenta, yellow.

## Install <color> cartridge

### Description

The toner cartridge is either not installed or not correctly installed in the product.

### Recommended action

Install the toner cartridge.

## Invalid driver Press [OK]

### Description

You are using an incorrect printer driver.

### Recommended action

Select the correct printer driver.

## Jam in Tray 1, Clear jam and then press OK

### Description

The product has detected a jam.

### Recommended action

Clear the jam from the tray, and then touch **OK**.

If the message persists, contact HP support.

## Load tray 1 Press [OK] for available media

### Description

The tray is empty.

### Recommended action

Load paper into the tray to continue printing. Touch the **OK** button to select a different tray.

## Load Tray 1 <TYPE> <SIZE>, Press OK to use available media

### Description

The tray is not configured for the paper type and size that the print job is requesting.

### Recommended action

Load the correct paper into Tray 1. Or touch the **OK** button to use the paper currently in the tray.

## Load Tray 1, <PLAIN> <SIZE> / Cleaning mode, OK to start

### Description

The product is ready to process the cleaning operation.

### **Recommended action**

Load Tray 1 with plain paper in the size indicated, and then touch the **OK** button.

## **Magenta Cartridge Low**

### **Description**

The toner cartridge is nearing the end of its useful life.

### **Recommended action**

Printing can continue, but consider having a replacement supply on hand.

## **Magenta in wrong position**

### **Description**

The toner cartridge is installed in the incorrect slot.

### **Recommended action**

Ensure that each toner cartridge is installed in the correct slot. From front to back, the toner cartridges are installed in this order: black, cyan, magenta, and yellow.

## **Magenta Very Low**

### **Description**

The toner cartridge is at the end of its useful life. A customer configurable option on this product is "Prompt to Remind Me in 100 pages, 200 pages, 300 pages, 400 pages, or never." This option is provided as a customer convenience and is not an indication these pages will have acceptable print quality.

### **Recommended action**

To ensure optimal print quality, HP recommends replacing the toner cartridge at this point. You can continue printing until you notice a decrease in print quality. Actual cartridge life might vary.

Once an HP supply has reached **Very Low**, HP's Premium Protection Warranty on that supply has ended. All print defects or cartridge failures incurred when an HP supply is used in **Continue** at very low mode will not be considered to be defects in materials or workmanship in the supply under the HP Print Cartridge Warranty Statement.

## **Manual Duplex Load Tray 1, Press OK**

### **Description**

The first side of a manual duplex job has printed, and the page needs to be loaded to process the second side.

### **Recommended action**

Load the page in the indicated tray with the side to be printed face up, and the top of the page away from you, and then touch the **OK** button.

### Memory is low. Press OK.

#### Description

The product memory is almost full.

#### Recommended action

Touch the OK button to finish the job, or touch the Cancel X button to cancel the job.

Break the job into smaller jobs that contain fewer pages.

### Misprint, Press OK

#### Description

Paper has been delayed as it moves through the product.

#### Recommended action

Touch the OK button to clear the message.

To avoid this problem, try the following solutions:

1. Adjust the paper guides in the tray. Ensure the front paper guide is pushing the paper against the back edge of the tray.
2. Use paper that meets HP specifications. Store paper unopened in its original packaging.
3. Use the product in an area that meets the environmental specifications for this product.

### Print failure, press OK. If error repeats, turn off then on.

#### Description

The product cannot process the page.

#### Recommended action

Touch the OK button to continue printing the job, but output might be affected.

If the error persists, turn the power off and then on. Resend the print job.

### Rear door open

#### Description

The product rear door is open.

#### Recommended action

Close the door.

## Remove shipping lock from <color> cartridge

### Description

A toner cartridge shipping lock is installed.

### Recommended action

Pull the orange tab to remove the shipping lock from the cartridge.

## Remove shipping locks from cartridges

### Description

A toner cartridge shipping lock is installed on one or more toner cartridges.

### Recommended action

Pull the orange tab to remove the shipping lock from the cartridge.

## Replace <color>

### Description

The toner cartridge is at the end of its useful life, and the product is customer-configured to stop printing when it reaches the very low state.

### Recommended action

To ensure optimal print quality, HP recommends replacing the toner cartridge at this point. You can continue printing until you notice a decrease in print quality. Actual cartridge life might vary. Once an HP supply has reached **Very Low**, HP's Premium Protection Warranty on that supply has ended. All print defects or cartridge failures incurred when an HP supply is used in [Continue](#) at very low mode will not be considered to be defects in materials or workmanship in the supply under the HP Print Cartridge Warranty Statement.

## Supplies low

### Description

More than one toner cartridge is nearing the end of its useful life.

### Recommended action

Check the supply level gauges on the control panel, or print a supplies status page to determine which toner cartridges are low.

Printing will continue until a **Very Low** message displays. Consider having replacement supplies on hand.

## Unexpected size in tray 1 Load <size> Press [OK]

### Description

The product has detected paper in the tray that does not match the configuration for the tray.



**Recommended action**

Load the correct paper into the tray, or configure the tray for the size that you have loaded.

**Unsupported <color> Press [OK] to continue****Description**

The product has detected a toner cartridge that was not made by HP.

**Recommended action**

Touch the **OK** button to continue printing.

If you believe you purchased an HP supply, go to [www.hp.com/go/anticounterfeit](http://www.hp.com/go/anticounterfeit). Service or repairs that are required as a result of using unsupported supplies is not covered under HP warranty.

**Used <color> in use****Description**

You are using a toner cartridge that reached the default low threshold while it was installed in a product.

**Recommended action**

Printing can continue, but consider having a replacement supply on hand.

**Used <color> installed, to accept press OK****Description**

You have installed a toner cartridge that reached the default low threshold while it was installed in another product.

**Recommended action**

Touch the **OK** button to continue.

**Used supplies in use****Description**

You are using more than one toner cartridge that reached the default low threshold while it was installed in a product.

**Recommended action**

Printing can continue, but consider having replacement supplies on hand.

**Yellow Cartridge Low****Description**

The toner cartridge is nearing the end of its useful life.

### **Recommended action**

Printing can continue, but consider having a replacement supply on hand.

## **Yellow in wrong position**

### **Description**

The toner cartridge is installed in the incorrect slot.

### **Recommended action**

Ensure that each toner cartridge is installed in the correct slot. From front to back, the toner cartridges are installed in this order: black, cyan, magenta, and yellow.

## **Yellow Very Low**

### **Description**

The toner cartridge is at the end of its useful life. A customer configurable option on this product is "Prompt to Remind Me in 100 pages, 200 pages, 300 pages, 400 pages, or never." This option is provided as a customer convenience and is not an indication these pages will have acceptable print quality.

### **Recommended action**

To ensure optimal print quality, HP recommends replacing the toner cartridge at this point. You can continue printing until you notice a decrease in print quality. Actual cartridge life might vary.

Once an HP supply has reached **Very Low**, HP's Premium Protection Warranty on that supply has ended. All print defects or cartridge failures incurred when an HP supply is used in [Continue](#) at very low mode will not be considered to be defects in materials or workmanship in the supply under the HP Print Cartridge Warranty Statement.

## Event-log messages

The following product events do not produce a message that appears on the control panel. Instead, they are recorded in the event log. To print the event log, open the secondary service menu, select **Service Reports**, and then select **Error Report**.

**Table 2-4** Event-log messages

Event code	Description
10.0000	Black e-label error
10.0001	Cyan e-label error
10.0002	Magenta e-label error
10.0003	Yellow e-label error
10.0004	Imaging drum e-label error
10.1000	Black e-label missing
10.1001	Cyan e-label missing
10.1002	Magenta e-label missing
10.1003	Yellow e-label missing
10.1004	Imaging drum e-label missing
10.3000	Non-HP black
10.3001	Non-HP cyan
10.3002	Non-HP magenta
10.3003	Non-HP yellow
10.3004	Non-HP drum
10.3100	Non-HP cloned black
10.3101	Non-HP cloned cyan
10.3102	Non-HP cloned magenta
10.3103	Non-HP cloned yellow
10.3104	Non-HP cloned imaging drum
10.3200	Unauthorized black supply
10.3201	Unauthorized cyan supply
10.3202	Unauthorized magenta supply
10.3203	Unauthorized yellow supply
10.3300	Used (moved) black supply
10.3301	Used (moved) cyan supply
10.3302	Used (moved) magenta supply
10.3303	Used (moved) yellow supply

**Table 2-4 Event-log messages (continued)**

<b>Event code</b>	<b>Description</b>
10.3400	Used (beyond life) black supply
10.3401	Used (beyond life) cyan supply
10.3402	Used (beyond life) magenta supply
10.3403	Used (beyond life) yellow supply
10.3500	Incompatible black supply
10.3501	Incompatible cyan supply
10.3502	Incompatible magenta supply
10.3503	Incompatible yellow supply
10.4000	Genuine HP supplies installed (transition caused by black)
10.4001	Genuine HP supplies installed (transition caused by cyan)
10.4002	Genuine HP supplies installed (transition caused by magenta)
10.4003	Genuine HP supplies installed (transition caused by yellow)
10.4100	Unsupported black supply
10.4101	Unsupported cyan supply
10.4102	Unsupported magenta supply
10.4103	Unsupported yellow supply
10.7000	Printing past very low black
10.7001	Printing past very low cyan
10.7002	Printing past very low magenta
10.7003	Printing past very low yellow
10.7100	Printing black only
10.8100	Not printing black only
10.9531	Unspecified supply error in Toner Collection Unit
10.9800	Waste Toner Out (full) black
10.9801	Waste Toner Out (full) cyan
10.9802	Waste Toner Out (full) magenta
10.9803	Waste Toner Out (full) yellow
13.0000	Paper jam
13.1200	External device paper jam (13.12XX)
19.0000	Fax modem reset and power cycle
20.0000	Memory out in print
20.0001	Memory out in copy

**Table 2-4 Event-log messages (continued)**

<b>Event code</b>	<b>Description</b>
20.0002	Memory out in scan
20.0003	Memory out in photo
20.0004	Memory out in fax
20.0005	Memory out in fax flash
20.0006	Memory out in scan calibration
21.0000	Page punt
25.0000	SMTP error
30.0012	Scanner motor test failure
41.2000	Beam detect malfunction
41.3000	Unexpected size
50.0000	Fuser error
50.1000	Low fuser temperature error
50.1100	High subthermistor area 3 fuser error
50.1200	Low subthermistor area 3 fuser error
50.2000	Slow fuser error
50.3000	High fuser temperature error
50.4000	Fuser drive circuit error
50.7000	Fuser open error
50.8000	Low subthermistor fuser error
50.9000	High subthermistor fuser error
51.0000	Beam detect or laser error
51.2000	Black scanner laser error (inline devices only)
51.2100	Cyan scanner laser error (inline devices only)
51.2200	Magenta scanner laser error (inline devices only)
51.2300	Yellow scanner laser error (inline devices only)
52.0000	Scanner error
54.0100	Environmental sensor error
54.0600	Density sensor error
54.0700	Yellow drum phase control sensor error
54.0800	Magenta drum phase control sensor error
54.0900	Cyan drum phase control sensor error
54.1000	Black drum phase control sensor error

**Table 2-4 Event-log messages (continued)**

<b>Event code</b>	<b>Description</b>
54.1100	Black density out of range
54.1101	Cyan density out of range
54.1102	Magenta density out of range
54.1103	Yellow density out of range
54.1200	Black density measurement abnormality
54.1201	Cyan density measurement abnormality
54.1202	Magenta density measurement abnormality
54.1203	Yellow density measurement abnormality
54.1400	Color plane registration sensor error (inline devices only)
54.1599	Black CPR pattern can't be read
54.1501	Cyan CPR pattern can't be read
54.1502	Magenta CPR pattern can't be read
54.1503	Yellow CPR pattern can't be read
54.1500	Yellow toner level sensor error
54.1600	Magenta toner level sensor error
54.1700	Cyan toner level sensor error
54.1800	Black toner level sensor error
54.1900	Bad TOP sensor
54.2000	Carousel rotation error
54.2100	BD error
54.2500	TOP sensor error
54.2800	Density sensor or CPR contamination warning (54.1C)
55.0000	Engine internal communication error
55.0601	DC controller NVRAM data error
55.0602	DC controller NVRAM access error
55.1000	DC controller memory error
55.3000	Engine/ formatter communication error
55.4000	Engine communication timeout error
55.9028	DC controller NVRAM restore
56.0100	Illegal input
57.0000	Fan motor error
57.0100	Fan motor error

**Table 2-4 Event-log messages (continued)**

<b>Event code</b>	<b>Description</b>
57.0200	Fan error
57.0600	Fan motor error
58.0400	Low voltage power supply error
59.0160	Main motor rotation error (59.A0)
59.0192	Developer motor rotation error (59.C0)
59.0240	Transfer alientation failure (59.F0)
59.3000	Fuser motor startup error
59.4000	Fuser motor error
59.5000	Image drum motor startup error- black
59.5100	Image drum motor startup error- cyan
59.5200	Image drum motor startup error- magenta
59.5300	Image drum motor startup error- yellow
59.6000	Image drum motor rotation error- black
59.6100	Image drum motor rotation error- cyan
59.6200	Image drum motor rotation error- magenta
59.6300	Image drum motor rotation error- yellow
59.7000	Black developer motor startup error
59.7300	Yellow developer motor startup error
59.8000	Black developer motor rotation error
59.8300	Yellow developer motor rotation error
59.9000	ETB motor start error
59.9900	T2 Clutch error
65.1200	External device operation error (65.12XX)
66.1200	External device critical error (66.12XX)
66.0015	External device communication error
79.0000	79 service, firmware exception
79.0001	79 service, firmware ASIC fault
79.0003	79 service, firmware Boba ASIC fault
79.0004	79 service, firmware memory interface fault
79.0005	79 service, firmware text write fault
49.<line #>	Firmware asserts

**Table 2-4 Event-log messages (continued)**

<b>Event code</b>	<b>Description</b>
99.0028	Download error - bad signature accepted
99.0029	Download error - bad signature canceled

**Table 2-5 Fax event log codes**

<b>Event code</b>	<b>Description</b>
20.0016	Receive fax directory missing
20.0032	Send fax directory missing
20.0048	Send ID file is corrupted
20.0064	Receive ID file is corrupted
20.0080	Flash log corrupted
20.0096	Flash init due to firmware upgrade
20.0119	Fax flash sec store missing
20.2467	Write to flash failed



# Clear jams

## Jam locations

Jams can occur in these locations:

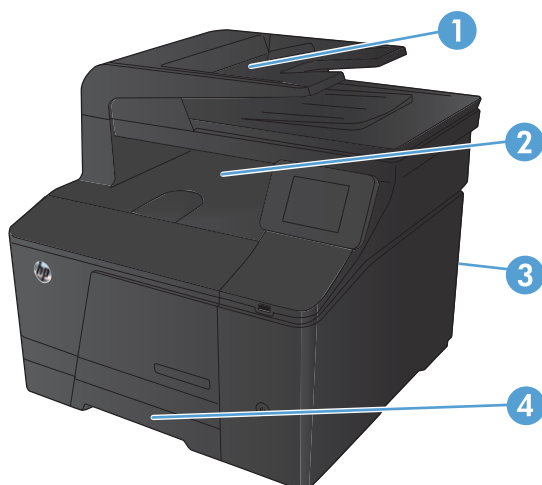

1	Document feeder
2	Output bin
3	Rear door
4	Input tray

Loose toner might remain in the product after a jam. This problem typically resolves itself after a few sheets have been printed.

## Clear jams from the document feeder

1. Turn the product off.



2. Open the document feeder cover.

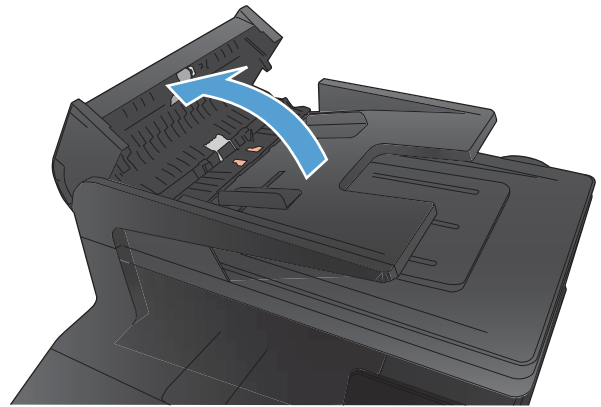

3. Lift the document feeder roller assembly, and gently pull the jammed paper out.

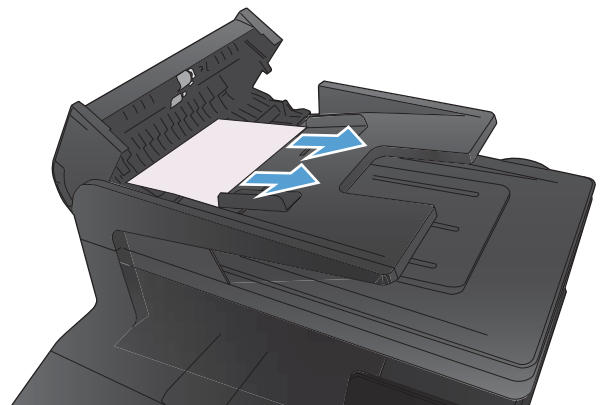

4. Close the document feeder roller assembly, and then close the document feeder cover.

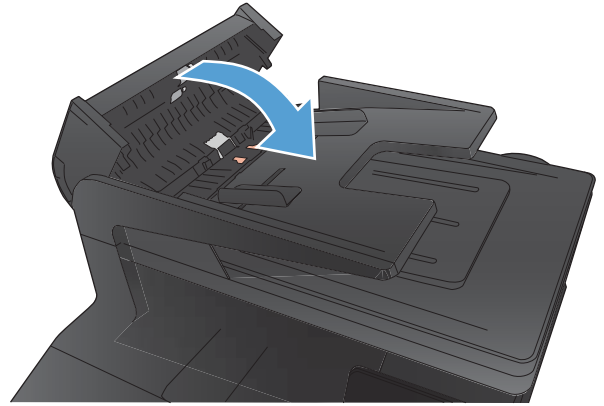

5. Open the scanner lid. If paper is jammed behind the white plastic backing, gently pull it out.

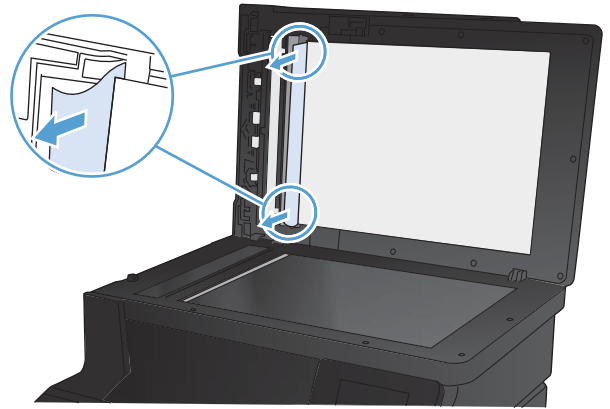

## Clear jams in the paper input tray

**⚠ CAUTION:** Do not use sharp objects, such as tweezers or needle-nose pliers, to remove jams. Damage caused by sharp objects is not covered by the warranty.

When removing jammed paper, pull it straight out from the product. Pulling jammed paper out of the product at an angle can damage the product.

**📝 NOTE:** Depending on where the jam is located, some of the following steps might not be necessary.

1. Pull out the tray, and lift the jam access door above the tray.

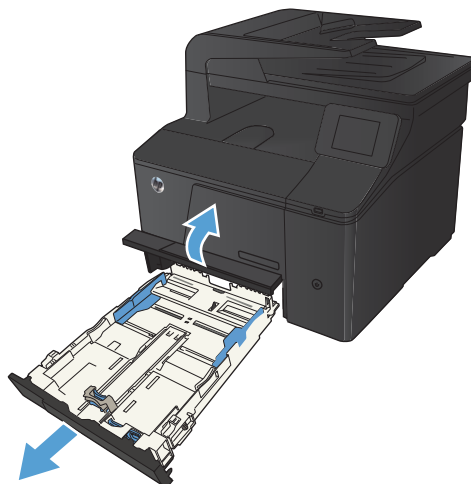

2. With both hands, grasp the paper, and carefully pull it free from the product.

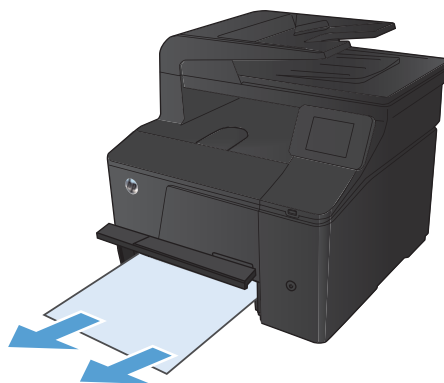

3. Replace the tray.

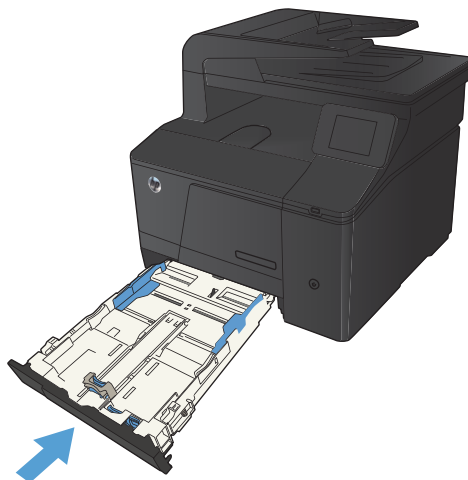

4. Press the **OK** button to continue printing.

## Clear jams from the output bin

**⚠ CAUTION:** Do not use sharp objects, such as tweezers or needle-nose pliers, to remove jams. Damage caused by sharp objects will not be covered by the warranty.

1. With both hands, grasp the paper, and carefully pull it free from the product.



## Clear jams from the rear door

1. Open the rear door.

**CAUTION:** The fuser is located above the rear door, and it is hot. Do not attempt to reach into the area above the rear door until the fuser is cool.

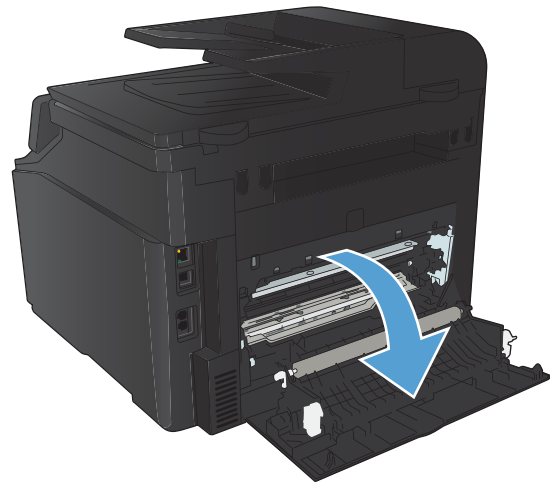

2. With both hands, grasp the paper, and carefully pull it free from the product.

**NOTE:** If the sheet tears, remove all fragments before continuing. Do not use sharp objects to remove fragments.



3. Close the rear door.

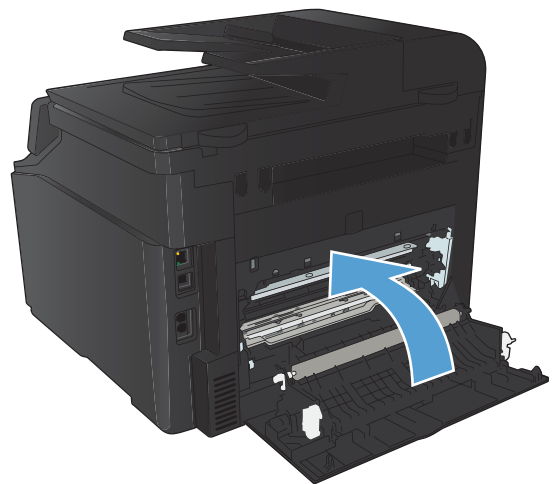

# Solve paper-handling problems

## The product picks up multiple sheets of paper

If the product picks up multiple sheets of paper from the tray, try these solutions.

1. Remove the stack of paper from the tray and flex it, rotate it 180 degrees, and flip it over. *Do not fan the paper.* Return the stack of paper to the tray.
2. Use only paper that meets HP specifications for this product.
3. Use paper that is not wrinkled, folded, or damaged. If necessary, use paper from a different package.
4. Make sure the tray is not overfilled. If it is, remove the entire stack of paper from the tray, straighten the stack, and then return some of the paper to the tray.
5. Make sure the paper guides in the tray are adjusted correctly for the size of paper. Align the guides with the paper-size markings in the bottom of the tray.

## The product does not pick up paper

If the product does not pick up paper from the tray, try these solutions.

1. Open the product and remove any jammed sheets of paper.
2. Load the tray with the correct size of paper for your job.
3. Make sure the paper guides in the tray are adjusted correctly for the size of paper. Align the guides with the paper-size markings in the bottom of the tray.
4. Check the product control panel to see if the product is waiting for you to acknowledge a prompt to feed the paper manually. Load paper, and continue.

# Solve image quality problems

You can prevent most print-quality problems by following these guidelines.

- [Use the correct paper type setting in the printer driver](#)
- [Adjust color settings in the printer driver](#)
- [Use paper that meets HP specifications](#)
- [Print a cleaning page](#)
- [Calibrate the product to align the colors](#)
- [Check the toner cartridges](#)
- [Use the printer driver that best meets your printing needs](#)

## Use the correct paper type setting in the printer driver

Check the paper type setting if you are having any of the following problems:

- Toner is smearing on the printed pages.
- Repeated marks occur on the printed pages.
- Printed pages are curled.
- Toner flakes off the printed pages.
- Printed pages have small unprinted areas.

## Change the paper type setting for Windows

1. On the **File** menu in the software program, click **Print**.
2. Select the product, and then click the **Properties** or **Preferences** button.
3. Click the **Paper/Quality** tab.
4. From the **Paper type** drop-down list, click the **More...** option.
5. Expand the list of **Type is:** options.
6. Expand each category of paper types until you find the paper type that you are using.
7. Select the option for the type of paper you are using, and click the **OK** button.

## Change the paper type setting for Mac

1. On the **File** menu in the software program, click the **Print** option.
2. In the **Copies & Pages** menu, click the **Page Setup** button.
3. Select a size from the **Paper Size** drop-down list, and then click the **OK** button.



4. Open the **Finishing** menu.
5. Select a type from the **Media-type** drop-down list.
6. Click the **Print** button.

## Adjust color settings in the printer driver

### Change the color theme for a print job

1. On the **File** menu in the software program, click **Print**.
2. Click **Properties** or **Preferences**.
3. Click the **Color** tab.
4. Select a color theme from the **Color Themes** drop-down list.

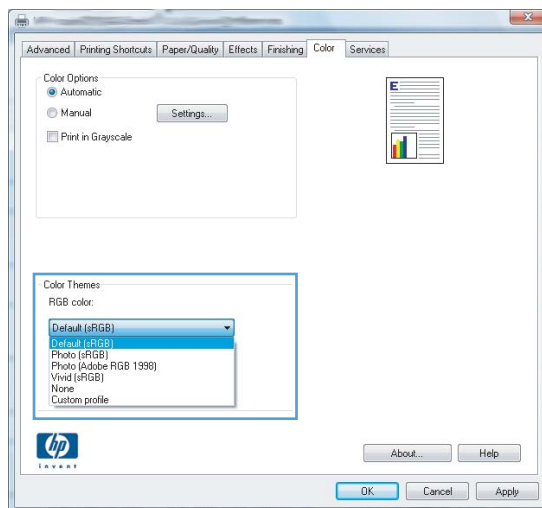

- **Default (sRGB):** This theme sets the product to print RGB data in raw device mode. When using this theme, manage color in the software program or in the operating system for correct rendering.
- **Vivid:** The product increases the color saturation in the midtones. Use this theme when printing business graphics.
- **Photo:** The product interprets RGB color as if it were printed as a photograph using a digital mini lab. The product renders deeper, more saturated colors differently than with the Default (sRGB) theme. Use this theme when printing photos.
- **Photo (Adobe RGB 1998):** Use this theme with printing digital photos that use the AdobeRGB color space rather than sRGB. Turn off color management in the software program when using this theme.
- **None**

## Change the color options

Change the color options settings for the current print job from the color tab of the printer driver.

1. On the **File** menu in the software program, click **Print**.
2. Click **Properties** or **Preferences**.
3. Click the **Color** tab.
4. Click the **Automatic** or **Manual** setting.
  - **Automatic** setting: Select this setting for most color print jobs
  - **Manual** setting: Select this setting to adjust the color settings independent from other settings.

 **NOTE:** Changing color settings manually can impact output. HP recommends that only color graphics experts change these settings.

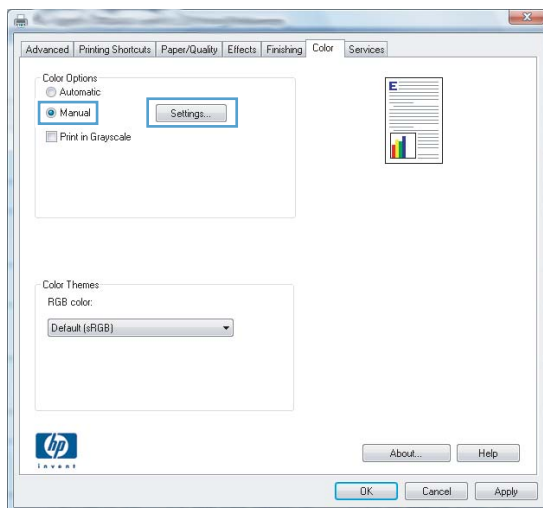

5. Click the **Print in Grayscale** option to print a color document in black and white. Use this option to print color documents for photocopying or faxing.
6. Click the **OK** button.

## Use paper that meets HP specifications

Use different paper if you are having any of the following problems:

- The printing is too light or seems faded in areas.
- Specks of toner are on the printed pages.
- Toner is smearing on the printed pages.
- Printed characters seem misformed.
- Printed pages are curled.

Always use a paper type and weight that this product supports. In addition, follow these guidelines when selecting paper:

- Use paper that is of good quality and free of cuts, nicks, tears, spots, loose particles, dust, wrinkles, voids, staples, and curled or bent edges.
- Use paper that has not been previously printed on.
- Use paper that is designed for use in laser printers. Do not use paper that is designed only for use in Inkjet printers.
- Use paper that is not too rough. Using smoother paper generally results in better print quality.

## Print a cleaning page

Print a cleaning page to remove dust and excess toner from the paper path if you are having any of the following problems:

- Specks of toner are on the printed pages.
  - Toner is smearing on the printed pages.
  - Repeated marks occur on the printed pages.
1. From the Home screen on the product control panel, touch the Setup  button.
  2. Touch the [Service](#) menu.
  3. Touch the [Cleaning Page](#) button.
  4. Load plain letter or A4 paper when you are prompted.
  5. Touch the [OK](#) button to begin the cleaning process.
  6. The product prints the first side and then prompts you to remove the page from the output bin and reload it in Tray 1, keeping the same orientation (the side with the black stripe should be face-down with the arrow toward the back of the product).
  7. Press the [OK](#) button to continue the cleaning process. Wait until the process is complete. Discard the page that prints.

## Calibrate the product to align the colors

If the printed output has colored shadows, blurry graphics, or areas that have poor color, you might need to calibrate the product to align the colors. Print the Diagnostics Page from the Reports menu on the control panel to check the color alignment. If the blocks of color on that page are not aligned with each other, you need to calibrate the product.

1. On the product control panel, open the [System Setup](#) menu.
2. Open the [Print Quality](#) menu, and select the [Color Calibration](#) item.
3. Select the [Calibrate Now](#) option.

## Check the toner cartridges

Check each toner cartridge, and replace them if necessary, if any of the following problems occur:

- The printing is too light or seems faded in areas.
- Printed pages have small unprinted areas.
- Printed pages have streaks or bands.

If a toner cartridge must be replaced, print the supplies status page to find the part number for the correct genuine HP toner cartridge.

Type of toner cartridge	Steps to resolve the problem
Refilled or remanufactured toner cartridge	Hewlett Packard Company cannot recommend the use of non-HP supplies, either new or remanufactured. Because they are not HP products, HP cannot influence their design or control their quality. If you are using a refilled or remanufactured toner cartridge and are not satisfied with the print quality, replace the toner cartridge with a genuine HP toner cartridge that includes “HP” or “Hewlett-Packard”, or has the HP logo on it.
Genuine HP toner cartridge	<ol style="list-style-type: none"><li>1. The product control panel or the <a href="#">Supplies Status</a> page indicates <b>Very Low</b> status when the toner cartridge has reached the end of its estimated life. Replace the toner cartridge if print quality is no longer acceptable.</li><li>2. Print a Print Quality Page from the <b>Reports</b> menu on the control panel. If streaks or marks are in one color on the page, the color cartridge may be defective. See the instructions in this document for interpreting the page. Replace the toner cartridge if necessary.</li><li>3. Visually inspect the toner cartridge for damage. See the instructions that follow. Replace the toner cartridge if necessary.</li><li>4. If printed pages have marks that repeat several times at the same distance apart, print a cleaning page. If this does not solve the problem, use the repetitive defects ruler in this document to identify the cause of the problem.</li></ol>

## Print the Supplies Status page

The [Supplies Status](#) page indicates the estimated life remaining in print cartridges. It also lists the part number for the correct genuine HP print cartridge for your product so you can order a replacement print cartridge, as well as other useful information.

1. On the product control panel, open the [Reports](#) menu.
2. Select the [Supplies Status](#) page to print it.

## Inspect the print cartridge for damage

1. Remove the print cartridge from the product, and verify that the sealing tape has been removed.
2. Check the memory chip for damage.

3. Examine the surface of the green imaging drum on the bottom of the print cartridge.

**CAUTION:** Do not touch the green roller (imaging drum) on the bottom of the cartridge. Fingerprints on the imaging drum can cause print-quality problems.

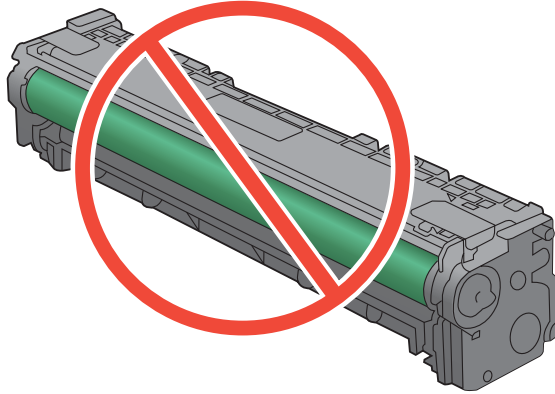

4. If you see any scratches, fingerprints, or other damage on the imaging drum, replace the print cartridge.
5. If the imaging drum does not appear to be damaged, rock the print cartridge gently several times and reinstall it. Print a few pages to see if the problem has resolved.

## Repeating defects

If defects repeat at any of the following intervals on the page, a print cartridge might be damaged.

- 22 mm
- 27 mm
- 29 mm
- 76 mm

## Use the printer driver that best meets your printing needs

You might need to use a different printer driver if the printed page has unexpected lines in graphics, missing text, missing graphics, incorrect formatting, or substituted fonts.

---

**HP PCL 6 driver**

- Provided as the default driver. This driver is automatically installed unless you select a different one.
- Recommended for all Windows environments
- Provides the overall best speed, print quality, and product-feature support for most users
- Developed to align with the Windows Graphic Device Interface (GDI) for the best speed in Windows environments
- Might not be fully compatible with third-party and custom software programs that are based on PCL 5

---

**HP UPD PS driver**

- Recommended for printing with Adobe® software programs or with other highly graphics-intensive software programs
- Provides support for printing from postscript emulation needs, or for postscript flash font support

---

**HP UPD PCL 5**

- Recommended for general office printing in Windows environments
  - Compatible with previous PCL versions and older HP LaserJet products
  - The best choice for printing from third-party or custom software programs
  - The best choice when operating with mixed environments, which require the product to be set to PCL 5 (UNIX, Linux, mainframe)
  - Designed for use in corporate Windows environments to provide a single driver for use with multiple printer models
  - Preferred when printing to multiple printer models from a mobile Windows computer
- 

Download additional printer drivers from this Web site: [www.hp.com/support/ljcolorm276series](http://www.hp.com/support/ljcolorm276series).

# Solve performance problems

## Factors affecting print performance

Problem	Cause	Solution
Pages print but are totally blank.	The sealing tape might still be in the toner cartridges.	Verify that the sealing tape has been completely removed from the toner cartridges.
	The document might contain blank pages.	Check the document that is printing to see if content appears on all of the pages.
	The product might be malfunctioning.	To check the product, print a Configuration page.
Pages print very slowly. <b>NOTE:</b> The product print speed is effected by various factors (for example, media size or page complexity).	Heavier media types can slow the print job.	Print on a different type of media.
	Complex pages can print slowly.	Proper fusing might require a slower print speed to ensure the best print quality.
	Paper type not set correctly.	Select the type to match the paper.
Pages did not print.	The product might not be pulling media correctly.	Ensure paper is loaded correctly in the tray.  If the problem persists, the pickup rollers and the separation pad may need to be replaced.
	The media is jamming in the device.	Clear the jam.
	The USB cable might be defective or incorrectly connected.	<ul style="list-style-type: none"><li>• Disconnect the USB cable at both ends and reconnect it.</li><li>• Try printing a job that has printed in the past.</li><li>• Try using a different USB cable.</li></ul>
	Other devices are running on your computer.	The product might not share a USB port. If an external hard drive or network switchbox is connected to the same port as the product, the other device might be interfering. To connect and use the product, disconnect the other device or use two USB ports on the computer.

## Print speeds

Print speed is the number of pages that print in one minute. Print speed depends on different engine-process speeds or operational pauses between printed pages during normal product operation. Factors that determine the print speed of the product include the following:

- Page formatting time

The product must pause for each page to be formatted before it prints. Complex pages take more time to format, resulting in reduced print speed. However, most jobs print at full engine speed (21 ppm on Letter-size media or 20 ppm on A4-size media).

- Color mode

Monochrome printing (black only) provides the maximum print speed. Full color print jobs cause a reduction in print speed.

- Media size

Legal-size media reduces print speed because it is longer than the standard Letter- or A4-size media. A reduced print speed is used when printing on narrow media to prevent the edges of the fuser from overheating.

- Media mode

Some media types require a reduced print speed to achieve maximum print quality on that media. For example, glossy, heavy, and specialty media (for example, envelopes or photos) require a reduced print speed. To maximize the print speed for special media types, ensure the correct media type is selected in the print driver.

- Product temperature

To prevent product damage, print speed is reduced if the product reaches a specific internal temperature (thermal slow down). The starting temperature of the product, the ambient environment temperature, and the print job size affect the number of pages that can be printed before the product reduces the print speed. Thermal slow-down reduces print speed by printing four pages and then pausing for an amount of time before printing continues.

- Other print speed reduction factors

Other factors (especially during large print jobs) that can cause reduced print speeds include:

- ITB cleaning and lubrication; occurs every 50 to 80 pages and takes about 60 seconds.
- CPR control sequence; occurs every 450 pages and takes about 90 seconds.
- Density control sequence; occurs every 150 pages and takes about 120 seconds.



## The product does not print or it prints slowly

### The product does not print

If the product does not print at all, try the following solutions.

1. Make sure the product is turned on and that the control panel indicates it is ready.
  - If the control panel does not indicate the product is ready, turn the product off and then on again.
  - If the control panel indicates the product is ready, try sending the job again.
2. If the control panel indicates the product has an error, resolve the error and then try sending the job again.
3. Make sure the cables are all connected correctly. If the product is connected to a network, check the following items:
  - Check the light next to the network connection on the product. If the network is active, the light is green.
  - Make sure that you are using a network cable and not a phone cord to connect to the network.
  - Make sure the network router, hub, or switch is turned on and that it is working correctly.
4. Install the HP software from the CD that came with the product. Using generic printer drivers can cause delays clearing jobs from the print queue.
5. From the list of printers on your computer, right-click the name of this product, click **Properties**, and open the **Ports** tab.
  - If you are using a network cable to connect to the network, make sure the printer name listed on the **Ports** tab matches the product name on the product configuration page.
  - If you are using a USB cable and are connecting to a wireless network, make sure the box is checked next to **Virtual printer port for USB**.
6. If you are using a personal firewall system on the computer, it might be blocking communication with the product. Try temporarily disabling the firewall to see if it is the source of the problem.
7. If your computer or the product is connected to a wireless network, low signal quality or interference might be delaying print jobs.

## The product prints slowly

If the product prints, but it seems slow, try the following solutions.

1. Make sure the computer meets the minimum specifications for this product. For a list of specifications, go to this Web site: [www.hp.com/support/ljcolorm276series](http://www.hp.com/support/ljcolorm276series).
2. When you configure the product to print on some paper types, such as heavy paper, the product prints more slowly so it can correctly fuse the toner to the paper. If the paper type setting is not correct for the type of paper you are using, change the setting to the correct paper type.
3. If your computer or the product is connected to a wireless network, low signal quality or interference might be delaying print jobs.

# Solve product connectivity problems

## Solve direct-connect problems

If you have connected the product directly to a computer, check the cable.

- Verify that the cable is connected to the computer and to the product.
- Verify that the cable is not longer than 5 m (16.4 ft). Try using a shorter cable.
- Verify that the cable is working correctly by connecting it to another product. Replace the cable if necessary.

## Solve network problems

Check the following items to verify that the product is communicating with the network. Before beginning, print a configuration page from the product control panel and locate the product IP address that is listed on this page.

- [Poor physical connection](#)
- [The computer is using the incorrect IP address for the product](#)
- [The computer is unable to communicate with the product](#)
- [The product is using incorrect link and duplex settings for the network](#)
- [New software programs might be causing compatibility problems](#)
- [The computer or workstation might be set up incorrectly](#)
- [The product is disabled, or other network settings are incorrect](#)

### Poor physical connection

1. Verify that the product is attached to the correct network port using a cable of the correct length.
2. Verify that cable connections are secure.
3. Look at the network port connection on the back of the product, and verify that the amber activity light and the green link-status light are lit.
4. If the problem continues, try a different cable or port on the hub.

### The computer is using the incorrect IP address for the product

1. Open the printer properties and click the **Ports** tab. Verify that the current IP address for the product is selected. The product IP address is listed on the product configuration page.
2. If you installed the product using the HP standard TCP/IP port, select the box labeled **Always print to this printer, even if its IP address changes.**

3. If you installed the product using a Microsoft standard TCP/IP port, use the hostname instead of the IP address.
4. If the IP address is correct, delete the product and then add it again.

### The computer is unable to communicate with the product

1. Test network communication by pinging the network.
  - a. Open a command-line prompt on your computer. For Windows, click **Start**, click **Run**, and then type `cmd`.
  - b. Type `ping` followed by the IP address for your product.
  - c. If the window displays round-trip times, the network is working.
2. If the ping command failed, verify that the network hubs are on, and then verify that the network settings, the product, and the computer are all configured for the same network.

### The product is using incorrect link and duplex settings for the network

Hewlett-Packard recommends leaving this setting in automatic mode (the default setting). If the settings are changed, they must also be changed for the network.

### New software programs might be causing compatibility problems

Verify that any new software programs are correctly installed and that they use the correct printer driver.

### The computer or workstation might be set up incorrectly

1. Check the network drivers, printer drivers, and the network redirection.
2. Verify that the operating system is configured correctly.

### The product is disabled, or other network settings are incorrect

1. Review the configuration page to check the status of the network protocol. Enable it if necessary.
2. Reconfigure the network settings if necessary.

## Solve wireless network problems

- [Wireless connectivity checklist](#)
- [The control panel displays the message: The wireless feature on this product has been turned off](#)
- [The product does not print after the wireless configuration completes](#)
- [The product does not print, and the computer has a third-party firewall installed](#)
- [The wireless connection does not work after moving the wireless router or product](#)
- [Cannot connect more computers to the wireless product](#)
- [The wireless product loses communication when connected to a VPN](#)
- [The network does not appear in the wireless networks list](#)
- [The wireless network is not functioning](#)

### Wireless connectivity checklist

- The product and the wireless router are turned on and have power. Also make sure the wireless radio in the product is turned on.
- The service set identifier (SSID) is correct. Print a configuration page to determine the SSID. If you are not sure the SSID is correct, run the wireless setup again.
- With secured networks, make sure the security information is correct. If the security information is incorrect, run the wireless setup again.
- If the wireless network is working correctly, try accessing other computers on the wireless network. If the network has Internet access, try connecting to the Internet over a wireless connection.
- The encryption method (AES or TKIP) is the same for the product as it is for the wireless access point (on networks using WPA security).
- The product is within the range of the wireless network. For most networks, the product must be within 30 m (100 ft) of the wireless access point (wireless router).
- Obstacles do not block the wireless signal. Remove any large metal objects between the access point and the product. Make sure poles, walls, or support columns containing metal or concrete do not separate the product and wireless access point.
- The product is located away from electronic devices that might interfere with the wireless signal. Many devices can interfere with the wireless signal including motors, cordless phones, security system cameras, other wireless networks, and some Bluetooth devices.
- The printer driver is installed on the computer.
- You have selected the correct printer port.
- The computer and product connect to the same wireless network.

## The control panel displays the message: The wireless feature on this product has been turned off

- ▲ Press the wireless button on the product to open the Wireless menu, and then turn the wireless radio on.

## The product does not print after the wireless configuration completes

1. Make sure the product is turned on and in the ready state.
2. Make sure you are connecting to the correct wireless network.
3. Make sure that the wireless network is working correctly.
  - a. Open the [Network Setup](#) menu, and then open the [Wireless Menu](#) item.
  - b. Select the [Run Network Test](#) item to test the wireless network. The product prints a report with the results.
4. Make sure that the correct port or product is selected.
  - a. From the list of printers on your computer, right-click the name of this product, click **Properties**, and then open the **Ports** tab.
  - b. Make sure the box is checked next to **Virtual printer port for USB**.
5. Make sure that your computer is working correctly. If necessary, restart your computer.

## The product does not print, and the computer has a third-party firewall installed

1. Update the firewall with the most recent update available from the manufacturer.
2. If programs request firewall access when you install the product or try to print, make sure you allow the programs to run.
3. Temporarily turn off the firewall, and then install the wireless product on the computer. Enable the firewall when you have completed the wireless installation.

## The wireless connection does not work after moving the wireless router or product

Make sure that the router or product connects to the same network that your computer connects to.

1. Open the [Reports](#) menu, and select the [Configuration Report](#) item to print the report.
2. Compare the service set identifier (SSID) on the configuration report to the SSID in the printer configuration for your computer.
3. If the SSIDs are not the same, the devices are not connecting to the same network. Reconfigure the wireless setup for your product.

## Cannot connect more computers to the wireless product

1. Make sure that the other computers are within the wireless range and that no obstacles block the signal. For most networks, the wireless range is within 30 m (100 ft) of the wireless access point.
2. Make sure the product is turned on and in the ready state.
3. Turn off any third-party firewalls on your computer.
4. Make sure that the wireless network is working correctly.
  - a. On the product control panel, open the [Network Setup](#) menu, and then open the [Wireless Menu](#) item.
  - b. Select the [Run Network Test](#) item to test the wireless network. The product prints a report with the results.
5. Make sure that the correct port or product is selected.
  - a. From the list of printers on your computer, right-click the name of this product, click **Properties**, and then open the **Ports** tab.
  - b. Click the **Configure Port** button to verify that the IP address matches the IP address listed on the Run Network Test report.
6. Make sure that your computer is working correctly. If necessary, restart your computer.

## The wireless product loses communication when connected to a VPN

- Typically, you cannot connect to a VPN and other networks at the same time.

## The network does not appear in the wireless networks list

- Make sure the wireless router is turned on and has power.
- The network might be hidden. However, you can still connect to a hidden network.

## The wireless network is not functioning

1. To verify if the network has lost communication, try connecting other devices to the network.
2. Test network communication by pinging the network.
  - a. Open a command-line prompt on your computer. For Windows, click **Start**, click **Run**, and then type `cmd`.
  - b. Type `ping` followed by the service set identifier (SSID) for your network.
  - c. If the window displays round-trip times, the network is working.
3. Make sure that the router or product connects to the same network that your computer connects to.
  - a. Open the [Reports](#) menu, and select the [Configuration Report](#) item to print the report.
  - b. Compare the service set identifier (SSID) on the configuration report to the SSID in the printer configuration for your computer.
  - c. If the SSIDs are not the same, the devices are not connecting to the same network. Reconfigure the wireless setup for your product.



# Service mode functions

## Secondary service menu

Use the secondary service menu to print service-related reports and to run special tests. Customers do not have access to this menu.

### Open the secondary service menu

1. Touch the Setup  button.
2. Touch the middle of the screen along the left-hand edge (callout 1), and then immediately touch the lower-right corner (callout 2) of the screen.



3. When the Home screen appears, touch the Setup  button.
4. Touch the [2ndary Service](#) button to open the menu.

 **TIP:** When you are finished with the [2ndary Service](#) menu, touch the lower-right corner of the screen until the **Job settings cleared.** message appears on the Home screen. This step removes the [2ndary Service](#) option from the [Setup Menu](#).

## Secondary service menu structure

**Table 2-6** Secondary service menu

Menu item	Sub-menu item	Description
Service Reports	Cont. Self-Test	This item prints a continuous configuration page.
	Error report	This item prints an error report that contains the last 5 instances of <b>49 Error, Turn off then on</b> or <b>79 Error Turn off then on</b> errors.

**Table 2-6 Secondary service menu (continued)**

Menu item	Sub-menu item	Description
<b>Location</b>	A list of available locations appears	<p>This item sets certain product parameters that are dependent on the location, such as the default paper size and the symbol set.</p> <p>Scroll to the appropriate location and select <b>Yes</b> to set the location. The product automatically restarts after you change the location.</p>
<b>Display test</b>		<p>This test verifies that the LEDs and characters on the control-panel display function correctly.</p> <p>At the beginning of the test, each of the LEDs turns on one-at-a-time. Touch the <b>OK</b> button to continue to the next LED.</p> <p>After the LED test is complete, the character test begins by testing the pixels on each line. Then, each of the 255 characters is displayed in groups of 16. Touch the <b>OK</b> button to continue to the next group of 16 characters. You can cancel the test at any time by touching the <b>Cancel</b> <b>X</b> button.</p>
<b>Button test</b>		This test verifies that the control-panel buttons function correctly. The display prompts you to touch each button.
<b>Color Cal.</b>	<b>Adjust color</b>	This item adjusts density settings for contrast, highlights, midtones, and shadows. Adjust each color individually.
	<b>Timing</b>	This item specifies how frequently the product should automatically perform a color calibration. The default setting is 48 hours. You can turn automatic calibration off.
<b>PBX ring detect</b>	On or Off	Configure the PBX ring detect setting.
<b>Clean Belt</b>		This item runs additional belt-cleaning cycles.
<b>Pick roller</b>		This item puts the pickup roller in position for replacement.

## Product resets

The product resets—**Restore Defaults** and the NVRAM initialization—perform the same function. If possible, use the **Restore Defaults** function in the **Service** menu. If that menu is not accessible, use the NVRAM sequence.

From the Home screen, touch the Setup  button.

## Restore the factory-set defaults

 **CAUTION:** Restoring the factory-set defaults returns all of the product and network settings to the factory defaults, and it also clears the fax header name, phone number, and any stored faxes in the product memory. This procedure also clears the fax phone book, and deletes any pages that are stored in the memory. The procedure then automatically restarts the product.

1. On the product control panel, touch the Setup  button.
2. Scroll to and touch the **Service** menu.
3. Scroll to and touch the **Restore Defaults** button, and then touch the **OK** button.

The product automatically restarts.

## NVRAM initialization

Performing an NVRAM initialization resets the following settings and information:

- All menu settings are reset to factory default values.
- All localization settings, including language and country/region, are reset.

 **CAUTION:** All onboard network settings are also reset. Be sure to print a configuration page before restoring defaults. Make note of the IP address that is listed on the HP Jetdirect configuration page. You might need to restore the IP address after an NVRAM initialization.

After performing an NVRAM initialization, reconfigure any computers that print to this product. Uninstall and then reinstall the product software on the computers.

1. Turn the product off.
2. Touch the right arrow button. Hold this button as you turn the product on.

 **NOTE:** The right arrow button is not visible when the product is off, but it is still active. Note its position before you turn off the product.

3. When **Permanent storage init.** appears on the display, release the right arrow button.

When the product has finished the NVRAM initialization, it returns to the Ready state.

# Solve fax problems

## Fax troubleshooting checklist

- Several possible fixes are available. After each recommended action, retry faxing to see if the problem is resolved.
- For best results during fax problem solving, make sure the line from the product is plugged directly into the wall phone port. Disconnect all other devices that are connected to the product.
- 1. Verify that the telephone cord is plugged into the correct port on the back of the product.
- 2. Check the phone line by using the fax test:
  - a. From the Home screen on the product control panel, touch the Setup  button, and then open the [Service](#) menu.
  - b. Select the [Fax Service](#) option.
  - c. Select the [Run Fax Test](#) option. The product prints a fax test report.

The report contains the following possible results:

- **Pass:** The report contains all of the current fax settings for review.
  - **Fail:** The cord is in the wrong port. The report contains suggestions for how to resolve the issue.
  - **Fail :** The phone line is not active. The report contains suggestions for how to resolve the issue.
3. Verify that the product firmware is current:
    - a. Print a configuration page from the control panel [Reports](#) menu to obtain the current firmware date code.
    - b. Go to [www.hp.com](http://www.hp.com).
      1. Click the **Support & Drivers** link.
      2. Click the **Download drivers and software (and firmware)** link option.
      3. In the **For product** box, type the product model number, and then click the **Go** button.

4. Click the link for your operating system.
5. Scroll to the Firmware section of the table.
  - If the listed version matches the version on the configuration page, you have the most current version.
  - If the versions are different, download the firmware upgrade and update the firmware on the product following the instructions onscreen.



---

**NOTE:** The product must be connected to a computer with internet access to upgrade firmware.

---

- Resend the fax.

4. Verify that the fax was set up when the product software was installed.

From the computer, in the HP program folder, run the Fax Setup Utility.

5. Verify that the telephone service supports analog fax.
  - If using ISDN or digital PBX, contact your service provider for information about configuring to an analog fax line.
  - If using a VoIP service, change the [Fax Speed](#) setting to [Slow\(V.29\)](#) or disable [Fast\(V.34\)](#) from the control panel. Ask if your service provider supports fax and for the recommended fax modem speed. Some companies might require an adapter.
  - If using a DSL service, ensure that a filter is included on the phone line connection to the product. Contact the DSL service provider or purchase a DSL filter if you do not have one. If a DSL filter is installed, try another because these filters can be defective.
6. If the error persists, find more detailed problem-solving solutions in the sections that follow this one.

## Solve problems receiving faxes

- [The fax does not respond](#)
- [An error message displays on the control panel](#)
- [A fax is received but does not print](#)
- [Sender receives a busy signal](#)
- [No dial tone](#)
- [Fax cuts off or prints on two pages](#)

### The fax does not respond

#### The fax has a dedicated phone line

- Set the [Answer Mode](#) option to the [Automatic](#) setting from the control panel.
  - a. Touch the Setup  button.
  - b. Open the [Fax Setup](#) menu.
  - c. Open the [Basic Setup](#) menu.
  - d. Open the [Answer Mode](#) menu.
  - e. Select the [Automatic](#) setting.

#### An answering machine is connected to the product

- Set the [Answer Mode](#) option to the [TAM](#) setting and plug the answering machine into the “telephone” port.
  - a. Touch the Setup  button.
  - b. Open the [Fax Setup](#) menu.
  - c. Open the [Basic Setup](#) menu.
  - d. Open the [Answer Mode](#) menu.
  - e. Select the [TAM](#) setting.

If the [TAM](#) setting is unavailable, set the [Answer Mode](#) option to the [Automatic](#) setting.

- Set the [Rings to Answer](#) setting to at least one ring more than the number of rings for which the answering machine is set.
  - a. Touch the Setup  button.
  - b. Open the [Fax Setup](#) menu.
  - c. Open the [Basic Setup](#) menu.

- d. Open the [Rings to Answer](#) menu.
- e. Select the correct setting.
- Connect the answering machine into the “telephone” port.
- If the product has a telephone handset connected, set the [Answer Mode](#) option to the [Fax/Tel](#) setting to route calls to the correct device. When detecting a voice call, the product generates a ring tone that alerts you to pick up the telephone handset.
  - a. Touch the Setup  button.
  - b. Open the [Fax Setup](#) menu.
  - c. Open the [Basic Setup](#) menu.
  - d. Open the [Answer Mode](#) menu.
  - e. Select the [Fax/Tel](#) setting.

### A telephone handset is connected to the product

Set the [Answer Mode](#) option to the [Automatic](#) setting.

1. Touch the Setup  button.
2. Open the [Fax Setup](#) menu.
3. Open the [Basic Setup](#) menu.
4. Open the [Answer Mode](#) menu.
5. Select the [Automatic](#) setting.

### The Answer Mode setting is set to the Manual setting

- Touch the [Start Fax](#) button on the control panel.

### Voice mail is available on the fax line

- Add a distinctive ring service to your telephone line and change the [Distinctive Ring](#) setting on the product to match the ring pattern supplied by the telephone company. Contact your telephone company for information.
  - a. Verify that the answer mode is set to the [Automatic](#) setting.
  - b. Touch the Setup  button.
  - c. Open the [Fax Setup](#) menu.
  - d. Open the [Basic Setup](#) menu.

- e. Open the [Distinctive Ring](#) menu.
- f. Select the correct setting.
- Buy a dedicated line for faxing.
- Set the [Answer Mode](#) option to the [Manual](#) setting.
  - a. Touch the Setup  button.
  - b. Open the [Fax Setup](#) menu.
  - c. Open the [Basic Setup](#) menu.
  - d. Open the [Answer Mode](#) menu.
  - e. Select the [Manual](#) setting.

---

 **NOTE:** You must be present to receive faxes.

---

### The product is connected to a DSL phone service

- Check the installation and features. A DSL modem requires a high-pass filter on the phone line connection to the product. Contact your DSL service provider for a filter or buy a filter.
- Verify that the filter is plugged in.
- Replace the existing filter to make sure that it is not defective.

### The product uses a fax over IP or VoIP phone service

- Set the [Fax Speed](#) option to the [Slow\(V.29\)](#) or [Medium\(V.17\)](#) setting, or disable the [Fast\(V.34\)](#) setting.
  - a. Touch the Setup  button.
  - b. Open the [Fax Setup](#) menu.
  - c. Open the [Advanced Setup](#) menu.
  - d. Open the [Fax Speed](#) menu.
  - e. Select the correct setting.
- Contact your service provider to make sure that fax is supported and for a recommended fax speed settings. Some companies might require an adapter.



## An error message displays on the control panel

### The No fax detected. message displays

 **NOTE:** This error does not always refer to a missed fax. If a voice call is made to a fax number by mistake and the caller hangs up, the **No fax detected.** message displays on the control panel.

- Ask the sender to resend the fax.
- Make sure that the telephone cord from the product is plugged into the wall telephone jack.
- Try a different phone cord.
- Connect the product phone cord into a jack for another phone line.
- Make sure the telephone line and phone wall jack are active by plugging in a telephone and checking for a dial tone.
- Make sure that the telephone cord is plugged into the “line” port on the product.
- Check the phone line by running a fax test from the control panel.
- If the error persists, contact HP. See [www.hp.com/support/ljcolorm276series](http://www.hp.com/support/ljcolorm276series) or the support flyer that came in the product box.

### The Communication error. message displays

- Ask the sender to send the fax again or send at a later time when line conditions have improved.
- Unplug the product telephone cord from the wall, connect a telephone, and try making a call. Connect the product phone cord into a jack for another phone line.
- Try a different phone cord.
- Set the **Fax Speed** option to the **Slow(V.29)** or **Medium(V.17)** setting, or disable the **Fast(V.34)** setting.
  - a. Touch the **Setup**  button.
  - b. Open the **Fax Setup** menu.
  - c. Open the **Advanced Setup** menu.
  - d. Open the **Fax Speed** menu.
  - e. Select the correct setting.
- Turn off the **Error Correction** feature to prevent automatic error correction.

 **NOTE:** Turning off the **Error Correction** feature can reduce image quality.

- a. Touch the **Setup**  button.
- b. Open the **Service** menu.
- c. Open the **Fax Service** menu.

- d. Open the **Error Correction** menu.
  - e. Select the **Off** setting.
- Print the **Fax Activity Log** report from the control panel to determine if the error occurs with a specific fax number.
  - a. Touch the **Fax** button, and then touch the **Fax Menu** button.
  - b. Open the **Fax Reports** menu.
  - c. Open the **Fax Activity Log** menu.
  - d. Select the **Print Log Now** option.
- If the error persists, contact HP. See [www.hp.com/support/ljcolorm276series](http://www.hp.com/support/ljcolorm276series) or the support flyer that came in the product box.

### The Fax storage is full. message displays

- Turn the product off then on.
- Print all of the faxes, and then have the sender resend the fax.
- Ask the sender to divide a large fax job into smaller sections, and then fax them individually.
- Make sure that the resolution of the sending fax machine is not set to the **Photo** setting or the **Superfine** setting.
  - a. Touch the **Setup**  button.
  - b. Open the **Fax Setup** menu.
  - c. Open the **Advanced Setup** menu.
  - d. Open the **Fax Resolution** menu.
  - e. Select the correct setting.
- Cancel all fax jobs or clear the faxes from memory.

### The Fax is busy. message displays

- The product cannot receive a fax while attempting to send one. Cancel the fax send and try sending at a later time.
- Allow the product to try sending the fax again.

## A fax is received but does not print

### The Private Receive feature is on

- When the [Private Receive](#) feature is activated, received faxes are stored in memory. A password is required to print the stored faxes.
- Enter the password to print the fax. If you do not know the password, contact the product administrator.



**NOTE:** Memory errors might occur if the faxes are not printed. The product will not answer if the memory is full.

## Sender receives a busy signal

### A handset is connected to the product

- Make sure the phone is hung up.
- Change the [Answer Mode](#) option to match the product setup.
  - a. Touch the Setup  button.
  - b. Open the [Fax Setup](#) menu.
  - c. Open the [Basic Setup](#) menu.
  - d. Open the [Answer Mode](#) menu.
  - e. Select the setting that matches the product setup.

Set the [Answer Mode](#) option to the [Fax/Tel](#) setting to automatically receive faxes. The [Fax/Tel](#) setting automatically detects whether the incoming transmission is a fax or a voice call and routes the call to the appropriate device.

### A phone line splitter is being used

- If you are using a phone line splitter, remove the splitter and set up the phone as a downstream phone.
- Make sure the phone is hung up.
- Make sure the phone is not being used for a voice call when faxing.

## No dial tone

- If using a phone line splitter, remove the phone line splitter and set up the phone as a downstream phone.

## Fax cuts off or prints on two pages

- Set the [Default Paper Size](#) setting. Faxes print on a single size of paper based on the [Default Paper Size](#) settings.
  - a. Open the [Setup Menu](#) menu.
  - b. Open the [System Setup](#) menu.
  - c. Open the [Paper Setup](#) menu.
  - d. Open the [Default Paper Size](#) menu.
  - e. Select the correct setting.
- Set the paper type and size for the tray used for faxes.
- Turn on the [Fit to Page](#) setting to print longer length faxes on letter or A4 size paper.
  - a. Open the [Setup Menu](#) menu.
  - b. Open the [Fax Setup](#) menu.
  - c. Open the [Advanced Setup](#) menu.
  - d. Open the [Fit to Page](#) menu.
  - e. Select the [On](#) setting.



---

**NOTE:** If the [Fit to Page](#) setting is off and the [Default Paper Size](#) setting is set to letter, a legal size original prints on two pages.



---

## Solve problems sending faxes

- [An error message displays on the control panel](#)
- [The control panel displays a Ready message with no attempt to send the fax](#)
- [The control panel displays the message "Storing page 1" and does not progress beyond that message](#)
- [Faxes can be received, but not sent](#)
- [Unable to use fax functions from the control panel](#)
- [Unable to use speed dials](#)
- [Unable to use group dials](#)
- [Receive a recorded error message from the phone company when trying to send a fax](#)
- [Unable to send a fax when a phone is connected to the product](#)

## An error message displays on the control panel

### The Communication error. message displays

- Allow the product to retry sending the fax. Re-sending temporarily reduces the fax speed.
- Unplug the product telephone cord from the wall, connect a telephone, and try making a call. Connect the product phone cord into a jack for another phone line.  
  
If the product is connected to a digital phone line, verify that you are using the correct filter and settings provided by the digital service provider.
- Try a different phone cord.
- From the control panel, change the **Fax Speed** option to the **Medium(V.17)** setting or **Slow(V.29)** setting.
  - a. Touch the **Setup**  button.
  - b. Open the **Fax Setup** menu.
  - c. Open the **Advanced Setup** menu.
  - d. Open the **Fax Speed** menu.
  - e. Select the correct setting.
- Turn off the **Error Correction** option.
  - a. Touch the **Setup**  button.
  - b. Open the **Service** menu.
  - c. Open the **Fax Service** menu.
  - d. Open the **Error Correction** menu.
  - e. Touch the **Off** setting.



**NOTE:** Turning off the **Error Correction** option can reduce image quality.

- If the error persists, contact HP. See [www.hp.com/support/ljcolorm276series](http://www.hp.com/support/ljcolorm276series) or the support flyer that came in the product box.

### No dial tone.

- Make sure that the telephone cord is plugged into the correct port on the product.
- Make sure that the telephone cord from the product is plugged directly into the wall telephone jack.
- Check for a dial tone on the phone line by using the **Start Fax** button.
- Unplug the product telephone cord from the wall, connect a telephone, and try making a voice call.

- Unplug the telephone cord from both the product and the wall and replug the cord.
- Make sure that you are using the telephone cord that came with the product.
- Connect the product phone cord into a jack for another phone line.
- Check the phone line by using the [Run Fax Test](#) option from the [Service](#) menu on the control panel.
  - a. Touch the Setup  button.
  - b. Open the [Service](#) menu.
  - c. Open the [Fax Service](#) menu.
  - d. Select the [Run Fax Test](#) item.

### The Fax is busy. message displays

- Try sending the fax again.
- Call the recipient to ensure that the fax machine is on and ready.
- Check that you are dialing the correct fax number.
- Check for a dial tone on the phone line by using the [Start Fax](#) button.
- Make sure that the phone is working by disconnecting the product, plugging in a telephone to the phone line, and making a voice call.
- Connect the product phone cord into a jack for another phone line, and try sending the fax again.
- Try a different phone cord.
- Send the fax at a later time.
- If the error persists, contact HP. See [www.hp.com/support/ljcolorm276series](http://www.hp.com/support/ljcolorm276series) or the support flyer that came in the product box.

### The No fax answer. message displays

- Try to resend the fax.
- Call the recipient to ensure that the fax machine is on and ready.
- Check that you are dialing the correct fax number.
- Unplug the product telephone cord from the wall, connect a telephone, and try making a voice call.
- Connect the product phone cord into a jack for another phone line.
- Try a different phone cord.
- Make sure that the phone cord from the wall telephone jack is plugged into the line  port.

- Check the phone line by using the [Run Fax Test](#) option from the [Service](#) menu on the control panel.
  - a.** Touch the Setup  button.
  - b.** Open the [Service](#) menu.
  - c.** Open the [Fax Service](#) menu.
  - d.** Select the [Run Fax Test](#) item.
- If the error persists, contact HP. See [www.hp.com/support/ljcolorm276series](http://www.hp.com/support/ljcolorm276series) or the support flyer that came in the product box.

### Document feeder paper jam

- Verify that the paper meets product size requirements. The product does not support pages longer than 381 mm (15 in) for faxing.
- Copy or print the original to letter, A4, or legal size paper, and then resend the fax.

### The Fax storage is full. message displays

- Turn the product off then on.
- Print stored faxes that have not been printed.
  - a.** Touch the [Fax](#) button, and then open the [Fax Menu](#) menu.
  - b.** Open the [Receive Options](#) menu.
  - c.** Select the [Print Private Faxes](#) item.
  - d.** Provide the password when the product prompts you.
- Delete stored faxes from memory.
  - a.** Touch the Setup  button.
  - b.** Open the [Service](#) menu.
  - c.** Open the [Fax Service](#) menu.
  - d.** Select the [Clear Saved Faxes](#) item.
- Divide the large fax job into smaller sections, and then fax them individually.

### Scanner error

- Verify that the paper meets product size requirements. The product does not support pages longer than 381 mm (15 in) for faxing.
- Copy or print the original onto letter, A4, or legal size paper and then resend the fax.

## The control panel displays a Ready message with no attempt to send the fax

- Check the fax activity log for errors.
  - a. Touch the [Fax](#) button, and then open the [Fax Menu](#) item.
  - b. Open the [Fax Reports](#) menu.
  - c. Open the [Fax Activity Log](#) menu.
  - d. Select the [Print Log Now](#) option.
- If a phone is connected to the product, make sure that the phone is hung up.
- Disconnect all other lines between the fax and the product.
- Connect the product directly into the wall telephone jack and resend the fax.

## The control panel displays the message "Storing page 1" and does not progress beyond that message

- Delete stored faxes from memory.
  - a. Touch the [Setup](#)  button.
  - b. Open the [Service](#) menu.
  - c. Open the [Fax Service](#) menu.
  - d. Select the [Clear Saved Faxes](#) item.

## Faxes can be received, but not sent

Send fax and nothing happens.

1. Check for a dial tone on the phone line by using the [Start Fax](#) button.
2. Turn the product off then on.
3. Use the control panel or the HP Fax Setup Wizard to configure the fax time, date, and fax header information.
  - a. Touch the [Setup](#)  button.
  - b. Open the [Fax Setup](#) menu.
  - c. Open the [Basic Setup](#) menu.
  - d. Open the [Fax Header](#) menu.
  - e. Enter the correct settings.
4. Verify that any extension phones on the line are hung up.
5. If using a DSL service, make sure that the phone line connection to the product includes a high-pass filter.



## Unable to use fax functions from the control panel

- The product might be password protected. Use the HP Embedded Web Server, HP Toolbox software, or the control panel to set a password.
- If you do not know the password for the product, contact your system administrator.
- Verify with the system administrator that the fax functionality has not been disabled.

## Unable to use speed dials

- Make sure that the fax number is valid.
- If an outside line requires a prefix, turn on the [Dial Prefix](#) option or include the prefix in the speed dial number.
  - a. Touch the Setup  button.
  - b. Open the [Fax Setup](#) menu.
  - c. Open the [Basic Setup](#) menu.
  - d. Open the [Dial Prefix](#) menu.
  - e. Select the [On](#) setting.

## Unable to use group dials

- Make sure that the fax number is valid.
- If an outside line requires a prefix, turn on the [Dial Prefix](#) option or include the prefix in the speed dial number.
  - a. Touch the Setup  button.
  - b. Open the [Fax Setup](#) menu.
  - c. Open the [Basic Setup](#) menu.
  - d. Open the [Dial Prefix](#) menu.
  - e. Select the [On](#) setting.
- Set up all entries in the group with speed dial entries.
  - a. Open an unused speed dial entry.
  - b. Enter the fax number for the speed dial.
  - c. Touch the [OK](#) button to save the speed dial.

## Receive a recorded error message from the phone company when trying to send a fax

- Make sure you dial the fax number correctly, and make sure that the phone service is not blocked. For example, some phone services might prevent long distance calling.
- If an outside line requires a prefix, turn on the [Dial Prefix](#) option or include the prefix in the speed dial number.
  - a. Touch the Setup  button.
  - b. Open the [Fax Setup](#) menu.
  - c. Open the [Basic Setup](#) menu.
  - d. Open the [Dial Prefix](#) menu.
  - e. Select the [On](#) setting.



---

**NOTE:** To send a fax without a prefix, when the [Dial Prefix](#) option is turned on, send the fax manually.

---

- Send a fax to an international number
  - a. If a prefix is required, manually dial the telephone number with the prefix.
  - b. Enter the country/region code before dialing the phone number.
  - c. Wait for pauses as you hear the tones on the phone.
  - d. Send the fax manually from the control panel.

## Unable to send a fax when a phone is connected to the product

- Make sure that the telephone is hung up.
- Make sure that the telephone is not being used for a voice call when faxing.
- Unplug the phone from the line, and then try sending the fax.

## Solve fax performance problems

- [Faxes are sending slowly](#)
- [Fax quality is poor](#)

### Faxes are sending slowly

The product is experiencing poor phone line quality.

- Retry sending the fax when the line conditions have improved.
- Check with the phone service provider that the line supports fax.
- Turn off the [Error Correction](#) setting.
  - a. Open the [Setup Menu](#) menu.
  - b. Open the [Service](#) menu.
  - c. Open the [Fax Service](#) menu.
  - d. Open the [Error Correction](#) menu.
  - e. Select the [Off](#) setting.



---

**NOTE:** This can reduce image quality.

---

- Use white paper for the original. Do not use colors such as gray, yellow, or pink.
- Increase the [Fax Speed](#) setting.
  - a. Open the [Setup Menu](#) menu.
  - b. Open the [Fax Setup](#) menu.
  - c. Open the [Advanced Setup](#) menu.
  - d. Open the [Fax Speed](#) menu.
  - e. Select the correct setting.
- Divide large fax jobs into smaller sections, and then fax them individually.
- Change the fax settings on the control panel to a lower resolution.
  - a. Open the [Setup Menu](#) menu.
  - b. Open the [Fax Setup](#) menu.
  - c. Open the [Advanced Setup](#) menu.
  - d. Open the [Fax Resolution](#) menu.
  - e. Select the correct setting.

## Fax quality is poor

If the fax is blurry or light, try the following steps to correct the problem.

- Increase fax resolution when sending faxes. Resolution does not affect received faxes.
  - a. Open the [Setup Menu](#) menu.
  - b. Open the [Fax Setup](#) menu.
  - c. Open the [Advanced Setup](#) menu.
  - d. Open the [Fax Resolution](#) menu.
  - e. Select the correct setting.



---

**NOTE:** Increasing resolution slows transmission speed.

---

- Turn on the [Error Correction](#) setting from the control panel.
  - a. Open the [Setup Menu](#) menu.
  - b. Open the [Service](#) menu.
  - c. Open the [Fax Service](#) menu.
  - d. Open the [Error Correction](#) menu.
  - e. Select the [On](#) setting.
- Check the toner cartridge. Replace it if necessary.
- Ask the sender to darken the contrast setting on the sending fax machine, and then resend the fax.

## Solve DSL problems

### Cannot send or receive a fax on a PBX line

- If you are using a PBX phone line, contact your PBX administrator to configure an analog fax line for your product.

## Product updates

Software and firmware updates and installation instructions for this product are available at [www.hp.com/support/ljcolorm276series](http://www.hp.com/support/ljcolorm276series). Click **Support & Drivers**, click the operating system, and then select the download for the product.

---

# A Service and support

- [Hewlett-Packard limited warranty statement](#)
- [HP's Premium Protection Warranty: LaserJet print cartridge limited warranty statement](#)
- [Data stored on the print cartridge](#)
- [End User License Agreement](#)
- [OpenSSL](#)
- [Customer support](#)
- [Repack the product](#)

# Hewlett-Packard limited warranty statement

HP PRODUCT	DURATION OF LIMITED WARRANTY
HP Color LaserJet Pro 200 color M276	One-year product exchange

HP warrants to you, the end-user customer, that HP hardware and accessories will be free from defects in materials and workmanship after the date of purchase, for the period specified above. If HP receives notice of such defects during the warranty period, HP will, at its option, either repair or replace products which prove to be defective. Replacement products may be either new or equivalent in performance to new.

HP warrants to you that HP software will not fail to execute its programming instructions after the date of purchase, for the period specified above, due to defects in material and workmanship when properly installed and used. If HP receives notice of such defects during the warranty period, HP will replace software which does not execute its programming instructions due to such defects.

HP does not warrant that the operation of HP products will be uninterrupted or error free. If HP is unable, within a reasonable time, to repair or replace any product to a condition as warranted, you will be entitled to a refund of the purchase price upon prompt return of the product.

HP products may contain remanufactured parts equivalent to new in performance or may have been subject to incidental use.

Warranty does not apply to defects resulting from (a) improper or inadequate maintenance or calibration, (b) software, interfacing, parts or supplies not supplied by HP, (c) unauthorized modification or misuse, (d) operation outside of the published environmental specifications for the product, or (e) improper site preparation or maintenance.

TO THE EXTENT ALLOWED BY LOCAL LAW, THE ABOVE WARRANTIES ARE EXCLUSIVE AND NO OTHER WARRANTY OR CONDITION, WHETHER WRITTEN OR ORAL, IS EXPRESSED OR IMPLIED AND HP SPECIFICALLY DISCLAIMS ANY IMPLIED WARRANTIES OR CONDITIONS OF MERCHANTABILITY, SATISFACTORY QUALITY, AND FITNESS FOR A PARTICULAR PURPOSE. Some countries/regions, states or provinces do not allow limitations on the duration of an implied warranty, so the above limitation or exclusion might not apply to you. This warranty gives you specific legal rights and you might also have other rights that vary from country/region to country/region, state to state, or province to province.

HP's limited warranty is valid in any country/region or locality where HP has a support presence for this product and where HP has marketed this product. The level of warranty service you receive may vary according to local standards. HP will not alter form, fit or function of the product to make it operate in a country/region for which it was never intended to function for legal or regulatory reasons.

TO THE EXTENT ALLOWED BY LOCAL LAW, THE REMEDIES IN THIS WARRANTY STATEMENT ARE YOUR SOLE AND EXCLUSIVE REMEDIES. EXCEPT AS INDICATED ABOVE, IN NO EVENT WILL HP OR ITS SUPPLIERS BE LIABLE FOR LOSS OF DATA OR FOR DIRECT, SPECIAL, INCIDENTAL, CONSEQUENTIAL (INCLUDING LOST PROFIT OR DATA), OR OTHER DAMAGE, WHETHER BASED IN CONTRACT, TORT, OR OTHERWISE. Some countries/regions, states or provinces do not allow the exclusion or limitation of incidental or consequential damages, so the above limitation or exclusion may not apply to you.

THE WARRANTY TERMS CONTAINED IN THIS STATEMENT, EXCEPT TO THE EXTENT LAWFULLY PERMITTED, DO NOT EXCLUDE, RESTRICT OR MODIFY AND ARE IN ADDITION TO THE MANDATORY STATUTORY RIGHTS APPLICABLE TO THE SALE OF THIS PRODUCT TO YOU.

# HP's Premium Protection Warranty: LaserJet print cartridge limited warranty statement

This HP product is warranted to be free from defects in materials and workmanship.

This warranty does not apply to products that (a) have been refilled, refurbished, remanufactured or tampered with in any way, (b) experience problems resulting from misuse, improper storage, or operation outside of the published environmental specifications for the printer product or (c) exhibit wear from ordinary use.

To obtain warranty service, please return the product to place of purchase (with a written description of the problem and print samples) or contact HP customer support. At HP's option, HP will either replace products that prove to be defective or refund your purchase price.

TO THE EXTENT ALLOWED BY LOCAL LAW, THE ABOVE WARRANTY IS EXCLUSIVE AND NO OTHER WARRANTY OR CONDITION, WHETHER WRITTEN OR ORAL, IS EXPRESSED OR IMPLIED AND HP SPECIFICALLY DISCLAIMS ANY IMPLIED WARRANTIES OR CONDITIONS OF MERCHANTABILITY, SATISFACTORY QUALITY, AND FITNESS FOR A PARTICULAR PURPOSE.

TO THE EXTENT ALLOWED BY LOCAL LAW, IN NO EVENT WILL HP OR ITS SUPPLIERS BE LIABLE FOR DIRECT, SPECIAL, INCIDENTAL, CONSEQUENTIAL (INCLUDING LOST PROFIT OR DATA), OR OTHER DAMAGE, WHETHER BASED IN CONTRACT, TORT, OR OTHERWISE.

THE WARRANTY TERMS CONTAINED IN THIS STATEMENT, EXCEPT TO THE EXTENT LAWFULLY PERMITTED, DO NOT EXCLUDE, RESTRICT OR MODIFY AND ARE IN ADDITION TO THE MANDATORY STATUTORY RIGHTS APPLICABLE TO THE SALE OF THIS PRODUCT TO YOU.



## Data stored on the print cartridge

The HP print cartridges used with this product contain a memory chip that assists in the operation of the product.

In addition, this memory chip collects a limited set of information about the usage of the product, which might include the following: the date when the print cartridge was first installed, the date when the print cartridge was last used, the number of pages printed using the print cartridge, the page coverage, the printing modes used, any printing errors that might have occurred, and the product model. This information helps HP design future products to meet our customers' printing needs.

The data collected from the print cartridge memory chip does not contain information that can be used to identify a customer or user of the print cartridge or their product.

HP collects a sampling of the memory chips from print cartridges returned to HP's free return and recycling program (HP Planet Partners: [www.hp.com/recycle](http://www.hp.com/recycle)). The memory chips from this sampling are read and studied in order to improve future HP products. HP partners who assist in recycling this print cartridge might have access to this data, as well.

Any third party possessing the print cartridge might have access to the anonymous information on the memory chip. If you prefer to not allow access to this information, you can render the chip inoperable. However, after you render the memory chip inoperable, the memory chip cannot be used in an HP product.

# End User License Agreement

PLEASE READ CAREFULLY BEFORE USING THIS SOFTWARE PRODUCT: This End-User License Agreement (“EULA”) is a contract between (a) you (either an individual or the entity you represent) and (b) Hewlett-Packard Company (“HP”) that governs your use of the software product (“Software”). This EULA does not apply if there is a separate license agreement between you and HP or its suppliers for the Software, including a license agreement in online documentation. The term “Software” may include (i) associated media, (ii) a user guide and other printed materials, and (iii) “online” or electronic documentation (collectively “User Documentation”).

RIGHTS IN THE SOFTWARE ARE OFFERED ONLY ON THE CONDITION THAT YOU AGREE TO ALL TERMS AND CONDITIONS OF THIS EULA. BY INSTALLING, COPYING, DOWNLOADING, OR OTHERWISE USING THE SOFTWARE, YOU AGREE TO BE BOUND BY THIS EULA. IF YOU DO NOT ACCEPT THIS EULA, DO NOT INSTALL, DOWNLOAD, OR OTHERWISE USE THE SOFTWARE. IF YOU PURCHASED THE SOFTWARE BUT DO NOT AGREE TO THIS EULA, PLEASE RETURN THE SOFTWARE TO YOUR PLACE OF PURCHASE WITHIN FOURTEEN DAYS FOR A REFUND OF THE PURCHASE PRICE; IF THE SOFTWARE IS INSTALLED ON OR MADE AVAILABLE WITH ANOTHER HP PRODUCT, YOU MAY RETURN THE ENTIRE UNUSED PRODUCT.

1. **THIRD PARTY SOFTWARE.** The Software may include, in addition to HP proprietary software (“HP Software”), software under licenses from third parties (“Third Party Software” and “Third Party License”). Any Third Party Software is licensed to you subject to the terms and conditions of the corresponding Third Party License. Generally, the Third Party License is located in a file such as license.txt; you should contact HP support if you cannot find any Third Party License. If the Third Party Licenses include licenses that provide for the availability of source code (such as the GNU General Public License) and the corresponding source code is not included with the Software, then check the product support pages of HP’s website (hp.com) to learn how to obtain such source code.

2. **LICENSE RIGHTS.** You will have the following rights provided you comply with all terms and conditions of this EULA:

a. **Use.** HP grants you a license to Use one copy of the HP Software. “Use” means installing, copying, storing, loading, executing, displaying, or otherwise using the HP Software. You may not modify the HP Software or disable any licensing or control feature of the HP Software. If this Software is provided by HP for Use with an imaging or printing product (for example, if the Software is a printer driver, firmware, or add-on), the HP Software may only be used with such product (“HP Product”). Additional restrictions on Use may appear in the User Documentation. You may not separate component parts of the HP Software for Use. You do not have the right to distribute the HP Software.

b. **Copying.** Your right to copy means you may make archival or back-up copies of the HP Software, provided each copy contains all the original HP Software’s proprietary notices and is used only for back-up purposes.

3. **UPGRADES.** To Use HP Software provided by HP as an upgrade, update, or supplement (collectively “Upgrade”), you must first be licensed for the original HP Software identified by HP as eligible for the Upgrade. To the extent the Upgrade supersedes the original HP Software, you may no longer use such HP Software. This EULA applies to each Upgrade unless HP provides other terms with the Upgrade. In case of a conflict between this EULA and such other terms, the other terms will prevail.

4. **TRANSFER.**

a. Third Party Transfer. The initial end user of the HP Software may make a one-time transfer of the HP Software to another end user. Any transfer will include all component parts, media, User Documentation, this EULA, and if applicable, the Certificate of Authenticity. The transfer may not be an indirect transfer, such as a consignment. Prior to the transfer, the end user receiving the transferred Software will agree to this EULA. Upon transfer of the HP Software, your license is automatically terminated.

b. Restrictions. You may not rent, lease or lend the HP Software or Use the HP Software for commercial timesharing or bureau use. You may not sublicense, assign or otherwise transfer the HP Software except as expressly provided in this EULA.

5. PROPRIETARY RIGHTS. All intellectual property rights in the Software and User Documentation are owned by HP or its suppliers and are protected by law, including applicable copyright, trade secret, patent, and trademark laws. You will not remove any product identification, copyright notice, or proprietary restriction from the Software.

6. LIMITATION ON REVERSE ENGINEERING. You may not reverse engineer, decompile, or disassemble the HP Software, except and only to the extent that the right to do so is allowed under applicable law.

7. CONSENT TO USE OF DATA. HP and its affiliates may collect and use technical information you provide in relation to (i) your Use of the Software or the HP Product, or (ii) the provision of support services related to the Software or the HP Product. All such information will be subject to HP's privacy policy. HP will not use such information in a form that personally identifies you except to the extent necessary to enhance your Use or provide support services.

8. LIMITATION OF LIABILITY. Notwithstanding any damages that you might incur, the entire liability of HP and its suppliers under this EULA and your exclusive remedy under this EULA will be limited to the greater of the amount actually paid by you for the Product or U.S. \$5.00. TO THE MAXIMUM EXTENT PERMITTED BY APPLICABLE LAW, IN NO EVENT WILL HP OR ITS SUPPLIERS BE LIABLE FOR ANY SPECIAL, INCIDENTAL, INDIRECT, OR CONSEQUENTIAL DAMAGES (INCLUDING DAMAGES FOR LOST PROFITS, LOST DATA, BUSINESS INTERRUPTION, PERSONAL INJURY, OR LOSS OF PRIVACY) RELATED IN ANY WAY TO THE USE OF OR INABILITY TO USE THE SOFTWARE, EVEN IF HP OR ANY SUPPLIER HAS BEEN ADVISED OF THE POSSIBILITY OF SUCH DAMAGES AND EVEN IF THE ABOVE REMEDY FAILS OF ITS ESSENTIAL PURPOSE. Some states or other jurisdictions do not allow the exclusion or limitation of incidental or consequential damages, so the above limitation or exclusion may not apply to you.

9. U.S. GOVERNMENT CUSTOMERS. If you are a U.S. Government entity, then consistent with FAR 12.211 and FAR 12.212, Commercial Computer Software, Computer Software Documentation, and Technical Data for Commercial Items are licensed under the applicable HP commercial license agreement.

10. COMPLIANCE WITH EXPORT LAWS. You will comply with all laws, rules, and regulations (i) applicable to the export or import of the Software, or (ii) restricting the Use of the Software, including any restrictions on nuclear, chemical, or biological weapons proliferation.

11. RESERVATION OF RIGHTS. HP and its suppliers reserve all rights not expressly granted to you in this EULA.

(c) 2007 Hewlett-Packard Development Company, L.P.

Rev. 11/06

# OpenSSL

This product includes software developed by the OpenSSL Project for use in the OpenSSL Toolkit (<http://www.openssl.org/>)

THIS SOFTWARE IS PROVIDED BY THE OpenSSL PROJECT "AS IS" AND ANY EXPRESSED OR IMPLIED WARRANTIES, INCLUDING, BUT NOT LIMITED TO, THE IMPLIED WARRANTIES OF MERCHANTABILITY AND FITNESS FOR A PARTICULAR PURPOSE ARE DISCLAIMED. IN NO EVENT SHALL THE OpenSSL PROJECT OR ITS CONTRIBUTORS BE LIABLE FOR ANY DIRECT, INDIRECT, INCIDENTAL, SPECIAL, EXEMPLARY, OR CONSEQUENTIAL DAMAGES (INCLUDING, BUT NOT LIMITED TO, PROCUREMENT OF SUBSTITUTE GOODS OR SERVICES;

LOSS OF USE, DATA, OR PROFITS; OR BUSINESS INTERRUPTION) HOWEVER CAUSED AND ON ANY THEORY OF LIABILITY, WHETHER IN CONTRACT, STRICT LIABILITY, OR TORT (INCLUDING NEGLIGENCE OR OTHERWISE) ARISING IN ANY WAY OUT OF THE USE OF THIS SOFTWARE, EVEN IF ADVISED OF THE POSSIBILITY OF SUCH DAMAGE.

This product includes cryptographic software written by Eric Young (eay@cryptsoft.com). This product includes software written by Tim Hudson (tjh@cryptsoft.com).

## Customer support

Get telephone support for your country/region	Country/region phone numbers are on the flyer that was in the box with your product or at <a href="http://www.hp.com/support/">www.hp.com/support/</a> .
Have the product name, serial number, date of purchase, and problem description ready.	
Get 24-hour Internet support	<a href="http://www.hp.com/support/ljcolorm276series">www.hp.com/support/ljcolorm276series</a>
Get support for products used with a Macintosh computer	<a href="http://www.hp.com/go/macosex">www.hp.com/go/macosex</a>
Download software utilities, drivers, and electronic information	<a href="http://www.hp.com/support/ljcolorm276series">www.hp.com/support/ljcolorm276series</a>
Order additional HP service or maintenance agreements	<a href="http://www.hp.com/go/carepack">www.hp.com/go/carepack</a>
Register your product	<a href="http://www.register.hp.com">www.register.hp.com</a>

# Repack the product

If HP Customer Care determines that your product needs to be returned to HP for repair, follow these steps to repack the product before shipping it.

---

 **CAUTION:** Shipping damage as a result of inadequate packing is the customer's responsibility.

---

1. Remove and retain the print cartridges.

 **CAUTION:** It is *extremely important* to remove the print cartridges before shipping the product. A print cartridge that remains in the product during shipping can leak and cover the product engine and other parts with toner.

To prevent damage to the print cartridges, avoid touching the rollers on them, and store the print cartridges so that they are not exposed to light.

---

2. Remove and retain the power cable, interface cable, and any optional accessories.
3. If possible, include print samples and 50 to 100 sheets of paper that did not print correctly.
4. In the U.S., call HP Customer Care to request new packing material. In other areas, use the original packing material, if possible.



---

## B Product specifications

- [Physical specifications](#)
- [Power consumption, electrical specifications, and acoustic emissions](#)
- [Environmental specifications](#)

# Physical specifications

**Table B-1 Physical specifications**

Product	Height	Depth	Width	Weight
HP LaserJet Pro 200 color MFP M276 Series	414 mm (16.3 in)	476 mm (18.7 in)	449 mm (17.7 in)	Without toner cartridges installed: 21 kg (46.3 lb)  With toner cartridges installed: 23.6 kg (52.0 lb)

## Power consumption, electrical specifications, and acoustic emissions

See [www.hp.com/support/ljcolorm276series](http://www.hp.com/support/ljcolorm276series) for current information.

**CAUTION:** Power requirements are based on the country/region where the product is sold. Do not convert operating voltages. This will damage the product and void the product warranty.

## Environmental specifications

**Table B-2 Environmental specifications<sup>1</sup>**

	Recommended	Operating	Storage
Temperature	15° to 32.5° C (59° to 90.5° F)	15° to 32.5° C (59° to 90.5° F)	-20° to 40° C (-4° to 104° F)
Relative humidity	20 to 70%	10 to 80%	95% or less
Altitude		0 to 3048 m (0 to 10,000 ft)	

<sup>1</sup> Values are subject to change.



---

# C Regulatory information

- [FCC regulations](#)
- [Environmental product stewardship program](#)
- [Declaration of conformity](#)
- [Declaration of conformity \(wireless model\)](#)
- [Certificate of Volatility](#)
- [Safety statements](#)
- [Additional statements for telecom \(fax\) products](#)
- [Additional statements for wireless products](#)

## FCC regulations

This equipment has been tested and found to comply with the limits for a Class B digital device, pursuant to Part 15 of the FCC rules. These limits are designed to provide reasonable protection against harmful interference in a residential installation. This equipment generates, uses, and can radiate radio frequency energy. If this equipment is not installed and used in accordance with the instructions, it may cause harmful interference to radio communications. However, there is no guarantee that interference will not occur in a particular installation. If this equipment does cause harmful interference to radio or television reception, which can be determined by turning the equipment off and on, the user is encouraged to try to correct the interference by one or more of the following measures:

- Reorient or relocate the receiving antenna.
- Increase separation between equipment and receiver.
- Connect equipment to an outlet on a circuit different from that to which the receiver is located.
- Consult your dealer or an experienced radio/TV technician.



**NOTE:** Any changes or modifications to the printer that are not expressly approved by HP could void the user's authority to operate this equipment.

Use of a shielded interface cable is required to comply with the Class B limits of Part 15 of FCC rules.

# Environmental product stewardship program

## Protecting the environment

Hewlett-Packard Company is committed to providing quality products in an environmentally sound manner. This product has been designed with several attributes to minimize impacts on our environment.

## Ozone production

This product generates no appreciable ozone gas (O<sub>3</sub>).

## Power consumption

Power usage drops significantly while in Ready or Sleep mode, which saves natural resources and saves money without affecting the high performance of this product. Hewlett-Packard printing and imaging equipment marked with the ENERGY STAR® logo is qualified to the U.S. Environmental Protection Agency's ENERGY STAR specifications for imaging equipment. The following mark will appear on ENERGY STAR qualified imaging products:



Additional ENERGY STAR qualified imaging product model information is listed at:

[www.hp.com/go/energystar](http://www.hp.com/go/energystar)

## Paper use

This product's manual duplex feature (two-sided printing) and N-up printing (multiple pages printed on one page) capability can reduce paper usage and the resulting demands on natural resources.

## Plastics

Plastic parts over 25 grams are marked according to international standards that enhance the ability to identify plastics for recycling purposes at the end of the product's life.

## HP LaserJet print supplies

It's easy to return and recycle your HP LaserJet print cartridges after use—free of charge—with HP Planet Partners. Multilingual program information and instructions are included in every new HP LaserJet print cartridge and supplies package. You help reduce the toll on the environment further when you return multiple cartridges together rather than separately.

HP is committed to providing inventive, high-quality products and services that are environmentally sound, from product design and manufacturing to distribution, customer use and recycling. When you

participate in the HP Planet Partners program, we ensure your HP LaserJet print cartridges are recycled properly, processing them to recover plastics and metals for new products and diverting millions of tons of waste from landfills. Since this cartridge is being recycled and used in new materials, it will not be returned to you. Thank you for being environmentally responsible!

 **NOTE:** Use the return label to return original HP LaserJet print cartridges only. Please do not use this label for HP inkjet cartridges, non-HP cartridges, refilled or remanufactured cartridges or warranty returns. For information about recycling your HP inkjet cartridges please go to <http://www.hp.com/recycle>.

## Return and recycling instructions

### United States and Puerto Rico

The enclosed label in the HP LaserJet toner cartridge box is for the return and recycling of one or more HP LaserJet print cartridges after use. Please follow the applicable instructions below.

#### Multiple returns (more than one cartridge)

1. Package each HP LaserJet print cartridge in its original box and bag.
2. Tape the boxes together using strapping or packaging tape. The package can weigh up to 31 kg (70 lb).
3. Use a single pre-paid shipping label.

#### OR

1. Use your own suitable box, or request a free bulk collection box from [www.hp.com/recycle](http://www.hp.com/recycle) or 1-800-340-2445 (holds up to 31 kg (70 lb) of HP LaserJet print cartridges).
2. Use a single pre-paid shipping label.

#### Single returns

1. Package the HP LaserJet print cartridge in its original bag and box.
2. Place the shipping label on the front of the box.

#### Shipping

For all HP LaserJet print cartridge recycling returns, give the package to UPS during your next delivery or pickup, or take it to an authorized UPS drop-off center. For the location of your local UPS drop-off center, call 1-800-PICKUPS or visit [www.ups.com](http://www.ups.com). If you are returning via USPS label, give the package to a U.S. Postal Service carrier or drop off at a U.S. Postal Service Office. For more information, or to order additional labels or boxes for bulk returns, visit [www.hp.com/recycle](http://www.hp.com/recycle) or call 1-800-340-2445. Requested UPS pickup will be charged normal pickup rates. Information subject to change without notice.

## Residents of Alaska and Hawaii

Do not use the UPS label. Call 1-800-340-2445 for information and instructions. The U.S. Postal Service provides no-cost cartridge return transportation services under an arrangement with HP for Alaska and Hawaii.

## Non-U.S. returns

To participate in HP Planet Partners return and recycling program, just follow the simple directions in the recycling guide (found inside the packaging of your new product supply item) or visit [www.hp.com/recycle](http://www.hp.com/recycle). Select your country/region for information on how to return your HP LaserJet printing supplies.

## Paper

This product is capable of using recycled papers when the paper meets the guidelines outlined in the *HP LaserJet Printer Family Print Media Guide*. This product is suitable for the use of recycled paper according to EN12281:2002.

## Material restrictions

This HP product does not contain added mercury.

This HP product contains a battery that might require special handling at end-of-life. The batteries contained in or supplied by Hewlett-Packard for this product include the following:

<b>HP LaserJet Pro 200 color MFP M276 Series</b>	
Type	Carbon monofluoride lithium
Weight	0.8 g
Location	On formatter board
User-removable	No



### 廢電池請回收

For recycling information, you can go to [www.hp.com/recycle](http://www.hp.com/recycle), or contact your local authorities or the Electronics Industries Alliance: [www.eiae.org](http://www.eiae.org).

## Disposal of waste equipment by users in private households in the European Union

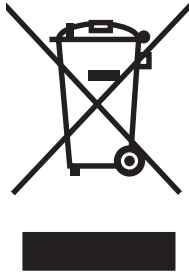

This symbol on the product or on its packaging indicates that this product must not be disposed of with your other household waste. Instead, it is your responsibility to dispose of your waste equipment by handing it over to a designated collection point for the recycling of waste electrical and electronic equipment. The separate collection and recycling of your waste equipment at the time of disposal will help to conserve natural resources and ensure that it is recycled in a manner that protects human health and the environment. For more information about where you can drop off your waste equipment for recycling, please contact your local city office, your household waste disposal service or the shop where you purchased the product.

## Chemical substances

HP is committed to providing our customers with information about the chemical substances in our products as needed to comply with legal requirements such as REACH (Regulation EC No 1907/2006 of the European Parliament and the Council). A chemical information report for this product can be found at: [www.hp.com/go/reach](http://www.hp.com/go/reach).

## Material Safety Data Sheet (MSDS)

Material Safety Data Sheets (MSDS) for supplies containing chemical substances (for example, toner) can be obtained by accessing the HP Web site at [www.hp.com/go/msds](http://www.hp.com/go/msds) or [www.hp.com/hpinfo/community/environment/productinfo/safety](http://www.hp.com/hpinfo/community/environment/productinfo/safety).

## For more information

To obtain information about these environmental topics:

- Product environmental profile sheet for this and many related HP products
- HP's commitment to the environment
- HP's environmental management system
- HP's end-of-life product return and recycling program
- Material Safety Data Sheets

Visit [www.hp.com/go/environment](http://www.hp.com/go/environment) or [www.hp.com/hpinfo/globalcitizenship/environment](http://www.hp.com/hpinfo/globalcitizenship/environment).

# Declaration of conformity

## Declaration of Conformity

according to ISO/IEC 17050-1 and EN 17050-1

**Manufacturer's Name:** Hewlett-Packard Company DoC#: BOISB-1104-02 Rel.1.0

**Manufacturer's Address:** 11311 Chinden Boulevard  
Boise, Idaho 83714-1021, USA

### declares, that the product

**Product Name:** HP LaserJet Pro 200 color MFP M276n

**Regulatory Model Numbers:**<sup>2)</sup> BOISB-1104-02  
BOISB-1102-00 – (US-Fax Module LIU)  
BOISB-1102-01 – (EURO-Fax Module LIU)

**Product Options:** All

**Print Cartridges:** CF210A, CF210X, CF211A, CF212A, CF213A

### conforms to the following Product Specifications:

**SAFETY:** IEC 60950-1:2005 +A1 / EN60950-1: 2006 +A11:2009 +A1:2010 +A12:2011  
IEC 60825-1:2007 / EN 60825-1:2007 (Class 1 Laser/LED Product)  
IEC 62479:2010/EN 62479:2010

GB4943-2001

**EMC:** CISPR22:2005 +A1/ EN55022:2006 +A1 - Class B<sup>1)</sup>

EN 61000-3-2 :2006 +A1:2009 +A2:2009

EN 61000-3-3:2008

EN 55024:1998 +A1 +A2

FCC Title 47 CFR, Part 15 Class B<sup>1)</sup> / ICES-003, Issue 4

GB9254-2008, GB17625.1-2003

**TELECOM:** ES 203 021; FCC Title 47 CFR, Part 68<sup>3)</sup>

**ENERGY USE:** Regulation (EC) No. 1275/2008

ENERGY STAR® Qualified Imaging Equipment Typical Electricity Consumption (TEC) Test Procedure

### Supplementary Information:

The product herewith complies with the requirements of the R&TTE Directive 1999/5/EC, EMC Directive 2004/108/EC, the Low Voltage Directive 2006/95/EC and the Ecodesign Directive 2009/125/EC, and carries the CE-Marking  accordingly.

This Device complies with Part 15 of the FCC Rules. Operation is subject to the following two Conditions: (1) this device may not cause harmful interference, and (2) this device must accept any interference received, including interference that may cause undesired operation.

1. The product was tested in a typical configuration with Hewlett-Packard Personal Computer Systems.
2. For regulatory purposes, these products are assigned a Regulatory model number. This number should not be confused with the product name or the product number(s).
3. Telecom approvals and standards appropriate for the target countries/regions have been applied to this product, in addition to those listed above.
4. This product uses an analog fax accessory module which Regulatory Model numbers are: BOISB-1102-00 (US-LIU) or BOISB-1102-01 (EURO LIU), as needed to meet technical regulatory requirements for the countries/regions this product will be sold.

**Boise, Idaho USA**

**January 2012**

**For Regulatory Topics only, contact:**

European Contact: Your Local Hewlett-Packard Sales and Service Office or Hewlett-Packard GmbH, Department HQ-TRE / Standards Europe, Herrenberger Straße 140, D-71034, Böblingen (Fax: +49-7031-14-3143)  
[www.hp.eu/certificates](http://www.hp.eu/certificates)

USA Contact: Product Regulations Manager, Hewlett-Packard Company, PO Box 15, Mail Stop 160, Boise, Idaho 83707-0015 (Phone: 208-396-6000)



# Declaration of conformity (wireless model)

## Declaration of Conformity

according to ISO/IEC 17050-1 and EN 17050-1

**Manufacturer's Name:** Hewlett-Packard Company DoC#: BOISB-1104-03 Rel.1.0

**Manufacturer's Address:** 11311 Chinden Boulevard  
Boise, Idaho 83714-1021, USA

### declares, that the product

**Product Name:** HP LaserJet Pro 200 color MFP M276nw

**Regulatory Model:<sup>2)</sup>** BOISB-1104-03  
BOISB-1102-00 – (US-Fax Module LIU)  
BOISB-1102-01 – (EURO-Fax Module LIU)  
SDGOB – 0892 – (Radio Module)

**Product Options:** All

**Toner Cartridges:** CF210A, CF211A, CF212A, CF213A, CF210X

### conforms to the following Product Specifications:

**SAFETY:** IEC 60950-1:2005 +A1 / EN60950-1: 2006 +A11:2009 +A1:2010 +A12:2011  
IEC 60825-1:2007 / EN 60825-1:2007 (Class 1 Laser/LED Product)  
IEC 62479:2010/EN 62479:2010  
GB4943-2001

**EMC:** CISPR22:2005 +A1/ EN55022:2006 +A1 - Class B<sup>1)</sup>  
EN 61000-3-2 :2006 +A1:2009 +A2:2009  
EN 61000-3-3:2008  
EN 55024:1998 +A1 +A2  
FCC Title 47 CFR, Part 15 Class B<sup>1)</sup> / ICES-003, Issue 4  
GB9254-2008, GB17625.1-2003

TELECOM ES 203 021; FCC Title 47 CFR, Part 68<sup>3)</sup>

**Radio:<sup>5)</sup>** EN 301 489-1 v1.8.1 (2008-04) / EN 301 489-17 v2.1.1 (2009-05)  
EN 300 328: V1.7.1 (2006-10)  
FCC Title 47 CFR, Part 15 Subpart C (Section 15.247) / IC: RSS-210  
IEC 62311: 2007/ EN62311: 2008

**ENERGY USE:** Regulation (EC) No. 1275/2008  
ENERGY STAR® Qualified Imaging Equipment Typical Electricity Consumption (TEC) Test Procedure

**Supplementary Information:**

The product herewith complies with the requirements of the R&TTE Directive 1999/5/EC, EMC Directive 2004/108/EC, the Low Voltage Directive 2006/95/EC and the Ecodesign Directive 2009/125/EC, and carries the CE-Marking  accordingly.

This Device complies with Part 15 of the FCC Rules. Operation is subject to the following two Conditions: (1) this device may not cause harmful interference, and (2) this device must accept any interference received, including interference that may cause undesired operation.

1. The product was tested in a typical configuration with Hewlett-Packard Personal Computer Systems.
2. For regulatory purposes, this product is assigned a Regulatory model number. This number should not be confused with the product name or the product number(s).
3. Telecom approvals and standards appropriate for the target countries/regions have been applied to this product, in addition to those listed above.
4. This product uses an analog fax accessory module which Regulatory Model numbers are: BOISB-1102-00 (US-LIU) or BOISB-1102-01 (EURO LIU), as needed to meet technical regulatory requirements for the countries/regions this product will be sold.
5. This product uses a radio module device which Regulatory Model number is SDGOB-0892 as needed to meet technical regulatory requirements for the countries/regions this product will be sold.

**Boise, Idaho USA**

**January 2012**

**For Regulatory Topics only, contact:**

European Contact: Your Local Hewlett-Packard Sales and Service Office or Hewlett-Packard GmbH, Department HQ-TRE / Standards Europe, Herrenberger Straße 140, D-71034, Böblingen (FAX: +49-7031-14-3143)  
[www.hp.eu/certificates](http://www.hp.eu/certificates)

USA Contact: Product Regulations Manager, Hewlett-Packard Company, PO Box 15, Mail Stop 160, Boise, Idaho 83707-0015 (Phone: 208-396-6000)

# Certificate of Volatility

Hewlett Packard Certificate of Volatility			
Model: M276n MFP M276nw MFP	Part Number: CF144A CF145A	Address: 11311 Chinden Blvd. Boise, ID 83714	
Volatile Memory			
Does the device contain volatile memory (Memory whose contents are lost when power is removed)? <input checked="" type="checkbox"/> Yes <input type="checkbox"/> No If Yes, please describe the type, size, function, and steps to clear the memory below.			
Type (SRAM, DRAM, etc): DDR3	Size: 256 MB	Function: Run-time firmware image, print job info during printing	Steps to clear Memory: Power off printer
Non-Volatile Memory			
Does the device contain non-volatile memory (Memory whose contents are retained when power is removed)? <input checked="" type="checkbox"/> Yes <input type="checkbox"/> No If Yes, please describe the type, size, function, and steps to clear the memory below.			
Type (Flash, EEPROM, etc): EEPROM	Size: 16 kB	Function: Printer Specific Data	Steps to clear memory: NVRAM Initialization
Type (Flash, EEPROM, etc): NAND Flash	Size: 256 MB	Function: Firmware and Smart Install	Steps to clear memory: Preferred method: Clear Saved Faxes (Go to Setup→Service→Fax Service→Clear Saved Faxes  Alternate Method: NVRAM init
			Steps to clear memory:
Mass Storage			
Does the device contain mass storage memory (Hard Disk Drive, Tape Backup)? <input type="checkbox"/> Yes <input checked="" type="checkbox"/> No If Yes, please describe the type, size, function, and steps to clear the memory below.			
Type (HDD, Tape, etc):	Size:	Function:	Steps to clear memory:
Type (HDD, Tape, etc):	Size:	Function:	Steps to clear memory:
Author Information			
Name:	Title: Technical Marketing Engineer	Email:	Business Unit: LaserJet Business
			Date Prepared: 4/1/2012

# Safety statements

## Laser safety

The Center for Devices and Radiological Health (CDRH) of the U.S. Food and Drug Administration has implemented regulations for laser products manufactured since August 1, 1976. Compliance is mandatory for products marketed in the United States. The device is certified as a “Class 1” laser product under the U.S. Department of Health and Human Services (DHHS) Radiation Performance Standard according to the Radiation Control for Health and Safety Act of 1968. Since radiation emitted inside the device is completely confined within protective housings and external covers, the laser beam cannot escape during any phase of normal user operation.

**⚠ WARNING!** Using controls, making adjustments, or performing procedures other than those specified in this user guide may result in exposure to hazardous radiation.

## Canadian DOC regulations

Complies with Canadian EMC Class B requirements.

« Conforme à la classe B des normes canadiennes de compatibilité électromagnétiques. « CEM ». »

## VCCI statement (Japan)

この装置は、クラスB情報技術装置です。この装置は、家庭環境で使用することを目的としていますが、この装置がラジオやテレビジョン受信機に近接して使用されると、受信障害を引き起こすことがあります。取扱説明書に従って正しい取り扱いをして下さい。

VCCI-B

## Power cord instructions

Make sure your power source is adequate for the product voltage rating. The voltage rating is on the product label. The product uses either 100-127 Vac or 220-240 Vac and 50/60 Hz.

Connect the power cord between the product and a grounded AC outlet.

**⚠ CAUTION:** To prevent damage to the product, use only the power cord that is provided with the product.

## Power cord statement (Japan)

製品には、同梱された電源コードをお使い下さい。  
同梱された電源コードは、他の製品では使用出来ません。

## EMC statement (Korea)

B급 기기 (가정용 방송통신기기)	이 기기는 가정용(B급)으로 전자파적합등록을 한 기기로서 주로 가정에서 사용하는 것을 목적으로 하며, 모든 지역에서 사용할 수 있습니다.
-----------------------	--

## Laser statement for Finland

### Luokan 1 laserlaite

Klass 1 Laser Apparat

HP Color LaserJet Pro 200 color M276, laserkirjoitin on käyttäjän kannalta turvallinen luokan 1 laserlaite. Normaalisessa käytössä kirjoittimen suojakoteloitinta estää lasersäteiden pääsyn laitteen ulkopuolelle. Laitteen turvallisuusluokka on määritetty standardin EN 60825-1 (2007) mukaisesti.

### VAROITUS !

Laitteen käyttäminen muulla kuin käyttöohjeessa mainitulla tavalla saattaa altistaa käyttäjän turvallisuusluokan 1 ylittävälle näkymättömälle lasersäteilylle.

### VARNING !

Om apparaten används på annat sätt än i bruksanvisning specificerats, kan användaren utsättas för osynlig laserstrålning, som överskrider gränsen för laserklass 1.

### HUOLTO

HP Color LaserJet Pro 200 color M276 - kirjoittimen sisällä ei ole käyttäjän huollettavissa olevia kohteita. Laitteen saa avata ja huoltaa ainoastaan sen huoltamiseen koulutettu henkilö. Tällaiseksi huoltotoimenpiteeksi ei katsota väriainekasetin vaihtamista, paperiradan puhdistusta tai muita käyttäjän käsikirjassa lueteltuja, käyttäjän tehtäväksi tarkoitettuja ylläpitotoimia, jotka voidaan suorittaa ilman erikoistyökaluja.

### VARO !

Mikäli kirjoittimen suojakotelo avataan, olet alttiina näkymättömälle lasersäteilylle laitteen ollessa toiminnassa. Älä katso säteeseen.

### VARNING !

Om laserprinterns skyddshölje öppnas då apparaten är i funktion, utsättas användaren för osynlig laserstrålning. Betrakta ej strålen.

Tiedot laitteessa käytettävän laserdiodin säteilyominaisuuksista: Aallonpituus 775-795 nm Teho 5 m W Luokan 3B laser.

## GS statement (Germany)

Das Gerät ist nicht für die Benutzung im unmittelbaren Gesichtsfeld am Bildschirmarbeitsplatz vorgesehen. Um störende Reflexionen am Bildschirmarbeitsplatz zu vermeiden, darf dieses Produkt nicht im unmittelbaren Gesichtsfeld platziert werden.

## Substances Table (China)

### 有毒有害物质表

根据中国电子信息产品污染控制管理办法的要求而出台

部件名称	有毒有害物质和元素					
	铅 (Pb)	汞 (Hg)	镉 (Cd)	六价铬 (Cr(VI))	多溴联苯 (PBB)	多溴二苯醚 (PBDE)
打印引擎	X	0	X	0	0	0
复印机组件	X	0	0	0	0	0
控制面板	0	0	0	0	0	0
塑料外壳	0	0	0	0	0	0
格式化板组件	X	0	0	0	0	0
碳粉盒	X	0	0	0	0	0

3690

0：表示在此部件所用的所有同类材料中，所含的此有毒或有害物质均低于 SJ/T11363-2006 的限制要求。

X：表示在此部件所用的所有同类材料中，至少一种所含的此有毒或有害物质高于 SJ/T11363-2006 的限制要求。

注：引用的“环保使用期限”是根据在正常温度和湿度条件下操作使用产品而确定的。

## Restriction on Hazardous Substances statement (Turkey)

Türkiye Cumhuriyeti: EEE Yönetmeliğine Uygundur

# Additional statements for telecom (fax) products

## EU Statement for Telecom Operation

This product is intended to be connected to the analog Public Switched Telecommunication Networks (PSTN) of European Economic Area (EEA) countries/regions.

It meets requirements of EU R&TTE Directive 1999/5/EC (Annex II) and carries appropriate CE conformity marking.

For more details see Declaration of Conformity issued by the manufacturer in another section of this manual.

However due to differences between individual national PSTNs the product may not guarantee unconditional assurance of successful operation on every PSTN termination point. Network compatibility depends on the correct setting being selected by the customer in preparation of its connection to the PSTN. Please follow the instructions provided in the user manual.

If you experience network compatibility issues, please contact your equipment supplier or Hewlett-Packard help desk in the country/region of operation.

Connecting to a PSTN termination point may be the subject of additional requirements set out by the local PSTN operator.

## New Zealand Telecom Statements

The grant of a Telepermit for any item of terminal equipment indicates only that Telecom has accepted that the item complies with minimum conditions for connection to its network. It indicates no endorsement of the product by Telecom, nor does it provide any sort of warranty. Above all, it provides no assurance that any item will work correctly in all respects with another item of Telepermitted equipment of a different make or model, nor does it imply that any product is compatible with all of Telecom's network services.

This equipment may not provide for the effective hand-over of a call to another device connected to the same line.

This equipment shall not be set up to make automatic calls to the Telecom "111" Emergency Service.

This product has not been tested to ensure compatibility with the FaxAbility distinctive ring service for New Zealand.

## Additional FCC statement for telecom products (US)

This equipment complies with Part 68 of the FCC rules and the requirements adopted by the ACTA. On the back of this equipment is a label that contains, among other information, a product identifier in the format US:AAAEQ##TXXXX. If requested, this number must be provided to the telephone company.

The REN is used to determine the quantity of devices, which may be connected to the telephone line. Excessive RENs on the telephone line may result in the devices not ringing in response to an incoming call. In most, but not all, areas, the sum of the RENs should not exceed five (5.0). To be certain of the

number of devices that may be connected to the line, as determined by the total RENs, contact the telephone company to determine the maximum REN for the calling area.

This equipment uses the following USOC jacks: RJ11C.

An FCC-compliant telephone cord and modular plug is provided with this equipment. This equipment is designed to be connected to the telephone network or premises wiring using a compatible modular jack, which is Part 68 compliant. This equipment cannot be used on telephone company-provided coin service. Connection to Party Line Service is subject to state tariffs.

If this equipment causes harm to the telephone network, the telephone company will notify you in advance that temporary discontinuance of service may be required. If advance notice is not practical, the telephone company will notify the customer as soon as possible. Also, you will be advised of your right to file a complaint with the FCC if you believe it is necessary.

The telephone company may make changes in its facilities, equipment, operations, or procedures that could affect the operation of the equipment. If this happens, the telephone company will provide advance notice in order for you to make the necessary modifications in order to maintain uninterrupted service.

If trouble is experienced with this equipment, please see the numbers in this manual for repair and (or) warranty information. If the trouble is causing harm to the telephone network, the telephone company may request you remove the equipment from the network until the problem is resolved.

The customer can do the following repairs: Replace any original equipment that came with the device. This includes the print cartridge, the supports for trays and bins, the power cord, and the telephone cord. It is recommended that the customer install an AC surge arrestor in the AC outlet to which this device is connected. This is to avoid damage to the equipment caused by local lightning strikes and other electrical surges.

## Telephone Consumer Protection Act (US)

The Telephone Consumer Protection Act of 1991 makes it unlawful for any person to use a computer or other electronic device, including fax machines, to send any message unless such message clearly contains, in a margin at the top or bottom of each transmitted page or on the first page of the transmission, the date and time it is sent and an identification of the business, other entity, or individual sending the message and the telephone number of the sending machine or such business, or other entity, or individual. (The telephone number provided cannot be a 900 number or any other number for which charges exceed local or long distance transmission charges).

## Industry Canada CS-03 requirements

**Notice:** The Industry Canada label identifies certified equipment. This certification means the equipment meets certain telecommunications network protective, operational, and safety requirements as prescribed in the appropriate Terminal Equipment Technical Requirement document(s). The Department does not guarantee the equipment will operate to the user's satisfaction. Before installing this equipment, users should ensure that it is permissible for the equipment to be connected to the facilities of the local telecommunications company. The equipment must also be installed using an acceptable method of connection. The customer should be aware that compliance with the above conditions may not prevent degradation of service in some situations. Repairs to certified equipment should be coordinated by a representative designated by the supplier. Any repairs or alterations made by the user to this equipment, or equipment malfunctions, may give the telecommunications company



cause to request the user to disconnect the equipment. Users should ensure for their own protection that the electrical ground connections of the power utility, telephone lines, and internal metallic water pipe system, if present, are connected together. This precaution can be particularly important in rural areas.

---

**⚠ CAUTION:** Users should not attempt to make such connections themselves, but should contact the appropriate electric inspection authority, or electrician, as appropriate. The Ringer Equivalence Number (REN) of this device is 0.0.

---

Notice: The Ringer Equivalence Number (REN) assigned to each terminal device provides an indication of the maximum number of terminals allowed to be connected to a telephone interface. The termination on an interface may consist of any combination of devices subject only to the requirement that the sum of the Ringer Equivalence Number of all the devices does not exceed five (5.0). The standard connecting arrangement code (telephone jack type) for equipment with direct connections to the telephone network is CA11A.

# Additional statements for wireless products

## FCC compliance statement—United States

### Exposure to radio frequency radiation

**⚠ CAUTION:** The radiated output power of this device is far below the FCC radio frequency exposure limits. Nevertheless, the device shall be used in such a manner that the potential for human contact during normal operation is minimized.

In order to avoid the possibility of exceeding the FCC radio frequency exposure limits, human proximity to the antenna shall not be less than 20 cm ( 8 in)) during normal operation.

This device complies with Part 15 of the FCC Rules. Operation is subject to the following two conditions: (1) this device may not cause interference, and (2) this device must accept any interference, including interference that may cause undesired operation of the device.

**⚠ CAUTION:** Based on Section 15.21 of the FCC rules, changes of modifications to the operation of this product without the express approval by Hewlett-Packard Company may invalidate its authorized use.

## Australia statement

This device incorporates a radio-transmitting (wireless) device. For protection against radio transmission exposure, it is recommended that this device be operated no less than 20 cm from the head, neck, or body.

## Brazil ANATEL statement

Este equipamento opera em caráter secundário, isto é, não tem direito à proteção contra interferência prejudicial, mesmo de estações do mesmo tipo, e não pode causar interferência a sistemas operando em caráter primário.

## Canadian statements

**For Indoor Use.** This digital apparatus does not exceed the Class B limits for radio noise emissions from digital apparatus as set out in the radio interference regulations of the Canadian Department of Communications. The internal wireless radio complies with RSS 210 of Industry Canada.

**Pour l'usage d'intérieur.** Le présent appareil numérique n'émet pas de bruits radioélectriques dépassant les limites applicables aux appareils numériques de Classe B prescrites dans le règlement sur le brouillage radioélectrique édicté par le Ministère des Communications du Canada. Le composant RF interne est conforme à la norme CNR-210 d'Industrie Canada.

## European Union regulatory notice

The telecommunications functionality of this product may be used in the following EU and EFTA countries/regions:

Austria, Belgium, Bulgaria, Cyprus, Czech Republic, Denmark, Estonia, Finland, France, Germany, Greece, Hungary, Iceland, Ireland, Italy, Latvia, Liechtenstein, Lithuania, Luxembourg, Malta, Netherlands, Norway, Poland, Portugal, Romania, Slovak Republic, Slovenia, Spain, Sweden, Switzerland, and United Kingdom.

## Notice for use in France

For 2.4 GHz Wireless LAN operation of this product certain restrictions apply: This equipment may be used indoor for the entire 2400-2483.5 MHz frequency band (channels 1-13). For outdoor use, only 2400-2454 MHz frequency band (channels 1-9) may be used. For the latest requirements, see [www.arcep.fr](http://www.arcep.fr).

L'utilisation de cet équipement (2.4 GHz Wireless LAN) est soumise à certaines restrictions : Cet équipement peut être utilisé à l'intérieur d'un bâtiment en utilisant toutes les fréquences de 2400-2483.5 MHz (Chaîne 1-13). Pour une utilisation en environnement extérieur, vous devez utiliser les fréquences comprises entre 2400-2454 MHz (Chaîne 1-9). Pour les dernières restrictions, voir, [www.arcep.fr](http://www.arcep.fr).

## Notice for use in Russia

Существуют определенные ограничения по использованию беспроводных сетей (стандарта 802.11 b/g) с рабочей частотой 2,4 ГГц: Данное оборудование может использоваться внутри помещений с использованием диапазона частот 2400-2483,5 МГц (каналы 1-13). При использовании внутри помещений максимальная эффективная изотропно-излучаемая мощность (ЭИИМ) должна составлять не более 100мВт.

## Korean statement

**당해 무선설비는 운용 중 전파혼선 가능성이 있음**

## Taiwan statement

### 低功率電波輻射性電機管理辦法

第十二條 經型式認證合格之低功率射頻電機，非經許可，公司、商號或使用者均不得擅自變更頻率、加大功率或變更原設計之特性及功能。

第十四條 低功率射頻電機之使用不得影響飛航安全及干擾合法通信；經發現有干擾現象時，應立即停用，並改善至無干擾時方得繼續使用。  
前項合法通信，指依電信法規定作業之無線電通信。  
低功率射頻電機須忍受合法通信或工業、科學及醫療用電波輻射性電機設備之干擾。

# Index

## Symbols/Numerics

2ndary service menu 109

## A

acoustic specifications 140  
advanced setup  
fax 51

## B

batteries included 145  
billing filters  
fax 26  
tone 26  
bin, output  
jams, clearing 89  
blank pages, troubleshooting 99

## C

cables  
USB, troubleshooting 99  
calibrating color 110  
Canadian DOC regulations 152  
cartridges  
image-formation system 10  
recycling 143  
warranty 132  
cautions iii  
certificate of volatility 151  
checklist  
fax troubleshooting 112  
checklists  
pre-troubleshooting 32  
checklists, printing 60  
cleaning  
paper path 45, 95  
cleaning stage, image formation  
operations 17  
CO operations 22

color  
calibrating 110  
color alignment, calibrating 47,  
95  
color settings  
adjusting 93  
Configuration page 46  
configuration page 46  
connectivity  
solving problems 103  
connectors  
DC controller 39  
control panel  
blank, troubleshooting 34  
button test 110  
Configuration page 46  
display test 110  
menus 48  
message types 67  
messages, troubleshooting 67  
controls  
hook switch control 26  
conventions, document iii  
copy menu 63  
copying  
sequence 21  
current control, fax line 26  
customer support  
online 136  
repacking product 137

## D

data path  
fax 25  
DC controller  
connectors 39  
engine control system 5

laser/scanner system  
operations 9  
pickup-and-feed system  
operations 18  
defaults  
NVRAM initialization 111  
defaults, restoring 111  
defects, repeating 97  
defects, repetitive 46  
developing stage 12  
device  
downstream detection, fax 26  
dialing  
pulse 26  
dimensions 140  
disposal, end-of-life 145  
distinctive ring 23  
document conventions iii  
document feeder  
jams 86  
downstream device detection  
fax 26  
dpi (dots per inch)  
faxing 51  
drum, image formation  
operations 11

## E

electrical specifications 140  
end-of-life disposal 145  
environmental specifications 140  
environmental stewardship  
program 143  
error messages  
event log 79  
error messages, control panel 67  
error messages, fax 114, 120  
European Union, waste disposal  
146

## F

- factory defaults, restoring
  - NVRAM initialization 111
- factory-set defaults, restoring 111
- fax
  - answer mode 50
  - billing (metering) tone filters 26
  - card 24
  - data path 25
  - distinctive ring 23
  - downstream current detection 26
  - factory-set defaults, restoring 111
  - flash memory storage 27
  - functions 22
  - hook state 25
  - hook switch control 26
  - line current control 26
  - operations 22
  - page storage 26, 27
  - PSTN operations 22
  - pulse dialing 26
  - receiving 22
  - reports 61
  - ring detect 26
  - ring type 51
  - safety isolation 24
  - safety protection circuitry 25
  - solve performance problems 127
  - subsystem 24
  - unable to receive 114
  - unable to send 120
  - voice over IP (VoIP) services 23
- fax card
  - CODEC 24
  - DSP 24
  - fax subsystem 24
  - hook switch control 26
  - pulse dialing 26
  - regional versions 24
  - ring detect 26
- fax menu 61
- fax reports, printing 61
- fax security
  - security features, computer 22
  - security features, network 22

## fax subsystem

- fax card 24
  - operations 24
- ## fax troubleshooting
- checklist 112
- ## Finnish laser safety statement 153
- ## flash memory, fax 27
- ## fusing stage 15

## G

- graph paper, printing 60

## H

- hook state
  - fax 25
- hook switch control 26
- HP Customer Care 136
- HP Jetdirect print server
  - NVRAM initialization 111
- humidity specifications
  - environment 140

## I

- image formation
  - cleaning stage 17
  - developing stage 12
  - fusing stage 15
  - latent-image stage 11
  - process 10
  - systems 10
  - transfer stage 14
- image quality
  - repetitive image defects 46
  - solving 92
- image transfer stage 14
- information pages
  - configuration page 46
- initialization
  - NVRAM 111

## J

- jams
  - detection operations 19
  - document feeder, clearing 86
  - locating 85
  - output bin, clearing 89
  - rear door, clearing 89
- Japanese VCCI statement 152
- Jetdirect print server
  - NVRAM initialization 111

## K

- Korean EMC statement 153

## L

- laser safety statements 152, 153
- laser-beam exposure stage 12
- laser/scanner system operations 9
- latent-image formation stage 11
- LEDs, troubleshooting 35
- license, software 134
- line current control, fax 26
- location
  - setting 110

## M

- Macintosh
    - support 136
  - material restrictions 145
  - Material Safety Data Sheet (MSDS) 146
  - media
    - jam detection operations 19
    - media feed stage 14
  - memory
    - flash, fax 27
    - NVRAM initialization 111
  - memory chip, print cartridge
    - description 133
  - menu
    - control panel, access 48
    - copy 63
    - fax 61
    - Fax setup 50
    - Network config 59
    - Quick Forms 60
    - Reports 49
    - Service 57
    - System setup 53
    - USB 61
  - menu map, printing 32
  - mercury-free product 145
  - messages, control panel 67
  - music paper, printing 60
- ## N
- network
    - configuring 59
    - Network config menu 59
  - networks
    - security features 22

- notebook paper, printing 60
- notes iii
- NVRAM initialization 111

## O

- off-hook 26
- on-hook 26
- online support 136
- operating environment, specifications 140
- operations
  - engine control system 4
  - fax 22
  - fax card in subsystem 24
  - fax subsystem 24
  - fax, PSTN 22
  - image-formation system 10
  - jam detection 19
  - laser/scanner system 9
  - pickup-and-feed system 18
  - product systems 5
  - PSTN 22
  - scanner system 20
  - sequence of 4
- output quality
  - repetitive image defects 46

## P

- packaging product 137
- pages
  - blank 99
  - not printing 99
  - printing slowly 99
- paper
  - jam detection operations 19
  - selecting 94
- paper pickup problems solving 91
- paper type changing 92
- PBX ring detect 110
- photosensitive drum
  - image formation operations 11
- physical specifications 140
- pickup-and-feed system operations 18
- power
  - consumption 140
  - fax line current control 26

- power-on
  - scanner sequence 20
  - troubleshooting 34
- pre-troubleshooting checklist 32
- primary charging stage 12
- print cartridges
  - checking for damage 96
  - memory chips 133
  - recycling 143
  - warranty 132
- print quality
  - improving 92
  - repetitive image defects 46
- print quality page
  - interpreting 44
  - printing 44
- printer drivers choosing 97
- printing
  - configuration page 46
  - troubleshooting 99
- problem-solving
  - no response 101
  - slow response 102
- product
  - fax, functions 22
- PSTN operations 22
- pulse dialing 26

## Q

- quality
  - repetitive image defects 46

## R

- rear door
  - jams 89
- receiving faxes 22
  - distinctive ring 23
- recycling 143
  - HP printing supplies returns and environmental program 144
- regional versions
  - fax card 24
- repacking product 137
- repeating defects, troubleshooting 97
- repetitive defects, troubleshooting 46, 97
- reports
  - configuration page 49

- demo page 49
- diagnostics page 49
- error 79, 109
- fax 61
- menu map 49
- network report 49
- PCL 6 font list 49
- PCL font list 49
- print quality page 49
- PS font list 49
- service 109
- service page 49
- supplies status page 49
- usage page 49

## resets

- NVRAM initialization 111
- restoring
  - default settings 111
  - NVRAM initialization 111
- restoring factory-set defaults 111
- ring detect
  - fax card 26
- RING operations 22
- rollers
  - image formation operations 11
  - repetitive image defects 46

## S

- safety
  - protection circuitry, fax 25
  - isolation, fax 24
- safety statements 152, 153
- secondary service menu 109
- security features
  - computer 22
  - network 22
- sensors
  - jam detection 19
- separation stage, image formation 15
- sequence of operations 4
- service
  - repacking product 137
- Service menu 57
  - secondary 109
- settings
  - factory-set defaults, restoring 111
- shipping product 137

- size 140
- software
  - software license agreement 134
- solve
  - fax problems 120
- solve problems
  - fax 127
- solving
  - direct-connect problems 103
  - network problems 103
- specifications
  - electrical and acoustic 140
  - environmental 140
  - physical 140
- storing
  - environmental specifications 140
  - fax pages in flash memory 26
- supplies
  - recycling 143
- supplies status page
  - printing 96
- support
  - online 136
  - repacking product 137
- System setup menu 53
- systems 5

**T**

- technical support
  - online 136
  - repacking product 137
- temperature specifications
  - environment 140
- TIP operations 22
- tips iii
- toner cartridges
  - image-formation system 10
- transfer stage 14
- trays
  - jams, clearing 87
- troubleshooting
  - about 32
  - blank pages 99
  - checklist 32
  - control panel messages 67
  - control-panel diagnostics 37
  - direct-connect problems 103
  - faxes 112

- LED diagnostics 35
- network problems 103
- NVRAM initialization 111
- pages not printing 99
- pages printing slowly 99
- power-on 34
- receive fax 114
- repeating defects 97
- send fax 120
- USB cables 99

**U**

- USB menu 61
- USB port
  - troubleshooting 99

**V**

- voice over IP (VoIP) services 23
- volume
  - settings 55

**W**

- warnings iii
- warranty
  - license 134
  - print cartridges 132
  - product 130
- Web sites
  - customer support 136
  - Macintosh customer support 136
  - Material Safety Data Sheet (MSDS) 146
- weight 140
- wireless
  - configuring 59







CF144-90996

