

HP Designjet T1100 MFP, 4500mfp, 4500 Scanner and 820 MFP Scanner Series



Service Manual

For HP Internal Use Only

©Copyright Hewlett-Packard Company
2007

This document contains proprietary information that is protected by copyright. All rights are reserved. No part of this document may be photocopied, reproduced, or translated to another language without the prior written consent of Hewlett-Packard Company.

Fourth Edition, May 2007

Warranty

The information contained in this document is subject to change without notice.

Hewlett-Packard makes no warranty of any kind with regard to this material, including, but not limited to, the implied warranties of merchantability and fitness for a particular purpose.

Hewlett-Packard shall not be liable for errors contained herein or for incidental or consequential damages in connection with the furnishing, performance, or use of this material.

WARNING

The procedures described in this manual are to be performed by HP-qualified service personnel only.

Electrical Shock Hazard

Serious shock hazard leading to death or injury may result if you do not take the following precautions:

- Ensure that the ac power outlet (mains) has a protective earth (ground) terminal.
- Disconnect the product from the power source prior to performing any maintenance.
- Prevent water or any other liquids from running onto electrical components or circuits, or through openings in the enclosure.

Electrostatic Discharge

Refer to the beginning of Chapter 4 of this manual, for precautions you should take to prevent damage to the Printer circuits from electrostatic discharge.

Safety Symbols

General definitions of safety symbols are given immediately after the table of contents.

WARNING

The Warning symbol calls attention to a procedure, practice, or the like, which, if not correctly performed or adhered to, could result in personal injury. Do not proceed beyond a Warning symbol until the indicated conditions are fully understood and met.

CAUTION

The Caution symbol calls attention to an operating procedure, practice, or the like, which, if not correctly performed or adhered to, could result in damage to or destruction of part or all of the product. Do not proceed beyond a Caution symbol until the indicated conditions are fully understood and met.

HP Designjet T1 100 MFP, 4500mfp, 4500 Scanner and 820 MFP Scanner Series



Service Manual

Using this Manual

Purpose

This Service Manual contains information necessary to troubleshoot and service:

- HP Designjet 4500 Scanner- Model Q1277A
- HP Designjet T1100 MFP- Model Q6713A
- HP Designjet 820 MFP- Model Q6685
- HP Designjet 4500mfp-Model Q1276A

For information about using this product, refer to the corresponding User and Quick Reference Guides.

This Service Manual is about the Scanner and the integration with the printer as a multi-functional printer and copier. In order to troubleshoot the printer, refer to the corresponding Service Manual for the printer.

Readership

The procedures described in this Service Manual are to be performed by HP Certified service personnel only.

Part Numbers

Part Numbers for service parts are located in Chapter 3.

Conventions

A small arrow \Rightarrow is used to indicate other parts of the Service Manual where you can find information related to the topic you are consulting.

Table of Contents

- 1. Troubleshooting**
- 2. System Error Codes**
- 3. Parts and Diagrams**
- 4. Removal and Installation**
- 5. Scanner Adjustments and Calibrations**



Troubleshooting

1

| | |
|---|------|
| Troubleshooting Tips | 1-2 |
| Is the problem with the printer or with the scanner? | 1-2 |
| Image-quality problems | 1-2 |
| No Output or Output is not as expected | 1-3 |
| Troubleshooting System Error Codes | 1-3 |
| Using the SCANtest 6 Diagnostic Software | 1-3 |
| Troubleshooting Issues | 1-9 |
| Troubleshooting print-quality and copy issues | 1-9 |
| Troubleshooting general scanner issues | 1-13 |
| Troubleshooting Specific Scanner Issues | 1-21 |
| Cleaning the Scanning Area | 1-24 |
| Troubleshooting Specific Panel PC Problems | 1-27 |
| Power failure. | 1-27 |
| Boot up failure. | 1-28 |
| LCD/Inverter failure: | 1-28 |
| No backlight and no display | 1-28 |
| With backlight but no display | 1-29 |
| How to check the voltage of the Inverter PCA in the Panel PC. | 1-30 |
| DDR DRAM failure: | 1-31 |
| DVD-ROM failure: | 1-31 |
| The CD/DVD is stuck in the DVD-ROM and cannot be ejected out. | 1-31 |
| Touch screen is working but cannot control the cursor. | 1-33 |
| Risks of not running the Scanner Maintenance | 1-36 |

Guide to Troubleshooting the HP family of MFPs and Scanners

This chapter guides you through the various procedures for troubleshooting the HP family of MFPs and scanners.

Troubleshooting Tips

- 1 First record whether the problem is with the Printer, the Scanner, or the Touch Screen.
- 2 Make sure that the scanning area is completely clean.
- 3 **Test 20: Noise Test** can help you find whether or not the scanning area is dirty.
- 4 The SCAN dump files can help you to understand the light profile of the affected scanner.
- 5 Remember, in order to cancel when copying, press the Cancel button on the Touch Screen **and** the Cancel button on the printer.

Is the problem with the printer or with the scanner?

If you experience one of the following symptoms, the problem could be related to the **scanner**:

- System Error on the Touch Screen.
- LED's flashing on the Scanner Operator Panel.
- WIDEsystem error message.
- Vertical lines (either color or black) in the scanned image.

If you experience one of the following symptoms, perform an Image Preview in the scanner and send a Test Print to the printer:

- Image Quality Problems.
- No Output.
- Output is not as expected.

If the Image Preview fails, this points to a problem with the Scanner. If the Test Print fails, this points to a problem with the Printer.

Image-quality problems

If you have Image Quality problems in any of your prints, try the following:

- 1 Print out a file already stored or print out the demo plot.
- 2 Once the print is finished, insert it into the Scanner.
- 3 Once scanned, print out the scanned image.
 - If the original print is the same as the copied print, then the problem is related to the Printer.
 - If the original print is NOT the same as the copied print, then the problem is related to the Scanner.

No Output or Output is not as expected

If the output is not as you expected it to be, try the following:

- Check all the settings in the Software: Color Settings and Margins.
- Check media settings: Media profile (in software) and media loaded in the printer (front panel selection) should be the same.
- Perform Color Calibration (both Scanner and Printer).
- Check the Preview Image.

If there is no output at all, then try the following:

- Check the connection between the Printer and the Scanner.
- Check the selected settings: List, Collate, Scan to file, etc.

Troubleshooting System Error Codes

Chapter 2 - *System Error Codes* contains a list of system error codes and their respective descriptions and recommended corrective actions. Only try one recommended action at a time and check if the error code has disappeared.

If you have an error code which is not documented in this Service Manual, or you have an error which you cannot resolve, report the error to the HP Response Center or the nearest HP Support Office. When reporting the error, have the following information ready:

- Model and serial number of the MFP or scanner
- Software and firmware version for the MFP or scanner. To check the software and firmware version, press the Setup tab, and then select **Options > General > About**).
- The complete error number
- ScanDump of Light Profiles

Make sure you provide the full error code and the full software and firmware version. Without this information, the HP Support personnel cannot help you.

Using the SCANTest 6 Diagnostic Software

Here we briefly describe the various tests found in the SCANTest 6 Diagnostic Software, for more detail of some of the Adjustments shown below refer to Chapter 5 -

The purpose of the SCANTest 6 diagnostic software is to support the troubleshooting and adjustment of the Scanner.

To access the software you must go to the Setup Tab and to: Options->System->Service-> (this part is password protected, the password is '**support**')->Scantest

When the SCANTest 6 diagnostic software has been started, the Scanner is switched ON in Test Mode, and the Diagnostic LED in the Operator Panel is

turned ON.

To get the complete information of the system error code, enter the scanner's Error Mode and launch the ScanTest 6 Diagnostic test. The error code and a short description of the error is displayed on the Touch Screen.

When possible, always perform a service test on the component that you are about to replace to ensure that is the component that has failed. If the test on that component passes, there is no need to replace it.

Scanner Test Program Menu

- Test 1: Scanner Information
- Test 2: LED Test
- Test 3: Key Test
- Test 4: Original-Sensor Test
- Test 5: Lamp Test
- Test 6: Motor Test
- Test 7: Complete Hardware Test
- Test 9: Camera Adjustment
- Test 11: Stitching and Vertical Alignment
- Test 12: Adjust Y-Axis Scaling
- Test 13: Switch Scanner to Test Mode
- Test 20: Noise Test
- Test 21: Scan Dump
- Test 27: Camera Adjustment Wizard
- Test 28: Original Guide Sensor Test
- Test 30: Calibrate ATAC
- Test 31: Driver Board Communication Test

If SCANtest 6 is started when the scanner is in Error Mode, the Error Code Number and a short description of the error will be displayed on the screen.

Test 1: Scanner Information

This test displays general information regarding the scanner. When executed, the test displays the following:

- Scanner Model:
- Firmware Release:
- Firmware Release Date:
- Firmware Build:
- FPGA Revision:
- FPGA Release Date:
- Boot Code Revision:
- Boot Code Release Date:
- Scanner ID Switch:
- SCSI ID:

Test 2: LED Test

This test checks the functionality of the LED Indicators on the Operator Panel. When the test is executed, all the LEDs are sequentially switched ON/OFF until Test 2 is terminated. If any of the LEDs fail, you will NOT get an error message, instead the LED will NOT switch ON or OFF. If the LED test fails, replace the Right Cover (which contains the Operator Panel).

Test 3: Key Test

This test checks the functionality of the Keys on the Operator Panel. When the test is executed, each key on the Operator Panel will turn an LED ON when pressed.

| Key | LED |
|---------------------|---------------|
| Forward and Reverse | Ready (Green) |
| Power | Wait (Yellow) |

The only way to know if the test fails is by inspection, there is no error message that is displayed.

If the Key test fails, replace the Right Cover (which contains the Operator Panel).

Test 4: Original-Sensor Test

This test checks the functionality of the Media Sensors.

When the test is executed, the following LEDs turn ON when one of the Media Sensors is activated.

| Actuator | LED |
|--------------------|---------------|
| Media Entry Sensor | Ready (Green) |
| Media Exit Sensor | Ready (Green) |

To test the Media Sensors, load a sheet of media (A4) and the Ready LED switches ON and when you remove it the Ready LED switches OFF.

If the test fails (if any of the LEDs fail to switch ON), then the problem will be related to corresponding Sensor.

Test 5: Lamp Test

This test checks the functionality of the Lamp and the associated electronics.

When the test is executed, a message on the Touch Screen will indicate whether the **Lamp** is turned ON or OFF (Lamp power is turned ON/OFF) and whether the **Light** is ON/OFF (Light is detected or not). The Lamp is delayed for approximately 2 seconds when switched ON.

Test 6: Motor Test

This test checks the functionality of the Stepper Motor and any associated

electronics.

When the test is executed, a menu appears that allows you to select the motor speed and the motor direction.

If the Stepper Motor or the Driver Board fails to run when the test is executed, then the Stepper Motor should be replaced.

Test 7: Complete Hardware Test

This test checks the various functions of the Driver and Camera Boards.

Test 9: Camera Adjustment

Always use Test 9: Camera adjustment to adjust the cameras. Do not use Test 27: Camera Adjustment Wizard.

This test contains a Software Oscilloscope that allows you to check and adjust the CCD-Cameras. The following functions can be selected from the Test Program Menu.

- Uncorrected or Corrected Light Profiles.
- Red, Green, or Blue Color Channels.
- Special Detail Views for Light Profile, Scan Width, and Vertical Positioning.
- Forward / Reverse controls for the Camera Motor.
- Save screen images.
- Print screen images.

The content of the Detail Views is marked on the upper overview window by red vertical lines. The continuous lines refer to the left Detail View and the dashed lines to the right Detail View.

Test 11: Stitching and Vertical Alignment

This test is also included in the Scanner Maintenance Software.

This test performs Automatic Vertical Alignment and Horizontal Stitching.

Once the test has been started:

- Insert Calibration Sheet.
- Select Vertical Alignment to align the cameras.
- Select Horizontal Stitching to stitch the cameras.

The screen image can be saved or printed.

This test allows manual setting of the Stitch Values. The Stitch Values are stored in the Flash Memory on the Driver Board.

The Vertical Alignment may be adjusted manually by controlling the Camera Motor from the control field '<<dddd>>'. The two buttons marked '<<' respectively '>>' are used to start the motor and to determine the direction of rotation. When started, the motor runs for dddd mili-seconds as entered into the control field.

Test 12: Adjustment of Y-Axis Scaling

This test allows you to adjust the Y-Axis Scaling.

The scaling (dpi) in the mechanical scan direction (Y-Axis) depends on the speed of the stepper motor relative to the scanline Exposure Time. The default motor speed can be changed $\pm 1\%$, either from Test 12 or by using the 'Scanner Setup/Correction factor ...' option of SW copying. The correction factor is stored in the Flash Memory on the Driver Board.

Test 13: Switch Scanner to Test Mode

This test allows you to switch the scanner back to Test Mode. Useful if the scanner gets out of Test Mode, e.g. if it has to be turned OFF/ON during troubleshooting.

Test 20: Noise Test

The purpose of this test is to detect and locate the possible cause (dust, dirt, scratches,..) of vertical lines running from top to bottom of the scanned image.

When the test is executed, it scans the White Calibration Area of the Calibration Sheet and displays, for each color channel, the graytone values of each separate pixel averaged over the scanned band.

The displayed image of the Calibration Sheet will be superimposed by low level noise caused by the CCD chip, and larger spikes most likely caused by dust, dirt, scratches, or similar defects on the Glass Plate. In rare cases, larger spikes may be caused by dust, dirt, or pixel faults on the CCD chip.

The positions of larger spikes are shown by the numbers (cm or inch units) opposite to the spikes. The numbers refer to the Sideload-ruler on the scanner. Larger spikes going downwards are often caused by dust, dirt, scratches, or similar defects on the Glass Plate and may be removed by cleaning the Glass Plate. Downward spikes often show up as darker vertical lines in the scanned image.

Larger spikes going upwards are often caused by dust or dirt present on the Glass Plate during the last calibration with Scanner Maintenance. These defects are memorized by the Light Profiles stored in the Flash Memory and can only be removed by cleaning of the Glass Plate followed by running Scanner Maintenance again. Upward spikes show up as very bright vertical lines in the scanned image.

White vertical lines in the scanned image may be found even if Noise Test shows a perfectly 'clean' scanner. In this case, the cause may be white dust or particles on the backside of the Glass Plate having the same color as the white background. In this case, the Light Profiles of SCANTest 6, Test 9 may show upwards going spikes when a dark original is placed in the scan-area.

Test 21: SCANDump

SCANDump is a tool for remote diagnostic. SCANDump saves the light profile from the cameras, error codes, and statistics.

When the test is executed, the file SCANDump.con will be placed in the

directory c:\Temp\.

Remember to perform the SCANdump test and provide the HP Support personnel with the information file stored in the c:\Temp directory.

Test 27: Camera Adjustment Wizard

This allows you to adjust the camera using a wizard that guides you through the complete process. Use this test **only** if you do not have experience in adjusting the camera, otherwise you should always use Test 9. See 5-19, *Adjusting the Camera Using the Camera Wizard*.

Test 28: Original Guide Sensor Test

This is to test the Guide Plate Sensors which are located under the Guide Plate. See 5-28, *Original Guide Sensor Test*

Test 30: Calibrate ATAC (Automatic Thickness Adjustment Control)

This test sets the current level at which the ATAC will stop if something is preventing it from moving down. See 5-32, *Calibrate ATAC (Automatic Thickness Adjustment Control)*

Test 31: Driver Board Communication Test

This test checks the communication between the Scanner and the Driver Board. See 5-32, *Driver Board Communication Test*.

Troubleshooting Issues

The following guide will help you to find a solution to some typical problems that some customers may experience.

The problems (P#) that can be solved remotely through on-phone support and customer intervention are marked C.

The problems that require on-site intervention performed by a Support Technician are marked T.

Before sending a Support Technician to the customer, identify whether the problem is related to the scanner or the Panel PC (PPC).

If the problem is scanner-related, erase the parameter block and run the scanner maintenance. Then perform the system recover using the most recent version of the software.

If the problem is PPC-related, perform the system recovery using the most recent version of the software.

If the problem persists, try the solutions listed in the tables below.

Troubleshooting print-quality and copy issues

| P# | Category | Problem | Q# | Question | Yes/No | C/T | Solution |
|----|--------------|--|----|--|--------|-----|--|
| 1 | Copy problem | The colors on one side of the copy does not correspond to the colors on the other side of the copy | 1 | Have you cleaned and calibrated your scanner recently? | No | C | Camera differences - The scanner needs to be cleaned and calibrated (refer to P24 and P25) |
| | | | | | Yes | | Refer to Q2 |
| | | | 2 | Have you upgraded the system software to the latest version? | No | C | Upgrade system software (use Update System DVD) |
| | | | | | Yes | T | Cameras need adjusting or the Camera Board replacing |

| P# | Category | Problem | Q# | Question | Yes/No | C/T | Solution |
|----|--------------|---|----|--|--------|-----|--|
| 2 | Copy problem | I get thin lines of wrong colors in my copy | 1 | Are the lines vertical and also present in your preview? | Yes | C | Erase the parameter block and run the scanner maintenance. Then clean and calibrate the scanner (refer to P24 and P25) |
| | | | | | No | | Refer to Q2 |

| P# | Category | Problem | Q# | Question | Yes/No | C/T | Solution |
|----|----------|---------|----|---|--------|-----|---|
| | | | 2 | Are the lines horizontal and equally spaced? | Yes | C | Check printheads by starting printhead test on Printer. By using the built-in test print function in the Designjet Scan Copy application, you can also get an idea whether the Printer is performing OK |
| | | | | | No | | Refer to Q3 |
| | | | 3 | Are the lines horizontal, but irregular (maybe only 1 line)? | Yes | C | The lines could be caused by a data error. Upgrade system software |
| | | | | | No | | Refer to Q4 |
| | | | 4 | Do you have a great number of regular spaced lines very close to each other and restricted to one side (1 camera) only? | Yes | T | You have a camera error. Replace Camera Board |

| P# | Category | Problem | Q# | Question | Yes/No | C/T | Solution |
|----|--------------|---|----|--|--------|-----|---|
| 3 | Copy problem | I get thick lines of slightly wrong colors in my copy | 1 | Are the lines vertical and also present in your preview? | Yes | C | The scanner needs to be cleaned and calibrated (refer to P24 and P25) |
| | | | | | No | | Refer to Q2 |
| | | | 2 | Are the lines horizontal and equally spaced? | Yes | C | Check printheads by starting printhead test on Printer. By using the built-in test print function in the Designjet Scan Copy application, you can also get an idea whether the Printer is performing OK |
| No | | Refer to P2 | | | | | |

| P# | Category | Problem | Q# | Question | Yes/No | C/T | Solution |
|----|--------------|--|----|--------------------------------------|--------|-----|---|
| 4 | Copy problem | Some colors are not the same when I compare the master print with the copy | 1 | Is the scanner clean and calibrated? | No | C | Refer to P1. Clean and calibrate the scanner (refer to P24 and P25) |
| | | | | | Yes | | Refer to Q2 |

| P# | Category | Problem | Q# | Question | Yes/No | C/T | Solution |
|----|----------|---------|----|--|--------|-----|---|
| | | | 2 | Do you use the correct media profile for the actual media? | No | C | If you are using e.g. Glossy Media for this copy, the media profile selected should also be for Glossy Media. |
| | | | | | Yes | | Refer to Q3 |
| | | | 3 | Is the media profile valid? | No | C | Create a new media profile (refer to P26) |
| | | | | | Yes | | Refer to Q4 |
| | | | 4 | Is the option 'Ink Printer Original' set in accordance with your original? | No | C | If original was printed using an Inkjet Printer, set this option (refer to P27) |
| | | | | | Yes | | Refer to Q5 |
| | | | 5 | Is the media you are printing on the same type as the original? | No | C | e.g. Use Glossy Media to reproduce a Glossy original |
| | | | | | Yes | C | Create a new media profile (refer to P26) |

| P# | Category | Problem | Q# | Question | Yes/No | C/T | Solution |
|----|--------------|---|----|---|--------|-----|--|
| 5 | Copy problem | Only a part of the master print is being copied | 1 | Are you scanning a thick original? | Yes | C | Uncheck extended media handling box in scanner settings (using extended media will load the original between both entry and exit rollers before scanning - this means that you will not have the start of the thick original scanned. Also the scan speed will be slower, and no "back-ups"/reversing is allowed while scanning) |
| | | | | | No | | Refer to Q2 |
| | | | 2 | Have you selected 'Auto size'? | Yes | C | The scanner needs to be cleaned (refer to P24) |
| | | | | | No | | Refer to Q3 |
| | | | 3 | Is the length too short and the width OK? | Yes | C | The problem may be with the Printer (not able to print close to the edges) or Panel PC (Hard Disk is full). |
| | | | | | No | C | Check that the margins that are set are not too big. Also check Scanner Media Offsets |

| P# | Category | Problem | Q# | Question | Yes/No | C/T | Solution |
|----|--------------|--|----|----------|--------|-----|--|
| 6 | Copy problem | Which setting will give me the best result when copying? | - | - | - | C | See section about media profile (P4). Use copy quality best. Choose the correct Type of original ("Map" for maps, "Photo" for photos, etc). Eventually go to Original Setup to fine adjust colors and sharpening. (See also online help for more details - button with "?" symbol) |

| P# | Category | Problem | Q# | Question | Yes/No | C/T | Solution |
|----|--------------|--------------------------------|----|---------------------------------------|--------|--|---|
| 7 | Copy Problem | Nesting feature is not working | 1 | Is the correct printer selected? | No | C | Select the correct Printer |
| | | | | | Yes | | Refer to Q2 |
| | | | 2 | Is the Hard Disk close to being full? | Yes | C | Free up some space, or try to run a nesting job with only 2 or 3 small pictures. If that works refer to P27 |
| | | | | No | C | Make sure that Nesting is set: Select: Output layout Nesting optimized | |

| P# | Category | Problem | Q# | Question | Yes/No | C/T | Solution |
|----|--------------|---|----|----------------------------------|--------|-----|---|
| 8 | Copy problem | The Collate Copy function does not work | 1 | Is your Hard Disk close to full? | Yes | C | Free up some space, or try to run a collate job with a smaller picture. |
| | | | | | No | C | Follow the step by step instructions in the online help under "Collate Copy". |

| P# | Category | Problem | Q# | Question | Yes/No | C/T | Solution |
|----|--------------|----------------------------|----|-----------------------------------|--------|-----|--|
| 9 | Copy problem | The lines are not accurate | 1 | Are the lines wavy and irregular? | Yes | C/T | C: The original could be curled or crumpled. Try to flattten the original (in case of very irregular waves there could be a mechanical problem with the scanner). T: check motor and belt drive tension according to TSM |
| | | | | | No | | Refer to Q2 |

| P# | Category | Problem | Q# | Question | Yes/No | C/T | Solution |
|----|----------|---------|----|--|--------|-----|--|
| | | | 2 | Are the lines not sharp? | Yes | C/T | C: Are you using the correct copy method? Try sharpening. If sharpness is different between Cameras, you may have a Focus Problem. T: Check focus of cameras with Focus Adjustment Pattern |
| | | | | | No | | Refer to Q3 |
| | | | 3 | Are the lines broken and the errors situated in a vertical column between 2 columns? | Yes | C | You might have a visible stitching error (refer to P28) |
| | | | | | No | C | Check the dpi. In the case of too low resolution, jagged diagonal lines will appear |

| P# | Category | Problem | Q# | Question | Yes/No | C/T | Solution |
|----|--------------|----------------------------------|----|---|--------|-----|--|
| 10 | Copy Problem | One side of the preview is black | 1 | Have you upgraded the scanner firmware to the latest version? | No | C | Upgrade scanner firmware to latest version. See 5-33. |
| | | | | | Yes | | Refer to Q2 |
| | | | 2 | Have you upgraded the system software to the latest version? | No | C | Upgrade system software (use System Recovery DVD) |
| | | | | | Yes | T | Most likely a Camera Error. Perform the Manual Camera Adjustment (Test 9). Replace the Camera Board if necessary |

Troubleshooting general scanner issues

| P# | Category | Problem | Q# | Question | Yes/No | C/T | Solution |
|----|--------------|---|----|------------------------------------|--------|-----|--|
| 11 | Copy problem | Only a part of the master print is being copied | 1 | Are you scanning a thick original? | Yes | C | Uncheck extended media handling box in scanner settings (using extended media will load the original between both entry and exit rollers before scanning - this means that you will not have the start of the thick original scanned. Also the scan speed will be slower, and no "back-ups"/reversing is allowed while scanning) |
| | | | | | No | | Refer to Q2 |

| P# | Category | Problem | Q# | Question | Yes/No | C/T | Solution |
|----|----------|---------|----|---|--------|-----|---|
| | | | 2 | Have you selected 'Auto size'? | Yes | C | The scanner needs to be cleaned (refer to P24) |
| | | | | | No | | Refer to Q3 |
| | | | 3 | Is the length too short and the width OK? | Yes | C | The problem may be with the Printer (not able to print close to the edges) or Panel PC (Hard Disk is full). |
| | | | | | No | C | Check that the margins that are set are not too big. Also check Scanner Media Offsets |

| P# | Category | Problem | Q# | Question | Yes/No | C/T | Solution |
|----|--------------|--|----|-----------------------------|--------|-----|---|
| 12 | System Error | What should I do when the program hangs? | 1 | Are you running a copy job? | Yes | C | Making a copy takes a lot of resources according to the settings. Wait till the copy is done before performing another action |
| | | | | | No | | Restart the system. If the problem is coming back, run the System recovery (refer to P17) |

| P# | Category | Problem | Q# | Question | Yes/No | C/T | Solution |
|----|--------------|---|----|----------------------------|--------|-----|--|
| 13 | File problem | When I scan to file, the file is very big | 1 | Are you scanning in color? | Yes | C | Scanning large drawings will generate very big files. An A0 color drawing scanned at 300 dpi will generate a file size of approx. 3 Gigabytes when scanned in an uncompressed format. In order to reduce file size, select TIFF - pack bits as format. You can reduce size even more by selecting JPEG format, but this format will reduce picture quality |
| | | | | | No | | Refer to Q2 |

| P# | Category | Problem | Q# | Question | Yes/No | C/T | Solution |
|----|----------|---------|----|---------------------------------|--------|-----|--|
| | | | 2 | Are you scanning in gray tones? | Yes | C | Scanning large drawings will generate big files. An A0 gray tone drawing scanned at 300 dpi will generate a file size of approx. 300 Mbytes when scanned in an uncompressed format. In order to reduce file size, select TIFF - pack bits as format. You can reduce size even more by selecting JPEG format, but this format will reduce picture quality |
| | | | | | No | | In order to reduce file size on scanned B/W drawings, select TIFF group 4 compression |

| P# | Category | Problem | Q# | Question | Yes/No | C/T | Solution |
|----|--------------|---|----|--|--------|-----|---|
| 14 | File problem | When I scan to file my application cannot read the file | 1 | Did you get an error message when creating the file? | Yes | C | Check that you have enough disk space and scan to file again, choosing TIFF uncompressed as format |
| | | | | | No | C | We only recommend to use the built-in viewer for file viewing. Large format drawing files may not load correctly in other viewers due to file size. Try to scan a smaller original (A4) |

| P# | Category | Problem | Q# | Question | Yes/No | C/T | Solution |
|----|-----------------|---|----|-------------------------------------|--------|-----|----------------------------------|
| 15 | Network Problem | I cannot access the system from the network | 1 | Is the PC connected to the network? | Yes | C | Do basic network troubleshooting |
| | | | | | No | C | Connect the PC to the Network |

| P# | Category | Problem | Q# | Question | Yes/No | C/T | Solution |
|----|-----------------|---------------------------------|----|---|--------|-----|--|
| 16 | Scan to network | I cannot access network drivers | 1 | With the PPC connected to the LAN, can you access the PPC from another computer on the network? | Yes | C | Go to Q2 |
| | | | | | No | C | Check the network performance and connection to the scanner PPC. |

| P# | Category | Problem | Q# | Question | Yes/No | C/T | Solution |
|----|----------|---------|----|--|--------|-----|---|
| | | | 2 | Is the folder of the server you are trying to map already mapped by another user in the PPC? | Yes | C | Windows does not allow the same server to be mapped by two different users on one computer. Use the access connection previously mapped or delete the connection and map a new access connection. |
| | | | | | No | C | Go to Q3 |
| | | | 3 | Do you have permission to access and write to the network folder you are trying to map? | Yes | C | Go to Q4 |
| | | | | | No | C | You cannot access this network folder. Select a network folder for which you have read and write permissions. |
| | | | 4 | Are you using the correct user name and password? | Yes | C | Try to map the network file from another computer by selecting Windows Explorer > Tools > Map network drive. If you are able to map the drive in this manner, you should also be able to map through the PPC. |
| | | | | | No | C | Use the correct user name and password. |

| P# | Category | Problem | Q# | Question | Yes/No | C/T | Solution |
|----|----------|--|----|----------|--------|-----|---|
| 17 | Recovery | How and when is the Recovery DVD used? | - | - | - | C | The recovery DVD is used if the system needs to be reinstalled. Insert the DVD in to the PC and reboot the system |

| P# | Category | Problem | Q# | Question | Yes/No | C/T | Solution |
|----|-----------------------------|-------------------------------------|----|--|--------|-----|---|
| 18 | Scanner Calibration Problem | Scanner Maintenance did not succeed | 1 | Did any error occur when performing the Scanner Maintenance? | Yes | C | Refer to Q2 |
| | | | | | No | C | Clean the scanner and then run Scanner Maintenance again (refer to P24 and P25). If that does not help, refer to Q5 |

| P# | Category | Problem | Q# | Question | Yes/No | C/T | Solution |
|----|----------|---------|----|---|--------|-----|--|
| | | | 2 | Error: "Basic calibration was performed. but failed to stitch scanner" or "Could not find horizontal line" or "Could not read bar lines" or "Could not recognize the scanned IT8 picture" | Yes | C | Clean the scanner and then run Scanner Maintenance again (refer to P24 and P25). If that does not help, refer to Q5 |
| | | | | | No | | Refer to Q3 |
| | | | 3 | Error: "Sheet not recognized" | Yes | C | Reinsert calibration sheet correctly and run Scanner Maintenance again. If that does not help, refer to Q5 |
| | | | | | No | | Refer to Q4 |
| | | | 4 | Error: "No movement in camera position has been detected during vertical camera alignment" | Yes | T | Check the camera. |
| | | | | | No | | Refer to Q5 |
| | | | 5 | Have you upgraded the system software to the latest version? | No | C | Upgrade system software (use Update System DVD). Clean the scanner and then run Scanner Maintenance again (refer to P24 and P25) |
| | | | | | Yes | T | Check the camera. |

| P# | Category | Problem | Q# | Question | Yes/No | C/T | Solution |
|----|--------------|---|----|----------|--------|-----|--|
| 19 | System error | I cannot install my application on the system | - | - | - | C | The copy system is only meant to handle the factory installed software and applications. |

| P# | Category | Problem | Q# | Question | Yes/No | C/T | Solution |
|----|----------|-----------------------------|----|----------|--------|-----|---|
| 20 | Updating | How do I update the system? | - | - | - | C | Insert the System Recovery DVD into the DVD drive and reboot the PPC. |

| P# | Category | Problem | Q# | Question | Yes/No | C/T | Solution |
|----|------------------|------------------------------|----|---|--------|-----|---|
| 21 | Start-up Problem | The system does not power up | 1 | Is the system dead (no LEDs are lit, the PPC screen is black, and no fan-noise can be heard)? | Yes | C | 1 - Check that all power switches on the equipment are ON. 2 - Check if there is power at the wall outlet. 3 - Check power cables between wall outlet and the individual units. |
| | | | | | No | | Refer to Q2 |
| | | | 2 | Does PPC start with the normal initial screen? | Yes | C | Refer to Q5 |
| | | | | | No | | Refer to Q3 |
| | | | 3 | Does PPC start normally, but the software does not work? | Yes | C | Reinstall system software |
| | | | | | No | | Refer to Q4 |
| | | | 4 | Is the PPC dead (no fan noise can be heard and no screen image appears)? | Yes | T | Troubleshoot the PPC |
| | | | | | No | | Refer to Q5 |
| | | | 5 | Is the Scanner dead (no fan noise can be heard and no LEDs are lit)? | No | | Refer to Q6 |
| | | | | | Yes | T | Check, and if necessary replace: 1 - Power Supply Unit 2 - Driver Board |
| | | | 6 | Does the scanner hang-up with all LEDs lit? | Yes | T | Try the following: 1 - Erase parameter block 2 - Update the system software 3 - Replace the Main Board |
| | | | | | No | | Refer to P23 |

| P# | Category | Problem | Q# | Question | Yes/No | C/T | Solution |
|----|--------------------|----------------------------|----|--|--------|-----|---|
| 22 | Mechanical Problem | I cannot load the original | 1 | Please try to load a new piece of A4 paper at the center of the scanner. Does this paper load? | Yes | C | You have a problem with your original. Please check that paper edges are not bent or curled in any way |
| | | | | | No | | Refer to Q2 |
| | | | 2 | Can paper be loaded by pressing the "Forward" key? | Yes | C | Refer to Q3 |
| | | | | | No | T | Try replacing the following: 1 - Driver Board 2 - Power Supply Unit 3 - Feed Motor 4 - Main Board |
| | | | 3 | Does the Ready LED turn ON when activating Original Sensor (insert paper)? | No | T | Check, and if necessary replace: 1 - Original Sensors 2 - Main Board |
| | | | | | Yes | C | Check the settings in the software for media loading |

| P# | Category | Problem | Q# | Question | Yes/No | C/T | Solution |
|----|------------|------------------------------------|----|--|--------|-----|---|
| 23 | Error Code | I get an Error Code, what do I do? | - | - | - | - | Re-power the system, and check if the error code reappears. If it does, refer to Q1. |
| | | | 1 | Have you upgraded the system software to the latest version? | No | C | Upgrade the system software by using the System Recovery DVD). Check if Error Codes reappears. If it does, refer to P23a. |

| P# | Category | Problem | Q# | Question | Yes/No | C/T | Solution |
|-----|------------|--|----|---|--------|----------------------|---|
| 23a | Error Code | I still get an error code, what do I do? | | Does the Diagnostic LED (and, in some cases also other LEDs) blink? | Yes | C | Lower Guide Plate to Normal position, start Preview Scan to obtain an Error Code or check if WIDESystem gives an Error Code |
| | | Error Code 100: 3002 to 3013 3019 to 3037 | | Have you cleaned the white background and glass plate, and performed Scanner Maintenance? | Yes | T | Check Camera Adjustment. If necessary, replace the Camera Board |
| | | | No | | C | Refer to P24 and P25 | |
| | | Error Code 100: 3014 to 3018 | | Have you cleaned the white background and glass plate, and performed Scanner Maintenance? | Yes | T | Try the following: 1 - Upgrade the firmware 2 - Check the Stitching Wire 3 - Check Camera Adjustment 4 - Replace Main Board |
| | | | No | | C | Refer to P23 and P25 | |
| | | Error Code 100: 4003x and 4004x | 1 | Does the Lamp light up? | No | T | Try replacing the following: 1 - Lamp 2 - Driver Board 3 - Main Board |
| | | | | | Yes | | Refer to Q2 |
| | | | 2 | Have you cleaned the white background and glass plate, and performed Scanner Maintenance? | Yes | | Refer to complete list. |
| | | | | | No | C | Refer to P24 and P25 |

| Problem | Q# | Question | Yes/No | C/T | Solution |
|-----------------------|----|---|--------|-----|----------------------|
| Error Code 100: 500xx | 1 | Have you performed Scanner Maintenance? | No | C | Refer to P24 and P25 |
| | | | Yes | T | Replace Main Board |

| Problem | Q# | Question | Yes/No | C/T | Solution |
|------------------|----|------------------------|--------|-----|-------------------------|
| Error Code 600xx | 1 | Is it Error Code 600xx | Yes | T | Replace Interface Board |

| Problem | Q# | Question | Yes/No | C/T | Solution |
|--------------------|----|---|--------|-----|--|
| "No scanner found" | 1 | Does the scanner start normally? | No | C | Refer to P23 |
| | | | Yes | C | Refer to Q2 |
| | 2 | Are the interface cables (USB, FireWire, or LAN) properly connected to the scanner and the PPC? | Yes | C | Refer to Q3 |
| | 3 | Have you run the System Recovery DVD? | Yes | T | 1 - Replace Interface Cable 2 - Replace Interface Board |

| P# | Category | Problem | Q# | Question | Yes/No | C/T | Solution |
|----|----------|-----------------------------|----|----------|--------|-----|--|
| 24 | Cleaning | How do I clean the scanner? | - | - | - | C | Clean the Glass Plate on both sides with mild detergent, and wipe thoroughly with a lint-free cloth until dry. Check for scratches. Deep scratches on the glass plate or background platen means replacement of the part |

| P# | Category | Problem | Q# | Question | Yes/No | C/T | Solution |
|----|-------------------|---------------------------------------|----|---|--------|-----|--|
| 25 | Color Calibration | How do I color calibrate the scanner? | 1 | Do you have the correct and "as new" scanner maintenance sheet for the scanner? | Yes | C | Clean scanner (refer to P24). Insert the scanner maintenance sheet. Start scanner maintenance. The process is automatic and will also include stitching. |
| | | | | | No | C | Get Correct/New Scanner Maintenance Sheet |

| P# | Category | Problem | Q# | Question | Yes/No | C/T | Solution |
|----|------------------|--|----|----------|--------|-----|--|
| 26 | Media Validation | What is media validation? How do I validate? | - | - | - | C | If the validate feature is chosen, a new color patch sheet is printed and can be scanned for validation. In this way it can be determined whether the produced color map has passed. |

| P# | Category | Problem | Q# | Question | Yes/No | C/T | Solution |
|----|----------------------|-------------------------------|----|----------|--------|-----|--|
| 27 | Ink Printer Original | What is Ink Printer Original? | - | - | - | C | When the original has been printed on an Inkjet printer this option should be enabled. |

| P# | Category | Problem | Q# | Question | Yes/No | C/T | Solution |
|----|--------------------------|------------------------------------|----|----------|--------|-----|---|
| 28 | Visible stitching Errors | What is a visible stitching error? | - | - | - | C | A visible stitching error appears typically as a column of broken lines between 2 cameras. Normally it can be solved by running Scanner Maintenance, which will perform an automatic stitching adjustment. With some curled or creased/crumpled originals it is necessary to straighten out the original to prevent it from lifting from the glass plate. With thick originals it can be necessary to adjust the stitching (stitching used for thick originals only, set this in scanner setup). A visible stitching error should not be confused with the error message "Error 32 - Could not stitch Camera A and B" |

Troubleshooting Specific Scanner Issues

| P# | Category | Problem | Q# | Question | Yes/No | C/T | Solution |
|----|--|---|----|----------|--------|-----|---|
| 29 | Vertical lines (possible dust problem) | The image has a vertical, white or black line, which could be caused by dust. To verify that the line is caused by dust, preview the image and inspect the preview using the viewing section buttons. | - | - | - | C | Perform Scanner Maintenance: Cleaning and Camera Alignment. Using Test 20 from SCANtest 6 may help to identify dusty/dirty areas. |

| P# | Category | Problem | Q# | Question | Yes/No | C/T | Solution |
|----|----------|--|----|----------|--------|-----|---|
| 30 | Firmware | You are receiving firmware-related errors. | - | - | - | C | Try upgrading the firmware version. See 5-33. |

| P# | Category | Problem | Q# | Question | Yes/No | C/T | Solution |
|----|---------------|----------------------------------|----|----------|--------|-----|---|
| 31 | Stepper Motor | The Stepper Motor does not work. | - | - | - | C | Try the following: 1 - Use Test 6: Motor Test to check the functionality of the Stepper Motor. 2 - Replace the Driver Board. 3 - Replace the Stepper Motor. |

| P# | Category | Problem | Q# | Question | Yes/No | C/T | Solution |
|----|----------|-------------------------|----|----------|--------|-----|--|
| 32 | Lamp | The lamp does not work. | - | - | - | C | Try the following: 1 - Reseat the lamp cartridge. 2 - Ensure that the Driver Board is connected to the power supply unit. 3 - Ensure that the lamp sensor and the Driver Board are functioning correctly. |

| P# | Category | Problem | Q# | Question | Yes/No | C/T | Solution |
|----|----------|----------------------------|----|----------|--------|-----|---|
| 33 | Skewing | There is a skewing problem | - | - | - | C | Try the following: 1 - Ensure that the Guide Plate is closed and latched. 2 - Replace the Guide Plate. 3 - Clean the rollers with isopropyl alcohol. 4 - Replace the rollers. |

| P# | Category | Problem | Q# | Question | Yes/No | C/T | Solution |
|----|---------------|---|----|----------|--------|-----|--|
| 34 | Media Loading | The media cannot be loaded or there are other media loading problems. | - | - | - | C | Try the following: 1 - Check the Original Sensor (green LED when loading media), or use Test 4: Original-Sensor Test to check the functionality of the sensor. 2 - Use Test 6: Motor Test to check the functionality of the Stepper Motor. |

| P# | Category | Problem | Q# | Question | Yes/No | C/T | Solution |
|----|----------|------------------------|----|----------|--------|-----|---|
| 35 | Fan | The fan is not working | - | - | - | C | Try the following: 1 - Ensure that the fan is correctly connected. 2 - If the fan is connected and still doesn't work, replace the Driver Board or the fan. 3 - If the fan and driver board are working correctly, the problem could be related to the NTC Sensor. |

| P# | Category | Problem | Q# | Question | Yes/No | C/T | Solution |
|----|----------|---|----|----------|--------|-----|---|
| 36 | Software | You are experiencing problems with the software | - | - | - | C | <p>Try the following:</p> <ol style="list-style-type: none"> 1 - Use the System Recovery DVD to reload the software 2 - After reloading the software, set-up the system on the network again (if necessary). 3 - If the problems persist, run the System Recovery DVD again, and delete the user's files (press F12) |

| P# | Category | Problem | Q# | Question | Yes/No | C/T | Solution |
|----|----------|---|----|----------|--------|-----|--|
| 37 | Firmware | <p>All of the LEDs in the scanner's front panel are flashing when you turn on the scanner (as shown in the image below), indicating that printer firmware needs to be upgraded.</p> <p>NOTE: This describes a different situation than when the scanner is turned on in special boot mode, in which the LEDs also flash.</p> | - | - | - | C | <p>The most probable reason for this situation is that the last firmware upgrade attempt was not successful. To remedy this situation, upgrade the firmware (see 5-33). NOTE: Before launching the firmware upgrade utility, verify that the scanner is connected directly to the touchscreen by the Firewire or USB cable, and then press the rescan bus button. The scanner will not detect the necessary connection without the use of the Firewire or USB.</p> |



Cleaning the Scanning Area

The following parts must be cleaned using a soft lint-free cloth and a mild, streak-free, cleaning detergent. Alternatively, the parts may be cleaned without the use of cleaning detergents by using a damp micro-fibre cleaning cloth (soak the cloth with water and wring until damp):

- Main scanner cover. Clean the main scanner cover to ensure that no dust is introduced into the scanning area when you scan an original.
- White Background Plate on the Guide Plate
- The Glass Plate. If you clean both sides, be very careful not to touch the Stitching Wire (located under the Glass Plate) out of position. Do *not* use solvents, as this may dissolve the paint used for the black masks on the Glass Plate. Do *not* recommend that customers clean the underside of the glass plate; it should only be cleaned by an HP support technician.
- The Mirrors. It is necessary to remove the Mirror Chassis to get access to the Mirrors for cleaning. The Camera Adjustment must be checked and if necessary readjusted after the replacement of the Mirror Chassis.

The mirrors are normally "Out of Focus", therefore small dust particles on the mirrors will not deteriorate the scanning result.

- The Feed Rollers. These may be cleaned with a damp micro-fibre cleaning cloth.

Once all these procedures have been completed, the scanner will be ready to work correctly.

The Cleaning Procedure

When cleaning any part of the scanning area DO NOT use abrasives, acetone, benzene or fluids that contain these chemicals. Do not spray liquids directly onto the scanner glass plate or anywhere else in the scanner.

- 1 Turn the scanner power off.
- 2 Disconnect the scanner power cable.
- 3 Open the Guide Plate by pushing down on the left and right locking levers and flip it upwards to expose the scan area.

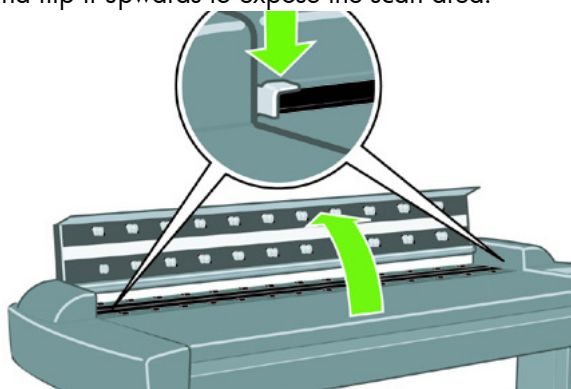

- 4** Gently wipe the Glass Plate. Clean the glass with a lint-free cloth and a mild, streak-free, glass cleaner.

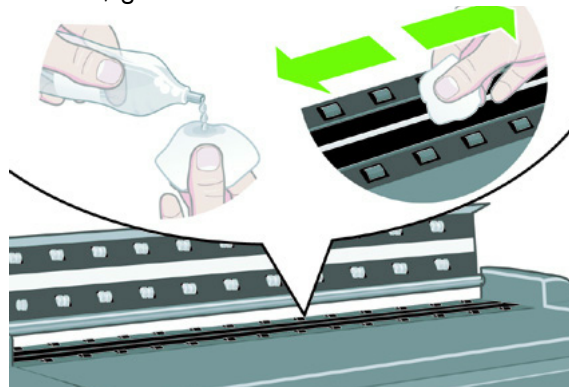

- 5** Dry the glass completely using a separate clean, dry lint-free cloth like the one provided with the maintenance kit.

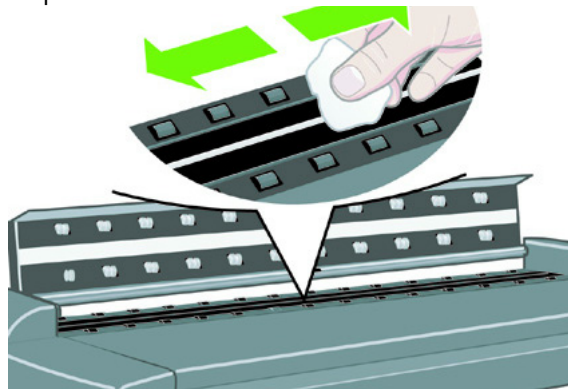

- 6** Clean the white background assembly. Wipe the white metal area with a lint-free cloth and a mild, streak-free, glass cleaner.

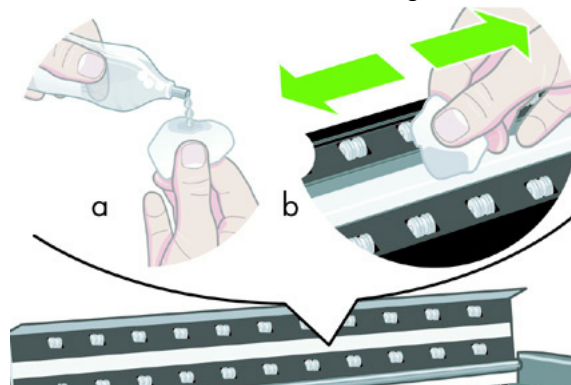

- 7** Clean the platen rollers. Wipe the rollers with a lint-free cloth and a mild, streak-free, glass cleaner.

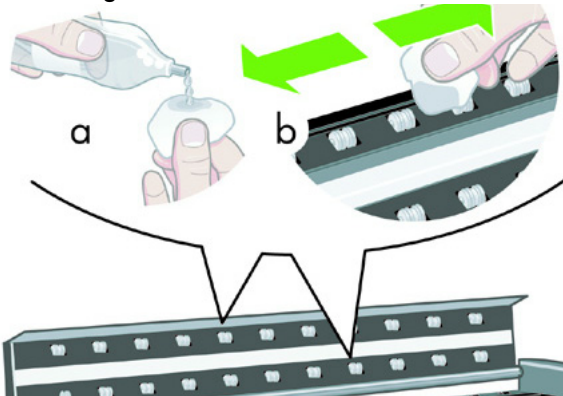

- 8** Dry the platen and rollers completely using a separate clean, dry lint-free cloth.

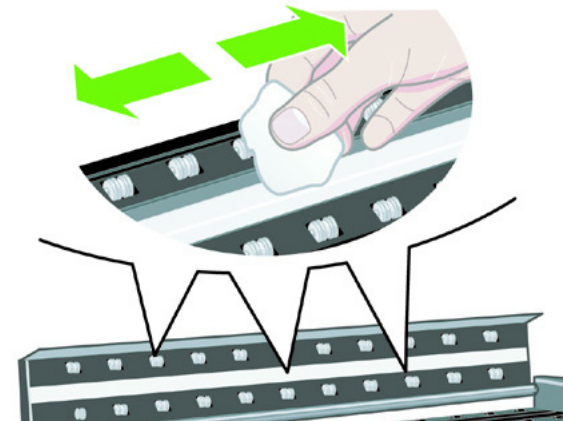

- 9** Close the Guide Plate.

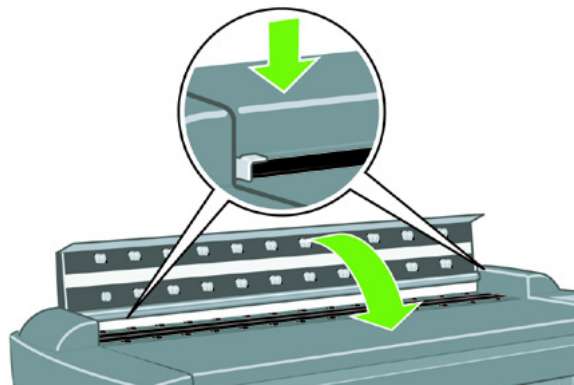

- 10** Use the dust sheet to protect the Scanner when not in use.



Troubleshooting Specific Panel PC Problems

The following section helps you to troubleshoot problems related to the scanner's Panel PC and related components. The diagram below will help you to identify the Panel PC electronic components, and might be of assistance in troubleshooting possible system problems.

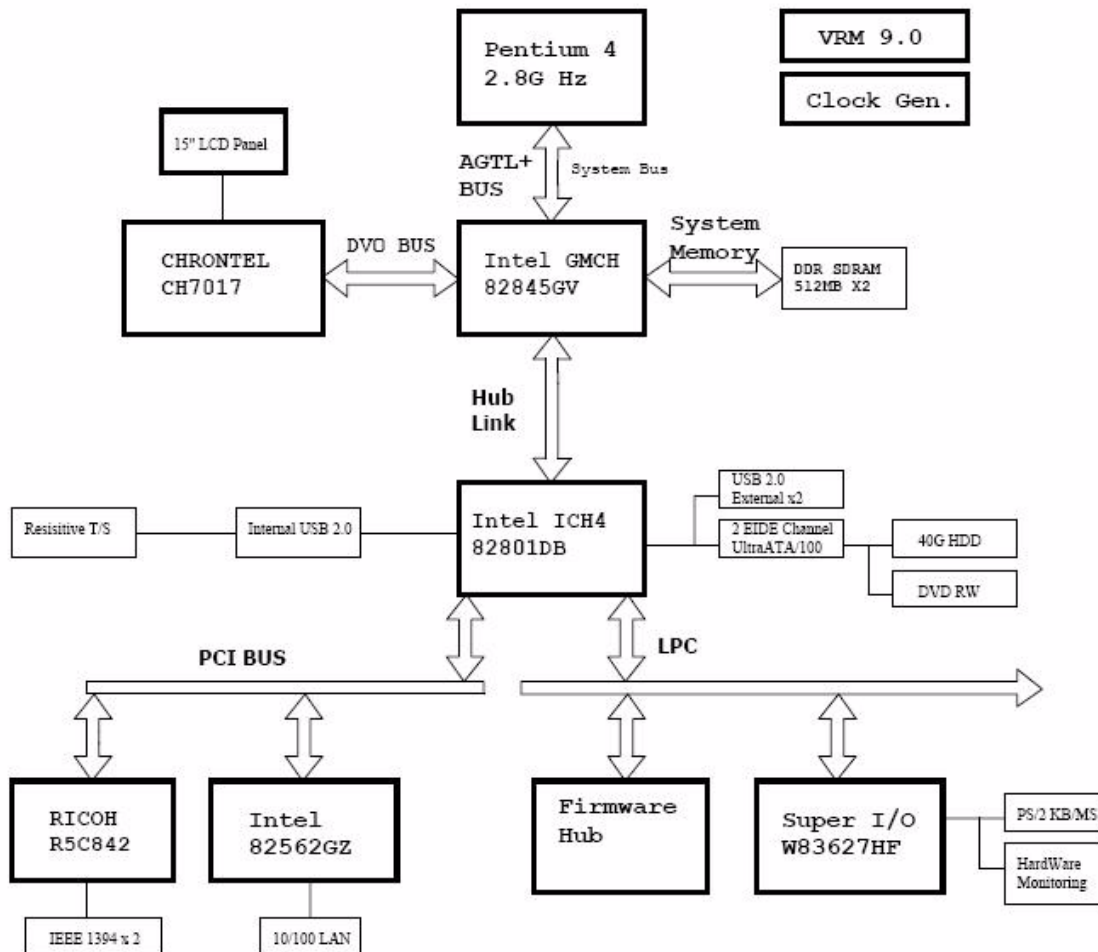

The sections below help you to troubleshoot Panel PC component failures and detect which system has failed. Check or replace one component at a time, and then see if the failure is resolved before investigating further. Proceeding this way will help you to determine which component has failed.

Power failure.

If the power has been turned on, and there is no message on the screen, try the following:

- Make sure the power cord is correctly connected.
- Plug the power cord to another power outlet.
- The DVD-ROM indicator lights should flash.
- The system fan should start up if there is power in the Panel PC, if not replace the PSU ⇒ Page 4-98.

Boot up failure.

The Panel PC issues a series of beeps which can be used to identify which part is failing.

- One short beep: No error during POST (Power on Self-Test).
- One long beep followed by two short beeps: Video initial error.
- One long beep followed by nine short beeps: BIOS Bootblock error.
- Single long beep repeatedly: DRAM error.

LCD/Inverter failure:

The failure of the LCD display can be divided into two issues, the Panel PC has no backlight and no display, or the Panel PC has the backlight but there is no display. Use the two troubleshooting flow charts to solve the problem:

No backlight and no display

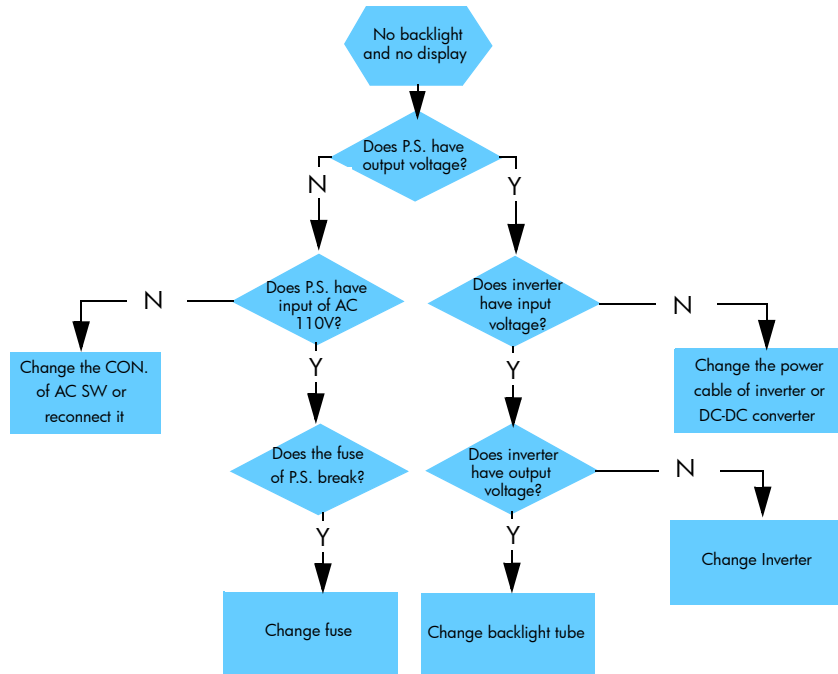

With backlight but no display

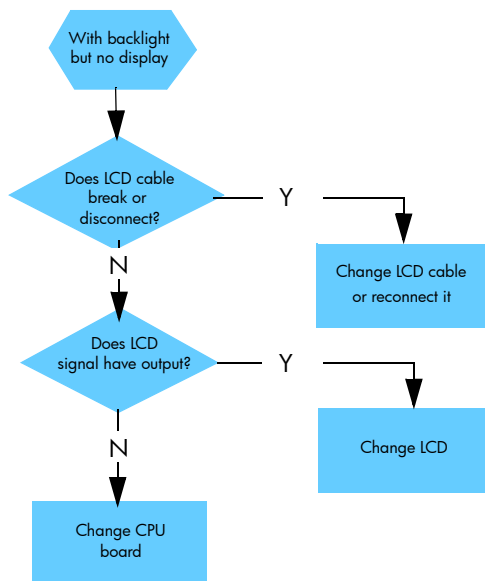

How to check the voltage of the Power Supply Unit in the Panel PC.

With power on, measure the red pins and the yellow pins of the power connector.

- Output voltage of the red pins should be $5V \pm 5\%$.
- Output voltage of the yellow pins should be $12V \pm 5\%$.

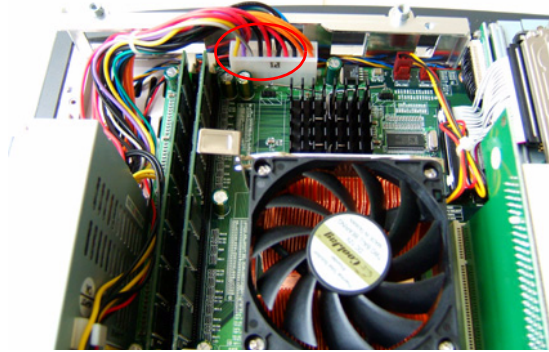

- Output voltage of the yellow pins should be $12V \pm 5\%$.

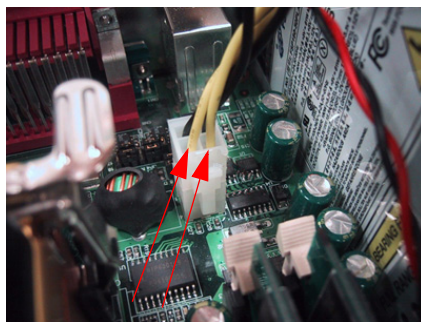

How to check the voltage of the Inverter PCA in the Panel PC.

With power on, measure pin 1 of the Inverter PCA input and output connectors.

- Output voltage should be between 600V and 710V (typical value is 640V).
- Input voltage should be $12V \pm 10\%$.

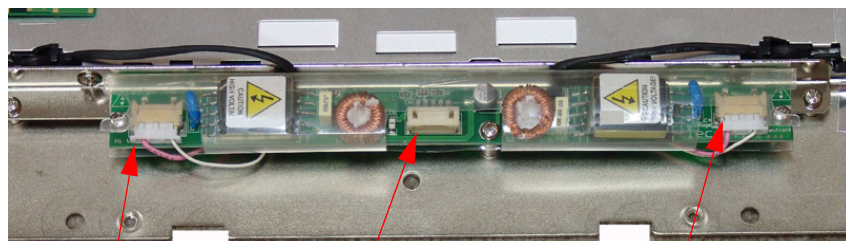

Pin 1
Output connector

Pin 1
Input connector

Pin 1
Output connector

The HDD failure:

The HDD is running, and the system configuration has identified the HDD's ID while booting up. Try the following:

- Set the type of hard disk to AUTO in STANDARD CMOS SETUP.
- Reconnect the cable between HDD and main board.
- Change the HDD ⇒ Page 4-97.

The HDD is not running, and the system configuration can not identify the HDD's ID while booting up. Try the following:

- Reconnect the cable between HDD and main board.
- Change the cable between HDD and main board.
- Change HDD ⇒ Page 4-97.

DDR DRAM failure:

If the computer repeatedly makes a long beep, and the display is blank when you power on, this indicates a DDR DRAM error, replace the DDR DRAM ⇒ Page 4-88.

DVD-ROM failure:

The DVD-ROM indicator light is on when you switch on. Try the following:

- Check the possible damage on the cable between DVD-ROM and main board.
- The DVD-ROM indicator light is off when power up and the screen show no message of any DVD-ROM installed.
- Check for DVD-ROM auto detection in the BIOS setup:
 Procedure to do this: In the BIOS setup, select standard CMOS features, set all IDE detections (ie Primary master, Primary slave ,secondary master, secondary slave) to AUTO
- Reconnect the cable between DVD-ROM and main board.
- Replace the DVD-ROM ⇒ Page 4-89.

The CD/DVD is stuck in the DVD-ROM and cannot be ejected out.

- Push a pin into the hole at the right side of the DVD-ROM eject button.

Image failure:

Follow the steps in the flowchart below to quickly check an image problem.

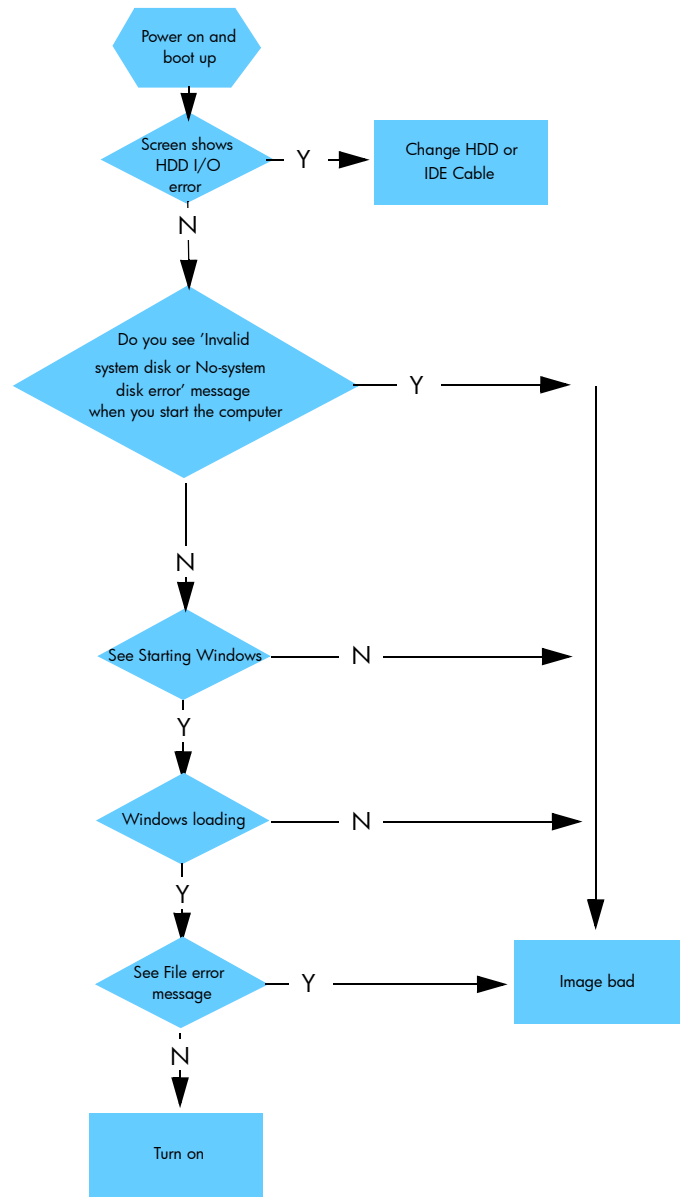

Touch screen failure:

Follow the steps in the flowchart below to quickly check if the touch screen fails

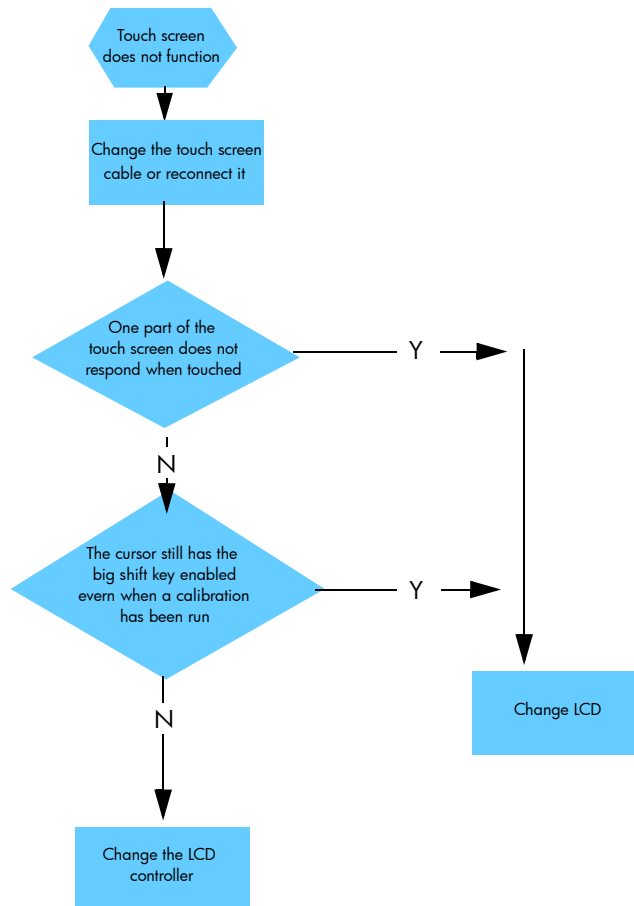

Touch screen is working but cannot control the cursor.

Try the following:

- Run the calibration program.
- Check that the cable between the LCD controller and the LCD is connected in the correct position
- Replace the LCD controller ⇒ Page 4-92.
- Replace the LCD ⇒ Page 4-83.

Erase the Parameter Block in the Scanner

The Scanner has a memory block called the Parameter block. The Parameter block contains the following:

- Stitching values camera transition a/b and b/c
- Basic calibration information
- Level for uncorrected light profile
- Corrected light profile
- Camera matching, gray
- NTSC color space
- sRGB color space
- Date of the last calibration

The information that is stored in the Parameter block is gathered during the calibration of the scanner (Scanner Maintenance).

In rare instances, the stored values will vary too greatly from current read values, which can cause the scanner to report an error. The easiest way to solve this problem is to erase the Parameter block.

When to Erase the Parameter Block

It is beneficial to erase the parameter block under the following circumstances:

- If the Scanner Maintenance is unable to recognize the calibrating sheet.
- If error messages such as the the following appear:
 - "Unable to correct camera x"
 - "Unable to stitch camera x/x"
- Before changing any hardware, especially before changing the main board or the camera boards
- Before performing any camera adjustments

How to Erase the Parameter Block

All of the information in the Parameter block is restored when the Scanner Maintenance is run.

To erase the Parameter block and run the Scanner Maintenance, follow

these steps:

- 1 Press the **Setup** tab on the Touch Screen, and then select **Options**.

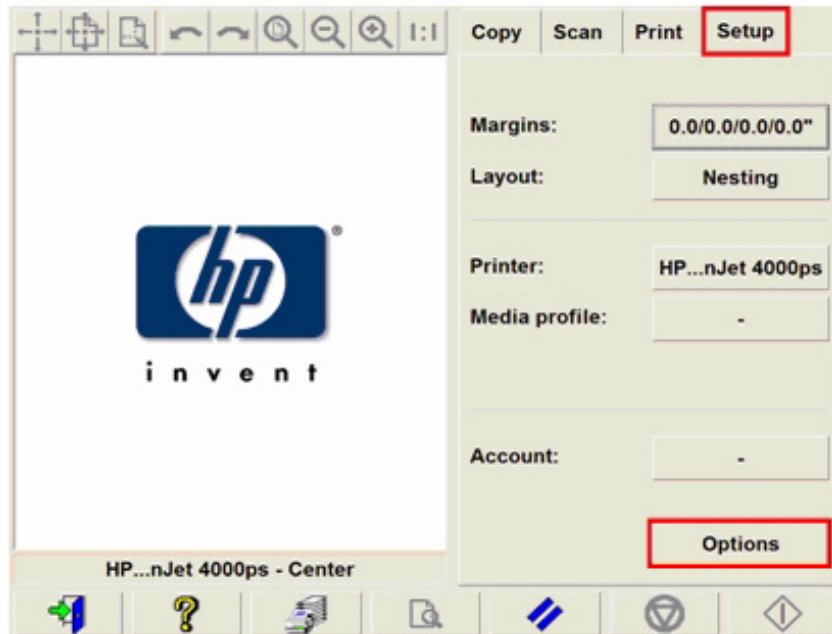

- 2 In the **Options** dialog box, select **Scanning**.

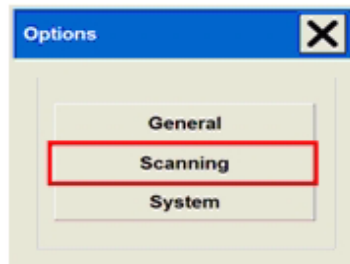

- 3 In the **Scan Options** dialog box, select **Scanner Maintenance**.

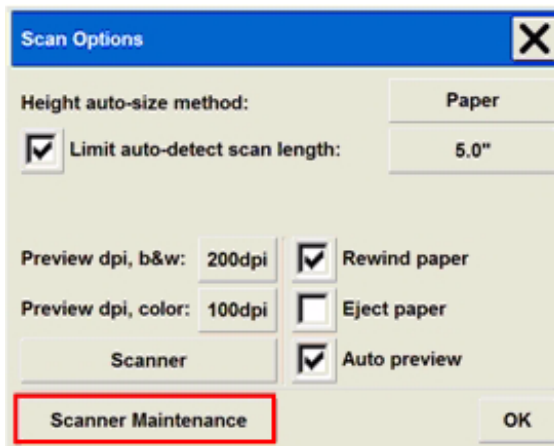

- 4 In the **Scanner Maintenance - Welcome** window, click on the upper-left icon, and then select **Erase Parameter Block** from the drop-down menu.

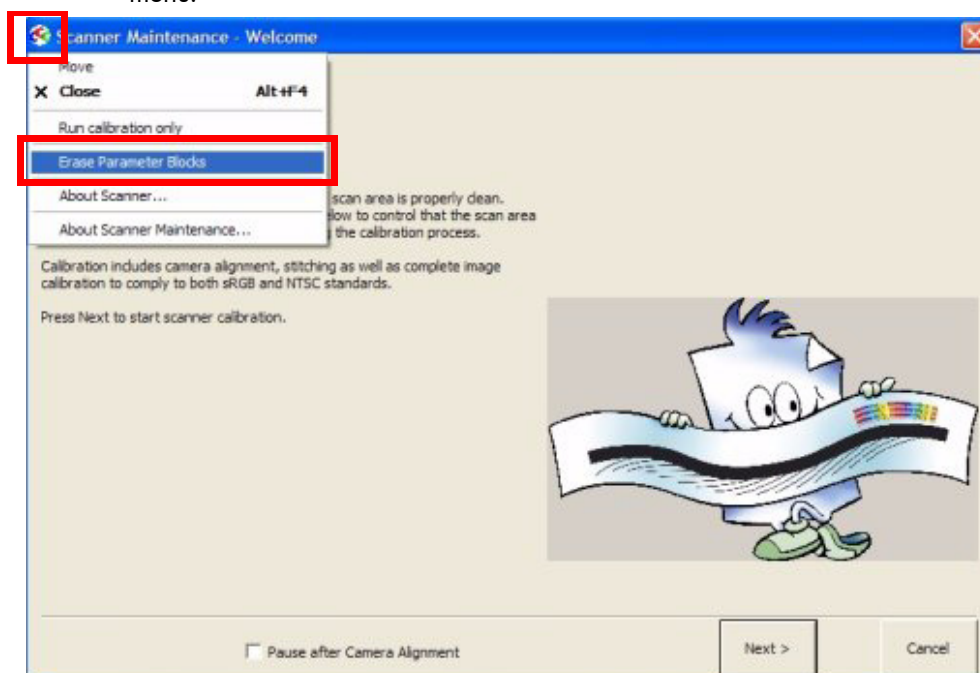

Make sure that the scanner and the Scanner Maintenance sheet is clean and is free of scratches before you run the Scanner Maintenance.

- 5 Clean the scanner and run the Scanner Maintenance.

Risks of not running the Scanner Maintenance

The scanner will not report any errors if the Scanner Maintenance is neglected, but image quality will deteriorate. The following image defects are likely:

- Lightened or darkened scan: basic light level is not set.
- Poor camera-to-camera match: transition is visible, with one lighter or darker than another.
- Insufficient camera height alignment: broken vertical lines in camera transition area.
- Unstitched scanner: overlap or gap between cameras.
- Wrong colors and color shifts from one camera to another.



System Error Codes

2

- Introduction 2-2
- Error Codes Displayed on the Operator Panel 2-3
- Error Codes Reported by the Software 2-4
- Error Codes for the JetImage Software RIP 2-32
- Error Messages for the Touch Screen 2-40

Introduction

The following pages contain a list of system error codes and their respective descriptions and recommended corrective actions. Only try one recommended action at a time and check if the error code has disappeared.

If you have an error code which is not documented in this Service Manual or you have an error which you cannot resolve, then report the error to the HP Response Center or the nearest HP Support Office.

When reporting the error, have the following information ready:

- **Model and Serial Number of the scanner.**
- **Which firmware revision the printer and the scanner is using.**
- **SW version.**
- **The complete error number.**
- **ScanDump of Light Profiles.**

Error Codes Displayed on the Operator Panel

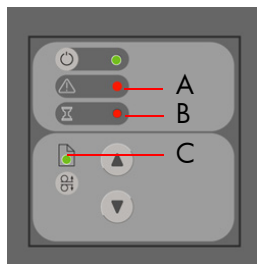

A flashing Diagnostic Indicator indicates an error condition. The error can be identified by an error code number being displayed on the Touch Screen and/or by the following combination of flashing indicators on the Operator Panel:

| Diagnostic LED (A) | Wait LED (B) | Ready LED (C) | Error Description |
|--------------------|---------------|-----------------|--|
| Flashing | Flashes Once | OFF | Correction of camera A failed |
| Flashing | Flashes Twice | OFF | Correction of camera B failed |
| Flashing | OFF | Flashes Once | Error on Main PCA |
| Flashing | OFF | Flashes Twice | Error on Camera Board |
| Flashing | OFF | Flashes 3 times | Invalid Scanner ID setting |
| Flashing | OFF | Flashes 4 times | Error on Interface Board |
| Flashing | Flashing | Flashing | Scanner is in Boot Mode |
| Flashing | OFF | OFF | Refer to Error Codes |
| OFF | Flashing | Red | Guide plate assembly is not in the right position, to solve it press down the guide plate to move it to the original position (step 0: 2mm/0.8") |

Error Codes Reported by the Software

The first set of numbers in the error code refers to a part of the Scanner software or the Scanner.

| Software Modules | Comments/Notes |
|------------------------------|---|
| 51 - Scanner API | Low level scanner control library. All scanner communication goes through this API. |
| 52 - Image Format Library | Printer and file formatting. All printing and file read/write is formatted/decoded by this library. |
| 53 - Copy Engine | The central processing engine in the (JETimage) software |
| 54 - Closed Loop Calibration | Color Management math library that calculates the media profiles |
| 55 - Test Software | Scanner Maintenance / SCANtest |
| 56 - Jetimage container | All user interface and business logic except for Scanner Maintenance / SCANtest and WIDESystem |
| 57 - WIDESystem (WS) | Scanner surveillance utility |
| 100 - Scanner | Mechanical part of the Scanner |

System Error: 55-203

Problem Description: No movement in camera position has been detected during vertical camera alignment. Check the camera.

Corrective Action: Try the following:

- Check that all the cables are connected correctly to the Cameras and the Camera Boards.
- Run SCANtest 6, test 9 or 11 and check each Camera Motor functions correctly.

System Error: 51-1

Problem Description: Incorrect scanner status.

Corrective Action: Try the following:

- Check the paper path and reload the media.

| | |
|-----------------------------|--|
| System Error: | 51-12 |
| Problem Description: | The driver for the scanner cannot be found. |
| Corrective Action: | Try the following: <ul style="list-style-type: none">■ Perform a system recovery using the System Recovery DVD. |
| System Error: | 51-18 |
| Problem Description: | No supported scanner was found |
| Corrective Action: | Try the following: <ul style="list-style-type: none">■ Verify that your scanner is properly connected, and then retry the operation. |
| System Error: | 51-19 |
| Problem Description: | The driver for the scanner cannot be found. |
| Corrective Action: | Try the following: <ul style="list-style-type: none">■ Perform a system recovery using the System Recovery DVD. |
| System Error: | 51-26 |
| Problem Description: | Internal command error in driver |
| Corrective Action: | Try the following: <ul style="list-style-type: none">■ Reboot your system. |
| System Error: | 51-27 |
| Problem Description: | Windows failed to lock STI/WIA device. |
| Corrective Action: | Try the following: |
| System Error: | 51-28 |
| Problem Description: | Windows failed to unlock STI/WIA device. |
| Corrective Action: | Try the following: |
| System Error: | 51-29 |
| Problem Description: | The connection to the scanner has been lost. |
| Corrective Action: | Try the following: <ul style="list-style-type: none">■ Reboot your system. |

| | |
|-----------------------------|---|
| System Error: | 51-30 |
| Problem Description: | Unable to find scanner |
| Corrective Action: | Try the following: <ul style="list-style-type: none">■ Check the cabling between the scanner and the Touch Screen and reboot your system. |
| System Error: | 51-31 |
| Problem Description: | The scanner is currently reserved by another application or user. |
| Corrective Action: | Try the following: <ul style="list-style-type: none">■ Please wait for the scanner to become available. |
| System Error: | 51-32 |
| Problem Description: | The operation was aborted due to an internal Windows error. |
| Corrective Action: | Try the following: <ul style="list-style-type: none">■ Reboot your system. |
| System Error: | 55-101 |
| Problem Description: | No scanner was found. |
| Corrective Action: | Try the following: <ul style="list-style-type: none">■ Check that the scanner is properly connected and turned on. |
| System Error: | 55-104 |
| Problem Description: | The scanner has not been adjusting for more than 1 hour. |
| Corrective Action: | Try the following: <ul style="list-style-type: none">■ Lower the guide plate and wait 2 minute before retrying the operation. |
| System Error: | 55-108 |
| Problem Description: | Your scanner firmware must be upgraded to run this program. |
| Corrective Action: | Try the following: <ul style="list-style-type: none">■ Upgrade the firmware version.■ If necessary, perform a system recovery using the System Recovery DVD. |

| | |
|-----------------------------|--|
| System Error: | 55-109 |
| Problem Description: | The scanner firmware does not comply with the Scanner Maintenance Calibration Sheet. |
| Corrective Action: | Try the following: <ul style="list-style-type: none">■ Upgrade the firmware version. |
| System Error: | 55-111 |
| Problem Description: | The scanner returns no picture width. |
| Corrective Action: | Try the following: <ul style="list-style-type: none">■ Upgrade the firmware version. |
| System Error: | 55-113 |
| Problem Description: | The scanner firmware does not support this type of calibration sheet. |
| Corrective Action: | Try the following: <ul style="list-style-type: none">■ Upgrade the firmware version.■ Use a new calibration sheet if necessary. |
| System Error: | 55-116 |
| Problem Description: | Unable to read version information from the registry. |
| Corrective Action: | Try the following: |
| System Error: | 55-117 |
| Problem Description: | The resource file is missing. |
| Corrective Action: | Try the following: <ul style="list-style-type: none">■ Perform a system recovery using the System Recovery DVD. |
| System Error: | 55-201 |
| Problem Description: | Could not find ruler on the calibration sheet. |
| Corrective Action: | Try the following: <ul style="list-style-type: none">■ Check the calibration sheet for scratches and wear. |

- System Error:** 55-203
- Problem Description:** No movement in camera position has been detected during vertical camera alignment. Check the camera.
- Corrective Action:** Try the following:
- Check that all the cables are connected correctly to the Cameras and the Camera Boards.
 - Run SCANtest 6, test 9 or 11 and check each Camera Motor functions correctly.
- System Error:** 55-205
- Problem Description:** The program has performed an alignment.
- Corrective Action:** Try the following:
- For optimal performance, this should be followed by a scanner maintenance.
- System Error:** 55-206
- Problem Description:** Could not recognize the sheet in the scanner as the "Stitching and Adjustment Chart".
- Corrective Action:** Try the following:
- Load the calibration sheet again.
- System Error:** 55-210
- Problem Description:** The scanner's vertical alignment is not good enough to perform the horizontal stitching.
- Corrective Action:** Try the following:
- Run SCANtest 6, test 11 ⇒ Page 7-6.
- System Error:** 55-211
- Problem Description:** The vertical difference for camera A is too big for automated stitching.
- Corrective Action:** Try the following:
- Run SCANtest 6, test 11 ⇒ Page 7-6.
- System Error:** 55-212
- Problem Description:** The vertical difference for camera B is too big for automated stitching.
- Corrective Action:** Try the following:
- Run SCANtest 6, test 11 ⇒ Page 7-6.

| | |
|-----------------------------|--|
| System Error: | 55-213 |
| Problem Description: | The vertical difference for camera C is too big for automated stitching. |
| Corrective Action: | Try the following: <ul style="list-style-type: none">■ Run SCANtest 6, test 11 ⇒ Page 7-6. |
| System Error: | 55-214 |
| Problem Description: | The vertical difference for camera D is too big for automated stitching. |
| Corrective Action: | Try the following: <ul style="list-style-type: none">■ Run SCANtest 6, test 11 ⇒ Page 7-6. |
| System Error: | 55-317 |
| Problem Description: | Could not read bar codes on the calibration sheet. |
| Corrective Action: | Try the following: <ul style="list-style-type: none">■ To use default calibration parameters during adjustment, press OK. Press Cancel to end the program. |
| System Error: | 55-318 |
| Problem Description: | Basic calibration was performed, but failed to stitch the scanner. |
| Corrective Action: | Try the following: <ul style="list-style-type: none">■ Inspect the calibration sheet for scratches or wear, replace it if the problem continues, and then run the program again. |
| System Error: | 55-319 |
| Problem Description: | The calibration sheet was not recognized as the right sheet for this scanner. |
| Corrective Action: | Try the following: <ul style="list-style-type: none">■ Inspect the calibration sheet for scratches or wear and replace it if the problem continues. |
| System Error: | 55-401 |
| Problem Description: | Can't find stitchlines. |
| Corrective Action: | Try the following: <ul style="list-style-type: none">■ Inspect the calibration sheet for scratches or wear and replace it if the problem continues. |

| | |
|-----------------------------|---|
| System Error: | 55-402 |
| Problem Description: | Can't find gray area. |
| Corrective Action: | Try the following: <ul style="list-style-type: none">■ Inspect the calibration sheet for scratches or wear and replace it if the problem continues. |
| System Error: | 55-503 |
| Problem Description: | Color calibration failed. |
| Corrective Action: | Try the following: <ul style="list-style-type: none">■ Run the program again. |
| System Error: | 55-506 |
| Problem Description: | The program cannot find the IT8 reference file. |
| Corrective Action: | Try the following: <ul style="list-style-type: none">■ If you have received a new calibration sheet, insert the CD.■ If the problem persists, perform a system recovery using the System Recovery DVD. |
| System Error: | 55-508 |
| Problem Description: | Couldn't read bar lines. |
| Corrective Action: | Try the following: <ul style="list-style-type: none">■ Inspect the calibration sheet for scratches or wear and replace it if the problem continues. |
| System Error: | 55-509 |
| Problem Description: | IT8 file is not accessible. |
| Corrective Action: | Try the following: <ul style="list-style-type: none">■ If you have received a new calibration sheet, insert the CD.■ If the problem persists, perform a system recovery using the System Recovery DVD. |
| System Error: | 55-510 |
| Problem Description: | The IT8 sheet was not recognized. |
| Corrective Action: | Try the following: <ul style="list-style-type: none">■ Please reinsert the calibration sheet. |

| | |
|-----------------------------|---|
| System Error: | 55-511 |
| Problem Description: | The IT8 sheet was not recognized. |
| Corrective Action: | Try the following: <ul style="list-style-type: none">■ Inspect the calibration sheet for scratches or wear and replace it if the problem continues. |
| System Error: | 55-518 |
| Problem Description: | Aborting Color Calibration Calculation. |
| Corrective Action: | Try the following: <ul style="list-style-type: none">■ Inspect the calibration sheet for scratches or wear and replace it if the problem continues. |
| System Error: | 55-520 |
| Problem Description: | The NTSC calculations failed. |
| Corrective Action: | Try the following: <ul style="list-style-type: none">■ Inspect the calibration sheet for scratches or wear and replace it if the problem continues. |
| System Error: | 55-521 |
| Problem Description: | The sRGB calculations failed. |
| Corrective Action: | Try the following: <ul style="list-style-type: none">■ Inspect the calibration sheet for scratches or wear and replace it if the problem continues. |
| System Error: | 55-522 |
| Problem Description: | The IT8DATA.IT8 reference file could not be found. |
| Corrective Action: | Try the following: <ul style="list-style-type: none">■ Perform a system recovery using the System Recovery DVD. |
| System Error: | 55-523 |
| Problem Description: | Sheet not recognized |
| Corrective Action: | Try the following: <ul style="list-style-type: none">■ Inspect the calibration sheet for scratches or wear and replace it if the problem continues. |

System Error: 55-525
Problem Description: The IT8 reference file could not be found.
Corrective Action: Try the following:
■ A standard IT8 reference file will be used instead. Note that optimal color calibration requires the correct reference file for the current IT8 sheet.

System Error: 55-527
Problem Description: Could not recognize the scanned IT8 picture.
Corrective Action: Try the following:
■ Inspect the calibration sheet for scratches or wear and replace it if the problem continues.

System Error: 55-530
Problem Description: When checking new calibration, the result was not within the limits.
Corrective Action: Try the following:
■ Inspect the calibration sheet for scratches or wear and replace it if the problem continues.

System Error: 55-531
Problem Description: Calibration stopped
Corrective Action: Try the following:
■ Maximum time was exceeded. Turn scanner off and then turn it back on. Wait 15 minutes before running the program.

System Error: 55-601
Problem Description: Scanner is initializing
Corrective Action: Try the following:
■ Turn scanner off and then turn it back on. Wait 15 minutes before running the program.

| | |
|-----------------------------|---|
| System Error: | 55-602 |
| Problem Description: | Scanner is warming up |
| Corrective Action: | Try the following: <ul style="list-style-type: none">■ Turn scanner off and then turn it back on. Wait 15 minutes before running the program. |
| System Error: | 55-603 |
| Problem Description: | Scanner is adjusting |
| Corrective Action: | Try the following: <ul style="list-style-type: none">■ Turn scanner off and then turn it back on. Wait 15 minutes before running the program. |
| System Error: | 55-604 |
| Problem Description: | The paper guide is in extended position |
| Corrective Action: | Try the following: <ul style="list-style-type: none">■ Lower the ATAC system. Click OK to restart the scanner maintenance wizard. |
| System Error: | 55-605 |
| Problem Description: | Calibration of the scanner is not possible because the scanner is in programming mode. |
| Corrective Action: | Try the following: <ul style="list-style-type: none">■ Turn scanner off and then turn it back on. Wait 15 minutes before running the program. |
| System Error: | 55-607 |
| Problem Description: | The scanner is already in calibration mode. |
| Corrective Action: | Try the following: <ul style="list-style-type: none">■ Turn scanner off and then turn it back on. Wait 15 minutes before running the program. |
| System Error: | 55-608 |
| Problem Description: | The camera signals in the scanner is not stitched together. |
| Corrective Action: | Try the following: <ul style="list-style-type: none">■ Press OK to allow the scanner to perform the calibration, and then press Cancel to exit the program. |

| | |
|-----------------------------|---|
| System Error: | 55-609 |
| Problem Description: | Unable to position the sheet |
| Corrective Action: | Try the following: <ul style="list-style-type: none">■ Reinsert the sheet. |
| System Error: | 55-612 |
| Problem Description: | The calibration failed during camera adjustment. |
| Corrective Action: | Try the following: <ul style="list-style-type: none">■ Inspect the calibration sheet for scratches or wear, and replace it if the problem persists. |
| System Error: | 56-6 |
| Problem Description: | No scanner selected or selected scanner is not present. |
| Corrective Action: | Try the following: <ul style="list-style-type: none">■ Ensure that the scanner is turned on and ready. |
| System Error: | 56-24 |
| Problem Description: | Unable to view file. |
| Corrective Action: | Try the following: <ul style="list-style-type: none">■ Ensure that the file is valid. |
| System Error: | 56-25 |
| Problem Description: | The file path is not valid. |
| Corrective Action: | Try the following: <ul style="list-style-type: none">■ A file name cannot contain any of the following characters: \ / : * ? " < > |
| System Error: | 56-27 |
| Problem Description: | Unable to create a temporary ICC profile on the disk. |
| Corrective Action: | Try the following: <ul style="list-style-type: none">■ Ensure that hard disk space is available. |

| | |
|-----------------------------|---|
| System Error: | 56-28 |
| Problem Description: | Cannot recognize the patch sheet. |
| Corrective Action: | Try the following: <ul style="list-style-type: none">■ Ensure that the sheet is correctly aligned in the scanner and that it is in good condition. |
| System Error: | 56-29 |
| Problem Description: | Cannot recognize the patch sheet. |
| Corrective Action: | Try the following: <ul style="list-style-type: none">■ Ensure that the sheet is correctly aligned in the scanner and that it is in good condition. |
| System Error: | 56-30 |
| Problem Description: | Could not open the file: %s. |
| Corrective Action: | Try the following: <ul style="list-style-type: none">■ Ensure that the file path is writable and ensure that there is space available on the hard disk. |
| System Error: | 56-32 |
| Problem Description: | Could not write to the file: %s. |
| Corrective Action: | Try the following: <ul style="list-style-type: none">■ Ensure that the file path is writable and ensure that there is space available on the hard disk. |
| System Error: | 56-33 |
| Problem Description: | Could not open the ICC profile: %s. |
| Corrective Action: | Try the following: <ul style="list-style-type: none">■ Ensure that the file exists in the designated location. |
| System Error: | 56-35 |
| Problem Description: | Could not read from the file: %s. |
| Corrective Action: | Try the following: <ul style="list-style-type: none">■ Ensure that the file path is readable. |

- System Error:** 56-36
Problem Description: Could not find the ICC file generated by the Profiler tool (%s).
Corrective Action: Try the following:
■ Ensure that there is space available on the hard disk.
- System Error:** 56-37
Problem Description: Could not launch the Profiler tool used to process the patch sheet: %s.
Corrective Action: Try the following:
■ Perform a system recovery using the System Recovery DVD.
- System Error:** 56-41
Problem Description: An error occurred while applying network settings.
Corrective Action: Try the following:
■ Ensure that the entered settings are valid for the network.
- System Error:** 56-42
Problem Description: An error occurred while applying the new computer name.
Corrective Action: Try the following:
■ Ensure that the name is valid for the network.
- System Error:** 56-43
Problem Description: The CD/DVD drive is not ready.
Corrective Action: Try the following:
■ Check the CD/DVD media.
- System Error:** 56-44
Problem Description: Unable to write to the CD/DVD.
Corrective Action: Try the following:
■ Check the CD/DVD media.

| | |
|-----------------------------|---|
| System Error: | 56-45 |
| Problem Description: | The system was unable to detect the scanner. |
| Corrective Action: | Try the following: <ul style="list-style-type: none">■ Verify that the cables are secured.■ Reboot the system. |
| System Error: | 56-46 |
| Problem Description: | It is not possible to retrieve the necessary information about the current printer. |
| Corrective Action: | Try the following: <ul style="list-style-type: none">■ A likely cause is that the printer is accessed through a print server, as the operation requires the driver to be installed locally. |
| System Error: | 56-47 |
| Problem Description: | Unable to add file %s. |
| Corrective Action: | Try the following: <ul style="list-style-type: none">■ Ensure that the file is valid. |
| System Error: | 56-63 |
| Problem Description: | Unable to create network mapping. |
| Corrective Action: | Try the following: <ul style="list-style-type: none">■ Ensure that the entered settings are valid and that the network is working. |
| System Error: | 56-68 |
| Problem Description: | You do not have access to the network resource. |
| Corrective Action: | Try the following: <ul style="list-style-type: none">■ Ensure that the entered settings are valid. |
| System Error: | 56-69 |
| Problem Description: | A folder on the network resource has already been mapped using another name. |
| Corrective Action: | Try the following: <ul style="list-style-type: none">■ Disconnect all network folders for the resource. |

| | |
|-----------------------------|---|
| System Error: | 56-70 |
| Problem Description: | Invalid network folder |
| Corrective Action: | Try the following: <ul style="list-style-type: none">■ Ensure that the entered network folder setting is valid. |
| System Error: | 56-71 |
| Problem Description: | Logon failure |
| Corrective Action: | Try the following: <ul style="list-style-type: none">■ Ensure that the entered user name and password are valid. |
| System Error: | 56-72 |
| Problem Description: | There are too many network connections. |
| Corrective Action: | Try the following: <ul style="list-style-type: none">■ Remove some network connections. |
| System Error: | 100-118 |
| Problem Description: | Unable to communicate with the scanner. |
| Corrective Action: | Try the following: <ul style="list-style-type: none">■ Ensure a secure cable connection between the Panel PC and the scanner. |
| System Error: | 100-128 |
| Problem Description: | There is a paper jam. |
| Corrective Action: | Try the following: <ul style="list-style-type: none">■ Reload the media. |
| System Error: | 100-129 |
| Problem Description: | The scanner does not support this test command in normal mode. |
| Corrective Action: | Try the following: <ul style="list-style-type: none">■ Turn off the scanner, and then turn it back on. |

| | |
|-----------------------------|---|
| System Error: | 100-130 |
| Problem Description: | The scanner does not support this command in test mode. |
| Corrective Action: | Try the following: <ul style="list-style-type: none">■ Turn off the scanner, and then turn it back on. |
| System Error: | 100-131 |
| Problem Description: | The scanner is initializing. |
| Corrective Action: | Try the following: <ul style="list-style-type: none">■ Retry the operation when the scanner has finished initializing. |
| System Error: | 100-132 |
| Problem Description: | The scanner is warming up. |
| Corrective Action: | Try the following: <ul style="list-style-type: none">■ Retry the operation when the scanner has finished initializing. |
| System Error: | 100-133 |
| Problem Description: | The scanner cannot reverse the media while the ATAC system is in the extended position. |
| Corrective Action: | Try the following: <ul style="list-style-type: none">■ Manually reload the media. |
| System Error: | 100-134 |
| Problem Description: | The scanner is calibrating. |
| Corrective Action: | Try the following: <ul style="list-style-type: none">■ Retry the operation when the scanner has finished calibrating. |
| System Error: | 100-136 |
| Problem Description: | The scanner is on standby. |
| Corrective Action: | Try the following: <ul style="list-style-type: none">■ Turn on the scanner and retry the operation when the scanner is ready. |

System Error: 100-1004

Problem Description: The media is currently being loaded by the scanner.

Corrective Action: Try the following:

- Retry the operation when the media has been loaded.

System Error: 100-1005

Problem Description: The media is currently being positioned by the scanner.

Corrective Action: Try the following:

- Retry the operation when the media has been positioned.

System Error: 100-1006

Problem Description: There is a paper jam.

Corrective Action: Try the following:

- Manually reload the media.

System Error: 100-1007

Problem Description: The scanner cannot reverse the media while the ATAC system is in the extended position.

Corrective Action: Try the following:

- Manually reload the media.

System Error: 100-1008

Problem Description: The scanner is calibrating.

Corrective Action: Try the following:

- Retry the operation when the scanner has finished calibrating.

System Error: 100-2000

Problem Description: The scanner is powering up.

Corrective Action: Try the following:

- Wait until the scanner is ready, and then retry the operation.

| | |
|-----------------------------|---|
| System Error: | 100-2001 |
| Problem Description: | Incorrect scanner status |
| Corrective Action: | Try the following: <ul style="list-style-type: none">■ Check the paper path and reload the media. |
| System Error: | 100-2002 |
| Problem Description: | The scanner does not support this test command in normal mode. |
| Corrective Action: | Try the following: <ul style="list-style-type: none">■ Reboot the system. |
| System Error: | 100-2003 |
| Problem Description: | The scanner does not support this command in test mode. |
| Corrective Action: | Try the following: <ul style="list-style-type: none">■ Turn off the scanner, and then turn it on again. |
| System Error: | 100-2014 |
| Problem Description: | The scanner is on standby. |
| Corrective Action: | Try the following: <ul style="list-style-type: none">■ Turn on the scanner and retry the operation when the scanner is ready. |
| System Error: | 100-2015 |
| Problem Description: | The scanner did not find any Hollerith data on the aperture card. |
| Corrective Action: | Try the following: <ul style="list-style-type: none">■ Ensure that the card is valid and correctly inserted. |
| System Error: | 100-2016 |
| Problem Description: | The scanner cover is open. |
| Corrective Action: | Try the following: <ul style="list-style-type: none">■ Close the cover before retrying the operation. |

- System Error:** 100-3000
Problem Description: The firmware was not downloaded properly.
Corrective Action: Try the following:
■ Perform a system recovery using the System Recovery DVD.
- System Error:** 100-3002 through 100-3037
Problem Description: Unable to adjust camera X, unable to stitch camera X to camera, error calibrating camera X
Corrective Action: Try the following:
■ Clean the white background and the glass plate, and then run the scanner maintenance.
- System Error:** 100-3051
Problem Description: The scanner's ID switch has been set to an invalid value. Please change switch setting.
Corrective Action: Try the following:
■ Check that all the cables are connected correctly to the Main Electronics Board, Control Panel Board in the Right Cover.
■ Run SCANtest 6, test 7 ⇒ Page 1-6.
■ Replace the Right Cover ⇒ Page 4-9.
■ Replace the Main Electronics Board ⇒ Page 4-37.
- System Error:** 100-3054
Problem Description: Unable to write to EEPROM/FLASH
Corrective Action: Try the following:
■ Check that all the cables are connected correctly to the Main Electronics Board.
■ Run SCANtest 6, test 7 ⇒ Page 1-6.
■ Replace the Main Electronics Board ⇒ Page 4-37.
- System Error:** 100-3056
Problem Description: Flash Error: Unable to erase
Corrective Action: Try the following:
■ Check that all the cables are connected correctly to the Main Electronics Board.
■ Run SCANtest 6, test 7 ⇒ Page 1-6
■ Replace the Main Electronics Board ⇒ Page 4-37.

- System Error:** 100-3057
Problem Description: Flash Error: Unable to program
Corrective Action: Try the following:
- Check that all the cables are connected correctly to the Main Electronics Board.
 - Run SCANtest 6, test 7 ⇒ Page 1-6
 - Replace the Main Electronics Board ⇒ Page 4-37.
- System Error:** 100-3058
Problem Description: SCU Board Error
Corrective Action: Try the following:
- Check that all the cables are connected correctly to the Main Electronics Board.
 - Run SCANtest 6, test 7 ⇒ Page 1-6.
 - Replace the Main Electronics Board ⇒ Page 4-37.
- System Error:** 100-3059
Problem Description: Camera Board, Error
Corrective Action: Try the following:
- To find out which board has an error Run SCANtest 6, test 7 and check the performance of each camera.
 - Check that all the cables are connected correctly to the Cameras Boards.
 - Run SCANtest 6, test 9 and check the Camera Board.
 - Replace the Camera Board ⇒ Page 4-29.
 - Replace the Main Electronics Board ⇒ Page 4-37.
- System Error:** 100-3061
Problem Description: There is a problem with the Interface Board
Corrective Action: Try the following:
- Check that the Interface Board is correctly installed.
 - Run SCANtest 6, test 7 ⇒ Page 1-6.
 - Replace the Interface Board ⇒ Page 4-39.

System Error: 100-3062

Problem Description: Fan error

Corrective Action: Try the following:

- Check that all the cables are connected correctly to the Fans.
- Check that all the cables are connected correctly to the Driver Board.
- Perform the Driver Board Communication Test ⇒ Page 5-32.
- Replace the Fan ⇒ Page 4-35
- Replace the Driver Board ⇒ Page 4-33

System Error: 100-3063

Problem Description: The scanner's replaceable lamp cartridge is detached.

Corrective Action: Try the following:

- Ensure that the lamp cartridge is correctly installed.

System Error: 100-4001

Problem Description: No supported scanner could be found.

Corrective Action: Try the following:

- Verify that the scanner is turned on and connected to the Touch Screen.

System Error: 100-8220

Problem Description: The scanner's replaceable lamp cartridge is detached.

Corrective Action: Try the following:

- Ensure that the lamp cartridge is correctly inserted.

System Error: 100-20086

Problem Description: Unable to communicate with the ATAC Controller Board.

Corrective Action: Try the following:

- Check that all the cables are connected correctly to the ATAC Board and the Main Electronics Board.
- Run SCANtest 6, test 7 ⇒ Page 7-6.
- Replace the ATAC Board ⇒ Page 4-44
- Replace the Main Electronics Board ⇒ Page 4-37.

- System Error:** 100-20087
Problem Description: Unable to perform paper guide movement (ATAC).
Corrective Action: Try the following:
- Check that all the cables are connected correctly to the ATAC Board and the Main Electronics Board.
 - Run SCANtest 6, test 7 ⇒ Page 1-6.
 - Replace the ATAC Board ⇒ Page 4-44
 - Replace the Main Electronics Board ⇒ Page 4-37.
- System Error:** 100-20219
Problem Description: There is a problem with one of the Fans.
Corrective Action: Try the following:
- Check that all the cables are connected correctly to the Fans.
 - Check that all the cables are connected correctly to the Driver Board.
 - Perform the Driver Board Communication Test ⇒Page 5-32.
 - Replace the Fan ⇒ Page 4-35
 - Replace the Driver Board ⇒Page 4-33
- System Error:** 100-20221
Problem Description: There is a problem with the Driver Board.
Corrective Action: Try the following:
- Check that all the cables are connected correctly to the Driver Board and the Main Electronics Board.
 - Perform the Driver Board Communication Test ⇒Page 5-32.
 - Run SCANtest 6, test 7 ⇒ Page 1-6.
 - Replace the Driver Board ⇒Page 4-33.
 - Replace the Main Electronics Board ⇒ Page 4-37.
- System Error:** 100-30140
Problem Description: Correction of Camera A failed.
Corrective Action: Try the following:
- Clean the white background and the glass plate.
 - Erase the parameter block.
 - Run the scanner maintenance software.
 - Replace the camera board.

System Error: 100-30141

Problem Description: Correction of Camera B failed.

Corrective Action: Try the following:

- Clean the white background and the glass plate.
- Erase the parameter block.
- Run the scanner maintenance software.
- Replace the camera board.

System Error: 100-30142

Problem Description: Correction of Camera C failed.

Corrective Action: Try the following:

- Clean the white background and the glass plate.
- Erase the parameter block.
- Run the scanner maintenance software.
- Replace the camera board.

System Error: 100-30240

Problem Description: Correction of Camera A failed.

Corrective Action: Try the following:

- Clean the white background and the glass plate.
- Erase the parameter block.
- Run the scanner maintenance software.
- Replace the camera board.

System Error: 100-30241

Problem Description: Correction of Camera B failed.

Corrective Action: Try the following:

- Clean the white background and the glass plate.
- Erase the parameter block.
- Run the scanner maintenance software.
- Replace the camera board.

System Error: 100-30242
Problem Description: Correction of Camera C failed.
Corrective Action: Try the following:

- Clean the white background and the glass plate.
- Erase the parameter block.
- Run the scanner maintenance software.
- Replace the camera board.

System Error: 100-32144
Problem Description: Stitching between Camera A and Camera B failed.
Corrective Action: Try the following:

- Clean the white background and the glass plate.
- Erase the parameter block.
- Run the scanner maintenance software.
- Replace the camera board.

System Error: 100-32145
Problem Description: Stitching between Camera B and Camera C failed.
Corrective Action: Try the following:

- Clean the white background and the glass plate.
- Erase the parameter block.
- Run the scanner maintenance software.
- Replace the camera board.

System Error: 100-32244
Problem Description: Stitching between Camera A and Camera B failed.
Corrective Action: Try the following:

- Clean the white background and the glass plate.
- Erase the parameter block.
- Run the scanner maintenance software.
- Replace the camera board.

System Error: 100-32245

Problem Description: Stitching between Camera B and Camera C failed.

Corrective Action: Try the following:

- Clean the white background and the glass plate.
- Erase the parameter block.
- Run the scanner maintenance software.
- Replace the camera board.

System Error: 100-4003x/4004x

Problem Description: Error on Camera Board. Use the table below to identify the failing Camera Board.

| Camera (A) | Camera (B) | Camera (C) |
|------------|------------|------------|
| 40035 | 40036 | 40037 |
| 40039 | 40040 | 40041 |
| 40043 | 40044 | 40045 |
| 40047 | 40048 | 40049 |

Corrective Action: Try the following:

- Run SCANtest 6, test 7 to verify the error.
- Check that all the cables are connected correctly.
- Run SCANtest 6, test 9 and check the light profiles ⇒ Page 1-6.
- Erase the Parameter Blocks.
- Run the Scanner Maintenance ⇒ Page 5-26.
- Replace the Camera Board ⇒ Page 4-29.

System Error: 100-4017x/4018x

Problem Description: Unable to calibrate a camera. Use the following table to identify the failing camera.

| Camera (A) | Camera (B) | Camera (C) |
|------------|------------|------------|
| 40170 | 40171 | 40172 |
| 40174 | 40175 | 40176 |
| 40178 | 40179 | 40180 |
| 40182 | 40183 | 40184 |
| 40186 | 40187 | 40188 |

- Corrective Action:** Try the following:
- Erase the parameter block and perform scanner maintenance ⇒ Page 5-26.
 - Check that all cables are connected correctly to the Camera Board and the Main Electronics Board.
 - Switch Mode Power Supply
 - Run SCANtest 6, test 9 ⇒ Page 1-6.
 - Replace the Main Electronics Board ⇒ Page 4-37.
 - Replace the failing Camera Board ⇒ Page 4-29

System Error: 100-40075
Problem Description: Camera Board, FPGA CB status error.

- Corrective Action:** Try the following:
- Check that all the cables are connected correctly to the Cameras Boards.
 - Replace the Camera Board ⇒ Page 4-29
 - Replace the Main Electronics Board ⇒ Page 4-37.

System Error: 100-40076
Problem Description: Camera Board, FPGA CB done error.

- Corrective Action:** Try the following:
- Check that all the cables are connected correctly to the Cameras Boards.
 - Run SCANtest 6, test 9 ⇒ Page 1-6.
 - Replace the Camera Board ⇒ Page 4-29.
 - Run SCANtest 6, test 7 ⇒ Page 1-6.
 - Replace the Main Electronics Board ⇒ Page 4-37.

System Error: 100-40084
Problem Description: Camera Board, Camera Cables disconnected.

- Corrective Action:** Try the following:
- Check that all the cables are connected correctly to the Cameras Boards.
 - Run SCANtest 6, test 9 ⇒ Page 1-6.
 - Replace the Camera Board ⇒ Page 4-29.
 - Run SCANtest 6, test 7 ⇒ Page 1-6.
 - Replace the Main Electronics Board ⇒ Page 4-37.

- System Error:** 100-4013x
- Problem Description:** Unable to calibrate an undefined Camera
- Corrective Action:** Try the following:
- Erase the parameter block and perform scanner maintenance ⇒ Page 5-26.
 - Switch Mode Power Supply
 - Check that all the cables are connected correctly to the Cameras Boards.
 - Run SCANtest 6, test 9 ⇒ Page 1-6.
 - Replace the Camera Board ⇒ Page 4-29.
 - Run SCANtest 6, test 7 ⇒ Page 1-6.
 - Replace the Main Electronics Board ⇒ Page 4-37.
- System Error:** 100-501xx
- Problem Description:** Error on the Main Electronics Board.
- Corrective Action:** Try the following:
- Check that all the cables are connected correctly to the Main Electronics Board.
 - Run Scanner Maintenance ⇒ Page 5-26.
 - Upgrade the Scanner Firmware.
 - Run SCANtest 6, test 7 ⇒ Page 1-6.
 - Replace the Main Electronics Board ⇒ Page 4-37.
- System Error:** 100-50199
- Problem Description:** Incorrect Main Electronics Board and Camera Board. Please validate the combination for this scanner.
- Corrective Action:** Try the following:
- Check that all the cables are connected correctly to the Cameras Boards.
 - Update the firmware
 - Run SCANtest 6, test 9 ⇒ Page 1-6.
 - Replace the Camera Board ⇒ Page 4-29.
 - Run SCANtest 6, test 7 ⇒ Page 1-6.
 - Replace the Main Electronics Board ⇒ Page 4-37.

System Error: 100-600xx

Problem Description: Communications Interface Error

Corrective Action: Try the following:

- Check that all the cables are connected correctly to the Main Electronics Board and the Interface Board is correctly installed.
- Run SCANtest 6, test 7 ⇒ Page 1-6.
- Replace the Camera Board ⇒ Page 4-29
- Replace the Main Electronics Board ⇒ Page 4-37.

Error Codes for the JetImage Software RIP

Introduction

This set of number system error codes refers to the systems related to the JetImage Software RIP.

| | |
|-----------------------------|--|
| System Error: | -19 |
| FP Message | -19 When combining thick media handling (paper guide in extended position) with auto size detection, the size detection must be done separately by running a preview scan before the final copy or scan operation. |
| Problem Description: | When combining thick media handling (paper guide in extended position) with auto size detection, the size detection must be done separately by running a preview scan before the final copy or scan operation. |
| Corrective Action: | Try the following: <ul style="list-style-type: none"> ■ Run a preview scan before the final copy or scan operation ■ Perform the copy or scan to file instead. |
| System Error: | -16 |
| FP Message | -16 error reading the RIP gray balance file. |
| Problem Description: | If current media profile specifies to use CSV-file in the RIP gray balance and the file is not found. |
| Corrective Action: | Either disable the use of gray balance or attempt to create the file again. |
| System Error: | -14 |
| FP Message | -14 Unable to reserve the scanner. |
| Problem Description: | Unable to reserve the scanner. |
| Corrective Action: | Check and see if any other application is using the scanner. |
| System Error: | -13 |
| FP Message | -13 Unable to rename the folder. |
| Problem Description: | Unable to rename the folder. |
| Corrective Action: | Occurs during file browsing operations, usually due to a share issue. |
| System Error: | -12 |
| FP Message | -12 Unable to delete the folder. |
| Problem Description: | Unable to delete the folder (occurs during file browsing operations, typically |

if a folder is shared).

Corrective Action: Close all the applications and try again.

System Error: -11

FP Message -11 The folder must be empty.

Problem Description: The folder must be empty (occurs during file browsing operations).

Corrective Action: Check that the folder is empty before deleting it.

System Error: -9

FP Message -9 The currently selected printer is not installed in the system.

Problem Description: The windows printer driver for the currently selected printer is not found.

Corrective Action: Try the following:

- Check that the printer driver is installed.
- Install the printer driver if not already installed.

System Error: -6

FP Message -6 No scanner selected or selected scanner not present.

Problem Description: No scanner selected or selected scanner not present. If the scanner was turned Off during application start-up.

Corrective Action: Try the following:

- Check that the scanner is turned On.
- Check that the scanner is selected.

System Error: -2

FP Message -2 No media profile selected for current printer.

Problem Description: No media profile selected for current printer.

Corrective Action: Prepare a Media Profile before performing the operation.

System Error: -1

FP Message -1 No printer selected.

Problem Description: No printer selected.

Corrective Action: Select a printer. A printer must be configured in the application before trying to print.

| | |
|-----------------------------|---|
| System Error: | 02 |
| FP Message | 02 Invalid scan coordinates. The paper frame was placed fully outside the scan image. |
| Problem Description: | Invalid scan coordinates. The paper frame was placed fully outside the scan image. |
| Corrective Action: | Try repositioning the paper frame so that it covers some of the scannable area. |
| System Error: | 06 |
| FP Message | 06 Not enough disk space for spool file. |
| Problem Description: | Not enough disk space for spool file. |
| Corrective Action: | Make sure that the environment TEMP (or secondary TMP) points to a folder with plenty of space. |
| System Error: | 08 |
| FP Message | 08 The scanner is currently on standby. Please press the soft power button on the scanner to activate it. |
| Problem Description: | The scanner is currently on standby. |
| Corrective Action: | Press the soft power button on the scanner to activate it. |
| System Error: | 00003 |
| FP Message | 00003 Scanning invalid size of area requested for scanning. |
| Problem Description: | Negative scan-width specified. |
| Corrective Action: | Reselect the scan area and try again. |
| System Error: | 01003 |
| FP Message | 01003 Error printing colorsheet. |
| Problem Description: | Error printing colorsheet. |
| Corrective Action: | Try the following: <ul style="list-style-type: none">■ Check the printer to make sure it is switched On and connected to the scanner.■ Try printing a test print to make sure that the printer is working. |

| | |
|-----------------------------|--|
| System Error: | 01013 |
| FP Message | 01013 Error detecting index-mark. |
| Problem Description: | Skew: Error detecting the index mark. |
| Corrective Action: | Try the following: <ul style="list-style-type: none">■ Try restarting the system.■ If the problem persists, view the scandump.tif file for further diagnosis. |
| System Error: | 01014 |
| FP Message | 01014 Sheet bad aligned. |
| Problem Description: | Sheet badly aligned. |
| Corrective Action: | Try the following: <ul style="list-style-type: none">■ Reinsert the sheet, making sure that it is straight and at the right position.■ If the problem persists, view the scandump.tif file for further diagnosis. |
| System Error: | 01015 |
| FP Message | 01015 Error detecting left margin. |
| Problem Description: | Error detecting the left margin of the sheet. |
| Corrective Action: | Try the following: <ul style="list-style-type: none">■ Try reinserting the sheet.■ If the problem persists, view the scandump.tif file for further diagnosis. |
| System Error: | 01016 |
| FP Message | 01016 Error detecting right margin. |
| Problem Description: | Error detecting the right margin of the sheet. |
| Corrective Action: | Try the following: <ul style="list-style-type: none">■ Try reinserting the sheet.■ If the problem persists, view the scandump.tif file for further diagnosis. |
| System Error: | 01017 |
| FP Message | 01017 Error reading colorsheet. |
| Problem Description: | Error reading the colorsheet. The end of the sheet is reached before expected. |
| Corrective Action: | Check that the correct colorsheet is being used. |

| | |
|-----------------------------|---|
| System Error: | 01018 |
| FP Message | 01018 CLC aborted. |
| Problem Description: | The Close Loop Calibration (CLC) has been aborted. |
| Corrective Action: | The user has cancelled the color map operation. |
| System Error: | 01019 |
| FP Message | 01019 Wrong insert position. |
| Problem Description: | The sheet has been inserted in the wrong position. |
| Corrective Action: | Try the following: <ul style="list-style-type: none">■ Reinsert the sheet, making sure that it is at the right position.■ If the problem persists, view the scandump.tif file for further diagnosis. |
| System Error: | 01020 |
| FP Message | 01020 Can't find top of sheet. |
| Problem Description: | The top of the sheet couldn't be found. |
| Corrective Action: | Reinsert the sheet, making sure that it is at the right position. |
| System Error: | 01021 |
| FP Message | 01021 Can't find bottom of sheet. |
| Problem Description: | The bottom of the sheet couldn't be found. |
| Corrective Action: | Reinsert the sheet, making sure that it is at the right position. |
| System Error: | 01022 |
| FP Message | 01022 Does not correspond to this version or clc.dll. |
| Problem Description: | Incorrect version of the language resource dll. |
| Corrective Action: | Install the correct version of the language resource dll. |
| System Error: | 02004 |
| FP Message | 02004 Unable to open device for reading. |
| Problem Description: | Unable to open the device for reading. |
| Corrective Action: | Check that the device (file) is available. |

System Error: 02005
FP Message 02005 Unable to open device for writing.
Problem Description: Unable to open the device for writing.
Corrective Action: Check that the device (file or printer) is available.

System Error: 02006
FP Message 02006 Unable to read from device.
Problem Description: Unable to read from the device.
Corrective Action: Try the operation again.

System Error: 02007
FP Message 02007 Unable to write to device.
Problem Description: Unable to write to the device.
Corrective Action: Try the operation again.

System Error: 02013
FP Message 02013 Destination already exists.
Problem Description: Destination already exists.
Corrective Action: Try the operation again with a different file name.

System Error: 03008
FP Message 03008 Device not available.
Problem Description: Scanner not found.
Corrective Action: Try the following:
■ Check that the scanner is turned On.
■ Check the connection to the scanner.

System Error: 13496
FP Message 13496 The scanner is initializing or warming up
Problem Description: The scanner is initializing.
Corrective Action: This happens if you try to scan too quickly after powering On the scanner. Wait a short while and then try scanning again.

System Error: 17977
FP Message 17977 Media is present in scanner, but command was aborted by user.
Problem Description: User interfered with the scanner.
Corrective Action: Try the operation again.

System Error: 17980
FP Message 17980 Paper jam.
Problem Description: Paper jam.
Corrective Action: Check rollers and mechanical paper detectors for any paper jam. Once paper jam is cleared, try the operation again.

Error Messages for the Touch Screen

Introduction

This set of number system error codes refers to the systems and parts relating to the Touch Screen.

- FP Message:** BIOS ROM checksum error - system halted
Problem Description: Error during initialization.
Corrective Action: Reboot the system and enter the BIOS setting. Load "Setup Default" and save the BIOS setting.
- FP Message:** CMOS battery failed
Problem Description: The battery life is approximately 3 years before it requires replacement.
Corrective Action: Replace the CMOS Battery.
- FP Message:** CMOS checksum error - defaults loaded
Problem Description: Error detected in the CMOS.
Corrective Action: Reboot the system and enter the BIOS setting. Load "Setup Default" and save the BIOS setting.
- FP Message:** Display switch is set incorrectly
Problem Description: Problem found with the Touch Screen.
Corrective Action: Connect the Touch Screen to a CRT Monitor and check the resolution setting for the display. If the CRT Monitor is working well then it seems there is an LCD problem. Return the Panel PC to Repair Center for further tests.
- FP Message:** Hard Disk install failure
Problem Description: No Hard Disk detected, error related to Hard Disk Drive.
Corrective Action: Try the following:
 - In the BIOS setup select Standard CMOS Features and check if the IDE detection method is set to AUTO (password to access the BIOS is *bigcoco*)?
 - If Yes: In Advanced BIOS features, set HDD to first boot device.
 - If No: Choose auto for all IDE detection.
 - Check if HDD can be detected in the boot-up system configuration table:
 - If Yes: check the boot up files in HDD, recover it if necessary.

– If No: replace HDD.

FP Message: Primary master hard disk fail

Problem Description: No Hard Disk detected, error related to Hard Disk Drive.

Corrective Action: Try the following:

- In the BIOS setup select Standard CMOS Features and check if the IDE detection method is set to AUTO (password to access the BIOS is *bigcoco*)?
 - If Yes: In Advanced BIOS features, set HDD to first boot device.
 - If No: Choose auto for all IDE detection.
- Check if HDD can be detected in the boot-up system configuration table:
 - If Yes: check the boot up files in HDD, recover it if necessary.
 - If No: replace HDD.

FP Message: Secondary master hard disk fail

Problem Description: No Hard Disk detected, error related to Hard Disk Drive.

Corrective Action: Try the following:

- In the BIOS setup select Standard CMOS Features and check if the IDE detection method is set to AUTO (password to access the BIOS is *bigcoco*)?
 - If Yes: In Advanced BIOS features, set HDD to first boot device.
 - If No: Choose auto for all IDE detection.
- Check if HDD can be detected in the boot-up system configuration table:
 - If Yes: check the boot up files in HDD, recover it if necessary.
 - If No: replace HDD.

FP Message: Primary slave hard disk fail

Problem Description: No Hard Disk detected, error related to Hard Disk Drive.

Corrective Action: Try the following:

- In the BIOS setup select Standard CMOS Features and check if the IDE detection method is set to AUTO (password to access the BIOS is *bigcoco*)?
 - If Yes: In Advanced BIOS features, set HDD to first boot device.
 - If No: Choose auto for all IDE detection.
- Check if HDD can be detected in the boot-up system configuration table:
 - If Yes: check the boot up files in HDD, recover it if necessary.
 - If No: replace HDD.

- FP Message:** Secondary slave hard disk fail
- Problem Description:** No Hard Disk detected, error related to Hard Disk Drive.
- Corrective Action:** Try the following:
- In the BIOS setup select Standard CMOS Features and check if the IDE detection method is set to AUTO (password to access the BIOS is *bigcoco*)?
 - If Yes: In Advanced BIOS features, set HDD to first boot device.
 - If No: Choose auto for all IDE detection.
 - Check if HDD can be detected in the boot-up system configuration table:
 - If Yes: check the boot up files in HDD, recover it if necessary.
 - If No: replace HDD.
- FP Message:** Floppy disk(s) fail
- Problem Description:** No Floppy Disk detected.
- Corrective Action:** Try the following:
- Check if the Floppy Disk Drive cable is connected correctly, reconnect the cable if necessary.
 - Replace the Floppy Disk Drive.
- FP Message:** Floppy disk(s) fail (40)
- Problem Description:** No Floppy Disk detected.
- Corrective Action:** Try the following:
- Check if the Floppy Disk Drive cable is connected correctly, reconnect the cable if necessary.
 - Replace the Floppy Disk Drive.
- FP Message:** Floppy disk(s) fail (80)
- Problem Description:** No Floppy Disk detected.
- Corrective Action:** Try the following:
- Check if the Floppy Disk Drive cable is connected correctly. Reconnect the cable if necessary.
 - Replace the Floppy Disk Drive.

| | |
|-----------------------------|---|
| FP Message: | Keyboard error or no keyboard present |
| Problem Description: | No keyboard has been detected. |
| Corrective Action: | Try the following: <ul style="list-style-type: none">■ Check if the Keyboard is connected correctly. Reconnect the cable if necessary.■ Replace the Keyboard. |
| FP Message: | The driver is not ready |
| Problem Description: | The system cannot read from the DVD drive. |
| Corrective Action: | Try the following: <ul style="list-style-type: none">■ Eject the DVD currently in the DVD drive and place it into a different DVD drive. Can the DVD be read in the other DVD drive?<ul style="list-style-type: none">– If Yes: Replace the DVD drive.– If No: Replace the DVD; it could be damaged. |
| FP Message: | Memory test fail |
| Problem Description: | Memory test has failed. |
| Corrective Action: | Try the following: <ul style="list-style-type: none">■ Re-install the SDRAM and check if the problem is solved:<ul style="list-style-type: none">– If Yes: There was a poor connection between the Main Board and the SDRAM Memory Module.– If No: Replace the SDRAM Memory Module. |



Parts and Diagrams

3

- Copier Stand & Touch Screen 3-3
- Copier Covers 3-6
- Top Assemblies 3-8
- Inside Guide Plate 3-10
- Drive Assemblies 3-12
- Camera Components and Fan 3-14
- Electronic Boards 3-16
- Touch Screen 3-18
- Touch Screen Cabinet Components (Part 1) 3-20
- Touch Screen Cabinet Components (Part 2) 3-22
- Miscellaneous Items 3-24



Copier Stand & Touch Screen

As of February 2008, the DJ4500 family of scanners will have the same scanner hardware as the DJT1100 MFP family of scanners (the DJ820 MFP will retain the components it has at the time of publishing this document, meaning that all of the hardware components, with the exception of external aesthetics and accessories such as nameplate, legs, arms, and the like, will remain the same).

The following graphics belong to the DJ4500 family of scanners. The external components of the DJT1100 MFP and DJ820 MFP scanners may differ in shape, dimension, or color.

| Copier Stand & Touch Screen | | | | | | |
|-----------------------------|----------------|----------|---------------|--------|---------|--|
| Reference on Drawing | HP Part Number | Quantity | Scanner Model | | | Description/Comments |
| | | | DJ820 | DJ4500 | DJT1100 | |
| 1 | Q1277-60037 | 1 | | x | | Top Bar |
| | Q6685-60004 | | x | | x | Top Bar |
| 2 | Q1277-60038 | 2 | | x | | Leg |
| | Q6685-60005 | 2 | x | | x | Leg |
| 3 | Q1277-60039 | 2 | | x | | Feet (includes Castors) |
| | Q6685-60006 | 2 | x | | x | Feet (includes Castors) |
| 4 | Q1277-60040 | 1 | | x | | Rear Bar |
| | Q6685-60007 | 1 | x | | x | Rear Bar |
| 5 | Q1277-60041 | 1 | | x | | Arm |
| | Q6685-60008 | 1 | x | | | Arm |
| | Q6713-60006 | 1 | | | x | Arm |
| 6 | - | 1 | x | x | x | Touch Screen (refer to Page 3-18 and Page 3-20 for individual component part number) |
| 7 | Q1277-60042 | 1 | x | x | x | Bracket |
| 8 | Q1277-60026 | 1 | | x | | Nameplate |
| | Q6685-60002 | 1 | x | | | Nameplate |
| | Q6713-60005 | 1 | | | x | Nameplate |

| Copier Stand & Touch Screen | | | | | | |
|-----------------------------|----------------|----------|---------------|--------|---------|------------------------------------|
| Reference on Drawing | HP Part Number | Quantity | Scanner Model | | | Description/Comments |
| | | | DJ820 | DJ4500 | DJT1100 | |
| 9 | Q1277-60020 | 1 | x | x | x | Paper Guides |
| 10 | Q1277-60044 | 1 | | x | | Keyboard Shelf |
| | Q6685-60010 | 1 | x | | x | Keyboard Shelf |
| 11 | Q1277-60045 | 1 | x | x | x | Keyboard English |
| | Q1277-60046 | 1 | x | x | x | Keyboard French |
| | Q1277-60047 | 1 | x | x | x | Keyboard Italian |
| | Q1277-60048 | 1 | x | x | x | Keyboard German |
| | Q1277-60049 | 1 | x | x | x | Keyboard Spanish |
| | Q1277-60050 | 1 | x | x | x | Keyboard Portuguese |
| | Q1277-60051 | 1 | x | x | x | Keyboard Chinese |
| | Q1277-60052 | 1 | x | x | x | Keyboard Taiwanese |
| | Q1277-60053 | 1 | x | x | x | Keyboard Japanese |
| - | Q1277-60036 | 1 | | x | | Assembly Kit (Screws and nuts etc) |
| - | Q6685-60003 | 1 | x | | x | Assembly Kit (Screws and nuts etc) |

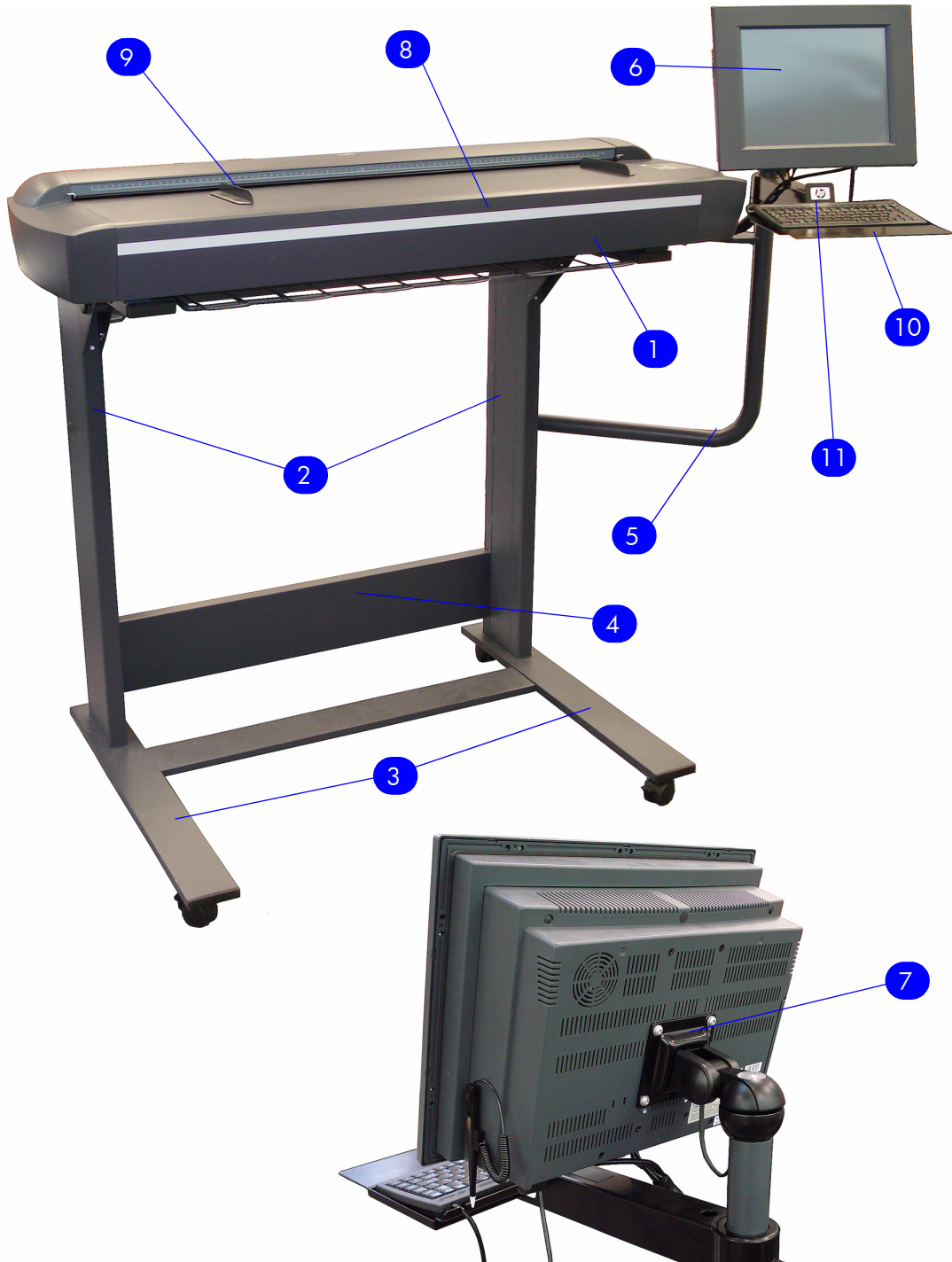

Figure 1: Copier Stand & Touch Screen

Copier Covers

| Copier Stand & Touch Screen | | | | | | |
|-----------------------------|----------------|----------|---------------|--------|---------|------------------------------------|
| Reference on Drawing | HP Part Number | Quantity | Scanner Model | | | Description/Comments |
| | | | DJ820 | DJ4500 | DJT1100 | |
| 1 | Q1277-60023 | 1 | x | x | x | Top Cover |
| 2 | Q1277-60021 | 1 | x | x | x | Left Cover |
| 3 | Q1277-60022 | 1 | | x | | Right Cover (includes Front Panel) |
| | Q6685-60012 | 1 | x | | | Right Cover (includes Front Panel) |
| | Q6713-60007 | 1 | | | x | Right Cover (includes Front Panel) |
| 4 | Q1277-60024 | 1 | x | x | | Top Profile |
| | Q6713-60003 | 1 | | | x | Top Profile |
| 5 | Q1277-60029 | 1 | x | x | x | Firewire Connector Cover |
| 6 | Q1277-60028 | 1 | x | x | x | Fluorescent Lamp Access Cover |

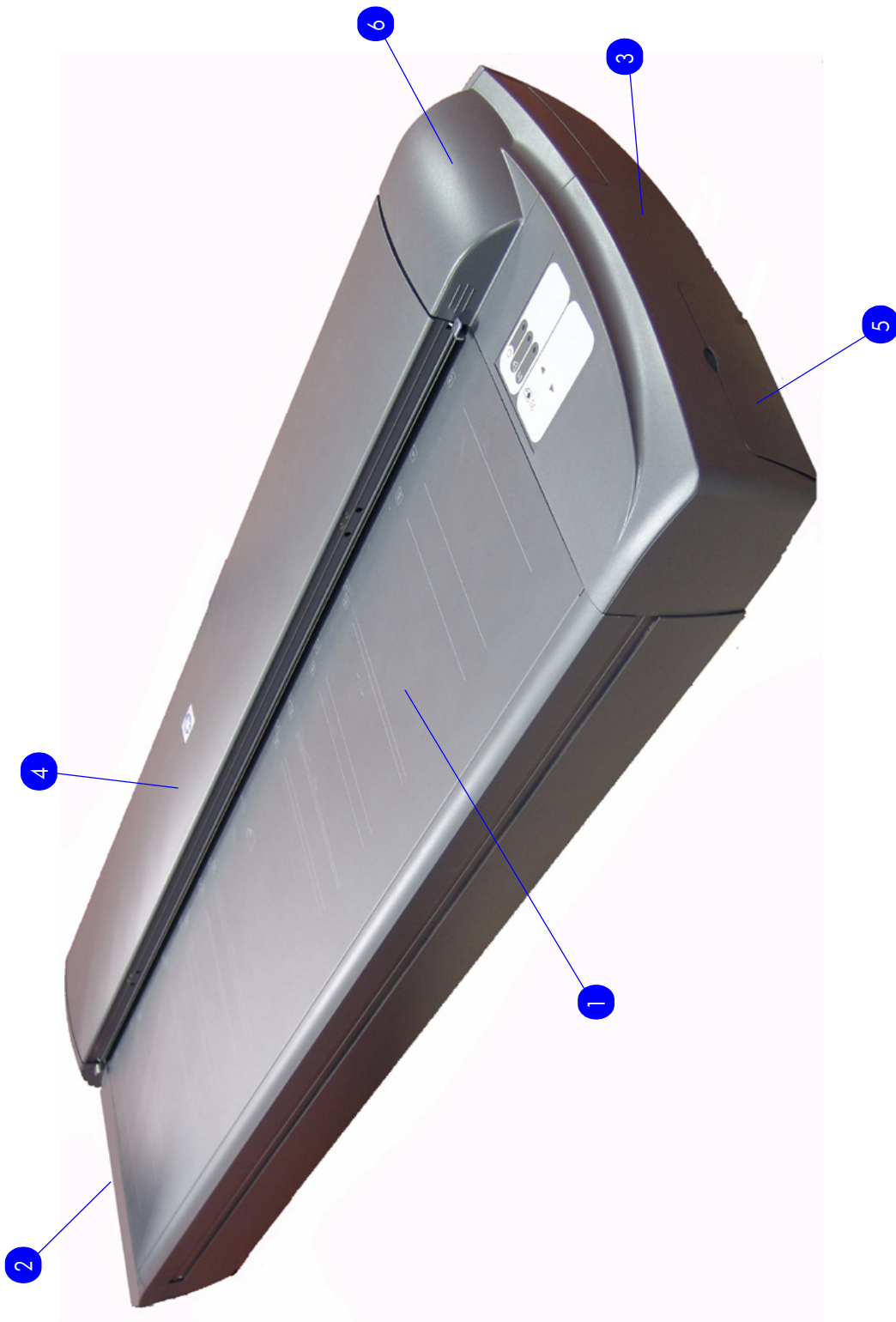

Figure 2: Copier Covers

Top Assemblies

| Copier Stand & Touch Screen | | | | | | |
|-----------------------------|----------------|----------|---------------|--------|---------|---------------------------|
| Reference on Drawing | HP Part Number | Quantity | Scanner Model | | | Description/Comments |
| | | | DJ820 | DJ4500 | DJT1100 | |
| 1 | Q1277-60025 | 1 | x | x | | Guide Plate Assembly |
| | Q6713-60004 | 1 | | | x | Guide Plate Assembly |
| 2 | Q1277-60014 | 1 | x | x | x | Glass Plate |
| 3 | Q1277-60027 | 1 | x | x | x | White Background Assembly |
| 4 | Q1277-60013 | 1 | x | x | x | Fluorescent Lamp |

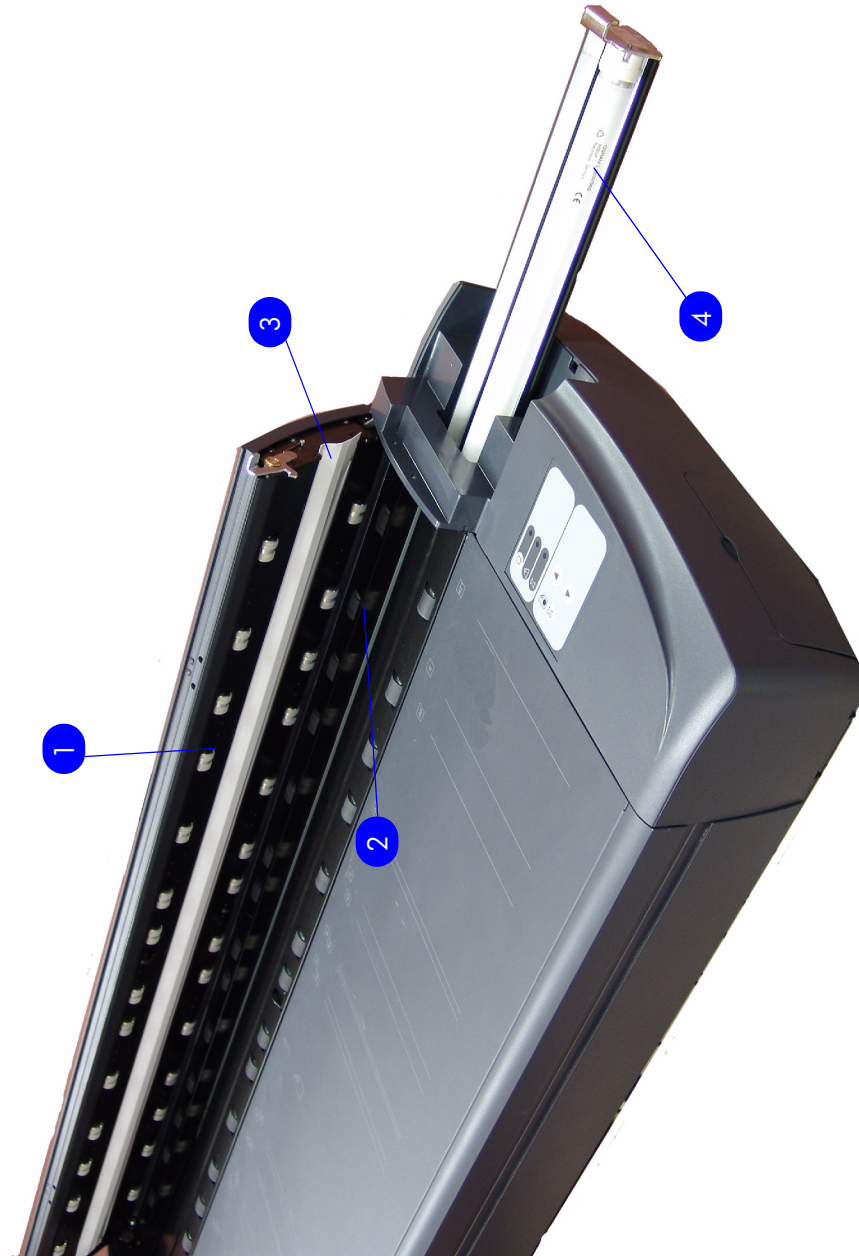

Figure 3: Top Assemblies

Inside Guide Plate

| Copier Stand & Touch Screen | | | | | | |
|-----------------------------|----------------|----------|---------------|--------|---------|-------------------------------|
| Reference on Drawing | HP Part Number | Quantity | Scanner Model | | | Description/Comments |
| | | | DJ820 | DJ4500 | DJT1100 | |
| 1 | Q1277-60005 | 1 | x | x | x | MDA Board |
| 2 | Q1277-60008 | 1 | x | x | x | Opto Interrupter media sensor |
| 3 | Q1277-60011 | 1 | x | x | | Elevation Motor |
| | Q6713-60002 | 1 | | | x | Elevation Moror |

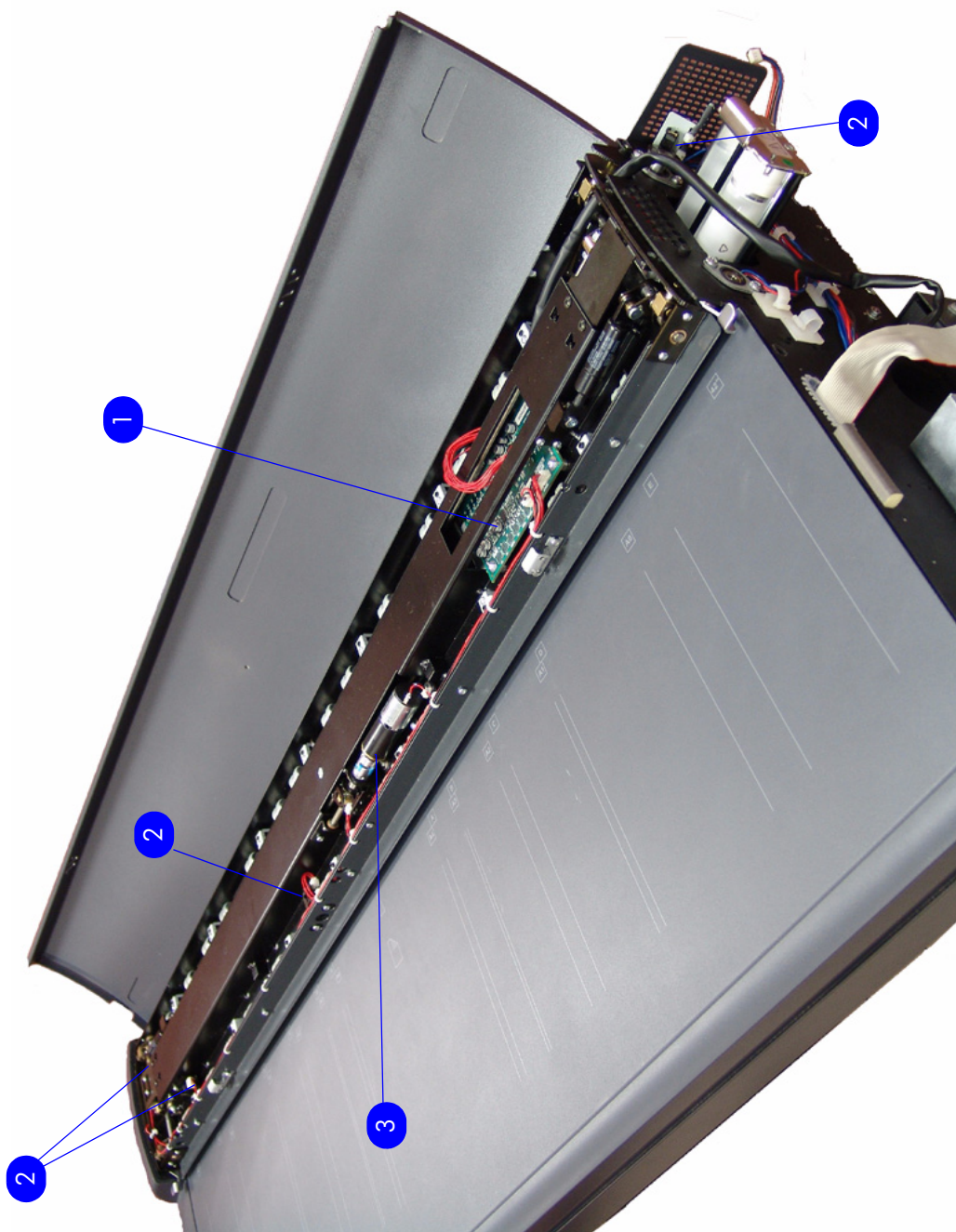

Figure 4: Inside Guide Plate

Drive Assemblies

| Copier Stand & Touch Screen | | | | | | |
|-----------------------------|----------------|----------|---------------|--------|---------|---|
| Reference on Drawing | HP Part Number | Quantity | Scanner Model | | | Description/Comments |
| | | | DJ820 | DJ4500 | DJT1100 | |
| 1 | Q1277-60018 | 1 | x | x | x | Roller Shields |
| 2 | Q1277-60015 | 1 | x | x | x | Rollers |
| 3 | Q1277-60009 | 1 | x | x | x | Stepper Motor Assembly |
| 4 | Q1277-60016 | 1 | x | x | x | Belt |
| 5 | Q1277-60091 | 1 | x | x | x | Entry Media Sensor (included in Media Sensor Kit) |
| 6 | Q1277-60091 | 1 | x | x | x | Exit Media Sensor (included in Media Sensor Kit) |
| 7 | Q1261-60008 | 1 | x | x | x | Stitching Wire |

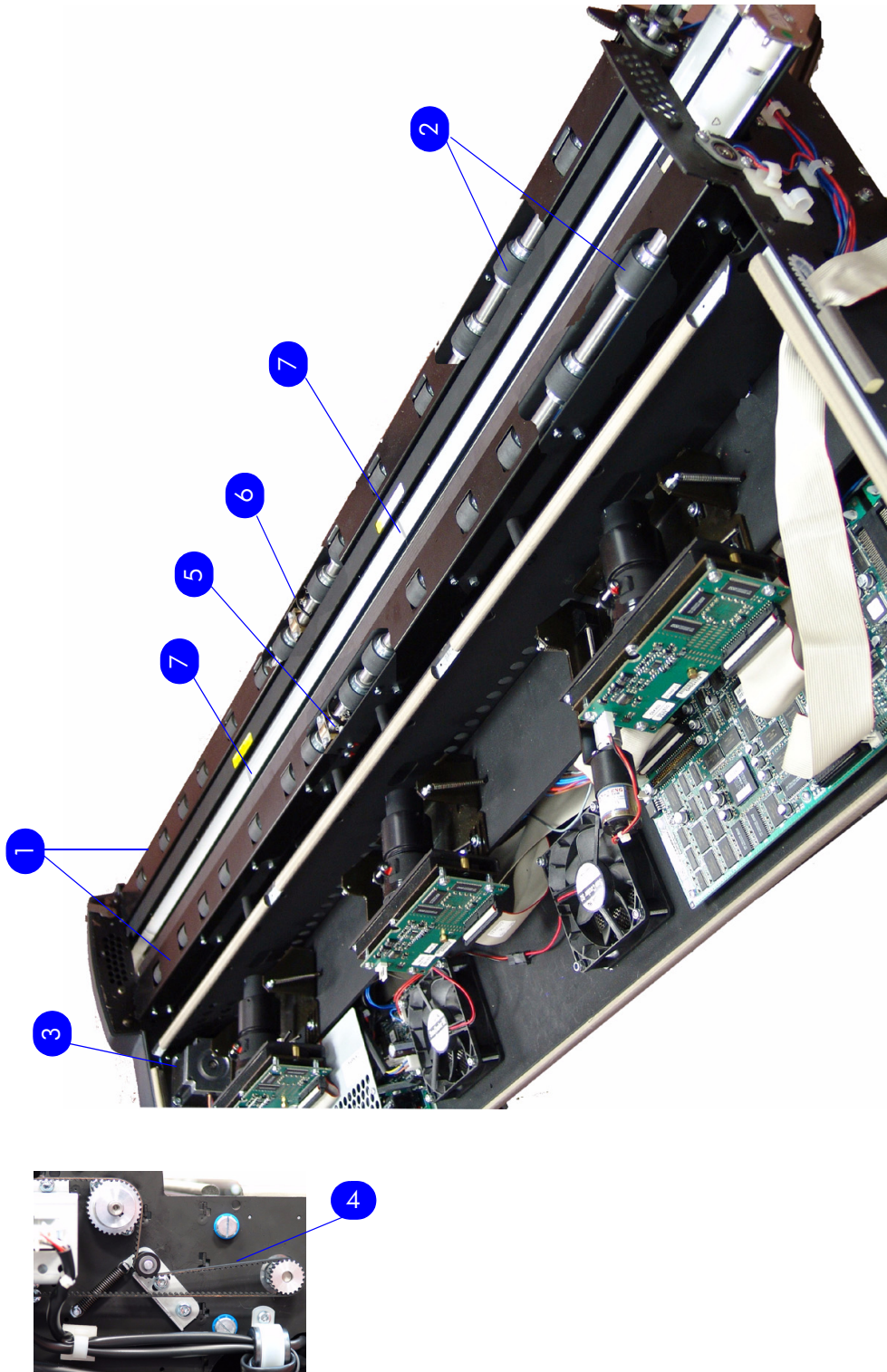

Figure 5: Drive Assemblies

Camera Components and Fan

| Copier Stand & Touch Screen | | | | | | |
|-----------------------------|----------------|----------|---------------|--------|---------|---------------------------------|
| Reference on Drawing | HP Part Number | Quantity | Scanner Model | | | Description/Comments |
| | | | DJ820 | DJ4500 | DJT1100 | |
| 1 | Q1277-60002 | 2 | x | x | x | Camera Board |
| 2 | Q1277-60010 | 1 | x | x | x | Camera Motor |
| 3 | Q1277-60012 | 1 | x | x | x | Fan |
| 4 | Q1277-60033 | 1 | x | x | x | Complete Camera (without Motor) |
| 5 | Q1277-60034 | 1 | x | x | x | Complete Camera (with Motor) |

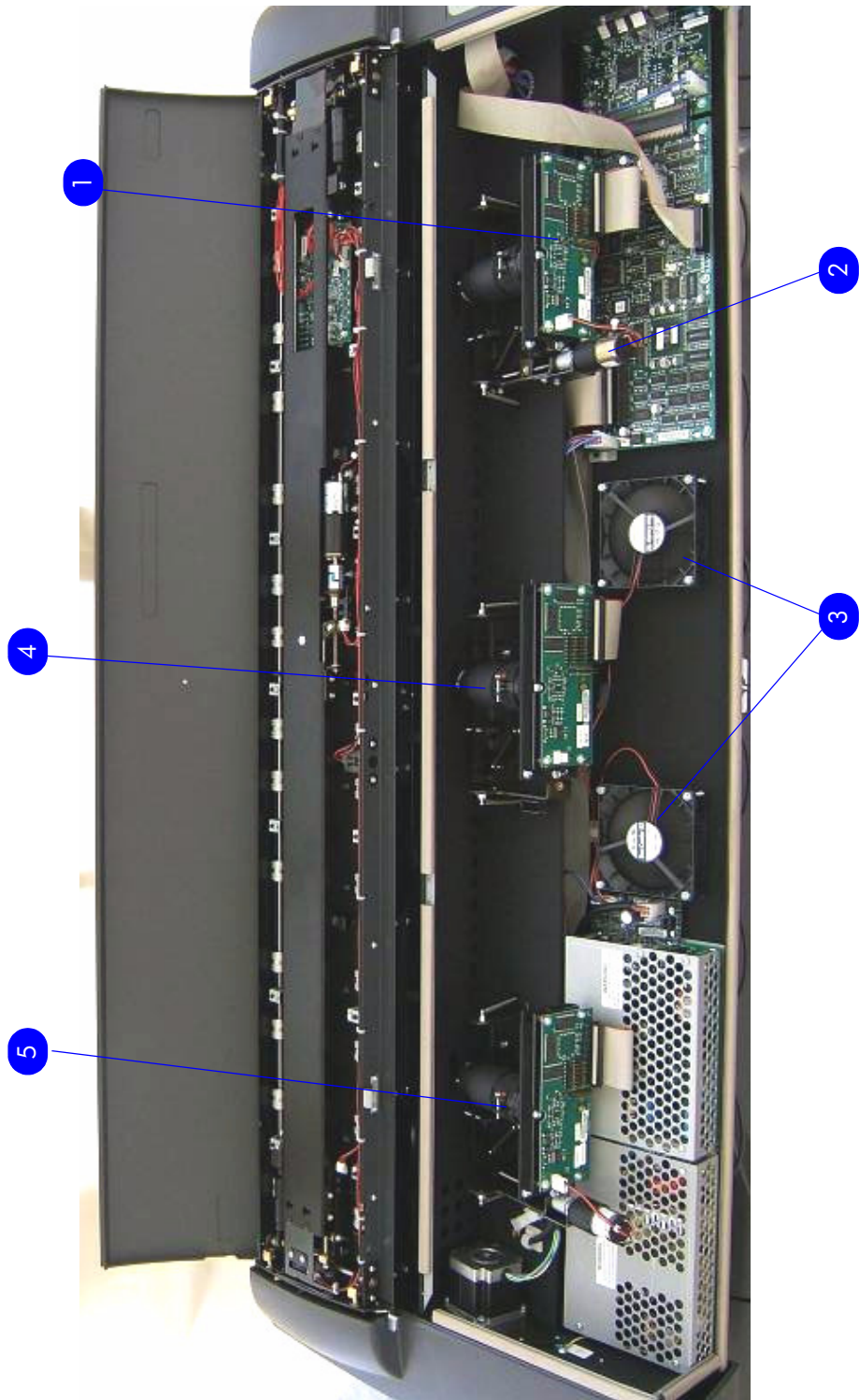

Figure 6: Camera Components and Fan

Electronic Boards

| Copier Stand & Touch Screen | | | | | | |
|-----------------------------|----------------|----------|---------------|--------|---------|----------------------|
| Reference on Drawing | HP Part Number | Quantity | Scanner Model | | | Description/Comments |
| | | | DJ820 | DJ4500 | DJT1100 | |
| 1 | Q1277-60090 | 1 | x | x | x | Scanner PSU |
| 2 | Q1277-60001 | 1 | x | x | x | Driver Board |
| 3 | Q1277-60003 | 1 | x | x | | Main Board |
| | Q6713-60001 | 1 | | | x | Main Board |
| 4 | Q1277-60004 | 1 | x | x | x | Interface Board |



Figure 7: Electronic Boards

Touch Screen

| Copier Stand & Touch Screen | | | | | | |
|-----------------------------|----------------|----------|---------------|--------|---------|-----------------------|
| Reference on Drawing | HP Part Number | Quantity | Scanner Model | | | Description/Comments |
| | | | DJ820 | DJ4500 | DJT1100 | |
| 1 | Q1277-60059 | 1 | x | x | x | LCD + Touch Screen |
| 2 | Q1277-60060 | 1 | x | x | x | Touch Screen Inverter |

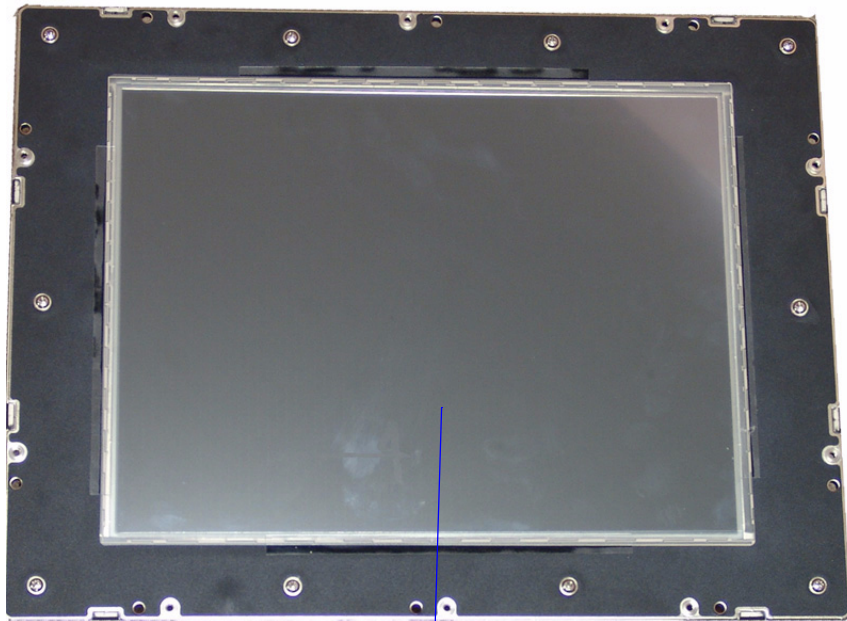

Figure 8: Touch Screen

Touch Screen Cabinet Components (Part 1)

| Copier Stand & Touch Screen | | | | | | |
|-----------------------------|----------------|----------|---------------|--------|---------|----------------------|
| Reference on Drawing | HP Part Number | Quantity | Scanner Model | | | Description/Comments |
| | | | DJ820 | DJ4500 | DJT1100 | |
| 1 | Q1277-60065 | 1 | x | x | x | System Fan |
| 2 | Q1277-60057 | 1 | x | x | x | Power Supply Unit |
| 3 | Q1277-60056 | 1 | x | x | x | Hard Disk Drive |
| 4 | Q1277-60064 | 1 | x | x | x | LCD Controller |
| 5 | Q1277-60061 | 1 | x | x | x | CPU Fan |
| 6 | Q1277-60058 | 1 | x | x | x | SDRAM Memory Module |

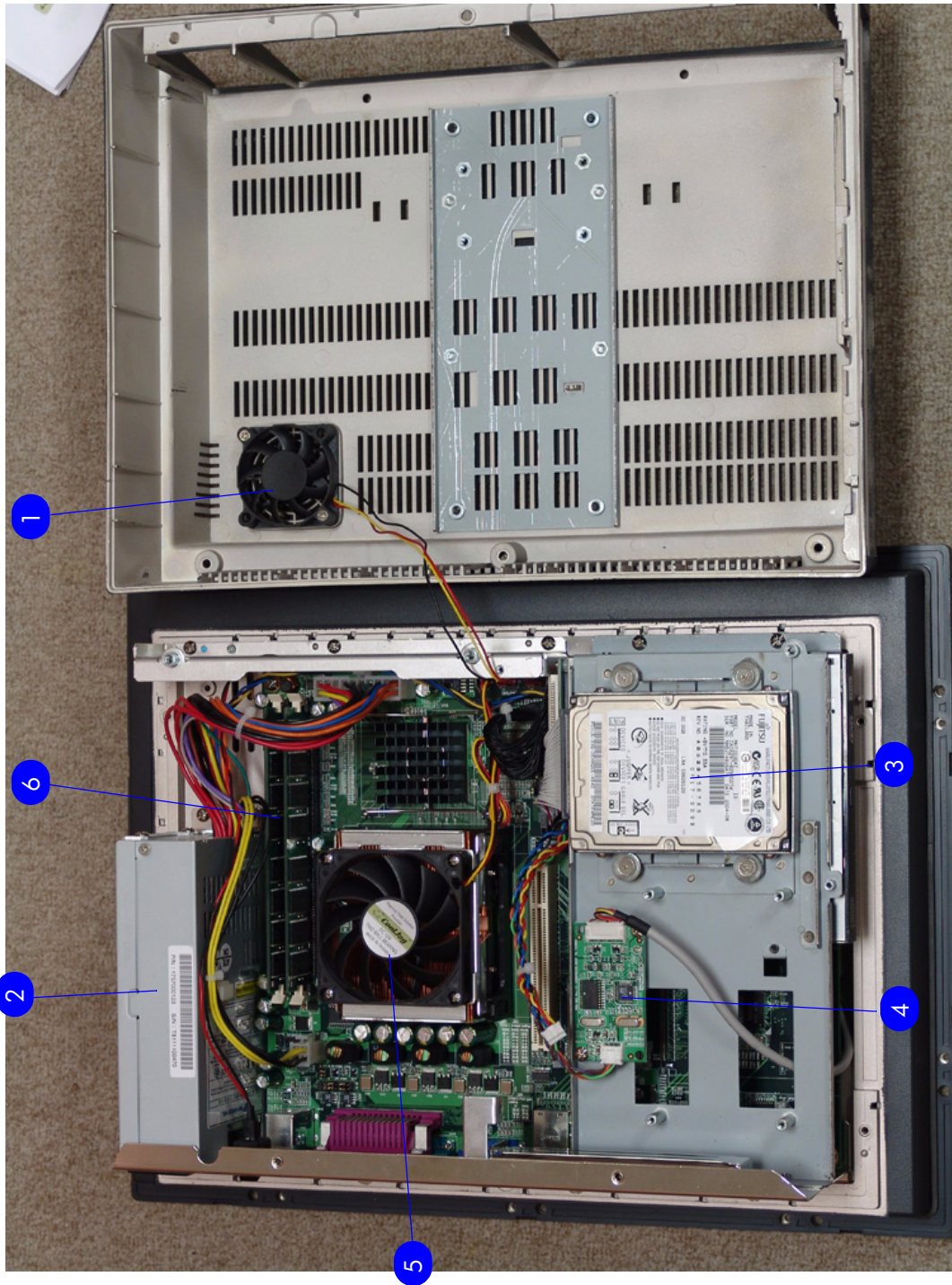

Figure 9: Touch Screen Components (Part 2)

Touch Screen Cabinet Components (Part 2)

| Copier Stand & Touch Screen | | | | | | |
|-----------------------------|----------------|----------|---------------|--------|---------|----------------------|
| Reference on Drawing | HP Part Number | Quantity | Scanner Model | | | Description/Comments |
| | | | DJ820 | DJ4500 | DJT1100 | |
| 1 | Q1277-60054 | 1 | x | x | x | Main Board |
| 2 | Q1277-60055 | 1 | x | x | x | DVD-ROM |
| 3 | Q1277-60062 | 1 | x | x | x | CPU |

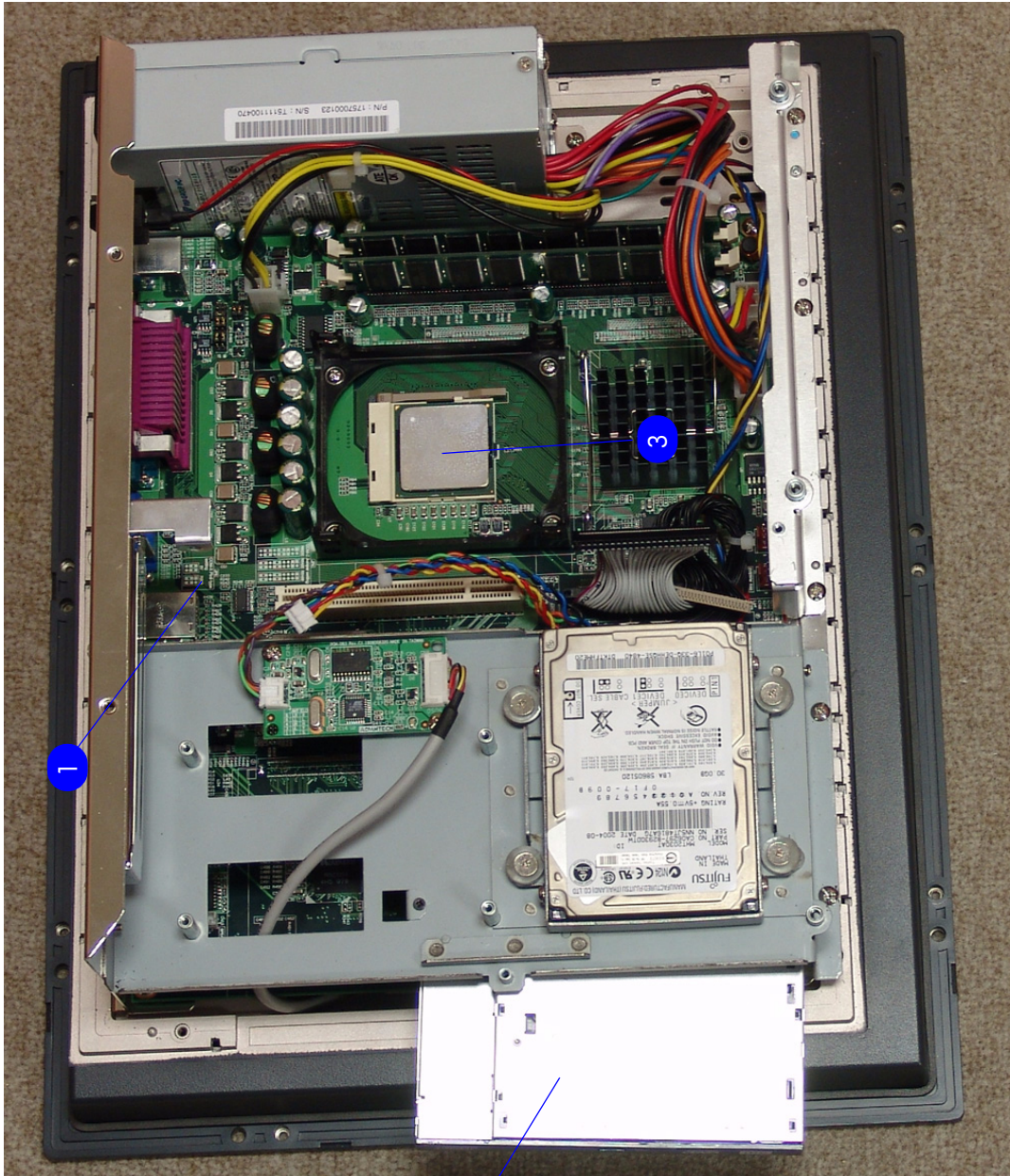

Figure 10: Touch Screen Components (Part 2)

Miscellaneous Items

| Copier Stand & Touch Screen | | | | | | |
|-----------------------------|----------------|----------|---------------|--------|---------|---|
| Reference on Drawing | HP Part Number | Quantity | Scanner Model | | | Description/Comments |
| | | | DJ820 | DJ4500 | DJT1100 | |
| - | Q1277-60030 | 1 | x | x | x | Service Patterns (includes the focus pattern and the calibration sheet) |
| - | Q1277-60031 | 1 | x | x | x | Optical Pattern |
| - | Q1277-60032 | 1 | x | x | x | Calibration Sheet |
| - | Q1261-60044 | 1 | x | x | x | Stylus |
| - | Q1277-60035 | 1 | x | x | x | Harness Assembly |
| - | Q1261-60042 | 1 | x | x | x | A2 Scan Cover |
| - | Q1277-60019 | 1 | x | x | x | Dust Cover 40" |
| - | Q1277-60092 | 1 | x | x | x | Scanner Firewire Cable |
| | Q1277-60084 | 1 | x | x | x | Adjustment Tools for ATAC Sensors |
| | Q1277-60093 | 1 | x | x | x | PPC, Cable harness |
| | Q1277-60094 | 1 | x | x | x | PPC, Power switch button |
| | Q1276-60003 | 1 | x | x | x | Printer Firewire Cable |

Removal and Installation

4

| | |
|------------------------------|------|
| Introduction | 4-3 |
| Top Cover | 4-5 |
| Left Cover | 4-7 |
| Right Cover | 4-9 |
| Rear Cover | 4-13 |
| Top Profile | 4-15 |
| Guide Plate | 4-18 |
| Glass Plate | 4-23 |
| Entry Roller Shield | 4-24 |
| Exit Roller Shield | 4-25 |
| Camera Motor | 4-26 |
| Camera Lens Assembly | 4-27 |
| Camera Board | 4-29 |
| Power Supply Board | 4-31 |
| Driver Board | 4-33 |
| Fan | 4-35 |
| Main Electronics Board | 4-37 |
| Interface Board | 4-39 |
| Stepper Motor | 4-41 |
| Fluorescent Lamp | 4-43 |
| Elevation Motor Driver Board | 4-44 |
| Elevation Motor | 4-47 |
| Entry Roller | 4-50 |
| Exit Roller | 4-56 |
| Exit Roller | 4-65 |
| Exit Media Sensor | 4-67 |
| Belt | 4-68 |
| Bottom Cover | 4-70 |
| Mirror Chassis | 4-73 |
| Stitching Wire | 4-76 |
| White Background Assembly | 4-78 |
| Panel PC | 4-79 |
| Open Cabinet | 4-79 |
| Screen Bezel | 4-82 |
| LCD | 4-83 |
| Back Plate | 4-84 |
| CPU Cooling Fan | 4-86 |

CPU 4-87
DRAM PCA 4-88
The DVD 4-89
The Hard Disk Drive 4-91
LCD Controller PCA 4-92
Inverter PCA 4-93
HDD/DVD Deck 4-94
Main PCA 4-96
Power Supply Unit 4-98
System Fan 4-100

Introduction

This chapter is a step by step guide to the removal and installation of the key components in the product. You may find it useful to tick off the steps as they are performed. Use the illustration at each procedure to identify the parts referred to in the text.

The procedures appear in order of removal. So the whole product can be stripped down by starting at the beginning of this chapter and working through the subsequent procedures.

Safety Precautions

Review WARNING and CAUTION instructions before you service the product. Follow these warnings and cautions for your protection and to avoid damaging the product.

Serious shock hazard leading to death or injury may result if you do not take the following precautions:

Ensure that the AC power outlet (mains) has a protective earth (ground) terminal.

Switch off the printer, the scanner, and the PC, and then disconnect them from the power source prior to performing any maintenance.

Prevent water or other liquids from running onto electrical components or circuits, or through openings in the module.

Electrostatic Discharge (ESD) Precautions

To prevent damage to the product circuits from high-voltage electrostatic discharge (ESD):

1. Do not wear clothing that is subject to static build-up.
2. Do not handle integrated circuits (ICs) in carpeted areas.
3. Do not remove an IC or a printed circuit assembly (PCA) from its conductive foam pad or conductive packaging until you are ready to install it.
4. Ground (earth) your body while disassembling and working on the Scanner. This can be done by touching any metallic part of the Scanner.
5. After removing a cover from the Scanner, attach an earthing (ground) lead between the PCA common and earth ground. Touch all tools to earth ground to remove static charges before using them on the Scanner.
6. After removing any PCA from the Scanner, place it on a conductive foam pad or into its conductive packaging to prevent ESD damage to any ICs on the PCA.

Required Tools

The following tools are required to disassemble and repair the Scanner:

- Screwdriver (0.8 x 5)
- 1.3 mm Allen Key
- 1.5 mm Allen Key
- 5.5 mm Wrench
- 6 mm Wrench
- 7 mm Wrench
- 8 mm Wrench
- 13 mm Wrench
- Torx 5 L shape
- Torx 6 L shape
- Torx 8 L shape
- Torx 9 L shape
- Torx 10 L shape
- Torx 20 L shape
- Philips PH1 Screw driver
- Philips PH2 Screwdriver

Top Cover

Removal

Switch off the printer, the scanner, and the PC, and then disconnect them from the power source prior to performing any maintenance.

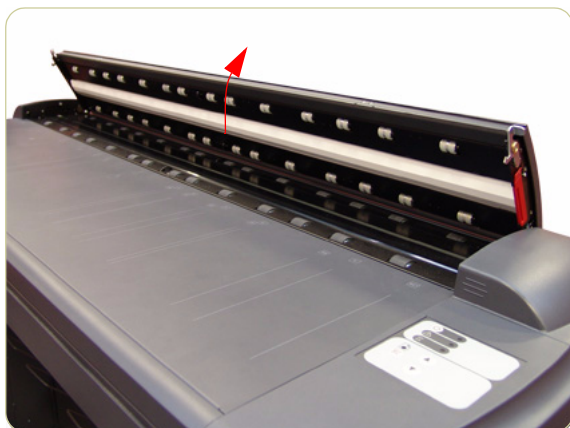

1. Open the Guide Plate.



2. Remove two T20 screws along the lower edge of the Top Cover.



3. Pull the front part of the Top Cover away from the Scanner in order to release the upper part of the Top Cover.



4. Lift up the Top Cover and remove from the Scanner.

Left Cover

Removal

Switch off the printer, the scanner, and the PC, and then disconnect them from the power source prior to performing any maintenance.

1. Remove the Top Cover ⇒ Page 4-5.
2. Remove four T10 screws that secure the Left Cover from underneath.



3. Remove two T20 screws that secure the Left Cover from the side.

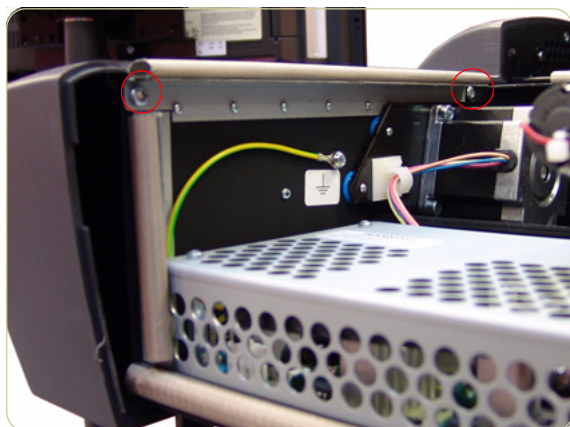

4. Remove one T20 screw that secures the Left Cover from the top.



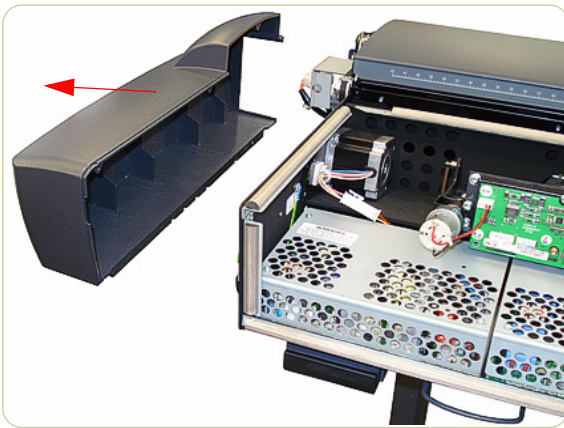

5. Remove the Left Cover from the Scanner.

Right Cover

Removal

Switch off the printer, the scanner, and the PC, and then disconnect them from the power source prior to performing any maintenance.

1. Remove the Top Cover ⇒ Page 4-5.
2. Remove the Fluorescent Lamp Access Cover.



3. Press the metal tab to release the Fluorescent Lamp.

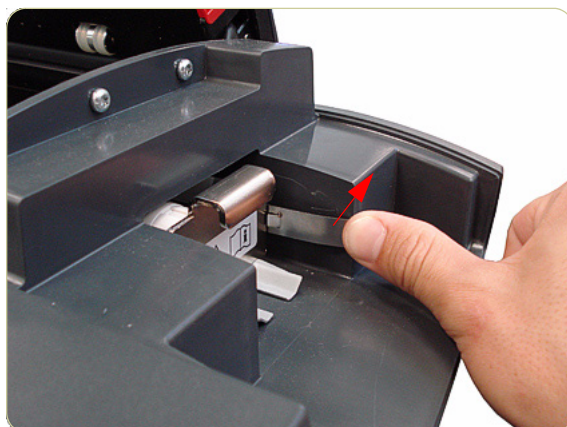

4. Slide out the Fluorescent Lamp.



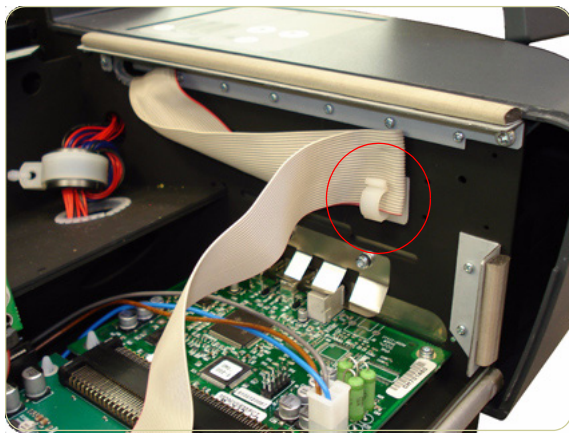

5. Remove the Operator Panel Cable from a cable clamp.

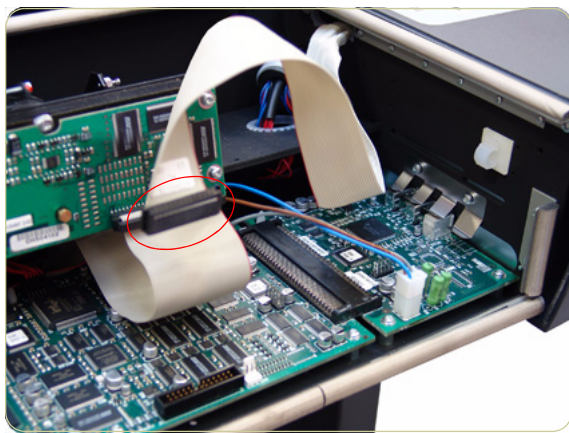

6. Disconnect the Operator Panel Cable from the Main Electronics PCA.



7. Remove four T10 screws that secure the Right Cover from underneath.

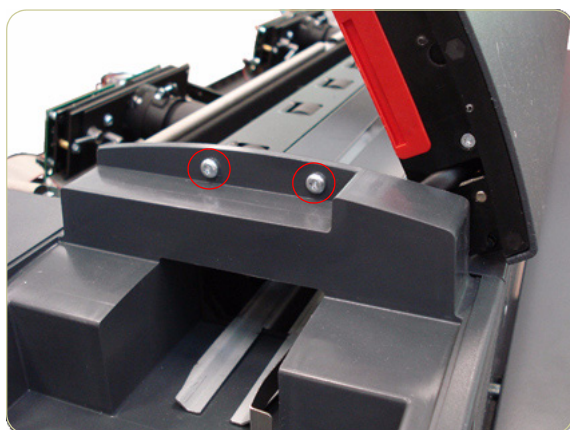

- 8.** Remove two T20 screws that secure the Right Cover from the top.

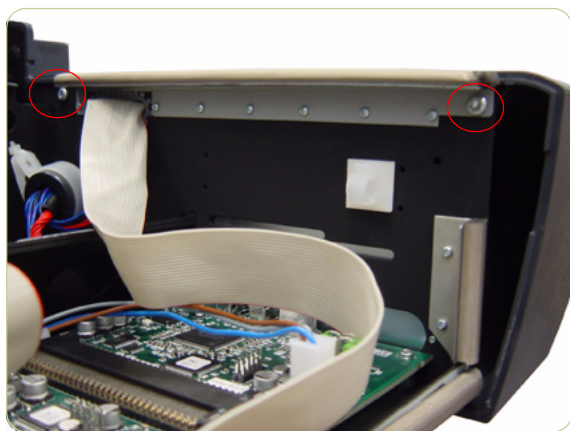

- 9.** Remove two T20 screws that secure the Right Cover from the side.

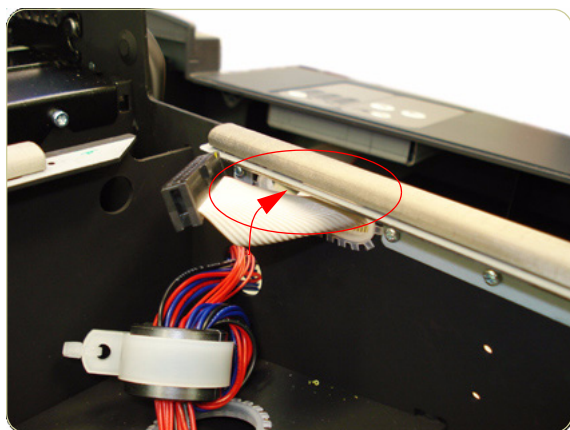

- 10.** Pass the Operator Panel Cable through an access hole.

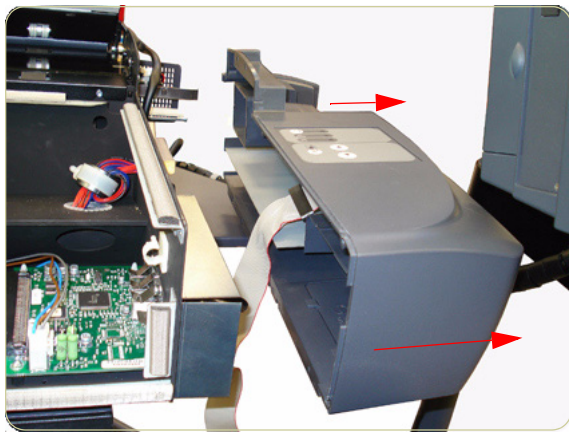

11. Remove the Right Cover from the Scanner.

Rear Cover

Removal

Switch off the printer, the scanner, and the PC, and then disconnect them from the power source prior to performing any maintenance.



1. Remove five T10 screws (and one washer) that secure the Rear Cover to the rear of the Scanner.

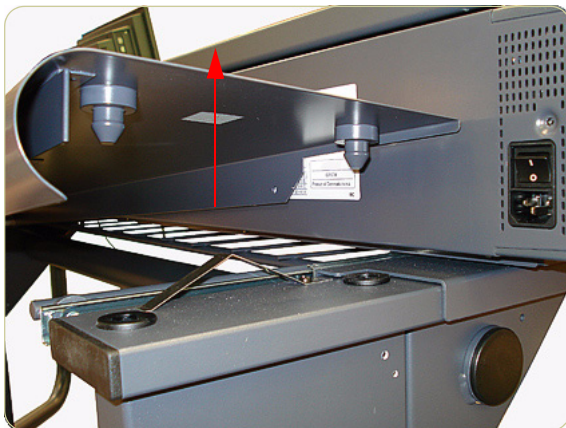

2. Lift up and release the left side of the metal shelf.



3. Lift up and release the right side of the metal shelf.



4. Remove the metal shelf.



5. Remove five T10 screws (and one washer) that secure the Rear Cover to the lower edge of the Scanner.

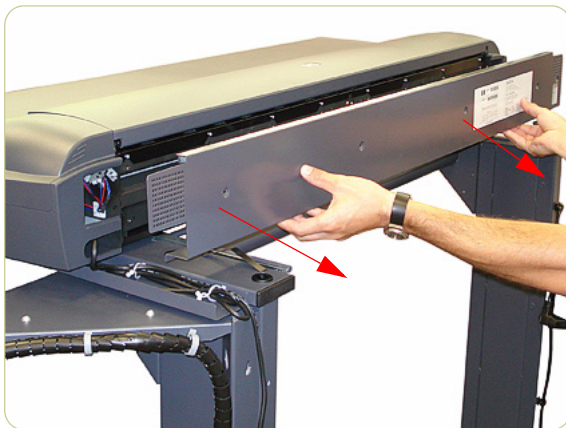

6. Remove the Rear Cover from the Scanner.

Top Profile

Removal

Switch off the printer, the scanner, and the PC, and then disconnect them from the power source prior to performing any maintenance.

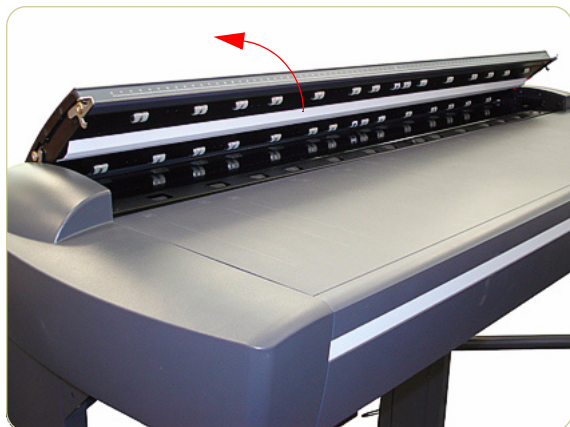

1. Lift the Top Profile cover so that you can access the rule.

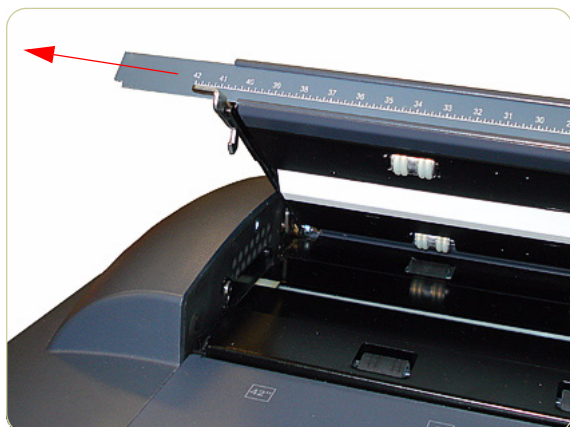

2. Remove the rule from the front of the Guide Plate.

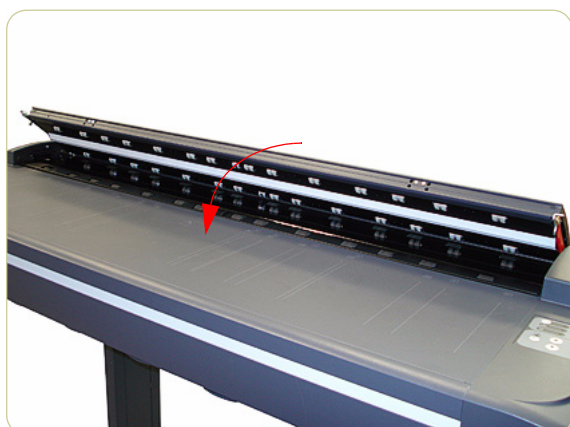

3. Close the Top Profile.

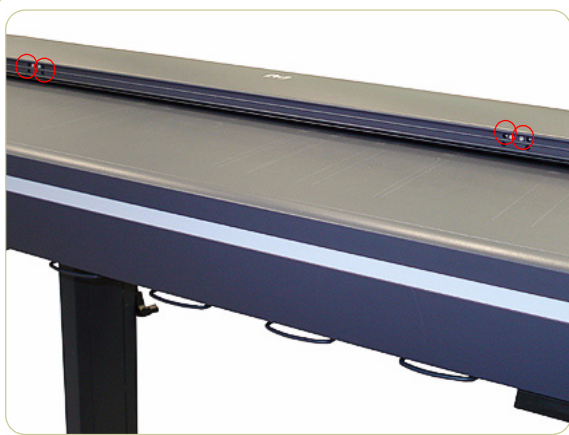

4. Remove four T10 screws that secure the front of the Top Profile to the Guide Plate.



5. Lift up the Top Profile of the Guide Plate.

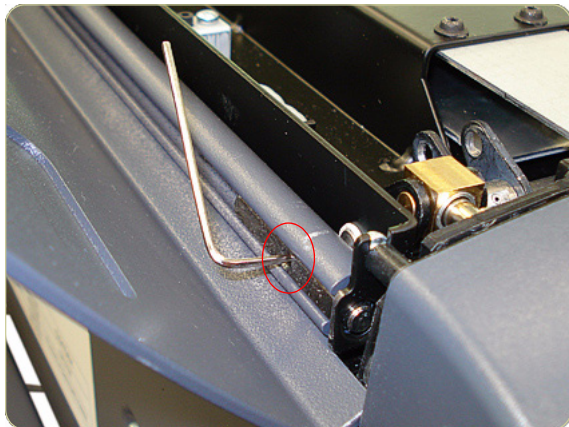

6. Use an Allen key (size 1.5) to loosen the screw at the left side of the scanner.



- 7.** Slide the retainer bar from its fitting to release the left side of the Top Profile.



- 8.** Slide the Top Profile slightly toward the left to release the right side of the Top Profile.

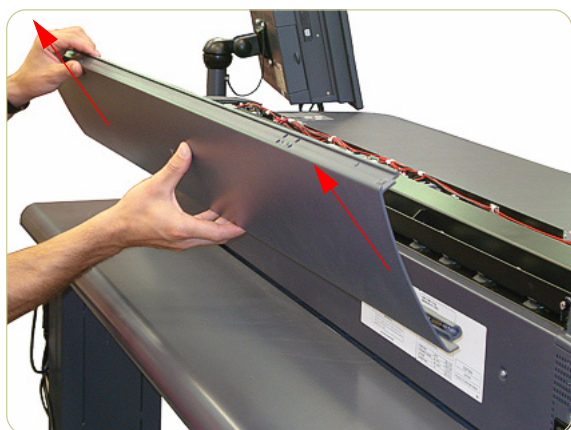

- 9.** Remove the Top Profile.

Guide Plate

Removal

Switch off the printer, the scanner, and the PC, and then disconnect them from the power source prior to performing any maintenance.

1. Remove the Top Cover ⇒ Page 4-5.
2. Remove the Right Cover ⇒ Page 4-9.
3. Remove the Top Profile ⇒ Page 4-15.
4. Disconnect the Guide Plate Cable from the Main Electronics Board (J20) in the Guide Plate.

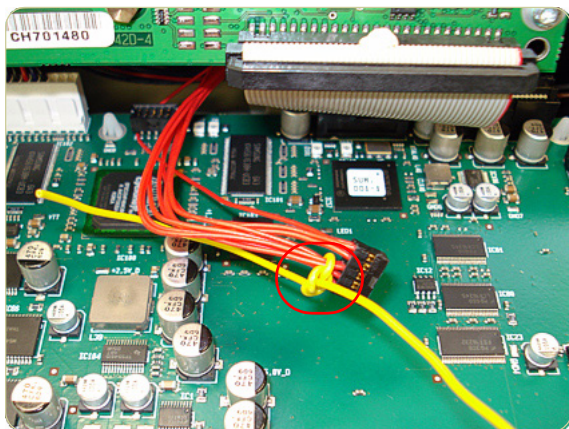
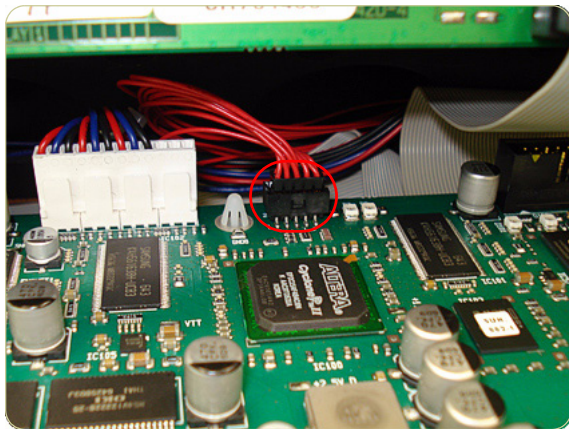

5. Tie a cable or a piece of string (the yellow cable in the photo) to the Guide Plate Cable to facilitate passing the Guide Plate Cable through the access hole.

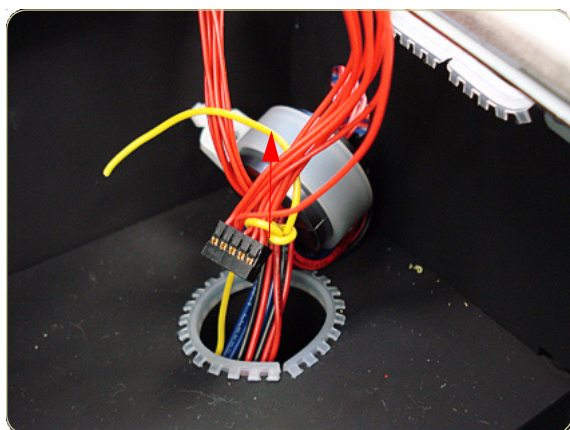

6. Pass the cable through the access hole.

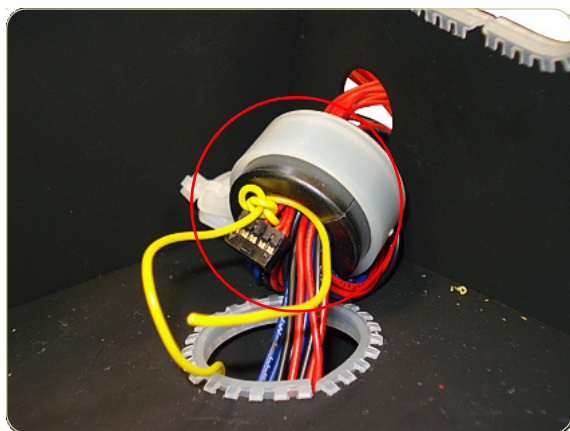

7. Pass the cable through the ferrite core and through the access hole in the side of the chassis.



8. After passing the Guide Plate Cable through the access hole and the ferrite core, detach the cable you used to assist in pulling it through.

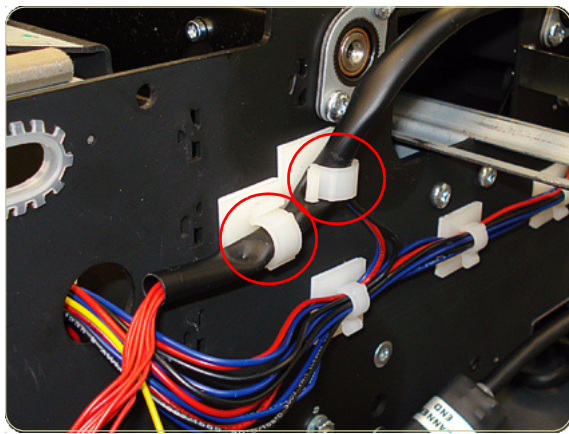

9. Remove the Guide Plate Cable from the cable clamps.

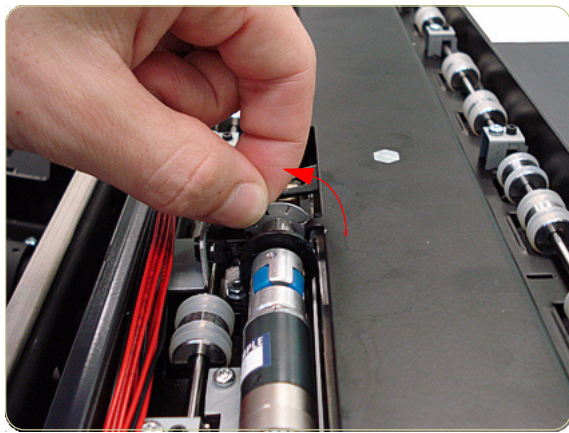

10. The Guide Plate must be in a raised position. Manually rotate the motor wheel **toward you** (as shown in the photo) until it no longer turns.

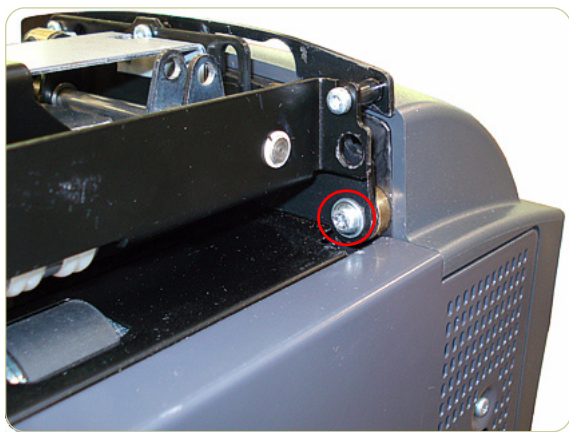

11. Remove one T20 screw that secures the left side of the Guide Plate.

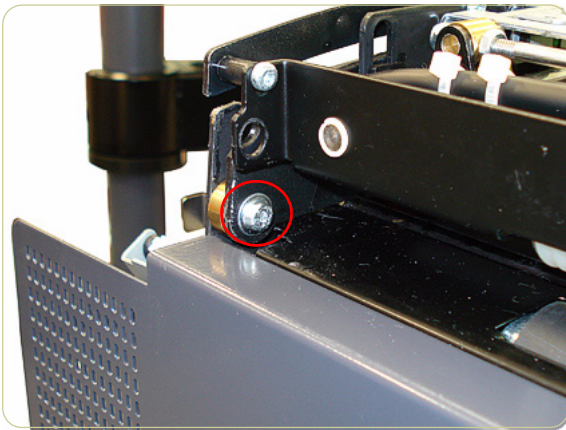

12. Remove one T20 screw that secures the right side of the Guide Plate.

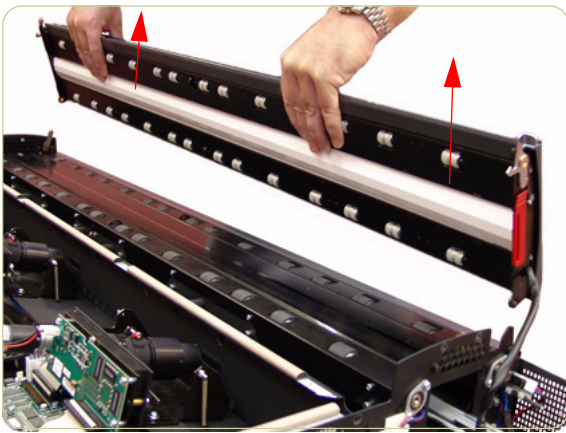

13. Remove the Guide Plate from the Scanner.

Guide Plate

Installation

Switch off the printer, the scanner, and the PC, and then disconnect them from the power source prior to performing any maintenance.

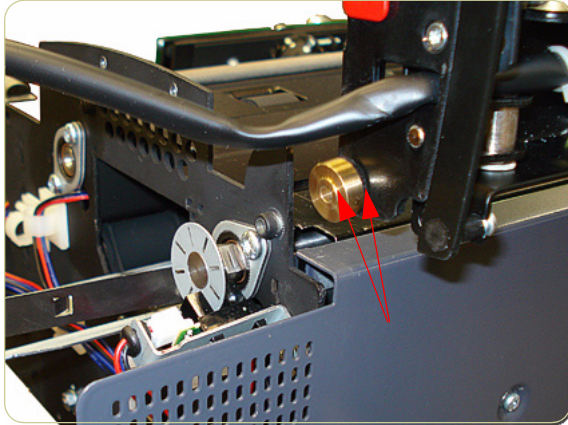

1. On the right side of the scanner, position the brass piece into its fitting as shown in the photo, and then fit the right side of the cover into place.

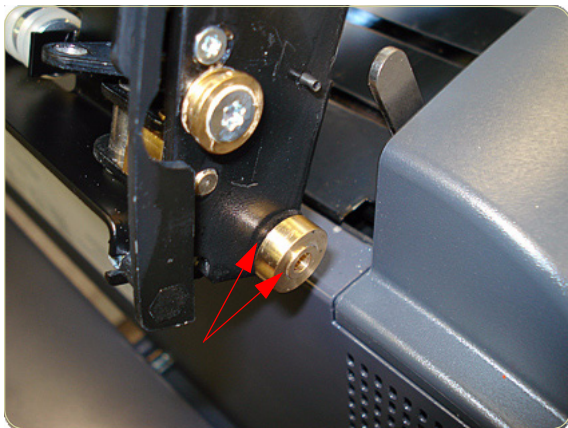

2. On the left side of the scanner, position the brass piece into its fitting as shown in the photo, and then fit the left side of the cover into place.

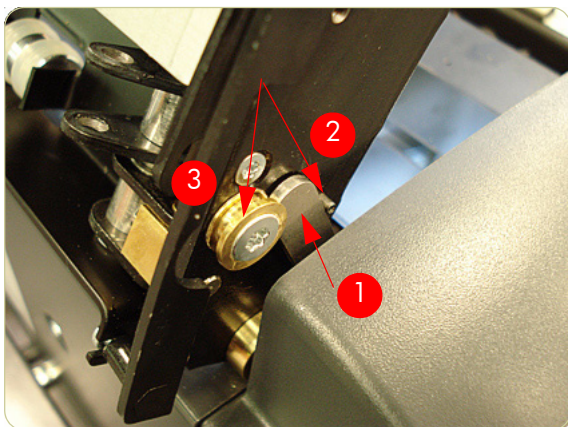

3. When closing the cover, be sure to place the gray lever (1) between the pin (2) and the brass piece (3).

4. To complete the installation of the Guide Plate, follow steps 1-12 from the Guide Plate removal procedure in reverse order.

Glass Plate

Removal

Switch off the printer, the scanner, and the PC, and then disconnect them from the power source prior to performing any maintenance.



1. Open the Guide Plate.
2. Carefully lift up the rear of the Glass Plate at both ends.

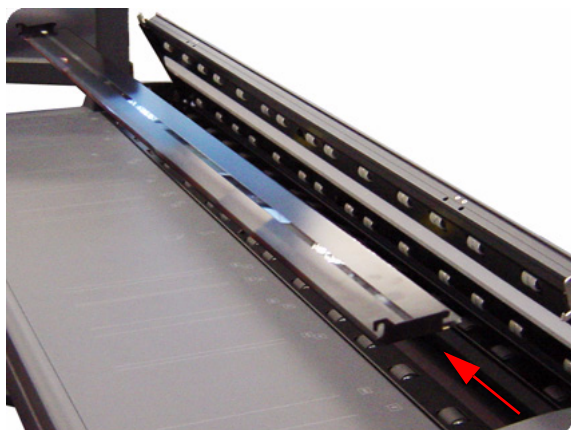

3. Remove the Glass Plate from the Scanner.

Always clean the new glass before installation.

Entry Roller Shield

Removal

Switch off the printer, the scanner, and the PC, and then disconnect them from the power source prior to performing any maintenance.

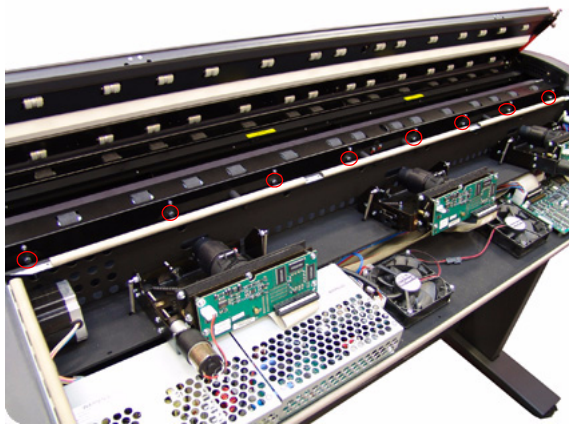

1. Remove the Top Cover ⇒ Page 4-5.
2. Use a size 6 wrench to loosen the eight guide pins on the front side of the Entry Roller Shield.



3. Loosen eight screws on the front side of the Entry Roller Shield.

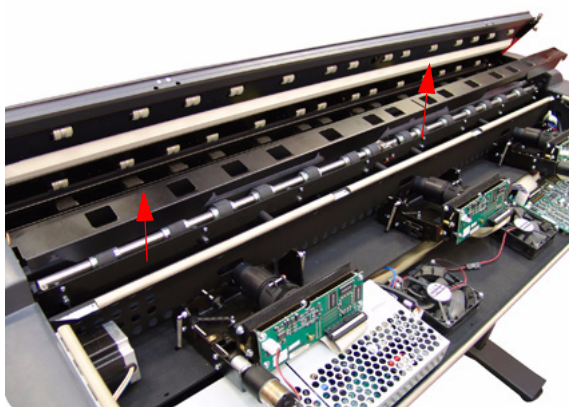

4. Gently remove the Entry Roller Shield from the Scanner. Be careful NOT to bend it or damage it while removing.

Exit Roller Shield

Removal

Switch off the printer, the scanner, and the PC, and then disconnect them from the power source prior to performing any maintenance.

1. Remove the Guide Plate ⇒ Page 4-18.
2. Remove the Rear Cover ⇒ Page 4-13.
3. Use a size 6 wrench to loosen the eight guide pins on the rear side of the Exit Roller Shield.

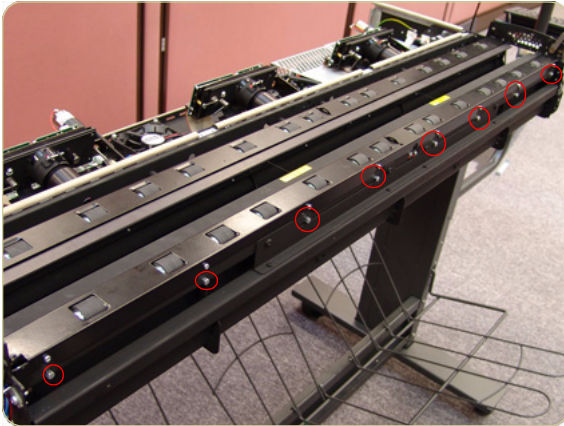

4. Loosen eight T8 screws on the rear side of the Exit Roller Shield.



5. Gently remove the Exit Roller Shield from the Scanner. Be careful NOT to bend it or damage it while removing.



Camera Motor

Removal

Switch off the printer, the scanner, and the PC, and then disconnect them from the power source prior to performing any maintenance.

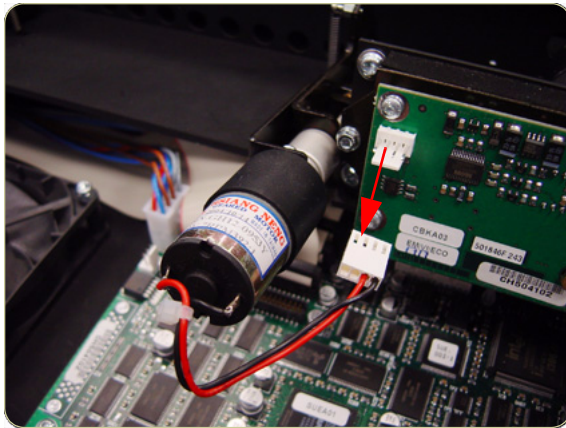

1. Remove the Top Cover ⇒ Page 4-5.
2. Disconnect the Camera Motor cable.

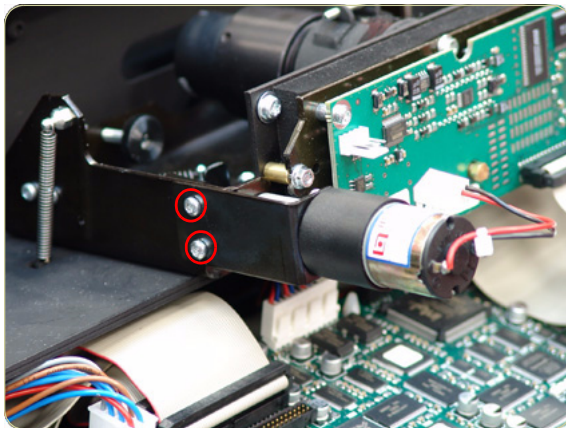

3. Remove the two T10 screws that secure the Camera Motor.

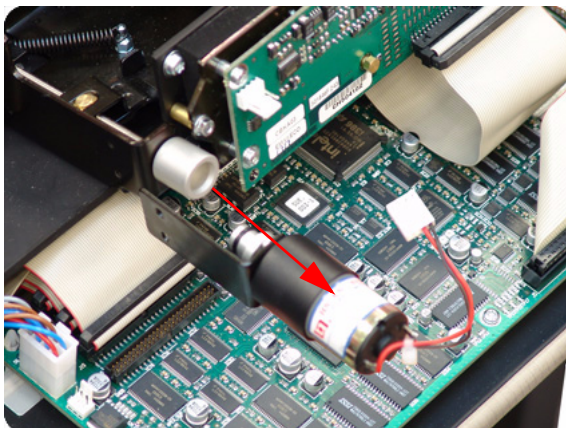

4. Remove the Camera Motor from the Scanner.

After reinstalling the Camera Motor, make sure you run the Scanner Maintenance.

The middle Camera does not have a Motor.

Camera Lens Assembly

Removal

Switch off the printer, the scanner, and the PC, and then disconnect them from the power source prior to performing any maintenance.

1. Remove the Top Cover ⇒ Page 4-5.
2. If installed, remove the Camera Motor ⇒ Page 4-26.
3. Disconnect the cable from the Camera Board.

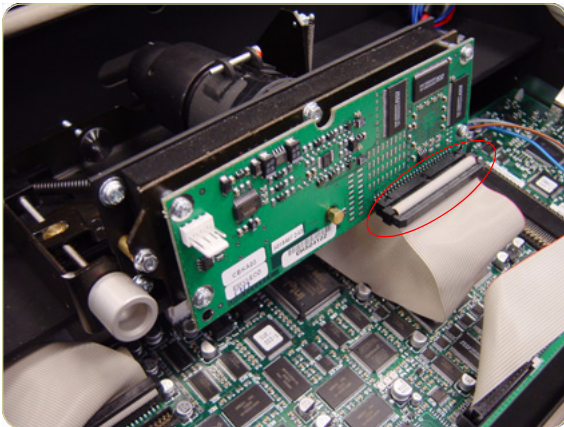

4. Remove three T20 screws that secure the Camera Lens to the Chassis.

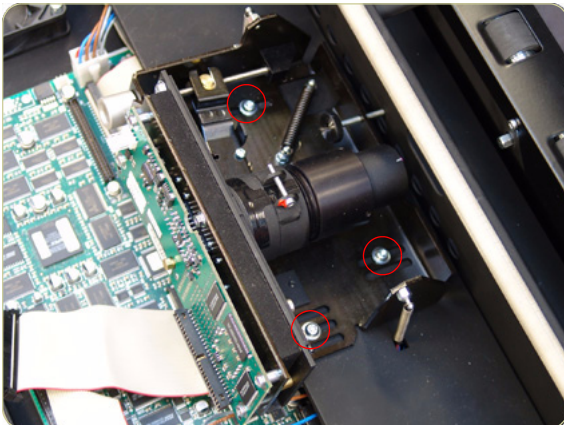

5. Release three springs that secure the Camera Lens to the Chassis.



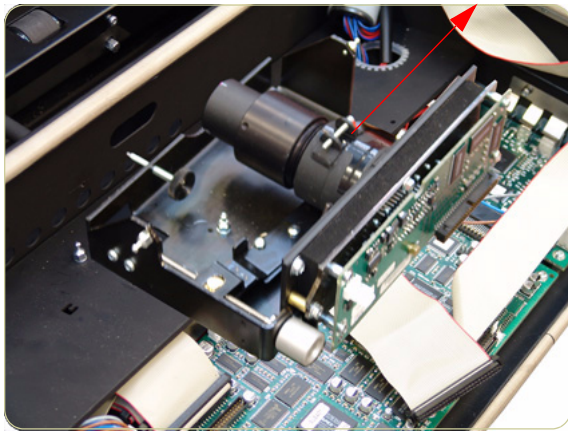

6. Remove the Camera Lens Assembly from the Scanner.

Make sure you perform the Camera Adjustment procedure after replacing the Camera Lens.

Camera Board

Removal

Switch off the printer, the scanner, and the PC, and then disconnect them from the power source prior to performing any maintenance.

1. Remove the Top Cover ⇒ Page 4-5.
2. If installed, remove the Camera Motor ⇒ Page 4-26.
3. Disconnect the cable from the Camera Board.

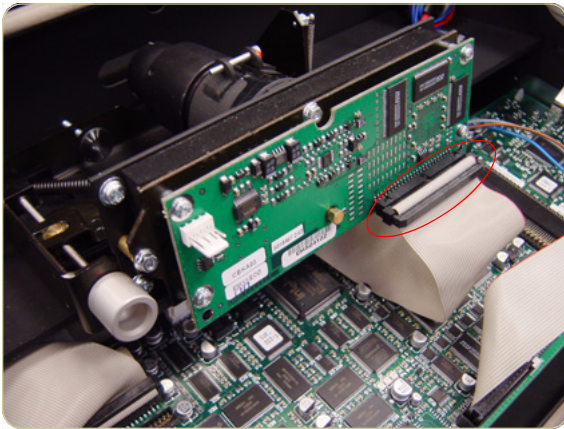

4. Using a size 5.5 wrench, remove the three nuts that secure the Camera Board from the front.

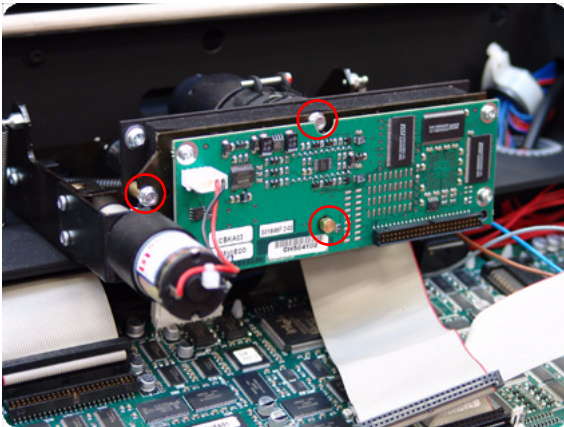

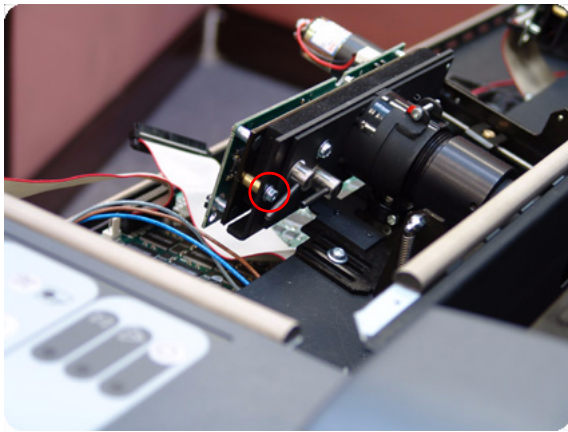

5. Using a size 5.5 wrench, remove one nut that secures the Camera Board from the rear.

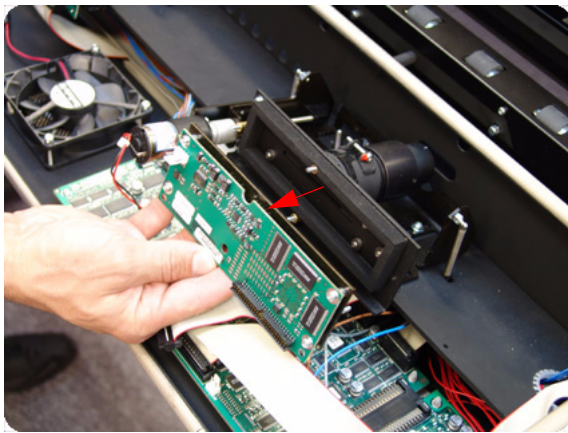

6. Remove the Camera Board.

Power Supply Board

Removal

Switch off the printer, the scanner, and the PC, and then disconnect them from the power source prior to performing any maintenance.

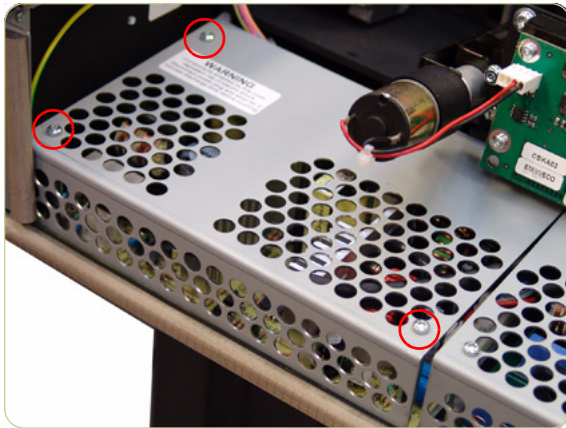

1. Remove the Top Cover ⇒ Page 4-5.
2. Remove three T10 screws that secure the Metal Shield that covers the Power Supply Board.

The components underneath the Metal shield represent a risk of electric shock, once the power has been disconnected allow three minutes discharge time before touching.

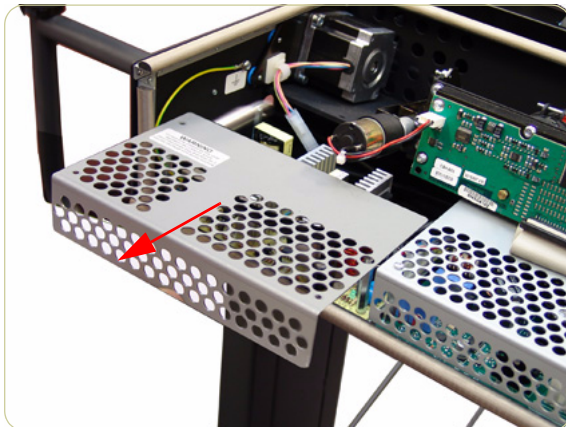

3. Remove the Metal Shield.



4. Remove the T20 screw that secures the grounding cable to the chassis and disconnect ALL the cables from the Power Supply Board.

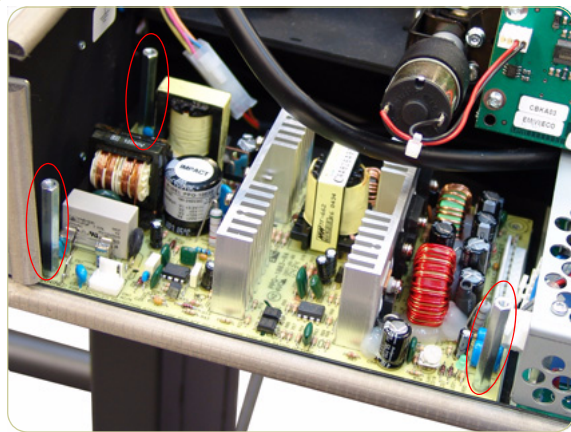

5. Remove the three bolts that secure the Power Supply Board.

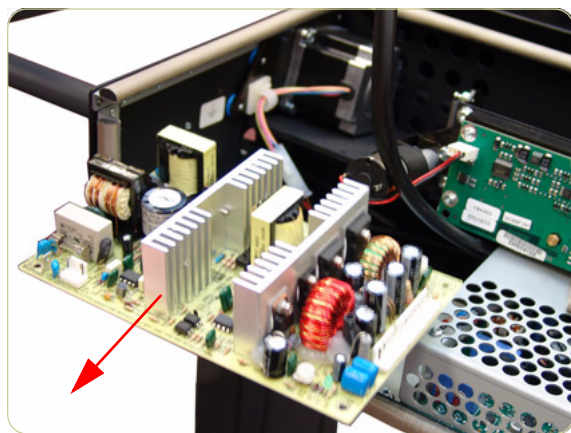

6. Remove the Power Supply Board from the Scanner.

Driver Board

Removal

Switch off the printer, the scanner, and the PC, and then disconnect them from the power source prior to performing any maintenance.

1. Remove the Top Cover ⇒ Page 4-5.
2. Remove Left Camera Lens Assembly ⇒ Page 4-27
3. Remove three T10 screws from the Metal Shield that covers the Driver Board.



The components underneath the Metal shield represent a risk of electric shock, once the power has been disconnected allow three minutes discharge time before touching.

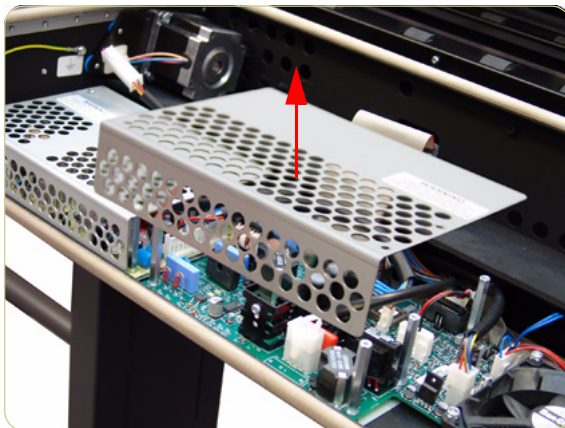

4. Remove the Metal Shield.

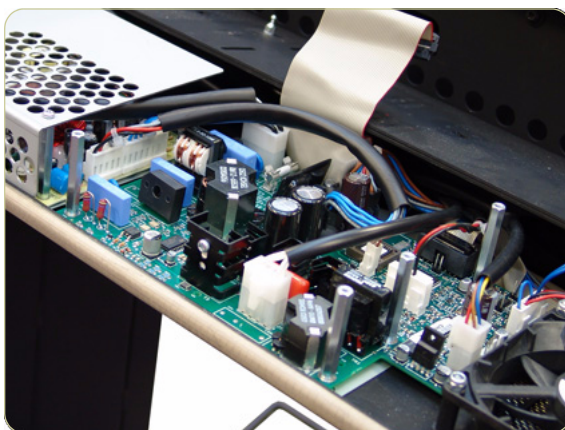

5. Disconnect ALL the cables from the Driver Board.

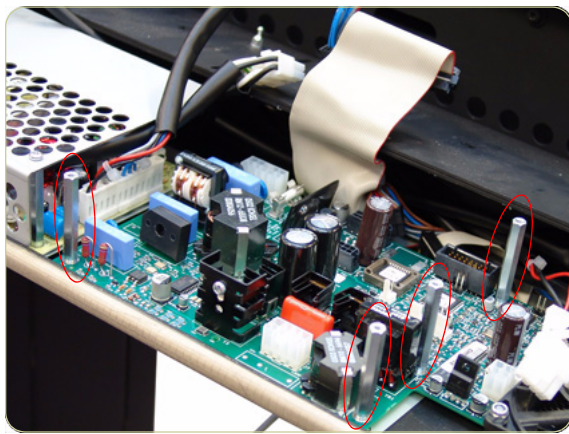

6. Remove four bolts that secure the Driver Board.

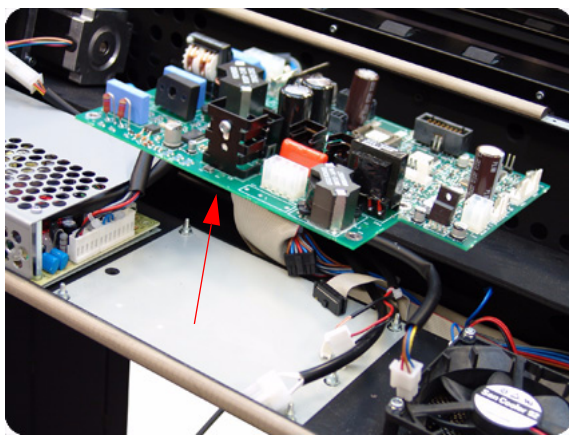

7. Remove the Driver Board from the Scanner.

Fan

Removal

Switch off the printer, the scanner, and the PC, and then disconnect them from the power source prior to performing any maintenance.

1. Remove the Top Cover ⇒ Page 4-5.
2. Pull out the metal paper bin to gain access to the Fan Filter.

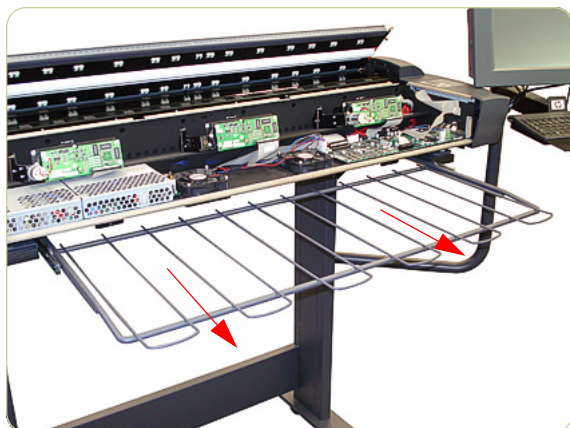

3. Unclip the Fan Filter from underneath the Scanner.

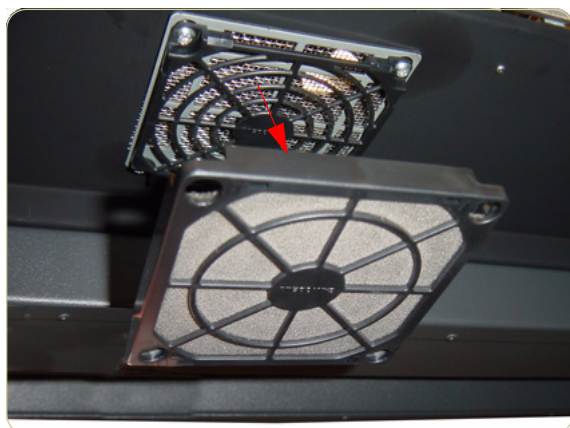

4. Gripping the nuts from the top, remove the four T20 screws from the bottom that secure the Fan.



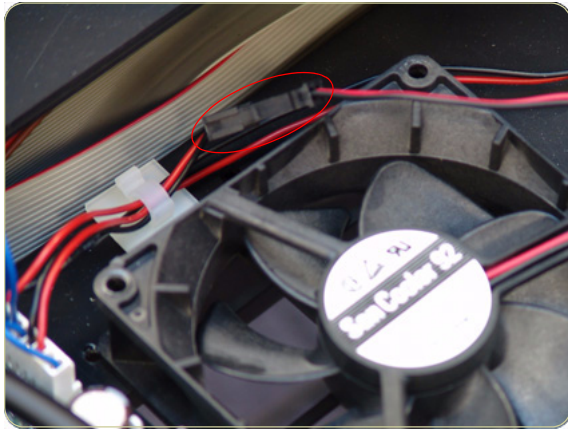

5. Disconnect the Fan Cable.

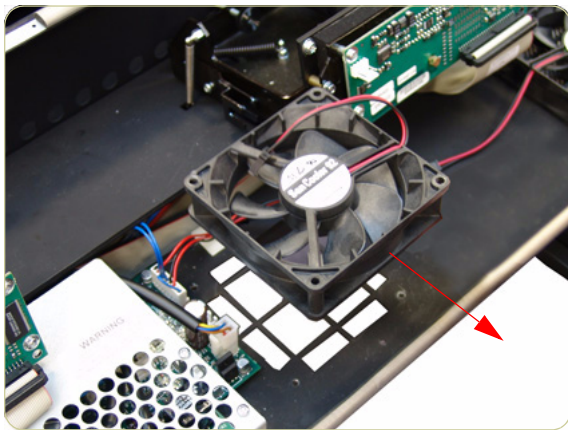

6. Remove the Fan from the Scanner.

Main Electronics Board

Removal

Switch off the printer, the scanner, and the PC, and then disconnect them from the power source prior to performing any maintenance.

1. Remove the Top Cover ⇒ Page 4-5.
2. Disconnect ALL the cables from the Main Electronics Board.

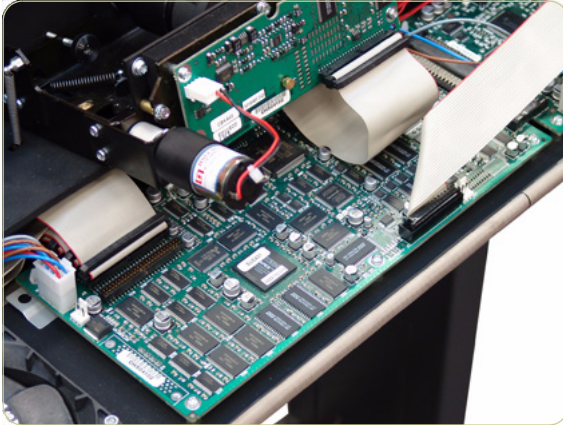

3. Remove three T10 screws that secure the Main Electronics Board.

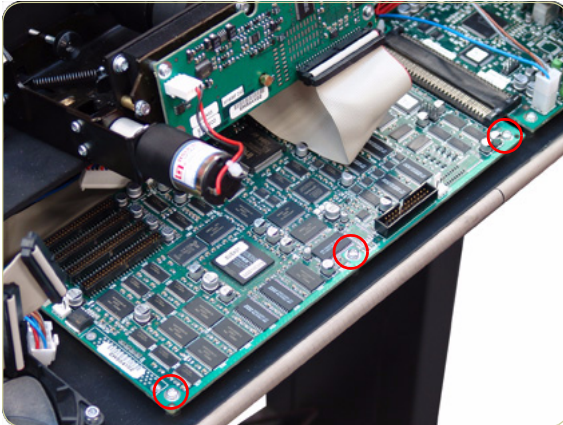

4. Move the Main Electronics Board to the left to disconnect it from the connector and to release it from the three plastic locators (located at the rear of the Board).

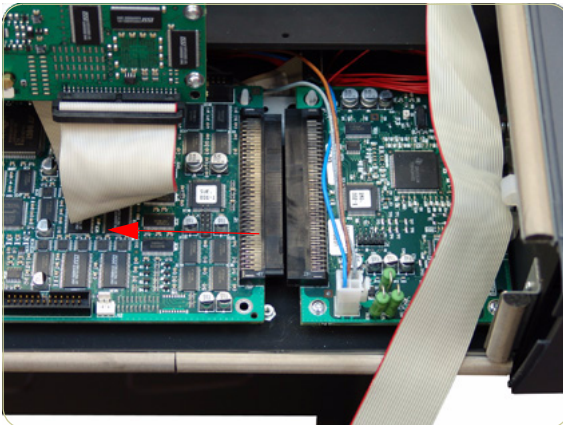

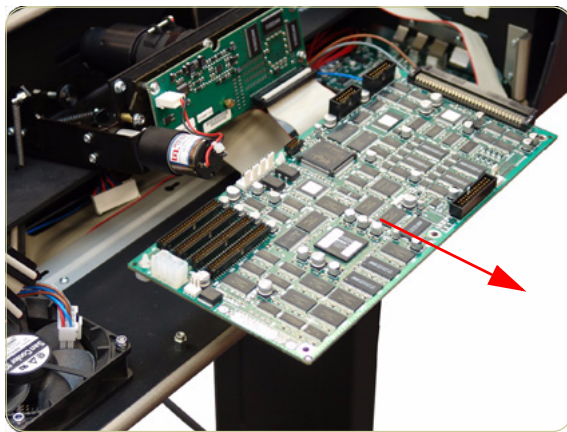

5. Remove the Main Electronics Board from the Scanner.

After reinstalling the Main Electronics Board, make sure you run the Scanner Maintenance and the ATAC Calibration ⇒ Page 5-32.

Interface Board

Removal

Switch off the printer, the scanner, and the PC, and then disconnect them from the power source prior to performing any maintenance.

1. Remove the Top Cover ⇒ Page 4-5
2. Remove the Main Electronics Board ⇒ Page 4-37.
3. Disconnect the cable from the board.



4. Remove two T10 screws that secure the board.



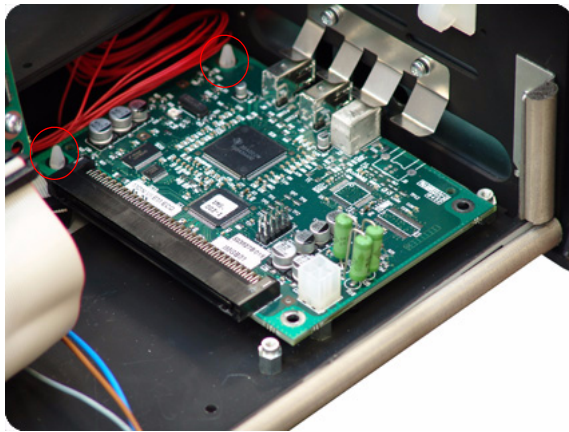

5. Release the board from the two plastic locators located at the rear.

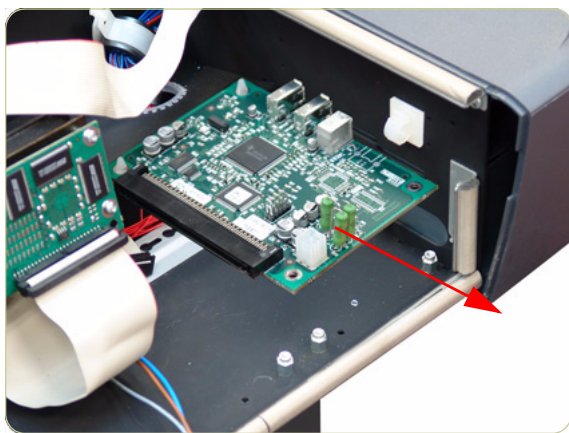

6. Remove the Interface board from the Scanner.

Stepper Motor

Removal

Switch off the printer, the scanner, and the PC, and then disconnect them from the power source prior to performing any maintenance.

1. Remove the Top Cover ⇒ Page 4-5.
2. Remove the Left Cover ⇒ Page 4-7.
3. Disconnect the Stepper Motor cable.

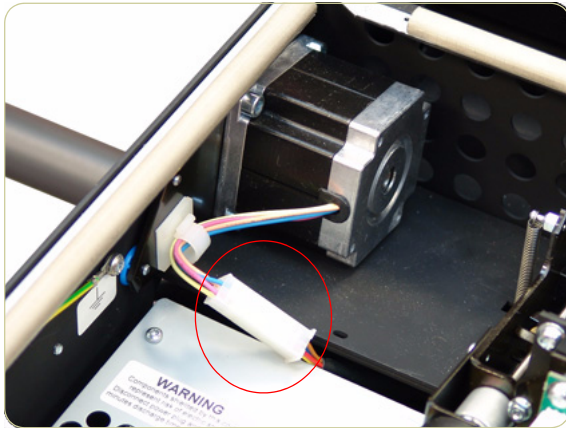

4. Loosen two T20 screws on the Belt Tensioner Bracket.

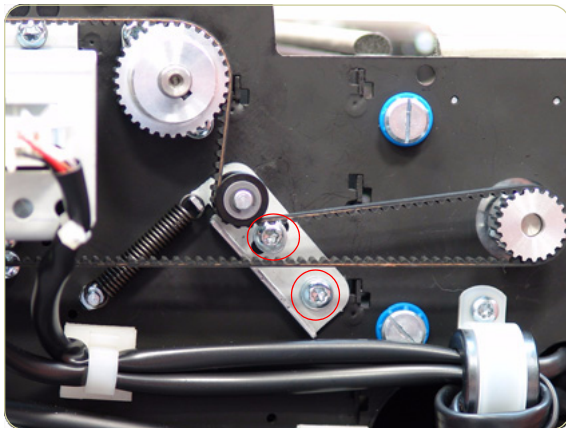

5. Push the belt tensioner assembly to the right to release the belt from the Stepper Motor Pulley.

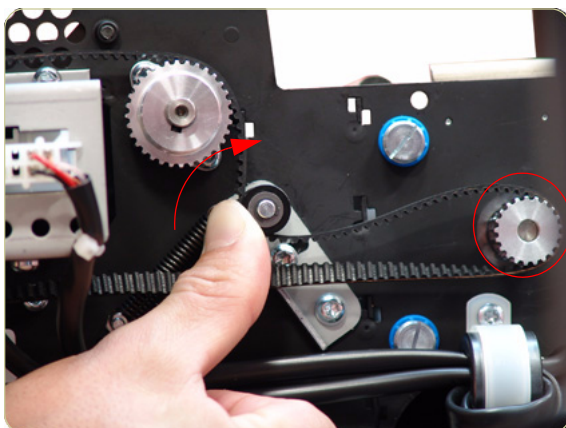

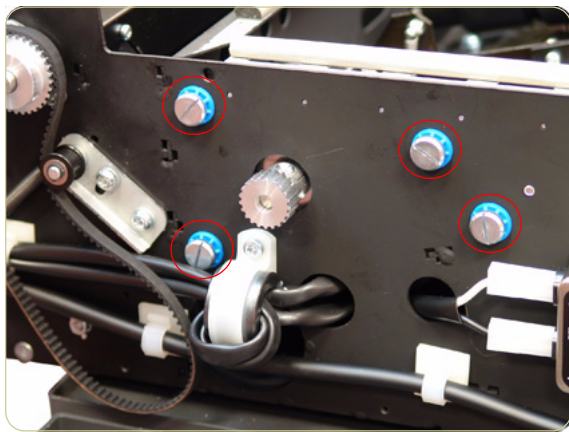

6. Remove four screws that secure the Stepper Motor to the chassis.

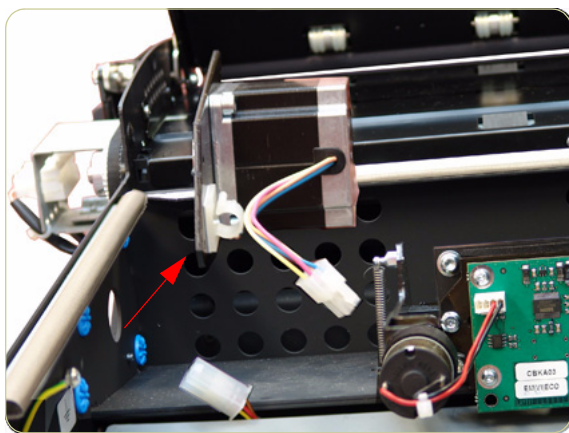

7. Remove the Stepper Motor from the Scanner.

Fluorescent Lamp

Removal

Switch off the printer, the scanner, and the PC, and then disconnect them from the power source prior to performing any maintenance.

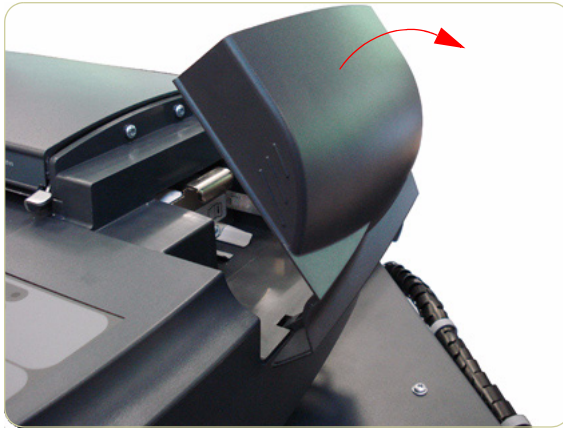

1. Remove the Fluorescent Lamp Access Cover.



2. Press the metal tab to release the Fluorescent Lamp.



3. Slide out the Fluorescent Lamp from the Scanner.

Take care not to touch the Stitching Wire while removing or installing the Fluorescent Lamp.

After installing a new Fluorescent Lamp, you must also install the new Fan Filters which come with the Lamp ⇒ Page 4-35.

Elevation Motor Driver Board

Removal

Switch off the printer, the scanner, and the PC, and then disconnect them from the power source prior to performing any maintenance.



1. Open the Top Profile.

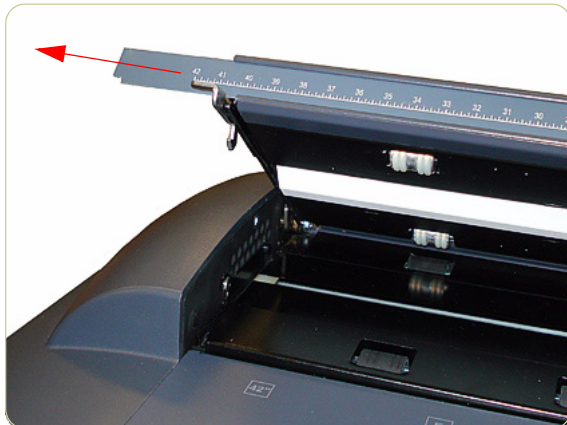

2. Remove the rule from the front of the Guide Plate.

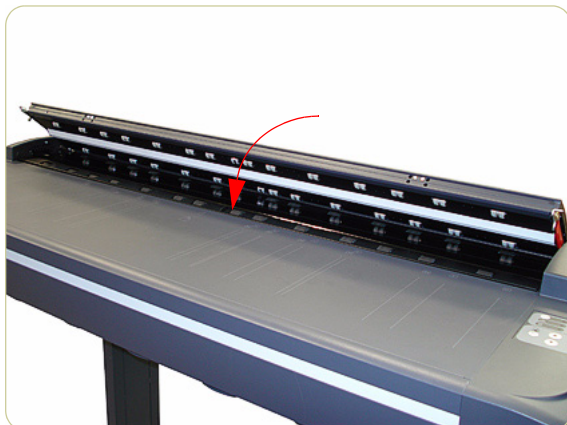

3. Close the Top Profile.

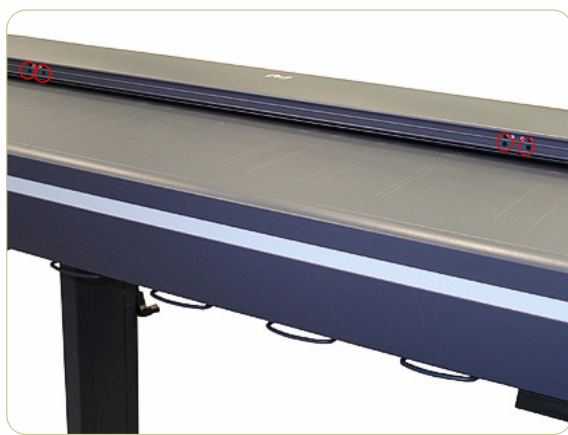

- 4.** Remove the four T10 screws that are used to secure the front of the Top Profile to the Guide Plate.



- 5.** Lift up the Top Profile of the Guide Plate.

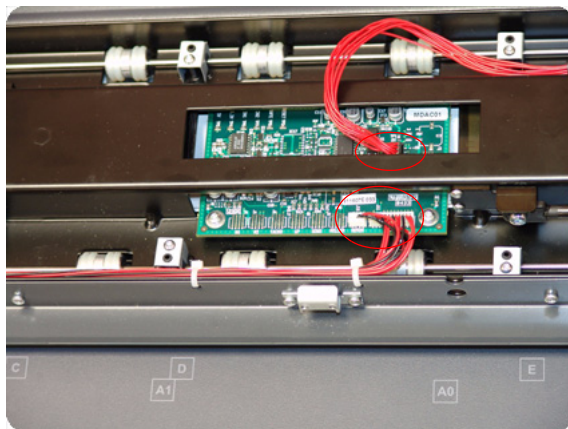

- 6.** Disconnect all cables from the Elevation Motor Driver Board.

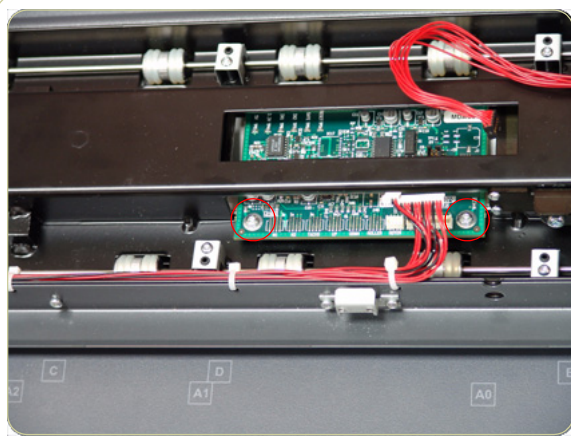

7. Remove two T10 screws that secure the Elevation Motor Driver Board to the Guide Plate.

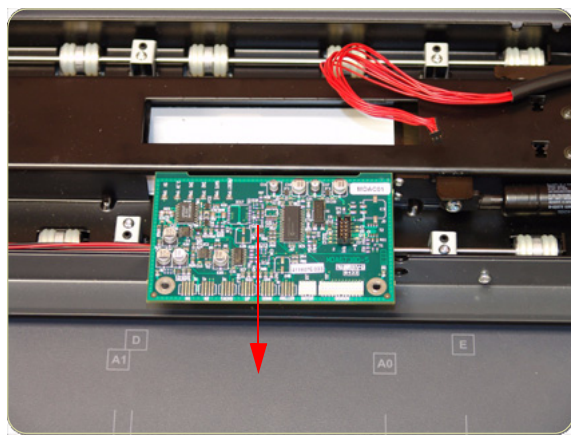

8. Remove the Elevation Motor Driver Board from the Scanner.

Elevation Motor

Removal

Switch off the printer, the scanner, and the PC, and then disconnect them from the power source prior to performing any maintenance.



1. Open the Top Profile.

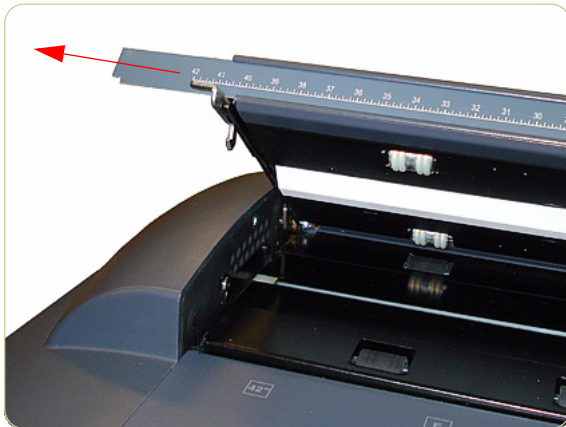

2. Remove the rule from the front of the Guide Plate.

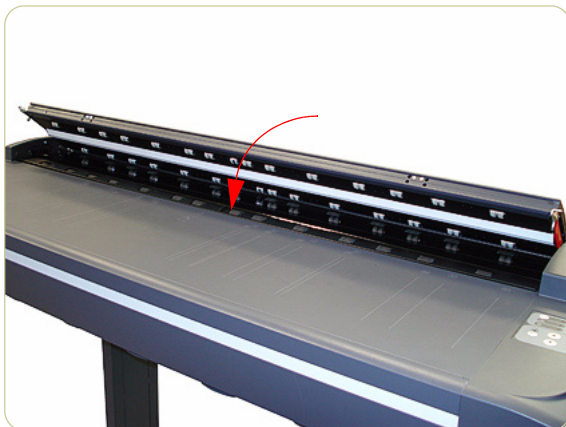

3. Close the Top Profile.

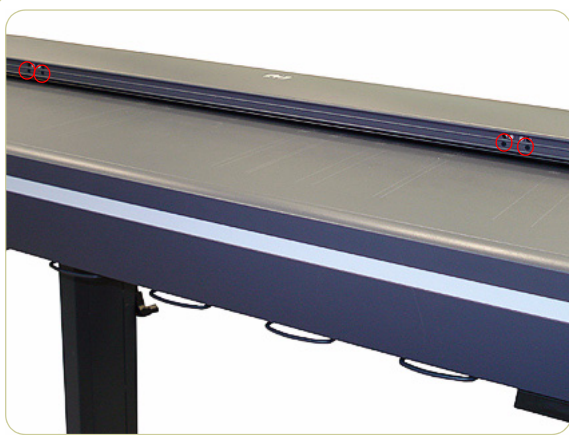

4. Remove the four T10 screws that are used to secure the front of the Top Profile to the Guide Plate.



5. Lift up the Top Profile cover of the Guide Plate.

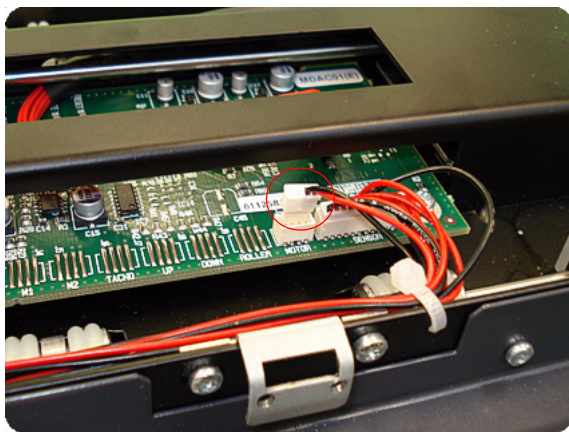

6. Disconnect the Elevator Motor cable (the small connector only) from the Elevation Motor Driver Board.

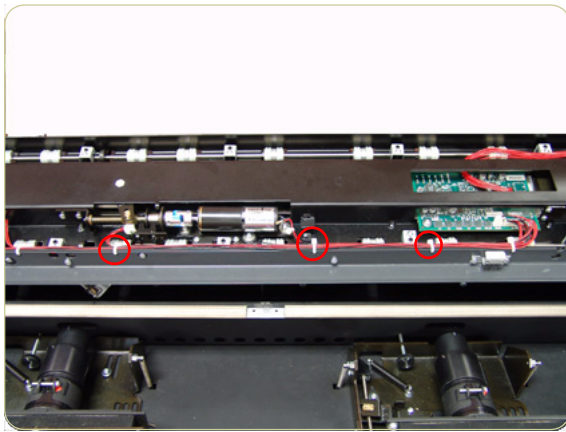

- 7.** Cut the cable clamps holding the cables to the Guide Plate.

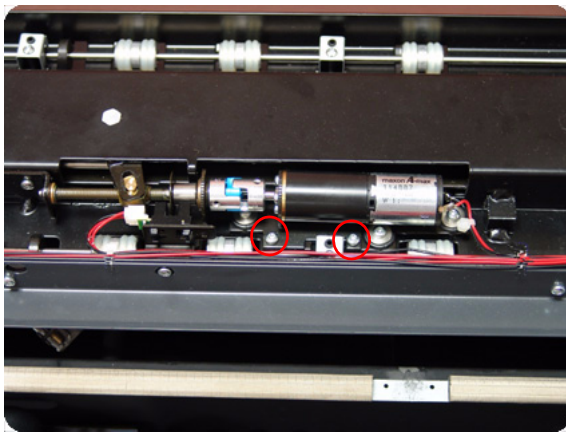

- 8.** Remove two T10 screws that secure the Elevation Motor to the Guide Plate Assembly.

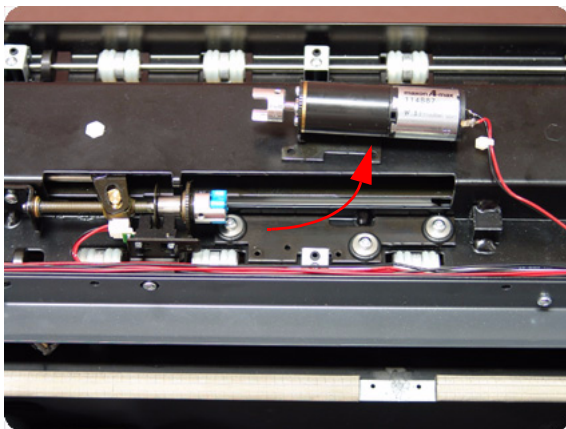

- 9.** Remove the Elevation Motor from the Guide Plate Assembly.

Entry Roller

Removal

Switch off the printer, the scanner, and the PC, and then disconnect them from the power source prior to performing any maintenance.

1. Remove the Top Cover ⇒ Page 4-5.
2. Remove the Left Cover ⇒ Page 4-7.
3. Remove the Right Cover ⇒ Page 4-9
4. Remove the Glass Plate ⇒ Page 4-23.
5. Remove the Entry Roller Shield ⇒ Page 4-24.
6. Loosen two screws from the Belt Tensioner Bracket.

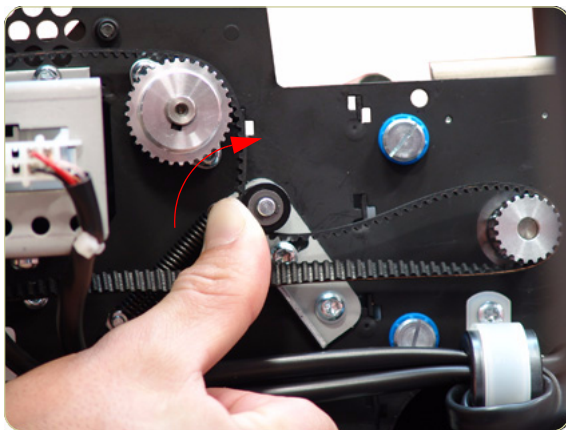
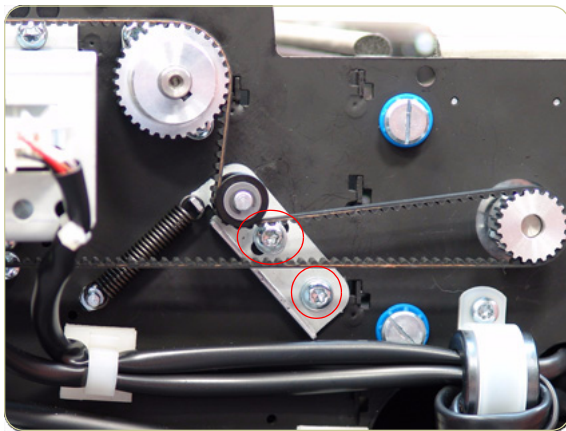

7. Push the Belt Tensioner Bracket to the right to release the belt.

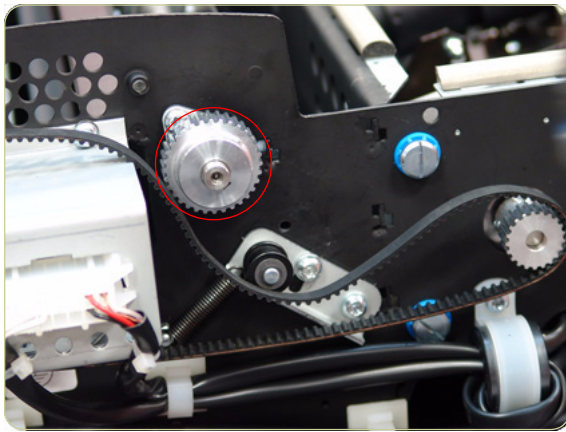

8. Release the Belt from the Entry Roller Gear.

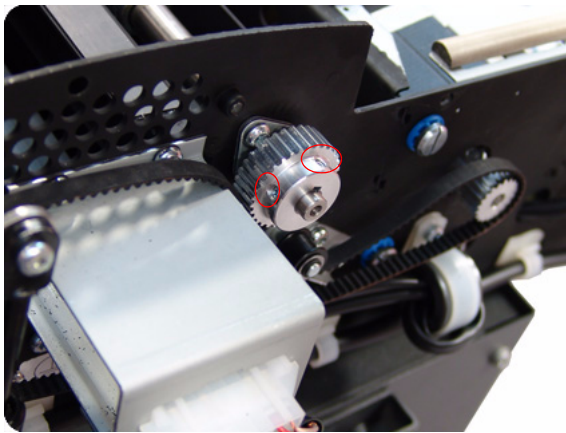

9. Loosen the T8 Allen screws from the Entry Roller Gear on the left side of the Scanner.

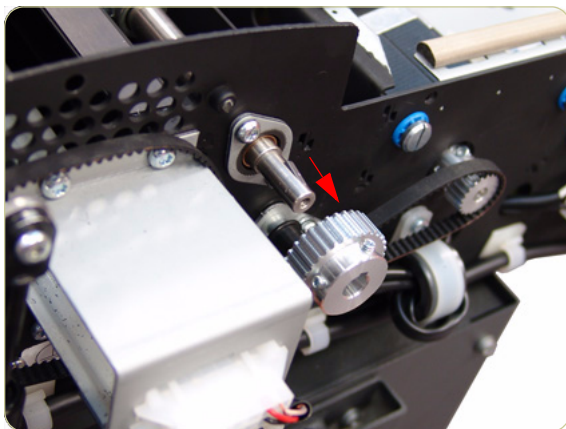

10. Remove the Entry Roller Gear.

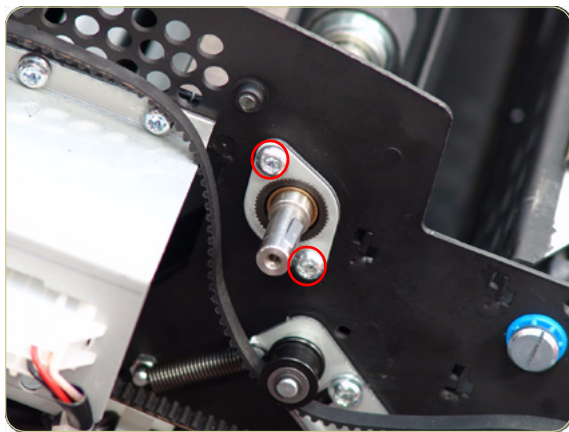

11. Remove two T20 screws that secure the Entry Roller Mount Bushing from the left side of the Scanner.

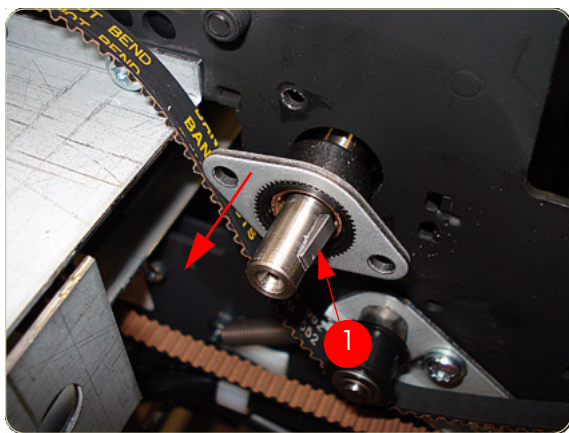

12. Remove the Entry Roller Mount Bushing.

Flatten the metal clip (1) with your finger or a screwdriver, and then slide off the bushing.

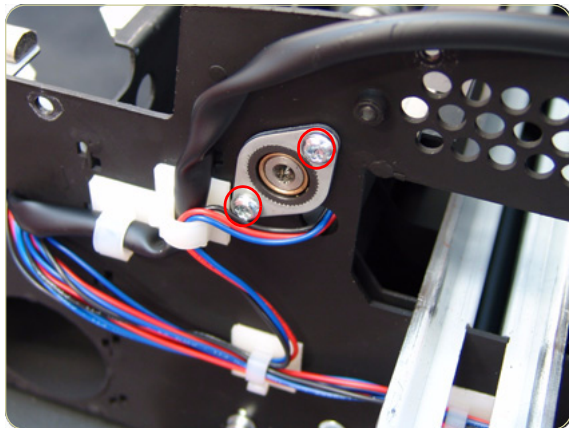

13. Remove two T20 screws that secure the Entry Roller Mount Bushing from the right side of the Scanner.

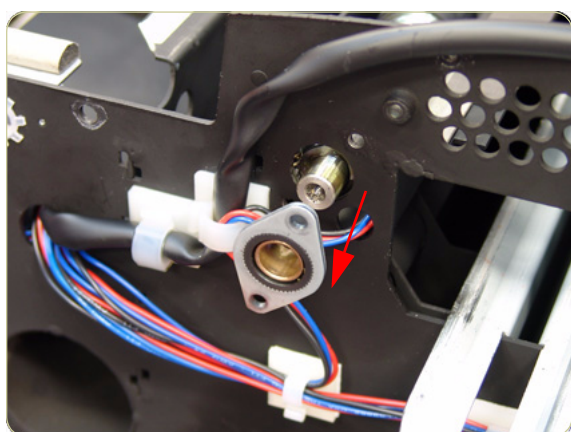

14. Remove the Entry Roller Mount Bushing.

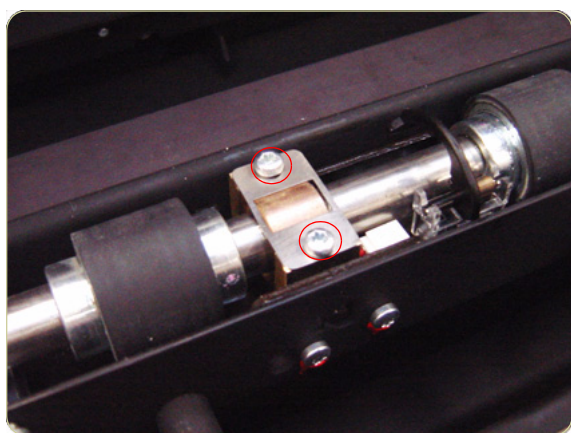

15. Remove the two T10 screws from the Roller Clamp that secures the Entry Roller.

The Roller Clamps for the Entry and Exit Rollers must not be interchanged, so please mark the Top Roller Clamp before removing.

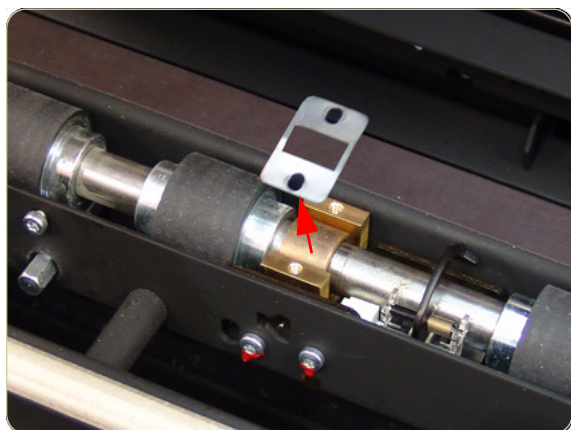

16. Remove the Roller Clamp.

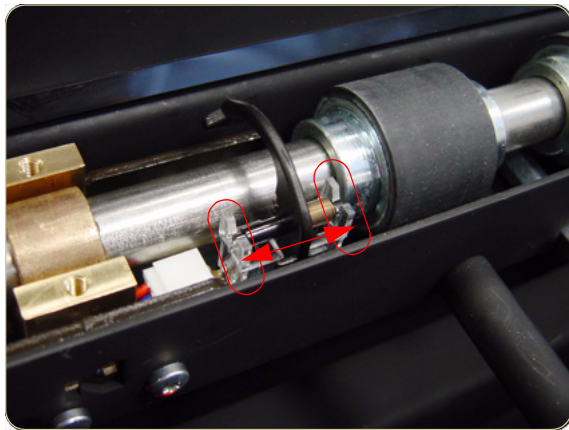

17. Carefully release the Media Entry Switch from the plastic holder

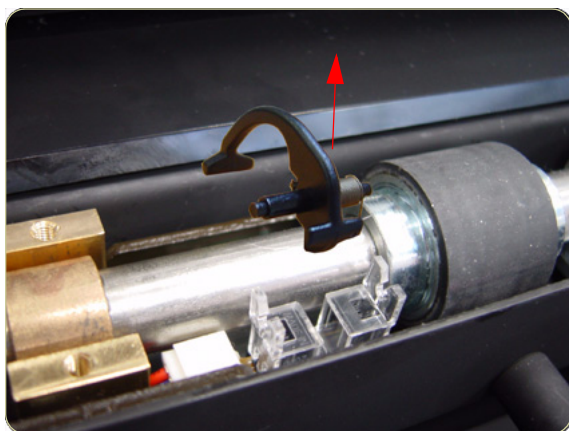

18. Remove the Media Entry Switch from the Scanner

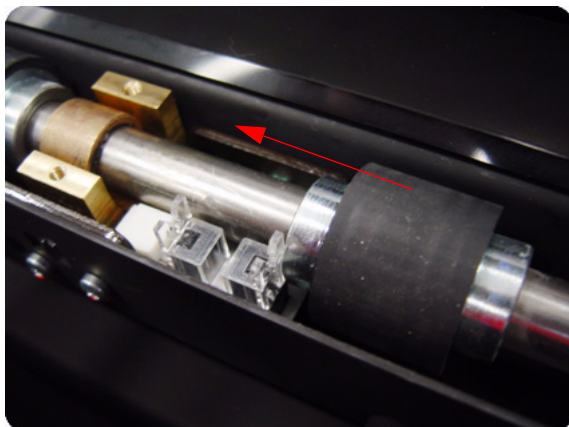

19. Slide the Entry Roller towards the pulley end to remove it out of the bearing at the opposite end.

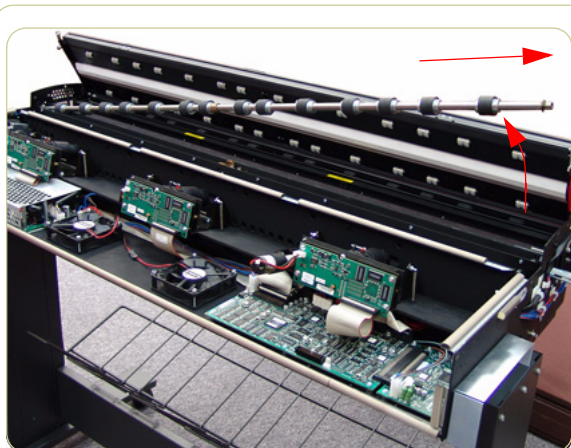

20. Remove the Entry Roller from the Scanner.

When removing the Entry Roller note the number of washers on the end of the shaft so that they can be replaced later.

Exit Roller

Removal

Switch off the printer, the scanner, and the PC, and then disconnect them from the power source prior to performing any maintenance.

1. Remove the Top Cover ⇒ Page 4-5.
2. Remove the Left Cover ⇒ Page 4-7.
3. Remove the Right Cover ⇒ Page 4-9
4. Remove the Rear Cover ⇒ Page 4-13.
5. Remove the Guide Plate ⇒ Page 4-18
6. Remove the Glass Plate ⇒ Page 4-23.
7. Remove the Exit Roller Shield ⇒ Page 4-25.
8. Loosen the two T20 screws on the Belt Tension Bracket.

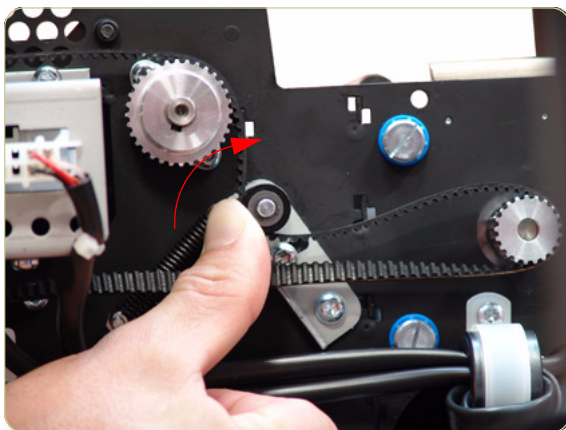
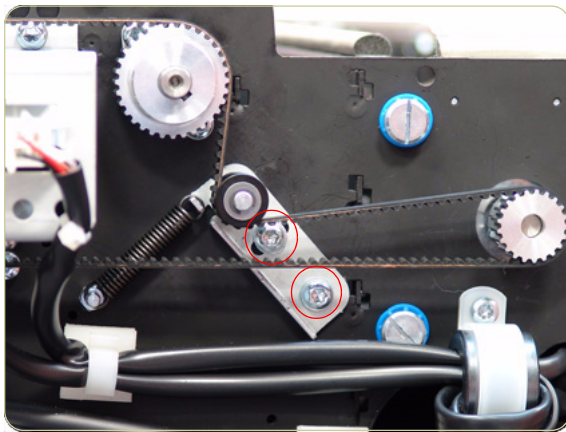

9. Push the Belt Tension Bracket to the right to release the belt.

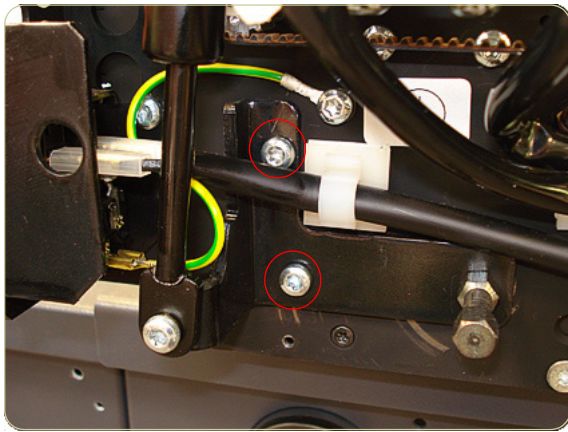

10. Remove the two T20 screws.

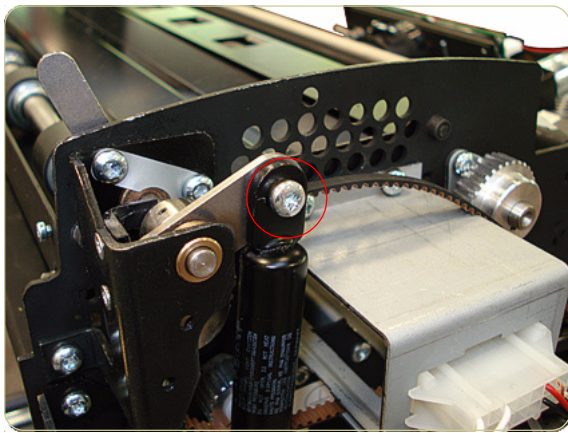

11. Remove the one screw and bushing that secure the piston spring.

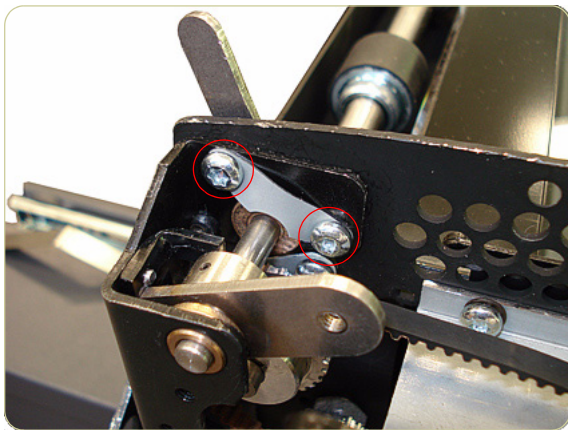

12. Remove the two T20 screws used to secure the small silver plate.

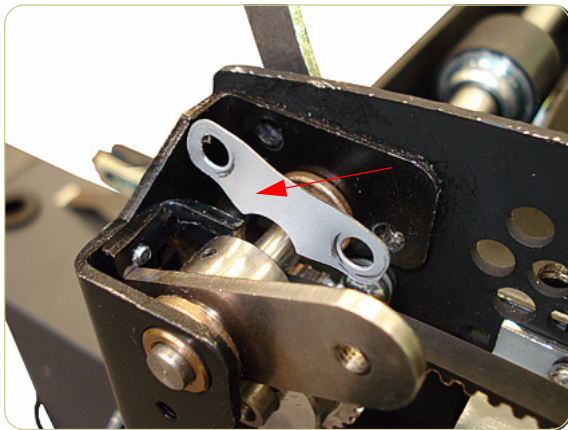

13. Remove the silver plate.

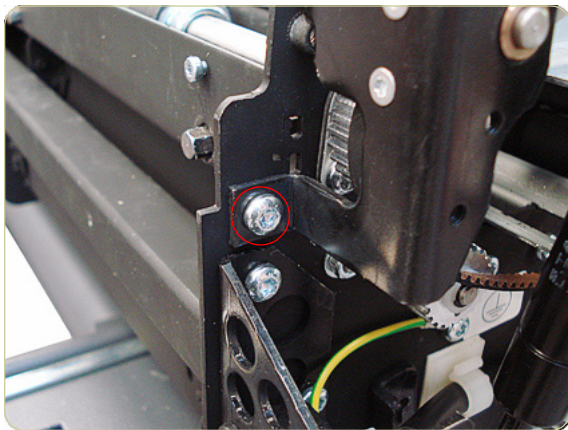

14. Remove one T20 screw.

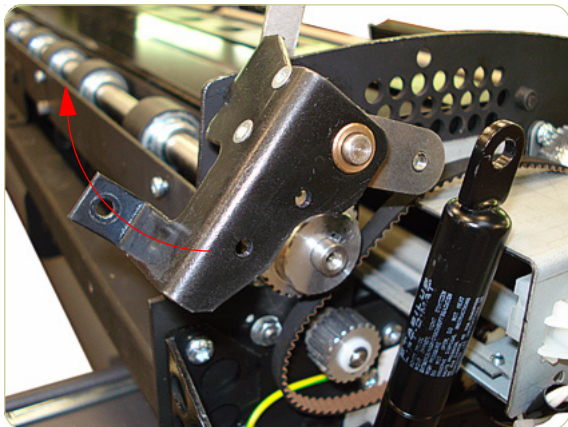

15. Rotate the black piece upward to gain access to the Exit Roller Gear.

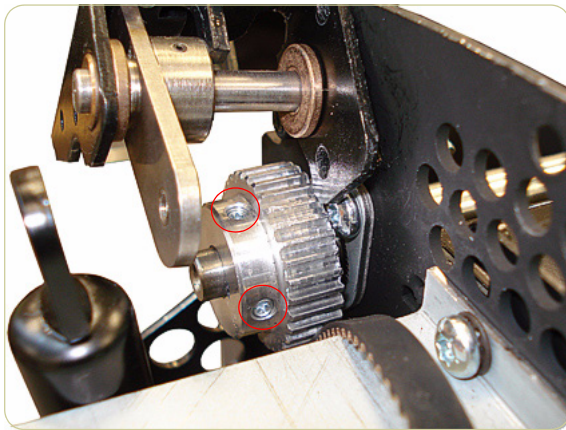

- 16.** Loosen the T8 Allen screws from the Exit Roller Gear on the left side of the Scanner.

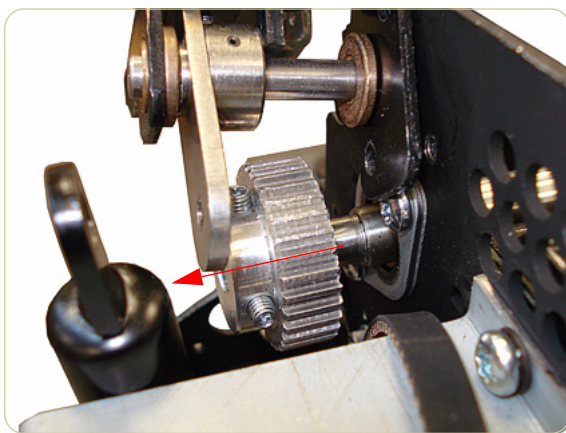

- 17.** Remove the Exit Roller Gear by sliding it off of the Exit Roller.

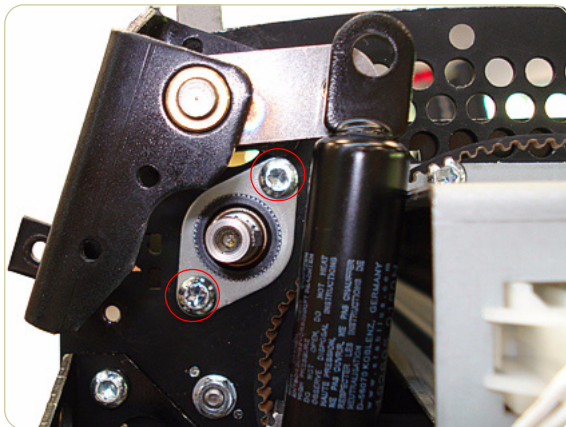

- 18.** Remove the two T20 screws that secure the Exit Roller Mount Bushing from the left side of the Scanner.

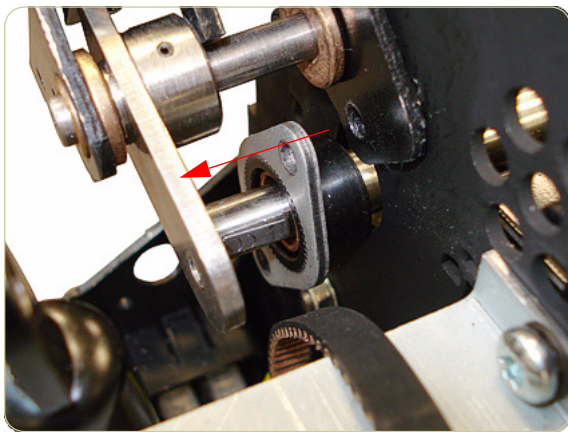

- 19.** Slide the Exit Roller Mount Bushing off of the Exit Roller.

Flatten the metal clip (1) with your finger, and then slide off the bushing.

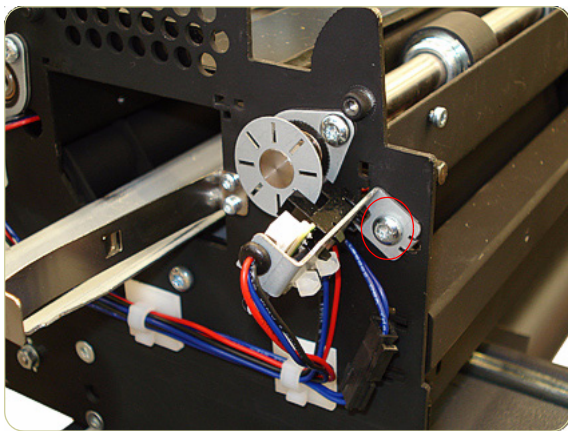

- 20.** Remove the one T20 screw that secures the Encoder Sensor Bracket from the right side of the Scanner.

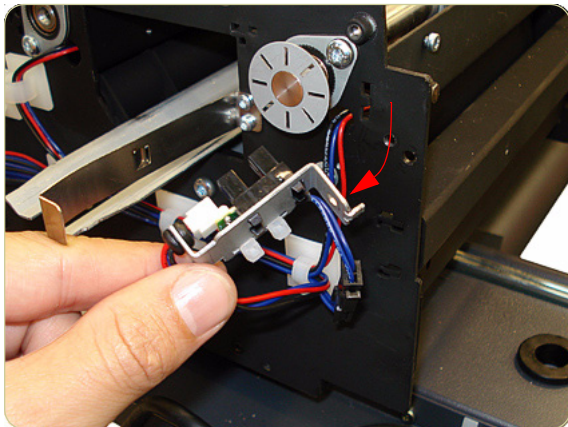

- 21.** Detach the Encoder Sensor Bracket from the Scanner.

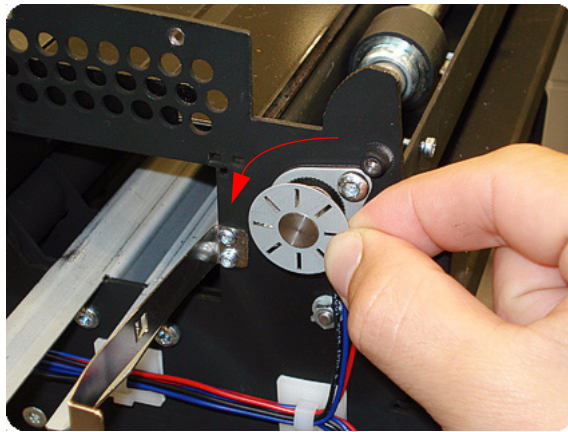

22. Unscrew the Disc Encoder on the right side of the Scanner by turning clockwise.

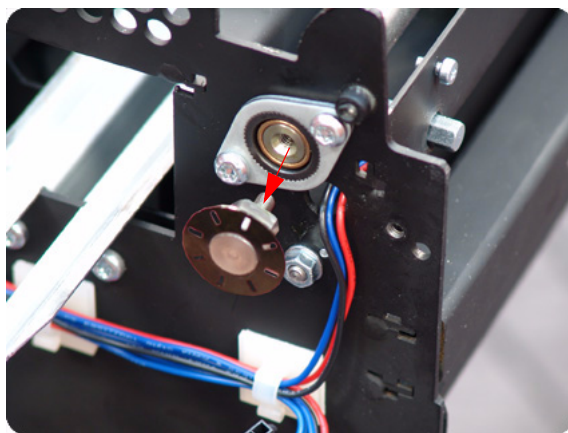

23. Remove the Disc Encoder from the right side of the Scanner.

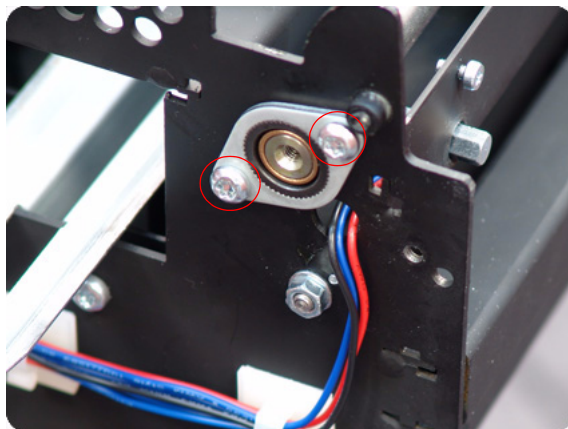

24. Remove the two T20 screws that secure the Exit Roller Mount Bushing from the right side of the Scanner.

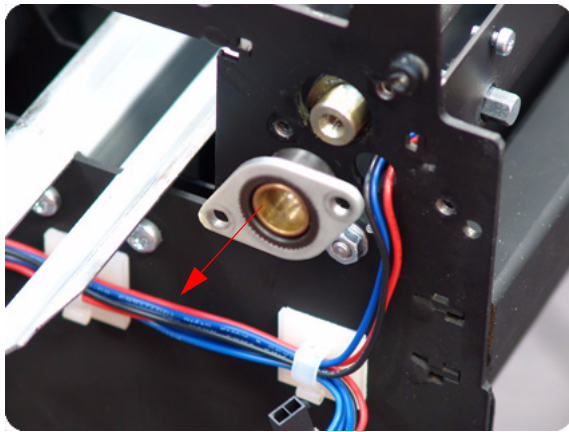

25. Remove the Exit Roller Mount Bushing.

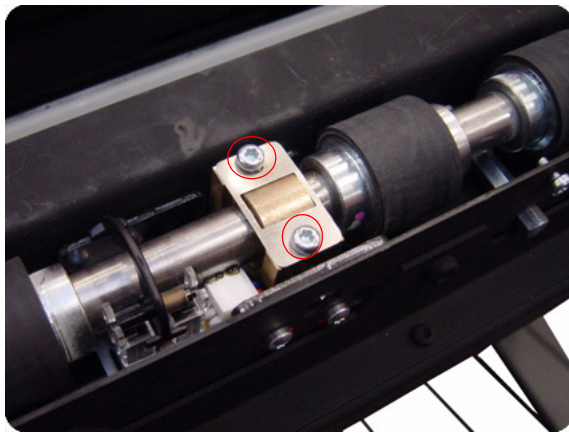

26. Remove the two T10 screws from the Roller Clamp that secures the Exit Roller.



27. Remove the Roller Clamp.

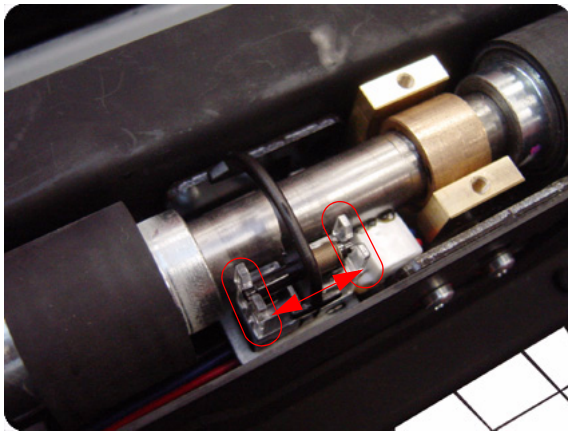

28. Carefully release the Media Entry Rocker Switch from the plastic holder.



29. Remove the Media Exit Rocker Switch from the Scanner.

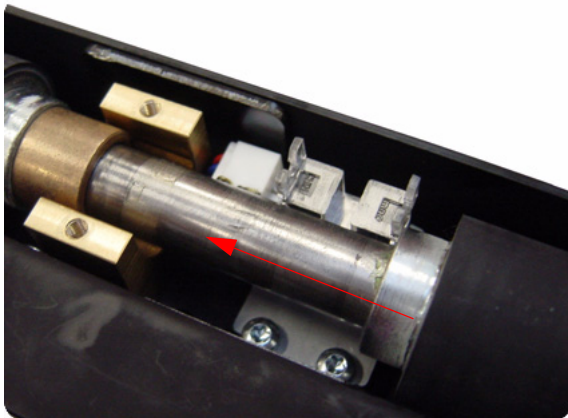

30. Slide the Exit Roller towards the pulley end to remove it out of the bearing at the opposite end.

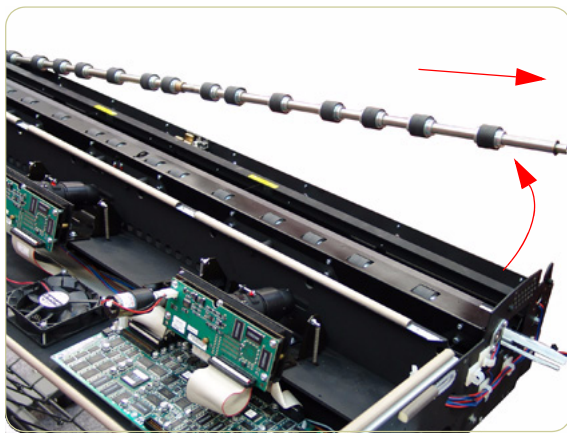

31. Remove the Exit Roller from the Scanner.

As you remove the exit roller from the Scanner, the Roller Mount Bushing and Exit Roller Gear will fall off the left side of the Scanner.

Exit Roller

Installation

Switch off the printer, the scanner, and the PC, and then disconnect them from the power source prior to performing any maintenance.

1. To install the Exit Roller, follow steps 1-31 from the Exit Roller removal procedure in reverse order.

When you are ready to reattach the piston spring, be sure to follow steps 10 and 11 from the removal process in reverse order, as highlighted below.

Step 3 (below) guides you in the handling of the piston spring as you affix the screws.

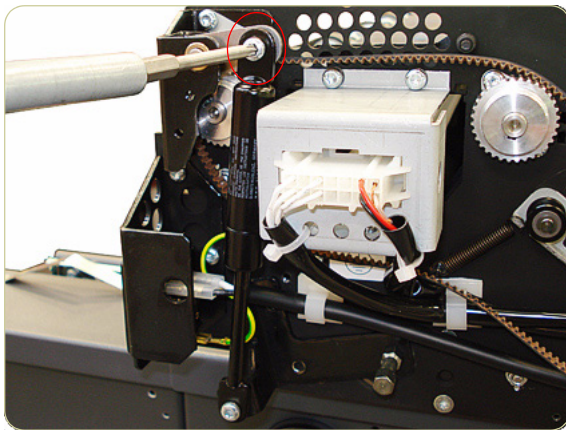

2. First, use the screw to attach the uppermost part of the piston spring.

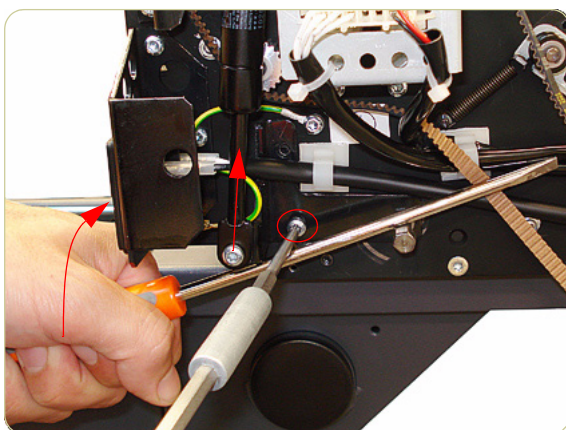

3. Then use a second screwdriver (or similar implement) to act as a lever, and pry the piston spring upward. You will then be able to affix the screws as shown in the photo and described in step 10 of the removal process.

Entry Media Sensor

Removal

Switch off the printer, the scanner, and the PC, and then disconnect them from the power source prior to performing any maintenance.

1. Remove the Top Cover ⇒ Page 4-5.
2. Remove the Entry Roller Shield ⇒ Page 4-24.
3. Remove two T10 screws that secure the Entry Media Sensor.
4. Pull out the Entry Media Sensor from below the Entry Roller and disconnect the cable to remove.

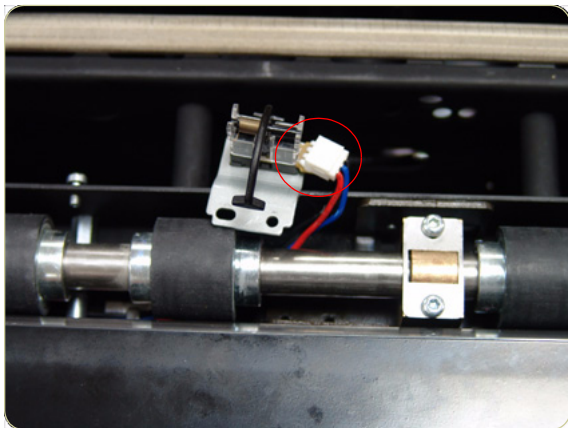
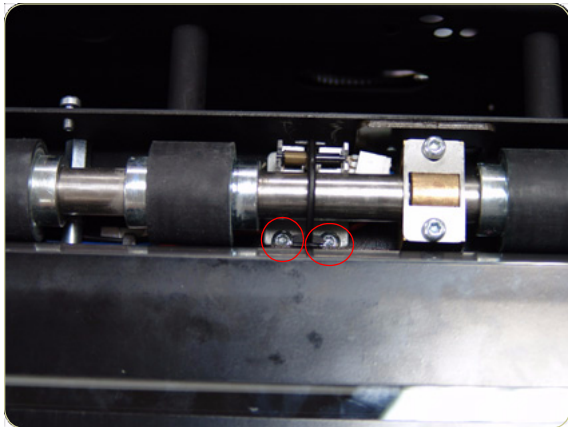

Exit Media Sensor

Removal

Switch off the printer, the scanner, and the PC, and then disconnect them from the power source prior to performing any maintenance.

1. Remove the Top Cover ⇒ Page 4-5.
2. Remove the Right Cover ⇒ Page 4-9
3. Remove the Rear Cover ⇒ Page 4-13.
4. Remove the Guide Plate ⇒ Page 4-18
5. Remove the Exit Roller Shield ⇒ Page 4-25.
6. Remove the two T10 screws that secure the Exit Media Sensor.

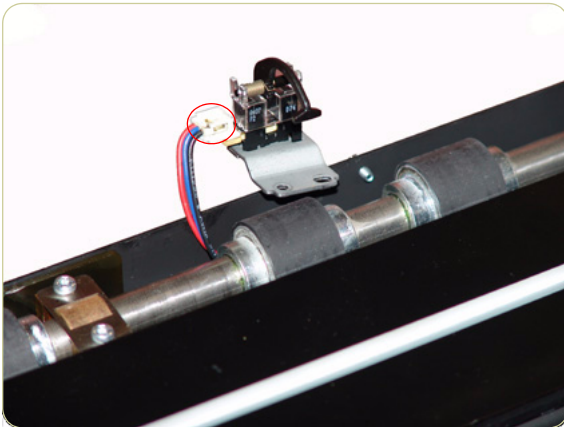
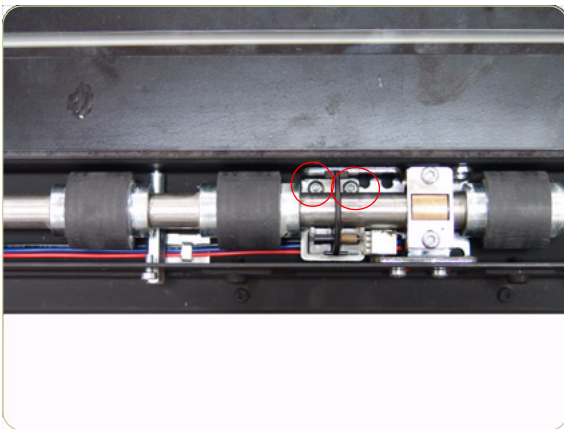

7. Pull out the Exit Media Sensor from below the Exit Roller and disconnect the cable to remove.

Belt

Removal

Switch off the printer, the scanner, and the PC, and then disconnect them from the power source prior to performing any maintenance.

1. Remove the Fluorescent Lamp ⇒ Page 4-43.
2. Remove the Top Cover ⇒ Page 4-5.
3. Remove the Left Cover ⇒ Page 4-7.
4. Cut the cable clamps on the Lamp Power Cable on the left of the Scanner.

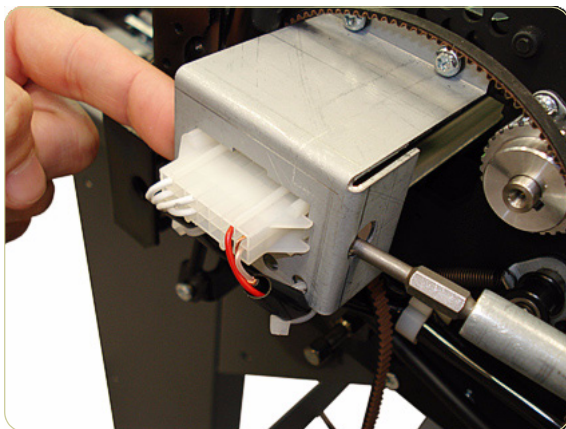
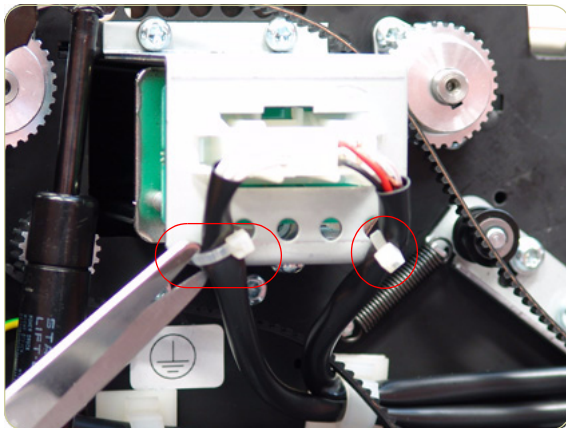

5. Using your finger and a screwdriver (or similar implement), press the clips and disconnect the Lamp Power cable.

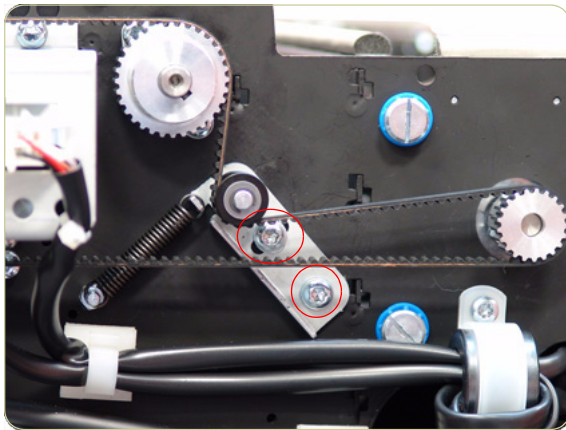

6. Loosen two screws from the Belt Tension Bracket.

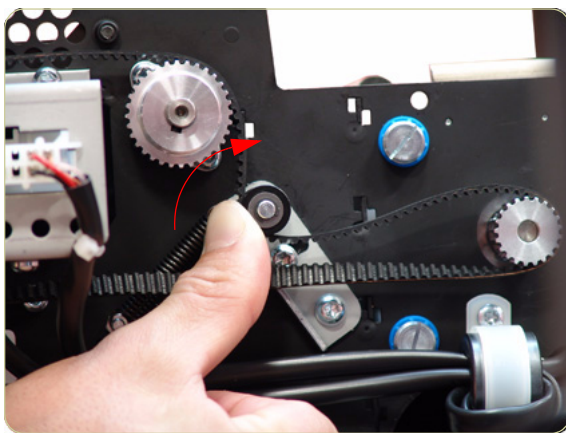

7. Push the Belt Tension Bracket to the right to release the belt from tension.

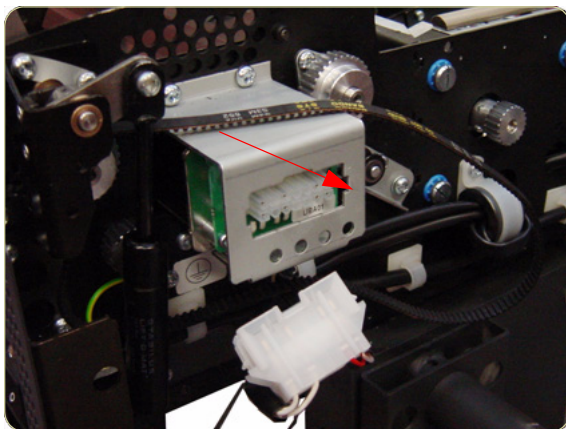

8. Remove the belt from the Scanner.

When reinstalling the Belt, make sure that you adjust the belt tension when securing the Tension Bracket.

Bottom Cover

Removal

Switch off the printer, the scanner, and the PC, and then disconnect them from the power source prior to performing any maintenance.

1. Remove the Top Cover ⇒ Page 4-5.
2. Remove the Left Cover ⇒ Page 4-7.
3. Remove the Right Cover ⇒ Page 4-9.
4. Remove the Rear Cover ⇒ Page 4-13.
5. Use a size 2.5 Allen key to remove the two screws that secure the left side of the Scanner to the legs.

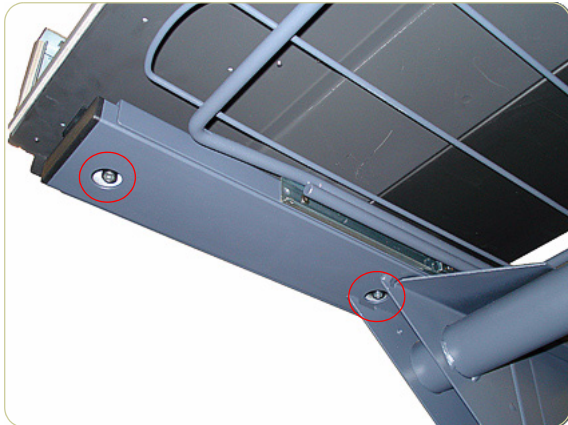

6. Remove two screws that secure the right side of the Scanner to the legs.

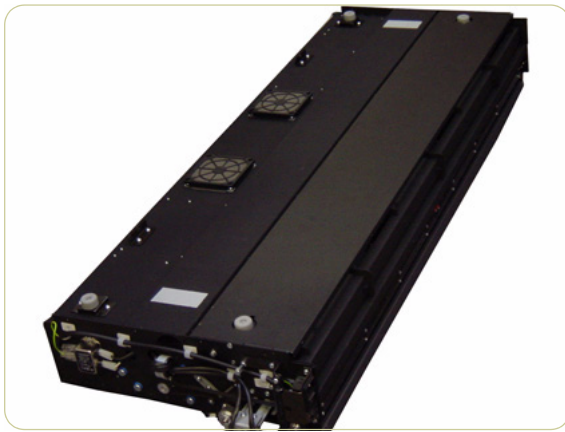

7. Turn the Scanner upside down.

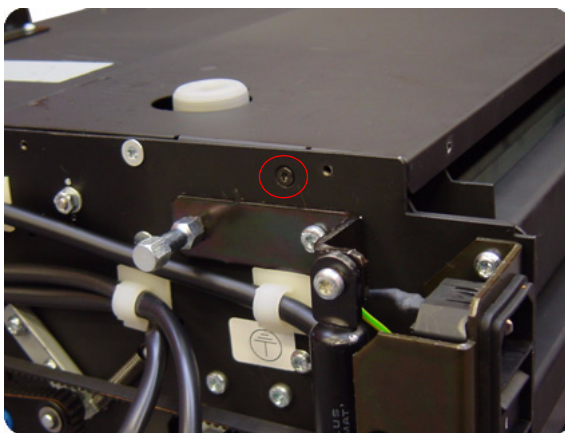

8. Remove the one T10 screw that secures the left side of the Bottom Cover.

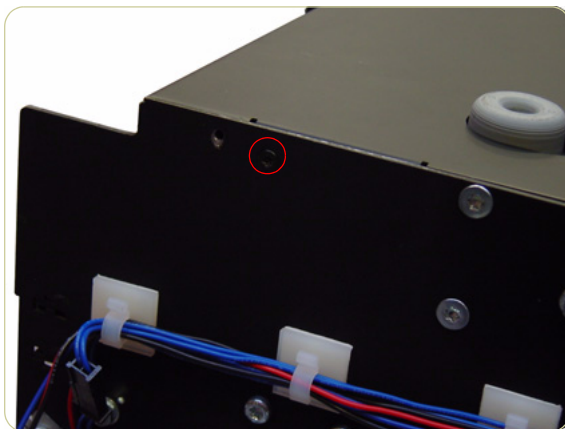

9. Remove the one T10 screw that secures the right side of the Bottom Cover.

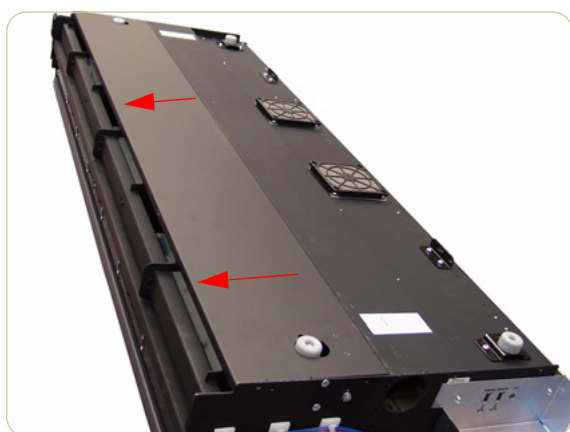

10. Slide the Bottom Cover backwards.



11. Raise the cover slightly from the front.

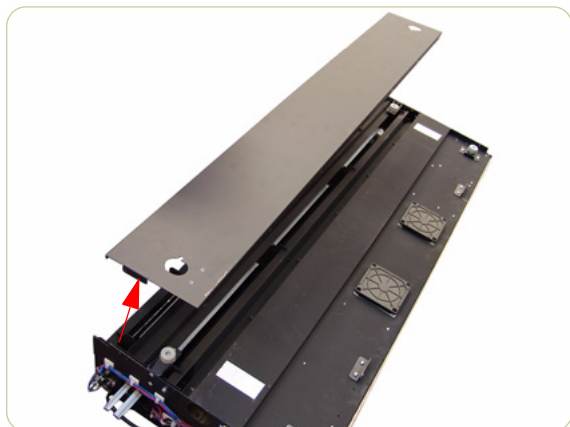

12. Remove the Bottom Cover from the Scanner.

Mirror Chassis

Removal

Switch off the printer, the scanner, and the PC, and then disconnect them from the power source prior to performing any maintenance.

1. Remove the Top Cover ⇒ Page 4-5.
2. Remove the Left Cover ⇒ Page 4-7.
3. Remove the Right Cover ⇒ Page 4-9.
4. Remove the Rear Cover ⇒ Page 4-13.
5. Remove the Bottom Cover ⇒ Page 4-70.
6. Remove the two T20 screws from each plastic foot (only the two rear feet).



7. Remove the two rear plastic feet.

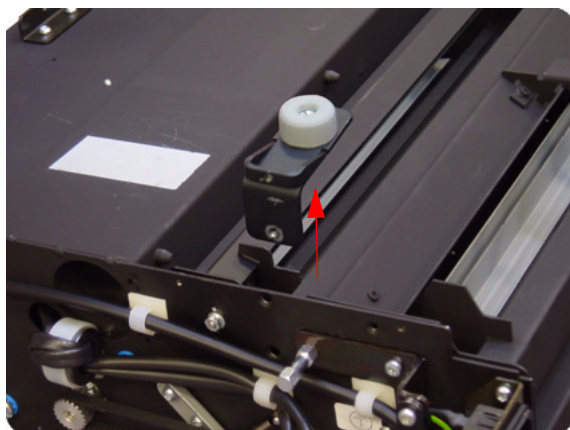

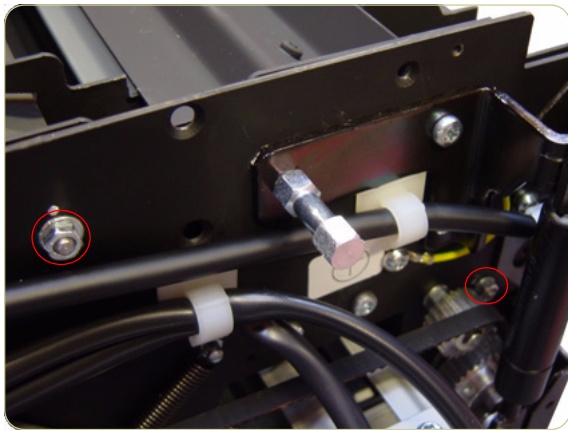

- 8.** Remove two nuts that secure the left side of the Mirror Chassis.

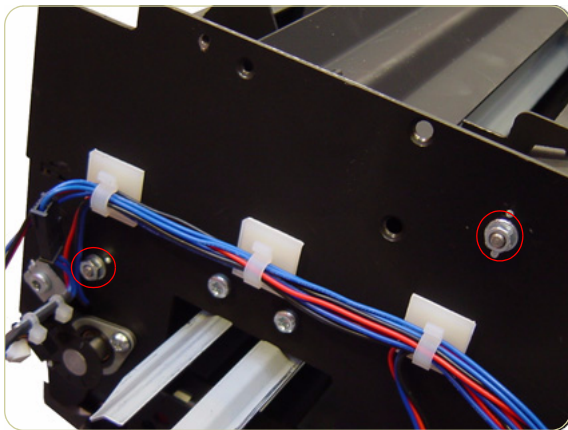

- 9.** Use a size 7 wrench to remove the two nuts and one washer that secure the right side of the Mirror Chassis.

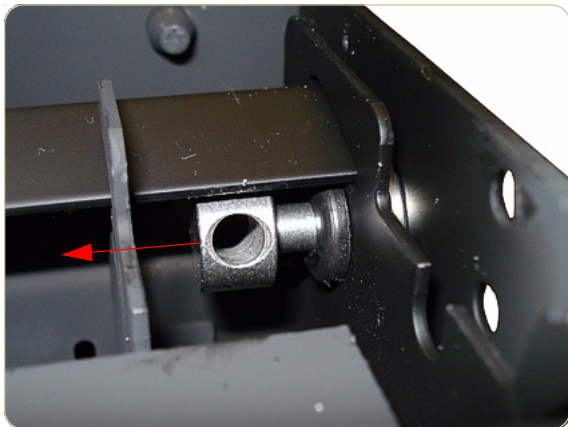

- 10.** Remove two locating screws from both sides of the Mirror Chassis. Upon installation, ensure that the rubber is not squeezed. Wiggle the screw to verify that it is correctly fitted.

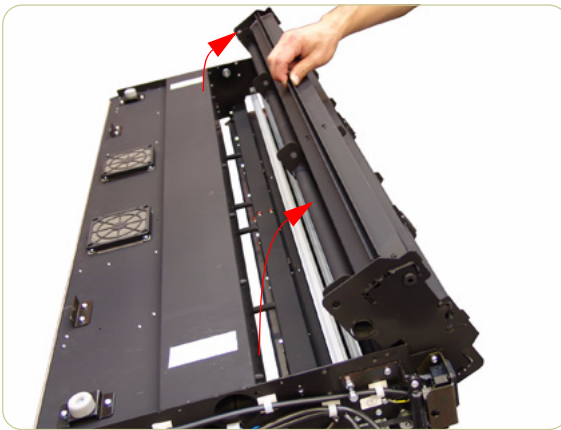

- 11.** Rotate the Mirror Chassis towards you and lift up.

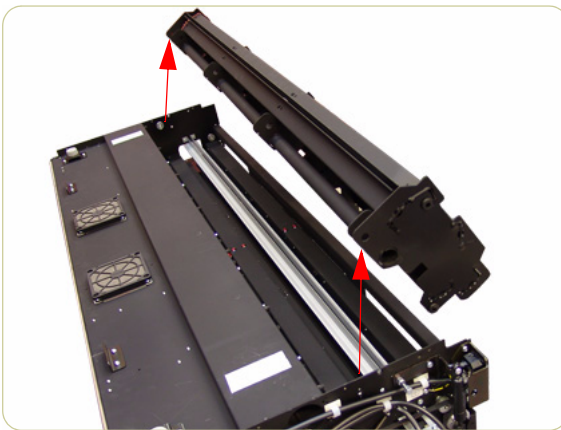

- 12.** Remove the Mirror Chassis.

Always clean the mirrors before replacing the Mirror Chassis.

Stitching Wire

Removal

Switch off the printer, the scanner, and the PC, and then disconnect them from the power source prior to performing any maintenance.

1. Remove the Top Cover ⇒ Page 4-5.
2. Remove the Left Cover ⇒ Page 4-7.
3. Remove the Right Cover ⇒ Page 4-9.
4. Remove the Fluorescent Lamp ⇒ Page 4-43.
5. Remove the Bottom Cover ⇒ Page 4-70.
6. Remove the Mirror Chassis ⇒ Page 4-73.
7. Remove the four T20 screws that secure the Fluorescent Lamp Guides to the left side of the Scanner.

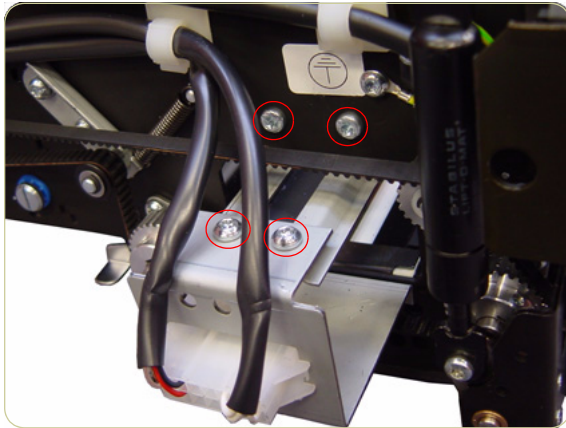

8. Remove the two T20 screws that secure the Fluorescent Lamp Guides to the right side of the Scanner.

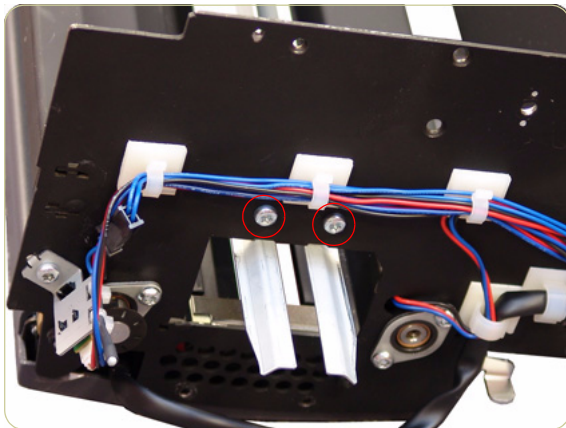



9. Remove the Fluorescent Lamp Guides from the Scanner.

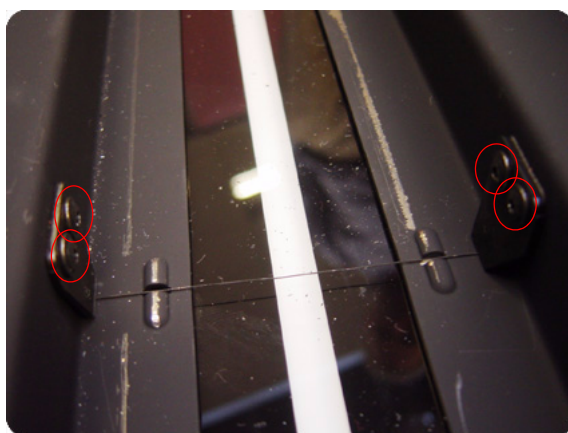

10. Use a 2.5 size Allen key to remove the four screws that secure the Leaf Springs.

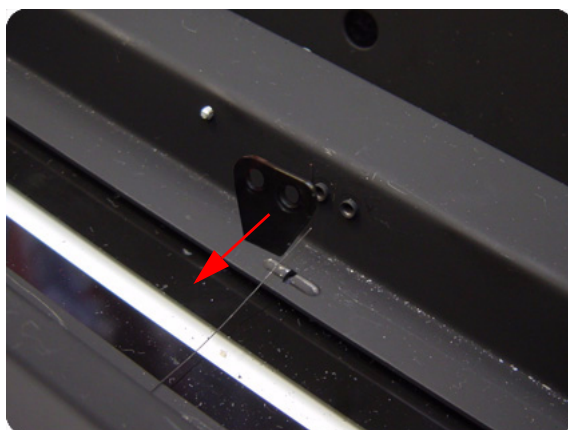

11. Remove the Leaf Springs and the Stitching Wire.

White Background Assembly

Removal

Switch off the printer, the scanner, and the PC, and then disconnect them from the power source prior to performing any maintenance.



1. Open the Guide Plate.
2. Remove the Red Retaining Cover from the right of the Guide Plate.



3. Slide out the White Background Assembly from the Guide Plate.

You cannot remove and replace the White Background if the Guide Plate is in the elevated position.

When replacing the White Background make sure it is fully inserted and the Red Retaining Cover is installed before you close the Guide Plate.

Panel PC

This chapter is a step by step guide to the removal and installation of the key components in the Panel PC.

Open Cabinet

Removal

Switch off the printer, the scanner, and the PC, and then disconnect them from the power source prior to performing any maintenance.

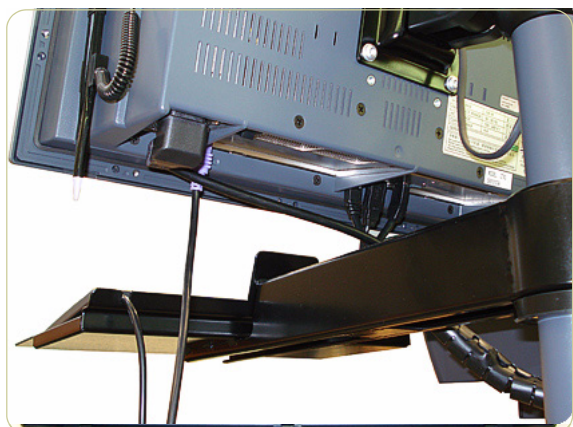

1. Disconnect all of the cables from the Panel PC.



2. Remove the four T20 screws that are used to secure the Cabinet to the Bracket.

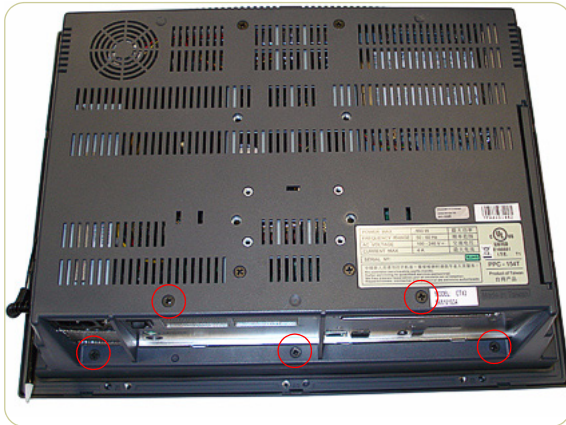

3. Use a Phillips screwdriver to remove the five screws at the back of the Cabinet.

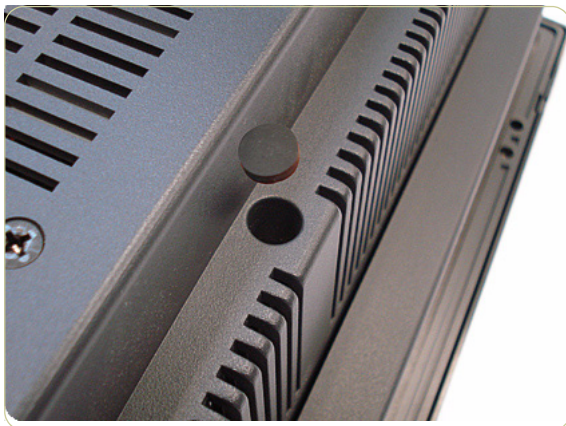

4. Remove the three rubber covers to gain access to the screws underneath them.

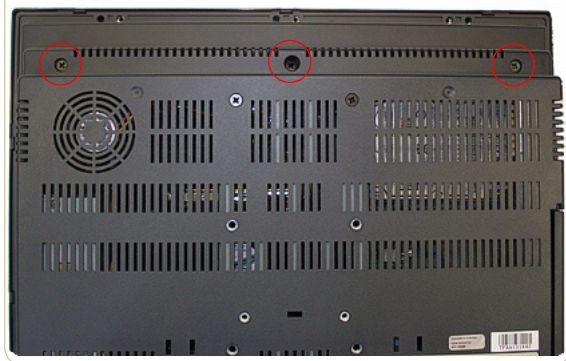

5. Use a Phillips screwdriver to remove the three screws at the back of the Cabinet.

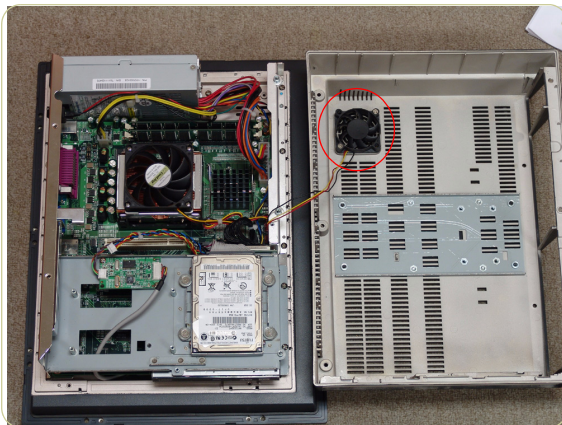

6. As you open the Cabinet, make sure that you do not damage the cables to the System Fan.

Screen Bezel

Removal

Switch off the printer, the scanner, and the PC, and then disconnect them from the power source prior to performing any maintenance.

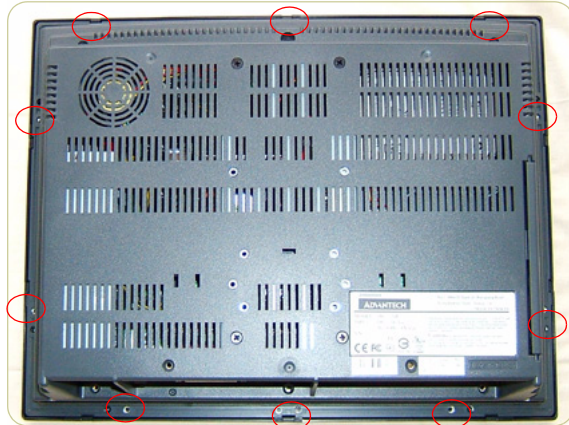

1. Apply pressure with a flat head screw driver at the rear of the Cabinet at the places indicated.



2. Use a Phillips screwdriver to remove the Screen Bezel from the Cabinet.

LCD

Removal

Switch off the printer, the scanner, and the PC, and then disconnect them from the power source prior to performing any maintenance.

1. Remove the Screen Bezel ⇒ Page 4-82.
2. Remove ten screws that secure the LCD to the PanelPC.

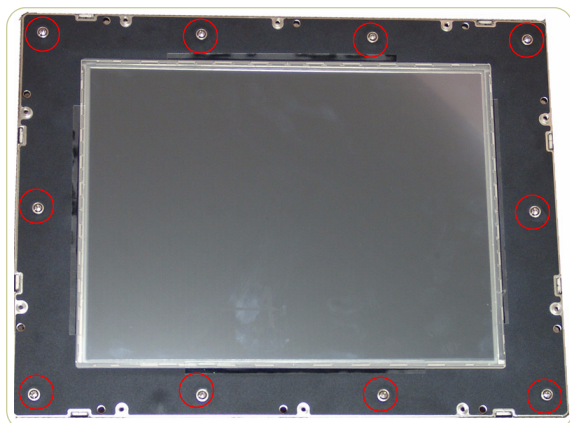

3. Carefully lift up the screen and disconnect ALL three cables.

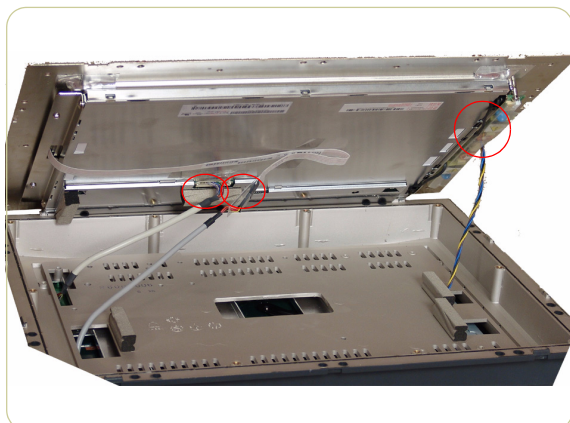

4. Remove the LCD.

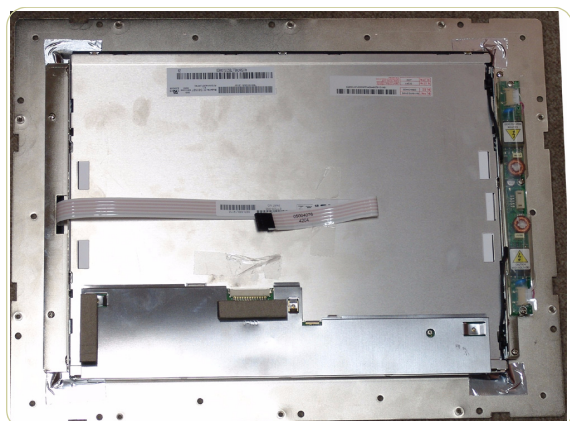

Back Plate

Removal

Switch off the printer, the scanner, and the PC, and then disconnect them from the power source prior to performing any maintenance.



1. Open Cabinet ⇒ Page 4-79.
2. Use a Phillips screwdriver to remove the three screws that secure the PSU to the Back Plate.

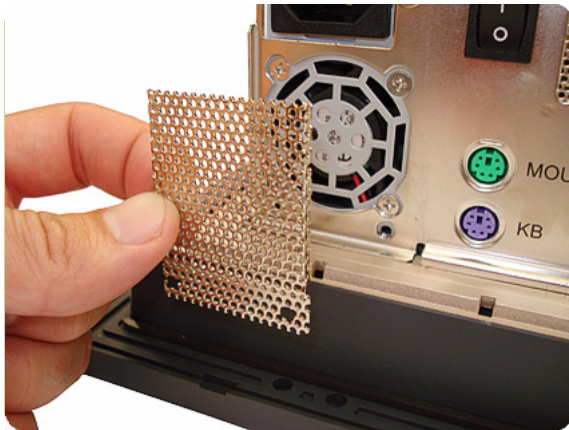

3. Remove the metal cover.

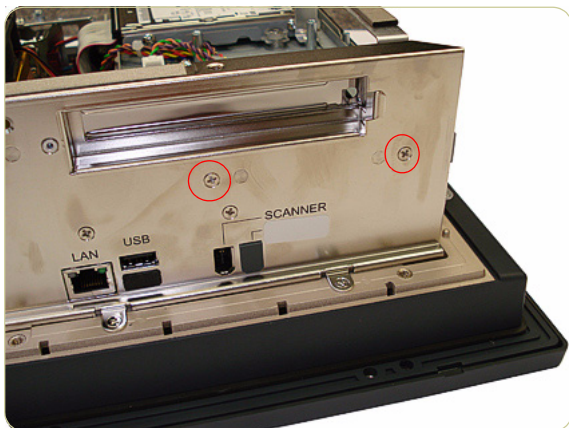

4. Use a Phillips screwdriver to remove the two screws that secure the HDD/DVD deck to the Back Plate.

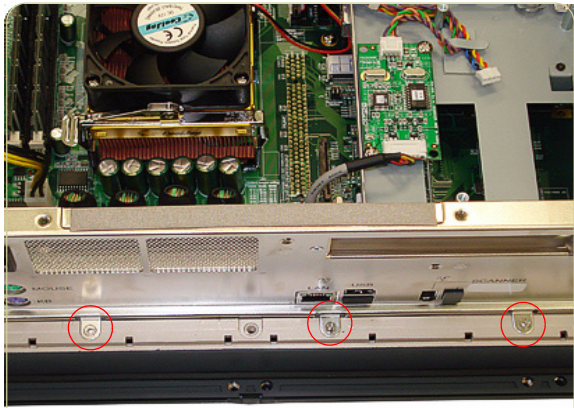

5. Use a Phillips screwdriver to remove the three screws that secure the Back Plate to the Cabinet.

CPU Cooling Fan

Removal

Switch off the printer, the scanner, and the PC, and then disconnect them from the power source prior to performing any maintenance.

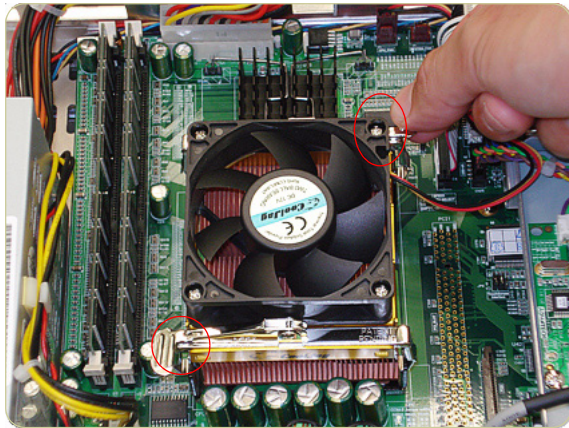

1. Open Cabinet ⇒ Page 4-79.
2. Pull up on the two clips that secure the CPU Cooling Fan.

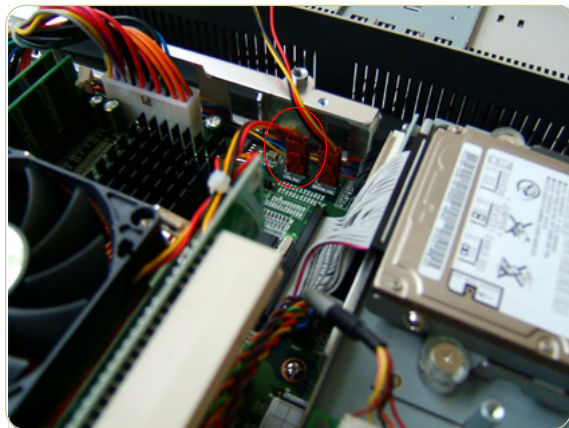

3. Disconnect the CPU Cooling Fan Cable from the Power PCA.

CPU

Removal

Switch off the printer, the scanner, and the PC, and then disconnect them from the power source prior to performing any maintenance.

1. Open Cabinet ⇒ Page 4-79.
2. Remove the CPU Cooling Fan ⇒ Page 4-86.
3. Pull aside the clip securing the CPU.

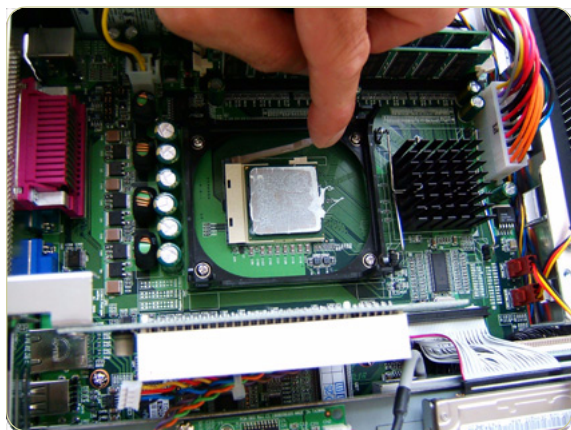

4. Remove the CPU.

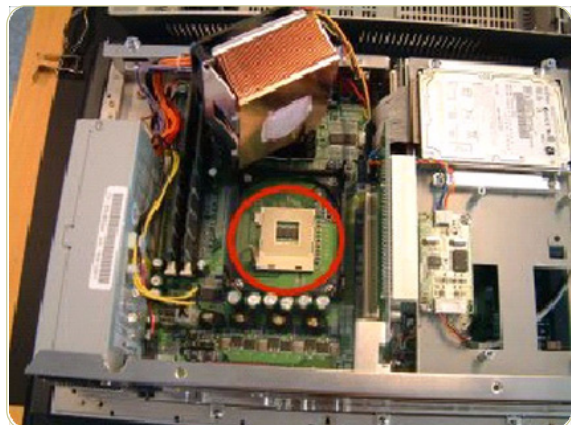

DRAM PCA

Removal

Switch off the printer, the scanner, and the PC, and then disconnect them from the power source prior to performing any maintenance.

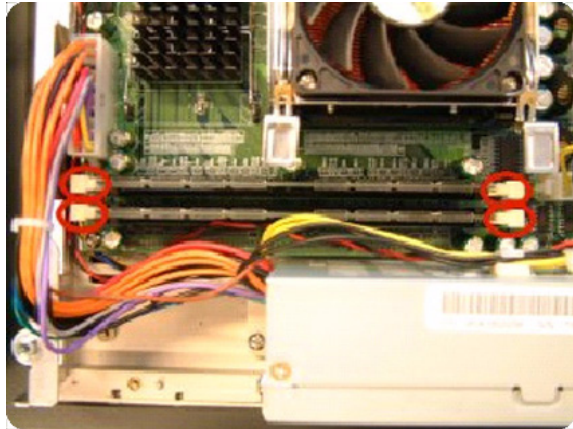

1. Open Cabinet ⇒ Page 4-79.
2. Push the securing clips to the side to release the DRAM PCA.



3. Remove the DRAM PCA.

The DVD

Removal

Switch off the printer, the scanner, and the PC, and then disconnect them from the power source prior to performing any maintenance.

1. Open the Cabinet ⇒ Page 4-79.
2. Disconnect the cable from the HDD.

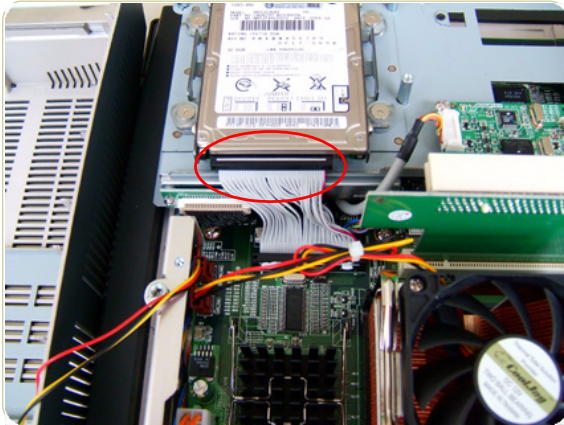

3. Disconnect the cable from the DVD.

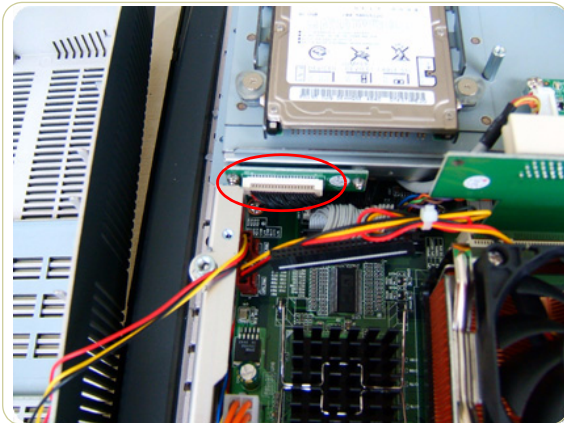

4. Remove two screws that secure the DVD.

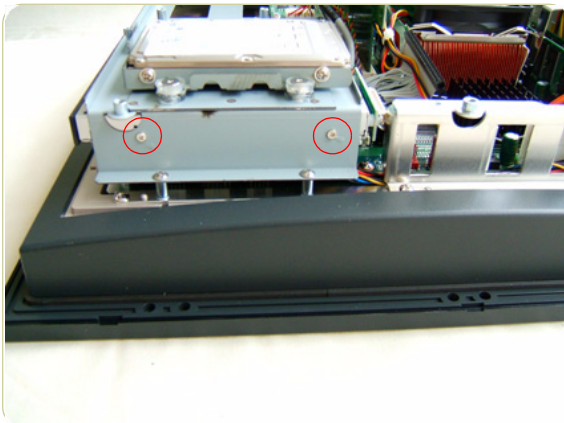

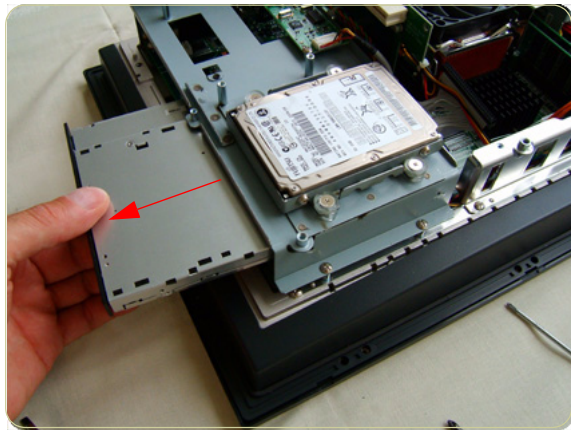

5. Remove the DVD by sliding it out from the PanelPC.

The Hard Disk Drive

Removal

Switch off the printer, the scanner, and the PC, and then disconnect them from the power source prior to performing any maintenance.

1. Open the Cabinet ⇒ Page 4-79.
2. Disconnect the cable from the Hard Disk Drive.

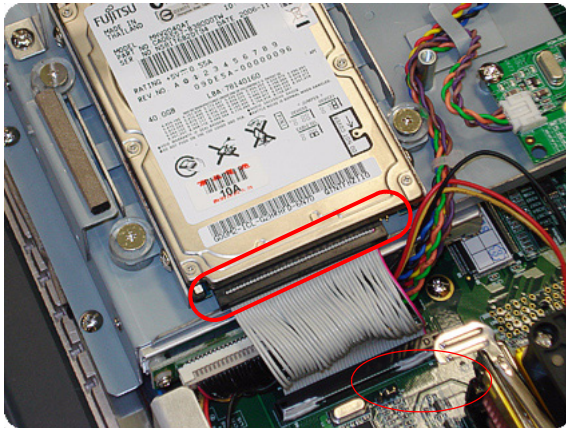

3. Remove four screws that secure the Hard Disk Drive.

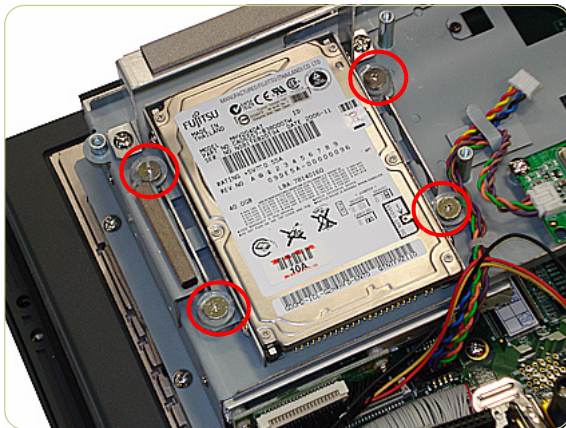

4. Remove the Hard Disk Drive from the PanelPC and remove four screws (two each side) from the frame surrounding the Hard Disk Drive.

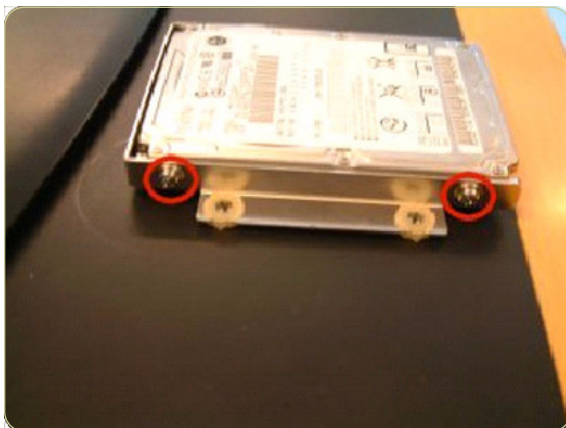

After reinstalling the Hard Disk Drive you will need to reinstall the system software.

LCD Controller PCA

Removal

Switch off the printer, the scanner, and the PC, and then disconnect them from the power source prior to performing any maintenance.

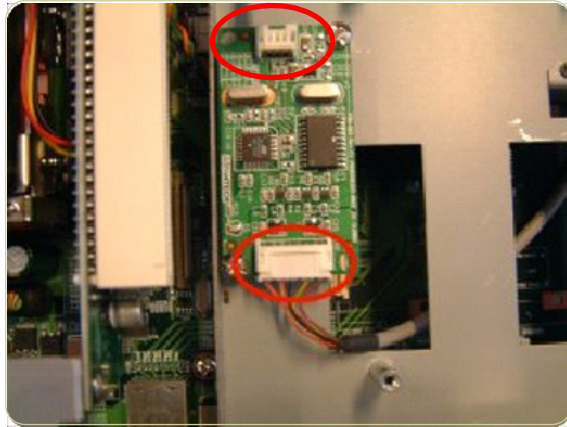

1. Open the Cabinet ⇒ Page 4-79.
2. Disconnect ALL cables connected to the LCD Controller.

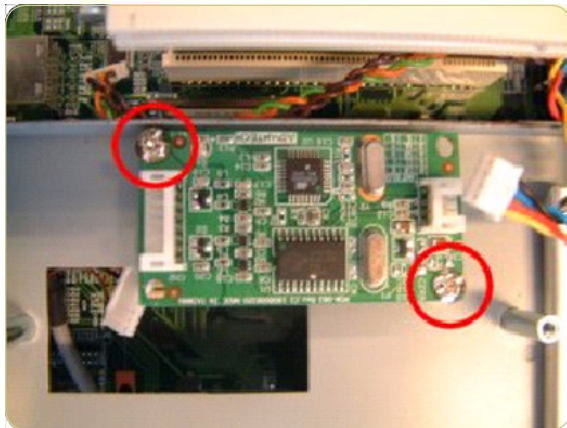

3. Remove two screws that secure the LCD Controller.

Inverter PCA

Removal

Switch off the printer, the scanner, and the PC, and then disconnect them from the power source prior to performing any maintenance.

1. Remove the Screen Bezel ⇒ Page 4-82.
2. Remove the LCD ⇒ Page 4-83.
3. Use a Phillips screwdriver to remove three screws that are used to secure the inverter PCA to the LCD.

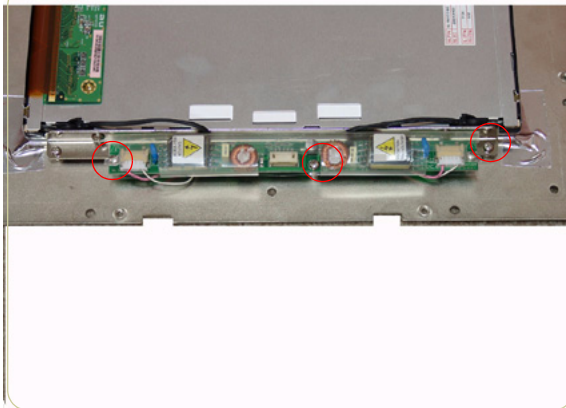

4. Disconnect two cables from the inverter PCA.

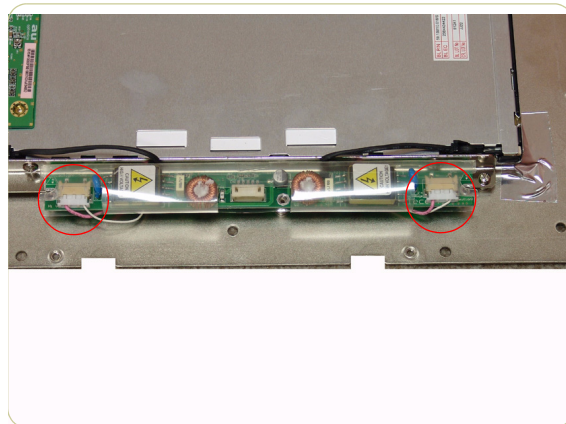

5. Remove the inverter PCA.

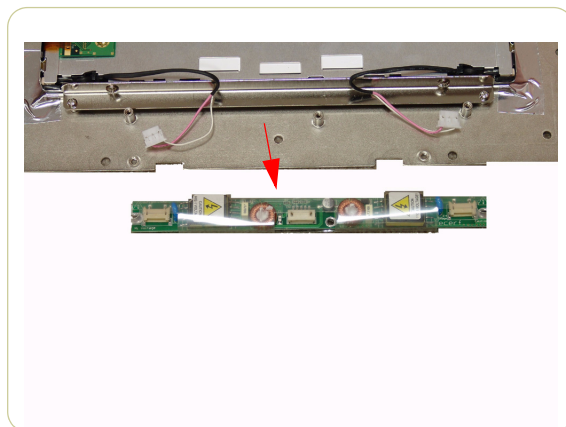

HDD/DVD Deck

Removal

Switch off the printer, the scanner, and the PC, and then disconnect them from the power source prior to performing any maintenance.



1. Open the Cabinet ⇒ Page 4-79.
2. Remove two screws that secure the HDD/DVD Deck to the Back Plate.

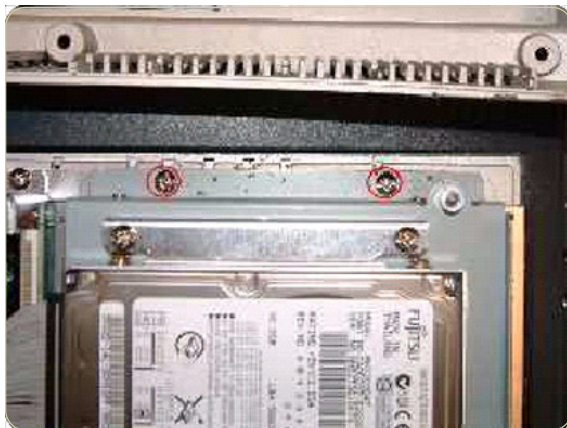

3. Remove two screws that secure the HDD/DVD to the Cabinet.



4. Disconnect two cables from the DVD and the HDD.

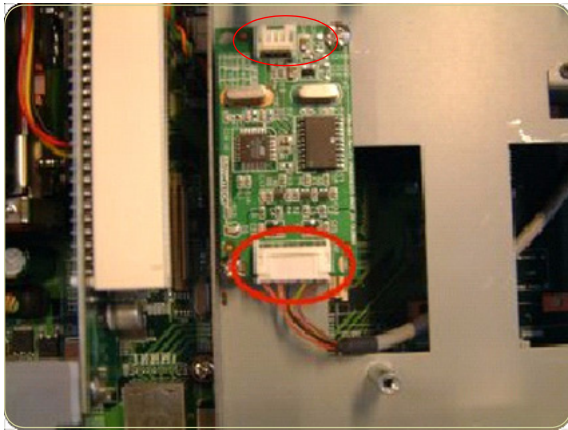

5. Disconnect all cables from the LCD Controller PCA.



6. Remove the HDD/DVD Deck from the PanelPCA.

Main PCA

Removal

Switch off the printer, the scanner, and the PC, and then disconnect them from the power source prior to performing any maintenance.

1. Open Cabinet ⇒ Page 4-79.
2. Remove the Back Plate ⇒ Page 4-84.
3. Remove the HDD/DVD Deck ⇒ Page 4-94.
4. Disconnect the ATX PSU Cable.

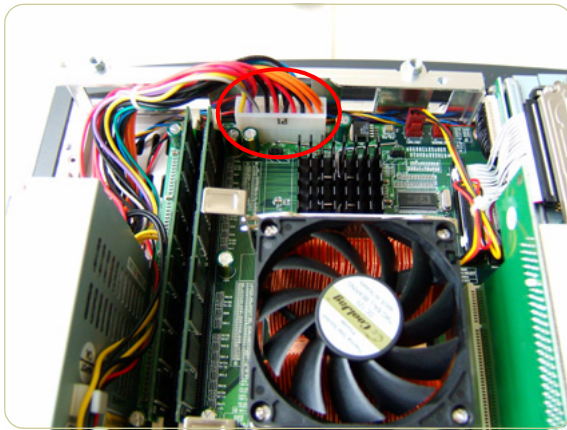

5. Disconnect the P4 ATX power cable.

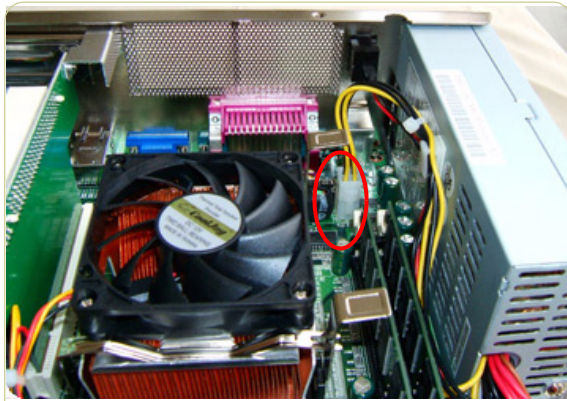

6. Disconnect the System Fan Cable.

For the purpose of installing a new Main PCA, take note of the cable routing before you remove.

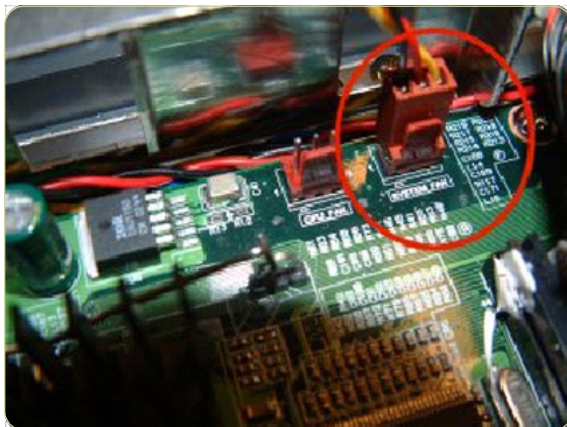

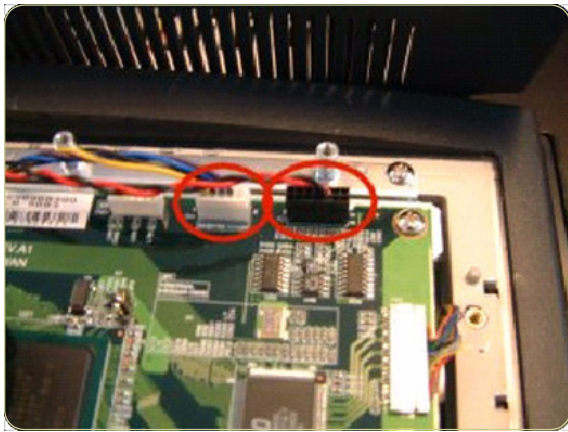

7. Disconnect the Inverter PCA Power Cable and the Power ON Switch Cable.

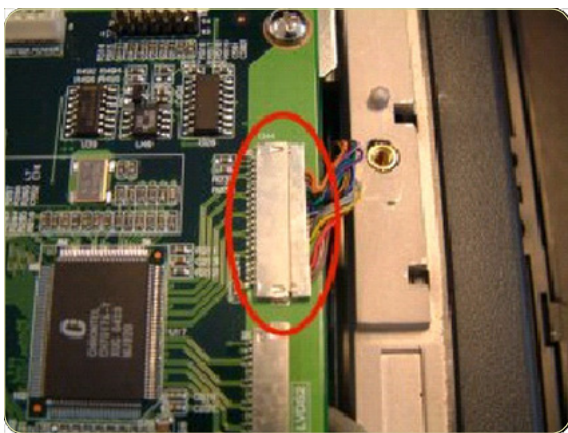

8. Disconnect the LVDS1 cable carefully.



9. Remove eight screws that secure the Main PCA.

10. Remove the Main PCA from the PanelPC.

When installing a new Main PCA, make sure you install the components from the old Main PCA.

Power Supply Unit

Removal

Switch off the printer, the scanner, and the PC, and then disconnect them from the power source prior to performing any maintenance.



1. Open the Cabinet⇒ Page 4-79.
2. Remove three screws that secure the Power Supply Unit to the Back Plate.

These three screws also secure the System Fan shield to the Back Plate.



3. Remove two screws that secure the Power Supply Unit to the Cabinet.

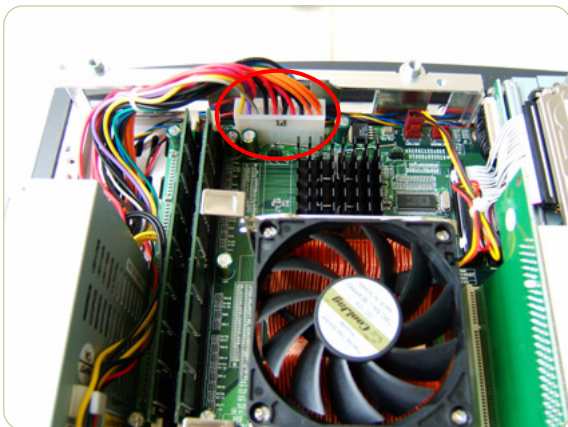

4. Disconnect the ATX Power Supply Unit Cable.

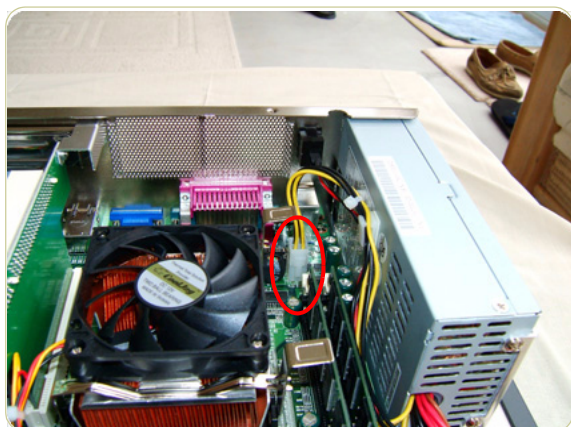

5. Disconnect the P4 ATX Power Cable.

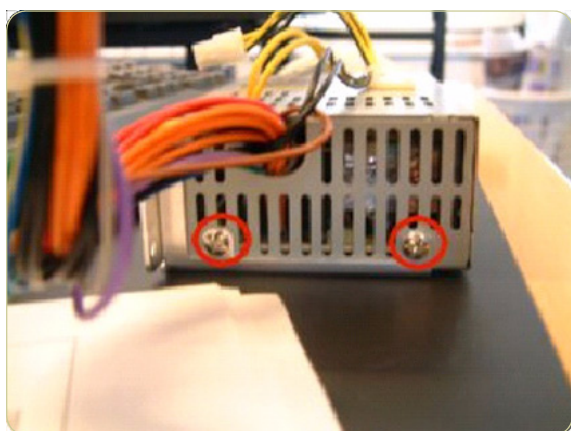

6. Remove two screws that secure the Power Supply Unit to the metal cover.

System Fan

Removal

Switch off the printer, the scanner, and the PC, and then disconnect them from the power source prior to performing any maintenance.

1. Open Cabinet ⇒ Page 4-79.
2. Disconnect the System Fan Cable.

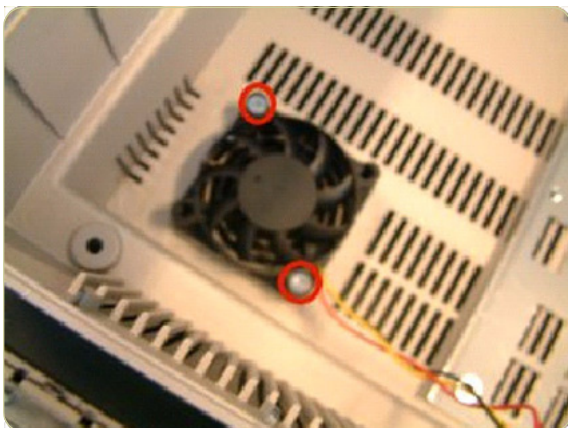
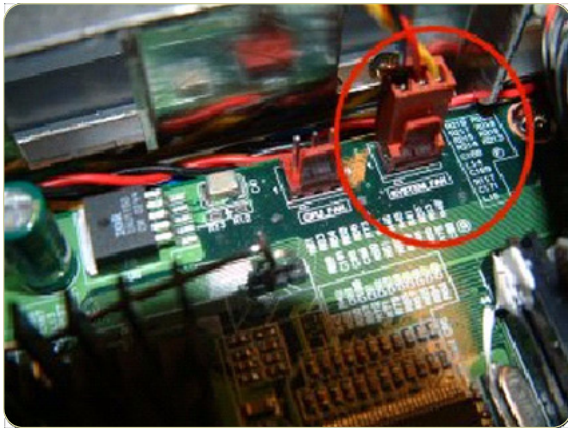

3. Remove two screws that secure the system fan.



Scanner Adjustments and Calibrations

5

| | |
|---|------|
| Introduction | 5-2 |
| Tools Required | 5-2 |
| Terminology | 5-2 |
| Camera Design Overview | 5-3 |
| Adjusting the Camera Using Manual Procedure | 5-7 |
| Adjusting the Camera Using the Camera Wizard | 5-19 |
| Scanner Maintenance | 5-26 |
| ATAC Position Sensors check | 5-27 |
| Original Guide Sensor Test | 5-28 |
| Calibrate ATAC (Automatic Thickness Adjustment Control) | 5-32 |
| Upgrade Scanner Firmware | 5-33 |

Introduction

This chapter explains how to adjust the scanner for optimal scanning-quality. It describes the adjusting procedures in detail and provides additional information regarding acceptance criteria.

A general concept when adjusting the scanner is to loosen screws just slightly. If you loosen the screws too much, you will have difficulties controlling the adjustments, because of too much play in the adjustment levers and other adjustment points. Unless this chapter states otherwise, always loosen screws and nuts **only** slightly. They should be snug; there should be no play when you try to wiggle them. When tightening a set of screws, tighten all of them little by little, rather than fully tightening one, and then another, and so on.

Tools Required

To perform the Camera Adjustment you will need:

- Focus Adjustment Pattern sheet (included in the Service Patterns pn Q1277-60030).
- Optical Adjustment Pattern (pn Q1277-60031).
- Torx 10
- Torx 20

To perform the Sensor Adjustments you will need:

- Adjustment Tools for ATAC Sensors (Q1277-60084).
- Torx 10

Terminology

Throughout this chapter a number of visual elements are used to guide you through the adjustment process.



The exclamation mark is used to point out possible sources of errors. If something can go wrong when performing a specific action, this visual item describes it.



Thumbs up symbol is used with hints, tips and tricks that make a specific action easier to complete.



A hand in an illustration means that this particular adjustment does not require a tool. It can be adjusted with your fingers.



A screwdriver in an illustration means that this particular adjustment requires a tool. It cannot be adjusted with your fingers alone.

Text in **bold** describes a mechanical part, an item, or a program button, which can be located in one of the illustrations.

Camera Design Overview

Introduction

The HP Designjet scanner uses 3 cameras, where each camera scans its own part of the image.

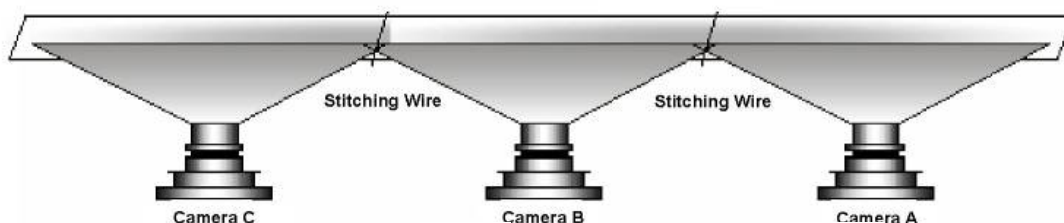

The cameras are named A, B and C. Camera A is on the right and Camera C is furthest to the left. The cameras scan-area overlaps slightly, this is to ensure that the scanner scans the complete image.

Most of the scanner adjustments are focused on getting the correct Scan-Width. The adjustment ensures that a camera scans the right amount of image data so that the basic DPI resolution of the camera is precise. This fine-tunes the accuracy of the scanner. A metal wire (**stitching wire**) in the overlapping area helps the scanner to adjust the cameras electronically.

The following picture shows what the camera actually looks like. Only Camera A and C have a motor at the rear (Camera B does not have a motor).

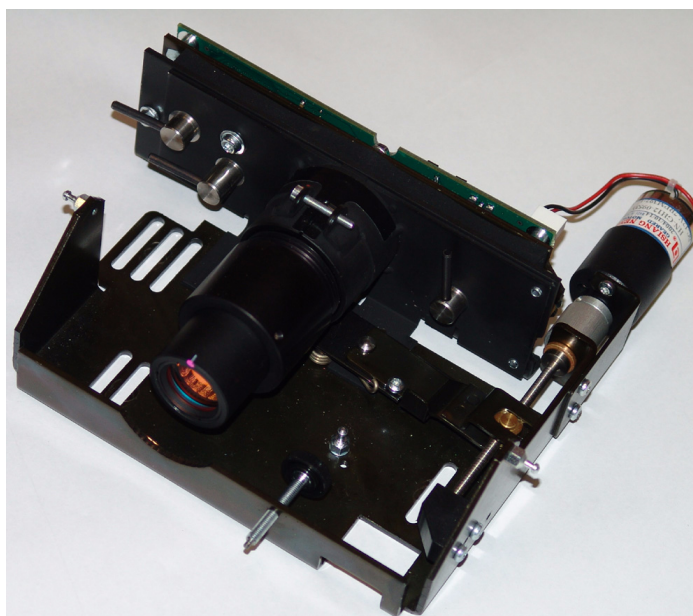

The CCD Element

The central component of the Camera is the Sony CCD (Charge Coupled Device) element, which is responsible for capturing the colors reflected from the original image.



The CCD is formed as a chip, and is inserted into a standard dual in-line socket just like a normal chip. The chip has 4 rows each containing 7500 pixels.

The 4 rows each scan a different color. Combined, the 3 rows provide 24 bit color. The last row is for panchromatic scanning. Each CCD pixel is formed as a square with a side length of $5\ \mu\text{m}$. There is $40\ \mu\text{m}$ between the adjacent lines.

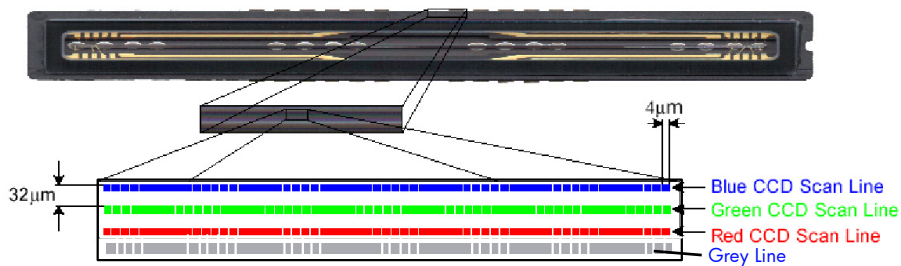

Camera Board Adjustments

The **Scan-Width Adjustment Screw** moves the camera backwards and forwards, which influences the Scan-Width of the camera.

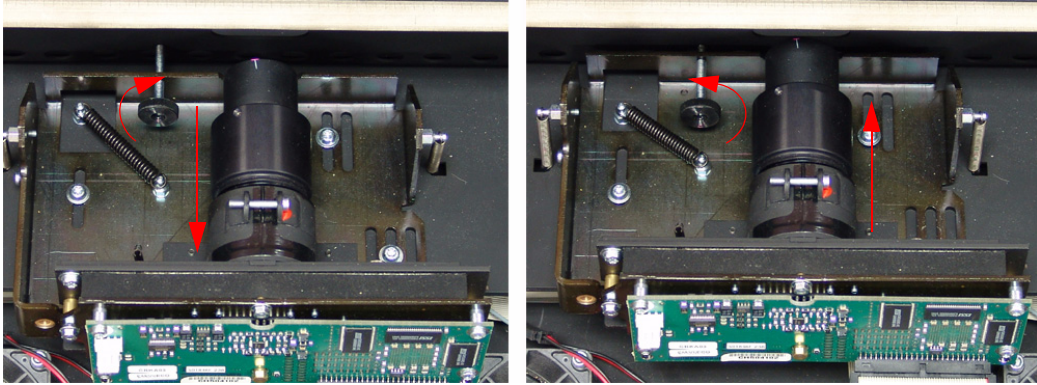

When the **Scan-Width Screw** is screwed in, as illustrated on the left side of the above picture, the camera has a greater possible scan-width. When it is screwed out (right side of picture), the camera has a smaller possible scan-width.



The **Scan-Width Screw** is fixed on the camera assembly and not on the scanner chassis. This means, that when screwing the screw backwards, you have to loosen two T15 screws and push the camera forward manually to decrease the scan-width. When screwing forward, the screw will push the camera backwards on it's own.

The CBE Camera Board, where the CCD is placed, can be moved relative to the camera using 3 adjustment levers.

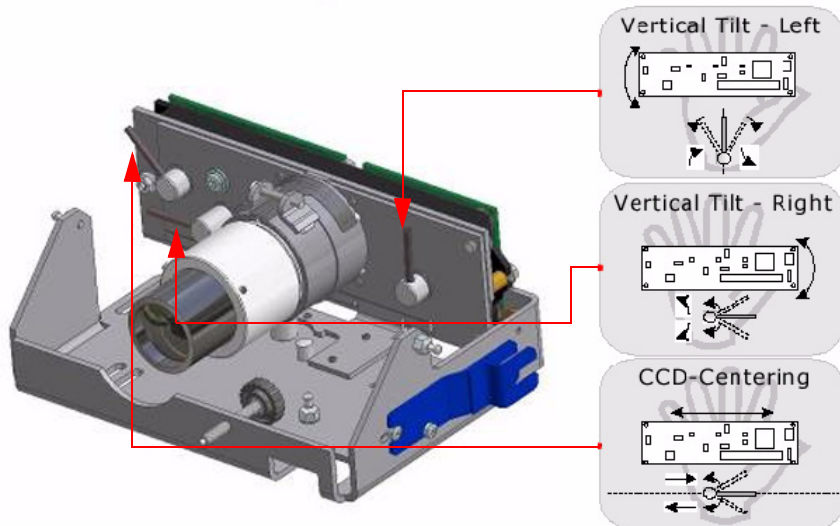
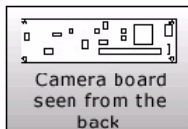

This is an easy and quick way of adjusting the camera, as it does not involve moving the camera itself, but only the camera board, which can be done very precisely.

- Vertical Tilt – Left: moves the left upper edge of the **CCD Mounting Plate** and the **CBE Camera Board** up and down, making the field of vision tilt in proportion to the horizon.
- Vertical Tilt – Right: moves the right upper edge of the **CCD Mounting Plate** and the **CBE Camera Board** up and down, making the field of vision tilt in proportion to the horizon.
- CCD Centering: moves the **CCD Mounting Plate** and the **CBE Camera Board** horizontally left and right and thereby making the field of vision move horizontally left and right.

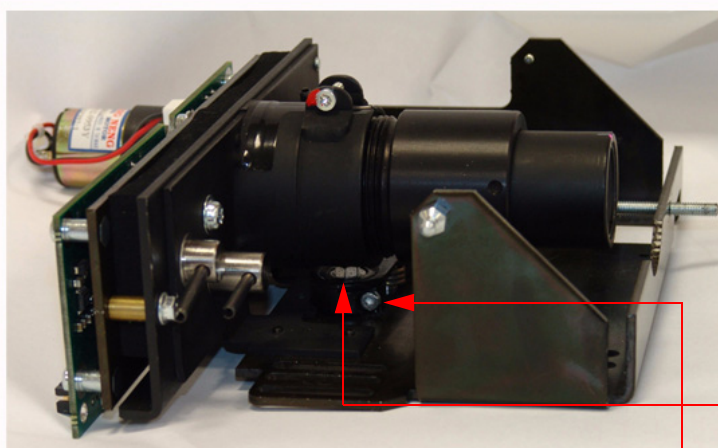

The camera itself can be tilted up and down which causes the field of vision to move up and down. The **Vertical Positioning Hexagonal Nut** is used for coarse adjustments and the **Tilt Levers** are used for finer adjustments. When you rotate the **Vertical Alignment Hexagonal Nut** counter-clockwise you raise the camera and the field of vision and vice versa.

To rotate the **Vertical Positioning Hexagonal Nut** use the adjustment tool which comes with the Camera B, the tool is shown mounted on the side of the camera in the graphic on the previous page.



When using the **Vertical Positioning Hexagonal Nut**, loosen the **Lock Screw** first, so that the **Vertical Alignment Arm** doesn't move simultaneously. You will normally not adjust directly on the **Vertical Alignment Screw**, but instead via an extension and through a hole in the scanner front.

Adjusting the Camera Using Manual Procedure



This Chapter explains how to adjust Camera A manually using oscilloscope software which comes with the scanner. In this procedure we focus on Camera A, but the procedure is exactly the same for Cameras B and C.

It is important that you use this procedure (Test 9) to manually adjust the camera and NOT the Camera Adjustment Wizard (Test 27).

Light Profile

Make sure that the left and right covers are installed and the top cover is removed. The scanner and the touch screen must be switched ON.



When you install a camera in the scanner for the first time, the camera is completely out of adjustment. If you get an Error 30 from SCANtest when setting the Light Profile to **Corrected**, start with **Uncorrected** and follow steps 3 and 4 as well as you can and then start over with the **Corrected Light Profile** again.

The first thing to be done before adjusting the camera that has been replaced is to ensure that the camera is at least looking in the right direction.

- 1 Make sure that camera is completely installed and all cables are correctly connected.
- 2 Select button **9. Camera Adjustment** in SCANtest 6.
- 3 A software oscilloscope is now activated and looks something like this:

When the uncorrected light profile is selected, verify that the Green color channel is selected. You adjust the scan width, tilt, and height in uncorrected mode.

Select the Reference Image button in order to view the Reference Image section

Reference Image

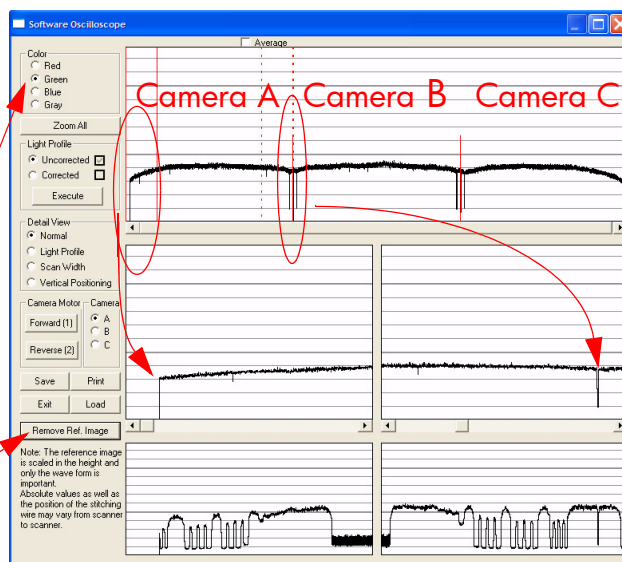

- 4 You see the uncorrected light profile, for Cameras A, B and C that the scanner receives from the reflection of the White Background on the back of the Guide Plate. Camera A is on the left, Camera B is in the middle and Camera C is on the right. You can zoom in with the buttons on the touch

screen. You can see that the output is lower at the edges. This is because of the lens in the camera. If you get a screen that looks distorted in comparison with the above image, then maybe your camera is looking into the chassis instead of the mirrors in the copier. To correct this, use the tool to rotate the Vertical Alignment Screw located underneath the camera, rotate the screw left or right until you get an oscilloscope image similar to the one shown.

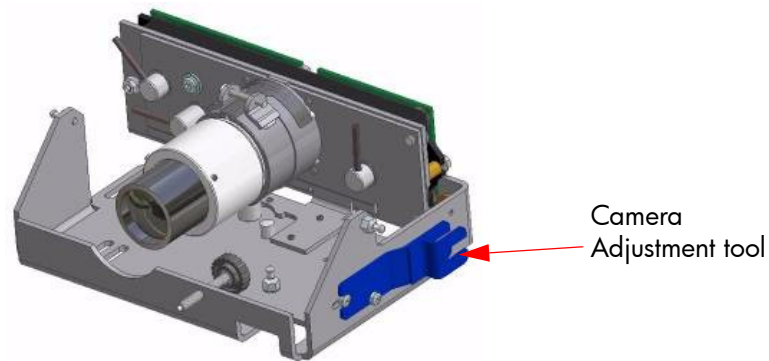

Focus Adjustment

The first adjustment that you need to make is the focus. This adjustment ensures, that the camera has the right focus, so that the following adjustments aren't blurred out. The focus setting is not as sensitive as some of the other adjustments, which makes it a good example to start with. When you are finished with all the adjustments, you should check the focus again just to be sure that it's still OK.

- 1 Stay in the Software Oscilloscope and select **Corrected** and then press the **Execute** button. Only adjust the focus in the corrected mode. Make sure that the Blue color channel is selected.

2 Wait approximately 90 seconds until SCANtest 6 is ready.

Make sure that the Blue color channel is selected.

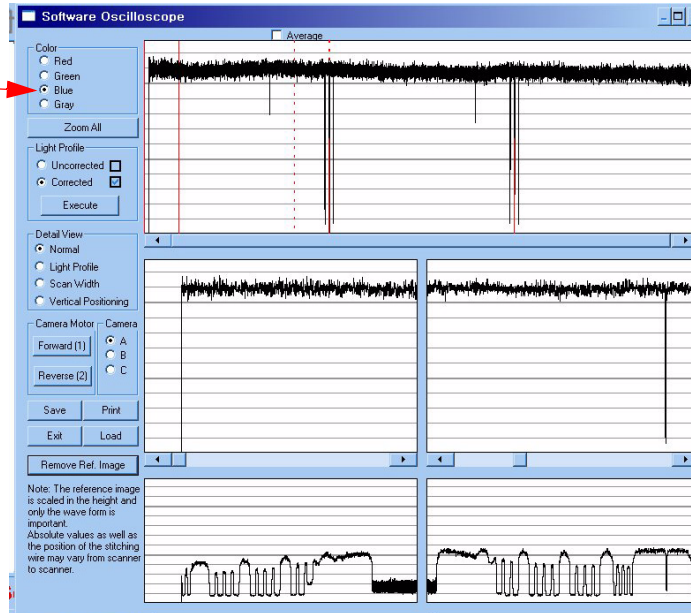

3 Insert the Focus Pattern in the scanner.



It's best to insert the sheet from the back of the copier and use the Reverse Key to position the pattern correctly. This way the sheet won't cover the cameras when you adjust them. It requires a little practice but makes the focus adjustment a lot easier.

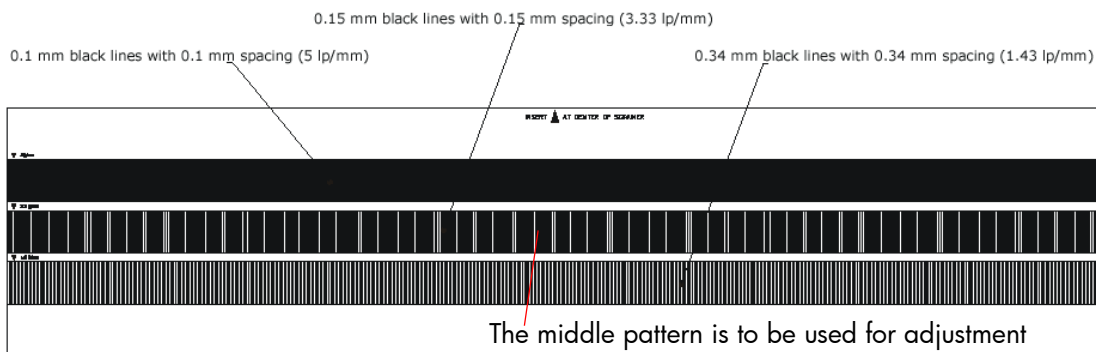

Use the operation panel keys to move the sheet so that the cameras see the

3.33 lp/mm pattern.

- 4** Loosen the **Focus Lock Screw** and turn the **Lens Adapter** to adjust the focus.

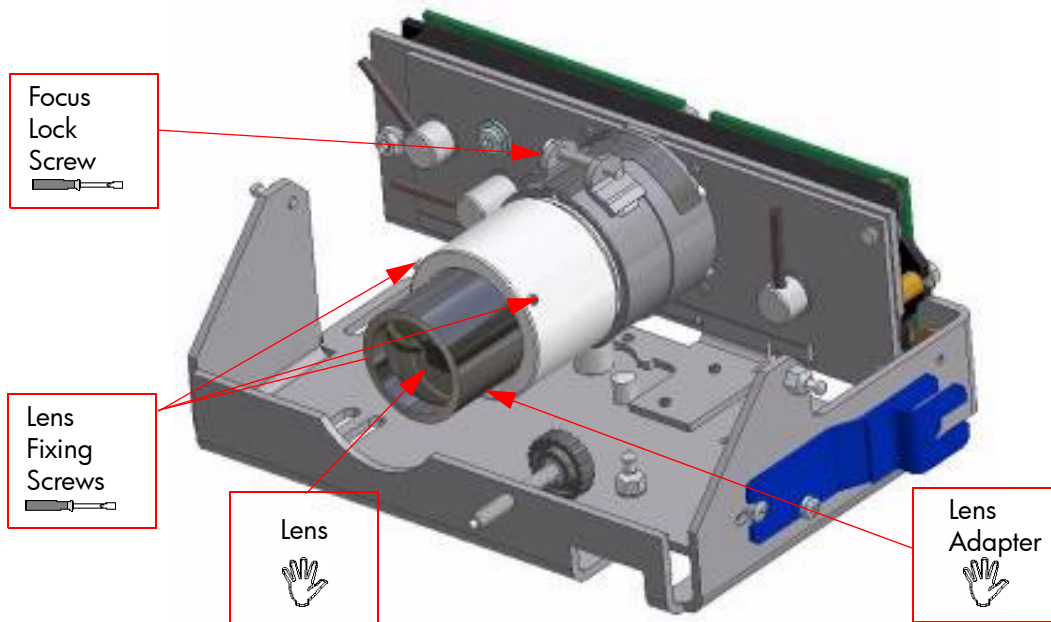

The Focus adjustment greatly influences the Scan-Width. Therefore, the Scan-Width must be checked and readjusted whenever the Focus adjustment has been changed.

The Focus adjustment, however, is relatively tolerant to Scan-Width adjustments. After adjusting the Scan-Width, check the Focus adjustment again; it will only need further adjusting if the Scan-Width has change greatly. However, you should check both the Focus and the Scan-Width after an adjustment to either to ensure that they are both correctly adjusted.

Loosen the **Focus Lock Screw** and ensure that it is not too loose. Turn the **Lens Adapter** until you get this picture on the software oscilloscope

(Camera A has been zoomed in):

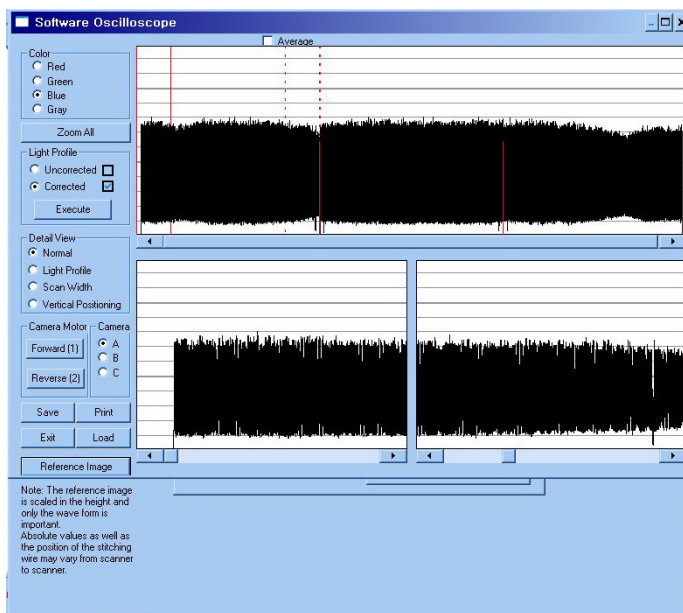

The signal has to be as even as possible and especially the ends have to be at their highest possible level.

When the focus is right, tighten the **Focus Lock Screw**.

Keep in mind that if you adjusted the Focus, the Scan-Width has changed and must be adjusted.

There is a mark on every lens, which indicates its “best position”. If you have completed the focus adjustments and this mark isn’t pointing upwards, mark the upward position on the **Lens Adapter**. Turn the **Lens Adapter** and loosen the **Focus Lock Screw** and the three **Lens Fixing Screws** (with a 1,5 mm Allen key). Then turn the Lens so that the mark is pointing upwards, tighten the **Lens Fixing Screws** again. Turn the **Lens Adapter** back again and check that the focus it still correct before tightening the **Focus Lock Screw**.

Scan-Width Units

When adjusting the Scan-Width, you adjust up against some line on an **Optical Adjustment Pattern**.



The Optical Adjustment Pattern is a metal construction with a pattern glued

on one side. This pattern contains three sub-patterns: A, B and C.

- Sub-pattern A contains a pattern used for Scan-Width adjustment.
- Sub-pattern B contains a pattern used for Vertical Position adjustment.
- Sub-pattern C contains a pattern used for coarse Focus adjustment.



The **A** part of the pattern consists of scan-width units (SWU).

Each of the black lines represents a scan-width unit (SWU) as does the white space in between the lines. This makes a total of seven SWU's.

The black lines and white spaces work like a marker or indicator that tells you how wide the camera scan-width is.

The scan-width units help you adjust the cameras, so that they have the correct scan-width. This ensures that the scanner has the correct optical resolution. Thereby ensuring that the scaling factor of the scanner is correct.

Camera A has three **A** patterns in its view:

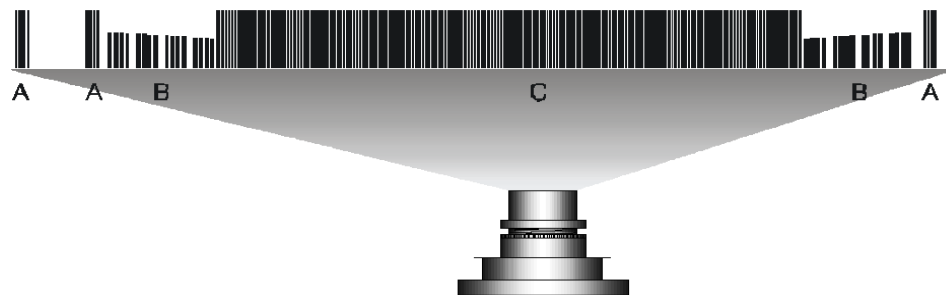

To ensure that the camera has the correct optical resolution, you are going to adjust the camera, so that it covers six scan-width units. This means that the camera has to see a total of six units at the ends of the view field. This can be two on the left and four on the right or five on the left or one on the right. The unit arrangement is not important as long as there are six in total.

Later on you will center the camera, so that there will be three units at each end.

Scan-Width Adjustment

The purpose of Scan-Width adjustment is to position the camera so the field of vision is correct.

- 1 Open the Guide Plate and place the Optical Pattern on the scanner. Align the pattern by pressing it to the right towards the operator panel and backwards toward the back of the scanner.
- 2 If not selected, select button 9 in SCANtest 6. Select **Uncorrected** Light Profile and press **Execute** (make sure that the Green Channel is selected).

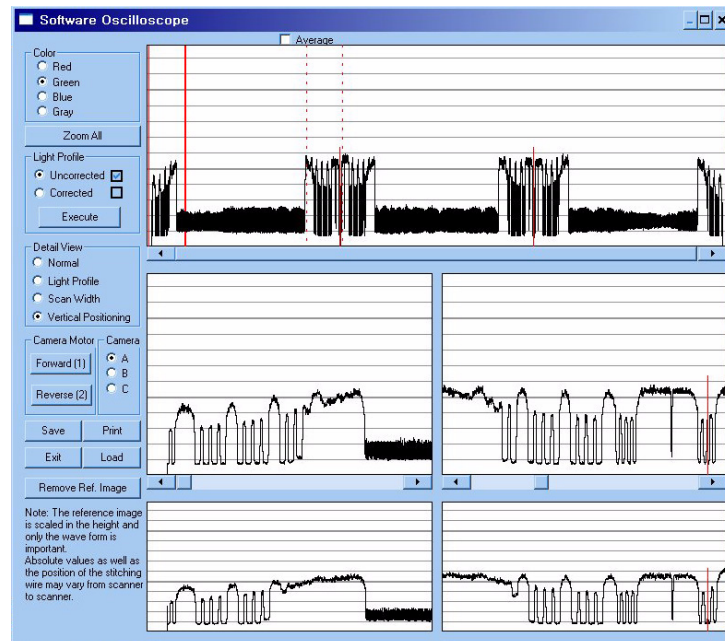

- 3 This is what **Camera A** is going to see, when the scan-width adjustment is finished:



Camera A scans from right to left, so the image above is a mirrored section of the total **Scan-Width pattern** as the copier actually sees it. The camera only sees a single line of pixels with the green CCD pixel line that

we enabled under step 2. The goal is to adjust the camera so that the green pixel line of the CCD is positioned as the green line below:

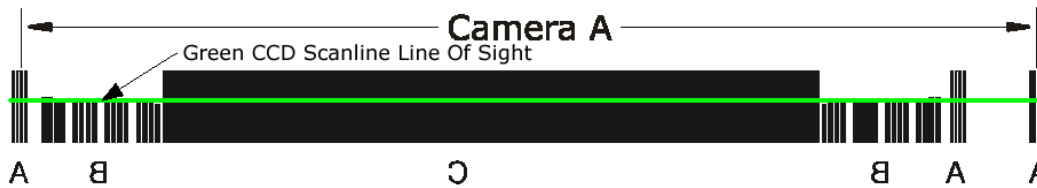

When you have succeeded in getting this, most of the adjustments for **Camera A** are finished.

If the scan width changes by more than one scan-width unit (SWU), you must check the focus.

But first we start by setting the Scan-Width of Camera A. You use the software oscilloscope to guide you, and this is what you are going to see:

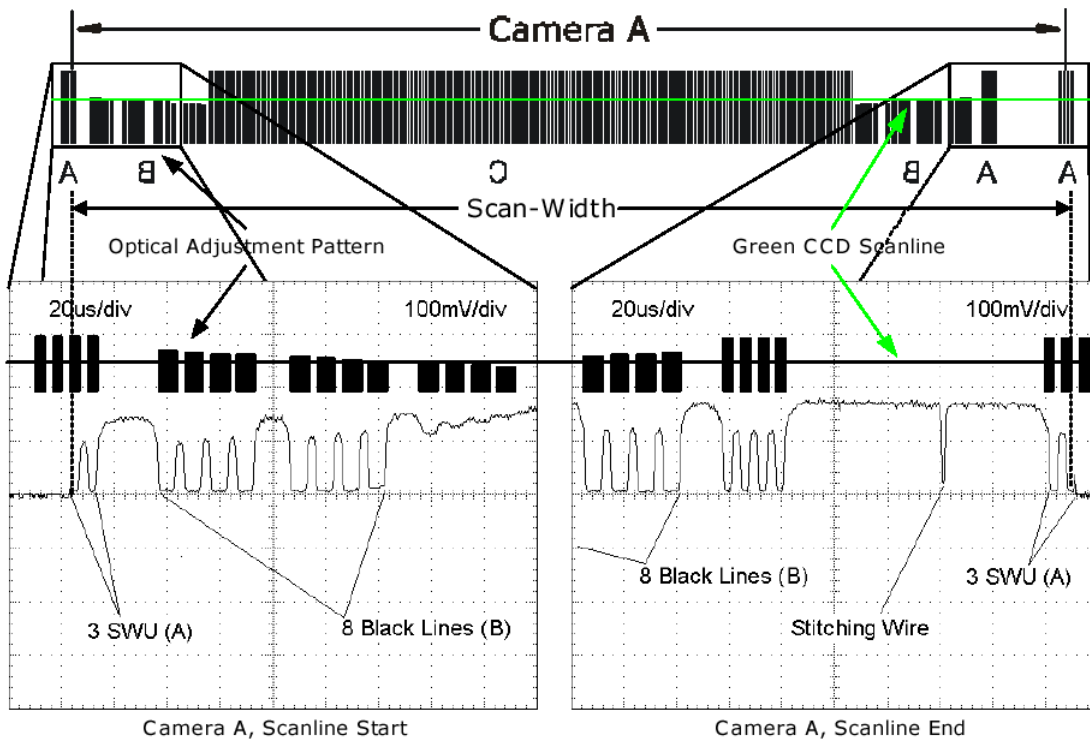

In the image you see a real oscilloscope image of the left- and the right most part of the **Camera A Scan-Width pattern**. Whenever the camera sees a black line, the output level goes down. It goes up when seeing white. When the **Green CCD Scanline** is in the correct position, each end of the camera output will have the appearance as shown.

- 4 Now press **Scan Width** under Detail View on the software and the program automatically zooms in on the left and right part (Scanline Start/

End) of the output. On the left side you will get an output like one of these (or something in between):

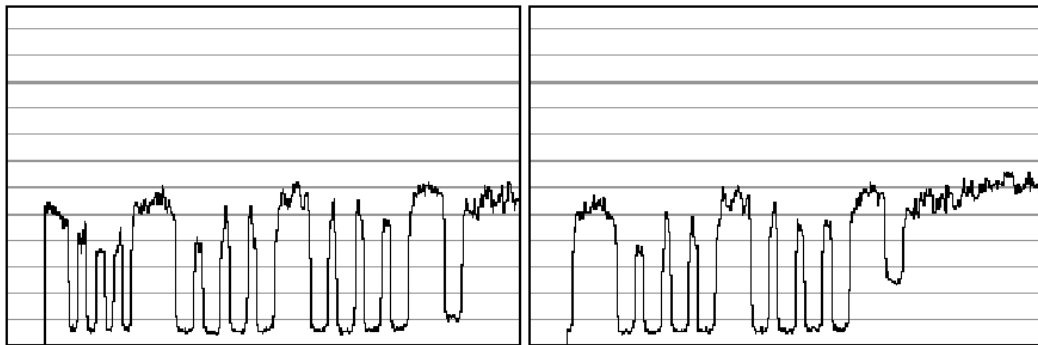

The output we are aiming for can be seen below, therefore:

- The left output is too much to the left – if you have an output like this, you need to slide the CCD board to the right by turning the **CCD Centering** tab upwards.
 - The right output is too much to the right – if you have an output like this, you need to slide the CCD board to the left by turning the **CCD Centering** tab downwards.
- 5 When you have one, two or three scan-width units (SWU) on the left side of the camera, look at the right side of the camera.
 - 6 On the right side (Scanline End) you will get output like one of the following:

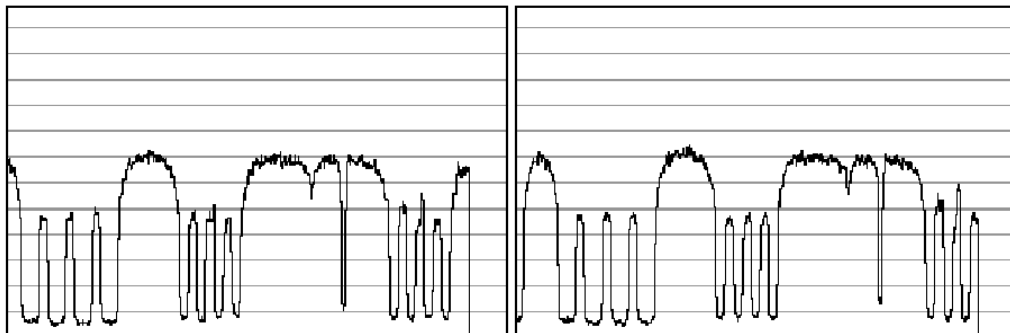

Remember how many scan-width units you had on the left side and remember that there has to be six in total.

If you had three SWU's on the left side of the output you also have to have three on the right and the output we are aiming for is as shown below. Therefore:

- On the left picture above the Scan-Width is too wide – if you have an output like this, you need to move the camera forward to decrease the Scan-Width.
- On the right picture above the Scan-Width is too narrow - if you have an output like this, you need to move the camera backward to increase the Scan-Width.



Look for the **Stitching Wire**. There's only one of these on the right side of

the camera. If you don't see the Stitching Wire, then the camera has to be pulled back quite a lot because the scan-width is too narrow.

- 7 Repeat steps 4 to 6 until the camera sees a total of six SWU's.
- 8 When you have six SWU's in total, use the **CCD-Centering** lever to adjust the camera so that there is three SWU's on each side of the camera as shown below:

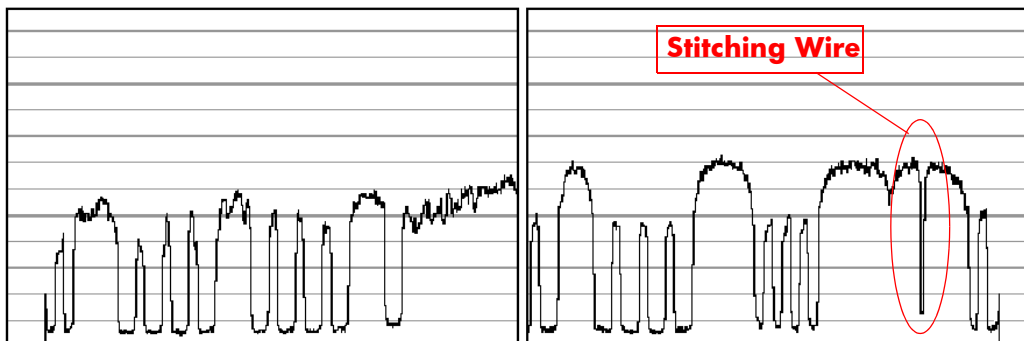

- 9 Check the focus again because large changes to the Scan-Width adjustment also affects the focus.
- 10 If the focus needed adjusting, start over with the Scan-Width from step 4, because a slight change in the focus will affect the Scan-width considerably.
- 11 When you are finished, and both the focus and the Scan-Width are correct, tighten the three **Camera Fixing Screws** without moving the camera.
- 12 Proceed to the Vertical Positioning section without altering anything about your set-up.

Vertical Positioning

The purpose of the vertical positioning is to adjust the camera, so the **Green CCD Scanline** looks at the correct vertical position on the **Optical Adjustment Pattern** as seen on the picture below. Furthermore it ensures that the Scanline is horizontal.

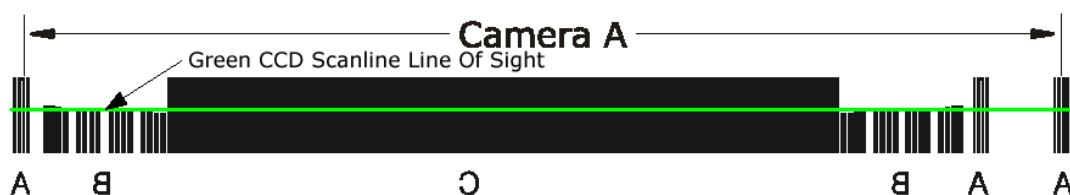

- 1 SCANtest 6 should still show **Uncorrected Light Profile, Green**. If not, change it to those settings.
- 2 Loosen the **Camera Back-Plate Fixing Screws** if they are not already loose.

- 3** Select **Vertical Positioning** under Detail View and look at the left part (Scanline Start) of the camera output. You will get an image similar to one of these (or even less lines than shown on the right image):

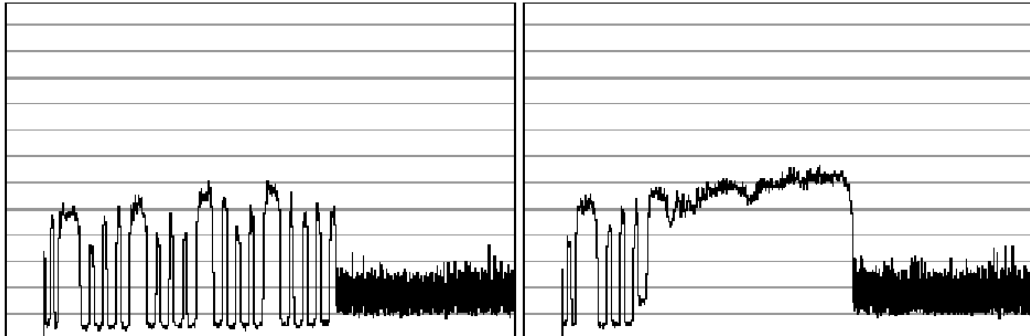

The output we are aiming for can be seen below, therefore:

- On the left image the vertical position is too low – if you have an output like this, you need to lower the left side of camera with the left **Vertical Tilt** lever, by turning to the left.
- On the right image the vertical position is too high - if you have an output like this, you need to raise the left side of camera with the left **Vertical Tilt** lever, by turning it to the right.

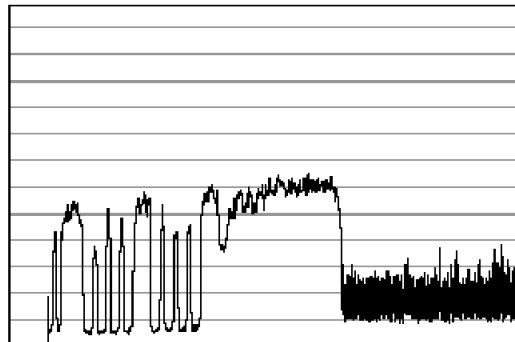

- 4** When you have adjusted the Vertical Tilt so that the output displays 8 black lines (your output does not have to be identical to the above picture or the Reference Image, just close) on the left side of the camera, look at the right side of the camera.
- 5** On the right side (Scanline End) you will get an output similar to one of these:

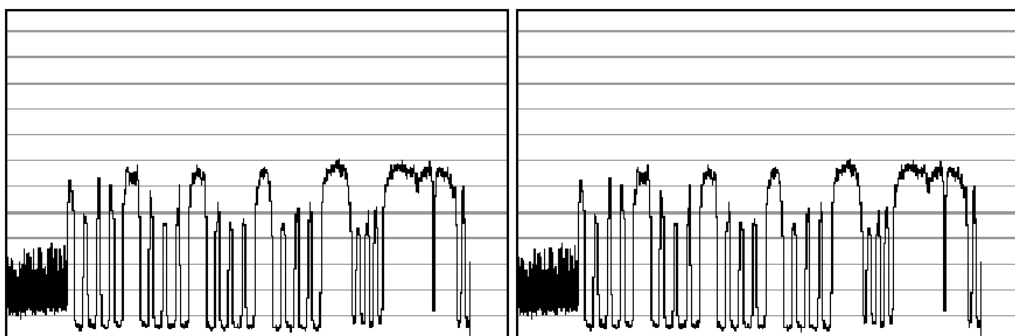



The **Vertical Tilt** lever can't be moved very far before it loses its grip. If this happens while you are adjusting the camera, move the **Vertical Tilt** levers back to the middle position and use the **Vertical Position Pre-Set Screw** to make a coarse adjustment. Then fine tune again with the **Vertical Tilt** lever.



When adjusting the Vertical Position, you continuously have to readjust the CCD Centering (3 scan-width units) with the **CCD Centering** lever, because the **Vertical Tilt** lever moves the camera a little in the horizontal direction.

The output we are aiming for can be seen below, therefore:

- On the left image the vertical position is too low – if you have an output like this, you need lower the right side of camera with the right **Vertical Tilt** lever, by turning downwards.
- On the right image the vertical position is too high - if you have an output like this, you need raise the right side of camera with the right **Vertical Tilt** lever, by turning it upwards.

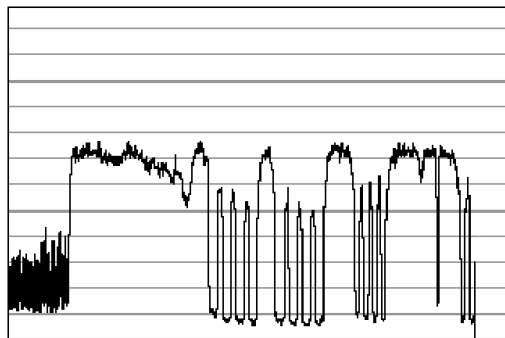

When you have adjusted the Vertical Tilt so that the output displays 8 black lines and 4 smaller lines (it doesn't have to be precise, just close to the above picture) on the right side of the camera, look at the left side again to check that it's still okay (it's probably not). It very likely that you have to go back and forth between left and right a couple of times until both sides are adjusted the right way. That is because adjusting one side affects the other side a little.

- 6 Check that the CCD Centering is OK. That is that you still have 3 SWU's on each side of the Camera. If you don't then adjust it with the **CCD Centering Lever**.
- 7 Tighten the **Camera Back-Plate Fixing Screws** gently to prevent the camera from moving out of adjustment.
- 8 Once the cameras are adjusted, you will need to adjust the whole scanner to fine-tune it by performing the Scanner Maintenance (refer to Page 5-26).

Adjusting the Camera Using the Camera Wizard

Preparing the Scanner

Before you start make sure that you have the following items, which are necessary to complete the Camera Adjustment:

- The SCANtest6 is installed in the touch screen (programs - Scanner Test Program - Scantest 6).
- Focus Adjustment Pattern sheet (included in the Service Patterns pn Q1277-60030).
- Optical Adjustment Pattern (pn Q1277-60031).

Make sure that the scanner you are adjusting is fully functional. If the scanner is not operational, you will not be able to adjust the camera.

Make sure that the left and right covers are installed and the top cover is removed. The scanner and the touch screen must be switched ON.

- 1 Make sure that the cameras are all installed correctly and all cables are connected.
- 2 Start SCANtest 6 and select: **27. Camera Adjustment Wizard**.

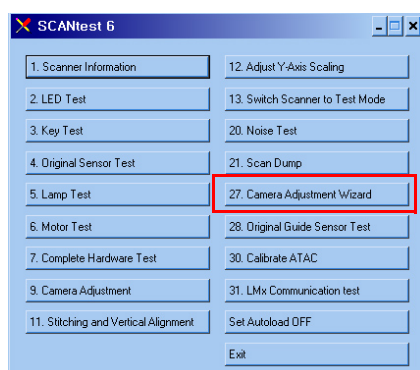

Select button 27

- 3 The Camera Adjustment Wizard will start with the welcome screen. Select **next** to continue.



Select next to continue

- 4 The screen will display the list of Service Tools necessary to complete the Camera Adjustment correctly. Select **next** to continue.

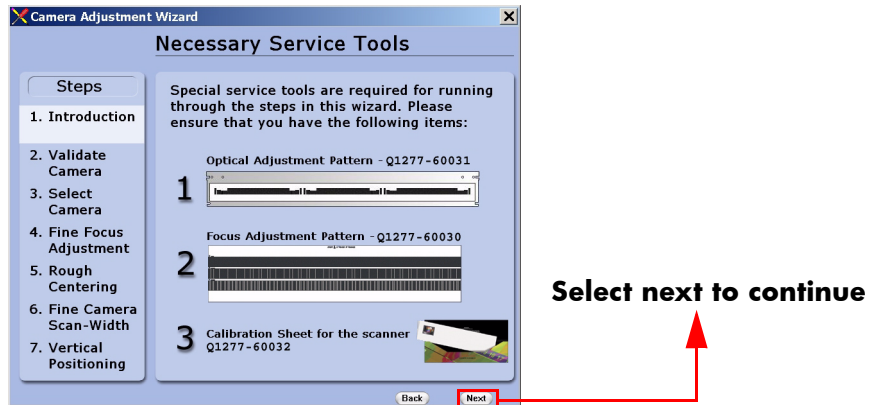

- 5 The next 4 screens contain information on how to perform the camera Adjustment correctly. Select **next** after reading each screen.

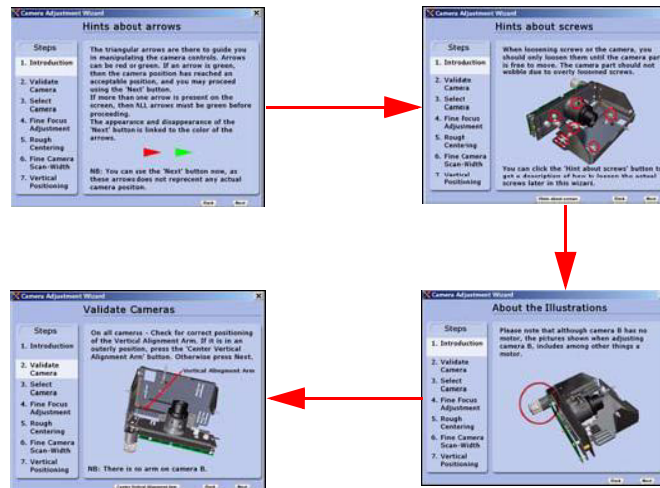

- 6 In order to validate the current state of the cameras you will need to open the Guide Plate and place the Optical Adjustment Pattern on the Scanner. Align the pattern by pressing it to the right towards the Operator Panel and backwards towards the back of the scanner. Once the cameras have been validated, select **next** to continue.

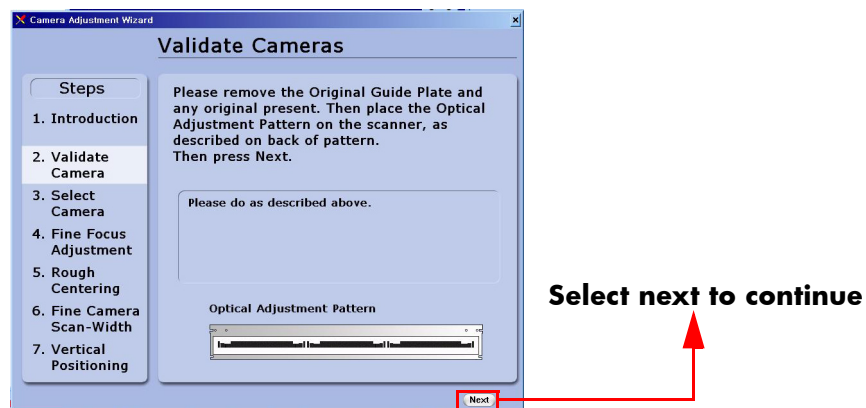

- 7** The Scanner will now perform some internal adjustments. In order to do this you will need to remove the Optical Adjustment Pattern and close the Guide Plate.

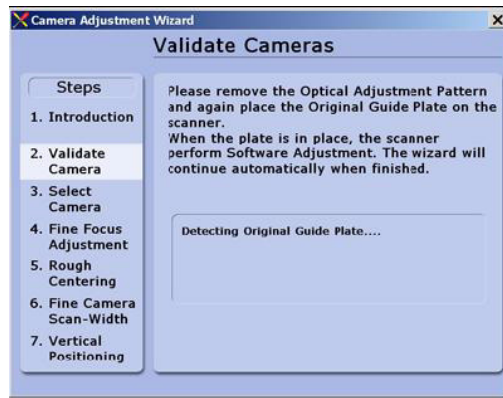

- 8** Once the internal adjustment has been done, you will need to insert the Focus Adjustment Pattern in the Scanner.



It's best to insert the left corner of the Focus Adjustment Pattern first and then slide the right side of the pattern in to place.

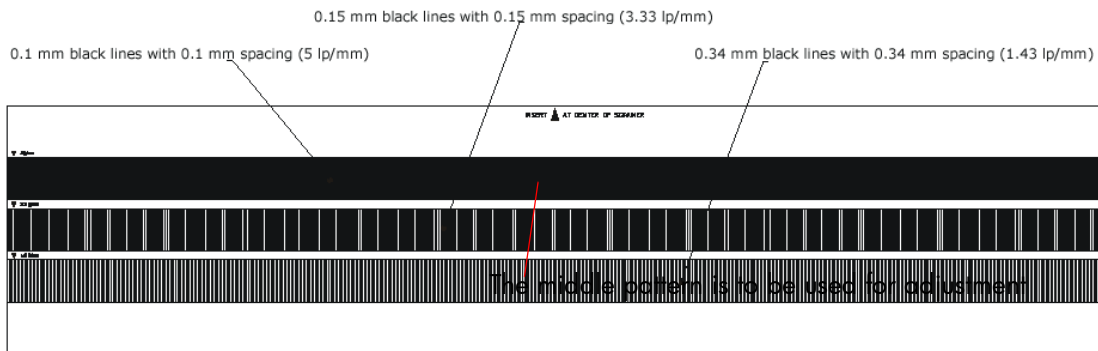

- 9** Once the Scanner detects that the Focus Adjustment Pattern is correctly positioned you will be able to select **next** to continue.

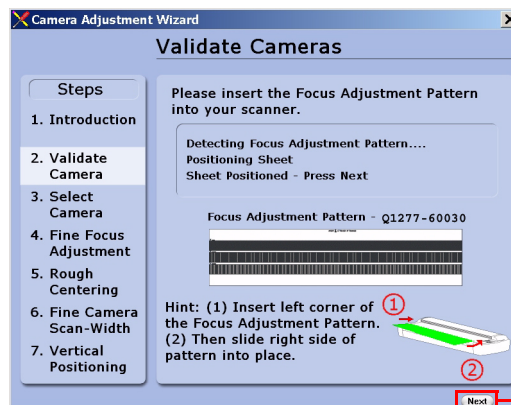

Select next to continue (when it appears)

- 10** Select the camera that you need to adjust. Camera A is the one closer to the front panel.

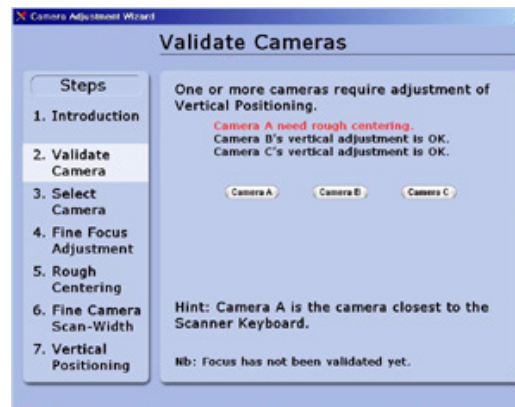

- 11** Remove the Focus Adjustment Pattern and place the Optical Adjustment Pattern on the Scanner. Align the pattern by pressing it to the right and backwards towards the back of the scanner. Once the pattern has been detected, select **next** to continue.

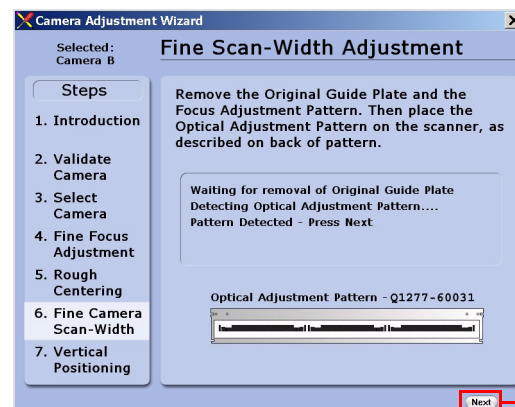

Select next to continue

- 12** In this example, the camera requires partial adjustment before completion. Loosen the **3 Camera Back-Plate Fixing Screws** and then select **next**.

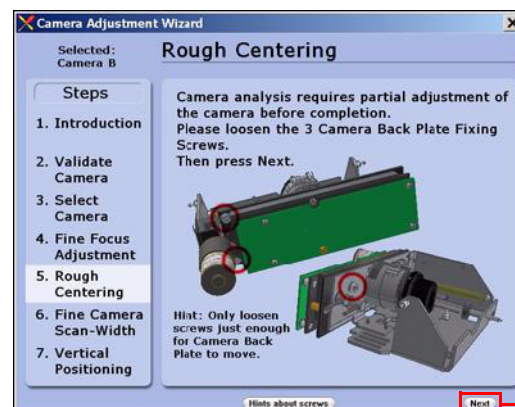

Select next to continue

- 13** Turn the **Centering Lever** until the arrow on the screen is in the center of the scale and the value is 0 (or as close as possible). Once the value is within tolerance, you will be able to select **next** to continue.

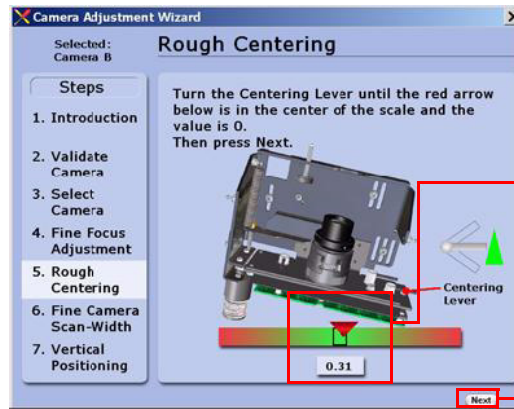

The arrow needs to be in the center and the value 0

Select next to continue (when it appears)

- 14** Turn the **Left and Right Vertical Tilt Levers** until the horizon is level with the arrows. Also turn the Centering Lever so the center scale is 0 (or as close as possible). Once the value is within tolerance and the horizon is level with the arrows, you will be able to select **next** to continue.

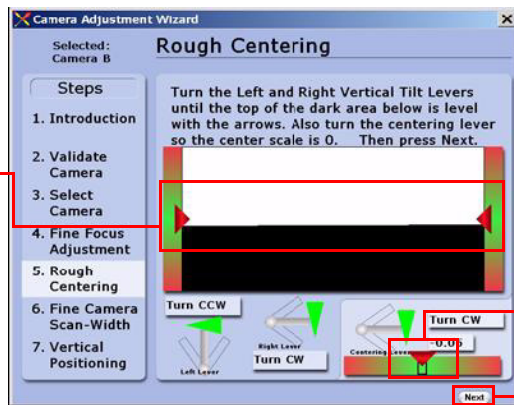

The horizon needs to be in level with the arrows

The arrow needs to be in the center and the value 0

Select next to continue (when it appears)

- 15** Tighten the **3 Camera Back-Plate Fixing Screws** and then select **next**.

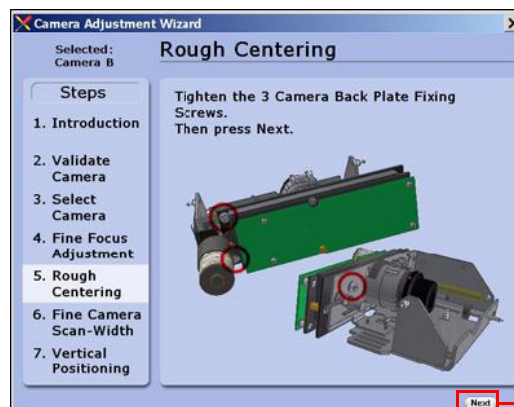

Select next to continue

- 16** Loosen the **Camera Fixing Screws** slightly so that the camera housing can be moved. Select **next** to continue.

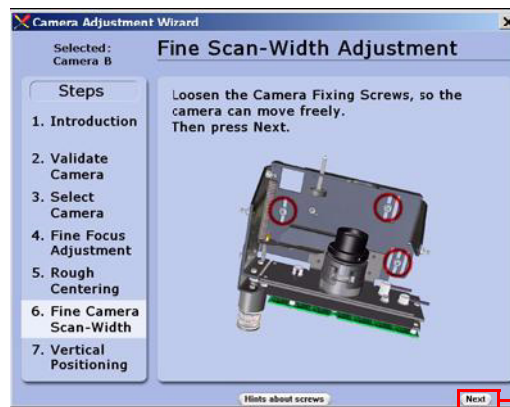

Select next to continue

- 17** Turn the **Scan-Width Screw** until the arrow on the screen is in the center of the scale and the value is 6.0. Once the value is 6.0 (or as close as possible), tighten the **Camera Fixing Screws** while maintaining the correct adjustment. Once the screws are tightened, select **next** to continue.

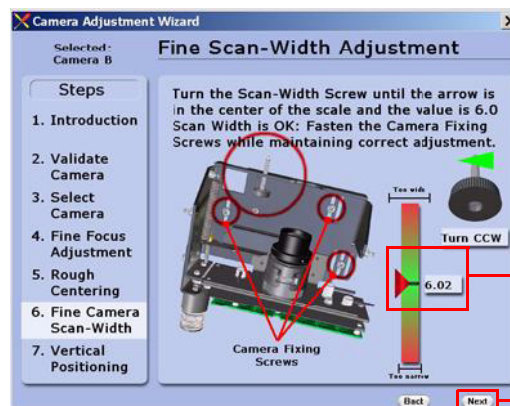

The arrow needs to be in the center and the value 6.0

Select next to continue (when it appears)

- 18** Loosen the **Camera Back-Plate Fixing Screws** slightly so that the camera housing can be moved. Select **next** to continue.

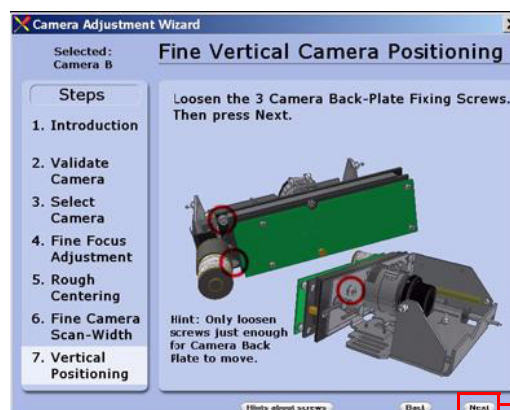

Select next to continue

- 19** Turn the **Left and Right Vertical Tilt Levers** until the horizon is in level with the arrows. Also turn the Centering Lever so the center scale is 0. Once the value is 0 (or as close as possible) and the horizon is level with the arrows, you will be able to select **next** to continue.

The horizon needs to be in level with the arrows

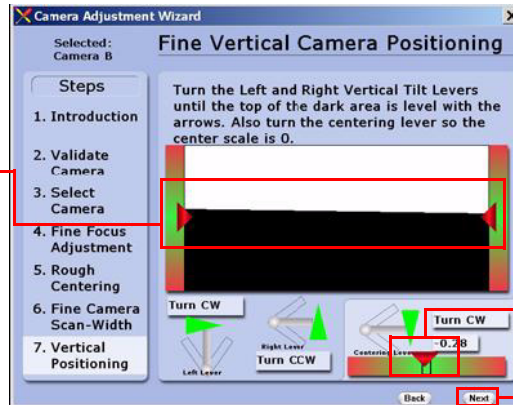

The arrow needs to be in the center and the value 0

Select next to continue (when it appears)

- 20** Tighten the **Camera Back-Plate Fixing Screws** gently to prevent the camera from moving out of adjustment. The Camera Adjustment has now been completed.

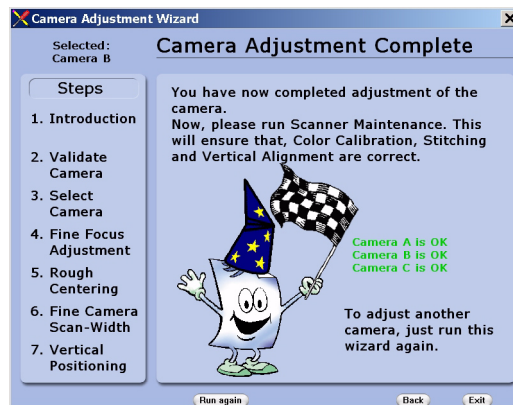

- 21** Perform the Scanner Maintenance to ensure that Color Calibration, Stitching and Vertical Alignment are correct.

Scanner Maintenance

Once the cameras are adjusted, you will need to adjust the whole scanner to fine-tune it by performing the Scanner Maintenance. Scanner Maintenance does the following three things **automatically**:

- 1 Runs Vertical Alignment, which adjusts the vertical position of the Cameras.
- 2 Adjusts the Stitching, which controls the overlap between the Cameras.
- 3 Color Calibrates the Scanner to get optimal colors and gray tones.

Performing Scanner Maintenance

For this part of the adjustments you will need the following item:

- Scanner Maintenance Calibration Sheet 42" (included in the Service Patterns pn Q1277-60030).

- 1 Start by removing the **Optical Adjustment Pattern**, cleaning the scanning area, and then closing the Guide Plate.
- 2 Exit the Camera Adjustment Wizard and exit SCANtest 6.
- 3 Wait for the Scanner to reboot and then start Scanner Maintenance when only the green lamp is lit up on the scanner keyboard.

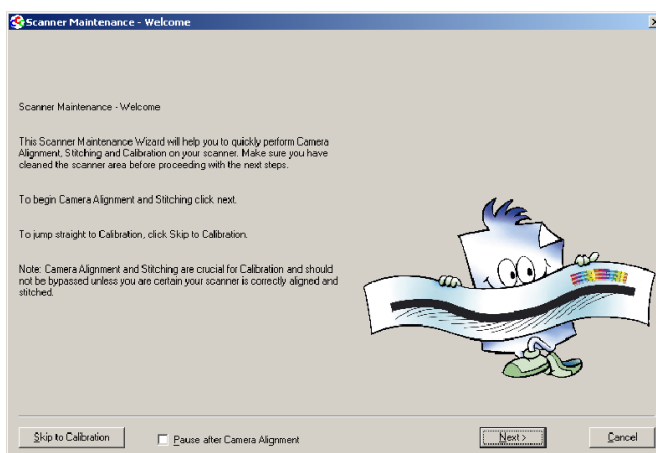

- 4 Insert the Scanner Maintenance Calibration sheet and press **Next** two times.
- 5 Wait for Scanner Maintenance to finish. It takes about 20 minutes.
- 6 Remember to put the calibration sheets back into the original packing, so that they last longer.

ATAC Position Sensors check

This procedure is to check the sensors in the Original Guide come on when the media sensors are activated.

- 1 Start SCANtest 6 and select **Test 28, Original Guide Sensor Test**
- 2 If the guide plate is in the lowered position, press the UP Key on the scanner front panel to move the Guide Plate to the Top Position and observe that:
 - Ready LED is OFF
 - Wait LED is OFF
 - The Power LED turns green (Top Position Sensor activated)

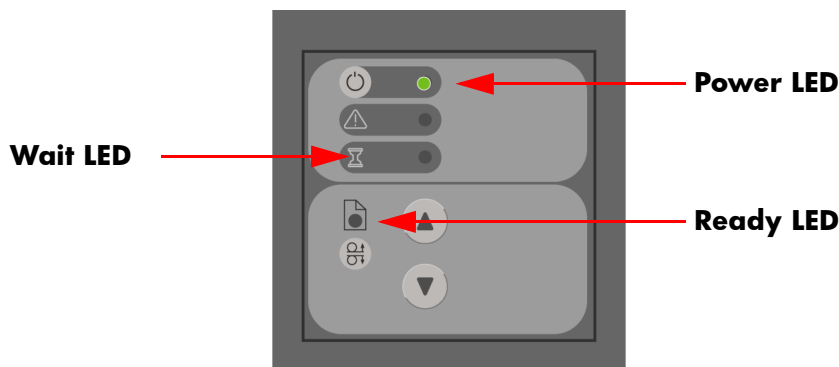

- 3 Move the Guide Plate down by pressing the Down Key on the scanner front panel and observe the LEDs in following sequence:
 - Power LED turns OFF
 - Wait LED turns yellow (Down Position Sensor* activated)
 - Ready LED turns green (Roller sensor activated)

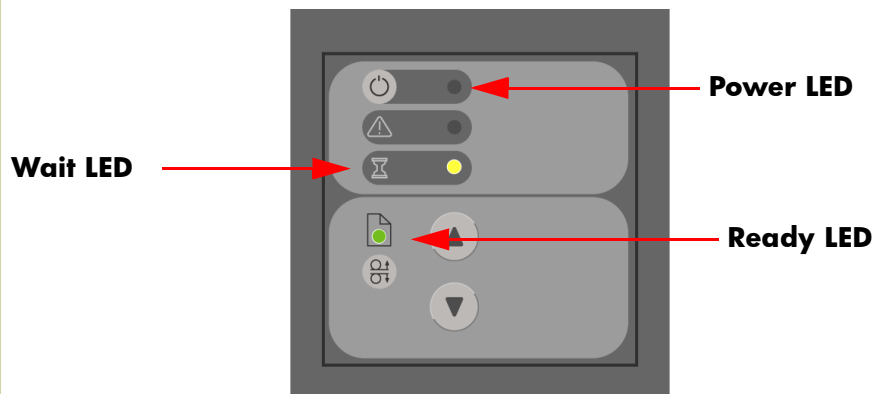

*The Down Position Sensor cannot be adjusted.

Original Guide Sensor Test

This is to test the sensors which are located inside the Guide Plate.

Adjustment of the Roller Sensor

To perform this adjustment you will need the two Roller Sensor Adjustment tools.

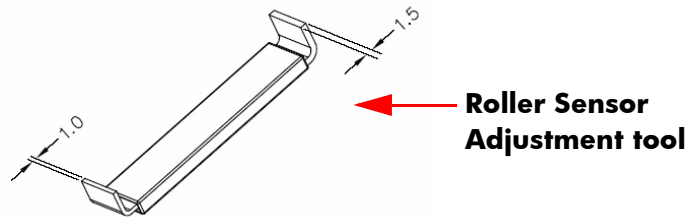

- 1 Perform the following:
 - Remove ruler from the front of the Guide Plate.
 - Open the Top Profile on the Guide Plate ⇒ Page 4-15.
- 2 Start SCANtest 6 and select **Test 28. Original Guide Sensor Test**

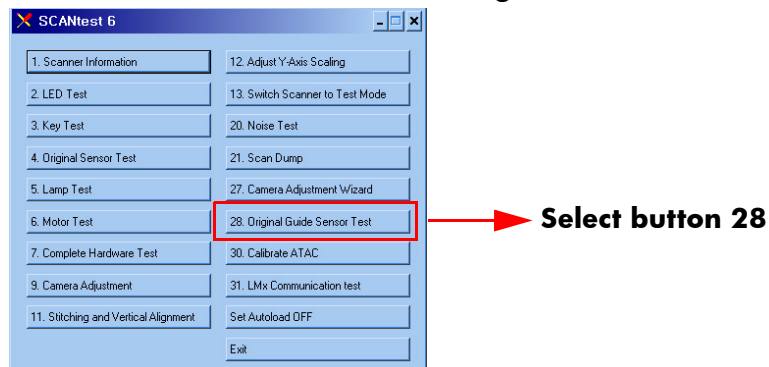

- 3 Press the UP Key on the front panel of the Scanner to move the Guide Plate up until the Ready LED turns OFF.



- 4 Loosen the two screws that secure the Roller Sensor.
- 5 Using the 1.5 mm end of each of the two Adjustment Tools, insert them on both sides of the Roller Sensor under the roller shaft.

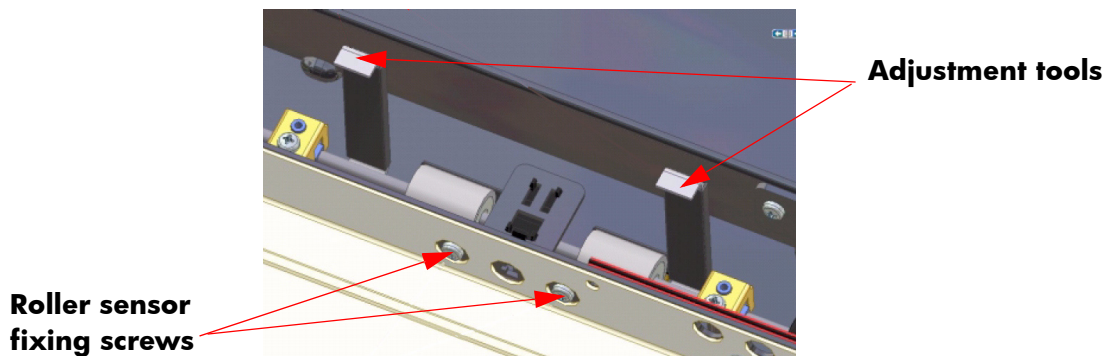

- 6 Adjust the position of the Roller Sensor so that the green Ready LED just about turns ON.

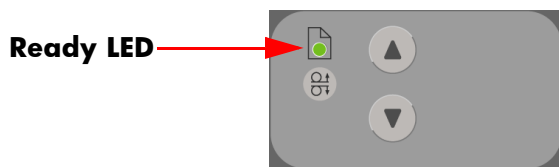

- 7 Using the 1 mm end of each of the two Adjustment Tools, insert them on both sides of the Roller Sensor under the roller shaft

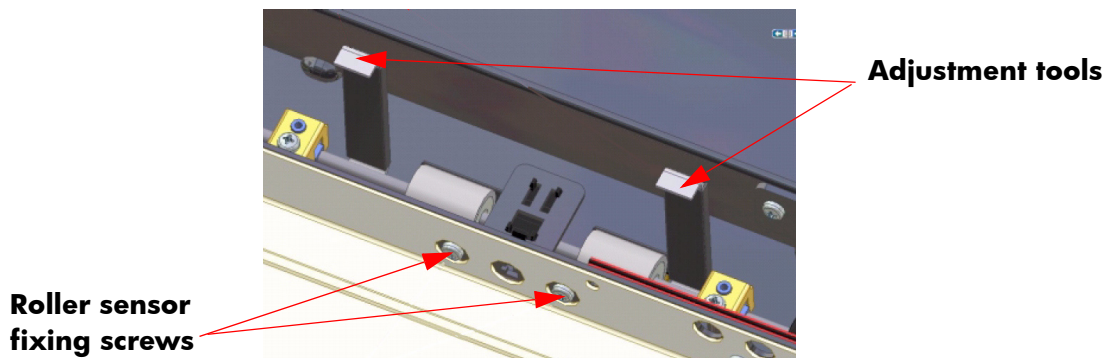

- 8 Check that the green Ready LED is OFF.

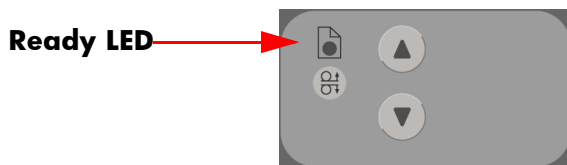

- 9 Tighten the two screws that secure the Roller Sensor.

Adjustment of Top Position Sensor

To perform this adjustment you will need the adjustment tool for the Top Position Sensor:

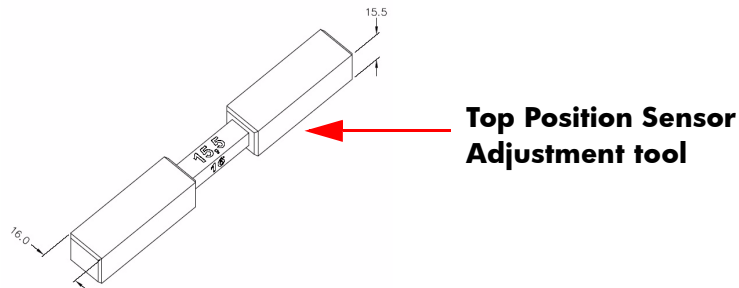

- 1 Perform the following:
 - Remove the ruler from the front of the Guide Plate.
 - Open the Top Profile on the Guide Plate ⇒ Page 4-15.
- 2 Close and lock the Guide Plate.
- 3 Start SCANtest 6 and select **Test 28. Original Guide Sensor Test**
- 4 Loosen the four screws that secure the sensor bracket, move the sensor to its uppermost position and tighten the four screws.

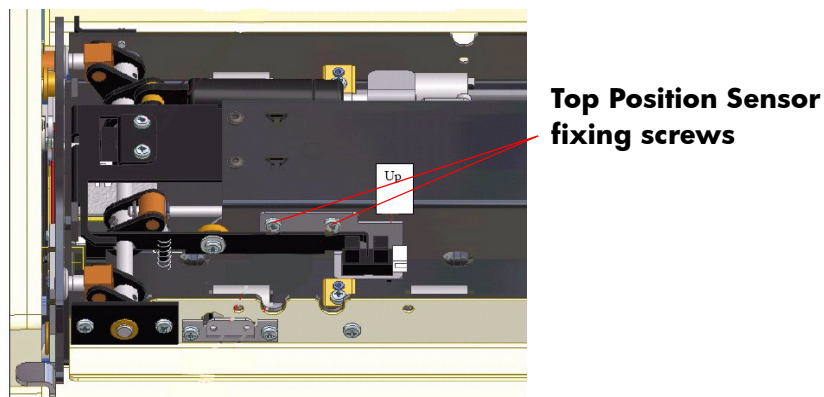

- 5 Press the UP Key to move the Guide Plate to the highest position.

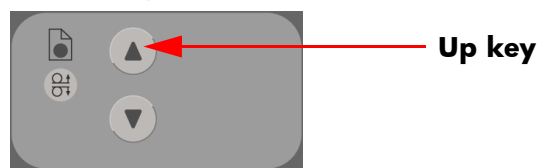

- 6 Open the Guide Plate.
- 7 Orientate the two adjustment guides for 16 mm spacing and insert the guides under the Guide Plate at both ends of the scan area.
- 8 Place the two adjustment guides so that the surface marked "16" is facing the White Background. To avoid possible damage to the White Background, place the cut-out centered over the light aperture of the glass plate.
- 9 Close the Guide Plate and make sure that both Release Handles are locked.

- 10** Press the Down Key to move the Guide Plate down until it automatically stops against the adjustment guides.

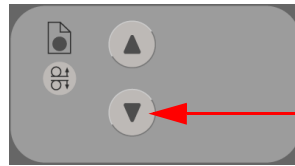

Down key

If the Down Key is pressed after the Guide Plate has stopped, the MDA Board turns OFF and you need to power the scanner ON again.

- 11** Loosen two screws that secure the Top Position sensor.
12 Adjust the Top Position sensor so that the green Power LED just about turns ON.

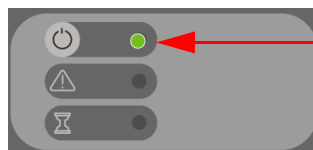

Power LED

- 13** Tighten the two screws that secure the Top Position sensor.
14 Open the Guide Plate.
15 Orientate the two adjustment guides for 15.5 mm spacing and insert the guides under the Guide Plate at both ends of the scan area.
16 Place the two adjustment guides so that the surface marked "15.5" is facing the White Background. To avoid possible damage to the White Background, place the cut-out centered over the light aperture of the glass plate.
17 Close the Guide Plate and make sure that both Release Handles are locked.
18 Press the Down Key on the Scanner front panel to move the Guide Plate down until it automatically stops against the adjustment guides.
19 Check that the Power LED is OFF.

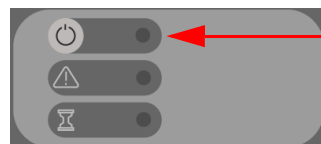

Power LED

Calibrate ATAC (Automatic Thickness Adjustment Control)

To run this test start SCANtest 6 and select: **30. Calibrate ATAC**

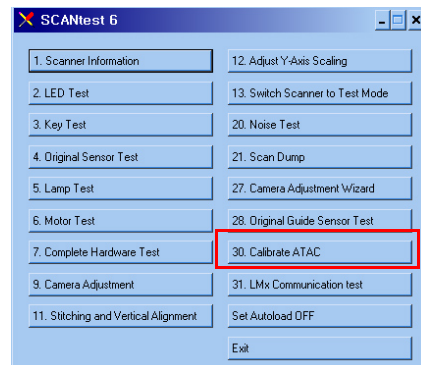

Select button 30

This test sets the current level at which the ATAC will stop if something is preventing it from moving. It is a safety measure designed to prevent fingers from being inadvertently pinched in the guide plate.

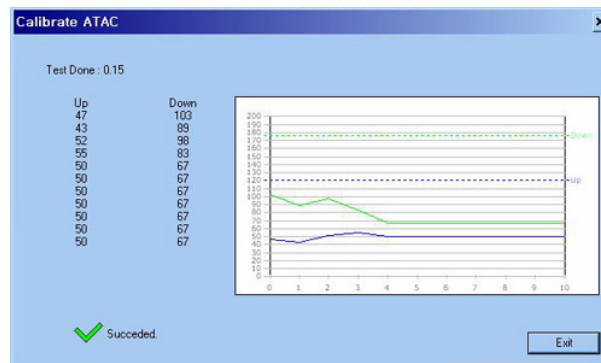

Driver Board Communication Test

To run this test start SCANtest 6 and select: **31. LMx Communication Test.**

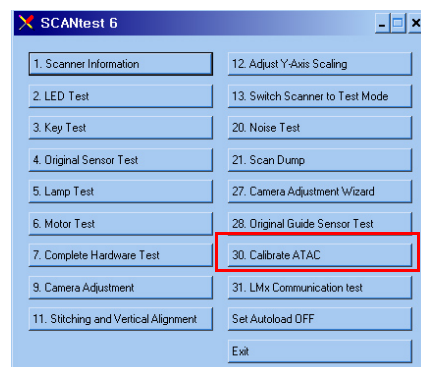

Select button 31

This tests the communication between the Driver Board and the Scanner. When the test is run it will check the:

- Lamp

- The Light levels
- The two fans

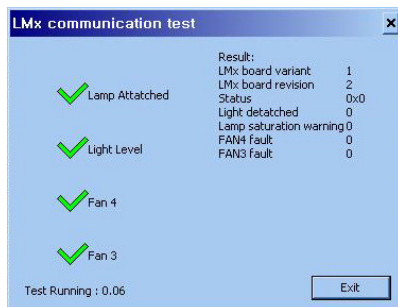

Upgrade Scanner Firmware

Scanner software version 14 or later

If you have a scanner with software version 14 or later, you can upgrade the firmware without having to upgrade the entire system. To upgrade the scanner firmware, follow these steps:

- 1 In the **Setup** tab, press the **Options** button.
- 2 Press the **System** button.
- 3 Press the **Service** button.
- 4 Press the **Upgrade firmware** button.

When the upgrade has finished, you are prompted to reboot the system.

Scanner software version 14 or earlier

If you have a scanner with software version 14 or earlier, you are required to perform a complete system recovery using the most recent software version in order to upgrade the firmware.





Preventive Maintenance

6

Preventive Maintenance 6-2

Preventive Maintenance

Introduction

This chapter describes the scanner messages that are shown in the Touch screen, signaling the need for maintenance. It also describes the preventive maintenance procedures that users must follow to ensure that the scanner performs optimally.

Over time, several messages will appear in the Scanner Messages window. Most of them signal the need for maintenance.

Scanner Messages

The following scanner messages appear in the Scanner Messages window of the Touch Screen. The Scanner Messages window can also be recalled manually by pressing the progress bar area of JETimage.

User warnings:

- Scanner Maintenance has not been run for 30 days.
- Maintenance kit #1 required. Please contact HP to order the kit.

The lamp quality is electrically monitored and the warning appears after approximately 4000 hours of usage (average value). The scanner maintenance warning appears when scanner maintenance has not been performed for 30 days. However, the frequency with which scanner maintenance should be performed depends on the scanner messages.

Preventive Maintenance Kit #1

The Preventive Maintenance Kit #1 is available for the following model:

| Model | Part Number |
|------------------------|--------------|
| HP Designjet T1100 MFP | Model Q6713A |

It is also available for the following scanners once they have been updated to System Recovery SW 14:

| Model | Part Number |
|---------------------------|--------------------------------|
| HP Designjet 4500 Scanner | Model Q6713A (from October'07) |
| HP Designjet 4500mpf | Model Q1276A (from October'07) |
| HP Designjet 820 MFP | Model Q6685 |

The user can order the Preventive Maintenance Kit #1 through HP Support (P/N Q1277-600013 PMK#1 Lamp Cartridge, Q1277A).

The message that appears in the Scanner Messages window is shown

below.

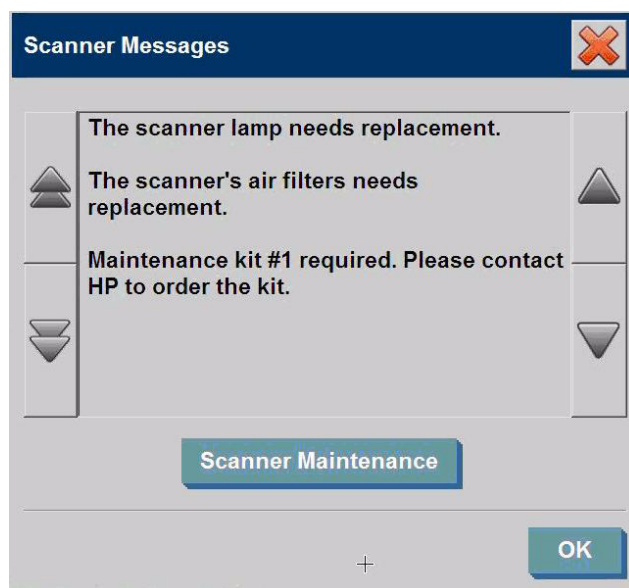

User Self Replacement parts

The scanner components that a customer can order through HP Support are shown below.

| Part Number | Description |
|-----------------------------------|--------------------------------|
| White Background Assembly, 40/42" | Q1277-60027 |
| Guide Plate Assembly | Q1277-60025, Q1277A, and Q6685 |

Replace the scanner maintenance parts

You can replace key scanner parts that wear down over long-term use. Changing these parts will renew your scanner and ensure optimal performance.

Before replacing any parts, you should clean the scan area as described in the Scanner Maintenance section ⇒ Page 5-26, to see if any errors or image defects are alleviated.

Replace the Preventive Maintenance Kit

Replace the Lamp

Lamp effectiveness gradually weakens over time. Replacement of the lamp-unit (lamp, reflector, power connectors) is recommended after long term use. Before replacing the lamp, you should clean the scan area as described in the Scanner Maintenance section ⇒ Page 5-26, to see if any errors or image

defects are alleviated.

To replace the lamp unit follow these steps:

1. Turn off the scanner and disconnect the power plug.

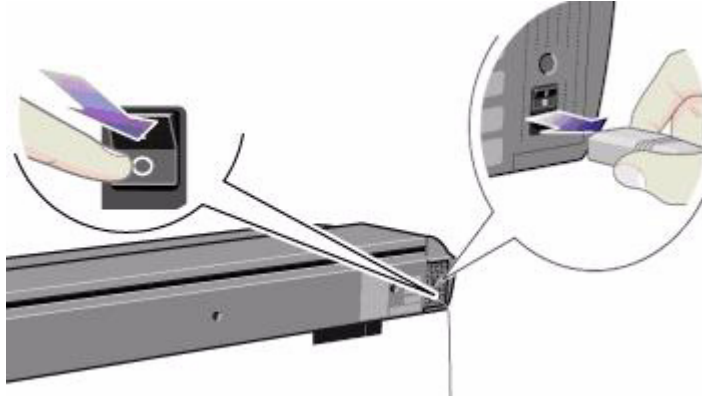

2. The lamp cover is on the top right edge of the scanner. Grasp the cover on each side with both hands and pull back to detach it. Lift the cover upwards to free it from the scanner.

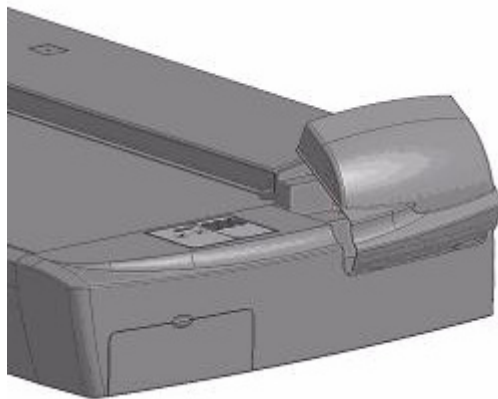

3. You must replace the whole lamp-unit. A lamp-unit consists of a lamp mounted in a reflector brace and fixed power connectors. Grasp the edge of the lamp-unit and carefully pull it out of the scanner.

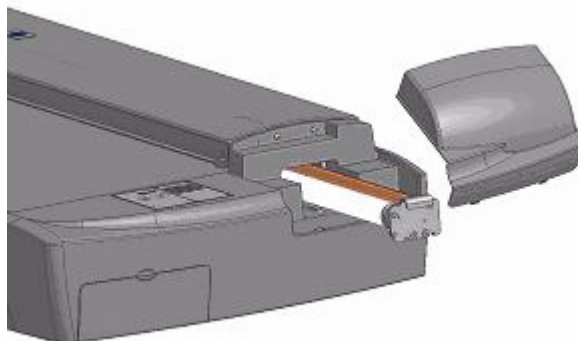

4. Reinsert the new lamp-unit by resting the power-connector side on the slider and carefully slide the lamp-unit into the scanner.

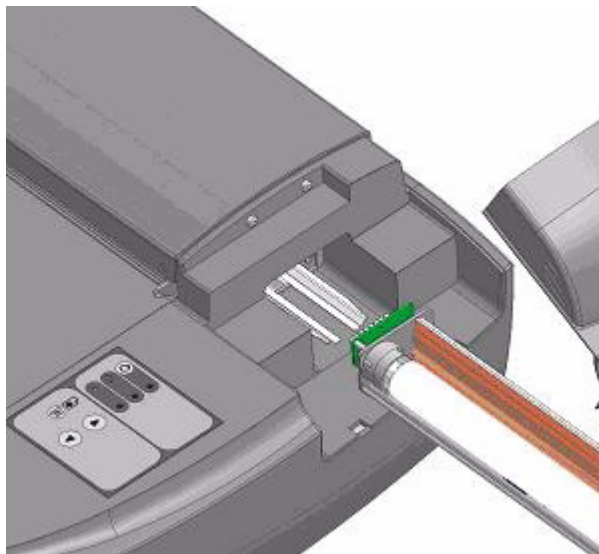

5. Insert the lamp-unit all the way so that the internal power connections engage with the connections on the lamp-unit.
6. Replace the lamp cover on the scanner. Fit the bottom notches in the holes and snap the cover shut. The cover must always be closed before turning on the scanner.
7. Test the lamp by turning on the scanner to see if the lamp illuminates.

Replace the air filters

Fresh air filters can reduce the amount of time spent on cleaning and calibration. The air filters protect your scanner's air-cooling vents and keep out dust and unwanted particles.

To replace the air filters:

1. Turn off the scanner and disconnect the power plug.

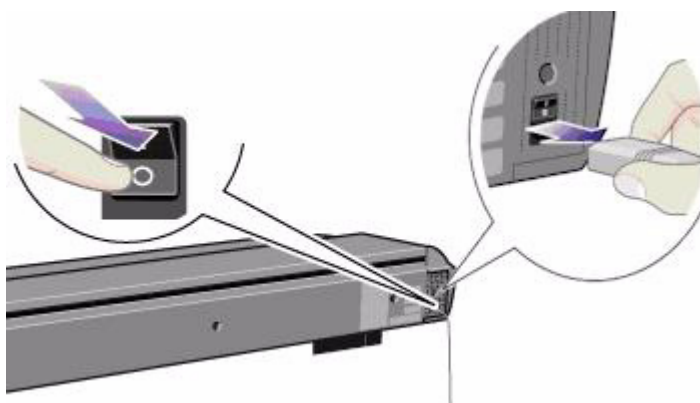

2. Locate the 2 square-shaped dust filter bins on the underside of the scanner.

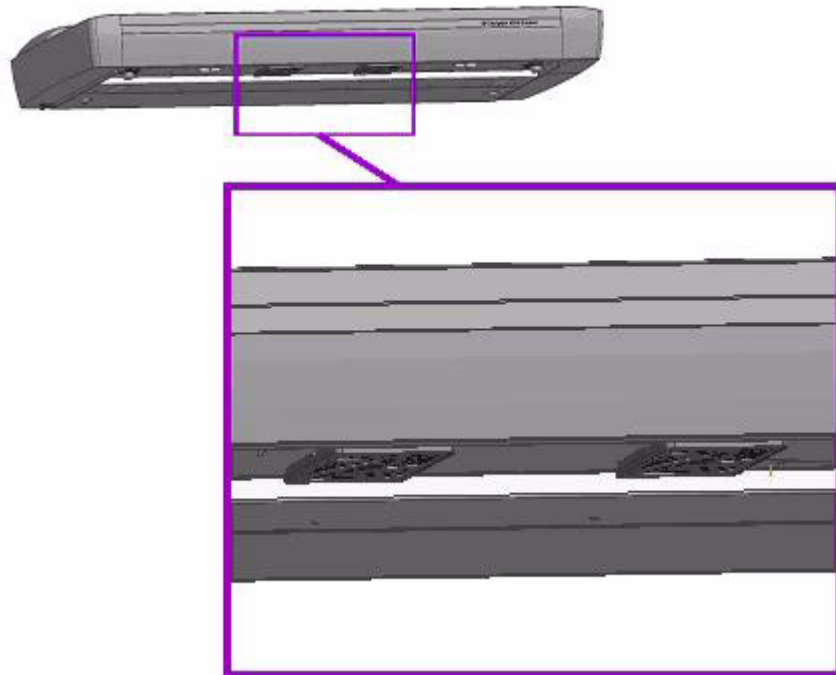

3. Pull down on the edge of a dust filter bin to detach it from its frame.
4. The filter (soft material) is inside the bin. Remove the old filter and replace it with a fresh one.

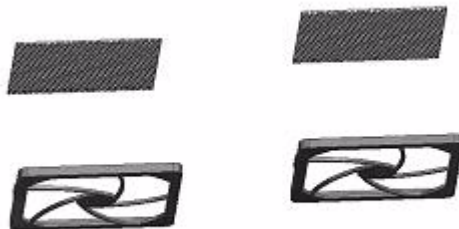

5. Reattach (click on) the bin to its frame on the underside of the scanner.
6. Repeat the process with the second filter.

Replace the User Self Replacement parts

Replace the Glass Plate

Small scratches on the glass plate can reduce scanning quality. Replacement with a new glass plate can be recommended by the program. Before replacing the white background platen, you should try to clean glass plate to

see if errors or image defects are alleviated.

To replace the glass plate:

1. Turn off the scanner and disconnect the power plug.

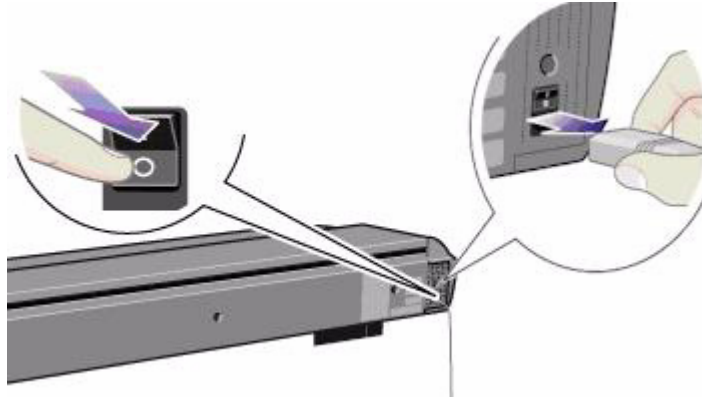

2. Push down on the two lever buttons found near the insertion slot on each side of the scanning area lid. The scanning area lid locking mechanism should now be disengaged.

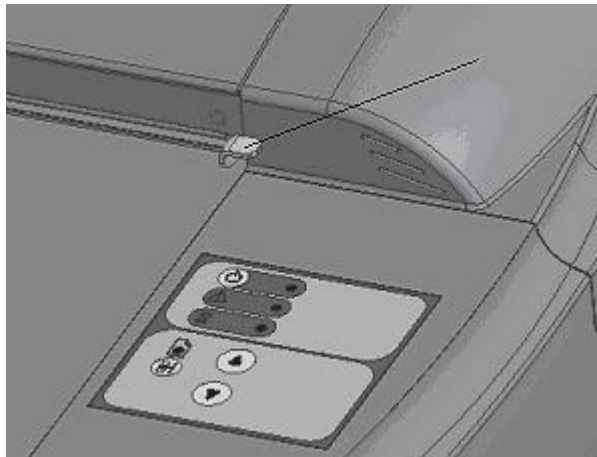

3. As you hold both lever buttons down, place your free fingers in the insertion slot and flip open the scanning area lid. The glass plate will be exposed and accessible.



4. On each side of the glass plate there is a small lever and round finger-handle, as shown in the image below. Place your thumbs under both handles on each side. With both hands, simultaneously pull on the left and right handles to flip the levers and glass plate towards your body.

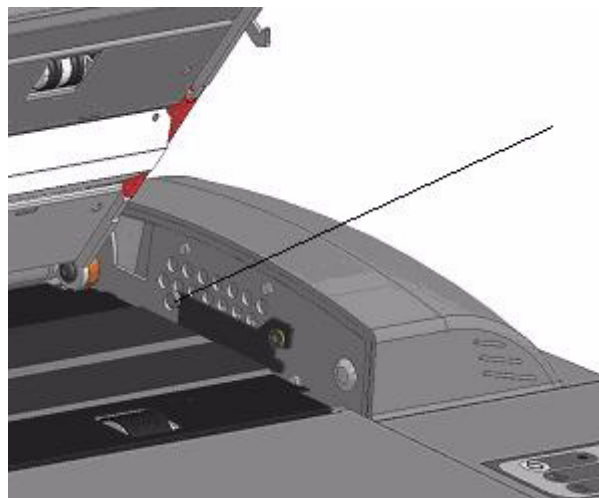

5. Each lever is attached to the scanner chassis with a small hook that rests on a pin. With your thumbs still on the handles, simultaneously lift both levers

upwards to detach their hooks from the pins and free the glass plate from the scanner.

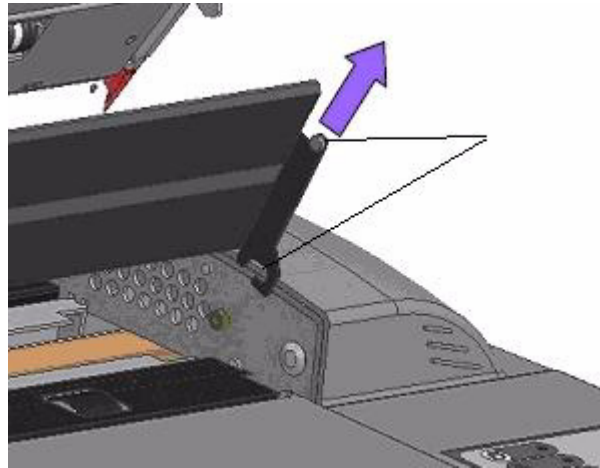

6. To reinsert a new glass plate. Fit the new glass plate's lever hooks on the pins on each side of the scanner.
7. While supporting the glass plate with your thumbs on the finger handles, carefully push the glass plate backwards (away from your body) and ease it down into place.
8. Close the scanning area lid so that the locking mechanism engages.

Make sure you clean a new glass plate before using it with the scanner.

Replace the White-Background Platen

A white-background platen can become worn and discolored after long periods of use. In such cases replacement with a new white-background platen is recommended. Before replacing the white-background platen, clean it to see if errors or image defects are alleviated.

To replace the white-background platen:

1. Turn off the scanner and disconnect the power plug.

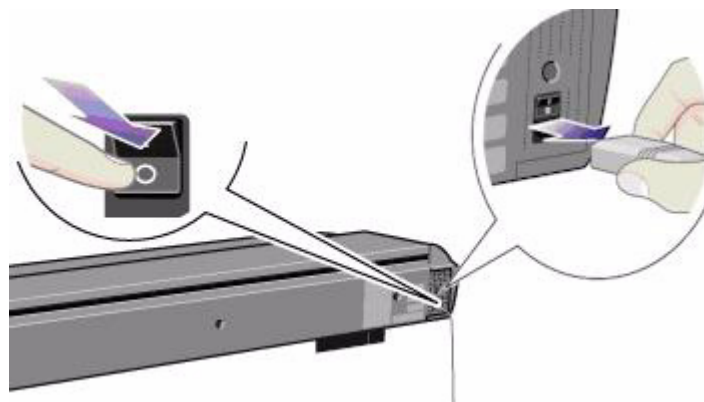

2. Push down on the two lever buttons found near the insertion slot on each side of the scanning area lid. The scanning area lid locking mechanism should now be disengaged.

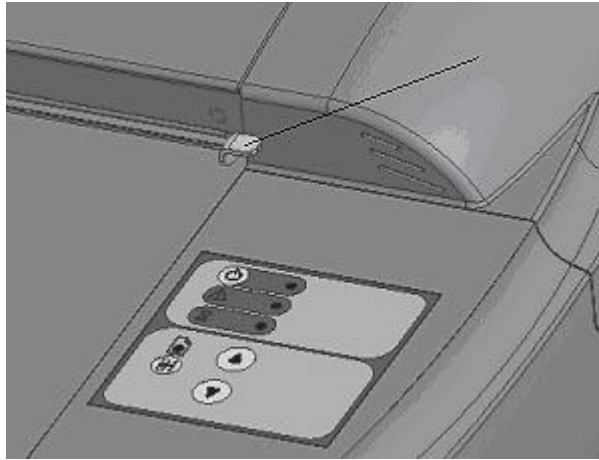

3. As you hold both lever buttons down, place your free fingers in the insertion slot and flip the scanning area lid open.



4. On the lid's right edge, you will find a red strip. Remove the red strip to expose the edge of the white-background platen.



5. Grip the edge of the white-background platen with your fingers and pull to slide it out of the scanner.

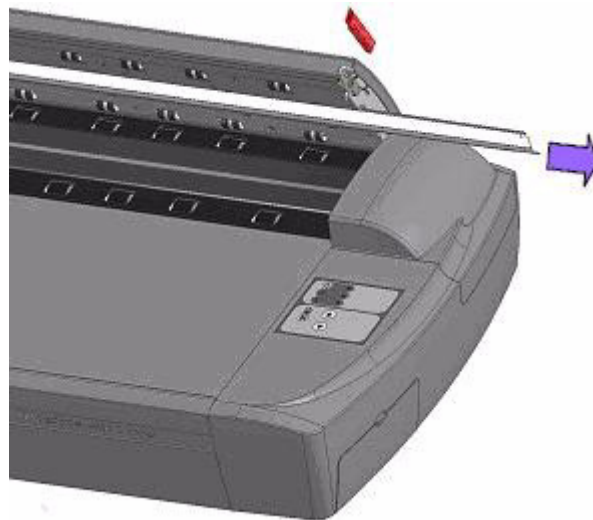

6. Slide in the new white-background platen.
7. Reattach the red strip.
8. Close the scanning area lid so the locking mechanism engages.



About this Edition

This is the 4th edition of this Service Manual

What's in this Service Manual

This manual contains information necessary to test, calibrate and service:

- HP Designjet 4500 Scanner - Model Q1277A
- HP Designjet T1100 MFP - Model Q6713A
- HP Designjet 820 MFP - Model Q6685
- HP Designjet 4500mpf - Model Q1276A

For information about using these printers, refer to the corresponding User and Quick Reference Guides.

The procedures described in this manual are to be performed by HP-qualified Service Personnel only.

© 2007 Hewlett-Packard Development Company, L.P.

Printed in Germany Imprimé en Allemagne Stampato in Germania

www.hp.com

