



HP LaserJet MFP E72525, E72530, E72535

Service Manual



www.hp.com/videos/laserjet
www.hp.com/support/lje72500mfp



HP LaserJet Managed MFP E72525 Series
HP LaserJet Managed MFP E72530 Series
HP LaserJet Managed MFP E72535 Series
Service Manual

SUMMARY

Learn about theory of operation, remove and replace, troubleshooting on the printer. Parts are either customer-self repair (CSR) replaceable, or field replaceable units (FRUs) which require installation by a trained field-service technician. Use the provided parts diagrams and tables to identify the required part.

Copyright and License

© Copyright 2020 HP Development Company, L.P.

Reproduction, adaptation, or translation without prior written permission is prohibited, except as allowed under the copyright laws.

The information contained herein is subject to change without notice.

The only warranties for HP products and services are set forth in the express warranty statements accompanying such products and services. Nothing herein should be construed as constituting an additional warranty. HP shall not be liable for technical or editorial errors or omissions contained herein.

Edition 14, 5/2020

Revision History

View a list of document revisions.

The information contained herein is subject to change without notice. The only warranties for HP products and services are set forth in the express warranty statements accompanying such products and services. Nothing herein should be construed as constituting an additional warranty. HP shall not be liable for technical or editorial errors or omissions contained herein.

Table -1 Revision History

Revision Number	Revision Date	Revision Notes
14.0	May, 2020	Part number updates and general edits.
13.0	May, 2020	Part number updates and general edits. Updated SSBM sections to current HPPK content. See Stapler/stacker and booklet maker (SSBM) on page 905 . SRM migration to SDL Tridion Docs. Updated BHCI sections. See High-capacity input (HCI) tray (workgroup) on page 588 . Added HP EPA 3.0 compliance content. See Service parts changes For Environmental Protection Agency 3.0 Compliant Products on page 2813 .
11.0	January, 2020	Updated numerous part numbers throughout based on HP PN format. Added Electrical Mechanical diagrams to aide in troubleshooting. See Electrical-mechanical diagrams on page 867 . Removed references to Control panel that used 8"(inch) in title. This is due to the marketing change to definition of the control panel. See Table 1.1 Technical specifications on page 8 .
10.0	June, 2019	Updated all inner finisher content. See Inner finisher on page 2203 . Updated developer unit remove and replace procedure. See Removal and replacement: Developer unit on page 205 . Added right door dampner kit remove and replace. See Removal and replacement: Right door dampener and lever kit on page 338 .
6.0	July, 2018	Updated parts numbers throughout document to remove "SAM-" prefix and updated new part numbers as identified. Minor content edits (including graphics)

Table -1 Revision History (continued)

Revision Number	Revision Date	Revision Notes
5.0	March, 2018	Upload all graphics to data base. Part number updates. Minor changes/updates.
4.0	January, 2018	Minor changes to environmental specs and engine dimensions.
3.0	November, 2017	Updated code data for Diagnostics and Service Functions Replaced Product Overview with the UG-style Printer Views and removed the previous "Machine external view" section. Updated R&R TOC level to 1. Replaced references to SAW with WISE and removed QR codes. Replaced Samsung Paper Jam content with the UG content Moved specifications out of the appendix to the Product Specifications chapter Added additional specification content to the Product Specifications chapter from the UG Removed the lists of tables and figures and the alphabetical and numerical lists of parts Placed ESD cautions at the beginning of the R&R sections for the main printer and both finishers. Removed the Samsung precaution sections Updated variable list items to refer only to Diamond Updated part numbers, part descriptions, diagrams, and photos Linked Removal and Replacement procedures are linked to part number information.
2.0	July, 2017	Updated TOC to only consist of 3 levels Add error code and CPMD overview Added "How to search for documentation" section. Updated toner average yield data Changed all occurrences of #2 Phillips to #2 JIS
1.0	April, 2017	Service manual initial release

Conventions used in this guide

Learn about the conventions used in this publication.

 **TIP:** Tips provide helpful hints or shortcuts.

 **NOTE:** Notes provide important information to explain a concept or to complete a task.

 **CAUTION:** Cautions indicate procedures that you should follow to avoid losing data or damaging the product.

 **WARNING!** Warnings alert you to specific procedures that you should follow to avoid personal injury, catastrophic loss of data, or extensive damage to the product.

Table of contents

1 Product specifications and description	1
Printer views	2
Printer front view	2
Printer back view	3
Interface ports	3
Control-panel view	4
Inner finisher view	6
Stapler/stacker finisher view	6
Booklet finisher view	6
Specifications	8
Technical specifications	8
Supported operating systems	10
Mobile printing solutions	12
Printer dimensions	13
Power consumption, electrical specifications, and acoustic emissions	14
Operating-environment range	14
General specifications	15
Print specifications	17
Scan specifications	19
Copy specifications	20
Paper handling specifications	23
Supplies	27
Maintenance parts	27
Optional	28
Feeding system	30
Feeding system overview	30
Main components and functions	31
Cassette	33
Pickup Assembly	34
Registration assembly	35
Tray 1 (MP) feed assembly	36
Image creation	38

Printing process overview	38
Imaging unit	39
Fuser unit	42
Fuser unit overview	42
Fuser unit drive	43
Fuser unit temperature control	43
Loop control	44
Laser scanner unit	46
Laser scanner unit overview	46
Laser scanning optical path	47
Laser synchronizing detectors	47
Drive system	49
Drive motors	49
Main Drive Unit (OPC/DEVE/Registration/Tray 1/Feed)	50
Pickup Drive	52
Duct Drive	52
Fuser/Exit Drive	53
Toner supply drive	54
Flatbed Scanner System	56
Flatbed scanner system overview	57
Scanning system components	59
Caution for moving the scanner	65
Document feeder LX (dn models)	67
Document feeder LX overview	67
Document feeder LX electrical parts	67
Document feeder LX registration	68
Document feeder LX drive system	69
Document feeder LX scanning position	71
Document feeder LX specifications	72
Flow document feeder z models (GX)	73
Flow document feeder overview	73
Flow document feeder sensors	73
Flow document feeder ultra sonic multi-feed (USM) sensor	75
Flow document feeder drive system	76
Flow document feeder specifications	78
Flow document feeder registration	78
Flow document feeder scanning position	79
Flow document feeder mixed size original (MSO) sensor	79
Flow document feeder dual sensor cleaning method	81
Flow ADF z bundles (GX)	81
Hardware configuration	83

Main controller	87
Low voltage power supply (LVPS; Type 5H) / switching mode power supply (SMPS)	91
Low voltage power supply (LVPS) PCA (Type 4) (GX/z models)	92
Fuser drive board (FDB)	94
High-voltage power supply (HVPS) PCA	95
Eraser PCA	97
Waste Sensor PCA	97
CRUM PCA	98
Toner CRUM joint PCA	98
Paper Size sensor PCA	98
Dual cassette feeder (DCF)	99
Inner finisher	103

2 Parts, diagrams, removal and replacement 107

HP service and support	107
How to search for printer documentation	108
Order parts by authorized service providers	112
Ordering	112
Orderable parts	112
How to use parts lists and diagrams	112
ESD precautions	112
Service approach	114
Precautions when replacing parts	114
Before performing service	115
After performing service	115
Post-service test	116
Maintenance (printer cleaning)	117
Cleaning the document feeder white bar and CIS (LX)	117
Cleaning the flow document feeder white bar and CIS (GX)	118
Cleaning the scanner glass	118
Cleaning the transfer roller	119
Main parts	121
Main assembly	122
Removal and replacement: ADF white backing (LX)	126
Removal and replacement: ADF white backing (GX)	129
Removal and replacement: ADF whole unit (LX)	132
Removal and replacement: Flow ADF whole unit (GX)	137
Removal and replacement: Flow ADF whole unit (GX)	143
Removal and replacement: Image scanner assembly (flatbed)	149
Removal and replacement: Feed sensor 1	158
Removal and replacement: Feed sensor 2	163

Removal and replacement: Exit unit	169
Removal and replacement: Fuser drive assembly board	172
Removal and replacement: Low voltage power supply (LVPS) type 5H board	176
Removal and replacement: Developer fan	180
Removal and replacement: Main board	184
Removal and replacement: Laser scanner assembly	190
Removal and replacement: High-voltage power supply (HVPS) board	194
Removal and replacement: Right door assembly	198
Removal and replacement: Fuser unit	202
Removal and replacement: Developer unit	205
Removal and replacement: Drum unit	213
Removal and replacement: Accelerator board	218
Install accessory: NFC Kit Installation	221
Install accessory: HP Foreign interface harness (FIH) solution	231
Removal and replacement: Removal and replacement: 500 GB FIPS HDD/500 GB formatter HDD .	233
Removal and replacement: Formatter and formatter cage	235
Removal and replacement: 500GB Main PCA HDD	242
Removal and replacement: Control panel	247
Removal and replacement: Keyboard	250
Exit assemblies	253
Upper and lower exit	254
Removal and replacement: Fuser out sensor	256
Cassettes tray 2/3	259
Cassettes Tray 2/3	260
Main frame assembly	262
Main engine frame	264
Removal and replacement: Toner supply drive unit	266
Removal and replacement: Toner duct drive unit	270
Removal and replacement: Pickup drive unit	275
Removal and replacement: Main drive unit	279
Removal and replacement: Fuser/exit drive assembly	283
Fuser exit drive	287
Fuser exit drive	288
Registration sub-frame	290
Registration sub-frame	292
Removal and replacement: Registration assembly	294
Main frame pickup 1 and 2	301
Main frame pickup 1 and 2	302
Main frame pickup	304
Main frame pickup	306
Removal and replacement: Trays 2–x main rollers	308

Main frame	314
Main frame	316
Removal and replacement: Paper size sensor PCA	318
Removal and replacement: Toner collection unit sensor	320
Removal and replacement: Toner duct	323
Removal and replacement: Transfer roller	332
Removal and replacement: Front door open switch	334
Removal and replacement: Right door dampener and lever kit	338
Removal and replacement: Right door open switch	343
Covers	346
Covers	348
Removal and replacement: Left cover	349
Removal and replacement: Rear covers	351
Right door	354
Right door	356
Removal and replacement: Right Door, Tray 1 and Tray 1 assemblies	358
Tray 1	373
Tray 1	374
Removal and replacement: Tray 1 pick/reverse/feed roller	376
Right door exit and takeaway	380
Right door exit	382
Right door duplex	384
Right door duplex	386
Removal and replacement: Duplex sensor	388
ADF (LX models)	391
ADF (LX models)	392
Removal and replacement: Removal and replacement: Document feeder (ADF) jam access cover (LX)	394
Removal and replacement: Removal and replacement: Document feeder (ADF) input tray (LX)	398
Removal and replacement: Removal and replacement: Contact Image Sensor (CIS) assembly	404
Removal and replacement: Removal and replacement: Document feeder (ADF) main motor (LX) ..	414
ADF exterior and ADF pickup (LX models)	419
ADF exterior and ADF pickup (LX)	420
Removal and replacement: Removal and replacement: Document feeder (ADF) PCA (LX)	422
Removal and replacement: Removal and replacement: Document feeder (ADF) pick/feed roller assembly (LX)	426
ADF main frame assembly (LX models)	432
ADF main frame assembly (LX/du models)	434
Removal and replacement: Removal and replacement: Document feeder (ADF) separation roller assembly (LX)	436
Removal and replacement: Removal and replacement: Document feeder (ADF) feed motor (LX) ...	443

Flow ADF (GX/z)	447
ADF (GX/z)	448
Removal and replacement: Document feeder input tray (GX)	450
Removal and replacement: Contact Image Sensor (CIS) assembly	457
Flow ADF open cover (GX/sGX)	464
Flow ADF open cover (GX/z)	466
Removal and replacement: Document feeder jam access cover (GX)	468
ADF upper pickup (GX/z)	474
ADF upper pickup (GX/z)	476
Removal and replacement: Flow document feeder pick roller assembly (GX)	478
Removal and replacement: ADF separation roller assembly (GX)	483
Flow ADF stacker (GX/z)	491
Flow ADF stacker (GX/sGX)	492
Flow ADF main frame (GX/z)	494
ADF main frame (GX/z)	496
Removal and replacement: Removal and replacement: Document feeder front motor (GX)	499
Removal and replacement: Document feeder rear motors (GX)	503
Removal and replacement: Document feeder PCA fan (GX)	512
Removal and replacement: Document feeder contact image sensor (CIS) fan (GX)	515
Removal and replacement: Flow ADF ultrasonic sensor with PCA (GX)	518
Removal and replacement: PCA-ADF HIC (GX)	526
Image scanner	529
Image scanner	530
Image scanner assembly	532
Image scanner assembly	534
Removal and replacement: Scan glass	536
HP LaserJet Managed MFP E72525-E72535, E77822-E77830 - Removal and replacement: Scanner LED lamp module	539
Image scanner, lower (LX)	543
Image scanner, lower (LX)	544
Removal and replacement: Scanner assembly – CCD and lens	546
Removal and replacement: Scanner APS sensor	550
Second Exit (Optional)	554
Remove the second eixt (Optional)	554
Remove the return gate solenoid (Optional)	556
Dual cassette feeder (DCF)	559
DCF main	560
DCF main frame pickup 1	578
DCF main frame pickup	580
DCF main frame pickup,upper	586
High-capacity input (HCI) tray (workgroup)	588

HCI main	589
HCI sub - frame	606
HCI sub - pickup upper/lower	628
HCI drive	635
HCI sub - cassette	660
3 Problem solving	673
Control panel messages document (CPMD)	674
Error codes	674
How to search for printer documentation	676
Troubleshooting process	680
Determine the problem source	681
Tools for troubleshooting	700
Problem-solving checklist	701
Print menu map	703
Print current settings pages	703
Print event log	704
Pre-boot menu options	705
Control panel menus	723
Clear paper jams	789
Paper jam locations	789
13.A1 tray 1 paper jam	789
13.A2, 13.A3 tray 2, tray 3 paper jam	790
Clear paper jams in the Bottom HCI	793
Service mode (tech mode)	795
Entering service mode	795
Service mode menu tree	795
Information	802
Maintenance counts	804
Diagnostics	806
Service functions	825
Print quality troubleshooting guide	828
Image quality problems and solutions	829
Other errors	845
Adjusting the flow ADF/ADF skew	863
4 Electrical-mechanical diagrams	867
PCAs, Boards, and Laser Scanning Unit (LSU)	867
Exit section	871
Drive section	872
Paper handling section	878

Frame section	880
Fuser section	883
MP right door section	885
Scanner section	889
Document feeder section	891
Image formation section	893
Optional dual-cassette feeder (DCF)	896
Optional high-capacity input (HCI)	899

5 Stapler/stacker and booklet maker (SSBM) 905

Product specification and description	906
Stapler/stacker finisher and booklet finisher view	906
Specification	908
Stapler/stacker finisher and booklet finisher system	915
Service approach	987
Precautions when replacing parts	988
Before performing service	990
ESD precautions	990
After performing service	990
Post-service test	991
Order parts by authorized service providers	992
Parts, diagrams, removal and replacement (stapler/ stacker and booklet finishers)	993
Parts, diagrams (stapler/stacker)	994
Parts, diagrams (Booklet finisher)	1040
Bridge unit	1066
Covers	1090
Entrance unit	1160
Punch unit	1166
Tray diverter unit	1173
Top exit unit	1202
Top output tray unit	1229
Main exit unit	1243
Paddle unit	1270
End fence unit	1303
Tamper unit	1338
Stapler unit	1495
Ejector unit	1576
Main output tray unit	1732
Paper holding unit	1793
Buffer unit	1851
Booklet maker	1865

Booklet entrance unit	1876
Booklet paddle unit	1894
Booklet end fence unit	1907
Booklet presser unit	1929
Booklet tamper unit	1952
Booklet stapler unit	2009
Booklet fold unit	2028
Booklet diverter unit	2112
Booklet exit unit	2136
Booklet output tray unit	2155
PCA	2159
Problem solving	2177
Control panel message document (CPMD)	2177
Clear paper jams	2178
Finisher system diagram	2191

6 Diagrams 2193

Diagrams (connection)	2193
Diagrams (FUSER EXIT)	2194
Diagrams (PICKUP/PH DRIVE/SIDE)	2194
Diagrams (laser scanner assembly/HVPS)	2195
Diagrams (toner)	2196
Diagrams (FDB/LVPS)	2197
Diagrams (UI)	2198
Diagrams (FRONT/OPC)	2199
Diagrams (scanner)	2200
Diagrams (Dual Cassette Feeder)	2201

7 Inner finisher 2203

Product specification and description	2204
Inner finisher view	2204
Specification	2205
Inner finisher system	2210
Service approach	2248
Precautions when replacing parts	2249
Before performing service	2251
ESD precautions	2251
After performing service	2251
Post-service test	2252
Order parts by authorized service providers	2253
Parts, diagrams, removal and replacement (inner finisher)	2254

Parts and diagrams (inner finisher)	2255
Covers	2272
Entrance unit	2299
Exit unit	2316
Paper support unit	2338
Paddle unit	2424
Tamper unit	2449
Stapler unit	2560
Ejector unit	2589
End fence unit	2655
Output tray unit	2667
Paper holding unit	2730
Punch unit	2777
Problem solving	2792
Control panel message document (CPMD)	2792
Electrical Mechanical Diagrams (Inner finisher)	2793
Punch waste full sensor	2793
Punch waste box sensor and finisher docking sensor	2794
Entrance motor	2795
Exit sensor	2796
Exit motor, main paddle motor & home sensor, output tray lower limit switch, and paper holding solenoid	2797
Paper support motor & home sensor	2798
Front tamper motor and home sensor	2799
Rear tamper motor and home sensor	2800
End fence sensor	2801
Stapler position motor and sensor	2802
Ejector 1 motor and home sensor, ejector 2 motor, motor sensor, and home sensor	2803
Output tray motor and sensor	2804
Output tray top of stack sensor	2805
Top cover switch	2806
Front cover switch	2807
Appendix A Certificate of Volatility	2809
Certificate of Volatility	2809
Appendix B Service parts changes For Environmental Protection Agency 3.0 Compliant Products	2813
Glossary of terms	2817
Index	2825

1 Product specifications and description

You will learn more about the following sub sections:

Printer views

Learn more specifically about the different views of the printer.

Printer front view

Learn about the printer components (front view).

Figure 1-1 Printer front view

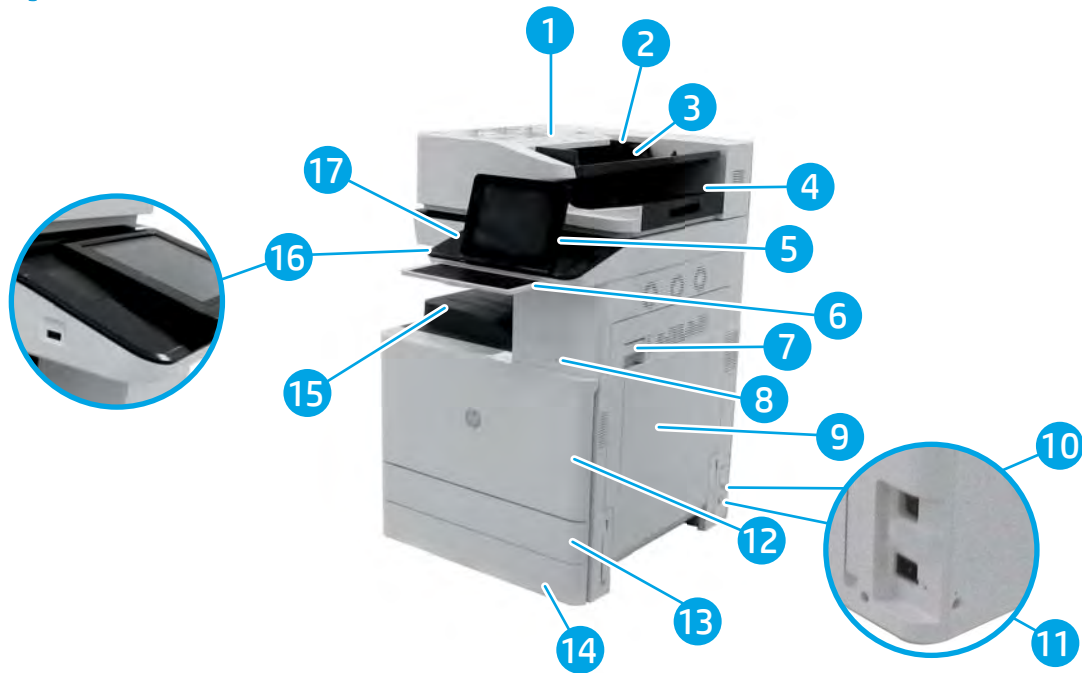

Item	Description
1	Automatic document feeder cover (access for clearing jams)
2	Automatic document feeder width guides
3	Automatic document feeder input tray
4	Automatic document feeder output tray
5	Control panel with color touchscreen display (tilts up for easier viewing)
6	Physical keyboard (Flow models only). Pull the keyboard straight out to use it. (NOTE: Close the keyboard when it is not in use.)
7	Right door (access for clearing jams)
8	On/off button
9	Tray 1
10	Power switch

Item	Description
11	Power connection
12	Front door (access to the toner cartridges)
13	Tray 2
14	Tray 3
15	Output bin
16	Easy-access USB port. Insert a USB flash drive for printing or scanning without a computer, or to update the printer firmware. (NOTE: An administrator must enable this port before use.)
17	Hardware integration pocket (for connecting accessory and third-party devices)

Printer back view

Learn about the printer components (back view).

Figure 1-2 Printer rear view

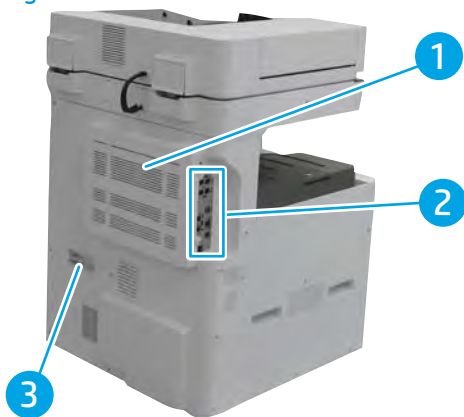

Item	Description
1	Formatter cover
2	Interface ports
3	Serial number and product number label

Interface ports

Learn about the printer components (interface ports).

Figure 1-3 Interface ports

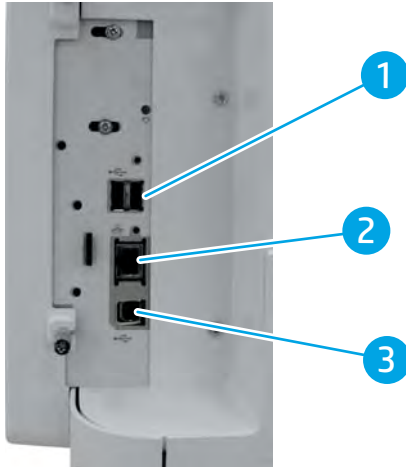

Item	Description
1	USB port for connecting external USB devices (NOTE: For easy-access USB printing, use the USB port near the control panel.)
2	Local area network (LAN) Ethernet network port
3	Hi-Speed USB 2.0 printing port

Control-panel view

Learn about the printer components (control-panel).

 **NOTE:** Tilt the control panel for easier viewing.



The Home screen provides access to the printer features and indicates the current status of the printer.

Return to the Home screen at any time by touching the Home  button on the printer control panel.

 **NOTE:** The features that appear on the Home screen can vary, depending on the printer configuration.

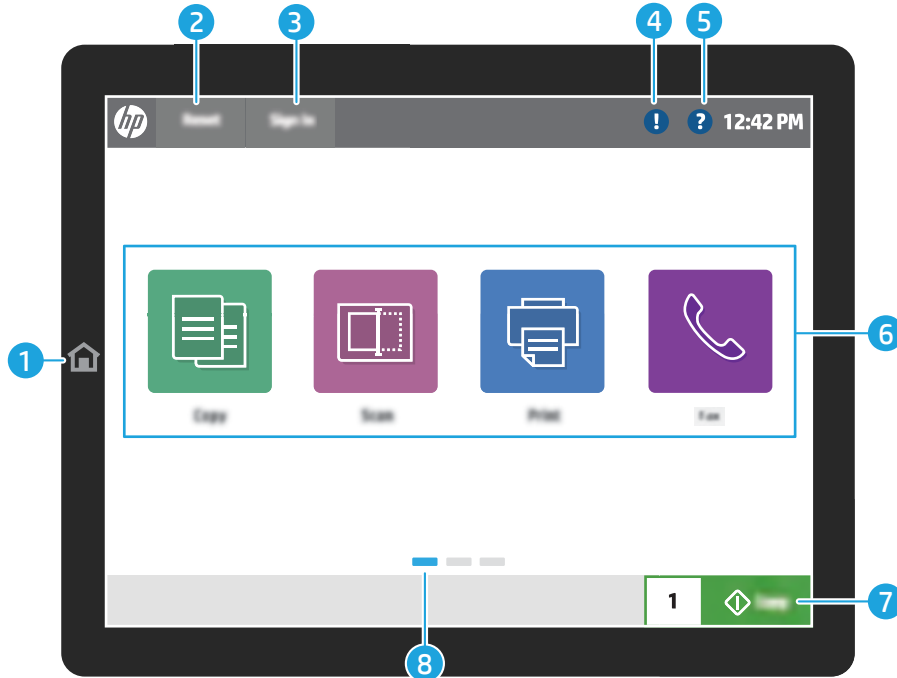
Figure 1-4 Printer control panel



Item	Button	Description
1	Home  button	Touch the Home button to return to the Home screen.
2	Reset button	The Reset button returns the printer to default settings and is always present if users are not logged in. The Reset button is not present when the Sign Out button is present. Touch the Reset button to resume and release jobs from the previous pause state and interrupt mode, reset the quick copy count in the copy count field, exit special modes, reset the display language and the keyboard layout.
3	Sign In or Sign Out button	Touch the Sign In button to access secured features. Touch the Sign Out button to sign out of the printer. The printer restores all options to the default settings. NOTE: This button displays only if the administrator has configured the printer to require permission for access to features.
4	Information  button	Touch the information button to access a screen that provides access to several types of printer information. Touch the buttons at the bottom of the screen for the following information: <ul style="list-style-type: none"> • Display Language: Change the language setting for the current user session. • Sleep Mode: Place the printer into sleep mode. • Wi-Fi Direct: View information for how to connect directly to the printer using a phone, tablet, or other device with Wi-Fi. • Wireless: View or change wireless connection settings (only when an optional wireless accessory is installed). • Ethernet: View or change Ethernet connection settings. • HP Web Services: View information to connect and print to the printer using HP Web Services (ePrint).

Item	Button	Description
5	Help  button	Touch the Help button to open the embedded help system. The status line provides information about the overall printer status.
6	Applications area	Touch any of the icons to open the application. Swipe the screen sideways to access more applications. NOTE: The available applications vary by printer. The administrator can configure which applications appear and the order in which they appear.
7	Start Copy button	Touch the Start Copy button to start a copy job.
8	Home-screen page indicator	Indicates the number of pages on the Home screen or in an application. The current page is highlighted. Swipe the screen sideways to scroll between pages.

Inner finisher view

Learn about the printer components (inner finisher).



Stapler/stacker finisher view

Learn about the printer components (stapler/stacker finisher).



Booklet finisher view

Learn about the printer components (booklet finisher).



Specifications

Learn about the specifications.

Technical specifications

Learn technical specifications for model bundles.



NOTE: Hole punch accessories are optional for the stapler/stacker, inner finisher, and booklet maker accessories.

Table 1-1 E72525dn, E72525z, E72530dn, E72530z, E72535dn, E72535z

Model number		E72525dn	E72525z	E72530dn	E72530z	E72535dn	E72535z
Product number	Item	X3A60A	X3A59A	X3A63A	X3A62A	X3A66A	X3A65A
Paper handling	Tray 1 (100-sheet capacity)	Supported	Supported	Supported	Supported	Supported	Supported
	Tray 2 (520-sheet capacity)	Supported	Supported	Supported	Supported	Supported	Supported
	Tray 3 (520-sheet capacity)	Supported	Supported	Supported	Supported	Supported	Supported
	HP LaserJet dual cassette feeder (DCF) (workgroup)	Optional	Optional	Optional	Optional	Optional	Optional
	2,000-sheet high-capacity input tray (HCI) (workgroup)	Optional	Optional	Optional	Optional	Optional	Optional
	HP LaserJet Printer cabinet (workgroup)	Optional	Optional	Optional	Optional	Optional	Optional
	HP LaserJet Stapler/stacker finisher	Optional	Optional	Optional	Optional	Optional	Optional
	HP LaserJet Booklet finisher	Optional	Optional	Optional	Optional	Optional	Optional
	HP LaserJet Inner finisher	Optional	Optional	Optional	Optional	Optional	Optional
	HP LaserJet 2/3 hole punch	Optional	Optional	Optional	Optional	Optional	Optional
	HP LaserJet 2/4 hole punch	Optional	Optional	Optional	Optional	Optional	Optional
	Swedish hole punch	Optional	Optional	Optional	Optional	Optional	Optional
	HP LaserJet Job separator	Optional	Optional	Optional	Optional	Optional	Optional
	HP LaserJet Spacer	Optional	Optional	Optional	Optional	Optional	Optional
Automatic duplex printing	Supported	Supported	Supported	Supported	Supported	Supported	
Connectivity	10/100/1000 Ethernet LAN connection with IPv4 and IPv6	Supported	Supported	Supported	Supported	Supported	Supported

Table 1-1 E72525dn, E72525z, E72530dn, E72530z, E72535dn, E72535z (continued)

Model number		E72525dn	E72525z	E72530dn	E72530z	E72535dn	E72535z
Product number	Item	X3A60A	X3A59A	X3A63A	X3A62A	X3A66A	X3A65A
	Hi-Speed USB 2.0	Supported	Supported	Supported	Supported	Supported	Supported
	Easy-access USB port for printing without a computer and upgrading the firmware	Supported	Supported	Supported	Supported	Supported	Supported
	Hardware Integration Pocket for connecting accessory and third-party devices	Supported	Supported	Supported	Supported	Supported	Supported
Memory	6 GB base memory	Supported	Not supported	Supported	Not supported	Supported	Not supported
	7 GB base memory	Not supported	Supported	Not supported	Supported	Not supported	Supported
Mass storage	320 GB HP Secure High-Performance Hard Disk	Supported	Not supported	Supported	Not supported	Supported	Not supported
	2x 320 GB HP Secure High-Performance Hard Disk	Not supported	Supported	Not supported	Supported	Not supported	Supported
	16 GB embedded Multi-Media Controller (eMMC)	Supported	Not supported	Supported	Not supported	Supported	Not supported
Control-panel display	Color touchscreen control panel	Supported	Supported	Supported	Supported	Supported	Supported
	Retractable keyboard	Not supported	Supported	Not supported	Supported	Not supported	Supported
Print	Prints 25 pages per minute (ppm) on A4 and on letter-size paper.	Supported	Supported	Not supported	Not supported	Not supported	Not supported
	Prints 30 pages per minute (ppm) on A4 and on letter-size paper	Not supported	Not supported	Supported	Supported	Not supported	Not supported
	Prints 35 pages per minute (ppm) on A4 and on letter-size paper	Not supported	Not supported	Not supported	Not supported	Supported	Supported
	Easy-access USB printing (no computer required)	Supported	Supported	Supported	Supported	Supported	Supported
Fax		Optional	Optional	Optional	Optional	Optional	Optional
Copy and Scan	Scans 80 pages per minute (ppm) on A4 and letter-size paper	Supported	Not supported	Supported	Not supported	Supported	Not supported
	Scans 120 pages per minute (ppm) on A4 and letter-size paper	Not supported	Supported	Not supported	Supported	Not supported	Supported

Table 1-1 E72525dn, E72525z, E72530dn, E72530z, E72535dn, E72535z (continued)

Model number		E72525dn	E72525z	E72530dn	E72530z	E72535dn	E72535z
Product number	Item	X3A60A	X3A59A	X3A63A	X3A62A	X3A66A	X3A65A
	100-page document feeder with dual-head scanning for single-pass duplex copying and scanning	Supported	Not supported	Supported	Not supported	Supported	Not supported
	250-page document feeder with dual-head scanning for single-pass duplex copying and scanning	Not supported	Supported	Not supported	Supported	Not supported	Supported
	HP EveryPage Technologies including ultrasonic multi-feed detection	Not supported	Supported	Not supported	Supported	Not supported	Supported
	Embedded optical character recognition (OCR) provides the ability to convert printed pages into text that can be edited or searched using a computer	Not supported	Supported	Not supported	Supported	Not supported	Supported
	SMART Label feature provides paper-edge detection for automatic page cropping	Not supported	Supported	Not supported	Supported	Not supported	Supported
	Automatic page orientation for pages that have at least 100 characters of text	Not supported	Supported	Not supported	Supported	Not supported	Supported
	Automatic tone adjustment sets contrast, brightness, and background removal for each page	Not supported	Supported	Not supported	Supported	Not supported	Supported
Digital Send	Send documents to E-mail, USB, and shared folders on a network	Supported	Supported	Supported	Supported	Supported	Supported
	Send documents to SharePoint®	Not supported	Supported	Not supported	Supported	Not supported	Supported

Supported operating systems

Learn about supported operating systems.

The following information applies to the Printer-Specific Windows PCL 6 and HP print drivers for OS X and to the software installer.

Windows: The HP Software Installer can be downloaded from the printer support website for this printer and installs the “HP PCL.6” version 3 print driver, the “HP PCL 6” version 3 print driver, or the “HP PCL-6” version 4 print driver, depending on the Windows operating system, along with optional software when using the software installer. Download the “HP PCL.6” version 3 print driver, the “HP PCL 6” version 3 print driver, and the “HP PCL-6” version 4 print driver from the printer-support website for this printer: www.hp.com/support/lje72500mfp or www.hp.com/support/colorlje78323mfp.

OS X: Mac computers are supported with this printer. Download HP Easy Start either from 123.hp.com/LaserJet or from the Printer Support page, and then use HP Easy Start to install the HP print driver. HP Easy Start is not included in the HP Software Installer.

1. Go to 123.hp.com/LaserJet.
2. Follow the steps provided to download the printer software.

Linux: For information and print drivers for Linux, go to www.hp.com/go/linuxprinting.

UNIX: For information and print drivers for UNIX®, go to www.hp.com/go/unixmodelscripts.

Table 1-2 Supported operating systems and print drivers

Operating system	Print driver installed (from the software on the web)	Notes
Windows® XP SP3, 32-bit	The “HP PCL.6” printer-specific print driver is installed for this operating system as part of the software installation.	Microsoft retired mainstream support for Windows XP in April 2009. HP will continue to provide best effort support for the discontinued XP operating system. Some features and page sizes in the print driver are not supported.
Windows Vista®, 32-bit	The “HP PCL.6” printer-specific print driver is installed for this operating system as part of the software installation.	Microsoft retired mainstream support for Windows Vista in April 2012. HP will continue to provide best effort support for the discontinued Vista operating system. Some features and page sizes in the print driver are not supported.
Windows Server 2003 SP2, 32-bit	The “HP PCL.6” printer-specific print driver is available for download from the printer-support website. Download the driver, and then use the Microsoft Add Printer tool to install it.	Microsoft retired mainstream support for Windows Server 2003 in July 2010. HP will continue to provide best effort support for the discontinued Server 2003 operating system. Some features and page sizes in the print driver are not supported.
Windows 7 SP1, 32-bit and 64-bit	The “HP PCL 6” printer-specific print driver is installed for this operating system as part of the software installation.	
Windows 8, 32-bit and 64-bit	The “HP PCL 6” printer-specific print driver is installed for this operating system as part of the software installation.	Windows 8 RT support is provided through Microsoft IN OS Version 4, 32-bit driver.
Windows 8.1, 32-bit and 64-bit	The “HP PCL-6” V4 printer-specific print driver is installed for this operating system as part of the software installation.	Windows 8.1 RT support is provided through Microsoft IN OS Version 4, 32-bit driver.
Windows 10, 32-bit and 64-bit	The “HP PCL-6” V4 printer-specific print driver is installed for this operating system as part of the software installation.	

Table 1-2 Supported operating systems and print drivers (continued)

Operating system	Print driver installed (from the software on the web)	Notes
Windows Server 2008 SP2, 32-bit	The “HP PCL.6” printer-specific print driver is available for download from the printer-support website. Download the driver, and then use the Microsoft Add Printer tool to install it.	Microsoft retired mainstream support for Windows Server 2008 in January 2015. HP will continue to provide best effort support for the discontinued Server 2008 operating system. Some features and page sizes in the print driver are not supported.
Windows Server 2008 SP2, 64-bit	The “HP PCL 6” printer-specific print driver is available for download from the printer-support website. Download the driver, and then use the Microsoft Add Printer tool to install it.	
Windows Server 2008 R2, SP 1, 64-bit	The “HP PCL 6” printer-specific print driver is available for download from the printer-support website. Download the driver, and then use the Microsoft Add Printer tool to install it.	
Windows Server 2012, 64-bit	The PCL 6 printer-specific print driver is available for download from the printer-support website. Download the driver, and then use the Microsoft Add Printer tool to install it.	
Windows Server 2012 R2, 64-bit	The PCL 6 printer-specific print driver is available for download from the printer-support website. Download the driver, and then use the Microsoft Add Printer tool to install it.	
OS X 10.10 Yosemite, OS X 10.11 El Capitan, and OS X 10.12 Sierra	To install the print driver, download HP Easy Start from 123.hp.com/LaserJet . Follow the steps provided to install the printer software and print driver.	

 **NOTE:** Supported operating systems can change. For a current list of supported operating systems, go to www.hp.com/support/lje72500mfp or <http://www.hp.com/support/colorlje78323mfp> for HP’s all-inclusive help for the printer.

 **NOTE:** For details on client and server operating systems and for HP UPD driver support for this printer, go to www.hp.com/go/upd. Under **Additional information**, click the links.

Table 1-3 Minimum system requirements

Windows	OS X
<ul style="list-style-type: none"> • An Internet connection • Dedicated USB 1.1 or 2.0 connection or a network connection • 2 GB of available hard-disk space 	<ul style="list-style-type: none"> • Internet connection • 1 GB of available hard-disk space

Mobile printing solutions

Learn what HP offers for mobile printing solutions.

HP offers multiple mobile and ePrint solutions to enable easy printing to an HP printer from a laptop, tablet, smartphone, or other mobile device. To see the full list and to determine the best choice, go to [HP Customer Support - Knowledge Base](#).

- Wi-Fi Direct
- HP ePrint via email (Requires HP Web Services to be enabled and the printer to be registered with HP Connected)
- HP ePrint app (Available for Android, iOS, and Blackberry)
- HP All-in-One Remote app for iOS and Android devices
- HP ePrint software
- Google Cloud Print
- AirPrint
- Android Printing

Printer dimensions

Learn about printer dimensions.

 **NOTE:** A color printer model is shown in the figure below. However, the dimension information applies to mono and color printers.

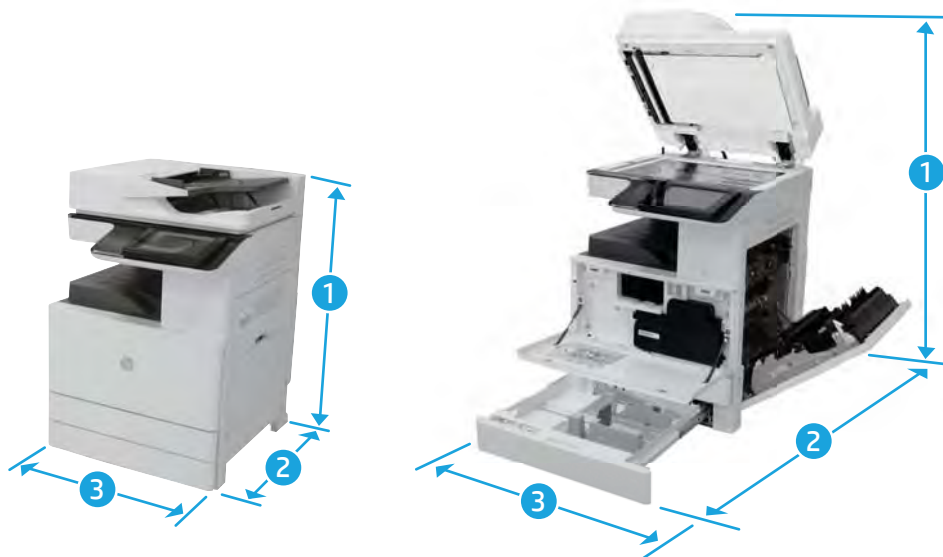

Table 1-4 Printer dimensions

Item	Normal operating dimensions	Maximum operating dimensions
Height	877 mm (34.5 in) (dn models)	1241 mm (49 in) (dn models)
	925 mm (36.5 in) (z models)	1375 mm (54.25 in) (z models)
Depth	730 mm (28.75 in) (dn models)	1115 mm (44 in) (dn models)
	780 mm (30.75 in) (z models)	1216 mm (48 in) (z models)

Table 1-4 Printer dimensions (continued)

Item	Normal operating dimensions	Maximum operating dimensions
Width	568 mm (22.5 in) (dn models)	1010 mm (39.75 in) (dn models)
	584 mm (23 in) (z models)	1026 mm (40.5 in) (z models)
Weight	91.1 kg (200.8 lb) (dn models)	
	102.61 kg (226.2 lb) (z models)	

Table 1-5 Printer accessory dimensions and weights

Product	Length	Width	Depth	Height	Weight
HP LaserJet Cabinet (workgroup)	790 mm (31.1 in)	566 mm (22.3 in)	610 mm (24 in)	265 mm (10.4 in)	13.4 kg (29.5 lbs)
HP LaserJet 2x520-sheet dual cassette feeder (DCF) (workgroup)	790 mm (31.1 in)	566 mm (22.3 in)	610 mm (24 in)	265 mm (10.4 in)	21 kg (46.3 lbs)
HP LaserJet 2000 sheet high capacity input (HCI) feeder (workgroup)	790 mm (31.1 in)	585 mm (23 in)	670 mm (26.4 in)	312 mm (12.3 in)	29.3 kg (64.59 lbs)
HP LaserJet Job separator (workgroup)	790 mm (31.1 in)	464 mm (18.3 in)	394.7 mm (15.5 in)	124.5 mm (4.9 in)	3 kg (1.4 lbs)
HP LaserJet Inner finisher	790 mm (31.1 in)	458 mm (18 in)	491 mm (19.3 in)	173 mm (6.8 in)	15kg (33.1 lbs)
HP LaserJet Booklet finisher	790 mm (31.1 in)	1016.4 mm (39.75 in)	673 mm (26.75 in)	587.5 mm (23.5 in)	62 kg (136.7 lbs)
HP LaserJet Stapler/Stacker finisher	790 mm (31.1 in)	1016.4 mm (39.75 in)	673 mm (26.75 in)	587.5 mm (23.5 in)	40kg (88.2 lbs)

 **NOTE:** HP recommends that 30 mm (1.81 in) be added to the printer dimensions provided in this chapter to make sure there is sufficient space to open doors and covers, and to provide proper ventilation.

Power consumption, electrical specifications, and acoustic emissions

In order to operate properly, the printer must be in an environment that meets certain power specifications.

See www.hp.com/support/lje72500mfp for current information.

 **CAUTION:** Power requirements are based on the country/region where the printer is sold. Do not convert operating voltages. This will damage the printer and void the printer warranty.

Operating-environment range

In order to operate properly, the printer must be in an environment that meets certain specifications.

Table 1-6 Operating-environment specifications

Environment	Recommended	Allowed
Temperature	17° to 25°C (62.6° to 77°F)	Not available
Relative humidity	30% to 70% relative humidity (RH)	Not available

General specifications

Learn about the general specifications.

 **NOTE:** Acoustic values are subject to change. For current information, see www.hp.com/support.

Table 1-7 General specifications

Item	Description	Specification
Processor	CPU	1.2 GHz
User Interface	Control Panel	20.3 cm (8 in) Color Graphics Display (CGD) with touchscreen; rotating (adjustable angle) display; illuminated Home button (for quick return to the Home menu); USB High-speed 2.0 port; Hardware Integration Pocket; Extended Keyboard (Flow models only)
User Interface	LED	2 (Power/Status)
User Interface	Key/Button	1 (Power)
Memory	Standard	Flow 7 GB, Managed 6 GB
Storage	Standard	One 320 GB Standard, embedded HP High-Performance Secure Hard Disk; AES 256 hardware encryption or greater; Secure erase capabilities (Secure File Erase-Temporary Job Files, Secure Erase-Job Data, Secure ATA Erase-Disk). NOTE: US Government SKU uses 500 GB FIPS 140-2 validated hard disk.
Storage	Optional	N/A
Interface	USB (Device)	Yes (Hi-Speed USB 2.0)
Interface	USB (Host)	Yes (Hi-Speed USB 2.0)
Interface	USB (EDI)	N/A
Interface	Wired LAN	Standard (Ethernet 10/100/1G Base TX)
Interface	Wireless LAN	Optional (IEEE 802.11b/g/n + NFC Active Type)
Interface	NFC	Optional (IEEE 802.11b/g/n + NFC Active Type)
Interface	Other	N/A
Warmup Time	From Power off (power on to ready)	Less than 25 sec
	From Sleep	Less than 23 sec

Table 1-7 General specifications (continued)

Item	Description	Specification
Power Consumption	Ready	Less than 250 Wh
Power Consumption	Normal operation	Less than 800 Wh
Power Consumption	Max/Peak	Less than 1200 Wh
Power Consumption	Sleep	Less than 1.5 Wh
Power Consumption	Power off	Less than 0 W
Power Consumption	TEC	<ul style="list-style-type: none"> • E72525: 1.478 Wh • E72530: 1.789 Wh • E72535: 2.279 Wh
Default Sleep Delay Time	Sleep mode operation	2 minutes
Maximum Sleep Delay Time	Sleep mode operation	<ul style="list-style-type: none"> • E72525E72530: 60 minutes • E72535: 120 minutes
Power Requirement	Operation	<ul style="list-style-type: none"> • Input Voltage (Europe): AC 187–253 V (-10%–6%) • Input voltage (USA): AC 93.5–137 V (-10%–6%) • Input Voltage (Korea): AC 187–253 V (-10%–6%) • Rated Frequency: 50/60 Hz
Acoustic Noise Level (Power)	Power Emissions	<ul style="list-style-type: none"> • E72525: 6.5 Bel (A) , printing mono simplex, A4 at 25 ppm • E72530: 6.6 Bel (A), printing mono simplex, A4 at 30 ppm • E72535: 6.8 Bel (A), printing mono simplex, A4 at 25 ppm
Acoustic Noise Level (Power)	Acoustic Power Emissions (ready)	<ul style="list-style-type: none"> • E72525: 6.7 Bel (A), ADF copy mono simplex • E72530: 6.8 Bell (A), ADF copy mono simplex • E72535: 6.8 Bel (A), ADF copy mono simplex
Acoustic Noise Level (Power)	Acoustic Power Emissions (active, scan)	<p>E72525/E72530/E72535: 6.2 Bel (A), ADF scan mono simplex at 44 ipm</p> <p>6.9 Bel (A), ADF scan mono simplex at 85 ipm</p>

Table 1-7 General specifications (continued)

Item	Description	Specification
Acoustic Noise Level (Pressure)	Acoustic Pressure Emissions Bystander (active, printing)	<ul style="list-style-type: none"> E72525: 49 dB(A), printing mono simplex, A4 at 25 ppm E72530: 50 dB(A), printing mono simplex, A4 at 30 ppm E72535: 51 dB(A), printing mono simplex, A4 at 25 ppm
Acoustic Noise Level (Pressure)	Acoustic Pressure Emissions Bystander (ready)	Inaudible
Acoustic Noise Level (Pressure)	Acoustic Pressure Emissions Bystander (active, copy)	E72525/E72530/E72535: 52 dB(A), ADF copy mono simplex
Acoustic Noise Level (Pressure)	Acoustic Pressure Emissions Bystander (active, scan)	E72525/E72530/E72535: 47 dB(A), ADF scan mono simplex at 44 ipm 54 dB(A), ADF scan mono simplex at 85 ipm
Recommended monthly print volume	Operation	<ul style="list-style-type: none"> E72525: 5000 pages E72530: 6000 pages E72535: 7000 pages
Max monthly duty cycle	Operation	Up to 50,000 recommended monthly page volume

Print specifications

Learn about the print specifications.

Table 1-8 Print specifications

Item	Description	Specification
Print speed	Simplex	<ul style="list-style-type: none"> E72525 <ul style="list-style-type: none"> Up to 25 ppm E72530 <ul style="list-style-type: none"> Up to 30 ppm E72535 <ul style="list-style-type: none"> Up to 35 ppm
FPOT	From Ready	<ul style="list-style-type: none"> E72525: Less than 9 seconds E72530: Less than 8 seconds E72535: Less than 7.6 seconds
FPOT	From Sleep	<ul style="list-style-type: none"> E72525: Less than 31.5 seconds E72530: Less than 30.0 seconds E72535: Less than 30.5 seconds

Table 1-8 Print specifications (continued)

Item	Specification
Resolution	Optical 600 × 600 dpi
Resolution	Enhanced Up to 1200 × 1200 dpi with reduced speed
Printer Language	HP PCL 6/HP PCL 5c/HP PostScript Level 3 Emulation/PDF (v1.7)/AirPrint™ compatible
Font	84 scalable TrueType fonts
Network Protocol	<ul style="list-style-type: none"> • IP Management (DHCP, BOOTP, AutoIP, SetIP, Static) • Discovery Protocol (SLP, UPnP, Bonjour, DNS, WINS) • Printing Protocol (TCP/IP, LPR, IPP, WSD) • Management Protocol (SNMP v1.2, SNMP3, SMTP, Talnet) • Scan Protocol (SMTP, FTP, SMB, WSD) • Security Protocol (SMB, Kerberos, LDAP, IPsec, EAP)
Duplex Print	Built in
Direct Print	PRN/PDF/TIFF/JPEG/XPS
Print Features	<ul style="list-style-type: none"> • WSD print • Secure print • Stored print • Booklet • N-up • Cover page • Insert page • Except page • Barcode • Eco • Poster • Glossy • Watermark • Tray priority setting • Auto tray setting • Tray protection • USB print • Secure PDF print • Google Cloud print

Scan specifications

Learn about the scan specifications.

Table 1-9 Scan specifications

Item	Specification
Scan method	MMT
Compatibility	Network TWAIN/Network SANE
Color Mode	Mono/Gray/Color
Scan Speed	<p data-bbox="922 554 1110 604">Scan to folder speeds (hardware)</p> <p data-bbox="1203 554 1463 604">DN bundles (black and white, gray scale, and color):</p> <ul data-bbox="1203 632 1463 758" style="list-style-type: none"> <li data-bbox="1203 632 1463 682">• Simplex up to 80 ipm @ 600 dpi <li data-bbox="1203 709 1463 758">• Duplex up to 120 ipm @ 600 dpi <p data-bbox="1203 785 1463 835">Z bundles (black and white, gray scale, and color):</p> <ul data-bbox="1203 863 1463 989" style="list-style-type: none"> <li data-bbox="1203 863 1463 913">• Simplex up to 120 ipm @ 600 dpi <li data-bbox="1203 940 1463 989">• Duplex up to 240 ipm @ 600 dpi
File Formats	<ul data-bbox="1203 1016 1463 1801" style="list-style-type: none"> <li data-bbox="1203 1016 1283 1037">• PDF <li data-bbox="1203 1064 1394 1085">• Search-able PDF <li data-bbox="1203 1113 1362 1134">• Compact PDF <li data-bbox="1203 1161 1378 1182">• PDF Encryption <li data-bbox="1203 1209 1463 1230">• Digital Signature in PDF <li data-bbox="1203 1260 1299 1281">• PDF/A <li data-bbox="1203 1308 1394 1329">• Single-Page PDF <li data-bbox="1203 1356 1378 1377">• Multi-page PDF <li data-bbox="1203 1407 1283 1428">• TIFF <li data-bbox="1203 1455 1394 1476">• Single-Page TIFF <li data-bbox="1203 1503 1378 1524">• Multi-page TIFF <li data-bbox="1203 1554 1283 1575">• XPS <li data-bbox="1203 1602 1394 1623">• Single-Page XPS <li data-bbox="1203 1650 1378 1671">• Multi-page XPS <li data-bbox="1203 1701 1283 1722">• JPEG <li data-bbox="1203 1749 1283 1770">• PNG
Resolution	Optical (ADF) Up to 600 x 600 dpi

Table 1-9 Scan specifications (continued)

Item		Specification
Resolution	Optical (flatbed)	Up to 600 x 600 dpi
Resolution	Enhanced (ADF)	Up to 4800 x 4800 dpi
Resolution	Enhanced (flatbed)	Up to 4800 x 4800 dpi
Scan Destinations		<ul style="list-style-type: none"> • Email • FTP • SMB • HDD • USB • WSD • PC
Multi-destinations		Yes
Communication Protocol		<ul style="list-style-type: none"> • SMTP (IPv4, IPv6, SSL/TLS) • FTP (IPv4, IPv6) • SMB (IPv4, IPv6) • WSD • T4Net
Scan Size	ADF	Minimum for dn bundles: 128 x 140 mm (5 x 5.5 in) Minimum for z bundles: 105 x 148 mm (4.13 x 5.82 in) Maximum: 297 x 437 mm (11.7 x 17.2 in)
	Flatbed	Maximum: 297 x 437 mm (11.7 x 17.2 in)
Scan Original Types		Text/Text & Photo/Photo

Copy specifications

Learn about the copy specifications.

Table 1-10 Copy specifications

Item		Specification
Copy Speed	Single Document Multiple Copy (SDMC)	<ul style="list-style-type: none"> • E72525 <ul style="list-style-type: none"> – Up to 25 cpm • E72530

Table 1-10 Copy specifications (continued)

Item		Specification
		– Up to 30 cpm
		• E72535
		– Up to 35 cpm
FCOT	From Ready	• E72525: Less than 6.2 seconds
		• E72530: Less than 5.5 seconds
		• E72535: Less than 4.9 seconds
Resolution	ADF (Flow ADF/ADF)	• Scan: 600 x 600 dpi
		• Printing: 600 x 600 dpi
	Flatbed	• Scan: 600 x 600 dpi
		• Printing: 600 x 600 dpi
Reduce/Enlarge	ADF (Flow ADF/ADF)	25–400%
Reduce/Enlarge	Flatbed	25–400%

Table 1-10 Copy specifications (continued)

Item	Specification
Copier Settings	• 2-sided copying
	• Scalability
	• Image adjustments (darkness, contrast, background clean up, sharpness)
	• Optimized text/picture (text, mixed, printed picture, photograph)
	• N-Up
	• N or Z-ordering
	• Content orientation
	• Collation
	• Booklet
	• ID scan
	• Job build
	• Job storage
	• Watermark
	• Stamps
	• Book mode scans
	• Erase edges
• Automatically detect color/mono	
• Image preview	
Copy Original Type	• Text
	• Text and Printed Photo
	• Text and Glossy Photo
	• Newspaper
	• Printed Photo
	• Glossy Photo
	• Copied Original
	• Map
	• Light Original
	• ID Copy
	• N-up
	• Booklet
	• Image Repeat
	• Auto Fit
	• Book Copy
	• Watermark
	• Image Overlay
	• Stamp

Paper handling specifications

Learn about the paper handling specifications.

Table 1-11 Paper handling specifications

Item		Specification
Input Capacity	Standard	1040 sheets
Input Capacity	Multipurpose	100 sheets
Input Capacity	Other Options	Dual Cassette Feeder (2 x 520 sheets)
Input Capacity	Bottom High Capacity Input (bHCI)	2000 sheets, A4 only
Input Capacity	Maximum	1040 Std + 100 Tray 1 + 2000 bHCI
Standard Cassette Tray	Capacity	520 sheets x 2
Standard Cassette Tray	Media Sizes	<ul style="list-style-type: none"> • Tray2: 140 x 210 mm to 297 x 364 mm (5.5 x 8.27 in) to (11.7 x 14.33 in) • Tray3: 140 x 210 mm to 297 x 432 mm (5.5 x 8.27 in) to (11.7 x 17 in)
Standard Cassette Tray	Media Types	<ul style="list-style-type: none"> • Plain • Thin • Bond • Hole Punched • Pre-Printed • Recycled • Thin Cardstock • Letterhead • Thick • Cotton • Colored • Archive • Thin Glossy • Heavy Weight

Table 1-11 Paper handling specifications (continued)

Item		Specification
Standard Cassette Tray	Media Weight	<ul style="list-style-type: none"> • Plain Paper: 70-90 g/m² (18.5-24 lb/ Duplex) • Thick Paper: 91-105 g/m² (25-28 lb/ Duplex) • Heavy Weight Paper : 106-176 g/m² (Duplex) • Extra Heavy Weight 1 Paper : 177-220 g/m² • Thin Paper: 60-69 g/m² (16-19 lb/Duplex) • Cotton paper: 75-90 g/m² (Duplex) • Colored: 75-90 g/m² (Duplex) • Pre-Printed: 71-90 g/m² (Duplex) • Recycled: 60-90 g/m² (Duplex)² • Bond Paper: 105-120 g/m² (Duplex)² • Letterhead: 75-90 g/m² (Duplex)² • Hole Punched Paper: 75-90 g/m² (Duplex) • Thin CardStock: 105-163 g/m² (Duplex) • Thin Glossy : 106-163 g/m² (Duplex)
Standard Cassette Tray	Sensing	<ul style="list-style-type: none"> • H/W Install Detect: Yes • Paper Empty and Low Level Detect: Yes • Paper Type Detect: No • Paper Size Detect: Yes
Tray 1	Capacity	100 sheets
Tray 1	Media Sizes	98 x 148 mm to 297 x 432 mm (3.8 x 5.8 in) to (11.7 x 17 in)

Table 1-11 Paper handling specifications (continued)

Item	Specification	
Tray 1	Media Types	
	<ul style="list-style-type: none"> • Plain • Thin • Bond • Hole Punched • Pre-Printed • Recycled • Thin Cardstock • Letterhead • Thick • Cotton • Colored • Archive • Thin Glossy • Heavy Weight • Envelope • Label • Card transparency 	
Tray 1	Media Weight	
	60 to 176 g/m ² (16 to 47 lb): Simplex, Duplex Envelope (75 to 90 g/m ²) Label (120 to 150 g/m ²): Simplex	
Tray 1	Sensing	
	Paper Empty Detect: Yes Paper Size Detect: No	
Automatic document feeder (ADF) (LX/dn models)	Capacity	
		<ul style="list-style-type: none"> • 250 sheets for flow (GX/z models) • 100 sheets for Managed (LX/dn models)
	Duplex document scanning	Yes
	Document Size	<ul style="list-style-type: none"> • Width: 128 mm-297 mm ((5 in-11.7 in)) • Length: 128 mm-432 mm ((5 in- 17in))
	Document Weight	<ul style="list-style-type: none"> • E72525/72825 <ul style="list-style-type: none"> – Simplex: 42 — 163 g/m² (11.25— 43.25 lb) – Duplex: 50 — 128 g/m² (12.25— 34 lb) • E72530/72830, E72535/72835

Table 1-11 Paper handling specifications (continued)

Item	Specification	
		<ul style="list-style-type: none"> - Simplex: 42 — 163 g/m² (11.25— 43.25 lb) - Duplex: 50 — 128 g/m² (12.25— 34 lb) • E77822, E78323 - Simplex: 42 — 163 g/m² (11.25— 43.25 lb) - Duplex: 50 — 128 g/m² (12.25— 34 lb) • E77825, E77830, E78325, E78330 - Simplex: 42 — 163 g/m² (11.25— 43.25 lb) - Duplex: 50 — 128 g/m² (12.25— 34 lb)
Automatic document feeder (ADF) (GX/d models)	Capacity	250 sheets
	Document size	<ul style="list-style-type: none"> • Width : 105 mm - 297 mm (5in - 11.7in) • Length : 140 mm - 432 mm (5.5in - 17in)
	Document Weight	Simplex: 60 — 163 g/m ² (11.25— 43.24 lb) (guarantee) 42-60 g/m and 163-220 g/m ² (support)
	Auto Detected Size	A3/A4/A5/A6 SEF/B4/B5/Letter/Legal/Statement/Folio/Executive
Printer Output Capacity	Standard	500 sheets, face down
Printer Output Capacity	Maximum	615 sheets 500 sheets (Standard) + 125 sheets (Job Separator)
Printing Size	Maximum Size	297 x 432 mm (11.7 x 17 in)
Printing Size	Minimum Size	98 mm x 148 mm (3.8 in x 5.8 in)
Maximum Printing Area	Trays 1–3	Top: 4.23 +/- 1.5 mm / Left: 4.23 +/- 1.5 mm
Maximum Printing Area	Simplex from optional trays	Top and Left: 4.23 +/- 2 mm
Maximum Printing Area	Duplex	Top: 4.23 +/- 2 mm / Left: 4.23 +/- 2 mm
Duplex Printing	Support	Built-in
Duplex Printing	Media Sizes	<ul style="list-style-type: none"> • 140 mm x 182 mm (5.5in x 7.2 in) • 297 mm x 432 mm (11.7 in x 17 in)

Table 1-11 Paper handling specifications (continued)

Item		Specification
Duplex Printing	Media Types	<ul style="list-style-type: none"> • Plain • Thin • Bond • Punched • Pre-Printed • Recycled • Thin Cardstock • Letterhead • Thick • Cotton • Colored • Archive • Thin Glossy • Heavy Weight
Duplex Printing	Media weight	60 to 176 g/m ² (16 to 47 lb)

Supplies

Learn about the required toner cartridge and toner collection unit (TCU).

Table 1-12 Supplies

Item	Part number	Average yield
HP Black Managed LJ Toner Cartridge ¹	X3A65-67901	Approx. 48,000 pages
HP Managed LJ Toner Collection Unit	X3A60-67901	Approx. 100,000 pages

¹Print cartridge life is approximate, based on average A4 /Letter-size page count with ISO coverage. Declared cartridge yield value in accordance with ISO/IEC 19798. Actual yields vary considerably based on images printed and other factors. For more information, visit www.hp.com/go/learnaboutsupplies.

 **NOTE:** Depending on the print pattern and job mode used, the lifespan of the consumable can vary.

 **IMPORTANT:** Toner cartridges or other supplies must be purchased in the same country/region as the printer being used. Otherwise, new toner cartridges or other supplies will be incompatible with the printer. This is due to differing configurations of toner cartridges and other supplies according to the conditions of a specific country/region.

Maintenance parts

Learn about the printer maintenance parts.

HP recommends replacing the following maintenance parts at specific intervals to make sure the printer produces quality copies and to extend the service life of the printer.

Some of the printer parts have a shorter lifespan than the life of the printer.

Table 1-13 Maintenance parts

Item	Product number	Life
HP Managed LJ Imaging Drum	X3A65-67916	200,000 pages
HP Managed LJ Toner Collection Unit	X3A60-67901	100,000 pages
HP LaserJet Black Developer Unit	JC96-11669A	400,000 pages
HP LaserJet 110V Fuser Assembly	JC82-00479A	320,000 pages
HP LaserJet 220V Fuser Assembly	JC82-00481A	320,000 pages
HP LaserJet Transfer Roller	JC82-00466A	150,000 pages
HP LaserJet Trays 2-x Rollers	JC93-00540A	200,000 pages
HP LaserJet Tray 1 Roller	JC93-00540B	200,000 pages
HP LaserJet Flow ADF Pick Roller	JC97-04650A	200,000 pages
HP LaserJet Flow ADF Separation Roller	JC97-04915A	200,000 pages
HP LaserJet ADF Pick Roller	JC97-04857A	200,000 pages
HP LaserJet ADF Separation Roller	JC97-04852A	100,000 pages



NOTE: Depending on print patterns and the job mode used, maintenance part lifespans vary.

Optional

Learn about the printer optional parts.

Table 1-14 Optional list

Item	Model	E72535	E72530	E72525
HP LaserJet Dual Cassette Workgroup Feeder	Y1F97A	Yes	Yes	Yes
HP LaserJet Workgroup Cabinet	Y1G17A	Yes	Yes	Yes
HP LaserJet 2000 Sheet High Capacity Tray WG	Y1F99A	Yes	Yes	Yes
HP LaserJet Inner Finisher	Y1G00A	Yes	Yes	Yes
HP LaserJet Booklet Finisher	Y1G07A	Yes	Yes	Yes
HP LaserJet Job Separator WG	Y1G15A	Yes	Yes	Yes
HP LaserJet Stapler/Stacker Finisher Staples	Y1G14A	Yes	Yes	Yes

Table 1-14 Optional list (continued)

Item	Model	E72535	E72530	E72525
HP LaserJet Inner/ Booklet Finisher Staples	Y1G13A	Yes	Yes	Yes
HP LaserJet Inner Finisher Hole 2/3 Punch	Y1G02A	Yes	Yes	Yes
HP LaserJet Inner Finisher Hole 2/4 Punch	Y1G03A	Yes	Yes	Yes
HP LaserJet Inner Finisher Swedish Punch	Y1G04A	Yes	Yes	Yes
HP LaserJet Hole Punch 2/3 Accessory	Y1G10A	Yes	Yes	Yes
HP LaserJet Hole Punch 2/4 Accessory	Y1G11A	Yes	Yes	Yes
HP LaserJet Hole Punch Swedish Accessory	Y1G12A	Yes	Yes	Yes
HP LaserJet Paper Tray Heaters WG	Y1G22A	Yes	Yes	Yes
HP LaserJet Paper Tray Heaters Accessory WG 110V	Y1G22A#BGJ	Yes	Yes	Yes
HP LaserJet Paper Tray Heaters Accessory WG 220V	Y1G22A#B19	Yes	Yes	Yes
HP Second Exit ¹	Y1G23A	Yes	Yes	Yes
HP Spacer ²	Y1G24A	Yes	Yes	Yes

¹Required to attach an external finisher and installing an inner finisher.

²Required to attach an external finisher to a **monochrome** model printer.

Feeding system

Learn about the feeding system.

Feeding system overview

Learn about the feeding system overview.

The feeding system picks up paper from the cassette or Tray 1 and moves it to the printing mechanism inside the printer. The feeding system consists of the pickup unit, registration unit, transfer roller assembly, and exit unit.

Figure 1-5 Feeding system overview

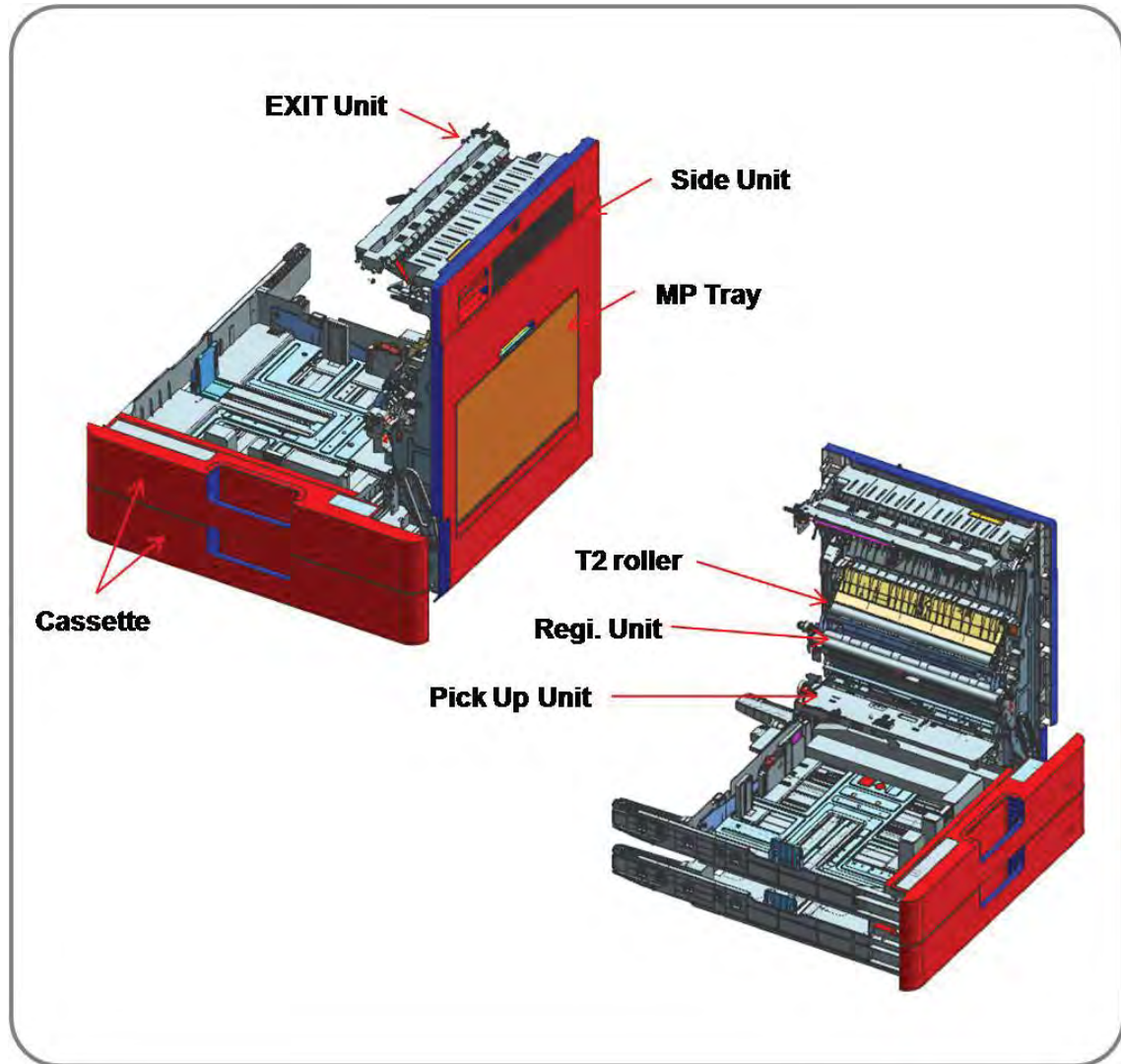

Main components and functions

Learn about main components and their functions.

Rollers

Learn about the rollers.

Figure 1-6 Rollers

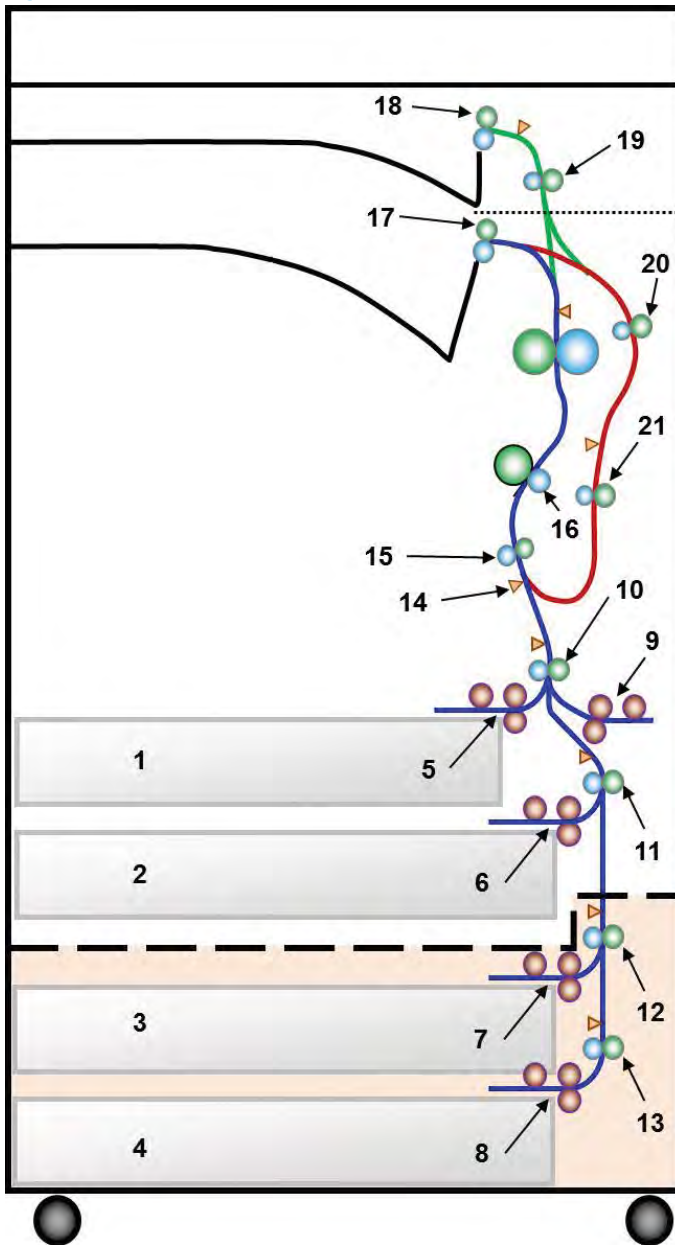

Callout	Description	Callout	Description
1	Tray 2	12	Tray 4 paper path rollers
2	Tray 3	13	Tray 5 paper path rollers
3	Tray 4 (optional)	14	Sensor registration

(continued)

Callout	Description	Callout	Description
4	Tray 5 (optional)	15	Roller registration
5	Tray 2 pick/separation/feed rollers	16	Roller transfer
6	Tray 3 pick/separation/feed rollers	17	Roller output 1st
7	Tray 4 pick/separation/feed rollers	18	Roller output 2nd
8	Tray 5 pick/separation/feed rollers	19	Roller invert
9	Tray 1 pick/separation/feed rollers	20	Roller duplex 1
10	Tray 2 paper path rollers	21	Roller duplex 2
11	Tray 3 paper path rollers		

- Pickup roller (Tray 1, 2, 3, 4, and 5)
 - This roller picks up the paper from the tray.
- Feed roller (Tray 1, 2, 3, 4, and 5)
 - This roller is placed against the reverse roller. It transfers the paper from the pickup roller to the feed roller.
- Separation roller (Tray 1, 2, 3, 4, and 5)
 - This roller is placed against the feed roller and transfers only one sheet of paper to the feed roller. When two or more sheets of paper are being transferred from the pickup roller, the load of the torque limiter of the reverse roller is heavier than the frictional force between the sheets of paper. As a result, the reverse roller is stopped and the lower sheet of paper is not transferred.
- Feed roller
 - This roller transfers the paper came from the forward/separation roller to the registration roller.
- Registration roller
 - This roller aligns the leading edge of the paper and transfers the paper to the transfer roller assembly.

Sensor, motor, and solenoid

Learn about the sensor, motor, and solenoid.

Figure 1-7 Sensor, motor, and solenoid

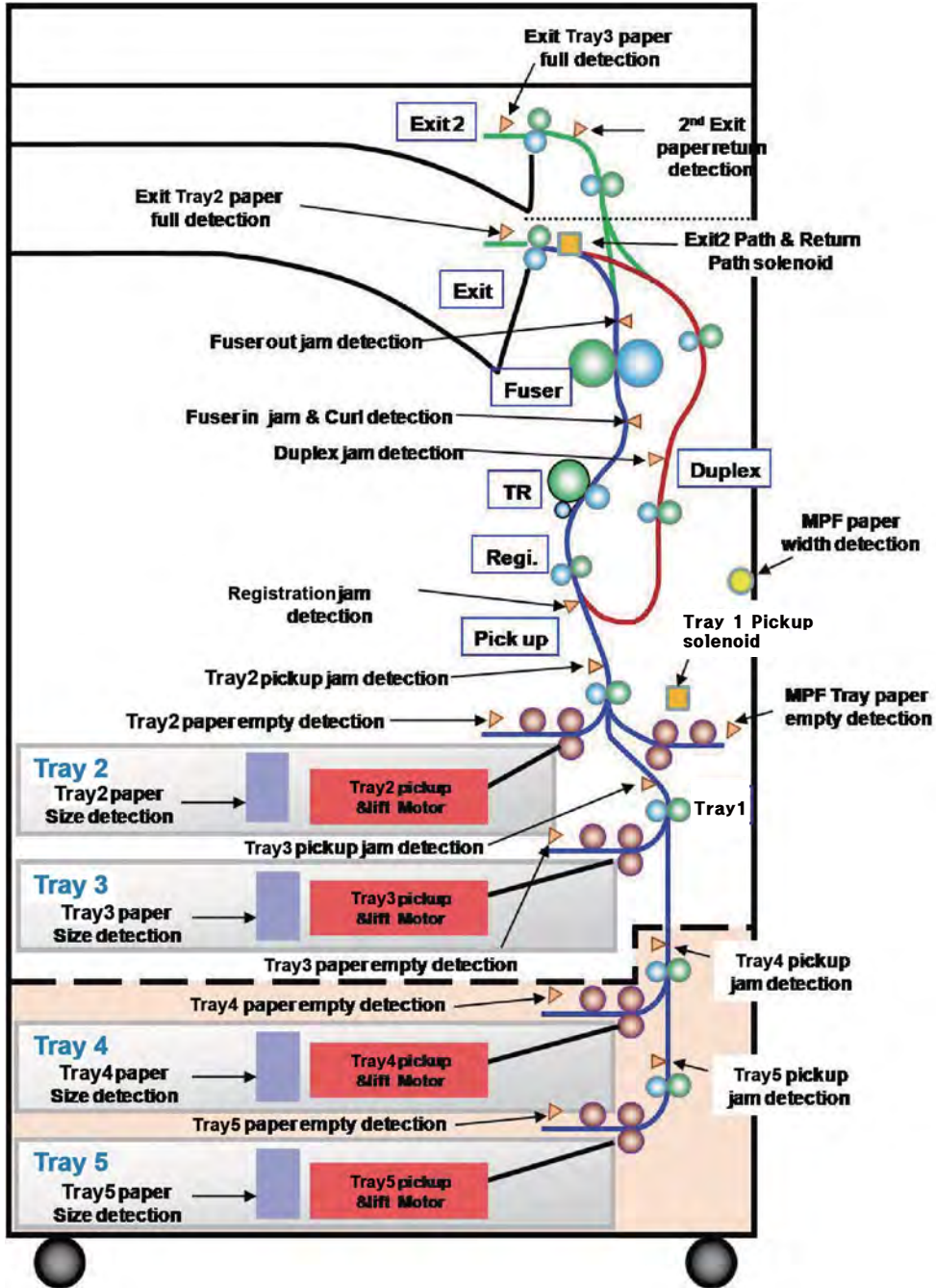

Cassette

Learn about the cassette.

The tray stores paper. The paper size is set using the guides in each tray.

Figure 1-8 Basic cassette

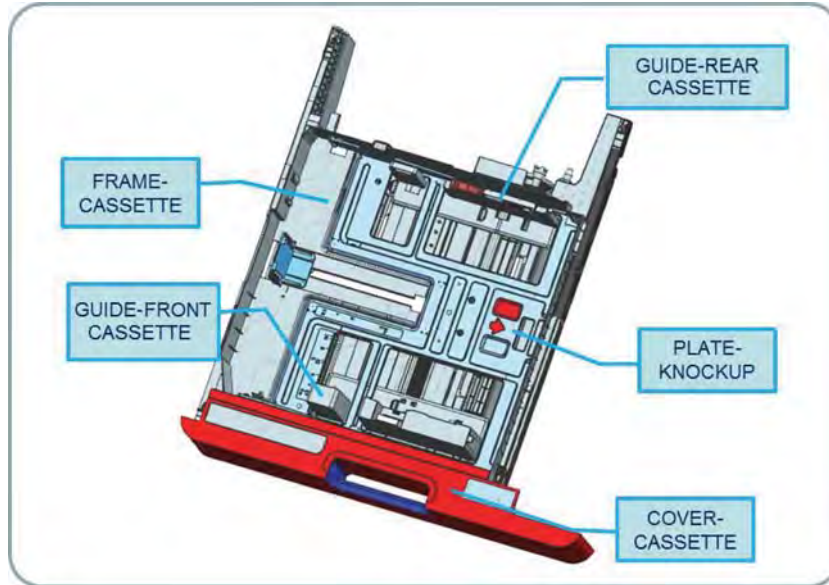

Item	Description
1	Structure: Drawer Type
2	Capacity: 520 sheets (80 g/m ² paper standard)
3	Paper type NOTE: Tray 2 does not support A3 or 11 x 17 paper.
4	Paper weight <ul style="list-style-type: none"> Plain paper: 60–220 g/m²
5	Plate knock up lift type: Lift Motor + Up Limit Sensor

Pickup Assembly

Learn about the pickup assembly.

When paper pickup occurs, the pickup roller moves down in order to come in contact with the surface of the paper. If the cassette is installed, the LEVER-INPUT CST is pushed and the pickup roller moves down. The feed and separation rollers make sure that a single sheet of paper is moved into the paper path, and that the feed roller moves the paper as far as the registration (REGI) roller.

 **NOTE:** The pickup unit 1 and pickup unit 2 are not interchangeable.

Figure 1-9 Pickup unit 1

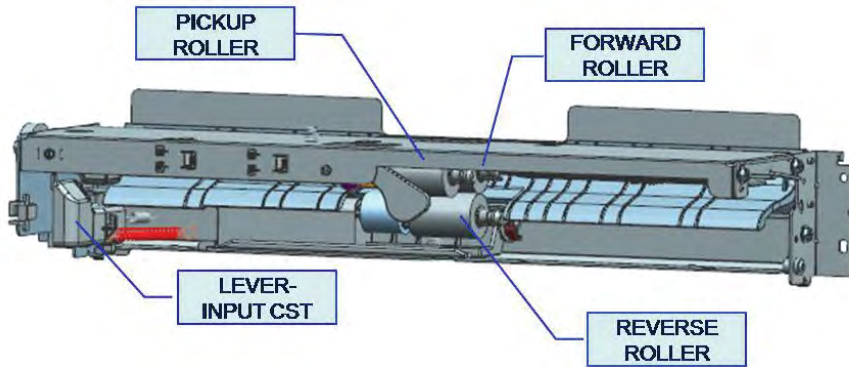
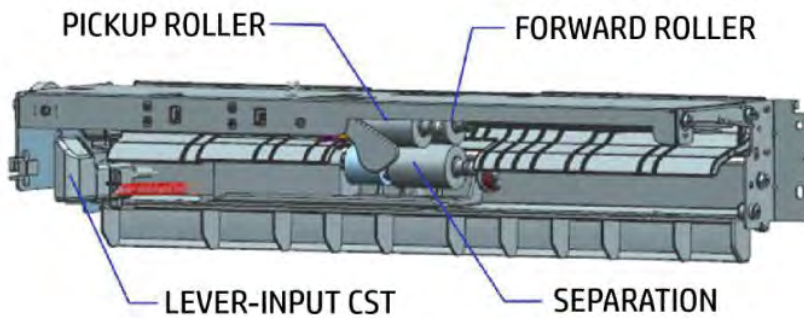

Figure 1-10 Pickup unit 2



Registration assembly

Learn about the registration assembly.

The registration roller is driven by the registration/multipurpose motor.

The registration roller clutch is located between the registration/Tray 1 motor and registration roller, or on the transfer belt (for color), and it controls power to the registration roller in order to match paper and an image on the drum at the predetermined registration point.

Figure 1-11 Registration roller

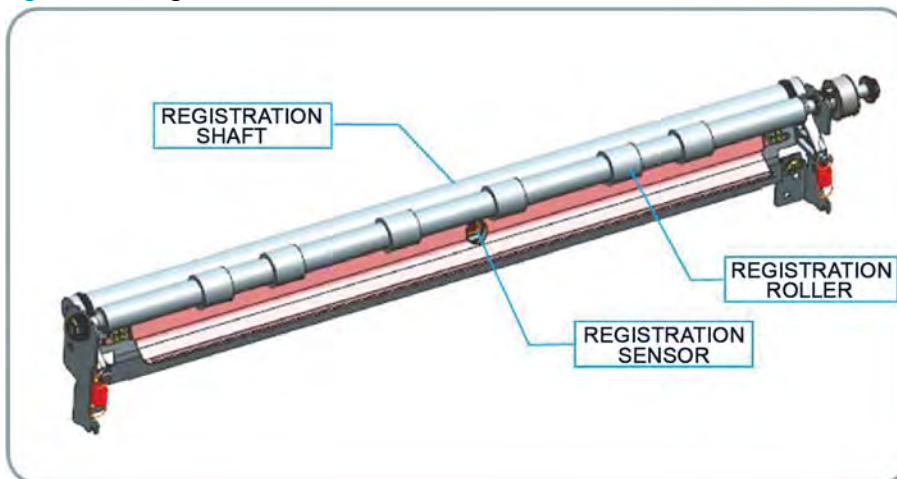

Tray 1 (MP) feed assembly

Learn about the Tray 1 feed assembly.

The Tray 1 feed assembly allows feeding of special media cardstock and custom size paper.

Figure 1-12 Tray 1 feeder assembly

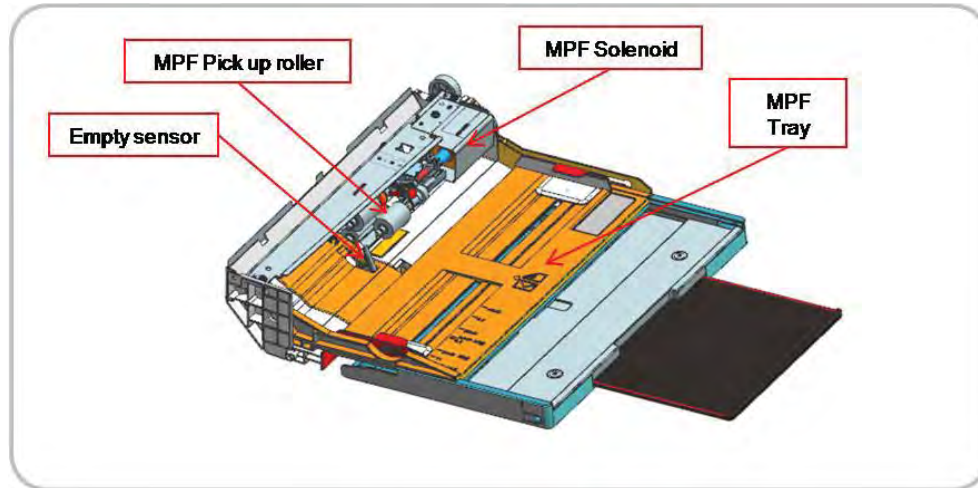

Specification

- Capacity: 100 sheets (80g/m² / 21 lb paper standard)
- Media size: 297mm x 432 mm – 98 mm x 148 mm (11.7 in x 17 in – 3.87 in x 5.8 in)
- Media weight: Plain paper 60 – 176 g/m²
- Feeding speed: 30 ppm (E77430/78330), 25 ppm (E77425/78325), 22 ppm (E77422), 23 ppm (E78323)
Letter/A4 LEF (Long Edge Feeding)

Paper separation

Figure 1-13 Paper separation

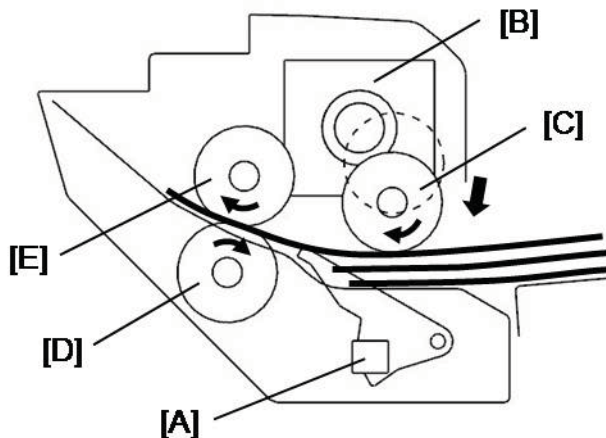

When the Tray 1 paper detection [A] sensor detects paper and the machine gets a Tray 1 printing job, the Tray 1 solenoid [B] drops the pickup roller [C] onto the top of the paper stack in Tray 1.

This machine uses a Feed and Separation Roller (FSR) system for feeding paper. The friction between the separation roller [D] and feed roller [E] separates the top sheet of paper from the stack.

Image creation

Learn about image creation.

Printing process overview

Learn about the printing process overview.

This printer uses one imaging unit and one laser for mono printing. The imaging unit consists of a drum unit and developer unit.

The drum unit consists of an Organic Photo Conductor (OPC) drum, charging roller, and cleaning blade.

Figure 1-14 Printing process overview

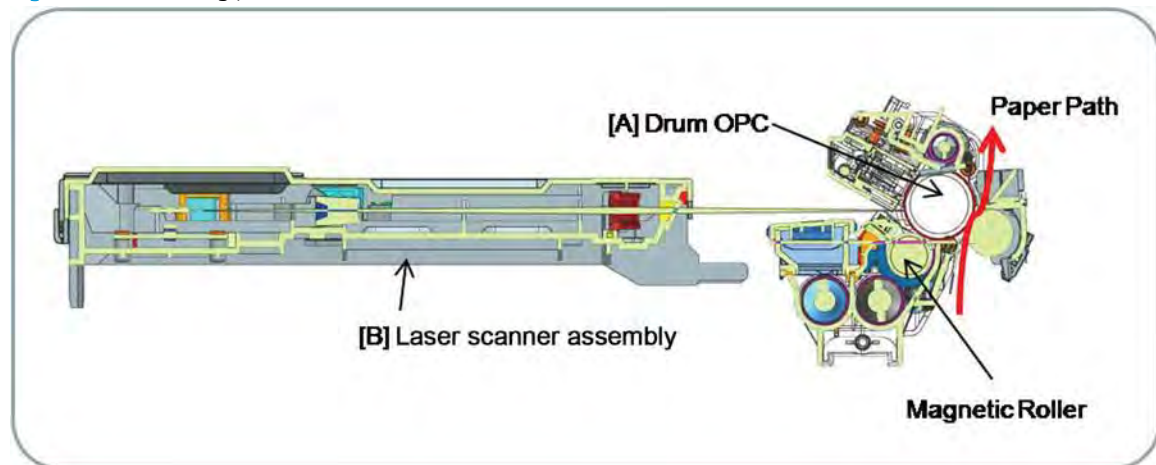

The OPC drum (A) is charged with a negative voltage and is exposed to light from the laser scanner assembly (B). The light produced by a laser creates a latent image by discharging on the surface of the OPC drum. The negatively charged toners are attracted to the latent drum image by an electric field. The toners (real image) on the OPC drum are transferred to the transfer media by the positive bias applied to the transfer roller.

1. **OPC drum charge:** The charge roller gives the drum a negative charge.
2. **Laser exposure:** Light produced by a laser diode hits the charged OPC through the lens and mirrors.
3. **Development:** The magnetic roller carries negatively charged toner to the latent image on the drum surface.
4. **Transfer:** The transfer roller opposite the OPC drum transfers toner from the drum to the paper.
5. **Cleaning the OPC drum:** The cleaning blade removes remaining toner on the drum surface after image transfer to the paper.
6. **Erasing for OPC drum:** Discharge cleaning is done by illuminating the whole area of the drum with the cleaning lamp at the end of every job.

Imaging unit

Learn about the imaging unit.

Imaging unit overview

Learn about the imaging unit.

The imaging unit consists of the drum unit and the developer unit.

The diameter of the drum is 30 mm (1.2 in) with a circumference of approximately 94.2 mm (3.7 in).

The developing gap between a drum and the corresponding magnetic roller cannot be adjusted. The CRUM chip is the sub part of the drum unit. The CRUM chip stores job count information and other data.

Figure 1-15 Drum unit

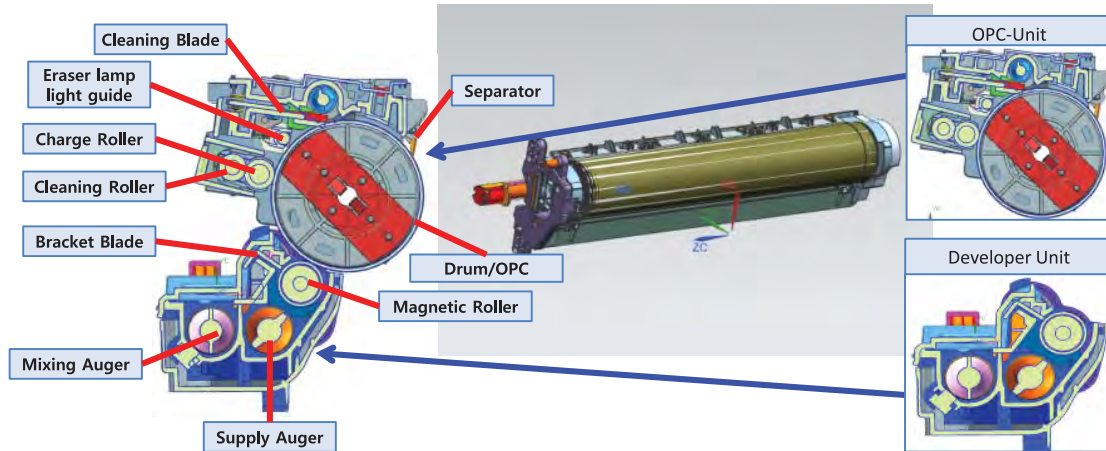

Drum drive

Learn about the drum drive unit.

The OPC drum and magnetic roller are driven by one BLDC motor and supplied with power from the coupling.

The drive shaft is directly inserted into the OPC drum to fix the drum unit. This structure provides stable printing quality.

Figure 1-16 Drum drive

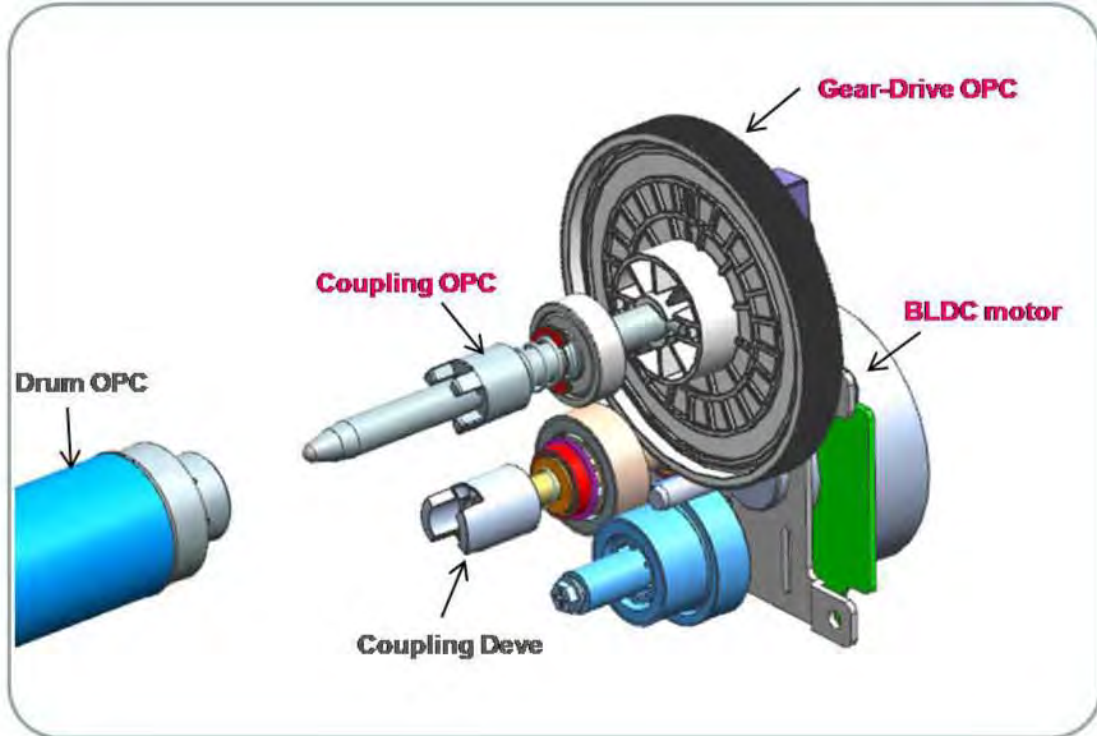

Developer unit

Learn about the developer unit.

This printer uses a dual-component development system. The development unit contains 340 g (12 oz) of toner carrier that is supplied to the magnetic (development) roller by the two mixing augers.

The developer unit has a toner concentration (TC) sensor. The TC sensor is used for controlling the operating range of toner density.

Figure 1-17 Developer unit

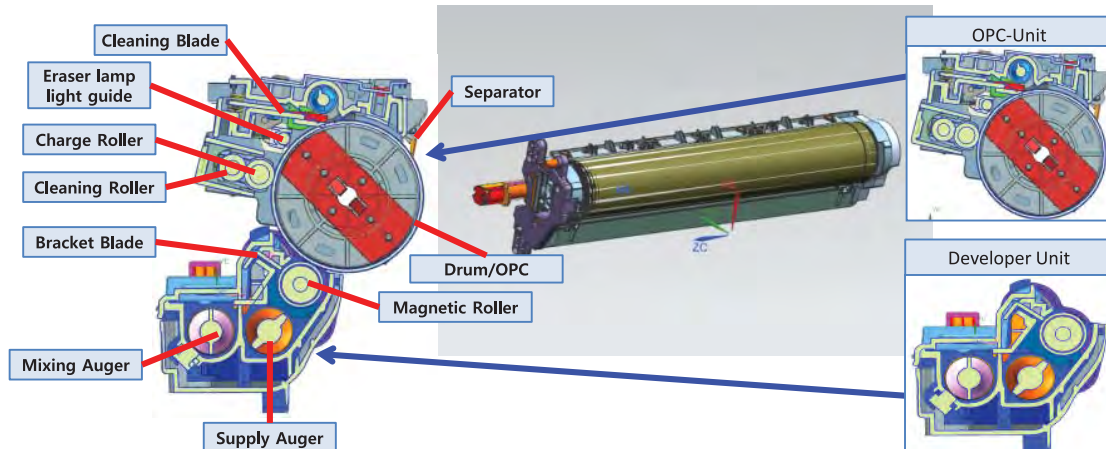

Agitation occurs at the following times:

- During the process control self-checking
- During toner supply job
- During development job

The developer unit must be stored below 50°C (122°F) or the toner hardens and does not work properly.

Fuser unit

Learn about the fuser unit.

Fuser unit overview

Learn about the fuser unit.

This section describes the image fusing process used by the printer.

This unit fuses the toner that was transferred by the transfer roller onto the paper by applying heat and pressure. The printer uses a two-roller fusing system and thinner heat roller to decrease warm-up time.

Figure 1-18 Fuser unit

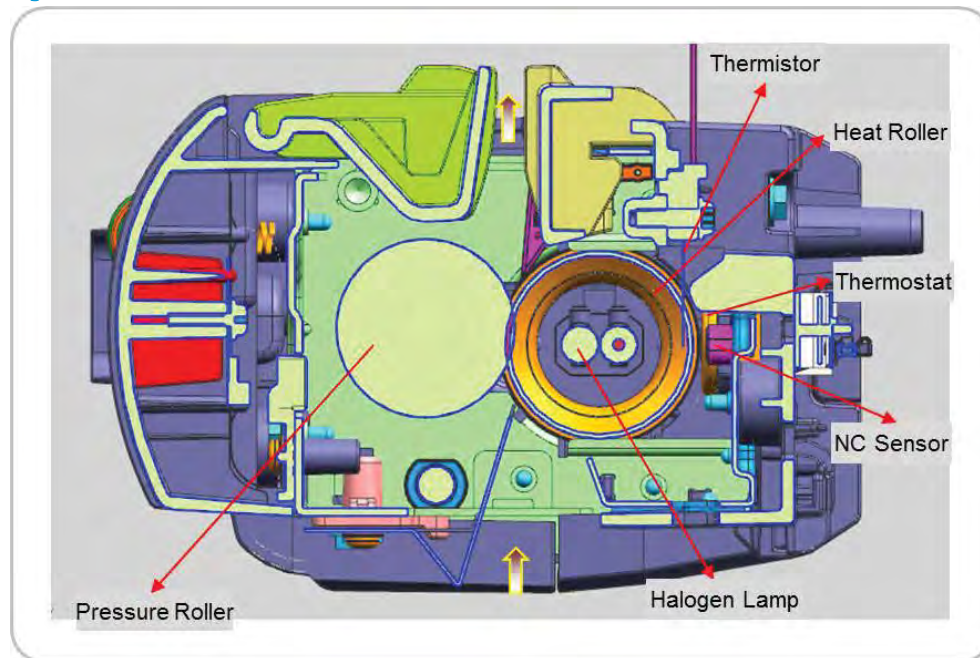

- **Lamp halogen**

The fuser unit has two halogen lamps. One lamp heats the center of the heat roller, and the other lamp heats the end of axial direction. The halogen lamps are lit alternately to heat the heat roller. Each lamp has its coil in a different location. The coil of the center heater lamp is in the center. The coils of the side heater lamp are located on both sides. The lamps are fixed inside of the heat roller. The lamps do not rotate when the heat roller rotates.
- **Heat roller**

The aluminum heat roller transfers heat from the halogen lamp to the toner and paper. The thinner heat roller reduces the time needed to warm-up and switch modes. To prevent the heat roller from adhering to the toner, its surface has a PFA coating. The heat roller is rotated by a gear located on the side of the roller.
- **Pressure Roller**

The pressure roller is made of rubber, which ensures proper nip width between the pressure roller and the heat roller. The force applied by the pressure roller ensures toner effectively adheres to the paper.
- **Non-Contact (NC) Sensor**

NC sensors (non-contact type thermistors) are located near the center and the end of the heat roller and control the temperature of the heat roller.

- **Thermistor**

The thermistor detects the temperature on the surface of the heat roller and controls the halogen lamp.

- **Thermostats**

The thermostat cuts off the power supply to the halogen lamp by opening the circuit when the heat roller becomes abnormally hot as a result of problems such as a NC sensor malfunction. The force applied by the pressure roller ensures toner effectively adheres to the paper.

Fuser unit drive

Learn about the fuser unit drive.

The fuser motor (A) drives the heat roller (C) through the gear train. The pressure roller (B) is pressurized and rotated by the heat roller.

Figure 1-19 Fuser drive

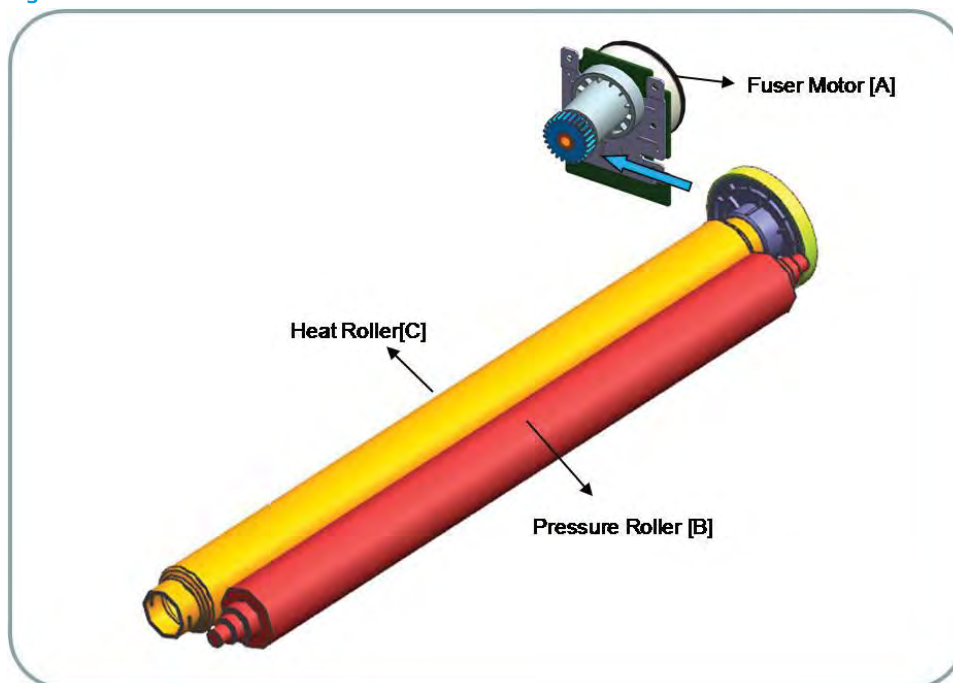

Fuser unit temperature control

Learn about fuser temperature control.

When the main switch turns on, the CPU turns on the fusing lamp. The lamp stays on until the contact thermistors detect the standby temperature. Then the CPU raises the temperature up to the printing temperature.

Figure 1-20 Fuser unit temperature control

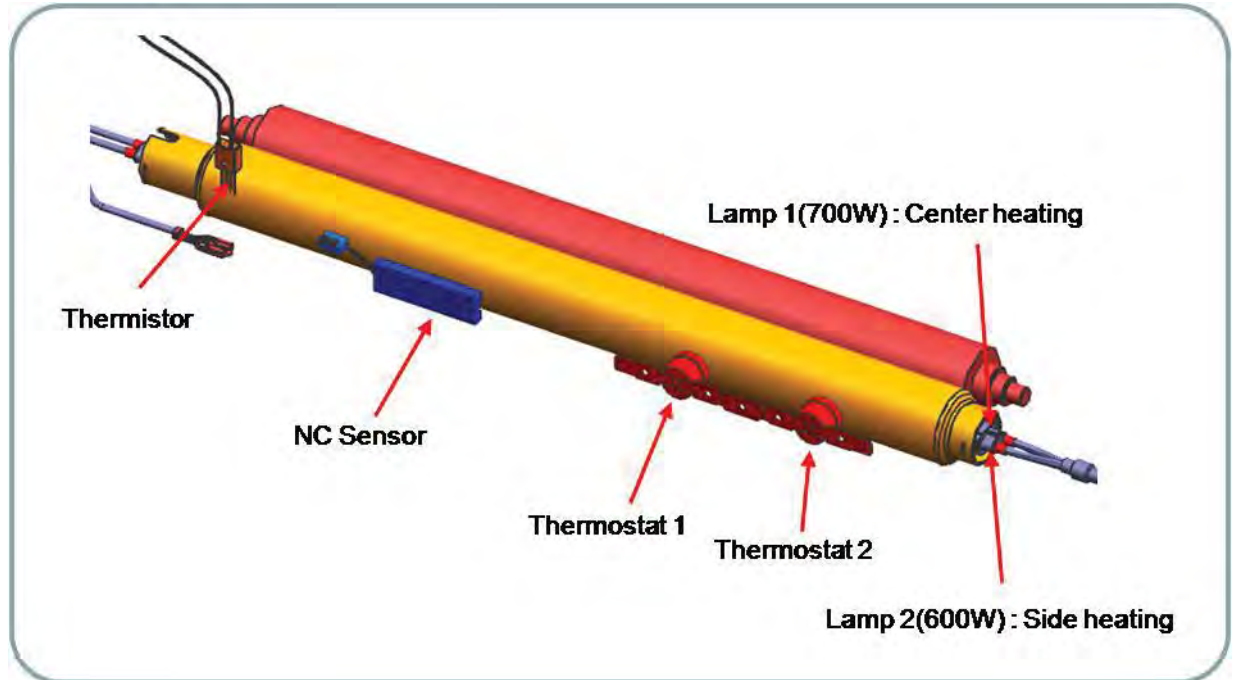

Overheat protection

The CPU cuts power to the fusing lamp in the following cases :

- The temperature detected by the thermistor stays higher than 240°C (464°F) for 20 seconds

The following components are used when thermistor overheat protection fails:

The CPU cuts power to the fusing lamp in the following cases :

The following components are used when thermistor overheat protection fails:

- Two thermostats get into line with the common ground wire of the fusing lamp.
- If one of the thermostat temperatures becomes higher than 195°C (383°F), power is turned off to the fusing lamp. If the other thermostat temperature becomes higher than 195°C (383°F), it also turns the power off to the fusing lamp.

Loop control

Learn about fuser loop control.

The tension of the paper between the OPC nip and the fuser nip is known as the paper loop level.

Figure 1-21 Loop control

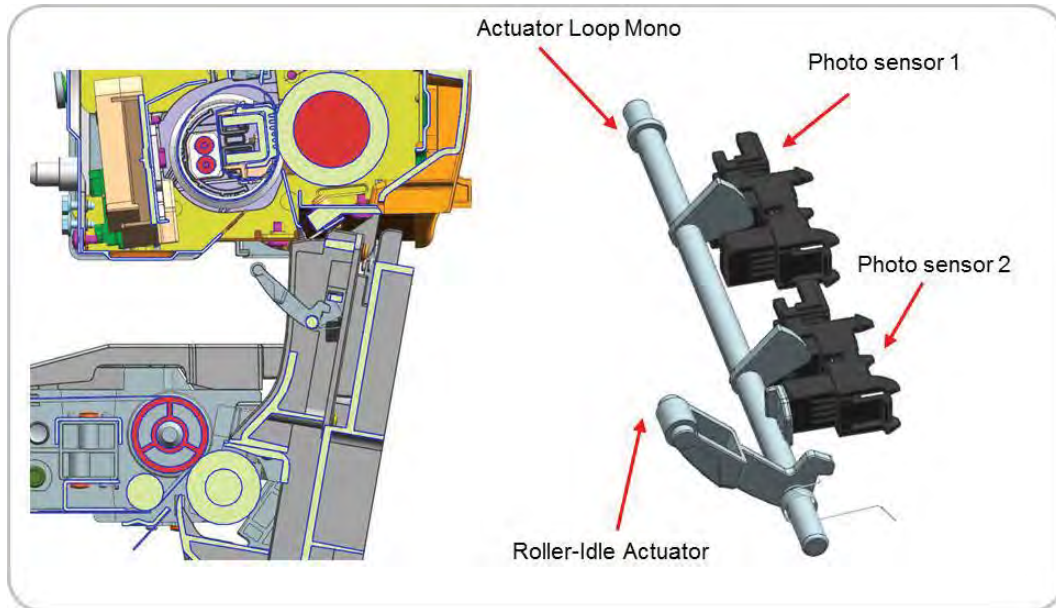

The paper loop level is controlled by monitoring photo sensors 1 and 2. The fuser unit controls the motor speed for the paper loop level.

Laser scanner unit

Learn about the laser scanner unit.

Laser scanner unit overview

Learn about the laser scanner unit general information.

The laser scanner unit consists of one polygon motor and one laser diodes (LD) unit. The laser scanner assembly forms a latent image on the surface of the OPC drum. For this process, the laser scanner assembly has a collimator lens, cylindrical lens, and an F-Theta lens on an optical path for each color.

The laser scanner assembly has cover glass to protect the glass on the optical path from contamination. The LD PCA interfaces with the printer.

Figure 1-22 Laser scanner unit overview

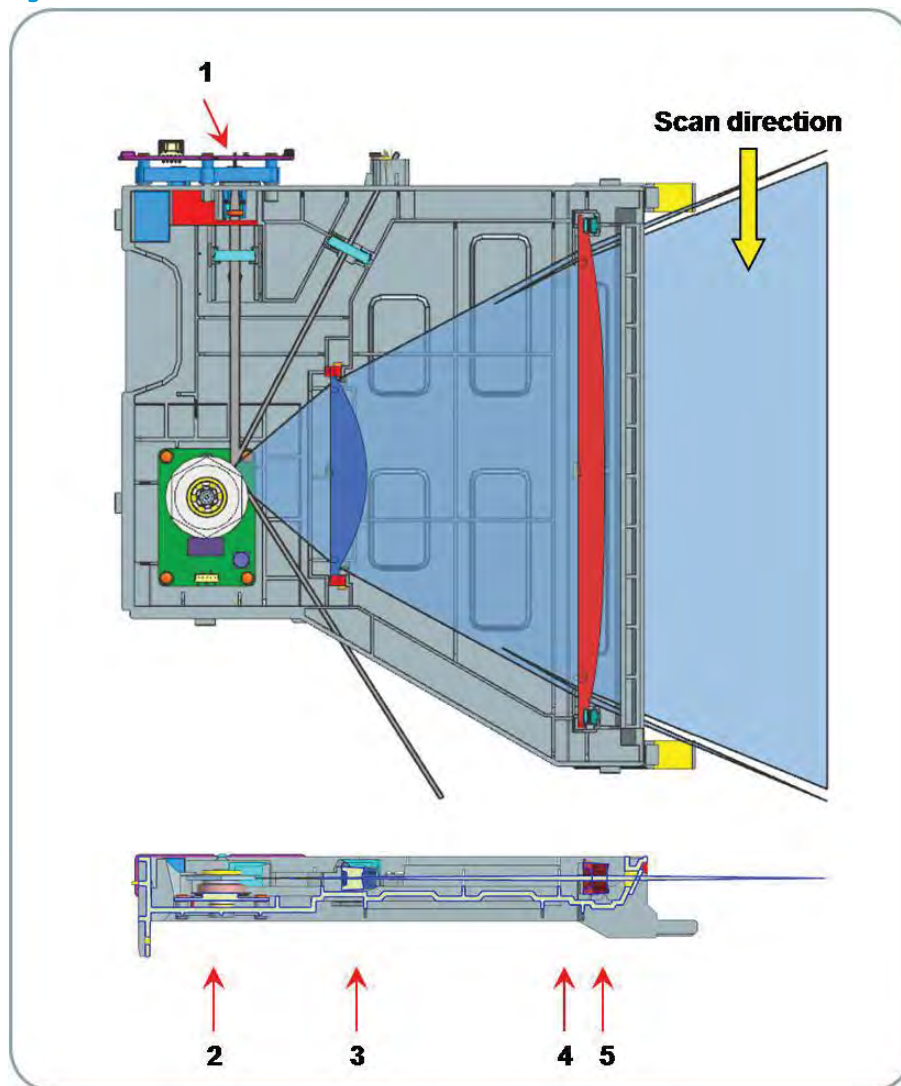

Table 1-17 Laser scanner unit overview

Callout	Description
1	LD PCA

Table 1-17 Laser scanner unit overview (continued)

Callout	Description
2	P/Mirror Motor
3	F1 Lens
4	F2 Lens
5	Cover glass

Laser scanning optical path

Learn about the laser scanner optical path.

The laser moves from the polygon motor (A) to the OPC drum (D). The F1 lens (B) and F2 lens (C) determine the scanning line and the image position. This setting is adjusted by the manufacturer.

The laser scanner assembly has three types depending on printing speed. The difference between the three models is shown in the following table.

Figure 1-23 Laser scanning optical path

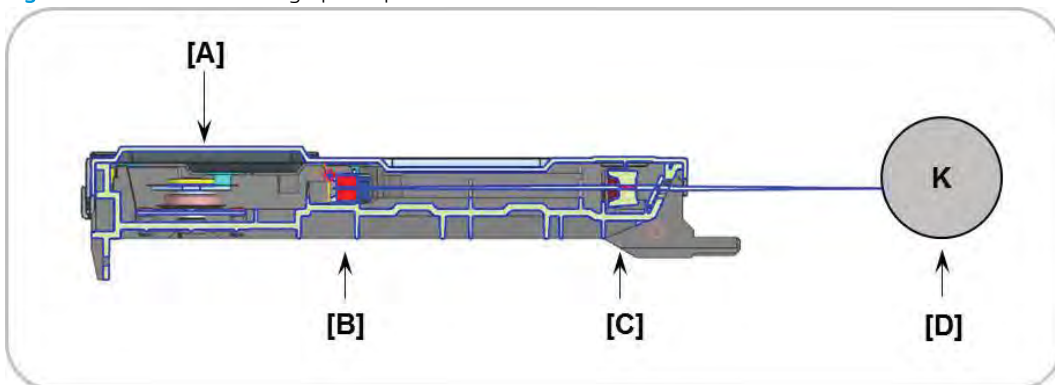

Laser synchronizing detectors

Learn about laser synchronizing detectors.

The laser scanner assembly has a beam detector sensor board (PD PCA). The PD PCA (A) detects the scanning start point.

Main Scan Start Detection

The beam is detected by the PD PCA at the scanning start point and creates the horizontal sync signal (Hsync).

The following diagram shows the data scanning direction.

Figure 1-24 Laser synchronizing detectors

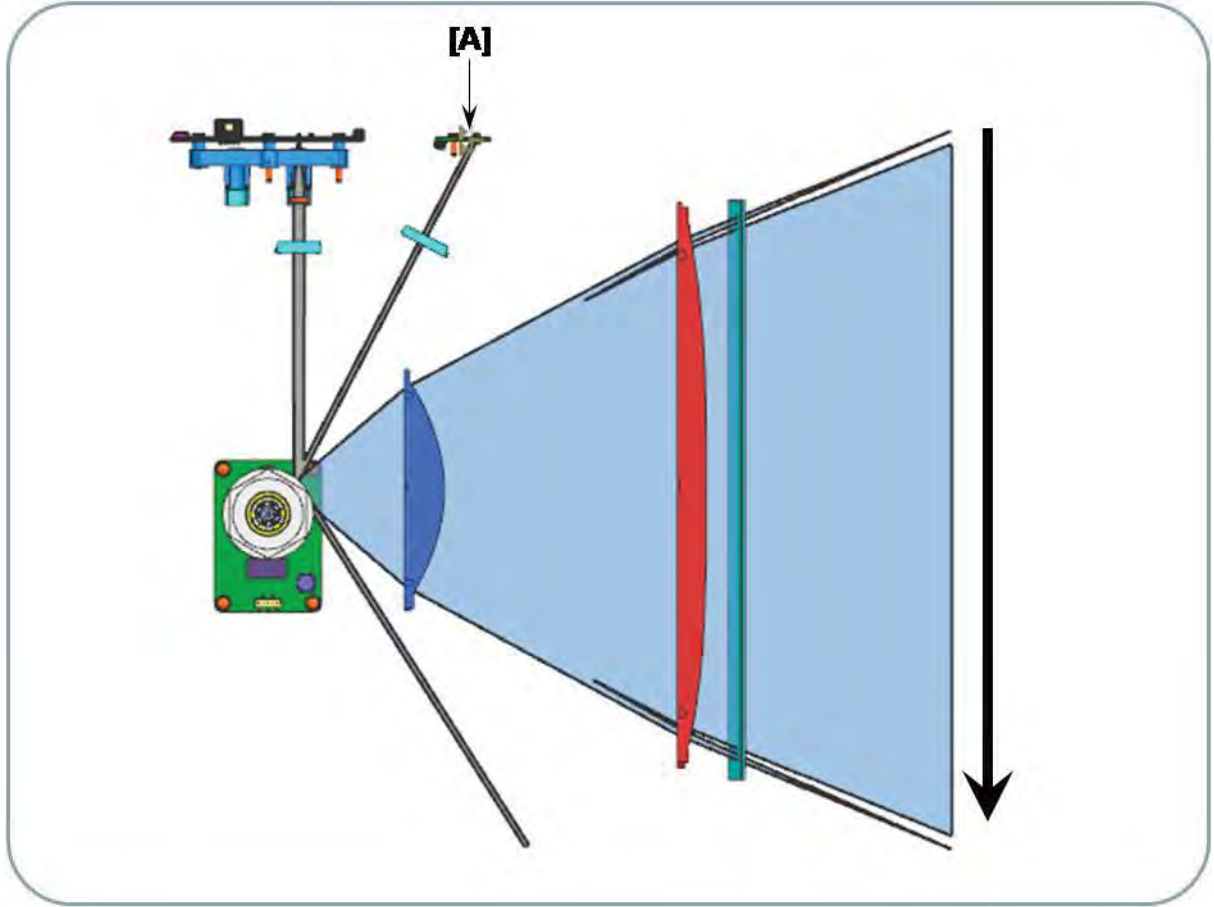

Drive system

Learn about the drive system.

Drive motors

Learn about the drive motors.

The following diagram shows the location of the printer drive motors.

Figure 1-25 Drive motors

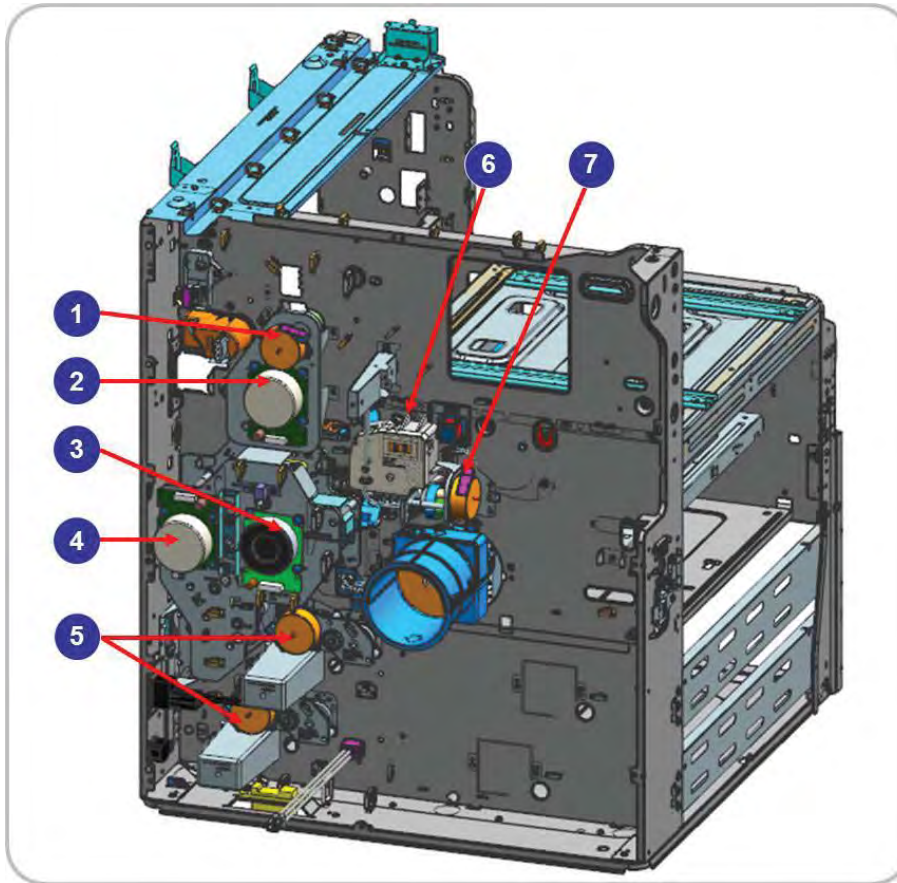

Number	Motor	Motor type	Qty	Function
1	Exit	PM-STEP	1	Exit drive (Reverse drive at duplex job)
2	Fuser	BLDC	1	Fuser drive/Fuser pressure mode (Reverse drive at pressure mode)
3	OPC/DEVE	BLDC	1	OPC/DEVE drive
4	Registration (Regi)/Tray 1	BLDC	1	Registration (Regi)/Tray 1/Feed 1, 2 drive
4	Feed 1, 2	E-Clutch	3	Registration (Regi)/Tray 1/Feed drive control
5	Pickup	PM-STEP	2	Pick roll/Tray 2 and 3 lift drive

Number	Motor	Motor type	Qty	Function
6	Toner supply	DC	1	Toner cartridge drive
7	Toner Duct	PM-STEP	1	Toner transport in toner cartridge drive duct

Main Drive Unit (OPC/DEVE/Registration/Tray 1/Feed)

Learn about the main drive unit.

Figure 1-26 Main drive unit (front view)

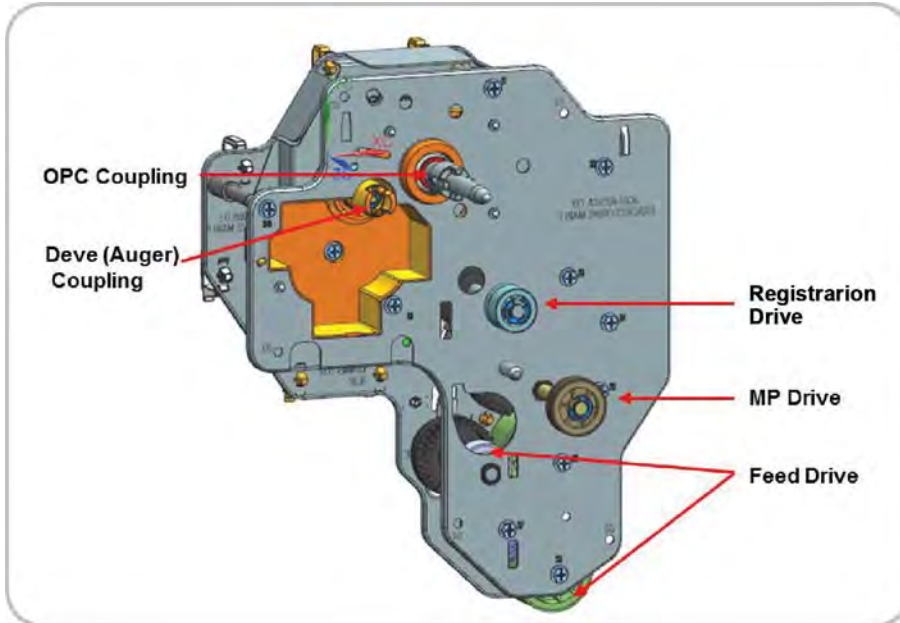

Figure 1-27 Main drive unit (rear view)

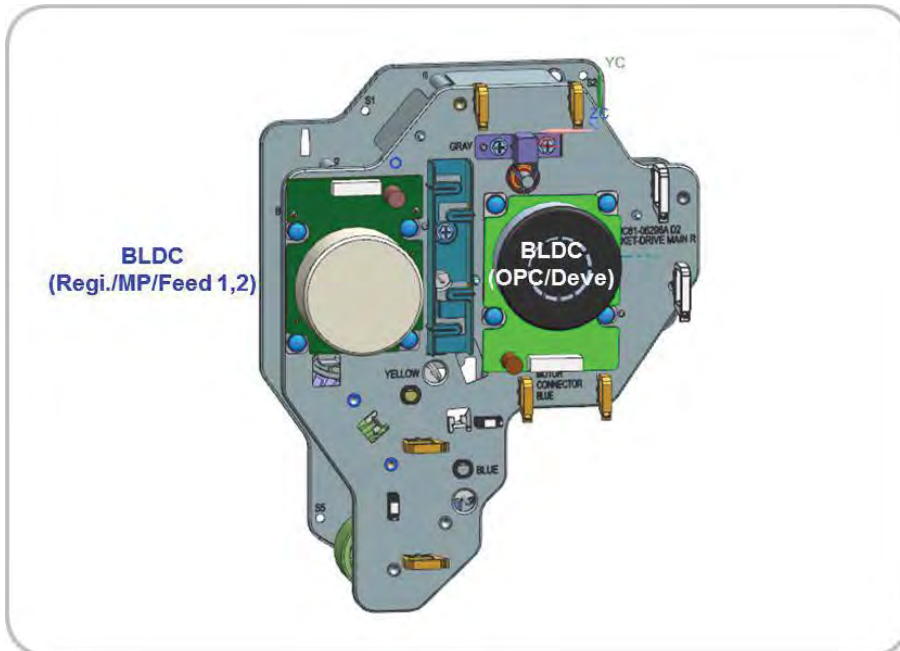
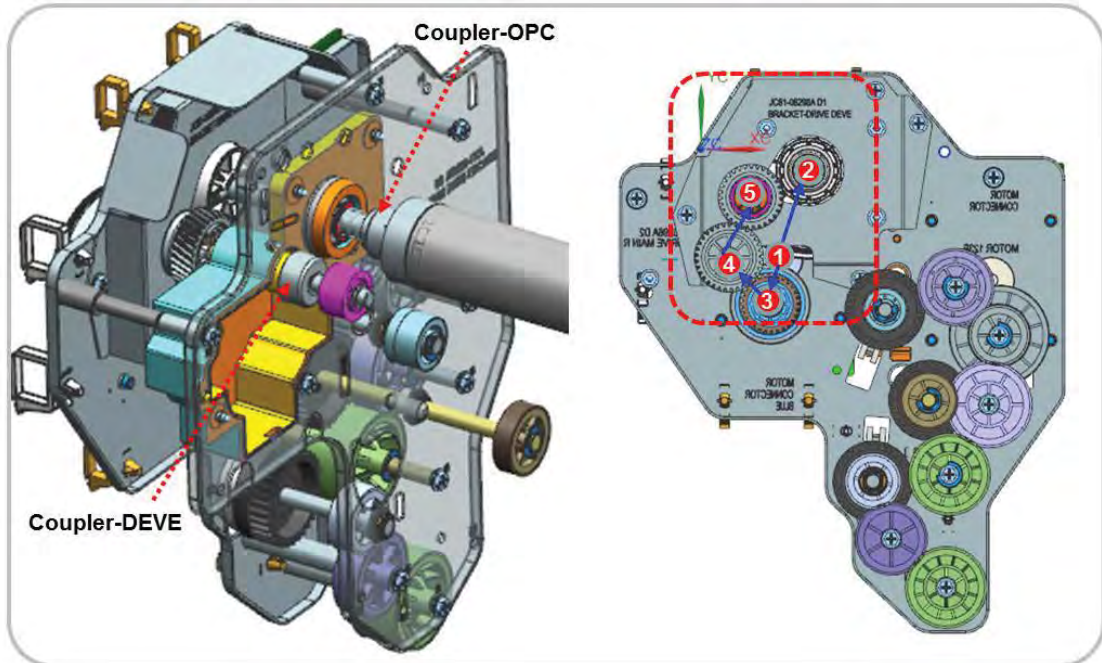

Figure 1-28 Main drive (OPC/Deve motors)



Power Train

OPC/Deve (Magnetic roller): BLDC motor drive control

- 1 → 2 (OPC drive)
- 1 → 3 → 4 → 5 (Deve [Magnetic roller] drive)

Figure 1-29 Main drive (Registration (Regi)/Tray 1/Feed 1, 2)

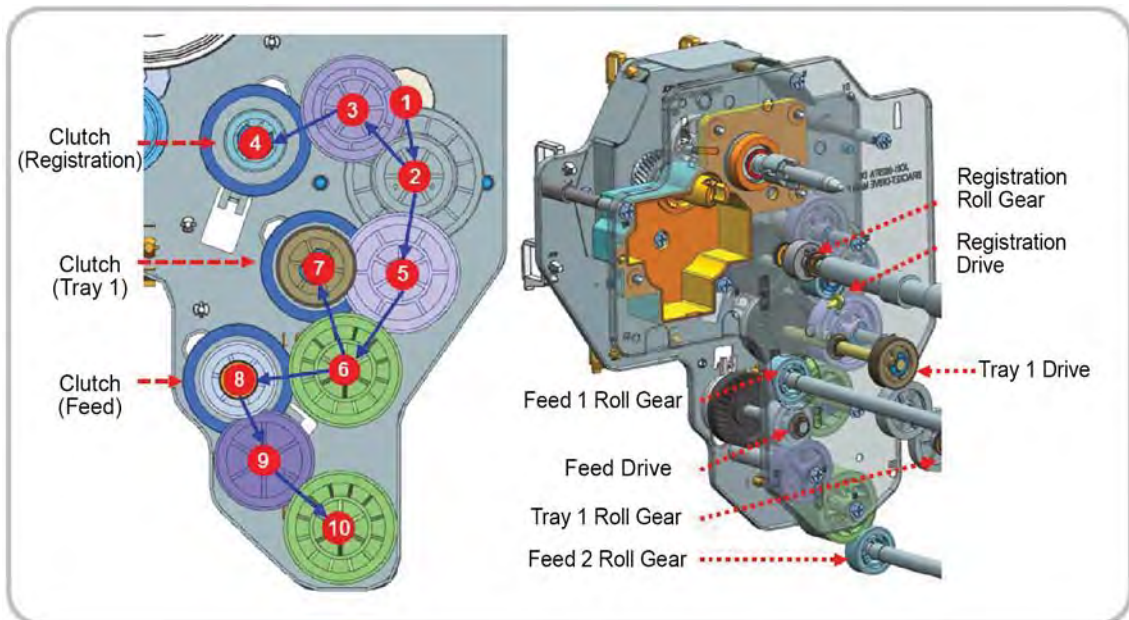

Power Train

Registration (Regi)/Tray 1/Feed 1, 2: BLDC motor drive, clutch drive control

- 1 → 2 → 3 → 4 Clutch/Gear (registration (Regi) input)
- 1 → 2 → 5 → 6 → 7 Clutch/Gear (Tray 1 input)
- 1 → 2 → 5 → 6 → 8 Clutch/Gear (feed 1 input) → 9 → 10 (feed 2 input)

Pickup Drive

Learn about the pickup drive.

Figure 1-30 Pickup drive

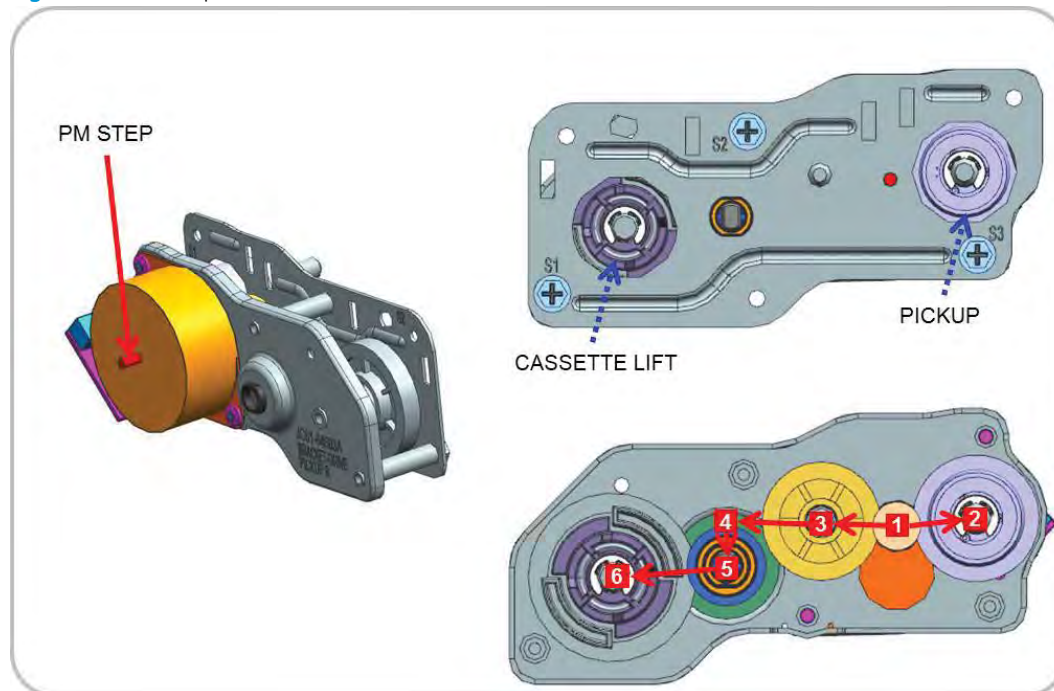

Power train

Pickup: rotating (pickup/input)/counter rotating (tray lift input)

- Step → Forward rotation → Gear 1 → Gear 2 (pickup)
- Step → Reverse rotation → Gear 1 → Gear 3 → Gear 4 → Gear 5 → Gear 6 (tray lift)

Duct Drive

Learn about the duct drive unit.

Figure 1-31 Duct drive

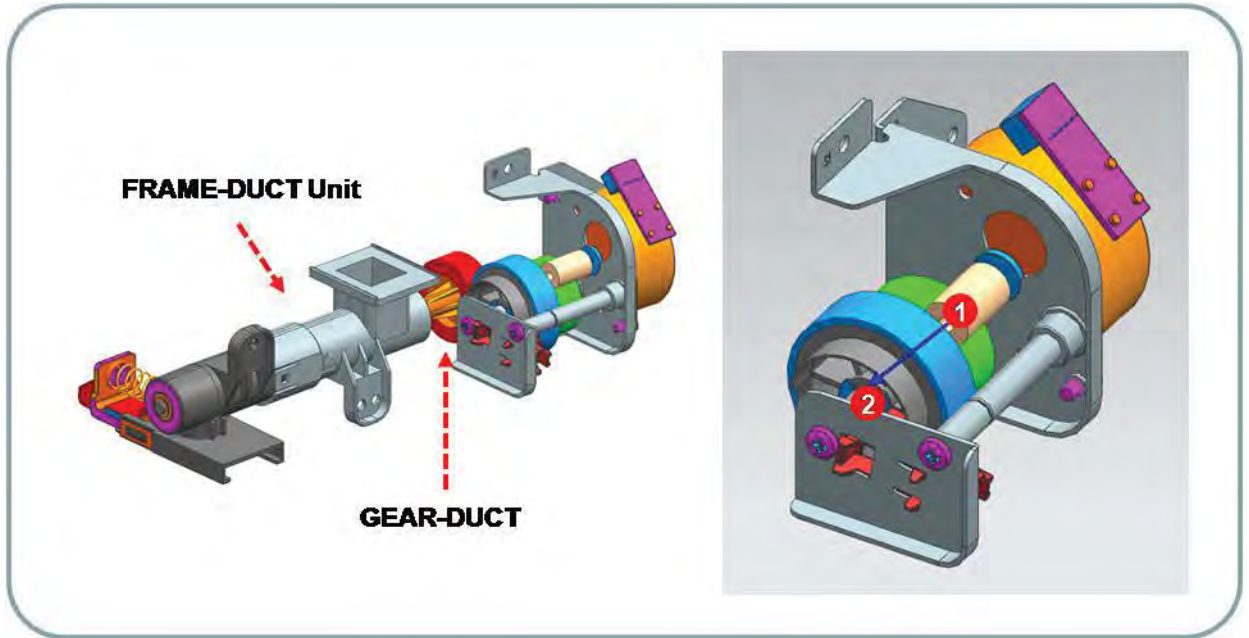

Power Train

DUCT: PM-STEP motor drive

- 1 PM-Step motor → 2 gear → gear duct drive

Fuser/Exit Drive

Learn about the fuser/exit drive.

Figure 1-32 Fuser/exit drive

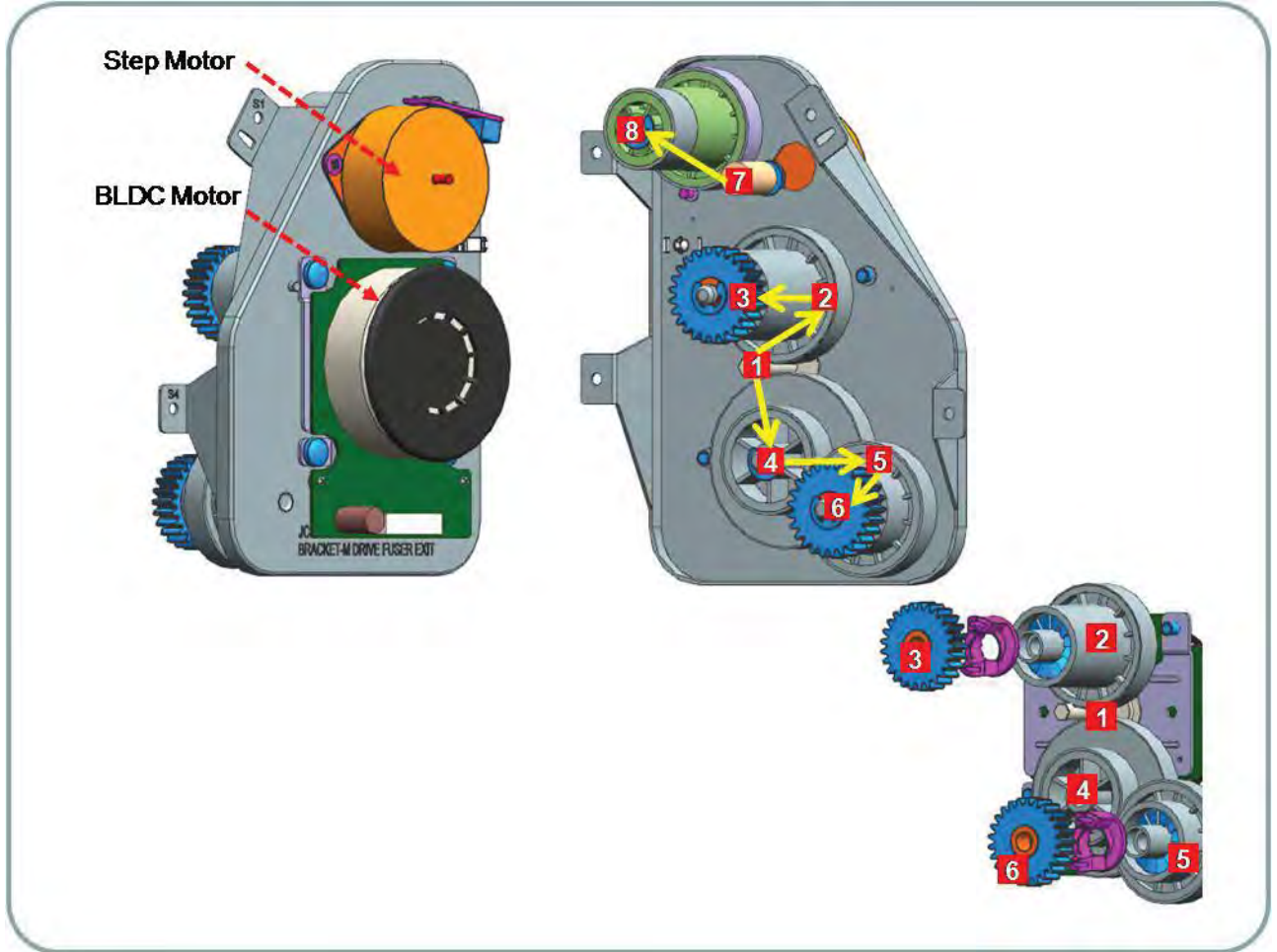

Power Train

Fuser and fuser release: One-way gear is used

- 1 BLDC Motor → counterclockwise rotation (CCW) → 2 clockwise rotations (CW) → 3 (CW) (Fuser drive)
- 1 BLDC Motor → 1 clockwise rotation (CW) → 4 (CCW) → 5 (CW) → 6 (CW) (Fuser release drive)
- 7 Step Motor → 8 RDCN Exit (Exit drive)

Toner supply drive

Learn about the toner supply drive.

Figure 1-33 Toner supply drive

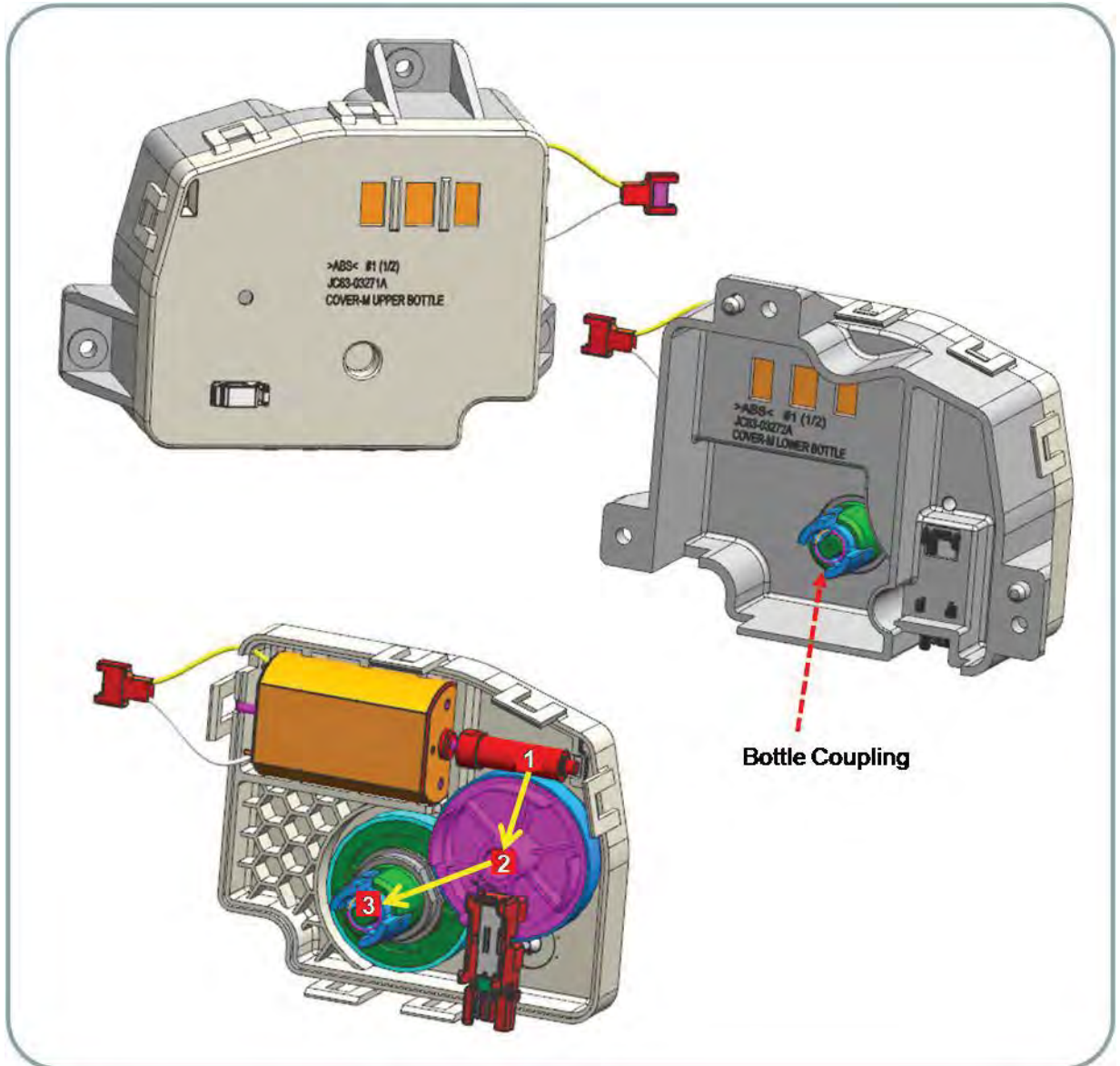

Power Train

Toner cartridge drive

- 1 DC Motor → 2 gear-M RDCN supply → 3 gear-M supply (toner cartridge drive)

Flatbed Scanner System

Learn about the flatbed scanner system.

Flatbed scanner system overview

Learn about the flatbed scanner system.

The scanner converts a hard copy original into data. To scan an original, the scanner uses the lens and Charge Coupled Device (CCD). The scanner stores and transfers the converted image to the storage space or transfers the scanned data to the printer engine for copy.

For scan operation, the scanner uses a full rate (FR) carriage and a half rate (HR) carriage that is moved by a wire. It scans the original document on the scanner glass or from the ADF.

The scanner system consists of the three following modules:

- **Full Rate (FR) carriage:** Illuminates the original and reflects the light at a 90 degree angle.
- **Half Rate (HR) carriage:** Transfers the reflected light from the FR carriage to the lens.
- **Imaging lens:** Makes an image on the CCD.

The HR carriage moves half the distance at half the speed of the FR carriage. This keeps a regular gap between the original and the imaging lens.

Figure 1-34 Scanner system overview

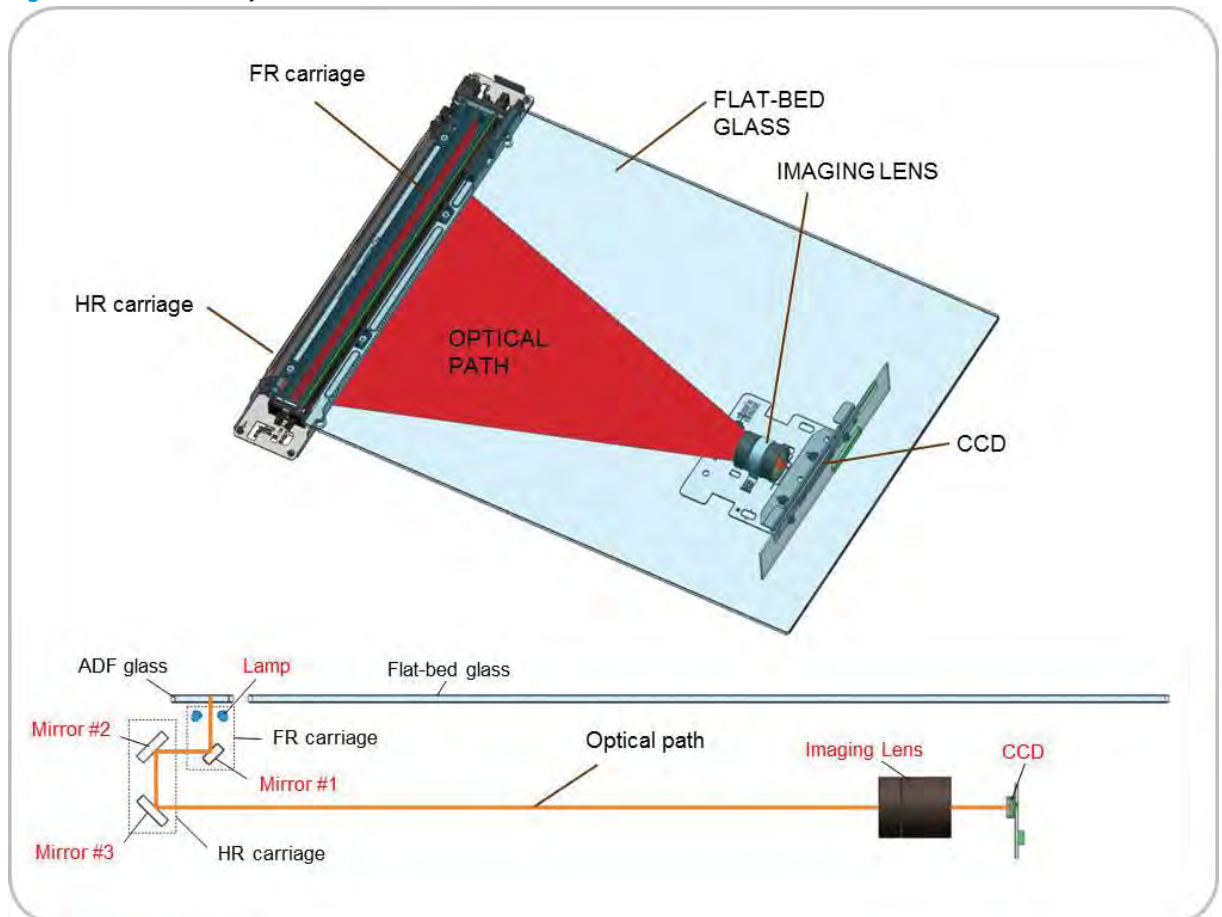

Scan process description

Learn about the scan process description.

1. The FR carriage lamp illuminates the original. The reflected light is moved to Mirror #1.
2. The reflected light from Mirror #1 is sent to the imaging lens through Mirror #2 and #3.
3. The light becomes smaller and makes an optical image.
4. The optical image is generated to the electrical signal by the CCD sensor.

To make a stable image, a gap must be maintained between the original and the lens. To maintain this gap, the HR carriage moves half the distance and half the speed of the FR carriage.

Figure 1-35 Scan process

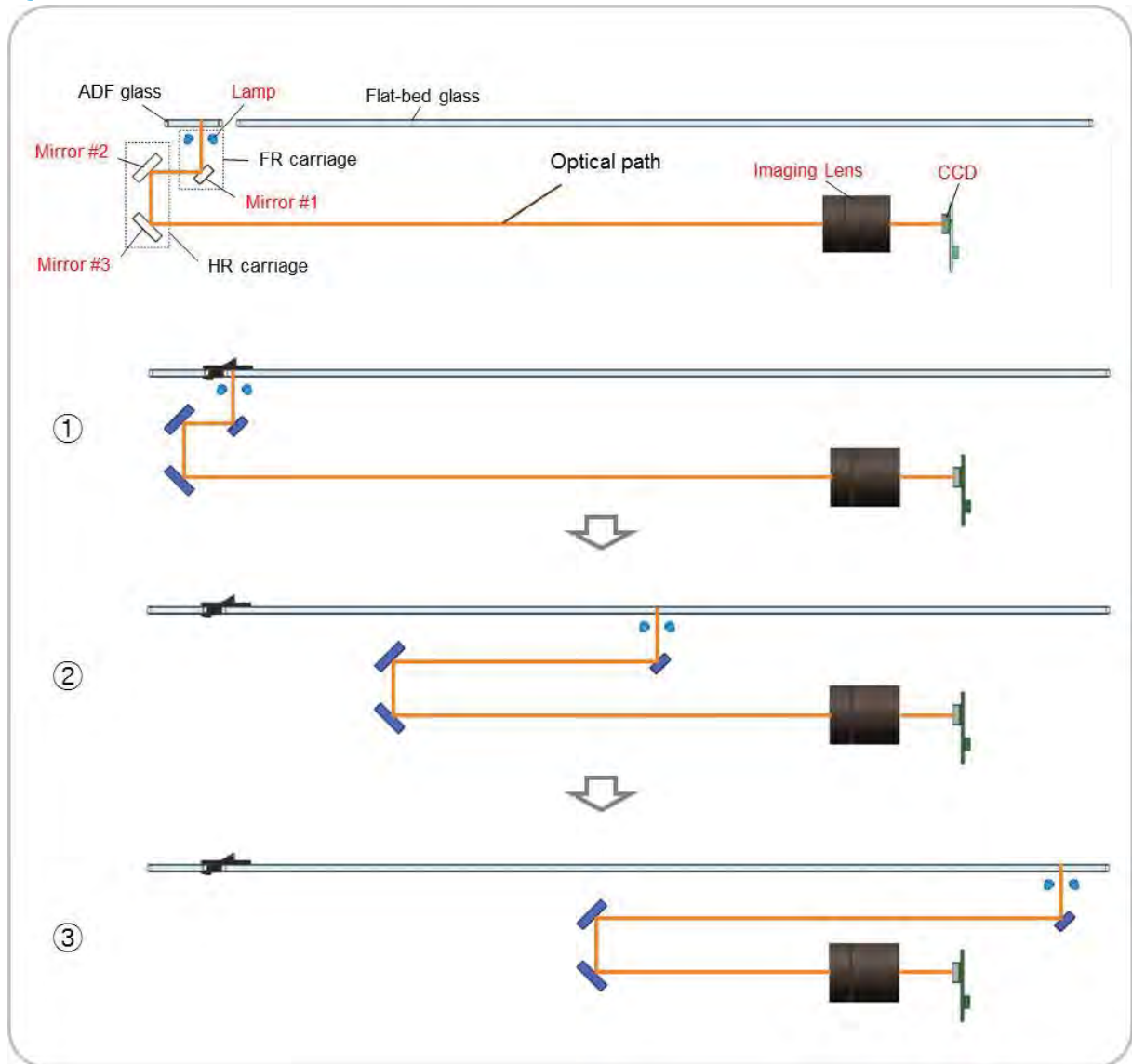

The optical image made by the CCD sensor is changed to an electrical-analog signal.

Each color element signal in the optical image is separated by the CCD sensor into red, green, and blue.

The red CCD sensor extracts the red color from the optical image, the green CCD sensor extracts the green color from the optical image, and the blue CCD sensor extracts the blue color from the optical image.

The analog image signal is changed to a digital image signal by the A/D converter and is transferred to the processor.

The image scan of the main scanning direction is performed by the CCD sensor. The CCD sensor consists of approximately 7500 pixels. The image scan of the sub scanning direction is performed by the FR carriage and HR carriage. The carriage is moved by a wire driven by the scan motor.

Scan resolution is 600 dpi.

Figure 1-36 Image processing

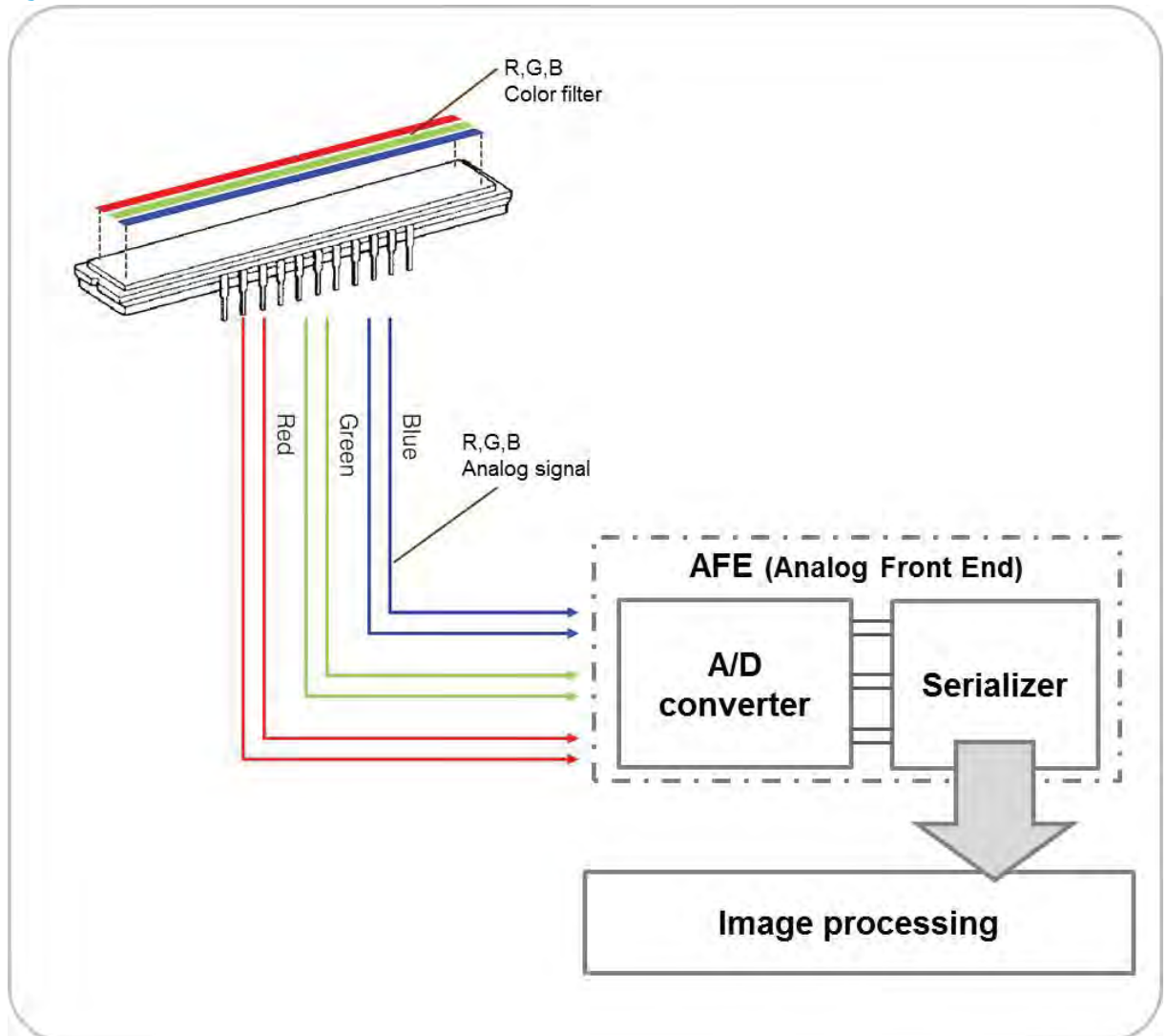

Scanning system components

The following shows the construction and purpose of the scanning system.

To scan the original on the scanner glass, two carriages driven by the motor move at a regular speed. The motor drives the timing belt, pulley, and wire. The wire pulley rolls and releases the wire to move the carriage.

The scanner consists of the scanner glass, FR carriage, HR carriage, imaging unit, and driving unit.

Figure 1-37 Scanning system components

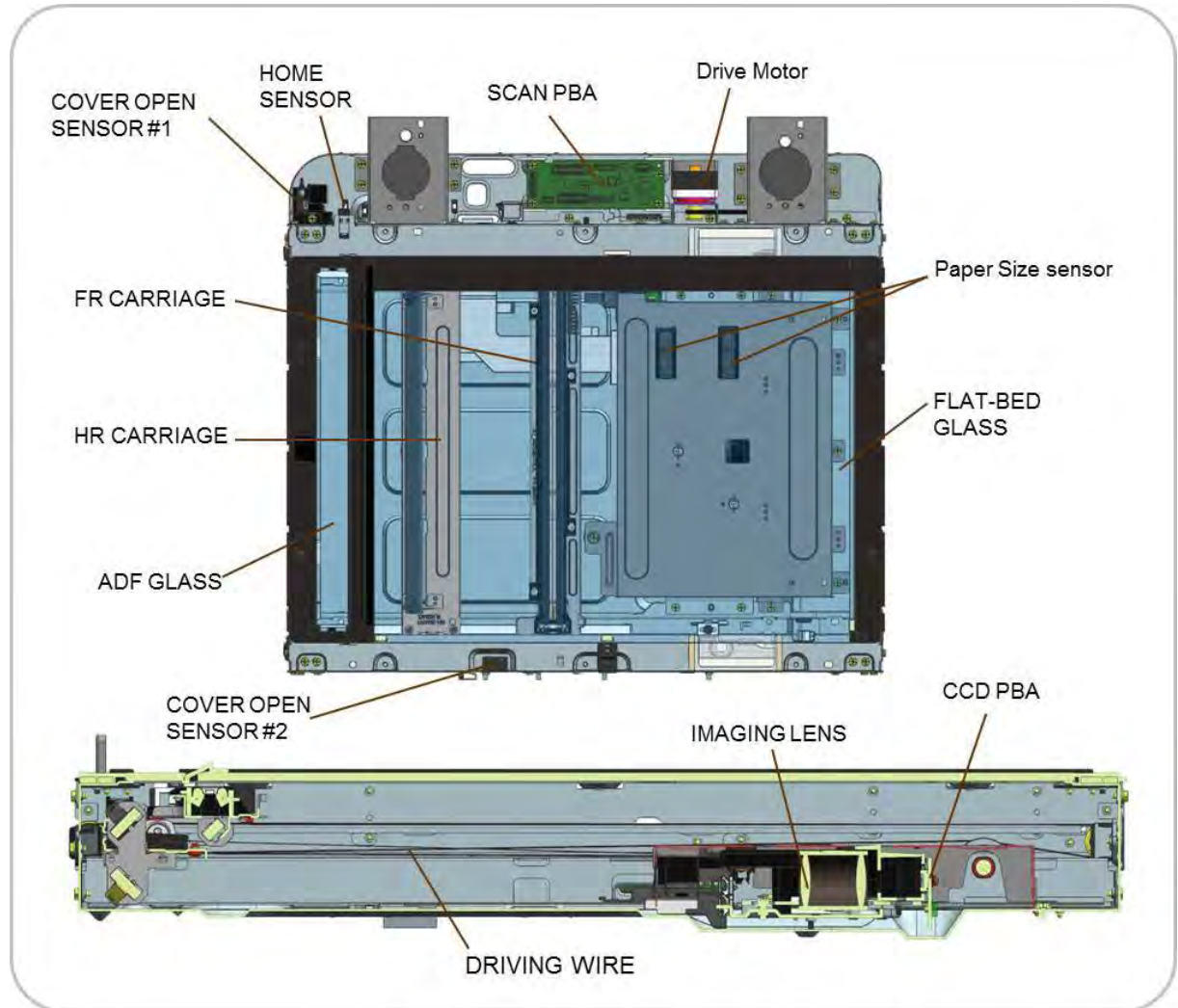

- FR Carriage

Figure 1-38 FR carriage

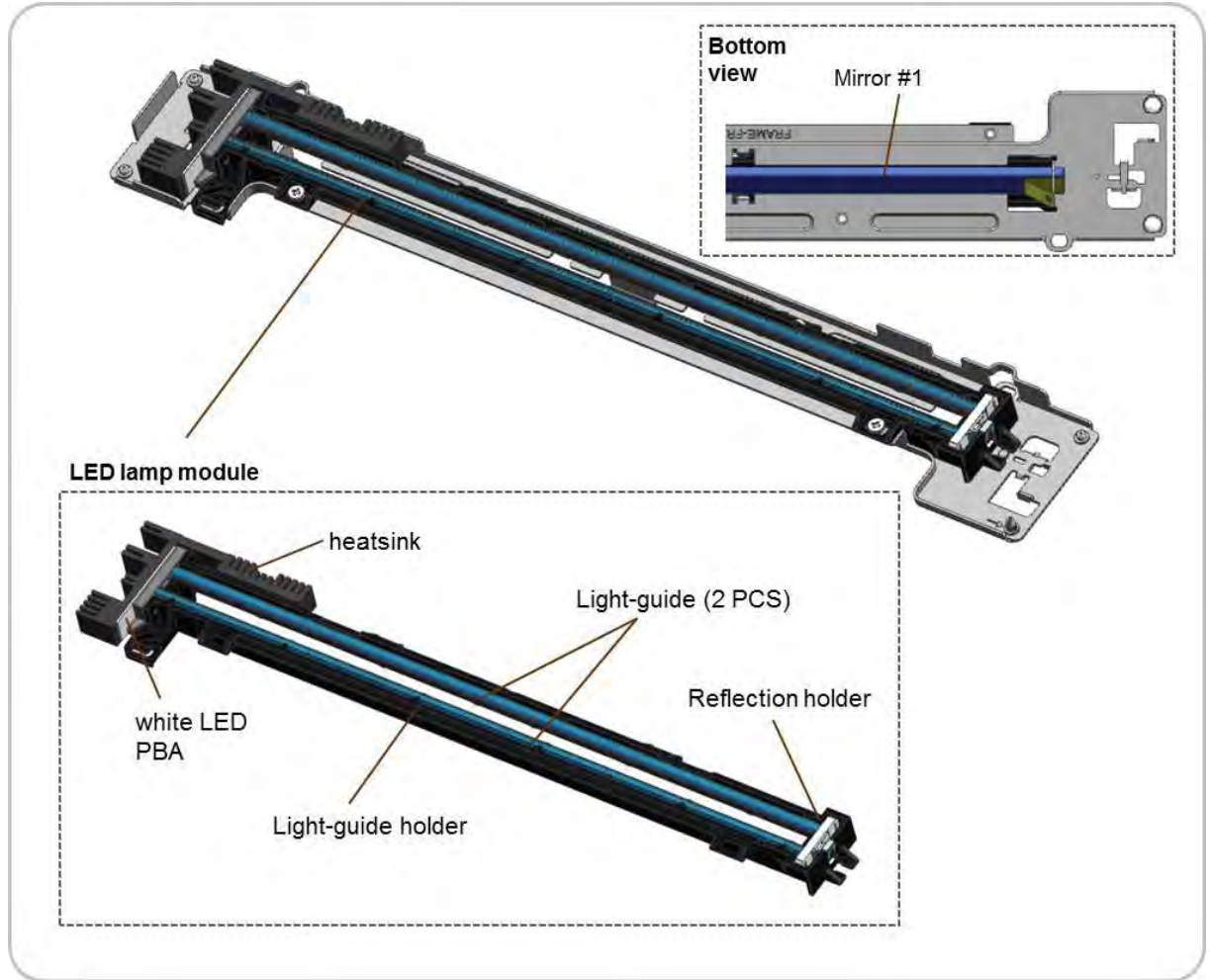

– LED lamp module

This module illuminates the original. Two white LEDs are assembled on the side of the module. The original is illuminated by the light-guide. The heat sink is attached to the LED PCB. When the heat sink is broken or expired, an engineer needs to replace it.

○ Light-guide

The light-guide changes the light from point type to line type. The light-guide is made by transparent resin and controls the amount of light in the scan area uniformly.

○ White LED

The white LED emits white light. The heat sink attached to the PCA prevents heat deterioration.

○ Reflection holder

The reflection holder reflects the light that has passed through the light-guide.

– Mirror #1

Mirror #1 reflects light at a 90 degree angle.

HR Carriage (mirror unit)

Figure 1-39 HR carriage

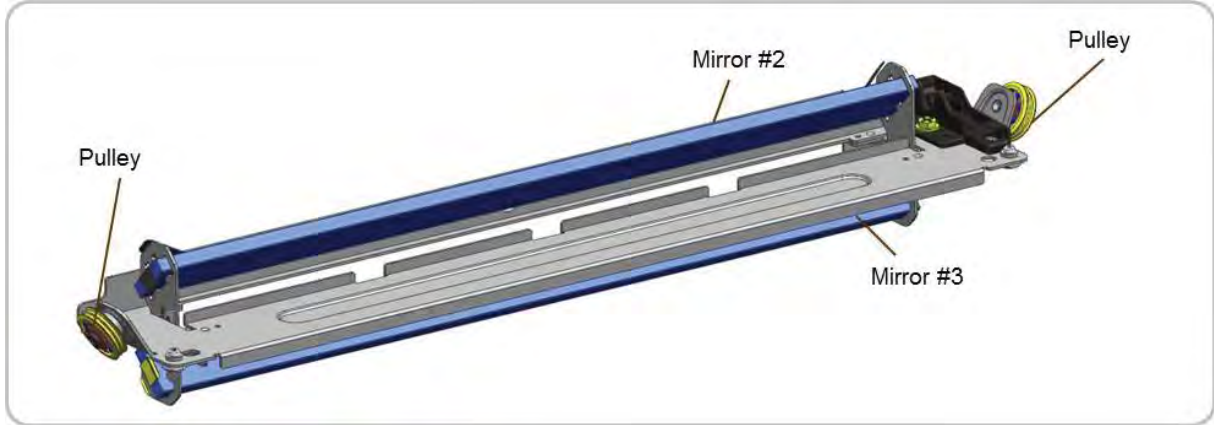

- Mirror #2 and #3

Mirrors #2 and #3 are positioned at a 45 degree angle in order to change the direction of the light. The reflected light from mirror #1 is sent to the imaging lens through mirrors #2 and #3.

- Pulley

The pulley is a ball bearing type. The pulley rolls and releases the wire which makes the HR carriage move. The HR carriage moves half the distance at half the speed of the FR carriage.

Imaging unit

The imaging unit changes the optical image to an electrical signal.

Figure 1-40 Imaging unit

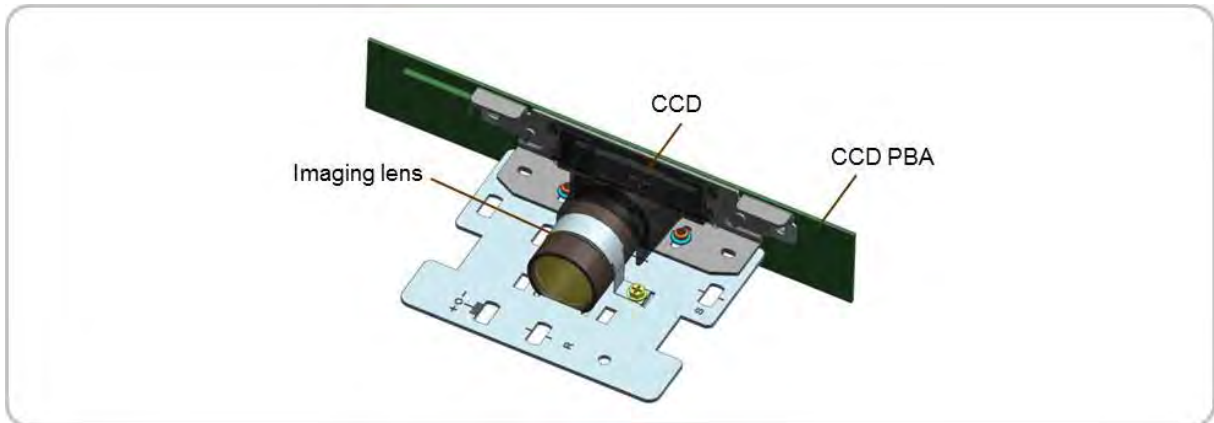

- Imaging lens

The reflected light from the imaging lens is focused on the CCD. The image is reduced to the fixed CCD sensor and pixel size.

- CCD PCA

The image made by the imaging lens is changed to an electrical signal by the CCD. The CCD consists of three channel line sensors for image creation. The brightness and darkness of the image depends on the voltage level from the CCD. The output voltage is changed to a digital signal. The digital signal makes the scanned image.

Wire driving

To move the carriages, the wire is assembled in the front and rear of the scanner. The pulley rolls and releases the wire which moves the FR carriage and the HR carriage.

Figure 1-41 Wire driving

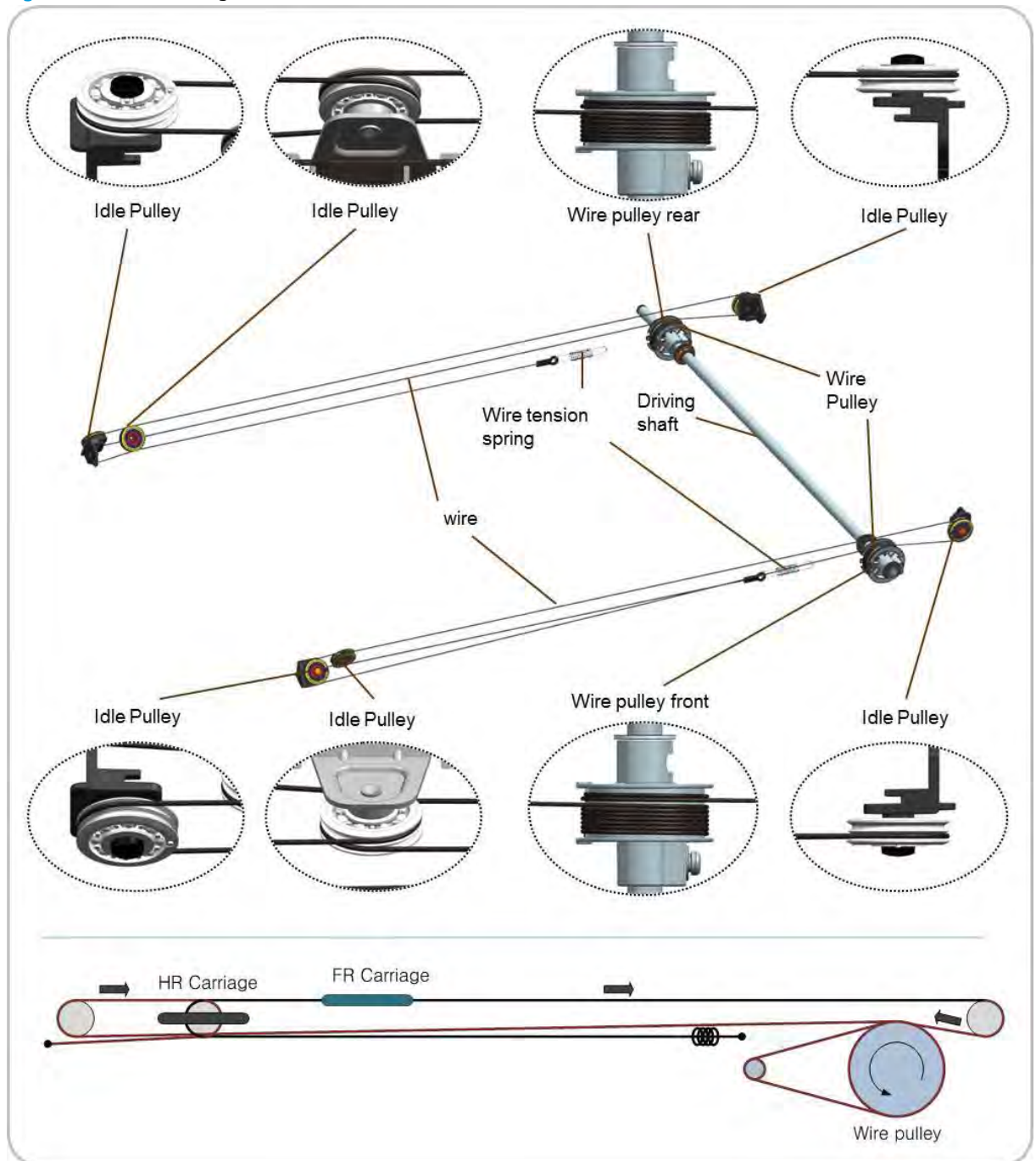

Scanner glass (flatbed glass)

The original is placed on the scanner glass for scan or copy jobs. The scanner glass is made of tempered glass and is held in place by the frame to prevent distortion.

Drive motor

The scanner drive system uses the step motor to move the carriage. The step motor controls the position and maintains constant speed. The motor power is transferred to the wire through the timing belt and pulley.

Timing belt

The timing belt has a regular saw tooth gear and transfers the motor power to the pulley.

Figure 1-42 Timing belt

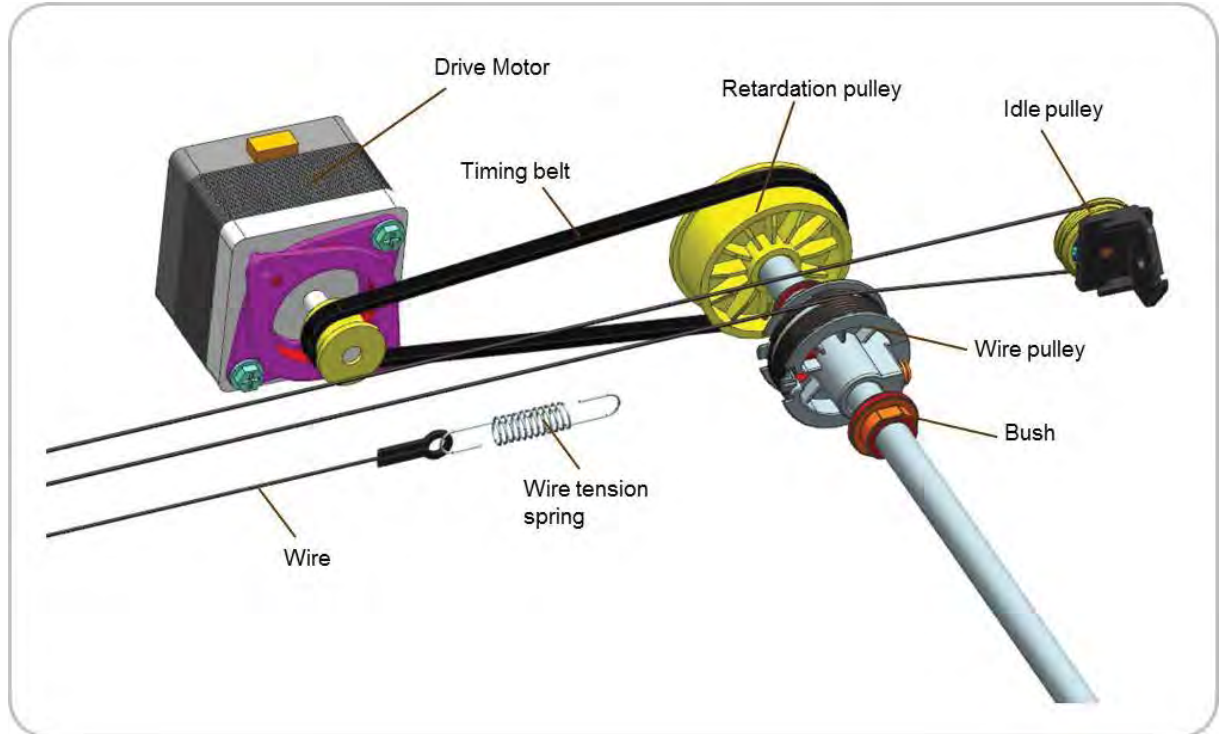

Paper size sensor

The paper size sensor automatically detects the size of the original on the scanner glass. The paper size sensor uses two sensors. An infrared LED is used to detect the dark original.

Home sensor

The home sensor detects the FR carriage position. The home sensor is a transmission photo sensor.

Cover open sensor #1

When the ADF unit opens and closes, a function is triggered which detects whether the paper size sensor is on or off.

Cover open sensor #2

The cover open sensor #2 detects when the ADF unit is closed using magnetic force.

ADF glass

Scanner read the original feed from ADF unit through ADF glass. The FR carriage read the original as it passes on ADF glass. If ADF glass is contaminated.

Shading sheet

The shading sheet is attached under flat-bed glass. Before every scan job, scanner read the shading sheet to get reference image with same optical conditions. If shading sheet is contaminated, a vertical line might occur on scan image.

Figure 1-43 Shading sheet

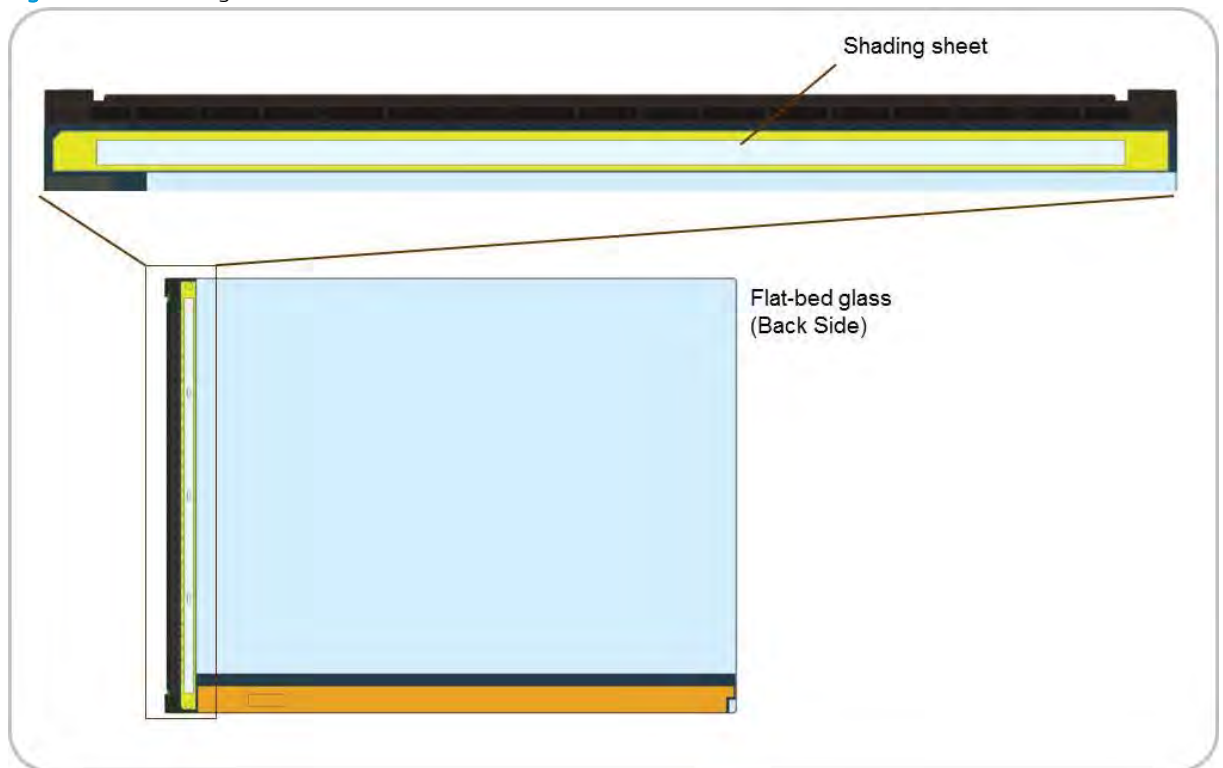

Caution for moving the scanner

Learn about cautions when moving the scanner.

When shipping or moving the printer, the FR and HR carriages in the scanner must be secured with a scan locking screw to prevent movement of these parts and possible damage to the scanner

This screw must be installed before moving the printer and then removed once the printer is positioned in place.

When installing

After unpacking, before turning on the printer, the scan locking screw must be removed. If the locking screw is not removed scanner failure will occur.

1. When installing the printer, remove the scan locking screw.
2. After removing the screw, assemble the screw cap from the accessory package.

Figure 1-44 Remove scan locking screw



When moving the printer

When moving the printer, tighten the scan locking screw to prevent damage to the carriages.

1. Make sure the FR carriage is located in the end of scanner side wall which is screw locked.
2. Remove the screw cap.
3. Tighten the M3x8 screw to secure the FR carriage.

Figure 1-45 Tighten scan locking screw



Document feeder LX (dn models)

Learn about the document feeder LX (dn models).

Document feeder LX overview

Learn about the document feeder LX.

Figure 1-46 Document feeder LX overview

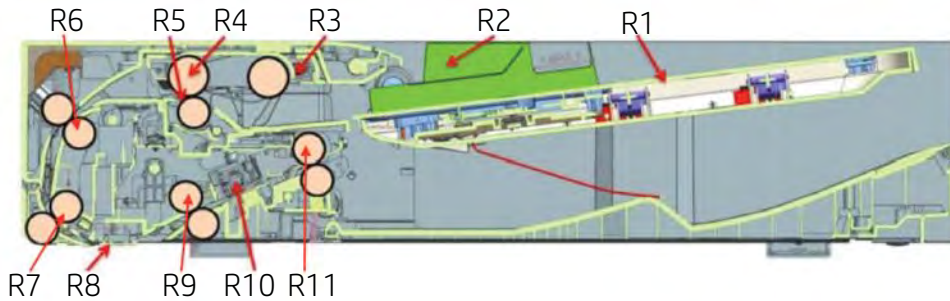

Table 1-18 Document feeder LX overview

Part	Description	Function
R1	STACKER ASSY	Original paper input tray
R2	GUIDE-DOC F&R	Original paper guide (front/rear)
R3	PICK ROLLER	Pick up original paper from the input tray
R4	ADF ROLLER	Original paper feed roller
R5	SEPARATION ROLLER	Original paper separation roller
R6	REGISTRATION (REGI) ROLLER	Original paper alignment roller
R7	SCAN IN ROLLER	Feeds an original paper before scanning
R8	SIMPLEX WHITE-BAR	Support of scanning unit
R9	SCAN OUT ROLLER	Transfer a scanned original paper to the exit roller
R10	D-CIS MODULE	Back side image scan unit
R11	EXIT ROLLER	Sends an original paper to the exit tray

Document feeder LX electrical parts

Learn about the document feeder LX electrical parts.

Figure 1-47 Document feeder LX electrical parts electrical parts locations

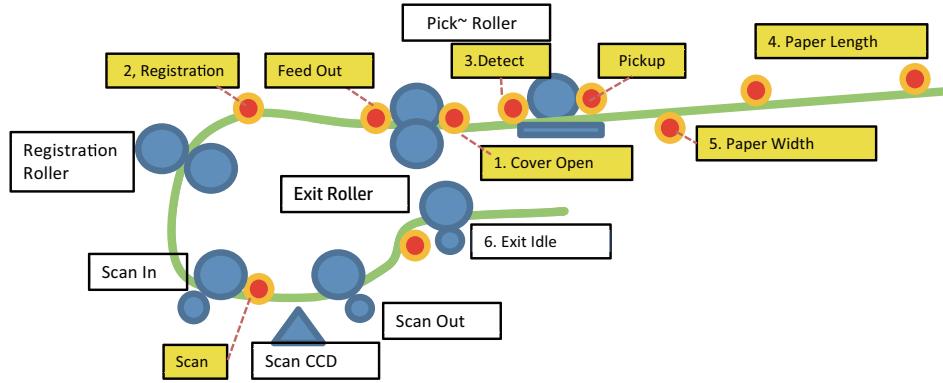

Table 1-19 Document feeder LX electrical parts

Callout	Item	Function
1	Cover Open	Detects if cover is open or closed
2	Registration (Regi) Sensor	Detects if there is a jam on the registration path
3	Detect Sensor	Detects if tray is empty
4	Paper Length Sensor	Detects paper length
5	Paper Width Sensor	Detects paper width

Document feeder LX registration

Learn about the document feeder LX registration.

Figure 1-48 Document feeder LX registration

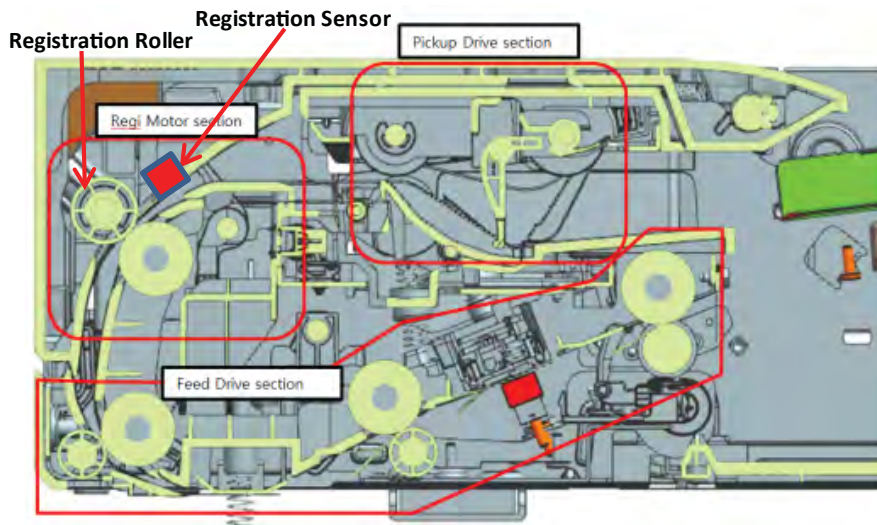

Item	Document feeder LX
Registration	1 times registration

Document feeder LX drive system

Learn about the document feeder LX drive system.

The drive system consists of one motor and two clutches to transfer the paper.

Figure 1-49 Document feeder LX drive system

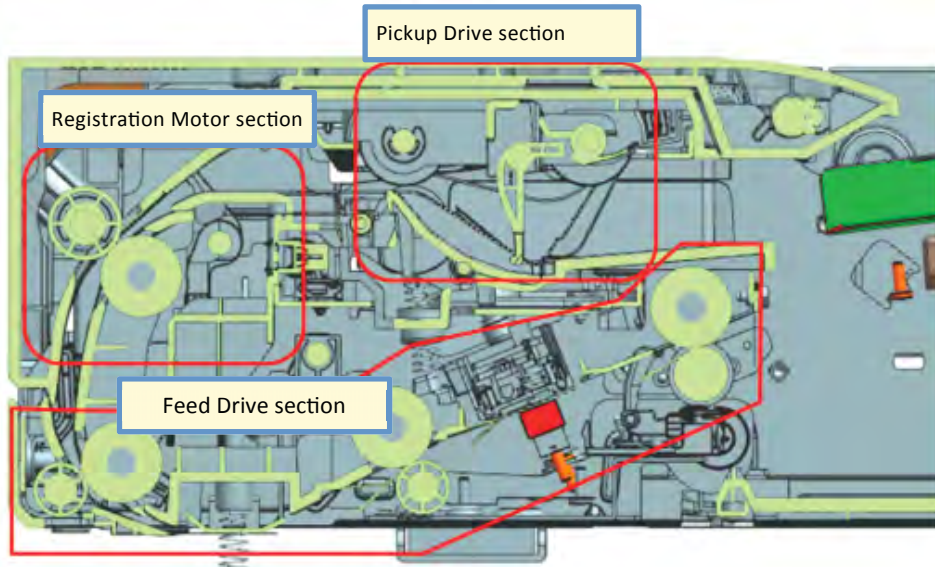

The document feeder LX drive system consists of two motors (BLDC and STEP) and one clutch that moves the paper.

- BLDC Motor > Feed and pickup
- STEP Motor > Regi
- Clutch > Pickup

There are three sections: pickup drive section, registration (regi) motor section, and feed drive section.

The pickup drive section has three assemblies: pickup drive assembly, pickup assembly, and guide pickup assembly.

The registration motor section has the regi motor, trans gear, regi roller, regi-idle roller, regi sensor, and actuator.

LX ADF original pickup assembly

Learn about the LX ADF original pickup assembly.

Figure 1-50 LX ADF pickup assembly

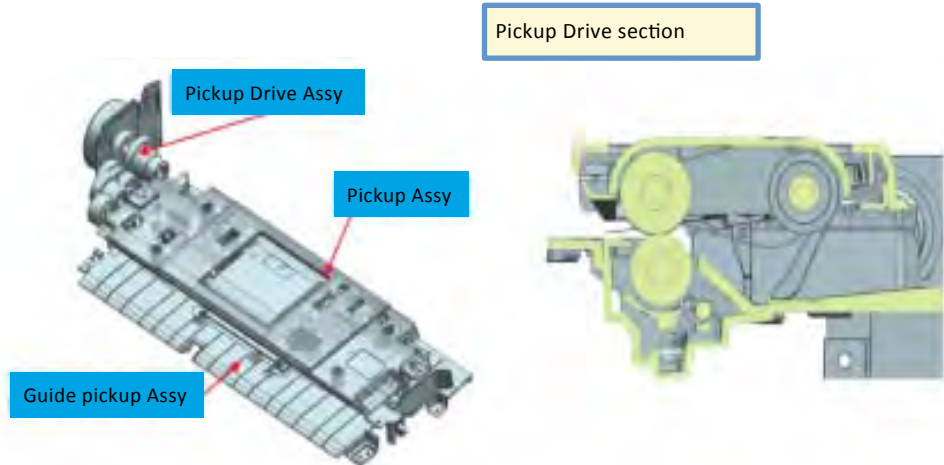

After detecting the paper, one motor controls the drive system.

The CLUTCH-ELECTRIC provides the power to pick up the paper.

The CLUTCH cannot rotate inversely. The spring that is included in the ADF GUIDE PICKUP ASSEMBLY is connected to COVER-OPEN. When the CLUTCH does not drive, stand-by status occurs and stops the operation.

The ADF roller and pick roller are connected by the belt.

The ADF roller is provided with power while the paper is picked up and transferred to the registration roller. When the pickup drive is stopped and the registration roller is driven, the ADF roller becomes idle.

The normal process is:

- When the original is setting up, the detect-sensor is activated and the printing job starts. The motor and pickup clutch begin working. The pick roller then moves down and contacts the original in the tray.
- When the registration sensor detects paper, the pickup clutch stops.
- When the detect-sensor detects that the tray is empty, the motor stops and the printer enters stand-by status.

LX ADF registration (regi) drive assembly

Learn about the LX ADF registration (regi) drive assembly.

Figure 1-51 LX ADF registration (regi) drive assembly

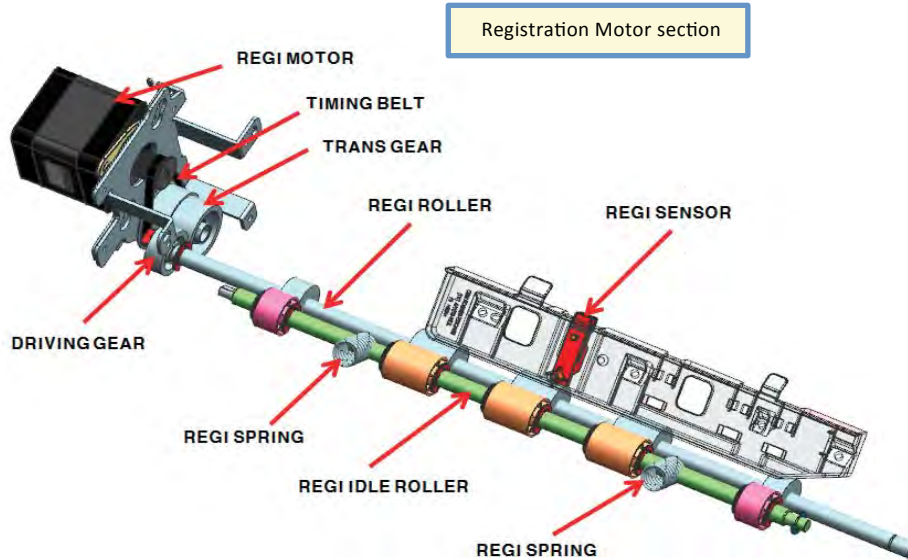

The registration drive uses the CLUTCH-ELECTRIC to drive the registration roller and transfer the paper to the ROLLER FEED.

The registration roller aligns the leading edge of the original. When the original is placed in the nip, the roller is rotated for alignment.

The CLUTCH-ELECTRIC repeats on/off to align each original.

Document feeder LX scanning position

Learn about the document feeder LX scanning position.

Figure 1-52 Document feeder LX scanning position

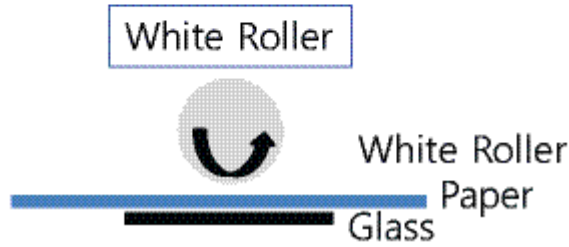
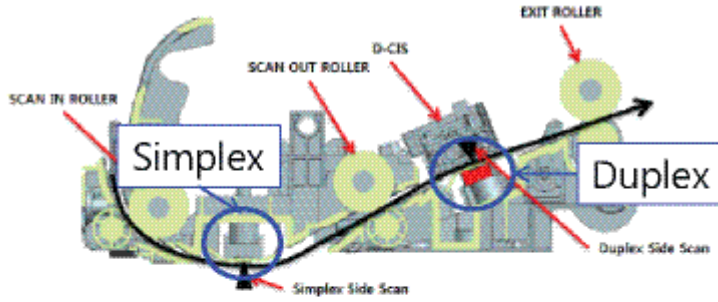

Item	Simplex	Duplex
Scanning	White Bar	White Bar

Document feeder LX specifications

Learn about the document feeder LX specifications.

Table 1-20 Document feeder LX specification

Item	Specification
Capacity	100 pages
Scan Speed	80/160 ipm
Pickup	Semi-Retard
Registration	1 times registration
Motor	2 each
Stacker	Not applicable
Scanning	White Bar
MSO	Not applicable

Flow document feeder z models (GX)

Learn about the flow document feeder z models (GX).

Flow document feeder overview

Learn about the flow document feeder.

Figure 1-53 Flow document feeder overview

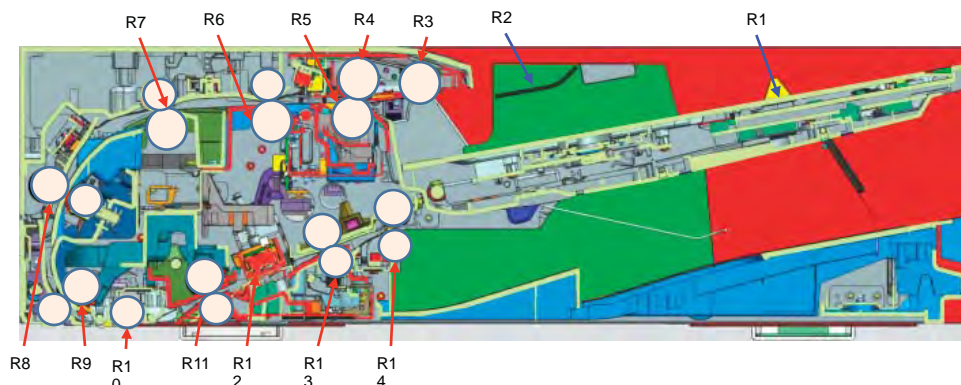

Table 1-21 Flow document feeder overview

Part	Description	Function
R1	STACKER ASSY	Original paper input tray
R2	GUIDE-DOC F&R	Original paper guide (front/rear)
R3	PICK ROLLER	Pick up original paper from the input tray
R4	ADF ROLLER	Original paper feed roller
R5	SEPARATION ROLLER	Original paper separation roller
R6	FEED ROLLER	Original paper transfer roller (A6 size)
R7	PRE REGI ROLLER	Original paper alignment roller (1 round)
R8	REGI ROLLER	Original paper alignment roller (2 round)
R9	SCAN IN ROLLER	Feeds an original paper before scanning
R10	SIMPLEX WHITE-ROLLER	Support of simplex scanning unit
R11	SIMPLEX SCAN OUT ROLLER	Transfer a scanned original paper to the duplex white-roller
R12	D-CIS MODULE	Back side image scan unit
R13	DUPLEX SCAN OUT ROLLER	Transfer a scanned original paper to the exit roller
R14	EXIT ROLLER	Sends an original paper to the exit tray

Flow document feeder sensors

Learn about the flow document feeder sensors.

Figure 1-54 Flow document feeder sensors

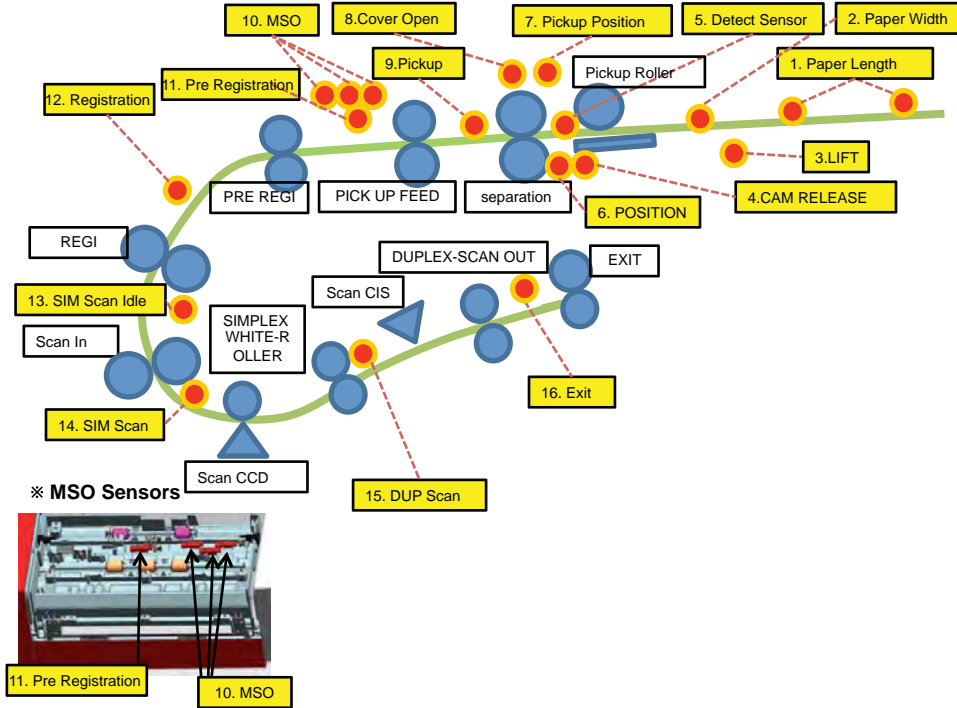

Table 1-22 Flow document feeder sensors

Callout	Item	Function
1	Paper Length Sensor	Detects paper length
2	Paper Width Sensor	Detects paper width
3	Stacker Lift Sensor	Detects Stacker Position
4	Cam Release Sensor	Sensing 'Separation Roller' rotation
5	Detect Sensor	Detects if tray is empty
6	Position Sensor	Detects Stacker Position
7	Pickup Position Sensor	Sensing 'Pickup Roller' rotation
8	Cover Open Sensor	Detects if cover is open or closed
9	Pickup Sensor	Detects if there is a jam on the feed path
10	MSO Sensor	Detects mix size
11	Pre-Regi Sensor	Detects if there is a jam on the pre-regi path
12	Regi Sensor	Detects if there is a jam on the Regi path
13	SIM Scan Idle Sensor	Sensing 'Scan In Roller' rotation
14	SIM Scan Sensor	Detects if there is a jam on the Scan In path
15	DUP Scan Sensor	Detects if there is a jam on the Scan Out path
16	Exit Sensor	Paper Exit Sensing

Flow document feeder ultra sonic multi-feed (USM) sensor

Learn about the flow document feeder ultra sonic multi-feed (USM) sensor.

Figure 1-55 Flow document feeder ultra sonic multi-feed (USM) sensor

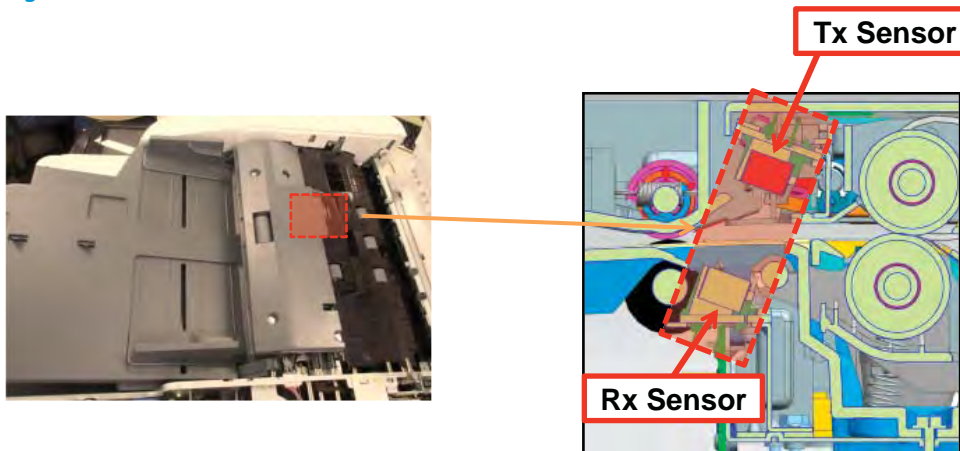

This sensor detects multi-feeds.

- Component: Ultrasonic Sensor Tx Board, Rx Board , HIC Board (Amp and Filter)
- The Rx Sensor has a different level on each paper status: no paper, one paper, multiple papers.
- Detect the multi-feeding through the level change of Rx Sensor.
- Transmit and receive operation of 300 khz frequency.

Flow document feeder drive system

Learn about the flow document feeder drive system.

The flow document feeder drive system drive system includes eight motors.

The Flow ADF drive system consists for the following sections:

- Pickup release drive
- Pickup drive
- Pre-regi drive
- Regi drive
- Scan-in roller release drive
- Scan drive
- Exit drive
- Lift drive

Figure 1-56 Flow document feeder drive system

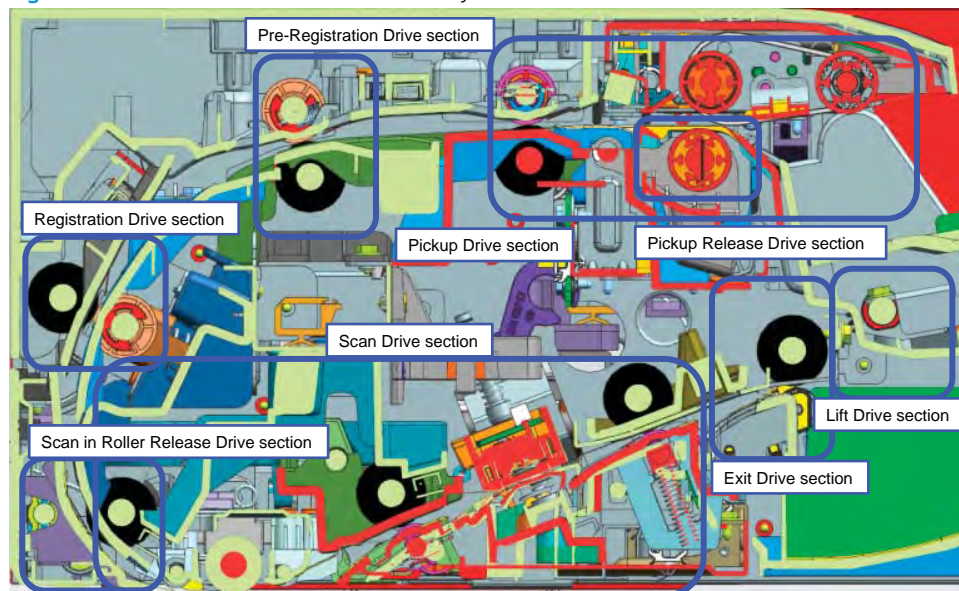

Flow document feeder lifting drive system

Learn about the flow document feeder lifting drive system.

Figure 1-57 Flow document feeder lifting drive system

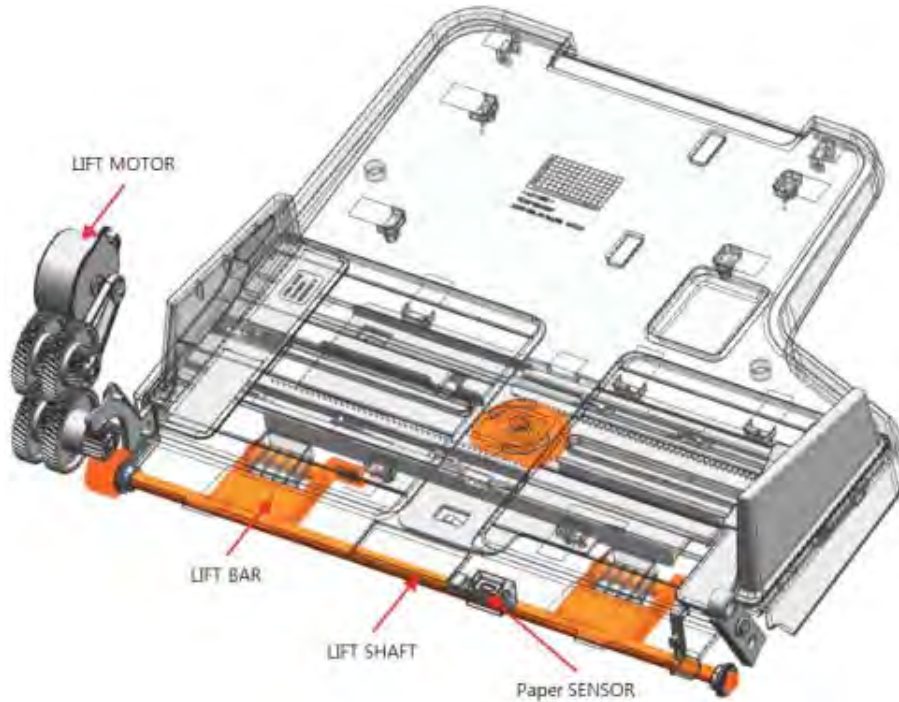

- Component: LIFT MOTOR, LIFT SHAFT, LIFT BAR, PAPER SENSOR
- LIFT MOTOR Starts > LIFT SHAFT and LIFT BAR lift Tray
- PAPER SENSOR detects paper in the Tray
- Paper contacts PICKUP ROLLER and stops movement
- Document is passed through SCAN OUT SENSOR. Duplex scanning starts.

Flow document feeder scan-in roller release drive system

Learn about the flow document feeder scan-in roller release drive system.

Figure 1-58 Flow document feeder scan-in roller release drive system

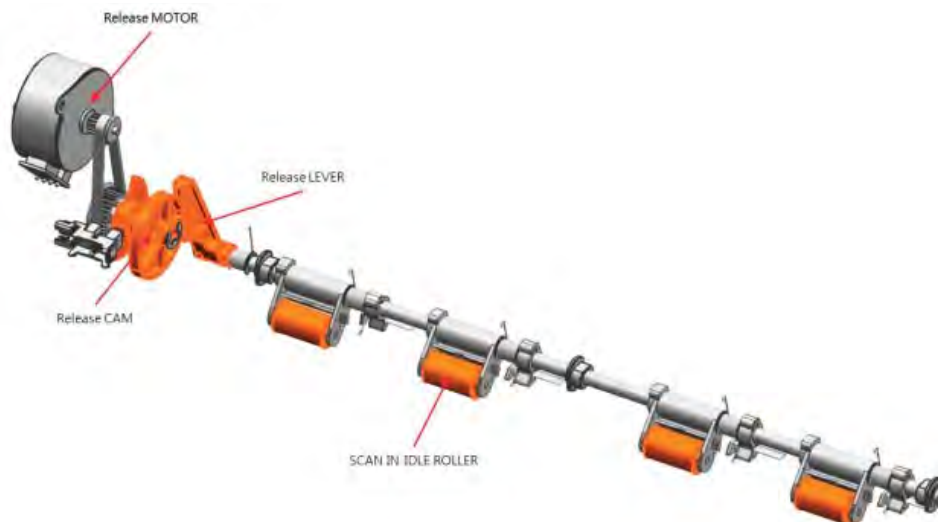

- Holds the rear of the paper using cam motion for improved scan quality
- Component: RELEASE MOTOR, RELEASE CAM, SCAN-IN IDLE ROLLER
- Motor and cam operation repeats for every piece of paper

Flow document feeder specifications

Learn about the flow document feeder specifications.

Table 1-23 Flow document feeder specification

Item	Specification
Capacity	250 pages (stacker lifting)
Scan Speed	120/240 ipm
Pickup	Semi-Retard
Registration	2 times registration
Motor	8 each
Stacker	Lifting
Scanning	White Roller/White Bar
MSO	Support

Flow document feeder registration

Learn about the flow document feeder registration.

The flow document feeder registration uses a two-times registration process.

Figure 1-59 Flow document feeder registration

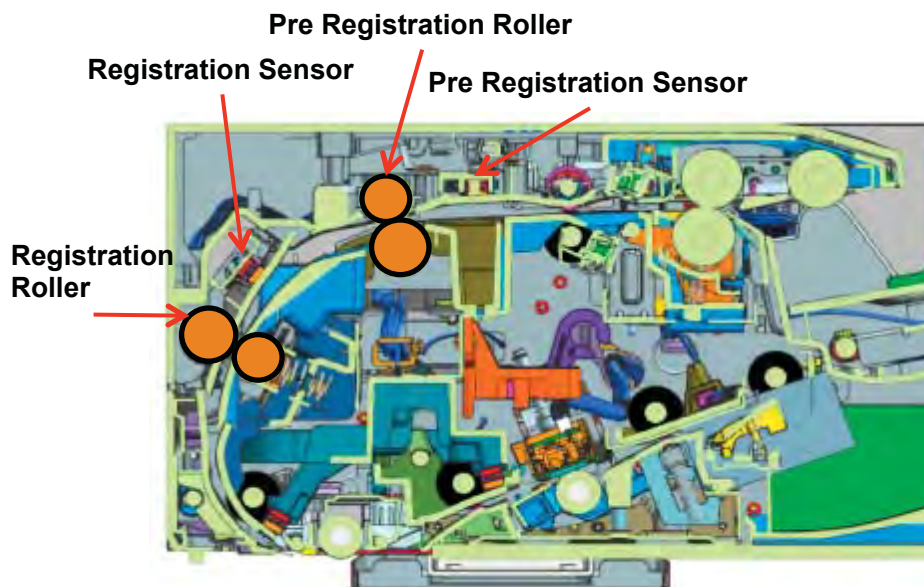

Flow document feeder scanning position

Learn about the flow document feeder scanning position.

Figure 1-60 Flow document feeder scanning position

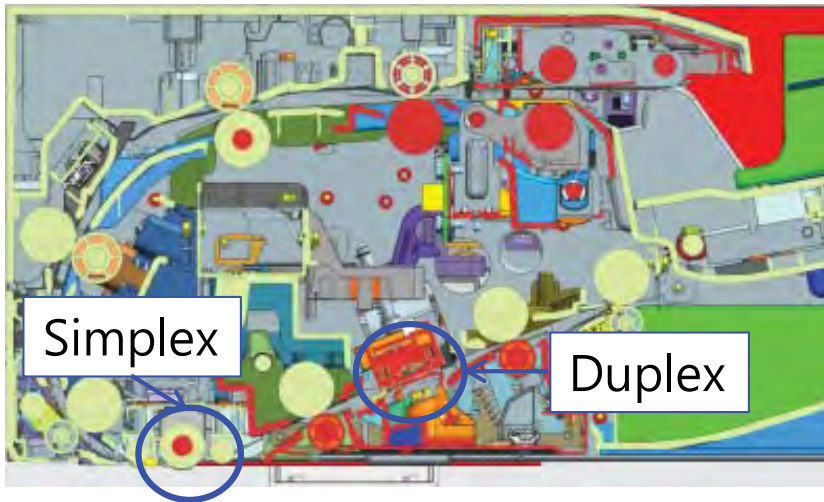

Table 1-24 Flow document feeder scanning position

Item	Simplex	Duplex
Scanning	White Roller	White Bar

Flow document feeder mixed size original (MSO) sensor

Learn about the flow document feeder mixed size original (MSO) sensor.

The MSO sensor detects the size of mixed size papers and sets the alignment of the papers to the rear.

Figure 1-61 Flow document feeder MSO 1



Figure 1-62 Flow document feeder MS0 2

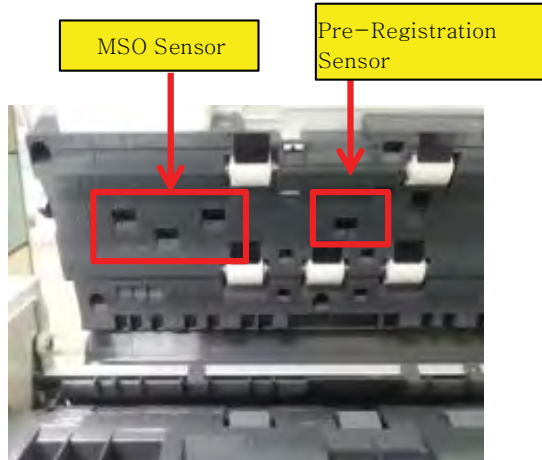

Table 1-25 Flow document feeder MS03 (length x max width)

	A3 SEF (297 mm) (11.7 in)	A4 LEF (297 mm) (11.7 in)	B4 SEF (257 mm) (10.1 in)	B5 LEF (257 mm) (10.1 in)	A4 SEF (210 mm) (8.3 in)	A5 LEF (210 mm) (8.3 in)	A5 LEF (182 mm) (7.2 in)	A5 SEF (148 mm) (5.8 in)
A3 SEF (420 mm) (16.5 in)		X						
A4 LEF (210 mm) (8.3 in)	X							
B4 SEF (363 mm) (14.3 in)	X	X		X				
B5 LEF (182 mm) (7.2 in)	X	X	X					
A4 SEF (297 mm) (11.7 in)	X	X	X	X		X		
A5 LEF (148 mm) (5.8 in)	X	X	X	X	X			
B5 SEF (257 mm) (10.1 in)			X	X	X	X		
A5 SEF (210 mm) (8.3 in)					X	X		

Flow document feeder dual sensor cleaning method

Learn about the flow document feeder dual sensor cleaning method.

- Component: LEVER GUIDE EXIT F, GUIDE-EXIT UPPER ASSEMBLY.
- Open LEVER GUIDE EXIT F.
- Cleans with a D-CIS GLASS in the direction indicated.
- Cleans the GUIDE EXIT UPPER ASSEMBLY in the direction indicated.

Figure 1-63 Flow document feeder dual sensor cleaning method (1 of 2)



Figure 1-64 Flow document feeder dual sensor cleaning method (2 of 2)

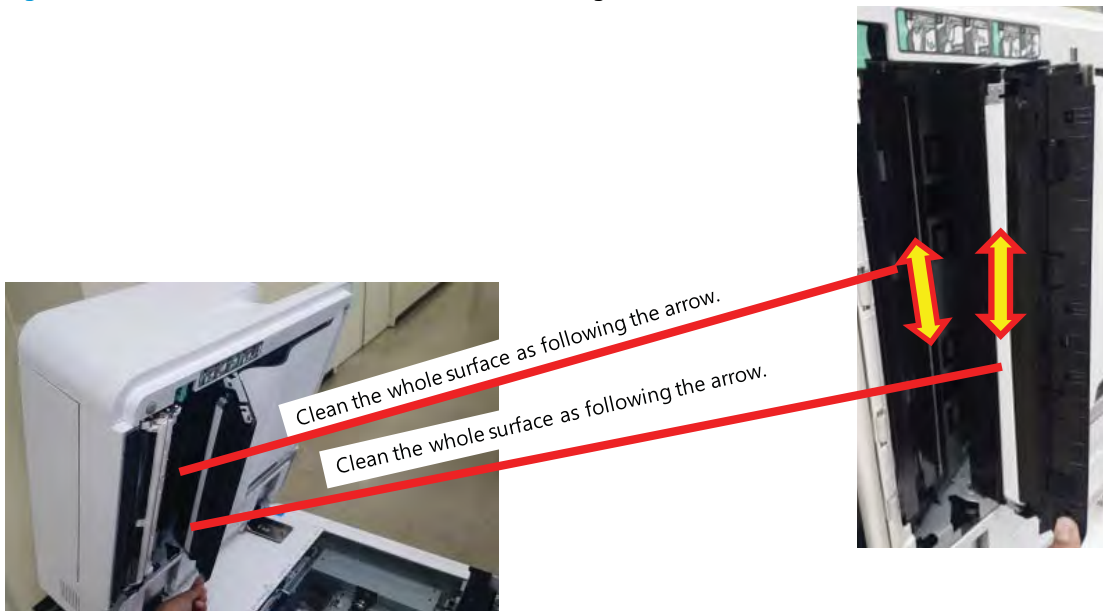

Flow ADF z bundles (GX)

Learn about the flow ADF z bundles (GX).

Model	Engine	Scanner
Platen		DN-sGX Z-GX

Model	Engine	Scanner							
Color	40 ppm	Same at whole model	Scan Speed	USM	Capacity	Scan Speed	USM	Capacity	
	50 ppm		80/160 ipm	X	100 sheet	120/240 ipm	0	250 sheet	
	60 ppm								
Mono	40 ppm								
	50 ppm								
	60 ppm								

Hardware configuration

Learn the functions and specifications of the hardware configuration.

The electronic circuit system consists of the following:

- Main controller (main board)
- OPE unit
- Document feeder (Flow/LX) controller
- HVPS board
- LVPS board
- Fuser drive assembly

Figure 1-65 Electronic circuit diagram

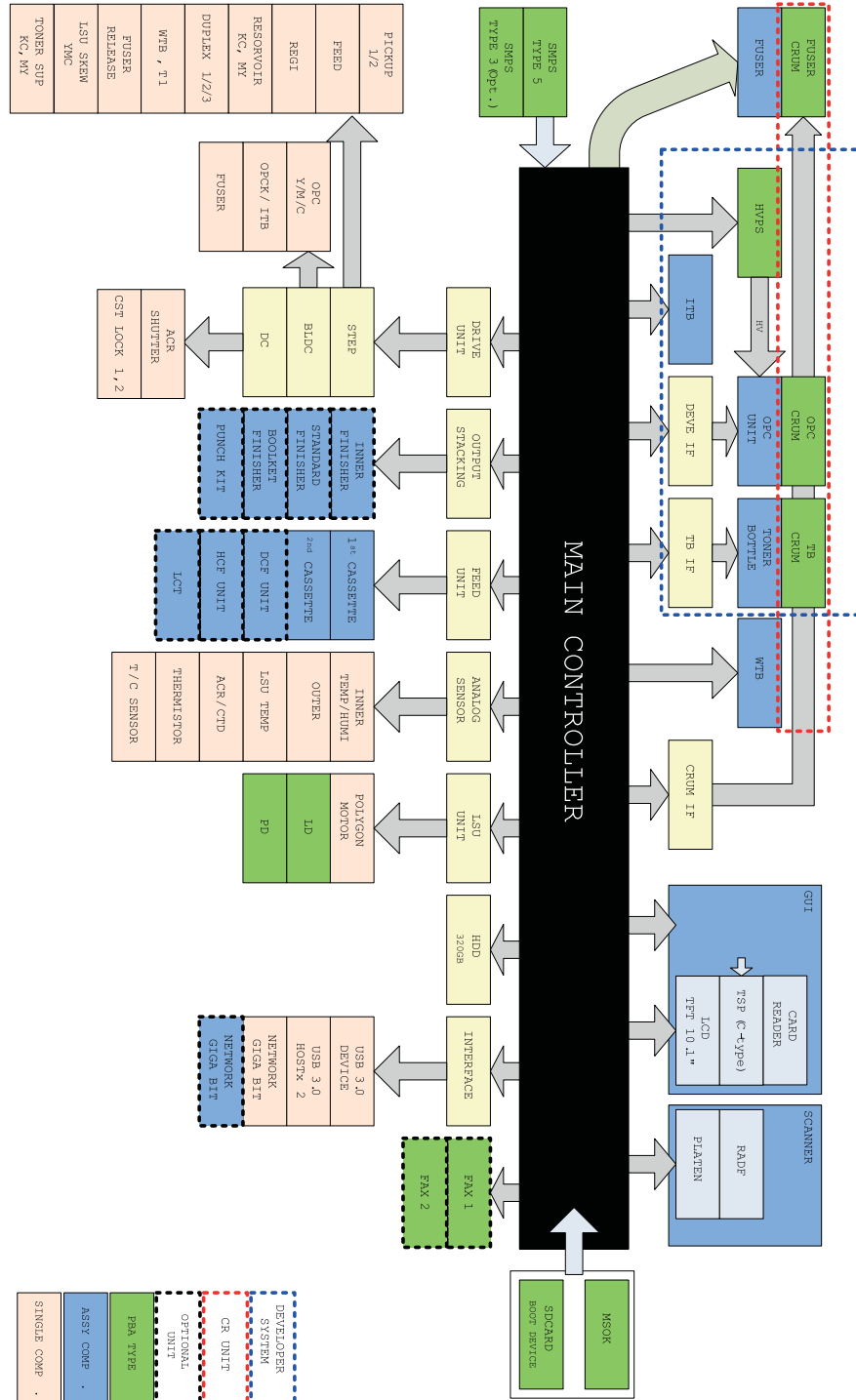

The main controller handles the video controller, engine controller, and scan controller.

The main controller receives print data from the host through the network or USB port and receives copy data from the scan controller. The main controller uses this information to generate printable video bitmap data. It controls all modules required to print, including the laser scanner assembly, HVPS, FAN, fuser, and so on.

The main controller communicates with the drive system and other devices through Universal Asynchronous Receiver Transmitter (UART). The main controller communicates with and checks the life of the toner cartridge, drum, and developer units through I2C.

The main controller uses Quad Core CPU 1.5 GHz, DDR3 4 GB memory, Micro SD 4 GB, and a 500 GB SATA HDD to control the engine driving, video signal processing, and user interface.

A MICOM controls power to the fuser lamp and power to the system according to an optimized energy saving algorithm. The MICOM communicates with the OPE controller through the USB 3.0 protocol to display the system information on the control panel.

The OPE unit displays the status of the system using the control panel TFT LCD in response to user actions or the main controller.

The soft power switch in the OPE unit is used to safely shut down the system.

The ADF controller controls some mechanisms required to scan continuously from the ADF. The ADF controller communicates with the main controller to synchronize scan timing.

The HVPS board generates and controls high-voltage channels. The fuser drive assembly controls power to the fuser lamp. The LVPS board generates 5 V and 24 V power for the system.

The following diagrams show the locations of the printer circuit boards:

Figure 1-66 Circuit board locations

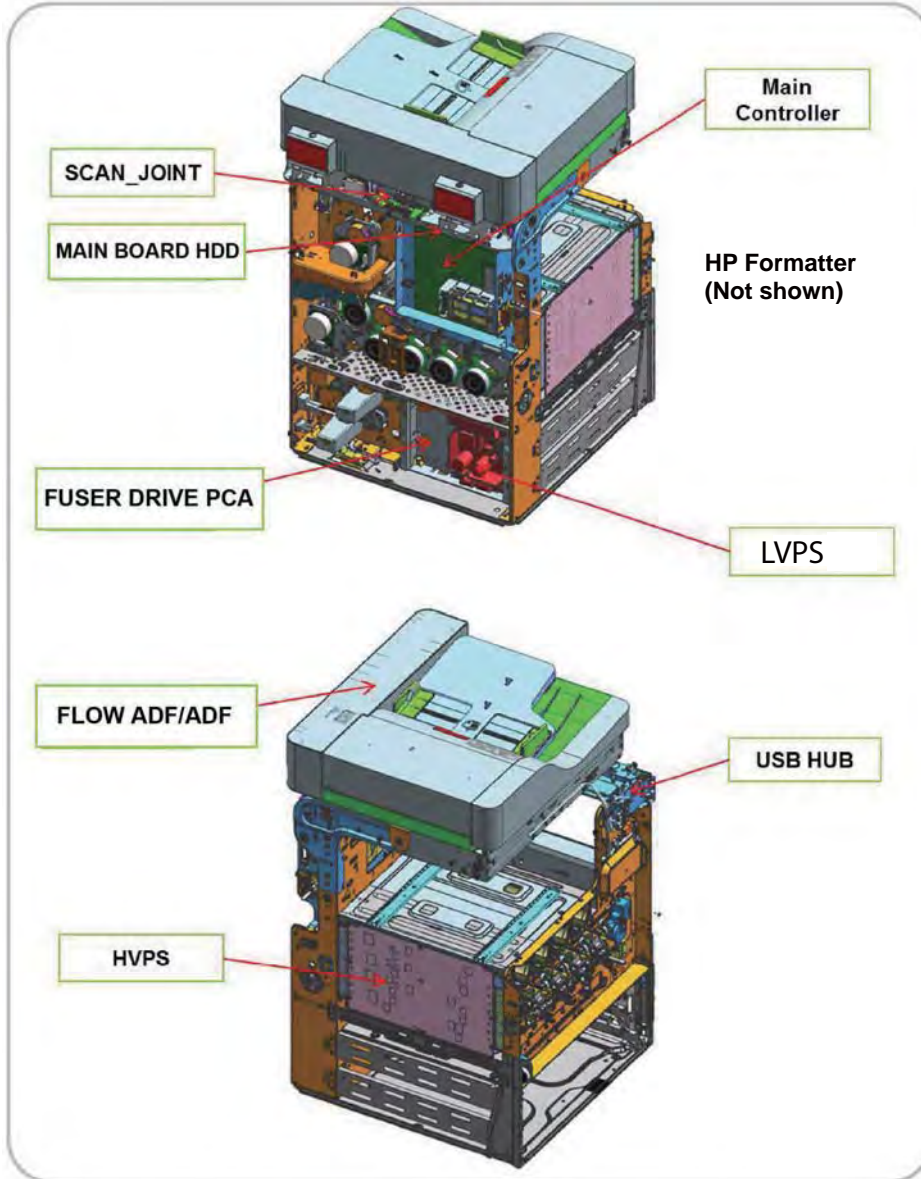

Main controller

Learn about the main controller.

This topic describes the main controller PCA and formatter cabling.

Main controller

Learn about the printer main controller.

The main controller consists of the main processor (Chorus4N), memory (DDR3 2 GB), flash (128 MB), 1 G Ethernet PHY, USB 2.0 HUB, Micom (power/fuser control), can/video/UI/fax signal interface connection, motor drive IC, engine signal interface connection, and power interface.

The main processor (Dual Core 1 GHz CPU) controls video, engine, UI display, and communicates with various devices. The HDD is connected to the main controller by SATA cable and to other devices (ADF, dual cassette feeder, finisher, modem) by UART.

Figure 1-67 Main controller block diagram

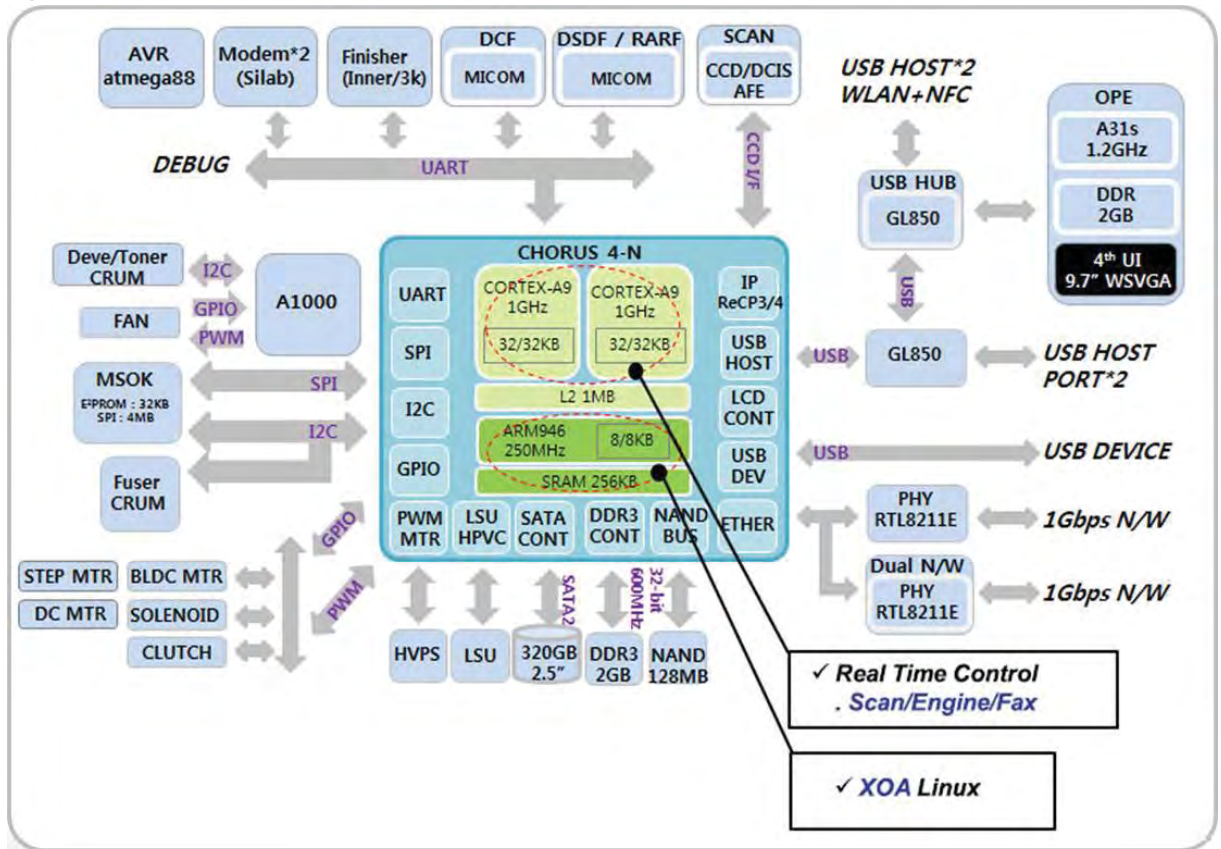

Figure 1-68 Main controller connection information

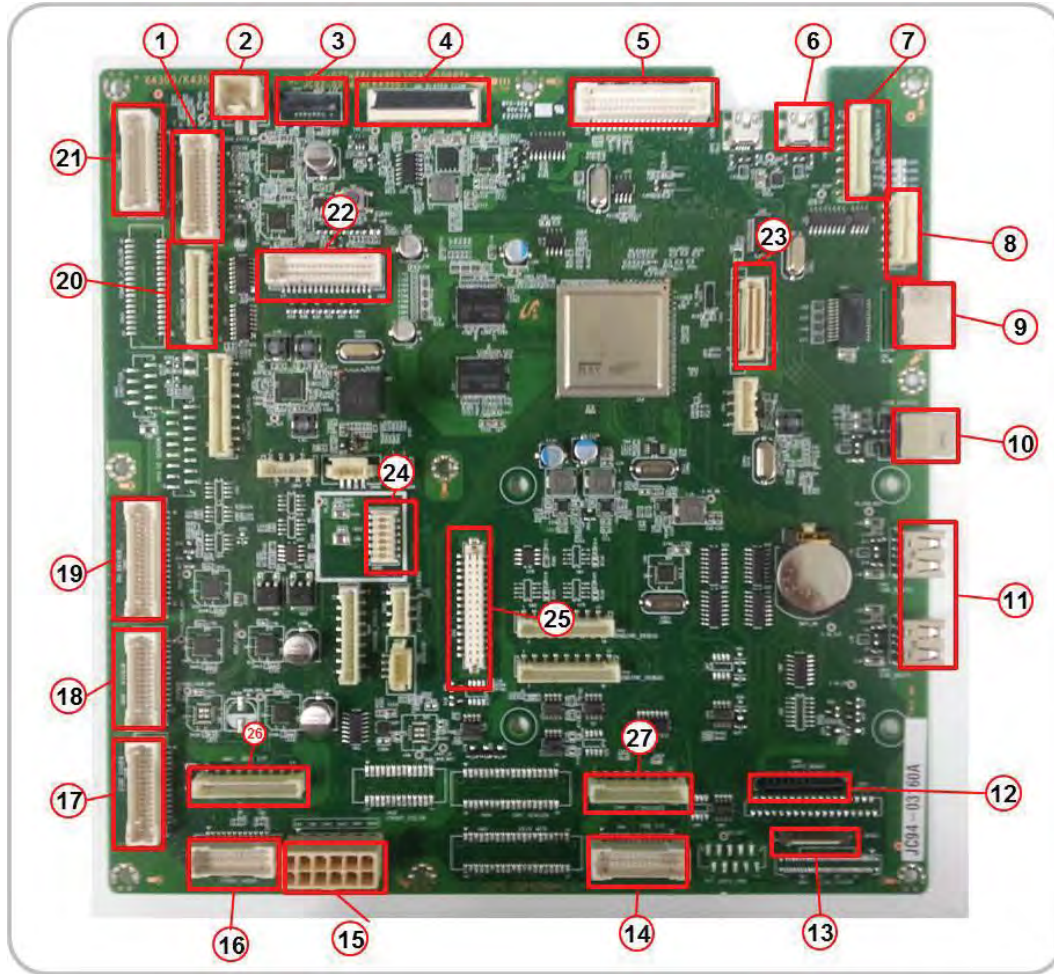

Table 1-26 Main controller connections

Item	Description	Item	Description	Item	Description	Item	Description
1	EXIT	8	Not used	15	POWER I/F	22	SCAN I/F
2	HDD POWER	9	GIGA N/W RJ45	16	FRONT MONO	23	2nd GIGA NPC
3	HDD I/F	10	USB HOST 1/2	17	Right door	24	MSOK I/F
4	Image scanner CCDM	11	USB DEVICE	18	PICKUP	25	MODEM JOINT
5	Flow ADF DCIS	12	HVPS MONO	19	PH DRIVER	26	Dual cassette feeder I/F
6	FRONT USB HUB	13	Laser scanner assembly MONO	20	TONER I/F MONO	27	FINISHER
7	OPE POWER I/F	14	Fuser drive assembly I/F	21	FUSER		

Information

- Part Number: JC82-00541A
- Part Name: PCA-MAIN

Master system operation key (MSOK)

Learn about the master system operation key (MSOK).

The MSOK PCA is used to store all system information and consists of serial flash memory, an EEPROM and an X-CRUM. The flash memory (4MB), EEPROM (256Kb), and X-CRUM are used for all system operations (system parameter, device status, tech information, and service information).

 **NOTE:** When a main board needs to be exchanged, reinstall the MSOK PCA to the new main board to retain the system information.

 **IMPORTANT:** Do not lose or damage the MSOK chip. It must be installed on the replacement main board in the same orientation as when it was removed in order for the printer to function.

Figure 1-69 MSOK



1

Main PCA I/F connector

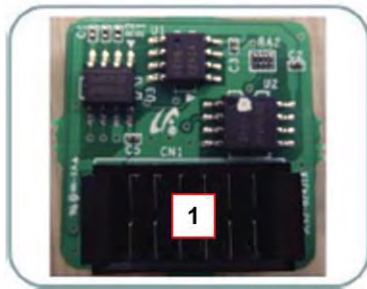
- Information
 - Part number: Not applicable
 - Part name: PCA-MSOK

Formatter cabling

Learn about the formatter cabling.

Figure 1-70 Formatter cabling (sGX/GX)

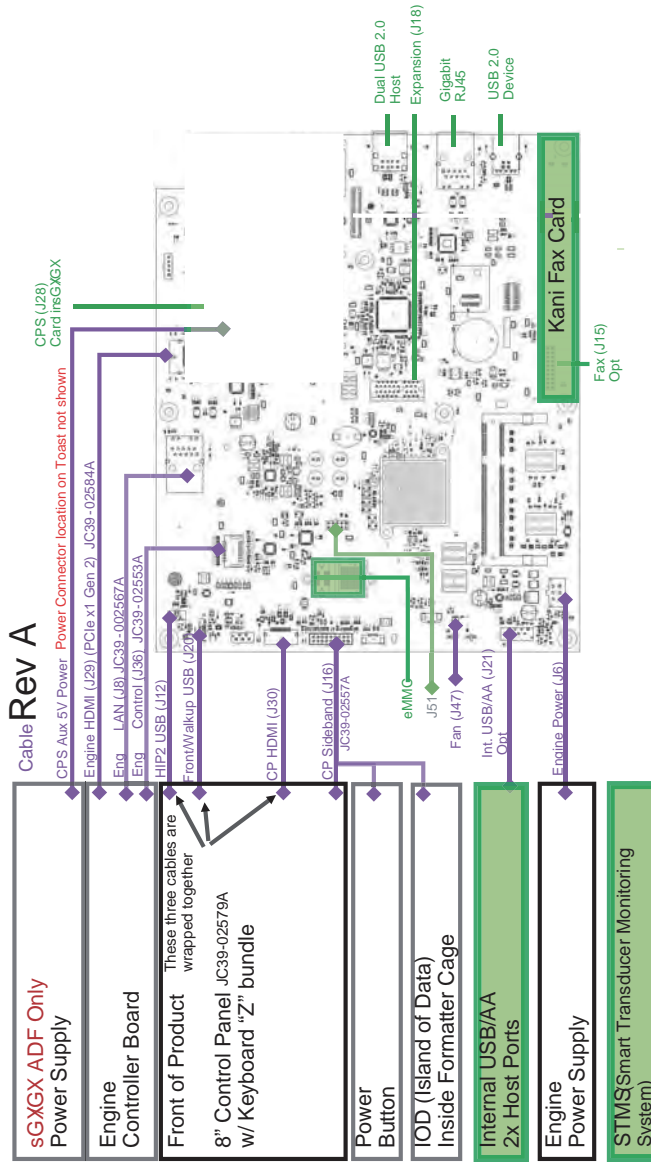

Table 1-27 Formatter cabling

Cable	Jxx	From	To	Purpose
Formatter cabling	NA	LVPS	Accelerator	Power for accelerator
Engine HDMI	J29	Main board	Formatter	High speed print data (JC39-02584A)
Engine LAN	J8	Main board	Formatter	High speed print data (JC39-02584A)
Engine control	J36	Main board	Formatter	Low level engine control (JC39-02553A)
HIP2 USB	J12	Formatter	HIP	USB for HIP NOTE: Cable bundled.

Table 1-27 Formatter cabling (continued)

Cable	Jxx	From	To	Purpose
Front walk-up USB	J20	Formatter	Front of printer	USB for walk u NOTE: Cable bundled.
CP HDMI	J30	Formatter	CP	Data to CP NOTE: Cable bundled.
CP side band	J16	Formatter	CP	Power, reset, wake lines, display power, keyboard (JC39-02557A)
Power button	J16	Formatter	Power button	Power ON/OFF
IOD	J16	Formatter	IOD	Data to/from Island of Data
Internal USB/AA	J21	Formatter	Accessory	Accessory
Engine power	J6	LVPS	Formatter	5V supply to formatter

Low voltage power supply (LVPS; Type 5H) / switching mode power supply (SMPS)

Learn about the low voltage power supply (LVPS; Type 5H) / switching mode power supply (SMPS).

The low voltage power supply (LVPS-SMPS) Type 5H PCA supplies electric power to the main PCA and other boards. The voltage provided includes +5V, and +24V from a 110V/220V power input. It has safety protection modes for over current and overload.

Figure 1-71 LVPS (SMPS) Type 5H PCA

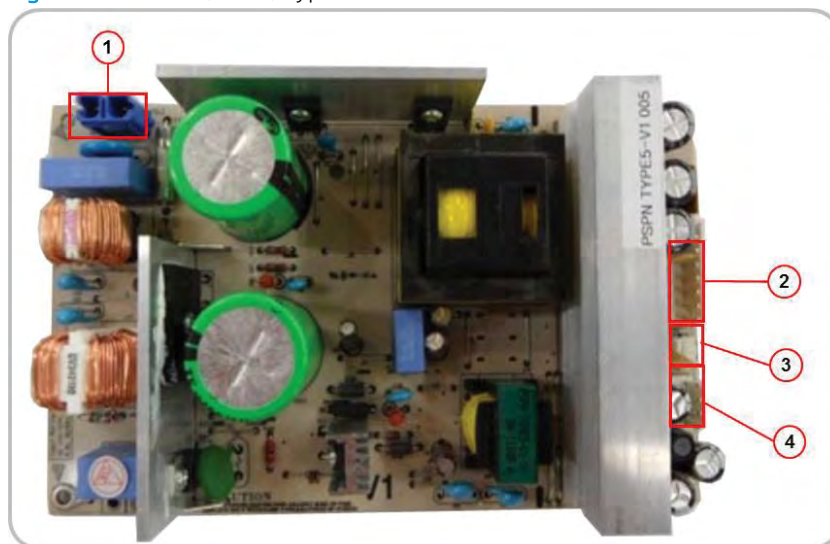

Specification

- General input/output voltage
 - AC 110V (90V-135V)
 - AC 220V (180V-270V)

- Input current: 13.7A (110V)/6.8A (220V)
- Output power: 1500W
 - DC 5V: 55W/DC 5VS: 30W/DC 24V: 432W

Table 1-28 Information

	110 V	220 V
Part number	JC44-00249A	JC44-00250A
Part name	LVPS 110V Type 5H	LVPS 220V Type 5H

Low voltage power supply (LVPS) PCA (Type 4) (GX/z models)

Learn about the low voltage power supply (LVPS) PCA (Type 4).

NOTE: The Type 4 LVPS only exists on some early models during original release. This has been removed from all new models.

Some models have three LVPS boards. (Type5 x 1 each, Type4 x 2 each)

The low voltage power supply (LVPS) board supplies electric power to the main board and other boards. The voltage provided includes +5 V, and +24 V from a 110 V/220 V power input. It has safety protection modes for over current and overload.

Figure 1-72 LVPS PCA (Type 4)

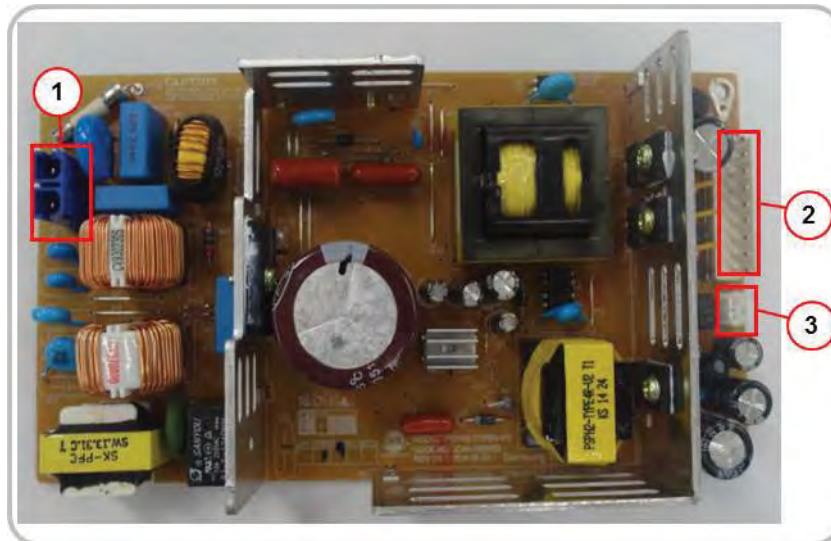

1	INPUT_AC
2	OUTPUT_DC +24 V1/2/3 and DC +5 V 1/2 (to Main PCA)
3	24 V on/off

Specification

- General input/output voltage

- AC 110 V (110 V — 127 V)
- AC 220 V (220 V — 240 V)
- Input current: 6.3 A (110 V)/5 A (220 V)
- Output power: 205 W
 - DC 5 V: 25 W
 - DC 24 V: 180 W

Information

Table 1-29 LVPS PCA (Type 4)

	110 V	220 V
Part number	JC44-00091D	JC44-00092D
Part name	LVPS 110V Type 4	LVPS 220V Type 4

Input/output connector

- AC input connector (CN1)

Table 1-30 LVPS PCA (Type 4)

PIN assign	PIN name	Description
1	AC_L	AC input
2	AC_N	

- DC output connector (CN4)

Table 1-31 LVPS PCA (Type 4)

PIN assign	PIN name	Description
1	+5V1	Power
2	GND	5 V ground
3	+5V2	Power
4	GND	5 V ground
5	+24V1	Power
6	GND	24 V ground
7	+24V2	Power
8	GND	24 V ground
9	+24V3	Power

- Signal Connector (CN3)

Table 1-32 LVPS PCA (Type 4)

PIN assign	PIN name	Description
1	GND	Active Low
2	24 V On/Off	
3	GND	

Fuser drive board (FDB)

Learn about the fuser drive board.

This board supplies voltage to the fuser AC, heater, and main board.

Figure 1-73 Fuser drive board (FDB)

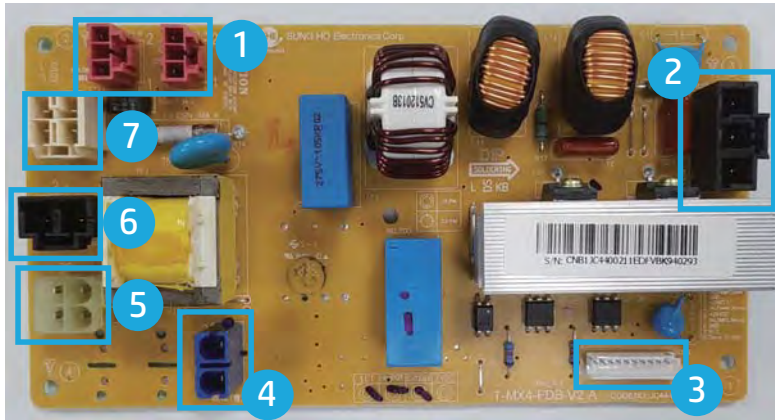

- Information

Table 1-33 Fuser drive board (FDB)

Part number	Description	Remark
JC44-00210E	FDB V1 (110V)	For E77822, E778425, E77830
JC44-00211E	FDB V2 (220V)	For E77822, E778425, E77830
8GR94-60001	FDB V1 (110V)	For E78323, E78325, E78330
8GR94-60002	FDB V2 (220V)	For E78323, E78325, E78330

- Connection

Table 1-34 Fuser drive board (FDB)

Item	Description
1	Heater I/F
2	Fuser AC
3	Fuser drive PCA I/F
4	Type 5
5	Main S/W

Table 1-34 Fuser drive board (FDB) (continued)

Item	Description
6	Inlet
7	Heater S/W

High-voltage power supply (HVPS) PCA

Learn about the high-voltage power supply (HVPS) PCA.

The HVPS generates 5 high-voltage channels, including FUSER, SAW, AC/DC, T2+/-, and MHV.

Figure 1-74 HVPS board

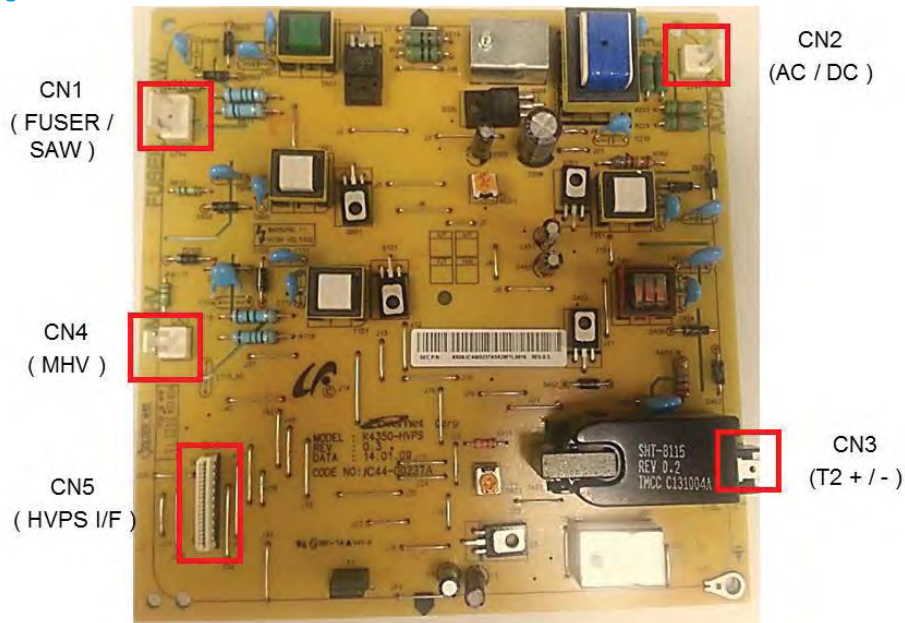

Specification

- Input voltage: DC 24V, 3.3V
- Output voltage
 - MHV: —1200V
 - DEV DC: —497V, AC: Vpp 1000V
 - THV+: 39.6uA, THV-: —1300V
 - SAW: —990V
 - FUSER: 400V

Connection

• **Table 1-35 CN1**

Description	PIN name	PIN assign
Output voltage	FUSER	1
Output voltage	SAW	2

Table 1-36 CN2

Description	PIN name	PIN assign
Output voltage	AC/DC	1, 2

Table 1-37 CN3

Description	PIN name	PIN assign
Output voltage	T2 +/-	1

Table 1-38 CN4

Description	PIN name	PIN assign
Output voltage	MHV	1, 2

Table 1-39 CN5

Description	PIN name	PIN assign
PWM signal	PWM SAW	1
PWM signal	PWM DEVE AC	2
PWM signal	PWM FUSER BIAS	3
PWM signal	PWM VPP AC	4
PWM signal	PWM MHV	5
nEN signal	nEN DEVE AC	6
Output signal	ADC MHV READ	7
PWM signal	PWM DEVE DC	8
nEN signal	nEN MHV	9
nEN signal	nEN THV	10
Input voltage	3.3V PS	11
PWM signal	PWM THV	12
Output signal	ADC_HVPS_24V	13
Output signal	ADC THV READ	14

Table 1-39 CN5 (continued)

Description	PIN name	PIN assign
GND	GND	15, 16, 17
	NC	18
Input voltage	24V	19, 20

Eraser PCA

Learn about the eraser PCA.

The eraser PCA has one LED. The LED is used for erasing the negative charges on the surface of the drum after printing.

Figure 1-75 Eraser PCA



Part number/name

- JC92-02747AB
- PCA-ERASER

Waste Sensor PCA

Learn about the waste sensor PCA.

The waste sensor PCA detects the waste toner level inside the toner collection unit.

Figure 1-76 Waste sensor PCA



Information

- Part name: WASTE SENSOR RX

CRUM PCA

Learn about the CRUM PCA.

The CRUM PCA includes memory for the drum, toner cartridge, and fuser.

Figure 1-77 CRUM PCA



Information

- Part name: PCA-ZCRUM

Toner CRUM joint PCA

Learn about the toner CRUM joint PCA.

The toner CRUM joint PCA is the interface PCA between the toner cartridge and the printer.

Figure 1-78 Toner CRUM joint PCA



Paper Size sensor PCA

The paper size sensor PCA is used for detecting the size of the paper in the tray.

Figure 1-79 Paper size sensor PCA



Dual cassette feeder (DCF)

Learn about the dual cassette feeder.

The DCF is an optional device that stores additional paper.

DCF front sectional view

Figure 1-80 DCF front sectional view

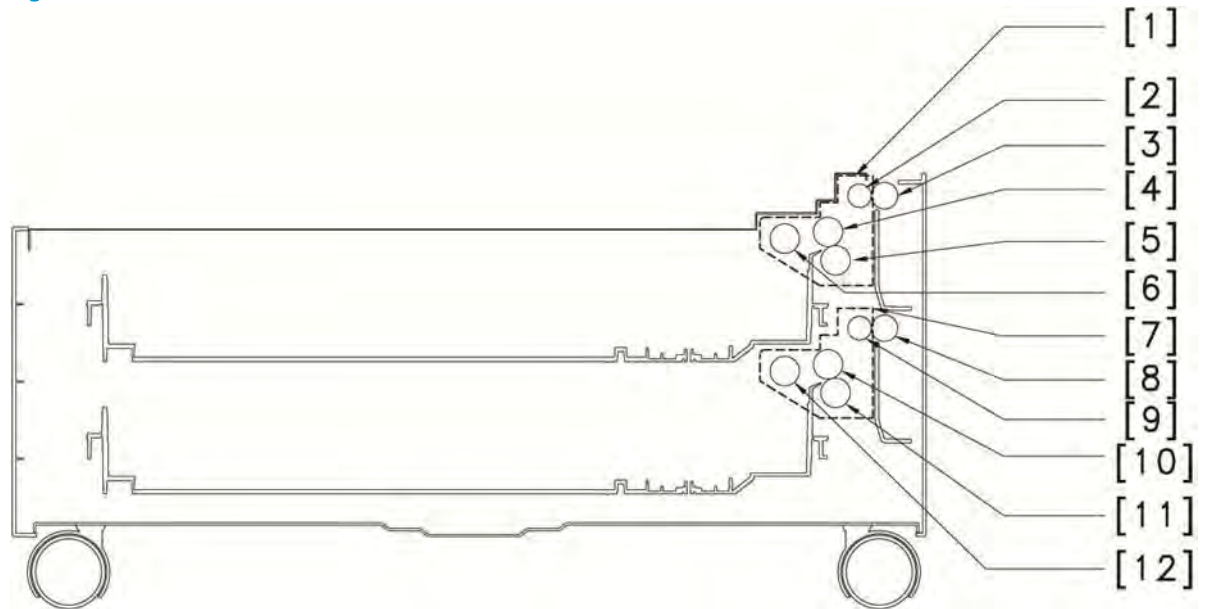

Item	Description	Item	Description
1	Global HCI to tray	7	HCI 4 pickup assembly
2	Feed roller (HCI 3)	8	Feed roller (HCI 4)
3	Idle roller (HCI 3)	9	Idle roller (HCI 4)
4	Feed roller (HCI 3)	10	Feed roller (HCI 4)
5	Separation roller (HCI 3)	11	Separation roller (HCI 4)
6	Pick roller (HCI 3)	12	Pick roller (HCI 4)

DCF paper path

Figure 1-81 DCF paper path

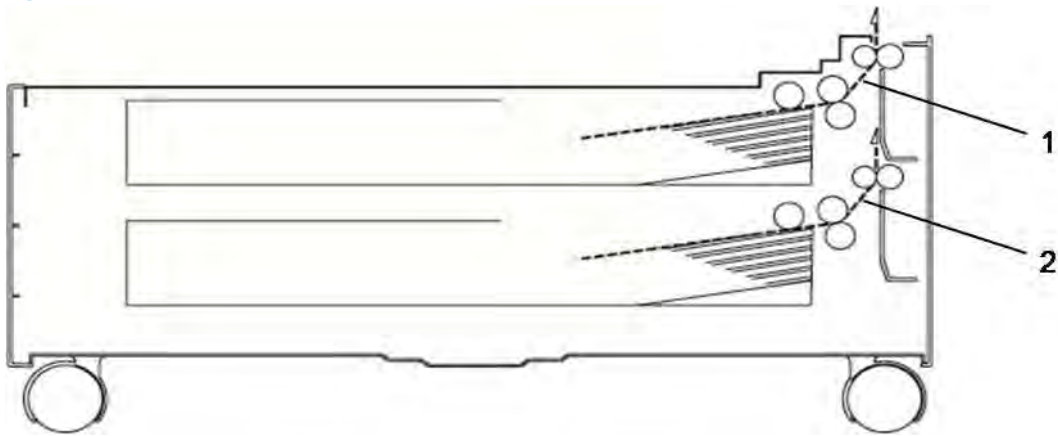

Item	Description
1	Tray 4 paper path
2	Tray 5 paper path

DCF electrical parts locations

Figure 1-82 DCF electrical parts locations

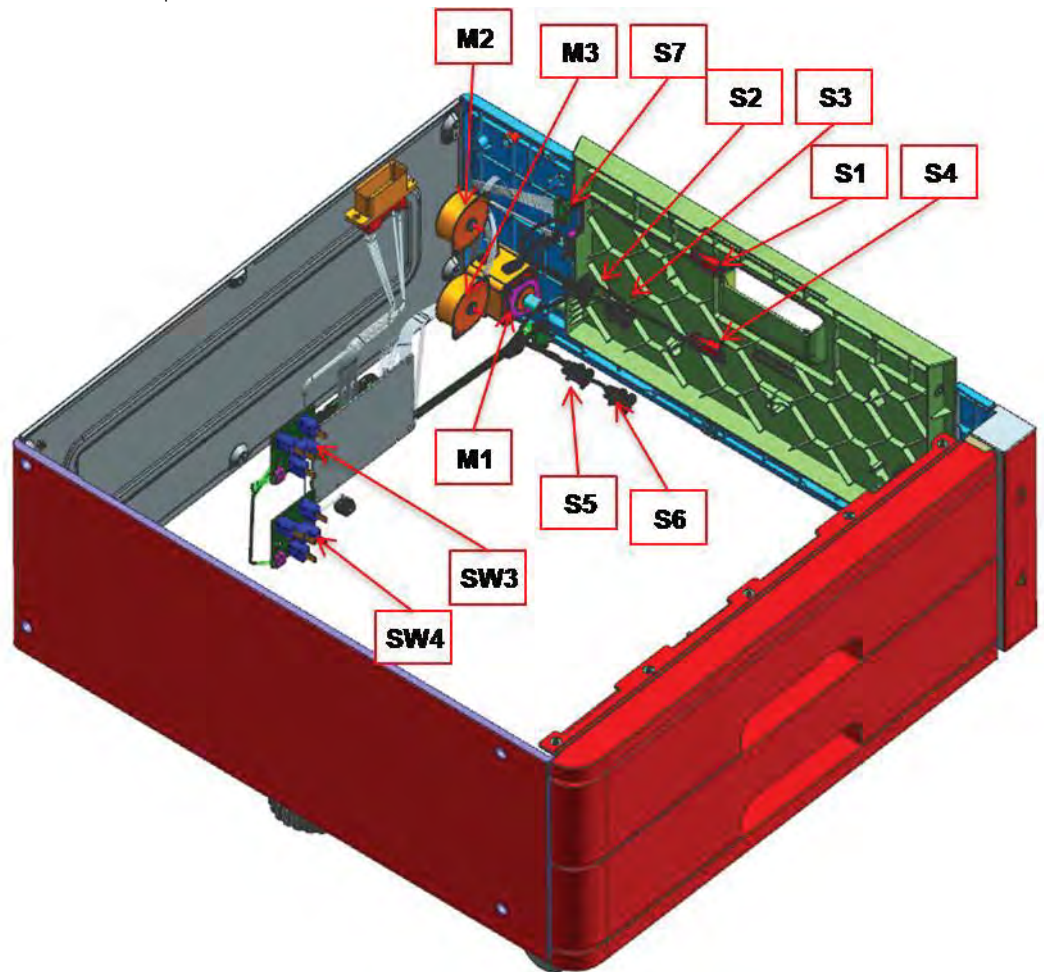

Item	Description	Part number	DC controller PCA	Item	Description	Part number	DC controller PCA
M1	Feed motor	JC31-00033B	CN5 3 to 6	S2	Tray 4 limit sensor	0604-00138 1	CN6 4 to 6
M2	Tray 4 pickup motor	JC31-00149A	CN5 9 to 12	S3	Tray 4 paper empty sensor	0604-00139 3	CN6 1 to 3
M3	Tray 5 pickup motor	JC31-00149A	CN5 13 to 16	S4	Tray 5 feed sensor	0604-00138 1	CN6 16 to 18
SW3	Tray 4 auto-size switch	JC32-00013A	CN9 1 to 4	S5	Tray 5 limit sensor	0604-00138 1	CN6 13 to 15
SW4	Tray 5 auto-size switch	JC32-00013A	CN9 5 to 8	S6	Tray 5 paper empty sensor	0604-00138 1	CN6 10 to 12
S1	Tray 4 feed sensor	0604-00138 1	CN6 7 to 9	S7	Door open sensor	JC39-01696A	CN3 1 to 2

DCF sensor and signal

Figure 1-83 DCF sensor and signal

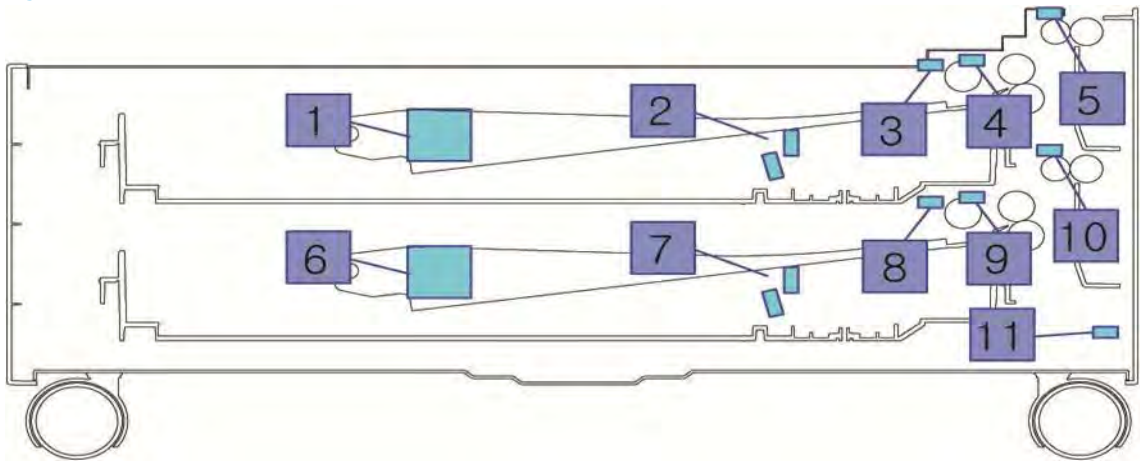

Item	Sensor	Signal
1	P_Size_DCF 1	Tray 4 paper size analog signal
3	nP_Empty_DCF 1_IHCF	Tray 4 paper empty signal
4	Limit_DCF 1_IHCF	Tray 4 paper limit signal
5	Feed_DCF 1_IHCF	Tray 4 feed signal
6	P_Size_DCF 2	Tray 5 paper size analog signal
8	nP_Empty_DCF 2	Tray 5 paper empty signal
9	Limit_DCF 2	Tray 5 paper limit signal
10	Feed_DCF 2	Tray 5 feed signal
11	nDoor_open	Door open signal

DCF PCA connection

Figure 1-84 DCF PCA connection

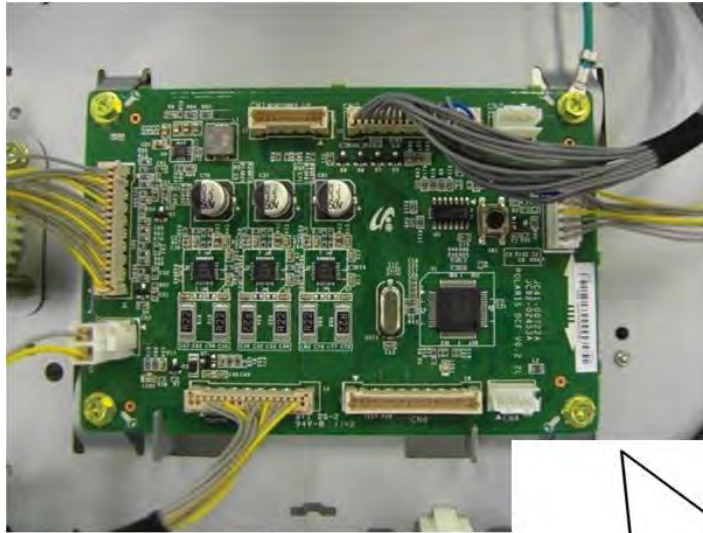
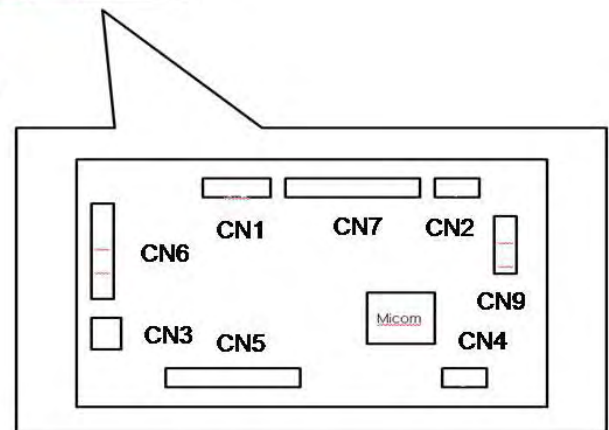

Figure 1



Connector number	Connection
CN1	Download tool I/F (minicube)
CN2	Debug I/F
CN3	Cover open switch (24V interlock switch)
CN4	USB I/F
CN5	EMPTY/LIFT/FEED (Tray 4 and 5) sensor
CN6	FEED/PICKUP 3, 4 motor
CN7	Interface with main
CN9	Paper size sensor (Tray 4 and 5)

Inner finisher

Learn about the inner finisher.

The inner finisher is an optional device that stores additional paper.

Inner finisher sectional view

Figure 1-85 Inner finisher sectional view

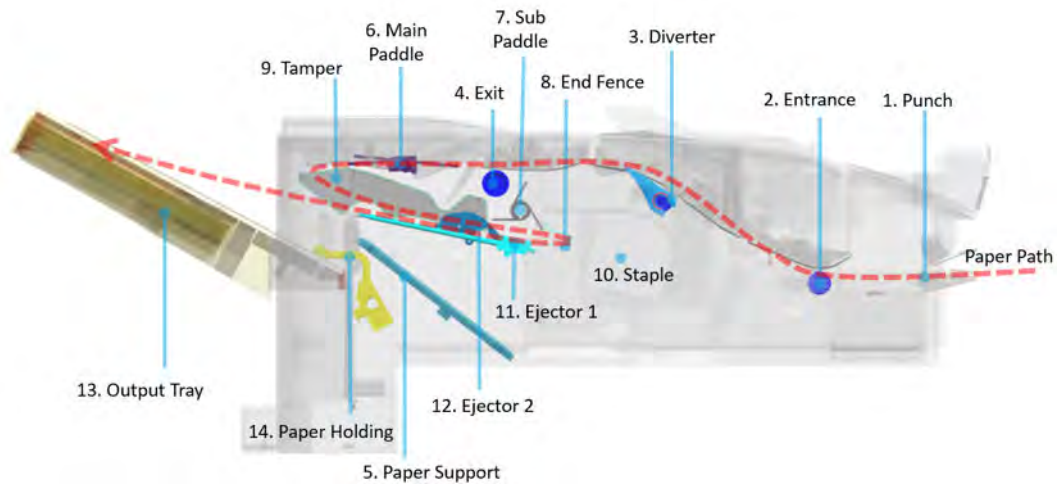

Item	Description	Item	Description
1	Punch unit	8	End fence unit
2	Entrance unit	9	Tamper unit
3	Diverter unit	10	Stapler unit
4	Exit unit	11	Ejector 1 unit
5	Paper support unit	12	Ejector 2 unit
6	Main paddle unit	13	Output tray unit
7	Sub paddle unit	14	Paper holding unit

Inner finisher paper path

Figure 1-86 Inner finisher paper path

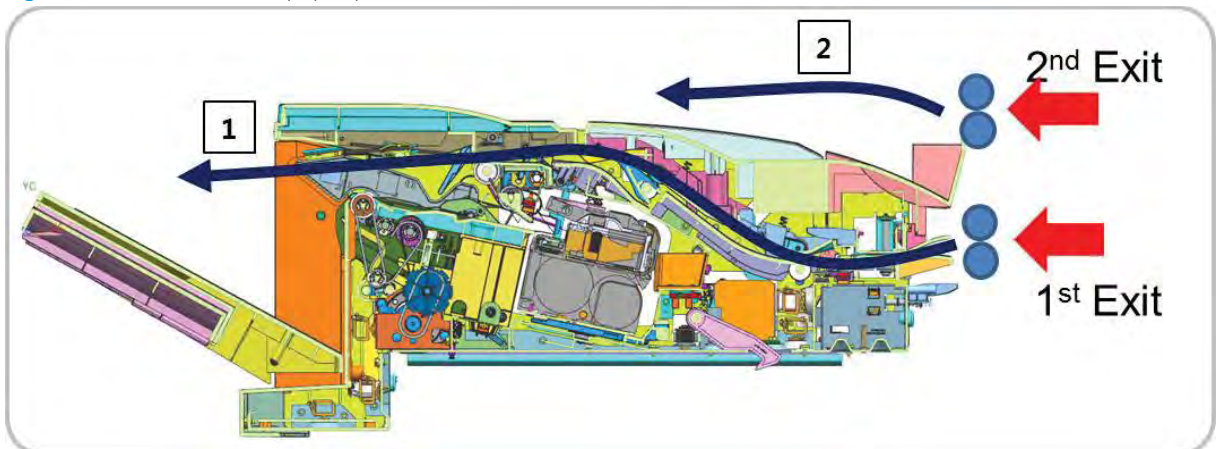

Item	Description
1	Finisher main tray — staple/offset/punch
2	Finisher top tray — stack only

Inner finisher electrical parts locations

Figure 1-87 Inner finisher electrical parts locations

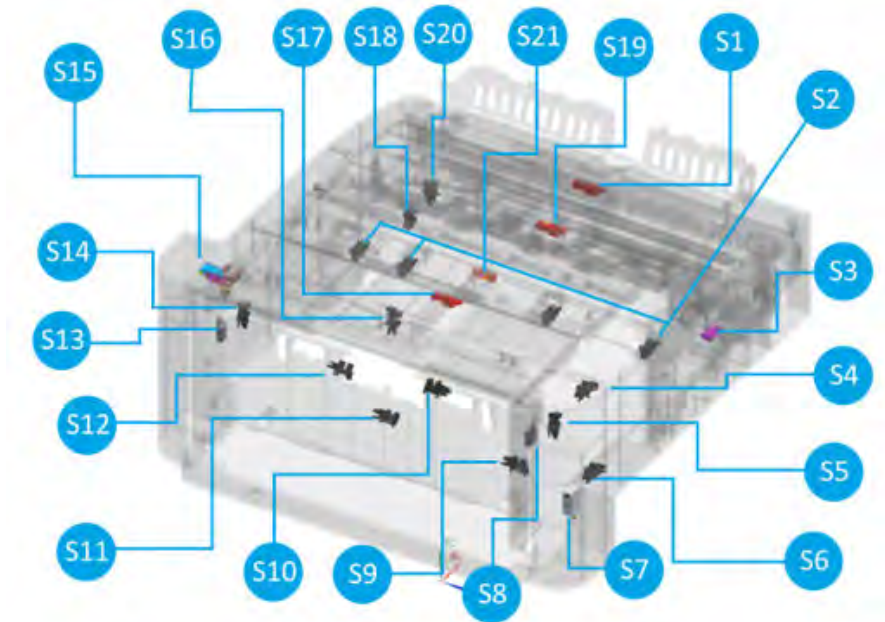

Item	Description	Part number	Item	Description	Part number
S1	Stapler position sensor	0604-001381	S12	Paper support home sensor	0604-001393
S2	Stapler position sensor	0604-001393	S13	Output tray top of stack sensor (LED)	0601-003440
S3	Front cover switch	JC39-01610A	S14	Rear tamper home sensor	0604-001393
S4	Main paddle home sensor	0604-001393	S15	Top cover switch	JC39-01610A
S5	Front tamper home sensor	0604-001393	S16		0604-001393
S6	Output tray motor sensor	0604-001393	S17	End fence sensor	0604-001381
S7	Output tray lower limit switch	JC90-01320A	S18	Punch waste box sensor	0604-001393
S8	Output tray top of stack sensor (receiver)	0603-001309	S19	Punch waste full sensor	0604-001381
S9	Paper holding sensor	0604-001393	S20	Finisher docking sensor	0604-001393
S10	Ejector 2 home sensor	0604-001393	S21	Exit sensor	0604-001415
S11	Ejector 2 motor sensor	0604-001393			

Inner finisher PCA connection

Figure 1-88 Inner finisher PCA connection

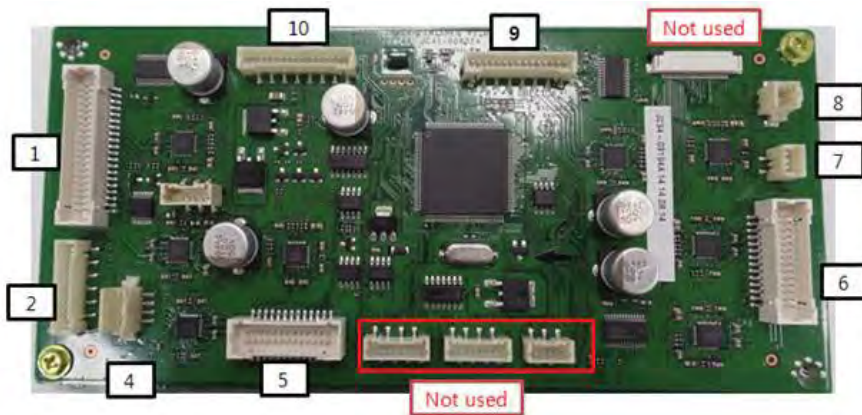

Connector number	Connection
1	CN3: REAR joint I/F
2	CN1: REAR sensor
3	CN10: Traverse mid sensor
4	CN8: Debug
5	CN2: REAR I/F
6	CN7: FRONT I/F
7	CN6: Stacker switch
8	CN9: Solenoid
9	CN4: Ejector and supporter I/F
10	CN5: Main I/F

2 Parts, diagrams, removal and replacement

Learn about parts, diagrams, removal and replacement.

HP service and support

Learn about HP access to additional service and support information.

Additional service and support for channel partners

Channel partners go to partner.hp.com, and then use the steps below to access the HP Web-based Interactive Search Engine (WISE).

Access WISE for Channel partners

1. Select [Services & Support](#) (near the top of the screen).
2. Under [Services Delivery](#), select [Technical Support](#).
3. Select [Technical Documentation](#).

Find information about the following topics

- Service manuals
- Service advisories
- Up-to-date control panel message (CPMD) troubleshooting
- Solutions for printer issues and emerging issues
- Remove and replace part instructions and videos
- Install and configure
- Printer specifications
- Warranty and regulatory information

Additional service and support for HP internal personnel

HP internal personnel, go to one of the following Web-based Interactive Search Engine (WISE) sites:

Americas (AMS)

- [WISE - English](#)
- [WISE - Spanish](#)
- [WISE - Portuguese](#)
- [WISE - French](#)

Asia Pacific / Japan (APJ)

- [WISE - English](#)
- [WISE - Japanese](#)
- [WISE - Korean](#)
- [WISE - Chinese \(simplified\)](#)
- [WISE - Chinese \(traditional\)](#)
- [WISE - Thai](#)

Europe / Middle East / Africa (EMEA)

- [WISE - English](#)

Additional technical support WISE videos

The videos below provide additional ways to access printer information using WISE.

How to search for printer documentation

Find printer documentation using the internal HP portals.

The CPMD, error codes, and other support documentation for each printer is found on the internal HP portals [GCSN](#) and [WISE](#) (formerly SAW). GCSN is available to HP channel partners and WISE is available to call agents, service technicians, and other HP internal users. The level of detail available will depend on your access credentials.

How to search WISE for printer documentation

These instructions are for HP internal use by call agents, service technicians, and other internal users. [View a video of how to find support content in WISE.](#)

To view a list of control panel message documents per printer in WISE, enter document ID **c05048451**, to locate CPMD list.

Go to WISE and enter this document ID **c05791539** for written instructions.

How to search GCSN for printer documentation

These instructions are for internal use by HP Channel Partners. [View a video of how find support content in GCSN](#), or follow the steps below.

1. On the Home screen in GCSN, open **Technical information** using one of the following two methods:

- Type **TINF** in the **Speedcode** field found in the upper right corner and press **Enter**, or
- On the Home page, click **Technical information** in the left pane.

Figure 2-1 GCSN home page

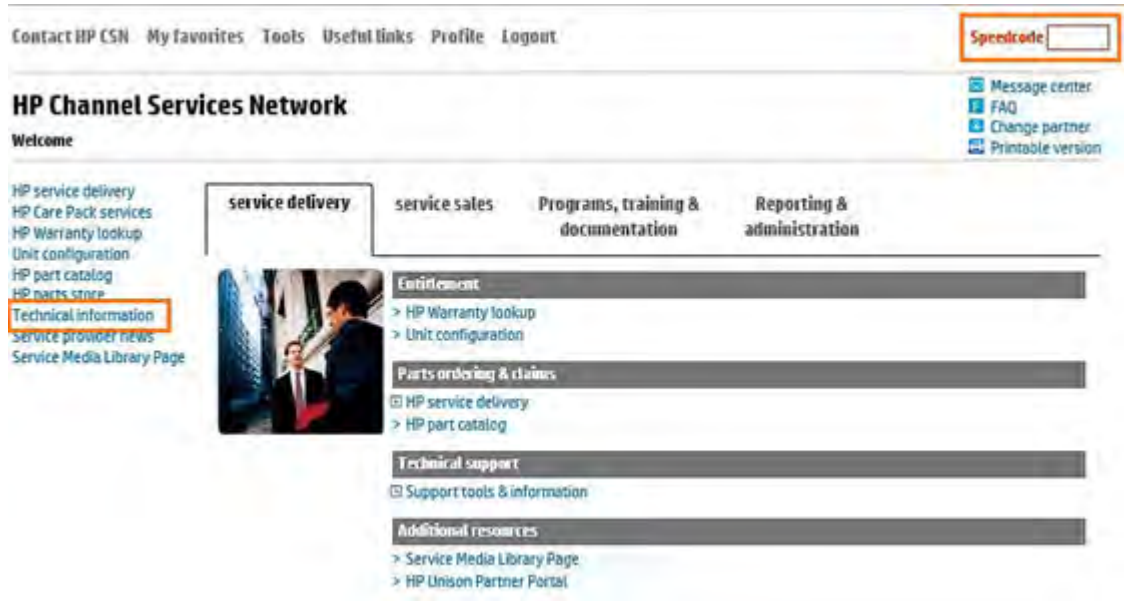

2. Under **Product Search**, select the **Type**, **Category**, **Family**, and **Series** that match your product model (leave the **Model** field as blank or the default).

 **NOTE:** Make sure to login to GCSN using your service-qualified credentials to access the most comprehensive content list available. To find out how to become service-qualified, contact your HP representative.

Figure 2-2 Sample product search criteria (GCSN)

Product Search **Add Favorites**

Type
Printers and Multifunction

Category
Multifunction and All-in-One

Family
HP LaserJet MFP and All-in-One Products

Series
HP Color LaserJet Enterprise MFP M682 series

Model
Select a Model

3. Click **Add Favorites** and then click **Add** to add the printer to your Favorites list and allow you to bypass the **Product Search** fields next time for that particular model (optional).

Figure 2-3 Add favorites (GCSN)

The screenshot shows a section titled 'Product Search' with a blue 'Add Favorites' button. Below the button are three dropdown menus: 'Type' set to 'Printers and Multifunction', 'Category' set to 'Multifunction and All-in-One', and 'Family' set to 'HP LaserJet MFP and All-in-One Products'.

4. Clear all of the high-level check boxes.

Figure 2-4 Clear search criteria (GCSN)

The screenshot shows a list of document types with checkboxes. The high-level categories 'Support Communications', 'Manuals and Guides', and 'Support Information' are highlighted with orange boxes. All checkboxes are currently unchecked.

5. Select the check boxes for the document types for which you want to search.

 **NOTE:** Select only the high-level **Manuals and Guides** search option if you are not sure in which type of manual or guide the content might be listed.

Figure 2-5 Select search criteria (GCSN)

The screenshot shows the same list of document types as Figure 2-4. In this view, several checkboxes are selected (checked) and highlighted with orange boxes: 'Maintenance/Service Guide', 'Service Guide/Manual', 'User Guide', 'CPMMap', and 'Support Information'.

6. Select **Submit**.
7. If needed, click **Back To selection Criteria** and narrow your search (the maximum allowed search result is 100 documents).



NOTE: Do not select the **Top Issue** option unless you only want to view top issues for that model. All other available content is filtered out.

Table 2-1 Information type selections

Technical information type	Select this checkbox
Control panel message document (CPMD)	CPMD-Map
List of all CPMDs per product	Support Information
Installation Guide or Hardware Install Guide	Maintenance/Service Guide or Install Guide
Service cost document	Install Guide or Service Guide/Manual
Service guide or Service manual	Service Guide/Manual
Self-solve or troubleshooting document	Support Information
User manual or User guide	User Guide
Warranty and Legal Guide	Warranty Statement

Order parts by authorized service providers

Find information about ordering parts and supplies for the printer.

Ordering

Order parts by authorized service providers.

Table 2-2 Ordering

Item or provider	Description
Order supplies and paper	www.hp.com/go/suresupply
Order parts from authorized service providers	www.hp.com/buy/parts or partsurfer.hp.com
Order through service or support providers	Contact an HP-authorized service or support provider.
Order using the HP Embedded Web Server (EWS)	To access, in a supported web browser on your computer, enter the printer IP address or host name in the address/URL field. The EWS contains a link to the HP SureSupply web site, which provides options for purchasing Original HP supplies.

Orderable parts

Not all of the parts shown in the exploded assembly diagrams are orderable parts.

Refer to the tables following the diagrams or the alphabetical/numerical parts lists to determine if a part is orderable.

How to use parts lists and diagrams

Learn how to use the parts lists and diagrams.

The figures in this chapter show the major sub-assemblies in the printer and their component parts. A parts list table follows each exploded view assembly diagram. The table lists the item number, the associated part number, and the description of each part. If a part is not listed in the table, then it is not a field replacement unit (FRU).

 **NOTE:** Be sure to order the correct part. When looking for part numbers for electrical parts, pay careful attention to the voltage that is listed in the part description. Doing so will make sure that the selected part number is for the correct printer model.

 **NOTE:** The abbreviation “PCA” stands for “printed circuit-board assembly.” Components described as a PCA might consist of a single circuit board or a circuit board plus other parts, such as cables and sensors.

ESD precautions

Learn the importance of electrostatic discharge.



CAUTION:



Some parts are sensitive to electrostatic discharge (ESD). Look for the ESD reminder when removing printer parts. Always perform service work at an ESD-protected workstation or mat. If an ESD workstation or mat is not available, touch the sheet-metal chassis to provide a static ground *before* touching an ESD-sensitive assembly.

Protect the ESD-sensitive assemblies by placing them in ESD pouches when they are out of the printer.

Service approach

Learn more about the service approach.

Precautions when replacing parts

Learn about precautions when replacing parts.

Precautions when assembling and disassembling

- Use only HP approved replacement parts. Make sure that the part number, product name, voltage, and current or temperature ratings are correct. Failure to do so might result in damage to the machine, circuit overload, fire, or electric shock.
- Do not make unauthorized changes or additions to the printer. Unauthorized changes might cause the printer to malfunction and create electric shock or fire hazards.
- Use caution when dismantling the unit. Take note of the location of each screw or other part. This printer contains different kinds of screws. Using the wrong screw might lead to system failure, short circuit or electric shock.
- Do not disassemble the laser scanner assembly. Once the laser scanner assembly is disassembled, dust might enter the mirror chamber and will seriously degrade print quality. There are no serviceable parts inside the laser scanner assembly.
- Regularly check the condition of the power cable, plug and socket. Bad contacts might lead to overheating and fire. Damaged cables might lead to electric shock or unit malfunction.

Precautions when handling PCAs

Static electricity might damage a PCA. Use approved, anti-static precautions when handling or storing a PCA. Service personnel should use grounded ESD straps and/or mats when handling PCAs.

- Precautions when moving and storing a PCA
 - Keep PCA in a conductive case, anti-static bag, or wrapped in aluminum foil.
 - Do not store a PCA where it is exposed to direct sunlight.
- Precautions when replacing a PCA
 - Disconnect power cables before disconnecting other cables.
 - Do not touch any soldered connections, connector terminals, or other electronic parts when handling insulated parts.
- Precautions when checking a PCA
 - Touch a grounded area of the printer chassis to discharge static electric charge before touching a PCA.
 - Do not touch a PCA with bare hands or metal objects. Doing so might create a short circuit or cause electric shock. Use caution when handling a PCA with moving parts such as sensors, motors, or lamps, as they might become very hot.

- Use caution when fitting and removing screws. Watch for hidden screens. Make sure that the correct screw is used and make sure that when toothed washers are removed, they are refitted in their original positions.
- Place the product on an ESD workstation or mat, or use an ESD strap (if one is available). If an ESD workstation, mat, or strap is not available, ground yourself by touching the sheet-metal chassis *before* touching an ESD-sensitive part.

Releasing plastic latches

Many of the parts are held in place with plastic latches. The latches might easily break. Be careful when releasing them . To remove such parts, press the hook end of the latch away from the part to which it is latched.

Before performing service

Learn what to do before performing service.

- Press the power button on the front of the printer, and then turn off the power switch next to the power cable.
- Unplug the power cable and interface cable or cables.
- Remove any finishing devices and the side HCI, if they are installed.
- Place the product on an ESD workstation or mat, or use an ESD strap (if one is available). If an ESD workstation, mat, or strap is not available, ground yourself by touching the sheet-metal chassis *before* touching an ESD-sensitive part.
- Remove the toner cartridges, if needed.

After performing service

Learn what to do after performing service.

- Verify that the service performed was successful.
- Verify that the most recent firmware is installed on the printer.
- Verify that all parts are correctly reinstalled and are properly working.
- Print any pages necessary to verify that the repair resolved the issue and did not create any new issues.
- Verify that the printer is in better condition than when you arrived, cosmetically and electrically.

Post-service test

Perform the following tests to verify that the repair or replacement was successful:

Print-quality test

Learn about the print-quality test.

1. Verify that you have completed the necessary reassembly steps.
2. Make sure that the tray contains clean, unmarked paper.
3. Attach the power cord and interface cable or interface cables, and then turn on the product.
4. Print a configuration page.
5. Print a print quality page, and then verify that there are no lines, streaks, banding, or other print quality defects.
6. Send a print job from the host computer, and then verify that the output meets expectations.

Copy-quality test

Learn about the copy-quality test.

1. Place the configuration page in the document feeder, print a copy job, and then verify the results.
2. Place the configuration page on the flatbed glass, print a copy job, and then verify the results

Fax-quality test

Learn about the fax-quality test.

1. Place the configuration page in the document feeder.
2. Type a valid fax number, and send the fax job.
3. Verify that the send quality and the receive quality meet expectations.

Parts removal order

For procedures and/or steps that require identifying the right, left, or rear side of the printer, face the front of the printer for correct orientation.

Maintenance (printer cleaning)

Learn about printer cleaning for maintenance.

Cleaning the document feeder white bar and CIS (LX)

Learn about cleaning the document feeder white bar and CIS (LX).

1. Open the document feeder unit.

Figure 2-6 Open document feeder unit



2. Clean the document feeder white bar and CIS using a lint-free cloth.

Figure 2-7 Clean document feeder white bar

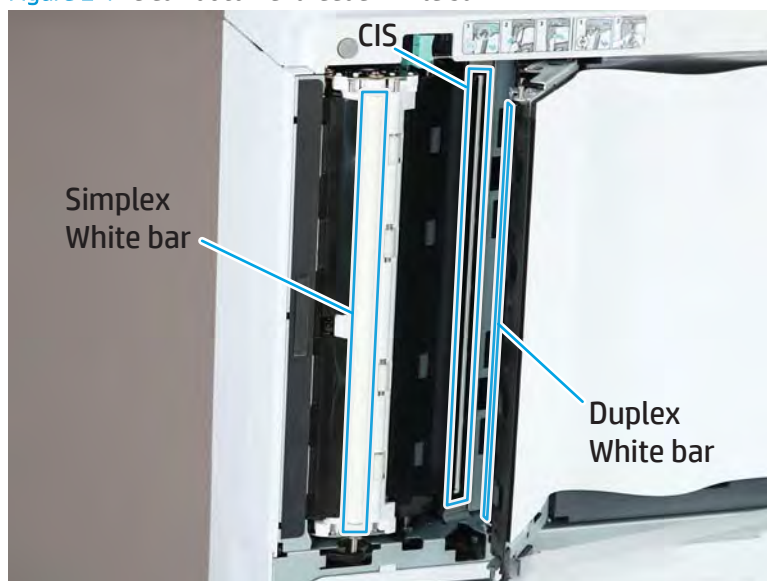

Cleaning the flow document feeder white bar and CIS (GX)

Learn about cleaning the flow document feeder white bar and CIS (GX).

1. Open the document feeder, peel back the white backing, and then release the green tab.

Figure 2-8 Peel back the white backing and release one tab

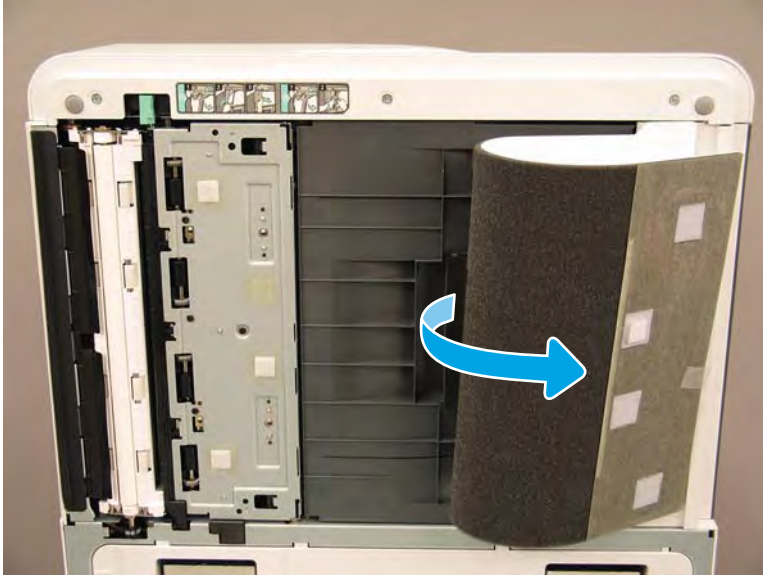

2. Open the access door. Clean the simplex white bar (callout 1), the CIS (callout 2), and the duplex white bar (callout 3) using a soft, lint-free, clean cloth.

Figure 2-9 Clean flow document feeder white bar

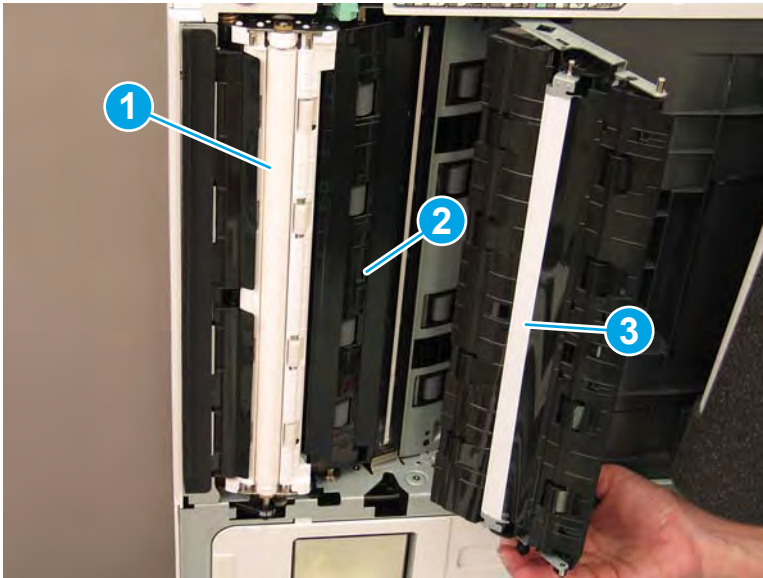

Cleaning the scanner glass

Learn about cleaning the scan glass.

- ▲ Open the document feeder. Clean the scanner glass (callout 1) using a soft, lint-free, clean cloth.

Figure 2-10 Clean the scanner glass (1 of 2)

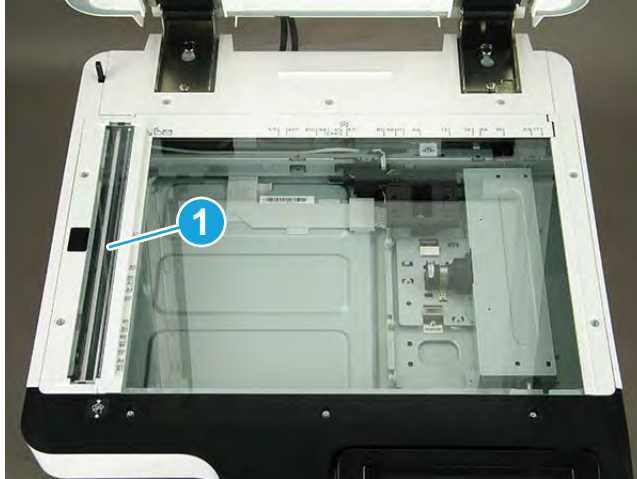

Figure 2-10 Clean the scanner glass (2 of 2)



Cleaning the transfer roller

Learn about cleaning the transfer roller.

1. Open the right door.

Figure 2-11 Open the right door



2. Clean the transfer roller (A) using a lint-free cloth.

Figure 2-12 Transfer roller cleaning



Main parts

Learn about the printer main parts.

Main assembly

Parts diagram and parts list for the main assembly.

Figure 2-13 Main assembly

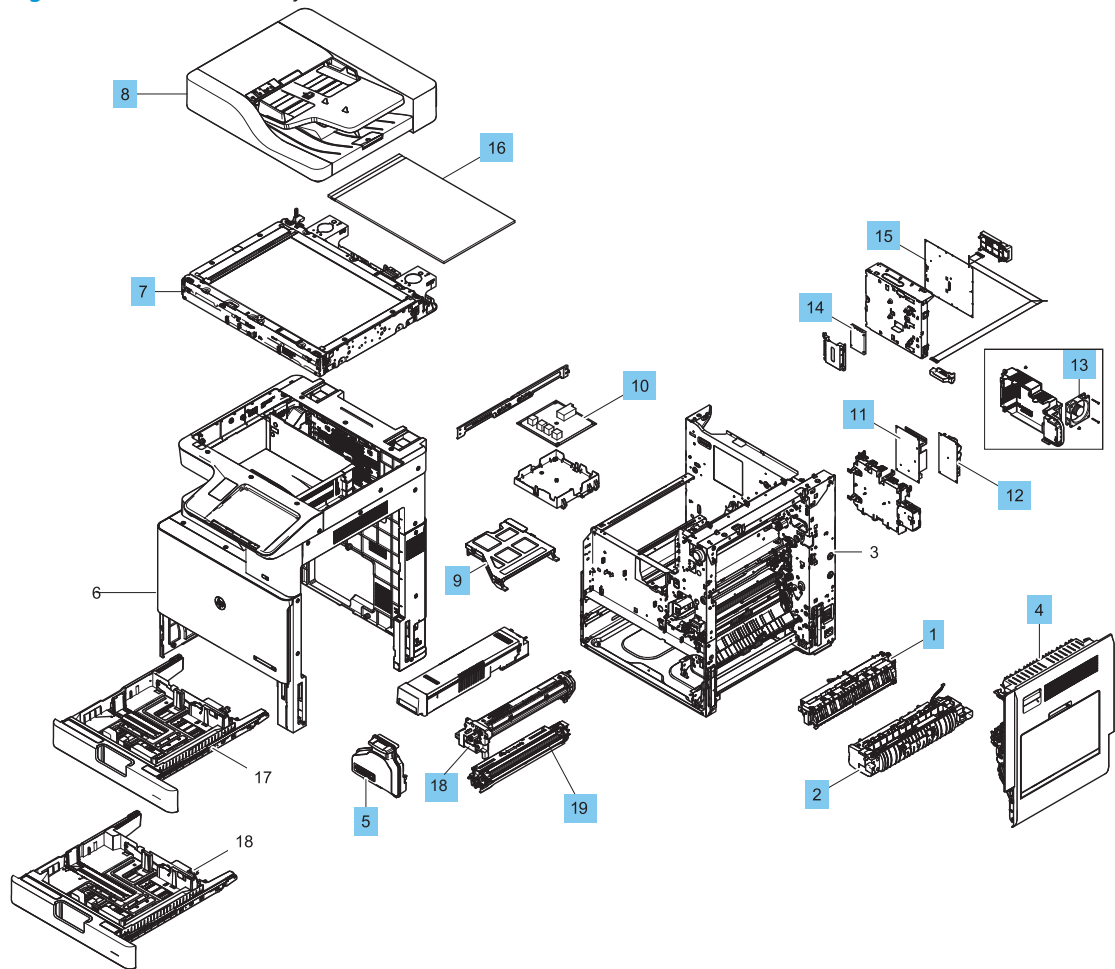

Table 2-3 Main assembly

Ref				
No	Part number	Description	Qty	Repair procedure
1	JC90-01118B	Exit	1	Removal and replacement: Exit unit on page 169
2	JC82-00481A	Fuser, 220V	1	Removal and replacement: Fuser unit on page 202
2	JC82-00479A	Fuser, 110V	1	Removal and replacement: Fuser unit on page 202
4	JC95-02080B	Right Door	1	Removal and replacement: Right door assembly on page 198
5	X3A60-67901	Toner Collection Unit	2	Not applicable
7	JC97-04520C	Image Scanner Assembly	1	Removal and replacement: Image scanner assembly (flatbed) on page 149
8	JC97-04954A	ADF LX whole unit	1	Removal and replacement: ADF whole unit (LX) on page 132
8	JC97-04955A	Flow/GX ADF whole unit	1	Removal and replacement: Flow ADF whole unit (GX) on page 137
9	JC97-04894A	Laser scanner unit	1	Removal and replacement: Laser scanner assembly on page 190
10	JC44-00237B	HVPS, 24V	1	Removal and replacement: High-voltage power supply (HVPS) board on page 194
11	JC44-00091D	LVPS (SMPS) 110V, Type 4 ¹	1	Removal and replacement: Low voltage power supply (LVPS) type 5H board on page 176
11	JC44-00092D	LVPS (SMPS) 220V, Type 4 ¹	1	Removal and replacement: Low voltage power supply (LVPS) type 5H board on page 176
11	JC44-00249A	LVPS (SMPS) 110V, Type 5H	1	Removal and replacement: Low voltage power supply (LVPS) type 5H board on page 176
11	JC44-00250A	LVPS (SMPS) 220V, Type 5H	1	Removal and replacement: Low voltage power supply (LVPS) type 5H board on page 176
12	JC44-00210E	Fuser drive PCA 110V (fuser drive board)	1	Removal and replacement: Fuser drive assembly board on page 172
12	JC44-00211E	Fuser drive PCA 220V (fuser drive board)	1	Removal and replacement: Fuser drive assembly board on page 172
13	JC31-00162A	Fan, Type 8, LVPS	1	Removal and replacement: Developer fan on page 180
14	5851-6712	HDD 500GB - Main PCA HDD	1	Removal and replacement: 500GB Main PCA HDD on page 242

Table 2-3 Main assembly (continued)

Ref				
No	Part number	Description	Qty	Repair procedure
15	JC82-00541A	PCA, Main Board	1	Removal and replacement: Main board on page 184
16	JC63-05410A	White backing (LX)	1	Removal and replacement: ADF white backing (LX) on page 126
16	JC63-05795A	White backing (GX)	1	Removal and replacement: ADF white backing (GX) on page 129
19	JC96-11669A	Black developer unit	1	Removal and replacement: Developer unit on page 205
Not shown	JC39-01202A	Cable, Sata, Main HDD	1	Not applicable
Not shown	JC39-01943A	Cable, PWR, Main HDD	1	Not applicable
Not shown	B5L47-60101	Pulsar Control Panel	1	Removal and replacement: Control panel on page 247
Not shown	B5L46-40002	Keyboard blank for non Flow	1	Not applicable
Not shown	B5L47-60102	US English Keyboard Assy	1	Removal and replacement: Keyboard on page 250
Not shown	B5L47-60103	UK English Keyboard Assy	1	Removal and replacement: Keyboard on page 250
Not shown	B5L46-40029	Bushing for Keyboard	1	Not applicable
Not shown	6502-001131	Wire Clip Formatter	1	Not applicable
Not shown	JC27-00014A	Inductor Unit - 220V ²	1	Not applicable
Not shown	JC27-00013A	Inductor Unit - 110V ²	1	Not applicable
Not shown	Y1G22-67901	Tray Heater (110v)	1	Not applicable
Not shown	Y1G22-67902	Tray Heater (220v)	1	Not applicable
Not shown	JC39-02112A	Lower Tray Connector	1	Not applicable
Not shown	JC92-02164A	Assy- Engine Side Crum Connector	1	Not applicable
Not shown	T3U55-60001	PCA Sada Riser	1	Not applicable
Not shown	B5L46-40014	HDD cradle	1	Not applicable
Not shown	B5L32-60002	eMMC card - 16gb	1	Not applicable
Not shown	X3A62-60001	Accelerator PCA ³	1	Removal and replacement: Accelerator board on page 218
Not shown	0380-5077	Stand off	1	Not applicable
Not shown	JC93-01538A	Formatter Cage	1	Removal and replacement: Formatter and formatter cage on page 235
Not shown	B5L46-40021	HIP Cover	1	Not applicable
Not shown	X3A92-60002	Island of Data Board	1	Not applicable

Table 2-3 Main assembly (continued)

Ref				
No	Part number	Description	Qty	Repair procedure
Not shown	B5L31-90902	Foreign Interface Harness (FIH)	1	Install accessory: HP Foreign interface harness (FIH) solution on page 231
Not shown	J8030-61001	Jetdirect Wireless Print Server with NFC Kit	1	Install accessory: NFC Kit Installation on page 221
Not shown	X3A65-67916	HP Black Managed LJ Imaging Drum	1	Removal and replacement: Drum unit on page 213
Not shown	0604-001393	Photo interrupter (feed sensor 1)	1	Removal and replacement: Feed sensor 1 on page 158
Not shown	0604-001393	Photo interrupter (feed sensor 2)	1	Removal and replacement: Feed sensor 2 on page 163
Not shown	JC39-02072A	Wiring harness (output device)	1	Not applicable
Not shown	X3A92-60003	Formatter PCA	1	Removal and replacement: Formatter and formatter cage on page 235

¹Type 4 LVPS is only installed in some early models during original release. Removed from all new models.

²Inductor Unit is only installed in some early models during original release. Removed from all new models.

³Accelerator PCA is only installed in some early models during original release. Removed from all new models.

Removal and replacement: ADF white backing (LX)

Learn how to remove and replace the ADF white backing (LX).

This document provides the procedures to remove the white backing assembly.



[View a video of how to remove and replace the document feeder white backing \(LX\).](#)



IMPORTANT: When applicable, special installation instructions are provided for an assembly at the end of the removal procedure. Always completely read the removal instructions and follow all special installation instructions.

Mean time to repair:

Service level:

Before performing service

Turn the printer power off

- Press the power button on the front of the printer, and then turn off the power switch next to the power cable.
- A shutting-down message appears on the control-panel display.



WARNING! To avoid damage to the printer, turn the power off and wait until the printer shuts down before removing the power cable.

- Disconnect the printer power cable after the printer has completely shut down (the control-panel display is blank).

Use the table below to identify the correct part number for your printer. To order the part, go to www.hp.com/buy/parts.

Table 2-4 Part information

Part number	Part description
JC63-05410A	ADF white backing (LX)

Required tools

- No special tools are required to remove or install this assembly.

After performing service

Turn the printer power on

- Connect the printer power cable.
- Turn on the power switch next to the power cable, and then press the power button on the front of the printer.
- Verify that the service performed was successful.

- Verify that the most recent firmware is installed on the printer.
- Verify that all parts are correctly reinstalled and are properly working.

Post service test

Print any pages necessary to verify that the repair resolved the issue and did not create any new issues.

Remove the document feeder white backing

Follow these steps to remove the document feeder white backing.

1. Open the document feeder cover.
2. Peel the white backing away to remove.

 **IMPORTANT:** Remove all the tape and foam from the bottom of the document feeder.

3. Position the new white backing on the scanner glass.
4. Peel the adhesive tape backing off the new white backing.
5. Close the document feeder cover to attach the white backing.

Figure 2-14 Close the document feeder cover

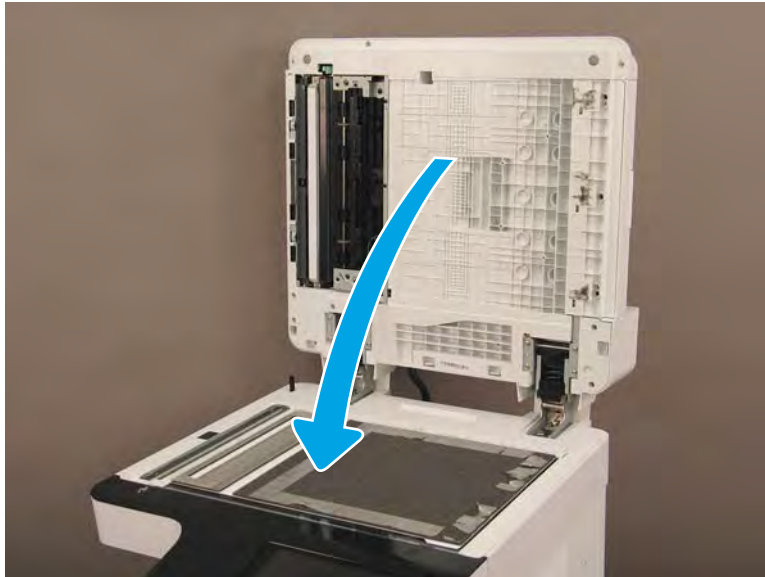

6. Open the cover again and smooth the white backing.

Figure 2-15 Smooth the white backing

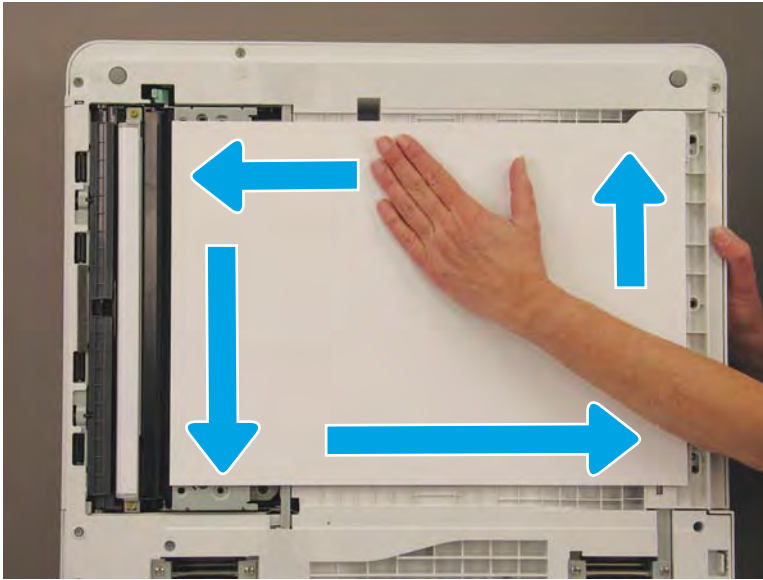

Unpack the replacement assembly



Follow these steps to unpack the replacement assembly.

1. Dispose of the defective part.

 **NOTE:** HP recommends responsible disposal of the defective part.

<http://www8.hp.com/us/en/hp-information/environment/product-recycling.html>

2. Unpack the replacement part from the packaging.

 **CAUTION:**  Some parts are sensitive to electrostatic discharge (ESD). Always perform service work at an ESD-protected workstation or mat. If an ESD workstation or mat is not available, touch the sheet-metal chassis to provide a static ground before touching an ESD-sensitive assembly. Protect the ESD-sensitive assemblies by placing them in ESD pouches when they are out of the printer.

 **IMPORTANT:** Make sure that all of the shipping materials (for example shipping tape) are removed from the replacement part prior to installation.

 **NOTE:** If the replacement part is a roller or pad, avoid touching the spongy part of it. Skin oils on the roller or pad can cause paper pickup and/or print-quality problems. HP recommends using disposable gloves when handling rollers or pads or washing your hands before touching rollers or pads.

3. To install an assembly, reverse the removal steps.

 **NOTE:** When applicable, special installation instructions are provided for an assembly at the end of the removal procedure. Always completely read the removal instructions and follow all special installation instructions.

Removal and replacement: ADF white backing (GX)

This document provides the procedures to remove the white backing assembly.

E72520-E72530:



https://players.brightcove.net/1160438706001/SyKVJeRXx_default/index.html?videoId=ref:REFIDPH0000000337

E77820-E77830:

Mean time to repair: 10 minutes

Service level: Basic



IMPORTANT: When applicable, special installation instructions are provided for an assembly at the end of the removal procedure. Always completely read the removal instructions and follow all special installation instructions.

Before performing service

- Disconnect the power cable.

Use the table below to identify the correct part number for your printer. To order the part, go to www.hp.com/buy/parts

Table 2-5 Part information

Part number	Part description
JC63-05795A	ADF White backing (GX)

Required tools

- #2 JIS screwdriver with a magnetic tip

After performing service

Turn the printer power on

- Connect the power cable.
- Use the power switch to turn the power on.

Post service test

Copy, scan, or print a document. Verify the document copies, scans, or prints correctly.

Remove the document feeder white backing

Follow these steps to remove the document feeder white backing.

1. Open the document feeder cover.
2. Peel the white backing away to remove.



IMPORTANT: Remove all the tape and foam from the bottom of the document feeder.

3. Position the new white backing on the scanner glass.
4. Peel the adhesive tape backing off the new white backing.
5. Close the document feeder cover to attach the white backing.
6. Open the cover again and smooth the white backing.

Figure 2-16 Smooth the white backing



Unpack the replacement assembly



Follow these steps to unpack the replacement assembly.

1. Dispose of the defective part.

 **NOTE:** HP recommends responsible disposal of the defective part.

<http://www8.hp.com/us/en/hp-information/environment/product-recycling.html>

2. Unpack the replacement part from the packaging.

 **CAUTION:**  Some parts are sensitive to electrostatic discharge (ESD). Always perform service work at an ESD-protected workstation or mat. If an ESD workstation or mat is not available, touch the sheet-metal chassis to provide a static ground before touching an ESD-sensitive assembly. Protect the ESD-sensitive assemblies by placing them in ESD pouches when they are out of the printer.

 **IMPORTANT:** Make sure that all of the shipping materials (for example shipping tape) are removed from the replacement part prior to installation.

 **NOTE:** If the replacement part is a roller or pad, avoid touching the spongy part of it. Skin oils on the roller or pad can cause paper pickup and/or print-quality problems. HP recommends using disposable gloves when handling rollers or pads or washing your hands before touching rollers or pads.

3. To install an assembly, reverse the removal steps.

 **NOTE:** When applicable, special installation instructions are provided for an assembly at the end of the removal procedure. Always completely read the removal instructions and follow all special installation instructions.

Removal and replacement: ADF whole unit (LX)

Learn how to remove and replace the ADF whole unit (LX bundles).

To view a short video of this procedure, click the link below.



[View a video of how to remove and replace the ADF whole unit \(LX/du bundles\).](#)



IMPORTANT: When applicable, special installation instructions are provided for an assembly at the end of the removal procedure. Always completely read the removal instructions and follow all special installation instructions.

Mean time to repair:

Service level:

Before performing service

Turn the printer power off

- Press the power button on the front of the printer, and then turn off the power switch next to the power cable.
- A shutting-down message appears on the control-panel display.



WARNING! To avoid damage to the printer, turn the power off and wait until the printer shuts down before removing the power cable.

- Disconnect the printer power cable after the printer has completely shut down (the control-panel display is blank).

Use the table below to identify the correct part number for your printer. To order the part, go to www.hp.com/buy/parts.

Table 2-6 Part information

Part number	Part description
JC97-05074A	Document feeder whole unit assembly (LX models)

Required tools

- #2 JIS screwdriver with a magnetic tip

After performing service

Turn the printer power on

- Connect the printer power cable.
- Turn on the power switch next to the power cable, and then press the power button on the front of the printer.
- Verify that the service performed was successful.

- Verify that the most recent firmware is installed on the printer.
- Verify that all parts are correctly reinstalled and are properly working.

Post service test

Print any pages necessary to verify that the repair resolved the issue and did not create any new issues.

Remove the formatter cover

Follow these steps to remove the formatter cover.

- ▲ Unscrew two captive thumbscrews on the formatter cover. Slide the formatter cover to the left, and then to the right to remove it.

Figure 2-17 Remove the formatter cover

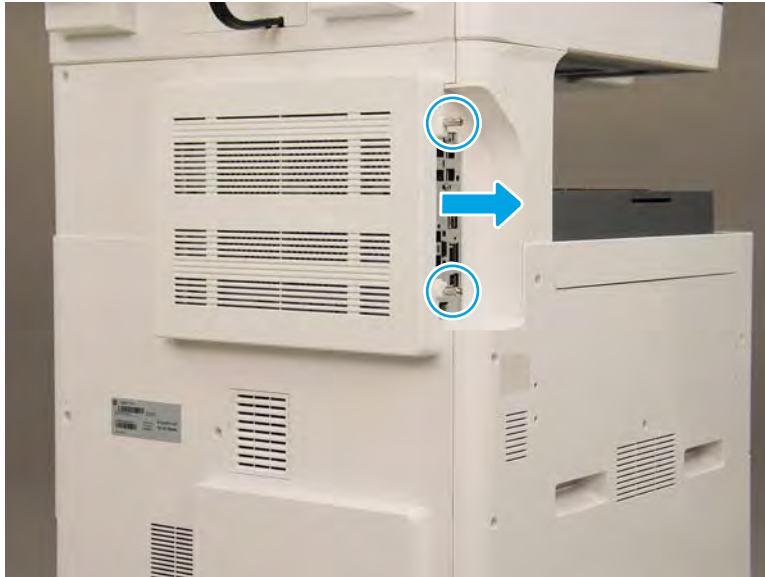

Remove the upper rear cover

Follow these steps to remove the upper rear cover.

- ▲ Remove three screw-caps and five screws. Lift the upper rear cover away from the printer to remove it.

Figure 2-18 Remove the upper rear cover

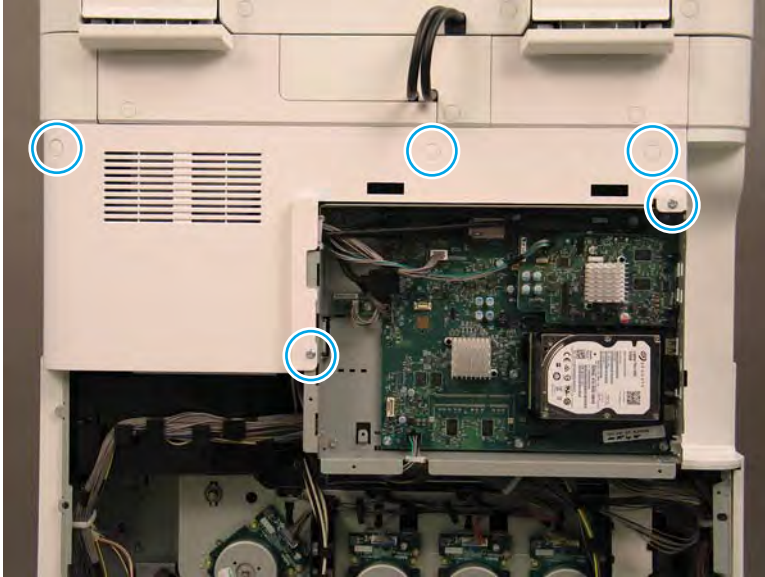

Remove the document feeder whole unit (LX)

Follow these steps to remove the document feeder whole unit (LX).

1. Remove one screw cap and screw (callout 1), and then remove the document feeder connector cover (callout 2).

Figure 2-19 Remove the document feeder connector cover

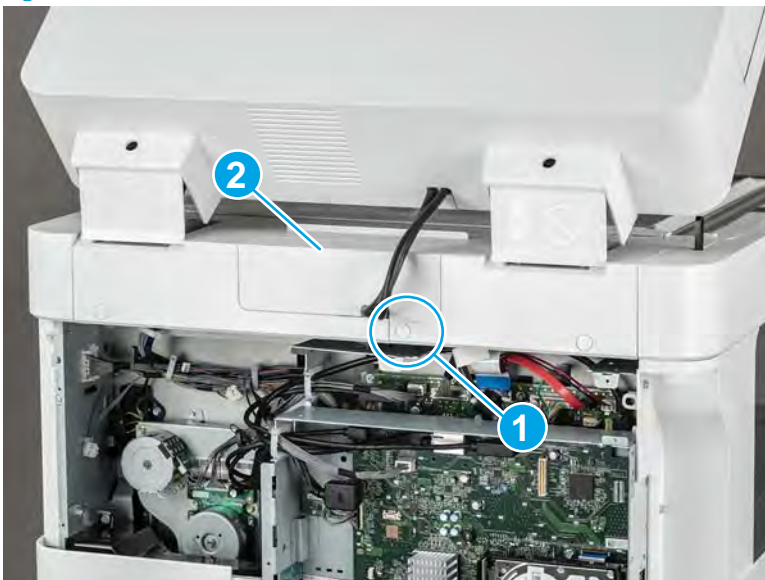

2. Remove one screw to release the ground wire (callout 1), and then disconnect three connectors (callout 2).

Figure 2-20 Remove the document feeder harness and ground wire

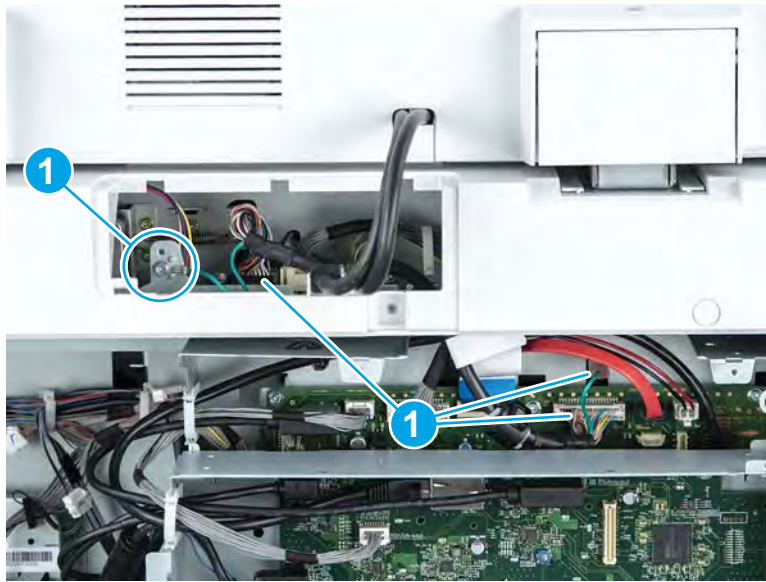

3. Disconnect the document feeder harness from the PCA - ADF HIC. Remove one connector and one grounding wire.
4. Release one screw on each hinge stop on the back of the document feeder.

Figure 2-21 Release the document feeder hinge screws



5. Remove two screws. Slide the assembly back, and then lift the document feeder to remove.

Figure 2-22 Lift and remove the document feeder

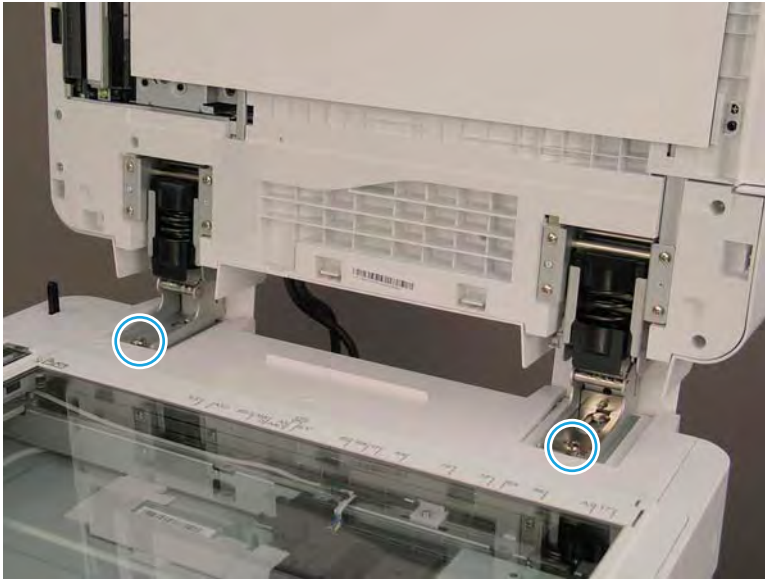

 **NOTE:** Complete a shading test and a skew alignment after replacing the document feeder unit.

Unpack the replacement assembly



Follow these steps to unpack the replacement assembly.

1. Dispose of the defective part.

 **NOTE:** HP recommends responsible disposal of the defective part.

<http://www8.hp.com/us/en/hp-information/environment/product-recycling.html>

2. Unpack the replacement part from the packaging.

 **CAUTION:**  Some parts are sensitive to electrostatic discharge (ESD). Always perform service work at an ESD-protected workstation or mat. If an ESD workstation or mat is not available, touch the sheet-metal chassis to provide a static ground before touching an ESD-sensitive assembly. Protect the ESD-sensitive assemblies by placing them in ESD pouches when they are out of the printer.

 **IMPORTANT:** Make sure that all of the shipping materials (for example shipping tape) are removed from the replacement part prior to installation.

 **NOTE:** If the replacement part is a roller or pad, avoid touching the spongy part of it. Skin oils on the roller or pad can cause paper pickup and/or print-quality problems. HP recommends using disposable gloves when handling rollers or pads or washing your hands before touching rollers or pads.

3. To install an assembly, reverse the removal steps.

 **NOTE:** When applicable, special installation instructions are provided for an assembly at the end of the removal procedure. Always completely read the removal instructions and follow all special installation instructions.

Removal and replacement: Flow ADF whole unit (GX)

This document provides the procedures to remove the document feeder whole unit assembly.

Mean time to repair: 5 minutes

Service level: Basic

 **IMPORTANT:** When applicable, special installation instructions are provided for an assembly at the end of the removal procedure. Always completely read the removal instructions and follow all special installation instructions.

Before performing service

- Disconnect the power cable.

Use the table below to identify the correct part number for your printer. To order the part, go to www.hp.com/buy/parts

Table 2-7 Part information

Part number	Part description
JC97-04955A	ADF whole unit assembly (GX/z models)

Required tools

- #2 JIS screwdriver with a magnetic tip

After performing service

Turn the printer power on

- Connect the power cable.
- Use the power switch to turn the power on.

Post service test

Copy, scan, or print a document. Verify the document copies, scans, or prints correctly.

Remove the formatter cover

Follow these steps to remove the formatter cover.

- ▲ Unscrew two captive thumbscrews on the formatter cover. Slide the formatter cover to the left, and then to the right to remove it.

Figure 2-23 Remove the formatter cover

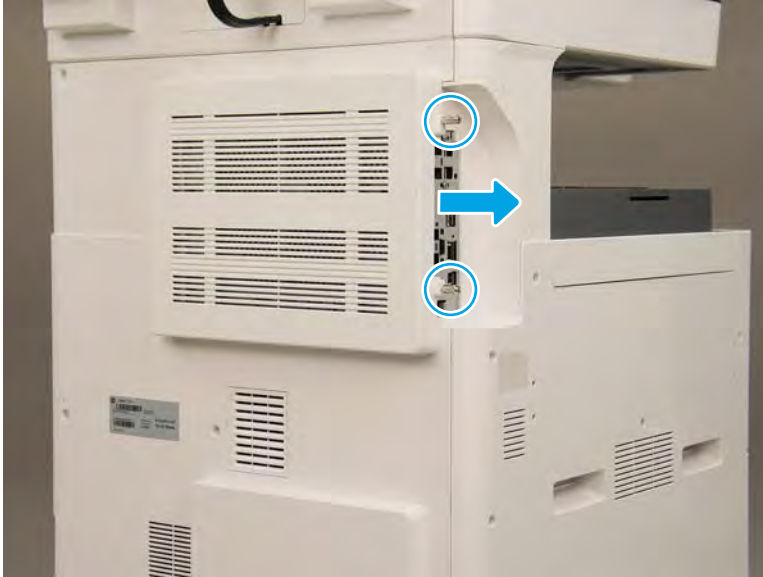

Remove the upper rear cover

Follow these steps to remove the upper rear cover.

- ▲ Remove three screw-caps and five screws. Lift the upper rear cover away from the printer to remove it.

Figure 2-24 Remove the upper rear cover

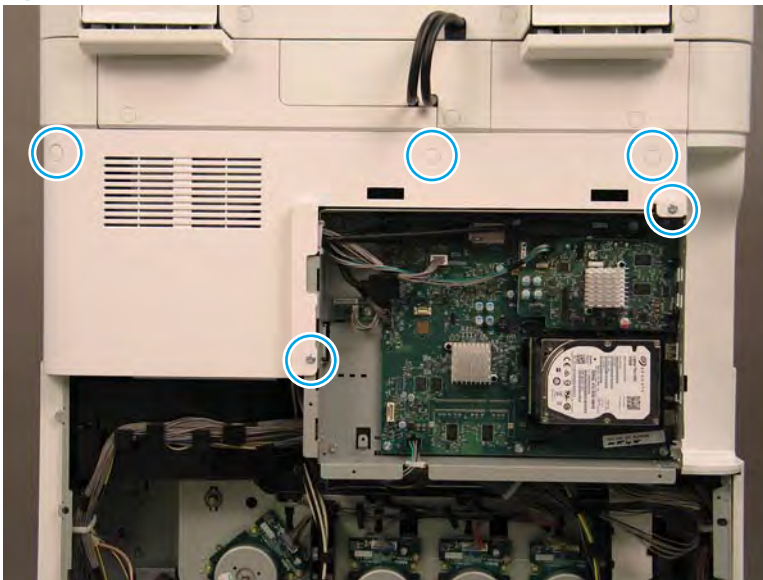

Remove the document feeder whole unit (GX)

Follow these steps to remove the document feeder whole unit (GX).

1. Open the document feeder cover, and then remove the document feeder connector cover.

Figure 2-25 Remove document feeder connector cover

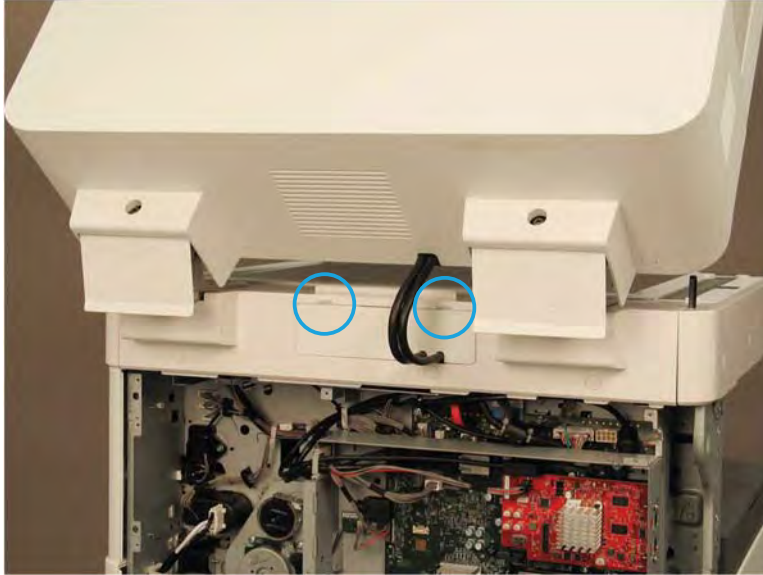

2. Remove the plastic cable choke from the wire harness, and then disconnect the document feeder harness from the main board. Disconnect the insulated ground wire from the chassis.

Figure 2-26 Remove the cable choke

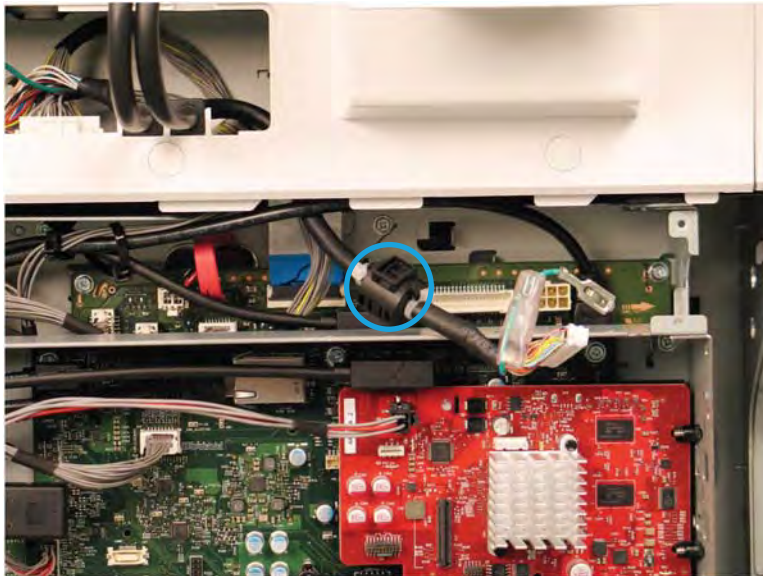

3. Disconnect the document feeder harness from the scanner PCA. Remove one connector and one grounding wire.

Figure 2-27 Disconnect document feeder harness

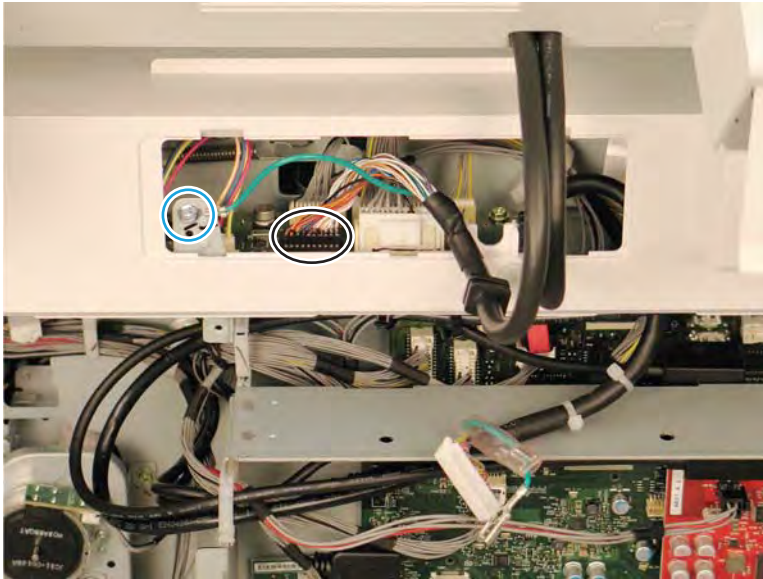

4. Release two hinge stops on the back of the document feeder to allow the document feeder to open to a full 90°.

 **IMPORTANT:** Note the alignment marks on the hinge stops. Any new document feeder must be reinstalled with the same alignment.

Figure 2-28 Alignment marks

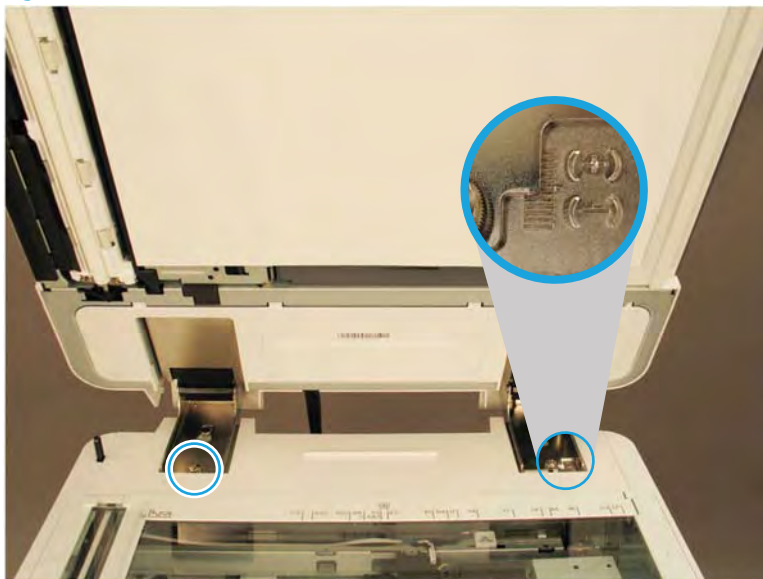

5. Remove two screws on each hinge stop.

Figure 2-29 Remove screws

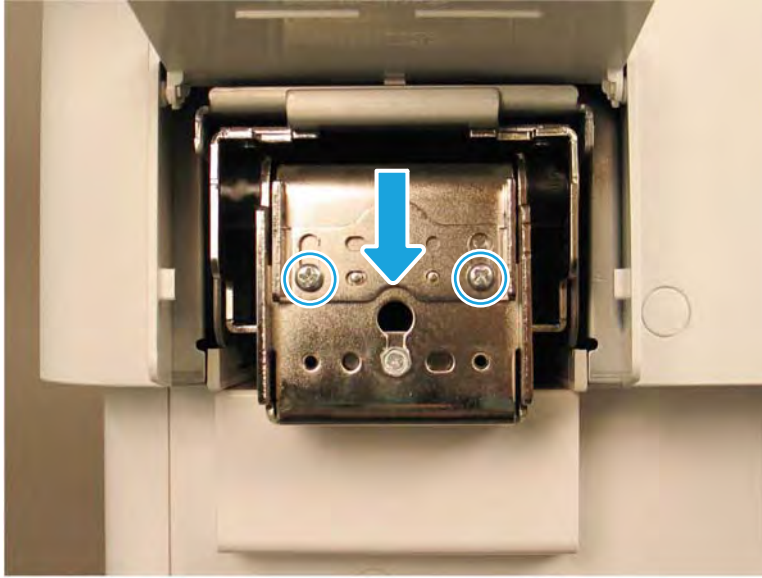

6. Pull back and then lift up to release the document feeder unit.

Figure 2-30 Release the document feeder



 **NOTE:** Complete a shading test and a skew alignment after replacing the document feeder unit.

Unpack the replacement assembly

Follow these steps to unpack the replacement assembly.

1. Dispose of the defective part.

 **NOTE:** HP recommends responsible disposal of the defective part.

<http://www8.hp.com/us/en/hp-information/environment/product-recycling.html>

2. Unpack the replacement part from the packaging.



CAUTION:



Some parts are sensitive to electrostatic discharge (ESD). Always perform service work at an ESD-protected workstation or mat. If an ESD workstation or mat is not available, touch the sheet-metal chassis to provide a static ground before touching an ESD-sensitive assembly. Protect the ESD-sensitive assemblies by placing them in ESD pouches when they are out of the printer.



IMPORTANT: Make sure that all of the shipping materials (for example shipping tape) are removed from the replacement part prior to installation.



NOTE: If the replacement part is a roller or pad, avoid touching the spongy part of it. Skin oils on the roller or pad can cause paper pickup and/or print-quality problems. HP recommends using disposable gloves when handling rollers or pads or washing your hands before touching rollers or pads.

3. To install an assembly, reverse the removal steps.



NOTE: When applicable, special installation instructions are provided for an assembly at the end of the removal procedure. Always completely read the removal instructions and follow all special installation instructions.

Removal and replacement: Flow ADF whole unit (GX)

This document provides the procedures to remove the document feeder whole unit assembly.

Mean time to repair: 5 minutes

Service level: Basic

 **IMPORTANT:** When applicable, special installation instructions are provided for an assembly at the end of the removal procedure. Always completely read the removal instructions and follow all special installation instructions.

Before performing service

- Disconnect the power cable.

Use the table below to identify the correct part number for your printer. To order the part, go to www.hp.com/buy/parts

Table 2-8 Part information

Part number	Part description
JC97-04955A	ADF whole unit assembly (GX/z models)

Required tools

- #2 JIS screwdriver with a magnetic tip

After performing service

Turn the printer power on

- Connect the power cable.
- Use the power switch to turn the power on.

Post service test

Copy, scan, or print a document. Verify the document copies, scans, or prints correctly.

Remove the formatter cover

Follow these steps to remove the formatter cover.

- ▲ Unscrew two captive thumbscrews on the formatter cover. Slide the formatter cover to the left, and then to the right to remove it.

Figure 2-31 Remove the formatter cover

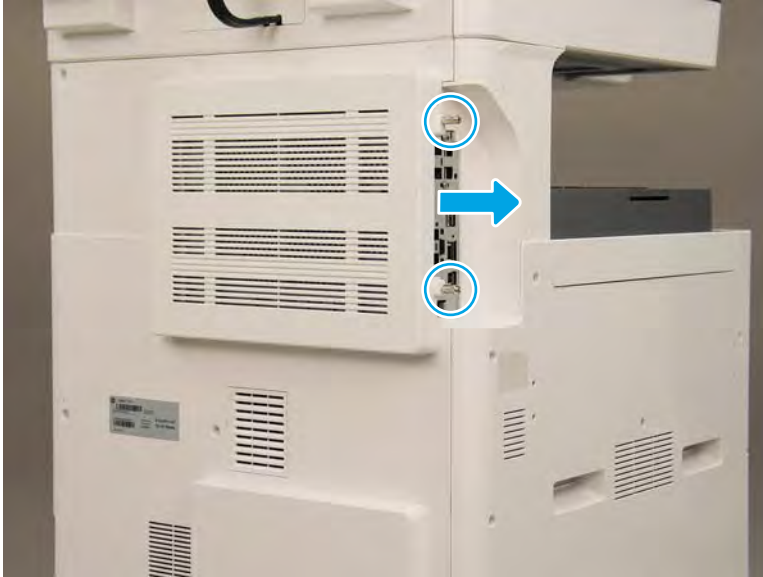

Remove the upper rear cover

Follow these steps to remove the upper rear cover.

- ▲ Remove three screw-caps and five screws. Lift the upper rear cover away from the printer to remove it.

Figure 2-32 Remove the upper rear cover

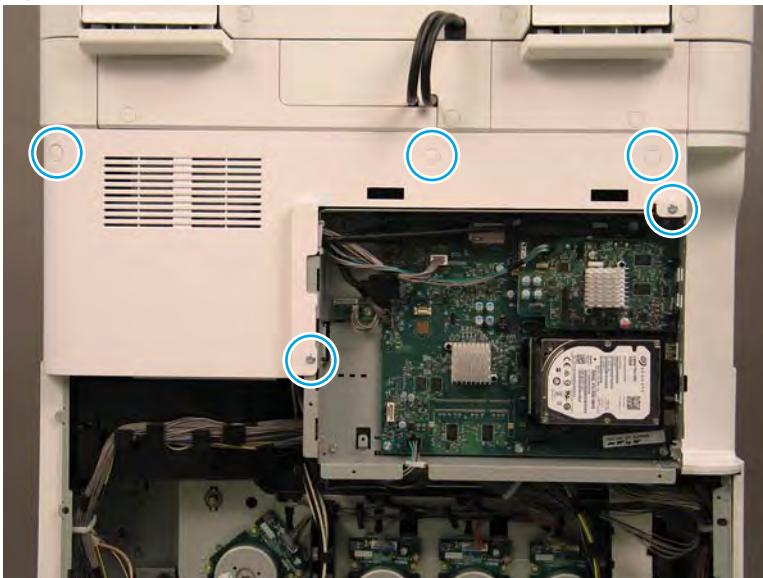

Remove the document feeder whole unit (GX)

Follow these steps to remove the document feeder whole unit (GX).

1. Open the document feeder cover, and then remove the document feeder connector cover.

Figure 2-33 Remove document feeder connector cover

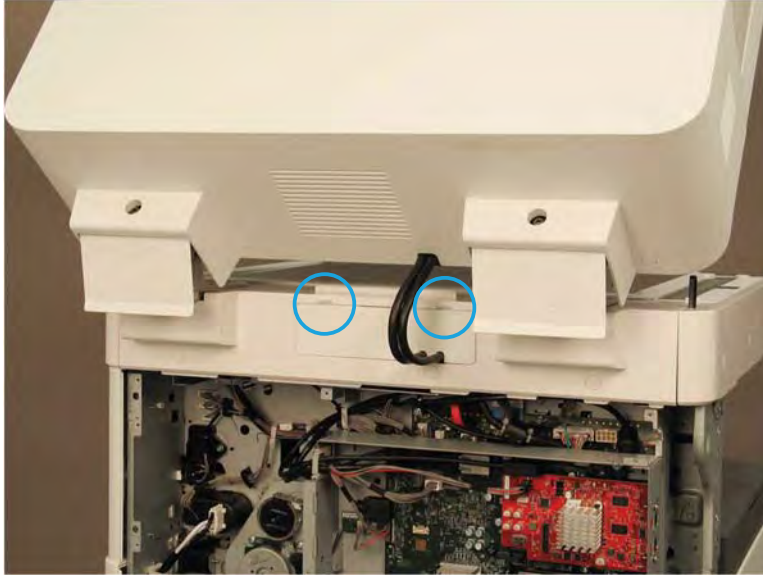

2. Remove the plastic cable choke from the wire harness, and then disconnect the document feeder harness from the main board. Disconnect the insulated ground wire from the chassis.

Figure 2-34 Remove the cable choke

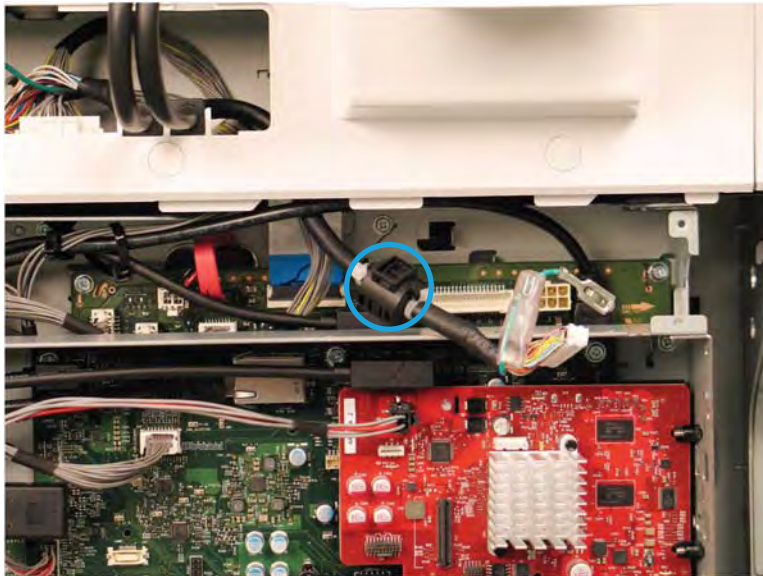

3. Disconnect the document feeder harness from the scanner PCA. Remove one connector and one grounding wire.

Figure 2-35 Disconnect document feeder harness

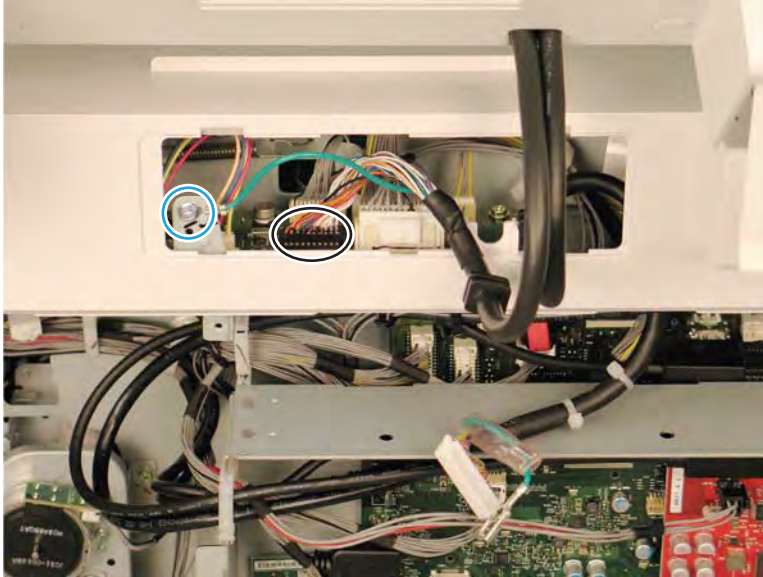

4. Release two hinge stops on the back of the document feeder to allow the document feeder to open to a full 90°.

 **IMPORTANT:** Note the alignment marks on the hinge stops. Any new document feeder must be reinstalled with the same alignment.

Figure 2-36 Alignment marks

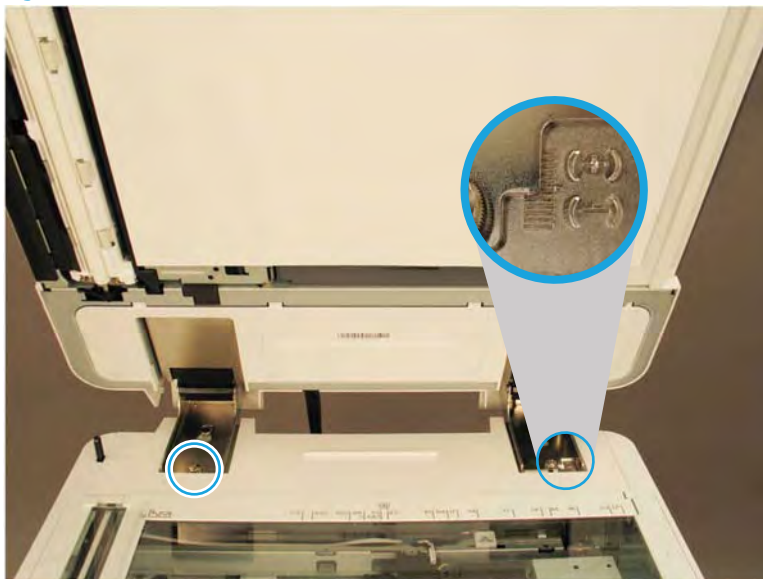

5. Remove two screws on each hinge stop.

Figure 2-37 Remove screws

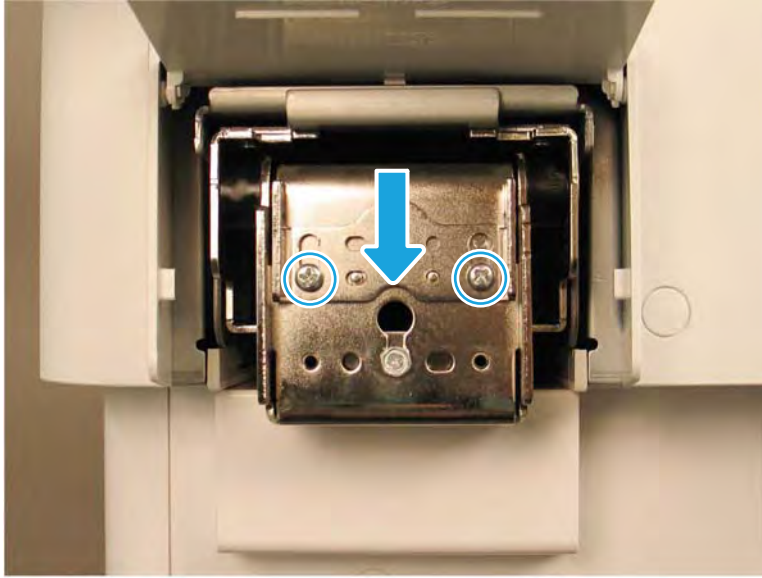

6. Pull back and then lift up to release the document feeder unit.

Figure 2-38 Release the document feeder

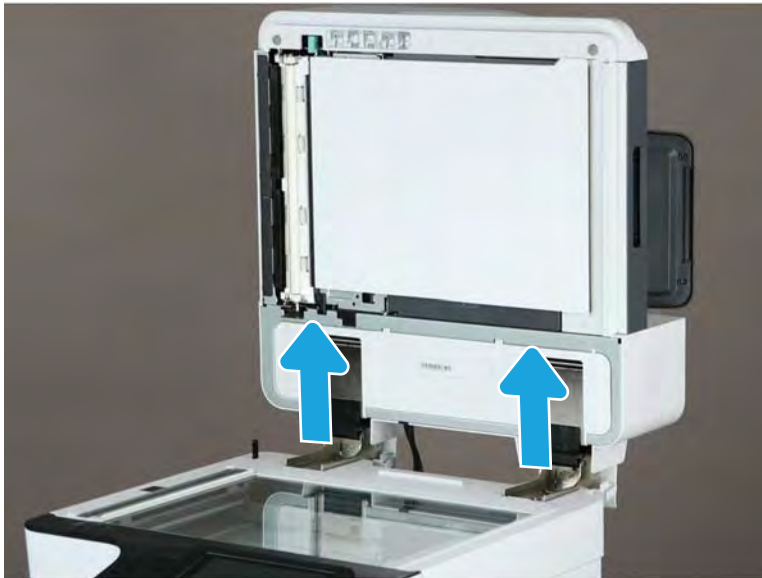

 **NOTE:** Complete a shading test and a skew alignment after replacing the document feeder unit.

Unpack the replacement assembly

Follow these steps to unpack the replacement assembly.

1. Dispose of the defective part.

 **NOTE:** HP recommends responsible disposal of the defective part.

<http://www8.hp.com/us/en/hp-information/environment/product-recycling.html>

2. Unpack the replacement part from the packaging.



CAUTION:  Some parts are sensitive to electrostatic discharge (ESD). Always perform service work at an ESD-protected workstation or mat. If an ESD workstation or mat is not available, touch the sheet-metal chassis to provide a static ground before touching an ESD-sensitive assembly. Protect the ESD-sensitive assemblies by placing them in ESD pouches when they are out of the printer.

 **IMPORTANT:** Make sure that all of the shipping materials (for example shipping tape) are removed from the replacement part prior to installation.

 **NOTE:** If the replacement part is a roller or pad, avoid touching the spongy part of it. Skin oils on the roller or pad can cause paper pickup and/or print-quality problems. HP recommends using disposable gloves when handling rollers or pads or washing your hands before touching rollers or pads.

3. To install an assembly, reverse the removal steps.

 **NOTE:** When applicable, special installation instructions are provided for an assembly at the end of the removal procedure. Always completely read the removal instructions and follow all special installation instructions.

Removal and replacement: Image scanner assembly (flatbed)

This document provides the procedures to remove the scanner whole unit.



[View a video of removing and replacing the image scanner \(E77820-E77830\).](#)

Mean time to repair: 30 minutes

Service level: Advanced



IMPORTANT: When applicable, special installation instructions are provided for an assembly at the end of the removal procedure. Always completely read the removal instructions and follow all special installation instructions.

Before performing service

- Disconnect the power cable.

Use the table below to identify the correct part number for your printer. To order the part, go to www.hp.com/buy/parts

Table 2-9 Part information

Part number	Part description
JC97-04520C	Scanner whole unit part number

Required tools

- #2 JIS screwdriver with a magnetic tip

After performing service

Turn the printer power on

- Connect the power cable.
- Use the power switch to turn the power on.

Post service test

Copy, scan, or print a document. Verify the document copies, scans, or prints correctly.

Remove the scanner whole unit

Follow these steps to remove the scanner whole unit.

1. Open the document feeder cover, and then remove the document feeder connector cover.

Figure 2-39 Remove document feeder connector cover



2. Remove the plastic cable choke from the wire harness, and then disconnect the document feeder harness from the main board. Disconnect the insulated ground wire from the chassis.

Figure 2-40 Remove the cable choke



3. Disconnect the document feeder harness from the PCA - ADF HIC. Remove one connector and one and one grounding wire.

Figure 2-41 Disconnect document feeder harness



4. Release two hinge stops on the back of the document feeder to allow the document feeder to open to a full 90°.

 **IMPORTANT:** If installing a replacement document feeder, note the alignment marks on the hinge stops. Any new document feeder must be reinstalled with the same alignment.

Figure 2-42 Alignment marks



5. Remove two screws on each hinge stop.

Figure 2-43 Remove screws

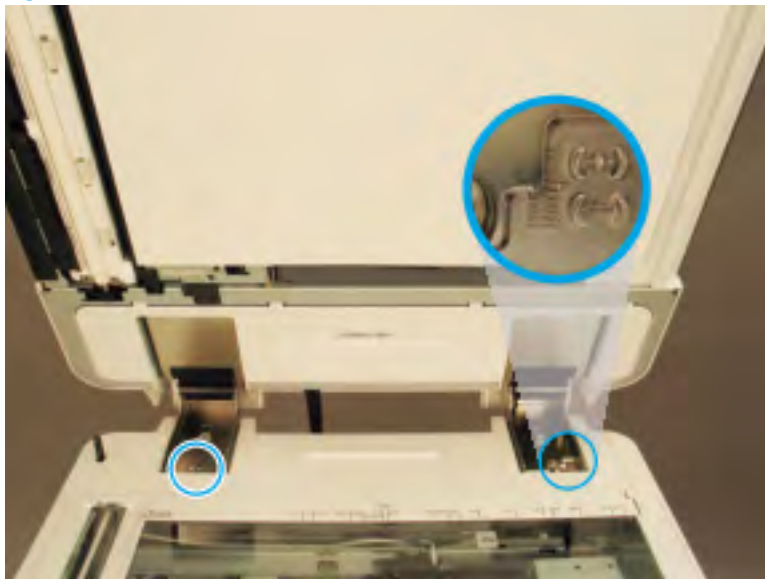
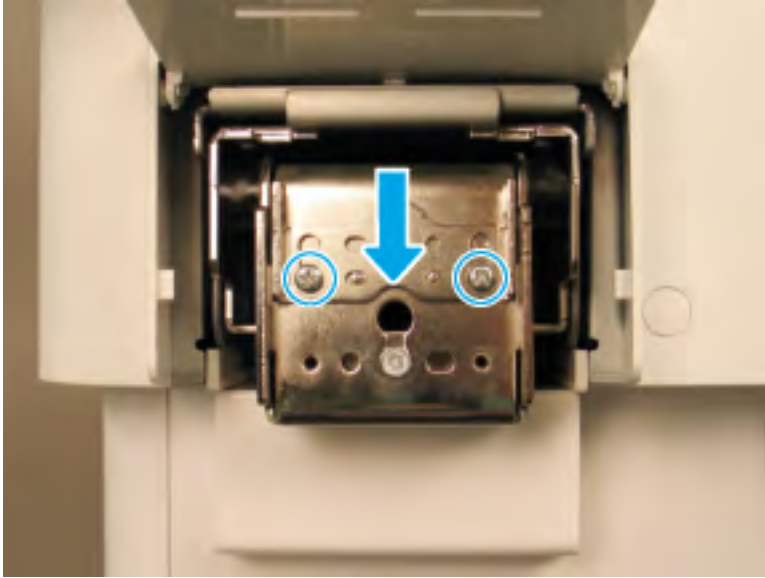

6. Pull back and then lift up to release the document feeder unit.

Figure 2-44 Release the document feeder

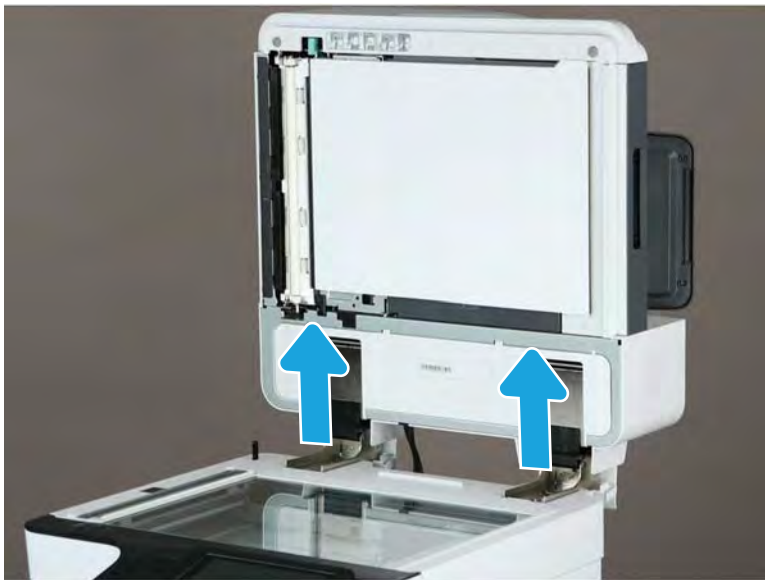

 **NOTE:** Complete a shading test and a skew alignment after replacing the document feeder unit.

7. Remove three screws.

Figure 2-45 Remove three screws



8. Place the control panel in the upright position.
9. Gently pry the control-panel bezel from the center screw hole, and then pry from the center of the control-panel bezel to the edges to release.

⚠ CAUTION: Do not pry against the scanner glass when removing the control-panel bezel.

10. Remove two screws on the control-panel frame.

Figure 2-46 Remove two screws



11. Disconnect one FFC, one connector, the HIP USB cable, and one HDMI connector.

12. Remove the USB interconnect cable from its retainer and reroute out of the way.

Figure 2-47 Remove USB interconnect cable



13. Slide the keyboard out, and then depress two latches to remove the keyboard.

Figure 2-48 Remove the keyboard



14. Lift the control panel up from the front to release the tabs at the rear, and then remove the control panel.

 **TIP:** Align the four tabs at the rear of the control panel, and then snap in the control panel.

15. Remove six screw-caps and six screws. It might be necessary to use leverage near the left hinge and then pull the cover toward the back.

Figure 2-49 Remove screw-caps and screws and release scan-front cover

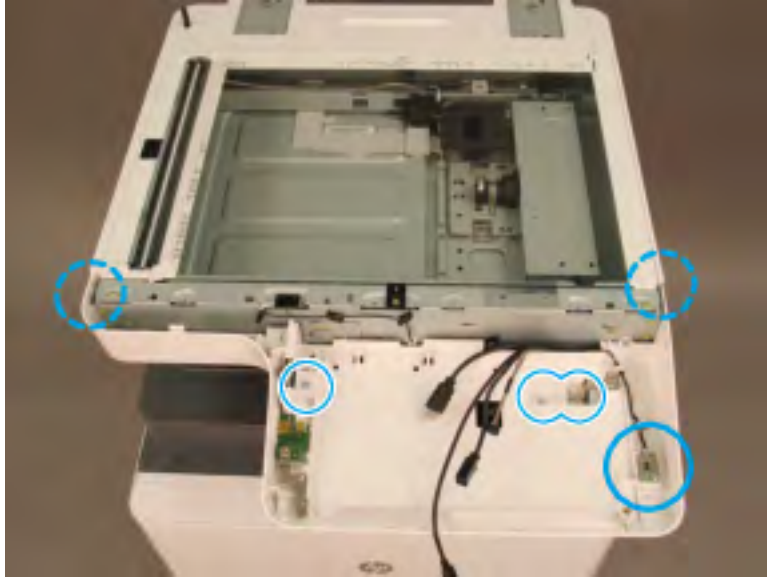

16. Remove three screw-caps and three screws. Release the scan-left cover.

Figure 2-50 Release scan-left cover

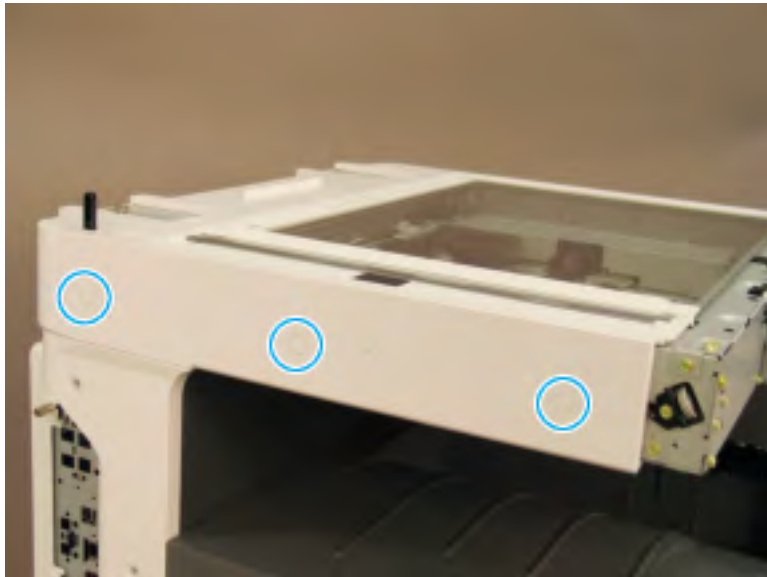

17. Remove three screw-caps and three screws (callout 1). Release the scan-right cover.

 **NOTE:** At the front of the scanner, remove the bracket (callout 2) and install it on the replacement scanner whole unit.

Figure 2-51 Remove scan-right cover

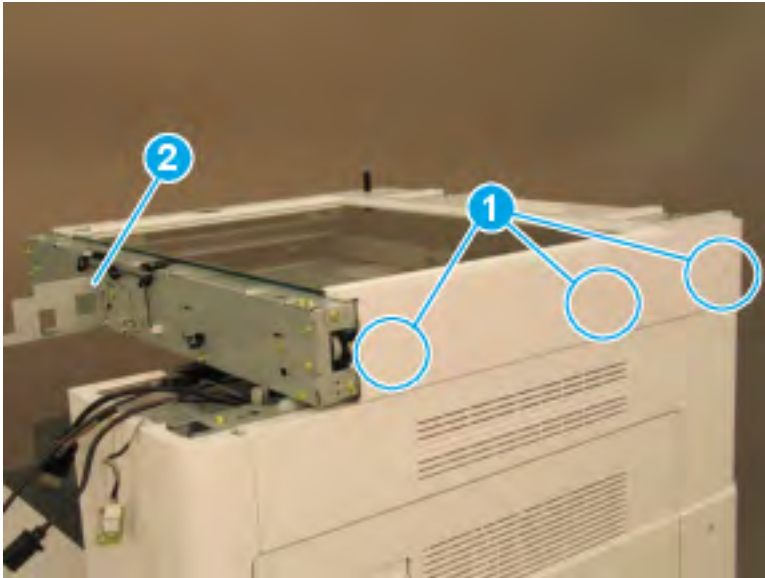

18. Remove two screws.

Figure 2-52 Remove two screws

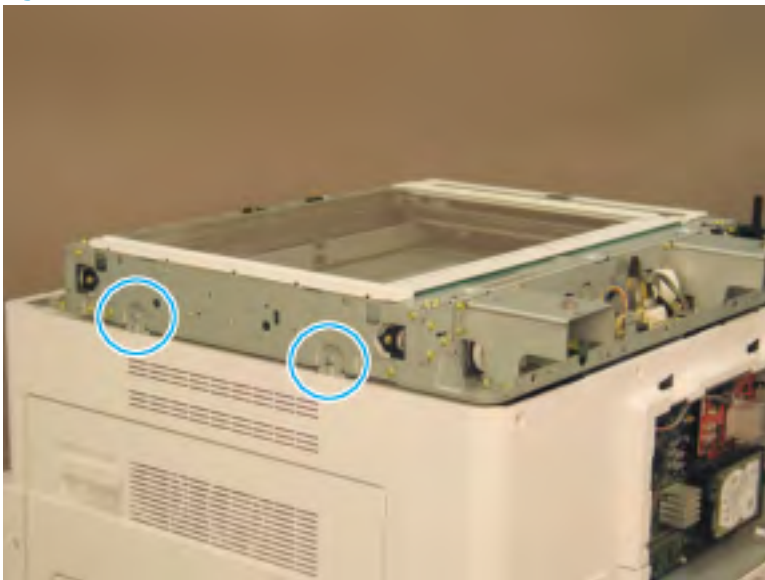

19. Disconnect the two scan cables and one FFC at the top of the main board.

Figure 2-53 Disconnect scan cables



20. Remove three screws. Lift the scanner straight up and off of the printer to remove it.

 **NOTE:** After reassembly, utilize the target to adjust the scanner location as necessary.

 **Reinstallation tip:** Reinstall the scan bed by lowering the left side first and then lower the right. Align the screw holes on the right, and then install the screws.

Reinstall the lower cover and ensure the cables are routed through the opening for the control panel and the bracket is properly aligned in the cover.

Figure 2-54 Remove three screws

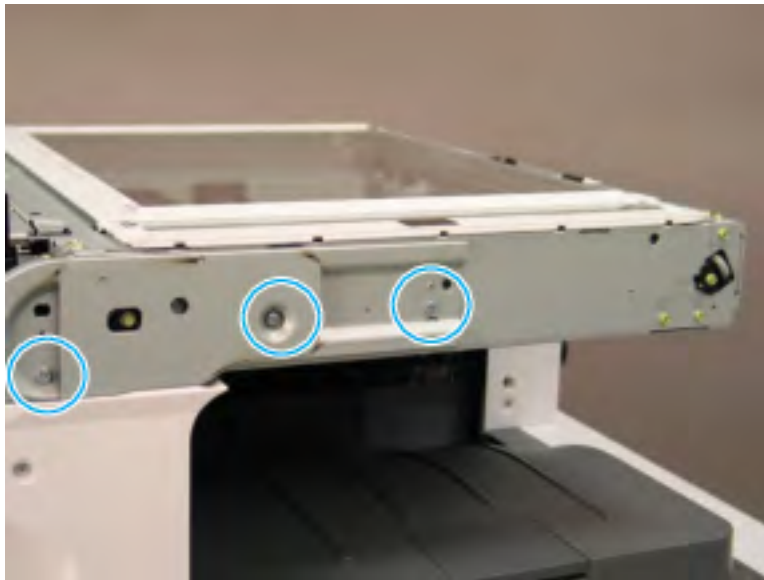

Removal and replacement: Feed sensor 1

This document provides the procedures to remove the feed sensor 1.



[View a video of removing and replacing the feed sensor 1.](#)

Mean time to repair: 10 minutes

Service level: Basic



IMPORTANT: When applicable, special installation instructions are provided for an assembly at the end of the removal procedure. Always completely read the removal instructions and follow all special installation instructions.

Before performing service

- Disconnect the power cable.

Use the table below to identify the correct part number for your printer. To order the part, go to www.hp.com/buy/parts

Table 2-10 Part information

Part number	Part description
0604-001393	Feed sensor 1

Required tools

- #2 JIS screwdriver with a magnetic tip

After performing service

Turn the printer power on

- Connect the power cable.
- Use the power switch to turn the power on.

Post service test

Copy, scan, or print a document. Verify the document copies, scans, or prints correctly.

Remove the right door

Follow these steps to remove the right door.



NOTE: Remove second exit drive if installed.

1. Remove three screws, and then remove the cover (A).

Figure 2-55 Remove cover

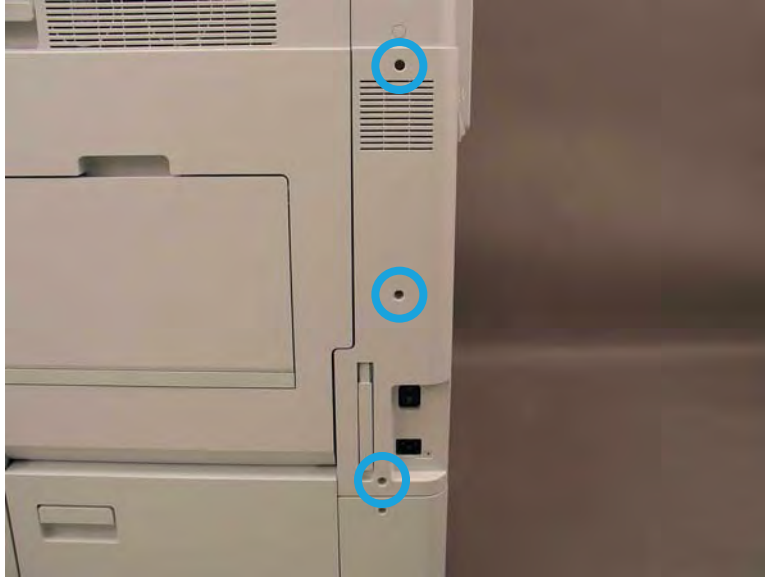

2. Disconnect the right door connector.

Figure 2-56 Disconnect right door connector



3. Release the right hinge (callout 1).

⚠ CAUTION: The right hinge spring tension can be dangerous. Use caution when releasing the right hinge to avoid injury.

Figure 2-57 Release right hinge

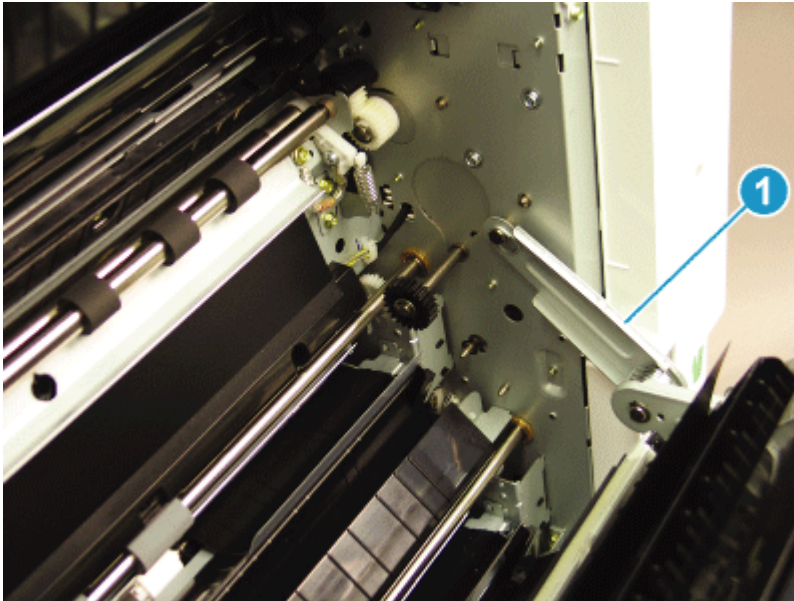

4. Release the left dampener (callout 1).

Figure 2-58 Release left dampener

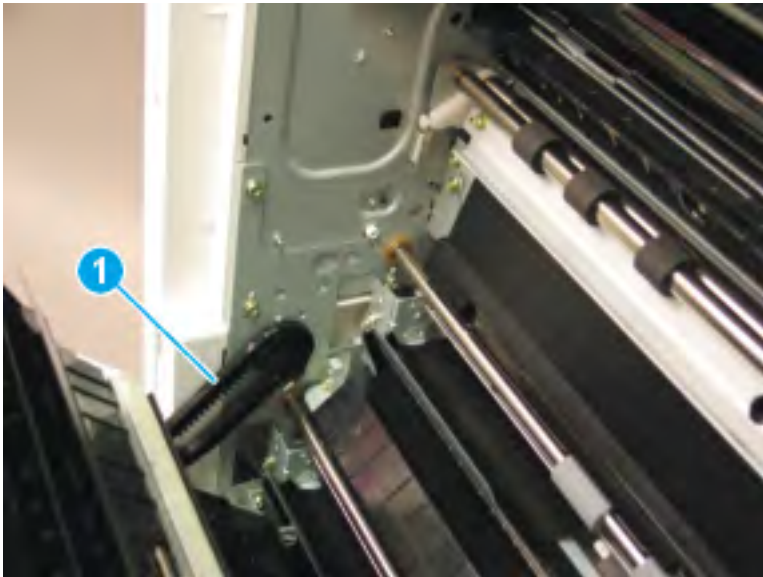

5. Remove the right door.

 **NOTE:** Open the lower access door. If there is an HCl or 2x520 input device, release the dampener to clear the lower right door. Remove clockwise.

Figure 2-59 Remove right door



Remove feed sensor 1

Follow these steps to remove feed sensor 1.

1. Remove two screws, and then remove the sensor cover.

Figure 2-60 Remove screws and sensor cover

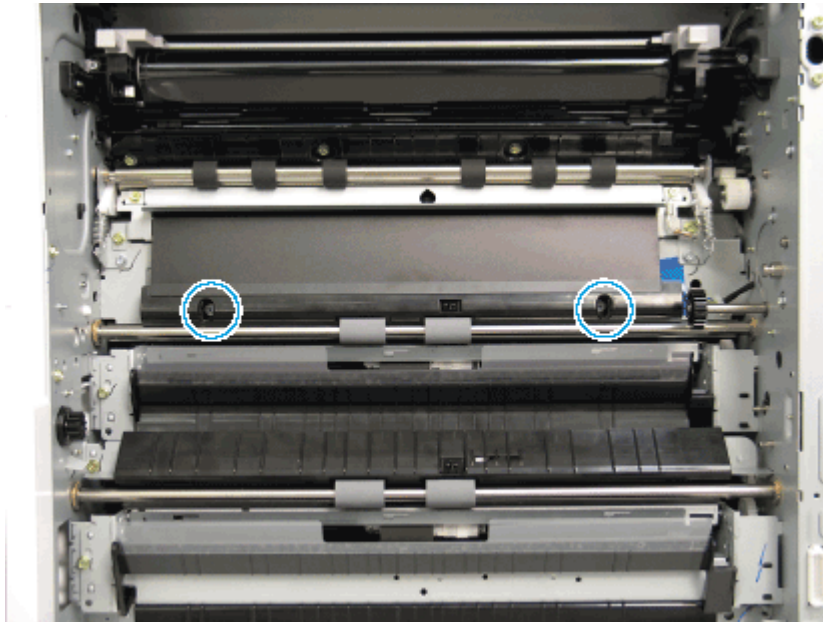

2. Disconnect the connector, remove one screw, and then remove the feed sensor cover.

Figure 2-61 Remove feed sensor

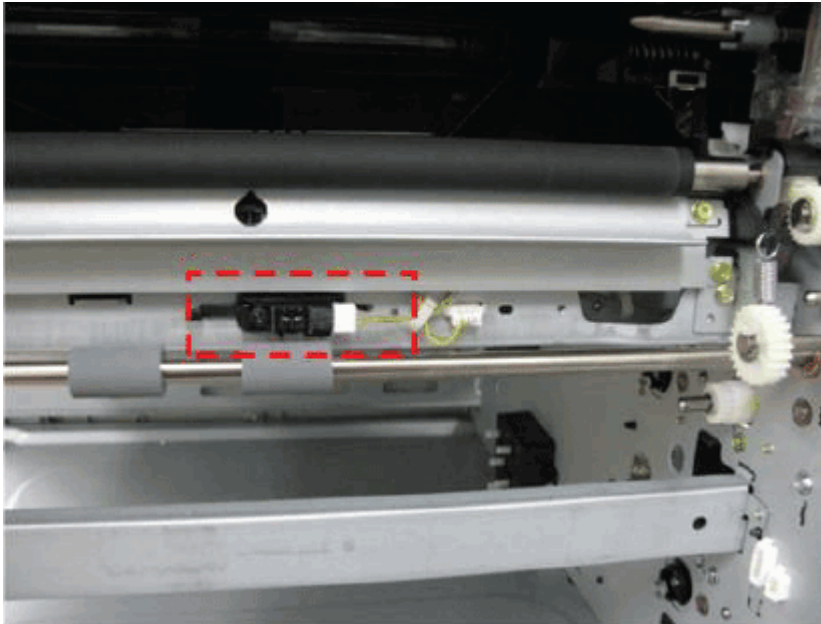

Unpack the replacement assembly



Follow these steps to unpack the replacement assembly.

1. Dispose of the defective part.

 **NOTE:** HP recommends responsible disposal of the defective part.

<http://www8.hp.com/us/en/hp-information/environment/product-recycling.html>

2. Unpack the replacement part from the packaging.

 **CAUTION:**  Some parts are sensitive to electrostatic discharge (ESD). Always perform service work at an ESD-protected workstation or mat. If an ESD workstation or mat is not available, touch the sheet-metal chassis to provide a static ground before touching an ESD-sensitive assembly. Protect the ESD-sensitive assemblies by placing them in ESD pouches when they are out of the printer.

 **IMPORTANT:** Make sure that all of the shipping materials (for example shipping tape) are removed from the replacement part prior to installation.

 **NOTE:** If the replacement part is a roller or pad, avoid touching the spongy part of it. Skin oils on the roller or pad can cause paper pickup and/or print-quality problems. HP recommends using disposable gloves when handling rollers or pads or washing your hands before touching rollers or pads.

3. To install an assembly, reverse the removal steps.

 **NOTE:** When applicable, special installation instructions are provided for an assembly at the end of the removal procedure. Always completely read the removal instructions and follow all special installation instructions.

Removal and replacement: Feed sensor 2

This document provides the procedures to remove the feed sensor 2.



[View a video of removing and replacing the feed sensor 2.](#)

Mean time to repair: 10 minutes

Service level: Basic



IMPORTANT: When applicable, special installation instructions are provided for an assembly at the end of the removal procedure. Always completely read the removal instructions and follow all special installation instructions.

Before performing service

- Disconnect the power cable.

Use the table below to identify the correct part number for your printer. To order the part, go to www.hp.com/buy/parts

Table 2-11 Part information

Part number	Part description
0604-001393	Feed sensor 2

Required tools

- #2 JIS screwdriver with a magnetic tip

After performing service

Turn the printer power on

- Connect the power cable.
- Use the power switch to turn the power on.

Post service test

Copy, scan, or print a document. Verify the document copies, scans, or prints correctly.

Remove the right door

Follow these steps to remove the right door.



NOTE: Remove second exit drive if installed.

1. Remove three screws, and then remove the cover (A).

Figure 2-62 Remove cover

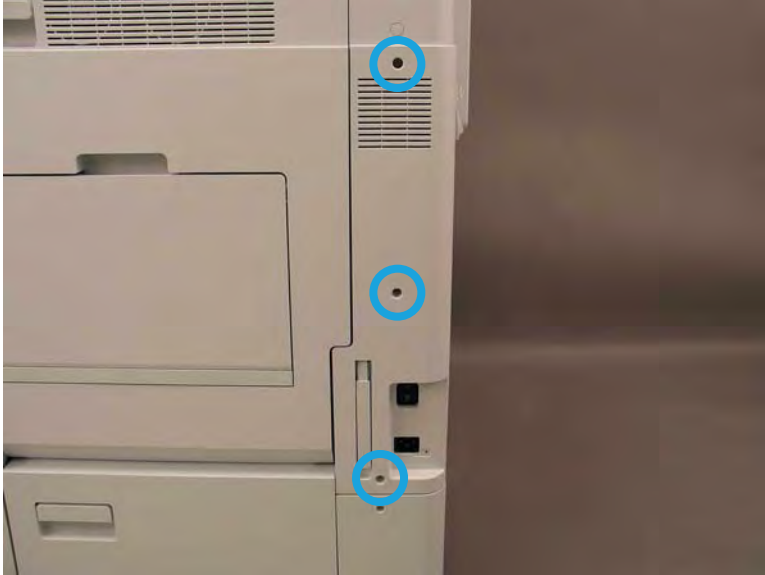

2. Disconnect the right door connector.

Figure 2-63 Disconnect right door connector



3. Release the right hinge (callout 1).

⚠ CAUTION: The right hinge spring tension can be dangerous. Use caution when releasing the right hinge to avoid injury.

Figure 2-64 Release right hinge

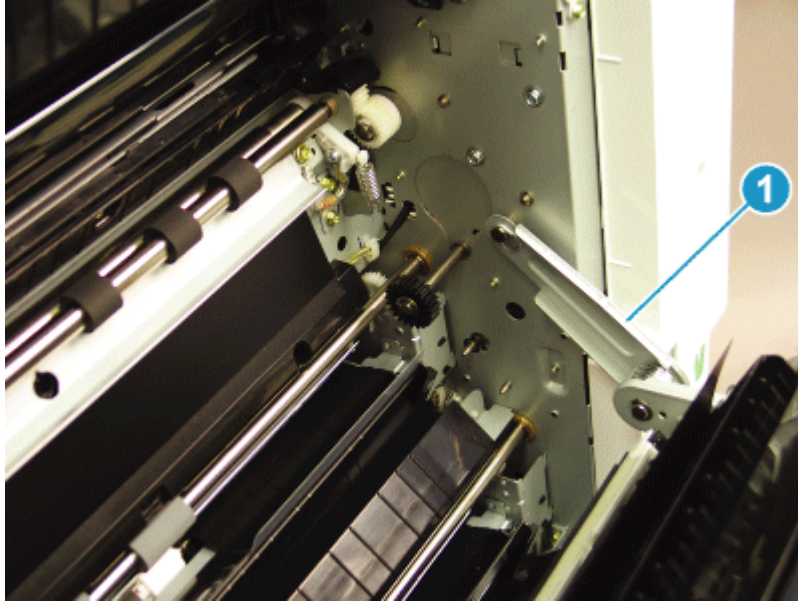

4. Release the left dampener (callout 1).

Figure 2-65 Release left dampener

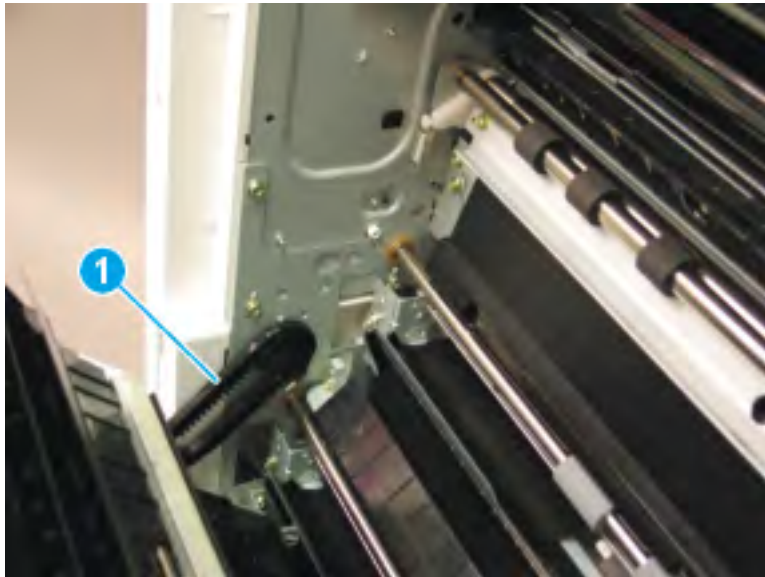

5. Remove the right door.

 **NOTE:** Open the lower access door. If there is an HCI or 2x520 input device, release the dampener to clear the lower right door. Remove clockwise.

Figure 2-66 Remove right door



Remove feed sensor 2

Follow these steps to remove feed sensor 2.

1. Remove one screw, and then remove the Feed Unit (A).

Figure 2-67 Remove screw and feed unit

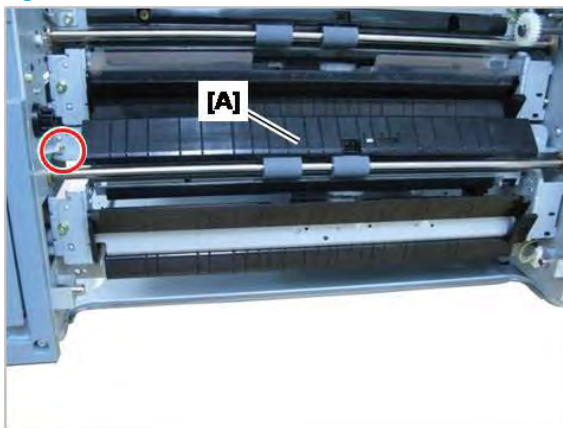

2. Remove three screws, and then remove the bracket (B).

Figure 2-68 Remove screws and bracket

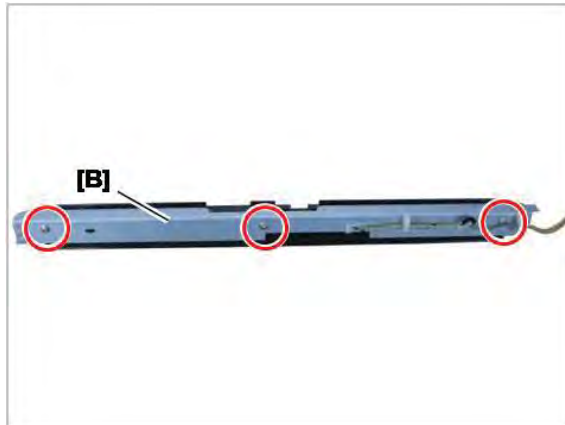

3. Disconnect the connector, and then remove the feed sensor 2.

Figure 2-69 Remove feed sensor 2



Unpack the replacement assembly

Follow these steps to unpack the replacement assembly.

1. Dispose of the defective part.

 **NOTE:** HP recommends responsible disposal of the defective part.

<http://www8.hp.com/us/en/hp-information/environment/product-recycling.html>

2. Unpack the replacement part from the packaging.



CAUTION:  Some parts are sensitive to electrostatic discharge (ESD). Always perform service work at an ESD-protected workstation or mat. If an ESD workstation or mat is not available, touch the sheet-metal chassis to provide a static ground before touching an ESD-sensitive assembly. Protect the ESD-sensitive assemblies by placing them in ESD pouches when they are out of the printer.

 **IMPORTANT:** Make sure that all of the shipping materials (for example shipping tape) are removed from the replacement part prior to installation.

 **NOTE:** If the replacement part is a roller or pad, avoid touching the spongy part of it. Skin oils on the roller or pad can cause paper pickup and/or print-quality problems. HP recommends using disposable gloves when handling rollers or pads or washing your hands before touching rollers or pads.

3. To install an assembly, reverse the removal steps.

 **NOTE:** When applicable, special installation instructions are provided for an assembly at the end of the removal procedure. Always completely read the removal instructions and follow all special installation instructions.

Removal and replacement: Exit unit

This document provides the procedures to remove the exit unit assembly.



https://players.brightcove.net/1160438706001/SyKVJeRXx_default/index.html?videoId=ref:REFIDPH0000000294

Mean time to repair: 10 minutes

Service level: Basic



IMPORTANT: When applicable, special installation instructions are provided for an assembly at the end of the removal procedure. Always completely read the removal instructions and follow all special installation instructions.

Before performing service

- Disconnect the power cable.

Use the table below to identify the correct part number for your printer. To order the part, go to www.hp.com/buy/parts

Table 2-12 Part information

Part number	Part description
JC90-01118B	Exit unit assembly

Required tools

- #2 JIS screwdriver with a magnetic tip

After performing service

Turn the printer power on

- Connect the power cable.
- Use the power switch to turn the power on.

Post service test

Copy, scan, or print a document. Verify the document copies, scans, or prints correctly.

Remove the exit unit

Follow these steps to remove the exit unit.



NOTE: Remove second exit drive if installed.

1. Open the right door. Disconnect the exit unit connector and two cable restraints.

Figure 2-70 Disconnect exit unit connector and cable restraints



2. Remove three screws, and then remove the exit unit.

Figure 2-71 Remove screws and exit unit



Unpack the replacement assembly

Follow these steps to unpack the replacement assembly.

1. Dispose of the defective part.

 **NOTE:** HP recommends responsible disposal of the defective part.

<http://www8.hp.com/us/en/hp-information/environment/product-recycling.html>

2. Unpack the replacement part from the packaging.



CAUTION:  Some parts are sensitive to electrostatic discharge (ESD). Always perform service work at an ESD-protected workstation or mat. If an ESD workstation or mat is not available, touch the sheet-metal chassis to provide a static ground before touching an ESD-sensitive assembly. Protect the ESD-sensitive assemblies by placing them in ESD pouches when they are out of the printer.

 **IMPORTANT:** Make sure that all of the shipping materials (for example shipping tape) are removed from the replacement part prior to installation.

 **NOTE:** If the replacement part is a roller or pad, avoid touching the spongy part of it. Skin oils on the roller or pad can cause paper pickup and/or print-quality problems. HP recommends using disposable gloves when handling rollers or pads or washing your hands before touching rollers or pads.

3. To install an assembly, reverse the removal steps.

 **NOTE:** When applicable, special installation instructions are provided for an assembly at the end of the removal procedure. Always completely read the removal instructions and follow all special installation instructions.

Removal and replacement: Fuser drive assembly board

This document provides the procedures to remove the fuser drive assembly board.

Mean time to repair: 15 minutes

Service level: Intermediate

 **IMPORTANT:** When applicable, special installation instructions are provided for an assembly at the end of the removal procedure. Always completely read the removal instructions and follow all special installation instructions.

Before performing service

- Disconnect the power cable.

 **CAUTION:** Wait five minutes after disconnecting the power cable before replacing the fuser drive assembly board. Not waiting long enough after disconnecting the power cable can cause electric shock.

Use the table below to identify the correct part number for your printer. To order the part, go to www.hp.com/buy/parts

Table 2-13 Part information

Part number	Part description
	Fuser Drive Board 110V
JC44-00211E	Fuser Drive Board 220V

Required tools

- #2 JIS screwdriver with a magnetic tip

After performing service

Turn the printer power on

- Connect the power cable.
- Use the power switch to turn the power on.

Post service test

Copy, scan, or print a document. Verify the document copies, scans, or prints correctly.

Remove the rear bottom cover

Follow these steps to remove the rear bottom cover.

1. Unscrew two captive thumbscrews on the formatter cover. Slide the formatter cover to the left, and then to the right to remove.

Figure 2-72 Remove the formatter cover

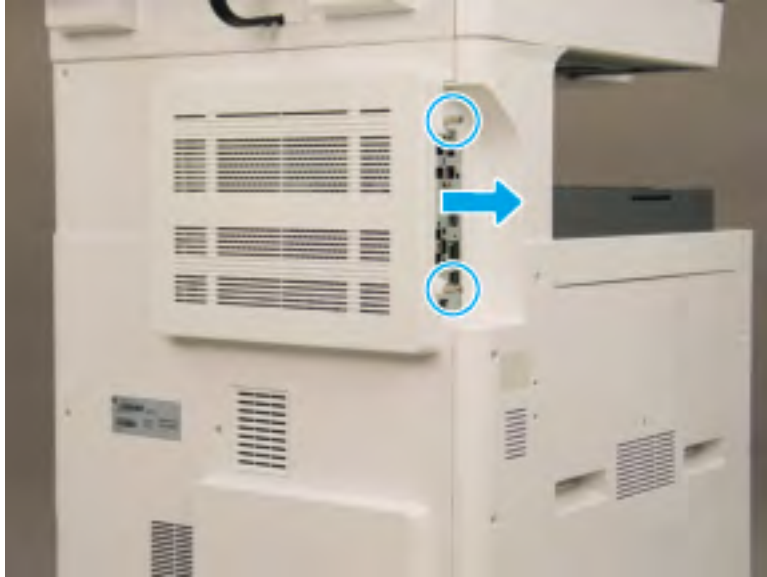

2. Remove seven screws, and then remove the rear-bottom cover.

Figure 2-73 Remove the rear-bottom cover

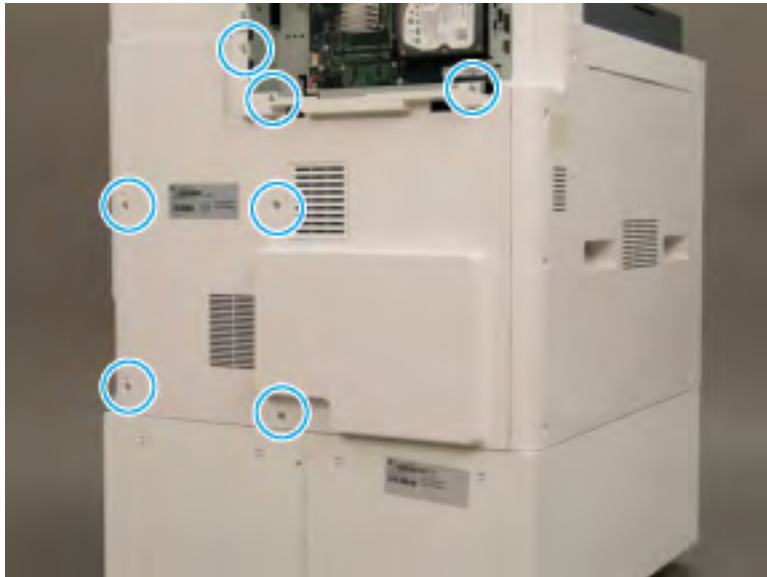

Remove the LVPS cover

Follow these steps to remove the LVPS cover.

- ▲ Remove four screws, and then remove the LVPS cover.

Figure 2-74 Remove the LVPS cover

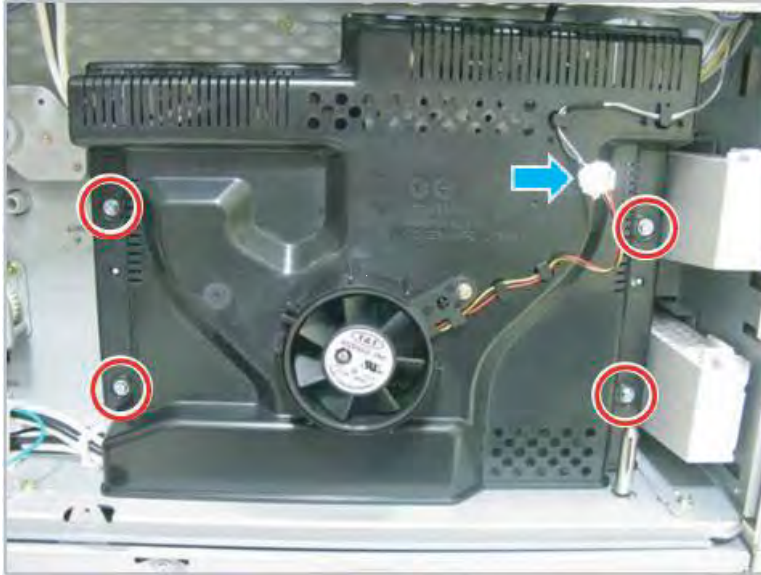

Remove the fuser drive assembly board

Follow these steps to remove the fuser drive assembly board.

- ▲ Disconnect seven connectors and cable restraints on the fuser-drive assembly board. Remove four screws, and then remove the fuser-drive assembly board.

 **NOTE:** Several of the connectors have tabs that need to be pressed in order to release.

Figure 2-75 Remove the fuser-drive assembly board



Unpack the replacement assembly

Follow these steps to unpack the replacement assembly.

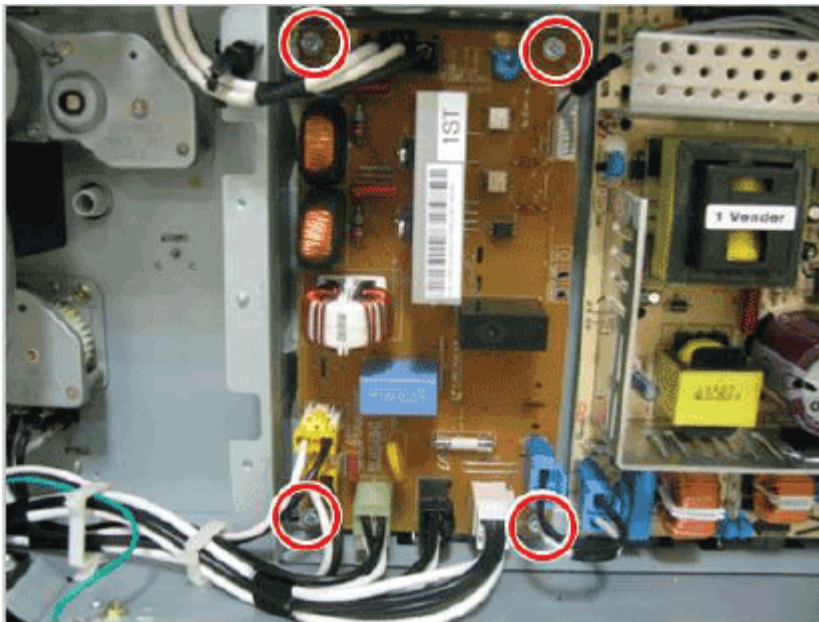
1. Dispose of the defective part.



NOTE: HP recommends responsible disposal of the defective part.

<http://www8.hp.com/us/en/hp-information/environment/product-recycling.html>

2. Unpack the replacement part from the packaging.



CAUTION:  Some parts are sensitive to electrostatic discharge (ESD). Always perform service work at an ESD-protected workstation or mat. If an ESD workstation or mat is not available, touch the sheet-metal chassis to provide a static ground before touching an ESD-sensitive assembly. Protect the ESD-sensitive assemblies by placing them in ESD pouches when they are out of the printer.



IMPORTANT: Make sure that all of the shipping materials (for example shipping tape) are removed from the replacement part prior to installation.



NOTE: If the replacement part is a roller or pad, avoid touching the spongy part of it. Skin oils on the roller or pad can cause paper pickup and/or print-quality problems. HP recommends using disposable gloves when handling rollers or pads or washing your hands before touching rollers or pads.

3. To install an assembly, reverse the removal steps.



NOTE: When applicable, special installation instructions are provided for an assembly at the end of the removal procedure. Always completely read the removal instructions and follow all special installation instructions.

Removal and replacement: Low voltage power supply (LVPS) type 5H board

This document provides the procedures to remove the LVPS Type 5H board.

Mean time to repair: 15 minutes

Service level: Intermediate

 **IMPORTANT:** When applicable, special installation instructions are provided for an assembly at the end of the removal procedure. Always completely read the removal instructions and follow all special installation instructions.

Before performing service

- Disconnect the power cable.

 **CAUTION:** Wait five minutes after disconnecting the power cable before replacing the LVPS board. Not waiting long enough after disconnecting the power cable can cause electric shock.

Use the table below to identify the correct part number for your printer. To order the part, go to www.hp.com/buy/parts

Table 2-14 Part information

Part number	Part description
JC44-00250A	LVPS 220V Type 5H
JC44-00249A	LVPS 110V Type 5H
JC44-00091D	LVPS 110V Type 4 NOTE: Type 4 LVPS only exists on some early models during original release. This has been removed from all new models.
JC44-00092D	LVPS 220V Type 4 NOTE: Type 4 LVPS only exists on some early models during original release. This has been removed from all new models.

Required tools

- #2 JIS screwdriver with a magnetic tip

After performing service

Turn the printer power on

- Connect the power cable.
- Use the power switch to turn the power on.

Post service test

Copy, scan, or print a document. Verify the document copies, scans, or prints correctly.

Remove the rear bottom cover

Follow these steps to remove the rear bottom cover.

1. Unscrew two captive thumbscrews on the formatter cover. Slide the formatter cover to the left, and then to the right to remove.

Figure 2-76 Remove the formatter cover

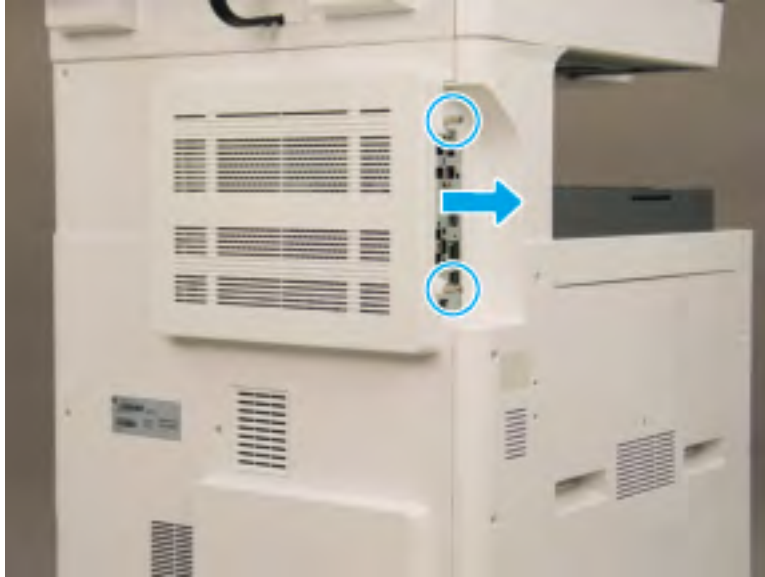

2. Remove seven screws, and then remove the rear-bottom cover.

Figure 2-77 Remove the rear-bottom cover

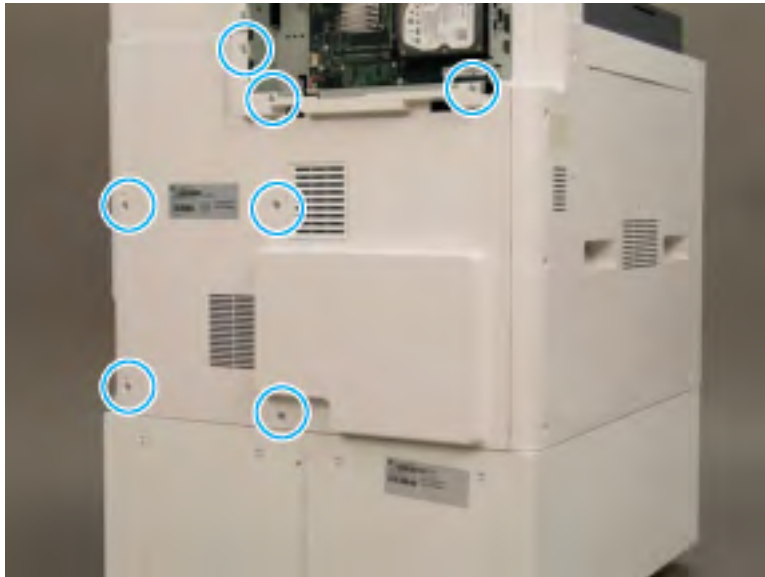

Remove the LVPS cover

Follow these steps to remove the LVPS cover.

- ▲ Remove four screws, and then remove the LVPS cover.

Figure 2-78 Remove the LVPS cover

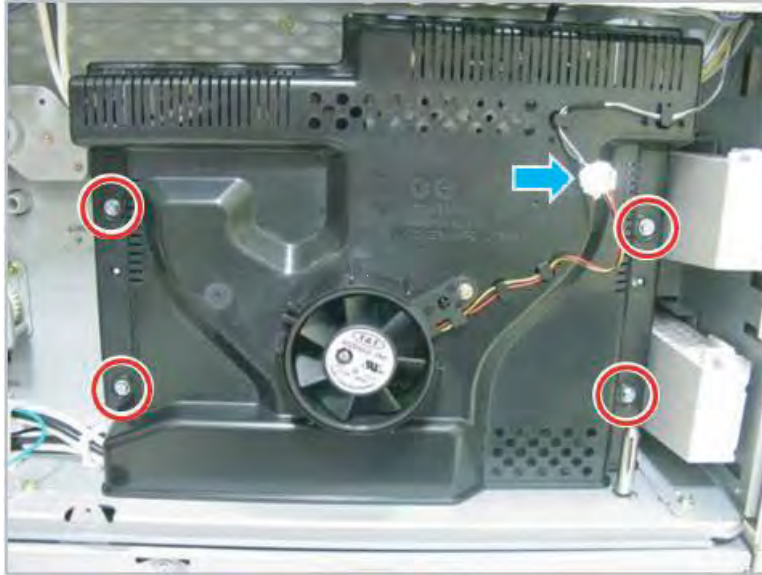

Remove the LVPS Type 5H board

Follow these steps to remove the LVPS Type 5H board.

- ▲ Disconnect four connectors, including one fuser-drive assembly connector and four other connectors, on the LVPS PCA (Type 5). Remove four screws, and then remove the scanner LVPS board (Type 5).

Figure 2-79 Remove the scanner LVPS (Type 5) board

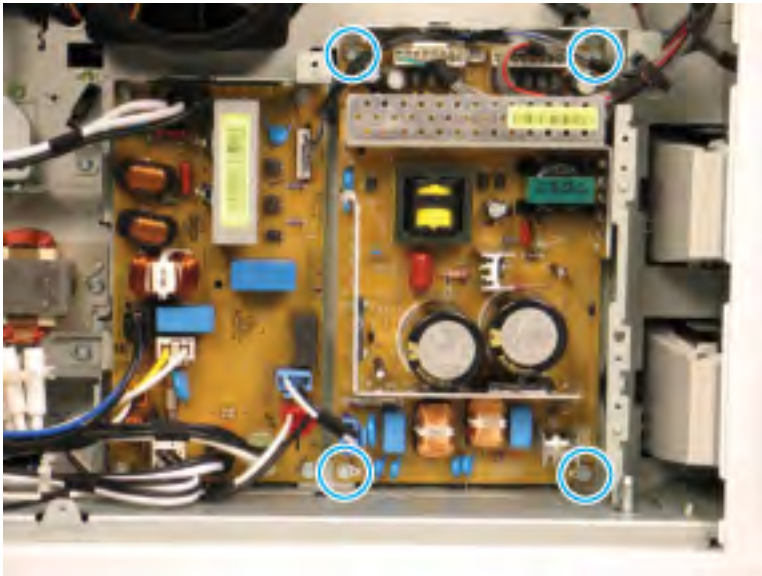

Unpack the replacement assembly

Follow these steps to unpack the replacement assembly.

1. Dispose of the defective part.

 **NOTE:** HP recommends responsible disposal of the defective part.

<http://www8.hp.com/us/en/hp-information/environment/product-recycling.html>

2. Unpack the replacement part from the packaging.



CAUTION:  Some parts are sensitive to electrostatic discharge (ESD). Always perform service work at an ESD-protected workstation or mat. If an ESD workstation or mat is not available, touch the sheet-metal chassis to provide a static ground before touching an ESD-sensitive assembly. Protect the ESD-sensitive assemblies by placing them in ESD pouches when they are out of the printer.

 **IMPORTANT:** Make sure that all of the shipping materials (for example shipping tape) are removed from the replacement part prior to installation.

 **NOTE:** If the replacement part is a roller or pad, avoid touching the spongy part of it. Skin oils on the roller or pad can cause paper pickup and/or print-quality problems. HP recommends using disposable gloves when handling rollers or pads or washing your hands before touching rollers or pads.

3. To install an assembly, reverse the removal steps.

 **NOTE:** When applicable, special installation instructions are provided for an assembly at the end of the removal procedure. Always completely read the removal instructions and follow all special installation instructions.

Removal and replacement: Developer fan

This document provides the procedures to remove the developer fan assembly.



https://players.brightcove.net/1160438706001/SyKVJeRXx_default/index.html?videoId=ref:REFIDPH0000000324

Mean time to repair: 15 minutes

Service level: Intermediate



IMPORTANT: When applicable, special installation instructions are provided for an assembly at the end of the removal procedure. Always completely read the removal instructions and follow all special installation instructions.

Before performing service

- Disconnect the power cable.



WARNING! To avoid damage to the printer, turn the printer off, wait 30 seconds, and then remove the power cable before attempting to service the printer.

Use the table below to identify the correct part number for your printer. To order the part, go to www.hp.com/buy/parts

Table 2-15 Part information

Part number	Part description
JC31-00162A	Fan Type 8

Required tools

- #2 JIS screwdriver with a magnetic tip

After performing service

Turn the printer power on

- Connect the power cable.
- Use the power switch to turn the power on.

Post service test

Copy, scan, or print a document. Verify the document copies, scans, or prints correctly.

Remove the rear covers

Follow these steps to remove the rear covers.

1. Unscrew two captive thumbscrews on the formatter cover. Slide the formatter cover to the left, and then to the right to remove.

Figure 2-80 Remove the formatter cover

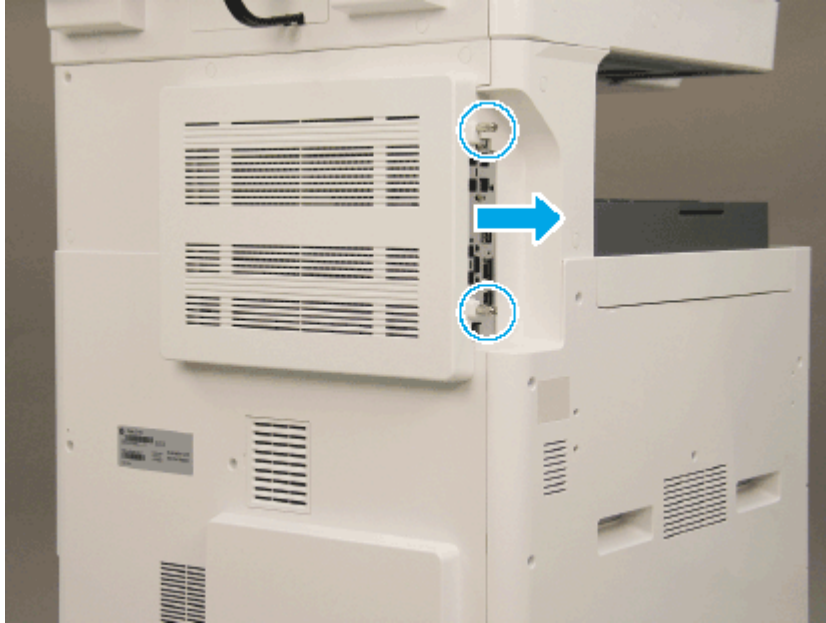

2. Remove seven screws, and then remove the rear-bottom cover.

Figure 2-81 Remove the rear-bottom cover

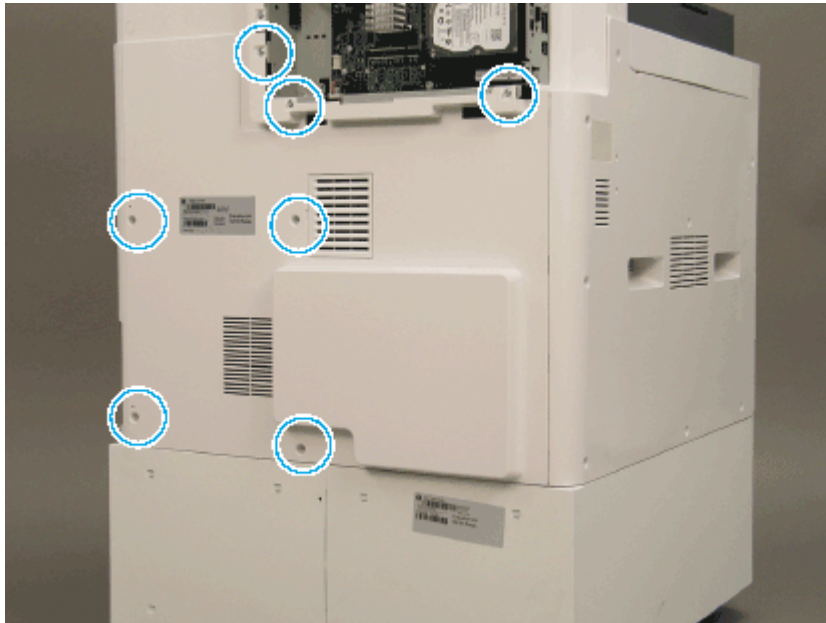

3. Remove six screws (callout 1), and then remove the rear-top cover.

Figure 2-82 Remove the rear-top cover

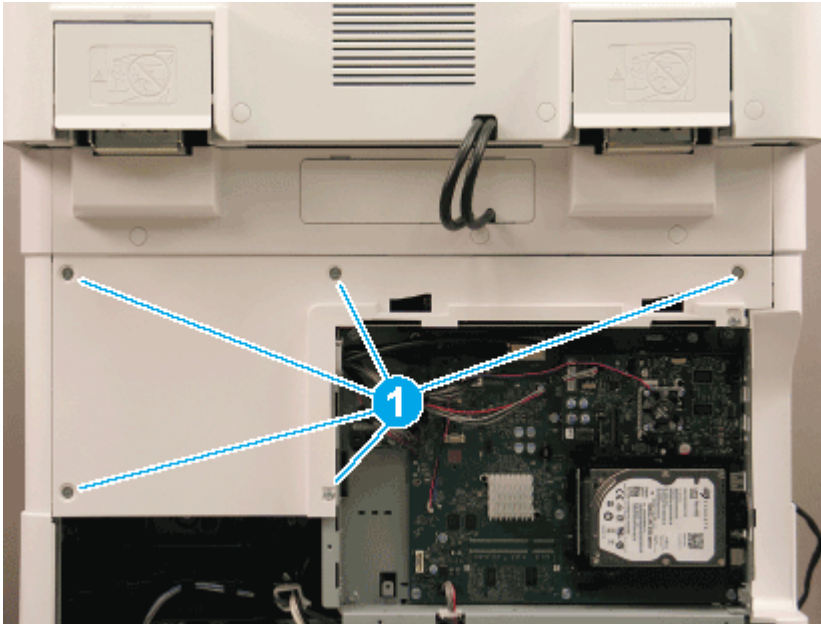

Remove the developer fan

Follow these steps to remove the developer fan.

 **NOTE:** The fan shown below might look slightly different than the one found in the printer. However, the removal steps are correct for this printer.

1. Release the cable restraint. Disconnect the in line connector and remove one screw. Remove the developer fan.

Figure 2-83 Remove developer fan

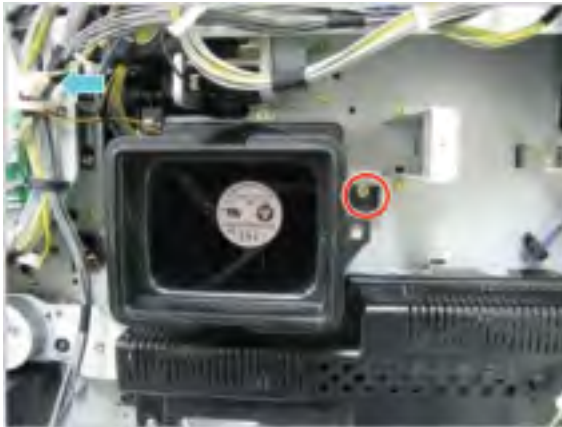

2. Remove one screw.
3. Separate the plastic housing.
4. Remove fan.

Unpack the replacement assembly

Follow these steps to unpack the replacement assembly.

1. Dispose of the defective part.



NOTE: HP recommends responsible disposal of the defective part.

<http://www8.hp.com/us/en/hp-information/environment/product-recycling.html>

2. Unpack the replacement part from the packaging.



CAUTION:  Some parts are sensitive to electrostatic discharge (ESD). Always perform service work at an ESD-protected workstation or mat. If an ESD workstation or mat is not available, touch the sheet-metal chassis to provide a static ground before touching an ESD-sensitive assembly. Protect the ESD-sensitive assemblies by placing them in ESD pouches when they are out of the printer.



IMPORTANT: Make sure that all of the shipping materials (for example shipping tape) are removed from the replacement part prior to installation.



NOTE: If the replacement part is a roller or pad, avoid touching the spongy part of it. Skin oils on the roller or pad can cause paper pickup and/or print-quality problems. HP recommends using disposable gloves when handling rollers or pads or washing your hands before touching rollers or pads.

3. To install an assembly, reverse the removal steps.



NOTE: When applicable, special installation instructions are provided for an assembly at the end of the removal procedure. Always completely read the removal instructions and follow all special installation instructions.

Removal and replacement: Main board

This document provides the procedures to remove the main board.



[View a video of removing and replacing the main board.](#)

Mean time to repair: 15 minutes

Service level: Intermediate



IMPORTANT: When applicable, special installation instructions are provided for an assembly at the end of the removal procedure. Always completely read the removal instructions and follow all special installation instructions.

Before performing service

- Disconnect the power cable.



WARNING! To avoid damage to the printer, turn the printer off, wait 30 seconds, and then remove the power cable before attempting to service the printer.

Use the table below to identify the correct part number for your printer. To order the part, go to www.hp.com/buy/parts

Table 2-16 Part information

Part number	Part description
JC82-00541A	Main Board PCA

Required tools

- #2 JIS screwdriver with a magnetic tip

After performing service

Turn the printer power on

- Connect the power cable.
- Use the power switch to turn the power on.

Post service test

Copy, scan, or print a document. Verify the document copies, scans, or prints correctly.

Remove the rear covers

Follow these steps to remove the rear covers.

1. Unscrew two captive thumbscrews on the formatter cover. Slide the formatter cover to the left, and then to the right to remove.

Figure 2-84 Remove the formatter cover

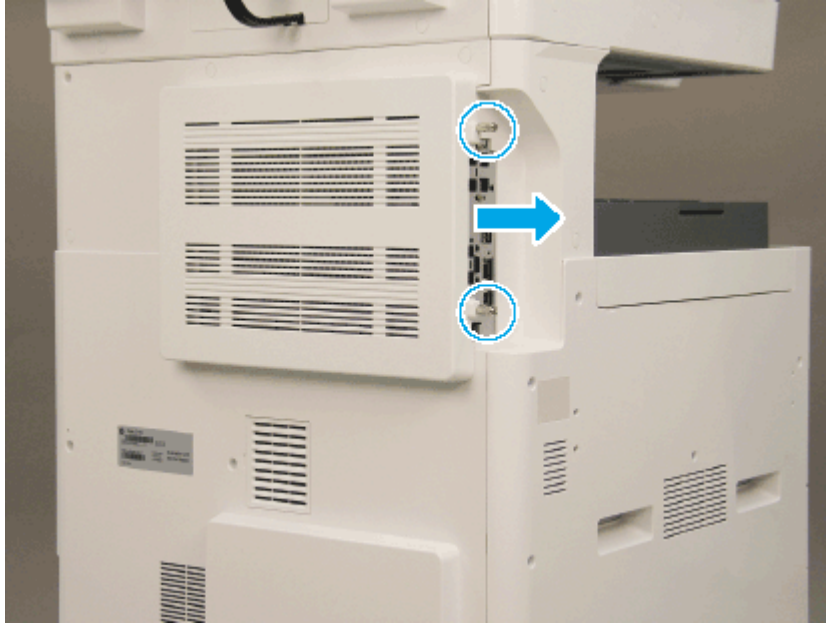

2. Remove seven screws, and then remove the rear-bottom cover.

Figure 2-85 Remove the rear-bottom cover

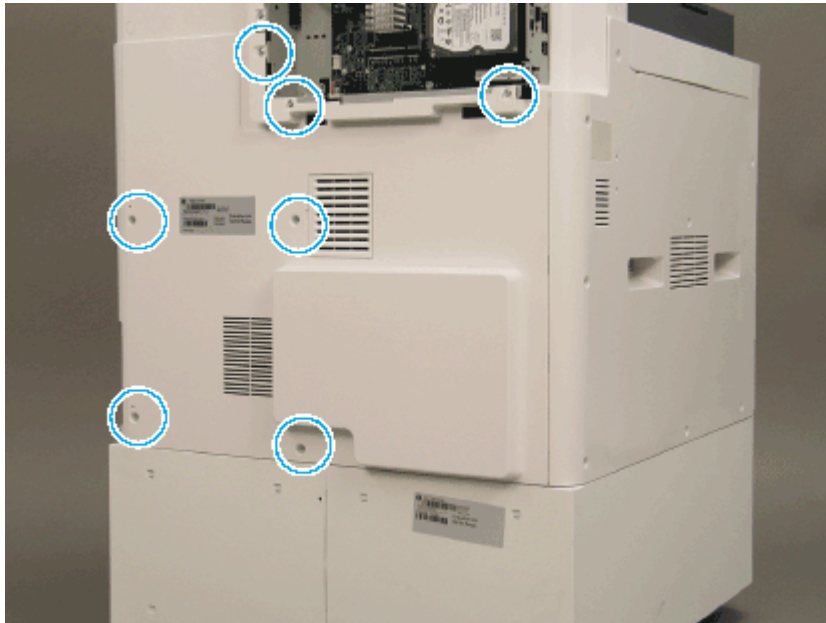

3. Remove six screws (callout 1), and then remove the rear-top cover.

Figure 2-86 Remove the rear-top cover

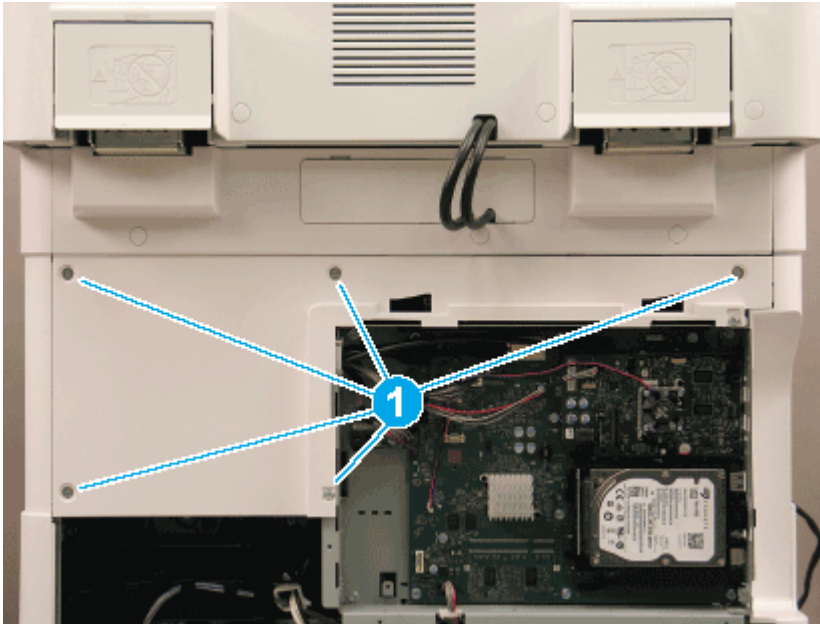

Remove the formatter cage

Follow these steps to remove the formatter cage.

1. Disconnect ten connectors and two cable restraints.
2. Remove four screws and screw-caps, and then remove the left-upper cover.

Figure 2-87 Remove the left-upper cover

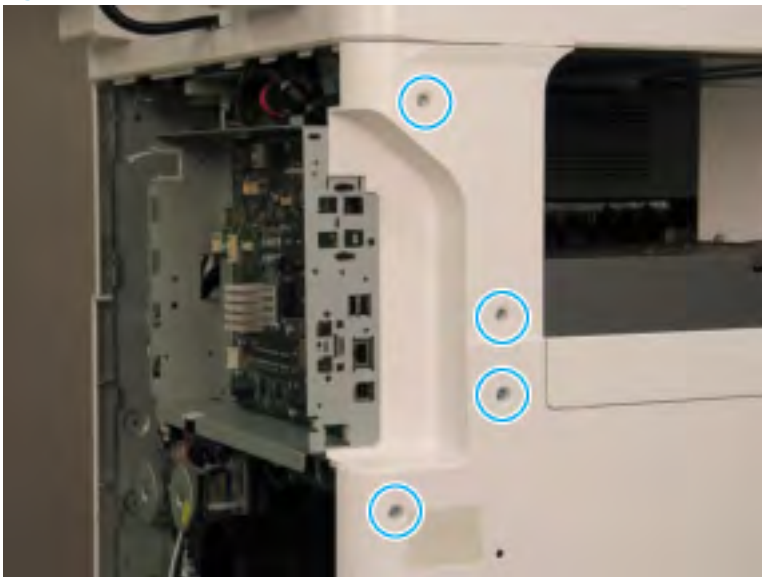

3. Remove one screw from the side of the formatter cage (beneath the left-upper cover location).

Figure 2-88 Remove the formatter cage side screw

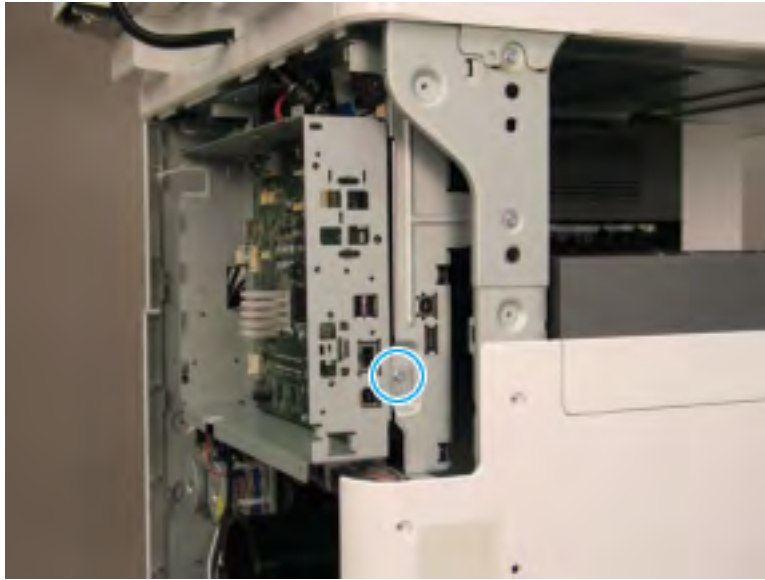

4. Remove three screws from the formatter cage face, and then release one tab to remove the formatter cage.

Figure 2-89 Remove three screws to remove the formatter cage



Remove the main board

Follow these steps to remove the main board.

1. Disconnect 19 connectors, a ground wire, and three FFCs on the main board.

Figure 2-90 Remove the main board connectors and screws





2. Remove nine screws, and then remove the main board.
3. Disconnect the MSOK from the removed main board, noting its orientation. Transfer the MSOK to the replacement main board and install it using the same orientation.

 **TIP:** The main board is marked to show the correct orientation of the MSOK when installed.

Figure 2-91 MSOK installation orientation



 **TIP:** See the screen-printed icon on the main board to ensure that the MSOK is aligned correctly during reinstallation.

 **IMPORTANT:** A Shading Test for the ADF unit must be completed after replacing the ADF unit or main board.

Unpack the replacement assembly

Follow these steps to unpack the replacement assembly.

1. Dispose of the defective part.



NOTE: HP recommends responsible disposal of the defective part.

<http://www8.hp.com/us/en/hp-information/environment/product-recycling.html>

2. Unpack the replacement part from the packaging.



CAUTION:  Some parts are sensitive to electrostatic discharge (ESD). Always perform service work at an ESD-protected workstation or mat. If an ESD workstation or mat is not available, touch the sheet-metal chassis to provide a static ground before touching an ESD-sensitive assembly. Protect the ESD-sensitive assemblies by placing them in ESD pouches when they are out of the printer.



IMPORTANT: Make sure that all of the shipping materials (for example shipping tape) are removed from the replacement part prior to installation.



NOTE: If the replacement part is a roller or pad, avoid touching the spongy part of it. Skin oils on the roller or pad can cause paper pickup and/or print-quality problems. HP recommends using disposable gloves when handling rollers or pads or washing your hands before touching rollers or pads.

3. To install an assembly, reverse the removal steps.



NOTE: When applicable, special installation instructions are provided for an assembly at the end of the removal procedure. Always completely read the removal instructions and follow all special installation instructions.

Removal and replacement: Laser scanner assembly

This document provides the procedures to remove the laser scanner assembly.

Mean time to repair: 15 minutes

Service level: Intermediate

 **IMPORTANT:** When applicable, special installation instructions are provided for an assembly at the end of the removal procedure. Always completely read the removal instructions and follow all special installation instructions.

Before performing service

- Disconnect the power cable.

 **WARNING!** To avoid damage to the printer, turn the printer off, wait 30 seconds, and then remove the power cable before attempting to service the printer.

Use the table below to identify the correct part number for your printer. To order the part, go to www.hp.com/buy/parts

Table 2-17 Part information

Part number	Part description
JC97-04894A	Laser scanner assembly

Required tools

- #2 JIS screwdriver with a magnetic tip

After performing service

Turn the printer power on

- Connect the power cable.
- Use the power switch to turn the power on.

Post service test

Copy, scan, or print a document. Verify the document copies, scans, or prints correctly.

Remove the left cover

Follow these steps to remove the left cover.

- ▲ Remove the left trim cover, and then remove ten screws to remove the left cover.

Figure 2-92 Remove the left trim cover

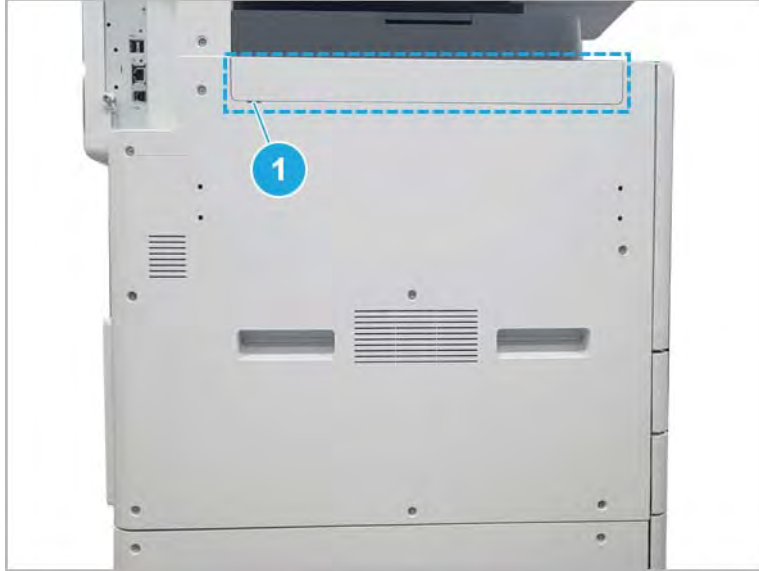
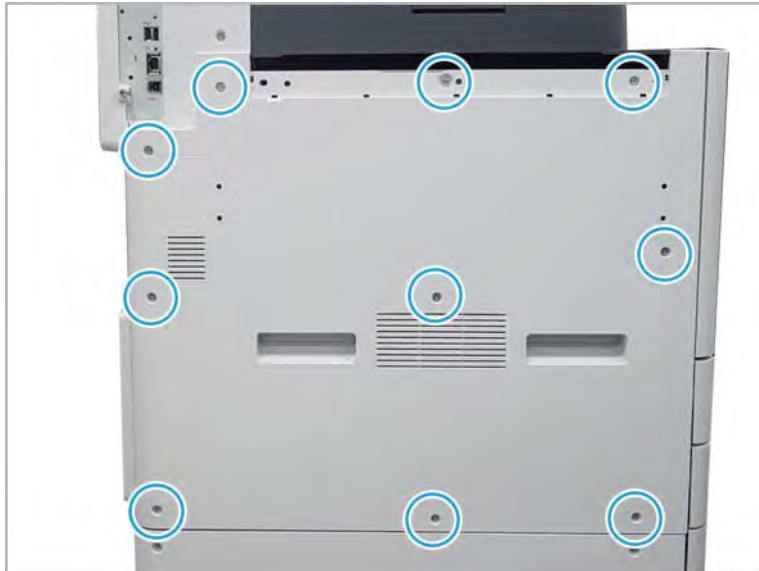

Figure 2-93 Remove the left cover



Remove the laser scanner assembly

Follow these steps to remove the laser scanner assembly.

1. Remove two screws.

Figure 2-94 Remove the laser scanner assembly



2. Disconnect the laser scanner assembly harness at the left, and then partially remove the assembly from the chassis. Disconnect the FFC cable, and then remove the laser scanner assembly completely.

⚠ CAUTION: If the laser scanner assembly is removed too rough or fast, the harness can be damaged.

Figure 2-95 Disconnect the laser scanner assembly harness and FFC cable

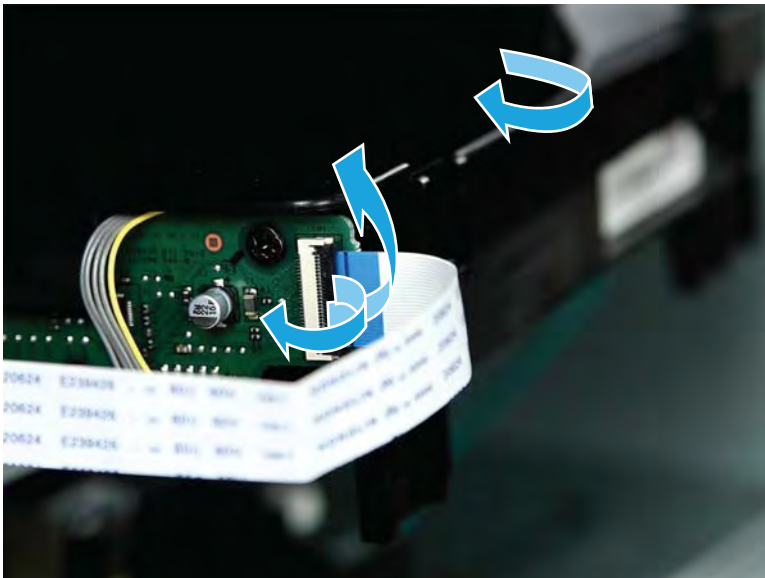

3. Complete a laser scanner assembly adjustment after a new laser scanner assembly has been installed.

Unpack the replacement assembly

Follow these steps to unpack the replacement assembly.

1. Dispose of the defective part.

 **NOTE:** HP recommends responsible disposal of the defective part.

<http://www8.hp.com/us/en/hp-information/environment/product-recycling.html>

2. Unpack the replacement part from the packaging.



CAUTION:  Some parts are sensitive to electrostatic discharge (ESD). Always perform service work at an ESD-protected workstation or mat. If an ESD workstation or mat is not available, touch the sheet-metal chassis to provide a static ground before touching an ESD-sensitive assembly. Protect the ESD-sensitive assemblies by placing them in ESD pouches when they are out of the printer.



IMPORTANT: Make sure that all of the shipping materials (for example shipping tape) are removed from the replacement part prior to installation.



NOTE: If the replacement part is a roller or pad, avoid touching the spongy part of it. Skin oils on the roller or pad can cause paper pickup and/or print-quality problems. HP recommends using disposable gloves when handling rollers or pads or washing your hands before touching rollers or pads.

3. To install an assembly, reverse the removal steps.



NOTE: When applicable, special installation instructions are provided for an assembly at the end of the removal procedure. Always completely read the removal instructions and follow all special installation instructions.

Removal and replacement: High-voltage power supply (HVPS) board

This document provides the procedures to remove the high voltage power supply (HVPS) board.



[View a video of removing and replacing the HVPS.](#)

Mean time to repair: 10 minutes

Service level: Basic



IMPORTANT: When applicable, special installation instructions are provided for an assembly at the end of the removal procedure. Always completely read the removal instructions and follow all special installation instructions.

Before performing service

- Disconnect the power cable.



WARNING! To avoid damage to the printer, turn the printer off, wait 30 seconds, and then remove the power cable before attempting to service the printer.

Use the table below to identify the correct part number for your printer. To order the part, go to www.hp.com/buy/parts

Table 2-18 Part information

Part number	Part description
JC44-00237A	High Voltage Power Supply (HVPS) board

Required tools

- #2 JIS screwdriver with a magnetic tip

After performing service

Turn the printer power on

- Connect the power cable.
- Use the power switch to turn the power on.

Post service test

Copy, scan, or print a document. Verify the document copies, scans, or prints correctly.

Remove the left cover

Follow these steps to remove the left cover.

- ▲ Remove the left trim cover, and then remove ten screws to remove the left cover.

Figure 2-96 Remove the left trim cover



Figure 2-97 Remove the left cover

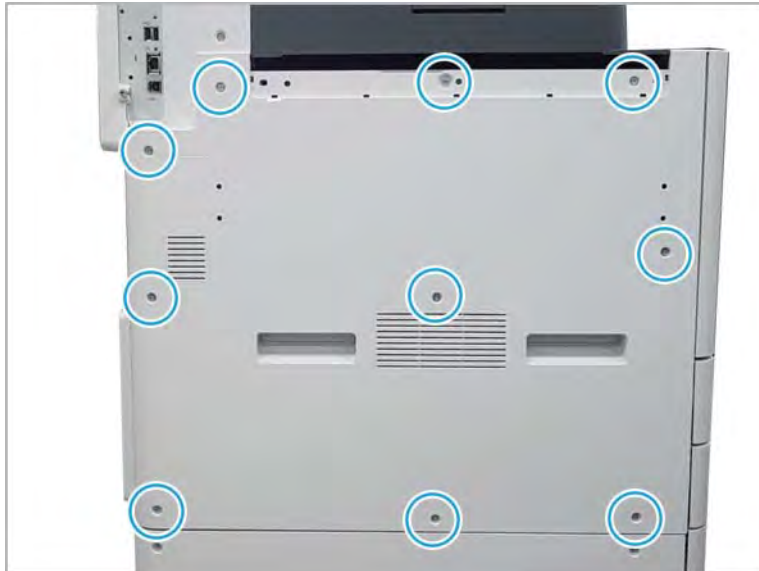

Remove the high-voltage power supply (HVPS)

Follow these steps to remove the high-voltage power supply (HVPS).

1. Remove eight screws, and then release middle hook.

Figure 2-98 Remove screws

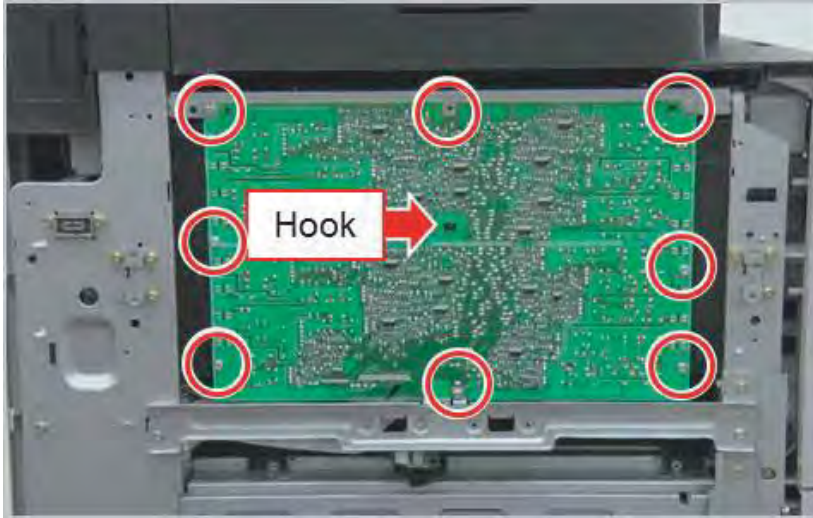

2. Unplug the connector and then remove the HVPS.

Figure 2-99 Remove the HVPS board

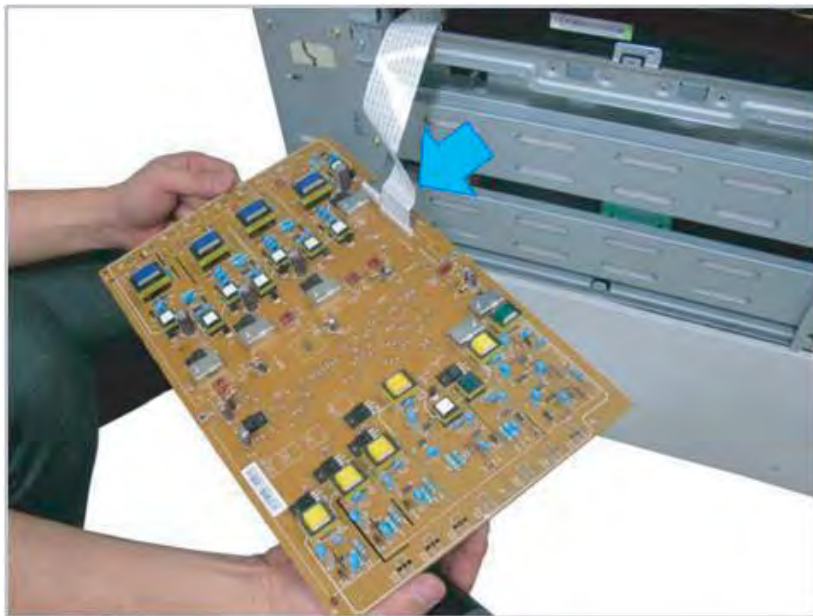

Unpack the replacement assembly

Follow these steps to unpack the replacement assembly.

1. Dispose of the defective part.

 **NOTE:** HP recommends responsible disposal of the defective part.

<http://www8.hp.com/us/en/hp-information/environment/product-recycling.html>

2. Unpack the replacement part from the packaging.



CAUTION:  Some parts are sensitive to electrostatic discharge (ESD). Always perform service work at an ESD-protected workstation or mat. If an ESD workstation or mat is not available, touch the sheet-metal chassis to provide a static ground before touching an ESD-sensitive assembly. Protect the ESD-sensitive assemblies by placing them in ESD pouches when they are out of the printer.

 **IMPORTANT:** Make sure that all of the shipping materials (for example shipping tape) are removed from the replacement part prior to installation.

 **NOTE:** If the replacement part is a roller or pad, avoid touching the spongy part of it. Skin oils on the roller or pad can cause paper pickup and/or print-quality problems. HP recommends using disposable gloves when handling rollers or pads or washing your hands before touching rollers or pads.

3. To install an assembly, reverse the removal steps.

 **NOTE:** When applicable, special installation instructions are provided for an assembly at the end of the removal procedure. Always completely read the removal instructions and follow all special installation instructions.

Removal and replacement: Right door assembly

This document provides the procedures to remove the right door assembly.

Mean time to repair: 3 minutes

Service level: Basic

 **IMPORTANT:** When applicable, special installation instructions are provided for an assembly at the end of the removal procedure. Always completely read the removal instructions and follow all special installation instructions.

Before performing service

- Disconnect the power cable.

Use the table below to identify the correct part number for your printer. To order the part, go to www.hp.com/buy/parts

Table 2-19 Part information

Part number	Part description
JC95-02080A	Right door assembly

Required tools

- #2 JIS screwdriver with a magnetic tip

After performing service

Turn the printer power on

- Connect the power cable.
- Use the power switch to turn the power on.

Post service test

Copy, scan, or print a document. Verify the document copies, scans, or prints correctly.

Remove the right door

Follow these steps to remove the right door.

 **NOTE:** Remove second exit drive if installed.

1. Remove three screws, and then remove the cover (A).

Figure 2-100 Remove cover

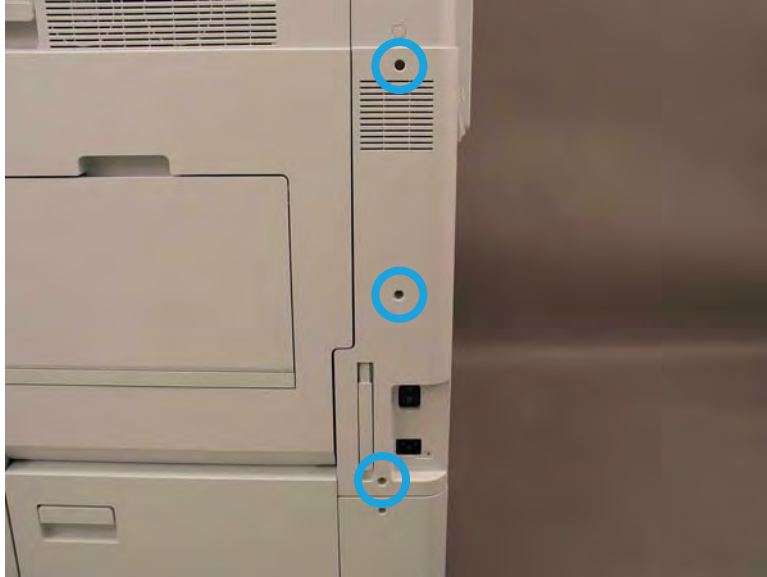

2. Disconnect the right door connector.

Figure 2-101 Disconnect right door connector



3. Release the right hinge (callout 1).

⚠ CAUTION: The right hinge spring tension can be dangerous. Use caution when releasing the right hinge to avoid injury.

Figure 2-102 Release right hinge

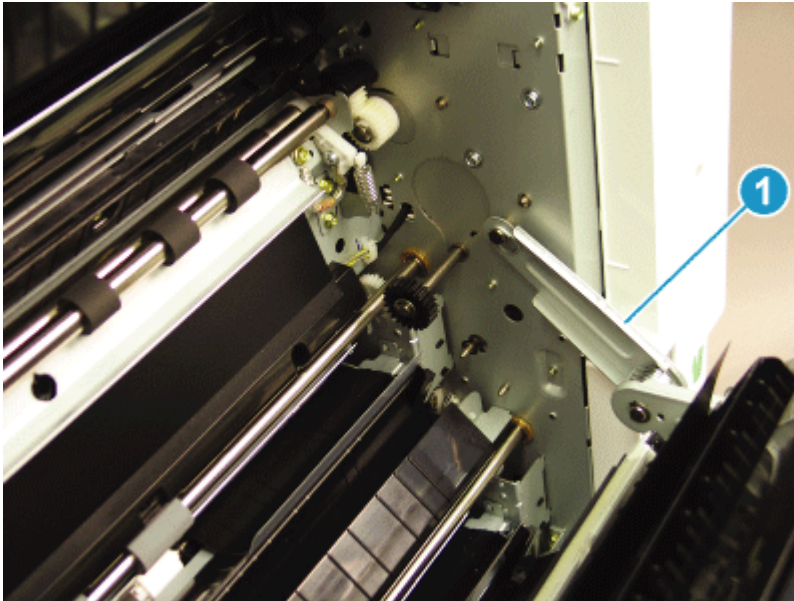

4. Release the left dampener (callout 1).

Figure 2-103 Release left dampener

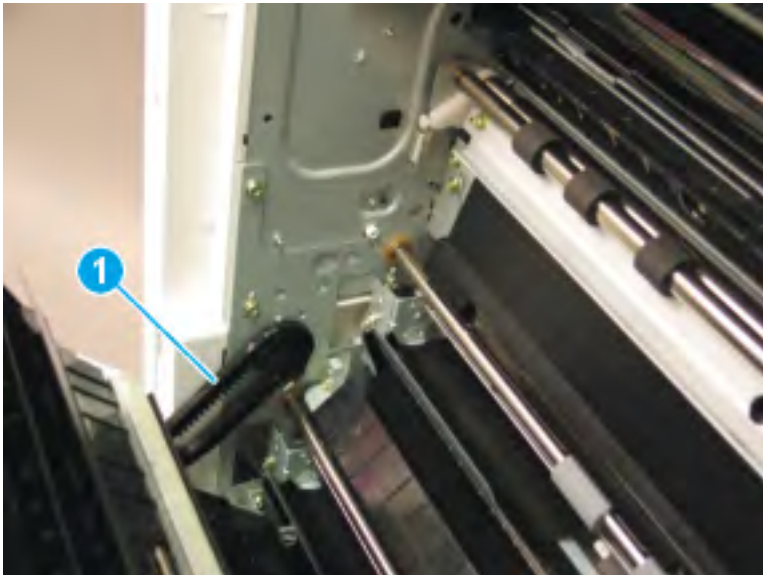

5. Remove the right door.

 **NOTE:** Open the lower access door. If there is an HCl or 2x520 input device, release the dampener to clear the lower right door. Remove clockwise.

Figure 2-104 Remove right door



Unpack the replacement assembly



Follow these steps to unpack the replacement assembly.

1. Dispose of the defective part.

 **NOTE:** HP recommends responsible disposal of the defective part.

<http://www8.hp.com/us/en/hp-information/environment/product-recycling.html>

2. Unpack the replacement part from the packaging.

 **CAUTION:**  Some parts are sensitive to electrostatic discharge (ESD). Always perform service work at an ESD-protected workstation or mat. If an ESD workstation or mat is not available, touch the sheet-metal chassis to provide a static ground before touching an ESD-sensitive assembly. Protect the ESD-sensitive assemblies by placing them in ESD pouches when they are out of the printer.

 **IMPORTANT:** Make sure that all of the shipping materials (for example shipping tape) are removed from the replacement part prior to installation.

 **NOTE:** If the replacement part is a roller or pad, avoid touching the spongy part of it. Skin oils on the roller or pad can cause paper pickup and/or print-quality problems. HP recommends using disposable gloves when handling rollers or pads or washing your hands before touching rollers or pads.

3. To install an assembly, reverse the removal steps.

 **NOTE:** When applicable, special installation instructions are provided for an assembly at the end of the removal procedure. Always completely read the removal instructions and follow all special installation instructions.

Removal and replacement: Fuser unit

This document provides the procedures to remove the fuser unit.



[View a video of removing and replacing the fuser.](#)

Mean time to repair: 3 minutes

Service level: Basic



IMPORTANT: When applicable, special installation instructions are provided for an assembly at the end of the removal procedure. Always completely read the removal instructions and follow all special installation instructions.

Before performing service

- Disconnect the power cable.



WARNING! To avoid damage to the printer, turn the printer off, wait 30 seconds, and then remove the power cable before attempting to service the printer.

Use the table below to identify the correct part number for your printer. To order the part, go to www.hp.com/buy/parts

Table 2-20 Part information

Part number	Part description
JC82-00479A	110V Fuser Assembly
JC82-00481A	220V Fuser Assembly

Required tools

- #2 JIS screwdriver with a magnetic tip

After performing service

Turn the printer power on

- Connect the power cable.
- Use the power switch to turn the power on.

Post service test

Copy, scan, or print a document. Verify the document copies, scans, or prints correctly.

Remove the fuser unit

Follow these steps to remove the fuser unit.

1. Open the right door.

2. Remove one screw, and then remove the cover (A).

Figure 2-105 Remove one screw



3. Disconnect two bulkhead connectors at the top and one high voltage connector at the bottom.

 **IMPORTANT:** Do not disconnect the inline connector.

Figure 2-106 Disconnect the connectors



4. Remove two screws, and then remove the fuser unit.

Figure 2-107 Remove two fuser unit screws



Unpack the replacement assembly



Follow these steps to unpack the replacement assembly.

1. Dispose of the defective part.

 **NOTE:** HP recommends responsible disposal of the defective part.

<http://www8.hp.com/us/en/hp-information/environment/product-recycling.html>

2. Unpack the replacement part from the packaging.

 **CAUTION:**  Some parts are sensitive to electrostatic discharge (ESD). Always perform service work at an ESD-protected workstation or mat. If an ESD workstation or mat is not available, touch the sheet-metal chassis to provide a static ground before touching an ESD-sensitive assembly. Protect the ESD-sensitive assemblies by placing them in ESD pouches when they are out of the printer.

 **IMPORTANT:** Make sure that all of the shipping materials (for example shipping tape) are removed from the replacement part prior to installation.

 **NOTE:** If the replacement part is a roller or pad, avoid touching the spongy part of it. Skin oils on the roller or pad can cause paper pickup and/or print-quality problems. HP recommends using disposable gloves when handling rollers or pads or washing your hands before touching rollers or pads.

3. To install an assembly, reverse the removal steps.

 **NOTE:** When applicable, special installation instructions are provided for an assembly at the end of the removal procedure. Always completely read the removal instructions and follow all special installation instructions.

Removal and replacement: Developer unit

This document provides the procedures to remove the formatter assembly.



[View a video of removing and replacing the developer unit.](#)

Mean time to repair: 10 minutes

Service level: Basic



IMPORTANT: When applicable, special installation instructions are provided for an assembly at the end of the removal procedure. Always completely read the removal instructions and follow all special installation instructions.

Before performing service

- Disconnect the power cable.



WARNING! To avoid damage to the printer, turn the printer off, wait 30 seconds, and then remove the power cable before attempting to service the printer.

Use the table below to identify the correct part number for your printer. To order the part, go to www.hp.com/buy/parts

Table 2-21 Part information

Part number	Part description
JC96-11669A	Developer Unit - Black

Required tools

- #2 JIS screwdriver with a magnetic tip

After performing service

Turn the printer power on

- Connect the power cable.
- Use the power switch to turn the power on.

Post service test

Copy, scan, or print a document. Verify the document copies, scans, or prints correctly.

Remove the TCU

Follow these steps to remove the TCU.

- ▲ Open the front door and remove the toner collection unit (callout A).

Figure 2-108 Remove the TCU



Remove the developer unit

Follow these steps to remove the developer unit.

1. Disconnect the drum unit connector. Remove two screws.

Figure 2-109 Disconnect drum unit and remove two screws



2. Remove the drum unit by pulling the gray tab.

Figure 2-110 Remove drum unit



3. Disconnect the connector.

Figure 2-111 Disconnect connector



4. Remove six screws securing the rear cover.

Figure 2-112 Remove rear cover screws



5. Remove the rear cover.

Figure 2-113 Remove rear cover



6. Separate the developer unit (B) from the drum unit (A). Remove the cable from the guide

Figure 2-114 Separate developer and drum units

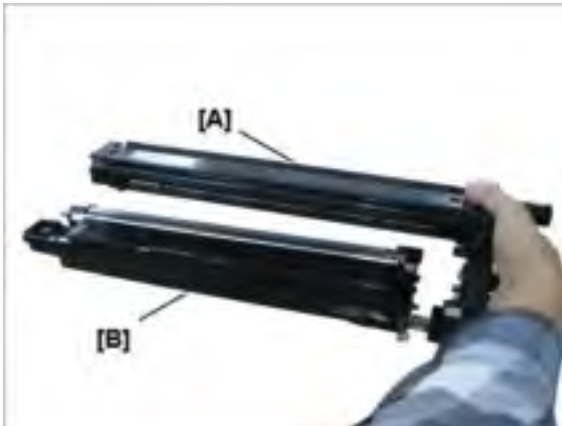

- Unpack the developer unit box and check the components (four items).

Figure 2-115 Unpack developer unit

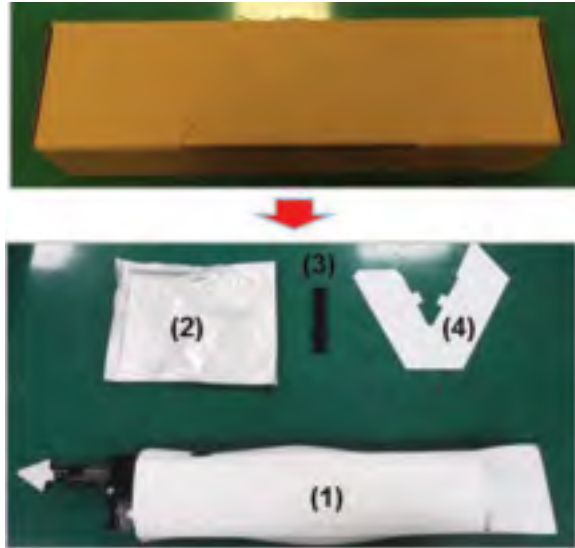

- Remove two protective sheets.

 **NOTE:**

- When removing the first protective sheet, make sure the magnetic roller is not contaminated.
- When removing the second protective sheet, make sure to avoid grease contamination.

Figure 2-116 Remove protective sheets

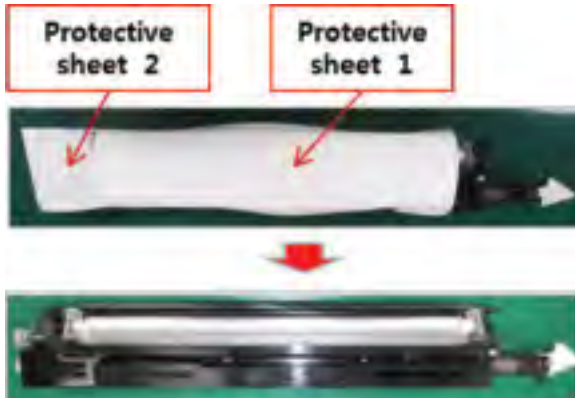

- Fold the sheet into a funnel shape as shown in the following graphic.

Figure 2-117 Fold protective sheet



10. Insert the paper funnel into the developer unit hole.

Figure 2-118 Insert paper funnel into developer unit

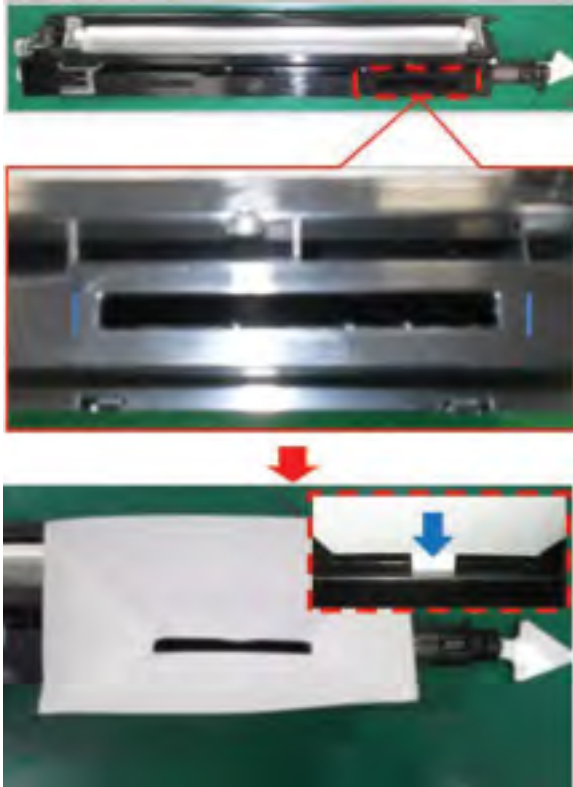

11. Pour the developer powder into the funnel.

 **NOTE:** When filling the developer, intermittently lean the developer unit to avoid overflow.

Figure 2-119 Fill developer unit with developer powder



12. After filling the developer, attach the seal tape to the developer unit hole.

Figure 2-120 Attach seal tape

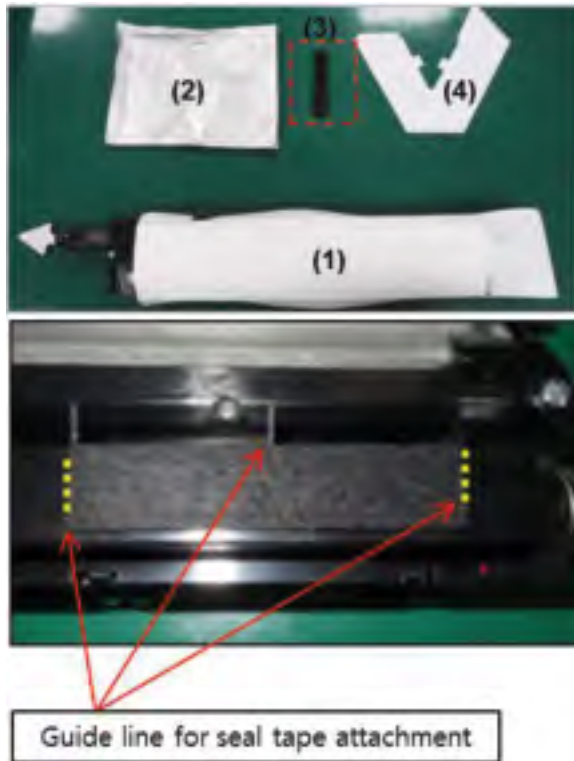

13. Remove the arrow label horizontally.

⚠ CAUTION: Do not remove the arrow label in a downward direction. Do not lean or tip the unit, as the developer will leak.

Figure 2-121 Remove arrow label



14. Install the developer unit and drum unit in the reverse order of removal.

Unpack the replacement assembly

Follow these steps to unpack the replacement assembly.

1. Dispose of the defective part.

 **NOTE:** HP recommends responsible disposal of the defective part.

<http://www8.hp.com/us/en/hp-information/environment/product-recycling.html>

2. Unpack the replacement part from the packaging.



CAUTION:  Some parts are sensitive to electrostatic discharge (ESD). Always perform service work at an ESD-protected workstation or mat. If an ESD workstation or mat is not available, touch the sheet-metal chassis to provide a static ground before touching an ESD-sensitive assembly. Protect the ESD-sensitive assemblies by placing them in ESD pouches when they are out of the printer.

 **IMPORTANT:** Make sure that all of the shipping materials (for example shipping tape) are removed from the replacement part prior to installation.

 **NOTE:** If the replacement part is a roller or pad, avoid touching the spongy part of it. Skin oils on the roller or pad can cause paper pickup and/or print-quality problems. HP recommends using disposable gloves when handling rollers or pads or washing your hands before touching rollers or pads.

3. To install an assembly, reverse the removal steps.

 **NOTE:** When applicable, special installation instructions are provided for an assembly at the end of the removal procedure. Always completely read the removal instructions and follow all special installation instructions.

Reverse the removal steps to install the assembly

Also use the following **special installation instructions**.

Removal and replacement: Drum unit

This document provides the procedures to remove the drum unit assembly.



[View a video of removing and replacing the drum unit.](#)

Mean time to repair: 5 minutes

Service level: Basic



IMPORTANT: When applicable, special installation instructions are provided for an assembly at the end of the removal procedure. Always completely read the removal instructions and follow all special installation instructions.

Before performing service

- Disconnect the power cable.



WARNING! To avoid damage to the printer, turn the printer off, wait 30 seconds, and then remove the power cable before attempting to service the printer.

Use the table below to identify the correct part number for your printer. To order the part, go to www.hp.com/buy/parts

Table 2-22 Part information

Part number	Part description
X3A65-67916	HP Black Managed LJ Imaging Drum

Required tools

- #2 JIS screwdriver with a magnetic tip

After performing service

Turn the printer power on

- Connect the power cable.
- Use the power switch to turn the power on.

Post service test

Copy, scan, or print a document. Verify the document copies, scans, or prints correctly.

Remove the TCU

Follow these steps to remove the TCU.

- ▲ Open the front door and remove the toner collection unit (callout A).

Figure 2-122 Remove the TCU



Remove the drum unit

Follow these steps to remove the drum unit.

1. Disconnect the drum unit connector. Remove two screws.

Figure 2-123 Disconnect drum unit connector



2. Remove the drum unit.

Figure 2-124 Remove drum unit



3. Disconnect the connector.

Figure 2-125 Disconnect connector



4. Remove six screws securing the rear cover.

Figure 2-126 Remove rear cover screws



5. Remove the rear cover.

Figure 2-127 Remove rear cover



6. Separate the developer unit (B) from the drum unit (A). Remove the cable from its guide.

Figure 2-128 Separate developer and drum units

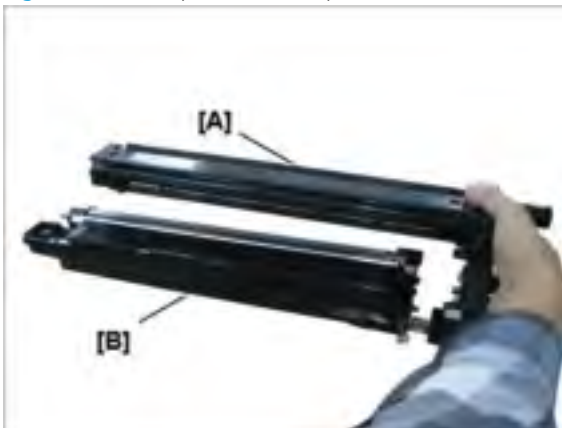

7. Replace with the new drum unit. Installation is the same steps as removal in reverse order.

 **NOTE:** The replacement drum unit ships with a dummy rear cover for support. Do not use the dummy rear cover in the product. It is missing the gear necessary to drive the developing unit.

Unpack the replacement assembly

Follow these steps to unpack the replacement assembly.

1. Dispose of the defective part.

 **NOTE:** HP recommends responsible disposal of the defective part.

<http://www8.hp.com/us/en/hp-information/environment/product-recycling.html>

2. Unpack the replacement part from the packaging.



CAUTION:  Some parts are sensitive to electrostatic discharge (ESD). Always perform service work at an ESD-protected workstation or mat. If an ESD workstation or mat is not available, touch the sheet-metal chassis to provide a static ground before touching an ESD-sensitive assembly. Protect the ESD-sensitive assemblies by placing them in ESD pouches when they are out of the printer.

 **IMPORTANT:** Make sure that all of the shipping materials (for example shipping tape) are removed from the replacement part prior to installation.

 **NOTE:** If the replacement part is a roller or pad, avoid touching the spongy part of it. Skin oils on the roller or pad can cause paper pickup and/or print-quality problems. HP recommends using disposable gloves when handling rollers or pads or washing your hands before touching rollers or pads.

3. To install an assembly, reverse the removal steps.

 **NOTE:** When applicable, special installation instructions are provided for an assembly at the end of the removal procedure. Always completely read the removal instructions and follow all special installation instructions.

Removal and replacement: Accelerator board

Learn how to remove and replace the accelerator board.

To view a short video of this procedure, click the link below.



[View a video of how to remove and replace the accelerator board.](#)



IMPORTANT: When applicable, special installation instructions are provided for an assembly at the end of the removal procedure. Always completely read the removal instructions and follow all special installation instructions.

Mean time to repair:

Service level:

Before performing service

Turn the printer power off

- Press the power button on the front of the printer, and then turn off the power switch next to the power cable.
- A shutting-down message appears on the control-panel display.



WARNING! To avoid damage to the printer, turn the power off and wait until the printer shuts down before removing the power cable.

- Disconnect the printer power cable after the printer has completely shut down (the control-panel display is blank).

Use the table below to identify the correct part number for your printer. To order the part, go to www.hp.com/buy/parts.

Table 2-23 Part information

Part number	Part description
X3A62-60002	Accelerator PCA



NOTE: An accelerator PCA is only installed on some early models during original release. This has been removed from all new models.

Required tools

- #2 JIS screwdriver with a magnetic tip

After performing service

Turn the printer power on

- Connect the printer power cable.
- Turn on the power switch next to the power cable, and then press the power button on the front of the printer.

- Verify that the service performed was successful.
- Verify that the most recent firmware is installed on the printer.
- Verify that all parts are correctly reinstalled and are properly working.

Post service test

Print any pages necessary to verify that the repair resolved the issue and did not create any new issues.

Remove the formatter cover

Follow these steps to remove the formatter cover.

- ▲ Unscrew two captive thumbscrews on the formatter cover. Slide the formatter cover to the left, and then to the right to remove it.

Figure 2-129 Remove the formatter cover

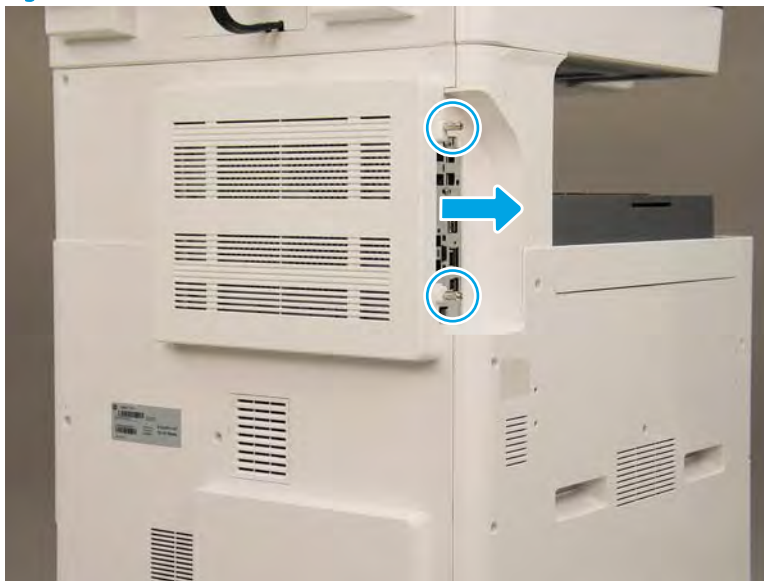

Remove the accelerator board

Follow these steps to remove the accelerator board.

CAUTION:  ESD sensitive part.

- ▲ Loosen two screws, retained in plastic clips, on the outside of the formatter cage. Disconnect one connector, release the plastic locator pin, and then gently lift the accelerator board away from the formatter by the edges.

NOTE:  A connector on the back of the accelerator board holds the board on the formatter.

IMPORTANT:  Do not lift the accelerator board by the heat sink.

Figure 2-130 Remove the accelerator PCA

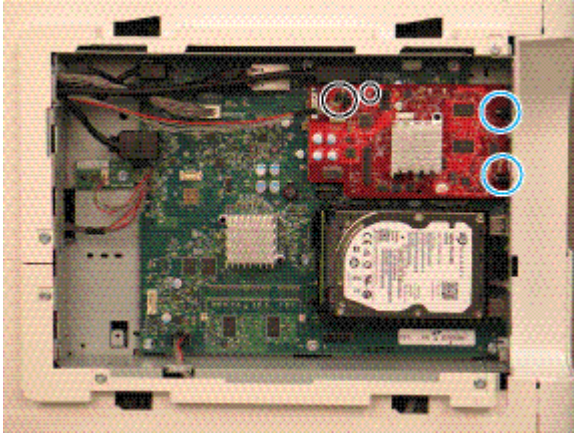

Unpack the replacement assembly



Follow these steps to unpack the replacement assembly.

1. Dispose of the defective part.

 **NOTE:** HP recommends responsible disposal of the defective part.

<http://www8.hp.com/us/en/hp-information/environment/product-recycling.html>

2. Unpack the replacement part from the packaging.

 **CAUTION:**  Some parts are sensitive to electrostatic discharge (ESD). Always perform service work at an ESD-protected workstation or mat. If an ESD workstation or mat is not available, touch the sheet-metal chassis to provide a static ground before touching an ESD-sensitive assembly. Protect the ESD-sensitive assemblies by placing them in ESD pouches when they are out of the printer.

 **IMPORTANT:** Make sure that all of the shipping materials (for example shipping tape) are removed from the replacement part prior to installation.

 **NOTE:** If the replacement part is a roller or pad, avoid touching the spongy part of it. Skin oils on the roller or pad can cause paper pickup and/or print-quality problems. HP recommends using disposable gloves when handling rollers or pads or washing your hands before touching rollers or pads.

3. To install an assembly, reverse the removal steps.

 **NOTE:** When applicable, special installation instructions are provided for an assembly at the end of the removal procedure. Always completely read the removal instructions and follow all special installation instructions.

Install accessory: NFC Kit Installation

This document provides the procedures to install the NFC kit.



[View a video of removing and replacing the NFC.](#)

Mean time to repair: 5 minutes

Service level: Basic



IMPORTANT: When applicable, special installation instructions are provided for an assembly at the end of the removal procedure. Always completely read the removal instructions and follow all special installation instructions.

Before performing service

Turn the printer power off

- Disconnect the power cable.



WARNING! To avoid damage to the printer, turn the printer off, wait 30 seconds, and then remove the power cable before attempting to service the printer.

Use the table below to identify the correct part number for your printer. To order the part, go to www.hp.com/buy/parts.

Table 2-24 Part information

Part number	Part description
J8030-61001	Jetdirect Wireless Print Server with NFC Kit

Required tools

- No special tools are required to remove this part.

After performing service

Turn the printer power on

- Connect the power cable.
- Use the power switch to turn the power on.

Post service test

Make sure that the printer initializes to a **Ready** state.

Connect a third party solution to the FIH, and then verify it correctly functions.

Unpack the NFC kit

Follow these steps to unpack the NFC kit.

- ▲ Unpack the NFC kit.

Install the NFC kit

Follow these steps to install the NFC kit.

1. Turn off the power to the product.

2. Remove the HIP cover.

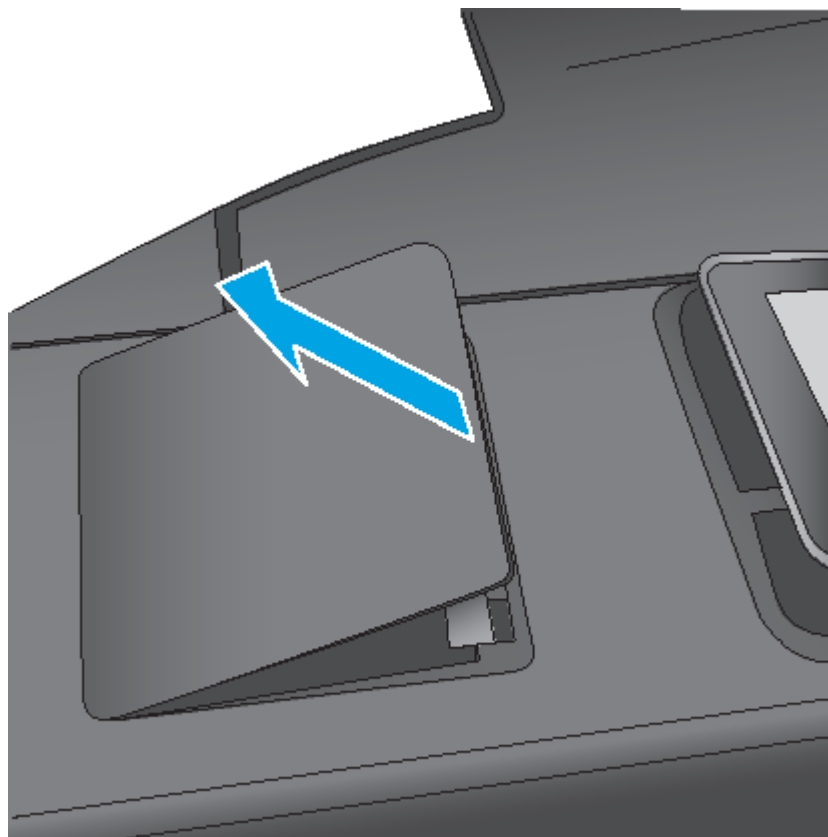
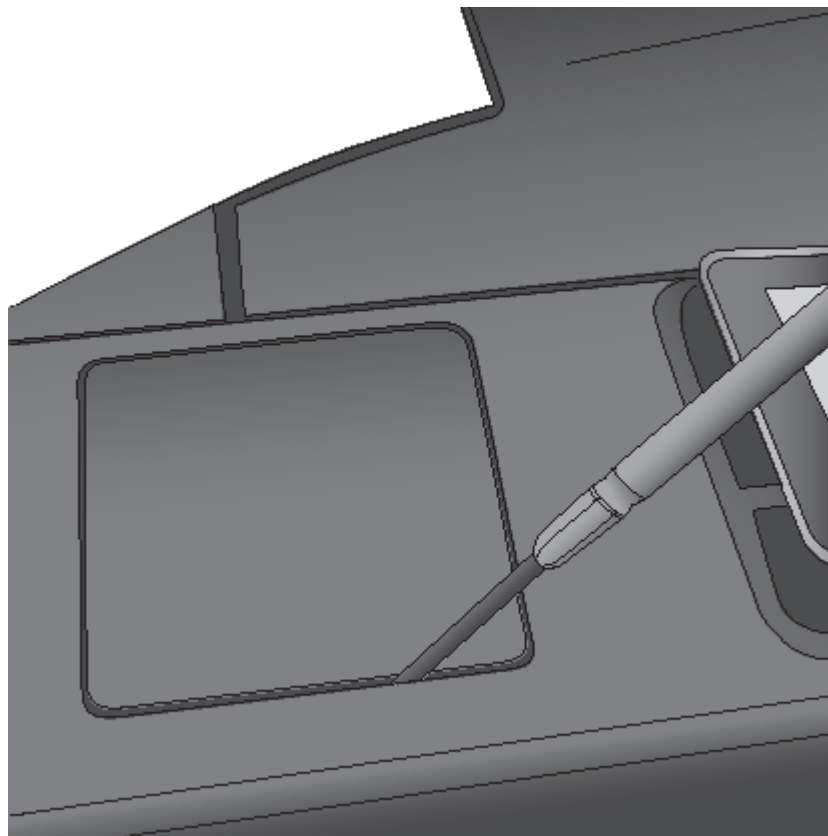

3. Identify the USB connector in the HIP and attach the appropriate USB cable:
 - a. Locate the USB connector that is along one of the short edges. A USB Mini B receptacle (callout 1.1) is the most common. However, on some models, a USB Mini B plug (callout 1.2) is used.

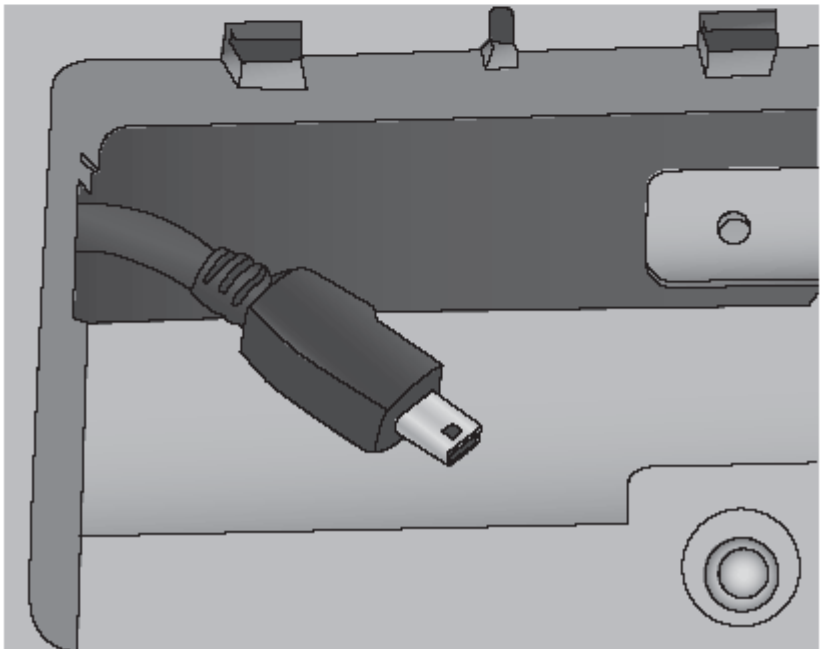
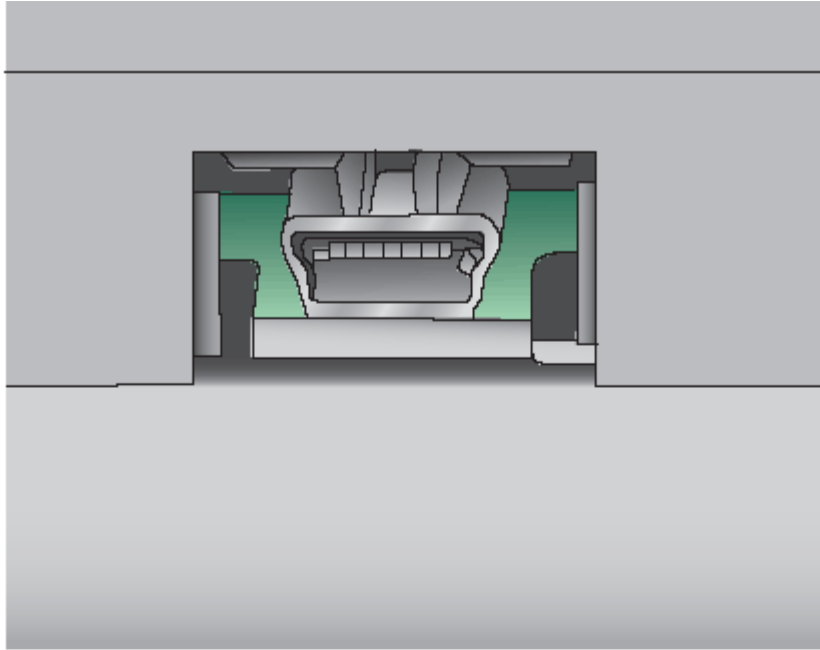

- b. Select the appropriate cable from the two that are provided.

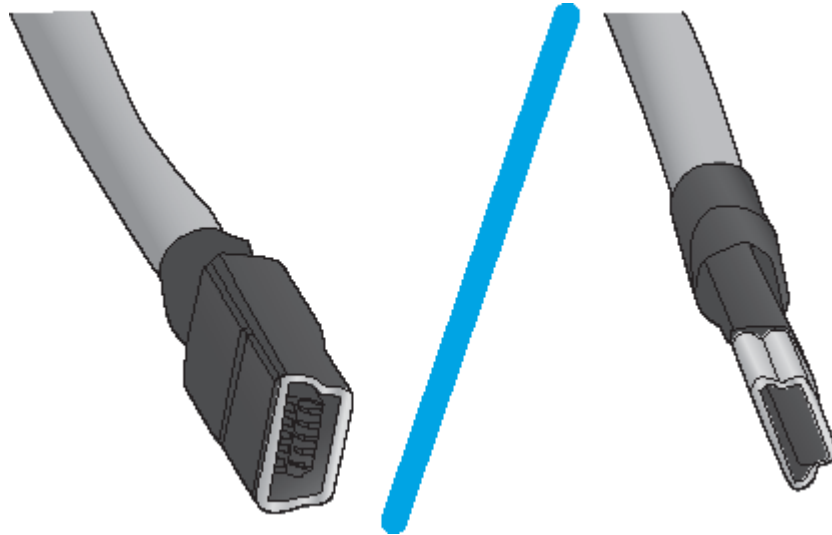

- c. Plug the USB cable into the socket in the HIP. Note that the USB logo on the connector may face down on some models of printers/MFPs.

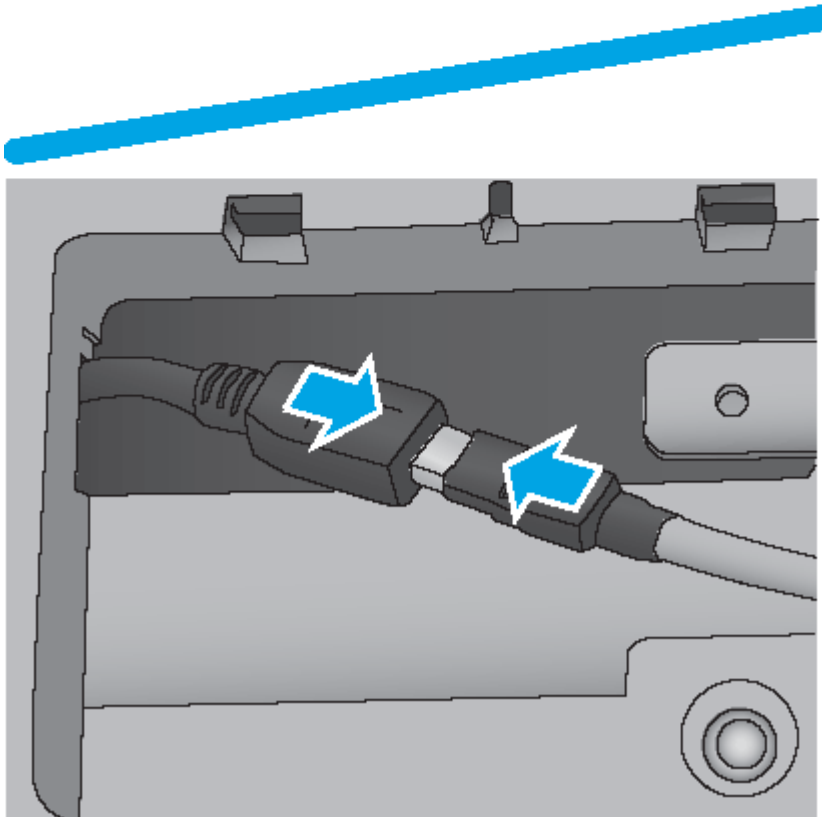
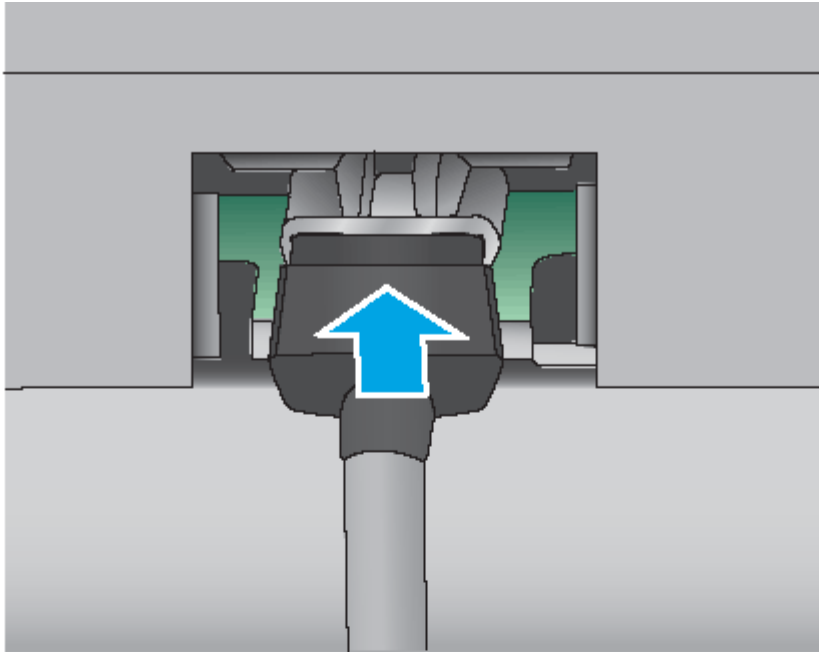

4. Attach the power and grounding ends of the USB cable:

 **NOTE:** Before connecting the NFC accessory to the USB connector, verify that the product power is turned off.

- a. Attach the white power connector of the cable into the corresponding receptacle on the underside of the NFC accessory with the contacts facing down.

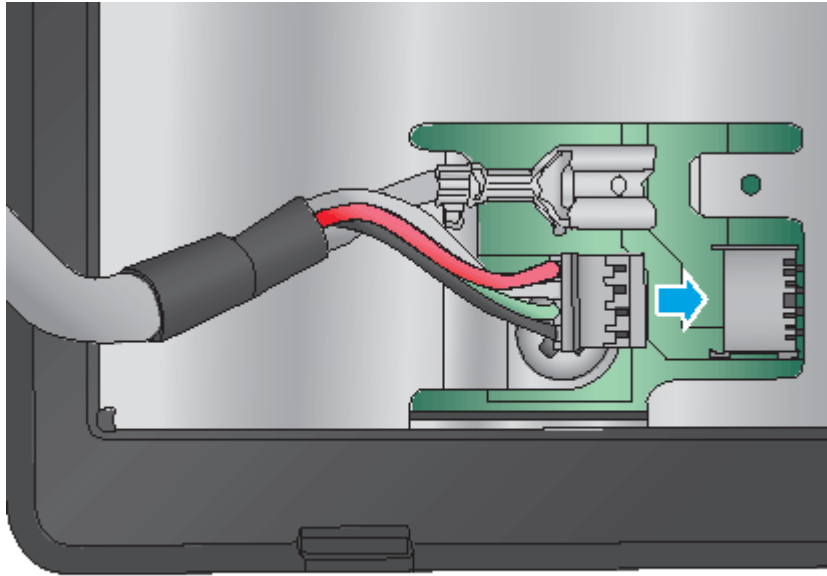

- b. Attach the metal ground connector of the cable to the grounding tab on the underside of the

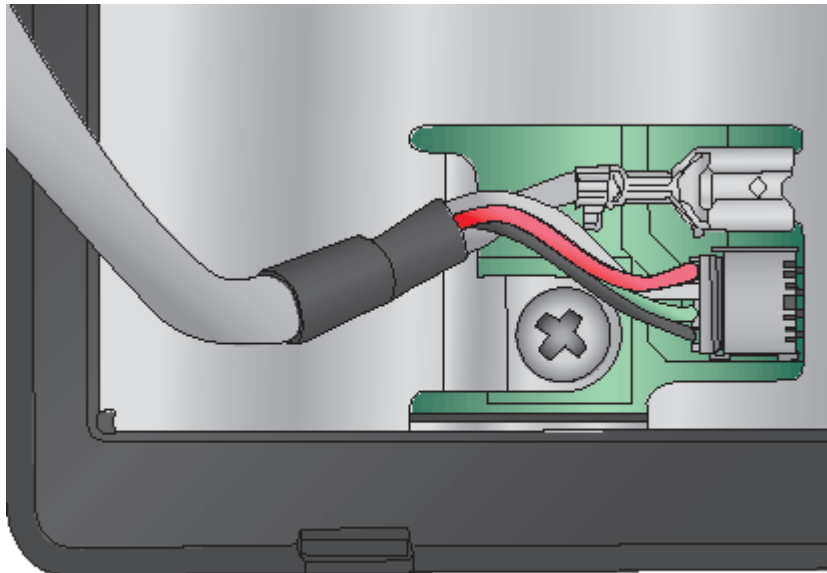

5. Insert the NFC accessory into the HIP recess.
 - a. Insert the NFC accessory into the HIP recess using the hook-shaped clips first.

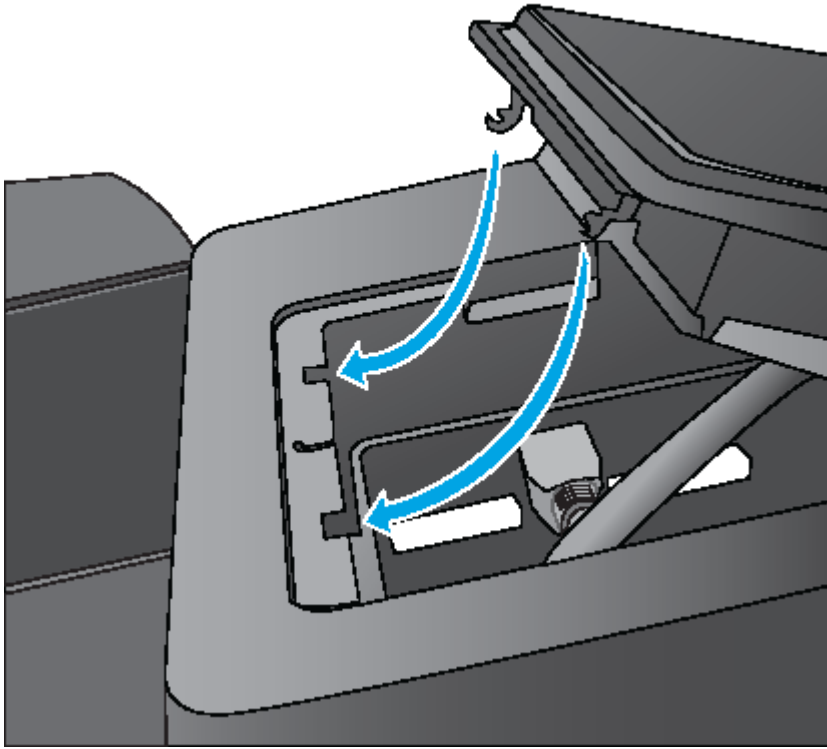

- b. Gently push the NFC accessory onto the rounded clips so that it is held securely in place within the recess.

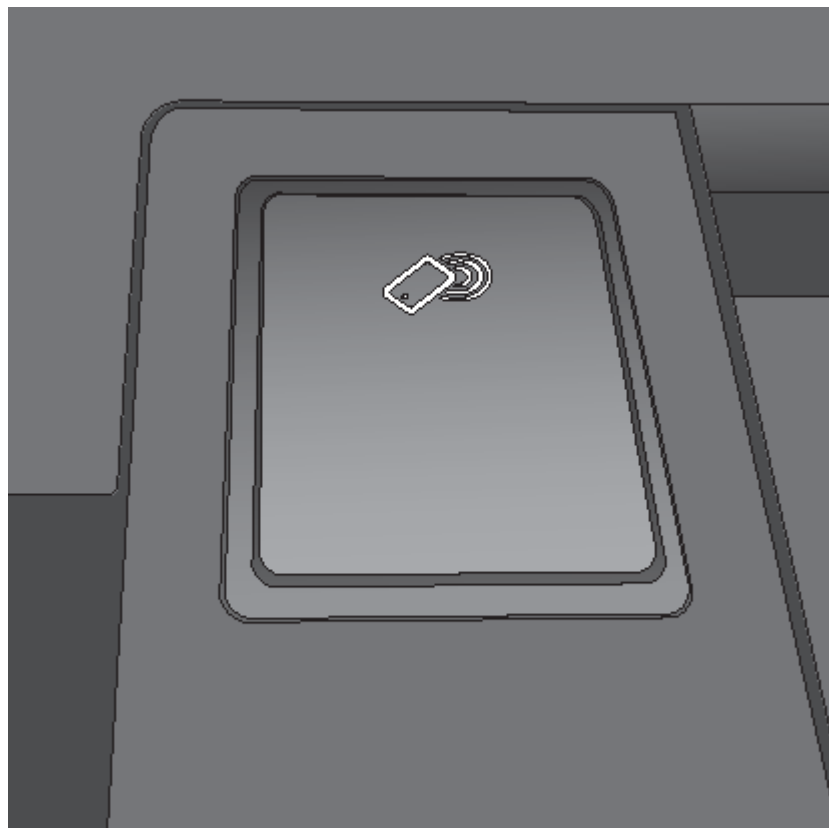
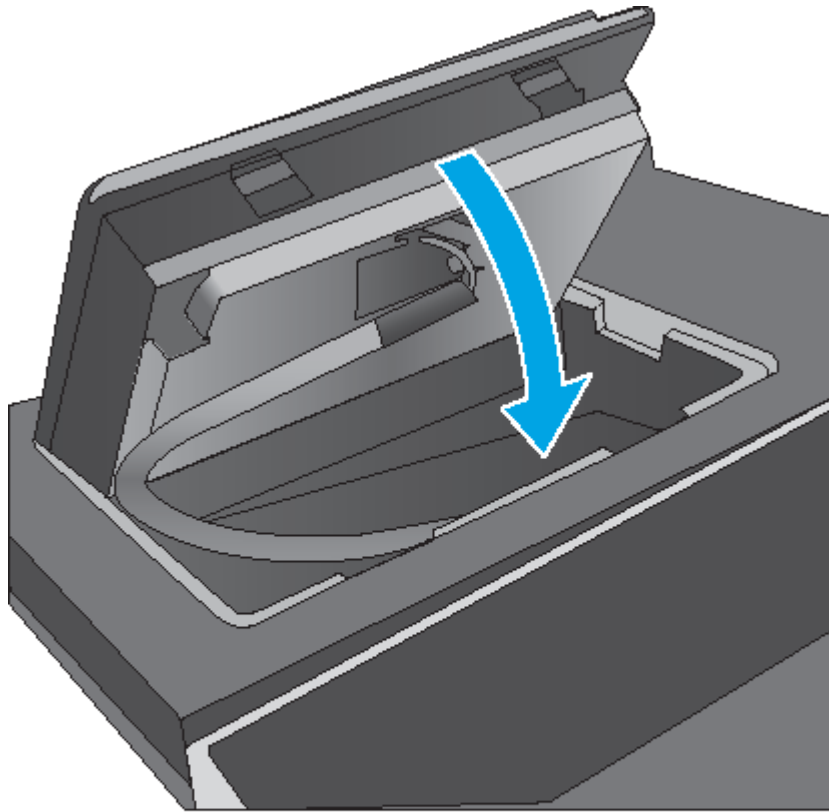

wireless network icon will also appear on the control panel.

Install accessory: HP Foreign interface harness (FIH) solution

This document provides the procedures to install the Foreign Interface Harness (FIH) accessory.



[View a video of installing the FIH.](#)

Mean time to repair: 1 minute

Service level: Basic



IMPORTANT: When applicable, special installation instructions are provided for an assembly at the end of the removal procedure. Always completely read the removal instructions and follow all special installation instructions.

Before performing service

Turn the printer power off

- Disconnect the power cable.



WARNING! To avoid damage to the printer, turn the printer off, wait 30 seconds, and then remove the power cable before attempting to service the printer.

Use the table below to identify the correct part number for your printer. To order the part, go to www.hp.com/buy/parts.

Table 2-25 Part information

Part number	Part description
B5L31-90902	Foreign Interface Harness (FIH)

Required tools

- No special tools are required to remove this part.

After performing service

Turn the printer power on

- Connect the power cable.
- Use the power switch to turn the power on.

Post service test

Make sure that the printer initializes to a **Ready** state.

Connect a third party solution to the FIH, and then verify it correctly functions.

Unpack the Foreign Interface Harness (FIH) accessory

Follow these steps to unpack the Foreign Interface Harness (FIH) accessory.

- ▲ Unpack the Foreign Interface Harness (FIH) accessory.

Install the FIH accessory

Follow these steps to install the FIH accessory.

- ▲ Locate the USB connector on the printer formatter. Connect the FIH to this connector

Figure 2-131 Connect the FIH

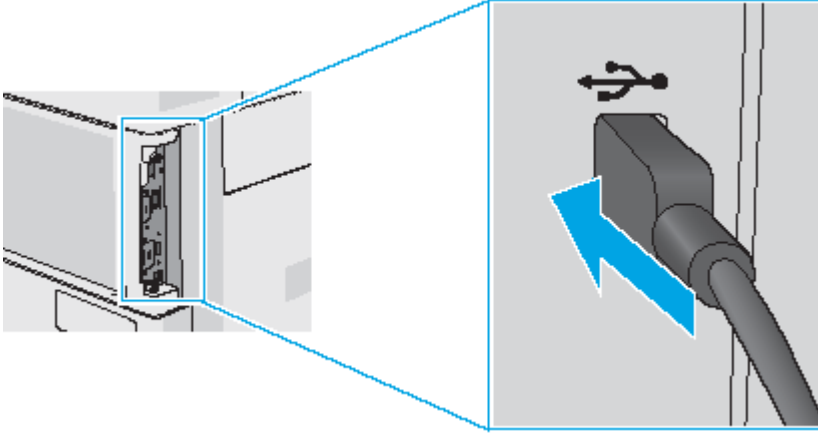

Removal and replacement: Removal and replacement: 500 GB FIPS HDD/500 GB formatter HDD

This procedure is for removing the 500 GB FIPS HDD installed on the formatter.



[View a video of removing and replacing the HDD \(E72520-E72530\).](#)



[View a video of removing and replacing the HDD \(E77820-E77830\).](#)

Mean time to repair: 20 minutes

Service level: Intermediate



IMPORTANT: When applicable, special installation instructions are provided for an assembly at the end of the removal procedure. Always completely read the removal instructions and follow all special installation instructions.

Before performing service

- Disconnect the power cable.



WARNING! To avoid damage to the printer, turn the printer off, wait 30 seconds, and then remove the power cable before attempting to service the printer.

Use the table below to identify the correct part number for your printer. To order the part, go to www.hp.com/buy/parts

Table 2-26 Part information

Part number	Part description
B5L29-67903	500 GB FIPS HDD
5851-6712	Formatter HDD - 500 GB SED

Required tools

- #2 JIS screwdriver with a magnetic tip

After performing service

Turn the printer power on

- Connect the power cable.
- Use the power switch to turn the power on.

Post service test

Copy, scan, or print a document. Verify the document copies, scans, or prints correctly.

Remove the formatter cover

Follow these steps to remove the formatter cover.

- ▲ Unscrew two captive thumbscrews on the formatter cover. Slide the formatter cover to the left, and then to the right to remove.

Figure 2-132 Remove the formatter cover

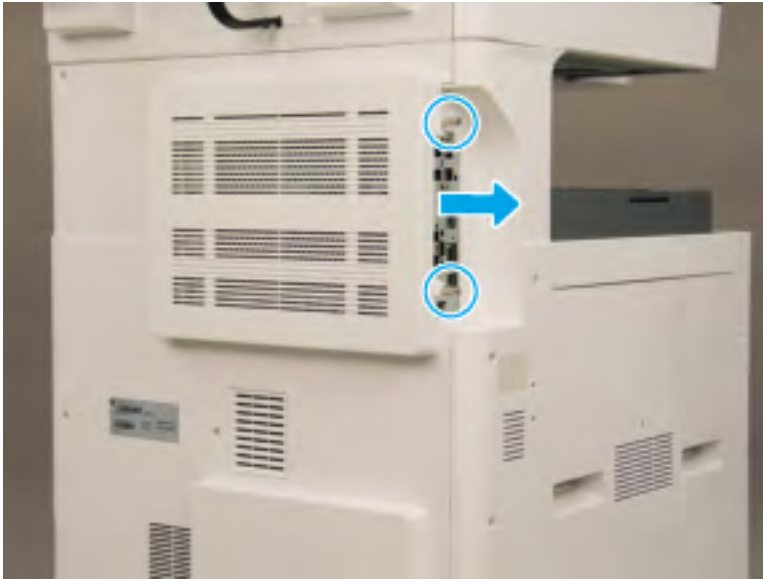

Remove the hard-disk drive (HDD)

Follow these steps to remove the hard-disk drive (HDD).

- ▲ Release one retainer, and then remove the HDD.

 **IMPORTANT:** The HDD and the IOD cannot be replaced at the same time.

Figure 2-133 Remove the hard-disk drive (HDD)



Removal and replacement: Formatter and formatter cage

This document provides the procedures to remove the formatter and formatter cage assembly.



[View a video of removing and replacing the formatter and formatter cage.](#)

Mean time to repair: 15 minutes

Service level: Basic



IMPORTANT: When applicable, special installation instructions are provided for an assembly at the end of the removal procedure. Always completely read the removal instructions and follow all special installation instructions.

Before performing service

- Disconnect the power cable.



WARNING! To avoid damage to the printer, turn the printer off, wait 30 seconds, and then remove the power cable before attempting to service the printer.

Use the table below to identify the correct part number for your printer. To order the part, go to www.hp.com/buy/parts

Table 2-27 Part information

Part number	Part description
JC93-01538A	Formatter Cage
X3A92-60003	Formatter PCA (E778xx series)
X3A92-60006	Formatter PCA - obsidian (E783xx series) (LX)
Y3K99-60005	Formatter PCA - Rock (E783xx series) (GX)

Required tools

- #2 JIS screwdriver with a magnetic tip

After performing service

Turn the printer power on

- Connect the power cable.
- Use the power switch to turn the power on.

Post service test

Copy, scan, or print a document. Verify the document copies, scans, or prints correctly.

Remove the rear covers

Follow these steps to remove the rear covers.

1. Unscrew two captive thumbscrews on the formatter cover. Slide the formatter cover to the left, and then to the right to remove.

Figure 2-134 Remove the formatter cover

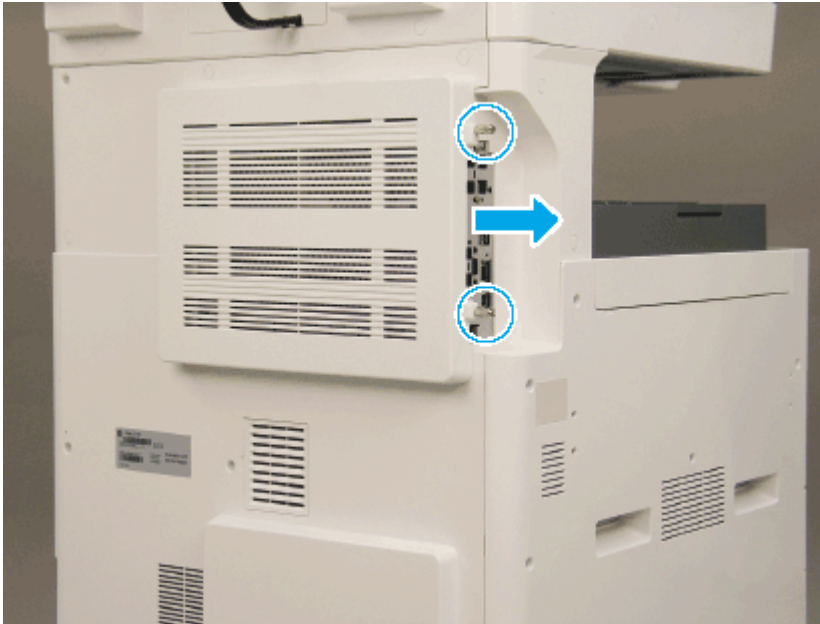

2. Remove seven screws, and then remove the rear-bottom cover.

Figure 2-135 Remove the rear-bottom cover

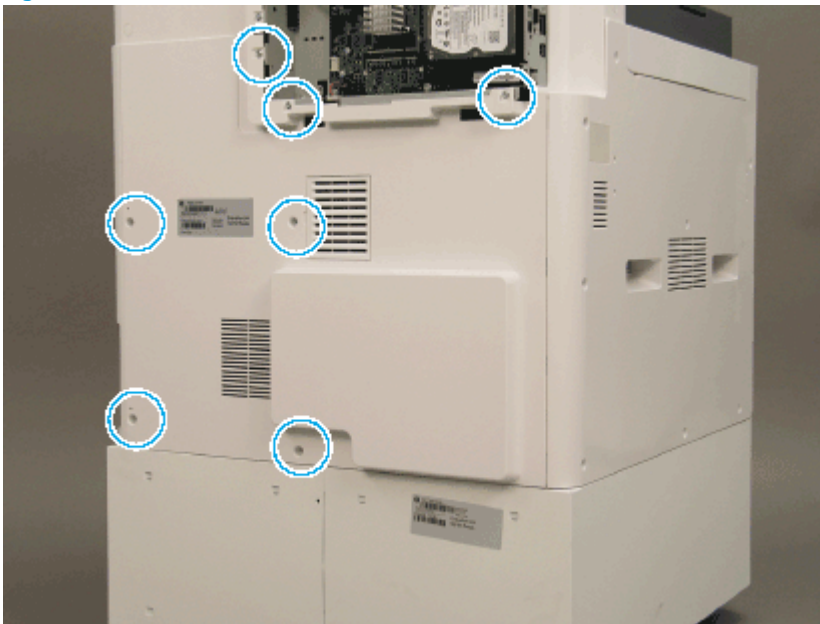

3. Remove six screws (callout 1), and then remove the rear-top cover.

Figure 2-136 Remove the rear-top cover

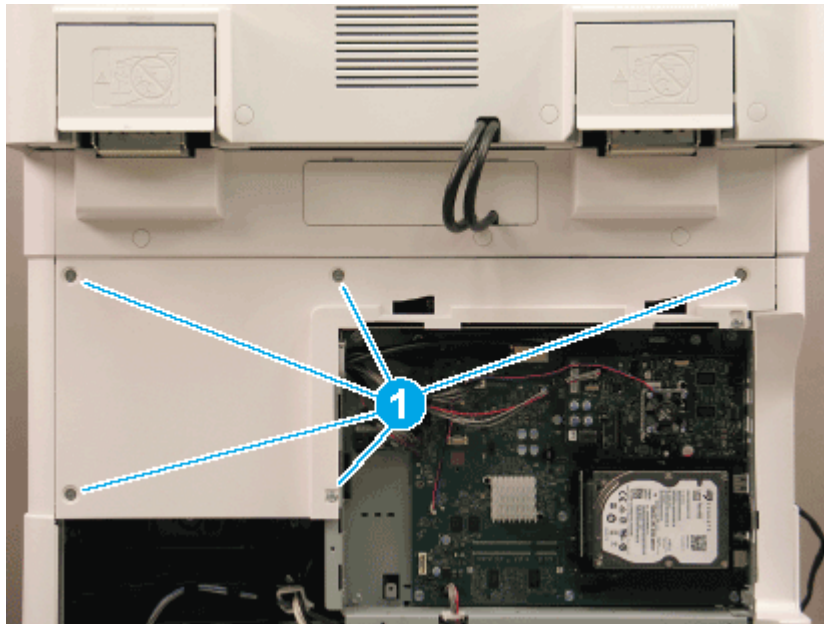

Remove the accelerator board

Follow these steps to remove the accelerator board.

 **CAUTION:**  ESD sensitive part.

- ▲ Loosen two screws, retained in plastic clips, on the outside of the formatter cage. Disconnect one connector, release the plastic locator pin, and then gently lift the accelerator board away from the formatter by the edges.

 **NOTE:** A connector on the back of the accelerator board holds the board on the formatter.

 **IMPORTANT:** Do not lift the accelerator board by the heat sink.

Figure 2-137 Remove the accelerator PCA



Remove the hard-disk drive (HDD)

Follow these steps to remove the hard-disk drive (HDD).

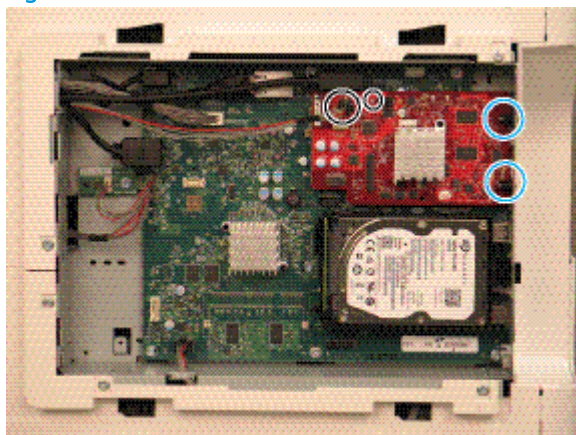
- ▲ Release one retainer, and then remove the HDD.

 **IMPORTANT:** The HDD and the IOD cannot be replaced at the same time.

Figure 2-138 Remove the hard-disk drive (HDD)



Remove the Island of data (IOD)

Follow these steps to remove the Island of data (IOD).

- ▲ Disconnect one connector and remove one screw, and then remove the IOD.

 **IMPORTANT:** The HDD and the IOD cannot be replaced at the same time.

Figure 2-139 Remove the IOD



Remove the formatter PCA

Follow these steps to remove the formatter PCA.

- ▲ Disconnect seven connectors and eight screws, and then remove formatter PCA.

Figure 2-140 Remove the formatter connectors and screws

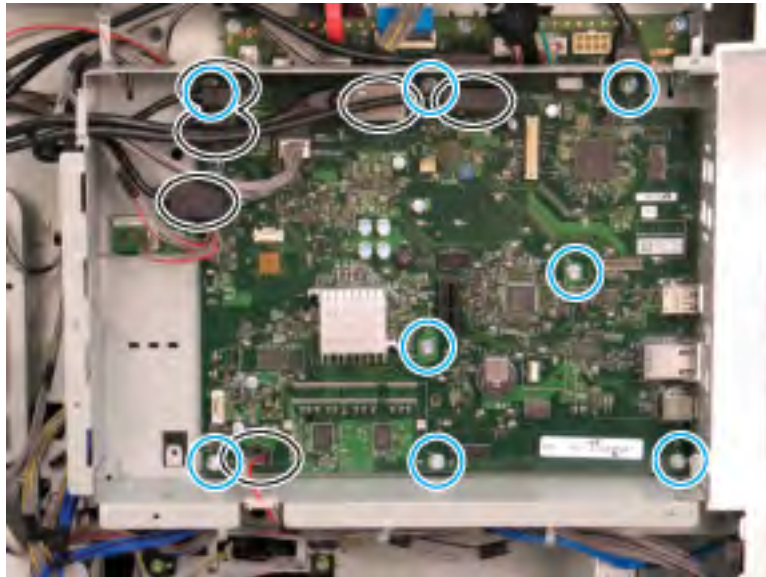

Remove the formatter cage

Follow these steps to remove the formatter cage.

1. Disconnect ten connectors and two cable restraints.
2. Remove four screws and screw-caps, and then remove the left-upper cover.

Figure 2-141 Remove the left-upper cover

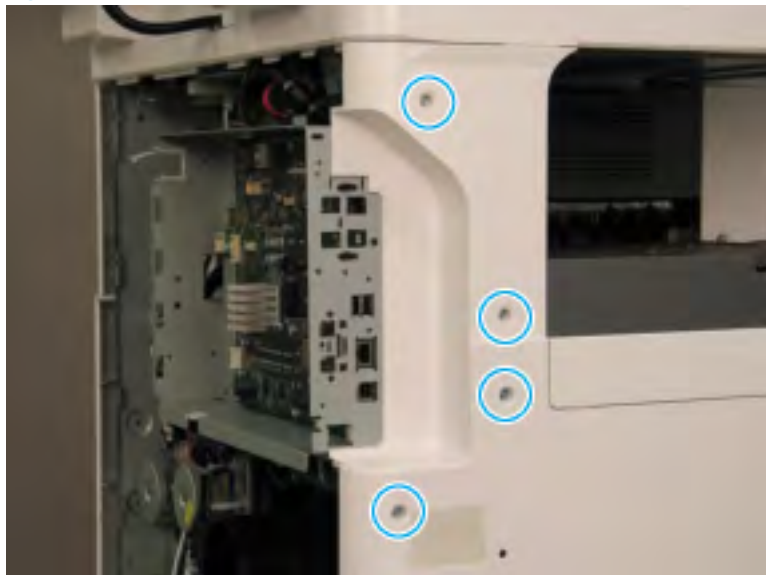

3. Remove one screw from the side of the formatter cage (beneath the left-upper cover location).

Figure 2-142 Remove the formatter cage side screw

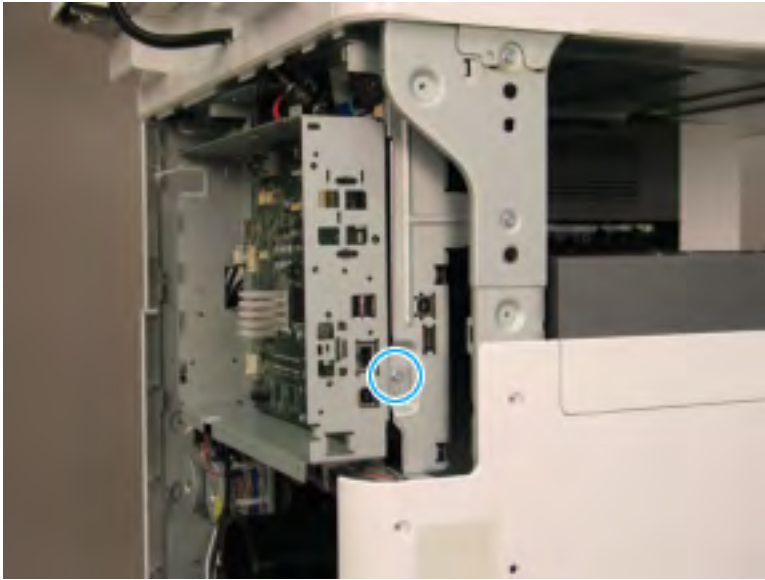

4. Remove three screws from the formatter cage face, and then release one tab to remove the formatter cage.

Figure 2-143 Remove three screws to remove the formatter cage



Unpack the replacement assembly

Follow these steps to unpack the replacement assembly.

1. Dispose of the defective part.

 **NOTE:** HP recommends responsible disposal of the defective part.

<http://www8.hp.com/us/en/hp-information/environment/product-recycling.html>

2. Unpack the replacement part from the packaging.



CAUTION:  Some parts are sensitive to electrostatic discharge (ESD). Always perform service work at an ESD-protected workstation or mat. If an ESD workstation or mat is not available, touch the sheet-metal chassis to provide a static ground before touching an ESD-sensitive assembly. Protect the ESD-sensitive assemblies by placing them in ESD pouches when they are out of the printer.



IMPORTANT: Make sure that all of the shipping materials (for example shipping tape) are removed from the replacement part prior to installation.



NOTE: If the replacement part is a roller or pad, avoid touching the spongy part of it. Skin oils on the roller or pad can cause paper pickup and/or print-quality problems. HP recommends using disposable gloves when handling rollers or pads or washing your hands before touching rollers or pads.

3. To install an assembly, reverse the removal steps.



NOTE: When applicable, special installation instructions are provided for an assembly at the end of the removal procedure. Always completely read the removal instructions and follow all special installation instructions.

Removal and replacement: 500GB Main PCA HDD

This document provides the procedures to remove the hard disk drive (HDD) assembly.



[View a video of removing and replacing the HDD \(E72525-E72535\).](#)



[View a video of removing and replacing the HDD \(E77822-E77830\).](#)

Mean time to repair: 15 minutes

Service level: Intermediate



IMPORTANT: When applicable, special installation instructions are provided for an assembly at the end of the removal procedure. Always completely read the removal instructions and follow all special installation instructions.

Before performing service

- Disconnect the power cable.

Use the table below to identify the correct part number for your printer. To order the part, go to www.hp.com/buy/parts

Table 2-28 Part information

Part number	Part description
5851-6712	Main disk drive assembly

Required tools

- #2 JIS screwdriver with a magnetic tip

After performing service

Turn the printer power on

- Connect the power cable.
- Use the power switch to turn the power on.

Post service test

Copy, scan, or print a document. Verify the document copies, scans, or prints correctly.

Remove the main disk drive

Follow these steps to remove the main disk drive.

1. Remove the inner finisher or paper pass, if installed.

2. Remove two screw-caps and two screws from the power-switch cover.

Figure 2-144 Remove the power-switch cover



3. Remove two screw-caps and two screws, and then remove the exit tray.

Figure 2-145 Remove screw-caps and screws



4. Remove one screw and cover exit right.

Figure 2-146 Remove the cover exit right



5. Remove four screws and three screw covers. Remove the cover exit rear by pulling from the right and rotating out.

Figure 2-147 Remove screws and cover exit rear

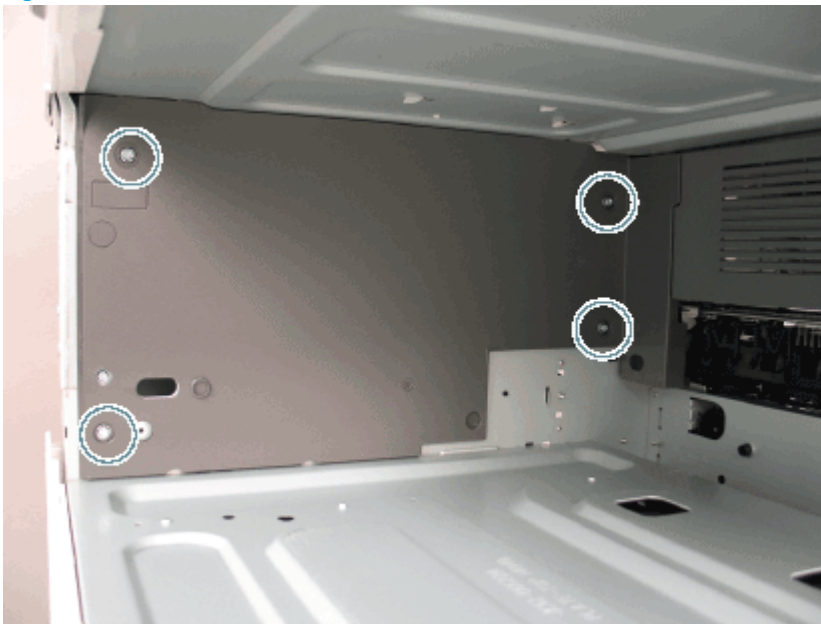

6. Remove four screws. Disconnect the cable and remove the main disk drive assembly.

Figure 2-148 Remove screws, disconnect cable and remove main disk drive assembly

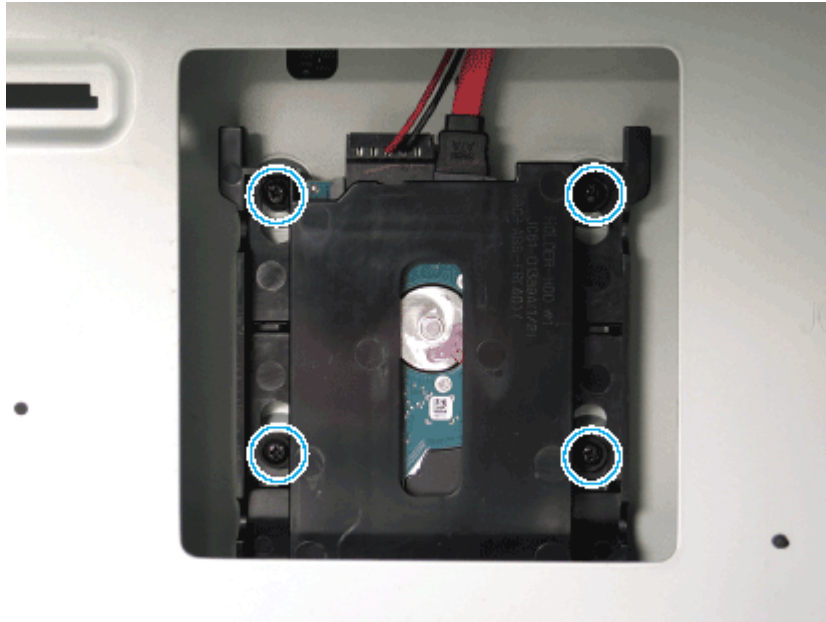

7. Remove four screws, and then remove main disk drive from its bracket.
8. Install the new main disk drive assembly.

 **TIP:** When reinstalling, make sure the plastic locator tabs on the rear exit cover are seated correctly.

Unpack the replacement assembly



Follow these steps to unpack the replacement assembly.

1. Dispose of the defective part.

 **NOTE:** HP recommends responsible disposal of the defective part.

<http://www8.hp.com/us/en/hp-information/environment/product-recycling.html>

2. Unpack the replacement part from the packaging.

 **CAUTION:**  Some parts are sensitive to electrostatic discharge (ESD). Always perform service work at an ESD-protected workstation or mat. If an ESD workstation or mat is not available, touch the sheet-metal chassis to provide a static ground before touching an ESD-sensitive assembly. Protect the ESD-sensitive assemblies by placing them in ESD pouches when they are out of the printer.

 **IMPORTANT:** Make sure that all of the shipping materials (for example shipping tape) are removed from the replacement part prior to installation.

 **NOTE:** If the replacement part is a roller or pad, avoid touching the spongy part of it. Skin oils on the roller or pad can cause paper pickup and/or print-quality problems. HP recommends using disposable gloves when handling rollers or pads or washing your hands before touching rollers or pads.

3. To install an assembly, reverse the removal steps.



NOTE: When applicable, special installation instructions are provided for an assembly at the end of the removal procedure. Always completely read the removal instructions and follow all special installation instructions.

Removal and replacement: Control panel

This document provides the procedures to remove the control panel assembly.



[View a video of removing and replacing the control panel \(E77820-E77830\).](#)

Mean time to repair: 15 minutes

Service level: Intermediate



IMPORTANT: When applicable, special installation instructions are provided for an assembly at the end of the removal procedure. Always completely read the removal instructions and follow all special installation instructions.

Before performing service

- Disconnect the power cable.



WARNING! To avoid damage to the printer, turn the printer off, wait 30 seconds, and then remove the power cable before attempting to service the printer.

Use the table below to identify the correct part number for your printer. To order the part, go to www.hp.com/buy/parts

Table 2-29 Part information

Part number	Part description
B5L47-60101	Control panel assembly

Required tools

- #2 JIS screwdriver with a magnetic tip

After performing service

Turn the printer power on

- Connect the power cable.
- Use the power switch to turn the power on.

Post service test

Copy, scan, or print a document. Verify the document copies, scans, or prints correctly.

Remove the control-panel bezel

Follow these steps to remove the control-panel bezel.

1. Open the document feeder, and then remove three screws.

Figure 2-149 Remove the document feeder bezel



2. Place the control panel in the upright position.
3. Gently pry the control-panel bezel from the center screw hole, and then pry from the center of the control-panel bezel to the edges to release.

CAUTION: Do not pry against the scanner glass when removing the control-panel bezel.

Remove the control-panel

Follow these steps to remove the control-panel.

1. Place the control panel in the upright position.
2. Disconnect one FFC, one connector, and one HDMI connector (callout 1), and then remove two screws on the control-panel frame.

Figure 2-150 Remove the control panel screws and disconnect connectors

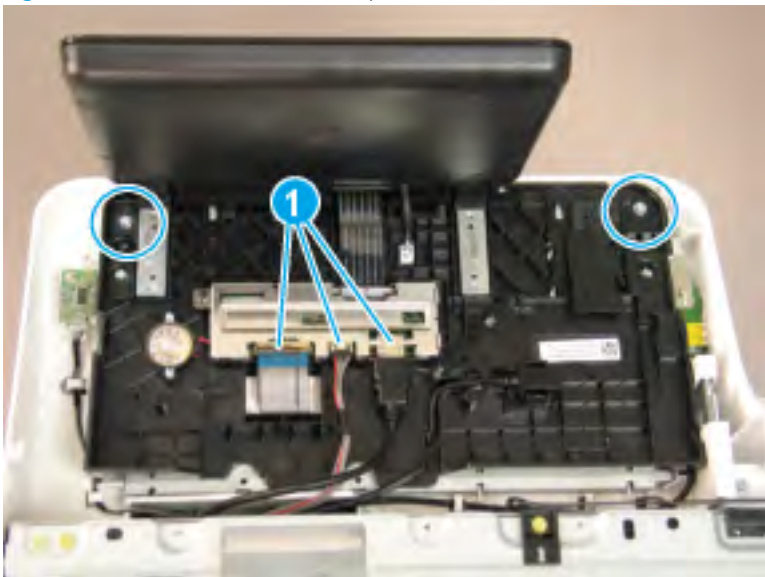

3. Remove the USB interconnect cable from its retainer and reroute out of the way.

Figure 2-151 Remove the USB interconnect cable



4. Lift the control panel up from the front to release the tabs at the rear, and then remove the control panel.

 **TIP:** Align the four tabs at the rear of control panel, and then snap in the control panel.

Unpack the replacement assembly



Follow these steps to unpack the replacement assembly.

1. Dispose of the defective part.

 **NOTE:** HP recommends responsible disposal of the defective part.

<http://www8.hp.com/us/en/hp-information/environment/product-recycling.html>

2. Unpack the replacement part from the packaging.

 **CAUTION:**  Some parts are sensitive to electrostatic discharge (ESD). Always perform service work at an ESD-protected workstation or mat. If an ESD workstation or mat is not available, touch the sheet-metal chassis to provide a static ground before touching an ESD-sensitive assembly. Protect the ESD-sensitive assemblies by placing them in ESD pouches when they are out of the printer.

 **IMPORTANT:** Make sure that all of the shipping materials (for example shipping tape) are removed from the replacement part prior to installation.

 **NOTE:** If the replacement part is a roller or pad, avoid touching the spongy part of it. Skin oils on the roller or pad can cause paper pickup and/or print-quality problems. HP recommends using disposable gloves when handling rollers or pads or washing your hands before touching rollers or pads.

3. To install an assembly, reverse the removal steps.

 **NOTE:** When applicable, special installation instructions are provided for an assembly at the end of the removal procedure. Always completely read the removal instructions and follow all special installation instructions.

Removal and replacement: Keyboard

This document provides the procedures to remove the keyboard assembly.



[View a video of removing and replacing the keyboard \(E72520-E72530\).](#)



[View a video of removing and replacing the keyboard \(E77820-E77830\).](#)

Mean time to repair: 10 minutes

Service level: Basic



IMPORTANT: When applicable, special installation instructions are provided for an assembly at the end of the removal procedure. Always completely read the removal instructions and follow all special installation instructions.

Before performing service

- Disconnect the power cable.



WARNING! To avoid damage to the printer, turn the printer off, wait 30 seconds, and then remove the power cable before attempting to service the printer.

Use the table below to identify the correct part number for your printer. To order the part, go to www.hp.com/buy/parts

Table 2-30 Part information

Part number	Part description
B5L47-60102	US English Keyboard Assy
B5L47-60103	UK English Keyboard Assy

Required tools

- #2 JIS screwdriver with a magnetic tip

After performing service

Turn the printer power on

- Connect the power cable.
- Use the power switch to turn the power on.

Post service test

Copy, scan, or print a document. Verify the document copies, scans, or prints correctly.

Remove the control-panel bezel

Follow these steps to remove the control-panel bezel.

1. Open the document feeder, and then remove three screws.

Figure 2-152 Remove the document feeder bezel



2. Place the control panel in the upright position.
3. Gently pry the control-panel bezel from the center screw hole, and then pry from the center of the control-panel bezel to the edges to release.

⚠ CAUTION: Do not pry against the scanner glass when removing the control-panel bezel.

Remove the keyboard

Follow these steps to remove the keyboard.

1. Disconnect one FFC.

Figure 2-153 Disconnect one FFC



2. Slide the keyboard out, and then depress two latches to remove the keyboard.

Figure 2-154 Remove the control-panel keyboard



Unpack the replacement assembly



Follow these steps to unpack the replacement assembly.

1. Dispose of the defective part.

 **NOTE:** HP recommends responsible disposal of the defective part.

<http://www8.hp.com/us/en/hp-information/environment/product-recycling.html>

2. Unpack the replacement part from the packaging.

 **CAUTION:**  Some parts are sensitive to electrostatic discharge (ESD). Always perform service work at an ESD-protected workstation or mat. If an ESD workstation or mat is not available, touch the sheet-metal chassis to provide a static ground before touching an ESD-sensitive assembly. Protect the ESD-sensitive assemblies by placing them in ESD pouches when they are out of the printer.

 **IMPORTANT:** Make sure that all of the shipping materials (for example shipping tape) are removed from the replacement part prior to installation.

 **NOTE:** If the replacement part is a roller or pad, avoid touching the spongy part of it. Skin oils on the roller or pad can cause paper pickup and/or print-quality problems. HP recommends using disposable gloves when handling rollers or pads or washing your hands before touching rollers or pads.

3. To install an assembly, reverse the removal steps.

 **NOTE:** When applicable, special installation instructions are provided for an assembly at the end of the removal procedure. Always completely read the removal instructions and follow all special installation instructions.

Exit assemblies

View the exit assemblies exploded view, parts list, and repair procedures.

Upper and lower exit

Parts diagram and parts list for the exit assemblies.

Figure 2-155 Upper and lower exit

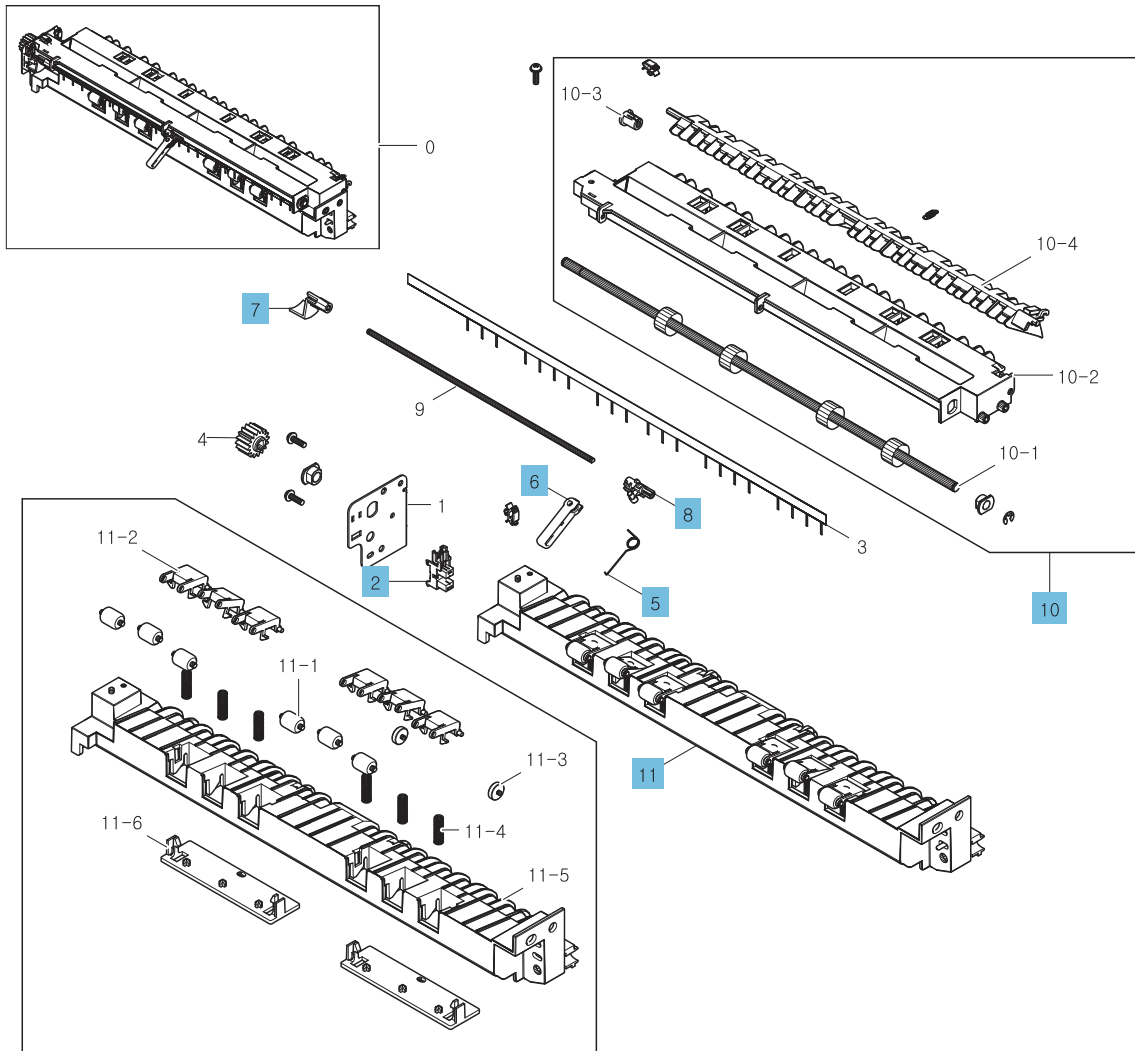

Table 2-31 Upper and lower exit

Ref				
No	Part number	Description	Qty	Repair procedure
2	0604-001393	Photo interrupter (fuser out sensor)	2	Removal and replacement: Fuser out sensor on page 256
4	JC66-02163A	Gear, exit	1	Not applicable
5	JC61-07185A	Spring, TS	1	Not applicable
6	JC66-04339A	Actuator-bin full exit	1	Not applicable
7	JC66-02218A	Lever-actuator F_D full	1	Not applicable
8	JC66-02278A	Lever-act full exit	1	Not applicable
10	JC90-01132A	Exit guide, upper	1	Not applicable
11	JC90-01133A	Exit guide, lower	1	Not applicable

Removal and replacement: Fuser out sensor

This document provides the procedures to remove the fuser out sensor.

Mean time to repair: 3 minutes

Service level: Basic

 **IMPORTANT:** When applicable, special installation instructions are provided for an assembly at the end of the removal procedure. Always completely read the removal instructions and follow all special installation instructions.

Before performing service

- Disconnect the power cable.

 **WARNING!** To avoid damage to the printer, turn the printer off, wait 30 seconds, and then remove the power cable before attempting to service the printer.

Use the table below to identify the correct part number for your printer. To order the part, go to www.hp.com/buy/parts

Table 2-32 Part information

Part number	Part description
0604-001393	Fuser-out sensor assembly

Required tools

- #2 JIS screwdriver with a magnetic tip

After performing service

Turn the printer power on

- Connect the power cable.
- Use the power switch to turn the power on.

Post service test

Copy, scan, or print a document. Verify the document copies, scans, or prints correctly.

Remove the fuser out sensor

Follow these steps to remove the fuser out sensor.

1. Remove two screws and two plastic guides. Lift up the right-door.

Figure 2-156 Lift right-door

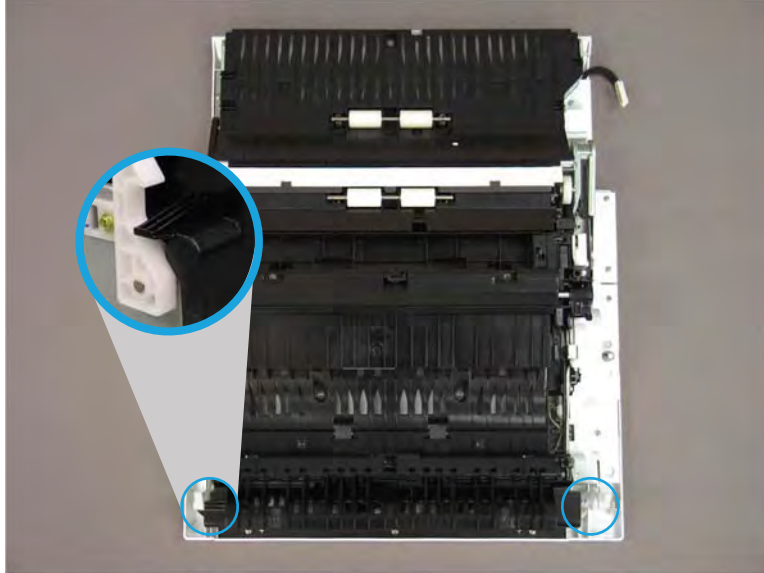

2. Disconnect the connector and remove the cable from the cable guide. Remove the right-door exit. Use caution as the springs are not retained.

Figure 2-157 Remove right-door exit



3. Remove three screws (plastic self-tapping), and then separate the right-door exit.

Figure 2-158 Remove screws and separate right-door exit

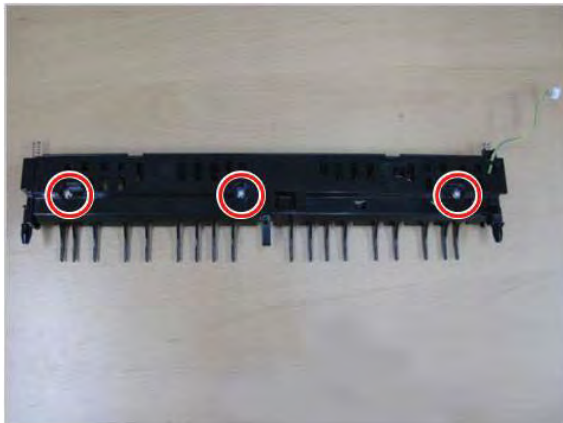

4. Disconnect the connector and remove the fuser-out sensor.

 **TIP:** When removing the sensor lift the flag, compress the bottom tabs and push from hole, and then rotate and release the top tabs.

Figure 2-159 Disconnect connector and remove fuser-out sensor



Unpack the replacement assembly

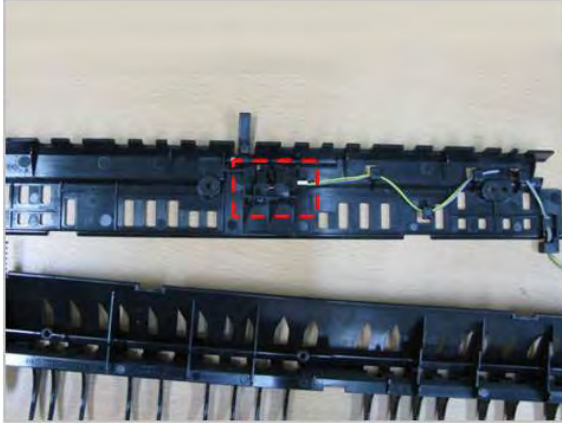

Follow these steps to unpack the replacement assembly.

1. Dispose of the defective part.

 **NOTE:** HP recommends responsible disposal of the defective part.

<http://www8.hp.com/us/en/hp-information/environment/product-recycling.html>

2. Unpack the replacement part from the packaging.

 **CAUTION:**  Some parts are sensitive to electrostatic discharge (ESD). Always perform service work at an ESD-protected workstation or mat. If an ESD workstation or mat is not available, touch the sheet-metal chassis to provide a static ground before touching an ESD-sensitive assembly. Protect the ESD-sensitive assemblies by placing them in ESD pouches when they are out of the printer.

 **IMPORTANT:** Make sure that all of the shipping materials (for example shipping tape) are removed from the replacement part prior to installation.

 **NOTE:** If the replacement part is a roller or pad, avoid touching the spongy part of it. Skin oils on the roller or pad can cause paper pickup and/or print-quality problems. HP recommends using disposable gloves when handling rollers or pads or washing your hands before touching rollers or pads.

3. To install an assembly, reverse the removal steps.

 **NOTE:** When applicable, special installation instructions are provided for an assembly at the end of the removal procedure. Always completely read the removal instructions and follow all special installation instructions.

Cassettes tray 2/3

View the cassettes tray 2/3 exploded view, parts list, and repair procedures.

Cassettes Tray 2/3

Parts diagram and parts list for the cassettes tray 2/3.

Figure 2-160 Cassettes Tray 2/3

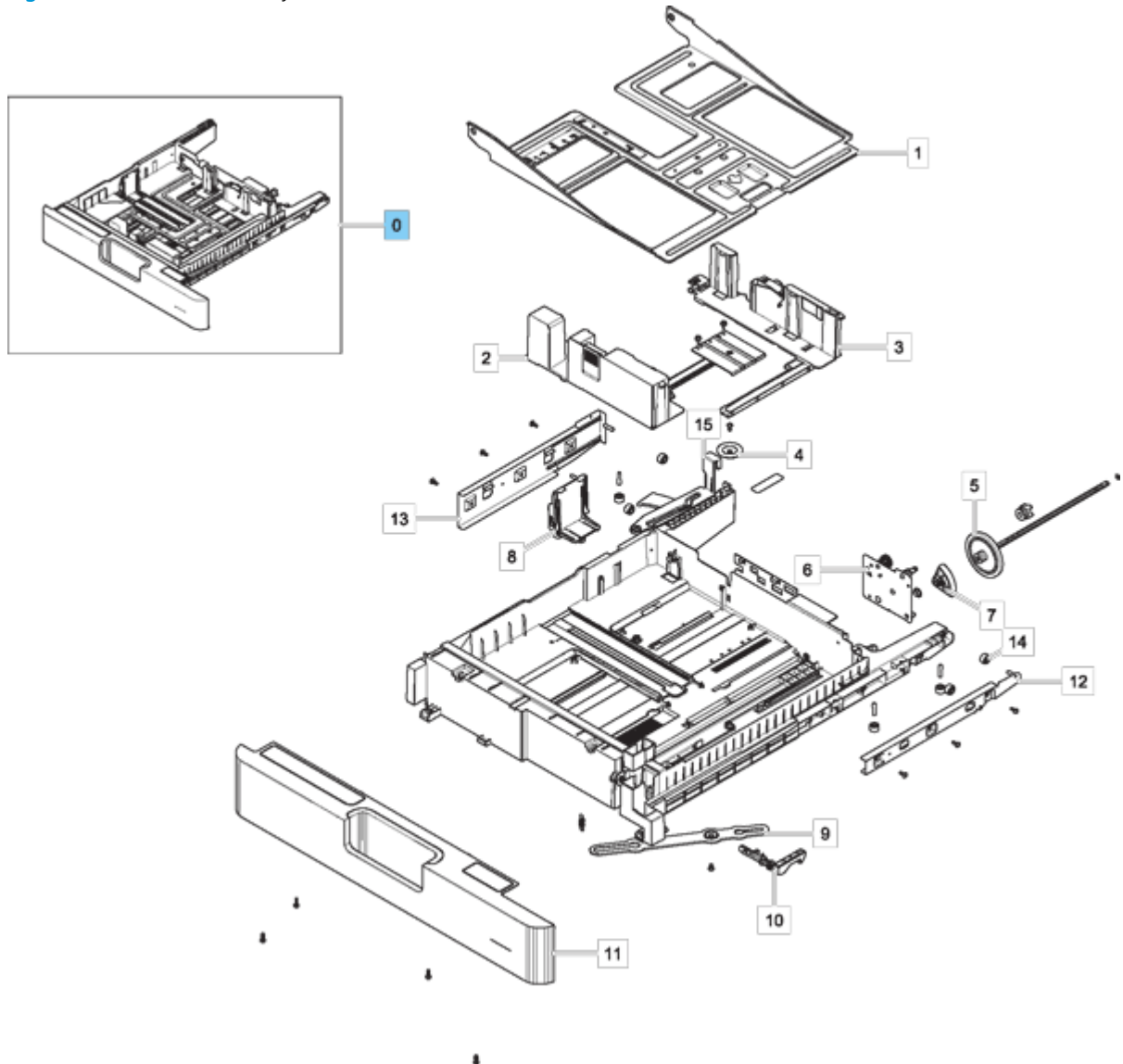

Table 2-33 Cassettes Tray 2/3

Ref				
No	Part number	Description	Qty	Repair procedure
0	JC90-01619A	Cassette, Tray 2	1	Not applicable
0	5QJ98-60109	Cassette, Tray 3	1	Not applicable

Main frame assembly

View the main frame assembly exploded view, parts list, and repair procedures.

Main engine frame

Parts diagram and parts list for the main engine frame.

Figure 2-161 Main engine frame

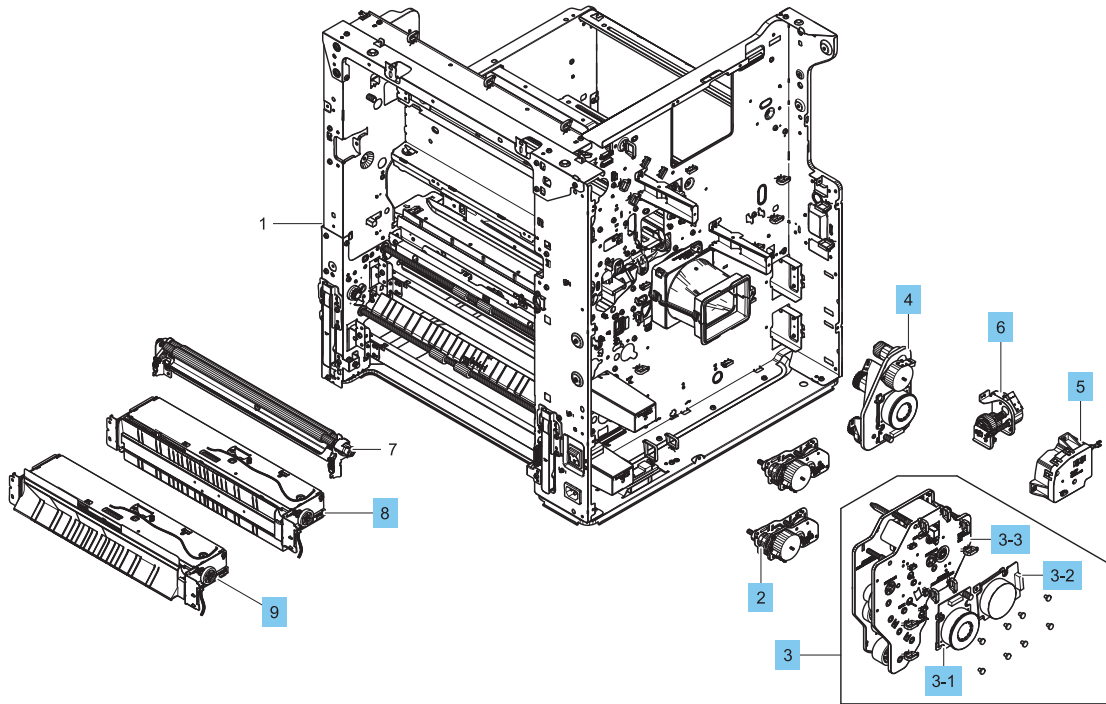

Table 2-34 Main engine frame

Ref				
No	Part number	Description	Qty	Repair procedure
2	JC93-00442A	Drive, pickup	2	Removal and replacement: Pickup drive unit on page 275
3	JC93-00912C	Drive, main	1	Removal and replacement: Main drive unit on page 279
3-1	JC31-00123B	Motor BLDC	1	Not applicable
3-2	JC31-00123A	Motor, BLDC	1	Not applicable
3-3	JC93-00911C	Drive, main sub	1	Not applicable
4	JC93-00449A	Drive, M fuser exit	1	Removal and replacement: Fuser/exit drive assembly on page 283
5	JC93-00450B	Drive, M toner supply	1	Removal and replacement: Toner supply drive unit on page 266
6	JC93-00451A	Drive, duct	1	Removal and replacement: Toner duct drive unit on page 270
8	JC93-01441A	Frame, main pickup 2nd	1	Not applicable
9	JC93-00511A	Frame, main pickup 1st	1	Not applicable

Removal and replacement: Toner supply drive unit

This document provides the procedures to remove the toner supply drive unit assembly.



[View a video of removing and replacing the toner supply unit.](#)

Mean time to repair: 15 minutes

Service level: Intermediate



IMPORTANT: When applicable, special installation instructions are provided for an assembly at the end of the removal procedure. Always completely read the removal instructions and follow all special installation instructions.

Before performing service

- Disconnect the power cable.

Use the table below to identify the correct part number for your printer. To order the part, go to www.hp.com/buy/parts

Table 2-35 Part information

Part number	Part description
JC93-00450B	Toner supply drive unit assembly (E72525, E72530, E72535 models)
5QJ87-64002	Toner supply drive unit assembly (E72825, E72830, E72835 models)

Required tools

- #2 JIS screwdriver with a magnetic tip

After performing service

Turn the printer power on

- Connect the power cable.
- Use the power switch to turn the power on.

Post service test

Copy, scan, or print a document. Verify the document copies, scans, or prints correctly.

Remove the rear covers

Follow these steps to remove the rear covers.

1. Unscrew two captive thumbscrews on the formatter cover. Slide the formatter cover to the left, and then to the right to remove.

Figure 2-162 Remove the formatter cover

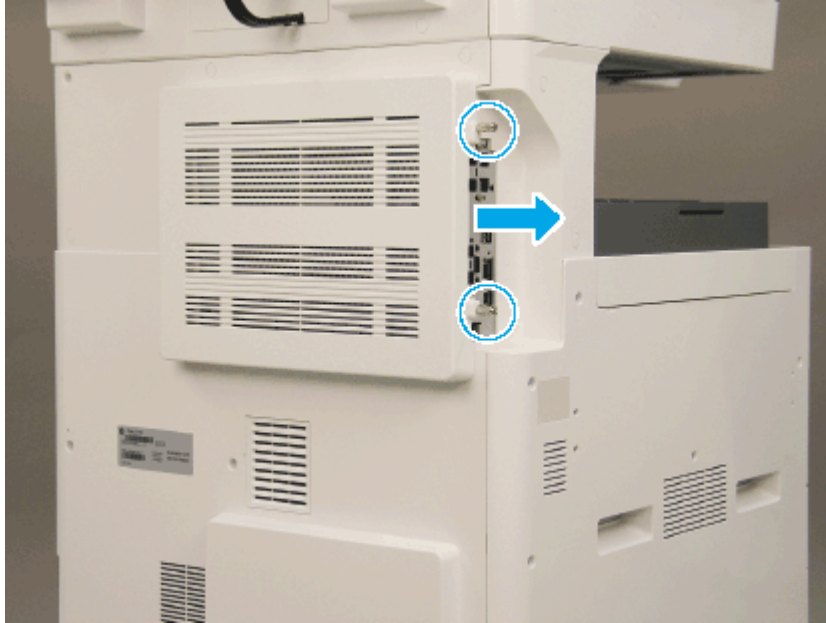

2. Remove seven screws, and then remove the rear-bottom cover.

Figure 2-163 Remove the rear-bottom cover

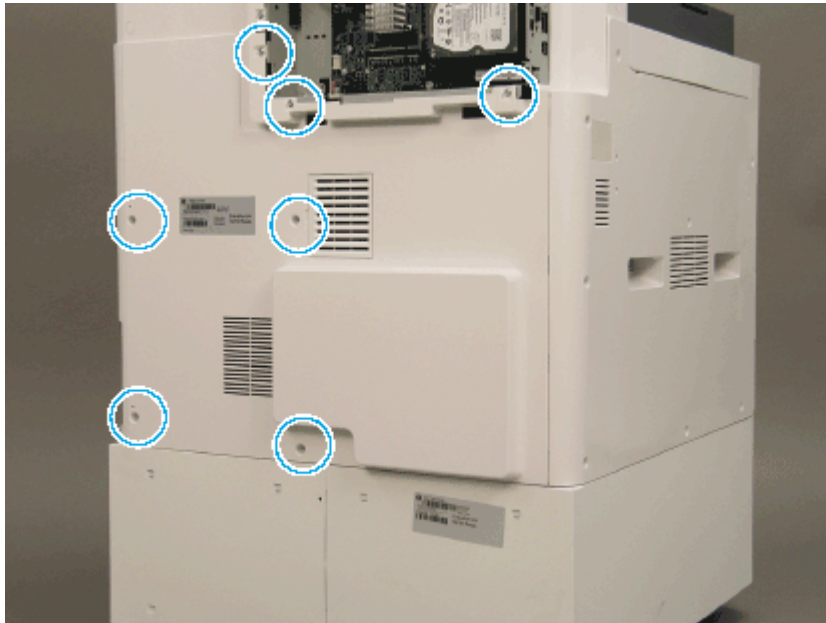

3. Remove six screws (callout 1), and then remove the rear-top cover.

Figure 2-164 Remove the rear-top cover

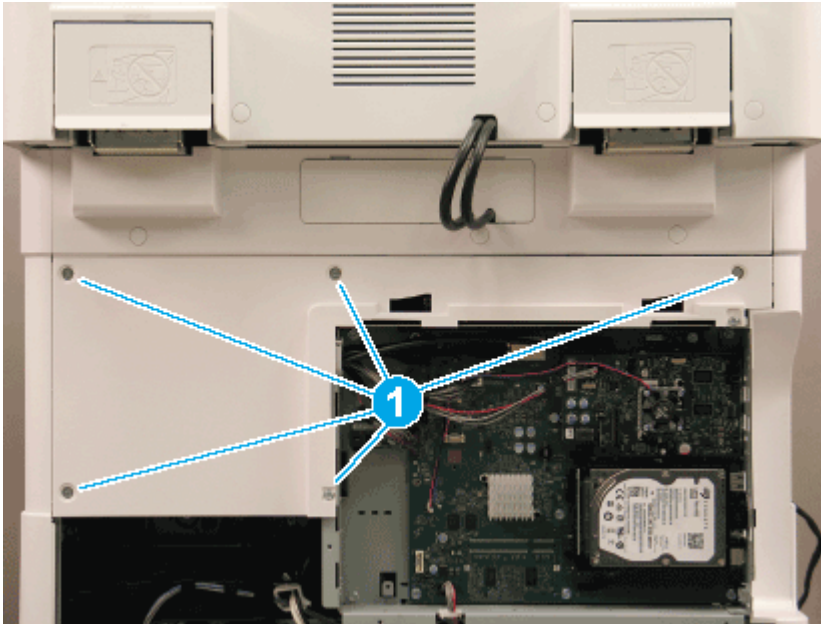

Remove the toner supply drive unit

Follow these steps to remove the toner supply drive unit.

1. Loosen the PCA cage by removing the two bottom screws. This enables access to the supply drive.
2. Release the cable restraint.
3. Disconnect the connector and remove three screws (callout 1). Remove the toner supply drive unit. Disconnect the second connector.

Figure 2-165 Remove toner supply drive unit and disconnect connector

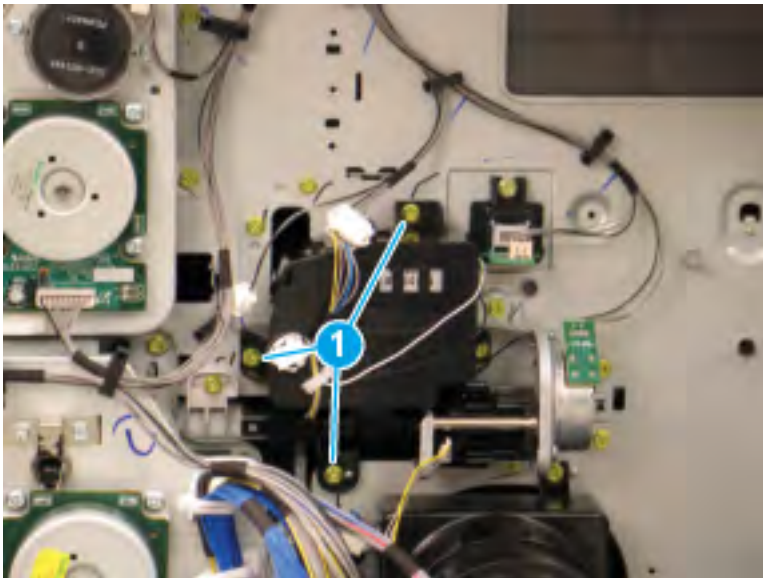

Unpack the replacement assembly

Follow these steps to unpack the replacement assembly.

1. Dispose of the defective part.



NOTE: HP recommends responsible disposal of the defective part.

<http://www8.hp.com/us/en/hp-information/environment/product-recycling.html>

2. Unpack the replacement part from the packaging.



CAUTION:  Some parts are sensitive to electrostatic discharge (ESD). Always perform service work at an ESD-protected workstation or mat. If an ESD workstation or mat is not available, touch the sheet-metal chassis to provide a static ground before touching an ESD-sensitive assembly. Protect the ESD-sensitive assemblies by placing them in ESD pouches when they are out of the printer.



IMPORTANT: Make sure that all of the shipping materials (for example shipping tape) are removed from the replacement part prior to installation.



NOTE: If the replacement part is a roller or pad, avoid touching the spongy part of it. Skin oils on the roller or pad can cause paper pickup and/or print-quality problems. HP recommends using disposable gloves when handling rollers or pads or washing your hands before touching rollers or pads.

3. To install an assembly, reverse the removal steps.



NOTE: When applicable, special installation instructions are provided for an assembly at the end of the removal procedure. Always completely read the removal instructions and follow all special installation instructions.

Removal and replacement: Toner duct drive unit

This document provides the procedures to remove the toner duct drive unit assembly.



[View a video of removing and replacing the toner duct drive.](#)

Mean time to repair: 15 minutes

Service level: Intermediate



IMPORTANT: When applicable, special installation instructions are provided for an assembly at the end of the removal procedure. Always completely read the removal instructions and follow all special installation instructions.

Before performing service

- Disconnect the power cable.

Use the table below to identify the correct part number for your printer. To order the part, go to www.hp.com/buy/parts

Table 2-36 Part information

Part number	Part description
JC93-00451A	Toner duct drive unit assembly (E72525, E72530, E72535 models)
JC93-01685A	Toner duct drive unit assembly (E72825, E72830, E72835 models)

Required tools

- #2 JIS screwdriver with a magnetic tip

After performing service

Turn the printer power on

- Connect the power cable.
- Use the power switch to turn the power on.

Post service test

Copy, scan, or print a document. Verify the document copies, scans, or prints correctly.

Remove the rear covers

Follow these steps to remove the rear covers.

1. Unscrew two captive thumbscrews on the formatter cover. Slide the formatter cover to the left, and then to the right to remove.

Figure 2-166 Remove the formatter cover

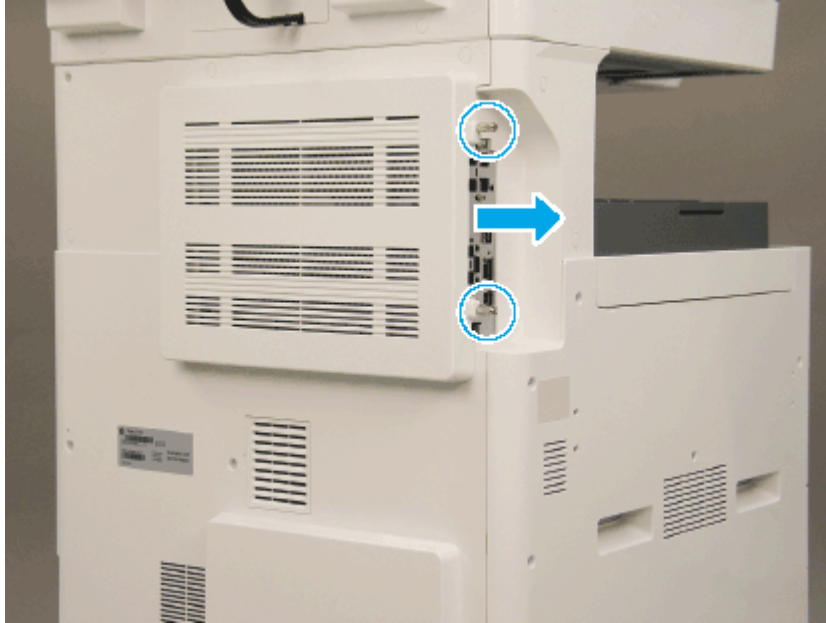

2. Remove seven screws, and then remove the rear-bottom cover.

Figure 2-167 Remove the rear-bottom cover

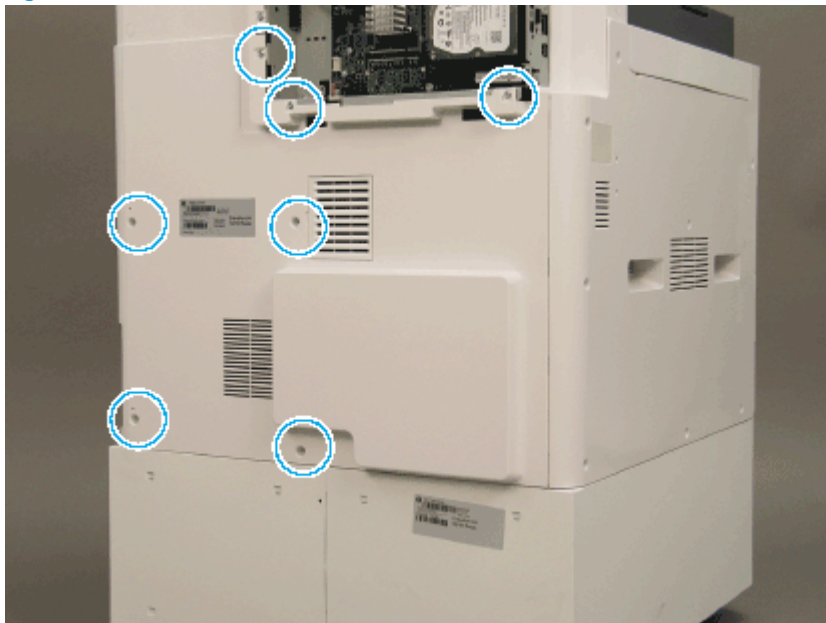

3. Remove six screws (callout 1), and then remove the rear-top cover.

Figure 2-168 Remove the rear-top cover

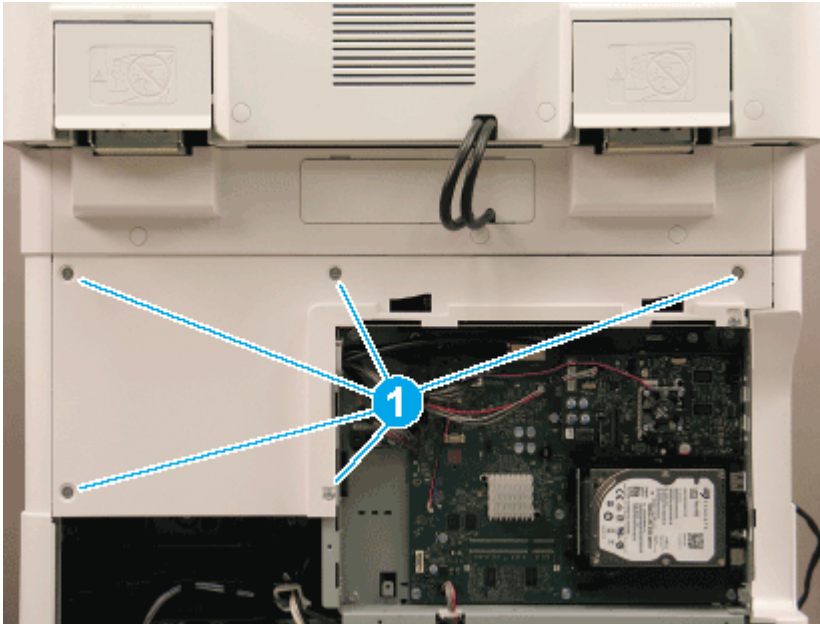

Remove the toner duct drive unit

Follow these steps to remove the toner duct drive unit.

1. Loosen the PCA cage. Remove two screws on the lower edge of the cage to allow access to the duct drive.
2. Remove one screw.

Figure 2-169 Remove screw



3. Disconnect one connector.

Figure 2-170 Disconnect connector

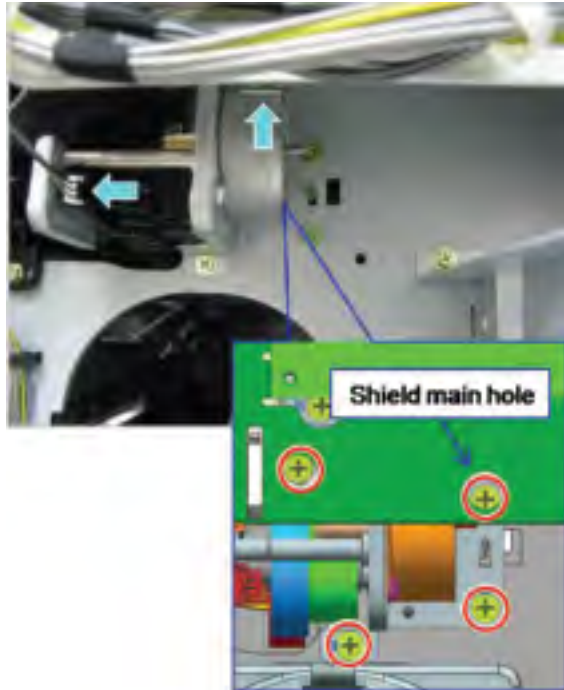

4. Remove four screws. Loosen the PCA by removing nine screws, enabling access to the screw located behind the board. Remove the toner duct drive unit and disconnect the second connector.

Unpack the replacement assembly



Follow these steps to unpack the replacement assembly.

1. Dispose of the defective part.

 **NOTE:** HP recommends responsible disposal of the defective part.

<http://www8.hp.com/us/en/hp-information/environment/product-recycling.html>

2. Unpack the replacement part from the packaging.

 **CAUTION:**  Some parts are sensitive to electrostatic discharge (ESD). Always perform service work at an ESD-protected workstation or mat. If an ESD workstation or mat is not available, touch the sheet-metal chassis to provide a static ground before touching an ESD-sensitive assembly. Protect the ESD-sensitive assemblies by placing them in ESD pouches when they are out of the printer.

 **IMPORTANT:** Make sure that all of the shipping materials (for example shipping tape) are removed from the replacement part prior to installation.

 **NOTE:** If the replacement part is a roller or pad, avoid touching the spongy part of it. Skin oils on the roller or pad can cause paper pickup and/or print-quality problems. HP recommends using disposable gloves when handling rollers or pads or washing your hands before touching rollers or pads.

3. To install an assembly, reverse the removal steps.

 **NOTE:** When applicable, special installation instructions are provided for an assembly at the end of the removal procedure. Always completely read the removal instructions and follow all special installation instructions.

Removal and replacement: Pickup drive unit

This document provides the procedures to remove the pickup drive unit assembly.



[View a video of removing and replacing the pickup drive.](#)

Mean time to repair: 20 minutes

Service level: Intermediate



IMPORTANT: When applicable, special installation instructions are provided for an assembly at the end of the removal procedure. Always completely read the removal instructions and follow all special installation instructions.

Before performing service

- Disconnect the power cable.

Use the table below to identify the correct part number for your printer. To order the part, go to www.hp.com/buy/parts

Table 2-37 Part information

Part number	Part description
JC93-00442A	Pickup drive unit assembly

Required tools

- #2 JIS screwdriver with a magnetic tip

After performing service

Turn the printer power on

- Connect the power cable.
- Use the power switch to turn the power on.

Post service test

Copy, scan, or print a document. Verify the document copies, scans, or prints correctly.

Remove the rear covers

Follow these steps to remove the rear covers.

1. Unscrew two captive thumbscrews on the formatter cover. Slide the formatter cover to the left, and then to the right to remove.

Figure 2-171 Remove the formatter cover

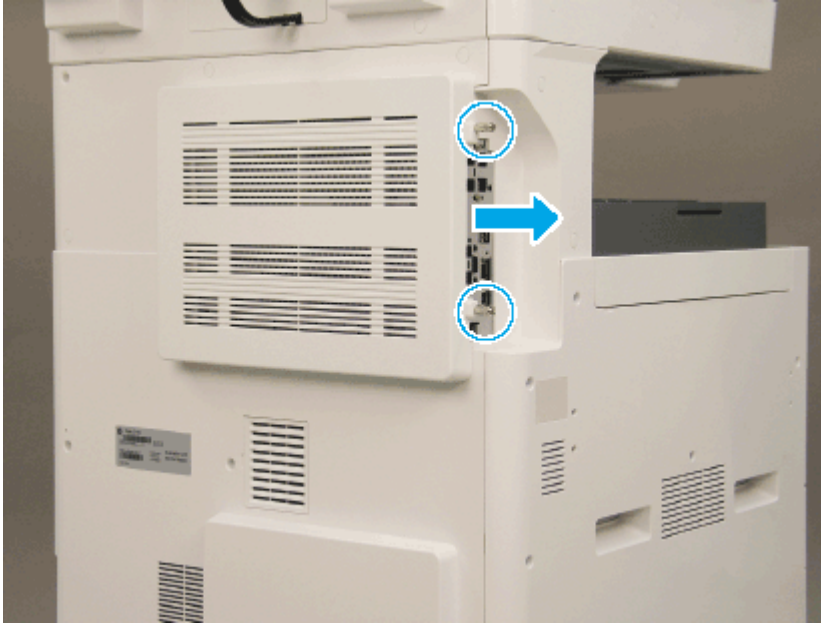

2. Remove seven screws, and then remove the rear-bottom cover.

Figure 2-172 Remove the rear-bottom cover

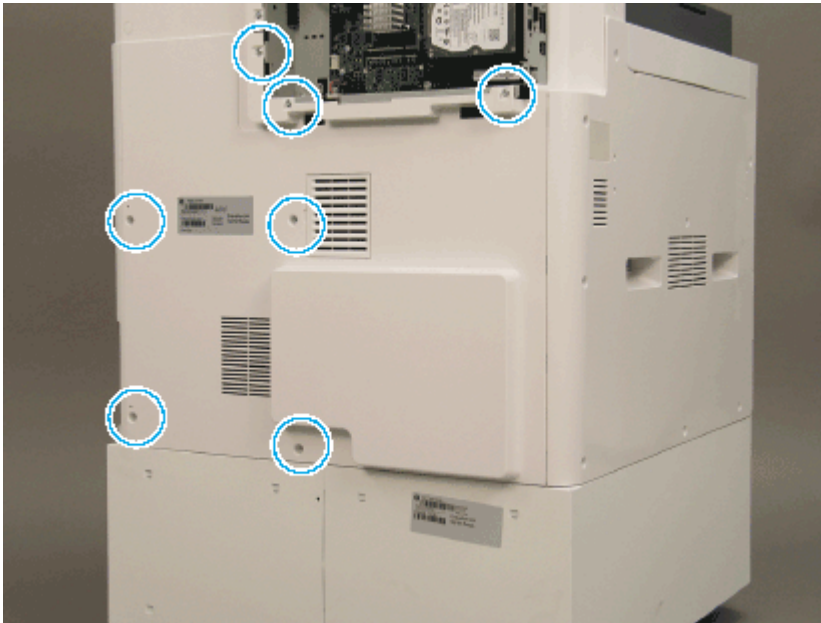

3. Remove six screws (callout 1), and then remove the rear-top cover.

Figure 2-173 Remove the rear-top cover

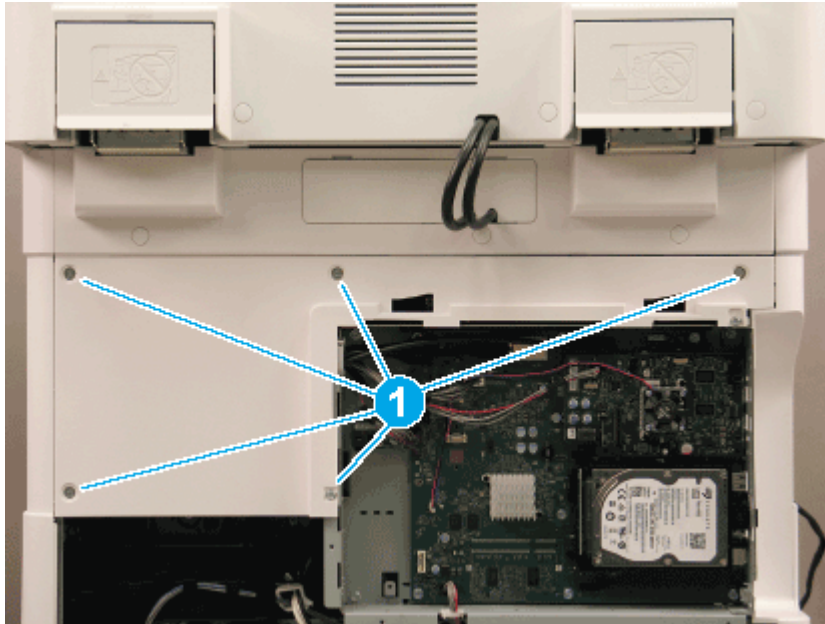

Remove the pickup drive unit

Follow these steps to remove the pickup drive unit.

- ▲ Release the cable restraint. Disconnect the connector and remove three screws. Remove the pickup drive unit.

Figure 2-174 Remove screws and pickup drive unit

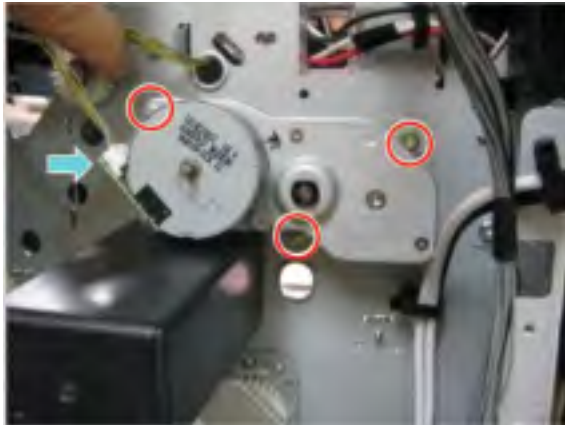

Unpack the replacement assembly

Follow these steps to unpack the replacement assembly.

1. Dispose of the defective part.

 **NOTE:** HP recommends responsible disposal of the defective part.

<http://www8.hp.com/us/en/hp-information/environment/product-recycling.html>

2. Unpack the replacement part from the packaging.



CAUTION:  Some parts are sensitive to electrostatic discharge (ESD). Always perform service work at an ESD-protected workstation or mat. If an ESD workstation or mat is not available, touch the sheet-metal chassis to provide a static ground before touching an ESD-sensitive assembly. Protect the ESD-sensitive assemblies by placing them in ESD pouches when they are out of the printer.

 **IMPORTANT:** Make sure that all of the shipping materials (for example shipping tape) are removed from the replacement part prior to installation.

 **NOTE:** If the replacement part is a roller or pad, avoid touching the spongy part of it. Skin oils on the roller or pad can cause paper pickup and/or print-quality problems. HP recommends using disposable gloves when handling rollers or pads or washing your hands before touching rollers or pads.

3. To install an assembly, reverse the removal steps.

 **NOTE:** When applicable, special installation instructions are provided for an assembly at the end of the removal procedure. Always completely read the removal instructions and follow all special installation instructions.

Removal and replacement: Main drive unit

This document provides the procedures to remove the main drive unit assembly.

Mean time to repair: 20 minutes

Service level: Intermediate

 **IMPORTANT:** When applicable, special installation instructions are provided for an assembly at the end of the removal procedure. Always completely read the removal instructions and follow all special installation instructions.

Before performing service

- Disconnect the power cable.

Use the table below to identify the correct part number for your printer. To order the part, go to www.hp.com/buy/parts

Table 2-38 Part information

Part number	Part description
JC93-00912C	Main drive unit assembly

Required tools

- #2 JIS screwdriver with a magnetic tip

After performing service

Turn the printer power on

- Connect the power cable.
- Use the power switch to turn the power on.

Post service test

Copy, scan, or print a document. Verify the document copies, scans, or prints correctly.

Remove the rear covers

Follow these steps to remove the rear covers.

1. Unscrew two captive thumbscrews on the formatter cover. Slide the formatter cover to the left, and then to the right to remove.

Figure 2-175 Remove the formatter cover

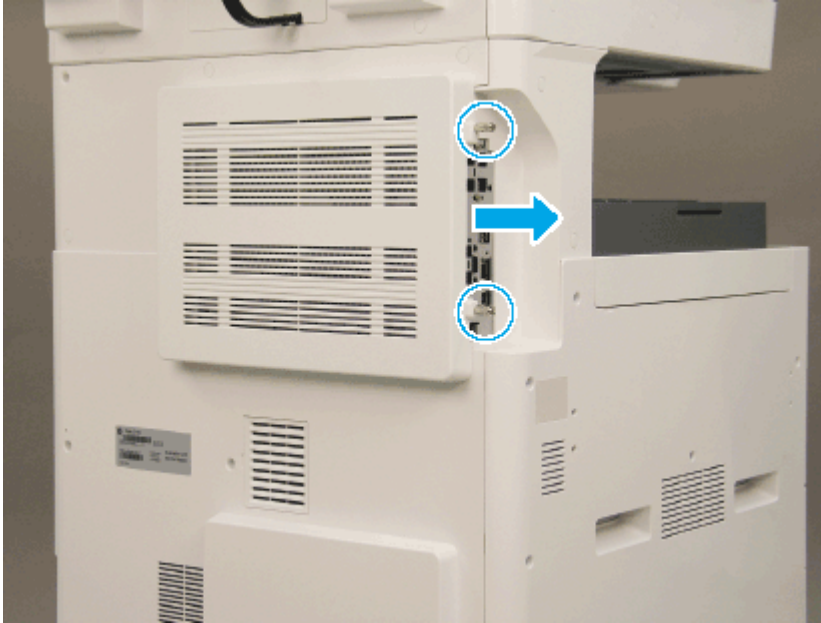

2. Remove seven screws, and then remove the rear-bottom cover.

Figure 2-176 Remove the rear-bottom cover

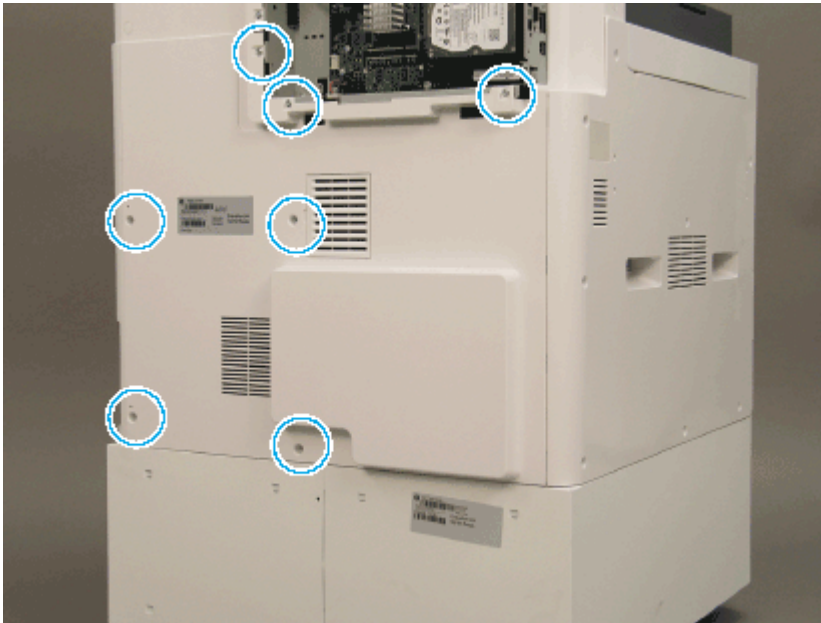

3. Remove six screws (callout 1), and then remove the rear-top cover.

Figure 2-177 Remove the rear-top cover

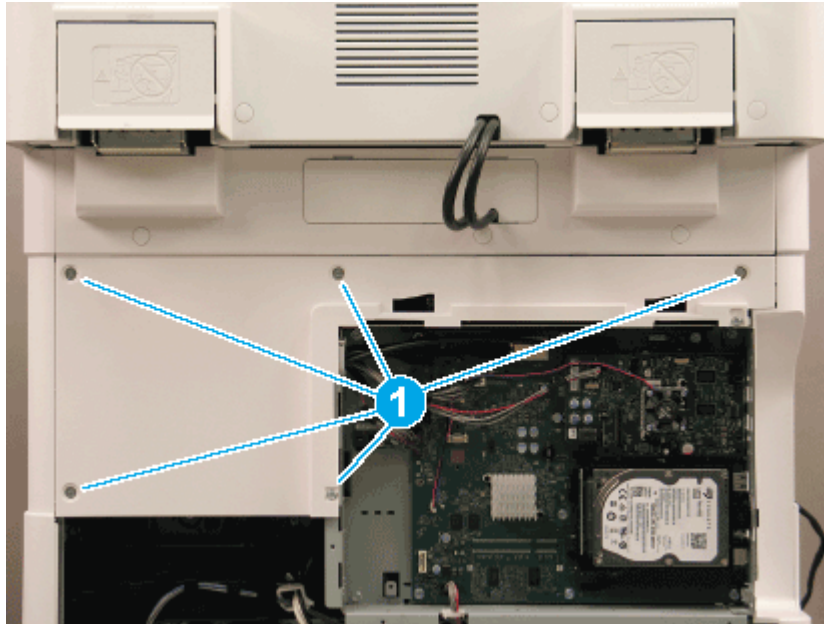

Remove the main drive unit

Follow these steps to remove the main drive unit.

1. Open the right door.
2. Disconnect five connectors and release eleven cable restraints. Remove five screws and then remove the main drive unit.

Figure 2-178 Remove screws and main drive unit

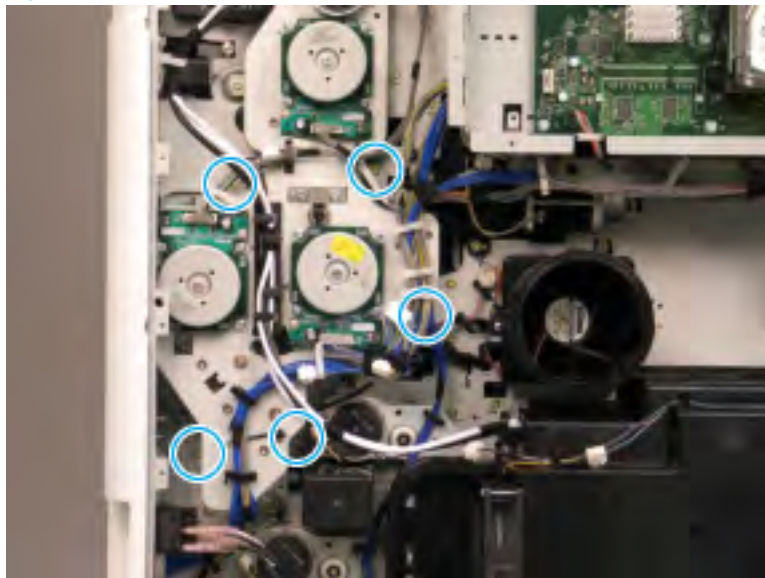

Unpack the replacement assembly



Follow these steps to unpack the replacement assembly.

1. Dispose of the defective part.

 **NOTE:** HP recommends responsible disposal of the defective part.

<http://www8.hp.com/us/en/hp-information/environment/product-recycling.html>

2. Unpack the replacement part from the packaging.

 **CAUTION:**  Some parts are sensitive to electrostatic discharge (ESD). Always perform service work at an ESD-protected workstation or mat. If an ESD workstation or mat is not available, touch the sheet-metal chassis to provide a static ground before touching an ESD-sensitive assembly. Protect the ESD-sensitive assemblies by placing them in ESD pouches when they are out of the printer.

 **IMPORTANT:** Make sure that all of the shipping materials (for example shipping tape) are removed from the replacement part prior to installation.

 **NOTE:** If the replacement part is a roller or pad, avoid touching the spongy part of it. Skin oils on the roller or pad can cause paper pickup and/or print-quality problems. HP recommends using disposable gloves when handling rollers or pads or washing your hands before touching rollers or pads.

3. To install an assembly, reverse the removal steps.

 **NOTE:** When applicable, special installation instructions are provided for an assembly at the end of the removal procedure. Always completely read the removal instructions and follow all special installation instructions.

Removal and replacement: Fuser/exit drive assembly

This document provides the procedures to remove the fuser/exit drive assembly.



[View a video of removing and replacing the fuser/exit drive.](#)

Mean time to repair: 15 minutes

Service level: Intermediate



IMPORTANT: When applicable, special installation instructions are provided for an assembly at the end of the removal procedure. Always completely read the removal instructions and follow all special installation instructions.

Before performing service

- Disconnect the power cable.

Use the table below to identify the correct part number for your printer. To order the part, go to www.hp.com/buy/parts

Table 2-39 Part information

Part number	Part description
JC93-00449A	Fuser/exit drive assembly

Required tools

- #2 JIS screwdriver with a magnetic tip

After performing service

Turn the printer power on

- Connect the power cable.
- Use the power switch to turn the power on.

Post service test

Copy, scan, or print a document. Verify the document copies, scans, or prints correctly.

Remove the rear covers

Follow these steps to remove the rear covers.

1. Unscrew two captive thumbscrews on the formatter cover. Slide the formatter cover to the left, and then to the right to remove.

Figure 2-179 Remove the formatter cover

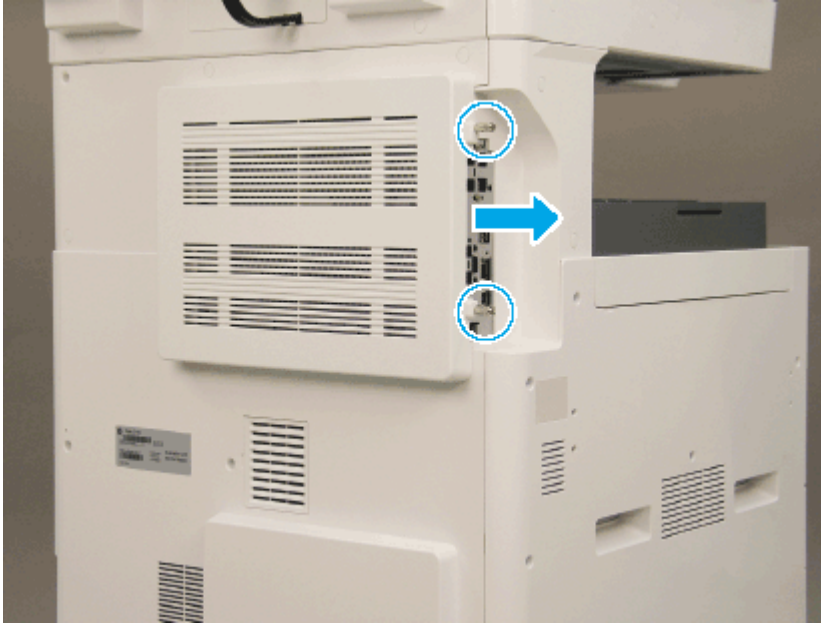

2. Remove seven screws, and then remove the rear-bottom cover.

Figure 2-180 Remove the rear-bottom cover

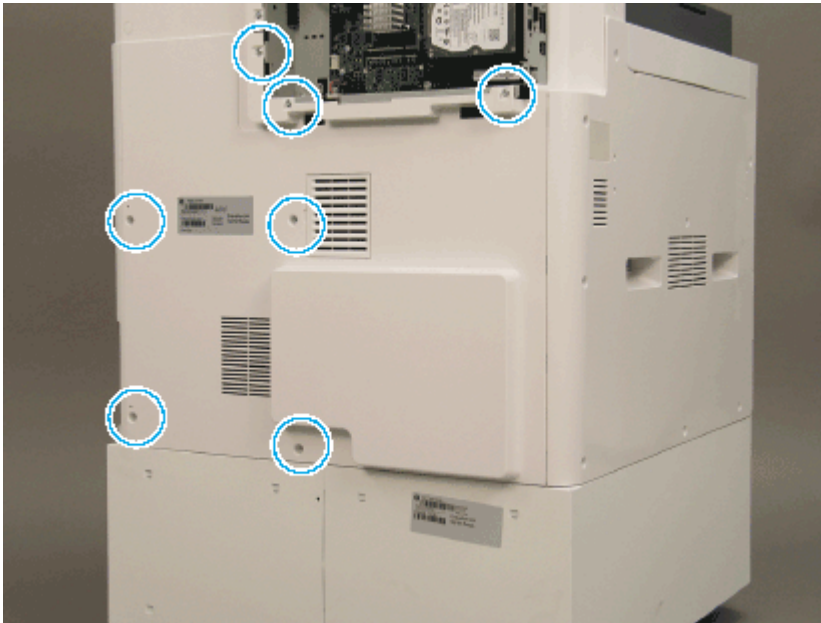

3. Remove six screws (callout 1), and then remove the rear-top cover.

Figure 2-181 Remove the rear-top cover

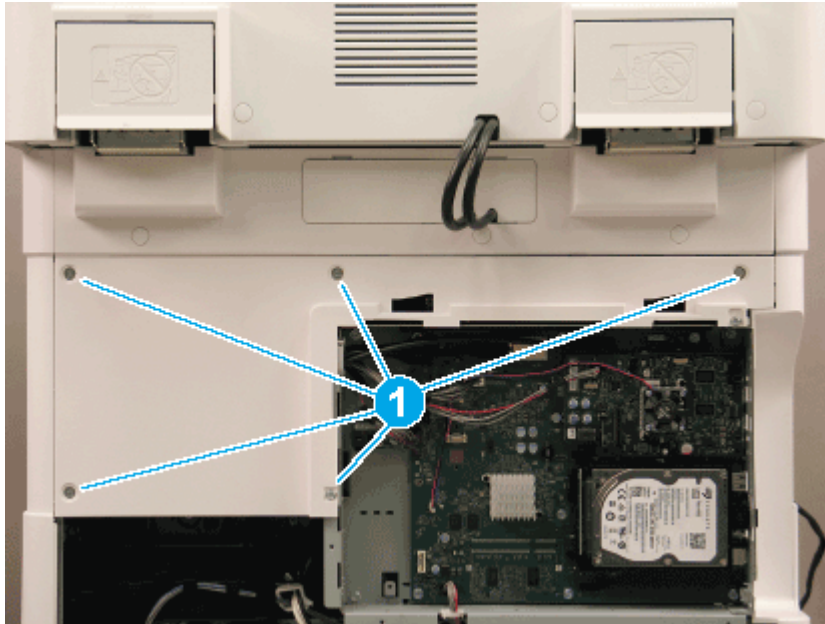

Remove the fuser/exit drive assembly

Follow these steps to remove the fuser/exit drive assembly.

- ▲ Disconnect two connectors and remove four screws. Remove the fuser/exit drive unit.

Figure 2-182 Remove screws and fuser/exit drive unit



Unpack the replacement assembly

Follow these steps to unpack the replacement assembly.

1. Dispose of the defective part.

 **NOTE:** HP recommends responsible disposal of the defective part.

<http://www8.hp.com/us/en/hp-information/environment/product-recycling.html>

2. Unpack the replacement part from the packaging.



CAUTION:  Some parts are sensitive to electrostatic discharge (ESD). Always perform service work at an ESD-protected workstation or mat. If an ESD workstation or mat is not available, touch the sheet-metal chassis to provide a static ground before touching an ESD-sensitive assembly. Protect the ESD-sensitive assemblies by placing them in ESD pouches when they are out of the printer.

 **IMPORTANT:** Make sure that all of the shipping materials (for example shipping tape) are removed from the replacement part prior to installation.

 **NOTE:** If the replacement part is a roller or pad, avoid touching the spongy part of it. Skin oils on the roller or pad can cause paper pickup and/or print-quality problems. HP recommends using disposable gloves when handling rollers or pads or washing your hands before touching rollers or pads.

3. To install an assembly, reverse the removal steps.

 **NOTE:** When applicable, special installation instructions are provided for an assembly at the end of the removal procedure. Always completely read the removal instructions and follow all special installation instructions.

Fuser exit drive

View the fuser exit drive exploded view, parts list, and repair procedures.

Fuser exit drive

Parts diagram and parts list for the fuser exit drive.

Figure 2-183 Fuser exit drive

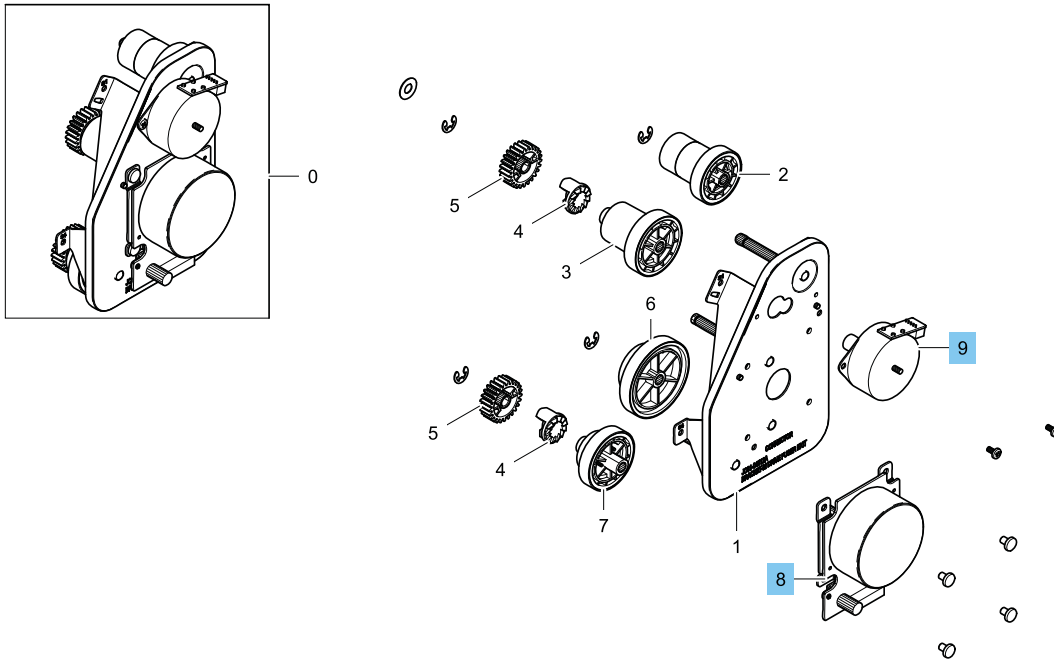

Table 2-40 Fuser exit drive

Ref				
No	Part number	Description	Qty	Repair procedure
8	JC31-00123B	Motor BLDC	1	Removal and replacement: Fuser/exit drive assembly on page 283
9	JC31-00123B	Drive, motor step	1	Removal and replacement: Fuser/exit drive assembly on page 283

Registration sub-frame

View the registration sub-frame exploded view, parts list, and repair procedures.

Registration sub-frame

Parts diagram and parts list for the registration sub-frame.

Figure 2-184 Registration sub-frame

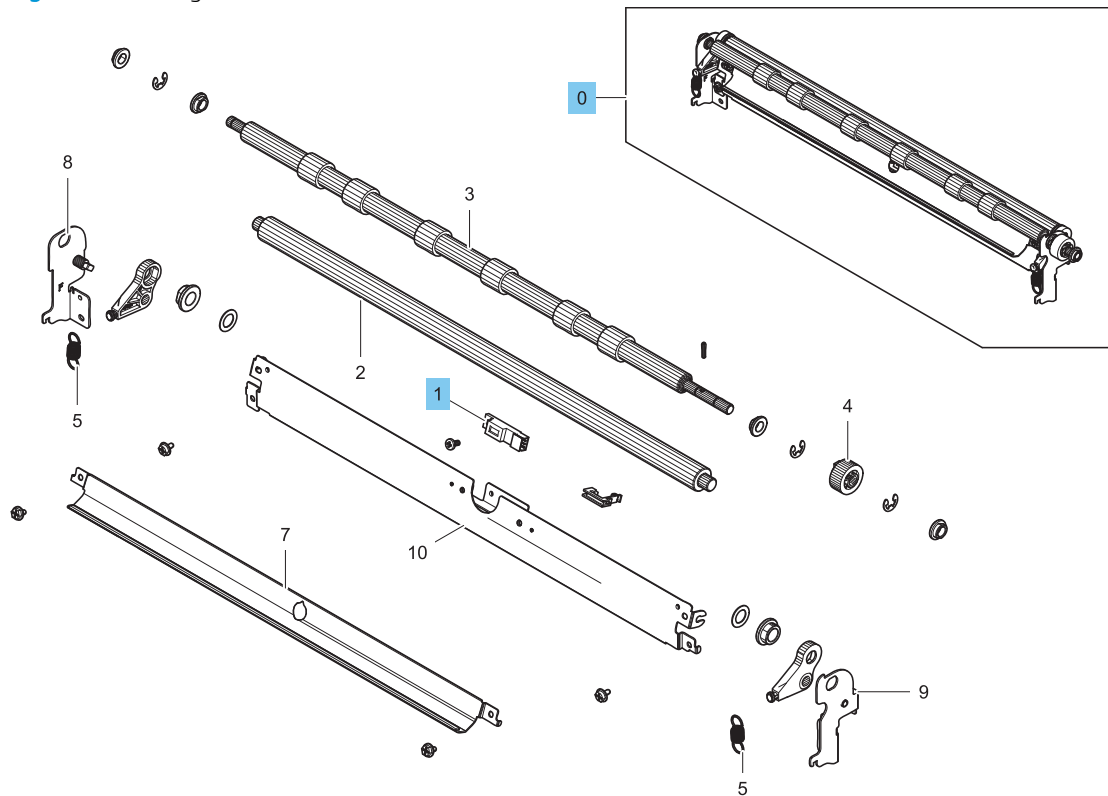

Table 2-41 Registration sub-frame

Ref				
No	Part number	Description	Qty	Repair procedure
0	JC93-01371A	Frame, sub registration	1	Removal and replacement: Registration assembly on page 294
1	0604-001381	Photo interrupter	1	Not applicable

Removal and replacement: Registration assembly

This document provides the procedures to remove the registration unit assembly.



[View a video of removing and replacing the registration assembly.](#)

Mean time to repair: 15 minutes

Service level: Intermediate



IMPORTANT: When applicable, special installation instructions are provided for an assembly at the end of the removal procedure. Always completely read the removal instructions and follow all special installation instructions.

Before performing service

- Disconnect the power cable.

Use the table below to identify the correct part number for your printer. To order the part, go to www.hp.com/buy/parts

Table 2-42 Part information

Part number	Part description
JC93-01371A	Registration unit assembly

Required tools

- #2 JIS screwdriver with a magnetic tip

After performing service

Turn the printer power on

- Connect the power cable.
- Use the power switch to turn the power on.

Post service test

Copy, scan, or print a document. Verify the document copies, scans, or prints correctly.

Remove the right door

Follow these steps to remove the right door.



NOTE: Remove second exit drive if installed.

1. Remove three screws, and then remove the cover (A).

Figure 2-185 Remove cover

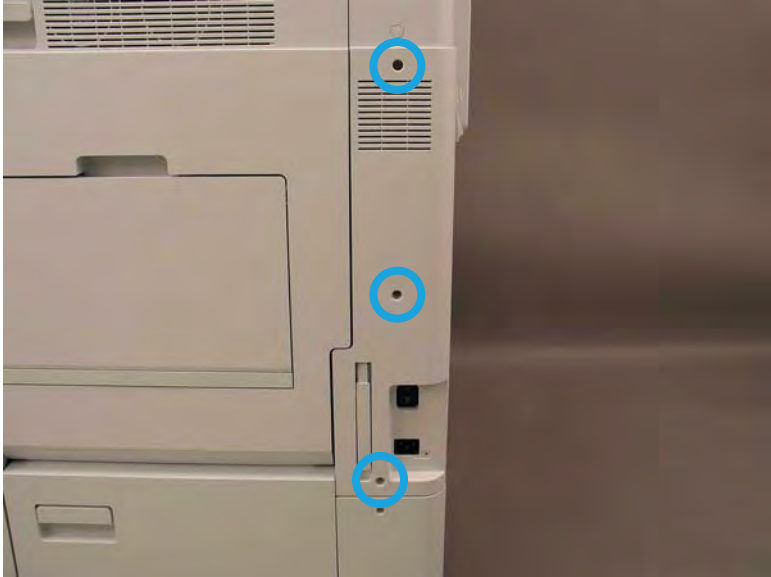

- 2. Disconnect the right door connector.

Figure 2-186 Disconnect right door connector



3. Release the right hinge (callout 1).

⚠ CAUTION: The right hinge spring tension can be dangerous. Use caution when releasing the right hinge to avoid injury.

Figure 2-187 Release right hinge

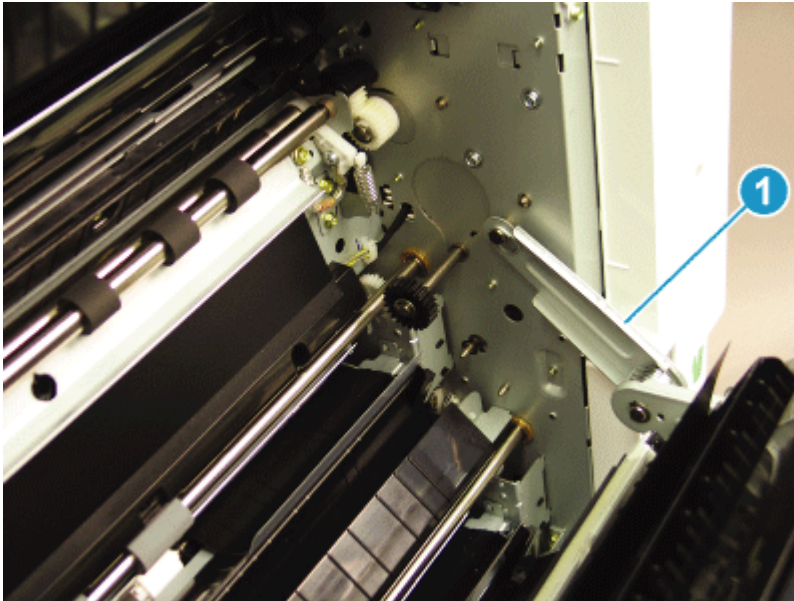

4. Release the left dampener (callout 1).

Figure 2-188 Release left dampener

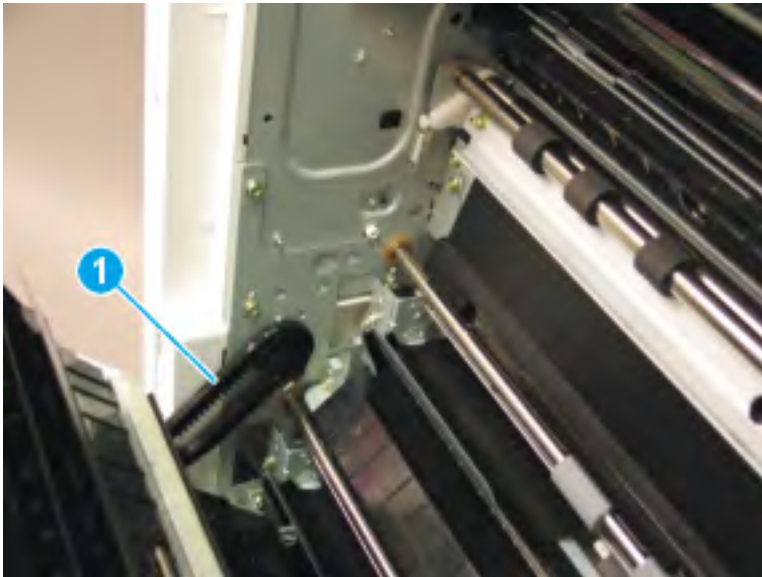

5. Remove the right door.

 **NOTE:** Open the lower access door. If there is an HCl or 2x520 input device, release the dampener to clear the lower right door. Remove clockwise.

Figure 2-189 Remove right door



Remove the TCU

Follow these steps to remove the TCU.

- ▲ Open the front door and remove the toner collection unit (callout A).

Figure 2-190 Remove the TCU



Remove the drum unit

Follow these steps to remove the drum unit.

1. Disconnect the drum unit connector. Remove two screws.

 **IMPORTANT:** To avoid damaging the drum unit, it must be removed to remove or install the registration unit.

Figure 2-191 Disconnect drum unit connector



2. Remove the drum unit.

Figure 2-192 Remove drum unit



Remove the registration unit

Follow these steps to remove the registration unit.

1. Remove the paper dust cleaner.

2. Remove two screws, and then remove the guide feed roller.

Figure 2-193 Remove screws and guide feed roller

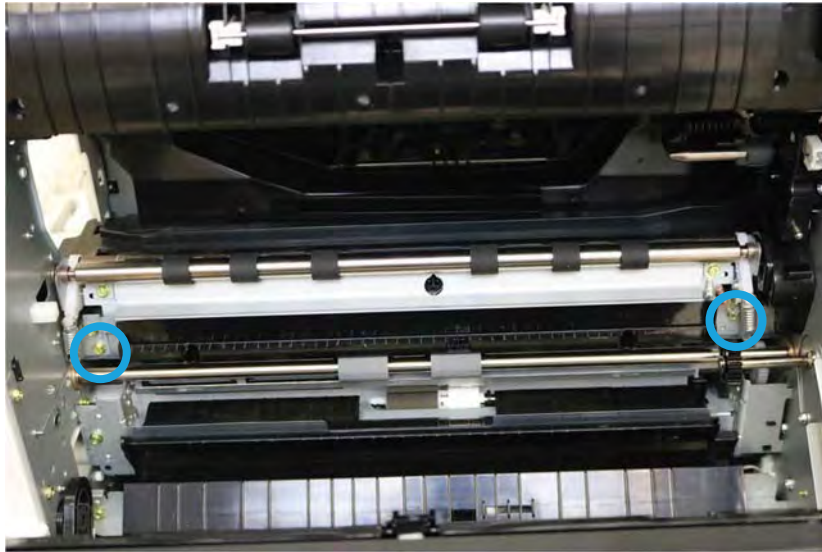

3. Remove four screws, two to loosen the unit and two to remove the bracket (B).

Figure 2-194 Remove screws

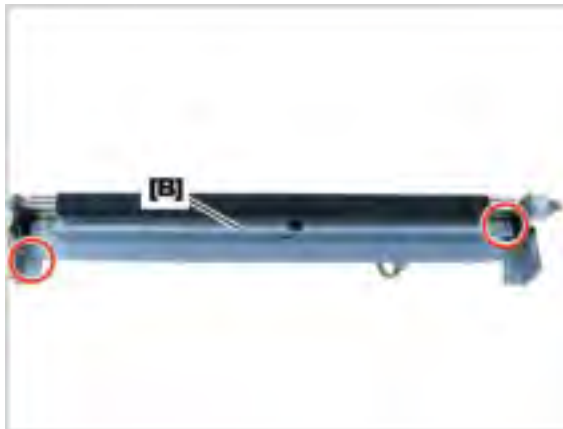

 **NOTE:** Reinstallation note: Make sure the notches on the sheet metal bracket seat fully in the grooves on the shaft.

4. Disconnect the connector. Remove the registration sensor.

Figure 2-195 Remove registration sensor



Unpack the replacement assembly



Follow these steps to unpack the replacement assembly.

1. Dispose of the defective part.

 **NOTE:** HP recommends responsible disposal of the defective part.

<http://www8.hp.com/us/en/hp-information/environment/product-recycling.html>

2. Unpack the replacement part from the packaging.

 **CAUTION:**  Some parts are sensitive to electrostatic discharge (ESD). Always perform service work at an ESD-protected workstation or mat. If an ESD workstation or mat is not available, touch the sheet-metal chassis to provide a static ground before touching an ESD-sensitive assembly. Protect the ESD-sensitive assemblies by placing them in ESD pouches when they are out of the printer.

 **IMPORTANT:** Make sure that all of the shipping materials (for example shipping tape) are removed from the replacement part prior to installation.

 **NOTE:** If the replacement part is a roller or pad, avoid touching the spongy part of it. Skin oils on the roller or pad can cause paper pickup and/or print-quality problems. HP recommends using disposable gloves when handling rollers or pads or washing your hands before touching rollers or pads.

3. To install an assembly, reverse the removal steps.

 **NOTE:** When applicable, special installation instructions are provided for an assembly at the end of the removal procedure. Always completely read the removal instructions and follow all special installation instructions.

Main frame pickup 1 and 2

View the main frame pickup 1 and 2 exploded view, parts list, and repair procedures.

Main frame pickup 1 and 2

Parts diagram and parts list for the main frame pickup 1 and 2.

Figure 2-196 Main frame pickup 1 and 2

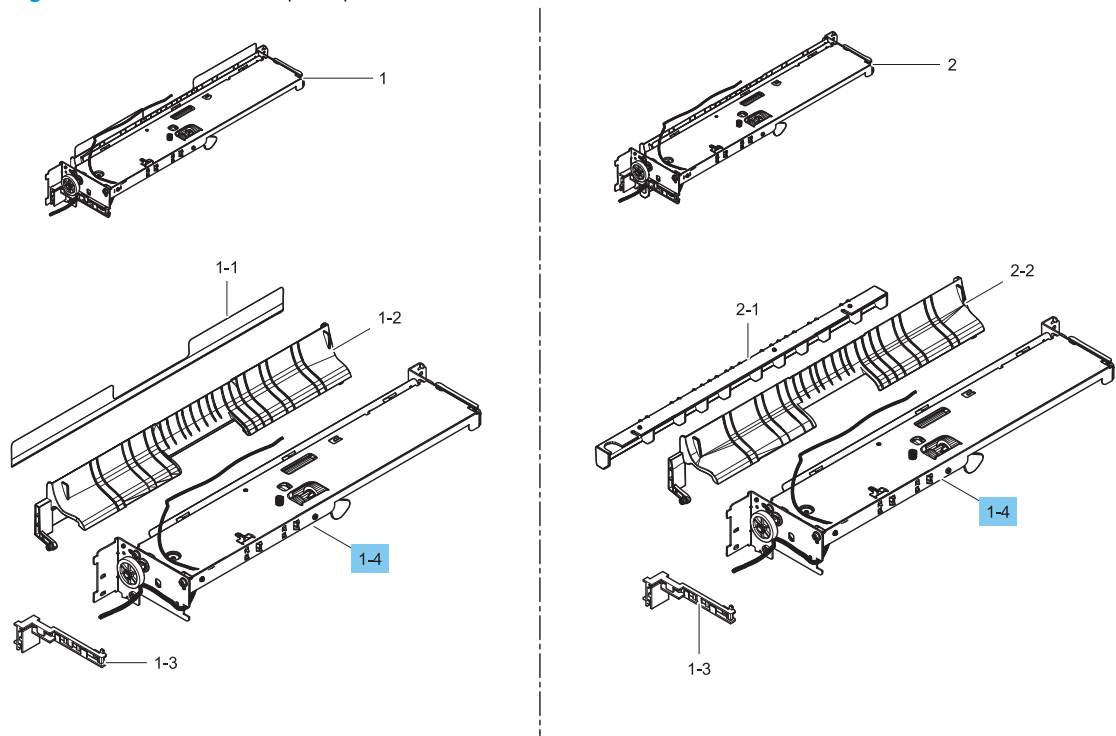

Table 2-43 Main frame pickup 1 and 2

Ref				
No	Part number	Description	Qty	Repair procedure
1-4	JC93-00510A	Main pickup frame	1	Not applicable

Main frame pickup

View the main frame pickup assemblies exploded view, parts list, and repair procedures.

Main frame pickup

Parts diagram and parts list for the main frame pickup.

Figure 2-197 Main frame pickup

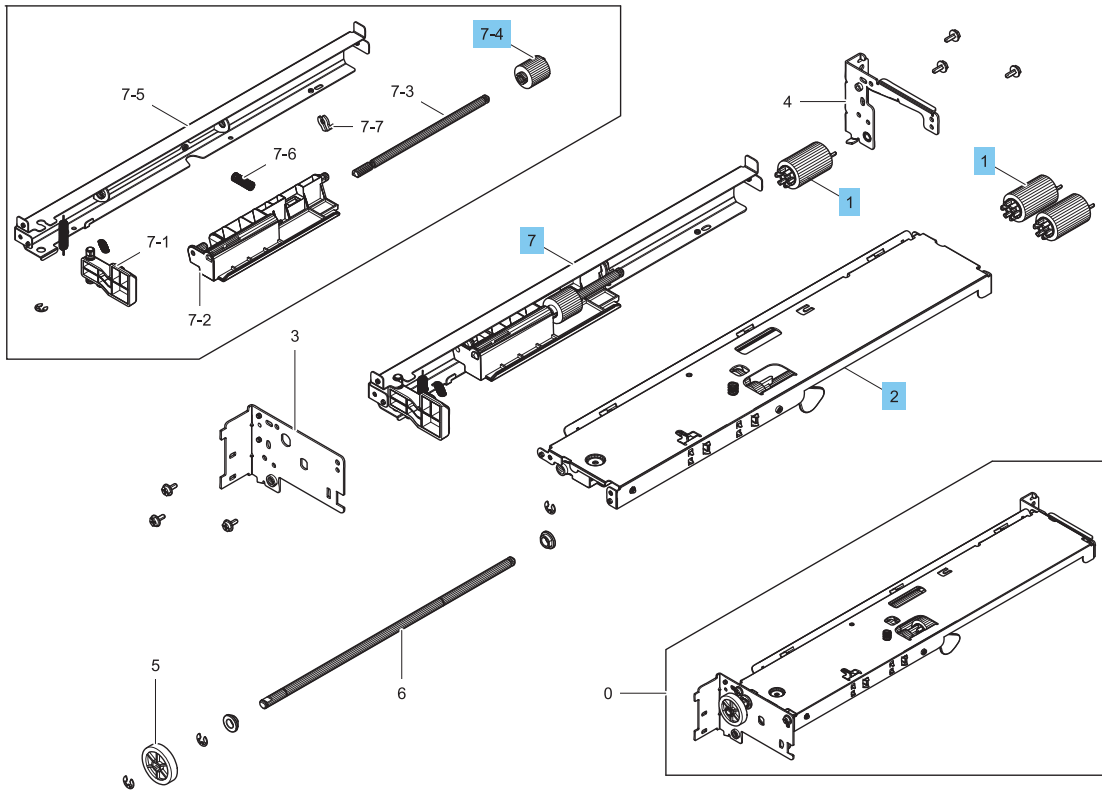

Table 2-44 Main frame pickup

Ref				
No	Part number	Description	Qty	Repair procedure
1	JC93-00540A	Trays 2-x rollers	3	Removal and replacement: Trays 2-x main rollers on page 308
2	JC93-00511A	Frame, main pickup upper	1	Not applicable
7	JC93-01441A	Frame, main pickup lower	1	Not applicable
7-4	JC67-00455A	Coupler, torque limiter	1	Not applicable

Removal and replacement: Trays 2–x main rollers

This document provides the procedures to remove the pickup/reverse/feed rollers.



[View a video of removing and replacing the rollers.](#)



[View an additional video of removing and replacing the rollers.](#)

Mean time to repair: 6 minutes

Service level: Basic



IMPORTANT: When applicable, special installation instructions are provided for an assembly at the end of the removal procedure. Always completely read the removal instructions and follow all special installation instructions.

Before performing service

- Disconnect the power cable.

Use the table below to identify the correct part number for your printer. To order the part, go to www.hp.com/buy/parts

Table 2-45 Part information

Part number	Part description
JC93-00540A	Trays 2-x main rollers

Required tools

- #2 JIS screwdriver with a magnetic tip

After performing service

Turn the printer power on

- Connect the power cable.
- Use the power switch to turn the power on.

Post service test

Copy, scan, or print a document. Verify the document copies, scans, or prints correctly.

Remove the right door

Follow these steps to remove the right door.



NOTE: Remove second exit drive if installed.

1. Remove three screws, and then remove the cover (A).

Figure 2-198 Remove cover

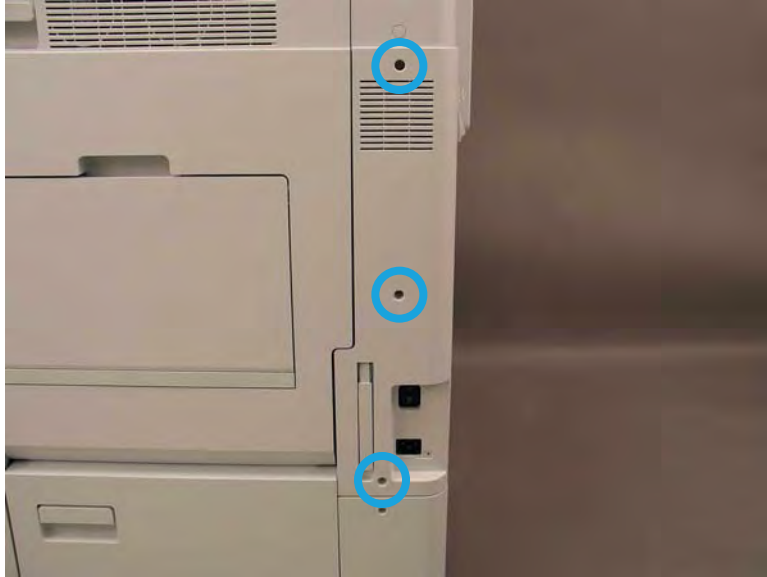

2. Disconnect the right door connector.

Figure 2-199 Disconnect right door connector



3. Release the right hinge (callout 1).

⚠ CAUTION: The right hinge spring tension can be dangerous. Use caution when releasing the right hinge to avoid injury.

Figure 2-200 Release right hinge

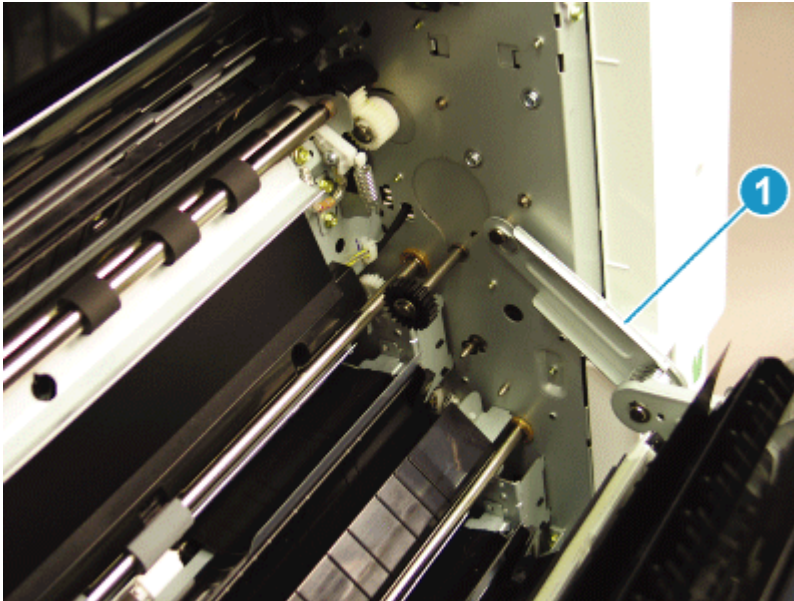

4. Release the left dampener (callout 1).

Figure 2-201 Release left dampener

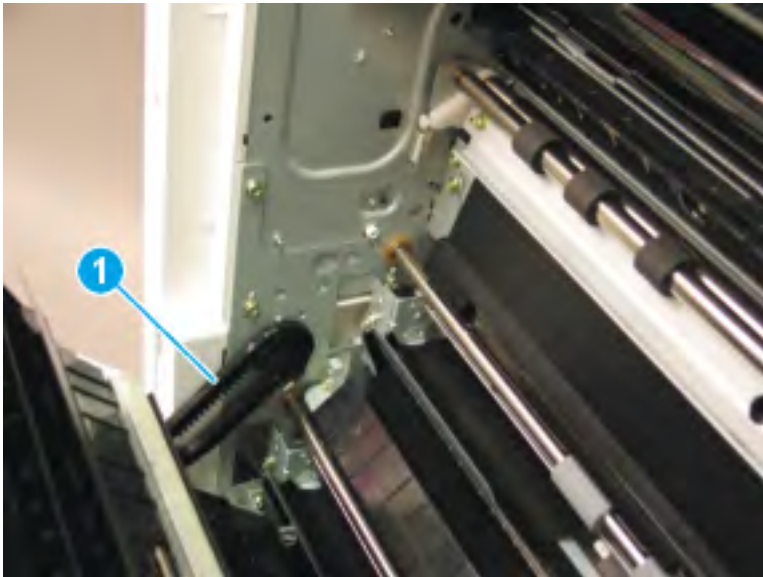

5. Remove the right door.

 **NOTE:** Open the lower access door. If there is an HCI or 2x520 input device, release the dampener to clear the lower right door. Remove clockwise.

Figure 2-202 Remove right door



Remove the pickup/feed/reverse roller

Follow these steps to remove the pickup/feed/reverse roller.

1. Remove one screw and disconnect one connector. Remove the pickup assembly.

Figure 2-203 Remove the pickup assembly



2. Release the small tab and remove the pickup/reverse/feed roller. Note the location of the clutches and gears.

Figure 2-204 Remove pickup/reverse/feed roller (1 of 2)

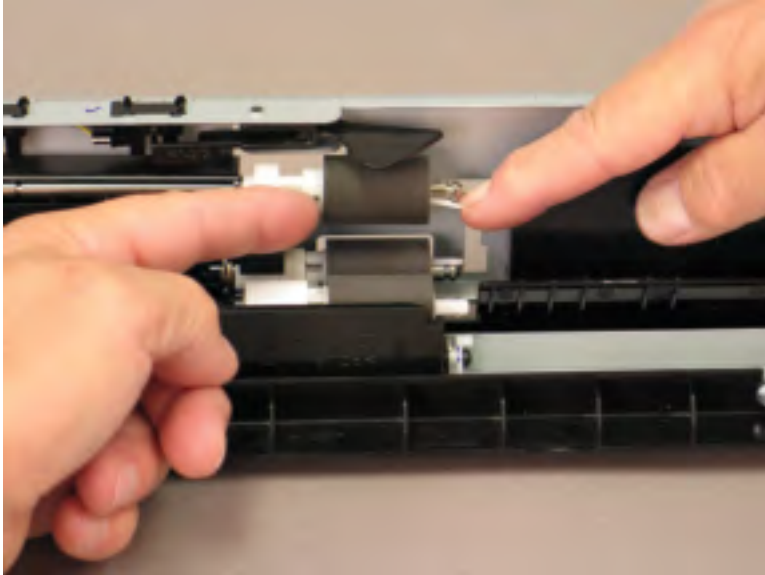
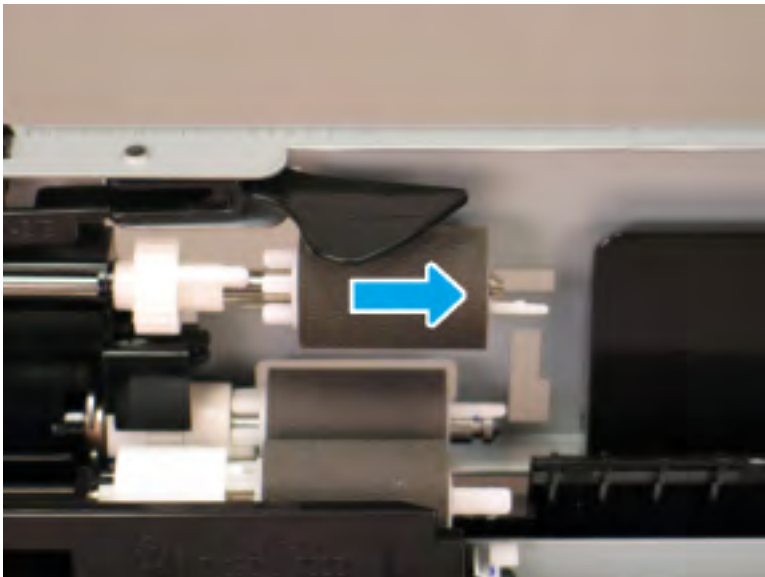

Figure 2-205 Remove pickup/reverse/feed roller (2 of 2)



 **NOTE:** It is recommended to replace all three rollers at the same time.

3. Enter service mode. Select the “Field Replacement Unit” menu item for the pickup/reverse/feed roller (Information > Supply Status > Field Replacement Unit). Select “Reset” to reset the current count to “0”.

Unpack the replacement assembly

Follow these steps to unpack the replacement assembly.

1. Dispose of the defective part.

 **NOTE:** HP recommends responsible disposal of the defective part.

<http://www8.hp.com/us/en/hp-information/environment/product-recycling.html>

2. Unpack the replacement part from the packaging.



CAUTION:  Some parts are sensitive to electrostatic discharge (ESD). Always perform service work at an ESD-protected workstation or mat. If an ESD workstation or mat is not available, touch the sheet-metal chassis to provide a static ground before touching an ESD-sensitive assembly. Protect the ESD-sensitive assemblies by placing them in ESD pouches when they are out of the printer.

 **IMPORTANT:** Make sure that all of the shipping materials (for example shipping tape) are removed from the replacement part prior to installation.

 **NOTE:** If the replacement part is a roller or pad, avoid touching the spongy part of it. Skin oils on the roller or pad can cause paper pickup and/or print-quality problems. HP recommends using disposable gloves when handling rollers or pads or washing your hands before touching rollers or pads.

3. To install an assembly, reverse the removal steps.

 **NOTE:** When applicable, special installation instructions are provided for an assembly at the end of the removal procedure. Always completely read the removal instructions and follow all special installation instructions.

Main frame

View the main frame exploded view, parts list, and repair procedures.

Main frame

Parts diagram and parts list for the main frame.

Figure 2-206 Main frame

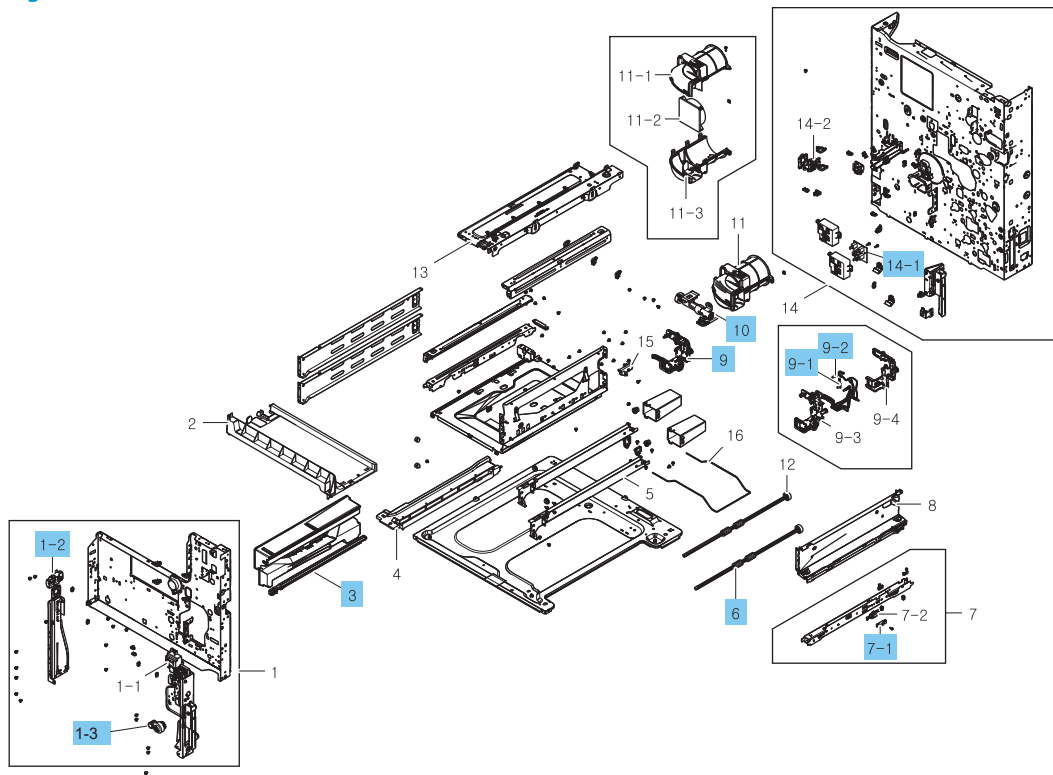

Table 2-46 Main frame

Ref				
No	Part number	Description	Qty	Repair procedure
1-2	JC93-00466A	Switch, front door open	3	Removal and replacement: Front door open switch on page 334
1-3	5CM76-67901	Right door damper and lever kit	1	Removal and replacement: Right door dampener and lever kit on page 338
3	JC93-00078C	Frame sub, clean registration	1	Not applicable
6	JC66-03203A	Roller idle, feed	2	Not applicable
7-1	0604-001381	Photo interrupter	1	Not applicable
9	JC93-00891A	Frame, HV package mono	1	Not applicable
9-1	JC92-02747A	PCA, eraser mono	1	Not applicable
9-2	JC97-01401A	MEA unit, terminal	1	Not applicable
10	JC93-00917A	Frame, duct	1	Removal and replacement: Toner duct on page 323
11-2	JC31-00161A	Fan Type 7 developer	1	Not applicable
14-1	JC92-02622C	PBA, paper size sensor	2	Removal and replacement: Paper size sensor PCA on page 318
Not shown	JC61-04900A	Registration stopper	1	Not applicable
Not shown	JC93-01467A	Switch, right door open	1	Removal and replacement: Paper size sensor PCA on page 318
Not shown	JC92-02471A	Sensor, toner collection unit	1	Removal and replacement: Toner collection unit sensor on page 320

Removal and replacement: Paper size sensor PCA

This document provides the procedures to remove the Paper size sensor PCA.



[View a video of removing and replacing the paper size sensor.](#)

Mean time to repair: 15 minutes

Service level: Intermediate



IMPORTANT: When applicable, special installation instructions are provided for an assembly at the end of the removal procedure. Always completely read the removal instructions and follow all special installation instructions.

Before performing service

- Disconnect the power cable.

Use the table below to identify the correct part number for your printer. To order the part, go to www.hp.com/buy/parts

Table 2-47 Part information

Part number	Part description
JC92-02622A	Paper Size Sensor PCA

Required tools

- #2 JIS screwdriver with a magnetic tip

After performing service

Turn the printer power on

- Connect the power cable.
- Use the power switch to turn the power on.

Post service test

Copy, scan, or print a document. Verify the document copies, scans, or prints correctly.

Remove the Paper Size Sensor PCA

Follow these steps to remove the Paper Size Sensor PCA.

- ▲ Do the following:
 - Remove all trays to access the inside of the printer.
 - Disconnect the connector. Remove two screws, and then remove the sensor.

Figure 2-207 Remove screws

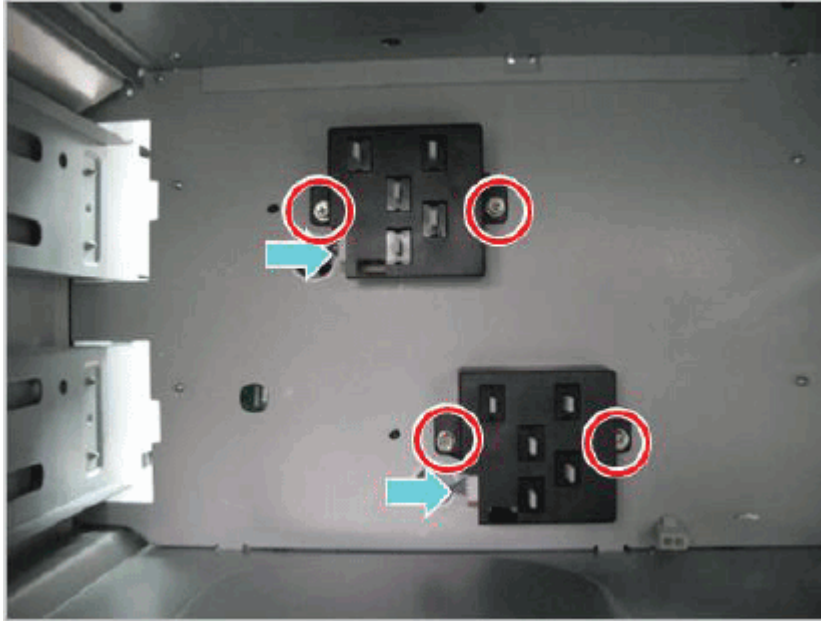

Unpack the replacement assembly



Follow these steps to unpack the replacement assembly.

1. Dispose of the defective part.

 **NOTE:** HP recommends responsible disposal of the defective part.

<http://www8.hp.com/us/en/hp-information/environment/product-recycling.html>

2. Unpack the replacement part from the packaging.

 **CAUTION:**  Some parts are sensitive to electrostatic discharge (ESD). Always perform service work at an ESD-protected workstation or mat. If an ESD workstation or mat is not available, touch the sheet-metal chassis to provide a static ground before touching an ESD-sensitive assembly. Protect the ESD-sensitive assemblies by placing them in ESD pouches when they are out of the printer.

 **IMPORTANT:** Make sure that all of the shipping materials (for example shipping tape) are removed from the replacement part prior to installation.

 **NOTE:** If the replacement part is a roller or pad, avoid touching the spongy part of it. Skin oils on the roller or pad can cause paper pickup and/or print-quality problems. HP recommends using disposable gloves when handling rollers or pads or washing your hands before touching rollers or pads.

3. To install an assembly, reverse the removal steps.

 **NOTE:** When applicable, special installation instructions are provided for an assembly at the end of the removal procedure. Always completely read the removal instructions and follow all special installation instructions.

Removal and replacement: Toner collection unit sensor

This document provides the procedures to remove the toner collection unit sensor.



[View a video of removing and replacing the TCU sensor.](#)

Mean time to repair: 10 minutes

Service level: Basic



IMPORTANT: When applicable, special installation instructions are provided for an assembly at the end of the removal procedure. Always completely read the removal instructions and follow all special installation instructions.

Before performing service

- Disconnect the power cable.

Use the table below to identify the correct part number for your printer. To order the part, go to www.hp.com/buy/parts

Table 2-48 Part information

Part number	Paer description
JC92-02471A	Toner collection unit sensor

Required tools

- #2 JIS screwdriver with a magnetic tip

After performing service

Turn the printer power on

- Connect the power cable.
- Use the power switch to turn the power on.

Post service test

Copy, scan, or print a document. Verify the document copies, scans, or prints correctly.

Remove the inner cover

Follow these steps to remove the inner cover.

1. Open the front cover. Remove the toner cartridge (callout 1) and the TCU (callout 2).

Figure 2-208 Remove the toner cartridge and TCU



2. Remove seven screws, and then remove the inner cover.

Figure 2-209 Remove the inner cover

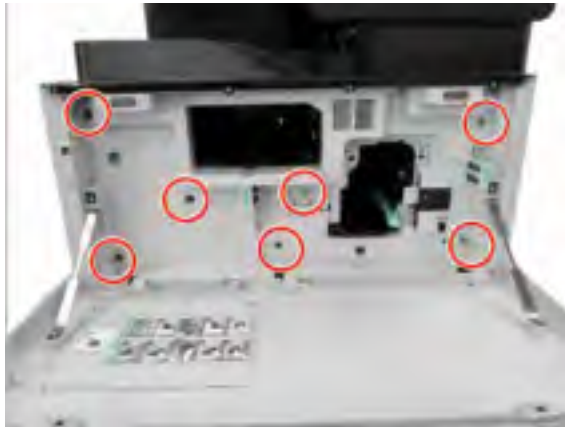

Remove the TCU sensor

Follow these steps to remove the TCU sensor.

- ▲ Disconnect the connector. Remove the sensor.

Figure 2-210 Disconnect connector and remove sensor



Unpack the replacement assembly

Follow these steps to unpack the replacement assembly.

1. Dispose of the defective part.



NOTE: HP recommends responsible disposal of the defective part.

<http://www8.hp.com/us/en/hp-information/environment/product-recycling.html>

2. Unpack the replacement part from the packaging.



CAUTION:  Some parts are sensitive to electrostatic discharge (ESD). Always perform service work at an ESD-protected workstation or mat. If an ESD workstation or mat is not available, touch the sheet-metal chassis to provide a static ground before touching an ESD-sensitive assembly. Protect the ESD-sensitive assemblies by placing them in ESD pouches when they are out of the printer.



IMPORTANT: Make sure that all of the shipping materials (for example shipping tape) are removed from the replacement part prior to installation.



NOTE: If the replacement part is a roller or pad, avoid touching the spongy part of it. Skin oils on the roller or pad can cause paper pickup and/or print-quality problems. HP recommends using disposable gloves when handling rollers or pads or washing your hands before touching rollers or pads.

3. To install an assembly, reverse the removal steps.



NOTE: When applicable, special installation instructions are provided for an assembly at the end of the removal procedure. Always completely read the removal instructions and follow all special installation instructions.

Removal and replacement: Toner duct

This document provides the procedures to remove the toner duct assembly.



[View a video of removing and replacing the toner duct.](#)

Mean time to repair: 15 minutes

Service level: Intermediate



IMPORTANT: When applicable, special installation instructions are provided for an assembly at the end of the removal procedure. Always completely read the removal instructions and follow all special installation instructions.

Before performing service

- Disconnect the power cable.

Use the table below to identify the correct part number for your printer. To order the part, go to www.hp.com/buy/parts

Table 2-49 Part information

Part number	Part description
JC93-00917A	Toner duct assembly

Required tools

- #2 JIS screwdriver with a magnetic tip

After performing service

Turn the printer power on

- Connect the power cable.
- Use the power switch to turn the power on.

Post service test

Copy, scan, or print a document. Verify the document copies, scans, or prints correctly.

Remove the toner cartridge and imaging unit

Follow these steps to remove the toner cartridge and imaging unit.

- ▲ Remove the toner cartridge and imaging unit.

Remove the rear covers

Follow these steps to remove the rear covers.

1. Unscrew two captive thumbscrews on the formatter cover. Slide the formatter cover to the left, and then to the right to remove.

Figure 2-211 Remove the formatter cover

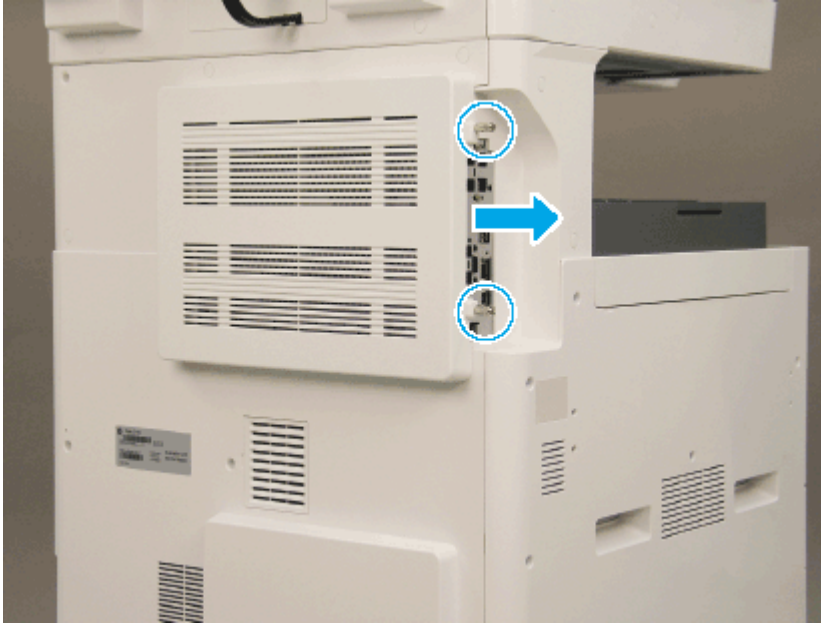

2. Remove seven screws, and then remove the rear-bottom cover.

Figure 2-212 Remove the rear-bottom cover

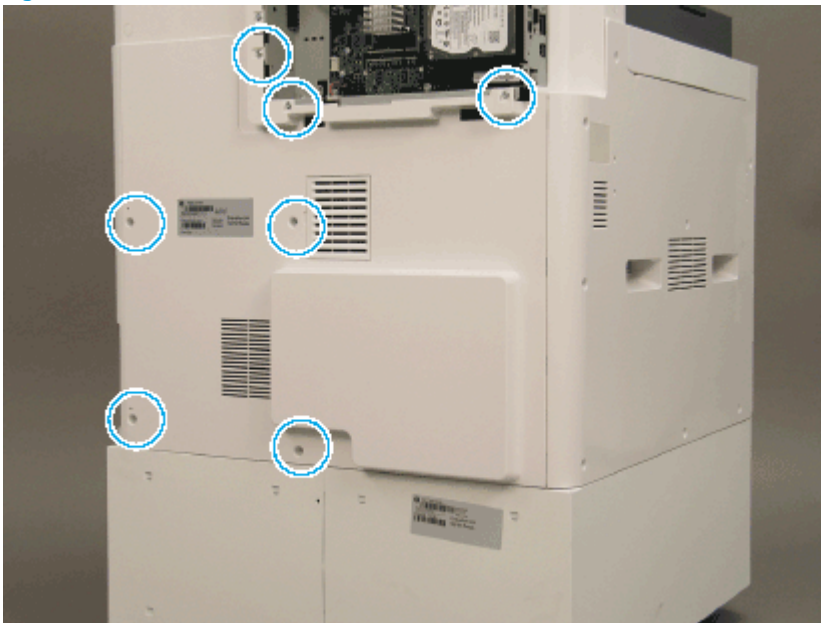

3. Remove six screws (callout 1), and then remove the rear-top cover.

Figure 2-213 Remove the rear-top cover

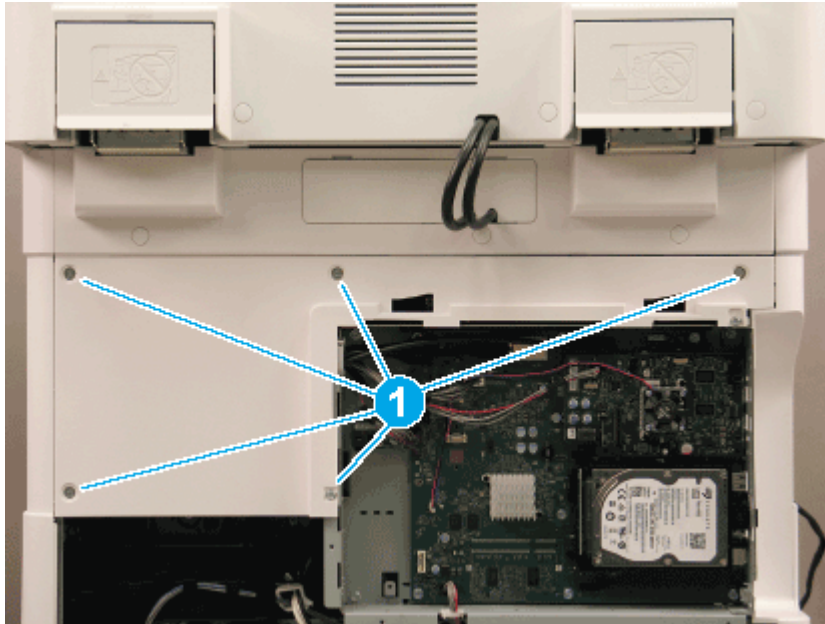

Remove the main drive unit

Follow these steps to remove the main drive unit.

1. Open the right door.
2. Disconnect five connectors and release eleven cable restraints. Remove five screws and then remove the main drive unit.

Figure 2-214 Remove screws and main drive unit

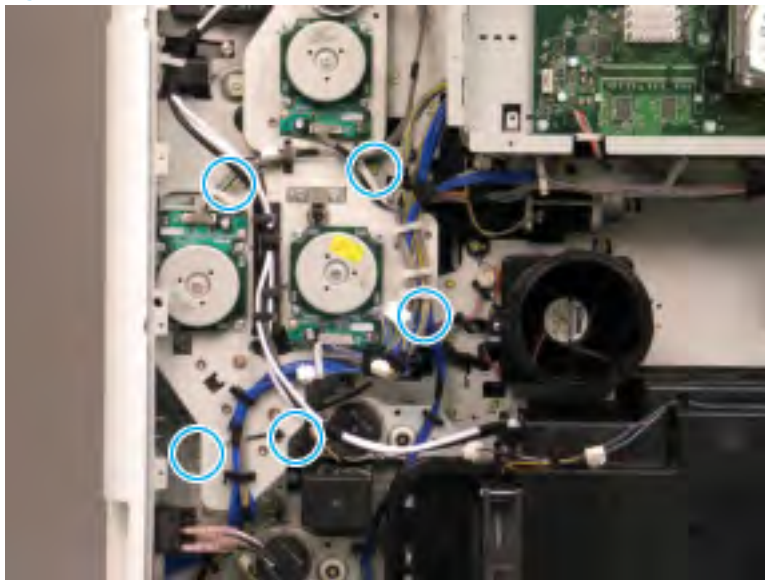

Remove the formatter PCA

Follow these steps to remove the formatter PCA.

- ▲ Disconnect seven connectors and eight screws, and then remove formatter PCA.

Figure 2-215 Remove the formatter connectors and screws

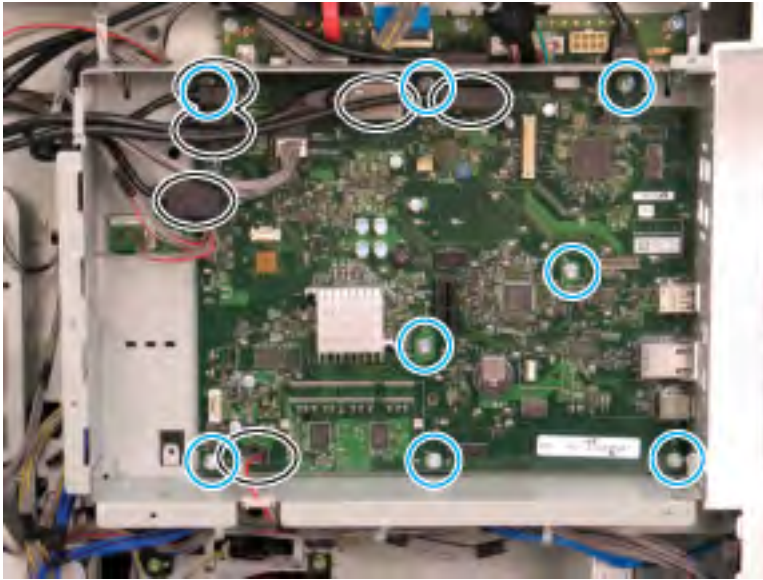

Remove the formatter cage

Follow these steps to remove the formatter cage.

1. Disconnect ten connectors and two cable restraints.
2. Remove four screws and screw-caps, and then remove the left-upper cover.

Figure 2-216 Remove the left-upper cover

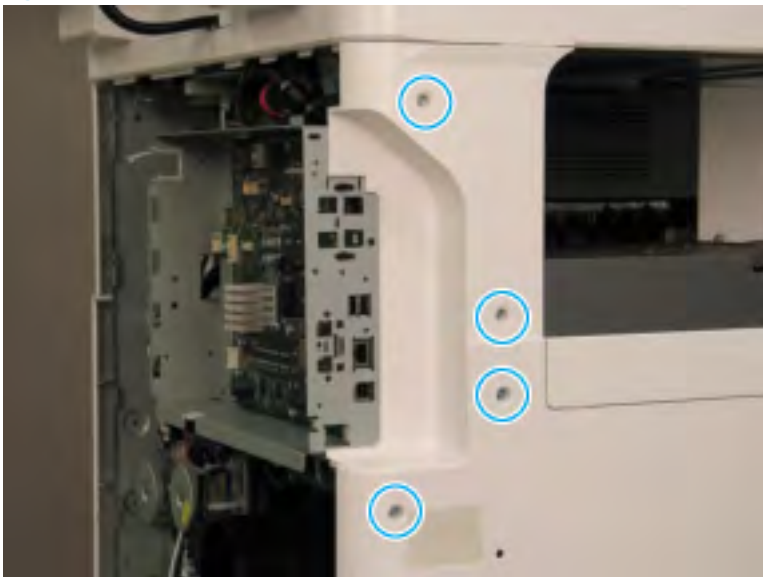

3. Remove one screw from the side of the formatter cage (beneath the left-upper cover location).

Figure 2-217 Remove the formatter cage side screw

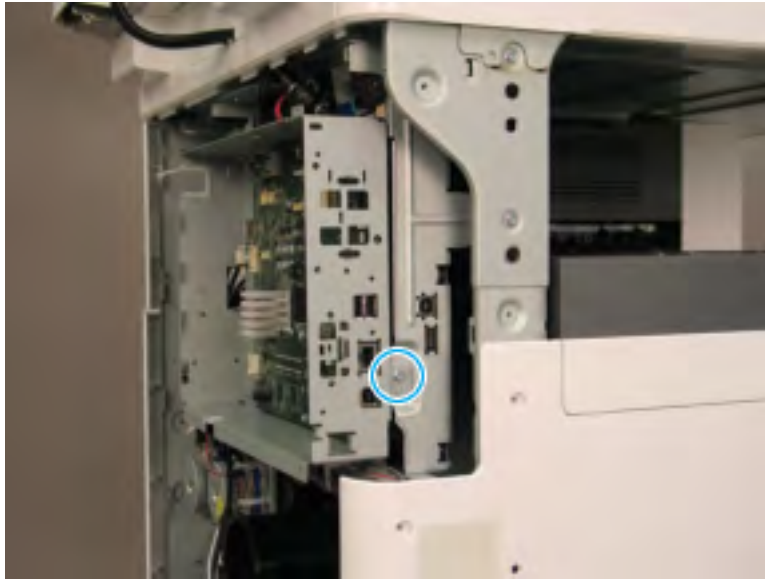

4. Remove three screws from the formatter cage face, and then release one tab to remove the formatter cage.

Figure 2-218 Remove three screws to remove the formatter cage



Remove the main board

Follow these steps to remove the main board.

1. Disconnect 19 connectors, a ground wire, and three FFCs on the main board.

Figure 2-219 Remove the main board connectors and screws





2. Remove nine screws, and then remove the main board.
3. Disconnect the MSOK from the removed main board, noting its orientation. Transfer the MSOK to the replacement main board and install it using the same orientation.

 **TIP:** The main board is marked to show the correct orientation of the MSOK when installed.

Figure 2-220 MSOK installation orientation



 **TIP:** See the screen-printed icon on the main board to ensure that the MSOK is aligned correctly during reinstallation.

 **IMPORTANT:** A Shading Test for the ADF unit must be completed after replacing the ADF unit or main board.

Remove the main board cage

Follow these steps to remove the main board cage.

1. Remove the FFC retainer at the bottom-right.
2. Pinch the ground strap (callout 1) to remove it from the top of the cage.

Figure 2-221 Remove the ground strap

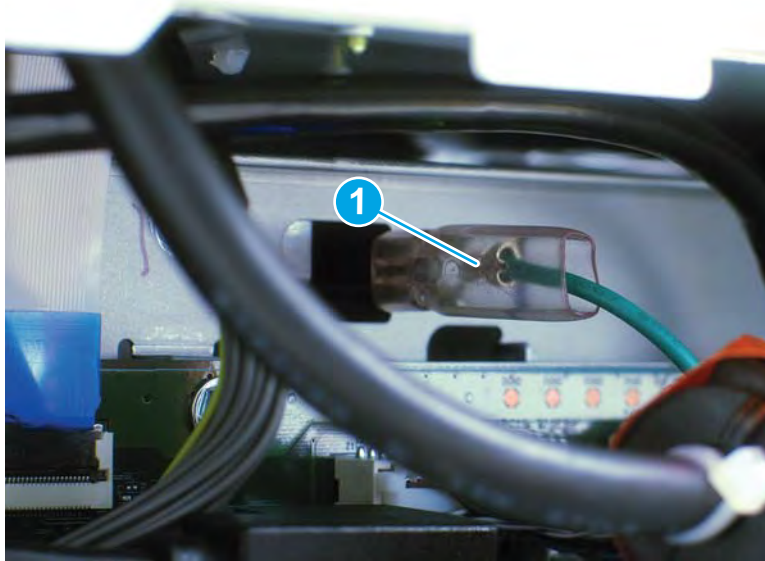

3. Open seven cable retainers.
4. Remove four screws.

Figure 2-222 Remove the main board cage screws



5. Lift the main board cage up slightly to release one bracket, and then pull out to remove.

Remove the toner drive unit

Follow these steps to remove the toner drive unit.

1. Loosen the PCA cage by removing the two bottom screws. This enables access to the supply drive.
2. Release the cable restraint.
3. Disconnect the connector and remove three screws (callout 1). Remove the toner supply drive unit. Disconnect the second connector.

Figure 2-223 Remove toner supply drive unit and disconnect connector

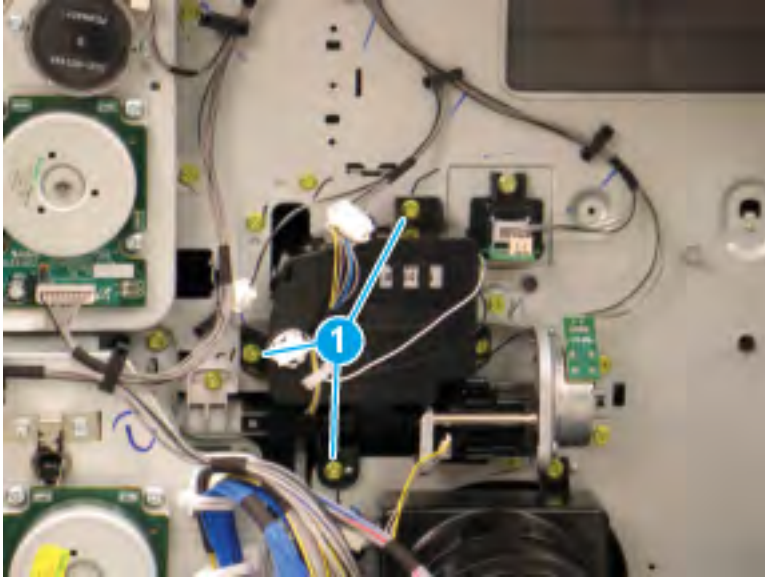

Remove the toner duct

Follow these steps to remove the toner duct.

- ▲ Remove two screws, and then remove the toner duct.

Figure 2-224 Remove screws and toner duct

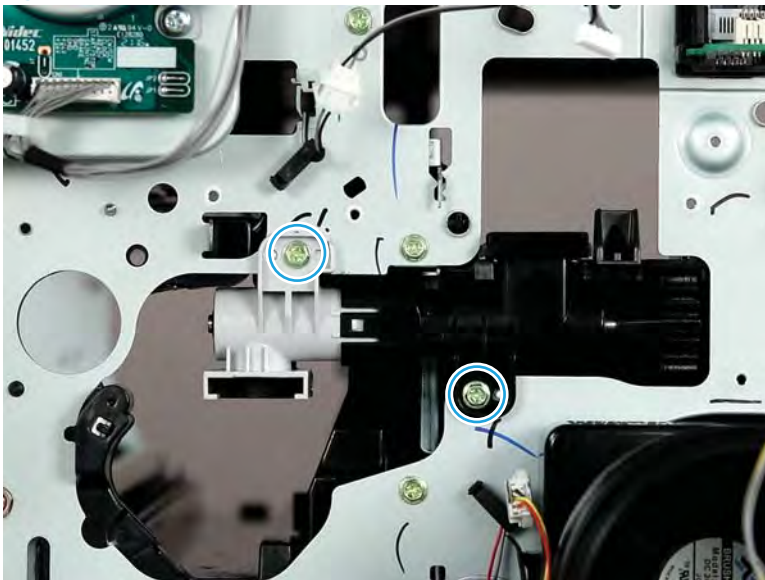

Unpack the replacement assembly

Follow these steps to unpack the replacement assembly.

1. Dispose of the defective part.



NOTE: HP recommends responsible disposal of the defective part.

<http://www8.hp.com/us/en/hp-information/environment/product-recycling.html>

2. Unpack the replacement part from the packaging.



CAUTION:  Some parts are sensitive to electrostatic discharge (ESD). Always perform service work at an ESD-protected workstation or mat. If an ESD workstation or mat is not available, touch the sheet-metal chassis to provide a static ground before touching an ESD-sensitive assembly. Protect the ESD-sensitive assemblies by placing them in ESD pouches when they are out of the printer.



IMPORTANT: Make sure that all of the shipping materials (for example shipping tape) are removed from the replacement part prior to installation.



NOTE: If the replacement part is a roller or pad, avoid touching the spongy part of it. Skin oils on the roller or pad can cause paper pickup and/or print-quality problems. HP recommends using disposable gloves when handling rollers or pads or washing your hands before touching rollers or pads.

3. To install an assembly, reverse the removal steps.



NOTE: When applicable, special installation instructions are provided for an assembly at the end of the removal procedure. Always completely read the removal instructions and follow all special installation instructions.

Removal and replacement: Transfer roller

This document provides the procedures to remove the transfer roller.



[View a video of removing and replacing the transfer roller.](#)

Mean time to repair: 5 minutes

Service level: Basic



IMPORTANT: When applicable, special installation instructions are provided for an assembly at the end of the removal procedure. Always completely read the removal instructions and follow all special installation instructions.

Before performing service

- Disconnect the power cable.

Use the table below to identify the correct part number for your printer. To order the part, go to www.hp.com/buy/parts

Table 2-50 Part information

Part number	Part description
JC82-00466A	Transfer roller assembly

Required tools

- #2 JIS screwdriver with a magnetic tip

After performing service

Turn the printer power on

- Connect the power cable.
- Use the power switch to turn the power on.

Post service test

Copy, scan, or print a document. Verify the document copies, scans, or prints correctly.

Remove the transfer roller

Follow these steps to remove the transfer roller.

1. Open the right door.

2. Hold and release both sides of the transfer roller to remove.

Figure 2-225 Remove transfer roller



Unpack the replacement assembly



Follow these steps to unpack the replacement assembly.

1. Dispose of the defective part.

 **NOTE:** HP recommends responsible disposal of the defective part.

<http://www8.hp.com/us/en/hp-information/environment/product-recycling.html>

2. Unpack the replacement part from the packaging.

 **CAUTION:**  Some parts are sensitive to electrostatic discharge (ESD). Always perform service work at an ESD-protected workstation or mat. If an ESD workstation or mat is not available, touch the sheet-metal chassis to provide a static ground before touching an ESD-sensitive assembly. Protect the ESD-sensitive assemblies by placing them in ESD pouches when they are out of the printer.

 **IMPORTANT:** Make sure that all of the shipping materials (for example shipping tape) are removed from the replacement part prior to installation.

 **NOTE:** If the replacement part is a roller or pad, avoid touching the spongy part of it. Skin oils on the roller or pad can cause paper pickup and/or print-quality problems. HP recommends using disposable gloves when handling rollers or pads or washing your hands before touching rollers or pads.

3. To install an assembly, reverse the removal steps.

 **NOTE:** When applicable, special installation instructions are provided for an assembly at the end of the removal procedure. Always completely read the removal instructions and follow all special installation instructions.

Removal and replacement: Front door open switch

This document provides the procedures to remove the front cover open switch assembly.

Mean time to repair: 15 minutes

Service level: Intermediate

 **IMPORTANT:** When applicable, special installation instructions are provided for an assembly at the end of the removal procedure. Always completely read the removal instructions and follow all special installation instructions.

Before performing service

- Disconnect the power cable.

Use the table below to identify the correct part number for your printer. To order the part, go to www.hp.com/buy/parts

Table 2-51 Part information

Part number	Part description
JC93-00466A	Front Door Switch Open

Required tools

- #2 JIS screwdriver with a magnetic tip

After performing service

Turn the printer power on

- Connect the power cable.
- Use the power switch to turn the power on.

Post service test

Copy, scan, or print a document. Verify the document copies, scans, or prints correctly.

Remove the front door open switch

Follow these steps to remove the front door open switch.

1. Open the right door.

Figure 2-226 Open right door



2. Remove two screw-caps and two screws.

 **NOTE:** Do not dislodge the power button (callout 2) when the cover is removed.

Figure 2-227 Remove screw-caps and screws



3. Open the front door. Remove the toner collection unit. Remove the toner cartridge.
4. Remove the imaging unit.

5. Remove eight screws. Release the front-inner cover.

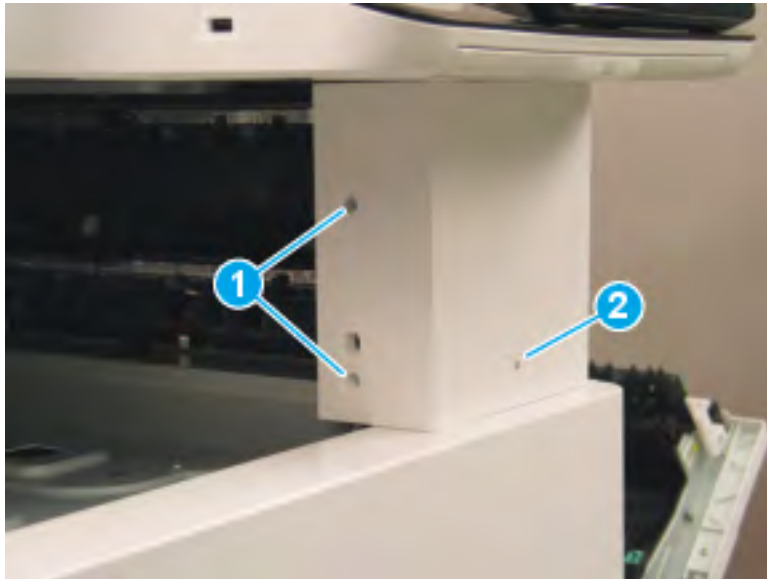
Figure 2-228 Remove screws and front-inner cover

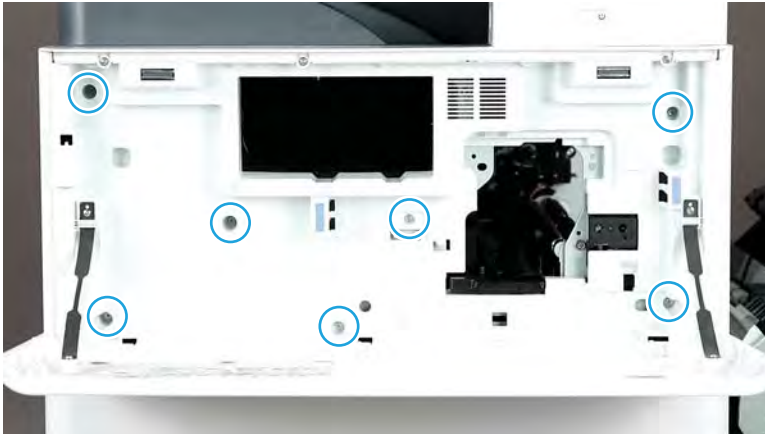

6. Disconnect one cable, and then release one cable stay.

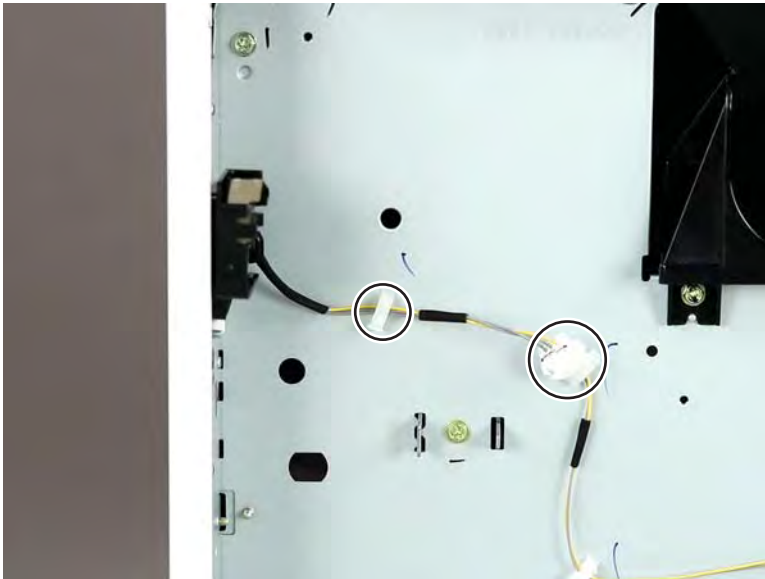

7. Remove one screw, and then remove the door-open switch.



Unpack the replacement assembly



Follow these steps to unpack the replacement assembly.

1. Dispose of the defective part.

 **NOTE:** HP recommends responsible disposal of the defective part.

<http://www8.hp.com/us/en/hp-information/environment/product-recycling.html>

2. Unpack the replacement part from the packaging.

 **CAUTION:**  Some parts are sensitive to electrostatic discharge (ESD). Always perform service work at an ESD-protected workstation or mat. If an ESD workstation or mat is not available, touch the sheet-metal chassis to provide a static ground before touching an ESD-sensitive assembly. Protect the ESD-sensitive assemblies by placing them in ESD pouches when they are out of the printer.

 **IMPORTANT:** Make sure that all of the shipping materials (for example shipping tape) are removed from the replacement part prior to installation.

 **NOTE:** If the replacement part is a roller or pad, avoid touching the spongy part of it. Skin oils on the roller or pad can cause paper pickup and/or print-quality problems. HP recommends using disposable gloves when handling rollers or pads or washing your hands before touching rollers or pads.

3. To install an assembly, reverse the removal steps.

 **NOTE:** When applicable, special installation instructions are provided for an assembly at the end of the removal procedure. Always completely read the removal instructions and follow all special installation instructions.

Removal and replacement: Right door dampener and lever kit

Learn how to remove and replace the right door dampener.

Before performing service

Turn the printer power off

- Press the power button on the front of the printer, and then turn off the power switch next to the power cable.
- A shutting-down message appears on the control-panel display.

 **WARNING!** To avoid damage to the printer, turn the power off and wait until the printer shuts down before removing the power cable.

- Disconnect the printer power cable after the printer has completely shut down (the control-panel display is blank).

Use the table below to identify the correct part number for your printer. To order the part, go to www.hp.com/buy/parts.

Table 2-52 Part information

Part number	Part description
5CM76-67901	Right door dampener and lever kit

Required tools

- #2 JIS screwdriver with a magnetic tip

After performing service

Turn the printer power on

- Connect the printer power cable.
- Turn on the power switch next to the power cable, and then press the power button on the front of the printer.
- Verify that the service performed was successful.
- Verify that the most recent firmware is installed on the printer.
- Verify that all parts are correctly reinstalled and are properly working.

Post service test

Print any pages necessary to verify that the repair resolved the issue and did not create any new issues.

Remove the right door dampener

Follow these steps to remove the right door dampener.

1. Remove Tray 2 and Tray 3.

2. Open the right door, and then release the right door stopper from the damper.

Figure 2-229 Release the right door stopper

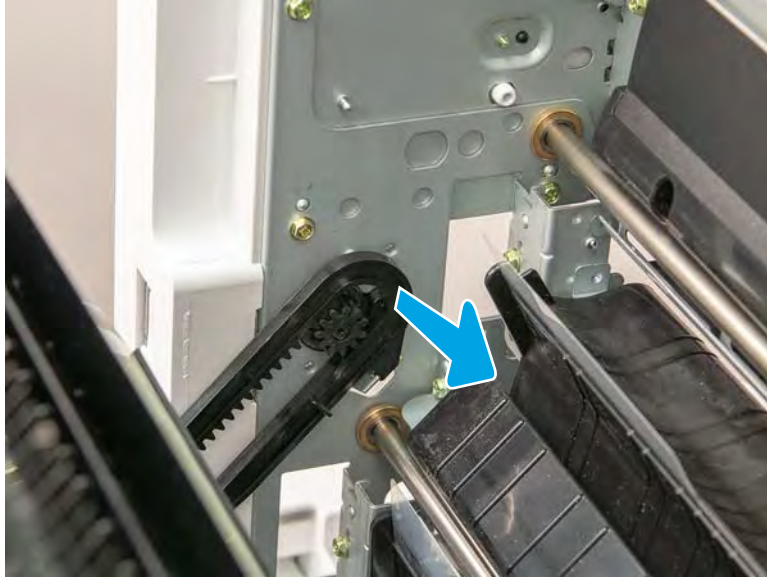

3. Remove three screws, and then remove the right front cover.

Figure 2-230 Remove the right front cover

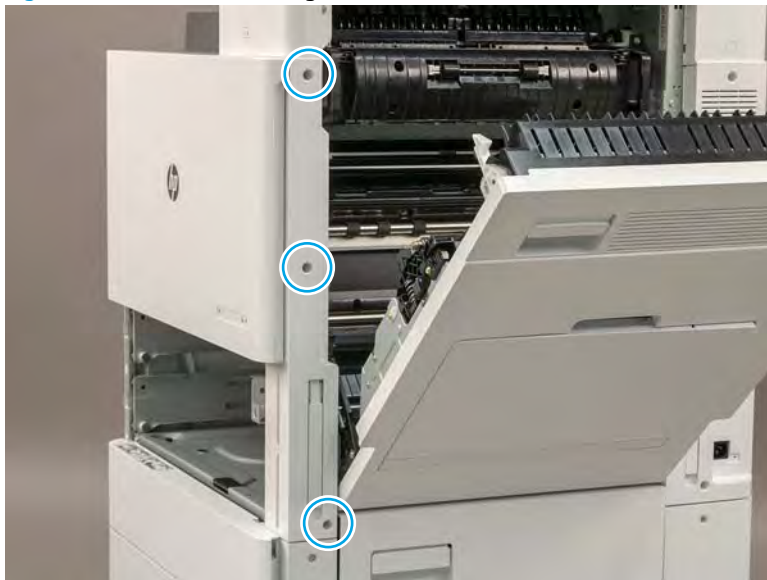

4. Remove two screws, and then remove the front lower cover.

 **TIP:** Slightly open Tray 4 to make removing the cover easier.

Figure 2-231 Remove the front lower cover



5. Remove two screws, and then remove the dampener cover.

Figure 2-232 Remove the dampener cover

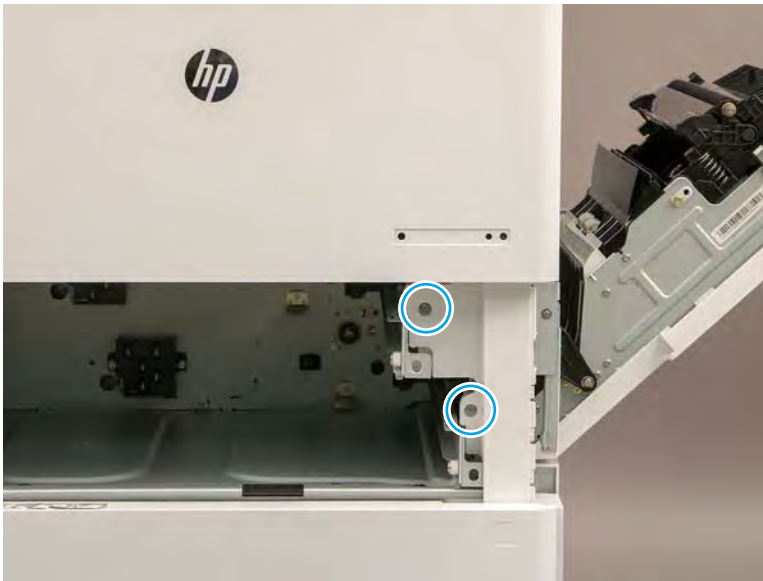
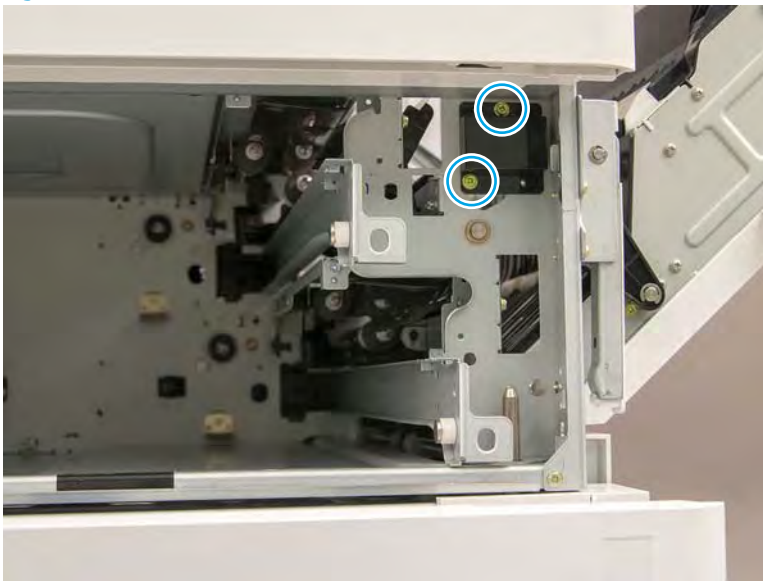

6. Remove the dampener gear assembly.

 **NOTE:** Do not discard the failed dampener. Return the assembly to HP for failure analysis.

Figure 2-233 Remove the dampener assembly



7. **Important:** Make sure that the right door stopper is reinstalled after servicing the printer. Closing the right door without the stopper installed will damage the damper.

Figure 2-234 Install the right door stopper

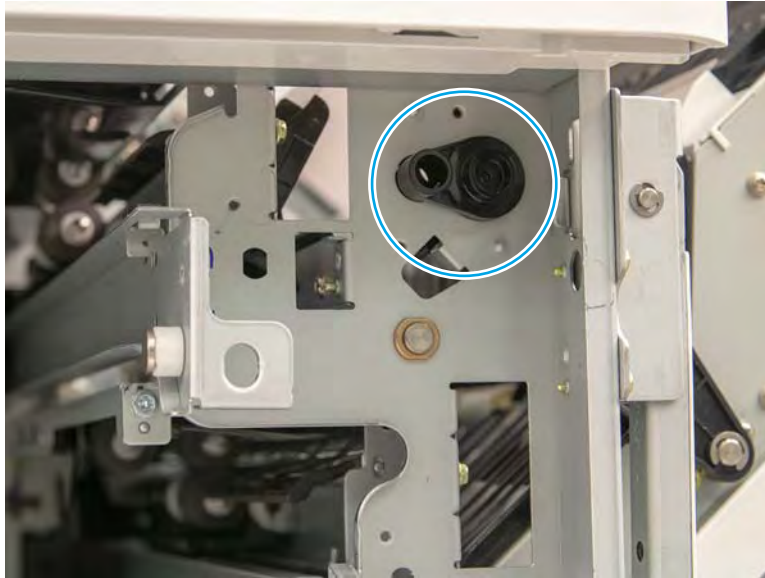
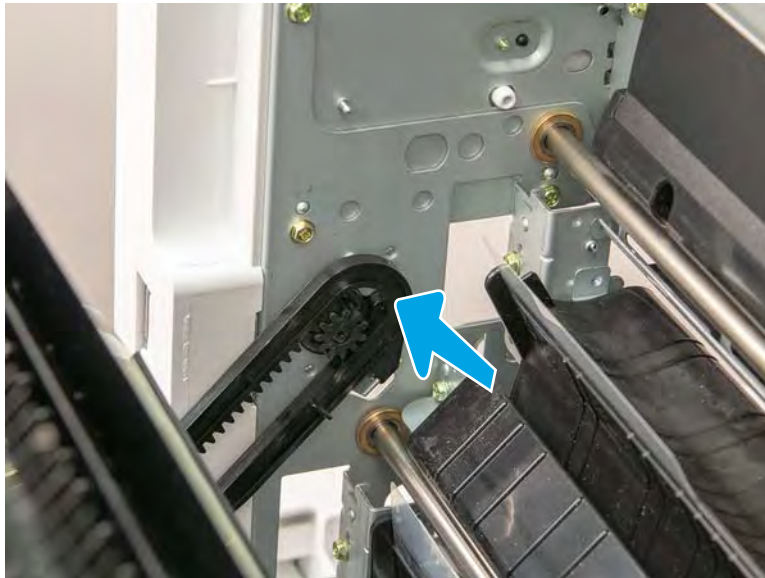

Unpack the replacement assembly

Follow these steps to unpack the replacement assembly.

1. Dispose of the defective part.

 **NOTE:** HP recommends responsible disposal of the defective part.

<http://www8.hp.com/us/en/hp-information/environment/product-recycling.html>

2. Unpack the replacement part from the packaging.



CAUTION:  Some parts are sensitive to electrostatic discharge (ESD). Always perform service work at an ESD-protected workstation or mat. If an ESD workstation or mat is not available, touch the sheet-metal chassis to provide a static ground before touching an ESD-sensitive assembly. Protect the ESD-sensitive assemblies by placing them in ESD pouches when they are out of the printer.

 **IMPORTANT:** Make sure that all of the shipping materials (for example shipping tape) are removed from the replacement part prior to installation.

 **NOTE:** If the replacement part is a roller or pad, avoid touching the spongy part of it. Skin oils on the roller or pad can cause paper pickup and/or print-quality problems. HP recommends using disposable gloves when handling rollers or pads or washing your hands before touching rollers or pads.

3. To install an assembly, reverse the removal steps.

 **NOTE:** When applicable, special installation instructions are provided for an assembly at the end of the removal procedure. Always completely read the removal instructions and follow all special installation instructions.

Removal and replacement: Right door open switch

This document provides the procedures to remove the right door open switch.

Mean time to repair: 15 minutes

Service level: Intermediate



IMPORTANT: When applicable, special installation instructions are provided for an assembly at the end of the removal procedure. Always completely read the removal instructions and follow all special installation instructions.

Before performing service

- Disconnect the power cable.

Use the table below to identify the correct part number for your printer. To order the part, go to www.hp.com/buy/parts

Table 2-53 Part information

Part number	Part description
JC93-01467A	Right door open switch

Required tools

- #2 JIS screwdriver with a magnetic tip

After performing service

Turn the printer power on

- Connect the power cable.
- Use the power switch to turn the power on.

Post service test

Copy, scan, or print a document. Verify the document copies, scans, or prints correctly.

Remove the right door open switch

Follow these steps to remove the right door open switch.

1. Remove the rear cover. Remove one screw securing the sensor.

Figure 2-235 Remove rear cover and screw

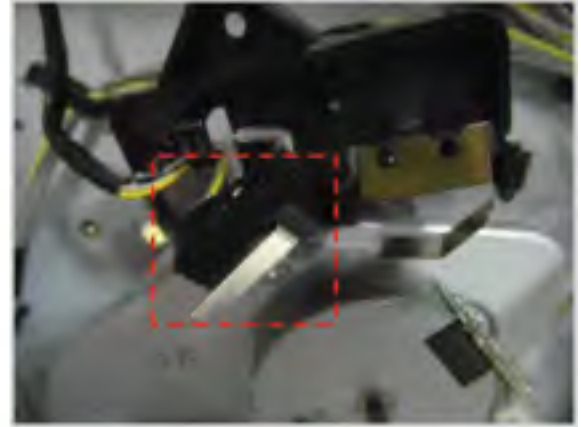
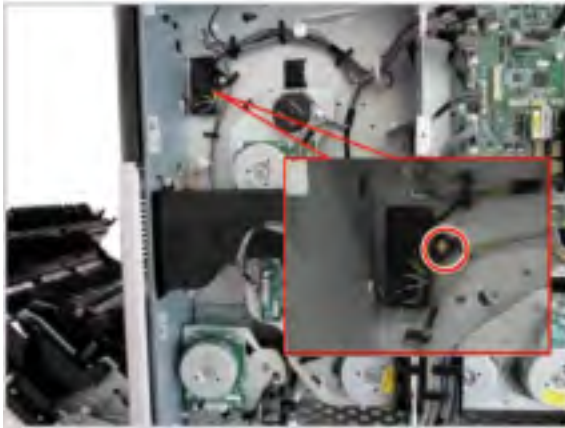

2. Remove the micro-switch.

Figure 2-236 Remove micro-switch

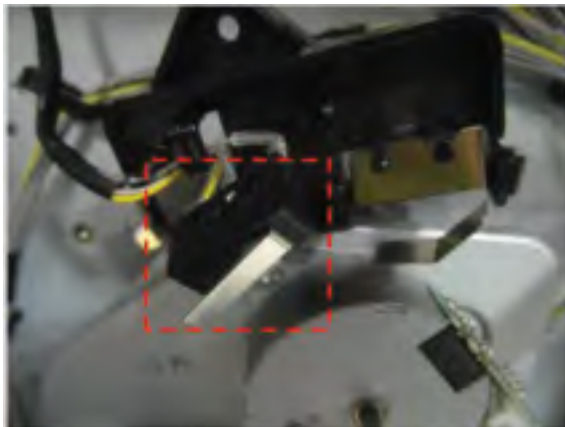

Unpack the replacement assembly

Follow these steps to unpack the replacement assembly.

1. Dispose of the defective part.

 **NOTE:** HP recommends responsible disposal of the defective part.

<http://www8.hp.com/us/en/hp-information/environment/product-recycling.html>

2. Unpack the replacement part from the packaging.



CAUTION:  Some parts are sensitive to electrostatic discharge (ESD). Always perform service work at an ESD-protected workstation or mat. If an ESD workstation or mat is not available, touch the sheet-metal chassis to provide a static ground before touching an ESD-sensitive assembly. Protect the ESD-sensitive assemblies by placing them in ESD pouches when they are out of the printer.

 **IMPORTANT:** Make sure that all of the shipping materials (for example shipping tape) are removed from the replacement part prior to installation.

 **NOTE:** If the replacement part is a roller or pad, avoid touching the spongy part of it. Skin oils on the roller or pad can cause paper pickup and/or print-quality problems. HP recommends using disposable gloves when handling rollers or pads or washing your hands before touching rollers or pads.

3. To install an assembly, reverse the removal steps.

 **NOTE:** When applicable, special installation instructions are provided for an assembly at the end of the removal procedure. Always completely read the removal instructions and follow all special installation instructions.

Covers

View covers exploded view, parts list, and repair procedures.

Covers

Parts diagram and parts list for the covers.

Figure 2-237 Covers

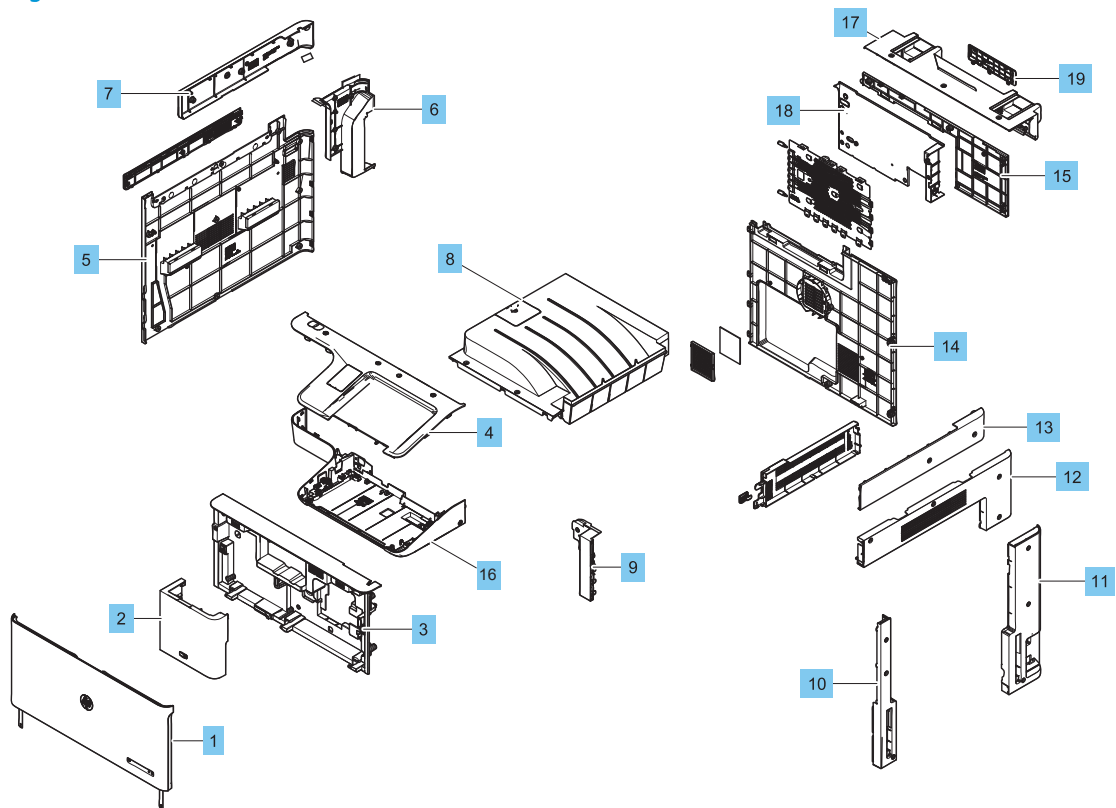

Table 2-54 Covers

Ref				
No	Part number	Description	Qty	Repair Procedure
1	JC95-02096A	Cover, front	1	Not applicable
2	JC95-02082A	Cover, middle right	1	Not applicable
3	JC95-02097A	Cover, inner	1	Not applicable
4	JC63-05647A	Cover, Control Panel Top	1	Not applicable
5	JC95-02095A	Cover, left	1	Removal and replacement: Left cover on page 349
6	JC63-05623A	Cover, left upper	1	Not applicable
7	JC63-05576A	Cover, scanner left	1	Not applicable
8	JC95-02208A	Cover, exit	1	Not applicable
9	JC63-04536B	Cover, front lower	1	Not applicable
10	JC63-04539B	Cover, right front	1	Not applicable
11	JC63-04540B	Cover, right rear	1	Not applicable
12	JC63-04520B	Cover, right upper	1	Not applicable
13	JC63-05575A	Cover, scanner right	1	Not applicable
14	JC63-05617A	Cover, rear lower	1	Removal and replacement: Rear covers on page 351
15	JC63-05618A	Cover, rear upper	1	Removal and replacement: Rear covers on page 351
16	JC63-05648A	Cover, control panel bottom	1	Not applicable
17	JC63-05577A	Cover, scanner rear	1	Not applicable
18	JC95-02088A	Cover, rear exit	1	Not applicable
19	JC63-04567B	Cover, rear dummy	1	Not applicable
Not shown	JC61-04626A	Strap, front cover	1	Not applicable
Not shown	JC41-00964A	PCA, Sub USB Host	1	Not applicable
Not shown	JC92-02969A	PCA, front power switch	1	Not applicable

Removal and replacement: Left cover

This document provides the procedures to remove the left cover assembly.



[View a video of removing and replacing the left cover.](#)

Mean time to repair: 5 minutes

Service level: Basic



IMPORTANT: When applicable, special installation instructions are provided for an assembly at the end of the removal procedure. Always completely read the removal instructions and follow all special installation instructions.

Before performing service

- Disconnect the power cable.

Use the table below to identify the correct part number for your printer. To order the part, go to www.hp.com/buy/parts

Table 2-55 Part information

Part number	Part description
SAM-JC95-02095A	Left cover assembly

Required tools

- #2 JIS screwdriver with a magnetic tip

After performing service

Turn the printer power on

- Connect the power cable.
- Use the power switch to turn the power on.

Post service test

Copy, scan, or print a document. Verify the document copies, scans, or prints correctly.

Removal and replacement: Rear covers

This document provides the procedures to remove the rear covers.



[View a video of removing and replacing the rear covers.](#)

Mean time to repair: 5 minutes

Service level: Basic



IMPORTANT: When applicable, special installation instructions are provided for an assembly at the end of the removal procedure. Always completely read the removal instructions and follow all special installation instructions.

Before performing service

- Disconnect the power cable.

Use the table below to identify the correct part number for your printer. To order the part, go to www.hp.com/buy/parts

Table 2-56 Part information

Part number	Part description
JC63-05618A	Rear-upper cover
JC63-05617A	Rear-lower cover

Required tools

- #2 JIS screwdriver with a magnetic tip

After performing service

Turn the printer power on

- Connect the power cable.
- Use the power switch to turn the power on.

Post service test

Copy, scan, or print a document. Verify the document copies, scans, or prints correctly.

Remove the rear covers

Follow these steps to remove the rear covers.

1. Unscrew two captive thumbscrews on the formatter cover. Slide the formatter cover to the left, and then to the right to remove.

Figure 2-238 Remove the formatter cover

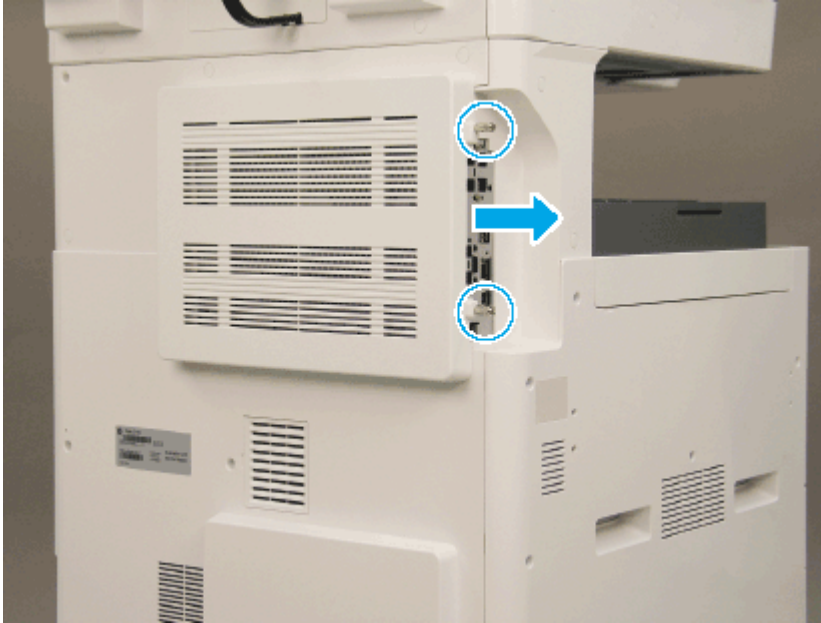

2. Remove seven screws, and then remove the rear-bottom cover.

Figure 2-239 Remove the rear-bottom cover

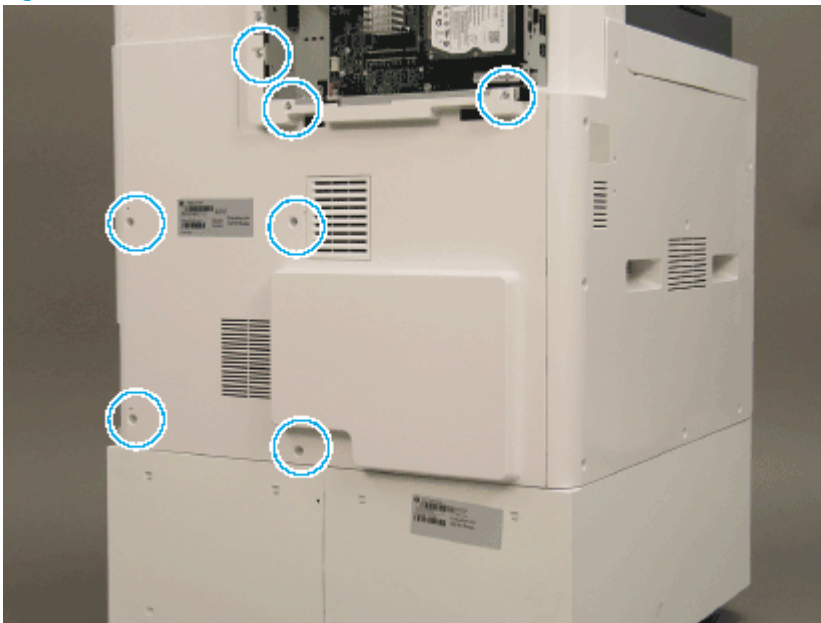

3. Remove six screws (callout 1), and then remove the rear-top cover.

Figure 2-240 Remove the rear-top cover

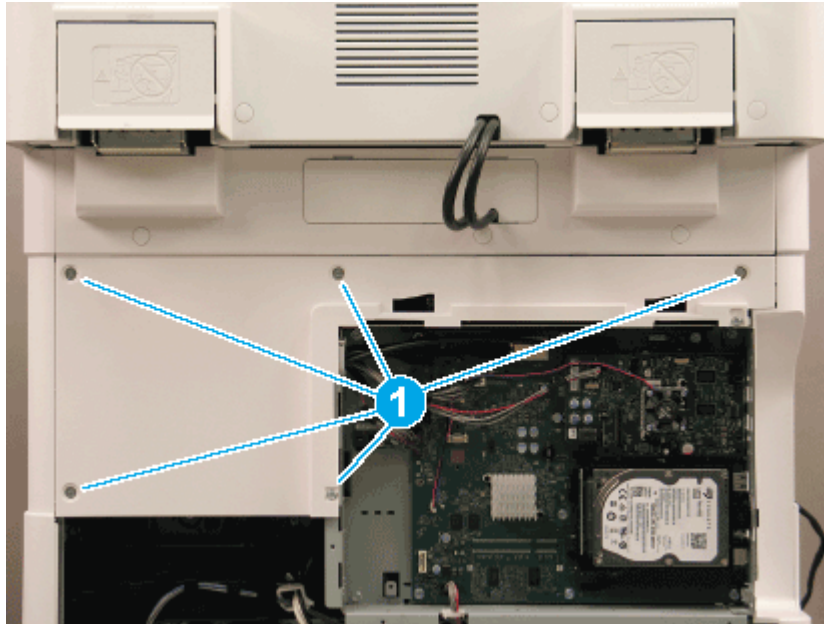

Unpack the replacement assembly



Follow these steps to unpack the replacement assembly.

1. Dispose of the defective part.

 **NOTE:** HP recommends responsible disposal of the defective part.

<http://www8.hp.com/us/en/hp-information/environment/product-recycling.html>

2. Unpack the replacement part from the packaging.

 **CAUTION:**  Some parts are sensitive to electrostatic discharge (ESD). Always perform service work at an ESD-protected workstation or mat. If an ESD workstation or mat is not available, touch the sheet-metal chassis to provide a static ground before touching an ESD-sensitive assembly. Protect the ESD-sensitive assemblies by placing them in ESD pouches when they are out of the printer.

 **IMPORTANT:** Make sure that all of the shipping materials (for example shipping tape) are removed from the replacement part prior to installation.

 **NOTE:** If the replacement part is a roller or pad, avoid touching the spongy part of it. Skin oils on the roller or pad can cause paper pickup and/or print-quality problems. HP recommends using disposable gloves when handling rollers or pads or washing your hands before touching rollers or pads.

3. To install an assembly, reverse the removal steps.

 **NOTE:** When applicable, special installation instructions are provided for an assembly at the end of the removal procedure. Always completely read the removal instructions and follow all special installation instructions.

Right door

View the right door exploded view, parts list, and repair procedures.

Right door

Parts diagram and parts list for the right door

Figure 2-241 Right door

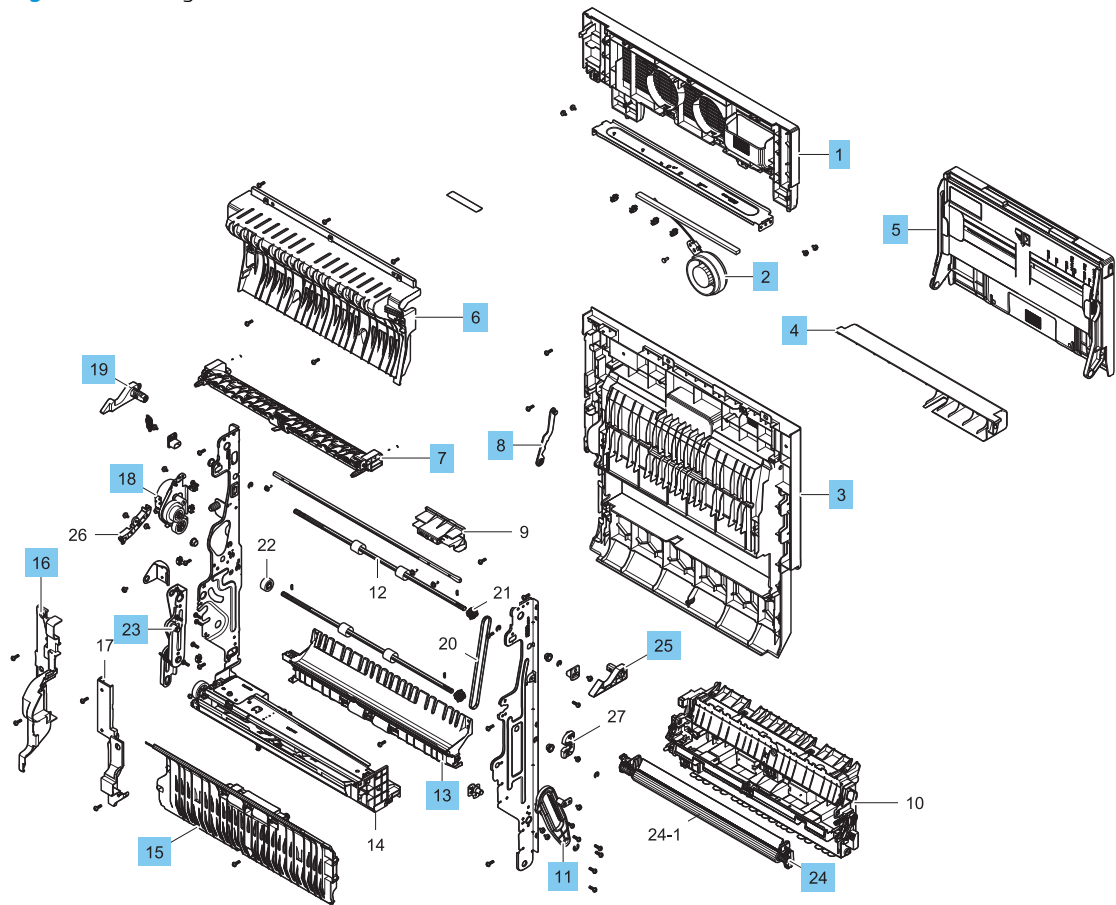

Table 2-57 Right door

Ref				
No	Part number	Description	Qty	Repair procedure
1	JC63-04573B	Cover, upper side	1	Not applicable
2	JC31-00160C	Fan Type 6, Fuser	1	Not applicable
3	JC95-02082A	Cover, right door	1	Not applicable
4	JC63-03356C	Cover, front Tray 1	1	Not applicable
5	JC90-01777A	Tray 1 Door	1	Removal and replacement: Right Door, Tray 1 and Tray 1 assemblies on page 358
6	JC63-05587A	Guide, duplex upper	1	Not applicable
7	JC95-01509C	Right door exit	1	Not applicable
8	JC66-03220B	Link, side	1	Not applicable
11	JC66-03235A	Right door dampner	3	Not applicable
13	JC95-01519A	Right door duplex lower	1	Removal and replacement: Right Door, Tray 1 and Tray 1 assemblies on page 358
15	JC95-02130A	Right door take away	1	Not applicable
16	JC63-03361C	Cover, harness	1	Not applicable
18	JC95-01510A	Motor right door duplex	1	Not applicable
19	JC64-00711A	Right rear lock	1	Not applicable
23	JC95-01518A	Right door link rear	1	Not applicable
24	JC82-00466A	Transfer roller assembly	1	Not applicable
25	JC64-00710A	Right door lock	1	Not applicable

Removal and replacement: Right Door, Tray 1 and Tray 1 assemblies

This document provides the procedures to remove the Right Door, Tray 1 (MP), and Tray 1 assemblies.



[View a video of removing and replacing the right door, Tray 1, and Tray 1 assemblies.](#)

Mean time to repair: 15 minutes

Service level: Intermediate



IMPORTANT: When applicable, special installation instructions are provided for an assembly at the end of the removal procedure. Always completely read the removal instructions and follow all special installation instructions.

Before performing service

- Disconnect the power cable.

Use the table below to identify the correct part number for your printer. To order the part, go to www.hp.com/buy/parts

Table 2-58 Part information

Part number	Part description
JC95-02080B	Right door
JC90-01777A	Tray 1 (MP)
JC95-01519A	Right Door Duplex Lower
JC33-00029B	Solenoid Tray 1

Required tools

- #2 JIS screwdriver with a magnetic tip

After performing service

Turn the printer power on

- Connect the power cable.
- Use the power switch to turn the power on.

Post service test

Copy, scan, or print a document. Verify the document copies, scans, or prints correctly.

Remove the right door

Follow these steps to remove the right door.



NOTE: Remove second exit drive if installed.

1. Remove three screws, and then remove the cover (A).

Figure 2-242 Remove cover

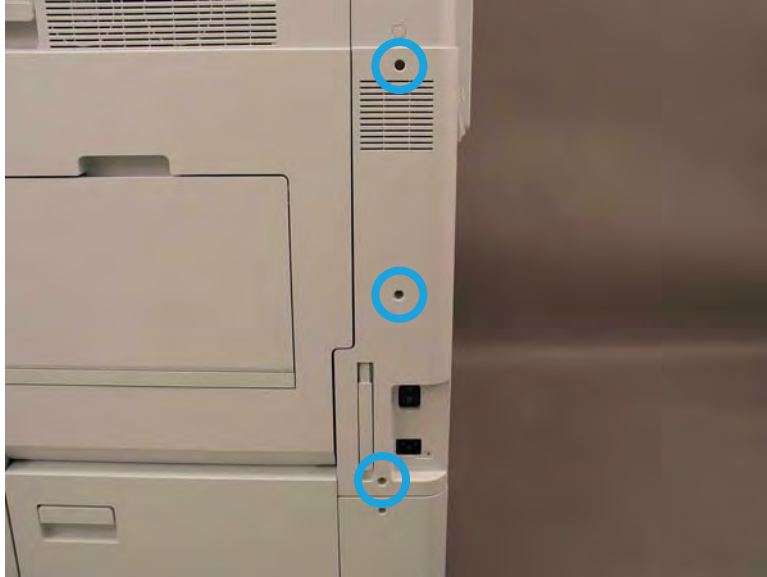

2. Disconnect the right door connector.

Figure 2-243 Disconnect right door connector



3. Release the right hinge (callout 1).

⚠ CAUTION: The right hinge spring tension can be dangerous. Use caution when releasing the right hinge to avoid injury.

Figure 2-244 Release right hinge

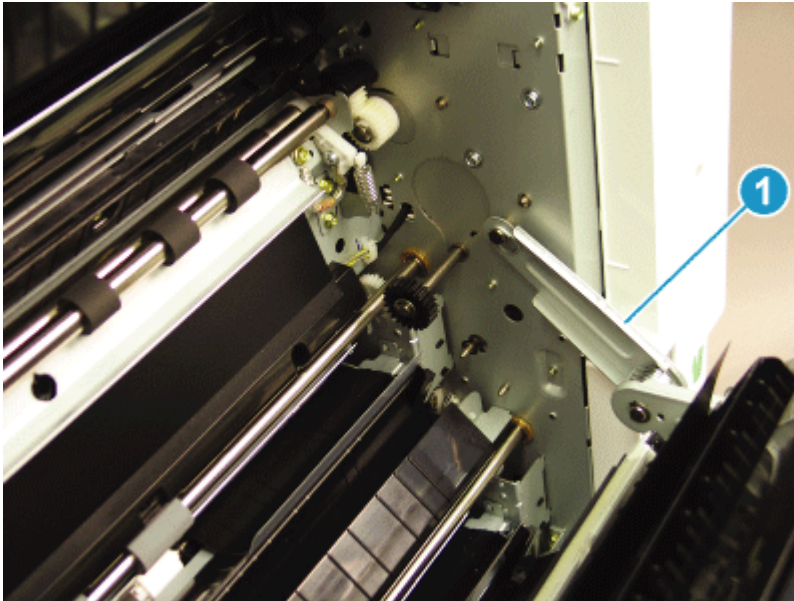

4. Release the left dampener (callout 1).

Figure 2-245 Release left dampener

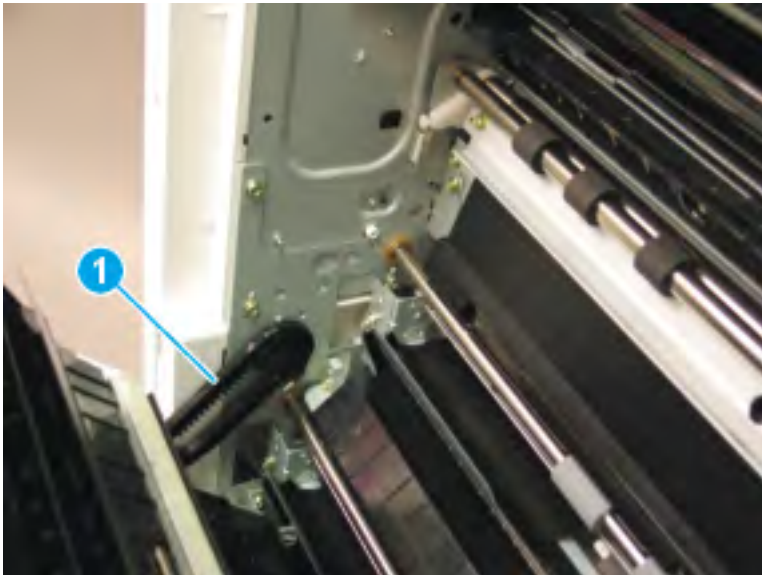

5. Remove the right door.

 **NOTE:** Open the lower access door. If there is an HCI or 2x520 input device, release the dampener to clear the lower right door. Remove clockwise.

Figure 2-246 Remove right door



Remove the multipurpose unit and MP assemblies

Follow these steps to remove the multipurpose unit and MP assemblies.

1. Open the MP tray and remove the MP roller cover. Release tabs at back of the roller cover and rotate to release.

Figure 2-247 Remove MP front cover

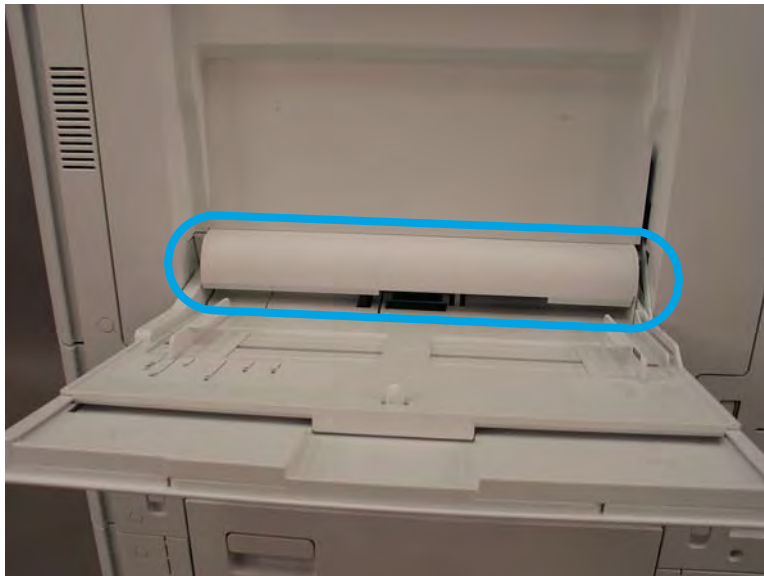

2. Open the MP tray and release the hinge from the right, flexing the linker to remove.

Figure 2-248 Open MP tray and release link

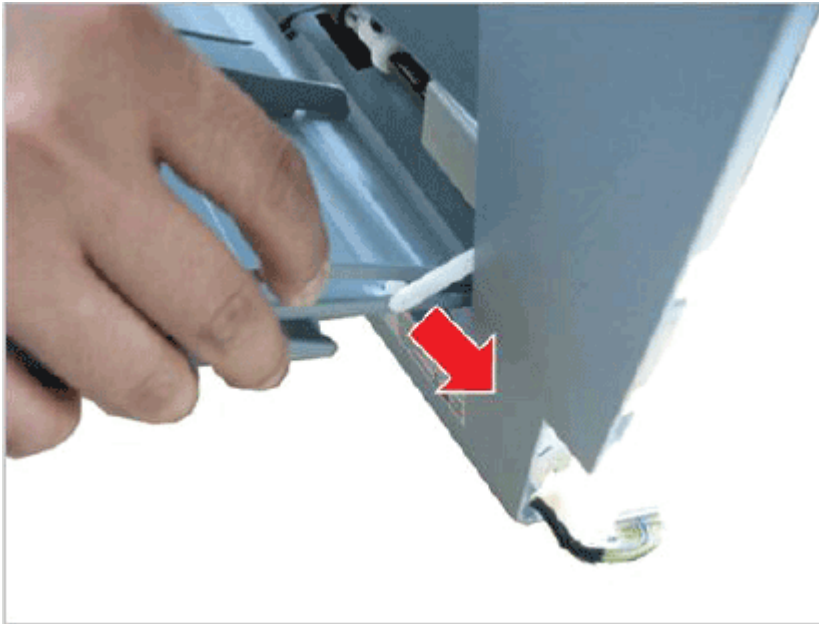

3. Remove two screws and then remove the cable cover.

Figure 2-249 Remove screws and cable cover

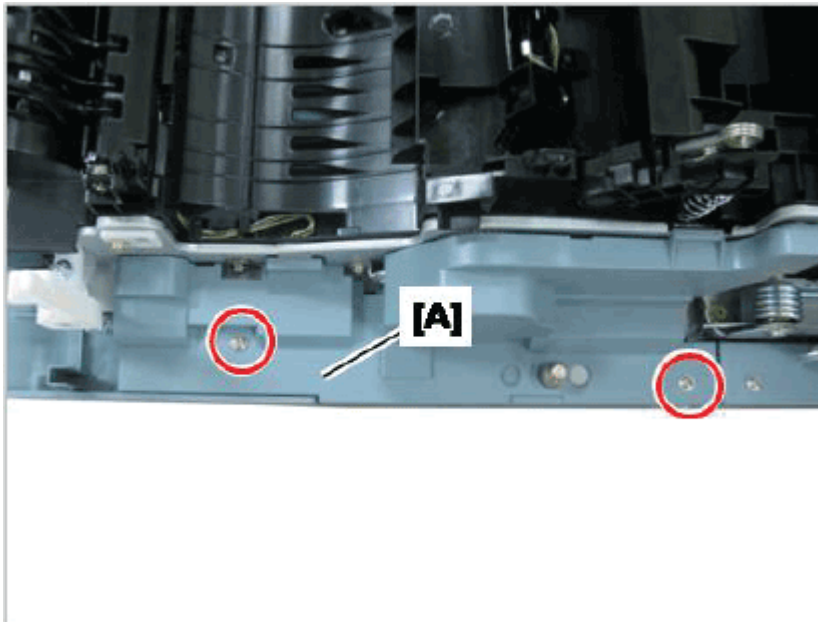

4. Remove three screws and then remove the cable cover lower.

Figure 2-250 Remove screws and cable cover lower

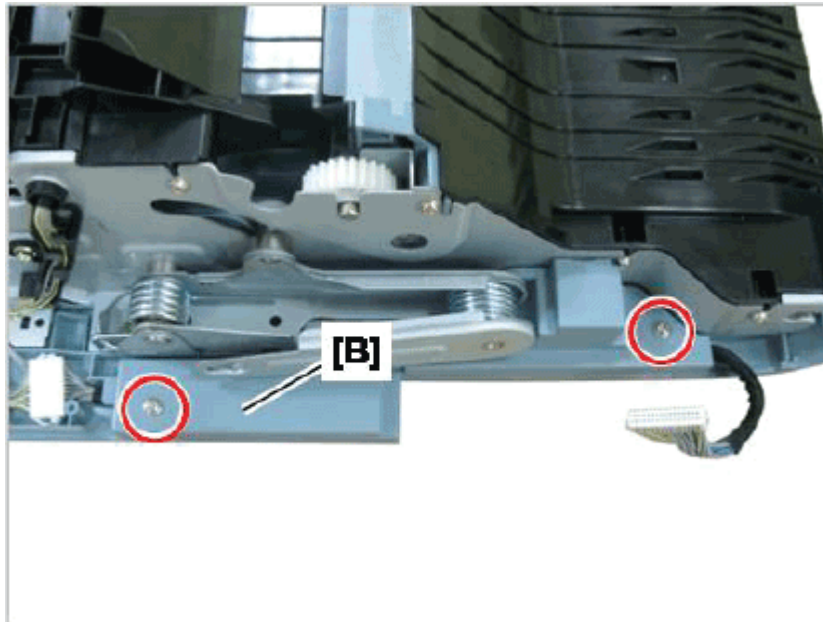

5. Remove one screw. Prop up the hinge on the door edge to keep it out of the way.

Figure 2-251 Remove screw and prop up hinge

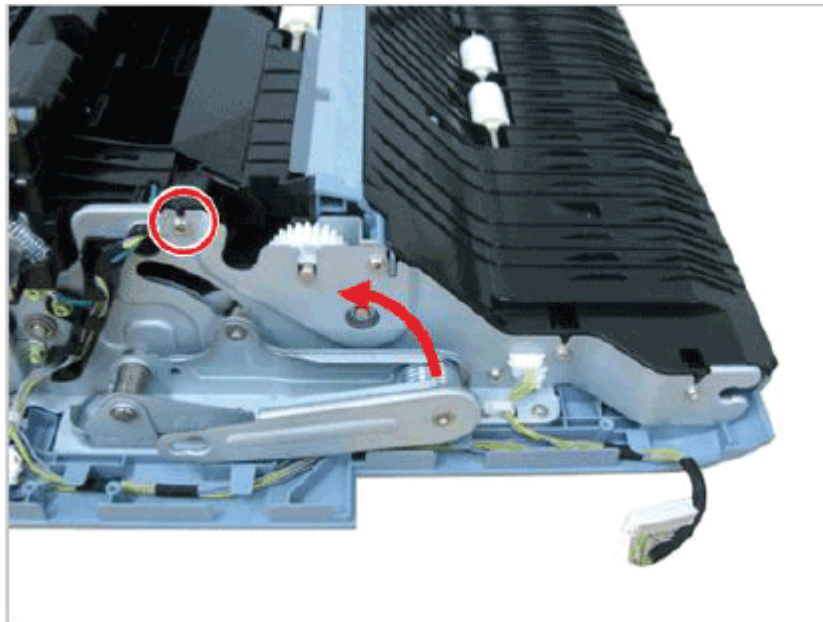

6. Remove three screws.

Figure 2-252 Remove screws

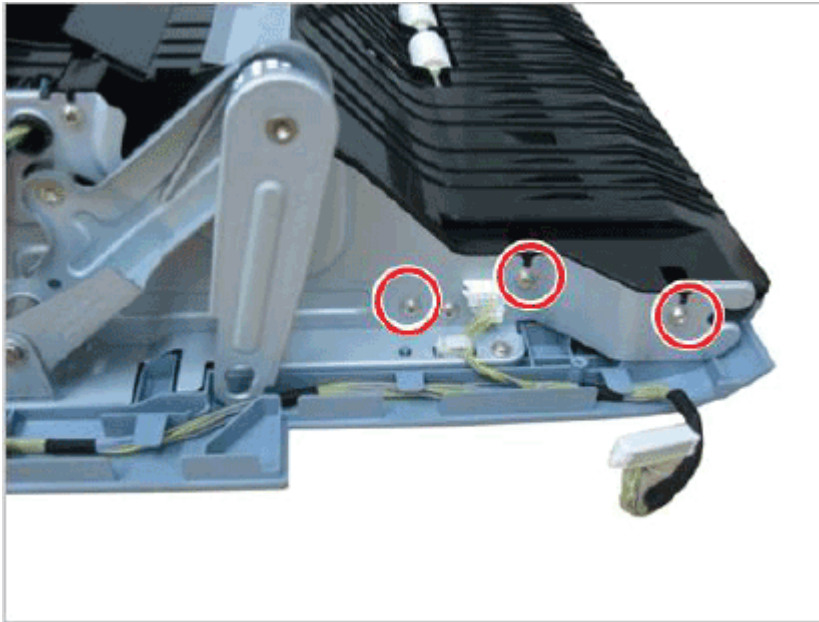

7. Remove one screw.

Figure 2-253 Remove screw

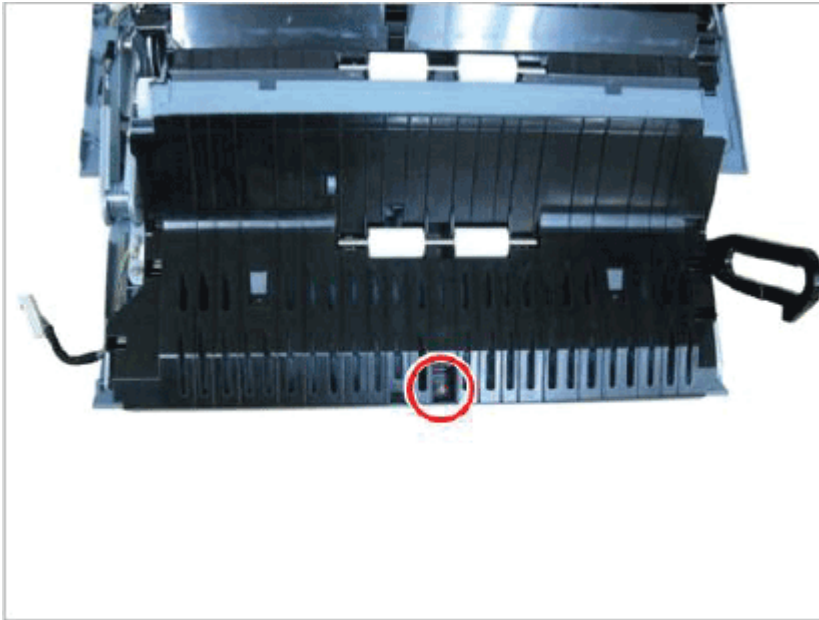

8. Remove two screws from the other side of the door.

Figure 2-254 Remove screws



9. Remove four screws.

Figure 2-255 Remove screws

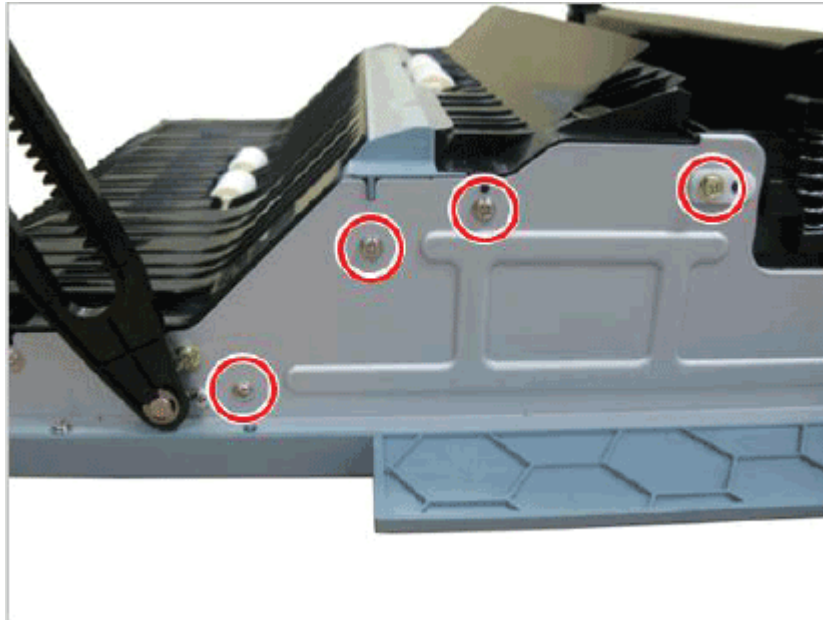

10. Swing out the guide feed (C) to the right. Remove the hinge pin from the front.

Figure 2-256 Remove hinge pin

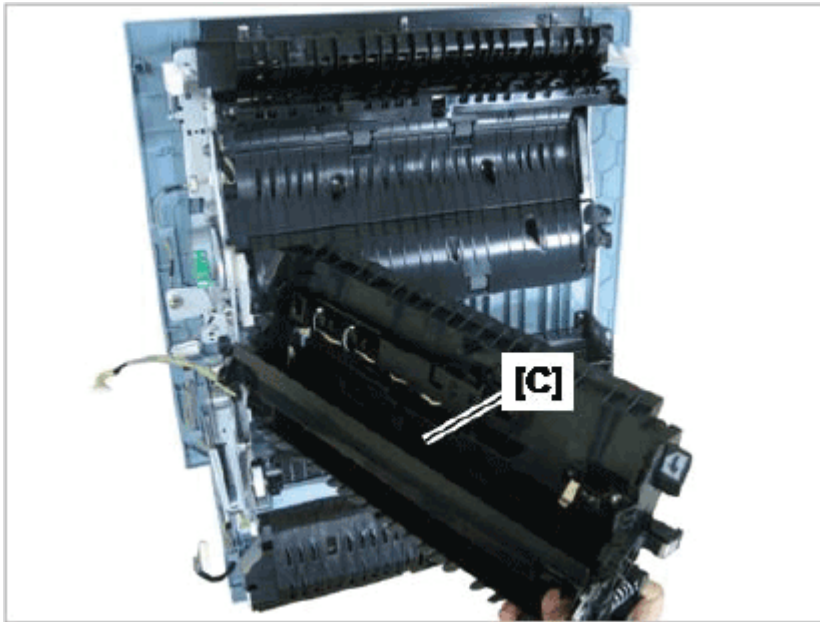

11. Gently lift up the right door.

Figure 2-257 Lift right door duplex lower

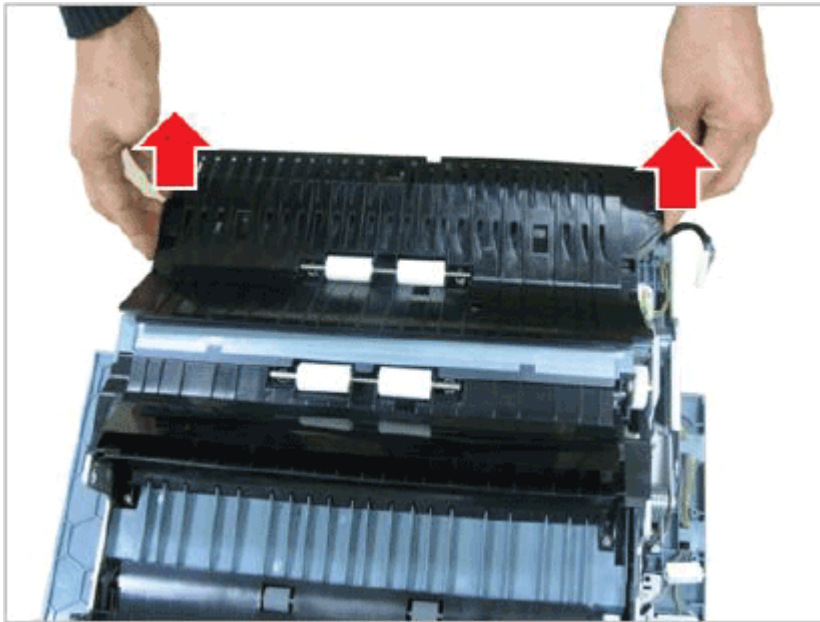

12. Remove two screws.

Figure 2-258 Remove screws

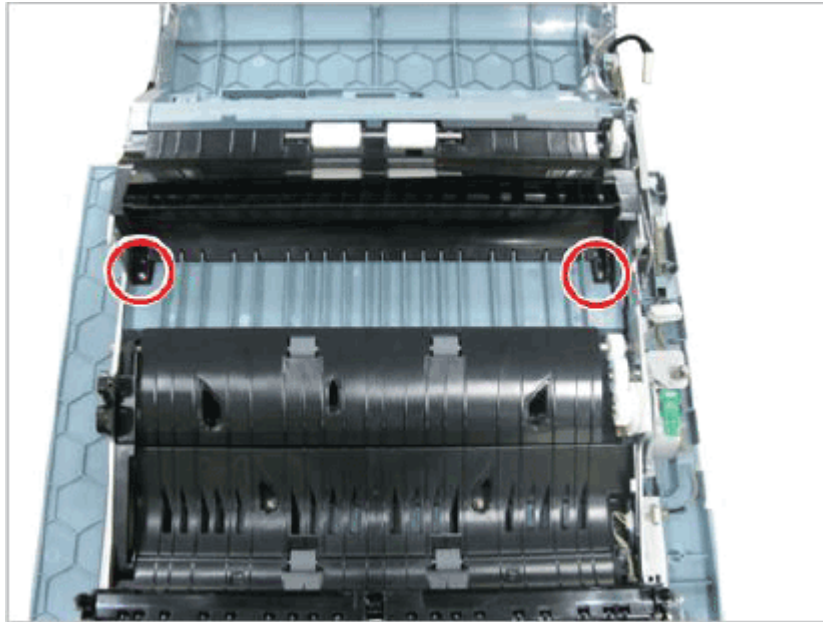

13. Disconnect three connectors near the hinge.

 **IMPORTANT:** Make sure the connector couplers stay attached to the door.

Figure 2-259 Disconnect connectors

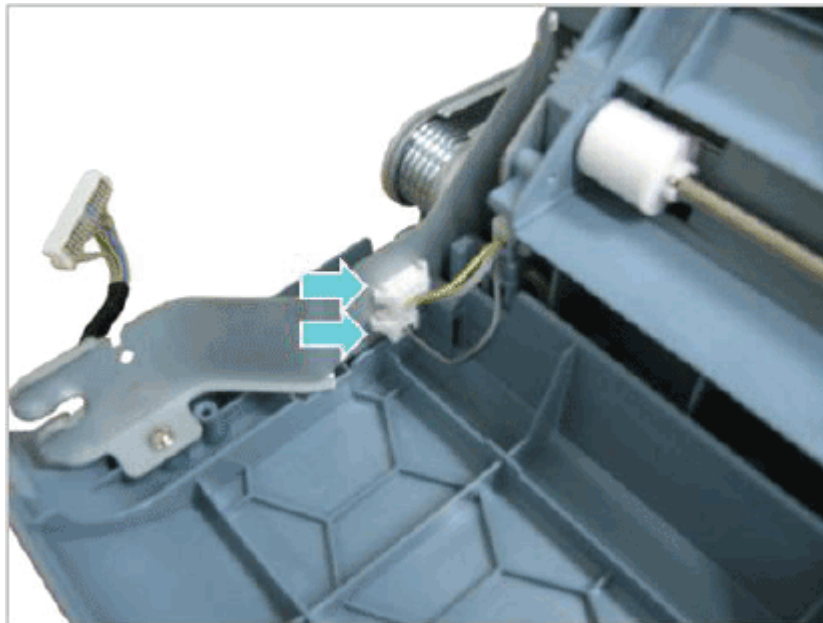

14. Remove one screw, and then remove the MP unit.

Figure 2-260 Remove screw and MP unit

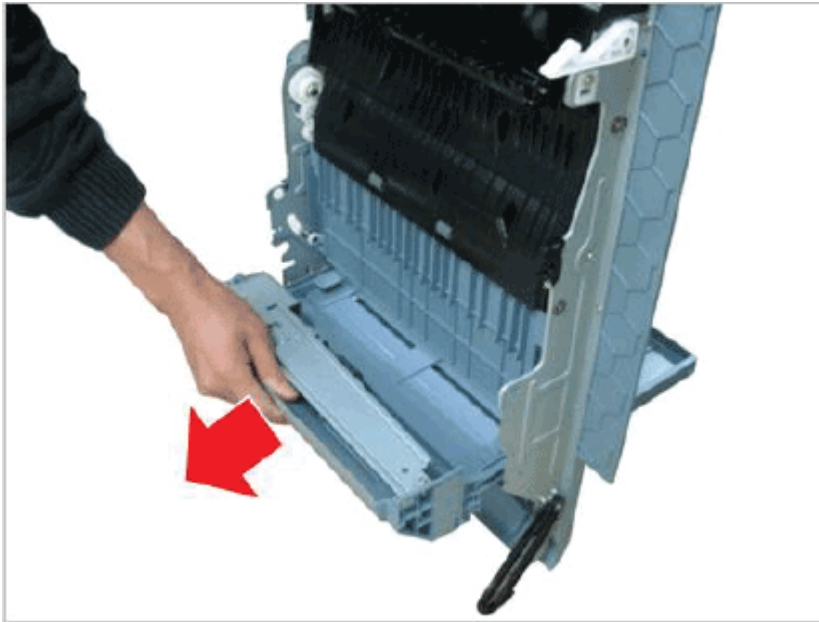

15. Remove the MP-cover base.

Figure 2-261 Remove MP-cover base

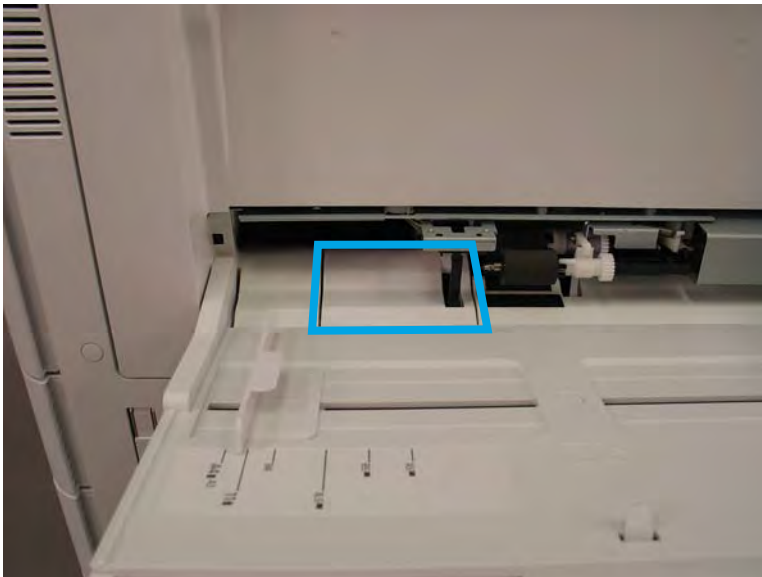

16. Remove the E-ring, and then remove the gear (C).

Figure 2-262 Remove e-ring and gear

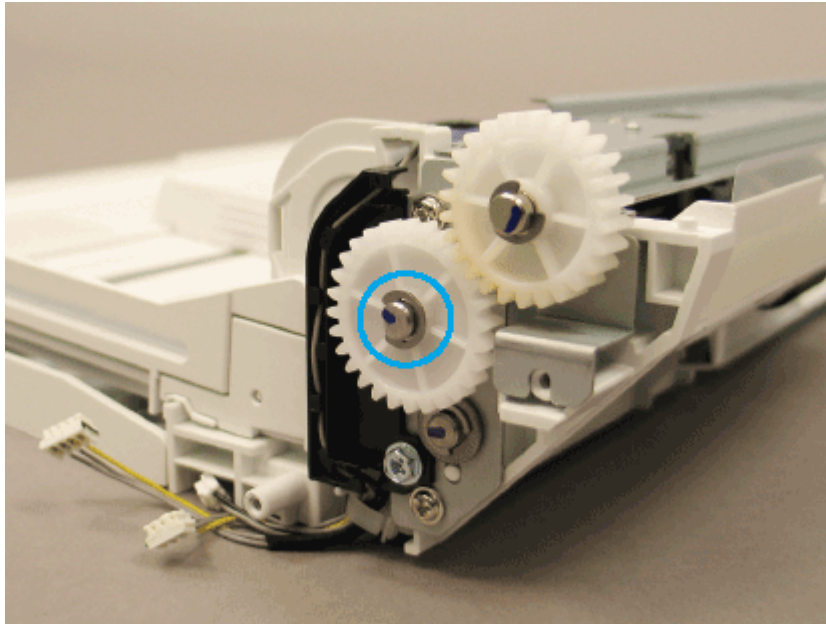

17. Remove the E-ring, and then remove the bushing (D).

Figure 2-263 Remove e-ring and bushing

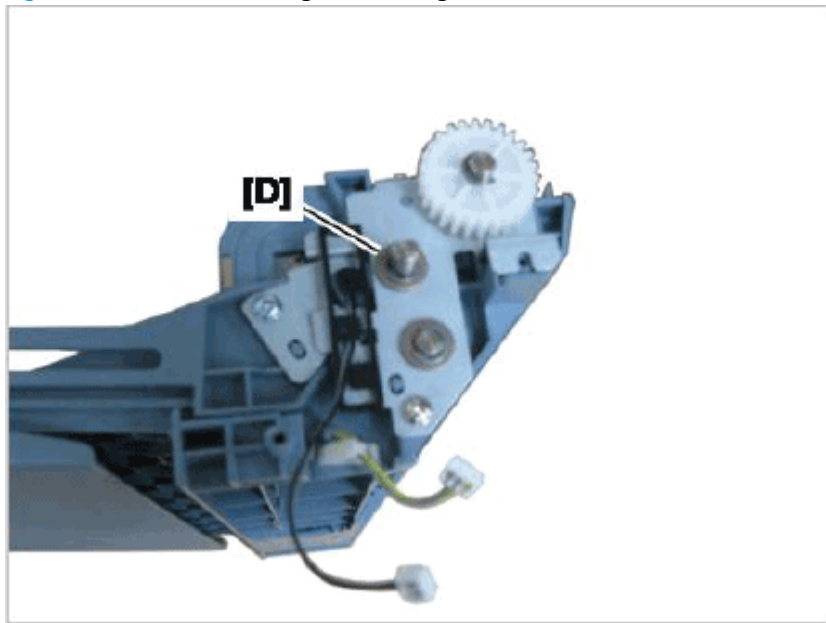

18. Remove one screw, and then remove the Bracket-Solenoid.

Figure 2-264 Remove screw and bracket-solenoid

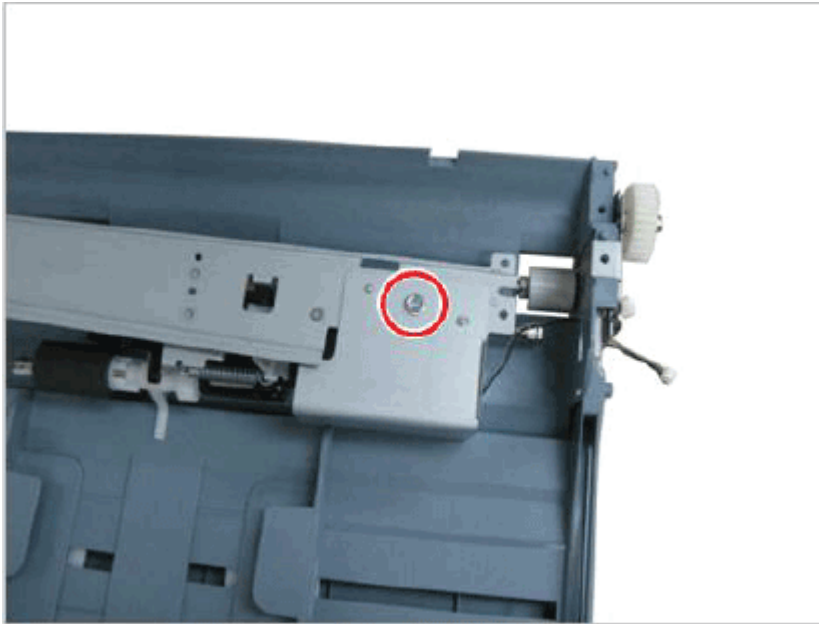

 **NOTE:** Reinstallation note: Route the cable before putting the cover back on during reinstallation.

19. Remove four screws, and then release the MP bracket pickup. Release the cable from the cable harness.

Figure 2-265 Release MP bracket pickup and release cable from harness

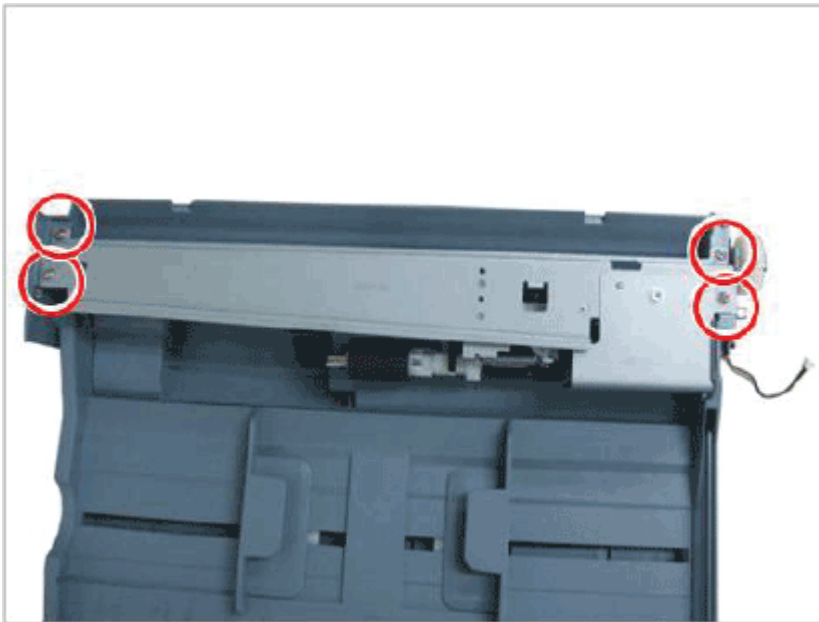

20. Release the cable from the cable retainer, and release the cable from the cable harness. Remove two screws, and then remove the MP solenoid.

Figure 2-266 Release cable and remove MP solenoid

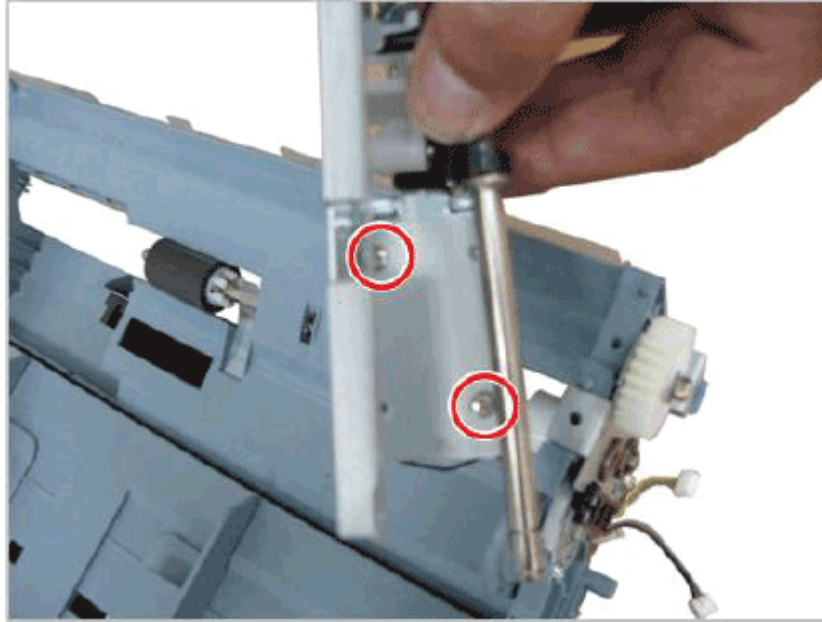

 **NOTE:** Reinstallation note: When reinstalling, the paper stopper needs to be located in the appropriate slot in the housing.

Unpack the replacement assembly



Follow these steps to unpack the replacement assembly.

1. Dispose of the defective part.

 **NOTE:** HP recommends responsible disposal of the defective part.

<http://www8.hp.com/us/en/hp-information/environment/product-recycling.html>

2. Unpack the replacement part from the packaging.

 **CAUTION:**  Some parts are sensitive to electrostatic discharge (ESD). Always perform service work at an ESD-protected workstation or mat. If an ESD workstation or mat is not available, touch the sheet-metal chassis to provide a static ground before touching an ESD-sensitive assembly. Protect the ESD-sensitive assemblies by placing them in ESD pouches when they are out of the printer.

 **IMPORTANT:** Make sure that all of the shipping materials (for example shipping tape) are removed from the replacement part prior to installation.

 **NOTE:** If the replacement part is a roller or pad, avoid touching the spongy part of it. Skin oils on the roller or pad can cause paper pickup and/or print-quality problems. HP recommends using disposable gloves when handling rollers or pads or washing your hands before touching rollers or pads.

3. To install an assembly, reverse the removal steps.

 **NOTE:** When applicable, special installation instructions are provided for an assembly at the end of the removal procedure. Always completely read the removal instructions and follow all special installation instructions.

Tray 1

View the tray 1 exploded view, parts list, and repair procedures.

Tray 1

Parts diagram and parts list for Tray 1.

Figure 2-267 Tray 1

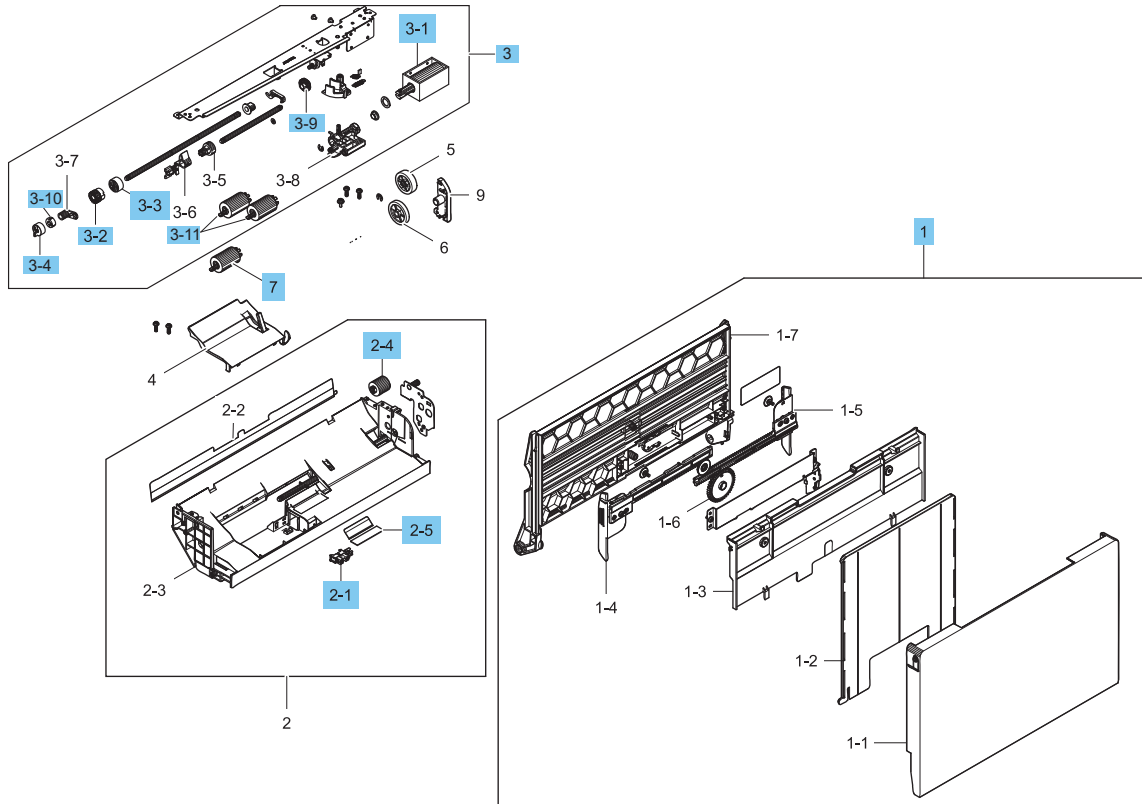

Table 2-59 Tray 1

Ref				
No	Part number	Description	Qty	Repair procedure
1	JC90-01778A	Tray 1 Door	1	Removal and replacement: Right Door, Tray 1 and Tray 1 assemblies on page 358
2-1	0604-001393	Photo interrupter	1	Not applicable
2-4	JC67-00455A	Coupler, Torque Limiter	1	Not applicable
2-5	JC62-01085A	Seal, pad tray 1	3	Not applicable
3	JC90-01125B	MP bracket pickup	1	Not applicable
3-1	JC33-00029B	Solenoid, tray 1	1	Removal and replacement: Right Door, Tray 1 and Tray 1 assemblies on page 358
3-2	JC90-00918A	MP one way clutch	1	Not applicable
3-3	JC66-00977A	Clutch, one way	2	Not applicable
3-4	JC61-01288A	Holder-M_idle one way	1	Not applicable
3-9	JC66-00940A	Gear-M_idle PU	1	Not applicable
3-10	JC66-00977A	Clutch-P_one way	1	Not applicable
3-11	JC93-00540B	Frame-main pickup roller	2	Removal and replacement: Tray 1 pick/reverse/feed roller on page 376
7	X3A92-67918	Tray 1 roller (kit)		Removal and replacement: Tray 1 pick/reverse/feed roller on page 376
Not shown	JC95-02079A	Right door assembly	1	

Removal and replacement: Tray 1 pick/reverse/feed roller

This document provides the procedures to remove the multipurpose (MP) pickup/reverse/feed roller.

Mean time to repair: 6 minutes

Service level: Basic

 **IMPORTANT:** When applicable, special installation instructions are provided for an assembly at the end of the removal procedure. Always completely read the removal instructions and follow all special installation instructions.

Before performing service

- Disconnect the power cable.

Use the table below to identify the correct part number for your printer. To order the part, go to www.hp.com/buy/parts

Table 2-60 Part information

Part number	Part description
JC93-00540B	Tray 1 Main Rollers
X3A92-67918	Tray 1 roller kit

Required tools

- #2 JIS screwdriver with a magnetic tip

After performing service

Turn the printer power on

- Connect the power cable.
- Use the power switch to turn the power on.

Post service test

Copy, scan, or print a document. Verify the document copies, scans, or prints correctly.

Remove the Tray 1 pick/reverse/feed roller

Follow these steps to remove the Tray 1 rollers.

1. Open Tray 1. Use a small flat blade screwdriver to release the tab on the right side of the cover

 **NOTE:** The plastic tabs on the edges of the cover might require extra pressure to remove.

Figure 2-268 Remove the cover

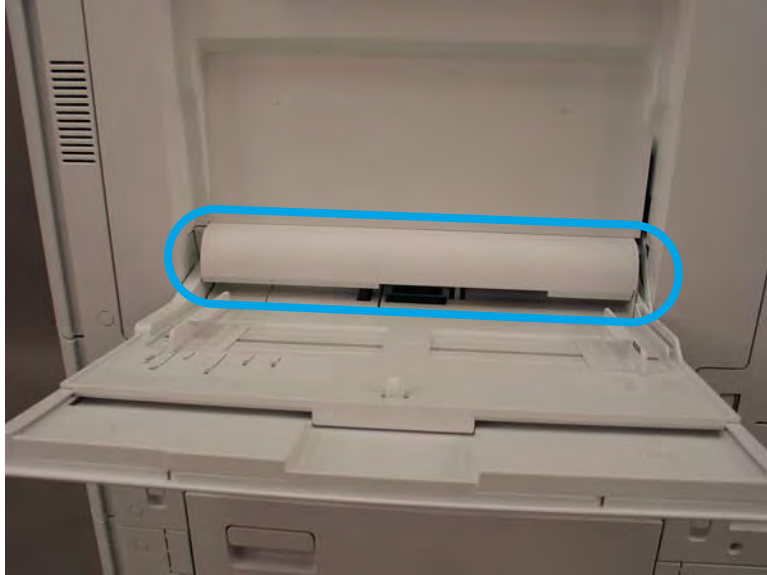

2. Remove the cover shown using a small flat blade screwdriver to release the tab on the right side of the cover.



NOTE: The flag, it will need to be moved out of the way to remove cover.

Figure 2-269 Remove the cover

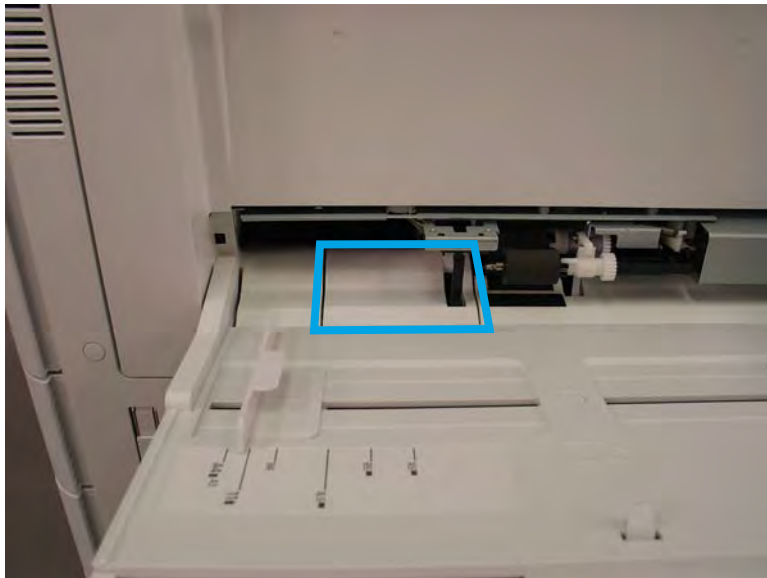

3. Release the small tab and remove the Tray 1 pick/reverse/feed roller (callout 2). Move the flag (callout 1) out of the way to release rollers.

⚠ CAUTION: Remove the rollers slowly to avoid loosening the parts behind the rollers. If these parts come loose, they might fall into the printer and be difficult to retrieve. Note the location of all components.

📝 NOTE: HP recommends replacing all three rollers at the same time.

Figure 2-270 Remove the Tray 1 pick/reverse/feed roller

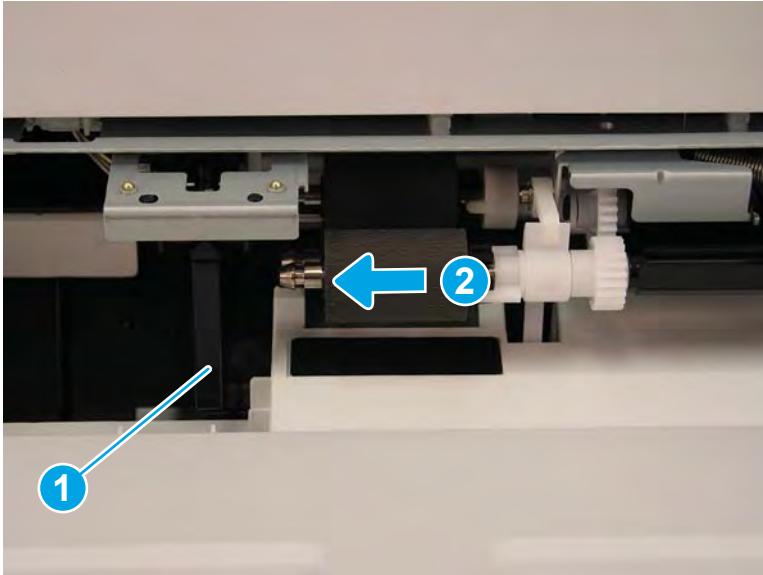

4. After the replacement rollers are installed, follow these instructions to reset the firmware counter:
 - a. From the Home screen on the printer control panel, select the [Support Tools](#) menu.
 - b. Select the [Service](#) menu.
 - c. Make sure that [Service Access Code](#) is selected in the drop-down menu, and then enter the service access code.
 - d. Select the [Service Tools](#) menu.
 - e. Select the [Supply Status](#) menu.
 - f. Select [Field Replacement Unit](#).
 - g. Select [Tray X Rollers](#).
 - h. Select [Tray 1 Roller Kit](#).
 - i. Select [Reset](#).

Unpack the replacement assembly

Follow these steps to unpack the replacement assembly.

1. Dispose of the defective part.

 **NOTE:** HP recommends responsible disposal of the defective part.

<http://www8.hp.com/us/en/hp-information/environment/product-recycling.html>

2. Unpack the replacement part from the packaging.



CAUTION:  Some parts are sensitive to electrostatic discharge (ESD). Always perform service work at an ESD-protected workstation or mat. If an ESD workstation or mat is not available, touch the sheet-metal chassis to provide a static ground before touching an ESD-sensitive assembly. Protect the ESD-sensitive assemblies by placing them in ESD pouches when they are out of the printer.



IMPORTANT: Make sure that all of the shipping materials (for example shipping tape) are removed from the replacement part prior to installation.



NOTE: If the replacement part is a roller or pad, avoid touching the spongy part of it. Skin oils on the roller or pad can cause paper pickup and/or print-quality problems. HP recommends using disposable gloves when handling rollers or pads or washing your hands before touching rollers or pads.

3. To install an assembly, reverse the removal steps.



NOTE: When applicable, special installation instructions are provided for an assembly at the end of the removal procedure. Always completely read the removal instructions and follow all special installation instructions.

Right door exit and takeaway

View the right door exit and takeaway exploded view, parts list, and repair procedures.

Right door exit

Parts diagram and parts list for the right door exit.

Figure 2-271 Right door exit

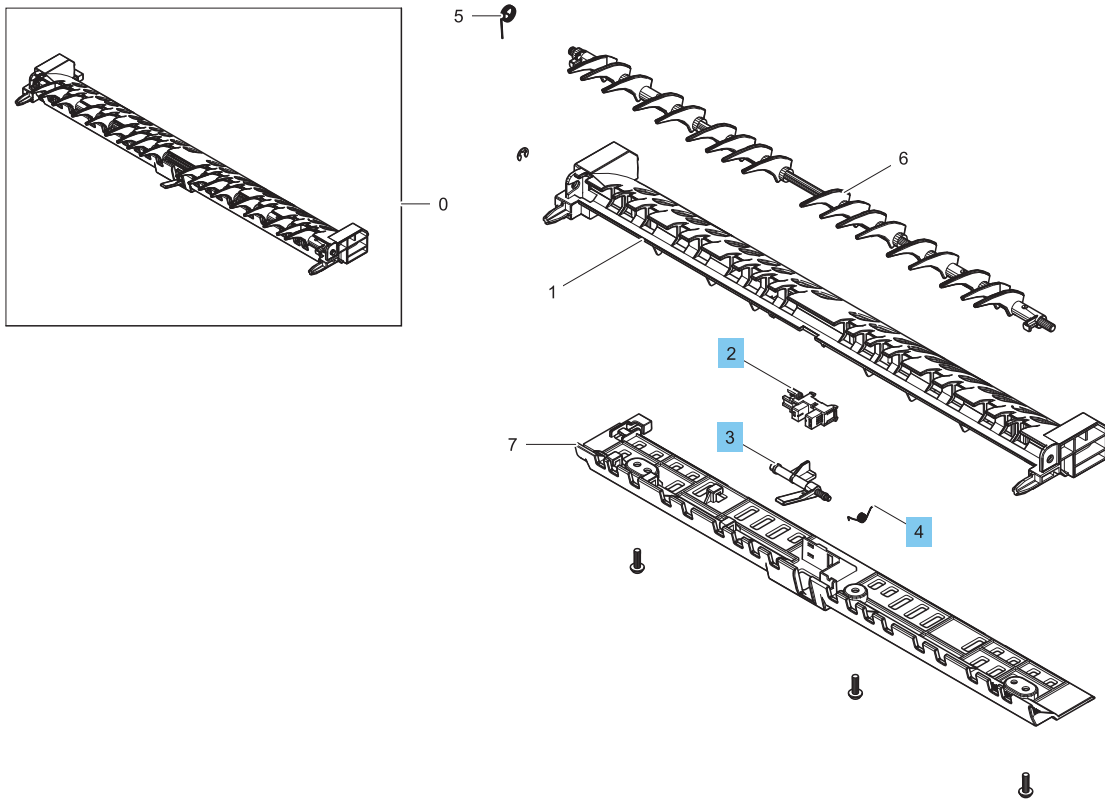

Table 2-61 Right door exit

Ref				
No	Part number	Description	Qty	Repair procedure
2	0604-001393	Photo interrupter	1	Removal and replacement: Duplex sensor on page 388
3	JC66-03307A	Actuator, fuser out	1	Not applicable
4	6107-001737	Spring, TS	1	Not applicable

Right door duplex

View the right door duplex exploded view, parts list, and repair procedures.

Right door duplex

Parts diagram and parts list for the right door duplex.

Figure 2-272 Right door duplex

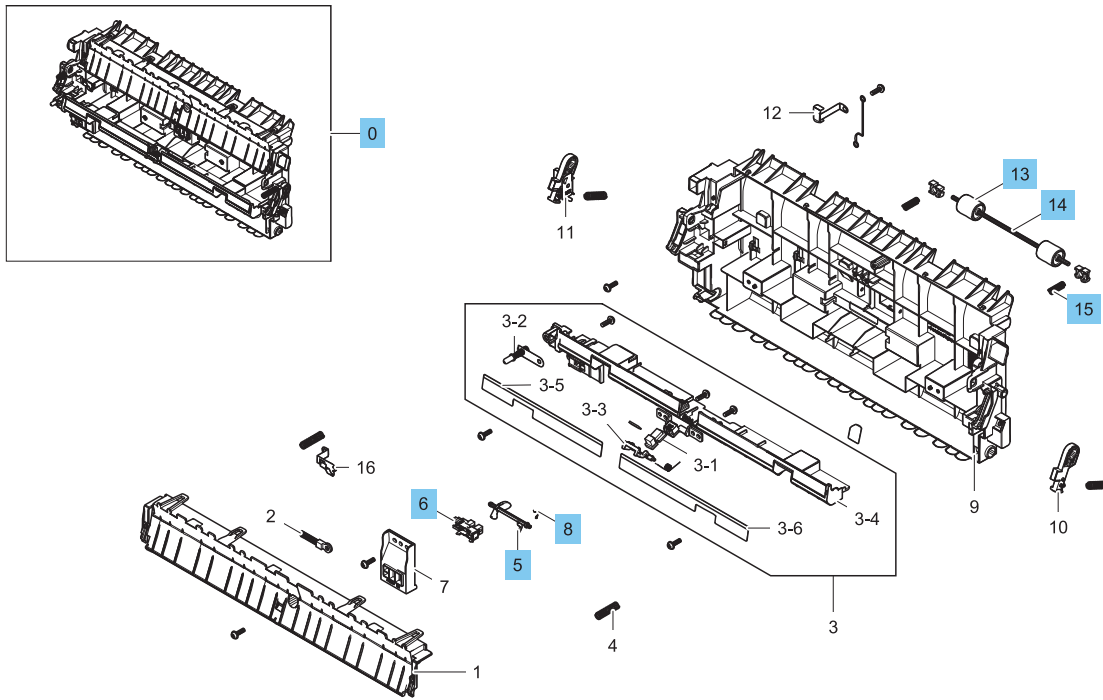

Table 2-62 Right door duplex

Ref				
No	Part number	Description	Qty	Repair procedure
0	JC95-01924A	Right Door Duplex	1	Not applicable
5	JC66-02180A	Actuator, duplex 2	1	Not applicable
6	0604-001393	Photo interrupter	1	Removal and replacement: Duplex sensor on page 388
8	6107-001737	Spring, TS	1	Not applicable
13	JC66-02289B	Roller idle	2	Not applicable
14	JC66-02354A	Shaft, roller idle L	1	Not applicable
15	6107-001731	Spring, CS	2	Not applicable

Removal and replacement: Duplex sensor

This document provides the procedures to remove the duplex sensor.



[View a video of removing and replacing the duplex sensor.](#)

Mean time to repair: 5 minutes

Service level: Basic



IMPORTANT: When applicable, special installation instructions are provided for an assembly at the end of the removal procedure. Always completely read the removal instructions and follow all special installation instructions.

Before performing service

- Disconnect the power cable.



WARNING! To avoid damage to the printer, turn the printer off, wait 30 seconds, and then remove the power cable before attempting to service the printer.

Use the table below to identify the correct part number for your printer. To order the part, go to www.hp.com/buy/parts

Table 2-63 Part information

Part number	Part description
0604-001393	Duplex sensor assembly

Required tools

- #2 JIS screwdriver with a magnetic tip

After performing service

Turn the printer power on

- Connect the power cable.
- Use the power switch to turn the power on.

Post service test

Copy, scan, or print a document. Verify the document copies, scans, or prints correctly.

Remove the duplex sensor

Follow these steps to remove the duplex sensor.

1. Remove the transfer roller assembly. Push the rear side to release the pin and lift up to release the sensor.

Figure 2-273 Remove transfer roller assembly



2. Remove one self-tapping screw. Open the Guide-transfer roller Upper by releasing four plastic snaps.

 **Reinstallation tip:** Make sure the top housing locates via the plastic locator pins on either side and snap into place.

Make sure the plastic tabs are installed properly. Move the assembly into position from a 45° angle.

Make sure the springs are located correctly and then snap into place.

Figure 2-274 Open guide-transfer roller upper

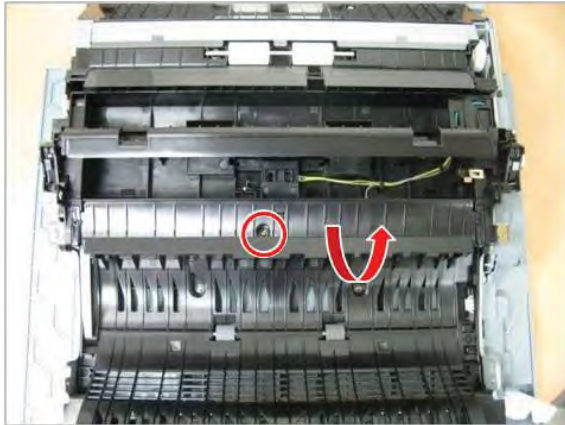

3. Remove one screw. Turn over the Holder-DUP SNR. Disconnect the connector and remove the duplex sensor.

Figure 2-275 Disconnect connector and remove duplex sensor

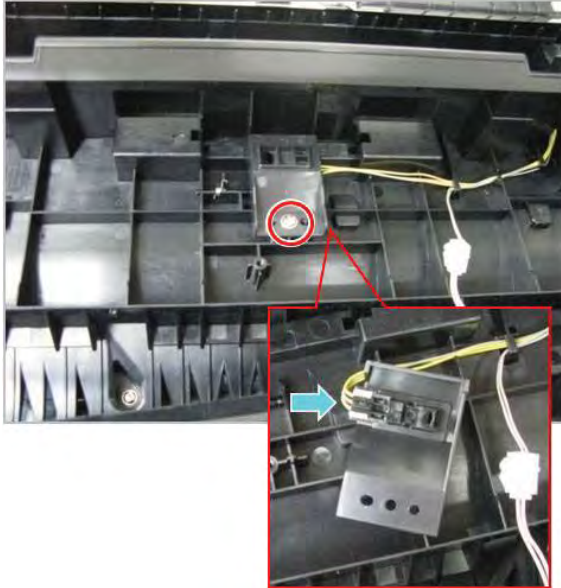

Unpack the replacement assembly



Follow these steps to unpack the replacement assembly.

1. Dispose of the defective part.

 **NOTE:** HP recommends responsible disposal of the defective part.

<http://www8.hp.com/us/en/hp-information/environment/product-recycling.html>

2. Unpack the replacement part from the packaging.

 **CAUTION:**  Some parts are sensitive to electrostatic discharge (ESD). Always perform service work at an ESD-protected workstation or mat. If an ESD workstation or mat is not available, touch the sheet-metal chassis to provide a static ground before touching an ESD-sensitive assembly. Protect the ESD-sensitive assemblies by placing them in ESD pouches when they are out of the printer.

 **IMPORTANT:** Make sure that all of the shipping materials (for example shipping tape) are removed from the replacement part prior to installation.

 **NOTE:** If the replacement part is a roller or pad, avoid touching the spongy part of it. Skin oils on the roller or pad can cause paper pickup and/or print-quality problems. HP recommends using disposable gloves when handling rollers or pads or washing your hands before touching rollers or pads.

3. To install an assembly, reverse the removal steps.

 **NOTE:** When applicable, special installation instructions are provided for an assembly at the end of the removal procedure. Always completely read the removal instructions and follow all special installation instructions.

ADF (LX models)

View the ADF (LX models) exploded view, parts list, and repair procedures.

ADF (LX models)

Parts diagram and parts list for the ADF (LX models).

Figure 2-276 ADF (LX models)

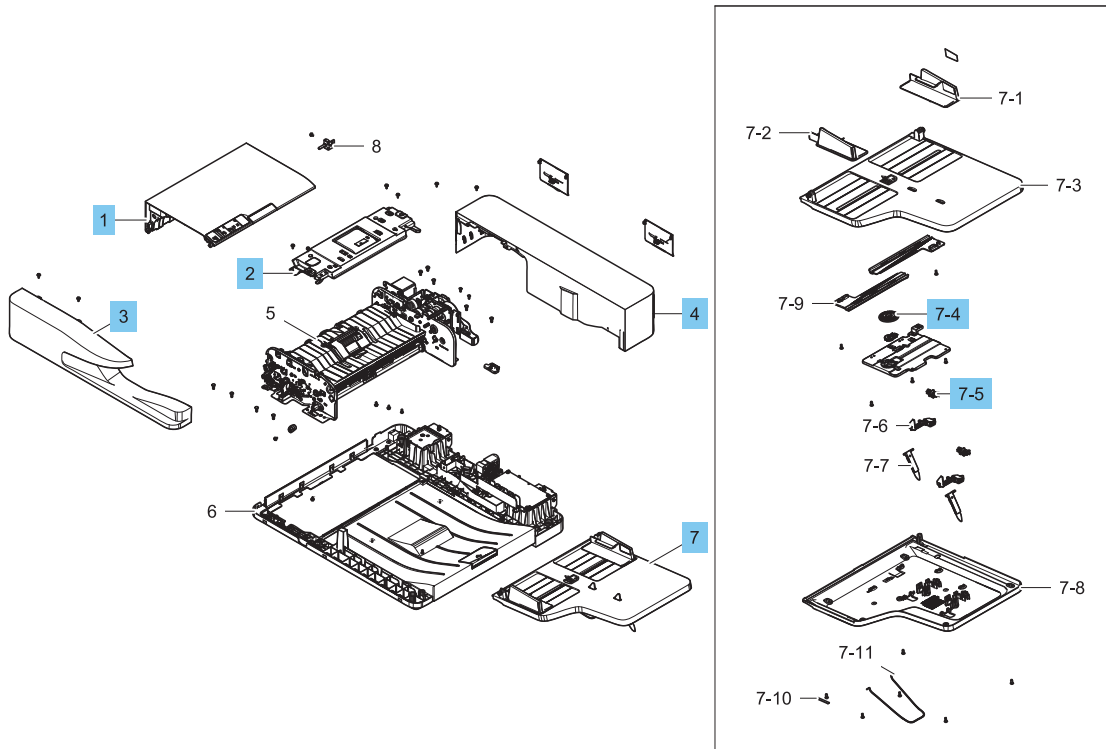

Table 2-64 ADF (LX models)

Ref				
No	Part number	Description	Qty	Repair procedure
1	JC97-04853A	ADF cover open (LX)	1	Removal and replacement: Document feeder (ADF) jam access cover (LX) on page 394
2	JC97-04856B	ADF pickup (LX)	1	Not applicable
3	JC63-05563A	ADF, front cover (LX)	1	Not applicable
4	JC63-05561A	ADF, cover rear (LX)	1	Not applicable
7	JC97-04859A	ADF stacker (LX) (For E77822, E77825, E77830)	1	Removal and replacement: Document feeder (ADF) input tray (LX) on page 398
7	X3A84-60103	ADF stacker (LX) (For E78323, E78325, E78330)	1	Removal and replacement: Document feeder (ADF) input tray (LX) on page 398
7-4	JC66-04079A	ADF pinion gear (LX)	1	Not applicable
7-5	0604-001393	Photo interrupter	1	Not applicable

Removal and replacement: Removal and replacement: Document feeder (ADF) jam access cover (LX)

Learn how to remove and replace the document feeder jam access cover (LX).

To view a short video of this procedure, click the link below.



[View a video of how to remove and replace the document feeder jam access cover \(LX\).](#)



IMPORTANT: When applicable, special installation instructions are provided for an assembly at the end of the removal procedure. Always completely read the removal instructions and follow all special installation instructions.

Mean time to repair:

Service level:

Before performing service

Turn the printer power off

- Press the power button on the front of the printer, and then turn off the power switch next to the power cable.
- A shutting-down message appears on the control-panel display.



WARNING! To avoid damage to the printer, turn the power off and wait until the printer shuts down before removing the power cable.

- Disconnect the printer power cable after the printer has completely shut down (the control-panel display is blank).

Use the table below to identify the correct part number for your printer. To order the part, go to www.hp.com/buy/parts.

Table 2-65 Part information

Part number	Part description
JC97-04853A	Jam access cover (LX)

Required tools

- #2 JIS screwdriver with a magnetic tip

After performing service

Turn the printer power on

- Connect the printer power cable.
- Turn on the power switch next to the power cable, and then press the power button on the front of the printer.
- Verify that the service performed was successful.

- Verify that the most recent firmware is installed on the printer.
- Verify that all parts are correctly reinstalled and are properly working.

Post service test

Print any pages necessary to verify that the repair resolved the issue and did not create any new issues.

Remove the document feeder (ADF) back cover

Follow these steps to remove the document feeder (ADF) back cover.

1. Remove two screws from the top of document feeder back cover.

Figure 2-277 Remove the document feeder back cover top screws

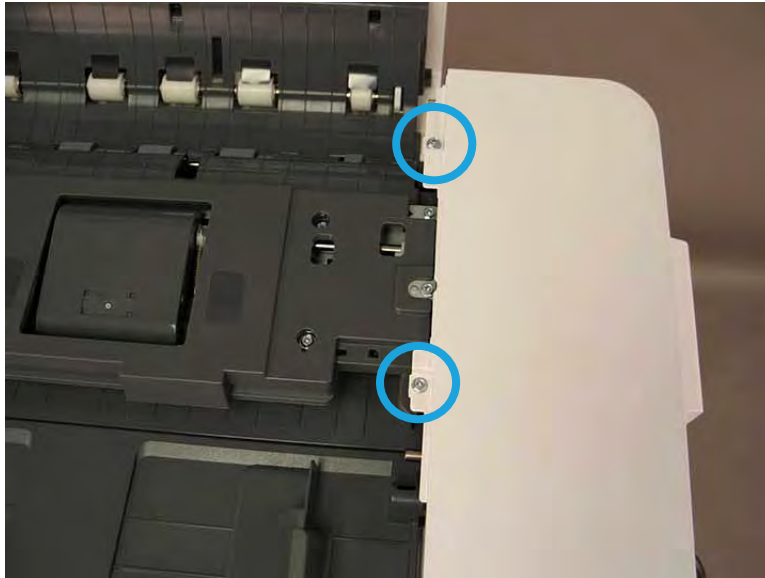

2. Remove 3 caps and 3 screws.

Figure 2-278 Remove 3 caps and 3 screws.



3. Release the top back cover.

Figure 2-279 Release the top back cover.

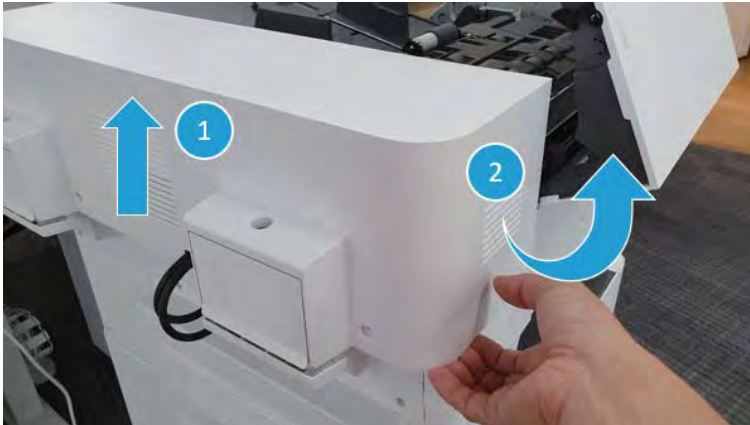

Remove the document feeder jam access cover

Follow these steps to remove the document feeder jam access cover.

1. Open the jam access cover, and then remove one screw.

Figure 2-280 Remove the jam access cover screw

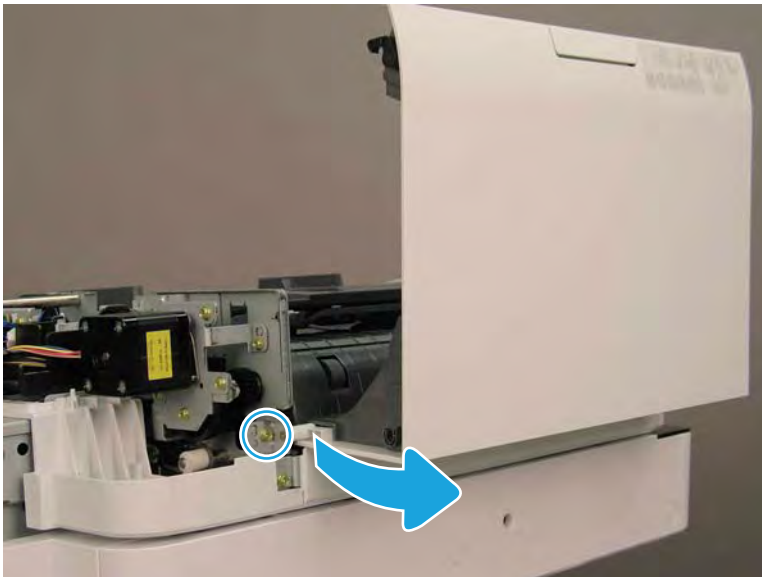

2. Remove the pivot pin, and then pivot the cover and release the hinge to remove the jam access cover.

Figure 2-281 Remove the jam access cover

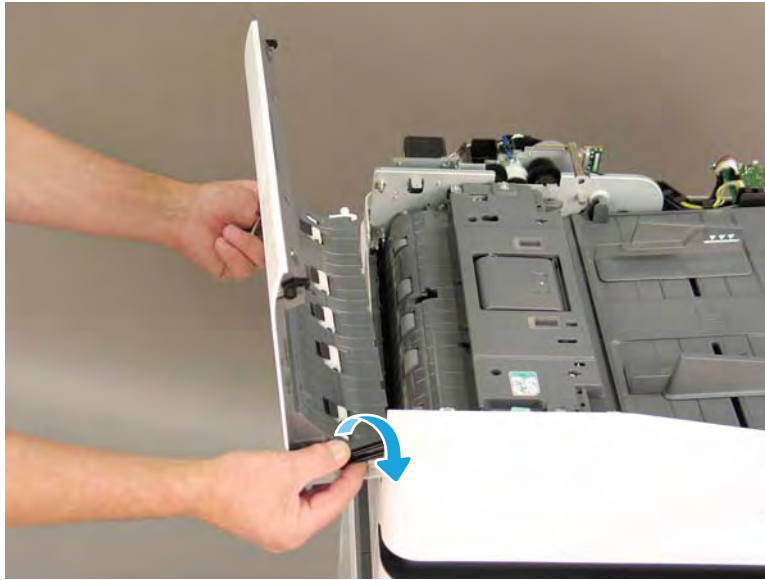

Unpack the replacement assembly



Follow these steps to unpack the replacement assembly.

1. Dispose of the defective part.

 **NOTE:** HP recommends responsible disposal of the defective part.

<http://www8.hp.com/us/en/hp-information/environment/product-recycling.html>

2. Unpack the replacement part from the packaging.

 **CAUTION:**  Some parts are sensitive to electrostatic discharge (ESD). Always perform service work at an ESD-protected workstation or mat. If an ESD workstation or mat is not available, touch the sheet-metal chassis to provide a static ground before touching an ESD-sensitive assembly. Protect the ESD-sensitive assemblies by placing them in ESD pouches when they are out of the printer.

 **IMPORTANT:** Make sure that all of the shipping materials (for example shipping tape) are removed from the replacement part prior to installation.

 **NOTE:** If the replacement part is a roller or pad, avoid touching the spongy part of it. Skin oils on the roller or pad can cause paper pickup and/or print-quality problems. HP recommends using disposable gloves when handling rollers or pads or washing your hands before touching rollers or pads.

3. To install an assembly, reverse the removal steps.

 **NOTE:** When applicable, special installation instructions are provided for an assembly at the end of the removal procedure. Always completely read the removal instructions and follow all special installation instructions.

Removal and replacement: Removal and replacement: Document feeder (ADF) input tray (LX)

Learn how to remove and replace the document feeder input tray (LX).

To view a short video of this procedure, click the link below.



[View a video of how to remove and replace the document feeder input tray \(LX\).](#)



IMPORTANT: When applicable, special installation instructions are provided for an assembly at the end of the removal procedure. Always completely read the removal instructions and follow all special installation instructions.

Mean time to repair:

Service level:

Before performing service

Turn the printer power off

- Press the power button on the front of the printer, and then turn off the power switch next to the power cable.
- A shutting-down message appears on the control-panel display.



WARNING! To avoid damage to the printer, turn the power off and wait until the printer shuts down before removing the power cable.

- Disconnect the printer power cable after the printer has completely shut down (the control-panel display is blank).

Use the table below to identify the correct part number for your printer. To order the part, go to www.hp.com/buy/parts.

Table 2-66 Part information

Part number	Part description
JC97-04859A	ADF stacker (LX) (E778xx series)
X3A84-60103	ADF stacker (LX) E783xx series)

Required tools

- #2 JIS screwdriver with a magnetic tip

After performing service

Turn the printer power on

- Connect the printer power cable.
- Turn on the power switch next to the power cable, and then press the power button on the front of the printer.
- Verify that the service performed was successful.

- Verify that the most recent firmware is installed on the printer.
- Verify that all parts are correctly reinstalled and are properly working.

Post service test

Print any pages necessary to verify that the repair resolved the issue and did not create any new issues.

Remove the document feeder (ADF) front cover

Follow these steps to remove the document feeder (ADF) front cover.

1. Remove two screws from the top of document feeder front cover.

Figure 2-282 Remove the document feeder front cover top screws



2. Open the document feeder. Detach a sticker and then remove a screw (Callout 1) from the bottom of the document feeder front cover.

Figure 2-283 Open the document feeder

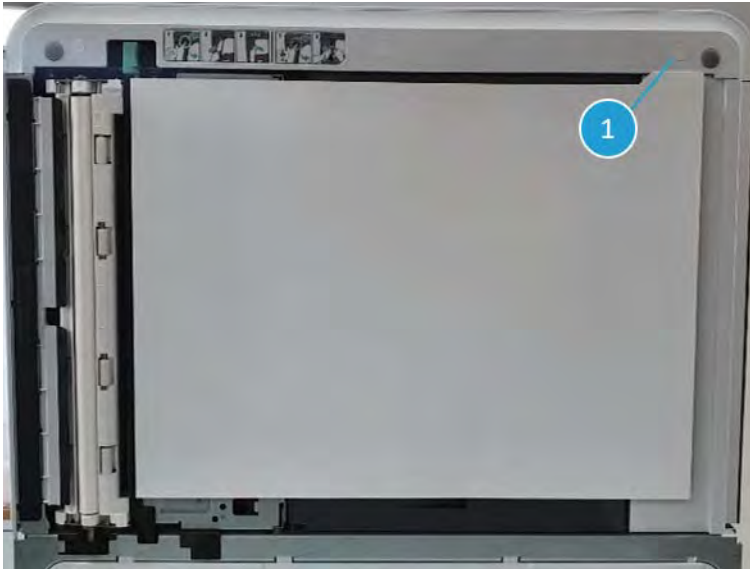

3. Remove the document feeder front cover.

Figure 2-284 Remove the document feeder front cover



Remove the document feeder (ADF) back cover

Follow these steps to remove the document feeder (ADF) back cover.

1. Remove two screws from the top of document feeder back cover.

Figure 2-285 Remove the document feeder back cover top screws

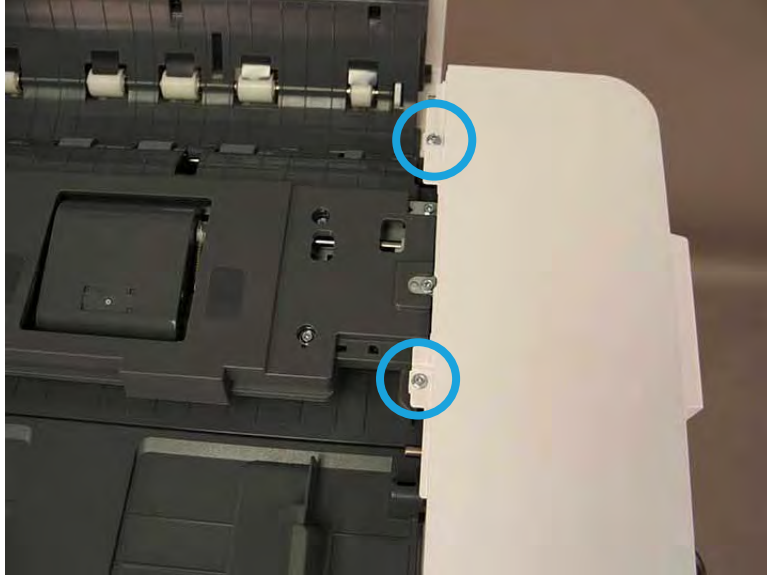

2. Remove 3 caps and 3 screws.

Figure 2-286 Remove 3 caps and 3 screws.



3. Release the top back cover.

Figure 2-287 Release the top back cover.



Remove the document feeder (ADF) input tray

Follow these steps to remove the document feeder (ADF) input tray.

1. Disconnect one connector on document feeder board (callout 1), remove one screw and hinge pin (callout 2), and then remove the input tray.

 **NOTE:** Carefully guide the cable out of the chassis while removing the tray.

Figure 2-288 Remove the input tray connector, screw, and hinge pin



Unpack the replacement assembly

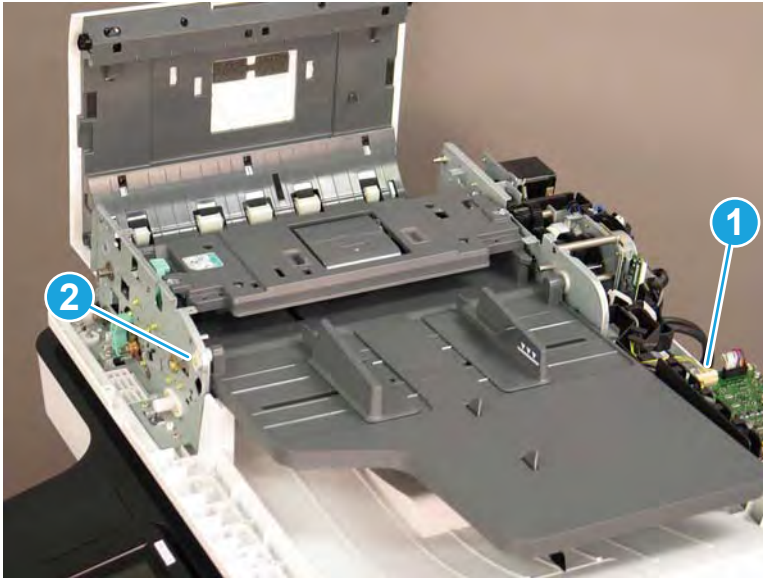

Follow these steps to unpack the replacement assembly.

1. Dispose of the defective part.

 **NOTE:** HP recommends responsible disposal of the defective part.

<http://www8.hp.com/us/en/hp-information/environment/product-recycling.html>

2. Unpack the replacement part from the packaging.

 **CAUTION:**  Some parts are sensitive to electrostatic discharge (ESD). Always perform service work at an ESD-protected workstation or mat. If an ESD workstation or mat is not available, touch the sheet-metal chassis to provide a static ground before touching an ESD-sensitive assembly. Protect the ESD-sensitive assemblies by placing them in ESD pouches when they are out of the printer.

 **IMPORTANT:** Make sure that all of the shipping materials (for example shipping tape) are removed from the replacement part prior to installation.

 **NOTE:** If the replacement part is a roller or pad, avoid touching the spongy part of it. Skin oils on the roller or pad can cause paper pickup and/or print-quality problems. HP recommends using disposable gloves when handling rollers or pads or washing your hands before touching rollers or pads.

3. To install an assembly, reverse the removal steps.

 **NOTE:** When applicable, special installation instructions are provided for an assembly at the end of the removal procedure. Always completely read the removal instructions and follow all special installation instructions.

Removal and replacement: Removal and replacement: Contact Image Sensor (CIS) assembly

Learn how to remove and replace the document feeder CIS (LX).

To view a short video of this procedure, click the link below.



[View a video of how to remove and replace the document feeder CIS \(LX\).](#)



IMPORTANT: When applicable, special installation instructions are provided for an assembly at the end of the removal procedure. Always completely read the removal instructions and follow all special installation instructions.

Mean time to repair:

Service level:

Before performing service

Turn the printer power off

- Press the power button on the front of the printer, and then turn off the power switch next to the power cable.
- A shutting-down message appears on the control-panel display.



WARNING! To avoid damage to the printer, turn the power off and wait until the printer shuts down before removing the power cable.

- Disconnect the printer power cable after the printer has completely shut down (the control-panel display is blank).

Use the table below to identify the correct part number for your printer. To order the part, go to www.hp.com/buy/parts.

Table 2-67 Part information

Part number	Part description
JC97-04920A	Contact image sensor (CIS)
JC97-04722A	Contact image sensor (CIS) (E778xx series)
JC97-04920A	Contact image sensor (CIS) (E783xx series)

Required tools

- #2 JIS screwdriver with a magnetic tip

After performing service

Turn the printer power on

- Connect the printer power cable.
- Turn on the power switch next to the power cable, and then press the power button on the front of the printer.

- Verify that the service performed was successful.
- Verify that the most recent firmware is installed on the printer.
- Verify that all parts are correctly reinstalled and are properly working.

Post service test

Print any pages necessary to verify that the repair resolved the issue and did not create any new issues.

Remove the document feeder (ADF) front cover

Follow these steps to remove the document feeder (ADF) front cover.

1. Remove two screws from the top of document feeder front cover.

Figure 2-289 Remove the document feeder front cover top screws



2. Open the document feeder. Detach a sticker and then remove a screw (Callout 1) from the bottom of the document feeder front cover.

Figure 2-290 Open the document feeder

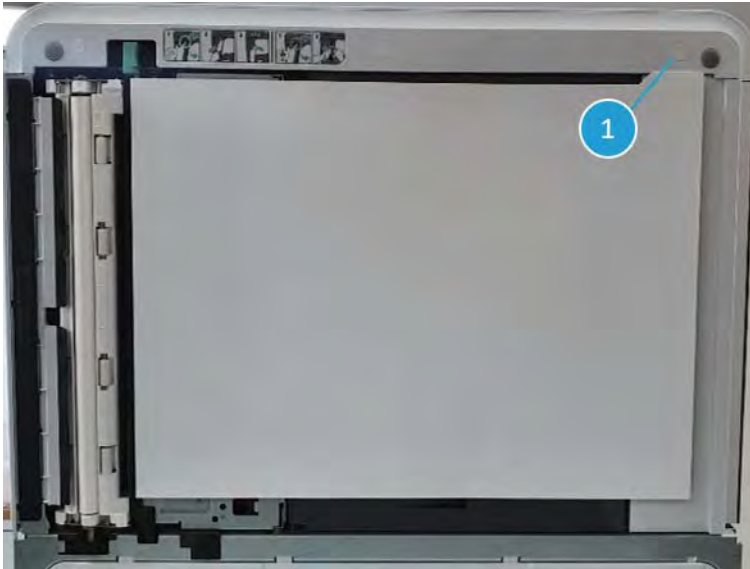

3. Remove the document feeder front cover.

Figure 2-291 Remove the document feeder front cover



Remove the document feeder (ADF) back cover

Follow these steps to remove the document feeder (ADF) back cover.

1. Remove two screws from the top of document feeder back cover.

Figure 2-292 Remove the document feeder back cover top screws

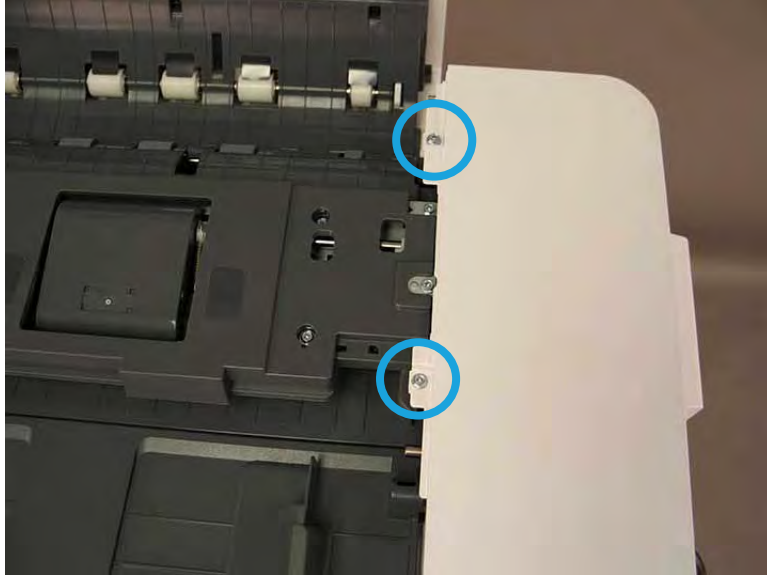

2. Remove 3 caps and 3 screws.

Figure 2-293 Remove 3 caps and 3 screws.



3. Release the top back cover.

Figure 2-294 Release the top back cover.



Remove the pick and feed roller assembly

Follow these steps to remove the pick and feed roller assembly.

1. Remove four screws.

Figure 2-295 Remove four screws



2. Remove two screws on the front cover.

Figure 2-296 Remove two screws on front cover

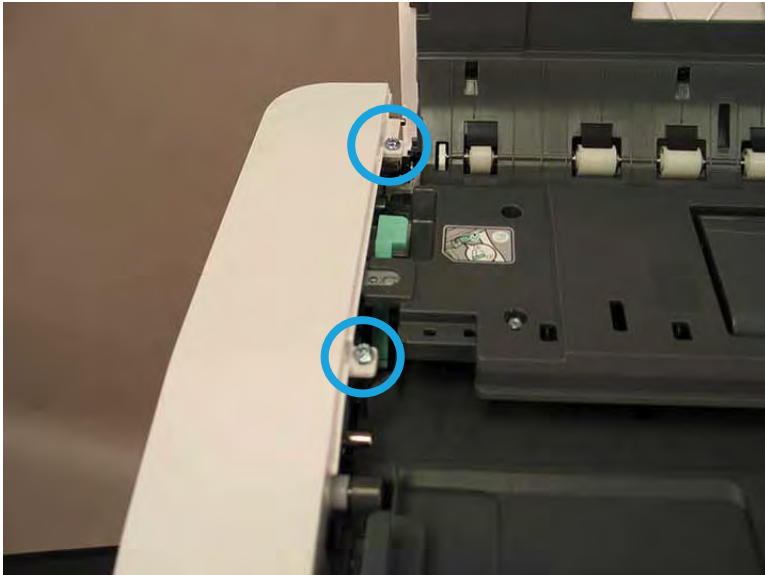

3. Open the ADF and then remove three screw caps.

Figure 2-297 Remove three screw caps

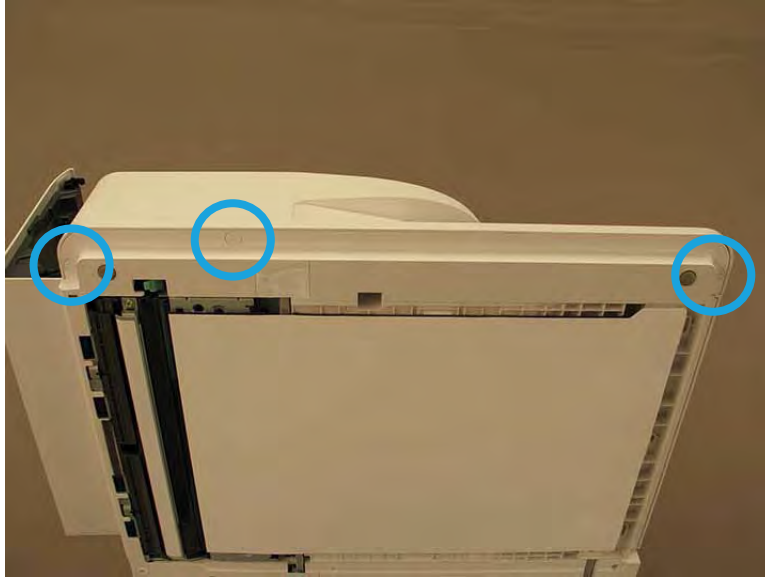

4. Remove three screws, and then remove the front cover.

Figure 2-298 Remove three screws and front cover

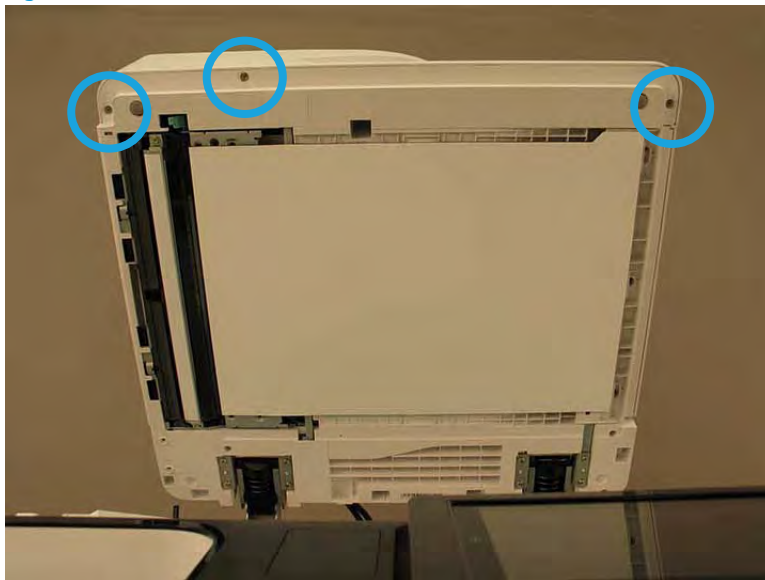

5. Rotate the pick/feed roller assembly to release the sheet metal tab from ADF frame.

Figure 2-299 Release the sheet metal tab from ADF frame

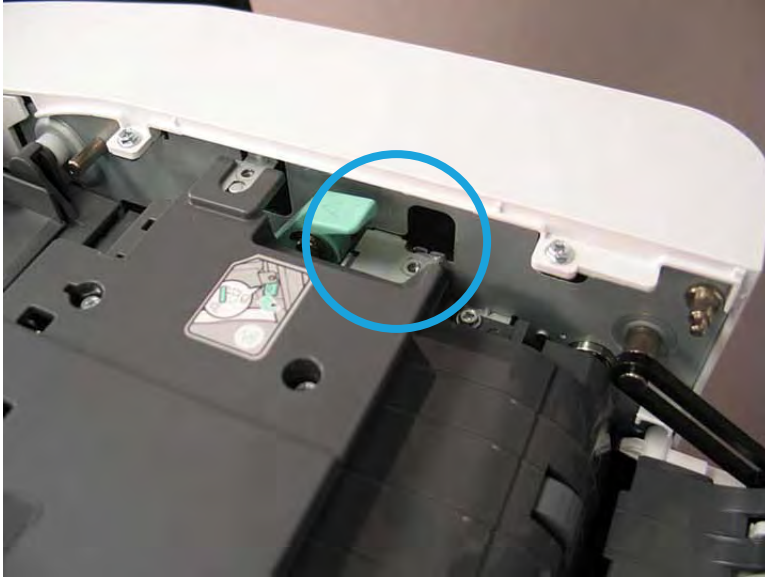

6. To remove the pick/feed roller assembly lift up on the front side (callout 1) and, then slide towards the front (callout 2) to release the pick/feed roller assembly.

Figure 2-300 Release the pick/feed roller assembly

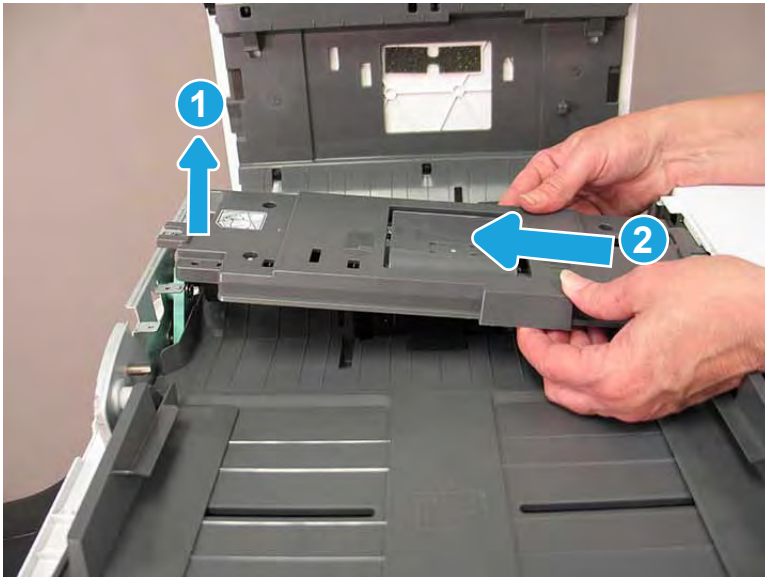

7. Rotate the roller assembly over, and then disconnect one connectors. Remove the document feeder pick roller assembly.

Figure 2-301 Remove the document feeder pick roller assembly

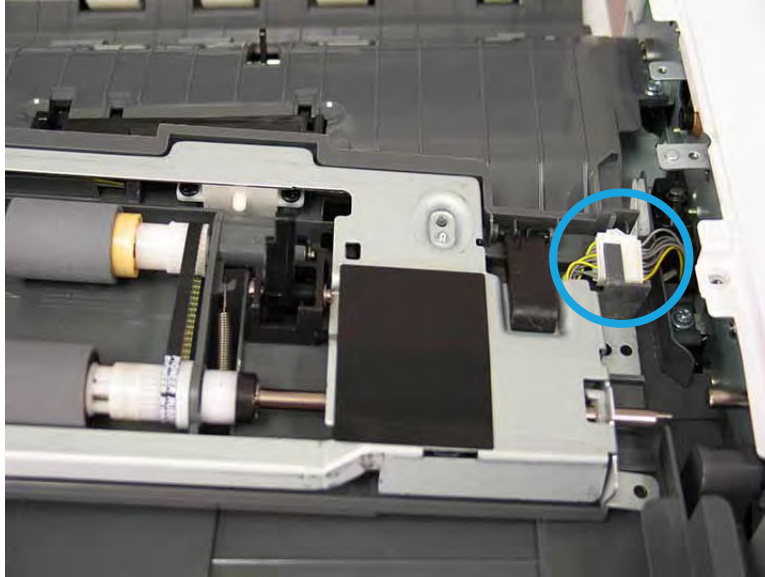

-  **Reinstallation tip:** Note the four flags (callout 1) on the bottom of the pick/feed roller assembly. When reinstalling, hold up the flags while reinstall to allow for proper installation.

Figure 2-302 Pick/Feed roller assembly four flags



Remove the CIS assembly

Follow these steps to remove the CIS assembly.

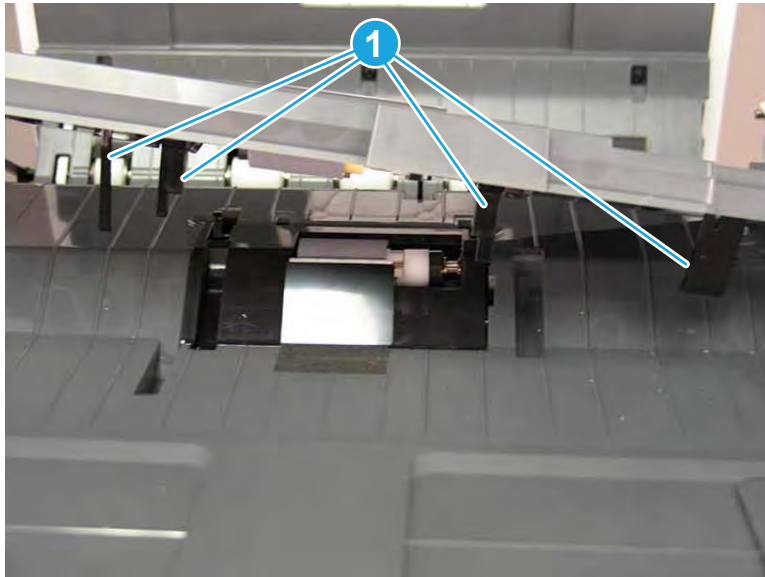
1. Remove one screw, and then remove the CIS front alignment cover.

-  **Reinstallation tip:** Note the orientation of the CIS front alignment cover. The cover must be reinstalled in the same orientation.

Figure 2-303 Remove the CIS front alignment cover screws



2. Disconnect one connector (callout 1), and then lift the alignment pin to release the CIS assembly (callout 2).

Figure 2-304 Disconnect the CIS connector and lift the alignment pin

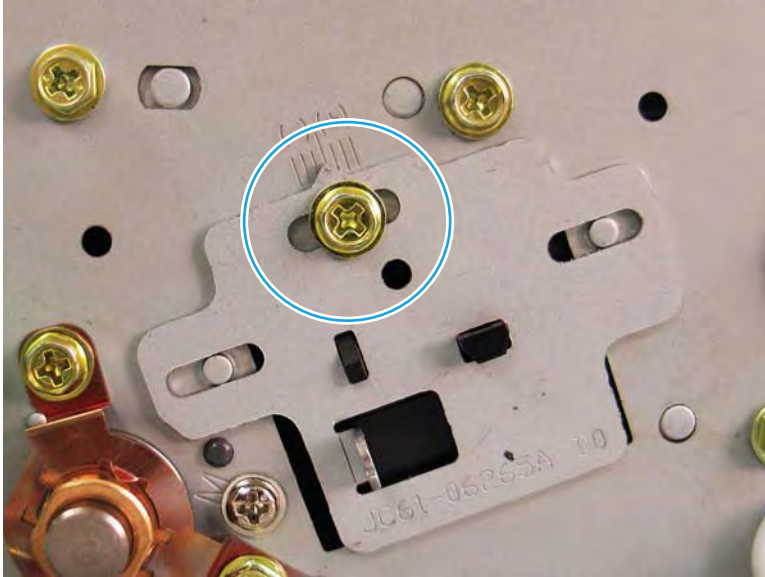
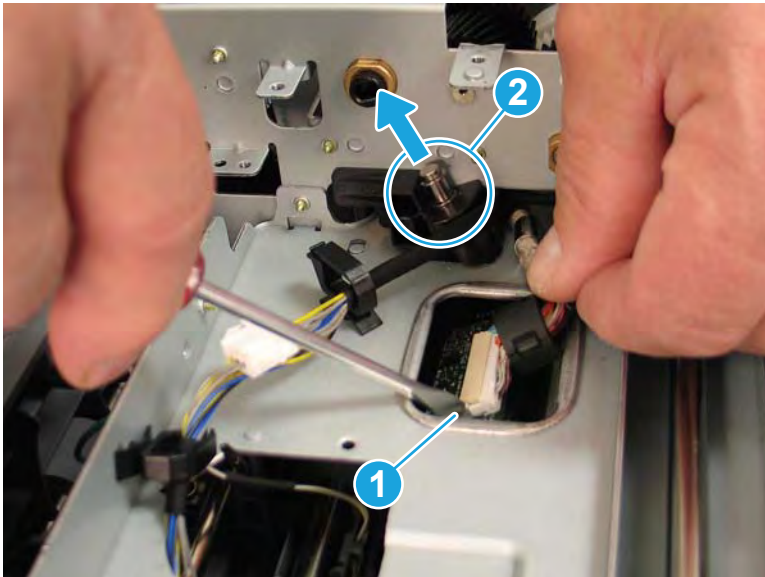

3. Remove the CIS assembly from the chassis.

Unpack the replacement assembly

Follow these steps to unpack the replacement assembly.

1. Dispose of the defective part.

 **NOTE:** HP recommends responsible disposal of the defective part.

<http://www8.hp.com/us/en/hp-information/environment/product-recycling.html>

2. Unpack the replacement part from the packaging.



CAUTION:  Some parts are sensitive to electrostatic discharge (ESD). Always perform service work at an ESD-protected workstation or mat. If an ESD workstation or mat is not available, touch the sheet-metal chassis to provide a static ground before touching an ESD-sensitive assembly. Protect the ESD-sensitive assemblies by placing them in ESD pouches when they are out of the printer.



IMPORTANT: Make sure that all of the shipping materials (for example shipping tape) are removed from the replacement part prior to installation.



NOTE: If the replacement part is a roller or pad, avoid touching the spongy part of it. Skin oils on the roller or pad can cause paper pickup and/or print-quality problems. HP recommends using disposable gloves when handling rollers or pads or washing your hands before touching rollers or pads.

3. To install an assembly, reverse the removal steps.



NOTE: When applicable, special installation instructions are provided for an assembly at the end of the removal procedure. Always completely read the removal instructions and follow all special installation instructions.

Removal and replacement: Removal and replacement: Document feeder (ADF) main motor (LX)

Learn how to remove and replace the document feeder main motor (LX).

To view a short video of this procedure, click the link below.



[View a video of this procedure for HP Color LaserJet MFP.](#)



[View a video of this procedure for HP LaserJet MFP](#)



IMPORTANT: When applicable, special installation instructions are provided for an assembly at the end of the removal procedure. Always completely read the removal instructions and follow all special installation instructions.

Mean time to repair:

Service level:

Before performing service

Turn the printer power off

- Press the power button on the front of the printer, and then turn off the power switch next to the power cable.
- A shutting-down message appears on the control-panel display.



WARNING! To avoid damage to the printer, turn the power off and wait until the printer shuts down before removing the power cable.

- Disconnect the printer power cable after the printer has completely shut down (the control-panel display is blank).

Use the table below to identify the correct part number for your printer. To order the part, go to www.hp.com/buy/parts.

Table 2-68 Part information

Part number	Part description
JC31-00163A	Main motor assembly (LX)

Required tools

- #2 JIS screwdriver with a magnetic tip

After performing service

Turn the printer power on

- Connect the printer power cable.
- Turn on the power switch next to the power cable, and then press the power button on the front of the printer.

- Verify that the service performed was successful.
- Verify that the most recent firmware is installed on the printer.
- Verify that all parts are correctly reinstalled and are properly working.

Post service test

Print any pages necessary to verify that the repair resolved the issue and did not create any new issues.

Remove the document feeder (ADF) back cover

Follow these steps to remove the document feeder (ADF) back cover.

1. Remove two screws from the top of document feeder back cover.

Figure 2-305 Remove the document feeder back cover top screws

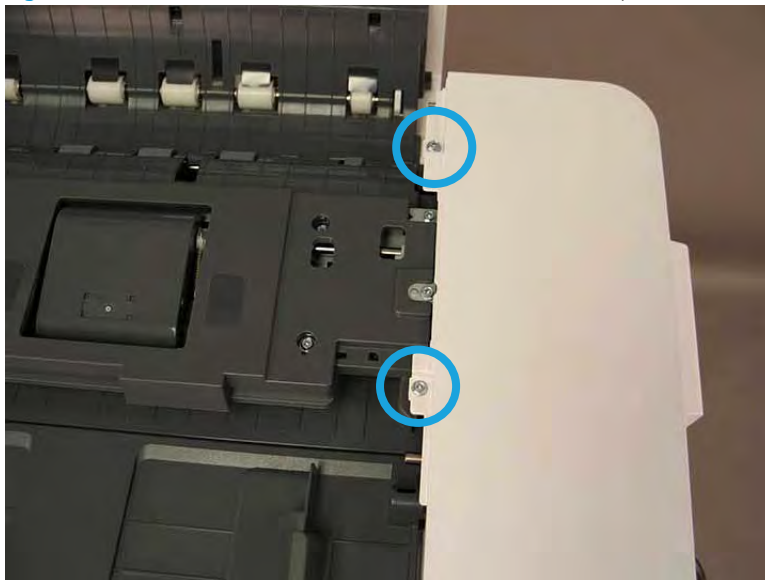

2. Remove 3 caps and 3 screws.

Figure 2-306 Remove 3 caps and 3 screws.



3. Release the top back cover.

Figure 2-307 Release the top back cover.



Remove the main motor

Follow these steps to remove the main motor.

1. Disconnect one connector (callout 1), remove the tension spring (callout 2), and then remove four screws (callout 3).

Figure 2-308 Remove the main motor connector, spring, and screws

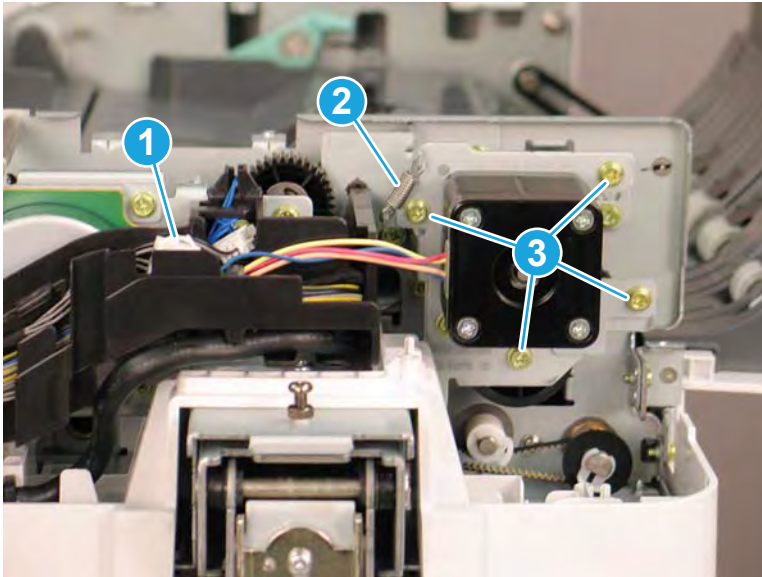

2. Carefully lift the motor out while releasing the gear belt.

 **Reinstallation tip:**

- a. Reinstall the motor and lift the gear belt up to engage the motor pulley.
 - b. Loosely install the motor mount screws.
 - c. Install the tension spring.
 - d. Tighten the motor mount screws just enough so that the tension spring (not the motor mount screws) is providing the tension to the belt.
-

Figure 2-309 Main motor and gear belt

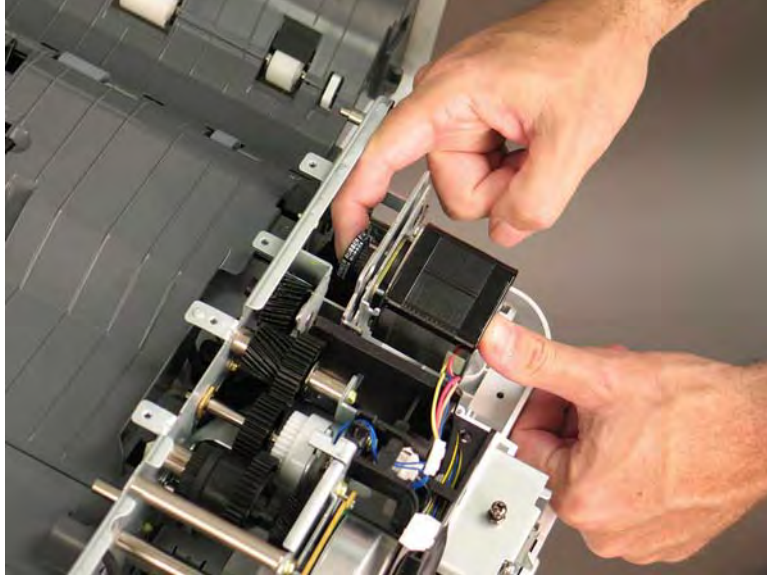

Remove the CIS assembly

Follow these steps to remove the CIS assembly.

1. Remove one screw, and then remove the CIS front alignment cover.

 **Reinstallation tip:** Note the orientation of the CIS front alignment cover. The cover must be reinstalled in the same orientation.

Figure 2-310 Remove the CIS front alignment cover screws

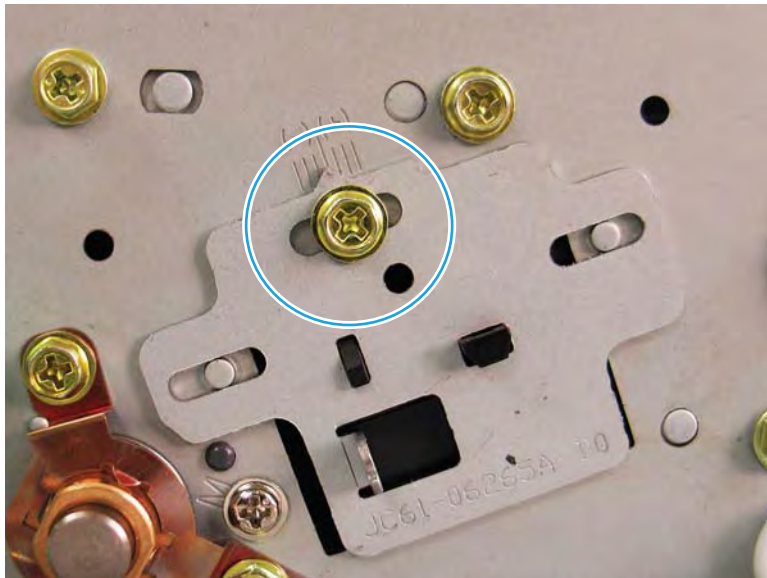

2. Disconnect one connector (callout 1), and then lift the alignment pin to release the CIS assembly (callout 2).

Figure 2-311 Disconnect the CIS connector and lift the alignment pin

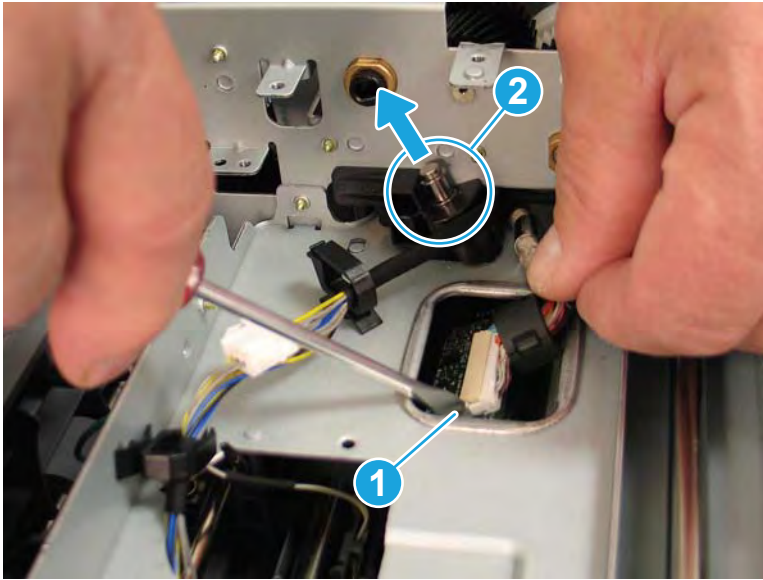

3. Remove the CIS assembly from the chassis.

Unpack the replacement assembly



Follow these steps to unpack the replacement assembly.

1. Dispose of the defective part.

 **NOTE:** HP recommends responsible disposal of the defective part.

<http://www8.hp.com/us/en/hp-information/environment/product-recycling.html>

2. Unpack the replacement part from the packaging.

 **CAUTION:**  Some parts are sensitive to electrostatic discharge (ESD). Always perform service work at an ESD-protected workstation or mat. If an ESD workstation or mat is not available, touch the sheet-metal chassis to provide a static ground before touching an ESD-sensitive assembly. Protect the ESD-sensitive assemblies by placing them in ESD pouches when they are out of the printer.

 **IMPORTANT:** Make sure that all of the shipping materials (for example shipping tape) are removed from the replacement part prior to installation.

 **NOTE:** If the replacement part is a roller or pad, avoid touching the spongy part of it. Skin oils on the roller or pad can cause paper pickup and/or print-quality problems. HP recommends using disposable gloves when handling rollers or pads or washing your hands before touching rollers or pads.

3. To install an assembly, reverse the removal steps.

 **NOTE:** When applicable, special installation instructions are provided for an assembly at the end of the removal procedure. Always completely read the removal instructions and follow all special installation instructions.

ADF exterior and ADF pickup (LX models)

View the ADF exterior and ADF pickup (LX models) exploded view, parts list, and repair procedures.

ADF exterior and ADF pickup (LX)

Parts diagram and parts list for the ADF exterior and ADF pickup (LX models).

Figure 2-312 ADF exterior and ADF pickup (LX models)

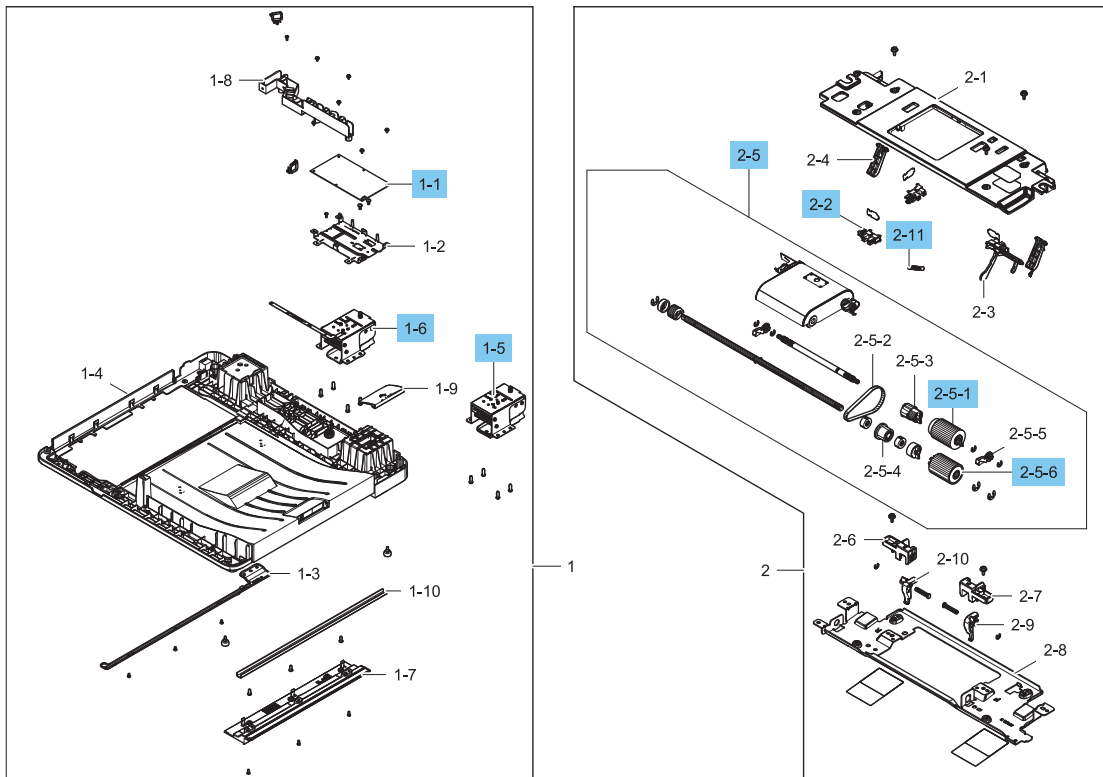

Table 2-69 ADF exterior and ADF pickup (LX models)

Ref				
No	Part number	Description	Qty	Repair procedure
1-1	JC92-02962A	LX PCA	1	Removal and replacement: Document feeder (ADF) PCA (LX) on page 422
1-5	JC97-04528A	LX, hinge r	1	Not applicable
1-6	JC97-04527A	LX, hinge l	1	Not applicable
2-2	0604-001393	Photo interrupter	1	Not applicable
2-5	JC97-04857A	Pick Roller Assy - LX	1	Removal and replacement: Document feeder (ADF) pick/feed roller assembly (LX) on page 426
2-5-1	JC97-04099A	LX pick roller	1	Not applicable
2-5-6	JC97-04860A	LX feed roller	1	Not applicable

Removal and replacement: Removal and replacement: Document feeder (ADF) PCA (LX)

Learn how to remove and replace the document feeder PCA (LX).

To view a short video of this procedure, click the link below.



[View a video of how to remove and replace the document feeder PCA \(LX\).](#)



IMPORTANT: When applicable, special installation instructions are provided for an assembly at the end of the removal procedure. Always completely read the removal instructions and follow all special installation instructions.

Mean time to repair:

Service level:

Before performing service

Turn the printer power off

- Press the power button on the front of the printer, and then turn off the power switch next to the power cable.
- A shutting-down message appears on the control-panel display.

 **WARNING!** To avoid damage to the printer, turn the power off and wait until the printer shuts down before removing the power cable.

- Disconnect the printer power cable after the printer has completely shut down (the control-panel display is blank).

Use the table below to identify the correct part number for your printer. To order the part, go to www.hp.com/buy/parts.

Table 2-70 Part information

Part number	Part description
JC92-02962A	Document feeder PCA assembly (LX)

Required tools

- #2 JIS screwdriver with a magnetic tip

After performing service

Turn the printer power on

- Connect the printer power cable.
- Turn on the power switch next to the power cable, and then press the power button on the front of the printer.
- Verify that the service performed was successful.

- Verify that the most recent firmware is installed on the printer.
- Verify that all parts are correctly reinstalled and are properly working.

Post service test

Print any pages necessary to verify that the repair resolved the issue and did not create any new issues.

Remove the document feeder (ADF) back cover

Follow these steps to remove the document feeder (ADF) back cover.

1. Remove two screws from the top of document feeder back cover.

Figure 2-313 Remove the document feeder back cover top screws

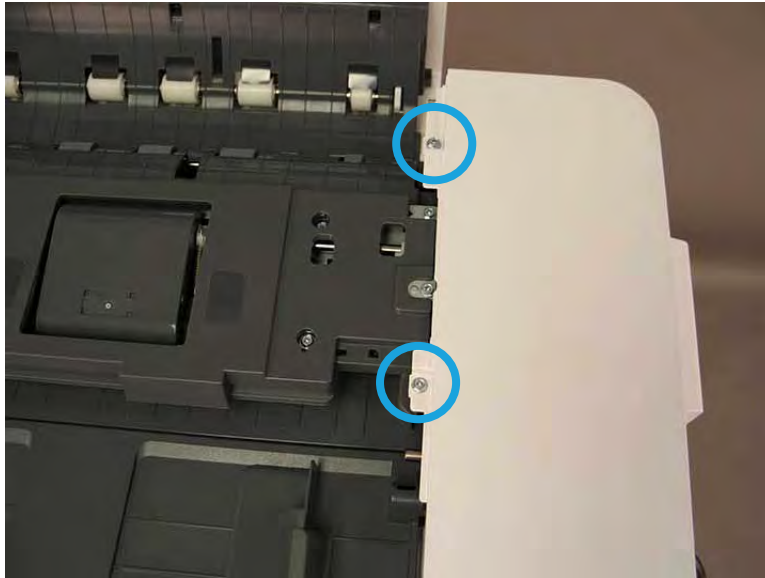

2. Remove 3 caps and 3 screws.

Figure 2-314 Remove 3 caps and 3 screws.



3. Release the top back cover.

Figure 2-315 Release the top back cover.



Remove the document feeder (ADF) PCA

Follow these steps to remove the document feeder (ADF) PCA.

- ▲ Disconnect six connectors and the ground wire from PCA, remove four screws, and then remove the document feeder PCA (LX).

Figure 2-316 Document feeder PCA (LX)

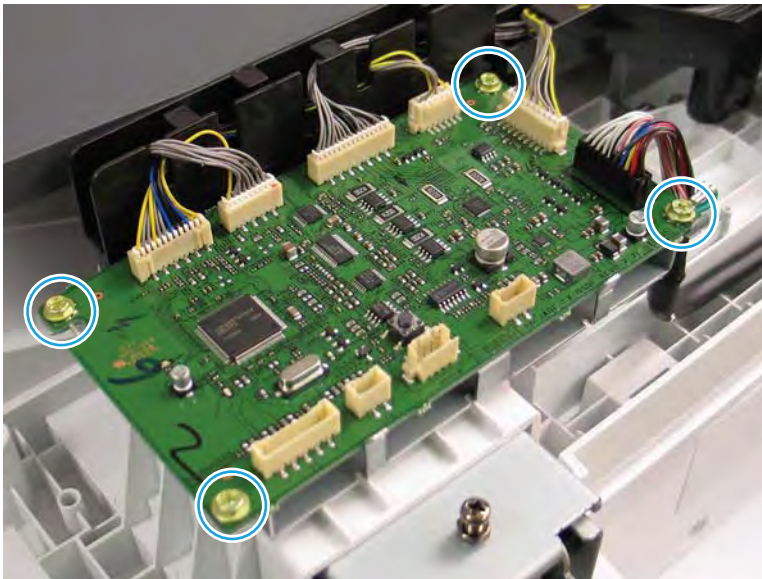

Unpack the replacement assembly

Follow these steps to unpack the replacement assembly.

1. Dispose of the defective part.

 **NOTE:** HP recommends responsible disposal of the defective part.

<http://www8.hp.com/us/en/hp-information/environment/product-recycling.html>

2. Unpack the replacement part from the packaging.



CAUTION:  Some parts are sensitive to electrostatic discharge (ESD). Always perform service work at an ESD-protected workstation or mat. If an ESD workstation or mat is not available, touch the sheet-metal chassis to provide a static ground before touching an ESD-sensitive assembly. Protect the ESD-sensitive assemblies by placing them in ESD pouches when they are out of the printer.



IMPORTANT: Make sure that all of the shipping materials (for example shipping tape) are removed from the replacement part prior to installation.



NOTE: If the replacement part is a roller or pad, avoid touching the spongy part of it. Skin oils on the roller or pad can cause paper pickup and/or print-quality problems. HP recommends using disposable gloves when handling rollers or pads or washing your hands before touching rollers or pads.

3. To install an assembly, reverse the removal steps.



NOTE: When applicable, special installation instructions are provided for an assembly at the end of the removal procedure. Always completely read the removal instructions and follow all special installation instructions.

Removal and replacement: Removal and replacement: Document feeder (ADF) pick/feed roller assembly (LX)

Learn how to remove and replace the document feeder pickup/feed roller assembly (LX/du models).

To view a short video of this procedure, click the link below.



[View a video of how to remove and replace the document feeder pickup/feed roller assembly \(LX\).](#)



IMPORTANT: When applicable, special installation instructions are provided for an assembly at the end of the removal procedure. Always completely read the removal instructions and follow all special installation instructions.

Mean time to repair:

Service level:

Before performing service

Turn the printer power off

- Press the power button on the front of the printer, and then turn off the power switch next to the power cable.
- A shutting-down message appears on the control-panel display.



WARNING! To avoid damage to the printer, turn the power off and wait until the printer shuts down before removing the power cable.

- Disconnect the printer power cable after the printer has completely shut down (the control-panel display is blank).

Use the table below to identify the correct part number for your printer. To order the part, go to www.hp.com/buy/parts.

Table 2-71 Part information

Part number	Part description
JC97-04857A	Pick feed roller assembly (LX)

Required tools

- #2 JIS screwdriver with a magnetic tip

After performing service

Turn the printer power on

- Connect the printer power cable.
- Turn on the power switch next to the power cable, and then press the power button on the front of the printer.
- Verify that the service performed was successful.

- Verify that the most recent firmware is installed on the printer.
- Verify that all parts are correctly reinstalled and are properly working.

Post service test

Print any pages necessary to verify that the repair resolved the issue and did not create any new issues.

Remove the document feeder (ADF) (LX/du models) pick and feed roller assembly

Follow these steps to remove the document feeder (ADF) (LX/du models) pick and feed roller assembly.

1. Open the document feeder cover.

Figure 2-317 Open the document feeder cover

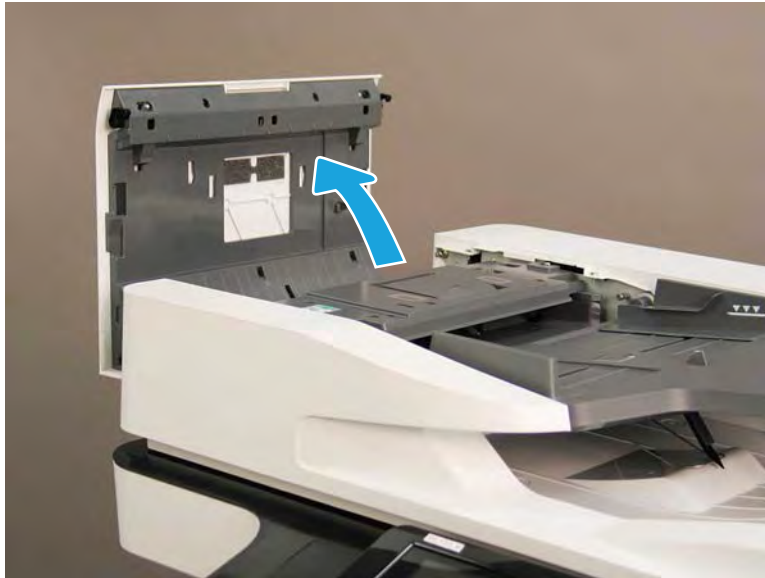

2. Remove four screws in the document feeder pick roller assembly cover.

 **NOTE:** Remove one spring (callout 2; not shown)

Figure 2-318 Remove the document feeder cover screws

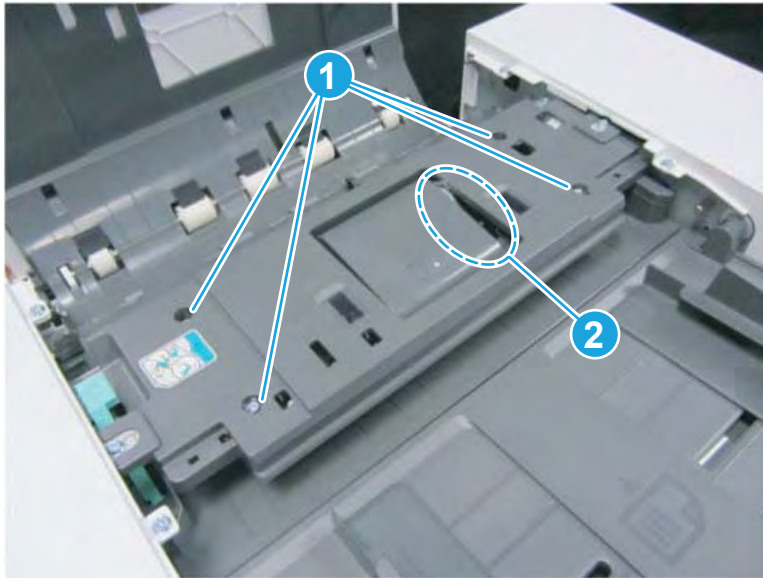

3. Rotate the document feeder pickup cover up, and then disconnect one connector (callout 1).

Figure 2-319 Turn the cover over and disconnect connector



4. Before proceeding, take note of the removed roller cover and the roller assembly.

Figure 2-320 Document feeder pick roller cover and roller assembly

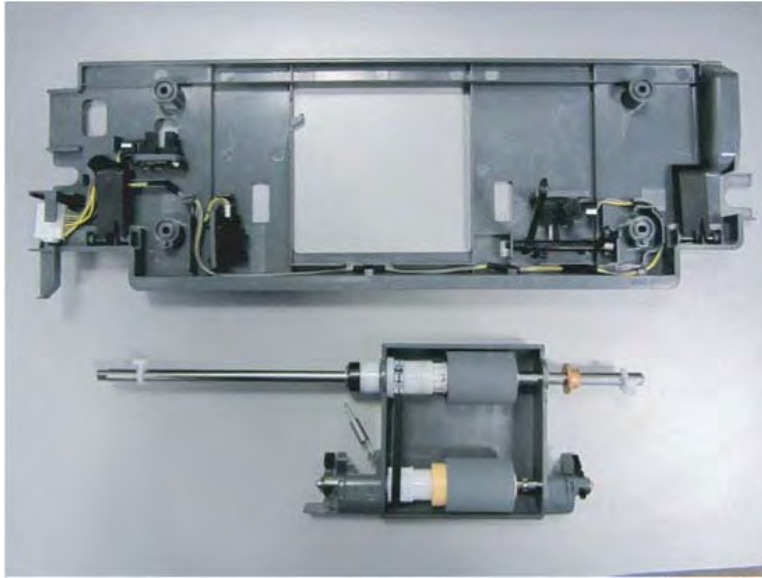

5. Remove one screw (callout 1), and then remove the sensor flag bracket (callout 2).

 **Reinstallation tip:** When the roller assembly is reinstalled, make sure that the sensor flags (on both sides of the assembly) are correctly installed and move freely.

Figure 2-321 Remove one screw and the sensor flag bracket



6. Release two plastic clips (callout 1), slide bushing toward roller assembly (callout 2), and then slide the shaft towards front of printer to release it (callout 3). Remove the roller assembly.

CAUTION: Do not damage the sensor flags when handling the roller assembly.

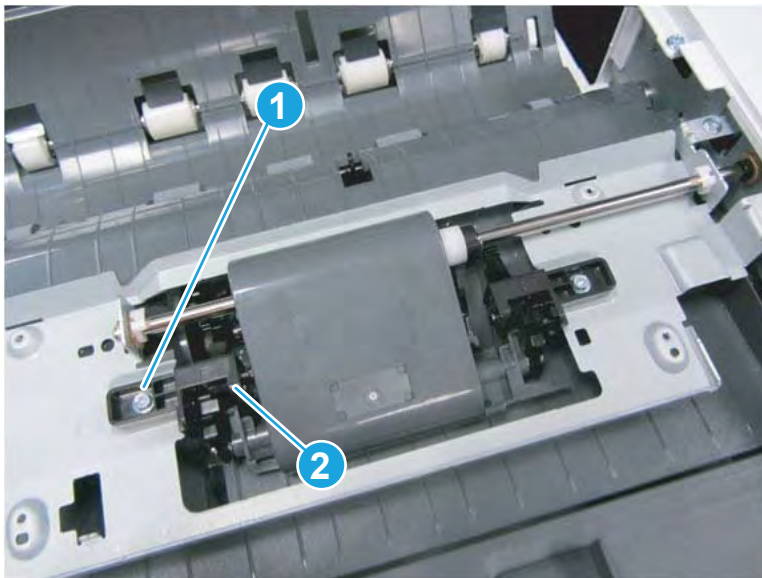
NOTE: The bushing is not captive. Do not lose it when handling the roller assembly.

Figure 2-322 Remove the document feeder pick roller assembly clips

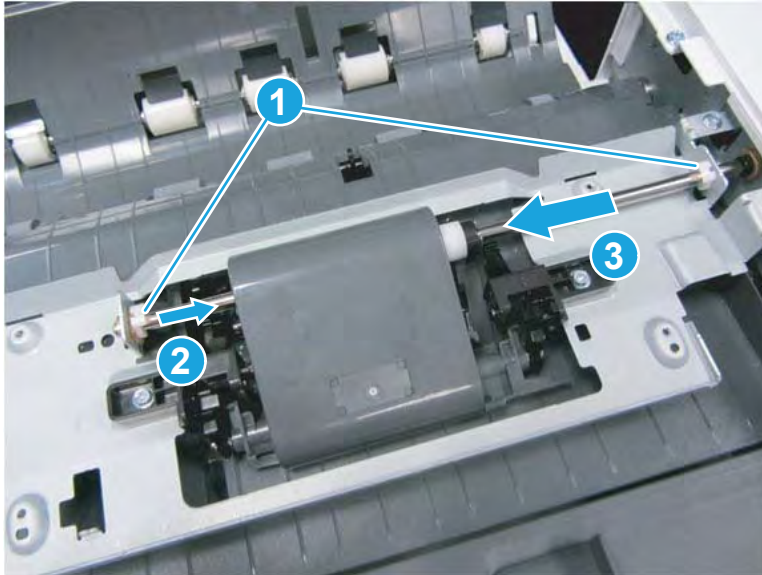

Unpack the replacement assembly

Follow these steps to unpack the replacement assembly.

1. Dispose of the defective part.

NOTE: HP recommends responsible disposal of the defective part.

<http://www8.hp.com/us/en/hp-information/environment/product-recycling.html>

2. Unpack the replacement part from the packaging.

CAUTION:  Some parts are sensitive to electrostatic discharge (ESD). Always perform service work at an ESD-protected workstation or mat. If an ESD workstation or mat is not available, touch the sheet-metal chassis to provide a static ground before touching an ESD-sensitive assembly. Protect the ESD-sensitive assemblies by placing them in ESD pouches when they are out of the printer.

IMPORTANT: Make sure that all of the shipping materials (for example shipping tape) are removed from the replacement part prior to installation.

NOTE: If the replacement part is a roller or pad, avoid touching the spongy part of it. Skin oils on the roller or pad can cause paper pickup and/or print-quality problems. HP recommends using disposable gloves when handling rollers or pads or washing your hands before touching rollers or pads.

3. To install an assembly, reverse the removal steps.

 **NOTE:** When applicable, special installation instructions are provided for an assembly at the end of the removal procedure. Always completely read the removal instructions and follow all special installation instructions.

ADF main frame assembly (LX models)

View the ADF main frame assembly (LX models) exploded view, parts list, and repair procedures.

ADF main frame assembly (LX/du models)

Parts diagram and parts list for the ADF main frame assembly (LX models).

Figure 2-323 ADF main frame (LX models)

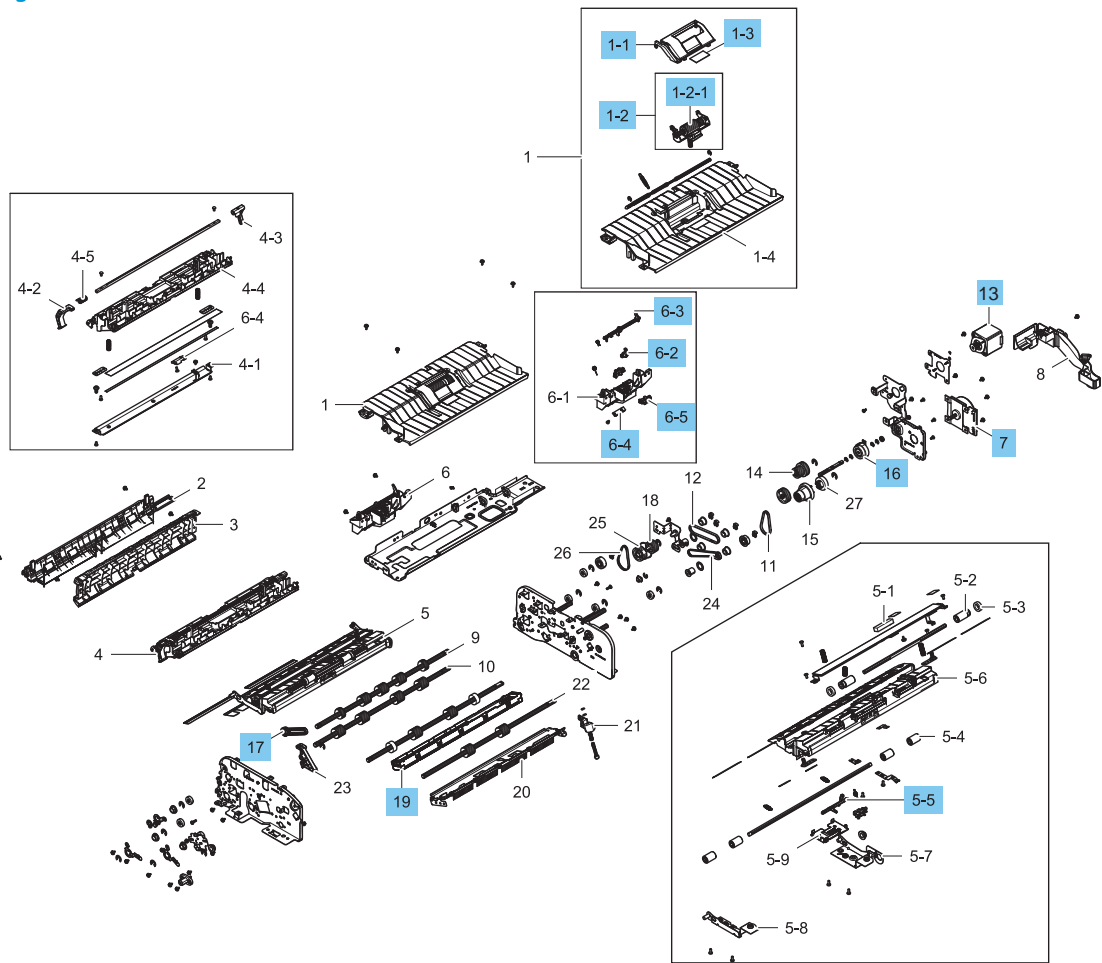

Table 2-72 ADF main frame assembly (LX models)

Ref				
No	Part number	Description	Qty	Repair procedure
1-1	JC97-04586A	LX separation housing	1	Not applicable
1-2	JC97-04852A	ADF LX separation roller	1	Removal and replacement: Document feeder (ADF) separation roller assembly (LX) on page 436
1-2-1	JC97-04861A	ADF LX separation sub roller		Not applicable
1-3	JC69-01326A	Friction pad	1	Not applicable
5-5	JC66-04104A	Actuator, output ¹	1	Not applicable
6-2	JC66-04105A	Actuator, feed out	1	Not applicable
6-3	JC66-04103A	Actuator, registration	1	Not applicable
6-4	0604-001381	Photo interrupter	1	Not applicable
6-5	0604-001393	Photo interrupter ¹	1	Not applicable
7	JC31-00156C	Feed motor assembly (Motor, bldc type 1)	1	Removal and replacement: Document feeder (ADF) feed motor (LX) on page 443
13	JC31-00163A	Motor - Step main	1	Not applicable
16	JC47-00038A	LX - Motor feed DC	1	Not applicable
17	JC66-04100A	LX - Link Cover Open	1	Not applicable
19	JC97-04920A	Contact Image Sensor (CIS)	1	Not applicable
19	JC97-04722A	Contact Image Sensor (CIS) (E778xx series)	1	Not applicable
19	JC97-04920A	Contact Image Sensor (CIS) (E783xx series)	1	Not applicable

¹Early models only during original release. This part removed from newer models.

Removal and replacement: Removal and replacement: Document feeder (ADF) separation roller assembly (LX)

Learn how to remove and replace the document feeder separation roller assembly (LX).

To view a short video of this procedure, click the link below.



[View a video of how to remove and replace the document feeder separation roller assembly \(LX\).](#)



IMPORTANT: When applicable, special installation instructions are provided for an assembly at the end of the removal procedure. Always completely read the removal instructions and follow all special installation instructions.

Mean time to repair:

Service level:

Before performing service

Turn the printer power off

- Press the power button on the front of the printer, and then turn off the power switch next to the power cable.
- A shutting-down message appears on the control-panel display.



WARNING! To avoid damage to the printer, turn the power off and wait until the printer shuts down before removing the power cable.

- Disconnect the printer power cable after the printer has completely shut down (the control-panel display is blank).

Use the table below to identify the correct part number for your printer. To order the part, go to www.hp.com/buy/parts.

Table 2-73 Part information

Part number	Part description
JC97-04852A	ADF separation roller assembly (LX)

Required tools

- #2 JIS screwdriver with a magnetic tip

After performing service

Turn the printer power on

- Connect the printer power cable.
- Turn on the power switch next to the power cable, and then press the power button on the front of the printer.
- Verify that the service performed was successful.

- Verify that the most recent firmware is installed on the printer.
- Verify that all parts are correctly reinstalled and are properly working.

Post service test

Print any pages necessary to verify that the repair resolved the issue and did not create any new issues.

Remove the document feeder (ADF) (LX/du models) pick and feed roller assembly

Follow these steps to remove the document feeder (ADF) (LX/du models) pick and feed roller assembly.

1. Open the document feeder cover.

Figure 2-324 Open the document feeder cover

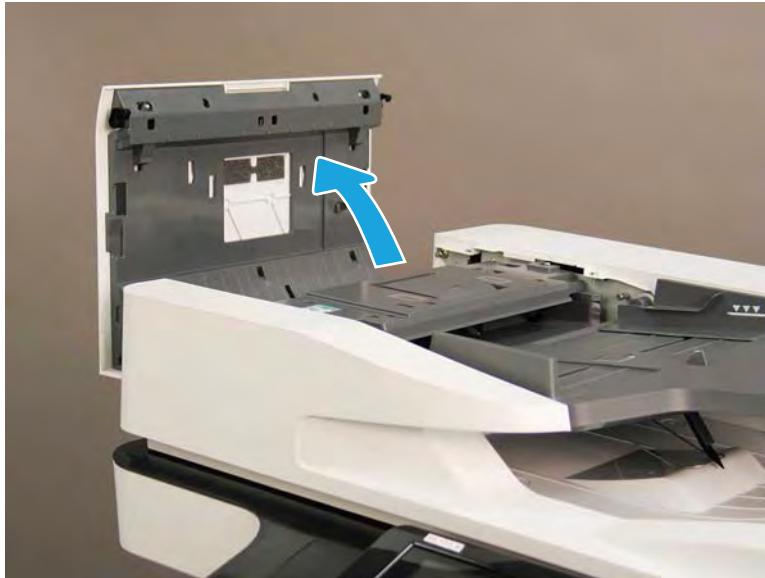

2. Remove four screws in the document feeder pick roller assembly cover.

 **NOTE:** Remove one spring (callout 2; not shown)

Figure 2-325 Remove the document feeder cover screws

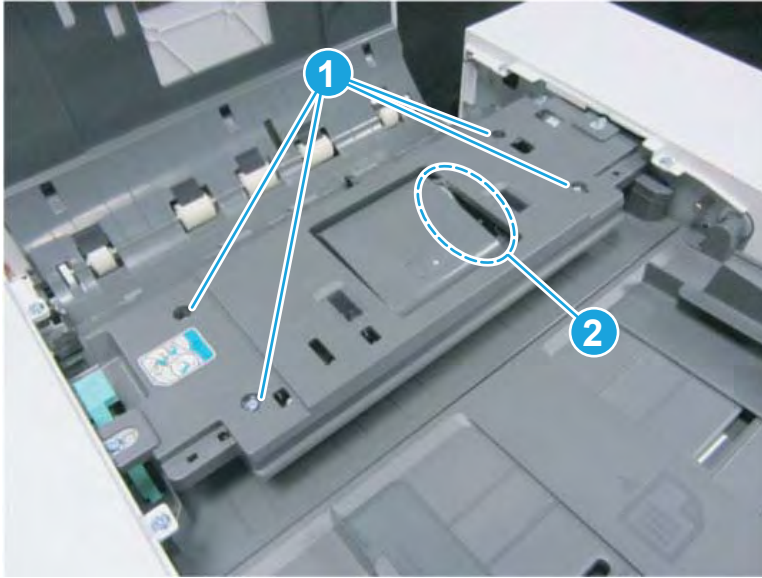

3. Rotate the document feeder pickup cover up, and then disconnect one connector (callout 1).

Figure 2-326 Turn the cover over and disconnect connector



4. Before proceeding, take note of the removed roller cover and the roller assembly.

Figure 2-327 Document feeder pick roller cover and roller assembly

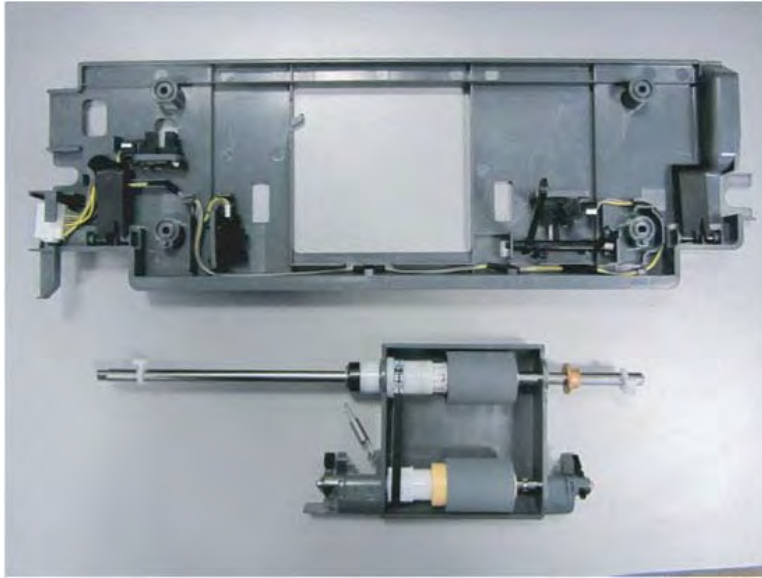

5. Remove one screw (callout 1), and then remove the sensor flag bracket (callout 2).

 **Reinstallation tip:** When the roller assembly is reinstalled, make sure that the sensor flags (on both sides of the assembly) are correctly installed and move freely.

Figure 2-328 Remove one screw and the sensor flag bracket



6. Release two plastic clips (callout 1), slide bushing toward roller assembly (callout 2), and then slide the shaft towards front of printer to release it (callout 3). Remove the roller assembly.

⚠ CAUTION: Do not damage the sensor flags when handling the roller assembly.

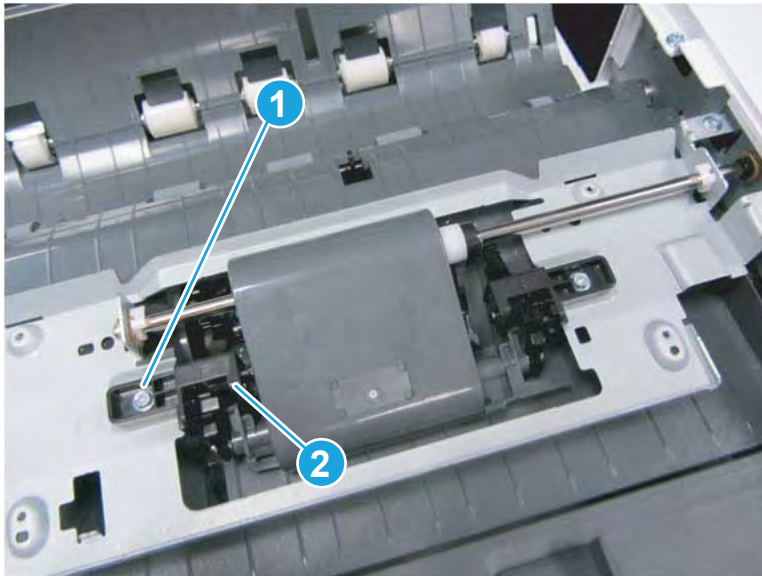
📝 NOTE: The bushing is not captive. Do not lose it when handling the roller assembly.

Figure 2-329 Remove the document feeder pick roller assembly clips

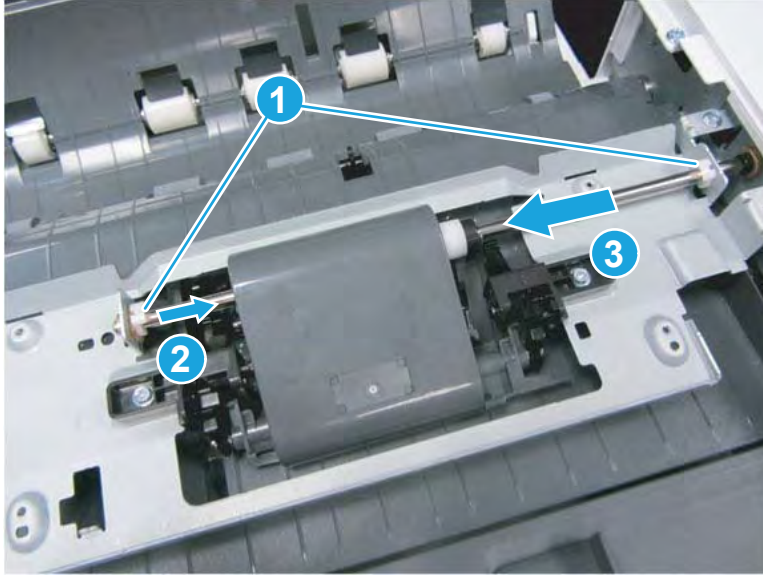

Remove the LX document feeder separation roller

Follow these steps to remove the LX document feeder separation roller.

1. Rotate the separation roller cover up to release it, and then remove the cover.

Figure 2-330 Remove the separation roller cover

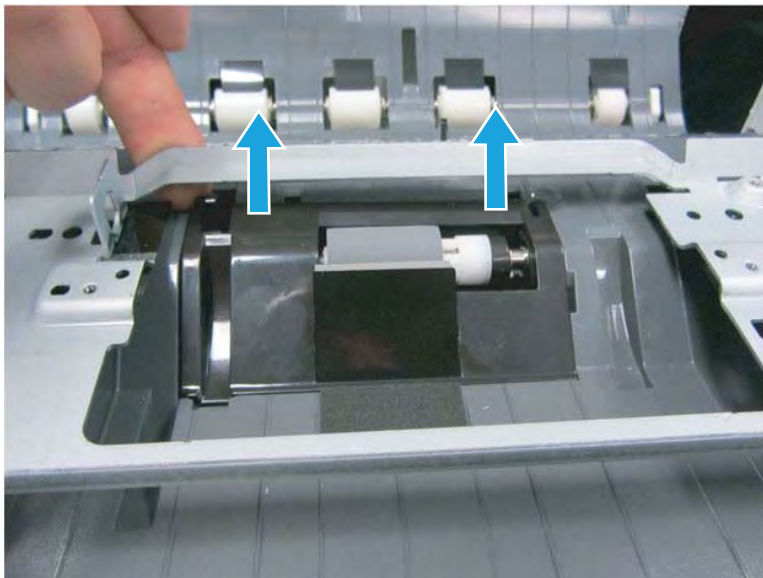

2. Before proceeding, take note of the removed roller cover and the roller assembly.

Figure 2-331 Document feeder separation roller cover and roller assembly



3. Release two claws, and then remove the separation roller assembly.

 **NOTE:** The separation roller assembly spring under the roller is not captive.

Figure 2-332 Remove the separation roller assembly



4. When the assembly is reinstalled, make sure that the spring is correctly seated in the holder.

Figure 2-333 Separation roller assembly spring

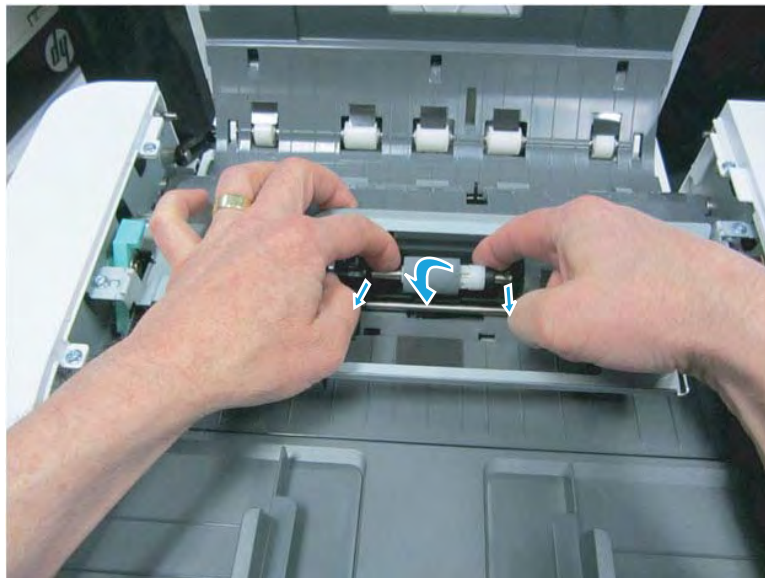
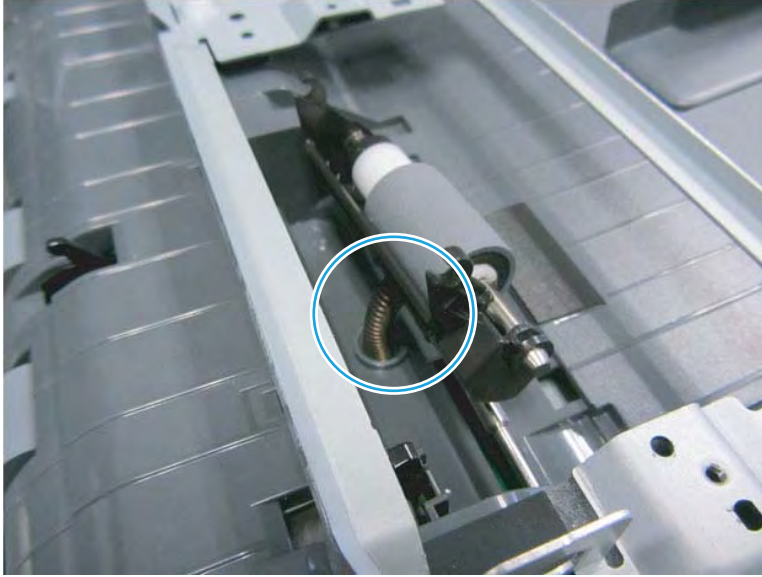

Unpack the replacement assembly



Follow these steps to unpack the replacement assembly.

1. Dispose of the defective part.

 **NOTE:** HP recommends responsible disposal of the defective part.

<http://www8.hp.com/us/en/hp-information/environment/product-recycling.html>

2. Unpack the replacement part from the packaging.

 **CAUTION:**  Some parts are sensitive to electrostatic discharge (ESD). Always perform service work at an ESD-protected workstation or mat. If an ESD workstation or mat is not available, touch the sheet-metal chassis to provide a static ground before touching an ESD-sensitive assembly. Protect the ESD-sensitive assemblies by placing them in ESD pouches when they are out of the printer.

 **IMPORTANT:** Make sure that all of the shipping materials (for example shipping tape) are removed from the replacement part prior to installation.

 **NOTE:** If the replacement part is a roller or pad, avoid touching the spongy part of it. Skin oils on the roller or pad can cause paper pickup and/or print-quality problems. HP recommends using disposable gloves when handling rollers or pads or washing your hands before touching rollers or pads.

3. To install an assembly, reverse the removal steps.

 **NOTE:** When applicable, special installation instructions are provided for an assembly at the end of the removal procedure. Always completely read the removal instructions and follow all special installation instructions.

Removal and replacement: Removal and replacement: Document feeder (ADF) feed motor (LX)

Learn how to remove and replace the document feeder feed motor (LX).

To view a short video of this procedure, click the link below.



[View a video of how to remove and replace the document feeder feed motor \(LX\).](#)



IMPORTANT: When applicable, special installation instructions are provided for an assembly at the end of the removal procedure. Always completely read the removal instructions and follow all special installation instructions.

Mean time to repair:

Service level:

Before performing service

Turn the printer power off

- Press the power button on the front of the printer, and then turn off the power switch next to the power cable.
- A shutting-down message appears on the control-panel display.



WARNING! To avoid damage to the printer, turn the power off and wait until the printer shuts down before removing the power cable.

- Disconnect the printer power cable after the printer has completely shut down (the control-panel display is blank).

Use the table below to identify the correct part number for your printer. To order the part, go to www.hp.com/buy/parts.

Table 2-74 Part information

Part number	Part description
JC31-00156C	Feed motor assembly (LX) (bldc type 1)

Required tools

- #2 JIS screwdriver with a magnetic tip

After performing service

Turn the printer power on

- Connect the printer power cable.
- Turn on the power switch next to the power cable, and then press the power button on the front of the printer.
- Verify that the service performed was successful.

- Verify that the most recent firmware is installed on the printer.
- Verify that all parts are correctly reinstalled and are properly working.

Post service test

Print any pages necessary to verify that the repair resolved the issue and did not create any new issues.

Remove the document feeder (ADF) back cover

Follow these steps to remove the document feeder (ADF) back cover.

1. Remove two screws from the top of document feeder back cover.

Figure 2-334 Remove the document feeder back cover top screws

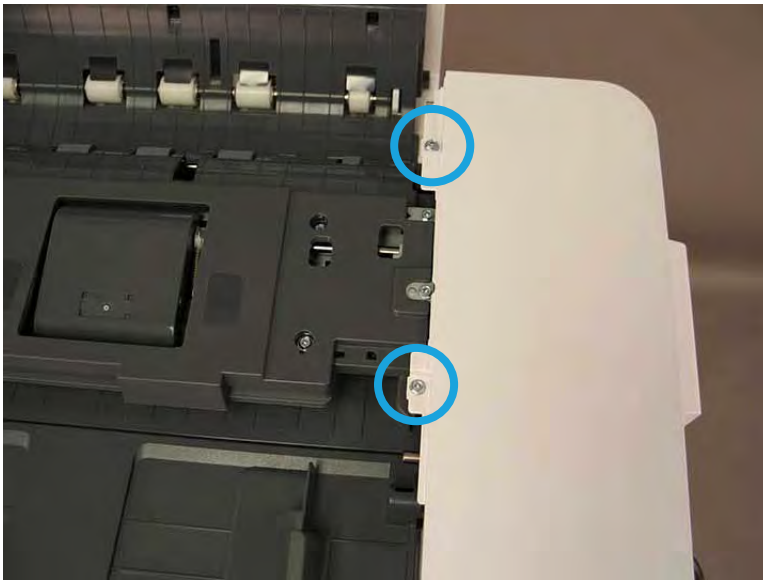

2. Remove 3 caps and 3 screws.

Figure 2-335 Remove 3 caps and 3 screws.



3. Release the top back cover.

Figure 2-336 Release the top back cover.



Remove the feed motor

Follow these steps to remove the feed motor.

1. Loosen the cables in the cable guide, remove two screws and then move the cable guide out of the way.

Figure 2-337 Feed motor cable guide

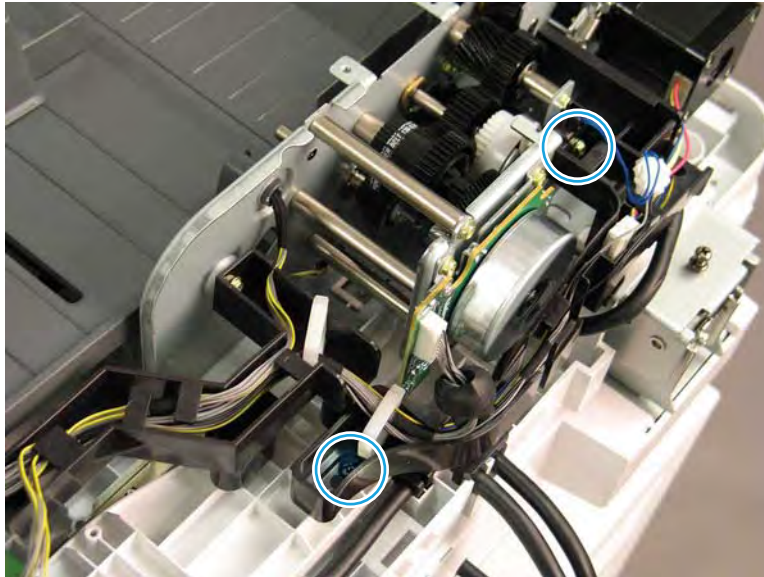

2. Disconnect one connector, remove four screws, and then carefully lift the motor out to remove.

Figure 2-338 Remove the feed motor

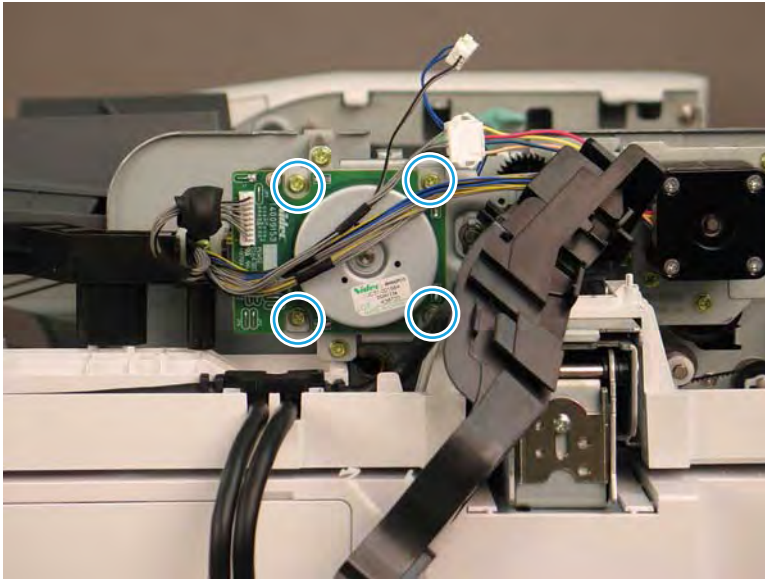

Unpack the replacement assembly



Follow these steps to unpack the replacement assembly.

1. Dispose of the defective part.

 **NOTE:** HP recommends responsible disposal of the defective part.

<http://www8.hp.com/us/en/hp-information/environment/product-recycling.html>

2. Unpack the replacement part from the packaging.

 **CAUTION:**  Some parts are sensitive to electrostatic discharge (ESD). Always perform service work at an ESD-protected workstation or mat. If an ESD workstation or mat is not available, touch the sheet-metal chassis to provide a static ground before touching an ESD-sensitive assembly. Protect the ESD-sensitive assemblies by placing them in ESD pouches when they are out of the printer.

 **IMPORTANT:** Make sure that all of the shipping materials (for example shipping tape) are removed from the replacement part prior to installation.

 **NOTE:** If the replacement part is a roller or pad, avoid touching the spongy part of it. Skin oils on the roller or pad can cause paper pickup and/or print-quality problems. HP recommends using disposable gloves when handling rollers or pads or washing your hands before touching rollers or pads.

3. To install an assembly, reverse the removal steps.

 **NOTE:** When applicable, special installation instructions are provided for an assembly at the end of the removal procedure. Always completely read the removal instructions and follow all special installation instructions.

Flow ADF (GX/z)

View the flow ADF (GX/z) exploded view, parts list, and repair procedures.

ADF (GX/z)

Parts diagram and parts list for the ADF (GX/z).

Figure 2-339 ADF (GX/z)

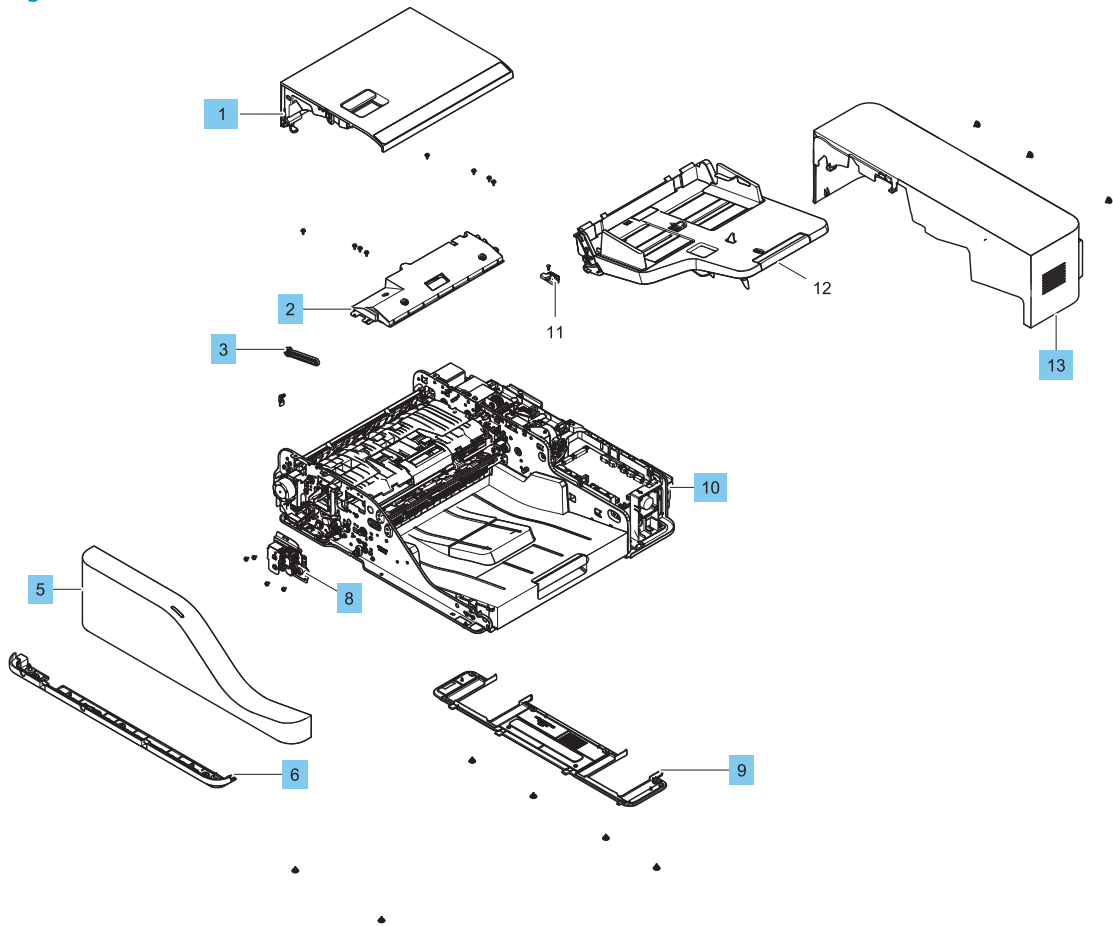

Table 2-75 ADF/ Scanner GX/z

Ref				
No	Part number	Description	Qty	Repair procedure
1	JC97-04869A	GX/z ADF open cover	1	Not applicable
2	JC97-04872A	GX/z ADF pickup upper	1	Not applicable
3	JC66-02270A	GX/z ADF cover hinge	1	Not applicable
5	JC97-04881A	GX/z ADF front cover	1	Not applicable
6	JC97-04879A	GX/z ADF dummy front	1	Not applicable
8	JC97-04692A	GX/z ADF damper	1	Not applicable
9	JC97-04880A	GX/z ADF cover, bottom	1	Not applicable
10	JC97-04883A	GX/z ADF main frame	1	Not applicable
12	JC97-04658C	GX/z ADF Stacker	1	Not applicable
13	JC63-05566A	GX/z ADF cover, rear	1	Not applicable

Removal and replacement: Document feeder input tray (GX)

This document provides the procedures to remove the input tray assembly.



[View a video of removing and replacing the input tray \(E77820-E77830\).](#)

Mean time to repair: 20 minutes

Service level: Intermediate



IMPORTANT: When applicable, special installation instructions are provided for an assembly at the end of the removal procedure. Always completely read the removal instructions and follow all special installation instructions.

Before performing service

- Disconnect the power cable.

Use the table below to identify the correct part number for your printer. To order the part, go to www.hp.com/buy/parts

Table 2-76 Part information

Part number	Part description
JC97-04658C	Input tray assembly

Required tools

- #2 JIS screwdriver with a magnetic tip

After performing service

Turn the printer power on

- Connect the power cable.
- Use the power switch to turn the power on.

Post service test

Copy, scan, or print a document. Verify the document copies, scans, or prints correctly.

Remove the document feeder (ADF) front cover

Follow these steps to remove the document feeder (ADF) front cover.

1. Remove two screws from the top of document feeder front cover.

Figure 2-340 Remove the document feeder front cover top screws



2. Open the document feeder. Detach a sticker and then remove a screw (Callout 1) from the bottom of the document feeder front cover.

Figure 2-341 Open the document feeder

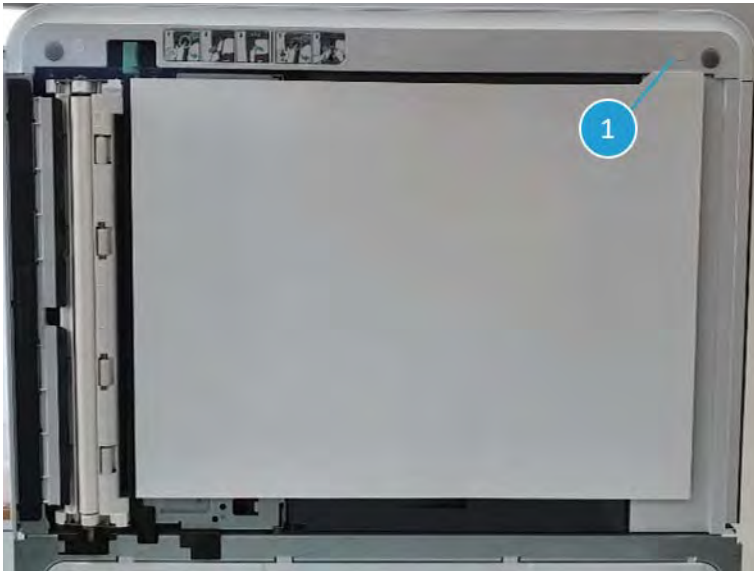

3. Remove the document feeder front cover.

Figure 2-342 Remove the document feeder front cover



Remove the document feeder back cover

Follow these steps to remove the document feeder back cover.

1. Remove two screws from the top of document feeder back cover.

Figure 2-343 Remove the document feeder back cover top screws

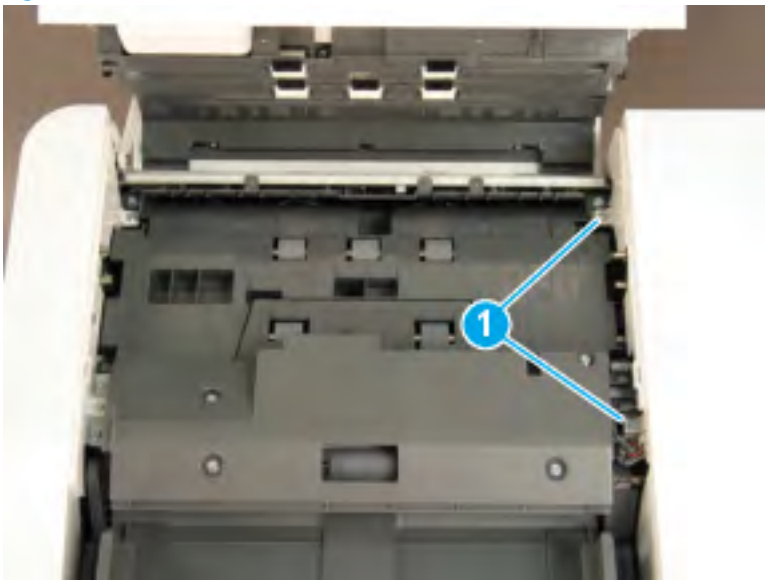

2. Remove three screws from the bottom of the document feeder back cover, and then remove the document feeder back cover.

Figure 2-344 Remove the document feeder back cover bottom screws



Remove the dampening unit

Follow these steps to remove the dampening unit.

- ▲ Remove three screws, and then remove the damping unit.

Figure 2-345 Remove the document feeder dampening unit

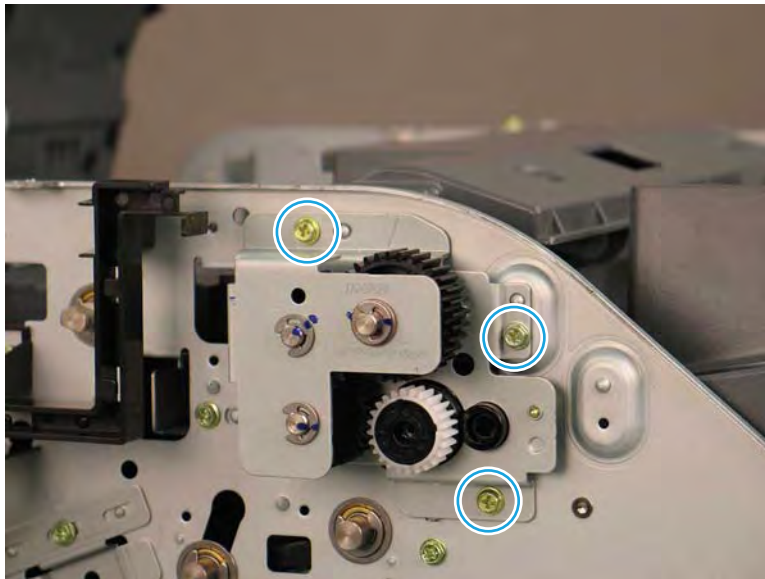

Remove the document feeder pickup and feed assembly

Follow these steps to remove the document feeder pickup and feed assembly.

1. Remove 4 screws.

Figure 2-346 Remove 4 screws.

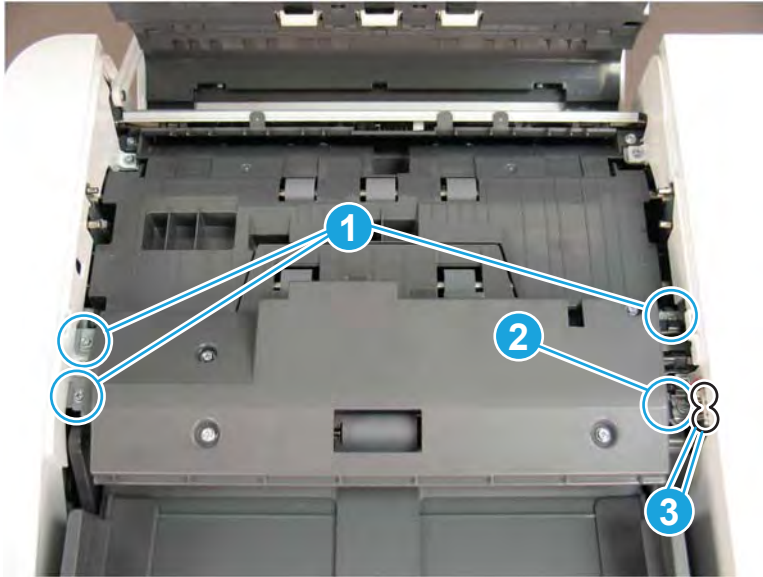

2. Remove 2 cables (callout 1) then remove the document feeder pickup roller assembly

Figure 2-347 Remove the pickup roller assembly



 **TIP:** Re-assembly

- Make sure shape of both the holes on the assembly and the shafts at the frame.



Remove the input tray

Follow these steps to remove the input tray.

1. Disconnect the document feeder PCA connector, and then remove cable from guide.

Figure 2-348 Disconnect the document feeder PCA connector



2. Lift the tray from the front, and pivot the tray outward to remove.

Removal and replacement: Contact Image Sensor (CIS) assembly

This document provides the procedures to remove the CIS assembly.



[View a video of removing and replacing the CIS \(E77820-E77830\).](#)

Mean time to repair: 20 minutes

Service level: Intermediate



IMPORTANT: When applicable, special installation instructions are provided for an assembly at the end of the removal procedure. Always completely read the removal instructions and follow all special installation instructions.

Before performing service

- Disconnect the power cable.

Use the table below to identify the correct part number for your printer. To order the part, go to www.hp.com/buy/parts

Table 2-77 Part information

Part number	Part description
0605-001246	Contact Image Sensor (CIS) assembly

Required tools

- #2 JIS screwdriver with a magnetic tip

After performing service

Turn the printer power on

- Connect the power cable.
- Use the power switch to turn the power on.

Post service test

Copy, scan, or print a document. Verify the document copies, scans, or prints correctly.

Remove the document feeder (ADF) front cover

Follow these steps to remove the document feeder (ADF) front cover.

1. Remove two screws from the top of document feeder front cover.

Figure 2-349 Remove the document feeder front cover top screws



2. Open the document feeder. Detach a sticker and then remove a screw (Callout 1) from the bottom of the document feeder front cover.

Figure 2-350 Open the document feeder

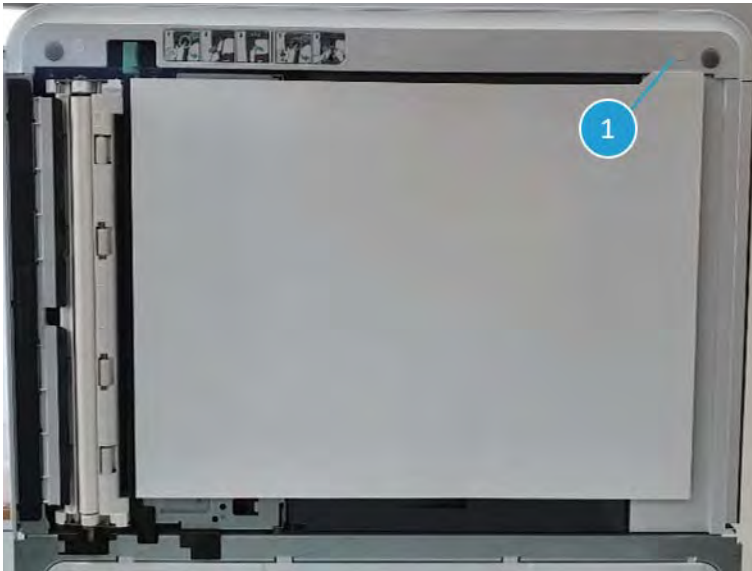

3. Remove the document feeder front cover.

Figure 2-351 Remove the document feeder front cover



Remove the document feeder back cover

Follow these steps to remove the document feeder back cover.

1. Remove two screws from the top of document feeder back cover.

Figure 2-352 Remove the document feeder back cover top screws

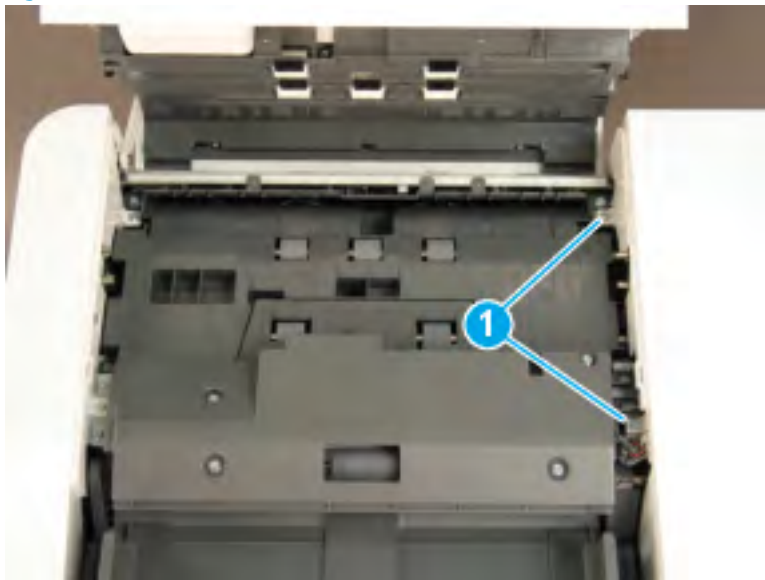

2. Remove three screws from the bottom of the document feeder back cover, and then remove the document feeder back cover.

Figure 2-353 Remove the document feeder back cover bottom screws



Remove the document feeder pickup and feed assembly

Follow these steps to remove the document feeder pickup and feed assembly.

1. Remove 4 screws.

Figure 2-354 Remove 4 screws.

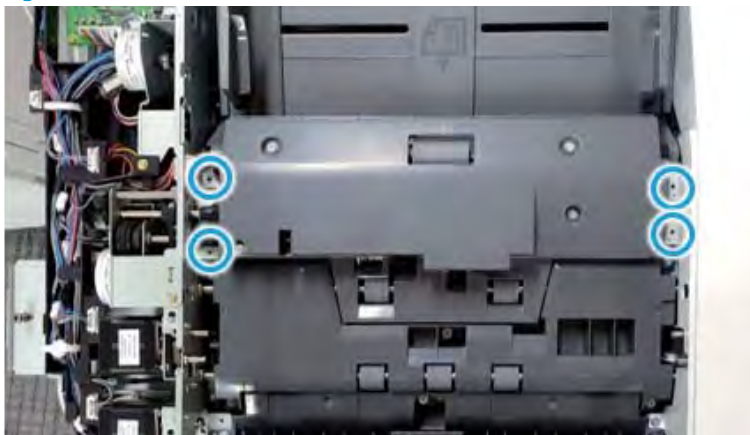

2. Remove 2 cables (callout 1) then remove the document feeder pickup roller assembly

Figure 2-355 Remove the pickup roller assembly



 **TIP:** Re-assembly

- Make sure shape of both the holes on the assembly and the shafts at the frame.

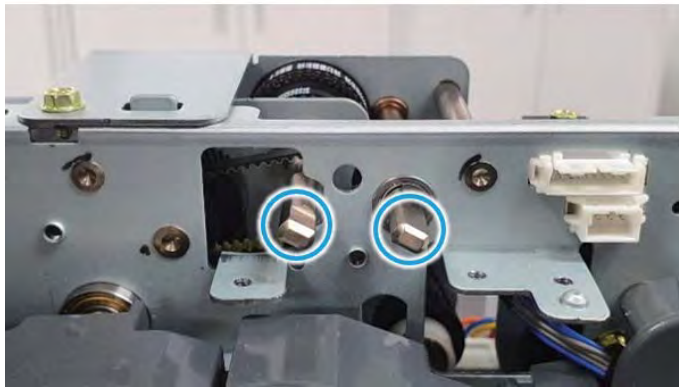

Remove the paper path cover

Follow these steps to remove the paper path cover.

- ▲ Remove five screws, and then remove the paper path cover.

Figure 2-356 Remove the document feeder paper path cover

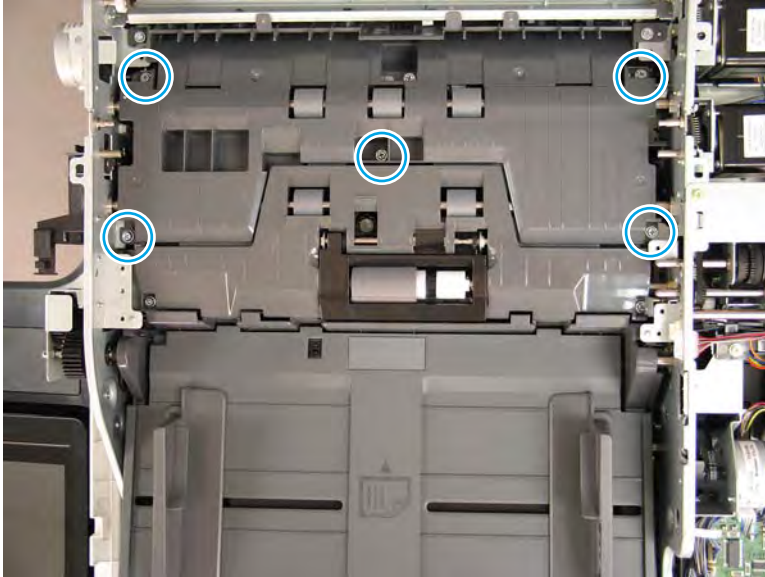

Remove the CIS assembly

Follow these steps to remove the CIS assembly.

1. Remove one screw, and then remove the CIS front alignment cover.

 **TIP:** Note the orientation of the CIS front alignment cover for reinstallation; the cover must be reinstalled with the same orientation.

Figure 2-357 Remove the CIS front alignment cover screws



2. Do the following:
 - a. Disconnect one connector (callout 1).
 - b. Use a pair of needle nose pliers to pull up on the metal pin, and then slide the CIS as shown below to remove it.

Figure 2-358 Remove the CIS

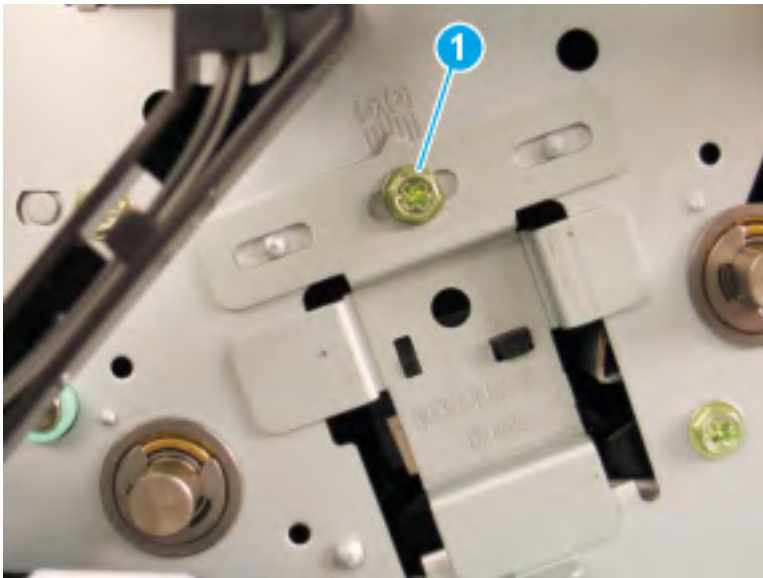
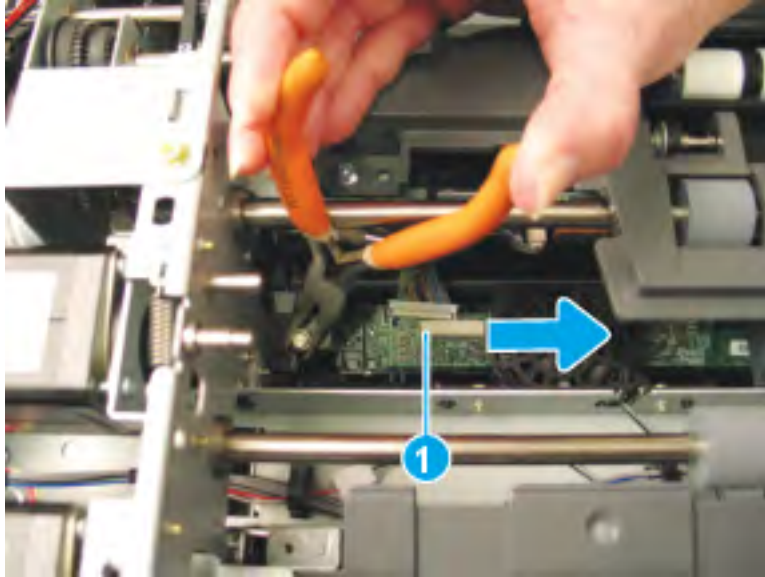

3. Remove the CIS assembly from the chassis.

Unpack the replacement assembly



Follow these steps to unpack the replacement assembly.

1. Dispose of the defective part.

 **NOTE:** HP recommends responsible disposal of the defective part.

<http://www8.hp.com/us/en/hp-information/environment/product-recycling.html>

2. Unpack the replacement part from the packaging.

 **CAUTION:**  Some parts are sensitive to electrostatic discharge (ESD). Always perform service work at an ESD-protected workstation or mat. If an ESD workstation or mat is not available, touch the sheet-metal chassis to provide a static ground before touching an ESD-sensitive assembly. Protect the ESD-sensitive assemblies by placing them in ESD pouches when they are out of the printer.

 **IMPORTANT:** Make sure that all of the shipping materials (for example shipping tape) are removed from the replacement part prior to installation.

 **NOTE:** If the replacement part is a roller or pad, avoid touching the spongy part of it. Skin oils on the roller or pad can cause paper pickup and/or print-quality problems. HP recommends using disposable gloves when handling rollers or pads or washing your hands before touching rollers or pads.

3. To install an assembly, reverse the removal steps.

 **NOTE:** When applicable, special installation instructions are provided for an assembly at the end of the removal procedure. Always completely read the removal instructions and follow all special installation instructions.

Flow ADF open cover (GX/sGX)

View the flow ADF open cover (GX/sGX) exploded view, parts list, and repair procedures.

Flow ADF open cover (GX/z)

Parts diagram and parts list for the ADF open cover (GX/z).

Figure 2-359 ADF open cover (GX/z)

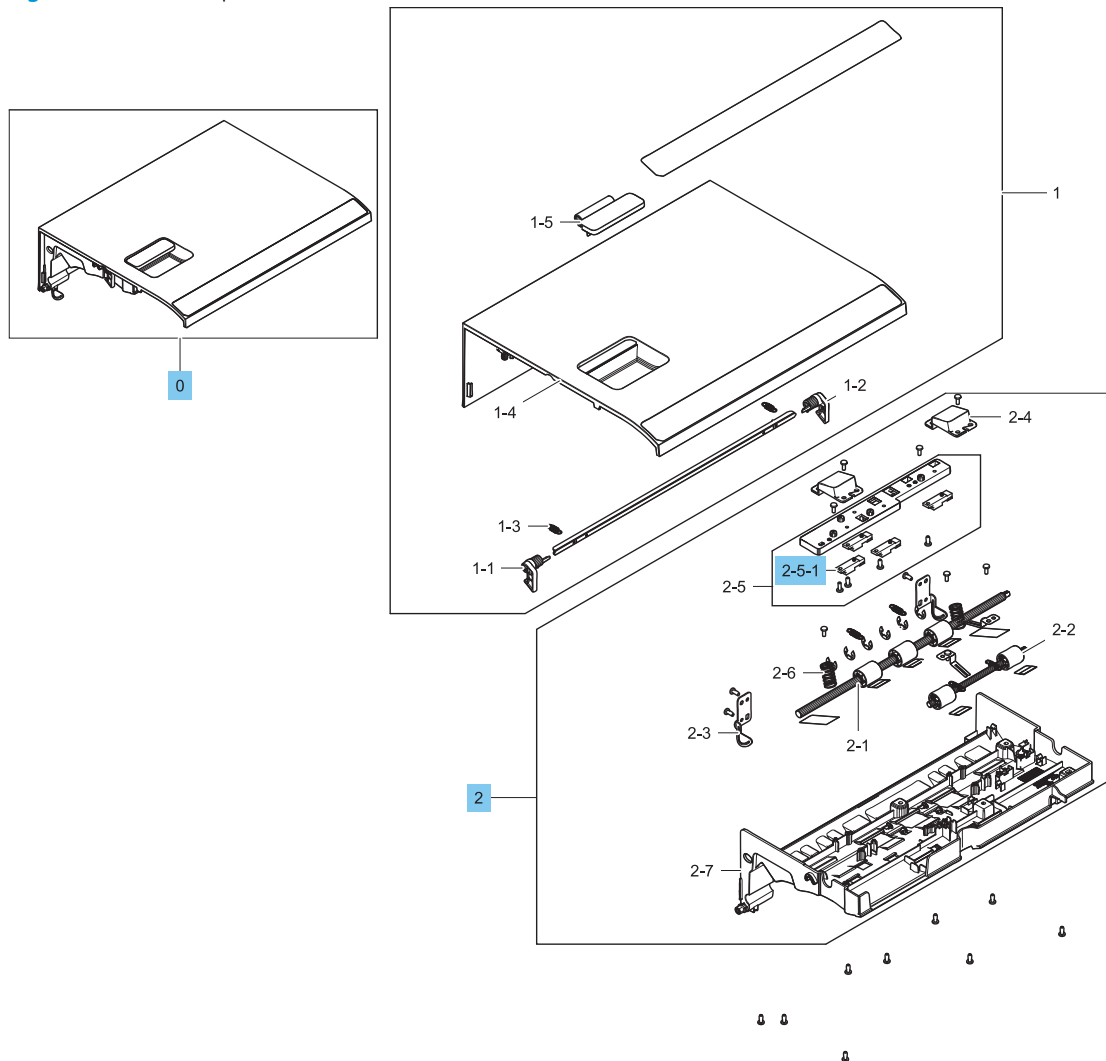

Table 2-78 Flow ADF open cover

Ref				
No	Part number	Description	Qty	Repair procedure
0	JC97-04869A	Cover, open (GX/z)	1	Removal and replacement: Document feeder jam access cover (GX) on page 468
2	JC97-04696B	Cover, open lower (GX/z)	1	Not applicable
2-5-1	0604-001381	Photo-interrupter	4	Not applicable

Removal and replacement: Document feeder jam access cover (GX)

This document provides the procedures to remove the jam access cover assembly.



[View a video of removing and replacing the jam access cover \(E72520-E72530\).](#)



[View a video of removing and replacing the jam access cover \(E77820-E77830\).](#)

Mean time to repair: 15 minutes

Service level: Intermediate



IMPORTANT: When applicable, special installation instructions are provided for an assembly at the end of the removal procedure. Always completely read the removal instructions and follow all special installation instructions.

Before performing service

- Disconnect the power cable.

Use the table below to identify the correct part number for your printer. To order the part, go to www.hp.com/buy/parts

Table 2-79 Part information

Part number	Part description
JC97-04869A	Jam access cover assembly

Required tools

- #2 JIS screwdriver with a magnetic tip

After performing service

Turn the printer power on

- Connect the power cable.
- Use the power switch to turn the power on.

Post service test

Copy, scan, or print a document. Verify the document copies, scans, or prints correctly.

Remove the document feeder (ADF) front cover

Follow these steps to remove the document feeder (ADF) front cover.

1. Remove two screws from the top of document feeder front cover.

Figure 2-360 Remove the document feeder front cover top screws



2. Open the document feeder. Detach a sticker and then remove a screw (Callout 1) from the bottom of the document feeder front cover.

Figure 2-361 Open the document feeder

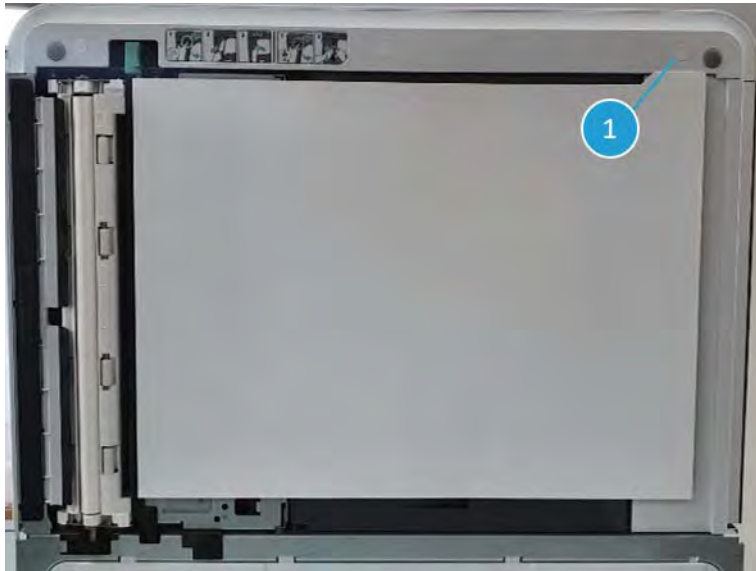

3. Remove the document feeder front cover.

Figure 2-362 Remove the document feeder front cover



Remove the document feeder back cover

Follow these steps to remove the document feeder back cover.

1. Remove two screws from the top of document feeder back cover.

Figure 2-363 Remove the document feeder back cover top screws

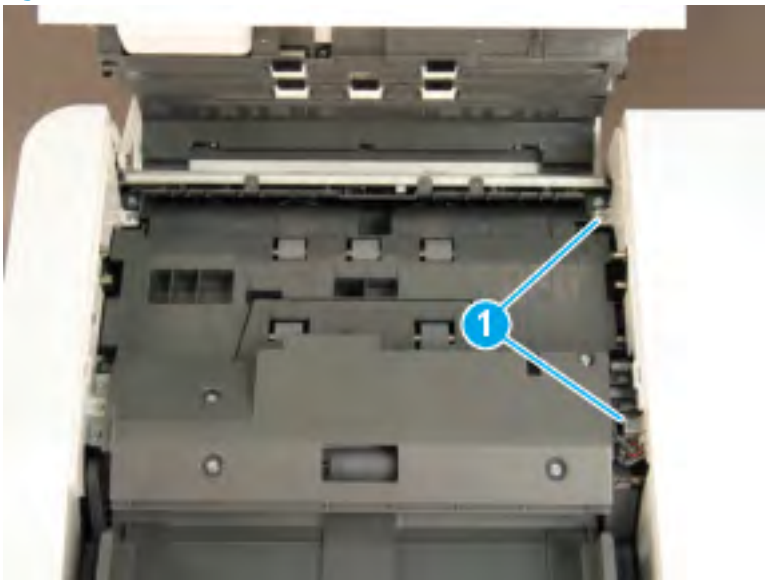

2. Remove three screws from the bottom of the document feeder back cover, and then remove the document feeder back cover.

Figure 2-364 Remove the document feeder back cover bottom screws



Remove the document feeder jam access cover

Follow these steps to remove the document feeder jam access cover.

1. Disconnect connector at document feeder PCA and route cable out.

Figure 2-365 Disconnect one connector



2. Disconnect the ground wire.

Figure 2-366 Remove the jam access cover ground wire

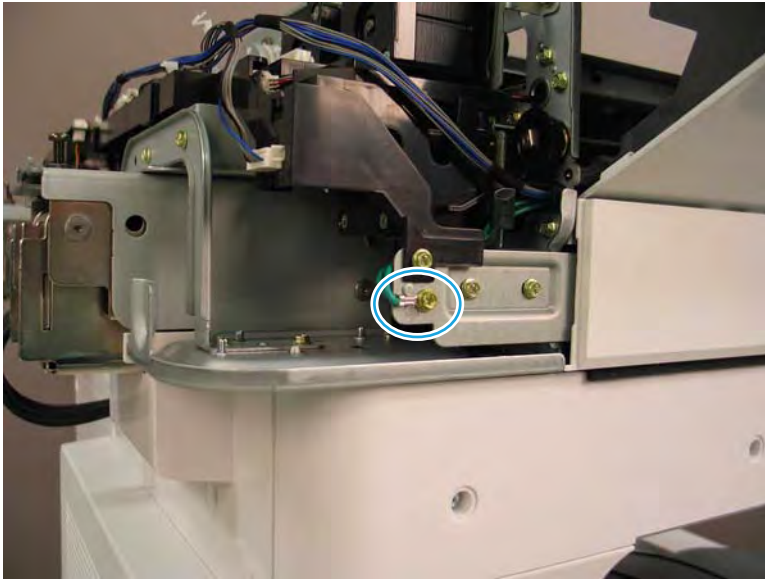

3. Remove one screw (callout 1), remove hinge (pivot) pin, and then remove door arm support (callout 2)

Figure 2-367 Remove the jam access cover door arm support

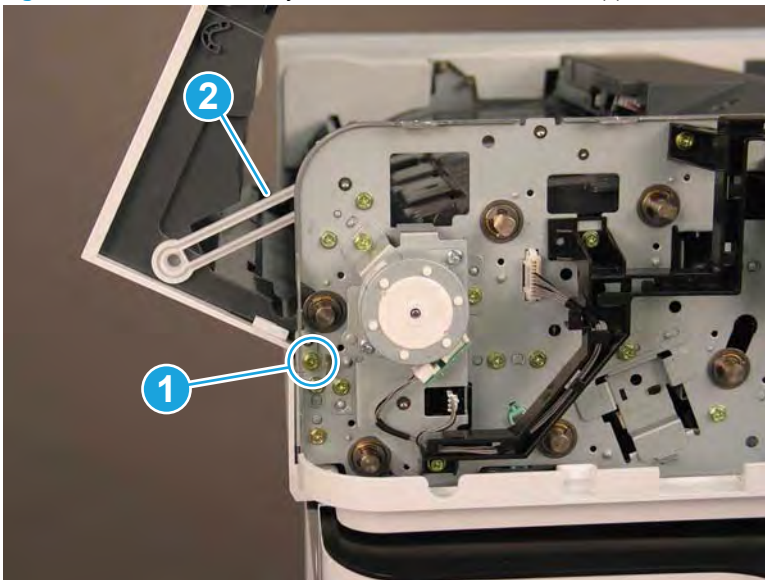

4. Remove the jam access cover.

Unpack the replacement assembly

Follow these steps to unpack the replacement assembly.

1. Dispose of the defective part.

 **NOTE:** HP recommends responsible disposal of the defective part.

<http://www8.hp.com/us/en/hp-information/environment/product-recycling.html>

2. Unpack the replacement part from the packaging.



CAUTION:  Some parts are sensitive to electrostatic discharge (ESD). Always perform service work at an ESD-protected workstation or mat. If an ESD workstation or mat is not available, touch the sheet-metal chassis to provide a static ground before touching an ESD-sensitive assembly. Protect the ESD-sensitive assemblies by placing them in ESD pouches when they are out of the printer.

 **IMPORTANT:** Make sure that all of the shipping materials (for example shipping tape) are removed from the replacement part prior to installation.

 **NOTE:** If the replacement part is a roller or pad, avoid touching the spongy part of it. Skin oils on the roller or pad can cause paper pickup and/or print-quality problems. HP recommends using disposable gloves when handling rollers or pads or washing your hands before touching rollers or pads.

3. To install an assembly, reverse the removal steps.

 **NOTE:** When applicable, special installation instructions are provided for an assembly at the end of the removal procedure. Always completely read the removal instructions and follow all special installation instructions.

ADF upper pickup (GX/z)

View the ADF upper pickup (GX/z) exploded view, parts list, and repair procedures.

ADF upper pickup (GX/z)

Parts diagram and parts list for the ADF upper pickup (GX/z).

Figure 2-368 ADF upper pickup (GX/z)

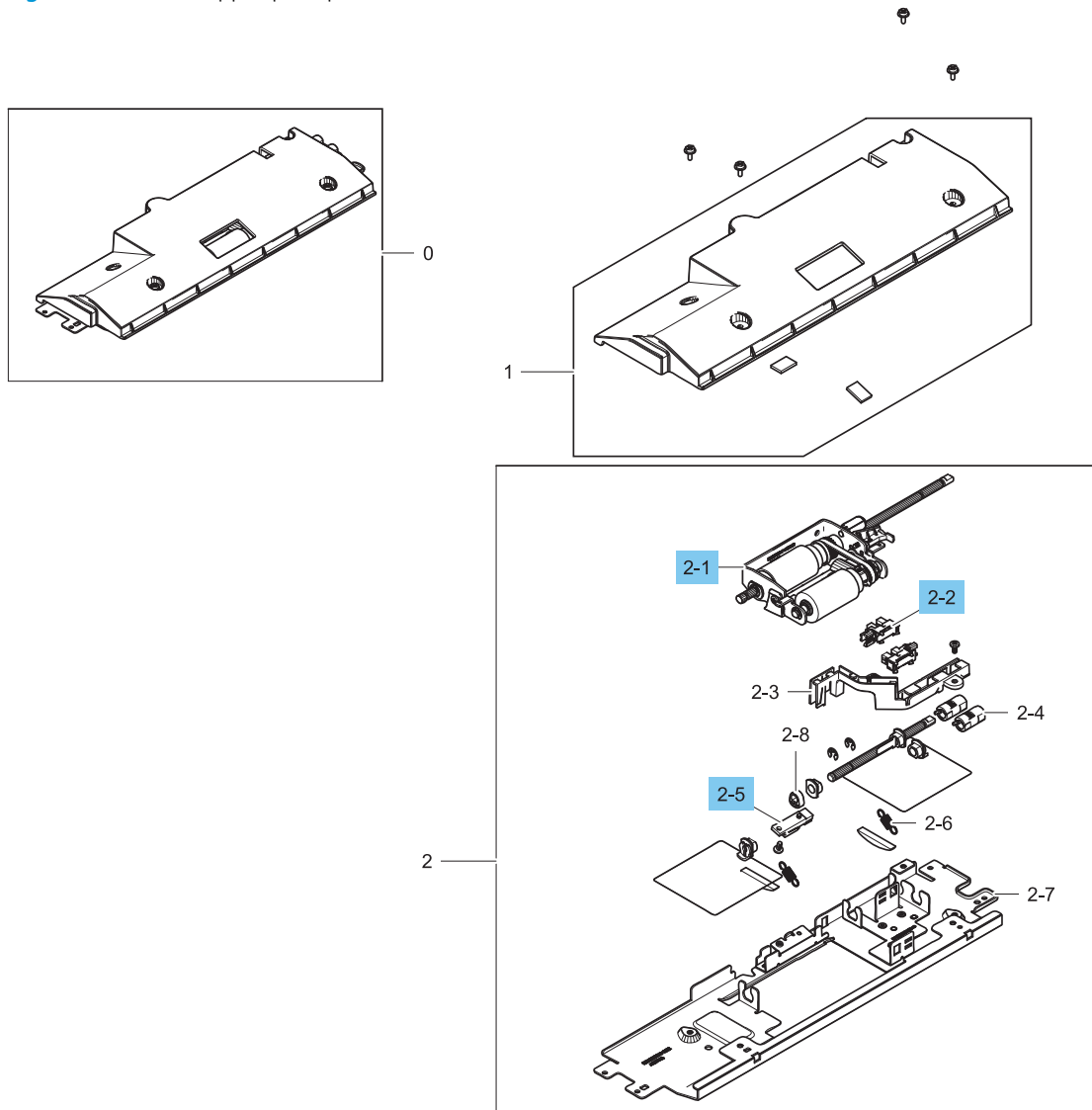

Table 2-80 ADF upper pickup (GX/z)

Ref				
No	Part number	Description	Qty	Repair procedure
2-1	JC97-04650A	GX/z ADF, sub-pickup	1	Removal and replacement: Flow document feeder pick roller assembly (GX) on page 478
2-2	0604-001393	Photo-interrupter	1	Not applicable
2-5	0604-001381	Photo-interrupter	1	Not applicable
Not shown	JC97-04915A	Document feeder separation roller assembly (GX/z models)	1	Removal and replacement: ADF separation roller assembly (GX) on page 483

Removal and replacement: Flow document feeder pick roller assembly (GX)

This document provides the procedures to remove the flow document feeder pickup roller assembly.



[View a video of removing and replacing the pick roller \(E77822-E77830\).](#)

Mean time to repair: 10 minutes

Service level: Basic



IMPORTANT: When applicable, special installation instructions are provided for an assembly at the end of the removal procedure. Always completely read the removal instructions and follow all special installation instructions.

Before performing service

- Disconnect the power cable.

Use the table below to identify the correct part number for your printer. To order the part, go to www.hp.com/buy/parts

Table 2-81 Part information

Part number	Part description
JC97-04650A	Pick roller assembly (GX/z models)

Required tools

- #2 JIS screwdriver with a magnetic tip

After performing service

Turn the printer power on

- Connect the power cable.
- Use the power switch to turn the power on.

Post service test

Copy, scan, or print a document. Verify the document copies, scans, or prints correctly.

Remove the flow ADF pickup roller assembly

Follow these steps to remove the flow ADF pickup roller assembly.

1. Open the document feeder top cover.
2. Remove the pickup roller assembly:
 - a. Remove 4 screws.

Figure 2-369 Remove 4 screws.



- b. Remove 2 cables (callout 1) then remove the document feeder pickup roller assembly

Figure 2-370 Remove the pickup roller assembly



 **TIP:** Re-assembly

- Make sure shape of both the holes on the assembly and the shafts at the frame.

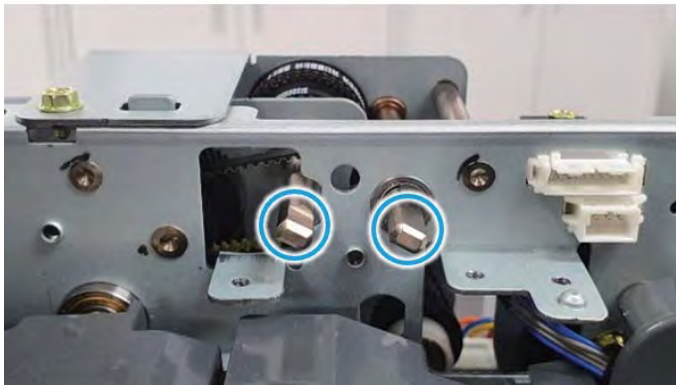

3. Remove the pickup rollers:

- a. Remove four screws and then remove the cover.

Figure 2-371 Remove the pickup roller assembly cover

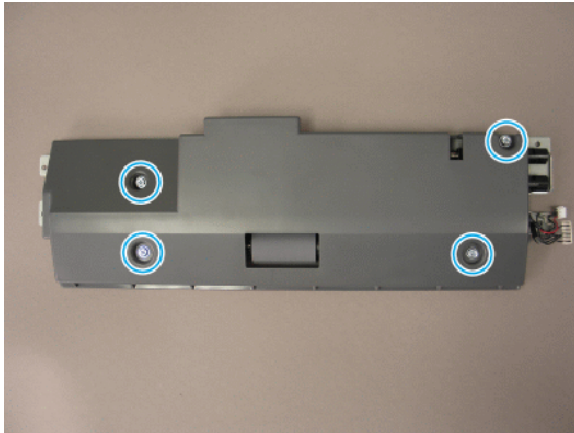

- b. Remove two plastic clips and two bushings, disconnect two springs, and then remove the shaft coupler.

 **NOTE:** The shaft is engaged in the coupler.

Figure 2-372 Remove the pickup roller components



- c. Slide the roller shaft and then remove the pickup roller assembly.

Figure 2-373 Remove the pickup roller assembly

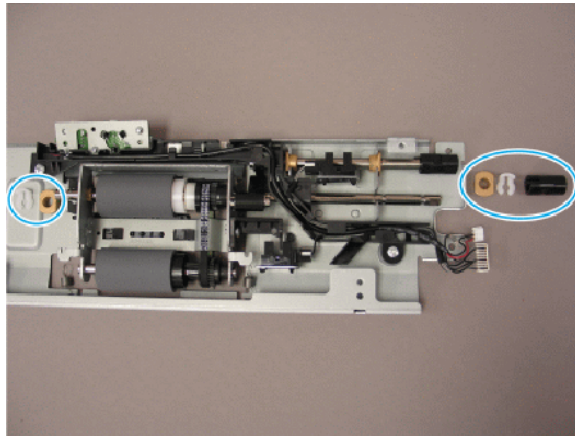
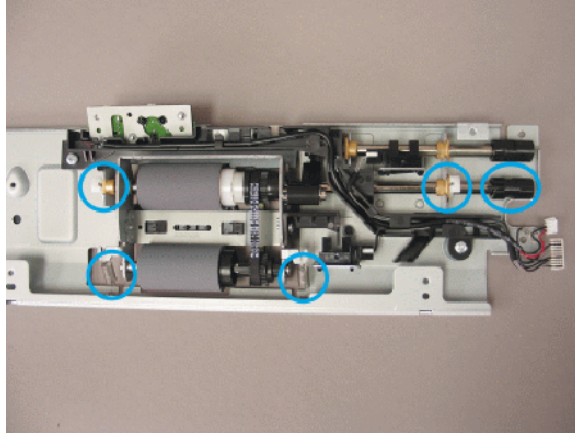
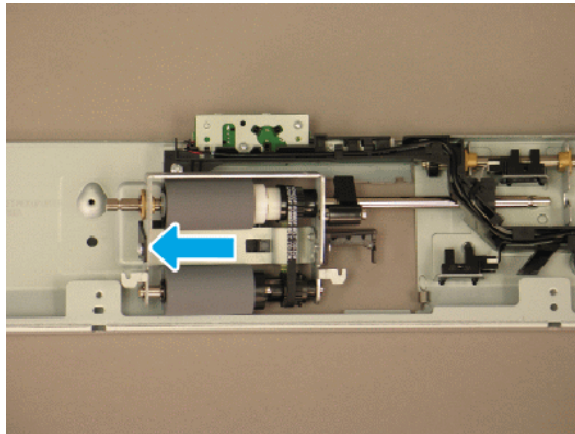

- 4. Reverse the removal steps to install the assembly.

Unpack the replacement assembly

Follow these steps to unpack the replacement assembly.

1. Dispose of the defective part.



NOTE: HP recommends responsible disposal of the defective part.

<http://www8.hp.com/us/en/hp-information/environment/product-recycling.html>

2. Unpack the replacement part from the packaging.



CAUTION:  Some parts are sensitive to electrostatic discharge (ESD). Always perform service work at an ESD-protected workstation or mat. If an ESD workstation or mat is not available, touch the sheet-metal chassis to provide a static ground before touching an ESD-sensitive assembly. Protect the ESD-sensitive assemblies by placing them in ESD pouches when they are out of the printer.



IMPORTANT: Make sure that all of the shipping materials (for example shipping tape) are removed from the replacement part prior to installation.



NOTE: If the replacement part is a roller or pad, avoid touching the spongy part of it. Skin oils on the roller or pad can cause paper pickup and/or print-quality problems. HP recommends using disposable gloves when handling rollers or pads or washing your hands before touching rollers or pads.

3. To install an assembly, reverse the removal steps.



NOTE: When applicable, special installation instructions are provided for an assembly at the end of the removal procedure. Always completely read the removal instructions and follow all special installation instructions.

Reverse the removal steps to install the assembly

Also use the following **special installation instructions**.

Removal and replacement: ADF separation roller assembly (GX)

This document provides the procedures to remove the flow document feeder separation roller assembly.



[View a video of removing and replacing the separation roller \(E72525-E72535\).](#)



[View a video of removing and replacing the separation roller \(E77822-E77830\).](#)

Mean time to repair: 10 minutes

Service level: Basic



IMPORTANT: When applicable, special installation instructions are provided for an assembly at the end of the removal procedure. Always completely read the removal instructions and follow all special installation instructions.

Before performing service

- Disconnect the power cable.

Use the table below to identify the correct part number for your printer. To order the part, go to www.hp.com/buy/parts

Table 2-82 Part information

Part number	Part description
JC97-04915A	Separation roller assembly (GX/z)

Required tools

- #2 JIS screwdriver with a magnetic tip

After performing service

Turn the printer power on

- Connect the power cable.
- Use the power switch to turn the power on.

Post service test

Copy, scan, or print a document. Verify the document copies, scans, or prints correctly.

Remove the flow ADF pickup roller assembly

Follow these steps to remove the flow ADF pickup roller assembly.

1. Open the document feeder top cover.
2. Remove the pickup roller assembly:
 - a. Remove 4 screws.

Figure 2-374 Remove 4 screws.



- b. Remove 2 cables (callout 1) then remove the document feeder pickup roller assembly

Figure 2-375 Remove the pickup roller assembly



💡 **TIP:** Re-assembly

- Make sure shape of both the holes on the assembly and the shafts at the frame.

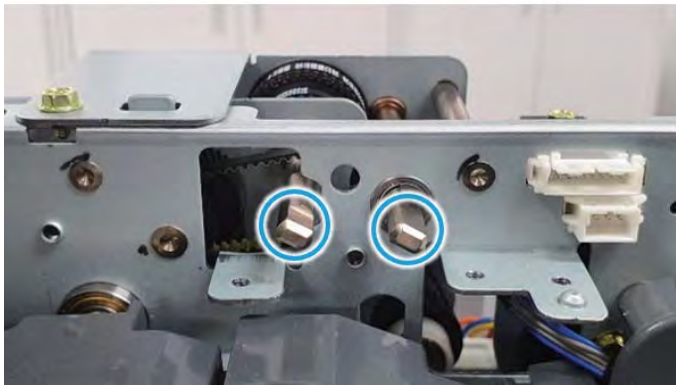

3. Remove the pickup rollers:

- a. Remove four screws and then remove the cover.

Figure 2-376 Remove the pickup roller assembly cover

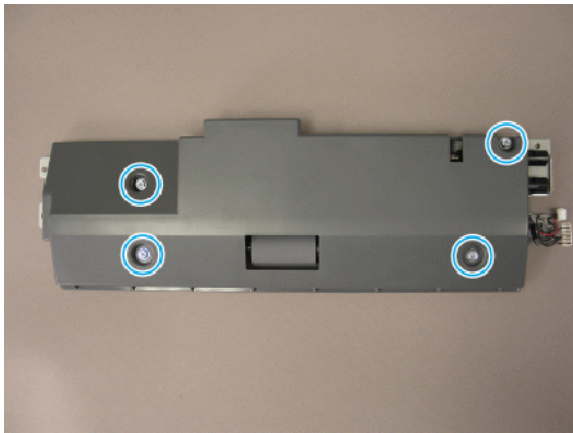

- b. Remove two plastic clips and two bushings, disconnect two springs, and then remove the shaft coupler.

 **NOTE:** The shaft is engaged in the coupler.

Figure 2-377 Remove the pickup roller components



- c. Slide the roller shaft and then remove the pickup roller assembly.

Figure 2-378 Remove the pickup roller assembly

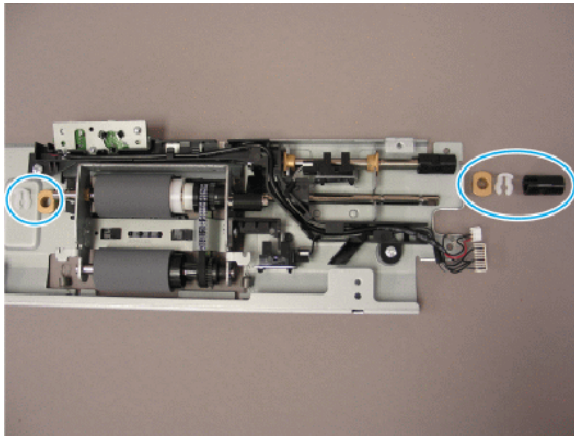
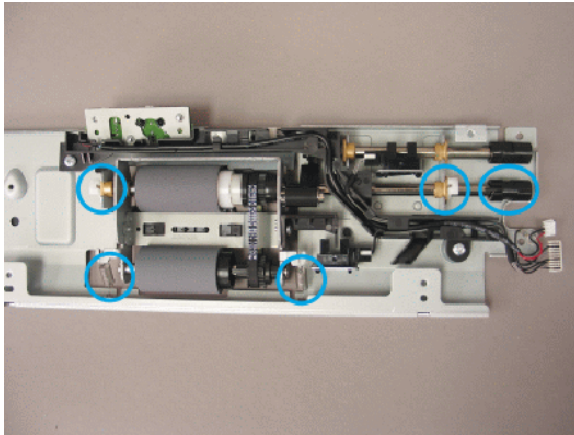
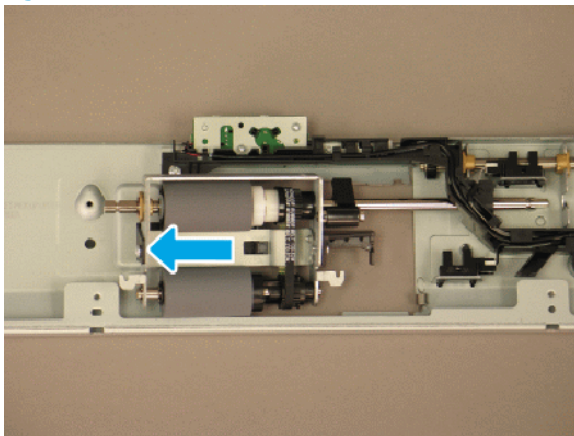

4. Reverse the removal steps to install the assembly.

Remove the flow ADF separation roller assembly

Follow these steps to remove the flow ADF separation roller assembly.

1. Slightly lift the input tray, and then remove the separation roller cover.

Figure 2-379 Remove the separation roller cover

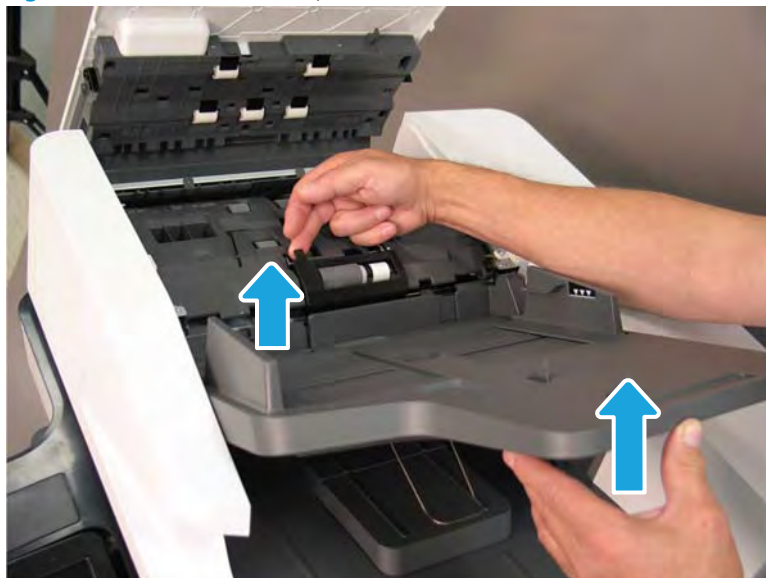

2. Remove one plastic clip.

 **NOTE:** The shaft is engaged in the coupler.

Figure 2-380 Remove one plastic clip



3. Slide the roller assembly to the front, and then pull up to release the claws from the shaft.

 **Reinstallation tip:** Position the spring and shaft before attaching the claws to the shaft.

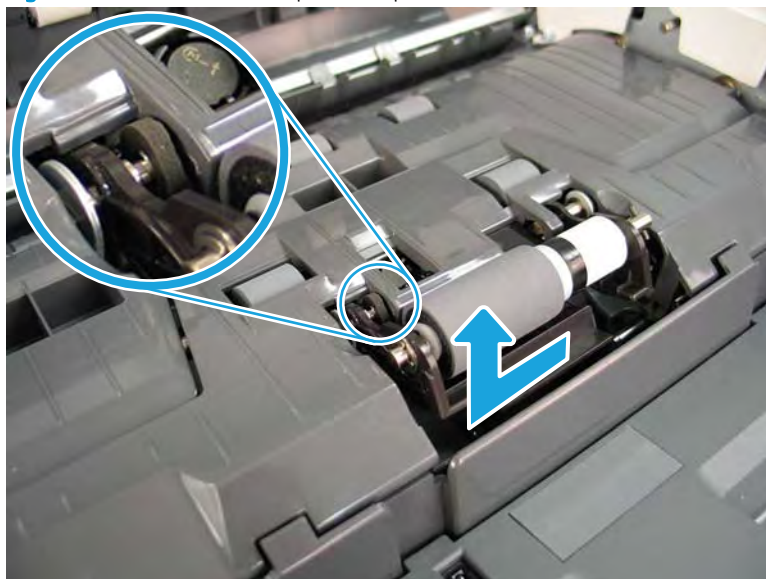
Figure 2-381 Release the separation roller



4. Remove the separation roller.

 **NOTE:** Make sure that the sponge washer (circled in a previous step) is retained during the removal of the roller assembly—it might fall off.

Figure 2-382 Remove the separation roller



 **TIP:** Re-assembly tip

Put the spring to the arrow direction at the bottom of the holder.

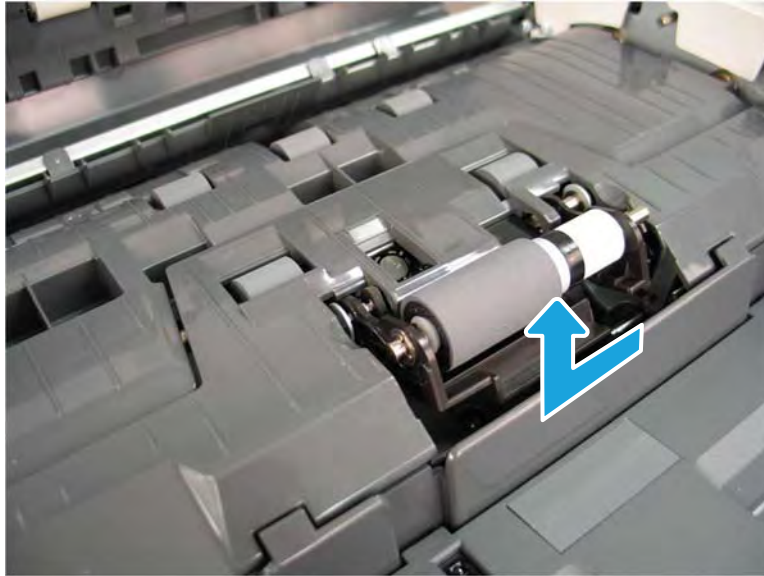

Insert the spring at the hole carefully.



Push the separation roller assembly to the bottom (Callout 1), then insert the assembly (2 joints) to the shaft (Callout 2)

Unpack the replacement assembly

Follow these steps to unpack the replacement assembly.

1. Dispose of the defective part.



NOTE: HP recommends responsible disposal of the defective part.

<http://www8.hp.com/us/en/hp-information/environment/product-recycling.html>

2. Unpack the replacement part from the packaging.



CAUTION:  Some parts are sensitive to electrostatic discharge (ESD). Always perform service work at an ESD-protected workstation or mat. If an ESD workstation or mat is not available, touch the sheet-metal chassis to provide a static ground before touching an ESD-sensitive assembly. Protect the ESD-sensitive assemblies by placing them in ESD pouches when they are out of the printer.



IMPORTANT: Make sure that all of the shipping materials (for example shipping tape) are removed from the replacement part prior to installation.



NOTE: If the replacement part is a roller or pad, avoid touching the spongy part of it. Skin oils on the roller or pad can cause paper pickup and/or print-quality problems. HP recommends using disposable gloves when handling rollers or pads or washing your hands before touching rollers or pads.

3. To install an assembly, reverse the removal steps.



NOTE: When applicable, special installation instructions are provided for an assembly at the end of the removal procedure. Always completely read the removal instructions and follow all special installation instructions.

Reverse the removal steps to install the assembly

Also use the following **special installation instructions**.

Flow ADF stacker (GX/z)

View the flow ADF stacker (GX/z) exploded view, parts list, and repair procedures.

Flow ADF stacker (GX/sGX)

Parts diagram and parts list for the flow ADF stacker (GX/sGX).

Figure 2-383 Flow ADF stacker (GX/sGX)

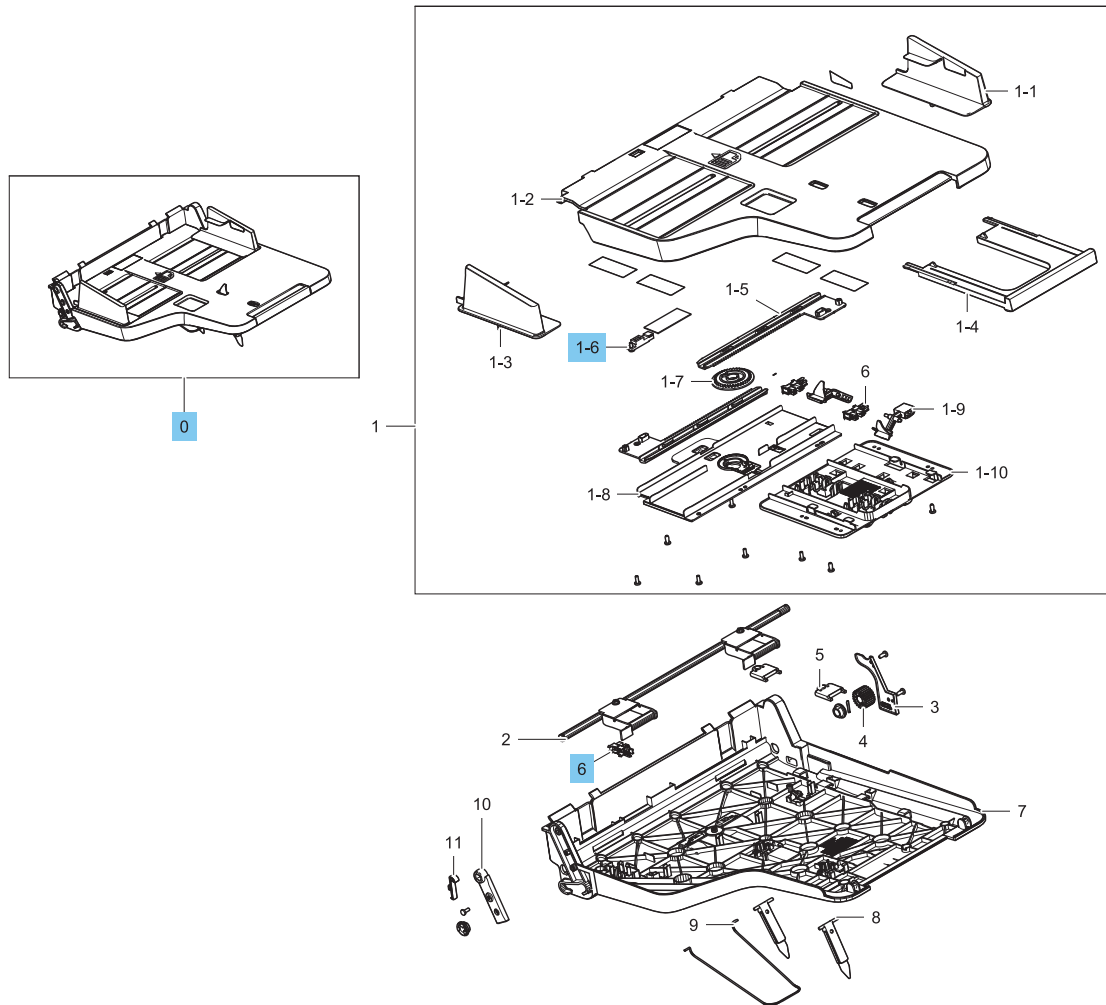

Table 2-83 Flow ADF stacker

Ref				
No	Part number	Description	Qty	Repair procedure
0	JC97-04658C	GX/z Flow ADF stacker	1	Removal and replacement: Document feeder input tray (GX) on page 450
1-6	0604-001381	Photo-interrupter	1	Not applicable
6	0604-001393	Photo-interrupter	1	Not applicable
Not shown	JC82-00693A	Flow ADF - stacker upper CM	1	Not applicable

Flow ADF main frame (GX/z)

View the flow ADF main frame (GX/z) exploded view, parts list, and repair procedures.

ADF main frame (GX/z)

Parts diagram and parts list for the ADF main frame (GX/z)

Figure 2-384 ADF main frame (GX/z)

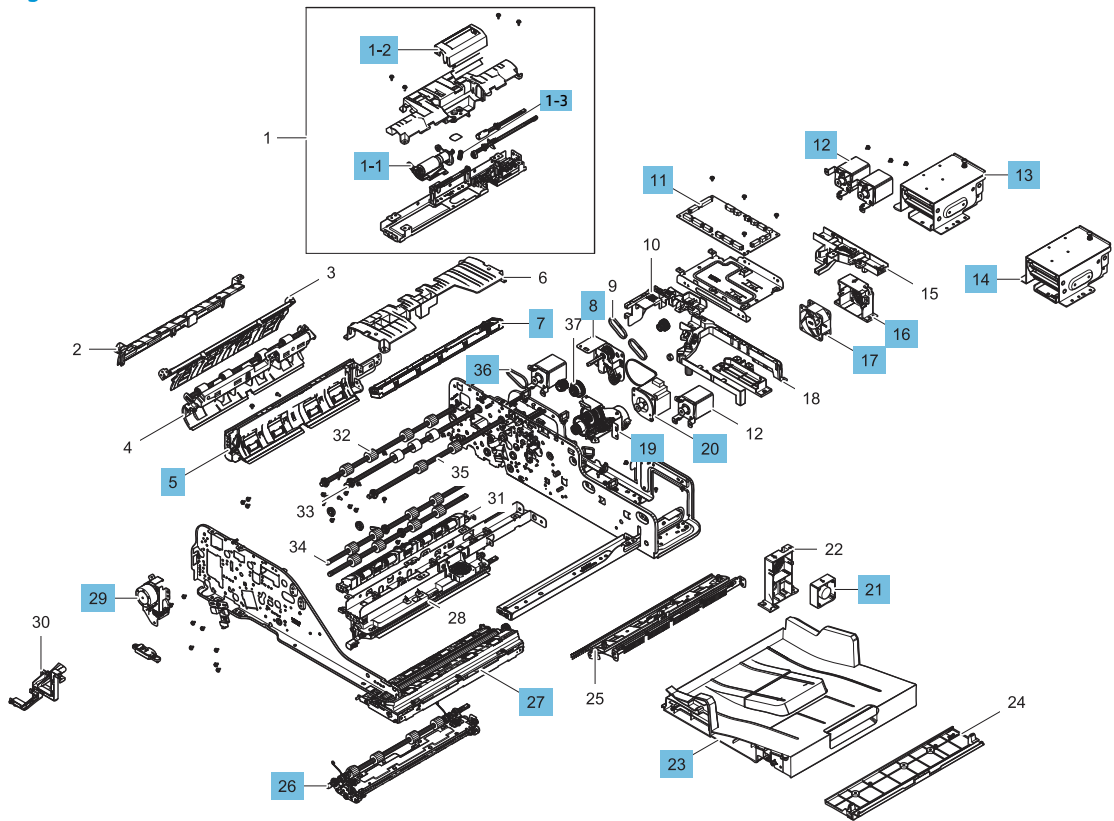

Table 2-84 ADF main frame (GX/z)

Ref				
No	Part number	Description	Qty	Repair procedure
1-1	JC97-04915A	GX Separation Roller Assy	1	Removal and replacement: ADF separation roller assembly (GX) on page 483
1-2	JC97-04652A	GX ADF - Separation Roller Cover	1	Not applicable
1-3	JC61-08235A	Spring CS	1	Not applicable
5	JC97-04656B	GX ADF scan in lower	1	Not applicable
7	0605-001246	Contact Image Sensor (CIS) assembly	1	Not applicable
8	JC97-04681A	GX ADF, pickup release drive	1	Removal and replacement: Document feeder rear motors (GX) on page 503
11	JC92-02964A	GX ADF, PCA	1	Removal and replacement: PCA-ADF HIC (GX) on page 526
12	JC97-04680A	GX ADF, feed drive motor	4	Removal and replacement: Document feeder rear motors (GX) on page 503
13	JC97-04640A	GX ADF, hinge L	1	Not applicable
14	JC97-04641A	GX ADF, hinge R	1	Not applicable
16	JC61-07694A	GX Fan motor housing	1	Not applicable
17	JC31-00168A	Fan, ADF CIS	1	Removal and replacement: Document feeder contact image sensor (CIS) fan (GX) on page 515
19	JC97-04679A	GX ADF, lift drive	1	Removal and replacement: Document feeder rear motors (GX) on page 503
20	JC31-00177A	GX Step motor, ip	1	Removal and replacement: Document feeder front motor (GX) on page 499
21	JC31-00146A	Fan type 4, ADF PCA (GX)	1	Removal and replacement: Document feeder PCA fan (GX) on page 512
23	JC97-04668B	GX ADF - Input Tray	1	Not applicable
26	JC97-04687A	GX ADF, white simplex roller	1	Not applicable
27	JC97-04830A	GX ADF scan out	1	Not applicable
29	JC97-04682A	GX ADF - Motor Drive Release Scan	1	Not applicable
36	6602-001730	Timing belt, gear	3	Not applicable
Not shown	JC92-02965A	PCA - ADF HIC (GX only)	1	Removal and replacement: Flow ADF ultrasonic sensor with PCA (GX) on page 518

Table 2-84 ADF main frame (GX/z) (continued)

Ref				
No	Part number	Description	Qty	Repair procedure
Not shown	JC92-02967A	PCA - ADF Receiver (GX only)	1	Removal and replacement: Flow ADF ultrasonic sensor with PCA (GX) on page 518
Not shown	JC92-02966A	PCA - ADF Transmitter (GX only)	1	Removal and replacement: Flow ADF ultrasonic sensor with PCA (GX) on page 518

Removal and replacement: Removal and replacement: Document feeder front motor (GX)

This document provides the procedures to remove the front motor assembly.



[View a video of removing and replacing the motor \(E77820-E77830\).](#)

Mean time to repair: 25 minutes

Service level: Advanced



IMPORTANT: When applicable, special installation instructions are provided for an assembly at the end of the removal procedure. Always completely read the removal instructions and follow all special installation instructions.

Before performing service

- Disconnect the power cable.

Use the table below to identify the correct part number for your printer. To order the part, go to www.hp.com/buy/parts

Table 2-85 Part information

Part number	Part description
JC31-00177A	Front motor assembly

Required tools

- #2 JIS screwdriver with a magnetic tip

After performing service

Turn the printer power on

- Connect the power cable.
- Use the power switch to turn the power on.

Post service test

Copy, scan, or print a document. Verify the document copies, scans, or prints correctly.

Remove the document feeder back cover

Follow these steps to remove the document feeder back cover.

1. Remove two screws from the top of document feeder back cover.

Figure 2-385 Remove the document feeder back cover top screws

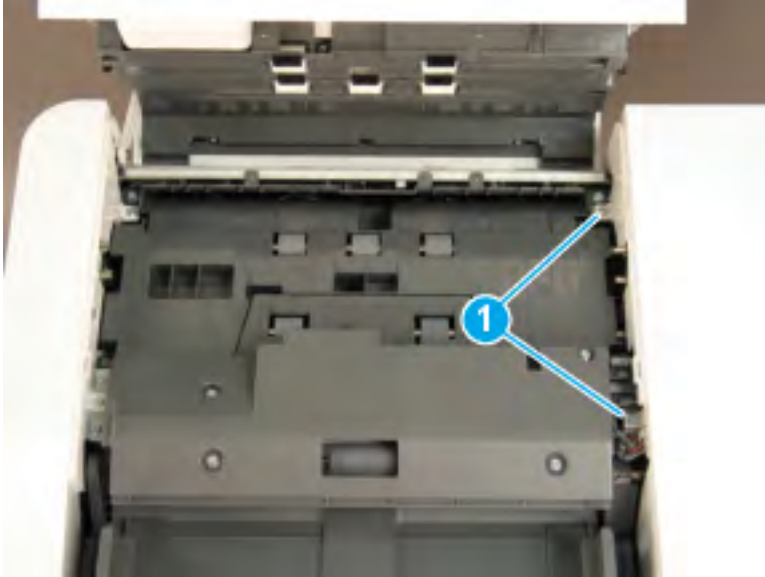

2. Remove three screws from the bottom of the document feeder back cover, and then remove the document feeder back cover.

Figure 2-386 Remove the document feeder back cover bottom screws



Remove the front motor

Follow these steps to remove the front motor.

- ▲ Remove two screws and disconnect one connector, and then remove the motor.

 **Reinstallation tip:**

- a. Reinstall the motor and lift the gear belt up to engage the motor pulley.
 - b. Loosely install the motor mount screws.
 - c. Install the tension spring.
 - d. Tighten the motor mount screws just enough so that the tension spring (not the motor mount screws) is providing the tension to the belt.
-

Figure 2-387 Remove the document feeder front motor

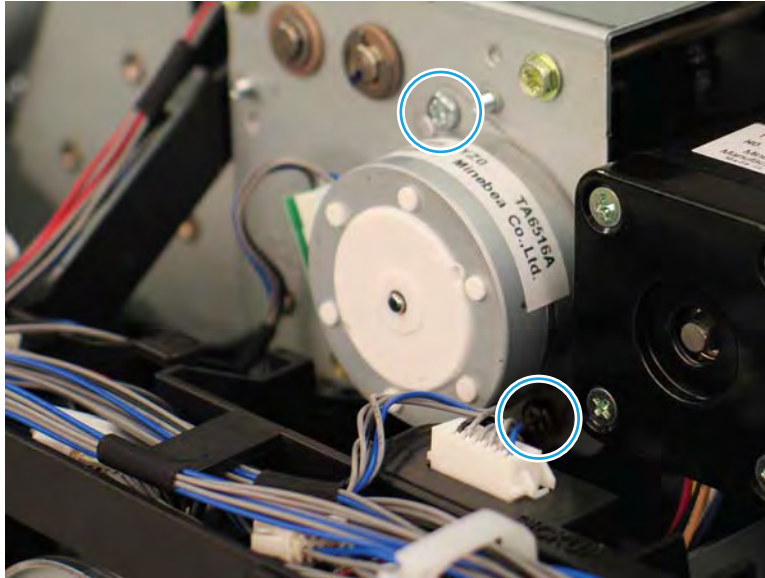

Unpack the replacement assembly

Follow these steps to unpack the replacement assembly.

1. Dispose of the defective part.

 **NOTE:** HP recommends responsible disposal of the defective part.

<http://www8.hp.com/us/en/hp-information/environment/product-recycling.html>

2. Unpack the replacement part from the packaging.



CAUTION:  Some parts are sensitive to electrostatic discharge (ESD). Always perform service work at an ESD-protected workstation or mat. If an ESD workstation or mat is not available, touch the sheet-metal chassis to provide a static ground before touching an ESD-sensitive assembly. Protect the ESD-sensitive assemblies by placing them in ESD pouches when they are out of the printer.

 **IMPORTANT:** Make sure that all of the shipping materials (for example shipping tape) are removed from the replacement part prior to installation.

 **NOTE:** If the replacement part is a roller or pad, avoid touching the spongy part of it. Skin oils on the roller or pad can cause paper pickup and/or print-quality problems. HP recommends using disposable gloves when handling rollers or pads or washing your hands before touching rollers or pads.

3. To install an assembly, reverse the removal steps.

 **NOTE:** When applicable, special installation instructions are provided for an assembly at the end of the removal procedure. Always completely read the removal instructions and follow all special installation instructions.

Removal and replacement: Document feeder rear motors (GX)

This document provides the procedures to remove the rear motor assemblies.



[View a video of removing and replacing the motors \(E72520-E72530\).](#)



[View a video of removing and replacing the motors \(E77820-E77830\).](#)

Mean time to repair: 15 minutes

Service level: Intermediate



IMPORTANT: When applicable, special installation instructions are provided for an assembly at the end of the removal procedure. Always completely read the removal instructions and follow all special installation instructions.

Before performing service

- Disconnect the power cable.

Use the table below to identify the correct part number for your printer. To order the part, go to www.hp.com/buy/parts

Table 2-86 Part information

Part number	Part description
JC97-04679A	Motor 1 - Flow ADF drive
JC97-04681A	Motor 2 -Flow ADF drive release pickup
JC97-04680A	Pickup motor
C97-04680A	Pre_REGI motor
JC97-04680A	Exit motor
JC97-04680A	Feed motor
JC31-00177A	REGI motor

Required tools

- #2 JIS screwdriver with a magnetic tip

After performing service

Turn the printer power on

- Connect the power cable.
- Use the power switch to turn the power on.

Post service test

Copy, scan, or print a document. Verify the document copies, scans, or prints correctly.

Identify the document feeder motors

Follow these steps to identify the document feeder motors.

- ▲ Use the figure below to locate the motor.

Figure 2-388 Document feeder motors identification

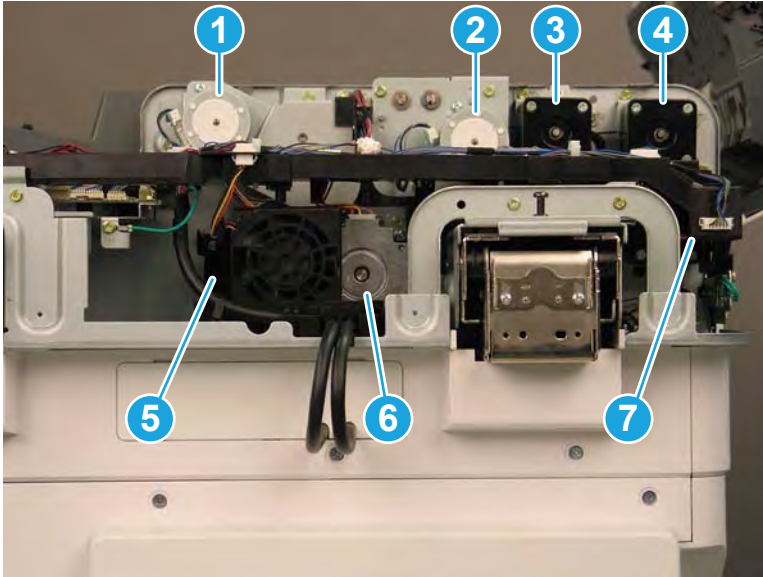

Callout	Description
1	Motor 1
2	Motor 2
3	Pickup motor
4	Pre-REGI motor
5	Exit motor
6	Feed motor
7	REGI motor

Remove the document feeder back cover

Follow these steps to remove the document feeder back cover.

1. Remove two screws from the top of document feeder back cover.

Figure 2-389 Remove the document feeder back cover top screws

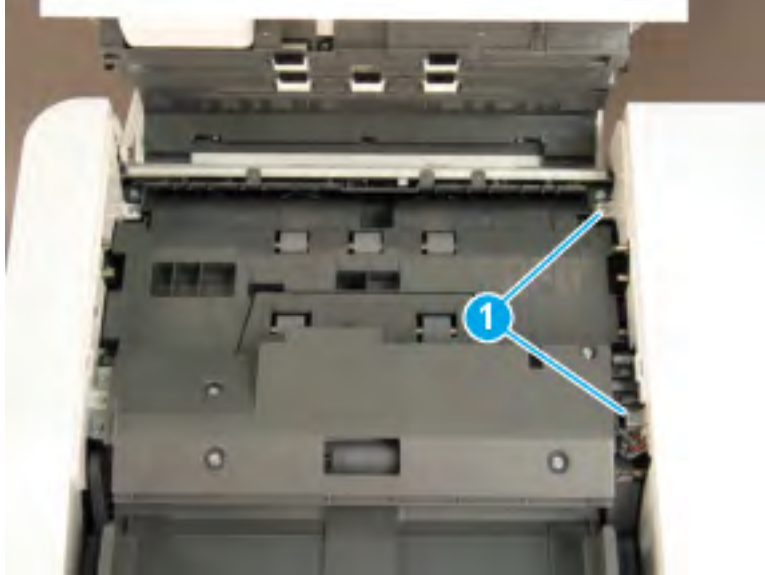

2. Remove three screws from the bottom of the document feeder back cover, and then remove the document feeder back cover.

Figure 2-390 Remove the document feeder back cover bottom screws



Remove motors 1 and 2

Follow these steps to remove motors 1 and 2.

- ▲ Remove two screws and one connector, and then remove the motor.

 **Reinstallation tip:** Reinstall the motor and lift the gear belt up to engage the motor pulley.

Figure 2-391 Remove the motor



Remove the pickup and pre-REGI motors

Follow these steps to remove the pickup and pre-REGI motors.

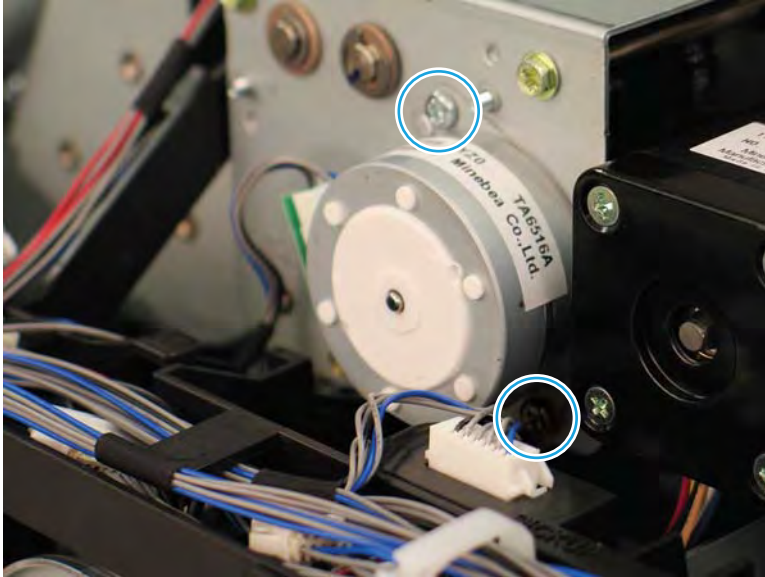
1. Loosen the cable retainer, and then disconnect one connector from the motor.

 **TIP:** Remove the connector harness from the retainer, and then disconnect the connector.

Figure 2-392 Disconnect one connector

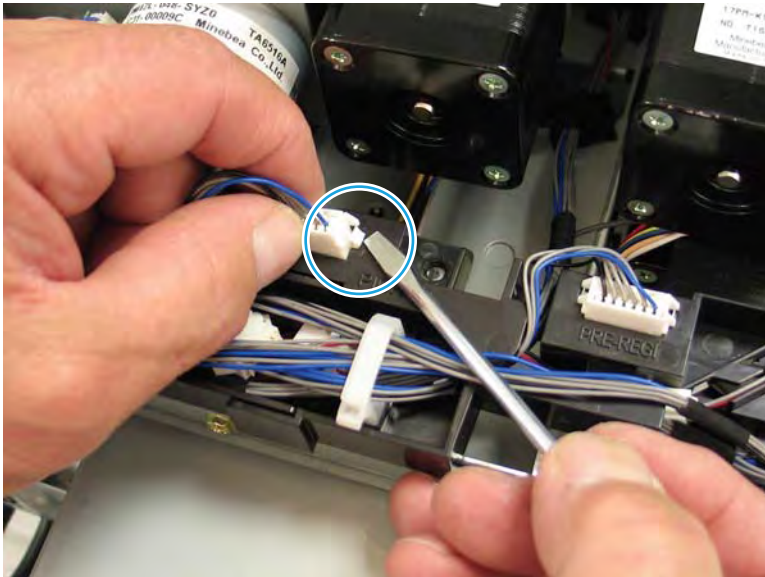

2. Remove one spring (callout 1), and then loosen (but do not remove) three screws. Slide the pickup motor off the screws to remove it.

 **NOTE:**

- Reinstall the motor on the motor mounting screws, and then lift the gear belt up to engage the motor pulley.
 - Install the tension spring.
 - Tighten the motor mount screws just enough so that the tension spring (not the motor mount screws) is providing the tension to the belt.
-

Figure 2-393 Pickup motor

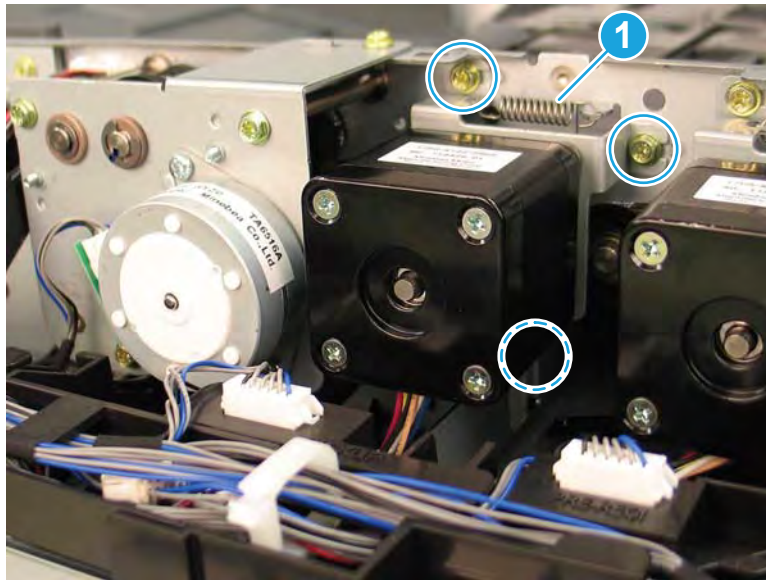

3. Remove one spring (callout 1), and then loosen (but do not remove) three screws. Slide the pre-REGI motor off the screws to remove it.

 **NOTE:**

- Reinstall the motor on the motor mounting screws, and then lift the gear belt up to engage the motor pulley.
 - Install the tension spring.
 - Tighten the motor mount screws just enough so that the tension spring (not the motor mount screws) is providing the tension to the belt.
-

Figure 2-394 Pre-REGI motor

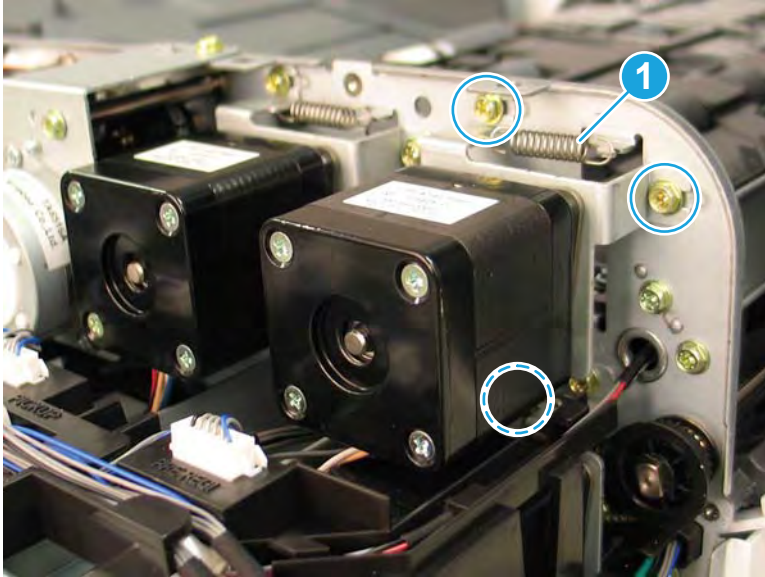

Remove the exit motor

Follow these steps to remove the exit motor.

1. Remove two screws and one connector, and then remove the CIS fan.

Figure 2-395 Remove the main fan

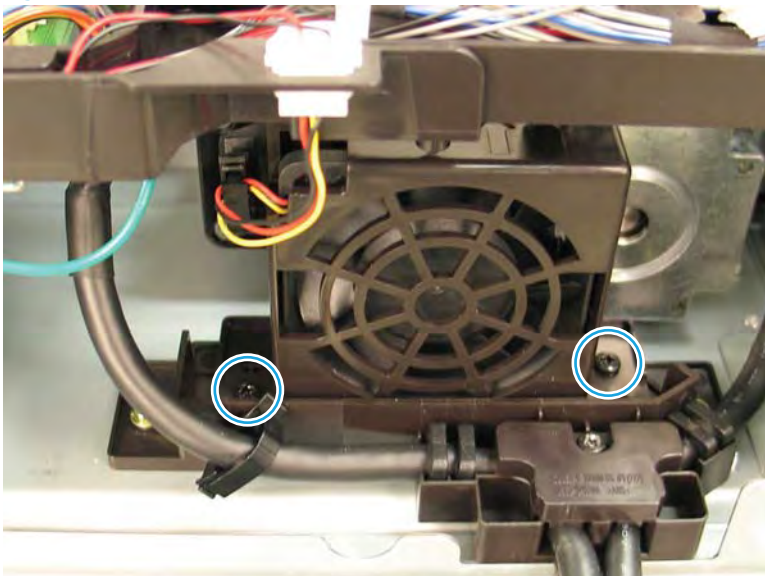

2. Remove the spring (callout 1), disconnect one connector (callout 2), loosen three screws, and then remove the exit motor.

 **Reinstallation tip:**

- a. Reinstall the motor and lift the gear belt up to engage the motor pulley.
- b. Install the tension spring.
- c. Tighten the motor mount screws just enough so that the tension spring (not the motor mount screws) is providing the tension to the belt.

Figure 2-396 Remove the motor

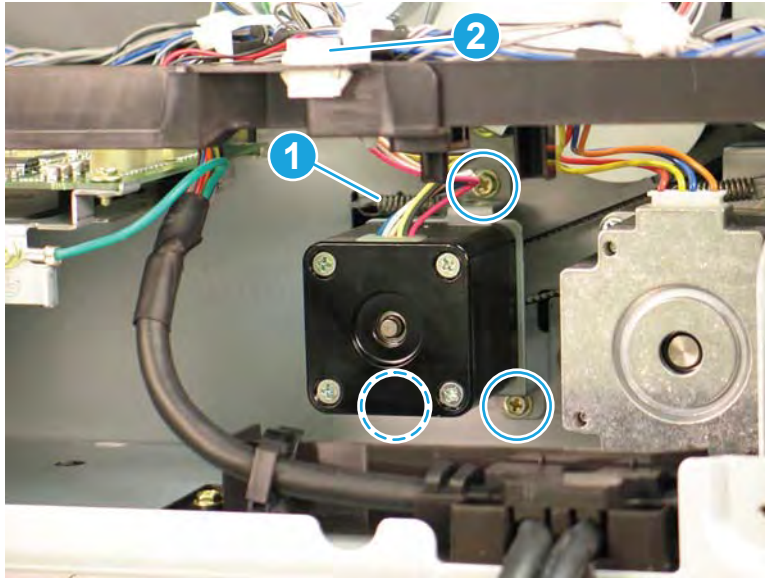

Remove the feed motor

Follow these steps to remove the feed motor.

1. Disconnect one connector (callout 1).

Figure 2-397 Disconnect one connector

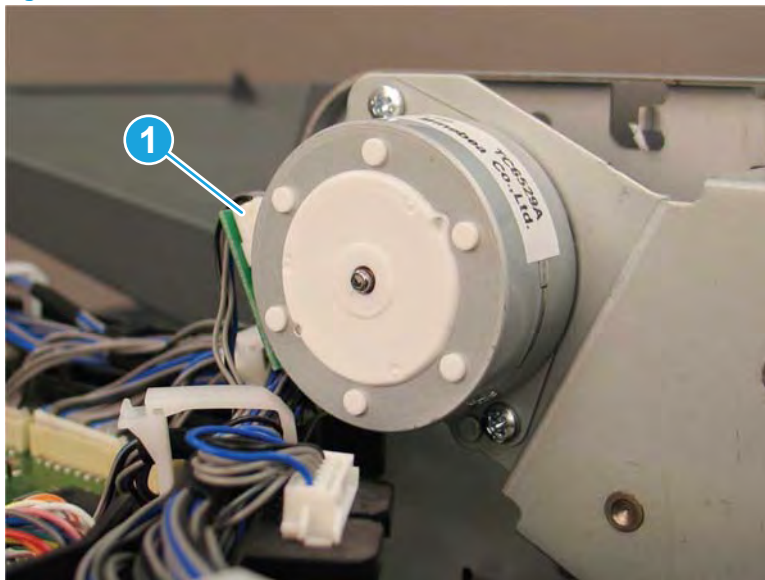

2. Remove two screws, and then remove motor.

Figure 2-398 Remove the motor

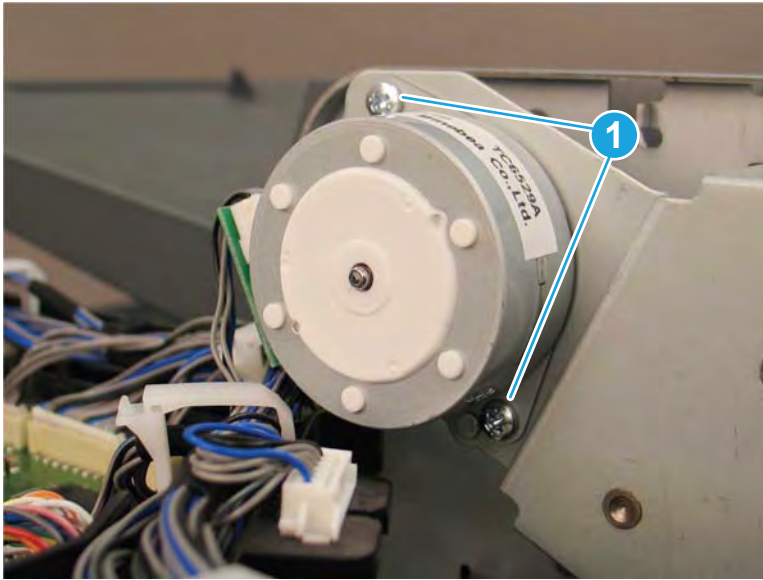

Remove the REGI motor

Follow these steps to remove the REGI motor.

1. Remove the rear cover.
2. Remove the Pre-REGI motor.
3. Disconnect one connector from the motor.

💡 **TIP:** Remove the connector harness from the cable retainer, and then disconnect the connector.

4. Remove one spring, loosen (do not remove) 3 screws, and then slide the motor off the screws to remove it.

💡 **Reinstallation tip:**

- a. Reinstall the motor and lift the gear belt up to engage the motor pulley.
 - b. Install the tension spring.
 - c. Tighten the motor mount screws just enough so that the tension spring (not the motor mount screws) is providing the tension to the belt.
-

Unpack the replacement assembly

Follow these steps to unpack the replacement assembly.

1. Dispose of the defective part.

 **NOTE:** HP recommends responsible disposal of the defective part.

<http://www8.hp.com/us/en/hp-information/environment/product-recycling.html>

2. Unpack the replacement part from the packaging.



CAUTION:  Some parts are sensitive to electrostatic discharge (ESD). Always perform service work at an ESD-protected workstation or mat. If an ESD workstation or mat is not available, touch the sheet-metal chassis to provide a static ground before touching an ESD-sensitive assembly. Protect the ESD-sensitive assemblies by placing them in ESD pouches when they are out of the printer.

 **IMPORTANT:** Make sure that all of the shipping materials (for example shipping tape) are removed from the replacement part prior to installation.

 **NOTE:** If the replacement part is a roller or pad, avoid touching the spongy part of it. Skin oils on the roller or pad can cause paper pickup and/or print-quality problems. HP recommends using disposable gloves when handling rollers or pads or washing your hands before touching rollers or pads.

3. To install an assembly, reverse the removal steps.

 **NOTE:** When applicable, special installation instructions are provided for an assembly at the end of the removal procedure. Always completely read the removal instructions and follow all special installation instructions.

Removal and replacement: Document feeder PCA fan (GX)

This document provides the procedures to remove the document feeder PCA fan assembly.



[View a video of removing and replacing the fan \(E77820-E77830\).](#)

Mean time to repair: 15 minutes

Service level: Intermediate



IMPORTANT: When applicable, special installation instructions are provided for an assembly at the end of the removal procedure. Always completely read the removal instructions and follow all special installation instructions.

Before performing service

- Disconnect the power cable.

Use the table below to identify the correct part number for your printer. To order the part, go to www.hp.com/buy/parts

Table 2-87 Part information

Part number	Part description
JC31-00146A	Document feeder PCA fan assembly

Required tools

- #2 JIS screwdriver with a magnetic tip

After performing service

Turn the printer power on

- Connect the power cable.
- Use the power switch to turn the power on.

Post service test

Copy, scan, or print a document. Verify the document copies, scans, or prints correctly.

Remove the document feeder back cover

Follow these steps to remove the document feeder back cover.

1. Remove two screws from the top of document feeder back cover.

Figure 2-399 Remove the document feeder back cover top screws

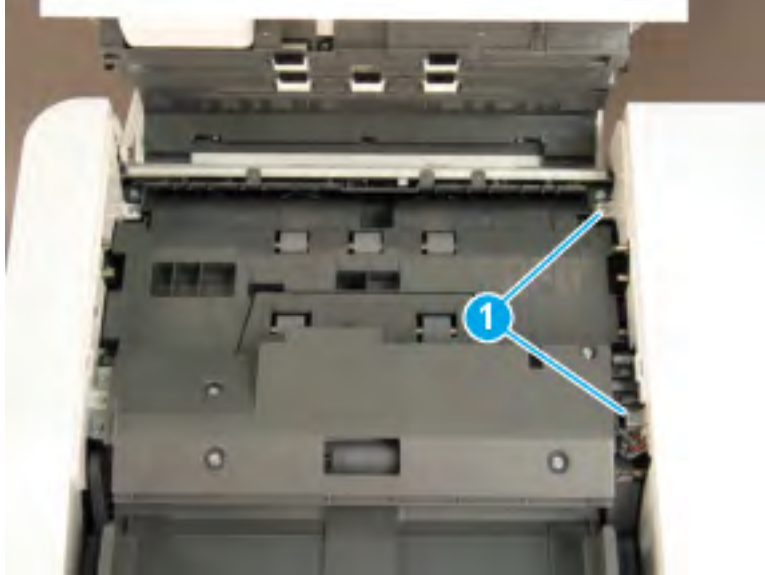

2. Remove three screws from the bottom of the document feeder back cover, and then remove the document feeder back cover.

Figure 2-400 Remove the document feeder back cover bottom screws



Remove the document feeder PCA fan

Follow these steps to remove the document feeder PCA fan.

- ▲ Disconnect one connector (callout 1) and then release two tabs (callout 2) to remove the fan.

 **Reinstallation tip:** Install the fan with the correct orientation when reinstalling.

Figure 2-401 Remove the document feeder PCA fan connector



Unpack the replacement assembly

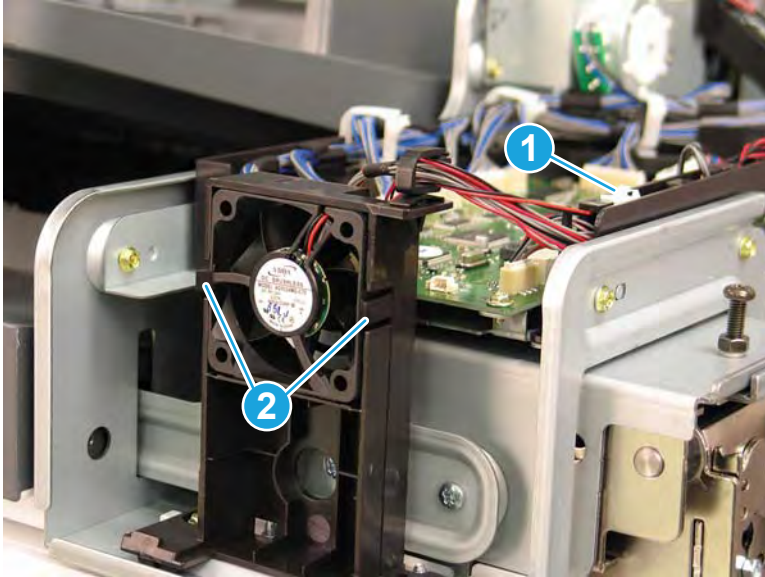

Follow these steps to unpack the replacement assembly.

1. Dispose of the defective part.

 **NOTE:** HP recommends responsible disposal of the defective part.

<http://www8.hp.com/us/en/hp-information/environment/product-recycling.html>

2. Unpack the replacement part from the packaging.

 **CAUTION:**  Some parts are sensitive to electrostatic discharge (ESD). Always perform service work at an ESD-protected workstation or mat. If an ESD workstation or mat is not available, touch the sheet-metal chassis to provide a static ground before touching an ESD-sensitive assembly. Protect the ESD-sensitive assemblies by placing them in ESD pouches when they are out of the printer.

 **IMPORTANT:** Make sure that all of the shipping materials (for example shipping tape) are removed from the replacement part prior to installation.

 **NOTE:** If the replacement part is a roller or pad, avoid touching the spongy part of it. Skin oils on the roller or pad can cause paper pickup and/or print-quality problems. HP recommends using disposable gloves when handling rollers or pads or washing your hands before touching rollers or pads.

3. To install an assembly, reverse the removal steps.

 **NOTE:** When applicable, special installation instructions are provided for an assembly at the end of the removal procedure. Always completely read the removal instructions and follow all special installation instructions.

Removal and replacement: Document feeder contact image sensor (CIS) fan (GX)

This document provides the procedures to remove the CIS fan assembly.



[View a video of removing and replacing the fan \(E77820-E77830\).](#)

Mean time to repair: 20 minutes

Service level: Intermediate



IMPORTANT: When applicable, special installation instructions are provided for an assembly at the end of the removal procedure. Always completely read the removal instructions and follow all special installation instructions.

Before performing service

- Disconnect the power cable.

Use the table below to identify the correct part number for your printer. To order the part, go to www.hp.com/buy/parts

Table 2-88 Part information

Part number	Part description
JC31-00168A	CIS fan

Required tools

- #2 JIS screwdriver with a magnetic tip

After performing service

Turn the printer power on

- Connect the power cable.
- Use the power switch to turn the power on.

Post service test

Copy, scan, or print a document. Verify the document copies, scans, or prints correctly.

Remove the document feeder back cover

Follow these steps to remove the document feeder back cover.

1. Remove two screws from the top of document feeder back cover.

Figure 2-402 Remove the document feeder back cover top screws

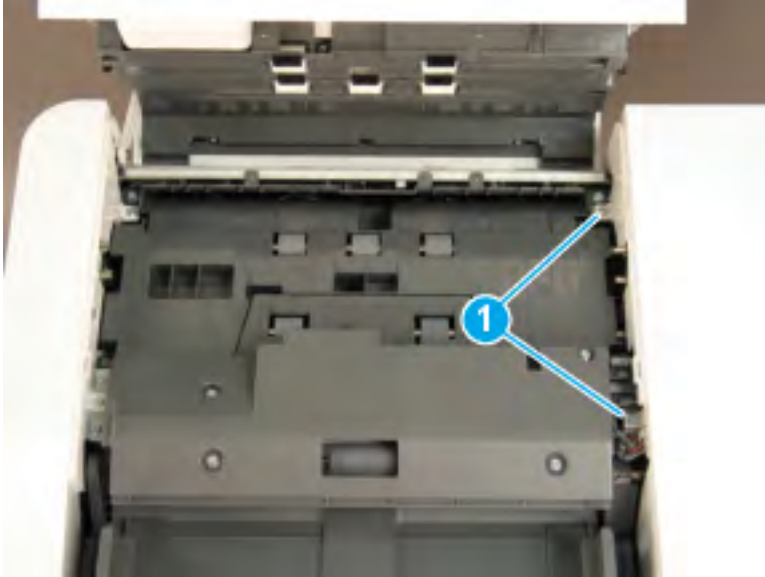

2. Remove three screws from the bottom of the document feeder back cover, and then remove the document feeder back cover.

Figure 2-403 Remove the document feeder back cover bottom screws



Remove the document feeder CIS fan

Follow these steps to remove the document feeder CIS fan.

- ▲ Remove one connector, and then remove two mounting screws to remove the fan.

Figure 2-404 Remove the document feeder CIS fan

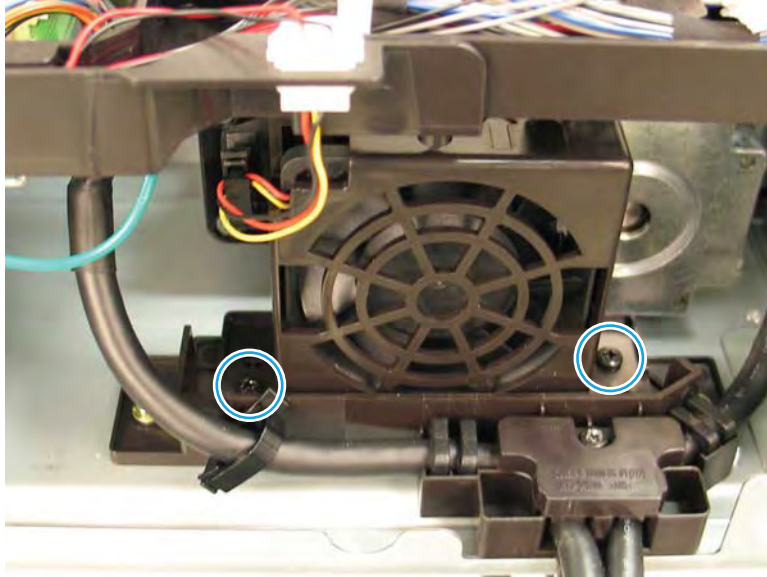

Unpack the replacement assembly



Follow these steps to unpack the replacement assembly.

1. Dispose of the defective part.

 **NOTE:** HP recommends responsible disposal of the defective part.

<http://www8.hp.com/us/en/hp-information/environment/product-recycling.html>

2. Unpack the replacement part from the packaging.

 **CAUTION:**  Some parts are sensitive to electrostatic discharge (ESD). Always perform service work at an ESD-protected workstation or mat. If an ESD workstation or mat is not available, touch the sheet-metal chassis to provide a static ground before touching an ESD-sensitive assembly. Protect the ESD-sensitive assemblies by placing them in ESD pouches when they are out of the printer.

 **IMPORTANT:** Make sure that all of the shipping materials (for example shipping tape) are removed from the replacement part prior to installation.

 **NOTE:** If the replacement part is a roller or pad, avoid touching the spongy part of it. Skin oils on the roller or pad can cause paper pickup and/or print-quality problems. HP recommends using disposable gloves when handling rollers or pads or washing your hands before touching rollers or pads.

3. To install an assembly, reverse the removal steps.

 **NOTE:** When applicable, special installation instructions are provided for an assembly at the end of the removal procedure. Always completely read the removal instructions and follow all special installation instructions.

Removal and replacement: Flow ADF ultrasonic sensor with PCA (GX)

This document provides the procedures to remove the ultrasonic sensor with PCA assembly.



[View a video of removing and replacing the sensor \(E72520-E72530\).](#)

E77820-E77830:

Mean time to repair: 15 minutes

Service level: Intermediate



IMPORTANT: When applicable, special installation instructions are provided for an assembly at the end of the removal procedure. Always completely read the removal instructions and follow all special installation instructions.

Before performing service

- Disconnect the power cable.

Use the table below to identify the correct part number for your printer. To order the part, go to www.hp.com/buy/parts

Table 2-89 Part information

Part number	Part description
JC92-02965A	PCA- ADF HIC (GX only)
JC92-02967A	PCA- ADF Receiver (GX only)
JC92-02966A	PCA- ADF Transmitter (GX only)

Required tools

- #2 JIS screwdriver with a magnetic tip

After performing service

Turn the printer power on

- Connect the power cable.
- Use the power switch to turn the power on.

Post service test

Copy, scan, or print a document. Verify the document copies, scans, or prints correctly.

Remove the document feeder (ADF) front cover

Follow these steps to remove the document feeder (ADF) front cover.

1. Remove two screws from the top of document feeder front cover.

Figure 2-405 Remove the document feeder front cover top screws



2. Open the document feeder. Detach a sticker and then remove a screw (Callout 1) from the bottom of the document feeder front cover.

Figure 2-406 Open the document feeder

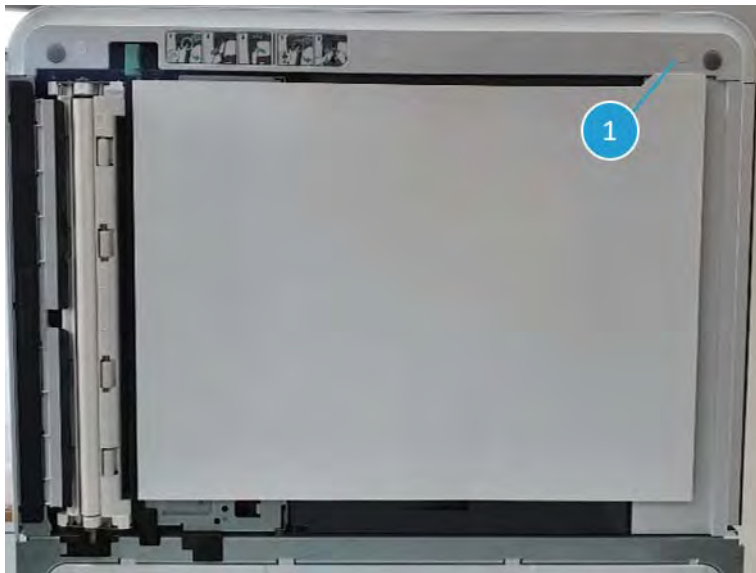

3. Remove the document feeder front cover.

Figure 2-407 Remove the document feeder front cover



Remove the document feeder back cover

Follow these steps to remove the document feeder back cover.

1. Remove two screws from the top of document feeder back cover.

Figure 2-408 Remove the document feeder back cover top screws

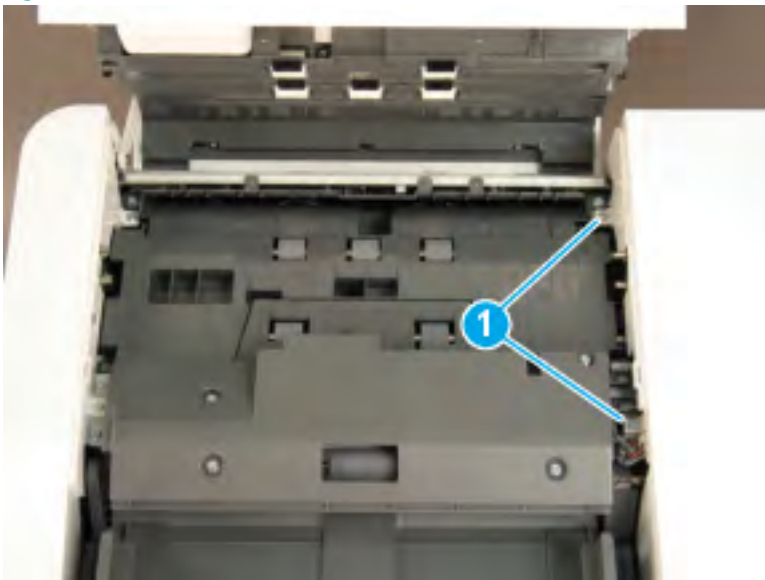

2. Remove three screws from the bottom of the document feeder back cover, and then remove the document feeder back cover.

Figure 2-409 Remove the document feeder back cover bottom screws



Remove the document feeder pickup and feed assembly

Follow these steps to remove the document feeder pickup and feed assembly.

1. Remove 4 screws.

Figure 2-410 Remove 4 screws.

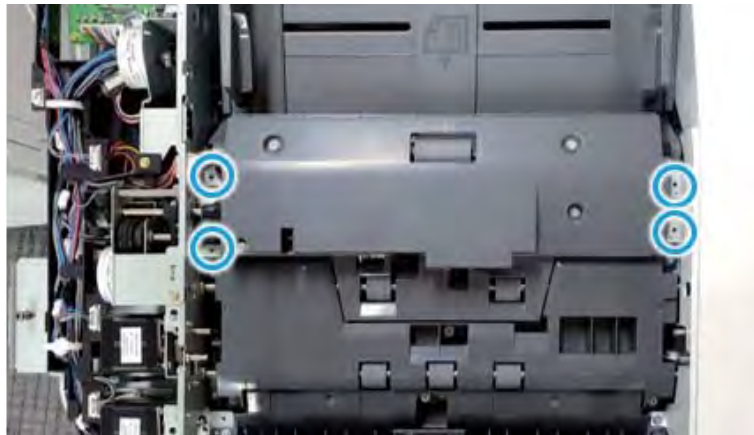

2. Remove 2 cables (callout 1) then remove the document feeder pickup roller assembly

Figure 2-411 Remove the pickup roller assembly



 **TIP:** Re-assembly

- Make sure shape of both the holes on the assembly and the shafts at the frame.

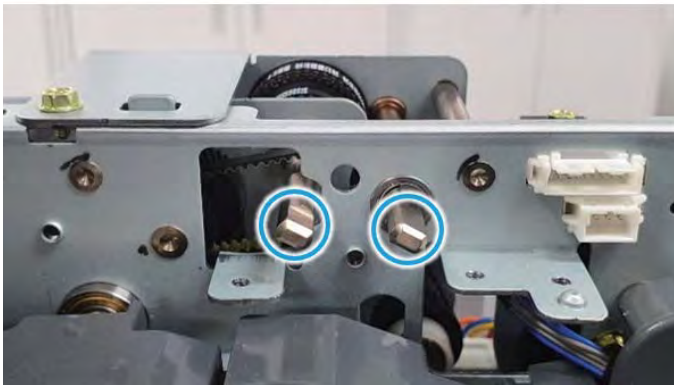

Remove the document feeder paper path cover

Follow these steps to remove the document feeder paper path cover.

- ▲ Remove five screws, and then remove the paper path cover.

Figure 2-412 Remove the document feeder paper path cover

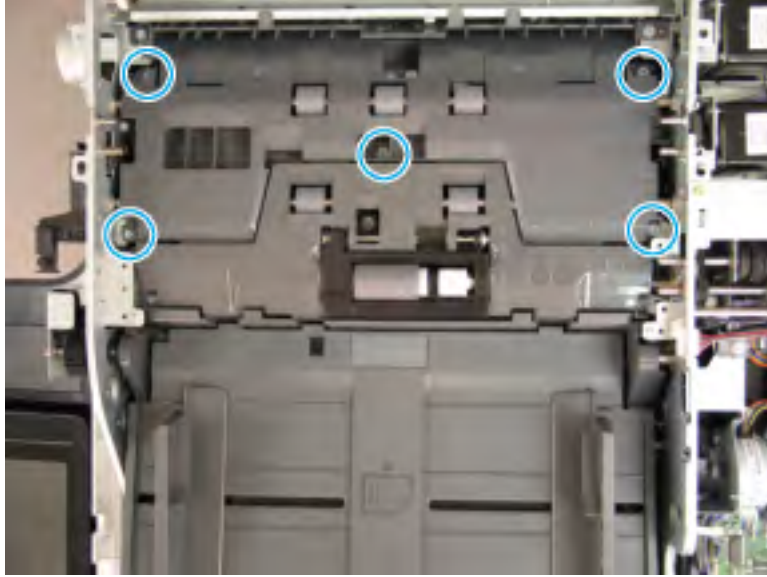

Remove the ultrasonic sensor with PCA

Follow these steps to remove the ultrasonic sensor with PCA.

1. Remove the separation roller, and then remove one screw (callout 1).

Figure 2-413 Remove one screw

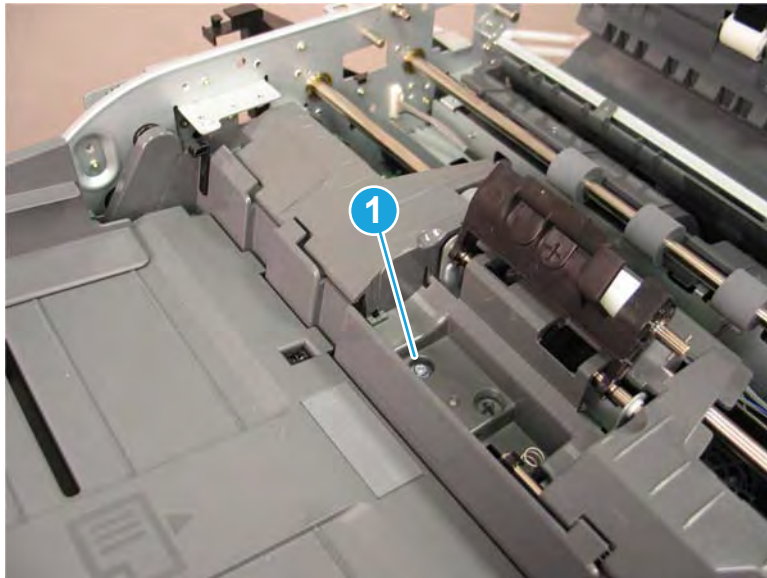

2. Remove the pick/feed cover.

Figure 2-414 Remove the pick/feed cover

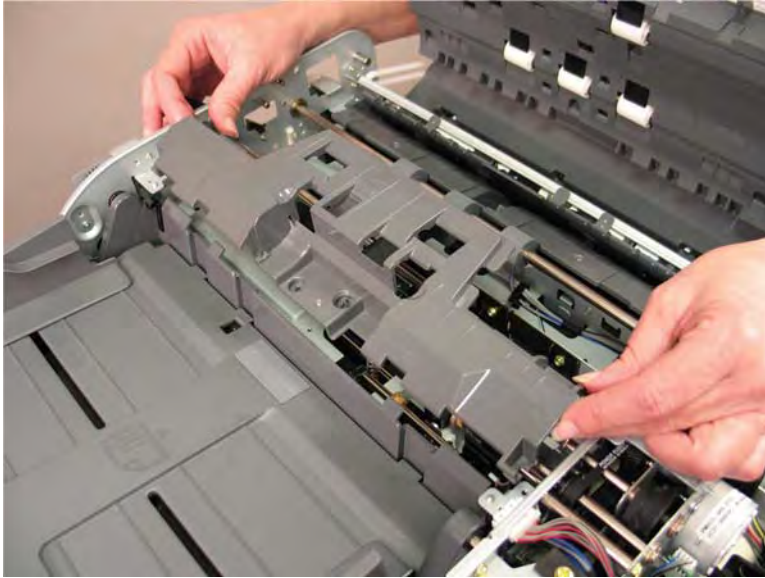

3. Remove two screws (callout 1), and then remove the ultrasonic sensor.

Figure 2-415 Remove the ultrasonic sensor

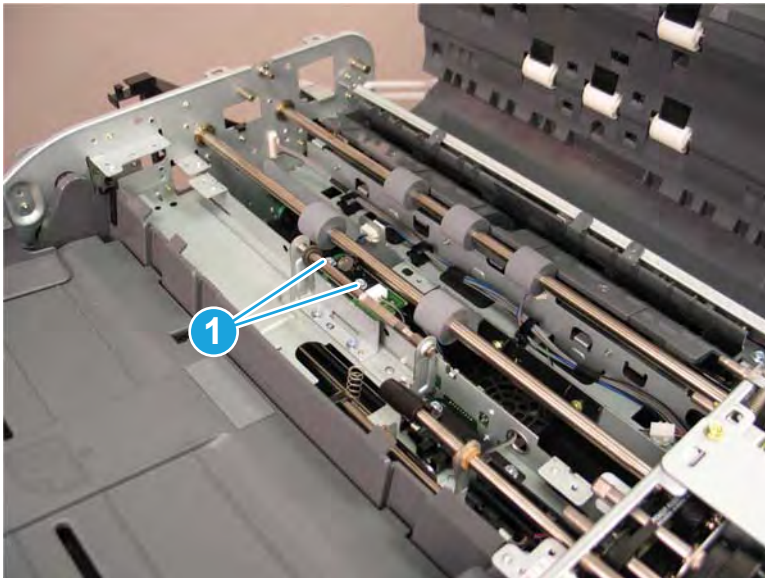

Unpack the replacement assembly

Follow these steps to unpack the replacement assembly.

1. Dispose of the defective part.

 **NOTE:** HP recommends responsible disposal of the defective part.

<http://www8.hp.com/us/en/hp-information/environment/product-recycling.html>

2. Unpack the replacement part from the packaging.



CAUTION:  Some parts are sensitive to electrostatic discharge (ESD). Always perform service work at an ESD-protected workstation or mat. If an ESD workstation or mat is not available, touch the sheet-metal chassis to provide a static ground before touching an ESD-sensitive assembly. Protect the ESD-sensitive assemblies by placing them in ESD pouches when they are out of the printer.

 **IMPORTANT:** Make sure that all of the shipping materials (for example shipping tape) are removed from the replacement part prior to installation.

 **NOTE:** If the replacement part is a roller or pad, avoid touching the spongy part of it. Skin oils on the roller or pad can cause paper pickup and/or print-quality problems. HP recommends using disposable gloves when handling rollers or pads or washing your hands before touching rollers or pads.

3. To install an assembly, reverse the removal steps.

 **NOTE:** When applicable, special installation instructions are provided for an assembly at the end of the removal procedure. Always completely read the removal instructions and follow all special installation instructions.

Removal and replacement: PCA-ADF HIC (GX)

This document provides the procedures to remove the document feeder PCA.



[View a video fo removing and replacing the PCA \(E72520-E72530\).](#)



[View a video fo removing and replacing the PCA \(E77820-E77830\).](#)

Mean time to repair: 15 minutes

Service level: Intermediate



IMPORTANT: When applicable, special installation instructions are provided for an assembly at the end of the removal procedure. Always completely read the removal instructions and follow all special installation instructions.

Before performing service

- Disconnect the power cable.

Use the table below to identify the correct part number for your printer. To order the part, go to www.hp.com/buy/parts

Table 2-90 Part information

Part number	Part description
JC92-02962A	Document feeder PCA assembly

Required tools

- #2 JIS screwdriver with a magnetic tip

After performing service

Turn the printer power on

- Connect the power cable.
- Use the power switch to turn the power on.

Post service test

Copy, scan, or print a document. Verify the document copies, scans, or prints correctly.

Remove the document feeder back cover

Follow these steps to remove the document feeder back cover.

1. Remove two screws from the top of document feeder back cover.

Figure 2-416 Remove the document feeder back cover top screws

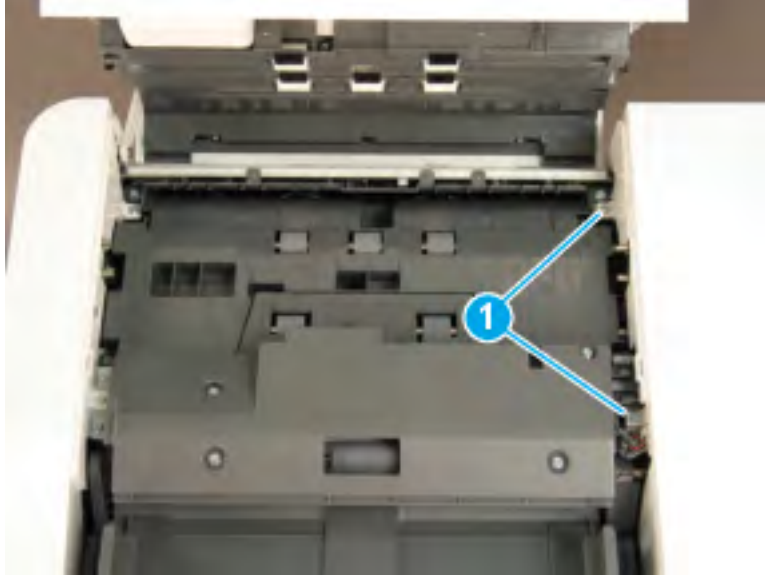

2. Remove three screws from the bottom of the document feeder back cover, and then remove the document feeder back cover.

Figure 2-417 Remove the document feeder back cover bottom screws



Remove the document feeder PCA

Follow these steps to remove the document feeder PCA.

1. Disconnect six connectors and the ground wire from PCA, and then remove four screws.

Figure 2-418 Document feeder PCA

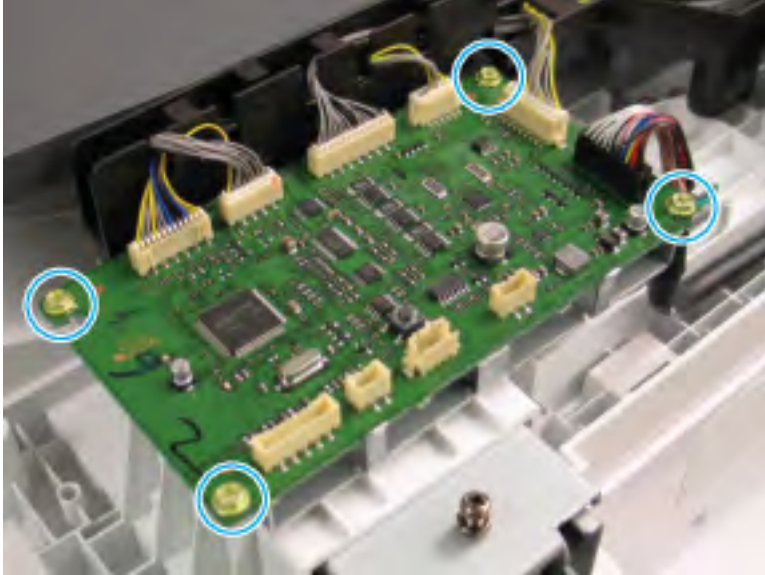

2. Remove the document feeder PCA.

Unpack the replacement assembly



Follow these steps to unpack the replacement assembly.

1. Dispose of the defective part.

 **NOTE:** HP recommends responsible disposal of the defective part.

<http://www8.hp.com/us/en/hp-information/environment/product-recycling.html>

2. Unpack the replacement part from the packaging.

 **CAUTION:**  Some parts are sensitive to electrostatic discharge (ESD). Always perform service work at an ESD-protected workstation or mat. If an ESD workstation or mat is not available, touch the sheet-metal chassis to provide a static ground before touching an ESD-sensitive assembly. Protect the ESD-sensitive assemblies by placing them in ESD pouches when they are out of the printer.

 **IMPORTANT:** Make sure that all of the shipping materials (for example shipping tape) are removed from the replacement part prior to installation.

 **NOTE:** If the replacement part is a roller or pad, avoid touching the spongy part of it. Skin oils on the roller or pad can cause paper pickup and/or print-quality problems. HP recommends using disposable gloves when handling rollers or pads or washing your hands before touching rollers or pads.

3. To install an assembly, reverse the removal steps.

 **NOTE:** When applicable, special installation instructions are provided for an assembly at the end of the removal procedure. Always completely read the removal instructions and follow all special installation instructions.

Image scanner

View the image scanner exploded view, parts list, and repair procedures.

Image scanner

Parts diagram and parts list for the image scanner.

Figure 2-419 Image scanner

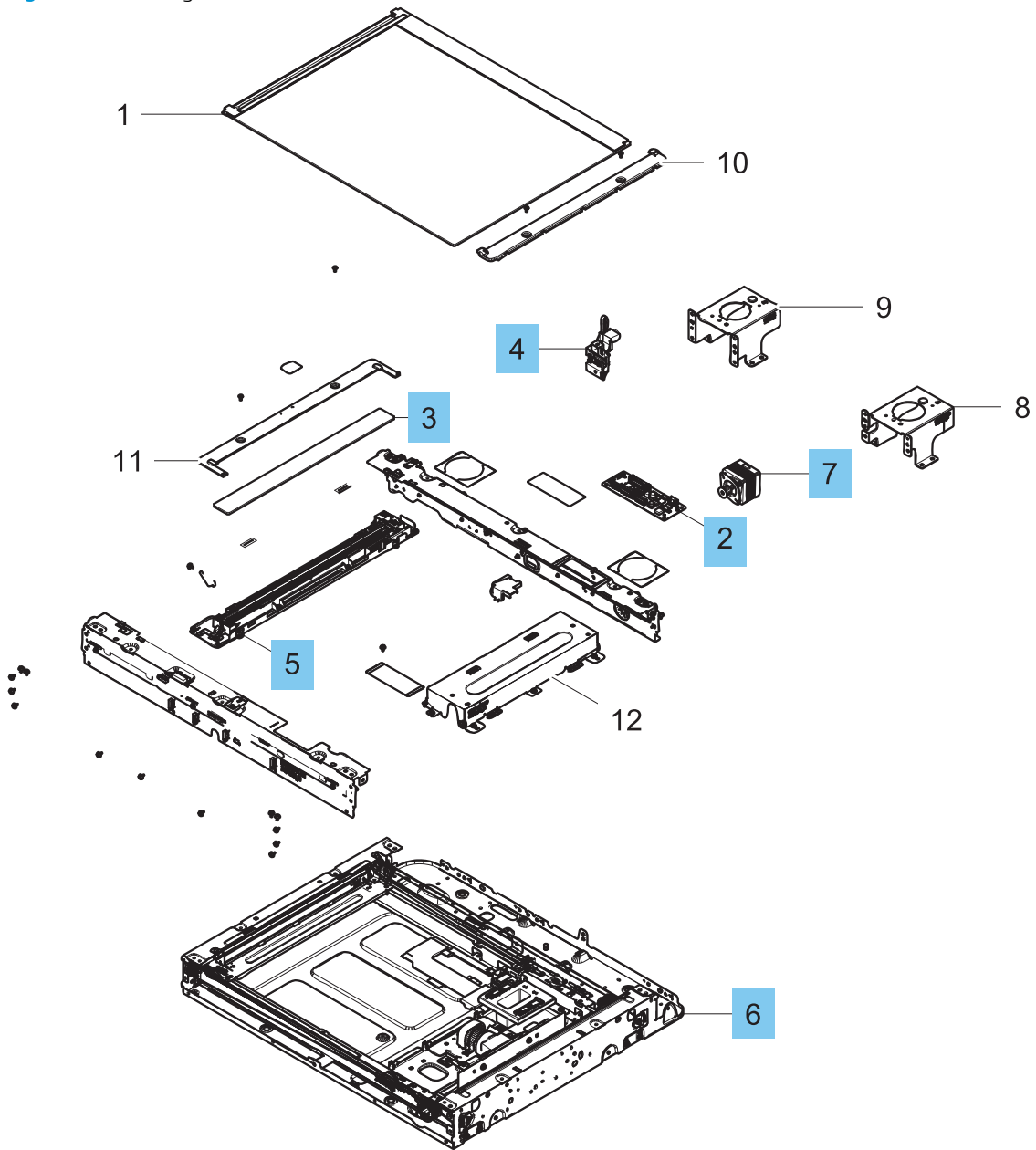

Table 2-91 Image scanner

Ref				
No	Part number	Description	Qty	Repair procedure
2	JC92-02781A	PCA - Scan Joint	1	Not applicable
3	JC01-00101A	SSA Tempered Glass	1	Not applicable
4	JC97-04516A	Image scanner open sensor	1	Not applicable
5	JC97-04521A	Scanner - FR Lamp	1	Not applicable
6	JC97-04515A	Image scanner, lower	1	Not applicable
7	JC31-00158A	Step motor, ip	1	Not applicable

Image scanner assembly

View the image scanner assembly exploded view, parts list, and repair procedures.

Image scanner assembly

Parts diagram and parts list for the image scanner assembly.

Figure 2-420 Image scanner assembly

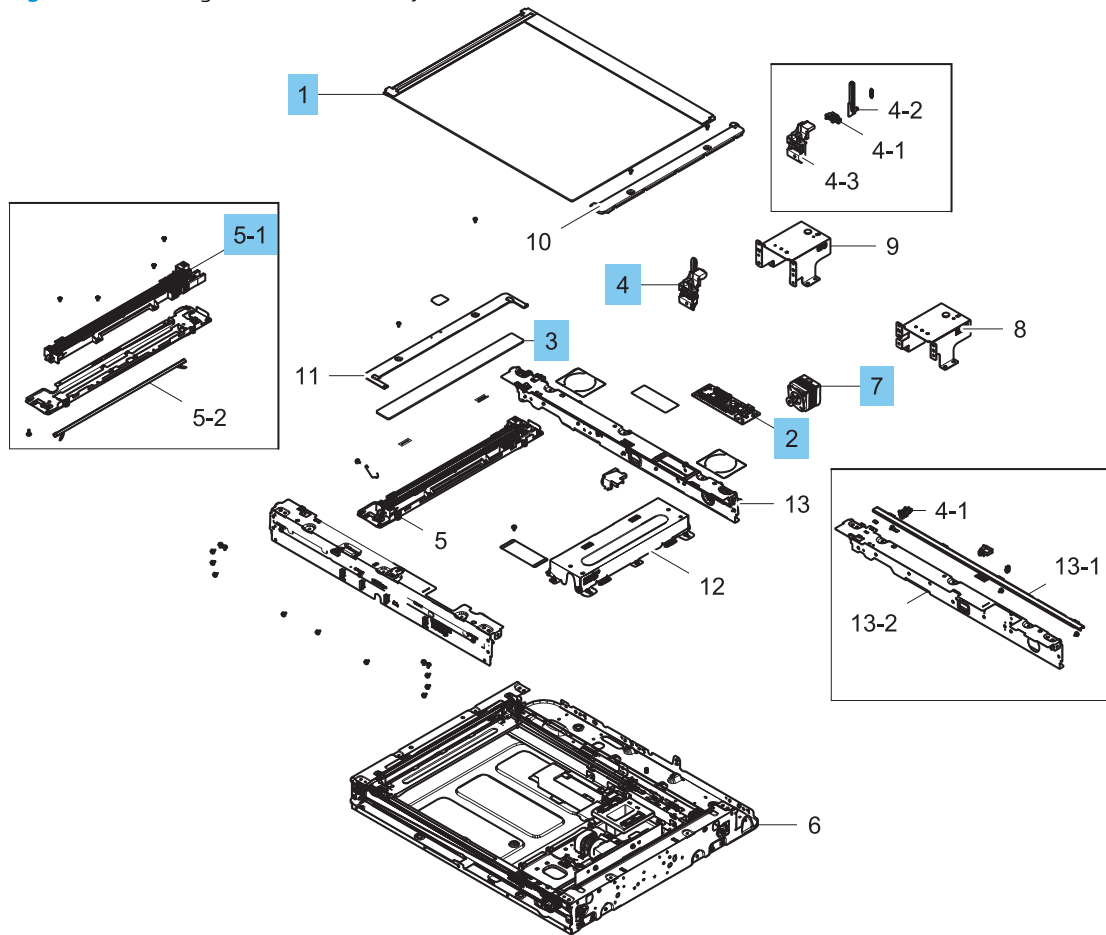



Table 2-92 Image scanner assembly

Ref				
No	Part number	Description	Qty	Repair procedure
1	JC97-04522B	Image scanner scan glass	1	Removal and replacement: Scan glass on page 536
2	JC92-02781A	PCA scanner	1	Not applicable
3	JC01-00101A	Tempered scan glass	1	Not applicable
4	JC97-04516A	Scanner assembly-DDC and lens	2	Not applicable
5-1	JC97-04521A	Image scanner lamp	1	HP LaserJet Managed MFP E72525-E72535, E77822-E77830 - Removal and replacement: Scanner LED lamp module on page 539
7	JC31-00158A	Step motor, ip	1	Not applicable

Removal and replacement: Scan glass

Learn how to remove and replace the scanner glass.

 **IMPORTANT:** When applicable, special installation instructions are provided for an assembly at the end of the removal procedure. Always completely read the removal instructions and follow all special installation instructions.

Mean time to repair:

Service level:

Before performing service

Turn the printer power off

- Press the power button on the front of the printer, and then turn off the power switch next to the power cable.
- A shutting-down message appears on the control-panel display.

 **WARNING!** To avoid damage to the printer, turn the power off and wait until the printer shuts down before removing the power cable.

- Disconnect the printer power cable after the printer has completely shut down (the control-panel display is blank).

Use the table below to identify the correct part number for your printer. To order the part, go to www.hp.com/buy/parts.

Table 2-93 Part information

Part number	Part description
JC97-04522B	Scanner glass

Required tools

- #2 JIS screwdriver with a magnetic tip

After performing service

Turn the printer power on

- Connect the printer power cable.
- Turn on the power switch next to the power cable, and then press the power button on the front of the printer.
- Verify that the service performed was successful.
- Verify that the most recent firmware is installed on the printer.
- Verify that all parts are correctly reinstalled and are properly working.

Post service test

Print any pages necessary to verify that the repair resolved the issue and did not create any new issues.

Remove the scanner glass

Follow these steps to remove the scanner glass.

CAUTION: Make sure not to be contaminated in scanner while scanner glass is removed.

Open the document-feeder cover, remove two screws, and then slide the scanner glass to the right to remove it.

Figure 2-421 Remove scanner glass

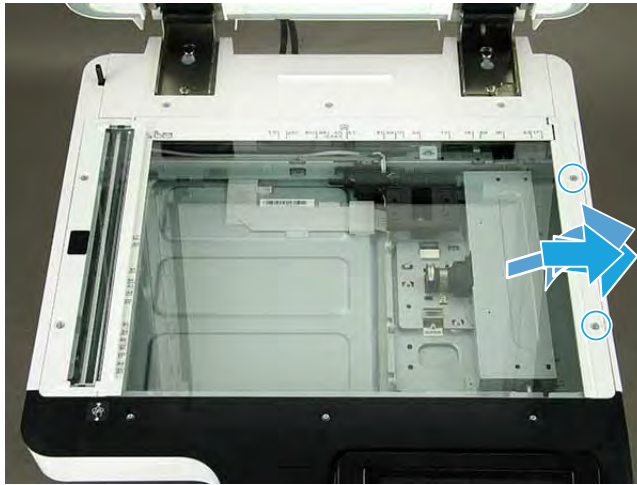

Unpack the replacement assembly

Follow these steps to unpack the replacement assembly.

1. Dispose of the defective part.

NOTE: HP recommends responsible disposal of the defective part.

<http://www8.hp.com/us/en/hp-information/environment/product-recycling.html>

2. Unpack the replacement part from the packaging.

CAUTION:  Some parts are sensitive to electrostatic discharge (ESD). Always perform service work at an ESD-protected workstation or mat. If an ESD workstation or mat is not available, touch the sheet-metal chassis to provide a static ground before touching an ESD-sensitive assembly. Protect the ESD-sensitive assemblies by placing them in ESD pouches when they are out of the printer.

IMPORTANT: Make sure that all of the shipping materials (for example shipping tape) are removed from the replacement part prior to installation.

NOTE: If the replacement part is a roller or pad, avoid touching the spongy part of it. Skin oils on the roller or pad can cause paper pickup and/or print-quality problems. HP recommends using disposable gloves when handling rollers or pads or washing your hands before touching rollers or pads.

3. To install an assembly, reverse the removal steps.



NOTE: When applicable, special installation instructions are provided for an assembly at the end of the removal procedure. Always completely read the removal instructions and follow all special installation instructions.

HP LaserJet Managed MFP E72525-E72535, E77822-E77830 - Removal and replacement: Scanner LED lamp module

This document provides the procedures to remove the LED lamp module assembly.

E72520-E72530:



https://players.brightcove.net/1160438706001/SyKVJeRXx_default/index.html?videoId=ref:REFIDPH0000000357

E77820-E77830:



https://players.brightcove.net/1160438706001/SyKVJeRXx_default/index.html?videoId=ref:REFIDPH0000000283

Mean time to repair: 45 minutes

Service level: Advanced



IMPORTANT: When applicable, special installation instructions are provided for an assembly at the end of the removal procedure. Always completely read the removal instructions and follow all special installation instructions.

Before performing service

- Disconnect the power cable.

Use the table below to identify the correct part number for your printer. To order the part, go to www.hp.com/buy/parts

Table 2-94 Part information

LED lamp module assembly part number
JC97-04521A
LED lamp module assembly

Required tools

- #2 JIS screwdriver with a magnetic tip

After performing service

Turn the printer power on

- Connect the power cable.
- Use the power switch to turn the power on.

Post service test

Copy, scan, or print a document. Verify the document copies, scans, or prints correctly.

Remove the scanner glass

Follow these steps to remove the scanner glass.

CAUTION: Make sure not to be contaminated in scanner while scanner glass is removed.

Open the document-feeder cover, remove two screws, and then slide the scanner glass to the right to remove it.

Figure 2-422 Remove scanner glass

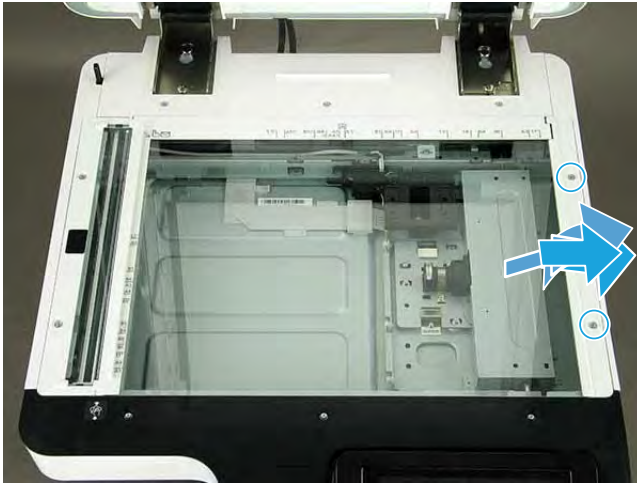

Remove the LED lamp module

Follow these steps to remove the LED lamp module.

- CAUTION:** Make sure not to be contaminated in scanner while scanner glass is removed. then remove the LED lamp module.
-

Remove the transparent tape.

Figure 2-423 Remove transparent tape

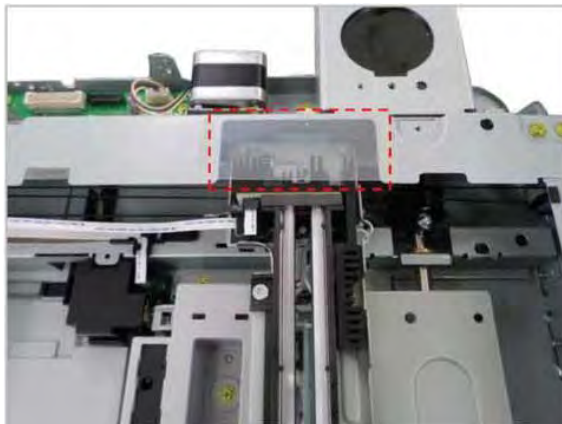

2. Disconnect the flat cable.

Figure 2-424 Disconnect cable



3. Remove four screws. Remove the LED lamp module.

Figure 2-425 Remove screws and release LED lamp module

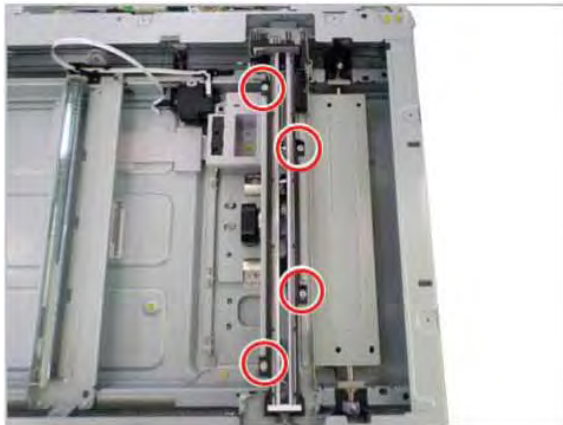

Unpack the replacement assembly

Follow these steps to unpack the replacement assembly.

1. Dispose of the defective part.

 **NOTE:** HP recommends responsible disposal of the defective part.

<http://www8.hp.com/us/en/hp-information/environment/product-recycling.html>

2. Unpack the replacement part from the packaging.



CAUTION:  Some parts are sensitive to electrostatic discharge (ESD). Always perform service work at an ESD-protected workstation or mat. If an ESD workstation or mat is not available, touch the sheet-metal chassis to provide a static ground before touching an ESD-sensitive assembly. Protect the ESD-sensitive assemblies by placing them in ESD pouches when they are out of the printer.

 **IMPORTANT:** Make sure that all of the shipping materials (for example shipping tape) are removed from the replacement part prior to installation.

 **NOTE:** If the replacement part is a roller or pad, avoid touching the spongy part of it. Skin oils on the roller or pad can cause paper pickup and/or print-quality problems. HP recommends using disposable gloves when handling rollers or pads or washing your hands before touching rollers or pads.

3. To install an assembly, reverse the removal steps.

 **NOTE:** When applicable, special installation instructions are provided for an assembly at the end of the removal procedure. Always completely read the removal instructions and follow all special installation instructions.

Image scanner, lower (LX)

View the image scanner, lower (LX) exploded view, parts list, and repair procedures.

Image scanner, lower (LX)

Parts diagram and parts list for the lower image scanner.

Figure 2-426 Image scanner, lower (LX)

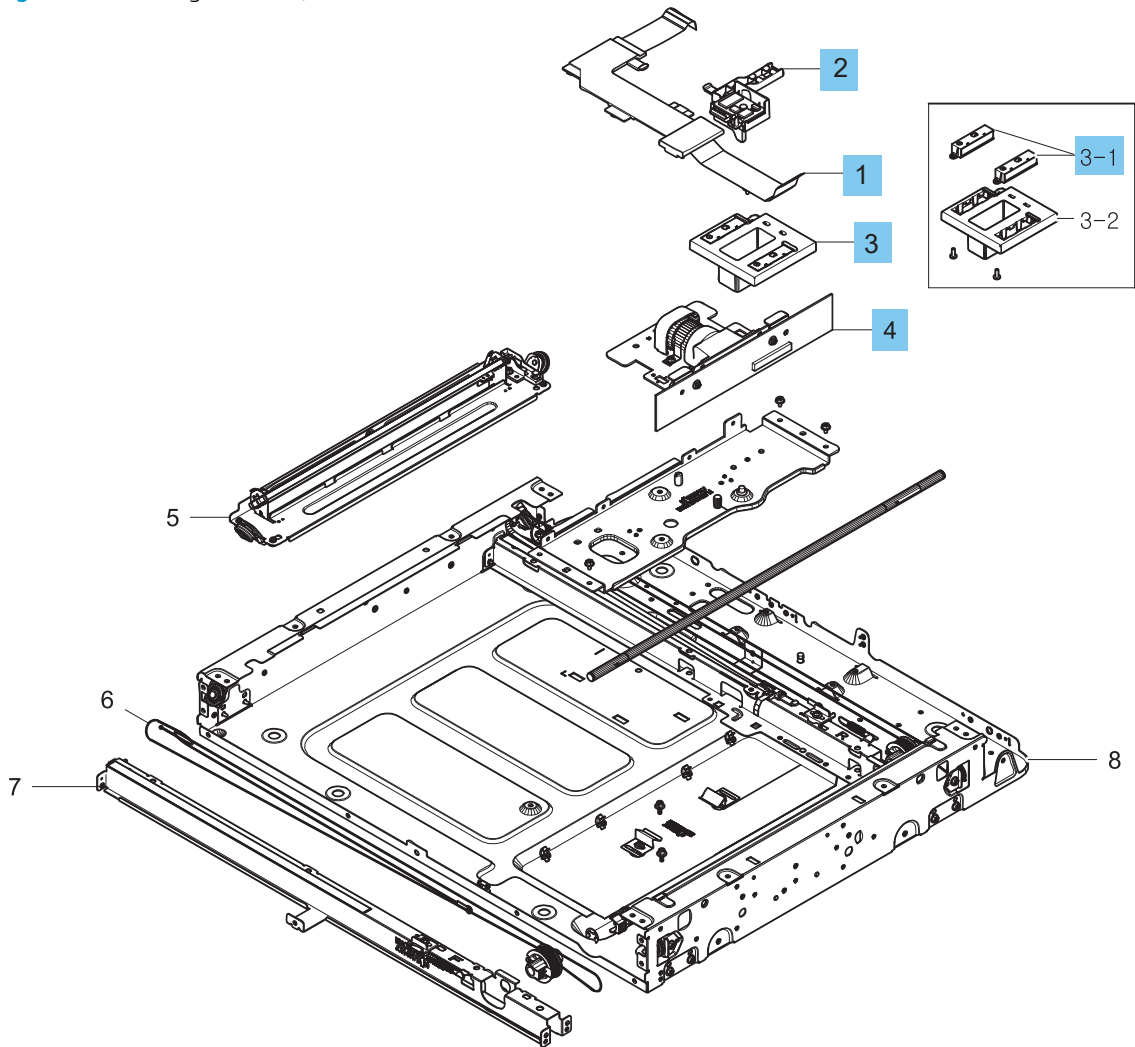

Table 2-95 Image scanner, lower (LX)

Ref				
No	Part number	Description	Qty	Repair procedure
1	JC97-04509A	Image scanner, ffc ccd	1	Not applicable
2	JC97-04512A	Image scanner guide harness	1	Not applicable
3	JC97-04507A	Image scanner, APS	1	Removal and replacement: Scanner APS sensor on page 550
3-1	604-001453	Photo interrupter	2	Not applicable
4	JC97-04523B	Image scanner lens	1	Removal and replacement: Scanner assembly – CCD and lens on page 546

Removal and replacement: Scanner assembly – CCD and lens

Learn how to remove and replace the scanner CDD and lens.



[View a video of how to remove and replace the scanner CDD and lens \(E72525-72535\).](#)



IMPORTANT: When applicable, special installation instructions are provided for an assembly at the end of the removal procedure. Always completely read the removal instructions and follow all special installation instructions.

Mean time to repair:

Service level:

Before performing service

Turn the printer power off

- Press the power button on the front of the printer, and then turn off the power switch next to the power cable.
- A shutting-down message appears on the control-panel display.



WARNING! To avoid damage to the printer, turn the power off and wait until the printer shuts down before removing the power cable.

- Disconnect the printer power cable after the printer has completely shut down (the control-panel display is blank).

Use the table below to identify the correct part number for your printer. To order the part, go to www.hp.com/buy/parts.

Table 2-96 Part information

Part number	Part description
JC97-04523B	Scanner assembly -CDD and lens

Required tools

- #2 JIS screwdriver with a magnetic tip

After performing service

Turn the printer power on

- Connect the printer power cable.
- Turn on the power switch next to the power cable, and then press the power button on the front of the printer.
- Verify that the service performed was successful.
- Verify that the most recent firmware is installed on the printer.
- Verify that all parts are correctly reinstalled and are properly working.

Post service test

Print any pages necessary to verify that the repair resolved the issue and did not create any new issues.

Remove the scanner assembly CDD and lens

Follow these steps to remove the scanner assembly CDD and lens.

1. Remove four screws, and then release the imaging unit cover.

Figure 2-427 Remove screws and release imaging unit cover

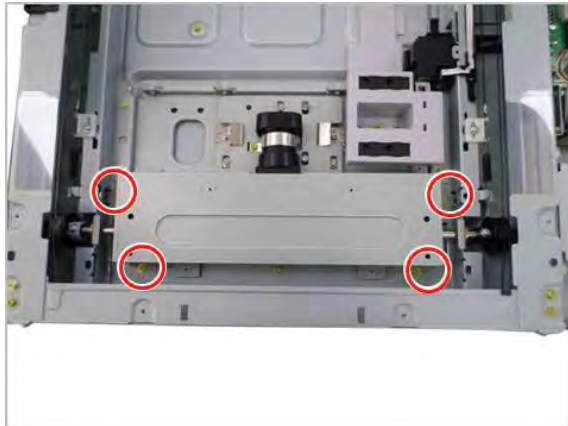

2. Disconnect the flat cable.

Figure 2-428 Disconnect flat cable

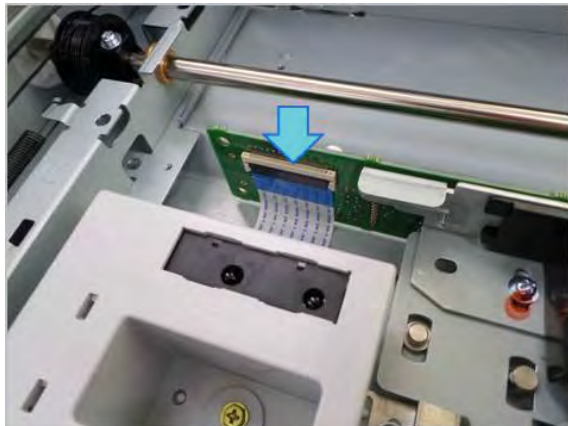

3. Remove two screws and release the scanner assembly CDD and lens.

⚠ CAUTION: Do not remove or adjust the other two screws shown as they require factory setting only.

Figure 2-429 Remove screws and release scanner imaging unit



4. Place Imaging unit according to label number as -1/0/+1 then assemble plate-spring after assembly of FFC into Imaging unit.

⚠ CAUTION: Do not remove or adjust the other two screws shown as they require factory setting only.

Figure 2-430 Place Imaging unit according to label number as -1/0/+1



Remove the scanner glass

Follow these steps to remove the scanner glass.

⚠ CAUTION: Make sure not to be contaminated in scanner while scanner glass is removed.

Open the document-feeder cover, remove two screws, and then slide the scanner glass to the right to remove it.

Figure 2-431 Remove scanner glass

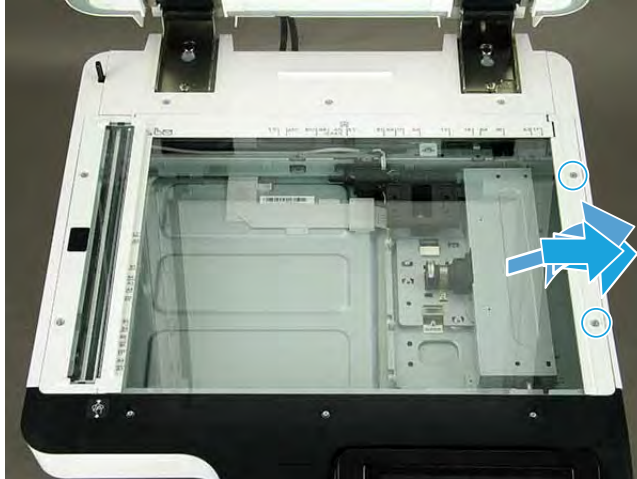

Unpack the replacement assembly



Follow these steps to unpack the replacement assembly.

1. Dispose of the defective part.

 **NOTE:** HP recommends responsible disposal of the defective part.

<http://www8.hp.com/us/en/hp-information/environment/product-recycling.html>

2. Unpack the replacement part from the packaging.

 **CAUTION:**  Some parts are sensitive to electrostatic discharge (ESD). Always perform service work at an ESD-protected workstation or mat. If an ESD workstation or mat is not available, touch the sheet-metal chassis to provide a static ground before touching an ESD-sensitive assembly. Protect the ESD-sensitive assemblies by placing them in ESD pouches when they are out of the printer.

 **IMPORTANT:** Make sure that all of the shipping materials (for example shipping tape) are removed from the replacement part prior to installation.

 **NOTE:** If the replacement part is a roller or pad, avoid touching the spongy part of it. Skin oils on the roller or pad can cause paper pickup and/or print-quality problems. HP recommends using disposable gloves when handling rollers or pads or washing your hands before touching rollers or pads.

3. To install an assembly, reverse the removal steps.

 **NOTE:** When applicable, special installation instructions are provided for an assembly at the end of the removal procedure. Always completely read the removal instructions and follow all special installation instructions.

Removal and replacement: Scanner APS sensor

This document provides the procedures to remove the APS sensor assembly.



[View a video of removing and replacing the sensor \(E77820-E77830\).](#)

Mean time to repair: 25 minutes

Service level: Advanced



IMPORTANT: When applicable, special installation instructions are provided for an assembly at the end of the removal procedure. Always completely read the removal instructions and follow all special installation instructions.

Before performing service

- Disconnect the power cable.

Use the table below to identify the correct part number for your printer. To order the part, go to www.hp.com/buy/parts

Table 2-97 Part information

Part number	Part description
JC97-04507A	APS sensor assembly

Required tools

- #2 JIS screwdriver with a magnetic tip

After performing service

Turn the printer power on

- Connect the power cable.
- Use the power switch to turn the power on.

Post service test

Copy, scan, or print a document. Verify the document copies, scans, or prints correctly.

Remove the scanner glass

Follow these steps to remove the scanner glass.



CAUTION: Make sure not to be contaminated in scanner while scanner glass is removed.

Open the document-feeder cover, remove two screws, and then slide the scanner glass to the right to remove it.

Figure 2-432 Remove scanner glass

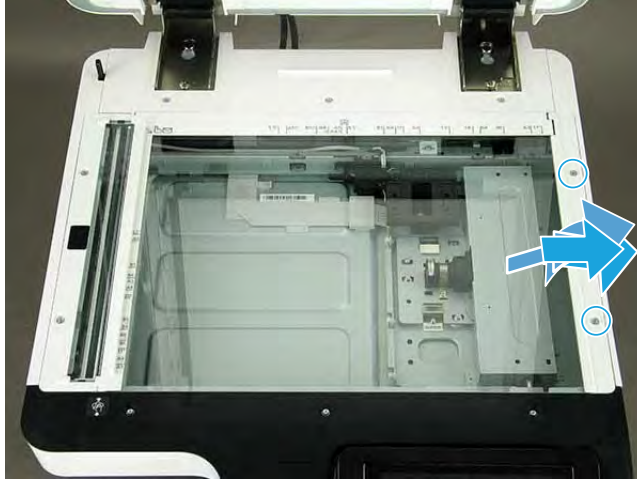

Remove the APS sensor

Follow these steps to remove the APS sensor.

1. Remove the joint board cover.

Figure 2-433 Remove joint board cover

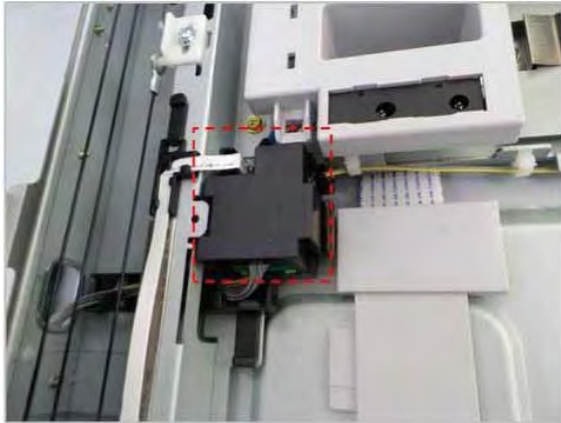

2. Remove one screw.

Figure 2-434 Remove screw



3. Disconnect the harness.

Figure 2-435 Disconnect harness



4. Remove two screws. Release the APS sensor.

Figure 2-436 Remove screws and release APS sensor

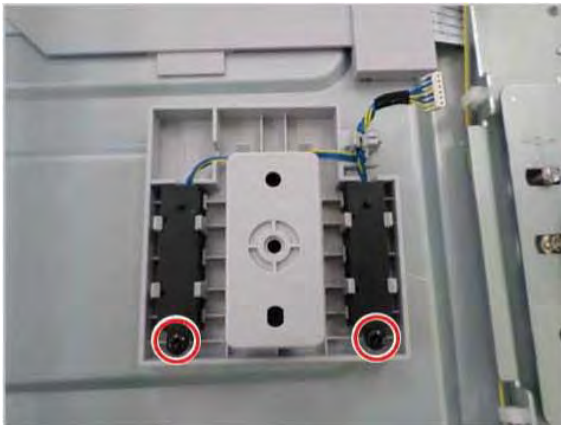

Unpack the replacement assembly

Follow these steps to unpack the replacement assembly.

1. Dispose of the defective part.

 **NOTE:** HP recommends responsible disposal of the defective part.

<http://www8.hp.com/us/en/hp-information/environment/product-recycling.html>

2. Unpack the replacement part from the packaging.



CAUTION:  Some parts are sensitive to electrostatic discharge (ESD). Always perform service work at an ESD-protected workstation or mat. If an ESD workstation or mat is not available, touch the sheet-metal chassis to provide a static ground before touching an ESD-sensitive assembly. Protect the ESD-sensitive assemblies by placing them in ESD pouches when they are out of the printer.



IMPORTANT: Make sure that all of the shipping materials (for example shipping tape) are removed from the replacement part prior to installation.



NOTE: If the replacement part is a roller or pad, avoid touching the spongy part of it. Skin oils on the roller or pad can cause paper pickup and/or print-quality problems. HP recommends using disposable gloves when handling rollers or pads or washing your hands before touching rollers or pads.

3. To install an assembly, reverse the removal steps.



NOTE: When applicable, special installation instructions are provided for an assembly at the end of the removal procedure. Always completely read the removal instructions and follow all special installation instructions.

Second Exit (Optional)

View the second exit repair procedures.

Remove the second exit (Optional)

Follow these steps to remove the second exit.

1. Open the right door, then remove the 1 screw.

Figure 2-437 Remove the screw



2. Remove 4 caps, then remove 4 screws.

Figure 2-438 Remove the screws

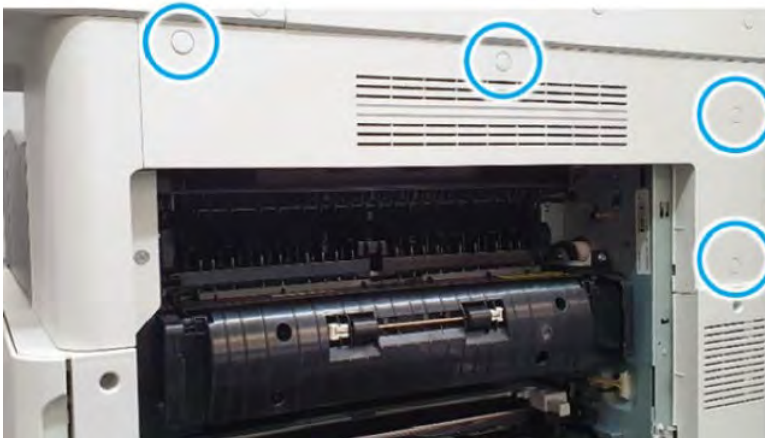

3. Pull the cover (callout 1) to the arrow direction carefully, and pull out the cover (callout 2) .

Figure 2-439 Remove the cover

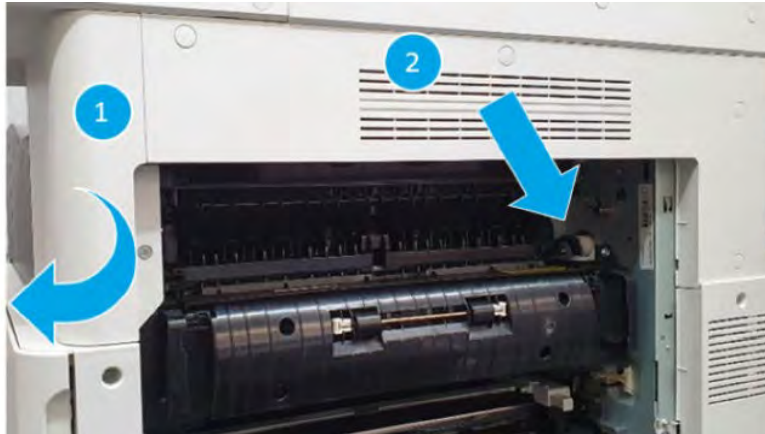

4. Remove 2 connectors, then remove 1 screw.

Figure 2-440 Remove the connectors and the screw

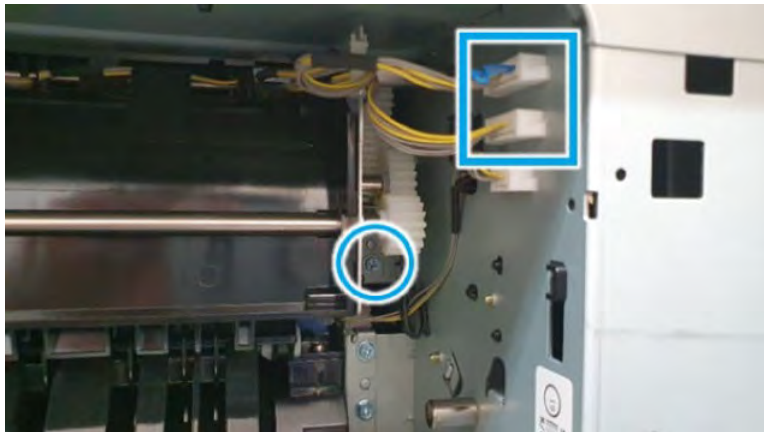

5. Pull the left side of the second exit unit (Callout 1), then remove second exit unit.

Figure 2-441 Remove the second exit unit



Remove the return gate solenoid (Optional)

Follow these steps to remove the return gate solenoid.

1. Open the right door, then remove the 1 screw.

Figure 2-442 Remove the screw



2. Remove 4 caps, then remove 4 screws.

Figure 2-443 Remove the screws

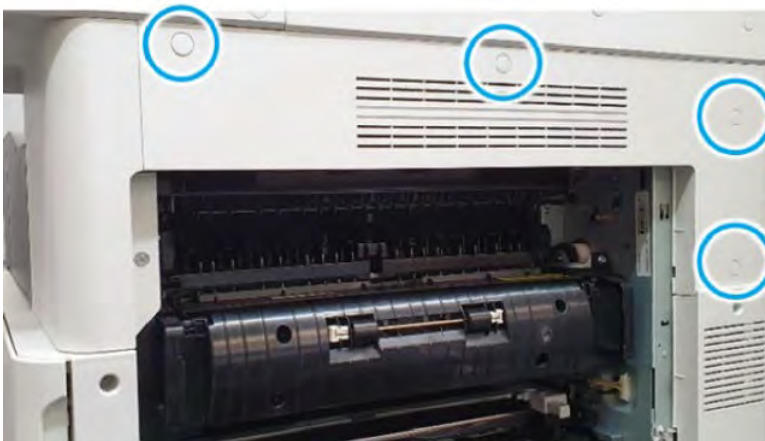

3. Pull the cover (callout 1) to the arrow direction carefully, and pull out the cover (callout 2) .

Figure 2-444 Remove the cover

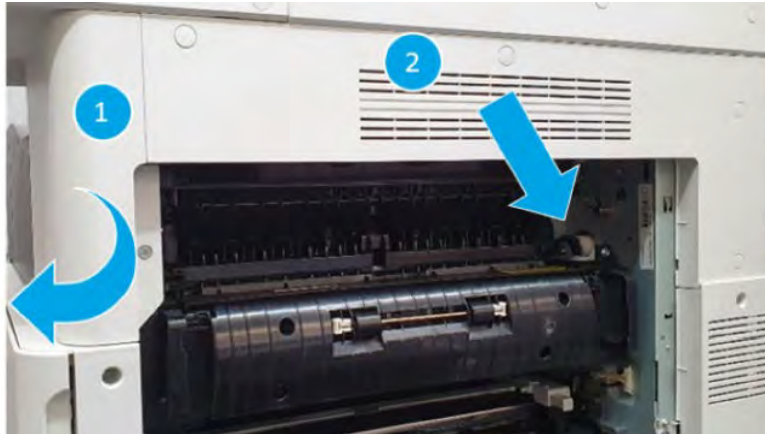

4. Remove 2 cables, then remove 1 screw.

Figure 2-445 Remove the connectors and the screw

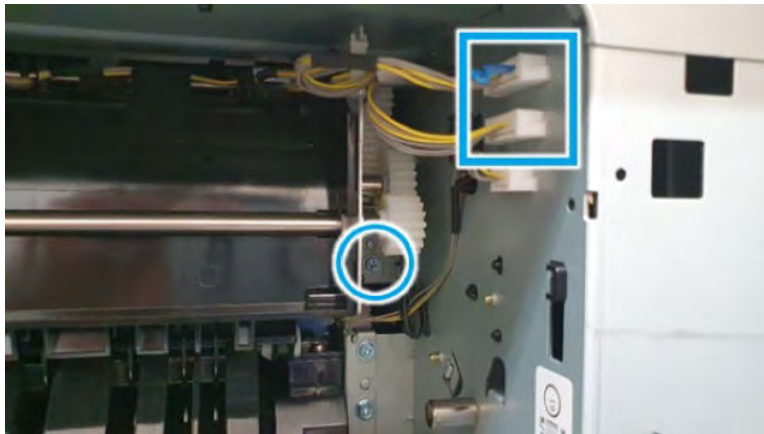

5. Pull the left side of the second exit unit (Callout 1), then remove second exit unit.

Figure 2-446 Remove the second exit unit



6. Remove 2 screws, then pull out the solenoid to the arrow direction carefully.

Figure 2-447 Remove the screws

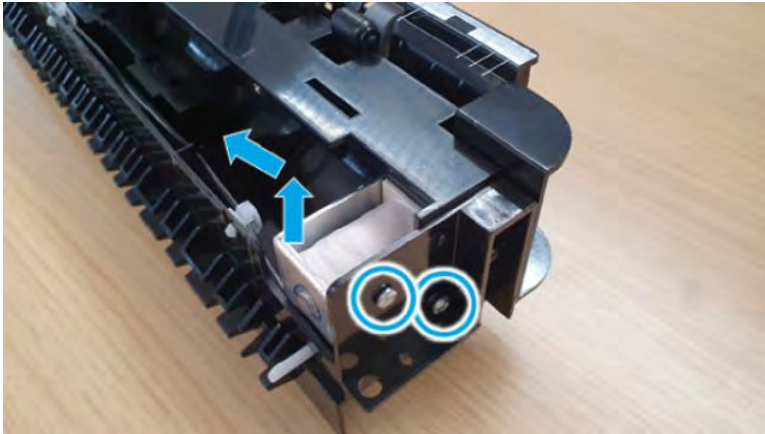

7. Remove 2 hooks(Callout1) and 1 plug(Callout 2). Then remove the solenoid(Callout 3)

Figure 2-448 Remove the solenoid

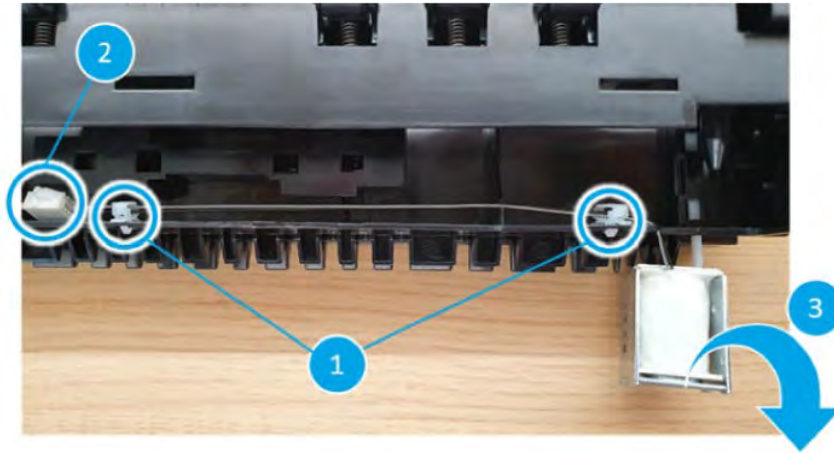

TIP: Reassembly tip

Be sure the wiring harness should be located under the solenoid (Callout 1)

you must assemble the arrow-shaped plastic into the hole in the solenoid (Callout 2)

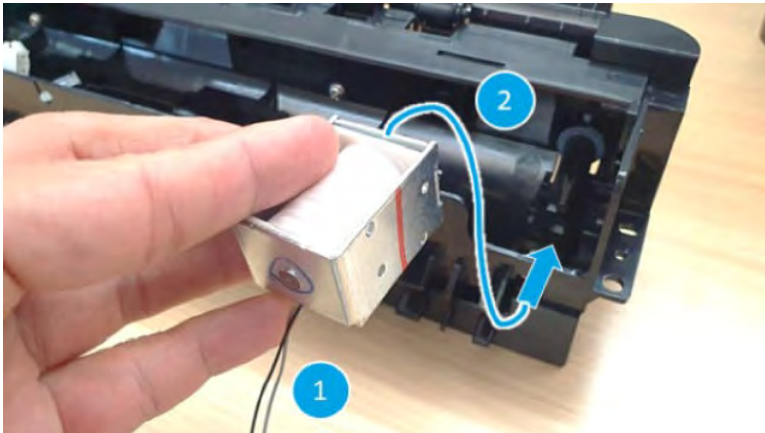

Dual cassette feeder (DCF)

Learn about the dual cassette feeder (DCF) exploded diagrams, parts lists, and repair procedures.

DCF main

View the DCF main exploded view, parts list, and repair procedures.

DCF main

Parts diagram and parts list for the DCF main.

Figure 2-449 DCF main

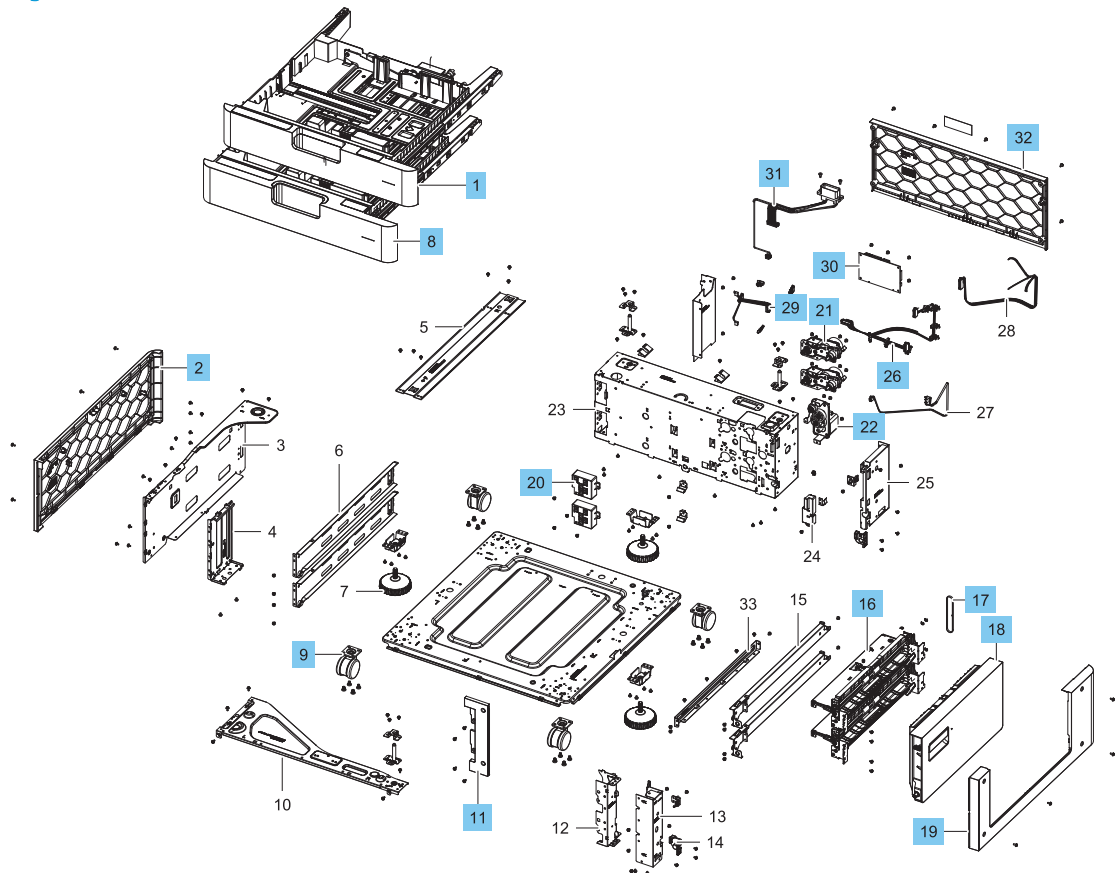

Table 2-98 DCF main

Ref				
No	Part number	Description	Qty	Repair procedure
1	JC90-01666A	Cassette, four		Not applicable
2	JC63-04607B	DCF, left cover		Not applicable
8	JC90-01664A	Cassette five		Not applicable
9	6109-001138	Caster wheel	4	Not applicable
11	JC63-04606B	DCF, front cover	2	Not applicable
16	JC93-00513A	Main pickup	2	Not applicable
17	6602-003185	Timing belt, gear	1	Not applicable
18	JC90-01285A	Right Door	1	Removal and replacement: Dual-cassette feeder (DCF) right door on page 564
19	JC63-04605B	DCF, right cover	1	Not applicable
20	JC93-00018A	Rear auto-size holder	2	Not applicable
21	JC93-00442B	Drive assembly - main, (DCF pickup motor)	1	Removal and replacement: Dual-cassette feeder (DCF) pickup motor on page 574
22	JC93-00447A	Drive Feed Assy (DCF motor)	1	Removal and replacement: Dual-cassette feeder (DCF) motor on page 570
26	JC39-01692A	Drive Feed Assy	1	Not applicable
29	JC39-01695A	Cable, DCR Size Sensor	1	Not applicable
30	JC92-02978A	PCA - MX4 DCF	1	Removal and replacement: Dual-cassette feeder (DCF) PCA on page 567
31	JC39-01690A	IF Cable	1	Not applicable
32	JC63-04604B	DCF, rear cover	1	Removal and replacement: Dual-cassette feeder (DCF) rear cover on page 562
Not shown	JC92-02622C	PCA Paper Size Sensor	1	Not applicable
Not shown	JC92-02978A	PCA, dual cassette feeder (DCF)		Removal and replacement: Dual-cassette feeder (DCF) PCA on page 567

Removal and replacement: Dual-cassette feeder (DCF) rear cover

This document provides the procedures to remove the dual cassette feeder (DCF) rear cover assembly.

Mean time to repair: 5 minutes

Service level: Basic

 **IMPORTANT:** When applicable, special installation instructions are provided for an assembly at the end of the removal procedure. Always completely read the removal instructions and follow all special installation instructions.

Before performing service

- Disconnect the power cable.

 **WARNING!** To avoid damage to the printer, turn the printer off, wait 30 seconds, and then remove the power cable before attempting to service the printer.

Use the table below to identify the correct part number for your printer. To order the part, go to www.hp.com/buy/parts

Table 2-99 Part information

Part number	Part description
JC63-04604B	Dual cassette feeder (DCF) rear cover assembly

Required tools

- #2 JIS screwdriver with a magnetic tip

After performing service

Turn the printer power on

- Connect the power cable.
- Use the power switch to turn the power on.

Post service test

Copy, scan, or print a document. Verify the document copies, scans, or prints correctly.

Remove the dual cassette feeder (DCF) rear cover

Follow these steps to remove the dual cassette feeder (DCF) rear cover.

- ▲ Remove four screw caps and four screws, and then remove the rear cover.

Figure 2-450 Remove the DCF rear cover



Unpack the replacement assembly



Follow these steps to unpack the replacement assembly.

1. Dispose of the defective part.

 **NOTE:** HP recommends responsible disposal of the defective part.

<http://www8.hp.com/us/en/hp-information/environment/product-recycling.html>

2. Unpack the replacement part from the packaging.

 **CAUTION:**  Some parts are sensitive to electrostatic discharge (ESD). Always perform service work at an ESD-protected workstation or mat. If an ESD workstation or mat is not available, touch the sheet-metal chassis to provide a static ground before touching an ESD-sensitive assembly. Protect the ESD-sensitive assemblies by placing them in ESD pouches when they are out of the printer.

 **IMPORTANT:** Make sure that all of the shipping materials (for example shipping tape) are removed from the replacement part prior to installation.

 **NOTE:** If the replacement part is a roller or pad, avoid touching the spongy part of it. Skin oils on the roller or pad can cause paper pickup and/or print-quality problems. HP recommends using disposable gloves when handling rollers or pads or washing your hands before touching rollers or pads.

3. To install an assembly, reverse the removal steps.

 **NOTE:** When applicable, special installation instructions are provided for an assembly at the end of the removal procedure. Always completely read the removal instructions and follow all special installation instructions.

Removal and replacement: Dual-cassette feeder (DCF) right door

This document provides the procedures to remove the dual cassette feeder (DCF) right door assembly.

Meant time to repair: 5 minutes

Service level: Basic

 **IMPORTANT:** When applicable, special installation instructions are provided for an assembly at the end of the removal procedure. Always completely read the removal instructions and follow all special installation instructions.

Before performing service

- Disconnect the power cable.

 **WARNING!** To avoid damage to the printer, turn the printer off, wait 30 seconds, and then remove the power cable before attempting to service the printer.

Use the table below to identify the correct part number for your printer. To order the part, go to www.hp.com/buy/parts

Table 2-100 Part information

Part number	Part description
JC90-01285A	DCF right door

Required tools

- #2 JIS screwdriver with a magnetic tip

After performing service

Turn the printer power on

- Connect the power cable.
- Use the power switch to turn the power on.

Post service test

Copy, scan, or print a document. Verify the document copies, scans, or prints correctly.

Remove the DCF right door

Follow these steps to remove the DCF right door.

1. Remove four screw caps and four screws, and then remove the lower right cover.

Figure 2-451 Remove the lower right cover



2. Open the DCF right door and slide the hinge pin to the left. Make sure that the pin slides under the tab (callout 1).

Figure 2-452 Slide the hinge pin

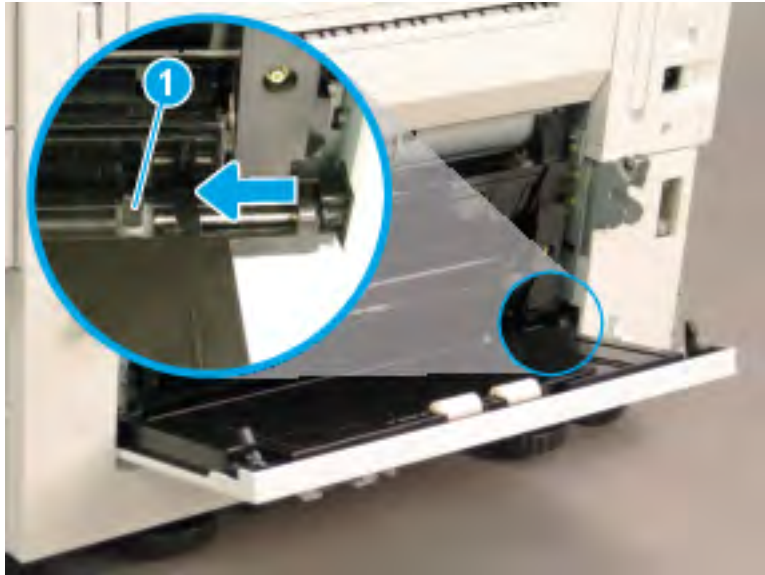

3. Rotate the right edge of the door away from the feeder (callout 1), and then slide the door to the right to remove it (callout 2).

Figure 2-453 Remove the DCF right door



Unpack the replacement assembly



Follow these steps to unpack the replacement assembly.

1. Dispose of the defective part.

 **NOTE:** HP recommends responsible disposal of the defective part.

<http://www8.hp.com/us/en/hp-information/environment/product-recycling.html>

2. Unpack the replacement part from the packaging.

 **CAUTION:**  Some parts are sensitive to electrostatic discharge (ESD). Always perform service work at an ESD-protected workstation or mat. If an ESD workstation or mat is not available, touch the sheet-metal chassis to provide a static ground before touching an ESD-sensitive assembly. Protect the ESD-sensitive assemblies by placing them in ESD pouches when they are out of the printer.

 **IMPORTANT:** Make sure that all of the shipping materials (for example shipping tape) are removed from the replacement part prior to installation.

 **NOTE:** If the replacement part is a roller or pad, avoid touching the spongy part of it. Skin oils on the roller or pad can cause paper pickup and/or print-quality problems. HP recommends using disposable gloves when handling rollers or pads or washing your hands before touching rollers or pads.

3. To install an assembly, reverse the removal steps.

 **NOTE:** When applicable, special installation instructions are provided for an assembly at the end of the removal procedure. Always completely read the removal instructions and follow all special installation instructions.

Removal and replacement: Dual-cassette feeder (DCF) PCA

This document provides the procedures to remove the dual cassette feeder (DCF) PCA assembly.

Mean time to repair: 15 minutes

Service level: Intermediate

 **IMPORTANT:** When applicable, special installation instructions are provided for an assembly at the end of the removal procedure. Always completely read the removal instructions and follow all special installation instructions.

Before performing service

- Disconnect the power cable.

 **WARNING!** To avoid damage to the printer, turn the printer off, wait 30 seconds, and then remove the power cable before attempting to service the printer.

Use the table below to identify the correct part number for your printer. To order the part, go to www.hp.com/buy/parts

Table 2-101 Part information

Part number	Part description
JC92-02978A	Dual cassette feeder (DCF) PCA assembly

Required tools

- #2 JIS screwdriver with a magnetic tip

After performing service

Turn the printer power on

- Connect the power cable.
- Use the power switch to turn the power on.

Post service test

Copy, scan, or print a document. Verify the document copies, scans, or prints correctly.

Remove the dual cassette feeder (DCF) rear cover

Follow these steps to remove the dual cassette feeder (DCF) rear cover.

- ▲ Remove four screw caps and four screws, and then remove the rear cover.

Figure 2-454 Remove the DCF rear cover



Remove the DCF PCA

Follow these steps to remove the DCF PCA.

- ▲ Disconnect eight connectors, remove three screws, and then remove the DCF PCA.

Figure 2-455 Remove the DCF PCA

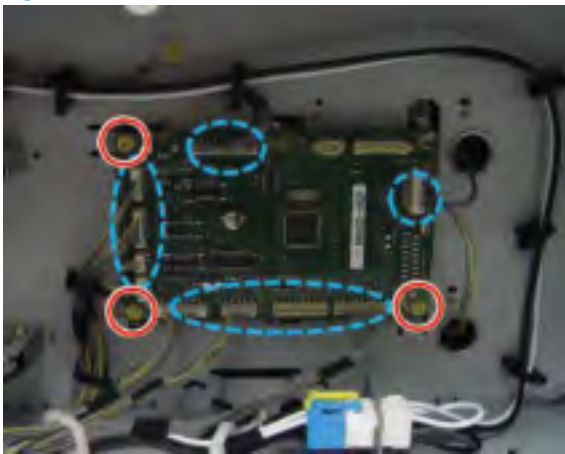

Unpack the replacement assembly

Follow these steps to unpack the replacement assembly.

1. Dispose of the defective part.

 **NOTE:** HP recommends responsible disposal of the defective part.

<http://www8.hp.com/us/en/hp-information/environment/product-recycling.html>

2. Unpack the replacement part from the packaging.



CAUTION:  Some parts are sensitive to electrostatic discharge (ESD). Always perform service work at an ESD-protected workstation or mat. If an ESD workstation or mat is not available, touch the sheet-metal chassis to provide a static ground before touching an ESD-sensitive assembly. Protect the ESD-sensitive assemblies by placing them in ESD pouches when they are out of the printer.

 **IMPORTANT:** Make sure that all of the shipping materials (for example shipping tape) are removed from the replacement part prior to installation.

 **NOTE:** If the replacement part is a roller or pad, avoid touching the spongy part of it. Skin oils on the roller or pad can cause paper pickup and/or print-quality problems. HP recommends using disposable gloves when handling rollers or pads or washing your hands before touching rollers or pads.

3. To install an assembly, reverse the removal steps.

 **NOTE:** When applicable, special installation instructions are provided for an assembly at the end of the removal procedure. Always completely read the removal instructions and follow all special installation instructions.

Removal and replacement: Dual-cassette feeder (DCF) motor

This document provides the procedures to remove the DCF motor assembly.

Mean time to repair: 10 minutes

Service level: Basic

 **IMPORTANT:** When applicable, special installation instructions are provided for an assembly at the end of the removal procedure. Always completely read the removal instructions and follow all special installation instructions.

Before performing service

- Disconnect the power cable.

 **WARNING!** To avoid damage to the printer, turn the printer off, wait 30 seconds, and then remove the power cable before attempting to service the printer.

Use the table below to identify the correct part number for your printer. To order the part, go to www.hp.com/buy/parts

Table 2-102 Part information

Part number	Part description
JC93-00447A	DCF motor

Required tools

- #2 JIS screwdriver with a magnetic tip

After performing service

Turn the printer power on

- Connect the power cable.
- Use the power switch to turn the power on.

Post service test

Copy, scan, or print a document. Verify the document copies, scans, or prints correctly.

Remove the dual cassette feeder (DCF) rear cover

Follow these steps to remove the dual cassette feeder (DCF) rear cover.

- ▲ Remove four screw caps and four screws, and then remove the rear cover.

Figure 2-456 Remove the DCF rear cover



Remove the DCF motor

Follow these steps to remove the DCF motor.

1. Disconnect two connectors, and then open one retainer.

Figure 2-457 Disconnect two connectors and open one retainer



2. Remove three screws, and then remove the feed drive unit.

Figure 2-458 Remove the feed drive unit



3. Remove two screws, and then remove the feed motor.

Figure 2-459 Remove the feed motor



Unpack the replacement assembly

Follow these steps to unpack the replacement assembly.

1. Dispose of the defective part.

 **NOTE:** HP recommends responsible disposal of the defective part.

<http://www8.hp.com/us/en/hp-information/environment/product-recycling.html>

2. Unpack the replacement part from the packaging.



CAUTION:  Some parts are sensitive to electrostatic discharge (ESD). Always perform service work at an ESD-protected workstation or mat. If an ESD workstation or mat is not available, touch the sheet-metal chassis to provide a static ground before touching an ESD-sensitive assembly. Protect the ESD-sensitive assemblies by placing them in ESD pouches when they are out of the printer.

 **IMPORTANT:** Make sure that all of the shipping materials (for example shipping tape) are removed from the replacement part prior to installation.

 **NOTE:** If the replacement part is a roller or pad, avoid touching the spongy part of it. Skin oils on the roller or pad can cause paper pickup and/or print-quality problems. HP recommends using disposable gloves when handling rollers or pads or washing your hands before touching rollers or pads.

3. To install an assembly, reverse the removal steps.

 **NOTE:** When applicable, special installation instructions are provided for an assembly at the end of the removal procedure. Always completely read the removal instructions and follow all special installation instructions.

Removal and replacement: Dual-cassette feeder (DCF) pickup motor

This document provides the procedures to remove the DCF pickup motor assembly.

Mean time to repair: 10 minutes

Service level: Basic

 **IMPORTANT:** When applicable, special installation instructions are provided for an assembly at the end of the removal procedure. Always completely read the removal instructions and follow all special installation instructions.

Before performing service

- Disconnect the power cable.

 **WARNING!** To avoid damage to the printer, turn the printer off, wait 30 seconds, and then remove the power cable before attempting to service the printer.

Use the table below to identify the correct part number for your printer. To order the part, go to www.hp.com/buy/parts

Table 2-103 Part information

Part number	Part description
JC93-00442B	DCF pickup motor assembly

Required tools

- #2 JIS screwdriver with a magnetic tip

After performing service

Turn the printer power on

- Connect the power cable.
- Use the power switch to turn the power on.

Post service test

Copy, scan, or print a document. Verify the document copies, scans, or prints correctly.

Remove the dual cassette feeder (DCF) rear cover

Follow these steps to remove the dual cassette feeder (DCF) rear cover.

- ▲ Remove four screw caps and four screws, and then remove the rear cover.

Figure 2-460 Remove the DCF rear cover



Remove the DCF pickup motor

Follow these steps to remove the DCF pickup motor.

- ▲ Disconnect the motor connector, remove two screws, and then remove the DCF pickup motor.

Figure 2-461 Remove the DCF pickup motor

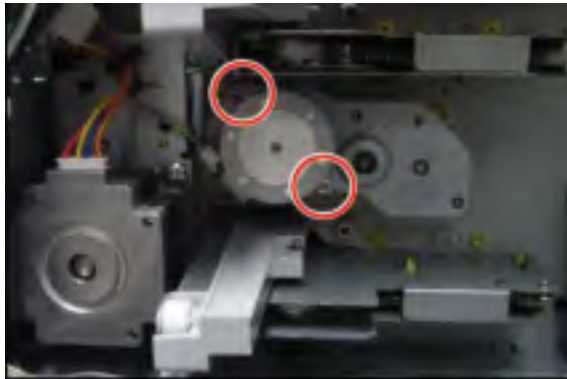

Unpack the replacement assembly



Follow these steps to unpack the replacement assembly.

1. Dispose of the defective part.

 **NOTE:** HP recommends responsible disposal of the defective part.

<http://www8.hp.com/us/en/hp-information/environment/product-recycling.html>

2. Unpack the replacement part from the packaging.

 **CAUTION:**  Some parts are sensitive to electrostatic discharge (ESD). Always perform service work at an ESD-protected workstation or mat. If an ESD workstation or mat is not available, touch the sheet-metal chassis to provide a static ground before touching an ESD-sensitive assembly. Protect the ESD-sensitive assemblies by placing them in ESD pouches when they are out of the printer.

 **IMPORTANT:** Make sure that all of the shipping materials (for example shipping tape) are removed from the replacement part prior to installation.

 **NOTE:** If the replacement part is a roller or pad, avoid touching the spongy part of it. Skin oils on the roller or pad can cause paper pickup and/or print-quality problems. HP recommends using disposable gloves when handling rollers or pads or washing your hands before touching rollers or pads.

3. To install an assembly, reverse the removal steps.



NOTE: When applicable, special installation instructions are provided for an assembly at the end of the removal procedure. Always completely read the removal instructions and follow all special installation instructions.

DCF main frame pickup 1

Parts diagram and parts list for the main frame pickup 1.

Figure 2-462 DCF main frame pickup 1

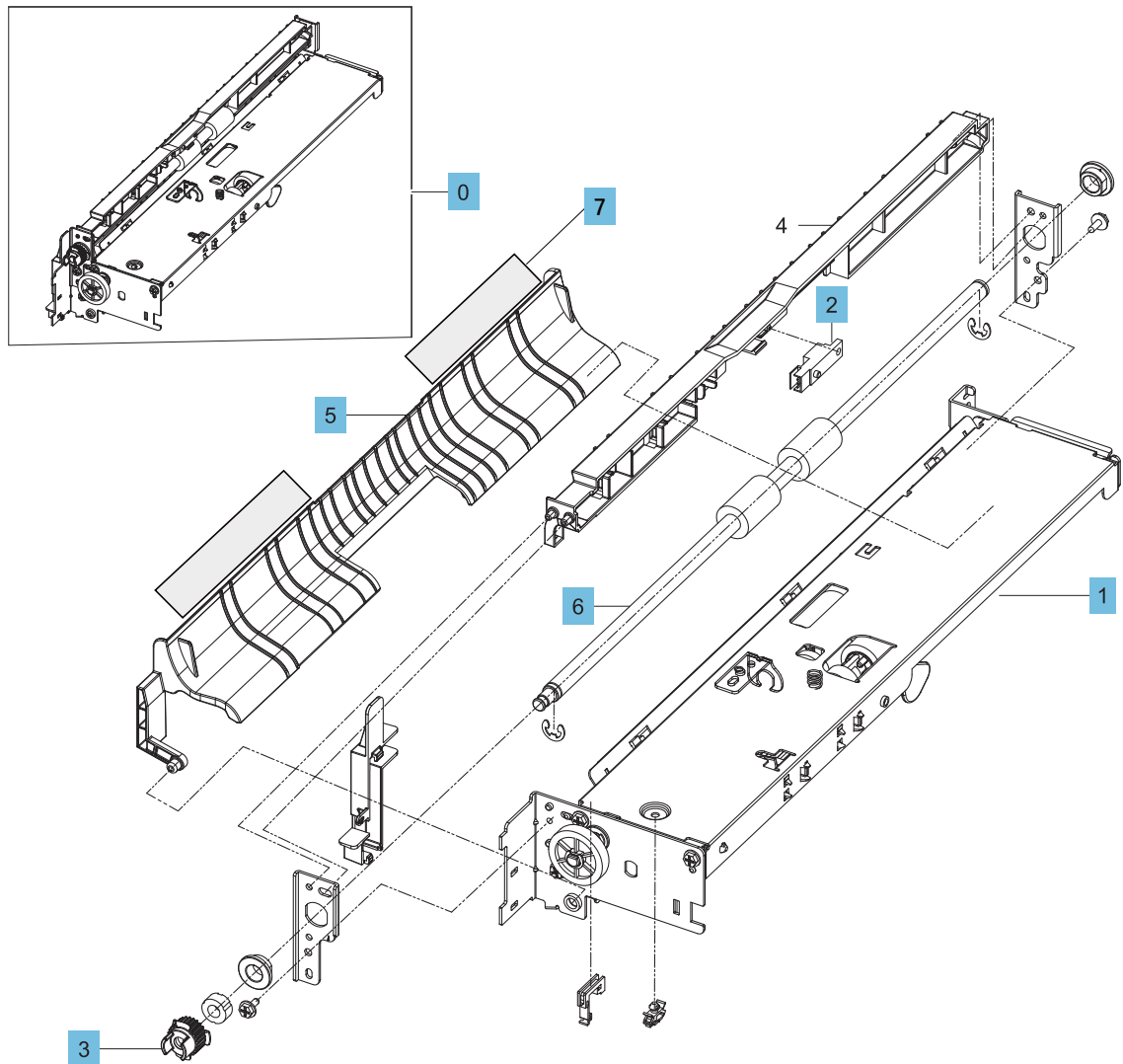

Table 2-104 DCF main frame pickup 1

Ref				
No	Part number	Description	Qty	Repair procedure
0	JC93-00513A	DCF, main pickup	2	Not applicable
1	JC93-00510A	Main Pickup Sub Assy	2	Not applicable
2	0640-001381	Photo interrupter	2	Not applicable
3	JC66-03288A	Feed pulley	2	Not applicable
5	JC61-04717A	Second pickup guide	2	Not applicable
6	JC66-03287A	Idle feed roller	2	Not applicable
7	JC63-03342A	Feed Mylar	2	Not applicable

DCF main frame pickup

View the DCF main frame pickup exploded view, parts list, and repair procedures.

DCF main frame pickup

Parts diagram and parts list for the DCF main frame pickup.

Figure 2-463 DCF main frame pickup

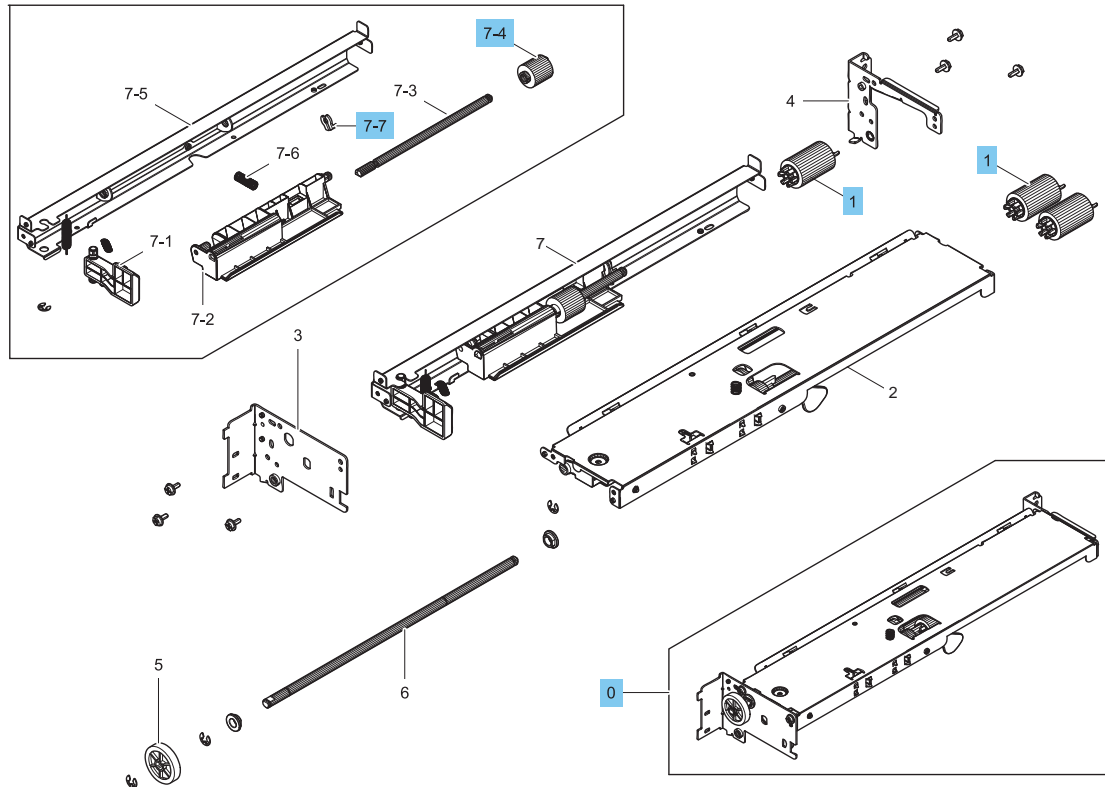

Table 2-105 DCF main frame pickup

Ref				
No	Part number	Description	Qty	Repair procedure
0	JC93-00510A	Main Pickup lower and upper	2	Removal and replacement: Dual-cassette feeder (DCF) pickup units on page 582
1	JC93-00540A	Tray 2-x rollers	6	Not applicable
7-4	JC67-00455A	Coupler, torque limiter	2	Not applicable
7-7	JC61-01367A	Fixer, e-ring	2	Not applicable

Removal and replacement: Dual-cassette feeder (DCF) pickup units

This document provides the procedures to remove the dual cassette feeder (DCF) pickup units assembly.

Mean time to repair: 15 minutes

Service level: Intermediate

 **IMPORTANT:** When applicable, special installation instructions are provided for an assembly at the end of the removal procedure. Always completely read the removal instructions and follow all special installation instructions.

Before performing service

- Disconnect the power cable.

 **WARNING!** To avoid damage to the printer, turn the printer off, wait 30 seconds, and then remove the power cable before attempting to service the printer.

Use the table below to identify the correct part number for your printer. To order the part, go to www.hp.com/buy/parts

Table 2-106 Part information

Part number	Part description
JC93-00510A	Dual cassette feeder (DCF) pickup units assembly

Required tools

- #2 JIS screwdriver with a magnetic tip

After performing service

Turn the printer power on

- Connect the power cable.
- Use the power switch to turn the power on.

Post service test

Copy, scan, or print a document. Verify the document copies, scans, or prints correctly.

Remove the Dual cassette feeder (DCF) pickup units

Follow these steps to remove the Dual cassette feeder (DCF) pickup units.

1. Remove the DCF right door.

2. Remove two screws, and then remove the cable cover.

Figure 2-464 Remove two screws and the cable cover

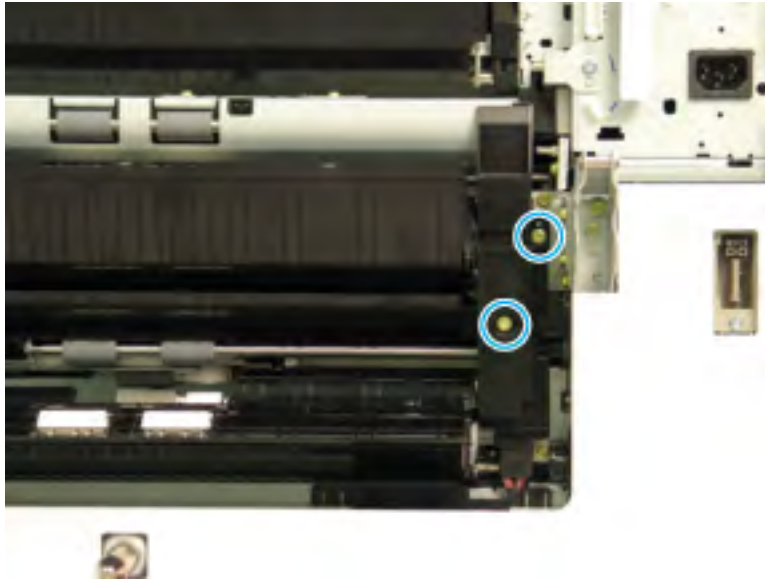

3. At the front of the printer, remove five screws, and then remove two brackets.

Figure 2-465 Remove five screws and two brackets



4. Disconnect two connectors (callout 1), and then remove the wire harness from the cable guide (callout 2). Remove eight screws (callout 3).

Figure 2-466 Disconnect two connectors and remove eight screws

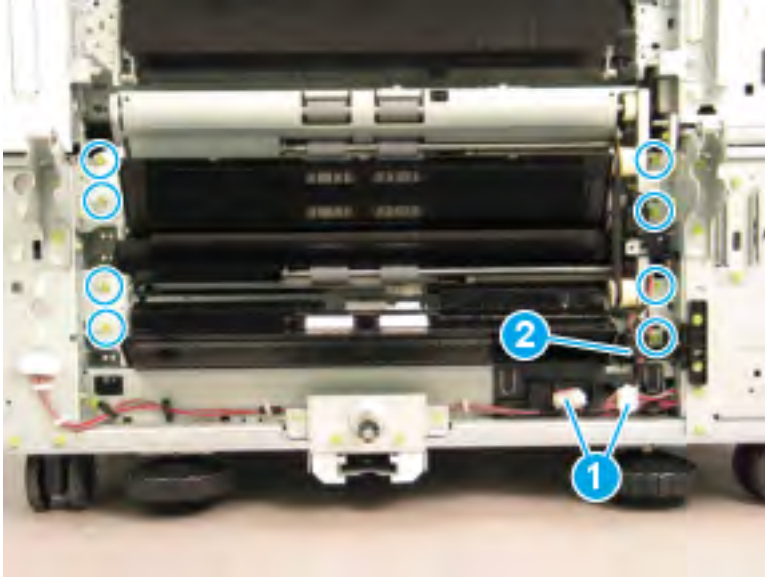

5. Rotate both pickup units away from the feeder on the left (callout 1). Release the belt (callout 2) that connects the two units. Slide the pickup units to the left (callout 3) to remove them.

Figure 2-467 Remove the pickup units

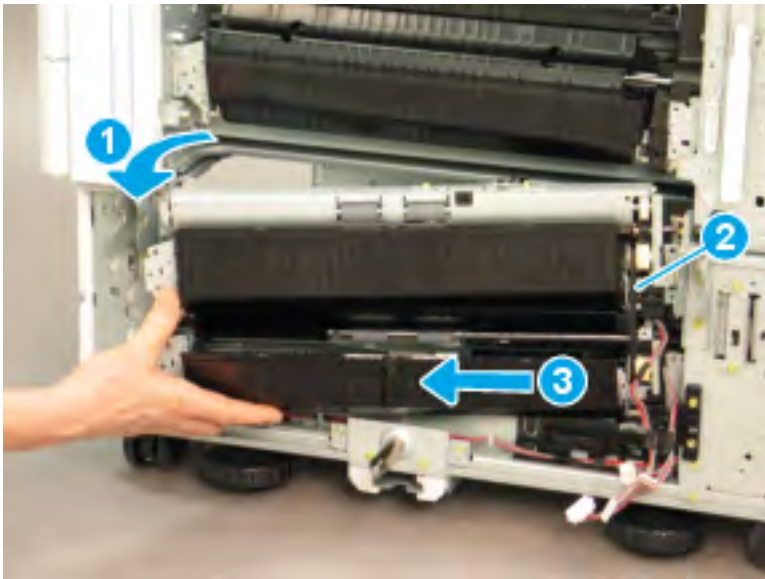

Unpack the replacement assembly

Follow these steps to unpack the replacement assembly.

1. Dispose of the defective part.

 **NOTE:** HP recommends responsible disposal of the defective part.

<http://www8.hp.com/us/en/hp-information/environment/product-recycling.html>

2. Unpack the replacement part from the packaging.



CAUTION:  Some parts are sensitive to electrostatic discharge (ESD). Always perform service work at an ESD-protected workstation or mat. If an ESD workstation or mat is not available, touch the sheet-metal chassis to provide a static ground before touching an ESD-sensitive assembly. Protect the ESD-sensitive assemblies by placing them in ESD pouches when they are out of the printer.

 **IMPORTANT:** Make sure that all of the shipping materials (for example shipping tape) are removed from the replacement part prior to installation.

 **NOTE:** If the replacement part is a roller or pad, avoid touching the spongy part of it. Skin oils on the roller or pad can cause paper pickup and/or print-quality problems. HP recommends using disposable gloves when handling rollers or pads or washing your hands before touching rollers or pads.

3. To install an assembly, reverse the removal steps.

 **NOTE:** When applicable, special installation instructions are provided for an assembly at the end of the removal procedure. Always completely read the removal instructions and follow all special installation instructions.

DCF main frame pickup, upper

Parts diagram and parts list for the main frame pickup upper.

Figure 2-468 DCF main frame pickup upper

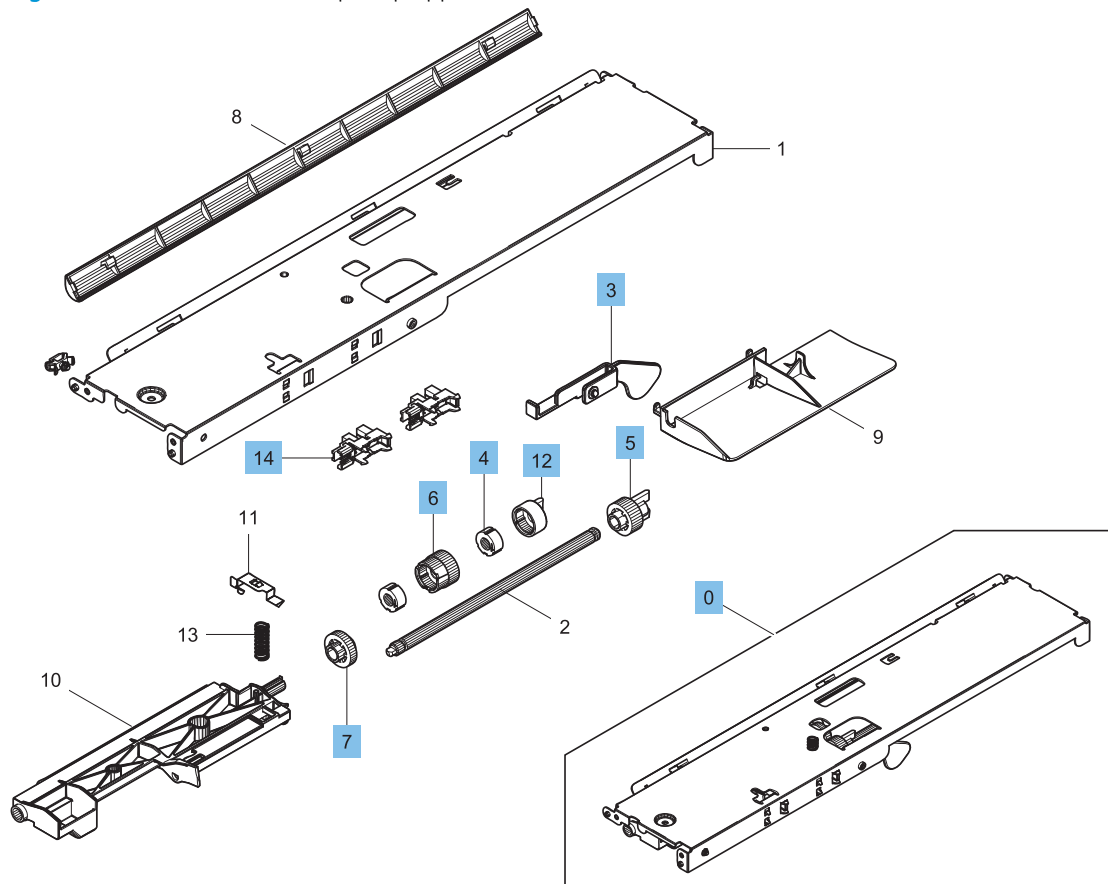

Table 2-107 DCF main frame pickup upper

Ref				
No	Part number	Description	Qty	Repair procedure
0	JC93-00504A	Main frame pickup, upper	2	Not applicable
3	JC66-03199A	Actuator, empty pickup	2	Not applicable
4	JC66-00977A	Clutch one way	4	Not applicable
5	JC66-00943A	Gear-m, joint	2	Not applicable
6	JC66-00941A	Gear-m, one way	2	Not applicable
7	JC66-00940A	Gear-m, idle	2	Not applicable
12	JC61-01288A	Holder-m, idle one way	2	Not applicable
14	0604-001393	Photo interrupter	4	Not applicable

High-capacity input (HCI) tray (workgroup)

View the high-capacity input (HCI) tray (workgroup) exploded diagrams and parts lists.

HCI main

View the HCI main exploded view, parts list, and repair procedures.

HCI main

Parts diagram and parts list for the HCI main.

Figure 2-469 HCI main

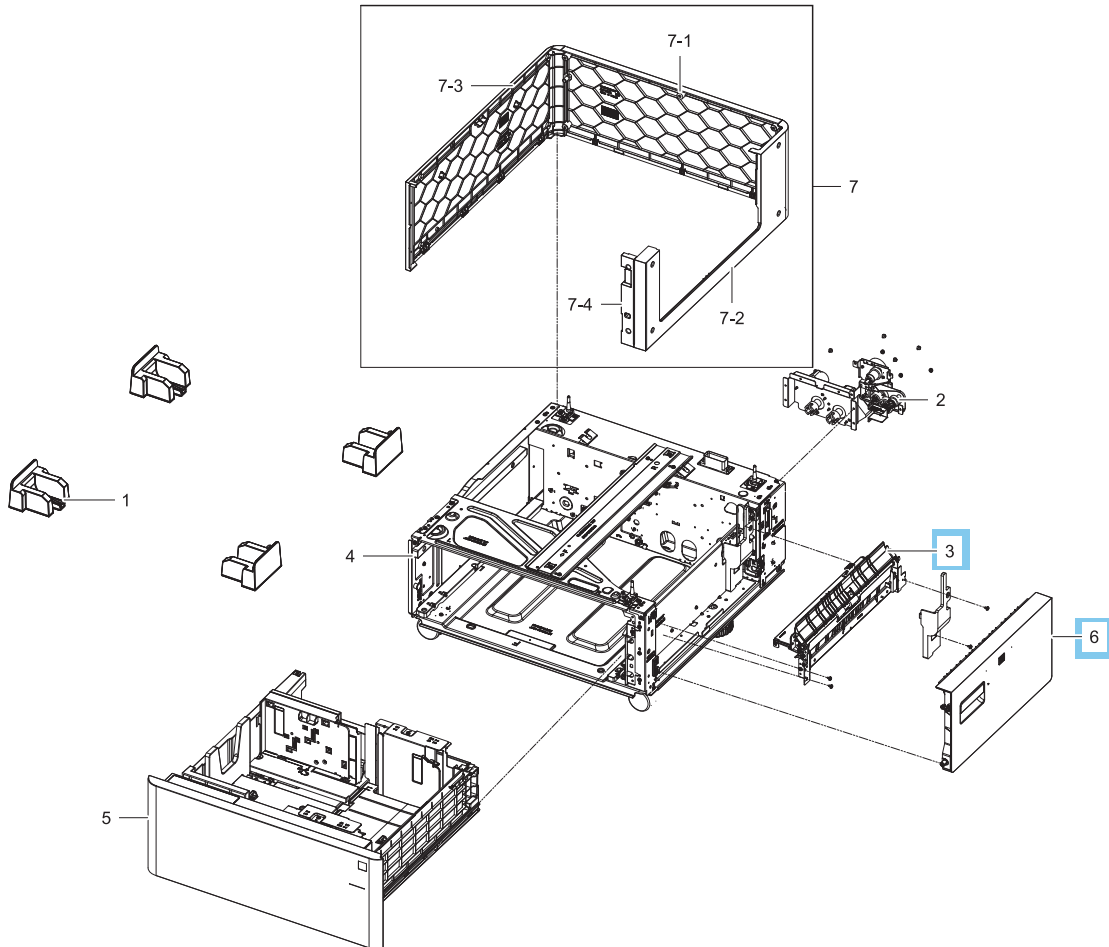

Table 2-108 HCl main

Ref				
No	Part number	Description	Qty	Repair procedure
3	JC90-01727A	Sub-pickup (HCl)	1	Removal and replacement: HCl sub - pickup on page 591
6	JC90-01734A	Takeaway (HCl) (right door)	1	Removal and replacement: HCl right door on page 601

Removal and replacement: HCI sub - pickup

This document provides the procedures to remove the HCI sub-pickup.



[View a video of removing and replacing the sub-pickup assembly.](#)

Mean time to repair:

Service level:



IMPORTANT: When applicable, special installation instructions are provided for an assembly at the end of the removal procedure. Always completely read the removal instructions and follow all special installation instructions.

Before performing service

- Disconnect the power cable.



WARNING! To avoid damage to the printer, turn the printer off, wait 30 seconds, and then remove the power cable before attempting to service the printer.

Use the table below to identify the correct part number for your printer. To order the part, go to www.hp.com/buy/parts

Table 2-109 Part information

Part number	Part description
JC90-01727A	HCI sub - pickup

Required tools

- #2 JIS screwdriver with a magnetic tip

After performing service

Turn the printer power on

- Connect the power cable.
- Turn on the power switch next to the power cable, and then press the power button on the front of the printer.
- Verify that the service performed was successful.
- Verify that the most recent firmware is installed on the printer.
- Verify that all parts are correctly reinstalled and are properly working.

Post service test

Print any pages necessary to verify that the repair resolved the issue and did not create any new issues.

Remove the HCI rear cover

Follow these steps to remove the Remove the HCI rear cover.

- ▲ Remove five screw caps (if installed), remove five screws, and then remove the rear cover.

Figure 2-470 Remove the HCI rear cover

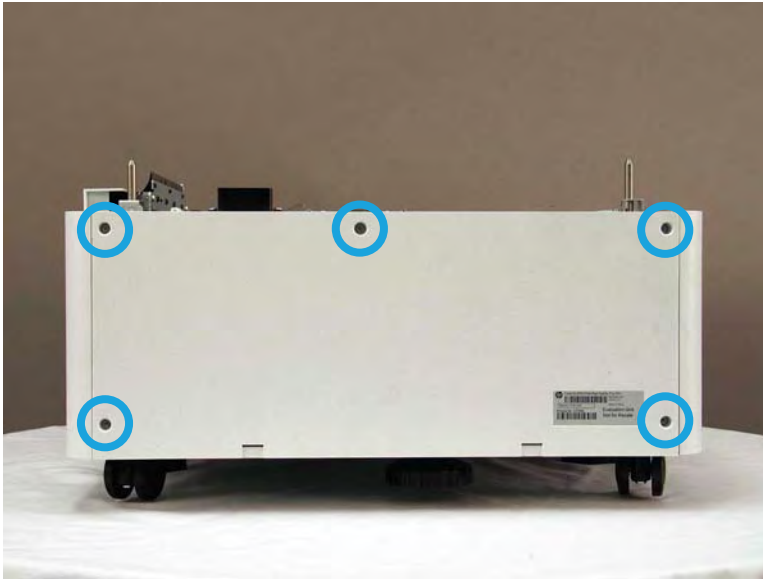

Remove the HCI drive assembly - feed

Follow these steps to remove the Remove the HCI drive assembly - feed.

1. Open the right door, and then remove two screws.

Figure 2-471 Remove two screws

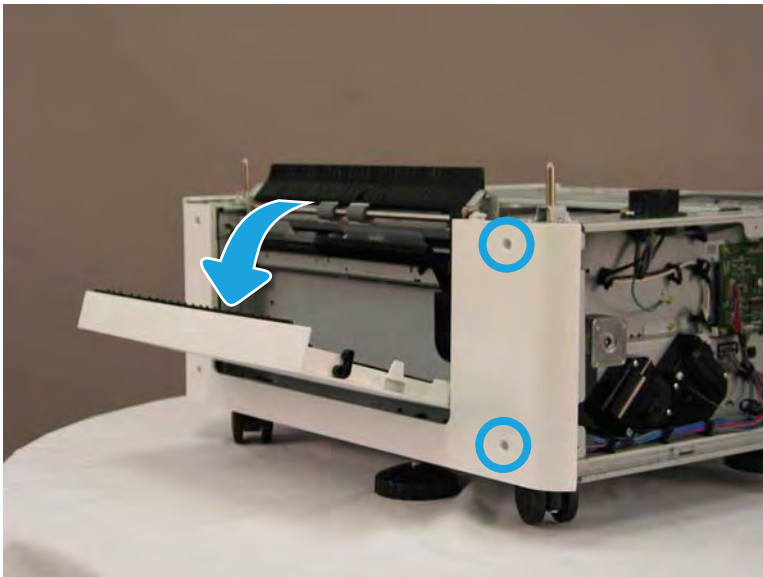

2. Release one tab, and then separate the rear edge of the right cover from the chassis.

Figure 2-472 Separate the rear edge of the right cover from the chassis

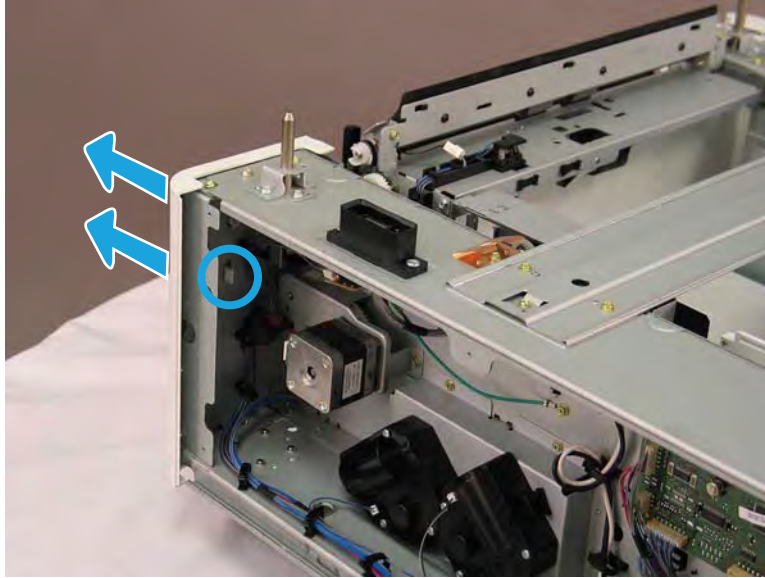

3. Disconnect one connector, and then release the wire harness from the retainer.

Figure 2-473 Disconnect one connector

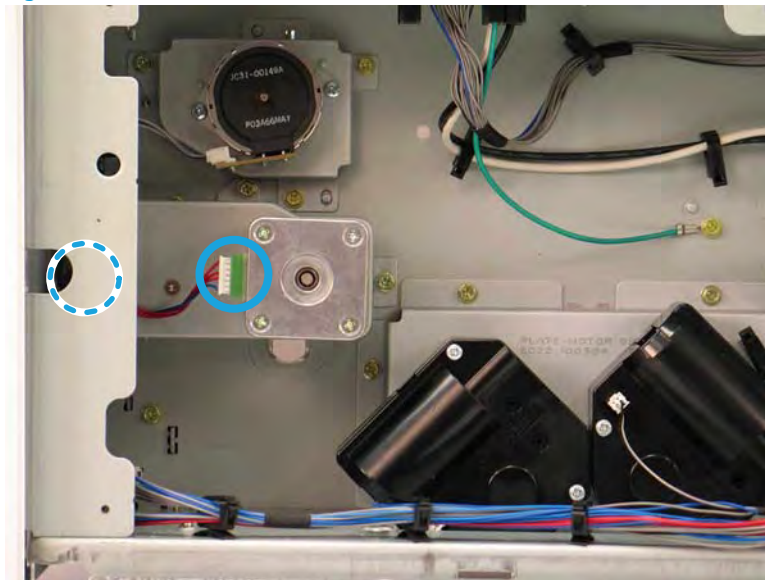

4. Remove three screws, and then remove the HCI drive assembly - feed.

Figure 2-474 Remove the HCI drive assembly - feed

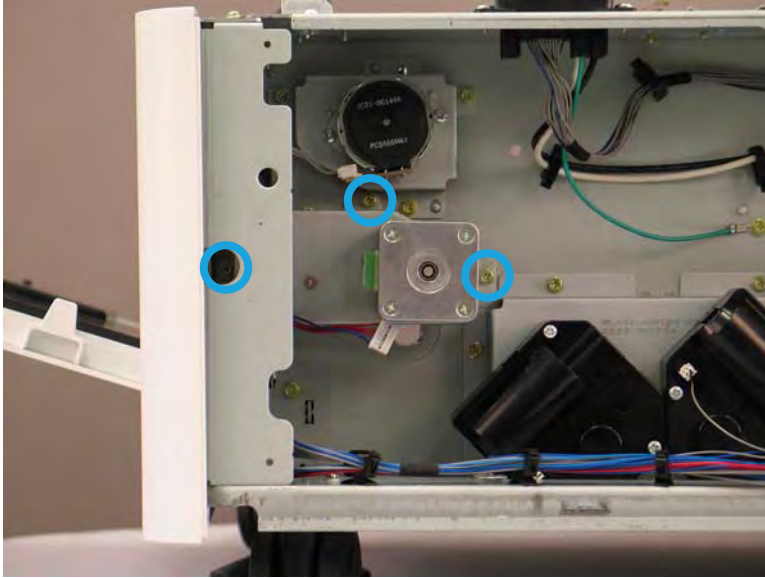

Remove the HCI right door

Follow these steps to remove the Remove the HCI right door.

1. Remove four screw caps (if installed), and then remove four screws.

 **NOTE:** If the feed drive assembly is removed, there are only two screws that secure this cover.

Figure 2-475 Remove four screws

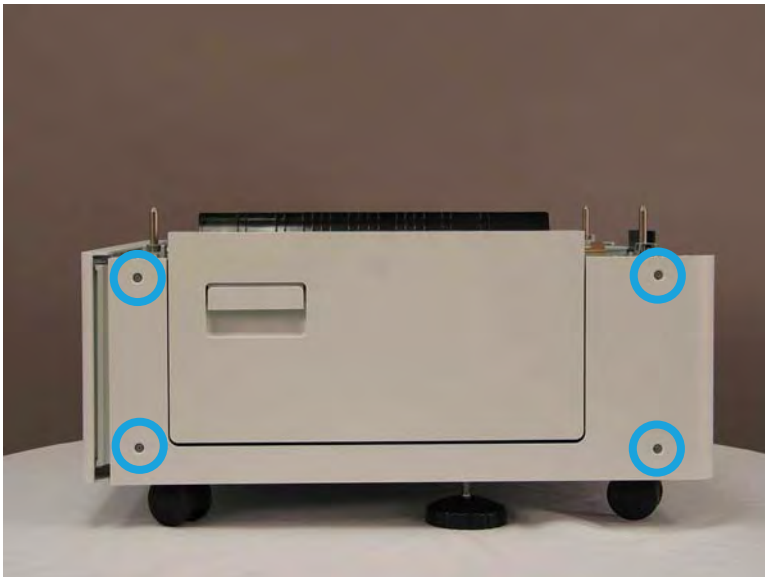

2. Release one tab, and then separate the rear edge of the right cover from the chassis.

Figure 2-476 Separate the rear edge of the right cover from the chassis

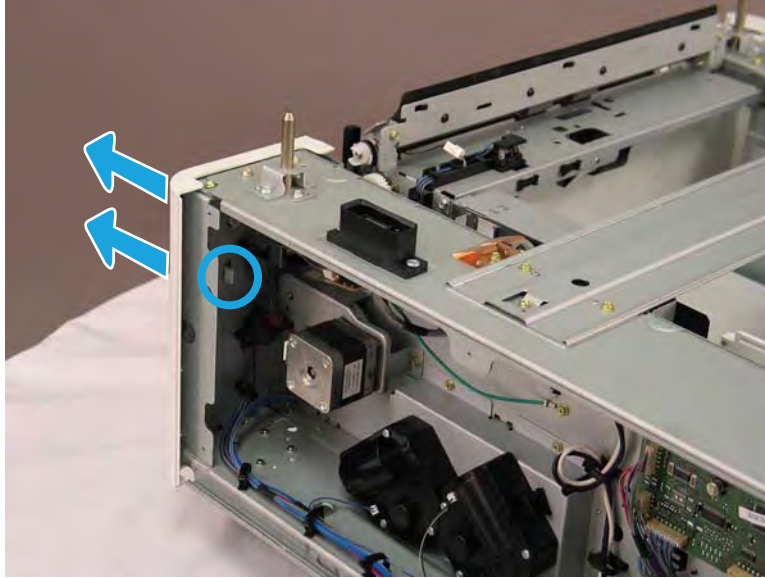

3. Lift up on the cover while rotating it away from the chassis to release three bosses.

⚠ CAUTION: Do not attempt to fully remove the cover. Stop as shown below. Fully removing the cover at this step will damage the remaining tab and boss on the cover

Figure 2-477 Release three bosses

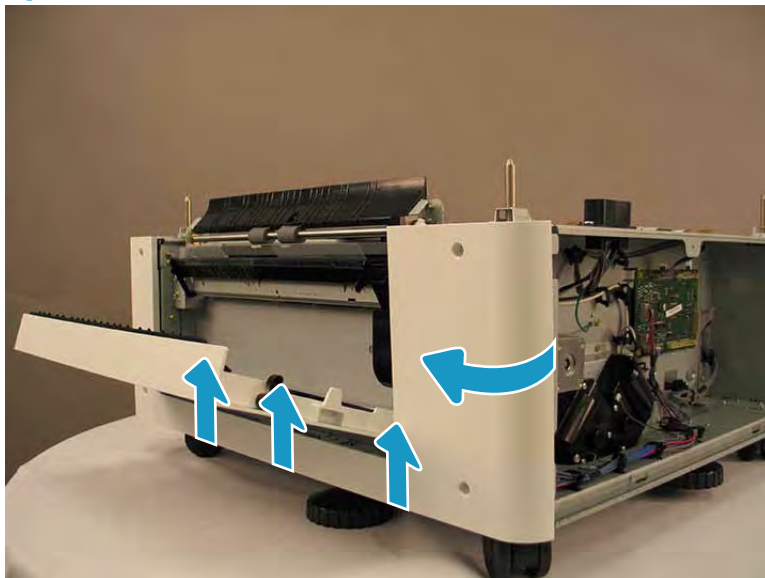

4. If the tray was not removed prior to servicing the HCI, remove it now. Look in the tray cavity and locate the right cover front tab. Release this tab.

Figure 2-478 Release one tab



5. Remove the HCI right cover.

 **NOTE:** The HCI right door will not stay in the latched position when this cover is removed.

Figure 2-479 Remove the HCI right cover



6. Rotate the right door front hinge pin out of the holder, and then slide the right door towards the front of the HCI to release the rear hinge pin and remove the door.

Figure 2-480 Remove the HCI right door

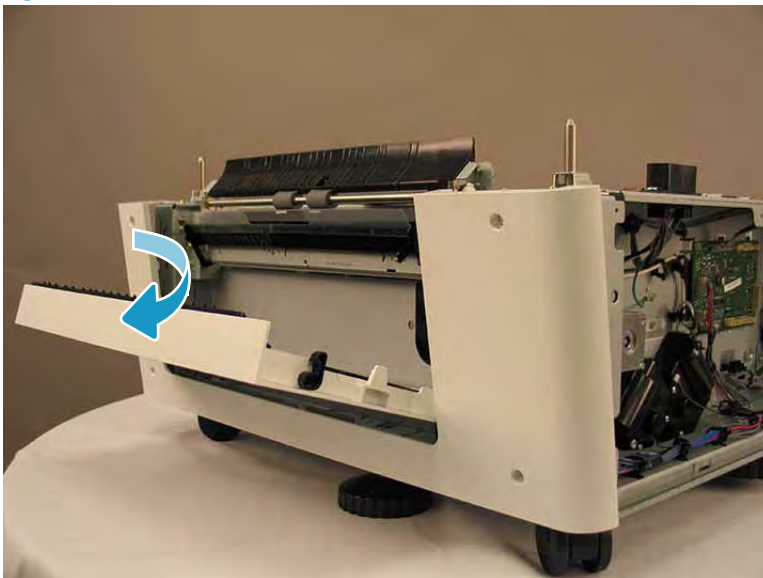
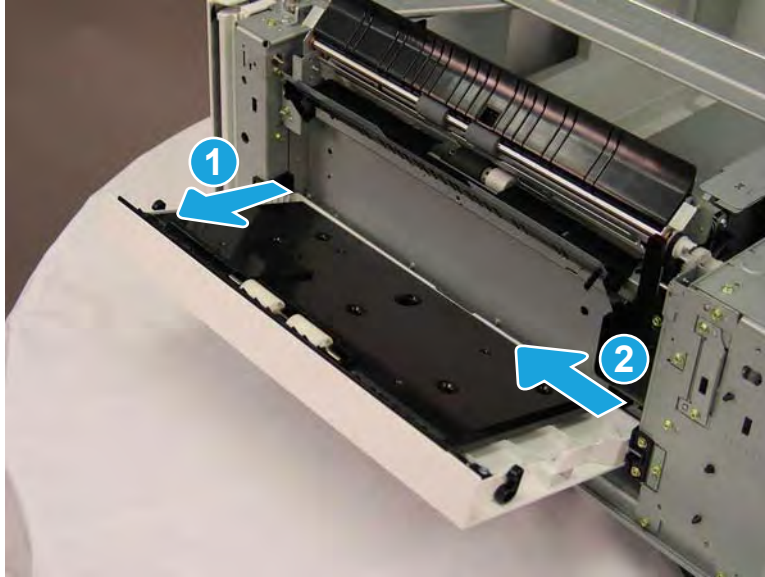

Remove the HCI drive assembly -sub pulley

Follow these steps to remove the Remove the HCI drive assembly -sub pulley.

1. Remove two screws, and then remove the black-plastic cover.

Figure 2-481 Remove the cover

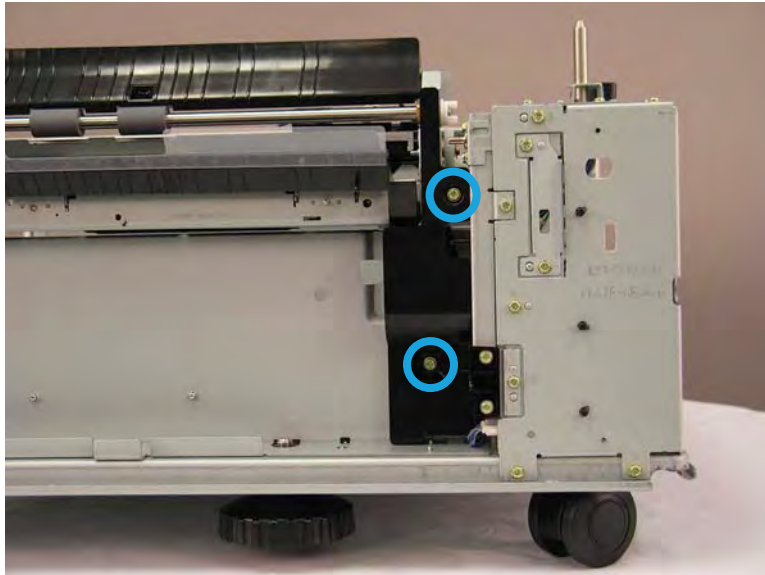

2. Remove two screws, and then remove the drive assembly - sub-pulley.

Figure 2-482 Remove the HCI drive assembly - sub-pulley

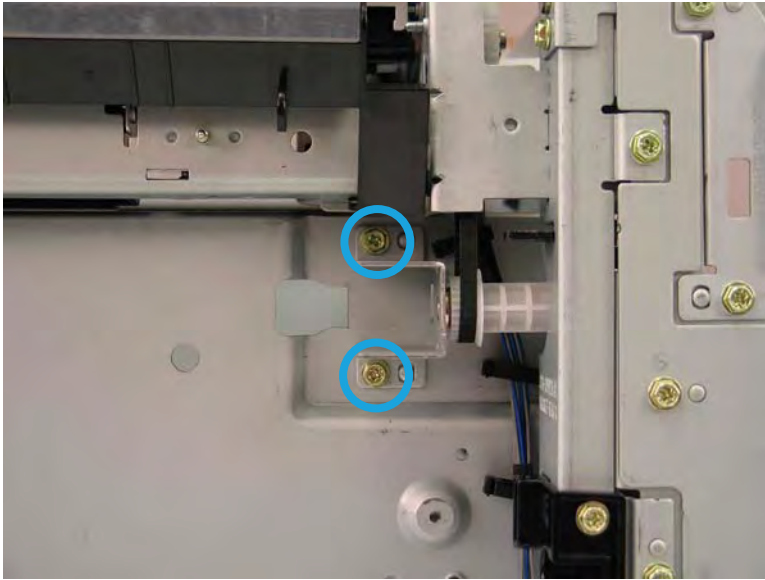

Remove the HCI belt - timing gear

Follow these steps to remove the Remove the HCI belt - timing gear.

- ▲ Remove the belt from the drive gear, and then remove it.

Figure 2-483 Remove the belt - timing gear

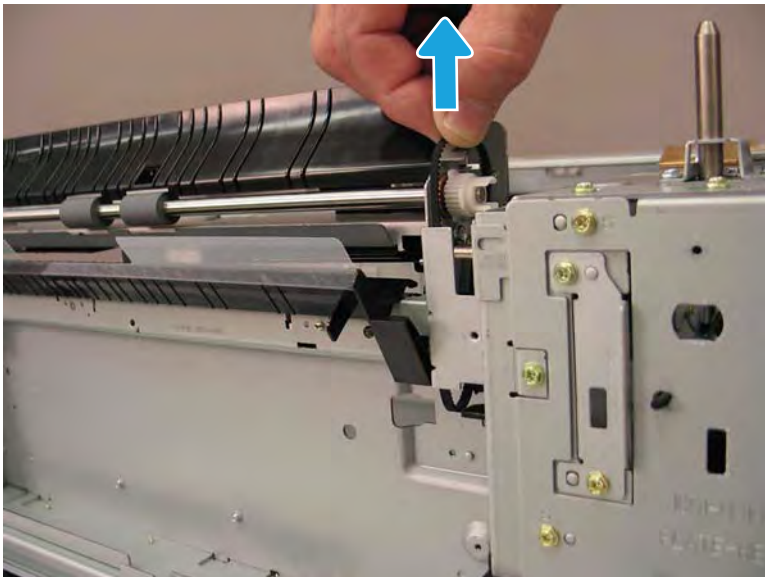

Remove the HCI sub - pickup

Follow these steps to remove the Remove the HCI sub - pickup.

1. Disconnect one connector, and then release three retainers.

Figure 2-484 Disconnect one connector

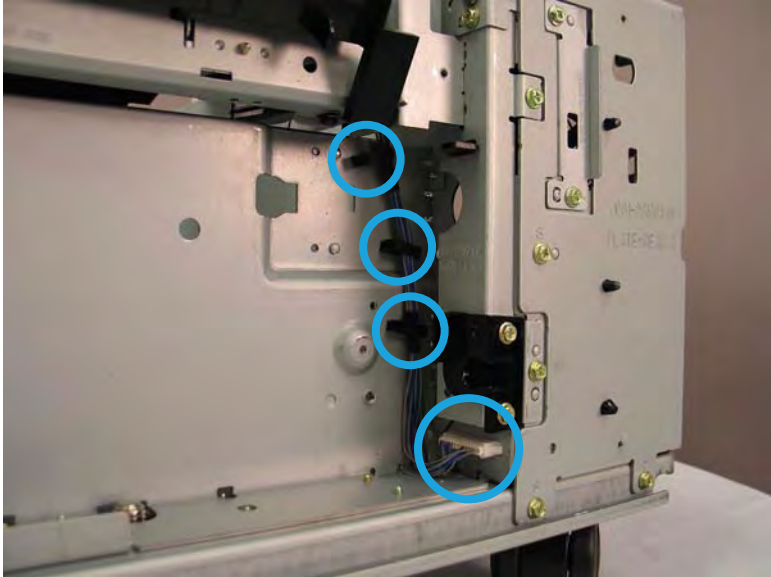

- 2. Remove two screws.

Figure 2-485 Remove two screws

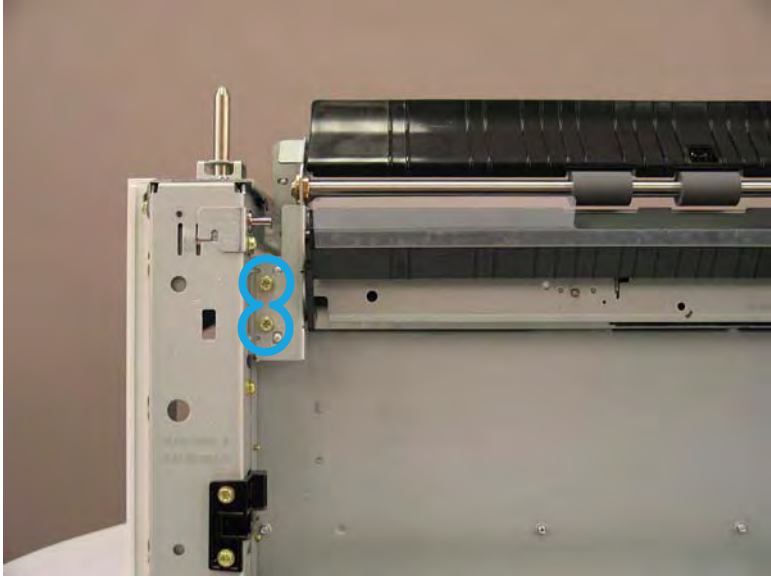

3. Rotate the front end of the sub - pickup away from the HCI, and then slide it toward the front to remove it.

Figure 2-486 Remove the sub - pickup

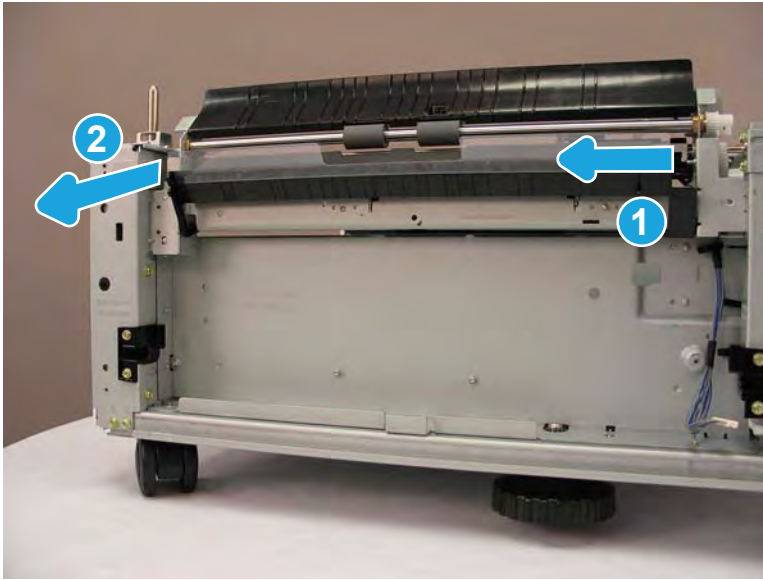

Unpack the replacement assembly



Follow these steps to unpack the replacement assembly.

1. Dispose of the defective part.

 **NOTE:** HP recommends responsible disposal of the defective part.

<http://www8.hp.com/us/en/hp-information/environment/product-recycling.html>

2. Unpack the replacement part from the packaging.

 **CAUTION:**  Some parts are sensitive to electrostatic discharge (ESD). Always perform service work at an ESD-protected workstation or mat. If an ESD workstation or mat is not available, touch the sheet-metal chassis to provide a static ground before touching an ESD-sensitive assembly. Protect the ESD-sensitive assemblies by placing them in ESD pouches when they are out of the printer.

 **IMPORTANT:** Make sure that all of the shipping materials (for example shipping tape) are removed from the replacement part prior to installation.

 **NOTE:** If the replacement part is a roller or pad, avoid touching the spongy part of it. Skin oils on the roller or pad can cause paper pickup and/or print-quality problems. HP recommends using disposable gloves when handling rollers or pads or washing your hands before touching rollers or pads.

3. To install an assembly, reverse the removal steps.

 **NOTE:** When applicable, special installation instructions are provided for an assembly at the end of the removal procedure. Always completely read the removal instructions and follow all special installation instructions.

Removal and replacement: HCI right door

This document provides the procedures to remove the HCI right door.



[View a video of removing and replacing the sub-right door.](#)

Mean time to repair:

Service level:



IMPORTANT: When applicable, special installation instructions are provided for an assembly at the end of the removal procedure. Always completely read the removal instructions and follow all special installation instructions.

Before performing service

- Disconnect the power cable.



WARNING! To avoid damage to the printer, turn the printer off, wait 30 seconds, and then remove the power cable before attempting to service the printer.

Use the table below to identify the correct part number for your printer. To order the part, go to www.hp.com/buy/parts

Table 2-110 Part information

Part number	Part description
JC90-01734A	HCI right door

Required tools

- #2 JIS screwdriver with a magnetic tip

After performing service

Turn the printer power on

- Connect the power cable.
- Turn on the power switch next to the power cable, and then press the power button on the front of the printer.
- Verify that the service performed was successful.
- Verify that the most recent firmware is installed on the printer.
- Verify that all parts are correctly reinstalled and are properly working.

Post service test

Print any pages necessary to verify that the repair resolved the issue and did not create any new issues.

Remove the HCI rear cover

Follow these steps to remove the Remove the HCI rear cover.

- ▲ Remove five screw caps (if installed), remove five screws, and then remove the rear cover.

Figure 2-487 Remove the HCI rear cover

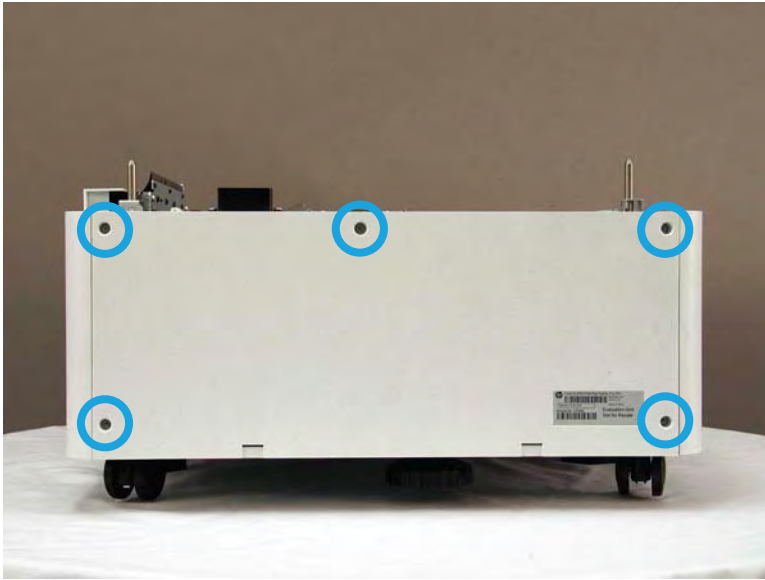

Remove the HCI right door

Follow these steps to remove the Remove the HCI right door.

1. Remove four screw caps (if installed), and then remove four screws.

 **NOTE:** If the feed drive assembly is removed, there are only two screws that secure this cover.

Figure 2-488 Remove four screws



2. Release one tab, and then separate the rear edge of the right cover from the chassis.

Figure 2-489 Separate the rear edge of the right cover from the chassis

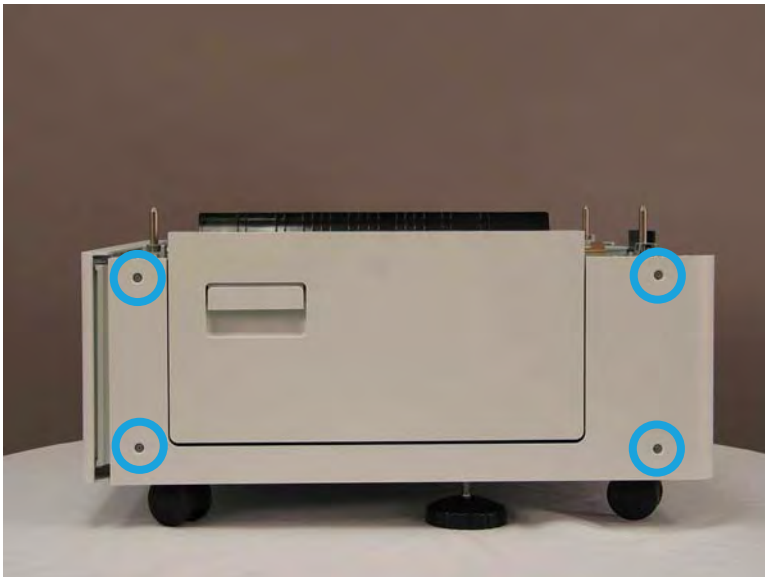
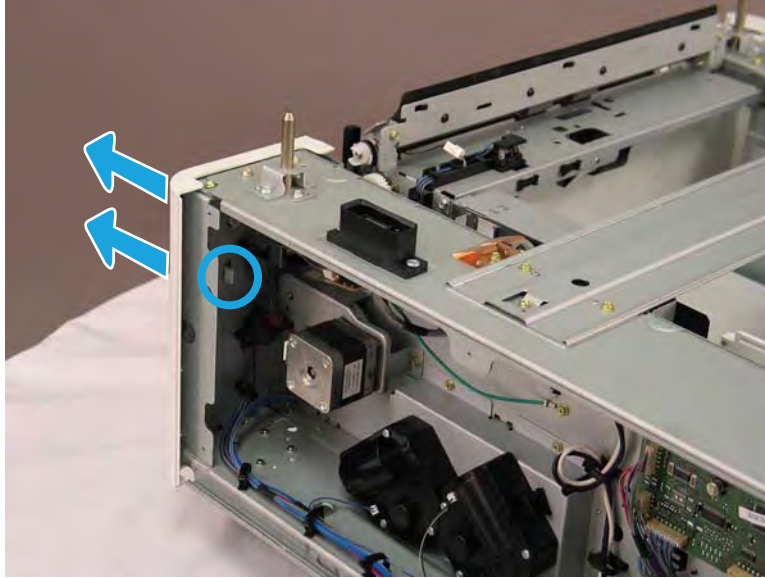

3. Lift up on the cover while rotating it away from the chassis to release three bosses.

⚠ CAUTION: Do not attempt to fully remove the cover. Stop as shown below. Fully removing the cover at this step will damage the remaining tab and boss on the cover

Figure 2-490 Release three bosses

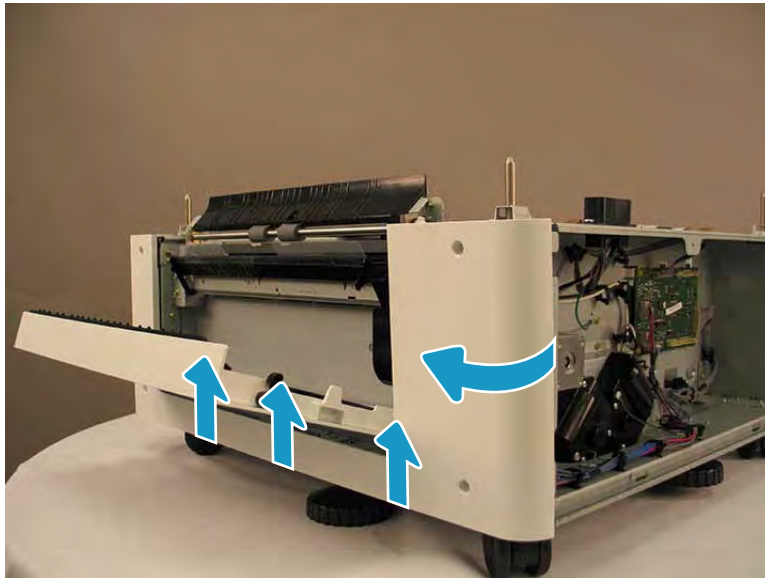

4. If the tray was not removed prior to servicing the HCI, remove it now. Look in the tray cavity and locate the right cover front tab. Release this tab.

Figure 2-491 Release one tab



5. Remove the HCI right cover.

 **NOTE:** The HCI right door will not stay in the latched position when this cover is removed.

Figure 2-492 Remove the HCI right cover



6. Rotate the right door front hinge pin out of the holder, and then slide the right door towards the front of the HCI to release the rear hinge pin and remove the door.

Figure 2-493 Remove the HCI right door

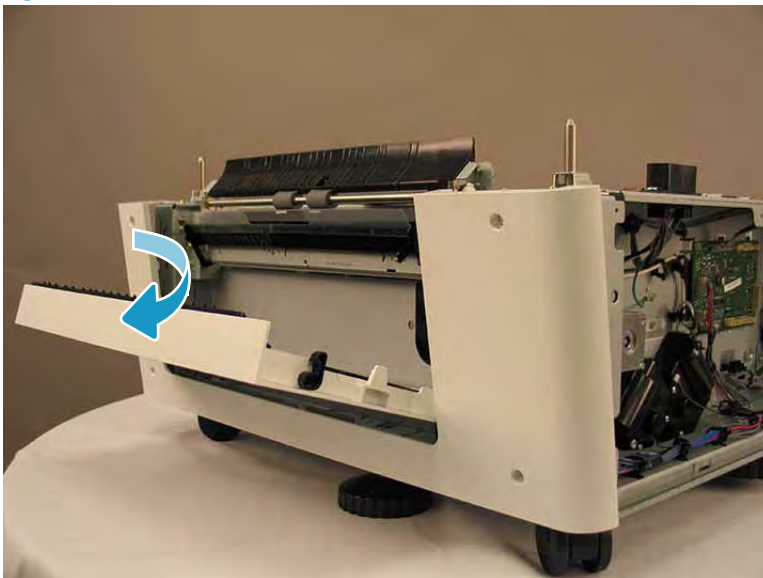
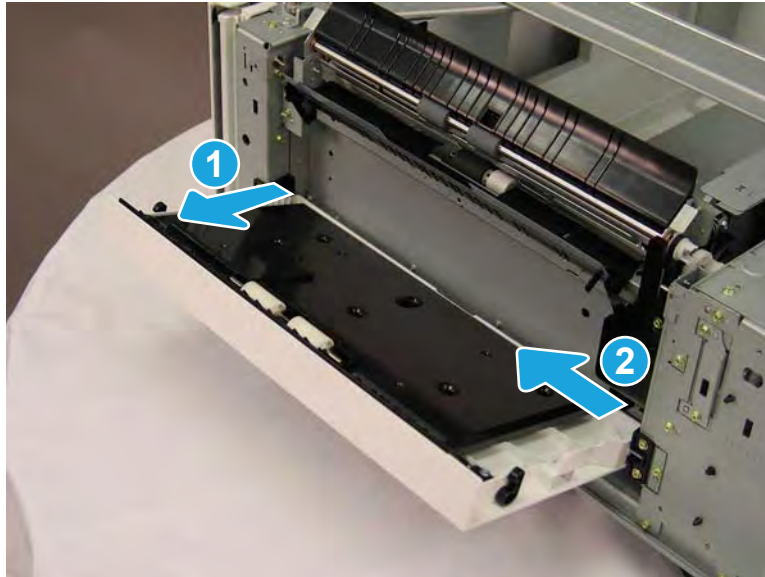

Unpack the replacement assembly



Follow these steps to unpack the replacement assembly.

1. Dispose of the defective part.

 **NOTE:** HP recommends responsible disposal of the defective part.

<http://www8.hp.com/us/en/hp-information/environment/product-recycling.html>

2. Unpack the replacement part from the packaging.

 **CAUTION:**  Some parts are sensitive to electrostatic discharge (ESD). Always perform service work at an ESD-protected workstation or mat. If an ESD workstation or mat is not available, touch the sheet-metal chassis to provide a static ground before touching an ESD-sensitive assembly. Protect the ESD-sensitive assemblies by placing them in ESD pouches when they are out of the printer.

 **IMPORTANT:** Make sure that all of the shipping materials (for example shipping tape) are removed from the replacement part prior to installation.

 **NOTE:** If the replacement part is a roller or pad, avoid touching the spongy part of it. Skin oils on the roller or pad can cause paper pickup and/or print-quality problems. HP recommends using disposable gloves when handling rollers or pads or washing your hands before touching rollers or pads.

3. To install an assembly, reverse the removal steps.

 **NOTE:** When applicable, special installation instructions are provided for an assembly at the end of the removal procedure. Always completely read the removal instructions and follow all special installation instructions.

HCI sub - frame

View the HCI sub - frame exploded view, parts list, and repair procedures.

HCI sub - frame

Parts diagram and parts list for the HCI sub - frame.

Figure 2-494 HCI sub - frame

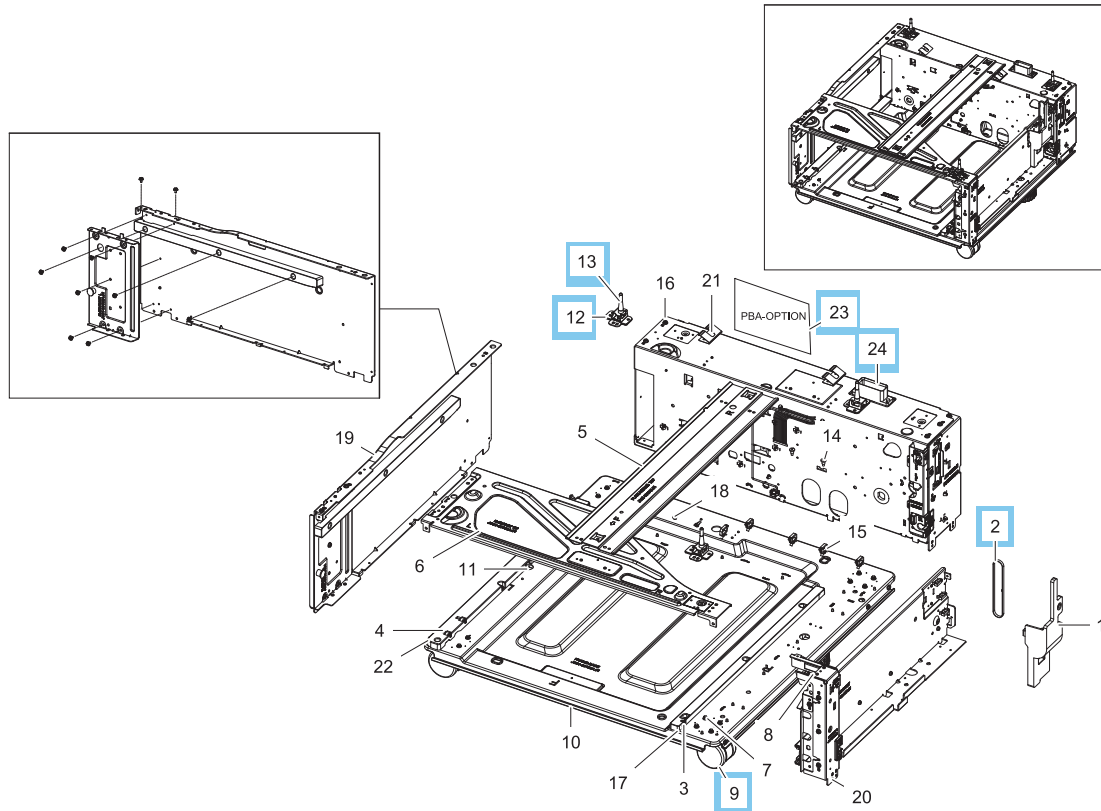

Table 2-111 HCI sub - frame

Ref				
No	Part number	Description	Qty	Repair procedure
2	6602-003185	Belt timing gear (HCI)	1	Removal and replacement: HCI belt - timing gear on page 608
9	6109-001138	Caster wheel (HCI)	4	Removal and replacement: HCI caster wheel on page 623
12	JC61-04660A	Plate guide post upper (HCI)	3	Removal and replacement: HCI guide post and guide post plate on page 625
13	JC61-04659A	Plate guide post (HCI)	3	Removal and replacement: HCI guide post and guide post plate on page 625
23	JC92-02738G	Printed circuit assembly (HCI)	1	Removal and replacement: HCI PCA on page 617
24	JC39-02600A	Main electrical connector (HCI)	3	Removal and replacement: HCI main electrical connector on page 620

Removal and replacement: HCI belt - timing gear

This document provides the procedures to remove the HCI belt - timing gear.



[View a video of removing and replacing the belt - timing gear.](#)

Mean time to repair:

Service level:



IMPORTANT: When applicable, special installation instructions are provided for an assembly at the end of the removal procedure. Always completely read the removal instructions and follow all special installation instructions.

Before performing service

- Disconnect the power cable.



WARNING! To avoid damage to the printer, turn the printer off, wait 30 seconds, and then remove the power cable before attempting to service the printer.

Use the table below to identify the correct part number for your printer. To order the part, go to www.hp.com/buy/parts

Table 2-112 Part information

Part number	Part description
6602-003185	HCI belt - timing gear

Required tools

- #2 JIS screwdriver with a magnetic tip

After performing service

Turn the printer power on

- Connect the power cable.
- Turn on the power switch next to the power cable, and then press the power button on the front of the printer.
- Verify that the service performed was successful.
- Verify that the most recent firmware is installed on the printer.
- Verify that all parts are correctly reinstalled and are properly working.

Post service test

Print any pages necessary to verify that the repair resolved the issue and did not create any new issues.

Remove the HCI rear cover

Follow these steps to remove the Remove the HCI rear cover.

- ▲ Remove five screw caps (if installed), remove five screws, and then remove the rear cover.

Figure 2-495 Remove the HCI rear cover

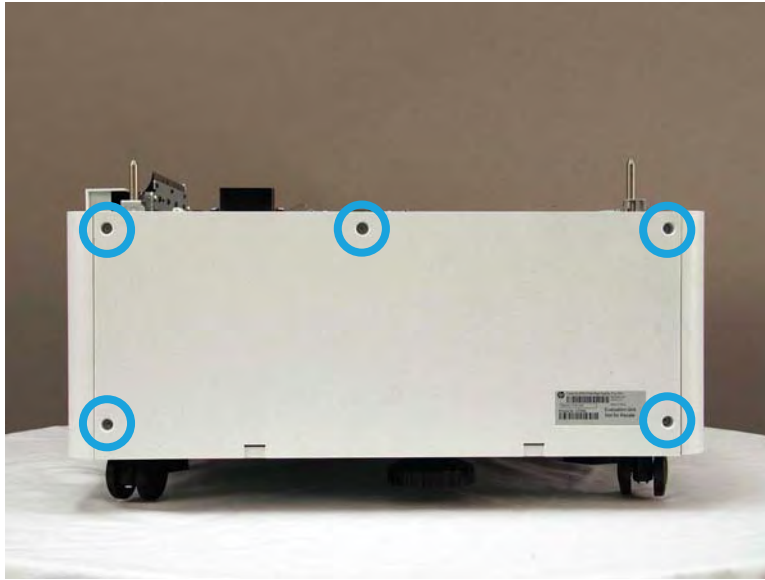

Remove the HCI drive assembly - feed

Follow these steps to remove the Remove the HCI drive assembly - feed.

1. Open the right door, and then remove two screws.

Figure 2-496 Remove two screws

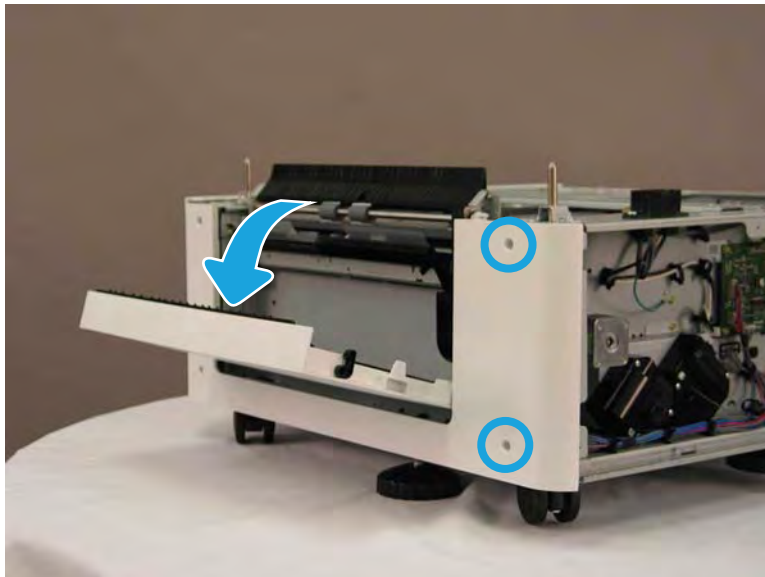

2. Release one tab, and then separate the rear edge of the right cover from the chassis.

Figure 2-497 Separate the rear edge of the right cover from the chassis

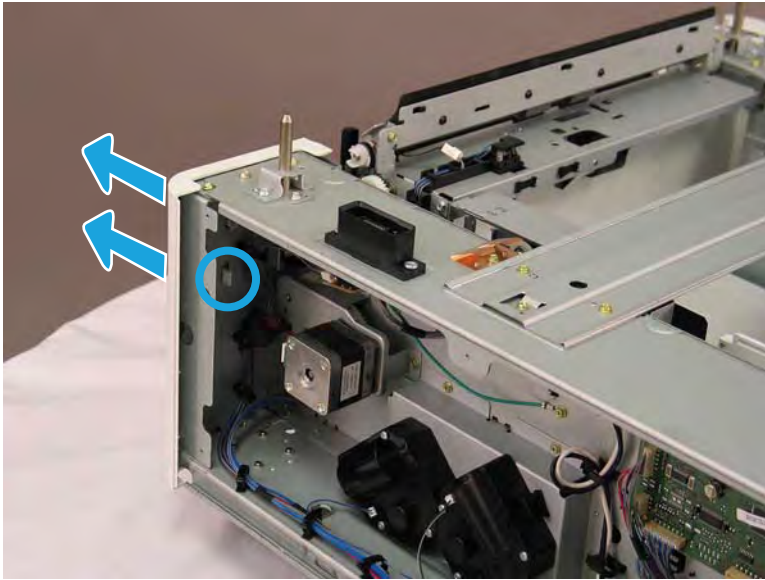

3. Disconnect one connector, and then release the wire harness from the retainer.

Figure 2-498 Disconnect one connector

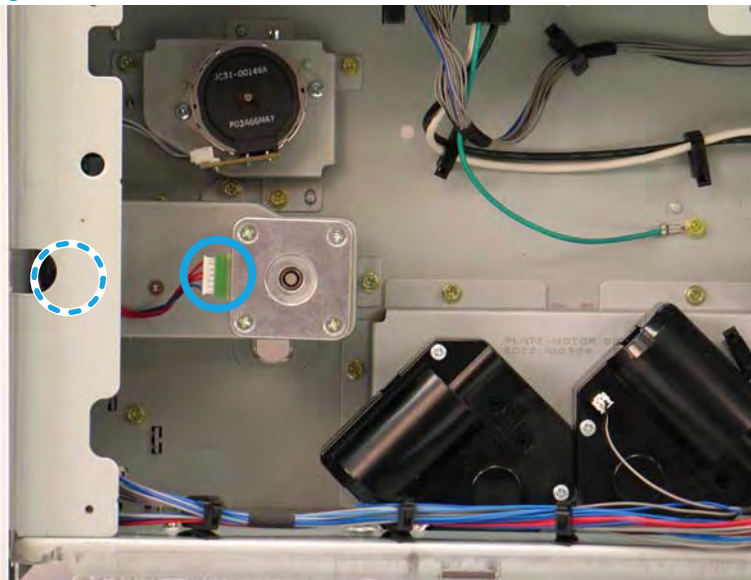

4. Remove three screws, and then remove the HCI drive assembly - feed.

Figure 2-499 Remove the HCI drive assembly - feed

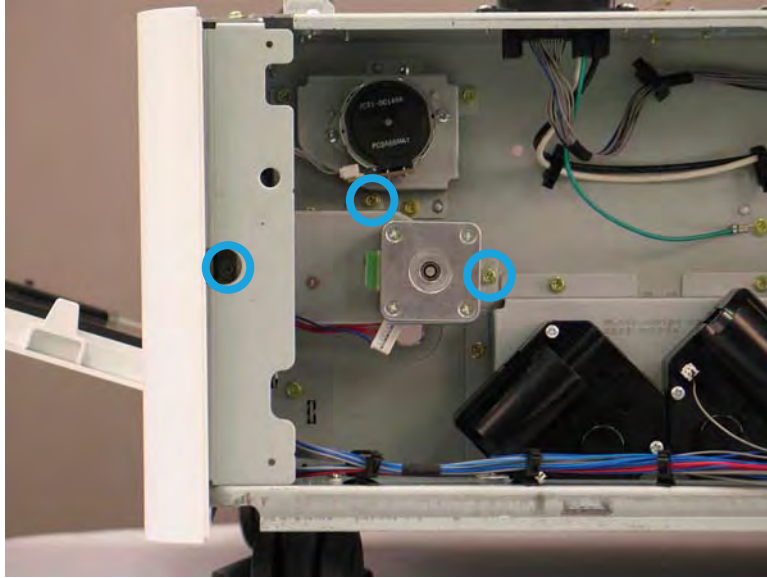

Remove the HCI right door

Follow these steps to remove the Remove the HCI right door.

1. Remove four screw caps (if installed), and then remove four screws.

 **NOTE:** If the feed drive assembly is removed, there are only two screws that secure this cover.

Figure 2-500 Remove four screws

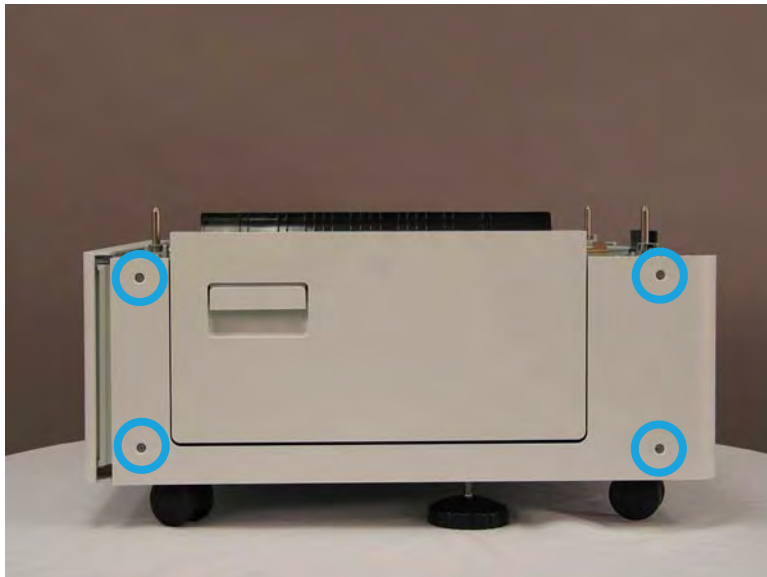

2. Release one tab, and then separate the rear edge of the right cover from the chassis.

Figure 2-501 Separate the rear edge of the right cover from the chassis

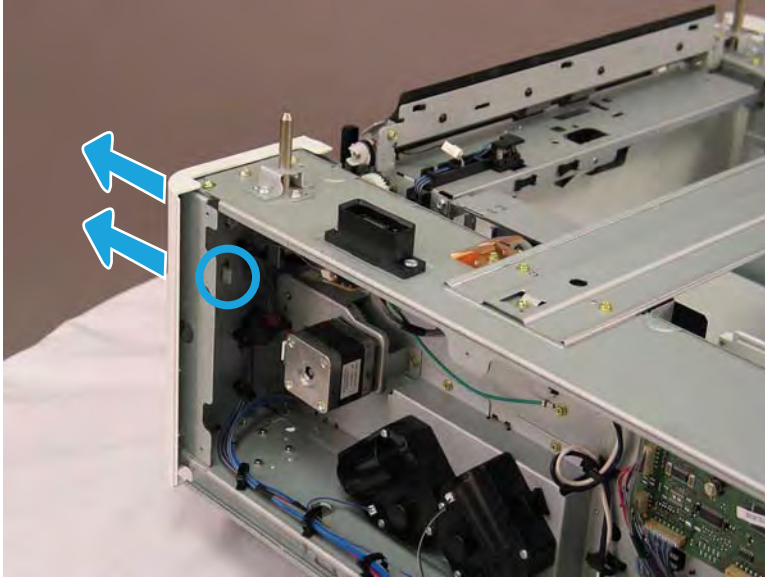

3. Lift up on the cover while rotating it away from the chassis to release three bosses.

CAUTION: Do not attempt to fully remove the cover. Stop as shown below. Fully removing the cover at this step will damage the remaining tab and boss on the cover

Figure 2-502 Release three bosses

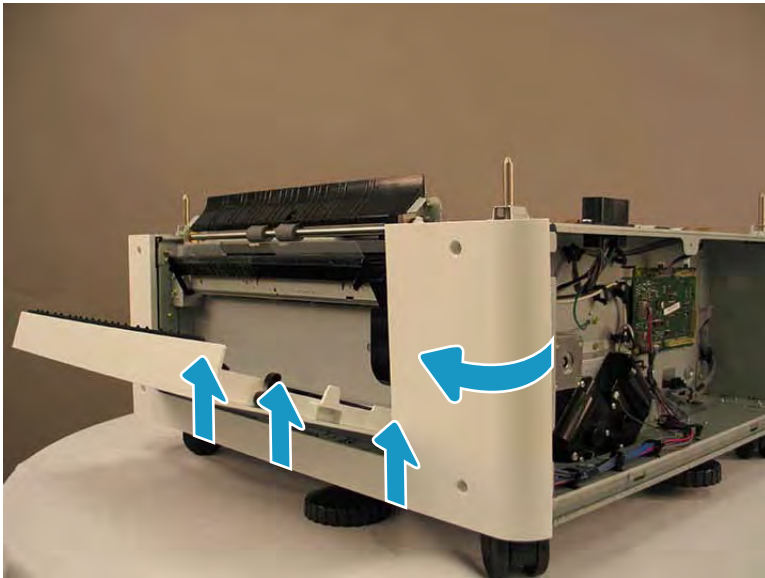

4. If the tray was not removed prior to servicing the HCI, remove it now. Look in the tray cavity and locate the right cover front tab. Release this tab.

Figure 2-503 Release one tab



5. Remove the HCI right cover.



NOTE: The HCI right door will not stay in the latched position when this cover is removed.

Figure 2-504 Remove the HCI right cover

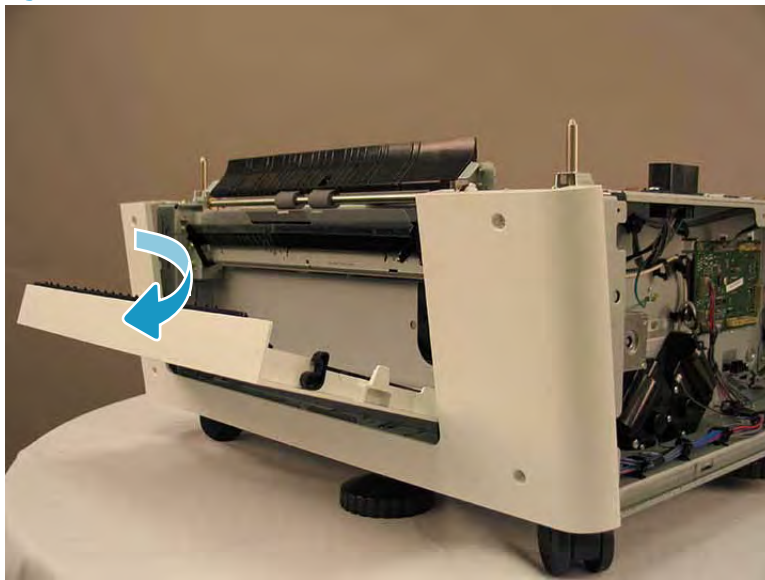

6. Rotate the right door front hinge pin out of the holder, and then slide the right door towards the front of the HCI to release the rear hinge pin and remove the door.

Figure 2-505 Remove the HCI right door

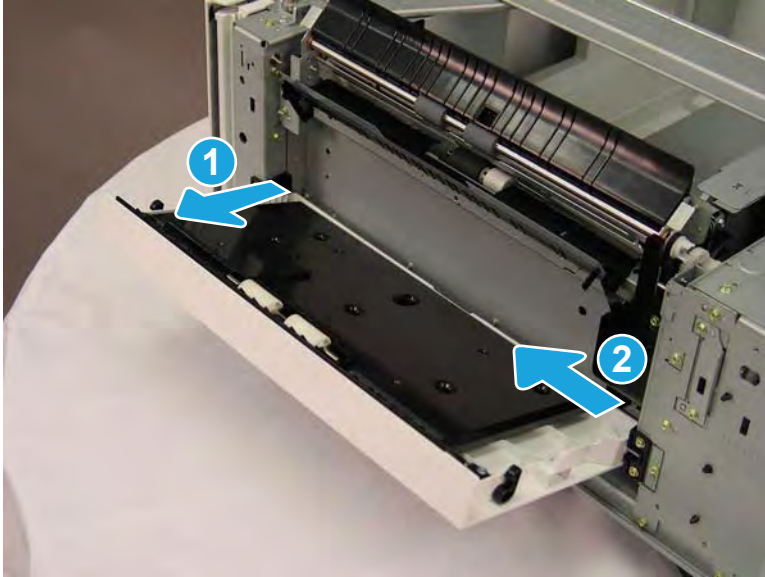

Remove the HCI drive assembly -sub pulley

Follow these steps to remove the Remove the HCI drive assembly -sub pulley.

1. Remove two screws, and then remove the black-plastic cover.

Figure 2-506 Remove the cover

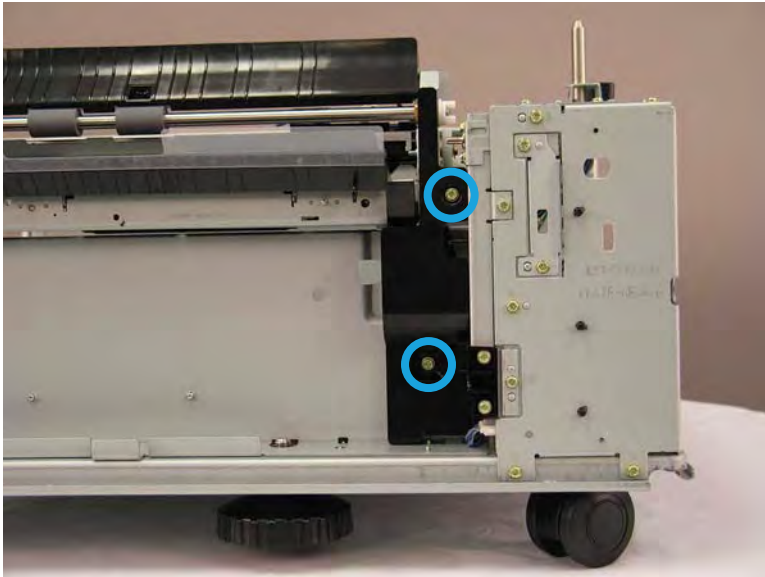

2. Remove two screws, and then remove the drive assembly - sub-pulley.

Figure 2-507 Remove the HCI drive assembly - sub-pulley

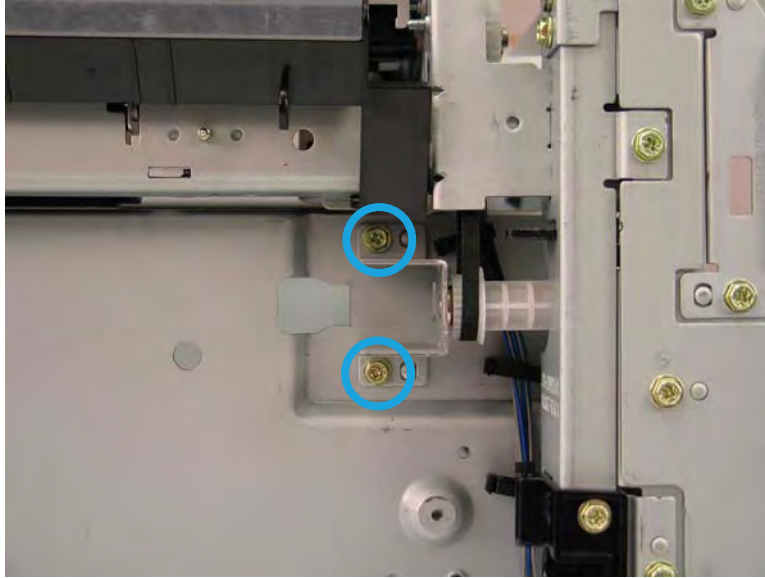

Remove the HCI belt - timing gear

Follow these steps to remove the Remove the HCI belt - timing gear.

- ▲ Remove the belt from the drive gear, and then remove it.

Figure 2-508 Remove the belt - timing gear

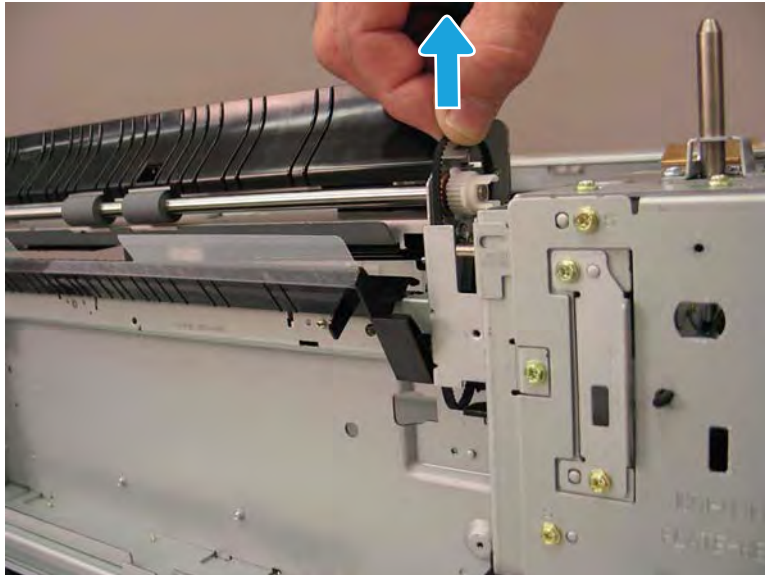

Unpack the replacement assembly

Follow these steps to unpack the replacement assembly.

1. Dispose of the defective part.

 **NOTE:** HP recommends responsible disposal of the defective part.

<http://www8.hp.com/us/en/hp-information/environment/product-recycling.html>

2. Unpack the replacement part from the packaging.



CAUTION:  Some parts are sensitive to electrostatic discharge (ESD). Always perform service work at an ESD-protected workstation or mat. If an ESD workstation or mat is not available, touch the sheet-metal chassis to provide a static ground before touching an ESD-sensitive assembly. Protect the ESD-sensitive assemblies by placing them in ESD pouches when they are out of the printer.

 **IMPORTANT:** Make sure that all of the shipping materials (for example shipping tape) are removed from the replacement part prior to installation.

 **NOTE:** If the replacement part is a roller or pad, avoid touching the spongy part of it. Skin oils on the roller or pad can cause paper pickup and/or print-quality problems. HP recommends using disposable gloves when handling rollers or pads or washing your hands before touching rollers or pads.

3. To install an assembly, reverse the removal steps.

 **NOTE:** When applicable, special installation instructions are provided for an assembly at the end of the removal procedure. Always completely read the removal instructions and follow all special installation instructions.

Removal and replacement: HCI PCA

This document provides the procedures to remove the HCI PCA.



[View a video of removing and replacing the PCA.](#)

Mean time to repair:

Service level:



IMPORTANT: When applicable, special installation instructions are provided for an assembly at the end of the removal procedure. Always completely read the removal instructions and follow all special installation instructions.

Before performing service

- Disconnect the power cable.



WARNING! To avoid damage to the printer, turn the printer off, wait 30 seconds, and then remove the power cable before attempting to service the printer.

Use the table below to identify the correct part number for your printer. To order the part, go to www.hp.com/buy/parts

Table 2-113 Part information

Part number	Part description
JC92-02738G	HCI PCA

Required tools

- #2 JIS screwdriver with a magnetic tip

After performing service

Turn the printer power on

- Connect the power cable.
- Turn on the power switch next to the power cable, and then press the power button on the front of the printer.
- Verify that the service performed was successful.
- Verify that the most recent firmware is installed on the printer.
- Verify that all parts are correctly reinstalled and are properly working.

Post service test

Print any pages necessary to verify that the repair resolved the issue and did not create any new issues.

Remove the HCI rear cover

Follow these steps to remove the Remove the HCI rear cover.

- ▲ Remove five screw caps (if installed), remove five screws, and then remove the rear cover.

Figure 2-509 Remove the HCI rear cover

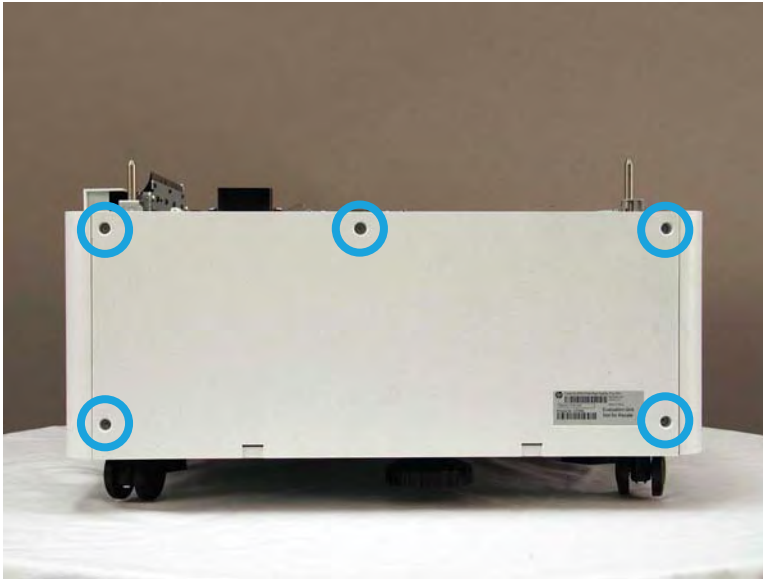

Remove the HCI PCA

Follow these steps to remove the HCI PCA.

- ▲ Disconnect five connectors (callout 1), remove three screws, and then remove the HCI PCA.

Figure 2-510 Remove the HCI PCA

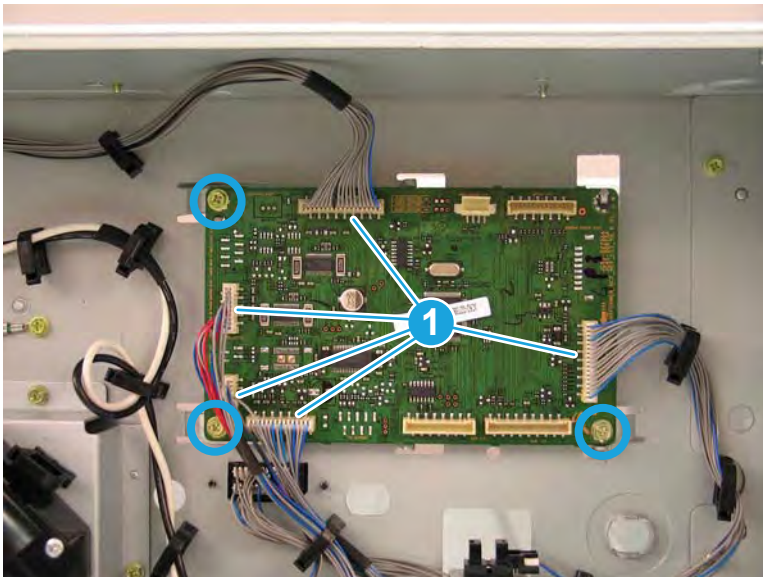

Unpack the replacement assembly

Follow these steps to unpack the replacement assembly.

1. Dispose of the defective part.

 **NOTE:** HP recommends responsible disposal of the defective part.

<http://www8.hp.com/us/en/hp-information/environment/product-recycling.html>

2. Unpack the replacement part from the packaging.



CAUTION:  Some parts are sensitive to electrostatic discharge (ESD). Always perform service work at an ESD-protected workstation or mat. If an ESD workstation or mat is not available, touch the sheet-metal chassis to provide a static ground before touching an ESD-sensitive assembly. Protect the ESD-sensitive assemblies by placing them in ESD pouches when they are out of the printer.



IMPORTANT: Make sure that all of the shipping materials (for example shipping tape) are removed from the replacement part prior to installation.



NOTE: If the replacement part is a roller or pad, avoid touching the spongy part of it. Skin oils on the roller or pad can cause paper pickup and/or print-quality problems. HP recommends using disposable gloves when handling rollers or pads or washing your hands before touching rollers or pads.

3. To install an assembly, reverse the removal steps.



NOTE: When applicable, special installation instructions are provided for an assembly at the end of the removal procedure. Always completely read the removal instructions and follow all special installation instructions.

Removal and replacement: HCI main electrical connector

This document provides the procedures to remove the HCI main electrical connector.



[View a video of removing and replacing the main electrical connector.](#)

Mean time to repair:

Service level:



IMPORTANT: When applicable, special installation instructions are provided for an assembly at the end of the removal procedure. Always completely read the removal instructions and follow all special installation instructions.

Before performing service

- Disconnect the power cable.



WARNING! To avoid damage to the printer, turn the printer off, wait 30 seconds, and then remove the power cable before attempting to service the printer.

Use the table below to identify the correct part number for your printer. To order the part, go to www.hp.com/buy/parts

Table 2-114 Part information

Part number	Part description
JC39-02600A	HCI main electrical connector

Required tools

- #2 JIS screwdriver with a magnetic tip

After performing service

Turn the printer power on

- Connect the power cable.
- Turn on the power switch next to the power cable, and then press the power button on the front of the printer.
- Verify that the service performed was successful.
- Verify that the most recent firmware is installed on the printer.
- Verify that all parts are correctly reinstalled and are properly working.

Post service test

Print any pages necessary to verify that the repair resolved the issue and did not create any new issues.

Remove the HCI rear cover

Follow these steps to remove the Remove the HCI rear cover.

- ▲ Remove five screw caps (if installed), remove five screws, and then remove the rear cover.

Figure 2-511 Remove the HCI rear cover

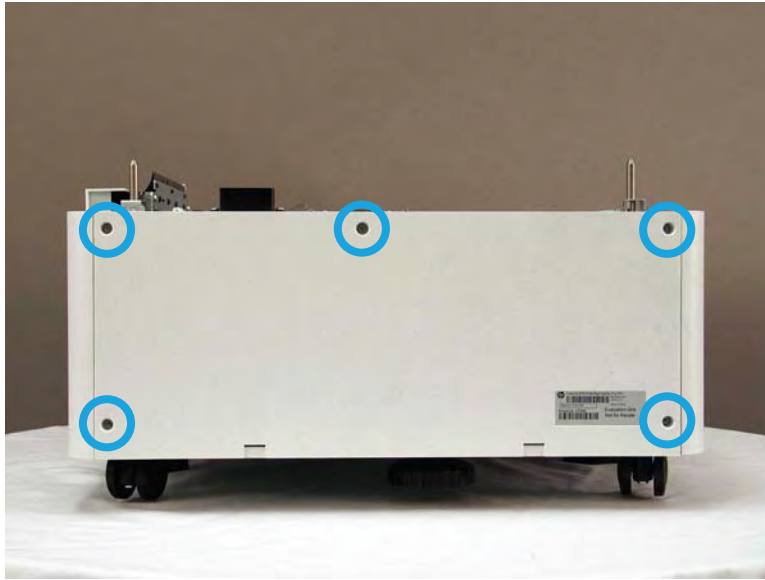

Remove the main electrical connector

Follow these steps to remove the HCI main electrical connector.

- ▲ Do the following:
 1. Squeeze two tabs and release one connector (callout 1; black and white wire harness) from the chassis, and then release five retainers.
 2. Disconnect one connector (callout 2; on the HCI PCA), and then release two retainers.
 3. Remove one ground screw (callout 3; green wire).
 4. Remove two shoulder screws (callout 4; main electrical connector), and then remove the main connector.

Figure 2-512 Remove the HCI main electrical connector

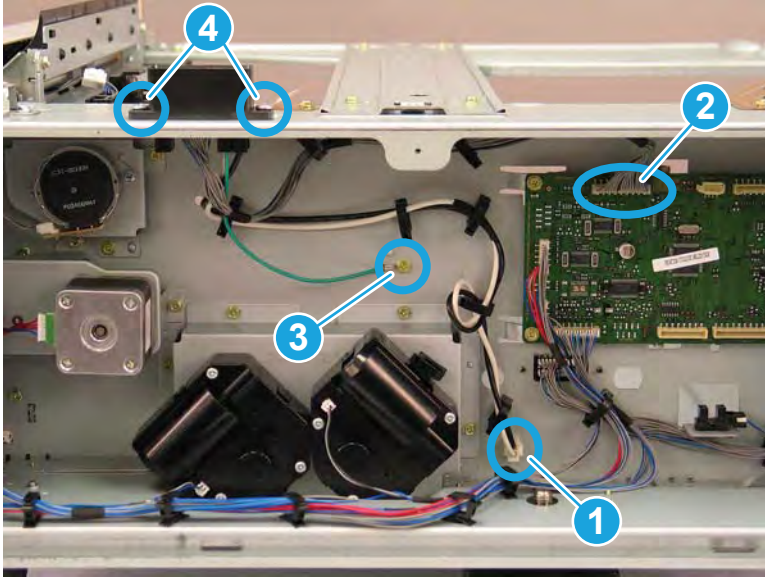

Unpack the replacement assembly



Follow these steps to unpack the replacement assembly.

1. Dispose of the defective part.

 **NOTE:** HP recommends responsible disposal of the defective part.

<http://www8.hp.com/us/en/hp-information/environment/product-recycling.html>

2. Unpack the replacement part from the packaging.

 **CAUTION:**  Some parts are sensitive to electrostatic discharge (ESD). Always perform service work at an ESD-protected workstation or mat. If an ESD workstation or mat is not available, touch the sheet-metal chassis to provide a static ground before touching an ESD-sensitive assembly. Protect the ESD-sensitive assemblies by placing them in ESD pouches when they are out of the printer.

 **IMPORTANT:** Make sure that all of the shipping materials (for example shipping tape) are removed from the replacement part prior to installation.

 **NOTE:** If the replacement part is a roller or pad, avoid touching the spongy part of it. Skin oils on the roller or pad can cause paper pickup and/or print-quality problems. HP recommends using disposable gloves when handling rollers or pads or washing your hands before touching rollers or pads.

3. To install an assembly, reverse the removal steps.

 **NOTE:** When applicable, special installation instructions are provided for an assembly at the end of the removal procedure. Always completely read the removal instructions and follow all special installation instructions.

Removal and replacement: HCI caster wheel

This document provides the procedures to remove the HCI caster.



[View a video of removing and replacing the caster.](#)

Mean time to repair:

Service level:



IMPORTANT: When applicable, special installation instructions are provided for an assembly at the end of the removal procedure. Always completely read the removal instructions and follow all special installation instructions.

Before performing service

- Disconnect the power cable.



WARNING! To avoid damage to the printer, turn the printer off, wait 30 seconds, and then remove the power cable before attempting to service the printer.

Use the table below to identify the correct part number for your printer. To order the part, go to www.hp.com/buy/parts

Table 2-115 Part information

Part number	Part description
6109-001138	HCI caster wheel

Required tools

- #2 JIS screwdriver with a magnetic tip

After performing service

Turn the printer power on

- Connect the power cable.
- Turn on the power switch next to the power cable, and then press the power button on the front of the printer.
- Verify that the service performed was successful.
- Verify that the most recent firmware is installed on the printer.
- Verify that all parts are correctly reinstalled and are properly working.

Post service test

Print any pages necessary to verify that the repair resolved the issue and did not create any new issues.

Remove the HCI caster wheel

Follow these steps to remove the HCI caster.

- ▲ Carefully position the HCI on its side, remove four screws, and then remove the HCI caster wheel.

Figure 2-513 Remove the HCI caster wheel

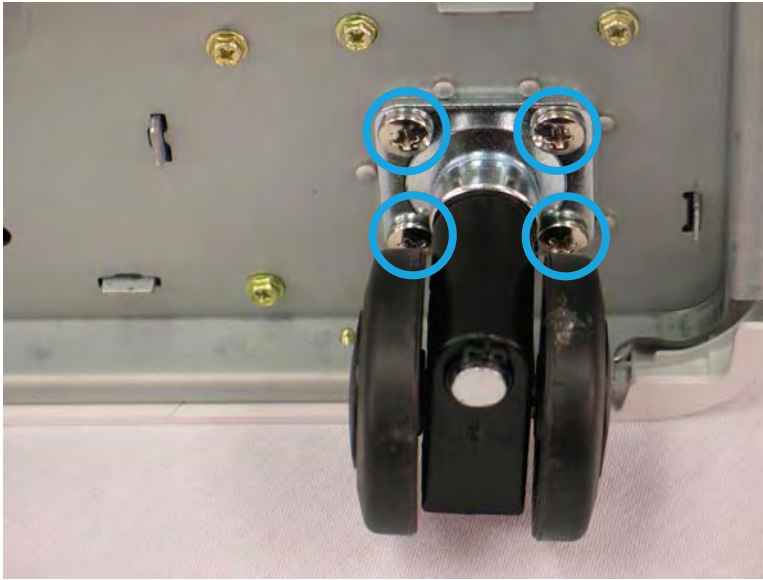

Unpack the replacement assembly



Follow these steps to unpack the replacement assembly.

1. Dispose of the defective part.

 **NOTE:** HP recommends responsible disposal of the defective part.

<http://www8.hp.com/us/en/hp-information/environment/product-recycling.html>

2. Unpack the replacement part from the packaging.

 **CAUTION:**  Some parts are sensitive to electrostatic discharge (ESD). Always perform service work at an ESD-protected workstation or mat. If an ESD workstation or mat is not available, touch the sheet-metal chassis to provide a static ground before touching an ESD-sensitive assembly. Protect the ESD-sensitive assemblies by placing them in ESD pouches when they are out of the printer.

 **IMPORTANT:** Make sure that all of the shipping materials (for example shipping tape) are removed from the replacement part prior to installation.

 **NOTE:** If the replacement part is a roller or pad, avoid touching the spongy part of it. Skin oils on the roller or pad can cause paper pickup and/or print-quality problems. HP recommends using disposable gloves when handling rollers or pads or washing your hands before touching rollers or pads.

3. To install an assembly, reverse the removal steps.

 **NOTE:** When applicable, special installation instructions are provided for an assembly at the end of the removal procedure. Always completely read the removal instructions and follow all special installation instructions.

Removal and replacement: HCI guide post and guide post plate

This document provides the procedures to remove the HCI guide post and guide post plate.



[View a video of removing and replacing the guide post and guide post plate.](#)

Mean time to repair:

Service level:



IMPORTANT: When applicable, special installation instructions are provided for an assembly at the end of the removal procedure. Always completely read the removal instructions and follow all special installation instructions.

Before performing service

- Disconnect the power cable.



WARNING! To avoid damage to the printer, turn the printer off, wait 30 seconds, and then remove the power cable before attempting to service the printer.

Use the table below to identify the correct part number for your printer. To order the part, go to www.hp.com/buy/parts

Table 2-116 Part information

Part number	Part description
JC61-04660A	HCI guide post
JC61-04659A	HCI guide post plate

Required tools

- #2 JIS screwdriver with a magnetic tip

After performing service

Turn the printer power on

- Connect the power cable.
- Turn on the power switch next to the power cable, and then press the power button on the front of the printer.
- Verify that the service performed was successful.
- Verify that the most recent firmware is installed on the printer.
- Verify that all parts are correctly reinstalled and are properly working.

Post service test

Print any pages necessary to verify that the repair resolved the issue and did not create any new issues.

Remove the HCI guide post upper and guide post plates

Follow these steps to remove the HCI guide post upper and guide post plates.

1. Remove four screws, and then remove the HCI guide post upper and guide post plates.

Figure 2-514 Remove the HCI guide post upper and guide post plates

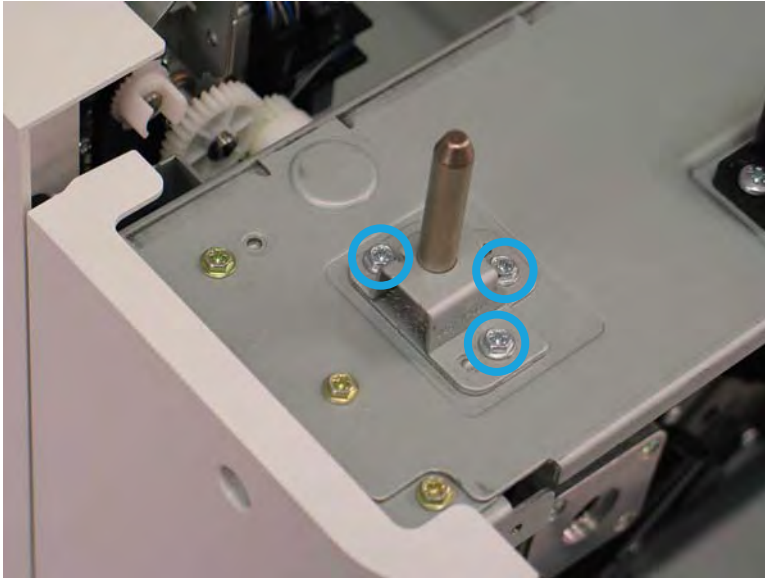

2. Separate the guide post upper (callout 1) and guide post (callout 2) plates.

Figure 2-515 Separate the HCI guide post upper and guide post plates

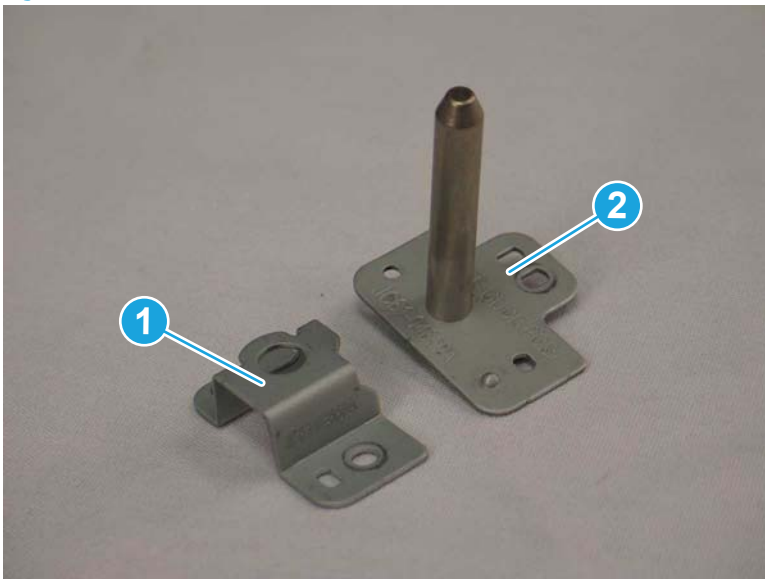

Unpack the replacement assembly

Follow these steps to unpack the replacement assembly.

1. Dispose of the defective part.

 **NOTE:** HP recommends responsible disposal of the defective part.

<http://www8.hp.com/us/en/hp-information/environment/product-recycling.html>

2. Unpack the replacement part from the packaging.



CAUTION:  Some parts are sensitive to electrostatic discharge (ESD). Always perform service work at an ESD-protected workstation or mat. If an ESD workstation or mat is not available, touch the sheet-metal chassis to provide a static ground before touching an ESD-sensitive assembly. Protect the ESD-sensitive assemblies by placing them in ESD pouches when they are out of the printer.



IMPORTANT: Make sure that all of the shipping materials (for example shipping tape) are removed from the replacement part prior to installation.



NOTE: If the replacement part is a roller or pad, avoid touching the spongy part of it. Skin oils on the roller or pad can cause paper pickup and/or print-quality problems. HP recommends using disposable gloves when handling rollers or pads or washing your hands before touching rollers or pads.

3. To install an assembly, reverse the removal steps.



NOTE: When applicable, special installation instructions are provided for an assembly at the end of the removal procedure. Always completely read the removal instructions and follow all special installation instructions.

HCI sub - pickup upper/lower

View the HCI sub - pickup upper/lower exploded view, parts list, and repair procedures.

HCI sub - pickup upper/lower

Parts diagram and parts list for the HCI sub - pickup upper/lower.

Figure 2-516 HCI sub - pickup upper/lower

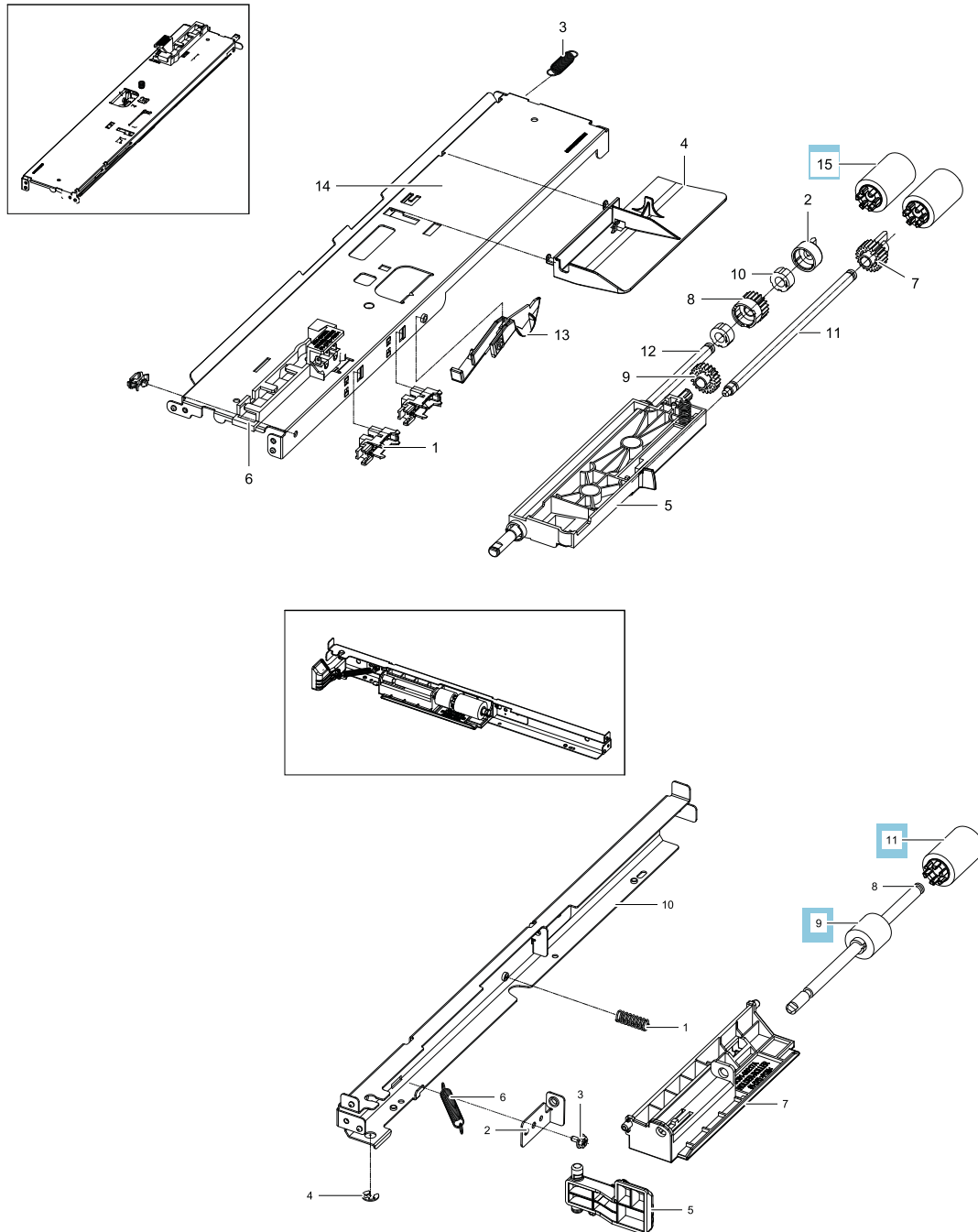

Table 2-117 HCI sub - pickup upper/lower

Ref				
No	Part number	Description	Qty	Repair procedure
9	JC67-00455A	HCI kit - HP LaserJet E7 tray 2-z rollers (coupler torque limiter) (HCI)	1	Removal and replacement: HCI kit - HP LaserJet E7 tray rollers on page 630
11	JC93-00504A	HCI kit - HP LaserJet E7 tray 2-x rollers (separation) (HCI)	2	Removal and replacement: HCI kit - HP LaserJet E7 tray rollers on page 630
15	JC93-00540A	HCI kit - HP LaserJet E7 tray 2-z rollers (pick/feed) (HCI)	1	Removal and replacement: HCI kit - HP LaserJet E7 tray rollers on page 630

Removal and replacement: HCI kit - HP LaserJet E7 tray rollers

This document provides the procedures to remove the HCI kit - HP LaserJet E7 tray rollers.



[View a video of removing and replacing the HP LaserJet E7 tray rollers.](#)

Mean time to repair:

Service level:



IMPORTANT: When applicable, special installation instructions are provided for an assembly at the end of the removal procedure. Always completely read the removal instructions and follow all special installation instructions.

Before performing service

- Disconnect the power cable.



WARNING! To avoid damage to the printer, turn the printer off, wait 30 seconds, and then remove the power cable before attempting to service the printer.

Use the table below to identify the correct part number for your printer. To order the part, go to www.hp.com/buy/parts

Table 2-118 Part information

Part number	Part description
JC67-00455A	HCI kit — HP LaserJet E7 tray 2-z rollers (coupler torque limiter) (HCI)
JC93-00504A	HCI kit — HP LaserJet E7 tray 2-z rollers (separation) (HCI)
JC93-00540A	HCI kit — HP LaserJet E7 tray 2-z rollers (pick/feed) (HCI)

Required tools

- #2 JIS screwdriver with a magnetic tip

After performing service

Turn the printer power on

- Connect the power cable.
- Turn on the power switch next to the power cable, and then press the power button on the front of the printer.
- Verify that the service performed was successful.
- Verify that the most recent firmware is installed on the printer.
- Verify that all parts are correctly reinstalled and are properly working.

Post service test

Print any pages necessary to verify that the repair resolved the issue and did not create any new issues.

Remove the HCI tray

Follow these steps to remove the HCI tray.

1. Pull the tray fully out of the HCI, and then at the left side of the tray release the hook lever on the tray.

 **TIP:** Slightly pull out on the left side of the tray so that the hook lever remains unlatched.

Figure 2-517 Release the tray left side hook lever

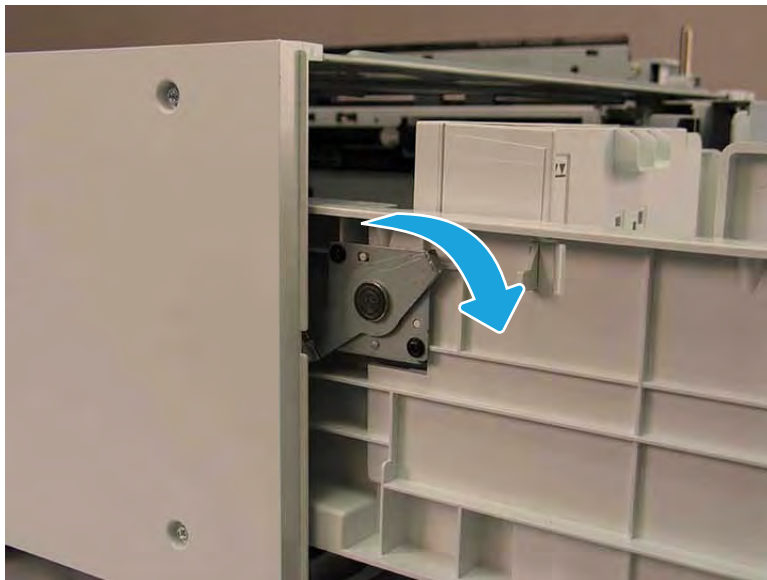

2. At the right side of the tray push in on the slide lock (callout 1) to release it, and then pull the tray away from the HCI (callout 2).

Figure 2-518 Release the tray right-side slide lock

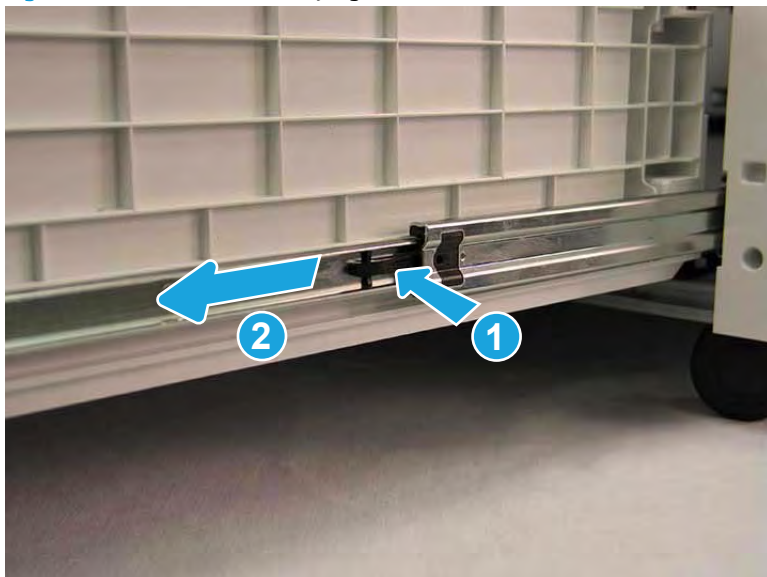

3. Continue to slide the tray away from the HCI to remove it.

Figure 2-519 Remove the tray

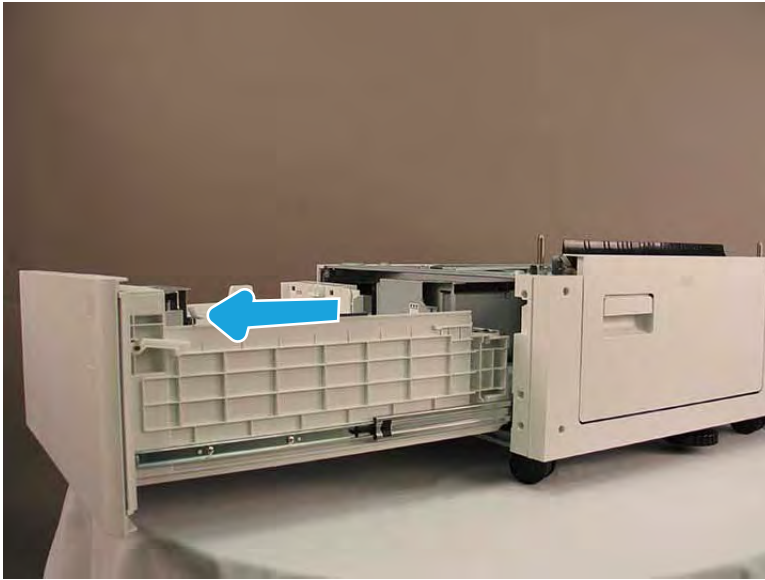

Remove the HCI LaserJet E7 tray rollers

Follow these steps to remove the HCI E7 tray rollers.

1. Look up into the tray cavity, and locate the feed (callout 1), pick (callout 2), and separation (callout 3) rollers.

Figure 2-520 Locate the feed, pick, and separation rollers

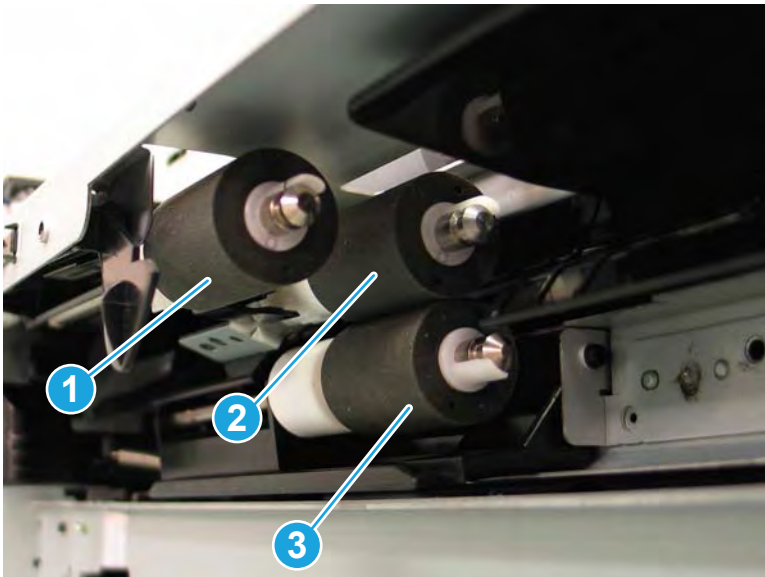

2. Release one tab (for each roller), and then slide the roller off of the shaft.

 **NOTE:** Open the right door before attempting to remove the rollers.

Figure 2-521 Remove the rollers

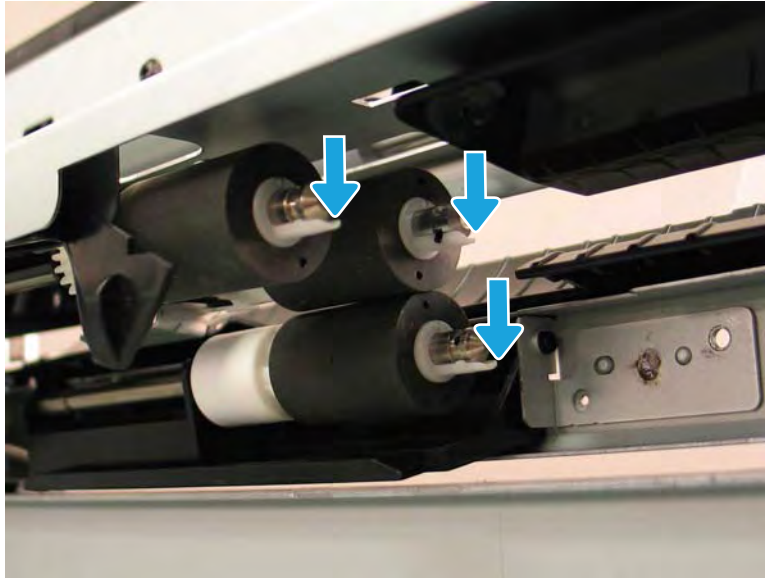

3. Slide the coupler (torque limiter) off of the separation roller shaft.

 **Reinstallation tip:** When the coupler (torque limiter) is installed, make sure it is fully seated on the separation roller shaft. If it is not fully seated, the separation roller will not correctly install on the shaft.

Figure 2-522 Remove the coupler (torque limiter)



Unpack the replacement assembly

Follow these steps to unpack the replacement assembly.

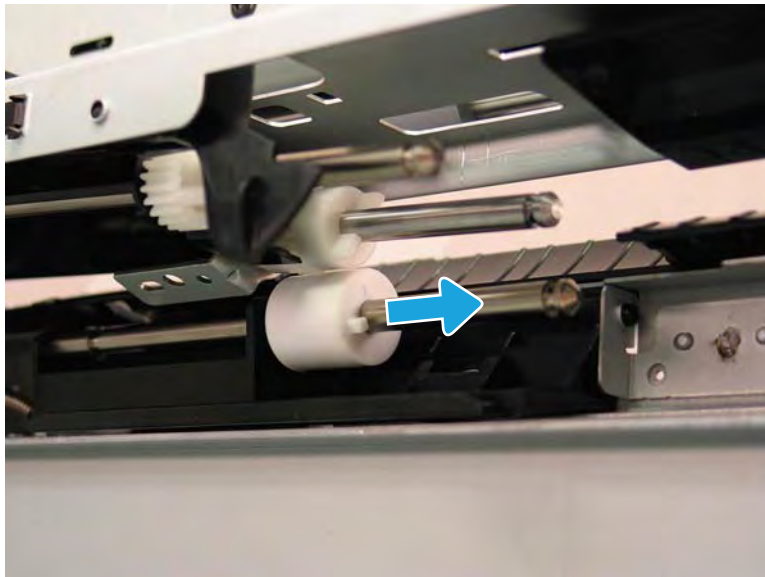
1. Dispose of the defective part.

 **NOTE:** HP recommends responsible disposal of the defective part.

<http://www8.hp.com/us/en/hp-information/environment/product-recycling.html>

2. Unpack the replacement part from the packaging.



CAUTION:  Some parts are sensitive to electrostatic discharge (ESD). Always perform service work at an ESD-protected workstation or mat. If an ESD workstation or mat is not available, touch the sheet-metal chassis to provide a static ground before touching an ESD-sensitive assembly. Protect the ESD-sensitive assemblies by placing them in ESD pouches when they are out of the printer.

 **IMPORTANT:** Make sure that all of the shipping materials (for example shipping tape) are removed from the replacement part prior to installation.

 **NOTE:** If the replacement part is a roller or pad, avoid touching the spongy part of it. Skin oils on the roller or pad can cause paper pickup and/or print-quality problems. HP recommends using disposable gloves when handling rollers or pads or washing your hands before touching rollers or pads.

3. To install an assembly, reverse the removal steps.

 **NOTE:** When applicable, special installation instructions are provided for an assembly at the end of the removal procedure. Always completely read the removal instructions and follow all special installation instructions.

HCI drive

View the HCI drive exploded view, parts list, and repair procedures.

HCI drive

Parts diagram and parts list for the HCI drive.

Figure 2-523 HCI drive

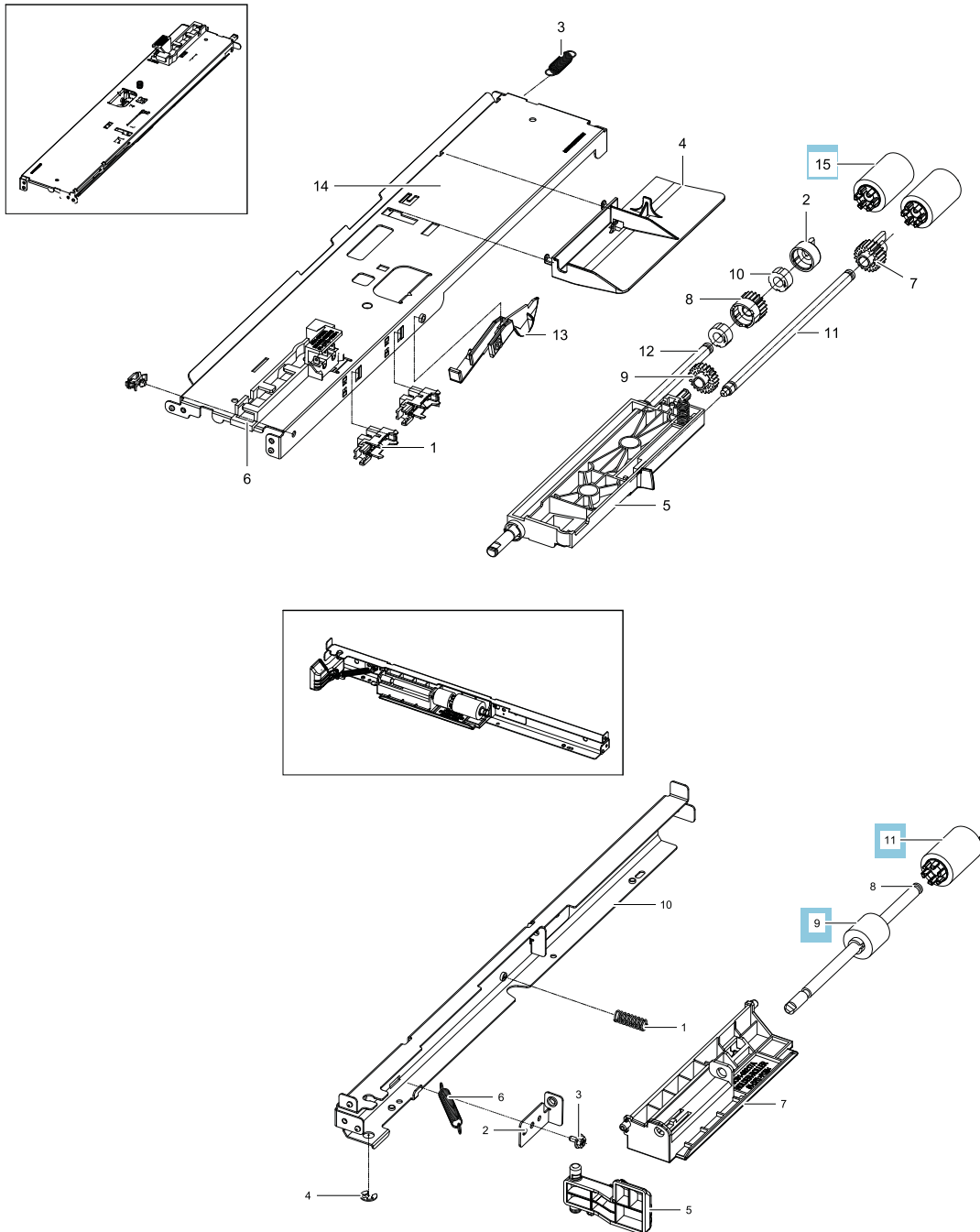

Table 2-119 HCl drive

Ref				
No	Part number	Description	Qty	Repair procedure
1	JC93-00447A	Drive assembly - feed (HCl)	1	Removal and replacement: HCl drive assembly - feed on page 637
1-6	JC31-00033B	Motor - feed (HCl)	1	Removal and replacement: HCl motor - feed drive on page 641
2-3	JC31-00109A	Motor - lifter drive right (HCl)	1	Removal and replacement: HCl motor - lift drive right and motor - lift drive left on page 646
2-3	JC31-00125A	Motor - lifter drive left (HCl)	1	Removal and replacement: HCl motor - lift drive right and motor - lift drive left on page 646
3	JC93-01465A	Drive assembly- sub-pulley (HCl)	1	Removal and replacement: HCl drive assembly - sub-pulley on page 652
4-5	JC93-00452A	Motor - step drive (HCl) (For E77822, E77825, E77830)	1	Removal and replacement: HCl motor - step drive on page 649
4-5	5QJ90-64002	Motor - step drive (HCl) (For E78323, E78325, E78330)	1	Removal and replacement: HCl motor - step drive on page 649

Removal and replacement: HCI drive assembly - feed

This document provides the procedures to remove the HCI drive assembly - feed.



[View a video of removing and replacing the drive assembly - feed.](#)

Mean time to repair:

Service level:



IMPORTANT: When applicable, special installation instructions are provided for an assembly at the end of the removal procedure. Always completely read the removal instructions and follow all special installation instructions.

Before performing service

- Disconnect the power cable.



WARNING! To avoid damage to the printer, turn the printer off, wait 30 seconds, and then remove the power cable before attempting to service the printer.

Use the table below to identify the correct part number for your printer. To order the part, go to www.hp.com/buy/parts

Table 2-120 Part information

Part number	Part description
JC93-00447A	HCI drive assembly - feed

Required tools

- #2 JIS screwdriver with a magnetic tip

After performing service

Turn the printer power on

- Connect the power cable.
- Turn on the power switch next to the power cable, and then press the power button on the front of the printer.
- Verify that the service performed was successful.
- Verify that the most recent firmware is installed on the printer.
- Verify that all parts are correctly reinstalled and are properly working.

Post service test

Print any pages necessary to verify that the repair resolved the issue and did not create any new issues.

Remove the HCI rear cover

Follow these steps to remove the Remove the HCI rear cover.

- ▲ Remove five screw caps (if installed), remove five screws, and then remove the rear cover.

Figure 2-524 Remove the HCI rear cover

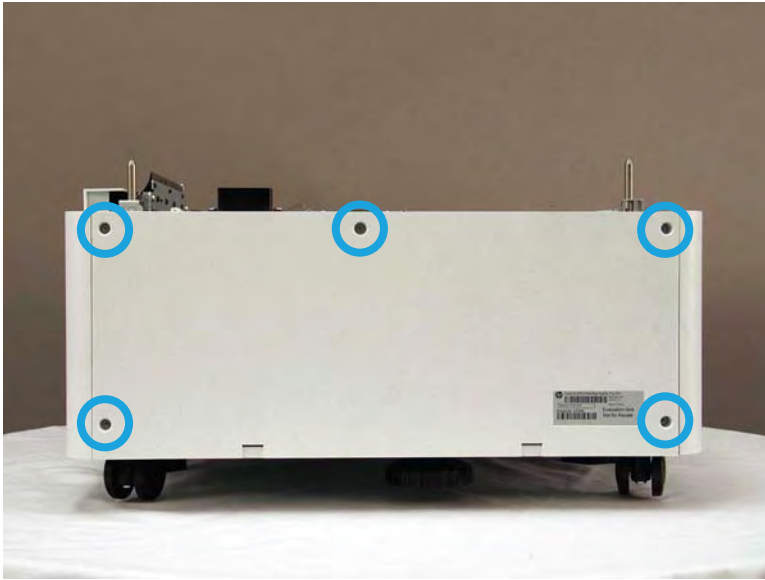

Remove the HCI drive assembly - feed

Follow these steps to remove the Remove the HCI drive assembly - feed.

1. Open the right door, and then remove two screws.

Figure 2-525 Remove two screws

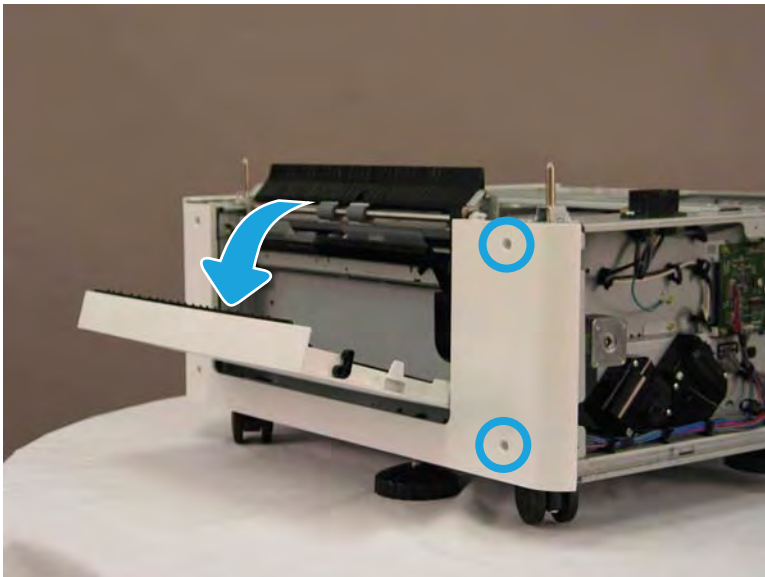

2. Release one tab, and then separate the rear edge of the right cover from the chassis.

Figure 2-526 Separate the rear edge of the right cover from the chassis

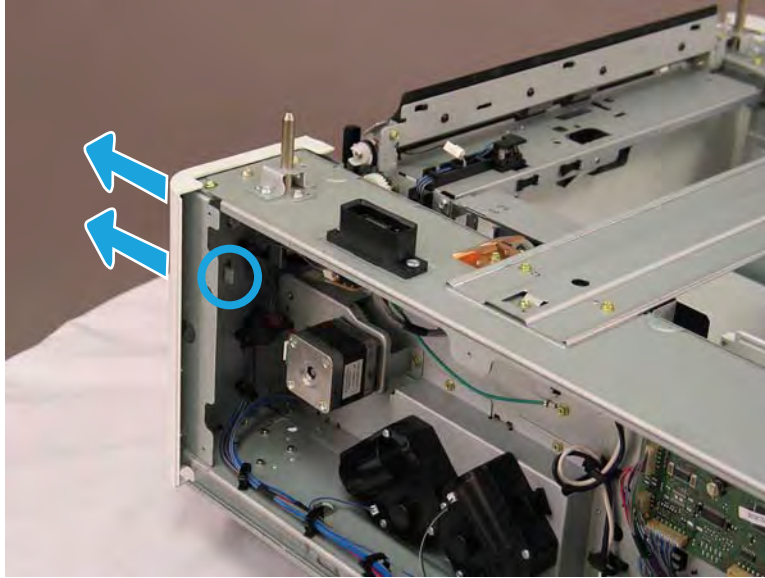

3. Disconnect one connector, and then release the wire harness from the retainer.

Figure 2-527 Disconnect one connector

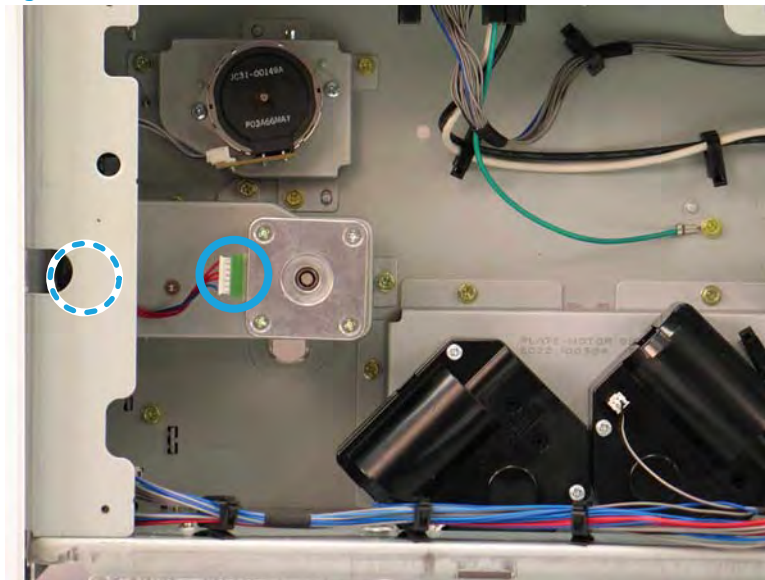

4. Remove three screws, and then remove the HCI drive assembly - feed.

Figure 2-528 Remove the HCI drive assembly - feed

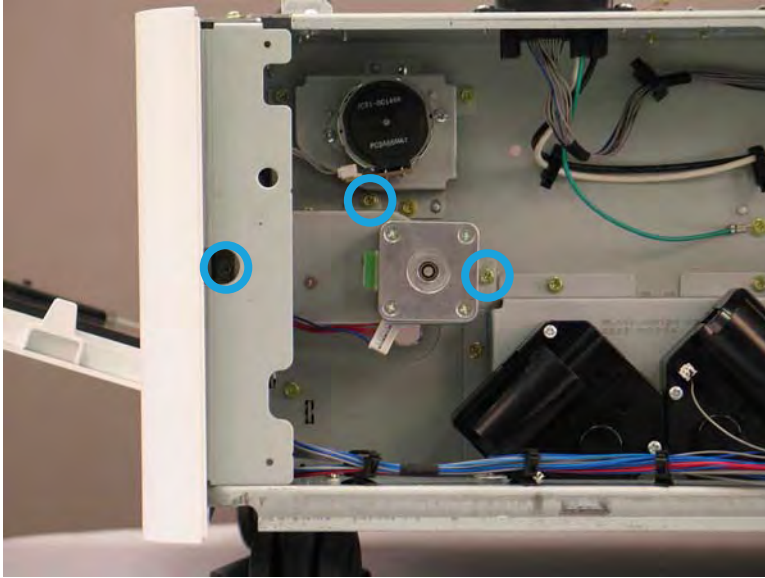

Unpack the replacement assembly



Follow these steps to unpack the replacement assembly.

1. Dispose of the defective part.

 **NOTE:** HP recommends responsible disposal of the defective part.

<http://www8.hp.com/us/en/hp-information/environment/product-recycling.html>

2. Unpack the replacement part from the packaging.

 **CAUTION:**  Some parts are sensitive to electrostatic discharge (ESD). Always perform service work at an ESD-protected workstation or mat. If an ESD workstation or mat is not available, touch the sheet-metal chassis to provide a static ground before touching an ESD-sensitive assembly. Protect the ESD-sensitive assemblies by placing them in ESD pouches when they are out of the printer.

 **IMPORTANT:** Make sure that all of the shipping materials (for example shipping tape) are removed from the replacement part prior to installation.

 **NOTE:** If the replacement part is a roller or pad, avoid touching the spongy part of it. Skin oils on the roller or pad can cause paper pickup and/or print-quality problems. HP recommends using disposable gloves when handling rollers or pads or washing your hands before touching rollers or pads.

3. To install an assembly, reverse the removal steps.

 **NOTE:** When applicable, special installation instructions are provided for an assembly at the end of the removal procedure. Always completely read the removal instructions and follow all special installation instructions.

Removal and replacement: HCI motor - feed drive

This document provides the procedures to remove the HCI motor - feed drive.



[View a video of removing and replacing the motor - feed drive.](#)

Mean time to repair:

Service level:



IMPORTANT: When applicable, special installation instructions are provided for an assembly at the end of the removal procedure. Always completely read the removal instructions and follow all special installation instructions.

Before performing service

- Disconnect the power cable.



WARNING! To avoid damage to the printer, turn the printer off, wait 30 seconds, and then remove the power cable before attempting to service the printer.

Use the table below to identify the correct part number for your printer. To order the part, go to www.hp.com/buy/parts

Table 2-121 Part information

Part number	Part description
JC31-00033B	HCI motor - feed drive

Required tools

- #2 JIS screwdriver with a magnetic tip

After performing service

Turn the printer power on

- Connect the power cable.
- Turn on the power switch next to the power cable, and then press the power button on the front of the printer.
- Verify that the service performed was successful.
- Verify that the most recent firmware is installed on the printer.
- Verify that all parts are correctly reinstalled and are properly working.

Post service test

Print any pages necessary to verify that the repair resolved the issue and did not create any new issues.

Remove the HCI rear cover

Follow these steps to remove the Remove the HCI rear cover.

- ▲ Remove five screw caps (if installed), remove five screws, and then remove the rear cover.

Figure 2-529 Remove the HCI rear cover

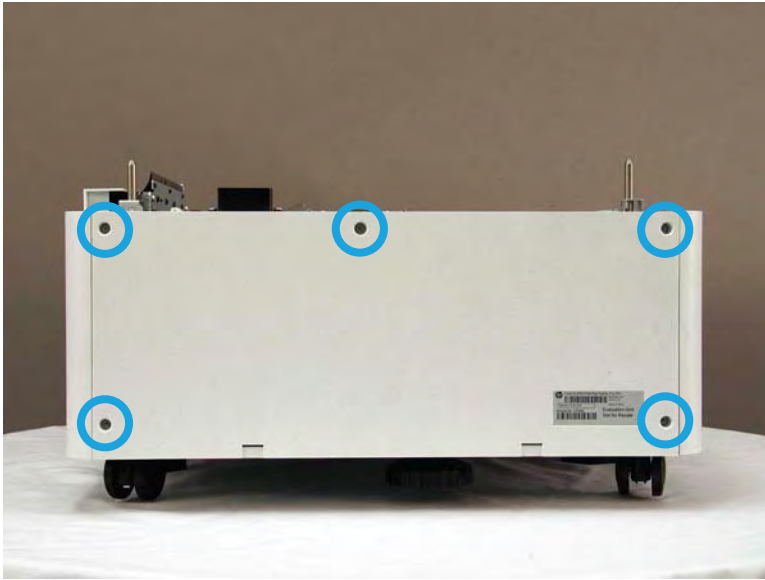

Remove the HCI drive assembly - feed

Follow these steps to remove the Remove the HCI drive assembly - feed.

1. Open the right door, and then remove two screws.

Figure 2-530 Remove two screws

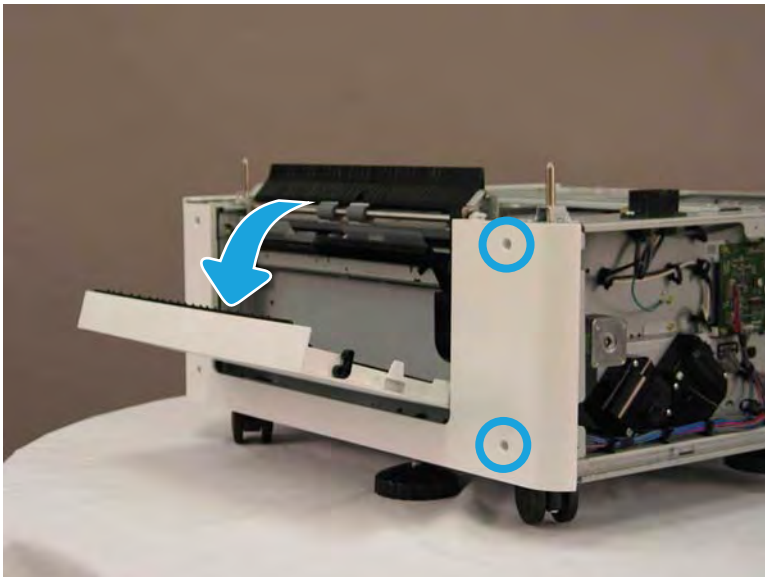

2. Release one tab, and then separate the rear edge of the right cover from the chassis.

Figure 2-531 Separate the rear edge of the right cover from the chassis

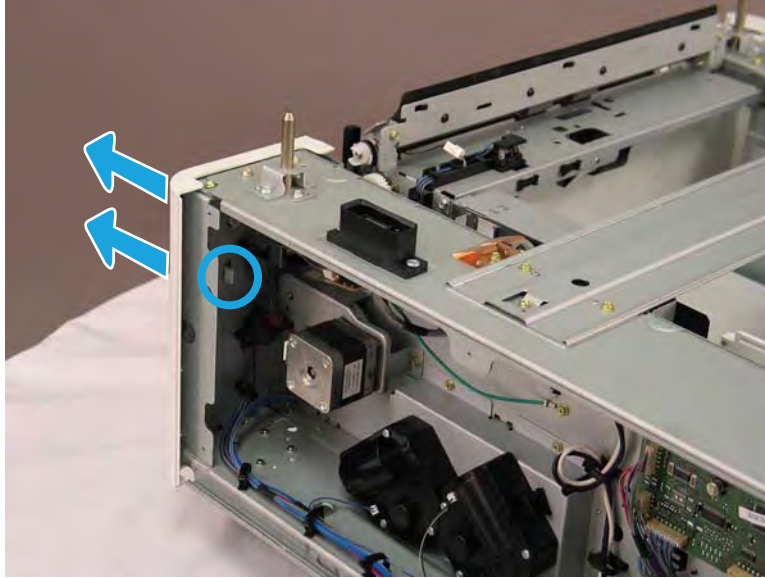

3. Disconnect one connector, and then release the wire harness from the retainer.

Figure 2-532 Disconnect one connector

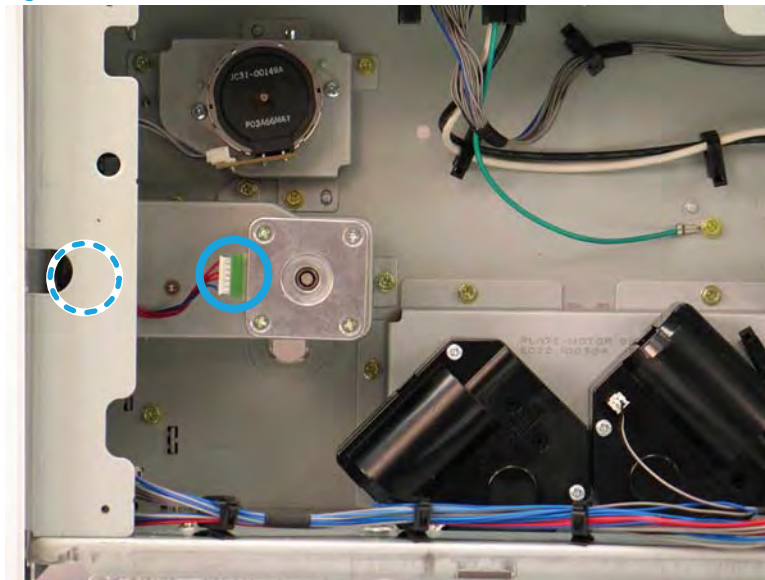

4. Remove three screws, and then remove the HCI drive assembly - feed.

Figure 2-533 Remove the HCI drive assembly - feed

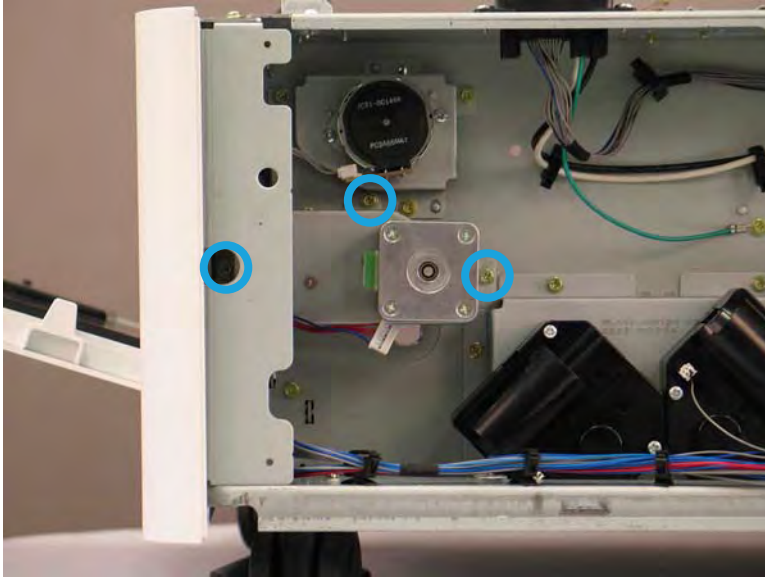

Remove the HCI motor - feed drive

Follow these steps to remove the HCI motor - feed drive.

- ▲ Remove two e-rings, remove two gears, and then remove two screws to separate the HCI motor - feed drive.

Figure 2-534 Remove the HCI motor - feed drive

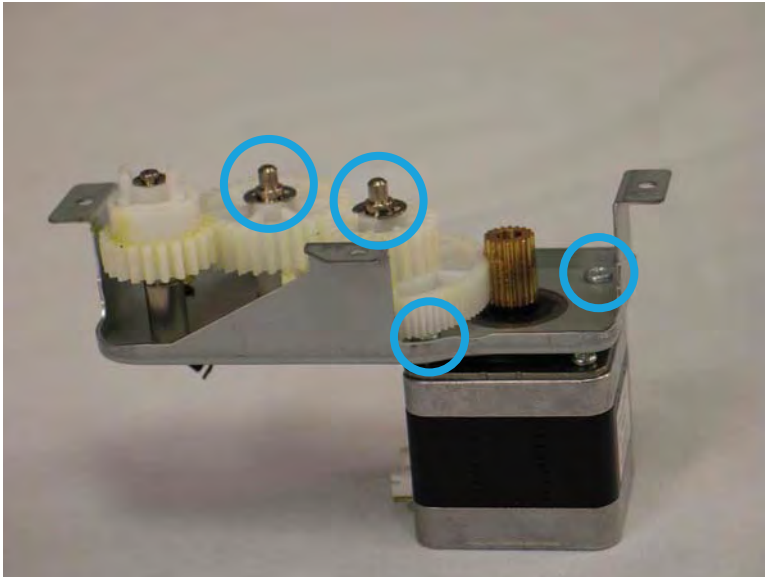

Unpack the replacement assembly

Follow these steps to unpack the replacement assembly.

1. Dispose of the defective part.

 **NOTE:** HP recommends responsible disposal of the defective part.

<http://www8.hp.com/us/en/hp-information/environment/product-recycling.html>

2. Unpack the replacement part from the packaging.



CAUTION:  Some parts are sensitive to electrostatic discharge (ESD). Always perform service work at an ESD-protected workstation or mat. If an ESD workstation or mat is not available, touch the sheet-metal chassis to provide a static ground before touching an ESD-sensitive assembly. Protect the ESD-sensitive assemblies by placing them in ESD pouches when they are out of the printer.

 **IMPORTANT:** Make sure that all of the shipping materials (for example shipping tape) are removed from the replacement part prior to installation.

 **NOTE:** If the replacement part is a roller or pad, avoid touching the spongy part of it. Skin oils on the roller or pad can cause paper pickup and/or print-quality problems. HP recommends using disposable gloves when handling rollers or pads or washing your hands before touching rollers or pads.

3. To install an assembly, reverse the removal steps.

 **NOTE:** When applicable, special installation instructions are provided for an assembly at the end of the removal procedure. Always completely read the removal instructions and follow all special installation instructions.

Removal and replacement: HCI motor - lift drive right and motor - lift drive left

This document provides the procedures to remove the HCI motor - lift drive right and motor - lift drive left.



[View a video of removing and replacing the motor - lift drive right and motor - lift drive left.](#)

Mean time to repair:

Service level:



IMPORTANT: When applicable, special installation instructions are provided for an assembly at the end of the removal procedure. Always completely read the removal instructions and follow all special installation instructions.

Before performing service

- Disconnect the power cable.



WARNING! To avoid damage to the printer, turn the printer off, wait 30 seconds, and then remove the power cable before attempting to service the printer.

Use the table below to identify the correct part number for your printer. To order the part, go to www.hp.com/buy/parts

Table 2-122 Part information

Part number	Part description
JC31-00109A	HCI motor - lift drive right
JC31-00125A	HCI motor - lift drive left

Required tools

- #2 JIS screwdriver with a magnetic tip

After performing service

Turn the printer power on

- Connect the power cable.
- Turn on the power switch next to the power cable, and then press the power button on the front of the printer.
- Verify that the service performed was successful.
- Verify that the most recent firmware is installed on the printer.
- Verify that all parts are correctly reinstalled and are properly working.

Post service test

Print any pages necessary to verify that the repair resolved the issue and did not create any new issues.

Remove the HCI rear cover

Follow these steps to remove the Remove the HCI rear cover.

- ▲ Remove five screw caps (if installed), remove five screws, and then remove the rear cover.

Figure 2-535 Remove the HCI rear cover

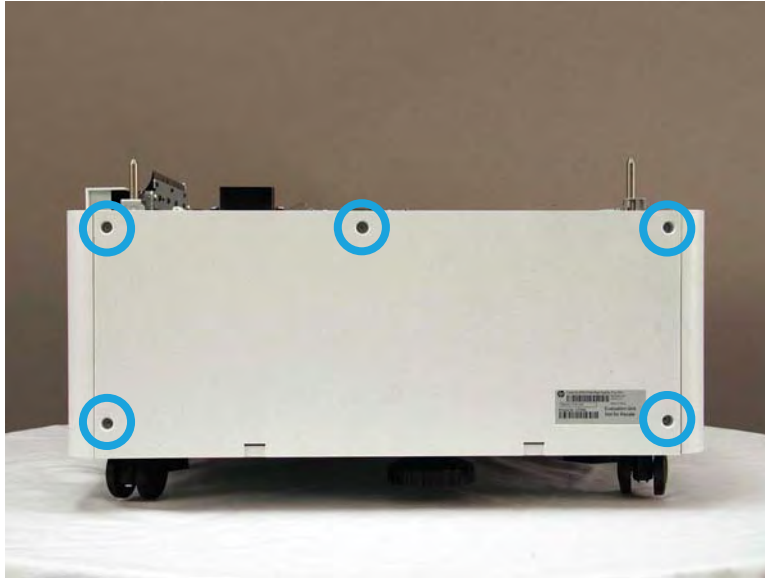

Remove the HCI motor - lift drive right and motor - lift drive left

Follow these steps to remove the Remove the HCI motor - lift drive right and motor - lift drive left.

1. Disconnect two connectors, remove four screws, and the remove the HCI motor - lift drive right and motor - lift drive left.

 **NOTE:** It might take some force to release the assembly from the chassis.

Figure 2-536 Remove the HCI motor - lift drive right and motor - lift drive left



2. Do one or both of the following:

- To remove the right-lift drive motor (callout 1): remove three screws.
- To remove the left-lift drive motor (callout 2): remove three screws.

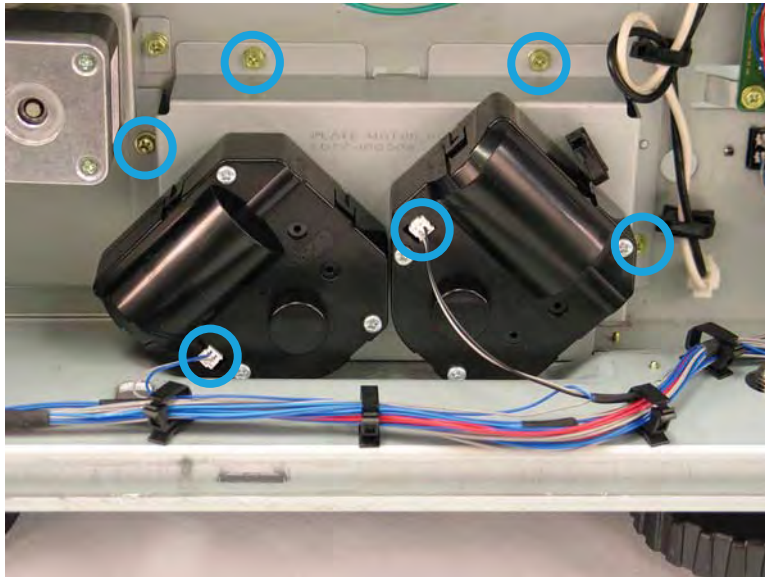
Figure 2-537 Remove the HCI tray right- and left-lift drive motors

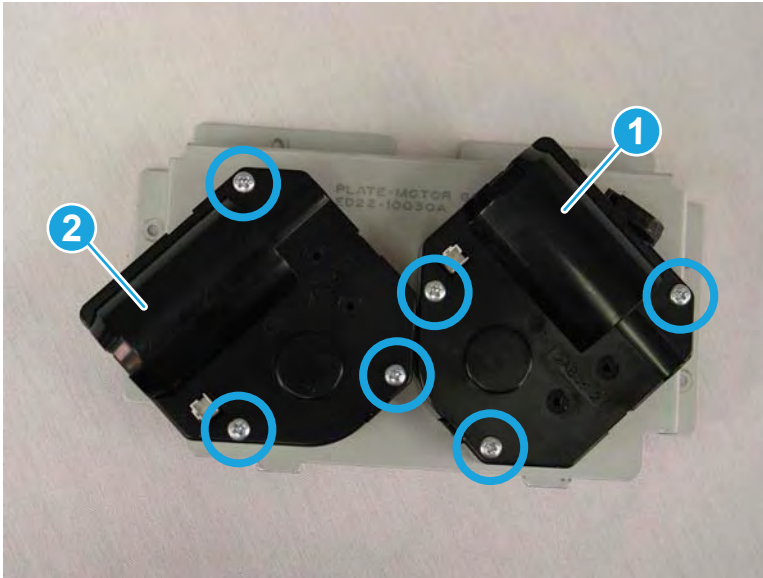

Unpack the replacement assembly

Follow these steps to unpack the replacement assembly.

1. Dispose of the defective part.



NOTE: HP recommends responsible disposal of the defective part.

<http://www8.hp.com/us/en/hp-information/environment/product-recycling.html>

2. Unpack the replacement part from the packaging.



CAUTION:  Some parts are sensitive to electrostatic discharge (ESD). Always perform service work at an ESD-protected workstation or mat. If an ESD workstation or mat is not available, touch the sheet-metal chassis to provide a static ground before touching an ESD-sensitive assembly. Protect the ESD-sensitive assemblies by placing them in ESD pouches when they are out of the printer.



IMPORTANT: Make sure that all of the shipping materials (for example shipping tape) are removed from the replacement part prior to installation.



NOTE: If the replacement part is a roller or pad, avoid touching the spongy part of it. Skin oils on the roller or pad can cause paper pickup and/or print-quality problems. HP recommends using disposable gloves when handling rollers or pads or washing your hands before touching rollers or pads.

3. To install an assembly, reverse the removal steps.



NOTE: When applicable, special installation instructions are provided for an assembly at the end of the removal procedure. Always completely read the removal instructions and follow all special installation instructions.

Removal and replacement: HCI motor - step drive

This document provides the procedures to remove the HCI motor - step drive.



[View a video of removing and replacing the motor - step drive.](#)

Mean time to repair:

Service level:



IMPORTANT: When applicable, special installation instructions are provided for an assembly at the end of the removal procedure. Always completely read the removal instructions and follow all special installation instructions.

Before performing service

- Disconnect the power cable.



WARNING! To avoid damage to the printer, turn the printer off, wait 30 seconds, and then remove the power cable before attempting to service the printer.

Use the table below to identify the correct part number for your printer. To order the part, go to www.hp.com/buy/parts

Table 2-123 Part information

Part number	Part description
JC93-00452A	HCI motor - step drive (E778xx series)
5QJ90-64002	HCI motor - step drive (E783xx series)

Required tools

- #2 JIS screwdriver with a magnetic tip

After performing service

Turn the printer power on

- Connect the power cable.
- Turn on the power switch next to the power cable, and then press the power button on the front of the printer.
- Verify that the service performed was successful.
- Verify that the most recent firmware is installed on the printer.
- Verify that all parts are correctly reinstalled and are properly working.

Post service test

Print any pages necessary to verify that the repair resolved the issue and did not create any new issues.

Remove the HCI rear cover

Follow these steps to remove the Remove the HCI rear cover.

- ▲ Remove five screw caps (if installed), remove five screws, and then remove the rear cover.

Figure 2-538 Remove the HCI rear cover

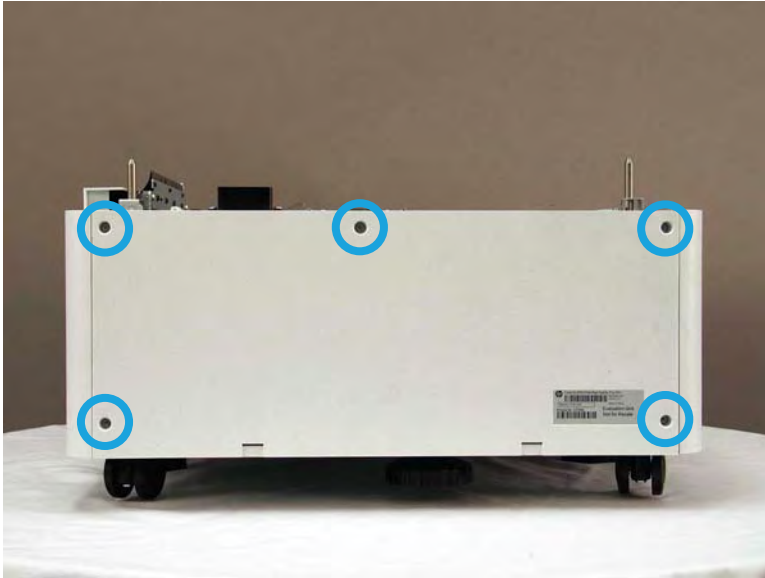

Remove the HCI motor - step drive

Follow these steps to remove the HCI motor - step drive.

- ▲ Disconnect the one connector, remove two screws, and remove the HCI motor - step drive.

💡 **TIP:** It might be easier to disconnect the connector after the motor is removed from the bracket.

Figure 2-539 Remove the HCI motor - step drive

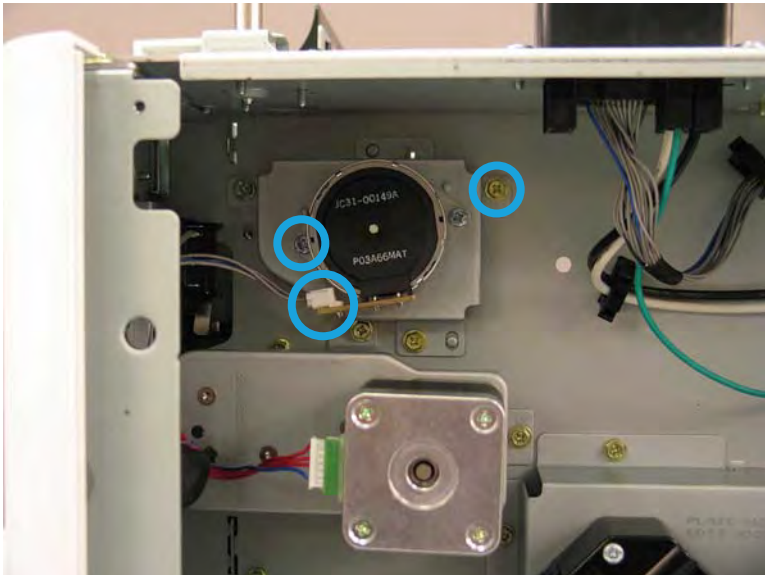

Unpack the replacement assembly

Follow these steps to unpack the replacement assembly.

1. Dispose of the defective part.



NOTE: HP recommends responsible disposal of the defective part.

<http://www8.hp.com/us/en/hp-information/environment/product-recycling.html>

2. Unpack the replacement part from the packaging.



CAUTION:  Some parts are sensitive to electrostatic discharge (ESD). Always perform service work at an ESD-protected workstation or mat. If an ESD workstation or mat is not available, touch the sheet-metal chassis to provide a static ground before touching an ESD-sensitive assembly. Protect the ESD-sensitive assemblies by placing them in ESD pouches when they are out of the printer.



IMPORTANT: Make sure that all of the shipping materials (for example shipping tape) are removed from the replacement part prior to installation.



NOTE: If the replacement part is a roller or pad, avoid touching the spongy part of it. Skin oils on the roller or pad can cause paper pickup and/or print-quality problems. HP recommends using disposable gloves when handling rollers or pads or washing your hands before touching rollers or pads.

3. To install an assembly, reverse the removal steps.



NOTE: When applicable, special installation instructions are provided for an assembly at the end of the removal procedure. Always completely read the removal instructions and follow all special installation instructions.

Removal and replacement: HCI drive assembly - sub-pulley

This document provides the procedures to remove the HCI drive assembly - sub-pulley.



[View a video of removing and replacing the sub-pulley.](#)

Mean time to repair:

Service level:



IMPORTANT: When applicable, special installation instructions are provided for an assembly at the end of the removal procedure. Always completely read the removal instructions and follow all special installation instructions.

Before performing service

- Disconnect the power cable.



WARNING! To avoid damage to the printer, turn the printer off, wait 30 seconds, and then remove the power cable before attempting to service the printer.

Use the table below to identify the correct part number for your printer. To order the part, go to www.hp.com/buy/parts

Table 2-124 Part information

Part number	Part description
JC93-01465A	HCI drive assembly - sub-pulley

Required tools

- #2 JIS screwdriver with a magnetic tip

After performing service

Turn the printer power on

- Connect the power cable.
- Turn on the power switch next to the power cable, and then press the power button on the front of the printer.
- Verify that the service performed was successful.
- Verify that the most recent firmware is installed on the printer.
- Verify that all parts are correctly reinstalled and are properly working.

Post service test

Print any pages necessary to verify that the repair resolved the issue and did not create any new issues.

Remove the HCI rear cover

Follow these steps to remove the Remove the HCI rear cover.

- ▲ Remove five screw caps (if installed), remove five screws, and then remove the rear cover.

Figure 2-540 Remove the HCI rear cover

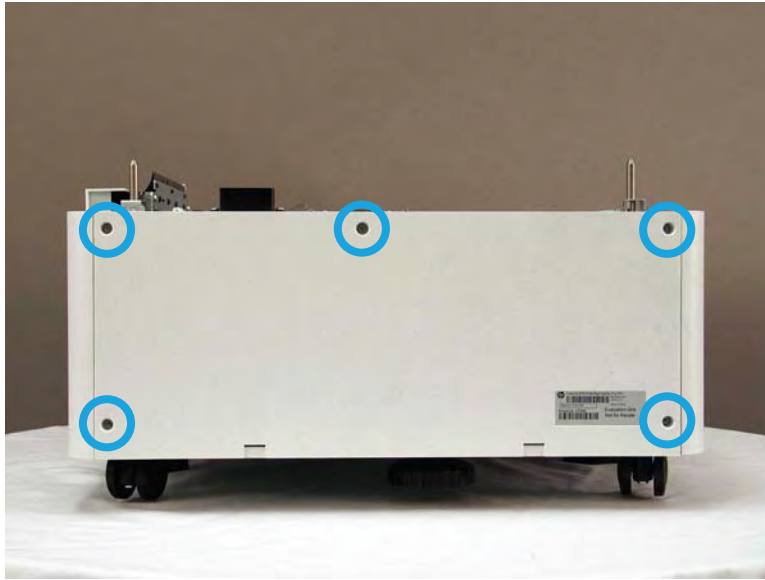

Remove the HCI drive assembly - feed

Follow these steps to remove the Remove the HCI drive assembly - feed.

1. Open the right door, and then remove two screws.

Figure 2-541 Remove two screws

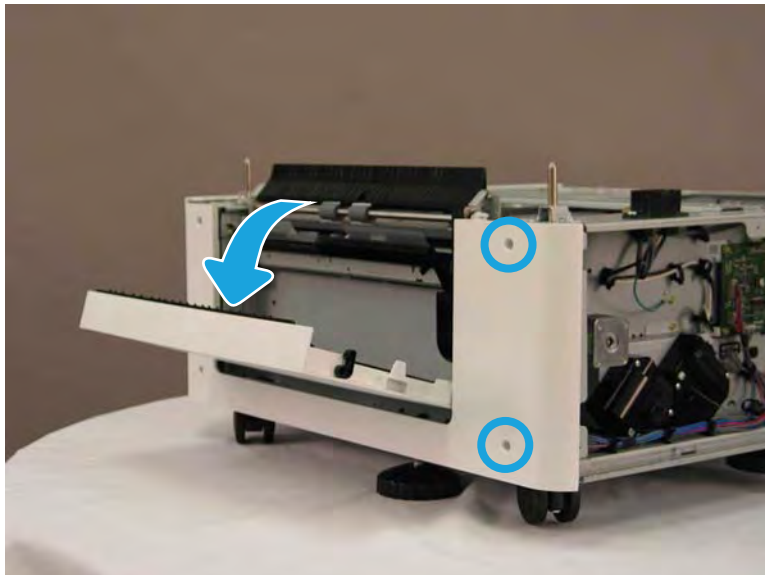

2. Release one tab, and then separate the rear edge of the right cover from the chassis.

Figure 2-542 Separate the rear edge of the right cover from the chassis

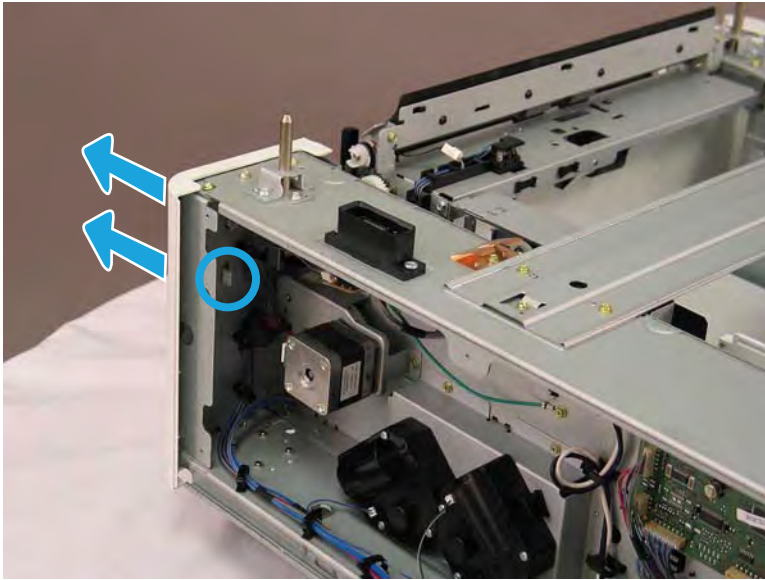

3. Disconnect one connector, and then release the wire harness from the retainer.

Figure 2-543 Disconnect one connector

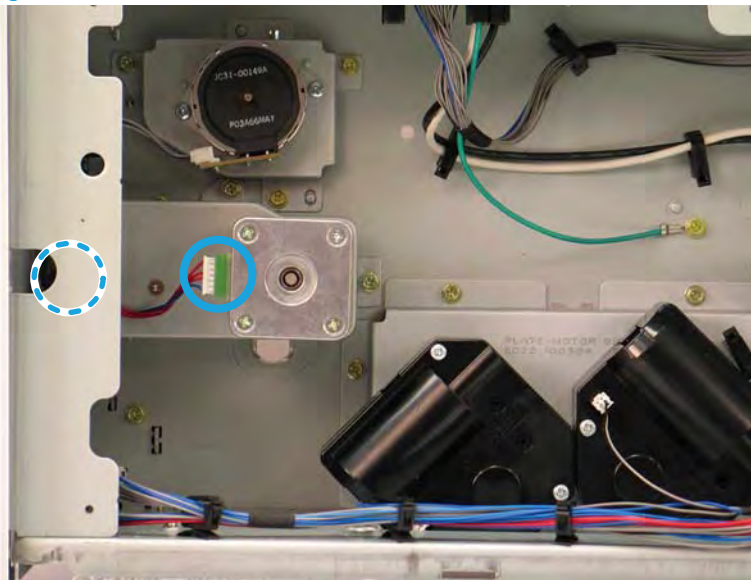

4. Remove three screws, and then remove the HCI drive assembly - feed.

Figure 2-544 Remove the HCI drive assembly - feed

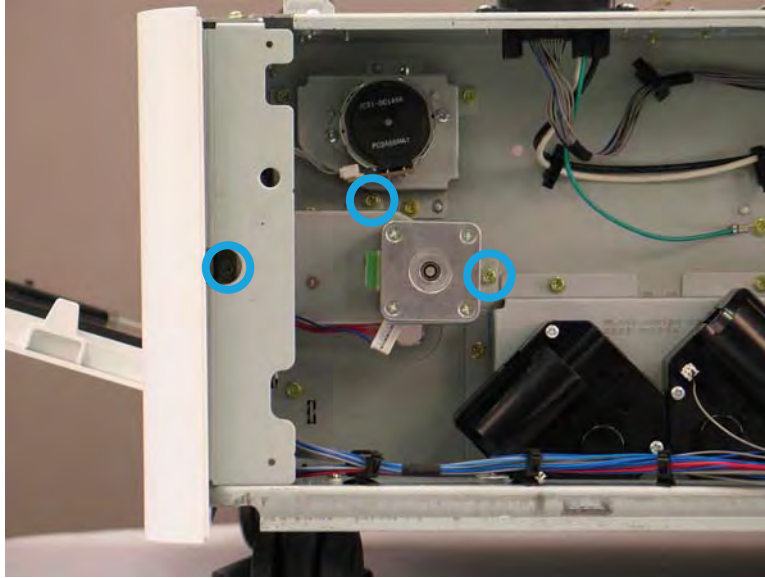

Remove the HCI right door

Follow these steps to remove the Remove the HCI right door.

1. Remove four screw caps (if installed), and then remove four screws.

 **NOTE:** If the feed drive assembly is removed, there are only two screws that secure this cover.

Figure 2-545 Remove four screws

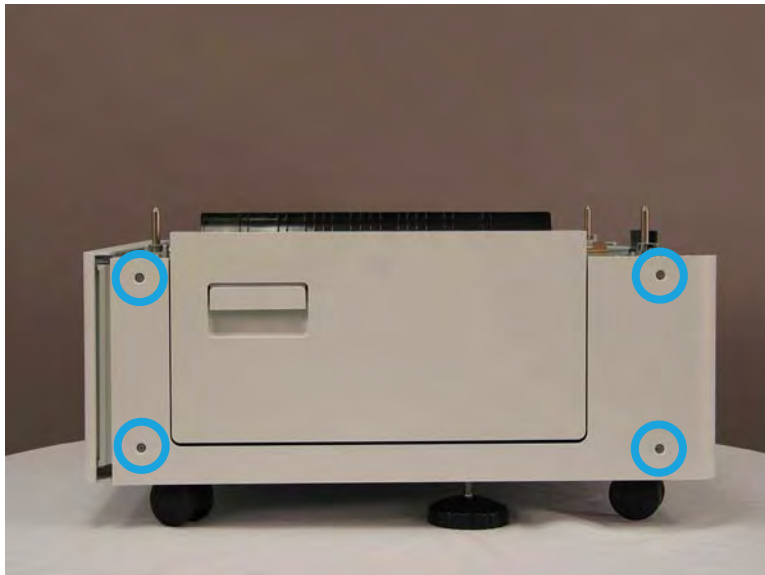

2. Release one tab, and then separate the rear edge of the right cover from the chassis.

Figure 2-546 Separate the rear edge of the right cover from the chassis

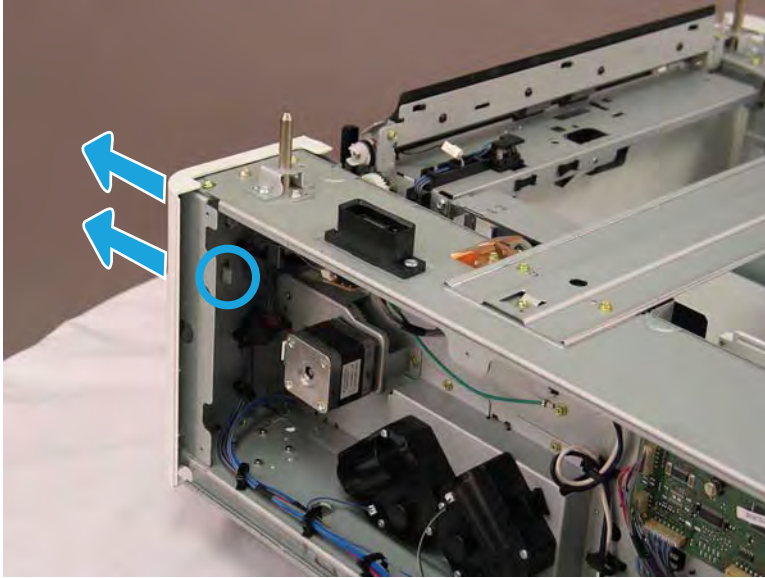

3. Lift up on the cover while rotating it away from the chassis to release three bosses.

CAUTION: Do not attempt to fully remove the cover. Stop as shown below. Fully removing the cover at this step will damage the remaining tab and boss on the cover

Figure 2-547 Release three bosses

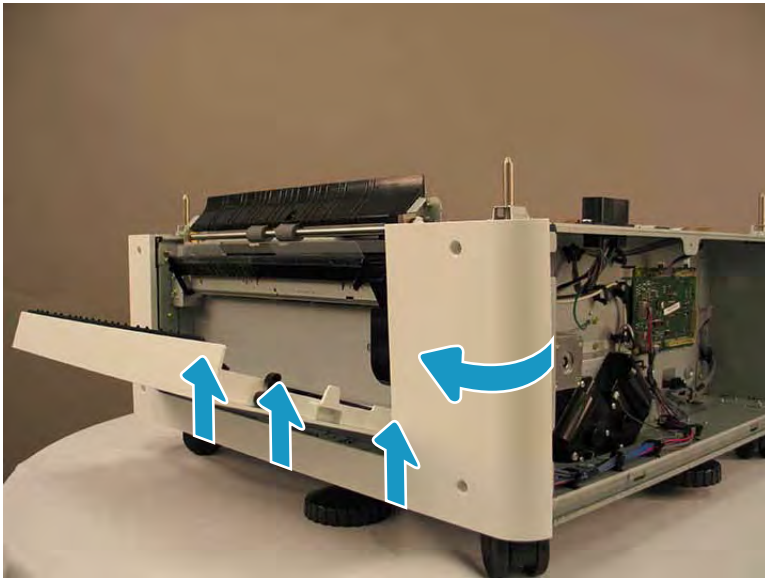

4. If the tray was not removed prior to servicing the HCI, remove it now. Look in the tray cavity and locate the right cover front tab. Release this tab.

Figure 2-548 Release one tab

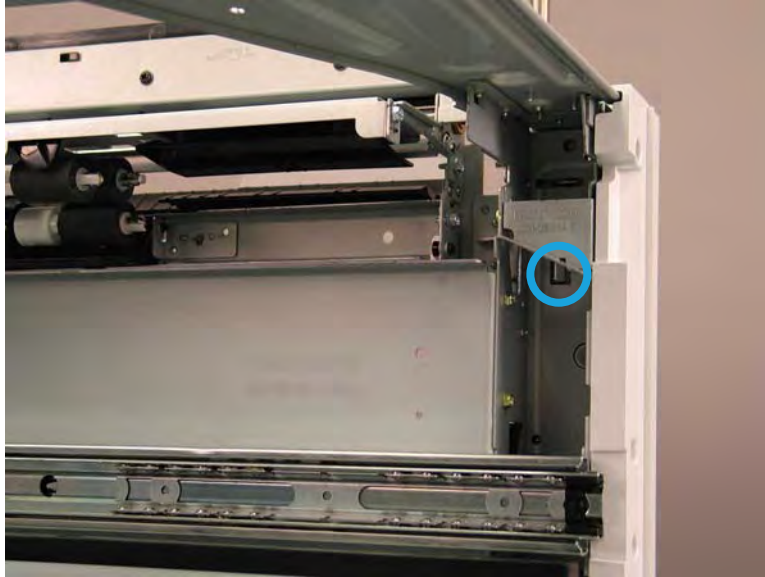

5. Remove the HCI right cover.

 **NOTE:** The HCI right door will not stay in the latched position when this cover is removed.

Figure 2-549 Remove the HCI right cover



6. Rotate the right door front hinge pin out of the holder, and then slide the right door towards the front of the HCI to release the rear hinge pin and remove the door.

Figure 2-550 Remove the HCI right door

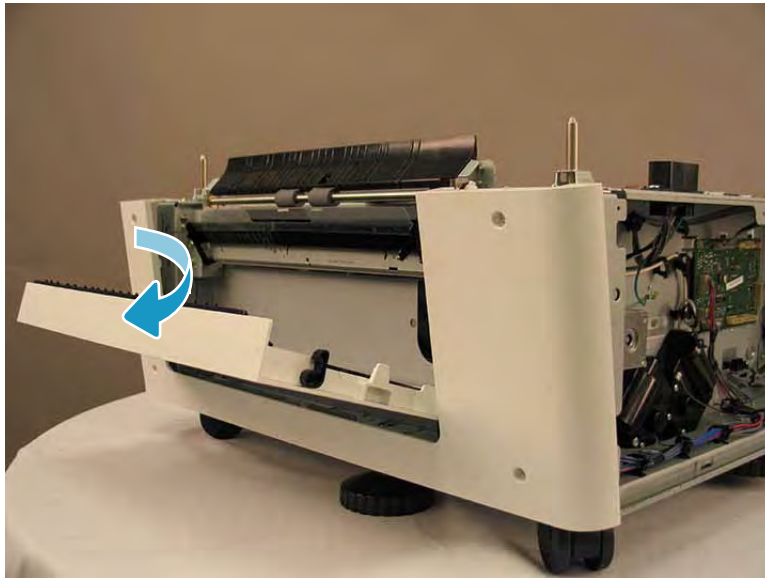
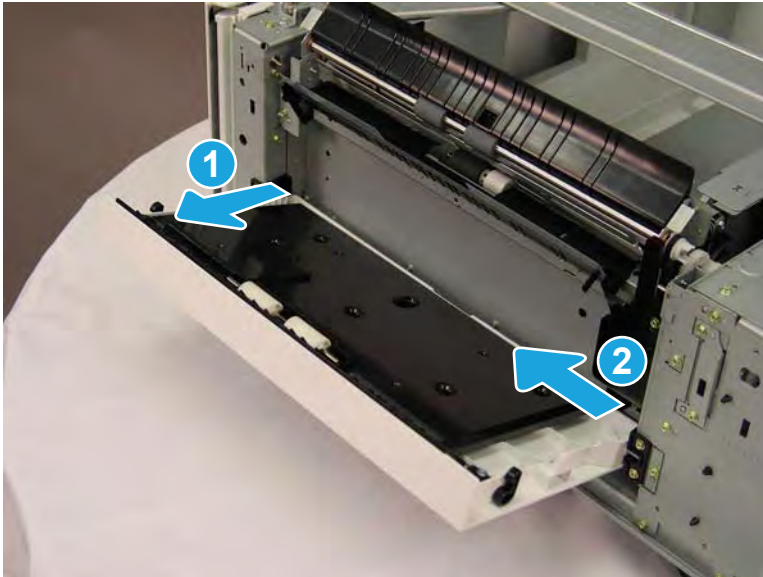

Remove the HCI drive assembly -sub pulley

Follow these steps to remove the Remove the HCI drive assembly -sub pulley.

1. Remove two screws, and then remove the black-plastic cover.

Figure 2-551 Remove the cover

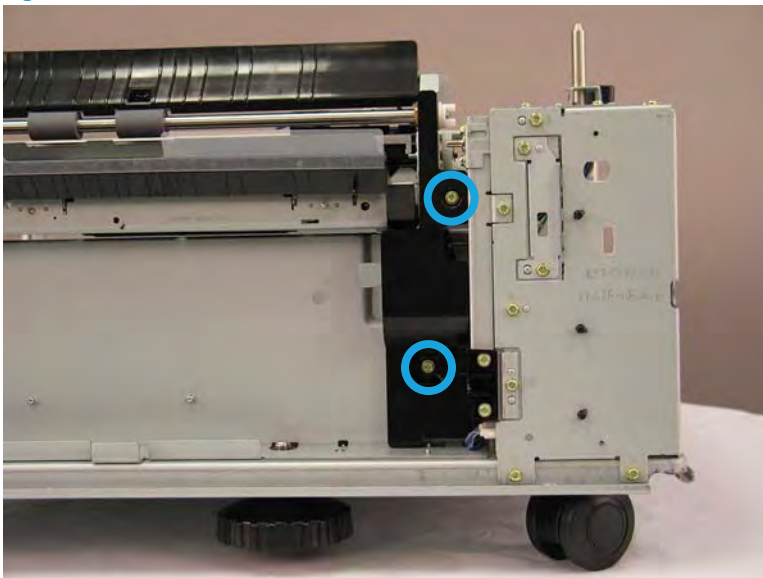

2. Remove two screws, and then remove the drive assembly - sub-pulley.

Figure 2-552 Remove the HCI drive assembly - sub-pulley

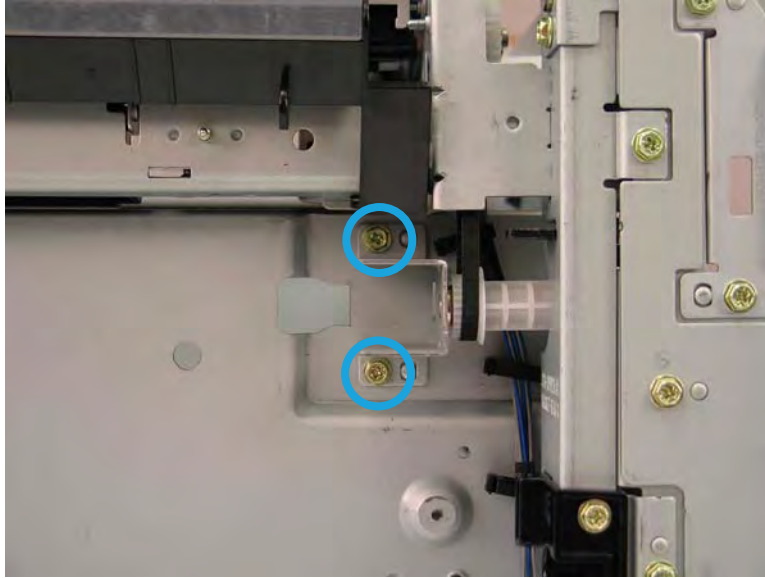

Unpack the replacement assembly



Follow these steps to unpack the replacement assembly.

1. Dispose of the defective part.

 **NOTE:** HP recommends responsible disposal of the defective part.

<http://www8.hp.com/us/en/hp-information/environment/product-recycling.html>

2. Unpack the replacement part from the packaging.

 **CAUTION:**  Some parts are sensitive to electrostatic discharge (ESD). Always perform service work at an ESD-protected workstation or mat. If an ESD workstation or mat is not available, touch the sheet-metal chassis to provide a static ground before touching an ESD-sensitive assembly. Protect the ESD-sensitive assemblies by placing them in ESD pouches when they are out of the printer.

 **IMPORTANT:** Make sure that all of the shipping materials (for example shipping tape) are removed from the replacement part prior to installation.

 **NOTE:** If the replacement part is a roller or pad, avoid touching the spongy part of it. Skin oils on the roller or pad can cause paper pickup and/or print-quality problems. HP recommends using disposable gloves when handling rollers or pads or washing your hands before touching rollers or pads.

3. To install an assembly, reverse the removal steps.

 **NOTE:** When applicable, special installation instructions are provided for an assembly at the end of the removal procedure. Always completely read the removal instructions and follow all special installation instructions.

HCI sub - cassette

View the HCI sub - cassette exploded view, parts list, and repair procedures.

HCI sub - cassette

Parts diagram and parts list for the HCI sub - cassette.

Figure 2-553 HCI sub - cassette

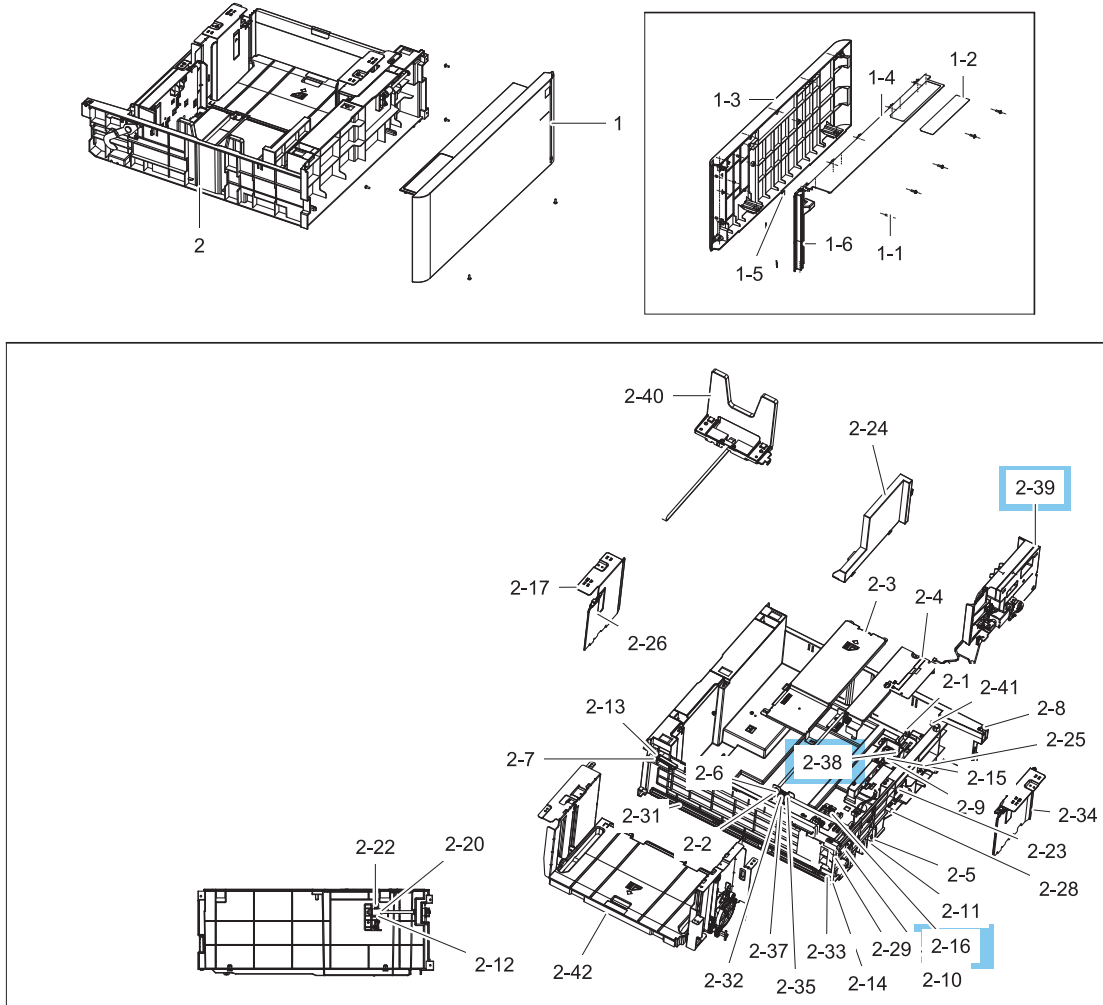

Table 2-125 HCl sub - cassette

Ref				
No	Part number	Description	Qty	Repair procedure
2-16	JC81-07468A	Bracket sensor (HCl)	1	Removal and replacement: HCl photo interrupter and sensor bracket on page 669
2-38	0604-001393	Photo interrupter (HCl)	1	Removal and replacement: HCl photo interrupter and sensor bracket on page 669
2-39	JC90-01723A	Sub-paper side right (HCl)	1	Removal and replacement: HCl sub-paper side right on page 662

Removal and replacement: HCI sub-paper side right

This document provides the procedures to remove the HCI sub-paper side right.



[View a video of removing and replacing the sub-paper side right.](#)

Mean time to repair:

Service level:



IMPORTANT: When applicable, special installation instructions are provided for an assembly at the end of the removal procedure. Always completely read the removal instructions and follow all special installation instructions.

Before performing service

- Disconnect the power cable.



WARNING! To avoid damage to the printer, turn the printer off, wait 30 seconds, and then remove the power cable before attempting to service the printer.

Use the table below to identify the correct part number for your printer. To order the part, go to www.hp.com/buy/parts

Table 2-126 Part information

Part number	Part description
JC90-01723A	HCI sub-paper side right

Required tools

- #2 JIS screwdriver with a magnetic tip

After performing service

Turn the printer power on

- Connect the power cable.
- Turn on the power switch next to the power cable, and then press the power button on the front of the printer.
- Verify that the service performed was successful.
- Verify that the most recent firmware is installed on the printer.
- Verify that all parts are correctly reinstalled and are properly working.

Post service test

Print any pages necessary to verify that the repair resolved the issue and did not create any new issues.

Remove the HCI tray

Follow these steps to remove the HCI tray.

1. Pull the tray fully out of the HCI, and then at the left side of the tray release the hook lever on the tray.

 **TIP:** Slightly pull out on the left side of the tray so that the hook lever remains unlatched.

Figure 2-554 Release the tray left side hook lever



2. At the right side of the tray push in on the slide lock (callout 1) to release it, and then pull the tray away from the HCI (callout 2).

Figure 2-555 Release the tray right-side slide lock

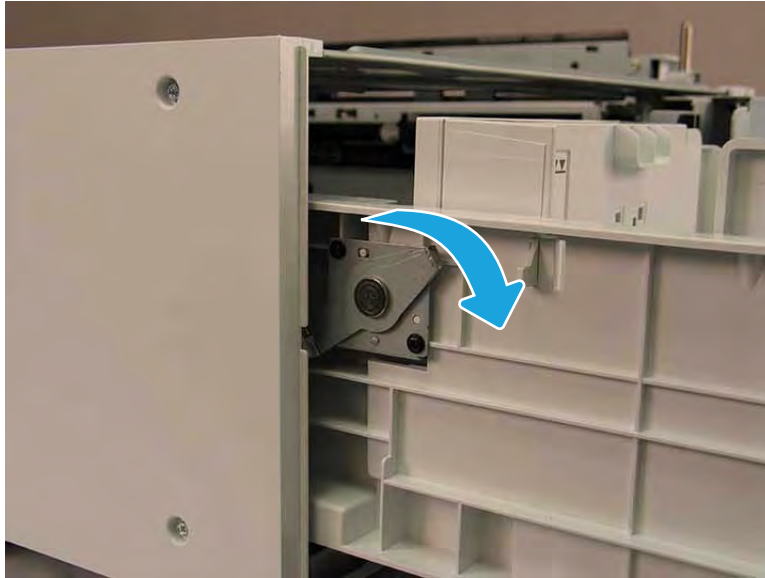
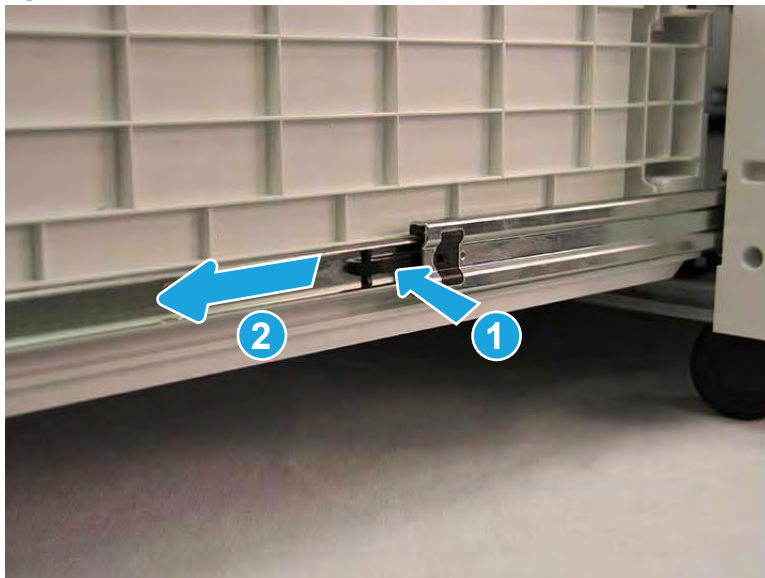

3. Continue to slide the tray away from the HCI to remove it.

Figure 2-556 Remove the tray

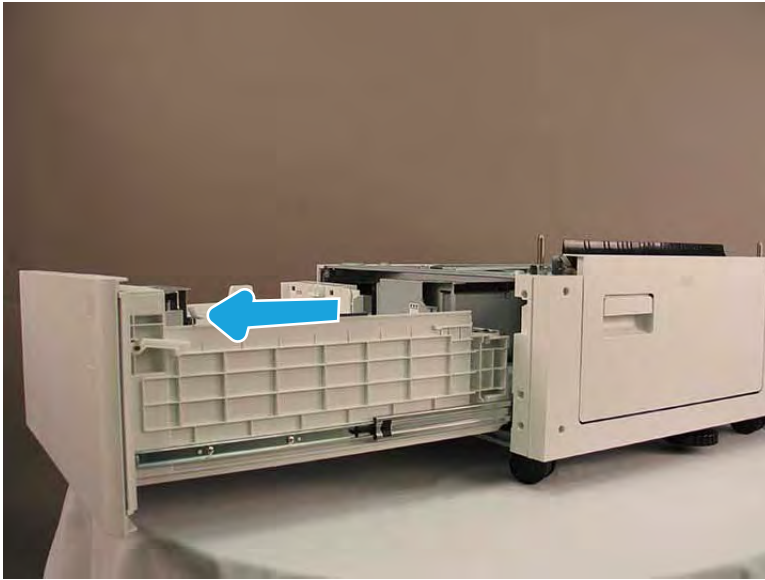

Remove the HCI sub-paper side right

Follow these steps to remove the HCI sub-paper side right.

1. Look into the tray, disconnect one connector, and then remove one screw.

Figure 2-557 Disconnect connector and remove one screw

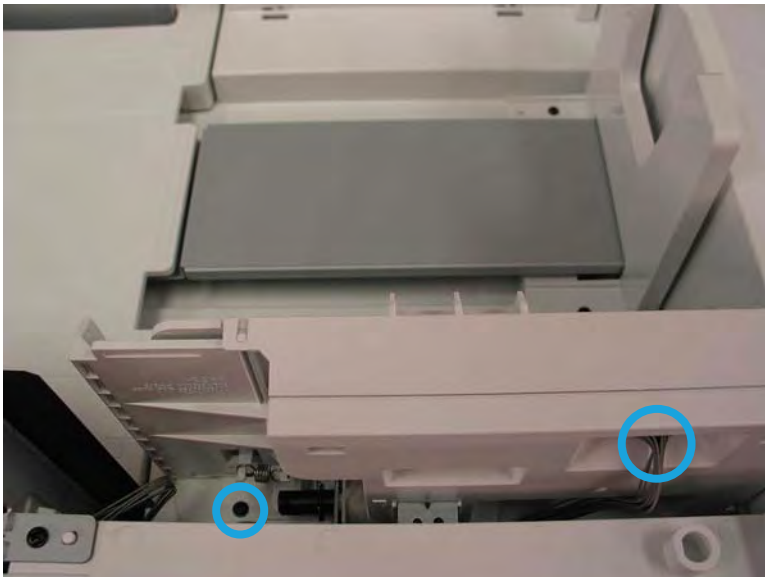

2. Slide the sub-paper side right assembly to the left to release it, and then slightly lit it up.

⚠ CAUTION: Do not attempt to completely remove the assembly. It is still attached to the tray by a wire harness and ground wire.

Figure 2-558 Release the sub-paper side right assembly

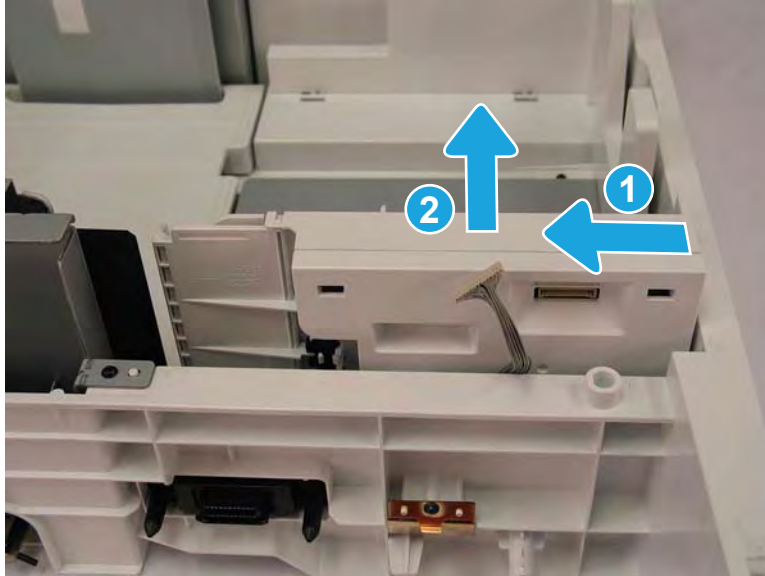

3. Remove one screw, and then release the wire harness from the retainer.

Figure 2-559 Remove one screw and release the wire harness



4. Remove one screw.

Figure 2-560 Remove one screw

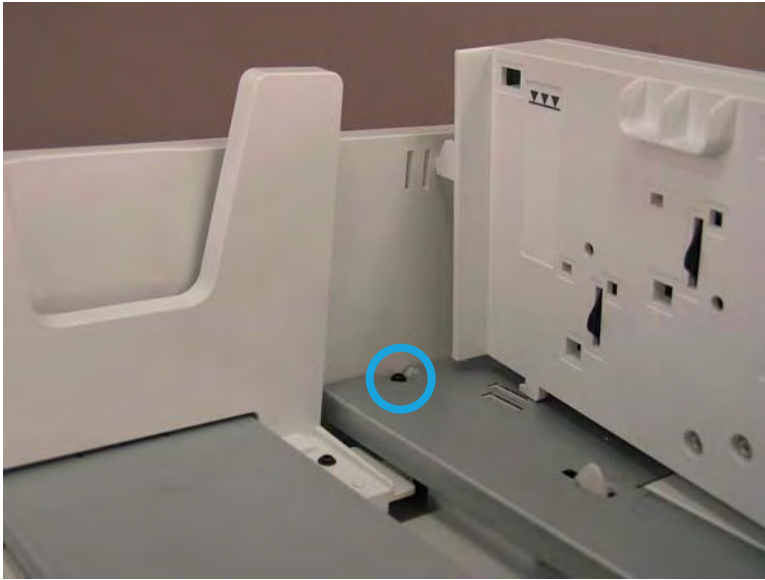

5. Raise the paper shelf, hold the sub-paper side right assembly up and out of the way, and then remove the sheet-metal cover.

Figure 2-561 Remove the cover

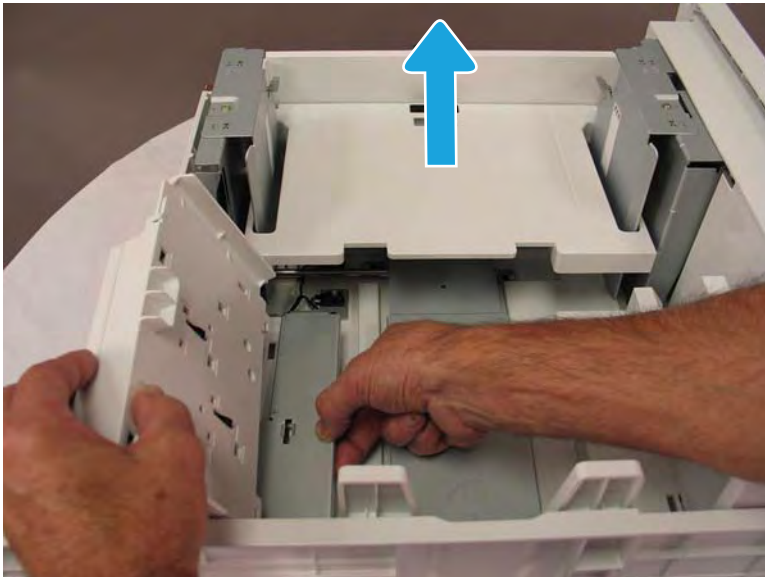

6. Disconnect three connectors, and then release the wire harness from the retainers.

 **TIP:** Fully raise the paper shelf to access two connectors.

Figure 2-562 Disconnect three connectors

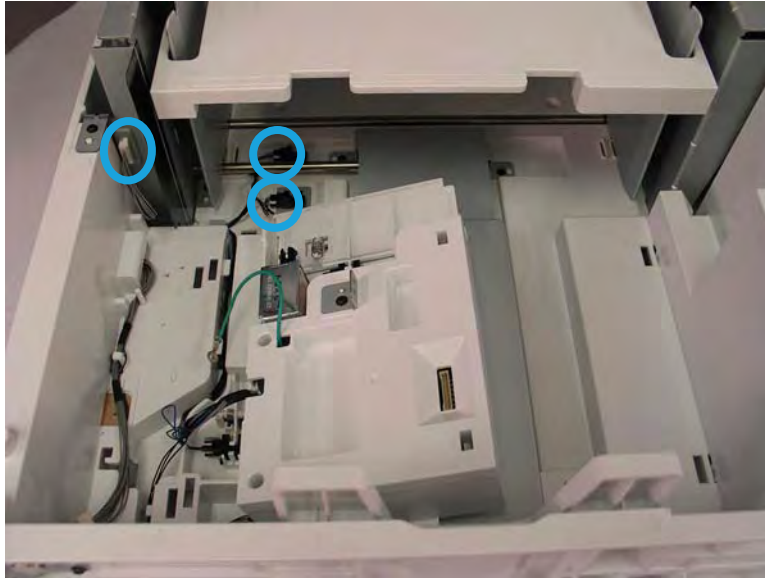

7. Disconnect two connectors, release the wire harnesses from the guides, and then remove the sub-paper side right assembly.

Figure 2-563 Remove the sub-paper side right assembly

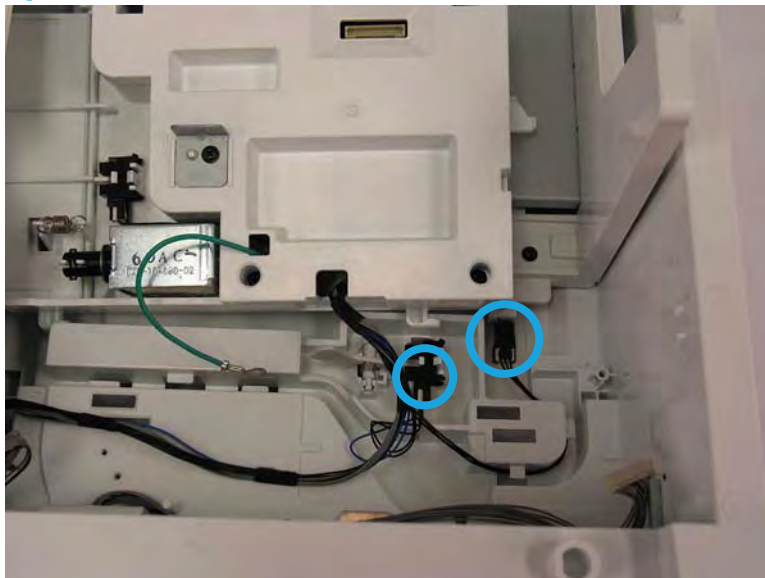

Unpack the replacement assembly

Follow these steps to unpack the replacement assembly.

1. Dispose of the defective part.

 **NOTE:** HP recommends responsible disposal of the defective part.

<http://www8.hp.com/us/en/hp-information/environment/product-recycling.html>

2. Unpack the replacement part from the packaging.



CAUTION:  Some parts are sensitive to electrostatic discharge (ESD). Always perform service work at an ESD-protected workstation or mat. If an ESD workstation or mat is not available, touch the sheet-metal chassis to provide a static ground before touching an ESD-sensitive assembly. Protect the ESD-sensitive assemblies by placing them in ESD pouches when they are out of the printer.

 **IMPORTANT:** Make sure that all of the shipping materials (for example shipping tape) are removed from the replacement part prior to installation.

 **NOTE:** If the replacement part is a roller or pad, avoid touching the spongy part of it. Skin oils on the roller or pad can cause paper pickup and/or print-quality problems. HP recommends using disposable gloves when handling rollers or pads or washing your hands before touching rollers or pads.

3. To install an assembly, reverse the removal steps.

 **NOTE:** When applicable, special installation instructions are provided for an assembly at the end of the removal procedure. Always completely read the removal instructions and follow all special installation instructions.

Removal and replacement: HCI photo interrupter and sensor bracket

This document provides the procedures to remove the HCI photo interrupter and sensor bracket.



[View a video of removing and replacing the sensor and bracket.](#)

Mean time to repair:

Service level:



IMPORTANT: When applicable, special installation instructions are provided for an assembly at the end of the removal procedure. Always completely read the removal instructions and follow all special installation instructions.

Before performing service

- Disconnect the power cable.



WARNING! To avoid damage to the printer, turn the printer off, wait 30 seconds, and then remove the power cable before attempting to service the printer.

Use the table below to identify the correct part number for your printer. To order the part, go to www.hp.com/buy/parts

Table 2-127 Part information

Part number	Part description
0604-001393	HCI photo interrupter
JC81-07468A	HCI sensor bracket

Required tools

- #2 JIS screwdriver with a magnetic tip

After performing service

Turn the printer power on

- Connect the power cable.
- Turn on the power switch next to the power cable, and then press the power button on the front of the printer.
- Verify that the service performed was successful.
- Verify that the most recent firmware is installed on the printer.
- Verify that all parts are correctly reinstalled and are properly working.

Post service test

Print any pages necessary to verify that the repair resolved the issue and did not create any new issues.

Remove the HCI tray

Follow these steps to remove the HCI tray.

1. Pull the tray fully out of the HCI, and then at the left side of the tray release the hook lever on the tray.

 **TIP:** Slightly pull out on the left side of the tray so that the hook lever remains unlatched.

Figure 2-564 Release the tray left side hook lever



2. At the right side of the tray push in on the slide lock (callout 1) to release it, and then pull the tray away from the HCI (callout 2).

Figure 2-565 Release the tray right-side slide lock

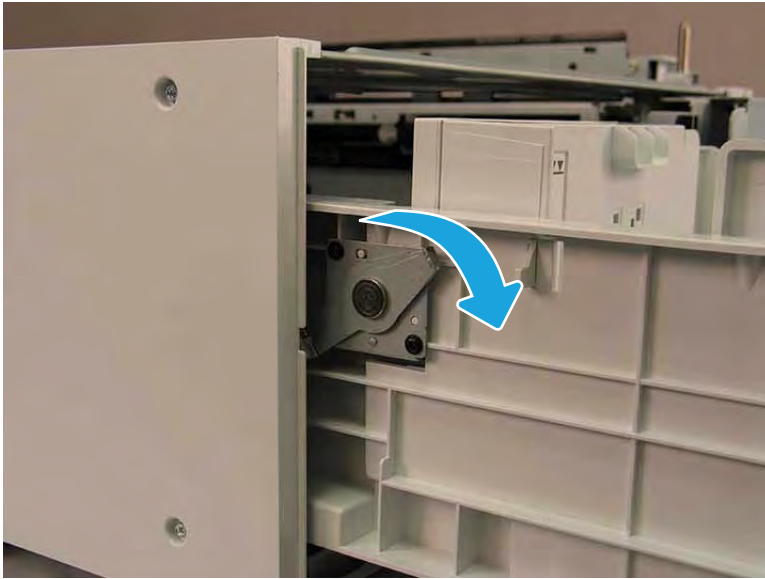
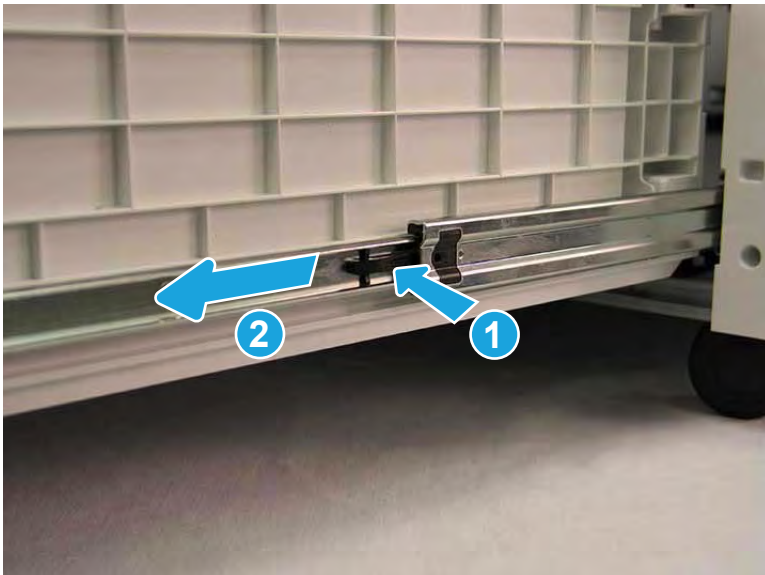

3. Continue to slide the tray away from the HCI to remove it.

Figure 2-566 Remove the tray

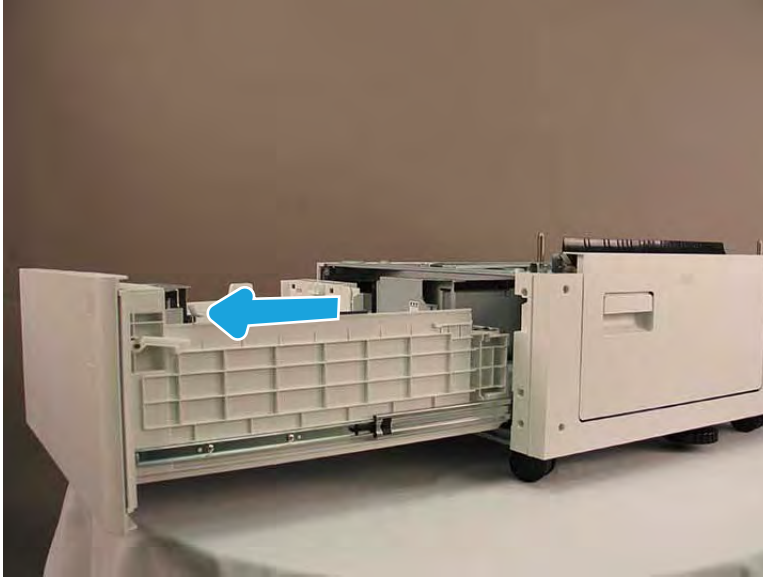

Remove the HCI photo interrupter and sensor bracket

Follow these steps to remove the HCI photo interrupter and sensor bracket.

- ▲ Raise the paper shelf, disconnect one connector, remove one screw, and then remove the HCI photo interrupter and sensor bracket.

 **NOTE:** It might be easier to disconnect the connector after the screw is removed.

Figure 2-567 Remove the HCI photo interrupter and sensor bracket



Unpack the replacement assembly



Follow these steps to unpack the replacement assembly.

1. Dispose of the defective part.

 **NOTE:** HP recommends responsible disposal of the defective part.

<http://www8.hp.com/us/en/hp-information/environment/product-recycling.html>

2. Unpack the replacement part from the packaging.

 **CAUTION:**  Some parts are sensitive to electrostatic discharge (ESD). Always perform service work at an ESD-protected workstation or mat. If an ESD workstation or mat is not available, touch the sheet-metal chassis to provide a static ground before touching an ESD-sensitive assembly. Protect the ESD-sensitive assemblies by placing them in ESD pouches when they are out of the printer.

 **IMPORTANT:** Make sure that all of the shipping materials (for example shipping tape) are removed from the replacement part prior to installation.

 **NOTE:** If the replacement part is a roller or pad, avoid touching the spongy part of it. Skin oils on the roller or pad can cause paper pickup and/or print-quality problems. HP recommends using disposable gloves when handling rollers or pads or washing your hands before touching rollers or pads.

3. To install an assembly, reverse the removal steps.

 **NOTE:** When applicable, special installation instructions are provided for an assembly at the end of the removal procedure. Always completely read the removal instructions and follow all special installation instructions.

3 Problem solving

Learn about problem solving.

Control panel messages document (CPMD)

Learn about the printer control panel messages document (CPMD).

 **NOTE:** A complete CPMD is not included in this service manual.

[Click here to access the complete CPMD for this printer.](#)

Error codes

Error codes and control-panel messages display on the printer control panel to indicate the current printer status or situations that might require action. Error codes are numerical, or alphanumeric, and have a set structure with six characters (example: 13.WX.YZ).

- The first two characters are numeric and represent the system component that is causing the error. For example, in error code 10 . 22 . 15, **10 = Supplies** for HP LaserJets.
- The remaining four characters (W, X, Y, and Z values) further define the error.

HP LaserJet and HP PageWide Enterprise error codes are documented in the control panel message document (CPMD) for each printer.

The CPMD is a comprehensive list of error codes, diagnostic and troubleshooting steps to clear or resolve the error, and other helpful information such as service mode pins and part numbers.

The CPMD is continually updated and republished with the latest information for the following error codes.

Table 3-1 ERROR CODES: The first two characters

Error code	System Component	System Error Description
10.WX.YZ	Supplies (LaserJet)	Supply error or supply memory error.
11.WX.YZ	Real-time clock	Internal error with the clock on the formatter.
13.WX.YZ	Jam (LaserJet)	Paper jam or open door jam error.
15.WX.YZ	Jam (PageWide)	Paper jam or open door jam error.
17.WX.YZ	Supplies (PageWide)	Supply error or supply memory error.
20.WX.YZ	Printer memory	Insufficient memory or buffering error.
21.WX.YZ	Page	Page complexity causing a decompression error when trying to process job.
30.WX.YZ	Scanner	Flatbed scanner error occurring inside the unit.
31.WX.YZ	Document feeder	Document feeder, scanner, or jam error.
32.WX.YZ	Backup, restore, or reset	Backup, restore, or reset notification or error.
33.WX.YZ	Security	Backup, Disk, EFI BIOS, Firmware integrity (SureStart), or Trusted Platform Module (TPM) notification or error.
40.WX.YZ	Input/Output (I/O)	Partition manager, secure erase, or USB accessory error.

Table 3-1 ERROR CODES: The first two characters (continued)

Error code	System Component	System Error Description
41.WX.YZ	Fuser, Laser scanner, or Paper path	Miscellaneous error including general and misprint or mismatch errors typically involving (but not limited to) the fuser, the laser scanner, or the paper path.
42.WX.YZ	Firmware	Firmware failure involving the Event Log, Shell, System Manager, or other component.
44.WX.YZ	Firmware	Firmware failure involving a digital sending component.
45.WX.YZ	OXPd/Web Kit (PageWide)	Informational notifications involving the OXPd Web Kit (communications log).
46.WX.YZ	Engine (LaserJet)	Engine communication error.
47.WX.YZ	Firmware	Job parser or printer calibration error.
48.WX.YZ	Firmware	PJA job accounting, job management, or job pipeline error.
49.WX.YZ	Firmware	Firmware communication error.
50.WX.YZ	Fuser (LaserJet)	Fuser error.
51.WX.YZ	Laser scanner (LaserJet)	Laser scanner beam error.
52.WX.YZ	Laser scanner (LaserJet)	Laser scanner startup error.
54.WX.YZ	Sensor	Sensor error (not jam related).
55.WX.YZ	DC controller (LaserJet)	DC controller communication error.
56.WX.YZ	Paper handling (LaserJet)	Paper input/output or accessory error.
57.WX.YZ	Fan	Fan error.
58.WX.YZ	Sensor	Engine sensor failure.
59.WX.YZ	Motor (LaserJet)	Motor error.
60.WX.YZ	Tray motor error (LaserJet)	Tray lifting or pick up error.
61.WX.YZ	Engine (PageWide)	Print engine error with the 8-bit data package.
62.WX.YZ	System (LaserJet)	LaserJet internal system error.
	Print bar (PageWide)	PageWide print system error.
63.WX.YZ	Engine (LaserJet)	General engine error (electrical, communication, etc.).
65.WX.YZ	Connector	Output accessory connection error.
66.WX.YZ	Output accessory	Output accessory error.
67.WX.YZ	Input accessory	Input accessory connection error
69.WX.YZ	Duplexer	Duplexer error.
70.WX.YZ	DC controller (LaserJet)	DC controller firmware error.
80.WX.YZ	Managed device	Embedded Jetdirect error.

Table 3-1 ERROR CODES: The first two characters (continued)

Error code	System Component	System Error Description
81.WX.YZ	Near Field Communication (NFC)	Wireless, Bluetooth or internal EIO error.
82.WX.YZ	Memory (hard disk, EMMC, etc.)	Disk hardware error.
90.WX.YZ	Internal diagnostics	Internal test of systems (i.e. disk, CPB, display) or interconnection error.
98.WX.YZ	Hard disk	Hard disk partition error.
99.WX.YZ	Firmware installer	Remote Firmware Upgrade (RFU), firmware install (engine or accessory), or disk error.

How to search for printer documentation

Find printer documentation using the internal HP portals.

The CPMD, error codes, and other support documentation for each printer is found on the internal HP portals [GCSN](#) and [WISE](#) (formerly SAW). GCSN is available to HP channel partners and WISE is available to call agents, service technicians, and other HP internal users. The level of detail available will depend on your access credentials.

How to search WISE for printer documentation

These instructions are for HP internal use by call agents, service technicians, and other internal users. [View a video of how to find support content in WISE.](#)

To view a list of control panel message documents per printer in WISE, enter document ID **c05048451**, to locate CPMD list.

Go to WISE and enter this document ID **c05791539** for written instructions.

How to search GCSN for printer documentation

These instructions are for internal use by HP Channel Partners. [View a video of how find support content in GCSN](#), or follow the steps below.

1. On the Home screen in GCSN, open **Technical information** using one of the following two methods:
 - Type **TINF** in the **Speedcode** field found in the upper right corner and press **Enter**, or
 - On the Home page, click **Technical information** in the left pane.

Figure 3-1 GCSN home page

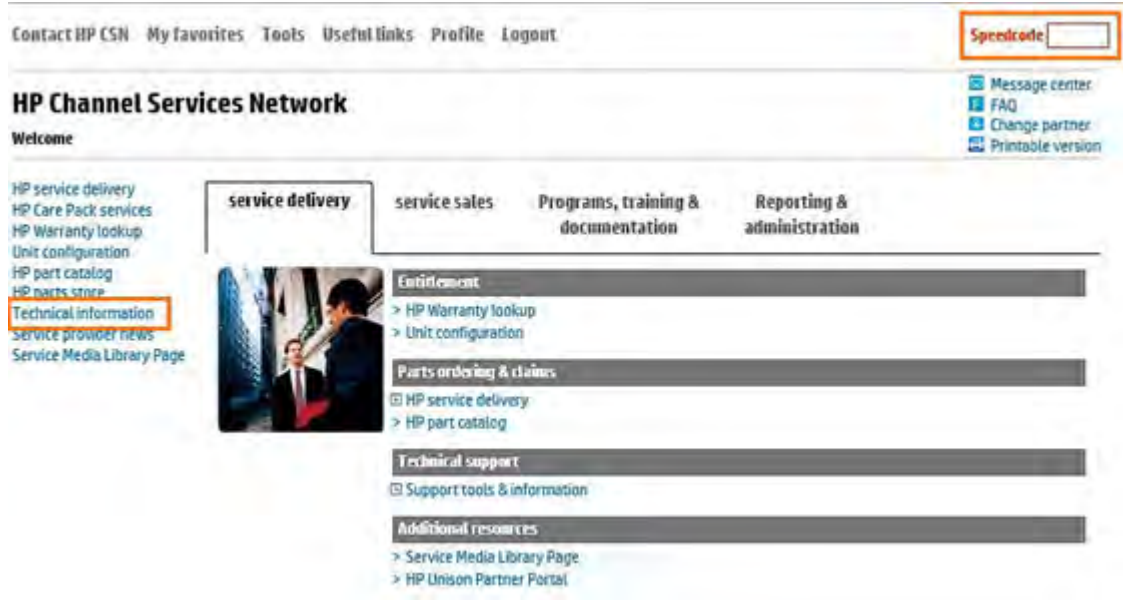

2. Under **Product Search**, select the **Type**, **Category**, **Family**, and **Series** that match your product model (leave the **Model** field as blank or the default).

 **NOTE:** Make sure to login to GCSN using your service-qualified credentials to access the most comprehensive content list available. To find out how to become service-qualified, contact your HP representative.

Figure 3-2 Sample product search criteria (GCSN)

Product Search [Add Favorites](#)

Type
Printers and Multifunction

Category
Multifunction and All-in-One

Family
HP LaserJet MFP and All-in-One Products

Series
HP Color LaserJet Enterprise MFP M682 series

Model
Select a Model

3. Click **Add Favorites** and then click **Add** to add the printer to your Favorites list and allow you to bypass the **Product Search** fields next time for that particular model (optional).

Figure 3-3 Add favorites (GCSN)

The screenshot shows a section titled 'Product Search' with a blue 'Add Favorites' button. Below the button are three dropdown menus: 'Type' set to 'Printers and Multifunction', 'Category' set to 'Multifunction and All-in-One', and 'Family' set to 'HP LaserJet MFP and All-in-One Products'.

4. Clear all of the high-level check boxes.

Figure 3-4 Clear search criteria (GCSN)

The screenshot shows a list of document types with checkboxes. The high-level categories are highlighted with orange boxes: 'Support Communications', 'Manuals and Guides', and 'Support Information'. The 'Manuals and Guides' category is also highlighted with a blue box.

5. Select the check boxes for the document types for which you want to search.

 **NOTE:** Select only the high-level **Manuals and Guides** search option if you are not sure in which type of manual or guide the content might be listed.

Figure 3-5 Select search criteria (GCSN)

The screenshot shows the same list of document types as Figure 3-4. In this view, several checkboxes are selected and highlighted with orange boxes: 'Maintenance/Service Guide', 'Service Guide/Manual', 'User Guide', 'CPMMap', and 'Support Information'.

6. Select **Submit**.
7. If needed, click **Back To selection Criteria** and narrow your search (the maximum allowed search result is 100 documents).



NOTE: Do not select the **Top Issue** option unless you only want to view top issues for that model. All other available content is filtered out.

Table 3-2 Information type selections

Technical information type	Select this checkbox
Control panel message document (CPMD)	CPMD-Map
List of all CPMDs per product	Support Information
Installation Guide or Hardware Install Guide	Maintenance/Service Guide or Install Guide
Service cost document	Install Guide or Service Guide/Manual
Service guide or Service manual	Service Guide/Manual
Self-solve or troubleshooting document	Support Information
User manual or User guide	User Guide
Warranty and Legal Guide	Warranty Statement

Troubleshooting process

Learn about the troubleshooting process.

Determine the problem source

When the printer malfunctions or encounters an unexpected situation, the printer control panel alerts you to the situation. This section contains a pre-troubleshooting checklist to filter out many possible causes of the problem. A troubleshooting flowchart helps you diagnose the root cause of the problem. The remainder of this chapter provides steps for correcting problems.

- Use the troubleshooting flowchart to pinpoint the root cause of hardware malfunctions. The flowchart guides you to the section of this chapter that contains steps for correcting the malfunction.

Before beginning any troubleshooting procedure, check the following issues:

- Are supply items within their rated life?
- Are supply items Genuine HP supplies?
- Does the configuration page reveal any configuration errors?



NOTE: The customer or service provider is responsible for checking supplies and for using supplies that are in good condition.

Power subsystem

Learn about the power subsystem.

Power-on checks

The basic printer functions should start up when the printer is connected into an electrical outlet and the power switch is pushed to the *on* position. If the printer does not start, use the information in this section to isolate and solve the problem.

If the control-panel display remains blank, random patterns display, or asterisks remain on the control-panel display, perform power-on checks to find the cause of the problem.

Power-on troubleshooting overview

If the control panel is blank 1 minute after turning on the printer, check the following items:

During normal operation, a cooling fan begins to spin briefly after the printer power is turned on. Place your hand over the vents at the rear of the printer, next to the formatter, or on the rear of the scanner. If the fan is operating, you will feel air passing out of the printer. You can lean close to the printer and hear the fan operating.

A fan begins to blow on the right door (fuser), and then the control panel goes through a series of set up functions. The main motor turns on (unless the left door or cartridge access door is open, a jam condition is sensed, or the paper-path sensors are damaged). You might be able to visually and audibly determine if the main motor is turned on.

If the fan and main motor are operating correctly, the next troubleshooting step is to isolate print engine, formatter, and control panel problems.

1. Make sure that the printer is connected directly into an active electrical outlet (not a power strip) that delivers the correct voltage.
2. Make sure that the power switch is in the *on* position, and then verify that the LED is on.
3. Make sure that the fan runs briefly, which indicates that the power supply is operational.
4. Depress the button on the back of the control panel to test the control panel functionality.
5. Make sure that the control-panel display wire harness is connected.
6. Remove any external solutions, and then try to turn the printer on again.

Troubleshooting a blank display, black display, no display, or no power situation

Customers usually report that the control-panel display is not showing anything. It is very important to collect as much information as possible from the customer about the issue to help resolve it.

Following are some printer behaviors the customer might encounter:

- The control panel is completely blank (no LEDs or back light).
- The control panel is blank, but there might be LEDs illuminated.
- The control panel is blank (LEDs are on or flashing) and the back light is on (but no text visible).

Following are some possible causes of a blank control-panel display:

- No power to the printer.
- The control panel contrast setting is not correctly adjusted.
- The formatter connector(s) are not fully seated into the connector(s) on the DC controller, or the connectors are not fully seated on the formatter.
- A faulty component is installed on the formatter (for example a memory DIMM, fax PCA, network PCA, USB device, or other component).
- The formatter is defective.
- The control panel connector is not fully seated, or the control panel is defective.
- The DC controller is defective.

Following are some questions to ask the customer:

- Was the printer newly install or has the printer been properly functioning?
 - For a new install, investigate to see if there was any shipping damage to the printer.
 - Did the customer notice any damage to the shipping box or any visible damage to the printer?
- What happened just prior to the control panel going blank?
 - Was the printer serviced recently, a power outage occurred?
 - Has a lightning storm recently occurred?
 - Did the customer recently add a memory DIMM or install a third-party component?
- Make sure to get a complete description of the failure.
 - Is the control-panel display completely blank (might be faint text and no back light)?
 - Is the control-panel display back light on?
 - Has a print job been sent to the printer? The customer might report that their print jobs seemed to print but when they go to the printer the control-panel display is blank.

Recommended actions

If the control-panel display is completely blank (no LEDs illuminated or no back light) check to see if the printer is getting power. Listen for fans or any printer initialization sounds when the power is turned on.

If there are no signs of power, then perform the following:

1. Make sure that the printer is plugged directly into an active electrical outlet (not a power strip or uninterruptible power supply) that delivers the correct voltage.

 **TIP:** Try using a different power cable if possible.

2. Turn the printer power on, and make sure that the fan(s) run briefly (this indicates that the power supply is operational).
3. Check if the yellow LED on formatter is flashing. If so, there is a communication issue between the formatter and the control panel.
4. Turn the printer power off.
5. Make sure that the control-panel display wire harness (and/or flat cable) is properly connected (and fully seated), and then turn the printer power on again.
6. Check control panel diagnostics by pressing the button on the back of the control panel to run different diagnostic tests.
7. Verify the status LEDs are illuminated, but the control-panel display is blank. If applicable: Check if the contrast setting is adjusted to very low. If so, try turning the contrast knob to see if the control-panel display becomes visible.
8. From a host computer, send a print job to the printer.

 **NOTE:** If the print job correctly prints, then the problem is most likely to a defective control panel.

9. Turn the printer power off, and then make sure that the memory DIMM is installed in the correct slot and is fully seated.

 **NOTE:** For some printers, there may be more than one memory DIMM installed. Some printers have third-party solutions/applications or fonts that use memory.

10. Remove all of the components/accessories installed on the formatter (for example, hard drive, solid-state drive, memory DIMM(s), fax PCA, network PCA, USB devices, or other devices).

- Make sure that the formatter is fully seated.

 **IMPORTANT:** This is important because the formatter or a component on the formatter might be defective or shorted, which causes the printer to lose power.

11. Reinstall the formatter. Make sure that it makes a good connection and is fully seated.

Make sure that all of the connectors on the formatter are correctly connected and fully seated.

12. Turn the printer power on, and then check the control-panel display.
13. If the printer control panel is properly working, replace each removed component (one at a time) to determine which one is causing the problem.

 **CAUTION:** Turn the printer power off, and then on again, after replacing a component on the formatter.

14. If the control-panel display is still blank after performing the above troubleshooting steps, and the control panel diagnostics do not function, replace the control panel. If the control panel diagnostics are functioning, then replace the formatter.

Control panel checks

Learn about the control panel checks.

Control panel diagnostic flowcharts

Learn about the control panel diagnostic flowcharts.

Use the flowcharts in this section to troubleshoot the following control panel problems.

- Touchscreen is blank, white, or dim (no image).
- Touchscreen is slow to respond or requires multiple presses to respond.
- Touchscreen has an unresponsive zone.
- No control panel sound.
- [Home](#) button is unresponsive.
- Hardware integration pocket (HIP) is not functioning (control panel functional).

Touchscreen black, white, or dim (no image)

Learn about the touchscreen black, white, or dim (no image).



NOTE: To open the diagnostic function, press the button on the back of the control panel.

Figure 3-6 Touchscreen blank, white, or dim (no image)

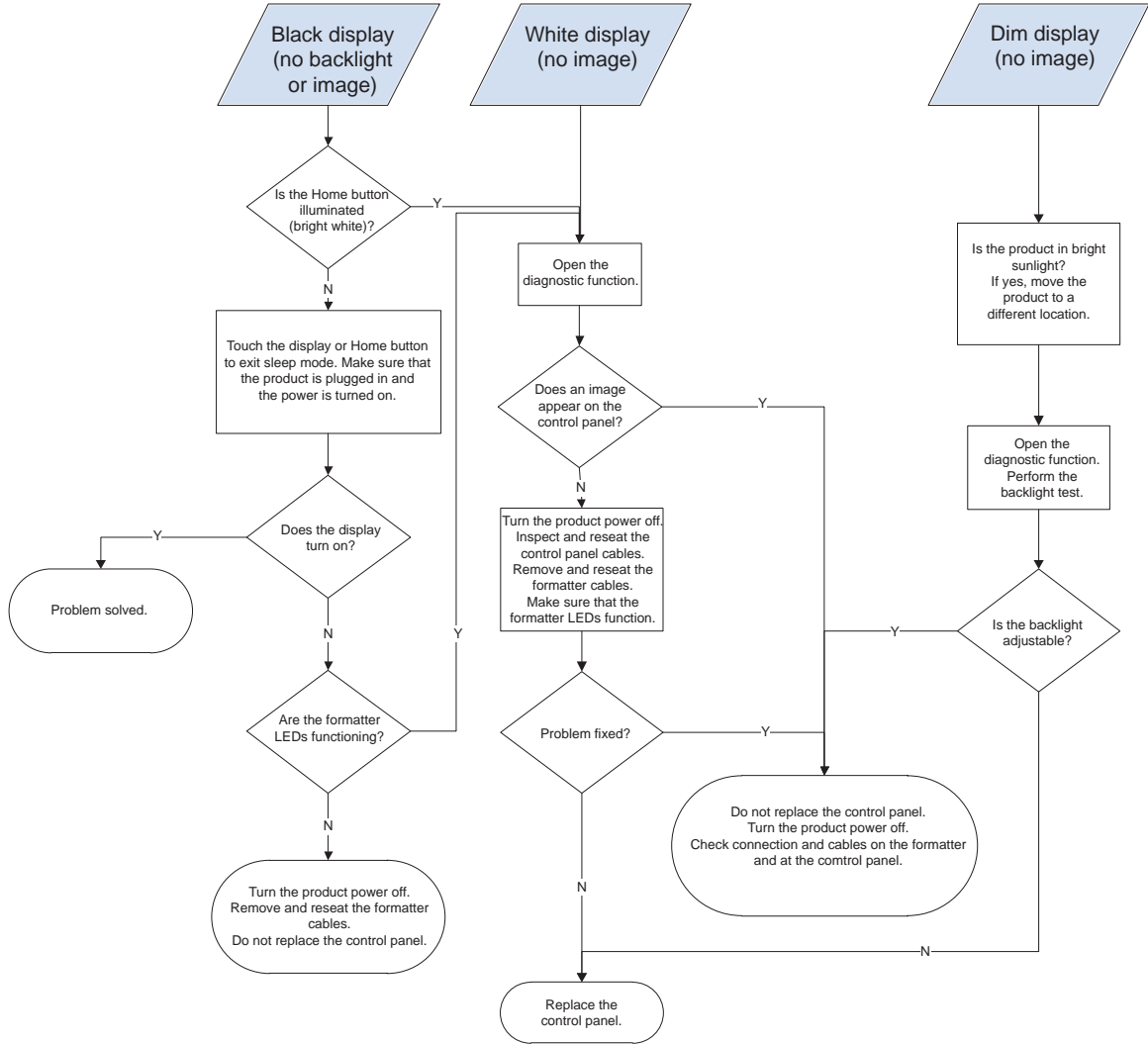

Touchscreen has an unresponsive zone

Learn about how the touchscreen has an unresponsive zone.

NOTE: To open the diagnostic function, press the button on the back of the control panel.

Figure 3-7 Touchscreen has an unresponsive zone

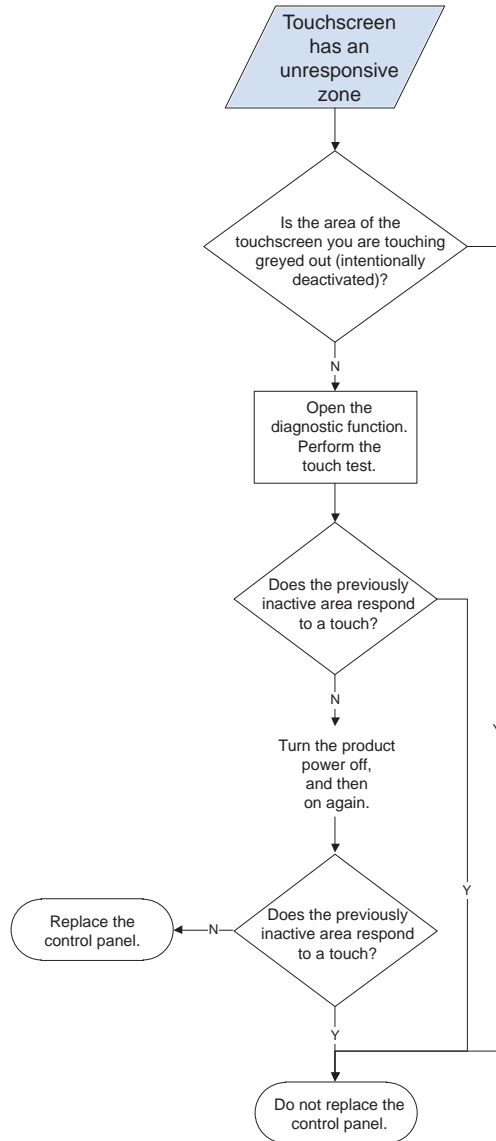

No control panel sound

Learn what to do when there is no control panel sound.



NOTE: To open the diagnostic function, press the button on the back of the control panel.

Figure 3-8 No control panel sound

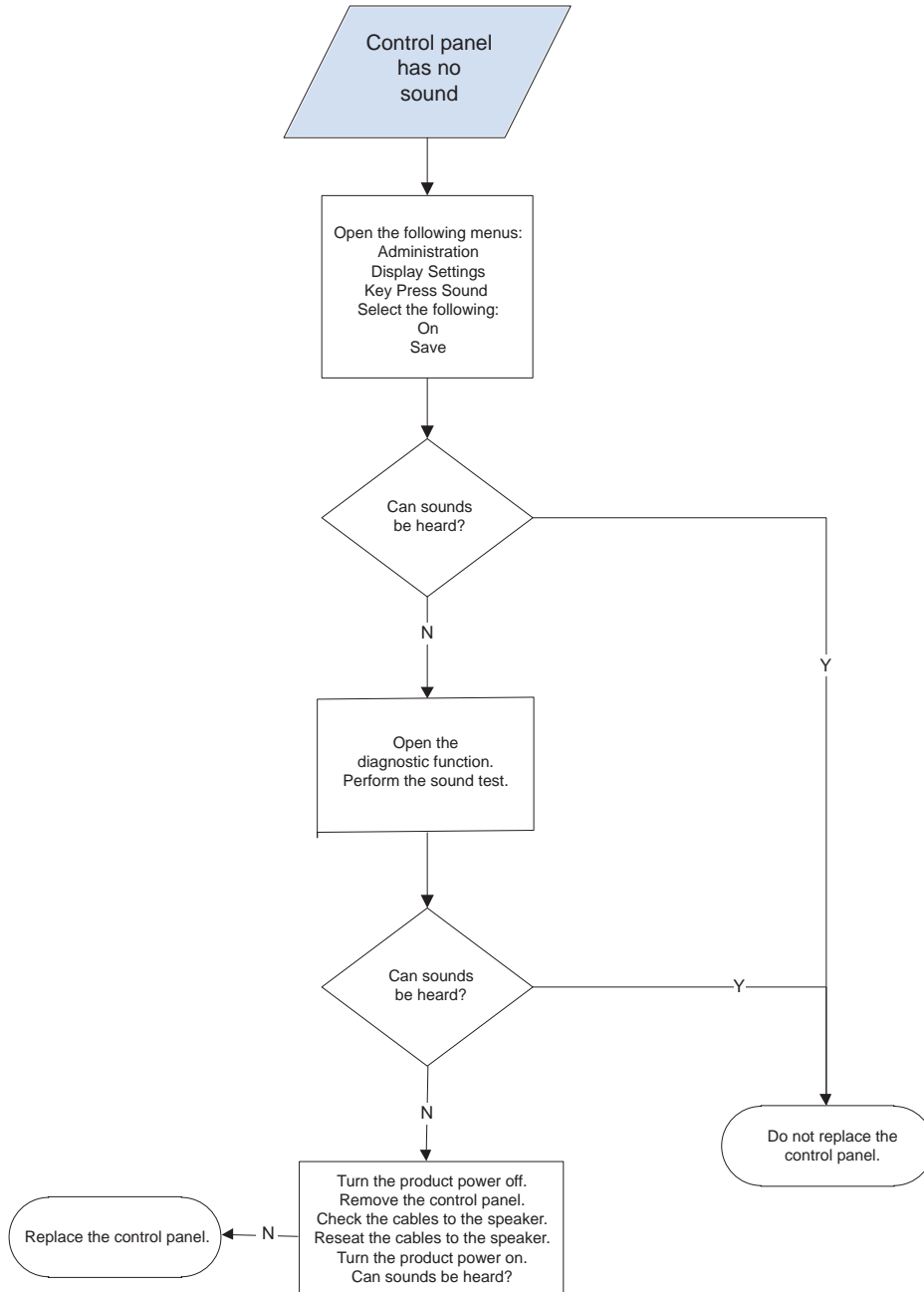

Home button is unresponsive

Learn what to do when the home button is unresponsive.



NOTE: To open the diagnostic function, press the button on the back of the control panel.

Figure 3-9 Home button is unresponsive

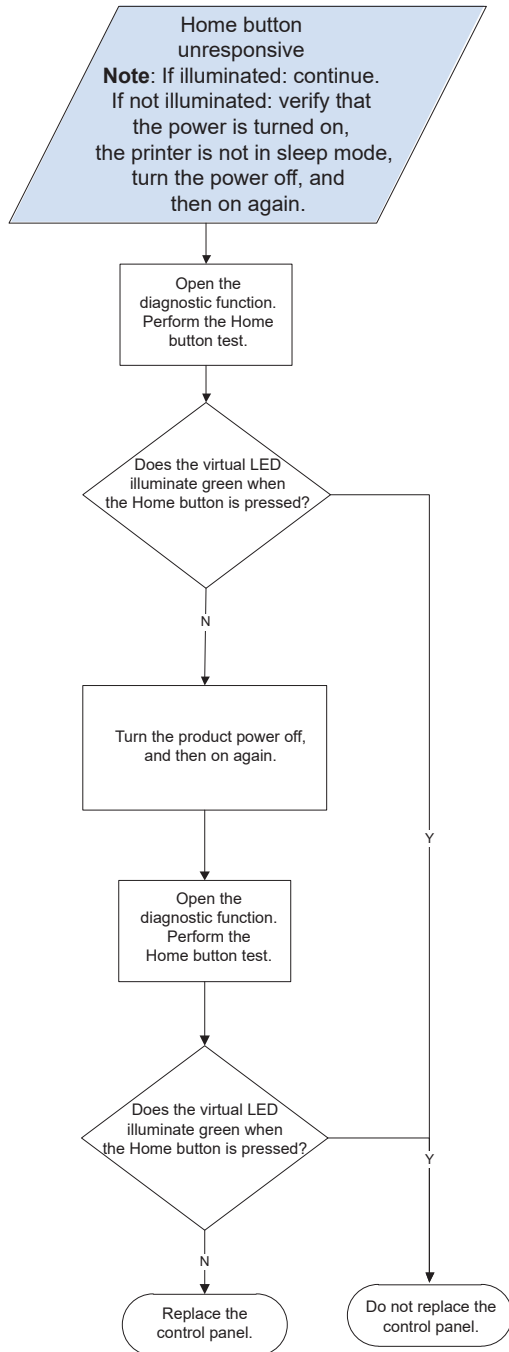

Hardware integration pocket (HIP) is not functioning (control panel functional)

Learn about when the hardware integration pocket (HIP) is not functioning (control panel functional).

Figure 3-10 Hardware integration pocket (HIP) is not functioning (control panel functional)

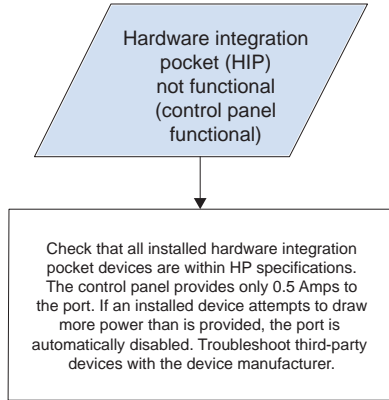

Individual component diagnostics

Learn about individual component diagnostics.

Tools for troubleshooting: LED diagnostics

LED, engine, and individual diagnostics can identify and troubleshoot printer problems.

Understand lights on the formatter

Three LEDs on the formatter indicate that the printer is functioning correctly.

Figure 3-11 LEDs

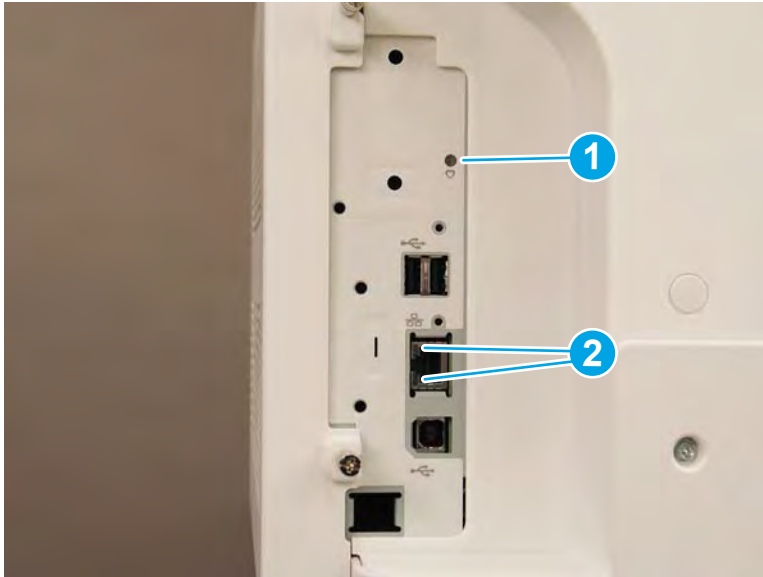

-
- | | |
|---|-------------------|
| 1 | Heartbeat LED |
| 2 | HP Jetdirect LEDs |
-

HP Jetdirect LEDs

Learn about the HP Jetdirect LEDs.

The embedded HP Jetdirect print server has two LEDs. The yellow LED indicates network activity, and the green LED indicates the link status. A blinking yellow LED indicates network traffic. If the green LED is off, a link has failed.

For link failures, check all the network cable connections. In addition, try to manually configure the link settings on the embedded print server by using the printer control-panel menus.

1. From the Home screen on the printer control panel, select **Settings**.
2. Open the following menus:
 - **Networking**
 - **Ethernet**
 - **Link Speed**
3. Select the appropriate link speed, and then select **OK**.

Tools for troubleshooting: Engine diagnostics

The printer contains extensive internal engine diagnostics that help in troubleshooting print quality, paper path, noise, assembly, and timing issues.

Defeating interlocks

Different tests can be used to isolate different types of issues. For assembly or noise isolation, run the diagnostic test when the toner cartridge door or right door is open.

Defeating the door interlocks allows observation of the paper pick operation (and view the page enter registration).

⚠ WARNING! Be careful when performing printer diagnostics to avoid risk of injury. Only trained service personnel should open and run the diagnostics with a door open. Never touch any of the power supplies when the printer is turned on.

Defeat the toner cartridge door interlock

Learn how to defeat the toner cartridge door interlock.

1. Open the toner cartridge door.
2. Insert a folded piece of paper into the slot.

💡 TIP: Fold a stiff piece of paper, for example a business card or index card, into two 10 mm (.375 in) strips, and insert the strips into the slot for the cartridge door logic switches.

Figure 3-12 Defeat the toner cartridge door interlock

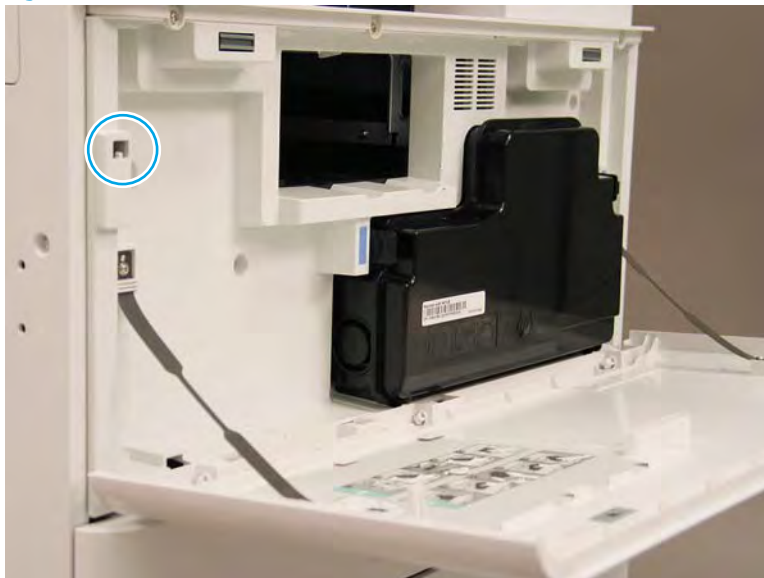

Defeat the front door interlock

Learn how to defeat the front door interlock.

1. Open the front door.

2. Insert a folded piece of paper into the slot.

 **TIP:** Fold a stiff piece of paper, for example a business card or index card, into two 10 mm (.375 in) strips, and insert the strips into the slot for the front door logic switches.

Figure 3-13 Defeat the front door interlock



Tools for troubleshooting

Use the procedure below to test various printer mechanical and electromechanical assemblies.

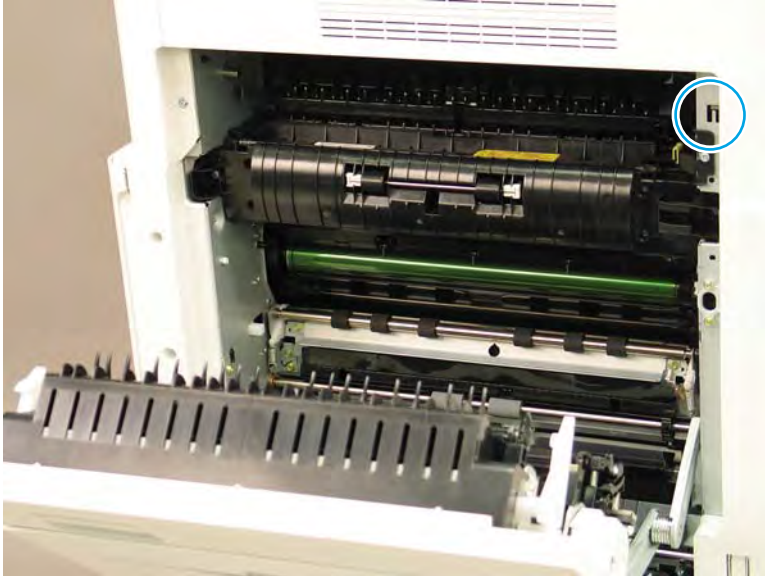
Individual component diagnostics (special-mode test)

Learn about the individual component diagnostics (special-mode test).

This test activates individual parts independently to isolate problems.

Each component test can be performed once or repeatedly.

Each component test can be performed once or repeatedly.



NOTE: The cartridge door interlocks must be defeated to run the component tests.

1. From the Home screen on the printer control panel, scroll to and touch the [Support Tools](#) button.
2. Select one of the following tests:
 - [Continuous Scan](#)
 - [Run Fax Test](#)
3. Select the component test options for the test.

Tools for troubleshooting

Learn about tools for troubleshooting.

Problem-solving checklist

Follow these steps when trying to solve a problem with the printer.

Step 1: Check that the printer power is on

Learn how to check that the printer power is on.

1. Make sure that the printer is plugged in and turned on. The power button should be lit with a white light. If it is not, press the power button. If the power button does not light up, check the following conditions.
 - Make sure that the power cable is connected to the printer and the outlet.
 - Check the power source by connecting the power cable to a different outlet.
2. If the printer motors do not rotate, make sure that the toner cartridges are installed and that the doors are all closed. The control panel displays messages to indicate these problems.

Step 2: Check the control panel for error messages

Learn how to check the control panel for error messages.

The control panel should indicate ready status. If an error message appears, resolve the error.

Print a supplies status page to ensure that the supplies are not at or over end of life.

 **NOTE:** HP long-life consumable and maintenance kit life specifications are estimations. Actual individual life or yield during normal use will vary depending on usage, environment, media, and other factors. Estimated life is not an implied warranty.

Step 3: Test print functionality

Learn how to test print functionality.

1. From the control panel Home screen, touch the [Reports](#) button.
2. Open the [Reports](#) menu, touch the [Configuration/Status Pages](#) menu, select the [Configuration Page](#) item, and then touch the [Print](#) button to print the report.
3. If the report does not print, make sure that paper is loaded in the tray, and check the control panel to see if paper is jammed inside the printer.

 **NOTE:** Make sure that the paper in the tray meets specifications for this printer.

Step 4: Test copy functionality

Learn how to test copy functionality.

1. Place the configuration page into the ADF and make a copy. If paper does not feed smoothly through the ADF, you might need to clean the ADF rollers and separation pad. Make sure that the paper meets specifications for this printer.
2. Place the configuration page onto the scanner glass and make a copy.
3. If the print quality on the copied pages is not acceptable, clean the scanner glass and the small glass strip.

Step 5: Test the fax sending functionality

Learn how to test the fax sending functionality.

1. From the control panel Home screen, touch the [Support Tools](#) button.
2. Open the [Troubleshooting](#) menu, and then open the [Diagnostics Tools](#) menu. Touch the [Run Fax Test](#) button to test the fax functionality.
3. Touch the [Fax](#) on the printer control panel, and then touch the [Start Fax](#) button.

Step 6: Test the fax receiving functionality

Learn how to test the fax receiving functionality.

1. From the control panel Home screen, touch the [Support Tools](#) button.
2. Touch the [Troubleshooting](#) menu, and then open the [Diagnostics Tests](#) menu. Touch the [Run Fax Test](#) button to test the fax functionality.
3. Use another fax machine to send a fax to the printer.
4. Review and reset the printer fax settings.

Step 7: Try sending a print job from a computer

Learn how to try sending a print job from a computer.

1. Use a word-processing program to send a print job to the printer.
2. If the job does not print, make sure that you selected the correct printer driver.
3. Uninstall and then reinstall the printer software.

Step 8: Test the Plug and Print USB Drive printing functionality

Learn how to test the plug and print USB drive printing functionality.

1. Load a .PDF document or .JPEG photo onto a USB flash drive, and insert it in the USB port near the control panel.
2. The [USB Flash Drive](#) menu opens. Try printing the document or photo.
3. If no documents are listed, try a different type of USB flash drive.

Factors that affect printer performance

Several factors affect the time it takes to print a job:

- The software program that you are using and its settings
- The use of special paper (such as heavy paper or custom-size paper)
- Printer processing and download time
- The complexity and size of graphics
- The speed of the computer you are using
- The USB or network connection

- Whether the printer is printing in color or in monochrome
- The type of USB drive, if you are using one
- Environmental factors, such as low temperature or high humidity

Print menu map

Learn how to print the menu map.

To more easily navigate individual settings, print a report of the complete [Reports](#) menu.

1. From the [Home](#) screen on the printer control panel, scroll to and touch the [Reports](#) button.
2. Open the [Configuration/Status Pages](#) menu.
3. Select the [Settings Menu Map](#) option.
4. Touch the [Print](#) button to print the report.

 **TIP:** Multiple report pages can be selected, and then printed together.

Print current settings pages

Learn how to print current settings pages.

Printing the current settings page provides a map of the user configurable settings that might be helpful in the troubleshooting process.

1. From the [Home](#) screen on the printer control panel, scroll to and touch the [Reports](#) button.
2. Open the [Configuration/Status Pages](#) menu.
3. Select the [Current Settings Page](#) option.
4. Touch the [Print](#) button to print the report.

 **TIP:** Multiple report pages can be selected, and then printed together.

Print event log

Printing the event log might be helpful in the troubleshooting process. For more information, see the Interpret control-panel messages and event log entries section in the printer troubleshooting manual.

Print the event log from the Reports menu from a touchscreen control panel

Learn how to print the event log from the Reports menu from a touchscreen control panel.

1. From the [Home](#) screen on the printer control panel, scroll to and touch the [Support Tools](#) button.
2. Open the following menus:
 - [Troubleshooting](#)
 - [Event Log](#)
3. The event log displays on the screen. To print it, touch the [Print](#) button.

Print the event log from the Service menu from a touchscreen control panel

Learn how to print the event log from the Service menu from a touchscreen control panel.

1. From the [Home](#) screen on the printer control panel, scroll to and touch the [Support Tools](#) button.
2. Open the [Service](#) menu.
3. Enter the following service access code for the printer:
 - Access code: 04082517
4. Touch the [Event Log](#) item.

Clear the event log from a touchscreen control panel

Learn how to clear the event log from a touchscreen control panel.

1. From the [Home](#) screen on the printer control panel, scroll to and touch the [Support Tools](#) button.
2. Open the [Service](#) menu.
3. On the sign-in screen, select the [Service Access Code](#) option from the drop-down list.
4. Enter the following service access code for the printer:
 - Access code: 04082517
5. Select the trash icon to clear the event log.

Pre-boot menu options

The **Pre-boot** menus are available prior to the printer initializing.

CAUTION: The **Format Disk** option (printers with a hard-disk drive only) performs a disk initialization for the entire disk. The operating system, firmware files, and third party files (among other files) will be completely lost. HP does not recommend this action.

TIP: The Pre-boot menu can be remotely accessed by using a telnet network protocol to establish an administration connection to the printer. See [Remote Admin on page 714](#).

Open the Pre-boot menu from a touchscreen control panel

Learn how to open the Pre-boot menu from a touchscreen control panel.

1. Touch the middle of the control-panel display when you see the **1/8** under the logo.

Figure 3-14 Open the Pre-boot menu

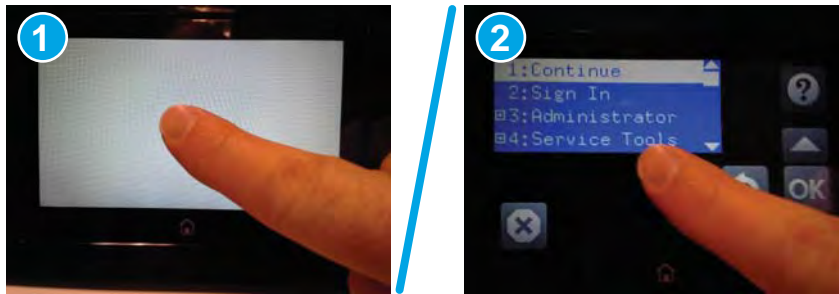

2. On the **Pre-boot** menu screen, use the following buttons to navigate the tests.

Figure 3-15 Pre-boot menu

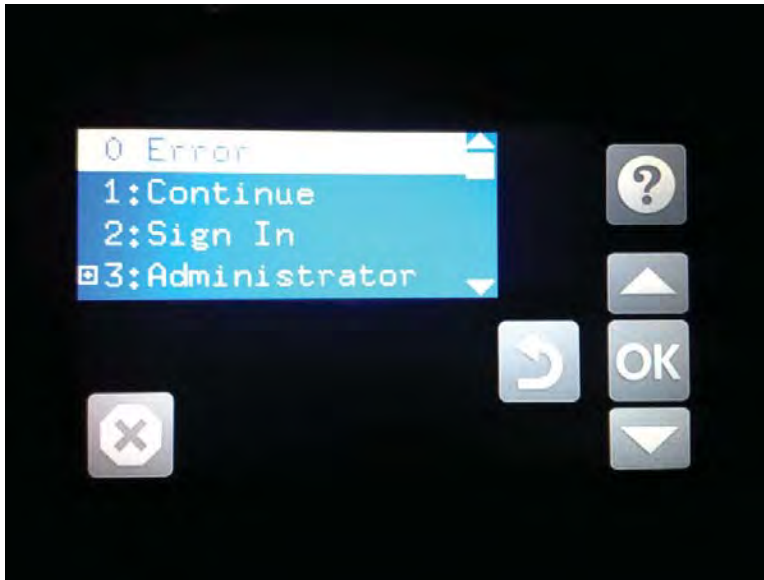

Use this button to see more information about a selected item.



Use this button to scroll up through menu items.



Use this button to select a highlighted menu item.



Use this button to scroll down through menu items.



Use this button to go back to the previous menu.



Not used.



Use this button to exit a diagnostic test.

3. Use the arrow buttons on the touchscreen to navigate the **Pre-boot** menu.
4. Touch the **OK** button to select a menu item.

Cold reset using the Pre-boot menu from a touchscreen control panel



Learn how to cold reset using the Pre-boot menu from a touchscreen control panel.

CAUTION: This procedure resets all printer configurations and settings to factory defaults (customer configurations and settings are lost).

1. Touch the middle of the control-panel display when you see the **1/8** under the logo.

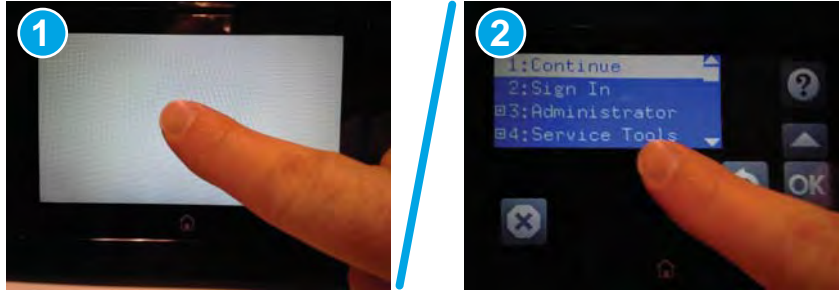
Figure 3-16 Open the Pre-boot menu



2. Use the  button to highlight the **+3:Administrator** item, and then touch the **OK** button.
3. Use the  button to highlight the **+8:Startup Options** item, and then touch the **OK** button.
4. Use the  button to highlight the **2 Cold Reset** item, and then touch the **OK** button to select it.
5. Touch the Home button to return to the main **Pre-boot** menu and highlight the **1:Continue** item, and then touch the **OK** button.

 **NOTE:** The printer will initialize.

 **NOTE:** Some of the pre-boot options in the following tables are not supported by the current version of the printer firmware and are included for information only. Future versions of firmware will support these options.

Table 3-3 Pre-boot menu options (1 of 7)

Menu option	First level	Second level	Third level	Description
Continue				<p>Selecting the Continue item exits the Pre-boot menu and continues the normal boot process.</p> <p>If a selection is not made in the initial menu within 30 seconds, the printer returns to a normal boot (the same as selecting Continue).</p> <p>If the user navigates to another menu, the timeout does not apply.</p>
Sign In				Enter the administrator PIN or service PIN if one is required to open the Pre-boot menu.
Administrator				<p>This item navigates to the Administrator submenus.</p> <p>If authentication is required (and the user is not already signed in) the Sign In prompt displays. The user is required to sign in.</p>
	Download	Network		This item initiates a Pre-boot firmware download process. A USB Thumbdrive option will work on all FutureSmart printers. USB or Network connections are not currently supported.
		USB		
		USB Thumbdrive		

Table 3-3 Pre-boot menu options (1 of 7) (continued)

Menu option	First level	Second level	Third level	Description
	Format Disk			<p>This item reinitializes the disk and cleans all disk partitions.</p> <p>CAUTION: Selecting the Format Disk item removes all data.</p> <p>A delete confirmation prompt is not provided.</p> <p>The system is not bootable after this action and a 99.09.67 error displays on the control panel. A firmware download must be performed to return the system to a bootable state.</p>
	Partial Clean			<p>This item reinitializes the disk (removing all data except the firmware repository where the master firmware bundle is downloaded and saved).</p> <p>CAUTION: Selecting the Partial Clean item removes all data except the firmware repository. A delete confirmation prompt is not provided.</p> <p>CAUTION: This procedure resets all printer configurations and settings to factory defaults (customer configurations and settings are lost).</p> <p>This allows a user to reformat the disk by removing the firmware image from the active directory without having to download new firmware code (printer remains bootable).</p>
	Change Password			<p>Select this item to set or change the administrator password.</p>
	Clear Password			<p>Select the Clear Password item to remove a password from the Administrator menu. Before the password is actually cleared, a message will be shown asking to confirm that the password should be cleared. Press the OK button to confirm the action.</p> <p>When the confirmation prompt displays, press the OK button to clear the password.</p>

Table 3-4 Pre-boot menu options (2 of 7)

Menu option	First level	Second level	Third level	Description
Administrator (continued)	Manage Disk	Clear disk		<p>Select the Clear disk item to enable using an external device for job storage. Job storage is normally enabled only for the Boot device. This will be grayed out unless the 99.09.68 error is displayed.</p>
		Lock Disk		<p>Select the Lock Disk item to lock (mate) a new secure disk to this printer.</p> <p>The secure disk already locked to this printer will remain accessible to this printer. Use this function to have more than one encrypted disk accessible by the printer when using them interchangeably.</p> <p>The data stored on the secure disk locked to this printer always remains accessible to this printer.</p>

Table 3-4 Pre-boot menu options (2 of 7) (continued)

Menu option	First level	Second level	Third level	Description
		Leave Unlocked		<p>Select the Leave Unlocked item to use a new secure disk in an unlocked mode for a single service event. The secure disk that is already locked to this printer will remain accessible to this printer and uses the old disk's encryption password with the new disk.</p> <p>The secure disk that is already locked to this printer remains accessible to this printer.</p>
		Clear Disk Pwd		<p>Select the Clear Disk Pwd item to continue using the non-secure disk and clear the password associated with the yet-to-be installed secure disk.</p> <p>CAUTION: Data on the missing secure disk will be permanently inaccessible.</p>
		Retain Password		<p>Select the Retain Password item to use the non-secure disk for this session only, and then search for the missing secure disk in future sessions.</p>
		Boot Device	Secure Erase	<p>Select the Secure Erase item to erase all of the data on the disk and unlock it if required.</p> <p>This might take a long time.</p> <p>NOTE: The system will be unusable until the system files are reinstalled. The ATA secure-erase command is a one-pass overwrite, which erases the entire disk including firmware. The disk remains an encrypted disk.</p>
			Erase/Unlock	<p>Select the Erase/Unlock item to cryptographically erase all data on the disk and unlock the disk to allow a user to gain access to it from any printer.</p> <p>NOTE: The system will be unusable until the system files are reinstalled. It erases the encryption key. The encryption key is erased, so the disk becomes a non-encrypted disk.</p>
			Get Status	<p>This item provides disk status information if any is available.</p>

Table 3-5 Pre-boot menu options (3 of 7)

Menu option	First level	Second level	Third level	Description
Administrator	Manage Disk	Internal Device		<p>Select the Internal Device item to erase the internal device or get a status about the internal device.</p>
(continued)	(continued)		Secure Erase	<p>Select the Secure Erase item to erase all of the data on the disk and unlock it if required.</p> <p>This might take a long time.</p> <p>NOTE: The system will be unusable until the system files are reinstalled. The ATA secure-erase command erases the entire disk, including firmware. The disk remains an encrypted disk.</p>

Table 3-5 Pre-boot menu options (3 of 7) (continued)

Menu option	First level	Second level	Third level	Description
			Erase/Unlock	Select the Erase/Unlock item to cryptographically erase all of the data on disk and unlock the disk to allow the user to gain access to it from any printer. NOTE: The system will be unusable until the system files are reinstalled. The HP High Performance Secure Hard Disk is erased.
			Get Status	This item provides disk status information if any is available.
		External Device		Select the External Device item to erase the external device or get status about the external device.
			Secure Erase	Select the Secure Erase item to erase all of the data on the disk and unlock it if required. This might take a long time. NOTE: The system will be unusable until the system files are reinstalled. The ATA secure-erase command erases the entire disk, including firmware. The disk remains an encrypted disk.
			Erase/Unlock	Select the Erase/Unlock item to cryptographically erase all of the data on disk and unlock the disk to allow a user to gain access to it from any printer. NOTE: The system will be unusable until the system files are reinstalled. The encryption key is erased, so the disk becomes a non-encrypted disk.
			Get Status	This item provides disk status information if any is available.

Table 3-6 Pre-boot menu options (4 of 7)

Menu option	First level	Second level	Third level	Description
Administrator	Configure LAN	IP Mode [DHCP]		The network can be configured to obtain the network settings from a DHCP server or as static.
(continued)	NOTE: This configuration is only active when the Pre-boot menu is open.			Use this item for automatic IP address acquisition from the DHCP server.
		IP Mode [STATIC]		Use this item to manually assign the network addresses.
			IP Address	Use this item to manually enter the IP addresses.
			Subnet Mask	Use this item to manually enter the subnet mask.
			Default Gateway	Use this item to manually enter the default gateway.
			Save	Select the Save item to save the manual settings.

Table 3-7 Pre-boot menu options (5 of 7)

Menu option	First level	Second level	Third level	Description	
Administrator (continued)	Startup Options			Select the Startup Options item to specify options that can be set for the next time the printer is turned on and initializes to the Ready state.	
			Show Revision	Not currently functional: Select the Show Revision item to allow the printer to initialize and show the firmware version when the printer reaches the Ready state. Once the printer power is turned on the next time, the Show Revision item is unchecked so that the firmware revision is not shown.	
			Cold Reset	Select the Cold Reset item to clear the IP address and all customer settings. (This item also returns all settings to factory defaults.) NOTE: Items in the Service menu are not reset.	
			Skip Disk Load	Select the Skip Disk Load item to disable installed third-party applications.	
			Skip Cal	Select the Skip Cal item to skip the printer calibration for the very next power-initialization cycle only.	
			Lock Service	CAUTION: Select the Lock Service item to lock the Service menu access (both in the Pre-boot menu and the Device Maintenance menu). Service personnel must have the administrator remove the Lock Service setting before they can open the Service menu.	
			Skip FSCK	Select the Skip FSCK item to disable Chkdisk/ScanVolume during startup.	
Administrator (continued)	Startup Options (continued)	First Power		Not currently functional: This item allows the printer to initialize as if it is the first time it has been turned on. For example, the user is prompted to configure first-time settings like date/time, language, and other settings. Select this item so that it is enabled for the next time the printer power is turned on. When the printer power is turned on the next time, this item is unchecked so that the pre-configured settings are used during configuration, and the first-time setting prompt is not used.	
				Embedded Jetdirect Off	Select the Embedded Jetdirect Off item to disable the embedded HP Jetdirect. By default this item is unchecked so that HP Jetdirect is always enabled.
				WiFi Accessory	Select the WiFi Accessory item to enable the wireless accessory.

Table 3-8 Pre-boot menu options (6 of 7)

Menu option	First level	Second level	Third level	Description
Administrator (continued)	Diagnostics			Diagnostic items are useful to diagnose hardware components and their interface connections. Use these items to troubleshoot specific hardware components, and the interface between them and other components.
		Memory	Do Not Run	Use the Do Not Run item to exclude the Memory diagnostic when executing multiple diagnostics.
			Short	Use the Short item to select a brief memory test. NOTE: This test requires about four minutes to execute.
			Long	Use the Long item to select an extended memory test. NOTE: This test requires about twenty minutes to execute.
		Disk	Do Not Run	Use the Do Not Run item to exclude the Disk diagnostic when executing multiple diagnostics.
			Short	Use the Short item to select a brief firmware self-test. NOTE: This test requires about two or three minutes to execute.
			Long	Use the Long item to select an extended firmware self-test. NOTE: This test requires about sixty minutes to execute.
			Optimized	Use the Optimized item to select a test that checks the active sectors on the disk. NOTE: This test requires about thirty minutes to execute.
			Raw	Use the Raw item to select a test that checks every sector on the disk. NOTE: This test requires about fifty minutes to execute.
			Smart	Use the Smart item to select a very brief test that checks the drive self-monitoring analysis and reporting technology (SMART) status—the drive detects and reports reliability indicators to help anticipate disk failures (SMART status).
		CPB		Use the CPB item to verify the integrity of the copy processor board (CPB) and the formatter PCA connections.

Table 3-8 Pre-boot menu options (6 of 7) (continued)

Menu option	First level	Second level	Third level	Description
		Interconnect		Use the Interconnect item to verify the integrity of the interconnect PCA (ICB) and its connections.
		Run Selected		Select the Run Selected item to execute a selected test. NOTE: If more than one test is selected, they are executed in sequence.

Table 3-9 Pre-boot menu options (7 of 7)

Menu option	First level	Second level	Third level	Description
Administrator (continued)	Remote Admin	Start Telnet		The Remote Admin item allows a service technician to access to the printer Pre-boot menu remotely, and to navigate the menu selections from a remote location. IMPORTANT: A Remote Admin connection must be initiated by a person that is physically present at the printer. This person will also need to provide a randomly generated PIN to the remote service technician. NOTE: For more information about using the Remote Admin function, see Remote Admin on page 714 .
		Stop Telnet		
		Refresh IP		
	System Triage	Copy Logs		If the device will not boot to the Ready state, or the diagnostic log feature found in the Troubleshooting menu is not accessible, then use the System Triage item to copy the diagnostic logs to a USB flash drive at the next printer start up. The files can then be sent to HP to help diagnose the problem.
	Change Svc PWD			Use this item to change the Service menu personal identification number (PIN).
	Reset Svc PWD			If the Service menu personal identification number (PIN) has been changed. Use this item to reset it to the original PIN.
Service Tools	Reset Password			Use this item to reset the Pre-boot administrator password.
	Subsystems			For manufacturing use only. Do not change these values.
Developer Tools	Netexec			

Remote Admin

The Remote Admin feature allows remote access the printer Pre-boot menu (BIOS environment). The printer functions as a telnet server which uses the telnet networking protocol to transmit text data. Any computer (with telnet installed and enabled) can function as the telnet client to remotely display and interact with the Pre-boot menu.



IMPORTANT: While the Remote Admin function allows remote access the Pre-boot menu, for security reasons the Remote Admin connection must be initiated by a person that is physically present at the printer.

This section describes the following Remote Admin items.

Required software and network connection

Before using the Remote Admin feature, make sure that the telnet network protocol is installed, and enabled, on the remote telnet client computer.

NOTE: This section describes enabling and configuring the telnet feature for computers using a Windows® operating system.

HP recommends that the telnet client computer be a Windows based system, however, there are other operating systems that support the telnet network protocol. For information about enabling and configuring the telnet network protocol for other operating systems, see the owner's manual for that operating system.

Telnet client

All computers using the Windows operating system have the telnet client installed, however, the telnet client function might not be enabled by default.

NOTE: The figures and menus in this section are for the Windows 7 Enterprise® operating system. Screens and menu selections might vary slightly for other operating systems.

1. Use the **Start** menu to open the **Control Panel**, and then click the **Programs** item to select it.

Figure 3-17 Open the Control Panel

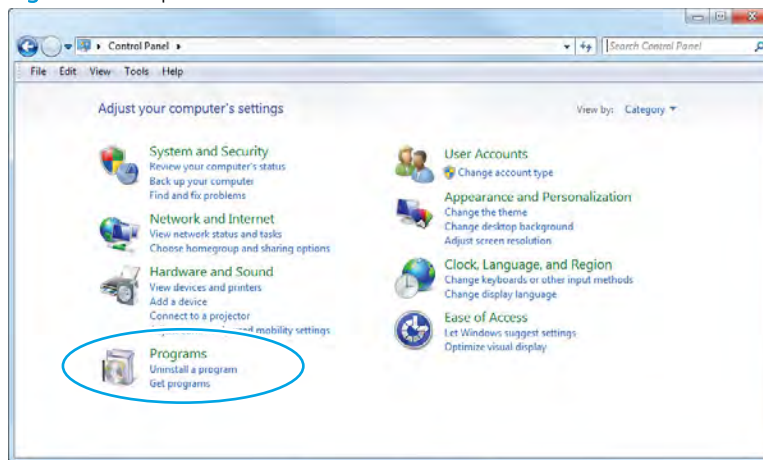

2. Click the **Turn Windows features on or off** item to select it.

Figure 3-18 Turn Windows features on or off

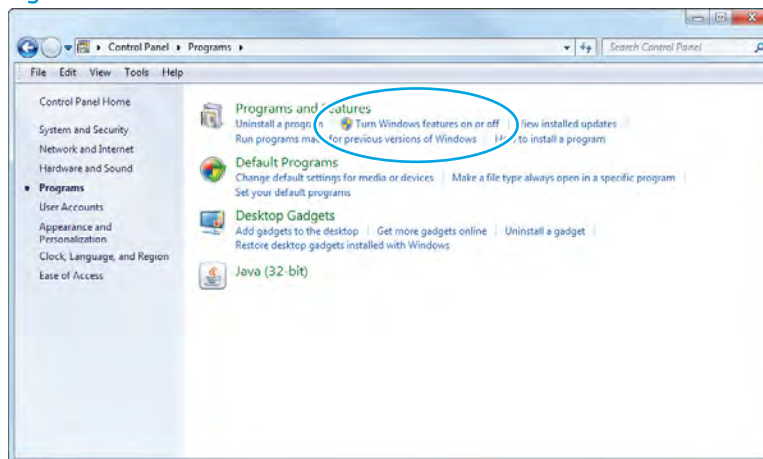

3. In the **Windows Features** box, scroll down to **Telnet Client**. If the check box is not checked, click the box to select it, and then click the **OK** button.

 **TIP:** If the check box is already checked then the telnet client function is already enabled. Click the **Cancel** button.

Figure 3-19 Enable the telnet client feature

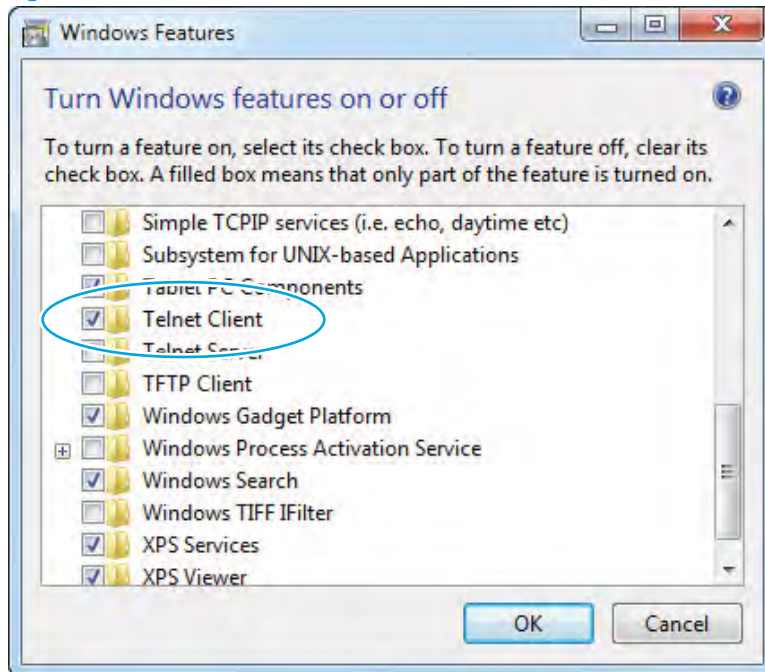

Network connection

The remote telnet client computer must have direct network access to the printer for the Remote Admin function to operate. This means that the telnet client computer must be on the same network as the printer. The Remote Admin function cannot be accessed through a network firewall or other remote access network security programs.

If a private network is not accessible, ask the network administrator to set up a virtual private network (VPN) connection to the network.

Connect a remote connection

Learn how to connect a remote connection using telnet.

Start the telnet server function at the printer

For security reasons the Remote Admin feature must be initiated by a person that is physically present at the printer. The following steps must be performed by a person that is physically present at the printer.

 **NOTE:** This person might need to sign in with an administrator or service password depending on how the printer is configured.

1. Turn the printer on.
2. The HP logo displays on the printer control panel. When a "1/8" with an underscore displays, touch the middle of the screen to open the [Pre-boot](#) menu.
3. Use the arrow buttons on the touchscreen to scroll down and highlight the **+3:Administrator** item, and then touch the [OK](#) button to select it.

Figure 3-20 Select the +3:Administrator item

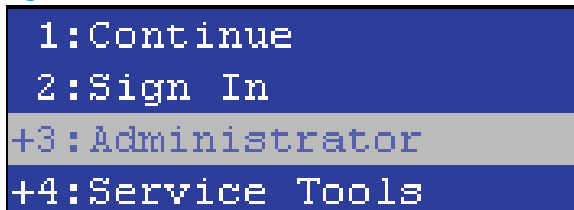

4. Use the arrow buttons on the touchscreen to scroll down and highlight the **+A:Remote Admin** item, and then touch the [OK](#) button to select it.

Figure 3-21 Select the +A:Remote Admin item



5. Use the arrow buttons on the touchscreen to scroll down and highlight the **1:Start Telnet** item, and then touch the [OK](#) button to select it.

Figure 3-22 Select the 1:Start Telnet item

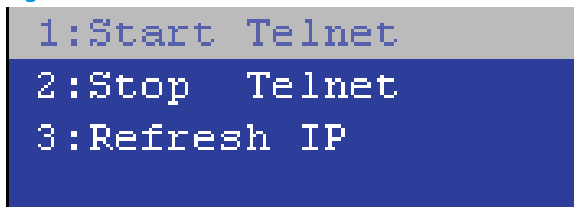

6. Do one of the following
 - If a connecting message displays briefly, go to step [7](#).

Figure 3-23 Telnet connecting message

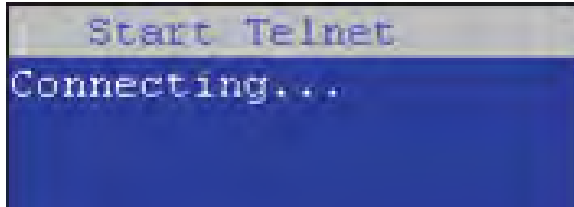

- If an error message displays, use the steps below to identify the problem.

Figure 3-24 Telnet error message

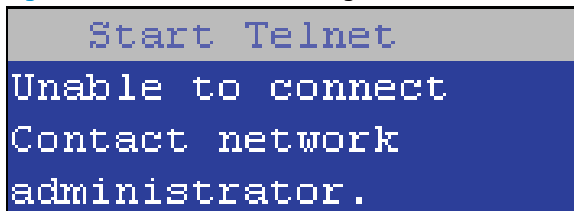

- a. The printer network cable is not correctly connected.
 - b. The BIOS LAN settings are incorrect.
 - The printer should be configured to use a static IP address, but is configured to use DHCP instead.
 - The printer is configured to use a static IP address, but the IP address is incorrect.
 - c. The printer is correctly configured to use DHCP, but the DHCP server is not turned on or is malfunctioning.
7. When the printer telnet server function is initialized, the following screen appears. Use the information on this screen to connect the remote telnet client computer to the printer.



NOTE: The printer is now ready to receive remote telnet client commands.

- **IP:** The static or dynamically allocated IP address for the printer.
- **Port:** The standard telnet port (23).
- **Pin:** A randomly generated 4-digit personal identification number (PIN).

Figure 3-25 Telnet server function initialized

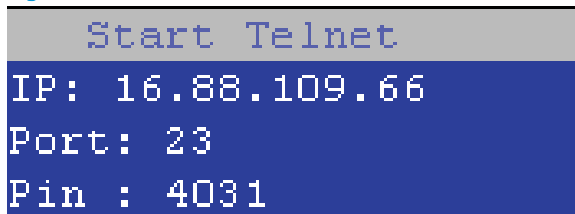

Start the telnet client function at the remote computer

The following steps establish a Remote Admin connection from a remote computer to the printer.

1. From the **Start** menu click **Run** to open a dialog box, type `cmd` in the **Open** field, and then click the **OK** button to open a Windows command window.

Figure 3-26 Open a command window

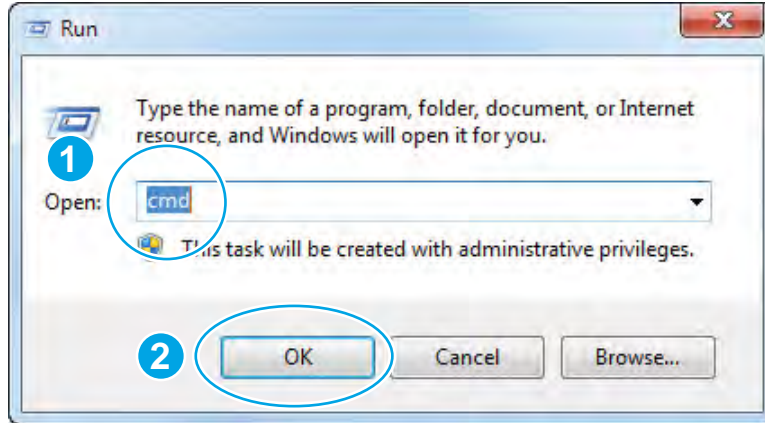

2. From any displayed directory, type `telnet` at the prompt, and then press the **Enter** key.

Figure 3-27 Start a telnet session

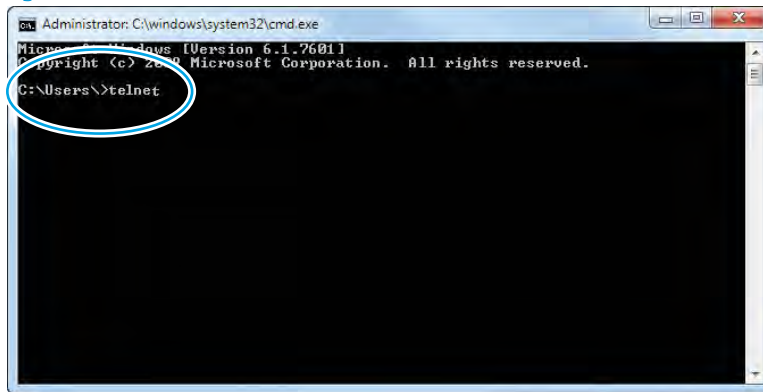

3. Type `<IP ADDRESS>` at the telnet prompt, and then press the **Enter** key.

 **NOTE:** For `<IP ADDRESS>`, substitute the IP address that was displayed in step 7 in [Start the telnet server function at the printer on page 717](#).

 **TIP:** If the telnet connection fails to establish a connection, the printer is probably behind a firewall or on a different network than the remote telnet client computer. See [Network connection on page 716](#).

Figure 3-28 Establish a telnet connection



4. Type the PIN that was displayed in step 7 in [Start the telnet server function at the printer on page 717](#) at the prompt, and then press the **Enter** key.

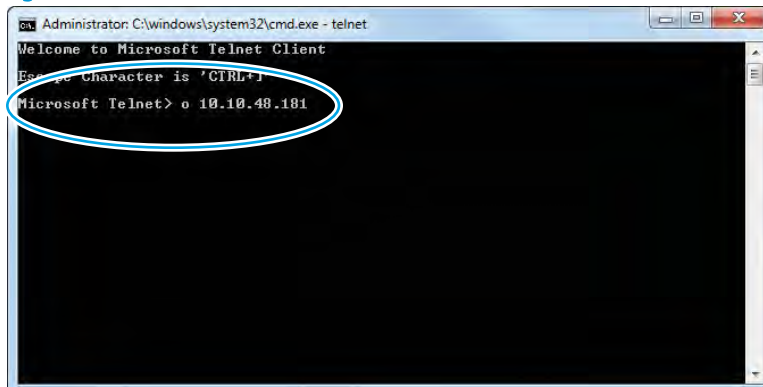

 **IMPORTANT:** Make sure to type the PIN correctly. After five incorrect PIN entries, the printer terminates the Remote Admin connection. The Remote Admin feature must be re-initiated at the printer. See [Start the telnet server function at the printer on page 717](#).

Figure 3-29 Enter the PIN

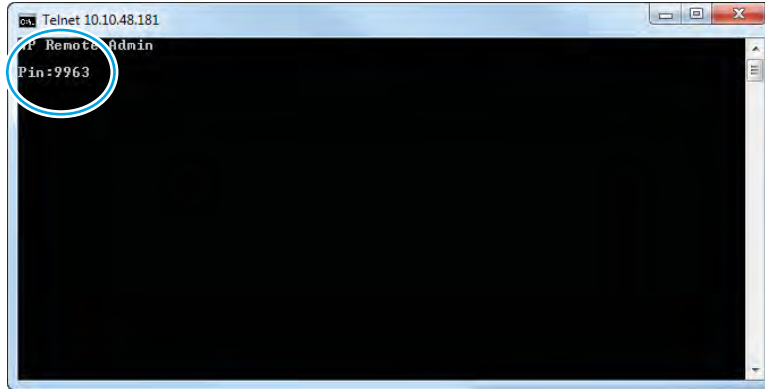

5. The following screen displays when the correct PIN is entered and the Remote Admin connection is successful. For information about the Pre-boot menu and options, see [Pre-boot menu options on page 705](#).

 **NOTE:** Because a Remote Admin connection is an unsecure telnet network protocol connection, the following Pre-boot menu items are disabled for the remote telnet client computer.

- The **+3:Administrator** menu **4:Change Password** item.
- The **+3:Administrator** menu **5:Clear Password** item.
- The **+3:Administrator** menu **6:Disk Manage** item.

Figure 3-30 Remote Admin window

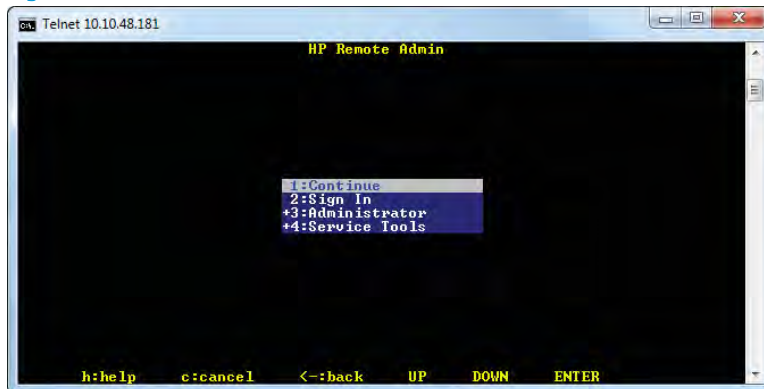

Disconnect a remote connection

Learn how to disconnect a remote connection.

The Remote Admin connection can be terminated from the printer control panel or the remote telnet client computer.

 **NOTE:** The following procedure describes terminating a Remote Admin connection from the remote telnet client computer.

1. From the Pre-boot main menu, use the arrow buttons on the keyboard to scroll down to the **+3:Administrator** item, and then press the **Enter** key.

Figure 3-31 Access the administrator menu

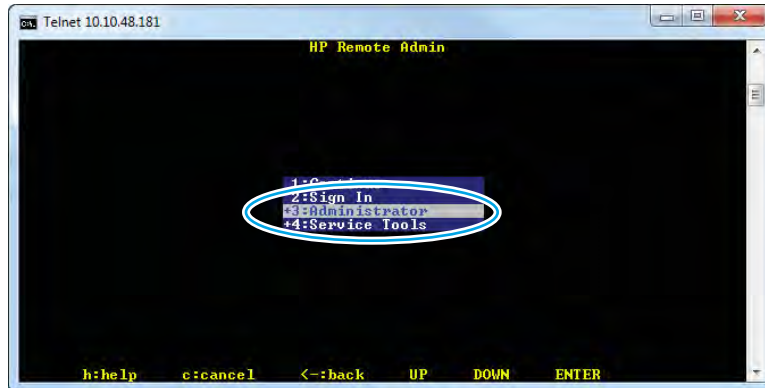

2. Use the arrow buttons on the keyboard to scroll down to the **+A:Remote Admin** item, and then press the **Enter** key.

Figure 3-32 Access the remote admin menu

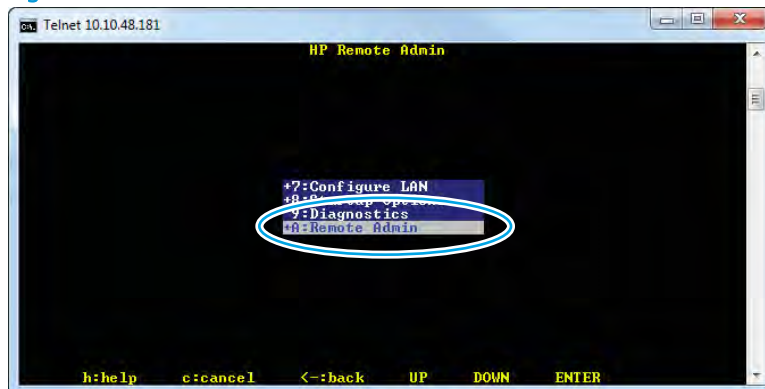

3. Use the arrow buttons on the keyboard to scroll down to the **2:Stop Telnet** item, and then press the **Enter** key. The Remote Admin connection between the printer and the remote telnet client computer terminates.

 **IMPORTANT:** The printer remains in the Pre-boot menu. Have the person that is physically present at the printer do the following:

- Touch the **Home** button to return to the main Pre-boot menu and highlight the **1:Continue** item, and then touch the **OK** button. The printer will continue to initialize.
-

Figure 3-33 Terminate the telnet connection

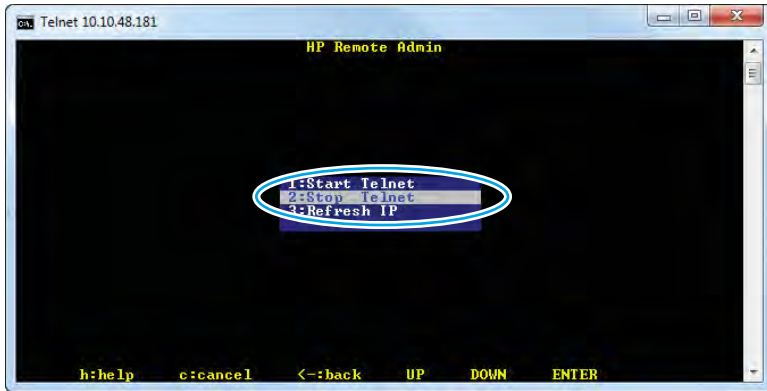

Control panel menus

You can perform basic printer setup by using the [Settings](#) menu. Use the HP Embedded Web Server for more advanced printer setup. To open the HP Embedded Web Server, enter the printer IP address or host name in the address bar of a web browser.

Reports menu

To display: At the printer control panel, select [Reports](#).

In the following table, asterisks (*) indicate the factory default setting.

Table 3-10 Reports menu

First level	Second level	Values	Description
Configuration/Status Pages	Settings Menu Map	Print	Shows a map of the entire control panel system and the selected values for each setting.
		View	
	Current Settings Page	Print	Shows a summary of the current settings for the printer. This might be helpful if you plan to make changes and need a record of the present configuration.
		View	
	Configuration Page	Print	Shows the printer settings and installed accessories.
		View	
	How to Connect Page	Print	Shows the network information typically needed to connect the printer to a network.
		View	
	Supplies Status Page	Print	Shows the approximate remaining life for the supplies; reports statistics on total number of pages and jobs processed, serial number, page counts, and maintenance information. HP provides approximations of the remaining life for the supplies as a customer convenience. The actual remaining supply levels might be different from the approximations provided.
		View	
Usage Page	Print	Shows a count of all paper sizes that have passed through the printer; lists whether they were simplex, duplex, monochrome, or color; and reports the page count.	
	View		
File Directory	Print	Shows the file name and folder name for files that are stored in the printer memory.	
	View		
Web Services Status Page	Print	Shows the detected Web Services for the printer.	
	View		
Color Usage Job Log	Print	Shows color jobs completed by the printer.	
	View		

Table 3-10 Reports menu (continued)

First level	Second level	Values	Description
Fax Reports (MFP fax models only)	Fax Activity Log	Print	Contains a list of the faxes that have been sent from or received by this printer.
		View	
	Billing Codes Report	Print	Provides a list of billing codes that have been used for outgoing faxes. This report shows how many sent faxes were billed to each code.
		View	
	Blocked Fax List	Print	A list of phone numbers that are blocked from sending faxes to this printer.
		View	
Speed Dial List	Print	Shows the speed dials that have been set up for this printer.	
	View		
Fax Call Report	Print	A detailed report of the last fax operation, either sent or received.	
	View		
Other Pages	Demonstration Page	Print	Prints a demonstration page.
	RGB samples	Print	Prints color samples for different RGB values. Use the samples as a guide for matching printed colors.
	CMYK samples	Print	Prints color samples for different CMYK values. Use the samples as a guide for matching printed colors.
	PCL Font List	Print	Prints the available PCL fonts.
	PS Font List	Print	Prints the available PS fonts.

Settings menu

To display: At the printer control panel, select the [Settings](#) menu.

In the following table, asterisks (*) indicate the factory default setting.

Table 3-11 Settings menu

First level	Second level	Third level	Fourth level	Fifth level	Values	Description
General	Date/Time Settings	Date/Time Format	Date Format		DD/MMM/YYYY	Use the Date/Time Settings menu to specify the date and time and to configure date/time settings.
					MMM/DD/YYYY	
					YYYY/MMM/DD	
			Time Format	12 hour (AM/PM)	Select the format that the printer uses to show the date and time, for example 12-hour format or 24-hour format.	
	24 hours					

Table 3-11 Settings menu (continued)

First level	Second level	Third level	Fourth level	Fifth level	Values	Description
		Date/Time	Date		Select the time zone from a list.	Select the time zone, date, and time that the printer uses.
			Time		Select the date from a pop-up calendar.	
			Time Zone		Select the time from a pop-up keypad.	
	Energy Settings	Sleep Schedule	A list of scheduled events displays.		+ (Add) Edit Delete	Use to configure the printer to automatically wake up or go to sleep at specific times on specific days. Using this feature saves energy. NOTE: You must configure the date and time settings before you can use this feature.
			New event	Event Type		Select whether to add or edit a Wake event or a Sleep event, and then select the time and the days for the wake or sleep event.
				Time		Set the wake or sleep event time parameters.
				Event Days	Select days of the week from a list.	Set the wake or sleep event day parameters.
		Sleep Settings	Auto Off After Sleep Sleep After Inactivity HP Auto Off/Auto On Shut Down		Range: 1 to 110 minutes Default = 0 minutes	Set the number of minutes after which the printer enters Sleep or Auto Off mode. Touch the existing number to open the virtual keypad, and then increase or decrease the number of minutes.
			Wake/Auto On to These Events		All Events* Network port Power button only	

Table 3-11 Settings menu (continued)

First level	Second level	Third level	Fourth level	Fifth level	Values	Description
	Display Settings	Display Brightness	Automatic*		The Manual setting uses a slider to manually control the display brightness.	Use to specify the intensity of the LCD control panel display.
			Manual			
		System Sound			On*	Use to specify whether you hear a sound when you touch the screen or press buttons on the control panel.
					Off	
	Language Settings	Language	Language		Select from a list of languages that the printer supports.	Use to select a different language for control panel messages and specify the default keyboard layout. When you select a new language, the keyboard layout automatically changes to match the factory default for the selected language.
			Keyboard Layout		Each language has a default keyboard layout. To change it, select from a list of layouts.	Select the default keyboard layout that matches the language you want to use.
			M681z/M682z only			
		Information Screen			Show connection information*	Use this menu item to display or hide connection information on the Home screen.
					Hide connection information	
		DisplayDate and Time			Show Date and Time*	Select whether to display or hide the date and time on the control panel Home screen.
					Hide Date and Time	
			M681/M682 only			
		Inactivity Timeout			Range: 10-300 seconds	Specifies the amount of time that elapses between any activity on the control panel and when the printer resets to the default settings. When the timeout expires, the control panel display returns to the Home menu, and any user signed in to the printer is signed out.
					Default = 60 seconds	

Table 3-11 Settings menu (continued)

First level	Second level	Third level	Fourth level	Fifth level	Values	Description
		Clearable Warnings			On Job*	Use this feature to set the period that a clearable warning displays on the control panel. If the On setting is selected, clearable warnings appear until the Clearable Warnings button is pressed. If the Job setting is selected, clearable warnings stay on the display during the job that generated the warning and disappear from the display when the next job starts.
		Continuable Events			Auto-continue (10 seconds)* Touch OK to continue	Use this option to configure the printer behavior when the printer encounters certain errors. If the Auto-continue (10 seconds) option is selected, the job will continue after 10 seconds. If the Touch OK to continue option is selected, the job will stop and require the user to touch the OK button before continuing.

Table 3-11 Settings menu (continued)

First level	Second level	Third level	Fourth level	Fifth level	Values	Description
	Jam Recovery				Auto* Off On	<p>This printer provides a jam recovery feature that reprints jammed pages. Select one of the following options:</p> <p>Auto: The printer attempts to reprint jammed pages when sufficient memory is available. This is the default setting.</p> <p>Off: The printer does not attempt to reprint jammed pages. Because no memory is used to store the most recent pages, performance is optimal.</p> <p>NOTE: When using this option, if the printer runs out of paper and the job is being printed on both sides, some pages can be lost.</p> <p>On: The printer always reprints jammed pages. Additional memory is allocated to store the last few pages printed. This might cause a decrease in overall performance.</p>
	Auto Recovery				Enabled Disabled*	<p>The printer attempts to reprint jammed pages when sufficient memory is available. This is the default setting.</p>

Table 3-11 Settings menu (continued)

First level	Second level	Third level	Fourth level	Fifth level	Values	Description
	Hold Off Print Job				Enabled* Disabled	Enable this feature if you want to prevent print jobs from starting while a user is initiating a copy job from the control panel. Held print jobs start printing after the copy job is finished, provided that no other copy job is in the print queue.
	Restore Factory Settings				Restore Cancel	Use to restore all printer settings to their factory defaults.
Copy/Print	Copy Settings	Image Preview				Display a preview of the image before printing it.
	Enable Device USB				Enabled Disabled*	Enables the printer to open a file from a USB drive.
	Manage Stored Jobs	Job Sort Order			Job Name* Date	This option allows you list the jobs either alphabetically or chronologically.
		Retain Temporary Jobs After Reboot			Do not retain Personal jobs only All temporary jobs	Sets which temporary jobs will be retained in the event of a printer reboot.
		Temporary Job Storage Limit			1-300 Default = 32	Configure global settings for jobs that are stored in the printer memory. The Temporary Job Storage Limit feature specifies the number of temporary jobs that can be stored on the printer. The maximum allowed value is 300.

Table 3-11 Settings menu (continued)

First level	Second level	Third level	Fourth level	Fifth level	Values	Description
		Temporary Stored Job Retention			1-300 Default = 32	Configure global settings for jobs that are stored in the printer memory. The Temporary Stored Job Retention feature specifies the number of temporary jobs that can be stored on the printer. The maximum allowed value is 300.
		Standard Stored Job Retention			1-300 Default = 32	Configure global settings for jobs that are stored in the printer memory. The Temporary Stored Job Retention feature specifies the number of standard jobs that can be stored on the printer. The maximum allowed value is 300.
Default Print Options		Number of Copies			Range: 1-32000 Default = 1	Sets the default number of copies for a copy job. This default applies when the Copy function or the Quick Copy function is initiated from the printer Home screen.
		Paper Selection			Select from a list of sizes that the printer supports.	Configures the default paper size used for print jobs.
	Default Custom Paper Size		X Dimension		Range: 3-8.5 inches Default = 8.5 inches	Configures the default paper size that is used when the user selects Custom as the paper size for a print job.
			Y Dimension		Range: 5-14 inches Default = 14 inches	
			Use Inches		Enabled* Disabled	

Table 3-11 Settings menu (continued)

First level	Second level	Third level	Fourth level	Fifth level	Values	Description
		Output Sides		1-sided* 2-sided		Use to indicate whether the original document is printed on one or both sides, and whether the copies should be printed on one or both sides. For example, select the 1-sided original, 2-sided output option when the original is printed on one side, but you want to make two-sided copies.
		Staple			None Top left Top right Top left or right	Sets the position of the staple on the page.
		Output Bin			Automatically select Standard bin Upper bin Middle bin	
		Resolution			FastRes1200 1200x1200dpi	Sets the resolution for sent documents. Higher resolution images have more dots per inch (dpi), so they show more detail. Lower resolution images have fewer dots per inch and show less detail, but the file size is smaller. Some file types, for example a file that will be processed with OCR, require a specific resolution. When these file types are selected, the Resolution setting might automatically change to a valid value.

Table 3-11 Settings menu (continued)

First level	Second level	Third level	Fourth level	Fifth level	Values	Description
	PCL and PostScript Settings	Courier Font			Regular* Dark	Select which version of the Courier font you want to use. The factory default setting is Regular , which uses an average stroke width. The Dark setting can be used if a heavier Courier font is needed.
		Wide A4			Enabled Disabled*	Changes the printable area of A4-size paper. If you enable this option, eighty 10-pitch characters can be printed on a single line of A4 paper.
		Print PS Errors			Enabled Disabled*	Use this feature to select whether a PostScript (PS) error page is printed when the printer encounters a PS error.
		Print PDF Errors			Enabled Disabled*	Selects whether a PDF error page is printed when the printer encounters a PDF error.
		Personality			Auto* PCL PS PDF	Configures the default print language or personality for the printer. Normally you should not change the printer language. If you change the setting to a specific printer language, the printer does not automatically switch from one language to another unless specific software commands are sent to it.

Table 3-11 Settings menu (continued)

First level	Second level	Third level	Fourth level	Fifth level	Values	Description
		PCL	Font Settings	Font Source	Internal Disk resident	Selects the font source for the user-soft default font. The list of available options varies depending on the installed printer options.
				Font Number	Range: 0-110 Default = 0	Specifies the font number for the user-soft default font using the source that is specified in the Font Source menu. The printer assigns a number to each font and lists it on the PCL font list. The font number displays in the Font # column of the printout.
				Font Pitch	Range: 0.44-99.99 Default = 10	If the Font Source option and the Font Number setting indicate a contour font, then use this feature to select a default pitch (for a fixed-spaced font).
			PCL Settings	Form Length	Range: 5-128 Default = 60	Controls the PCL print-command options. PCL is a set of printer commands that HP developed to provide access to printer features. Use the Form Length feature to select the user-soft default vertical form length.
				Orientation	Portrait* Landscape	Select the orientation that is most often used for copy or scan originals. Select the Portrait option if the short edge is at the top or select the Landscape option if the long edge is at the top.

Table 3-11 Settings menu (continued)

First level	Second level	Third level	Fourth level	Fifth level	Values	Description
				Symbol Set	Select from a list of symbol sets.	Select any one of several available symbol sets from the control panel. A symbol set is a unique grouping of all the characters in a font. The factory default value for this option is PC-8. Either PC-8 or PC-850 are recommended for line-draw characters.
				Append CR to LF	No* Yes	Configure whether a carriage return (CR) is appended to each line feed (LF) encountered in backwards-compatible PCL jobs (pure text, no job control). Select Yes to append the carriage return. The default setting is No. Some environments, such as UNIX, indicate a new line by using only the line-feed control code. This option allows the user to append the required carriage return to each line feed.
				Suppress Blank Pages	No* Yes	This option is for users who are generating their own PCL, which could include extra form feeds that would cause blank pages to be printed. When the Yes option is selected, form feeds are ignored if the page is blank.

Table 3-11 Settings menu (continued)

First level	Second level	Third level	Fourth level	Fifth level	Values	Description
				Media Source Mapping	Standard* Classic	Use to select and maintain input trays by number when you are not using the printer driver, or when the software program has no option for tray selection. The following options are available: Standard: Tray numbering is based on newer HP LaserJet models. Classic: Tray numbering is based on HP LaserJet 4 and older models.
	Print Quality	Adjust Color	Tonal Range	Highlights Midtones Shadows		
			Cyan Magenta Yellow Black			
		Image Registration	Tray	Tray 1 Tray 2 Tray 3 Tray 4 Tray 5 Depends upon number of trays installed		Specify tray to be adjusted

Table 3-11 Settings menu (continued)

First level	Second level	Third level	Fourth level	Fifth level	Values	Description
			Front-side Horizontal Shift		-5.00 mm to 5.00 mm	Shift the margin alignment to center the image on the page from top to bottom and from left to right. You can also align the image on the front with the image printed on the back.
			Front-side Vertical Shift			The direction that is perpendicular to the way the paper passes through the printer is referred to as X. This is also known as the scan direction. X1 is the scan direction for a single-sided page or for the second side of a two-sided page. X2 is the scan direction for the first side of a two-sided page.
			Back-side Horizontal Shift			The direction that the paper feeds through the printer is referred to as Y. Y1 is the feed direction for a single-sided page or for the second side of a two-sided page. Y2 is the feed direction for the first side of a two-sided page.
			Back-side Vertical Shift			Use the Adjust Tray <X> menu to adjust the registration settings for each tray. Before adjusting these values, print a registration test page. It provides alignment guides in the X and Y directions so you can determine which adjustments are necessary. You can adjust values for X1 Shift, X2 Shift, Y1 Shift, and Y2 Shift.

Table 3-11 Settings menu (continued)

First level	Second level	Third level	Fourth level	Fifth level	Values	Description
				Print Test Page		Use the Print Test Page option to print a page to test the image registration. It provides alignment guides in the X and Y directions so you can determine which adjustments are necessary.
		Auto Sense Behavior	Tray 1		Sense every page Sense first page Sense transparency only	
			All Other Trays		Sense first page Sense transparency only	
		Adjust paper types			Select from a list of paper types Reset Paper Types	
		Optimize			Normal Paper Heavy paper Envelope control Tray 1 Background Background 1 Uniformity Control Tracking Control Registration Transfer Control Moisture Control Reset Optimize	
		Edge Control			Off Light Normal Maximum	

Table 3-11 Settings menu (continued)

First level	Second level	Third level	Fourth level	Fifth level	Values	Description
	Manage Trays	Use Requested Tray			Exclusively* First	<p>Controls how the printer handles jobs that have specified a specific input tray. Two options are available:</p> <p>Exclusively: The printer never selects a different tray when the user has indicated that a specific tray should be used, even if that tray is empty.</p> <p>First: The printer pulls from another tray if the specified tray is empty, even though the user specifically indicated a tray for the job.</p>
		Manually Feed Prompt			Always* Unless loaded	<p>Indicate whether a prompt should appear when the type or size for a job does not match the specified tray and the printer pulls from the multipurpose tray instead. Two options are available:</p> <p>Always: A prompt always displays before using the multipurpose tray.</p> <p>Unless loaded: A message displays only if the multipurpose tray is empty.</p>

Table 3-11 Settings menu (continued)

First level	Second level	Third level	Fourth level	Fifth level	Values	Description
		Size/Type Prompt			Display* Do not display	<p>Controls whether the tray configuration message displays whenever a tray is closed. Two options are available:</p> <p>Display: Shows the tray configuration message when a tray is closed. The user is able to configure the tray settings directly from this message.</p> <p>Do not display: Prevents the tray configuration message from automatically appearing.</p>
		Use Another Tray			Enabled* Disabled	<p>Use to turn on or off the control panel prompt to select another tray when the specified tray is empty. Two options are available:</p> <p>Enabled: When this option is selected, the user is prompted either to add paper to the selected tray or to choose a different tray.</p> <p>Disabled: When this option is selected, the user is not given the option of selecting a different tray. The printer prompts the user to add paper to the tray that was initially selected.</p>

Table 3-11 Settings menu (continued)

First level	Second level	Third level	Fourth level	Fifth level	Values	Description
		Alternative Letterhead Mode			Disabled* Enabled	Use to load letterhead or preprinted paper into the tray the same way for all print jobs, whether you are printing to one side of the sheet or to both sides of the sheet. When this option is selected, load the paper as you would for printing on both sides. See the user documentation that came with the printer for instructions about loading letterhead for printing on both sides. When this option is selected, the printer speed slows to the speed required for printing on both sides.
		Duplex Blank Pages			Auto* Yes	Controls how the printer handles two-sided jobs (duplexing). Two options are available: Auto: Enables Smart Duplexing, which instructs the printer not to process blank pages. Yes: Disables Smart Duplexing and forces the duplexer to flip the sheet of paper even if it is printed on only one side. This might be preferable for certain jobs that use paper types such as letterhead or prepunched paper.

Table 3-11 Settings menu (continued)

First level	Second level	Third level	Fourth level	Fifth level	Values	Description
		Override A4/Letter			Yes* No	Prints on letter-size paper when an A4 job is sent but no A4-size paper is loaded in the printer (or to print on A4 paper when a letter-size job is sent but no letter-size paper is loaded). This option will also override A3 with ledger-size paper and ledger with A3-size paper.
Scan/Digital Send	E-mail Settings	E-mail Setup				Use to configure settings that apply to sending documents through email or saving documents to a folder on the network or on a USB multi-drive.
	Network Folder Settings	NOTE: Email Settings only				
	SharePoint Settings					
	Scan to USB Drive Settings					
	NOTE: The same options are available for each of these features, except where noted.					The E-mail Setup Wizard feature configures the printer to send scanned images as email attachments. To open the printer HP Embedded Web Server and set up the email notification server, enter the printer IP address into a Web browser.

Table 3-11 Settings menu (continued)

First level	Second level	Third level	Fourth level	Fifth level	Values	Description
		Image Preview			Make optional* Require preview Disable preview	<p>Defines the default job options for each function. If you do not specify the job options when creating the job, the default options are used. For complete setup, go to the HP Embedded Web Server by typing the IP address of the printer into a Web browser.</p> <p>Use the Image Preview feature to scan a document and display a preview before completing the job. Select whether this feature is available on the printer.</p> <p>Make optional: The feature is optional, depending on the user who is signed in.</p> <p>Require preview Previews are required for all users.</p> <p>Disable preview: Previews are disabled for all users.</p>

Table 3-11 Settings menu (continued)

First level	Second level	Third level	Fourth level	Fifth level	Values	Description
		Default File Name				The printer is shipped with a factory default file name of [Untitled] for any scanned files that are sent or saved. Use this feature to specify a different default file name. If you are saving a file to a network folder or USB storage printer and a file with the default file name already exists, a number is appended to the file name, for example, [Untitled]001.

Table 3-11 Settings menu (continued)

First level	Second level	Third level	Fourth level	Fifth level	Values	Description
		Document File Type			Select from a list of file types.	<p>PDF provides the best overall image and text quality.</p> <p>JPEG is a good choice for most graphics. Most computers have a browser that can view .JPEG files. This file type produces one file per page.</p> <p>TIFF is a standard file format that many graphics programs support. This file type produces one file per page.</p> <p>MTIFF: stands for multi-page TIFF. This file type saves multiple scanned pages in a single file.</p> <p>XPS (XML Paper Specification) creates an XML file that preserves the original formatting of the document and supports color graphics and embedded fonts.</p> <p>NOTE: OCR file types are not supported on this printer unless attached to DSS.</p>

Table 3-11 Settings menu (continued)

First level	Second level	Third level	Fourth level	Fifth level	Values	Description
		Optimize Text/ Picture			Manually Adjust* Text Printed picture Photograph	<p>Use to optimize the output for a particular type of content. You can optimize the output for text, printed pictures, or a mixture.</p> <p>Manually Adjust: Use to manually optimize the setting for text or for pictures.</p> <p>Text: Use to optimize the text portion of the copy when text and/or pictures are on the original.</p> <p>Printed picture: Use for line drawings and preprinted images, such as magazine clippings or pages from books.</p> <p>Photograph: Best suited for making copies of printed pictures.</p>
		Output Quality			High (large file) Medium* Low (small file)	<p>Use to select the quality for the output. Higher-quality images require a larger file size than lower-quality images. Larger files take more time to send, and some recipients might have trouble receiving larger files.</p>

Table 3-11 Settings menu (continued)

First level	Second level	Third level	Fourth level	Fifth level	Values	Description
		Original Sides			1-sided 2-sided	Use to describe the layout for each side of the original document. First select whether the original document is printed on one side or both sides. Then touch the Orientation setting to indicate whether the original has portrait or landscape orientation. If it is printed on both sides, also select the 2-sided format that matches the original document.
			Orientation		Automatically detect Portrait* Landscape	For some features to work correctly, you must specify the way the content of the original document is placed on the page. Portrait orientation means the short edge of the page is along the top. Landscape orientation means the long edge of the page is along the top. In the Orientation area, select whether the original document has a portrait or landscape orientation.

Table 3-11 Settings menu (continued)

First level	Second level	Third level	Fourth level	Fifth level	Values	Description
			2-Sided Format		Book-style Flip-style	<p>Book-style: The back side of the original is printed right-side-up, and the back side of the copy is printed the same way. Use this option for originals and copies that are bound along the left edge.</p> <p>Flip-style: The back side of the original is printed upside-down, and the back side of the copy is printed the same way. Use this option for originals and copies that are to be bound along the top edge.</p>
		Resolution			400 dpi 300 dpi 200 dpi 150 dpi* 75 dpi	<p>Sets the resolution for sent documents. Higher resolution images have more dots per inch (dpi), so they show more detail. Lower resolution images have fewer dots per inch and show less detail, but the file size is smaller. Some file types, for example a file that will be processed with OCR, require a specific resolution. When these file types are selected, the Resolution setting might automatically change to a valid value.</p>

Table 3-11 Settings menu (continued)

First level	Second level	Third level	Fourth level	Fifth level	Values	Description
		Content Orientation	Orientation		Auto Detect Portrait* Landscape	For some features to work correctly, you must specify the way the content of the original document is placed on the page. Portrait orientation means the short edge of the page is along the top. Landscape orientation means the long edge of the page is along the top. In the Orientation area, select whether the original document has a portrait or landscape orientation.
			2-Sided Format		Book-style* Flip-style	Use to configure the default style for 2-sided print jobs. If the Book-style option is selected, the back side of the page is printed the right way up. This option is for print jobs that are bound along the left edge. If the Flip-style option is selected, the back side of the page is printed upside-down. This option is for print jobs that are bound along the top edge.

Table 3-11 Settings menu (continued)

First level	Second level	Third level	Fourth level	Fifth level	Values	Description
		Color/Black			Automatically detect*	Use to enable or disable color scanning.
					Color	
					Black/Gray	Automatically detect:
					Black	Automatically scans documents in color if at least one page has color.
						Color: Scans documents in color.
						Black/Gray: Scans documents in grayscale.
						Black: Scans documents in black and white with a compressed file size.
		Original Size			Select from a list of supported sizes.	Use to describe the page size of the original document.
		Notification			Do not notify*	Configure to receive notification about the status of a sent document.
					Notify when job completes	
					Notify only if job fails	Do not notify: Turns off this feature.
					Print	
					E-mail	Notify when job completes: Select to receive notification for this job only.
						Notify only if job fails: Select to receive notification only if the job is not sent successfully.
						Print: Select to print the notification at this printer.
						E-mail: Select to receive the notification to an email account.

Table 3-11 Settings menu (continued)

First level	Second level	Third level	Fourth level	Fifth level	Values	Description
			Include Thumbnail			NOTE: When sending an analog fax, select Include Thumbnail to receive a thumbnail image of the first page of the fax in your notification.
			Notification E-mail address			E-mail: Select to receive the notification in an email. Touch the text box following Email Address , and then type the email address for the notification.
		Image Adjustment		Darkness		Use to improve the overall quality of the copy. Adjust the Darkness setting to increase or decrease the amount of white and black in the colors.
				Contrast		Adjust the Contrast setting to increase or decrease the difference between the lightest and darkest color on the page.
				Background Cleanup		Adjust the Background Cleanup setting if you are having trouble copying a faint image.
				Sharpness		Adjust the Sharpness setting to clarify or soften the image. For example, increasing the sharpness could make text appear crisper, but decreasing it could make photographs appear smoother.

Table 3-11 Settings menu (continued)

First level	Second level	Third level	Fourth level	Fifth level	Values	Description
				Automatic Tone		The printer automatically adjusts the Darkness , Contrast , and Background Cleanup settings to the most appropriate for the scanned document.
				Default		Select this to make the selected Image Adjustment setting the default value.
		Job Build			Job Build off* Job Build on	Use to combine several original documents into one job. Also use to scan an original document that has more pages than the document feeder can accommodate at one time. The printer temporarily saves all the scanned images. After you have scanned all the pages for the job, touch Finish to finish the job.
		Cropping Options			Do not crop* Crop to content Crop to paper	Use this menu item to automatically crop the scan for digital sending. Use the Crop to content option to scan the smallest possible area that has detectable content.
		Erase Edges			Use inches Back side erase Front side erase	Use this menu item to remove blemishes, such as dark borders or staple marks, by cleaning the specified edges of the scanned image. In each of the text boxes enter the measurements, in millimeters or inches, for how much of the top edge, bottom edge, left edge, and right edge to clean.

Table 3-11 Settings menu (continued)

First level	Second level	Third level	Fourth level	Fifth level	Values	Description
		Multi-feed Detection			Disabled Enabled*	This setting stops the scanning process if it detects multiple-page feeds through the document feeder.
		Blank Page Suppression			Disabled* Enabled	Use to prevent blank pages in the original document from being included in the output document.
		Create Multiple Files			Disabled* Enabled	Enable this item to scan pages into separate files based on a specified page limit. A page is one side of an original document. JPEG and TIFF have a limit of one page per file.
	Digital Sending Software Setup	Allow Use of a DSS Server			Disabled Enabled*	Configure how the printer interacts with the HP Digital Sending Software (DSS) server. HP DSS handles digital sending tasks, such as faxing, emailing, and sending scanned documents to a network folder or USB storage device.
		Allow Transfer to New DSS server				Use the Allow Use of a DSS Server and Allow Transfer to New DSS server options to configure the printer to use HP DSS.
Fax	Internal Fax Modem Setup					
	Fax Send Settings	Image Preview				

Table 3-11 Settings menu (continued)

First level	Second level	Third level	Fourth level	Fifth level	Values	Description
		Fax Dialing Settings	Fax Dial Volume		Off Low* High	These settings control how the fax modem dials the outgoing fax number when faxes are sent.
			Dialing Mode		Tone* Pulse	
			Redial Interval		1-5 Minutes Default = 5 minutes	
			Fax Send Speed		Fast* Medium Slow	
			Dialing Prefix			
			Detect Dial Tone			
			Redial on Error		Range: 0-9 Default = 2	
			Redial on No Answer		Range: 0-2 Default = 0	
			Redial on Busy		Range: 0-9 Default = 3	
		General Fax Send Settings	Fax Number Confirmation		Enabled Disabled*	If this feature is enabled, you must enter the fax number twice.
			PC Fax Send		Enabled* Disabled	Enables users who have the correct driver installed to send faxes through the printer from their computers.

Table 3-11 Settings menu (continued)

First level	Second level	Third level	Fourth level	Fifth level	Values	Description
			JBIG Compression		Enabled* Disabled	The JBIG compression reduces fax-transmission time, which can result in lower phone charges. However, using JBIG compression sometimes causes compatibility problems with older fax machines. If this occurs, turn off the JBIG compression.
			Error Correction Mode		Enabled* Disabled	When error-correction mode is enabled and an error occurs during fax transmission, the printer sends or receives the error portion again.
			Fax Header		Prepend* Overlay	Use to prepend or overlay the fax header page.
			Fax Number Speed Dial Matching		Enabled Disabled*	Use this item to match the fax number that you type to numbers that are saved as a speed dial.

Table 3-11 Settings menu (continued)

First level	Second level	Third level	Fourth level	Fifth level	Values	Description
		Billing Code Settings	Enable Billing Codes		Off* On	<p>When billing codes are enabled, a prompt displays that asks the user to enter the billing code for an outgoing fax. This prompt does not appear if the Allow users to edit billing codes check box is not checked.</p> <p>You can also use the billing codes report in the Reports menu to view the list of the billing codes that have been used for faxes that have been sent from the printer. The list is grouped by billing code and also shows fax details. This feature can be used for billing or usage tracking.</p>
			Default Billing Code			Specify a default billing code for faxing. If you specify a default billing code, this code displays in the Billing Code field when the user sends an outgoing fax. If this field is blank, no default billing code is provided for the user.
			Minimum Length		Range: 1-16 Default = 1	Specify the required length of the billing code. Billing codes can be between 1 and 16 characters long.
			Allow users to edit billing codes		Off On*	
	Fax Receive Settings	Fax Receive Setup	Ringer Volume		Off Low* High	Use to configure settings for receiving faxes.

Table 3-11 Settings menu (continued)

First level	Second level	Third level	Fourth level	Fifth level	Values	Description
			Rings To Answer		Range: 1-6 Default = 1	
			Fax Receive Speed		Fast* Medium Slow	
			Ring Interval		Range: 220-600 ms Default = 600 ms	
			Ring Frequency		Range: 1-200 Default = 68hz	
		Fax Printing Schedule			Always store faxes Always print faxes* Use Fax Printing Schedule	If you have concerns about the security of private faxes, use this feature to store faxes rather than having them automatically print. Open the Fax Printing Schedule sub-menu, and then you can choose to always store faxes, always print them, or you can set up a schedule for each day of the week.
			Schedule	+ (Add) Edit Delete (trash can)	Print incoming faxes Store incoming faxes Time Event Days	If you are using a fax printing schedule, use this menu to configure when to print faxes.
			Touch this to set up a fax printing schedule if you selected the Use Fax Printing Schedule option.			

Table 3-11 Settings menu (continued)

First level	Second level	Third level	Fourth level	Fifth level	Values	Description
		Blocked Fax Numbers	Fax Number to Block			<p>The blocked fax list can contain up to 30 numbers. When the printer receives a call from one of the blocked fax numbers, it deletes the incoming fax. It also logs the blocked fax in the activity log along with job-accounting information.</p> <p>Add blocked numbers: Enter a fax number into the Fax Number to Block field, and then touch the arrow button to add a new number to the blocked fax list.</p> <p>To remove blocked numbers: Select a number and touch the Delete button to delete it from the blocked fax list.</p> <p>To clear all blocked numbers: Touch the Delete All button to clear all of the numbers from the blocked fax list.</p> <p>You also can use the Blocked Fax List report in the Information menu to view the list of the fax numbers that have been blocked on this printer.</p>

Table 3-11 Settings menu (continued)

First level	Second level	Third level	Fourth level	Fifth level	Values	Description
		Default Job Options	Notification		Do not notify* Notify when job completes Notify only if job fails	Configure to receive notification about the status of a sent document. Do not notify: Turns off this feature. Notify when job completes: Select to receive notification for this job only. Notify only if job fails: Select to receive notification only if the job is not sent successfully.
					Print E-mail*	E-mail: Select to receive the notification in an email. Touch the text box following Email Address, and then enter the email address for the notification.
				Include Thumbnail		NOTE: When sending an analog fax, select Include Thumbnail to receive a thumbnail image of the first page of the fax in your notification.
				Notification E-mail address		Touch this text field, provide the email address to which you want notifications sent, and then touch the OK button.
		Stamp Received Faxes			Enabled Disabled*	Use this option to add the date, time, sender's phone number, and page number to each page of the faxes that this printer receives.

Table 3-11 Settings menu (continued)

First level	Second level	Third level	Fourth level	Fifth level	Values	Description
			Fit to Page		Enabled* Disabled	Use to shrink faxes that are larger than Letter-size or A4-size so that they can fit onto a Letter-size or A4-size page. If this feature set to Disabled, faxes larger than Letter or A4 will flow across multiple pages.
			Paper Tray		Automatic* Select from a list of the trays.	
			Output Bin		Automatically select Standard bin Upper bin Middle bin	
			Out Sides		1-sided* 2-sided	Use to describe the layout for each side of the original document. First select whether the original document is printed on one side or both sides.
	Fax Forwarding	Enable Fax Forwarding			Disabled* Enabled	Use to forward received faxes to another fax machine.
			Type of Fax Job to Forward		All faxes Sent faxes Received faxes	Use to select the type of fax jobs that you want forwarded.
			Fax Forwarding Number			Provide the forwarding phone number, and then touch the OK button.
	Clear Fax Activity Log					Clears all events from the fax activity log.

Table 3-11 Settings menu (continued)

First level	Second level	Third level	Fourth level	Fifth level	Values	Description
Manage Supplies	Low Warning Thresholds			Black Cartridge	1-100%	Set the estimated percentage at which the printer notifies you when a toner cartridge is very low.
				Cyan Cartridge	Default = 5%	
				Magenta Cartridge		
				Yellow Cartridge		
	Low Warning Threshold Message				On	Displays a message on the control panel when a cartridge is very low.
					Off	
	Very Low Behavior	Black Cartridge			Stop	
		Color Cartridges			Continue	
		Transfer Kit			Prompt to continue	
		Fuser Kit				
		Document Feeder Kit				
		Staples			Stop	
					Prompt to continue	
	Restrict Color Use				Enable	Use this feature to enable, restrict, or disable color printing or copying.
					Disable Color	
					Color if allowed*	

Table 3-11 Settings menu (continued)

First level	Second level	Third level	Fourth level	Fifth level	Values	Description
	Color/Black Mix				Auto Mostly Color Pages Mostly Black Pages	<p>Instructs the printer when to switch between color and monochrome printing modes for the best overall performance.</p> <p>Auto: Uses the mode that is appropriate for the first page of the job. If necessary, the printer switches modes during the middle of a job and then stays in that mode until the job is finished.</p> <p>Mostly Color Pages: The printer uses color mode for all jobs, even if the job contains no color pages.</p> <p>Mostly Black Pages: The printer uses monochrome mode until it detects a color page. The printer switches back to monochrome mode when it detects a sequence of several monochrome pages.</p>

Table 3-11 Settings menu (continued)

First level	Second level	Third level	Fourth level	Fifth level	Values	Description
	Store Usage Data				On supplies Not on supplies	The Store Usage Data provides a way to suppress the toner cartridges from storing most of the information gathered exclusively for the purpose of understanding the usage of the printer. Select the On supplies setting to store the data on the toner cartridge memory chip. Select the Not on supplies setting to suppress the information from being stored on the memory chip.
	Cartridge Protection				Off* Protect Cartridges	Select to permanently protect cartridges so that they can be used only in this product or fleet of products.
	Cartridge Policy				Off* Authorized HP	Set Authorized HP to allow only genuine HP cartridges to be used in this product.
Manage Stapler/ Stacker	Operation Mode				Mailbox Stacker Function Separator	
	Job Offset				On Off	
Networking	Ethernet	Information	Print Security Report		Yes No*	Yes : Prints a page that contains the current security settings on the HP Jetdirect print server. No : A security settings page is not printed.

Table 3-11 Settings menu (continued)

First level	Second level	Third level	Fourth level	Fifth level	Values	Description
		TCP/IP	Host Name		Use the arrow buttons to edit the host name. NP1XXXXXX*	An alphanumeric string, up to 32 characters, used to identify the printer. This name is listed on the HP Jetdirect configuration page. The default host name is NP1xxxxxx, where xxxxxx is the last six digits of the LAN hardware (MAC) address.
			IPv4 Settings	Config Method	Bootp DHCP* Auto IP Manual	<p>Specifies the method that TCP/IPv4 parameters will be configured on the HP Jetdirect print server.</p> <p>Bootp (Bootstrap Protocol): Use for automatic configuration from a BootP server.</p> <p>DHCP (Dynamic Host Configuration Protocol): Use for automatic configuration from a DHCPv4 server. If selected and a DHCP lease exists, the DHCP Release menu and the DHCP Renew menu are available to set DHCP lease options.</p> <p>Auto IP: Use for automatic link-local IPv4 addressing. An address in the form 169.254.x.x is assigned automatically.</p> <p>If you set this option to the Manual setting, use the Manual Settings menu to configure TCP/IPv4 parameters.</p>

Table 3-11 Settings menu (continued)

First level	Second level	Third level	Fourth level	Fifth level	Values	Description
				Default IP	Auto IP* Legacy	Specify the IP address to default to when the print server is unable to obtain an IP address from the network during a forced TCP/IP reconfiguration (for example, when manually configured to use BootP or DHCP). NOTE: This feature assigns a static IP address that might interfere with a managed network. Auto IP: A link-local IP address 169.254.x.x is set. Legacy: The address 192.0.0.192 is set, consistent with older HP Jetdirect printers.
				Primary DNS	Range: 0-255 Default = xxx.xxx.xx.xx	Specify the IP address (n.n.n.n) of a Primary Domain Name System (DNS) Server.
				Secondary DNS	Range: 0-255 Default = 0.0.0.0	Specify the IP address (n.n.n.n) of a Secondary DNS Server.
		IPv6 Settings	Enable	Off On*		Use this item to enable or disable IPv6 operation on the print server. Off: IPv6 is disabled. On: IPv6 is enabled.
				Address	Manual Settings Enable Address	Use this item to enable and manually configure a TCP/IPv6 address.

Table 3-11 Settings menu (continued)

First level	Second level	Third level	Fourth level	Fifth level	Values	Description
				DHCPv6 Policy	Router Specified Router Unavailable* Always	<p>Router Specified: The stateful auto-configuration method to be used by the print server is determined by a router. The router specifies whether the print server obtains its address, its configuration information, or both from a DHCPv6 server.</p> <p>Router Unavailable: If a router is not available, the print server should attempt to obtain its stateful configuration from a DHCPv6 server.</p> <p>Always: Whether a router is available, the print server always attempts to obtain its stateful configuration from a DHCPv6 server.</p>
				Primary DNS	Range: 0-255 Default = xxx.xxx.xx.xx	Specify the IP address (n.n.n.n) of a Primary Domain Name System (DNS) Server.
				Secondary DNS	Range: 0-255 Default = 0.0.0.0	Specify the IP address (n.n.n.n) of a Secondary DNS Server.

Table 3-11 Settings menu (continued)

First level	Second level	Third level	Fourth level	Fifth level	Values	Description
			Proxy Server		Select from a provided list.	<p>Specifies the proxy server to be used by embedded applications in the printer. A proxy server is typically used by network clients for Internet access. It caches Web pages, and provides a degree of Internet security for those clients.</p> <p>To specify a proxy server, enter its IPv4 address or fully-qualified domain name. The name can be up to 255 octets.</p> <p>For some networks, you might need to contact your Internet Service Provider (ISP) for the proxy server address.</p>
			Proxy Port		Default = 0080	<p>Enter the port number used by the proxy server for client support. The port number identifies the port reserved for proxy activity on your network, and can be a value from 0 to 65535.</p>
			Idle Timeout		Default = 0270	<p>The time period, in seconds, after which an idle TCP print data connection is closed (default is 270 seconds, 0 disables the timeout).</p>

Copy menu (MFP only)

To display: At the printer control panel, select the [Copy](#) menu.

In the following table, asterisks (*) indicate the factory default setting.

Table 3-12 Copy menu (MFP only)

First level	Second level	Third level	Values	Description	
Sides	Original Sides		1-sided*	Use to indicate whether the original document is printed on one or both sides.	
			2-sided		
	Output Sides		1-sided	Use to indicate whether the copies should be printed on one or both sides.	
			2-sided		
Color/Black			Automatically detect*	Select how the copy should be printed.	
			Color	<p>Automatically detect: Prints color documents in color, and black and white documents in black and white. For mixed documents, the printer will determine whether to print in color or black and white.</p> <p>Color: Prints documents in color.</p> <p>Black: Prints documents in black and white or grayscale.</p>	
			Black/Gray		
Quick Sets and Defaults			Load		
			Save		
Options	Sides	Original Sides	1-sided		
			2-sided		
	Output Sides	1-sided			
		2-sided			
	Color/Black			Automatically detect*	Select how the copy should be printed.
				Color	<p>Automatically detect: Prints color documents in color, and black and white documents in black and white. For mixed documents, the printer will determine whether to print in color or black and white.</p> <p>Color: Prints documents in color.</p> <p>Black: Prints documents in black and white or grayscale.</p>
				Black/Gray	
	Staple			None	Sets the position of the staple on the page.
			Top left angled		
			Top right angled		

Table 3-12 Copy menu (MFP only) (continued)

First level	Second level	Third level	Values	Description
	Scan mode		Standard Document	Book Mode allows the user to scan pages from a book.
			Book Mode	
			2-sided ID	2-sided ID allows the user to scan both sides of an identification card onto one sheet.
	Reduce/Enlarge		Automatic*	Use to scale the size of the document up or down. Select one of the predefined percentages, or select the Scaling field and type a percentage between 25 and 400. The Auto option automatically scales the image to fit the paper size in the tray. NOTE: To reduce the image, select a scaling percentage that is less than 100. To enlarge the image, select a scaling percentage that is greater than 100.
			Manual	
	Original Size		Select from a list of sizes that the printer supports.	Describes the page size of the original document.
	Paper Selection		Paper Size	For the best color and image quality, select the appropriate paper type from the control panel menu or from the print driver.
			Paper Type	
			Paper Tray	
	Booklet	Booklet Format	(Checkbox)	Use to copy two or more pages onto one sheet of paper so you can fold the sheets in the center to form a booklet. The printer arranges the pages in the correct order. For example, if the original document has eight pages, the printer prints pages 1 and 8 on the same sheet.
	Content Orientation		Auto Detect	For some features to work correctly, you must specify the way the content of the original document is placed on the page. Portrait orientation means the short edge of the page is along the top. Landscape orientation means the long edge of the page is along the top. In the Orientation area, select whether the original document has a portrait or landscape orientation.
			Portrait*	
			Landscape	

Table 3-12 Copy menu (MFP only) (continued)

First level	Second level	Third level	Values	Description
	Pages per Sheet		One (1) Two (2) Four (4)	Copies multiple pages onto one sheet of paper. NOTE: Before using this screen, use the Content Orientation screen to describe the original document orientation.
	Image Adjustment	Sharpness		Adjust the Sharpness setting to clarify or soften the image. For example, increasing the sharpness could make text appear crisper, but decreasing it could make photographs appear smoother.
		Darkness		Use to improve the overall quality of the copy. Adjust the Darkness setting to increase or decrease the amount of white and black in the colors.
		Contrast		Adjust the Contrast setting to increase or decrease the difference between the lightest and darkest color on the page.
		Background Cleanup		Adjust the Background Cleanup setting if you are having trouble copying a faint image.
	Optimize Text/Picture	Manually Adjust*	Optimize For: Text Mixed Printed picture Photograph	Optimizes the output for a particular type of content. You can optimize the output for text, printed pictures, or a mixture. Manually Adjust: Use to manually optimize the setting for text or for pictures. Text: Use to optimize the text portion of the copy where text and/or pictures are on the original. Printed picture: Use for line drawings and preprinted images, such as magazine clippings or pages from books. Photograph: Best suited for making copies of printed pictures.

Table 3-12 Copy menu (MFP only) (continued)

First level	Second level	Third level	Values	Description
	Erase Edges	Front Side	Use inches Apply same width to all edges Top edge Bottom edge Left edge Right edge	Use this menu item to remove blemishes, such as dark borders or staple marks, by cleaning the specified edges of the scanned image. In each of the text boxes enter the measurements, in millimeters or inches, for how much of the top edge, bottom edge, left edge, and right edge to clean.
		Back Side	Use inches Mirror front side Top edge Bottom edge Left edge Right edge	
	Collate		Collate on (Sets in page order)* Collate off (Pages grouped)	If you are making more than one copy, select the Collate on (Sets in page order) option to assemble the pages in the correct order in each set of copies. Select the Collate off (Pages grouped) option to group the same pages together. For example, if you are making five copies of an original document that has two pages, all five first pages would be grouped together and all five second pages would be grouped together.
	Multi-feed Detection		Enabled* Disabled	This setting stops the scanning process if it detects multiple-page feeds through the document feeder.
	Output Bin		Automatically select Standard bin Upper bin Middle bin	

Scan menu (MFP only)

To display: At the printer control panel, select the [Scan](#) menu.

In the following table, asterisks (*) indicate the factory default setting.

Table 3-13 Scan menu (MFP)

First level	Second level	Third level	Fourth level	Values	Description
Scan to Email					
Scan to Network Folder	Folder Paths				
	File Name				
	Quick Sets and Defaults				
	Options	File Type and Resolution			
		Original sides		1-sided 2-sided	Use to describe the layout for each side of the original document. First select whether the original document is printed on one side or both sides. Then touch the Orientation setting to indicate whether the original has portrait or landscape orientation. If it is printed on both sides, also select the 2-sided format that matches the original document.
		Color/Black		Automatically detect* Color Black/Gray Black	Use to enable or disable color scanning. Automatically detect : Automatically scans documents in color if at least one page has color. Color : Scans documents in color. Black/Gray : Scans documents in grayscale. Black : Scans documents in black and white with a compressed file size.
		Original Size		Select from a list of supported sizes.	Use to describe the page size of the original document.

Table 3-13 Scan menu (MFP) (continued)

First level	Second level	Third level	Fourth level	Values	Description
		Content Orientation	Orientation	Automatically Detect Portrait* Landscape	For some features to work correctly, you must specify the way the content of the original document is placed on the page. Portrait orientation means the short edge of the page is along the top. Landscape orientation means the long edge of the page is along the top. In the Orientation area, select whether the original document has a portrait or landscape orientation.
		Image Adjustment	Darkness		Use to improve the overall quality of the copy. Adjust the Darkness setting to increase or decrease the amount of white and black in the colors.
			Contrast		Adjust the Contrast setting to increase or decrease the difference between the lightest and darkest color on the page.
			Background Cleanup		Adjust the Background Cleanup setting if you are having trouble copying a faint image.
			Sharpness		Adjust the Sharpness setting to clarify or soften the image. For example, increasing the sharpness could make text appear crisper, but decreasing it could make photographs appear smoother.
			Automatic Tone		The printer automatically adjusts the Darkness , Contrast , and Background Cleanup settings to the most appropriate for the scanned document.

Table 3-13 Scan menu (MFP) (continued)

First level	Second level	Third level	Fourth level	Values	Description
			Default		Select this to make the selected Image Adjustment setting the default value.
		Optimize Text/Picture			
		Erase Edges		Use inches Back side erase Front side erase	Use this menu item to remove blemishes, such as dark borders or staple marks, by cleaning the specified edges of the scanned image. In each of the text boxes enter the measurements, in millimeters or inches, for how much of the top edge, bottom edge, left edge, and right edge to clean.
		Cropping Options		Do not crop Crop to content Crop to paper	Use this menu item to automatically crop the scan for digital sending. Use the Crop to content option to scan the smallest possible area that has detectable content.
		Automatically Straighten			
		Blank Page Suppression		Disabled Enabled	Use to prevent blank pages in the original document from being included in the output document.
		Multi-feed Detection		Disabled Enabled*	This setting stops the scanning process if it detects multiple-page feeds through the document feeder.
		Create Multiple Files		Disabled Enabled	Enable this item to scan pages into separate files based on a specified page limit. A page is one side of an original document. JPEG and TIFF have a limit of one page per file.

Table 3-13 Scan menu (MFP) (continued)

First level	Second level	Third level	Fourth level	Values	Description
		Notification		Do not notify Notify when job completes Notify only if job fails Print E-mail	Configure to receive notification about the status of a sent document. Do not notify: Turns off this feature. Notify when job completes: Select to receive notification for this job only. Notify only if job fails: Select to receive notification only if the job is not sent successfully. Print: Select to print the notification at this printer. E-mail: Select to receive the notification to an email account.
			Include Thumbnail		Select Include Thumbnail to receive a thumbnail image of the first page of the job in your notification.
			Notification Email		E-mail: Select to receive the notification in an email. Touch the text box following Email Address , and then type the email address for the notification.
Scan to USB Drive	Destination				
	Job Name				
	Options	File Type and Resolution			

Table 3-13 Scan menu (MFP) (continued)

First level	Second level	Third level	Fourth level	Values	Description
		Original sides		1-sided 2-sided	Use to describe the layout for each side of the original document. First select whether the original document is printed on one side or both sides. Then touch the Orientation setting to indicate whether the original has portrait or landscape orientation. If it is printed on both sides, also select the 2-sided format that matches the original document.
		Color/Black		Automatically detect* Color Black/Gray Black	Use to enable or disable color scanning. Automatically detect : Automatically scans documents in color if at least one page has color. Color : Scans documents in color. Black/Gray : Scans documents in grayscale. Black : Scans documents in black and white with a compressed file size.
		Original Size		Select from a list of supported sizes.	Use to describe the page size of the original document.
		Content Orientation		Automatically detect Portrait* Landscape	For some features to work correctly, you must specify the way the content of the original document is placed on the page. Portrait orientation means the short edge of the page is along the top. Landscape orientation means the long edge of the page is along the top. In the Orientation area, select whether the original document has a portrait or landscape orientation.

Table 3-13 Scan menu (MFP) (continued)

First level	Second level	Third level	Fourth level	Values	Description
		Image Adjustment	Darkness		Use to improve the overall quality of the copy. Adjust the Darkness setting to increase or decrease the amount of white and black in the colors.
			Contrast		Adjust the Contrast setting to increase or decrease the difference between the lightest and darkest color on the page.
			Background Cleanup		Adjust the Background Cleanup setting if you are having trouble copying a faint image.
			Sharpness		Adjust the Sharpness setting to clarify or soften the image. For example, increasing the sharpness could make text appear crisper, but decreasing it could make photographs appear smoother.
			Automatic Tone		The printer automatically adjusts the Darkness , Contrast , and Background Cleanup settings to the most appropriate for the scanned document.
			Default		Select this to make the selected Image Adjustment setting the default value.

Table 3-13 Scan menu (MFP) (continued)

First level	Second level	Third level	Fourth level	Values	Description
		Optimize Text/Picture		Manually Adjust* Text Printed picture Photograph	Use to optimize the output for a particular type of content. You can optimize the output for text, printed pictures, or a mixture. Manually Adjust: Use to manually optimize the setting for text or for pictures. Text: Use to optimize the text portion of the copy when text and/or pictures are on the original. Printed picture: Use for line drawings and preprinted images, such as magazine clippings or pages from books. Photograph: Best suited for making copies of printed pictures.
		Erase Edges		Use inches Back side erase Front side erase	Use this menu item to remove blemishes, such as dark borders or staple marks, by cleaning the specified edges of the scanned image. In each of the text boxes enter the measurements, in millimeters or inches, for how much of the top edge, bottom edge, left edge, and right edge to clean.
		Cropping Options		Do not crop Crop to content Crop to paper	Use this menu item to automatically crop the scan for digital sending. Use the Crop to content option to scan the smallest possible area that has detectable content.
		Automatically Straighten			
		Blank Page Suppression		Disabled Enabled	Use to prevent blank pages in the original document from being included in the output document.

Table 3-13 Scan menu (MFP) (continued)

First level	Second level	Third level	Fourth level	Values	Description
		Multi-feed Detection		Disabled Enabled*	This setting stops the scanning process if it detects multiple-page feeds through the document feeder.
		Create Multiple Files		Disabled Enabled	Enable this item to scan pages into separate files based on a specified page limit. A page is one side of an original document. JPEG and TIFF have a limit of one page per file.
		Notification		Do not notify Notify when job completes Notify only if job fails Print E-mail	Configure to receive notification about the status of a sent document. Do not notify: Turns off this feature. Notify when job completes: Select to receive notification for this job only. Notify only if job fails: Select to receive notification only if the job is not sent successfully. Print: Select to print the notification at this printer. E-mail: Select to receive the notification to an email account.
			Include Thumbnail		Select Include Thumbnail to receive a thumbnail image of the first page of the job in your notification.
			Notification Email		E-mail: Select to receive the notification in an email. Touch the text box following Email Address , and then type the email address for the notification.
	Scan to Job Storage			Folder Job Name	

Fax menu (fax models only)

To display: At the printer control panel, select the [Fax](#) menu.

In the following table, asterisks (*) indicate the factory default setting.

Table 3-14 Fax menu (fax models only)

First level	Second level	Third level	Values	Description
Dialing Prefix				
Fax Recipients				
Quick Sets and Defaults				
Options	Original Sides		1-sided* 2-sided	Use to describe the layout for each side of the original document. First select whether the original document is printed on one side or both sides. Then touch the Orientation setting to indicate whether the original has portrait or landscape orientation. If it is printed on both sides, also select the 2-sided format that matches the original document.
	Resolution		Standard (100 x 200dpi)* Fine (200 x 200dpi) Superfine (300 x 300dpi)	Select the resolution for outgoing faxes. If you increase the resolution, faxes might be clearer but they could transmit more slowly. Some file types, for example a file that will be processed with OCR, require a specific resolution. When these file types are selected, the Resolution setting might be automatically changed to a valid value.
	Original Size		Select from a list of sizes that the printer supports.	Use to describe the page size of the original document.
	Content Orientation	Orientation	Portrait* Landscape	For some features to work correctly, you must specify the way the content of the original document is placed on the page. Portrait : This setting means the short edge of the page is along the top. Landscape : This setting means the long edge of the page is along the top.

Table 3-14 Fax menu (fax models only) (continued)

First level	Second level	Third level	Values	Description
	Image Adjustment	Darkness		Use to improve the overall quality of the copy. Adjust the Darkness setting to increase or decrease the amount of white and black in the colors.
		Contrast		Adjust the Contrast setting to increase or decrease the difference between the lightest and darkest color on the page.
		Background Cleanup		Adjust the Background Cleanup setting if you are having trouble copying a faint image.
		Sharpness		Adjust the Sharpness setting to clarify or soften the image. For example, increasing the sharpness could make text appear crisper, but decreasing it could make photographs appear smoother.
		Automatic Tone		The printer automatically adjusts the Darkness , Contrast , and Background Cleanup settings to the most appropriate for the scanned document.
		Default		Select this to make the selected Image Adjustment setting the default value.

Table 3-14 Fax menu (fax models only) (continued)

First level	Second level	Third level	Values	Description
	Optimize Text/Picture	Manually Adjust*	Optimize For: Text Printed picture Photograph	Optimizes the output for a particular type of content. You can optimize the output for text, printed pictures, or a mixture. Manually Adjust: Use to manually optimize the setting for text or for pictures. Text: Use to optimize the text portion of the copy where text and/or pictures are on the original. Printed picture: Use for line drawings and preprinted images, such as magazine clippings or pages from books. Photograph: Best suited for making copies of printed pictures.
	Blank Page Suppression		Disabled* Enabled	Prevents blank pages in the original document from being included in the output document.
	Multi-feed Detection		Disabled Enabled*	Use this feature to prevent multiple pages being fed through the document feeder during document scans.
	Notification		Do not notify* Notify when job completes Notify only if job fails Print E-mail	Use to receive notification about the status of a sent document. Do not notify: Turns off this feature. Notify when job completes: Select to receive notification for this job only. Notify only if job fails: Select to receive notification only if the job is not sent successfully. Print: Select to print the notification at this printer. E-mail: Select to receive the notification in an email. Touch the text box following Email Address , and then enter the email address for the notification.

Table 3-14 Fax menu (fax models only) (continued)

First level	Second level	Third level	Values	Description
		Include Thumbnail		When sending an analog fax, select Include Thumbnail to receive a thumbnail image of the first page of the fax in your notification.
		Notification E-mail address		Provide the email address that will receive notifications.
		2-Sided Format	Book-style* Flip-style	Use to configure the default style for 2-sided print jobs. If the Book-style option is selected, the back side of the page is printed the right way up. This option is for print jobs that are bound along the left edge. If the Flip-style option is selected, the back side of the page is printed upside-down. This option is for print jobs that are bound along the top edge.

Print menu

To display: At the printer control panel, select the **Print** menu.

In the following table, asterisks (*) indicate the factory default setting.

Table 3-15 Print Options menu

First level	Second level	Values	Description
Print from Job Storage	Stored Job to Print	Untitled Stored Faxes	Print a job stored on the printer.
Print from USB Drive	Stored Job to Print	Choose file to print on USB drive.	Print a job stored on a USB drive.
Fax Polling	Fax Polling Number		

Supplies menu

To display: At the printer control panel, select the **Supplies** menu.

In the following table, asterisks (*) indicate the factory default setting.

Table 3-16 Supplies menu

First level	Values	Description
Supplies Summary		

Table 3-16 Supplies menu (continued)

First level	Values	Description
Black Cartridge	Status	
Cyan Cartridge	Order HP Part	
Magenta Cartridge	Pages Printed	
Yellow Cartridge	Approximate Pages Remaining	
Toner Collection Unit	Status	
Transfer Kit	Order HP Part	
Fuser Kit		
Document Feeder Kit		
Stapler 1		

Trays menu

To display: At the printer control panel, select the [Trays](#) menu.

In the following table, asterisks (*) indicate the factory default setting.

Table 3-17 Trays menu

First level	Second level	Values	Description
Tray 1	Size	Select paper size from a list of supported sizes.	Choose the paper size for the tray
Tray 2-x	Type	Select paper type from a list of supported types.	Choose the paper type for the tray.

Troubleshooting menu

To display: At the product control panel, select the [Support Tools](#) menu, and then select the [Troubleshooting](#) menu.

In the following table, asterisks (*) indicate the factory default setting.

Table 3-18 Troubleshooting

First level	Second level	Third level	Fourth level	Values	Description
Configuration/Status Pages	<ul style="list-style-type: none"> • Settings Menu Map • Current Settings Page • Configuration Page • How to Connect Page • Supplies Status Page • sage Page • File Directory Page • Web Services Status Page • Color Usage Job Log 				Select the configuration/Status reports to review, and then touch the Print or View button.
Reports					
Other Pages	<ul style="list-style-type: none"> • Demonstration Page • RGB Samples • CMYK Samples • PCL Font List • PS Font List 				
Event Log				Print	Prints the 50 most recent events in the Event Log. For each event, the printed log shows the error number, page count, error code, and description or personality.
Paper Path Page				View Print	Shows how many pages were printed from each tray.
Fax (Fax is optional)	Fax T.30 Trace	Print T.30 Report		Print	Use to print or configure the fax T.30 trace report. T.30 is the standard that specifies handshaking, protocols, and error correction between fax machines.

Table 3-18 Troubleshooting (continued)

First level	Second level	Third level	Fourth level	Values	Description
		When to Print Report		Never automatically print* Print after every fax Print only after fax send jobs Print after any fax error Print only after fax send errors Print only after fax receive errors	Configure the T.30 report to print after certain events. You can choose to print the report after every fax job, every fax job sent, every fax job received, every send error, or every receive error.
	Fax V.34			Normal* Off	Use to disable V.34 modulations if several fax failures have occurred or if phone line conditions require it.
	Fax Speaker Mode			Normal* Diagnostic	Used by a technician to evaluate and diagnose fax issues by listening to the sounds of fax modulations
	Fax Log Entries			On Off*	The standard fax log includes basic information such as the time and whether the fax was successful. The detailed fax log shows the intermediate results of the redial process not shown in the standard fax log.
Print Quality Pages	Print Fuser Test Page			Print	Use to print pages that help you resolve problems with print quality.
Diagnostic Tests					
	Continuous Scan			2-sided	
	Run Fax Test			Start	Use this menu to perform a test on specific components within the product to determine whether the components are functioning correctly.

Table 3-18 Troubleshooting (continued)

First level	Second level	Third level	Fourth level	Values	Description
Retrieve Diagnostic Data				Insert a US drive into the USB port. The exported data might contain personally identifiable information.	Create files that contain information about the product that can help identify the cause of problems.
Generate Debug Data				Start	

Maintenance menu

Learn about the Maintenance menu.

Backup/Restore menu

To display: At the product control panel, select [Support Tools](#) and then [Maintenance](#), and then select the [Backup/Restore](#) menu.

In the following table, asterisks (*) indicate the factory default setting.

Table 3-19 Backup/Restore menu

First level	Second level	Third level	Values	Description
Backup Data	Enable Scheduled Backups	Backup Time	Enter a time	
		Days Between Backups	Enter the number of days	
	Backup Now			
	Export Last Backup			
Restore Data			Insert a USB drive that contains the backup file.	

Calibration/Cleaning menu

To display: At the product control panel, select the [Maintenance](#) menu, and then select the [Calibrate/Cleaning](#) menu.

In the following table, asterisks (*) indicate the factory default setting.

Table 3-20 Calibrate/Cleaning menu

First level	Second level	Values	Description
Calibration/Cleaning Page		Print	Use to process the cleaning page that was created by using the Create Cleaning Page menu. The process takes up to 1.5 minutes.

Table 3-20 Calibrate/Cleaning menu (continued)

First level	Second level	Values	Description
Calibration		Start	<p>The product automatically calibrates itself at various times. However, you can calibrate the product immediately if you see problems with print quality. Use this feature to perform a full calibration, which can take up to three minutes. Use this calibration if the color layers seem to be shifted on the page.</p> <p>Before calibrating the product, make sure that the Ready indicator displays on the control-panel display. If a job is in progress, the calibration occurs when that job is complete.</p>
Delay Calibration at Wake/Power On		<p>No Delay</p> <p>Delay 15 minutes</p>	<p>Controls the timing of power-on calibration when the product wakes up or is turned on.</p> <p>Wake: Select if you are not using the feature and want to print jobs immediately when the product wakes up or is turned on, before calibration begins.</p> <p>No: The product will calibrate immediately when it wakes up or is turned on. The product will not print any jobs until it finishes calibrating.</p> <p>Yes: Enables the product that is asleep to accept print jobs before it calibrates. It might start calibrating before it has printed all the jobs it has received. This option allows quicker printing when coming out of sleep mode or when you turn the product on, but print quality might be reduced.</p> <p>NOTE: For the best results, allow the product to calibrate before printing. Print jobs performed before calibration might not be of the highest quality.</p>

USB Firmware Upgrade menu

To display: At the product control panel, select the **Maintenance** menu, and then select the **USB Firmware Upgrade** menu.

Insert a USB storage device with a firmware upgrade bundle into the USB port, and follow the on-screen instructions.

Clear paper jams

Learn about clearing paper jams.

Paper jam locations

Learn about paper jam locations.



1	Tray 1
2	Tray 2
3	Tray 3

13.A1 tray 1 paper jam

Learn about A1 tray 1 paper jams.

Use the following procedure to check for paper in all possible jam locations related to the Tray 1. When a jam occurs, the control panel might display a message and an animation that assists in clearing the jam.

- 13.A1.XX Jam in tray 1

1. Gently remove the jammed paper.



2. Open and then close the front door to resume printing.

13.A2, 13.A3 tray 2, tray 3 paper jam

Learn about A2, 13.A3 tray 2, tray 3 paper jams.

Use the following procedure to check for paper in all possible jam locations related to Tray 2 or Tray 3. When a jam occurs, the control panel might display a message and an animation that assists in clearing the jam.

- 13.A2.XX Jam in tray 2
- 13.A3.XX Jam in tray 3

⚠ CAUTION: The fuser can be hot while the printer is in use. Wait for the fuser to cool before handling it.

📝 NOTE: The procedure to clear a paper jam in Tray 3 is the same as for Tray 2. Only Tray 2 is shown here.

1. Open the right door.



2. Gently remove any jammed paper.



3. Close the right door.



4. Open the tray.



5. Gently remove any jammed paper.



6. Close the tray. Printing automatically resumes.



Clear paper jams in the Bottom HCI

Learn about clearing paper jams in the bottom HCI.

1. Open the HCI.

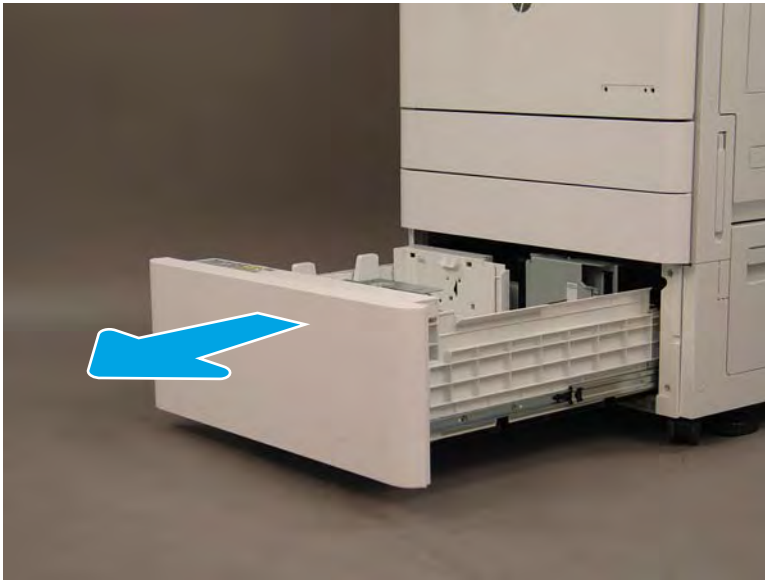

2. Remove any jammed paper.

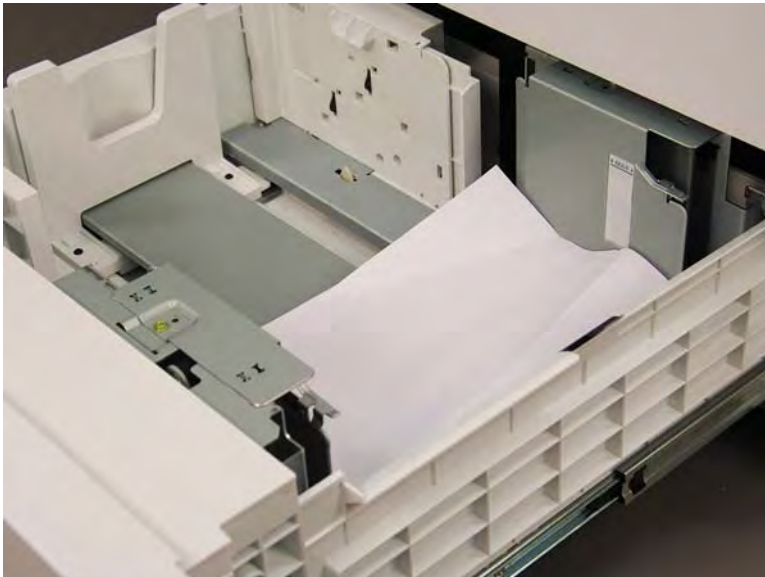

3. Close the HCI.

Service mode (tech mode)

Learn about service mode (tech mode).

In service (tech) mode, the technician can check the printer and perform various tests to isolate the cause of a malfunction. While in service mode, the printer still performs all normal operations.

Entering service mode

Learn about entering service mode.

1. From the control panel, select **Support tools** and then **Service**.
2. Enter the Service PIN ID.
 - 04072517
3. Select **Service tools**.

Figure 3-34 Service tools view

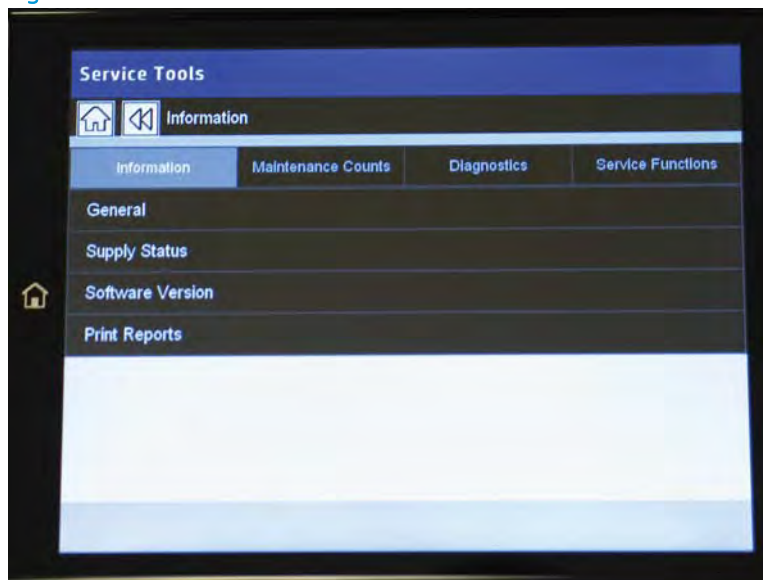

Service mode menu tree

Learn about the service mode menu tree.

Figure 3-35 Information

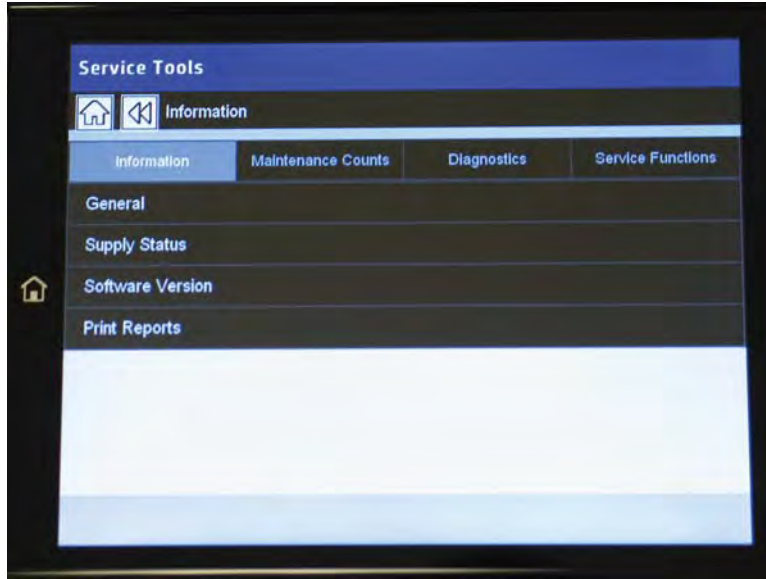

Level 1	Level 2	Level 3	Level 4
Information	General	Engine Board Serial Number	
		Supply Status	Customer Replacement Unit
	Field Replacement Unit		Imaging Unit (K)
			Development Unit (K)
			TCU
			Paper transfer belt (PTB)
			Fuser
			Tray x rollers
			ADF Pickup Roller
		ADF Separation Roller	
	Software Version	System Firmware Version	
		Main Firmware Version	
		Engine Firmware Version	
		Boot ROM Version	
		File System Version	
		ADF Firmware Version	
		Finisher Version	
		Scanner Version	
	Scan Control Version		
	Tray 2-5 Version		
	Fuser Version		

Level 1	Level 2	Level 3	Level 4
		Transfer Version	
		Toner Version	
		Print CMS Version	
		Copy CMS Version	
		Scan CMS Version	
	Print Reports	Supplies Information	
		Usage Counter	
		Error Information	
		Fax Protocol Dump (Line 1)	
		Fax Protocol Dump (Line 2)	
		Fax Diagnostics (Line 1)	
		Fax Diagnostics (Line 2)	
		Auto Color Registration	
		Job Duty	
		Auto Toning History	
		Full Auto Color Registration	
		ID Calibration History	
		Maintenance	
		Toner Event	
	Export Reports	RTF Format	
		XML Format	
		PDF Format	

Figure 3-36 Maintenance counts

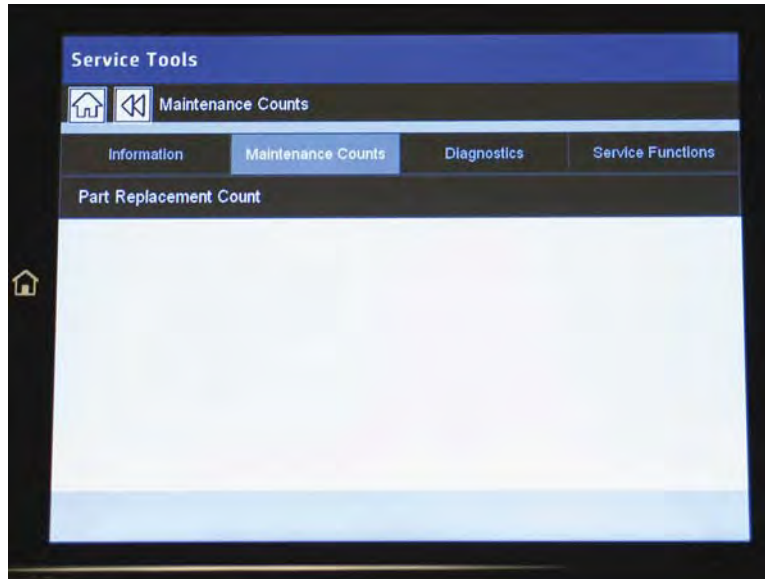

Level 1	Level 2	Level 3	Level 4
Maintenance counts	Part Replacement Count	Toner Cartridge (K)	
		Imaging Unit (K)	
		Development Unit (K)	
		Paper Transfer Belt (PTB)	
		Fuser	
		Tray x rollers	
		ADF Pickup Roller	
		ADF Separation Roller	

Figure 3-37 Diagnostics

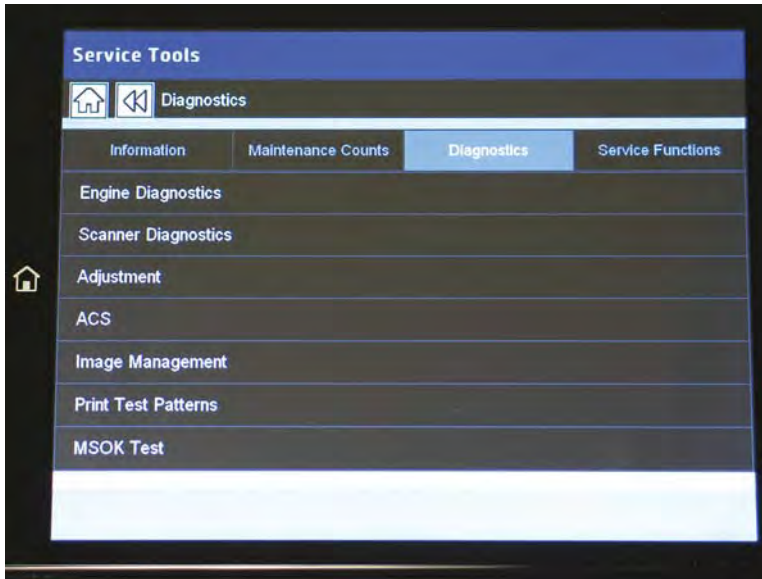

Level 1	Level 2	Level 3	Level 4
Diagnostics	Engine Diagnostics	Engine Diagnostics	
		Engine NVM Read/Write	
		Engine Test Routines	
		Fax Diagnostics	
Scanner Diagnostics	Scanner Diagnostics	Fax NVM Read/Write	
		Fax Test Routines	
		Shading Test	Shade and Print Report
			Print Last Shade Report
P	Adjustment		Shade and Print Report (ADF)
			Print Last Shade Report (ADF)
		Scanner/ADF NVM Read/Write	
		Scanner/ADF Test Routines	Chose from a list of tests.
	ACS	Print Adjustment	Automatic Adjustment
			Image Position
			Print Test Patterns
		Copy Adjustment	Image Position
	Image Management	Scan Area Adjustment	Automatic Adjustment
			Manual Adjustment
		ADF Adjustment	Automatic Adjustment
			Manual Adjustment
		ACS Page Adjustment	
		Auto Tone Adjustment Activation	Normal

Level 1	Level 2	Level 3	Level 4
			Full
		Auto Tone Adjustment	Normal
			Full
	Print Test Patterns	Skew Pattern	

Figure 3-38 Service functions

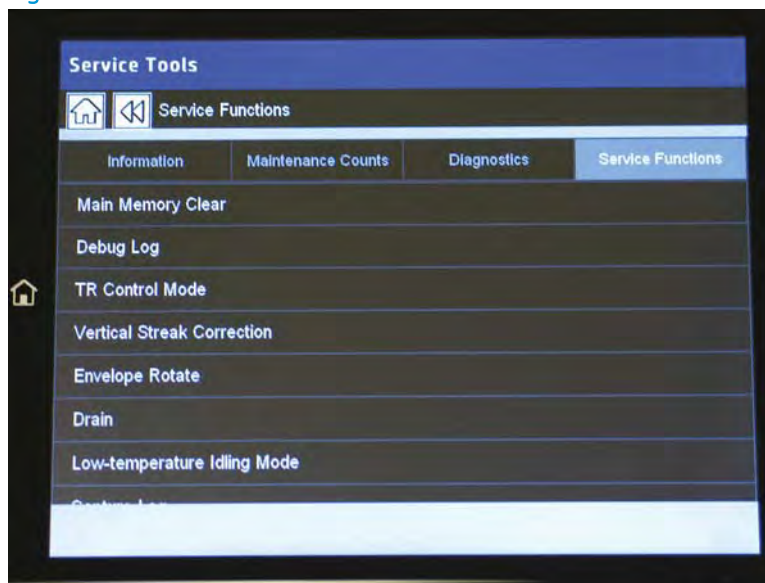

Level 1	Level 2	Level 3	Level 4
Service Functions	Debug Log	Info	
		Job Status	
	TR Control Mode	TR Control Mode	Paper Group/Paper Side/Paper Direction/T2 PWM
	Vertical Streak Correction		
	Drain	Off	
		On	
	Low Temperature Idling Mode		
	Capture Log	All	
		Period	Start Date/End Date
	IP Setting	IP address (manual entry)	
		Subnet Mask (manual entry)	
		Default Gateway (manual entry)	
	Footer		
	FW Upgrade		

Level 1	Level 2	Level 3	Level 4
	File Dump Mode	Enable Dump	Generate RGBa
			Generate Raw File
			Generate CMYK
			No Print Mode
			Debugging Mode
			Max Output file No 10
			Enable
		Retrieve Dump Image	Safely Remove USB
			Retrieve Dump Image
		Delete Dump Image	Delete Dump Image
		Disable Dump	Disable
	Copy Original Thickness	Thin (42-60 g/m2)	
		Normal*	
		Thick (163-220 g/m2)	
	Scan Original Thickness	Thin (42-60 g/m2)	
		Normal*	
		Thick (163-220 g/m2)	
	Altitude Adjustment	Normal (~1,000 m/3,280 ft)*	
		High 1 (~2,000 m/6562 ft)	
		High 2 (~3000 m/9842 ft)	
		High 3 (~4000 m/13123 ft)	
		High 4 (~5000 m/16404 ft)	
	Humidity	Normal*	
		High 1	
		High 2	
		High 3	
	Vapor Mode		
	Booklet Sub Tray		
	Event Logging		

Information

Learn more service mode information.

General

Learn general information about the menus.

Information > General

This menu displays the following information:

- Printer serial number
- Ethernet IP address
- Ethernet Mac address
- Optional Ethernet IP address
- Optional Ethernet Mac address
- Total printed impressions
- Installed date and time

Supply status

Learn about supply status.

Information > Supply Status > Customer Replacement Unit

- This menu displays the printer's customer replacement unit status. Users can select one item in the list to check the information of the selected unit.

Field replacement unit (FRU)

Information > Supply Status > Field Replacement Unit

- This menu displays the printer's field replacement unit status. Users can select one item in the list to check the information of the selected unit.

In this menu, there are five columns: Item, Threshold, Status, Count, and Maximum Life.

- Status: This column shows the current status of the selected item.
 - OK: The current count is smaller than the default warning value.
 - Check: The current count is bigger than the default warning value.
 - OFF: The current count exceeds the maximum life.
- Count: This column shows the current count of the selected item.
- Maximum Life: This column shows the maximum capacity of the selected item.

The technician can edit the default warning value within the given threshold.

Selecting some items will enable the reset button to reset the current count to zero after replacing the unit.

Software version

Learn about the software version.

Information > Software Version

- This menu displays the version of the software installed on the printer.

Print reports

Learn how to print reports.

Information > Print Reports

This menu displays reports that can be printed from the system. The following reports are available to print:

- Supplies Information
- Auto Toning History

Information > Print Reports > Auto Toning History

 **NOTE:** TRC means Tone Reproduction Curve.

This report shows a history of execution of the TRC control. The TRC control preserves color consistency against changes in supplies resulting from long-time use and environmental change. The purpose of the history report is to check if the TRC control is working normally.

- If the TRC control performs normally, **Pass** count must be a non-zero value and **Fail** count must be zero.
- If **Fail** count is not zero, check the image density sensor.

Maintenance counts

Learn about Maintenance counts.

Part replacement count

Learn about part replacement count.

This section provides detailed information about the service mode Maintenance Counts tab

Maintenance Counts > Part Replacement Count

- This menu displays fault counts. The technician can select one fault group and press **OK** to see detailed fault descriptions. The detailed fault description window displays engine diagnostic codes, descriptions of the fault, and the number of occurrences.

The following table shows the fault groups defined for the system:

Table 3-21 Fault Count

Item	Item	Item
A1 Motor	H2 Output (Bins) System	S3 Scan System
A2 Fan	M1 Input (Trays) System	S5 UI System
A3 Sensor	M2 Media Path System	S6 Network System
C1 Toner Cartridge Unit	M3 Output (Bins) System	S7 HDD System
C3 Imaging Unit	M4 ADF System	U1 Fusing Unit
C7 Fusing Unit	S1 Video System	U2 Laser Scanner Assembly Unit
H1 Input (Trays) System	S2 Engine System	

Maintenance Counts > Part Replacement Count

- This menu displays the replacement counts for the system parts. Users can select one group and press **OK** to see the exact name of the part and the occurrence of the replacement.

The following table shows replaceable parts groups of the system:

Table 3-22 Part Replacement Count

Unit	Item	Sensing Method
Toner Cartridge	Toner (Black)	Auto Sensing
Imaging Unit	Imaging Unit (Black)	Auto Sensing
Fuser	Fuser	Auto Sensing
Transfer Roller	Transfer Roller	Count Clear
Roller	Tray 2 Roller	Count Clear
Roller	Tray 3 Roller	Count Clear
Roller	Tray 4 Roller	Count Clear
Roller	Tray 5 Roller	Count Clear
ADF Roller	ADF Pick Roller	Count Clear

Table 3-22 Part Replacement Count (continued)

Unit	Item	Sensing Method
ADF Roller	ADF Separation Roller	Count Clear
Filter	Ozone filter	

Diagnostics

Learn about diagnostics.

Engine diagnostics

Learn about the engine diagnostics.

Diagnostics > Engine Diagnostics > Engine NVM Initialization

- This menu initializes all engine NVM values to the default.

Diagnostics > Engine Diagnostics > Engine NVM Read/Write

Table 3-23 Engine Diagnostics (Engine NVM Read/Write)

Purpose	To change a configuration value for the engine firmware
Operation procedure	<p>When the main NVM Read/Write window displays, users can navigate through the list of codes with descriptions and saved values.</p> <p>Users can also input a code through the text box to find a configuration value directly.</p> <p>After selecting one value, press the Edit button to open an interface for user input.</p>

Table 3-24 Engine NVM Read/Write codes

Code	Display	Meaning	Default	Max/Min
109-0200	Standby Center	Temperature offset	10	10
109-0201	Standby Side	Temperature offset	10	10
109-0205	Warmup Center	Temperature offset	10	10
109-0255	Thin Center	Temperature offset		
109-0256	Thin Side	Temperature offset	10	10
109-0265	Plain Center	Temperature offset	10	10
109-0266	Plain Side	Temperature offset	10	10
109-0275	Heavy Center	Temperature offset	10	
109-0276	Heavy Side	Temperature offset	10	10
109-0280	Extra Heavy Center	Temperature offset	10	10
109-0281	Extra Heavy Side	Temperature offset	10	10
109-0300	Envelopes Center	Temperature offset	10	10
109-0301	Envelopes Side	Temperature offset	10	10
109-0305	Labels Center	Temperature offset	10	10
109-0306	Labels Side	Temperature offset	10	10
109-0310	Thick Center	Temperature offset	10	10
109-0311	Thick Side	Temperature offset	10	10

Table 3-24 Engine NVM Read/Write codes (continued)

Code	Display	Meaning	Default	Max/Min
109-0315	Recycled Center	Temperature offset	10	10
109-0316	Recycled Side	Temperature offset	10	10
109-0320	Special Center	Temperature offset	10	10
109-0321	Special Side	Temperature offset	10	10
109-0325	1200 dpi_thin Center	Temperature offset	10	10
109-0326	1200 dpi_thin Side	Temperature offset	10	10
109-0330	1200 dpi_plain Center	Temperature offset	10	10
109-0331	1200 dpi_plain Side	Temperature offset	10	10
109-0335	1200 dpi_thick Center	Temperature offset	10	10
109-0336	1200 dpi_thick Side	Temperature offset	10	10
111-0030	Toner Vcon Black	Toner Vcon Black	100/100	100/100

Engine test routines

- Diagnostics > Engine Diagnostics > Engine Test Routines

Table 3-25 Engine Diagnostics (Engine Test Routines)

Purpose	To perform test routines for the engine
Operation procedure	<p>When the main Engine Test Routines window displays, users can navigate through the list of routines and descriptions that display. Users can directly input an EDC code through the text box to search for a routine. A maximum of three routines can be selected at the same time.</p> <p>After selecting one or more routines, press the OK button to open the test window. The selected routines will display and users can start/start the selected test routine.</p>
Verification	N/A
Specification	N/A
Reference	See the following table.

Table 3-26 Engine Test Routines codes

Code	Display	Meaning
100-000 0	Main BLDC Motor	Main BLDC Motor is On/Off
100-000 1	Main BLDC Motor Slow	Main BLDC Motor Slow On/Off
100-001 0	Main BLDC Motor Ready	Detects if Main BLDC Motor is running at normal speed

Table 3-26 Engine Test Routines codes (continued)

Code	Display	Meaning
100-004 4	Black Drum Motor	Black Drum motor is on/off
100-004 9	Black Drum Motor Ready	Detects if black drum motor is running at normal speed
100-007 6	Ozone Suction Fan Run	Start/Stop Ozone Suction Fan run
100-007 7	Ozone Suction Fan Ready	Detects if Ozone Suction Fan is running at normal speed
100-012 0	Exit Motor Forward Fast	Exit Motor Forward Fast On/Off
100-013 0	Exit Motor Forward Slow	Exit Motor Forward Slow On/Off
100-014 0	Duplex Motor Forward	Duplex motor forward on/off
100-014 1	Duplex Motor Forward Slow	Duplex motor forward slow on/off
100-016 0	Duplex Fan 1 Run	Start/stop duplex fan 1 run
100-018 0	Duplex Fan 1 Run Ready	Detects if duplex fan 1 is running at normal speed
100-020 0	Tray 2 Elevating Motor	Tray 2 elevate motor on/off
100-021 0	Tray 3 Elevating Motor	Tray 3 elevate motor on/off (optional)
100-022 0	Tray 4 Elevating Motor	Tray 4 elevate motor on/off (optional)
100-023 0	Tray 5 Elevating Motor	Tray 5 elevate motor on/off (optional)
100-024 1	Waste Toner LED	Waste Toner LED on/off
100-025 0	Waste Toner Full Sensor	Detects if the Waste Toner is full
100-026 0	SMPS Fan Run	Start/stop SMPS fan run
100-027 0	SMPS Fan Run Ready	Detects if SMPS fan is running at normal speed
100-037 0	Tray 2 Pickup Motor	Tray 2 motor is on/off
100-037 1	Tray 2 Pickup Motor Slow	Tray 2 motor slow on/off
100-038 0	Tray 3 Pickup Motor	Tray 3 motor is on/off

Table 3-26 Engine Test Routines codes (continued)

Code	Display	Meaning
100-038 1	Tray 3 Pickup Motor Slow	Tray 3 motor slow on/off
100-038 2	Tray 3 Pickup Motor Slowest	Tray 3 motor slowest on/off
100-039 0	Tray 4 Pickup Motor	Tray 4 motor is on/off
100-039 1	Tray 4 Pickup Motor Slow	Tray 4 motor slow on/off
100-039 2	Tray 4 Pickup Motor Slowest	Tray 4 motor slowest on/off
100-040 0	Tray 5 Pickup Motor	Tray 5 motor is on/off
100-040 1	Tray 5 Pickup Motor Slow	Tray 5 motor slow on/off
100-041 1	Registration Motor Slow	Registration motor slow on/off
100-041 2	Registration Motor Slowest	Registration motor slowest on/off
100-043 0	Exit 2 Motor Forward	Exit 2 motor is on/off
100-043 1	Exit 2 Motor Forward Slow	Exit 2 motor slow on/off
100-044 0	Exit 2 Motor Backward	Exit 2 Motor is On/Off
100-044 1	Exit 2 Motor Backward Slow	Exit 2 Motor Slow Backward On/Off
100-047 0	DCF Feed Motor	DCF Feed Motor is On/Off
100-047 1	DCF Feed Motor Slow	DCF Feed Motor Slow is On/Off
100-048 0	Duct Motor	Duct Motor On/Off
100-048 1	Duct Motor Sensor	Duct Motor Rib Sensing
101-005 0	Registration Clutch	Engages drive to registration roller
101-012 1	Tray 2 Feed Motor Slow	Tray 2 Feed Motor Slow On/Off
101-013 1	Tray 3 Feed Motor Slow	Tray 3 Feed Motor Slow On/Off
101-014 1	Tray 4 Feed Motor Slow	Tray 4 Feed Motor Slow On/Off

Table 3-26 Engine Test Routines codes (continued)

Code	Display	Meaning
101-015 1	Tray 5 Feed Motor Slow	Tray 5 Feed Motor Slow On/Off
101-019 0	Out bin Full Sensor	Detects when paper is at Out bin Full Sensor
101-019 1	Out-bin 2 Full Sensor	Detects when paper is at Out-bin 2 Full Sensor
101-027 0	Tray 1 Clutch	Tray 1 Clutch On/Off
101-027 1	Tray 1 Solenoid	Tray 1 Solenoid On/Off
101-028 0	Return Gate Solenoid	Return Gate Solenoid On/Off
102-000 0	Tray 2 Home Position	Detects when Tray 2 is closed
102-001 0	Tray 2 Paper Empty Sensor	Detects when paper is in Tray 2
102-004 1	Tray 2 Paper Size Read	Detects size of paper in Tray 2
102-005 0	Tray 2 Stack Height Sensor	Detects if paper in Tray 2 is elevated to the sensor
102-007 0	Tray 3 Home Position	Detects when Tray 3 is closed
102-008 0	Tray 3 Paper Empty Sensor	Detects when paper is in Tray 3
102-011 1	Tray 3 Paper Size Read	Detects size of paper in Tray 3
102-012 0	Tray 3 Stack Height Sensor	Detects if paper in Tray 3 is elevated to the sensor
102-014 0	Tray 4 Home Position	Detects when Tray 4 is closed
102-015 0	Tray 4 Paper Empty Sensor	Detects when paper is in Tray 4
102-018 1	Tray 4 Paper Size Read	Detects size of paper in Tray 4
102-019 0	Tray 4 Stack Height Sensor	Detects if paper in Tray 4 is elevated to the sensor
102-021 0	Tray 5 Home Position	Detect when Tray 5 is closed
102-022 0	Tray 5 Paper Empty Sensor	Detects when paper is in Tray 5
102-025 1	Tray 5 Size Read	Detects paper size in Tray 5

Table 3-26 Engine Test Routines codes (continued)

Code	Display	Meaning
102-026 0	Tray 5 Stack Height Sensor	Detects if paper in Tray 5 is elevated to the sensor
102-028 0	Tray 1 Paper Empty Sensor	Detects when paper is in Tray 1
102-028 1	Tray 1 Paper Size Read	Detects paper size in Tray 1
102-029 0	Feed 1 Sensor	Detects when paper is at the Feed 1 sensor
102-030 0	Tray 3 Feed Sensor (or Door Open)	Detects when paper is at Tray 3 Feed sensor (Optional)
102-032 0	Tray 4 Feed Sensor (or Door Open)	Detects when paper is at Tray 4 Feed sensor (Optional)
102-034 0	Tray 5 Feed Sensor (or Door Open)	Detects when paper is at Tray 5 Feed sensor (Optional)
102-036 0	Registration Sensor	Detects when paper is at the registration sensor
102-036 1	Fuser Out Sensor	Detects when paper is at the fuser out sensor.
102-037 1	Exit 2 Sensor	Detects when paper is at exit 2 sensor.
102-038 0	Duplex Jam 1 Sensor	Detects when paper is at duplex jam 1 sensor.
102-043 5	Front Cover Sensor	Detects status of front cover
102-043 6	Side Cover Sensor	Detects status of side cover
104-000 0	Waste Install Sensor	Detects if waste is installed
106-020 0	HVPS Installed	Detect HVPS unit
107-016 5	Black Eraser On	Black eraser lamp on/off
107-016 9	Black Eraser Detect	Detect black eraser status
109-003 0	Fuser Motor Forward	Fuser motor forward on/off
109-003 1	Fuser Motor Backward	Fuser Motor Backward On/Off
109-003 4	Fuser Motor Ready	Detects if Fuser Motor runs at each speed
109-004 0	Fuser Gap Home Sensor	Detects if the fuser press is located Home position

Table 3-26 Engine Test Routines codes (continued)

Code	Display	Meaning
109-020 0	Detect Fuser Relay	Detect fuser relay status
109-021 0	Detect Zero Cross Period	Detect zero cross period
109-030 0	Fuser Installed	Detect fuser unit
110-000 0	LSU Motor 1 Run Ready	Detects if LSU motor 1 runs at normal speed
110-006 0	LSU Motor 1 Run	LSU motor 1 on/off
110-017 0	LSU HSync 4	Detects LSU HSync 4 (black)
111-003 0	Toner Dispense Motor Black	Toner dispense (supply) motor on/off
111-007 0	Toner Sensor Black	TC sensor in developer tank
111-014 0	Toner Control Voltage Black	Black toner voltage on/off
112-034 0	Center ID Sensor P Read	Show center ID sensor P value
112-035 0	Center ID Sensor S Read	Show center ID sensor S value
113-000 0	Finisher Present Sensor	Detect if the finisher is in place
113-035 0	Finisher Entrance Sensor	Detects when paper is at entrance sensor
113-036 0	Finisher Exit Sensor	Detects when paper is at exit sensor
113-036 1	Finisher Compile Paper Sensor	Detect when a paper is at compile sensor
113-037 0	Finisher Paddle Home Sensor	Detects paddle home position
113-038 0	Finisher Left Tamper Home Sensor	Detects lift tamper home position
113-039 0	Finisher Right Tamper Home Sensor	Detects right tamper home position
113-041 0	Finisher Stapler Door Sensor	Detects if stapler door cover is closed
113-042 0	Finisher Jam Cover Sensor	Detects if jam door cover is closed
113-043 0	Finisher Stapler Home Sensor	Detects stapler home position

Table 3-26 Engine Test Routines codes (continued)

Code	Display	Meaning
113-044 0	Finisher Stapler Low Sensor	Detects stapler level
113-045 1	Finisher Stapler Ready Sensor	Detect stapler ready sensor
113-046 1	Finisher Ejector 1 Home Sensor	Detect ejector 1 home position
113-046 2	Finisher Ejector 2 Home Sensor	Detect ejector 2 home position
113-046 3	Finisher Ejector 2 Encoder Sensor	Detect ejector 2 encoder Sensor
113-047 0	Finisher Main Tray Home Sensor	Detects main tray home position
113-047 1	Finisher Main Tray Beam Sensor	Detect main tray beam sensor
113-047 2	Finisher Main Tray Low Limit Sensor	Detect main tray low limit sensor
113-047 3	Finisher Main Tray Encoder Sensor	Detect main tray encoder sensor
113-048 1	Finisher Paper Support Sensor	Detect paper support home sensor
113-049 1	Finisher Traverse Front Sensor	Detect traverse front home sensor
113-049 2	Finisher Traverse Rear Sensor	Detect traverse rear home sensor
113-050 1	Finisher Entrance Motor	Finisher entrance motor on/off
113-050 2	Finisher Exit Motor	Finisher exit motor on/off
113-051 0	Finisher Paddle Motor	Finisher paddle motor on/off
113-052 0	Finisher Left Tamper Motor	Finisher left tamper motor on/off
113-053 0	Finisher Right Tamper Motor	Finisher right tamper motor on/off
113-055 0	Finisher Staple Unit Motor	Finisher staple unit motor on/off
113-056 1	Finisher Ejector 1 Motor	Finisher ejector 1 motor on/off
113-056 2	Finisher Ejector 2 Motor	Finisher ejector 2 motor on/off
113-056 3	Finisher Ejector 2 Reverse Motor	Finisher ejector 2 reverse direction on/off

Table 3-26 Engine Test Routines codes (continued)

Code	Display	Meaning
113-057 0	Finisher Main Tray Motor	Finisher main tray motor on/off
113-057 1	Finisher Paper Support Motor	Finisher paper support motor on/off
113-058 1	Finisher Traverse Motor	Finisher staple unit traverse motor on/off
113-059 1	Finisher Paper Hold Solenoid	Finisher paper hold solenoid on/off



Scanner diagnostics

Learn about the scanner diagnostics.

Shading test

- Diagnostics > Scanner Diagnostics > Shading Test

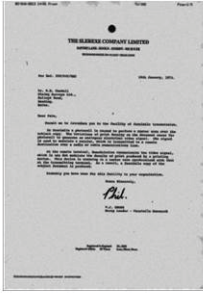
Table 3-27 Scanner Diagnostics (Shading Test)

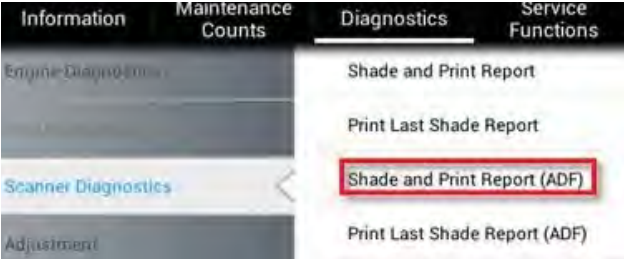
<p>Purpose</p>	<ul style="list-style-type: none"> - To check the quality of scanned images, especially if there might be defects in optical devices such as the lens, mirror, or lamp. - Check the quality problem as shown below: <div style="display: flex; justify-content: space-around; align-items: center;"> <div style="text-align: center;">  <p>Normal Image</p> </div> <div style="text-align: center;">  <p>Defected Image</p> </div> <div style="text-align: center;">  <p>Defected Image</p> </div> </div>
<p>Operation Procedure</p>	<p>For the Image Scanner Unit</p> <p>Press Shade and Print report to see if the current shading value is correct. Mono, red, green, and blue gray shading values will be shown on the printed report. When the previous shading value is needed, press "Print Last Shade Report".</p> <p>For the Flow ADF unit</p> <ol style="list-style-type: none"> 1. Load the shading sheet on the ADF tray. 2. Enter SCV mode. Select the following menu items: Diagnostics > Scanner Diagnostics > Shading Test > Shade and Print Report (ADF) <div style="text-align: center;">  </div> <p>Press Print Last Shade Report (ADF) for the previous shading value report.</p> <ol style="list-style-type: none"> 3. Check if the printed results are correct. <p>NOTE:</p> <ul style="list-style-type: none"> - When executing ADF shading, use only the shading sheet (JC63-05055A). - A Shading Test for the ADF unit must be completed after replacing the ADF unit or main board.
<p>Verification</p>	<p>Look at the bottom of the report page for a "RESULTS : OK" message.</p>

Scanner/Flow ADF NVM Read/Write

- Diagnostics > Scanner Diagnostics > Scanner/Flow ADF NVM Read/Write

Table 3-28 Scanner Diagnostics (Scanner/Flow ADF NVM Read/Write)

Purpose	To read and/or write values in the scanner and ADF memory.
Operation Procedure	<p>When the main NVM Read/Write window displays, users can navigate through the list of codes with descriptions and saved values. Users can also directly input a code through the text box to search for an NVM.</p> <p>After selecting a code, the Edit button will be enabled only if the code is writable.</p> <p>If the selected code is writable and the Edit button is enabled, press the button to configure the desired value for the code.</p>
Verification	N/A
Specification	N/A
Reference	See the following table.

Table 3-29 Scanner/Flow ADF NVM Read/Write codes

Code	NVM description	Default	Flow ADF	ADF
05-0000	Pick Up Count	0	0	0
05-0001	Separation Roller Count	0	0	0
05-0030	Simplex Registration Value (Registration 1)	0	X	0
05-0040	Duplex Registration Value (Registration 2)	0		0
05-0050	Width Guide Max Value	Depends on ADF	0	0
05-0060	Width Guide Min Value	Depends on ADF	0	0

Scanner/Flow ADF test routines

- Diagnostics > Scanner Diagnostics > Scanner/Flow ADF Test Routines

Table 3-30 Scanner Diagnostics (Scanner/Flow ADF Test Routines)

Purpose	To perform test routines for the scanner and Flow ADF.
Operation Procedure	<p>When the main Scanner/ADF Test Routines window displays, users can navigation through the list of routines and descriptions that display. Users can input a code through the text box to search for a routine.</p> <p>After selecting a routine, press OK to open the test window that lists the selected routine. Users can start/stop the selected test routine.</p>
Verification	N/A
Specification	N/A
Reference	See the following table.

Table 3-31 Scanner/Flow ADF Test Routines codes

Code	Name	Value	Flow ADF	ADF
06-0000	Scanner Original Size Detecting Sensor 1	High/Low	0	0
06-0001	Scanner Original Size Detecting Sensor 2	High/Low	0	0
06-0010	Scanner Cover Open/Close Sensor 1	High/Low	0	0
06-0011	Scanner Cover Open/Close Sensor 2	High/Low	0	0
06-0020	Scanner Platen Motor Forward	Start/Stop	0	0
06-0030	Scanner Platen Motor Backward	Start/Stop	0	0
06-0040	Scanner Platen Home Position Sensor	High/Low	0	0
05-0000	Document Length .1 Sensor	High/Low	0	0
05-0001	Document Length .2 Sensor	High/Low	0	0
05-0020	Document Cover Open Sensor	High/Low	0	0
05-0040	Document Detect Sensor	High/Low	0	0
05-0050	Document Feed Sensor	High/Low	0	0
05-0060	Document Simplex Registration Sensor	High/Low	0	0
05-0061	Document Duplex Registration Sensor		X	
05-0070	Document Scan Read Sensor 1	High/Low	0	0
05-0071	Document Scan Read Sensor 2	High/Low	0	X
05-0080	Document Exit Sensor	High/Low		0
05-0110	Document Motor Forward	Start/Stop		0
05-0111	Document Motor Backward	Start/Stop		0
05-0123	Document width 1 MSO Sensor	High/Low		
05-0124	Document width 2 MSO Sensor	High/Low		
05-0125	Document width 3 MSO Sensor	High/Low		

Table 3-31 Scanner/Flow ADF Test Routines codes (continued)

Code	Name	Value	Flow ADF	ADF
05-0130	Document Pickup Motor Forward	Start/Stop		
05-0131	Document Pickup Motor Backward	Start/Stop		
05-0140	Document Pickup Roller Detect Sensor	High/Low	0	0
05-0151	Document Stacker Lift Lower Sensor	High/Low		0
05-0152	Document Stacker Lift Home Position Sensor			
05-0153	Document Scan-In Release Sensor			
05-0154	Document Separation Up Down Sensor			
05-0160	Document Registration 1 Motor Forward	Start/Stop	0	X
05-0162	Document Registration 1 Motor Backward	Start/Stop	0	X
05-0170	Document Registration 2 Motor Forward	Start/Stop		
05-0171	Document Registration 2 Motor Backward	Start/Stop		
05-0180	Document Stacker Lift Motor Forward	Start/Stop		
05-0181	Document Stacker Lift Motor Backward	Start/Stop		
05-0182	Document Exit Motor Forward			
05-0183	Document Exit Motor Backward			
05-0184	Document Pickup Release Motor Forward			
05-0185	Document Pickup Release Motor Backward			
05-0186	Document Scan In Release Motor Forward			
05-0187	Document Scan In Release Motor Backward			
05-0190	Document Width Guide ADC Sensor	10Bit (0~1023)	0	0
05-0191	Document USM ADC Sensor			

Table 3-31 Scanner/Flow ADF Test Routines codes (continued)

Code	Name	Value	Flow ADF	ADF
05-0192	Document USM Calibration Test			
05-0210	Document Jig Test Low Speed Simplex	Start/Stop	0	0
05-0230	Document Jig Test High Speed Simplex	Start/Stop	0	0

Adjustment

Learn about the print adjustment.

Print adjustment

- Diagnostics > Adjustment > Print Adjustment > Image Position

Table 3-32 Print Adjustment (Image Position)

Purpose	Manually adjust the position of the printed image on the paper in the print engine.
Operational Procedure	<ol style="list-style-type: none"> 1. Select a tray to adjust. 2. Change the adjustment value using the + or - buttons, then press the OK button to save the changes. <ul style="list-style-type: none"> ○ Simplex Leading Edge ○ Simplex Side Edge ○ Duplex Leading Edge ○ Duplex Side Edge <p>NOTE:</p> <ul style="list-style-type: none"> ○ Adjustment must be done for each tray (Tray 1, 2, 3, 4, and MP). ○ Do not choose ALL for the tray selection. ○ Adjust for the tray with each new tray selection. 3. Print out the test pattern and check if the image is adjusted. If not, repeat Step 2.

- Diagnostics > Adjustment > Print Adjustment > Print Margin Test

This menu is used to print out the test pattern manually.

Copy adjustment

- Diagnostics > Adjustment > Copy Adjustment > Image Position

Table 3-33 Copy Adjustment (Image Position)

Purpose	Manually adjust the position of the copied image on the paper in the copy engine.
Operation Procedure	<p>NOTE: Before copy adjustment:</p> <ul style="list-style-type: none"> – Make sure that the initial values of margin adjustment are the same as the values of the print adjustment. – Perform an adjustment for each tray. Do not choose All for tray selection, as this can confuse the adjustment. <p>NOTE:</p> <ul style="list-style-type: none"> – Complete adjustment for each tray (Tray 1, 2, 3, 4, and MP). – Do not choose All for tray selection. – Adjust for the tray with each new tray selection. <ol style="list-style-type: none"> 1. Locate the Scanner A/S Chart at the scanner glass. 2. Change the adjustment value using the + or - button, and then press OK to save the changes. <ul style="list-style-type: none"> ○ Simplex Leading Edge ○ Simplex Side Edge ○ Duplex Leading Edge ○ Duplex Side Edge 3. Print out the test pattern and check if the image has moved. If not, repeat Step 2.

Scan area adjustment

- Diagnostics > Adjustment > Scan Area Adjustment > Automatic Adjustment

Table 3-34 Scan Area Adjustment (Automatic Adjustment)

Purpose	To correct the image position and magnification of scanned images automatically.
Operation Procedure	<ol style="list-style-type: none"> 1. Locate the Scanner A/S chart at the scanner glass.  <p style="text-align: center;">A4 Scanner A/S Chart</p>

Table 3-34 Scan Area Adjustment (Automatic Adjustment)

Purpose	To correct the image position and magnification of scanned images automatically.
	<p>Note that the Lead Edge arrows point to the left side of the scanner glass and are placed face down. The Scanner A/S Chart comes in two sizes, A4 and Letter.</p> <ol style="list-style-type: none"> 2. Press OK. A scan begins and the system will automatically calculate the proper value based on the scanning result of the chart. 3. The new value saves to the system. 4. Scan the Scanner A/S Chart and send it to a PC. The chart must be scanned from the scanner glass. 5. To check the image position, compare the position of the scale marks (a, b) from the chart to the scanned image. 6. To check the magnification, compare the length of line c from the chart to the scanned image. <p>NOTE: Specifications:</p> <ul style="list-style-type: none"> ○ a, b: 10, ± 1.5 mm ○ c: 190, ± 1.5 mm

- Diagnostics > Adjustment > Scan Area Adjustment > Manual Adjustment

Table 3-35 Scan Area Adjustment (Manual Adjustment)

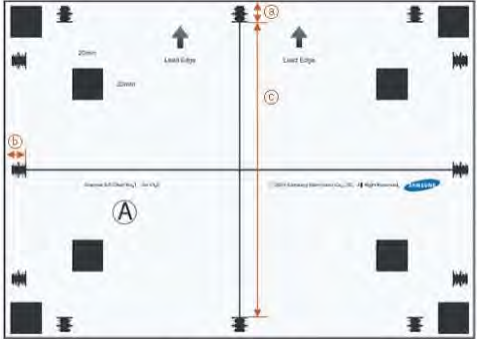
Purpose	To correct the position and magnification of scanned images manually.
Operation Procedure	<ol style="list-style-type: none"> 1. Choose one item from the table. There are three items to choose from: <ul style="list-style-type: none"> ○ Image Position — Leading Edge (Unit: mm, Scale: 0.1, Min/Max: -6/+6) ○ Image Position — Side Edge (Unit: mm, Scale: 0.1, Min/Max: -6/+6) ○ Magnification — Vertical Direction (Unit: %, Min/Max: 98.5/101.5) 2. Select one item and press the Edit button. 3. Change the adjustment value using the arrow button. 4. Image position (a, b): If the current value is smaller than the specification, press +, otherwise press -. 5. Magnification (c): If the current value is smaller than the specification, press -, otherwise, press +. 6. Press the OK button to apply the new value to the system. 7. Scan the Scanner A/S Chart and send it to a PC. The chart must be scanned from the scanner glass. 8. To check the image position, compare the position of the scale marks (a, b) from the chart to the scanned image. 9. To check the magnification, compare the length of line c from the chart to the scanned image. <p>NOTE: Specifications:</p> <ul style="list-style-type: none"> ○ a, b: 10, ± 1.5 mm ○ c: 190, ± 1.5 mm

ADF adjustment

- Diagnostics > Adjustment > ADF Adjustment > Automatic Adjustment

Table 3-36 ADF Adjustment (Automatic Adjustment)

<p>Purpose</p>	<p>To correct the image position and magnification of images scanned with the Flow ADF/ADF automatically.</p>
<p>Operation Procedure</p>	<ol style="list-style-type: none"> 1. Locate the Scanner A/S chart on the ADF tray. <div data-bbox="707 453 1182 793" style="text-align: center;"> <p style="text-align: center;">A4 Scanner A/S Chart</p> </div> 2. Press OK. A scan begins and the system will automatically calculate the proper value based on the scanning result of the chart. 3. The new value saves to the system. 4. Scan the Scanner A/S Chart and send it to a PC. The chart must be scanned from the Flow ADF/ADF. 5. To check the image position, compare the position of the scale marks (a, b) from the chart to the scanned image. 6. To check the magnification, compare the length of line c from the chart to the scanned image. <p>NOTE: Specifications:</p> <ul style="list-style-type: none"> ○ a, b: 10, ± 1.5 mm ○ c: 190, ± 1.5 mm <p>NOTE: After executing the ADF adjustment, perform a shading test. Refer to Scanner Diagnostics.</p>

- Diagnostics > Adjustment > ADF Adjustment > Manual Adjustment

Table 3-37 ADF Adjustment (Manual Adjustment)

<p>Purpose</p>	<p>To correct the position and magnification of scanned images manually.</p>
<p>Operation procedure</p>	<ol style="list-style-type: none"> 1. Choose one item from the table. There are three items to choose from:

Table 3-37 ADF Adjustment (Manual Adjustment)

Purpose	To correct the position and magnification of scanned images manually.
	<ul style="list-style-type: none"> ○ Image Position — Leading Edge (Unit: mm, Scale: 0.1, Min/Max: -6/+6) ○ Image Position — Side Edge (Unit: mm, Scale: 0.1, Min/Max: -6/+6) ○ Magnification — Vertical Direction (Unit: %, Min/Max: 98.5/101.5) <ol style="list-style-type: none"> 2. Select one item and press the Edit button. 3. Change the adjustment value using the arrow button. 4. Image position (a, b): If the current value is smaller than the specification, press +, otherwise press -. 5. Magnification (c): If the current value is smaller than the specification, press -, otherwise, press +. 6. Press the OK button to apply the new value to the system. 7. Scan the Scanner A/S Chart and send it to a PC. The chart must be scanned from the Flow ADF/ADF. 8. To check the image position, compare the position of the scale marks (a, b) from the chart to the scanned image. 9. To check the magnification, compare the length of line c from the chart to the scanned image. <p>NOTE: Specifications:</p> <ul style="list-style-type: none"> ○ a, b: 10, ± 1.5 mm ○ c: 190, ± 1.5 mm <p>NOTE: After executing the ADF adjustment, perform a shading test. Refer to Scanner Diagnostics.</p>

Image management

Learn about image management.

Auto tone adjustment activation

- Diagnostics > Image Management > Auto Tone Adjustment Activation > Normal

Table 3-38 Auto Tone Adjustment Activation (Normal)

Purpose	To correct image quality when density of the image is poor. Normal TRC Control is recommended after changing a unit, such as a toner cartridge, imaging unit, and PTB, or after restarting the printer.
Operation Procedure	<ol style="list-style-type: none"> 1. Select On or Off for Normal TRC Control execution. <ul style="list-style-type: none"> ○ Off: Normal TRC Control will not execute. ○ On: Normal TRC Control will execute during the determined conditions, 2. Change the execution condition(s) of Normal TRC Control. <ul style="list-style-type: none"> ○ Page Count: The system executes Normal TRC Control based on the count of printed pages since the last execution. ○ Time Left Alone: The system executes Normal TRC Control when the system returns from a power save

Table 3-38 Auto Tone Adjustment Activation (Normal) (continued)

Purpose	To correct image quality when density of the image is poor. Normal TRC Control is recommended after changing a unit, such as a toner cartridge, imaging unit, and PTB, or after restarting the printer.
	mode and the rest time exceeds the configured value.
Verification	Print out a test job and make sure the image quality has recovered.

- [Diagnostics > Image Management > Auto Tone Adjustment Activation > Full](#)

Table 3-39 Auto Tone Adjustment Activation (Full)

Purpose	To correct image quality when any OPC drum is replaced, the life of the OPC drum is changed, the density of the image is poor, or the temperature and/or humidity in the room changes suddenly.
Operation Procedure	<ol style="list-style-type: none"> Select On or Off for Full TRC Control execution. <ul style="list-style-type: none"> Off: Full TRC Control will not execute. On: Full TRC Control will execute during the determined conditions, Change the execution condition(s) of Full TRC Control. <ul style="list-style-type: none"> Page Count: The system executes Full TRC Control based on the count of printed pages since the last execution. Time Left Alone: The system executes Full TRC Control when the system returns from a power save mode and the rest time exceeds the configured value.
Verification	Print out a test job and make sure the image quality has recovered.

Print test patterns

Learn about the print test patterns.

[Diagnostics > Print Test Patterns > Skew Pattern](#)

- The skew pattern stored in the machine will be printed out as the selected size.

Service functions

Learn about service functions.

Main memory clear

Learn about the main memory clear.

Service Functions > Main Memory Clear

- This function resets the main memory of the system to the factory default setting. This function can be used to reset the system to the initial value when the product is functioning abnormally. User configured values return to the default values.

To clear the main memory, select the country/region where the system is located, and restart the printer.

Debug log

Learn about the debug log.

Service Functions > Debug Log

- This function sets the system log message level. Users can select three options:
 - Off: This option disables the logging option.
 - Job Status: This option only enables the logging of user created jobs.
 - Details: This option enables all the logging options of the running tasks of the system. This option might affect the performance of certain system operations. Use this option when the system performs abnormally and engineers need to investigate the problem.

Capture log

Learn about the capture log.

Service Functions > Capture Log

- This function copies all the saved logs in the system to a USB flash drive as a .zip file. The size of the system log could reach up to 1 GB. If the system log size becomes very large, it will take a longer time to copy to the USB flash drive.
 1. Connect the USB flash drive to the printer.
 2. Tap the **Service Mode** app.
 3. Go to **Service Functions > Debug Log** and change the debug log level to **INFO**.
 4. Go to **Service Functions > Capture Log**.
 5. Select **All** or **Period**. If selecting **Period**, enter the start and end date.
 6. Press the **Capture Log** button.
 7. Once the log is completed, a completion message will display. Restore the debug log level to **JOB STATUS**.

 **NOTE:** If the system log size becomes very large, it will take longer to copy to the USB flash drive.





8. Check that the Log File has been saved to the USB flash drive.

Transfer assembly control mode

Learn about the transfer assembly control mode.

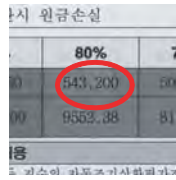
Service Functions > Transfer Assembly Control Mode

- **Table 3-40 Transfer Assembly Control Mode**

Purpose	To correct transfer related problems. This function can be used to change the transfer value to optimize image quality to a certain type of paper.
Operation Procedure	<ul style="list-style-type: none"> – T2 Control Mode <ul style="list-style-type: none"> ○ Choose the paper group, paper side, and paper direction. ○ Adjust PWM value based on the problem type. <ul style="list-style-type: none"> ● Blur: Increase PWM value ● Poor Transfer: Increase PWM value ● Re-transfer: Decrease PWM value ● White Spot: Decrease PWM value ● OPC Cyclic Ghost: Decrease PWM value
	<div style="display: flex; justify-content: space-around; align-items: center;"> <div style="text-align: center;">  <p>Blur</p> </div> <div style="text-align: center;">  <p>Poor Transfer</p> </div> <div style="text-align: center;">  <p>Retransfer</p> </div> </div> <div style="display: flex; justify-content: space-around; align-items: center;"> <div style="text-align: center;">  <p>White Spot</p> </div> <div style="text-align: center;">  <p>OPC Cyclic Ghost</p> </div> </div>
Verification	Print a test job and make sure the transfer problem has been resolved.
Specification	N/A
Reference	N/A

Envelope rotate

Learn about the envelope rotate function.

Service Functions > Envelope Rotate

- This menu enables rotation when printing on an envelope. The machine usually guides loaded envelopes with SEF direction. If this function is enabled, the user can load an envelope with LEF direction and the machine will rotate the image for printing on the envelope.

This function provides the following setting options:

- Off (default): Load envelope SEF direction
- 90 degrees: Load envelope LEF direction.
- 180 degrees: Load envelope SEF direction with flap on bottom side.



 **NOTE:** If the paper source is **Auto**, the device will feed from the Tray 1 because the LEF envelope can only be loaded in the Tray 1 according to paper specification.

If the length of envelope is over the maximum size of the custom width, the device will not rotate the image and determine that the direction of the envelope is SEF. For example, the A4 model supports custom sizes like W 98–216 ~ L148–356. This model does not support C5 Env (162x229) DL Env (110x220), No 9 Env (98x225), No 10 Env (105x241) rotation.

Print quality troubleshooting guide

Learn about print quality troubleshooting.

Image quality problems and solutions

Learn about print-quality troubleshooting.

Print quality defects can be caused by printer components, consumables, media, internal software, external software applications, and environmental conditions.

To successfully troubleshoot print quality problems, eliminate as many variables as possible.

First, generate prints using printable pages using laser paper. Use paper from an unopened ream that has been acclimated to room temperature. Make sure that genuine HP toner is installed in the printer.

Figure 3-39 A/S chart (A3)

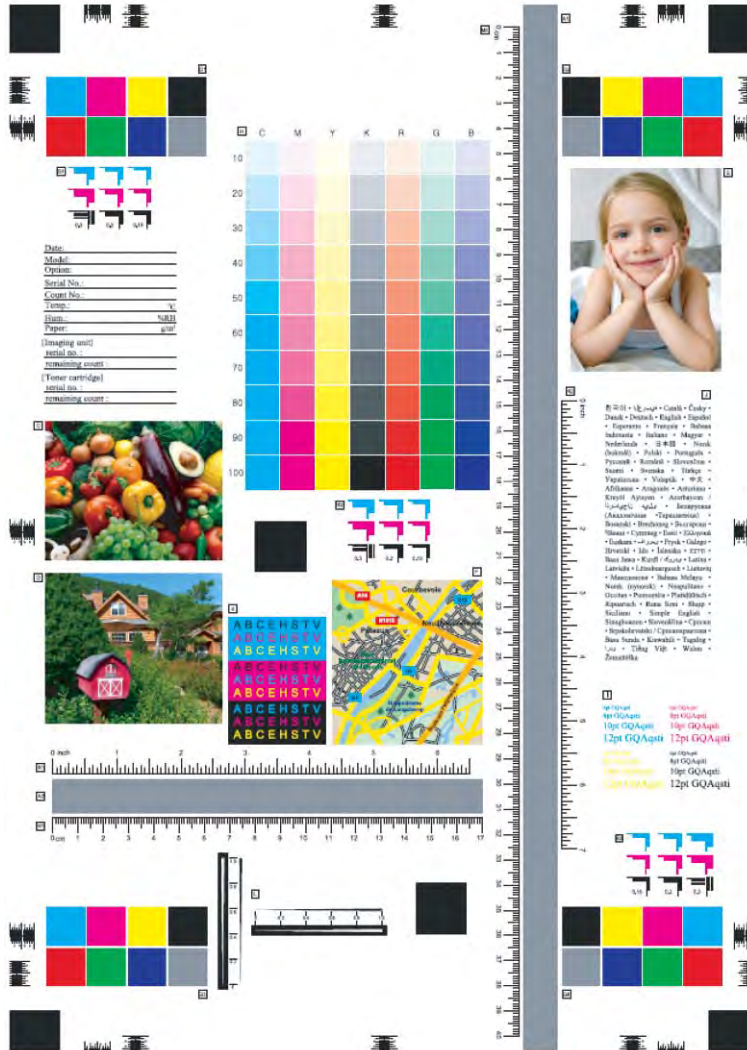

Figure 3-40 A/S chart

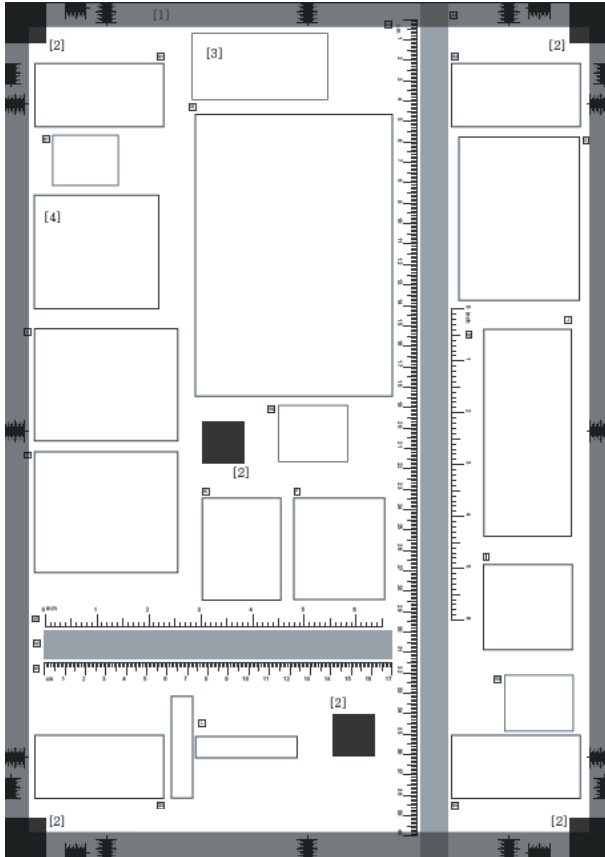

Table 3-41 A/S chart

Item	Description	Use
[1]	Grid pattern	For adjusting margin and magnification
[2]	Black patches	For adjusting skew error
[3]	Barcode	For checking the reproduction of the barcode
[4]	Note area	For recording the date, conditions, and so on.
[A]	Halftone band	For checking banding and jitter (K 50%)
[B, L]	Resolution patterns	For checking resolution
[C, D, E]	Images	For checking color reproduction
[F]	Map image	For checking fine line reproduction
[G]	Color patches	For checking color reproduction and uniformity
[H]	Gradation pattern	For checking tone reproduction of seven colors (C, M, Y, K, R, G, B/10~100%)
[I]	Color/Mono text	For checking the reproduction of color, mono text
[J]	Multilingual feature	For checking the reproduction of small text

Table 3-41 A/S chart (continued)

Item	Description	Use
[K]	White gap pattern	For checking color to color, color to mono white gap
[M]	Rulers	For checking the magnification error (unit: cm)
[N]	Rulers	For checking the magnification error (unit: inch)

How to analyze image defects

See the following flowchart.

 **TIP:** Depending on the remaining life of the part, the cause of the defect can vary. Check the remaining life of the part.

Check for defects even if the defect is not repeated.

Figure 3-41 Defect analysis flowchart

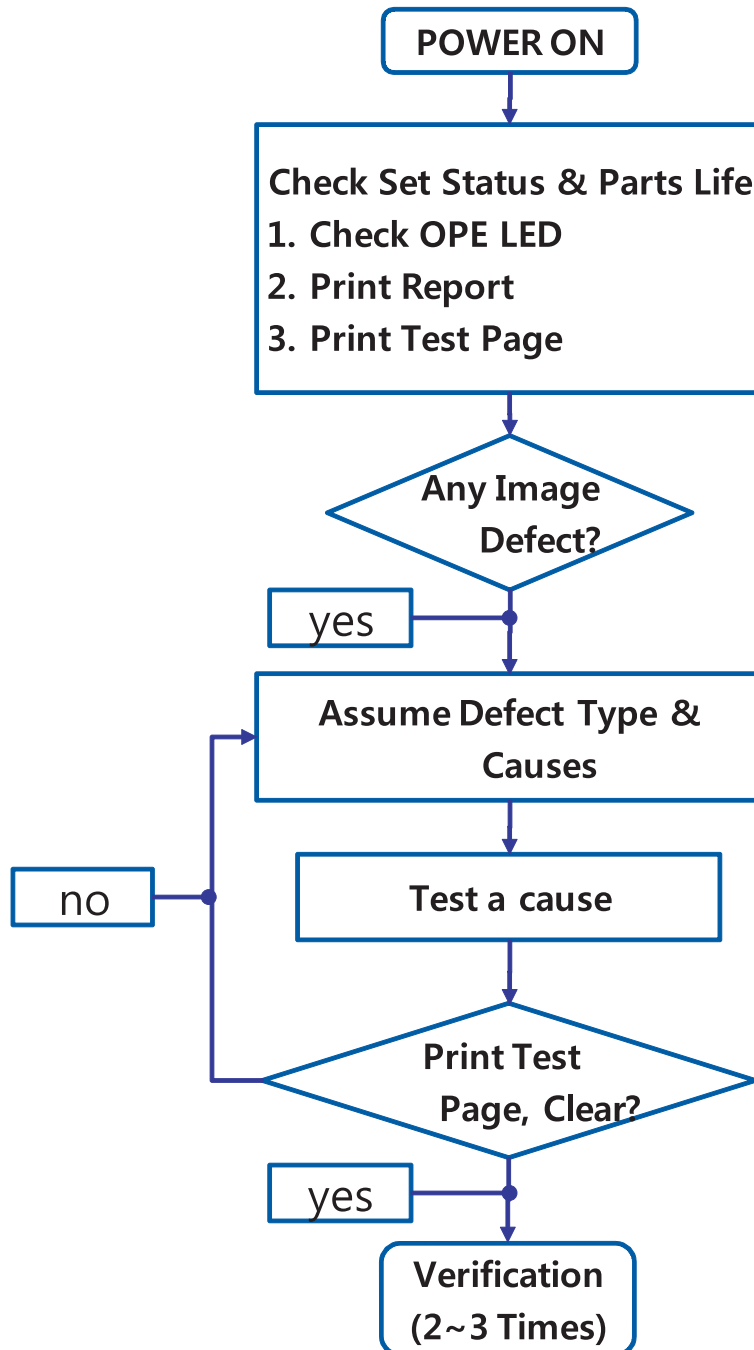

Vertical black lines

Learn about vertical black lines.

Figure 3-42 Typical faulty images



Table 3-42 Troubleshooting procedure





Step	Check item	Action
1	Check the OPC for scratches or contamination in a vertical direction.	Replace the drum unit.
		
2	Check the Charge Scorotron in the Developer unit for contamination.	Clean the Scorotron with the Cleaning bar.
		

Table 3-42 Troubleshooting procedure (continued)

Step	Check item	Action
3	Check the Charge Scorotron for defects.	Replace the Drum unit.
		
4	Scanner unit is contaminated (ADF glass/mirror/CCD sensor)	Wipe the surface of the contaminated parts with a soft cloth.
		

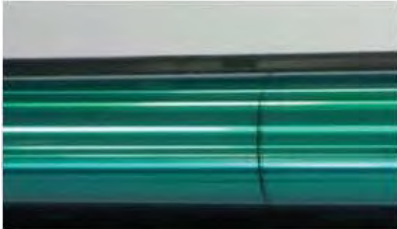
Vertical light or white lines

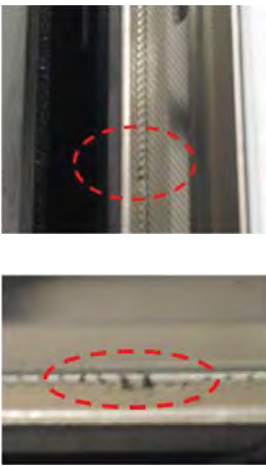
Learn about vertical light or white lines.

Figure 3-43 Typical faulty images

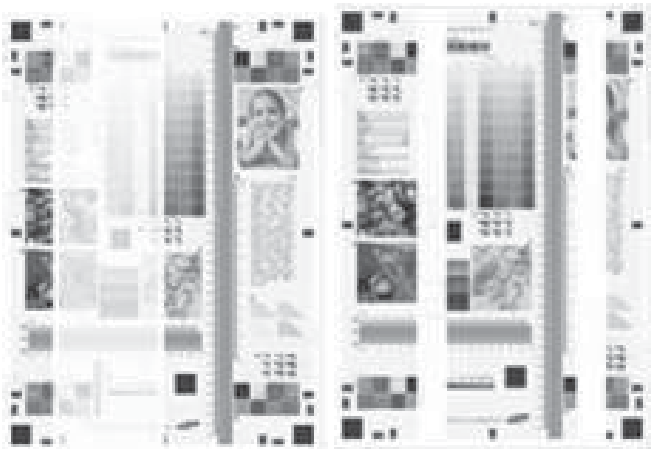
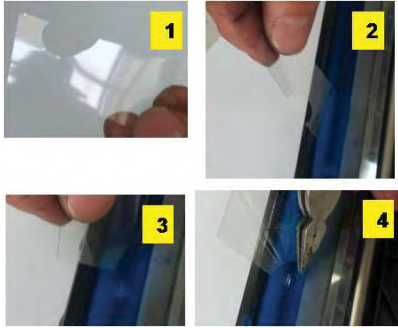

Table 3-43 Troubleshooting procedure

Step	Check item	Action
1	<p>A foreign substance is between the magnetic roller and the blade.</p> <p>No toner on magnetic roller.</p>	<p>Remove the foreign substance.</p>  <p>Make the hook (transparency sheet is recommended.)</p> <p>Put the hook into the gap between magnetic roller and blade.</p> <p>Pull out foreign substances.</p>
2	<p>The developer in the developer unit is empty or the developer unit life has expired.</p>	<ul style="list-style-type: none"> • Check the life remaining of the developer unit on the supply information report. <ul style="list-style-type: none"> – If its life has expired, replace the developer unit. • Check if the developer layer on magnetic roller is uniform. <ul style="list-style-type: none"> – If the developer layer is short, replace the developer unit.



Normal

Table 3-43 Troubleshooting procedure (continued)

Step	Check item	Action
3	The laser beam path is blocked. (Foreign substance is on the laser scanner assembly window.)	Clean the laser scanner assembly window.
4	The OPC is scratched or contaminated in a vertical direction.	Replace the drum unit.

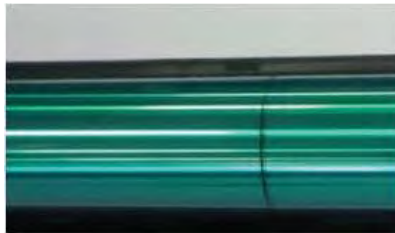

Horizontal periodic black lines, dots

Learn about horizontal periodic black lines and dots.

Figure 3-44 Typical faulty images

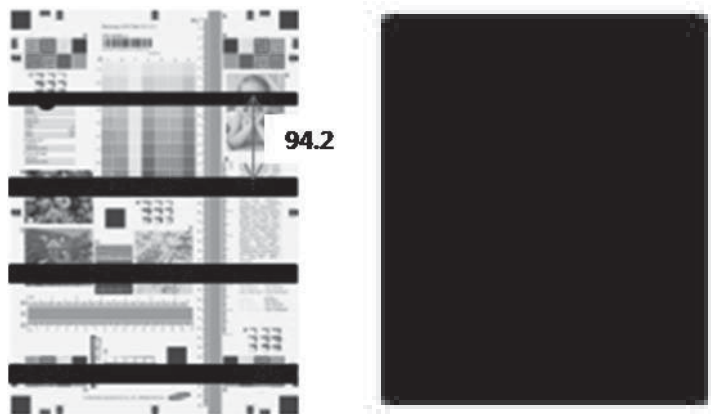

Table 3-44 Troubleshooting procedure

Step	Check item	Action
1	Poor connection between the CR terminal and Set.	Wipe clean the surface of the contaminated CR terminal. Typical faulty images
2	Poor charge voltage of HVPS (MHV).	Check the connection between the MHV terminal and the connector. Replace the HVPS.



Horizontal periodic light/dark lines, dots

Learn about horizontal periodic light/dark lines and dots.

Figure 3-45 Typical faulty images



Table 3-45 Troubleshooting procedure

Step	Check item	Action
1	Horizontal periodic bands (OPC, 94.2 mm) <ul style="list-style-type: none"> • OPC was exposed for too long. • Damage was caused by a high voltage in a short amount of time. 	This problem is likely to resolve itself over time. If the problem persists, replace the drum unit.
2	Poor charge voltage of HVPS (MHV)	Replace developer unit.

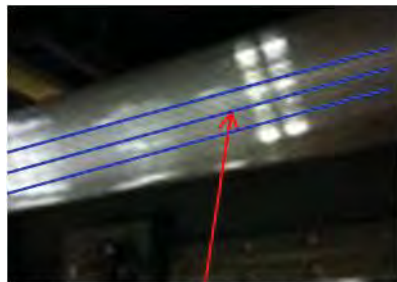

V-groove in Roller-Magnetic

Blurred image

Learn about blurred images.

Figure 3-46 Typical faulty images

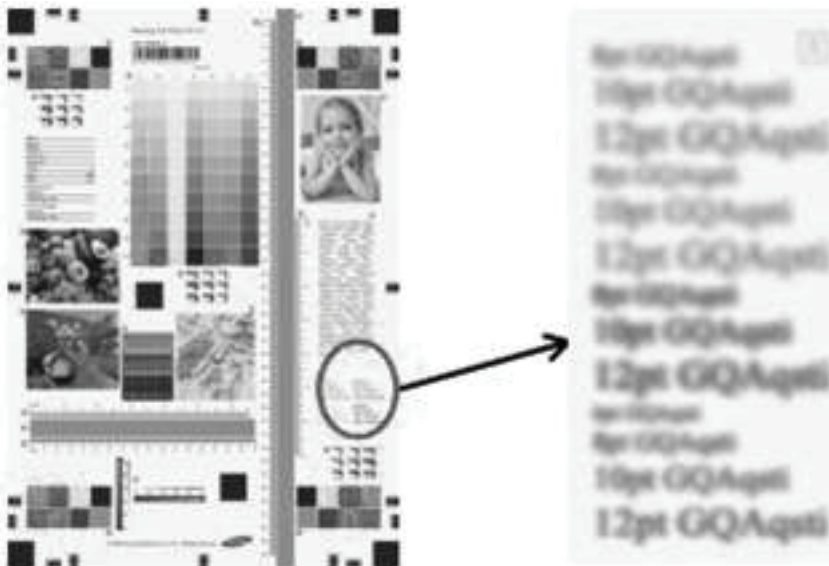

Table 3-46 Troubleshooting procedure

Step	Cause	Action
1	High humidity and/or the quality of the paper.	Use new, high quality paper.

Table 3-46 Troubleshooting procedure (continued)

Step	Cause	Action
2	THV transfer voltage is low.	Increase the THV transfer voltage.
3	Connection between HVPS and THV is incorrect.	Check if the connection between THV high voltage terminal and HVPS THV terminal is correct. Check if the connection between the HVPS and TR is correct.

Foggy image

Learn about foggy images.

Figure 3-47 Typical faulty images

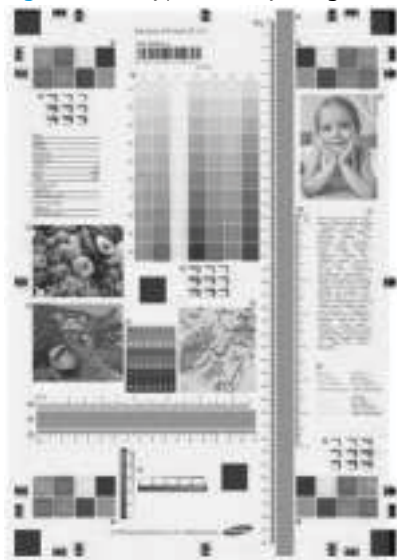

Table 3-47 Troubleshooting procedure

Step	Cause	Action
1	Voltage of OPC motor is abnormally low.	Replace the drum unit.
2	Toner is over supplied by abnormal TC sensor.	Replace the toner cartridge.
3	Transfer assembly voltage is abnormally high.	Check the HVPS connection. <ul style="list-style-type: none"> • Connection of transfer rollers in THV and TR. Replace HVPS.
4	HVPS operates abnormally. HVPS is damaged or broken.	Replace HVPS.

Light image

Learn about light image.

Figure 3-48 Typical faulty images



Table 3-48 Troubleshooting procedure

Step	Cause	Action
1	A poor transfer has occurred.	Replace HVPS.
2	Output voltage of HVPS is abnormally low. <ul style="list-style-type: none"> • Color density decreases. 	Replace HVPS.
3	TC sensor operates abnormally.	Replace the toner cartridge.

Uneven pitch and jitter image

Learn about uneven pitch and jitter image.

Figure 3-49 Typical faulty images



Table 3-49 Troubleshooting procedure

Step	Cause	Action
1	Under 3 mm periodic jitters or horizontal bands have occurred.	Remove foreign substance from the drive gears. Grease the drive gears. <ul style="list-style-type: none"> • Toner cartridge gears

Table 3-49 Troubleshooting procedure (continued)

Step	Cause	Action
		 <ul style="list-style-type: none"> • OPC unit gears.
		 <ul style="list-style-type: none"> • Main drive unit gears.
		<p>Replace abnormal units.</p> <ul style="list-style-type: none"> • Toner cartridge • Drum unit • Main drive unit
2	Under 1 mm periodic jitter or horizontal bands have occurred.	<p>Check if the laser scanner assembly is assembled correctly. If not, replace the screws.</p> <p>Replace the laser scanner assembly.</p>

Skewed image

Learn about skewed images.

Figure 3-50 Typical faulty images

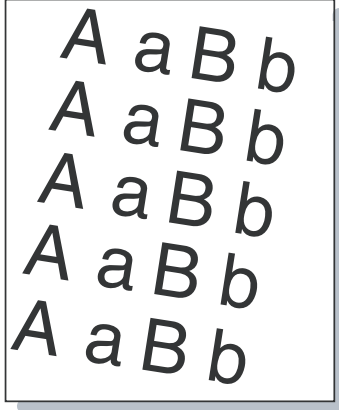

Table 3-50 Troubleshooting procedure

Step	Check item	Action
1	Is the tray properly installed?	Reinstall the tray correctly.
2	Is too much paper loaded in the tray?	Remove some paper.
3	Are the paper guides properly set?	Adjust the paper guides.
4	Is the surface of the pickup/reverse/feed roller dirty?	Clean or replace the contaminated roller.
5	Is the Flow ADF installed and adjusted properly?	Reinstall the Flow ADF unit. Adjust the Flow ADF skew.
6	Is the intermediate transfer belt installed properly?	Reinstall the ITB unit.

Poor fusing performance

Learn about poor fusing performance.

Figure 3-51 Typical faulty images

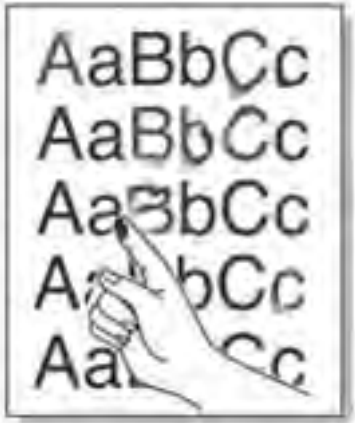
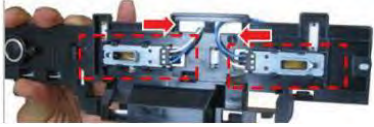

Table 3-51 Troubleshooting procedure

Step	Cause	Action
1	<p>Check the paper type.</p> <p>Depending on what type of paper is used, print speed varies.</p> <ul style="list-style-type: none"> • Plain (71~90g/), Thick (91~105g/): Full Speed • Heavy weight (106~175g/): Half Speed • Envelope (75~90 g/), Label (120~150 g/): Half Speed 	<p>Check that the paper type displayed on the control panel is the same type of paper being used for the print job.</p>
2	The fuser unit is worn out.	Replace the fuser unit.
3	Check the surface of the fuser belt and pressure roller for scratches.	Replace the fuser unit.
4	<p>Check the temperature control system for problems.</p> <ul style="list-style-type: none"> • Thermistor is broken or operates abnormally • Halogen lamp is broken or operates abnormally 	<p>Check the non-contact thermistor sensor</p>  <p>Check the halogen lamp.</p> <p>If parts are broken, replace the broken parts or the fuser unit.</p>
5	Check if the pressure control system operates properly.	<p>Check the pressure control system.</p> <p>If the problem persists, replace the fuser unit.</p>
6	Paper is wrapped on the heating roller.	<p>Remove the wrapped paper and print a test page.</p> <p>If the problem persists, replace the fuser unit.</p>

Stain on the paper back side

Learn about the stain on the paper back side.

Figure 3-52 Typical faulty images

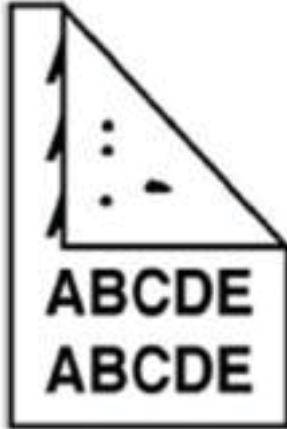

Table 3-52 Troubleshooting procedure

Step	Cause	Action
1	Is the transfer roller dirty or worn out?	Clean or replace the transfer roller assembly.
2	Is the fuser belt or pressure roller dirty?	Clean the fuser belt and pressure roller.
3	Check the pressure roller surface for damage or scratches.	Replace the fuser unit.

Other errors

Learn about other errors troubleshooting.

Image problem

Learn about image problems.

- Toner cartridge detection error
- Paper edge contamination

Toner cartridge detection error

Symptom

- Toner cartridge is installed, but the **Not Installed** message displays.

Cause

- Toner cartridge is not properly installed.
- Toner cartridge CRUM harness is defective.
- CRUM PCA or CRUM Chip is defective.
- CRUM connection (modular connector) is defective.
- CRUM joint PCA is defective.
- Bad connection between the main board and the CRUM Joint PCA.

Troubleshooting

- Toner cartridge installation problem:
 - Check if the toner cartridge is properly installed.
 - If the cartridge comes out automatically, check the cartridge fixing hook.
 - If the cartridge fixing hook is damaged, replace the cartridge cap or cartridge.
- CRUM harness problem:
 - Make sure the CRUM harness is correctly connected.
Check the modular jack for damage or abnormal assembly.
 - If the modular jack harness is defective, replace it with a new one.
If the modular jack has moved into the toner cartridge, remove it.
- CRUM PCA problem or CRUM data problem:
 - Replace the toner cartridge.
- CRUM connection (modular connector) installation problem:

- Open the front cover. Remove the toner cartridge.
- Make sure that the CRUM connection (modular connector) is correctly installed.
- If the modular connector is not installed correctly, open the rear cover and reinstall.
- CRUM joint PCA problem:
 - If the CRUM joint PCA, modular jack pin, or main board interface connector are damaged, replace the PCA (see the previous step).
- Bad connection between the main board and the CRUM joint PCA:
 - Check the connection between the main board and the CRUM joint PCA. If the connection is bad, replace the harness, the CRUM joint PCA, or the main board.

Paper edge contamination

Symptom

- Paper tail edge is contaminated by toner. Contamination positions correspond to paper guide rib positions.

Figure 3-53 Paper edge contamination



Cause

- The paper guide rib can be contaminated by splattered toner from the Development unit after long term use of the printer. The paper tail edge contamination can occur when the paper edge touches the paper guide rib.

Troubleshooting

- This problem can occur after long term use. (150,000 images or more).
- The service technician must clean the contaminated paper guide ribs when replacing the transfer roller unit. Cleaning the contaminated paper guide ribs will prevent paper edge contamination.

Figure 3-54 Paper guide rib contamination



Cleaning Position

Fuser problem

Learn about fuser problems.

- Acoustic noise in fuser unit

Acoustic noise in fuser unit

Symptom

- Acoustic noise from the fuser assembly in the early stages of printing.

Cause

- The fuser gear is damaged.

Troubleshooting

- Replace the fuser unit.

Scanner and ADF problem

Learn about scanner and ADF problems.

- How to resolve CCD lock due to spring-wire
- Noise of ADF hinge/Crack of ADF hinge/ADF will not stay open
- ADF paper jam (multi-feed)
- Scanner locked
- How to adjust image distortion
- Paper jam occurs due to registration ROLLER-IDLE of ADF
- ADF is not recognized. An S3-3211 error occurs or copying must be performed from the scanner glass.
- During copy or scan job, the original paper JAM and U3-3213 error occur.

How to resolve CCD lock because of spring wire

Symptom

- The control panel displays a CCD Lock message when turning on the printer. The FR Carriage cannot move on the rail.

Figure 3-55 CCD lock

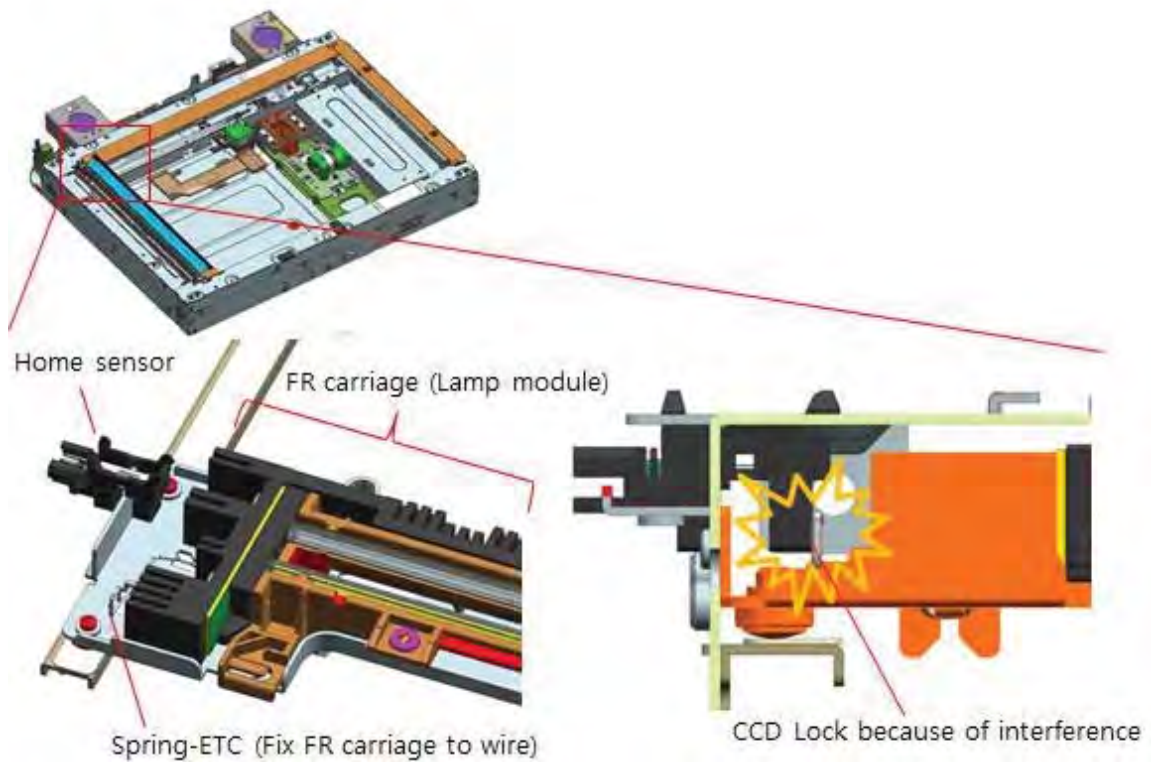

Cause

- The printer is tilted more than 20 degrees.
- When completing a scan with the FR pushed.

Troubleshooting

- Open the top cover to access the scanner glass.
- Bend the spring as shown in the following figure.

Figure 3-56 Bend FR carriage spring

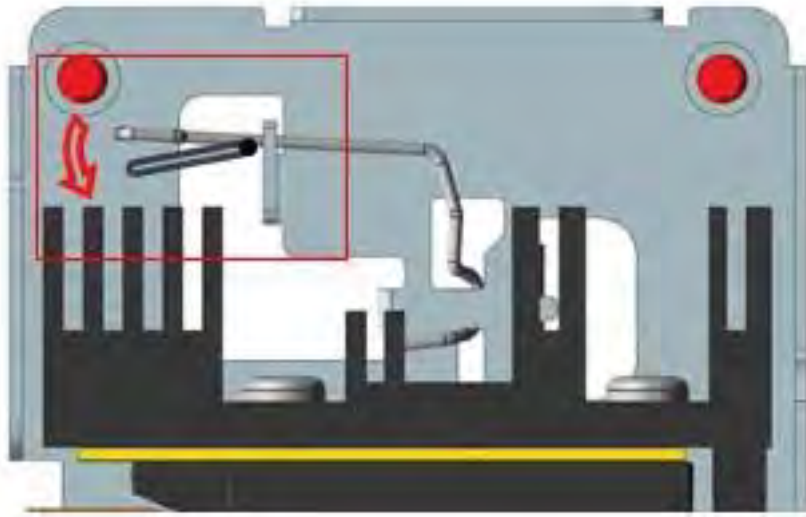

Noise of ADF hinge/Crack of ADF/ADF does not stay open

Symptom

- A noise comes from the ADF hinges when it is opened or closed.
- The ADF hinge is cracked.
- When the ADF is opened to access the scanner glass, the unit should remain at a 50° angle ($\pm 10^\circ$). The ADF does not remain open as expected.

Troubleshooting

1. Remove the ADF connector cover.

Figure 3-57 Remove ADF connector cover



2. Remove the connector and one screw.

Figure 3-58 Remove connector and screw

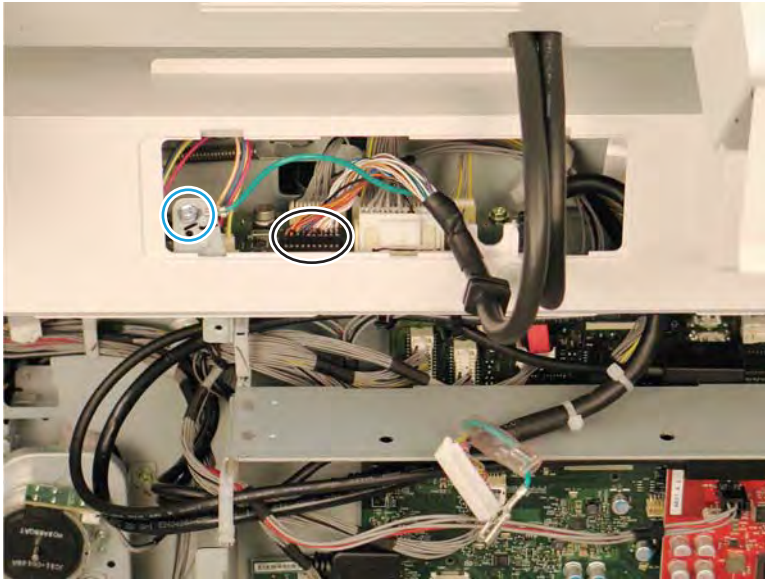

3. Remove two screws. Slide the assembly back, and then lift the ADF to remove it.

Figure 3-59 Remove ADF unit

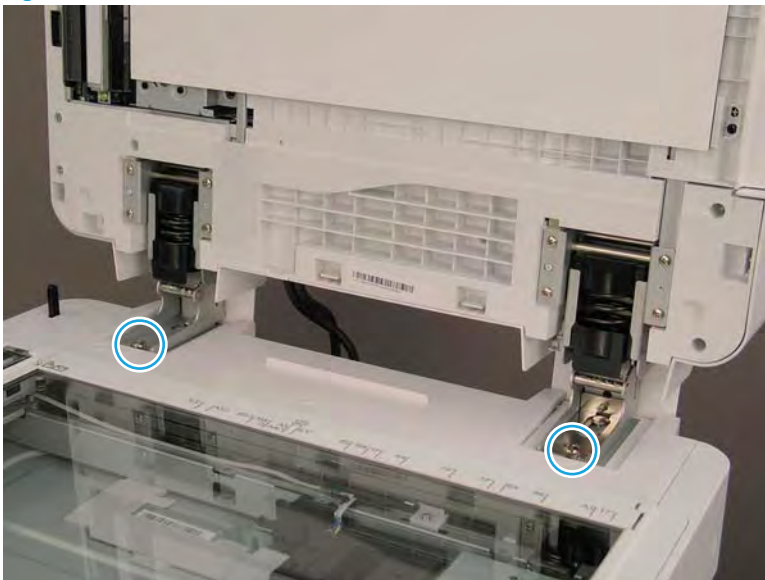

4. Remove four screws from the hinge unit. Remove and replace the hinge unit.
5. Reassemble the ADF.

ADF paper jam (multi-feed)

Symptom

- Paper stops between the ADF roller and the registration roller causing a paper jam.

Troubleshooting

- When a registration out jam occurs during multi-feeding, the guide pickup must be replaced. This also stabilizes the paper path.

 **NOTE:** The friction pad must be replaced at the time that the guide pickup is replaced.

Replacement procedure

1. Open the ADF assembly cover.

Figure 3-60 Open ADF assembly cover

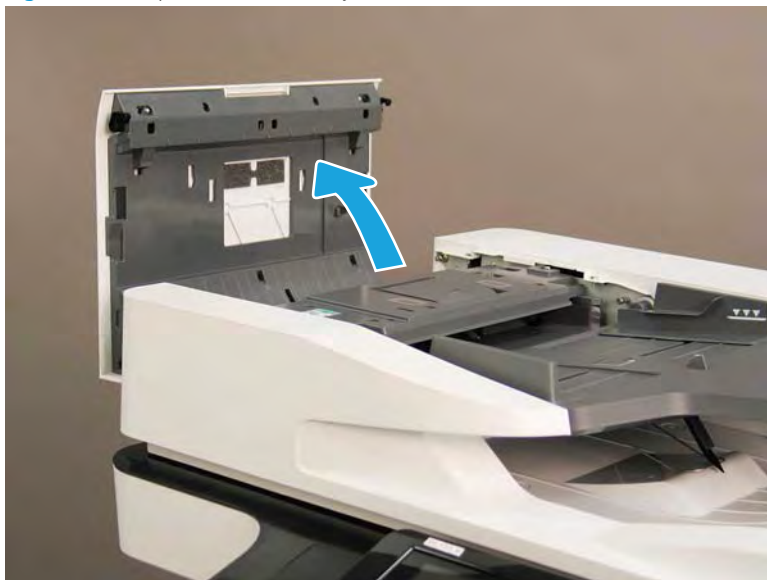

2. Remove the ADF separation pad. Replace with a new separation pad.
3. Update the firmware to the latest version.

Scanner locked/#U1-2115 error

Symptom

- Paper stops between the ADF roller and the registration roller causing a paper jam.

Cause

- All 24V channels output voltage is off (24V output voltage is nearly 0V) and 5V channels output is normal.

Troubleshooting

1. Check all 24V output channels (24VS1, 24VS2, 24VS3, 24VS4) whether or not 24V voltage occurs.

Figure 3-61 Check all 24V output channels

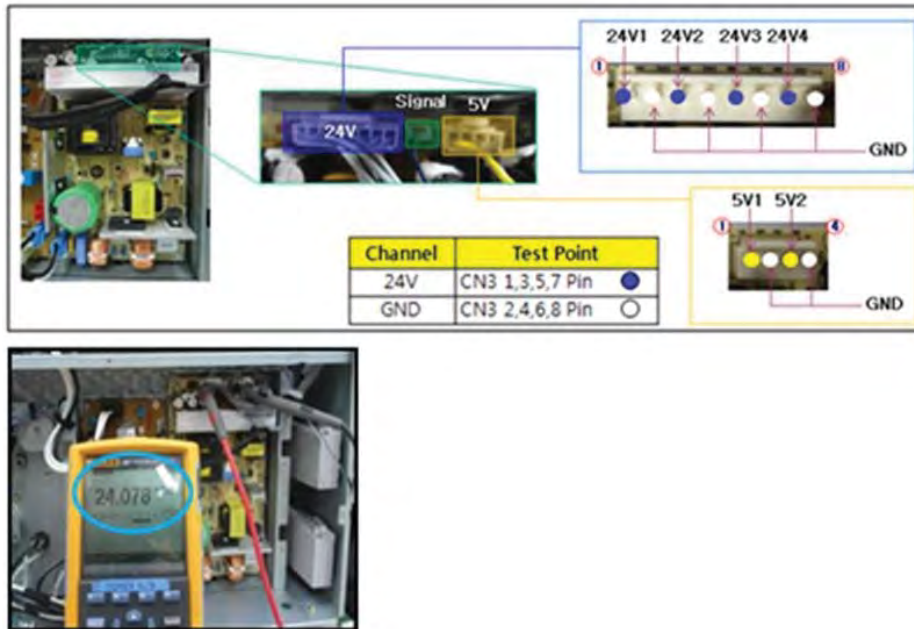

2. If 24V voltage does not occur, check the “24V on/off signal pin” on the main board.

Figure 3-62 Check 24V on/off signal pin



The voltage at “24V on/off signal pin” is 0V: Main board and signal is normal.

The voltage at signal pin 4~5.3V: Main board and signal is abnormal.

3. If the main board and signal is normal, and all 24V output channels are nearly 0V, check out parts (such as the Fuser motor, scanner harness, etc.) driven by 24V voltage before replacing the LVPS.
4. If the main board and signal is normal, and only 1–3 24V output channels are nearly 0V, inspect the harness from the abnormal 24V output channel(s) before replacing the LVPS.
5. If the main board and signal is abnormal and all 24V output channels are nearly 0V, inspect the harness, connector, and main board.

How to adjust image distortion

Symptom

- Image distortion occurs when paper is fed from the ADF.

Troubleshooting

1. Loosen the four screws on the left hinge, and then loosen the four screws on the right hinge. Adjust the ADF.
2. Perform a copy job from the ADF and check if image distortion occurs. Repeat steps 1 and 2 if there is distortion.
3. If the problem is resolved, tighten the screws on the hinges.

Paper jam occurs due to Registration ROLLER-IDLE of ADF

Symptom

- Paper jam occurs due to Registration ROLLER-IDLE of ADF.

When a paper jam occurs during original document scanning, the registration sensor and spring tension need to be checked. Otherwise, the Registration ROLLER-IDLE needs to be checked.

Cause

- A screw was tightened too much during ADF cover assembly. The cover presses the Registration ROLLER-IDLE and it cannot rotate smoothly, causing a paper jam.

Troubleshooting

1. Open the ADF cover.
2. Rotate the Registration ROLLER-IDLE by hand. If the Registration ROLLER-IDLE is too close to a screw, it will not rotate smoothly.
3. If the roller does not rotate smoothly, loosen the screw until the roller does rotate smoothly.
4. If loosening the screw does not resolve the problem, remove the ADF cover and scrape the contact point with a knife or sharp edge until the roller rotates smoothly. Install the ADF and adjust the screw.
 - Remove the ADF cover.
 - Remove the ADF pickup assembly.
 - Use a razor knife to shave the cover area which is in contact with the Registration ROLLER-IDLE.

ADF is not recognized. An S3–3211 error occurs or copying must be performed from the scanner glass

Symptom

- The ADF installation is not recognized.
- S3–3211 error occurs and a copy job must be performed using the scanner glass.

Cause

- The ADF power cable fails.

Troubleshooting

1. Reassemble the ADF power cable. If the problem is not resolved, replace the power cable.
2. Adjust the harness and fix it with a cable tie.
3. If the roller does not rotate smoothly, loosen the screw until the roller does rotate smoothly.

During copy or scan job, the original paper JAM and U3-3213 error occur

Symptom

- During a copy or scan job, the original paper JAM and U3-3213 error occur.

Troubleshooting

- Make sure the “Sponge-Damper Separation” is moved to other position.

Figure 3-63 Check Sponge-Damper Separation position



- If the “Sponge-Damper Separation” is in other position, do the following:
 - Remove three screws.

Figure 3-64 Remove screws



- Remove the linker that has the upper side pressed to the inner direction. Remove the front cover.

Figure 3-65 Remove linker and front cover

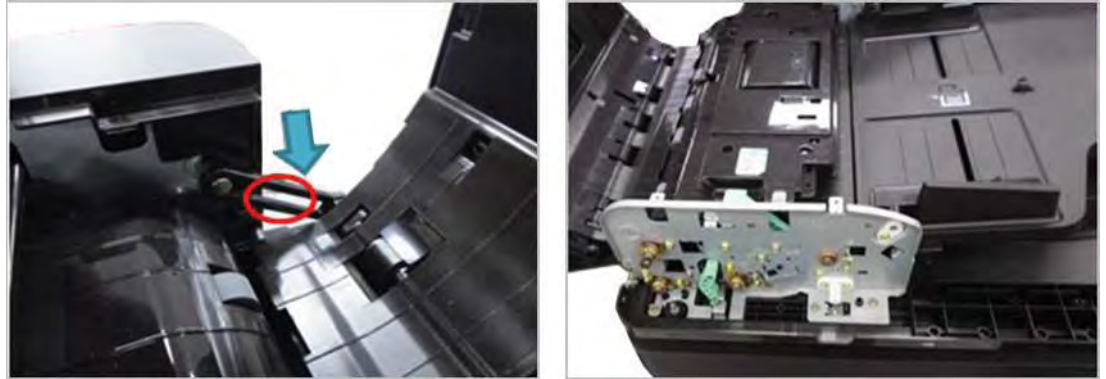

- Remove four screws.

Figure 3-66 Remove four screws



- Remove the Pickup Assembly.

Figure 3-67 Remove pickup assembly

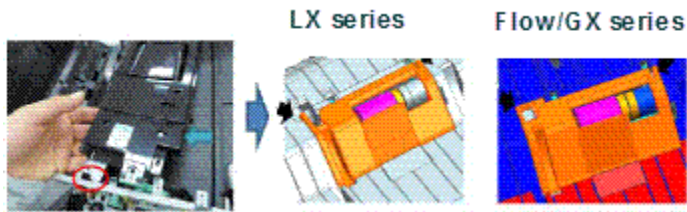

- Replace the flow ADF-HOUSING SEPARATION.

Figure 3-68 Replace housing separation

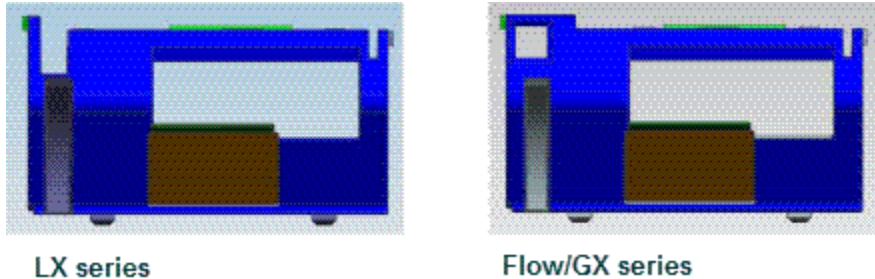

Drive unit problem

Learn about drive unit problems.

- Machine makes noise during print job

Machine makes noise during print job

Symptom

- Machine makes noise during a print job.

Cause

- The gear train needs to be greased.
- An old type gear is assembled.

Troubleshooting

1. Enter service mode.
2. Perform a fuser motor test.
Service Mode > Diagnostics > Engine Diagnostics > Engine Test Routines > Fuser Motor Forward
3. Remove the fuser unit and execute the fuser motor test again.
4. If the printer still makes a noise during a print job, replace the DRIVE-FUSER EXIT assembly.
5. If the problem is not resolved, replace the fuser unit.

Feeding system problem

Learn about feeding system problems.

- How to resolve tray locking
- Tray 1, Tray 2, and Tray 3 cannot pick up paper
- Printer cannot feed paper

How to resolve tray locking

Symptom

- Tray does not open or does not open easily.

Figure 3-69 Tray does not open



Cause

- Tray operation is not smooth because toner powder is attached to the tray locker.

Troubleshooting

1. Wipe away the toner powder that is attached to the tray locker.

Figure 3-70 Remove toner powder



2. Apply a small amount of grease to the tray locker.

HANARL grease

- Product name: HANARL SN-250
- Manufacturer: KANTO KASEI, Inc.
- Appearance: Orange
- Directions: Soak the object in HANARL, or apply HANARL to the object using a brush.
- After the object has dried for 30 minutes, apply HANARL to the assembly.

Tray 1, Tray 2, and Tray 3 cannot pick up paper

Symptom

- Tray 1, Tray 2, and Tray 3 cannot pick up paper.

Cause

- Bad harness connection on the main board.
- Connector defect of the main board.

Troubleshooting

1. Check the harness connection. Reconnect the harness if it is not connected correctly.
2. Check the pickup connector on the main board.

If the connector has a problem with the soldering, replace the main board.

Printer cannot feed paper

Symptom

- The printer cannot feed paper from Tray 2 or Tray 3.

Cause

- Feed motor problem
- Feed motor connection problem
- Main board defect

Troubleshooting

- Check the feed motor operation.
 - Open the right door and push the cover switch forcibly.

Figure 3-71 Open right door and push cover switch



- Enter service mode.
Press the 1, 2, and 3 keys simultaneously and enter the password (1934).
- Select the following menu items:
EDC Mode > Diagnostics > Engine Diagnostics > Engine Test Routine > Feed motor > On/Off
Check the operating status of the two feed rollers.

Figure 3-72 Check feed rollers



- If the feed rollers cannot rotate, open the rear cover and check the motor and gears.
 - Check the connection between the main board (CN27) and the feed motor.
 - If the problem persists, replace the main board.

Laser scanner assembly problem

Learn about laser scanner assembly problems.

- Laser scanner assembly motor makes a loud noise

Acoustic noise in fuser unit

Symptom

- The laser scanner assembly motor makes a loud noise while in printing mode.

Cause

- The laser scanner assembly motor is defective.

Troubleshooting

1. Enter service mode and execute the laser scanner assembly motor test.
2. If the laser scanner assembly motor running sound is loud, replace the laser scanner assembly.

Electrical circuit problem

Learn about electrical circuit problems.

- Right door recognition error
- LVPS output voltage drop error
- HDD makes a loud noise
- Network not functioning
- Control panel malfunction
- Different language displays on control panel when installing printer
- Home screen icon not visible or control panel is broken
- No power problem
- Active NFC does not detect NFC tag

Right door recognition error

Symptom

- The right door is closed but the right door open message displays on the control panel.

Cause

- The right door open sensor spring plate is damaged by the right door stopper.

Figure 3-73 Right door sensor spring plate is damaged



<The stopper of the side cover>



< the spring plate of the side cover sensor >

Troubleshooting

- Replace the right door open sensor assembly, or manually reshape the spring plate.

Figure 3-74 Right door open sensor assembly



< Normal Part >



< Defective Part >

LVPS output voltage drop error

Symptom

- A error message occurs on the OPE (C3-1312, S3-3121, M1-4111, M1-4211).

Cause

- 24V channel output voltage drops to under 21.6V and 5V channel output is normal.

Troubleshooting

1. Check all 24V output channels (24VS1, 24VS2, 24VS3, 24VS4) for 24V voltage.

Figure 3-75 Check all 24V output channels

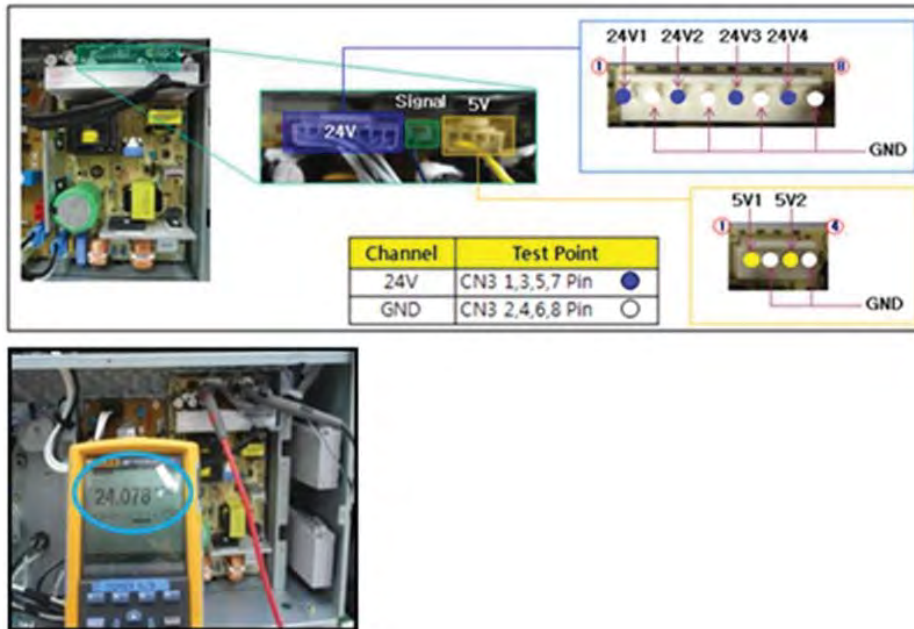

2. If 24V voltage does not occur, check the “24V on/off signal pin” on the main board.
 The voltage at “24V on/off signal pin” is 0V: Main board and signal is normal.
 The voltage at signal pin 4~5.3V: Main board and signal is abnormal.

Figure 3-76 Check 24V on/off signal pin



3. If the main board and signal is normal, and all 24V output channels are nearly 0V, check out parts (such as the Fuser motor, scanner harness, etc.) driven by 24V voltage before replacing the LVPS.
4. If the main board and signal is normal, and only 1–3 24V output channels are nearly 0V, inspect the harness from the abnormal 24V output channel(s) before replacing the LVPS.
5. If the main board and signal is abnormal and all 24V output channels are nearly 0V, inspect the harness, connector, and main board.

Hard Disk Drive (HDD) makes a loud noise

Symptom

- The Hard Disk Drive (HDD) makes a loud noise.

Cause

- The HDD has defects.

Troubleshooting

- Replace the HDD.

Networking not function

Symptom

- Network is not functioning.

Cause

- Network line itself is not working properly.
- Network configuration is wrong.
- Some related electronic components in the main board have defects.

Troubleshooting

1. Connect a network line to the PC and complete a ping test.
2. Complete a ping test after connecting the network line. If the connection is working, check the network configuration which might have been set incorrectly.
3. If the ping test does not have a result, open the rear cover and check the main board for visible defects on the network related components such as the connector (CN16), capacitor (C192), and other close components. Surge voltage from the outside can cause defects.
4. If any of the components have visible defects, then replace the main board.

Adjusting the flow ADF/ADF skew

Learn about adjusting the ADF/ADF skew.

1. Open the ADF. Loosen the two screws securing both hinges.

Figure 3-77 Open ADF and loosen screws

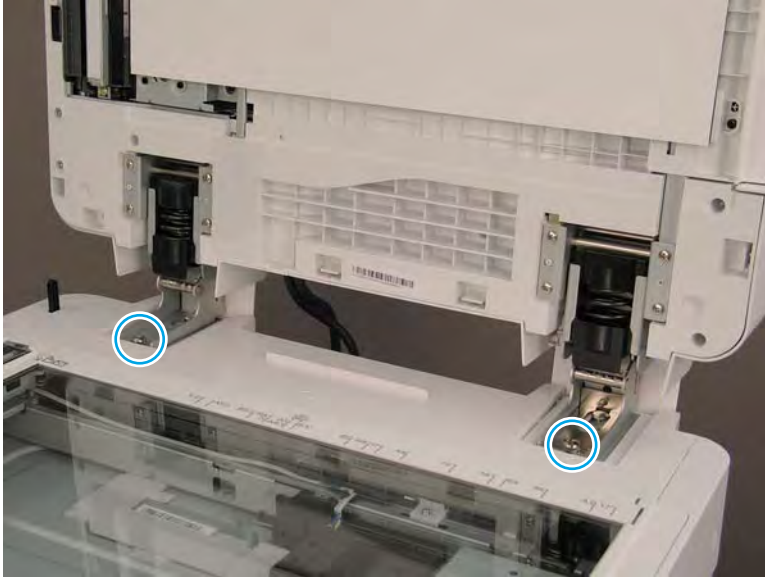

2. Adjust the position of the ADF hinge according to the skew status.

Figure 3-78 Adjust ADF hinge

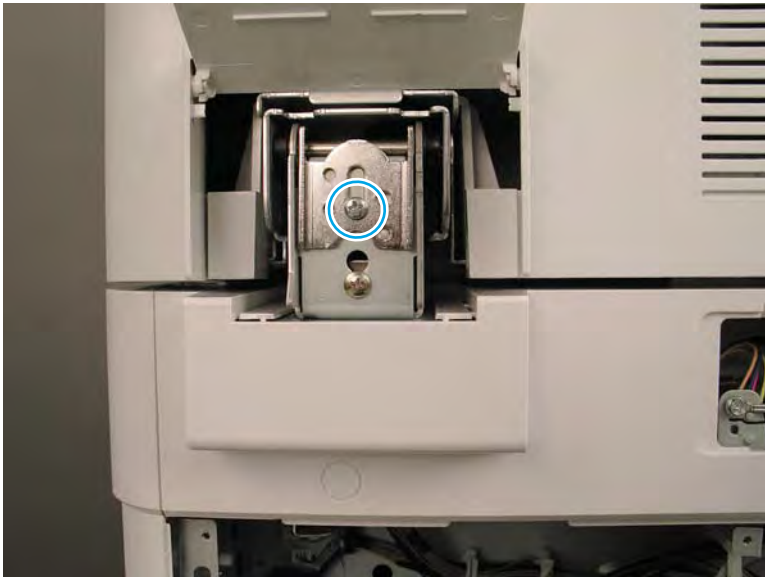

- a. If the skew image is similar to the following example, adjust the hinge unit in the direction of the arrow. (1 scale = >1.0 mm skew adjustment)

Figure 3-79 Adjust hinge



- b. If the skew image is like the following example, adjust the hinge unit in the direction of the arrow. (1 scale = >1.0 mm skew adjustment)

Figure 3-80 Adjust hinge

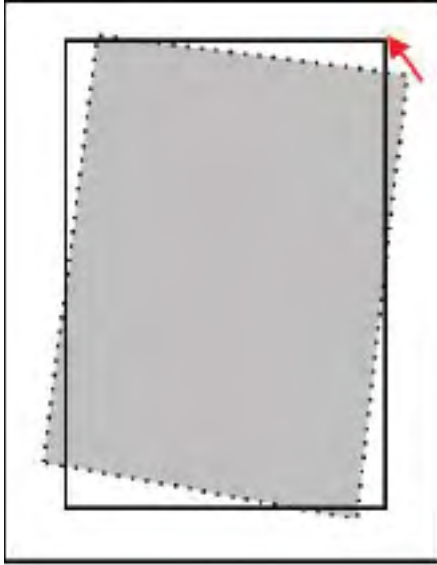

3. Detach the ADF sponge after adjusting the skew. Place the ADF sponge on the scanner glass. Close the ADF unit to attach the sponge.

4 Electrical-mechanical diagrams

Learn about the electrical-mechanical diagrams.

PCAs, Boards, and Laser Scanning Unit (LSU)

Learn about the electrical-mechanical relationships diagram for the PCAs, Boards, and Laser Scanning Unit (LSU).

Figure 4-1 Formatter

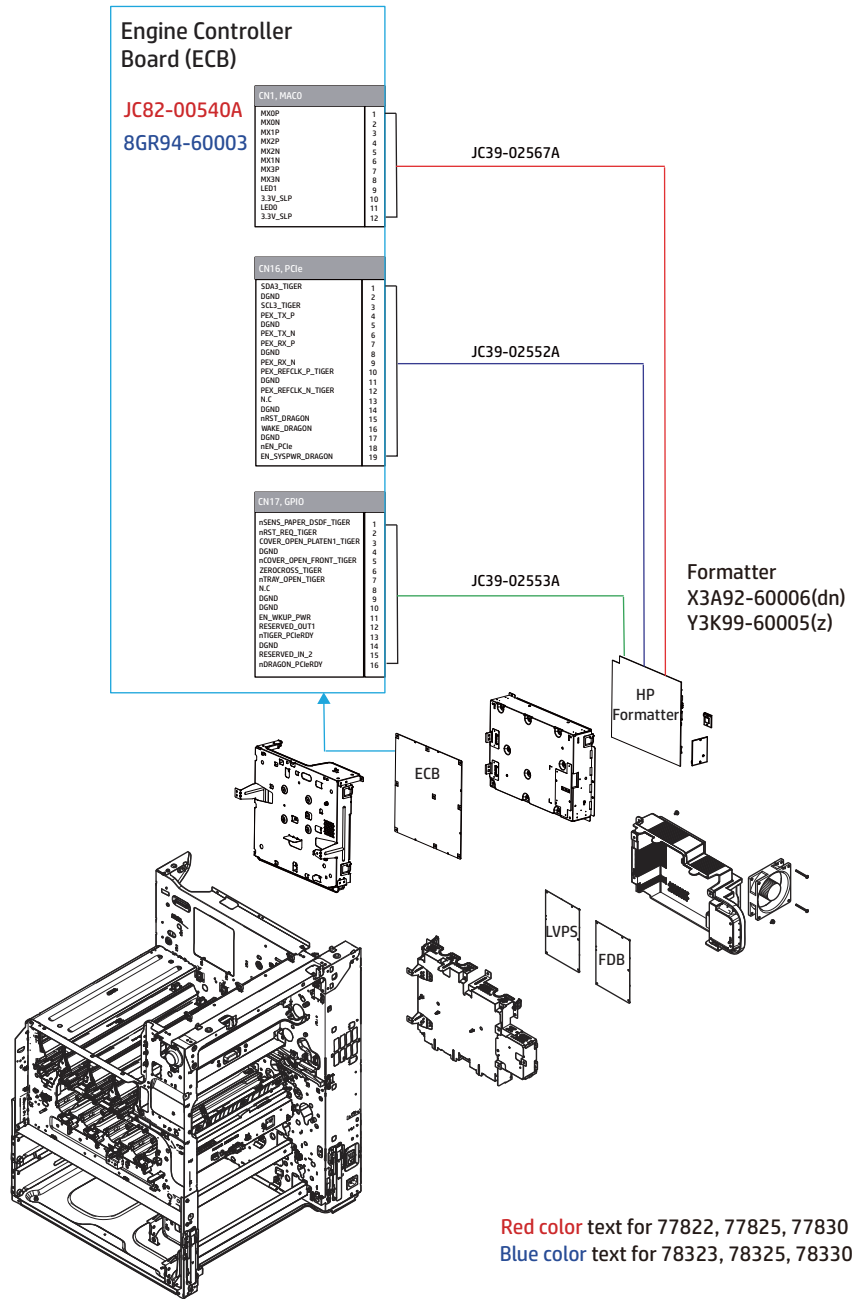

Figure 4-3 High Voltage Power Supply (HVPS) and Laser Scanning Unit (LSU)

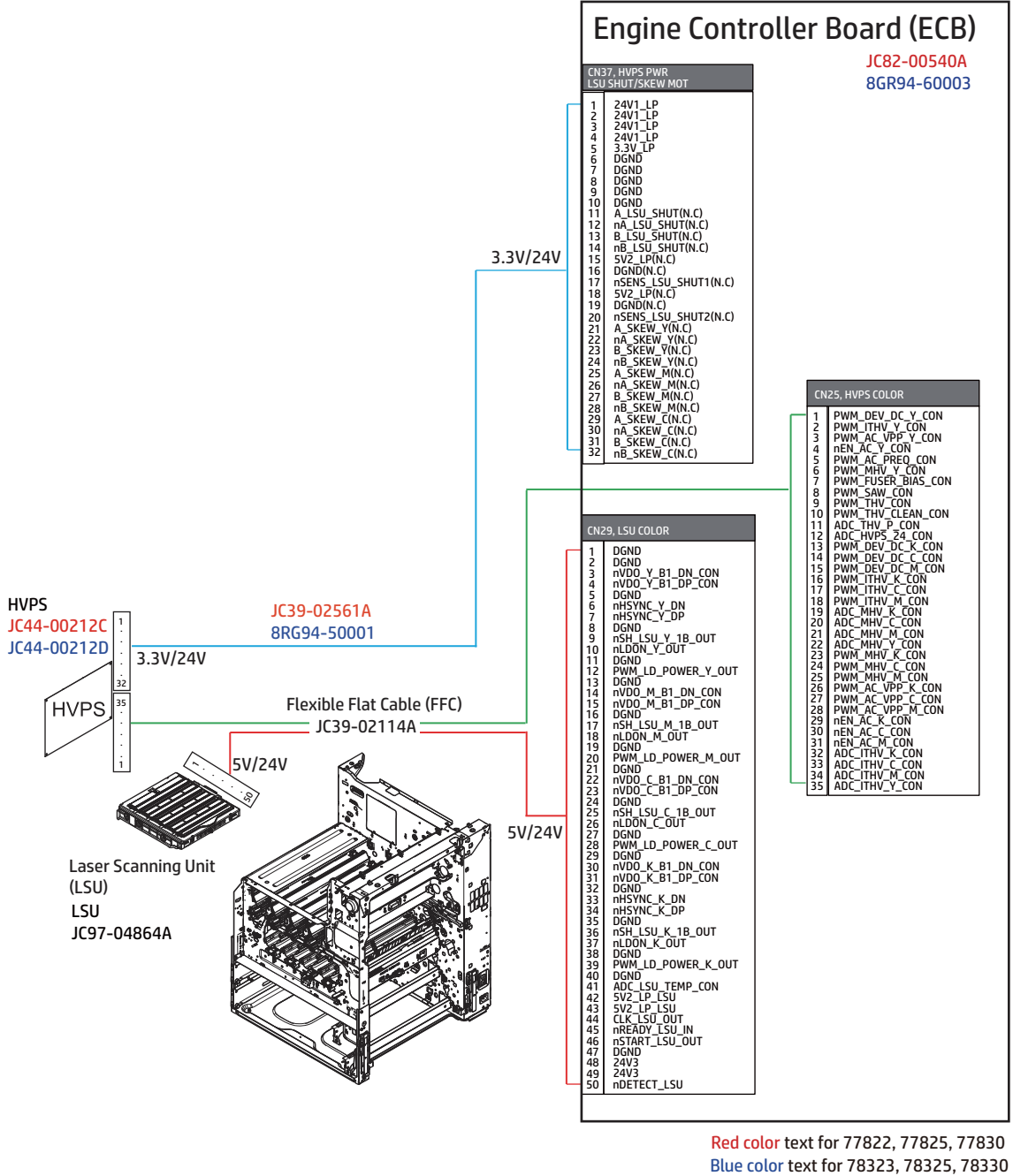
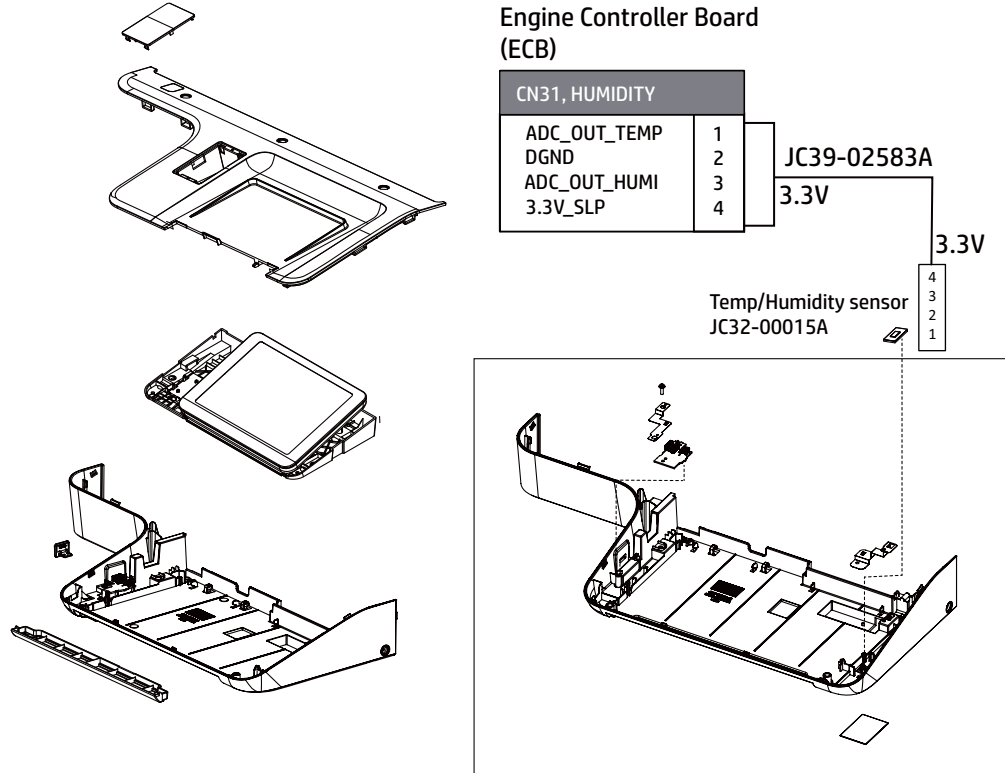

Figure 4-4 Temp/Humidity sensor



Exit section

Learn about the electrical-mechanical relationships diagram for the exit section.

Figure 4-5 Exit section

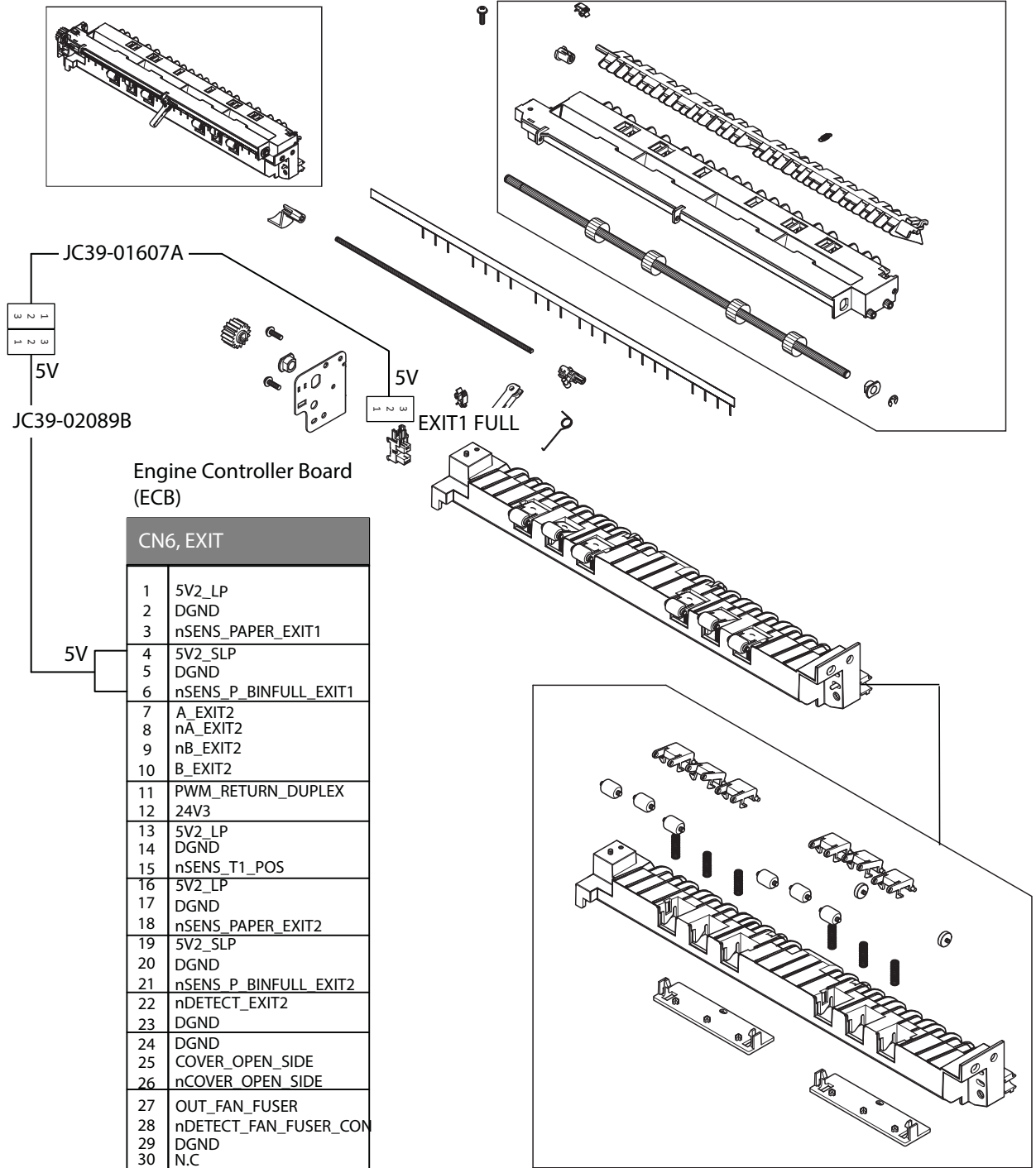

Drive section

Learn about the electrical-mechanical relationships diagram for the drive section.

Figure 4-6 Main drive assembly

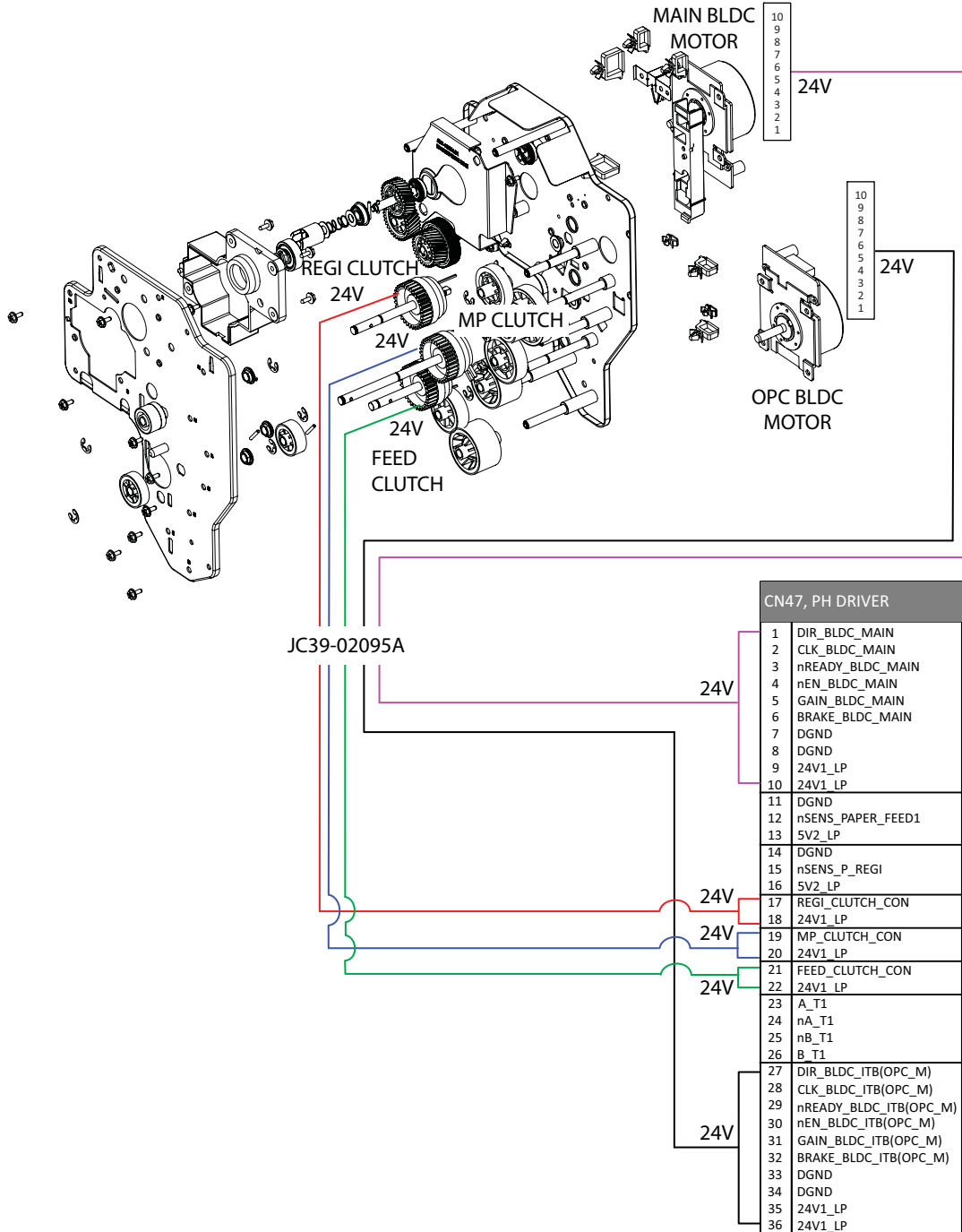
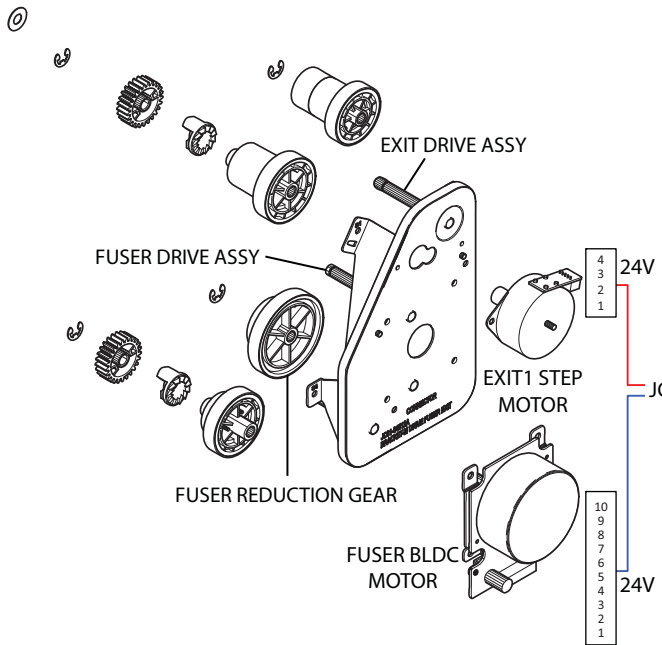
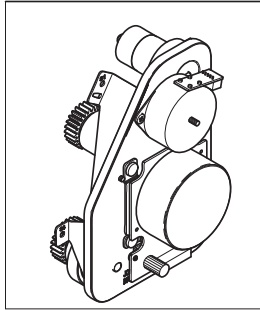

Figure 4-7 Fuser and Exit drive assembly



Engine Controller Board

CN40, FUSER	
1	SV2_LP
2	FUSER_CRUM
3	nSENS_FUSER_POS1
4	DGND
5	SDA2_CRUM_FUSER
6	SCL2_CRUM_FUSER
7	DGND
8	NC_C_TD
9	NC_C_TC
10	THERM_SIDE2
11	THERM_SIDE1
12	DGND
13	NC_S_TD
14	NC_S_TC
15	DIR_BLDC_FUSER
16	CLK_BLDC_FUSER
17	nREADY_BLDC_FUSER
18	nEN_BLDC_FUSER
19	GAIN_BLDC_FUSER
20	BRK_BLDC_FUSER
21	DGND
22	DGND
23	24V3
24	24V3
25	A_EXIT1
26	nA_EXIT1
27	nB_EXIT1
28	B_EXIT1

Figure 4-8 Duct drive assembly

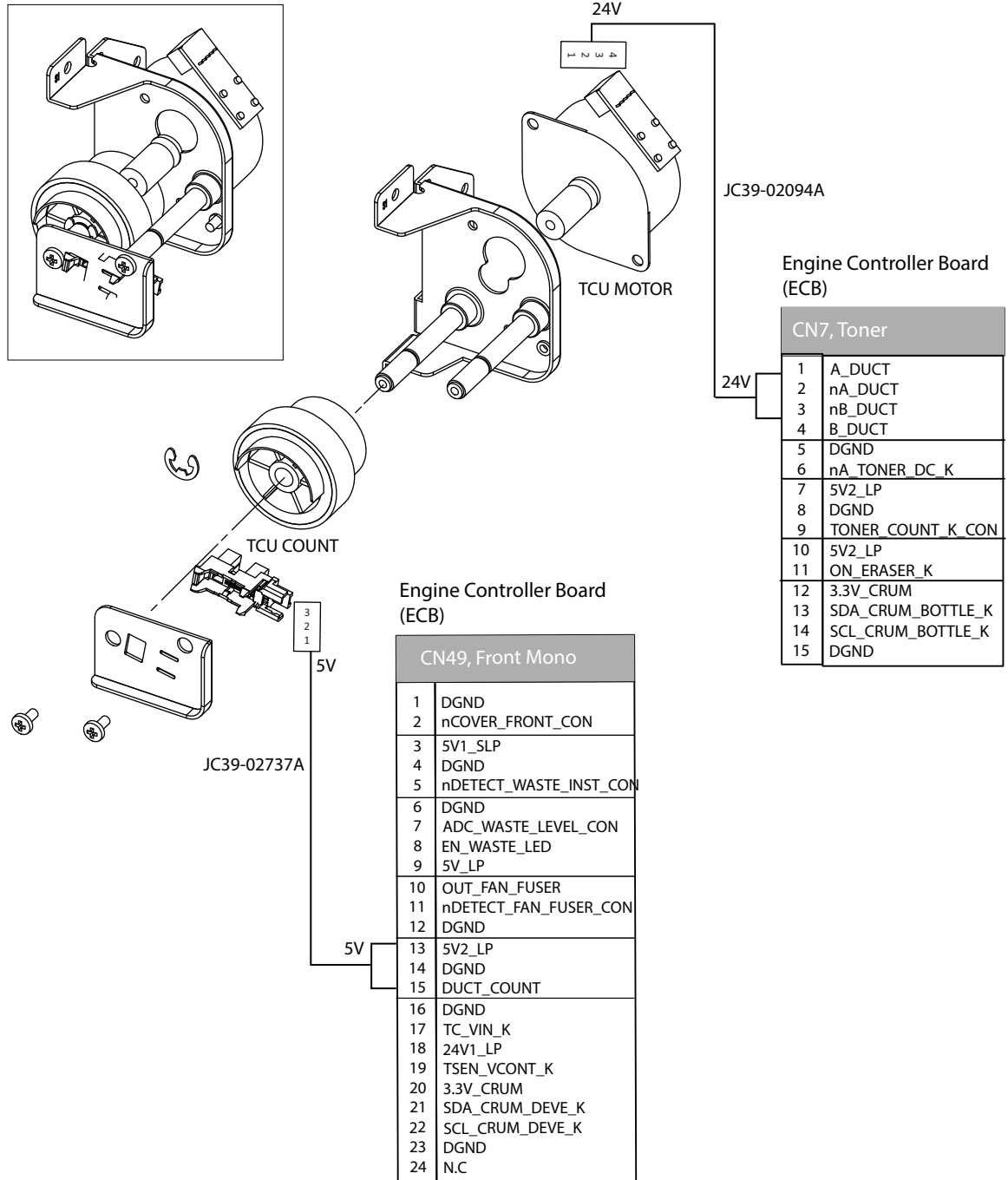

Figure 4-9 Toner supply drive assembly

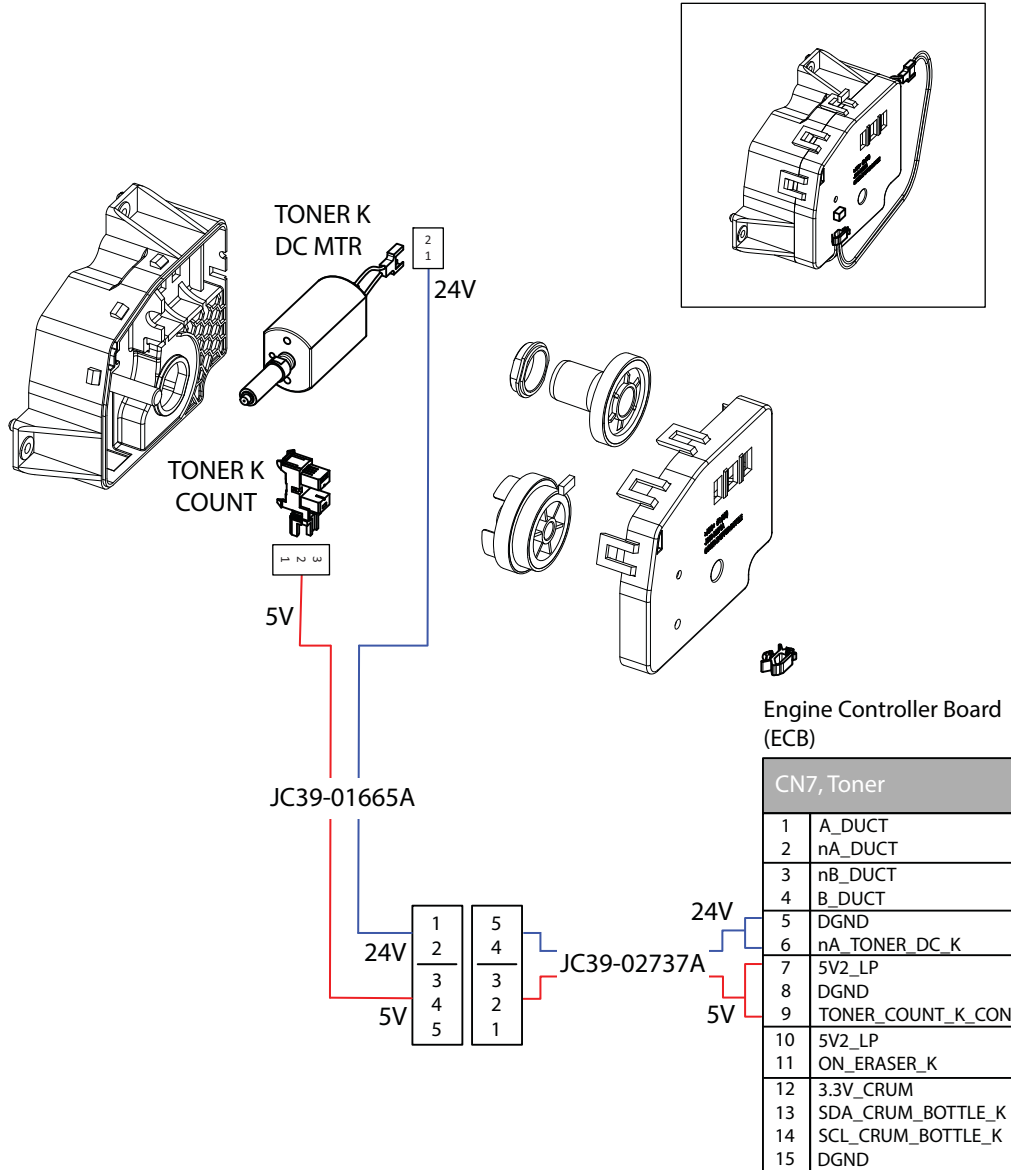
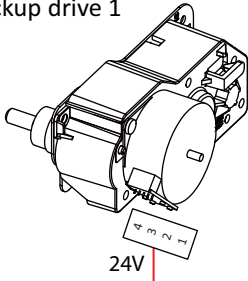
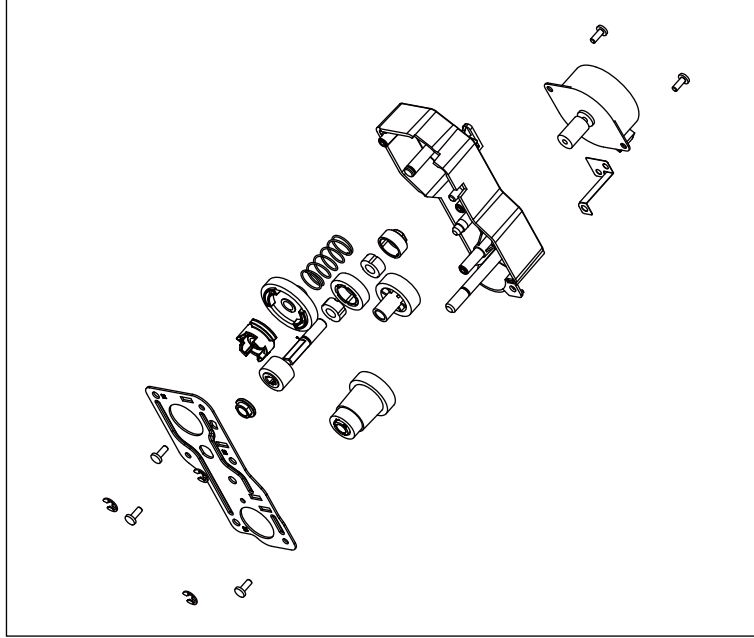
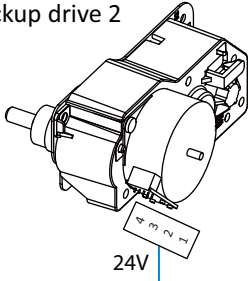

Figure 4-10 Paper pickup drive assembly

Pickup drive 1



Pickup drive 2



Engine Controller Board

CN46, PICKUP	
1	5V2_LP
2	DGND
3	PAPER_EMPTY1
4	5V2_LP
5	DGND
6	nSENS_PAPER_LIFT1
7	A_PICKUP1
8	nA_PICKUP1
9	nB_PICKUP1
10	B_PICKUP1
11	A_FEED
12	nA_FEED
13	nB_FEED
14	B_FEED
15	5V2_LP
16	DGND
17	PAPER_EMPTY2
18	5V2_LP
19	DGND
20	nSENS_PAPER_LIFT2
21	DGND
22	nSENS_PAPER_FEED2
23	5V2_LP
24	A_PICKUP2
25	nA_PICKUP2
26	nB_PICKUP2
27	B_PICKUP2
28	N.C

JC39-02093A

24V

24V

Paper handling section

Learn about the electrical-mechanical relationships diagram for the paper handling section.

Figure 4-11 First & Second pickup assembly

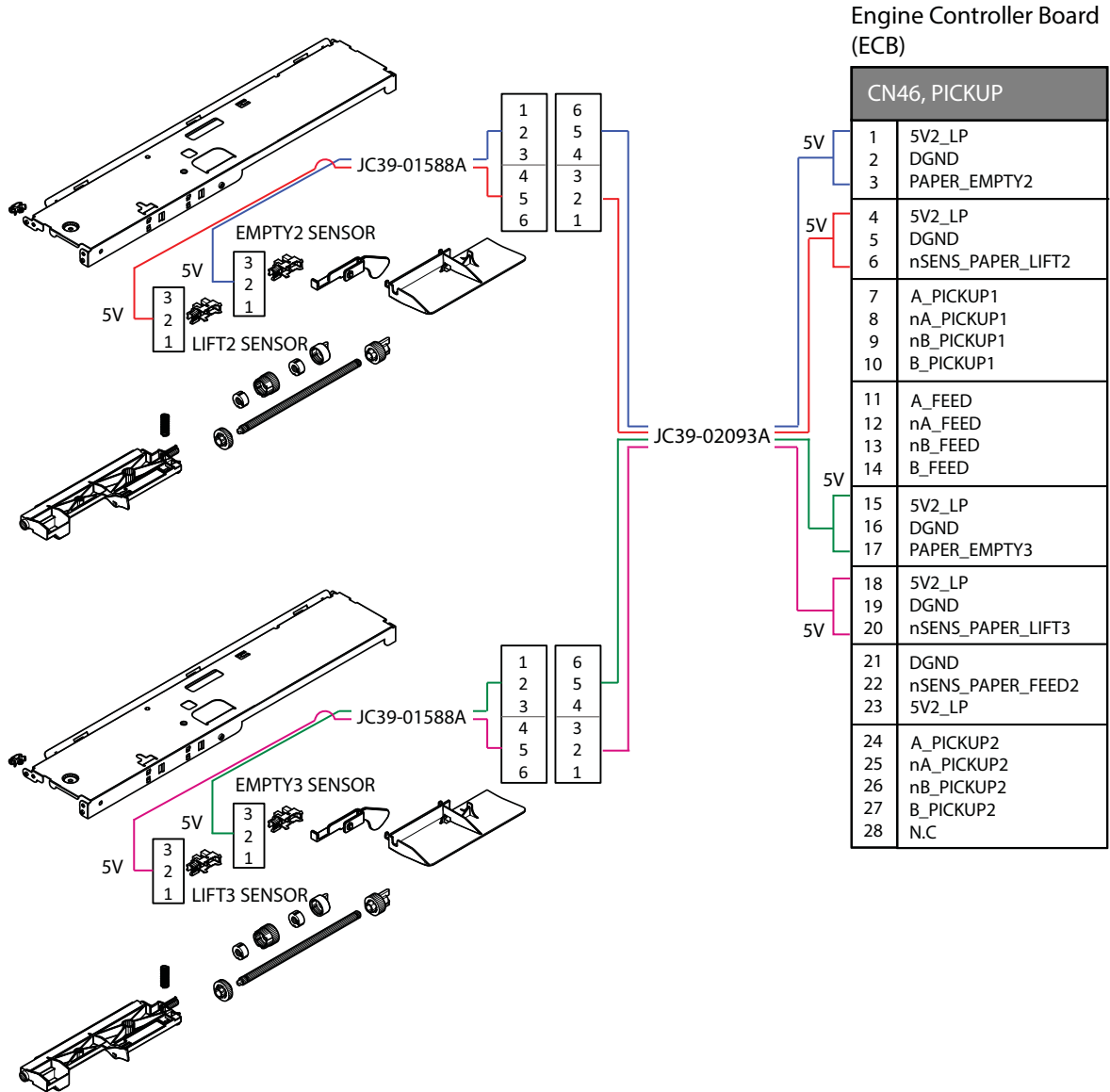

Engine Controller Board (ECB)

CN46, PICKUP	
1	5V2_LP
2	DGND
3	PAPER_EMPTY2
4	5V2_LP
5	DGND
6	nSENS_PAPER_LIFT2
7	A_PICKUP1
8	nA_PICKUP1
9	nB_PICKUP1
10	B_PICKUP1
11	A_FEED
12	nA_FEED
13	nB_FEED
14	B_FEED
15	5V2_LP
16	DGND
17	PAPER_EMPTY3
18	5V2_LP
19	DGND
20	nSENS_PAPER_LIFT3
21	DGND
22	nSENS_PAPER_FEED2
23	5V2_LP
24	A_PICKUP2
25	nA_PICKUP2
26	nB_PICKUP2
27	B_PICKUP2
28	N.C

Figure 4-12 Registration assembly

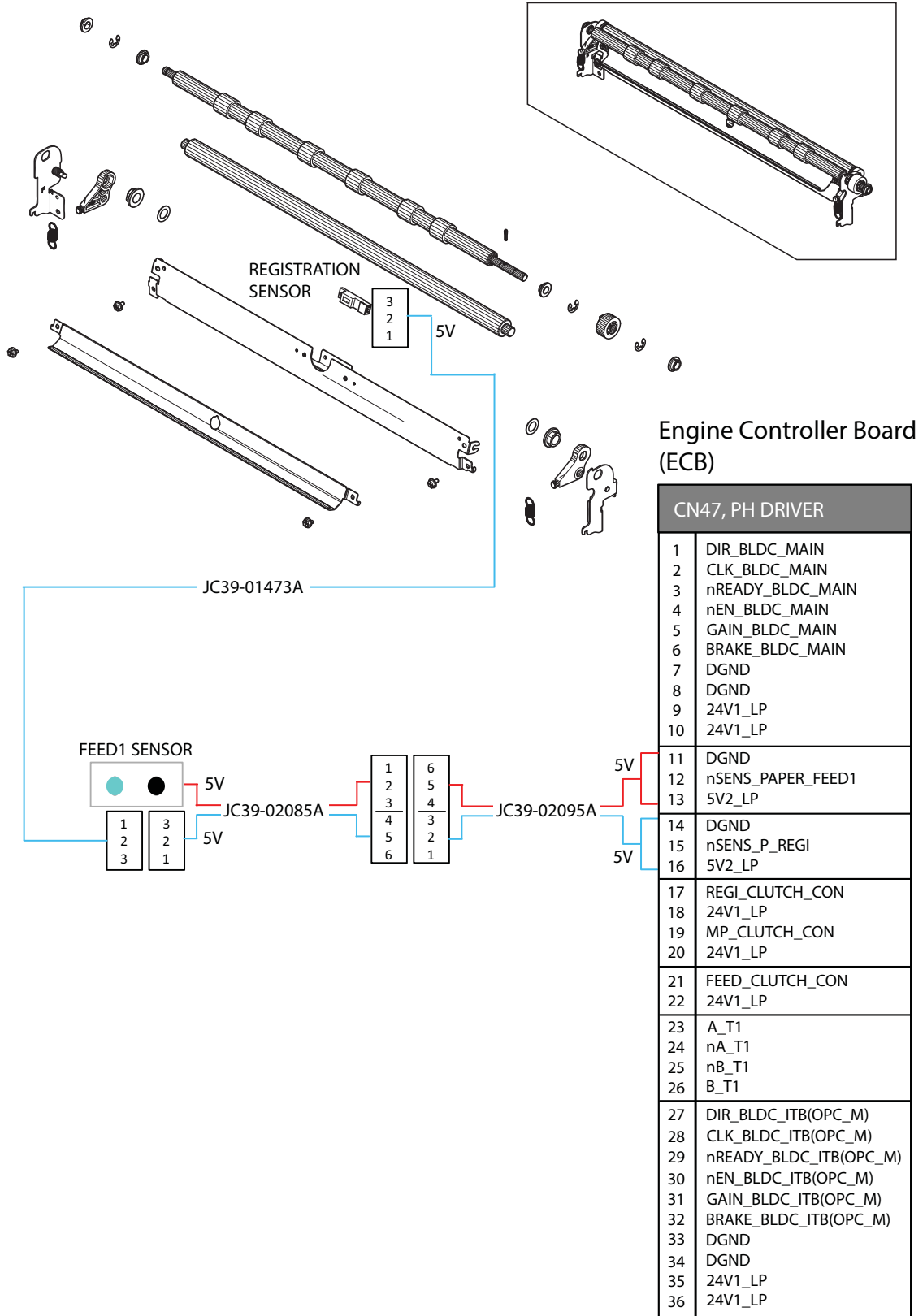

Frame section

Learn about the electrical-mechanical relationships diagram for the frame section.

Figure 4-13 Front frame

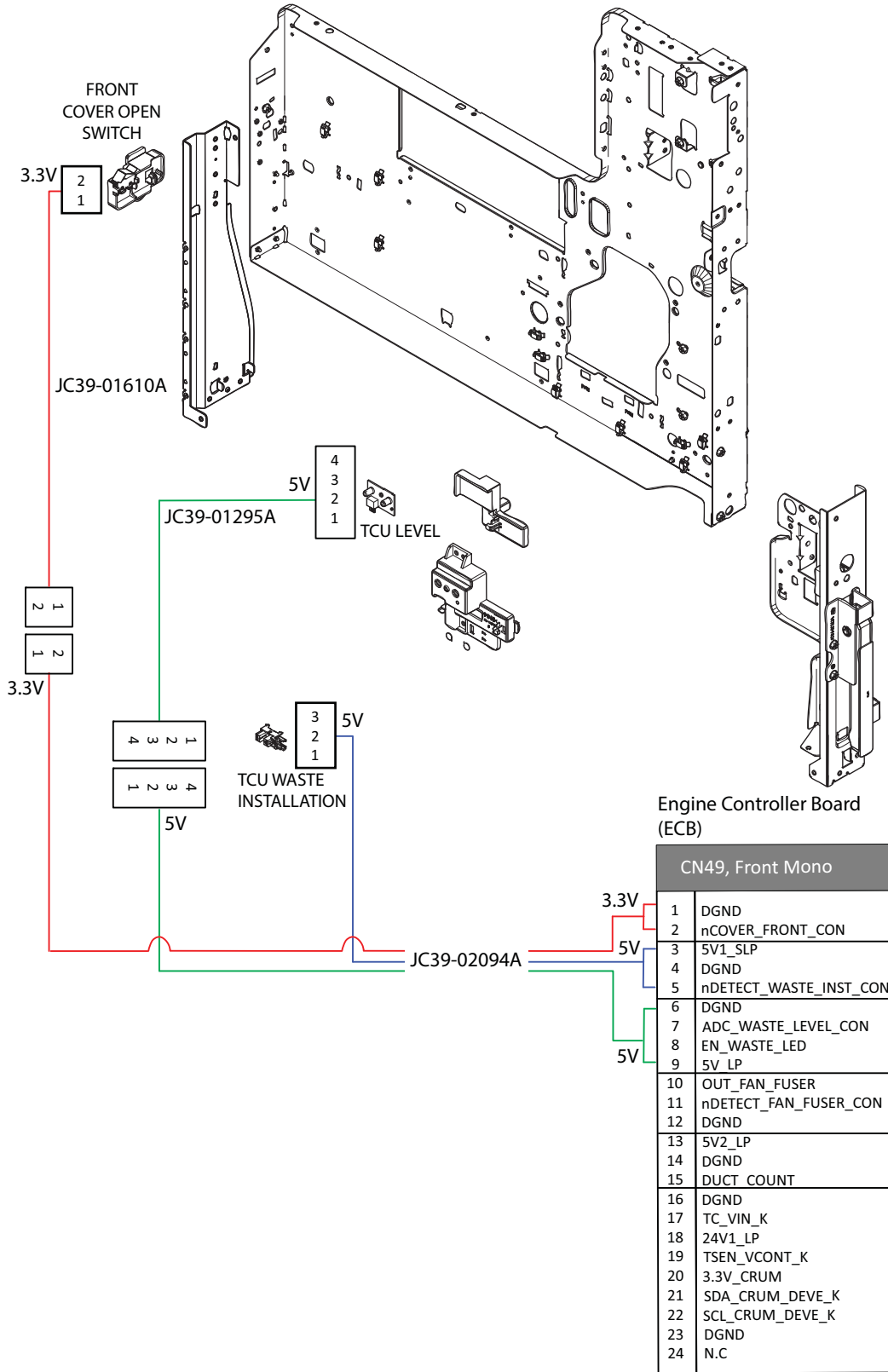

Figure 4-14 Rear frame

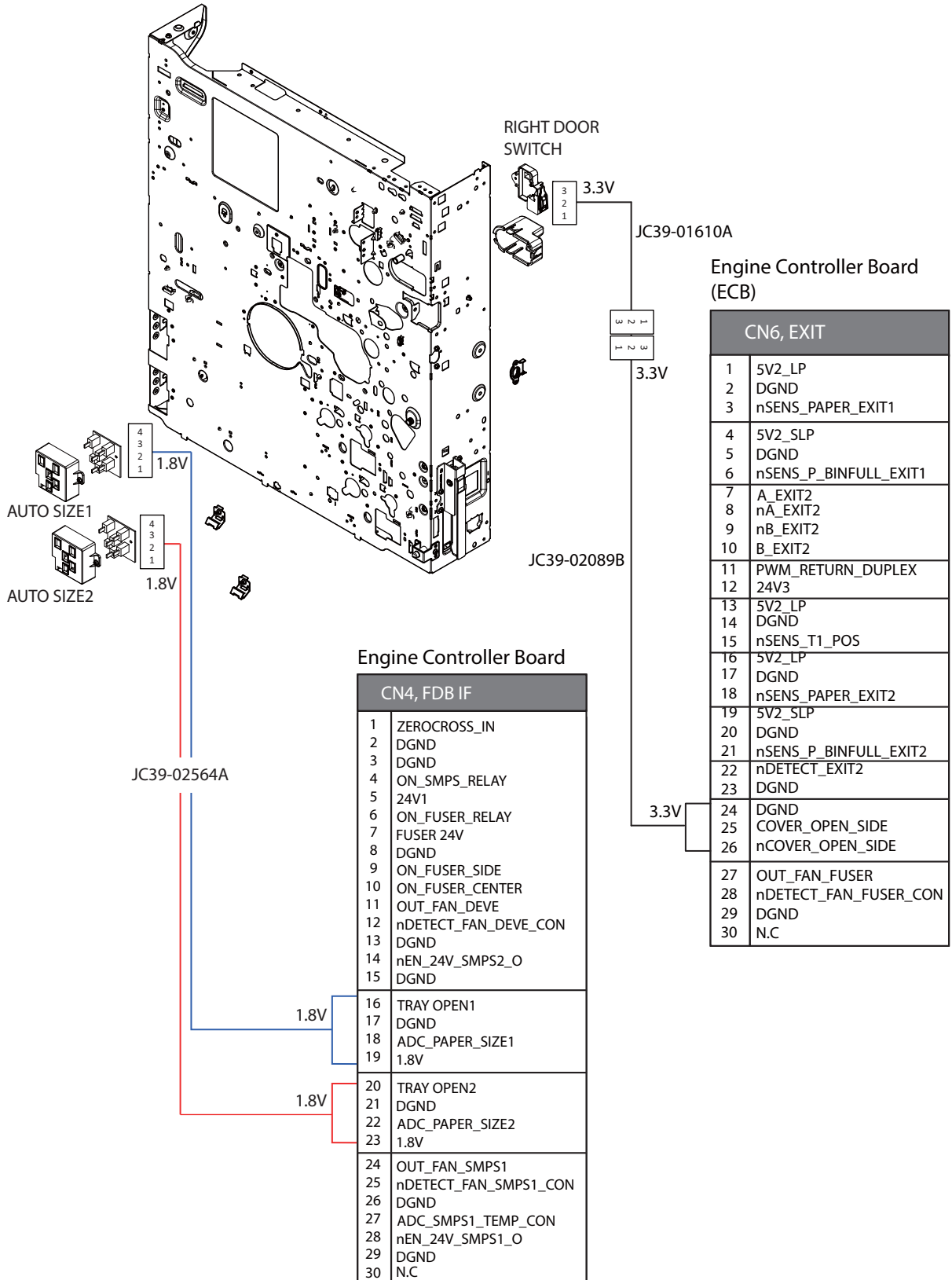
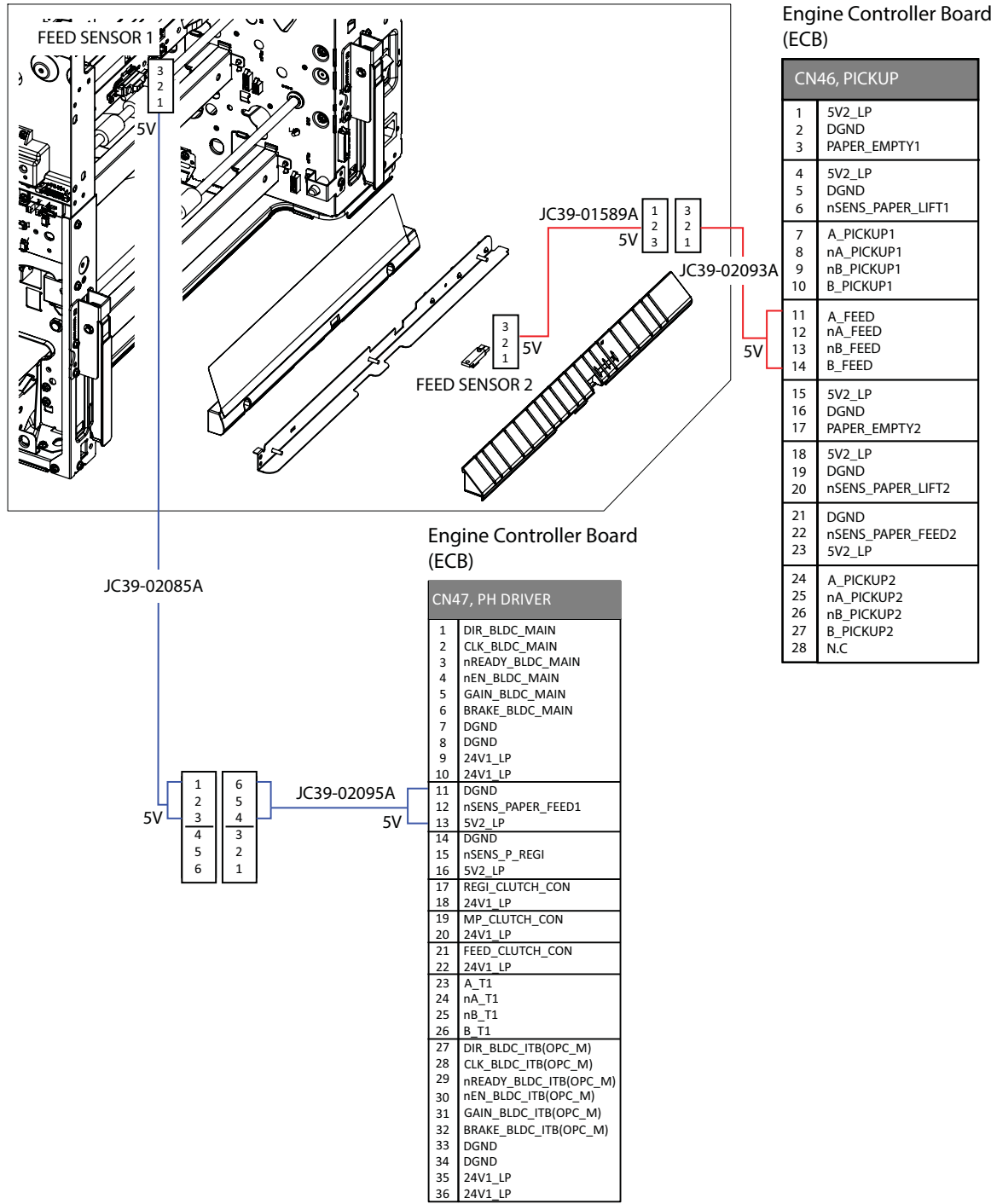

Figure 4-15 Feed sensor
< MAIN FRAME >



Fuser section

Learn about the electrical-mechanical relationships diagram for the fuser section.

Figure 4-16 Fuser frame lower part

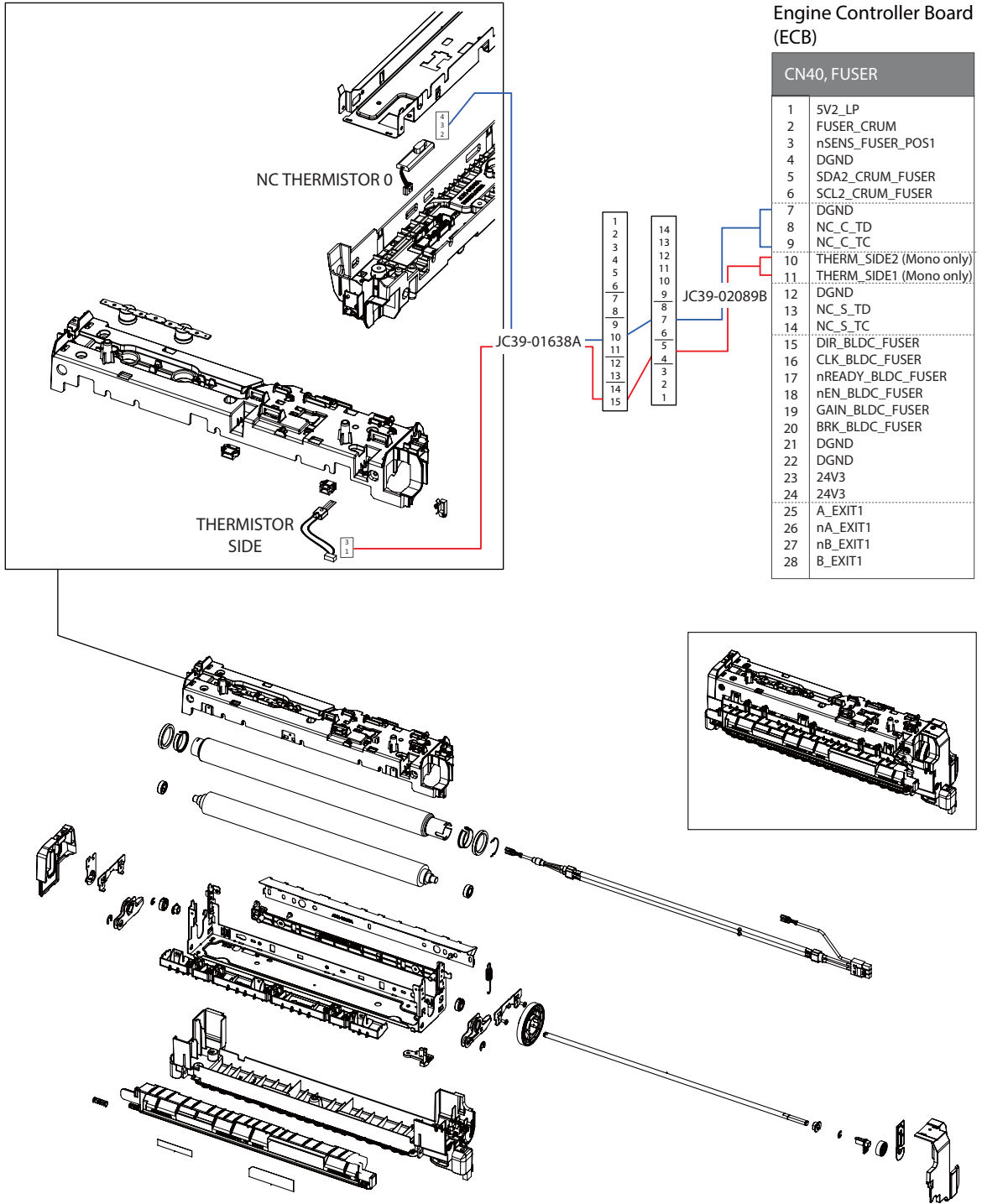
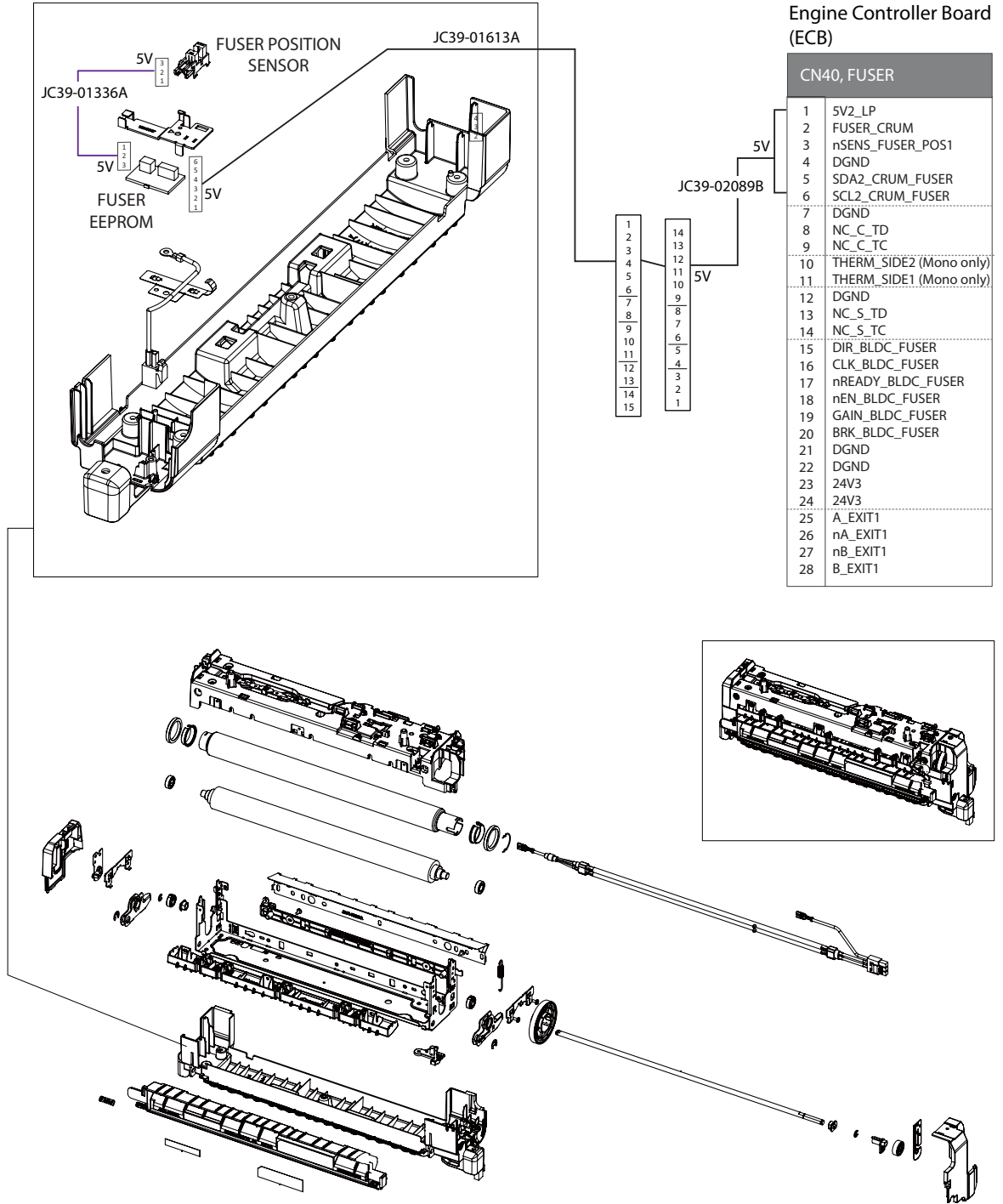

Figure 4-17 Fuser frame upper part



MP right door section

Learn about the electrical-mechanical relationships diagram for the MP right door section.

Figure 4-18 Right door assembly
Engine Controller Board
(ECB)

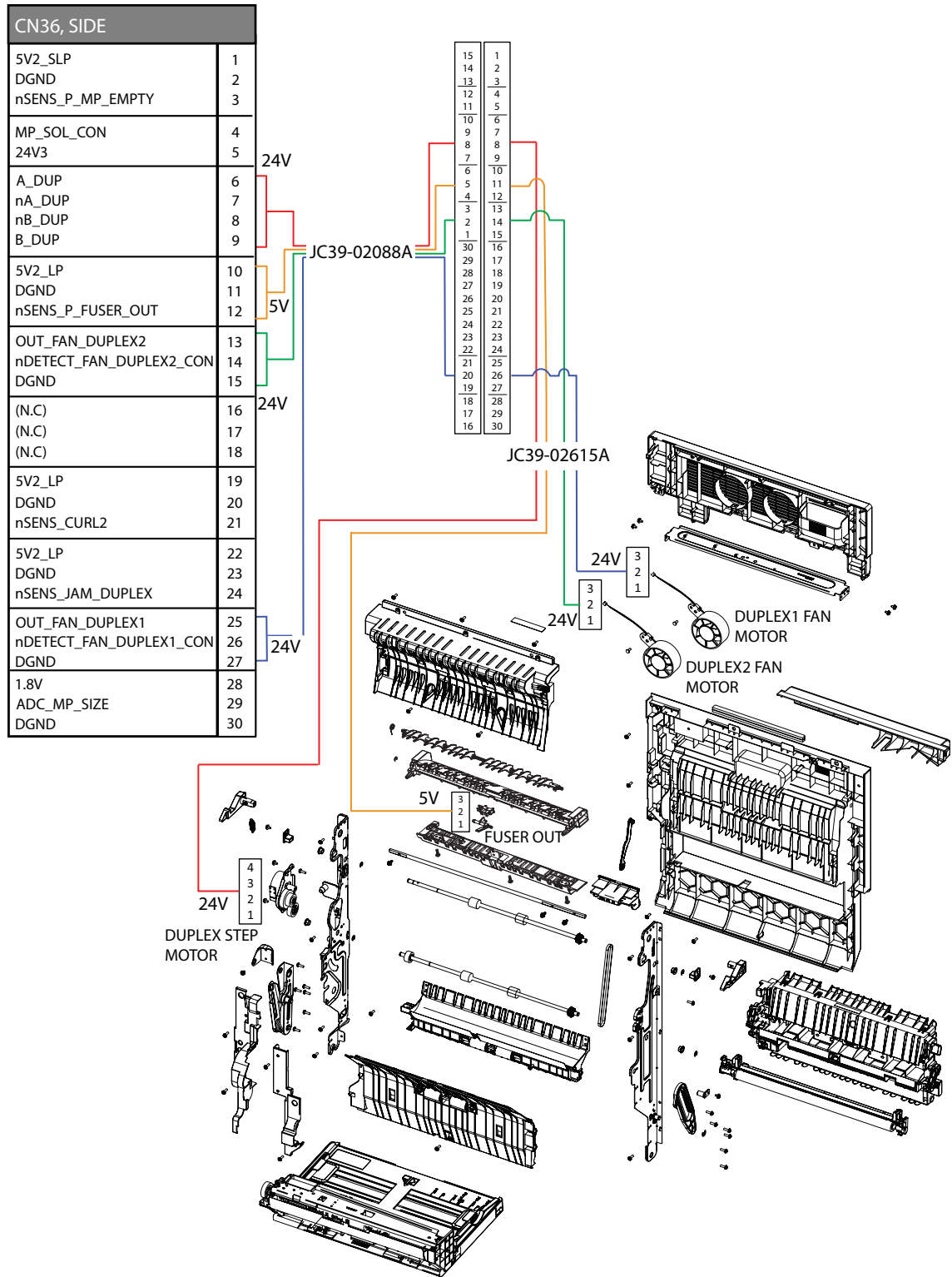
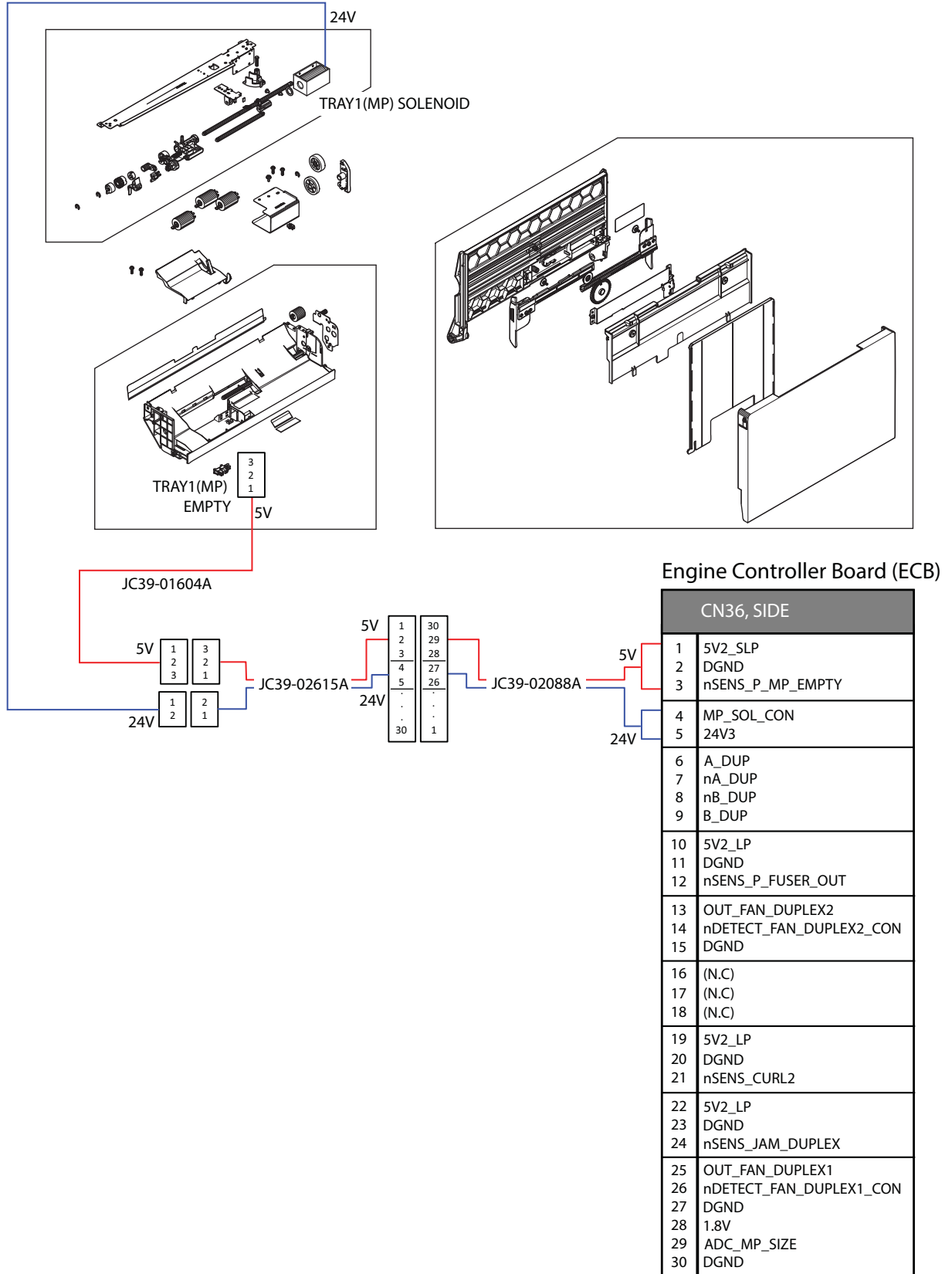

Figure 4-19 MP tray assembly



Engine Controller Board (ECB)

CN36, SIDE	
1	5V2_SLP
2	DGND
3	nSENS_P_MP_EMPTY
4	MP_SOL_CON
5	24V3
6	A_DUP
7	nA_DUP
8	nB_DUP
9	B_DUP
10	5V2_LP
11	DGND
12	nSENS_P_FUSER_OUT
13	OUT_FAN_DUPLEX2
14	nDETECT_FAN_DUPLEX2_CON
15	DGND
16	(N.C)
17	(N.C)
18	(N.C)
19	5V2_LP
20	DGND
21	nSENS_CURL2
22	5V2_LP
23	DGND
24	nSENS_JAM_DUPLEX
25	OUT_FAN_DUPLEX1
26	nDETECT_FAN_DUPLEX1_CON
27	DGND
28	1.8V
29	ADC_MP_SIZE
30	DGND

Figure 4-20 Right door duplex

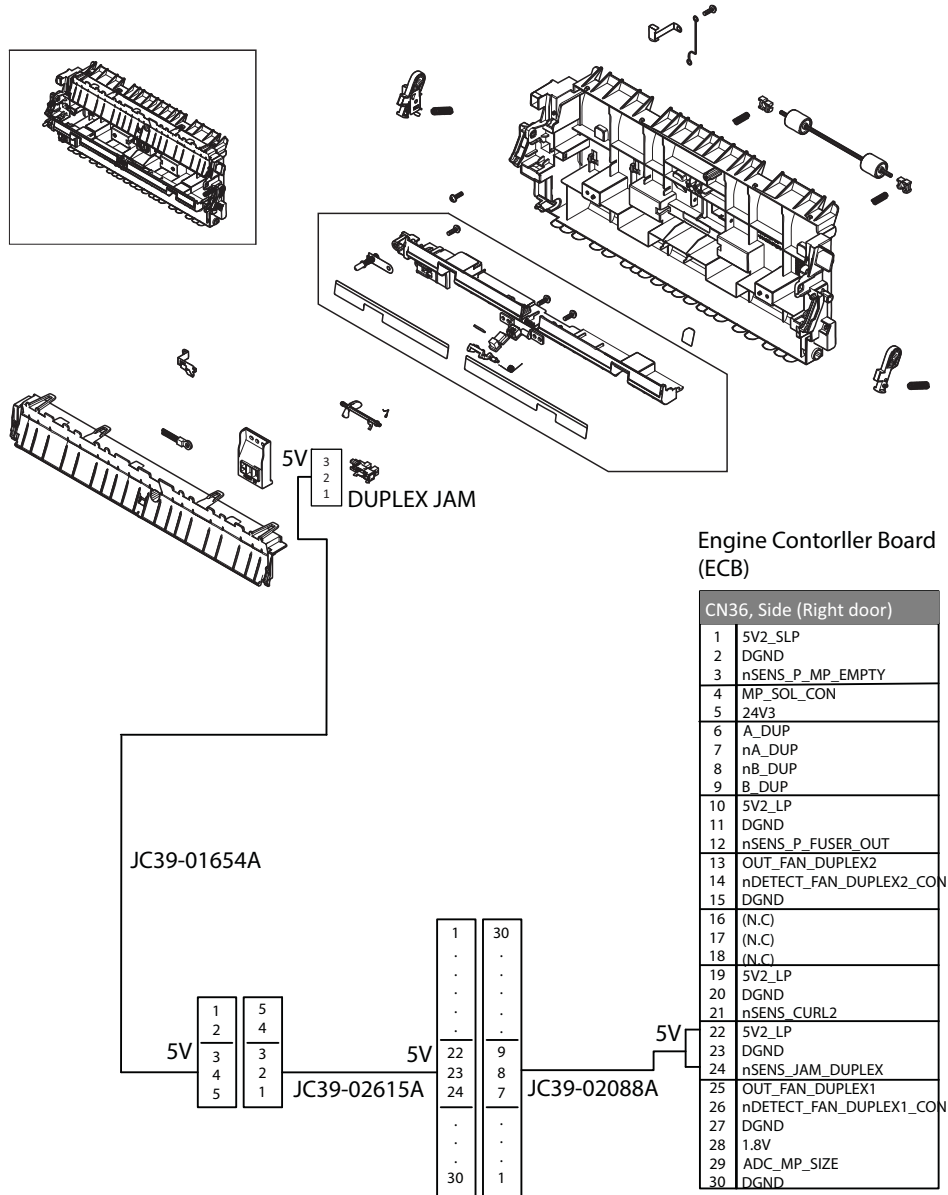
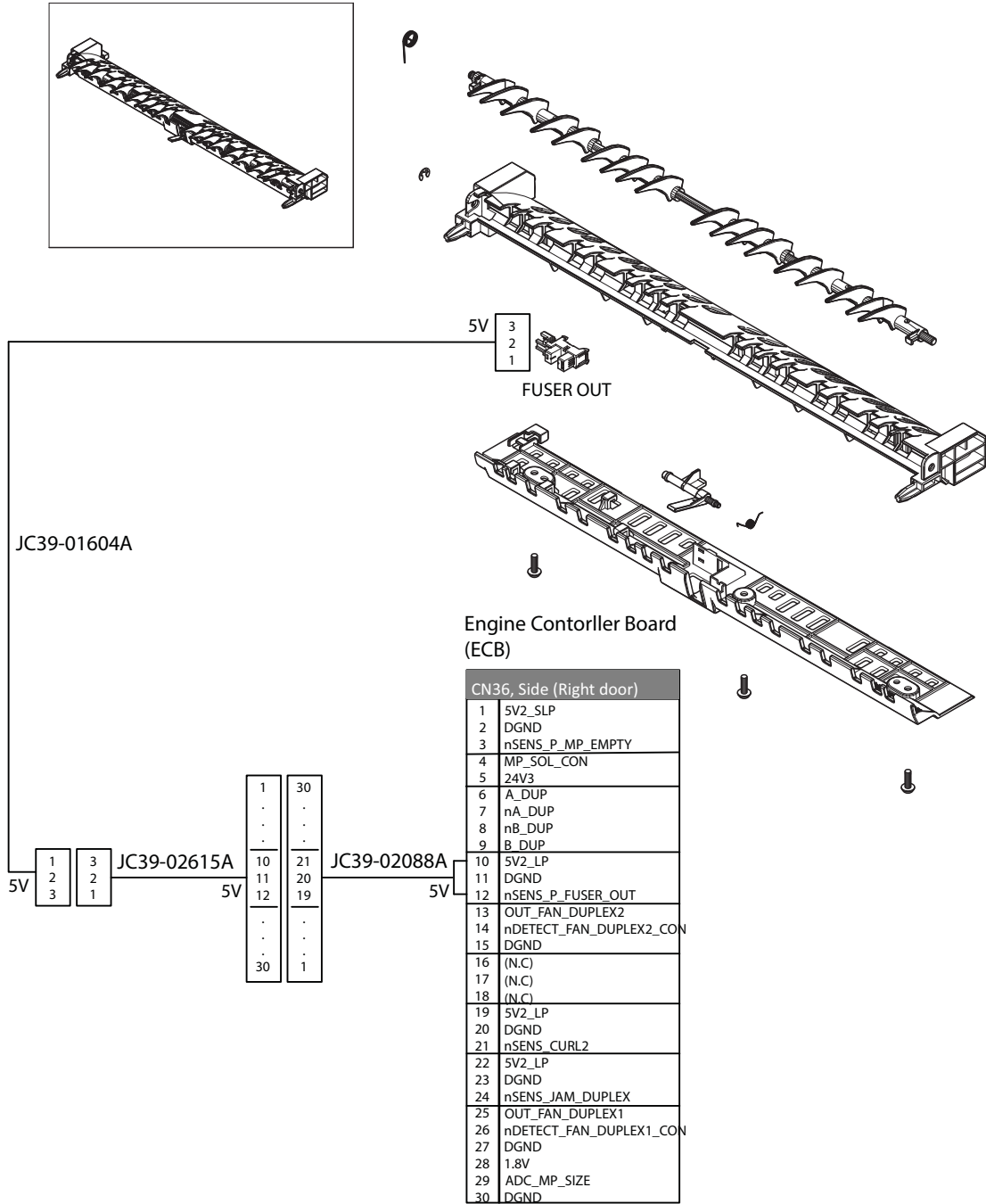

Figure 4-21 Right door output



Scanner section

Learn about the electrical-mechanical relationships diagram for the scanner section.

Figure 4-22 Scanner assembly (1 of 2)

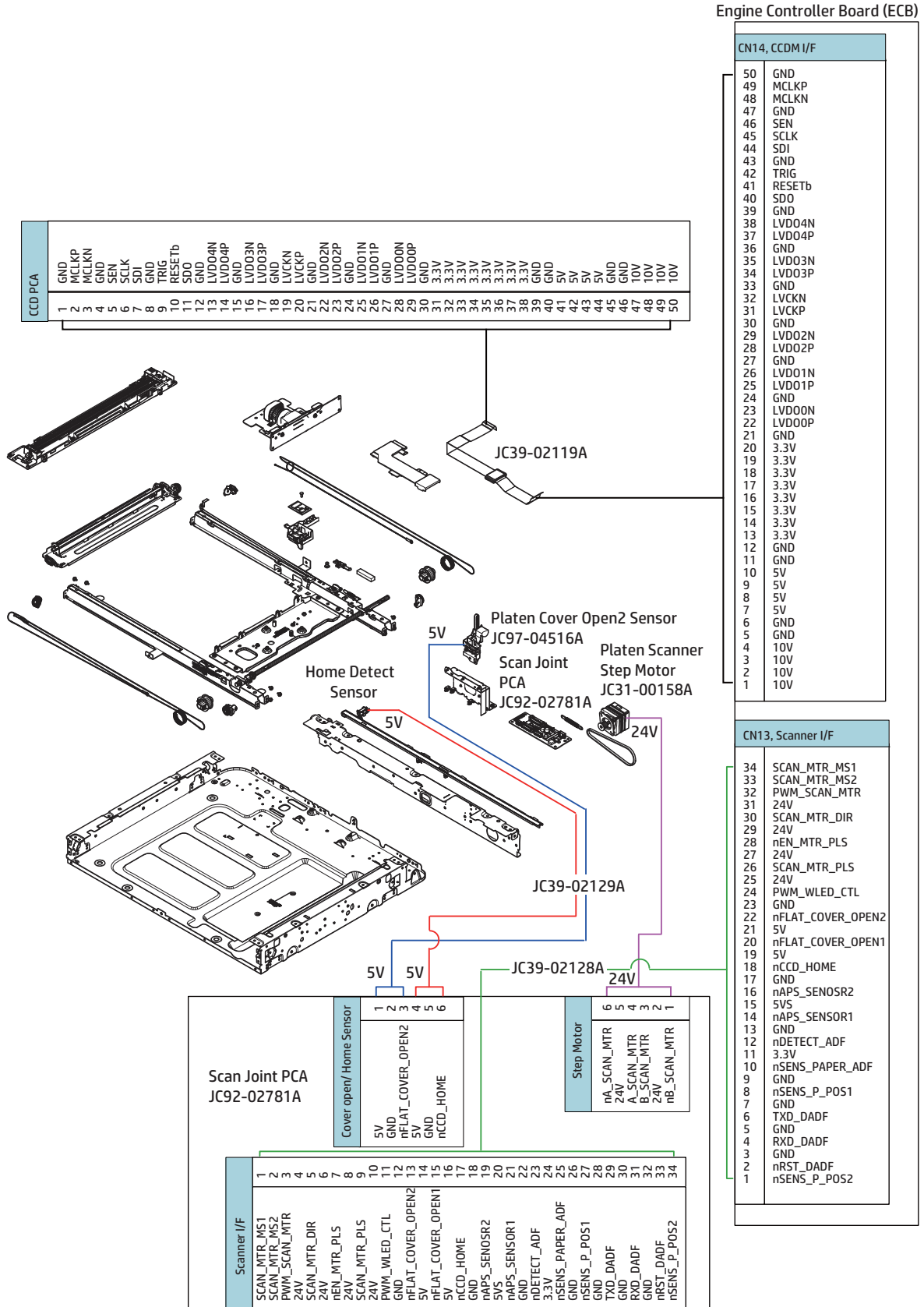
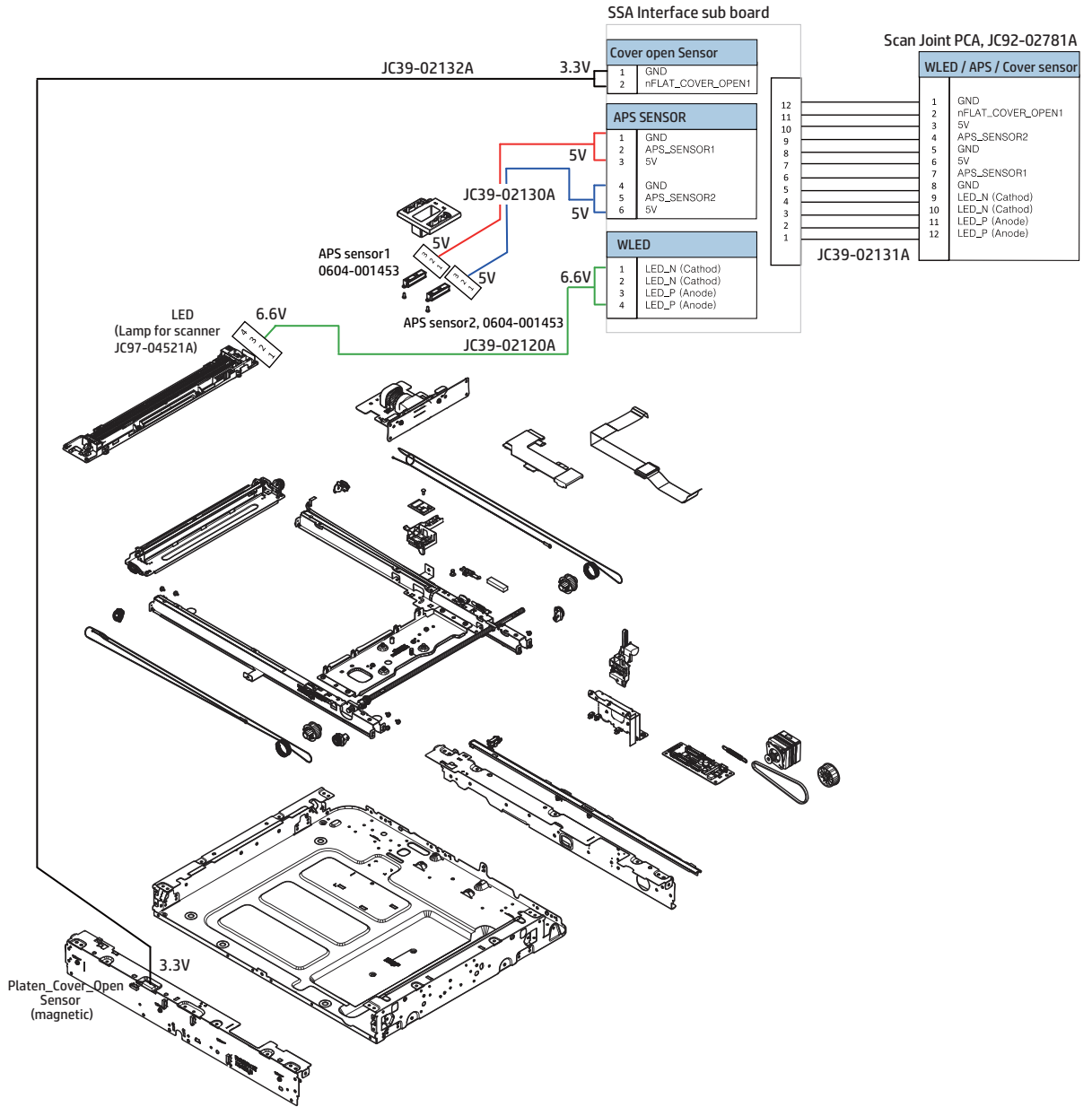

Figure 4-23 Scanner assembly (2 of 2)



Document feeder section

Learn about the electrical-mechanical relationships diagram for the document feeder section.

Figure 4-24 Document feeder (1 of 2)

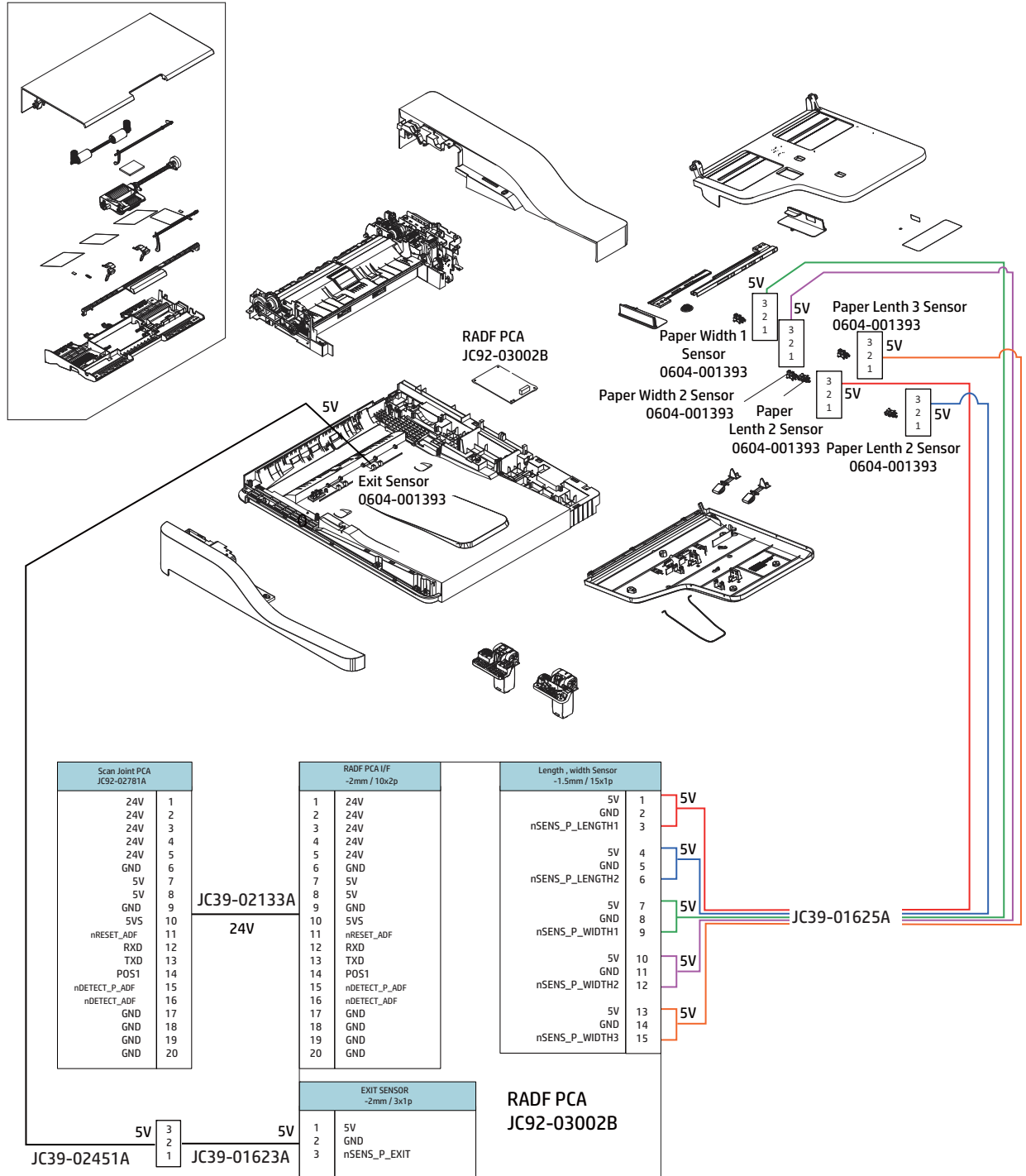

Figure 4-25 Document feeder (2 of 2)

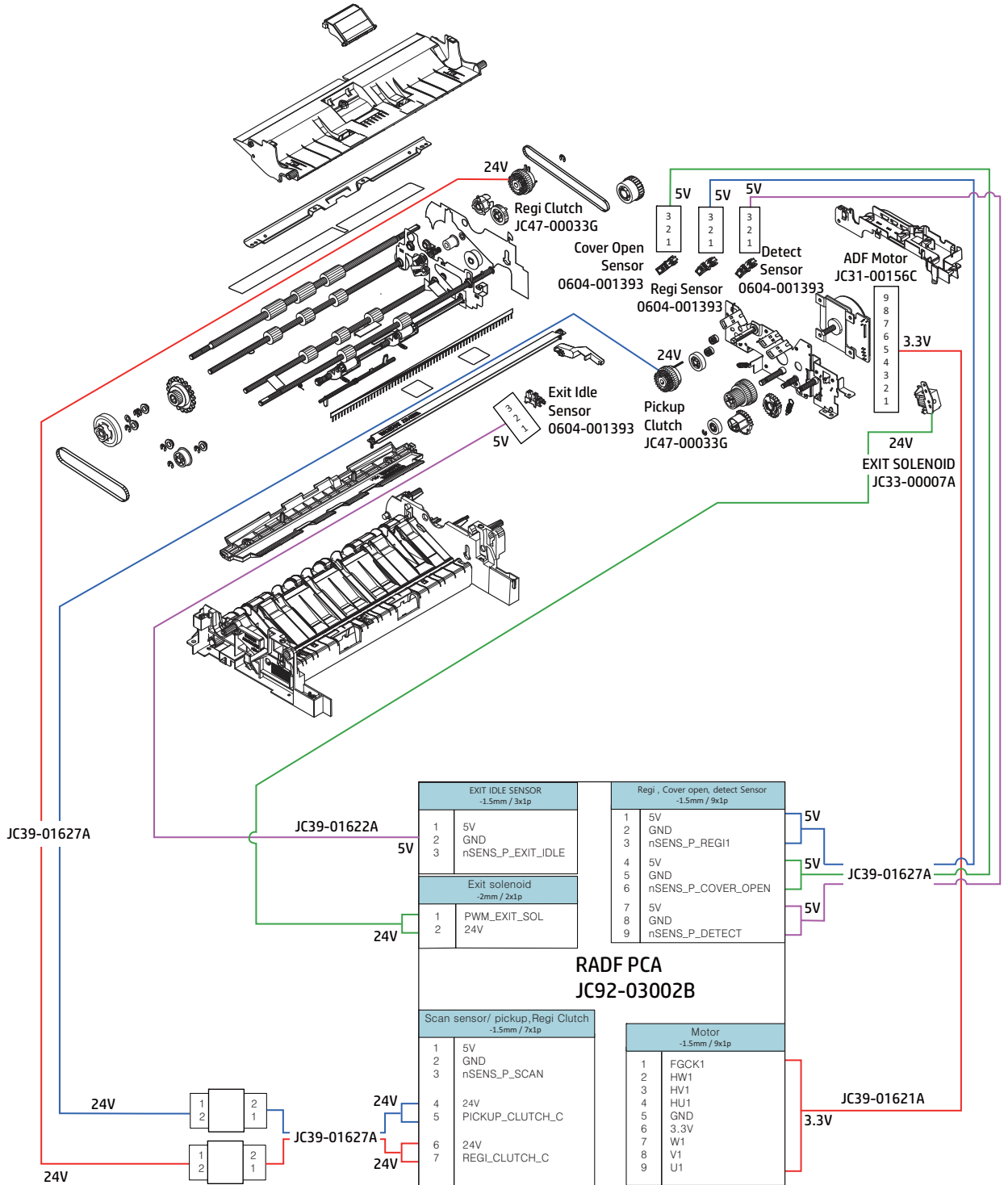
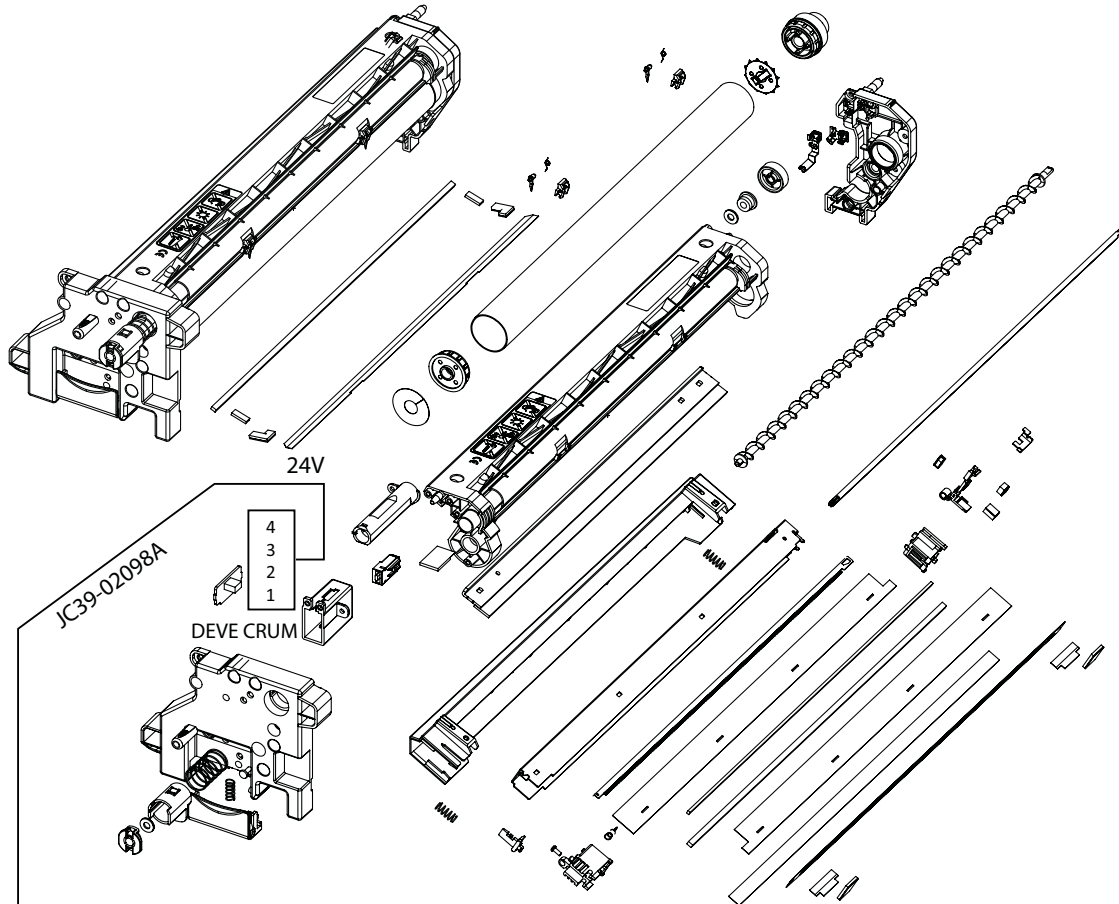

Image formation section

Learn about the electrical-mechanical relationships diagram for the image formation section.

Figure 4-26 Deve crum



Engine Controller Board (ECB)

CN49, Front Mono	
1	DGND
2	nCOVER_FRONT_CON
3	5V1_SLP
4	DGND
5	nDETECT_WASTE_INST_CON
6	DGND
7	ADC_WASTE_LEVEL_CON
8	EN_WASTE_LED
9	5V_LP
10	OUT_FAN_FUSER
11	nDETECT_FAN_FUSER_CON
12	DGND
13	5V2_LP
14	DGND
15	DUCT_COUNT
16	DGND
17	TC_VIN_K
18	24V1_LP
19	TSEN_VCONT_K
20	3.3V_CRUM
21	SDA_CRUM_DEVE_K
22	SCL_CRUM_DEVE_K
23	DGND
24	N.C

Figure 4-27 TC sensor

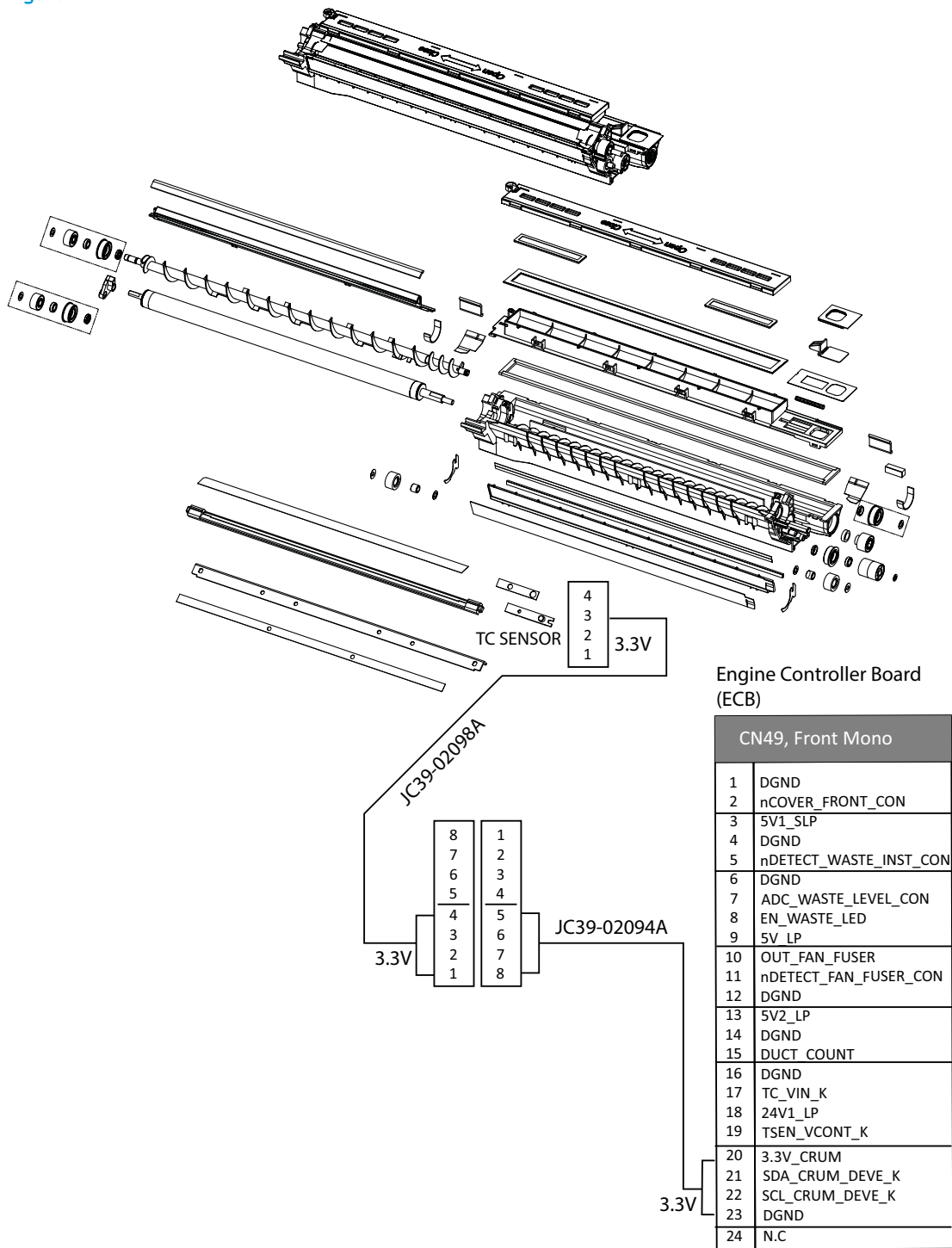
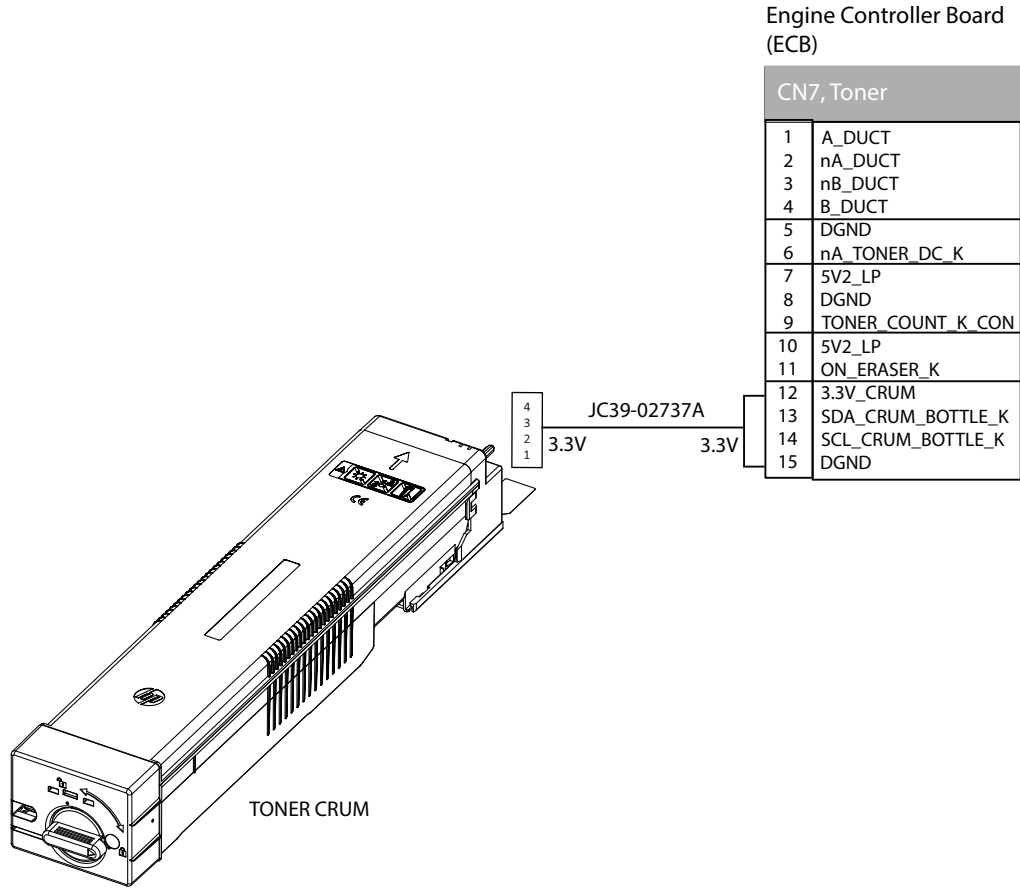

Figure 4-28 Toner crum



Optional dual-cassette feeder (DCF)

Learn about the electrical-mechanical relationships diagram for the optional dual-cassette feeder (DCF).

Figure 4-29 Pickup motor 1/2, feed motor, paper size sensor 1/2 and cover open sensor (DCF)

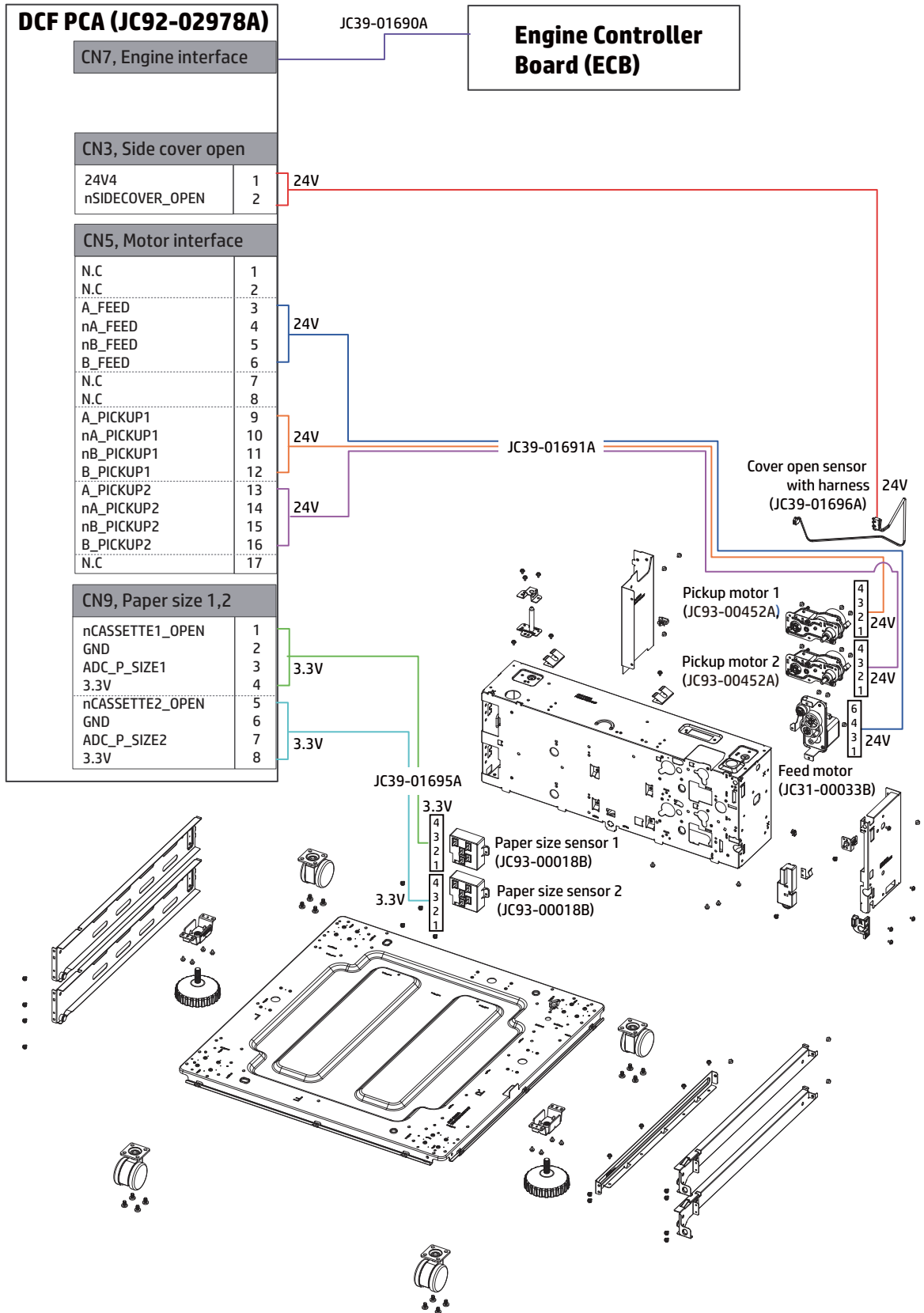

Figure 4-30 Feed sensor 1, empty sensor 1, and lift sensor 1 for Tray 4 (DCF)

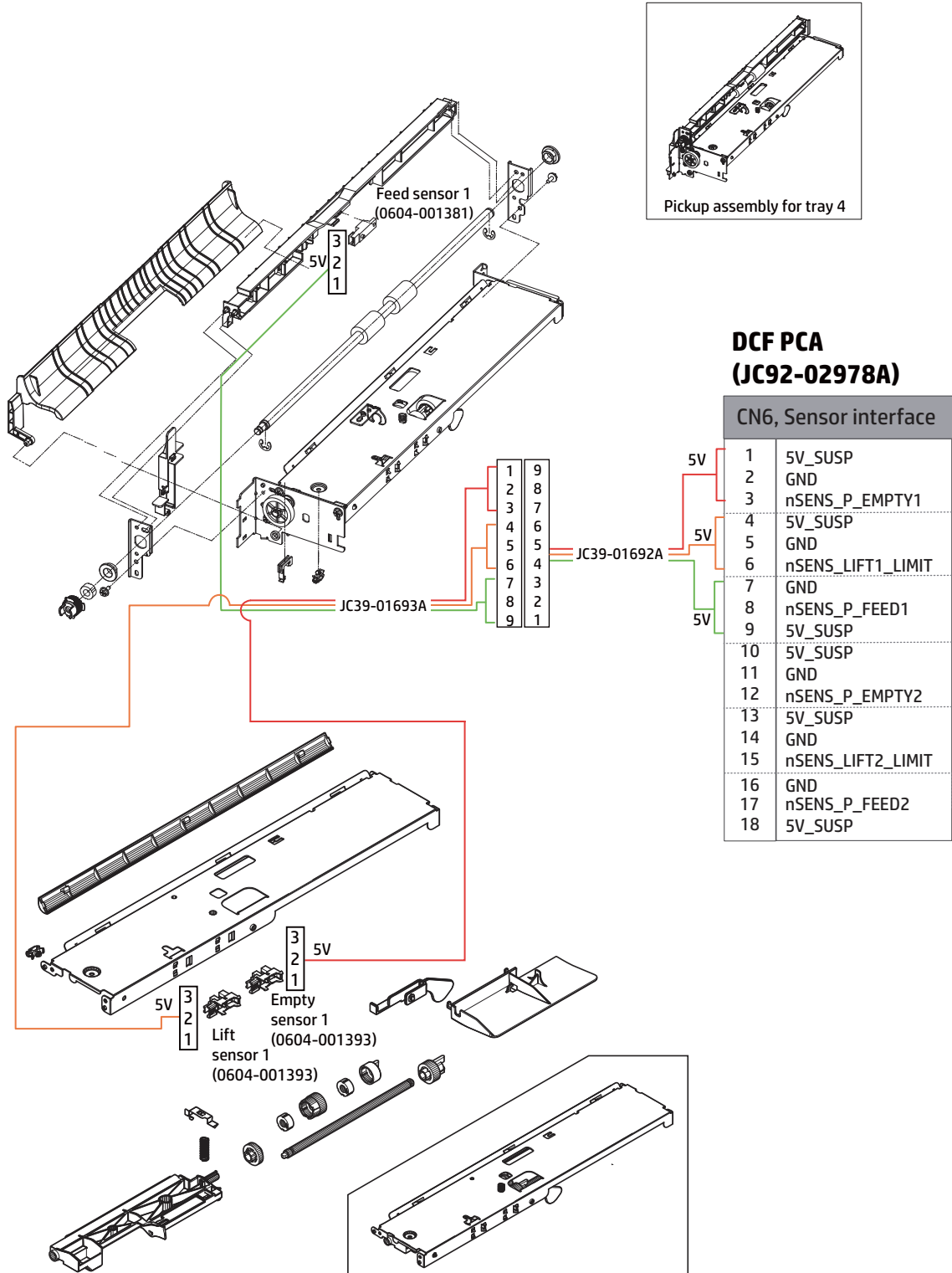
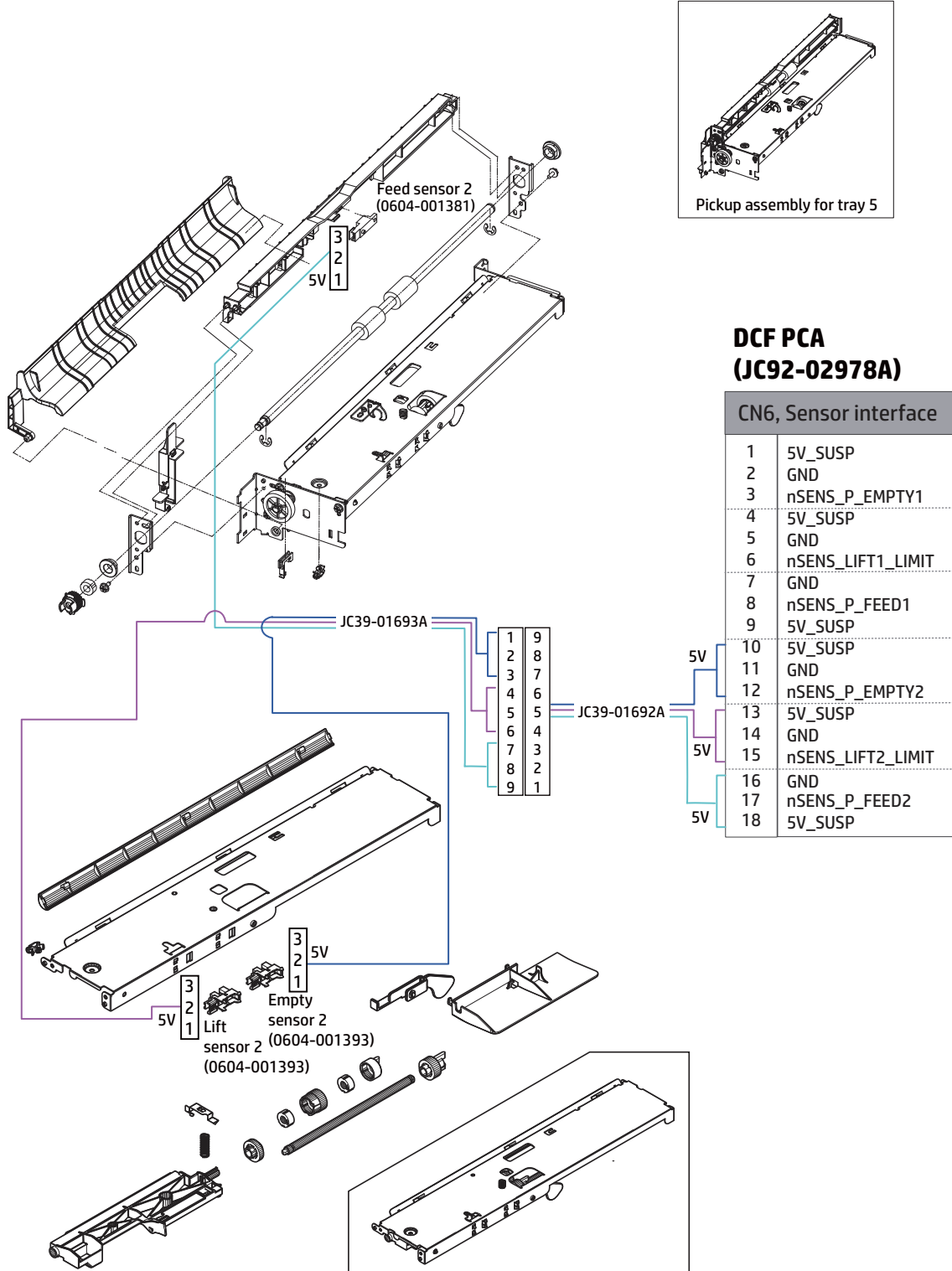

Figure 4-31 Feed sensor 2, empty sensor 2, and lift sensor 2 for Tray 5 (DCF)



Optional high-capacity input (HCI)

Learn about the electrical-mechanical relationships diagram for the optional high-capacity input (HCI).

Figure 4-32 Pickup, feed and lift motors, cover and cassette sensors (HCI)

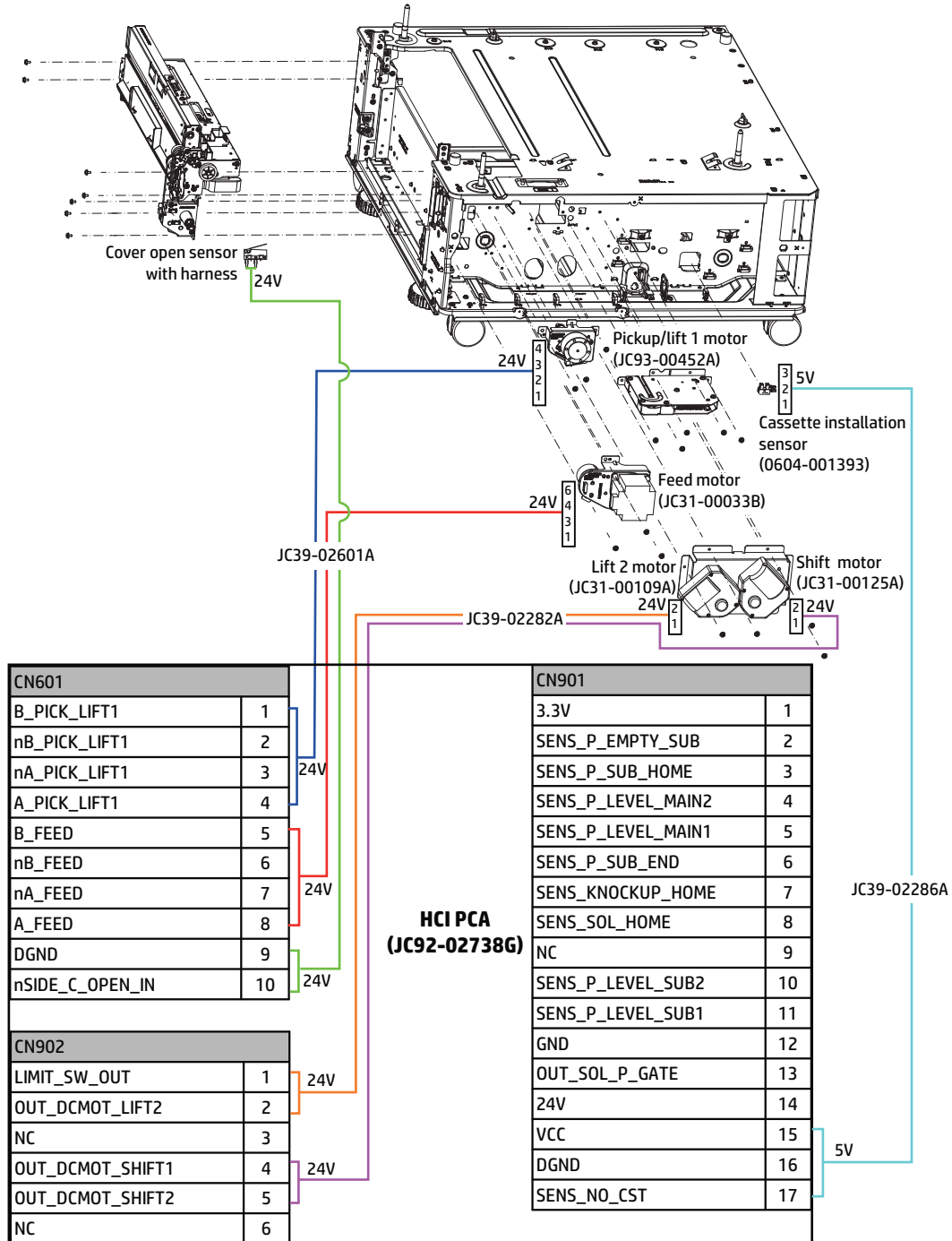

Figure 4-33 PCA, sub PCA and ECB (HCI)

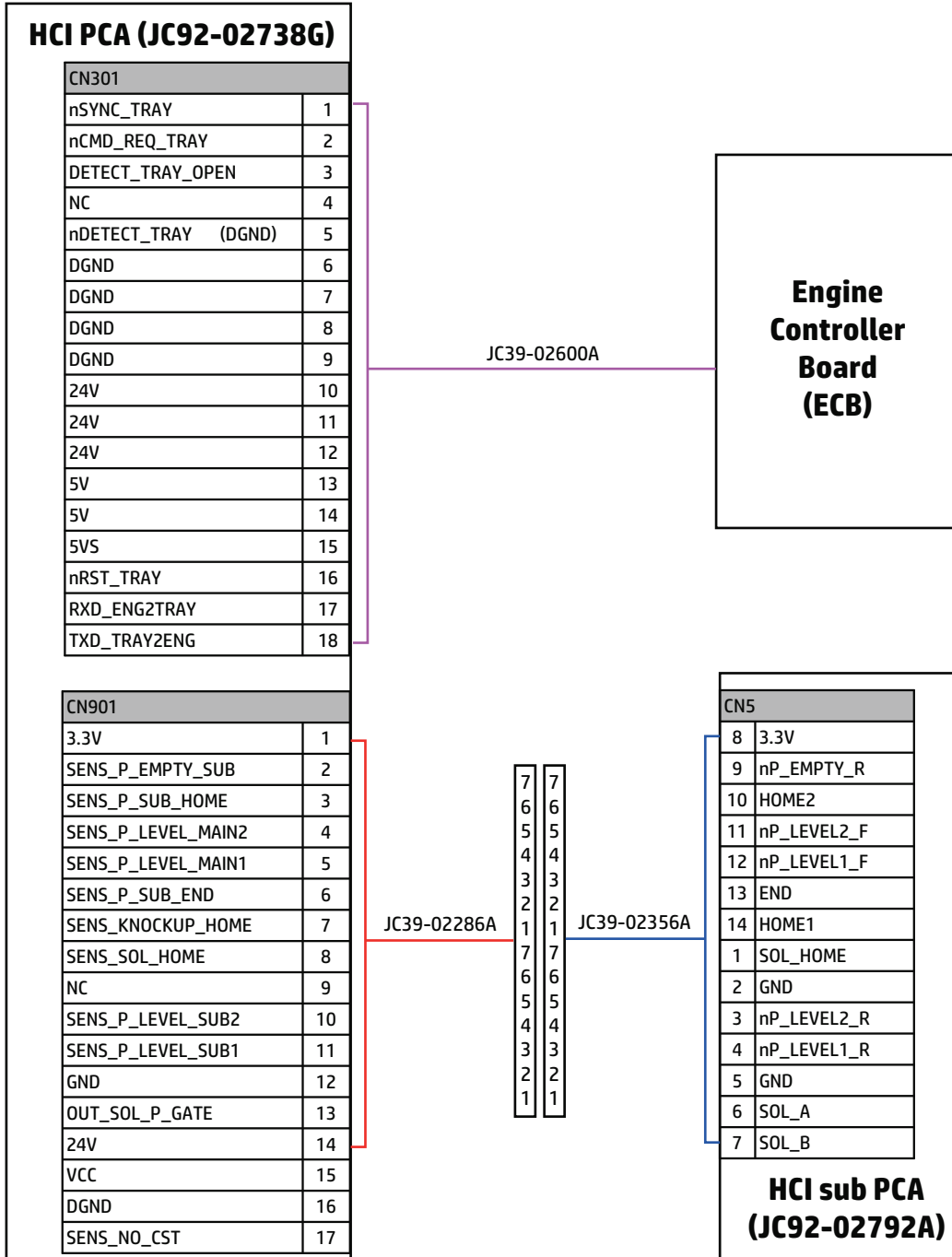

Figure 4-34 Feed, limit, empty and main sensors (HCI)

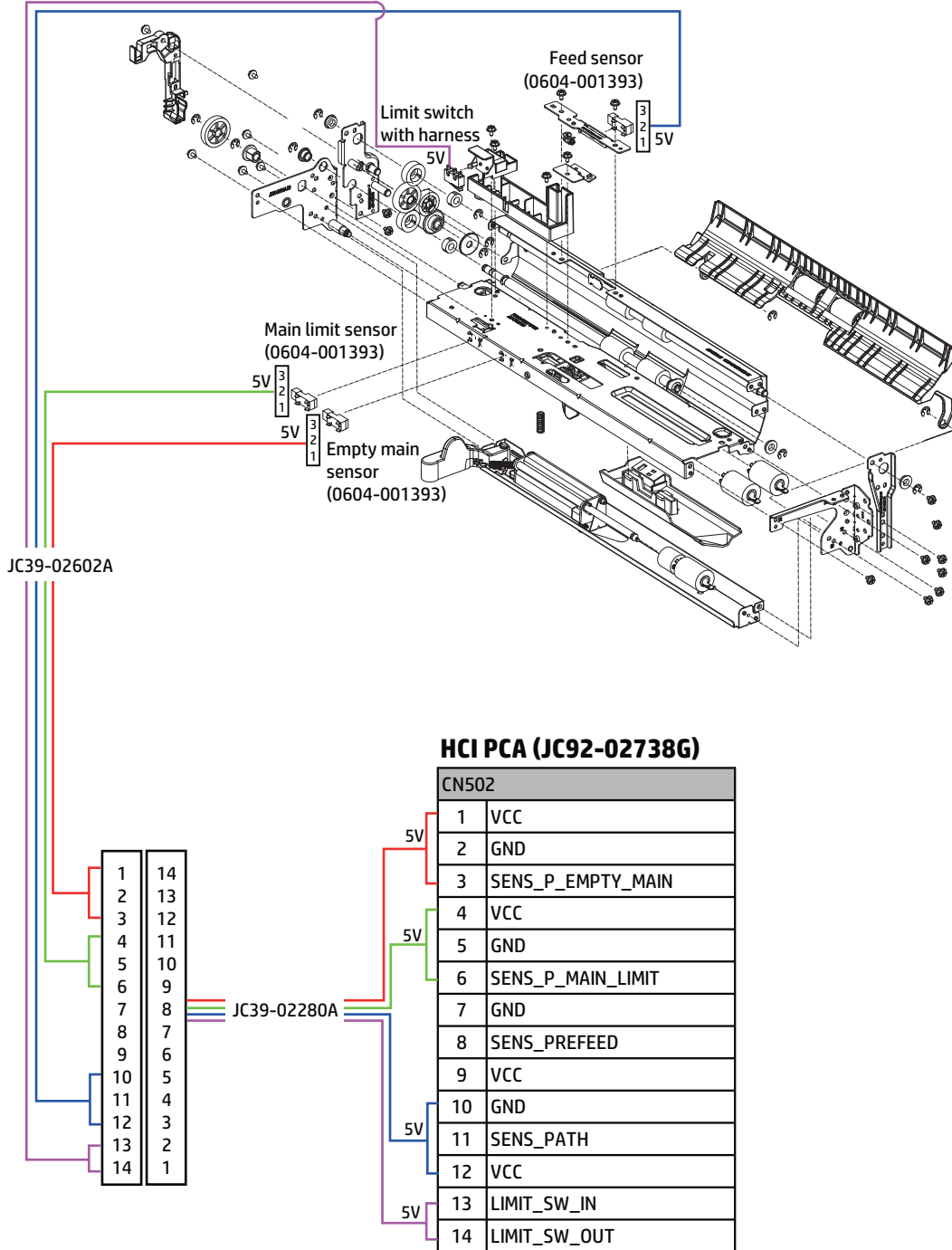

Figure 4-35 Level and home sensors (HCI)

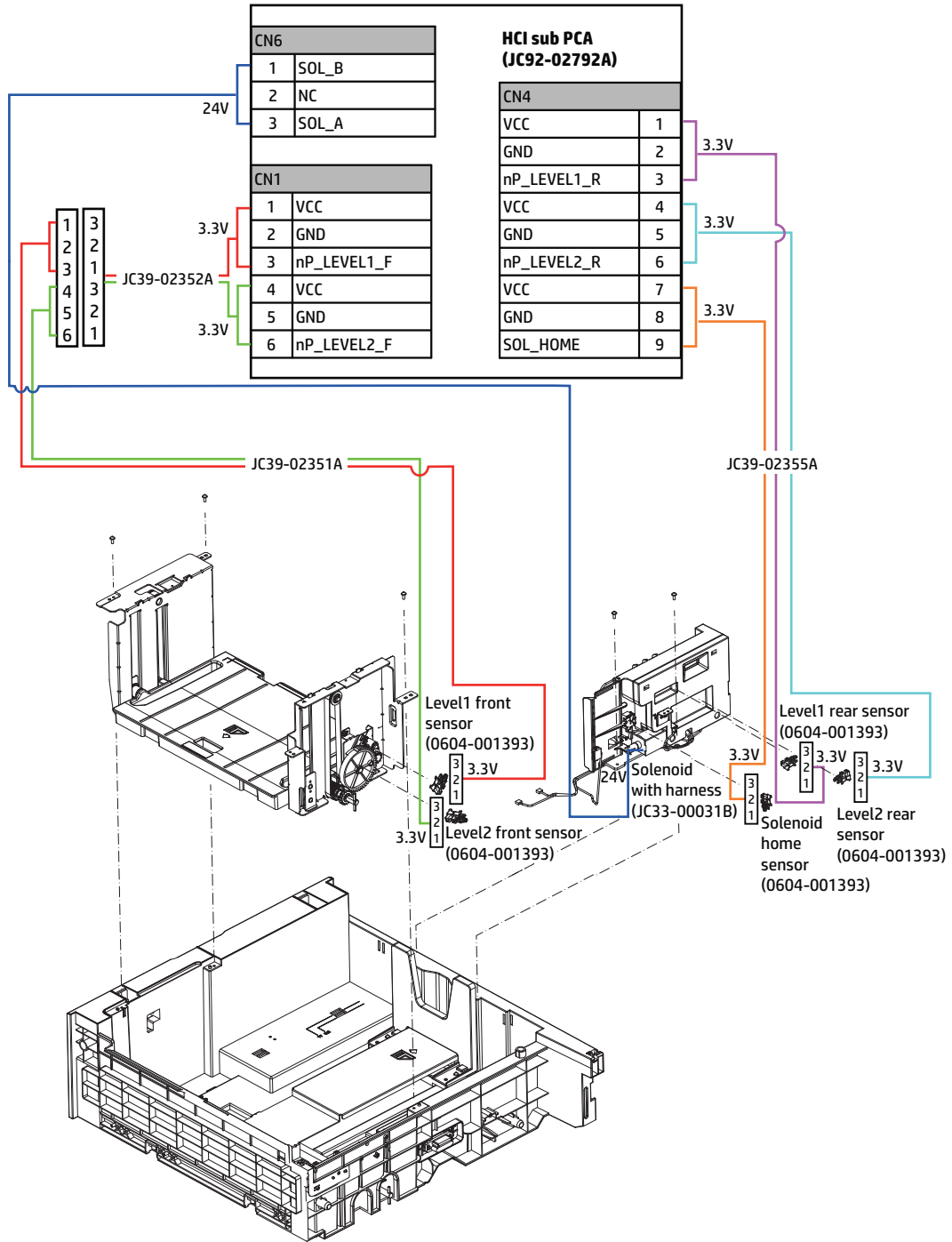
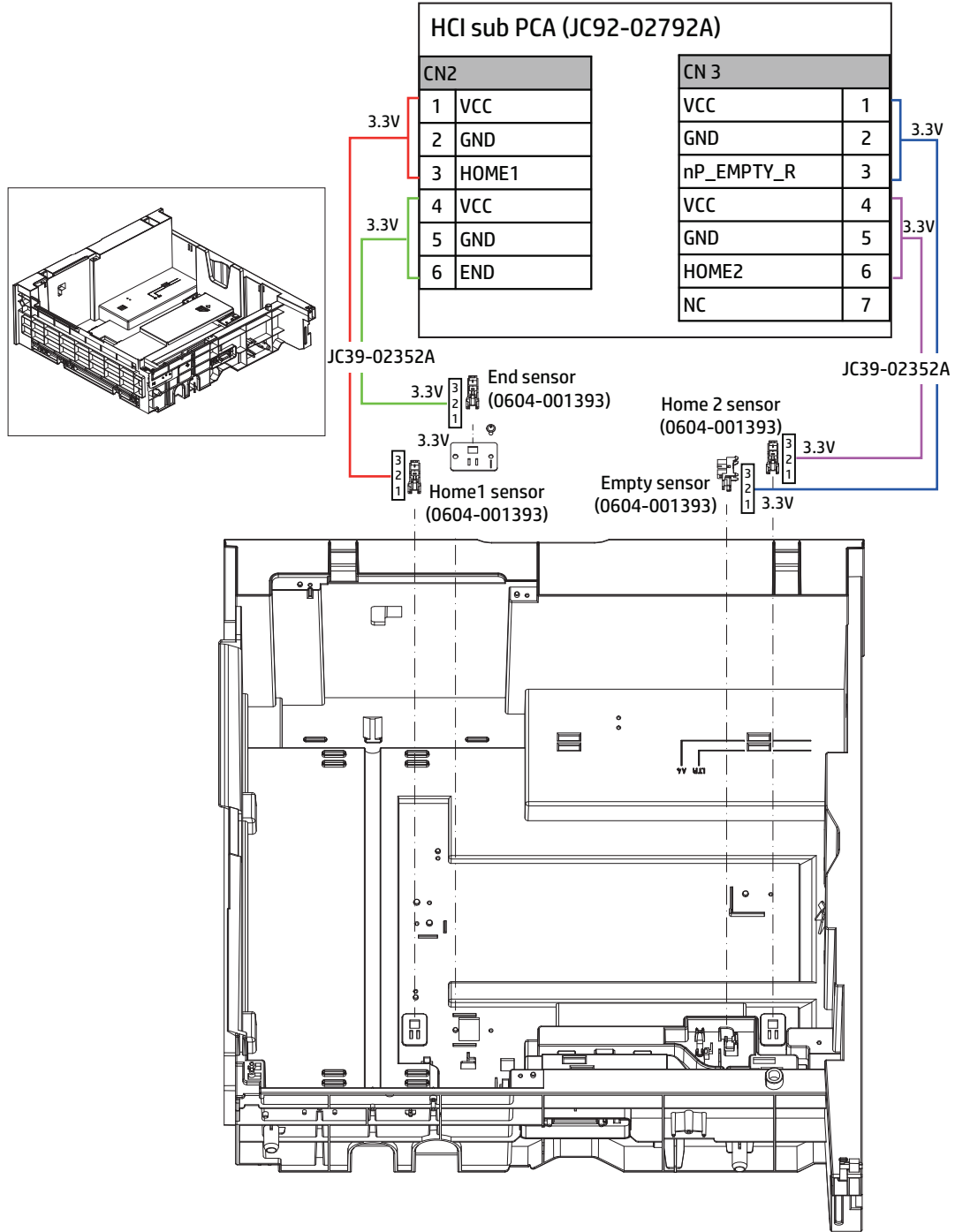

Figure 4-36 Empty and end sensors (HCI)



5 Stapler/stacker and booklet maker (SSBM)

Learn about the stapler/stacker and booklet maker.

Product specification and description

Learn about product specifications and descriptions.

Stapler/stacker finisher and booklet finisher view

Learn about the front view and rear view of the stapler/stacker finisher and booklet finisher.

Figure 5-1 Stapler/stacker finisher - front view

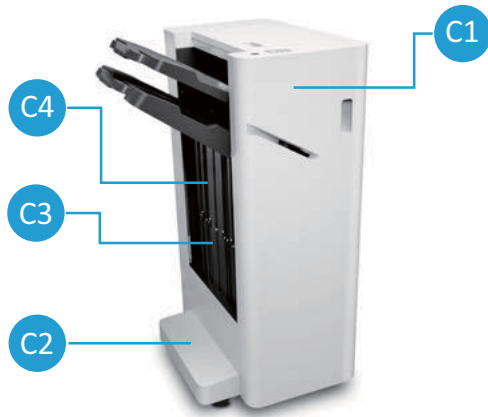

Figure 5-2 Booklet finisher - front view



Table 5-1 Stapler/stacker finisher and booklet finisher - front view

Item	Part name	Part number	Orderable ^(*)
C1	Front door	JC90-01444B	
C2	Caster cover	JC63-04985B	(*)
C3	Left lower cover (Stapler/stacker)	JC63-05001B	(*)
C3'	Left lower cover (Booklet)	JC90-01417B	(*)
C4	Left upper cover	JC90-01475B	(*)
C5	Booklet output tray	JC61-07253B, JC63-04978B	(*)

(*) This part is in ordering system.

Figure 5-3 Stapler/stacker finisher and booklet finisher - rear view



Table 5-2 Stapler/stacker finisher and booklet finisher - rear view

Item	Part name	Part number	Orderable ^(*)
C6	Top Output tray	JC63-04996B	
		JC63-05003B	(*)
C7	Main output tray	JC63-05002B	
C8	Rear cover	JC63-04988B	(*)

^(*) This part is in ordering system.

Figure 5-4 Stapler/stacker finisher and booklet finisher - top view



Table 5-3 Stapler/stacker finisher and booklet finisher - top view

Item	Part name	Part number	Orderable ^(*)
C9	Top cover	JC90-01446B	
C10	Top door	JC90-01445B	(*)

^(*) This part is in ordering system.

Figure 5-5 Booklet finisher – front-right view

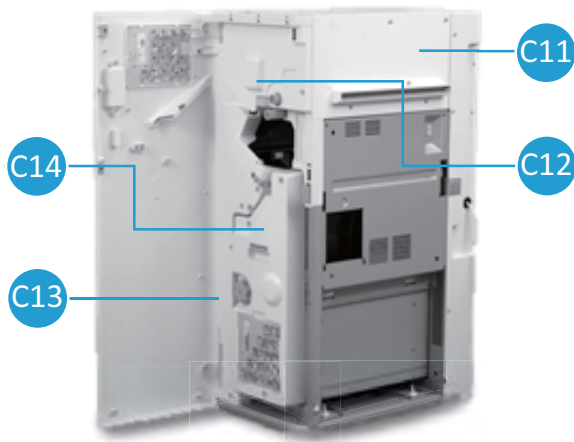

Table 5-4 booklet finisher - front-right view

Item	Part name	Part number	Orderable ^(*)
C11	Right upper cover	JC90-01448B	(*)
C12	Front cover	JC63-04986B	
C13	Front lower cover	JC63-04987B	
C14	Booklet front cover	JC90-01478B	

(*) This part is in ordering system.

Specification

Learn about the specifications of the stapler/stacker finisher and booklet finisher.

Finisher

Table 5-5 Finisher specifications

Item		Stapler/stacker Finisher	Booklet Finisher
Speed	PPM	18.3~70,(90ppm)	18.3~70,(90ppm)
Stack Capacity (A4/ Letter 80gsm)	Main	3,000 sheets	2,000 sheets
	Top	250 sheets	250 sheets
Paper Size	Main	98mm - 320mm x 139.7mm - 457.2mm (3.86in - 12.59in x 5.5in - 18in)	Statement SEF ~ 320 x 457
	Top	98mm - 320mm x 148.0mm - 430.0mm (3.86in - 12.59in x 5.83in - 16.93in)	98 x 148 ~ 13" x 19.2" (330x1200)
Paper Weight	Main	52 ~ 350 gsm	52 ~ 350 gsm
	Top	52 ~ 300 gsm	52 ~ 300 gsm

Table 5-5 Finisher specifications (continued)

Item		Stapler/stacker Finisher	Booklet Finisher
Offset (Non Staple) ※Exception SRA3 and larger size.		15mm(minimum)	15mm(minimum)
Staple	Clinching position	<ul style="list-style-type: none"> • Front/Rear Corner(45°,Flat) • Dual 	<ul style="list-style-type: none"> • Front/Rear Corner(45°,Flat) • Dual
	Paper weight	52~256 gsm	52~256 gsm
	Capacity	65 sheets (90gsm)	65 sheets (90gsm)
	Cartridge Capacity	5,000 clinching/cartridge	5,000 clinching/cartridge
	Offline	Yes	Yes
Hole Punch	Paper weight	52 ~ 300 gsm	52 ~ 300 gsm
	available unit (Auto change)	NA2/3, EU2/4, Swedish	NA2/3, EU2/4, Swedish

Booklet

Table 5-6 Booklet maker Specification

Item		Description
Set Speed	PPM	18.3~70(90ppm)
Paper size		B5 SEF ~ 12" x 18"
Paper weight		60 ~ 120 gsm
Staple + Fold Capacity(80gsm)		25 sheets
Fold Capacity(80gsm)		5 sheets
Tray Capacity		5 sets / 25 sheets
Staple Cartridge Capacity		5,000 clinching/cartridge
C - Folding		3 sheets Letter SEF, A4 SEF

Physical

Table 5-7 Physical

Module	Option (Reference)	Size W X D X H [mm]	Module Weight [Kg]	Packed Weight [Kg]
Stapler/stacker Finisher		751.7 x 610 x 1016.4	40	62
Booklet Finisher		751.7 x 610 x 1016.4	62	84.5
	Hole Punch	80 x 485 x 235	2.8	4.1

Paper size

Table 5-8 Paper size specification

Name	Paper size		Orientation	Output			Staple position			Punch				Booklet Maker	C-Folding		
	mm	Inches		direction	Main tray		Top tray	Corner		DUAL	NA 2/3		EU 2/4H			Swedish 4H	
					52-350g	Offset	52-300g	45°	Flat		2H	3H	2H				4H
A5	210 X148	8.3X5.8	LEF	X	X	X		F/R	X	X		X		X			
Statement	216 X140	8.5X5.5	LEF	X	X	X		F/R	X	X		X		X			
Latter	279 X216	11X8.5	LEF	X	X	X		F/R		X	X	X	X	X	X		
A4	297 X210	8.3X11.7	LEF	X	X	X		F/R		X	X	X	X	X	X		
B5(JIS)	257 X182	10.1×7.2	LEF	X	X	X		F/R		X	X	X	X		X		
B5(ISO)	250 X176	9.8×6.9	LEF	X	X	X		F/R		X	X	X	X		X		
Executive	267 X184	10.5X7.3	LEF	X	X	X		F/R		X	X	X	X	X	X		
No 9 Env	98X225	3.9X8.9	SEF			X											
Monarch Env	98.4×190.5	3.9×7.5	SEF			X											
PostCard 4x6	101.6×152.4	4.0×6.0	SEF			X											
A6	105 X148	4.1X5.8	SEF			X											
No 10 Env	105×241	4.1×9.5	SEF			X											
DL Env	110×220	4.3×8.7	SEF			X											

Table 5-8 Paper size specification (continued)

Name	Paper size		Orientation	Output			Staple position			Punch				Booklet Maker	C-Folding		
	mm	Inches		direction	Main tray		Top tray	Corner		DUAL	NA 2/3		EU 2/4H			Swedish 4H	
					52-350g	Offset	52-300g	45°	Flat		2H	3H	2H				4H
C6 Env	114 × 162	4.5 × 6.4	SEF			X											
B6	128 × 182	5.0 × 7.2	SEF			X											
Statement	140 × 216	5.5 × 8.5	SEF	X		X						X	X				
A5	148 × 210	5.8 × 8.3	SEF	X		X						X	X				
C5 Env	162 × 229	6.4 × 9.0	SEF			X											
B5(ISO)	176 × 250	6.9 × 9.8	SEF	X	X	X		F/R		X	X	X					
B5(JIS)	182 × 257	7.2 × 10.1	SEF	X	X	X		F/R		X	X	X	X				
Executive	184 × 267	7.3 × 10.5	SEF	X	X	X		F/R		X	X	X	X	X			
16k	195 × 270	7.7 × 10.6	SEF	X	X	X		F/R	X	X	X	X	X	X			
A4	210 × 297	8.3 × 11.7	SEF	X	X	X		F/R	X	X	X	X	X	X	X		
Legal	216 × 356	8.5 × 14	SEF	X	X	X		F/R	X	X	X	X	X	X			
Letter	216 × 279	8.5 × 11	SEF	X	X	X		F/R	X	X	X	X	X	X	X		
Folio	216 × 330	8.5 × 13	SEF	X	X	X		F/R	X	X	X	X	X	X			

Table 5-8 Paper size specification (continued)

Name	Paper size		Orientation	Output			Staple position			Punch				Booklet Maker	C-Folding		
	mm	Inches		direction	Main tray		Top tray	Corner		DUAL	NA 2/3		EU 2/4H			Swedish 4H	
					52-350g	Offset	52-300g	45°	Flat		2H	3H	2H				4H
Oficio	215.9×342.9	8.5×13.5	SEF	X	X	X		F/R	X	X		X	X	X	X		
C4 Env	229×324	9.1×12.8	SEF			X											
Tabloid	254×374	10×14.7	SEF	X	X	X		F/R		X	X	X	X		X	X	
B4	257×364	10×14.3	SEF	X	X	X		F/R		X	X	X	X	X	X	X	
8K	270×390	10.6×15.4	SEF	X	X	X		F/R		X	X	X	X	X	X	X	
Ledger	279×432	11×17	SEF	X	X	X		F/R		X	X	X	X	X	X	X	
A3	297×420	11.7×16.5	SEF	X	X	X		F/R		X	X	X	X	X	X	X	
Tabloid Extra	304.8×457.2	12×18	SEF	X		X										X	
SRA3	320×450	12.6×17.7	SEF	X		X											
13"×19.2"	330×487	13×19.2	SEF			X											
Custom	W9.8-320 L13.9-457.2	W3.86-12.59 L5.5-18	-	X	NA	O	NA	NA	NA	NA	NA	NA	NA	NA	NA	NA	

* F/R means Front side and Rear side can be supported.

Media performance

Table 5-9 Media performance

Paper Type	Function						
	Main Tray	Top Tray	Staple	HP	BM		
					Cover	Content	C-Fold
Plain (71-90 g/m ²)	X	X	X	X	X	X	X
Thick (91-105 g/m ²)	X	X	X	X	X		
Heavy weight (106-175 g/m ²)	X	X	X	X	X		
Extra Heavy weight 1 (176-216 g/m ²)	X	X	X	X	X		
Extra Heavy weight 2 (217-256 g/m ²)	X	X	X	X	X		
Extra Heavy weight 3 (257-300 g/m ²)	X	X		X	X		
Extra Heavy weight 4 (301-325 g/m ²)	X						
Thin (60-70 g/m ²)	X	X	X	X	X	X	X
Cotton (75-90 g/m ²)	X	X					
Colored (75-90 g/m ²)	X	X	X	X	X	X	X
Pre-Printed (75-90 g/m ²)	X	X	X	X	X	X	X
Recycled (60-90 g/m ²)	X	X	X	X	X	X	X
Bond	X	X	X	X	X	X	
Archive (75-105 g/m ²)	X	X	X	X	X	X	
Letter Head	X	X	X	X	X	X	
Pre-Punched	X	X	X				
Thin Cardstock (105-163 g/m ²)	X	X	X	X			
Thick Cardstock (170-216 g/m ²)	X	X	X				
Heavy Cardstock (217-256 g/m ²)	X	X	X				
Extra Heavy Cardstock 1 (257-300 g/m ²)	X	X					
Extra Heavy Cardstock 2 (301-325 g/m ²)	X						
Thin Glossy (106-169 g/m ²)	X	X	X	X	X		
Thick Glossy (170-216 g/m ²)	X	X	X		X		
Heavy Glossy (217-256 g/m ²)	X	X	X		X		
Envelope (75-90 g/m ²)		X					

Table 5-9 Media performance (continued)

Paper Type	Function						
	Main Tray	Top Tray	Staple	HP	BM		
					Cover	Content	C-Fold
Thick Envelope (217~256 g/m ²)		X					
Transparency (138~146 gsm)	X	X		X			
Labels (120~150 gsm)		X					
Tab	X	X		X			

Stapler/stacker finisher and booklet finisher system

Learn about the Stapler/stacker finisher and booklet finisher system.

Overview

Learn about the overview of the Stapler/stacker finisher and booklet finisher.

Work flow

Stapler/stacker finisher and booklet finisher work flow

Figure 5-6 Work flow overview

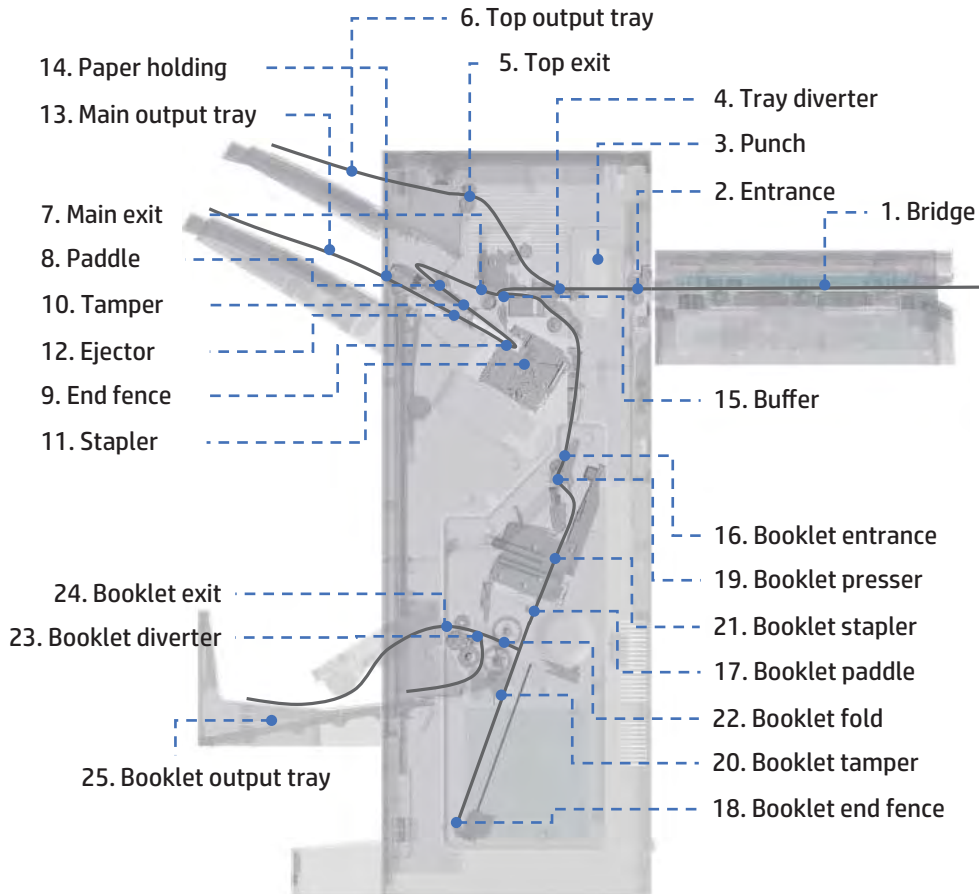

Table 5-10 work flow overview

Item	Unit	Description
1	Bridge unit	Moves paper from the printer to the finisher.
2	Entrance unit	Allows paper to move into the finisher.
3	Punch unit(optional)	Holes in a specific location on paper sheet.
4	Tray diverter unit	Changes the paper direction whether it is main output tray or top output tray.
5	Top exit unit	Moves paper from the diverter to the top output tray.
6	Top output tray unit	Stacks paper that completed its printing job.

Table 5-10 work flow overview (continued)

Item	Unit	Description
7	Main exit unit	Moves paper from the diverter unit to the ejector unit with forward direction or to the buffer unit with backward direction.
8	Paddle unit	Pushes to the end fence to be aligned towards top and bottom of the paper.
9	End fence unit	Sets the standard position of the paper to be aligned towards top and bottom of the paper.
10	Tamper unit	Aligns the paper on the right and left side of the paper.
11	Stapler unit	Staples a bundle of an aligned documents.
12	Ejector unit	Transfers a stapled paper loaded at the end fence unit to the output tray.
13	Main output tray unit	Stacks paper that completed its printing job.
14	Paper holding unit	Keeps paper static and controls the output tray movement.
15	Buffer unit	Maintains paper inside the unit for a while or moves it to the booklet maker.
16	Booklet entrance unit	Receives the paper into the booklet maker.
17	Booklet paddle unit	Pushes to the booklet end fence.
18	Booklet end fence unit	Supports paper that enters from the booklet paddle unit, then moves paper to the designated position for folding and stapling.
19	Booklet presser unit	Presses paper that enters to the booklet tamper unit to prevent paper shuffled.
20	Booklet tamper unit	Aligns the paper on the right and left side of the paper to make booklet.
21	Booklet stapler unit	Staples a bundle of aligned documents to make a booklet.
22	Booklet fold unit	Fold a bundle of aligned documents as a booklet.
23	Booklet diverter unit	Changes the paper direction to the booklet exit unit or the location to make c-fold.
24	Booklet exit unit	Moves paper to the booklet output tray.
25	Booklet output tray unit	Stacks the bundle of booklet.

Figure 5-7 Sensor – Stapler/stacker finisher and booklet finisher_1

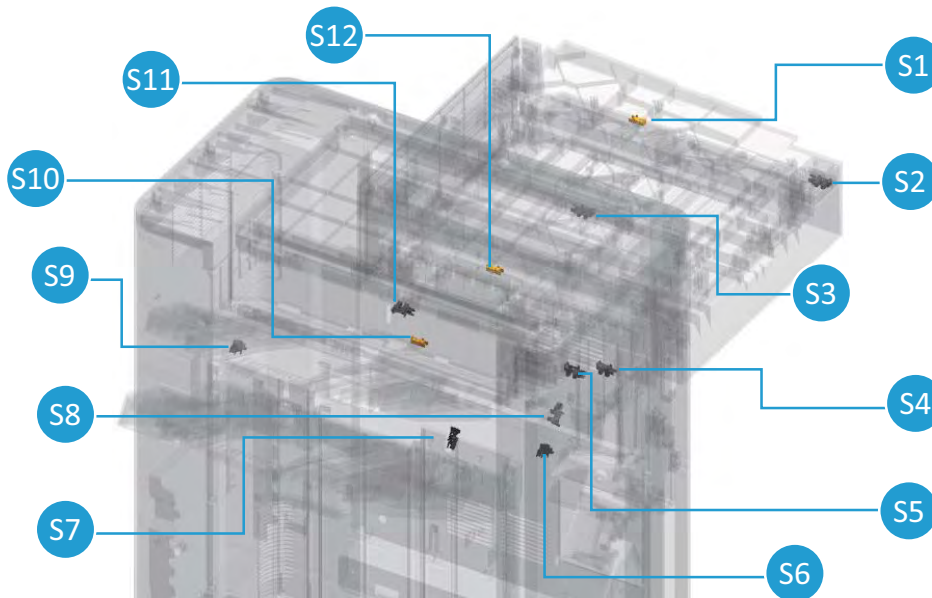

Table 5-11 Sensor – Stapler/stacker finisher and booklet finisher_1

No	Name	Part number	Orderable ^(*)	Diagnostics	Type	Description
S1	Bridge entrance sensor	JC32-00020A	(*)	113-2070	Paper sensor	Checks whether paper comes into the bridge entrance unit.
S2	Bridge door sensor	0604-001393	(*)	113-2180	Photo interrupter	Checks whether the bridge door is opened.
S3	Bridge exit sensor	0604-001393	(*)	113-2071	Photo interrupter	Checks whether paper comes into the bridge exit unit.
S4	Tray diverter home sensor	0604-001415	(*)	113-2020	Photo interrupter	Checks whether the tray diverter locates at the home position.
S5	Main exit cam home sensor	0604-001393	(*)	113-2000	Photo interrupter	Check whether the main exit CAM locates at the home position.
S6	Front tamper home sensor	0604-001393	(*)	113-2120	Photo interrupter	Checks whether the front tamper locates at the home position.
S7	End fence home sensor	0604-001393	(*)	113-2050	Photo interrupter	Checks whether the end fence locates at the home position.
S8	Paddle home sensor	0604-001393	(*)	113-2060	Photo interrupter	Checks whether the paddle locates at the home position.
S9	Rear tamper home sensor	0604-001393	(*)	113-2130	Photo interrupter	Checks whether the rear tamper locates at the home position.
S10	Main exit sensor	JC32-00020A	(*)	113-2090	Paper sensor	Checks whether paper comes into the main exit unit.
S11	Top exit sensor	0604-001393	(*)	113-2091	Photo interrupter	Checks whether paper comes into the top exit unit.
S12	Entrance sensor	JC32-00020A	(*)	113-2080	Paper sensor	Checks whether paper comes into the entrance unit.

(*) This part is in ordering system.

Figure 5-8 Sensor – Stapler/stacker finisher and booklet finisher_2

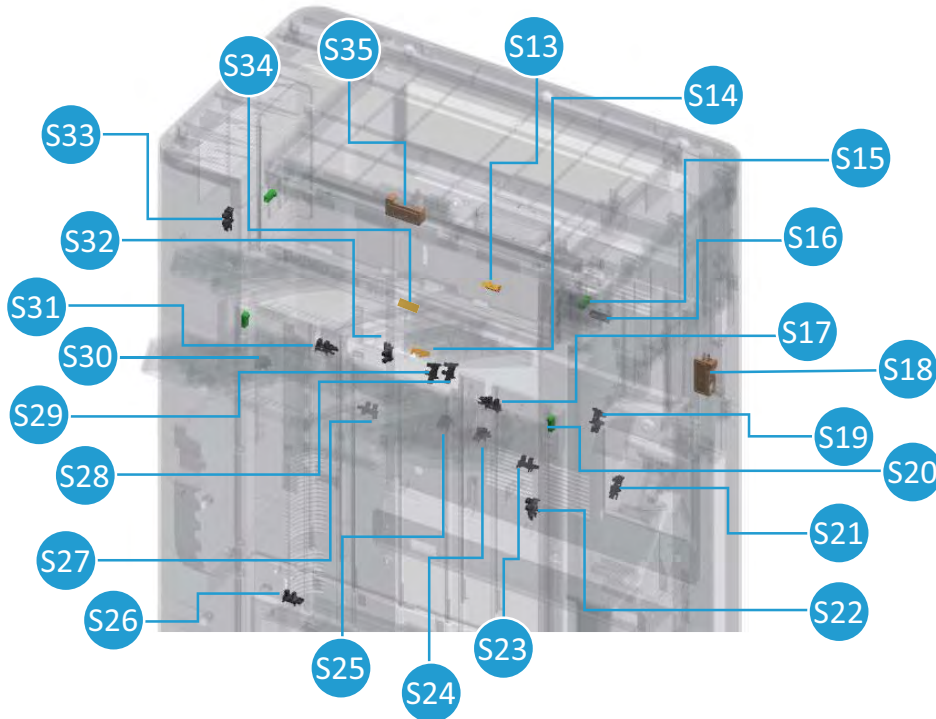

Table 5-12 Sensor – Stapler/stacker finisher and booklet finisher_2

No	Name	Part number	Orderable ^(*)	Diagnostics	Type	Description
S13	Buffer sensor	JC32-00020A	(*)	113-2100	Paper sensor	Checks whether paper exits out of the buffer unit
S14	Ejector sensor	JC32-00020A	(*)	113-2170	Paper sensor	Checks whether paper is on the ejector or not.
S15	Top output tray paper full sensor	JC82-01039A	(*)	113-2145	LED IR, Photo TR	Checks whether the top output tray is full or not.
S16	Buffer home sensor	0604-001393	(*)	113-2210	Photo interrupter	Checks whether the buffer roller and the idle roller whether attached or detached.
S17	Front Paper holding sensor	0604-001393	(*)	113-2141	Photo interrupter	Checks whether the location of the paper holding actuator for controlling the position of the main output tray.
S18	Front door switch	JC39-02309A		113-2182	Switch	Check whether the front door is open.
S19	Manual staple sensor	0604-001415	(*)	113-2160	Photo interrupter	Check whether the paper comes into the manual staple position.
S20	Main output tray top of stack sensor	JC82-01039A	(*)	113-2140	LED IR, Photo TR	Check whether the main output tray reaches the top of stack.
S21	Stapler front sensor	0604-001393	(*)	113-2113	Photo interrupter	Makes the stapler positioned in accordance with the manual stapling position.
S22	Paper holding home sensor	0604-001393	(*)	113-2010	Photo interrupter	Checks whether the paper holding actuator locates at the home position.

Table 5-12 Sensor – Stapler/stacker finisher and booklet finisher_2 (continued)

No	Name	Part number	Orderable ^(*)	Diagnostics	Type	Description
S23	Ejector2 motor sensor	0604-001415	(*)	113-2041	Photo interrupter	Checks whether the ejector2 motor is operational.
S24	Stapler mid front sensor	0604-001393	(*)	113-2112	Photo interrupter	Make the stapler positioned at the exact stapling position.
S25	Stapler mid rear sensor	0604-001393	(*)	113-2111	Photo interrupter	Make the stapler positioned at the exact stapling position.
S26	Main output tray lower limit sensor	0604-001415	(*)	113-2144	Photo interrupter	Checks whether the lower limit of the output tray (=output tray is full).
S27	Ejector1 motor sensor	0604-001415	(*)	113-2032	Photo interrupter	Checks whether the ejector1 motor is operational.
S28	Ejector1 end sensor	0604-001415	(*)	113-2030	Photo interrupter	Checks whether the ejector1 locates at the end position.
S29	Ejector1 home sensor	0604-001415	(*)	113-2031	Photo interrupter	Checks whether the ejector1 locates at the home position.
S30	Stapler rear sensor	0604-001393	(*)	113-2110	Photo interrupter	Checks whether the stapler locates at the home(rear) position.
S31	Rear paper holding sensor	0604-001393	(*)	113-2142	Photo interrupter	Checks whether the location of the paper holding actuator for controlling the position of the main output tray.
S32	Ejector2 home sensor	0604-001415	(*)	113-2040	Photo interrupter	Checks whether the ejector2 locates at the home position.
S33	Main output tray motor sensor	0604-001393	(*)	113-2143	Photo interrupter	Checks whether the Main output tray motor is operational.
S34	Main output tray top of stack switch	JC39-02316A		113-2190	Switch	Checks whether the main output tray reaches at the top of stack.
S35	Top door switch	JC39-02310A		113-2181	Switch	Checks whether the top door is open.

(*) This part is in ordering system.

Figure 5-9 Sensor – Booklet finisher

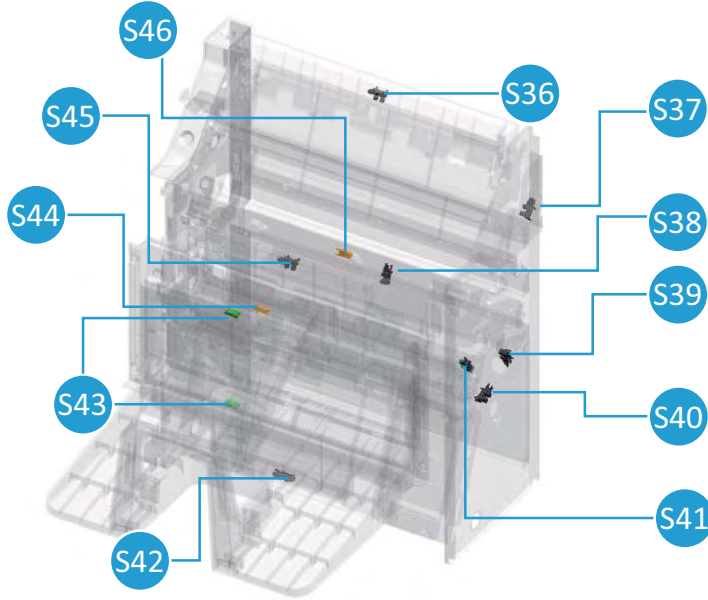
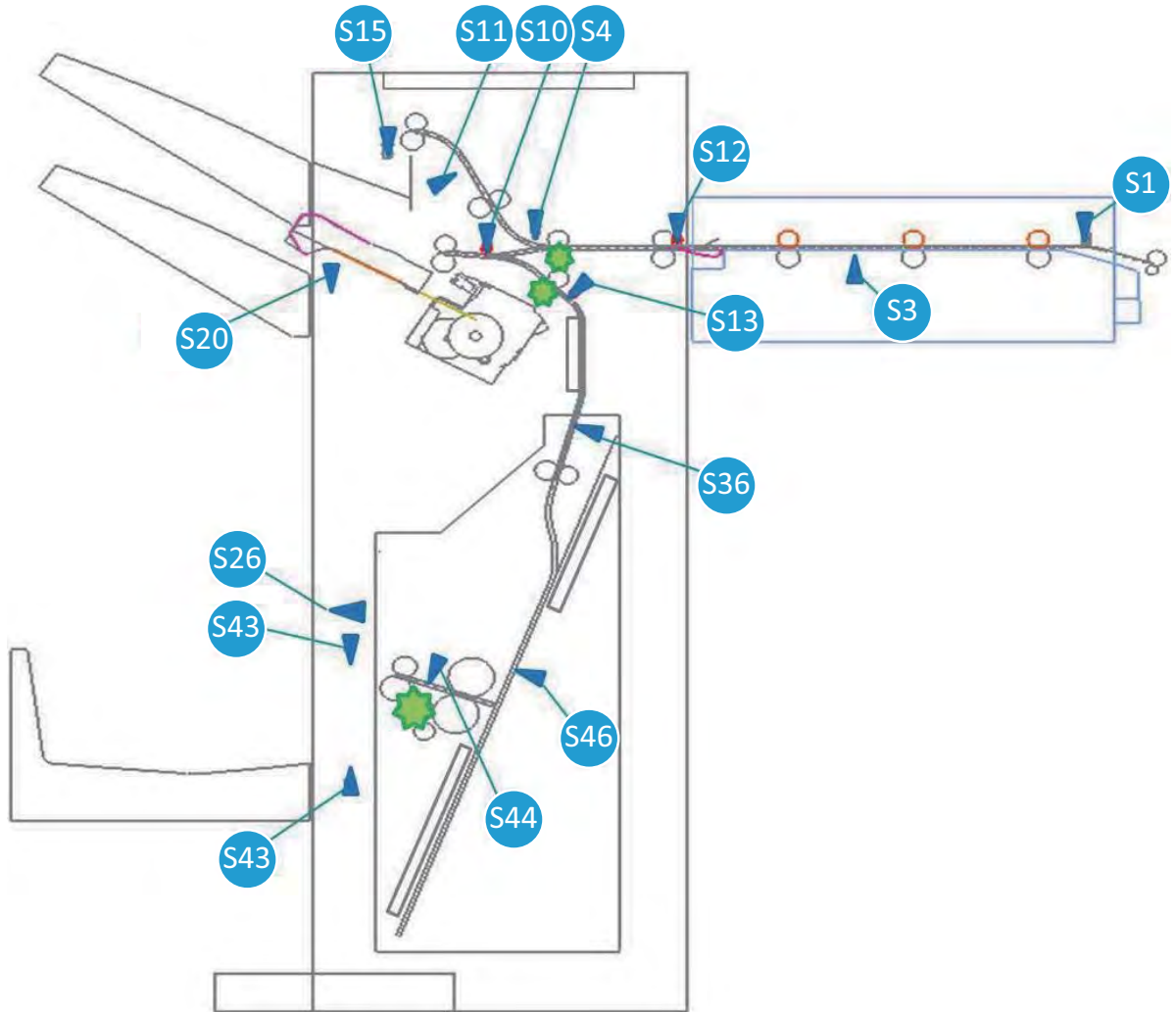

Table 5-13 Sensor – Booklet finisher

No	Name	Part number	Orderable ^(*)	Diagnostics	Type	Description
S36	Booklet entrance sensor	0604-001415	(*)	113-3100	Photo interrupter	Checks whether paper comes into the bridge entrance unit.
S37	Booklet presser home sensor	0604-001393	(*)	113-3130	Photo interrupter	Checks whether the booklet presser locates at the home position.
S38	Booklet tamper home sensor	0604-001393	(*)	113-3080	Photo interrupter	Checks whether the booklet tamper locates at the home position.
S39	Booklet c-fold blade home sensor	0604-001393	(*)	113-3050	Photo interrupter	Checks whether the booklet c-fold blade locates at the home position.
S40	Booklet diverter home sensor	0604-001415	(*)	113-3060	Photo interrupter	Checks whether the booklet diverter locates at the home position.
S41	Booklet paddle home sensor	0604-001393	(*)	113-3090	Photo interrupter	Checks whether the booklet paddle locates at the home position.
S42	Booklet end fence home sensor	0604-001393	(*)	113-3000	Photo interrupter	Checks whether the booklet end fence locates at the home position.
S43	Booklet output tray sensor	JC82-01039A	(*)	113-2150	LED IR, Photo TR	Checks whether paper goes out on the booklet output tray.
S44	Booklet exit sensor	JC32-00020A	(*)	113-3120	Paper sensor	Checks whether paper comes into the booklet exit unit.
S45	Booklet blade home sensor	0604-001393	(*)	113-3040	Photo interrupter	Checks whether the booklet blade locates at the home position.
S46	Booklet tamper sensor	JC32-00020A	(*)	113-3110	Paper sensor	Checks whether paper comes into the booklet tamper unit.

^(*) This part is in ordering system.

Figure 5-10 Sensor – Paper path



Motor and solenoid

Figure 5-11 Motor, solenoid – Stapler/stacker finisher and booklet finisher

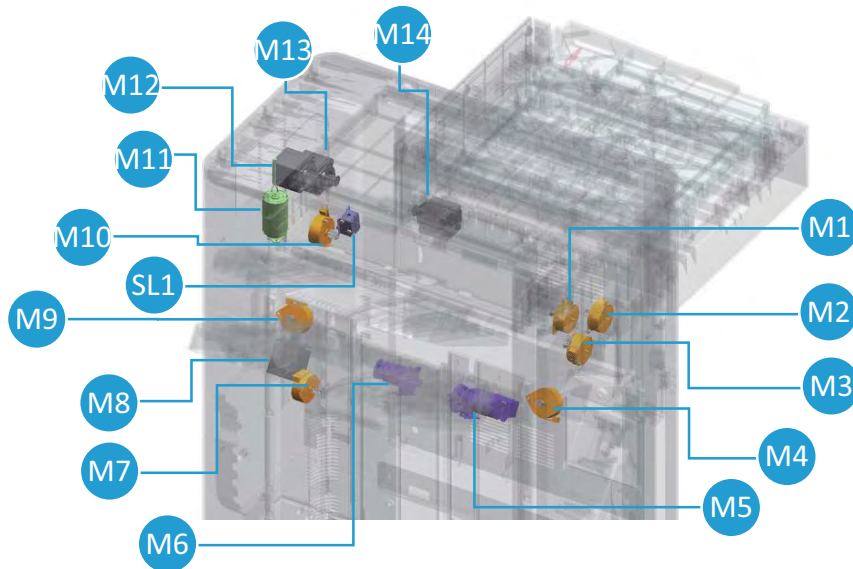

Table 5-14 Motor, solenoid – Stapler/stacker finisher and booklet finisher

No	Name	Part number	Orderable ^(*)	Diagnostics	Type	Description
M1	Paddle motor	JC93-01001A	(*)	113-3580	Step motor	Rotates the paddle and moves the paddle pusher up and downward at the same time.
M2	Main exit cam motor	JC93-01155A	(*)	113-2500	Step motor	Rotates the main exit cam to detach the exit roller from the exit idle roller.
M3	End fence motor	JC93-01001A	(*)	113-2590	Step motor	Moves front and rear end fence depending on paper size(width) so that paper is well arranged at the end fence.
M4	Front tamper motor	JC93-01001A	(*)	113-2630	Step motor	Moves the front tamper unit.
M5	Ejector2 motor	JC93-01168A		113-2540	DC motor	Moves the ejector2 and grabs paper.
M6	Ejector1 motor	JC93-01168A		113-2530	DC motor	Moves the ejector1 forward and backward
M7	Paper holding motor	JC93-01156A	(*)	113-2510	Step motor	Moves paper holding actuator up when paper goes out to the output tray
M8	Stapler position motor	JC31-00163A	(*)	113-2620	Hybrid Step motor	Moves the stapler.
M9	Rear tamper motor	JC93-01001A	(*)	113-2640	Step motor	Moves the rear tamper unit.
SL1	Buffer Solenoid	JC33-00038A	(*)	113-2670	Solenoid	Holds paper not to fall out to the booklet maker during buffering task.
M10	Buffer motor	JC93-01152A	(*)	113-2660	Step motor	Moves paper to the buffer space or the booklet maker.

Table 5-14 Motor, solenoid – Stapler/stacker finisher and booklet finisher (continued)

No	Name	Part number	Orderable ^(*)	Diagnostics	Type	Description
M11	Main output tray motor	JC31-00178B	(*)	113-2610	DC motor	Moves the main output tray up and down.
M12	Entrance motor	JC31-00163B	(*)	113-2570	Hybrid Step motor	Operates the entrance roller, middle roller, and top middle roller when driving in the forward and moves the diverter cam when driving in the backward.
M13	Exit motor	JC31-00163B	(*)	113-2580	Hybrid Step motor	Rotates the main exit roller and the top exit roller.
M14	Bridge motor	JC31-00163B	(*)	113-2560	Hybrid Step motor	Rotates the bridge entrance roller, the bridge middle roller and the bridge exit roller.

(*) This part is in ordering system.

Figure 5-12 Motor, solenoid – Booklet finisher

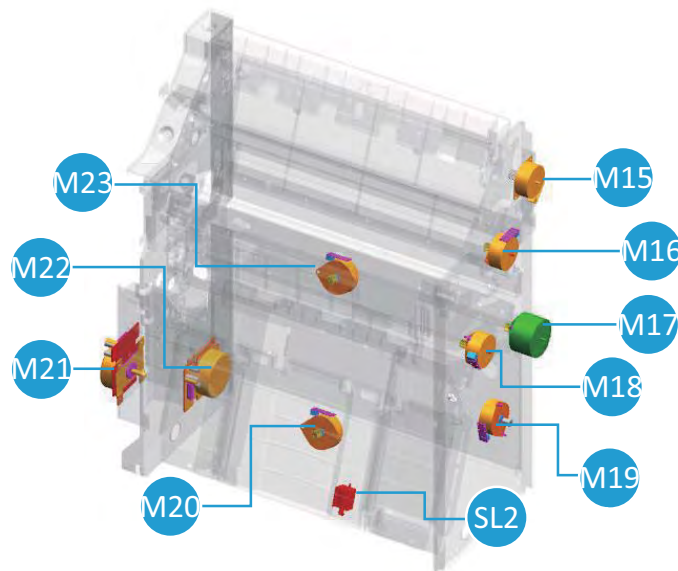

Table 5-15 Motor, solenoid – Booklet finisher

No	Name	Part number	Orderable ^(*)	Diagnostics	Type	Description
M15	Booklet entrance motor	JC93-01152A	(*)	113-3500	Step motor	Rotates the booklet entrance roller.
M16	Booklet presser motor	JC93-01155A	(*)	113-3570	Step motor	Operates the booklet presser.
M17	Booklet C-fold blade motor	JC93-01154A	(*)	113-3590	Step motor	Drives the booklet c-fold blade and the moving guide.
M18	Booklet diverter motor	JC93-01153A	(*)	113-3560	Step motor	Drives the booklet diverter
M19	Booklet paddle motor	JC93-01001A	(*)	113-3580	Step motor	Rotates the booklet paddle.

Table 5-15 Motor, solenoid – Booklet finisher (continued)

No	Name	Part number	Orderable ^(*)	Diagnostics	Type	Description
M20	Booklet end fence motor	JC93-01155A	(*)	113-3530	Step motor	Moves the booklet end fence up and down.
M21	Booklet Fold motor	JC31-00144A	(*)	113-3510	BLDC motor	Rotates the booklet fold roller, the booklet c-fold roller, and the booklet exit roller.
M22	Booklet blade motor	JC31-00144A	(*)	113-3550	BLDC motor	Drives the booklet blade.
M23	Booklet tamper motor	JC93-01155A	(*)	113-3540	Step motor	Moves the booklet tamper unit.
SL2	Booklet end fence solenoid	JC33-00038A	(*)	113-3520	Solenoid	Operates the gripper of the booklet end fence to grip paper that comes in the booklet end fence.

^(*) This part is in ordering system.

 **NOTE:** The motor sensor which is mounted near the driving motor detects whether the motor is operating or not. If a motor doesn't work properly, an event code only for the motor will occur. On the other hand, the home position sensor is installed for the purpose of checking the reference position or location when the specific unit is operating.

Figure 5-13 Motor sensor in the ejector unit

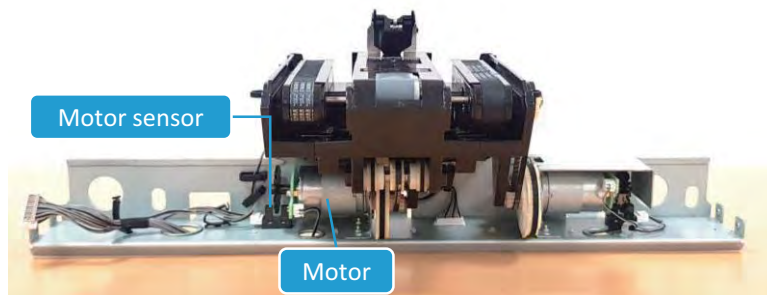
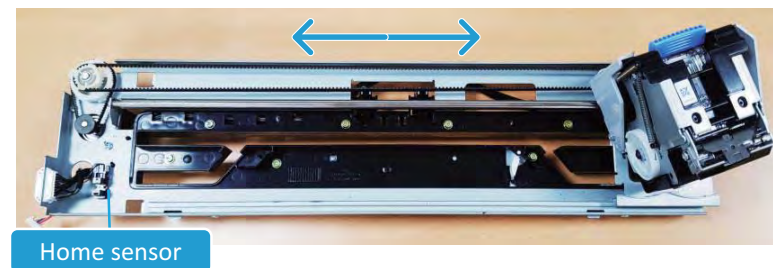

Figure 5-14 Home sensor in the stapler unit



Roller

Figure 5-15 Roller - Stapler/stacker finisher and booklet finisher

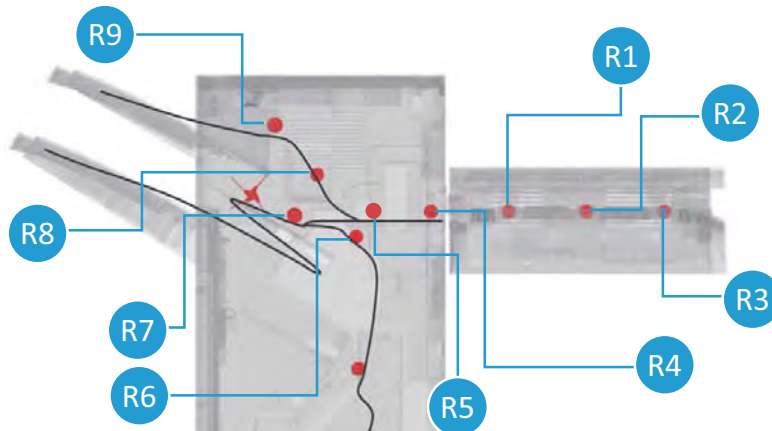

Table 5-16 Roller - Stapler/stacker finisher

No	Name	Part number	Orderable ^(*)	Drive motor	Description
R1	Bridge exit roller	JC66-04732A	(*)	Bridge motor	Moves paper from the machine to the bridge unit.
R2	Bridge middle roller	JC66-04732A	(*)	Bridge motor	Moves paper from the machine to the bridge unit.
R3	Bridge entrance roller	JC66-04733A	(*)	Bridge motor	Moves paper from the machine to the bridge unit
R4	Entrance roller	JC66-04722A	(*)	Entrance motor	Moves paper from the entrance unit to the exit unit
R5	Middle roller	JC66-04724A	(*)	Entrance motor	Moves paper from the entrance unit to the exit unit
R6	Buffer roller	JC66-05161A		Buffer motor	Moves paper to the booklet maker, and makes the gap between the buffer roller and the idle roller so that paper stays for the buffering.
R7	Main exit roller	JC66-04726A	(*)	Exit motor Main exit cam motor	Moves paper to the ejector unit or the buffer unit and makes the gap between the main exit roller and the idle roller so that paper stays for the buffering.
R8	Top middle roller	JC66-04725A	(*)	Entrance motor	Moves paper to the top output tray.
R9	Top exit roller	JC66-04727A	(*)	Exit motor	Moves paper to the top output tray.

(*) This part is in ordering system.

Figure 5-16 Roller – Booklet finisher

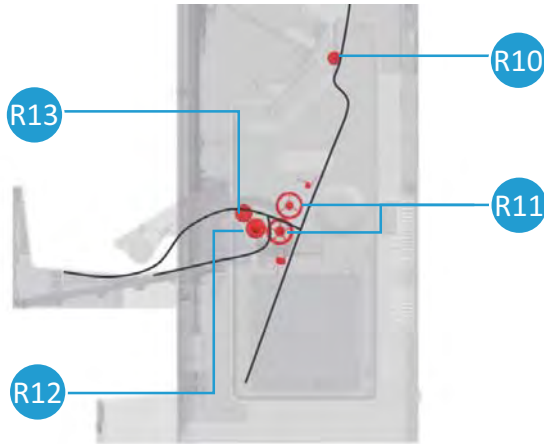

Table 5-17 Roller – Booklet finisher

No	Name	Part number	Orderable ^(*)	Drive motor	Description
R10	Booklet entrance roller	JC66-04717A		Booklet entrance motor	Moves paper from the machine to the bridge unit.
R11	Booklet fold roller	JC66-04748A		Booklet fold motor	Presses a stack of paper to fold completely.
R12	Booklet c-fold roller	JC66-04744A	(*)	Booklet fold motor	In case of c-fold, presses a stack of paper to fold completely.
R13	Booklet exit roller	JC66-04721A	(*)	Booklet fold motor	Moves paper to the booklet output tray unit

^(*) This part is in ordering system.

Figure 5-17 PCA

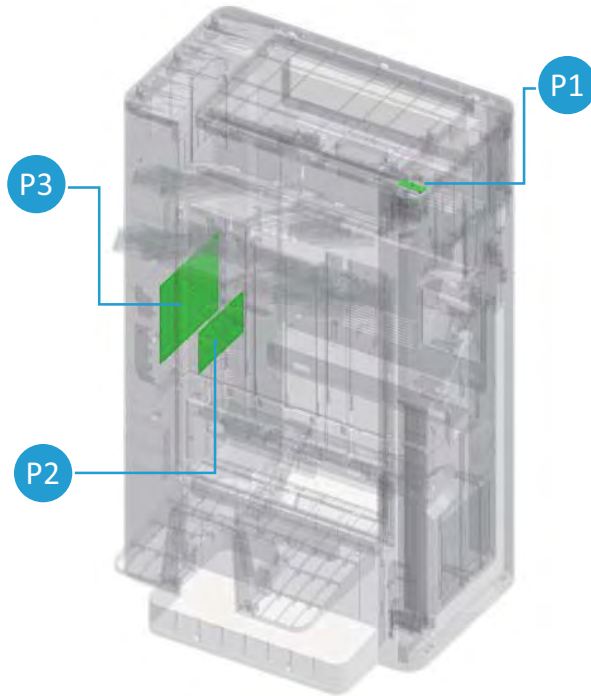

Table 5-18 PCA

No	Name	Part number	Orderable ^(*)	Description
P1	Manual staple PCA	JC92-02789B		This PCA shows the manual stapling condition and accepts the button input for manual staple.
P2	Booklet maker PCA	JC92-02789B	(*)	This PCA controls the booklet maker module and consists of the micro-controller and driver ICs.
P3	Finisher main PCA	JC92-02968A	(*)	This PCA controls the finisher modules and consists of the micro-controller and driver ICs.
Not shown	Hole punch PCA	-		This PCA controls the hole punch module and consists of the micro-controller and driver ICs.

(*) This part is in ordering system.

Bridge unit

The Bridge Unit is the asset to transfer paper from the printer to the finisher. The bridge entrance sensor (S1) detects paper entering the bridge unit from the printer. In the same way, the bridge exit sensor (S3) checks that the paper leaves from the bridge unit to the finisher. The bridge motor (M14) drive the bridge entrance roller, bridge middle roller, and bridge exit roller. It makes paper moves through the bridge unit. The jam removal door locating at the front side of the unit helps user to remove the jammed paper.

Figure 5-18 Bridge unit overview

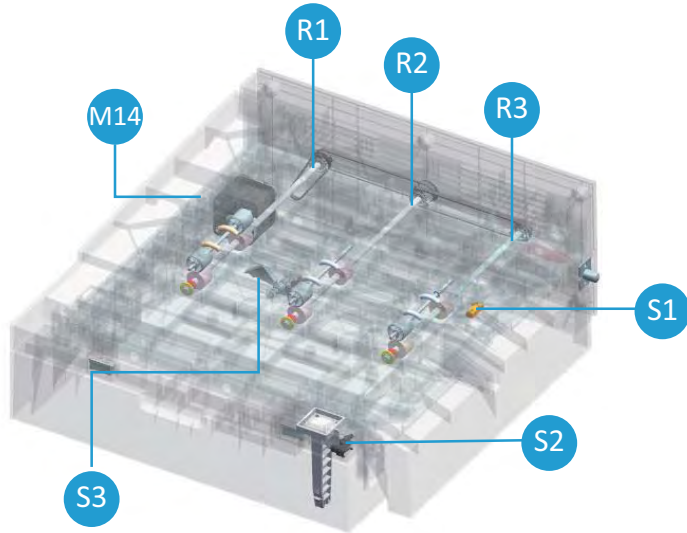

Figure 5-19 Bridge unit detail view

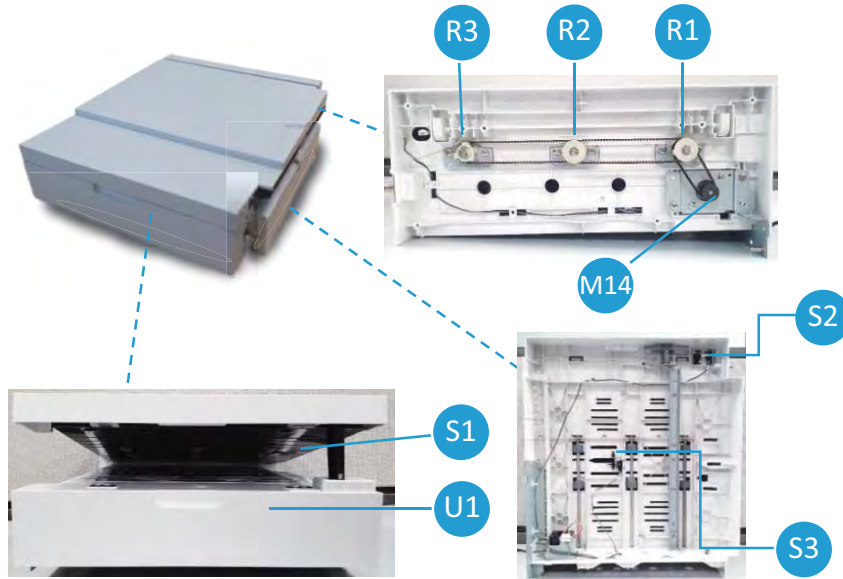

Table 5-19 Bridge unit parts information

No	Part Name	Part number	Orderable ^(*)	Diagnostics	Description
U1	Bridge unit	JC90-01772B	(*)		Moves paper from the printer to the finisher.
S2	Bridge door sensor	0604-001393	(*)	113-2180	Detects if the bridge door is open.
S1	Bridge entrance sensor	JC32-00020A	(*)	113-2070	Checks whether paper comes into the bridge entrance unit.
S3	Bridge exit sensor	0604-001393	(*)	113-2071	Checks whether paper move out of the bridge unit.
M14	Bridge motor	JC31-00163B	(*)	113-2560	Rotates the bridge entrance roller, the bridge middle roller and the bridge exit roller.
R3	Bridge entrance roller	JC66-04733A	(*)		Moves paper from the machine to the bridge unit.

Table 5-19 Bridge unit parts information (continued)

No	Part Name	Part number	Orderable ^(*)	Diagnostics	Description
R2	Bridge middle roller	JC66-04732A	(*)		Moves paper from the machine to the bridge unit.
R1	Bridge exit roller	JC66-04732A	(*)		Moves paper from the bridge unit to the finisher entrance unit.

(*) This part is in ordering system.

Entrance unit

Entrance unit moves paper from the bridge unit to the inside of the finisher. The Entrance sensor (S12) installed at the right side of the unit senses that the paper is entering the unit. The Entrance motor (M12) rotates forward to drive the entrance roller and the middle roller to move paper to the exit unit.

Figure 5-20 Entrance unit overview

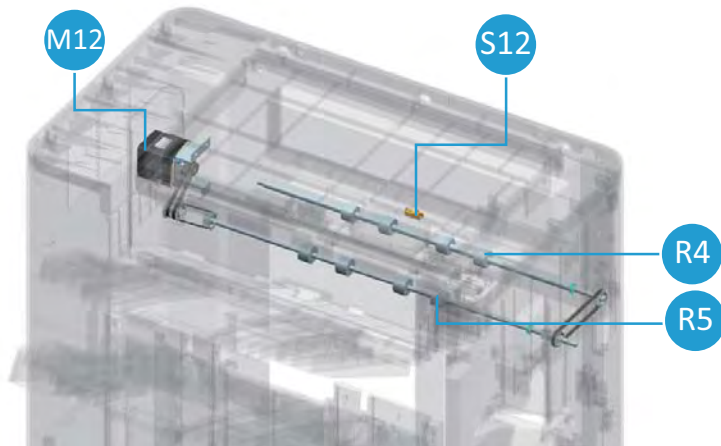

Figure 5-21 Entrance unit detail view - front

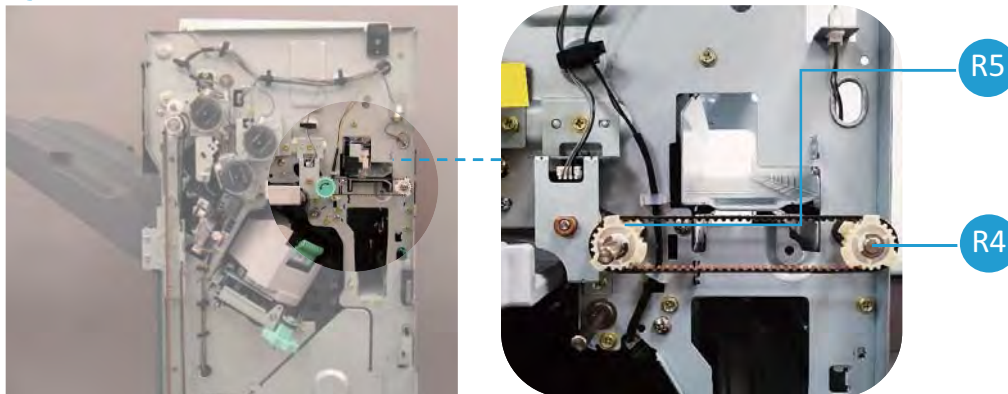

Figure 5-22 Entrance unit detail view - rear

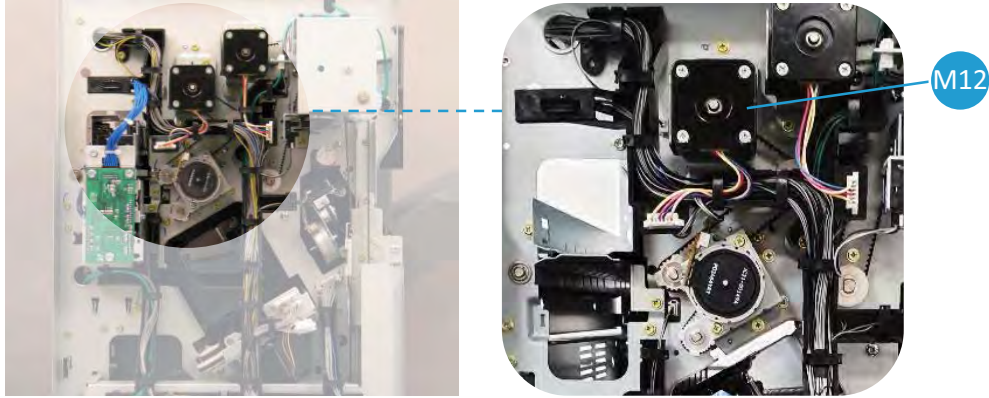

Figure 5-23 Entrance unit detail view - right



Table 5-20 Entrance unit parts information

No	Part Name	Part number	Orderable ^(*)	Diagnostics	Description
S12	Entrance sensor	JC32-00020A	(*)	113-2080	Detects whether paper enters at the entrance unit.
M12	Entrance motor	JC31-00163B	(*)	113-2570	Operates the entrance roller and middle roller when driving forward.
R4	Entrance roller	JC66-04722A	(*)		Moves paper from the entrance unit to the exit unit.
R5	Middle roller	JC66-04724A	(*)		Moves paper from the entrance unit to the exit unit.

(*) This part is in ordering system.

Punch unit (optional)

Learn about the punch unit of the Stapler/stacker finisher and booklet finisher.

The punch unit is a device that punches holes in a specific location on a sheet of paper. The punch unit is positioned right after the entrance unit.

- HP LaserJet Hole Punch 2/3 Accessory —Y1G10A
- HP LaserJet Hole Punch 2/4 Accessory — Y1G11A
- HP LaserJet Hole Punch Swedish Accessory — Y1G12A

 **NOTE:** Puncher types are various depending on the country.

In case of 2/3 hole punch, the 5 hole-punches are mounted in the punch unit. As the punch motor rotates forward, the inner gear moves to the right and the 3 hole-punches are moved downward to make the holes on the paper. When making 2 holes, the motor rotates in the backward direction and the inner gear rotates to the left to drill two holes. The travel distance and position of the hole-punches are detected and controlled by the 3 punch position sensors.

Figure 5-24 Punch unit overview



Figure 5-25 Punch unit detail view

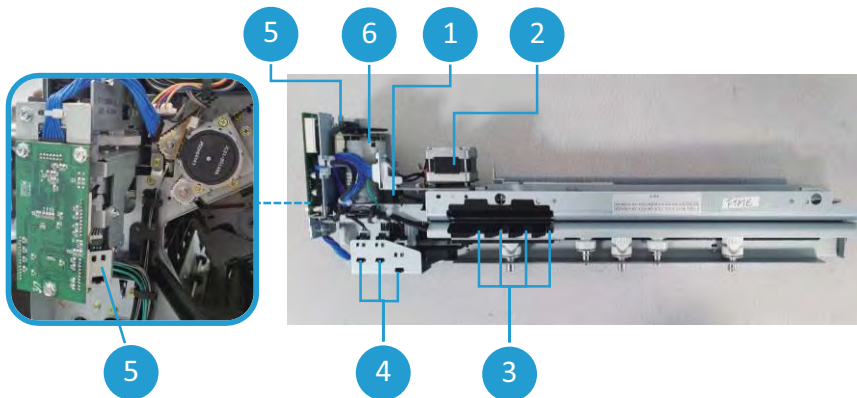

Table 5-21 Punch unit parts information

Item	Part name	Part number	Orderable ^(*)	Diagnostics	Description
U1	Punch unit				
	2-3 hole	Y1G10A	(*)		
	2-4 hole	Y1G11A	(*)		
	Swedish hole	Y1G12A	(*)		
1	Punch scan home sensor			113-4000	Detects the home position of the punch unit

Table 5-21 Punch unit parts information (continued)

Item	Part name	Part number	Orderable ^(*)	Diagnostics	Description
3	Punch scan edge sensor			113-4010 113-4011 113-4012 113-4013	Check the paper width to make hole on the right position of paper.
2	Punch scan motor			113-4500	Transmits the force to move the punch unit in the horizontal direction.
4	Punch position sensor			113-4020 113-4030 113-4031	Detects the travel distance and position of the hole-punches.
5	Punch motor sensor			113-4040	Checks whether the punch motor is operational
6	Punch motor			113-4510	Transmits the force to make holes on the paper

(*) This part is in system.

Punch unit operation

1. A paper enters into the punch unit, and it is aligned to drill holes.
2. The motor rotates forward or backward, then the punch rail in the punch unit moves in order to move the punch hole makers (callout 1).

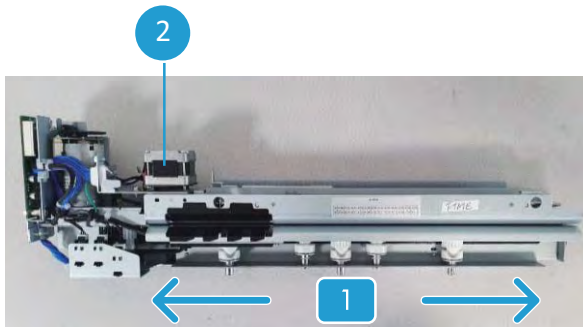

3. The punch position sensors determine the punch rail location (callout 2). It drives the punch hole makers up and down to make holes (callout 3).

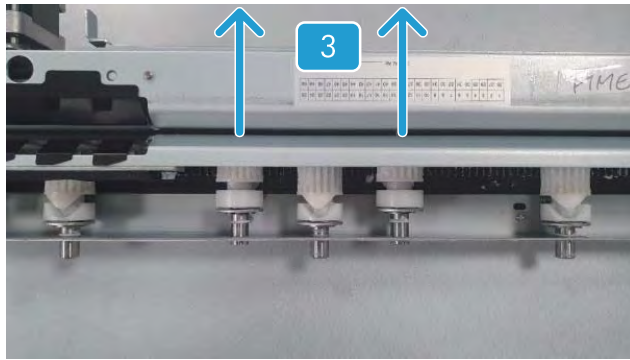
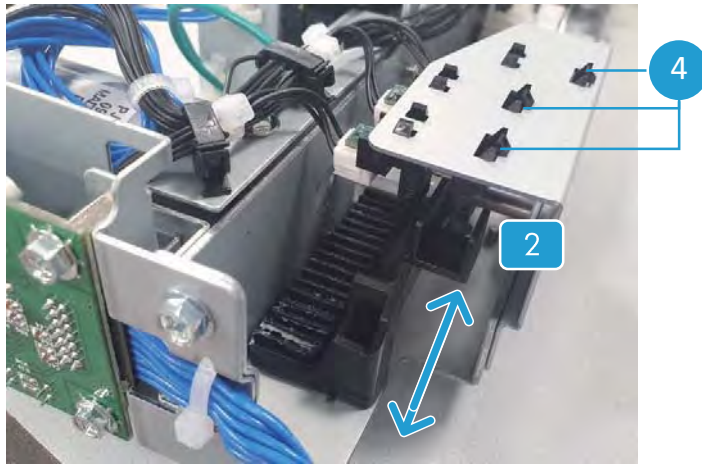

4. In some paper size, paper might be jammed in a place where punch hole maker is located. Therefore, the punch unit moves left and right (callout 4).



Tray diverter unit

Learn about the Tray diverter unit of the Stapler/stacker finisher and booklet finisher.

The tray diverter unit is responsible for determining the paper feed direction so that paper can be ejected to the main output tray or top output tray.

The entrance motor (M12) rotates this unit. When the entrance motor rotates backward, the phase of the diverter cam (callout1) changes so that the paper path direction changes. The tray diverter home sensor (S4) checks whether the tray diverter is located at the home position or not. (callout2).

Figure 5-26 Tray diverter unit overview

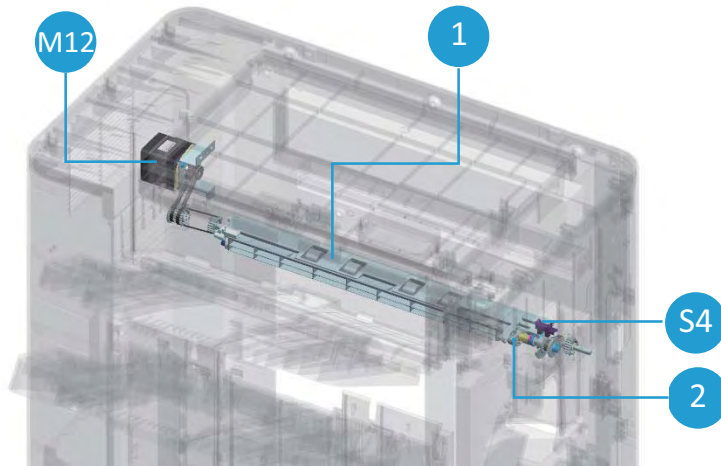

Figure 5-27 Tray diverter unit detail view – front-top

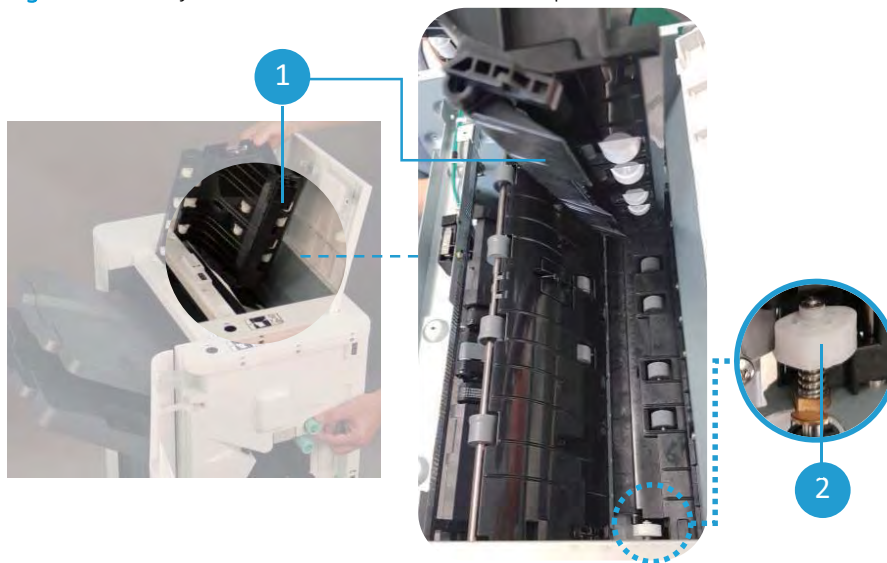

Figure 5-28 Tray diverter unit detail view – rear

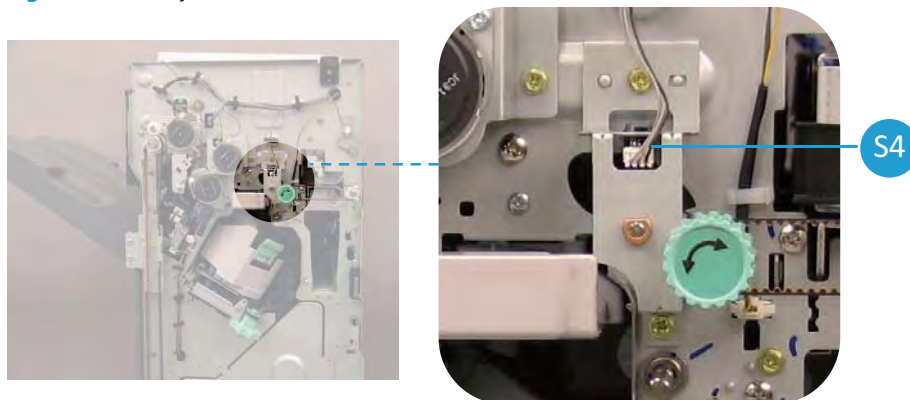

Table 5-22 Tray diverter unit parts information

Item	Part name	Part number	Orderable ^(*)	Diagnostics	Description
1	Tray diverter	JC61-07205A			Selects the paper path of either the main output tray or the top output tray
2	Tray diverter cam	JC66-04560A		113-2520	Changes the paper path
S4	Tray diverter home sensor	0604-001415	(*)	113-2020	Checks whether home position of the tray diverter
M12	Entrance motor	JC31-00163B	(*)		Operates the tray diverter cam when driving in the backward direction.

(*) This part is in ordering system.

Tray diverter unit operation

1. When printing or copying documents, the entrance motor operates backward so that the diverter cam (Callout 2) can be rotate.
2. The direction of the tray diverter(callout1) is changed to the main output tray or the top output tray by the tray diverter cam(callout2).

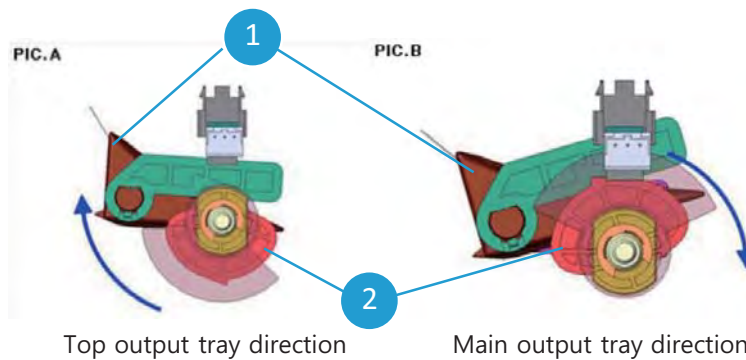

Top exit unit

Learn about the Top exit unit of the Stapler/stacker finisher and booklet finisher.

The top exit unit sends paper from the tray diverter unit to the top output tray unit.

The top exit sensor(S11) detects paper entry into the top exit unit. The entrance motor(M12) drives the top middle roller, and the exit motor(M13) transmit the force to rotate the top exit roller so that paper moves to the top output tray unit.

Figure 5-29 Top exit unit overview

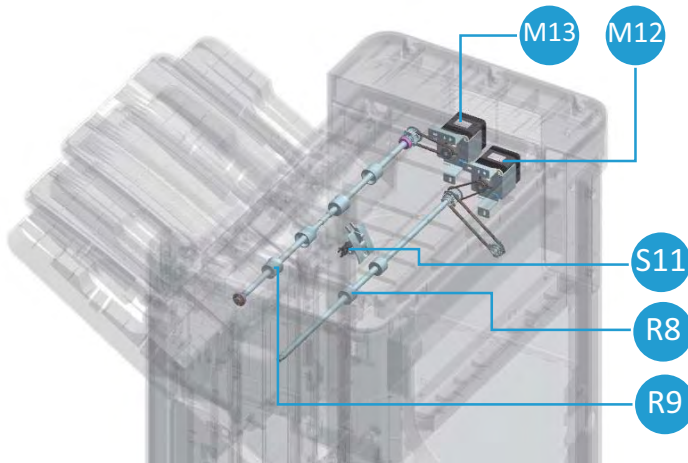

Figure 5-30 Top exit unit detail view – front-top

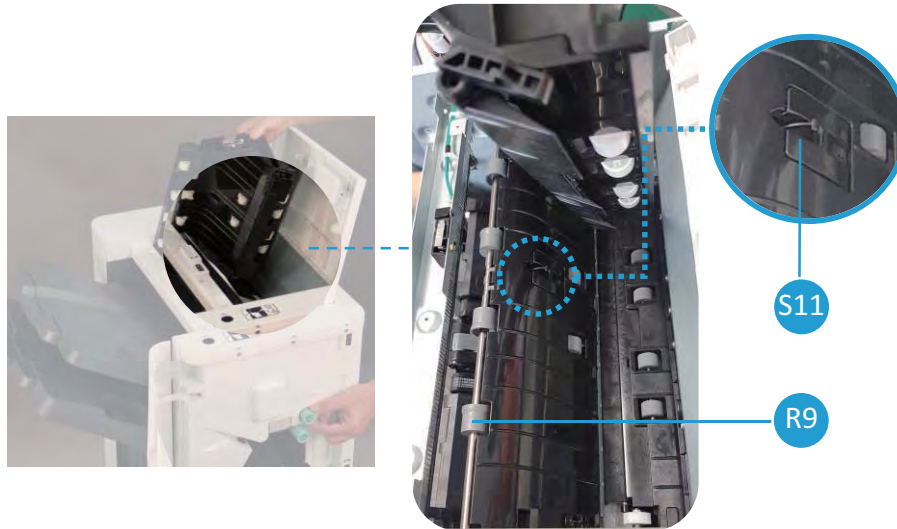

Table 5-23 Top exit unit parts information

Item	Part name	Part number	Orderable ^(*)	Diagnostics	Description
S11	Top exit sensor	0604-001393	(*)	113-2091	Checks whether paper has entered at the top exit unit
M12	Entrance motor	JC31-00163B	(*)	113-2570	Rotates the top middle roller when driving in the forward direction.
M13	Exit motor	JC31-00163B	(*)	113-2580	Rotates the top exit roller
R8	Top middle roller	JC66-04725A	(*)		Moves paper to the top output tray
R9	Top exit roller	JC66-04727A	(*)		Moves paper to the top output tray

(*) This part is in ordering system.

Top output tray unit

Learn about the Top output tray unit of the Stapler/stacker finisher and booklet finisher.

The top output tray unit loads discharged paper from the finisher.

It has the paper pull sensor(S15) to detect whether the tray is full with paper.

Figure 5-31 Top output tray unit overview

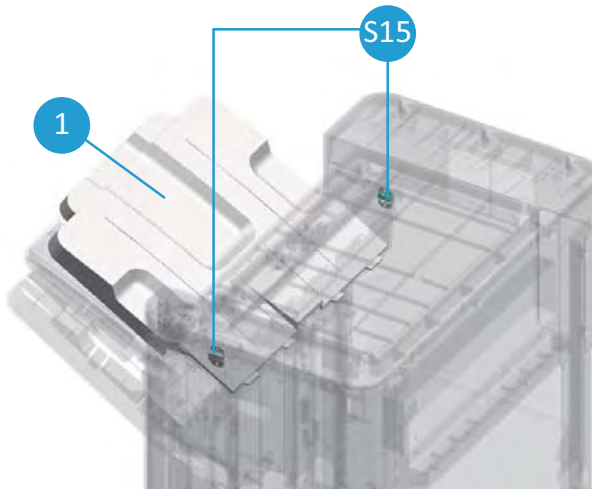

Figure 5-32 Top output tray unit detail view – front-left

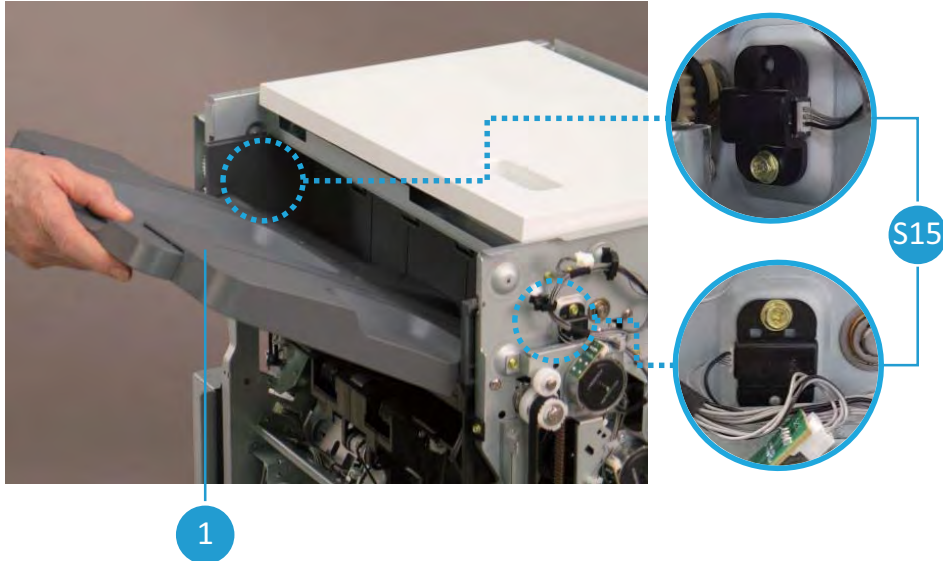

Table 5-24 Top output tray unit parts information

Item	Part name	Part number	Orderable ^(*)	Diagnostics	Description
1	Top output tray	JC63-04996B			Loads ejected paper
		JC63-05003B	(*)		
S15	Top output tray paper full sensor (receiver, led)	JC82-01039A	(*)	113-2145	Detects whether paper is fully stacked on the output tray.

^(*) This part is in ordering system.

Main exit unit

Learn about the Main exit unit of the Stapler/stacker finisher and booklet finisher.

The main exit unit delivers paper from the tray diverter unit to the ejector unit or buffer unit.

The main exit sensor (S10) detects whether paper comes in from main exit unit. The exit motor (M13) drives the main exit roller to send the paper to the ejector unit or buffer unit.

Figure 5-33 Main exit unit overview

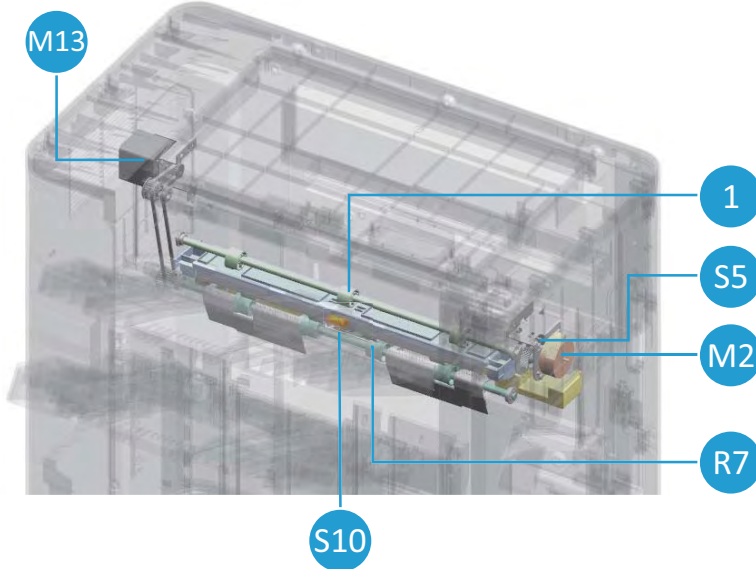

Figure 5-34 Main exit unit detail view – (front-rear)

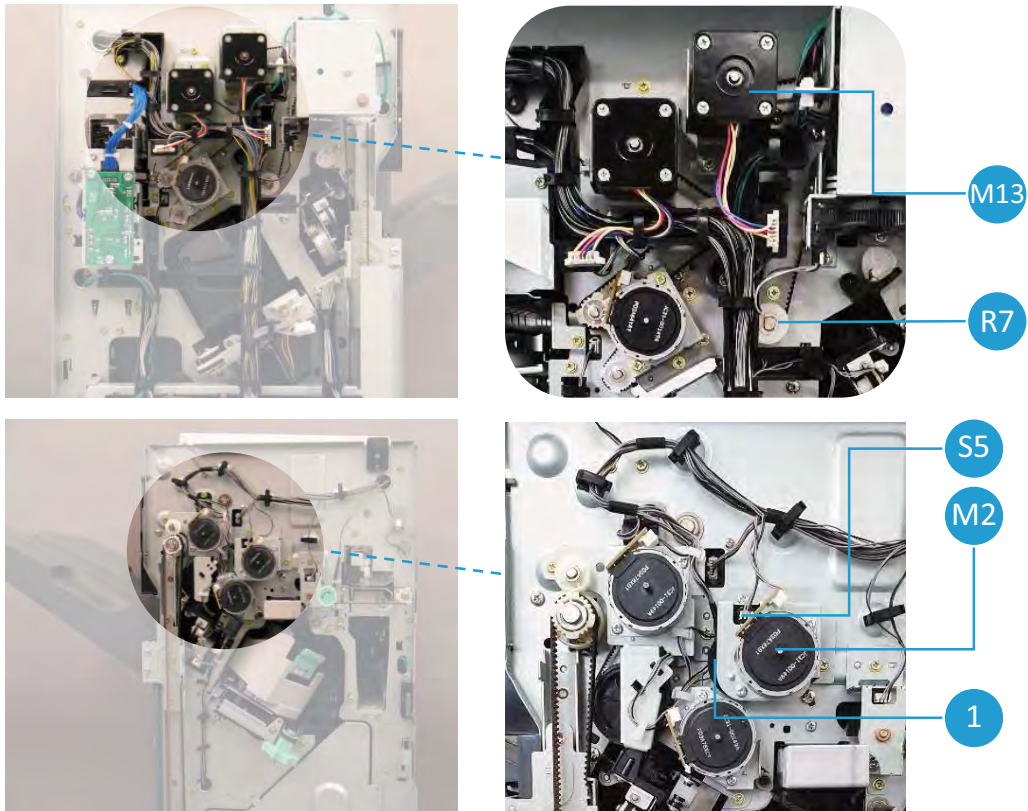

Table 5-25 Main exit unit parts information

Item	Part name	Part number	Orderable ^(*)	Diagnostics	Description
S10	Main exit sensor	JC32-00020A	(*)	113-2090	Detects whether paper entered at the main exit unit

Table 5-25 Main exit unit parts information (continued)

Item	Part name	Part number	Orderable ^(*)	Diagnostics	Description
M13	Exit motor	JC31-00163B	(*)	113-2580	Rotates the main exit roller
R7	Main exit roller	JC66-04726A	(*)		Moves paper to the ejector unit or the buffer unit
1	Main exit cam				Adjusts the gap between the main exit roller and the idle roller for the buffering. (*Please refer to 'buffer unit')
S5	Main exit cam home sensor	0604-001393	(*)	113-2000	Detects the home position of the main exit cam
M2	Main exit cam motor	JC93-01155A	(*)	113-2500	Rotates the main exit cam.

(*) This part is in ordering system.

Main exit unit operation

1. The exit motor(M13) drives forward so that paper will moves towards the ejector unit.

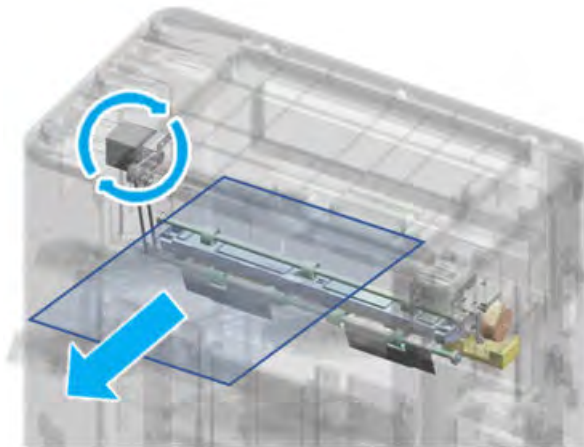

2. On the other hand, if the exit motor rotates backwards paper moves towards the buffer unit.

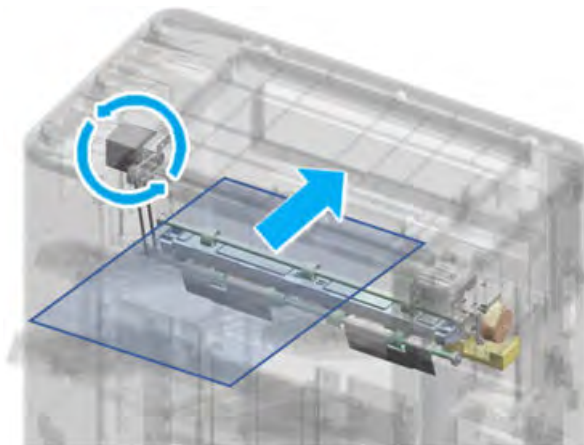

Paddle unit

Learn about the Paddle unit of the Stapler/stacker finisher and booklet finisher.

The paddle unit rotates the rubber paddles mounted on the shaft to move paper to the end fence unit, allowing paper to be arranged well for the next job. The paddle presser is mounted behind the rubber paddles and presses the end of paper to help paper be stacked well at the end fence unit. The Paddle home sensor (S8) checks the home position to drive the paddles. And the paddle motor(M1) drives the paddle and paddle presser.

Figure 5-35 Paddle unit overview

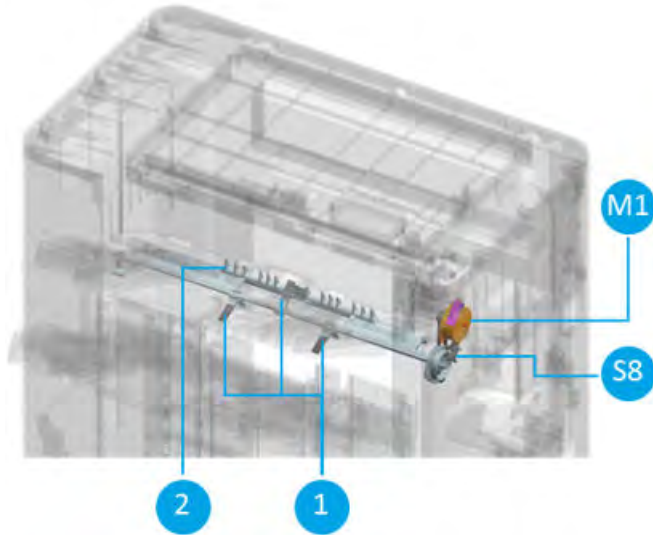

Figure 5-36 Paddle unit detail view - front

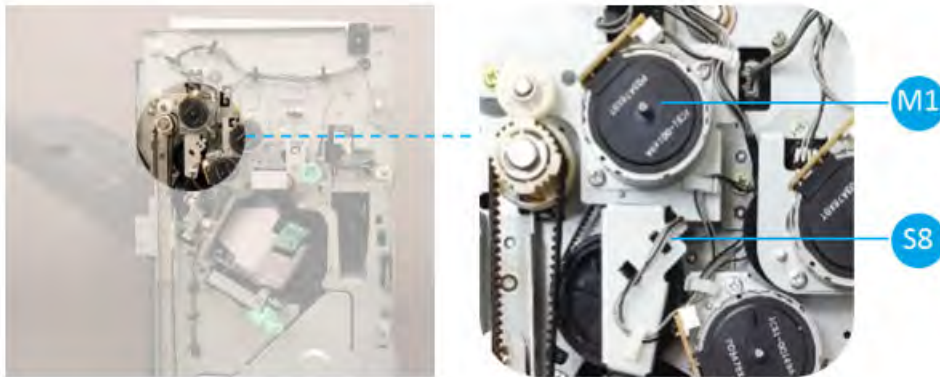

Figure 5-37 Paddle unit detail view - left

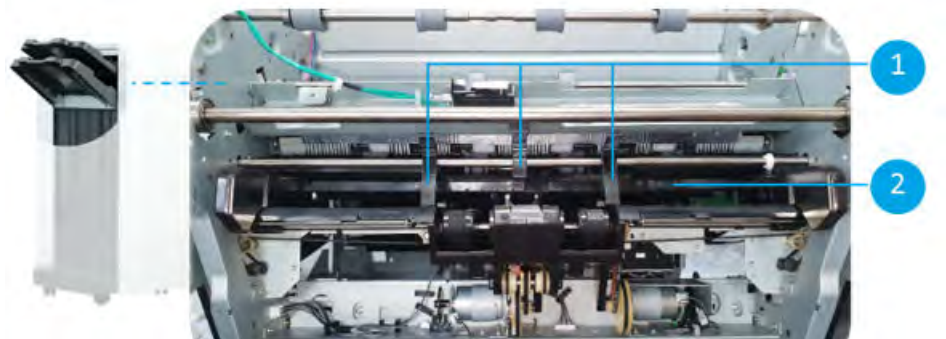

Table 5-26 Paddle unit parts information

Item	Part name	Part number	Orderable ^(*)	Diagnostics	Description
1	Paddle	JC90-01480A			Moves paper into the end fence unit
2	Paddle presser	JC61-07206A			Presses the end of bent paper helps paper to be loaded well at the end fence unit
S8	Paddle home sensor	0604-001393	(*)	113-2060	Detect the home position of the paddle
M1	Paddle motor	JC93-01001A	(*)	113-2600	Rotates the paddle, and moves the paddle presser up and downward at the same time

(*) This part is in ordering system.

Paddle unit operation

1. A paper falls downward by exit unit.
2. The paddles rotate to make a paper moves into the end fence unit. (callout 1)



3. The paddle presser presses the end of a paper so as not to be scattered. (callout 2).

End fence unit

Learn about the End fence unit of the Stapler/stacker finisher and booklet finisher.

The paddle unit moves paper to the end fence unit. The end fence unit sets the standard position of the paper to be aligned towards top and bottom of the paper.

End fence motor(M3) operates the two end fences and adjust width of them in order to stack paper correctly. The end fence home sensor(S7) detects the home position of the end fence.

Figure 5-38 End fence unit overview

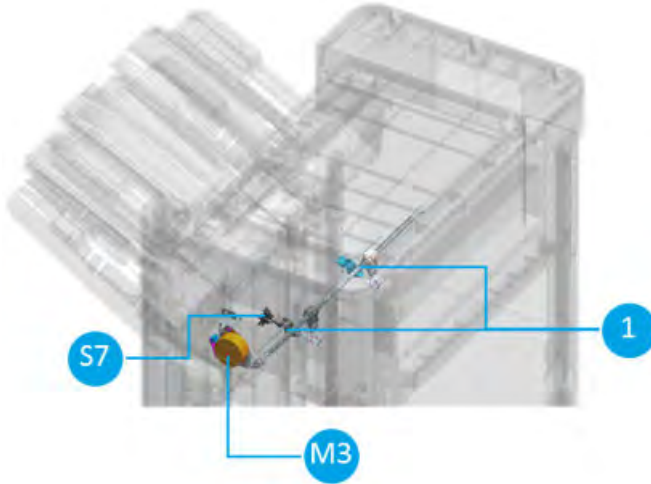

Figure 5-39 End fence unit detail view – front

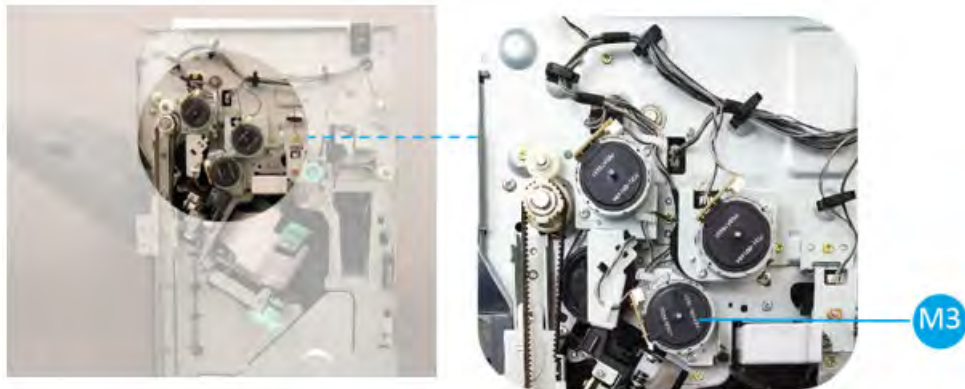

Figure 5-40 End fence unit detail view - left

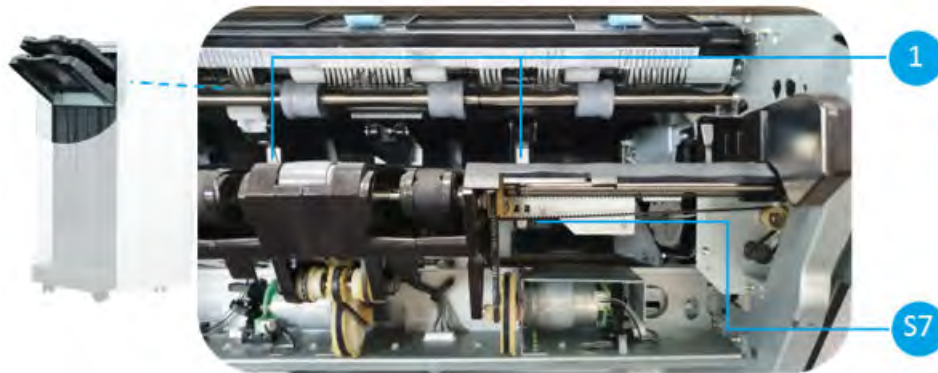

Table 5-27 End fence unit parts information

Item	Part name	Part number	Orderable ^(*)	Diagnostics	Description
1	End fence				Aligns top and bottom side of paper.
S7	End fence home sensor	0604-001393	(*)	113-2050	Detects the home position of the end fence

Table 5-27 End fence unit parts information (continued)

Item	Part name	Part number	Orderable ^(*)	Diagnostics	Description
M3	End fence motor	JC93-01001A	(*)	113-2590	Moves front and rear end fence depending on paper size(width) so that paper arranged well at the end fence

(*) This part is in ordering system.

End fence unit operation

1. The end fence motor(M3) moves the front and rear end fences in the arrow direction (callout 1) depending on paper width.

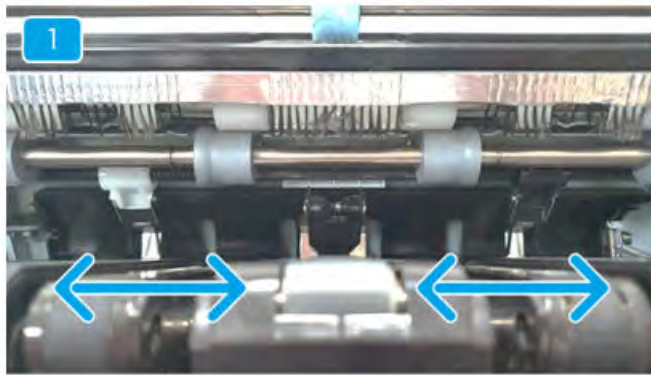

2. Paper goes into the end fence unit by the paddle unit. (callout 2)

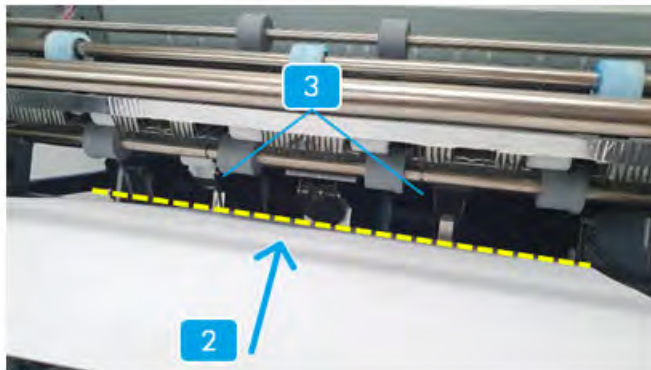

3. At the same time the end fence unit aligns paper to the direction of yellow line. (callout 3)

Tamper unit

Learn about the Tamper unit of the Stapler/stacker finisher and booklet finisher.

The tamper unit functions to align the left and right sides of a bundle of paper. When a certain amount of paper is collected after printing, the tamper unit hits the left and right ends of the paper to align the paper correctly.

Each tamper has a motor on the back side that delivers driving force to move. The tamper home sensors are mounted on the back side of the unit to check the home position of the tamper unit.

Figure 5-41 Tamper unit overview

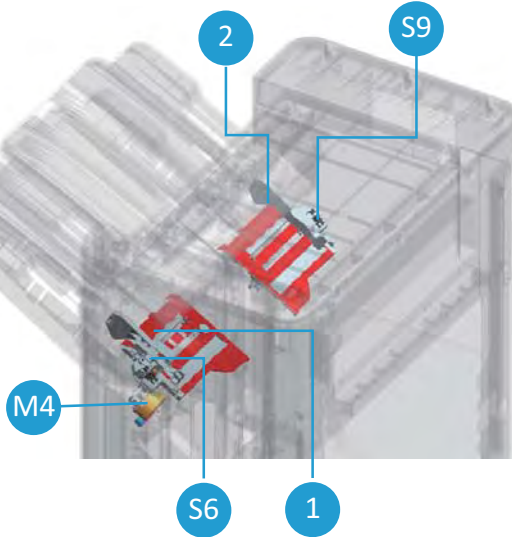

Figure 5-42 Tamper unit detail view - left



Figure 5-43 Tamper unit detail view - left-right

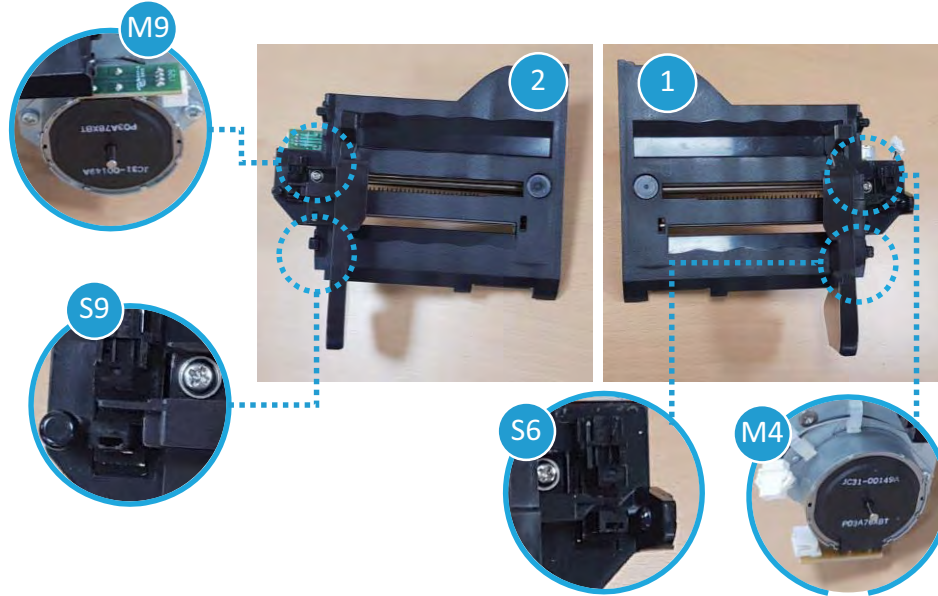

Table 5-28 tamper unit parts information

Item	Part name	Part number	Orderable ^(*)	Diagnostics	Description
1	Front tamper	JC82-00901A	(*)		Aligns left and right side of paper.
S6	Front tamper home sensor	0604-001393	(*)	113-2120	Detects the home position of the tamper unit.
M4	Front tamper motor	JC93-01001A	(*)	113-2630	Moves the front tamper unit.
2	Rear tamper	JC82-00898A	(*)		Aligns left and right side of paper.
S9	Rear tamper home sensor	0604-001393	(*)	113-2130	Detects the home position of the tamper unit.
M9	Rear tamper motor	JC93-01001A	(*)	113-2640	Moves the front tamper unit.

(*) This part is in ordering system.

Tamper unit operation

1. A stack of paper is arranged at the end fence unit.



2. The left and right tampers arrange them.

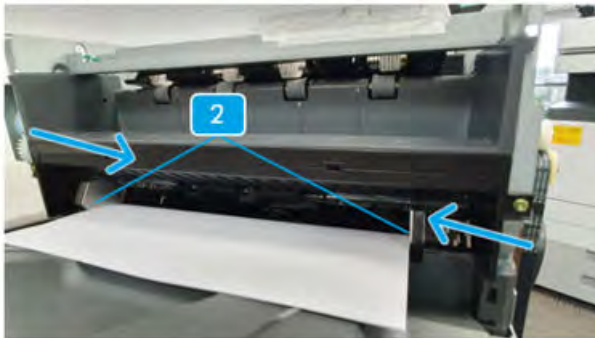

3. In case of offset printing, the tamper unit arranges the next bundle to be shifted. (callout 3)



Stapler unit

Learn about the Stapler unit of the Stapler/stacker finisher and booklet finisher.

Stapler unit is a device installed inside the finisher that staples a bundle of aligned documents. Documents are collected as a bundle by the tamper unit and the end fence unit for stapling, then stapler assembly staples the bundle. There are 6 options to make a bundle.

Figure 5-44 Stapling options



The stapler unit moves using the stapler motor (M8) installed inside. The one home sensor (rear sensor, S30) and two position sensors (mid-front, S24 and mid-rear sensor, S25) are mounted so that the stapler can be positioned in the exact stapling position whether it is stapled on the left, the right, or at the center of the document. Stapling is done by the motor inside the stapler assembly.

In addition, manual staple feature is available on the front-upper side of the finisher. The manual staple sensor (S19) detects whether a stack of paper comes into the manual staple location or not. The front sensor (stapler front sensor, S21) makes the stapler moves at the manual staple location.

Figure 5-45 Stapler unit overview

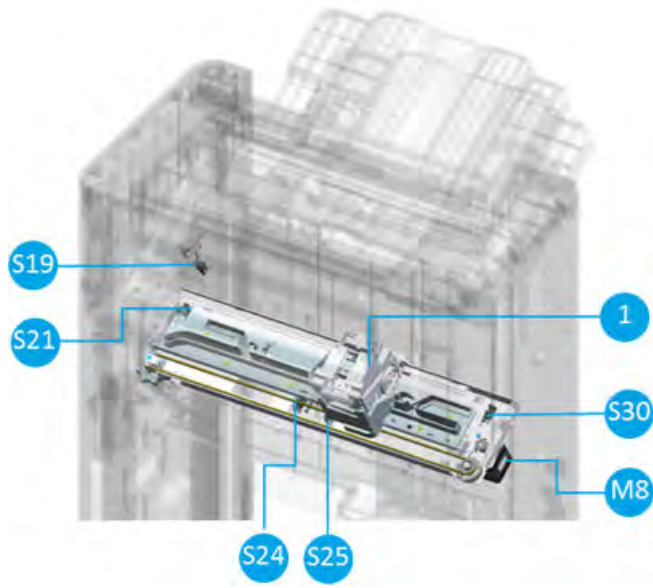

Figure 5-46 Stapler unit detail view - front

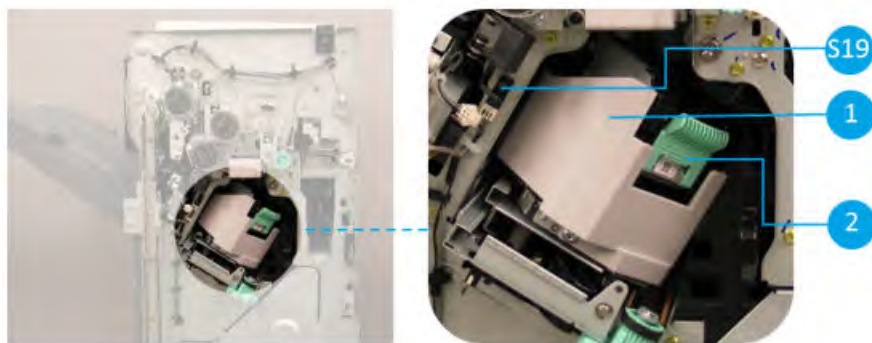

Figure 5-47 Stapler unit detail view

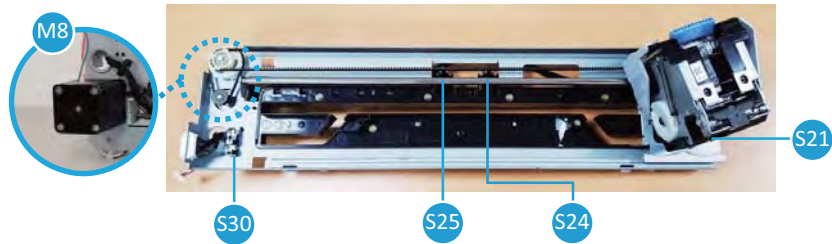

Table 5-29 Stapler unit parts information

Item	Part name	Part number	Orderable ^(*)	Diagnostics	Description
1	Stapler unit	JC82-00894A	(*)		Staples a bundle of paper
2	Staple cartridge	JC81-09882B	(*)	113-2115 113-2116	Staple cartridge
S21	Stapler front sensor	0604-001393	(*)	113-2113	Detect the stapler at the manual stapling position
S24	Stapler mid-front sensor	0604-001393	(*)	113-2112	Detect the stapler location

Table 5-29 Stapler unit parts information (continued)

Item	Part name	Part number	Orderable ^(*)	Diagnostics	Description
S25	Stapler mid-rear sensor	0604-001393	(*)	113-2111	Detect the stapler location
S30	Stapler rear sensor	0604-001393	(*)	113-2110	Detect the home position of the stapler
S19	Manual staple sensor	0604-001415	(*)	113-2160	Detect paper when manual stapling
M8	Stapler position motor	JC31-00163A	(*)	113-2620	Moves the stapler

(*) This part is in ordering system.

Stapler unit operation

1. The stapler position motor drives the stapler assembly to direction 1.

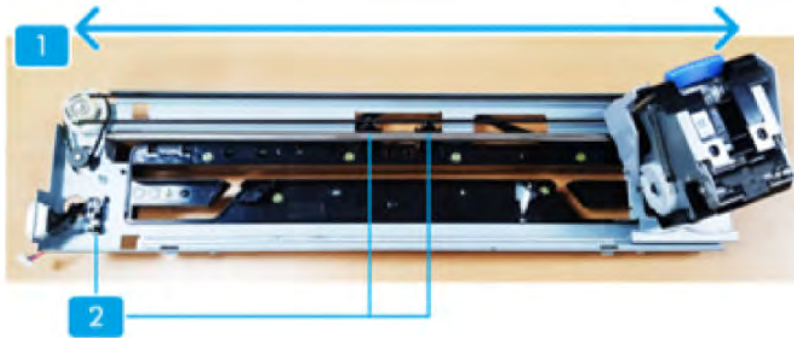

2. The stapler assembly moves through the rail using three stapler position sensors (callout 2) and staples a stack of paper.
3. In case of staple cartridge replacement, the stapler moves to direction 3.

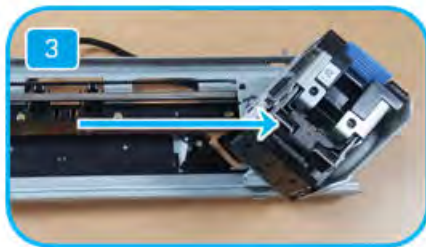

4. For manual stapling, the stapler moves in direction 4.

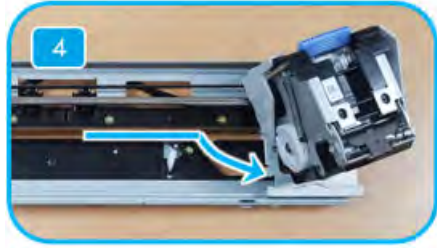

Ejector unit

Learn about the ejector unit of the Stapler/stacker finisher and booklet finisher.

The ejector unit ejects a bundle of paper out to the main output tray. The ejector unit consists of ejector1 and ejector2.

The ejector1 moves a stapled paper loaded at the end fence unit to the ejector2 unit. During this process, the ejector1 motor transmits the driving force to the ejector1 unit. And ejector1 motor sensor checks the ejector1 motor operation. And the ejector1 home sensor detects the home position of the ejector1. The ejector1 end sensor detects the end position of the ejector1.

When the paper arrives at the ejector2 unit, the ejector2 grabs a stack of paper and ejects it onto the main output tray. The ejector2 motor is responsible for this process, and the ejector2 motor sensor helps it to be controlled correctly. In addition, the ejector2 home sensor checks the location of the ejector2.

Figure 5-48 Ejector unit overview

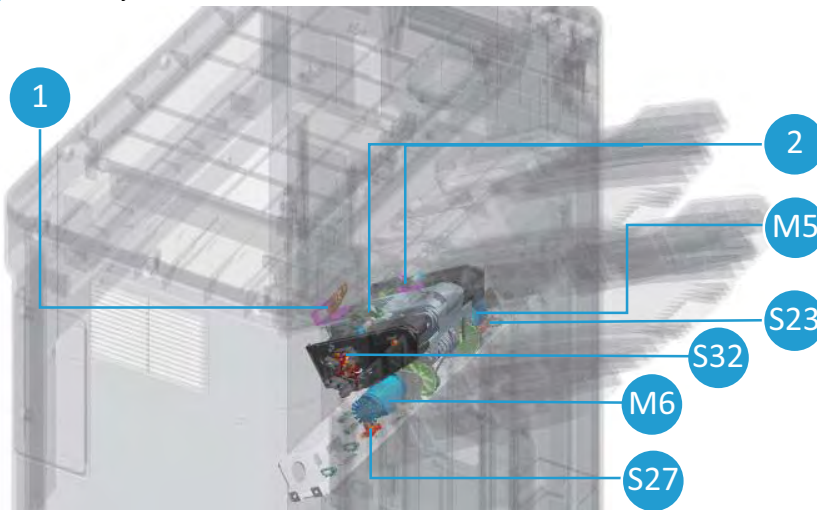

Figure 5-49 Ejector unit detail view - left

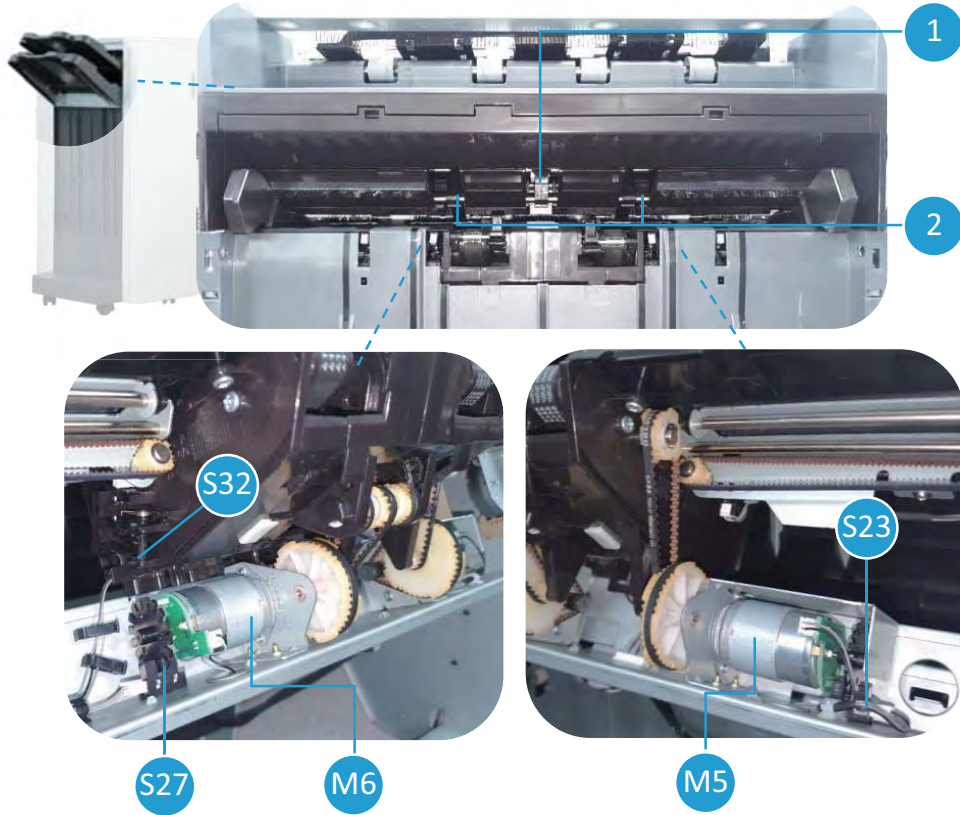

Table 5-30 Ejector unit parts information

Item	Part name	Part number	Orderable ^(*)	Diagnostics	Description
	Ejector unit	JC90-01409A	(*)		
S14	Ejector sensor	JC32-00020A	(*)	113-2170	Detects whether paper is on the ejector or not.
1	Ejector1				Moves the stack of paper from the end fence to the ejector2
S29	Ejector1 home sensor	0604-001415	(*)	113-2031	Detects the home position of the ejector1
S28	Ejector1 end sensor	0604-001415	(*)	113-2030	Detects the end position of the ejector1
S27	Ejector1 motor sensor	0604-001415	(*)	113-2032	Detects whether the Ejector1 motor rotates
M6	Ejector1 motor	JC93-01168A		113-2530	Moves the ejector1 forward and backward
2	Ejector2				Moves paper from the ejector1 to the main output tray
S32	Ejector2 home sensor	0604-001415	(*)	113-2040	Detects the home position of the ejector2
S23	Ejector2 motor sensor	0604-001415	(*)	113-2041	Detects the ejector2 motor rotation

Table 5-30 Ejector unit parts information (continued)

Item	Part name	Part number	Orderable ^(*)	Diagnostics	Description
M5	Ejector2 motor	JC93-01168A		113-2540	Moves the ejector2 and grabs paper

(*) This part is in ordering system.

Ejector unit operation

1. The ejector1(callout1) pushes aligned paper at the end fence unit to ejector2 unit(callout2).

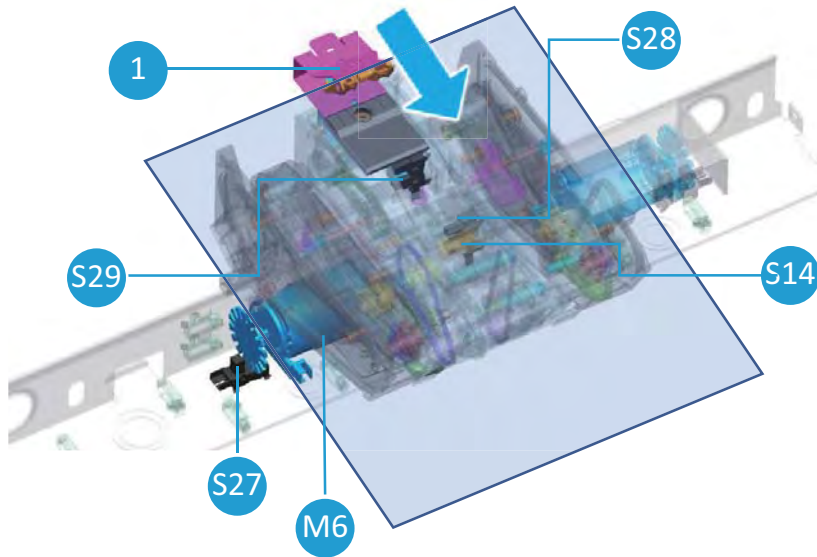

2. The ejector2(callout2) picks up paper, then moves forward to the main output tray direction.

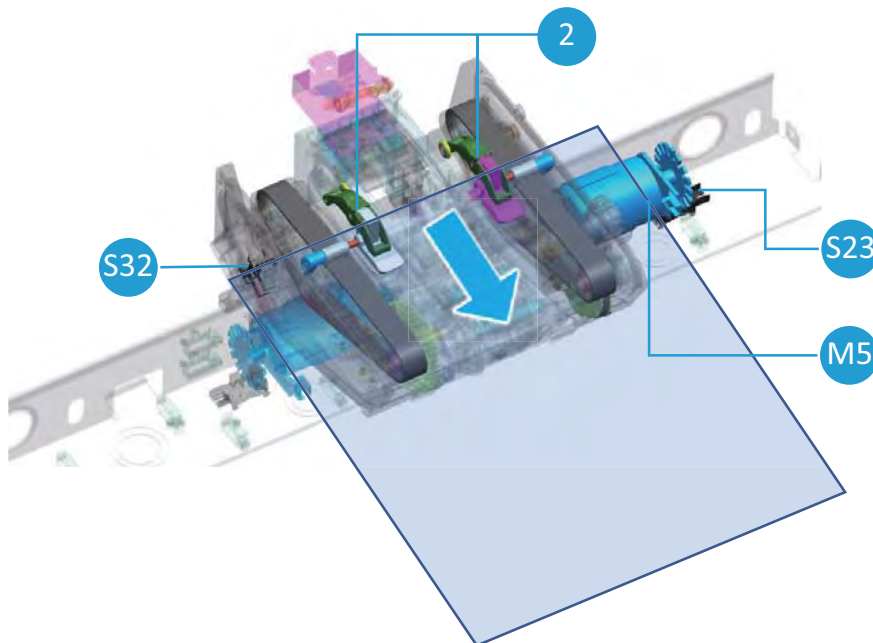

Main output tray unit

Learn about the Main output tray unit of the Stapler/stacker finisher and booklet finisher.

Printouts are stacked on the main output tray (C7). The main output tray moves up and down along the rails inside the finisher, and the main output tray motor (M11) controls those movements according to the signals of the front & rear paper holding sensor. Main output tray motor sensor (S33) checks whether the main output tray motor rotates properly.

When main output tray hits the lower limit sensor of the main output tray (S26), the machine detects that paper tray is full. The main output tray top of stack sensor(S20) detects that the main output tray is on the top.

Figure 5-50 Main output tray unit overview

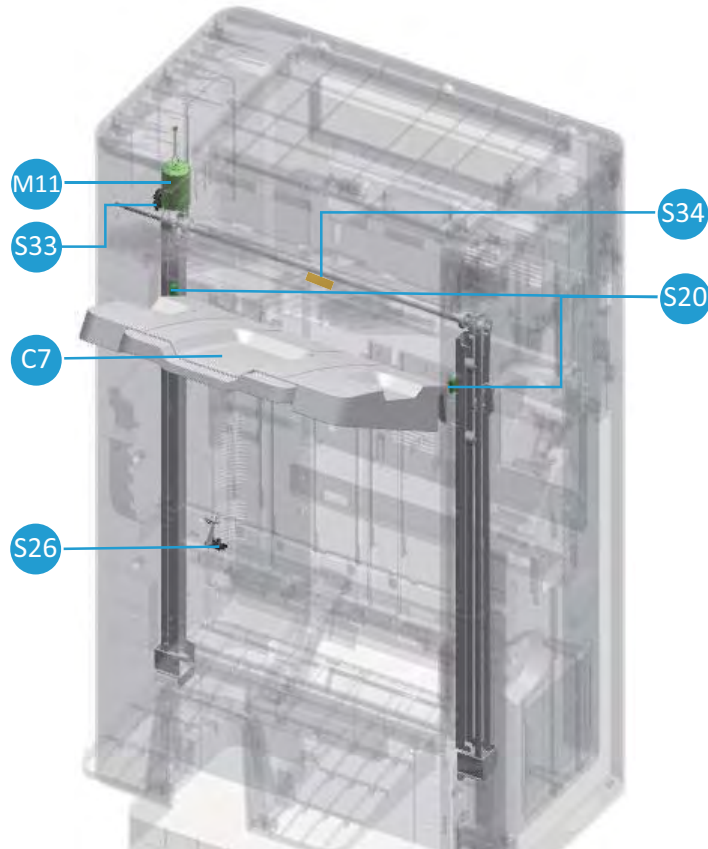

Figure 5-51 Main output tray unit detail view - left

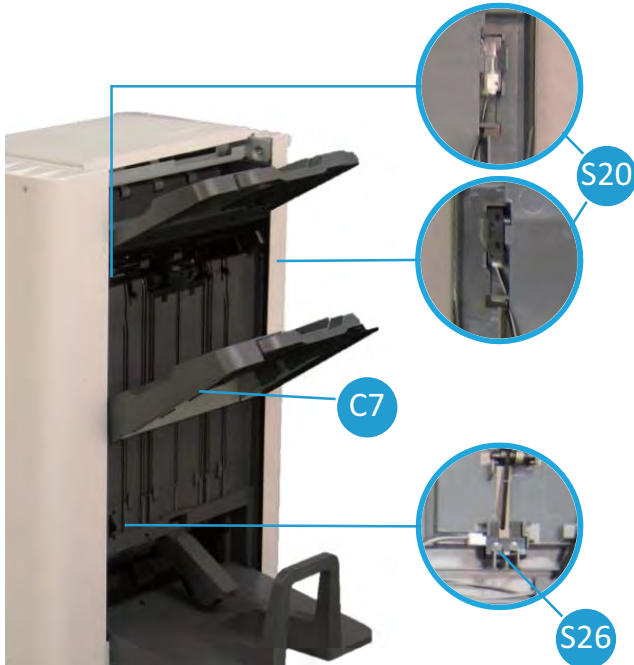

Figure 5-52 Main output tray unit detail view - rear

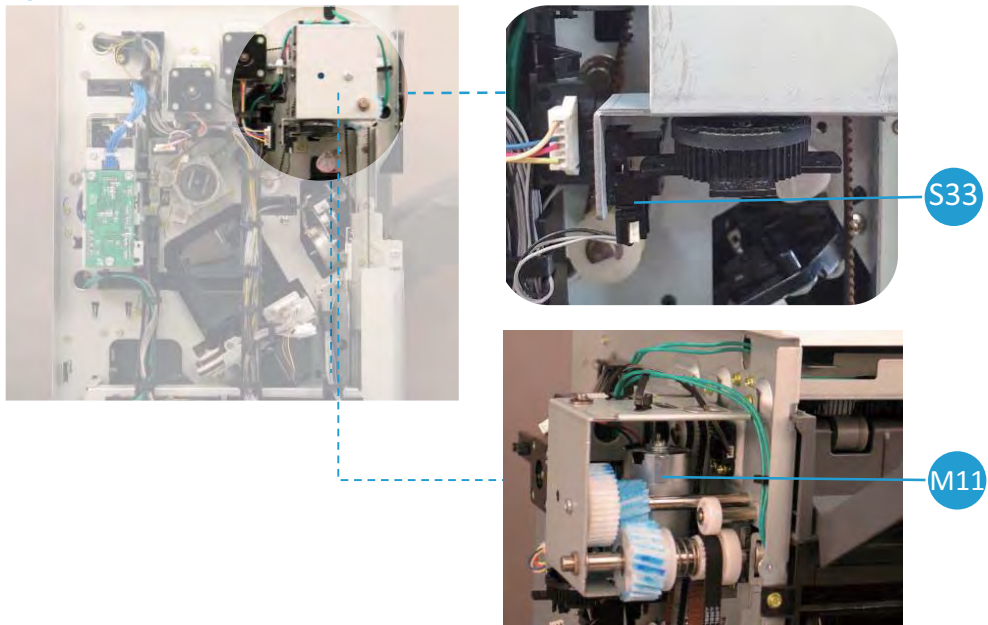

Table 5-31 Main output tray unit parts information

Item	Part name	Part number	Orderable ^(*)	Diagnostics	Description
C7	Main output tray	JC63-05002B			Stacking plate for ejected paper
S20	Main output tray top of stack sensor (receiver, led)	JC82-01039A	(*)	113-2140	Checks the upper limit of main output tray
S6	Main output tray lower limit sensor	0604-001415	(*)	113-2144	Detects the lowest position of the output tray

Table 5-31 Main output tray unit parts information (continued)

Item	Part name	Part number	Orderable ^(*)	Diagnostics	Description
S33	Main output tray motor sensor	0604-001393	(*)	113-2143	Detects whether the main output tray motor rotates
M11	Main output tray motor	JC31-00178B	(*)	113-2610	Moves the main output tray up and down
		JC90-01415B	(*)		
S34	Main output tray top of stack switch	JC39-02316A		113-2190	Checks the upper limit of main output tray so that detects abnormal movement of output tray

^(*) This part is in ordering system.

Paper holding unit

Learn about the Paper holding unit of the Stapler/stacker finisher and booklet finisher.

The paper holding unit holds printouts on the main output tray. It has a sensor that detects the height of stacked paper so that the output tray moves up and down to stack paper in a stable manner.

The paper holding motor(M7) lifts the paper holding actuator when printouts come out to the main output tray. The paper holding home sensor(S22) detects the location of paper holding actuator at the home position. The front & rear paper holding sensor (S17, S31) checks the volume of printouts on the main output tray and makes the main output tray move downward

Figure 5-53 Paper holding unit overview

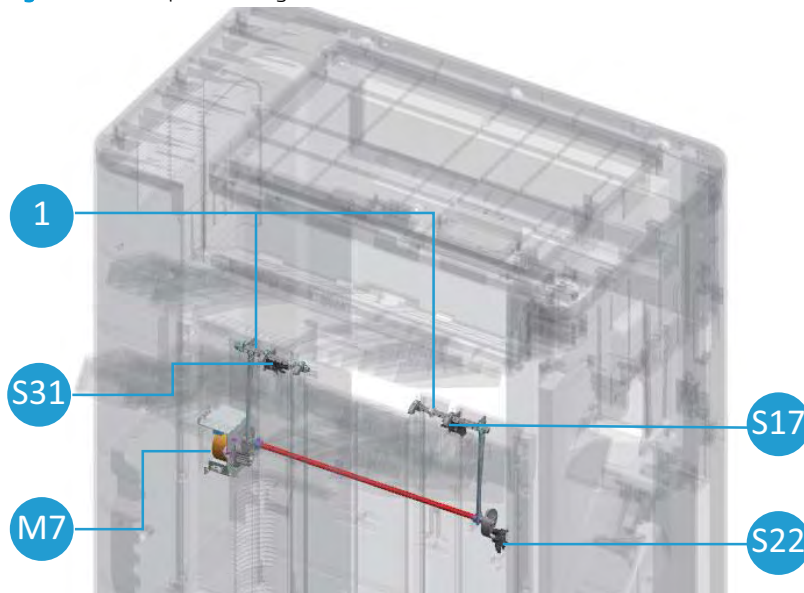

Figure 5-54 Paper holding unit detail view - left

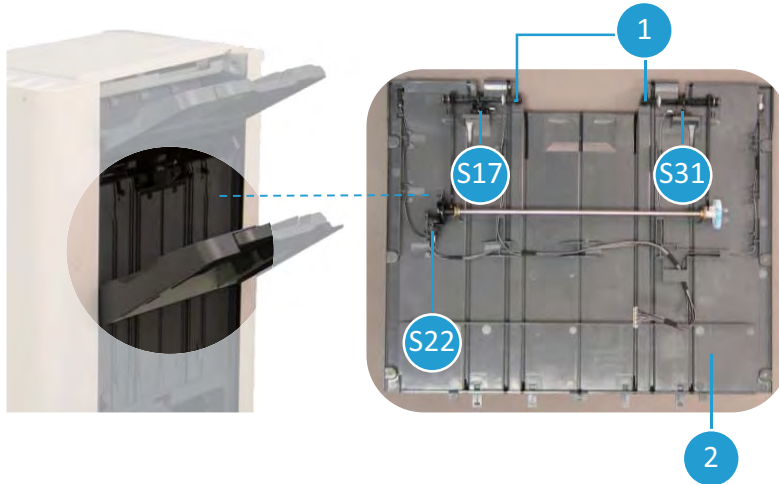

Figure 5-55 Paper holding unit detail view - left

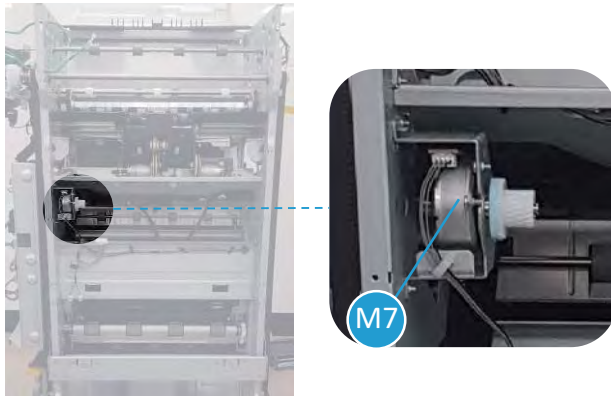

Table 5-32 paper holding unit parts information

Item	Part name	Part number	Orderable ^(*)	Diagnostics	Description
1	Paper holding actuator				Control the height of the main output tray and hold printouts so as not to be scattered
S17	Front paper holding sensor	0604-001393	(*)	113-2141	Detects stacked paper position
S31	Rear paper holding sensor	0604-001393	(*)	113-2142	Detects stacked paper position
S22	Paper holding home sensor	0604-001393	(*)	113-2010	Detects the home position of paper holding actuator
M7	Paper holding motor	JC90-01414A	(*)	113-2510	Lift paper holding actuator up when printouts delivered to the main output tray
2	Left upper cover	JC90-01475B			

(*) This part is in ordering system.

paper holding unit operation

1. When printouts are delivered to the main output tray, a paper holding motor moves paper holding actuator upward to create a paper path to prevent jam (callout1).



2. When printouts are stacked on top of the main output tray, the paper holding actuator goes down to hold them (callout2).

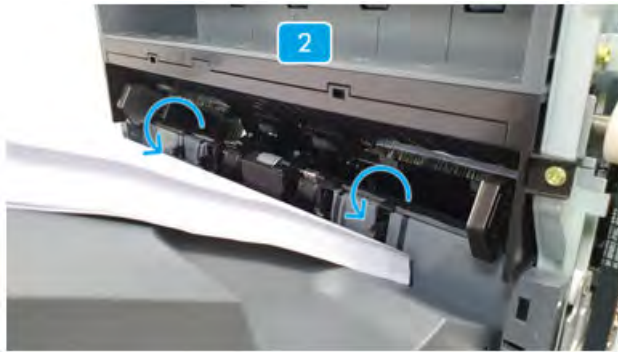

3. As paper stacks up on the main output tray, the paper holding actuator is lifted by papers. The front & rear paper holding sensors make the main output tray moves downward to store more printouts. (callout3)



4. As printouts are stacked on the main output tray, the tray goes down. When it reaches at the end of its moving range (callout 4), the main output tray touches the lower limit sensor. The sensor detects that the main output tray is full of printouts.



Buffer unit

Learn about the diverter unit of the Stapler/stacker finisher and booklet finisher.

The buffer unit keeps paper inside the unit or moves them to the booklet maker.

The buffer diverter creates a paper path so that paper can move to the buffer unit, and the buffer sensor detects whether paper moved out from the buffer unit. The buffer motor controls buffer roller, and buffer home sensors checks the location of buffer rollers. The buffer solenoid holds papers so that they do not fall into the booklet maker while buffering.

 **NOTE:** buffering: It is to maintain print speed when users print multiple copies continuously.

The 1st page of a print job stays in the buffer unit for a moment while the previous job is being ejected. After the previous print job was ejected, the 1st and 2nd page of the job move to the ejector unit together.

Figure 5-56 Buffer unit overview

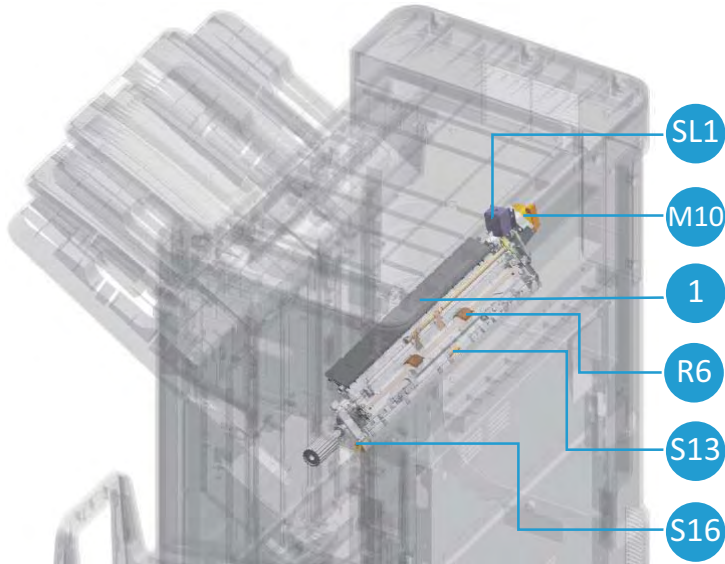

Figure 5-57 Buffer unit detail view - front

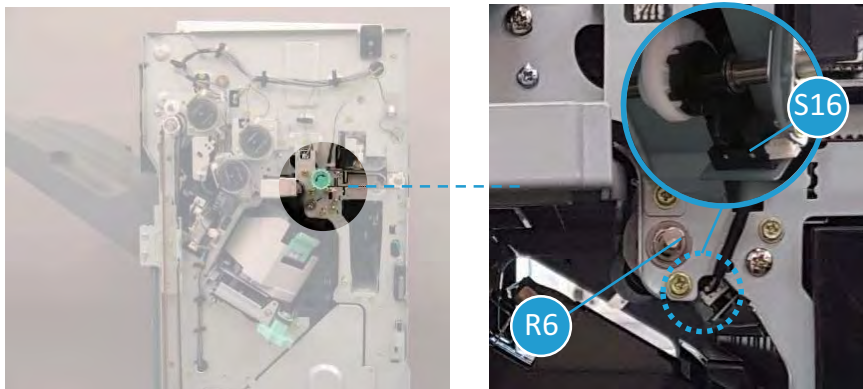

Figure 5-58 Buffer unit detail view - rear

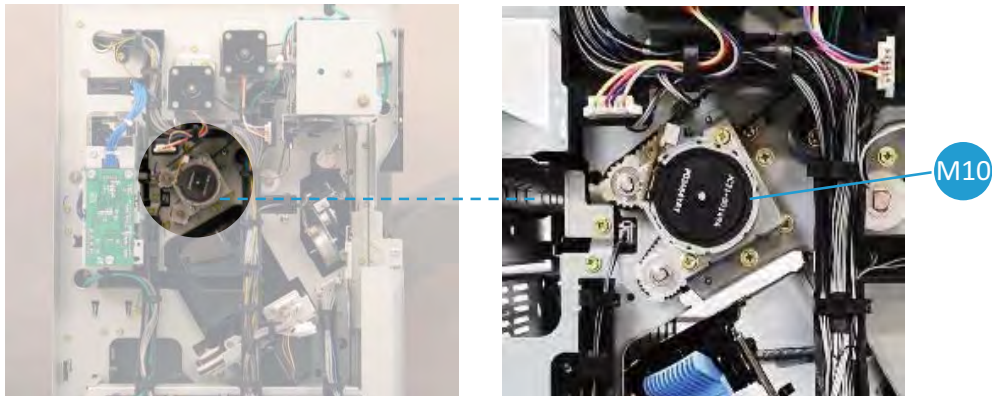

Figure 5-59 Buffer unit detail view - top

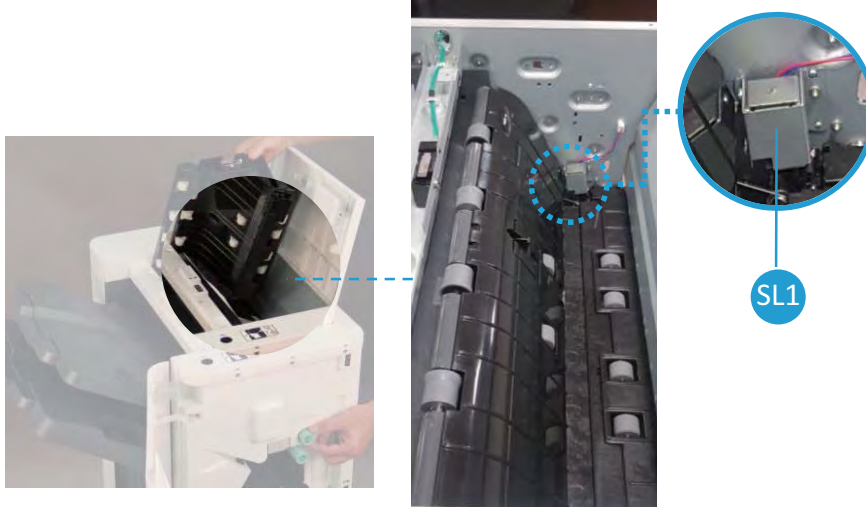

Table 5-33 Buffer unit parts information

Item	Part name	Part number	Orderable ^(*)	Diagnostics	Description
1	Buffer diverter	JC61-07204A			Makes the way to the buffer space
S13	Buffer sensor	JC32-00020A	(*)	113-2100	Detects whether paper has moved out from the buffer unit
S16	Buffer home sensor	0604-001393	(*)	113-2210	Detects the home position of the buffer roller.
M10	Buffer motor	JC93-01152A	(*)	113-2660	Moves paper to the buffer space or the booklet maker
SL1	Buffer solenoid	JC33-00038A	(*)	113-2670	Holds paper to prevent them from falling out to the booklet maker during buffering
R6	Buffer roller	JC66-05161A			Moves paper to the booklet maker or makes the gap so that paper stays in this space.

(*) This part is in ordering system.

Buffer unit operation

1. When the buffer motor rotates backward to move the cam, the buffer roller(R6) can have gap and then paper can stay inside the buffer unit
1. When the exit motor rotates backward to drive the main exit roller(R7), paper moves to the buffer unit through the buffer diverter(callout1).



2. The main exit cam motor moves the main exit cam so that the main exit roller(R7) is separated with the idle roller to have a gap, and then paper can stay in this place for a while.



3. When the next sheet comes to the main exit unit, the main exit motor turns the main exit cam so that the main exit roller is attached to the idle roller.



4. The exit motor rotates forward and operates the main exit roller. It makes 2 paper moves to the ejector together.



2. In case of booklet job, the buffer unit moves paper to the booklet maker.
 1. The buffer motor rotates, the buffer roller(R6) is attached to the idle roller.
 2. When paper arrives at the main exit unit, the exit motor rotates backward and moves the main exit roller(R7) so that paper moves to the buffer unit through the buffer diverter.



3. The buffer motor rotates the buffer roller to move paper to the booklet maker.



Booklet entrance unit

Learn about the Booklet entrance unit of the booklet finisher.

The booklet entrance unit receives paper into the booklet maker. The entrance sensor(S36) detects whether the paper enters the entrance unit. The entrance motor(M15) drives the booklet entrance roller(R10) to move the paper.

Figure 5-60 Booklet entrance unit overview

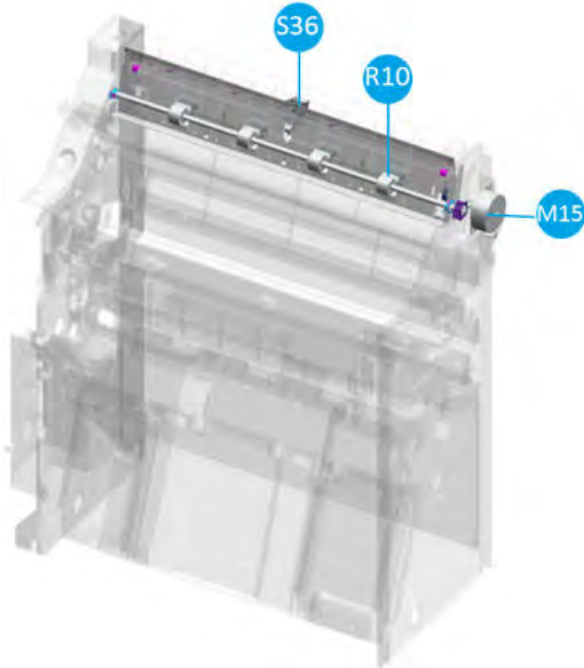

Figure 5-61 Booklet entrance unit detail view



Table 5-34 Entrance unit parts information

Item	Part name	Part number	Orderable ^(*)	Diagnostics	Description
S36	Booklet entrance sensor	0604-001415	(*)	113-3100	Detects whether paper has come into the booklet entrance unit
M15	Booklet entrance motor	JC93-01152A	(*)	113-3500	Drives the booklet entrance roller
R10	Booklet entrance roller	JC66-04717A			Moves paper into the booklet maker

(*) This part is in ordering system.

Booklet paddle unit

Learn about the Booklet paddle unit of the booklet finisher.

The booklet paddle unit pushes paper to the booklet end fence by rotating the rubber paddles. The booklet paddle motor (M19) rotates two booklet paddles, and the booklet paddle home sensor (S41) connected to the lower booklet paddle checks the home position of the booklet paddle.

Figure 5-62 Booklet paddle unit overview

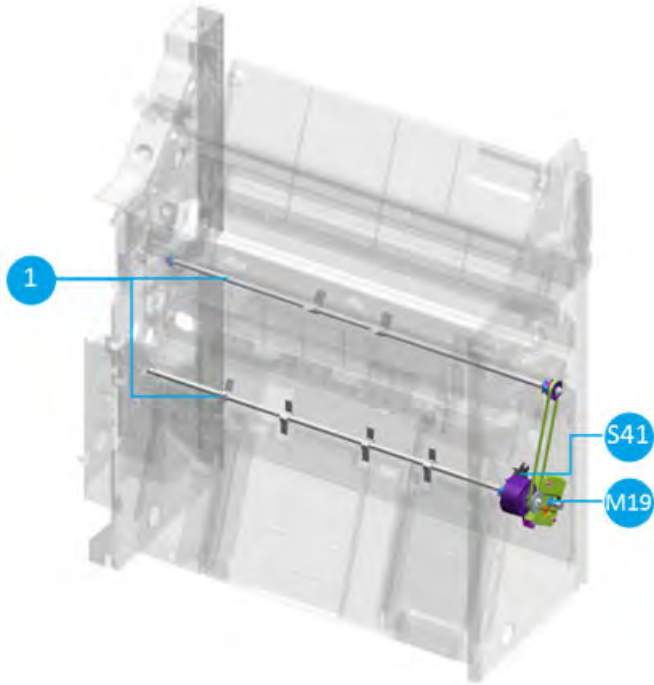

Figure 5-63 Booklet paddle unit detail view

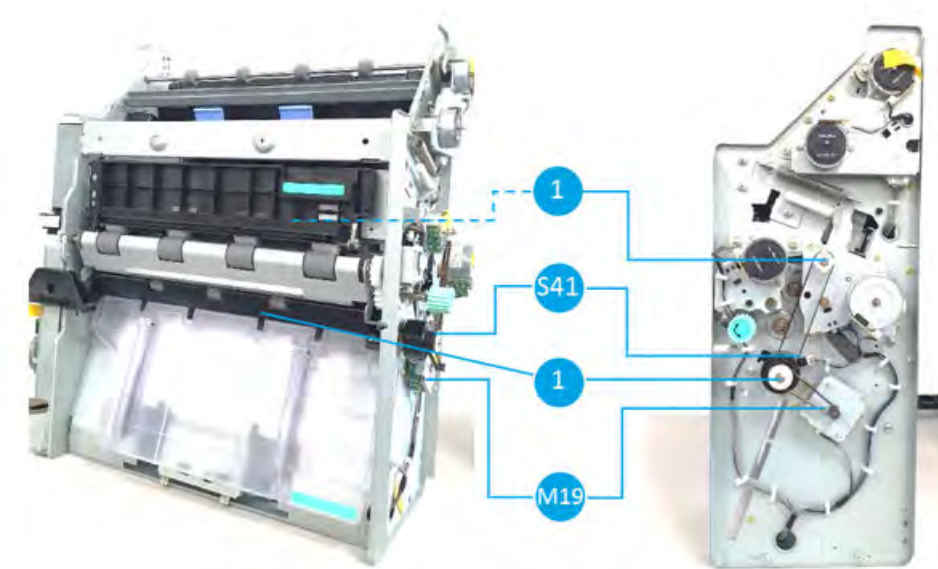

Table 5-35 booklet paddle unit parts information

Item	Part name	Part number	Orderable ^(*)	Diagnostics	Description
1	Upper booklet paddle	JC66-04718A			Moves paper to the booklet end fence unit
1	Lower booklet paddle	JC90-01429A			Moves paper to the booklet end fence unit
		JC61-07225A	(*)		
		JC66-04719A	(*)		

Table 5-35 booklet paddle unit parts information (continued)

Item	Part name	Part number	Orderable ^(*)	Diagnostics	Description
S41	Booklet paddle home sensor	0604-001393	(*)	113-2590	Check the home position of the booklet paddle
M19	Booklet paddle motor	JC93-01001A	(*)	113-3580	Drives two booklet paddles

^(*) This part is in ordering system.

Booklet end fence unit

Learn about the Booklet end fence unit of the booklet finisher.

The booklet end fence unit supports paper that enters from the booklet paddle unit, then moves paper to the designated position for folding and stapling. The Booklet end fence motor (M20) moves the booklet end fence up and down. The booklet end fence home sensor (S42) checks the home position of the booklet end fence. The booklet end fence solenoid (SL2) drives the clamp to hold paper that comes into the booklet end fence.

Figure 5-64 Booklet end fence unit overview

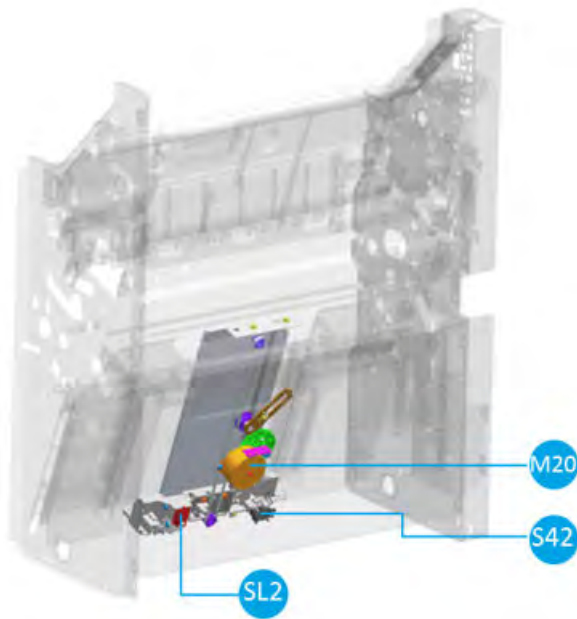

Figure 5-65 Booklet end fence unit detail view - left

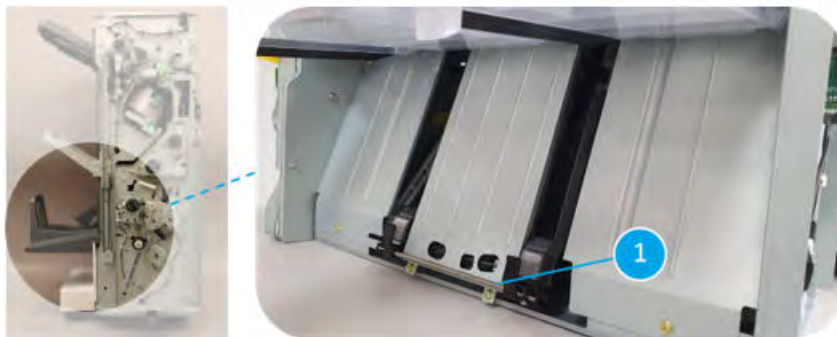

Figure 5-66 Booklet end fence unit detail view - right

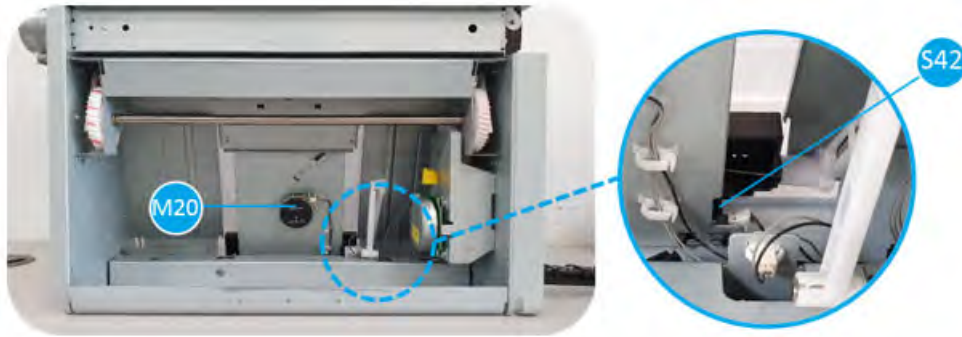

Table 5-36 booklet end fence unit parts information

Item	Part name	Part number	Orderable ^(*)	Diagnostics	Description
1	Booklet end fence	JC90-01432A			Supports paper, then moves it to the designated location to fold or staple
S42	Booklet end fence home sensor	0604-001393	(*)	113-3000	Checks the home position of the booklet end fence
M18	Booklet end fence motor	JC93-01155A	(*)	113-3530	Moves the booklet end fence up and down
Sl2	Booklet end fence solenoid	JC33-00038A	(*)	113-3520	drives the clamp to hold paper that comes into the booklet end fence

(*) This part is in ordering system.

Booklet end fence unit operation

1. The booklet end fence is located at the home position (callout1). When the booklet maker starts its job, the end fence goes to the direction 2.

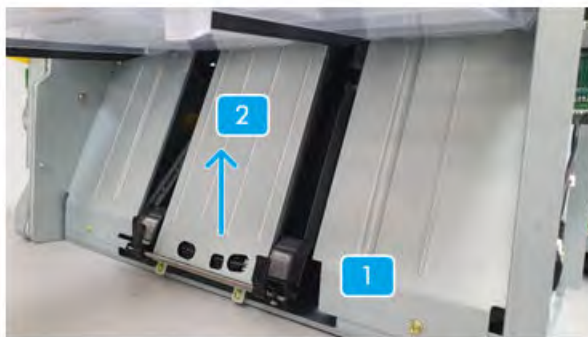

2. The booklet end fence unit supports paper comes from the booklet paddle unit and holds paper so as not to be scattered(callout3). Then it moves to the certain location to fold or staple it (callout 4).

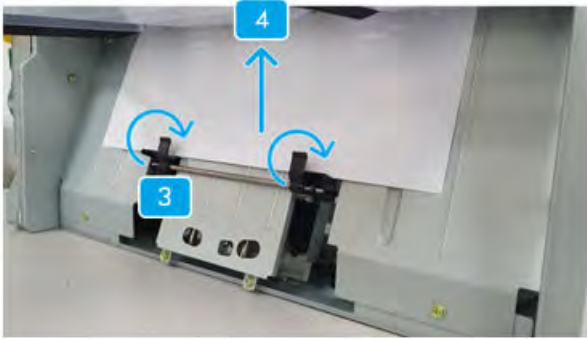

Booklet presser unit

Learn about the Booklet presser unit of the booklet finisher.

The booklet presser unit sort print pages that enter to the booklet maker in order. The Booklet presser motor (M16) moves the booklet presser, and the booklet presser home sensor (S37) checks whether the booklet presser is at the home position.

Figure 5-67 Booklet presser unit overview

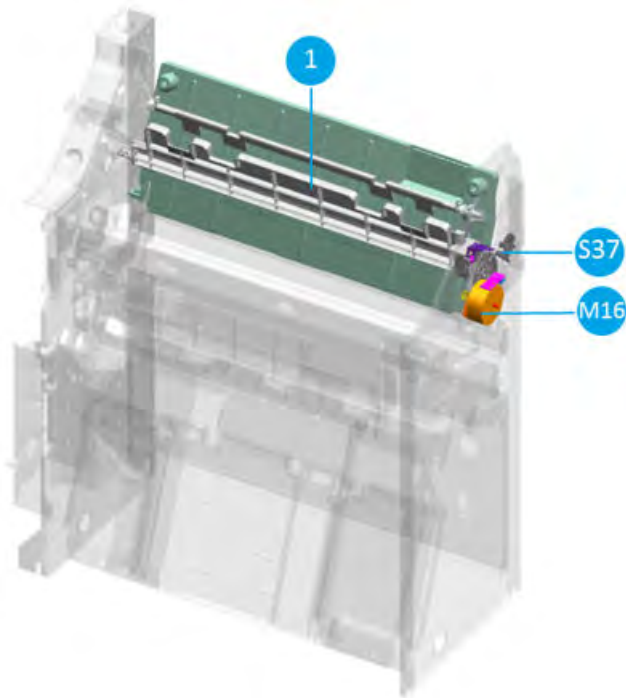

Figure 5-68 Booklet presser unit detail view

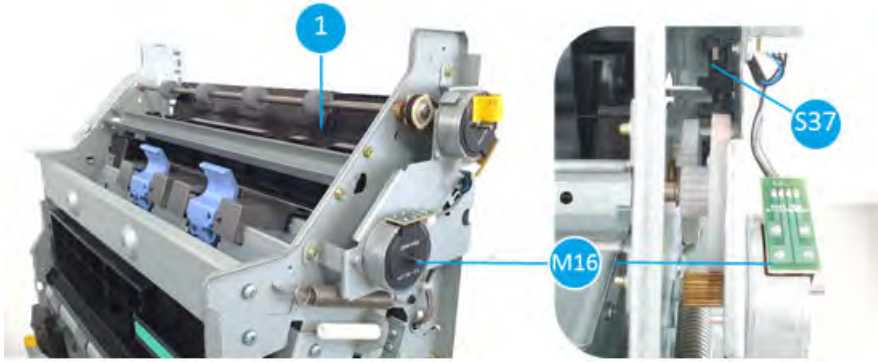

Table 5-37 Booklet presser unit parts information

Item	Part name	Part number	Orderable ^(*)	Diagnostics	Description
1	Booklet presser	JC61-07237A			Accumulates paper from the entrance unit not to be shuffled
S37	Booklet presser home sensor	0604-001393	(*)	113-3130	Checks the home position of the booklet presser
M16	Booklet presser motor	JC93-01155A	(*)	113-3570	Drives the booklet presser

(*) This part is in ordering system.

Booklet presser unit operation

1. Paper comes into the booklet presser unit (callout1). At this time the presser is located on the left side of the finisher (callout 2).

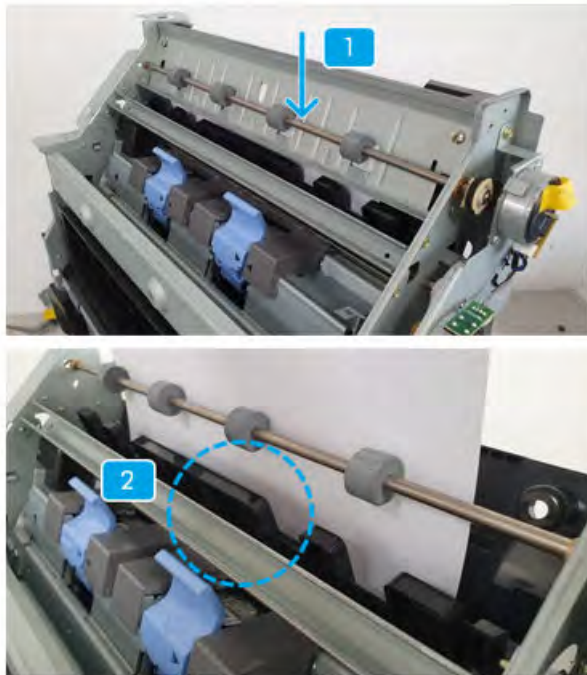

2. After paper exits the entrance roller, the booklet presser hits the end of paper. (callout 3).

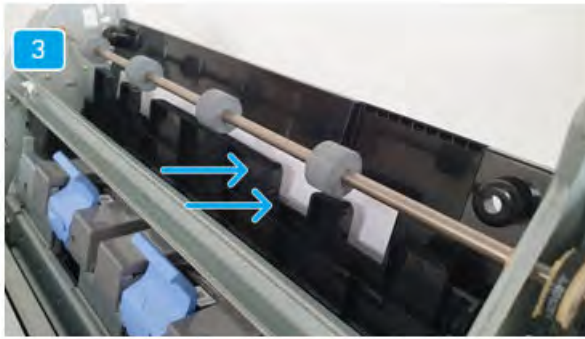

3. When a next sheet arrives at the unit, it will fall on the left side of the previous sheet pushed by the booklet presser (callout 4).

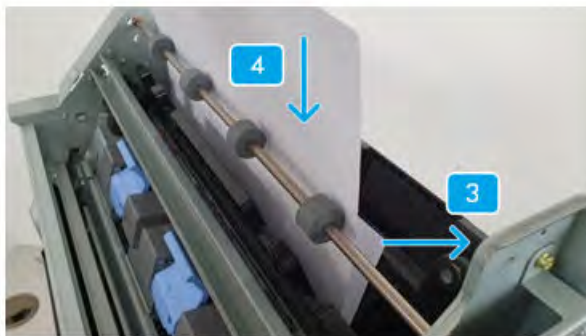

Booklet tamper unit

Learn about the Booklet tamper unit of the booklet finisher.

The booklet tamper unit aligns the left and right side of documents for stapling or folding.

The booklet tamper motor(M23) adjusts the booklet tampers' width according to paper size. The booklet tamper home sensor(S38) checks the home position of the booklet tamper.

Figure 5-69 Booklet tamper unit overview

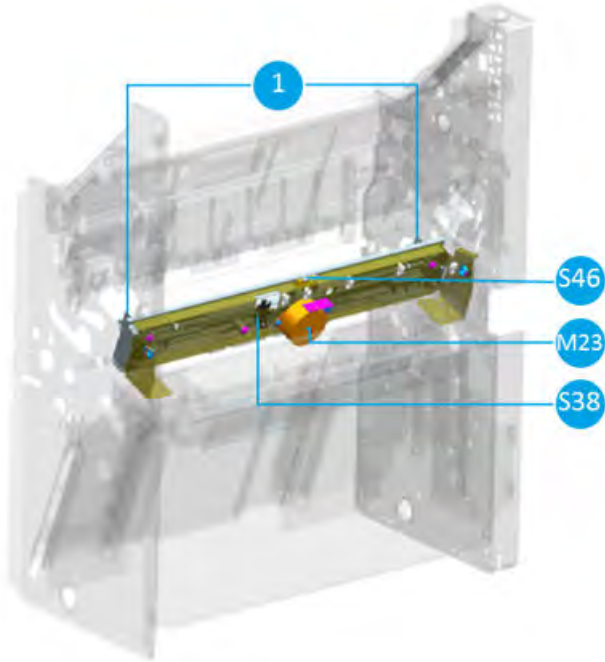

Figure 5-70 Booklet tamper unit detail view

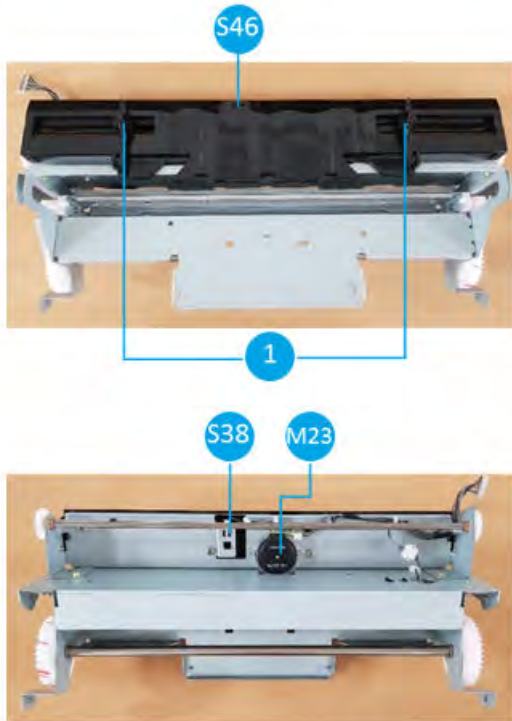

Table 5-38 Booklet tamper unit parts information

Item	Part name	Part number	Orderable ^(*)	Diagnostics	Description
1	Booklet tamper	JC90-01431A			Aligns documents for stapling or folding.

Table 5-38 Booklet tamper unit parts information (continued)

Item	Part name	Part number	Orderable ^(*)	Diagnostics	Description
S38	Booklet tamper home sensor	0604-001393	(*)	113-3080	Checks the home position of the booklet tamper
M23	Booklet tamper motor	JC93-01155A	(*)	113-3540	Drives the booklet tamper
S46	Booklet tamper sensor	JC32-00020A	(*)	113-3110	

^(*) This part is in ordering system.

Booklet tamper unit operation

- ▲ When a certain amount of paper is collected, the booklet tamper unit hits the left and right sides of the paper to align the paper correctly.



Booklet stapler unit

Learn about the Booklet stapler unit of the booklet finisher.

Booklet stapler unit is a device installed inside the booklet maker that staples a bundle of aligned documents as a booklet.

There is only 1 option to make a bundle. If the user selects the option, this unit staples at the two location in the middle of stacks.

Figure 5-71 Booklet staple option

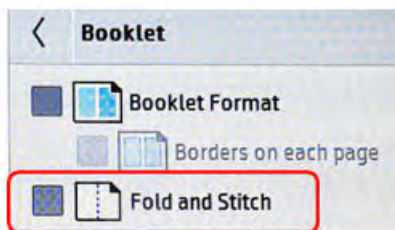

Figure 5-72 Booklet stapler unit overview

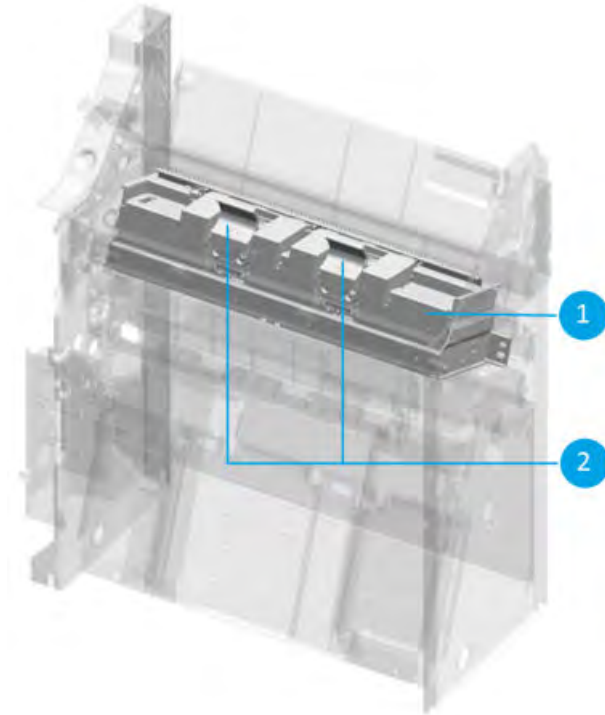

Figure 5-73 Booklet stapler unit detail view

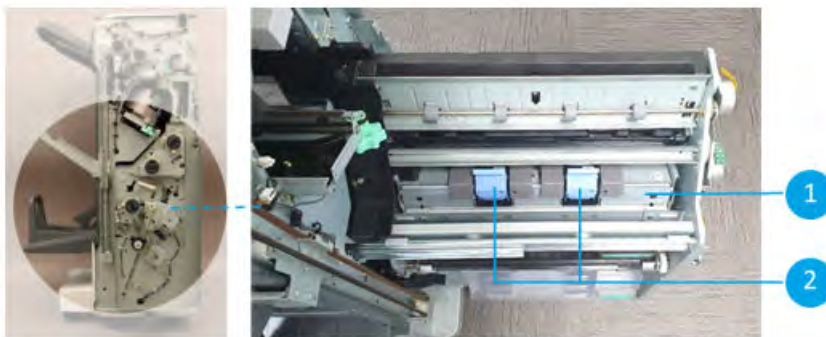

Table 5-39 Booklet stapler unit parts information

Item	Part name	Part number	Orderable ^(*)	Diagnostics	Description
1	Booklet stapler	JC81-08274B			
2	Booklet stapler cartridge	JC81-09881B	(*)	113-3020 113-3030	

(*) This part is in ordering system.

Booklet stapler unit operation

1. When a stack of sheets is collected in booklet end fence unit, the booklet end fence (callout 2) changes its location to be stapled.

2. The booklet stapler(callout1) staples at the middle of stacks.

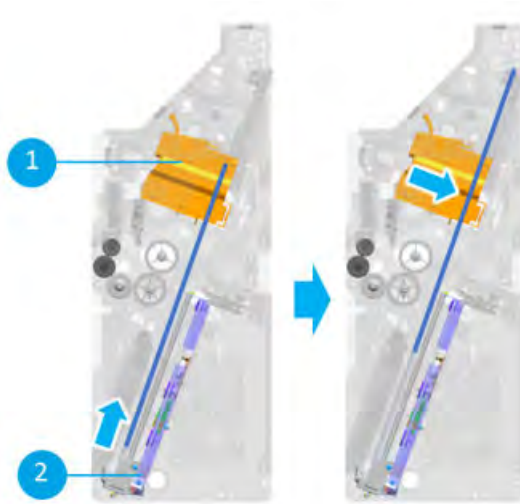

Booklet fold unit

Learn about the Booklet fold unit of the booklet finisher.

The booklet fold unit is a device installed inside the booklet maker that folds a bundle of aligned documents as a This unit consists of 2 types of blades: blade and c-fold blade. So, it creates two types of output.

Figure 5-74 Fold options

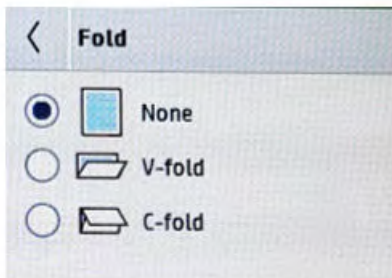

The booklet blade motor (M22) drives the booklet blades and lightly folds the stack of paper. The folded paper passes through the booklet fold rollers to be fully folded. The booklet blade home sensor (S45) checks the home position of the booklet blade, and the booklet fold motor (M21) drives the rollers that enable folding.

In case of c-fold, the booklet c-fold blade motor(M17) drives the booklet c-fold blade and lightly folds the stack of paper once more. The folded paper passes through the booklet c-fold roller to be fully folded. The booklet c-fold blade home sensor(S39) checks the home position of the c-fold blade.

Figure 5-75 Booklet fold unit overview – right-rear

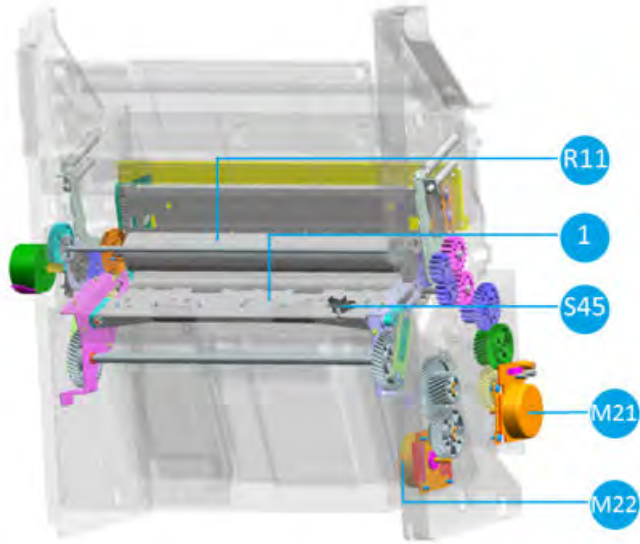

Figure 5-76 Booklet fold unit overview – left-front

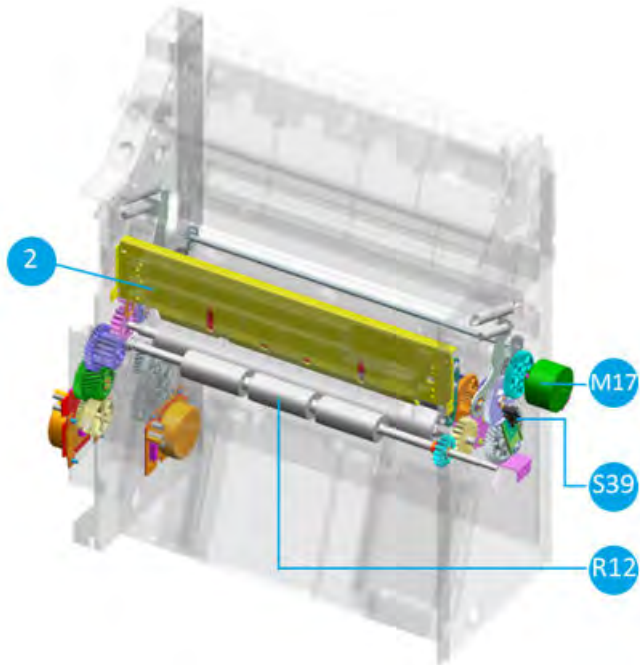

Figure 5-77 Booklet fold unit detail view - right

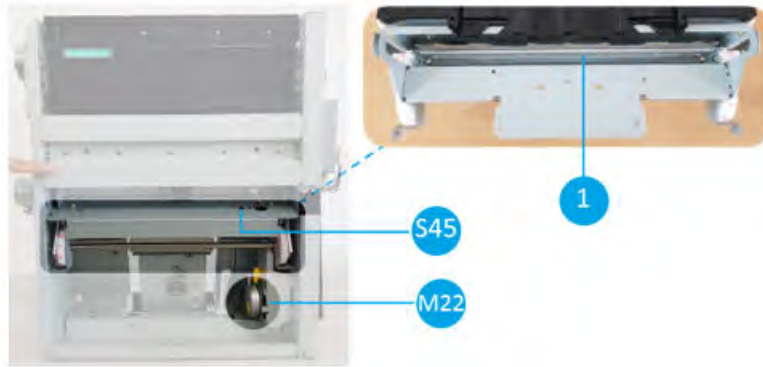

Figure 5-78 Booklet fold unit detail view – left

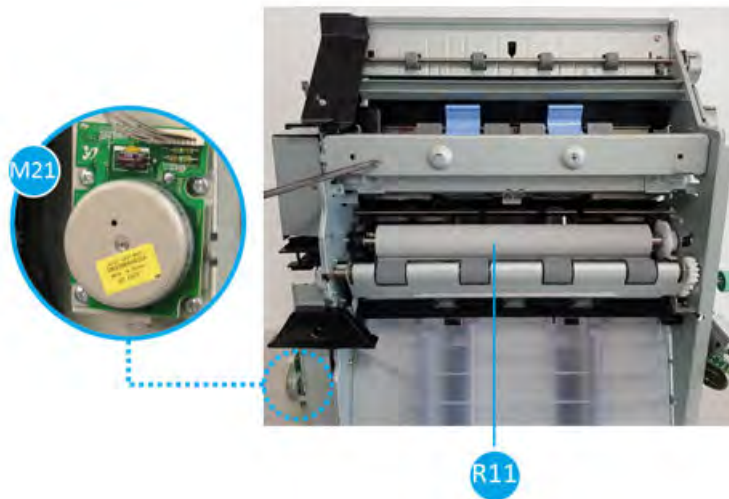

Figure 5-79 Booklet fold unit detail view – left-front

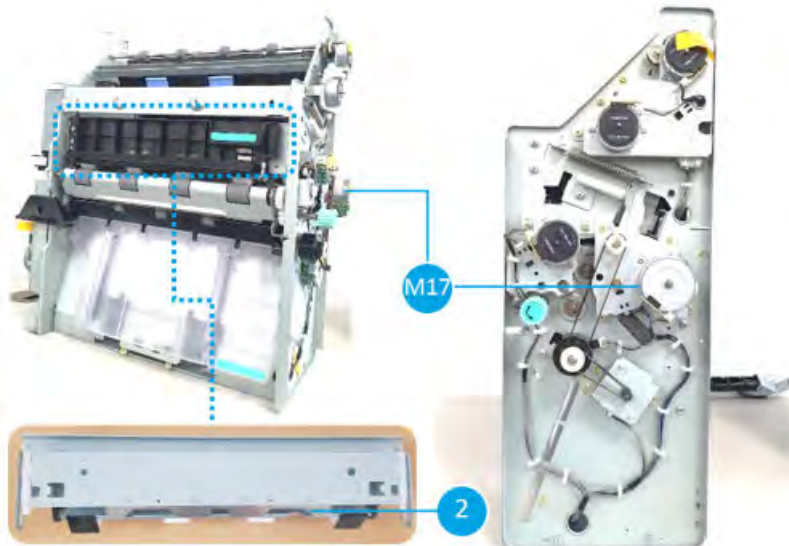

Table 5-40 Booklet fold unit parts information

Item	Part name	Part number	Orderable ^(*)	Diagnostics	Description
1	Booklet blade	JC93-01163A			Pushes a stack of paper to fold.
S45	Booklet blade home sensor	0604-001393	(*)	113-3040	Checks the home position of the booklet blade.
M22	Booklet blade motor	JC31-00144A	(*)	113-3550	Drives the booklet blade
M21	Booklet fold motor	JC31-00144A	(*)	113-3510	Drives the booklet roller and c-fold blade
R11	Booklet fold roller	JC66-04748A			Presses a stack of paper to be fully folded
2	Booklet c-fold blade	JC61-07366A			Pushes a stack of paper to fold for the c-fold task
S39	Booklet c-fold blade home sensor	0604-001393	(*)	113-3050	Checks the home position of the booklet c-fold blade
M17	Booklet c-fold blade motor	JC93-01154A	(*)	113-3590	Drives the booklet c-fold blade
R12	Booklet c-fold roller	JC66-04744A	(*)		In case of c-fold, presses a stack of paper to fold completely.

^(*) This part is in ordering system.

Booklet fold unit operation

1. In case of v-fold.

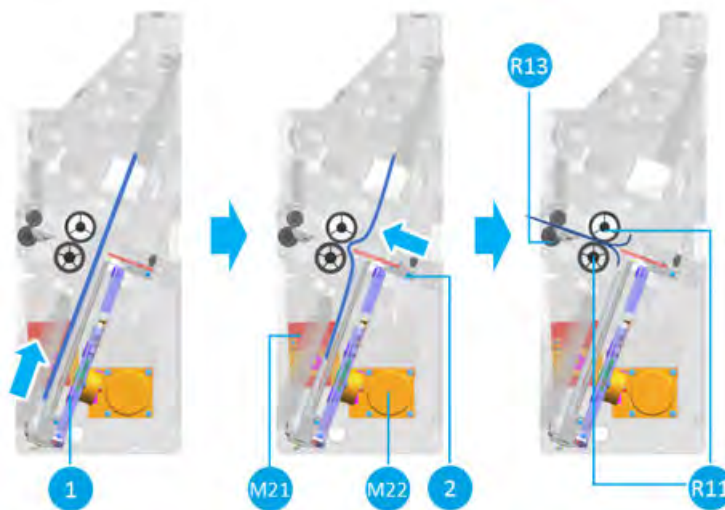

1. After a stack of paper is collected at a booklet end fence unit, the booklet end fence(callout1) moves to a designated location.
2. The booklet blade motor(M22) drives the booklet blade(callout2) to push the center of paper.
3. Paper enters between the booklet fold rollers(R11) by the booklet blade and it is completely folded between the rollers.
4. The folded paper stack is discharged to the booklet output tray via the booklet exit roller(R13).

2. In case of c-fold

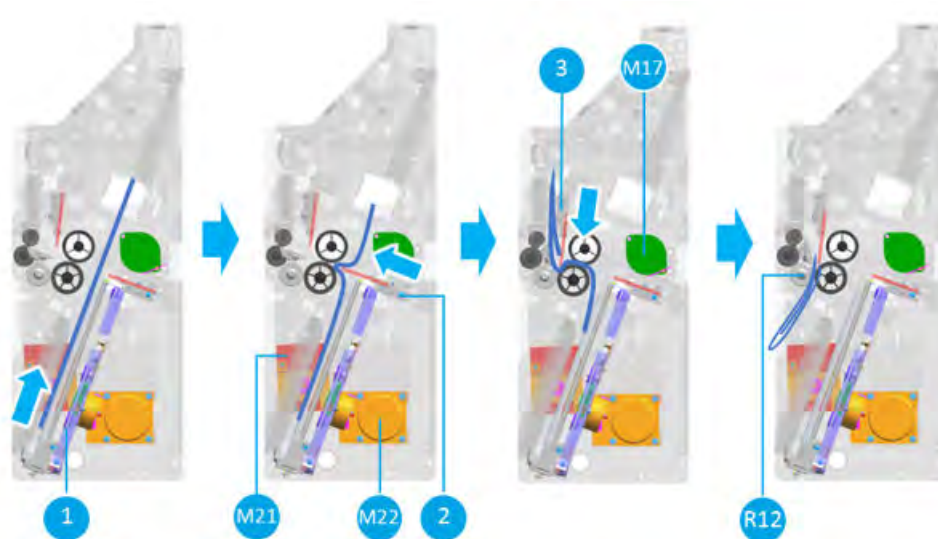

1. After a stack of paper is collected at a booklet end fence unit, the booklet end fence(callout1) is moved to a designated location.
2. The booklet blade motor(M22) drives the booklet blade(callout2) to push one-third of paper.
3. The paper enters between the booklet fold rollers(R11) by the booklet blade and it is completely folded between the rollers.
4. The folded sheets move to a location where they will be c-folded by a booklet diverter.
5. The booklet c-fold blade motor(M17) drives the booklet c-fold blade(callout3), pokes two-thirds of paper.
6. Paper enters between the booklet c-fold roller(R12) and the booklet fold roller by the booklet c-fold blade and it is completely folded between the rollers.

Booklet diverter unit

Learn about the Booklet diverter unit of the booklet finisher.

The booklet diverter unit determines a paper path to allow the stack of folded paper to exit to the booklet output tray during the v-fold. In case of c-fold, it makes another paper path so folded sheets can move to a location that can be c-folded. The booklet diverter motor(M18) drives the booklet diverter, and the booklet diverter home sensor(S40) checks whether the booklet diverter is at the home position.

Figure 5-80 Booklet diverter unit overview

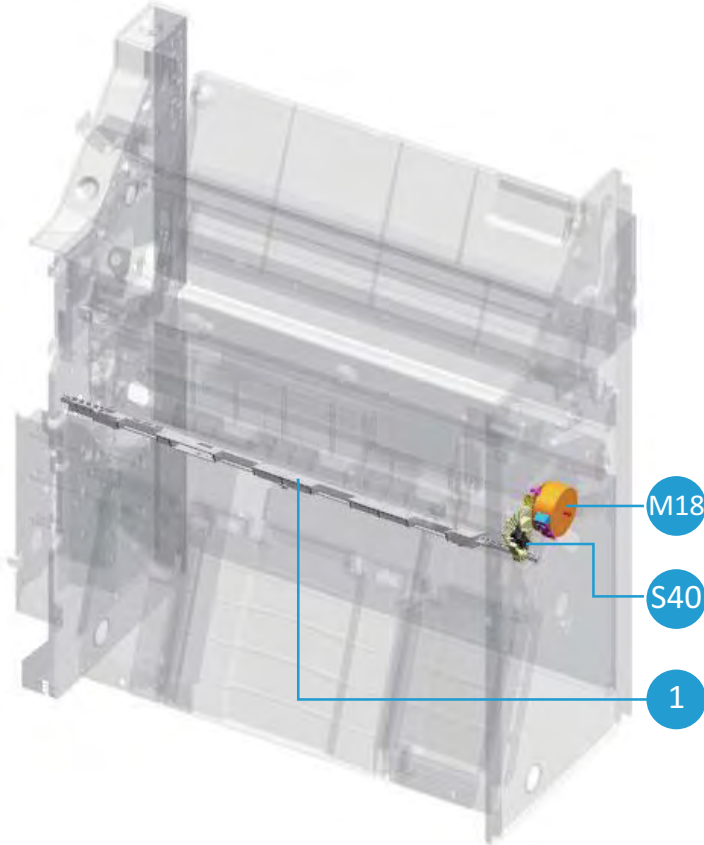

Figure 5-81 Booklet diverter unit detail view – left-front

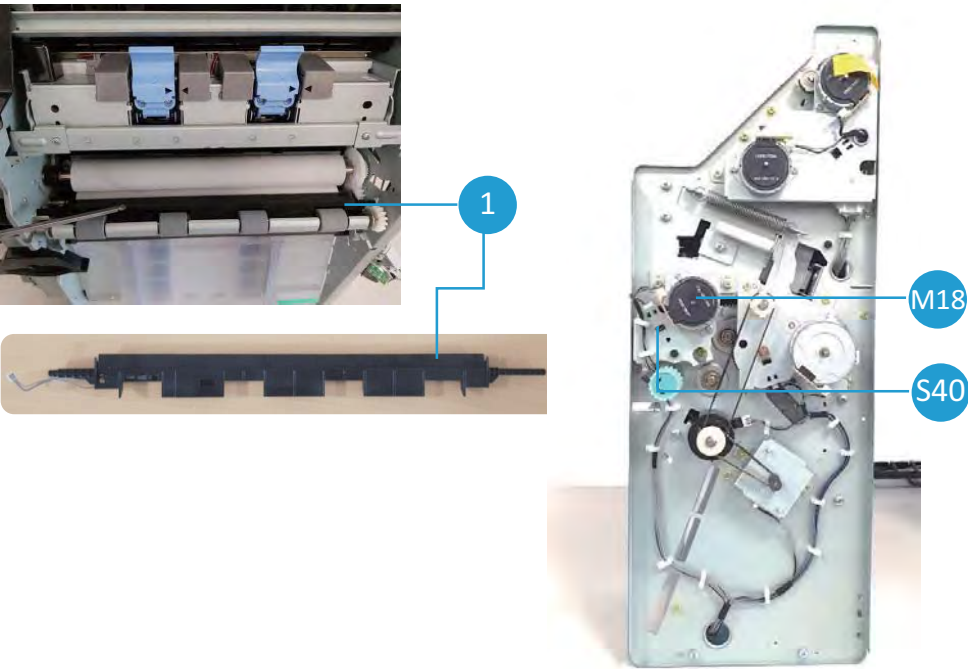

Table 5-41 Booklet diverter unit parts information

Item	Part name	Part number	Orderable ^(*)	Diagnostics	Description
1	Booklet diverter	JC90-01398A			Determines the paper path for either the booklet exit unit or the location for c-fold
S40	Booklet diverter home sensor	0604-001415	(*)	113-3060	Checks the home position of the booklet diverter
M18	Booklet diverter motor	JC93-01153A	(*)	113-3560	Drives the booklet diverter

^(*) This part is in ordering system.

Booklet diverter unit operation

1. In case of v-fold, the booklet diverter(callout1) determines the paper path so that the folded sheets exit to the booklet exit unit and into the booklet output tray.
2. On the other hand, in c-fold, it makes another paper path to fold it by c-fold blade(callout2).

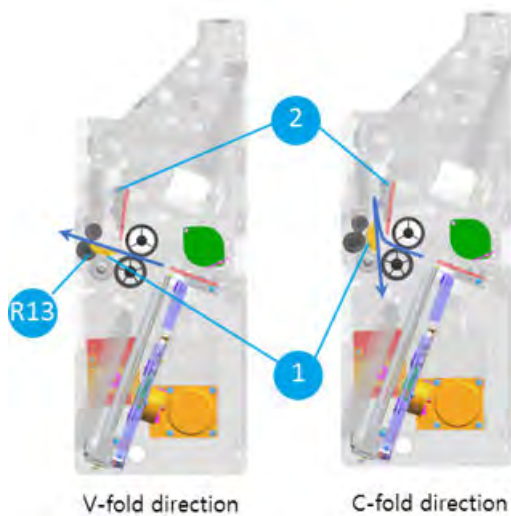

Booklet exit unit

Learn about the Booklet exit unit of the booklet finisher.

The booklet exit unit ejects a stack of v-fold paper to the booklet output tray unit. The booklet exit sensor(S44) detects paper entry into the booklet exit unit, and the booklet fold motor(M19) drives the booklet exit roller(R4) to discharge paper.

Figure 5-82 Booklet exit unit overview – front-right

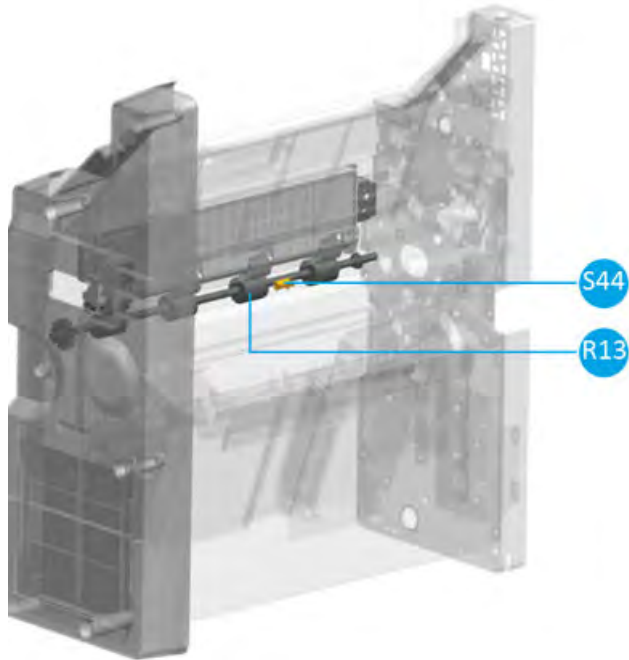

Figure 5-83 Booklet exit unit detail view

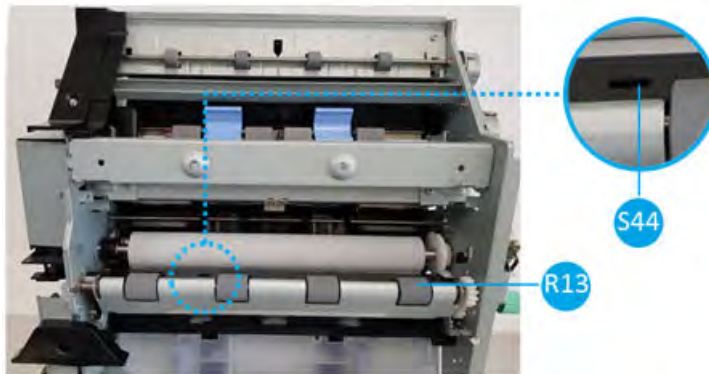

Table 5-42 Booklet exit unit parts information

Item	Part name	Part number	Orderable ^(*)	Diagnostics	Description
S44	Booklet exit sensor	JC32-00020A	(*)	113-3120	Check whether paper has come into the booklet unit
M21	Booklet fold motor	JC31-00144A	(*)	113-3510	Drives the booklet exit roller
R13	Booklet exit roller	JC66-04721A	(*)		Moves paper to the booklet output tray unit

^(*) This part is in ordering system.

Booklet output tray unit

Learn about the Booklet output tray unit of the booklet finisher.

The booklet output tray unit is the place where the ejected paper is stacked. The booklet output tray sensor(S43) detects whether paper is on the booklet output tray or not.

Figure 5-84 Booklet output tray unit overview

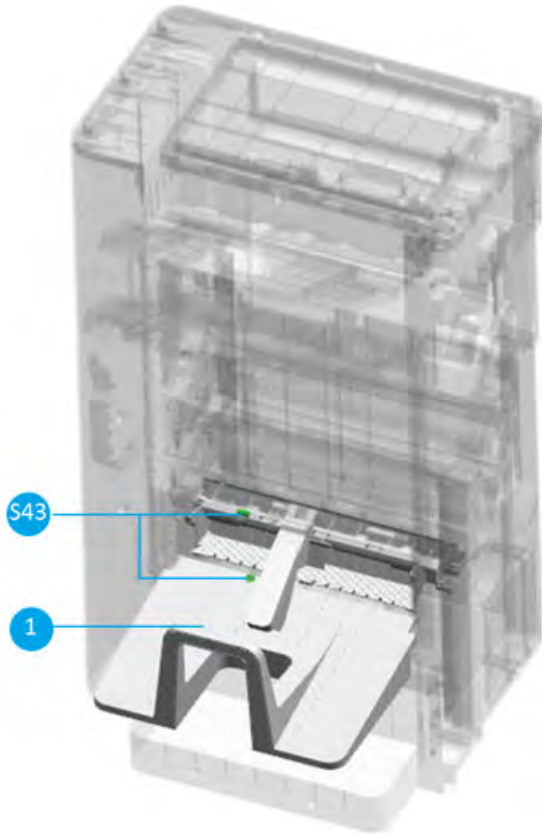

Figure 5-85 Booklet output tray unit detail view



Table 5-43 Booklet output tray unit parts information

Item	Part name	Part number	Orderable ^(*)	Diagnostics	Description
1	Booklet output tray	JC61-07253B	(*)		Stores paper stacks from the booklet exit unit
		JC63-04978B	(*)		

Table 5-43 Booklet output tray unit parts information (continued)

Item	Part name	Part number	Orderable ^(*)	Diagnostics	Description
S43	Booklet output tray sensor	JC82-01039A	(*)	113-2150	Detects whether paper is on the booklet output tray.pa

(*) This part is in ordering system.

How to print large number of booklets

Y1G07A Booklet finisher is support available to print a large number of booklets.

1. Remove the booklet output tray (Callout 1).

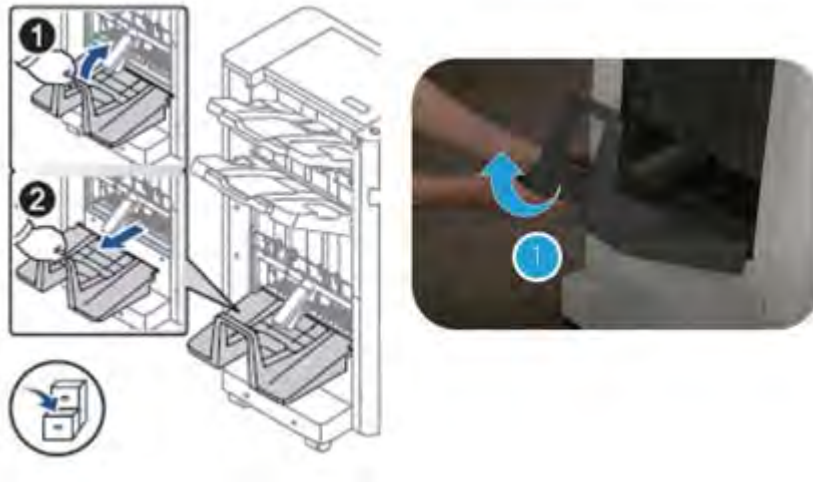

2. Install the booklet sub tray at the booklet output (Callout 2).

 **NOTE:**

- The booklet sub tray is included in the Booklet finisher product box. If a user misses the part, order and use the new part.
 - Booklet sub tray part number : JC61-07088A
-

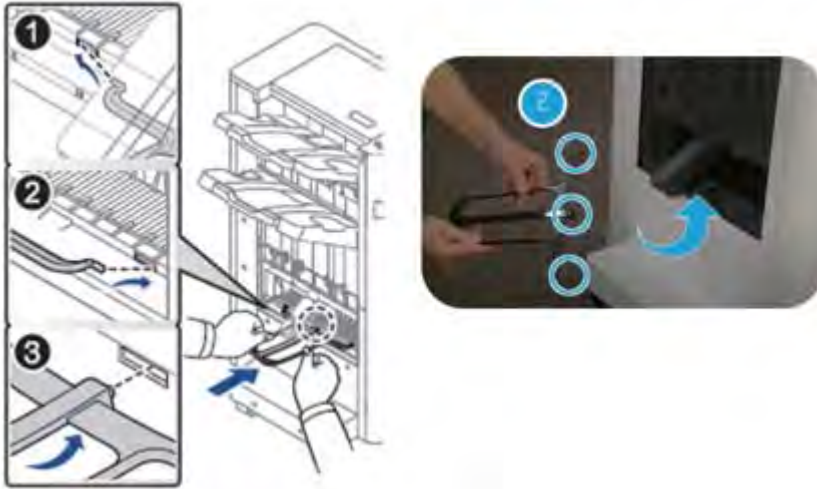

- 3. Install a box to store printouts(Callout 3).

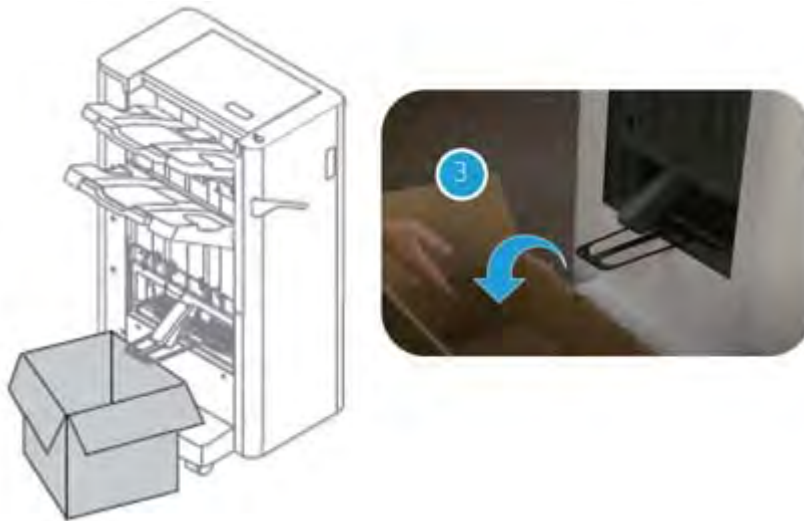

PCA connection information

Learn about the PCA connection information.

Figure 5-86 Stapler / Stacker finisher system - PCA connection information

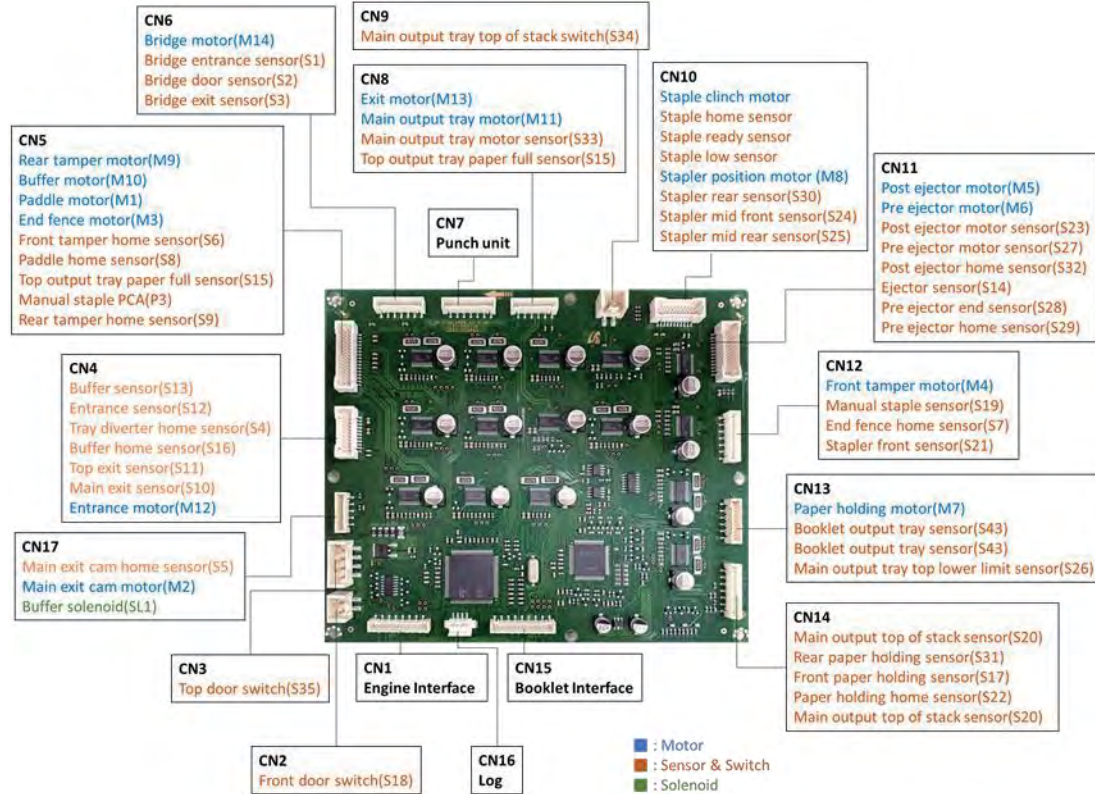

Table 5-44 Stapler/Stacker finisher system - PCA connectors, parts, and diagnostics information

Connector	Motor	Diagnostics	Sensor, Switch	Diagnostics	Solenoid, PCA	Diagnostics
CN1					MainPCA interface	
CN2			Front door switch(S35)	113-2181		
CN3			Top door switch(S18)	113-2182		
CN4	Entrance motor(M12)	113-2570	Buffer sensor(S13)	113-2100		
			Entrance sensor(S12)	113-2080		
			Tray diverter home sensor(S4)	113-2020		
			Buffer home sensor(S16)	113-2210		
			Top exit sensor(S11)	113-2091		
			Main exit sensor(S10)	113-2090		
CN5	Rear tamper motor(M9)	113-2640	Front tamper home sensor(S6)	113-2120	Manual staple PCA(P3)	
	Buffer motor(M10)	113-2660	Paddle home sensor(S8)	113-2060		
	Paddle motor(M1)	113-2600	Top output tray paper full sensor(S15)	113-2145		

Table 5-44 Stapler/Stacker finisher system - PCA connectors, parts, and diagnostics information (continued)

Connector	Motor	Diagnostics	Sensor, Switch	Diagnostics	Solenoid, PCA	Diagnostics
	End fence motor(M3)	113-2590	Rear tamper home sensor(S9)	113-2130		
CN6	Bridge motor(M14)	113-2560	Bridge entrance sensor(S1)	113-2070		
			Bridge door sensor(S2)	113-2180		
			Bridge exit sensor(S3)	113-2143		
CN7					Punch unit	
CN8	Exit motor(M13)	113-2580	Main output tray motor sensor(S33)	113-2143		
	Main output tray motor(M11)	113-2610	Top output tray paper full sensor(S15)	113-2145		
CN9			Main output tray top of stack switch(S34)	113-2190		
CN10	Staple clinch motor		Staple home sensor			
	Stapler position motor (M8)	113-2620	Staple ready sensor			
			Staple low sensor			
			Stapler rear sensor(S30)	113-2110		
			Stapler mid front sensor(S24)	113-2112		
			Stapler mid rear sensor(S25)	113-2111		
CN11	Ejector2 motor(M5)	113-2540	Ejector2 motor sensor(S23)	113-2041		
	Ejector1 motor(M6)	113-2530	Ejector1 motor sensor(S27)	113-2032		
			Ejector2 home sensor(S32)	113-2040		
			Ejector sensor(S14)	113-2170		
			Ejector1 end sensor(S28)	113-2030		
			Ejector1 home sensor(S29)	113-2031		
CN12	Front tamper motor(M4)	113-2630	Manual staple sensor(S19)	113-2160		
			End fence home sensor(S7)	113-2050		
			Stapler front sensor(S21)	113-2113		
CN13	Paper holding motor(M7)	113-2510	Booklet output tray sensor(S43)	113-2150		

Table 5-44 Stapler/Stacker finisher system - PCA connectors, parts, and diagnostics information (continued)

Connector	Motor	Diagnostics	Sensor, Switch	Diagnostics	Solenoid, PCA	Diagnostics
CN14			Main output top of stack sensor(S20)	113-2140		
			Rear paper holding sensor(S31)	113-2142		
			Front paper holding sensor(S17)	113-2141		
			Paper holding home sensor(S22)	113-2010		
			Main output top of stack sensor(S20)	113-2140		
CN15					Booklet interface	
CN16					Log	
CN17	Main exit cam motor(M2)	113-2500	Main exit cam home sensor(S5)	113-2000		
				Buffer solenoid(SL1)	113-2670	

Figure 5-87 Booklet finisher system - PCA connection information

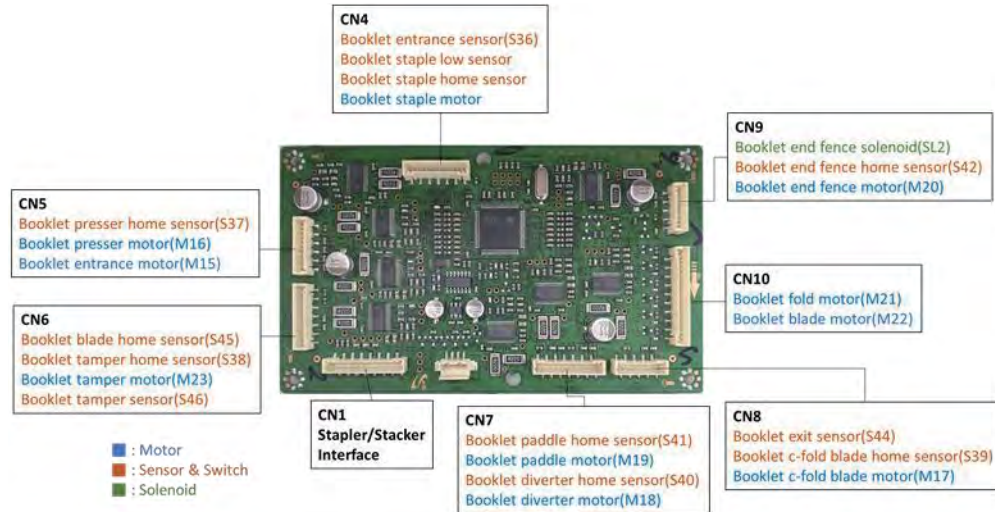

Table 5-45 Booklet finisher system - PCA connectors, parts, and diagnostics information

Connector	Motor	Diagnostics	Sensor	Diagnostics	Switch, Solenoid, PCA	Diagnostics
CN1						Stapler/Stacker interface
CN4	Booklet staple motor		Booklet entrance sensor(S36)	113-3100		
			Booklet staple low sensor			

Table 5-45 Booklet finisher system - PCA connectors, parts, and diagnostics information (continued)

Connector	Motor	Diagnostics	Sensor	Diagnostics	Switch, Solenoid, PCA	Diagnostics
			Booklet staple home sensor			
CN5	Booklet presser motor(M16)	113-2580	Booklet presser home sensor(S37)	113-3130		
			Booklet entrance motor(S13)	113-2100		
CN6	Booklet tamper motor(M23)	113-3540	Booklet blade home sensor(S45)	113-3040		
			Booklet tamper home sensor(S38)	113-3080		
			Booklet tamper sensor(S46)	113-3110		
CN7	Booklet paddle motor(M19)	113-3580	Booklet paddle home sensor(S41)	113-3090		
	Booklet diverter motor(M18)	113-3560	Booklet diverter home sensor(S40)	113-3060		
CN8	Booklet c-fold blade motor(M17)	113-3590	Booklet exit sensor(S44)	113-3120		
			Booklet c-fold blade home sensor(S39)	113-3050		
CN9	Booklet end fence motor(M20)	113-3530	Booklet end fence home sensor(S42)	113-3000	Booklet end fence solenoid(SL2)	
CN10	Booklet fold motor(M21)	113-3510				113-3520
	Booklet blade motor(M22)	113-3550				

Service approach

Learn about the service approach of the inner finisher.

 **CAUTION:** When working on the product, do not pick up the unit by the output tray, which will detach under the weight of the product.

Precautions when replacing parts

Learn about precautions when replacing parts.

Precautions when replacing parts

Learn about precautions when replacing parts.

Precautions when assembling and disassembling

- Use only HP approved replacement parts. Make sure that the part number, product name, voltage, and current or temperature ratings are correct. Failure to do so might result in damage to the machine, circuit overload, fire, or electric shock.
- Do not make unauthorized changes or additions to the printer. Unauthorized changes might cause the printer to malfunction and create electric shock or fire hazards.
- Use caution when dismantling the unit. Take note of the location of each screw or other part. This printer contains different kinds of screws. Using the wrong screw might lead to system failure, short circuit or electric shock.
- Do not disassemble the laser scanner assembly. Once the laser scanner assembly is disassembled, dust might enter the mirror chamber and will seriously degrade print quality. There are no serviceable parts inside the laser scanner assembly.
- Regularly check the condition of the power cable, plug and socket. Bad contacts might lead to overheating and fire. Damaged cables might lead to electric shock or unit malfunction.

Precautions when handling PCAs

Static electricity might damage a PCA. Use approved, anti-static precautions when handling or storing a PCA. Service personnel should use grounded ESD straps and/or mats when handling PCAs.

- Precautions when moving and storing a PCA
 - Keep PCA in a conductive case, anti-static bag, or wrapped in aluminum foil.
 - Do not store a PCA where it is exposed to direct sunlight.
- Precautions when replacing a PCA
 - Disconnect power cables before disconnecting other cables.
 - Do not touch any soldered connections, connector terminals, or other electronic parts when handling insulated parts.
- Precautions when checking a PCA
 - Touch a grounded area of the printer chassis to discharge static electric charge before touching a PCA.
 - Do not touch a PCA with bare hands or metal objects. Doing so might create a short circuit or cause electric shock. Use caution when handling a PCA with moving parts such as sensors, motors, or lamps, as they might become very hot.

- Use caution when fitting and removing screws. Watch for hidden screens. Make sure that the correct screw is used and make sure that when toothed washers are removed, they are refitted in their original positions.
- Place the product on an ESD workstation or mat, or use an ESD strap (if one is available). If an ESD workstation, mat, or strap is not available, ground yourself by touching the sheet-metal chassis *before* touching an ESD-sensitive part.

Releasing plastic latches

Many of the parts are held in place with plastic latches. The latches might easily break. Be careful when releasing them. To remove such parts, press the hook end of the latch away from the part to which it is latched.

Precautions when handling PCA

Static electric might damage a PCA. Use approved, anti-static precautions when handling or storing a PCA. Service personnel should use grounded ESD straps and/or mats when handling PCAs.

- Precautions when moving and storing a PCA
 - Keep PCA in a conductive case, anti-static bag, or wrapped in aluminum foil.
 - Do not store a PCA where it is exposed to direct sunlight.
- Precautions when replacing a PCA
 - Disconnect power cables before disconnecting other cables.
 - Do not touch any soldered connections, connector terminals, or other electronic parts when handling insulated parts.
- Precautions when checking a PCA
 - Touch a grounded area of the printer chassis to discharge static electric charge before touching a PCA.
 - Do not touch a PCA with bare hands or metal objects. Doing so might create a short circuit or cause electric shock. Use caution when handling a PCA with moving parts such as sensors, motors, or lamps, as they might become very hot.
 - Use caution when fitting and removing screws. Watch for hidden screens. Make sure that the correct screw is used and make sure that when toothed washers are removed, they are refitted in their original positions.
 - Place the product on an ESD workstation or mat, or use an ESD strap (if one is available). If an ESD workstation, mat, or strap is not available, ground yourself by touching the sheet-metal chassis *before* touching an ESD-sensitive part.

Releasing plastic latches

Learn about releasing plastic latches.

Many of the parts are held in place with plastic latches. The latches can break easily; release them carefully. To remove such parts, press the hook end of the latch away from the part to which it is latched.



Before performing service

Learn what to do before performing service.

- Remove all paper from the product.
- Turn off the power using the power button.
- Unplug the power cable and interface cable or cables.
- Place the product on an ESD workstation or mat, or use an ESD strap (if one is available). If an ESD workstation, mat, or strap is not available, ground yourself by touching the sheet-metal chassis *before* touching an ESD-sensitive part.
- Remove the toner cartridges.
- Remove the Tray 2 cassette.

ESD precautions

Learn the importance of electrostatic discharge.



CAUTION:



Some parts are sensitive to electrostatic discharge (ESD). Look for the ESD reminder when removing printer parts. Always perform service work at an ESD-protected workstation or mat. If an ESD workstation or mat is not available, touch the sheet-metal chassis to provide a static ground *before* touching an ESD-sensitive assembly.

Protect the ESD-sensitive assemblies by placing them in ESD pouches when they are out of the printer.

After performing service

Learn what to do after performing service.

- Verify that the service performed was successful.
- Verify that the most recent firmware is installed on the printer.
- Verify that all parts are correctly reinstalled and are properly working.
- Print any pages necessary to verify that the repair resolved the issue and did not create any new issues.
- Verify that the printer is in better condition than when you arrived, cosmetically and electrically.

Post-service test

Perform the following tests to verify that the repair or replacement was successful:

Print-quality test

Learn about the print-quality test.

1. Verify that you have completed the necessary reassembly steps.
2. Make sure that the tray contains clean, unmarked paper.
3. Attach the power cord and interface cable or interface cables, and then turn on the product.
4. Print a configuration page.
5. Print a print quality page, and then verify that there are no lines, streaks, banding, or other print quality defects.
6. Send a print job from the host computer, and then verify that the output meets expectations.

Order parts by authorized service providers

Find information about ordering parts and supplies for the printer.

Ordering

Order parts by authorized service providers.

Table 5-46 Ordering

Item or provider	Description
Order supplies and paper	www.hp.com/go/suresupply
Order parts from authorized service providers	www.hp.com/buy/parts or partsurfer.hp.com
Order through service or support providers	Contact an HP-authorized service or support provider.
Order using the HP Embedded Web Server (EWS)	To access, in a supported web browser on your computer, enter the printer IP address or host name in the address/URL field. The EWS contains a link to the HP SureSupply web site, which provides options for purchasing Original HP supplies.

Orderable parts

Not all of the parts shown in the exploded assembly diagrams are orderable parts.

Refer to the tables following the diagrams or the alphabetical/numerical parts lists to determine if a part is orderable.

Parts, diagrams, removal and replacement (stapler/ stacker and booklet finishers)

Learn about parts, diagrams, removal and replacement (stapler/ stacker and booklet finishers)



NOTE:  Some parts are sensitive to electrostatic discharge (ESD). Always perform service work at an ESD-protected workstation or mat. If an ESD workstation or mat is not available, touch the sheet-metal chassis to provide a static ground before touching an ESD-sensitive assembly. Protect the ESD-sensitive assemblies by placing them in ESD pouches when they are out of the printer.

Parts, diagrams (stapler/stacker)

Learn about parts, diagrams (stapler/stacker)



NOTE:

Some parts are sensitive to electrostatic discharge (ESD). Always perform service work at an ESD-protected workstation or mat. If an ESD workstation or mat is not available, touch the sheet-metal chassis to provide a static ground before touching an ESD-sensitive assembly. Protect the ESD-sensitive assemblies by placing them in ESD pouches when they are out of the printer.

Cover & harness

Cover & hanress

Parts diagram and parts list for the cover and hanress.

Figure 5-88 cover

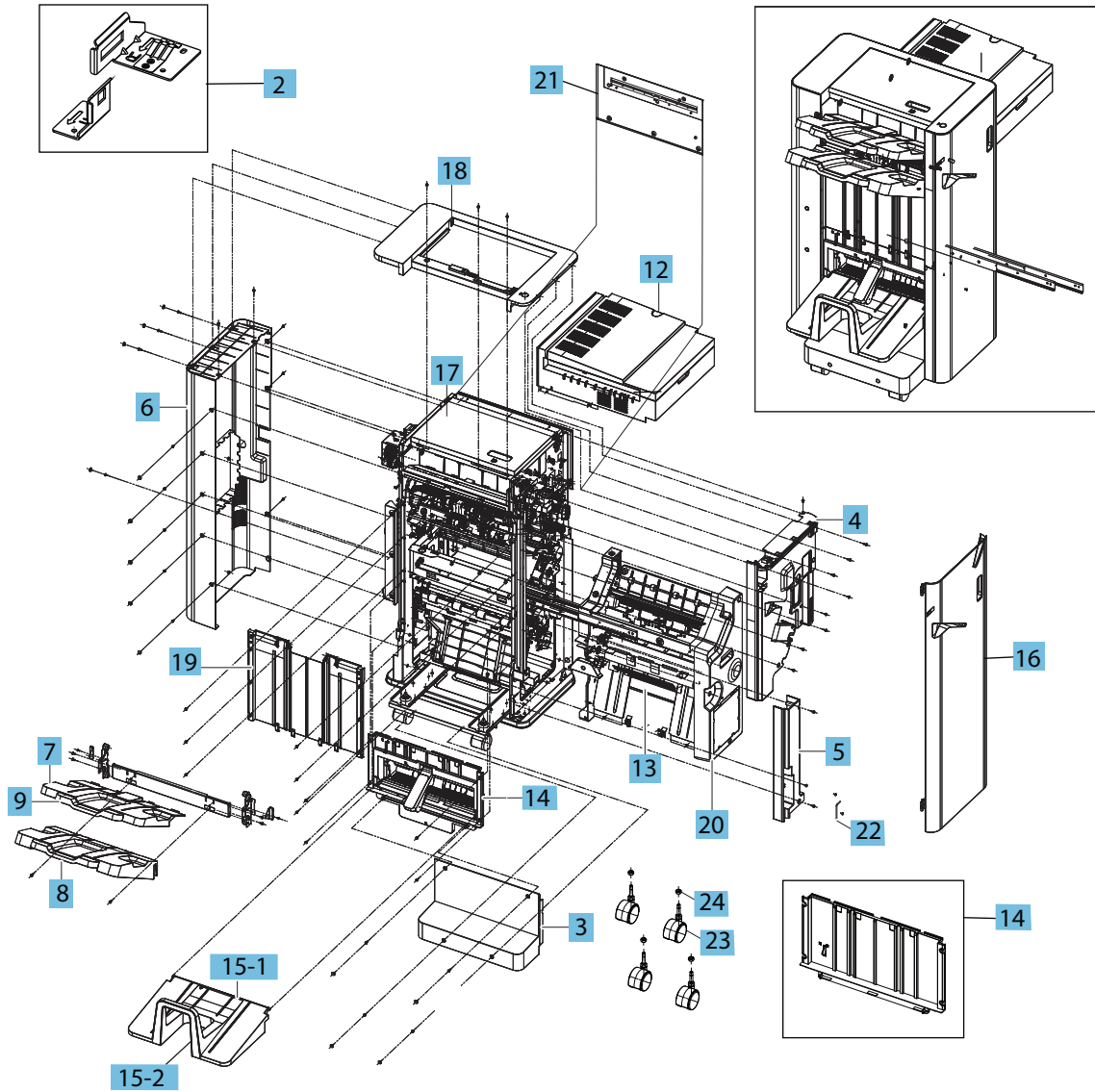

Table 5-47 cover

Ref	Description	Part number	Qty	Orderable
2	Finisher mount bracket	JC90-01442A	1	(*)
3	Caster cover	JC63-04985B	1	(*)
4	Front cover	JC63-04986B	1	(*)
5	Front lower cover	JC63-04987B	1	(*)
6	Rear cover	JC63-04988B	1	(*)
7	Top output tray upper	JC63-04996B	1	(*)
8	Main output tray	JC63-05002B	1	(*)
9	Top output tray lower	JC63-05003B	1	(*)
12	Bridge unit	JC90-01772B	1	(*)
13	Booklet maker	JC82-00905A	1	(*)
14	Left lower cover (Stacker-stapler)	JC90-01771B	1	(*)
14	Left lower cover (Booklet)	JC90-01417B	1	(*)
15-1	Booklet output tray	JC61-07253B	1	(*)
15-2	Booklet output tray cover	JC63-04978B	1	(*)
16	Front door	JC90-01444B	1	(*)
17	Top door	JC90-01445B	1	(*)
18	Top cover	JC90-01446B	1	(*)
19	Left upper cover	JC90-01475B	1	(*)
20	Booklet front cover	JC90-01478B	1	(*)
21	Right upper cover	JC90-01448B	1	(*)
22	Hinge	JC66-04767A	1	(*)
23	Caster	JC61-07452A	4	(*)
24	Caster fix nut	JC61-07444A	4	(*)

Table 5-48 harness

Ref	Description	Part number	Qty	Orderable
Not shown	Harness, finisher to copier PWR	JC39-02308A	1	(*)
Not shown	Harness, 3K finisher to copier PWR	JC39-02308A	1	(*)
Not shown	Harness, 3K finisher rear upper	JC39-02312A	1	(*)
Not shown	Harness, 3K finisher front upper	JC39-02313A	1	(*)
Not shown	Harness, 3K finisher punch relay	JC39-02314A	1	(*)
Not shown	Harness, 3K finisher staple relay	JC39-02315A	1	(*)
Not shown	Harness, 3K finisher eject relay	JC39-02317A	1	(*)
Not shown	Harness, 3K finisher front lower	JC39-02318A	1	(*)
Not shown	Harness, 3K finisher stack relay	JC39-02319A	1	(*)
Not shown	Harness, 3k finisher exit path	JC39-02322A	1	(*)
Not shown	Harness, 3K Finisher Bridge Sub	JC39-02327A	1	(*)
Not shown	Harness, 3K Finisher Bridge Pa	JC39-02328A	1	(*)
Not shown	Stack full harness	JC39-02331A	1	(*)

(*) This part is in ordering system.

Front door, Top door, Top cover, Right upper cover

Parts diagram and parts list for the front door, top door, top cover, right upper cover.

Figure 5-89 Front door, Top door, Top cover, Right upper cover

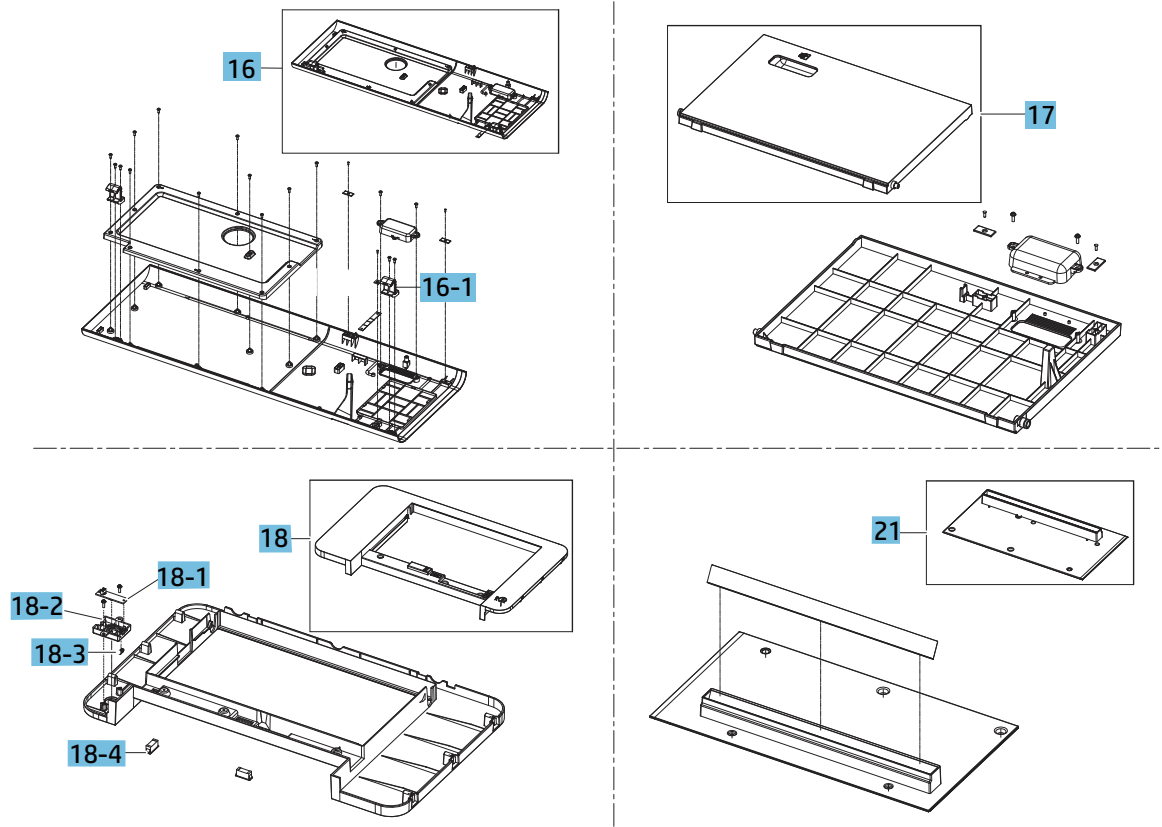

Table 5-49 Front door, Top door, Top cover, Right upper cover

Ref	Description	Part number	Qty	Orderable
16	Front door	JC90-01444B	1	(*)
16-1	Cover link	JC63-05004A	1	(*)
17	Top door	JC90-01445B	1	(*)
18	Top cover	JC90-01446B	1	(*)
18-1	Manual staple PCA	JC92-02789B	1	(*)
18-2	Magnet	JC81-08263A	1	(*)
18-3	Manual staple button LED	JC64-00996A	1	(*)
18-4	Manual staple button	JC64-00995A	1	(*)
21	Right upper cover	JC90-01448B	1	(*)

(*) This part is in ordering system.

Bridge unit

Upper bridge

Parts diagram and parts list for the bridge unit, upper bridge.

Figure 5-90 Bridge unit, Upper bridge

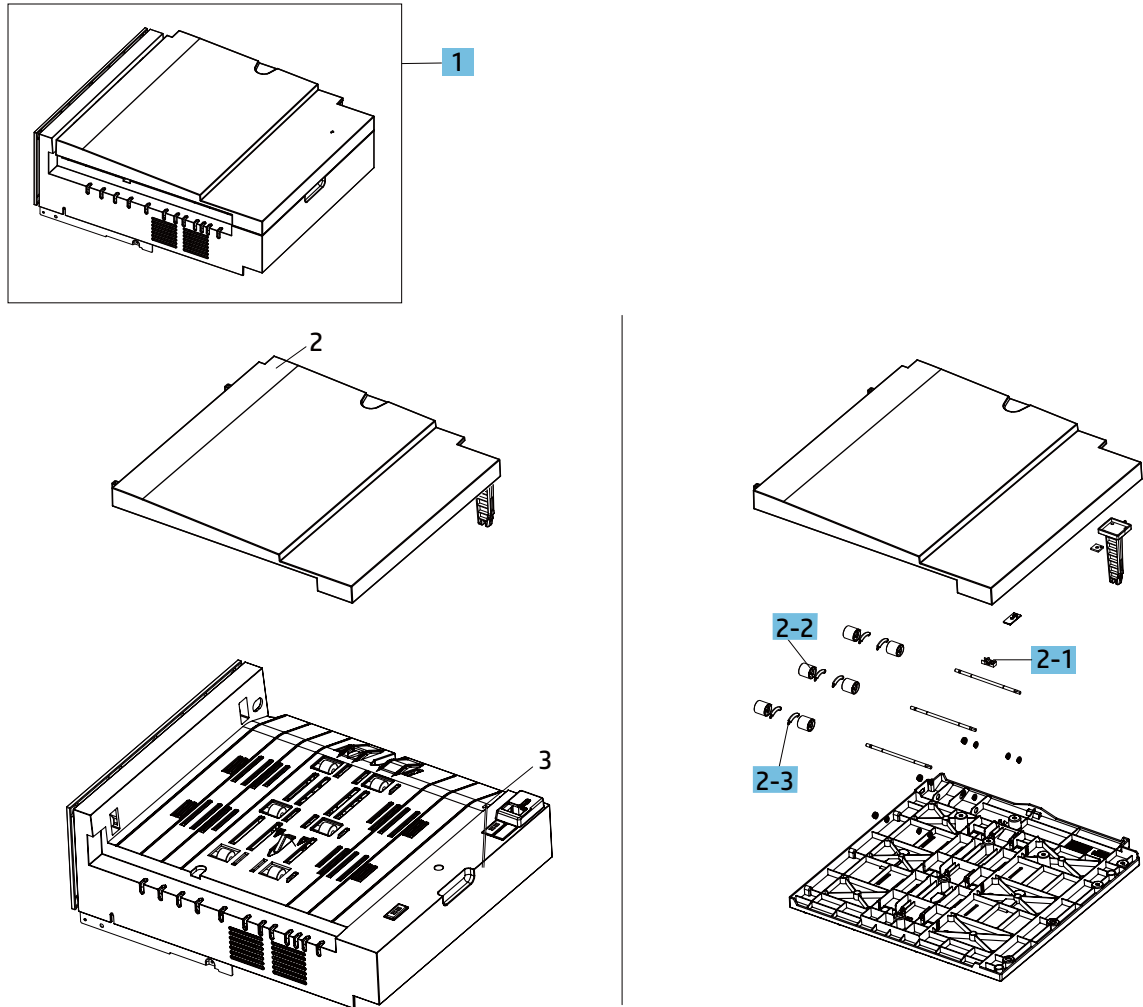

Table 5-50 Bridge unit, Upper bridge

Ref	Description	Part number	Qty	Orderable
1	Bridge unit	JC90-01772B	1	(*)
2	Upper bridge unit	JC90-01406B	1	
2-1	Bridge entrance sensor	JC32-00020A	1	(*)
2-2	Spring	JC61-07431A	4	(*)
2-3	Spring	JC61-07430A	2	(*)
3	Lower bridge unit	JC90-01401B	1	

(*) This part is in ordering system.

Lower bridge

Parts diagram and parts list for the bridge unit, lower bridge.

Figure 5-91 Bridge unit, Lower bridge

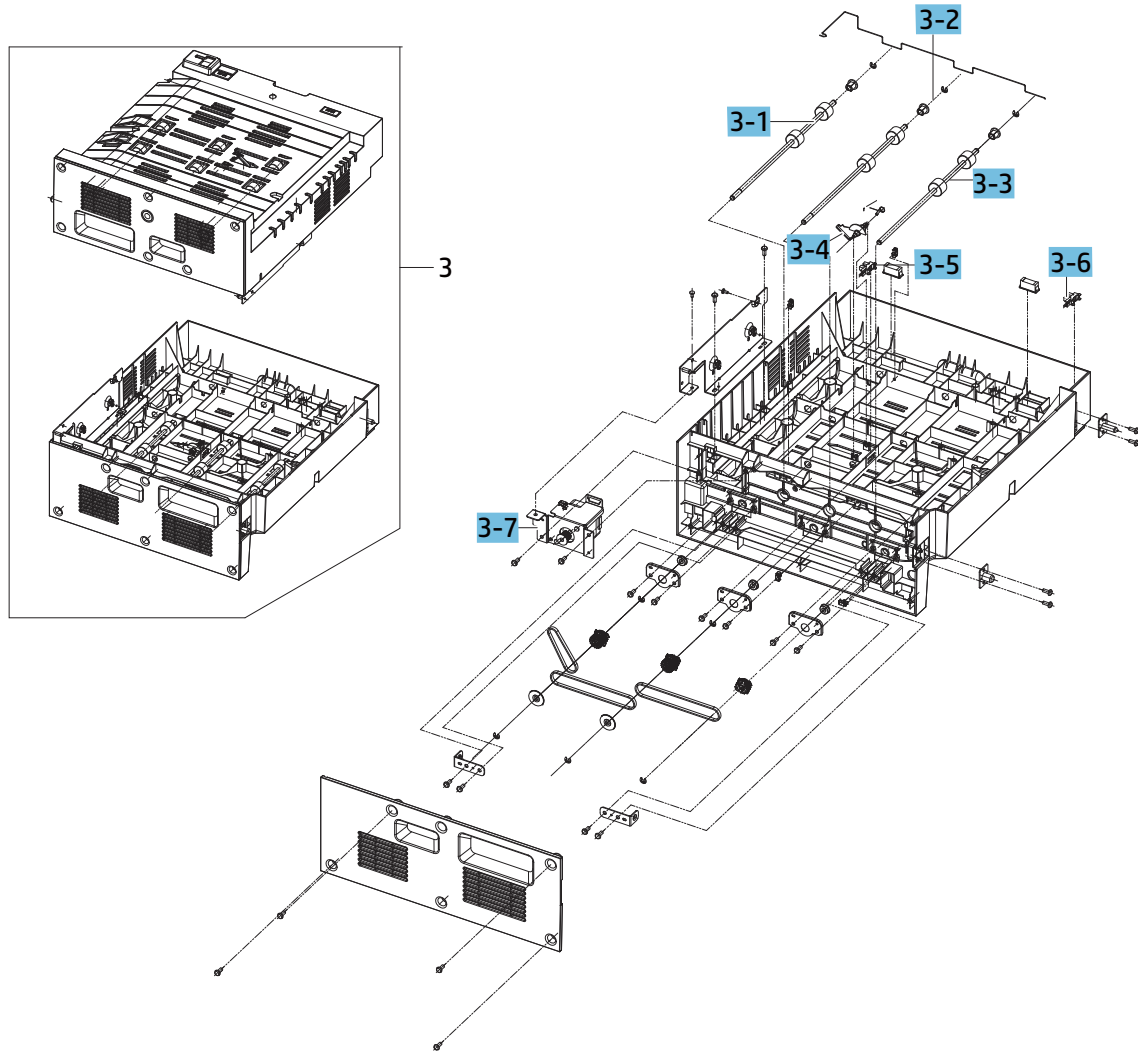

Table 5-51 Bridge unit, Lower bridge

Ref	Description	Part number	Qty	Orderable
3	Lower bridge unit	JC90-01401B	1	
3-1	Bridge entrance roller	JC66-04733A	1	
3-2	Bridge middle roller	JC66-04732A	1	(*)
3-3	Bridge exit roller	JC66-04732A	4	(*)
3-4	Bridge exit actuator	JC66-04569A	2	(*)
3-5	Bridge exit sensor	0604-001393	1	
3-6	Bridge door sensor	0604-001393	1	(*)
3-7	Bridge motor	JC31-00163B	1	(*)

(*) This part is in ordering system.

Entrance unit

Entrance unit

Parts diagram and parts list for the entrance unit.

Figure 5-92 Entrance unit

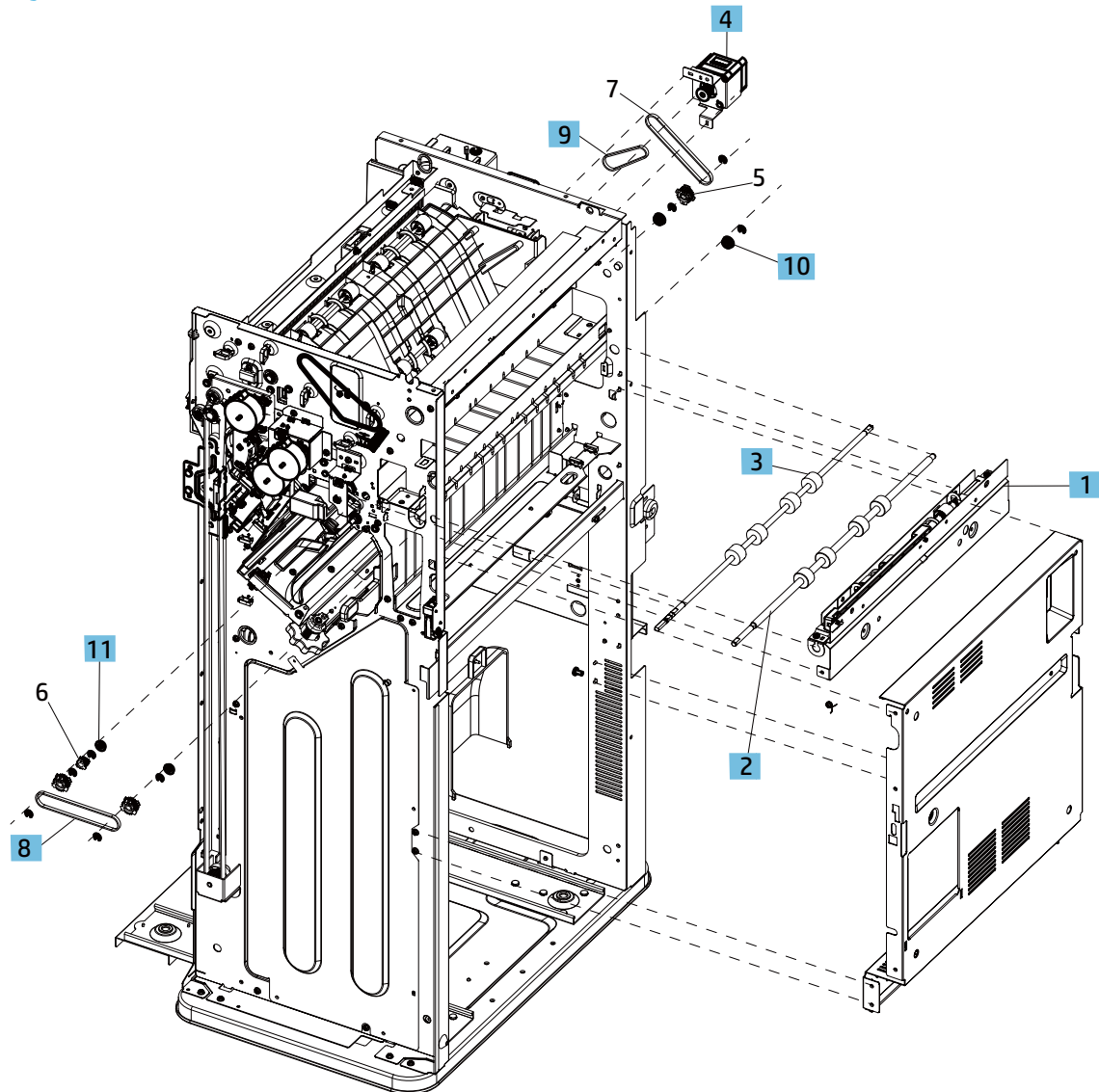

Table 5-52 Entrance unit

Ref	Description	Part number	Qty	Orderable
1	Entrance unit	JC90-01449A	1	(*)
2	Entrance roller	JC66-04722A	1	(*)
3	Middle roller	JC66-04724A	1	(*)
4	Entrance motor assembly	JC90-01459A	1	(*)
5	Gear	JC66-04656A	3	
6	Gear	JC66-04546A	1	
7	Belt	6602-003646	1	
8	Belt	6602-003647	1	(*)
9	Belt	6602-003645	1	(*)
10	Bushing	6601-001478	2	(*)
11	Bushing	6601-002584	2	(*)

(*) This part is in ordering system.

Entrance unit, Entrance motor

Parts diagram and parts list for the entrance unit, entrance motor.

Figure 5-93 Entrance unit, Entrance motor

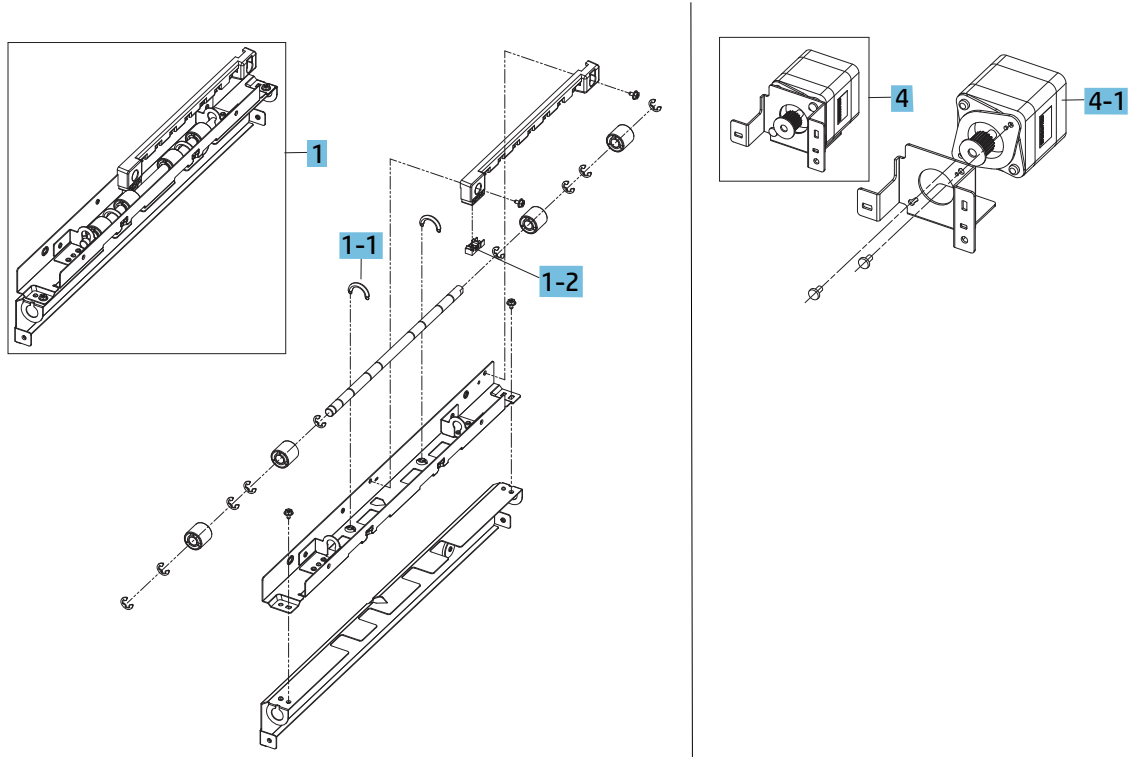

Table 5-53 Entrance unit, Entrance motor

Ref	Description	Part number	Qty	Orderable
1	Entrance unit	JC90-01449A	1	(*)
1-1	Spring	JC61-07408A	2	(*)
1-2	Entrance sensor	JC32-00020A	1	(*)
4	Entrance motor assembly	JC90-01459A	1	(*)
4-1	Entrance motor	JC31-00163B	1	(*)

(*) This part is in ordering system.

Tray diverter unit

Tray diverter unit

Parts diagram and parts list for the tray diverter unit.

Figure 5-94 Tray diverter unit

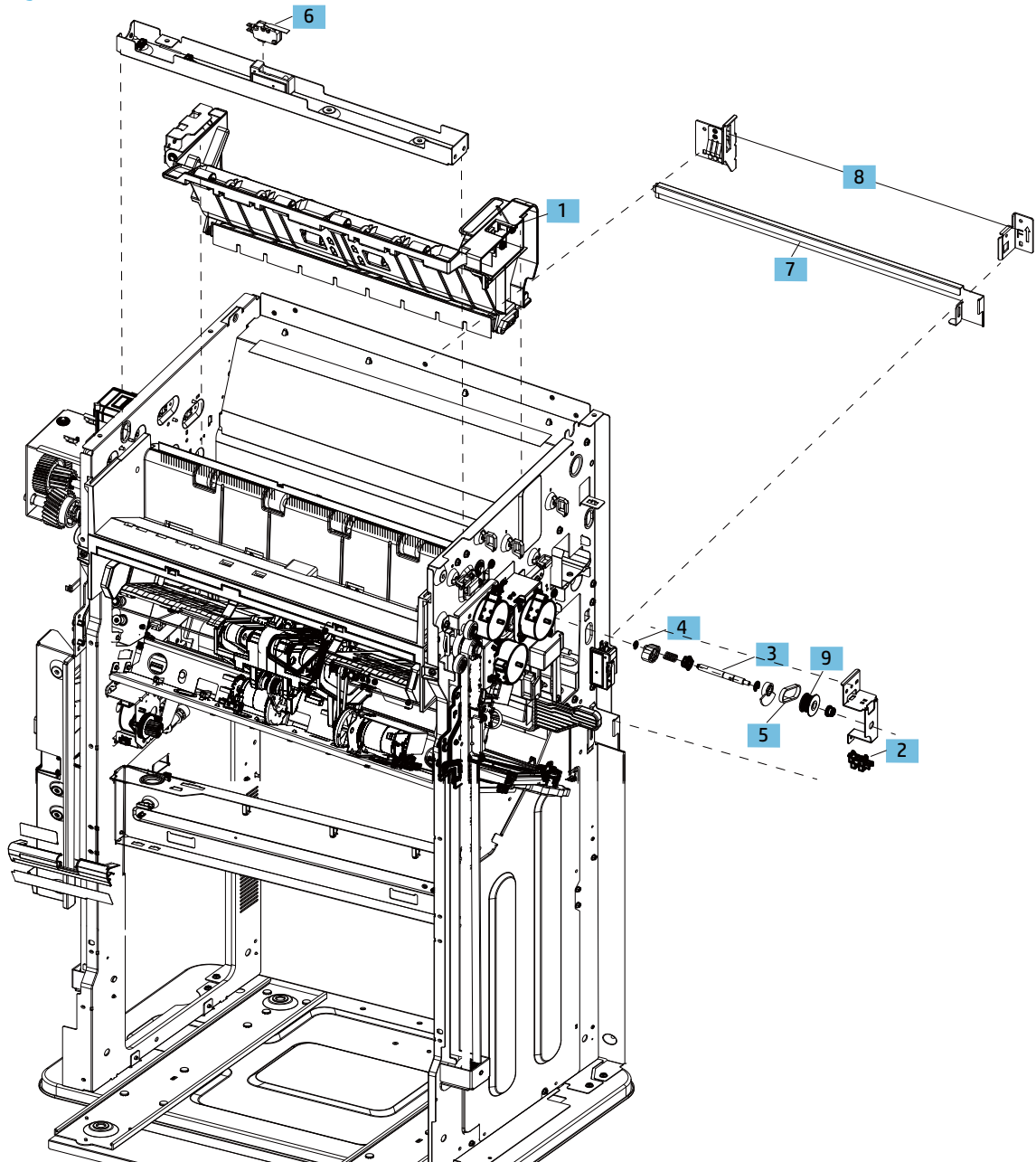

Table 5-54 Tray diverter unit

Ref	Description	Part number	Qty	Orderable
1	Top jam cover assembly	JC90-01455A	1	(*)
2	Tray diverter home sensor	0604-001415	1	(*)
3	Tray diverter cam	JC90-01458A	1	(*)
4	Bushing	JC61-00423A	1	(*)
5	Belt	6602-003639	1	(*)
6	Top door switch	JC39-02310A	1	(*)
7	Frame mount	JC61-06663A	1	(*)
8	Frame mount side bracket	JC90-01442A	1	(*)
9	Clutch	JC90-01474A	1	(*)

(*) This part is in ordering system.

Tray jam cover, Tray diverter CAM

Parts diagram and parts list for the tray jam cover, tray diverter CAM.

Figure 5-95 Tray jam cover, Tray diverter CAM

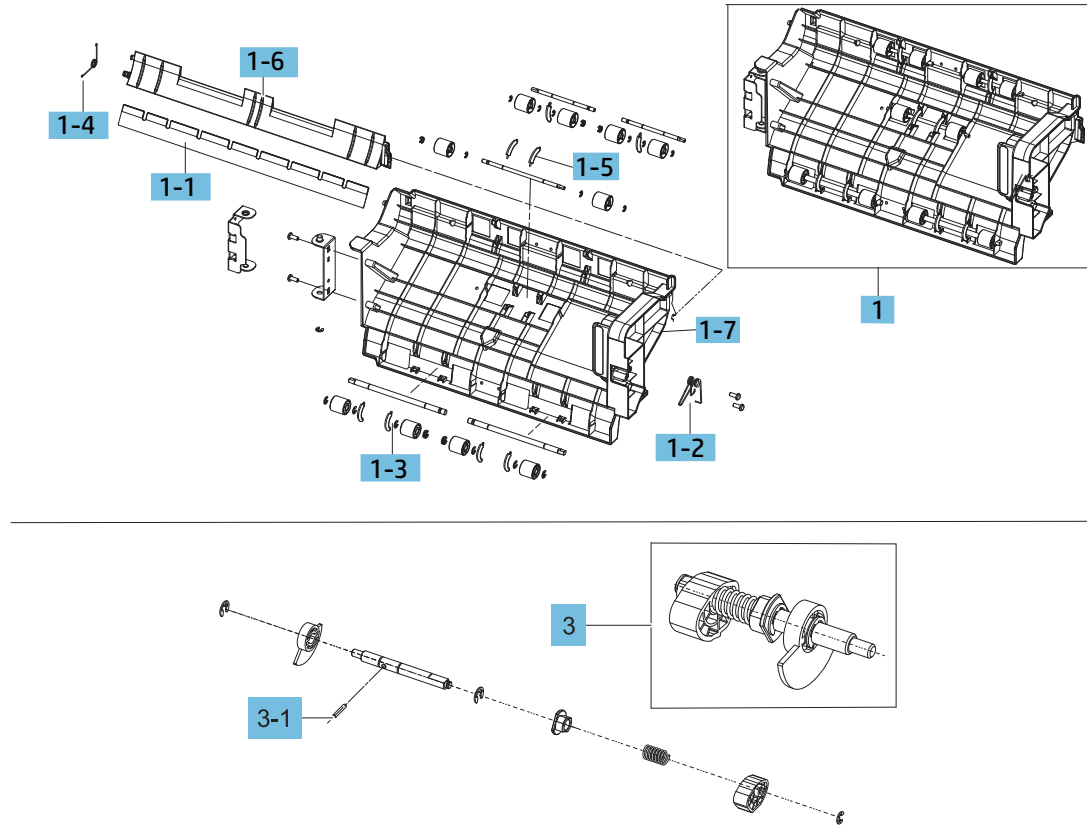

Table 5-55 Tray jam cover, Tray diverter CAM

Ref	Description	Part number	Qty	Orderable
1	Top jam cover assembly	JC90-01455A	1	(*)
1-1	Seal	JC62-01328A	1	(*)
1-2	Spring	JC61-07417A	1	(*)
1-3	Spring	JC61-07415A	1	(*)
1-4	Spring	JC61-07410A	1	(*)
1-5	Spring	JC61-07409A	1	(*)
1-6	Tray diverter	JC61-07205A	1	(*)
1-7	Tray jam cover	JC61-07196A	1	(*)
3	Tray diverter cam	JC90-01458A	1	(*)
3-1	Pin	JC70-40360A	1	(*)

(*) This part is in ordering system.

Top output tray unit, Top exit unit, Main exit unit

Top output tray unit, Top exit unit, Main exit unit

Parts diagram and parts list for the top output tray unit, top exit unit, main exit unit.

Figure 5-96 Top output tray unit, Top exit unit, Main exit unit

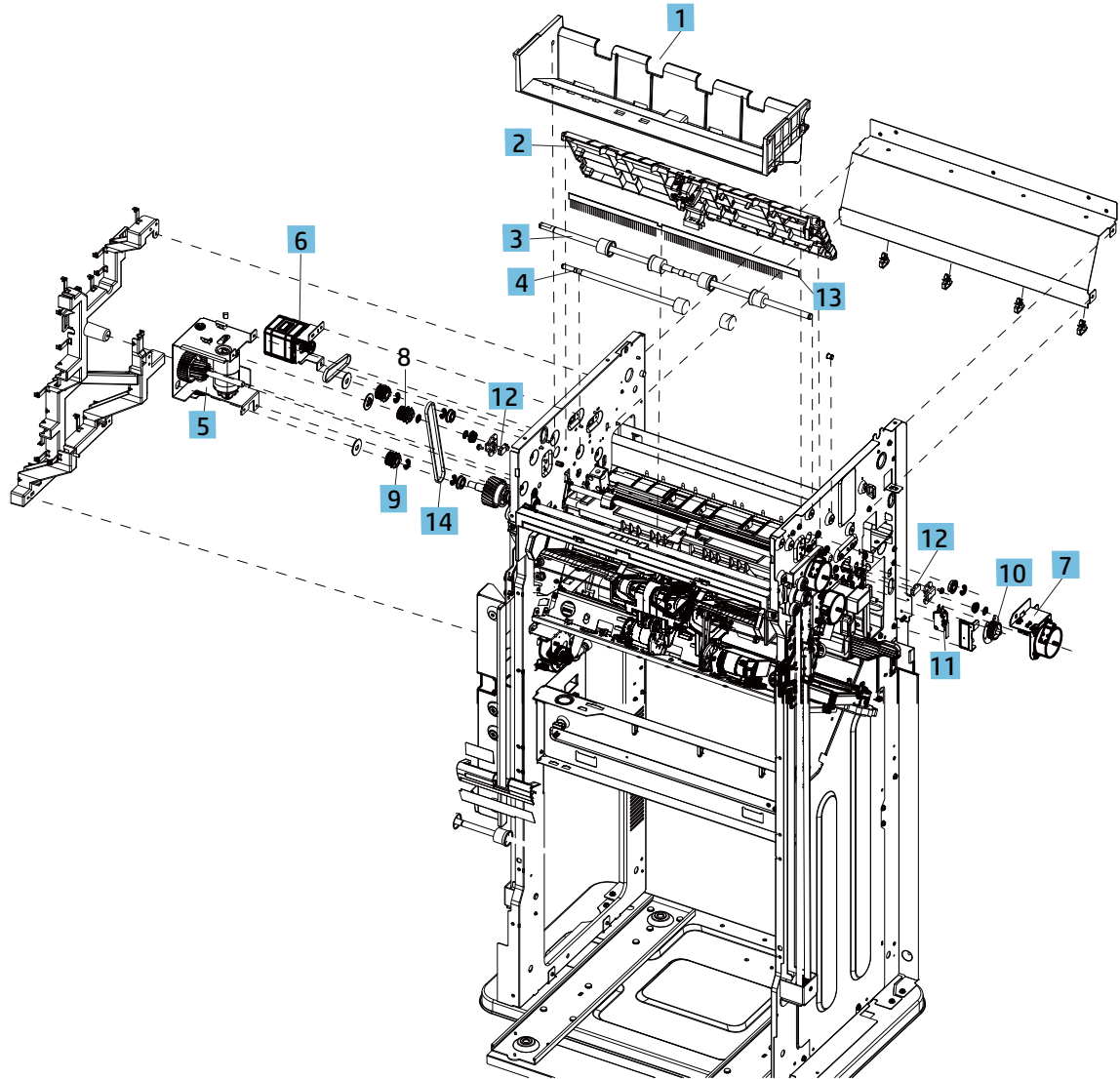

Table 5-56 Top output tray unit, Top exit unit, Main exit unit

Ref	Description	Part number	Qty	Orderable
1	Top output tray	JC63-04995B	1	(*)
2	Top lower feed assembly	JC90-01454A	1	(*)
3	Top exit roller	JC66-04727A	1	(*)
4	Top middle roller	JC66-04725A	1	(*)
5	Main output tray motor assembly	JC90-01415B	1	(*)
6	Exit motor assembly	JC90-01459A	1	(*)
7	Main exit CAM motor assembly	JC90-01453A	1	(*)
8	Gear	JC66-04657A	2	
9	Clutch	JC90-01404A	1	(*)
10	Gear	JC66-04602A	1	(*)
11	Front door switch	JC39-02310A	1	(*)
12	Top output tray paper full sensor	JC82-01039A	1	(*)
13	Top-brush exit	JC67-00818A	1	(*)
14	Belt	6602-003649	1	(*)

(*) This part is in ordering system.

Top lower cover, Exit motor, Main exit CAM motor

Parts diagram and parts list for the top lower cover, exit motor, main exit CAM motor.

Figure 5-97 Top lower cover, Exit motor, Main exit CAM motor

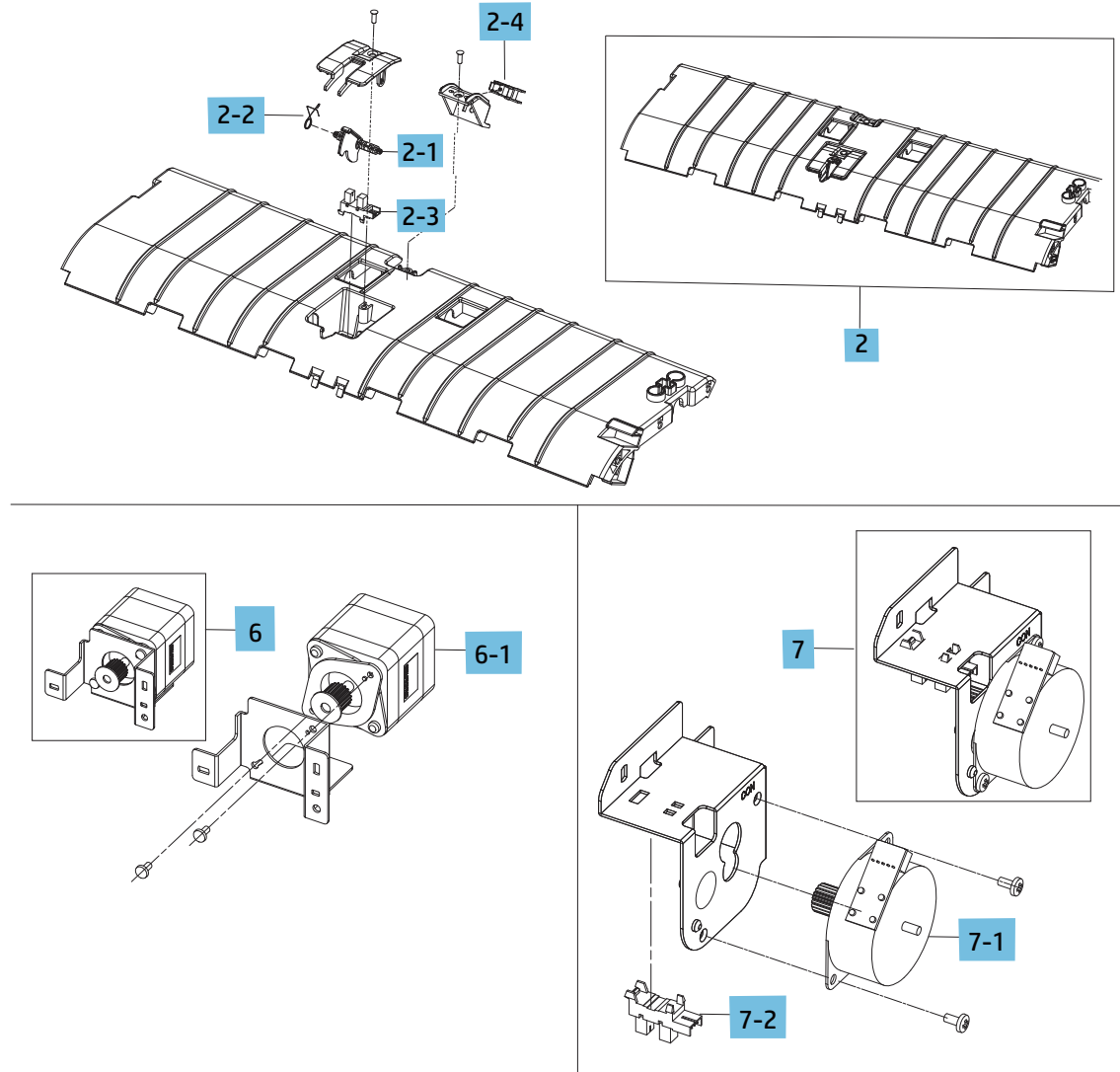

Table 5-57 Top lower cover, Exit motor, Main exit CAM motor

Ref	Description	Part number	Qty	Orderable
2	Top lower feed assembly	JC90-01454A	1	(*)
2-1	Top exit actuator	JC66-04525A	1	(*)
2-2	Spring	JC61-07411A	1	(*)
2-3	Top exit sensor	0604-001393	1	(*)
2-4	Main exit sensor	JC32-00020A	1	(*)
6	Exit motor assembly	JC90-01459A	1	(*)
6-1	Exit motor	JC31-00163B	1	(*)
7	Main exit CAM motor assembly	JC90-01453A	1	(*)
7-1	Main exit CAM motor	JC93-01155A	1	(*)
7-2	Main exit CAM home sensor	0604-001393	1	(*)

(*) This part is in ordering system.

Main exit unit, Paddle unit, End fence unit

Main exit unit, Paddle unit, End fence unit

Parts diagram and parts list for the main exit unit, paddle unit, end fence unit.

Figure 5-98 Main exit unit, Paddle unit, End fence unit

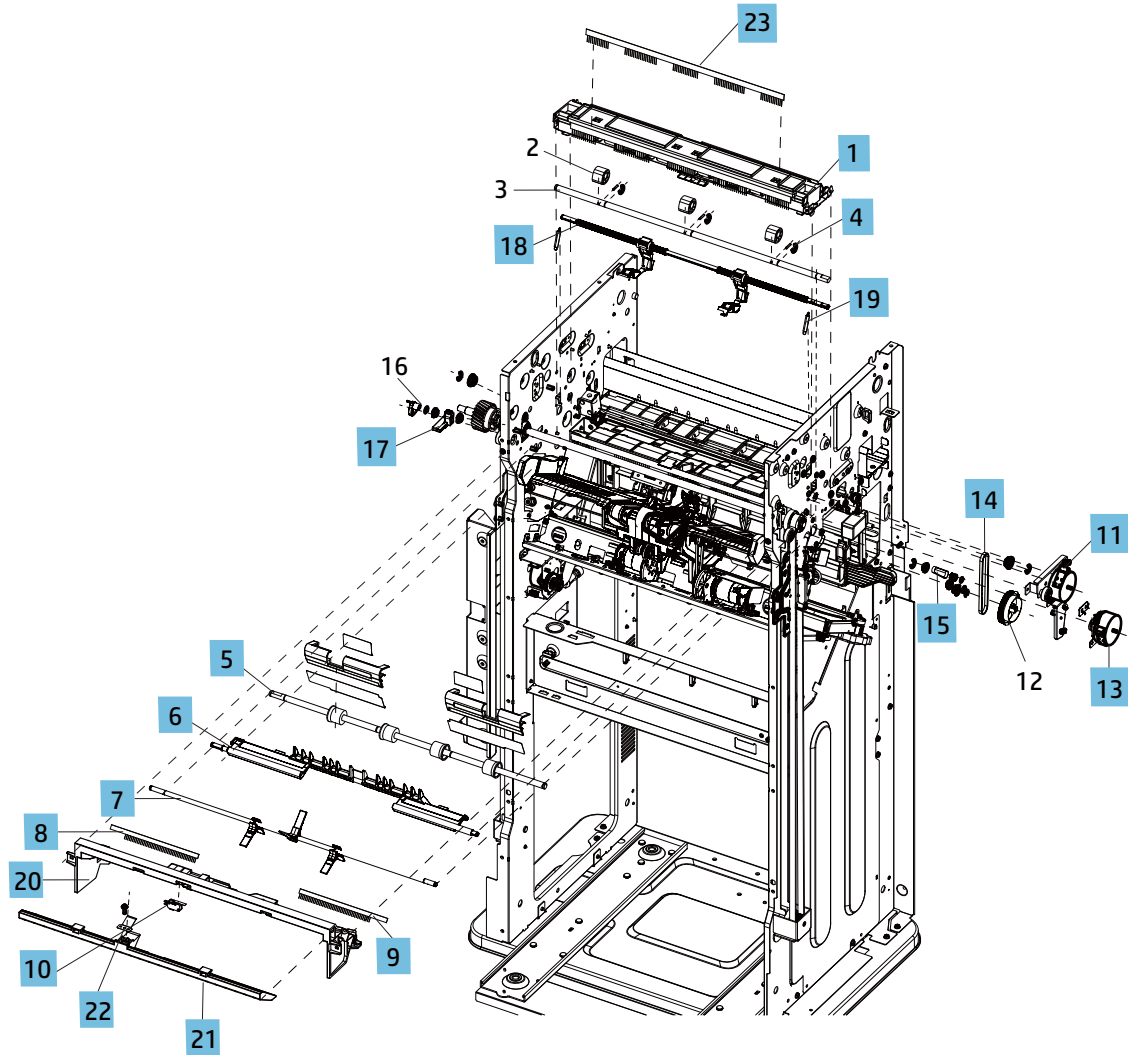

Table 5-58 Main exit unit, Paddle unit, End fence unit

Ref	Description	Part number	Qty	Orderable
1	Main exit CAM guide	JC90-01451A	1	(*)
2	Main exit CAM	JC66-04561A	3	
3	Main exit CAM shaft	JC66-04715A	1	
4	Pin	JC70-40360A	3	(*)
5	Main exit roller	JC66-04726A	1	(*)
6	Paddle pesser	JC61-07206A	1	(*)
7	Paddle	JC90-01480A	1	(*)
7-1	Paddle wing	JC90-01463A	2	(*)
7-2	Paddle mid	JC90-01462A	1	(*)
8	Brush	JC67-00819A	1	(*)
9	Brush	JC67-00820A	1	(*)
10	Main output tray top of stack switch	JC39-02316A	1	(*)
11	Paddle motor assembly	JC90-01461A	1	(*)
11-1	Paddle motor	JC93-01001A	1	(*)
11-2	Paddle home sensor	0604-001393	1	(*)
12	Paddle home gear	JC66-04558A	1	
13	End fence motor	JC90-01467A	1	(*)
14	Belt	6602-003270	1	(*)
15	Belt	6602-003640	1	(*)
16	CAM	JC66-04562A	1	
17	CAM guide	JC66-04526A	1	(*)
18	End fence	JC90-01466A	1	(*)
19	Spring	JC61-07414A	2	(*)
20	Main output tray top of stack switch guide	JC61-07189A	1	(*)
21	Main output tray top of stack switch lower guide	JC61-07192A	1	(*)
22	Ground	JC63-04984A	1	(*)
23	Brush	JC67-00817A	1	(*)

(*) This part is in ordering system.

Paddle, Paddle motor

Parts diagram and parts list for the paddle, paddle motor.

Figure 5-99 Paddle, Paddle motor

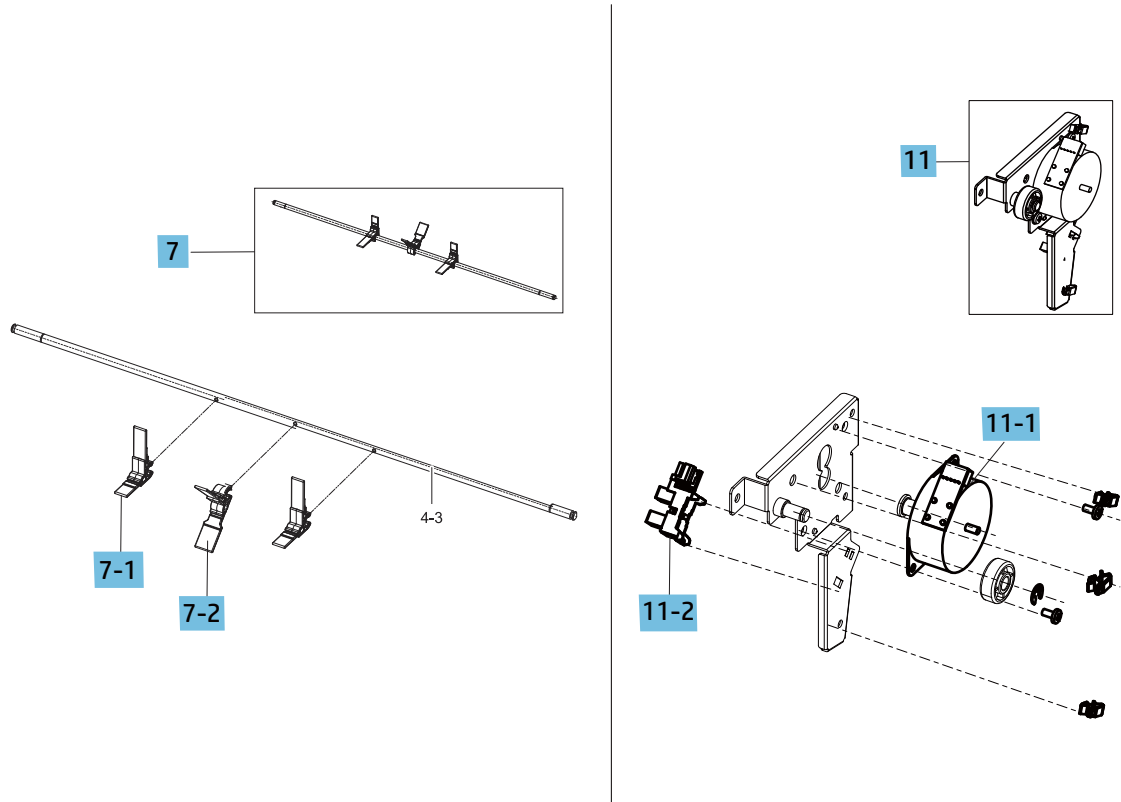

Table 5-59 Paddle, Paddle motor

Ref	Description	Part number	Qty	Orderable
7	Paddle	JC90-01480A	1	(*)
7-1	Paddle wing	JC90-01463A	2	(*)
7-2	Paddle mid	JC90-01462A	1	(*)
11	Paddle motor assembly	JC90-01461A	1	(*)
11-1	Paddle motor	JC93-01001A	1	(*)
11-2	Paddle home sensor	0604-001393	1	(*)

(*) This part is in ordering system.

Tamper unit, Ejector unit, Stapler unit, Main PCA

Tamper unit, Ejector unit, Stapler unit, Main PCA

Parts diagram and parts list for the tamper unit, ejector unit, stapler unit, main PCA.

Figure 5-100 Tamper unit, Ejector unit, Stapler unit, Main PCA

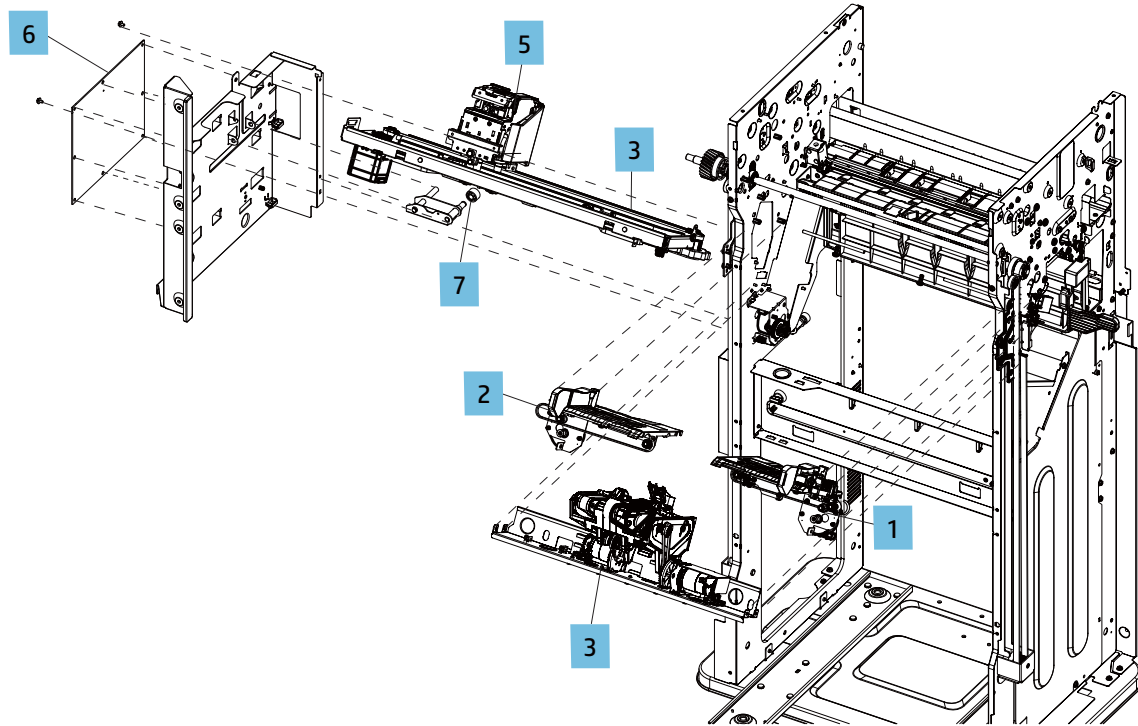

Table 5-60 Tamper unit, Ejector unit, Stapler unit, Main PCA

Ref	Description	Part number	Qty	Orderable
1	Front tamper unit	JC82-00901A	1	(*)
2	Rear tamper unit	JC82-00898A	1	(*)
3	Ejector unit	JC90-01409A	1	(*)
4	Stapler unit	JC82-00894A	1	(*)
5	Stapler cartridge	JC81-09882B	1	(*)
6	Finisher main PCA	JC92-02968A	1	(*)
7	Roller	JC66-04523A	1	(*)

(*) This part is in ordering system.

Tamper unit

Parts diagram and parts list for the tamper unit.

Figure 5-101 Tamper unit

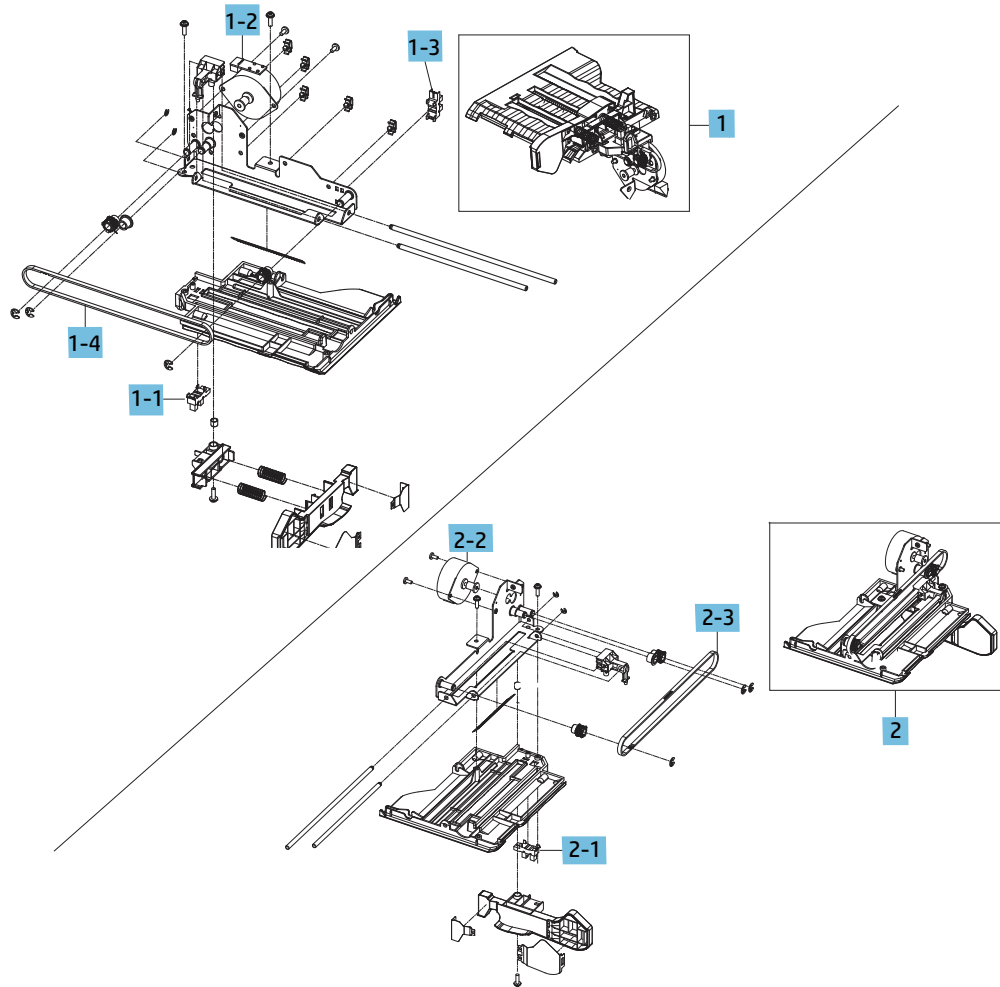

Table 5-61 Tamper unit

Ref	Description	Part number	Qty	Orderable
1	Front tamper unit	JC82-00901A	1	(*)
1-1	Front tamper home sensor	0604-001393	1	(*)
1-2	Front tamper motor	JC93-01001A	1	(*)
1-3	End fence home sensor	0604-001393	1	(*)
1-4	Belt	6602-003644	1	(*)
2	Rear tamper unit	JC82-00898A	1	(*)
2-1	Rear tamper home sensor	0604-001393	1	(*)
2-2	Rear tamper motor	JC93-01001A	1	(*)
2-3	Belt	6602-003644	1	(*)

(*) This part is in ordering system.

Ejector unit

Parts diagram and parts list for the ejector unit.

Figure 5-102 Ejector unit

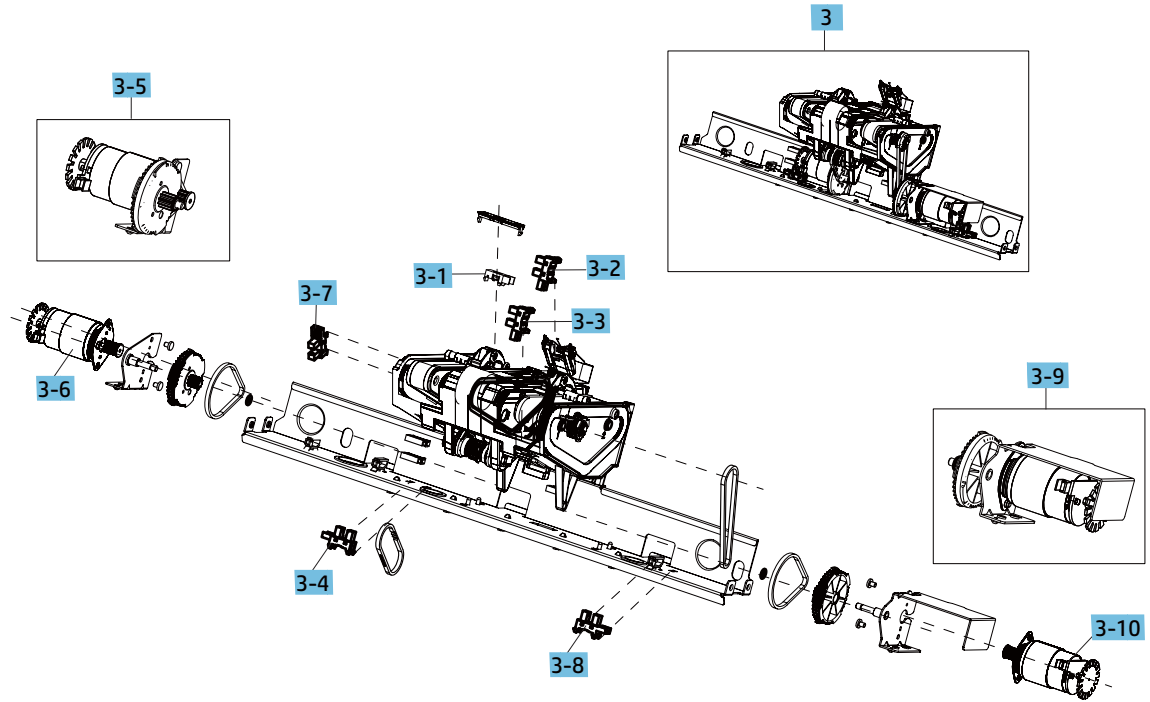

Table 5-62 Ejector unit

Ref	Description	Part number	Qty	Orderable
3	Ejector unit	JC90-01409A	1	(*)
3-1	Ejector sensor	JC32-00020A	1	(*)
3-2	Ejector1 home sensor	0604-001415	1	(*)
3-3	Ejector1 end sensor	0604-001415	1	(*)
3-4	Ejector1 motor sensor	0604-001415	1	(*)
3-5	Ejector1 motor assembly	JC90-01411A	1	(*)
3-6	Ejector1 motor	JC93-01168A	1	(*)
3-7	Ejector2 home sensor	0604-001415	1	(*)
3-8	Ejector2 motor sensor	0604-001415	1	(*)
3-9	Ejector2 motor assembly	JC90-01410A	1	(*)
3-10	Ejector2 motor	JC93-01168A	1	(*)

(*) This part is in ordering system.

Paper holding unit, Main output tray unit

Paper holding unit, Main output tray unit

Parts diagram and parts list for the paper holding unit, main output tray unit.

Figure 5-103 Paper holding unit, Main output tray unit

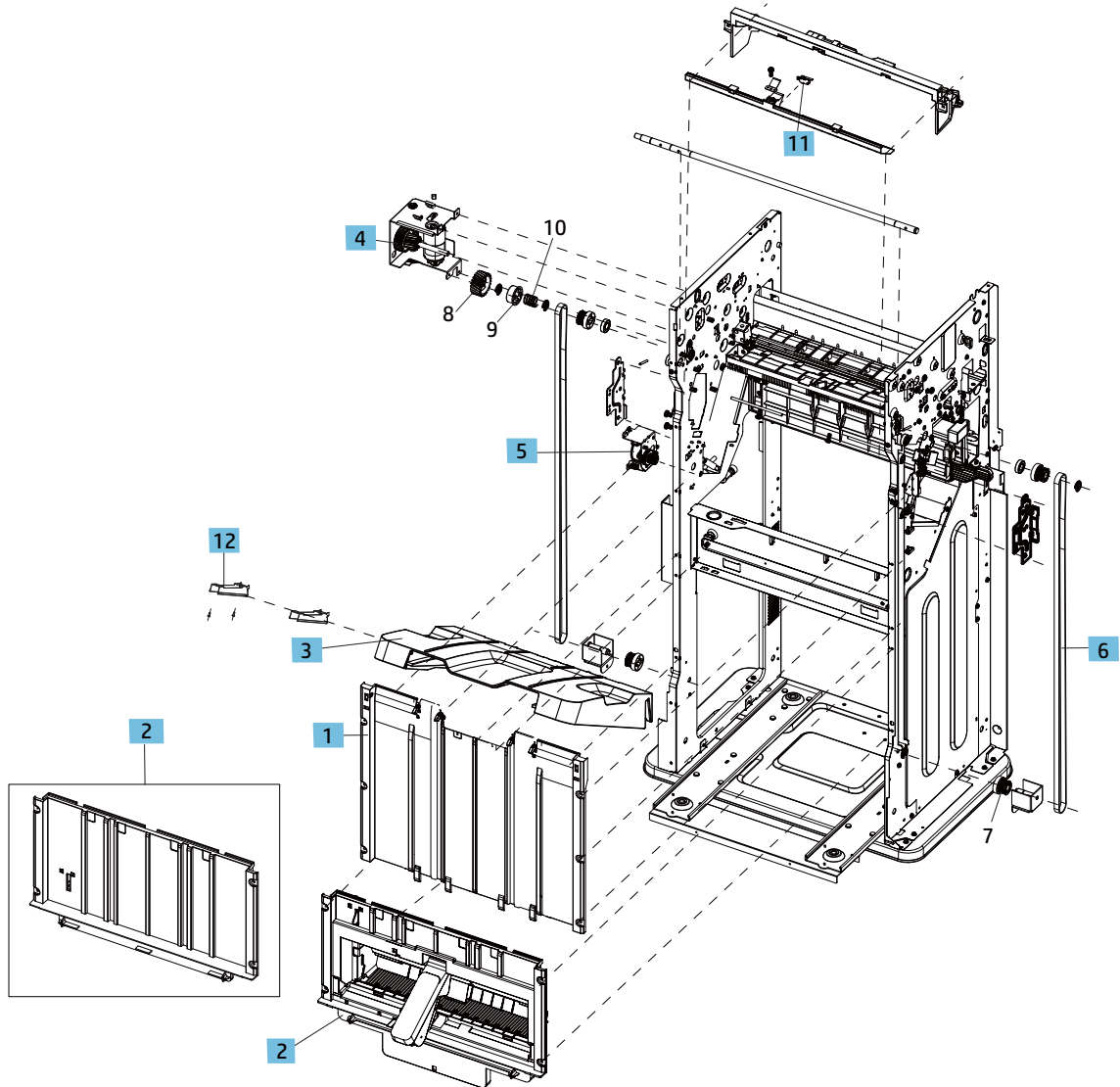

Table 5-63 Paper holding unit, Main output tray unit

Ref	Description	Part number	Qty	Orderable
1	Left upper cover	JC90-01475B	1	(*)
2	Left lower cover(Booklet finisher)	JC90-01417B	1	(*)
2	Left lower cover(Stapler-stacker finisher)	JC90-01771B	1	(*)
3	Main output tray	JC63-05002B	1	(*)
4	Main output tray motor aseembly	JC90-01415B	1	(*)
5	Paper holding motor	JC90-01414A	1	(*)
6	Belt	6602-003652	2	(*)
7	Gear	JC66-04663A	4	
8	Gear	JC66-04605A	1	
9	Gear	JC61-07305A	1	
10	Spring	JC61-07429A	1	
11	Main output tray top of stack switch	JC39-02316A	1	(*)
12	Main output tray support	JC61-06668A	2	(*)

(*) This part is in ordering system.

Left upper cover

Parts diagram and parts list for the left upper cover.

Figure 5-104 Left upper cover

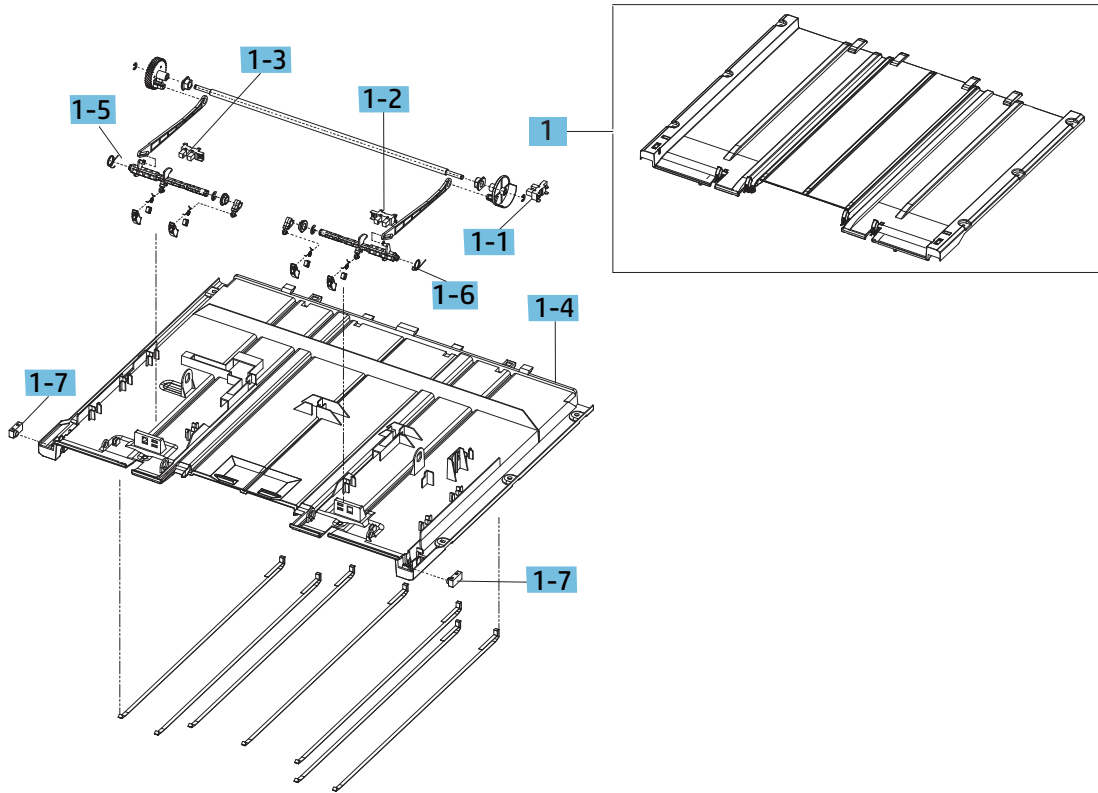

Table 5-64 Left upper cover

Ref	Description	Part number	Qty	Orderable
1	Left upper cover	JC90-01475B	1	(*)
1-1	Paper holding home sensor	0604-001393	1	(*)
1-2	Front paper holding sensor	0604-001393	1	(*)
1-3	Rear paper holding sensor	0604-001393	1	(*)
1-4	Left upper cover	JC63-04999B	1	(*)
1-5	Spring	JC61-07428A	1	(*)
1-6	Spring	JC61-07427A	1	(*)
1-7	Main output tray top of stack sensor	JC82-01039A	1	(*)

(*) This part is in ordering system.

Left lower cover

Parts diagram and parts list for the left lower cover.

Figure 5-105 Left lower cover

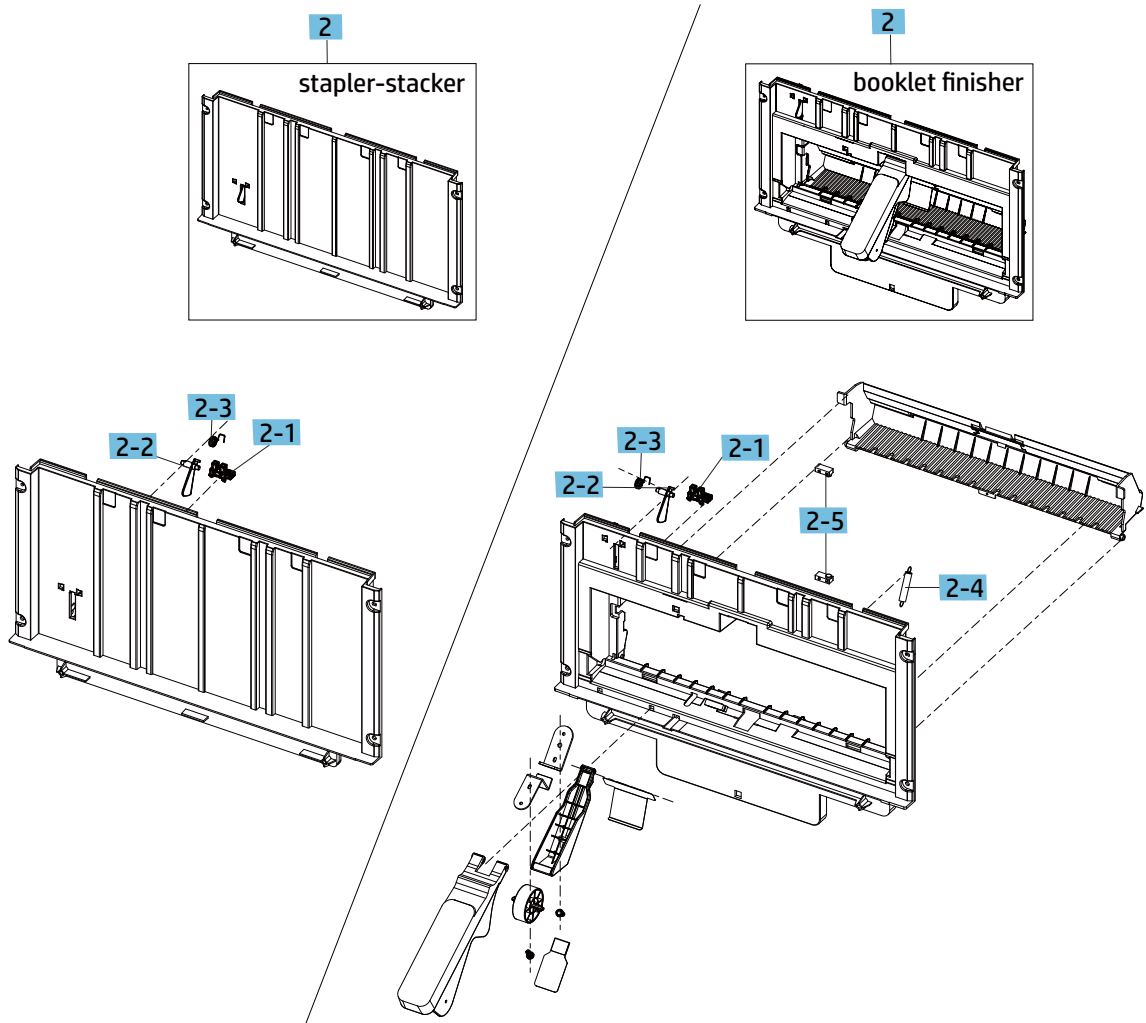

Table 5-65 Left lower cover

Ref	Description	Part number	Qty	Orderable
2	Left lower cover (Booklet finisher)	JC90-01417B	1	(*)
2	Left lower cover (Stapler-stacker finisher)	JC90-01771B	1	(*)
2-1	Main output tray lower limit switch	0604-001415	1	(*)
2-2	Main output tray lower limit actuator	JC81-07930A	1	(*)
2-3	Spring	JC81-09396A	1	(*)
2-4	Spring (Booklet finisher)	JC61-07407A	1	(*)
2-5	Booklet output tray sensor (Booklet finisher)	JC82-01039A	1	(*)

(*) This part is in ordering system.

Main output tray motor, Paper holding motor

Parts diagram and parts list for the main output tray motor, paper holding motor.

Figure 5-106 Main output tray motor, paper holding motor

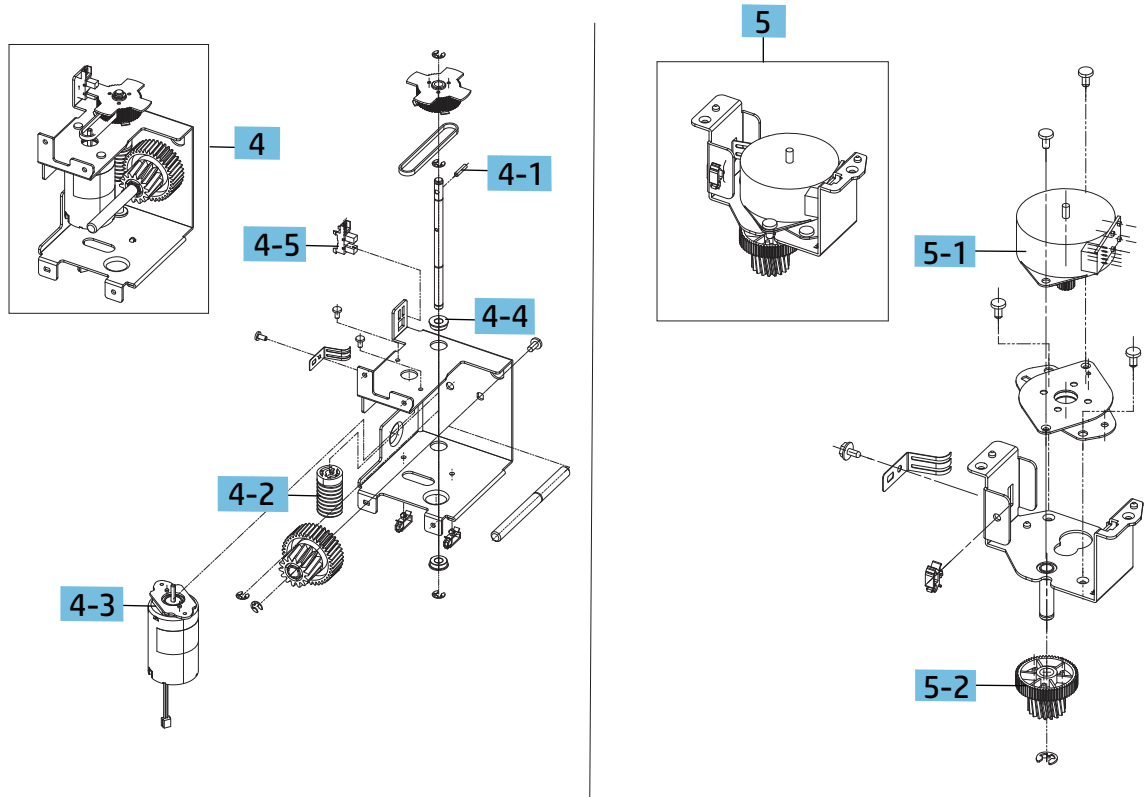

Table 5-66 Main output tray motor, paper holding motor

Ref	Description	Part number	Qty	Orderable
4	Main output tray motor assembly	JC90-01415B	1	(*)
4-1	Pin	JC70-40542A	1	(*)
4-2	Gear	JC81-07637A	1	(*)
4-3	Main output tray motor	JC31-00178B	1	(*)
4-4	Bearing	6601-001478	1	(*)
4-5	Main output tray motor sensor	0604-001415	1	(*)
5	Paper holding motor assembly	JC90-01414A	1	(*)
5-1	Paper holding motor	JC93-01156A	1	(*)
5-2	Gear	JC66-04604A	1	(*)

(*) This part is in ordering system.

Cover & harness

Buffer unit

Parts diagram and parts list for the buffer unit.

Figure 5-107 Buffer unit

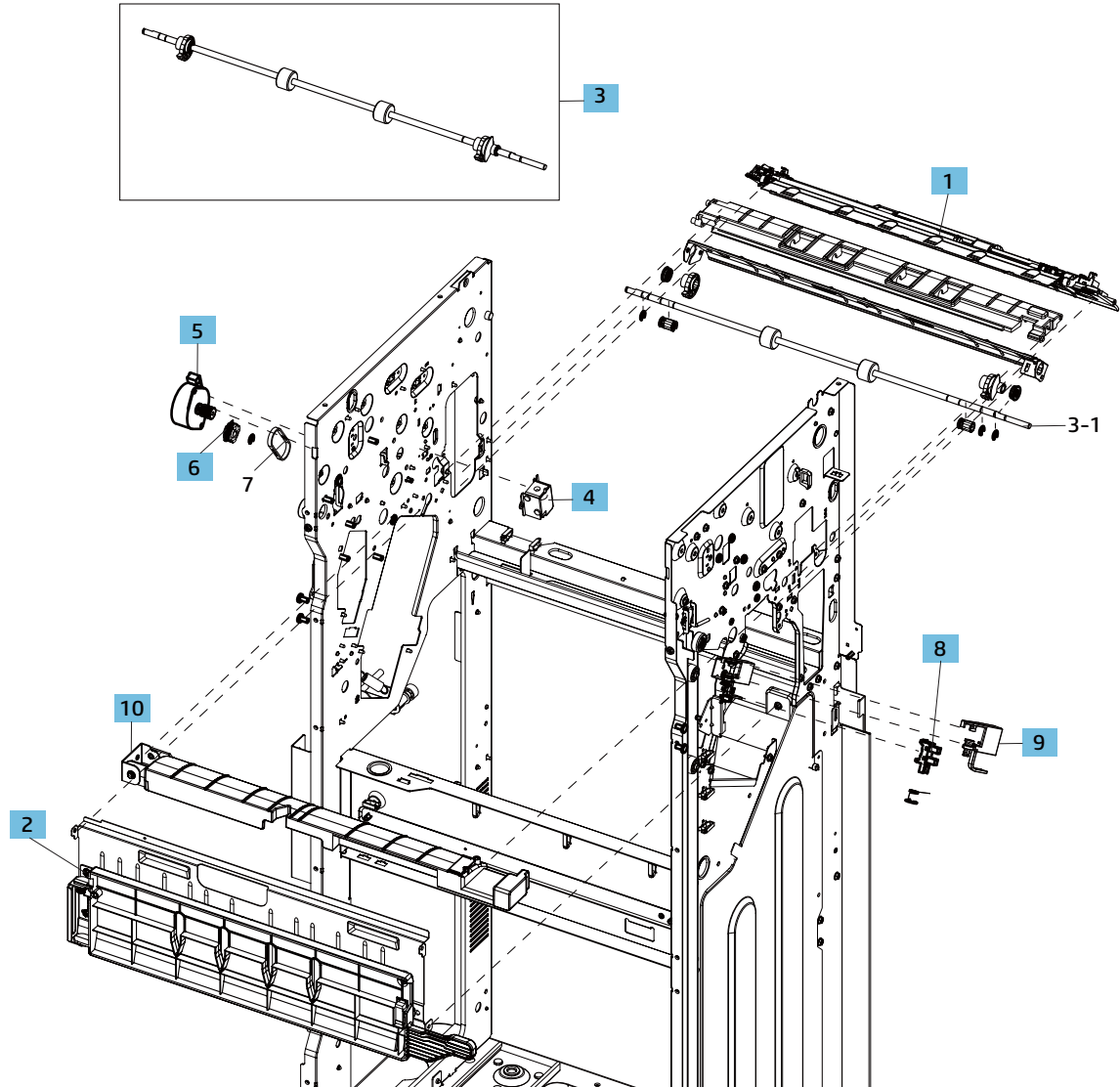

Table 5-67 Buffer unit

Ref	Description	Part number	Qty	Orderable
1	Buffer diverter assembly	JC90-01674A	1	(*)
2	Front jam cover assembly	JC90-01457A	1	(*)
3	Budder roller assembly	JC90-01672A	1	(*)
3-1	Buffer roller	JC66-05161A	1	
4	Buffer solenoid	JC90-01675A	1	(*)
5	Buffer motor	JC93-01152A	1	(*)
6	Gear	JC66-04582A	1	(*)
7	Belt	6602-003641	1	
8	Manual staple sensor	0604-001415	1	(*)
9	Manual staple actuator	JC66-04528A	1	(*)
10	Buffer jam cover	JC90-01450A	1	(*)

(*) This part is in ordering system.

Buffer diverter, Front jam cover

Parts diagram and parts list for the buffer diverter, front jam cover.

Figure 5-108 Buffer diverter, Front jam cover

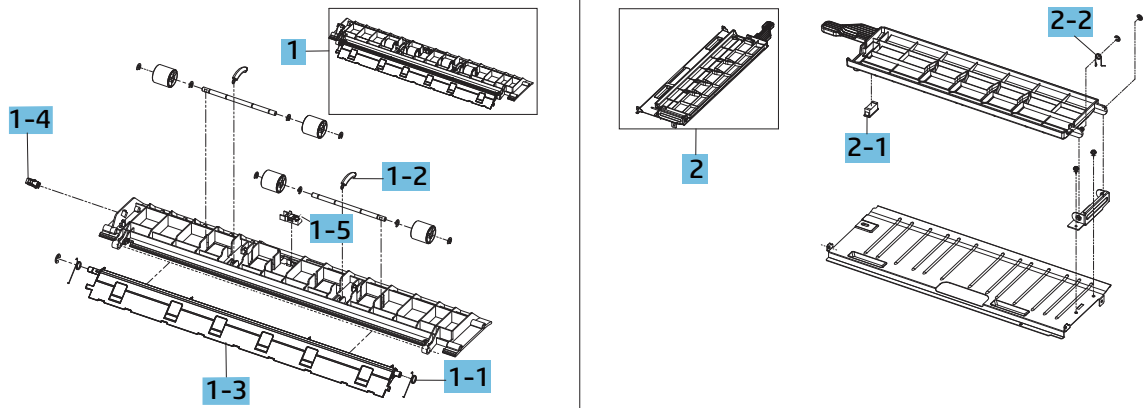

Table 5-68 Buffer diverter, Front jam cover

Ref	Description	Part number	Qty	Orderable
1	Buffer diverter assembly	JC90-01674A	1	(*)
1-1	Spring	JC61-07413A	2	(*)
1-2	Spring	JC61-07409A	2	(*)
1-3	Buffer diverter	JC61-07204A	1	(*)
1-4	Buffer home sensor	0604-001393	1	(*)
1-5	Buffer sensor	JC32-00020A	1	(*)
2	Front jam cover assembly	JC90-01457A	1	(*)
2-1	Magnet	JC81-08263A	1	(*)
2-2	Spring	JC61-07418A	1	(*)

(*) This part is in ordering system.

Parts, diagrams (Booklet finisher)

Learn about parts, diagrams (booklet finisher)



NOTE:  Some parts are sensitive to electrostatic discharge (ESD). Always perform service work at an ESD-protected workstation or mat. If an ESD workstation or mat is not available, touch the sheet-metal chassis to provide a static ground before touching an ESD-sensitive assembly. Protect the ESD-sensitive assemblies by placing them in ESD pouches when they are out of the printer.

Booklet maker

Parts diagram and parts list for the booklet maker.

Figure 5-109 Booklet maker

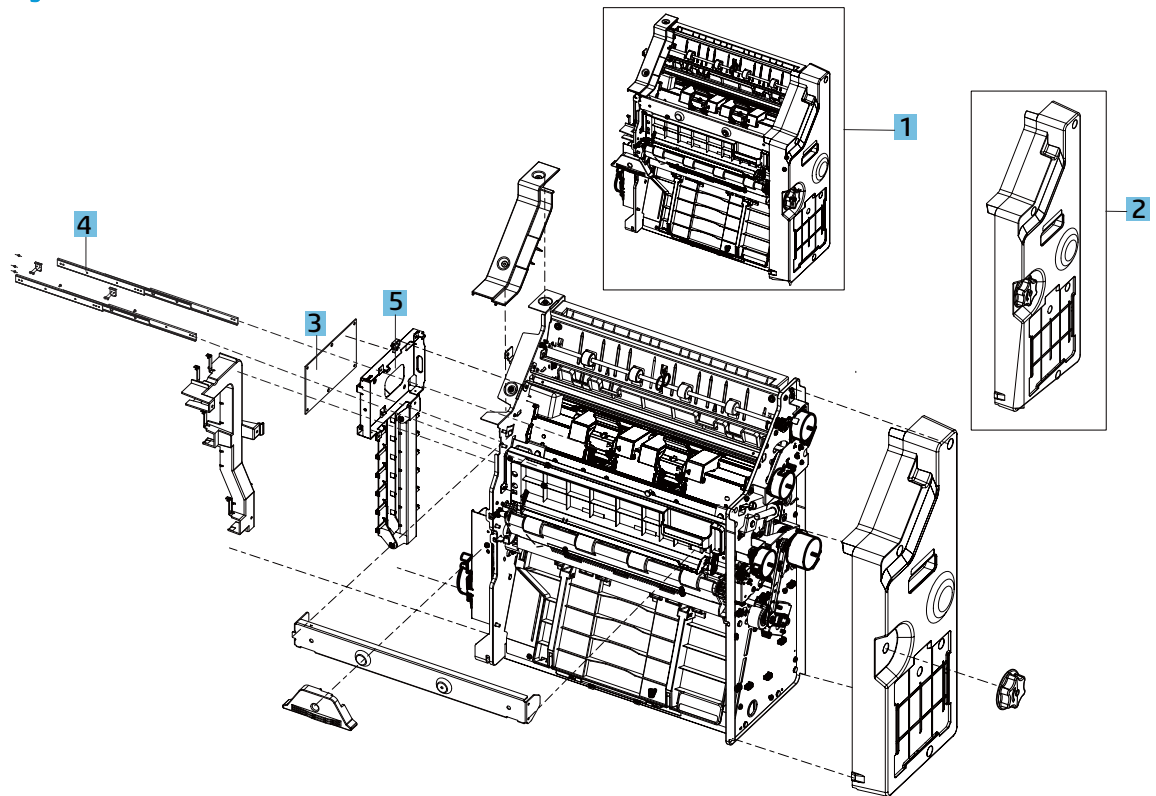

Table 5-69 Booklet maker

Ref	Description	Part number	Qty	Orderable
1	Booklet maker	JC82-00905A	1	(*)
2	Booklet front cover	JC90-01478B	1	(*)
3	Booklet maker PCA	JC92-02790B	1	(*)
4	Rail	6102-003369	2	(*)
5	Harness guide	JC90-01477A	1	(*)

(*) This part is in ordering system.

Booklet entrance unit, Booklet presser unit

Booklet entrance unit, Booklet presser unit

Parts diagram and parts list for the booklet entrance unit, booklet presser unit.

Figure 5-110 Booklet entrance unit, Booklet presser unit

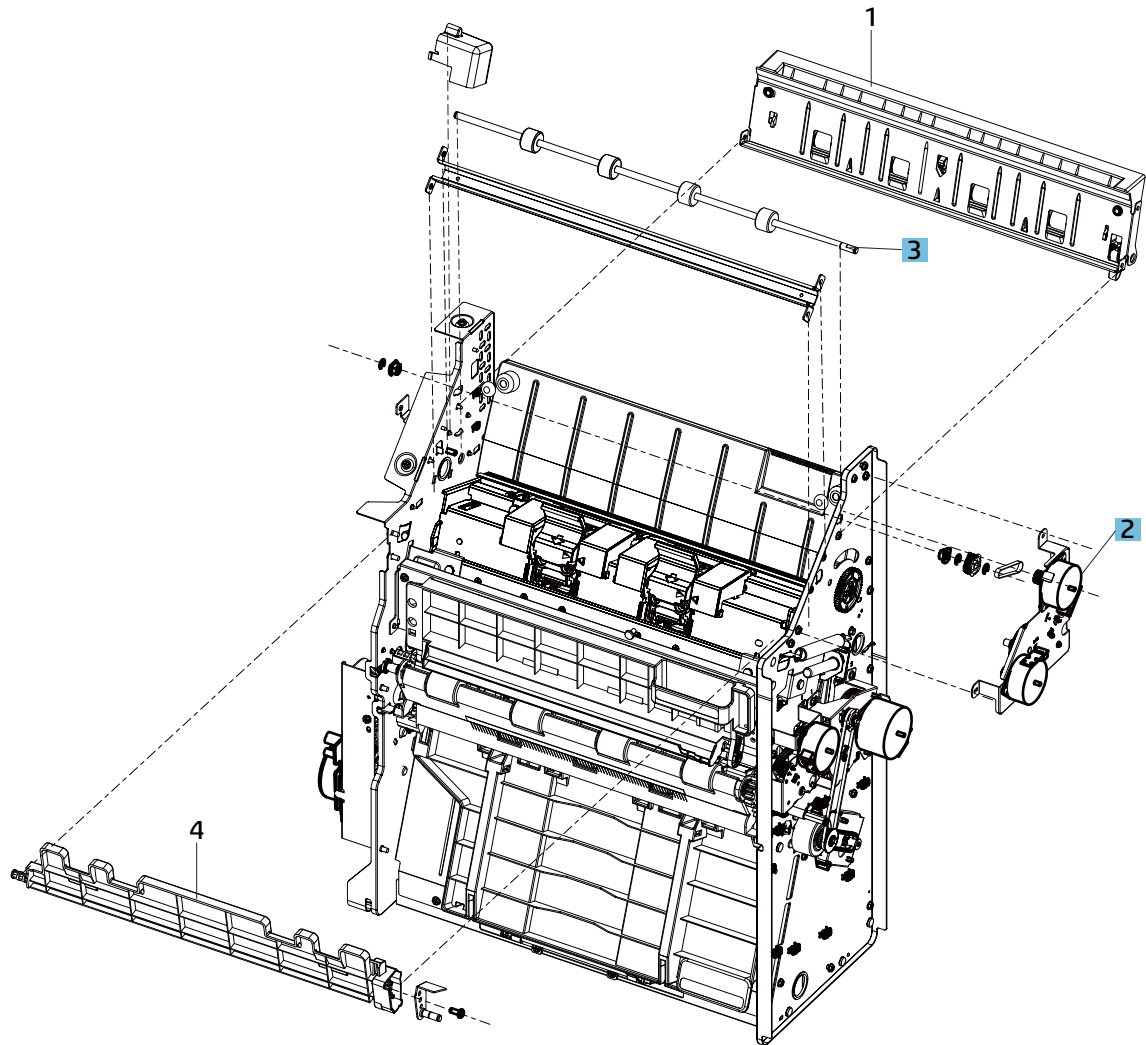

Table 5-70 Booklet entrance unit, Booklet presser unit

Ref	Description	Part number	Qty	Orderable
1	Booklet entrance unit	JC90-01424A	1	
2	Booklet entrance-presser motor assembly	JC90-01425A	1	(*)
3	Booklet entrance roller	JC66-04717A	1	(*)
4	Booklet presser unit	JC61-07237A	1	

(*) This part is in ordering system.

Booklet entrance, Booklet entrance-presser motor

Parts diagram and parts list for the booklet entrance, booklet entrance-presser motor.

Figure 5-111 Booklet entrance, Booklet entrance-presser motor

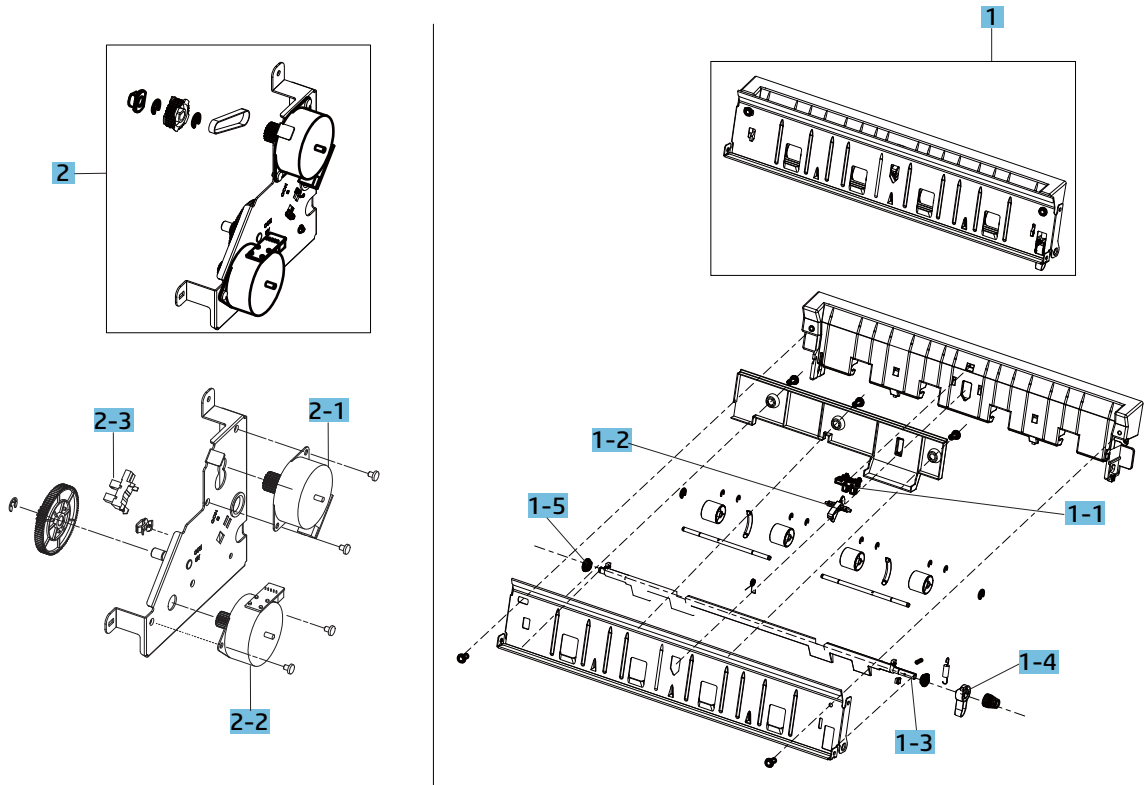

Table 5-71 Booklet entrance, Booklet entrance-presser motor

Ref	Description	Part number	Qty	Orderable
1	Booklet entrance unit	JC90-01424A	1	
1-1	Booklet entrance sensor	0604-001415	1	(*)
1-2	Booklet entrance actuator	JC66-04520A	1	(*)
1-3	Booklet presser guide	JC61-07331A	1	
1-4	Booklet presser guide actuator	JC66-04644A	1	(*)
1-5	Bushing	JC61-02372A	2	(*)
2	Booklet entrance-presser motor assembly	JC90-01425A	1	(*)
2-1	Booklet entrance motor	JC93-01152A	1	(*)
2-2	Booklet presser motor	JC93-01155A	1	(*)
2-3	Booklet presser home sensor	0604-001393	1	(*)

(*) This part is in ordering system.

Booklet stapler unit

Parts diagram and parts list for the booklet stapler unit.

Figure 5-112 Booklet stapler unit

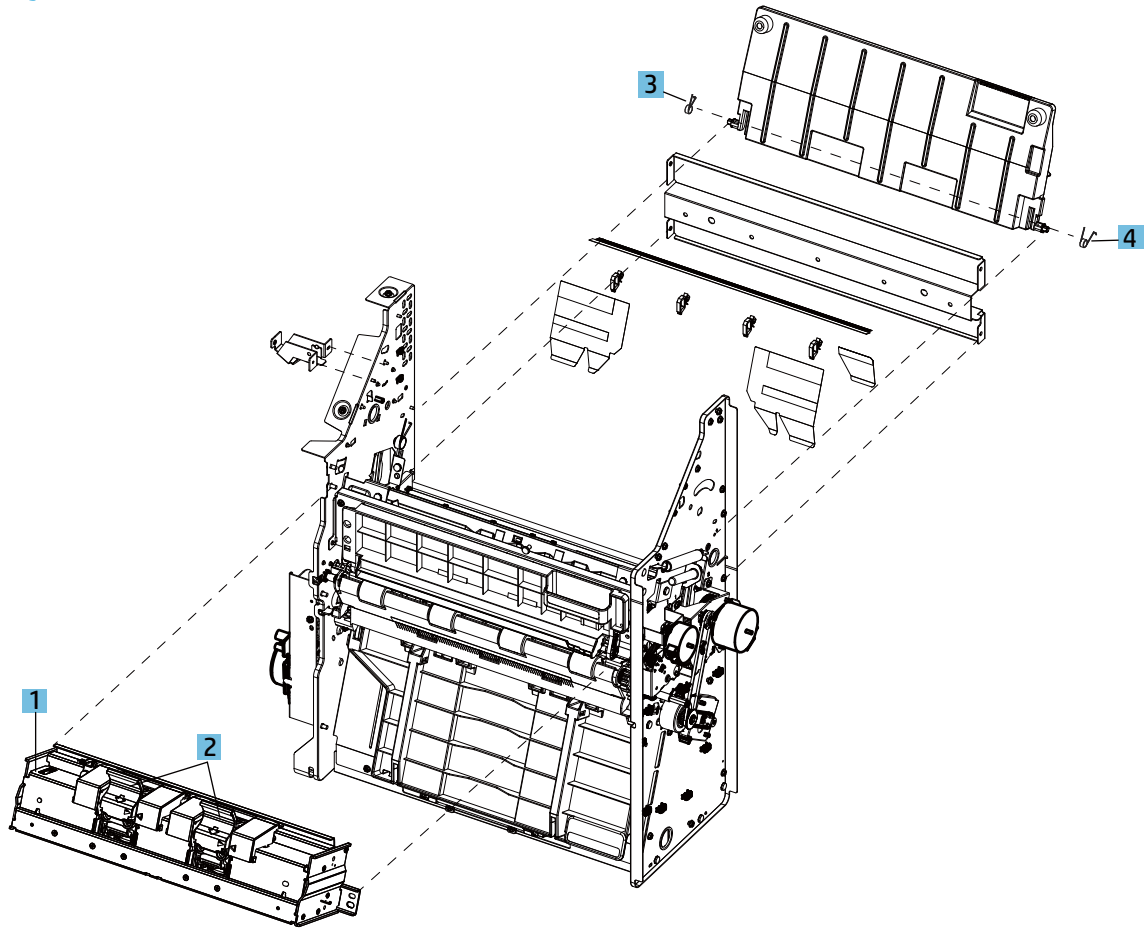

Table 5-72 Booklet stapler unit

Ref	Description	Part number	Qty	Orderable
1	Booklet stapler unit	JC81-08274B	1	(*)
2	Booklet stapler cartridge	JC81-09881B	2	(*)
3	Spring	JC61-07398A	1	(*)
4	Spring	JC61-07397A	2	(*)

(*) This part is in ordering system.

Booklet tamper unit

Parts diagram and parts list for the booklet tamper unit.

Figure 5-113 Booklet tamper unit

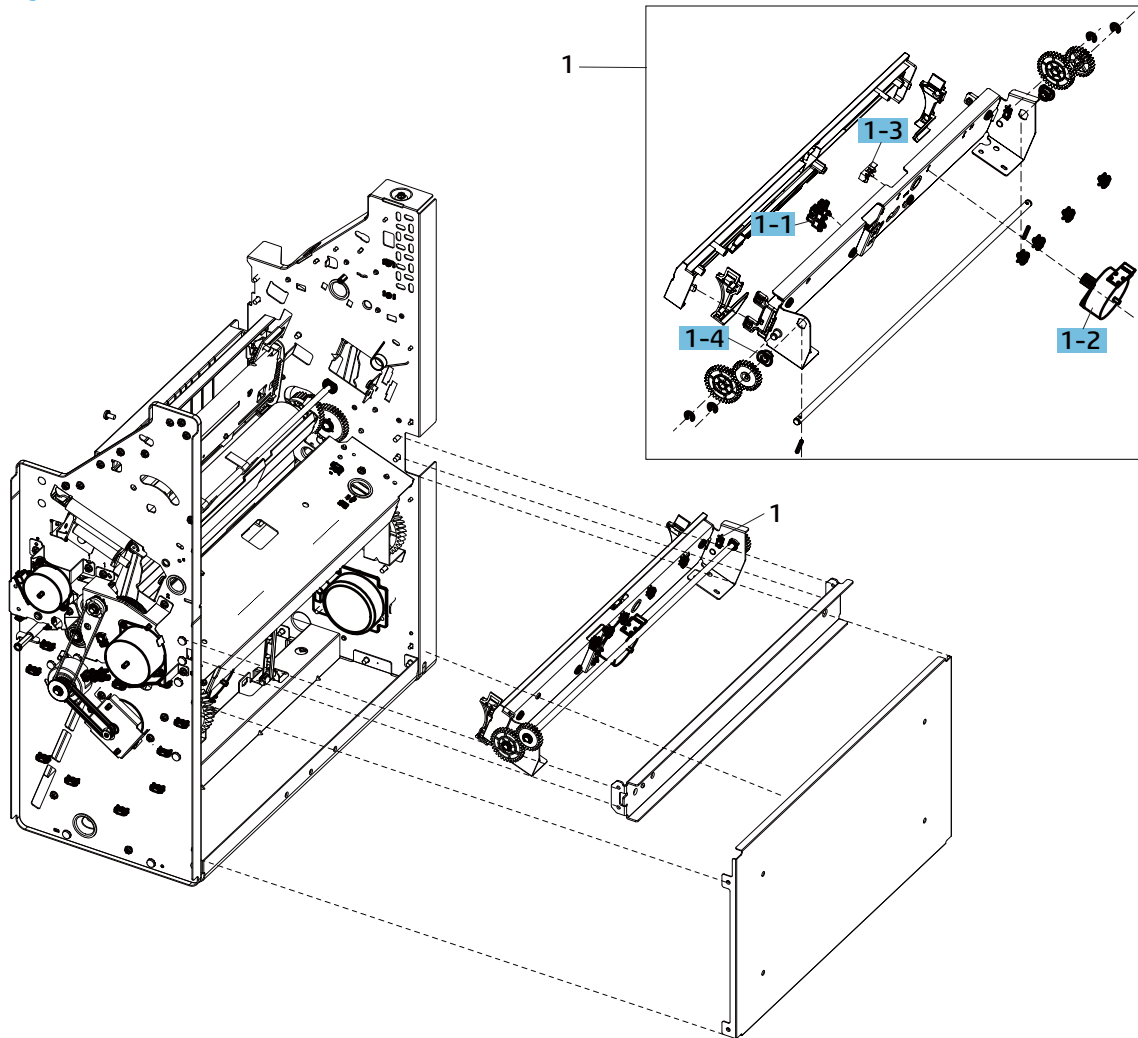

Table 5-73 Booklet tamper unit

Ref	Description	Part number	Qty	Orderable
1	Booklet tamper unit	JC90-01431A	1	
1-1	Booklet tamper home sensor	0604-001393	1	(*)
1-2	Booklet tamper motor	JC93-01155A	1	(*)
1-3	Booklet tamper sensor	JC32-00020A	1	(*)
1-4	Bushing	JC61-00423A	2	(*)

(*) This part is in ordering system.

Booklet fold unit, Booklet diverter unit, Booklet exit unit

Booklet fold unit, Booklet diverter unit, Booklet exit unit

Parts diagram and parts list for the booklet fold unit, booklet diverter unit, booklet exit unit.

Figure 5-114 Booklet fold unit, Booklet diverter unit, Booklet exit unit

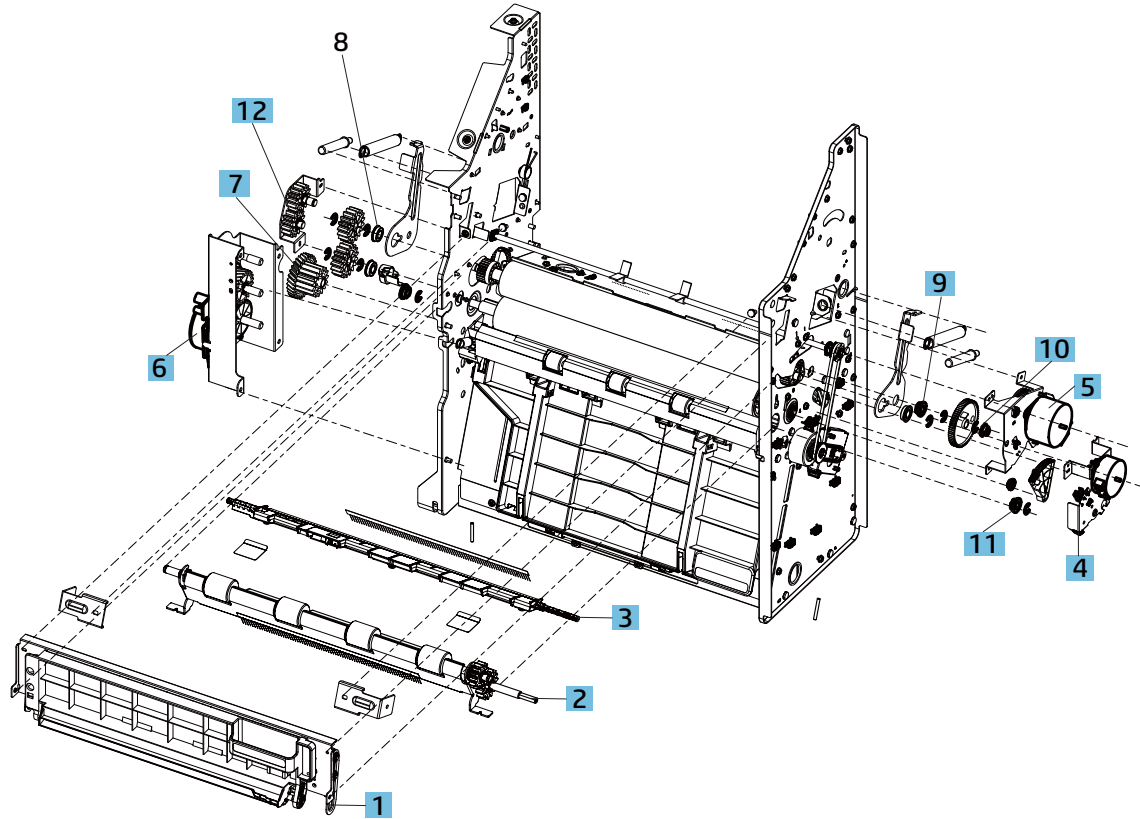

Table 5-74 Booklet fold unit, Booklet diverter unit, Booklet exit unit

Ref	Description	Part number	Qty	Orderable
1	Booklet c-fold blade assembly	JC90-01438A	1	(*)
2	Booklet exit unit	JC90-01400A	1	(*)
3	Booklet diverter	JC90-01398A	1	(*)
4	Booklet diverter motor assembly	JC90-01397A	1	(*)
5	Booklet c-fold blade motor assembly	JC90-01396A	1	(*)
6	Booklet fold motor assembly	JC90-01436A	1	(*)
7	Gear	JC66-04573A	1	(*)
8	Bushing	6601-003037	3	
9	Bushing	JC61-00426A	1	(*)
10	Bushing	JC61-00423A	2	(*)
11	Bushing	JC61-02372A	1	(*)
12	Gear	JC90-01479A	1	(*)

(*) This part is in ordering system.

Booklet c-fold blade, Booklet exit, Booklet diverter

Parts diagram and parts list for the booklet c-fold blade, booklet exit, booklet diverter.

Figure 5-115 Booklet c-fold blade, Booklet exit, Booklet diverter

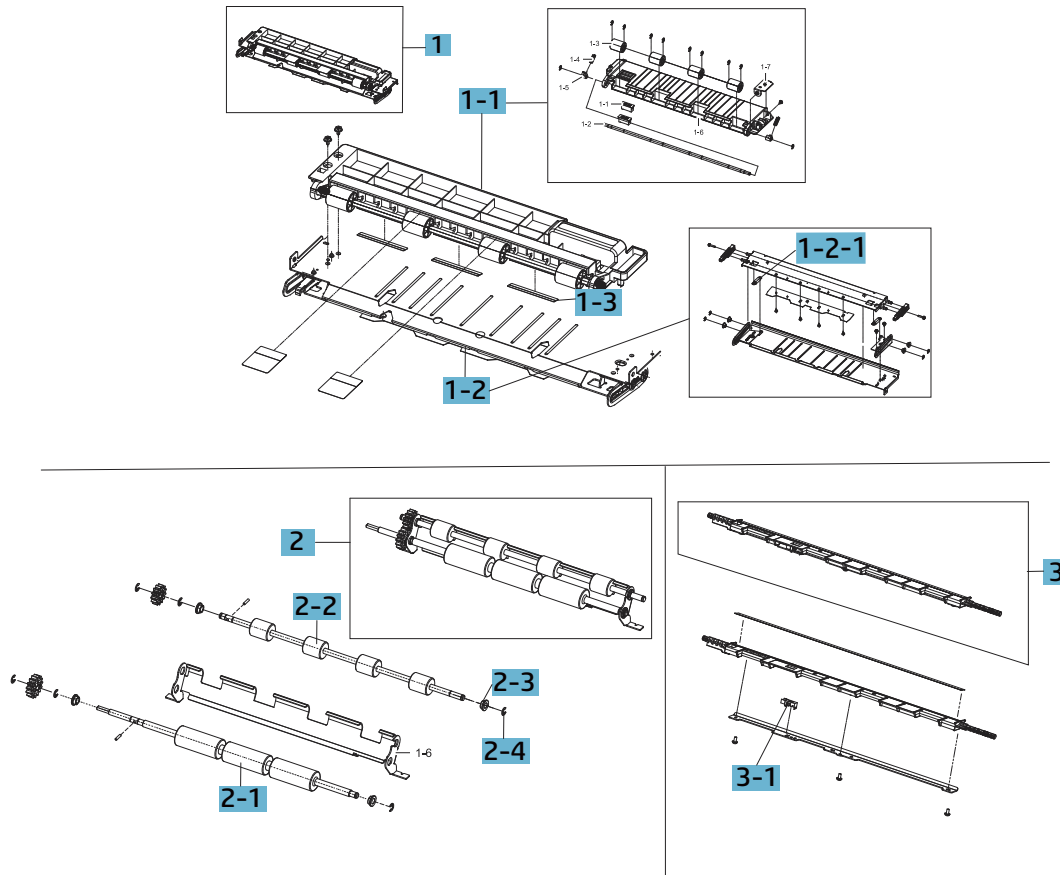

Table 5-75 Booklet c-fold blade, Booklet exit, Booklet diverter

Ref	Description	Part number	Qty	Orderable
1	Booklet c-fold blade assembly	JC90-01438A	1	(*)
1-1	Booklet sub exit roller assembly	JC90-01395A	1	(*)
1-2	Booklet c-fold blade	JC90-01394A	1	(*)
1-2-1	Spring	JC61-07391A	2	(*)
1-3	Jam guide sheet	JC63-05044A	3	(*)
2	Booklet exit unit	JC90-01400A	1	(*)
2-1	Booklet c-fold roller	JC66-04744A	1	
2-2	Booklet exit roller	JC66-04721A	1	(*)
2-3	Bushing	JC61-00426A	4	(*)
2-4	E-ring	6044-000129	2	(*)
3	Booklet diverter	JC90-01398A	1	(*)
3-1	Booklet exit sensor	JC32-00020A	1	(*)

(*) This part is in ordering system.

Booklet diverter motor, Booklet c-fold motor, Booklet fold motor

Parts diagram and parts list for the booklet diverter motor, booklet c-fold motor, booklet fold motor.

Figure 5-116 Booklet diverter motor, Booklet c-fold motor, Booklet fold motor

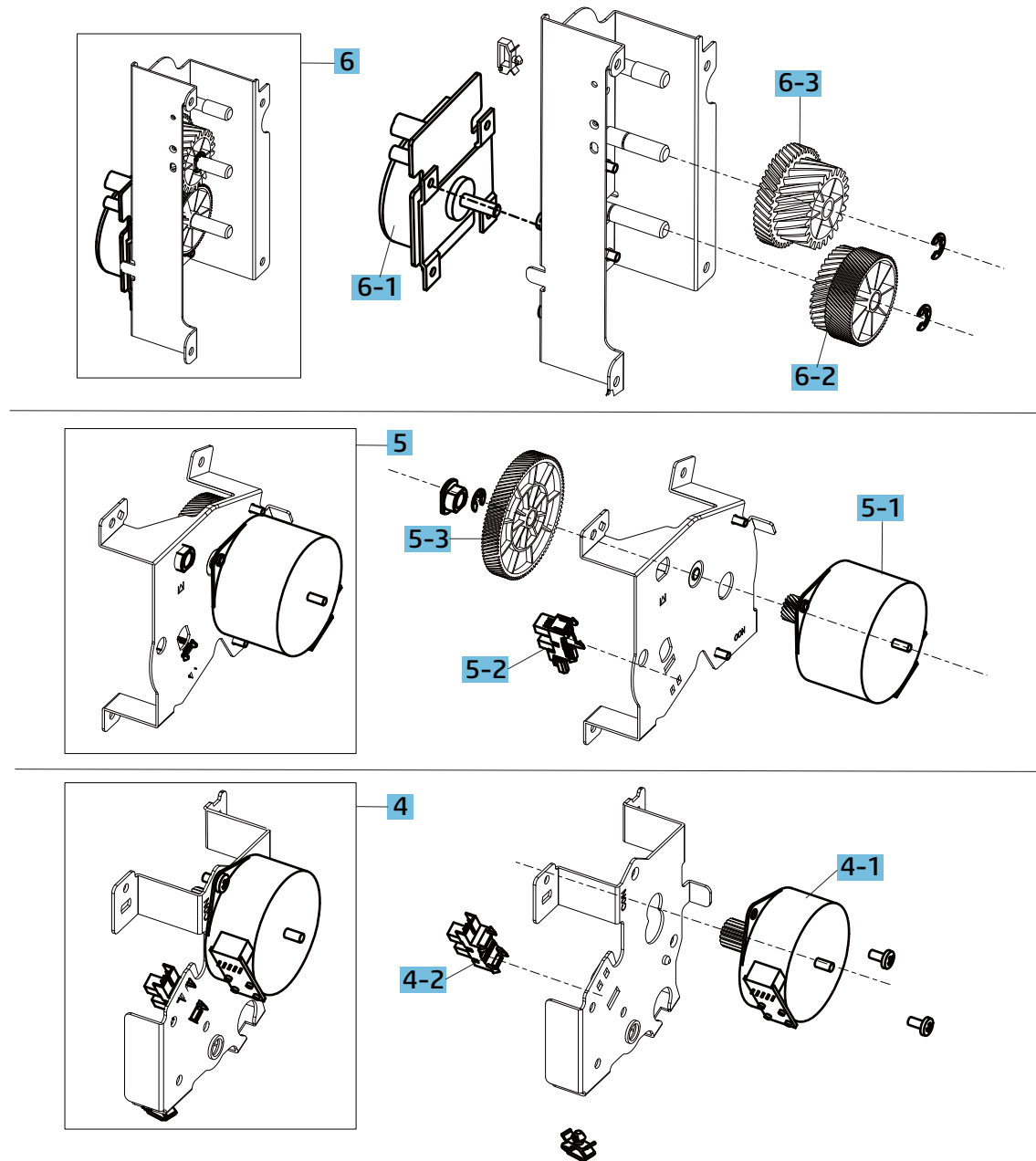

Table 5-76 Booklet diverter motor, Booklet c-fold motor, Booklet fold motor

Ref	Description	Part number	Qty	Orderable
4	Booklet diverter motor assembly	JC90-01397A	1	(*)
4-1	Booklet diverter motor	JC93-01153A	1	(*)
4-2	Booklet diverter home sensor	0604-001415	1	(*)
5	Booklet c-fold blade motor assembly	JC90-01396A	1	(*)
5-1	Booklet c-fold blade motor	JC93-01154A	1	(*)
5-2	Booklet c-fold blade home sensor	0604-001393	1	(*)
5-3	Gear	JC66-04579A	1	(*)
6	Booklet fold motor assembly	JC90-01436A	1	(*)
6-1	Booklet fold motor	JC31-00144A	1	(*)
6-2	Gear	JC66-04592A	1	(*)
6-3	Gear	JC66-04593A	1	(*)

(*) This part is in ordering system.

Booklet fold roller

Parts diagram and parts list for the booklet fold roller.

Figure 5-117 Booklet fold roller

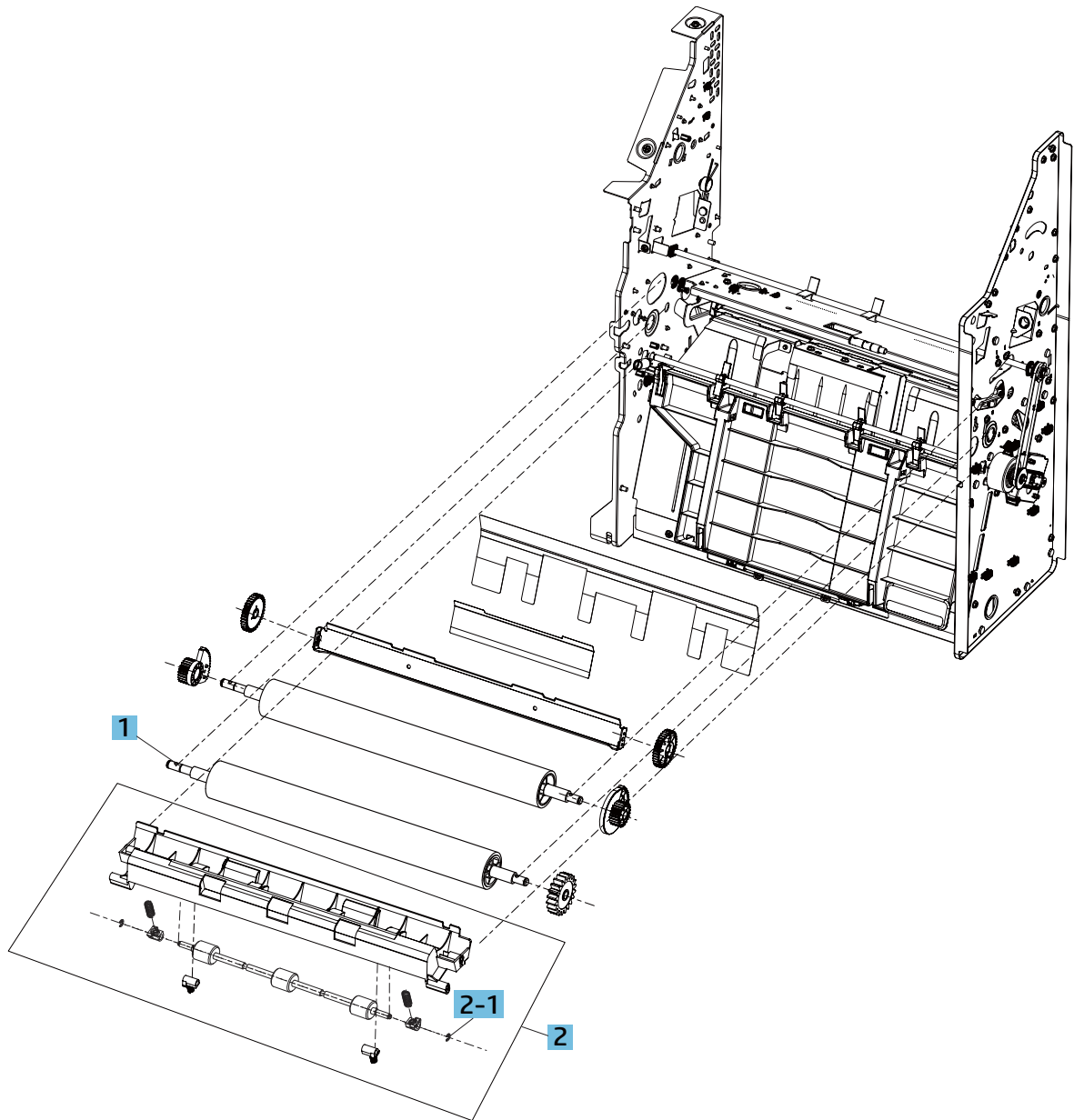

Table 5-77 Booklet fold roller

Ref	Description	Part number	Qty	Orderable
1	Booklet fold roller	JC66-04748A	2	(*)
2	Booklet fold exit	JC90-01399A	1	(*)
2-1	C-ring	6044-000159	1	(*)

(*) This part is in ordering system.

Booklet blade motor, Booklet blade

Parts diagram and parts list for the booklet blade motor, booklet blade.

Figure 5-118 Booklet blade motor, Booklet blade

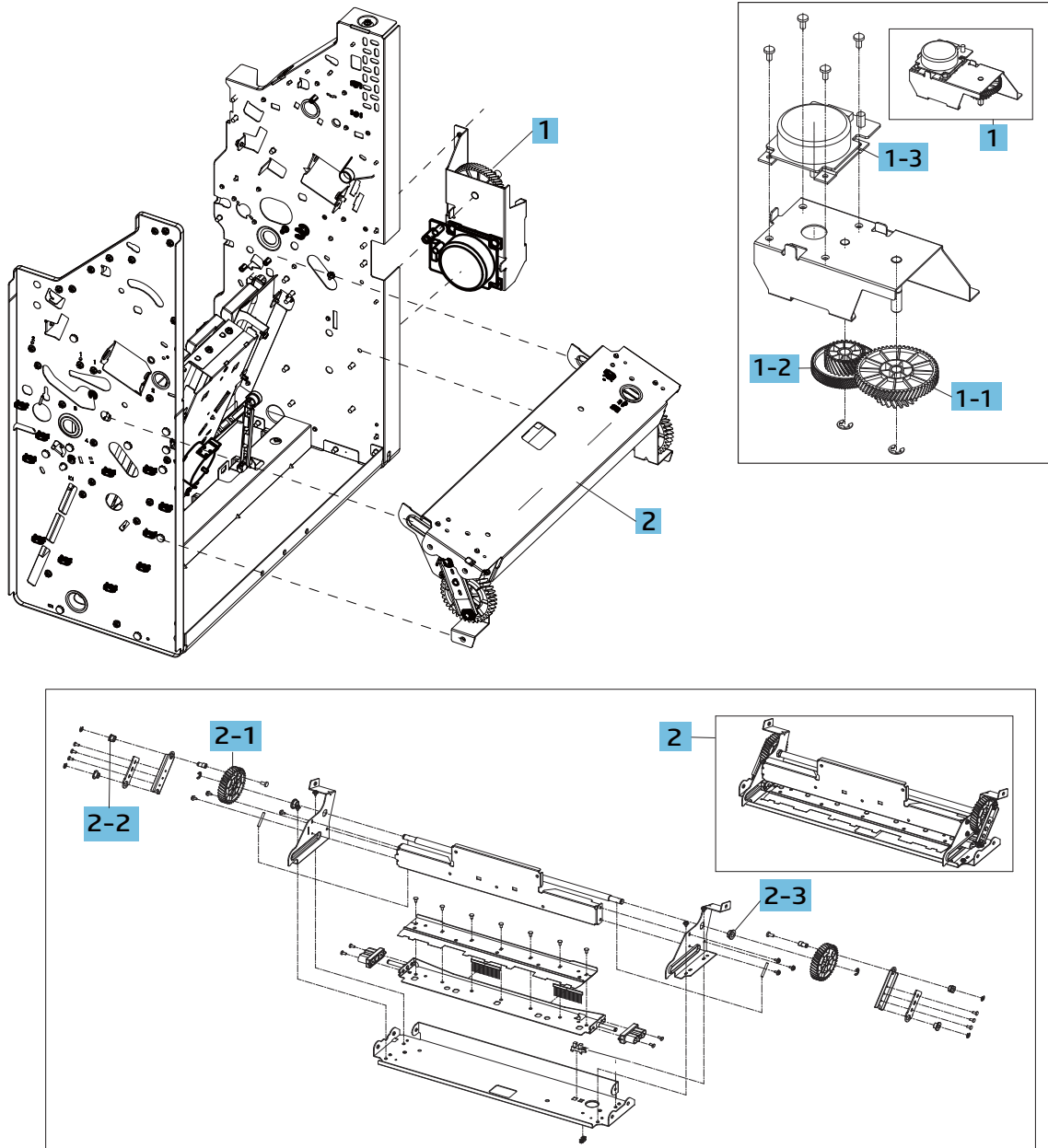

Table 5-78 Booklet blade motor, Booklet blade

Ref	Description	Part number	Qty	Orderable
1	Booklet blade motor assembly	JC90-01435A	1	(*)
1-1	Gear	JC66-04595A	1	(*)
1-2	Gear	JC66-04594A	1	(*)
1-3	Booklet blade motor	JC31-00144A	1	(*)
2	Booklet blade assembly	JC90-01437A	1	(*)
2-1	Gear	JC66-04591A	1	(*)
2-2	Bushing	JC61-00423A	1	(*)
2-3	Bushing	JC61-00426A	2	(*)

(*) This part is in ordering system.

Booklet paddle unit

Parts diagram and parts list for the booklet paddle unit.

Figure 5-119 Booklet paddle unit

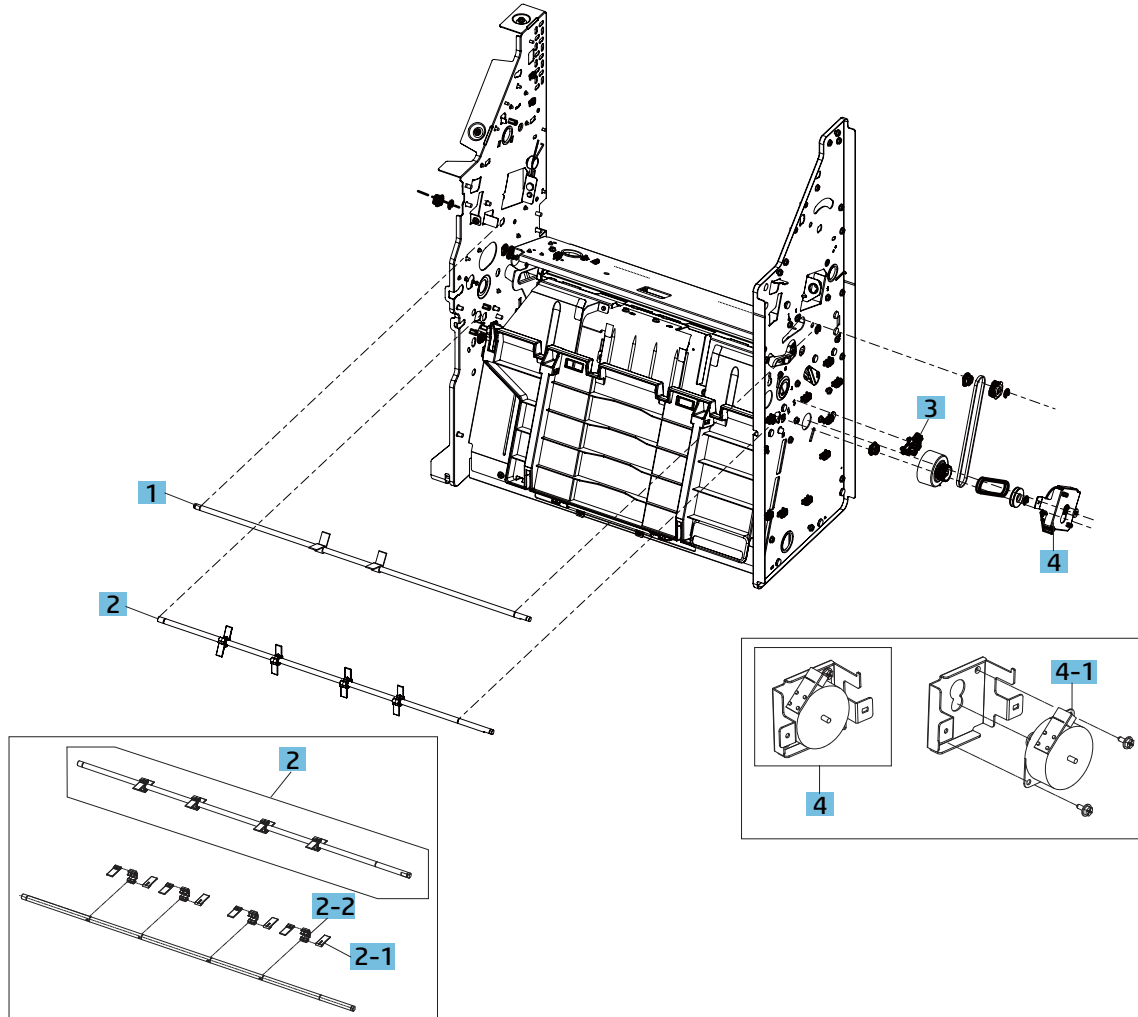

Table 5-79 Booklet paddle unit

Ref	Description	Part number	Qty	Orderable
1	Upper booklet paddle	JC66-04718A	1	(*)
2	Lower booklet paddle	JC90-01429A	1	(*)
2-1	Lower booklet paddle wing	JC61-07225A	1	(*)
2-2	Lower booklet paddle mid	JC66-04719A	1	(*)
3	Booklet paddle home sensor	0604-001393	1	(*)
4	Booklet paddle motor assembly	JC90-01430A	1	(*)
4-1	Booklet paddle motor	JC93-01001A	1	(*)

(*) This part is in ordering system.

Booklet end fence unit

Parts diagram and parts list for the booklet end fence unit.

Figure 5-120 Booklet end fence unit

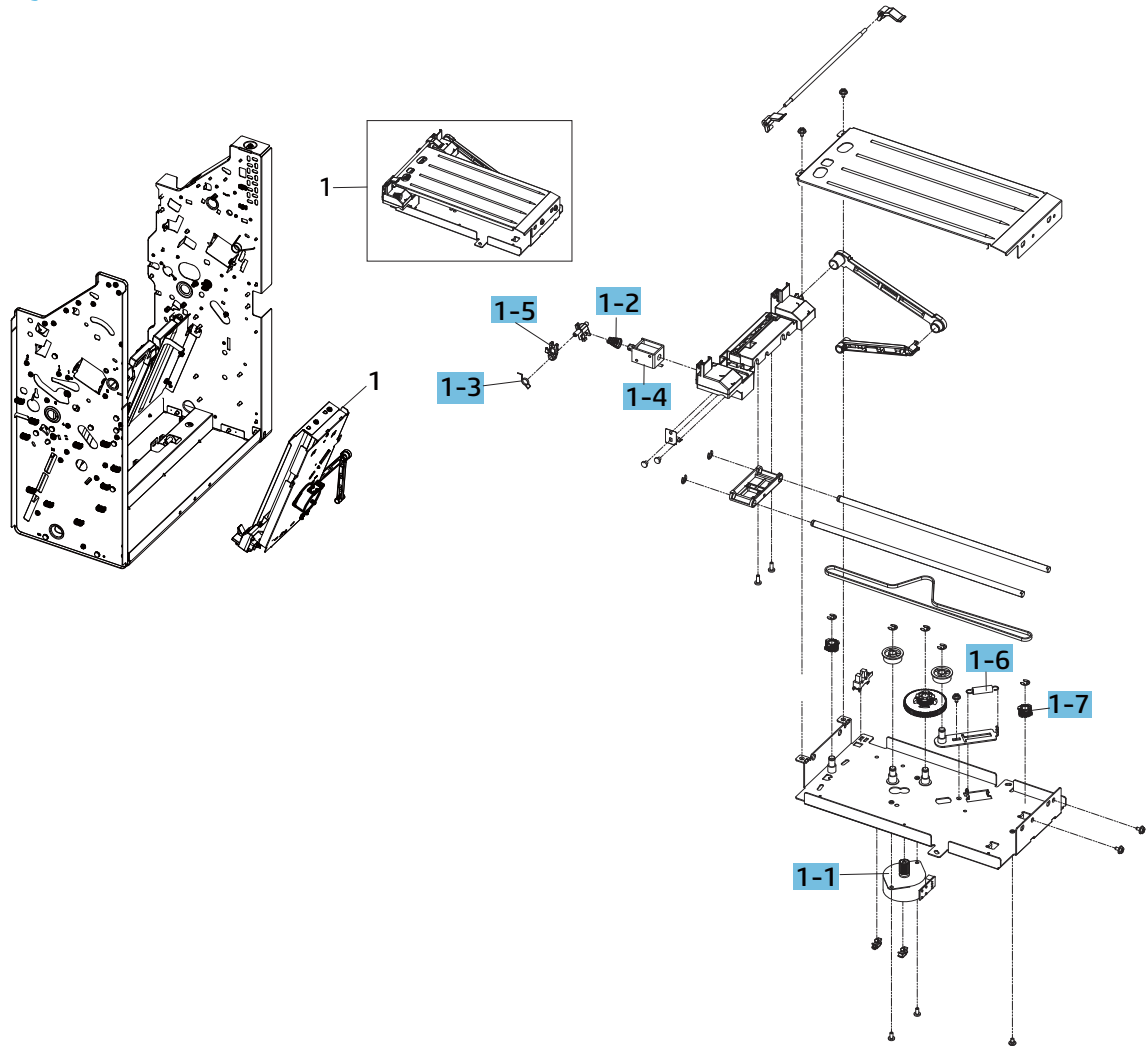

Table 5-80 Booklet end fence unit

Ref	Description	Part number	Qty	Orderable
1	Booklet end fence unit	JC90-01432A	1	
1-1	Booklet end fence motor	JC93-01155A	1	(*)
1-2	Spring	JC61-07403A	1	(*)
1-3	Spring	JC61-07401A	1	(*)
1-4	Solenoid	JC33-00038A	1	(*)
1-5	Booklet end fence home sensor	0604-001393	1	(*)
1-6	Spring	JC61-07400A	1	(*)
1-7	Gear	JC66-04583A	1	(*)

(*) This part is in ordering system.

Booklet maker base

Parts diagram and parts list for the booklet maker base.

Figure 5-121 Booklet maker base

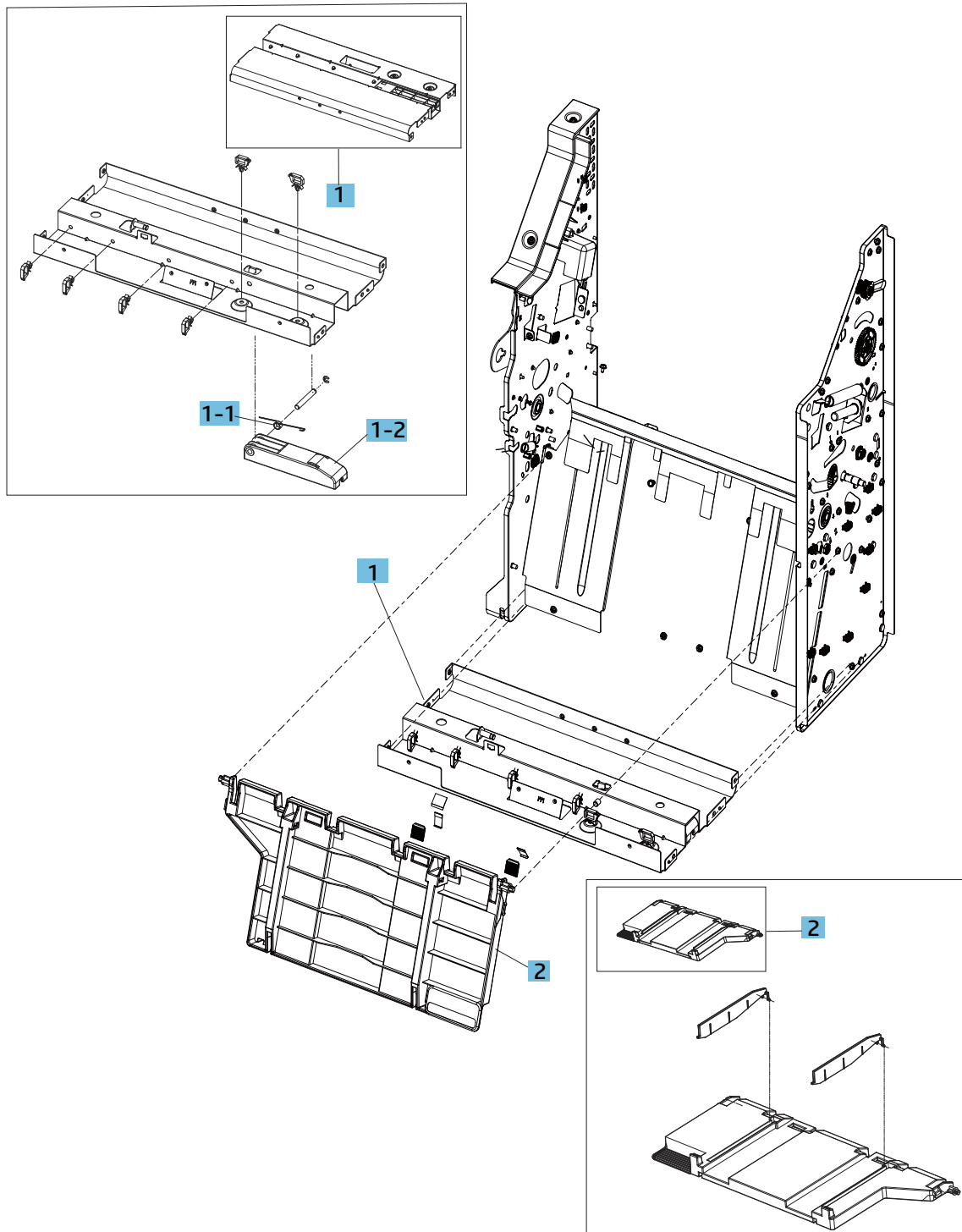

Table 5-81 Booklet maker base

Ref	Description	Part number	Qty	Orderable
1	Booklet maker base	JC90-01476A	1	(*)
1-1	Spring	JC61-07392A	1	(*)
1-2	Booklet maker base support	JC61-07279A	1	(*)
2	Booklet output jam cover	JC90-01433A	1	(*)

(*) This part is in ordering system.

Bridge unit

Removal and replacement: Bridge entrance sensor (S1)

Learn how to remove and replace the bridge entrance sensor.

Introduction

This document provides the procedures to remove and replace the bridge entrance sensor on the finisher.

 **IMPORTANT:** When applicable, special installation instructions are provided for an assembly at the end of the removal procedure. Always completely read the removal instructions and follow all special installation instructions.

Before performing service

- Turn the printer power off. A shutting-down message appears on the control-panel display.
- ⚠ **WARNING!** To avoid damage to the printer, turn the power off and wait until the printer shuts down before removing the power cable.
- Disconnect the printer power cable after the printer has completely shut down (the control-panel display is blank).
- Release the finisher from the printer by pulling out on the release latch inside the finisher door.
- Disconnect the cable from the bridge unit to the finisher.
- Disconnect the cable from the finisher to the printer.

Use the table below to identify the correct part number for your printer. To order the part, go to <https://parts.hp.com>.

Table 5-82 Part information

Part number	Part description
JC32-00020A	Bridge entrance sensor

Required tools

- #2 JIS screwdriver with a magnetic tip

After performing service

- Connect the cable from the finisher to the printer.
- Connect the cable from the bridge unit to the finisher.
- Attach the finisher to the printer, and then push in on the release latch inside the finisher door.
- Connect the printer power cable.
- Turn the printer power on.

Post service test

Process a job through the finisher and verify that the finisher works correctly.

Remove the bridge from the machine

Follow these steps to remove the bridge from the machine.

1. Open the front door (callout 1)

Figure 5-122 Open the front door



2. Pull the locker out (callout 1)

Figure 5-123 Pull the locker out



3. Separate the finisher from the printer and disconnect the two connectors (callout 1)

Figure 5-124 Separate the finisher from the printer and disconnect the two connectors



4. Pull out the bridge unit(Callout 1) from the printer

Figure 5-125 Pull out the bridge unit



Remove the bridge rear cover

Follow these steps to remove the bridge rear cover.

- ▲ Remove four screws(callout 1) and the bridge rear cover.

Figure 5-126 Remove the bridge rear cover

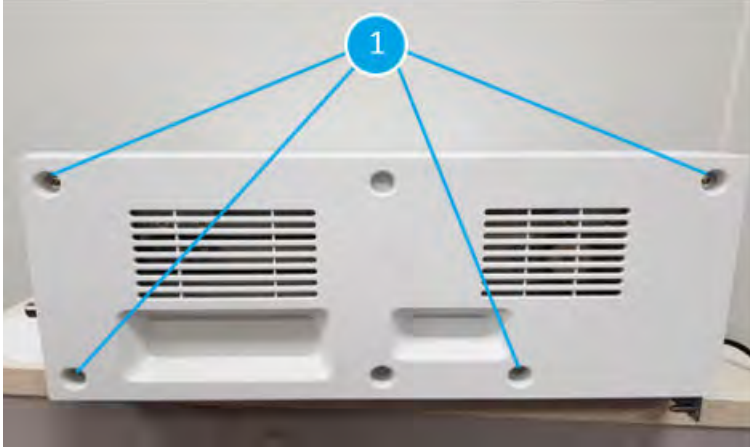

Remove the bridge door

Follow these steps to remove the bridge door.

1. Remove four screws(callout 1) and remove the metal holders each side then disconnect one connector(callout 2)

Figure 5-127 Remove the screws and a connector

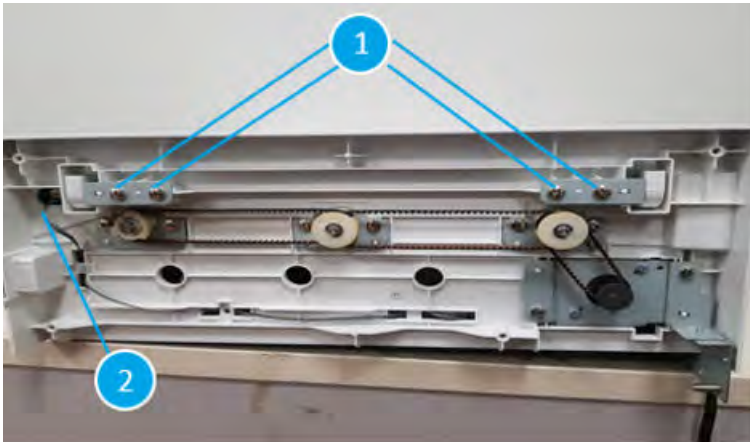

2. Lift the bridge door up(callout 1) and then remove the bridge door(callout 2)

Figure 5-128 Remove the bridge door

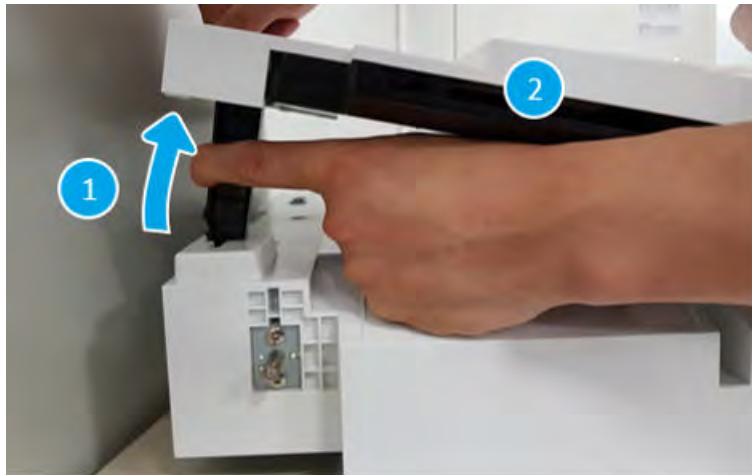

Remove the bridge paper guide

Follow these steps to remove the bridge paper guide.

- ▲ Remove thirteen screws(callout 1~3) and remove the bridge paper guide(callout 4) from the bridge door

Figure 5-129 Remove the bridge paper guide

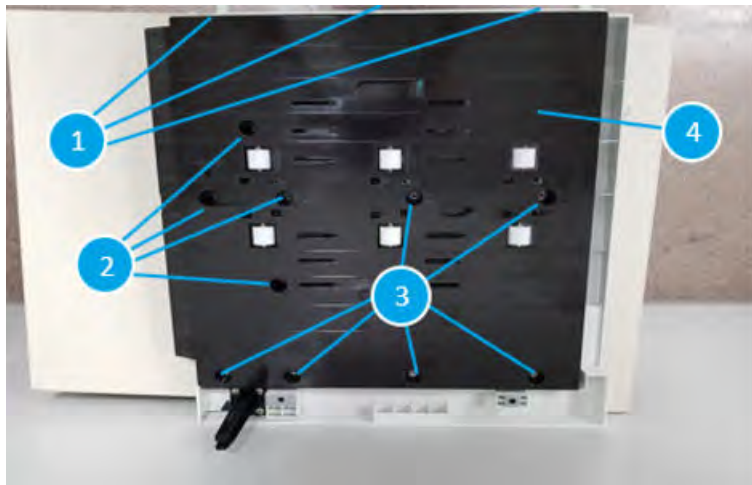

Remove the bridge entrance sensor (S1)

Follow these steps to remove the bridge entrance sensor (S1).

1. Unplug one connector (callout 1)

Figure 5-130 Unplug one connector

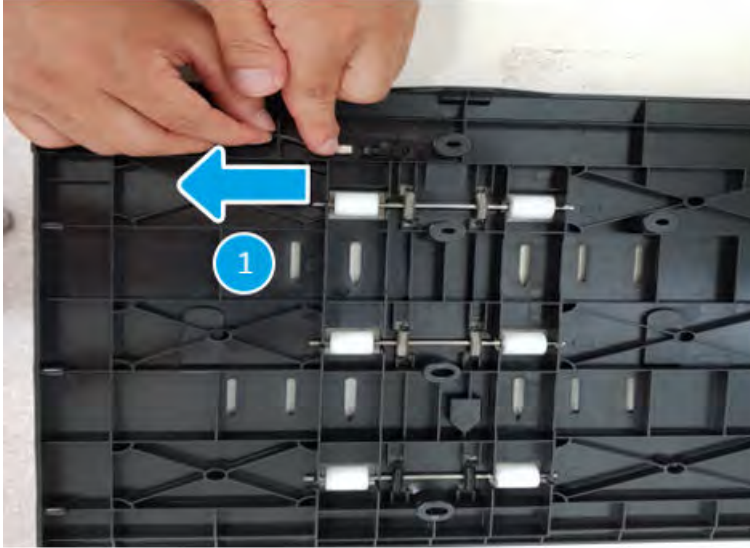

2. Use a tweezer to remove the bridge entrance sensor (S1, callout 1)

Figure 5-131 Remove the bridge entrance sensor

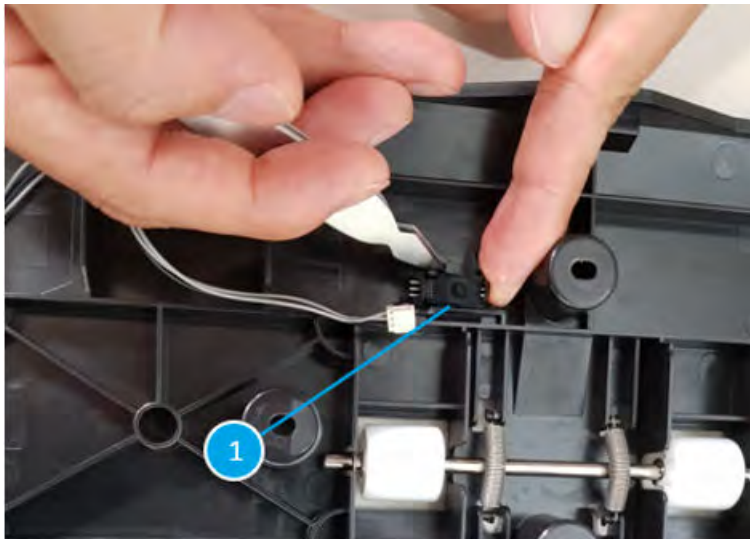

Unpack the replacement assembly

Follow these steps to unpack the replacement assembly.

1. Dispose of the defective part.

 **NOTE:** HP recommends responsible disposal of the defective part.

<http://www8.hp.com/us/en/hp-information/environment/product-recycling.html>

2. Unpack the replacement part from the packaging.



CAUTION:  Some parts are sensitive to electrostatic discharge (ESD). Always perform service work at an ESD-protected workstation or mat. If an ESD workstation or mat is not available, touch the sheet-metal chassis to provide a static ground before touching an ESD-sensitive assembly. Protect the ESD-sensitive assemblies by placing them in ESD pouches when they are out of the printer.

 **IMPORTANT:** Make sure that all of the shipping materials (for example shipping tape) are removed from the replacement part prior to installation.

 **NOTE:** If the replacement part is a roller or pad, avoid touching the spongy part of it. Skin oils on the roller or pad can cause paper pickup and/or print-quality problems. HP recommends using disposable gloves when handling rollers or pads or washing your hands before touching rollers or pads.

3. To install an assembly, reverse the removal steps.

 **NOTE:** When applicable, special installation instructions are provided for an assembly at the end of the removal procedure. Always completely read the removal instructions and follow all special installation instructions.

Removal and replacement: Bridge motor (M14)

Learn how to remove and replace the bridge motor.

Introduction

This document provides the procedures to remove and replace the bridge motor on the finisher.



IMPORTANT: When applicable, special installation instructions are provided for an assembly at the end of the removal procedure. Always completely read the removal instructions and follow all special installation instructions.

Before performing service

- Turn the printer power off. A shutting-down message appears on the control-panel display.
- ⚠ **WARNING!** To avoid damage to the printer, turn the power off and wait until the printer shuts down before removing the power cable.
- Disconnect the printer power cable after the printer has completely shut down (the control-panel display is blank).
- Release the finisher from the printer by pulling out on the release latch inside the finisher door.
- Disconnect the cable from the bridge unit to the finisher.
- Disconnect the cable from the finisher to the printer.

Use the table below to identify the correct part number for your printer. To order the part, go to <https://parts.hp.com>.

Table 5-83 Part information

Part number	Part description
JC31-00163B	Bridge motor

Required tools

- #2 JIS screwdriver with a magnetic tip

After performing service

- Connect the cable from the finisher to the printer.
- Connect the cable from the bridge unit to the finisher.
- Attach the finisher to the printer, and then push in on the release latch inside the finisher door.
- Connect the printer power cable.
- Turn the printer power on.

Post service test

Process a job through the finisher and verify that the finisher works correctly.

Remove the bridge from the machine

Follow these steps to remove the bridge from the machine.

1. Open the front door (callout 1)

Figure 5-132 Open the front door



2. Pull the locker out (callout 1)

Figure 5-133 Pull the locker out



3. Separate the finisher from the printer and disconnect the two connectors (callout 1)

Figure 5-134 Separate the finisher from the printer and disconnect the two connectors



4. Pull out the bridge unit (Callout 1) from the printer

Figure 5-135 Pull out the bridge unit



Remove the bridge rear cover

Follow these steps to remove the bridge rear cover.

- ▲ Remove four screws (callout 1) and the bridge rear cover.

Figure 5-136 Remove the bridge rear cover

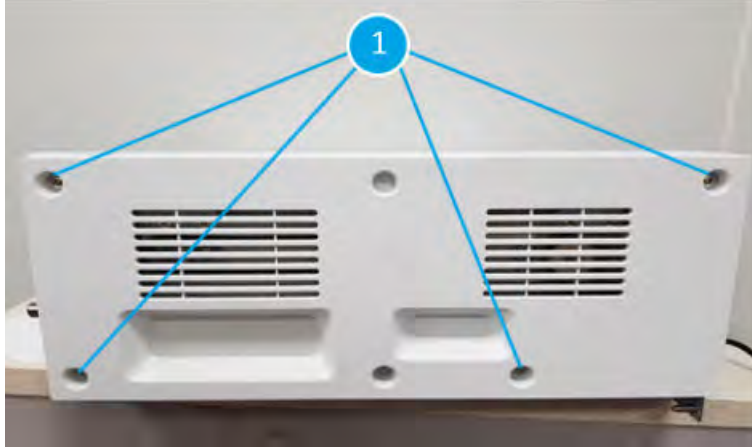

Remove the bridge motor (M14)

Follow these steps to remove the bridge motor (M14).

1. Remove three screws (callout 1)

Figure 5-137 Remove three screws

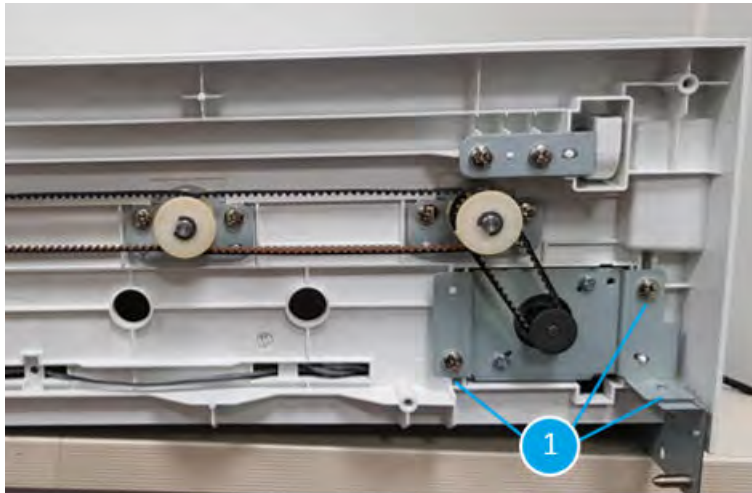

2. Disconnect one connector(callout 1)

 **NOTE:** It located on the bottom of the bridge

Figure 5-138 Disconnect one connector



3. Remove the belt (callout 1)

Figure 5-139 Remove the belt

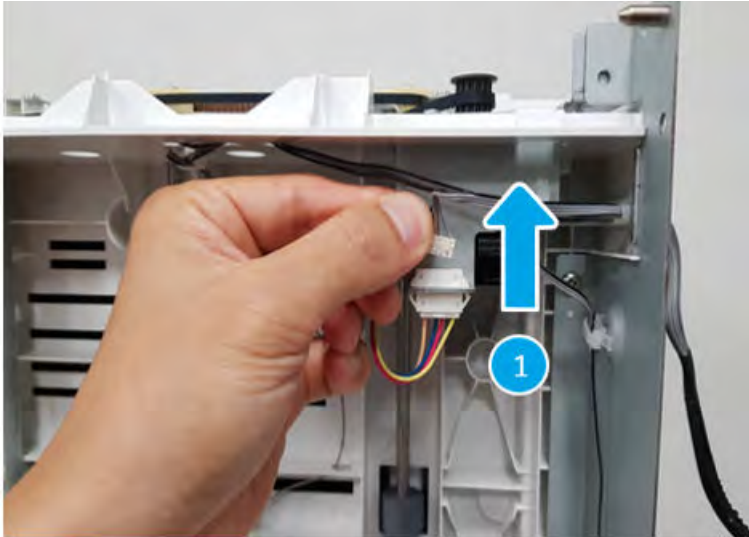

4. Remove the Bridge motor (M14, callout1)

Figure 5-140 Remove the Bridge motor

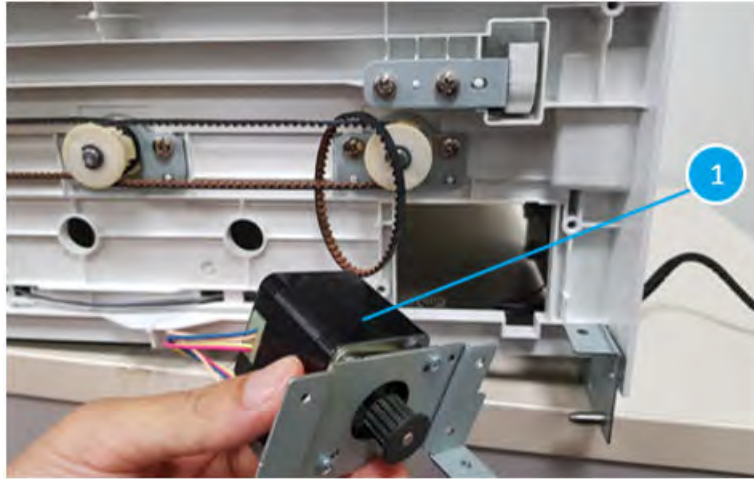

Unpack the replacement assembly

Follow these steps to unpack the replacement assembly.

1. Dispose of the defective part.



NOTE: HP recommends responsible disposal of the defective part.

<http://www8.hp.com/us/en/hp-information/environment/product-recycling.html>

2. Unpack the replacement part from the packaging.



CAUTION:  Some parts are sensitive to electrostatic discharge (ESD). Always perform service work at an ESD-protected workstation or mat. If an ESD workstation or mat is not available, touch the sheet-metal chassis to provide a static ground before touching an ESD-sensitive assembly. Protect the ESD-sensitive assemblies by placing them in ESD pouches when they are out of the printer.



IMPORTANT: Make sure that all of the shipping materials (for example shipping tape) are removed from the replacement part prior to installation.



NOTE: If the replacement part is a roller or pad, avoid touching the spongy part of it. Skin oils on the roller or pad can cause paper pickup and/or print-quality problems. HP recommends using disposable gloves when handling rollers or pads or washing your hands before touching rollers or pads.

3. To install an assembly, reverse the removal steps.



NOTE: When applicable, special installation instructions are provided for an assembly at the end of the removal procedure. Always completely read the removal instructions and follow all special installation instructions.

Removal and replacement: Bridge exit sensor (S3)

Learn how to remove and replace the bridge exit sensor.

Introduction

This document provides the procedures to remove and replace the bridge exit sensor on the finisher.



IMPORTANT: When applicable, special installation instructions are provided for an assembly at the end of the removal procedure. Always completely read the removal instructions and follow all special installation instructions.

Before performing service

- Turn the printer power off. A shutting-down message appears on the control-panel display.
- ⚠ **WARNING!** To avoid damage to the printer, turn the power off and wait until the printer shuts down before removing the power cable.
- Disconnect the printer power cable after the printer has completely shut down (the control-panel display is blank).
- Release the finisher from the printer by pulling out on the release latch inside the finisher door.
- Disconnect the cable from the bridge unit to the finisher.
- Disconnect the cable from the finisher to the printer.

Use the table below to identify the correct part number for your printer. To order the part, go to <https://parts.hp.com>.

Table 5-84 Part information

Part number	Part description
0604-001393	Bridge exit sensor

Required tools

- #2 JIS screwdriver with a magnetic tip

After performing service

- Connect the cable from the finisher to the printer.
- Connect the cable from the bridge unit to the finisher.
- Attach the finisher to the printer, and then push in on the release latch inside the finisher door.
- Connect the printer power cable.
- Turn the printer power on.

Post service test

Process a job through the finisher and verify that the finisher works correctly.

Remove the bridge from the machine

Follow these steps to remove the bridge from the machine.

1. Open the front door (callout 1)

Figure 5-141 Open the front door



2. Pull the locker out (callout 1)

Figure 5-142 Pull the locker out



3. Separate the finisher from the printer and disconnect the two connectors (callout 1)

Figure 5-143 Separate the finisher from the printer and disconnect the two connectors



4. Pull out the bridge unit(Callout 1) from the printer

Figure 5-144 Pull out the bridge unit



Remove the bridge exit sensor (S3)

Follow these steps to remove the bridge exit sensor (S3).

1. Unplug one connector

 **NOTE:** Bridge exit sensor(callout 1) located on the bottom of the bridge

Figure 5-145 Unplug one connector

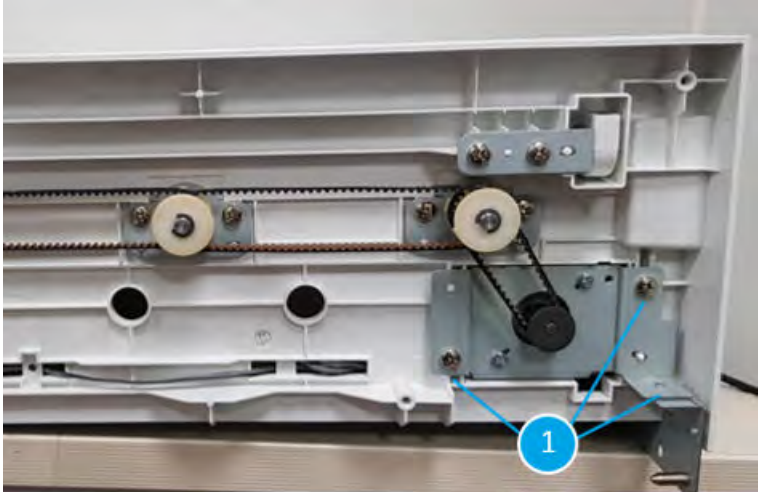
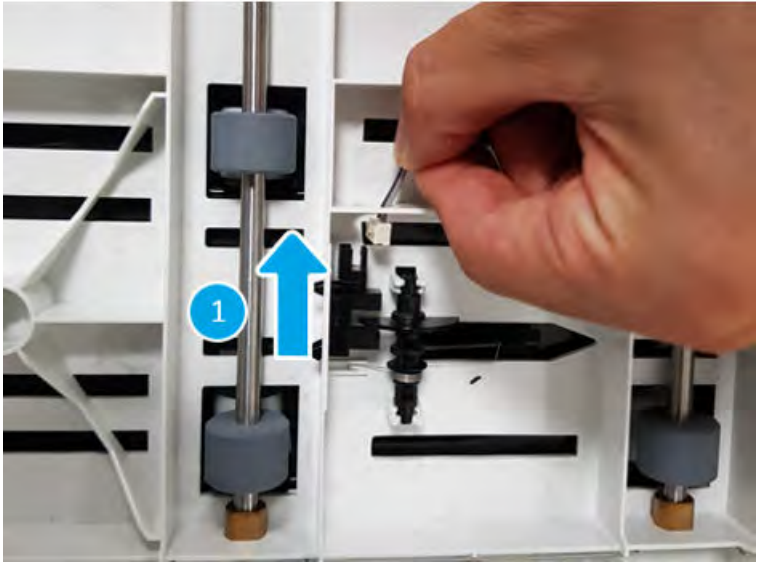
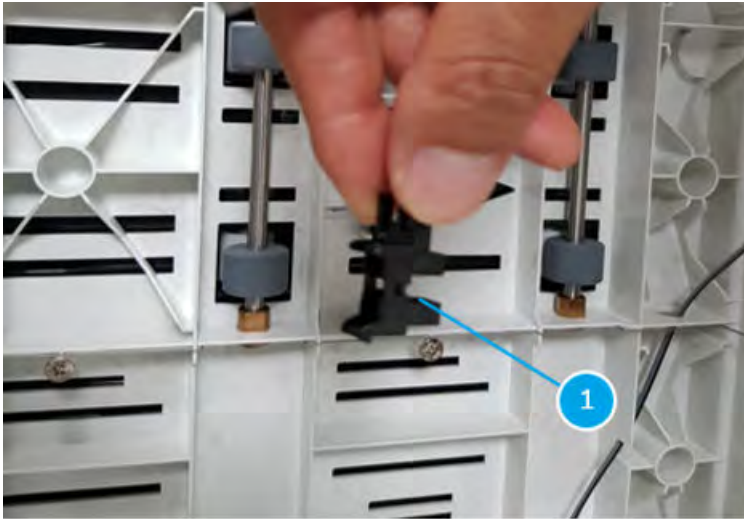

Figure 5-146 Unplug one connector



2. Use a tweezer to remove the bridge exit sensor(S3, callout1)

Figure 5-147 Remove the bridge exit sensor



Unpack the replacement assembly

Follow these steps to unpack the replacement assembly.

1. Dispose of the defective part.



NOTE: HP recommends responsible disposal of the defective part.

<http://www8.hp.com/us/en/hp-information/environment/product-recycling.html>

2. Unpack the replacement part from the packaging.



CAUTION:  Some parts are sensitive to electrostatic discharge (ESD). Always perform service work at an ESD-protected workstation or mat. If an ESD workstation or mat is not available, touch the sheet-metal chassis to provide a static ground before touching an ESD-sensitive assembly. Protect the ESD-sensitive assemblies by placing them in ESD pouches when they are out of the printer.



IMPORTANT: Make sure that all of the shipping materials (for example shipping tape) are removed from the replacement part prior to installation.



NOTE: If the replacement part is a roller or pad, avoid touching the spongy part of it. Skin oils on the roller or pad can cause paper pickup and/or print-quality problems. HP recommends using disposable gloves when handling rollers or pads or washing your hands before touching rollers or pads.

3. To install an assembly, reverse the removal steps.



NOTE: When applicable, special installation instructions are provided for an assembly at the end of the removal procedure. Always completely read the removal instructions and follow all special installation instructions.

Removal and replacement: Bridge door sensor (S2)

Learn how to remove and replace the bridge door sensor.

Introduction

This document provides the procedures to remove and replace the bridge door sensor on the finisher.

 **IMPORTANT:** When applicable, special installation instructions are provided for an assembly at the end of the removal procedure. Always completely read the removal instructions and follow all special installation instructions.

Before performing service

- Turn the printer power off. A shutting-down message appears on the control-panel display.
- ⚠ **WARNING!** To avoid damage to the printer, turn the power off and wait until the printer shuts down before removing the power cable.
- Disconnect the printer power cable after the printer has completely shut down (the control-panel display is blank).
- Release the finisher from the printer by pulling out on the release latch inside the finisher door.
- Disconnect the cable from the bridge unit to the finisher.
- Disconnect the cable from the finisher to the printer.

Use the table below to identify the correct part number for your printer. To order the part, go to <https://parts.hp.com>.

Table 5-85 Part information

Part number	Part description
0604-001393	Bridge door sensor

Required tools

- #2 JIS screwdriver with a magnetic tip

After performing service

- Connect the cable from the finisher to the printer.
- Connect the cable from the bridge unit to the finisher.
- Attach the finisher to the printer, and then push in on the release latch inside the finisher door.
- Connect the printer power cable.
- Turn the printer power on.

Post service test

Process a job through the finisher and verify that the finisher works correctly.

Remove the bridge from the machine

Follow these steps to remove the bridge from the machine.

1. Open the front door (callout 1)

Figure 5-148 Open the front door



2. Pull the locker out (callout 1)

Figure 5-149 Pull the locker out



3. Separate the finisher from the printer and disconnect the two connectors (callout 1)

Figure 5-150 Separate the finisher from the printer and disconnect the two connectors



4. Pull out the bridge unit(Callout 1) from the printer

Figure 5-151 Pull out the bridge unit



Remove the bridge door sensor (S2)

Follow these steps to remove the bridge door sensor (S2).

1. Bridge door sensor(callout 1) located on the bottom of the bridge

Figure 5-152 Location of the bridge door sensor

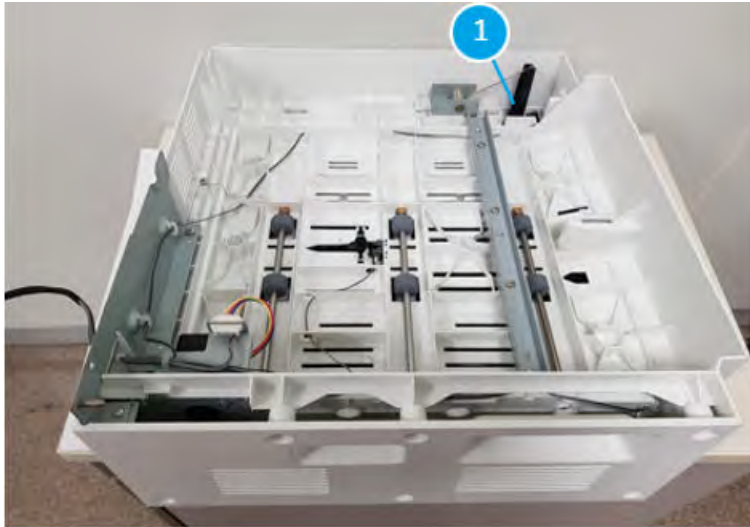

2. Open the bridge door to remove the bridge door sensor (S2)

Figure 5-153 Open the bridge door



3. Use a tweezer to remove the bridge door sensor(S2, callout 1)

Figure 5-154 Remove the bridge door sensor



Unpack the replacement assembly



Follow these steps to unpack the replacement assembly.

1. Dispose of the defective part.

 **NOTE:** HP recommends responsible disposal of the defective part.

<http://www8.hp.com/us/en/hp-information/environment/product-recycling.html>

2. Unpack the replacement part from the packaging.

 **CAUTION:**  Some parts are sensitive to electrostatic discharge (ESD). Always perform service work at an ESD-protected workstation or mat. If an ESD workstation or mat is not available, touch the sheet-metal chassis to provide a static ground before touching an ESD-sensitive assembly. Protect the ESD-sensitive assemblies by placing them in ESD pouches when they are out of the printer.

 **IMPORTANT:** Make sure that all of the shipping materials (for example shipping tape) are removed from the replacement part prior to installation.

 **NOTE:** If the replacement part is a roller or pad, avoid touching the spongy part of it. Skin oils on the roller or pad can cause paper pickup and/or print-quality problems. HP recommends using disposable gloves when handling rollers or pads or washing your hands before touching rollers or pads.

3. To install an assembly, reverse the removal steps.

 **NOTE:** When applicable, special installation instructions are provided for an assembly at the end of the removal procedure. Always completely read the removal instructions and follow all special installation instructions.

Covers

Removal and replacement: Right upper cover

Learn how to remove and replace the right upper cover.

Introduction

This document provides the procedures to remove and replace the right upper cover on the finisher.



IMPORTANT: When applicable, special installation instructions are provided for an assembly at the end of the removal procedure. Always completely read the removal instructions and follow all special installation instructions.

Before performing service

- Turn the printer power off. A shutting-down message appears on the control-panel display.
- ⚠ **WARNING!** To avoid damage to the printer, turn the power off and wait until the printer shuts down before removing the power cable.
- Disconnect the printer power cable after the printer has completely shut down (the control-panel display is blank).
- Release the finisher from the printer by pulling out on the release latch inside the finisher door.
- Disconnect the cable from the bridge unit to the finisher.
- Disconnect the cable from the finisher to the printer.

Use the table below to identify the correct part number for your printer. To order the part, go to <https://parts.hp.com>.

Table 5-86 Part information

Part number	Part description
JC90-01448B	Right upper cover

Required tools

- #2 JIS screwdriver with a magnetic tip

After performing service

- Connect the cable from the finisher to the printer.
- Connect the cable from the bridge unit to the finisher.
- Attach the finisher to the printer, and then push in on the release latch inside the finisher door.
- Connect the printer power cable.
- Turn the printer power on.

Post service test

Process a job through the finisher and verify that the finisher works correctly.

Remove the right upper cover (finisher)

Follow these steps to remove the right upper cover (finisher).

- ▲ Remove one screw cap and three machine screws on the upper edge of the cover (callout 1). Remove three sheet metal screws (callout 2) on the lower portion of the cover. Rotate the right edge of the cover away from the finisher, and then slide the cover right to release three tabs (callout 3).

 **TIP:** The lower screws are shorter in length than the upper screws.

TIP: Reverse the removal steps to install the assembly.

Figure 5-155 Remove the right upper cover

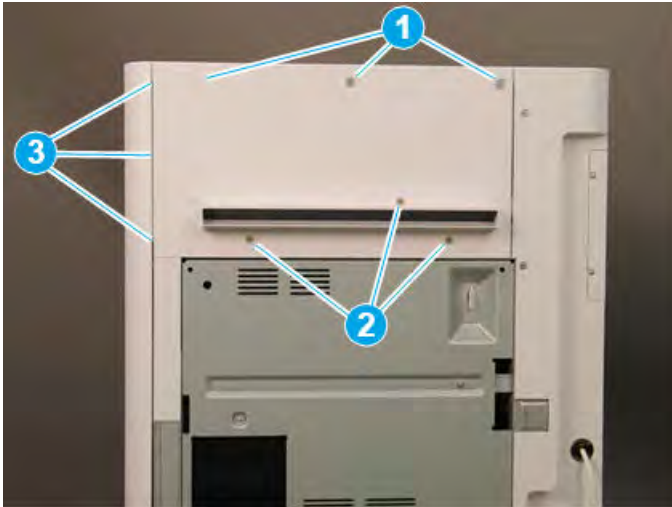

Unpack the replacement assembly



Follow these steps to unpack the replacement assembly.

1. Dispose of the defective part.

 **NOTE:** HP recommends responsible disposal of the defective part.

<http://www8.hp.com/us/en/hp-information/environment/product-recycling.html>

2. Unpack the replacement part from the packaging.

 **CAUTION:**  Some parts are sensitive to electrostatic discharge (ESD). Always perform service work at an ESD-protected workstation or mat. If an ESD workstation or mat is not available, touch the sheet-metal chassis to provide a static ground before touching an ESD-sensitive assembly. Protect the ESD-sensitive assemblies by placing them in ESD pouches when they are out of the printer.

 **IMPORTANT:** Make sure that all of the shipping materials (for example shipping tape) are removed from the replacement part prior to installation.

 **NOTE:** If the replacement part is a roller or pad, avoid touching the spongy part of it. Skin oils on the roller or pad can cause paper pickup and/or print-quality problems. HP recommends using disposable gloves when handling rollers or pads or washing your hands before touching rollers or pads.

3. To install an assembly, reverse the removal steps.



NOTE: When applicable, special installation instructions are provided for an assembly at the end of the removal procedure. Always completely read the removal instructions and follow all special installation instructions.

Removal and replacement: Top cover

Learn how to remove and replace the top cover.

Introduction

This document provides the procedures to remove and replace the top cover of the finisher.



IMPORTANT: When applicable, special installation instructions are provided for an assembly at the end of the removal procedure. Always completely read the removal instructions and follow all special installation instructions.

Before performing service

- Turn the printer power off. A shutting-down message appears on the control-panel display.
- ⚠ **WARNING!** To avoid damage to the printer, turn the power off and wait until the printer shuts down before removing the power cable.
- Disconnect the printer power cable after the printer has completely shut down (the control-panel display is blank).
- Release the finisher from the printer by pulling out on the release latch inside the finisher door.
- Disconnect the cable from the bridge unit to the finisher.
- Disconnect the cable from the finisher to the printer.

Use the table below to identify the correct part number for your printer. To order the part, go to <https://parts.hp.com>.

Table 5-87 Part information

Part number	Part description
JC90-01446B	Top cover

Required tools

- #2 JIS screwdriver with a magnetic tip

After performing service

- Connect the cable from the finisher to the printer.
- Connect the cable from the bridge unit to the finisher.
- Attach the finisher to the printer, and then push in on the release latch inside the finisher door.
- Connect the printer power cable.
- Turn the printer power on.

Post service test

Process a job through the finisher and verify that the finisher works correctly.

Remove the right upper cover (finisher)

Follow these steps to remove the right upper cover (finisher).

- ▲ Remove one screw cap and three machine screws on the upper edge of the cover (callout 1). Remove three sheet metal screws (callout 2) on the lower portion of the cover. Rotate the right edge of the cover away from the finisher, and then slide the cover right to release three tabs (callout 3).

💡 **TIP:** The lower screws are shorter in length than the upper screws.

TIP: Reverse the removal steps to install the assembly.

Figure 5-156 Remove the right upper cover

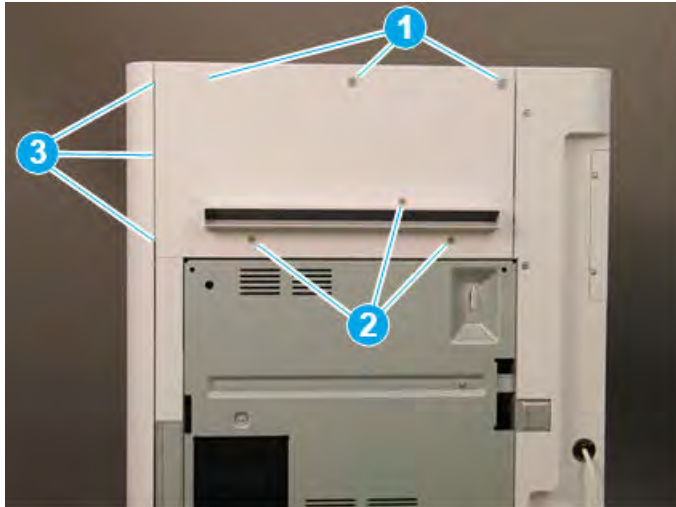

Remove the top cover (finisher)

Follow these steps to remove the top cover (finisher).

1. Remove three screw caps and three self-tapping screws at the top of the rear cover (callout 1), and then remove three machine screws (callout 2) on top of the cover.

Figure 5-157 Remove six screws

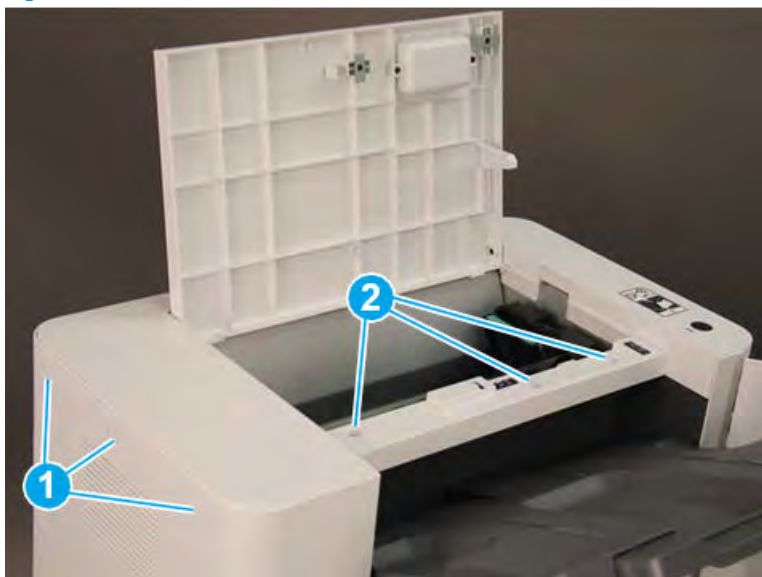

2. Remove three self-tapping screws at the top of the front cover (callout 1), and then remove two machine screws (callout 2) at the top of the right side.

Figure 5-158 Remove five screws

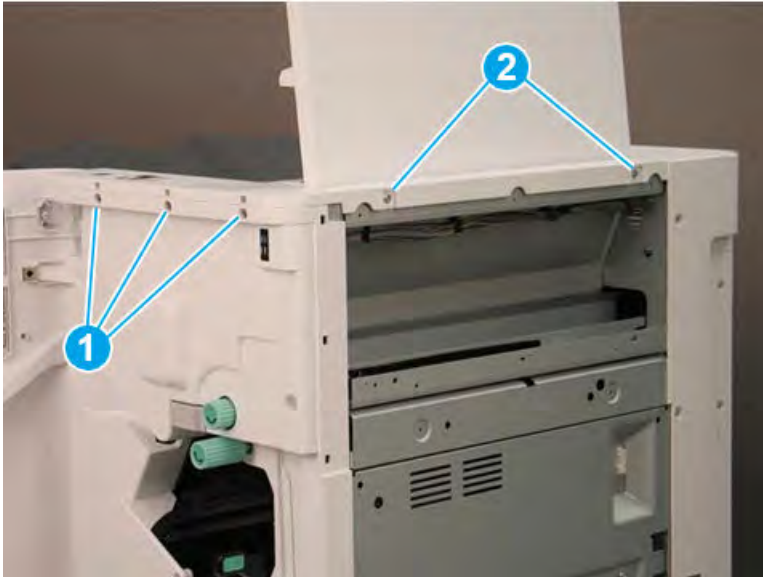

3. Lift the cover up slightly. Disconnect one in-line connector (callout 1), and then release one retainer (callout 2).

 **TIP:** Reverse the removal steps to install the assembly.

Figure 5-159 Disconnect one connector and release retainer



Unpack the replacement assembly

Follow these steps to unpack the replacement assembly.

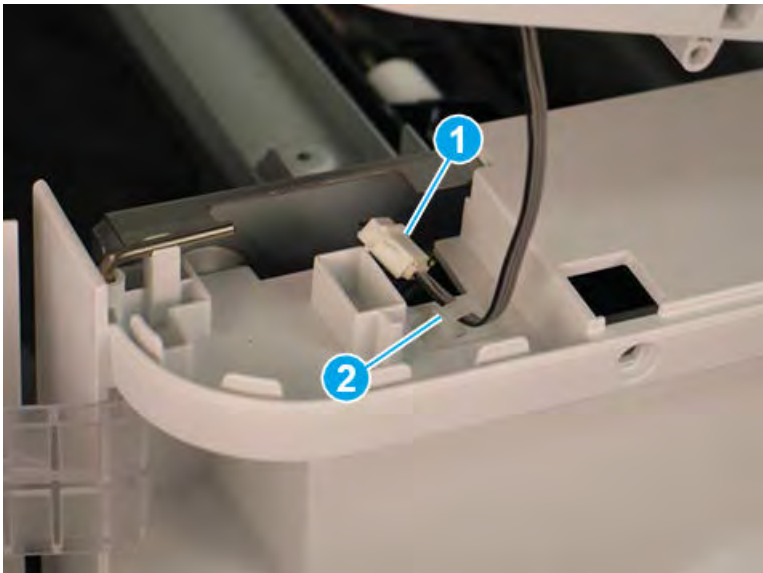
1. Dispose of the defective part.

 **NOTE:** HP recommends responsible disposal of the defective part.

<http://www8.hp.com/us/en/hp-information/environment/product-recycling.html>

2. Unpack the replacement part from the packaging.



CAUTION:  Some parts are sensitive to electrostatic discharge (ESD). Always perform service work at an ESD-protected workstation or mat. If an ESD workstation or mat is not available, touch the sheet-metal chassis to provide a static ground before touching an ESD-sensitive assembly. Protect the ESD-sensitive assemblies by placing them in ESD pouches when they are out of the printer.



IMPORTANT: Make sure that all of the shipping materials (for example shipping tape) are removed from the replacement part prior to installation.



NOTE: If the replacement part is a roller or pad, avoid touching the spongy part of it. Skin oils on the roller or pad can cause paper pickup and/or print-quality problems. HP recommends using disposable gloves when handling rollers or pads or washing your hands before touching rollers or pads.

3. To install an assembly, reverse the removal steps.



NOTE: When applicable, special installation instructions are provided for an assembly at the end of the removal procedure. Always completely read the removal instructions and follow all special installation instructions.

Removal and replacement: Front door

Learn how to remove and replace the front door.

Introduction

This document provides the procedures to remove and replace the front door for the finisher.



IMPORTANT: When applicable, special installation instructions are provided for an assembly at the end of the removal procedure. Always completely read the removal instructions and follow all special installation instructions.

Before performing service

- Turn the printer power off. A shutting-down message appears on the control-panel display.
- ⚠ **WARNING!** To avoid damage to the printer, turn the power off and wait until the printer shuts down before removing the power cable.
- Disconnect the printer power cable after the printer has completely shut down (the control-panel display is blank).
- Release the finisher from the printer by pulling out on the release latch inside the finisher door.
- Disconnect the cable from the bridge unit to the finisher.
- Disconnect the cable from the finisher to the printer.

Use the table below to identify the correct part number for your printer. To order the part, go to <https://parts.hp.com>.

Table 5-88 Part information

Part number	Part description
JC90-01444B	Front door

Required tools

- #2 JIS screwdriver with a magnetic tip
- Small, flat-blade screwdriver

After performing service

- Connect the cable from the finisher to the printer.
- Connect the cable from the bridge unit to the finisher.
- Attach the finisher to the printer, and then push in on the release latch inside the finisher door.
- Connect the printer power cable.
- Turn the printer power on.

Post service test

Process a job through the finisher and verify that the finisher works correctly.

Remove the right upper cover (finisher)

Follow these steps to remove the right upper cover (finisher).

- ▲ Remove one screw cap and three machine screws on the upper edge of the cover (callout 1). Remove three sheet metal screws (callout 2) on the lower portion of the cover. Rotate the right edge of the cover away from the finisher, and then slide the cover right to release three tabs (callout 3).

💡 **TIP:** The lower screws are shorter in length than the upper screws.

TIP: Reverse the removal steps to install the assembly.

Figure 5-160 Remove the right upper cover

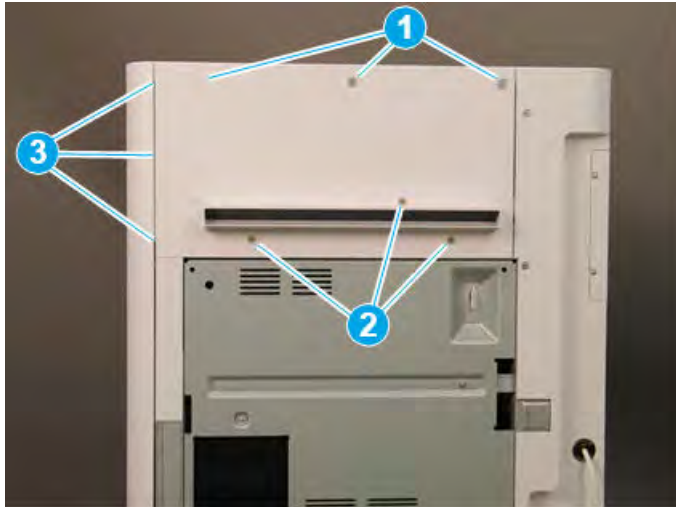

Remove the top cover (finisher)

Follow these steps to remove the top cover (finisher).

1. Remove three screw caps and three self-tapping screws at the top of the rear cover (callout 1), and then remove three machine screws (callout 2) on top of the cover.

Figure 5-161 Remove six screws

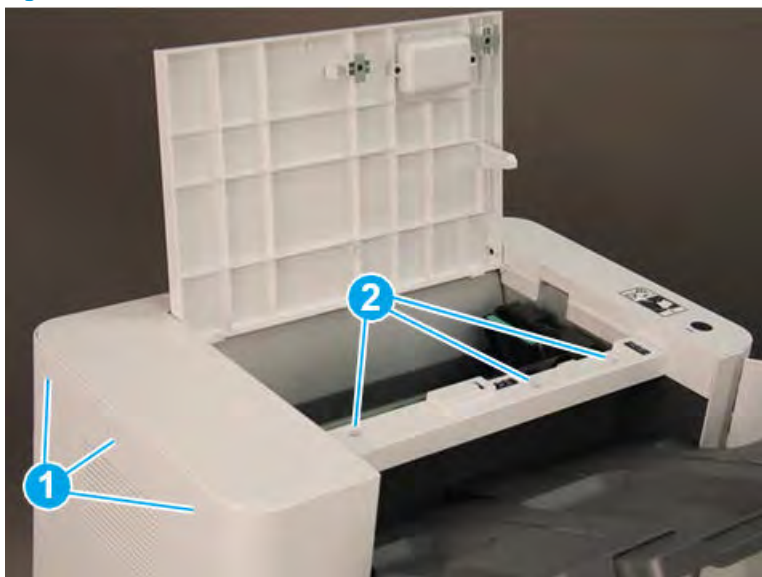

2. Remove three self-tapping screws at the top of the front cover (callout 1), and then remove two machine screws (callout 2) at the top of the right side.

Figure 5-162 Remove five screws

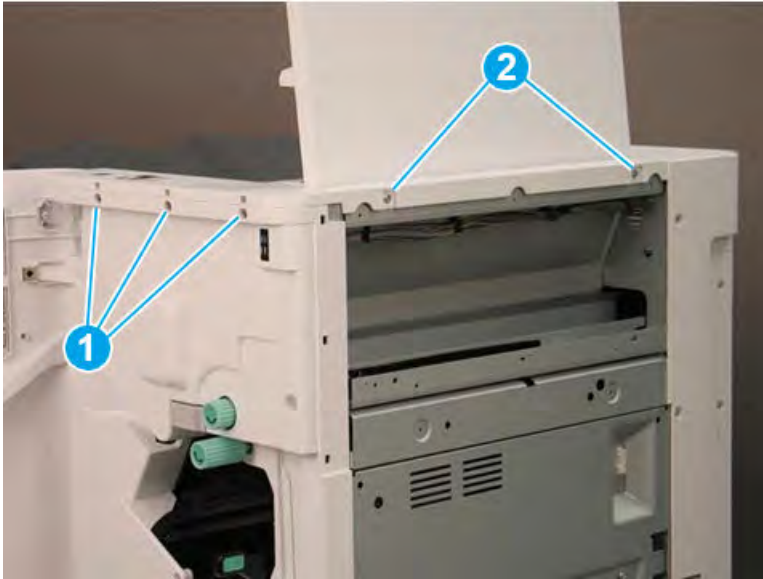

3. Lift the cover up slightly. Disconnect one in-line connector (callout 1), and then release one retainer (callout 2).

 **TIP:** Reverse the removal steps to install the assembly.

Figure 5-163 Disconnect one connector and release retainer



Remove the front door (finisher)

Follow these steps to remove the front door (finisher).

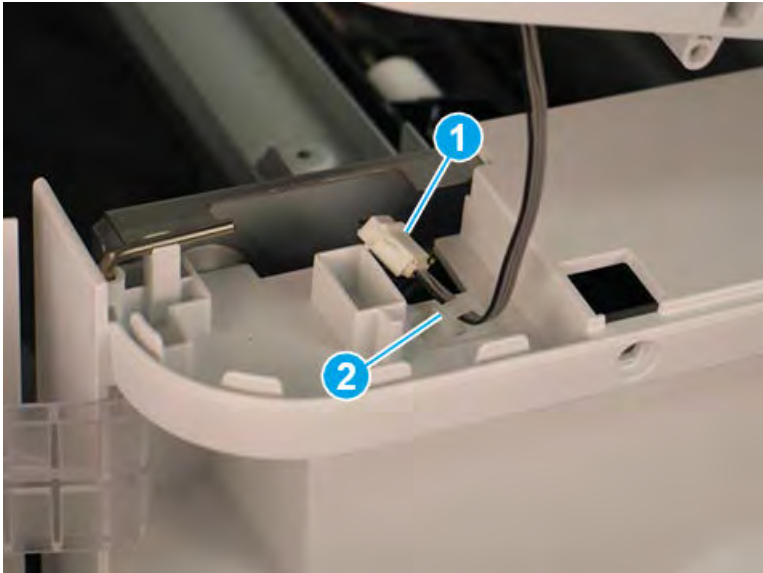
1. Lift the top hinge pin up to release it from the retainer.

Figure 5-164 Lift the top hinge pin

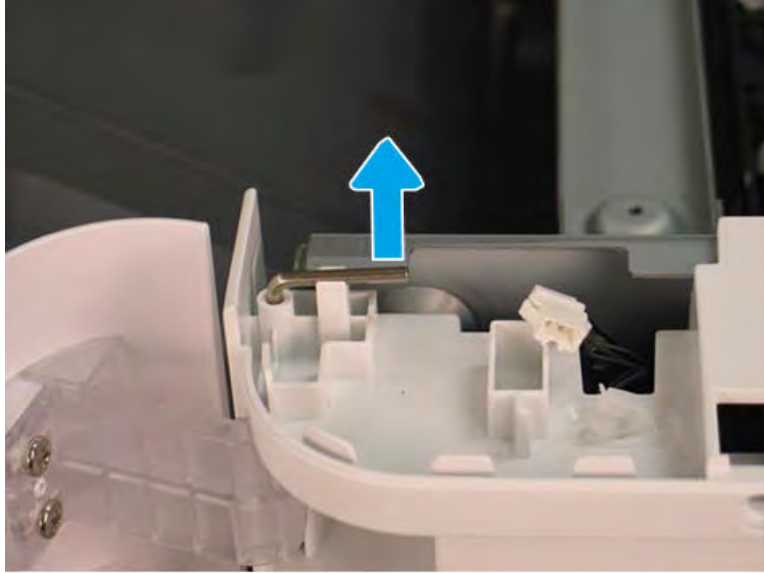

2. Pull the top hinge pin up to remove it.

Figure 5-165 Remove the top hinge pin

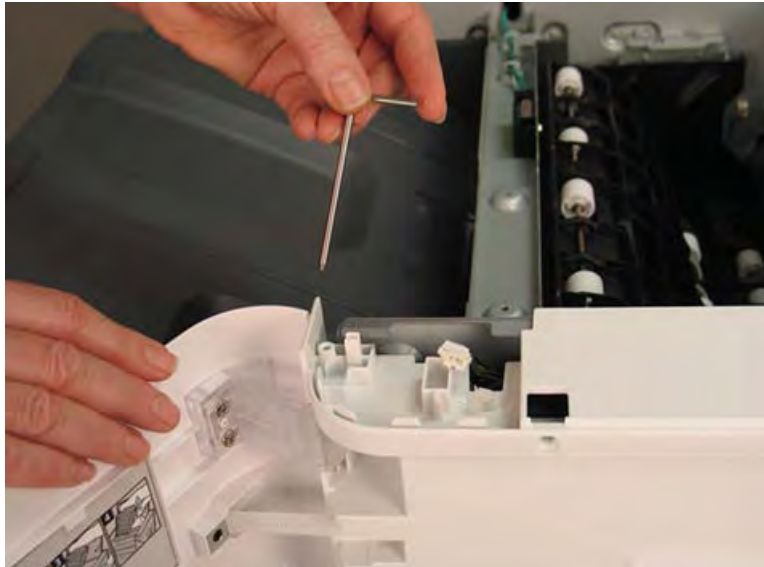

3. Use a small, flat-blade screwdriver to release the lower hinge pin from the retainer, and then rotate it away from the finisher.

Figure 5-166 Release the lower hinge pin



4. Support the door with one hand, and then pull the lower hinge pin straight up to remove it.

Figure 5-167 Remove the lower hinge pin



5. Support the door with one hand, and then remove one screw (callout 1) to release the strap. Remove the front door.

 **TIP:** Reverse the removal steps to install the assembly.

Figure 5-168 Remove the front door



Unpack the replacement assembly

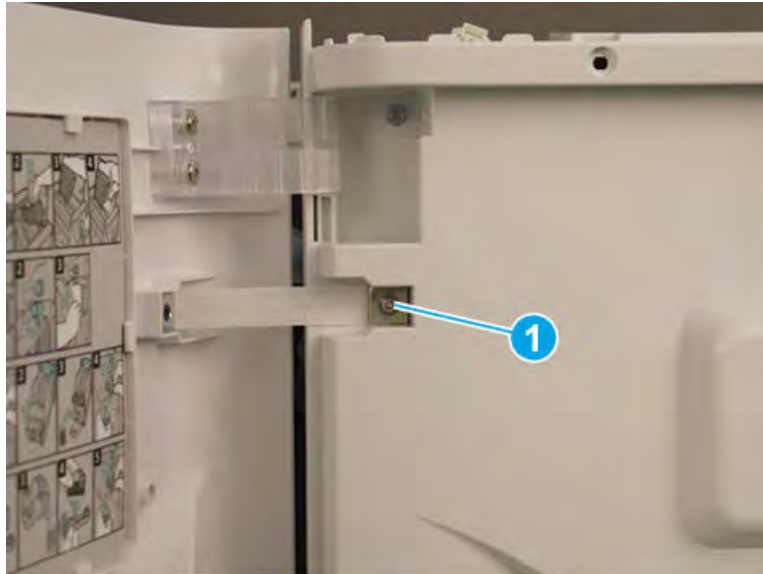

Follow these steps to unpack the replacement assembly.

1. Dispose of the defective part.

 **NOTE:** HP recommends responsible disposal of the defective part.

<http://www8.hp.com/us/en/hp-information/environment/product-recycling.html>

2. Unpack the replacement part from the packaging.

 **CAUTION:**  Some parts are sensitive to electrostatic discharge (ESD). Always perform service work at an ESD-protected workstation or mat. If an ESD workstation or mat is not available, touch the sheet-metal chassis to provide a static ground before touching an ESD-sensitive assembly. Protect the ESD-sensitive assemblies by placing them in ESD pouches when they are out of the printer.

 **IMPORTANT:** Make sure that all of the shipping materials (for example shipping tape) are removed from the replacement part prior to installation.

 **NOTE:** If the replacement part is a roller or pad, avoid touching the spongy part of it. Skin oils on the roller or pad can cause paper pickup and/or print-quality problems. HP recommends using disposable gloves when handling rollers or pads or washing your hands before touching rollers or pads.

3. To install an assembly, reverse the removal steps.

 **NOTE:** When applicable, special installation instructions are provided for an assembly at the end of the removal procedure. Always completely read the removal instructions and follow all special installation instructions.

Removal and replacement: Rear cover

Learn how to remove and replace the rear cover.

Introduction

This document provides the procedures to remove and replace the rear cover for the finisher.



IMPORTANT: When applicable, special installation instructions are provided for an assembly at the end of the removal procedure. Always completely read the removal instructions and follow all special installation instructions.

Before performing service

- Turn the printer power off. A shutting-down message appears on the control-panel display.
- ⚠ **WARNING!** To avoid damage to the printer, turn the power off and wait until the printer shuts down before removing the power cable.
- Disconnect the printer power cable after the printer has completely shut down (the control-panel display is blank).
- Release the finisher from the printer by pulling out on the release latch inside the finisher door.
- Disconnect the cable from the bridge unit to the finisher.
- Disconnect the cable from the finisher to the printer.

Use the table below to identify the correct part number for your printer. To order the part, go to <https://parts.hp.com>.

Table 5-89 Part information

Part number	Part description
JC63-04988B	Rear cover

Required tools

- #2 JIS screwdriver with a magnetic tip

After performing service

- Connect the cable from the finisher to the printer.
- Connect the cable from the bridge unit to the finisher.
- Attach the finisher to the printer, and then push in on the release latch inside the finisher door.
- Connect the printer power cable.
- Turn the printer power on.

Post service test

Process a job through the finisher and verify that the finisher works correctly.

Remove the right upper cover (finisher)

Follow these steps to remove the right upper cover (finisher).

- ▲ Remove one screw cap and three machine screws on the upper edge of the cover (callout 1). Remove three sheet metal screws (callout 2) on the lower portion of the cover. Rotate the right edge of the cover away from the finisher, and then slide the cover right to release three tabs (callout 3).

💡 **TIP:** The lower screws are shorter in length than the upper screws.

TIP: Reverse the removal steps to install the assembly.

Figure 5-169 Remove the right upper cover

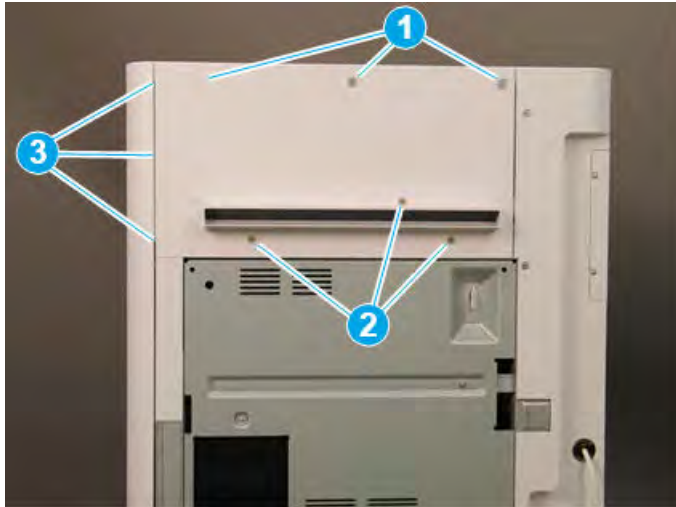

Remove the top cover (finisher)

Follow these steps to remove the top cover (finisher).

1. Remove three screw caps and three self-tapping screws at the top of the rear cover (callout 1), and then remove three machine screws (callout 2) on top of the cover.

Figure 5-170 Remove six screws

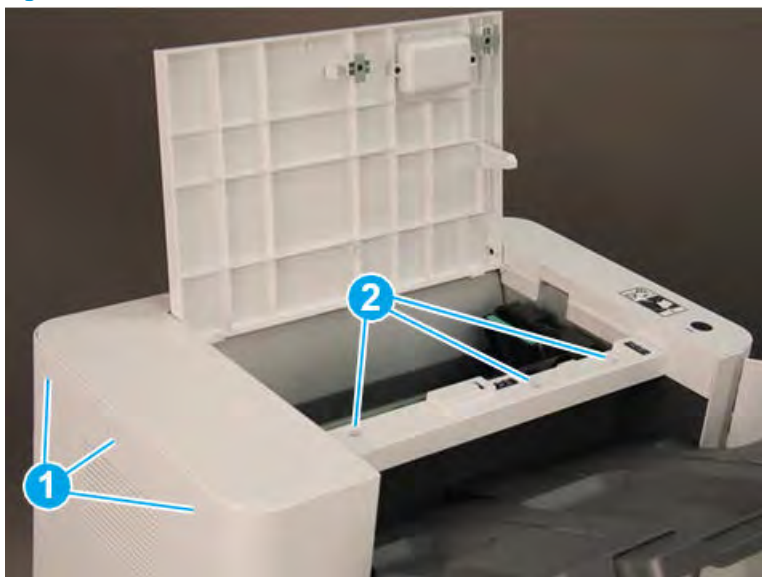

2. Remove three self-tapping screws at the top of the front cover (callout 1), and then remove two machine screws (callout 2) at the top of the right side.

Figure 5-171 Remove five screws

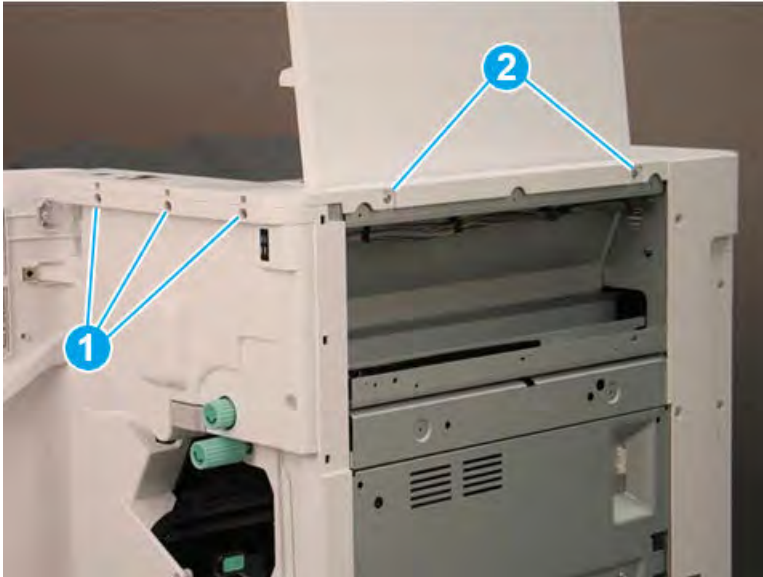

3. Lift the cover up slightly. Disconnect one in-line connector (callout 1), and then release one retainer (callout 2).

 **TIP:** Reverse the removal steps to install the assembly.

Figure 5-172 Disconnect one connector and release retainer



Remove the rear cover (finisher)

Follow these steps to remove the rear cover (finisher).

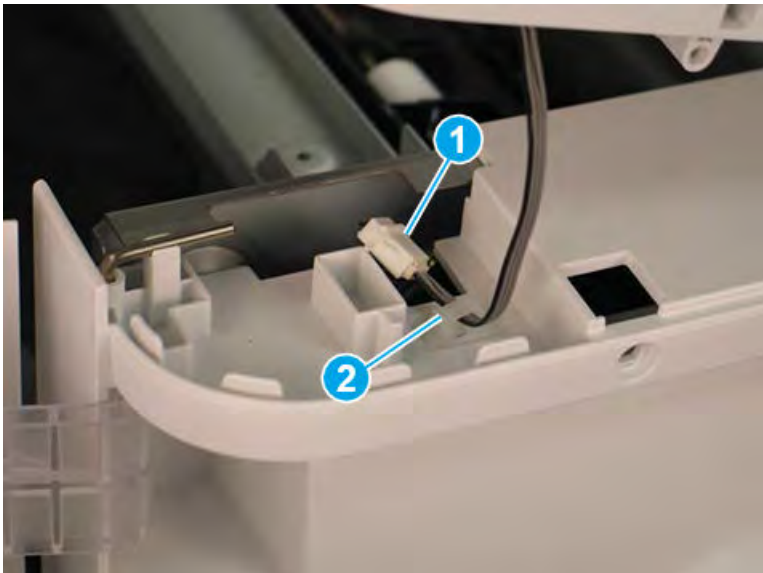
1. Remove two self-tapping screws (callout 1) on the top of the rear cover, and then remove five screw caps and five machine screws (callout 2) on the left side of the cover.

Figure 5-173 Remove seven screws

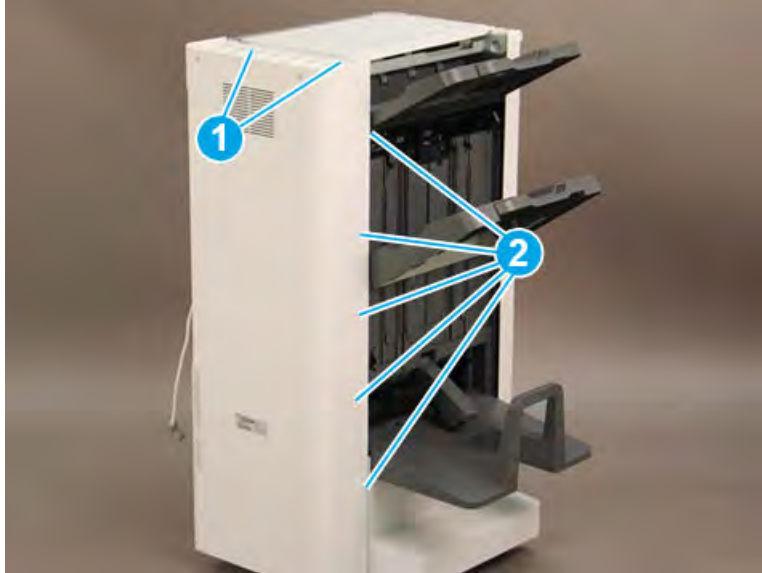

2. Remove one screw cap and four machine screws (callout 1) Remove the rear cover.

 **NOTE:** Make sure to thread the power cable (callout 2) through the opening in the cover.

 **TIP:** Reverse the removal steps to install the assembly

Figure 5-174 Remove the rear cover



Unpack the replacement assembly

Follow these steps to unpack the replacement assembly.

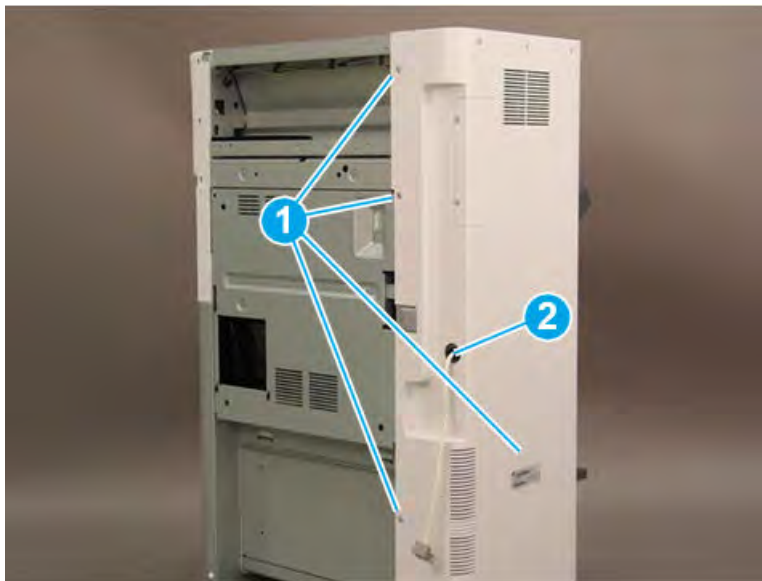
1. Dispose of the defective part.

 **NOTE:** HP recommends responsible disposal of the defective part.

<http://www8.hp.com/us/en/hp-information/environment/product-recycling.html>

2. Unpack the replacement part from the packaging.



CAUTION:  Some parts are sensitive to electrostatic discharge (ESD). Always perform service work at an ESD-protected workstation or mat. If an ESD workstation or mat is not available, touch the sheet-metal chassis to provide a static ground before touching an ESD-sensitive assembly. Protect the ESD-sensitive assemblies by placing them in ESD pouches when they are out of the printer.

 **IMPORTANT:** Make sure that all of the shipping materials (for example shipping tape) are removed from the replacement part prior to installation.

 **NOTE:** If the replacement part is a roller or pad, avoid touching the spongy part of it. Skin oils on the roller or pad can cause paper pickup and/or print-quality problems. HP recommends using disposable gloves when handling rollers or pads or washing your hands before touching rollers or pads.

3. To install an assembly, reverse the removal steps.

 **NOTE:** When applicable, special installation instructions are provided for an assembly at the end of the removal procedure. Always completely read the removal instructions and follow all special installation instructions.

Removal and replacement: Front cover

Learn how to remove and replace the front cover.

Introduction

This document provides the procedures to remove and replace the front cover for the finisher.

 **IMPORTANT:** When applicable, special installation instructions are provided for an assembly at the end of the removal procedure. Always completely read the removal instructions and follow all special installation instructions.

Before performing service

- Turn the printer power off. A shutting-down message appears on the control-panel display.
- ⚠ **WARNING!** To avoid damage to the printer, turn the power off and wait until the printer shuts down before removing the power cable.
- Disconnect the printer power cable after the printer has completely shut down (the control-panel display is blank).
- Release the finisher from the printer by pulling out on the release latch inside the finisher door.
- Disconnect the cable from the bridge unit to the finisher.
- Disconnect the cable from the finisher to the printer.

Use the table below to identify the correct part number for your printer. To order the part, go to <https://parts.hp.com>.

Table 5-90 Part information

Part number	Part description
JC63-04986B	Front cover

Required tools

- #2 JIS screwdriver with a magnetic tip
- Small, flat-blade screwdriver

After performing service

- Connect the cable from the finisher to the printer.
- Connect the cable from the bridge unit to the finisher.
- Attach the finisher to the printer, and then push in on the release latch inside the finisher door.
- Connect the printer power cable.
- Turn the printer power on.

Post service test

Process a job through the finisher and verify that the finisher works correctly.

Remove the right upper cover (finisher)

Follow these steps to remove the right upper cover (finisher).

- ▲ Remove one screw cap and three machine screws on the upper edge of the cover (callout 1). Remove three sheet metal screws (callout 2) on the lower portion of the cover. Rotate the right edge of the cover away from the finisher, and then slide the cover right to release three tabs (callout 3).

💡 **TIP:** The lower screws are shorter in length than the upper screws.

TIP: Reverse the removal steps to install the assembly.

Figure 5-175 Remove the right upper cover

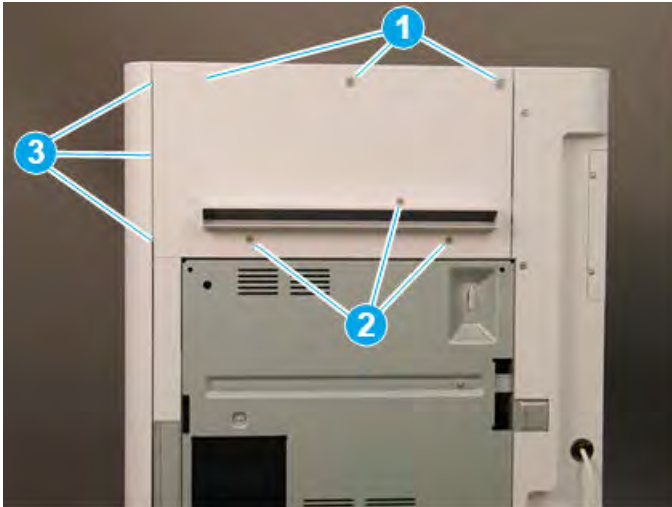

Remove the top cover (finisher)

Follow these steps to remove the top cover (finisher).

1. Remove three screw caps and three self-tapping screws at the top of the rear cover (callout 1), and then remove three machine screws (callout 2) on top of the cover.

Figure 5-176 Remove six screws

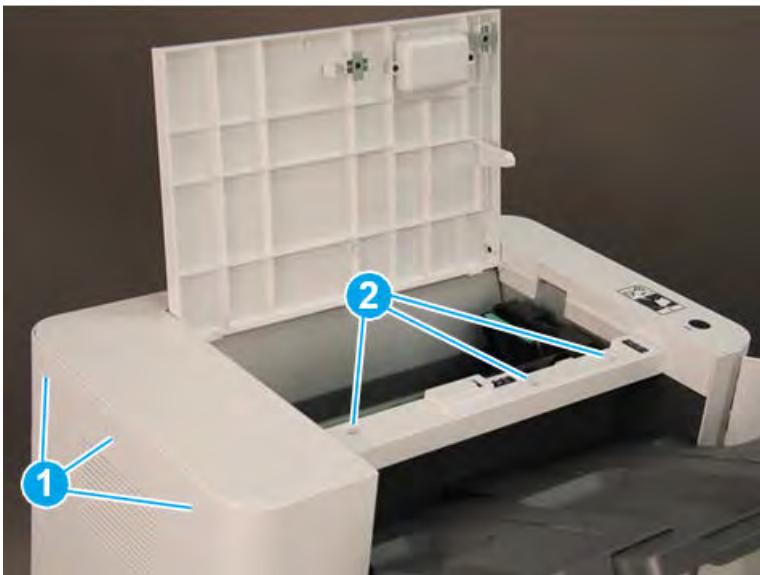

2. Remove three self-tapping screws at the top of the front cover (callout 1), and then remove two machine screws (callout 2) at the top of the right side.

Figure 5-177 Remove five screws

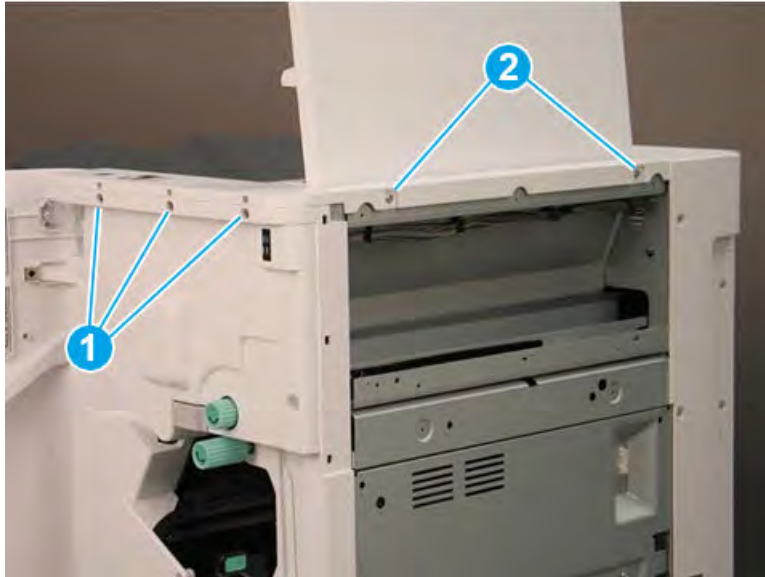

3. Lift the cover up slightly. Disconnect one in-line connector (callout 1), and then release one retainer (callout 2).

 **TIP:** Reverse the removal steps to install the assembly.

Figure 5-178 Disconnect one connector and release retainer



Remove the front door (finisher)

Follow these steps to remove the front door (finisher).

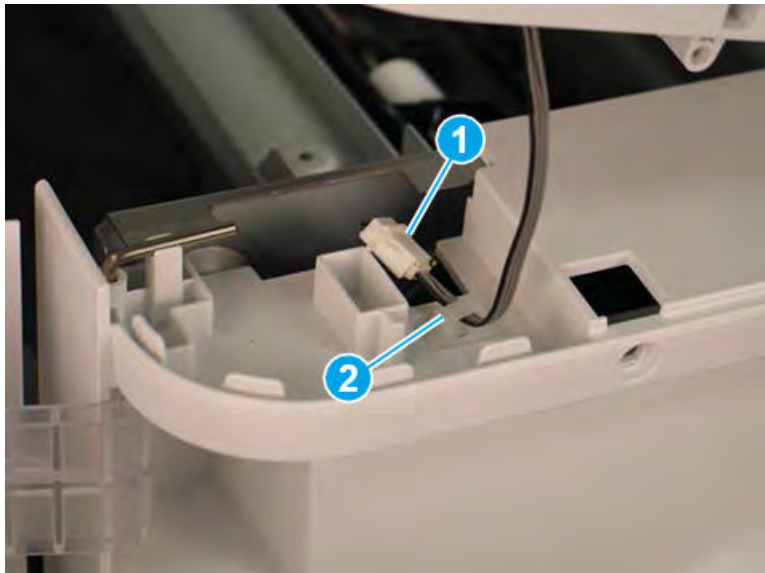
1. Lift the top hinge pin up to release it from the retainer.

Figure 5-179 Lift the top hinge pin

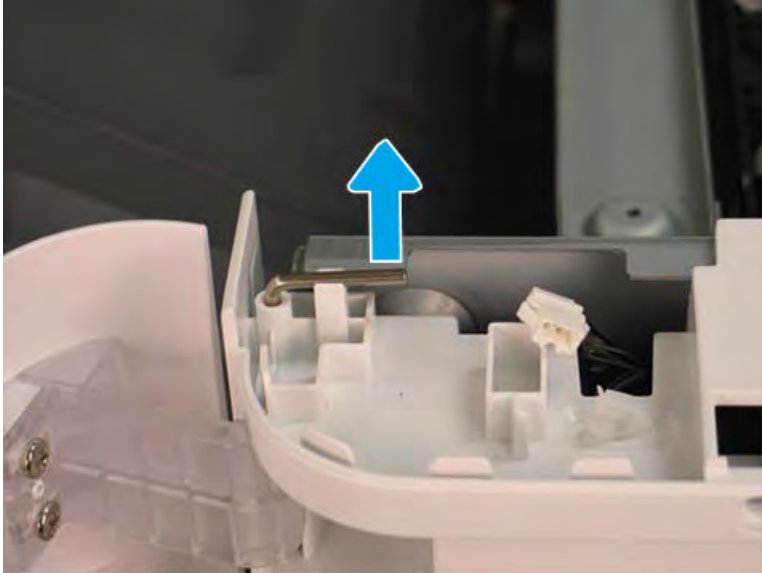

2. Pull the top hinge pin up to remove it.

Figure 5-180 Remove the top hinge pin

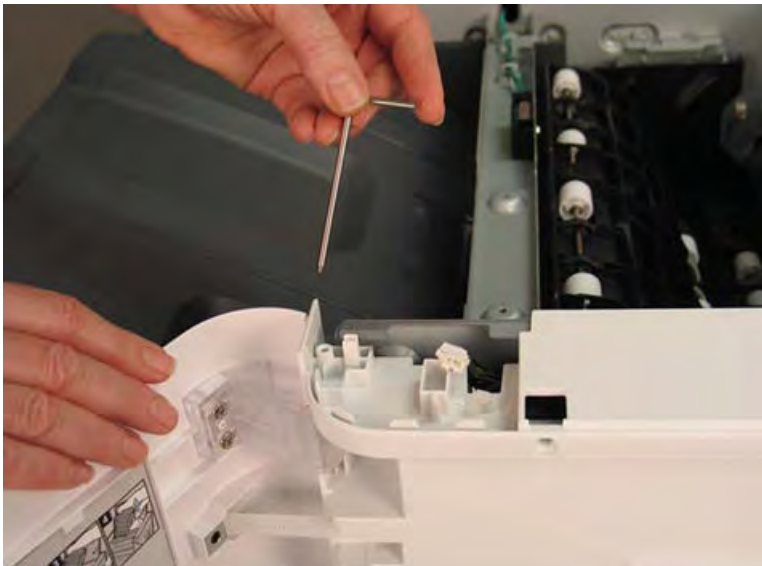

3. Use a small, flat-blade screwdriver to release the lower hinge pin from the retainer, and then rotate it away from the finisher.

Figure 5-181 Release the lower hinge pin



4. Support the door with one hand, and then pull the lower hinge pin straight up to remove it.

Figure 5-182 Remove the lower hinge pin



5. Support the door with one hand, and then remove one screw (callout 1) to release the strap. Remove the front door.

 **TIP:** Reverse the removal steps to install the assembly.

Figure 5-183 Remove the front door



Remove the front cover (finisher)

Follow these steps to remove the front cover (finisher).

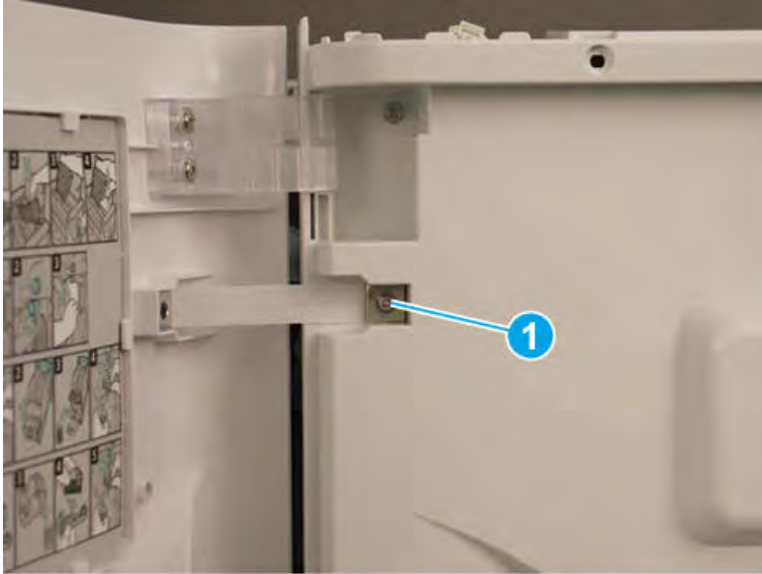
1. Release one tab (callout 1), and then pull the jam-access knob away from the finisher to remove it.

Figure 5-184 Remove the jam-access knob

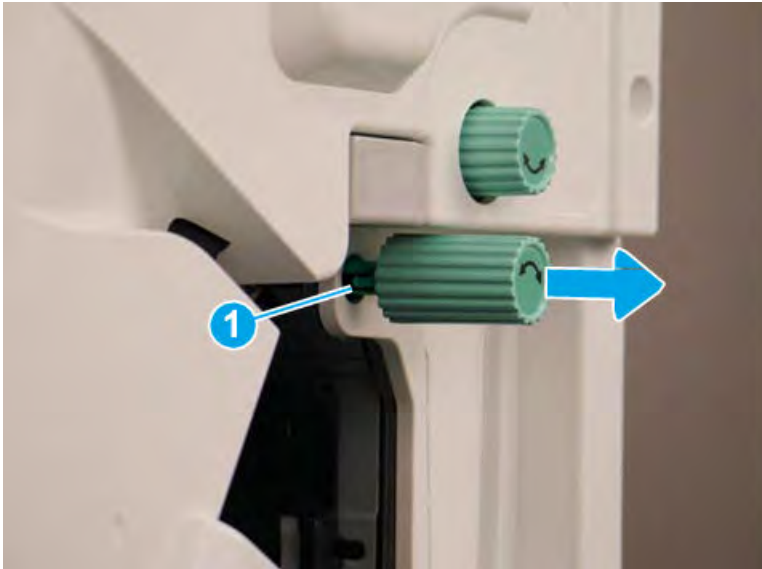

2. If the punch unit is installed, remove the punch waste bin (callout 1).

3. Remove one screw (callout 1) on top of the front cover.

Figure 5-185 Remove one screw



4. Remove five machine screws (callout 1), and then remove the front cover.

 **TIP:** Reverse the removal steps to install the assembly.

Figure 5-186 Remove the front cover



Unpack the replacement assembly

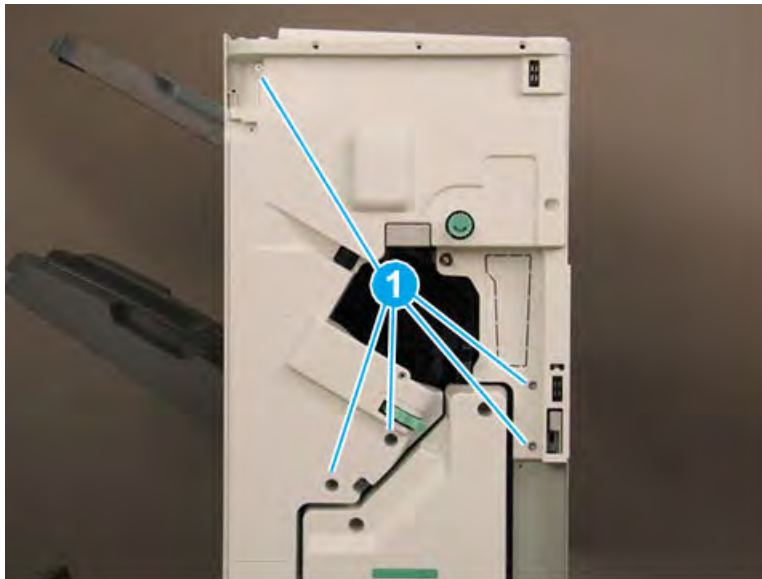

Follow these steps to unpack the replacement assembly.

1. Dispose of the defective part.

 **NOTE:** HP recommends responsible disposal of the defective part.

<http://www8.hp.com/us/en/hp-information/environment/product-recycling.html>

2. Unpack the replacement part from the packaging.

 **CAUTION:**  Some parts are sensitive to electrostatic discharge (ESD). Always perform service work at an ESD-protected workstation or mat. If an ESD workstation or mat is not available, touch the sheet-metal chassis to provide a static ground before touching an ESD-sensitive assembly. Protect the ESD-sensitive assemblies by placing them in ESD pouches when they are out of the printer.

 **IMPORTANT:** Make sure that all of the shipping materials (for example shipping tape) are removed from the replacement part prior to installation.

 **NOTE:** If the replacement part is a roller or pad, avoid touching the spongy part of it. Skin oils on the roller or pad can cause paper pickup and/or print-quality problems. HP recommends using disposable gloves when handling rollers or pads or washing your hands before touching rollers or pads.

3. To install an assembly, reverse the removal steps.

 **NOTE:** When applicable, special installation instructions are provided for an assembly at the end of the removal procedure. Always completely read the removal instructions and follow all special installation instructions.

Removal and replacement: Front lower cover

Learn how to remove and replace the front lower cover.

Introduction

This document provides the procedures to remove and replace the front lower cover for the finisher.



IMPORTANT: When applicable, special installation instructions are provided for an assembly at the end of the removal procedure. Always completely read the removal instructions and follow all special installation instructions.

Before performing service

- Turn the printer power off. A shutting-down message appears on the control-panel display.
- ⚠ **WARNING!** To avoid damage to the printer, turn the power off and wait until the printer shuts down before removing the power cable.
- Disconnect the printer power cable after the printer has completely shut down (the control-panel display is blank).
- Release the finisher from the printer by pulling out on the release latch inside the finisher door.
- Disconnect the cable from the bridge unit to the finisher.
- Disconnect the cable from the finisher to the printer.

Use the table below to identify the correct part number for your printer. To order the part, go to <https://parts.hp.com>.

Table 5-91 Part information

Part number	Part description
JC63-04987B	Front lower cover

Required tools

- #2 JIS screwdriver with a magnetic tip
- Small, flat-blade screwdriver

After performing service

- Connect the cable from the finisher to the printer.
- Connect the cable from the bridge unit to the finisher.
- Attach the finisher to the printer, and then push in on the release latch inside the finisher door.
- Connect the printer power cable.
- Turn the printer power on.

Post service test

Process a job through the finisher and verify that the finisher works correctly.

Remove the right upper cover (finisher)

Follow these steps to remove the right upper cover (finisher).

- ▲ Remove one screw cap and three machine screws on the upper edge of the cover (callout 1). Remove three sheet metal screws (callout 2) on the lower portion of the cover. Rotate the right edge of the cover away from the finisher, and then slide the cover right to release three tabs (callout 3).

💡 **TIP:** The lower screws are shorter in length than the upper screws.

TIP: Reverse the removal steps to install the assembly.

Figure 5-187 Remove the right upper cover

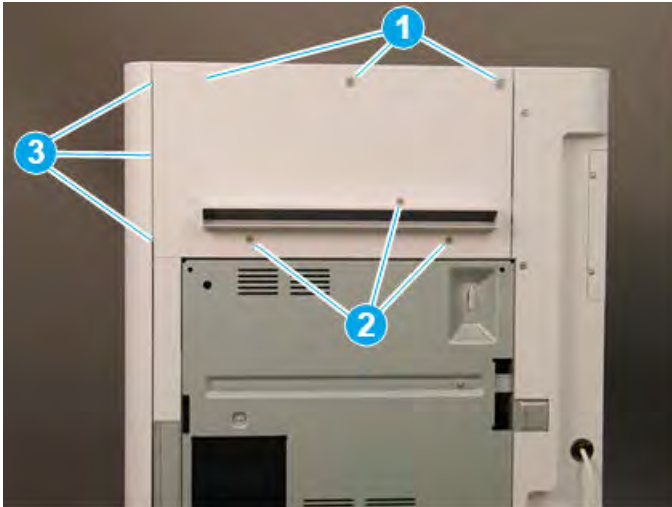

Remove the top cover (finisher)

Follow these steps to remove the top cover (finisher).

1. Remove three screw caps and three self-tapping screws at the top of the rear cover (callout 1), and then remove three machine screws (callout 2) on top of the cover.

Figure 5-188 Remove six screws

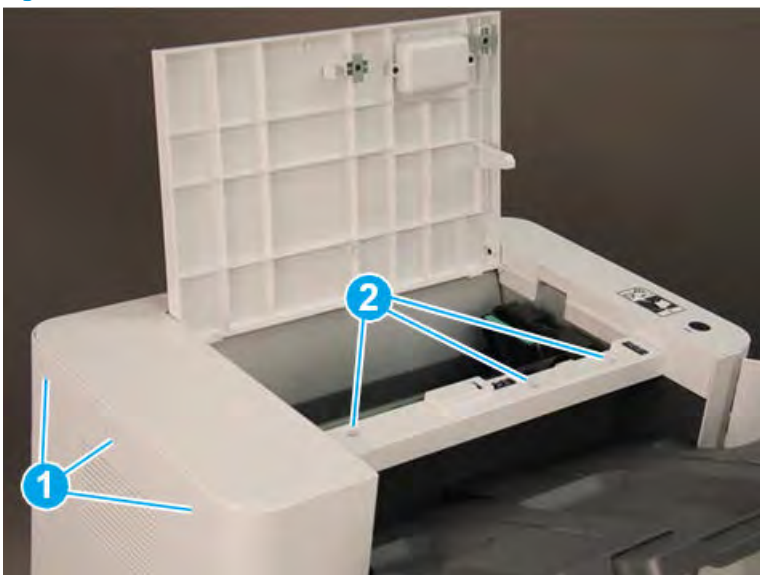

2. Remove three self-tapping screws at the top of the front cover (callout 1), and then remove two machine screws (callout 2) at the top of the right side.

Figure 5-189 Remove five screws

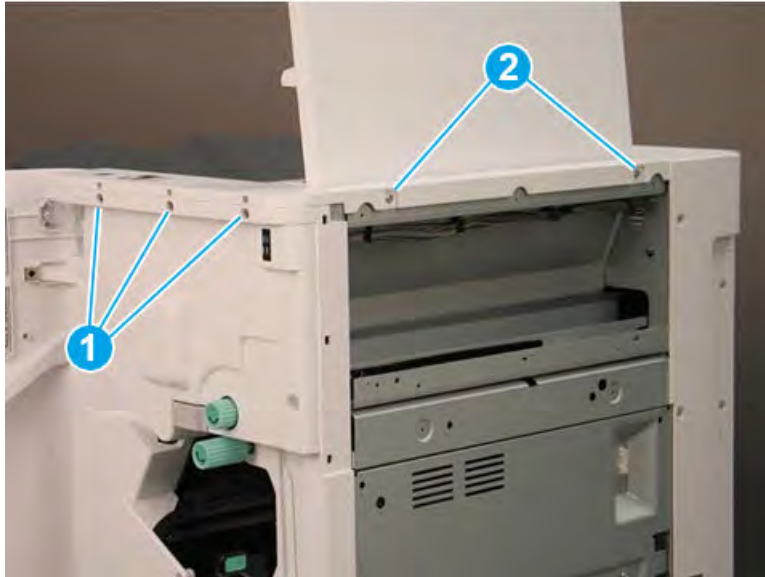

3. Lift the cover up slightly. Disconnect one in-line connector (callout 1), and then release one retainer (callout 2).

 **TIP:** Reverse the removal steps to install the assembly.

Figure 5-190 Disconnect one connector and release retainer



Remove the front door (finisher)

Follow these steps to remove the front door (finisher).

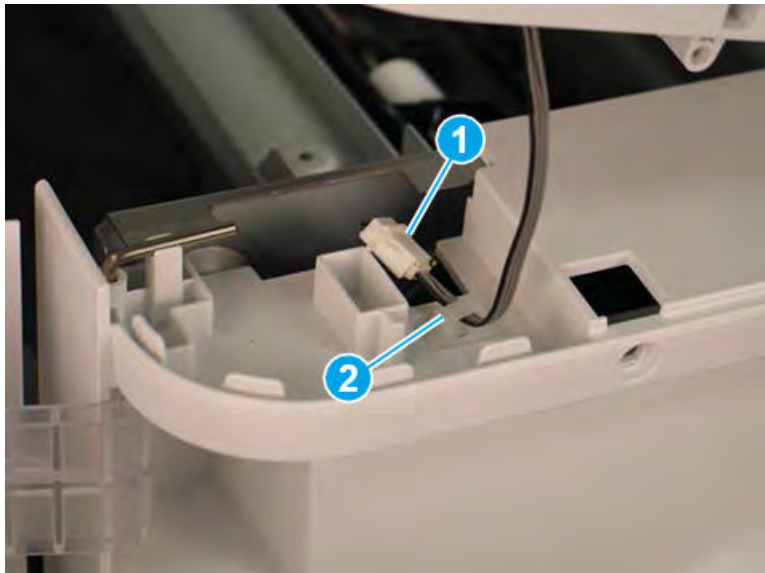
1. Lift the top hinge pin up to release it from the retainer.

Figure 5-191 Lift the top hinge pin

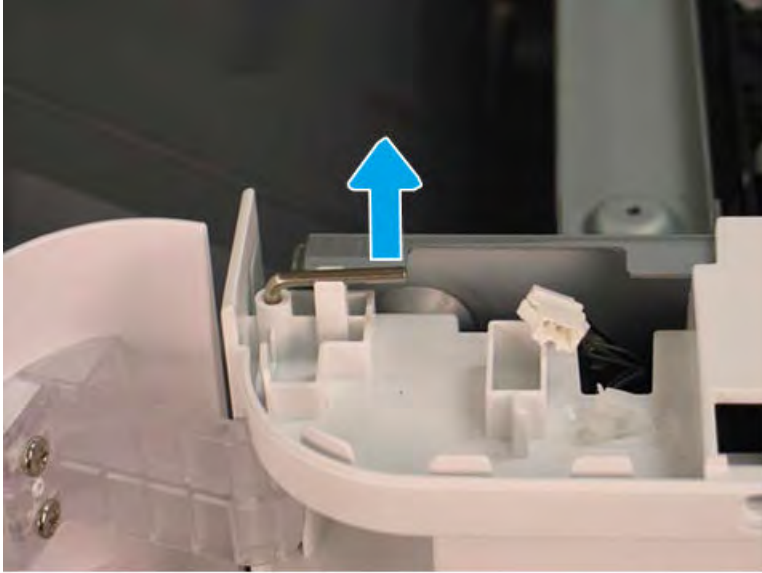

2. Pull the top hinge pin up to remove it.

Figure 5-192 Remove the top hinge pin

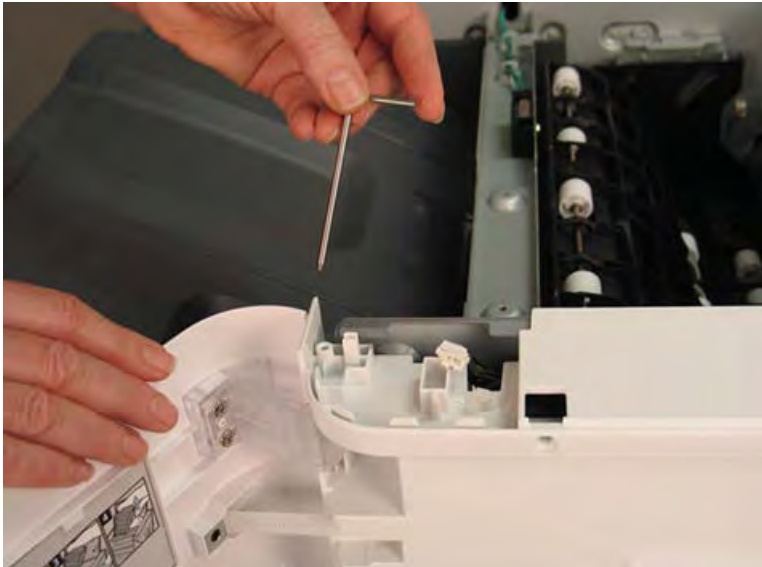

3. Use a small, flat-blade screwdriver to release the lower hinge pin from the retainer, and then rotate it away from the finisher.

Figure 5-193 Release the lower hinge pin



4. Support the door with one hand, and then pull the lower hinge pin straight up to remove it.

Figure 5-194 Remove the lower hinge pin



5. Support the door with one hand, and then remove one screw (callout 1) to release the strap. Remove the front door.

 **TIP:** Reverse the removal steps to install the assembly.

Figure 5-195 Remove the front door



Remove the front cover (finisher)

Follow these steps to remove the front cover (finisher).

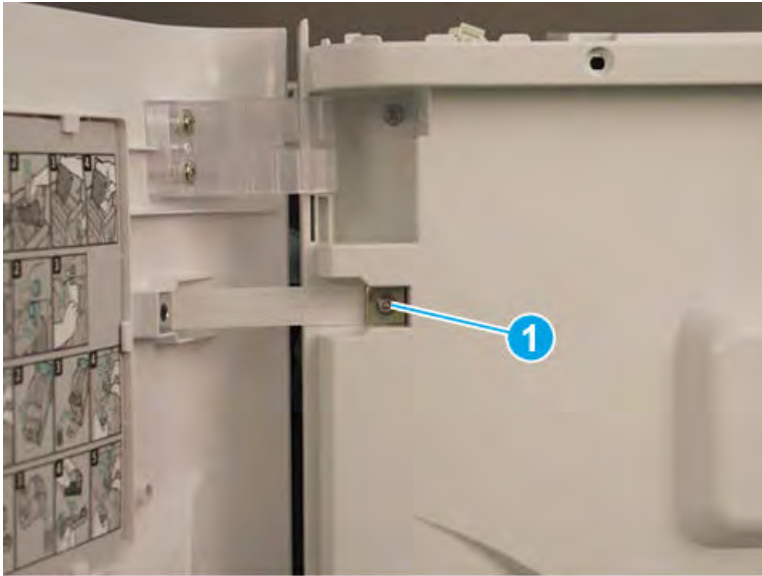
1. Release one tab (callout 1), and then pull the jam-access knob away from the finisher to remove it.

Figure 5-196 Remove the jam-access knob

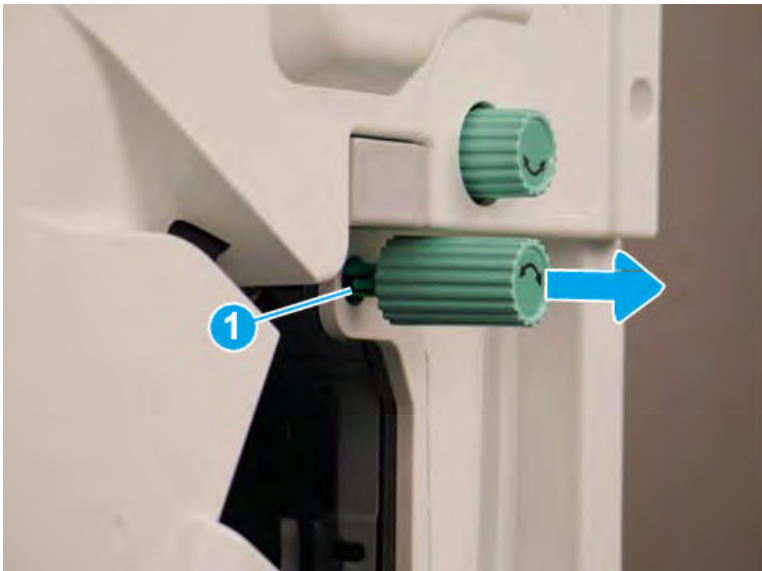

2. If the punch unit is installed, remove the punch waste bin (callout 1).

3. Remove one screw (callout 1) on top of the front cover.

Figure 5-197 Remove one screw



4. Remove five machine screws (callout 1), and then remove the front cover.

 **TIP:** Reverse the removal steps to install the assembly.

Figure 5-198 Remove the front cover



Remove the front lower cover (finisher)

Follow these steps to remove the front lower cover (finisher).

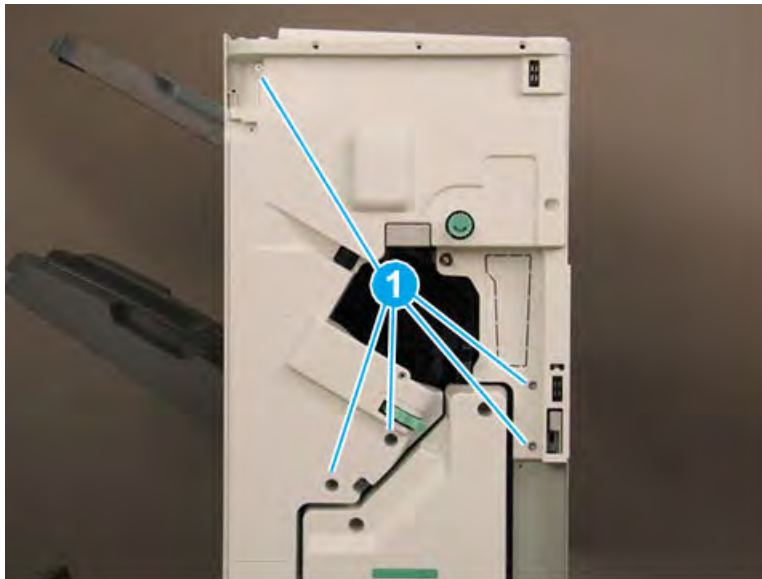
- ▲ Remove three machine screws (callout 1), and then remove the front lower cover.

 **TIP:** Reverse the removal steps to install the assembly.

Figure 5-199 Remove the front lower cover



Unpack the replacement assembly



Follow these steps to unpack the replacement assembly.

1. Dispose of the defective part.

 **NOTE:** HP recommends responsible disposal of the defective part.

<http://www8.hp.com/us/en/hp-information/environment/product-recycling.html>

2. Unpack the replacement part from the packaging.

 **CAUTION:**  Some parts are sensitive to electrostatic discharge (ESD). Always perform service work at an ESD-protected workstation or mat. If an ESD workstation or mat is not available, touch the sheet-metal chassis to provide a static ground before touching an ESD-sensitive assembly. Protect the ESD-sensitive assemblies by placing them in ESD pouches when they are out of the printer.

 **IMPORTANT:** Make sure that all of the shipping materials (for example shipping tape) are removed from the replacement part prior to installation.

 **NOTE:** If the replacement part is a roller or pad, avoid touching the spongy part of it. Skin oils on the roller or pad can cause paper pickup and/or print-quality problems. HP recommends using disposable gloves when handling rollers or pads or washing your hands before touching rollers or pads.

3. To install an assembly, reverse the removal steps.

 **NOTE:** When applicable, special installation instructions are provided for an assembly at the end of the removal procedure. Always completely read the removal instructions and follow all special installation instructions.

Removal and replacement: Caster cover

Learn how to remove and replace the caster cover.

Introduction

This document provides the procedures to remove and replace the caster cover on the finisher.

 **IMPORTANT:** When applicable, special installation instructions are provided for an assembly at the end of the removal procedure. Always completely read the removal instructions and follow all special installation instructions.

Before performing service

- Turn the printer power off. A shutting-down message appears on the control-panel display.
- ⚠ **WARNING!** To avoid damage to the printer, turn the power off and wait until the printer shuts down before removing the power cable.
- Disconnect the printer power cable after the printer has completely shut down (the control-panel display is blank).
- Release the finisher from the printer by pulling out on the release latch inside the finisher door.
- Disconnect the cable from the bridge unit to the finisher.
- Disconnect the cable from the finisher to the printer.

Use the table below to identify the correct part number for your printer. To order the part, go to <https://parts.hp.com>.

Table 5-92 Part information

Part number	Part description
JC63-04985B	Caster cover

Required tools

- #2 JIS screwdriver with a magnetic tip

After performing service

- Connect the cable from the finisher to the printer.
- Connect the cable from the bridge unit to the finisher.
- Attach the finisher to the printer, and then push in on the release latch inside the finisher door.
- Connect the printer power cable.
- Turn the printer power on.

Post service test

Process a job through the finisher and verify that the finisher works correctly.

Remove the booklet output tray

Follow these steps to remove the booklet output tray.

1. Raise the booklet output tray up (callout 1), and then pull it away from the finisher (callout 2) to remove it.

Figure 5-200 Remove the booklet output tray

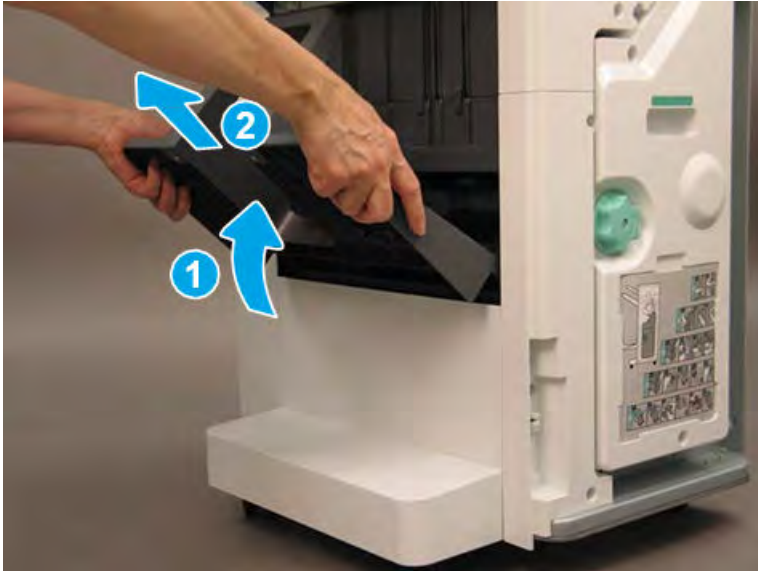

2. Reverse the removal steps to install the assembly. Also use the following special installation instructions.

 **NOTE:** Continue to reverse the removal steps to finish installing the assembly

Special installation instructions: booklet output tray

Position the tabs (callout 1) on the tray into the slots (callout 2) on the finisher.

Figure 5-201 Install the booklet output tray

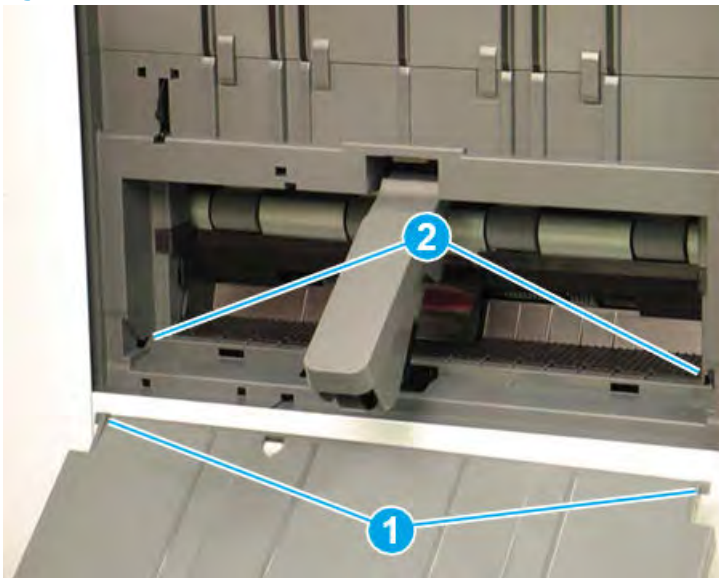

Remove the caster cover

Follow these steps to remove the caster cover.

1. Remove two screw caps and two self-tapping screws (callout 1). Remove two screw caps and two machine screws (callout 2).

Figure 5-202 Remove four screws

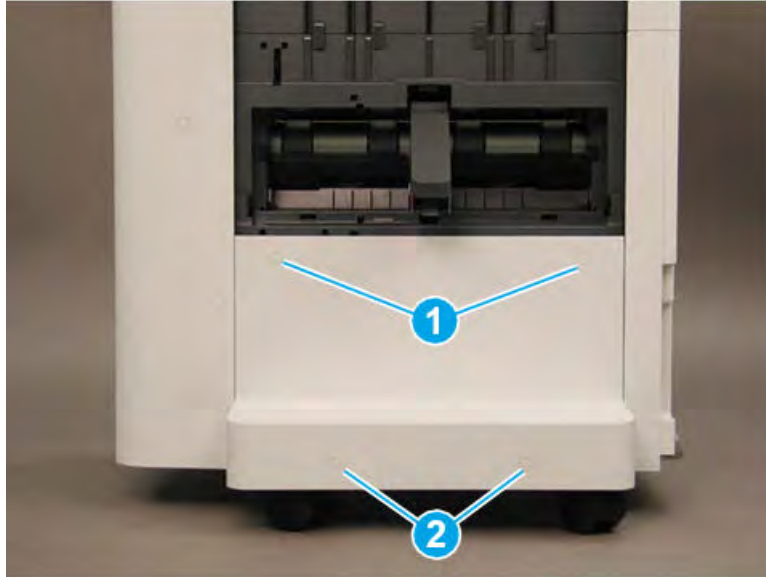

2. Rotate the left edge of the cover away from the finisher (callout 1), and then slide the cover to the left (callout 2) to remove it.

 **TIP:** Make sure that two tabs (callout 3) are positioned under the front lower cover when reinstalling the caster cover.

TIP: Reverse the removal steps to install the assembly

Figure 5-203 Remove the caster cover

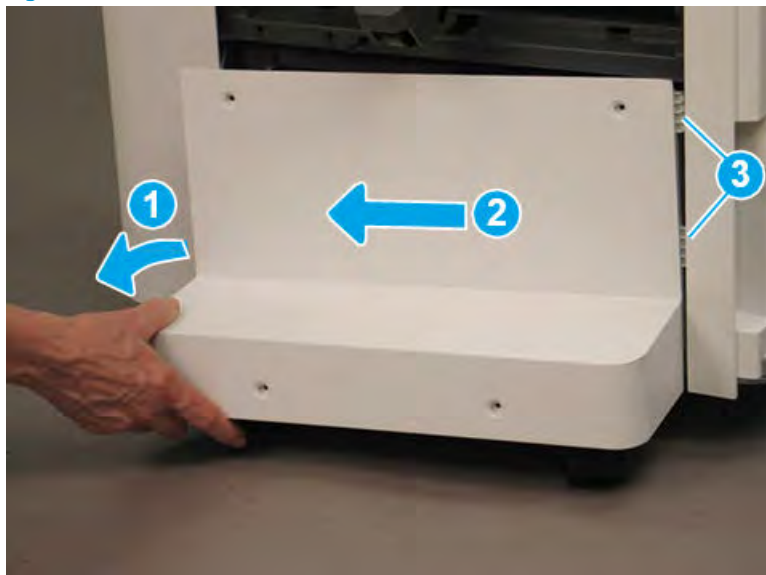

Unpack the replacement assembly



Follow these steps to unpack the replacement assembly.

1. Dispose of the defective part.

 **NOTE:** HP recommends responsible disposal of the defective part.

<http://www8.hp.com/us/en/hp-information/environment/product-recycling.html>

2. Unpack the replacement part from the packaging.

 **CAUTION:**  Some parts are sensitive to electrostatic discharge (ESD). Always perform service work at an ESD-protected workstation or mat. If an ESD workstation or mat is not available, touch the sheet-metal chassis to provide a static ground before touching an ESD-sensitive assembly. Protect the ESD-sensitive assemblies by placing them in ESD pouches when they are out of the printer.

 **IMPORTANT:** Make sure that all of the shipping materials (for example shipping tape) are removed from the replacement part prior to installation.

 **NOTE:** If the replacement part is a roller or pad, avoid touching the spongy part of it. Skin oils on the roller or pad can cause paper pickup and/or print-quality problems. HP recommends using disposable gloves when handling rollers or pads or washing your hands before touching rollers or pads.

3. To install an assembly, reverse the removal steps.

 **NOTE:** When applicable, special installation instructions are provided for an assembly at the end of the removal procedure. Always completely read the removal instructions and follow all special installation instructions.

Removal and replacement: Left lower cover

Learn how to remove and replace the left lower cover.

Introduction

This document provides the procedures to remove and replace the left lower cover on the finisher.

 **IMPORTANT:** When applicable, special installation instructions are provided for an assembly at the end of the removal procedure. Always completely read the removal instructions and follow all special installation instructions.

Before performing service

- Turn the printer power off. A shutting-down message appears on the control-panel display.
- ⚠ **WARNING!** To avoid damage to the printer, turn the power off and wait until the printer shuts down before removing the power cable.
- Disconnect the printer power cable after the printer has completely shut down (the control-panel display is blank).
- Release the finisher from the printer by pulling out on the release latch inside the finisher door.
- Disconnect the cable from the bridge unit to the finisher.
- Disconnect the cable from the finisher to the printer.

Use the table below to identify the correct part number for your printer. To order the part, go to <https://parts.hp.com>.

Table 5-93 Part information

Part number	Part description
JC90-01771B	Left lower cover (for stapler/stacker finisher)
JC90-01417B	Left lower cover (for booklet finisher)

Required tools

- #2 JIS screwdriver with a magnetic tip
- Small, flat-blade screwdriver

After performing service

- Connect the cable from the finisher to the printer.
- Connect the cable from the bridge unit to the finisher.
- Attach the finisher to the printer, and then push in on the release latch inside the finisher door.
- Connect the printer power cable.
- Turn the printer power on.

Post service test

Process a job through the finisher and verify that the finisher works correctly.

Remove the right upper cover (finisher)

Follow these steps to remove the right upper cover (finisher).

- ▲ Remove one screw cap and three machine screws on the upper edge of the cover (callout 1). Remove three sheet metal screws (callout 2) on the lower portion of the cover. Rotate the right edge of the cover away from the finisher, and then slide the cover right to release three tabs (callout 3).

💡 **TIP:** The lower screws are shorter in length than the upper screws.

TIP: Reverse the removal steps to install the assembly.

Figure 5-204 Remove the right upper cover

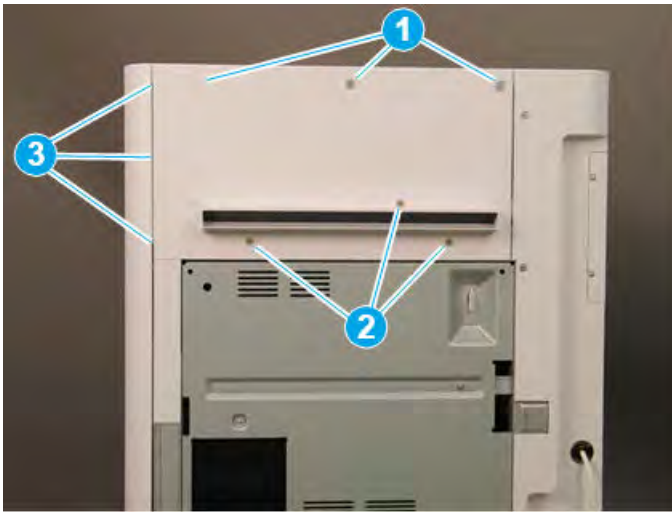

Remove the top cover (finisher)

Follow these steps to remove the top cover (finisher).

1. Remove three screw caps and three self-tapping screws at the top of the rear cover (callout 1), and then remove three machine screws (callout 2) on top of the cover.

Figure 5-205 Remove six screws

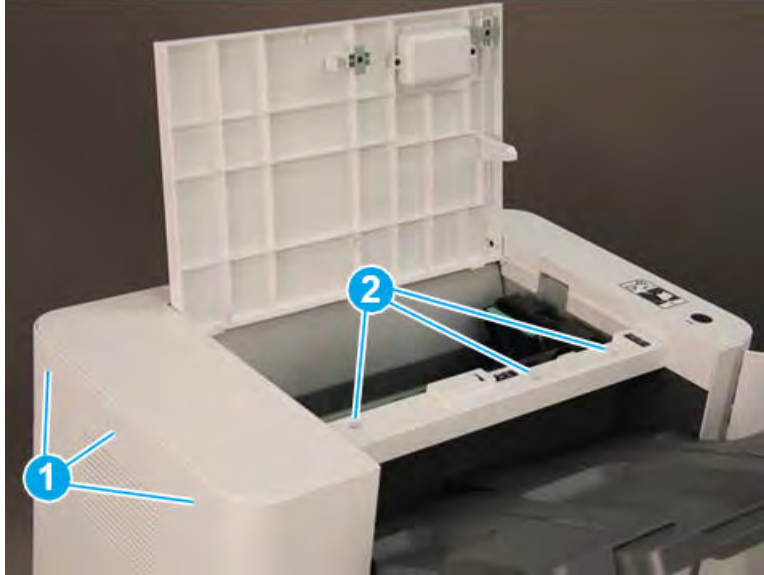

2. Remove three self-tapping screws at the top of the front cover (callout 1), and then remove two machine screws (callout 2) at the top of the right side.

Figure 5-206 Remove five screws

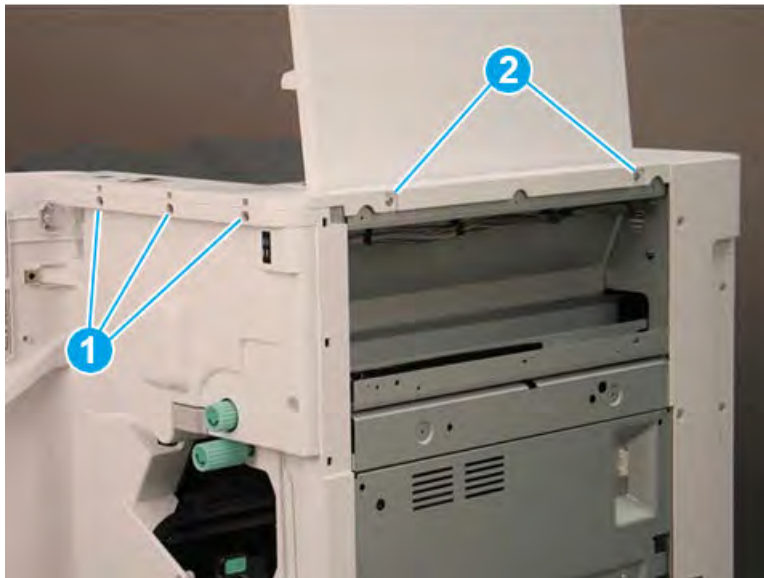

3. Lift the cover up slightly. Disconnect one in-line connector (callout 1), and then release one retainer (callout 2).

 **TIP:** Reverse the removal steps to install the assembly.

Figure 5-207 Disconnect one connector and release retainer



Remove the front door (finisher)

Follow these steps to remove the front door (finisher).

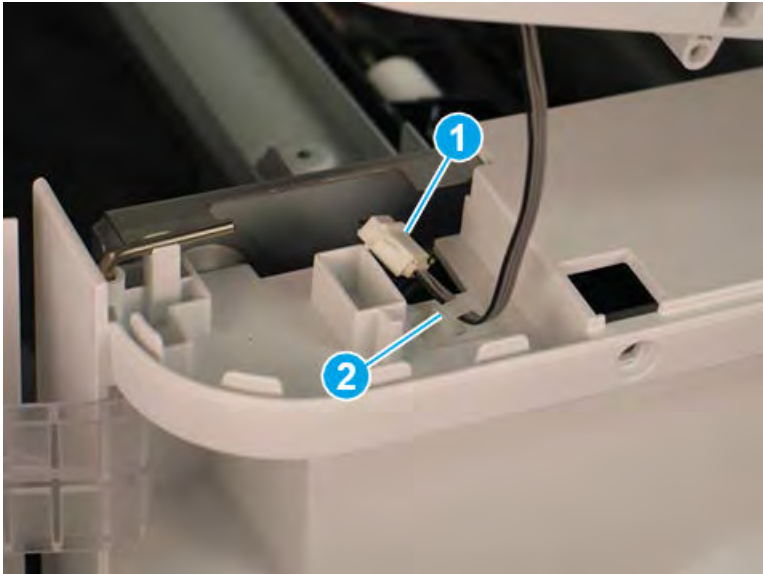
1. Lift the top hinge pin up to release it from the retainer.

Figure 5-208 Lift the top hinge pin

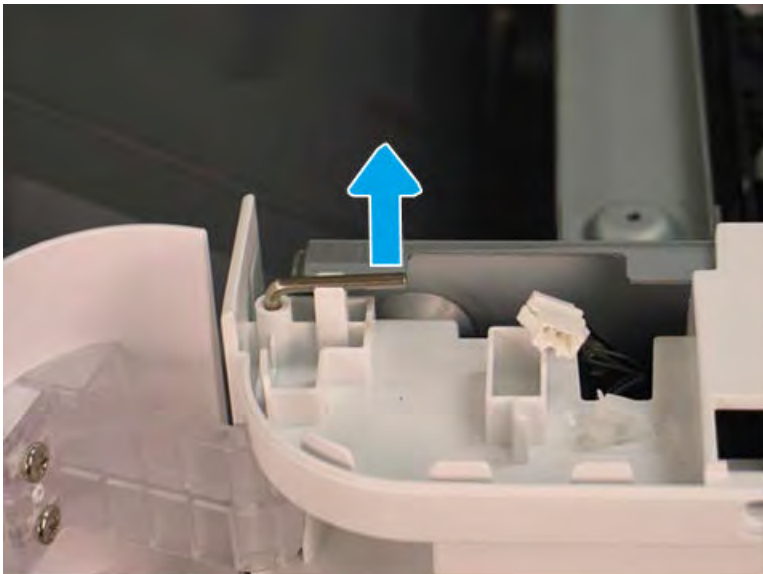

2. Pull the top hinge pin up to remove it.

Figure 5-209 Remove the top hinge pin

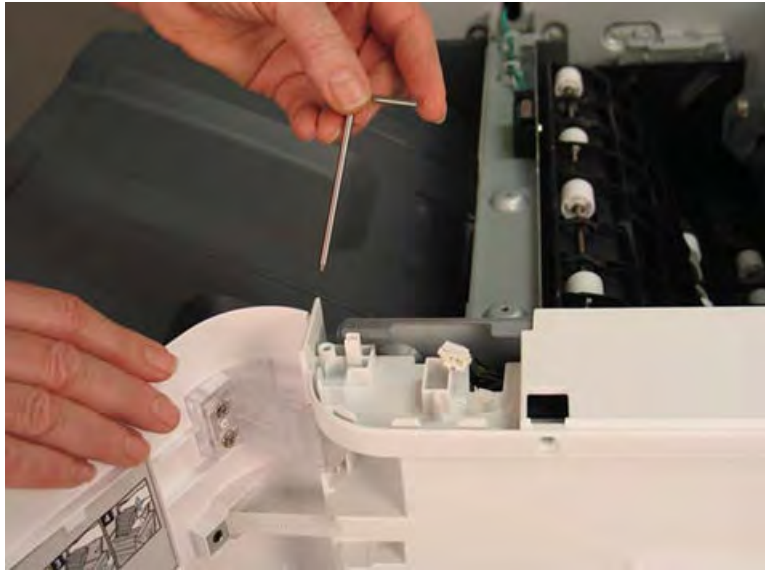

3. Use a small, flat-blade screwdriver to release the lower hinge pin from the retainer, and then rotate it away from the finisher.

Figure 5-210 Release the lower hinge pin



4. Support the door with one hand, and then pull the lower hinge pin straight up to remove it.

Figure 5-211 Remove the lower hinge pin



5. Support the door with one hand, and then remove one screw (callout 1) to release the strap. Remove the front door.

 **TIP:** Reverse the removal steps to install the assembly.

Figure 5-212 Remove the front door



Remove the front cover (finisher)

Follow these steps to remove the front cover (finisher).

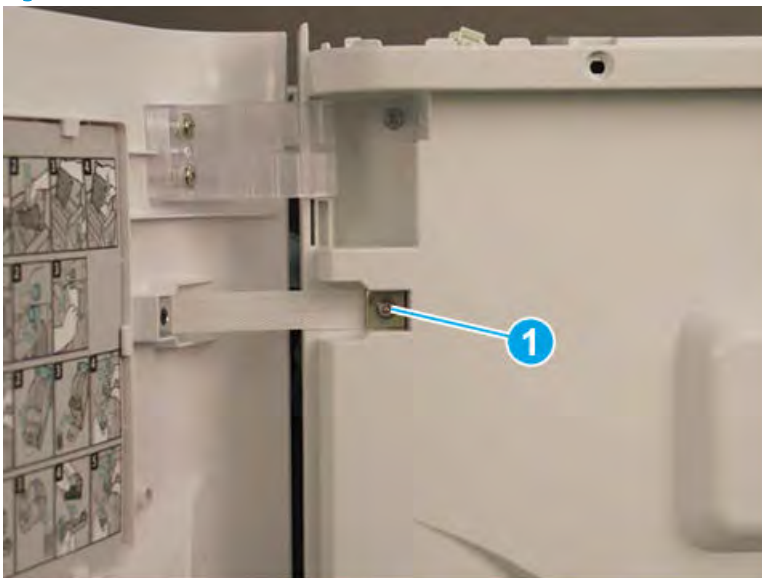
1. Release one tab (callout 1), and then pull the jam-access knob away from the finisher to remove it.

Figure 5-213 Remove the jam-access knob

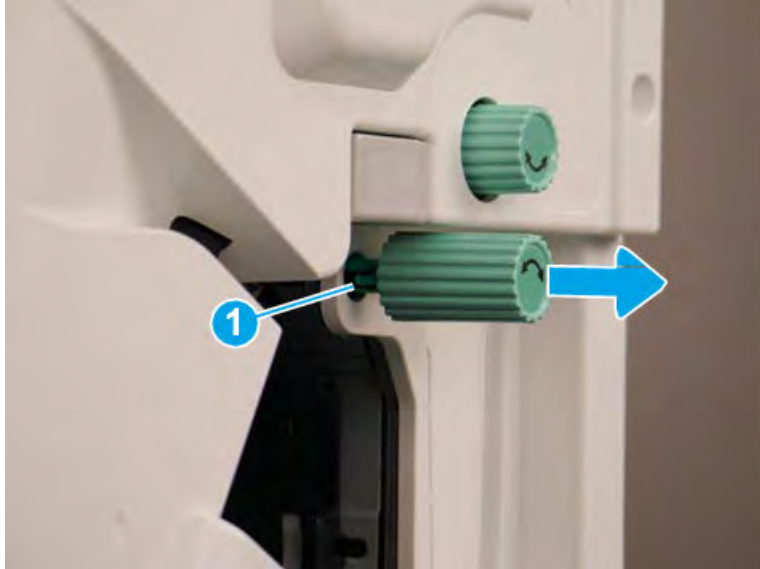

2. If the punch unit is installed, remove the punch waste bin (callout 1).
3. Remove one screw (callout 1) on top of the front cover.

Figure 5-214 Remove one screw



4. Remove five machine screws (callout 1), and then remove the front cover.

 **TIP:** Reverse the removal steps to install the assembly.

Figure 5-215 Remove the front cover



Remove the rear cover (finisher)

Follow these steps to remove the rear cover (finisher).

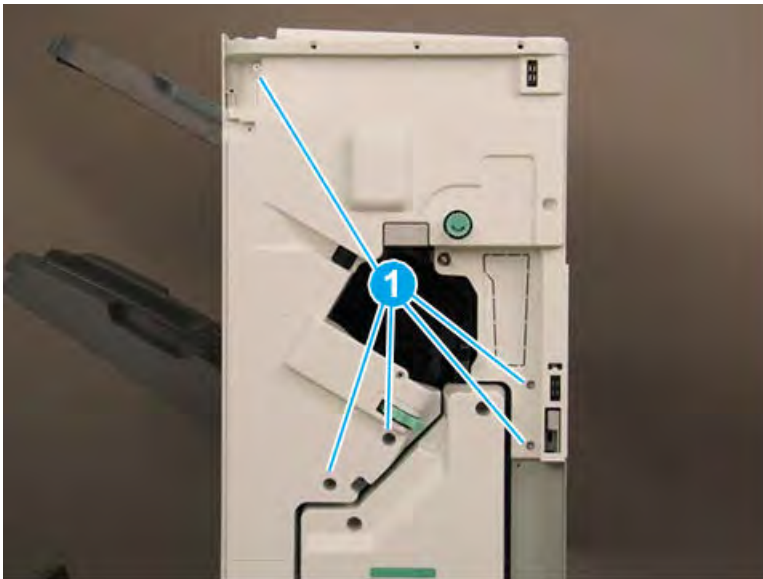
1. Remove two self-tapping screws (callout 1) on the top of the rear cover, and then remove five screw caps and five machine screws (callout 2) on the left side of the cover.

Figure 5-216 Remove seven screws

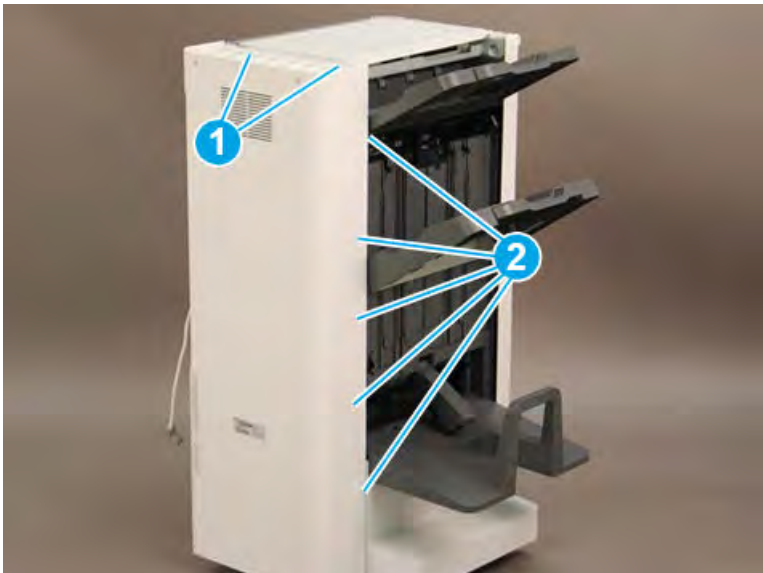

2. Remove one screw cap and four machine screws (callout 1) Remove the rear cover.

 **NOTE:** Make sure to thread the power cable (callout 2) through the opening in the cover.

 **TIP:** Reverse the removal steps to install the assembly

Figure 5-217 Remove the rear cover



Remove the booklet output tray

Follow these steps to remove the booklet output tray.

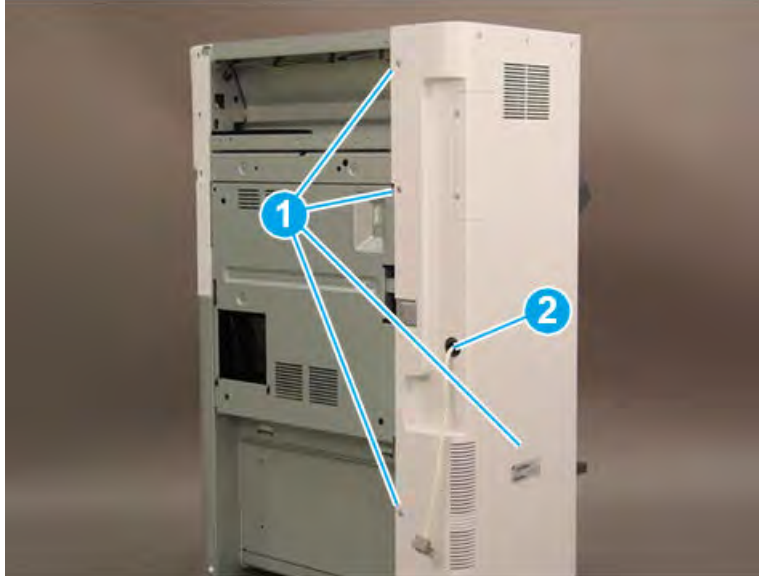
1. Raise the booklet output tray up (callout 1), and then pull it away from the finisher (callout 2) to remove it.

Figure 5-218 Remove the booklet output tray

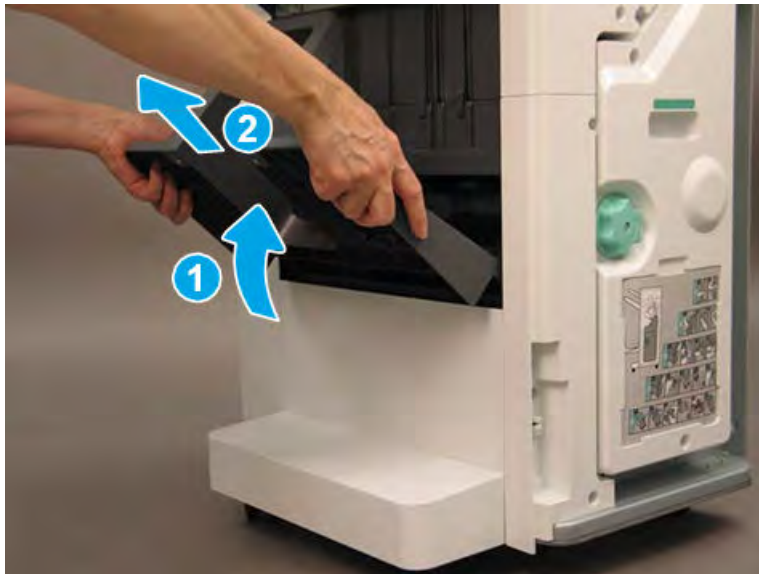

- Reverse the removal steps to install the assembly. Also use the following special installation instructions.

 **NOTE:** Continue to reverse the removal steps to finish installing the assembly

Special installation instructions: booklet output tray

Position the tabs (callout 1) on the tray into the slots (callout 2) on the finisher.

Figure 5-219 Install the booklet output tray

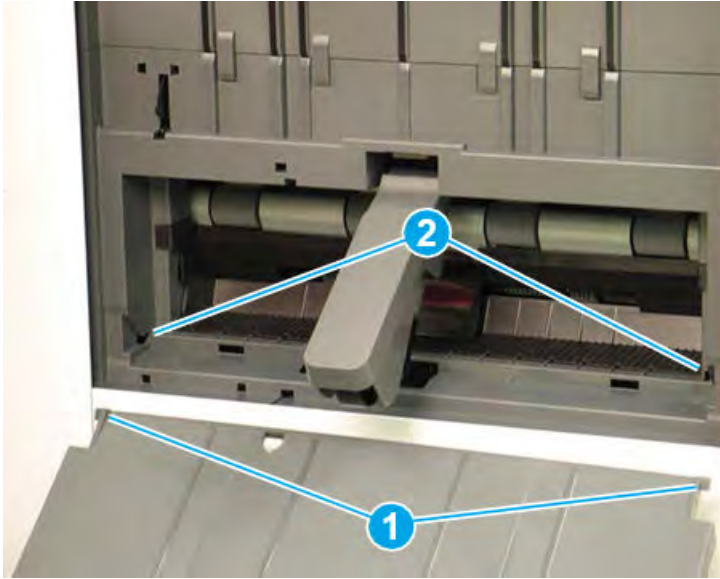

Remove the caster cover

Follow these steps to remove the caster cover.

- Remove two screw caps and two self-tapping screws (callout 1). Remove two screw caps and two machine screws (callout 2).

Figure 5-220 Remove four screws

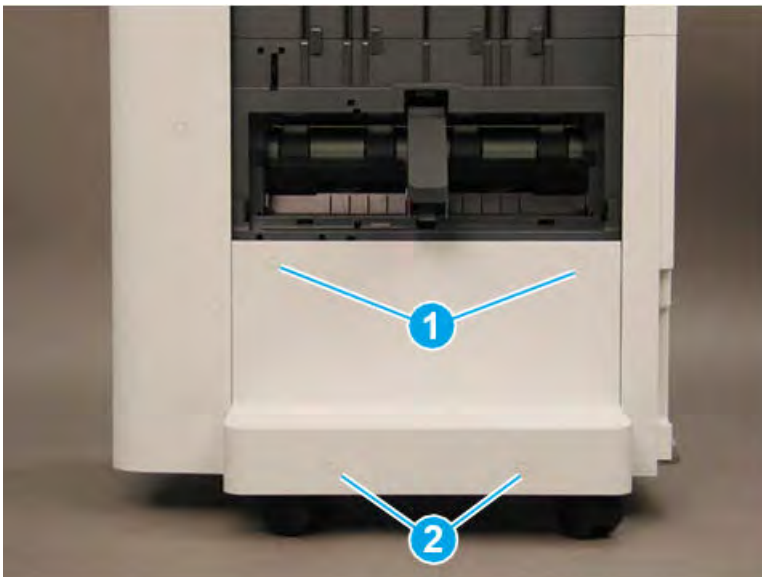

2. Rotate the left edge of the cover away from the finisher (callout 1), and then slide the cover to the left (callout 2) to remove it.

 **TIP:** Make sure that two tabs (callout 3) are positioned under the front lower cover when reinstalling the caster cover.

TIP: Reverse the removal steps to install the assembly

Figure 5-221 Remove the caster cover

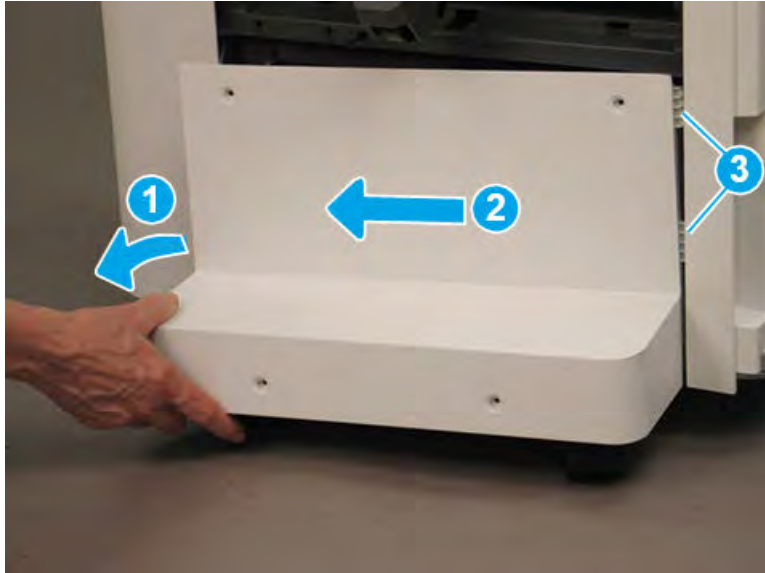

Remove the left lower cover (finisher)

Follow these steps to remove the left lower cover (finisher).

1. Remove four screws (callout 1).

 **NOTE:** Raise the lower output tray as needed to access the screws.

Figure 5-222 Remove four screws



- Slide the shield down (callout 1) to release it from four tabs (callout 2), and then rotate it away from the finisher (callout 3).

⚠ CAUTION: The shield is still attached to the finisher. Do not attempt to completely remove the shield.

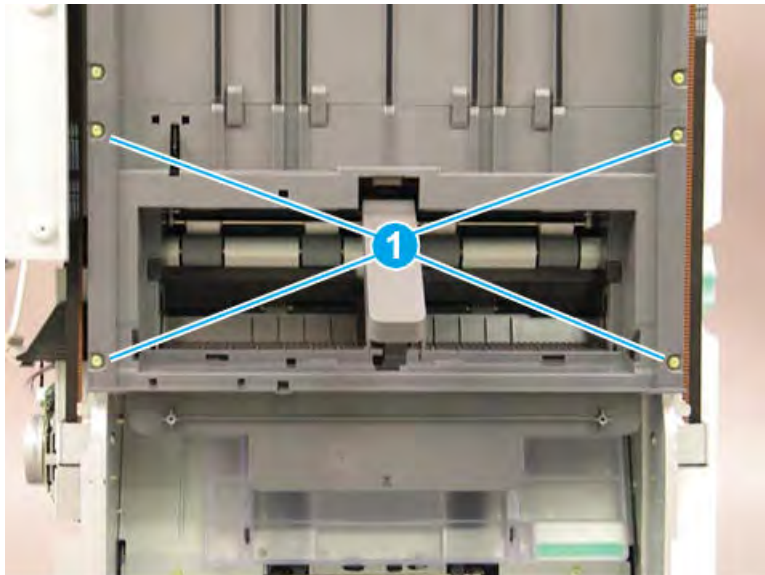
💡 TIP: Position the shield under the four tabs (callout 2) when reinstalling it.

Figure 5-223 Release the lower shield

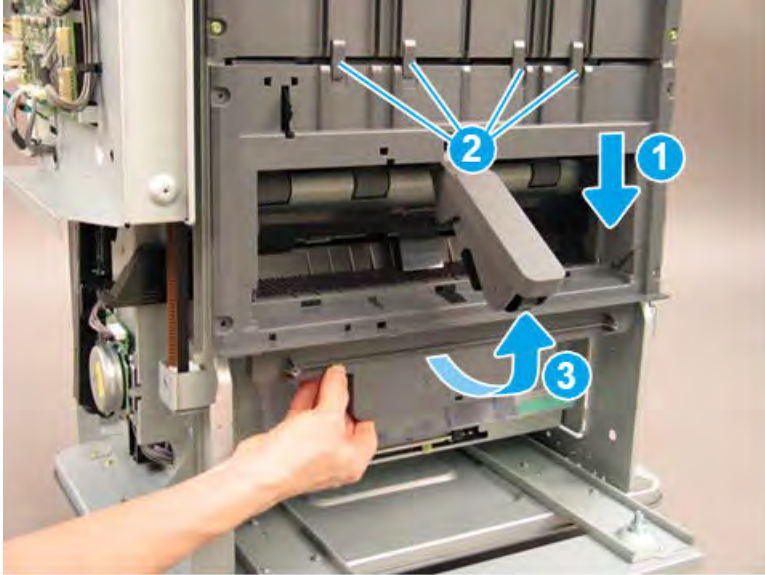

- Disconnect two connectors (callout 1), and then remove the shield.

💡 TIP: Reverse the removal steps to install the assembly.

Figure 5-224 Disconnect two connectors

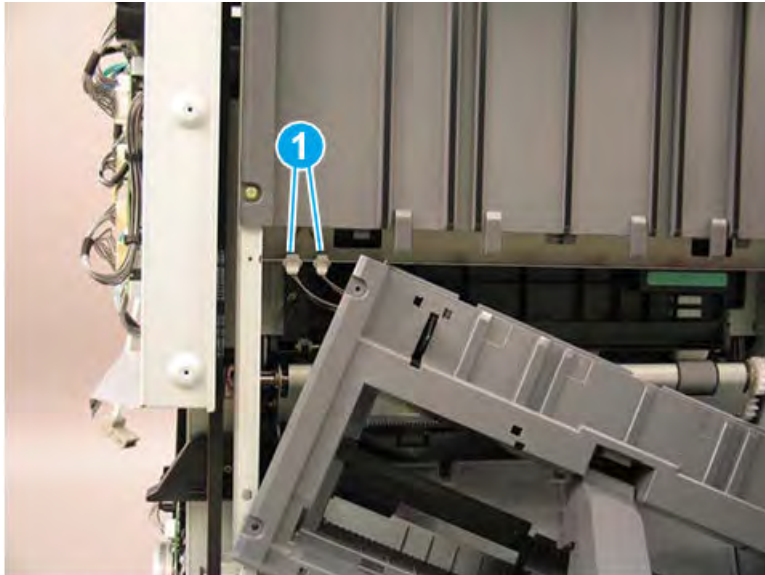

4. If you are replacing the left lower cover, locate three sensors (callout 1) on the back of the left lower cover. Remove these sensors and transfer them to the replacement part.

Figure 5-225 Remove the left lower cover

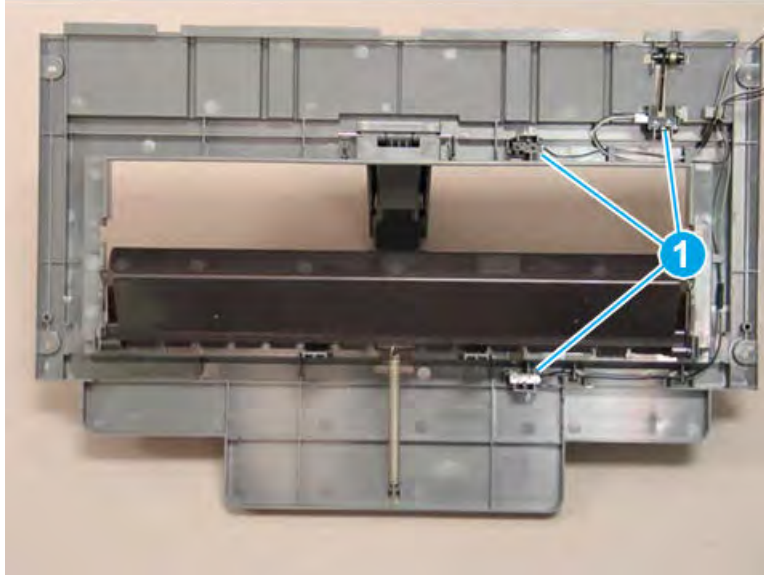

Unpack the replacement assembly

Follow these steps to unpack the replacement assembly.

1. Dispose of the defective part.



NOTE: HP recommends responsible disposal of the defective part.

<http://www8.hp.com/us/en/hp-information/environment/product-recycling.html>

2. Unpack the replacement part from the packaging.



CAUTION:  Some parts are sensitive to electrostatic discharge (ESD). Always perform service work at an ESD-protected workstation or mat. If an ESD workstation or mat is not available, touch the sheet-metal chassis to provide a static ground before touching an ESD-sensitive assembly. Protect the ESD-sensitive assemblies by placing them in ESD pouches when they are out of the printer.



IMPORTANT: Make sure that all of the shipping materials (for example shipping tape) are removed from the replacement part prior to installation.



NOTE: If the replacement part is a roller or pad, avoid touching the spongy part of it. Skin oils on the roller or pad can cause paper pickup and/or print-quality problems. HP recommends using disposable gloves when handling rollers or pads or washing your hands before touching rollers or pads.

3. To install an assembly, reverse the removal steps.



NOTE: When applicable, special installation instructions are provided for an assembly at the end of the removal procedure. Always completely read the removal instructions and follow all special installation instructions.

Removal and replacement: Left upper cover

Learn how to remove and replace the left upper cover.

Introduction

This document provides the procedures to remove and replace the left upper cover on the finisher.



IMPORTANT: When applicable, special installation instructions are provided for an assembly at the end of the removal procedure. Always completely read the removal instructions and follow all special installation instructions.

Before performing service

- Turn the printer power off. A shutting-down message appears on the control-panel display.
- ⚠ **WARNING!** To avoid damage to the printer, turn the power off and wait until the printer shuts down before removing the power cable.
- Disconnect the printer power cable after the printer has completely shut down (the control-panel display is blank).
- Release the finisher from the printer by pulling out on the release latch inside the finisher door.
- Disconnect the cable from the bridge unit to the finisher.
- Disconnect the cable from the finisher to the printer.

Use the table below to identify the correct part number for your printer. To order the part, go to <https://parts.hp.com>.

Table 5-94 Part information

Part number	Part description
JC90-01475B	Left upper cover

Required tools

- #2 JIS screwdriver with a magnetic tip
- Small, flat-blade screwdriver

After performing service

- Connect the cable from the finisher to the printer.
- Connect the cable from the bridge unit to the finisher.
- Attach the finisher to the printer, and then push in on the release latch inside the finisher door.
- Connect the printer power cable.
- Turn the printer power on.

Post service test

Process a job through the finisher and verify that the finisher works correctly.

Remove the right upper cover (finisher)

Follow these steps to remove the right upper cover (finisher).

- ▲ Remove one screw cap and three machine screws on the upper edge of the cover (callout 1). Remove three sheet metal screws (callout 2) on the lower portion of the cover. Rotate the right edge of the cover away from the finisher, and then slide the cover right to release three tabs (callout 3).

💡 **TIP:** The lower screws are shorter in length than the upper screws.

TIP: Reverse the removal steps to install the assembly.

Figure 5-226 Remove the right upper cover

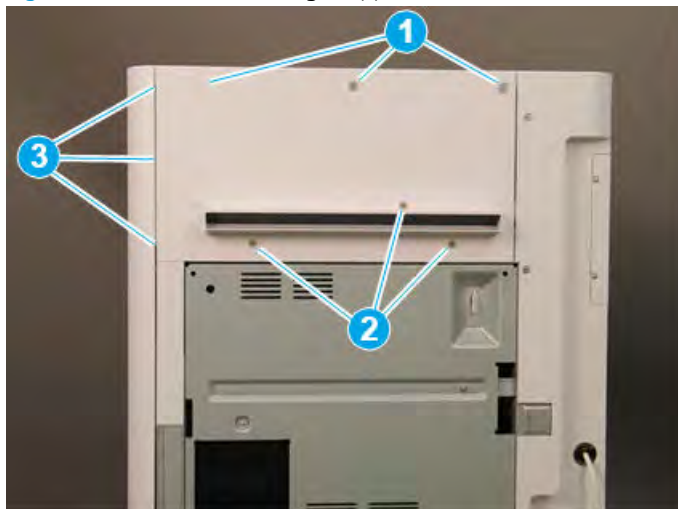

Remove the top cover (finisher)

Follow these steps to remove the top cover (finisher).

1. Remove three screw caps and three self-tapping screws at the top of the rear cover (callout 1), and then remove three machine screws (callout 2) on top of the cover.

Figure 5-227 Remove six screws

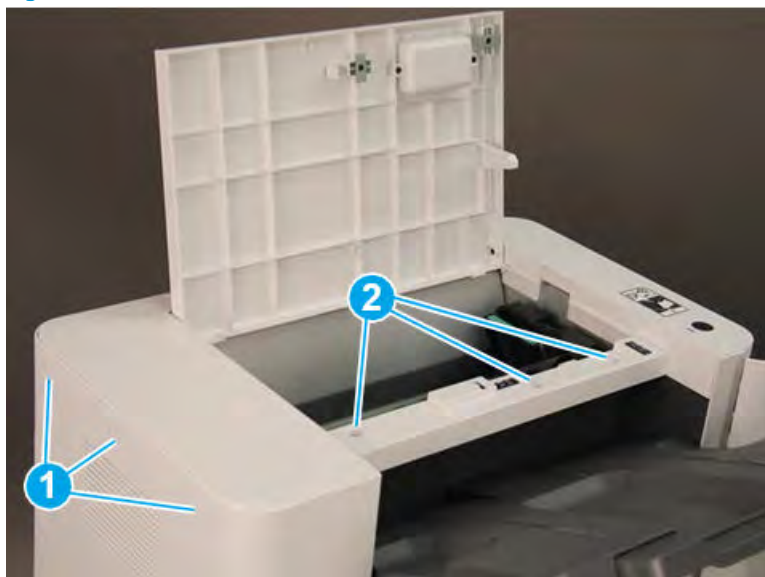

2. Remove three self-tapping screws at the top of the front cover (callout 1), and then remove two machine screws (callout 2) at the top of the right side.

Figure 5-228 Remove five screws

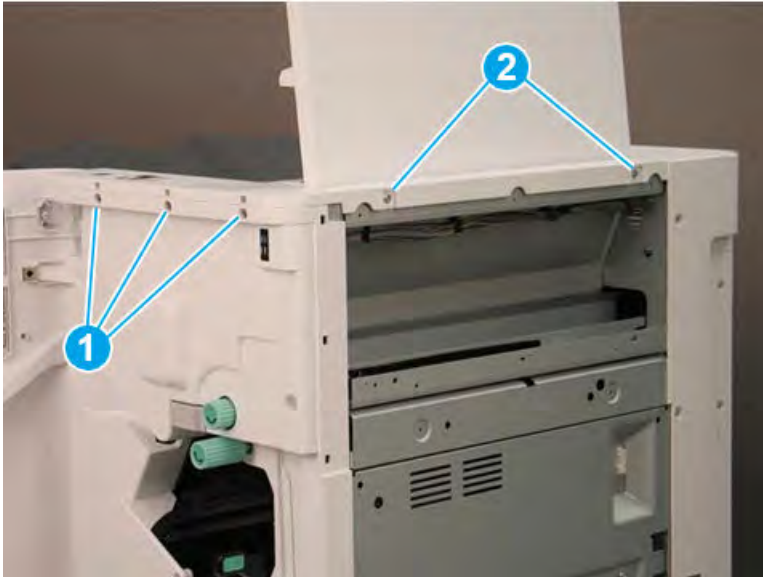

3. Lift the cover up slightly. Disconnect one in-line connector (callout 1), and then release one retainer (callout 2).

 **TIP:** Reverse the removal steps to install the assembly.

Figure 5-229 Disconnect one connector and release retainer



Remove the front door (finisher)

Follow these steps to remove the front door (finisher).

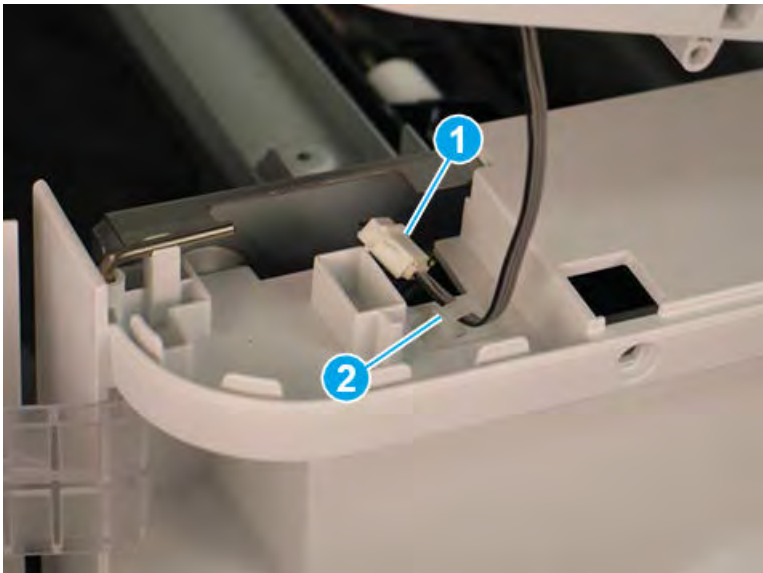
1. Lift the top hinge pin up to release it from the retainer.

Figure 5-230 Lift the top hinge pin

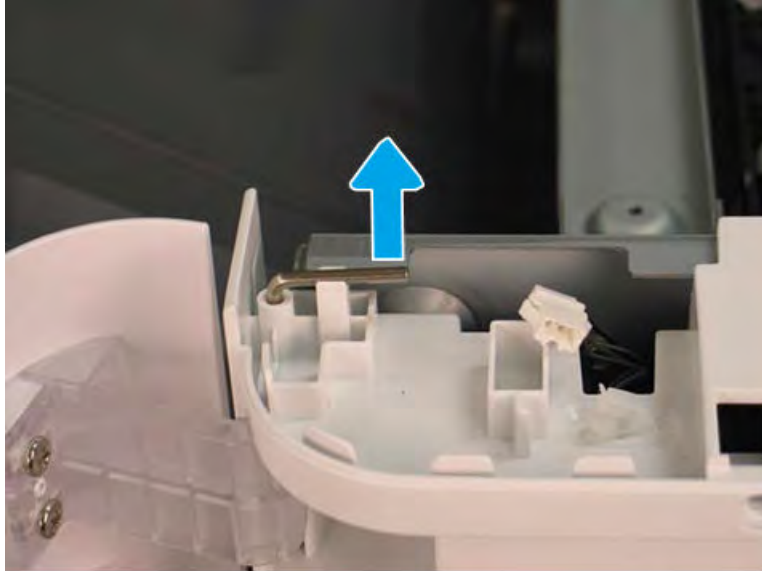

2. Pull the top hinge pin up to remove it.

Figure 5-231 Remove the top hinge pin

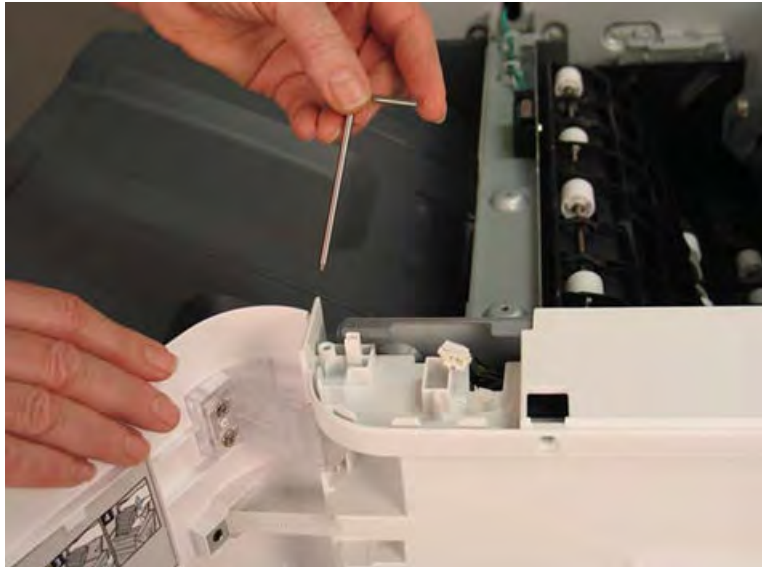

3. Use a small, flat-blade screwdriver to release the lower hinge pin from the retainer, and then rotate it away from the finisher.

Figure 5-232 Release the lower hinge pin



4. Support the door with one hand, and then pull the lower hinge pin straight up to remove it.

Figure 5-233 Remove the lower hinge pin



5. Support the door with one hand, and then remove one screw (callout 1) to release the strap. Remove the front door.

 **TIP:** Reverse the removal steps to install the assembly.

Figure 5-234 Remove the front door



Remove the front cover (finisher)

Follow these steps to remove the front cover (finisher).

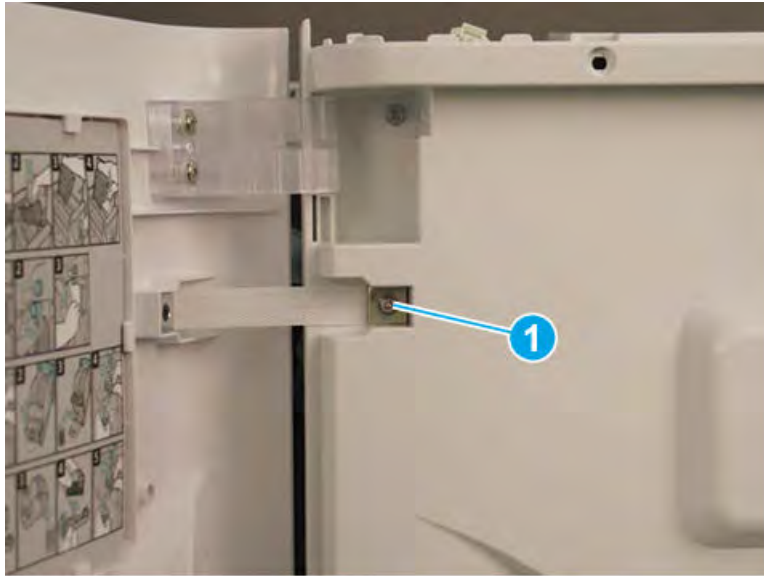
1. Release one tab (callout 1), and then pull the jam-access knob away from the finisher to remove it.

Figure 5-235 Remove the jam-access knob

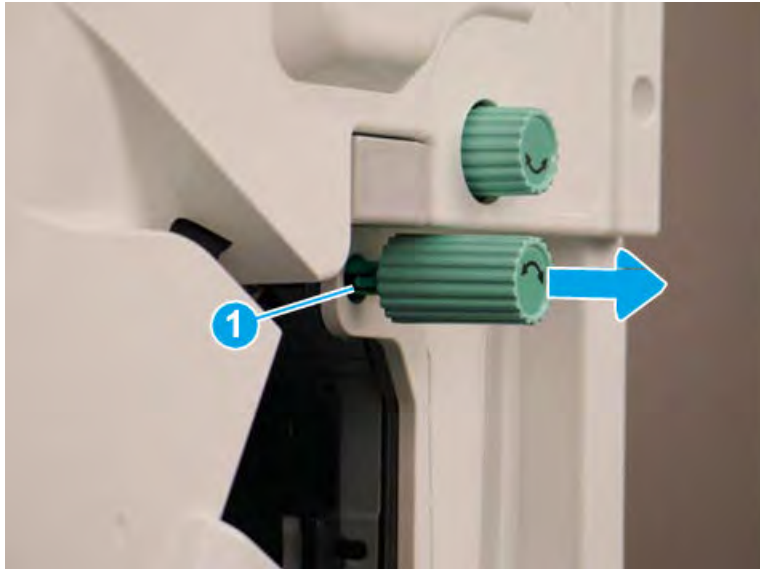

2. If the punch unit is installed, remove the punch waste bin (callout 1).

3. Remove one screw (callout 1) on top of the front cover.

Figure 5-236 Remove one screw



4. Remove five machine screws (callout 1), and then remove the front cover.

 **TIP:** Reverse the removal steps to install the assembly.

Figure 5-237 Remove the front cover



Remove the rear cover (finisher)

Follow these steps to remove the rear cover (finisher).

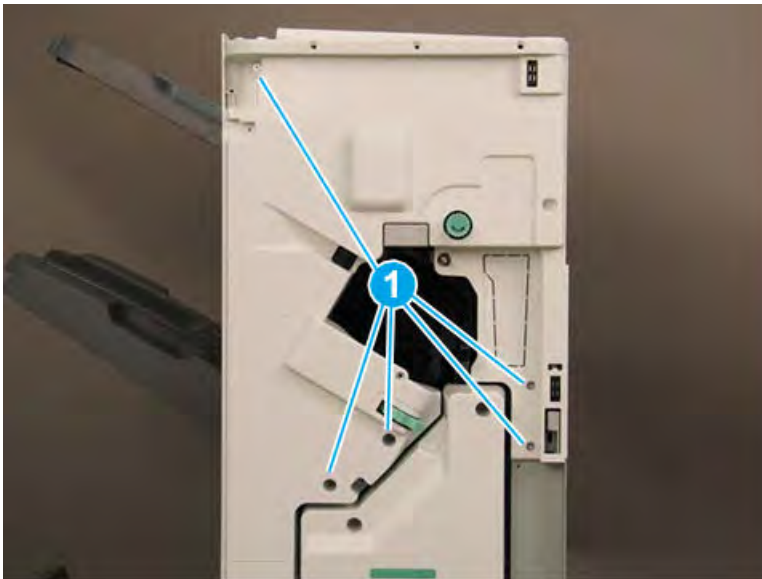
1. Remove two self-tapping screws (callout 1) on the top of the rear cover, and then remove five screw caps and five machine screws (callout 2) on the left side of the cover.

Figure 5-238 Remove seven screws



2. Remove one screw cap and four machine screws (callout 1) Remove the rear cover.

 **NOTE:** Make sure to thread the power cable (callout 2) through the opening in the cover.

 **TIP:** Reverse the removal steps to install the assembly

Figure 5-239 Remove the rear cover

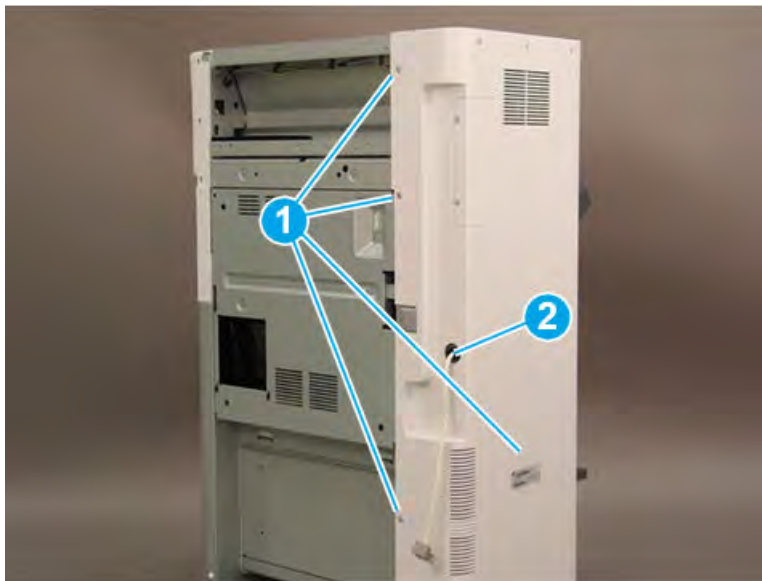

Remove the booklet output tray

Follow these steps to remove the booklet output tray.

1. Raise the booklet output tray up (callout 1), and then pull it away from the finisher (callout 2) to remove it.

Figure 5-240 Remove the booklet output tray



2. Reverse the removal steps to install the assembly. Also use the following special installation instructions.

 **NOTE:** Continue to reverse the removal steps to finish installing the assembly

Special installation instructions: booklet output tray

Position the tabs (callout 1) on the tray into the slots (callout 2) on the finisher.

Figure 5-241 Install the booklet output tray

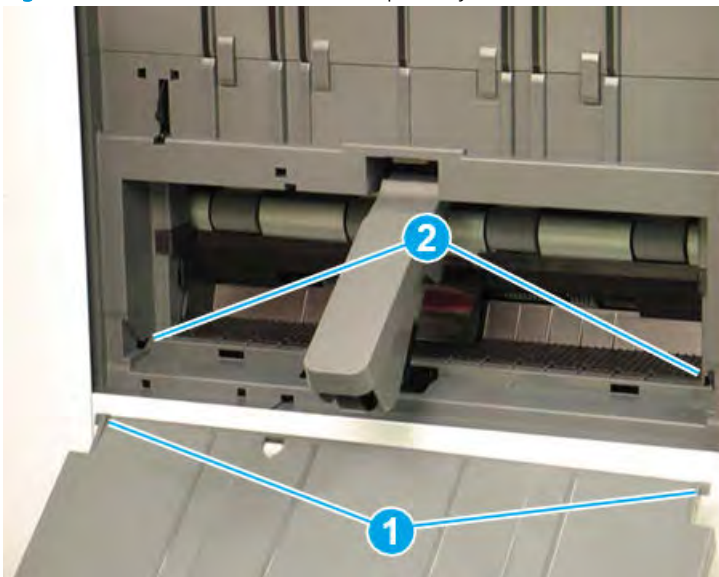

Remove the caster cover

Follow these steps to remove the caster cover.

1. Remove two screw caps and two self-tapping screws (callout 1). Remove two screw caps and two machine screws (callout 2).

Figure 5-242 Remove four screws

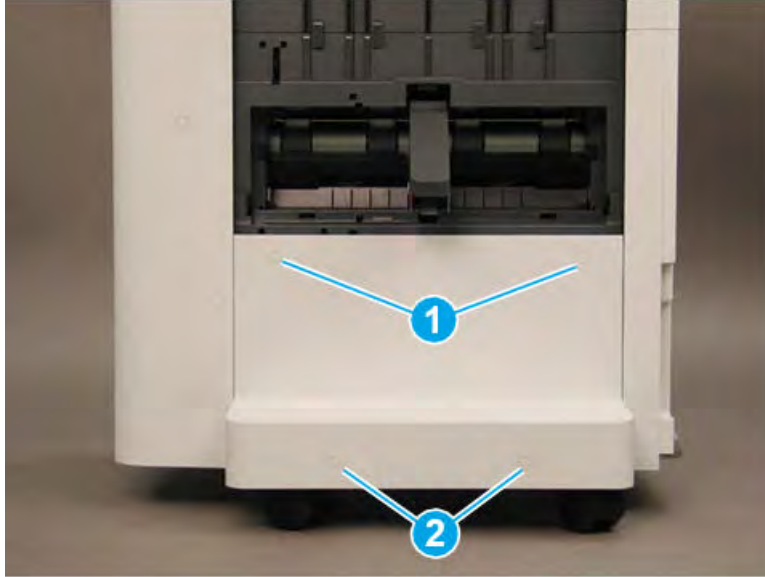

2. Rotate the left edge of the cover away from the finisher (callout 1), and then slide the cover to the left (callout 2) to remove it.

 **TIP:** Make sure that two tabs (callout 3) are positioned under the front lower cover when reinstalling the caster cover.

TIP: Reverse the removal steps to install the assembly

Figure 5-243 Remove the caster cover

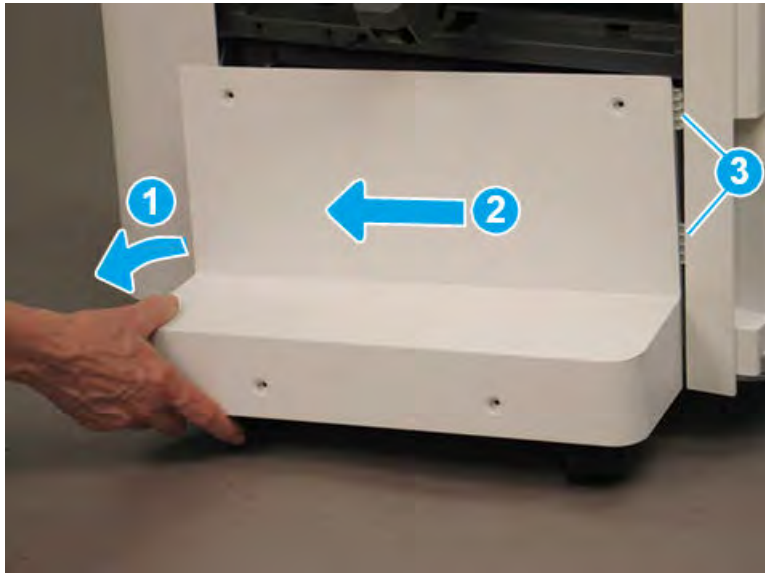

Remove the left lower cover (finisher)

Follow these steps to remove the left lower cover (finisher).

1. Remove four screws (callout 1).

 **NOTE:** Raise the lower output tray as needed to access the screws.

Figure 5-244 Remove four screws



2. Slide the shield down (callout 1) to release it from four tabs (callout 2), and then rotate it away from the finisher (callout 3).

⚠ CAUTION: The shield is still attached to the finisher. Do not attempt to completely remove the shield.

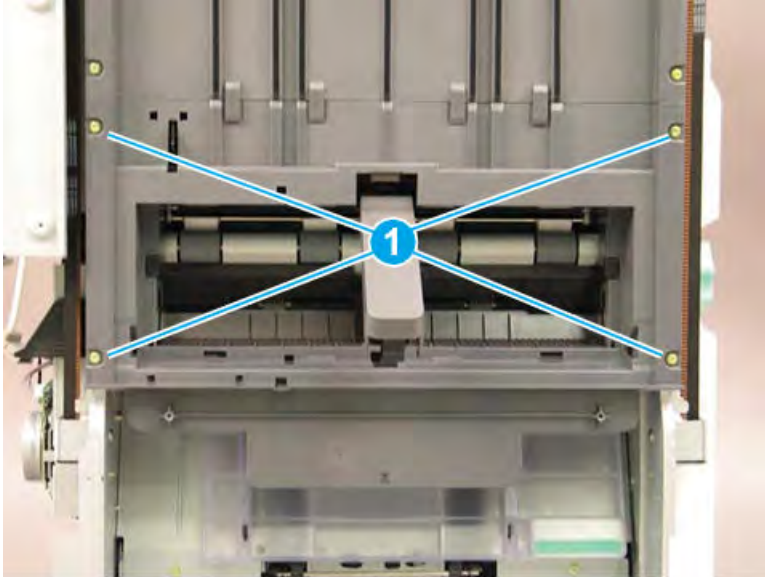
💡 TIP: Position the shield under the four tabs (callout 2) when reinstalling it.

Figure 5-245 Release the lower shield

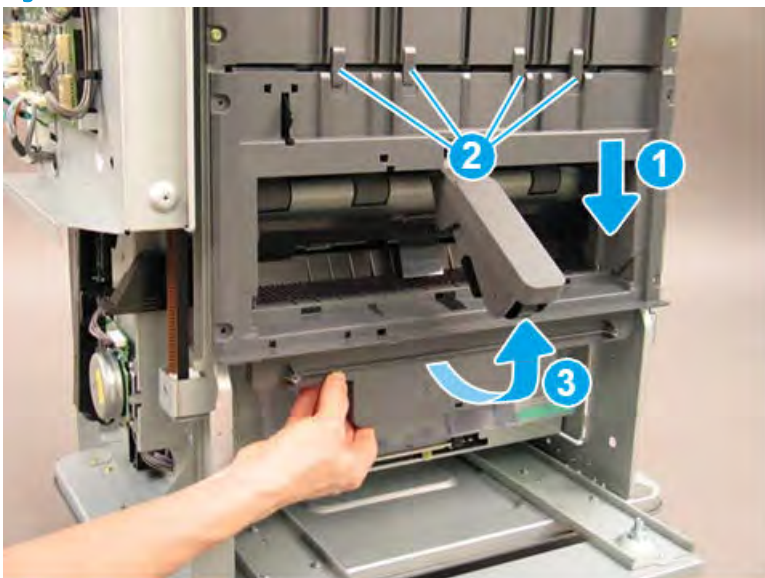

3. Disconnect two connectors (callout 1), and then remove the shield.

 **TIP:** Reverse the removal steps to install the assembly.

Figure 5-246 Disconnect two connectors

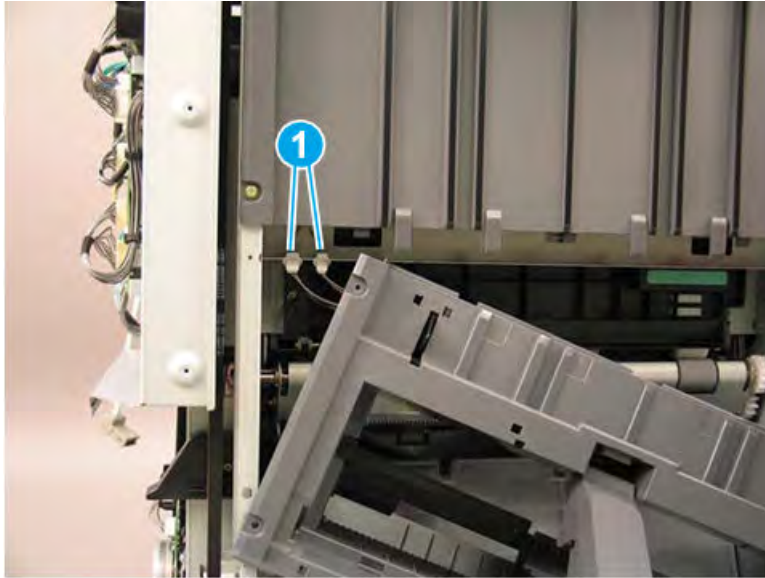

4. If you are replacing the left lower cover, locate three sensors (callout 1) on the back of the left lower cover. Remove these sensors and transfer them to the replacement part.

Figure 5-247 Remove the left lower cover

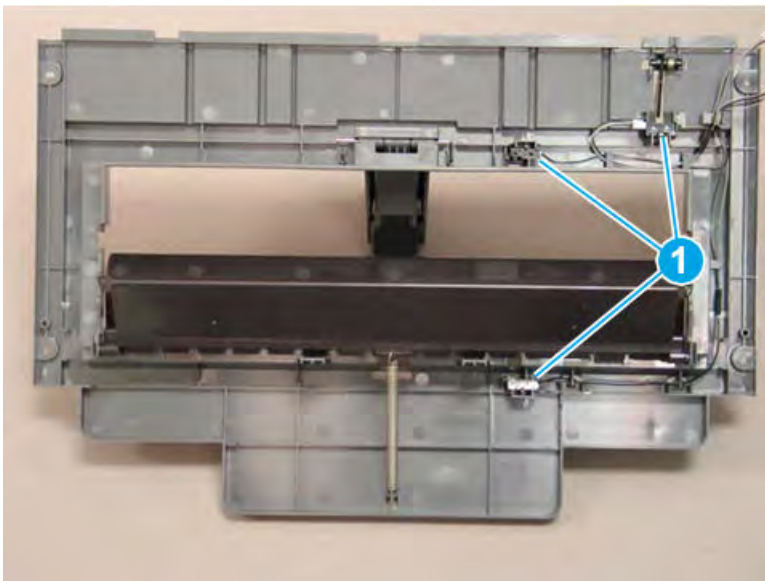

Remove the left upper cover (finisher)

Follow these steps to remove the left upper cover (finisher).

1. Bring the lower output tray down by positioning the shaft of a screwdriver on the clutch (callout 1) and gently pressing to the right to release the clutch. Hold the clutch in the released position and lower the tray (callout 2) to the lowest position.

Figure 5-248 Lower the output tray

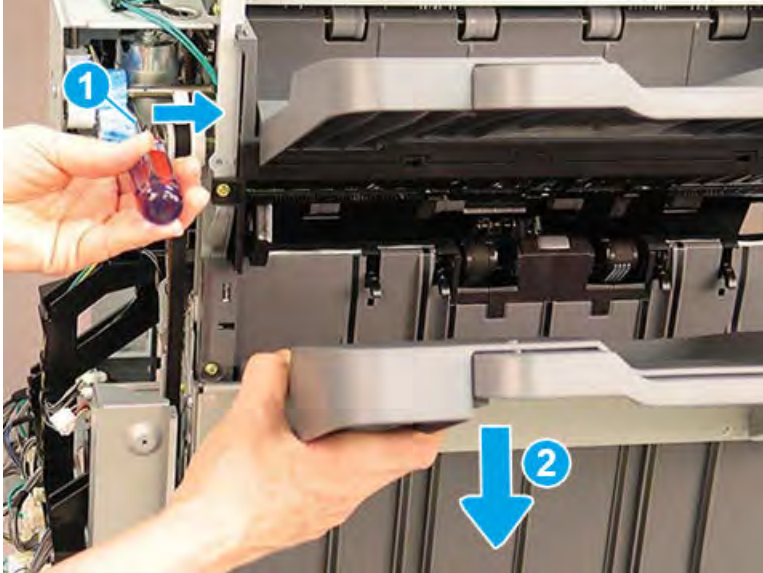

2. Remove six machine screws (callout 1).

Figure 5-249 Remove six screws

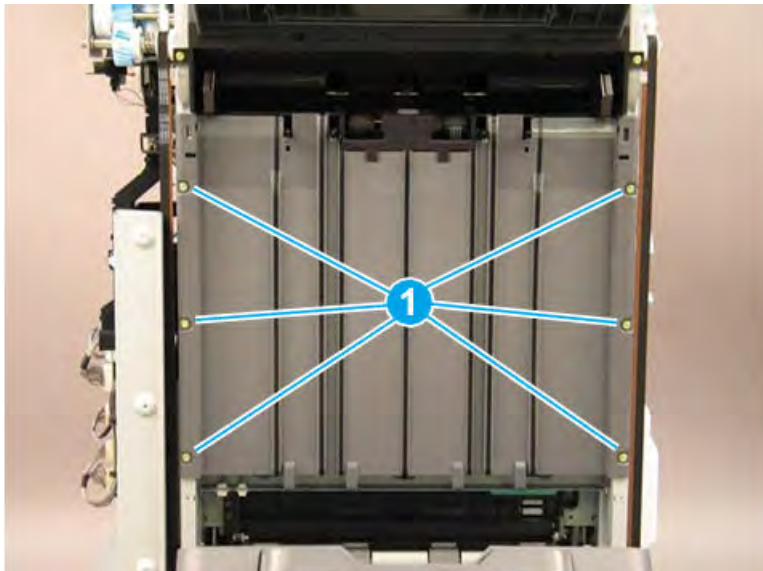

3. Rotate the lower edge of the shield away from the finisher (callout 1), and then slide the shield down (callout 2) to release it from two tabs (callout 3).

CAUTION: The shield is still attached to the finisher. Do not attempt to completely remove the shield.

TIP: Position the shield under the two tabs (callout 3) when reinstalling it.

Figure 5-250 Release the shield

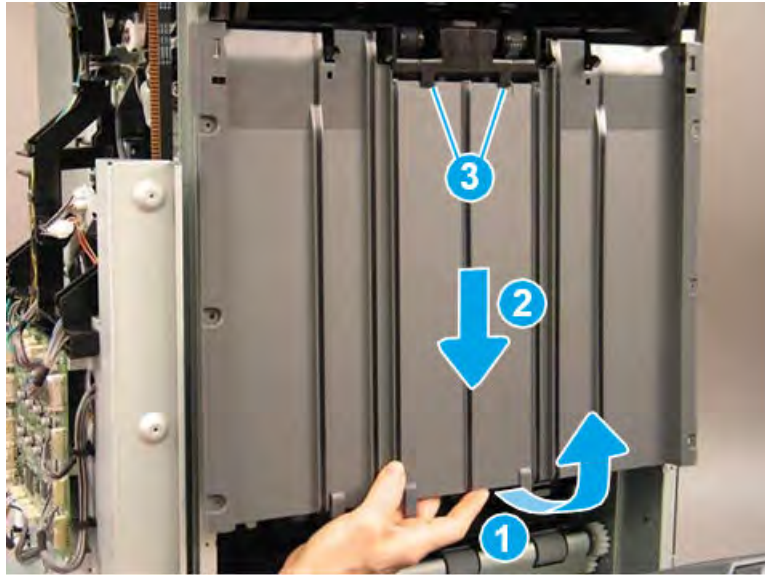

4. Disconnect one connector (callout 1), and then remove the upper shield assembly.

TIP: Reverse the removal steps to install the assembly.

Figure 5-251 Disconnect one connector

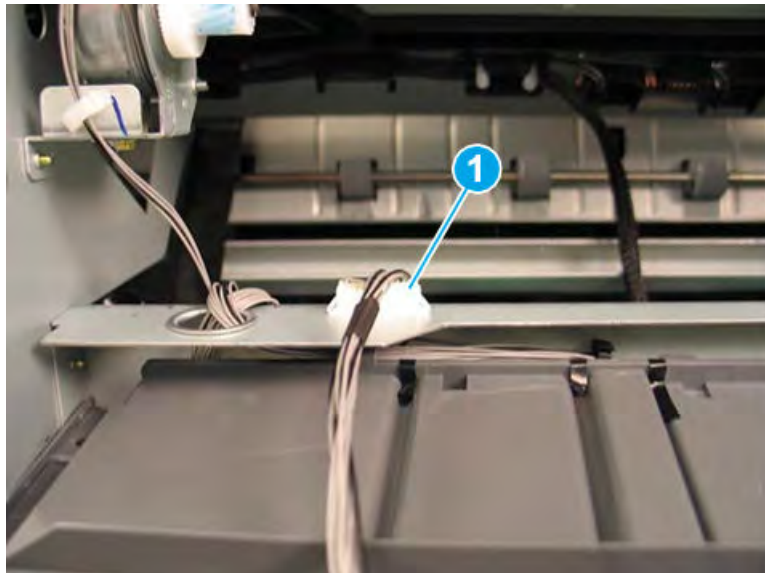

5. If you are replacing the left upper cover, locate three sensors (callout 1) on the back of the left upper cover. Remove these sensors and transfer them to the replacement part.

Figure 5-252 Remove the left upper cover

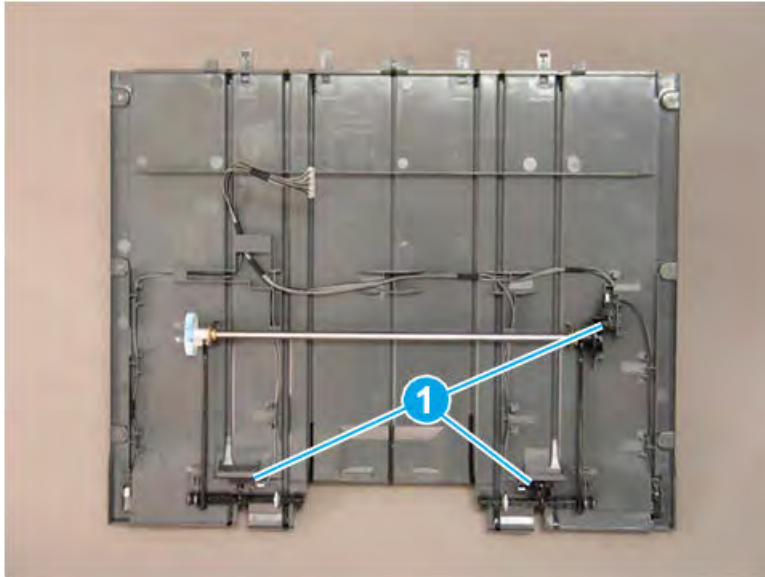

Unpack the replacement assembly

Follow these steps to unpack the replacement assembly.

1. Dispose of the defective part.



NOTE: HP recommends responsible disposal of the defective part.

<http://www8.hp.com/us/en/hp-information/environment/product-recycling.html>

2. Unpack the replacement part from the packaging.



CAUTION:  Some parts are sensitive to electrostatic discharge (ESD). Always perform service work at an ESD-protected workstation or mat. If an ESD workstation or mat is not available, touch the sheet-metal chassis to provide a static ground before touching an ESD-sensitive assembly. Protect the ESD-sensitive assemblies by placing them in ESD pouches when they are out of the printer.



IMPORTANT: Make sure that all of the shipping materials (for example shipping tape) are removed from the replacement part prior to installation.



NOTE: If the replacement part is a roller or pad, avoid touching the spongy part of it. Skin oils on the roller or pad can cause paper pickup and/or print-quality problems. HP recommends using disposable gloves when handling rollers or pads or washing your hands before touching rollers or pads.

3. To install an assembly, reverse the removal steps.



NOTE: When applicable, special installation instructions are provided for an assembly at the end of the removal procedure. Always completely read the removal instructions and follow all special installation instructions.

Removal and replacement: Booklet finisher front cover

Learn how to remove and replace the booklet front cover.

Introduction

This document provides the procedures to remove and replace the booklet front cover on the finisher.



IMPORTANT: When applicable, special installation instructions are provided for an assembly at the end of the removal procedure. Always completely read the removal instructions and follow all special installation instructions.

Before performing service

- Turn the printer power off. A shutting-down message appears on the control-panel display.
- ⚠ **WARNING!** To avoid damage to the printer, turn the power off and wait until the printer shuts down before removing the power cable.
- Disconnect the printer power cable after the printer has completely shut down (the control-panel display is blank).
- Release the finisher from the printer by pulling out on the release latch inside the finisher door.
- Disconnect the cable from the bridge unit to the finisher.
- Disconnect the cable from the finisher to the printer.

Use the table below to identify the correct part number for your printer. To order the part, go to <https://parts.hp.com>.

Table 5-95 Part information

Part number	Part description
JC90-01478B	Booklet front cover

Required tools

- #2 JIS screwdriver with a magnetic tip

After performing service

- Connect the cable from the finisher to the printer.
- Connect the cable from the bridge unit to the finisher.
- Attach the finisher to the printer, and then push in on the release latch inside the finisher door.
- Connect the printer power cable.
- Turn the printer power on.

Post service test

Process a job through the finisher and verify that the finisher works correctly.

Remove the booklet front cover

Follow these steps to remove the booklet front cover.

- ▲ Slide the booklet maker slightly away from the finisher (callout 1). Remove one screw (callout 2), and then slide the green knob away from the booklet maker to remove it (callout 3). Remove four screws (callout 4), and then remove the booklet front cover.

 **TIP:** Reverse the removal steps to install the assembly

Figure 5-253 Remove five screws and the cover



Unpack the replacement assembly

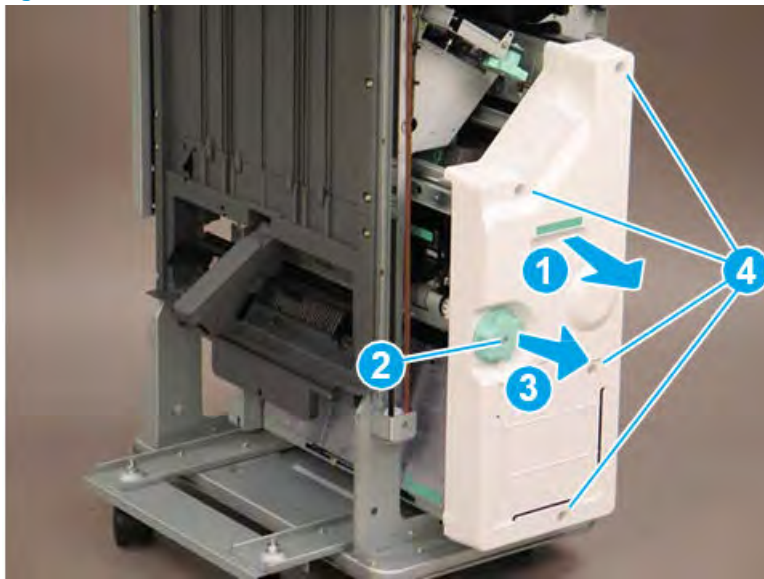

Follow these steps to unpack the replacement assembly.

1. Dispose of the defective part.

 **NOTE:** HP recommends responsible disposal of the defective part.

<http://www8.hp.com/us/en/hp-information/environment/product-recycling.html>

2. Unpack the replacement part from the packaging.

 **CAUTION:**  Some parts are sensitive to electrostatic discharge (ESD). Always perform service work at an ESD-protected workstation or mat. If an ESD workstation or mat is not available, touch the sheet-metal chassis to provide a static ground before touching an ESD-sensitive assembly. Protect the ESD-sensitive assemblies by placing them in ESD pouches when they are out of the printer.

 **IMPORTANT:** Make sure that all of the shipping materials (for example shipping tape) are removed from the replacement part prior to installation.

 **NOTE:** If the replacement part is a roller or pad, avoid touching the spongy part of it. Skin oils on the roller or pad can cause paper pickup and/or print-quality problems. HP recommends using disposable gloves when handling rollers or pads or washing your hands before touching rollers or pads.

3. To install an assembly, reverse the removal steps.



NOTE: When applicable, special installation instructions are provided for an assembly at the end of the removal procedure. Always completely read the removal instructions and follow all special installation instructions.

Entrance unit

Removal and replacement: Entrance motor (M12)

Learn how to remove and replace the feed entrance motor.

Introduction

This document provides the procedures to remove and replace the entrance motor on the finisher.



IMPORTANT: When applicable, special installation instructions are provided for an assembly at the end of the removal procedure. Always completely read the removal instructions and follow all special installation instructions.

Before performing service

- Turn the printer power off. A shutting-down message appears on the control-panel display.
- ⚠ **WARNING!** To avoid damage to the printer, turn the power off and wait until the printer shuts down before removing the power cable.
- Disconnect the printer power cable after the printer has completely shut down (the control-panel display is blank).
- Release the finisher from the printer by pulling out on the release latch inside the finisher door.
- Disconnect the cable from the bridge unit to the finisher.
- Disconnect the cable from the finisher to the printer.

Use the table below to identify the correct part number for your printer. To order the part, go to <https://parts.hp.com>.

Table 5-96 Part information

Part number	Part description
JC90-01459A	Entrance motor assembly
JC31-00163B	Entrance motor

Required tools

- #2 JIS screwdriver with a magnetic tip

After performing service

- Connect the cable from the finisher to the printer.
- Connect the cable from the bridge unit to the finisher.
- Attach the finisher to the printer, and then push in on the release latch inside the finisher door.
- Connect the printer power cable.
- Turn the printer power on.

Post service test

Process a job through the finisher and verify that the finisher works correctly.

Remove the right upper cover (finisher)

Follow these steps to remove the right upper cover (finisher).

- ▲ Remove one screw cap and three machine screws on the upper edge of the cover (callout 1). Remove three sheet metal screws (callout 2) on the lower portion of the cover. Rotate the right edge of the cover away from the finisher, and then slide the cover right to release three tabs (callout 3).

💡 **TIP:** The lower screws are shorter in length than the upper screws.

TIP: Reverse the removal steps to install the assembly.

Figure 5-254 Remove the right upper cover

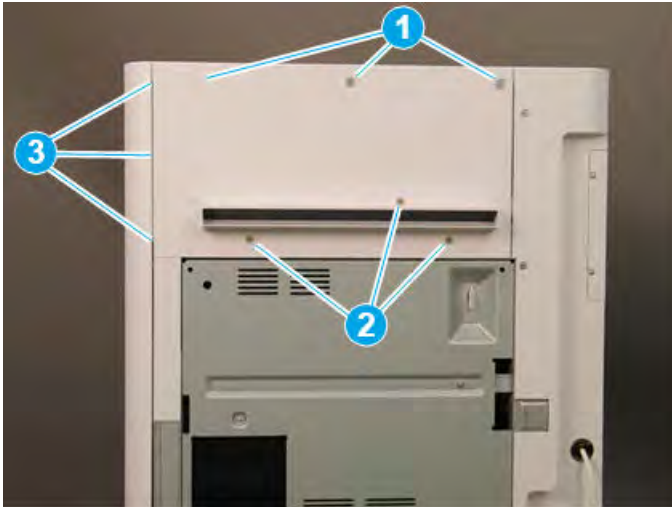

Remove the top cover (finisher)

Follow these steps to remove the top cover (finisher).

1. Remove three screw caps and three self-tapping screws at the top of the rear cover (callout 1), and then remove three machine screws (callout 2) on top of the cover.

Figure 5-255 Remove six screws

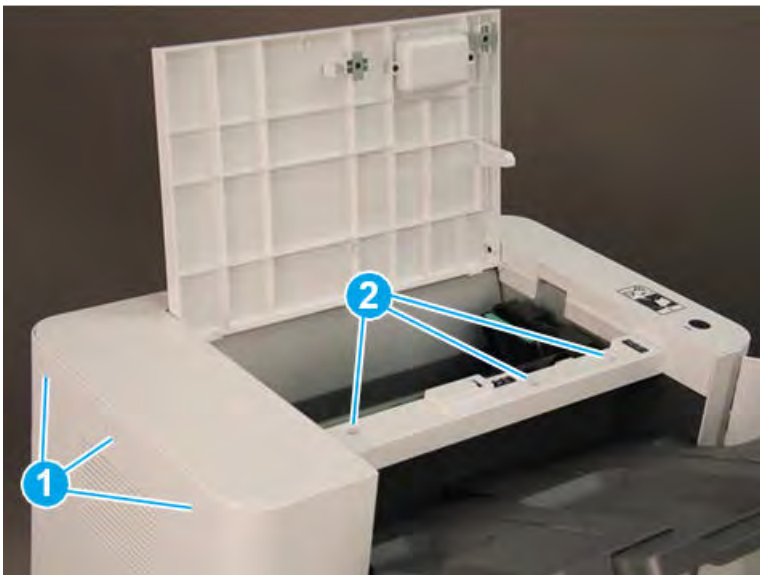

2. Remove three self-tapping screws at the top of the front cover (callout 1), and then remove two machine screws (callout 2) at the top of the right side.

Figure 5-256 Remove five screws

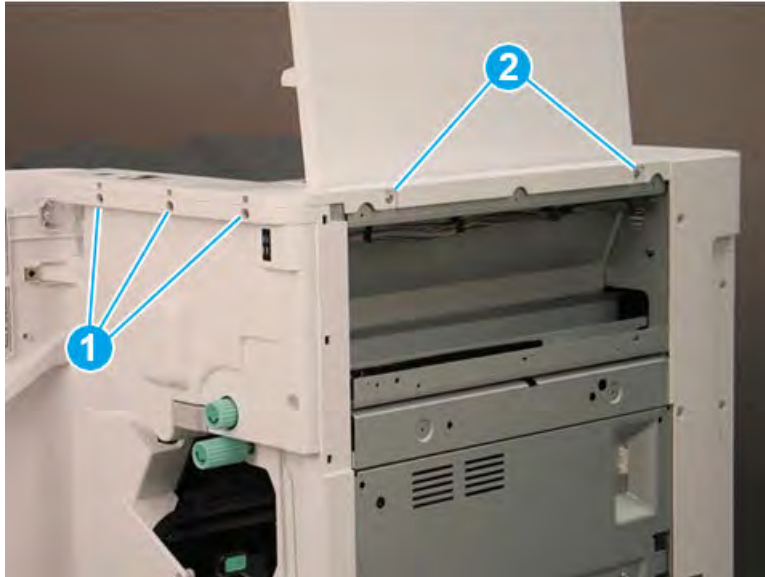

3. Lift the cover up slightly. Disconnect one in-line connector (callout 1), and then release one retainer (callout 2).

 **TIP:** Reverse the removal steps to install the assembly.

Figure 5-257 Disconnect one connector and release retainer



Remove the rear cover (finisher)

Follow these steps to remove the rear cover (finisher).

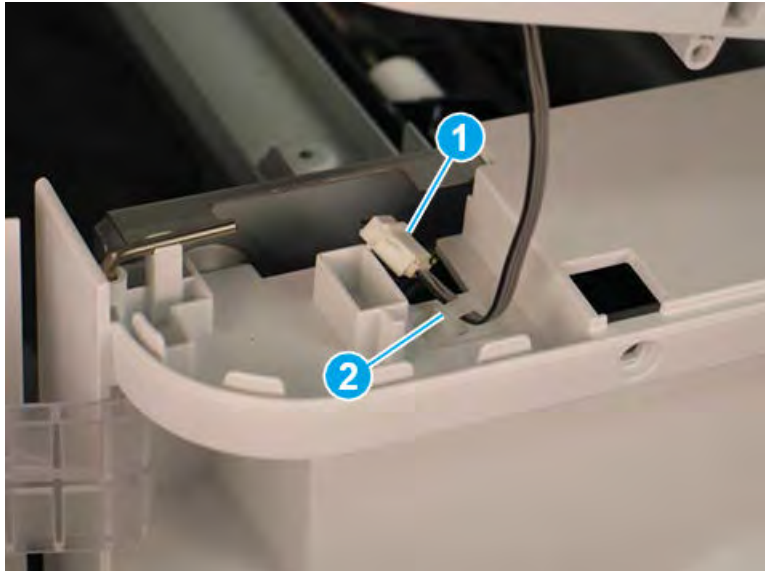
1. Remove two self-tapping screws (callout 1) on the top of the rear cover, and then remove five screw caps and five machine screws (callout 2) on the left side of the cover.

Figure 5-258 Remove seven screws

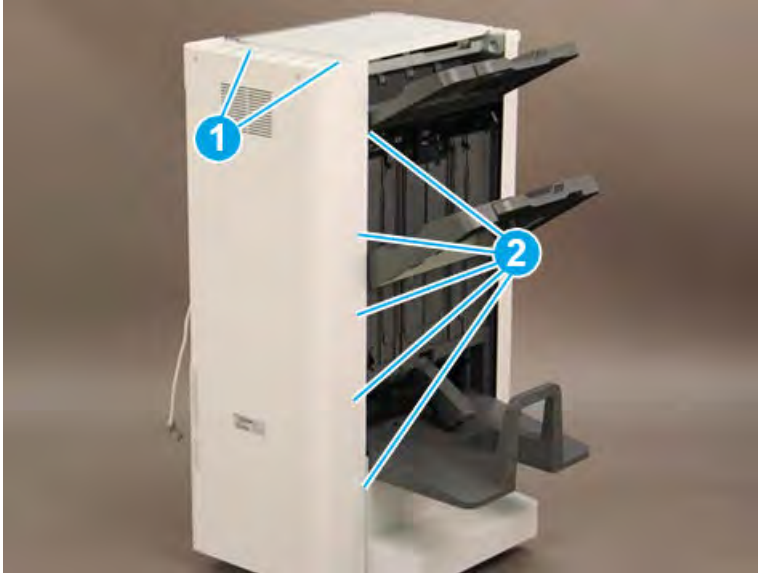

2. Remove one screw cap and four machine screws (callout 1) Remove the rear cover.

 **NOTE:** Make sure to thread the power cable (callout 2) through the opening in the cover.

 **TIP:** Reverse the removal steps to install the assembly

Figure 5-259 Remove the rear cover



Remove the entrance motor (M12)

Follow these steps to remove the entrance motor (M12).

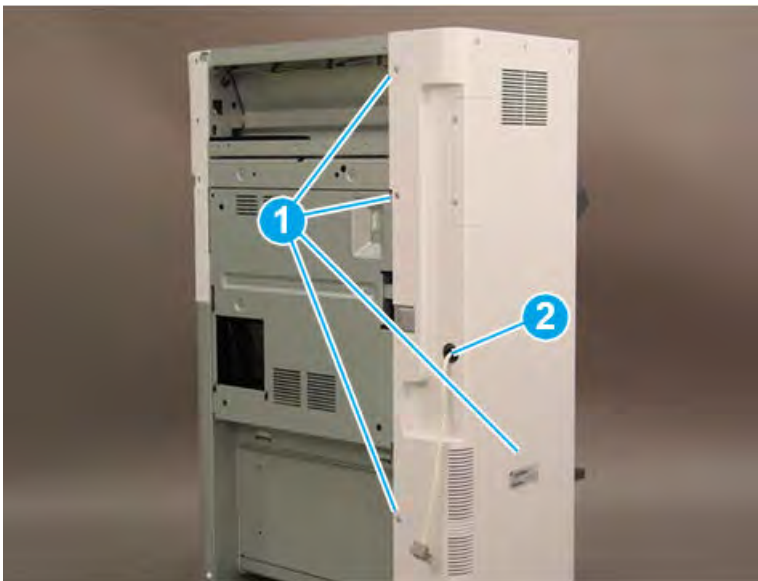
- ▲ Release one retainer (callout 1), and then disconnect one connector (callout 2). Remove two screws (callout 3), and then remove the entrance motor.

 **TIP:** Make sure that the belt (callout 4) is positioned on the gear behind the motor when reinstalling the motor.

TIP: Reverse the removal steps to install the assembly.

Figure 5-260 Remove the entrance motor

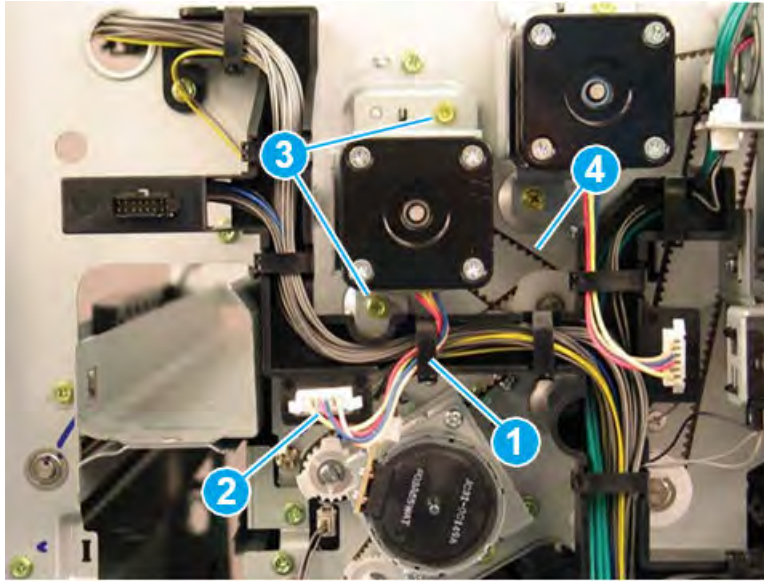

Unpack the replacement assembly



Follow these steps to unpack the replacement assembly.

1. Dispose of the defective part.

 **NOTE:** HP recommends responsible disposal of the defective part.

<http://www8.hp.com/us/en/hp-information/environment/product-recycling.html>

2. Unpack the replacement part from the packaging.

 **CAUTION:**  Some parts are sensitive to electrostatic discharge (ESD). Always perform service work at an ESD-protected workstation or mat. If an ESD workstation or mat is not available, touch the sheet-metal chassis to provide a static ground before touching an ESD-sensitive assembly. Protect the ESD-sensitive assemblies by placing them in ESD pouches when they are out of the printer.

 **IMPORTANT:** Make sure that all of the shipping materials (for example shipping tape) are removed from the replacement part prior to installation.

 **NOTE:** If the replacement part is a roller or pad, avoid touching the spongy part of it. Skin oils on the roller or pad can cause paper pickup and/or print-quality problems. HP recommends using disposable gloves when handling rollers or pads or washing your hands before touching rollers or pads.

3. To install an assembly, reverse the removal steps.

 **NOTE:** When applicable, special installation instructions are provided for an assembly at the end of the removal procedure. Always completely read the removal instructions and follow all special installation instructions.

Punch unit

Removal and replacement: Dummy feed guide

Learn how to remove and replace the dummy feed guide.

Introduction

This document provides the procedures to remove and replace the dummy feed guide on the finisher.



IMPORTANT: When applicable, special installation instructions are provided for an assembly at the end of the removal procedure. Always completely read the removal instructions and follow all special installation instructions.

Before performing service

- Turn the printer power off. A shutting-down message appears on the control-panel display.
- ⚠ **WARNING!** To avoid damage to the printer, turn the power off and wait until the printer shuts down before removing the power cable.
- Disconnect the printer power cable after the printer has completely shut down (the control-panel display is blank).
- Release the finisher from the printer by pulling out on the release latch inside the finisher door.
- Disconnect the cable from the bridge unit to the finisher.
- Disconnect the cable from the finisher to the printer.

Use the table below to identify the correct part number for your printer. To order the part, go to <https://parts.hp.com>.

Table 5-97 Part information

Part number	Part description
JC93-01161A	Dummy feed guide
Y1G10-67901	HP LaserJet Hole Punch 2/3 Accessory
Y1G11-67901	HP LaserJet Hole Punch 2/4 Accessory
Y1G12-67901	HP LaserJet Hole Punch Swedish Accessory

Required tools

- #2 JIS screwdriver with a magnetic tip

After performing service

- Connect the cable from the finisher to the printer.
- Connect the cable from the bridge unit to the finisher.
- Attach the finisher to the printer, and then push in on the release latch inside the finisher door.
- Connect the printer power cable.
- Turn the printer power on.

Post service test

Process a job through the finisher and verify that the finisher works correctly.

Remove the right upper cover (finisher)

Follow these steps to remove the right upper cover (finisher).

- ▲ Remove one screw cap and three machine screws on the upper edge of the cover (callout 1). Remove three sheet metal screws (callout 2) on the lower portion of the cover. Rotate the right edge of the cover away from the finisher, and then slide the cover right to release three tabs (callout 3).

💡 **TIP:** The lower screws are shorter in length than the upper screws.

TIP: Reverse the removal steps to install the assembly.

Figure 5-261 Remove the right upper cover

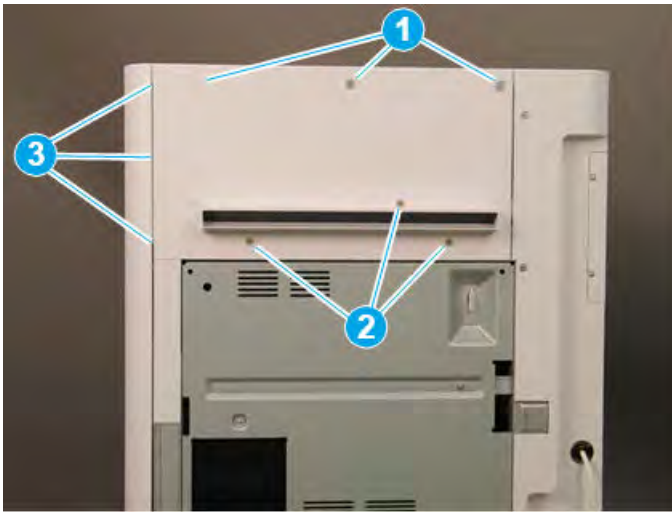

Remove the top cover (finisher)

Follow these steps to remove the top cover (finisher).

1. Remove three screw caps and three self-tapping screws at the top of the rear cover (callout 1), and then remove three machine screws (callout 2) on top of the cover.

Figure 5-262 Remove six screws

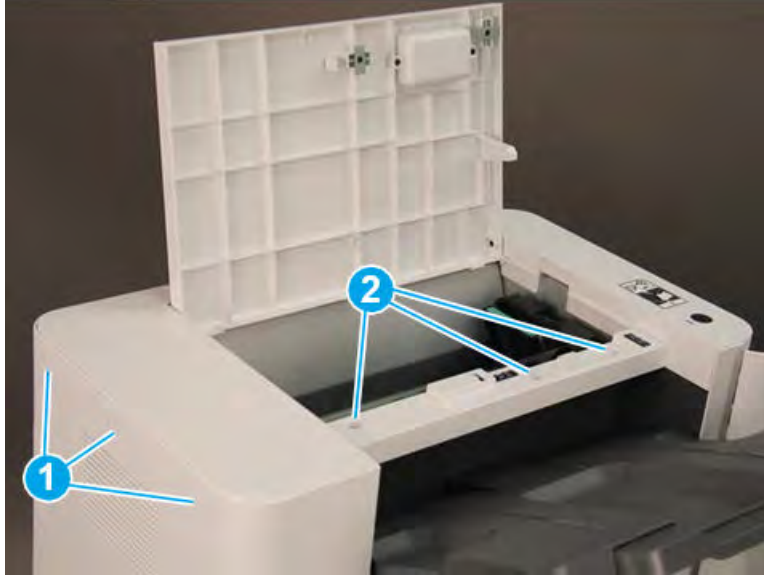

2. Remove three self-tapping screws at the top of the front cover (callout 1), and then remove two machine screws (callout 2) at the top of the right side.

Figure 5-263 Remove five screws

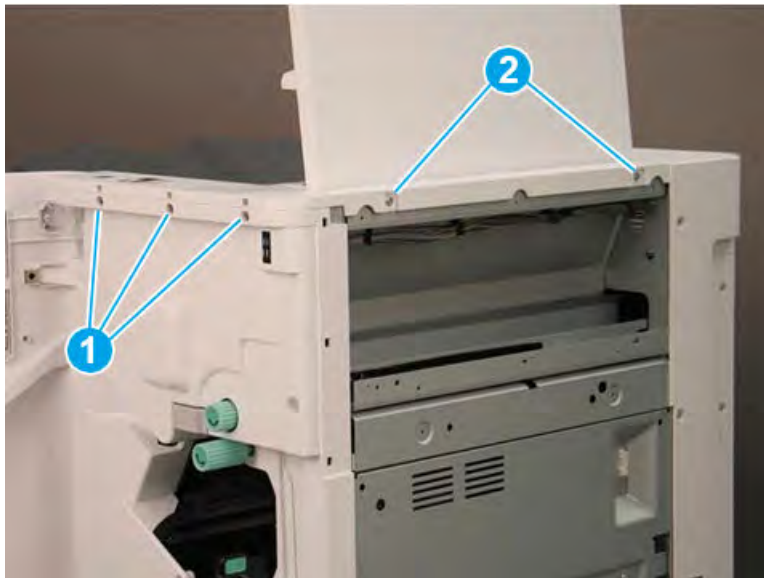

3. Lift the cover up slightly. Disconnect one in-line connector (callout 1), and then release one retainer (callout 2).

 **TIP:** Reverse the removal steps to install the assembly.

Figure 5-264 Disconnect one connector and release retainer



Remove the rear cover (finisher)

Follow these steps to remove the rear cover (finisher).

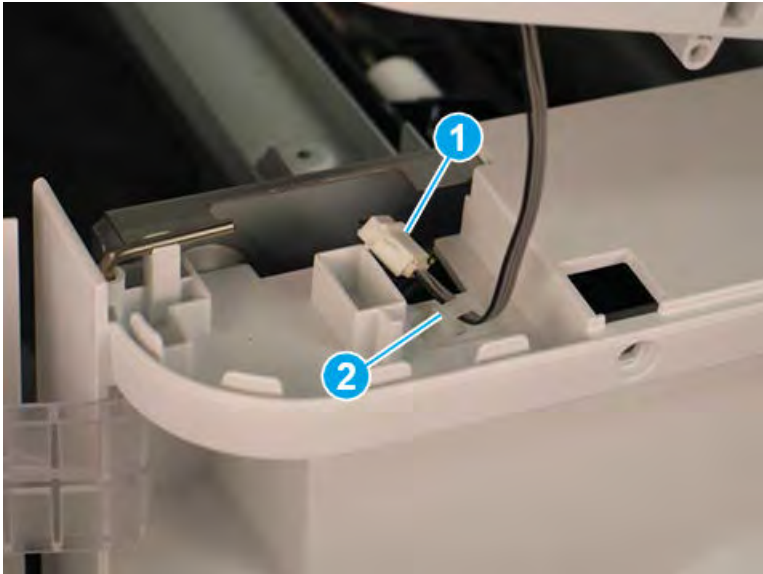
1. Remove two self-tapping screws (callout 1) on the top of the rear cover, and then remove five screw caps and five machine screws (callout 2) on the left side of the cover.

Figure 5-265 Remove seven screws

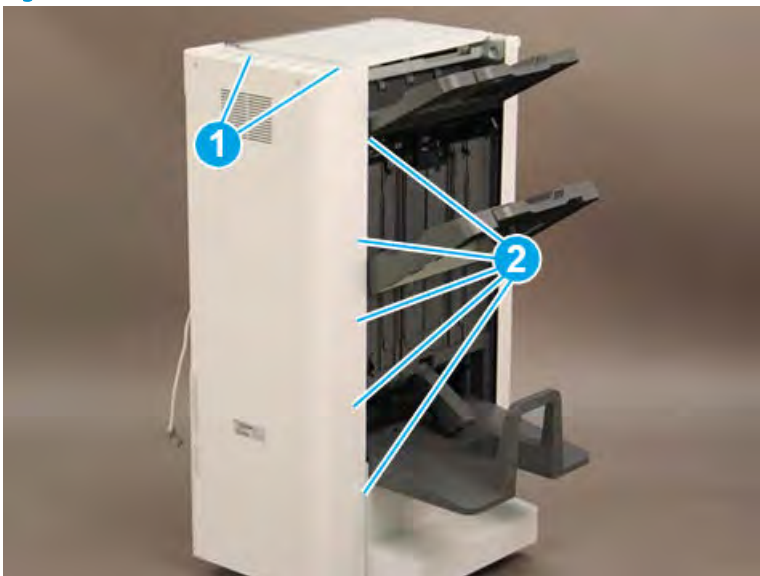

2. Remove one screw cap and four machine screws (callout 1) Remove the rear cover.

 **NOTE:** Make sure to thread the power cable (callout 2) through the opening in the cover.

 **TIP:** Reverse the removal steps to install the assembly

Figure 5-266 Remove the rear cover



Remove the dummy feed guide (finisher)

Follow these steps to remove the dummy feed guide (finisher).

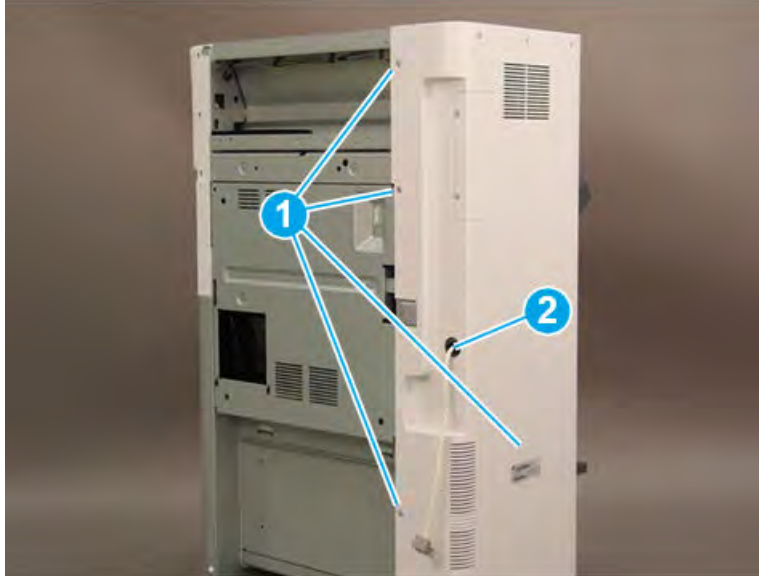
- ▲ At the rear of the finisher, remove two screws (callout 1), and then remove the dummy feed guide (callout 2).

 **TIP:** Reverse the removal steps to install the assembly.

Figure 5-267 Remove two screws and the feed guide

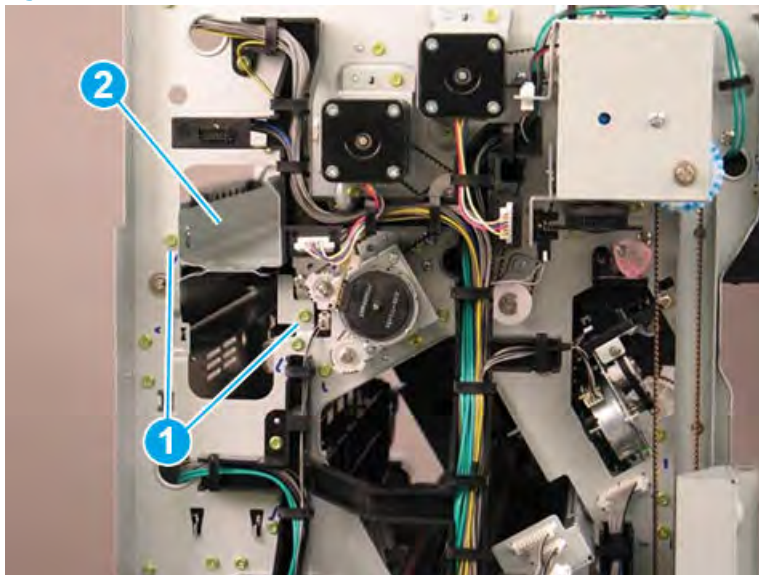

Unpack the replacement assembly



Follow these steps to unpack the replacement assembly.

1. Dispose of the defective part.

 **NOTE:** HP recommends responsible disposal of the defective part.

<http://www8.hp.com/us/en/hp-information/environment/product-recycling.html>

2. Unpack the replacement part from the packaging.

 **CAUTION:**  Some parts are sensitive to electrostatic discharge (ESD). Always perform service work at an ESD-protected workstation or mat. If an ESD workstation or mat is not available, touch the sheet-metal chassis to provide a static ground before touching an ESD-sensitive assembly. Protect the ESD-sensitive assemblies by placing them in ESD pouches when they are out of the printer.

 **IMPORTANT:** Make sure that all of the shipping materials (for example shipping tape) are removed from the replacement part prior to installation.

 **NOTE:** If the replacement part is a roller or pad, avoid touching the spongy part of it. Skin oils on the roller or pad can cause paper pickup and/or print-quality problems. HP recommends using disposable gloves when handling rollers or pads or washing your hands before touching rollers or pads.

3. To install an assembly, reverse the removal steps.

 **NOTE:** When applicable, special installation instructions are provided for an assembly at the end of the removal procedure. Always completely read the removal instructions and follow all special installation instructions.

Tray diverter unit

HP LaserJet Managed MFP E82540-E82560, E87640-E87660, E82540du-E82560du, E87640du-E87660du, E72525-E72535, E77822-E77830 – Removal and replacement: Top jam access cover

Learn how to remove and replace the top jam cover assembly.

Introduction

This document provides the procedures to remove and replace the top jam cover assembly for the finisher.



IMPORTANT: When applicable, special installation instructions are provided for an assembly at the end of the removal procedure. Always completely read the removal instructions and follow all special installation instructions.

Before performing service

- Turn the printer power off. A shutting-down message appears on the control-panel display.
- ⚠ **WARNING!** To avoid damage to the printer, turn the power off and wait until the printer shuts down before removing the power cable.
- Disconnect the printer power cable after the printer has completely shut down (the control-panel display is blank).
- Release the finisher from the printer by pulling out on the release latch inside the finisher door.
- Disconnect the cable from the bridge unit to the finisher.
- Disconnect the cable from the finisher to the printer.

Use the table below to identify the correct part number for your printer. To order the part, go to <https://parts.hp.com>.

Table 5-98 Part information

Part number	Part description
JC90-01455A	Top jam cover assembly

Required tools

- #2 JIS screwdriver with a magnetic tip

After performing service

- Connect the cable from the finisher to the printer.
- Connect the cable from the bridge unit to the finisher.
- Attach the finisher to the printer, and then push in on the release latch inside the finisher door.
- Connect the printer power cable.
- Turn the printer power on.

Post service test

Process a job through the finisher and verify that the finisher works correctly.

Remove the right upper cover (finisher)

Follow these steps to remove the right upper cover (finisher).

- ▲ Remove one screw cap and three machine screws on the upper edge of the cover (callout 1). Remove three sheet metal screws (callout 2) on the lower portion of the cover. Rotate the right edge of the cover away from the finisher, and then slide the cover right to release three tabs (callout 3).

💡 **TIP:** The lower screws are shorter in length than the upper screws.

TIP: Reverse the removal steps to install the assembly.

Figure 5-268 Remove the right upper cover

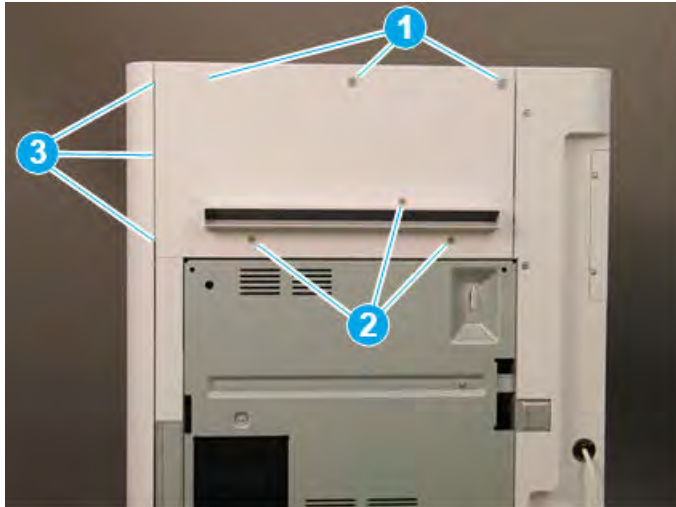

Remove the top cover (finisher)

Follow these steps to remove the top cover (finisher).

1. Remove three screw caps and three self-tapping screws at the top of the rear cover (callout 1), and then remove three machine screws (callout 2) on top of the cover.

Figure 5-269 Remove six screws

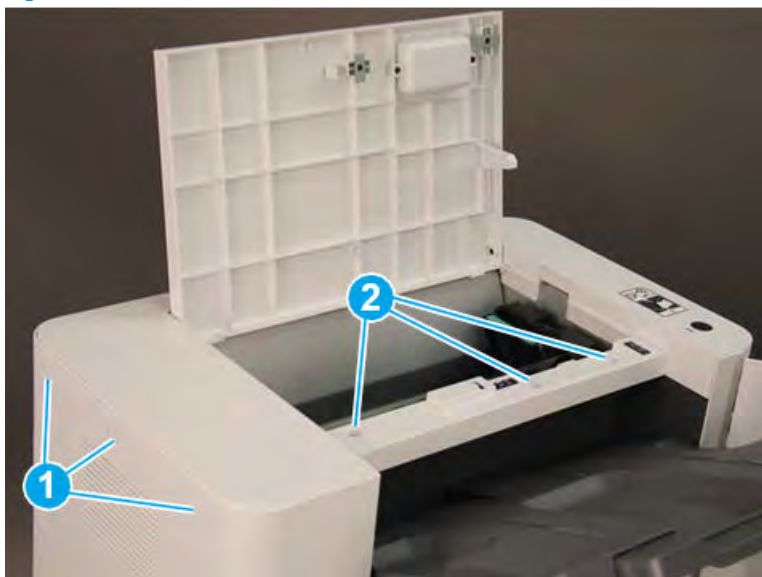

2. Remove three self-tapping screws at the top of the front cover (callout 1), and then remove two machine screws (callout 2) at the top of the right side.

Figure 5-270 Remove five screws

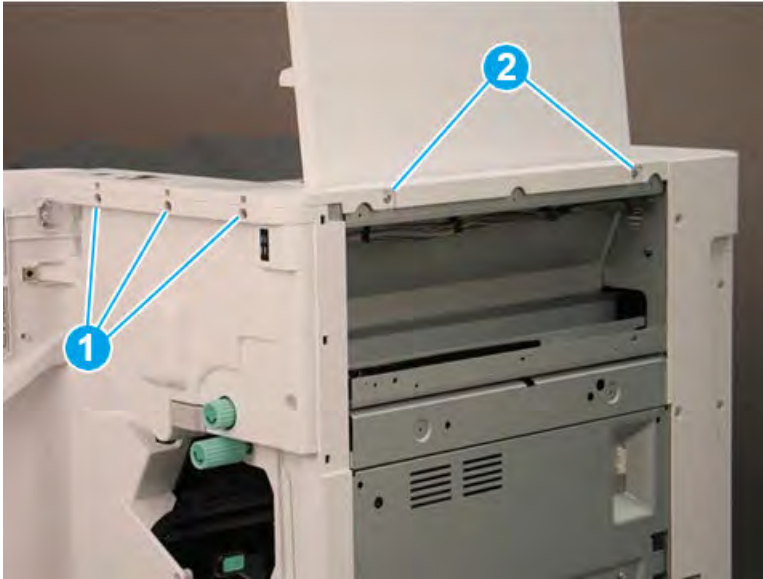

3. Lift the cover up slightly. Disconnect one in-line connector (callout 1), and then release one retainer (callout 2).

 **TIP:** Reverse the removal steps to install the assembly.

Figure 5-271 Disconnect one connector and release retainer

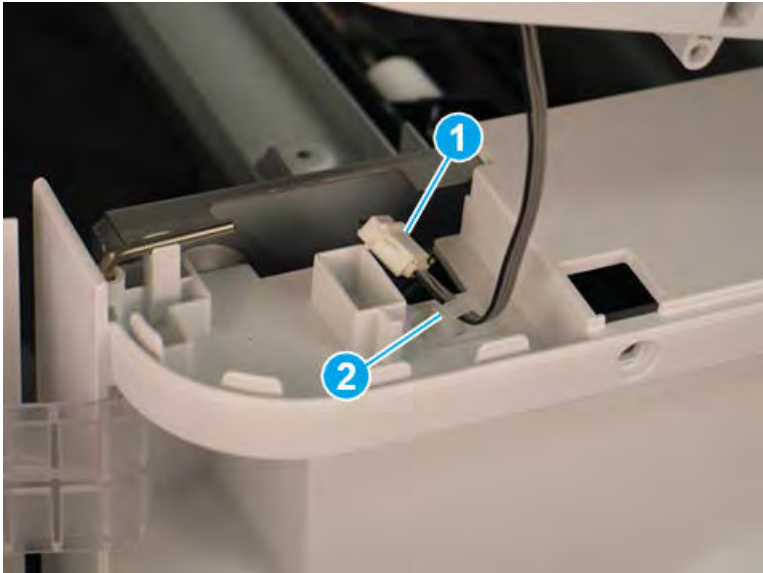

Remove the front door (finisher)

Follow these steps to remove the front door (finisher).

1. Lift the top hinge pin up to release it from the retainer.

Figure 5-272 Lift the top hinge pin

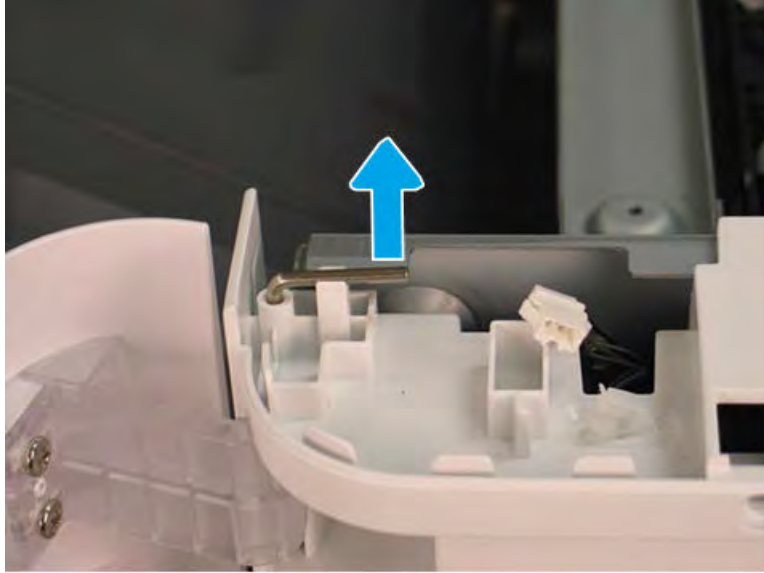

2. Pull the top hinge pin up to remove it.

Figure 5-273 Remove the top hinge pin

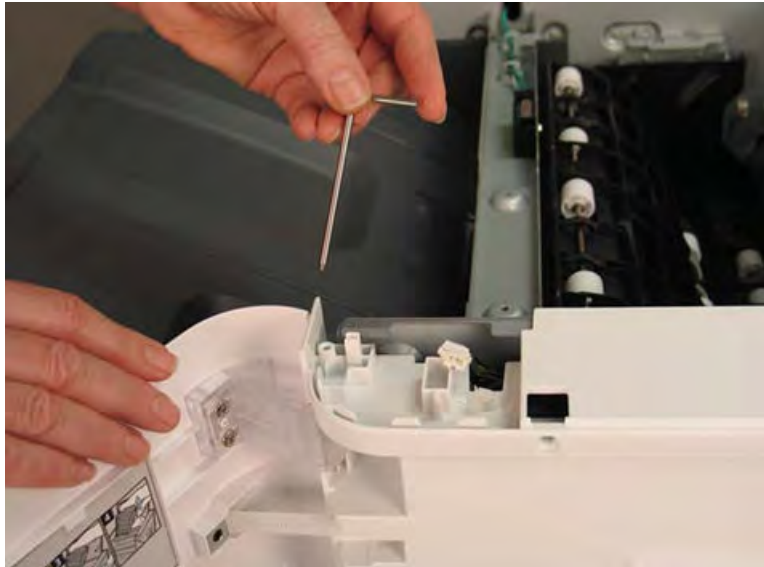

3. Use a small, flat-blade screwdriver to release the lower hinge pin from the retainer, and then rotate it away from the finisher.

Figure 5-274 Release the lower hinge pin



4. Support the door with one hand, and then pull the lower hinge pin straight up to remove it.

Figure 5-275 Remove the lower hinge pin



5. Support the door with one hand, and then remove one screw (callout 1) to release the strap. Remove the front door.

 **TIP:** Reverse the removal steps to install the assembly.

Figure 5-276 Remove the front door



Remove the front cover (finisher)

Follow these steps to remove the front cover (finisher).

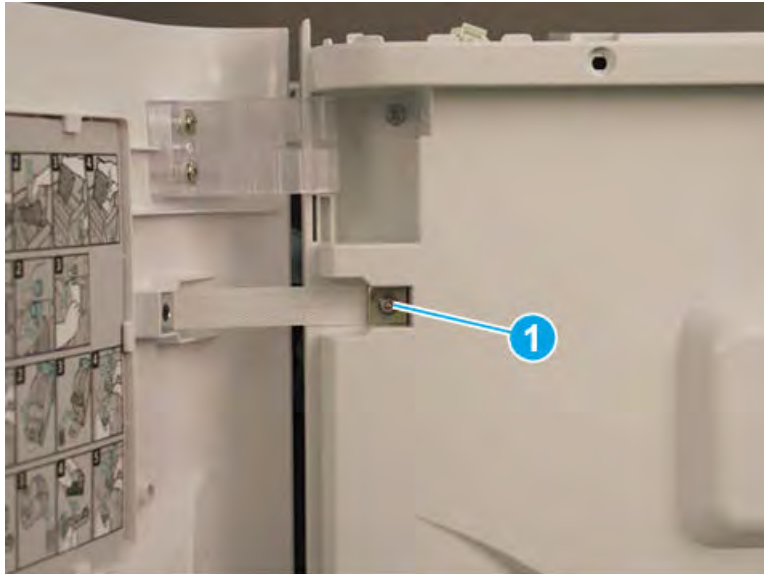
1. Release one tab (callout 1), and then pull the jam-access knob away from the finisher to remove it.

Figure 5-277 Remove the jam-access knob

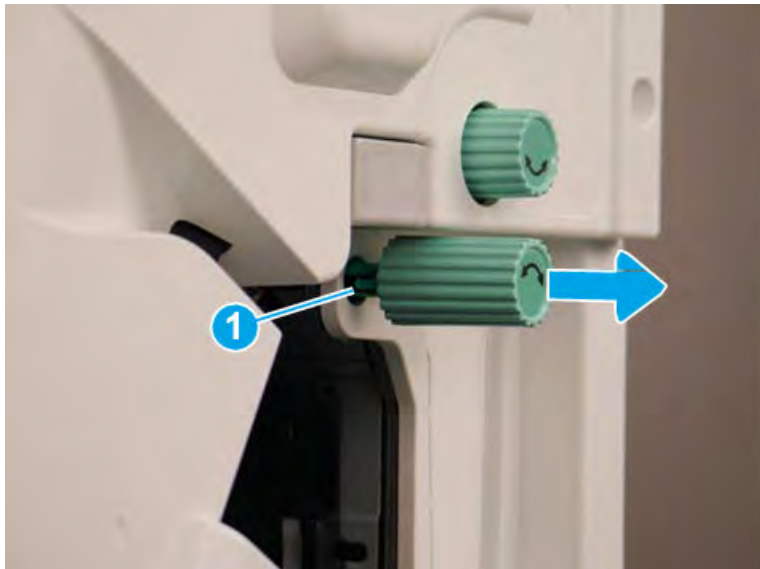

2. If the punch unit is installed, remove the punch waste bin (callout 1).

3. Remove one screw (callout 1) on top of the front cover.

Figure 5-278 Remove one screw



4. Remove five machine screws (callout 1), and then remove the front cover.

 **TIP:** Reverse the removal steps to install the assembly.

Figure 5-279 Remove the front cover



Remove the rear cover (finisher)

Follow these steps to remove the rear cover (finisher).

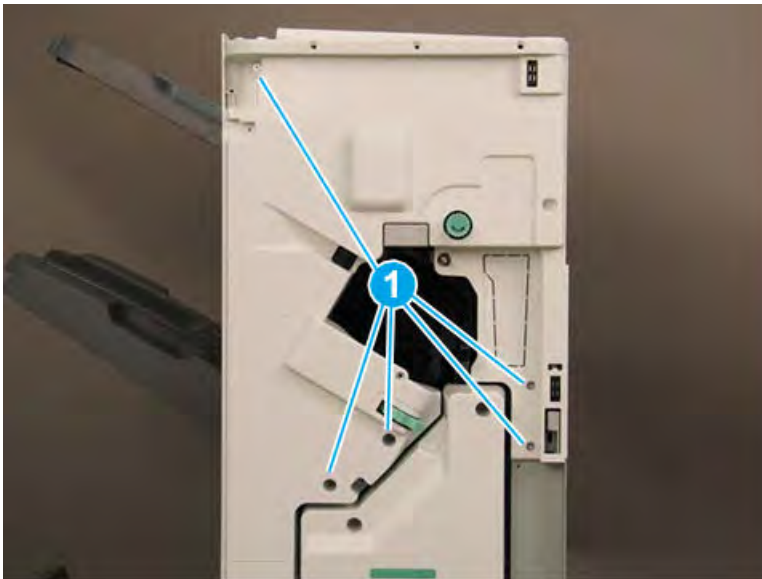
1. Remove two self-tapping screws (callout 1) on the top of the rear cover, and then remove five screw caps and five machine screws (callout 2) on the left side of the cover.

Figure 5-280 Remove seven screws



2. Remove one screw cap and four machine screws (callout 1) Remove the rear cover.

 **NOTE:** Make sure to thread the power cable (callout 2) through the opening in the cover.

 **TIP:** Reverse the removal steps to install the assembly

Figure 5-281 Remove the rear cover

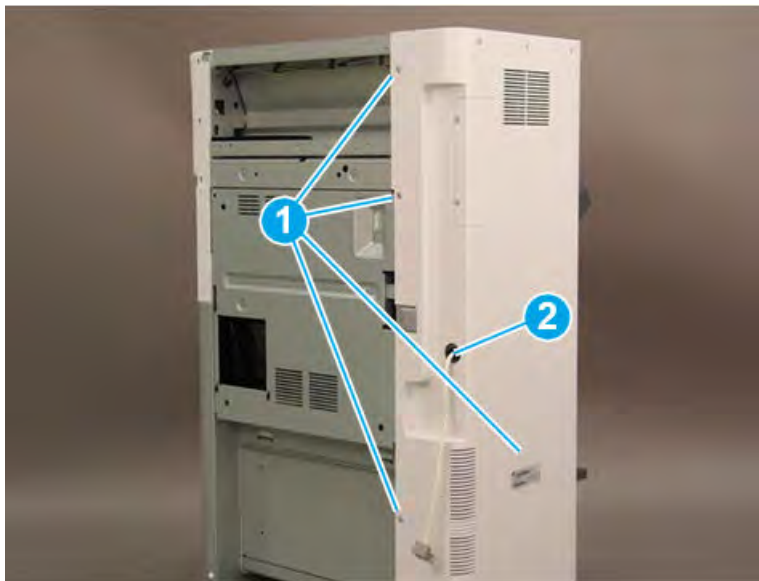

Remove the exit motor (M13)

Follow these steps to remove the exit motor (M13).

- ▲ Release one retainer (callout 1), and then disconnect one connector (callout 2). Remove two screws (callout 3), and then remove the exit motor.

 **TIP:** Make sure that the belt (callout 4) is positioned on the gear behind the motor when reinstalling the motor.

TIP: Reverse the removal steps to install the assembly.

Figure 5-282 Remove the exit motor

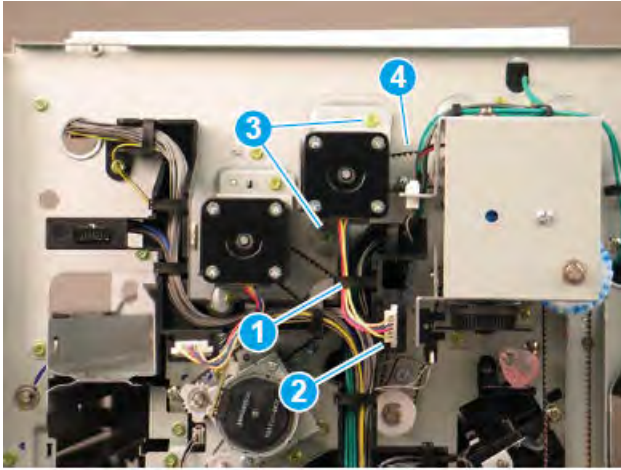

Remove the top jam access cover

Follow these steps to remove the top jam access cover.

1. At the rear of the finisher, remove two screws (callout 1).

Figure 5-283 Remove two screws

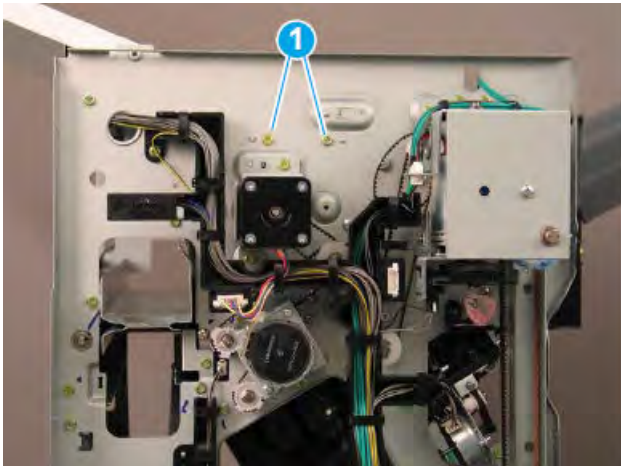

2. Remove the top jam access cover.

 **TIP:** Reverse the removal steps to install the assembly.

Figure 5-284 Remove the top jam access cover



Unpack the replacement assembly



Follow these steps to unpack the replacement assembly.

1. Dispose of the defective part.

 **NOTE:** HP recommends responsible disposal of the defective part.

<http://www8.hp.com/us/en/hp-information/environment/product-recycling.html>

2. Unpack the replacement part from the packaging.

 **CAUTION:**  Some parts are sensitive to electrostatic discharge (ESD). Always perform service work at an ESD-protected workstation or mat. If an ESD workstation or mat is not available, touch the sheet-metal chassis to provide a static ground before touching an ESD-sensitive assembly. Protect the ESD-sensitive assemblies by placing them in ESD pouches when they are out of the printer.

 **IMPORTANT:** Make sure that all of the shipping materials (for example shipping tape) are removed from the replacement part prior to installation.

 **NOTE:** If the replacement part is a roller or pad, avoid touching the spongy part of it. Skin oils on the roller or pad can cause paper pickup and/or print-quality problems. HP recommends using disposable gloves when handling rollers or pads or washing your hands before touching rollers or pads.

3. To install an assembly, reverse the removal steps.

 **NOTE:** When applicable, special installation instructions are provided for an assembly at the end of the removal procedure. Always completely read the removal instructions and follow all special installation instructions.

Removal and replacement: Tray diverter

Learn how to remove and replace the tray diverter.

Introduction

This document provides the procedures to remove and replace the tray diverter on the finisher.



IMPORTANT: When applicable, special installation instructions are provided for an assembly at the end of the removal procedure. Always completely read the removal instructions and follow all special installation instructions.

Before performing service

- Turn the printer power off. A shutting-down message appears on the control-panel display.
- ⚠ **WARNING!** To avoid damage to the printer, turn the power off and wait until the printer shuts down before removing the power cable.
- Disconnect the printer power cable after the printer has completely shut down (the control-panel display is blank).
- Release the finisher from the printer by pulling out on the release latch inside the finisher door.
- Disconnect the cable from the bridge unit to the finisher.
- Disconnect the cable from the finisher to the printer.

Use the table below to identify the correct part number for your printer. To order the part, go to <https://parts.hp.com>.

Table 5-99 Part information

Part number	Part description
JC61-07205A	Tray diverter

Required tools

- #2 JIS screwdriver with a magnetic tip

After performing service

- Connect the cable from the finisher to the printer.
- Connect the cable from the bridge unit to the finisher.
- Attach the finisher to the printer, and then push in on the release latch inside the finisher door.
- Connect the printer power cable.
- Turn the printer power on.

Post service test

Process a job through the finisher and verify that the finisher works correctly.

Remove the right upper cover (finisher)

Follow these steps to remove the right upper cover (finisher).

- ▲ Remove one screw cap and three machine screws on the upper edge of the cover (callout 1). Remove three sheet metal screws (callout 2) on the lower portion of the cover. Rotate the right edge of the cover away from the finisher, and then slide the cover right to release three tabs (callout 3).

💡 **TIP:** The lower screws are shorter in length than the upper screws.

TIP: Reverse the removal steps to install the assembly.

Figure 5-285 Remove the right upper cover

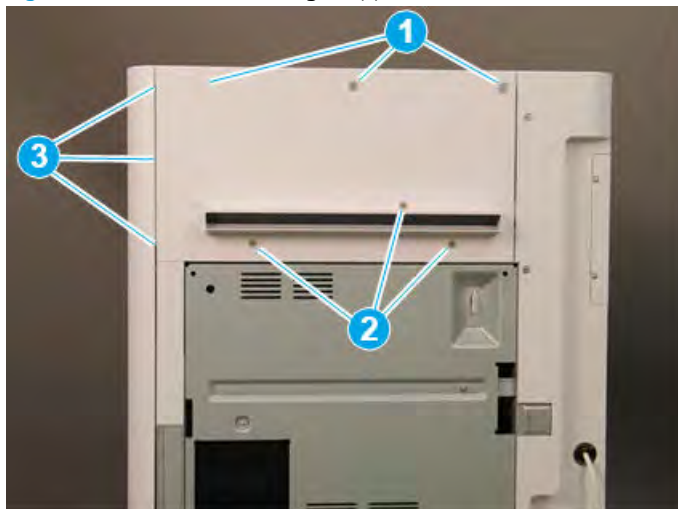

Remove the top cover (finisher)

Follow these steps to remove the top cover (finisher).

1. Remove three screw caps and three self-tapping screws at the top of the rear cover (callout 1), and then remove three machine screws (callout 2) on top of the cover.

Figure 5-286 Remove six screws

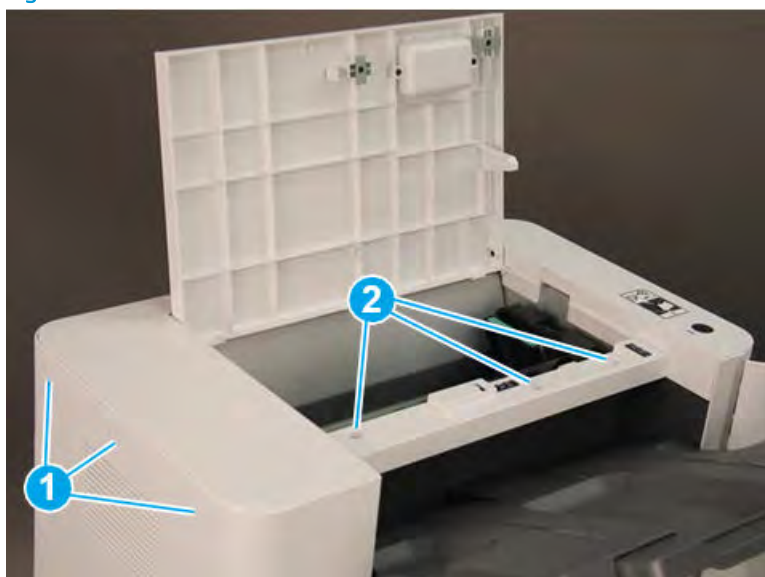

2. Remove three self-tapping screws at the top of the front cover (callout 1), and then remove two machine screws (callout 2) at the top of the right side.

Figure 5-287 Remove five screws

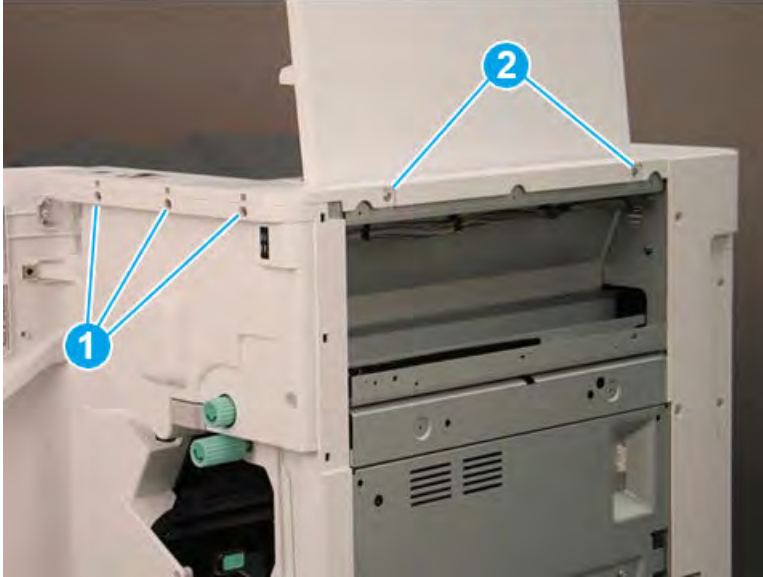

3. Lift the cover up slightly. Disconnect one in-line connector (callout 1), and then release one retainer (callout 2).

 **TIP:** Reverse the removal steps to install the assembly.

Figure 5-288 Disconnect one connector and release retainer

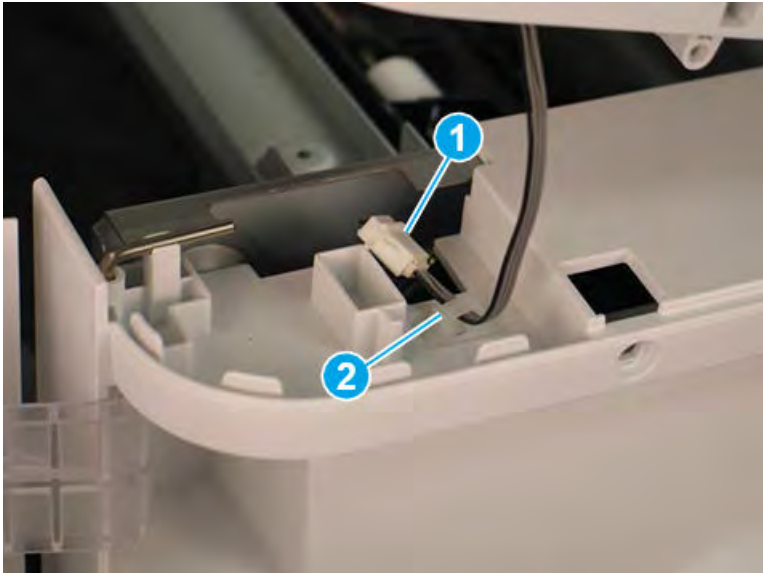

Remove the rear cover (finisher)

Follow these steps to remove the rear cover (finisher).

1. Remove two self-tapping screws (callout 1) on the top of the rear cover, and then remove five screw caps and five machine screws (callout 2) on the left side of the cover.

Figure 5-289 Remove seven screws

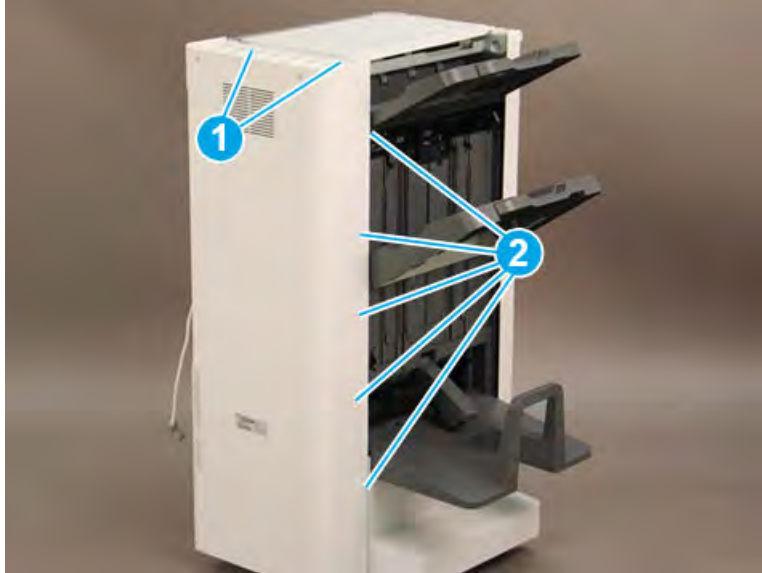

2. Remove one screw cap and four machine screws (callout 1) Remove the rear cover.

 **NOTE:** Make sure to thread the power cable (callout 2) through the opening in the cover.

 **TIP:** Reverse the removal steps to install the assembly

Figure 5-290 Remove the rear cover



Remove the tray diverter

Follow these steps to remove the tray diverter.

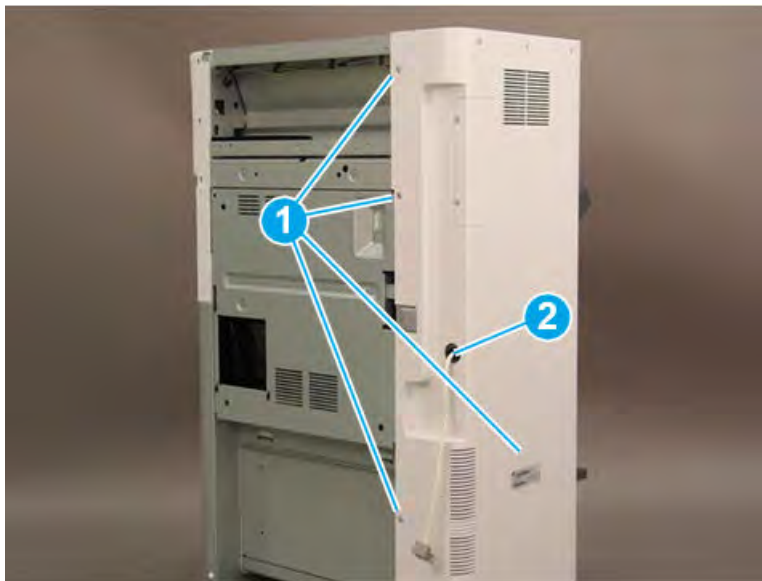
1. Remove two screws(callout 1) to take out the exit motor (callout 2)

Figure 5-291 Take out the exit motor

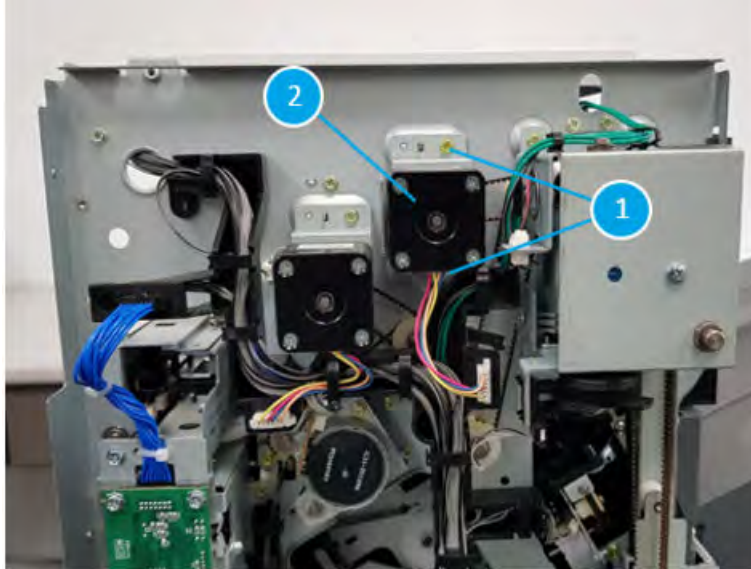

2. Remove two screws (callout 1)

Figure 5-292 Remove two screws

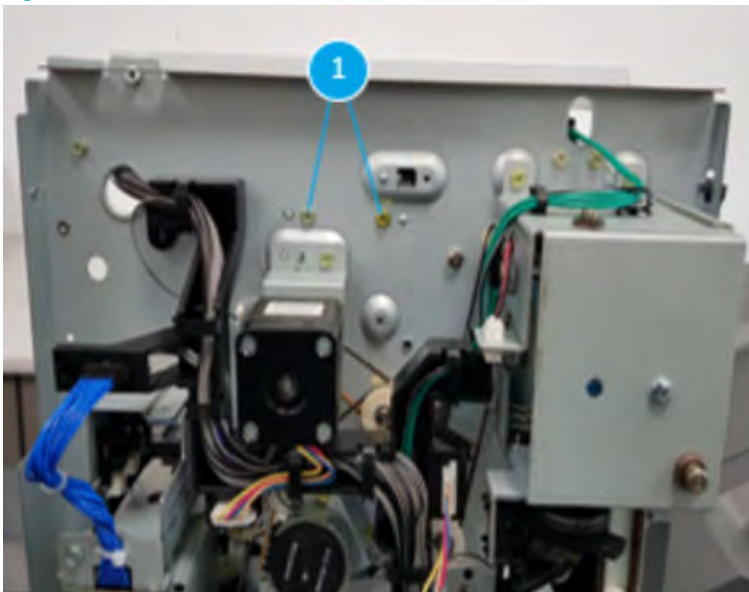

3. Pull the top jam cover assembly out.

Figure 5-293 Pull the top jam cover assembly out

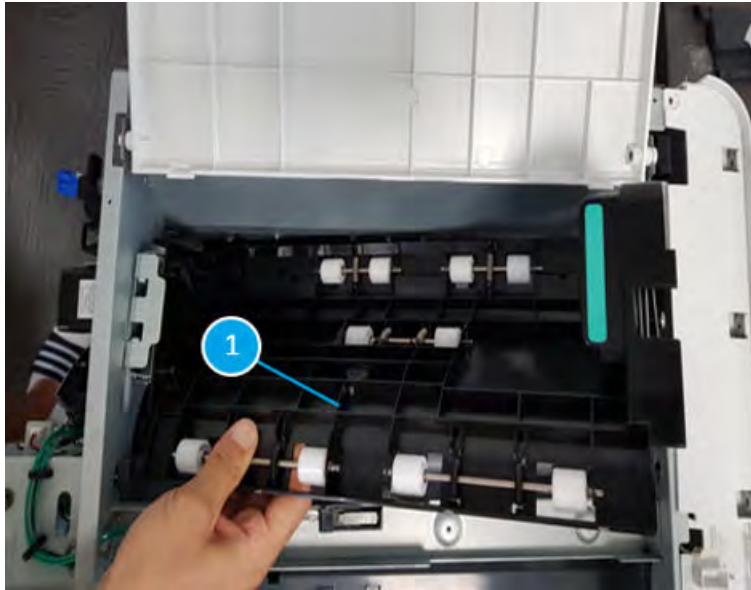

4. Remove the tray diverter (callout 1) from top jam cover assembly.

Figure 5-294 Remove the tray diverter

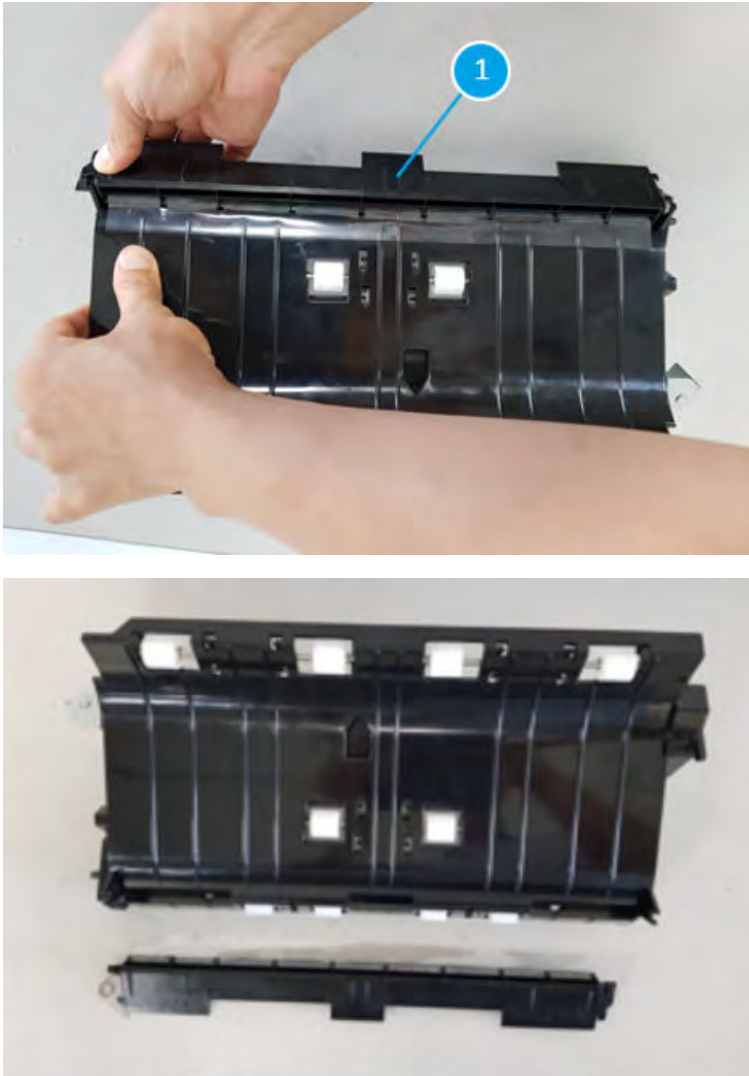

Unpack the replacement assembly

Follow these steps to unpack the replacement assembly.

1. Dispose of the defective part.

 **NOTE:** HP recommends responsible disposal of the defective part.

<http://www8.hp.com/us/en/hp-information/environment/product-recycling.html>

2. Unpack the replacement part from the packaging.



CAUTION:  Some parts are sensitive to electrostatic discharge (ESD). Always perform service work at an ESD-protected workstation or mat. If an ESD workstation or mat is not available, touch the sheet-metal chassis to provide a static ground before touching an ESD-sensitive assembly. Protect the ESD-sensitive assemblies by placing them in ESD pouches when they are out of the printer.

 **IMPORTANT:** Make sure that all of the shipping materials (for example shipping tape) are removed from the replacement part prior to installation.

 **NOTE:** If the replacement part is a roller or pad, avoid touching the spongy part of it. Skin oils on the roller or pad can cause paper pickup and/or print-quality problems. HP recommends using disposable gloves when handling rollers or pads or washing your hands before touching rollers or pads.

3. To install an assembly, reverse the removal steps.

 **NOTE:** When applicable, special installation instructions are provided for an assembly at the end of the removal procedure. Always completely read the removal instructions and follow all special installation instructions.

Removal and replacement: Tray diverter home sensor (S4)

Learn how to remove and replace the tray diverter home sensor.

Introduction

This document provides the procedures to remove and replace the tray diverter home sensor on the finisher.



IMPORTANT: When applicable, special installation instructions are provided for an assembly at the end of the removal procedure. Always completely read the removal instructions and follow all special installation instructions.

Before performing service

- Turn the printer power off. A shutting-down message appears on the control-panel display.
- ⚠ **WARNING!** To avoid damage to the printer, turn the power off and wait until the printer shuts down before removing the power cable.
- Disconnect the printer power cable after the printer has completely shut down (the control-panel display is blank).
- Release the finisher from the printer by pulling out on the release latch inside the finisher door.
- Disconnect the cable from the bridge unit to the finisher.
- Disconnect the cable from the finisher to the printer.

Use the table below to identify the correct part number for your printer. To order the part, go to <https://parts.hp.com>.

Table 5-100 Part information

Part number	Part description
0604-001415	Tray diverter home sensor

Required tools

- #2 JIS screwdriver with a magnetic tip

After performing service

- Connect the cable from the finisher to the printer.
- Connect the cable from the bridge unit to the finisher.
- Attach the finisher to the printer, and then push in on the release latch inside the finisher door.
- Connect the printer power cable.
- Turn the printer power on.

Post service test

Process a job through the finisher and verify that the finisher works correctly.

Remove the right upper cover (finisher)

Follow these steps to remove the right upper cover (finisher).

- ▲ Remove one screw cap and three machine screws on the upper edge of the cover (callout 1). Remove three sheet metal screws (callout 2) on the lower portion of the cover. Rotate the right edge of the cover away from the finisher, and then slide the cover right to release three tabs (callout 3).

💡 **TIP:** The lower screws are shorter in length than the upper screws.

TIP: Reverse the removal steps to install the assembly.

Figure 5-295 Remove the right upper cover

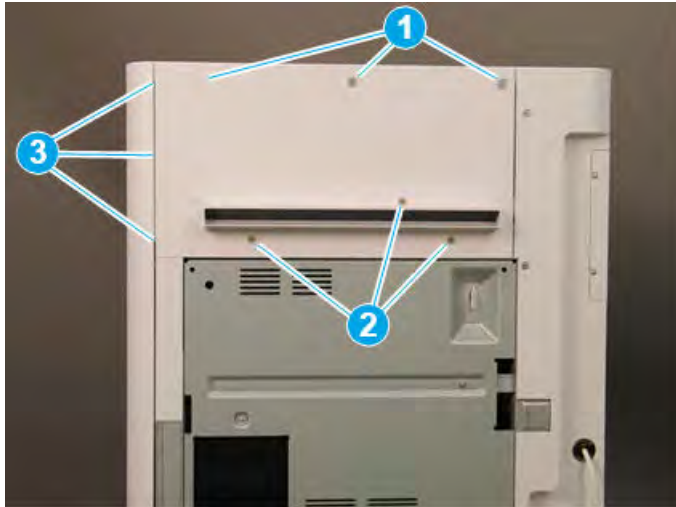

Remove the top cover (finisher)

Follow these steps to remove the top cover (finisher).

1. Remove three screw caps and three self-tapping screws at the top of the rear cover (callout 1), and then remove three machine screws (callout 2) on top of the cover.

Figure 5-296 Remove six screws

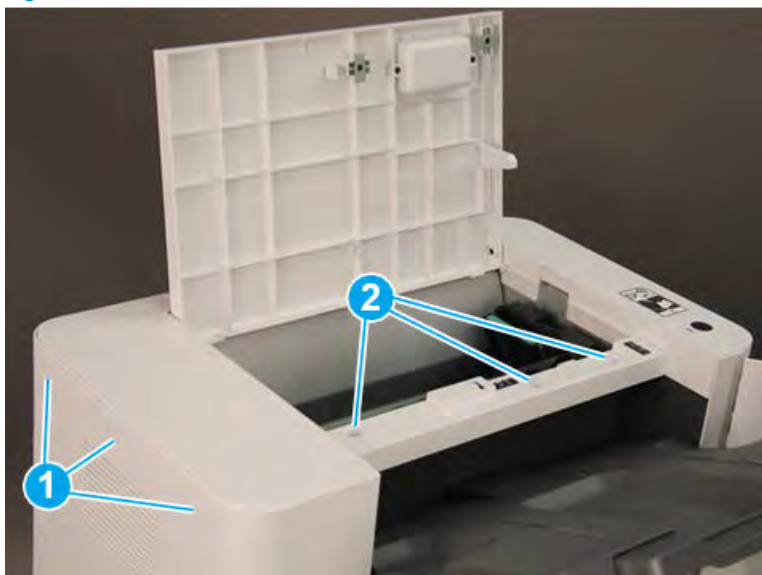

2. Remove three self-tapping screws at the top of the front cover (callout 1), and then remove two machine screws (callout 2) at the top of the right side.

Figure 5-297 Remove five screws

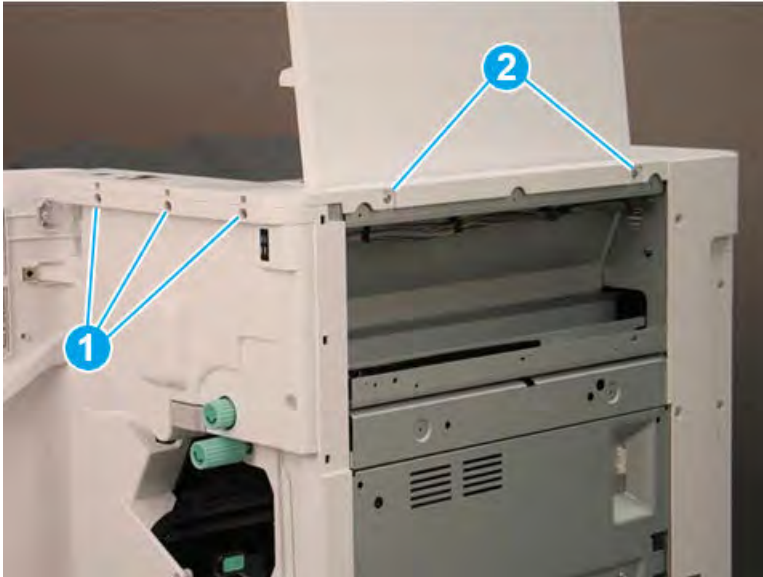

3. Lift the cover up slightly. Disconnect one in-line connector (callout 1), and then release one retainer (callout 2).

 **TIP:** Reverse the removal steps to install the assembly.

Figure 5-298 Disconnect one connector and release retainer



Remove the front door (finisher)

Follow these steps to remove the front door (finisher).

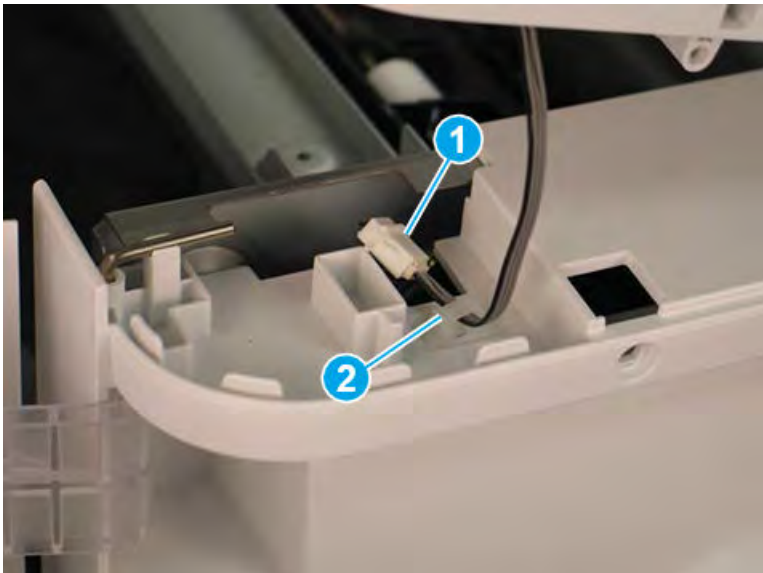
1. Lift the top hinge pin up to release it from the retainer.

Figure 5-299 Lift the top hinge pin

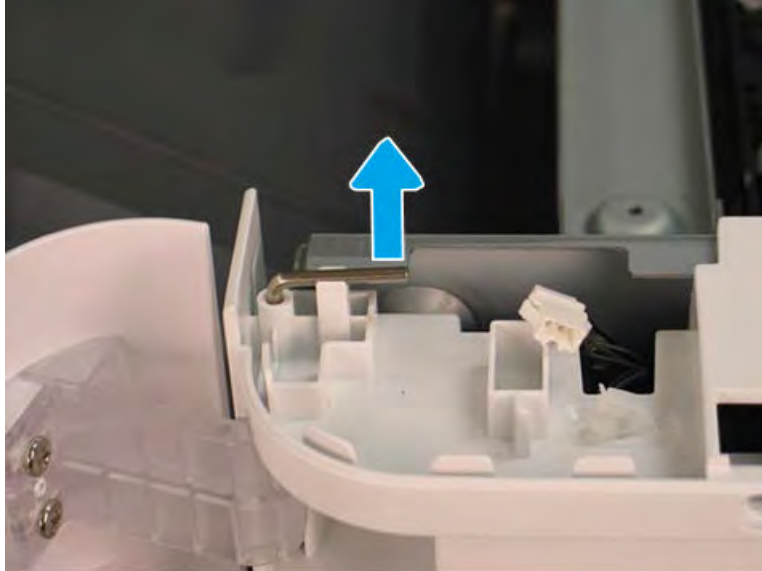

2. Pull the top hinge pin up to remove it.

Figure 5-300 Remove the top hinge pin

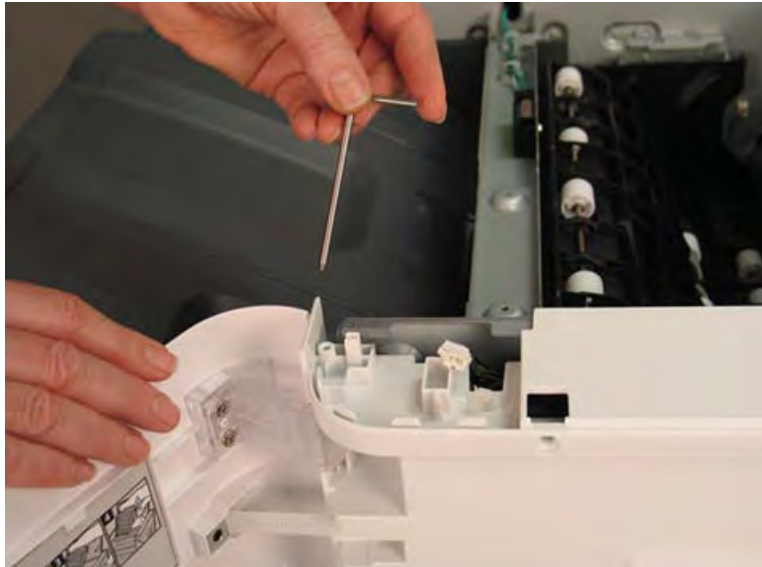

3. Use a small, flat-blade screwdriver to release the lower hinge pin from the retainer, and then rotate it away from the finisher.

Figure 5-301 Release the lower hinge pin



4. Support the door with one hand, and then pull the lower hinge pin straight up to remove it.

Figure 5-302 Remove the lower hinge pin



5. Support the door with one hand, and then remove one screw (callout 1) to release the strap. Remove the front door.

 **TIP:** Reverse the removal steps to install the assembly.

Figure 5-303 Remove the front door



Remove the front cover (finisher)

Follow these steps to remove the front cover (finisher).

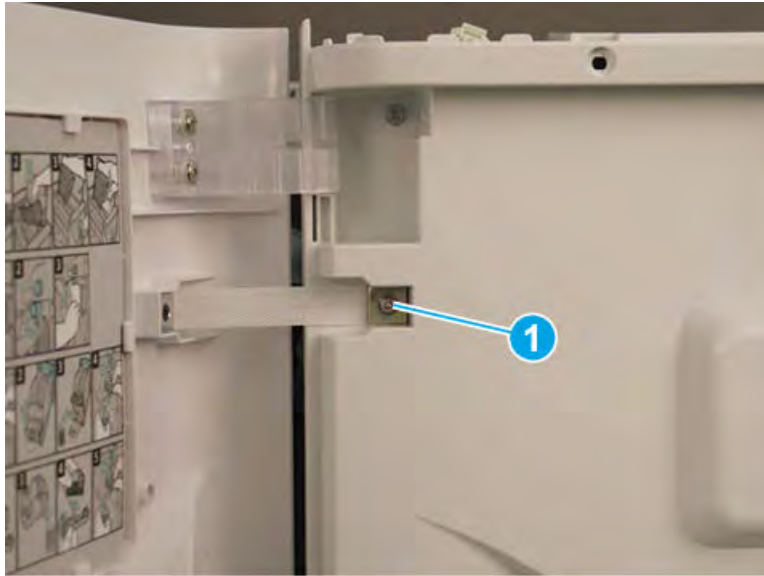
1. Release one tab (callout 1), and then pull the jam-access knob away from the finisher to remove it.

Figure 5-304 Remove the jam-access knob

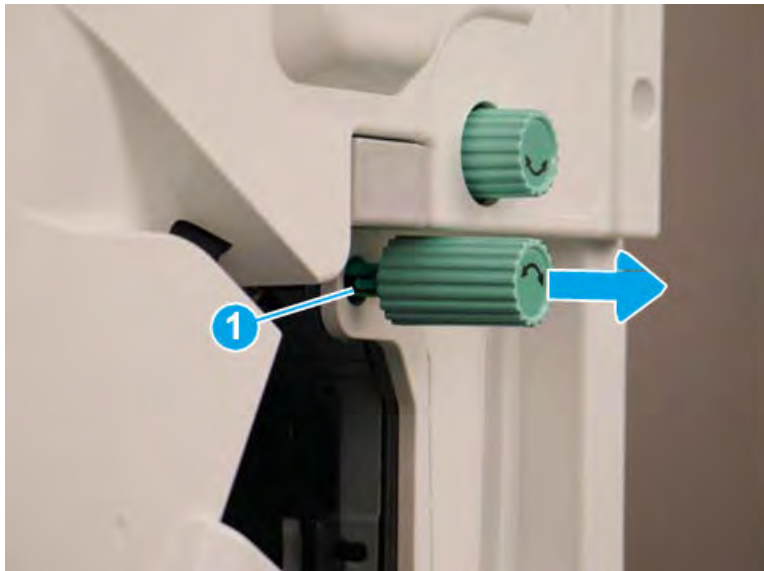

2. If the punch unit is installed, remove the punch waste bin (callout 1).

3. Remove one screw (callout 1) on top of the front cover.

Figure 5-305 Remove one screw



4. Remove five machine screws (callout 1), and then remove the front cover.

 **TIP:** Reverse the removal steps to install the assembly.

Figure 5-306 Remove the front cover



Remove the tray diverter home sensor (S4)

Follow these steps to remove the tray diverter home sensor (S4).

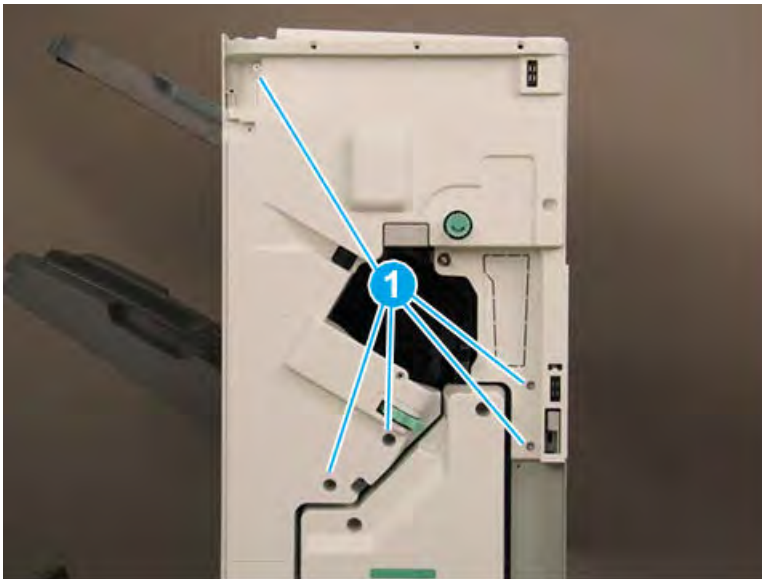
1. Disconnect one connector (callout 1)

Figure 5-307 Disconnect one connector



2. Remove the green handle (callout 1)

Figure 5-308 Remove the green handle

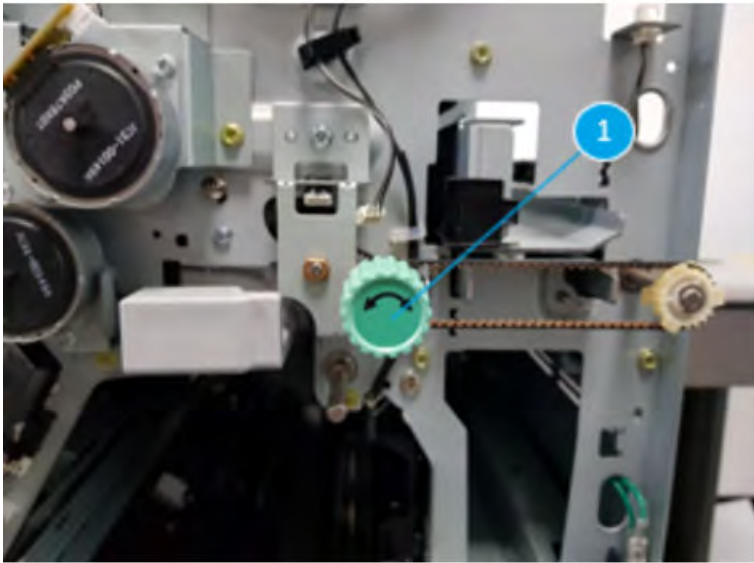

3. Remove the belt (callout 1)

Figure 5-309 Remove the belt

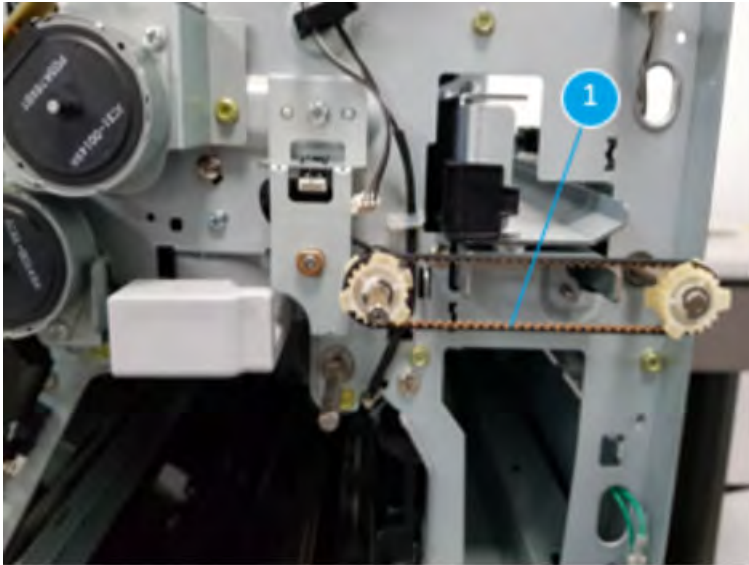

4. Remove two screws (callout 1) and remove the bracket (callout 2) to reach out the tray diverter home sensor

Figure 5-310 Remove two screws and remove the bracket

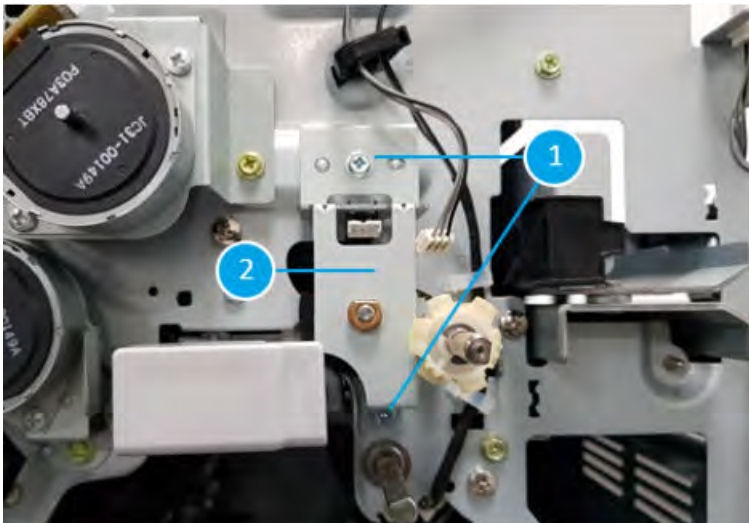

5. Remove the tray diverter home sensor (S4, callout 1)

Figure 5-311 Remove the tray diverter home sensor

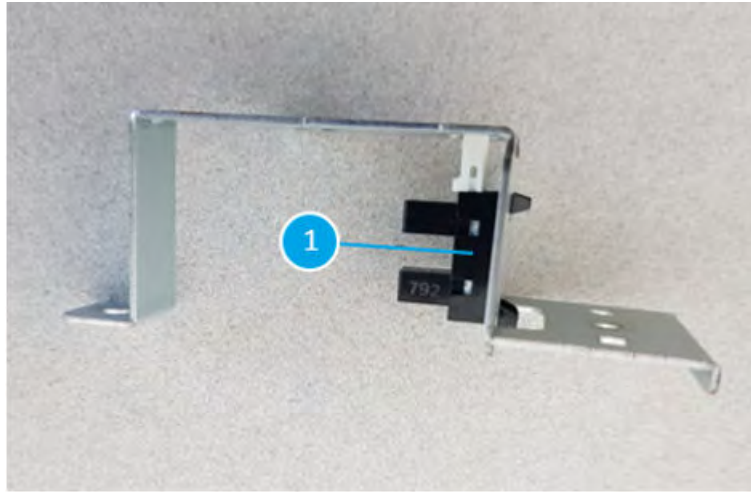

Unpack the replacement assembly

Follow these steps to unpack the replacement assembly.

1. Dispose of the defective part.



NOTE: HP recommends responsible disposal of the defective part.

<http://www8.hp.com/us/en/hp-information/environment/product-recycling.html>

2. Unpack the replacement part from the packaging.



CAUTION:  Some parts are sensitive to electrostatic discharge (ESD). Always perform service work at an ESD-protected workstation or mat. If an ESD workstation or mat is not available, touch the sheet-metal chassis to provide a static ground before touching an ESD-sensitive assembly. Protect the ESD-sensitive assemblies by placing them in ESD pouches when they are out of the printer.



IMPORTANT: Make sure that all of the shipping materials (for example shipping tape) are removed from the replacement part prior to installation.



NOTE: If the replacement part is a roller or pad, avoid touching the spongy part of it. Skin oils on the roller or pad can cause paper pickup and/or print-quality problems. HP recommends using disposable gloves when handling rollers or pads or washing your hands before touching rollers or pads.

3. To install an assembly, reverse the removal steps.



NOTE: When applicable, special installation instructions are provided for an assembly at the end of the removal procedure. Always completely read the removal instructions and follow all special installation instructions.

Top exit unit

Removal and replacement: Top lower feed assembly

Learn how to remove and replace the top lower feed assembly.

Introduction

This document provides the procedures to remove and replace the top lower feed assembly for the finisher.

 **IMPORTANT:** When applicable, special installation instructions are provided for an assembly at the end of the removal procedure. Always completely read the removal instructions and follow all special installation instructions.

Before performing service

- Turn the printer power off. A shutting-down message appears on the control-panel display.
- ⚠ **WARNING!** To avoid damage to the printer, turn the power off and wait until the printer shuts down before removing the power cable.
- Disconnect the printer power cable after the printer has completely shut down (the control-panel display is blank).
- Release the finisher from the printer by pulling out on the release latch inside the finisher door.
- Disconnect the cable from the bridge unit to the finisher.
- Disconnect the cable from the finisher to the printer.

Use the table below to identify the correct part number for your printer. To order the part, go to <https://parts.hp.com>.

Table 5-101 Part information

Part number	Part description
JC90-01454A	Top lower feed assembly

Required tools

- #2 JIS screwdriver with a magnetic tip

After performing service

- Connect the cable from the finisher to the printer.
- Connect the cable from the bridge unit to the finisher.
- Attach the finisher to the printer, and then push in on the release latch inside the finisher door.
- Connect the printer power cable.
- Turn the printer power on.

Post service test

Process a job through the finisher and verify that the finisher works correctly.

Remove the right upper cover (finisher)

Follow these steps to remove the right upper cover (finisher).

- ▲ Remove one screw cap and three machine screws on the upper edge of the cover (callout 1). Remove three sheet metal screws (callout 2) on the lower portion of the cover. Rotate the right edge of the cover away from the finisher, and then slide the cover right to release three tabs (callout 3).

💡 **TIP:** The lower screws are shorter in length than the upper screws.

TIP: Reverse the removal steps to install the assembly.

Figure 5-312 Remove the right upper cover

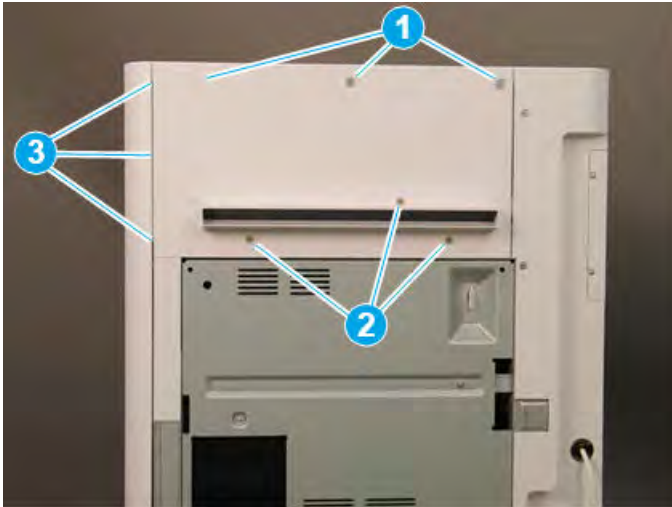

Remove the top cover (finisher)

Follow these steps to remove the top cover (finisher).

1. Remove three screw caps and three self-tapping screws at the top of the rear cover (callout 1), and then remove three machine screws (callout 2) on top of the cover.

Figure 5-313 Remove six screws

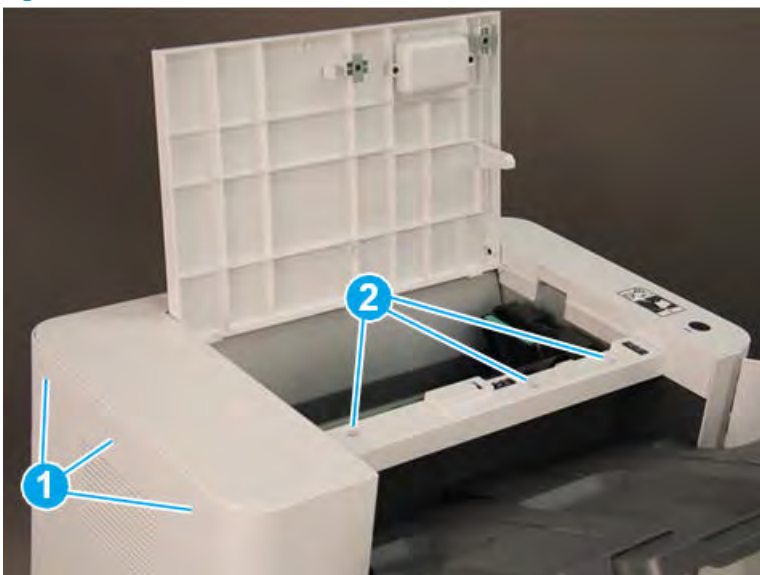

2. Remove three self-tapping screws at the top of the front cover (callout 1), and then remove two machine screws (callout 2) at the top of the right side.

Figure 5-314 Remove five screws

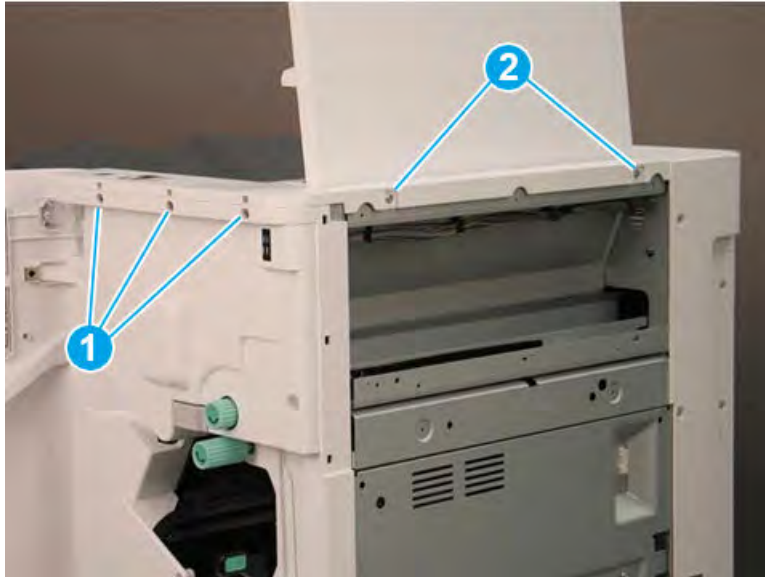

3. Lift the cover up slightly. Disconnect one in-line connector (callout 1), and then release one retainer (callout 2).

 **TIP:** Reverse the removal steps to install the assembly.

Figure 5-315 Disconnect one connector and release retainer



Remove the front door (finisher)

Follow these steps to remove the front door (finisher).

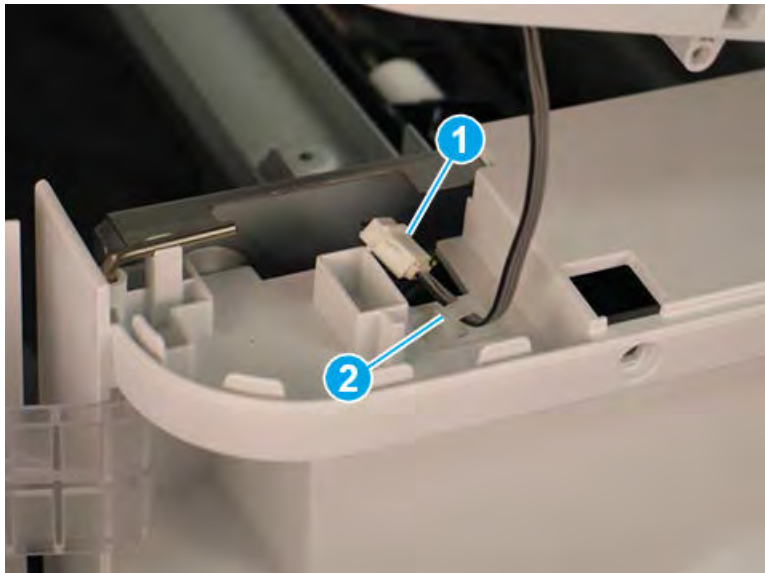
1. Lift the top hinge pin up to release it from the retainer.

Figure 5-316 Lift the top hinge pin

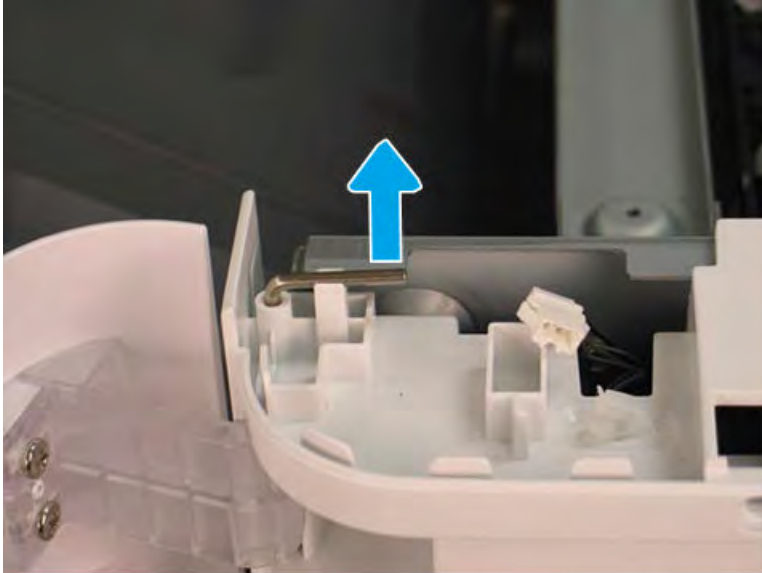

2. Pull the top hinge pin up to remove it.

Figure 5-317 Remove the top hinge pin

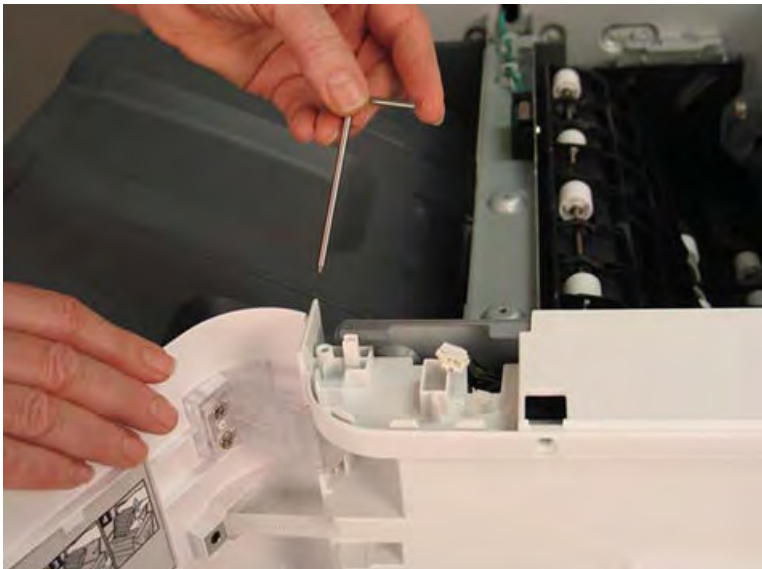

3. Use a small, flat-blade screwdriver to release the lower hinge pin from the retainer, and then rotate it away from the finisher.

Figure 5-318 Release the lower hinge pin



4. Support the door with one hand, and then pull the lower hinge pin straight up to remove it.

Figure 5-319 Remove the lower hinge pin



5. Support the door with one hand, and then remove one screw (callout 1) to release the strap. Remove the front door.

 **TIP:** Reverse the removal steps to install the assembly.

Figure 5-320 Remove the front door



Remove the front cover (finisher)

Follow these steps to remove the front cover (finisher).

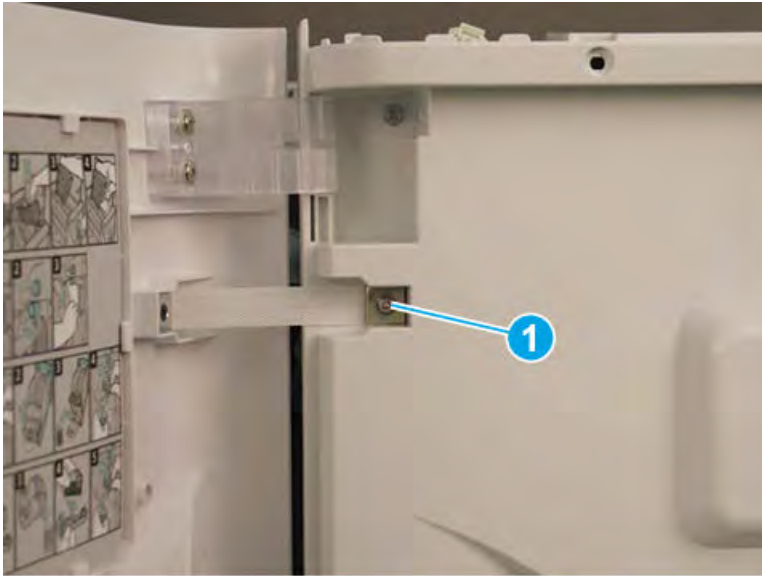
1. Release one tab (callout 1), and then pull the jam-access knob away from the finisher to remove it.

Figure 5-321 Remove the jam-access knob

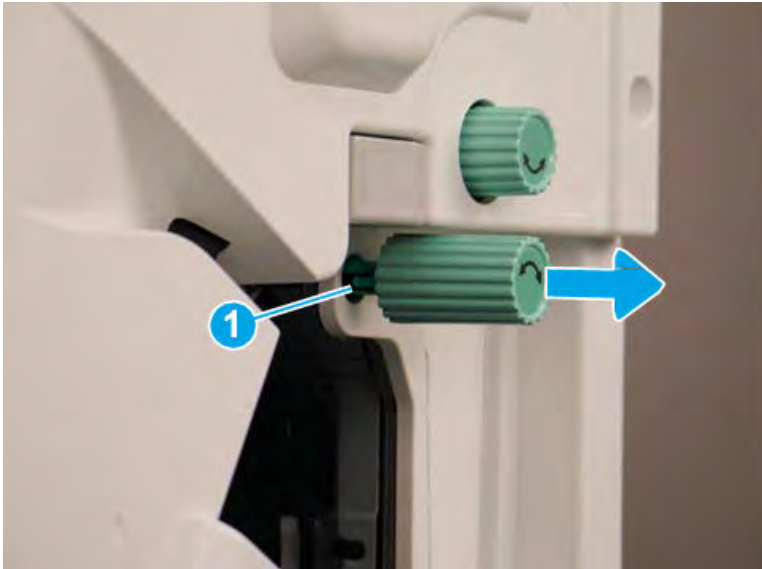

2. If the punch unit is installed, remove the punch waste bin (callout 1).

3. Remove one screw (callout 1) on top of the front cover.

Figure 5-322 Remove one screw



4. Remove five machine screws (callout 1), and then remove the front cover.

 **TIP:** Reverse the removal steps to install the assembly.

Figure 5-323 Remove the front cover



Remove the rear cover (finisher)

Follow these steps to remove the rear cover (finisher).

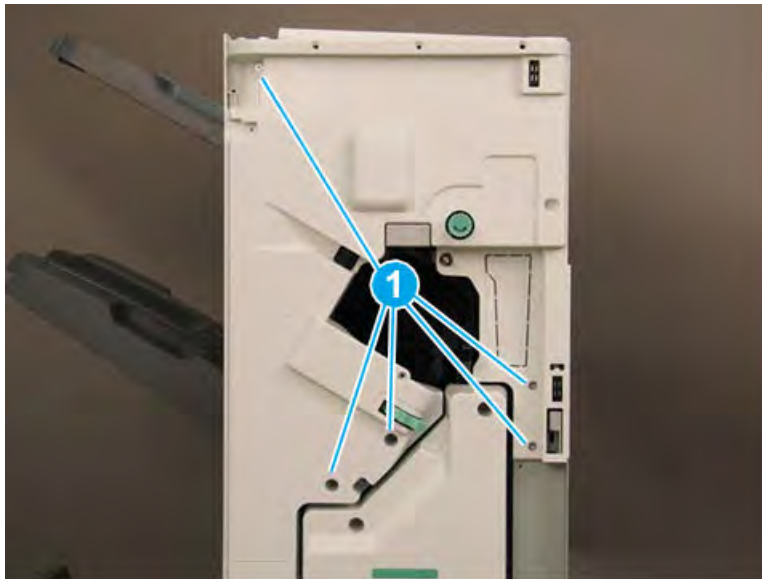
1. Remove two self-tapping screws (callout 1) on the top of the rear cover, and then remove five screw caps and five machine screws (callout 2) on the left side of the cover.

Figure 5-324 Remove seven screws

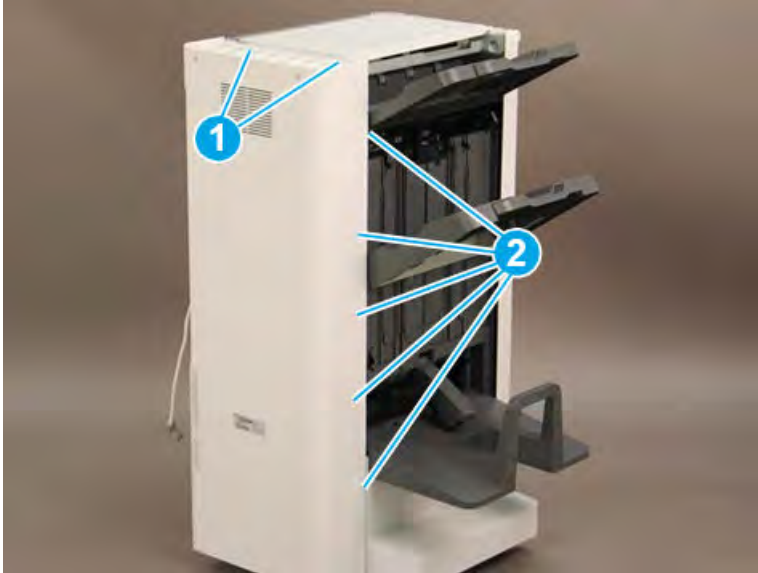

2. Remove one screw cap and four machine screws (callout 1) Remove the rear cover.

 **NOTE:** Make sure to thread the power cable (callout 2) through the opening in the cover.

 **TIP:** Reverse the removal steps to install the assembly

Figure 5-325 Remove the rear cover

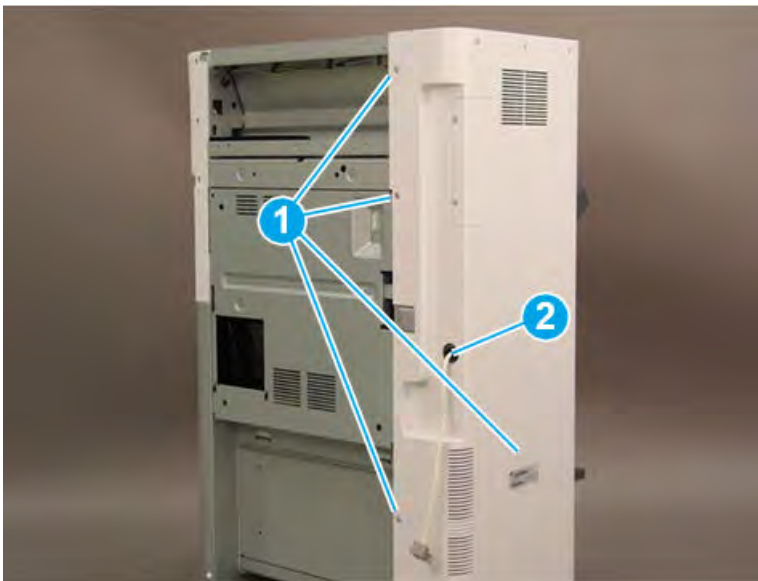

Remove the exit motor (M13)

Follow these steps to remove the exit motor (M13).

- ▲ Release one retainer (callout 1), and then disconnect one connector (callout 2). Remove two screws (callout 3), and then remove the exit motor.

 **TIP:** Make sure that the belt (callout 4) is positioned on the gear behind the motor when reinstalling the motor.

TIP: Reverse the removal steps to install the assembly.

Figure 5-326 Remove the exit motor

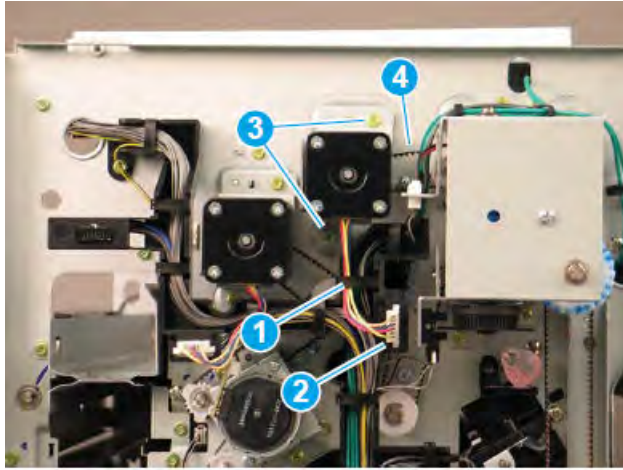

Remove the top jam access cover

Follow these steps to remove the top jam access cover.

1. At the rear of the finisher, remove two screws (callout 1).

Figure 5-327 Remove two screws

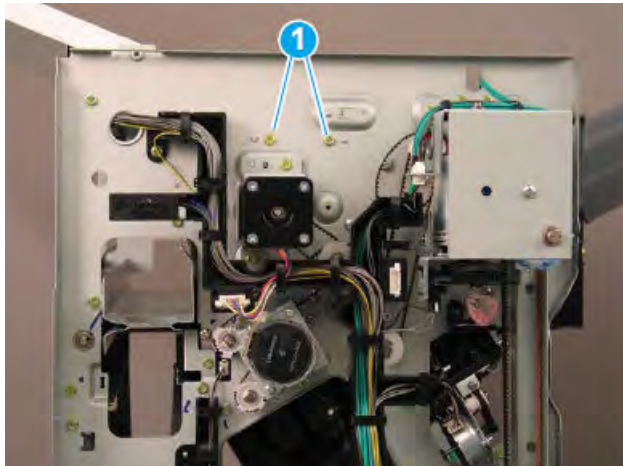

2. Remove the top jam access cover.

 **TIP:** Reverse the removal steps to install the assembly.

Figure 5-328 Remove the top jam access cover



Remove the top lower feed assembly (finisher)

Follow these steps to remove the top lower feed assembly (finisher).

1. At the front of the printer, remove two screws (callout 1) on the main exit cam motor housing, and then tilt the motor aside to access the screws under it.

Figure 5-329 Remove two screws

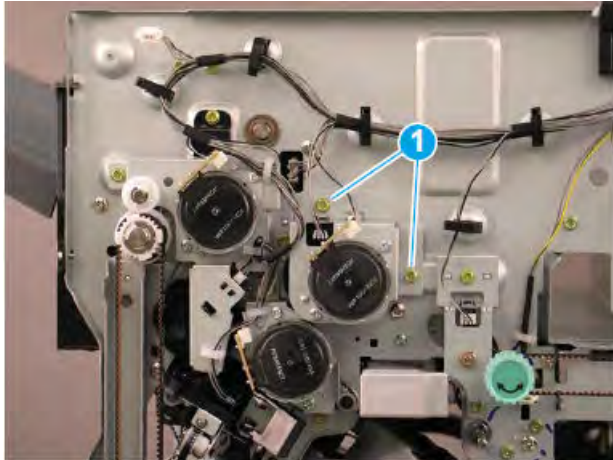

2. At the front of the finisher, remove three self-tapping screws (callout 1), and then disconnect one connector (callout 2).

Figure 5-330 Remove three screws and disconnect one connector

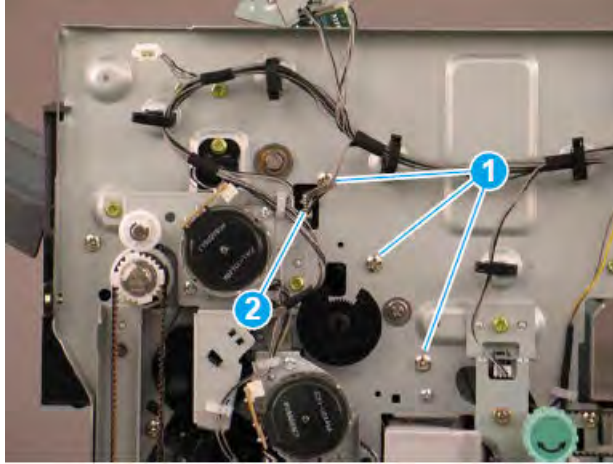

3. At the rear of the finisher, remove three machine screws (callout 1).

Figure 5-331 Remove three screws

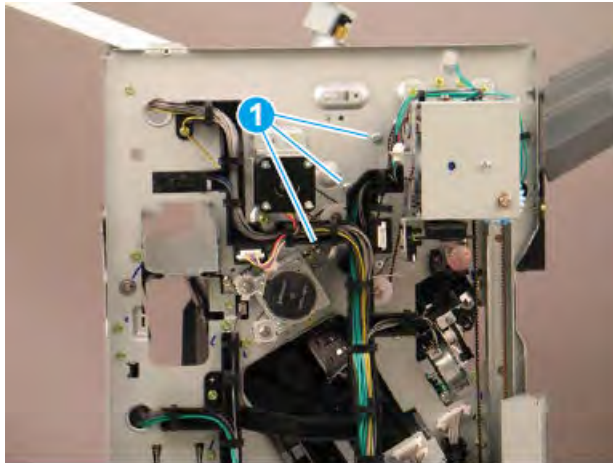

4. At the top of the finisher, lift the feed assembly straight up to disengage two tabs on the bottom and remove the assembly.

Figure 5-332 Remove the top lower feed assembly

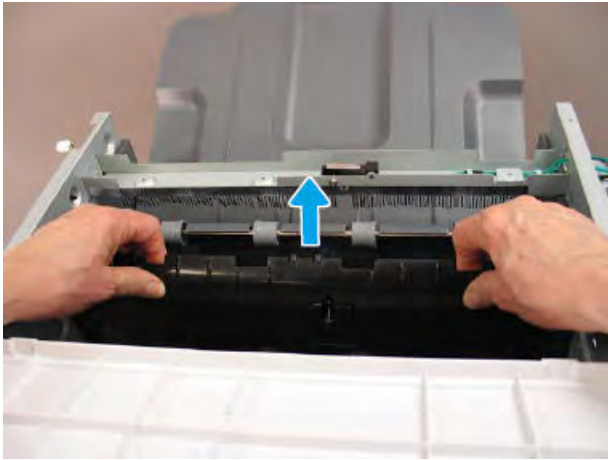

5. If you are replacing the top lower feed assembly, locate two sensors (callout 1) and one connector (callout 2) on the back of the assembly. Remove these items and transfer them to the replacement part.

 **TIP:** Reverse the removal steps to install the assembly.

Figure 5-333 Locate sensors and connector



Unpack the replacement assembly

Follow these steps to unpack the replacement assembly.

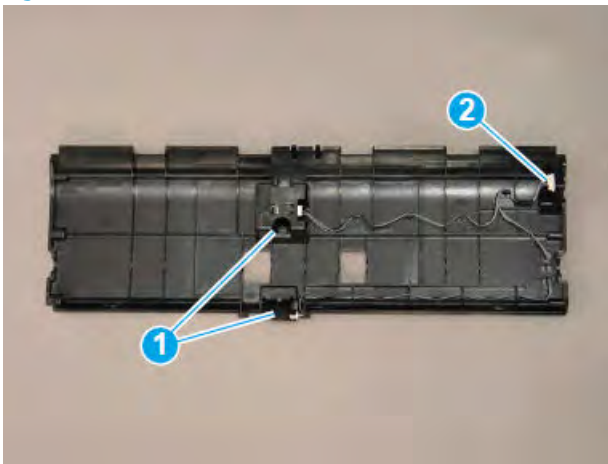
1. Dispose of the defective part.

 **NOTE:** HP recommends responsible disposal of the defective part.

<http://www8.hp.com/us/en/hp-information/environment/product-recycling.html>

2. Unpack the replacement part from the packaging.



CAUTION:  Some parts are sensitive to electrostatic discharge (ESD). Always perform service work at an ESD-protected workstation or mat. If an ESD workstation or mat is not available, touch the sheet-metal chassis to provide a static ground before touching an ESD-sensitive assembly. Protect the ESD-sensitive assemblies by placing them in ESD pouches when they are out of the printer.

 **IMPORTANT:** Make sure that all of the shipping materials (for example shipping tape) are removed from the replacement part prior to installation.

 **NOTE:** If the replacement part is a roller or pad, avoid touching the spongy part of it. Skin oils on the roller or pad can cause paper pickup and/or print-quality problems. HP recommends using disposable gloves when handling rollers or pads or washing your hands before touching rollers or pads.

3. To install an assembly, reverse the removal steps.

 **NOTE:** When applicable, special installation instructions are provided for an assembly at the end of the removal procedure. Always completely read the removal instructions and follow all special installation instructions.

HP LaserJet Managed MFP E82540-E82560, E87640-E87660, E82540du-E82560du, E87640du-E87660du, E72525-E72535, E77822-E77830 – Removal and replacement: Top exit sensor (S11)

Learn how to remove and replace the top exit sensor.

Introduction

This document provides the procedures to remove and replace the top exit sensor for the finisher.



IMPORTANT: When applicable, special installation instructions are provided for an assembly at the end of the removal procedure. Always completely read the removal instructions and follow all special installation instructions.

Before performing service

- Turn the printer power off. A shutting-down message appears on the control-panel display.
- ⚠ **WARNING!** To avoid damage to the printer, turn the power off and wait until the printer shuts down before removing the power cable.
- Disconnect the printer power cable after the printer has completely shut down (the control-panel display is blank).
- Release the finisher from the printer by pulling out on the release latch inside the finisher door.
- Disconnect the cable from the bridge unit to the finisher.
- Disconnect the cable from the finisher to the printer.

Use the table below to identify the correct part number for your printer. To order the part, go to <https://parts.hp.com>.

Table 5-102 Part information

Part number	Part description
0604-001393	Top exit sensor

Required tools

- #2 JIS screwdriver with a magnetic tip

After performing service

- Connect the cable from the finisher to the printer.
- Connect the cable from the bridge unit to the finisher.
- Attach the finisher to the printer, and then push in on the release latch inside the finisher door.
- Connect the printer power cable.
- Turn the printer power on.

Post service test

Process a job through the finisher and verify that the finisher works correctly.

Remove the right upper cover (finisher)

Follow these steps to remove the right upper cover (finisher).

- ▲ Remove one screw cap and three machine screws on the upper edge of the cover (callout 1). Remove three sheet metal screws (callout 2) on the lower portion of the cover. Rotate the right edge of the cover away from the finisher, and then slide the cover right to release three tabs (callout 3).

💡 **TIP:** The lower screws are shorter in length than the upper screws.

TIP: Reverse the removal steps to install the assembly.

Figure 5-334 Remove the right upper cover

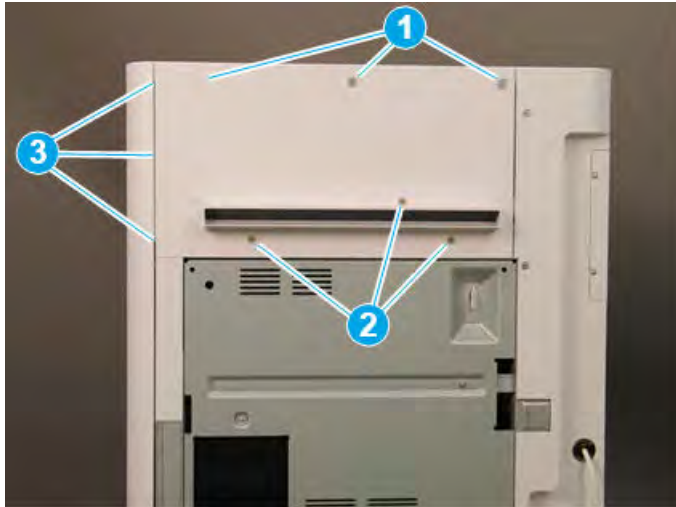

Remove the top cover (finisher)

Follow these steps to remove the top cover (finisher).

1. Remove three screw caps and three self-tapping screws at the top of the rear cover (callout 1), and then remove three machine screws (callout 2) on top of the cover.

Figure 5-335 Remove six screws

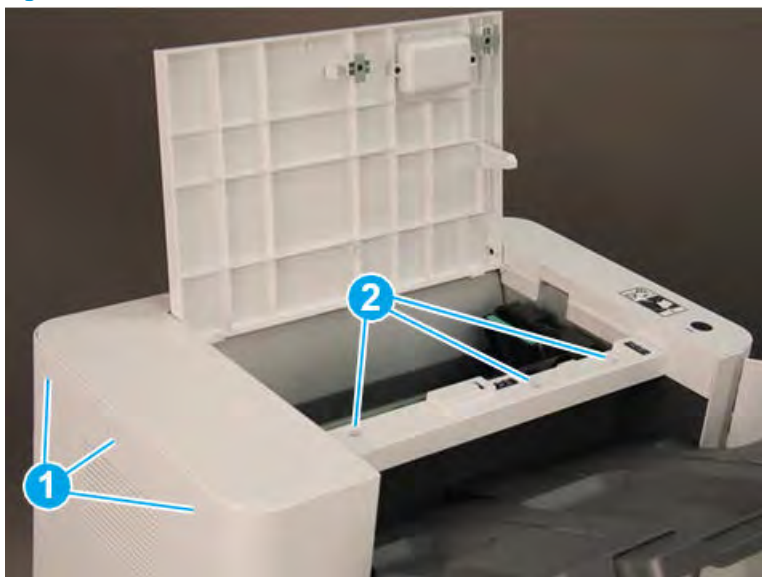

2. Remove three self-tapping screws at the top of the front cover (callout 1), and then remove two machine screws (callout 2) at the top of the right side.

Figure 5-336 Remove five screws

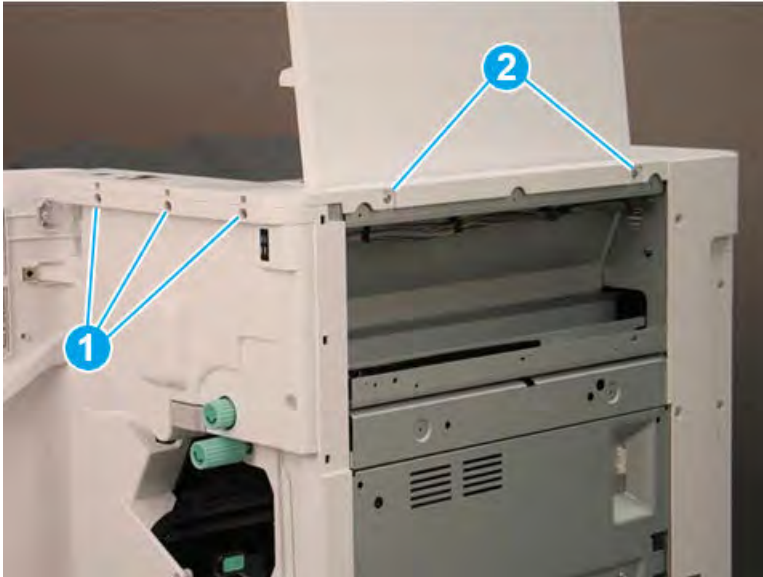

3. Lift the cover up slightly. Disconnect one in-line connector (callout 1), and then release one retainer (callout 2).

 **TIP:** Reverse the removal steps to install the assembly.

Figure 5-337 Disconnect one connector and release retainer



Remove the front door (finisher)

Follow these steps to remove the front door (finisher).

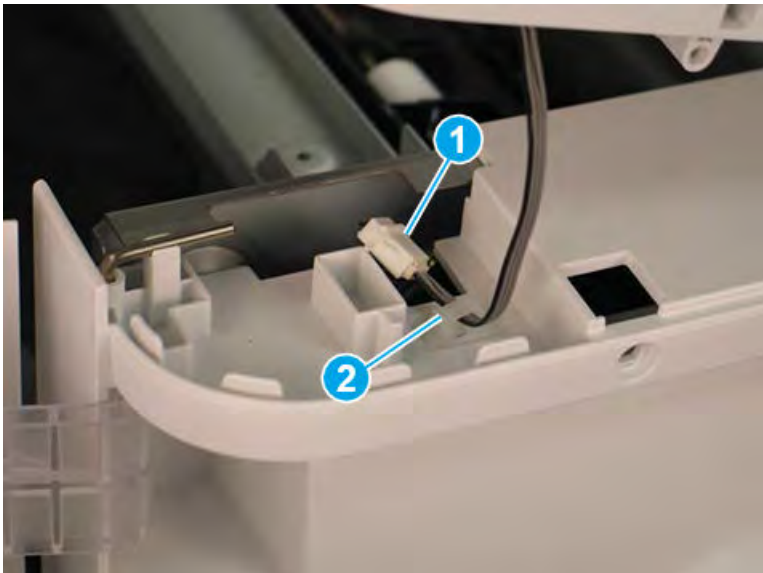
1. Lift the top hinge pin up to release it from the retainer.

Figure 5-338 Lift the top hinge pin

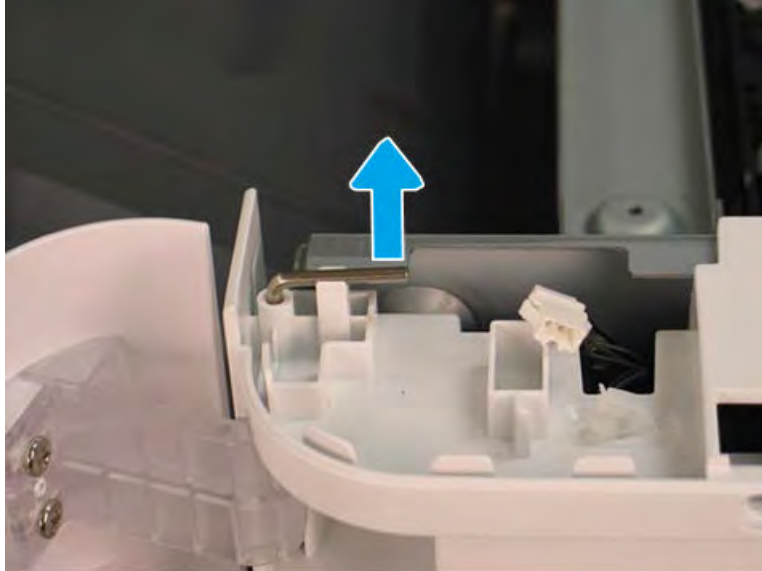

2. Pull the top hinge pin up to remove it.

Figure 5-339 Remove the top hinge pin

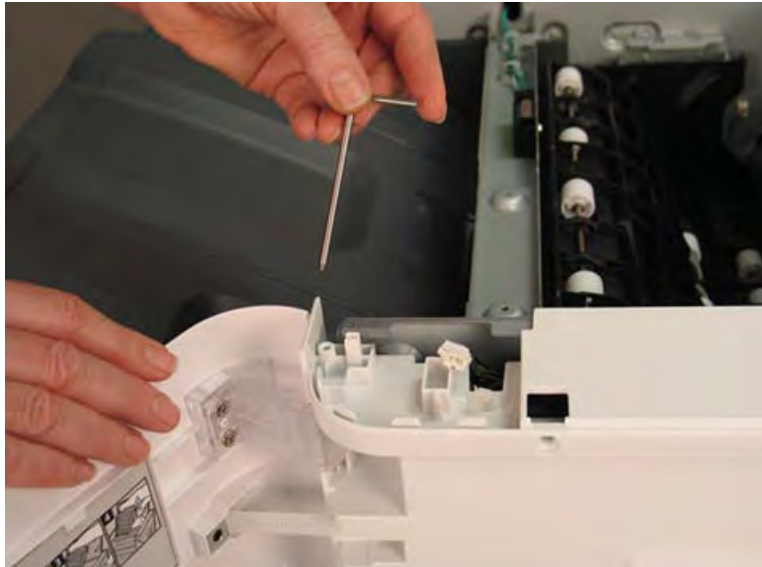

3. Use a small, flat-blade screwdriver to release the lower hinge pin from the retainer, and then rotate it away from the finisher.

Figure 5-340 Release the lower hinge pin



4. Support the door with one hand, and then pull the lower hinge pin straight up to remove it.

Figure 5-341 Remove the lower hinge pin



5. Support the door with one hand, and then remove one screw (callout 1) to release the strap. Remove the front door.

 **TIP:** Reverse the removal steps to install the assembly.

Figure 5-342 Remove the front door



Remove the front cover (finisher)

Follow these steps to remove the front cover (finisher).

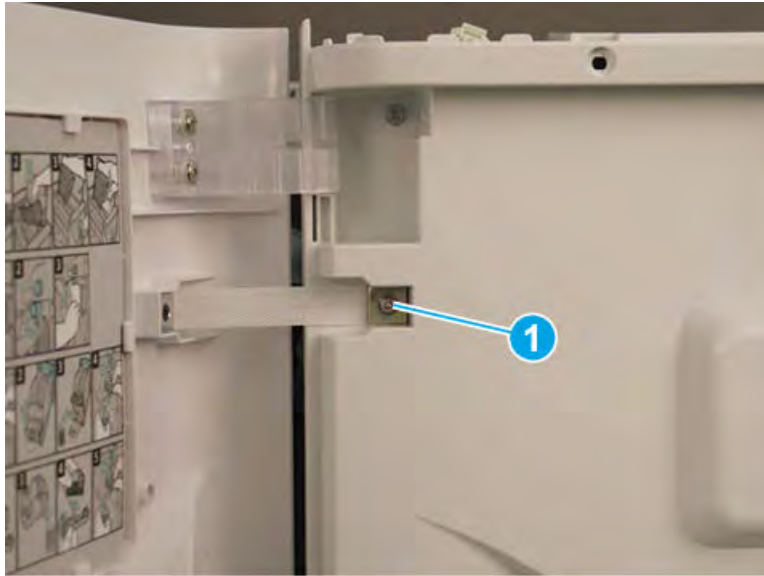
1. Release one tab (callout 1), and then pull the jam-access knob away from the finisher to remove it.

Figure 5-343 Remove the jam-access knob

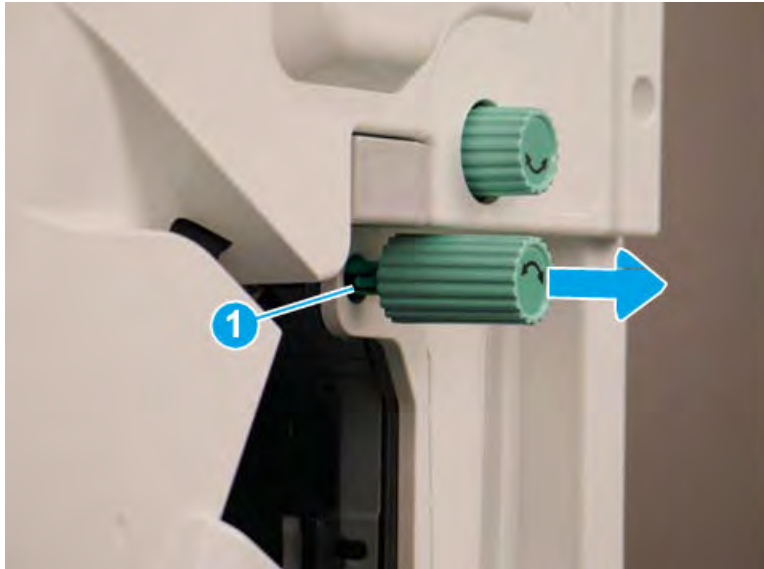

2. If the punch unit is installed, remove the punch waste bin (callout 1).

3. Remove one screw (callout 1) on top of the front cover.

Figure 5-344 Remove one screw



4. Remove five machine screws (callout 1), and then remove the front cover.

 **TIP:** Reverse the removal steps to install the assembly.

Figure 5-345 Remove the front cover



Remove the rear cover (finisher)

Follow these steps to remove the rear cover (finisher).

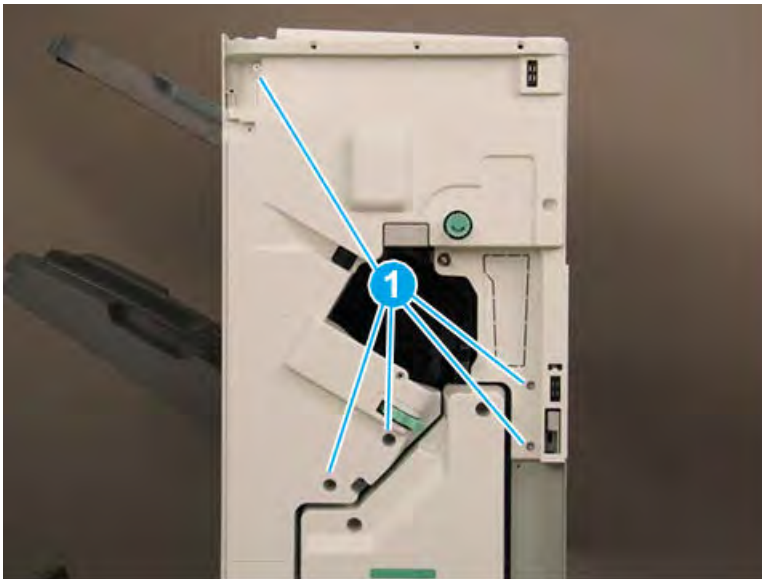
1. Remove two self-tapping screws (callout 1) on the top of the rear cover, and then remove five screw caps and five machine screws (callout 2) on the left side of the cover.

Figure 5-346 Remove seven screws

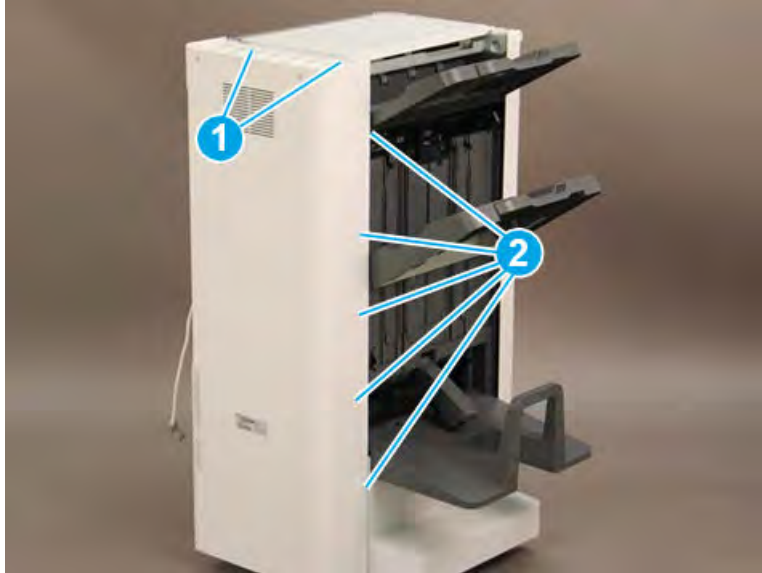

2. Remove one screw cap and four machine screws (callout 1) Remove the rear cover.

 **NOTE:** Make sure to thread the power cable (callout 2) through the opening in the cover.

 **TIP:** Reverse the removal steps to install the assembly

Figure 5-347 Remove the rear cover



Remove the exit motor (M13)

Follow these steps to remove the exit motor (M13).

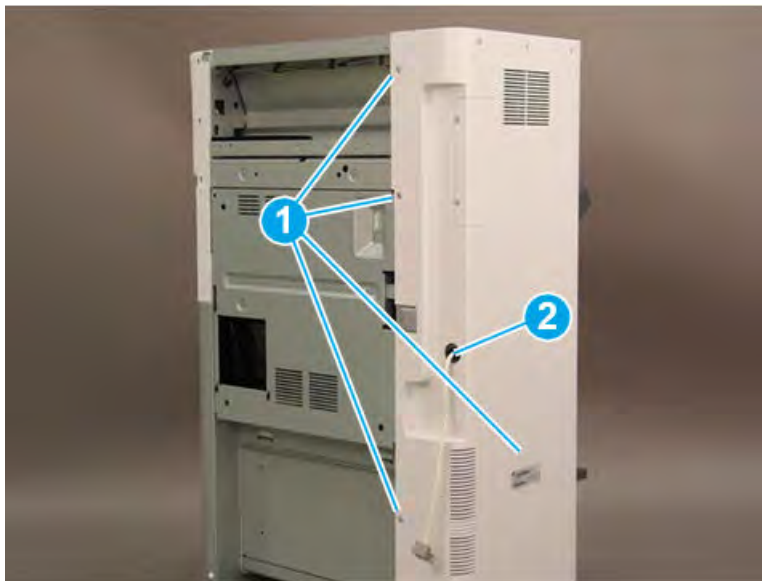
- ▲ Release one retainer (callout 1), and then disconnect one connector (callout 2). Remove two screws (callout 3), and then remove the exit motor.

 **TIP:** Make sure that the belt (callout 4) is positioned on the gear behind the motor when reinstalling the motor.

TIP: Reverse the removal steps to install the assembly.

Figure 5-348 Remove the exit motor

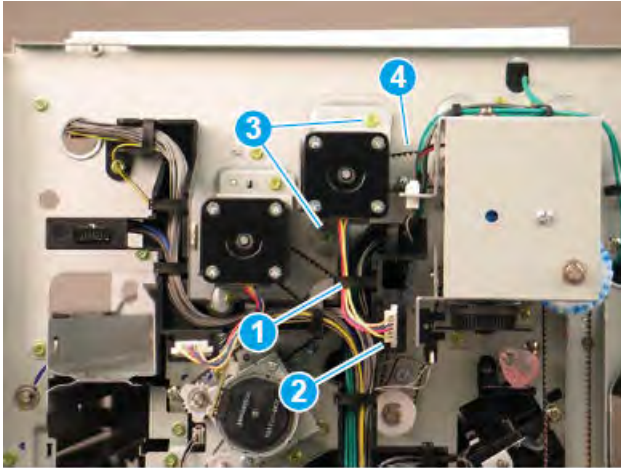

Remove the top jam access cover

Follow these steps to remove the top jam access cover.

1. At the rear of the finisher, remove two screws (callout 1).

Figure 5-349 Remove two screws

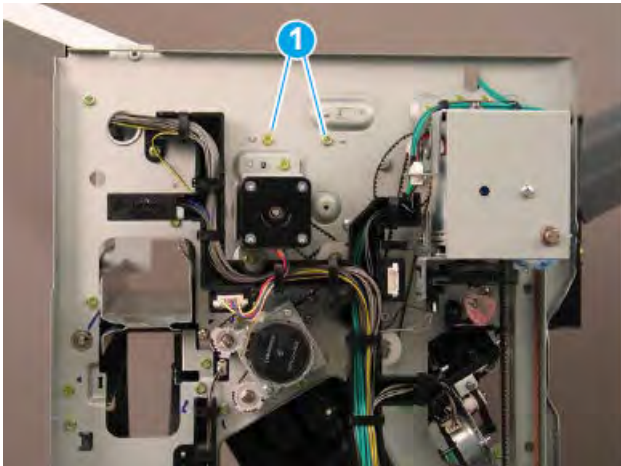

2. Remove the top jam access cover.

 **TIP:** Reverse the removal steps to install the assembly.

Figure 5-350 Remove the top jam access cover



Remove the top lower feed assembly (finisher)

Follow these steps to remove the top lower feed assembly (finisher).

1. At the front of the printer, remove two screws (callout 1) on the main exit cam motor housing, and then tilt the motor aside to access the screws under it.

Figure 5-351 Remove two screws

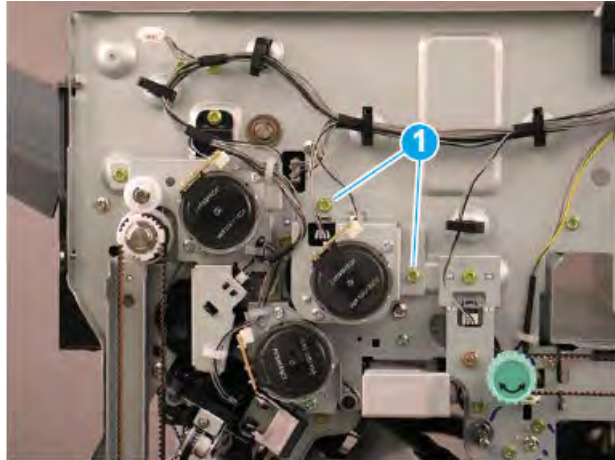

2. At the front of the finisher, remove three self-tapping screws (callout 1), and then disconnect one connector (callout 2).

Figure 5-352 Remove three screws and disconnect one connector

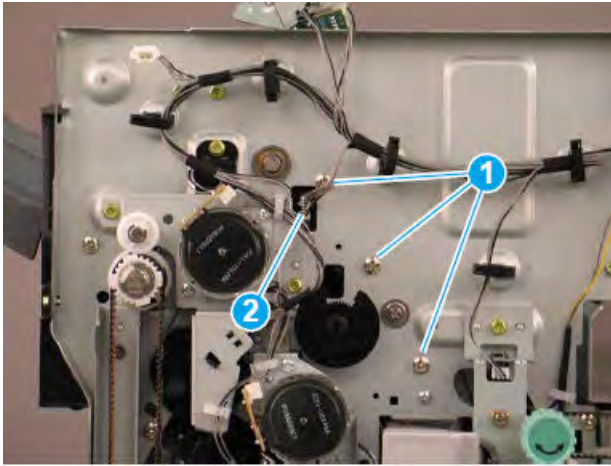

3. At the rear of the finisher, remove three machine screws (callout 1).

Figure 5-353 Remove three screws

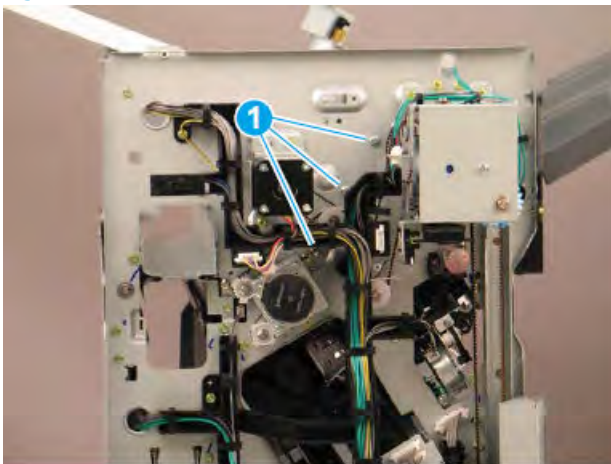

4. At the top of the finisher, lift the feed assembly straight up to disengage two tabs on the bottom and remove the assembly.

Figure 5-354 Remove the top lower feed assembly



5. If you are replacing the top lower feed assembly, locate two sensors (callout 1) and one connector (callout 2) on the back of the assembly. Remove these items and transfer them to the replacement part.

 **TIP:** Reverse the removal steps to install the assembly.

Figure 5-355 Locate sensors and connector

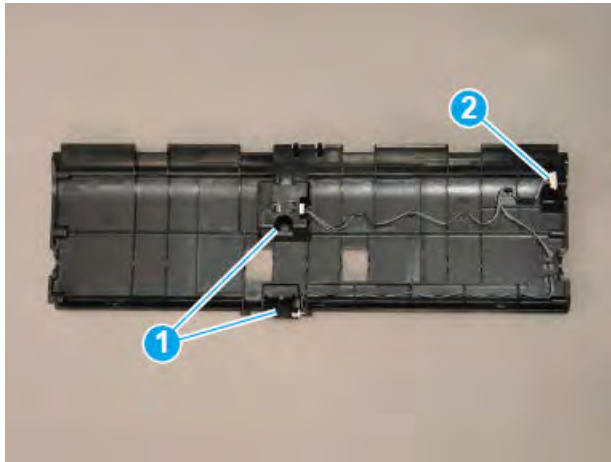

Remove the top exit sensor(S11)

Follow these steps to remove the top exit sensor(S11).

1. Remove one screw(callout 1) at the top lower feed assembly.

Figure 5-356 Remove one screw and then top lower feed assembly

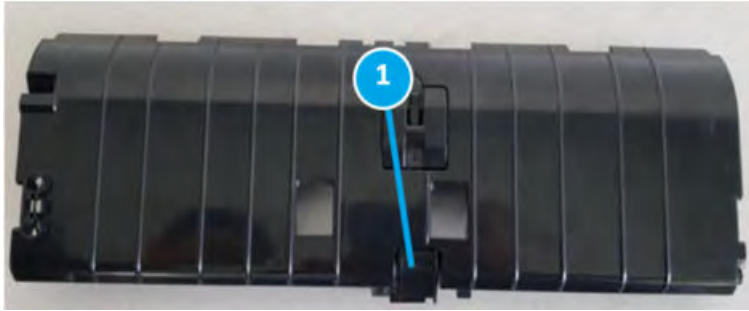

2. Remove harness (callout 1) and top exit sensor (S11, callout 2)

Figure 5-357 Remove harness and then top exit sensor

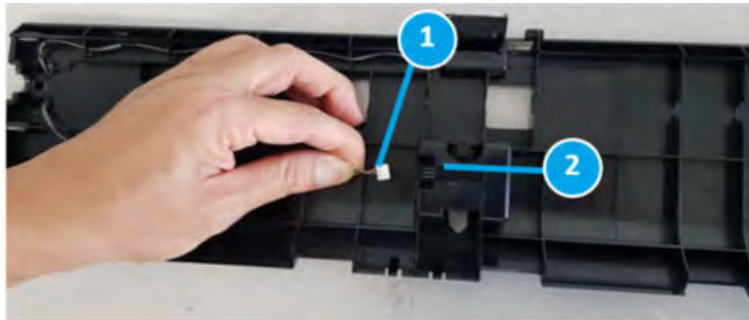

Unpack the replacement assembly

Follow these steps to unpack the replacement assembly.

1. Dispose of the defective part.



NOTE: HP recommends responsible disposal of the defective part.

<http://www8.hp.com/us/en/hp-information/environment/product-recycling.html>

2. Unpack the replacement part from the packaging.



CAUTION:  Some parts are sensitive to electrostatic discharge (ESD). Always perform service work at an ESD-protected workstation or mat. If an ESD workstation or mat is not available, touch the sheet-metal chassis to provide a static ground before touching an ESD-sensitive assembly. Protect the ESD-sensitive assemblies by placing them in ESD pouches when they are out of the printer.



IMPORTANT: Make sure that all of the shipping materials (for example shipping tape) are removed from the replacement part prior to installation.



NOTE: If the replacement part is a roller or pad, avoid touching the spongy part of it. Skin oils on the roller or pad can cause paper pickup and/or print-quality problems. HP recommends using disposable gloves when handling rollers or pads or washing your hands before touching rollers or pads.

3. To install an assembly, reverse the removal steps.



NOTE: When applicable, special installation instructions are provided for an assembly at the end of the removal procedure. Always completely read the removal instructions and follow all special installation instructions.

Top output tray unit

Removal and replacement: Top output tray

Learn how to remove and replace the top output tray.

Introduction

This document provides the procedures to remove and replace the top output tray on the finisher.



IMPORTANT: When applicable, special installation instructions are provided for an assembly at the end of the removal procedure. Always completely read the removal instructions and follow all special installation instructions.

Before performing service

- Turn the printer power off. A shutting-down message appears on the control-panel display.
- ⚠ **WARNING!** To avoid damage to the printer, turn the power off and wait until the printer shuts down before removing the power cable.
- Disconnect the printer power cable after the printer has completely shut down (the control-panel display is blank).
- Release the finisher from the printer by pulling out on the release latch inside the finisher door.
- Disconnect the cable from the bridge unit to the finisher.
- Disconnect the cable from the finisher to the printer.

Use the table below to identify the correct part number for your printer. To order the part, go to <https://parts.hp.com>.

Table 5-103 Part information

Part number	Part description
JC63-04995B	Top output tray

Required tools

- No special tools are needed to remove or install this assembly.

After performing service

- Connect the cable from the finisher to the printer.
- Connect the cable from the bridge unit to the finisher.
- Attach the finisher to the printer, and then push in on the release latch inside the finisher door.
- Connect the printer power cable.
- Turn the printer power on.

Post service test

Process a job through the finisher and verify that the finisher works correctly.

Remove the top output tray

Follow these steps to remove the top output tray.

- ▲ Raise the end of the top output tray (callout 1), and then lift it away from the finisher (callout 2) to remove it.

Figure 5-358 Remove the top output tray



Unpack the replacement assembly



Follow these steps to unpack the replacement assembly.

1. Dispose of the defective part.

 **NOTE:** HP recommends responsible disposal of the defective part.

<http://www8.hp.com/us/en/hp-information/environment/product-recycling.html>

2. Unpack the replacement part from the packaging.

 **CAUTION:**  Some parts are sensitive to electrostatic discharge (ESD). Always perform service work at an ESD-protected workstation or mat. If an ESD workstation or mat is not available, touch the sheet-metal chassis to provide a static ground before touching an ESD-sensitive assembly. Protect the ESD-sensitive assemblies by placing them in ESD pouches when they are out of the printer.

 **IMPORTANT:** Make sure that all of the shipping materials (for example shipping tape) are removed from the replacement part prior to installation.

 **NOTE:** If the replacement part is a roller or pad, avoid touching the spongy part of it. Skin oils on the roller or pad can cause paper pickup and/or print-quality problems. HP recommends using disposable gloves when handling rollers or pads or washing your hands before touching rollers or pads.

3. To install an assembly, reverse the removal steps.

 **NOTE:** When applicable, special installation instructions are provided for an assembly at the end of the removal procedure. Always completely read the removal instructions and follow all special installation instructions.

HP LaserJet Managed MFP E82540-E82560, E87640-E87660, E82540du-E82560du, E87640du-E87660du, E72525-E72535, E77822-E77830 - Top output tray paper full sensor (S15)

Learn how to remove and replace the top output tray paper full sensor.

Introduction

This document provides the procedures to remove and replace the top output tray paper full sensor for the finisher.



IMPORTANT: When applicable, special installation instructions are provided for an assembly at the end of the removal procedure. Always completely read the removal instructions and follow all special installation instructions.

Before performing service

- Turn the printer power off. A shutting-down message appears on the control-panel display.
- ⚠ **WARNING!** To avoid damage to the printer, turn the power off and wait until the printer shuts down before removing the power cable.
- Disconnect the printer power cable after the printer has completely shut down (the control-panel display is blank).
- Release the finisher from the printer by pulling out on the release latch inside the finisher door.
- Disconnect the cable from the bridge unit to the finisher.
- Disconnect the cable from the finisher to the printer.

Use the table below to identify the correct part number for your printer. To order the part, go to <https://parts.hp.com>.

Table 5-104 Part information

Part number	Part description
JC82-01039A	Top output tray paper full sensor

Required tools

- #2 JIS screwdriver with a magnetic tip

After performing service

- Connect the cable from the finisher to the printer.
- Connect the cable from the bridge unit to the finisher.
- Attach the finisher to the printer, and then push in on the release latch inside the finisher door.
- Connect the printer power cable.
- Turn the printer power on.

Post service test

Process a job through the finisher and verify that the finisher works correctly.

Remove the right upper cover (finisher)

Follow these steps to remove the right upper cover (finisher).

- ▲ Remove one screw cap and three machine screws on the upper edge of the cover (callout 1). Remove three sheet metal screws (callout 2) on the lower portion of the cover. Rotate the right edge of the cover away from the finisher, and then slide the cover right to release three tabs (callout 3).

💡 **TIP:** The lower screws are shorter in length than the upper screws.

TIP: Reverse the removal steps to install the assembly.

Figure 5-359 Remove the right upper cover

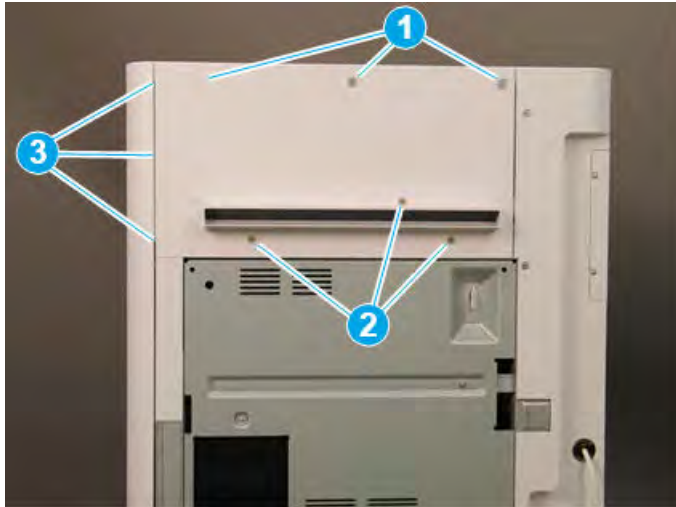

Remove the top cover (finisher)

Follow these steps to remove the top cover (finisher).

1. Remove three screw caps and three self-tapping screws at the top of the rear cover (callout 1), and then remove three machine screws (callout 2) on top of the cover.

Figure 5-360 Remove six screws

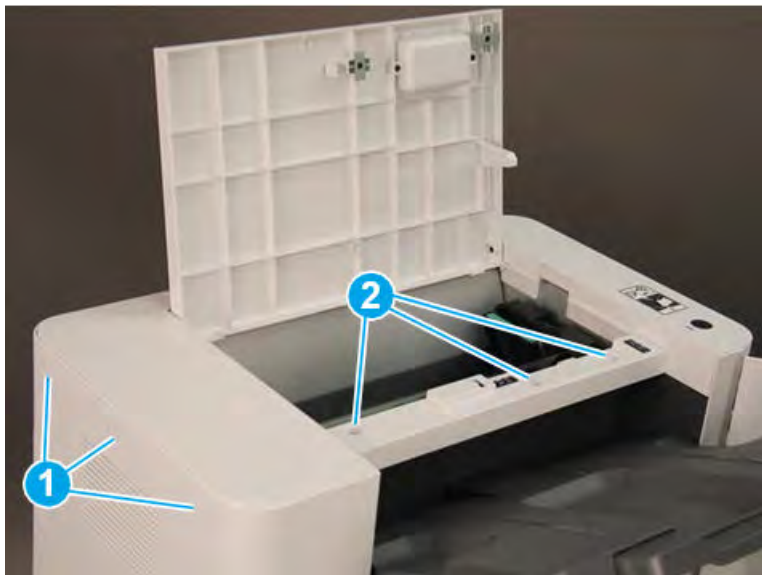

2. Remove three self-tapping screws at the top of the front cover (callout 1), and then remove two machine screws (callout 2) at the top of the right side.

Figure 5-361 Remove five screws

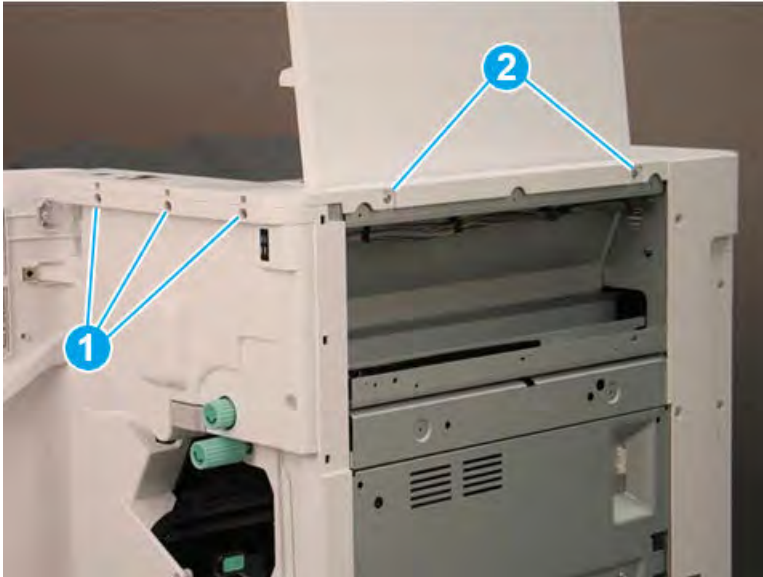

3. Lift the cover up slightly. Disconnect one in-line connector (callout 1), and then release one retainer (callout 2).

 **TIP:** Reverse the removal steps to install the assembly.

Figure 5-362 Disconnect one connector and release retainer

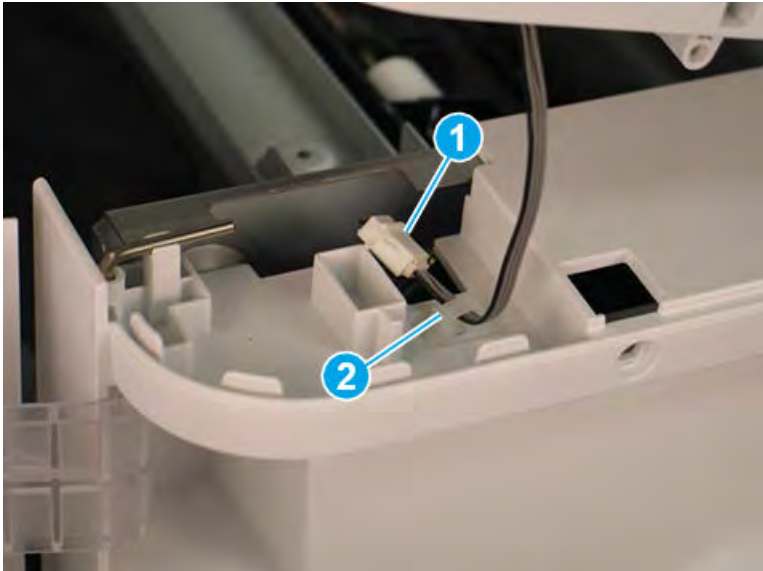

Remove the front door (finisher)

Follow these steps to remove the front door (finisher).

1. Lift the top hinge pin up to release it from the retainer.

Figure 5-363 Lift the top hinge pin

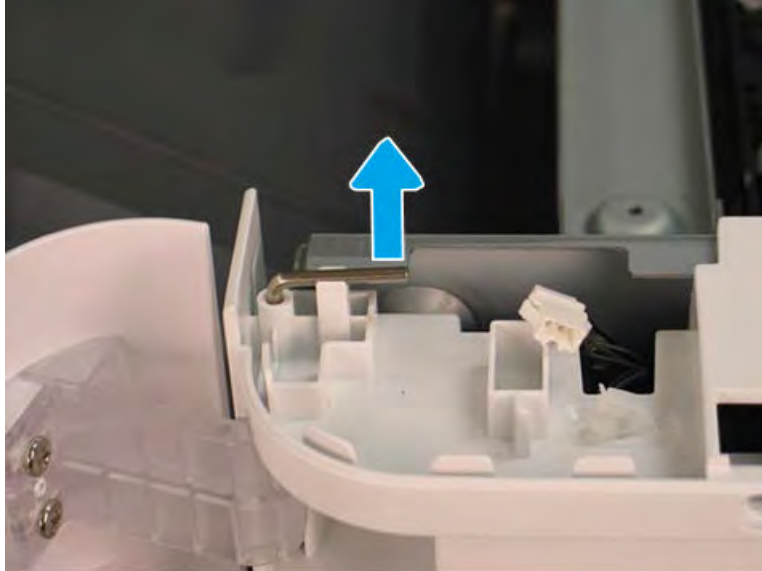

2. Pull the top hinge pin up to remove it.

Figure 5-364 Remove the top hinge pin

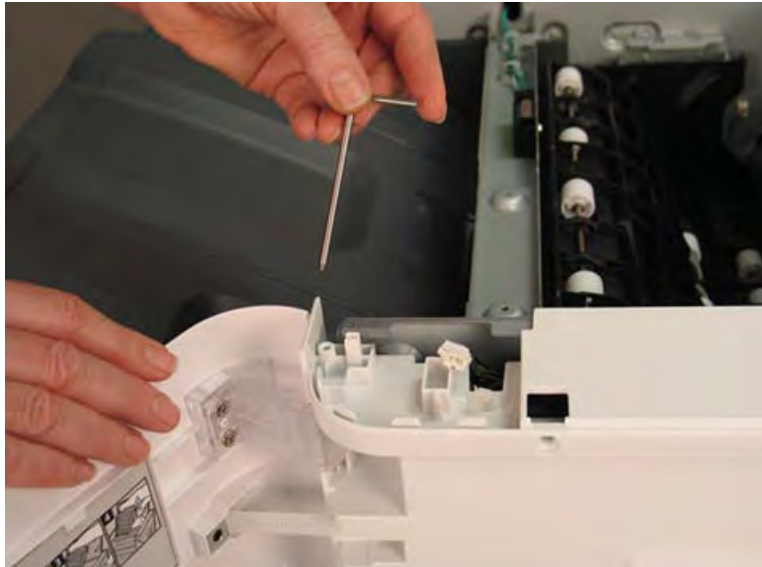

3. Use a small, flat-blade screwdriver to release the lower hinge pin from the retainer, and then rotate it away from the finisher.

Figure 5-365 Release the lower hinge pin



4. Support the door with one hand, and then pull the lower hinge pin straight up to remove it.

Figure 5-366 Remove the lower hinge pin



5. Support the door with one hand, and then remove one screw (callout 1) to release the strap. Remove the front door.

 **TIP:** Reverse the removal steps to install the assembly.

Figure 5-367 Remove the front door



Remove the front cover (finisher)

Follow these steps to remove the front cover (finisher).

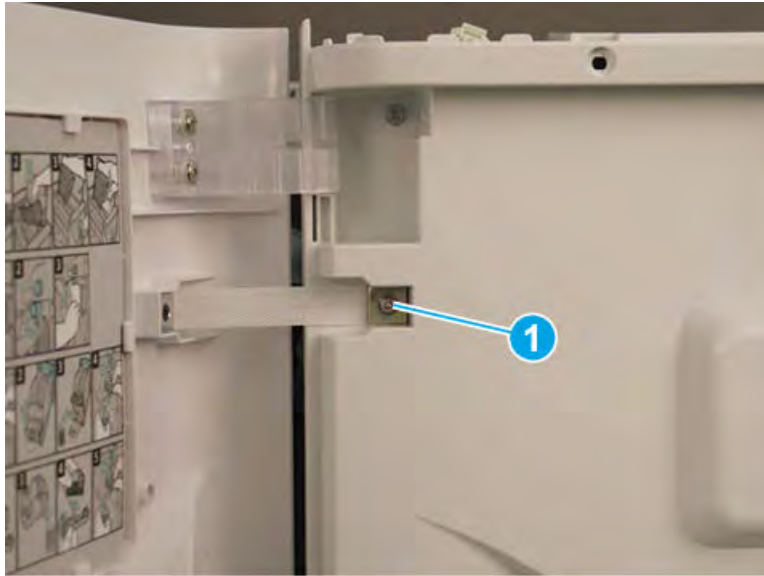
1. Release one tab (callout 1), and then pull the jam-access knob away from the finisher to remove it.

Figure 5-368 Remove the jam-access knob

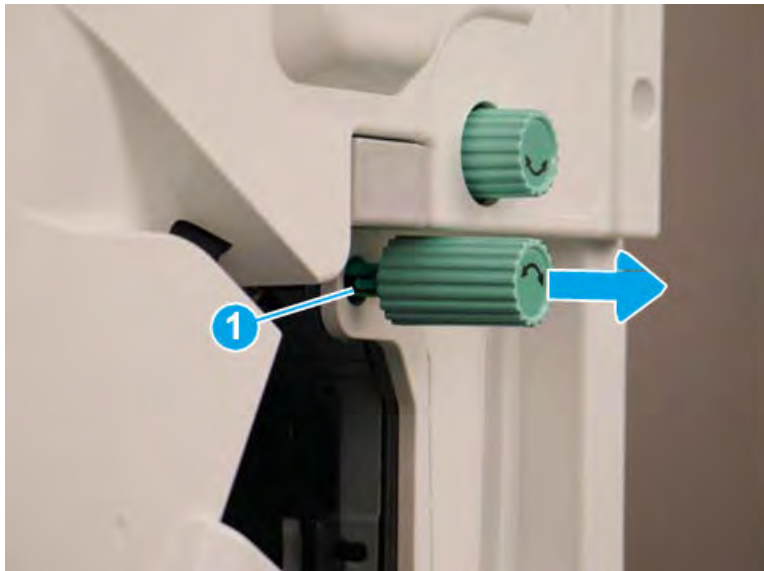

2. If the punch unit is installed, remove the punch waste bin (callout 1).

3. Remove one screw (callout 1) on top of the front cover.

Figure 5-369 Remove one screw



4. Remove five machine screws (callout 1), and then remove the front cover.

 **TIP:** Reverse the removal steps to install the assembly.

Figure 5-370 Remove the front cover



Remove the rear cover (finisher)

Follow these steps to remove the rear cover (finisher).

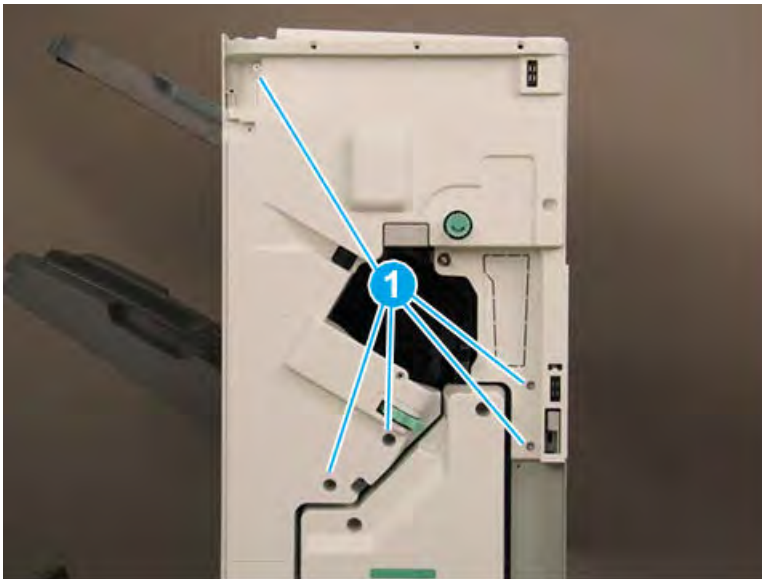
1. Remove two self-tapping screws (callout 1) on the top of the rear cover, and then remove five screw caps and five machine screws (callout 2) on the left side of the cover.

Figure 5-371 Remove seven screws

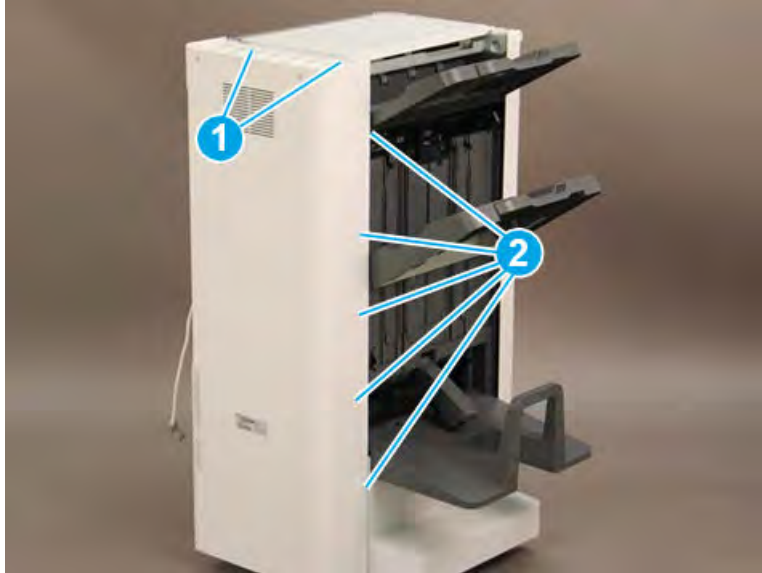

2. Remove one screw cap and four machine screws (callout 1) Remove the rear cover.

 **NOTE:** Make sure to thread the power cable (callout 2) through the opening in the cover.

 **TIP:** Reverse the removal steps to install the assembly

Figure 5-372 Remove the rear cover



Remove top output tray paper full sensor (S15)

Follow these steps to remove top output tray paper full sensor (S15).

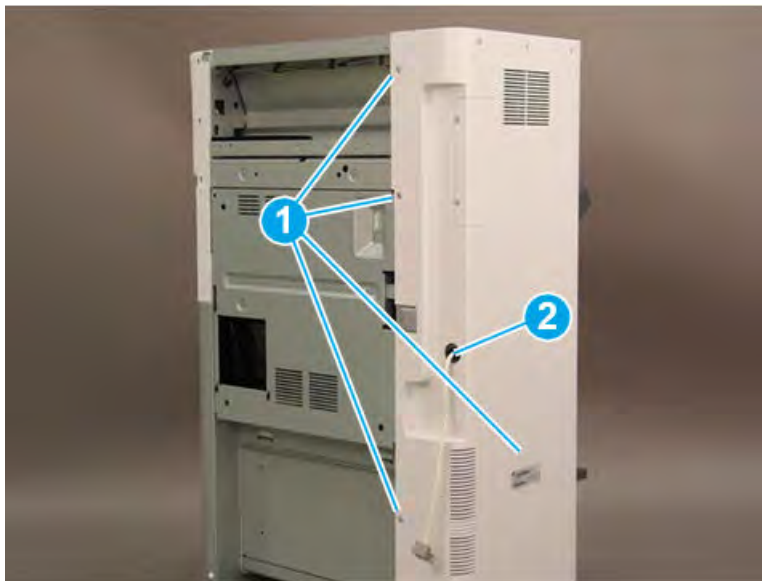
1. At the front of the finisher, remove screw (callout 1), disconnect the connector (callout 2) and then remove the sensor assembly (callout 3)

Figure 5-373 Remove screw and connector and sensor assy

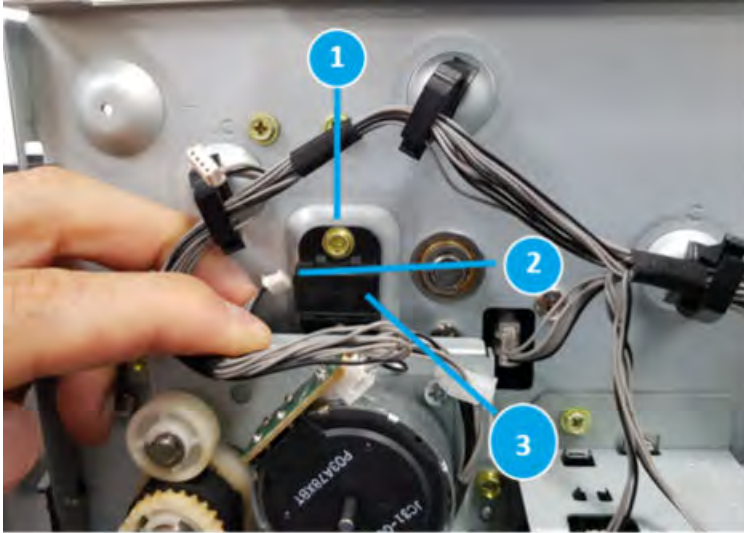

2. Remove top output tray paper full sensor- detector (callout 1).

Figure 5-374 Remove top output tray paper full sensor

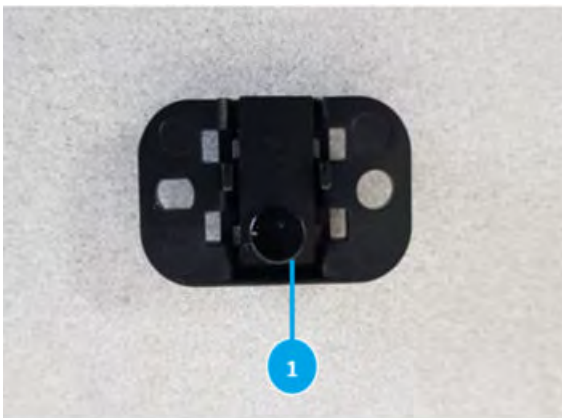

3. At the rear of the finisher, remove four screws (callout 1).

Figure 5-375 Remove four screws

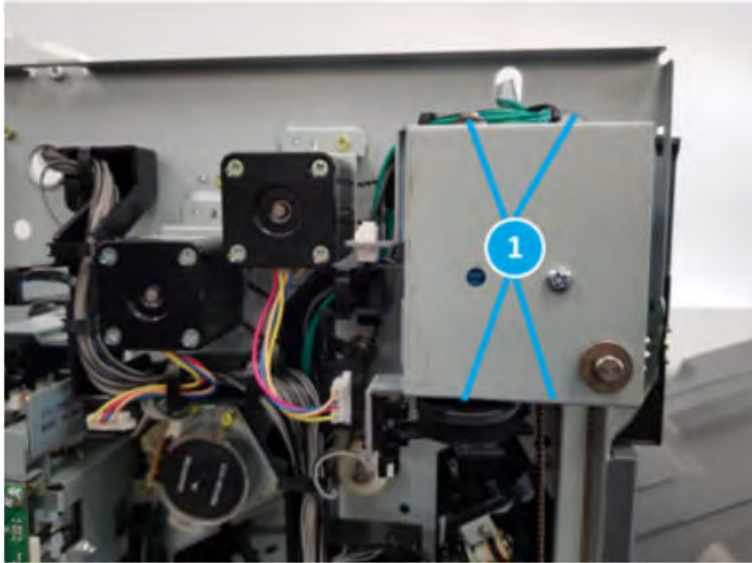

4. Remove screw (callout 1), disconnect the connector (callout 2), and then remove the sensor assembly (callout 3).

Figure 5-376 Remove screw and connector and sensor assy

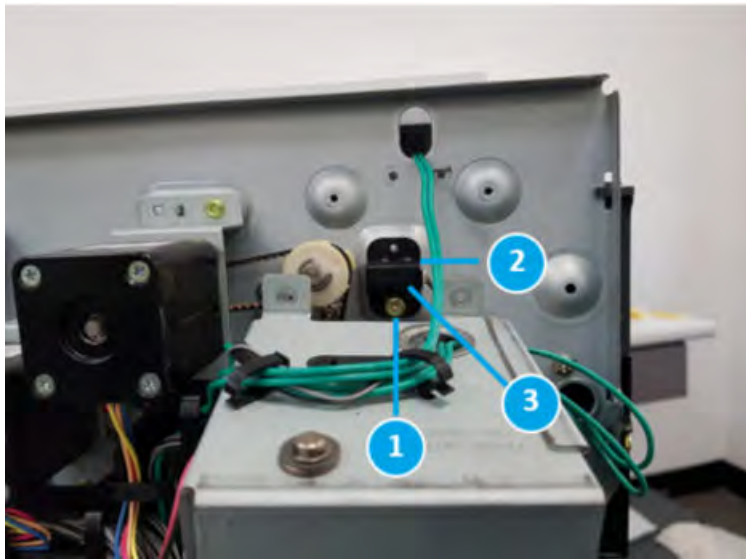

5. Remove top output tray paper full sensor- emitter (callout 1).

Figure 5-377 Remove top output tray paper full sensor

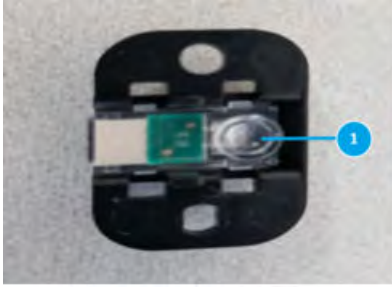

Unpack the replacement assembly



Follow these steps to unpack the replacement assembly.

1. Dispose of the defective part.

 **NOTE:** HP recommends responsible disposal of the defective part.

<http://www8.hp.com/us/en/hp-information/environment/product-recycling.html>

2. Unpack the replacement part from the packaging.

 **CAUTION:**  Some parts are sensitive to electrostatic discharge (ESD). Always perform service work at an ESD-protected workstation or mat. If an ESD workstation or mat is not available, touch the sheet-metal chassis to provide a static ground before touching an ESD-sensitive assembly. Protect the ESD-sensitive assemblies by placing them in ESD pouches when they are out of the printer.

 **IMPORTANT:** Make sure that all of the shipping materials (for example shipping tape) are removed from the replacement part prior to installation.

 **NOTE:** If the replacement part is a roller or pad, avoid touching the spongy part of it. Skin oils on the roller or pad can cause paper pickup and/or print-quality problems. HP recommends using disposable gloves when handling rollers or pads or washing your hands before touching rollers or pads.

3. To install an assembly, reverse the removal steps.

 **NOTE:** When applicable, special installation instructions are provided for an assembly at the end of the removal procedure. Always completely read the removal instructions and follow all special installation instructions.

Main exit unit

Removal and replacement: Main exit sensor (S10)

Learn how to remove and replace the main exit sensor.

Introduction

This document provides the procedures to remove and replace the main exit sensor for the finisher.



IMPORTANT: When applicable, special installation instructions are provided for an assembly at the end of the removal procedure. Always completely read the removal instructions and follow all special installation instructions.

Before performing service

- Turn the printer power off. A shutting-down message appears on the control-panel display.
- ⚠ **WARNING!** To avoid damage to the printer, turn the power off and wait until the printer shuts down before removing the power cable.
- Disconnect the printer power cable after the printer has completely shut down (the control-panel display is blank).
- Release the finisher from the printer by pulling out on the release latch inside the finisher door.
- Disconnect the cable from the bridge unit to the finisher.
- Disconnect the cable from the finisher to the printer.

Use the table below to identify the correct part number for your printer. To order the part, go to <https://parts.hp.com>.

Table 5-105 Part information

Part number	Part description
JC32-00020A	Main exit sensor

Required tools

- #2 JIS screwdriver with a magnetic tip

After performing service

- Connect the cable from the finisher to the printer.
- Connect the cable from the bridge unit to the finisher.
- Attach the finisher to the printer, and then push in on the release latch inside the finisher door.
- Connect the printer power cable.
- Turn the printer power on.

Post service test

Process a job through the finisher and verify that the finisher works correctly.

Remove the right upper cover (finisher)

Follow these steps to remove the right upper cover (finisher).

- ▲ Remove one screw cap and three machine screws on the upper edge of the cover (callout 1). Remove three sheet metal screws (callout 2) on the lower portion of the cover. Rotate the right edge of the cover away from the finisher, and then slide the cover right to release three tabs (callout 3).

💡 **TIP:** The lower screws are shorter in length than the upper screws.

TIP: Reverse the removal steps to install the assembly.

Figure 5-378 Remove the right upper cover

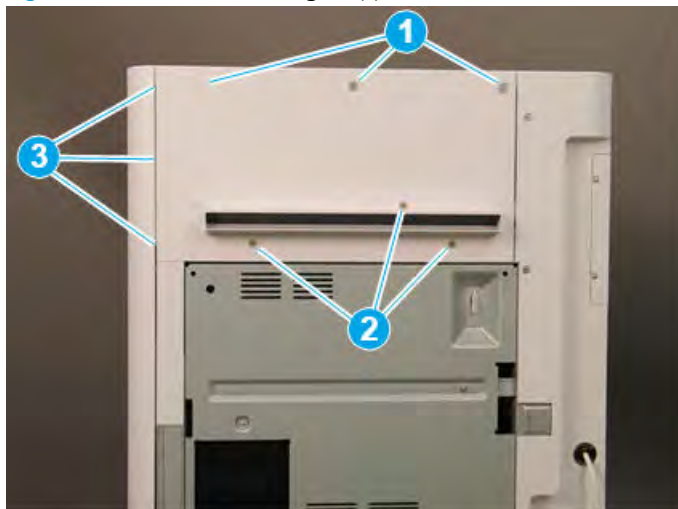

Remove the top cover (finisher)

Follow these steps to remove the top cover (finisher).

1. Remove three screw caps and three self-tapping screws at the top of the rear cover (callout 1), and then remove three machine screws (callout 2) on top of the cover.

Figure 5-379 Remove six screws

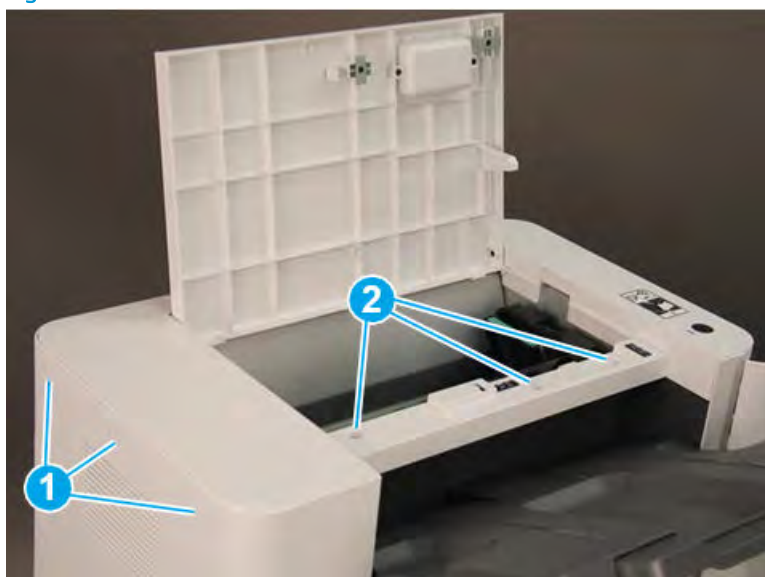

2. Remove three self-tapping screws at the top of the front cover (callout 1), and then remove two machine screws (callout 2) at the top of the right side.

Figure 5-380 Remove five screws

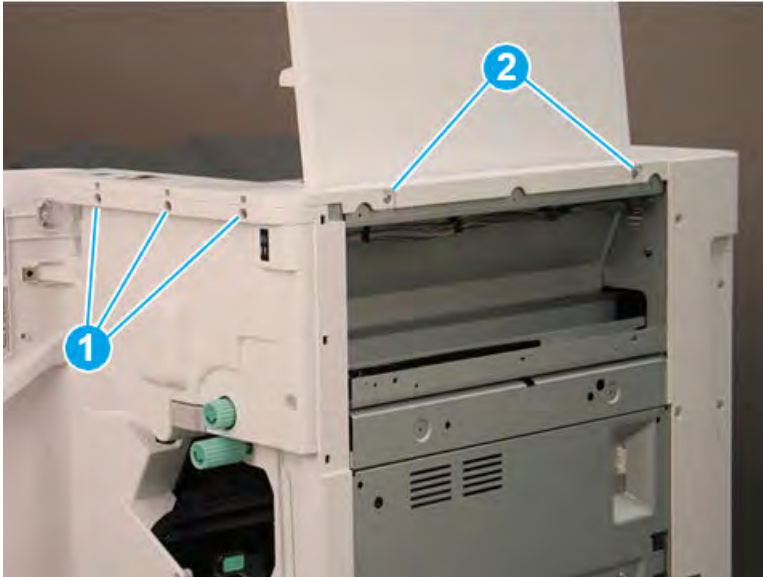

3. Lift the cover up slightly. Disconnect one in-line connector (callout 1), and then release one retainer (callout 2).

 **TIP:** Reverse the removal steps to install the assembly.

Figure 5-381 Disconnect one connector and release retainer



Remove the front door (finisher)

Follow these steps to remove the front door (finisher).

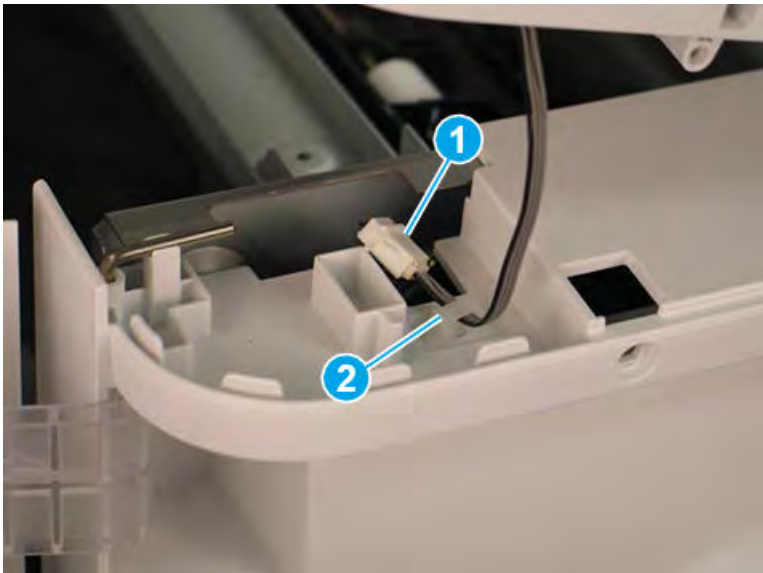
1. Lift the top hinge pin up to release it from the retainer.

Figure 5-382 Lift the top hinge pin

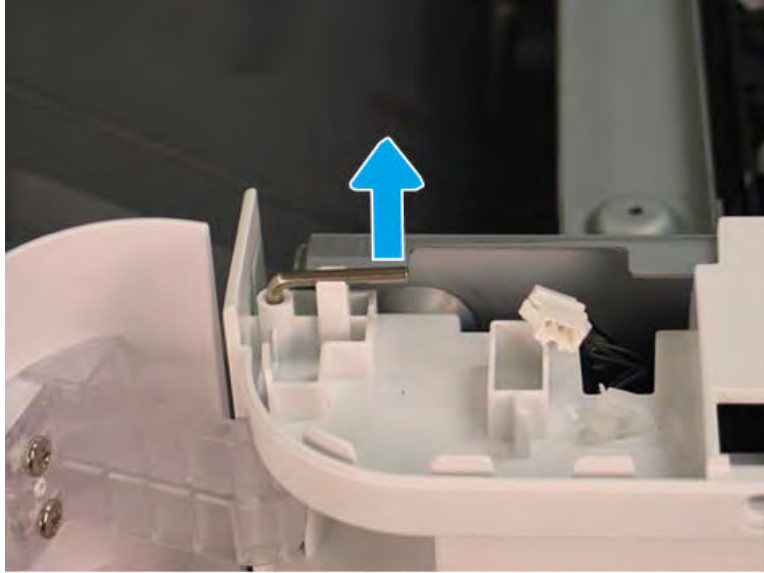

2. Pull the top hinge pin up to remove it.

Figure 5-383 Remove the top hinge pin

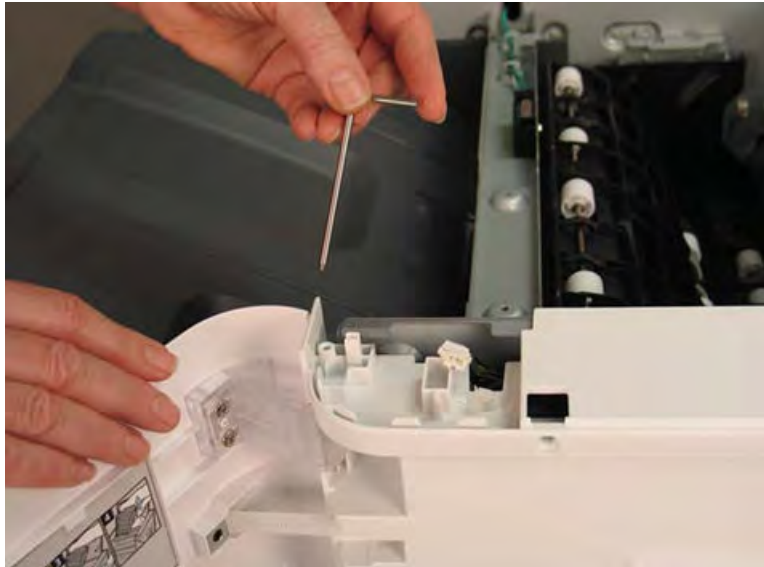

3. Use a small, flat-blade screwdriver to release the lower hinge pin from the retainer, and then rotate it away from the finisher.

Figure 5-384 Release the lower hinge pin



4. Support the door with one hand, and then pull the lower hinge pin straight up to remove it.

Figure 5-385 Remove the lower hinge pin



5. Support the door with one hand, and then remove one screw (callout 1) to release the strap. Remove the front door.

 **TIP:** Reverse the removal steps to install the assembly.

Figure 5-386 Remove the front door



Remove the front cover (finisher)

Follow these steps to remove the front cover (finisher).

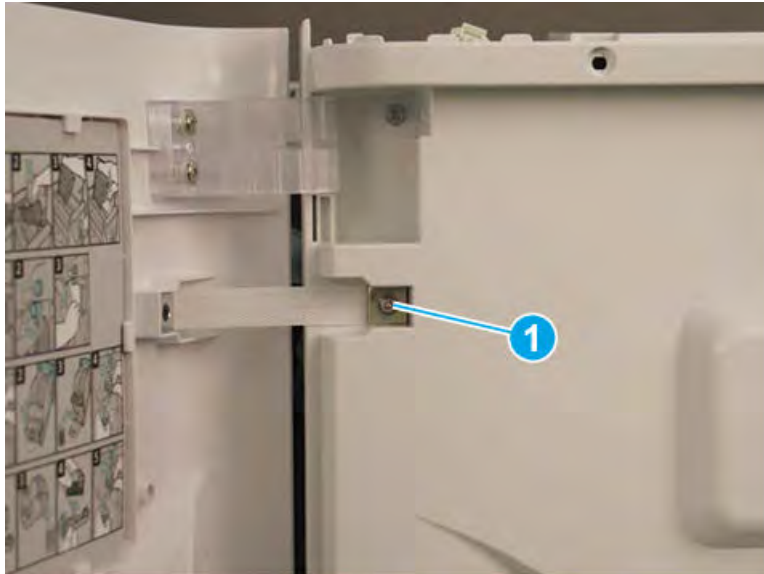
1. Release one tab (callout 1), and then pull the jam-access knob away from the finisher to remove it.

Figure 5-387 Remove the jam-access knob

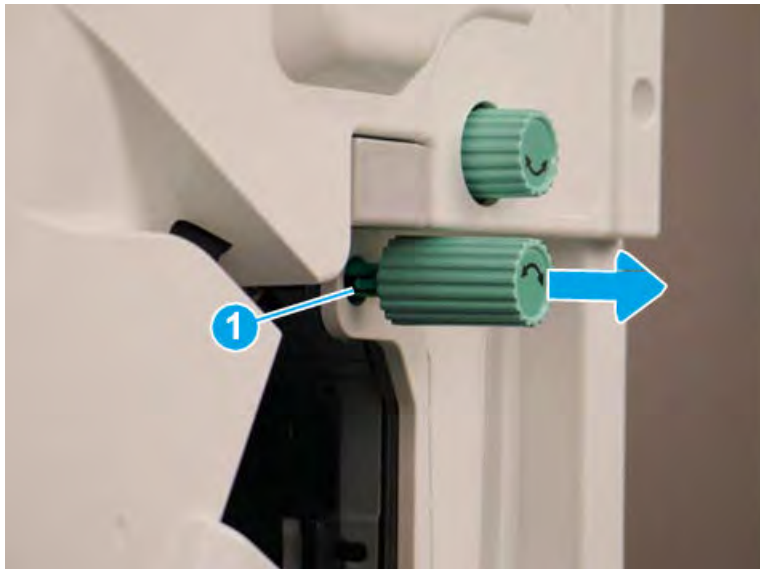

2. If the punch unit is installed, remove the punch waste bin (callout 1).

3. Remove one screw (callout 1) on top of the front cover.

Figure 5-388 Remove one screw



4. Remove five machine screws (callout 1), and then remove the front cover.

 **TIP:** Reverse the removal steps to install the assembly.

Figure 5-389 Remove the front cover



Remove the rear cover (finisher)

Follow these steps to remove the rear cover (finisher).

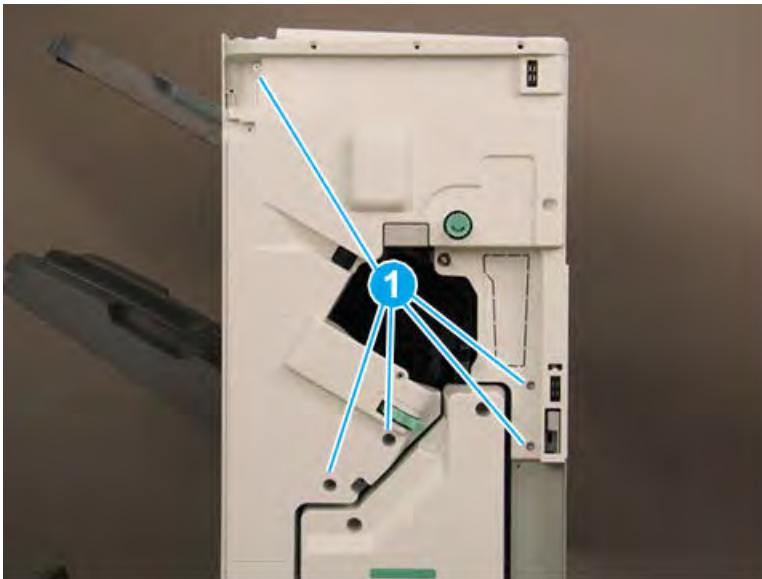
1. Remove two self-tapping screws (callout 1) on the top of the rear cover, and then remove five screw caps and five machine screws (callout 2) on the left side of the cover.

Figure 5-390 Remove seven screws

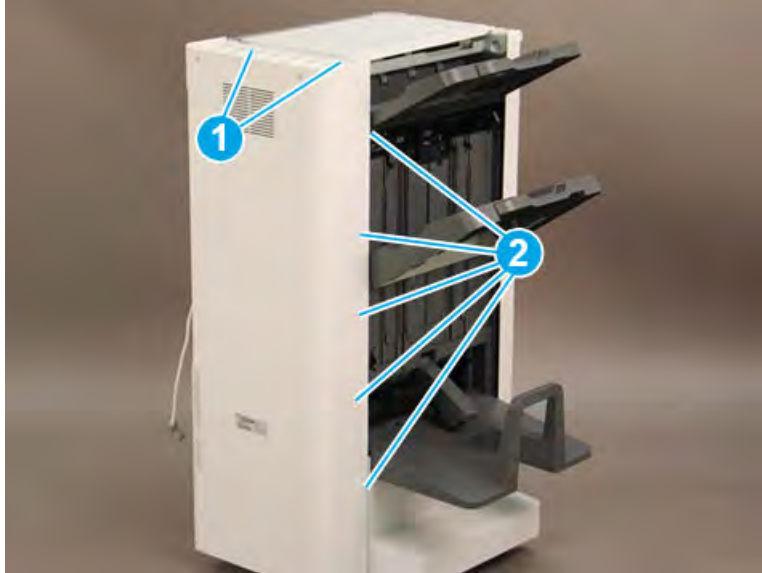

2. Remove one screw cap and four machine screws (callout 1) Remove the rear cover.

 **NOTE:** Make sure to thread the power cable (callout 2) through the opening in the cover.

 **TIP:** Reverse the removal steps to install the assembly

Figure 5-391 Remove the rear cover



Remove the exit motor (M13)

Follow these steps to remove the exit motor (M13).

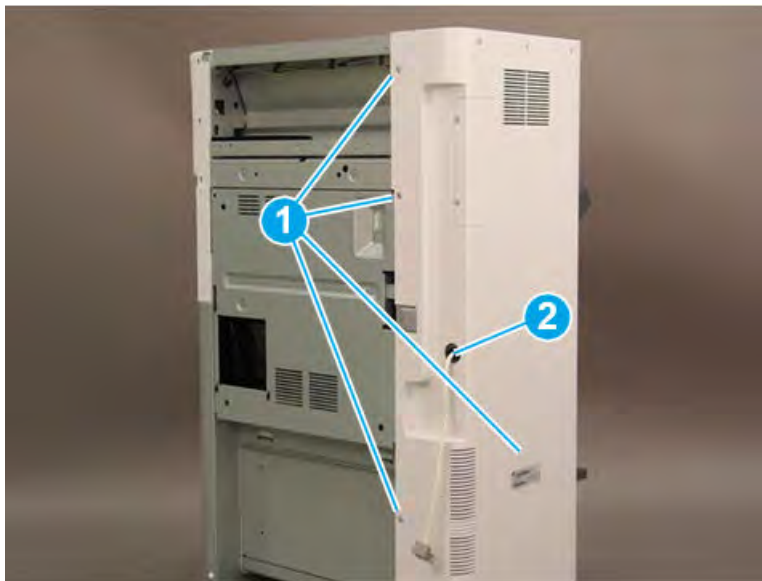
- ▲ Release one retainer (callout 1), and then disconnect one connector (callout 2). Remove two screws (callout 3), and then remove the exit motor.

 **TIP:** Make sure that the belt (callout 4) is positioned on the gear behind the motor when reinstalling the motor.

TIP: Reverse the removal steps to install the assembly.

Figure 5-392 Remove the exit motor

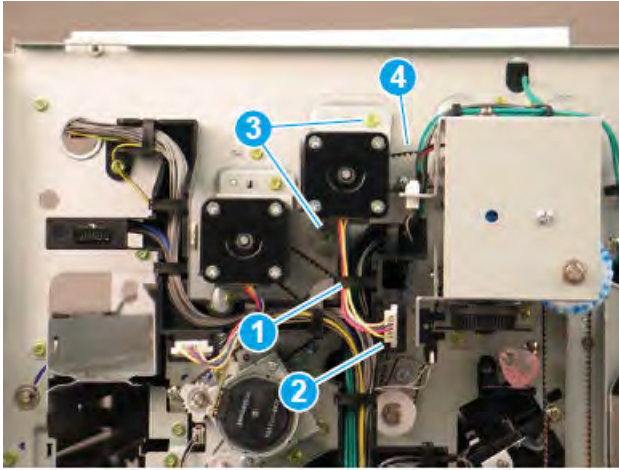

Remove the top jam access cover

Follow these steps to remove the top jam access cover.

1. At the rear of the finisher, remove two screws (callout 1).

Figure 5-393 Remove two screws

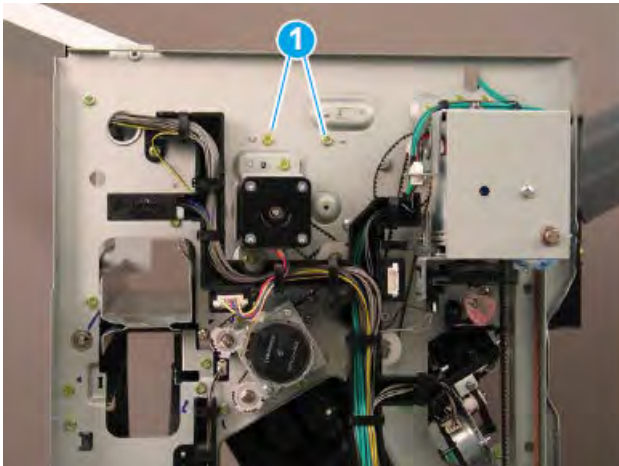

2. Remove the top jam access cover.

 **TIP:** Reverse the removal steps to install the assembly.

Figure 5-394 Remove the top jam access cover



Remove the top lower feed assembly (finisher)

Follow these steps to remove the top lower feed assembly (finisher).

1. At the front of the printer, remove two screws (callout 1) on the main exit cam motor housing, and then tilt the motor aside to access the screws under it.

Figure 5-395 Remove two screws

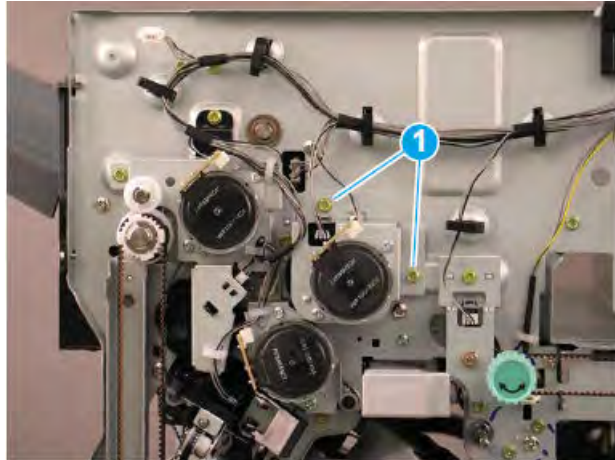

2. At the front of the finisher, remove three self-tapping screws (callout 1), and then disconnect one connector (callout 2).

Figure 5-396 Remove three screws and disconnect one connector

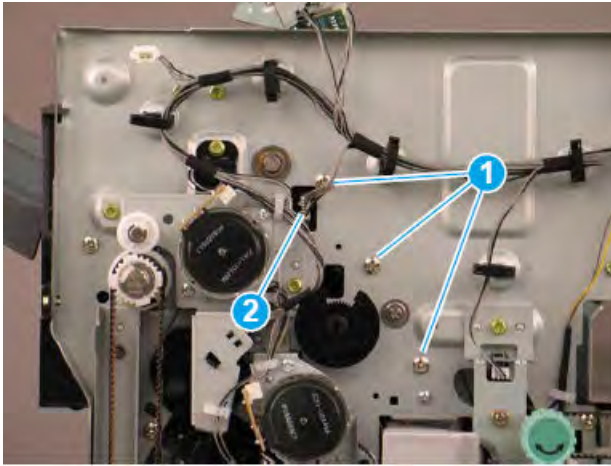

3. At the rear of the finisher, remove three machine screws (callout 1).

Figure 5-397 Remove three screws

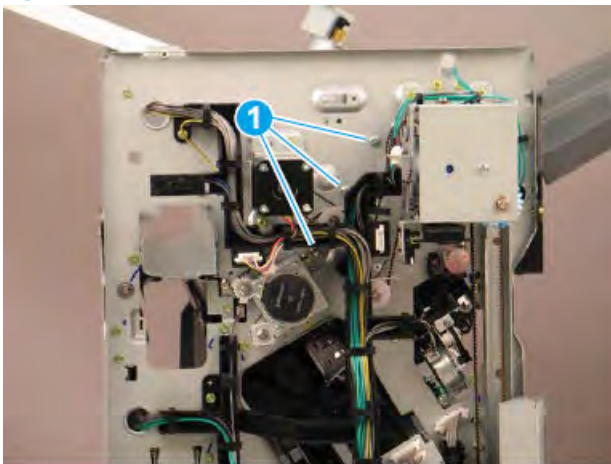

4. At the top of the finisher, lift the feed assembly straight up to disengage two tabs on the bottom and remove the assembly.

Figure 5-398 Remove the top lower feed assembly

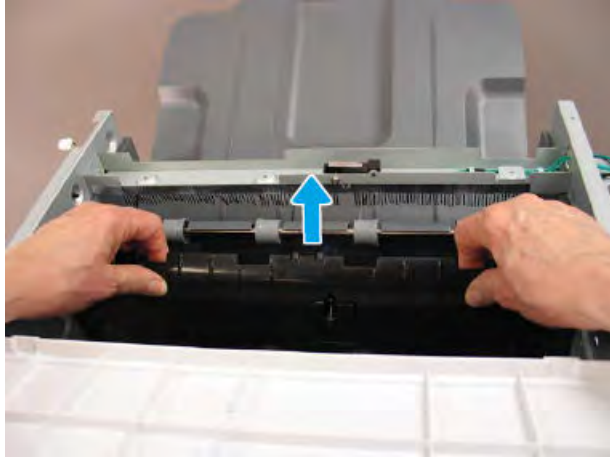

5. If you are replacing the top lower feed assembly, locate two sensors (callout 1) and one connector (callout 2) on the back of the assembly. Remove these items and transfer them to the replacement part.

 **TIP:** Reverse the removal steps to install the assembly.

Figure 5-399 Locate sensors and connector



Remove the main exit sensor(S10)

Follow these steps to remove the main exit sensor(S10).

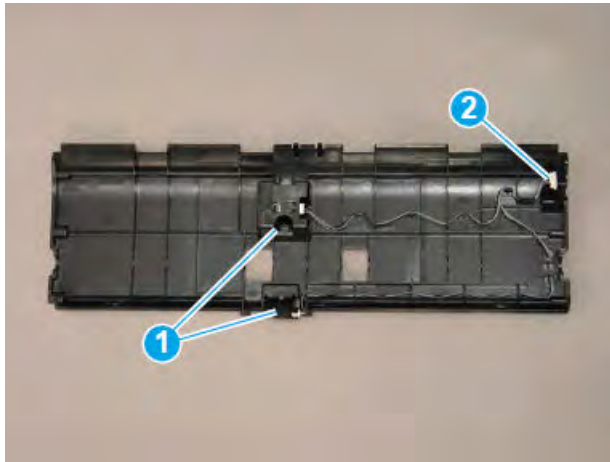
- ▲ Remove one screw (callout 1) and main exit sensor (S10; callout 2) at the top lower feed assembly.

Figure 5-400 Remove the main exit sensor

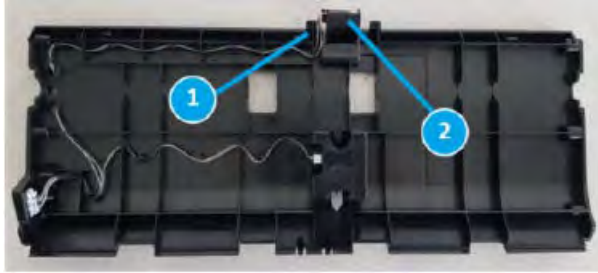

Unpack the replacement assembly

Follow these steps to unpack the replacement assembly.

1. Dispose of the defective part.



NOTE: HP recommends responsible disposal of the defective part.

<http://www8.hp.com/us/en/hp-information/environment/product-recycling.html>

2. Unpack the replacement part from the packaging.



CAUTION:



Some parts are sensitive to electrostatic discharge (ESD). Always perform service work at an ESD-protected workstation or mat. If an ESD workstation or mat is not available, touch the sheet-metal chassis to provide a static ground before touching an ESD-sensitive assembly. Protect the ESD-sensitive assemblies by placing them in ESD pouches when they are out of the printer.



IMPORTANT: Make sure that all of the shipping materials (for example shipping tape) are removed from the replacement part prior to installation.



NOTE: If the replacement part is a roller or pad, avoid touching the spongy part of it. Skin oils on the roller or pad can cause paper pickup and/or print-quality problems. HP recommends using disposable gloves when handling rollers or pads or washing your hands before touching rollers or pads.

3. To install an assembly, reverse the removal steps.



NOTE: When applicable, special installation instructions are provided for an assembly at the end of the removal procedure. Always completely read the removal instructions and follow all special installation instructions.

Removal and replacement: Exit motor (M13)

Learn how to remove and replace the exit motor.

Introduction

This document provides the procedures to remove and replace the exit motor on the finisher.



IMPORTANT: When applicable, special installation instructions are provided for an assembly at the end of the removal procedure. Always completely read the removal instructions and follow all special installation instructions.

Before performing service

- Turn the printer power off. A shutting-down message appears on the control-panel display.
- ⚠ **WARNING!** To avoid damage to the printer, turn the power off and wait until the printer shuts down before removing the power cable.
- Disconnect the printer power cable after the printer has completely shut down (the control-panel display is blank).
- Release the finisher from the printer by pulling out on the release latch inside the finisher door.
- Disconnect the cable from the bridge unit to the finisher.
- Disconnect the cable from the finisher to the printer.

Use the table below to identify the correct part number for your printer. To order the part, go to <https://parts.hp.com>.

Table 5-106 Part information

Part number	Part description
JC90-01459A	Exit motor assembly

Required tools

- #2 JIS screwdriver with a magnetic tip

After performing service

- Connect the cable from the finisher to the printer.
- Connect the cable from the bridge unit to the finisher.
- Attach the finisher to the printer, and then push in on the release latch inside the finisher door.
- Connect the printer power cable.
- Turn the printer power on.

Post service test

Process a job through the finisher and verify that the finisher works correctly.

Remove the right upper cover (finisher)

Follow these steps to remove the right upper cover (finisher).

- ▲ Remove one screw cap and three machine screws on the upper edge of the cover (callout 1). Remove three sheet metal screws (callout 2) on the lower portion of the cover. Rotate the right edge of the cover away from the finisher, and then slide the cover right to release three tabs (callout 3).

💡 **TIP:** The lower screws are shorter in length than the upper screws.

TIP: Reverse the removal steps to install the assembly.

Figure 5-401 Remove the right upper cover

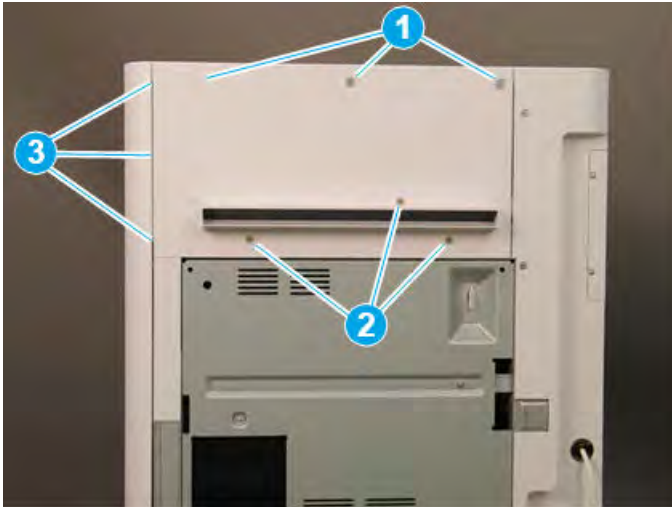

Remove the top cover (finisher)

Follow these steps to remove the top cover (finisher).

1. Remove three screw caps and three self-tapping screws at the top of the rear cover (callout 1), and then remove three machine screws (callout 2) on top of the cover.

Figure 5-402 Remove six screws

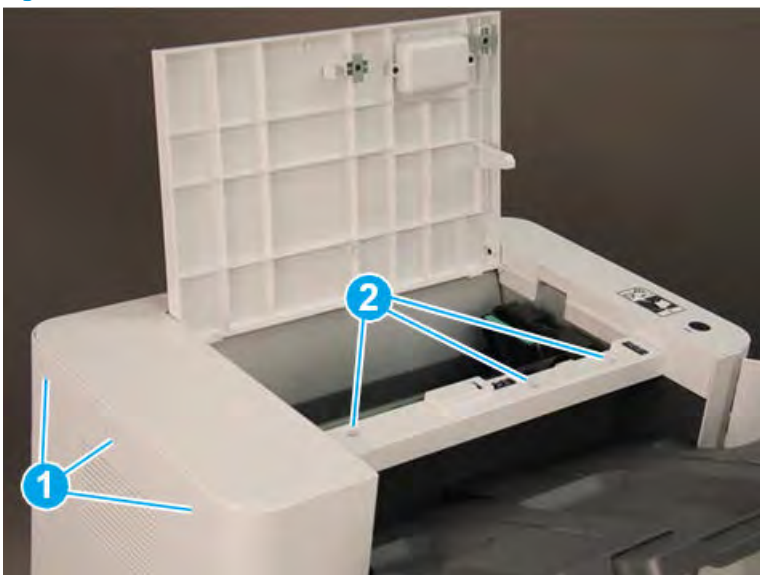

2. Remove three self-tapping screws at the top of the front cover (callout 1), and then remove two machine screws (callout 2) at the top of the right side.

Figure 5-403 Remove five screws

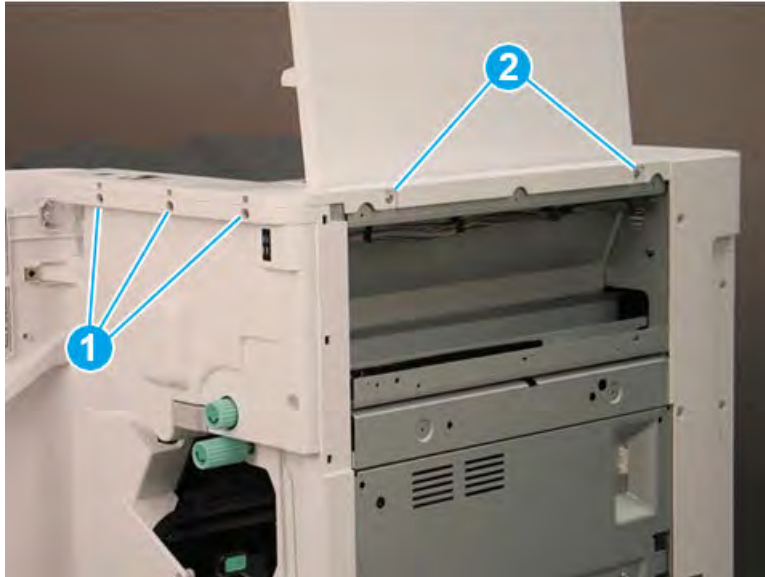

3. Lift the cover up slightly. Disconnect one in-line connector (callout 1), and then release one retainer (callout 2).

 **TIP:** Reverse the removal steps to install the assembly.

Figure 5-404 Disconnect one connector and release retainer



Remove the rear cover (finisher)

Follow these steps to remove the rear cover (finisher).

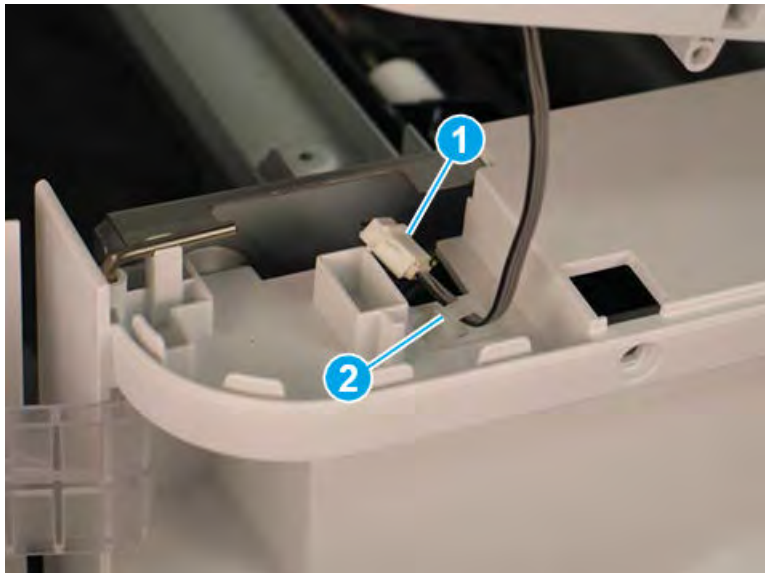
1. Remove two self-tapping screws (callout 1) on the top of the rear cover, and then remove five screw caps and five machine screws (callout 2) on the left side of the cover.

Figure 5-405 Remove seven screws

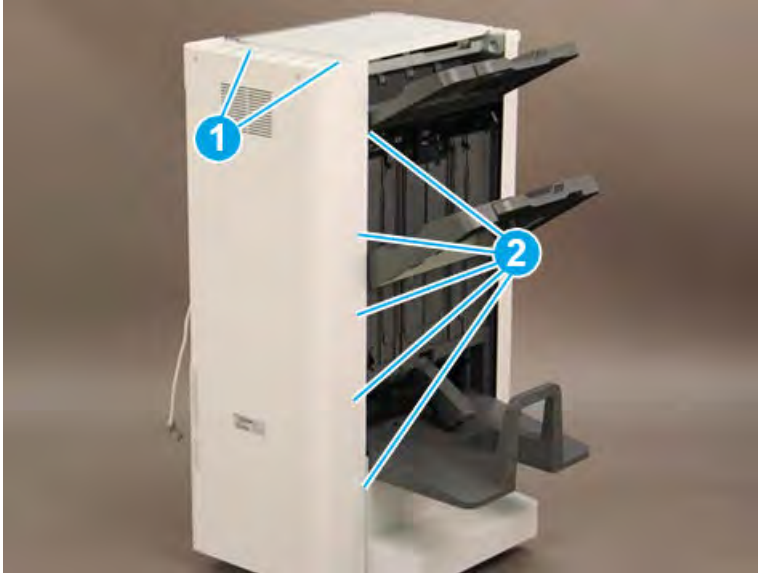

2. Remove one screw cap and four machine screws (callout 1) Remove the rear cover.

 **NOTE:** Make sure to thread the power cable (callout 2) through the opening in the cover.

 **TIP:** Reverse the removal steps to install the assembly

Figure 5-406 Remove the rear cover



Remove the exit motor (M13)

Follow these steps to remove the exit motor (M13).

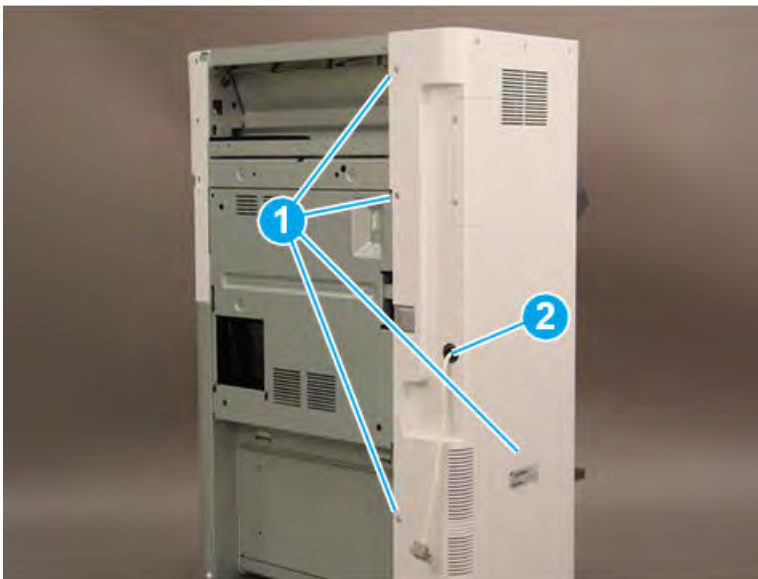
- ▲ Release one retainer (callout 1), and then disconnect one connector (callout 2). Remove two screws (callout 3), and then remove the exit motor.

 **TIP:** Make sure that the belt (callout 4) is positioned on the gear behind the motor when reinstalling the motor.

TIP: Reverse the removal steps to install the assembly.

Figure 5-407 Remove the exit motor

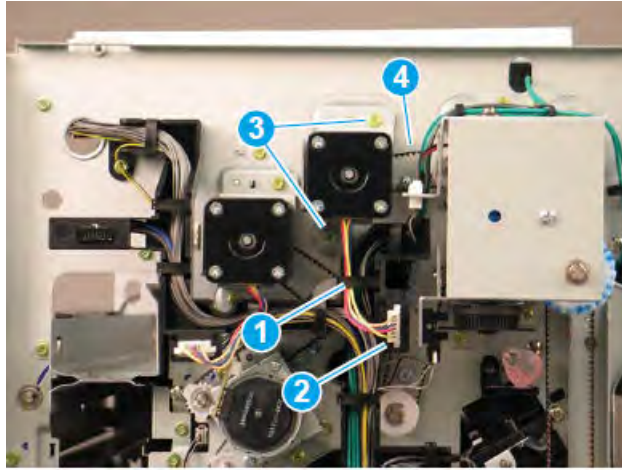

Unpack the replacement assembly

Follow these steps to unpack the replacement assembly.

1. Dispose of the defective part.



NOTE: HP recommends responsible disposal of the defective part.

<http://www8.hp.com/us/en/hp-information/environment/product-recycling.html>

2. Unpack the replacement part from the packaging.



CAUTION:  Some parts are sensitive to electrostatic discharge (ESD). Always perform service work at an ESD-protected workstation or mat. If an ESD workstation or mat is not available, touch the sheet-metal chassis to provide a static ground before touching an ESD-sensitive assembly. Protect the ESD-sensitive assemblies by placing them in ESD pouches when they are out of the printer.



IMPORTANT: Make sure that all of the shipping materials (for example shipping tape) are removed from the replacement part prior to installation.



NOTE: If the replacement part is a roller or pad, avoid touching the spongy part of it. Skin oils on the roller or pad can cause paper pickup and/or print-quality problems. HP recommends using disposable gloves when handling rollers or pads or washing your hands before touching rollers or pads.

3. To install an assembly, reverse the removal steps.



NOTE: When applicable, special installation instructions are provided for an assembly at the end of the removal procedure. Always completely read the removal instructions and follow all special installation instructions.

Removal and replacement: Main exit cam motor (M2)

Learn how to remove and replace the main exit cam motor.

Introduction

This document provides the procedures to remove and replace the main exit cam motor on the finisher.



IMPORTANT: When applicable, special installation instructions are provided for an assembly at the end of the removal procedure. Always completely read the removal instructions and follow all special installation instructions.

Before performing service

- Turn the printer power off. A shutting-down message appears on the control-panel display.
- ⚠ **WARNING!** To avoid damage to the printer, turn the power off and wait until the printer shuts down before removing the power cable.
- Disconnect the printer power cable after the printer has completely shut down (the control-panel display is blank).
- Release the finisher from the printer by pulling out on the release latch inside the finisher door.
- Disconnect the cable from the bridge unit to the finisher.
- Disconnect the cable from the finisher to the printer.

Use the table below to identify the correct part number for your printer. To order the part, go to <https://parts.hp.com>.

Table 5-107 Part information

Part number	Part description
JC90-01453A	Main exit cam motor assembly

Required tools

- #2 JIS screwdriver with a magnetic tip
- Small, flat-blade screwdriver

After performing service

- Connect the cable from the finisher to the printer.
- Connect the cable from the bridge unit to the finisher.
- Attach the finisher to the printer, and then push in on the release latch inside the finisher door.
- Connect the printer power cable.
- Turn the printer power on.

Post service test

Process a job through the finisher and verify that the finisher works correctly.

Remove the right upper cover (finisher)

Follow these steps to remove the right upper cover (finisher).

- ▲ Remove one screw cap and three machine screws on the upper edge of the cover (callout 1). Remove three sheet metal screws (callout 2) on the lower portion of the cover. Rotate the right edge of the cover away from the finisher, and then slide the cover right to release three tabs (callout 3).

💡 **TIP:** The lower screws are shorter in length than the upper screws.

TIP: Reverse the removal steps to install the assembly.

Figure 5-408 Remove the right upper cover

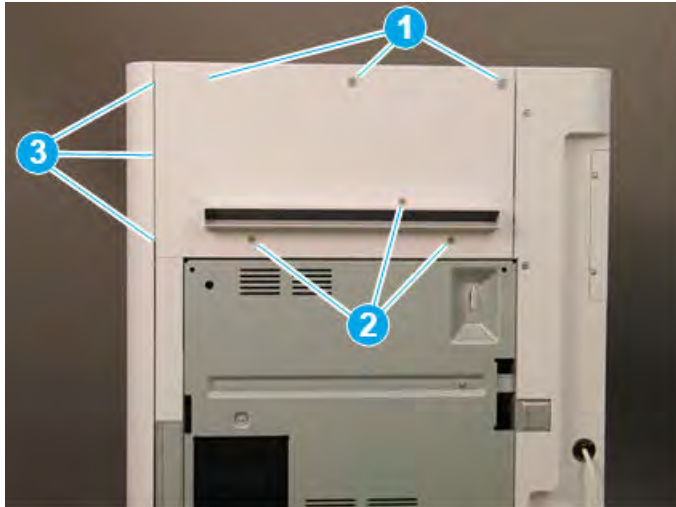

Remove the top cover (finisher)

Follow these steps to remove the top cover (finisher).

1. Remove three screw caps and three self-tapping screws at the top of the rear cover (callout 1), and then remove three machine screws (callout 2) on top of the cover.

Figure 5-409 Remove six screws

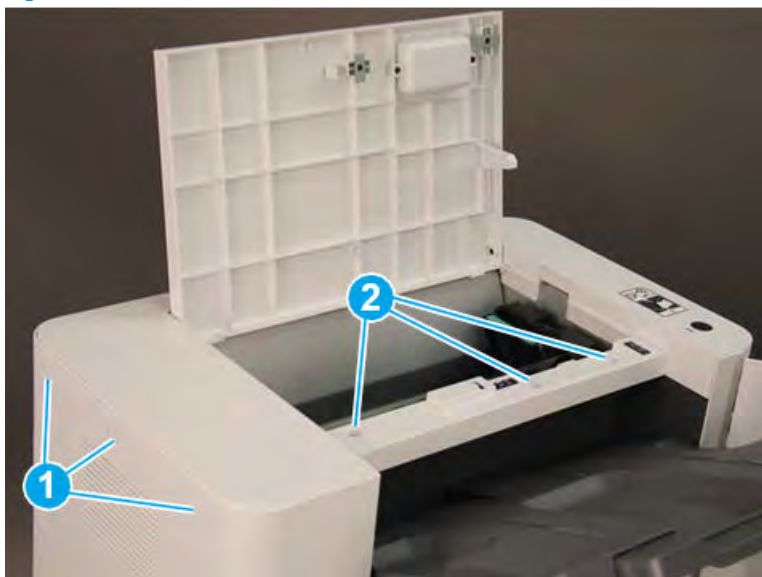

2. Remove three self-tapping screws at the top of the front cover (callout 1), and then remove two machine screws (callout 2) at the top of the right side.

Figure 5-410 Remove five screws

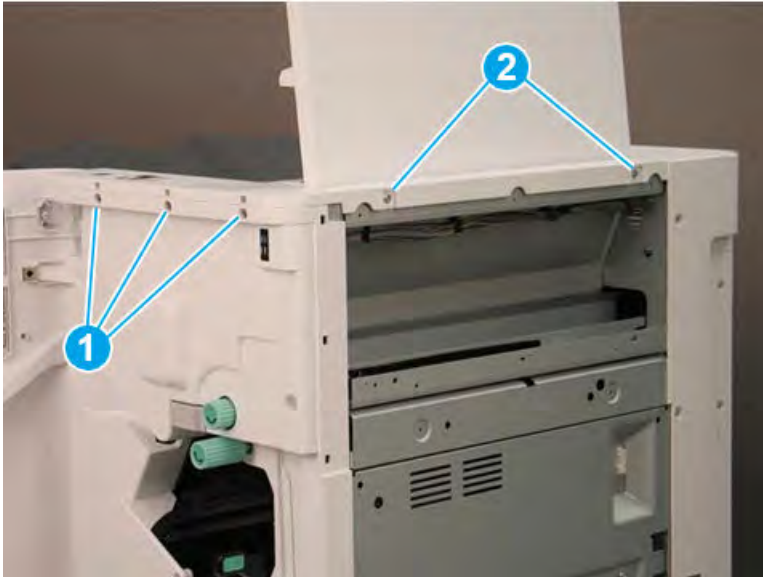

3. Lift the cover up slightly. Disconnect one in-line connector (callout 1), and then release one retainer (callout 2).

 **TIP:** Reverse the removal steps to install the assembly.

Figure 5-411 Disconnect one connector and release retainer



Remove the front cover (finisher)

Follow these steps to remove the front cover (finisher).

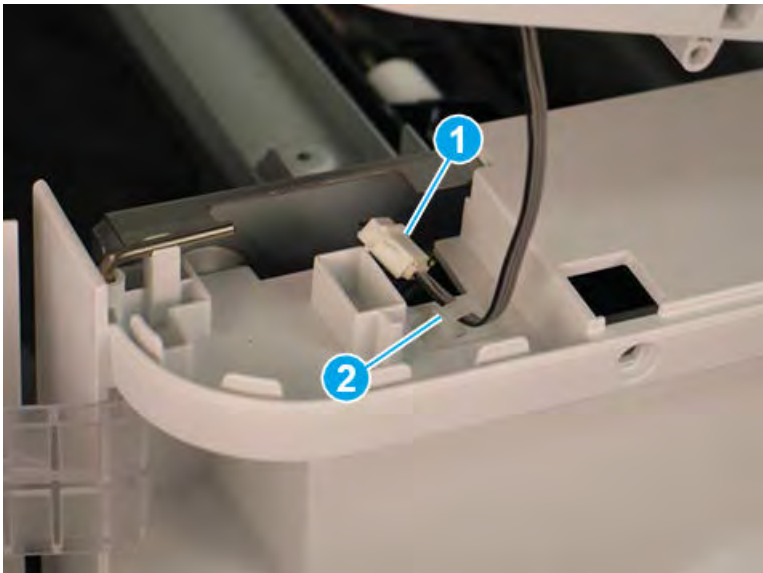
1. Release one tab (callout 1), and then pull the jam-access knob away from the finisher to remove it.

Figure 5-412 Remove the jam-access knob

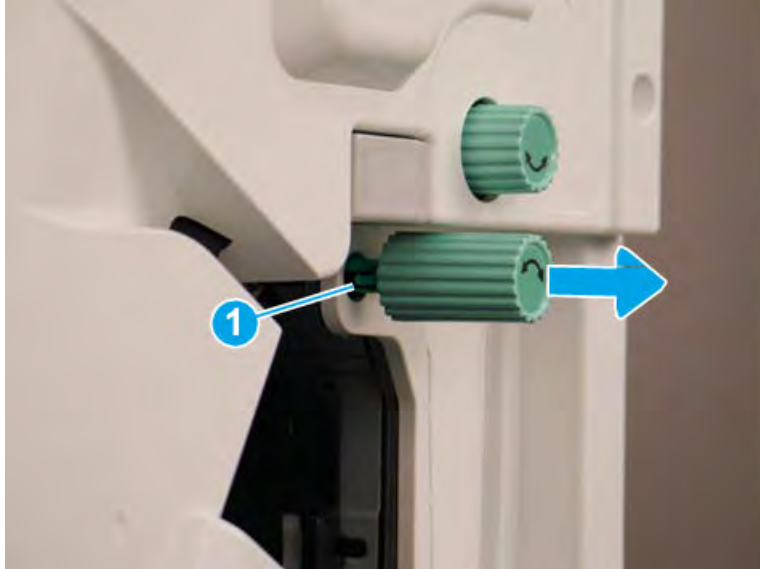

2. If the punch unit is installed, remove the punch waste bin (callout 1).
3. Remove one screw (callout 1) on top of the front cover.

Figure 5-413 Remove one screw



4. Remove five machine screws (callout 1), and then remove the front cover.

 **TIP:** Reverse the removal steps to install the assembly.

Figure 5-414 Remove the front cover



Remove the Main exit cam motor (M2)

Follow these steps to remove the Main exit cam motor (M2).

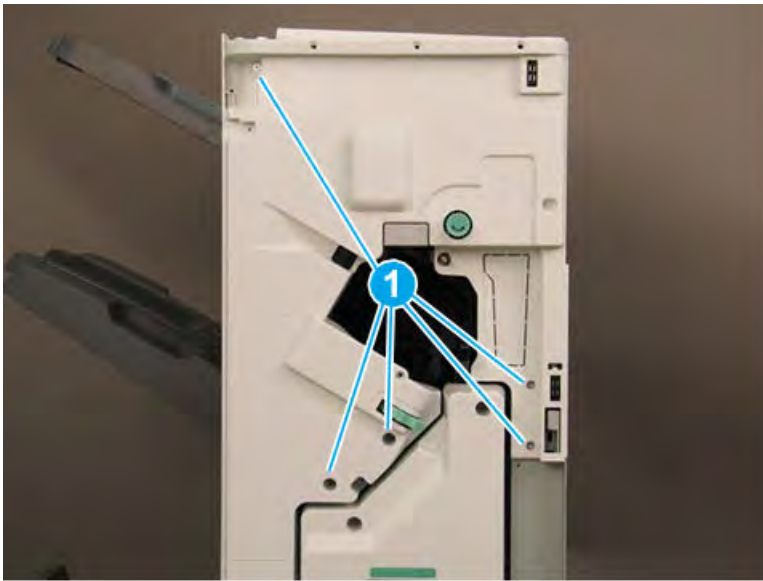
1. Disconnect two connectors (callout 1), and then remove two screws (callout 2).

Figure 5-415 Disconnect two connectors and then two screws

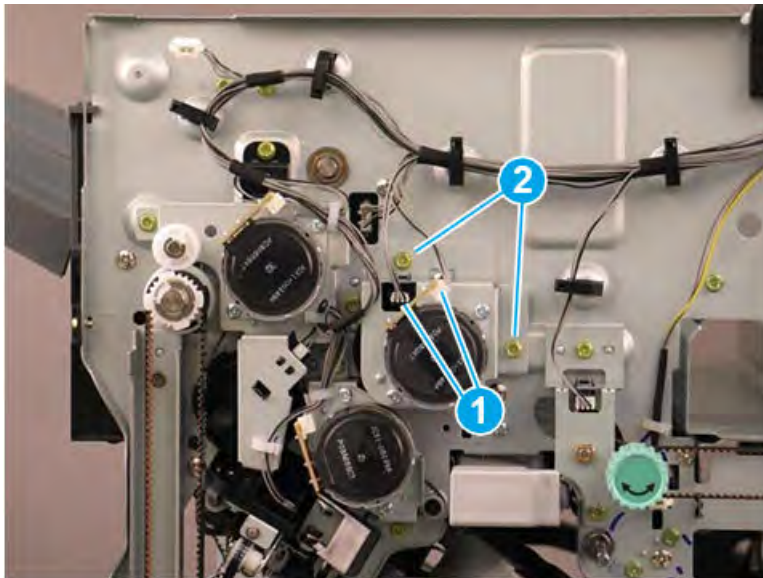

2. If you are replacing the gear, slide it off of the shaft

Figure 5-416 Slide the gear off of the shaft

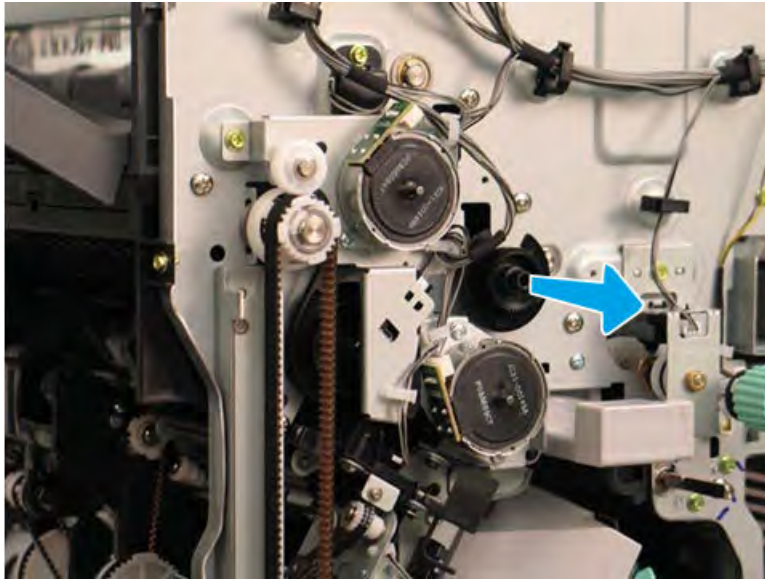

3. If you are replacing the sensor (callout 1), remove it from the motor housing.

Figure 5-417 Remove the sensor

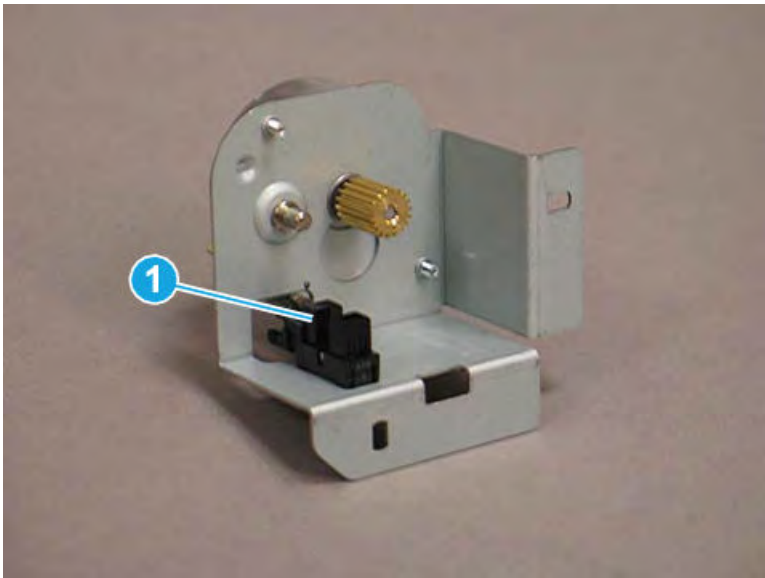

4. If you are replacing the motor, do the following.
 - a. Remove two screws (callout 1)

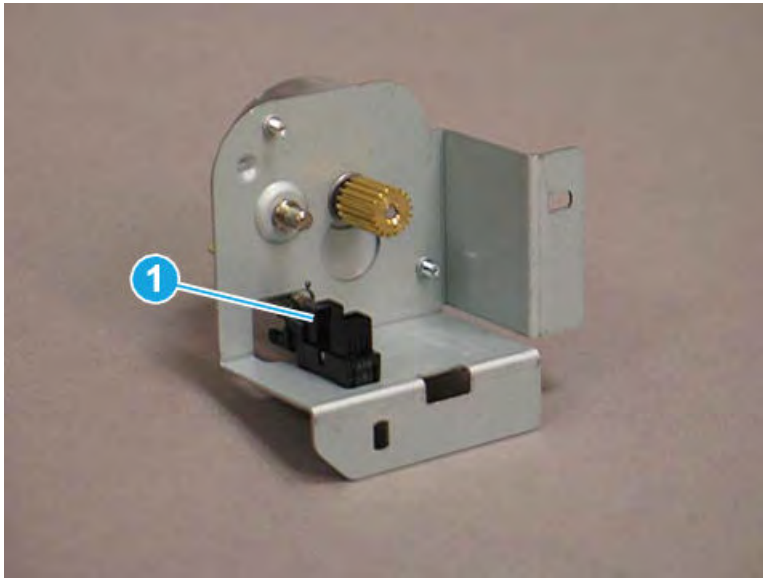

- b. Lower the motor (callout 1) and then pull it away from the housing (callout 2) to remove it.

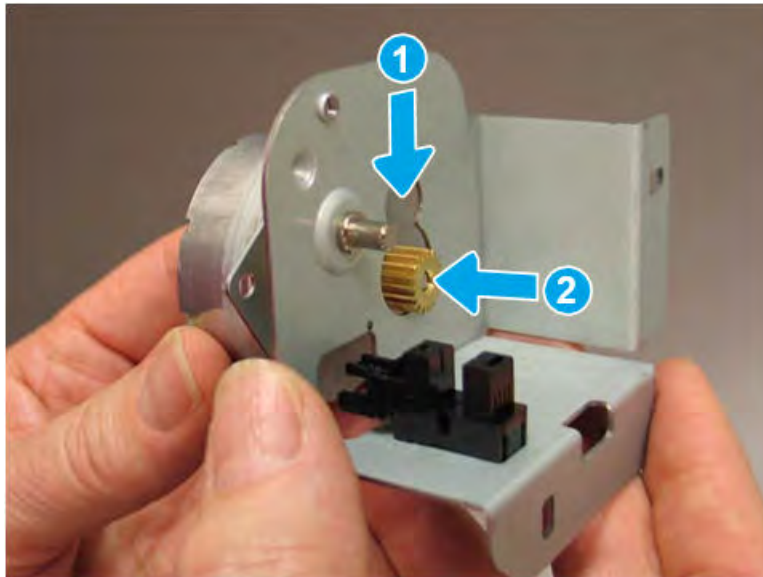

Unpack the replacement assembly

Follow these steps to unpack the replacement assembly.

1. Dispose of the defective part.

 **NOTE:** HP recommends responsible disposal of the defective part.

<http://www8.hp.com/us/en/hp-information/environment/product-recycling.html>

2. Unpack the replacement part from the packaging.



CAUTION:  Some parts are sensitive to electrostatic discharge (ESD). Always perform service work at an ESD-protected workstation or mat. If an ESD workstation or mat is not available, touch the sheet-metal chassis to provide a static ground before touching an ESD-sensitive assembly. Protect the ESD-sensitive assemblies by placing them in ESD pouches when they are out of the printer.



IMPORTANT: Make sure that all of the shipping materials (for example shipping tape) are removed from the replacement part prior to installation.



NOTE: If the replacement part is a roller or pad, avoid touching the spongy part of it. Skin oils on the roller or pad can cause paper pickup and/or print-quality problems. HP recommends using disposable gloves when handling rollers or pads or washing your hands before touching rollers or pads.

3. To install an assembly, reverse the removal steps.



NOTE: When applicable, special installation instructions are provided for an assembly at the end of the removal procedure. Always completely read the removal instructions and follow all special installation instructions.

Paddle unit

Removal and replacement: Paddle

Learn how to remove and replace the paddle.

Introduction

This document provides the procedures to remove and replace the paddle for the finisher.

 **IMPORTANT:** When applicable, special installation instructions are provided for an assembly at the end of the removal procedure. Always completely read the removal instructions and follow all special installation instructions.

Before performing service

- Turn the printer power off. A shutting-down message appears on the control-panel display.
- ⚠ **WARNING!** To avoid damage to the printer, turn the power off and wait until the printer shuts down before removing the power cable.
- Disconnect the printer power cable after the printer has completely shut down (the control-panel display is blank).
- Release the finisher from the printer by pulling out on the release latch inside the finisher door.
- Disconnect the cable from the bridge unit to the finisher.
- Disconnect the cable from the finisher to the printer.

Use the table below to identify the correct part number for your printer. To order the part, go to <https://parts.hp.com>.

Table 5-108 Part information

Part number	Part description
JC90-01462A	Paddle mid
JC90-01463A	Paddle wing

Required tools

- #2 JIS screwdriver with a magnetic tip

After performing service

- Connect the cable from the finisher to the printer.
- Connect the cable from the bridge unit to the finisher.
- Attach the finisher to the printer, and then push in on the release latch inside the finisher door.
- Connect the printer power cable.
- Turn the printer power on.

Post service test

Process a job through the finisher and verify that the finisher works correctly.

Remove the right upper cover (finisher)

Follow these steps to remove the right upper cover (finisher).

- ▲ Remove one screw cap and three machine screws on the upper edge of the cover (callout 1). Remove three sheet metal screws (callout 2) on the lower portion of the cover. Rotate the right edge of the cover away from the finisher, and then slide the cover right to release three tabs (callout 3).

💡 **TIP:** The lower screws are shorter in length than the upper screws.

TIP: Reverse the removal steps to install the assembly.

Figure 5-418 Remove the right upper cover

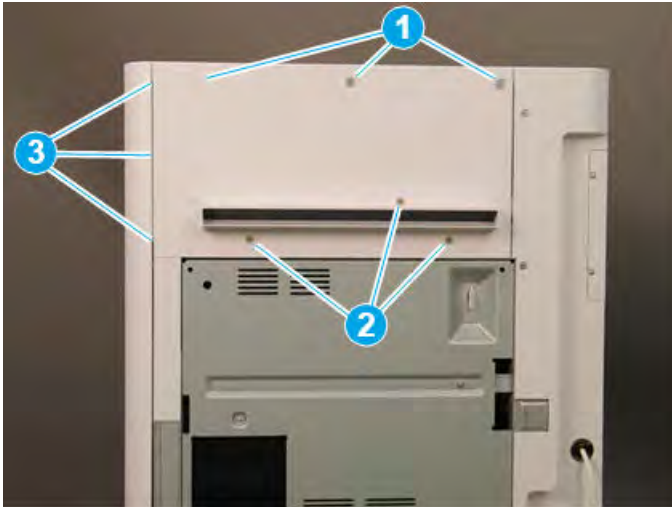

Remove the top cover (finisher)

Follow these steps to remove the top cover (finisher).

1. Remove three screw caps and three self-tapping screws at the top of the rear cover (callout 1), and then remove three machine screws (callout 2) on top of the cover.

Figure 5-419 Remove six screws

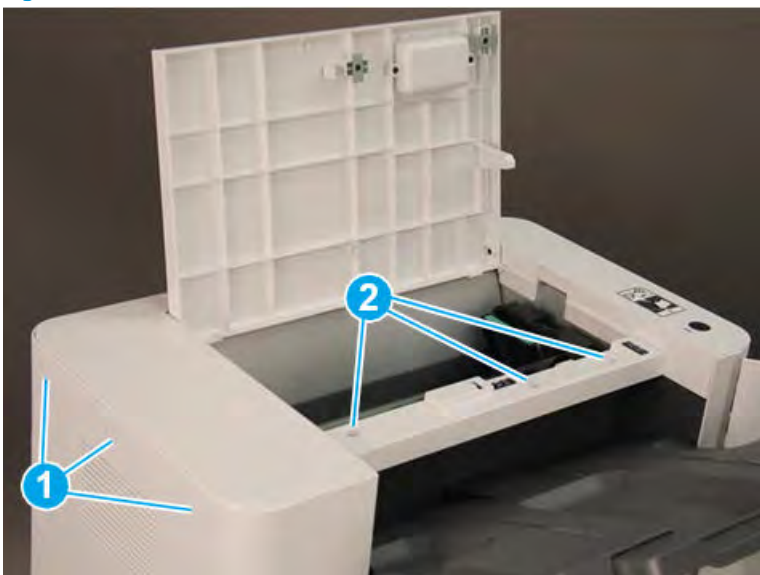

2. Remove three self-tapping screws at the top of the front cover (callout 1), and then remove two machine screws (callout 2) at the top of the right side.

Figure 5-420 Remove five screws

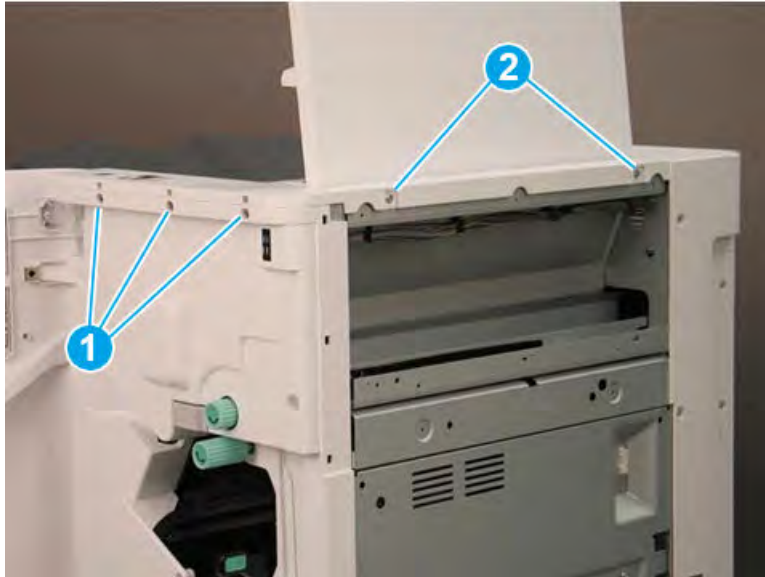

3. Lift the cover up slightly. Disconnect one in-line connector (callout 1), and then release one retainer (callout 2).

 **TIP:** Reverse the removal steps to install the assembly.

Figure 5-421 Disconnect one connector and release retainer



Remove the front door (finisher)

Follow these steps to remove the front door (finisher).

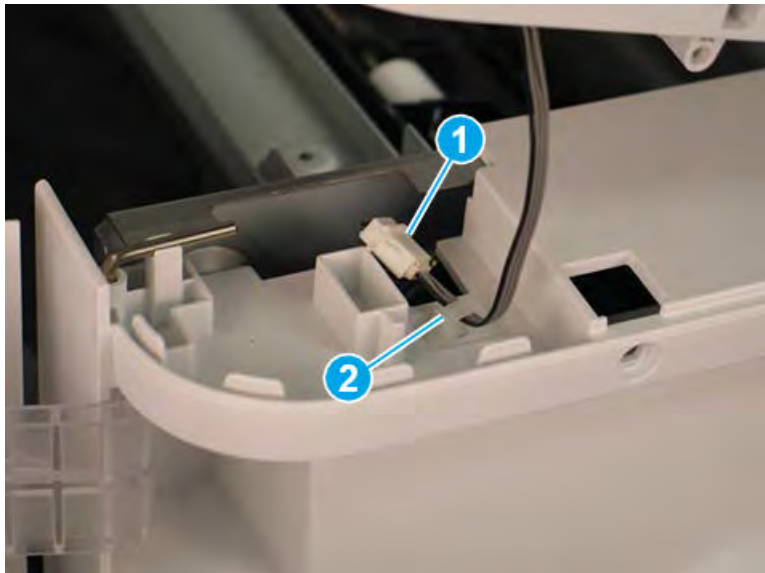
1. Lift the top hinge pin up to release it from the retainer.

Figure 5-422 Lift the top hinge pin

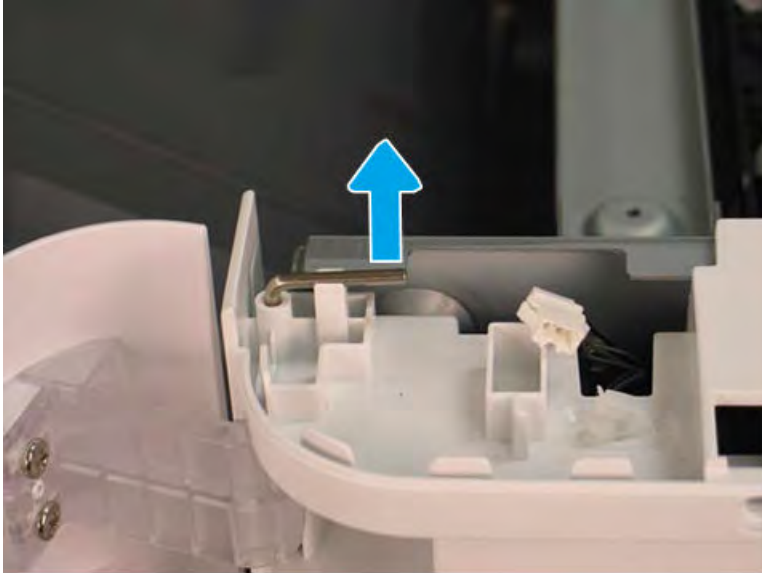

2. Pull the top hinge pin up to remove it.

Figure 5-423 Remove the top hinge pin

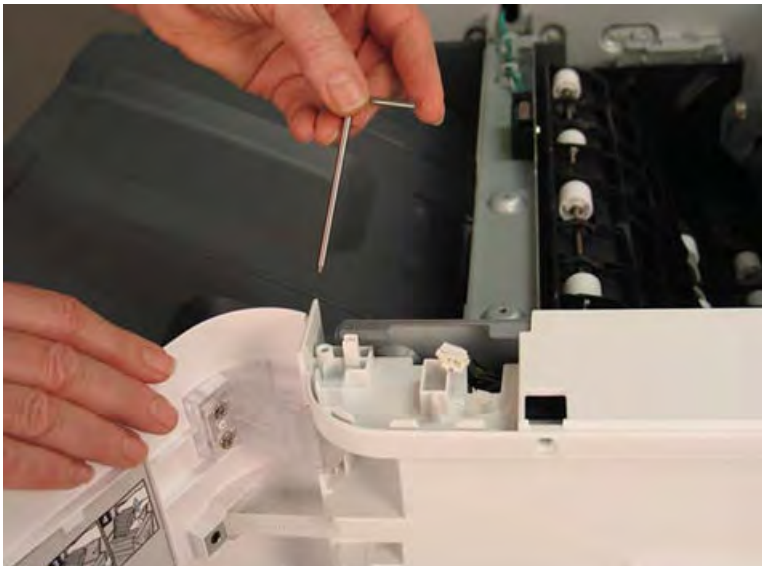

3. Use a small, flat-blade screwdriver to release the lower hinge pin from the retainer, and then rotate it away from the finisher.

Figure 5-424 Release the lower hinge pin



4. Support the door with one hand, and then pull the lower hinge pin straight up to remove it.

Figure 5-425 Remove the lower hinge pin



5. Support the door with one hand, and then remove one screw (callout 1) to release the strap. Remove the front door.

 **TIP:** Reverse the removal steps to install the assembly.

Figure 5-426 Remove the front door



Remove the front cover (finisher)

Follow these steps to remove the front cover (finisher).

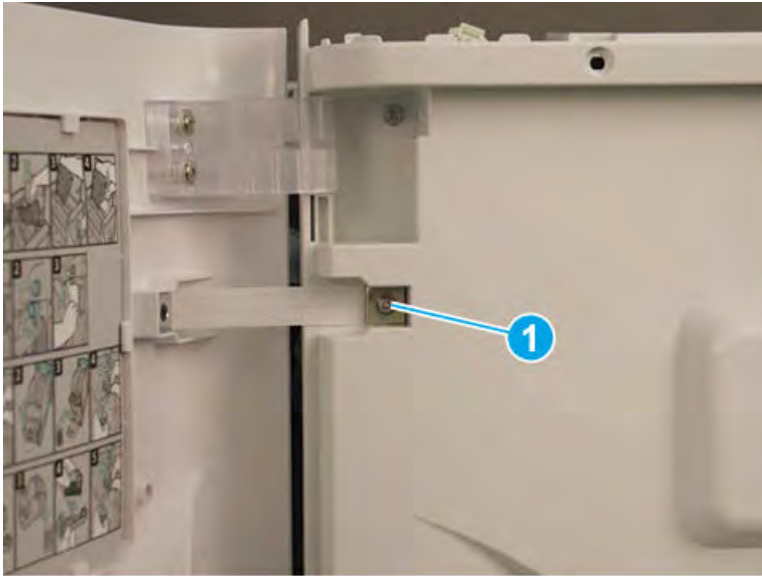
1. Release one tab (callout 1), and then pull the jam-access knob away from the finisher to remove it.

Figure 5-427 Remove the jam-access knob

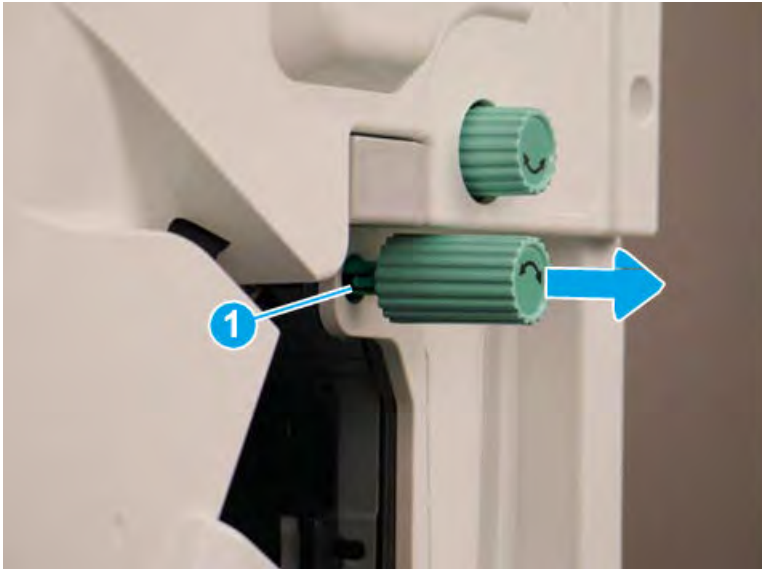

2. If the punch unit is installed, remove the punch waste bin (callout 1).

3. Remove one screw (callout 1) on top of the front cover.

Figure 5-428 Remove one screw



4. Remove five machine screws (callout 1), and then remove the front cover.

 **TIP:** Reverse the removal steps to install the assembly.

Figure 5-429 Remove the front cover

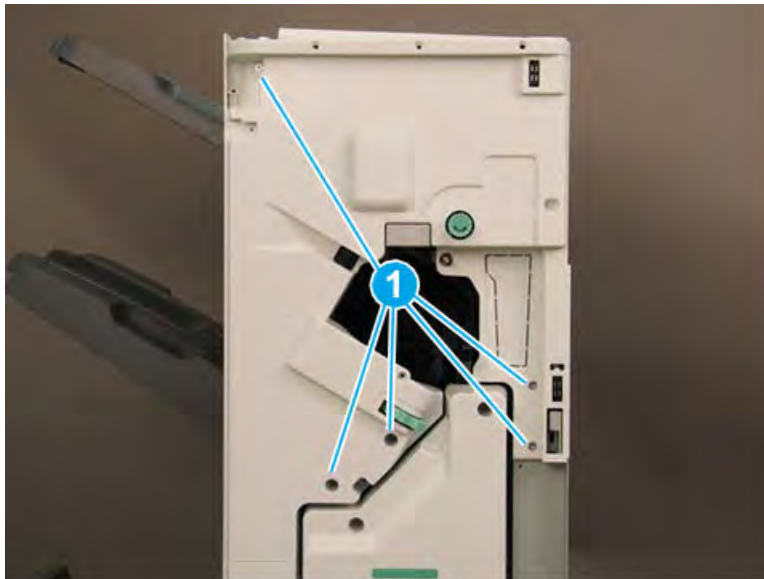

Remove the rear cover (finisher)

Follow these steps to remove the rear cover (finisher).

1. Remove two self-tapping screws (callout 1) on the top of the rear cover, and then remove five screw caps and five machine screws (callout 2) on the left side of the cover.

Figure 5-430 Remove seven screws



2. Remove one screw cap and four machine screws (callout 1) Remove the rear cover.

 **NOTE:** Make sure to thread the power cable (callout 2) through the opening in the cover.

 **TIP:** Reverse the removal steps to install the assembly

Figure 5-431 Remove the rear cover



Remove the paddle (finisher)

Follow these steps to remove the paddle (finisher).

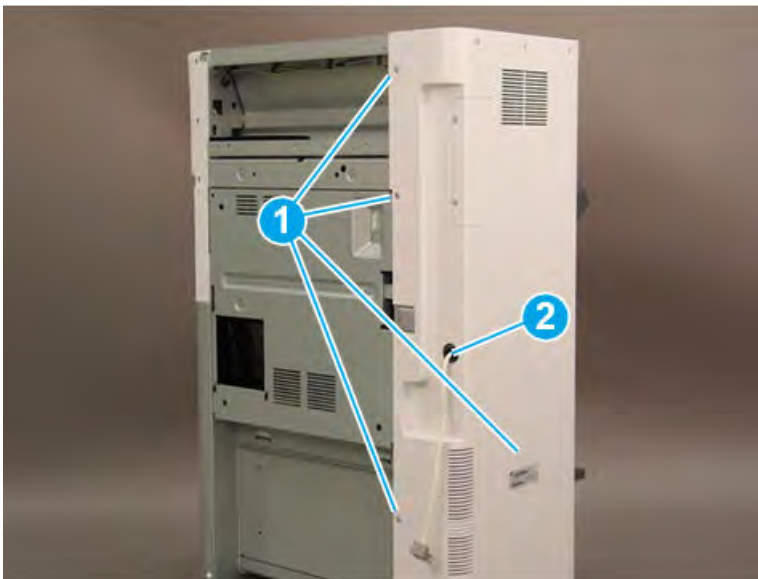
1. At the front of the finisher, remove two screws (callout 1).

Figure 5-432 Remove two screws

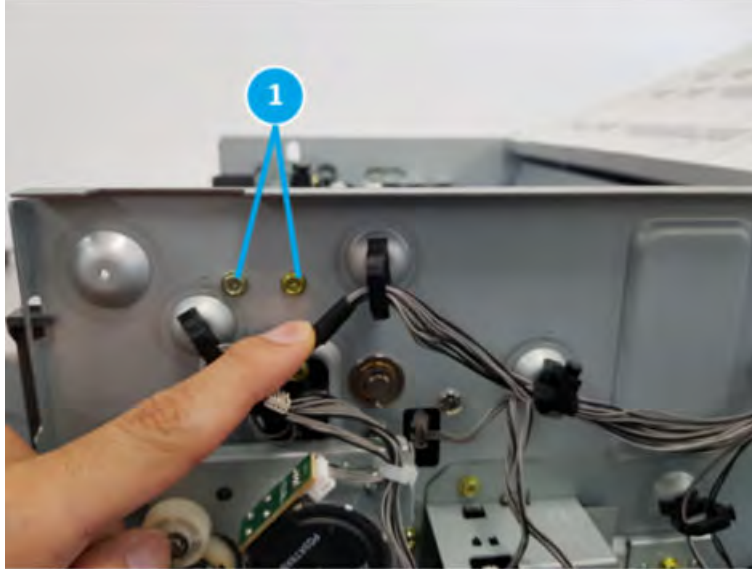

2. At the rear of the finisher, remove two screws (callout 1).

Figure 5-433 Remove two screws



3. Do not remove the frame (callout 1) but pull it one side.

Figure 5-434 Pull it one side

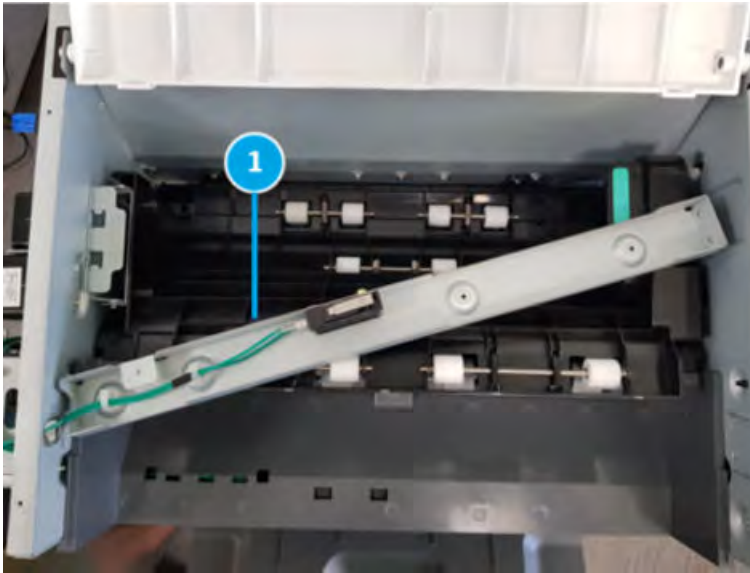

4. At the front of the finisher, remove two screws (callout 1)

Figure 5-435 Remove two screws

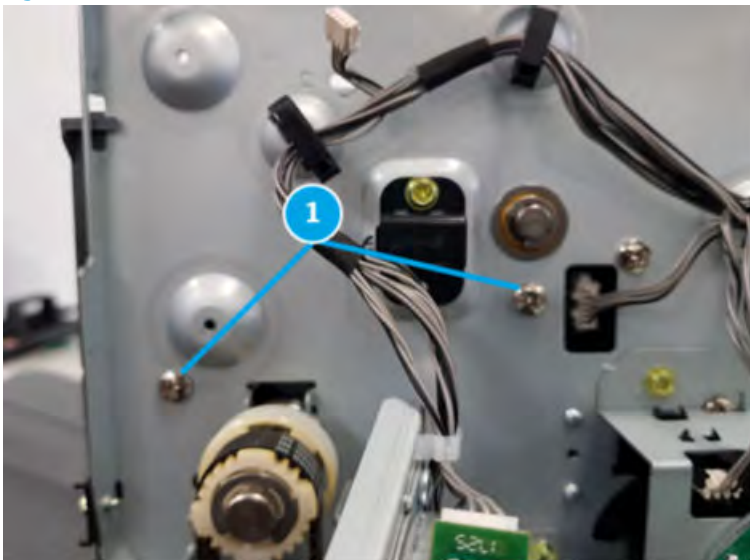

5. At the rear of the finisher, remove four screws (callout 1).

Figure 5-436 Remove four screws

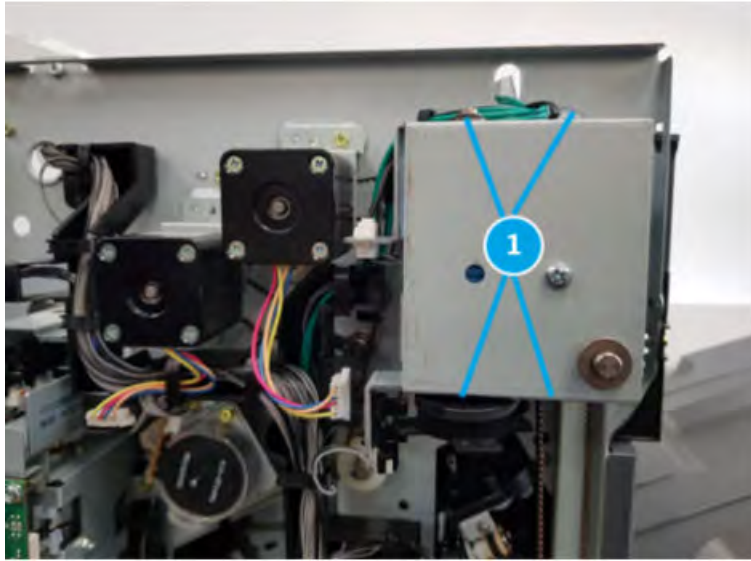

6. Bring the lower output tray down by positioning the shaft of a screwdriver or tweezers on the clutch (callout 1) and gently pressing to the right to release the clutch. Hold the clutch in the released position and lower the tray (callout 2) to the lowest position.(S11)

Figure 5-437 Pressing to the right to release the clutch

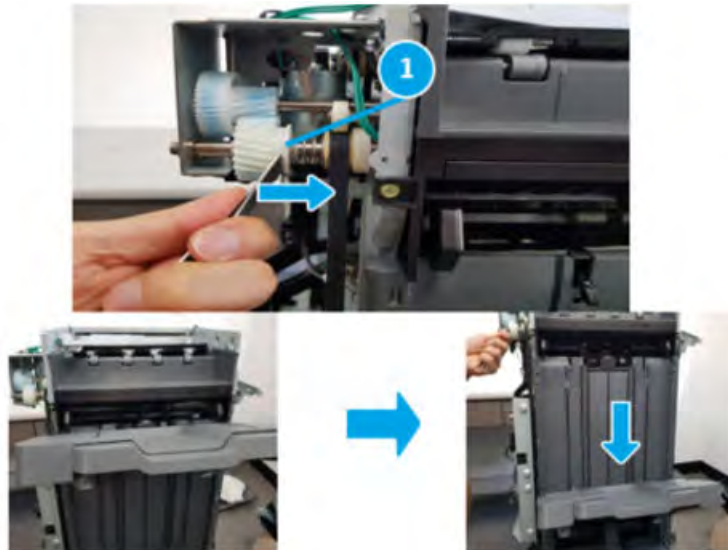

7. At the rear of the finisher, remove two screws (callout 1).

Figure 5-438 Remove two screws

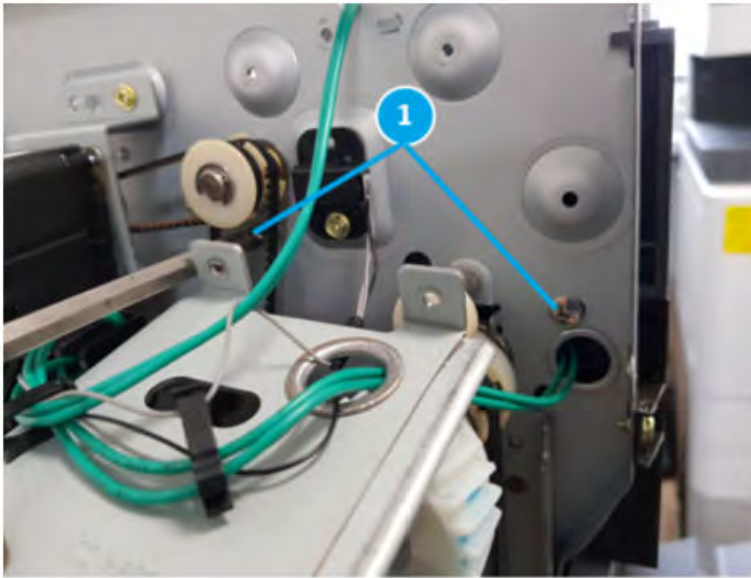

8. Remove two screws (callout 1)

Figure 5-439 Remove two screws



9. Take supporter of top output bin (callout 1) forward and put it down.

Figure 5-440 Take supporter of top output bin forward and put it down.

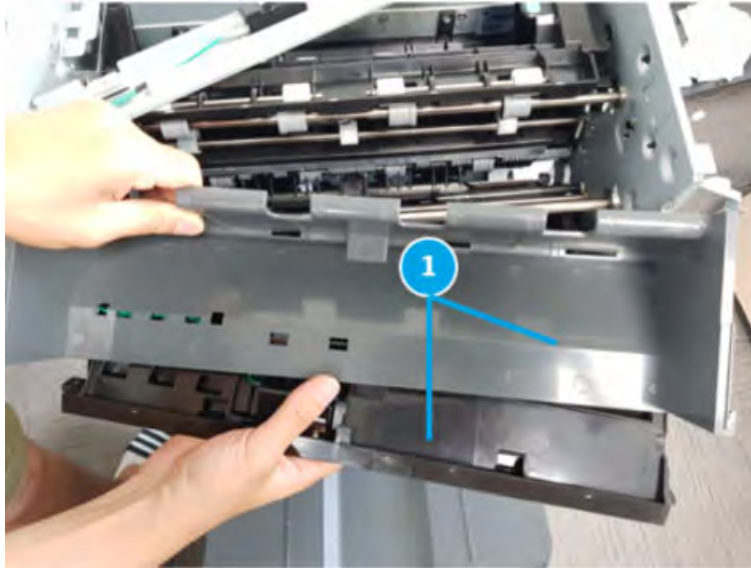

10. Remove three paddles (callout 1) from shaft

Figure 5-441 Remove the paddle

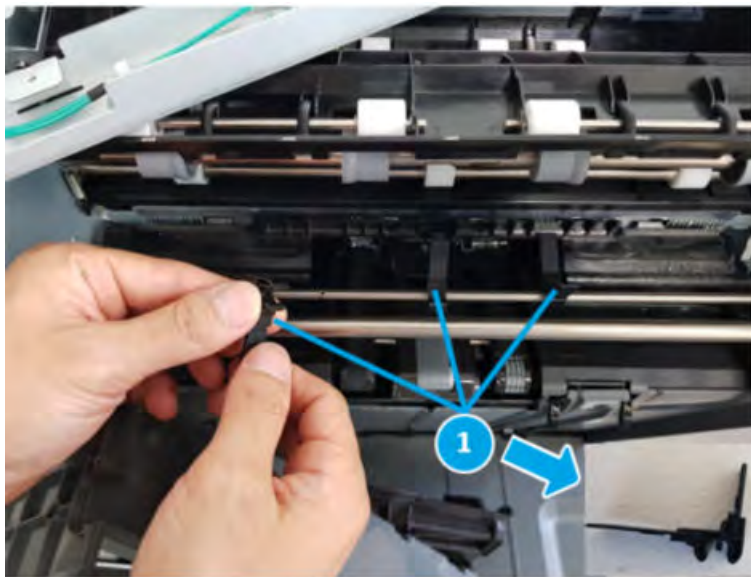

Unpack the replacement assembly

Follow these steps to unpack the replacement assembly.

1. Dispose of the defective part.

 **NOTE:** HP recommends responsible disposal of the defective part.

<http://www8.hp.com/us/en/hp-information/environment/product-recycling.html>

2. Unpack the replacement part from the packaging.



CAUTION:  Some parts are sensitive to electrostatic discharge (ESD). Always perform service work at an ESD-protected workstation or mat. If an ESD workstation or mat is not available, touch the sheet-metal chassis to provide a static ground before touching an ESD-sensitive assembly. Protect the ESD-sensitive assemblies by placing them in ESD pouches when they are out of the printer.

 **IMPORTANT:** Make sure that all of the shipping materials (for example shipping tape) are removed from the replacement part prior to installation.

 **NOTE:** If the replacement part is a roller or pad, avoid touching the spongy part of it. Skin oils on the roller or pad can cause paper pickup and/or print-quality problems. HP recommends using disposable gloves when handling rollers or pads or washing your hands before touching rollers or pads.

3. To install an assembly, reverse the removal steps.

 **NOTE:** When applicable, special installation instructions are provided for an assembly at the end of the removal procedure. Always completely read the removal instructions and follow all special installation instructions.

Removal and replacement: Paddle home sensor (S8)

Learn how to remove and replace the paddle home sensor.

Introduction

This document provides the procedures to remove and replace the paddle home sensor for the finisher.



IMPORTANT: When applicable, special installation instructions are provided for an assembly at the end of the removal procedure. Always completely read the removal instructions and follow all special installation instructions.

Before performing service

- Turn the printer power off. A shutting-down message appears on the control-panel display.
- ⚠ **WARNING!** To avoid damage to the printer, turn the power off and wait until the printer shuts down before removing the power cable.
- Disconnect the printer power cable after the printer has completely shut down (the control-panel display is blank).
- Release the finisher from the printer by pulling out on the release latch inside the finisher door.
- Disconnect the cable from the bridge unit to the finisher.
- Disconnect the cable from the finisher to the printer.

Use the table below to identify the correct part number for your printer. To order the part, go to <https://parts.hp.com>.

Table 5-109 Part information

Part number	Part description
0604-001393	Paddle home sensor

Required tools

- #2 JIS screwdriver with a magnetic tip
- Small, flat-blade screwdriver

After performing service

- Connect the cable from the finisher to the printer.
- Connect the cable from the bridge unit to the finisher.
- Attach the finisher to the printer, and then push in on the release latch inside the finisher door.
- Connect the printer power cable.
- Turn the printer power on.

Post service test

Process a job through the finisher and verify that the finisher works correctly.

Remove the right upper cover (finisher)

Follow these steps to remove the right upper cover (finisher).

- ▲ Remove one screw cap and three machine screws on the upper edge of the cover (callout 1). Remove three sheet metal screws (callout 2) on the lower portion of the cover. Rotate the right edge of the cover away from the finisher, and then slide the cover right to release three tabs (callout 3).

💡 **TIP:** The lower screws are shorter in length than the upper screws.

TIP: Reverse the removal steps to install the assembly.

Figure 5-442 Remove the right upper cover

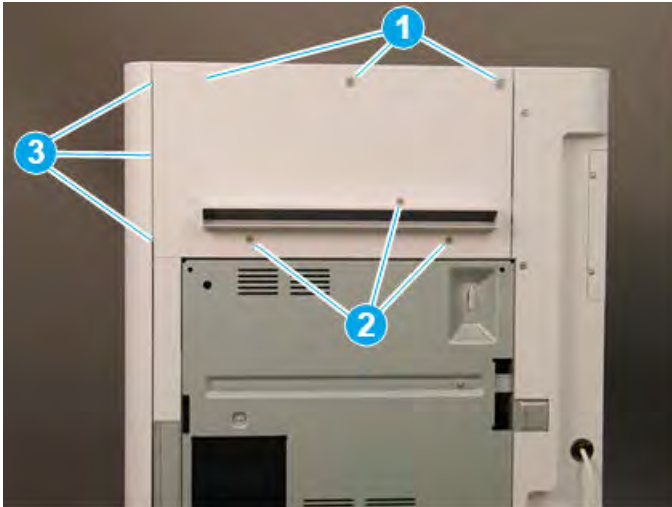

Remove the top cover (finisher)

Follow these steps to remove the top cover (finisher).

1. Remove three screw caps and three self-tapping screws at the top of the rear cover (callout 1), and then remove three machine screws (callout 2) on top of the cover.

Figure 5-443 Remove six screws

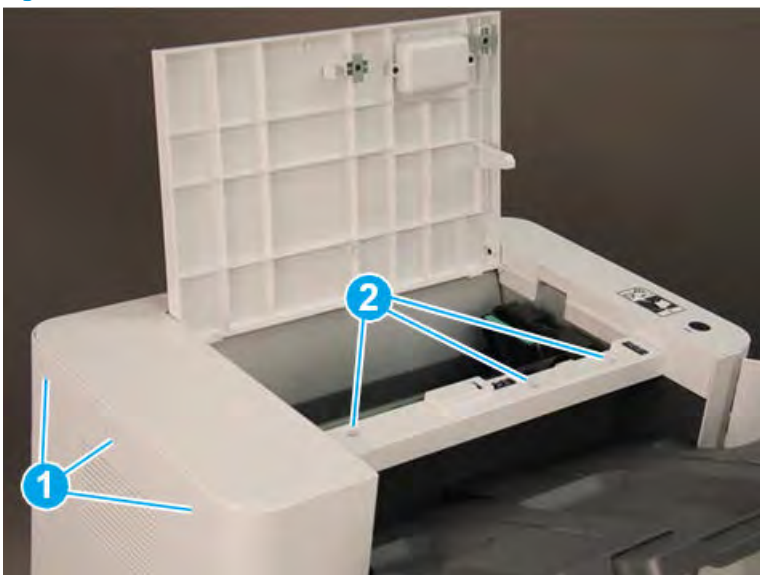

2. Remove three self-tapping screws at the top of the front cover (callout 1), and then remove two machine screws (callout 2) at the top of the right side.

Figure 5-444 Remove five screws

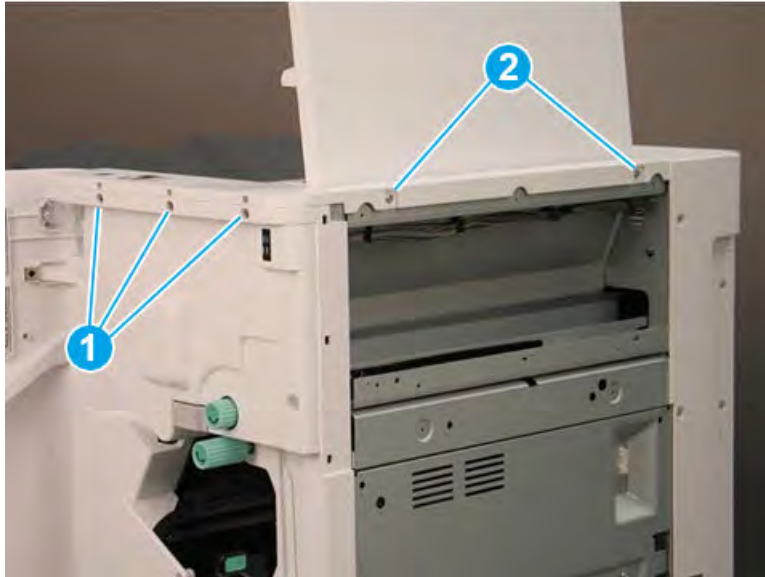

3. Lift the cover up slightly. Disconnect one in-line connector (callout 1), and then release one retainer (callout 2).

 **TIP:** Reverse the removal steps to install the assembly.

Figure 5-445 Disconnect one connector and release retainer



Remove the front door (finisher)

Follow these steps to remove the front door (finisher).

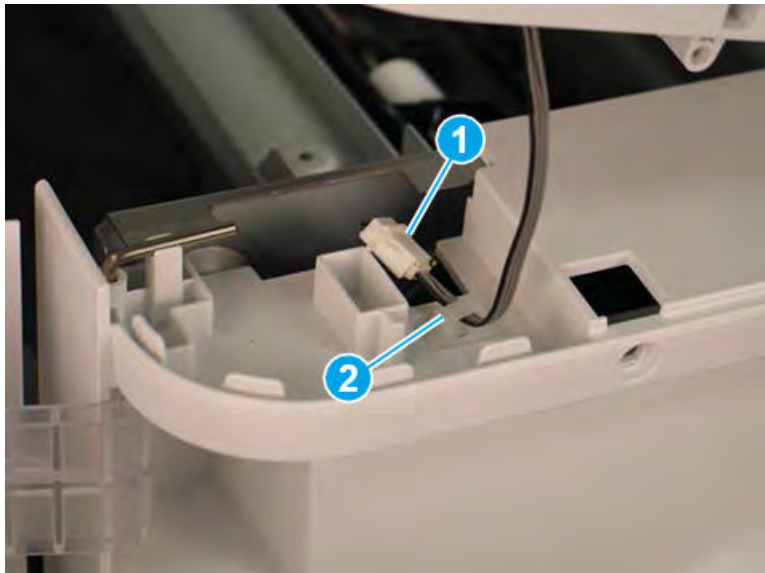
1. Lift the top hinge pin up to release it from the retainer.

Figure 5-446 Lift the top hinge pin

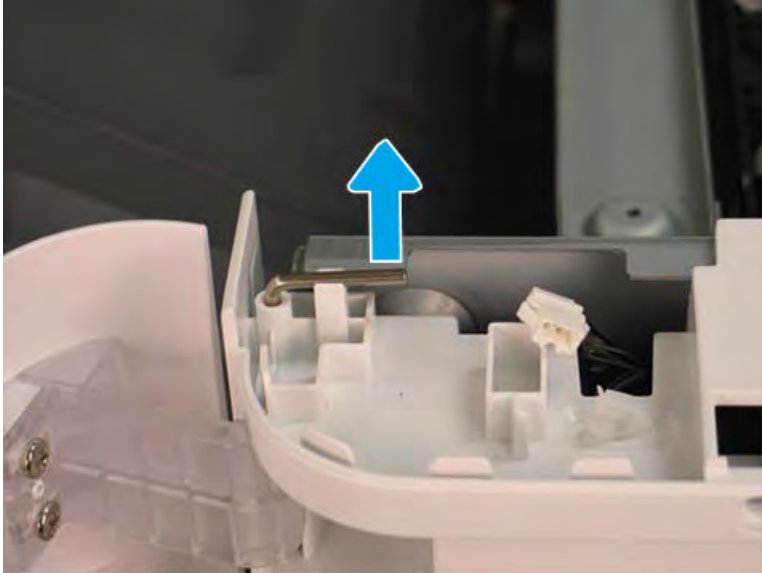

2. Pull the top hinge pin up to remove it.

Figure 5-447 Remove the top hinge pin

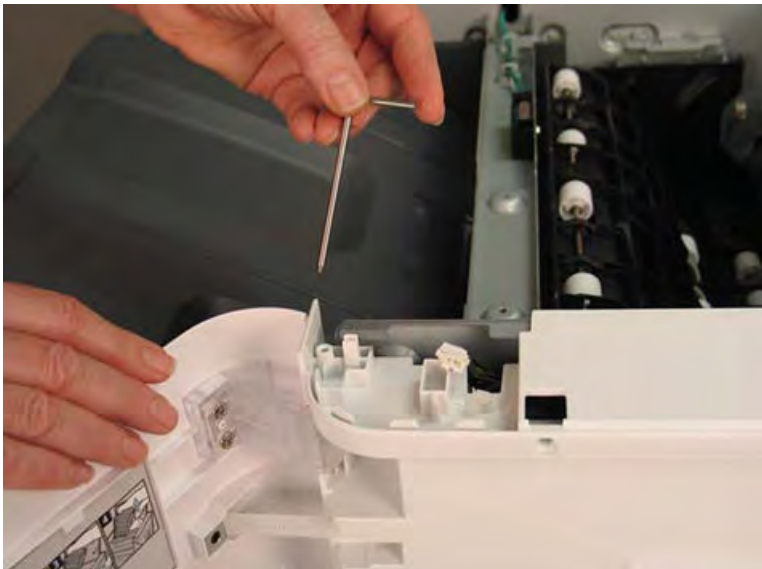

3. Use a small, flat-blade screwdriver to release the lower hinge pin from the retainer, and then rotate it away from the finisher.

Figure 5-448 Release the lower hinge pin



4. Support the door with one hand, and then pull the lower hinge pin straight up to remove it.

Figure 5-449 Remove the lower hinge pin



5. Support the door with one hand, and then remove one screw (callout 1) to release the strap. Remove the front door.

 **TIP:** Reverse the removal steps to install the assembly.

Figure 5-450 Remove the front door



Remove the front cover (finisher)

Follow these steps to remove the front cover (finisher).

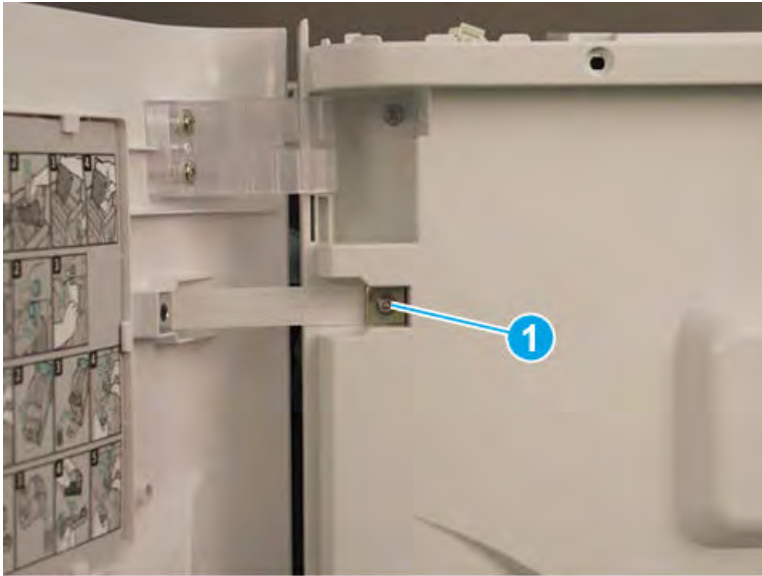
1. Release one tab (callout 1), and then pull the jam-access knob away from the finisher to remove it.

Figure 5-451 Remove the jam-access knob

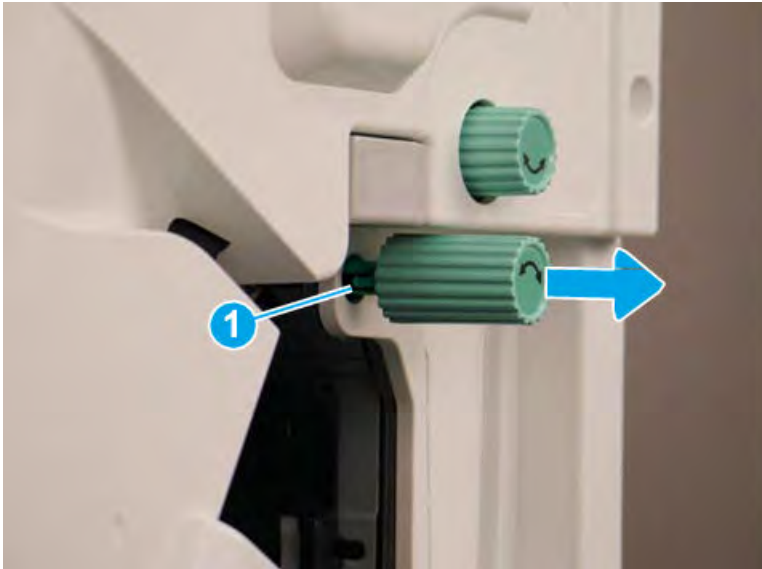

2. If the punch unit is installed, remove the punch waste bin (callout 1).

3. Remove one screw (callout 1) on top of the front cover.

Figure 5-452 Remove one screw



4. Remove five machine screws (callout 1), and then remove the front cover.

 **TIP:** Reverse the removal steps to install the assembly.

Figure 5-453 Remove the front cover



Remove the paddle home sensor (S8)

Follow these steps to remove the paddle home sensor (S8).

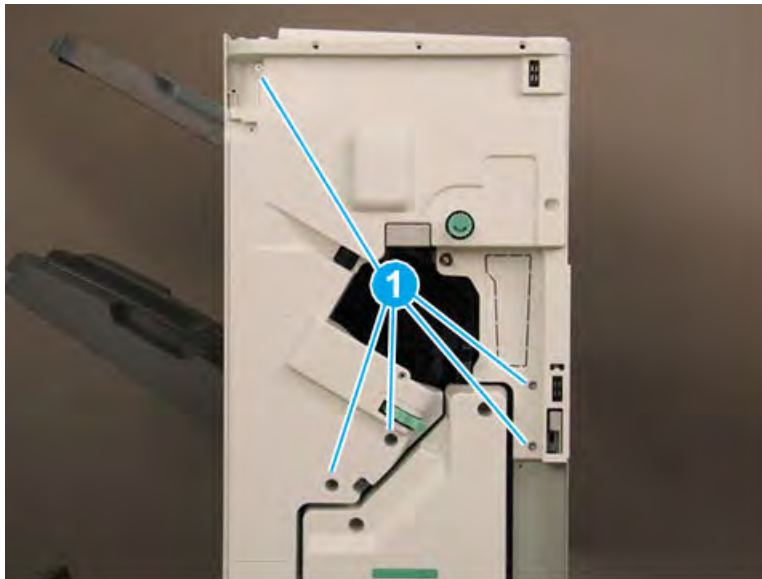
1. At the front of the finisher, remove two screws (callout 1) and disconnect two connectors (callout 2)

Figure 5-454 Remove two screws and disconnect two connectors

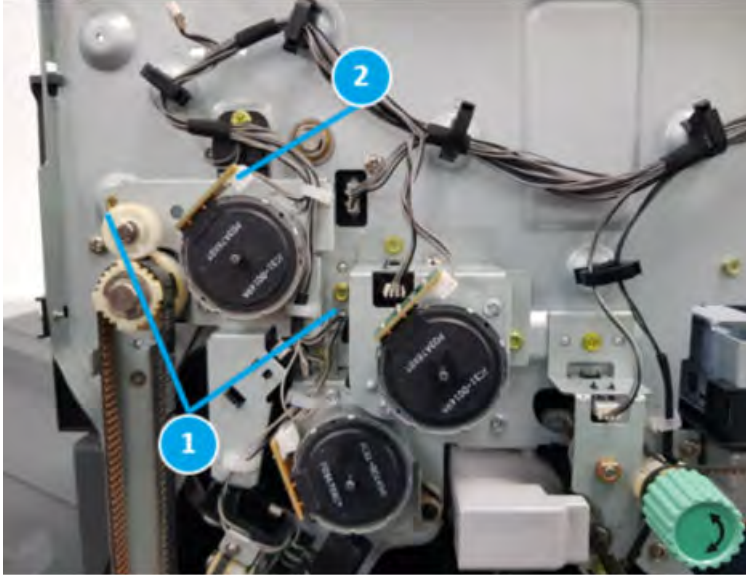

2. Disconnect connector from paddle home sensor

Figure 5-455 Disconnect connector from paddle home sensor

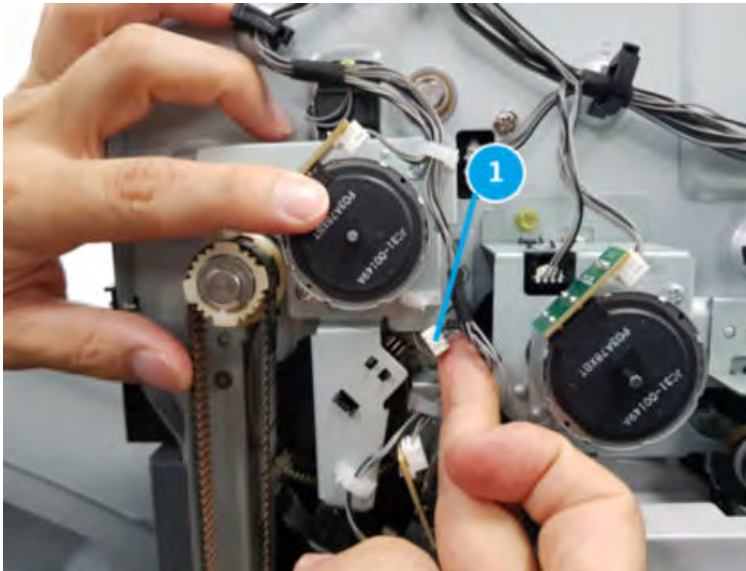

3. Remove paddle home sensor (S8; callout1)

Figure 5-456 Remove paddle home sensor

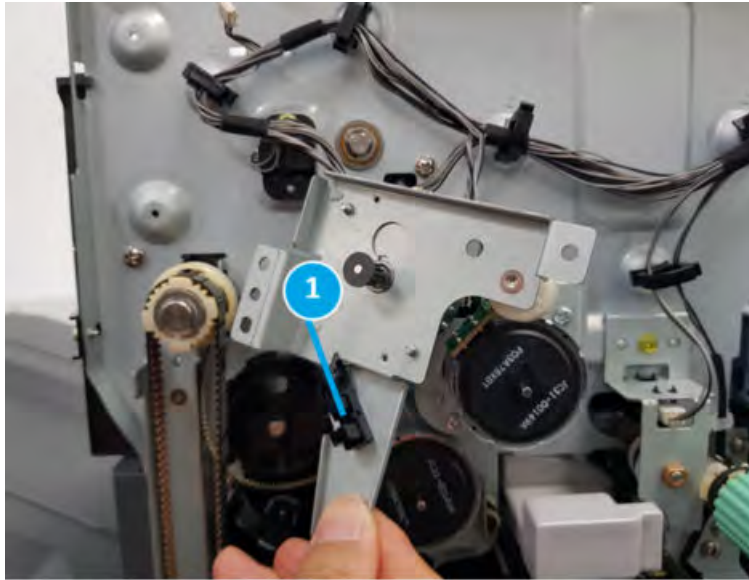

Unpack the replacement assembly



Follow these steps to unpack the replacement assembly.

1. Dispose of the defective part.

 **NOTE:** HP recommends responsible disposal of the defective part.

<http://www8.hp.com/us/en/hp-information/environment/product-recycling.html>

2. Unpack the replacement part from the packaging.

 **CAUTION:**  Some parts are sensitive to electrostatic discharge (ESD). Always perform service work at an ESD-protected workstation or mat. If an ESD workstation or mat is not available, touch the sheet-metal chassis to provide a static ground before touching an ESD-sensitive assembly. Protect the ESD-sensitive assemblies by placing them in ESD pouches when they are out of the printer.

 **IMPORTANT:** Make sure that all of the shipping materials (for example shipping tape) are removed from the replacement part prior to installation.

 **NOTE:** If the replacement part is a roller or pad, avoid touching the spongy part of it. Skin oils on the roller or pad can cause paper pickup and/or print-quality problems. HP recommends using disposable gloves when handling rollers or pads or washing your hands before touching rollers or pads.

3. To install an assembly, reverse the removal steps.

 **NOTE:** When applicable, special installation instructions are provided for an assembly at the end of the removal procedure. Always completely read the removal instructions and follow all special installation instructions.

Removal and replacement: Paddle motor (M1)

Learn how to remove and replace the paddle motor.

Introduction

This document provides the procedures to remove and replace the paddle motor for the finisher.



IMPORTANT: When applicable, special installation instructions are provided for an assembly at the end of the removal procedure. Always completely read the removal instructions and follow all special installation instructions.

Before performing service

- Turn the printer power off. A shutting-down message appears on the control-panel display.
- ⚠ **WARNING!** To avoid damage to the printer, turn the power off and wait until the printer shuts down before removing the power cable.
- Disconnect the printer power cable after the printer has completely shut down (the control-panel display is blank).
- Release the finisher from the printer by pulling out on the release latch inside the finisher door.
- Disconnect the cable from the bridge unit to the finisher.
- Disconnect the cable from the finisher to the printer.

Use the table below to identify the correct part number for your printer. To order the part, go to <https://parts.hp.com>.

Table 5-110 Part information

Part number	Part description
JC90-01461A	Paddle motor assembly
JC93-01001A	Paddle motor

Required tools

- #2 JIS screwdriver with a magnetic tip
- Small, flat-blade screwdriver

After performing service

- Connect the cable from the finisher to the printer.
- Connect the cable from the bridge unit to the finisher.
- Attach the finisher to the printer, and then push in on the release latch inside the finisher door.
- Connect the printer power cable.
- Turn the printer power on.

Post service test

Process a job through the finisher and verify that the finisher works correctly.

Remove the right upper cover (finisher)

Follow these steps to remove the right upper cover (finisher).

- ▲ Remove one screw cap and three machine screws on the upper edge of the cover (callout 1). Remove three sheet metal screws (callout 2) on the lower portion of the cover. Rotate the right edge of the cover away from the finisher, and then slide the cover right to release three tabs (callout 3).

💡 **TIP:** The lower screws are shorter in length than the upper screws.

TIP: Reverse the removal steps to install the assembly.

Figure 5-457 Remove the right upper cover

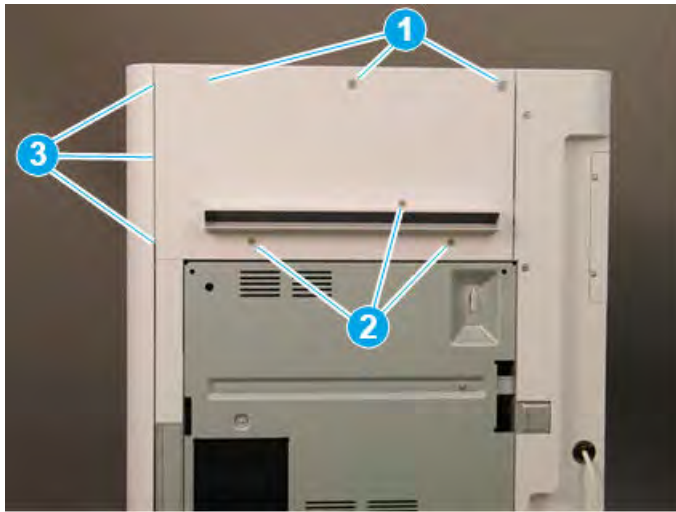

Remove the top cover (finisher)

Follow these steps to remove the top cover (finisher).

1. Remove three screw caps and three self-tapping screws at the top of the rear cover (callout 1), and then remove three machine screws (callout 2) on top of the cover.

Figure 5-458 Remove six screws

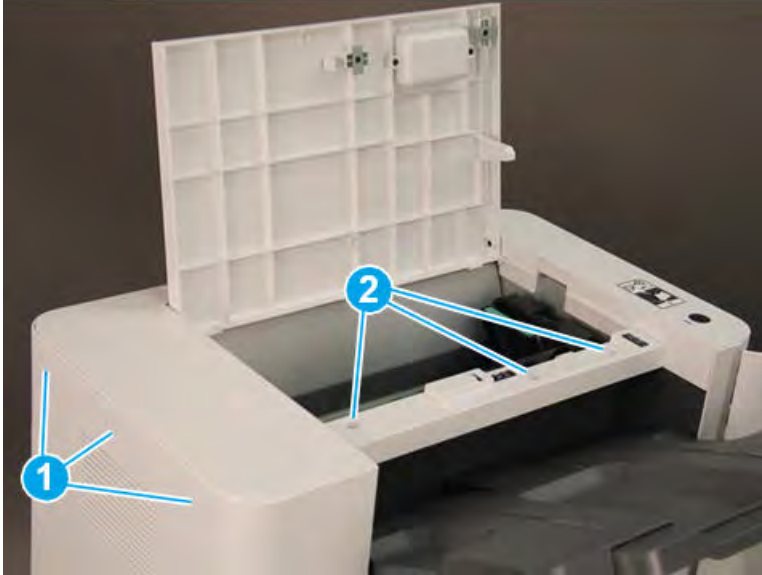

2. Remove three self-tapping screws at the top of the front cover (callout 1), and then remove two machine screws (callout 2) at the top of the right side.

Figure 5-459 Remove five screws

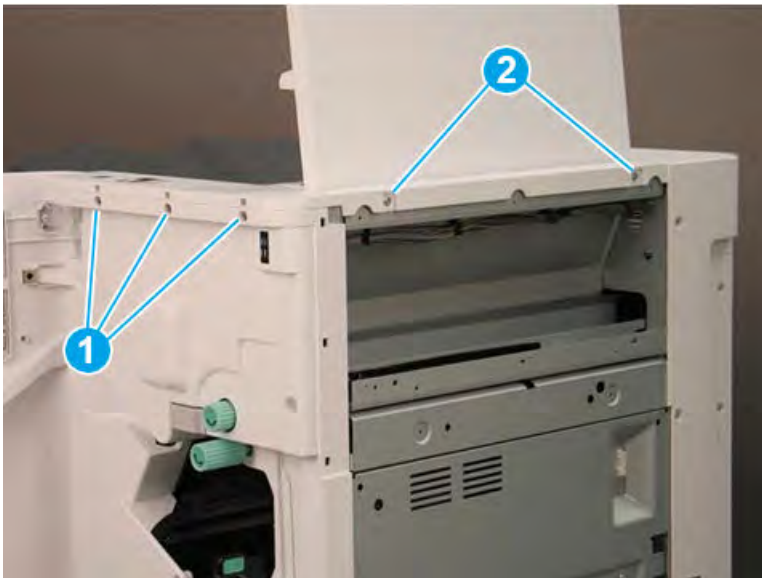

3. Lift the cover up slightly. Disconnect one in-line connector (callout 1), and then release one retainer (callout 2).

 **TIP:** Reverse the removal steps to install the assembly.

Figure 5-460 Disconnect one connector and release retainer



Remove the front door (finisher)

Follow these steps to remove the front door (finisher).

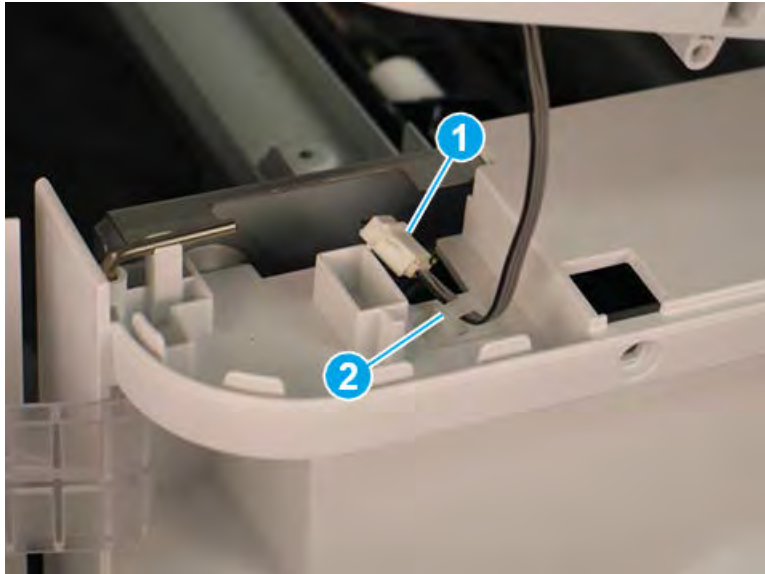
1. Lift the top hinge pin up to release it from the retainer.

Figure 5-461 Lift the top hinge pin

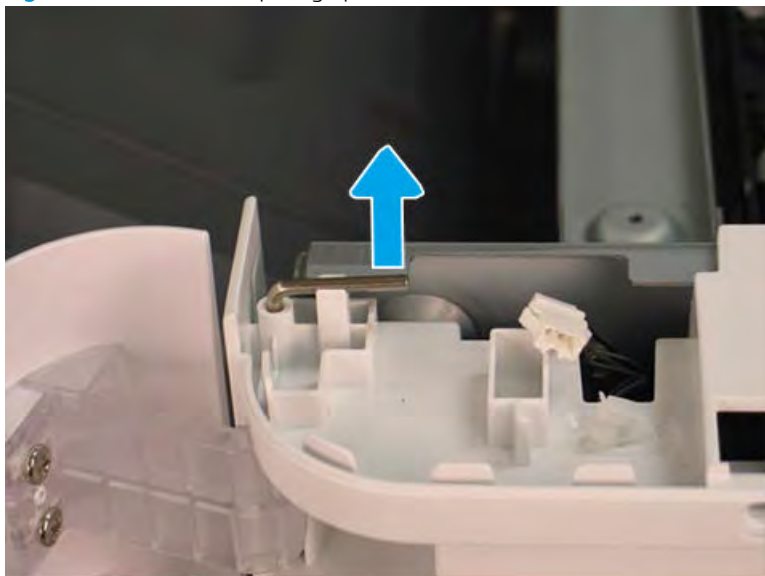

2. Pull the top hinge pin up to remove it.

Figure 5-462 Remove the top hinge pin

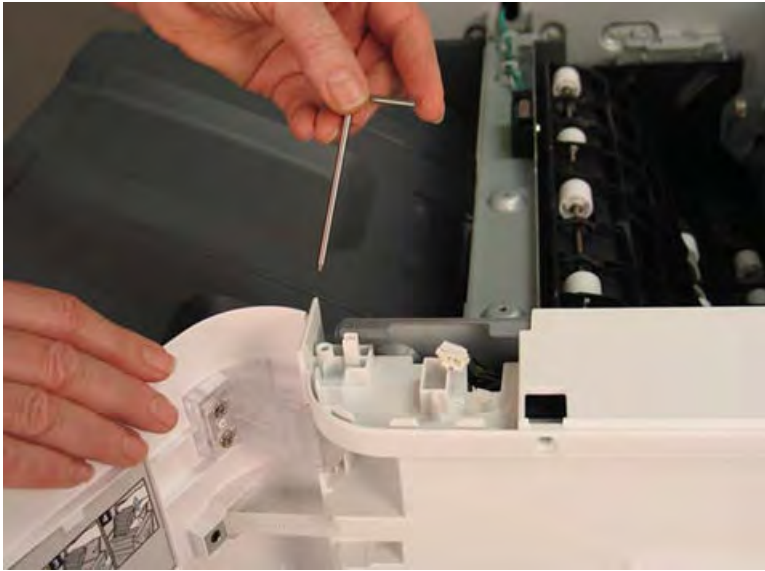

3. Use a small, flat-blade screwdriver to release the lower hinge pin from the retainer, and then rotate it away from the finisher.

Figure 5-463 Release the lower hinge pin



4. Support the door with one hand, and then pull the lower hinge pin straight up to remove it.

Figure 5-464 Remove the lower hinge pin



5. Support the door with one hand, and then remove one screw (callout 1) to release the strap. Remove the front door.

 **TIP:** Reverse the removal steps to install the assembly.

Figure 5-465 Remove the front door



Remove the front cover (finisher)

Follow these steps to remove the front cover (finisher).

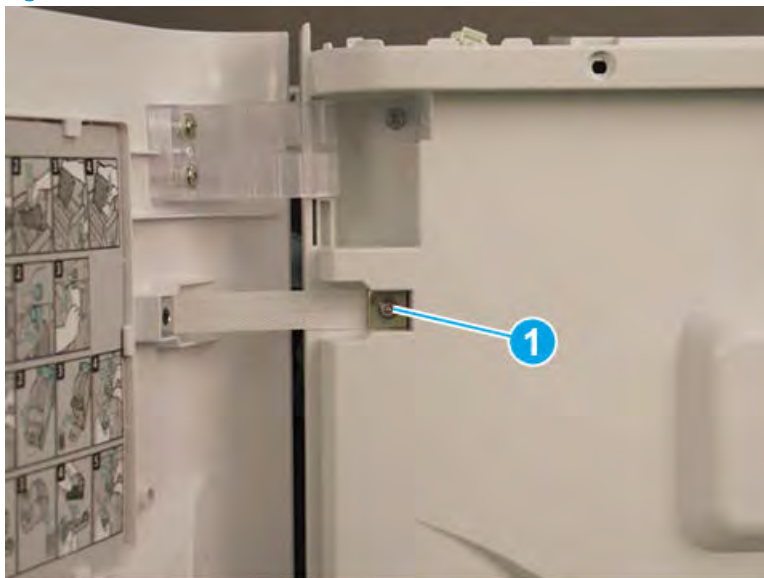
1. Release one tab (callout 1), and then pull the jam-access knob away from the finisher to remove it.

Figure 5-466 Remove the jam-access knob

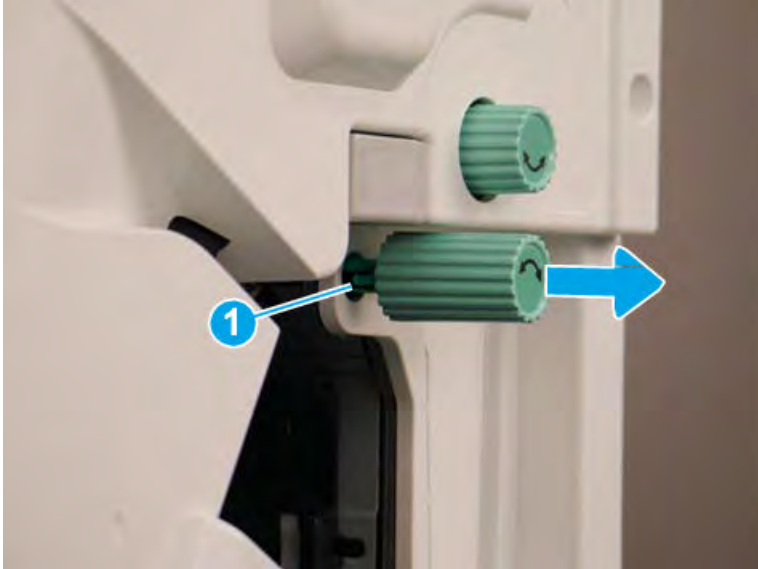

2. If the punch unit is installed, remove the punch waste bin (callout 1).
3. Remove one screw (callout 1) on top of the front cover.

Figure 5-467 Remove one screw



4. Remove five machine screws (callout 1), and then remove the front cover.

 **TIP:** Reverse the removal steps to install the assembly.

Figure 5-468 Remove the front cover



Remove the paddle motor (M1)

Follow these steps to remove the paddle motor (M1).

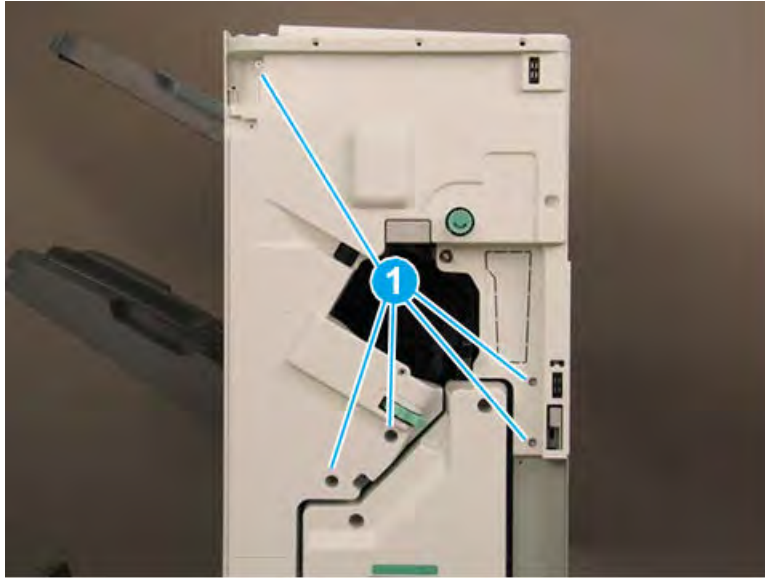
1. At the front of the finisher, remove two screws (callout 1) and disconnect two connectors (callout 2)

Figure 5-469 Remove two screws and disconnect two connectors

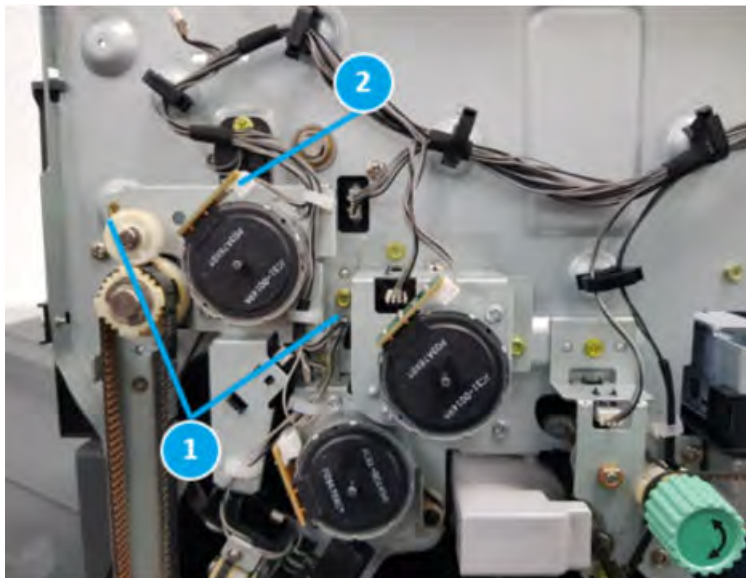

2. Remove two screws (callout 1) and then remove paddle motor (M1; callout 2)

Figure 5-470 Remove the paddle motor

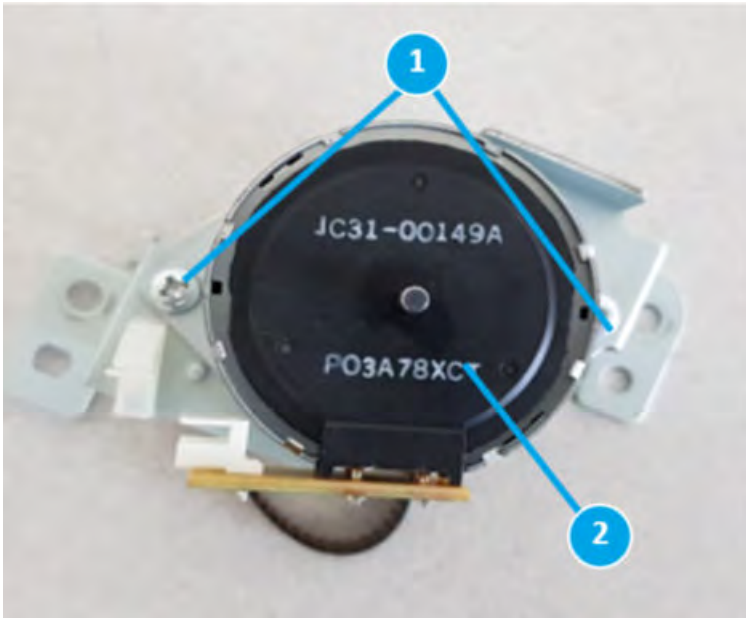

Unpack the replacement assembly



Follow these steps to unpack the replacement assembly.

1. Dispose of the defective part.

 **NOTE:** HP recommends responsible disposal of the defective part.

<http://www8.hp.com/us/en/hp-information/environment/product-recycling.html>

2. Unpack the replacement part from the packaging.

 **CAUTION:**  Some parts are sensitive to electrostatic discharge (ESD). Always perform service work at an ESD-protected workstation or mat. If an ESD workstation or mat is not available, touch the sheet-metal chassis to provide a static ground before touching an ESD-sensitive assembly. Protect the ESD-sensitive assemblies by placing them in ESD pouches when they are out of the printer.

 **IMPORTANT:** Make sure that all of the shipping materials (for example shipping tape) are removed from the replacement part prior to installation.

 **NOTE:** If the replacement part is a roller or pad, avoid touching the spongy part of it. Skin oils on the roller or pad can cause paper pickup and/or print-quality problems. HP recommends using disposable gloves when handling rollers or pads or washing your hands before touching rollers or pads.

3. To install an assembly, reverse the removal steps.

 **NOTE:** When applicable, special installation instructions are provided for an assembly at the end of the removal procedure. Always completely read the removal instructions and follow all special installation instructions.

End fence unit

Removal and replacement: End fence home sensor (S7)

Learn how to remove and replace the end fence home sensor.

Introduction

This document provides the procedures to remove and replace the end fence home sensor on the finisher.

 **IMPORTANT:** When applicable, special installation instructions are provided for an assembly at the end of the removal procedure. Always completely read the removal instructions and follow all special installation instructions.

Before performing service

- Turn the printer power off. A shutting-down message appears on the control-panel display.
- ⚠ **WARNING!** To avoid damage to the printer, turn the power off and wait until the printer shuts down before removing the power cable.
- Disconnect the printer power cable after the printer has completely shut down (the control-panel display is blank).
- Release the finisher from the printer by pulling out on the release latch inside the finisher door.
- Disconnect the cable from the bridge unit to the finisher.
- Disconnect the cable from the finisher to the printer.

Use the table below to identify the correct part number for your printer. To order the part, go to <https://parts.hp.com>.

Table 5-111 Part information

Part number	Part description
0604-001393	End fence home sensor

Required tools

- #2 JIS screwdriver with a magnetic tip
- Small, flat-blade screwdriver

After performing service

- Connect the cable from the finisher to the printer.
- Connect the cable from the bridge unit to the finisher.
- Attach the finisher to the printer, and then push in on the release latch inside the finisher door.
- Connect the printer power cable.
- Turn the printer power on.

Post service test

Process a job through the finisher and verify that the finisher works correctly.

Remove the right upper cover (finisher)

Follow these steps to remove the right upper cover (finisher).

- ▲ Remove one screw cap and three machine screws on the upper edge of the cover (callout 1). Remove three sheet metal screws (callout 2) on the lower portion of the cover. Rotate the right edge of the cover away from the finisher, and then slide the cover right to release three tabs (callout 3).

💡 **TIP:** The lower screws are shorter in length than the upper screws.

TIP: Reverse the removal steps to install the assembly.

Figure 5-471 Remove the right upper cover

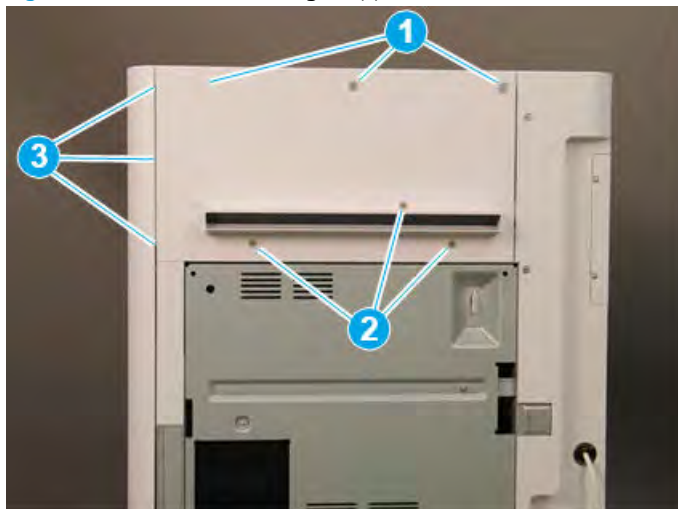

Remove the top cover (finisher)

Follow these steps to remove the top cover (finisher).

1. Remove three screw caps and three self-tapping screws at the top of the rear cover (callout 1), and then remove three machine screws (callout 2) on top of the cover.

Figure 5-472 Remove six screws

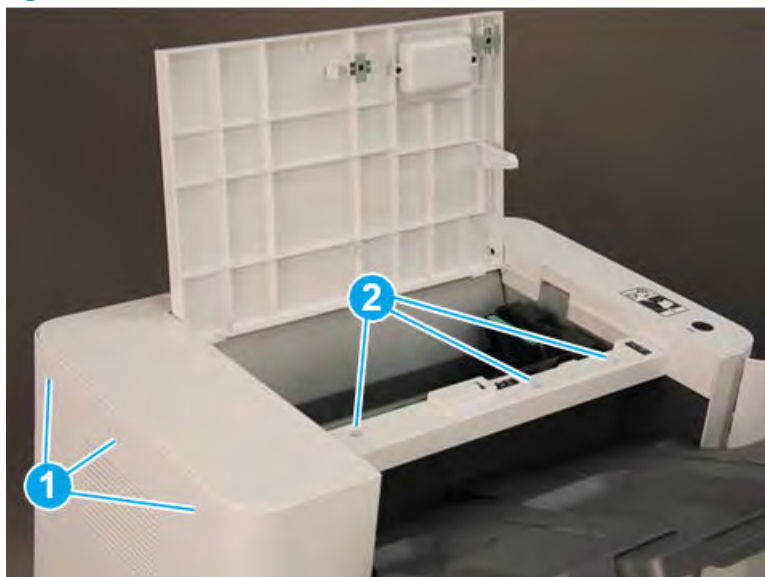

2. Remove three self-tapping screws at the top of the front cover (callout 1), and then remove two machine screws (callout 2) at the top of the right side.

Figure 5-473 Remove five screws

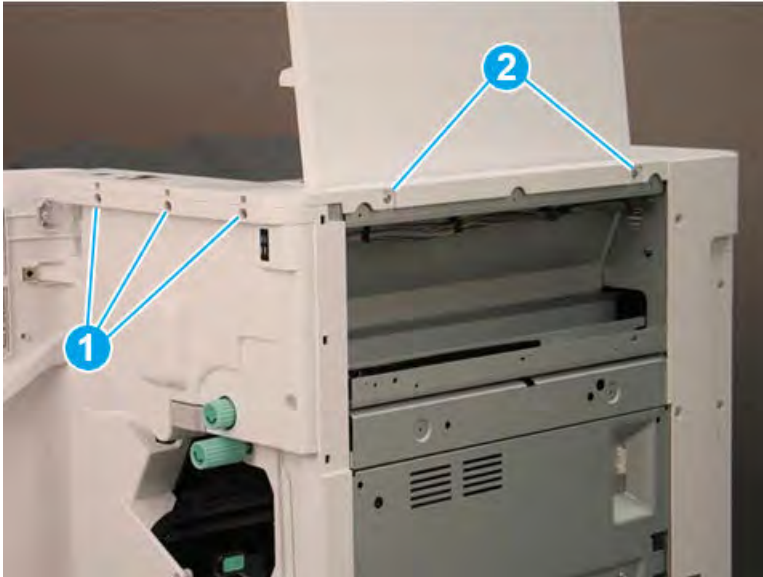

3. Lift the cover up slightly. Disconnect one in-line connector (callout 1), and then release one retainer (callout 2).

 **TIP:** Reverse the removal steps to install the assembly.

Figure 5-474 Disconnect one connector and release retainer



Remove the front door (finisher)

Follow these steps to remove the front door (finisher).

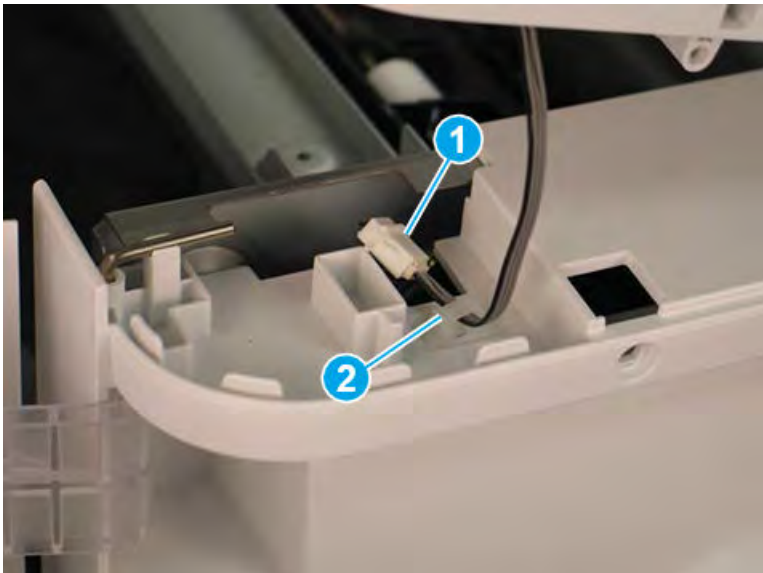
1. Lift the top hinge pin up to release it from the retainer.

Figure 5-475 Lift the top hinge pin

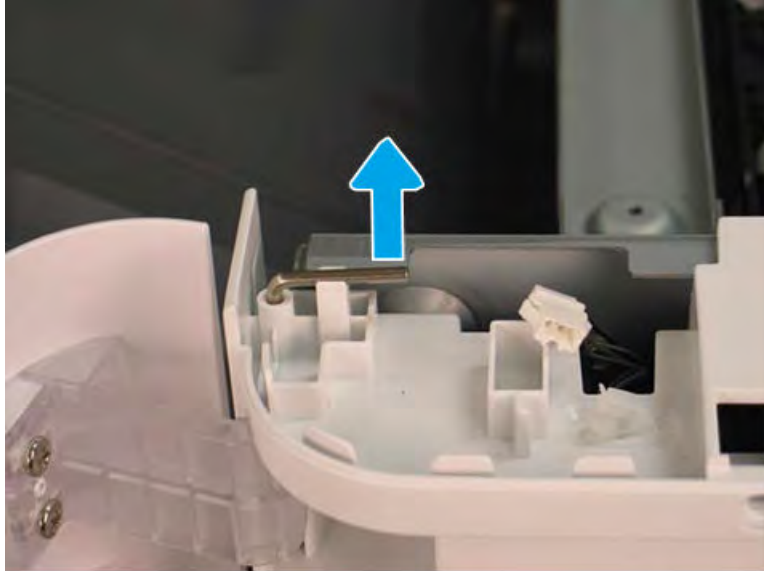

2. Pull the top hinge pin up to remove it.

Figure 5-476 Remove the top hinge pin

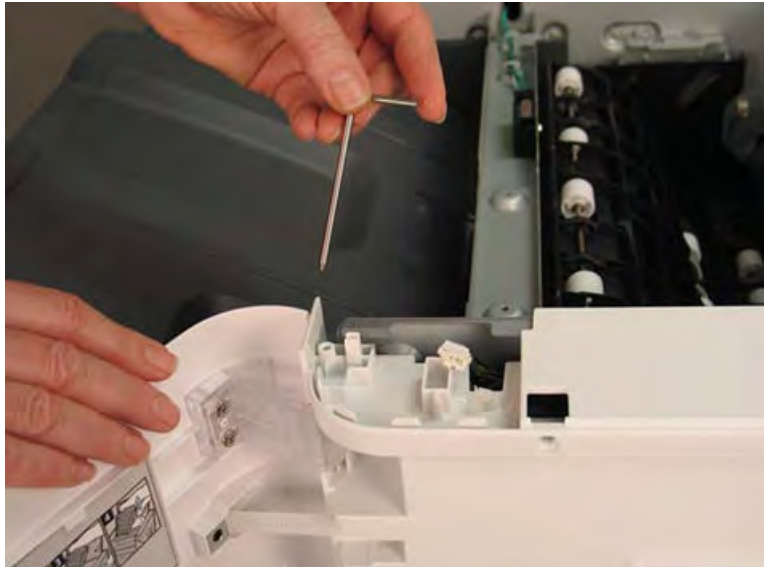

3. Use a small, flat-blade screwdriver to release the lower hinge pin from the retainer, and then rotate it away from the finisher.

Figure 5-477 Release the lower hinge pin



4. Support the door with one hand, and then pull the lower hinge pin straight up to remove it.

Figure 5-478 Remove the lower hinge pin



5. Support the door with one hand, and then remove one screw (callout 1) to release the strap. Remove the front door.

 **TIP:** Reverse the removal steps to install the assembly.

Figure 5-479 Remove the front door



Remove the front cover (finisher)

Follow these steps to remove the front cover (finisher).

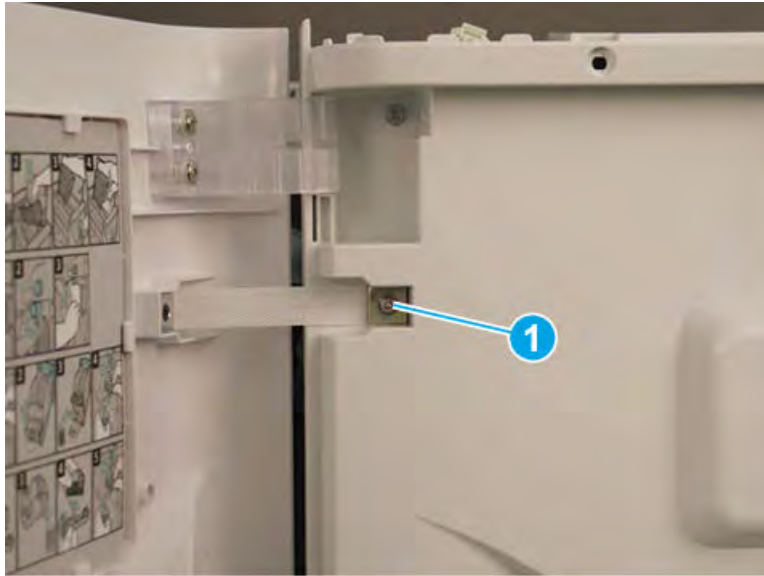
1. Release one tab (callout 1), and then pull the jam-access knob away from the finisher to remove it.

Figure 5-480 Remove the jam-access knob

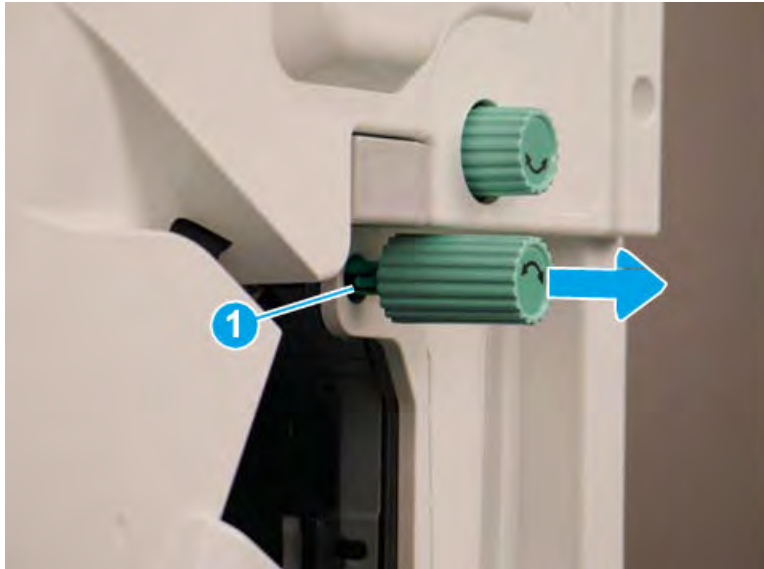

2. If the punch unit is installed, remove the punch waste bin (callout 1).

3. Remove one screw (callout 1) on top of the front cover.

Figure 5-481 Remove one screw



4. Remove five machine screws (callout 1), and then remove the front cover.

 **TIP:** Reverse the removal steps to install the assembly.

Figure 5-482 Remove the front cover

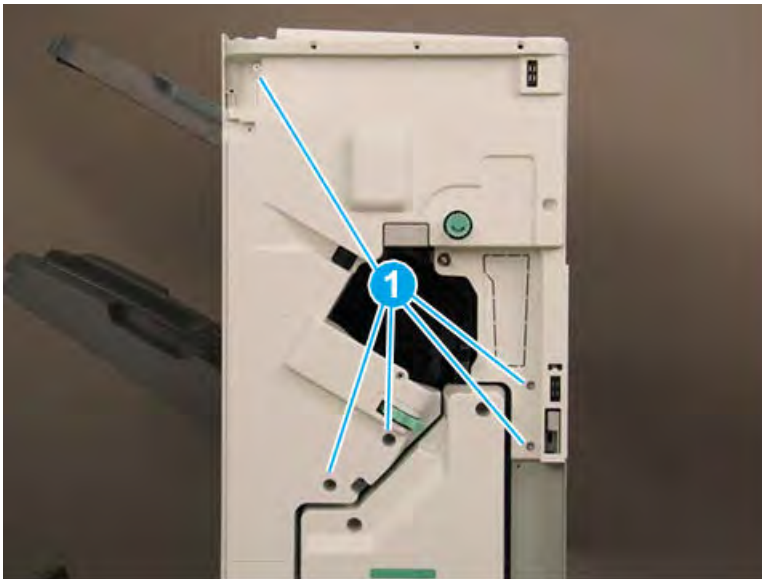

Remove the rear cover (finisher)

Follow these steps to remove the rear cover (finisher).

1. Remove two self-tapping screws (callout 1) on the top of the rear cover, and then remove five screw caps and five machine screws (callout 2) on the left side of the cover.

Figure 5-483 Remove seven screws

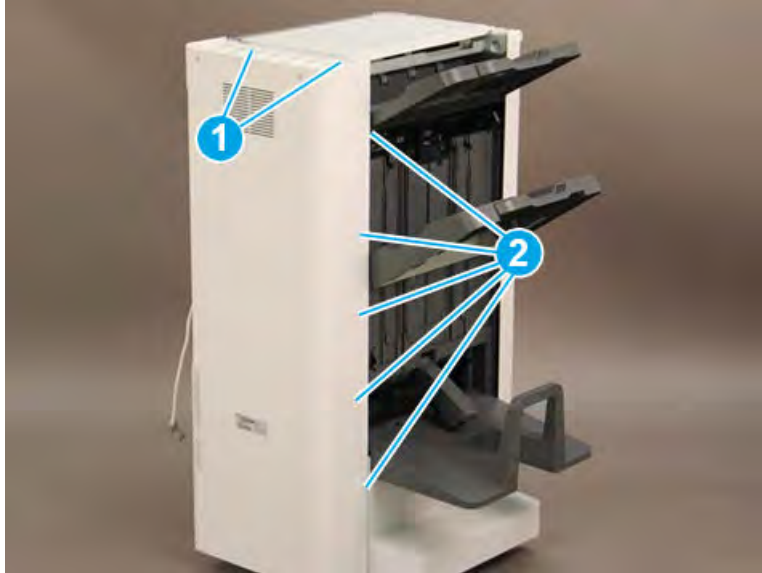

2. Remove one screw cap and four machine screws (callout 1) Remove the rear cover.

 **NOTE:** Make sure to thread the power cable (callout 2) through the opening in the cover.

 **TIP:** Reverse the removal steps to install the assembly

Figure 5-484 Remove the rear cover



Remove the booklet output tray

Follow these steps to remove the booklet output tray.

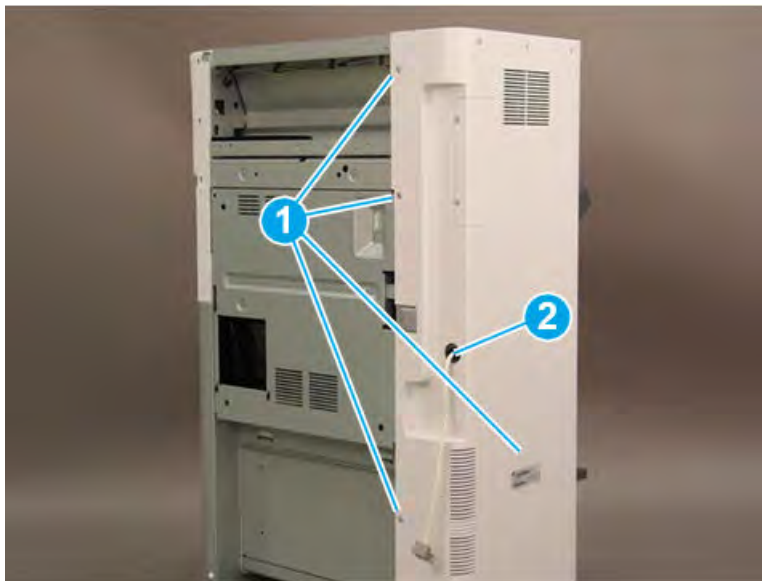
1. Raise the booklet output tray up (callout 1), and then pull it away from the finisher (callout 2) to remove it.

Figure 5-485 Remove the booklet output tray



2. Reverse the removal steps to install the assembly. Also use the following special installation instructions.

 **NOTE:** Continue to reverse the removal steps to finish installing the assembly

Special installation instructions: booklet output tray

Position the tabs (callout 1) on the tray into the slots (callout 2) on the finisher.

Figure 5-486 Install the booklet output tray

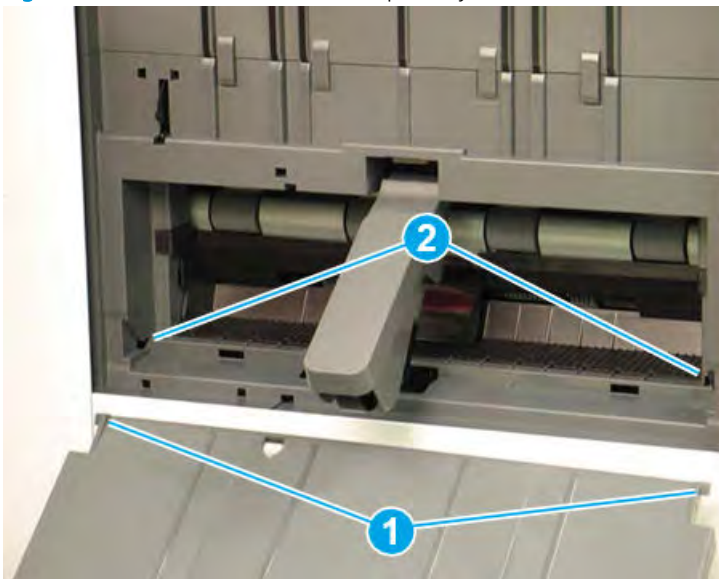

Remove the caster cover

Follow these steps to remove the caster cover.

1. Remove two screw caps and two self-tapping screws (callout 1). Remove two screw caps and two machine screws (callout 2).

Figure 5-487 Remove four screws

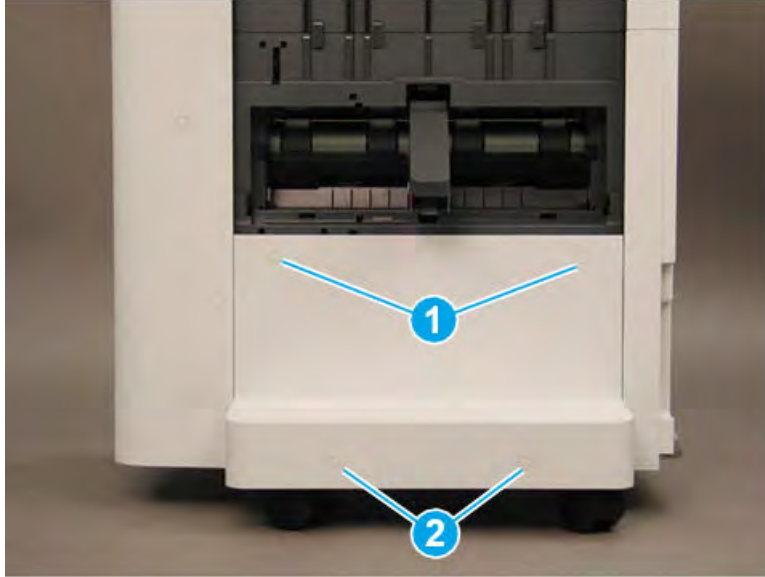

2. Rotate the left edge of the cover away from the finisher (callout 1), and then slide the cover to the left (callout 2) to remove it.

 **TIP:** Make sure that two tabs (callout 3) are positioned under the front lower cover when reinstalling the caster cover.

TIP: Reverse the removal steps to install the assembly

Figure 5-488 Remove the caster cover

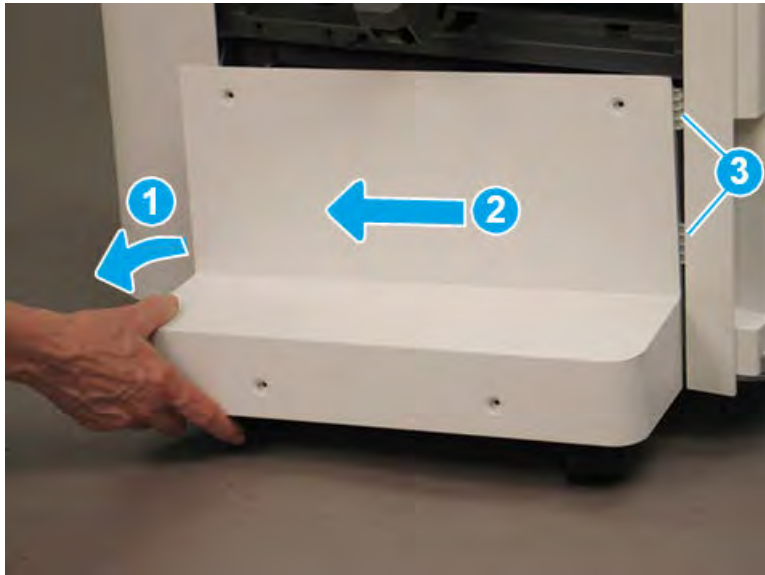

Remove the left lower cover (finisher)

Follow these steps to remove the left lower cover (finisher).

1. Remove four screws (callout 1).

 **NOTE:** Raise the lower output tray as needed to access the screws.

Figure 5-489 Remove four screws



2. Slide the shield down (callout 1) to release it from four tabs (callout 2), and then rotate it away from the finisher (callout 3).

⚠ CAUTION: The shield is still attached to the finisher. Do not attempt to completely remove the shield.

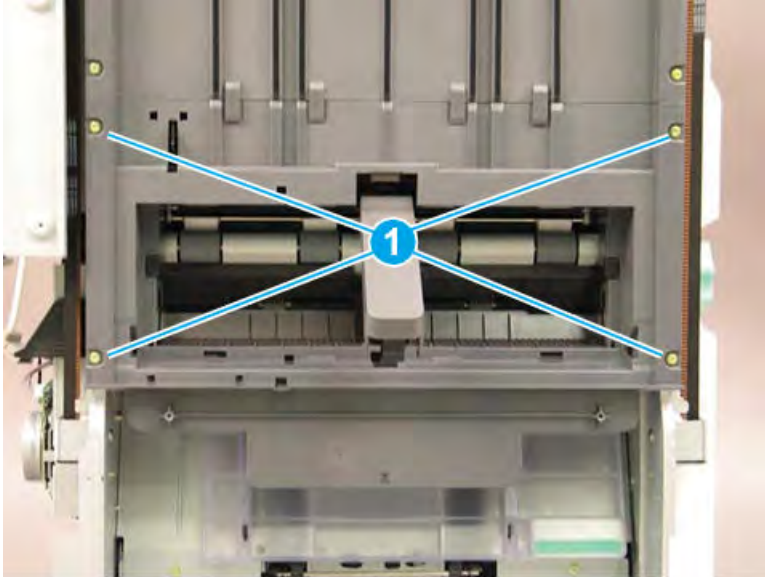
💡 TIP: Position the shield under the four tabs (callout 2) when reinstalling it.

Figure 5-490 Release the lower shield

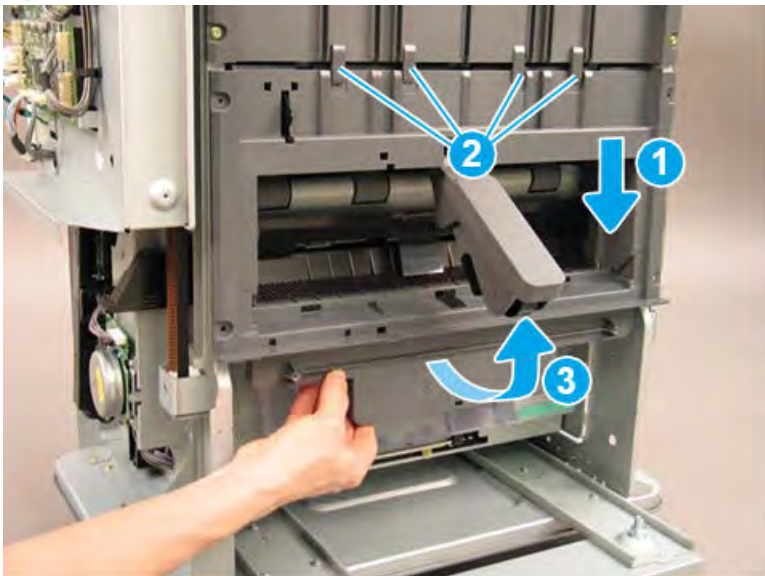

3. Disconnect two connectors (callout 1), and then remove the shield.

 **TIP:** Reverse the removal steps to install the assembly.

Figure 5-491 Disconnect two connectors



4. If you are replacing the left lower cover, locate three sensors (callout 1) on the back of the left lower cover. Remove these sensors and transfer them to the replacement part.

Figure 5-492 Remove the left lower cover

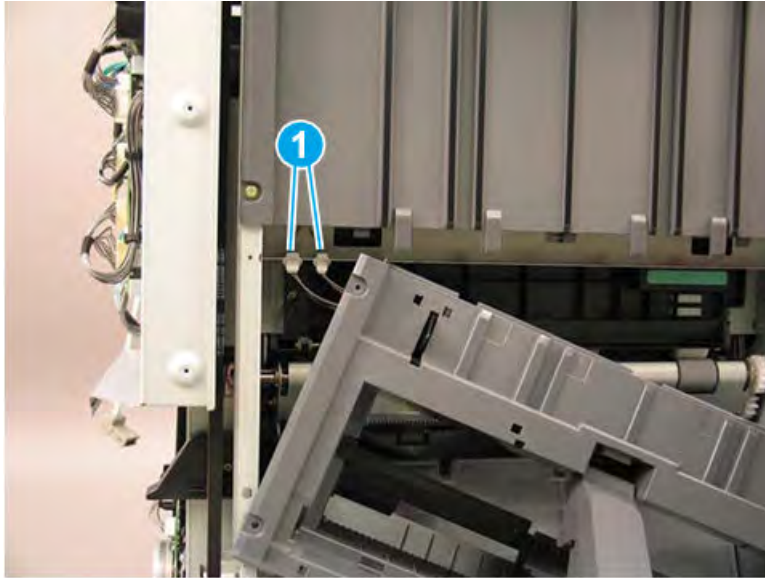
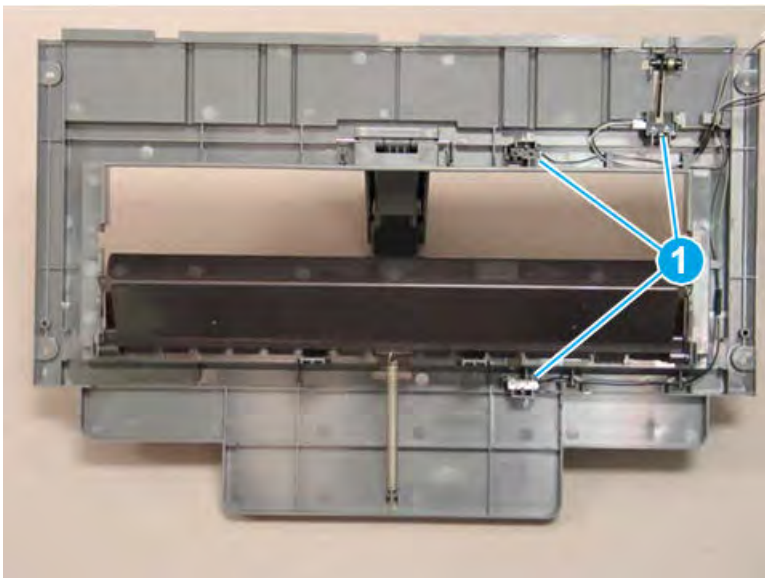

Remove the left upper cover (finisher)

Follow these steps to remove the left upper cover (finisher).

1. Bring the lower output tray down by positioning the shaft of a screwdriver on the clutch (callout 1) and gently pressing to the right to release the clutch. Hold the clutch in the released position and lower the tray (callout 2) to the lowest position.

Figure 5-493 Lower the output tray

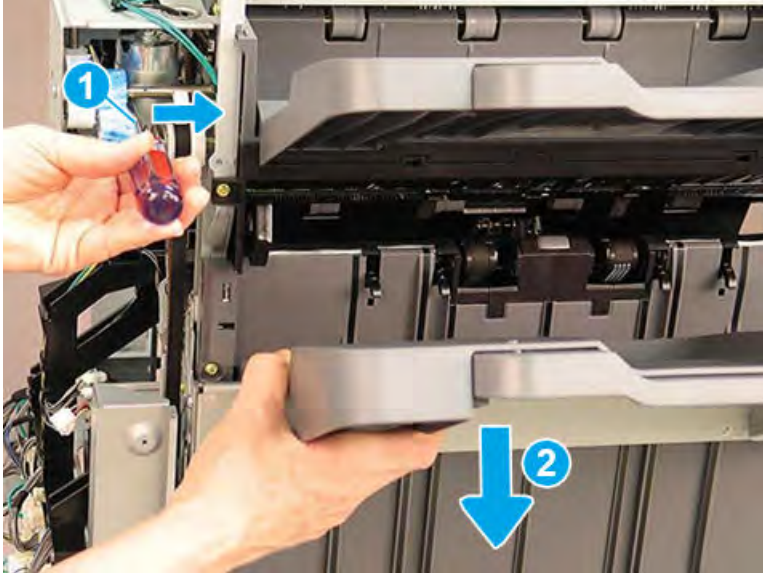

2. Remove six machine screws (callout 1).

Figure 5-494 Remove six screws

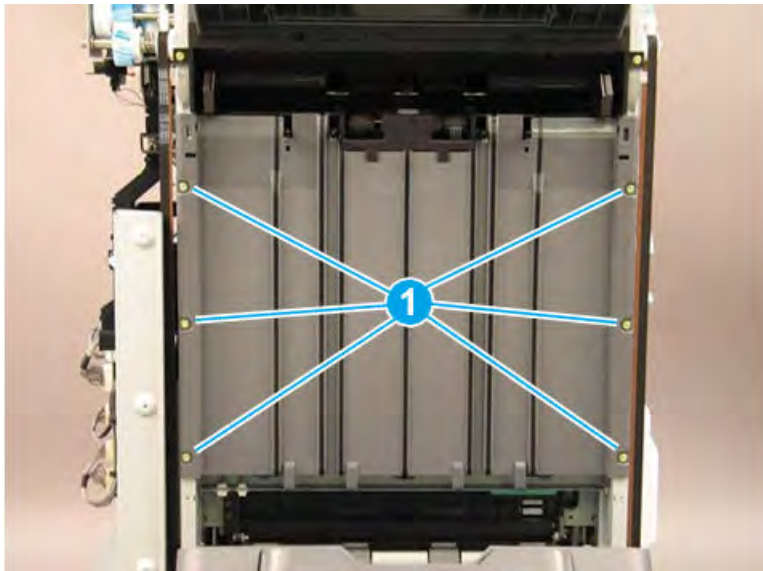

3. Rotate the lower edge of the shield away from the finisher (callout 1), and then slide the shield down (callout 2) to release it from two tabs (callout 3).

CAUTION: The shield is still attached to the finisher. Do not attempt to completely remove the shield.

TIP: Position the shield under the two tabs (callout 3) when reinstalling it.

Figure 5-495 Release the shield

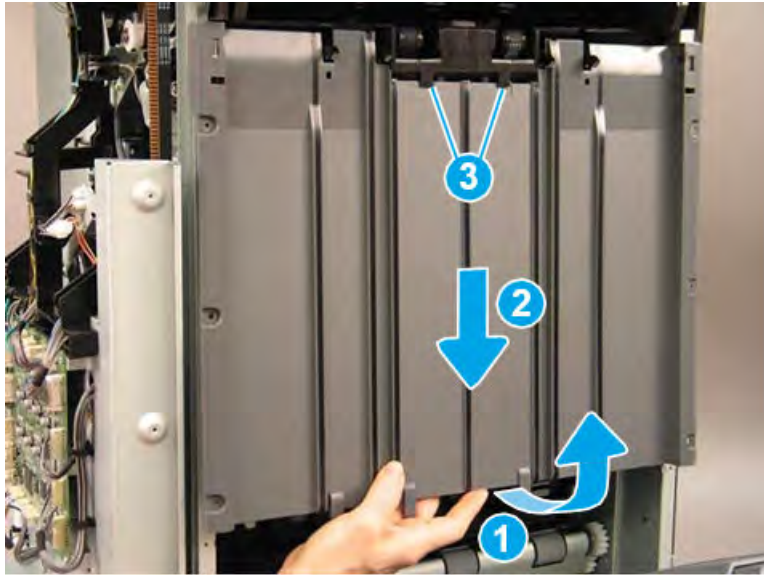

4. Disconnect one connector (callout 1), and then remove the upper shield assembly.

TIP: Reverse the removal steps to install the assembly.

Figure 5-496 Disconnect one connector

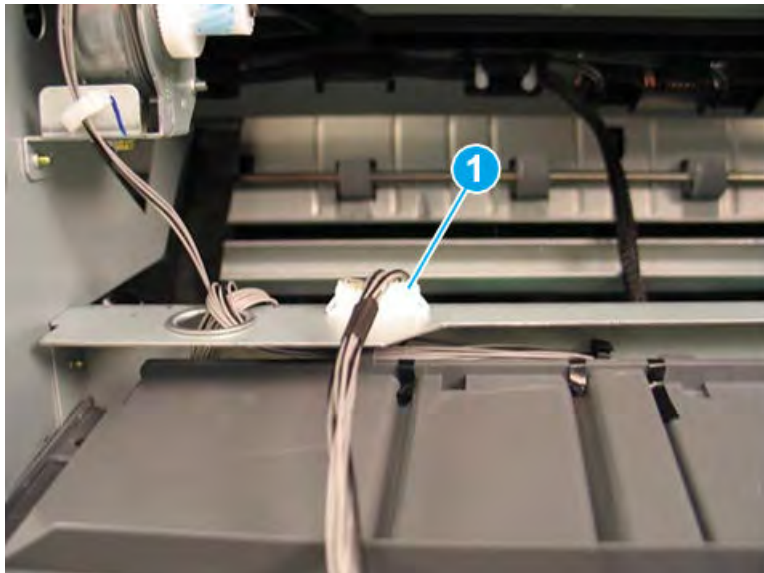

5. If you are replacing the left upper cover, locate three sensors (callout 1) on the back of the left upper cover. Remove these sensors and transfer them to the replacement part.

Figure 5-497 Remove the left upper cover

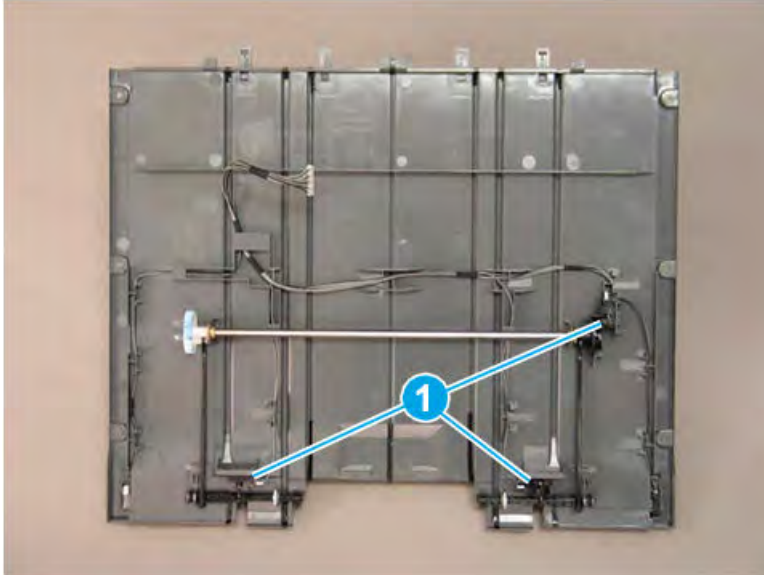

Remove the ejector unit (finisher)

Follow these steps to remove the ejector unit (finisher).

1. Rotate the green wheel to move the staple unit to the center of the finisher.

Figure 5-498 Move the staple unit to the center

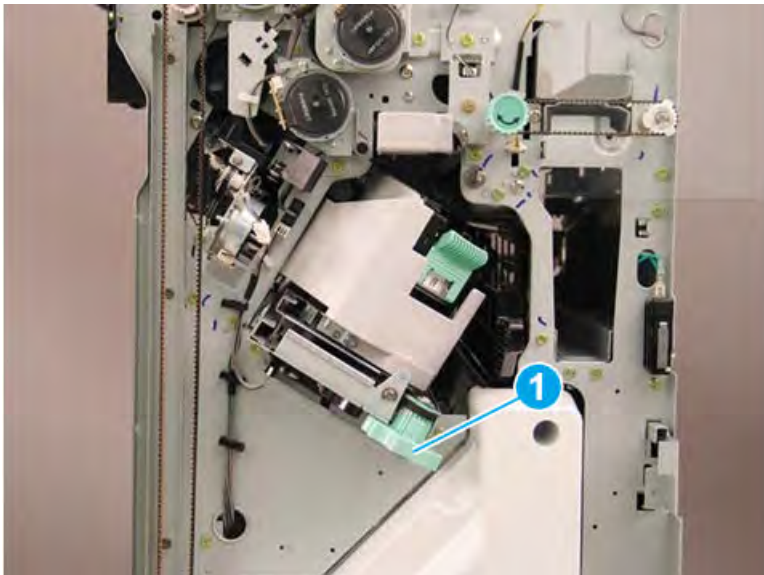

2. Release one retainer (callout 1), and then disconnect three connectors (callout 2).

Figure 5-499 Disconnect three connectors

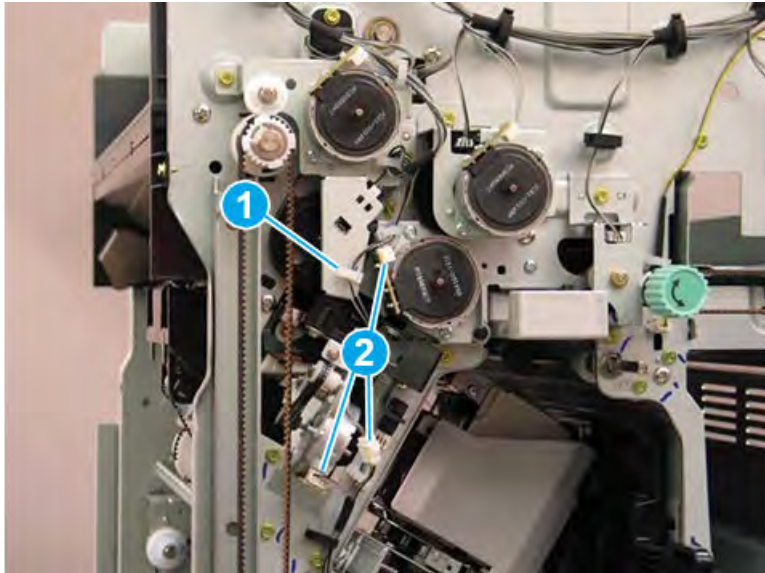

3. Remove two screws (callout 1).

Figure 5-500 Remove two screws

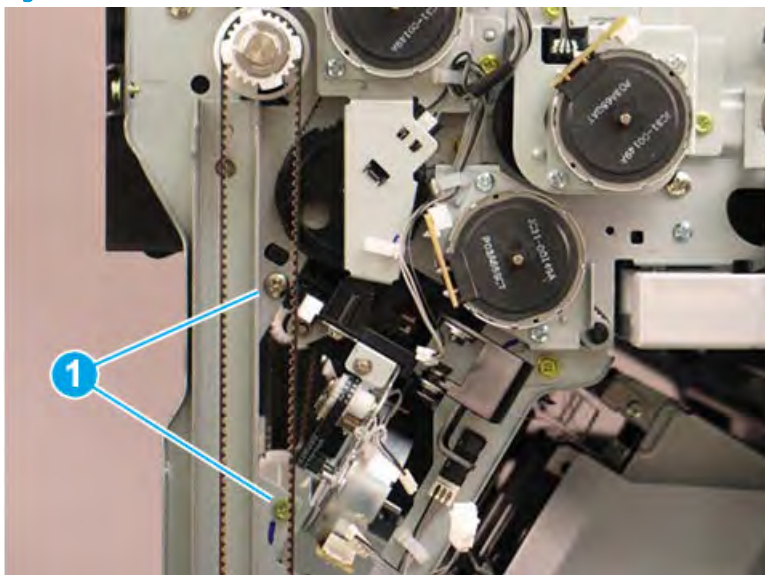

4. At the left side of the finisher, remove one screw (callout 1).

Figure 5-501 Remove one screw

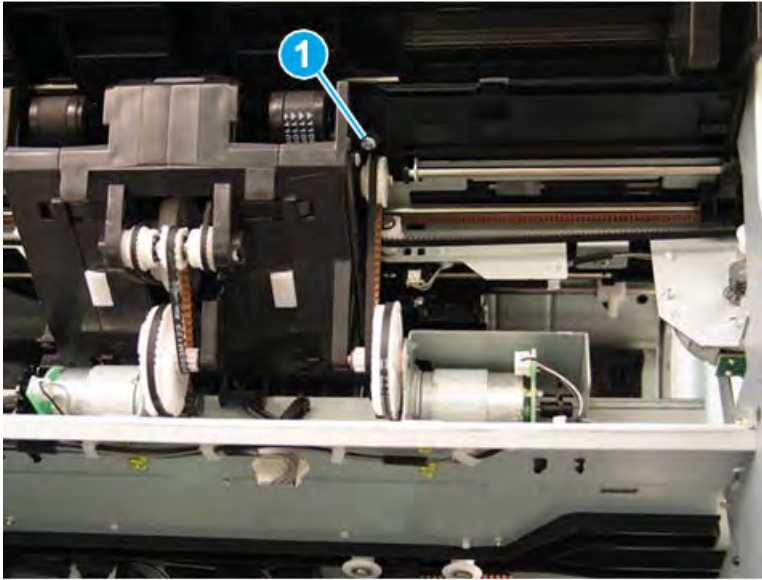

5. Press up on the hinge (callout 1), release one tab (callout 2), and then rotate the sensor away from the finisher (callout 3).

Figure 5-502 Rotate the sensor

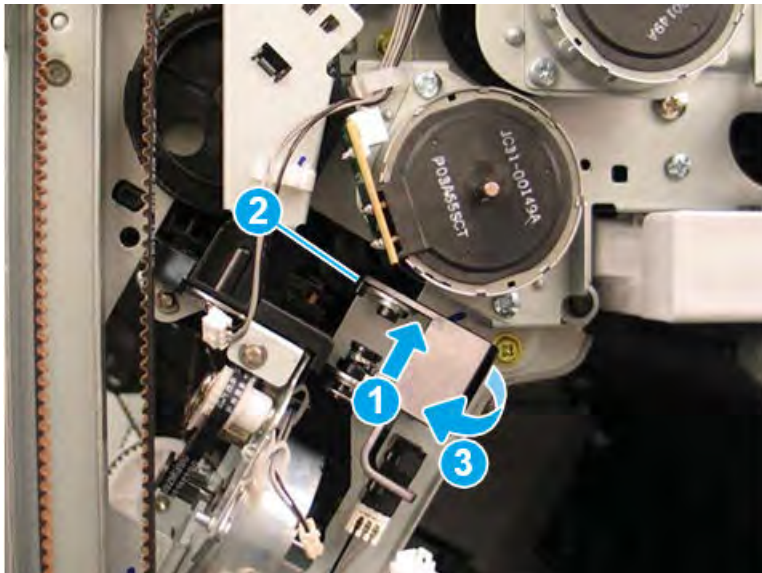

6. Remove one screw (callout 1).

Figure 5-503 Remove one screw

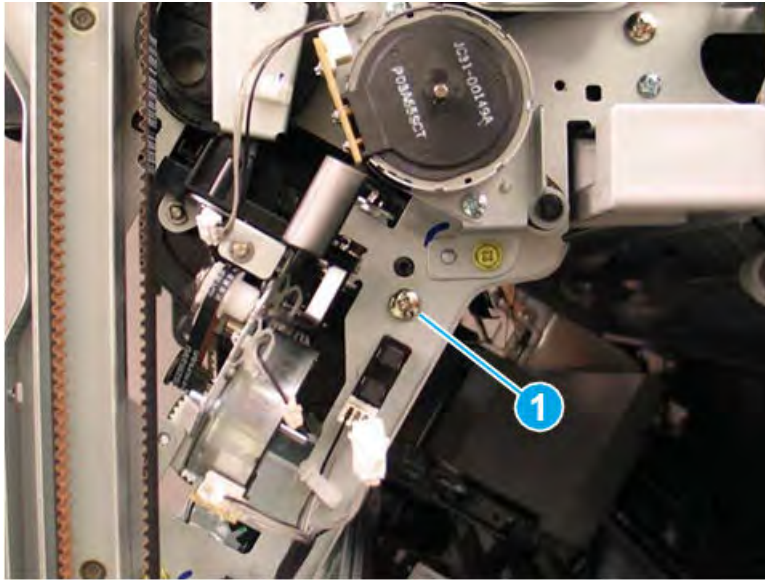

7. Look inside the finisher through the stapler opening in the front and pull down to release and remove one shaft (callout 1) on the front tamper unit.

Figure 5-504 Remove the front tamper shaft

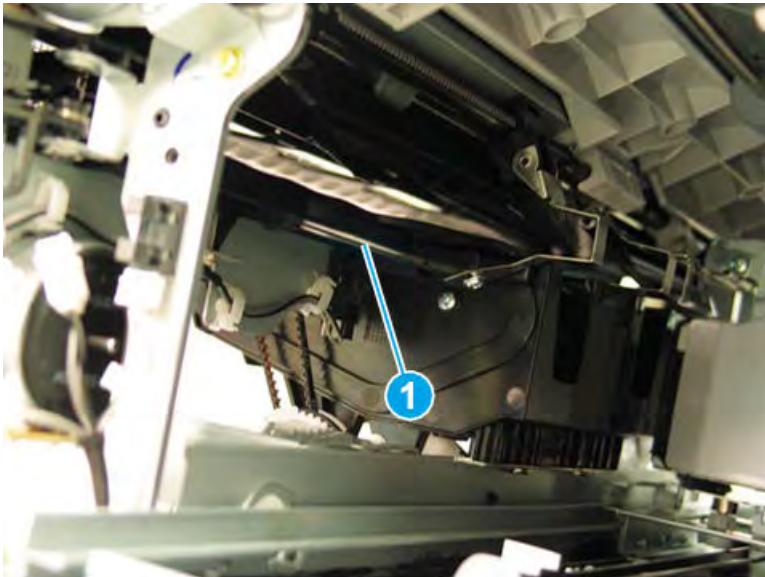

8. At the rear of the finisher, disconnect two connectors (callout 1), and then remove three screws (callout 2).

Figure 5-505 Disconnect two connectors and remove three screws

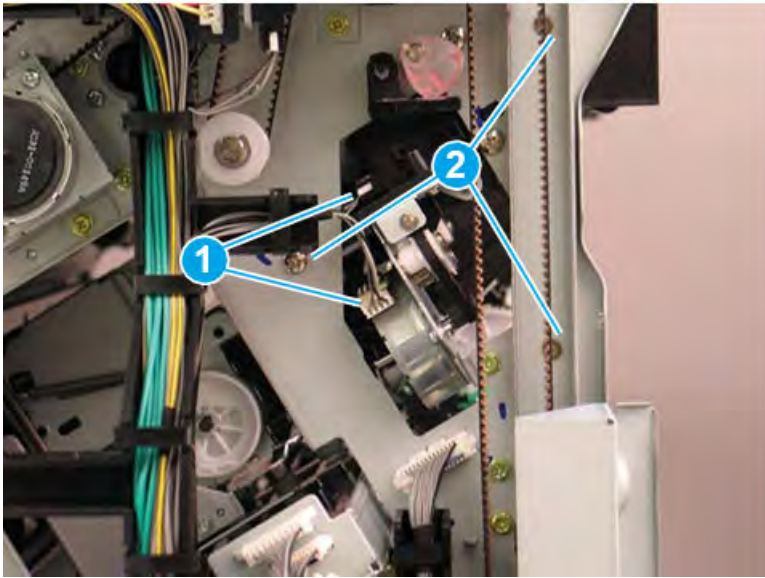

9. At the left side of the finisher, remove one screw (callout 1).

Figure 5-506 Remove one screw

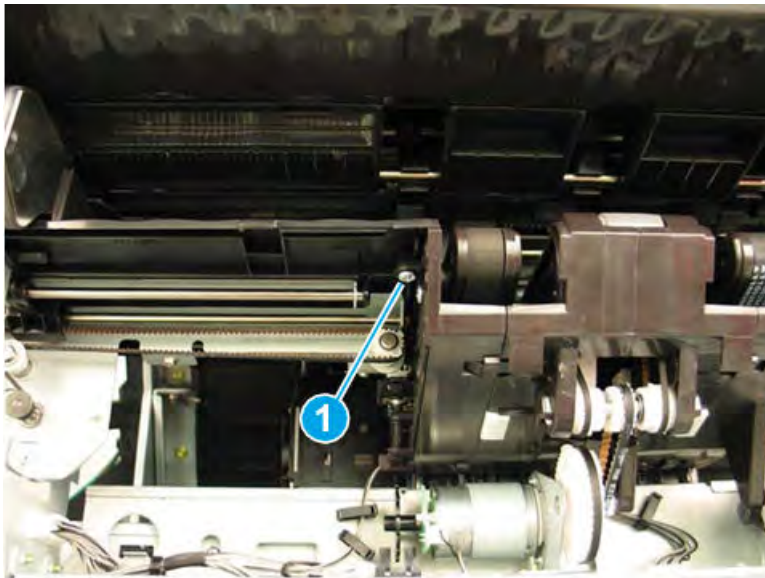

10. Look inside the finisher through the stapler opening in the rear and pull down to release and remove one shaft (callout 1) on the rear tamper unit.

Figure 5-507 Remove the rear tamper shaft

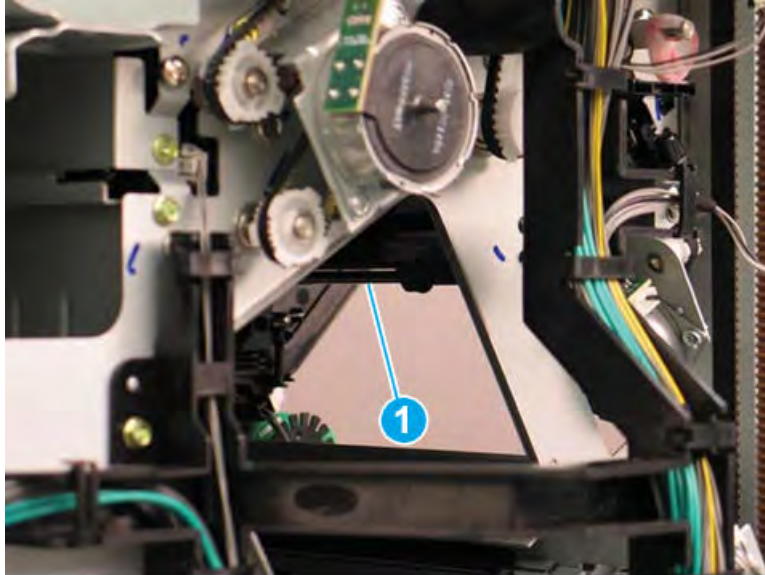

11. At the left side of the finisher, disconnect one connector (callout 1).

Figure 5-508 Disconnect one connector

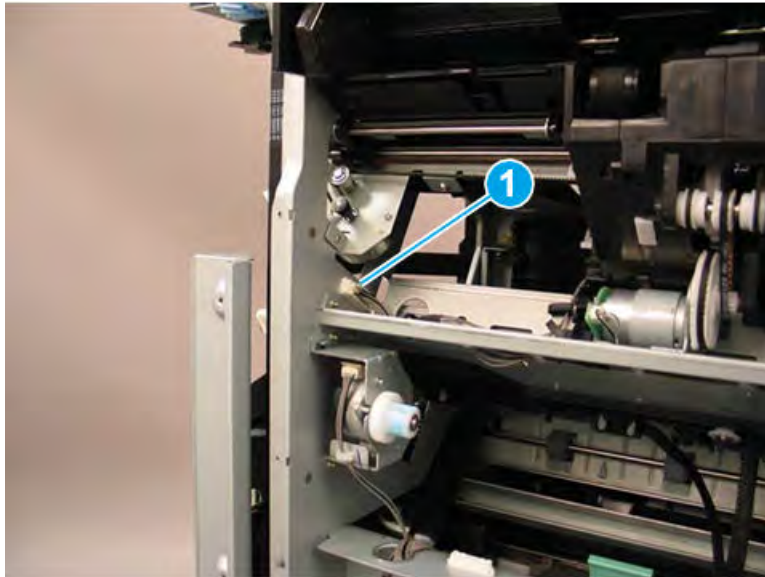

12. At the rear of the finisher, disconnect one connector (callout 1).

Figure 5-509 Disconnect one connector

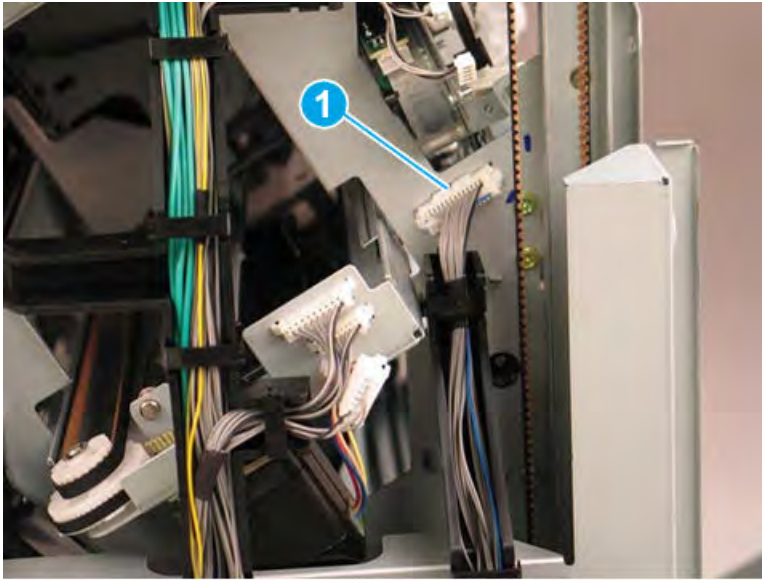

13. At the rear of the finisher, press the wire retainer to the right to access and remove two screws (callout 1).

Figure 5-510 Disconnect one connector

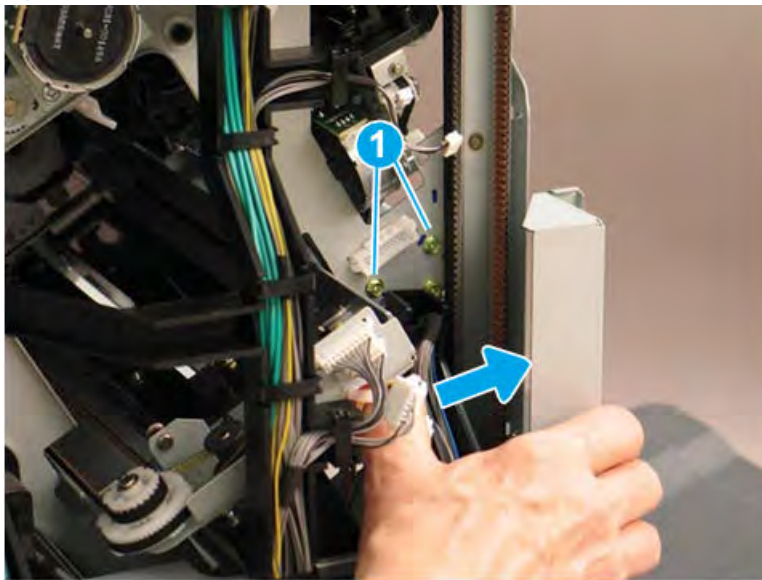

14. At the front of the finisher, remove two screws (callout 1).

Figure 5-511 Remove two screws

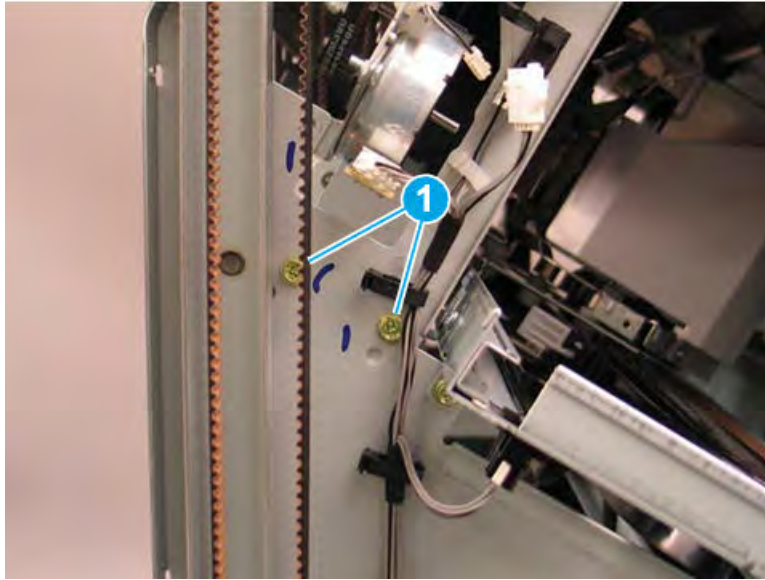

15. Lift the inside edges of the front and rear tampers up.

Figure 5-512 Lift the edges of the tampers

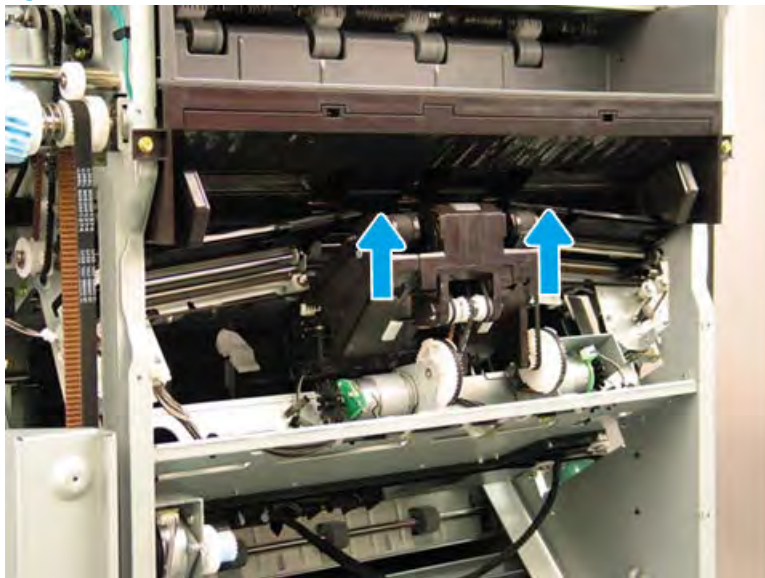

16. Rotate the rear edge of the ejector unit away from the finisher (callout 1), and then slide it toward the rear of the finisher (callout 2) to remove it. Make sure that the PCA (callout 3) stays clear of the sheet metal frame.

Figure 5-513 Remove the ejector unit

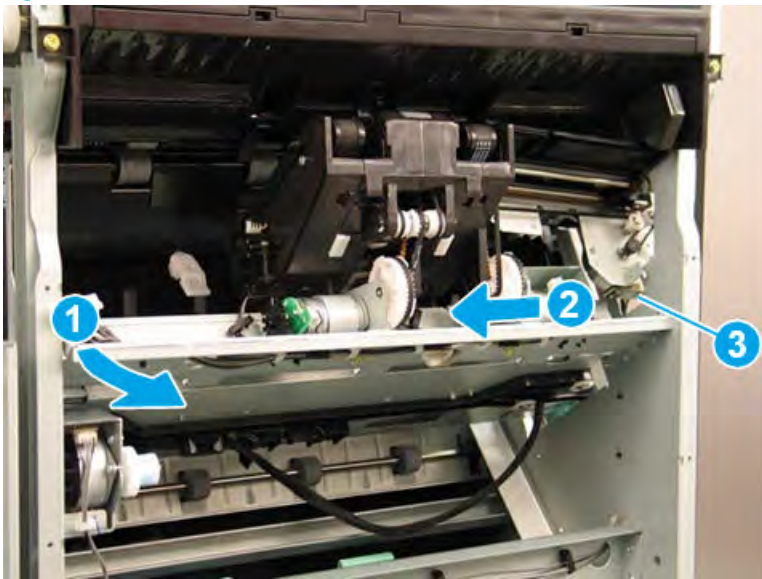

17. Reverse the removal steps to install the assembly. Also use the following special installation instructions.

 **NOTE:** Continue to reverse the removal steps to finish installing the assembly.

Special installation instructions: Ejector unit

- a. When the front tamper shaft is removed, the retainer arm that held the one end of the shaft will drop down. When reinstalling the shaft, raise the retainer arm and position the end of the shaft in the notch (callout 1).

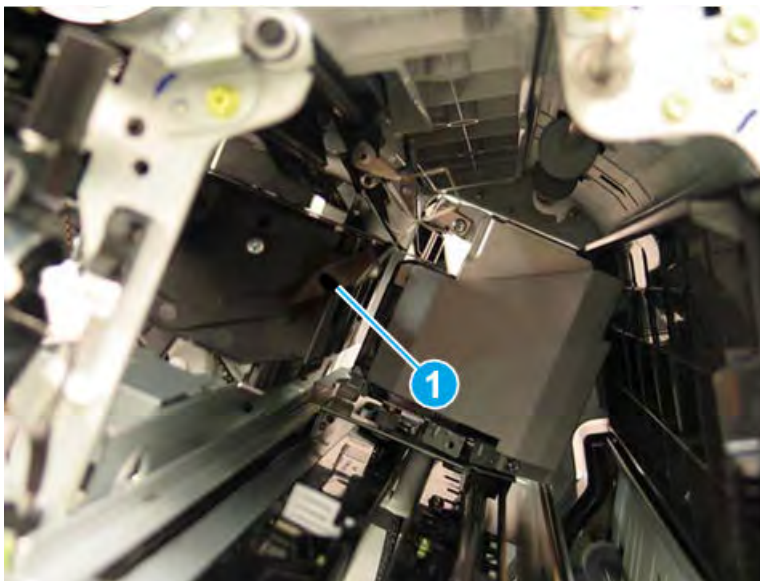

- b. When the rear tamper shaft is removed, the retainer arm that held the one end of the shaft will drop down. When reinstalling the shaft, raise the retainer arm and position the end of the shaft in the notch (callout 1).

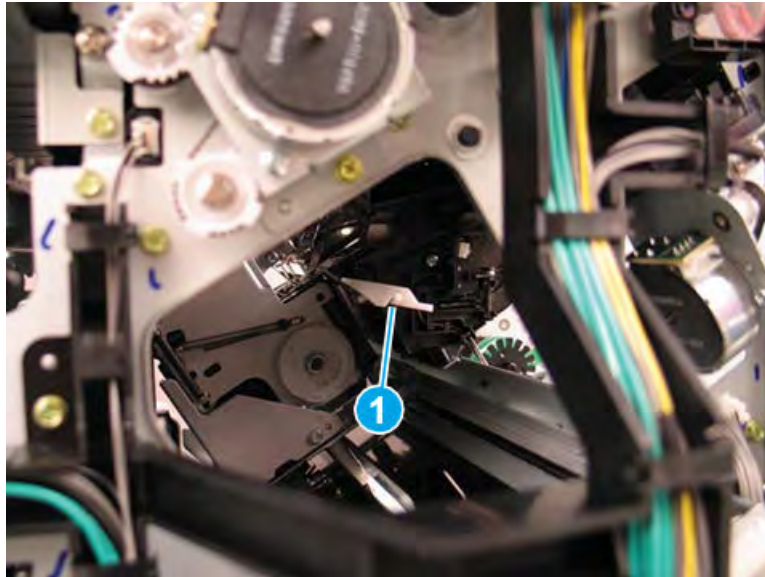

Remove the front tamper unit

Follow these steps to remove the front tamper unit.

- ▲ Lift the front tamper away from the finisher to remove it

Figure 5-514 Remove the front tamper



Remove the end of fence home sensor(S7)

Follow these steps to remove the end of fence home sensor(S7).

- ▲ At the front tamper, disconnect the connector(callout 1) and remove end fence home sensor(S7, callout 2)

Figure 5-515 Remove end fence home sensor

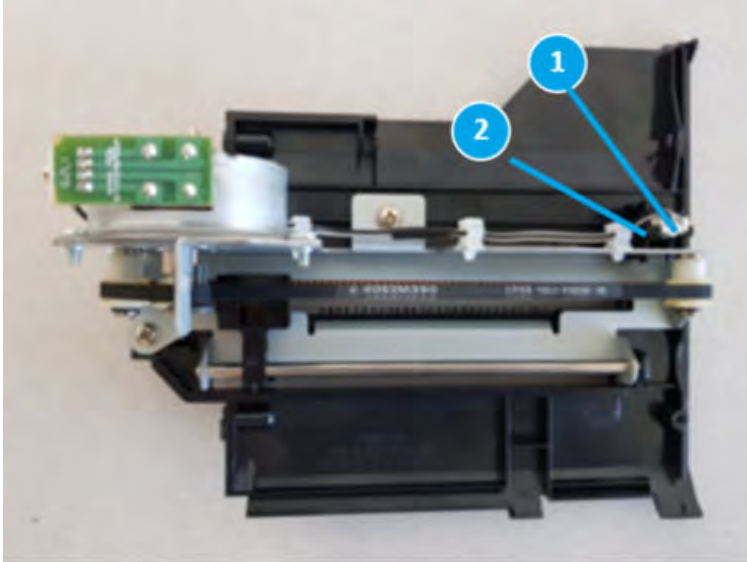

Unpack the replacement assembly

Follow these steps to unpack the replacement assembly.

1. Dispose of the defective part.



NOTE: HP recommends responsible disposal of the defective part.

<http://www8.hp.com/us/en/hp-information/environment/product-recycling.html>

2. Unpack the replacement part from the packaging.



CAUTION:  Some parts are sensitive to electrostatic discharge (ESD). Always perform service work at an ESD-protected workstation or mat. If an ESD workstation or mat is not available, touch the sheet-metal chassis to provide a static ground before touching an ESD-sensitive assembly. Protect the ESD-sensitive assemblies by placing them in ESD pouches when they are out of the printer.



IMPORTANT: Make sure that all of the shipping materials (for example shipping tape) are removed from the replacement part prior to installation.



NOTE: If the replacement part is a roller or pad, avoid touching the spongy part of it. Skin oils on the roller or pad can cause paper pickup and/or print-quality problems. HP recommends using disposable gloves when handling rollers or pads or washing your hands before touching rollers or pads.

3. To install an assembly, reverse the removal steps.



NOTE: When applicable, special installation instructions are provided for an assembly at the end of the removal procedure. Always completely read the removal instructions and follow all special installation instructions.

HP LaserJet Managed MFP E82540-E82560, E87640-E87660, E82540du-E82560du, E87640du-E87660du, E72525-E72535, E77822-E77830 - Removal and replacement: End fence motor (M3)

Learn how to remove and replace the end fence motor.

Introduction

This document provides the procedures to remove and replace the end fence motor for the finisher.

 **IMPORTANT:** When applicable, special installation instructions are provided for an assembly at the end of the removal procedure. Always completely read the removal instructions and follow all special installation instructions.

Before performing service

- Turn the printer power off. A shutting-down message appears on the control-panel display.
- ⚠ **WARNING!** To avoid damage to the printer, turn the power off and wait until the printer shuts down before removing the power cable.
- Disconnect the printer power cable after the printer has completely shut down (the control-panel display is blank).
- Release the finisher from the printer by pulling out on the release latch inside the finisher door.
- Disconnect the cable from the bridge unit to the finisher.
- Disconnect the cable from the finisher to the printer.

Use the table below to identify the correct part number for your printer. To order the part, go to <https://parts.hp.com>.

Table 5-112 Part information

Part number	Part description
JC90-01467A	End fence motor

Required tools

- #2 JIS screwdriver with a magnetic tip

After performing service

- Connect the cable from the finisher to the printer.
- Connect the cable from the bridge unit to the finisher.
- Attach the finisher to the printer, and then push in on the release latch inside the finisher door.
- Connect the printer power cable.
- Turn the printer power on.

Post service test

Process a job through the finisher and verify that the finisher works correctly.

Remove the right upper cover (finisher)

Follow these steps to remove the right upper cover (finisher).

- ▲ Remove one screw cap and three machine screws on the upper edge of the cover (callout 1). Remove three sheet metal screws (callout 2) on the lower portion of the cover. Rotate the right edge of the cover away from the finisher, and then slide the cover right to release three tabs (callout 3).

💡 **TIP:** The lower screws are shorter in length than the upper screws.

TIP: Reverse the removal steps to install the assembly.

Figure 5-516 Remove the right upper cover

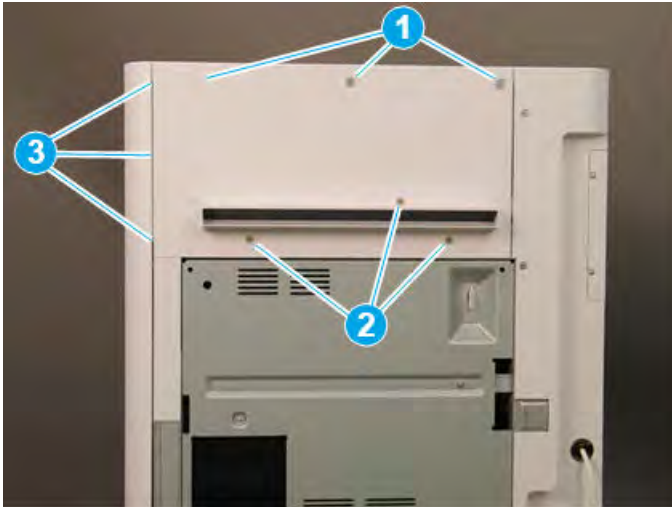

Remove the top cover (finisher)

Follow these steps to remove the top cover (finisher).

1. Remove three screw caps and three self-tapping screws at the top of the rear cover (callout 1), and then remove three machine screws (callout 2) on top of the cover.

Figure 5-517 Remove six screws

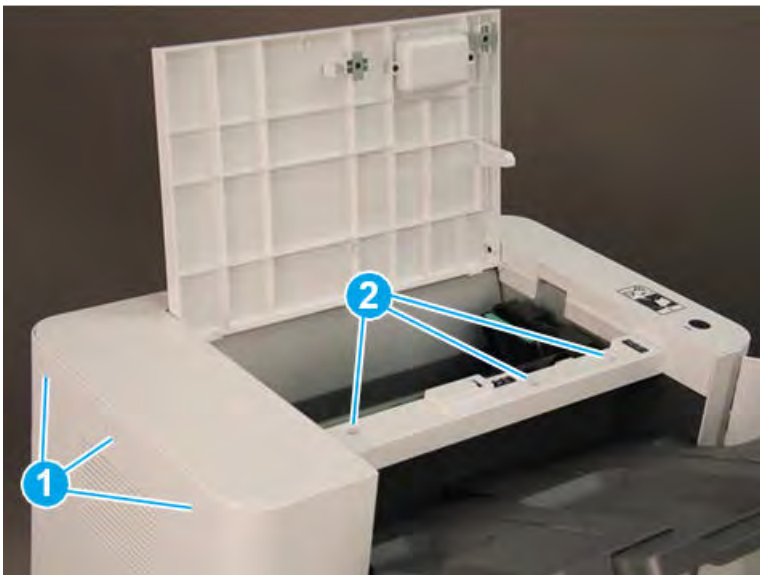

2. Remove three self-tapping screws at the top of the front cover (callout 1), and then remove two machine screws (callout 2) at the top of the right side.

Figure 5-518 Remove five screws

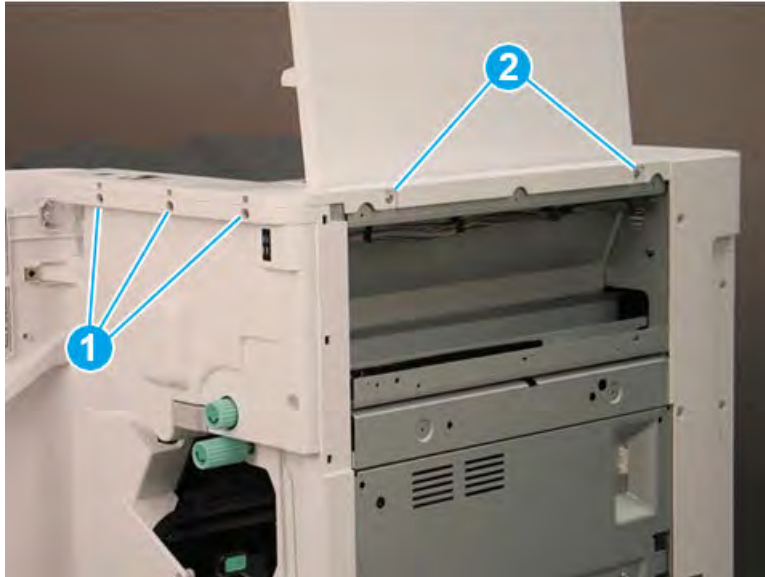

3. Lift the cover up slightly. Disconnect one in-line connector (callout 1), and then release one retainer (callout 2).

 **TIP:** Reverse the removal steps to install the assembly.

Figure 5-519 Disconnect one connector and release retainer



Remove the front door (finisher)

Follow these steps to remove the front door (finisher).

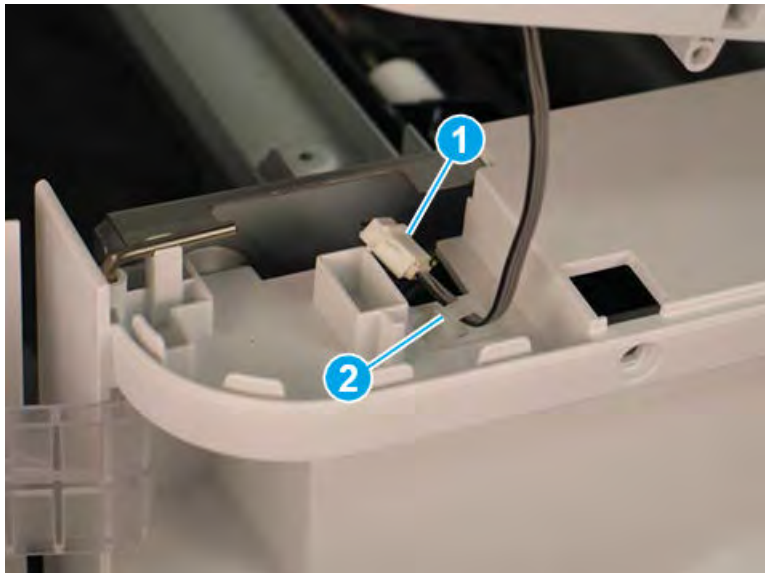
1. Lift the top hinge pin up to release it from the retainer.

Figure 5-520 Lift the top hinge pin

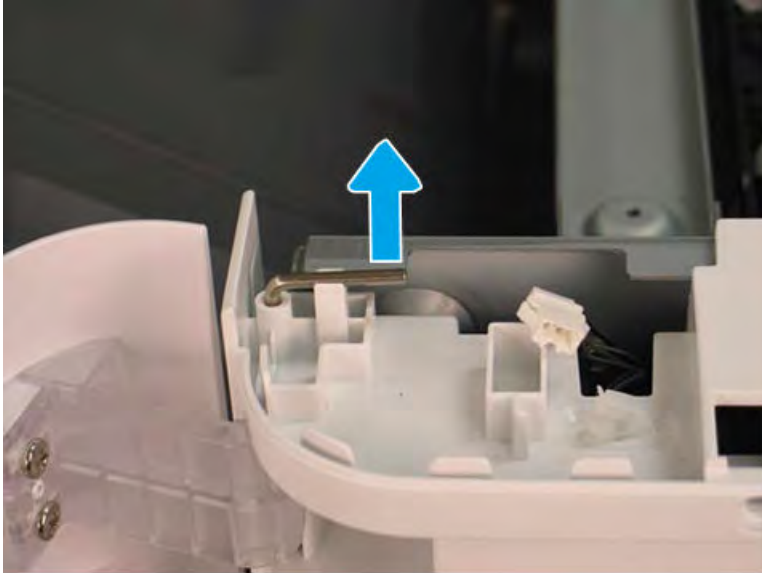

2. Pull the top hinge pin up to remove it.

Figure 5-521 Remove the top hinge pin

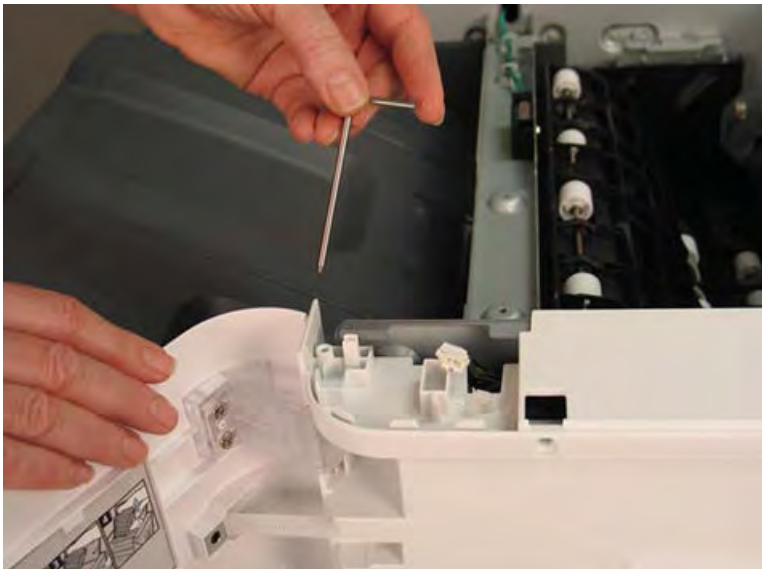

3. Use a small, flat-blade screwdriver to release the lower hinge pin from the retainer, and then rotate it away from the finisher.

Figure 5-522 Release the lower hinge pin



4. Support the door with one hand, and then pull the lower hinge pin straight up to remove it.

Figure 5-523 Remove the lower hinge pin



5. Support the door with one hand, and then remove one screw (callout 1) to release the strap. Remove the front door.

 **TIP:** Reverse the removal steps to install the assembly.

Figure 5-524 Remove the front door



Remove the front cover (finisher)

Follow these steps to remove the front cover (finisher).

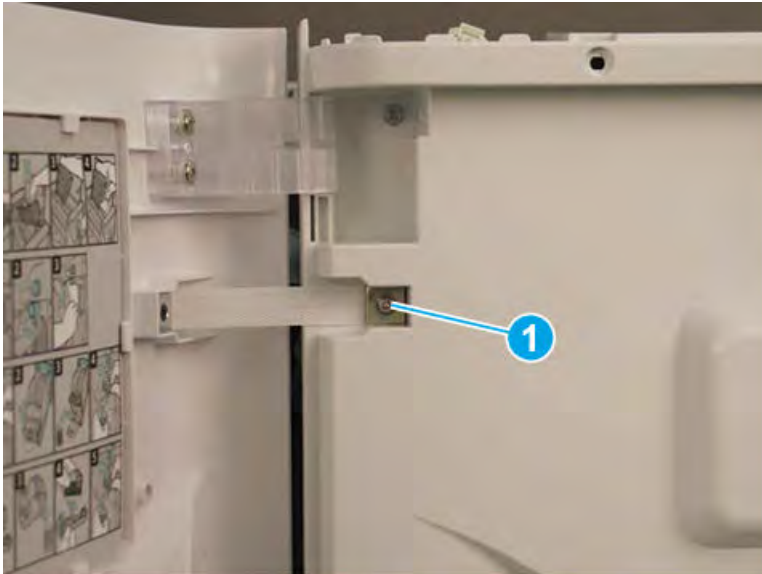
1. Release one tab (callout 1), and then pull the jam-access knob away from the finisher to remove it.

Figure 5-525 Remove the jam-access knob

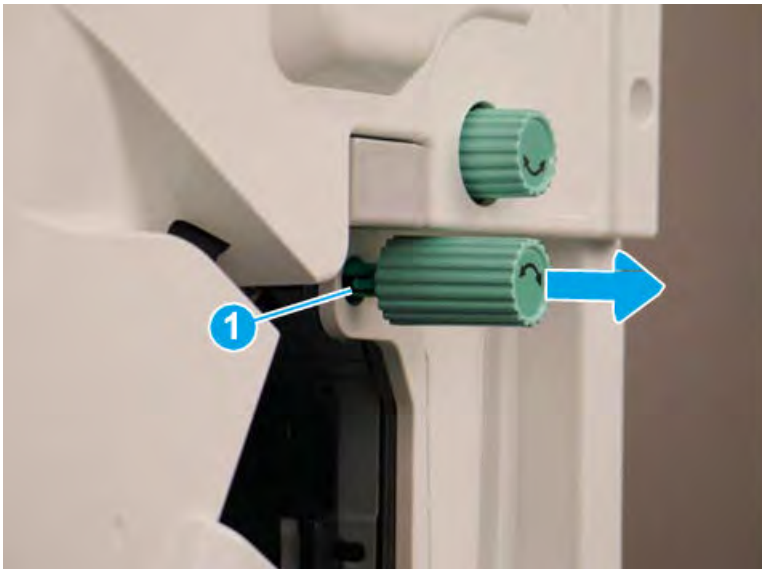

2. If the punch unit is installed, remove the punch waste bin (callout 1).

3. Remove one screw (callout 1) on top of the front cover.

Figure 5-526 Remove one screw



4. Remove five machine screws (callout 1), and then remove the front cover.

 **TIP:** Reverse the removal steps to install the assembly.

Figure 5-527 Remove the front cover



Remove the end fence motor(M3)

Follow these steps to remove the end fence motor(M3).

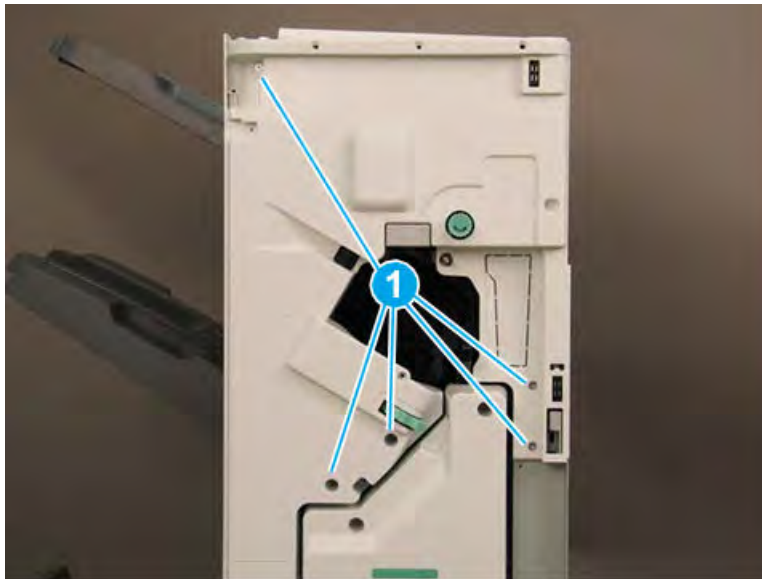
1. At the front of the finisher, remove two screws(callout 1) and disconnect connector(callout 2)

Figure 5-528 Remove two screws and disconnect connector

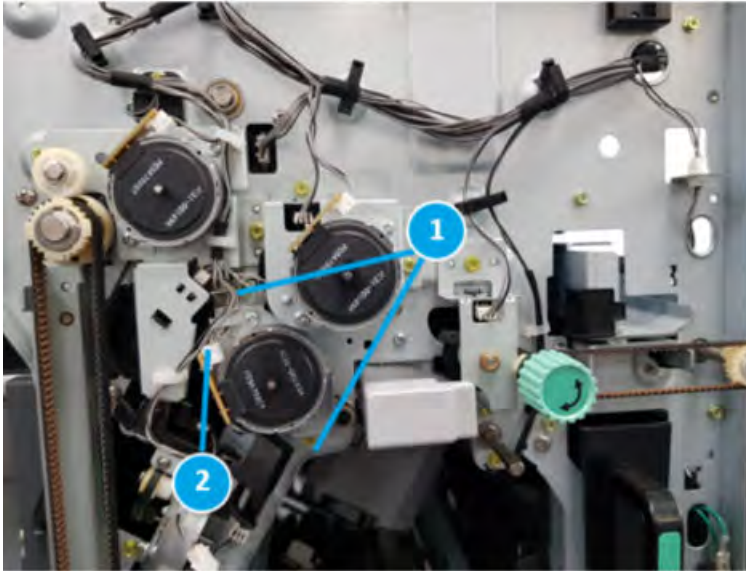

2. Remove two screws(callout 1) and end fence motor (M3, callout 1)

Figure 5-529 Remove end fence motor

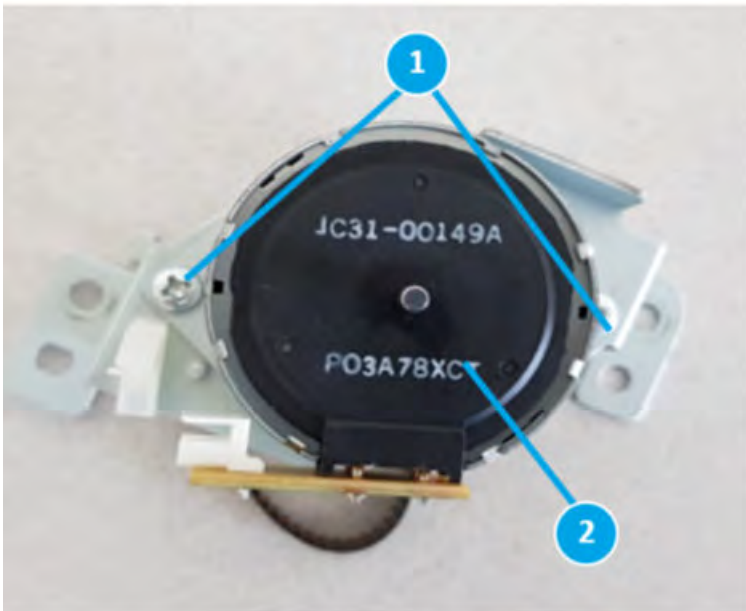

Unpack the replacement assembly

Follow these steps to unpack the replacement assembly.

1. Dispose of the defective part.

 **NOTE:** HP recommends responsible disposal of the defective part.

<http://www8.hp.com/us/en/hp-information/environment/product-recycling.html>

2. Unpack the replacement part from the packaging.



CAUTION:  Some parts are sensitive to electrostatic discharge (ESD). Always perform service work at an ESD-protected workstation or mat. If an ESD workstation or mat is not available, touch the sheet-metal chassis to provide a static ground before touching an ESD-sensitive assembly. Protect the ESD-sensitive assemblies by placing them in ESD pouches when they are out of the printer.

 **IMPORTANT:** Make sure that all of the shipping materials (for example shipping tape) are removed from the replacement part prior to installation.

 **NOTE:** If the replacement part is a roller or pad, avoid touching the spongy part of it. Skin oils on the roller or pad can cause paper pickup and/or print-quality problems. HP recommends using disposable gloves when handling rollers or pads or washing your hands before touching rollers or pads.

3. To install an assembly, reverse the removal steps.

 **NOTE:** When applicable, special installation instructions are provided for an assembly at the end of the removal procedure. Always completely read the removal instructions and follow all special installation instructions.

Tamper unit

Front tamper

HP LaserJet Managed MFP E82540-E82560, E87640-E87660, E82540du-E82560du, E87640du-E87660du, E72525-E72535, E77822-E77830 - Removal and replacement: Front tamper unit

Learn how to remove and replace the front tamper unit.

Introduction

This document provides the procedures to remove and replace the front tamper unit on the finisher.



IMPORTANT: When applicable, special installation instructions are provided for an assembly at the end of the removal procedure. Always completely read the removal instructions and follow all special installation instructions.

Before performing service

- Turn the printer power off. A shutting-down message appears on the control-panel display.
- ⚠ **WARNING!** To avoid damage to the printer, turn the power off and wait until the printer shuts down before removing the power cable.
- Disconnect the printer power cable after the printer has completely shut down (the control-panel display is blank).
- Release the finisher from the printer by pulling out on the release latch inside the finisher door.
- Disconnect the cable from the bridge unit to the finisher.
- Disconnect the cable from the finisher to the printer.

Use the table below to identify the correct part number for your printer. To order the part, go to <https://parts.hp.com>.

Table 5-113 Part information

Part number	Part description
JC82-00901A	Front tamper

Required tools

- #2 JIS screwdriver with a magnetic tip
- Small, flat-blade screwdriver

After performing service

- Connect the cable from the finisher to the printer.
- Connect the cable from the bridge unit to the finisher.
- Attach the finisher to the printer, and then push in on the release latch inside the finisher door.
- Connect the printer power cable.
- Turn the printer power on.

Post service test

Process a job through the finisher and verify that the finisher works correctly.

Remove the right upper cover (finisher)

Follow these steps to remove the right upper cover (finisher).

- ▲ Remove one screw cap and three machine screws on the upper edge of the cover (callout 1). Remove three sheet metal screws (callout 2) on the lower portion of the cover. Rotate the right edge of the cover away from the finisher, and then slide the cover right to release three tabs (callout 3).

💡 **TIP:** The lower screws are shorter in length than the upper screws.

TIP: Reverse the removal steps to install the assembly.

Figure 5-530 Remove the right upper cover

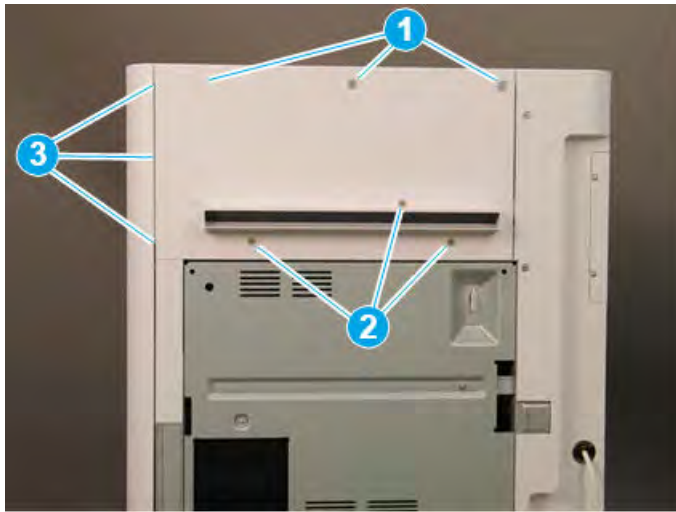

Remove the top cover (finisher)

Follow these steps to remove the top cover (finisher).

1. Remove three screw caps and three self-tapping screws at the top of the rear cover (callout 1), and then remove three machine screws (callout 2) on top of the cover.

Figure 5-531 Remove six screws

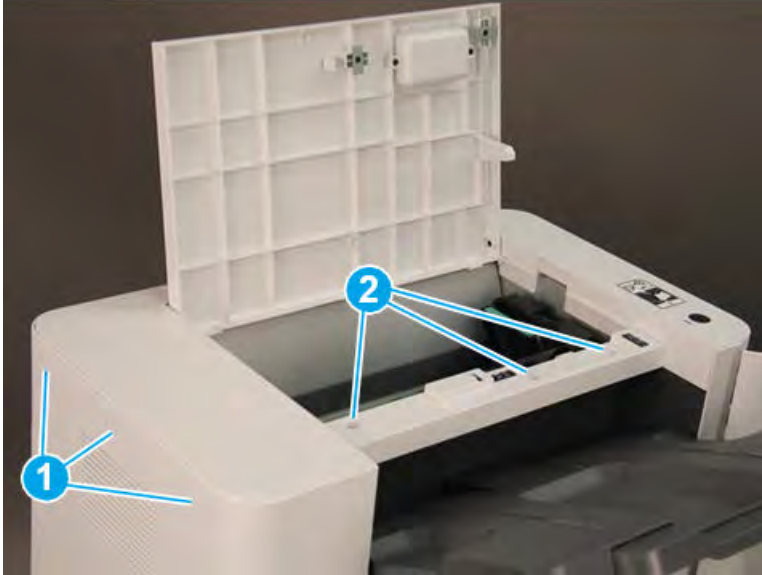

2. Remove three self-tapping screws at the top of the front cover (callout 1), and then remove two machine screws (callout 2) at the top of the right side.

Figure 5-532 Remove five screws

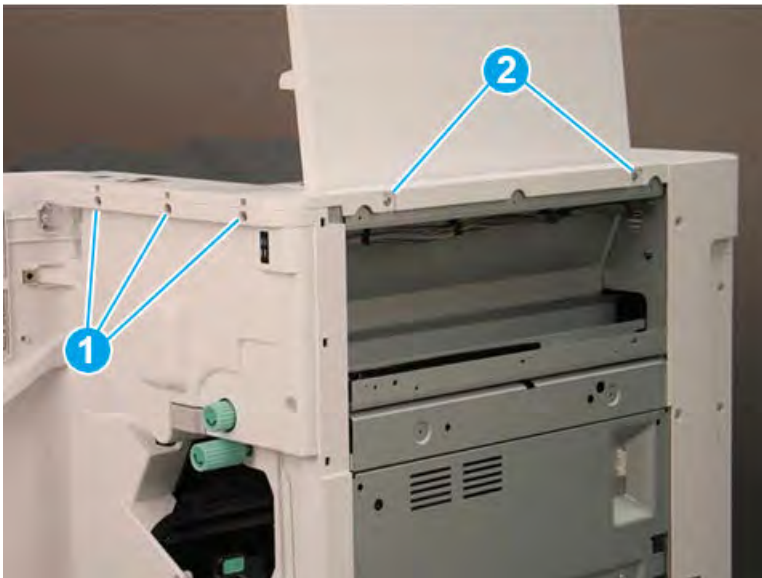

3. Lift the cover up slightly. Disconnect one in-line connector (callout 1), and then release one retainer (callout 2).

 **TIP:** Reverse the removal steps to install the assembly.

Figure 5-533 Disconnect one connector and release retainer



Remove the front door (finisher)

Follow these steps to remove the front door (finisher).

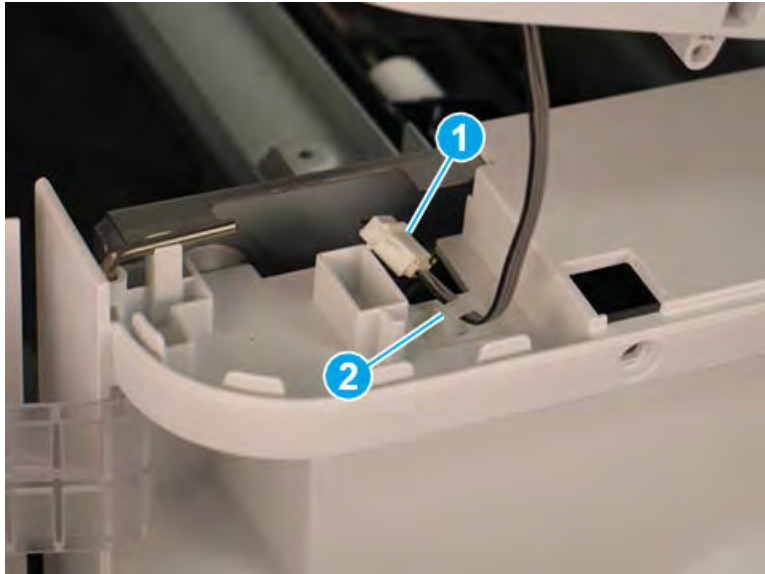
1. Lift the top hinge pin up to release it from the retainer.

Figure 5-534 Lift the top hinge pin

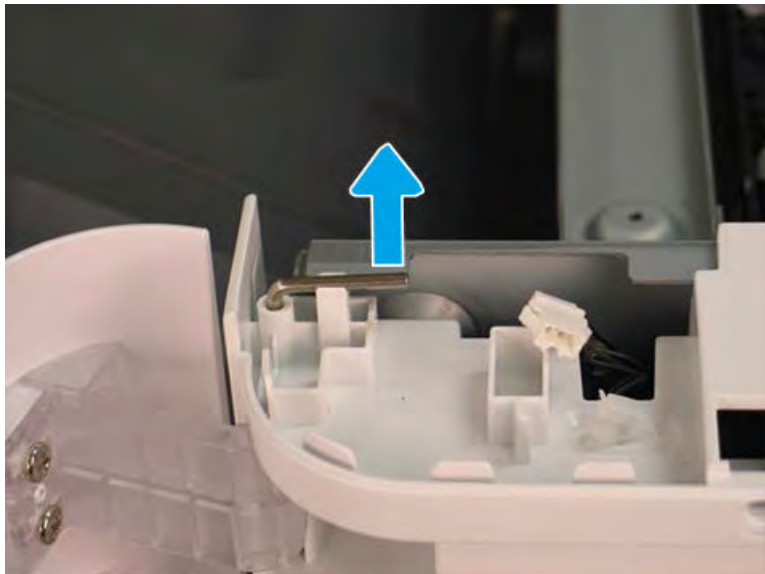

2. Pull the top hinge pin up to remove it.

Figure 5-535 Remove the top hinge pin

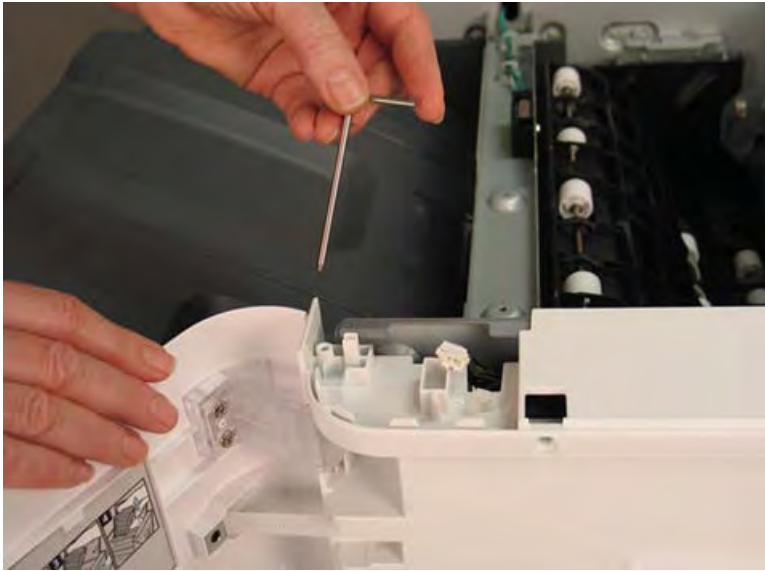

3. Use a small, flat-blade screwdriver to release the lower hinge pin from the retainer, and then rotate it away from the finisher.

Figure 5-536 Release the lower hinge pin



4. Support the door with one hand, and then pull the lower hinge pin straight up to remove it.

Figure 5-537 Remove the lower hinge pin



5. Support the door with one hand, and then remove one screw (callout 1) to release the strap. Remove the front door.

 **TIP:** Reverse the removal steps to install the assembly.

Figure 5-538 Remove the front door



Remove the front cover (finisher)

Follow these steps to remove the front cover (finisher).

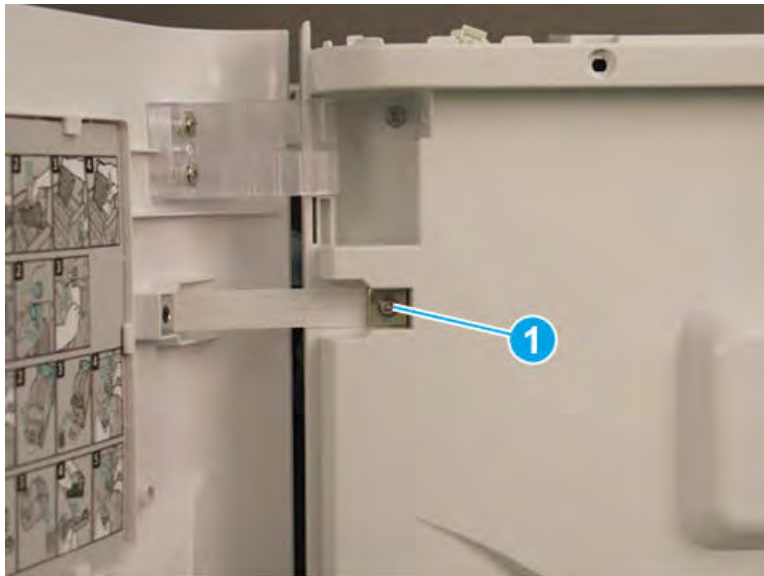
1. Release one tab (callout 1), and then pull the jam-access knob away from the finisher to remove it.

Figure 5-539 Remove the jam-access knob

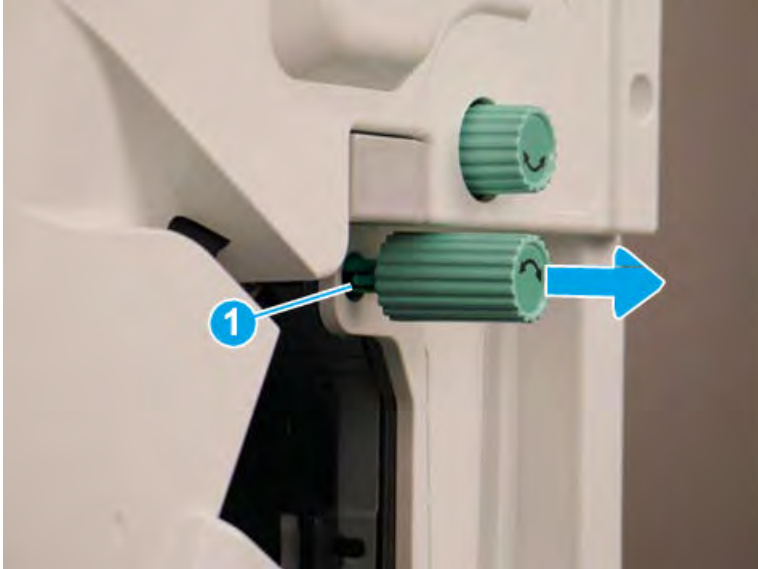

2. If the punch unit is installed, remove the punch waste bin (callout 1).
3. Remove one screw (callout 1) on top of the front cover.

Figure 5-540 Remove one screw



4. Remove five machine screws (callout 1), and then remove the front cover.

 **TIP:** Reverse the removal steps to install the assembly.

Figure 5-541 Remove the front cover



Remove the rear cover (finisher)

Follow these steps to remove the rear cover (finisher).

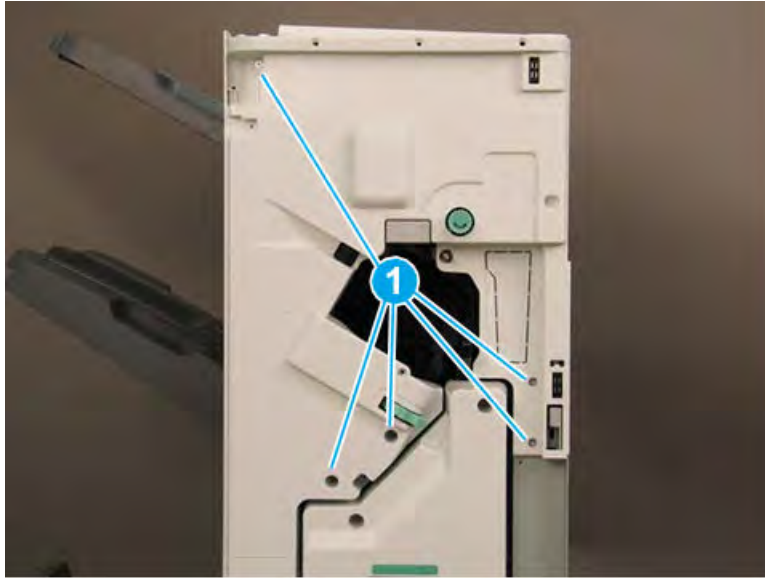
1. Remove two self-tapping screws (callout 1) on the top of the rear cover, and then remove five screw caps and five machine screws (callout 2) on the left side of the cover.

Figure 5-542 Remove seven screws

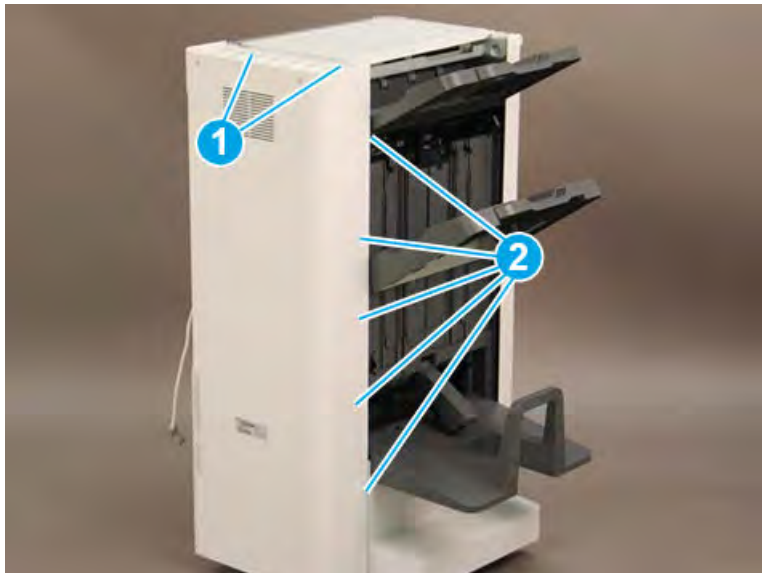

2. Remove one screw cap and four machine screws (callout 1) Remove the rear cover.

 **NOTE:** Make sure to thread the power cable (callout 2) through the opening in the cover.

 **TIP:** Reverse the removal steps to install the assembly

Figure 5-543 Remove the rear cover



Remove the booklet output tray

Follow these steps to remove the booklet output tray.

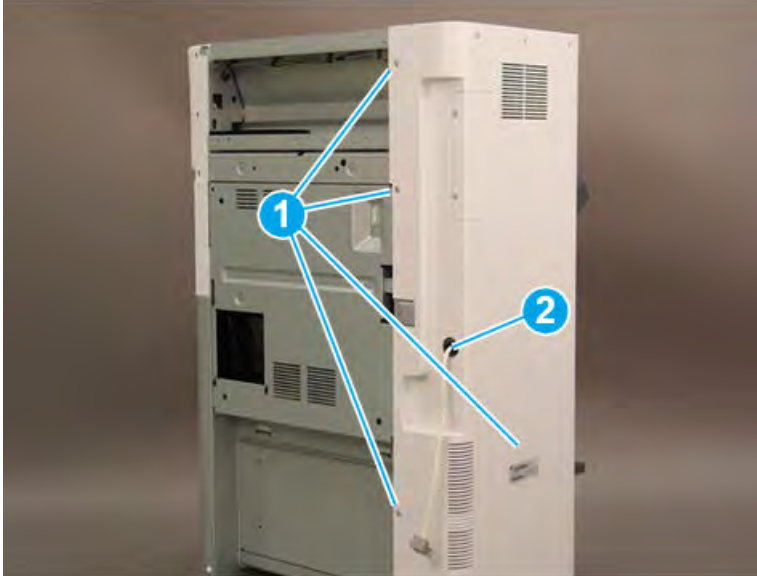
1. Raise the booklet output tray up (callout 1), and then pull it away from the finisher (callout 2) to remove it.

Figure 5-544 Remove the booklet output tray

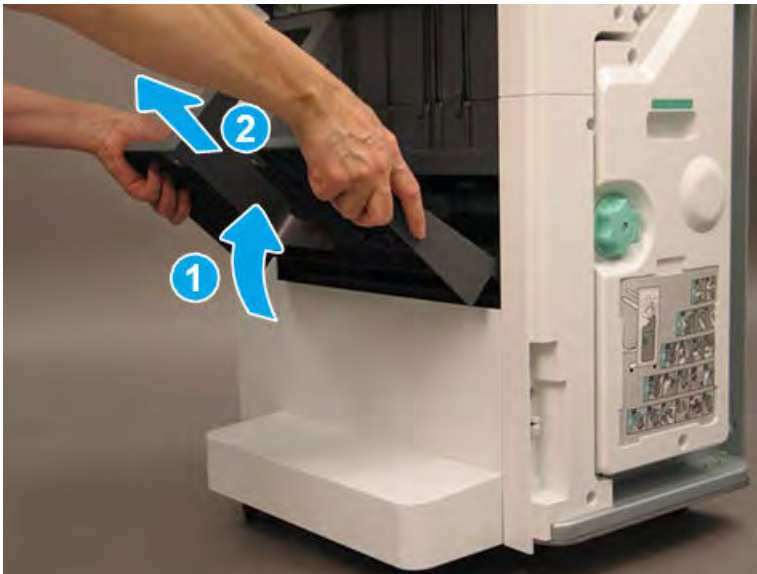

- Reverse the removal steps to install the assembly. Also use the following special installation instructions.

 **NOTE:** Continue to reverse the removal steps to finish installing the assembly

Special installation instructions: booklet output tray

Position the tabs (callout 1) on the tray into the slots (callout 2) on the finisher.

Figure 5-545 Install the booklet output tray

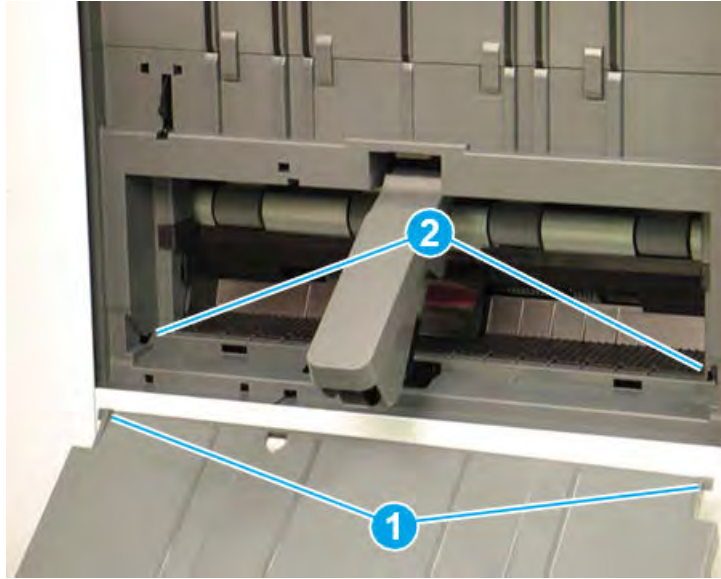

Remove the caster cover

Follow these steps to remove the caster cover.

- Remove two screw caps and two self-tapping screws (callout 1). Remove two screw caps and two machine screws (callout 2).

Figure 5-546 Remove four screws

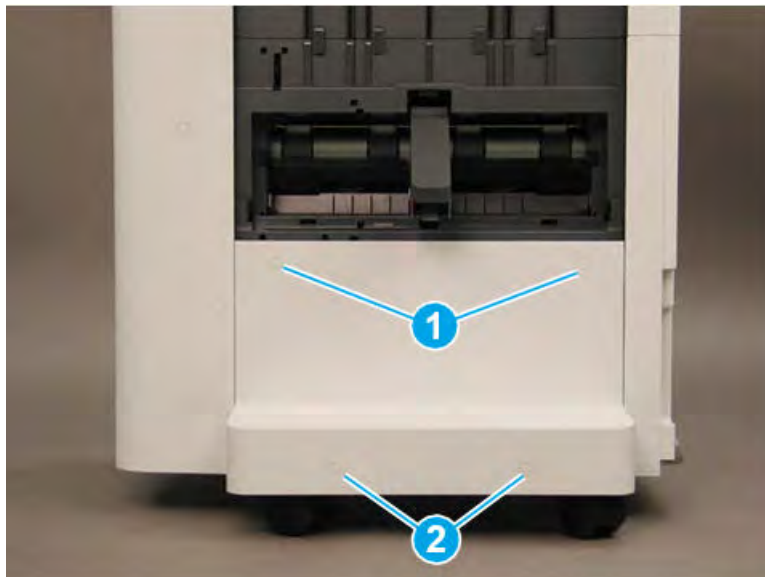

2. Rotate the left edge of the cover away from the finisher (callout 1), and then slide the cover to the left (callout 2) to remove it.

 **TIP:** Make sure that two tabs (callout 3) are positioned under the front lower cover when reinstalling the caster cover.

TIP: Reverse the removal steps to install the assembly

Figure 5-547 Remove the caster cover

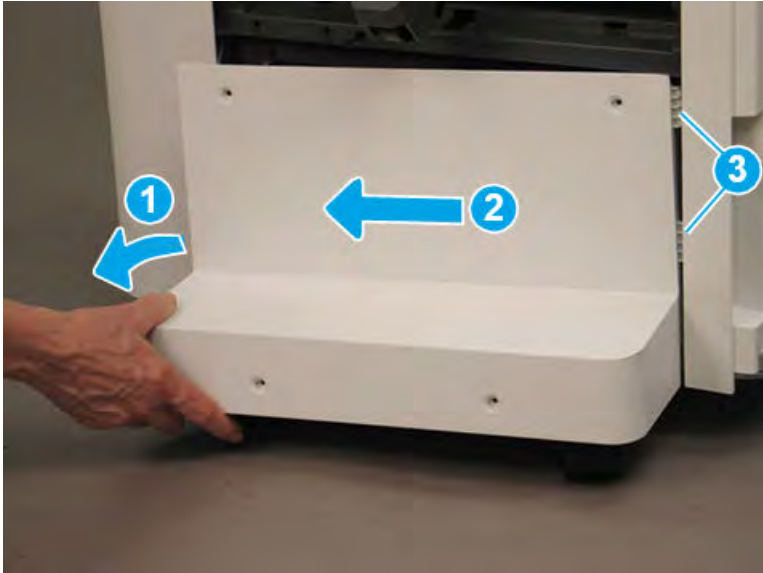

Remove the left lower cover (finisher)

Follow these steps to remove the left lower cover (finisher).

1. Remove four screws (callout 1).

 **NOTE:** Raise the lower output tray as needed to access the screws.

Figure 5-548 Remove four screws



2. Slide the shield down (callout 1) to release it from four tabs (callout 2), and then rotate it away from the finisher (callout 3).

CAUTION: The shield is still attached to the finisher. Do not attempt to completely remove the shield.

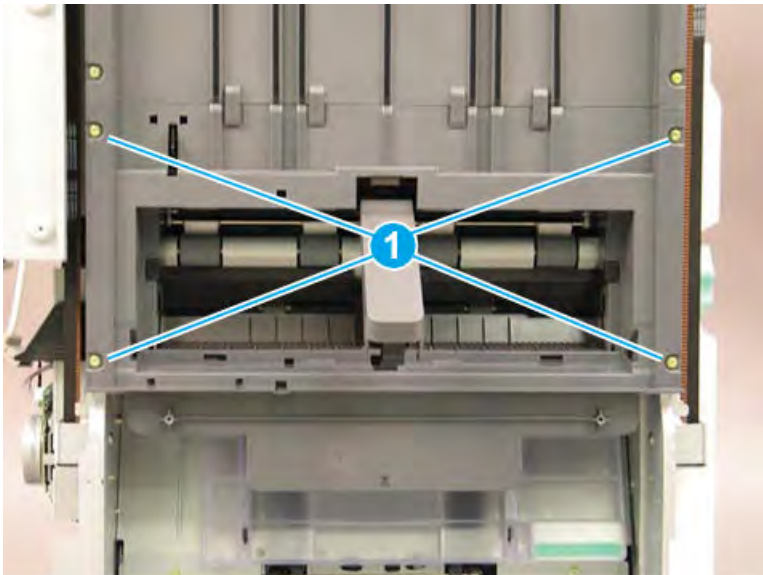
TIP: Position the shield under the four tabs (callout 2) when reinstalling it.

Figure 5-549 Release the lower shield

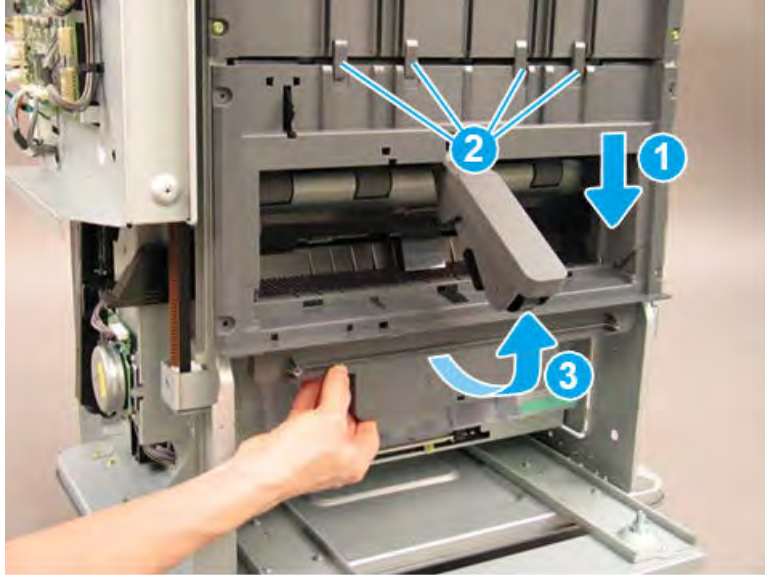

3. Disconnect two connectors (callout 1), and then remove the shield.

TIP: Reverse the removal steps to install the assembly.

Figure 5-550 Disconnect two connectors

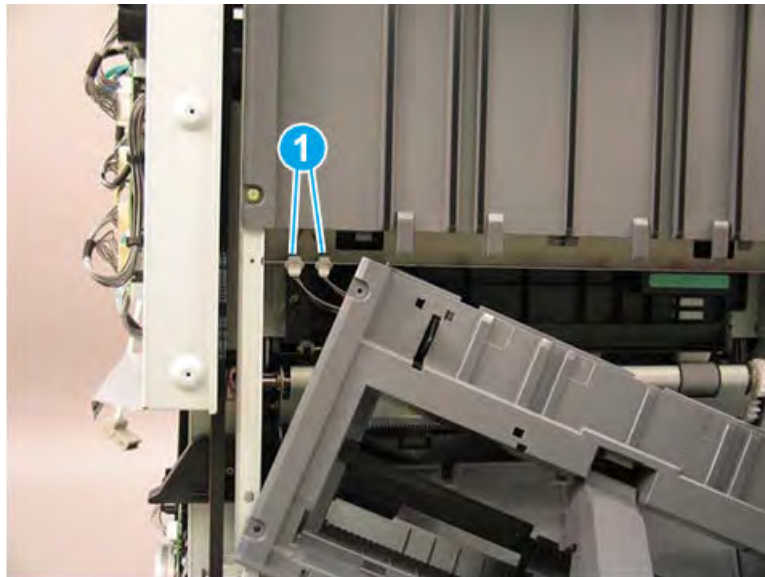

4. If you are replacing the left lower cover, locate three sensors (callout 1) on the back of the left lower cover. Remove these sensors and transfer them to the replacement part.

Figure 5-551 Remove the left lower cover

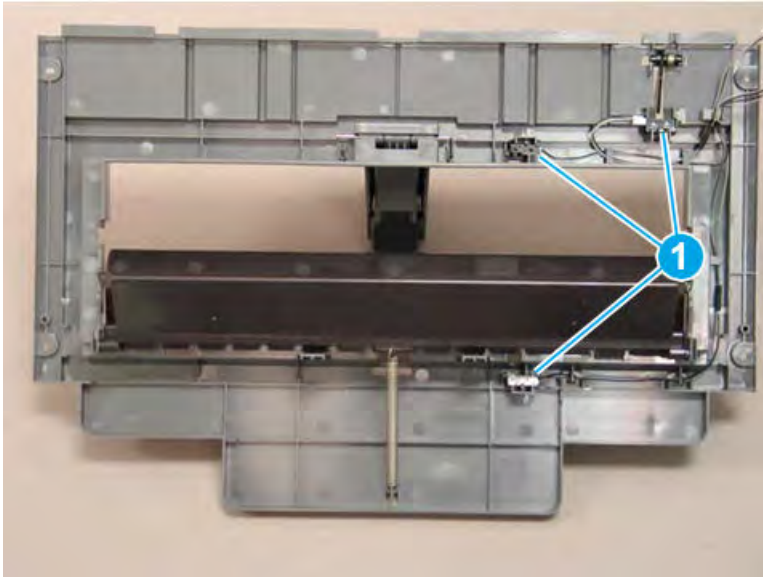

Remove the left upper cover (finisher)

Follow these steps to remove the left upper cover (finisher).

1. Bring the lower output tray down by positioning the shaft of a screwdriver on the clutch (callout 1) and gently pressing to the right to release the clutch. Hold the clutch in the released position and lower the tray (callout 2) to the lowest position.

Figure 5-552 Lower the output tray

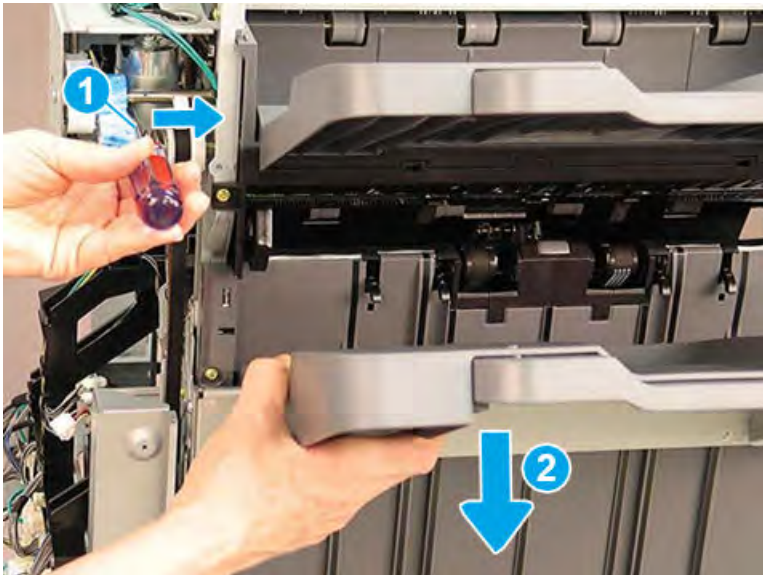

2. Remove six machine screws (callout 1).

Figure 5-553 Remove six screws

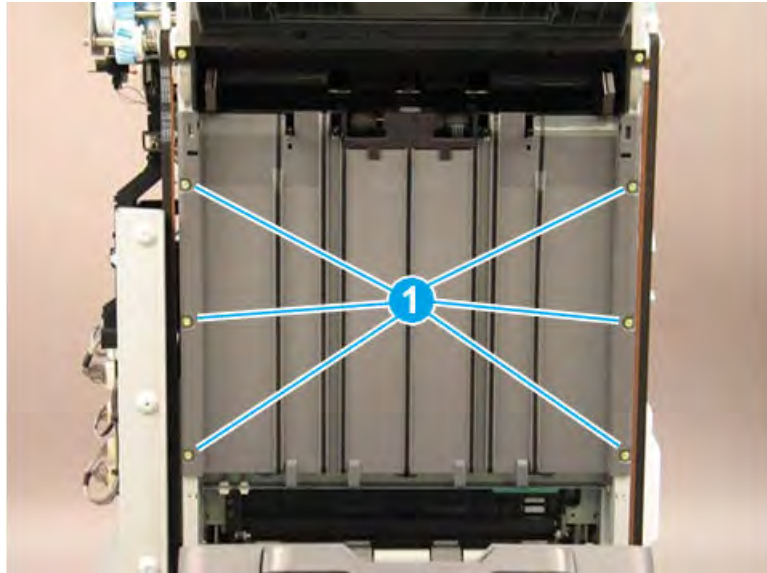

3. Rotate the lower edge of the shield away from the finisher (callout 1), and then slide the shield down (callout 2) to release it from two tabs (callout 3).

CAUTION: The shield is still attached to the finisher. Do not attempt to completely remove the shield.

TIP: Position the shield under the two tabs (callout 3) when reinstalling it.

Figure 5-554 Release the shield

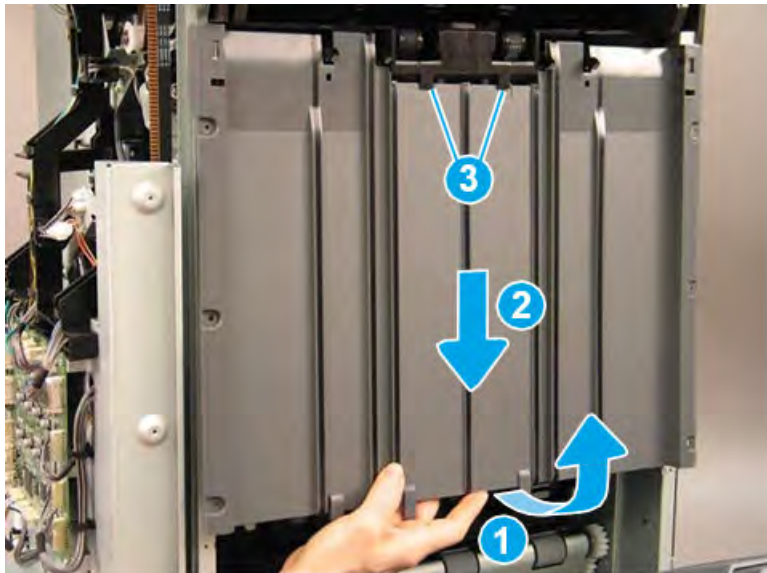

4. Disconnect one connector (callout 1), and then remove the upper shield assembly.

 **TIP:** Reverse the removal steps to install the assembly.

Figure 5-555 Disconnect one connector



5. If you are replacing the left upper cover, locate three sensors (callout 1) on the back of the left upper cover. Remove these sensors and transfer them to the replacement part.

Figure 5-556 Remove the left upper cover

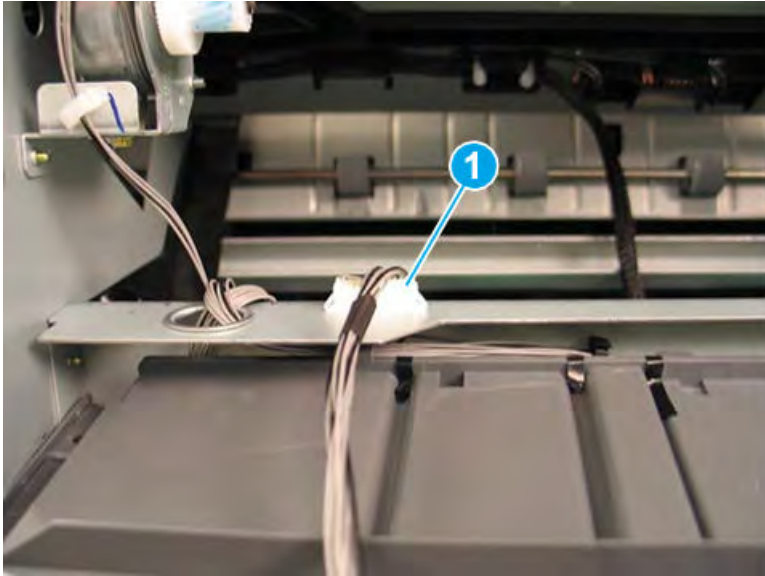
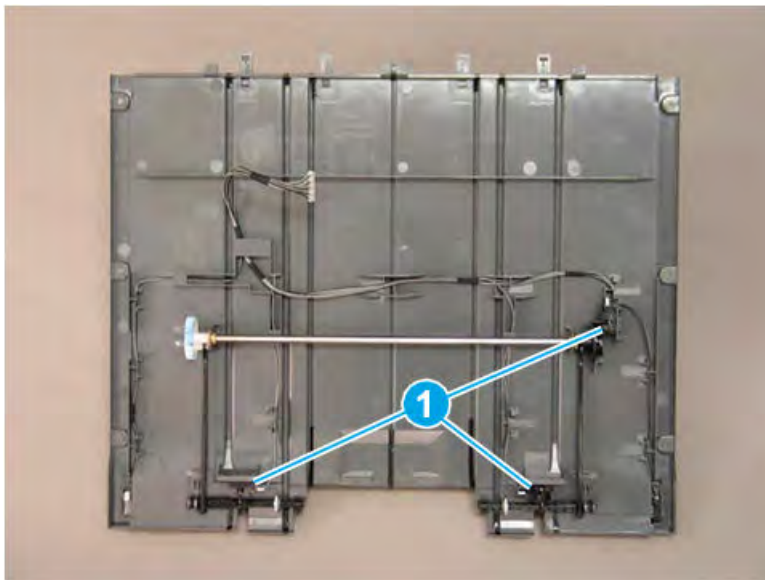

Remove the ejector unit (finisher)

Follow these steps to remove the ejector unit (finisher).

1. Rotate the green wheel to move the staple unit to the center of the finisher.

Figure 5-557 Move the staple unit to the center

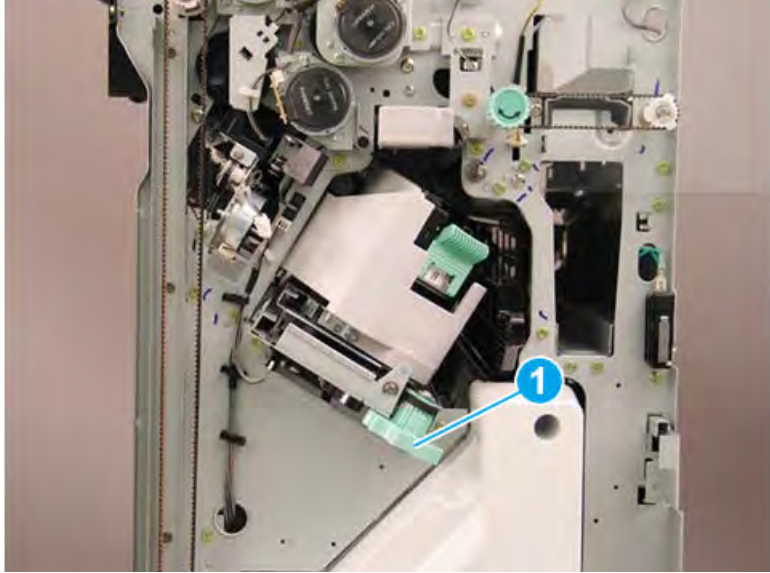

2. Release one retainer (callout 1), and then disconnect three connectors (callout 2).

Figure 5-558 Disconnect three connectors

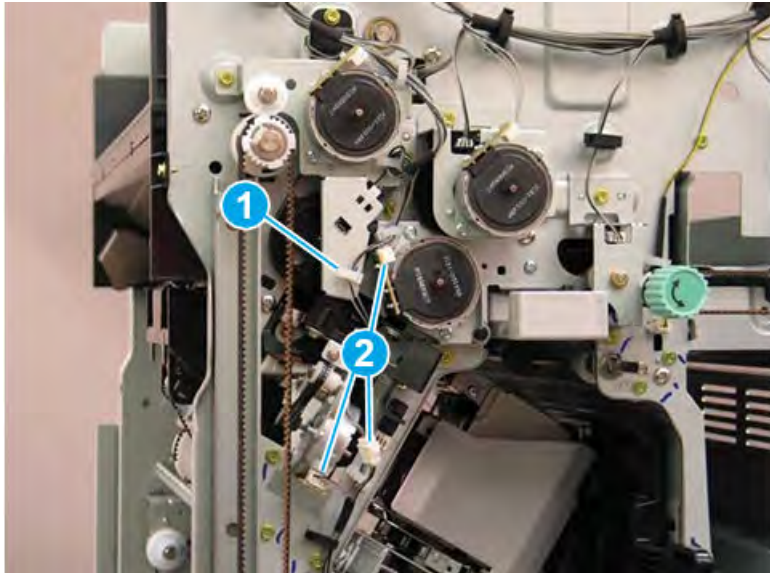

3. Remove two screws (callout 1).

Figure 5-559 Remove two screws

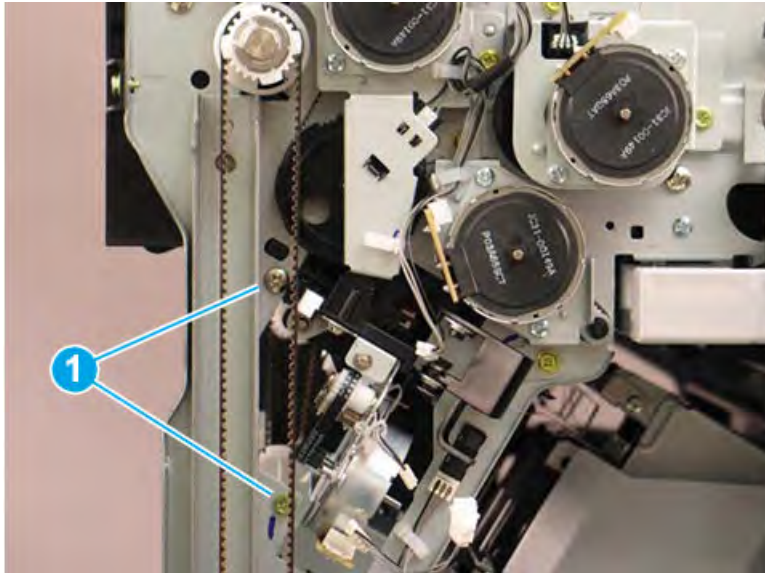

4. At the left side of the finisher, remove one screw (callout 1).

Figure 5-560 Remove one screw

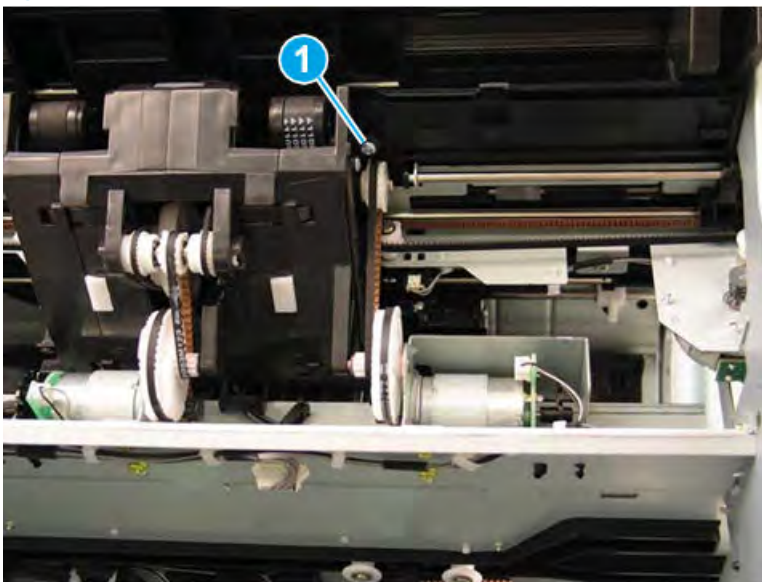

5. Press up on the hinge (callout 1), release one tab (callout 2), and then rotate the sensor away from the finisher (callout 3).

Figure 5-561 Rotate the sensor

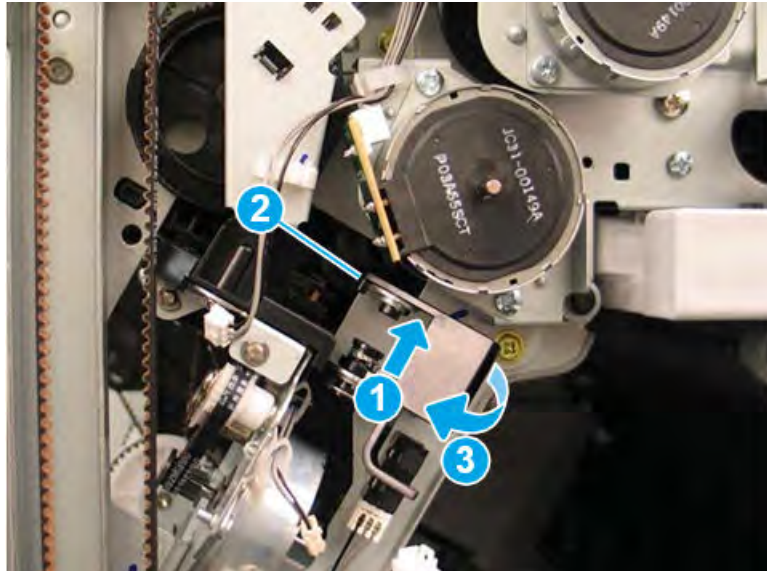

6. Remove one screw (callout 1).

Figure 5-562 Remove one screw

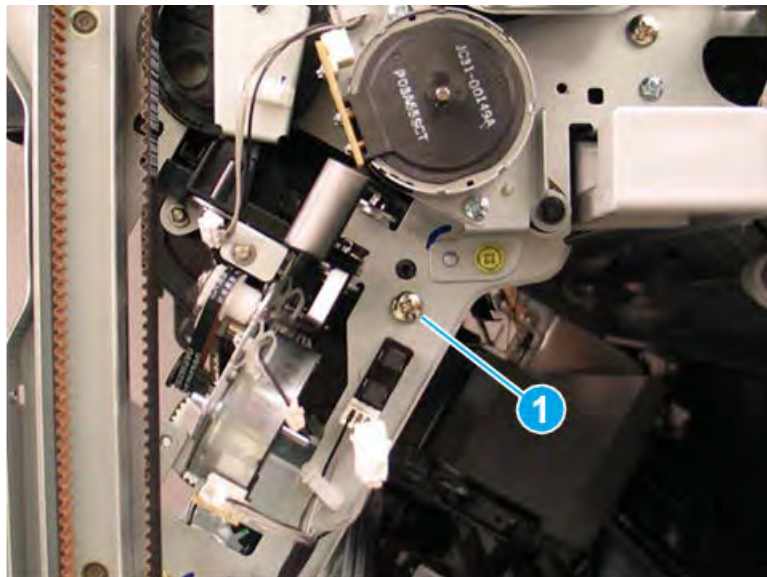

7. Look inside the finisher through the stapler opening in the front and pull down to release and remove one shaft (callout 1) on the front tamper unit.

Figure 5-563 Remove the front tamper shaft

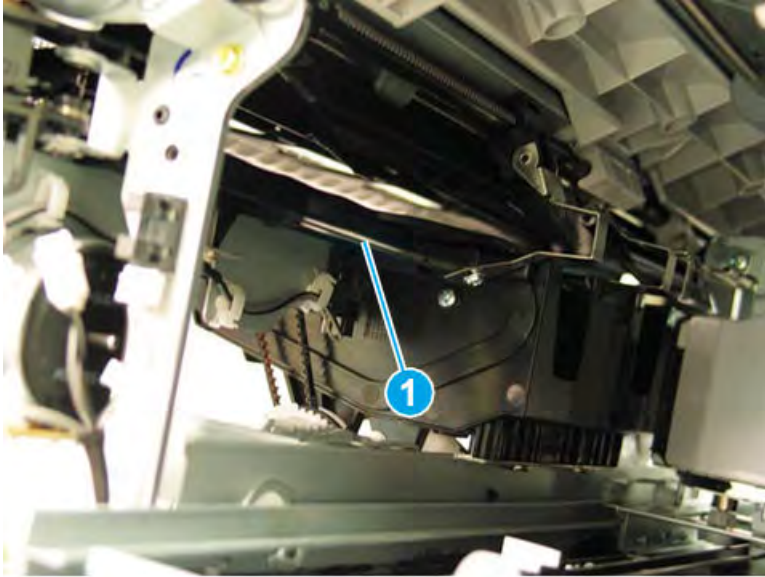

8. At the rear of the finisher, disconnect two connectors (callout 1), and then remove three screws (callout 2).

Figure 5-564 Disconnect two connectors and remove three screws

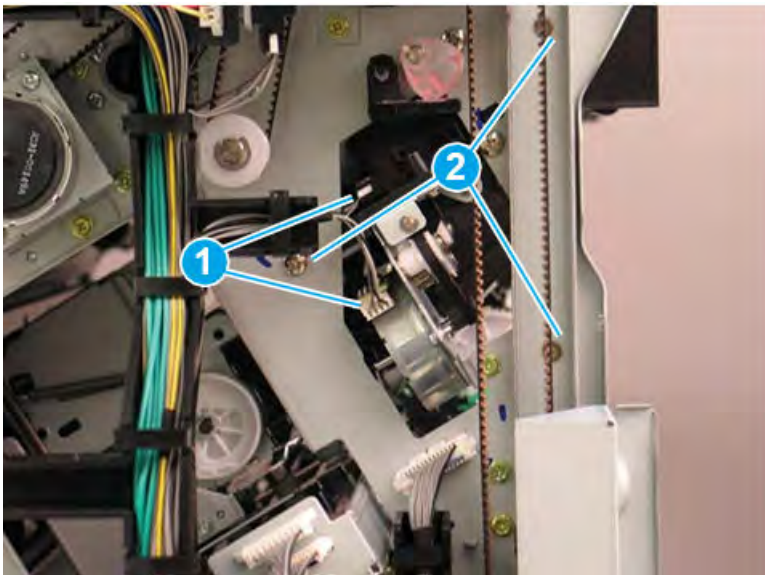

9. At the left side of the finisher, remove one screw (callout 1).

Figure 5-565 Remove one screw

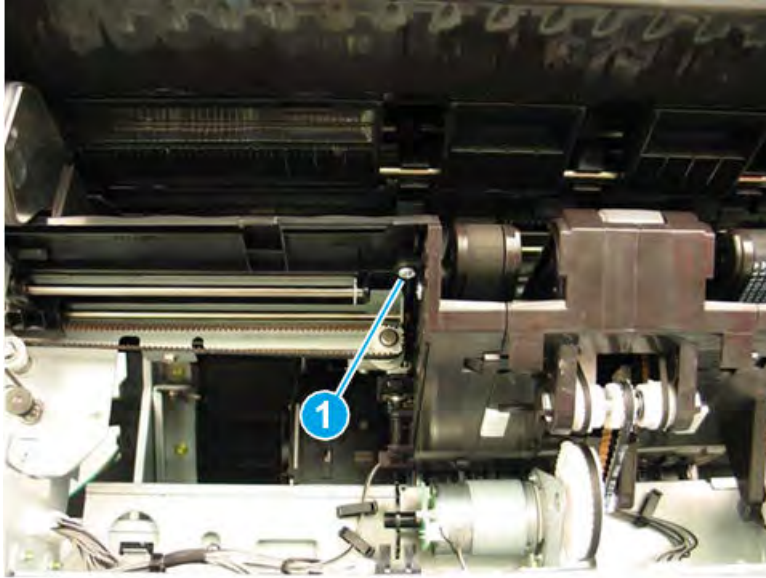

10. Look inside the finisher through the stapler opening in the rear and pull down to release and remove one shaft (callout 1) on the rear tamper unit.

Figure 5-566 Remove the rear tamper shaft

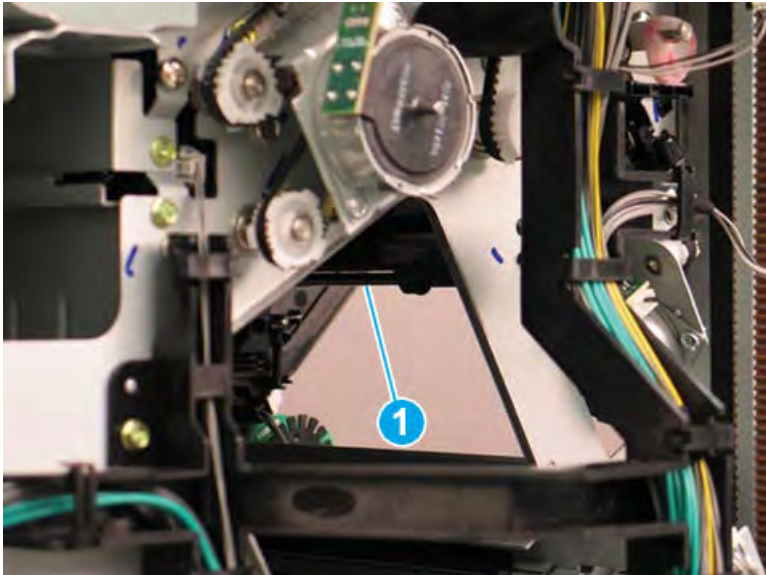

11. At the left side of the finisher, disconnect one connector (callout 1).

Figure 5-567 Disconnect one connector

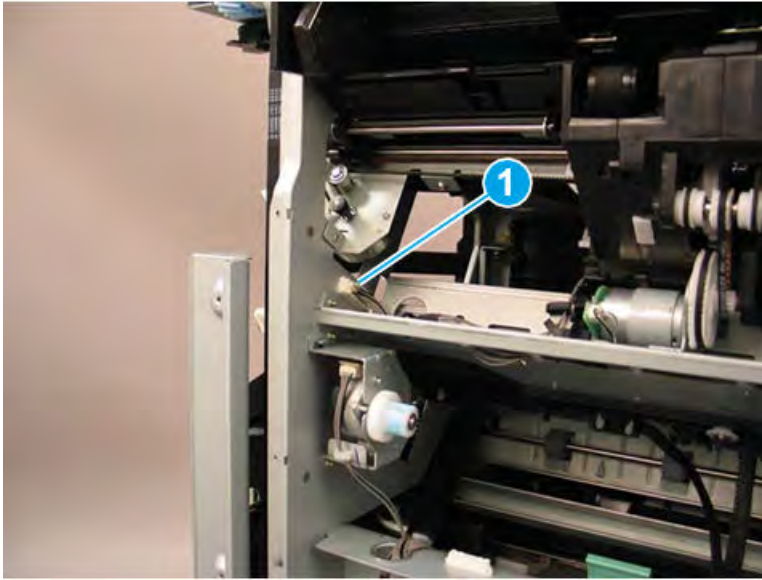

12. At the rear of the finisher, disconnect one connector (callout 1).

Figure 5-568 Disconnect one connector

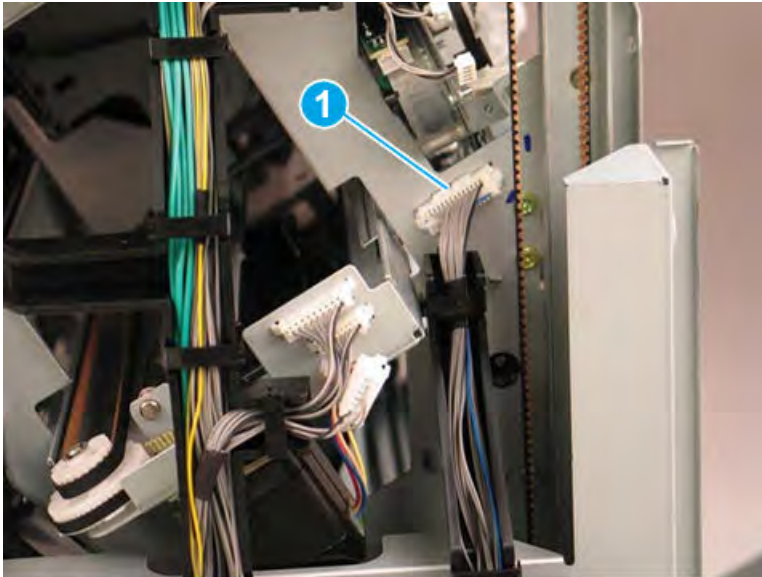

13. At the rear of the finisher, press the wire retainer to the right to access and remove two screws (callout 1).

Figure 5-569 Disconnect one connector

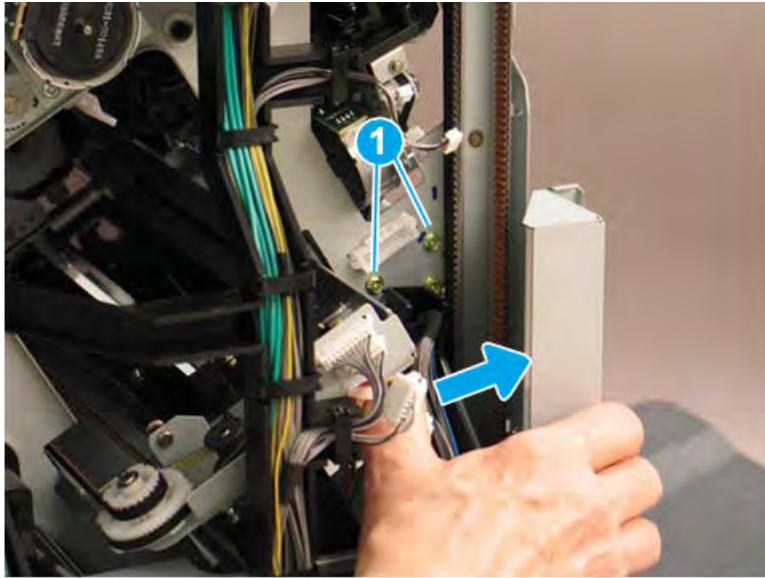

14. At the front of the finisher, remove two screws (callout 1).

Figure 5-570 Remove two screws

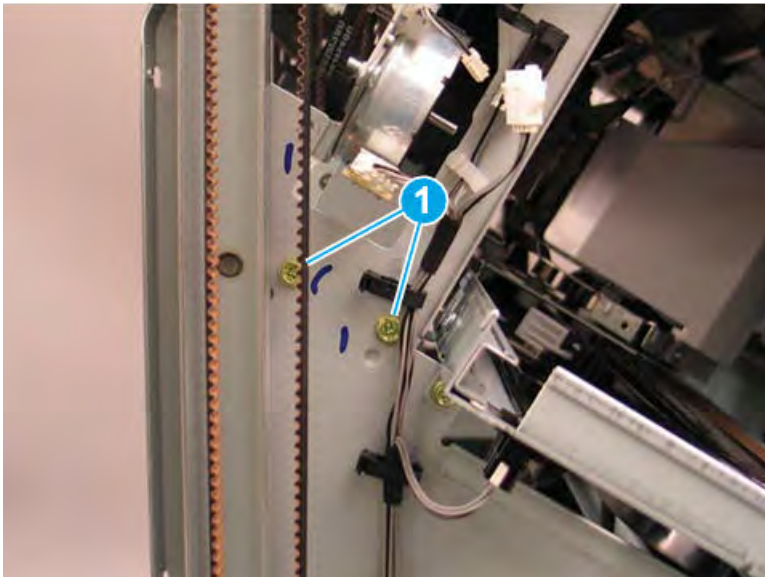

15. Lift the inside edges of the front and rear tampers up.

Figure 5-571 Lift the edges of the tampers

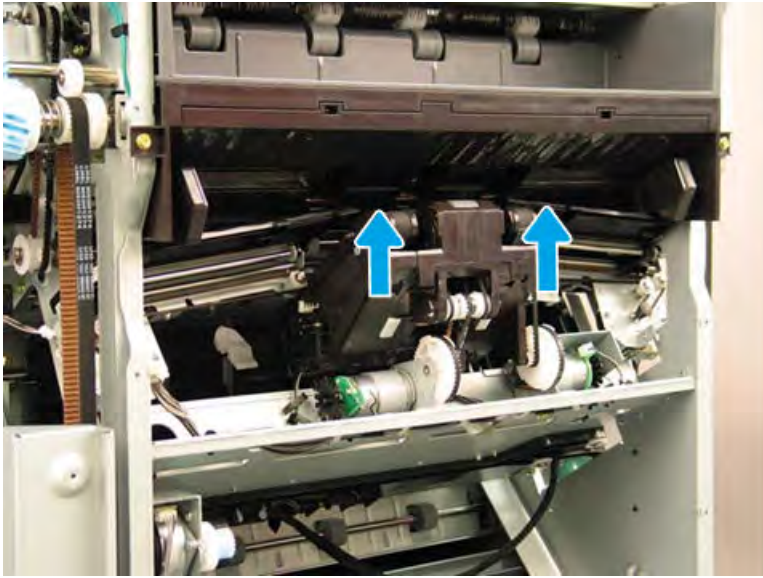

16. Rotate the rear edge of the ejector unit away from the finisher (callout 1), and then slide it toward the rear of the finisher (callout 2) to remove it. Make sure that the PCA (callout 3) stays clear of the sheet metal frame.

Figure 5-572 Remove the ejector unit

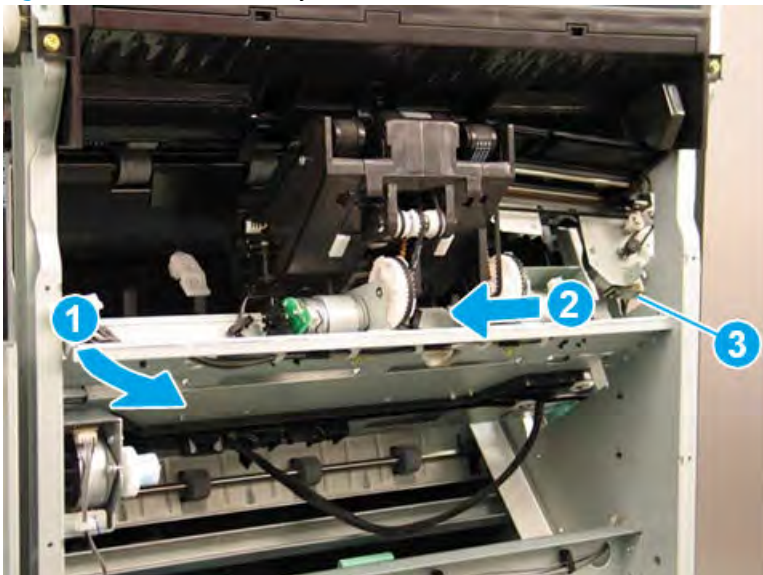

17. Reverse the removal steps to install the assembly. Also use the following special installation instructions.

 **NOTE:** Continue to reverse the removal steps to finish installing the assembly.

Special installation instructions: Ejector unit

- a. When the front tamper shaft is removed, the retainer arm that held the one end of the shaft will drop down. When reinstalling the shaft, raise the retainer arm and position the end of the shaft in the notch (callout 1).

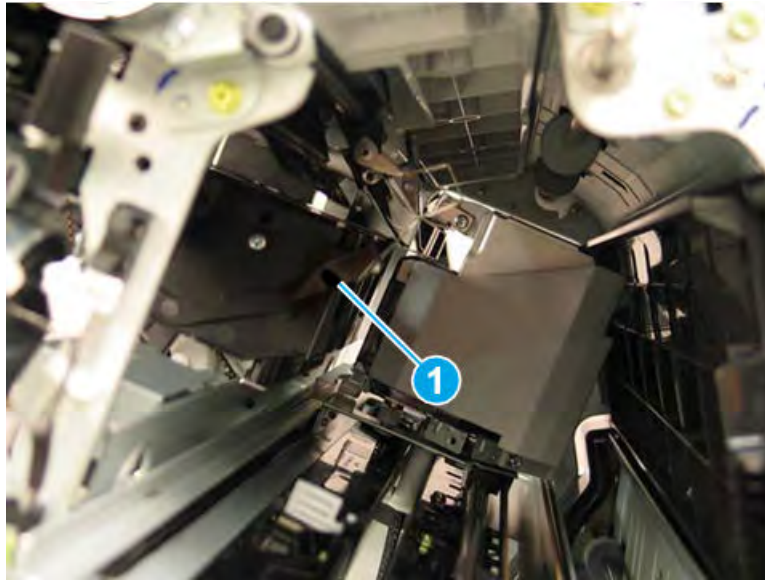

- b. When the rear tamper shaft is removed, the retainer arm that held the one end of the shaft will drop down. When reinstalling the shaft, raise the retainer arm and position the end of the shaft in the notch (callout 1).

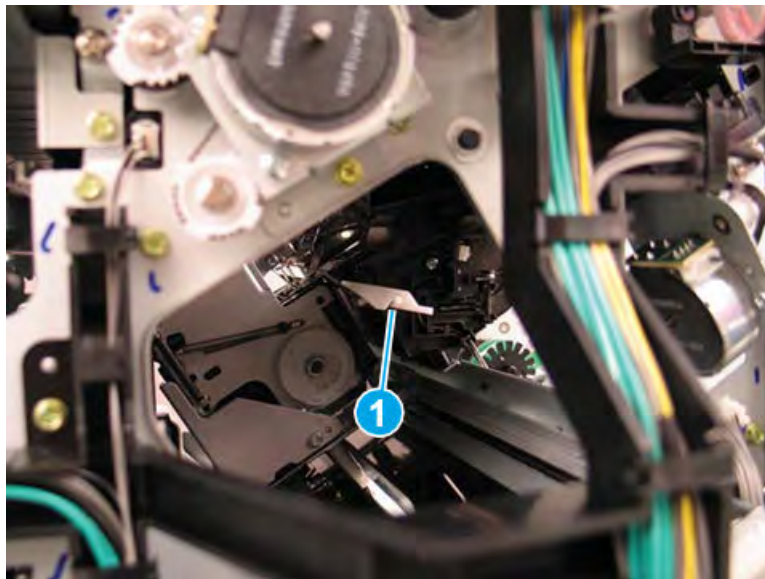

Remove the front tamper unit

Follow these steps to remove the front tamper unit.

- ▲ Lift the front tamper away from the finisher to remove it

Figure 5-573 Remove the front tamper



Unpack the replacement assembly



Follow these steps to unpack the replacement assembly.

1. Dispose of the defective part.

 **NOTE:** HP recommends responsible disposal of the defective part.

<http://www8.hp.com/us/en/hp-information/environment/product-recycling.html>

2. Unpack the replacement part from the packaging.

 **CAUTION:**  Some parts are sensitive to electrostatic discharge (ESD). Always perform service work at an ESD-protected workstation or mat. If an ESD workstation or mat is not available, touch the sheet-metal chassis to provide a static ground before touching an ESD-sensitive assembly. Protect the ESD-sensitive assemblies by placing them in ESD pouches when they are out of the printer.

 **IMPORTANT:** Make sure that all of the shipping materials (for example shipping tape) are removed from the replacement part prior to installation.

 **NOTE:** If the replacement part is a roller or pad, avoid touching the spongy part of it. Skin oils on the roller or pad can cause paper pickup and/or print-quality problems. HP recommends using disposable gloves when handling rollers or pads or washing your hands before touching rollers or pads.

3. To install an assembly, reverse the removal steps.

 **NOTE:** When applicable, special installation instructions are provided for an assembly at the end of the removal procedure. Always completely read the removal instructions and follow all special installation instructions.

Removal and replacement: Front tamper home sensor (S6)

Learn how to remove and replace the front tamper home sensor.

Introduction

This document provides the procedures to remove and replace the front tamper home sensor on the finisher.

 **IMPORTANT:** When applicable, special installation instructions are provided for an assembly at the end of the removal procedure. Always completely read the removal instructions and follow all special installation instructions.

Before performing service

- Turn the printer power off. A shutting-down message appears on the control-panel display.
- ⚠ **WARNING!** To avoid damage to the printer, turn the power off and wait until the printer shuts down before removing the power cable.
- Disconnect the printer power cable after the printer has completely shut down (the control-panel display is blank).
- Release the finisher from the printer by pulling out on the release latch inside the finisher door.
- Disconnect the cable from the bridge unit to the finisher.
- Disconnect the cable from the finisher to the printer.

Use the table below to identify the correct part number for your printer. To order the part, go to <https://parts.hp.com>.

Table 5-114 Part information

Part number	Part description
0604-001393	Front tamper home sensor

Required tools

- #2 JIS screwdriver with a magnetic tip
- Small, flat-blade screwdriver

After performing service

- Connect the cable from the finisher to the printer.
- Connect the cable from the bridge unit to the finisher.
- Attach the finisher to the printer, and then push in on the release latch inside the finisher door.
- Connect the printer power cable.
- Turn the printer power on.

Post service test

Process a job through the finisher and verify that the finisher works correctly.

Remove the right upper cover (finisher)

Follow these steps to remove the right upper cover (finisher).

- ▲ Remove one screw cap and three machine screws on the upper edge of the cover (callout 1). Remove three sheet metal screws (callout 2) on the lower portion of the cover. Rotate the right edge of the cover away from the finisher, and then slide the cover right to release three tabs (callout 3).

💡 **TIP:** The lower screws are shorter in length than the upper screws.

TIP: Reverse the removal steps to install the assembly.

Figure 5-574 Remove the right upper cover

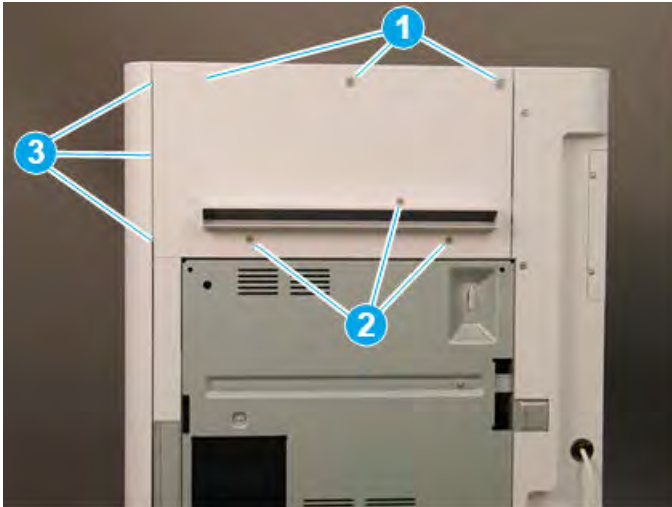

Remove the top cover (finisher)

Follow these steps to remove the top cover (finisher).

1. Remove three screw caps and three self-tapping screws at the top of the rear cover (callout 1), and then remove three machine screws (callout 2) on top of the cover.

Figure 5-575 Remove six screws

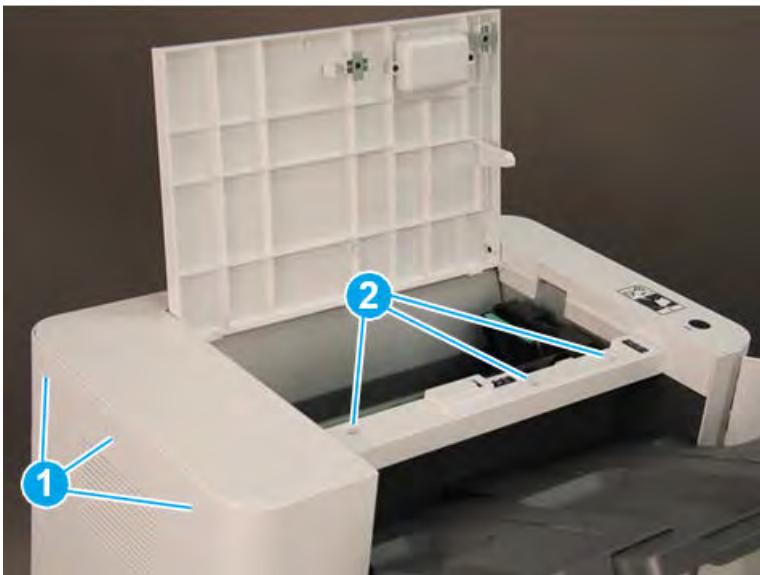

2. Remove three self-tapping screws at the top of the front cover (callout 1), and then remove two machine screws (callout 2) at the top of the right side.

Figure 5-576 Remove five screws

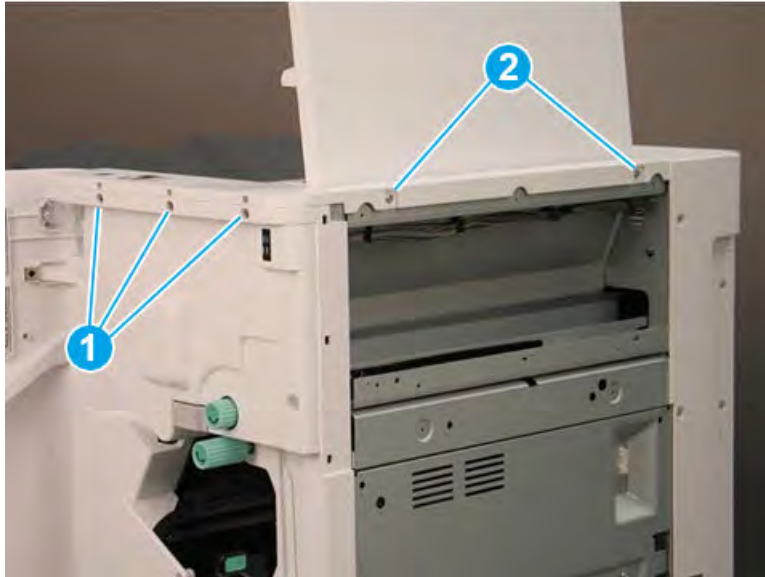

3. Lift the cover up slightly. Disconnect one in-line connector (callout 1), and then release one retainer (callout 2).

 **TIP:** Reverse the removal steps to install the assembly.

Figure 5-577 Disconnect one connector and release retainer



Remove the front door (finisher)

Follow these steps to remove the front door (finisher).

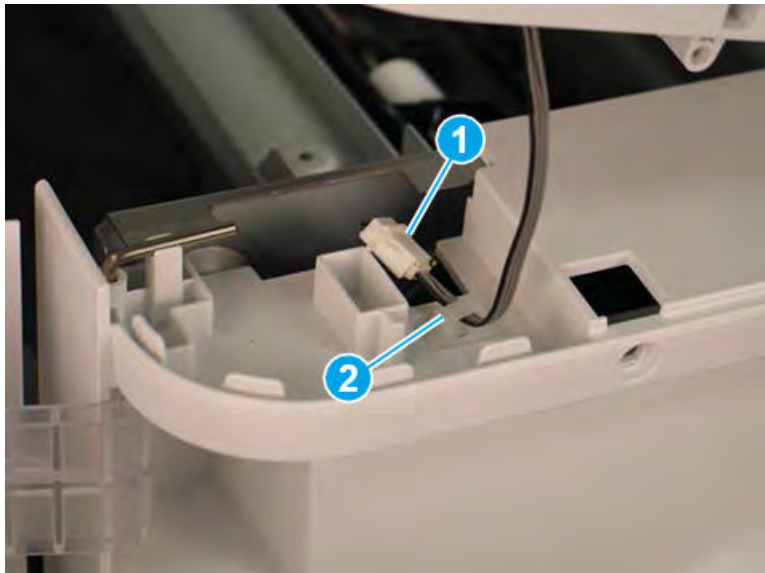
1. Lift the top hinge pin up to release it from the retainer.

Figure 5-578 Lift the top hinge pin

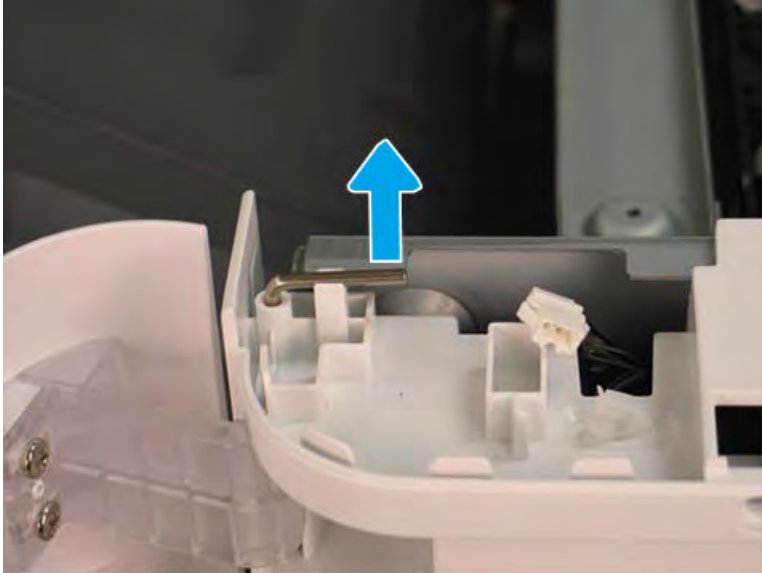

2. Pull the top hinge pin up to remove it.

Figure 5-579 Remove the top hinge pin

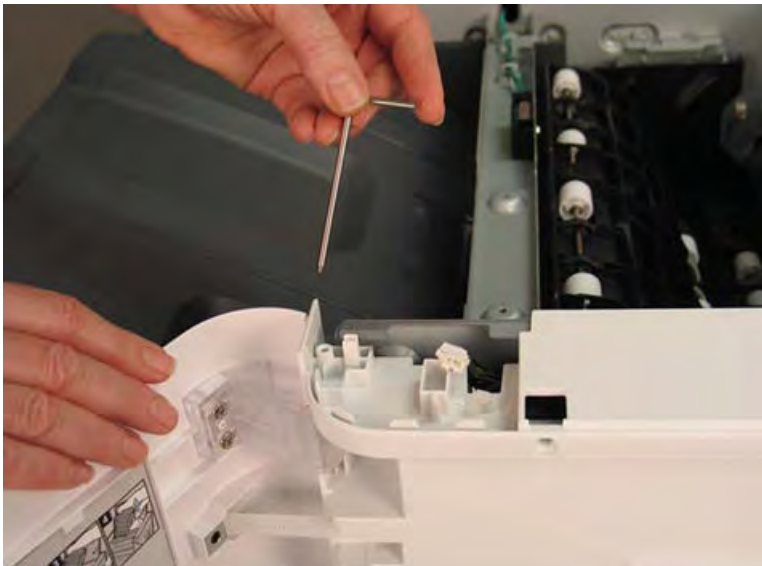

3. Use a small, flat-blade screwdriver to release the lower hinge pin from the retainer, and then rotate it away from the finisher.

Figure 5-580 Release the lower hinge pin



4. Support the door with one hand, and then pull the lower hinge pin straight up to remove it.

Figure 5-581 Remove the lower hinge pin



5. Support the door with one hand, and then remove one screw (callout 1) to release the strap. Remove the front door.

 **TIP:** Reverse the removal steps to install the assembly.

Figure 5-582 Remove the front door



Remove the front cover (finisher)

Follow these steps to remove the front cover (finisher).

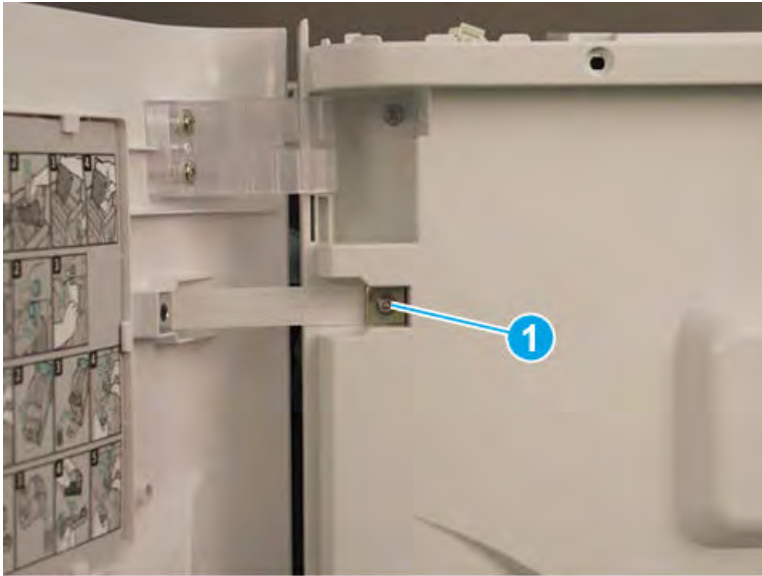
1. Release one tab (callout 1), and then pull the jam-access knob away from the finisher to remove it.

Figure 5-583 Remove the jam-access knob

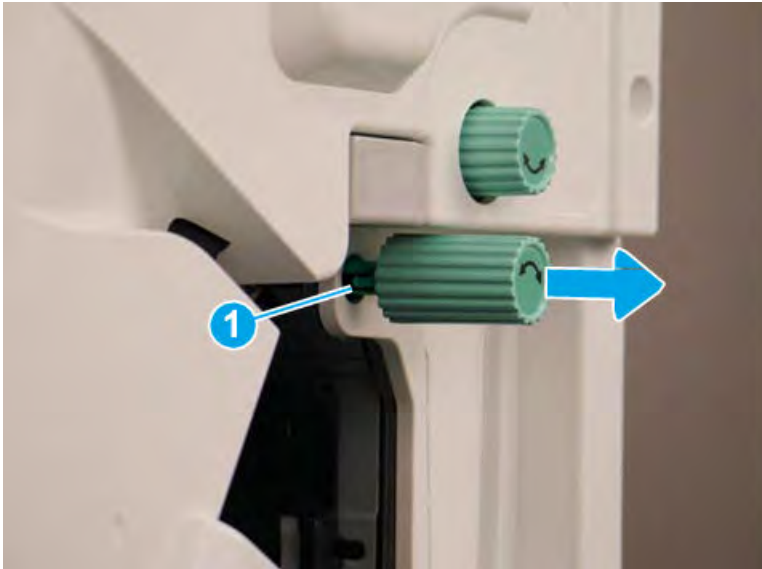

2. If the punch unit is installed, remove the punch waste bin (callout 1).

3. Remove one screw (callout 1) on top of the front cover.

Figure 5-584 Remove one screw



4. Remove five machine screws (callout 1), and then remove the front cover.

 **TIP:** Reverse the removal steps to install the assembly.

Figure 5-585 Remove the front cover

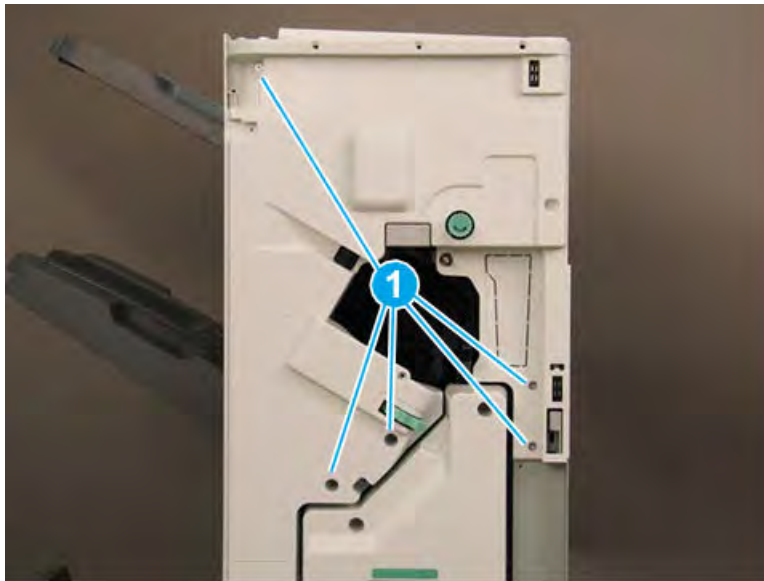

Remove the rear cover (finisher)

Follow these steps to remove the rear cover (finisher).

1. Remove two self-tapping screws (callout 1) on the top of the rear cover, and then remove five screw caps and five machine screws (callout 2) on the left side of the cover.

Figure 5-586 Remove seven screws

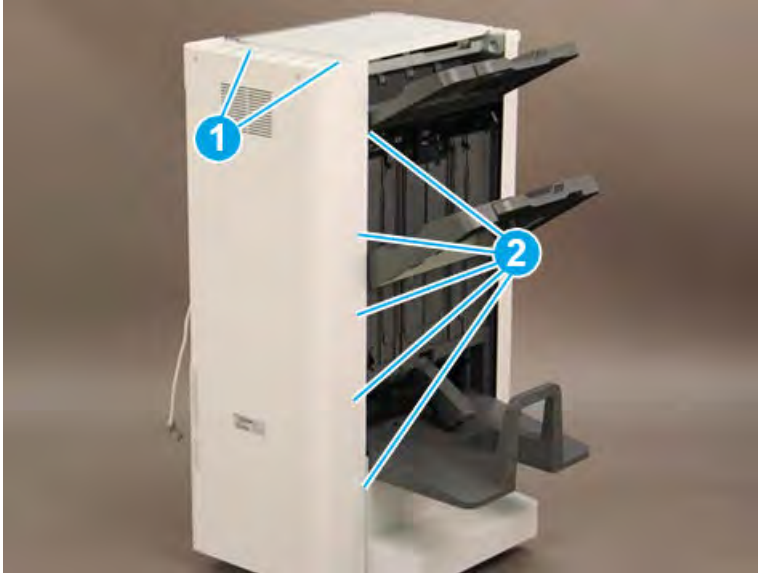

2. Remove one screw cap and four machine screws (callout 1) Remove the rear cover.

 **NOTE:** Make sure to thread the power cable (callout 2) through the opening in the cover.

 **TIP:** Reverse the removal steps to install the assembly

Figure 5-587 Remove the rear cover



Remove the booklet output tray

Follow these steps to remove the booklet output tray.

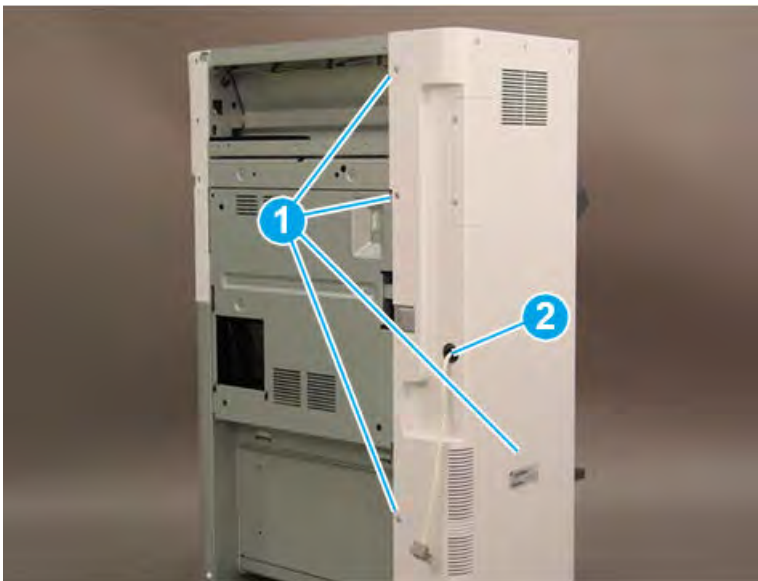
1. Raise the booklet output tray up (callout 1), and then pull it away from the finisher (callout 2) to remove it.

Figure 5-588 Remove the booklet output tray



2. Reverse the removal steps to install the assembly. Also use the following special installation instructions.

 **NOTE:** Continue to reverse the removal steps to finish installing the assembly

Special installation instructions: booklet output tray

Position the tabs (callout 1) on the tray into the slots (callout 2) on the finisher.

Figure 5-589 Install the booklet output tray

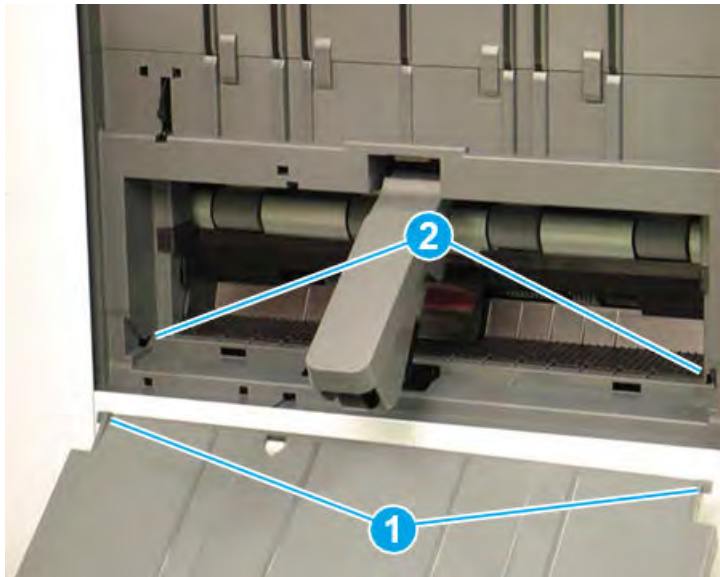

Remove the caster cover

Follow these steps to remove the caster cover.

1. Remove two screw caps and two self-tapping screws (callout 1). Remove two screw caps and two machine screws (callout 2).

Figure 5-590 Remove four screws

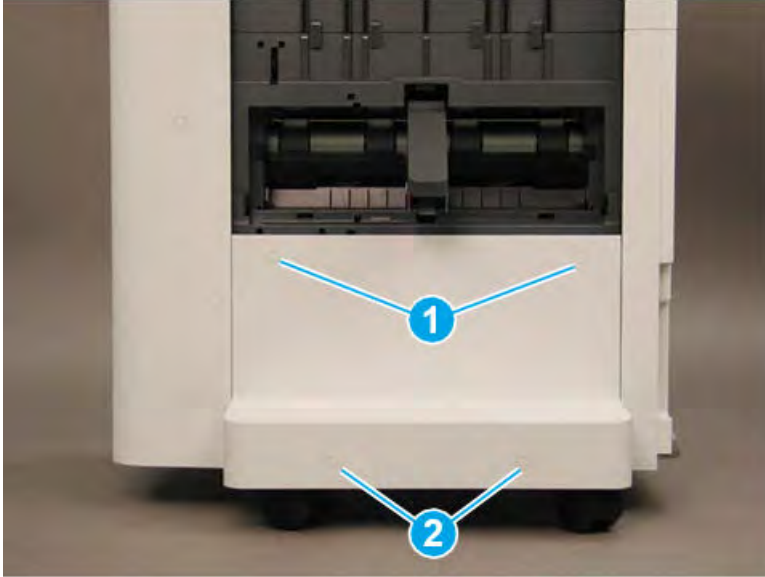

2. Rotate the left edge of the cover away from the finisher (callout 1), and then slide the cover to the left (callout 2) to remove it.

 **TIP:** Make sure that two tabs (callout 3) are positioned under the front lower cover when reinstalling the caster cover.

TIP: Reverse the removal steps to install the assembly

Figure 5-591 Remove the caster cover

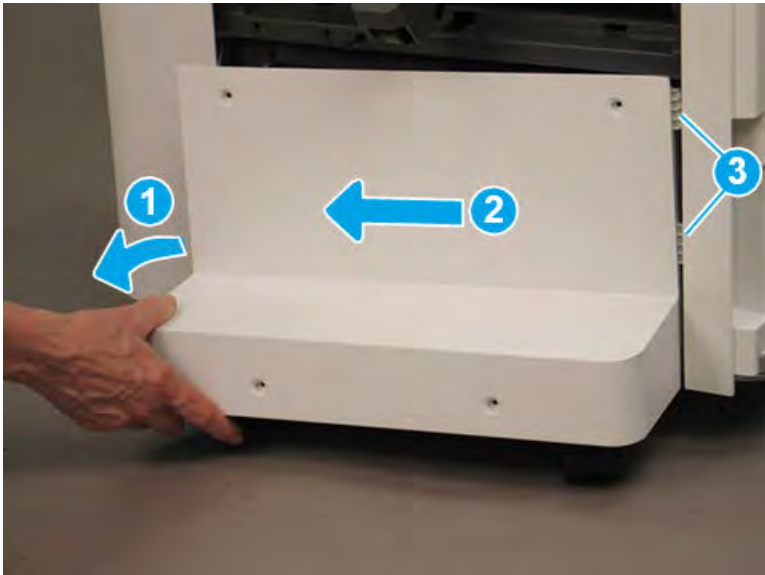

Remove the left lower cover (finisher)

Follow these steps to remove the left lower cover (finisher).

1. Remove four screws (callout 1).

 **NOTE:** Raise the lower output tray as needed to access the screws.

Figure 5-592 Remove four screws



2. Slide the shield down (callout 1) to release it from four tabs (callout 2), and then rotate it away from the finisher (callout 3).

⚠ CAUTION: The shield is still attached to the finisher. Do not attempt to completely remove the shield.

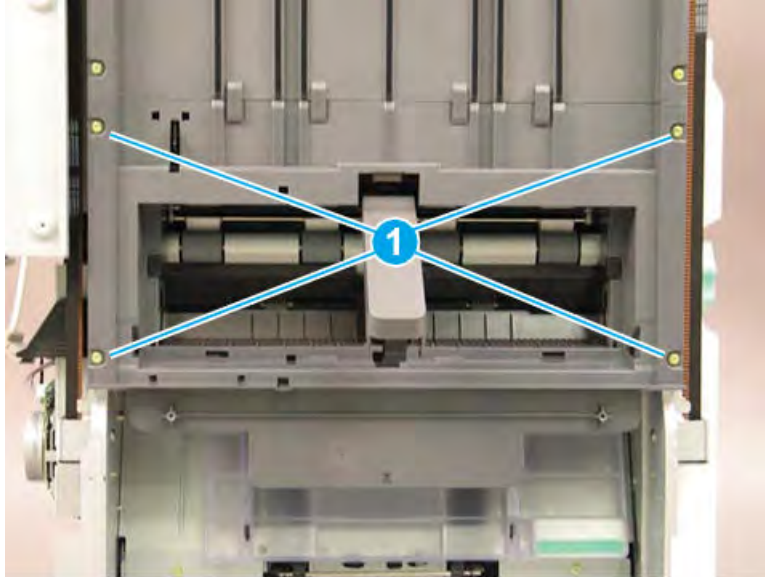
💡 TIP: Position the shield under the four tabs (callout 2) when reinstalling it.

Figure 5-593 Release the lower shield

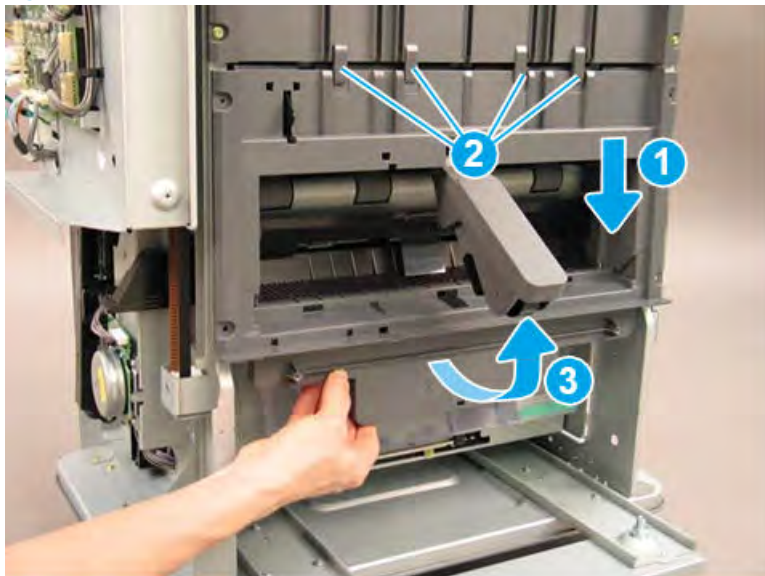

3. Disconnect two connectors (callout 1), and then remove the shield.

 **TIP:** Reverse the removal steps to install the assembly.

Figure 5-594 Disconnect two connectors



4. If you are replacing the left lower cover, locate three sensors (callout 1) on the back of the left lower cover. Remove these sensors and transfer them to the replacement part.

Figure 5-595 Remove the left lower cover

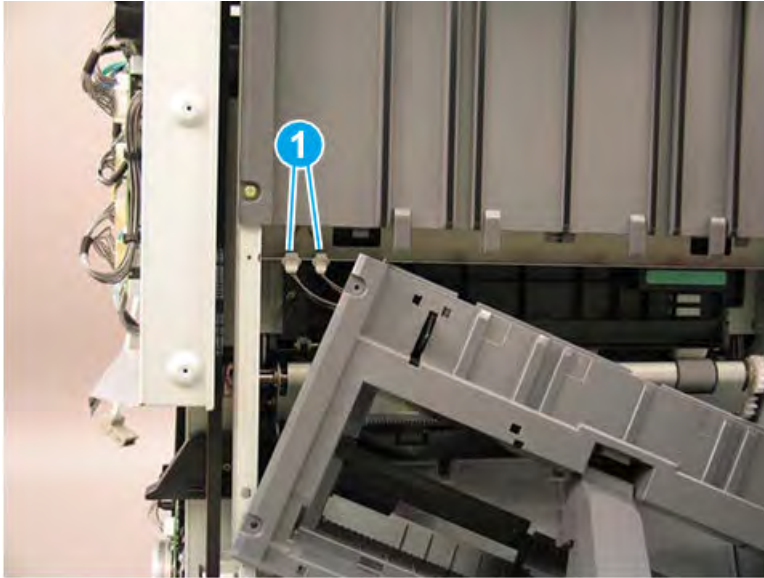
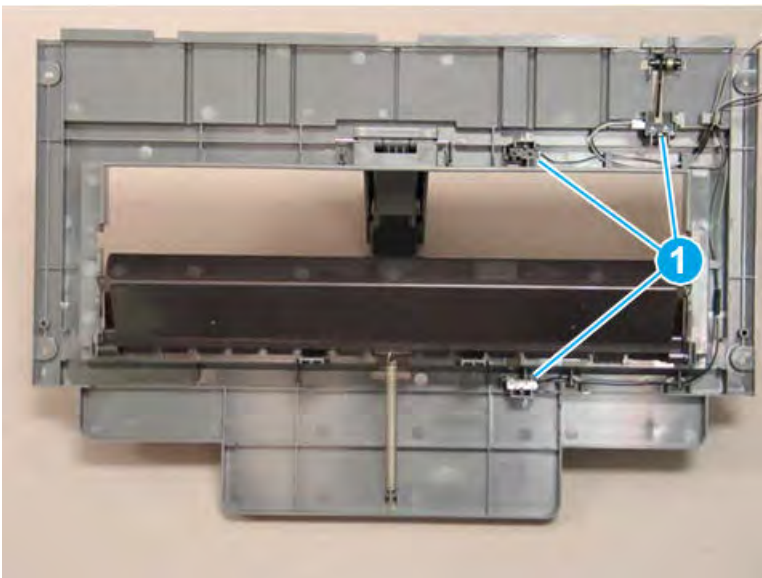

Remove the left upper cover (finisher)

Follow these steps to remove the left upper cover (finisher).

1. Bring the lower output tray down by positioning the shaft of a screwdriver on the clutch (callout 1) and gently pressing to the right to release the clutch. Hold the clutch in the released position and lower the tray (callout 2) to the lowest position.

Figure 5-596 Lower the output tray

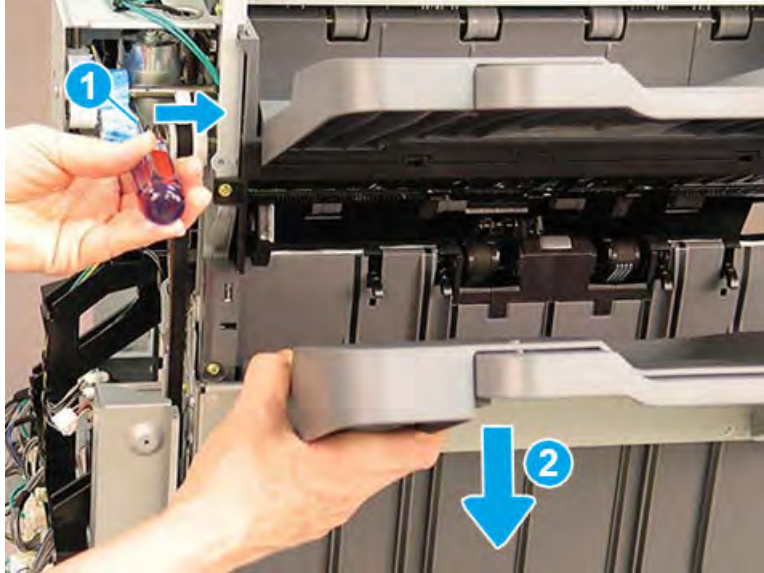

2. Remove six machine screws (callout 1).

Figure 5-597 Remove six screws

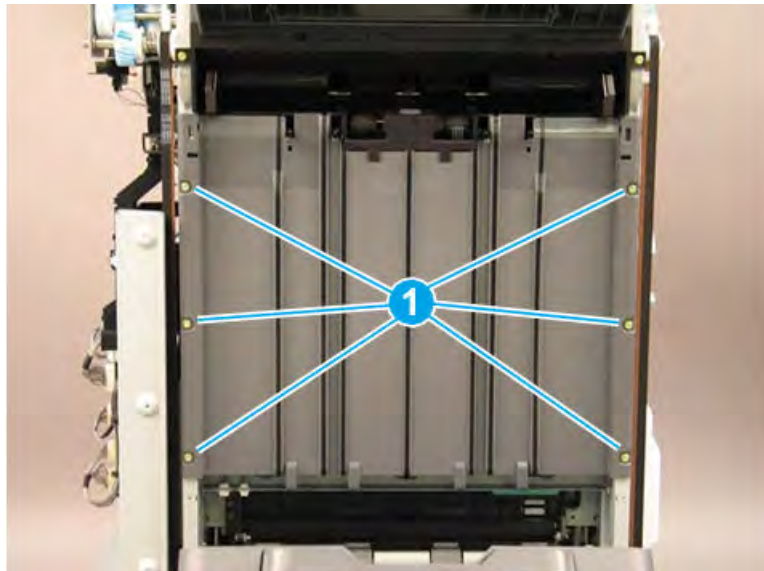

3. Rotate the lower edge of the shield away from the finisher (callout 1), and then slide the shield down (callout 2) to release it from two tabs (callout 3).

⚠ CAUTION: The shield is still attached to the finisher. Do not attempt to completely remove the shield.

💡 TIP: Position the shield under the two tabs (callout 3) when reinstalling it.

Figure 5-598 Release the shield

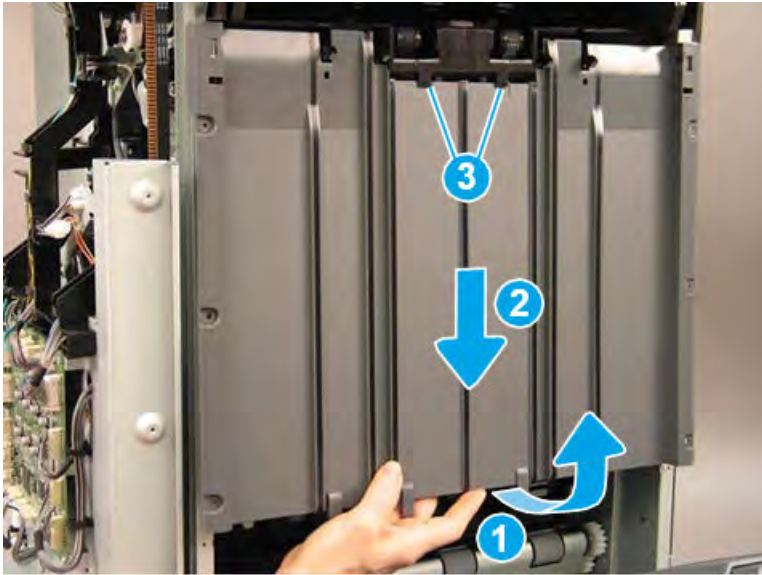

4. Disconnect one connector (callout 1), and then remove the upper shield assembly.

💡 TIP: Reverse the removal steps to install the assembly.

Figure 5-599 Disconnect one connector

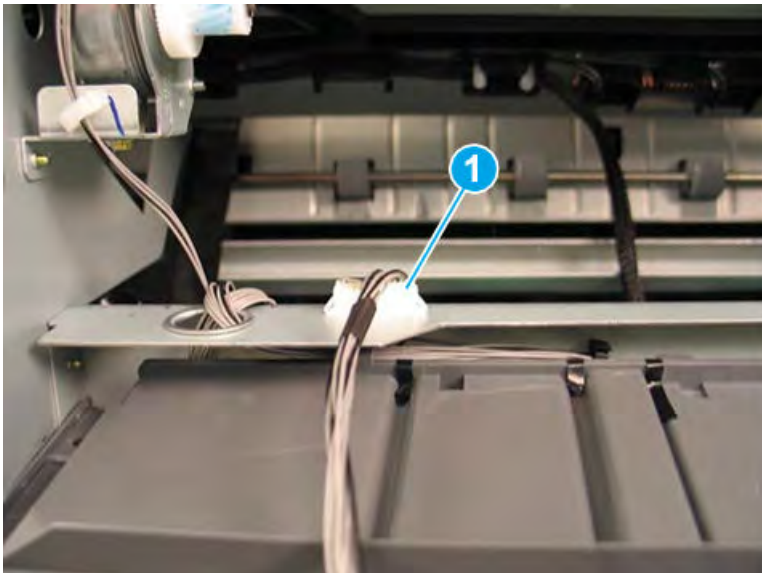

5. If you are replacing the left upper cover, locate three sensors (callout 1) on the back of the left upper cover. Remove these sensors and transfer them to the replacement part.

Figure 5-600 Remove the left upper cover

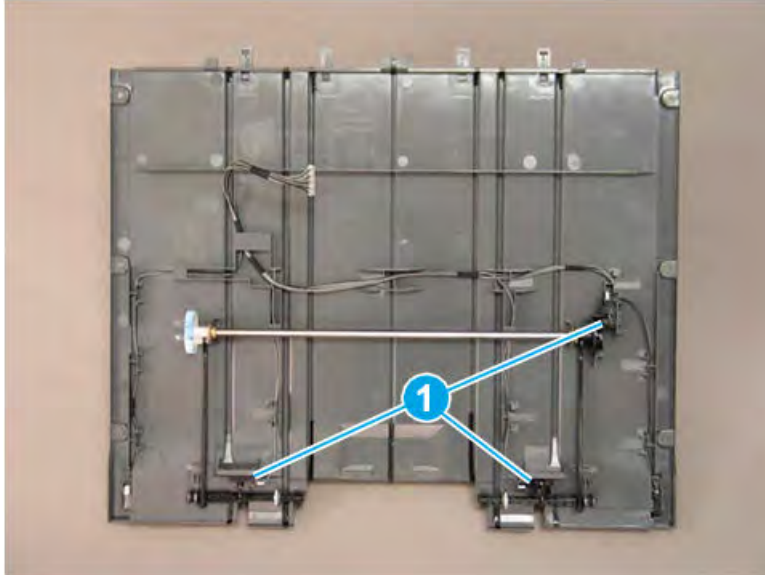

Remove the ejector unit (finisher)

Follow these steps to remove the ejector unit (finisher).

1. Rotate the green wheel to move the staple unit to the center of the finisher.

Figure 5-601 Move the staple unit to the center

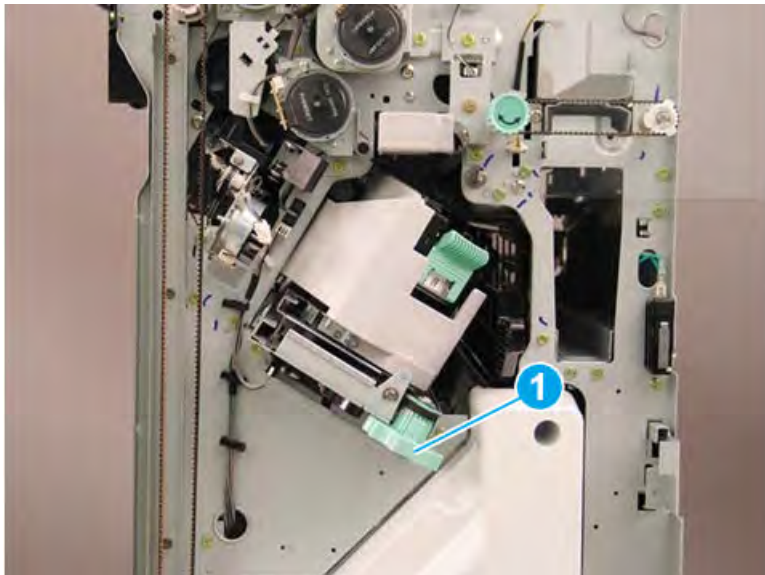

2. Release one retainer (callout 1), and then disconnect three connectors (callout 2).

Figure 5-602 Disconnect three connectors

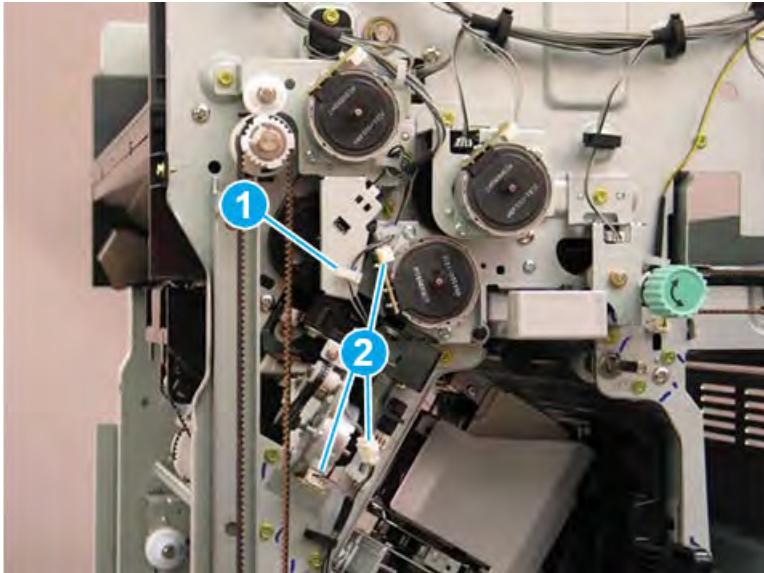

3. Remove two screws (callout 1).

Figure 5-603 Remove two screws

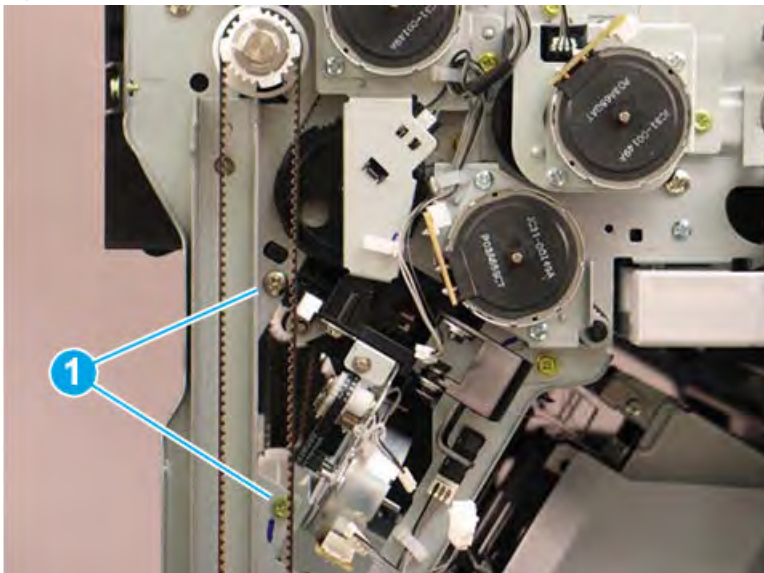

4. At the left side of the finisher, remove one screw (callout 1).

Figure 5-604 Remove one screw

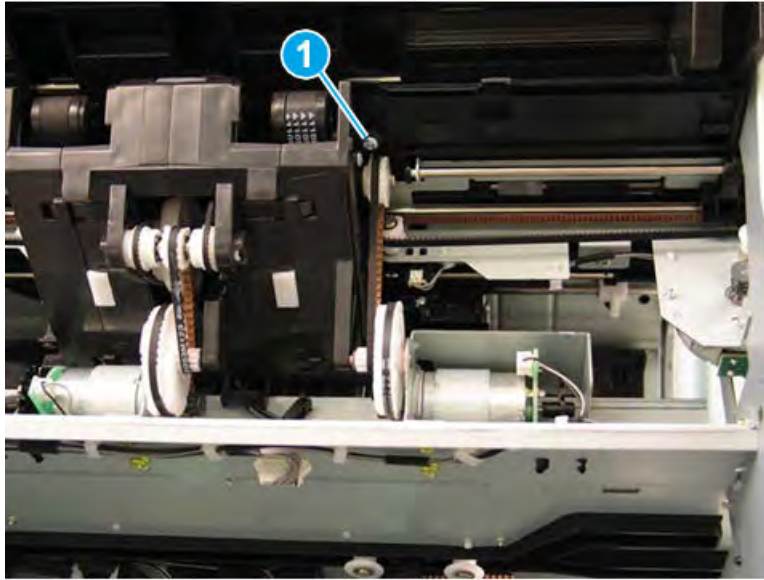

5. Press up on the hinge (callout 1), release one tab (callout 2), and then rotate the sensor away from the finisher (callout 3).

Figure 5-605 Rotate the sensor

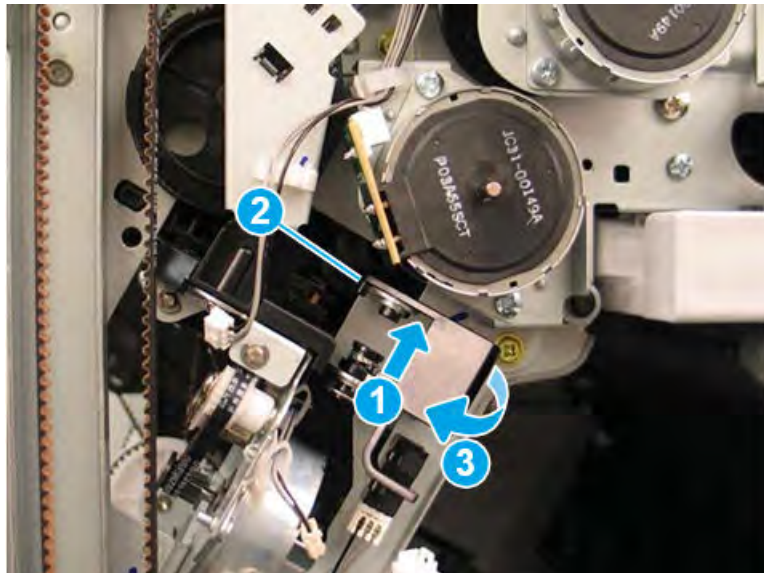

6. Remove one screw (callout 1).

Figure 5-606 Remove one screw

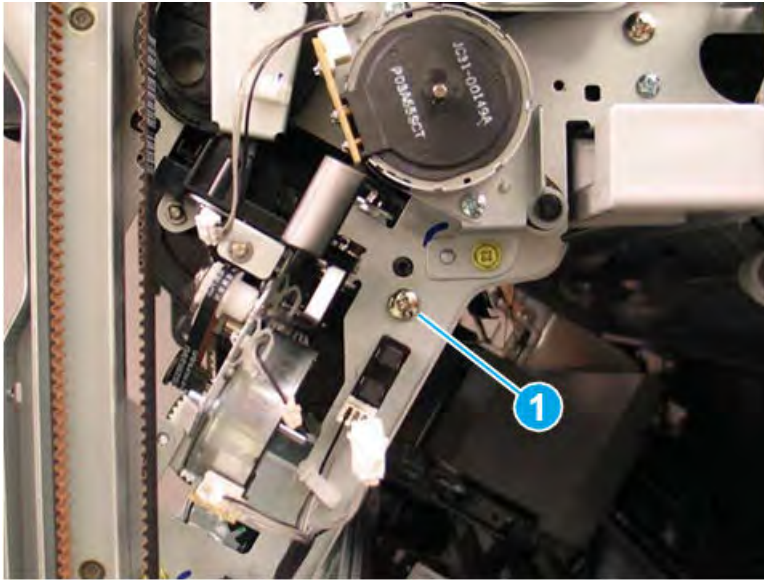

7. Look inside the finisher through the stapler opening in the front and pull down to release and remove one shaft (callout 1) on the front tamper unit.

Figure 5-607 Remove the front tamper shaft

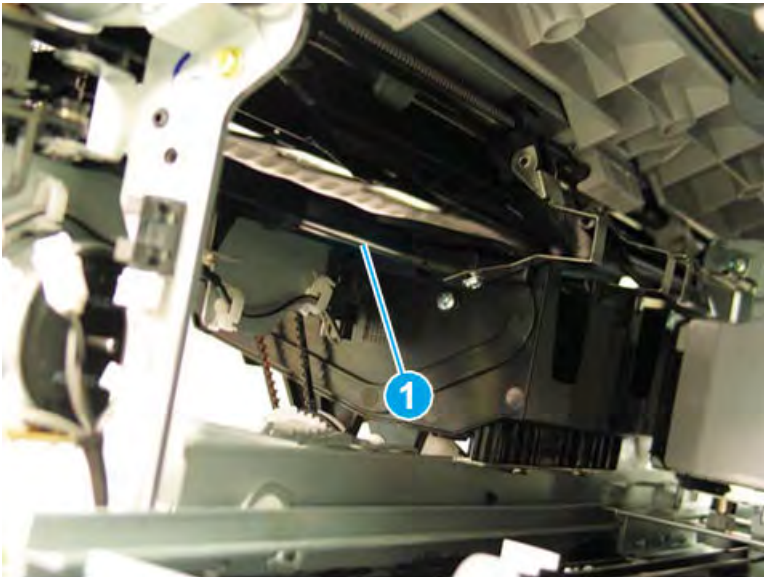

8. At the rear of the finisher, disconnect two connectors (callout 1), and then remove three screws (callout 2).

Figure 5-608 Disconnect two connectors and remove three screws

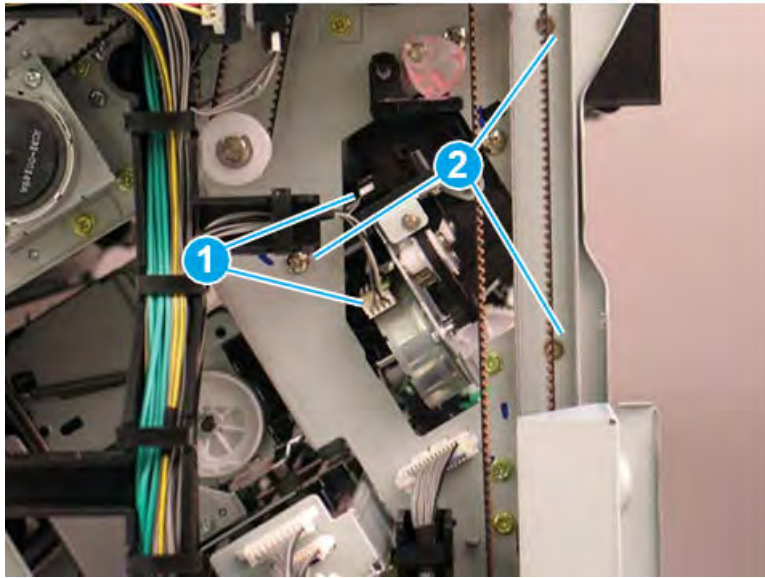

9. At the left side of the finisher, remove one screw (callout 1).

Figure 5-609 Remove one screw

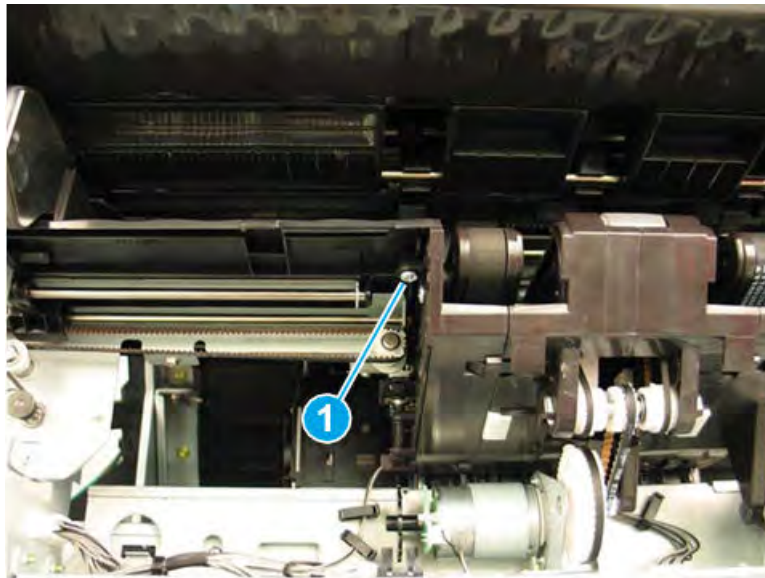

10. Look inside the finisher through the stapler opening in the rear and pull down to release and remove one shaft (callout 1) on the rear tamper unit.

Figure 5-610 Remove the rear tamper shaft

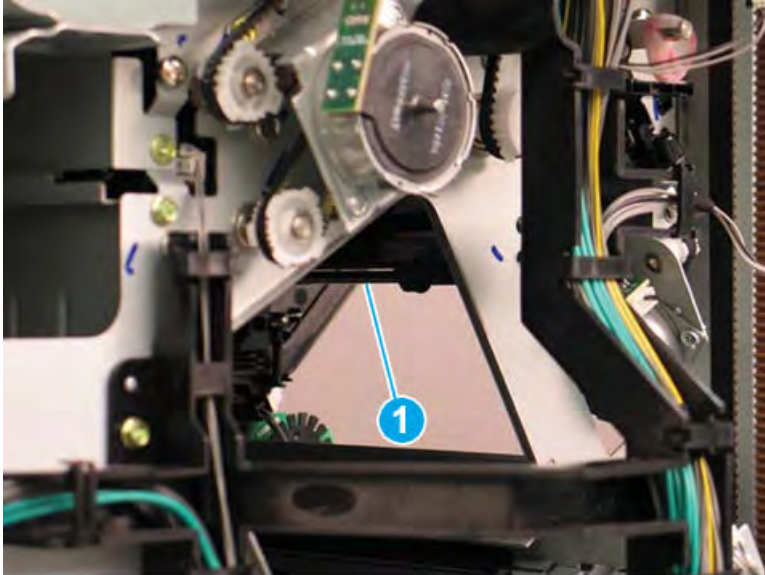

11. At the left side of the finisher, disconnect one connector (callout 1).

Figure 5-611 Disconnect one connector

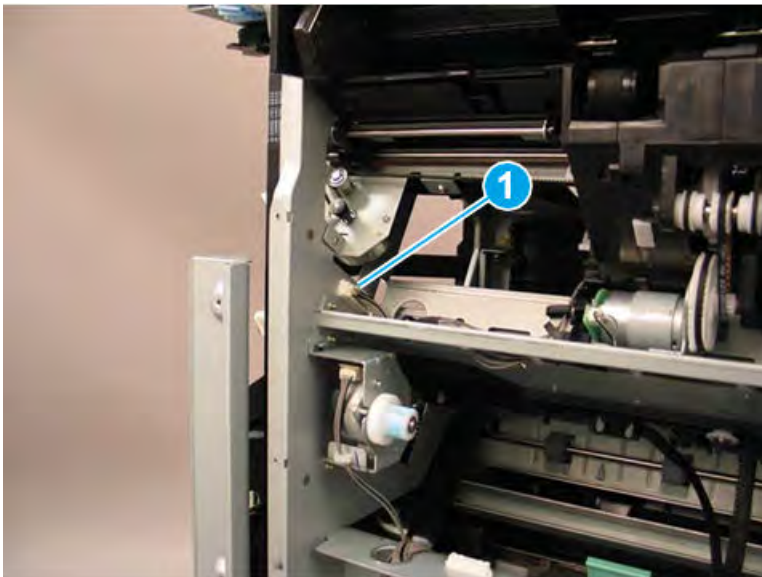

12. At the rear of the finisher, disconnect one connector (callout 1).

Figure 5-612 Disconnect one connector

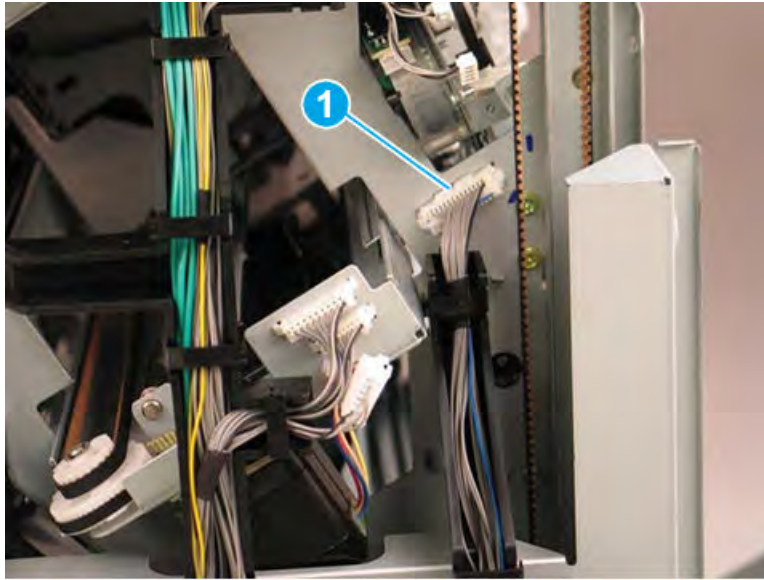

13. At the rear of the finisher, press the wire retainer to the right to access and remove two screws (callout 1).

Figure 5-613 Disconnect one connector

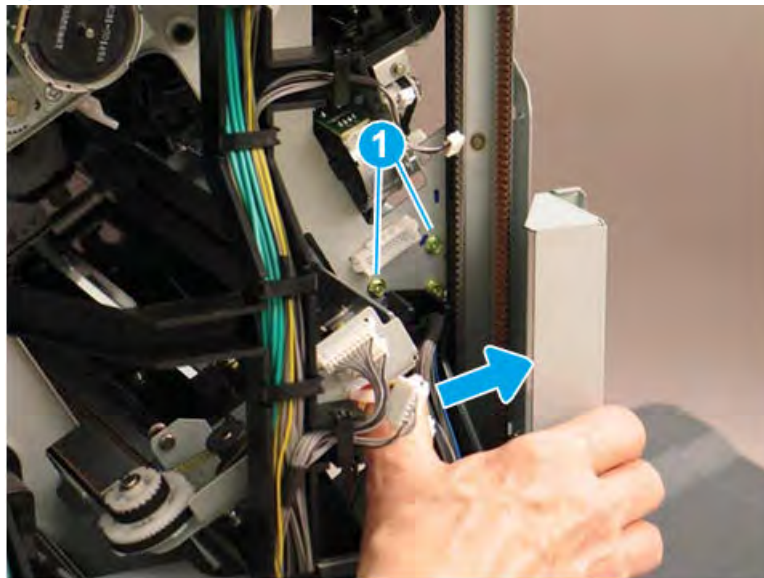

14. At the front of the finisher, remove two screws (callout 1).

Figure 5-614 Remove two screws

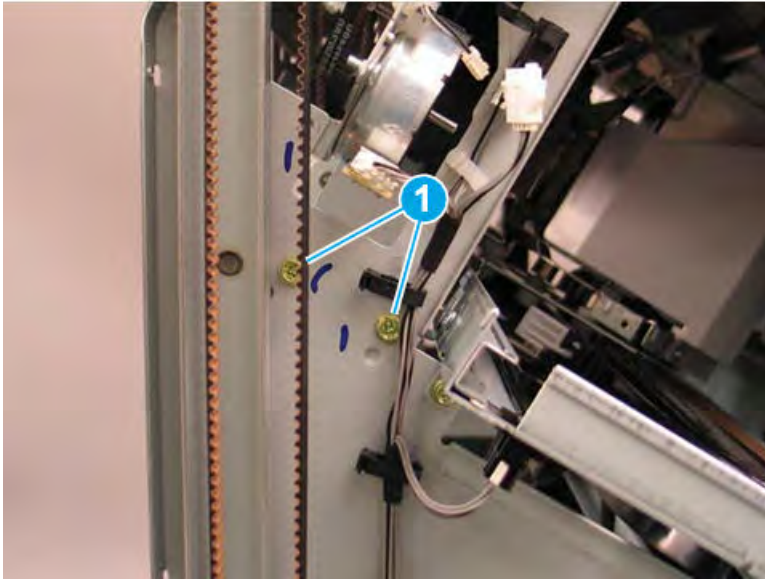

15. Lift the inside edges of the front and rear tampers up.

Figure 5-615 Lift the edges of the tampers

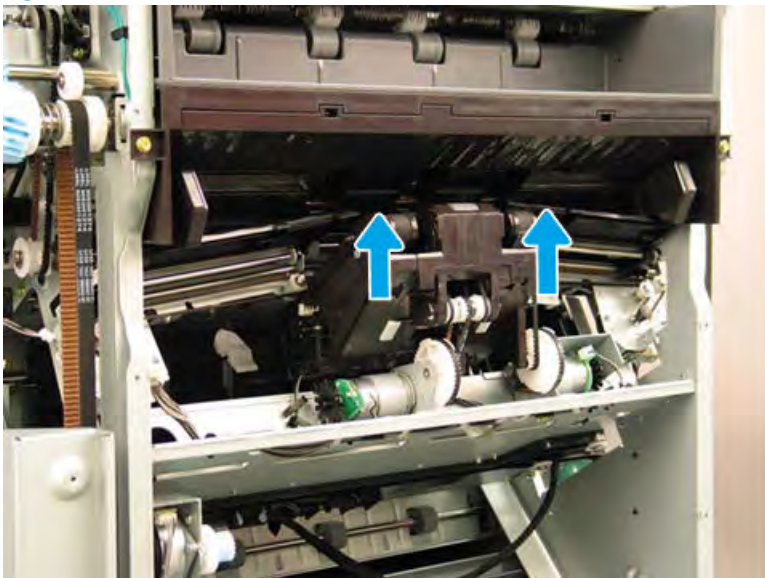

16. Rotate the rear edge of the ejector unit away from the finisher (callout 1), and then slide it toward the rear of the finisher (callout 2) to remove it. Make sure that the PCA (callout 3) stays clear of the sheet metal frame.

Figure 5-616 Remove the ejector unit

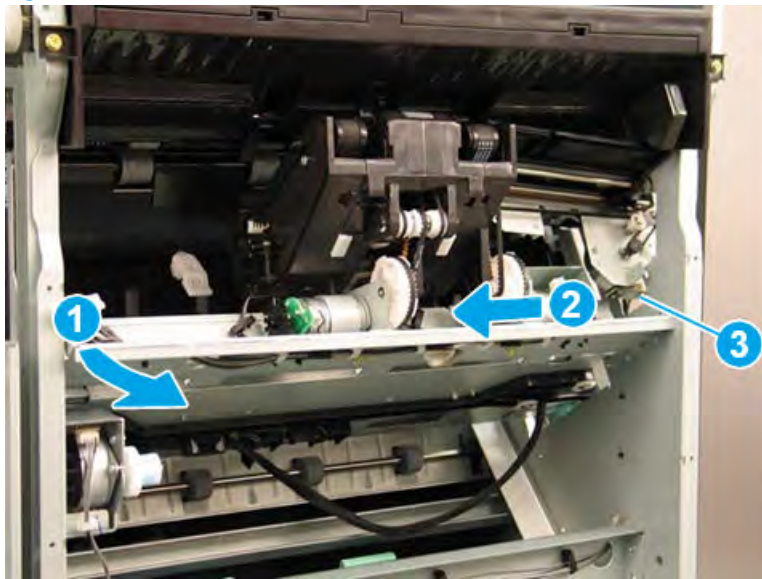

17. Reverse the removal steps to install the assembly. Also use the following special installation instructions.

 **NOTE:** Continue to reverse the removal steps to finish installing the assembly.

Special installation instructions: Ejector unit

- a. When the front tamper shaft is removed, the retainer arm that held the one end of the shaft will drop down. When reinstalling the shaft, raise the retainer arm and position the end of the shaft in the notch (callout 1).

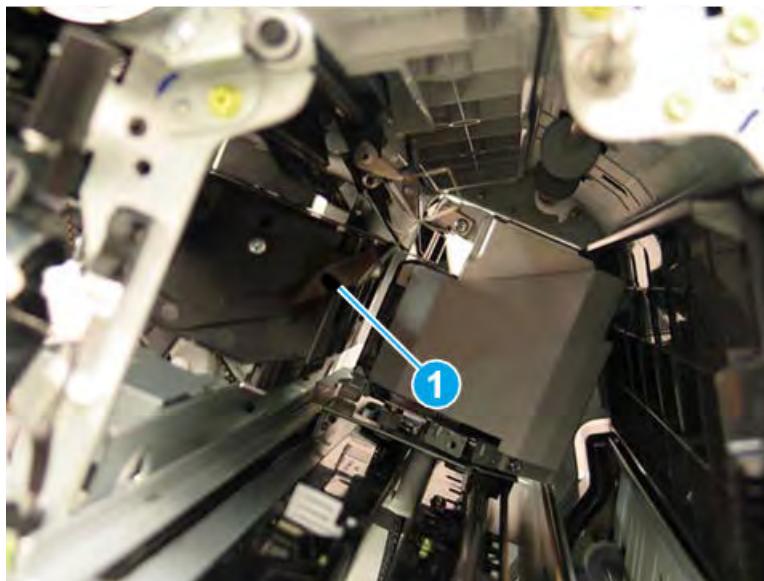

- b. When the rear tamper shaft is removed, the retainer arm that held the one end of the shaft will drop down. When reinstalling the shaft, raise the retainer arm and position the end of the shaft in the notch (callout 1).

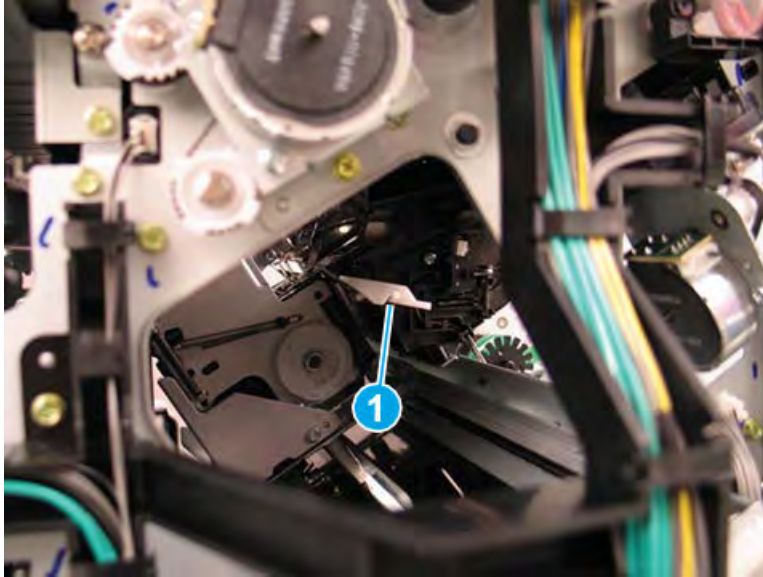

Remove the front tamper unit

Follow these steps to remove the front tamper unit.

- ▲ Lift the front tamper away from the finisher to remove it

Figure 5-617 Remove the front tamper



Remove the front tamper home sensor(S6)

Follow these steps to remove the front tamper home sensor(S6).

1. Remove two screws (callout 1) at front tamper.

Figure 5-618 Remove two screws

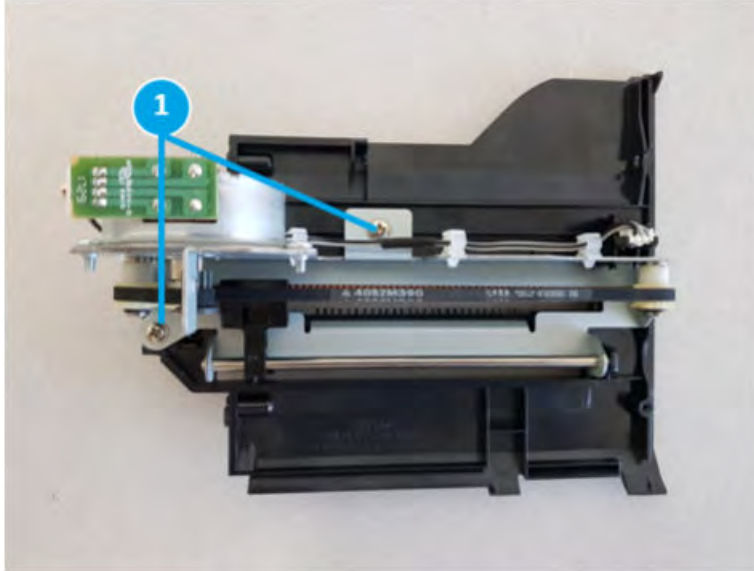

2. Remove one screw (callout 1)

Figure 5-619 Remove one screw

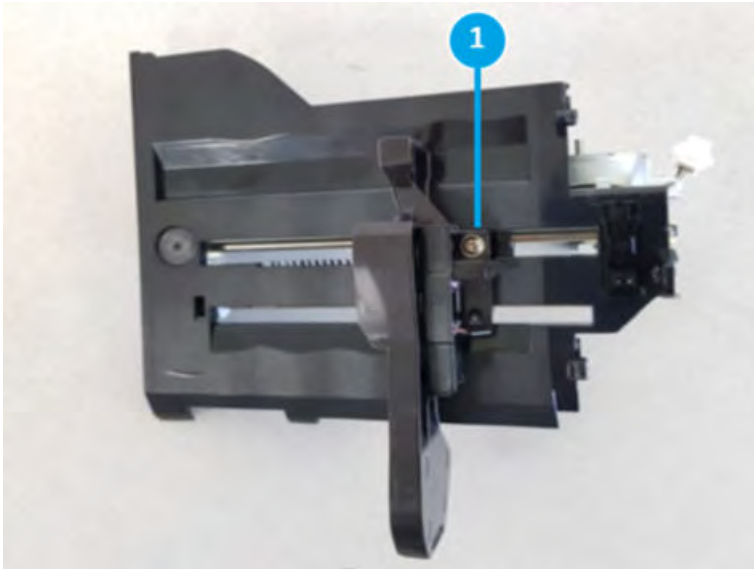

3. Remove front tamper home sensor(S6, callout 1)

Figure 5-620 Remove front tamper home sensor

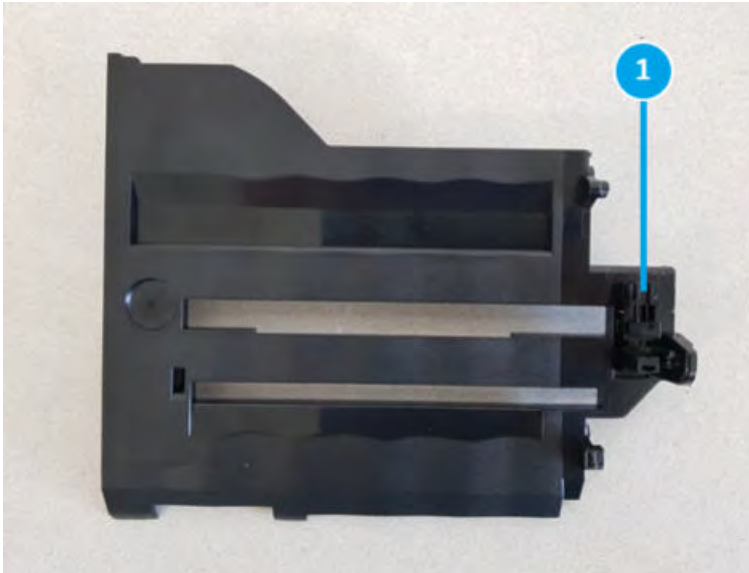

Unpack the replacement assembly

Follow these steps to unpack the replacement assembly.

1. Dispose of the defective part.

 **NOTE:** HP recommends responsible disposal of the defective part.

<http://www8.hp.com/us/en/hp-information/environment/product-recycling.html>

2. Unpack the replacement part from the packaging.



CAUTION:  Some parts are sensitive to electrostatic discharge (ESD). Always perform service work at an ESD-protected workstation or mat. If an ESD workstation or mat is not available, touch the sheet-metal chassis to provide a static ground before touching an ESD-sensitive assembly. Protect the ESD-sensitive assemblies by placing them in ESD pouches when they are out of the printer.

 **IMPORTANT:** Make sure that all of the shipping materials (for example shipping tape) are removed from the replacement part prior to installation.

 **NOTE:** If the replacement part is a roller or pad, avoid touching the spongy part of it. Skin oils on the roller or pad can cause paper pickup and/or print-quality problems. HP recommends using disposable gloves when handling rollers or pads or washing your hands before touching rollers or pads.

3. To install an assembly, reverse the removal steps.

 **NOTE:** When applicable, special installation instructions are provided for an assembly at the end of the removal procedure. Always completely read the removal instructions and follow all special installation instructions.

Removal and replacement: Front tamper motor (M4)

Learn how to remove and replace the front tamper motor.

Introduction

This document provides the procedures to remove and replace the front tamper motor on the finisher.

 **IMPORTANT:** When applicable, special installation instructions are provided for an assembly at the end of the removal procedure. Always completely read the removal instructions and follow all special installation instructions.

Before performing service

- Turn the printer power off. A shutting-down message appears on the control-panel display.

 **WARNING!** To avoid damage to the printer, turn the power off and wait until the printer shuts down before removing the power cable.

- Disconnect the printer power cable after the printer has completely shut down (the control-panel display is blank).
- Release the finisher from the printer by pulling out on the release latch inside the finisher door.
- Disconnect the cable from the bridge unit to the finisher.
- Disconnect the cable from the finisher to the printer.

Use the table below to identify the correct part number for your printer. To order the part, go to <https://parts.hp.com>.

Table 5-115 Part information

Part number	Part description
JC93-01001A	Front tamper motor

Required tools

- #2 JIS screwdriver with a magnetic tip

After performing service

- Connect the cable from the finisher to the printer.
- Connect the cable from the bridge unit to the finisher.
- Attach the finisher to the printer, and then push in on the release latch inside the finisher door.
- Connect the printer power cable.
- Turn the printer power on.

Post service test

Process a job through the finisher and verify that the finisher works correctly.

Remove the right upper cover (finisher)

Follow these steps to remove the right upper cover (finisher).

- ▲ Remove one screw cap and three machine screws on the upper edge of the cover (callout 1). Remove three sheet metal screws (callout 2) on the lower portion of the cover. Rotate the right edge of the cover away from the finisher, and then slide the cover right to release three tabs (callout 3).

💡 **TIP:** The lower screws are shorter in length than the upper screws.

TIP: Reverse the removal steps to install the assembly.

Figure 5-621 Remove the right upper cover

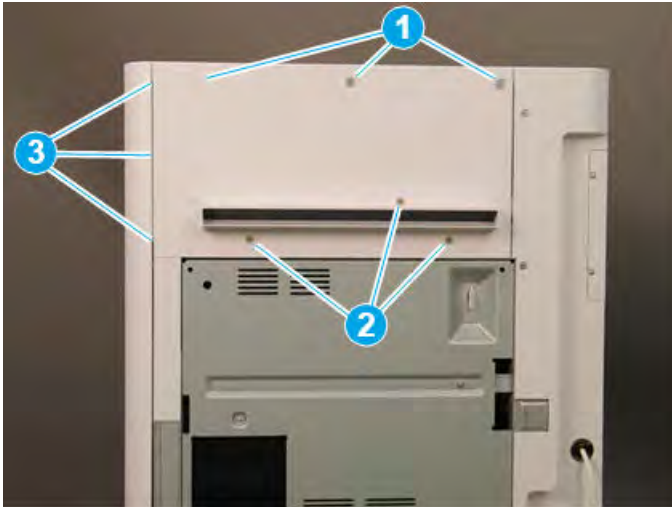

Remove the top cover (finisher)

Follow these steps to remove the top cover (finisher).

1. Remove three screw caps and three self-tapping screws at the top of the rear cover (callout 1), and then remove three machine screws (callout 2) on top of the cover.

Figure 5-622 Remove six screws

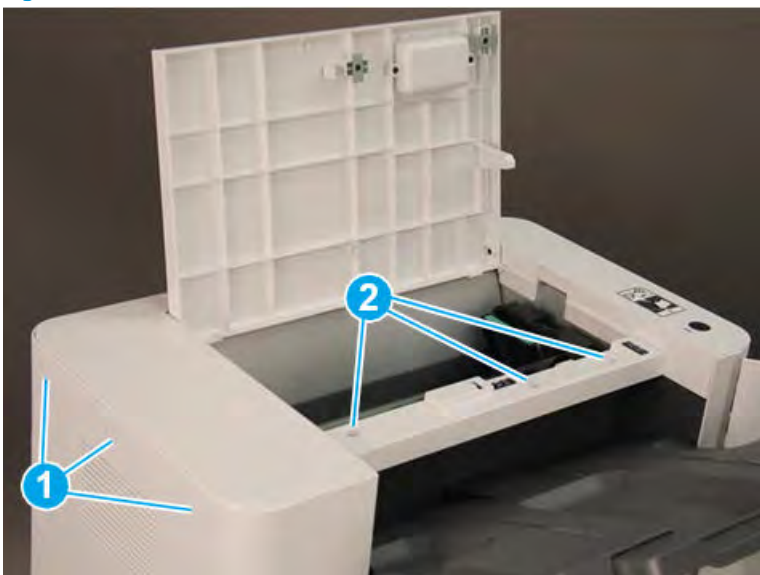

2. Remove three self-tapping screws at the top of the front cover (callout 1), and then remove two machine screws (callout 2) at the top of the right side.

Figure 5-623 Remove five screws

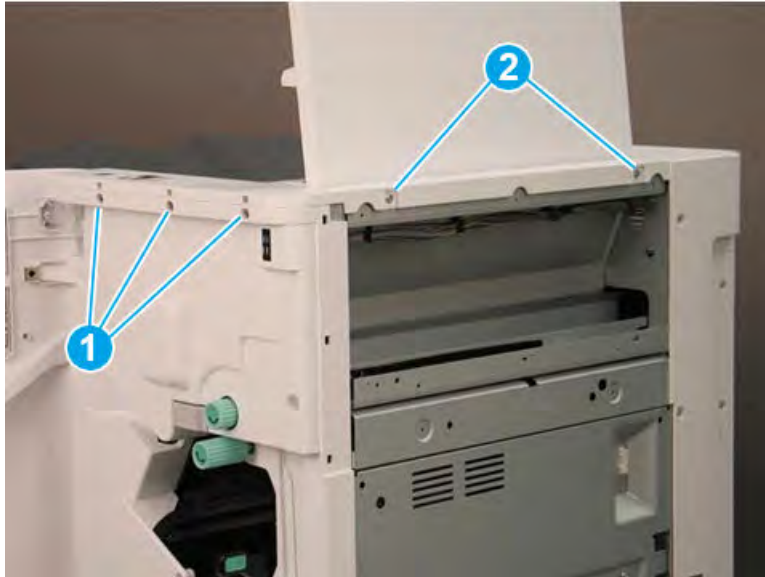

3. Lift the cover up slightly. Disconnect one in-line connector (callout 1), and then release one retainer (callout 2).

 **TIP:** Reverse the removal steps to install the assembly.

Figure 5-624 Disconnect one connector and release retainer



Remove the front door (finisher)

Follow these steps to remove the front door (finisher).

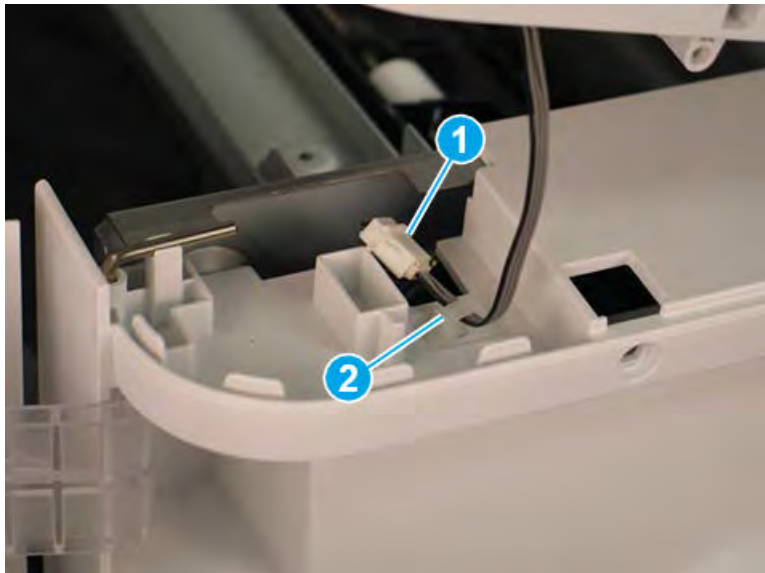
1. Lift the top hinge pin up to release it from the retainer.

Figure 5-625 Lift the top hinge pin

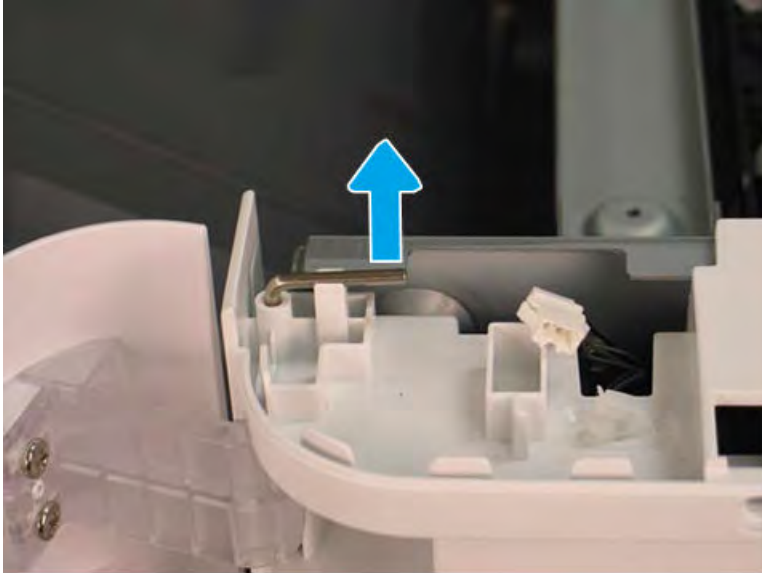

2. Pull the top hinge pin up to remove it.

Figure 5-626 Remove the top hinge pin

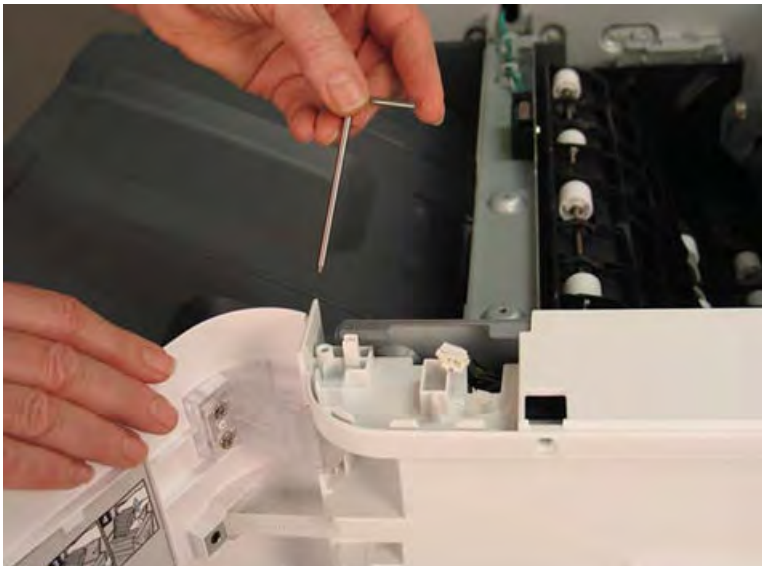

3. Use a small, flat-blade screwdriver to release the lower hinge pin from the retainer, and then rotate it away from the finisher.

Figure 5-627 Release the lower hinge pin



4. Support the door with one hand, and then pull the lower hinge pin straight up to remove it.

Figure 5-628 Remove the lower hinge pin



5. Support the door with one hand, and then remove one screw (callout 1) to release the strap. Remove the front door.

 **TIP:** Reverse the removal steps to install the assembly.

Figure 5-629 Remove the front door



Remove the front cover (finisher)

Follow these steps to remove the front cover (finisher).

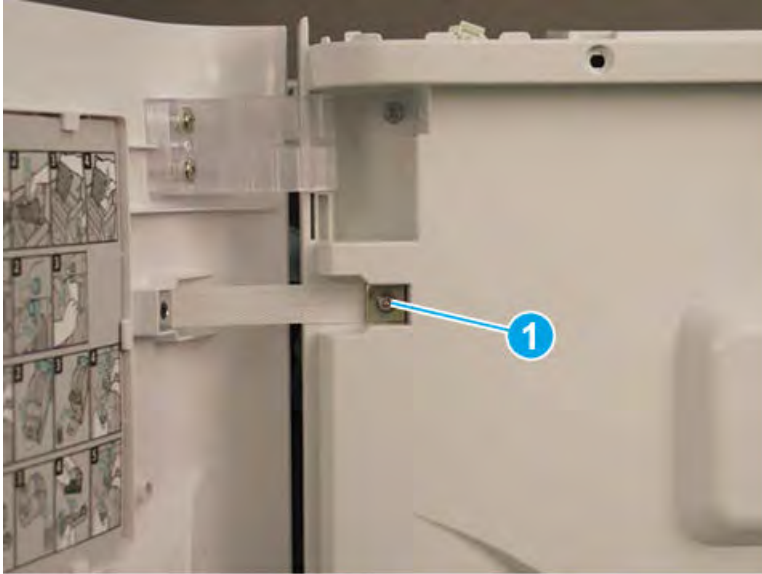
1. Release one tab (callout 1), and then pull the jam-access knob away from the finisher to remove it.

Figure 5-630 Remove the jam-access knob

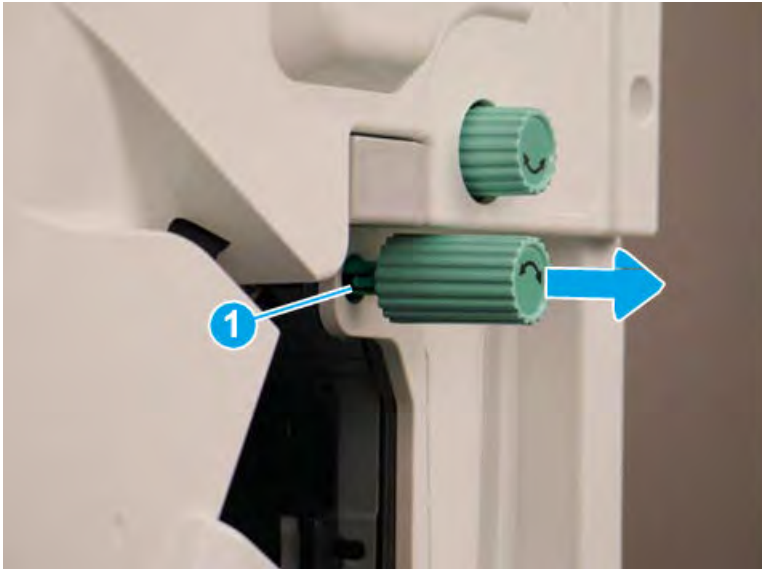

2. If the punch unit is installed, remove the punch waste bin (callout 1).

3. Remove one screw (callout 1) on top of the front cover.

Figure 5-631 Remove one screw



4. Remove five machine screws (callout 1), and then remove the front cover.

 **TIP:** Reverse the removal steps to install the assembly.

Figure 5-632 Remove the front cover



Remove the rear cover (finisher)

Follow these steps to remove the rear cover (finisher).

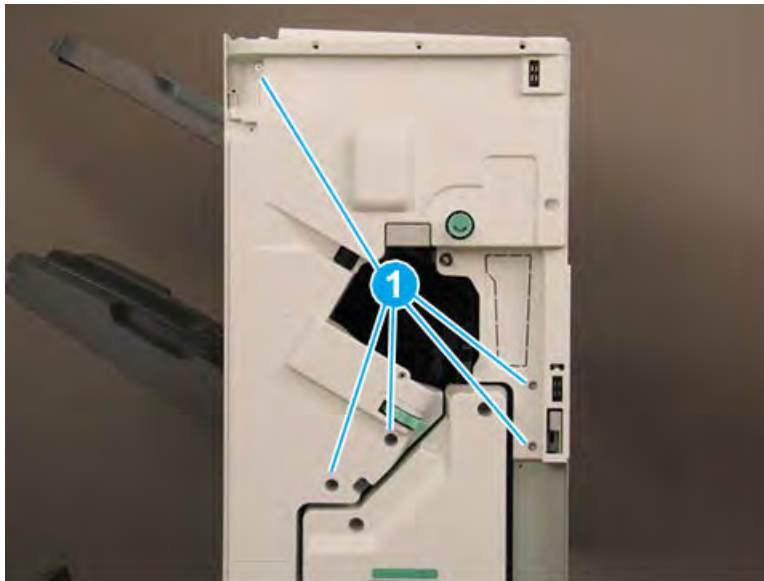
1. Remove two self-tapping screws (callout 1) on the top of the rear cover, and then remove five screw caps and five machine screws (callout 2) on the left side of the cover.

Figure 5-633 Remove seven screws



2. Remove one screw cap and four machine screws (callout 1) Remove the rear cover.

 **NOTE:** Make sure to thread the power cable (callout 2) through the opening in the cover.

 **TIP:** Reverse the removal steps to install the assembly

Figure 5-634 Remove the rear cover

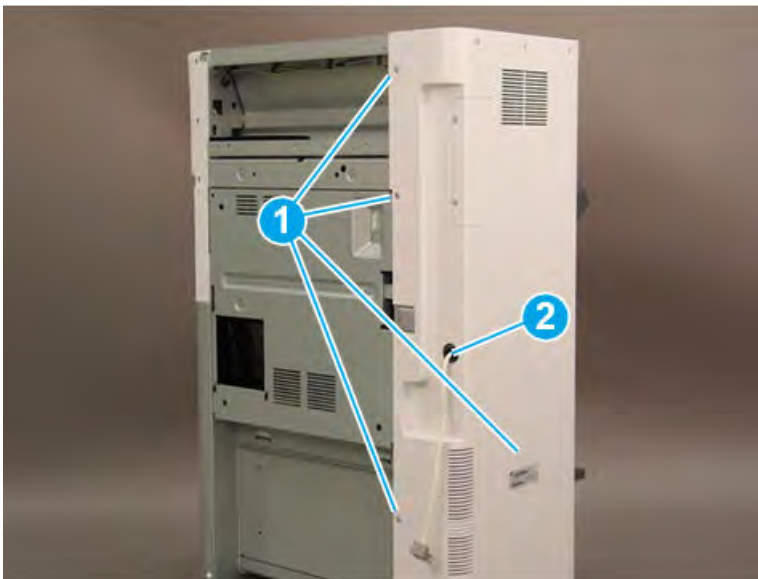

Remove the booklet output tray

Follow these steps to remove the booklet output tray.

1. Raise the booklet output tray up (callout 1), and then pull it away from the finisher (callout 2) to remove it.

Figure 5-635 Remove the booklet output tray



2. Reverse the removal steps to install the assembly. Also use the following special installation instructions.

 **NOTE:** Continue to reverse the removal steps to finish installing the assembly

Special installation instructions: booklet output tray

Position the tabs (callout 1) on the tray into the slots (callout 2) on the finisher.

Figure 5-636 Install the booklet output tray

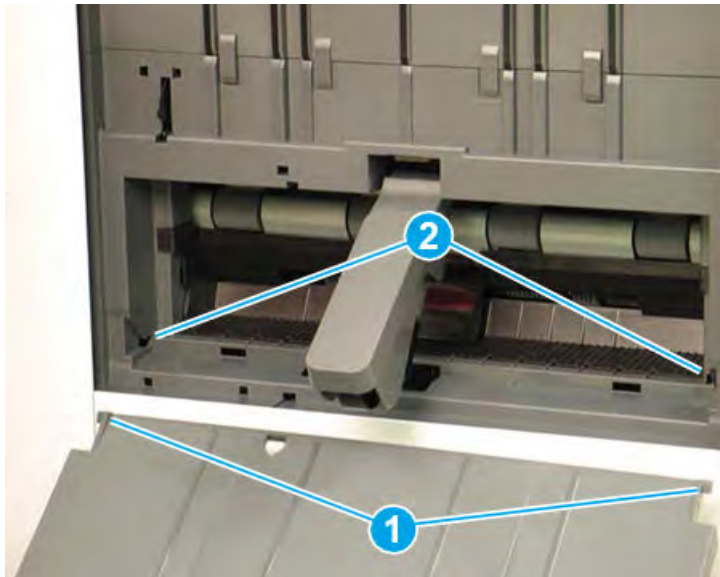

Remove the caster cover

Follow these steps to remove the caster cover.

1. Remove two screw caps and two self-tapping screws (callout 1). Remove two screw caps and two machine screws (callout 2).

Figure 5-637 Remove four screws

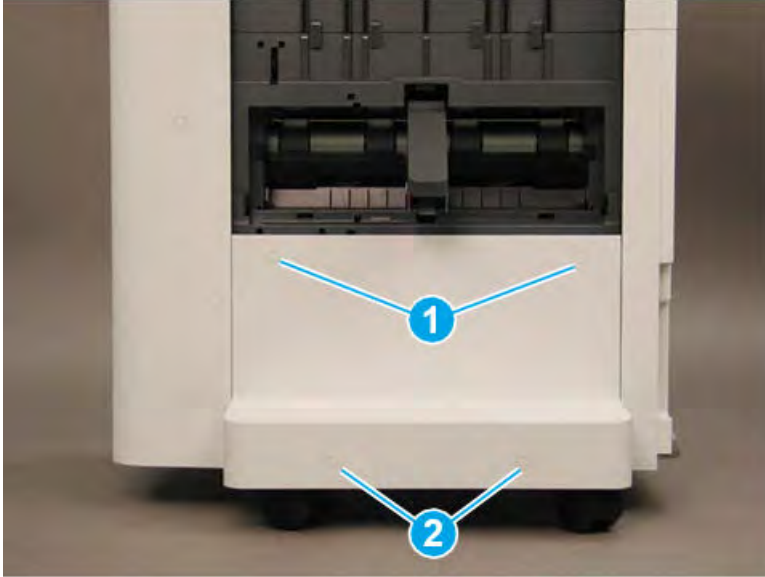

2. Rotate the left edge of the cover away from the finisher (callout 1), and then slide the cover to the left (callout 2) to remove it.

 **TIP:** Make sure that two tabs (callout 3) are positioned under the front lower cover when reinstalling the caster cover.

TIP: Reverse the removal steps to install the assembly

Figure 5-638 Remove the caster cover

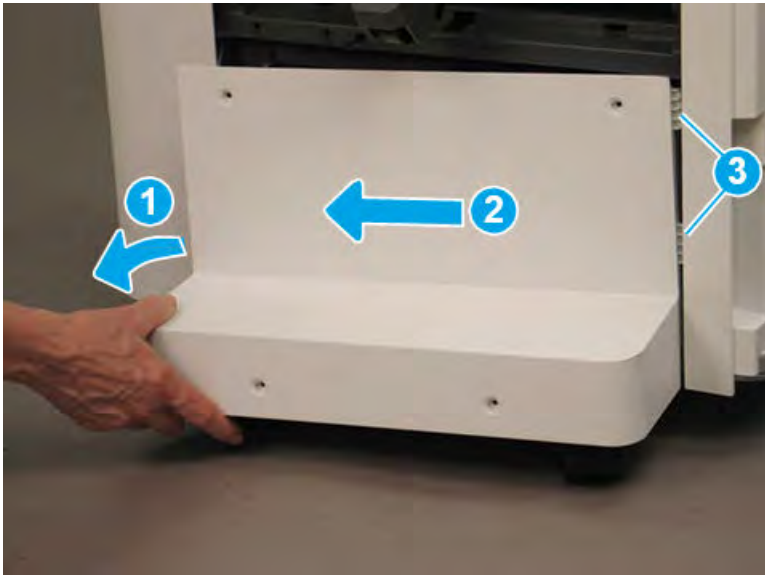

Remove the left lower cover (finisher)

Follow these steps to remove the left lower cover (finisher).

1. Remove four screws (callout 1).

 **NOTE:** Raise the lower output tray as needed to access the screws.

Figure 5-639 Remove four screws



2. Slide the shield down (callout 1) to release it from four tabs (callout 2), and then rotate it away from the finisher (callout 3).

⚠ CAUTION: The shield is still attached to the finisher. Do not attempt to completely remove the shield.

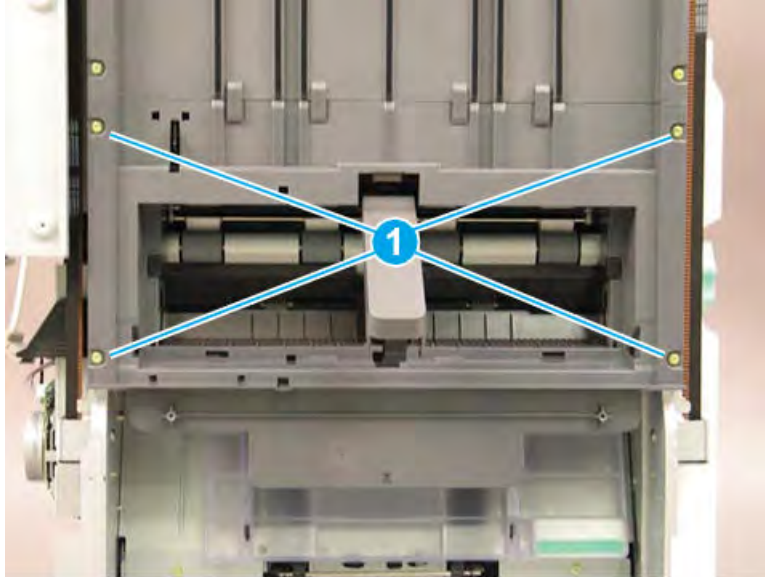
💡 TIP: Position the shield under the four tabs (callout 2) when reinstalling it.

Figure 5-640 Release the lower shield

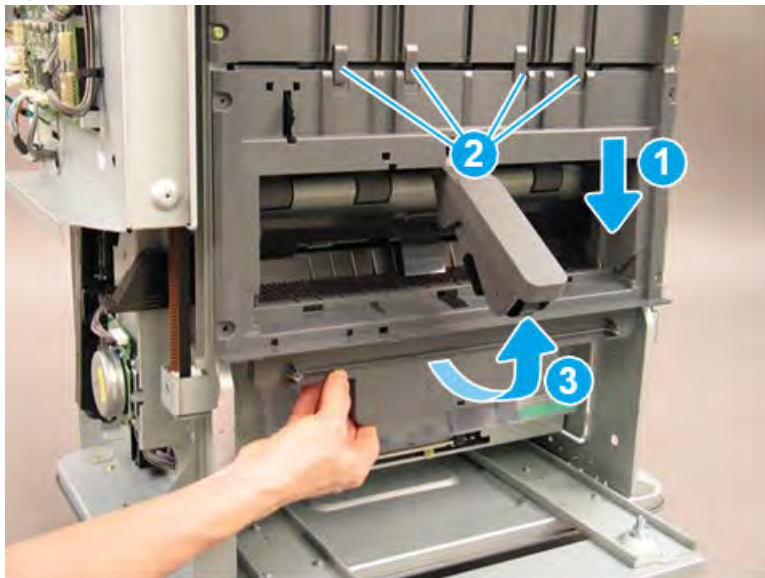

3. Disconnect two connectors (callout 1), and then remove the shield.

 **TIP:** Reverse the removal steps to install the assembly.

Figure 5-641 Disconnect two connectors



4. If you are replacing the left lower cover, locate three sensors (callout 1) on the back of the left lower cover. Remove these sensors and transfer them to the replacement part.

Figure 5-642 Remove the left lower cover

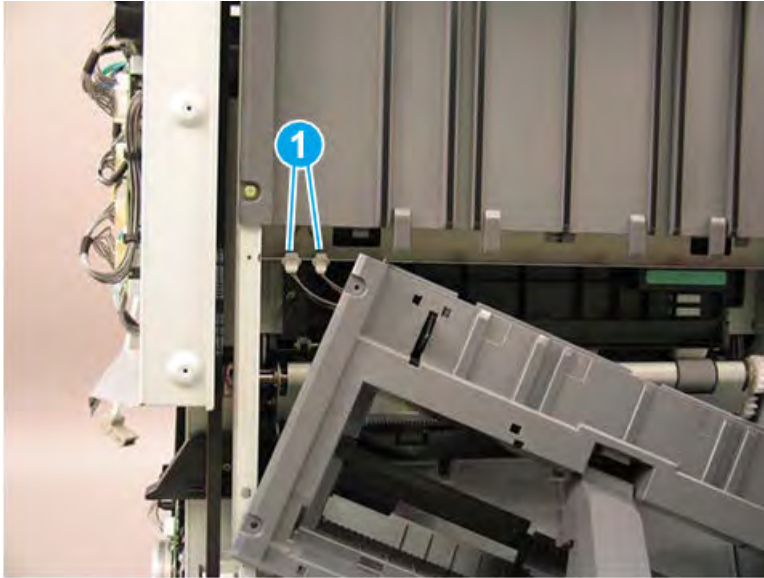
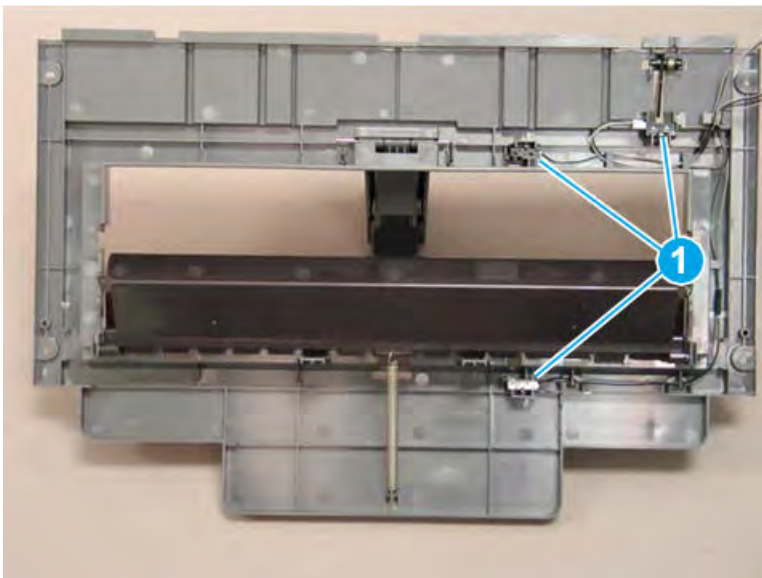

Remove the left upper cover (finisher)

Follow these steps to remove the left upper cover (finisher).

1. Bring the lower output tray down by positioning the shaft of a screwdriver on the clutch (callout 1) and gently pressing to the right to release the clutch. Hold the clutch in the released position and lower the tray (callout 2) to the lowest position.

Figure 5-643 Lower the output tray

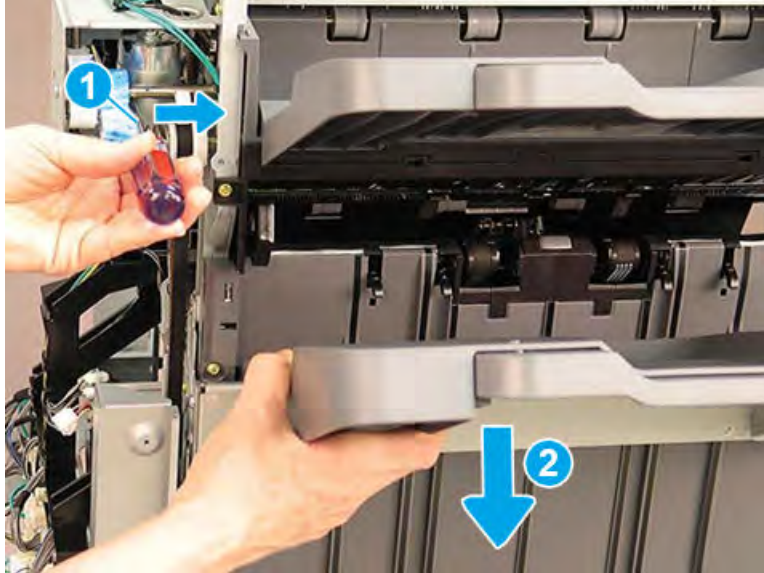

2. Remove six machine screws (callout 1).

Figure 5-644 Remove six screws

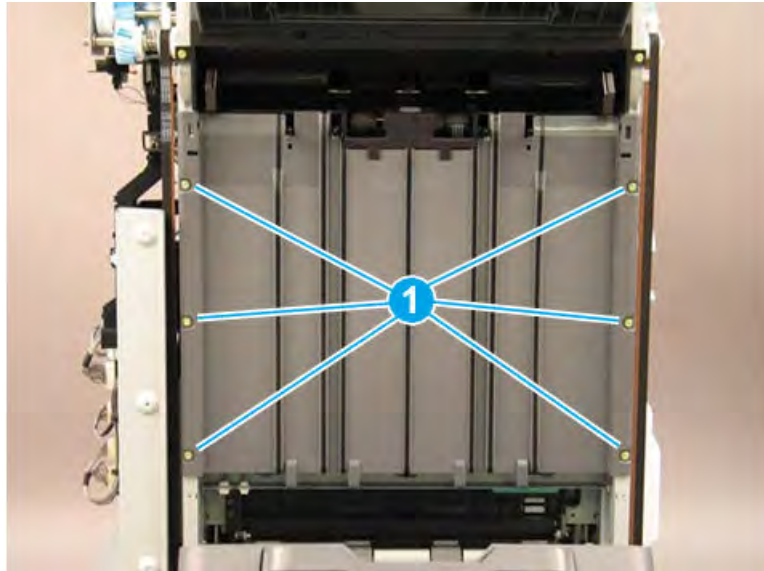

3. Rotate the lower edge of the shield away from the finisher (callout 1), and then slide the shield down (callout 2) to release it from two tabs (callout 3).

⚠ CAUTION: The shield is still attached to the finisher. Do not attempt to completely remove the shield.

💡 TIP: Position the shield under the two tabs (callout 3) when reinstalling it.

Figure 5-645 Release the shield

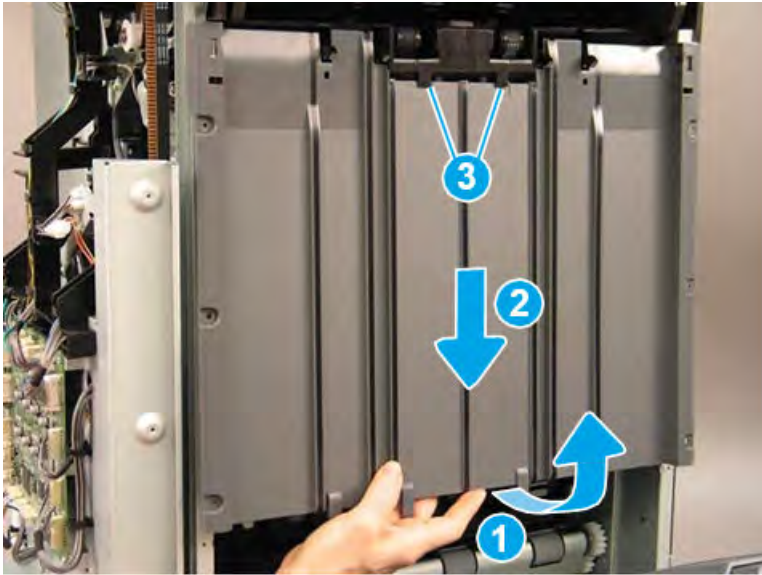

4. Disconnect one connector (callout 1), and then remove the upper shield assembly.

💡 TIP: Reverse the removal steps to install the assembly.

Figure 5-646 Disconnect one connector

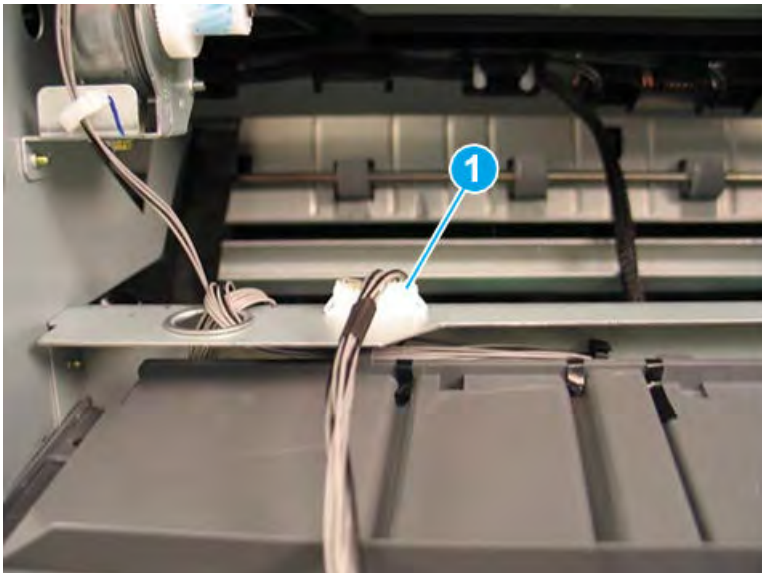

5. If you are replacing the left upper cover, locate three sensors (callout 1) on the back of the left upper cover. Remove these sensors and transfer them to the replacement part.

Figure 5-647 Remove the left upper cover

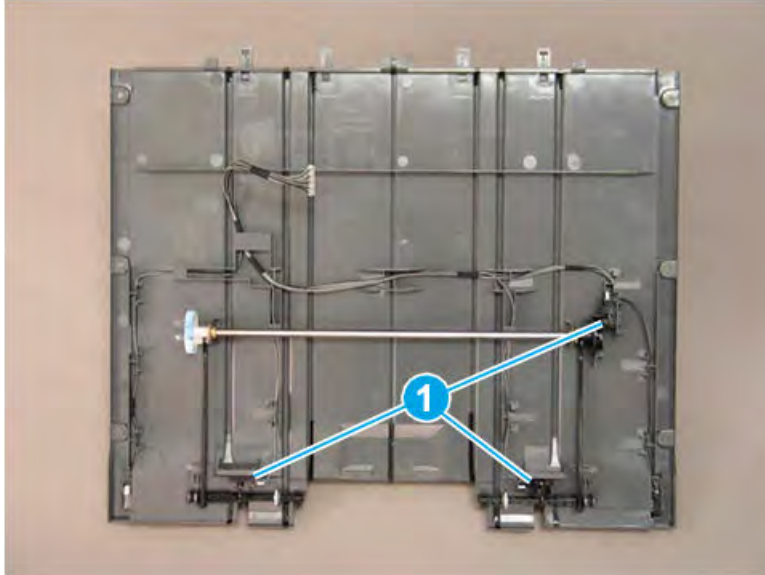

Remove the ejector unit (finisher)

Follow these steps to remove the ejector unit (finisher).

1. Rotate the green wheel to move the staple unit to the center of the finisher.

Figure 5-648 Move the staple unit to the center

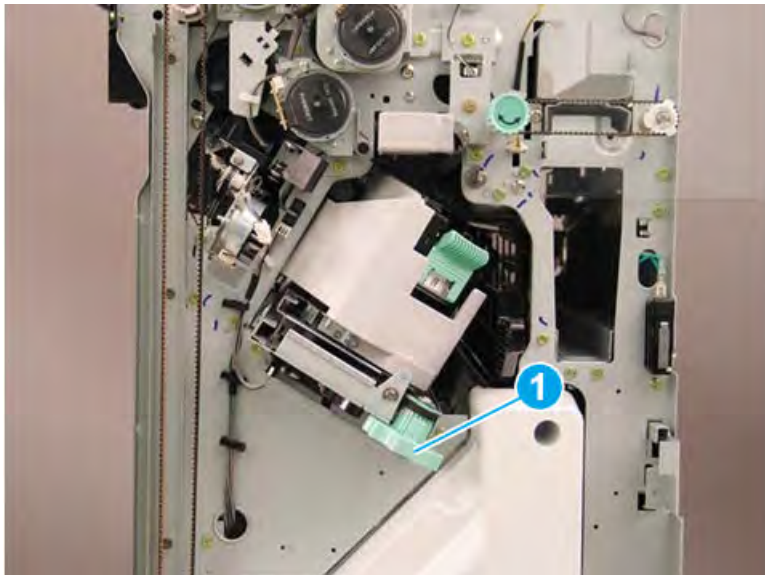

2. Release one retainer (callout 1), and then disconnect three connectors (callout 2).

Figure 5-649 Disconnect three connectors

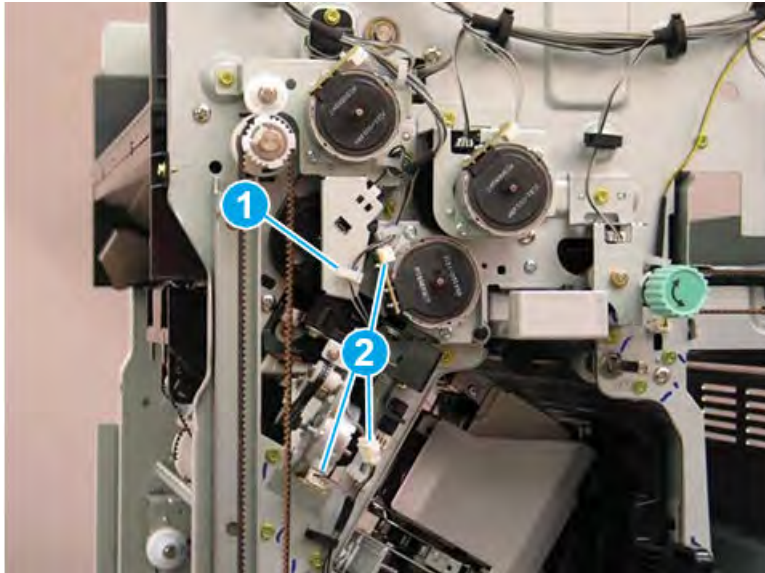

3. Remove two screws (callout 1).

Figure 5-650 Remove two screws

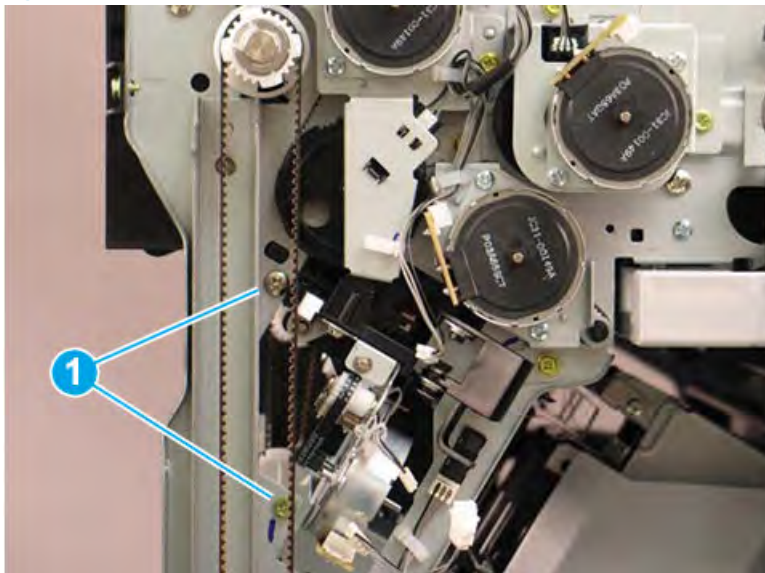

4. At the left side of the finisher, remove one screw (callout 1).

Figure 5-651 Remove one screw

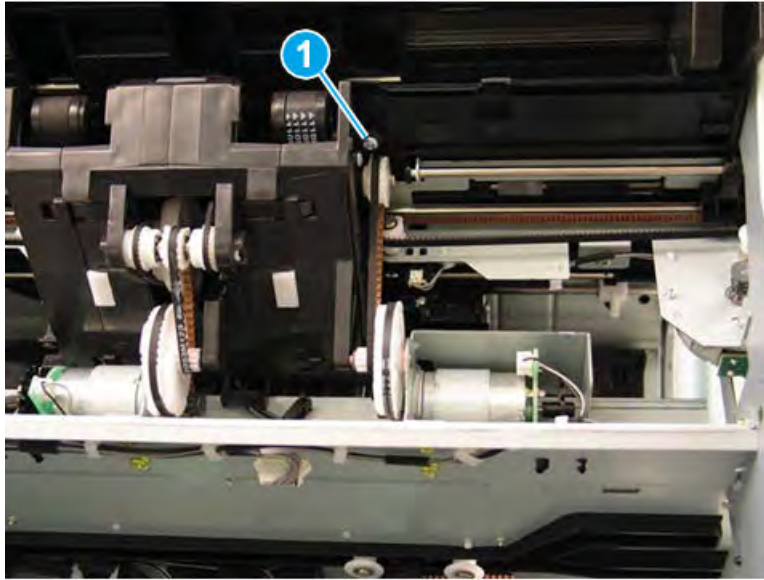

5. Press up on the hinge (callout 1), release one tab (callout 2), and then rotate the sensor away from the finisher (callout 3).

Figure 5-652 Rotate the sensor

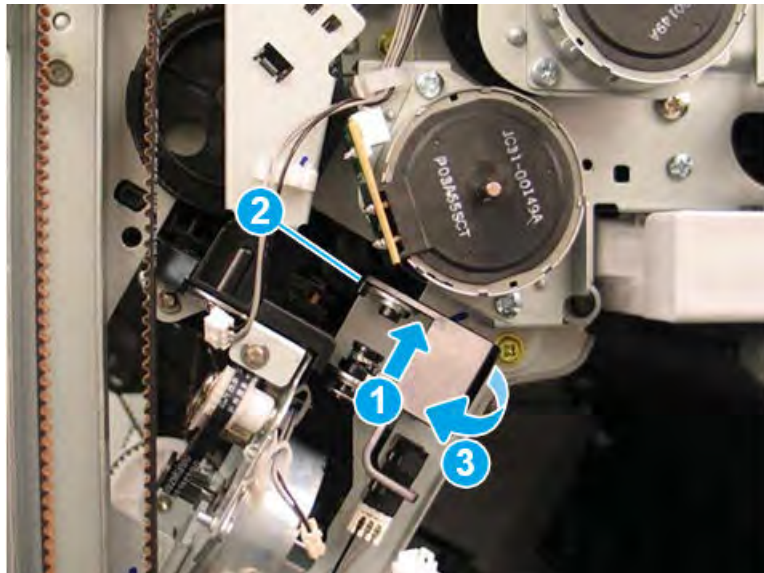

6. Remove one screw (callout 1).

Figure 5-653 Remove one screw

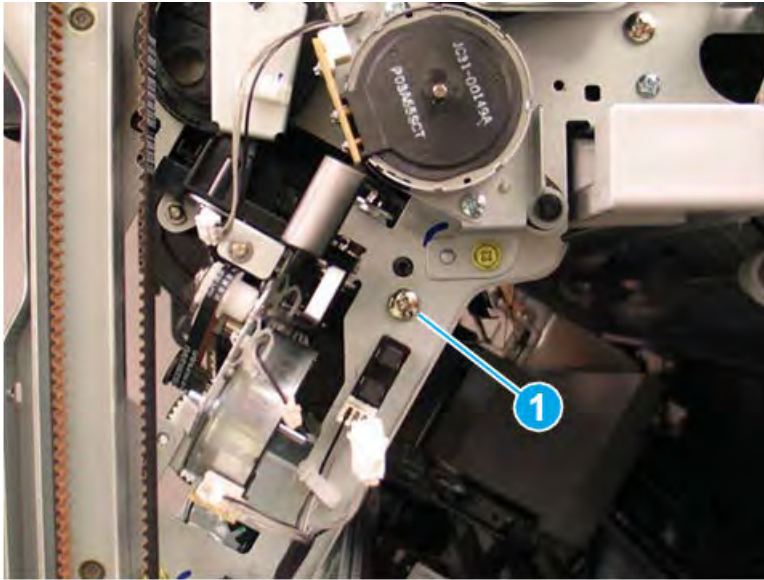

7. Look inside the finisher through the stapler opening in the front and pull down to release and remove one shaft (callout 1) on the front tamper unit.

Figure 5-654 Remove the front tamper shaft

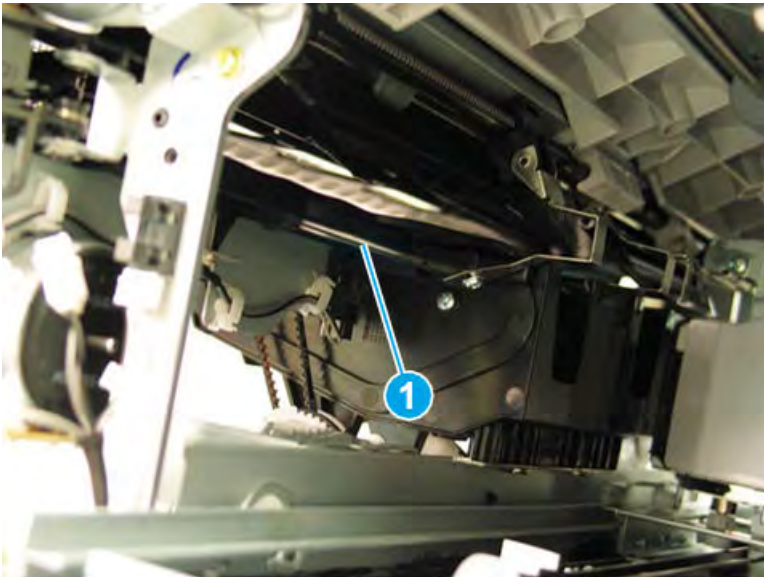

8. At the rear of the finisher, disconnect two connectors (callout 1), and then remove three screws (callout 2).

Figure 5-655 Disconnect two connectors and remove three screws

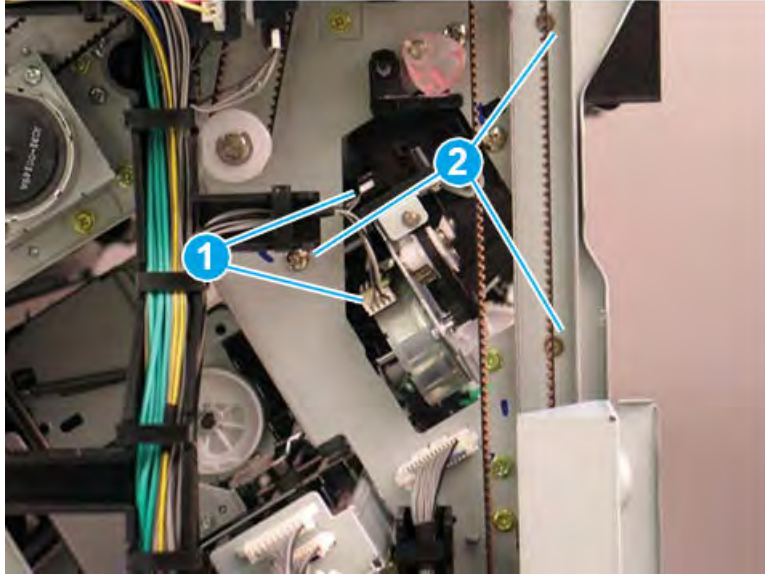

9. At the left side of the finisher, remove one screw (callout 1).

Figure 5-656 Remove one screw

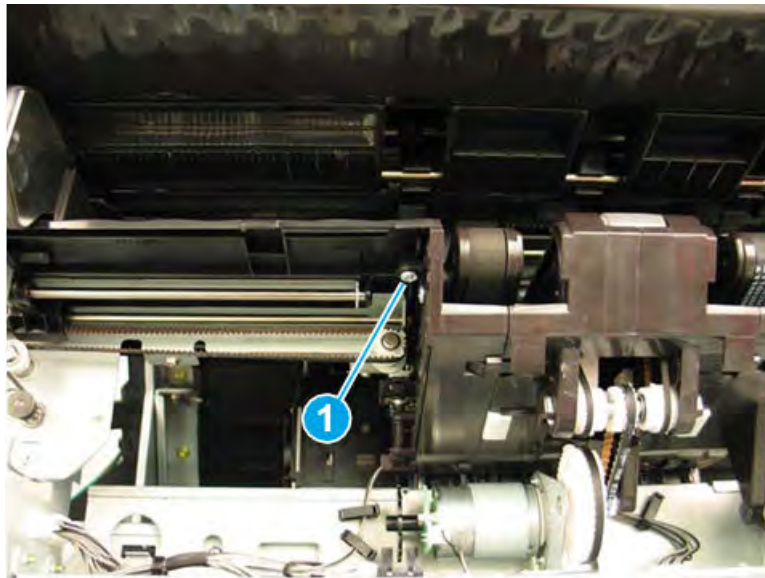

10. Look inside the finisher through the stapler opening in the rear and pull down to release and remove one shaft (callout 1) on the rear tamper unit.

Figure 5-657 Remove the rear tamper shaft

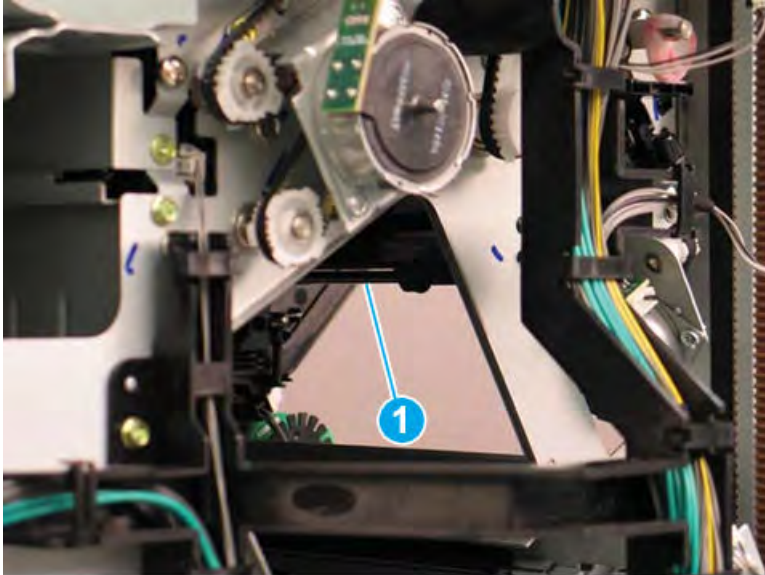

11. At the left side of the finisher, disconnect one connector (callout 1).

Figure 5-658 Disconnect one connector

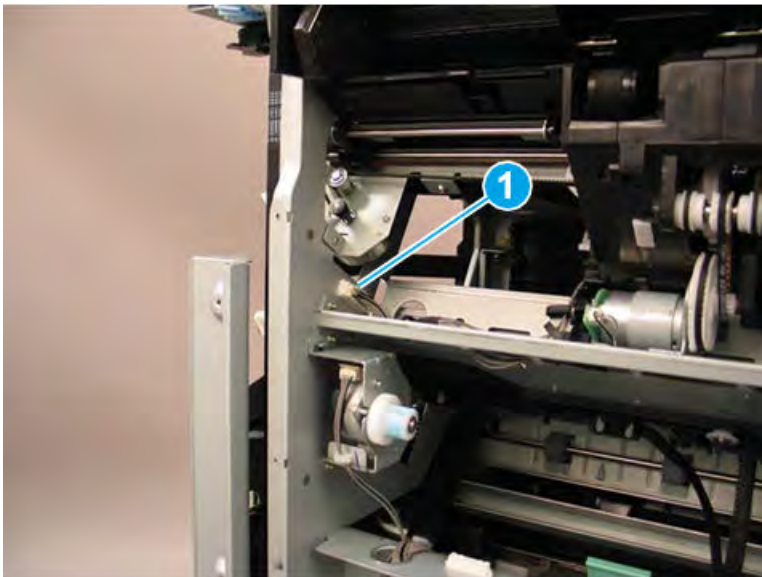

12. At the rear of the finisher, disconnect one connector (callout 1).

Figure 5-659 Disconnect one connector

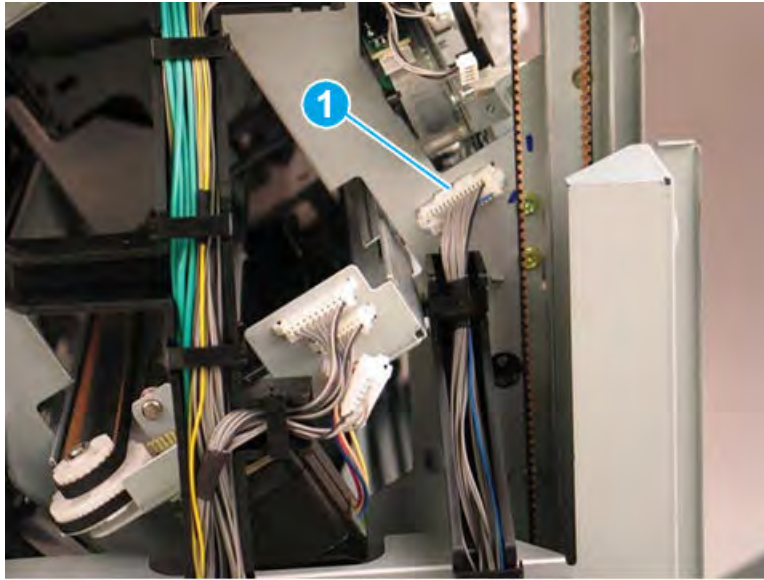

13. At the rear of the finisher, press the wire retainer to the right to access and remove two screws (callout 1).

Figure 5-660 Disconnect one connector

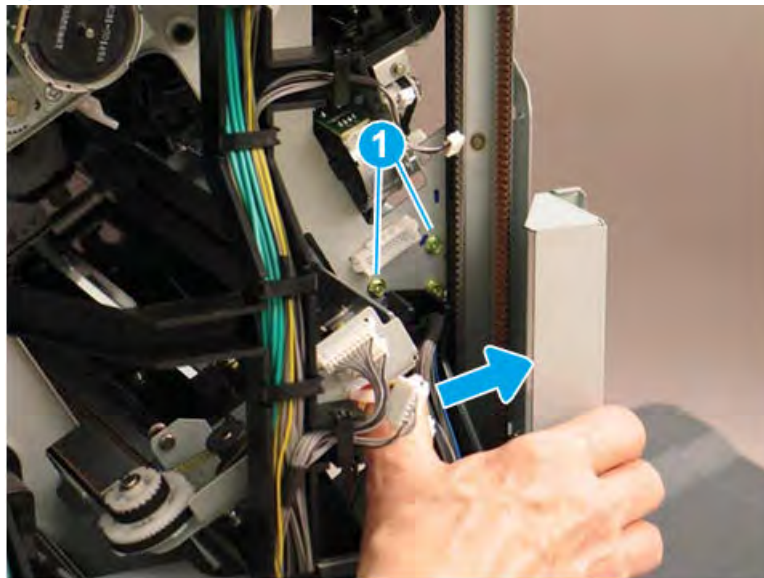

14. At the front of the finisher, remove two screws (callout 1).

Figure 5-661 Remove two screws

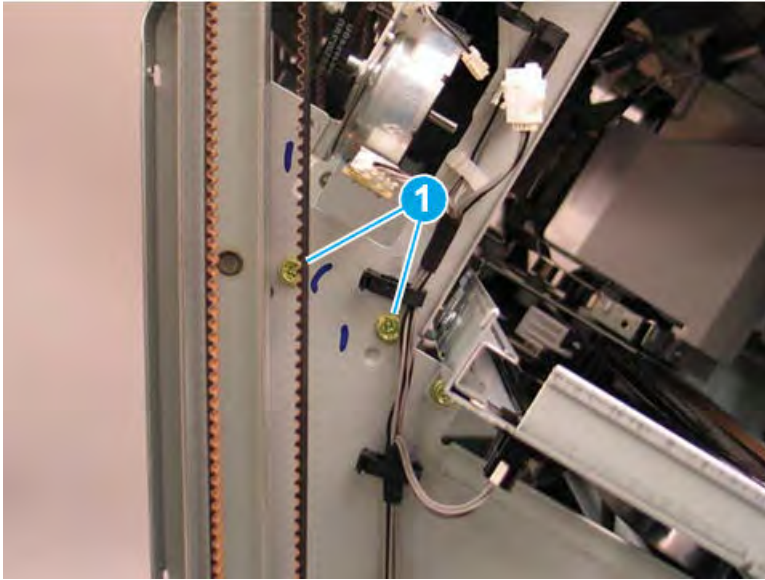

15. Lift the inside edges of the front and rear tampers up.

Figure 5-662 Lift the edges of the tampers

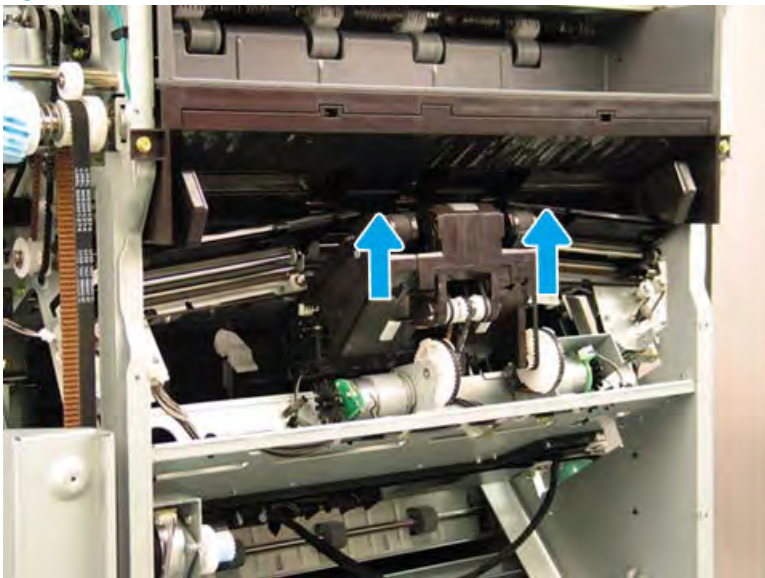

16. Rotate the rear edge of the ejector unit away from the finisher (callout 1), and then slide it toward the rear of the finisher (callout 2) to remove it. Make sure that the PCA (callout 3) stays clear of the sheet metal frame.

Figure 5-663 Remove the ejector unit

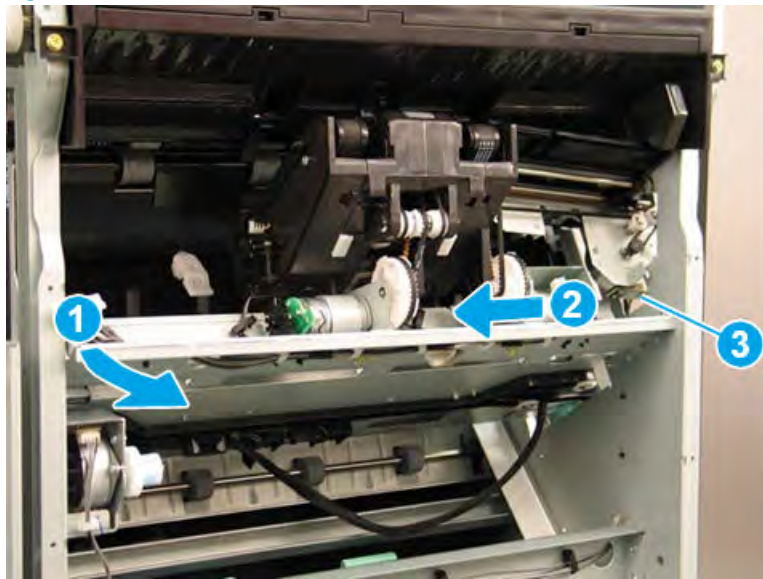

17. Reverse the removal steps to install the assembly. Also use the following special installation instructions.

 **NOTE:** Continue to reverse the removal steps to finish installing the assembly.

Special installation instructions: Ejector unit

- a. When the front tamper shaft is removed, the retainer arm that held the one end of the shaft will drop down. When reinstalling the shaft, raise the retainer arm and position the end of the shaft in the notch (callout 1).

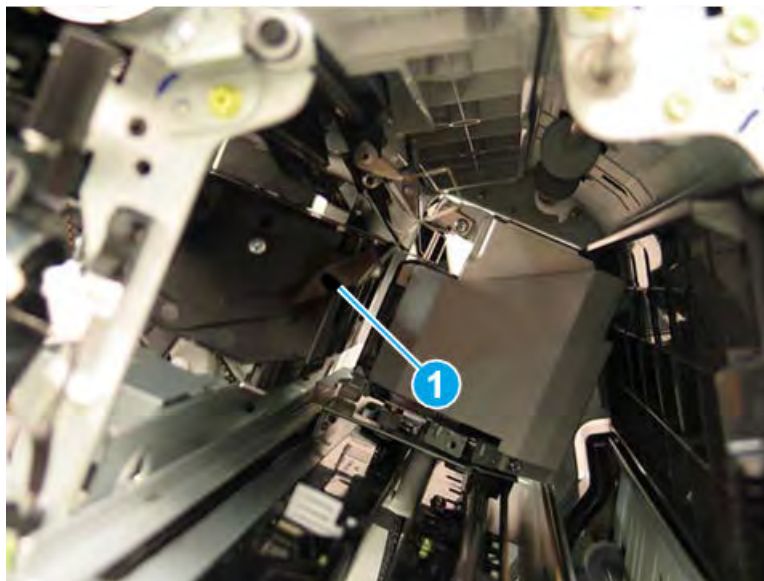

- b. When the rear tamper shaft is removed, the retainer arm that held the one end of the shaft will drop down. When reinstalling the shaft, raise the retainer arm and position the end of the shaft in the notch (callout 1).

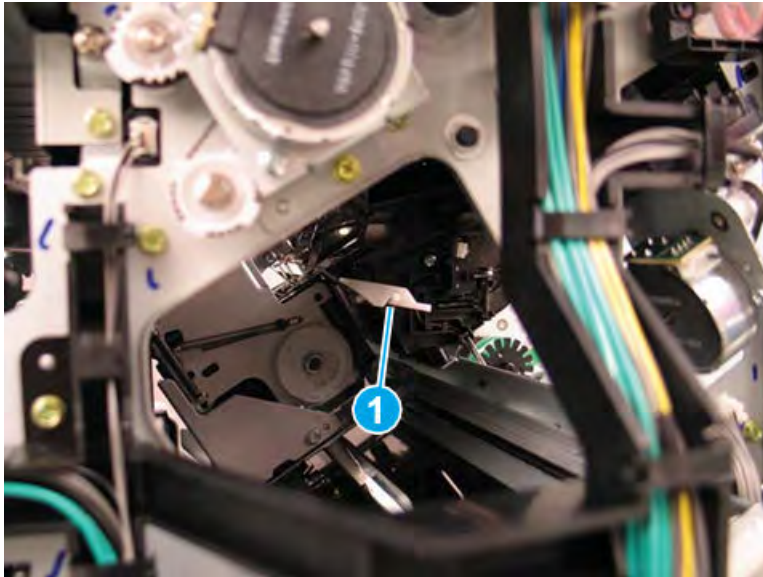

Remove the front tamper unit

Follow these steps to remove the front tamper unit.

- ▲ Lift the front tamper away from the finisher to remove it

Figure 5-664 Remove the front tamper



Remove the front tamper motor (M4)

Follow these steps to remove the front tamper motor (M4).

1. Remove two screws (callout 1).

Figure 5-665 Remove two screws

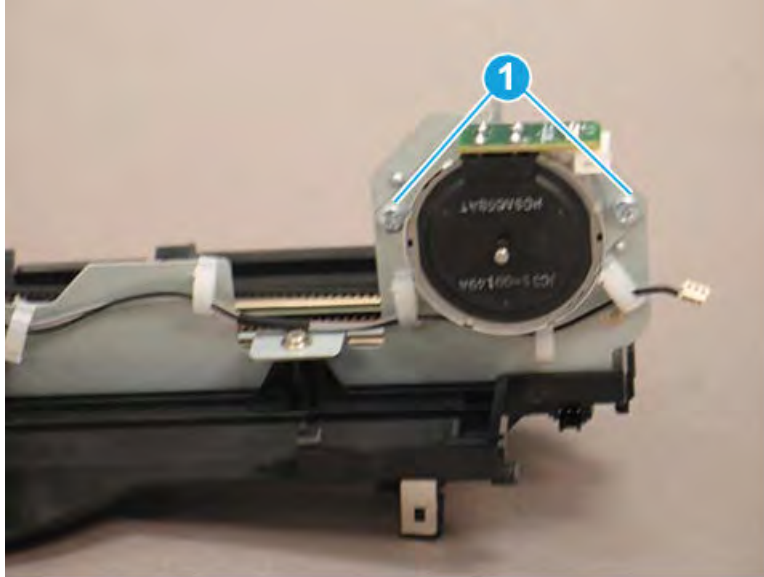

2. Release the belt (callout 1), and then remove the front tamper motor.

 **TIP:** Make sure that the belt is routed correctly when reinstalling the motor.

TIP: Reverse the removal steps to install the assembly.

Figure 5-666 Release the belt and remove the motor

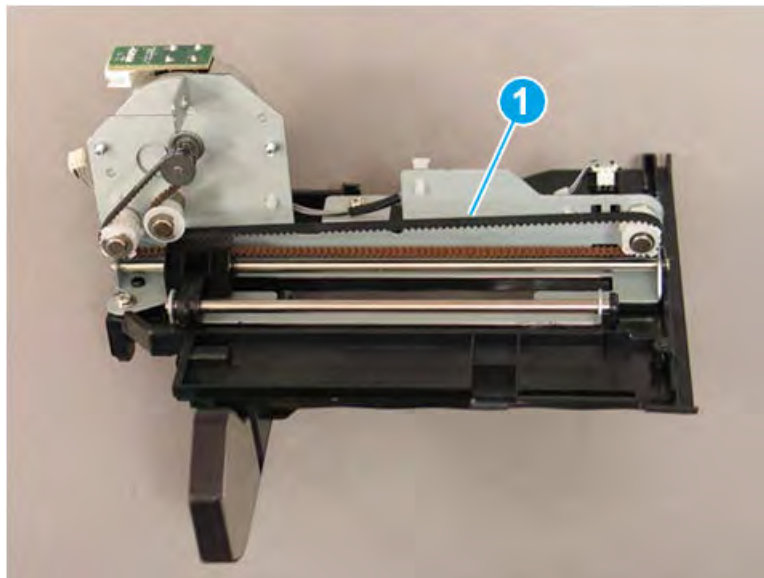

Unpack the replacement assembly

Follow these steps to unpack the replacement assembly.

1. Dispose of the defective part.

 **NOTE:** HP recommends responsible disposal of the defective part.

<http://www8.hp.com/us/en/hp-information/environment/product-recycling.html>

2. Unpack the replacement part from the packaging.



CAUTION:  Some parts are sensitive to electrostatic discharge (ESD). Always perform service work at an ESD-protected workstation or mat. If an ESD workstation or mat is not available, touch the sheet-metal chassis to provide a static ground before touching an ESD-sensitive assembly. Protect the ESD-sensitive assemblies by placing them in ESD pouches when they are out of the printer.

 **IMPORTANT:** Make sure that all of the shipping materials (for example shipping tape) are removed from the replacement part prior to installation.

 **NOTE:** If the replacement part is a roller or pad, avoid touching the spongy part of it. Skin oils on the roller or pad can cause paper pickup and/or print-quality problems. HP recommends using disposable gloves when handling rollers or pads or washing your hands before touching rollers or pads.

3. To install an assembly, reverse the removal steps.

 **NOTE:** When applicable, special installation instructions are provided for an assembly at the end of the removal procedure. Always completely read the removal instructions and follow all special installation instructions.

Rear tamper

Removal and replacement: Rear tamper unit

Learn how to remove and replace the rear tamper unit.

Introduction

This document provides the procedures to remove and replace the rear tamper unit on the finisher.

 **IMPORTANT:** When applicable, special installation instructions are provided for an assembly at the end of the removal procedure. Always completely read the removal instructions and follow all special installation instructions.

Before performing service

- Turn the printer power off. A shutting-down message appears on the control-panel display.
- ⚠ **WARNING!** To avoid damage to the printer, turn the power off and wait until the printer shuts down before removing the power cable.
- Disconnect the printer power cable after the printer has completely shut down (the control-panel display is blank).
- Release the finisher from the printer by pulling out on the release latch inside the finisher door.
- Disconnect the cable from the bridge unit to the finisher.
- Disconnect the cable from the finisher to the printer.

Use the table below to identify the correct part number for your printer. To order the part, go to <https://parts.hp.com>.

Table 5-116 Part information

Part number	Part description
JC82-00898A	Rear tamper

Required tools

- #2 JIS screwdriver with a magnetic tip
- Small, flat-blade screwdriver

After performing service

- Connect the cable from the finisher to the printer.
- Connect the cable from the bridge unit to the finisher.
- Attach the finisher to the printer, and then push in on the release latch inside the finisher door.
- Connect the printer power cable.
- Turn the printer power on.

Post service test

Process a job through the finisher and verify that the finisher works correctly.

Remove the right upper cover (finisher)

Follow these steps to remove the right upper cover (finisher).

- ▲ Remove one screw cap and three machine screws on the upper edge of the cover (callout 1). Remove three sheet metal screws (callout 2) on the lower portion of the cover. Rotate the right edge of the cover away from the finisher, and then slide the cover right to release three tabs (callout 3).

💡 **TIP:** The lower screws are shorter in length than the upper screws.

TIP: Reverse the removal steps to install the assembly.

Figure 5-667 Remove the right upper cover

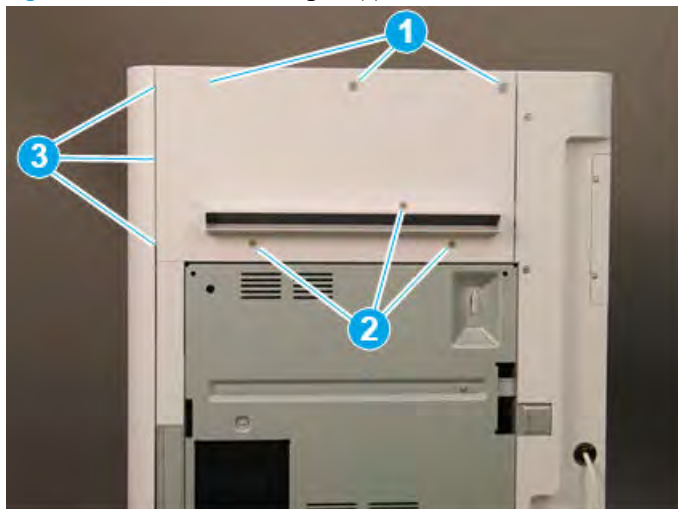

Remove the top cover (finisher)

Follow these steps to remove the top cover (finisher).

1. Remove three screw caps and three self-tapping screws at the top of the rear cover (callout 1), and then remove three machine screws (callout 2) on top of the cover.

Figure 5-668 Remove six screws

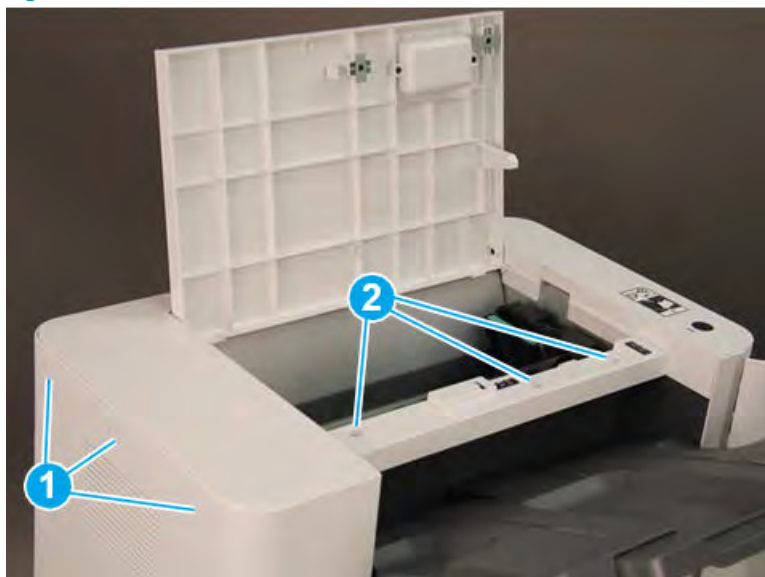

2. Remove three self-tapping screws at the top of the front cover (callout 1), and then remove two machine screws (callout 2) at the top of the right side.

Figure 5-669 Remove five screws

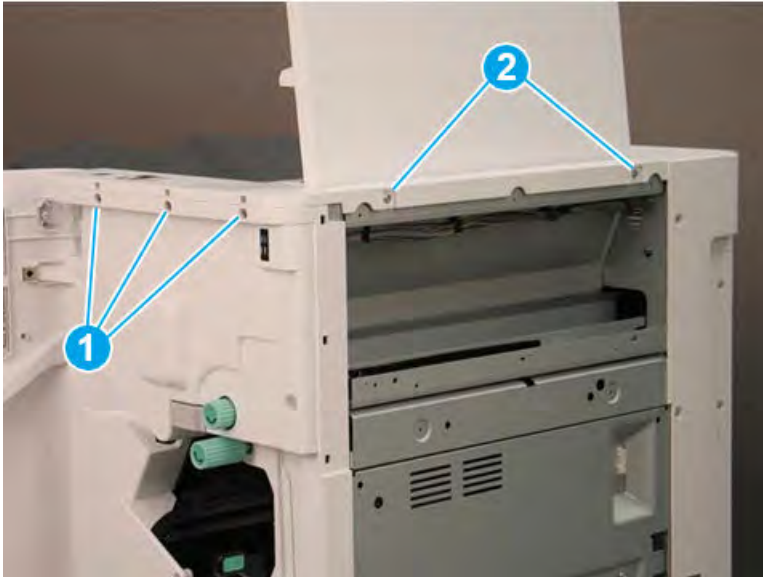

3. Lift the cover up slightly. Disconnect one in-line connector (callout 1), and then release one retainer (callout 2).

 **TIP:** Reverse the removal steps to install the assembly.

Figure 5-670 Disconnect one connector and release retainer



Remove the front door (finisher)

Follow these steps to remove the front door (finisher).

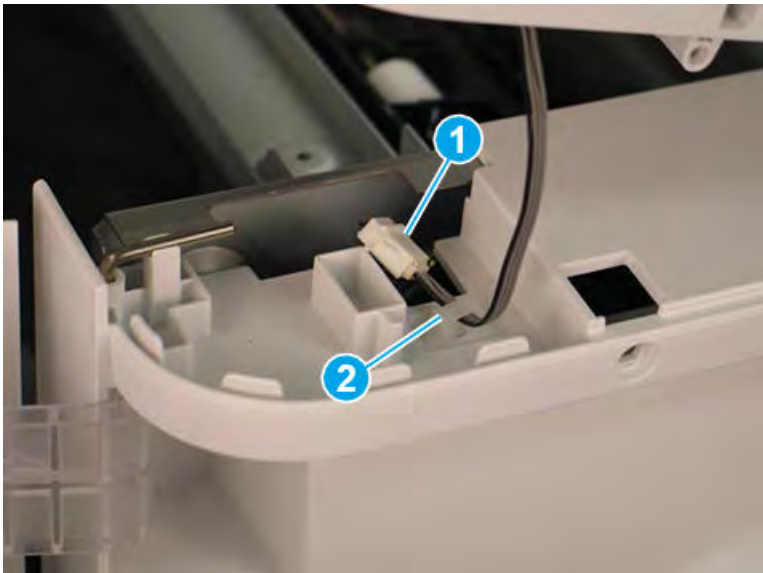
1. Lift the top hinge pin up to release it from the retainer.

Figure 5-671 Lift the top hinge pin

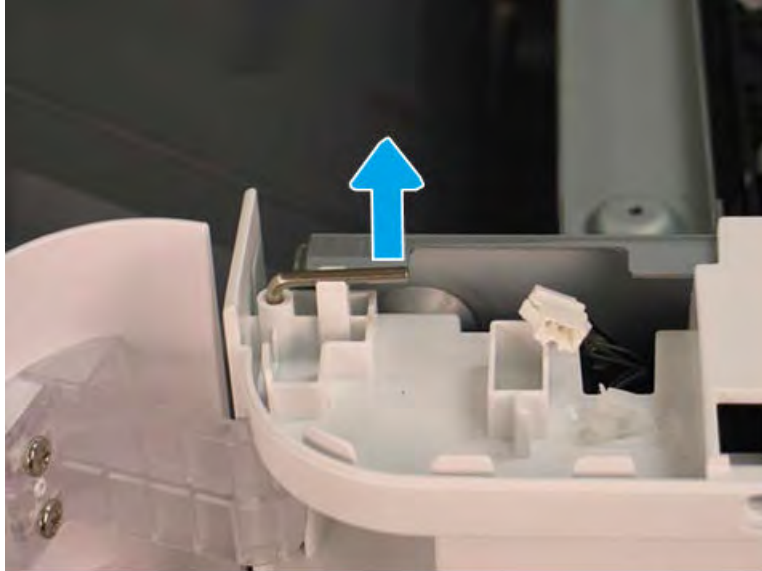

2. Pull the top hinge pin up to remove it.

Figure 5-672 Remove the top hinge pin

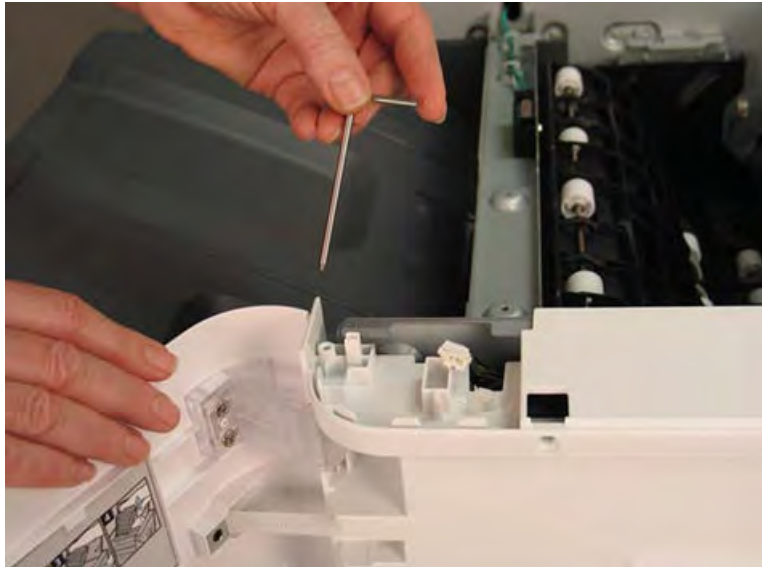

3. Use a small, flat-blade screwdriver to release the lower hinge pin from the retainer, and then rotate it away from the finisher.

Figure 5-673 Release the lower hinge pin



4. Support the door with one hand, and then pull the lower hinge pin straight up to remove it.

Figure 5-674 Remove the lower hinge pin



5. Support the door with one hand, and then remove one screw (callout 1) to release the strap. Remove the front door.

 **TIP:** Reverse the removal steps to install the assembly.

Figure 5-675 Remove the front door



Remove the front cover (finisher)

Follow these steps to remove the front cover (finisher).

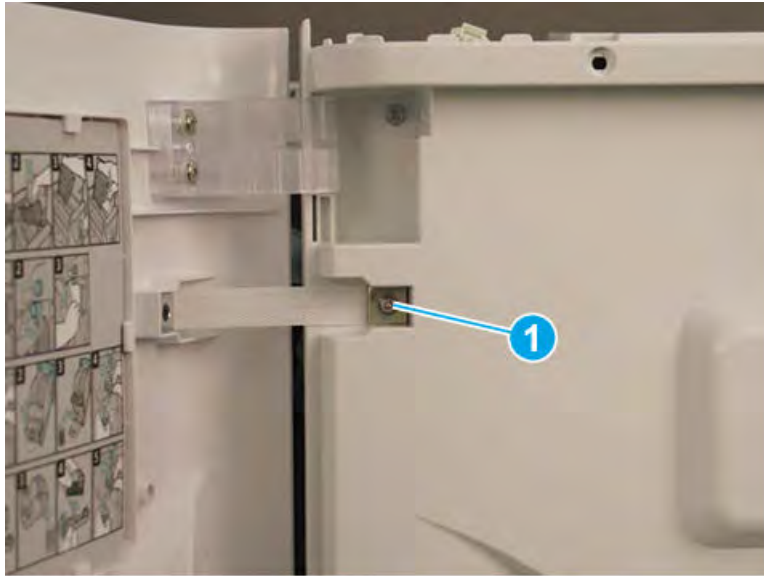
1. Release one tab (callout 1), and then pull the jam-access knob away from the finisher to remove it.

Figure 5-676 Remove the jam-access knob

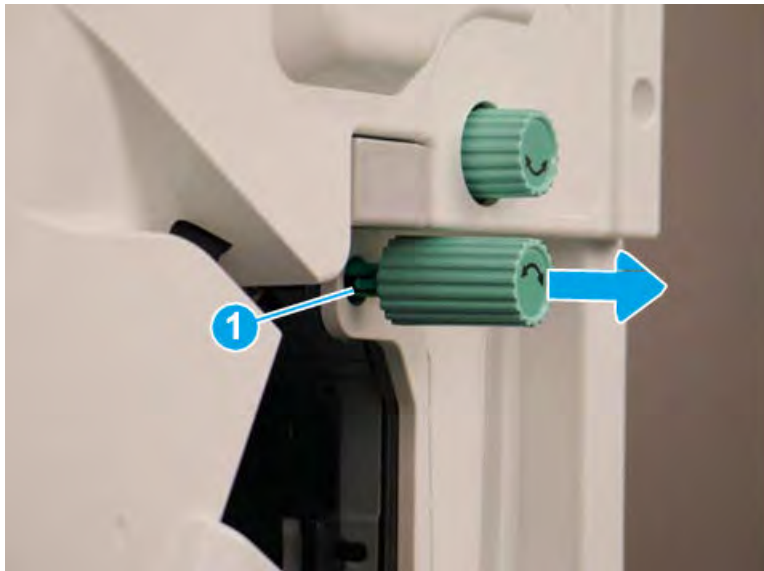

2. If the punch unit is installed, remove the punch waste bin (callout 1).

3. Remove one screw (callout 1) on top of the front cover.

Figure 5-677 Remove one screw



4. Remove five machine screws (callout 1), and then remove the front cover.

 **TIP:** Reverse the removal steps to install the assembly.

Figure 5-678 Remove the front cover



Remove the rear cover (finisher)

Follow these steps to remove the rear cover (finisher).

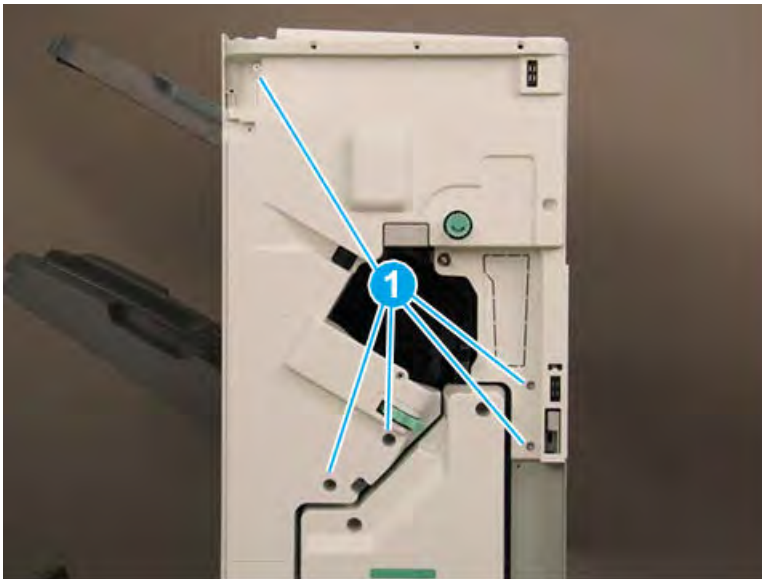
1. Remove two self-tapping screws (callout 1) on the top of the rear cover, and then remove five screw caps and five machine screws (callout 2) on the left side of the cover.

Figure 5-679 Remove seven screws

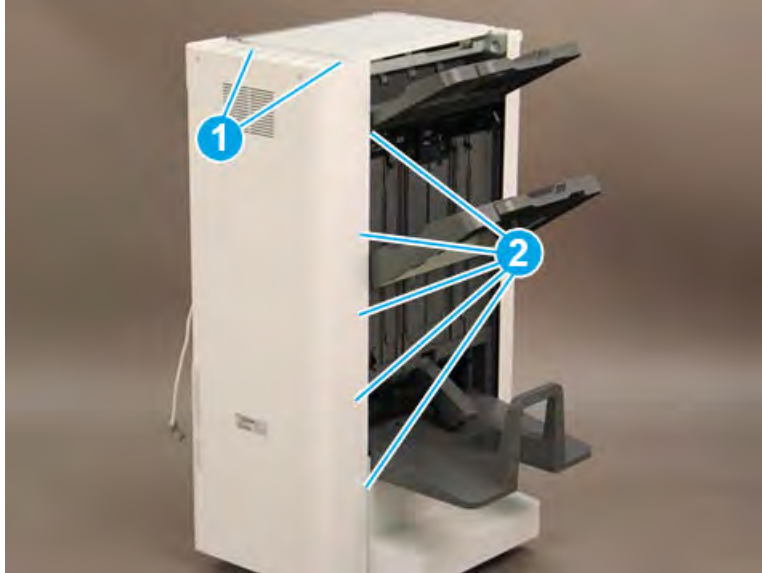

2. Remove one screw cap and four machine screws (callout 1) Remove the rear cover.

 **NOTE:** Make sure to thread the power cable (callout 2) through the opening in the cover.

 **TIP:** Reverse the removal steps to install the assembly

Figure 5-680 Remove the rear cover



Remove the booklet output tray

Follow these steps to remove the booklet output tray.

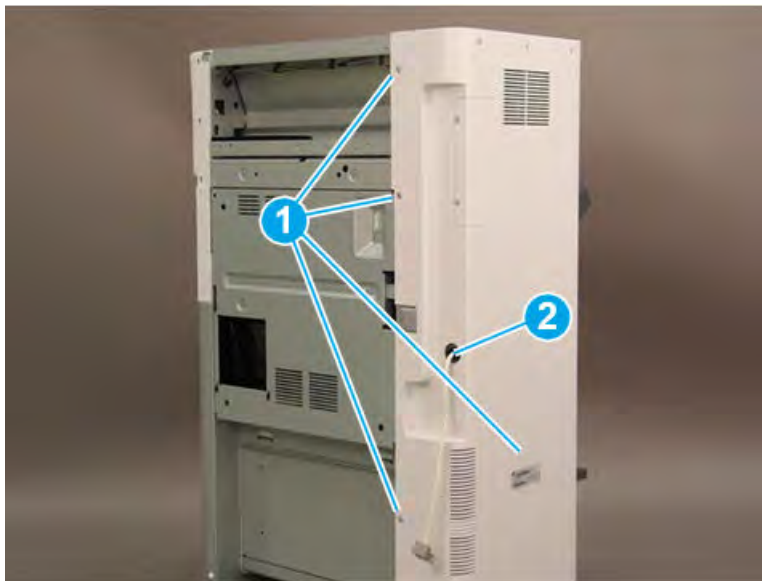
1. Raise the booklet output tray up (callout 1), and then pull it away from the finisher (callout 2) to remove it.

Figure 5-681 Remove the booklet output tray



2. Reverse the removal steps to install the assembly. Also use the following special installation instructions.

 **NOTE:** Continue to reverse the removal steps to finish installing the assembly

Special installation instructions: booklet output tray

Position the tabs (callout 1) on the tray into the slots (callout 2) on the finisher.

Figure 5-682 Install the booklet output tray

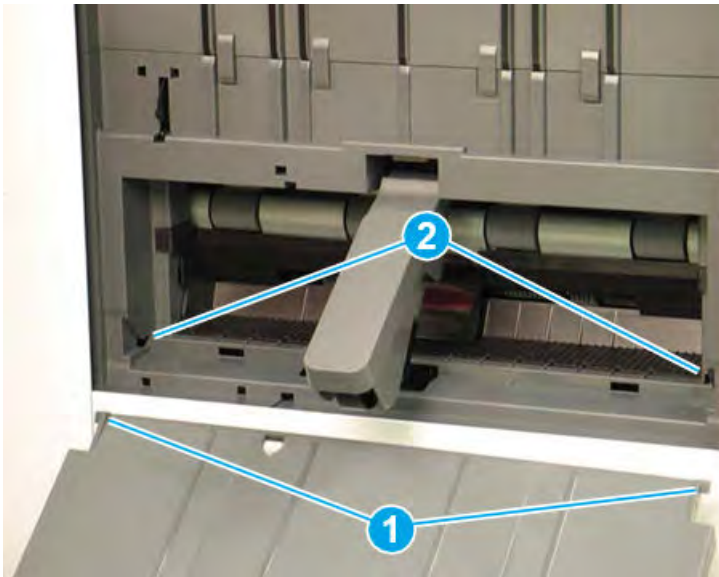

Remove the caster cover

Follow these steps to remove the caster cover.

1. Remove two screw caps and two self-tapping screws (callout 1). Remove two screw caps and two machine screws (callout 2).

Figure 5-683 Remove four screws

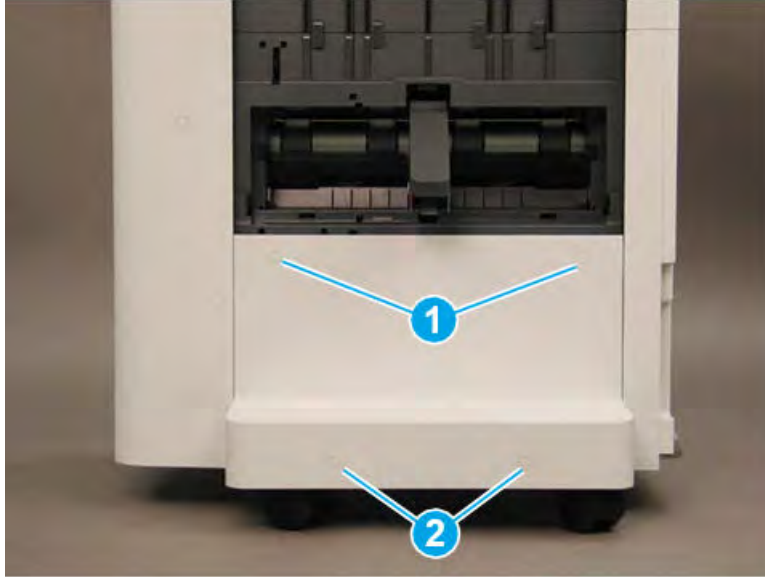

2. Rotate the left edge of the cover away from the finisher (callout 1), and then slide the cover to the left (callout 2) to remove it.

 **TIP:** Make sure that two tabs (callout 3) are positioned under the front lower cover when reinstalling the caster cover.

TIP: Reverse the removal steps to install the assembly

Figure 5-684 Remove the caster cover

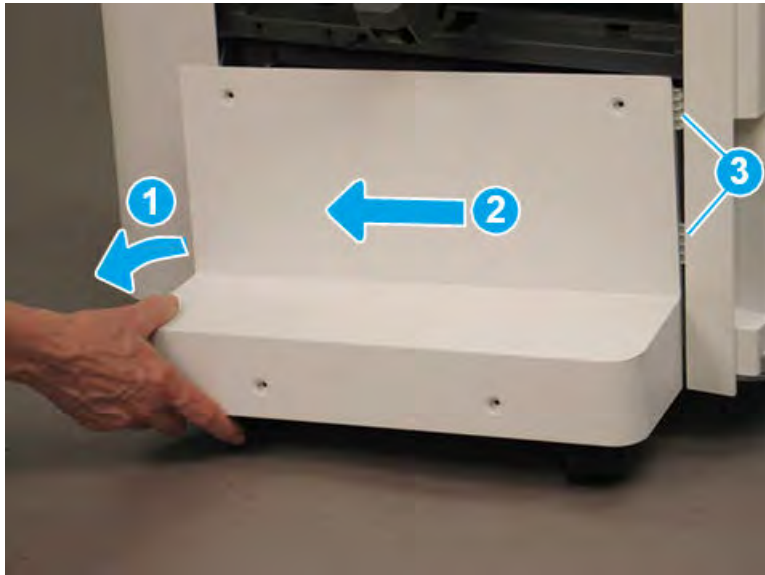

Remove the left lower cover (finisher)

Follow these steps to remove the left lower cover (finisher).

1. Remove four screws (callout 1).

 **NOTE:** Raise the lower output tray as needed to access the screws.

Figure 5-685 Remove four screws



2. Slide the shield down (callout 1) to release it from four tabs (callout 2), and then rotate it away from the finisher (callout 3).

⚠ CAUTION: The shield is still attached to the finisher. Do not attempt to completely remove the shield.

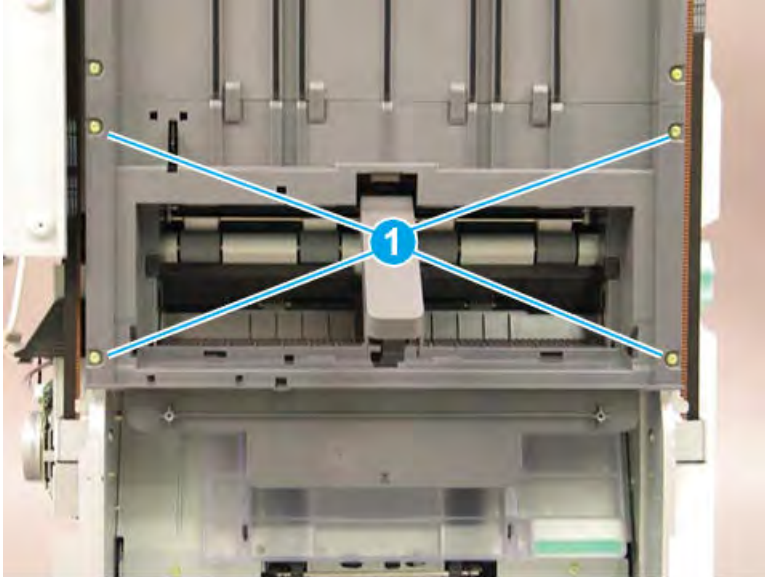
💡 TIP: Position the shield under the four tabs (callout 2) when reinstalling it.

Figure 5-686 Release the lower shield

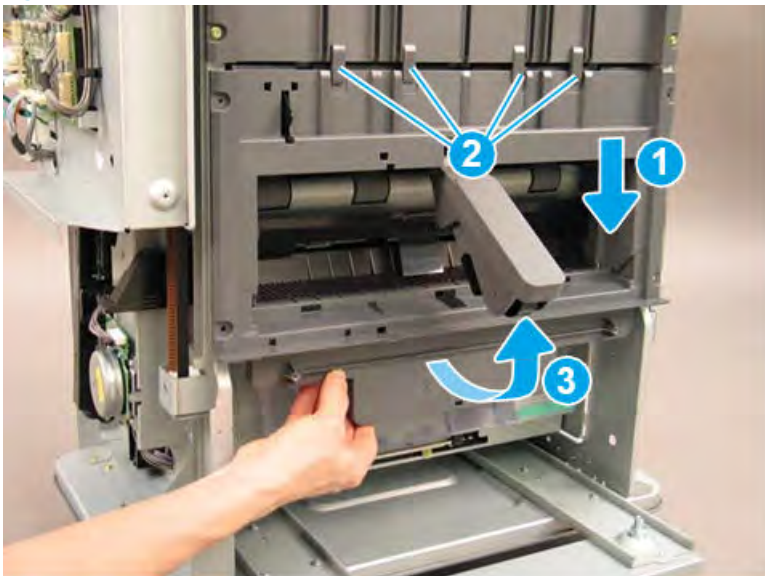

3. Disconnect two connectors (callout 1), and then remove the shield.

 **TIP:** Reverse the removal steps to install the assembly.

Figure 5-687 Disconnect two connectors

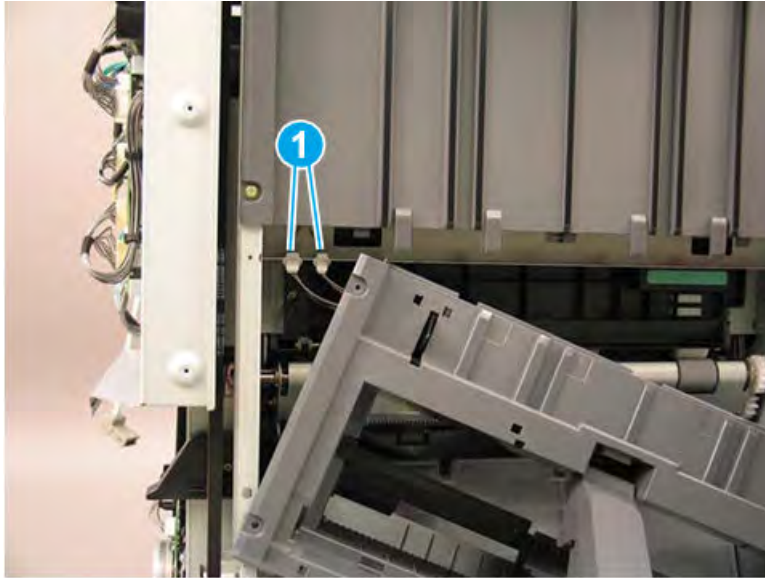

4. If you are replacing the left lower cover, locate three sensors (callout 1) on the back of the left lower cover. Remove these sensors and transfer them to the replacement part.

Figure 5-688 Remove the left lower cover

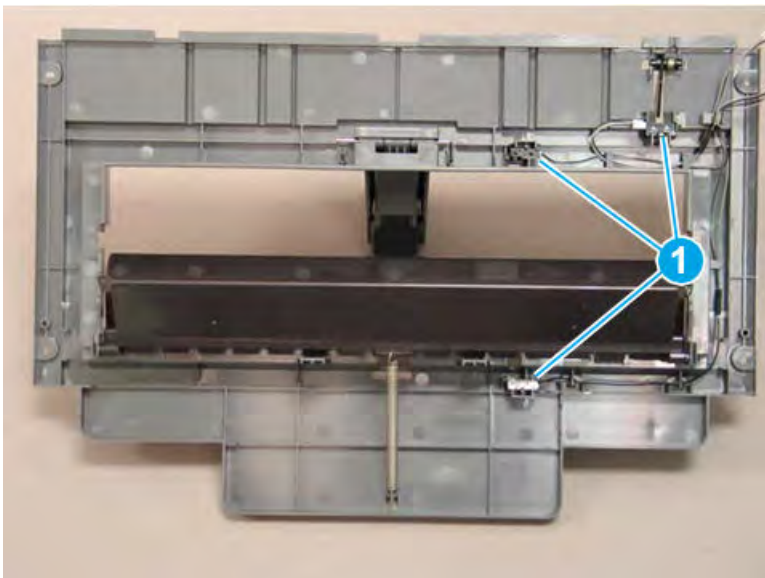

Remove the left upper cover (finisher)

Follow these steps to remove the left upper cover (finisher).

1. Bring the lower output tray down by positioning the shaft of a screwdriver on the clutch (callout 1) and gently pressing to the right to release the clutch. Hold the clutch in the released position and lower the tray (callout 2) to the lowest position.

Figure 5-689 Lower the output tray

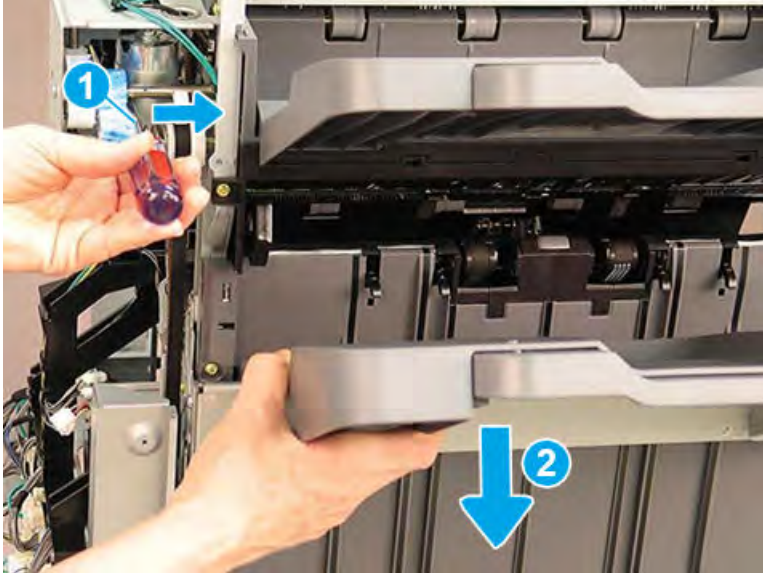

2. Remove six machine screws (callout 1).

Figure 5-690 Remove six screws

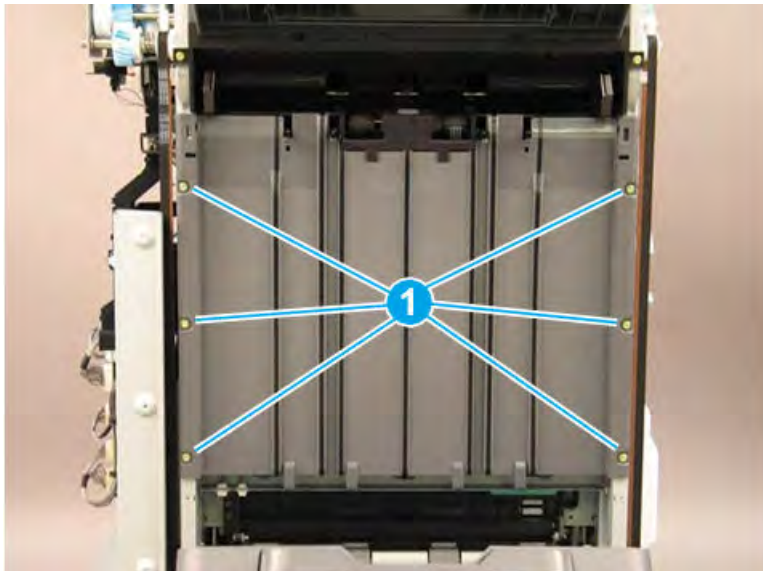

3. Rotate the lower edge of the shield away from the finisher (callout 1), and then slide the shield down (callout 2) to release it from two tabs (callout 3).

CAUTION: The shield is still attached to the finisher. Do not attempt to completely remove the shield.

TIP: Position the shield under the two tabs (callout 3) when reinstalling it.

Figure 5-691 Release the shield

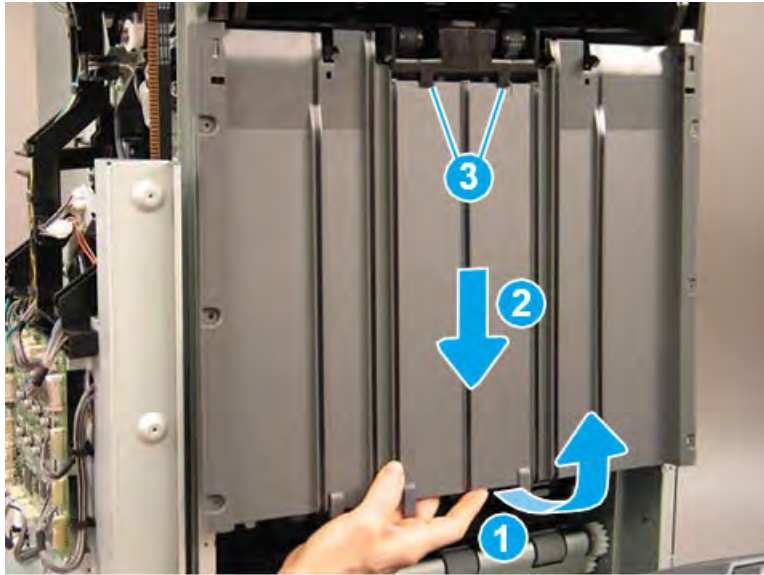

4. Disconnect one connector (callout 1), and then remove the upper shield assembly.

TIP: Reverse the removal steps to install the assembly.

Figure 5-692 Disconnect one connector

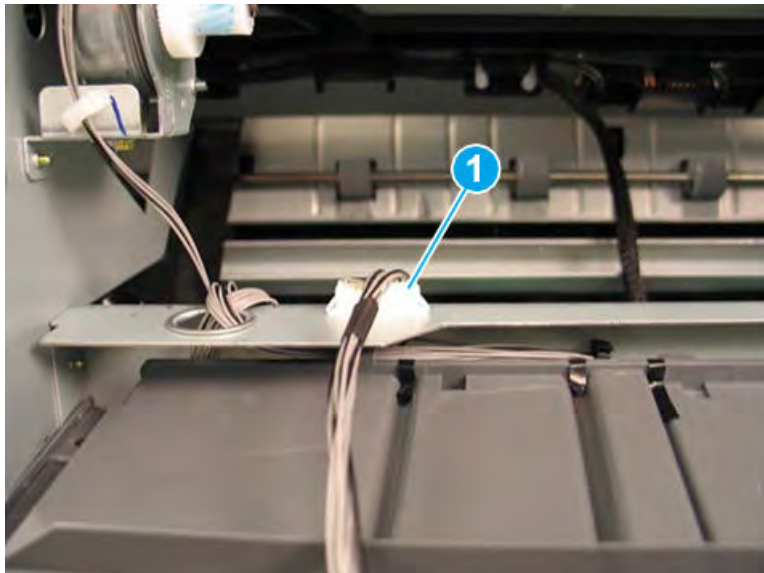

5. If you are replacing the left upper cover, locate three sensors (callout 1) on the back of the left upper cover. Remove these sensors and transfer them to the replacement part.

Figure 5-693 Remove the left upper cover

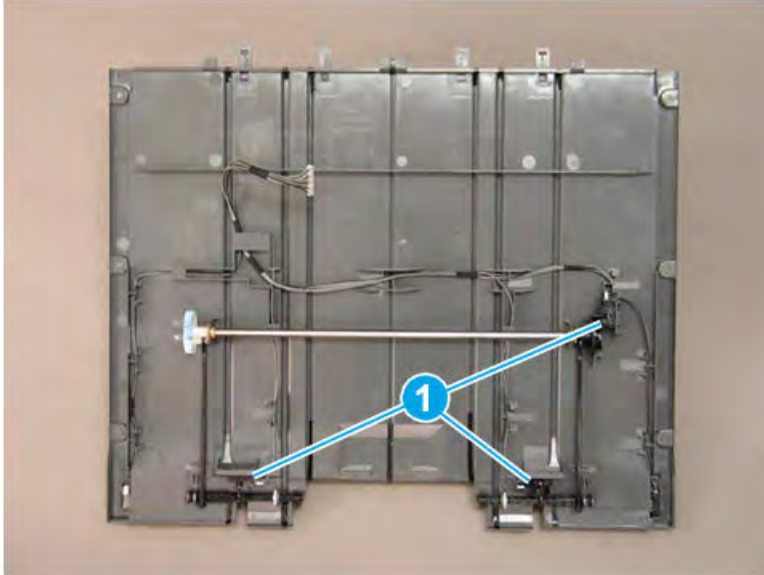

Remove the ejector unit (finisher)

Follow these steps to remove the ejector unit (finisher).

1. Rotate the green wheel to move the staple unit to the center of the finisher.

Figure 5-694 Move the staple unit to the center

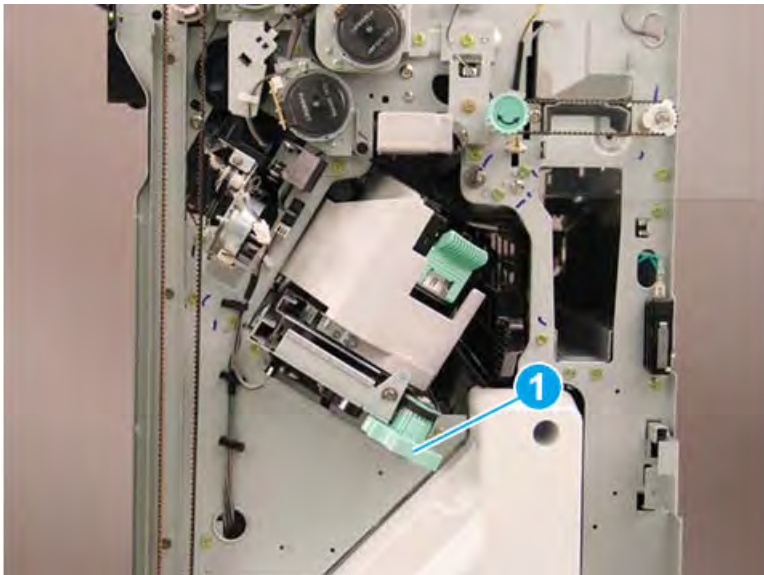

2. Release one retainer (callout 1), and then disconnect three connectors (callout 2).

Figure 5-695 Disconnect three connectors

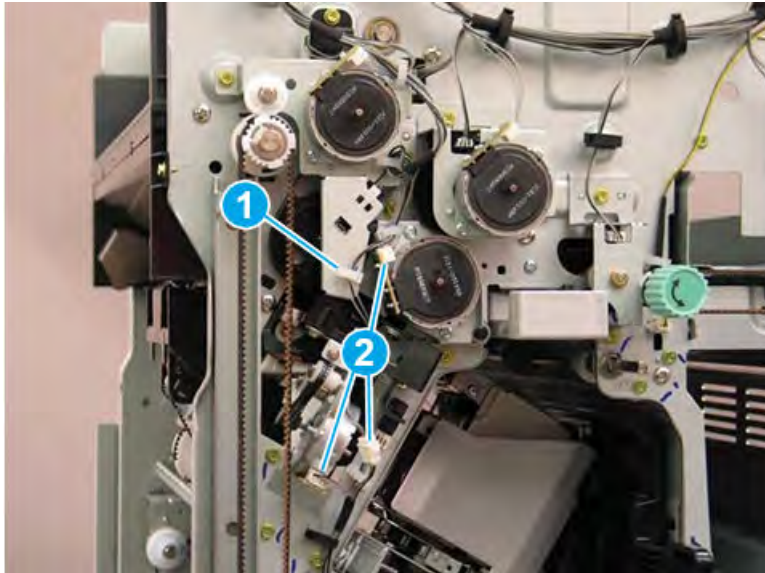

3. Remove two screws (callout 1).

Figure 5-696 Remove two screws

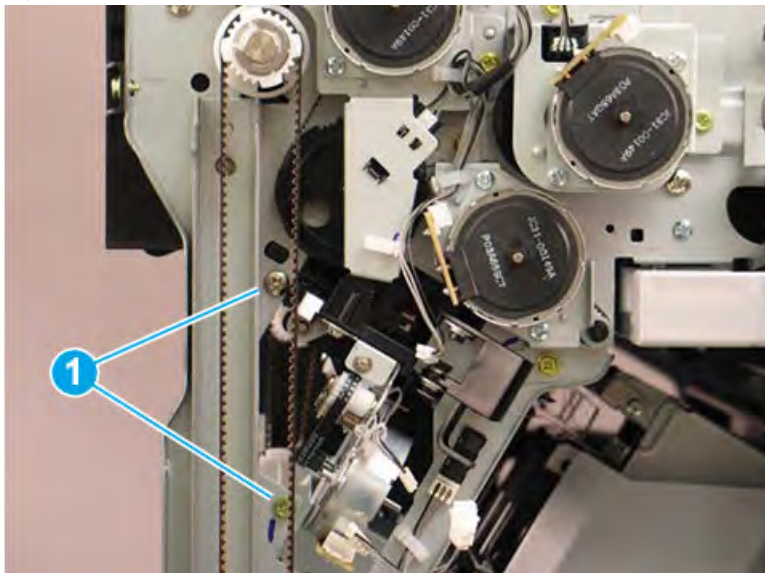

4. At the left side of the finisher, remove one screw (callout 1).

Figure 5-697 Remove one screw

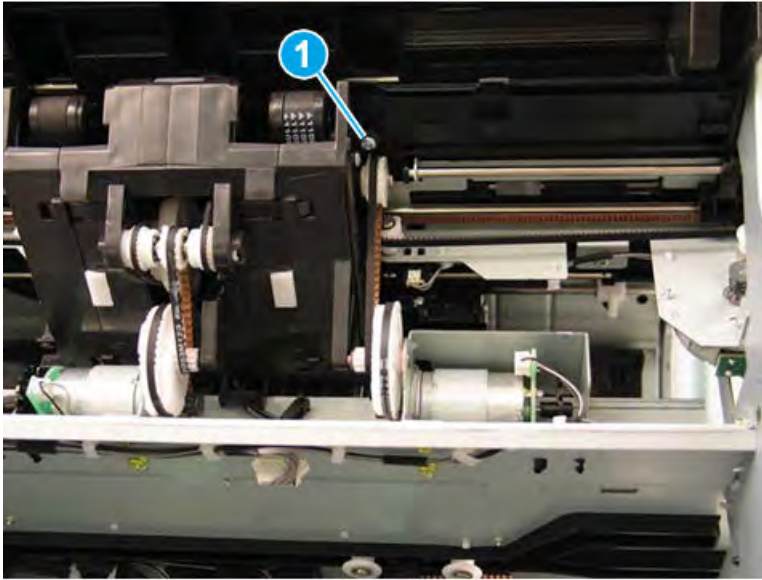

5. Press up on the hinge (callout 1), release one tab (callout 2), and then rotate the sensor away from the finisher (callout 3).

Figure 5-698 Rotate the sensor

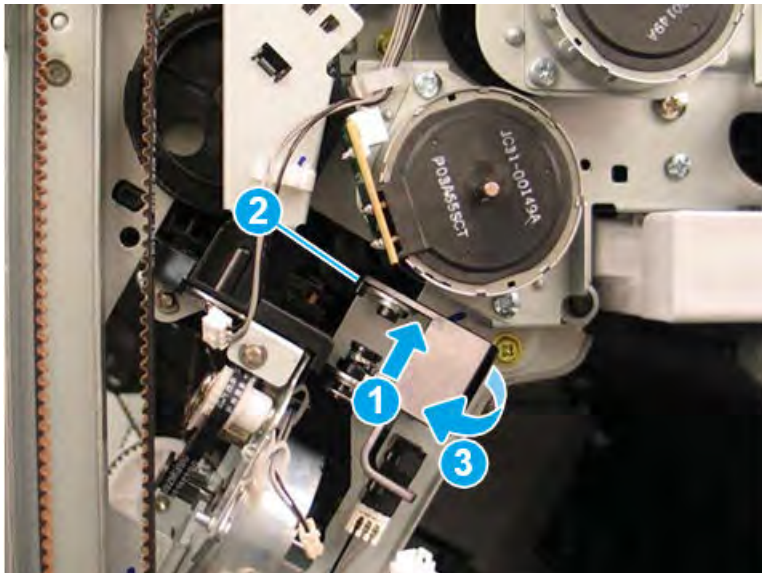

6. Remove one screw (callout 1).

Figure 5-699 Remove one screw

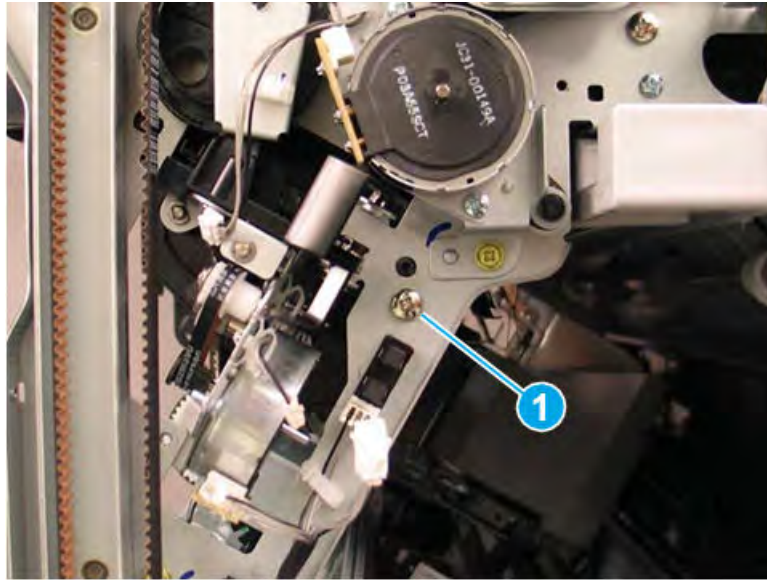

7. Look inside the finisher through the stapler opening in the front and pull down to release and remove one shaft (callout 1) on the front tamper unit.

Figure 5-700 Remove the front tamper shaft

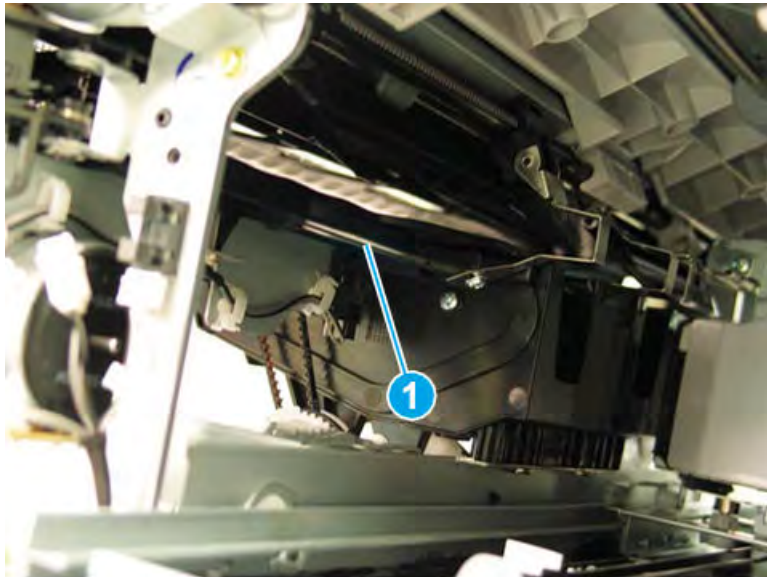

8. At the rear of the finisher, disconnect two connectors (callout 1), and then remove three screws (callout 2).

Figure 5-701 Disconnect two connectors and remove three screws

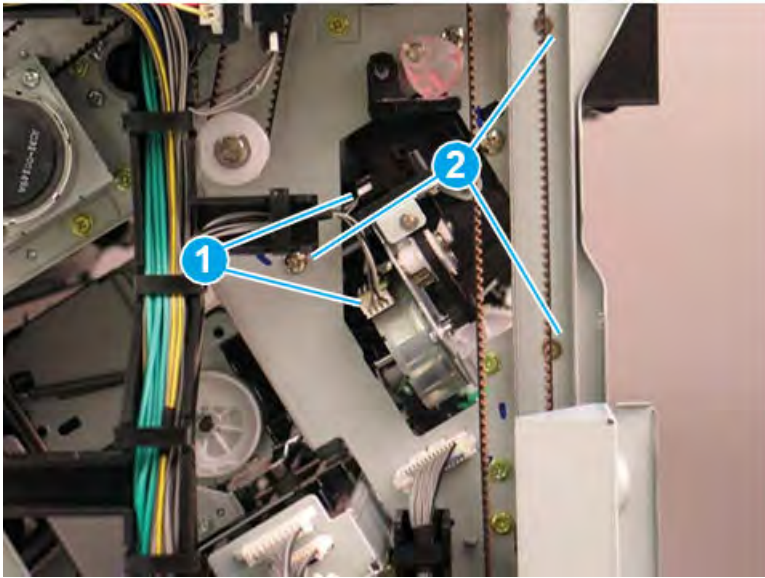

9. At the left side of the finisher, remove one screw (callout 1).

Figure 5-702 Remove one screw

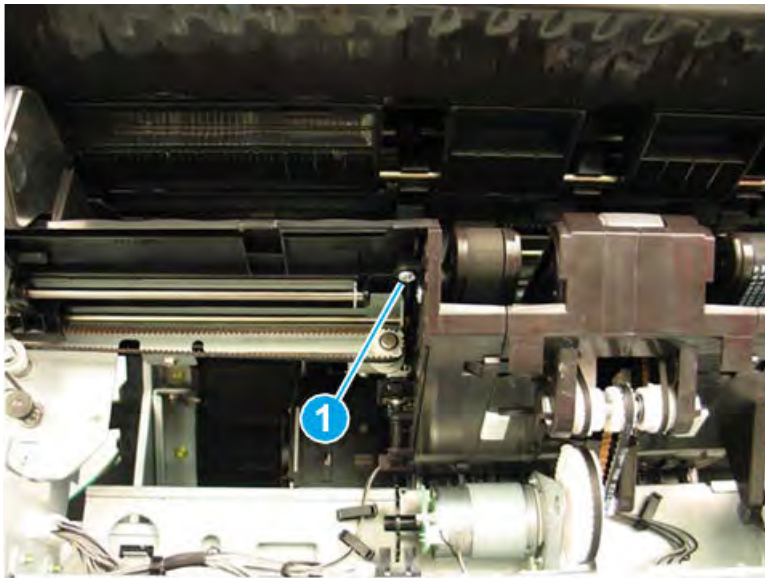

10. Look inside the finisher through the stapler opening in the rear and pull down to release and remove one shaft (callout 1) on the rear tamper unit.

Figure 5-703 Remove the rear tamper shaft

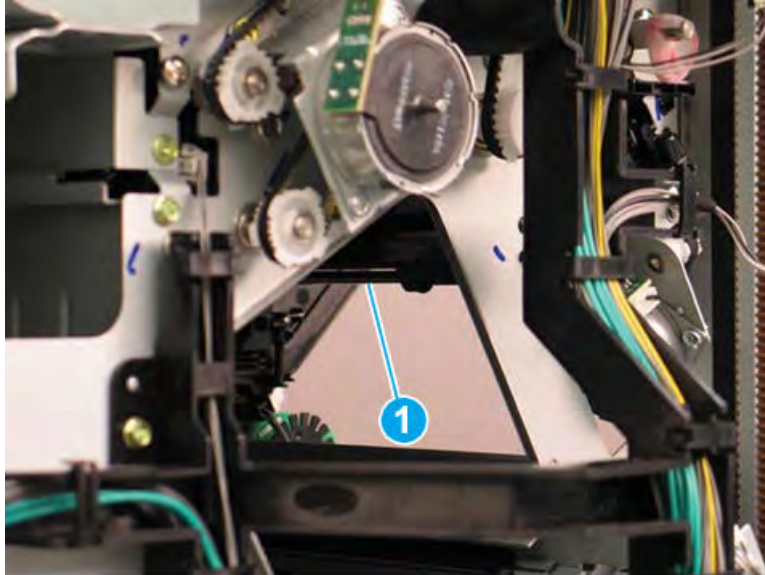

11. At the left side of the finisher, disconnect one connector (callout 1).

Figure 5-704 Disconnect one connector

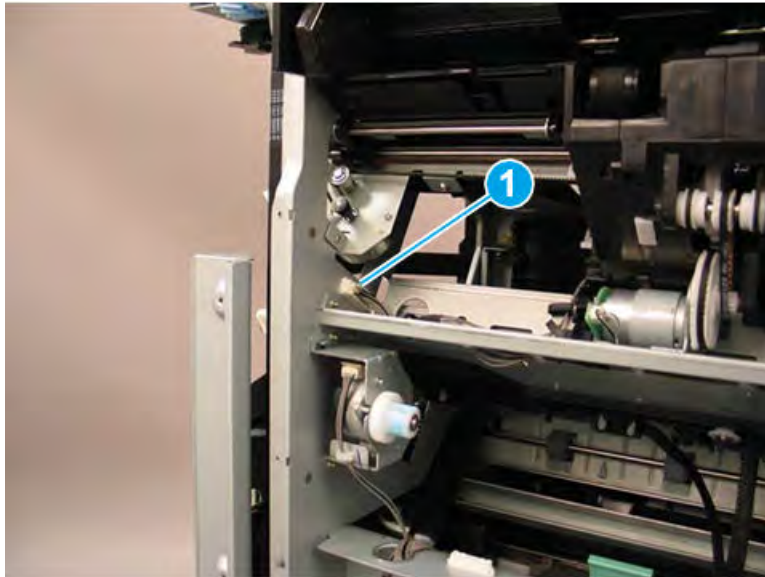

12. At the rear of the finisher, disconnect one connector (callout 1).

Figure 5-705 Disconnect one connector

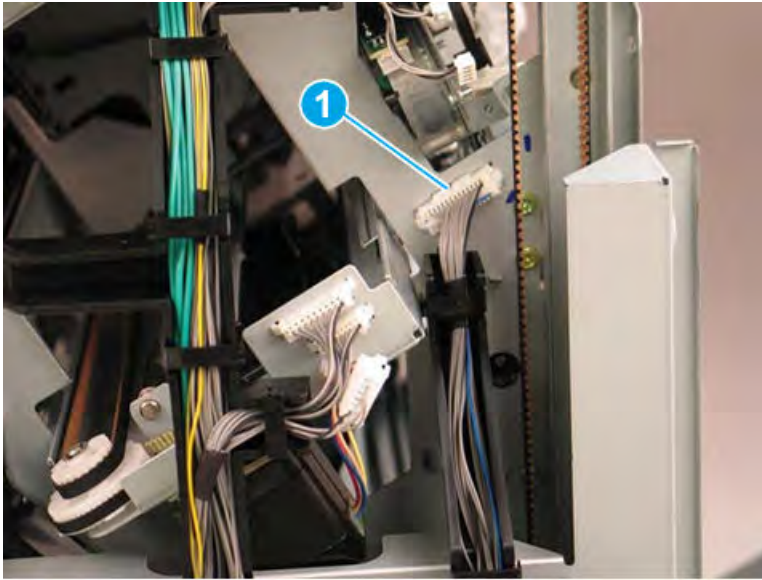

13. At the rear of the finisher, press the wire retainer to the right to access and remove two screws (callout 1).

Figure 5-706 Disconnect one connector

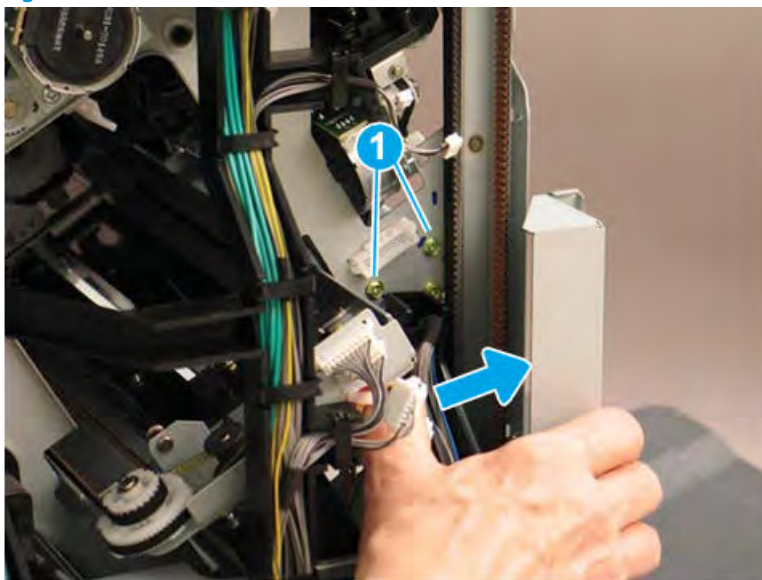

14. At the front of the finisher, remove two screws (callout 1).

Figure 5-707 Remove two screws

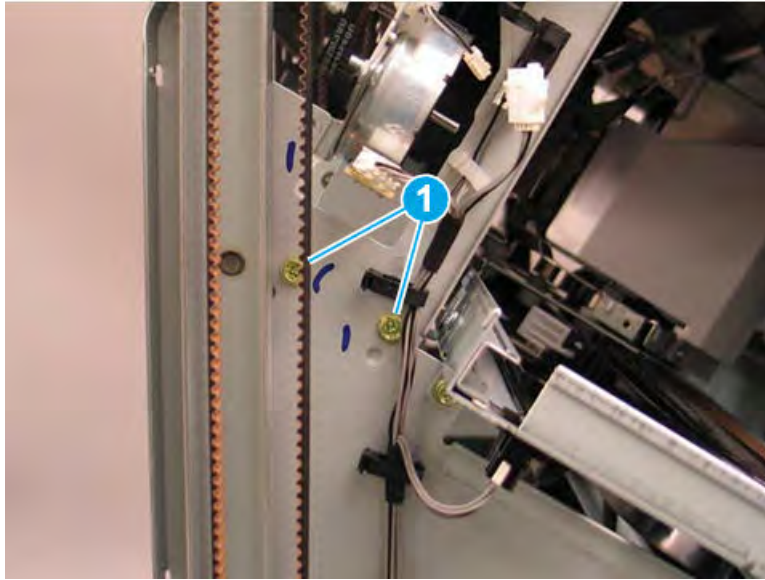

15. Lift the inside edges of the front and rear tampers up.

Figure 5-708 Lift the edges of the tampers

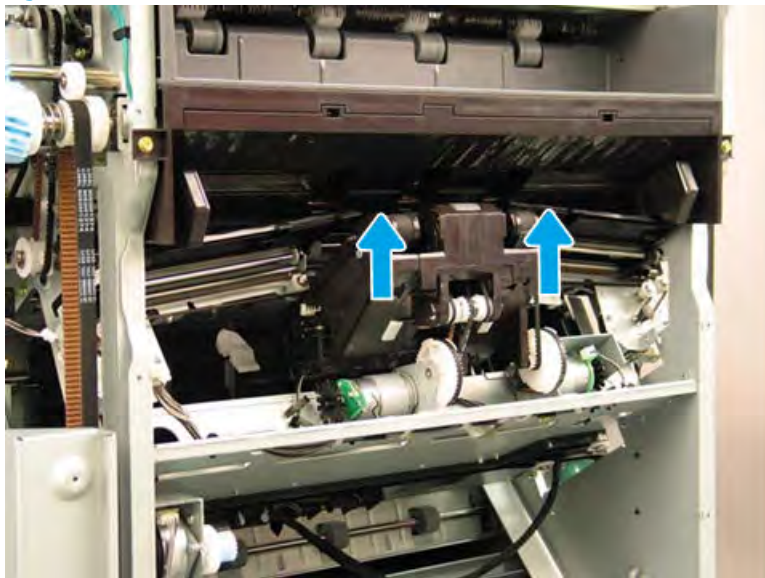

16. Rotate the rear edge of the ejector unit away from the finisher (callout 1), and then slide it toward the rear of the finisher (callout 2) to remove it. Make sure that the PCA (callout 3) stays clear of the sheet metal frame.

Figure 5-709 Remove the ejector unit

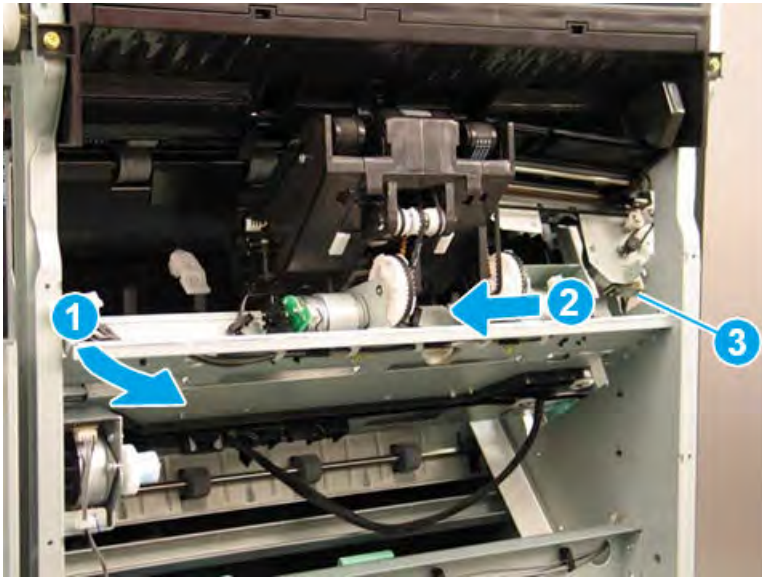

17. Reverse the removal steps to install the assembly. Also use the following special installation instructions.

 **NOTE:** Continue to reverse the removal steps to finish installing the assembly.

Special installation instructions: Ejector unit

- a. When the front tamper shaft is removed, the retainer arm that held the one end of the shaft will drop down. When reinstalling the shaft, raise the retainer arm and position the end of the shaft in the notch (callout 1).

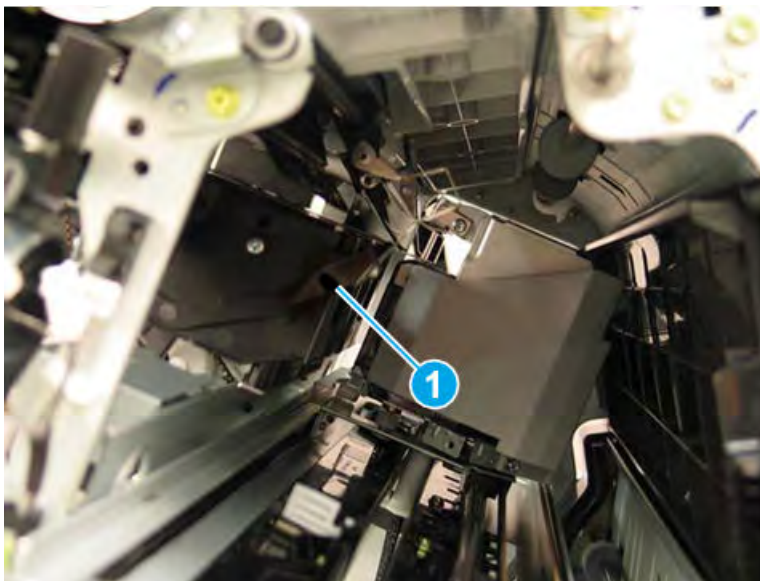

- b. When the rear tamper shaft is removed, the retainer arm that held the one end of the shaft will drop down. When reinstalling the shaft, raise the retainer arm and position the end of the shaft in the notch (callout 1).

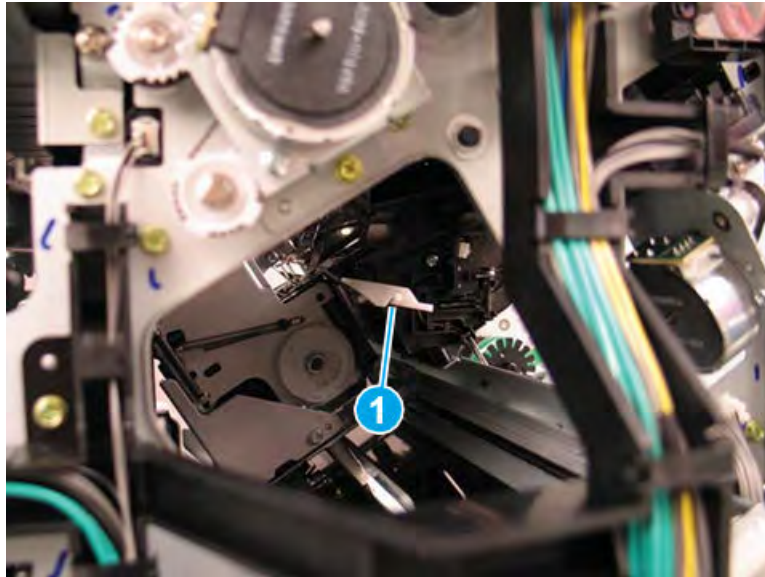

Remove the rear tamper unit

Follow these steps to remove the rear tamper unit.

- ▲ Lift the rear tamper away from the finisher to remove it

 **NOTE:** Reverse the removal steps to install the assembly.

Figure 5-710 Remove the rear tamper



Unpack the replacement assembly



Follow these steps to unpack the replacement assembly.

1. Dispose of the defective part.

 **NOTE:** HP recommends responsible disposal of the defective part.

<http://www8.hp.com/us/en/hp-information/environment/product-recycling.html>

2. Unpack the replacement part from the packaging.

 **CAUTION:**  Some parts are sensitive to electrostatic discharge (ESD). Always perform service work at an ESD-protected workstation or mat. If an ESD workstation or mat is not available, touch the sheet-metal chassis to provide a static ground before touching an ESD-sensitive assembly. Protect the ESD-sensitive assemblies by placing them in ESD pouches when they are out of the printer.

 **IMPORTANT:** Make sure that all of the shipping materials (for example shipping tape) are removed from the replacement part prior to installation.

 **NOTE:** If the replacement part is a roller or pad, avoid touching the spongy part of it. Skin oils on the roller or pad can cause paper pickup and/or print-quality problems. HP recommends using disposable gloves when handling rollers or pads or washing your hands before touching rollers or pads.

3. To install an assembly, reverse the removal steps.

 **NOTE:** When applicable, special installation instructions are provided for an assembly at the end of the removal procedure. Always completely read the removal instructions and follow all special installation instructions.

Removal and replacement: Rear tamper home sensor (S9)

Learn how to remove and replace the rear tamper home sensor.

Introduction

This document provides the procedures to remove and replace the rear tamper home sensor on the finisher.

 **IMPORTANT:** When applicable, special installation instructions are provided for an assembly at the end of the removal procedure. Always completely read the removal instructions and follow all special installation instructions.

Before performing service

- Turn the printer power off. A shutting-down message appears on the control-panel display.
- ⚠ **WARNING!** To avoid damage to the printer, turn the power off and wait until the printer shuts down before removing the power cable.
- Disconnect the printer power cable after the printer has completely shut down (the control-panel display is blank).
- Release the finisher from the printer by pulling out on the release latch inside the finisher door.
- Disconnect the cable from the bridge unit to the finisher.
- Disconnect the cable from the finisher to the printer.

Use the table below to identify the correct part number for your printer. To order the part, go to <https://parts.hp.com>.

Table 5-117 Part information

Part number	Part description
0604-001393	Rear tamper home sensor

Required tools

- #2 JIS screwdriver with a magnetic tip
- Small, flat-blade screwdriver

After performing service

- Connect the cable from the finisher to the printer.
- Connect the cable from the bridge unit to the finisher.
- Attach the finisher to the printer, and then push in on the release latch inside the finisher door.
- Connect the printer power cable.
- Turn the printer power on.

Post service test

Process a job through the finisher and verify that the finisher works correctly.

Remove the right upper cover (finisher)

Follow these steps to remove the right upper cover (finisher).

- ▲ Remove one screw cap and three machine screws on the upper edge of the cover (callout 1). Remove three sheet metal screws (callout 2) on the lower portion of the cover. Rotate the right edge of the cover away from the finisher, and then slide the cover right to release three tabs (callout 3).

💡 **TIP:** The lower screws are shorter in length than the upper screws.

TIP: Reverse the removal steps to install the assembly.

Figure 5-711 Remove the right upper cover

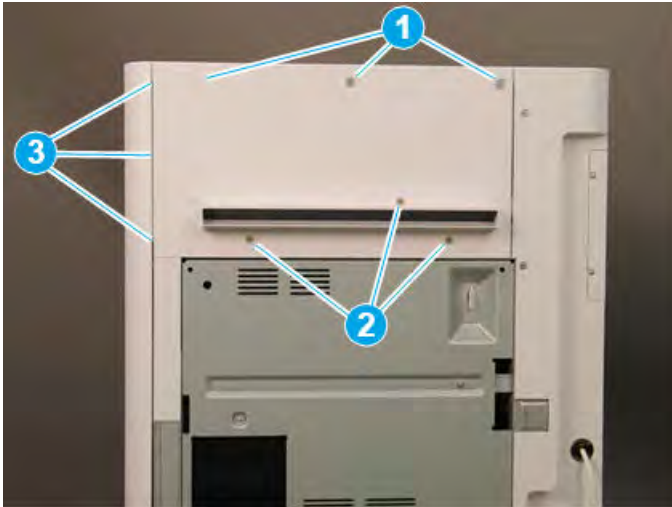

Remove the top cover (finisher)

Follow these steps to remove the top cover (finisher).

1. Remove three screw caps and three self-tapping screws at the top of the rear cover (callout 1), and then remove three machine screws (callout 2) on top of the cover.

Figure 5-712 Remove six screws

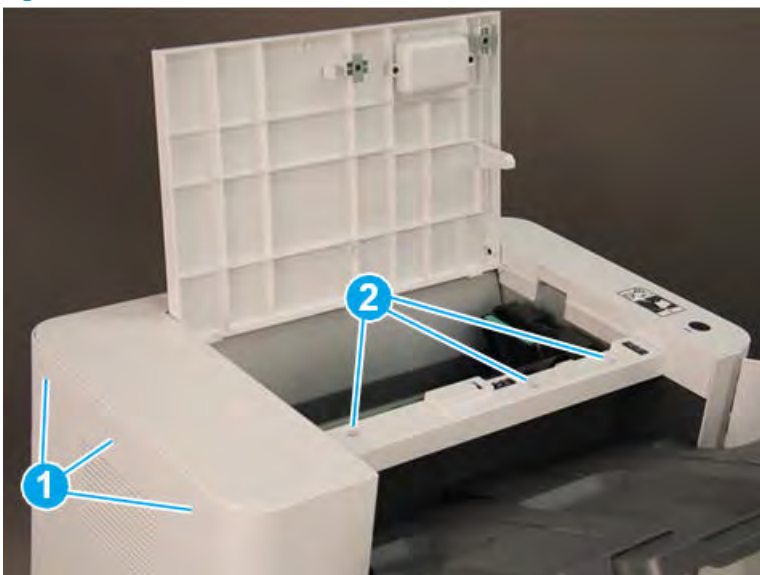

2. Remove three self-tapping screws at the top of the front cover (callout 1), and then remove two machine screws (callout 2) at the top of the right side.

Figure 5-713 Remove five screws

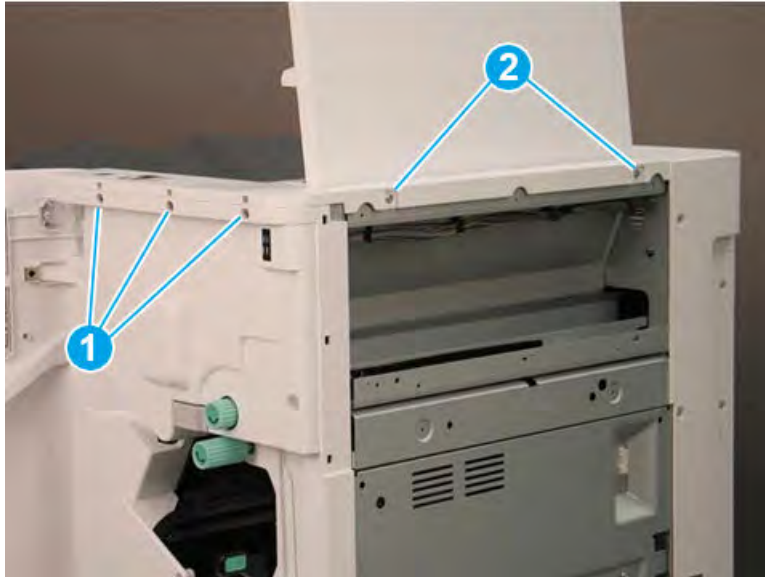

3. Lift the cover up slightly. Disconnect one in-line connector (callout 1), and then release one retainer (callout 2).

 **TIP:** Reverse the removal steps to install the assembly.

Figure 5-714 Disconnect one connector and release retainer



Remove the front door (finisher)

Follow these steps to remove the front door (finisher).

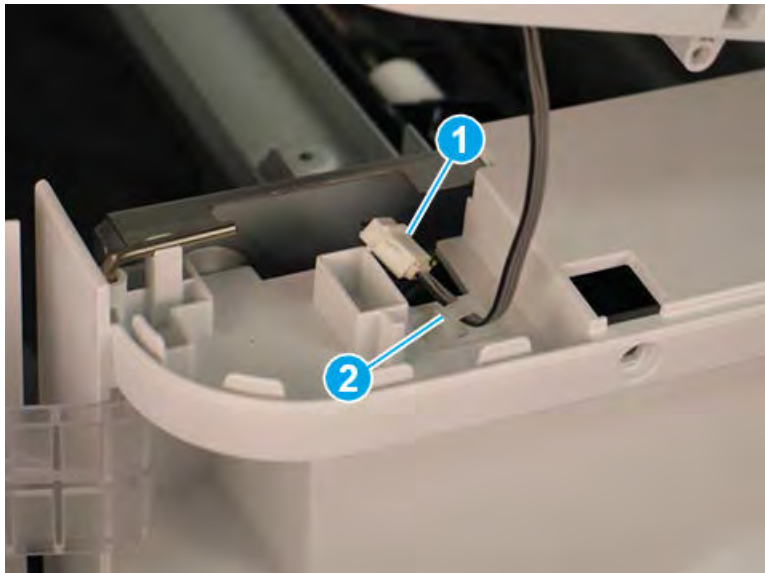
1. Lift the top hinge pin up to release it from the retainer.

Figure 5-715 Lift the top hinge pin

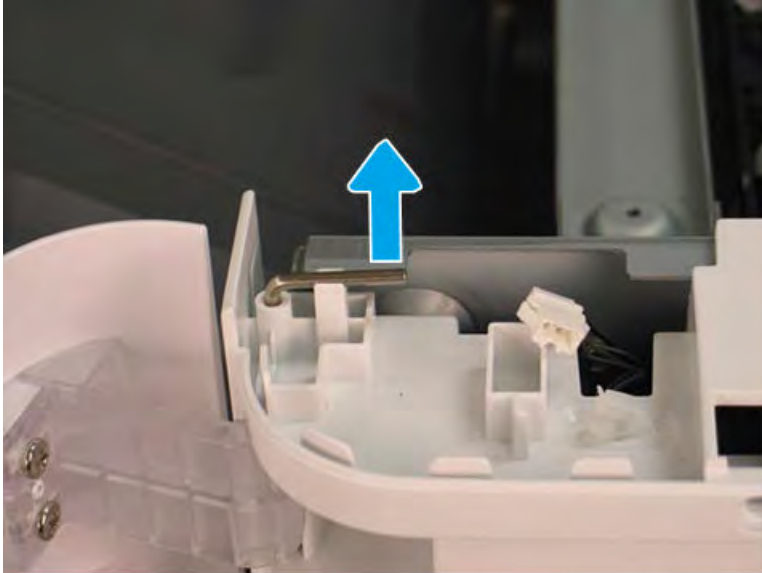

2. Pull the top hinge pin up to remove it.

Figure 5-716 Remove the top hinge pin

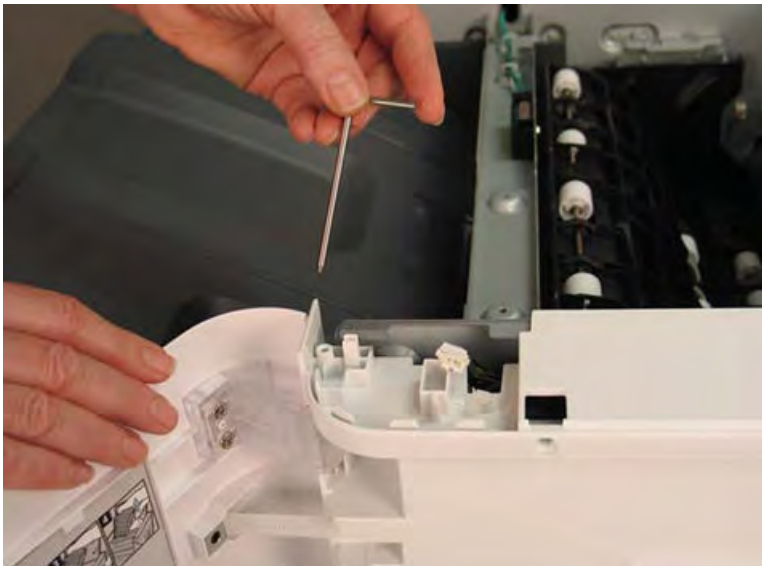

3. Use a small, flat-blade screwdriver to release the lower hinge pin from the retainer, and then rotate it away from the finisher.

Figure 5-717 Release the lower hinge pin



4. Support the door with one hand, and then pull the lower hinge pin straight up to remove it.

Figure 5-718 Remove the lower hinge pin



5. Support the door with one hand, and then remove one screw (callout 1) to release the strap. Remove the front door.

 **TIP:** Reverse the removal steps to install the assembly.

Figure 5-719 Remove the front door



Remove the front cover (finisher)

Follow these steps to remove the front cover (finisher).

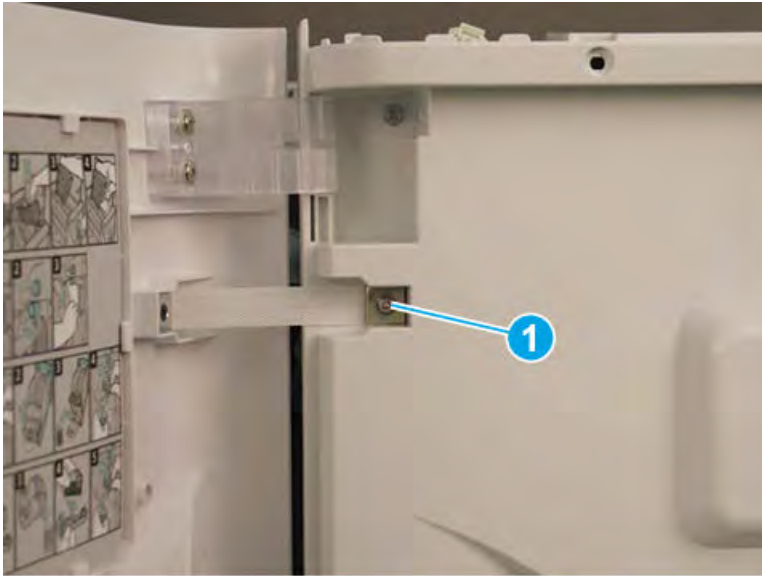
1. Release one tab (callout 1), and then pull the jam-access knob away from the finisher to remove it.

Figure 5-720 Remove the jam-access knob

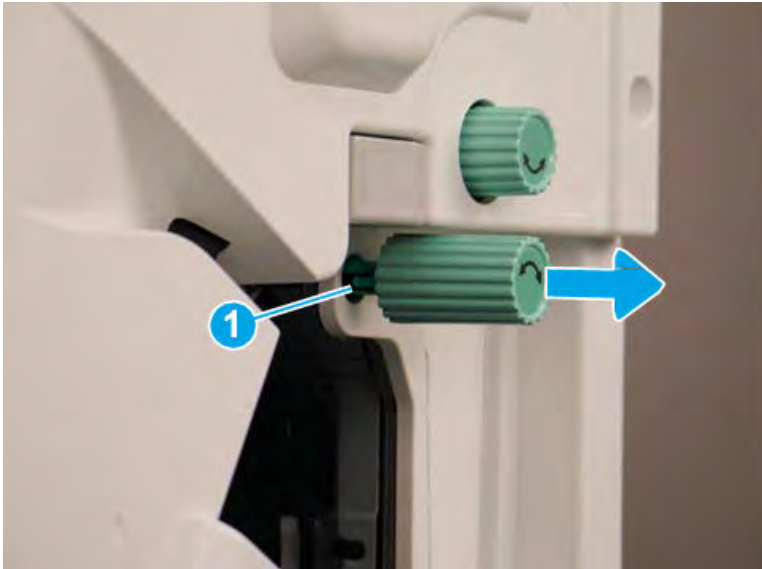

2. If the punch unit is installed, remove the punch waste bin (callout 1).

3. Remove one screw (callout 1) on top of the front cover.

Figure 5-721 Remove one screw



4. Remove five machine screws (callout 1), and then remove the front cover.

 **TIP:** Reverse the removal steps to install the assembly.

Figure 5-722 Remove the front cover



Remove the rear cover (finisher)

Follow these steps to remove the rear cover (finisher).

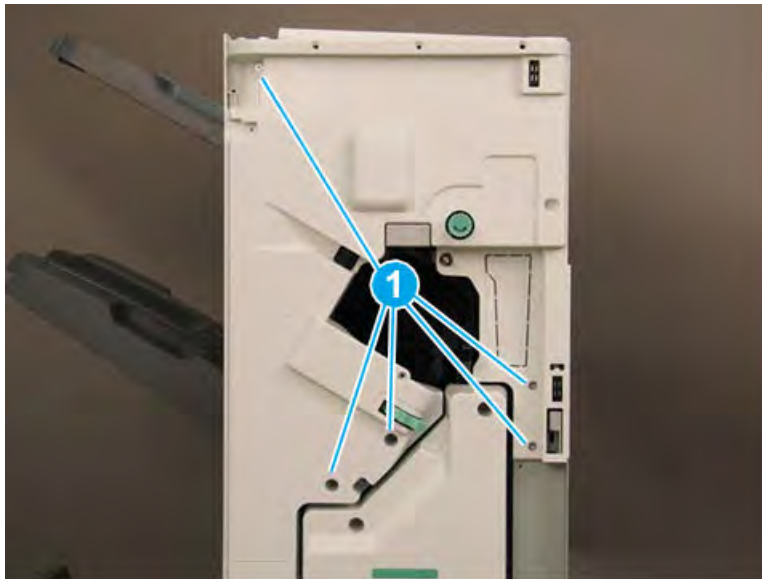
1. Remove two self-tapping screws (callout 1) on the top of the rear cover, and then remove five screw caps and five machine screws (callout 2) on the left side of the cover.

Figure 5-723 Remove seven screws

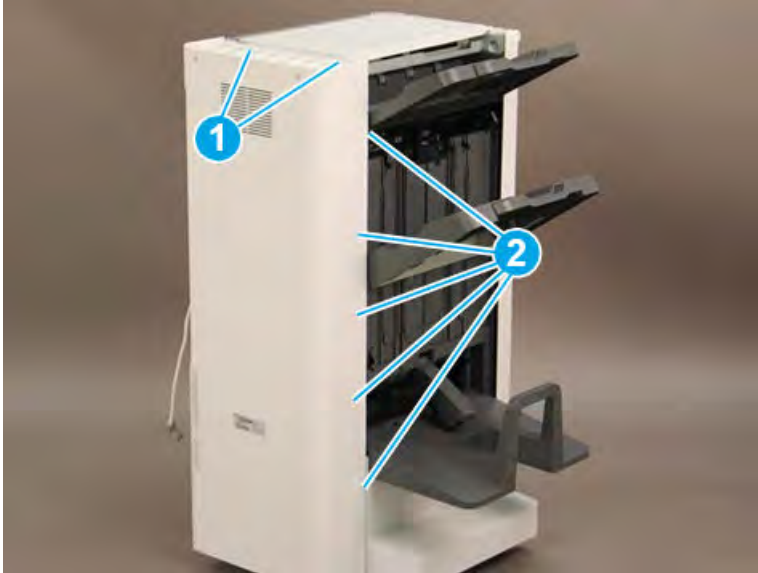

2. Remove one screw cap and four machine screws (callout 1) Remove the rear cover.

 **NOTE:** Make sure to thread the power cable (callout 2) through the opening in the cover.

 **TIP:** Reverse the removal steps to install the assembly

Figure 5-724 Remove the rear cover



Remove the booklet output tray

Follow these steps to remove the booklet output tray.

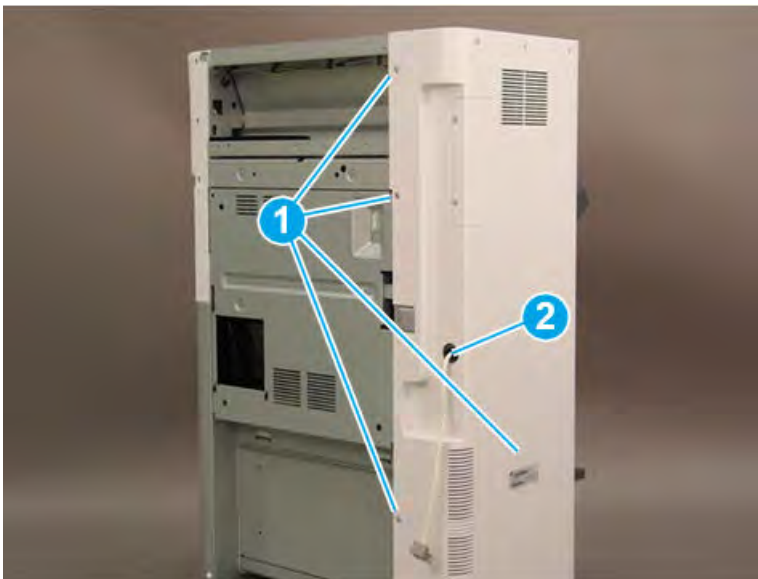
1. Raise the booklet output tray up (callout 1), and then pull it away from the finisher (callout 2) to remove it.

Figure 5-725 Remove the booklet output tray



2. Reverse the removal steps to install the assembly. Also use the following special installation instructions.

 **NOTE:** Continue to reverse the removal steps to finish installing the assembly

Special installation instructions: booklet output tray

Position the tabs (callout 1) on the tray into the slots (callout 2) on the finisher.

Figure 5-726 Install the booklet output tray

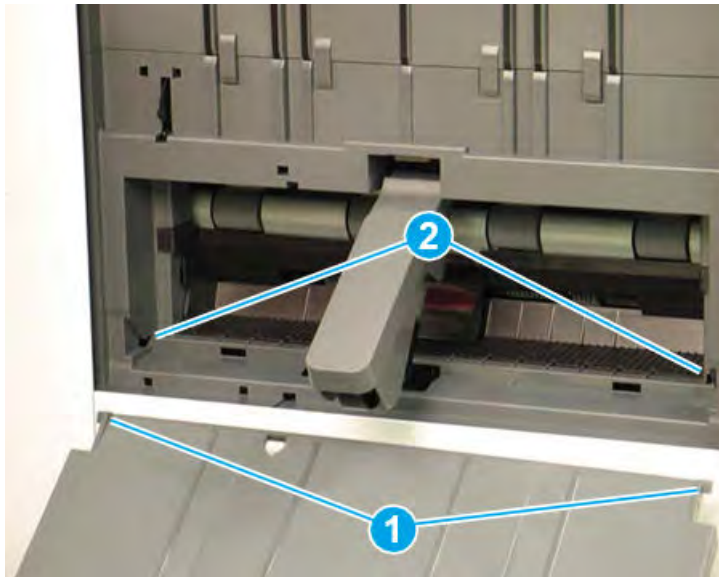

Remove the caster cover

Follow these steps to remove the caster cover.

1. Remove two screw caps and two self-tapping screws (callout 1). Remove two screw caps and two machine screws (callout 2).

Figure 5-727 Remove four screws

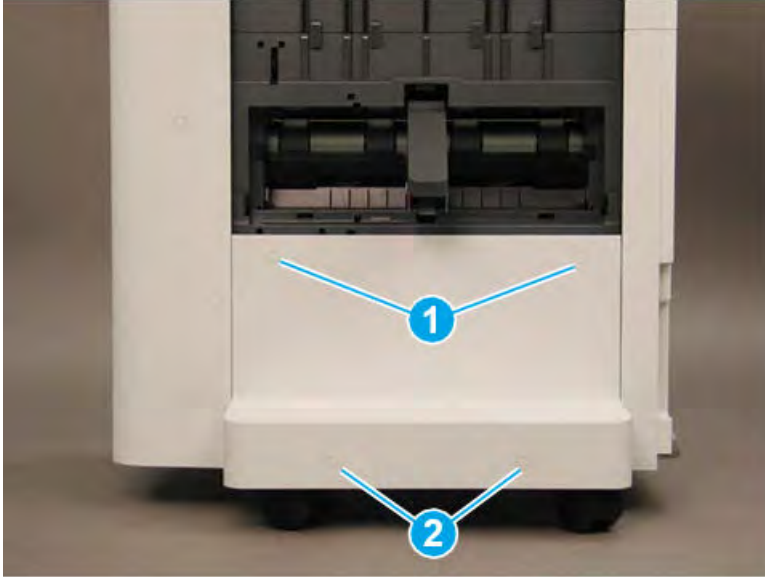

2. Rotate the left edge of the cover away from the finisher (callout 1), and then slide the cover to the left (callout 2) to remove it.

 **TIP:** Make sure that two tabs (callout 3) are positioned under the front lower cover when reinstalling the caster cover.

TIP: Reverse the removal steps to install the assembly

Figure 5-728 Remove the caster cover

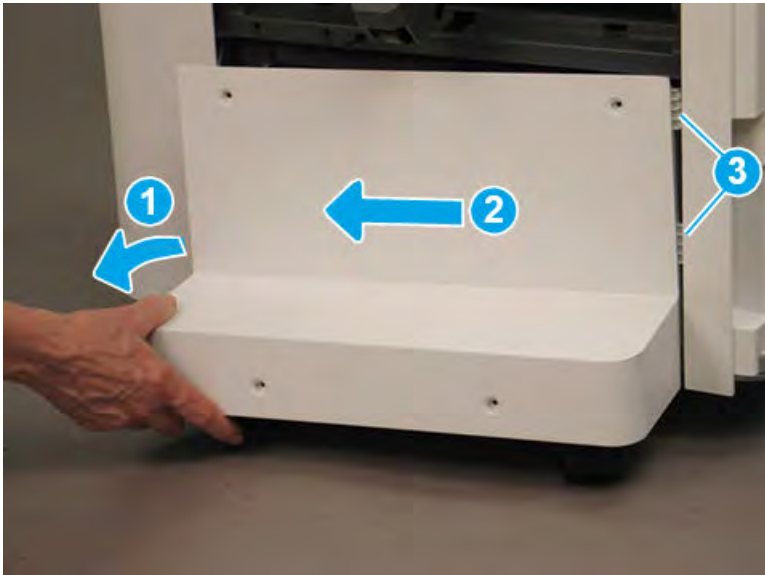

Remove the left lower cover (finisher)

Follow these steps to remove the left lower cover (finisher).

1. Remove four screws (callout 1).

 **NOTE:** Raise the lower output tray as needed to access the screws.

Figure 5-729 Remove four screws



2. Slide the shield down (callout 1) to release it from four tabs (callout 2), and then rotate it away from the finisher (callout 3).

⚠ CAUTION: The shield is still attached to the finisher. Do not attempt to completely remove the shield.

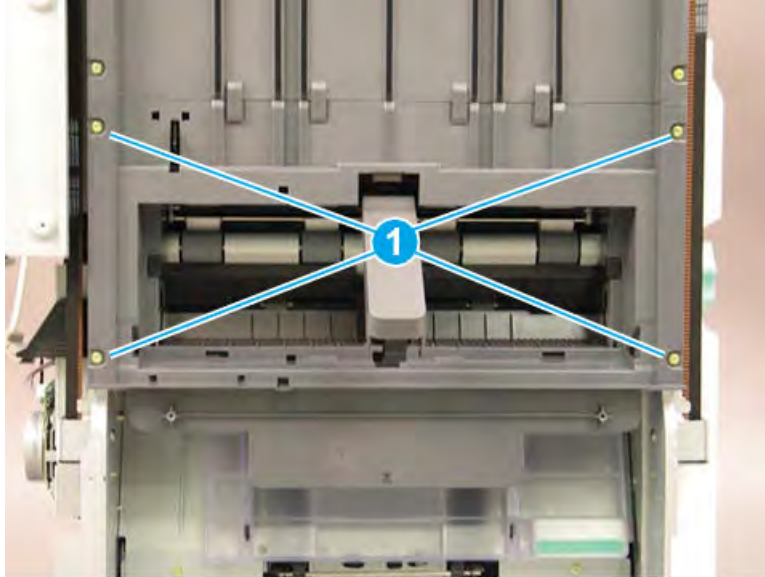
💡 TIP: Position the shield under the four tabs (callout 2) when reinstalling it.

Figure 5-730 Release the lower shield

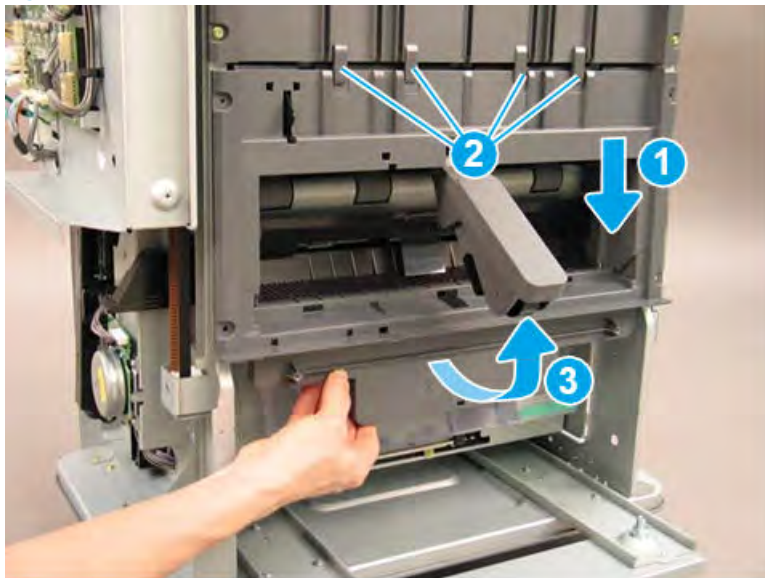

3. Disconnect two connectors (callout 1), and then remove the shield.

 **TIP:** Reverse the removal steps to install the assembly.

Figure 5-731 Disconnect two connectors



4. If you are replacing the left lower cover, locate three sensors (callout 1) on the back of the left lower cover. Remove these sensors and transfer them to the replacement part.

Figure 5-732 Remove the left lower cover

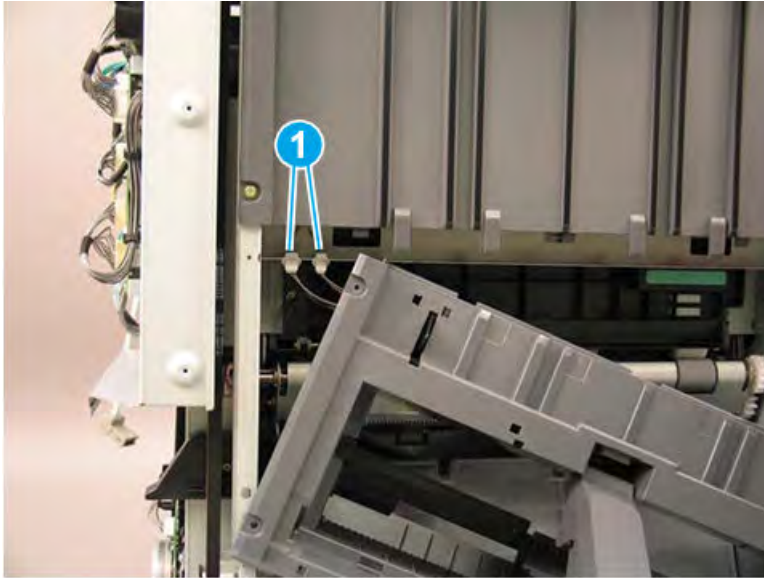
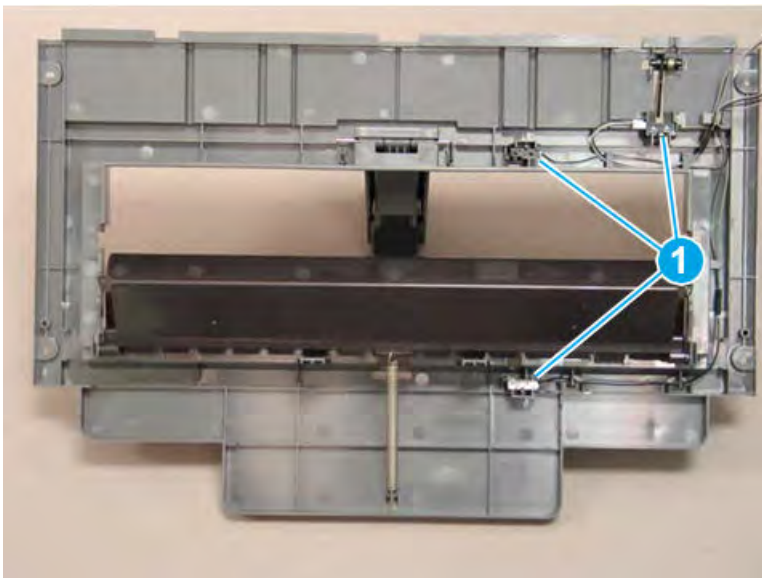

Remove the left upper cover (finisher)

Follow these steps to remove the left upper cover (finisher).

1. Bring the lower output tray down by positioning the shaft of a screwdriver on the clutch (callout 1) and gently pressing to the right to release the clutch. Hold the clutch in the released position and lower the tray (callout 2) to the lowest position.

Figure 5-733 Lower the output tray

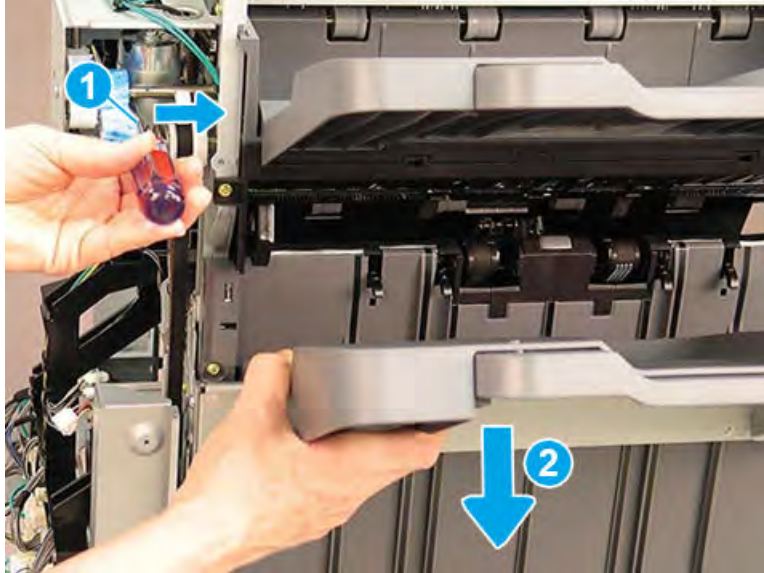

2. Remove six machine screws (callout 1).

Figure 5-734 Remove six screws

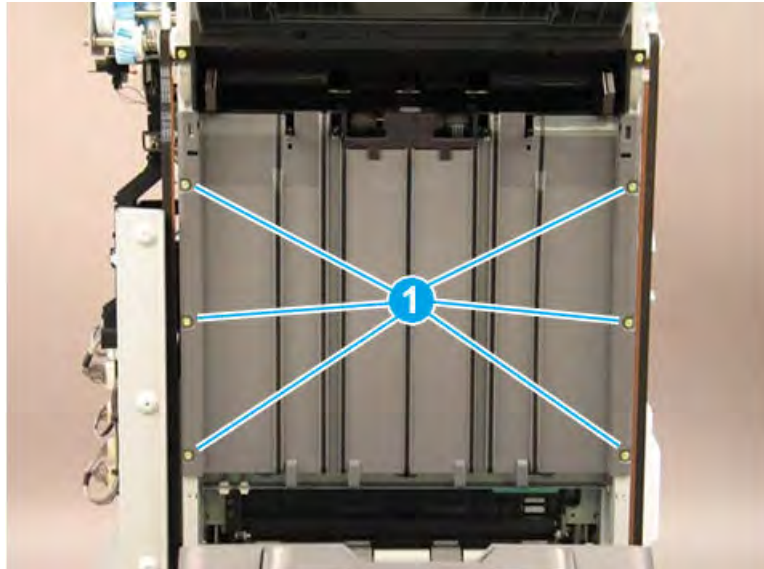

3. Rotate the lower edge of the shield away from the finisher (callout 1), and then slide the shield down (callout 2) to release it from two tabs (callout 3).

⚠ CAUTION: The shield is still attached to the finisher. Do not attempt to completely remove the shield.

💡 TIP: Position the shield under the two tabs (callout 3) when reinstalling it.

Figure 5-735 Release the shield

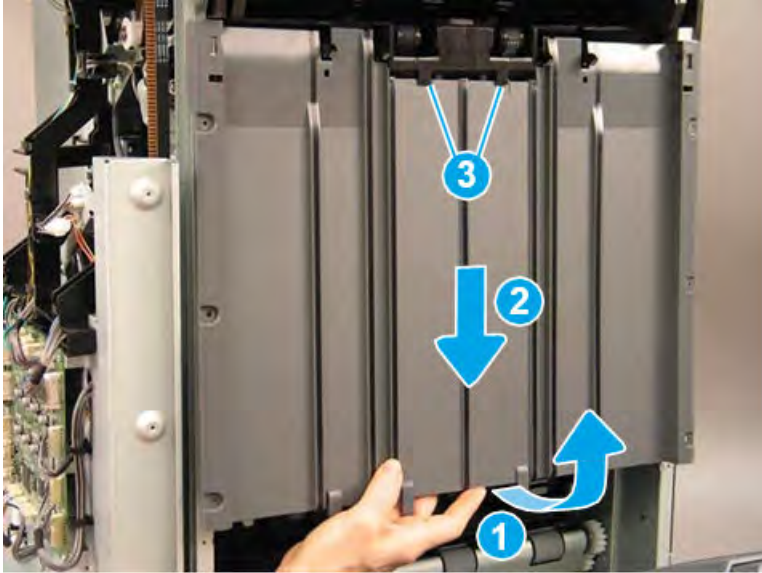

4. Disconnect one connector (callout 1), and then remove the upper shield assembly.

💡 TIP: Reverse the removal steps to install the assembly.

Figure 5-736 Disconnect one connector

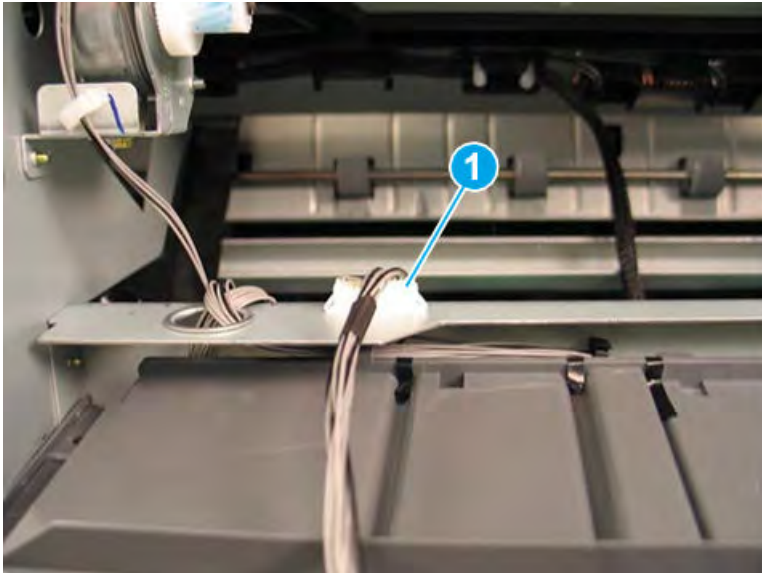

5. If you are replacing the left upper cover, locate three sensors (callout 1) on the back of the left upper cover. Remove these sensors and transfer them to the replacement part.

Figure 5-737 Remove the left upper cover

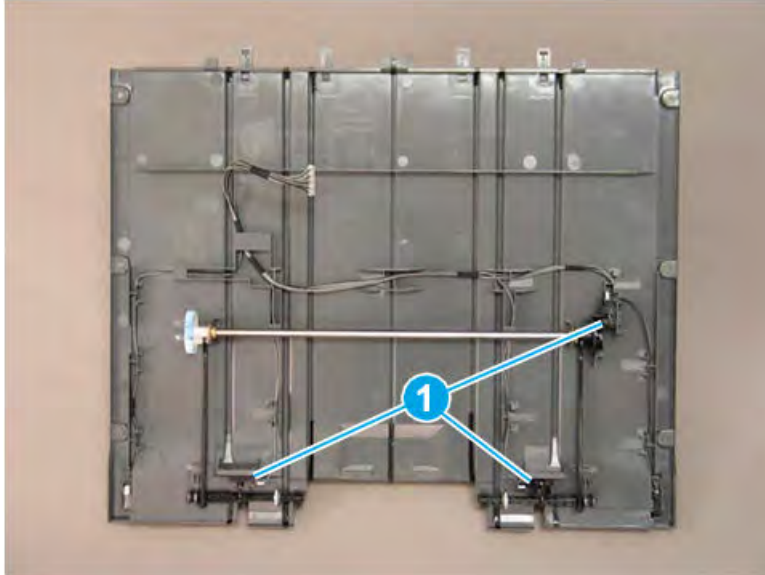

Remove the ejector unit (finisher)

Follow these steps to remove the ejector unit (finisher).

1. Rotate the green wheel to move the staple unit to the center of the finisher.

Figure 5-738 Move the staple unit to the center

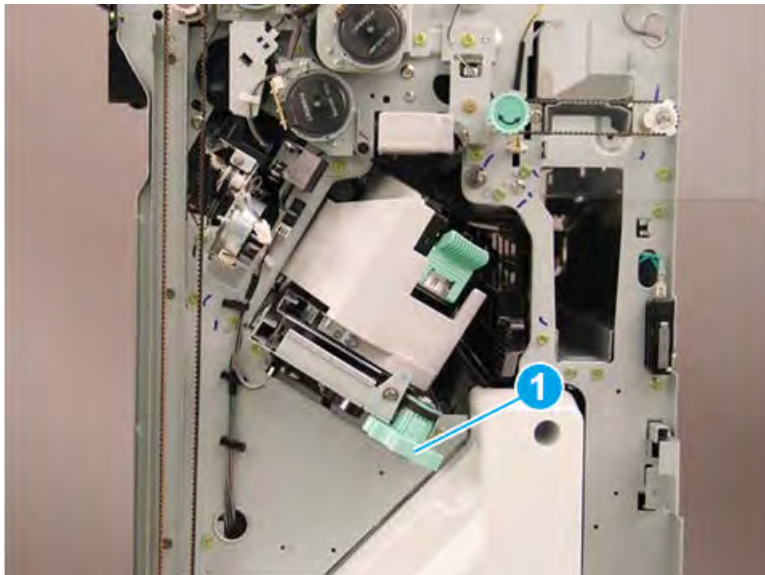

2. Release one retainer (callout 1), and then disconnect three connectors (callout 2).

Figure 5-739 Disconnect three connectors

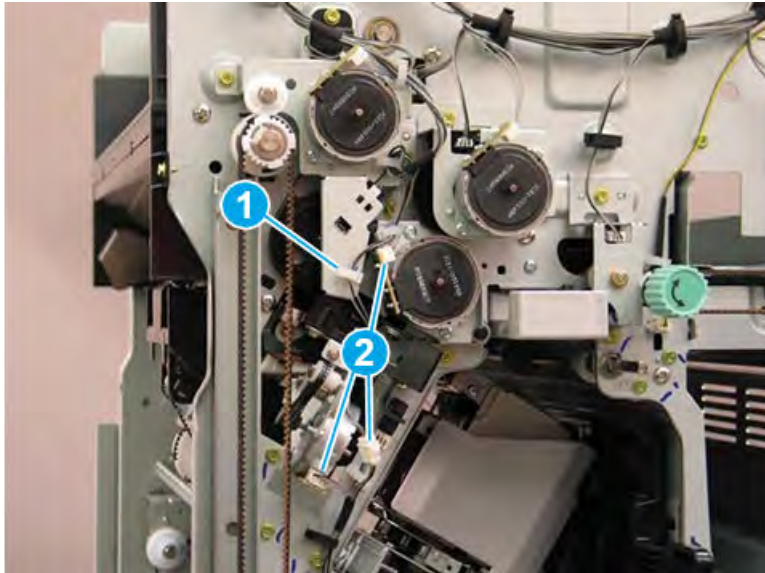

3. Remove two screws (callout 1).

Figure 5-740 Remove two screws

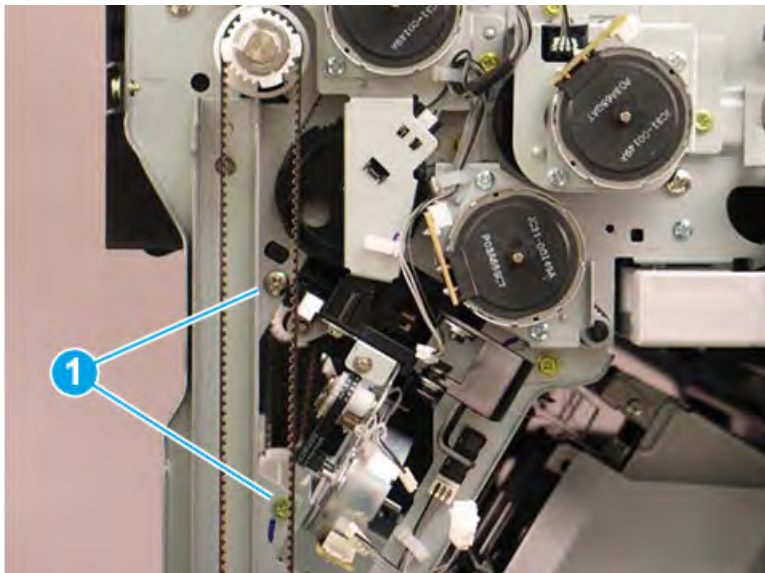

4. At the left side of the finisher, remove one screw (callout 1).

Figure 5-741 Remove one screw

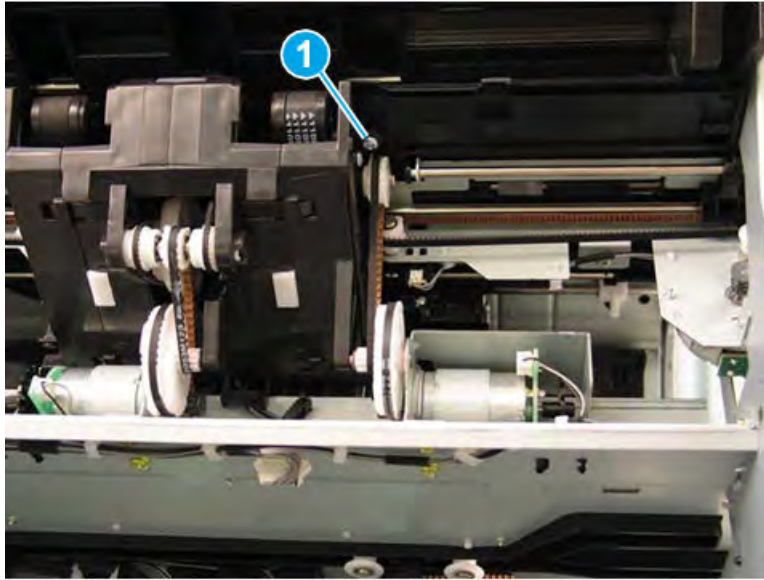

5. Press up on the hinge (callout 1), release one tab (callout 2), and then rotate the sensor away from the finisher (callout 3).

Figure 5-742 Rotate the sensor

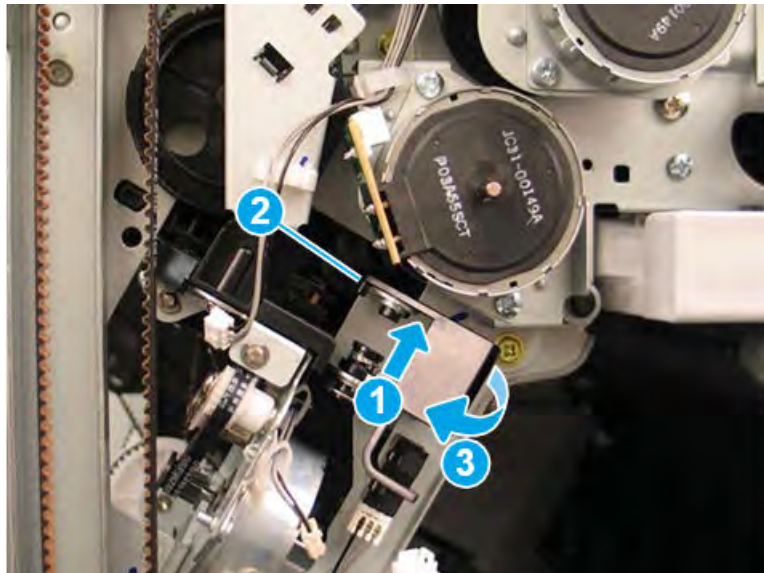

6. Remove one screw (callout 1).

Figure 5-743 Remove one screw

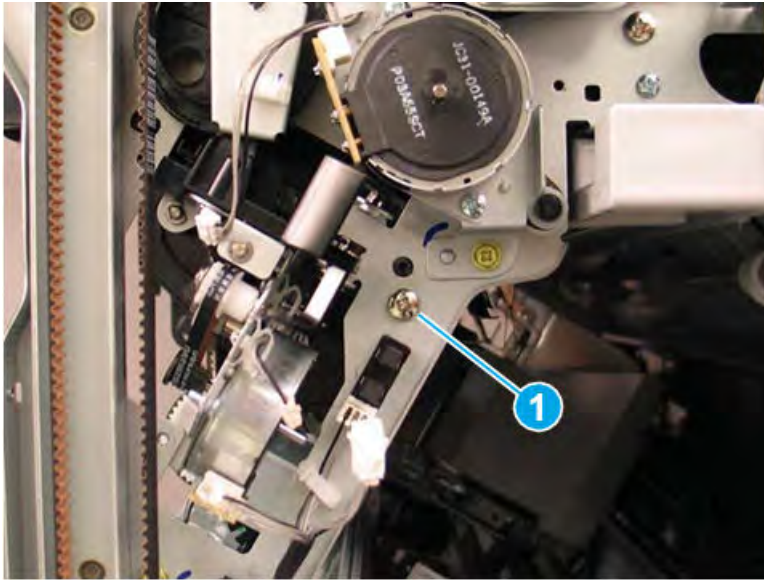

7. Look inside the finisher through the stapler opening in the front and pull down to release and remove one shaft (callout 1) on the front tamper unit.

Figure 5-744 Remove the front tamper shaft

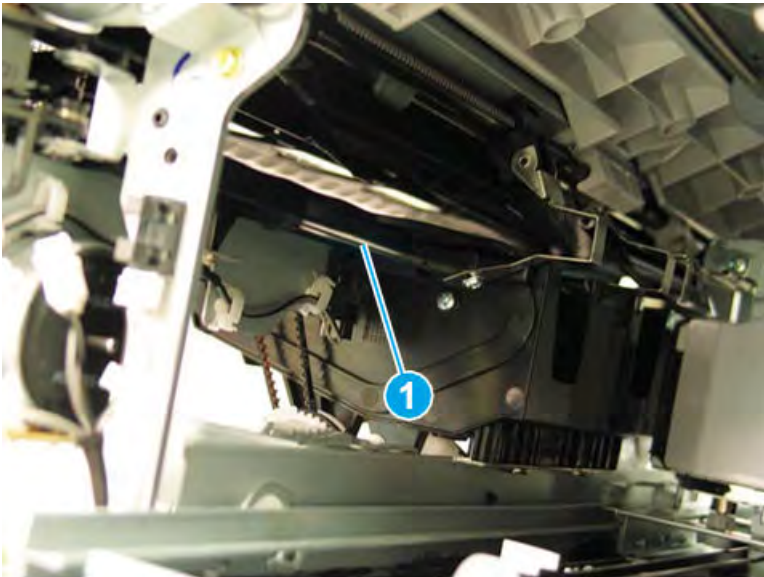

8. At the rear of the finisher, disconnect two connectors (callout 1), and then remove three screws (callout 2).

Figure 5-745 Disconnect two connectors and remove three screws

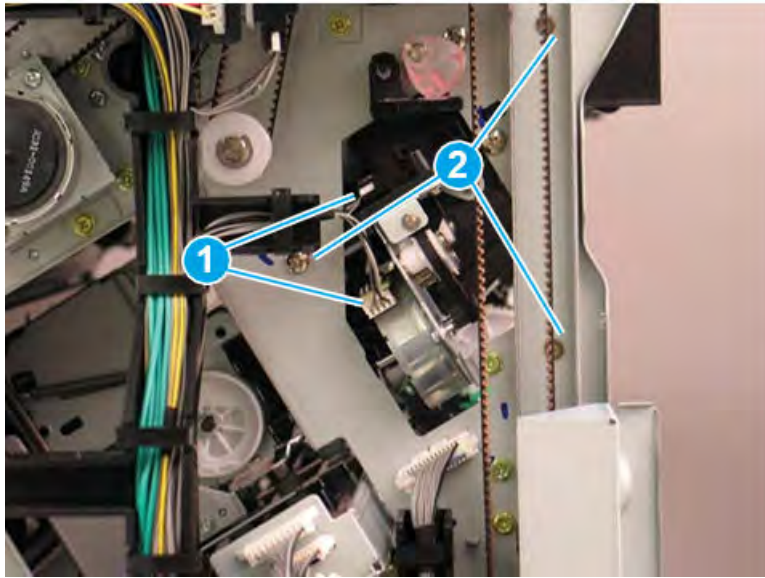

9. At the left side of the finisher, remove one screw (callout 1).

Figure 5-746 Remove one screw

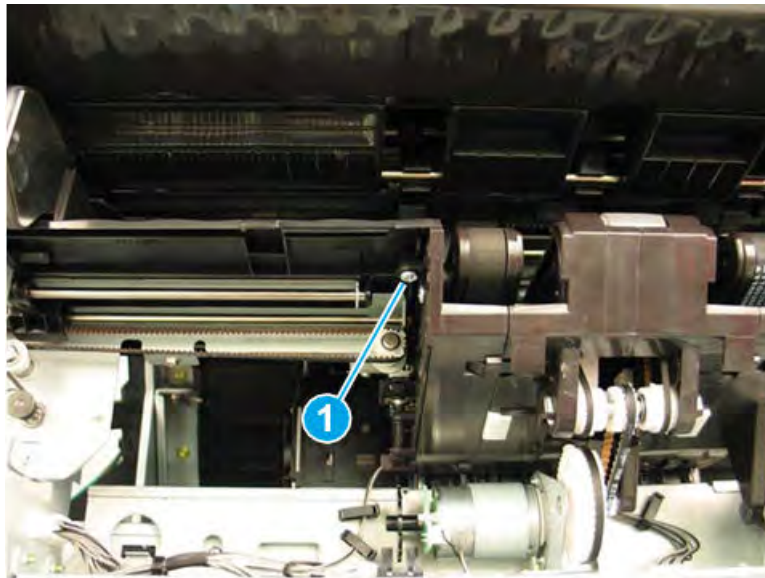

10. Look inside the finisher through the stapler opening in the rear and pull down to release and remove one shaft (callout 1) on the rear tamper unit.

Figure 5-747 Remove the rear tamper shaft

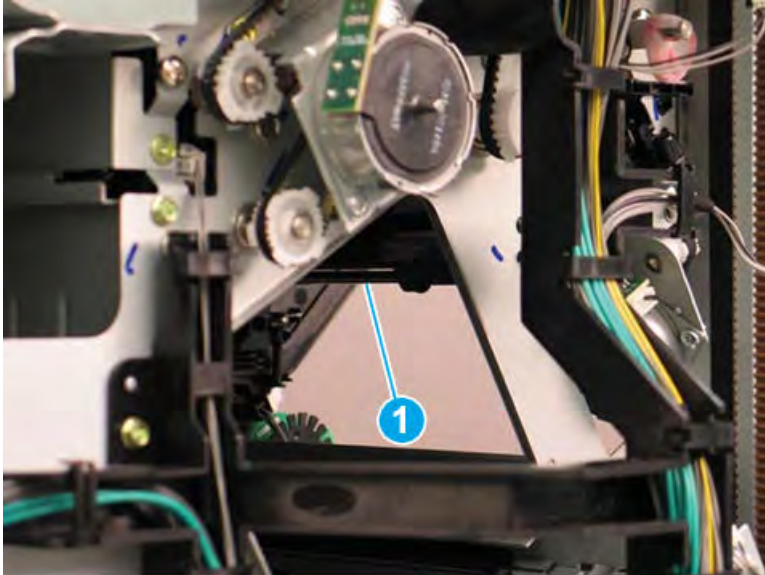

11. At the left side of the finisher, disconnect one connector (callout 1).

Figure 5-748 Disconnect one connector

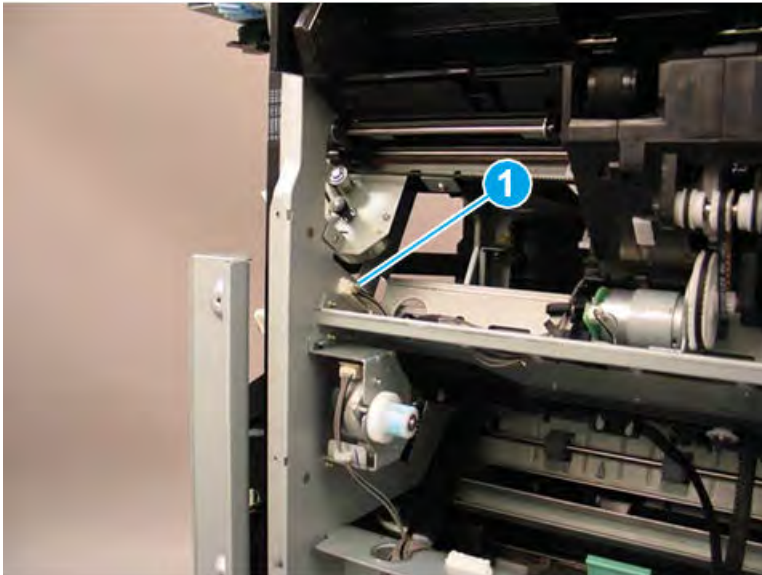

12. At the rear of the finisher, disconnect one connector (callout 1).

Figure 5-749 Disconnect one connector

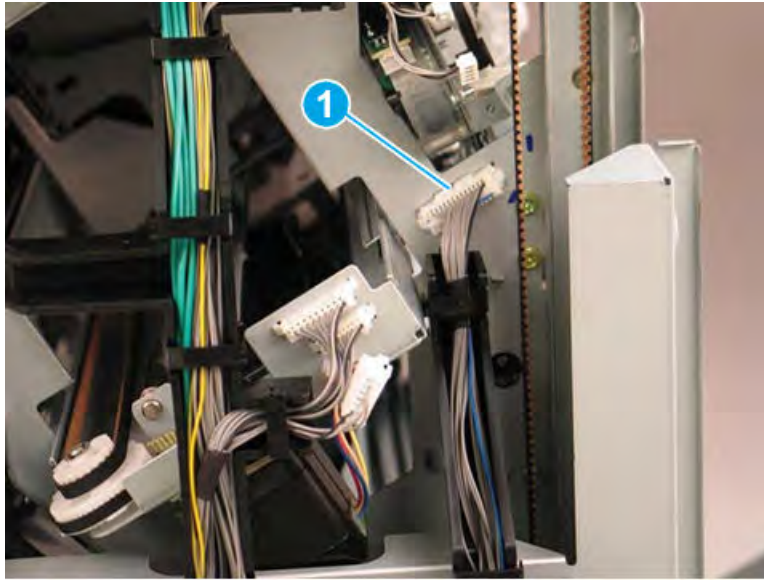

13. At the rear of the finisher, press the wire retainer to the right to access and remove two screws (callout 1).

Figure 5-750 Disconnect one connector

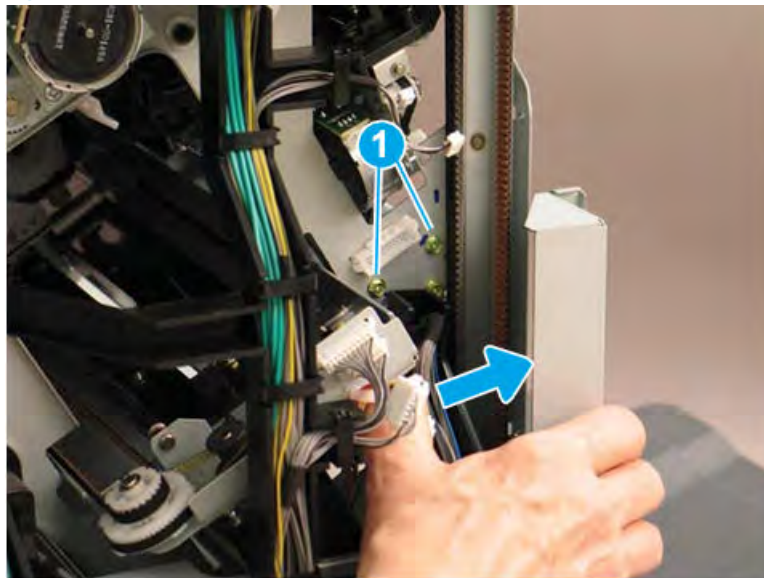

14. At the front of the finisher, remove two screws (callout 1).

Figure 5-751 Remove two screws

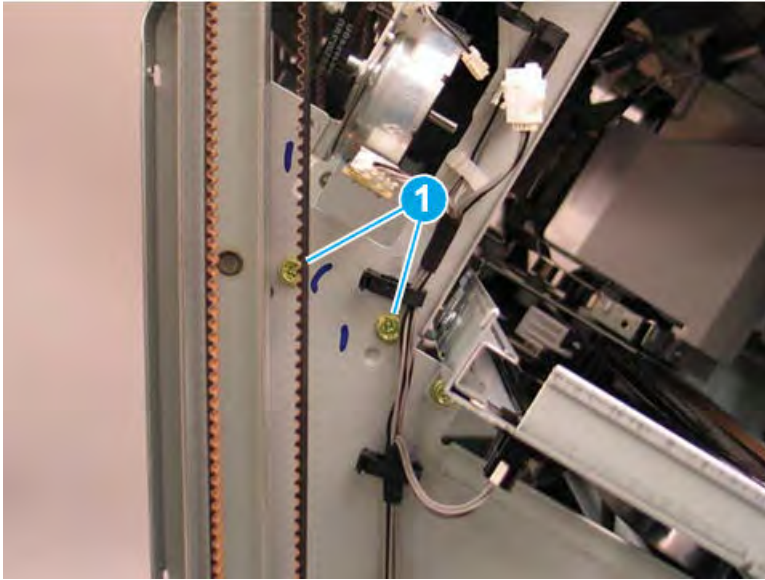

15. Lift the inside edges of the front and rear tampers up.

Figure 5-752 Lift the edges of the tampers

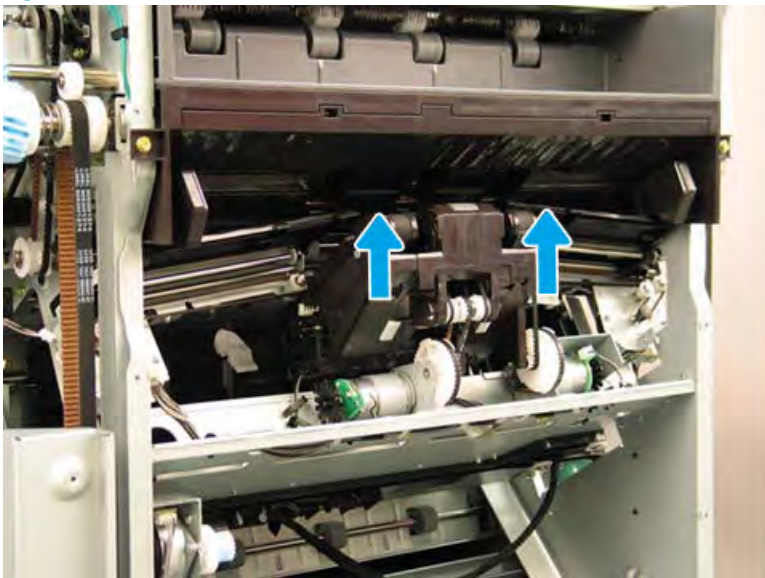

16. Rotate the rear edge of the ejector unit away from the finisher (callout 1), and then slide it toward the rear of the finisher (callout 2) to remove it. Make sure that the PCA (callout 3) stays clear of the sheet metal frame.

Figure 5-753 Remove the ejector unit

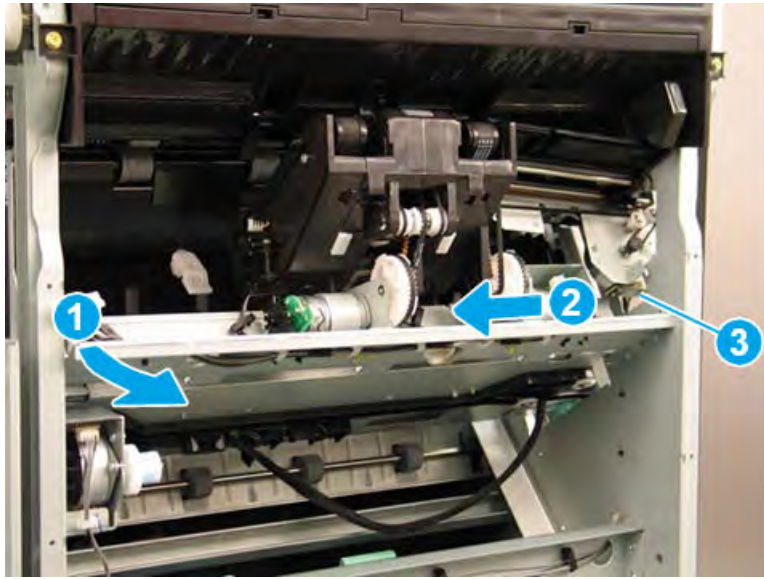

17. Reverse the removal steps to install the assembly. Also use the following special installation instructions.

 **NOTE:** Continue to reverse the removal steps to finish installing the assembly.

Special installation instructions: Ejector unit

- a. When the front tamper shaft is removed, the retainer arm that held the one end of the shaft will drop down. When reinstalling the shaft, raise the retainer arm and position the end of the shaft in the notch (callout 1).

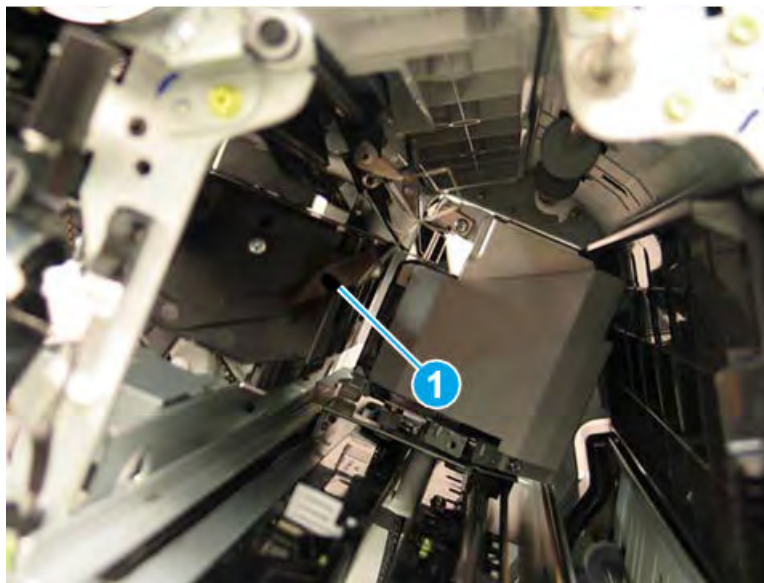

- b. When the rear tamper shaft is removed, the retainer arm that held the one end of the shaft will drop down. When reinstalling the shaft, raise the retainer arm and position the end of the shaft in the notch (callout 1).

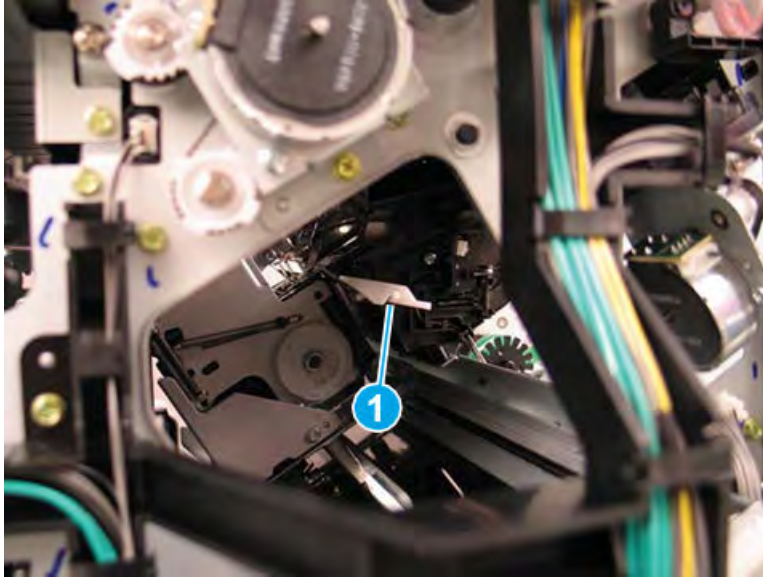

Remove the rear tamper unit

Follow these steps to remove the rear tamper unit.

- ▲ Lift the rear tamper away from the finisher to remove it

 **NOTE:** Reverse the removal steps to install the assembly.

Figure 5-754 Remove the rear tamper

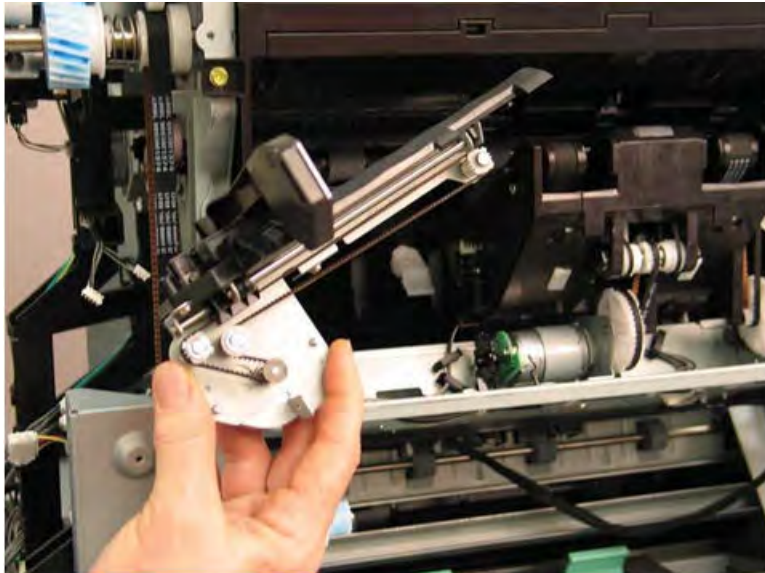

Remove the rear tamper home sensor(S9)

Follow these steps to remove the rear tamper home sensor(S9).

1. Remove two screws(callout 1) at the rear tamper.

Figure 5-755 Remove two screws

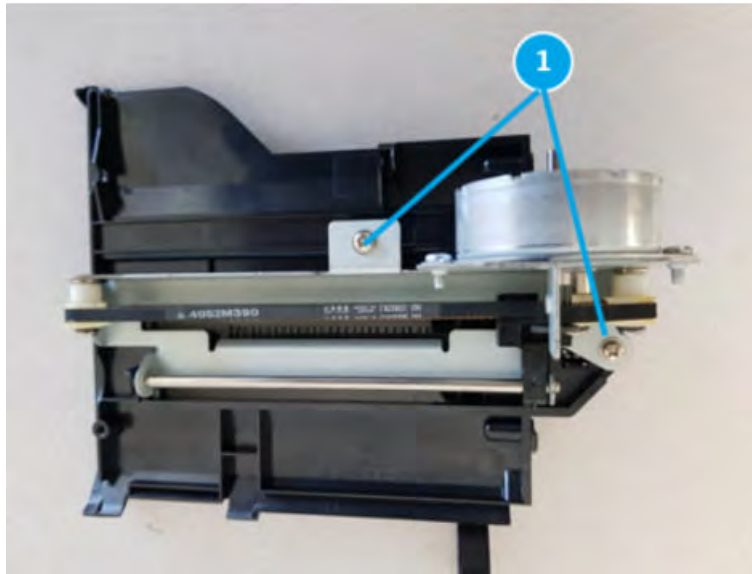

2. Remove one screw in front side(callout 1)

Figure 5-756 Remove one screw

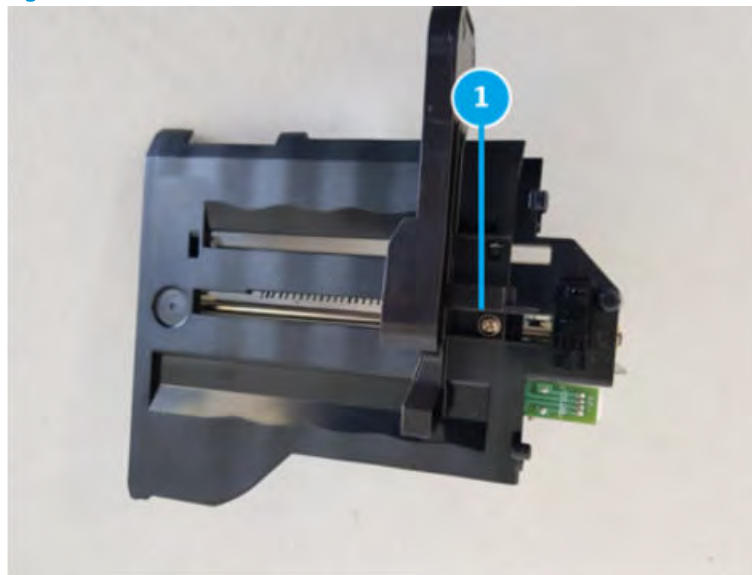

3. Remove rear tamper home sensor(S9, callout 1)

Figure 5-757 Remove rear tamper home sensor



Unpack the replacement assembly



Follow these steps to unpack the replacement assembly.

1. Dispose of the defective part.

 **NOTE:** HP recommends responsible disposal of the defective part.

<http://www8.hp.com/us/en/hp-information/environment/product-recycling.html>

2. Unpack the replacement part from the packaging.

 **CAUTION:**  Some parts are sensitive to electrostatic discharge (ESD). Always perform service work at an ESD-protected workstation or mat. If an ESD workstation or mat is not available, touch the sheet-metal chassis to provide a static ground before touching an ESD-sensitive assembly. Protect the ESD-sensitive assemblies by placing them in ESD pouches when they are out of the printer.

 **IMPORTANT:** Make sure that all of the shipping materials (for example shipping tape) are removed from the replacement part prior to installation.

 **NOTE:** If the replacement part is a roller or pad, avoid touching the spongy part of it. Skin oils on the roller or pad can cause paper pickup and/or print-quality problems. HP recommends using disposable gloves when handling rollers or pads or washing your hands before touching rollers or pads.

3. To install an assembly, reverse the removal steps.

 **NOTE:** When applicable, special installation instructions are provided for an assembly at the end of the removal procedure. Always completely read the removal instructions and follow all special installation instructions.

Removal and replacement: Rear tamper motor (M9)

Learn how to remove and replace the rear tamper motor.

Introduction

This document provides the procedures to remove and replace the rear tamper motor on the finisher.

 **IMPORTANT:** When applicable, special installation instructions are provided for an assembly at the end of the removal procedure. Always completely read the removal instructions and follow all special installation instructions.

Before performing service

- Turn the printer power off. A shutting-down message appears on the control-panel display.
-  **WARNING!** To avoid damage to the printer, turn the power off and wait until the printer shuts down before removing the power cable.
- Disconnect the printer power cable after the printer has completely shut down (the control-panel display is blank).
- Release the finisher from the printer by pulling out on the release latch inside the finisher door.
- Disconnect the cable from the bridge unit to the finisher.
- Disconnect the cable from the finisher to the printer.

Use the table below to identify the correct part number for your printer. To order the part, go to <https://parts.hp.com>.

Table 5-118 Part information

Part number	Part description
JC93-01001A	Rear tamper motor

Required tools

- #2 JIS screwdriver with a magnetic tip

After performing service

- Connect the cable from the finisher to the printer.
- Connect the cable from the bridge unit to the finisher.
- Attach the finisher to the printer, and then push in on the release latch inside the finisher door.
- Connect the printer power cable.
- Turn the printer power on.

Post service test

Process a job through the finisher and verify that the finisher works correctly.

Remove the right upper cover (finisher)

Follow these steps to remove the right upper cover (finisher).

- ▲ Remove one screw cap and three machine screws on the upper edge of the cover (callout 1). Remove three sheet metal screws (callout 2) on the lower portion of the cover. Rotate the right edge of the cover away from the finisher, and then slide the cover right to release three tabs (callout 3).

💡 **TIP:** The lower screws are shorter in length than the upper screws.

TIP: Reverse the removal steps to install the assembly.

Figure 5-758 Remove the right upper cover

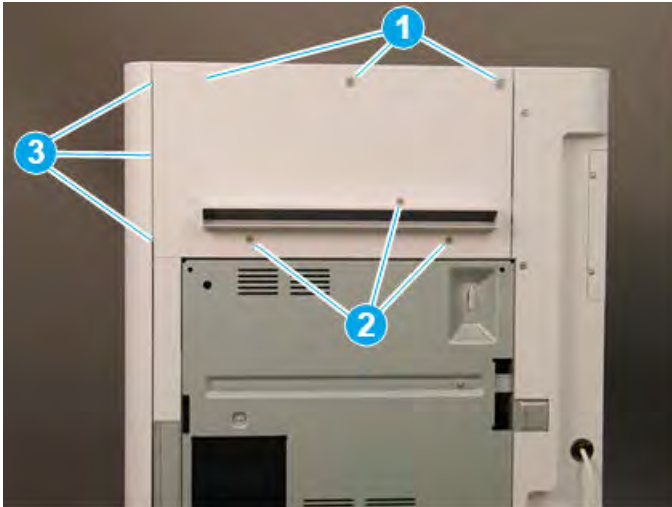

Remove the top cover (finisher)

Follow these steps to remove the top cover (finisher).

1. Remove three screw caps and three self-tapping screws at the top of the rear cover (callout 1), and then remove three machine screws (callout 2) on top of the cover.

Figure 5-759 Remove six screws

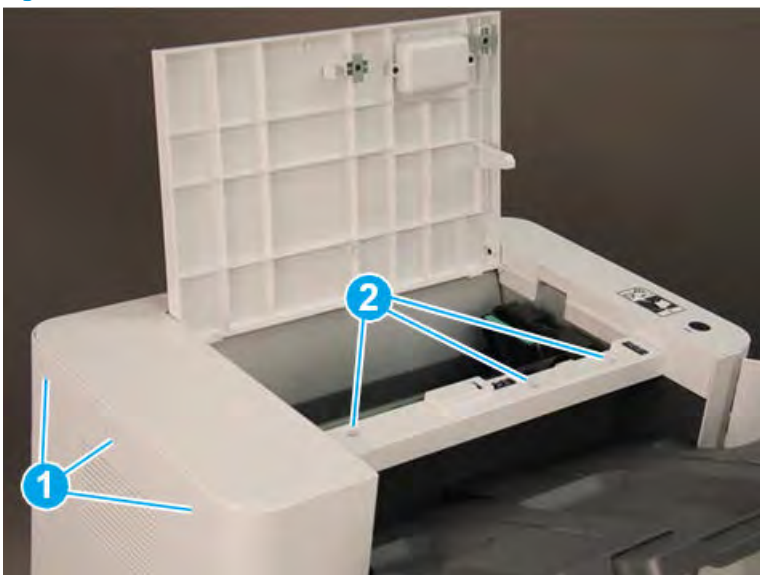

2. Remove three self-tapping screws at the top of the front cover (callout 1), and then remove two machine screws (callout 2) at the top of the right side.

Figure 5-760 Remove five screws

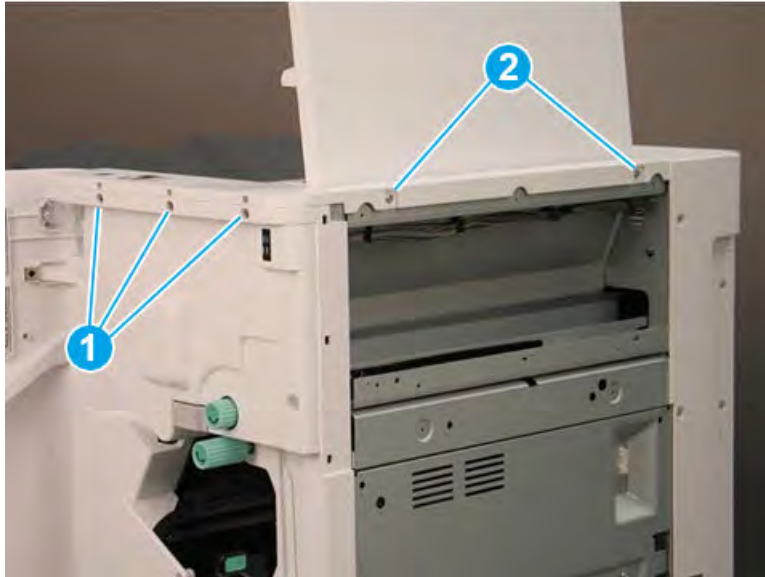

3. Lift the cover up slightly. Disconnect one in-line connector (callout 1), and then release one retainer (callout 2).

 **TIP:** Reverse the removal steps to install the assembly.

Figure 5-761 Disconnect one connector and release retainer



Remove the front door (finisher)

Follow these steps to remove the front door (finisher).

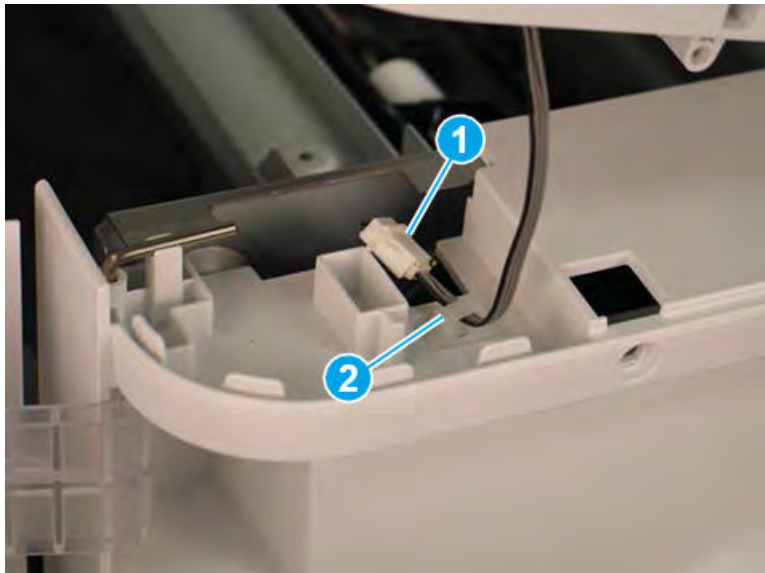
1. Lift the top hinge pin up to release it from the retainer.

Figure 5-762 Lift the top hinge pin

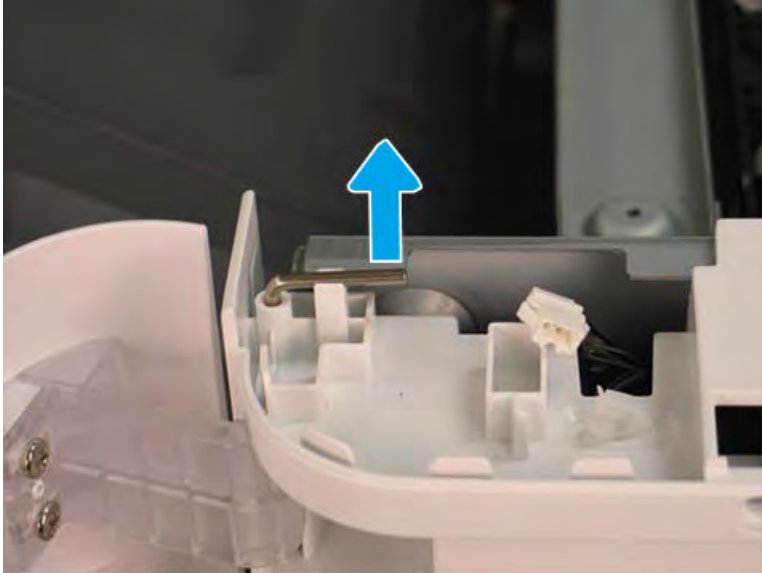

2. Pull the top hinge pin up to remove it.

Figure 5-763 Remove the top hinge pin

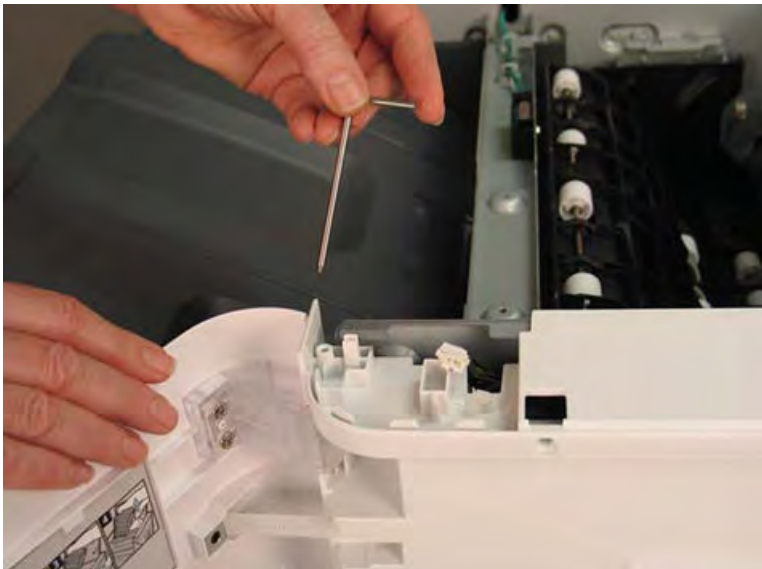

3. Use a small, flat-blade screwdriver to release the lower hinge pin from the retainer, and then rotate it away from the finisher.

Figure 5-764 Release the lower hinge pin



4. Support the door with one hand, and then pull the lower hinge pin straight up to remove it.

Figure 5-765 Remove the lower hinge pin



5. Support the door with one hand, and then remove one screw (callout 1) to release the strap. Remove the front door.

 **TIP:** Reverse the removal steps to install the assembly.

Figure 5-766 Remove the front door



Remove the front cover (finisher)

Follow these steps to remove the front cover (finisher).

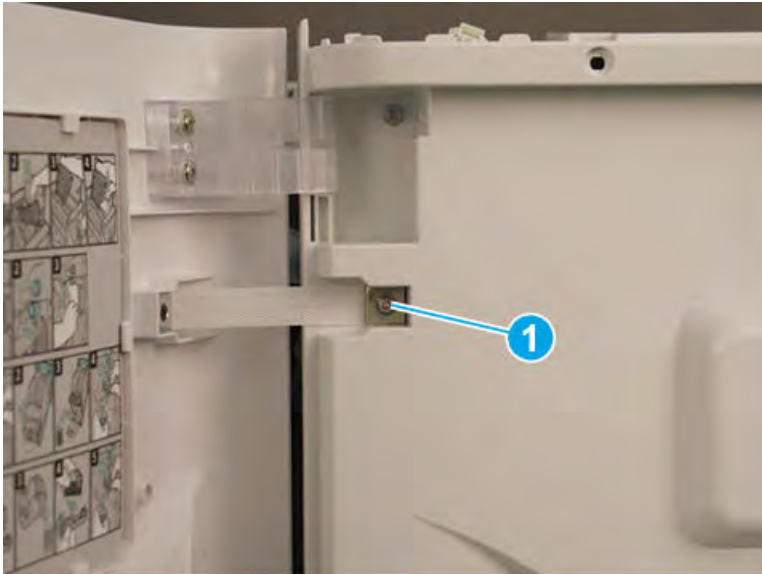
1. Release one tab (callout 1), and then pull the jam-access knob away from the finisher to remove it.

Figure 5-767 Remove the jam-access knob

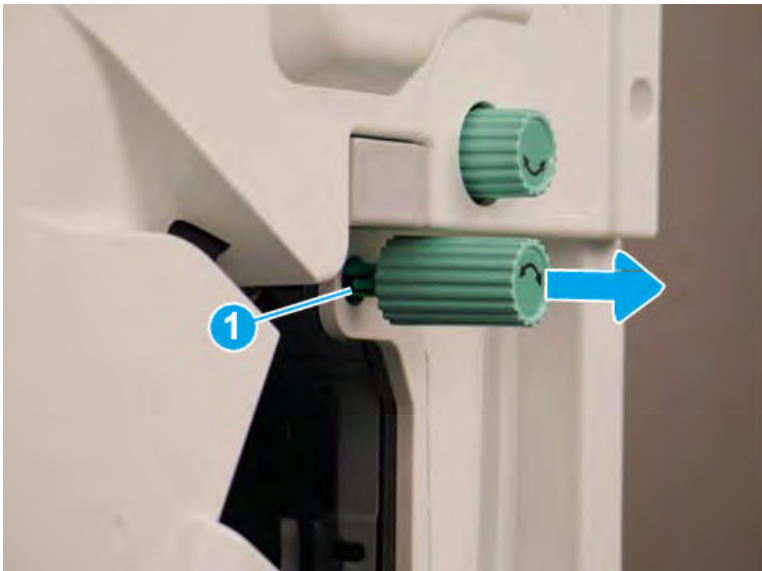

2. If the punch unit is installed, remove the punch waste bin (callout 1).

3. Remove one screw (callout 1) on top of the front cover.

Figure 5-768 Remove one screw



4. Remove five machine screws (callout 1), and then remove the front cover.

 **TIP:** Reverse the removal steps to install the assembly.

Figure 5-769 Remove the front cover



Remove the rear cover (finisher)

Follow these steps to remove the rear cover (finisher).

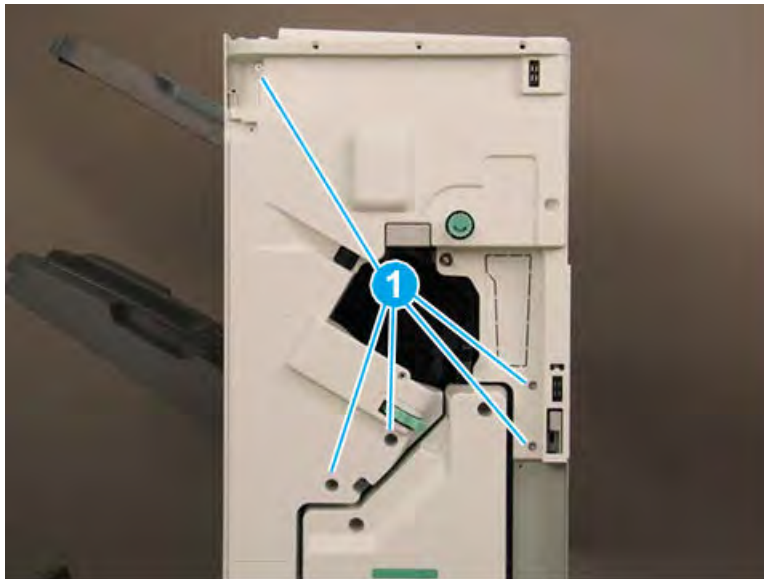
1. Remove two self-tapping screws (callout 1) on the top of the rear cover, and then remove five screw caps and five machine screws (callout 2) on the left side of the cover.

Figure 5-770 Remove seven screws

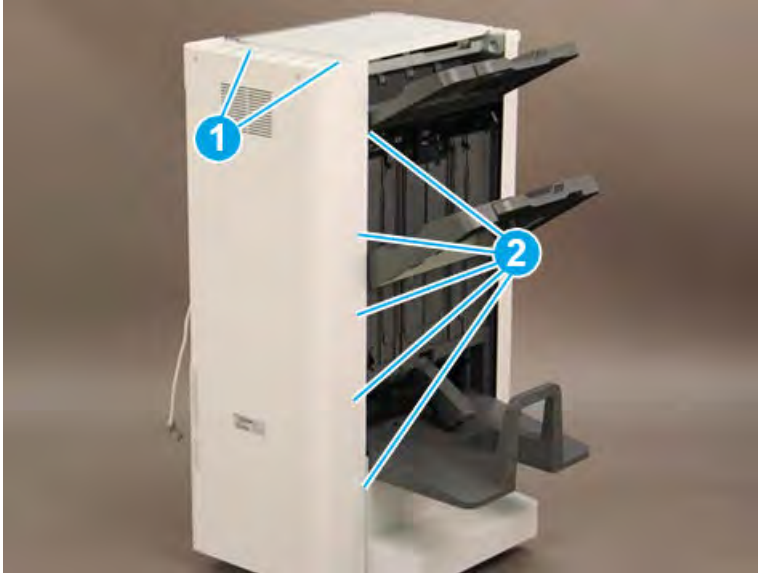

2. Remove one screw cap and four machine screws (callout 1) Remove the rear cover.

 **NOTE:** Make sure to thread the power cable (callout 2) through the opening in the cover.

 **TIP:** Reverse the removal steps to install the assembly

Figure 5-771 Remove the rear cover



Remove the booklet output tray

Follow these steps to remove the booklet output tray.

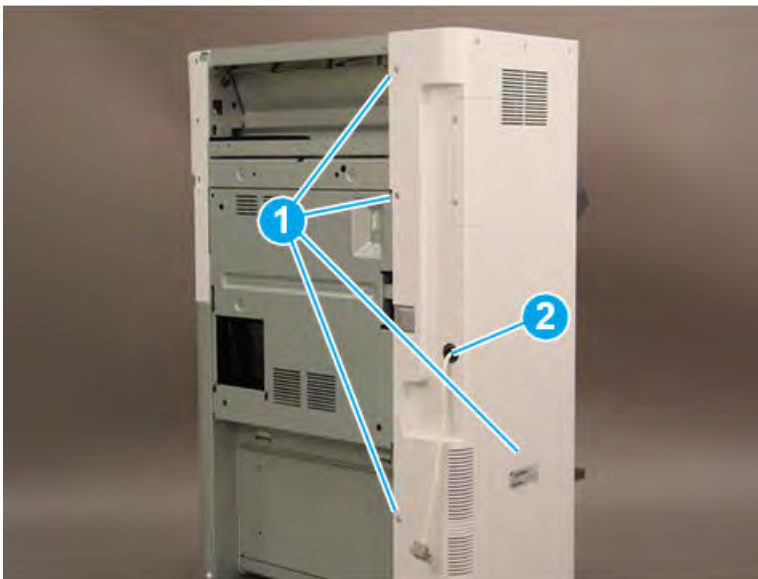
1. Raise the booklet output tray up (callout 1), and then pull it away from the finisher (callout 2) to remove it.

Figure 5-772 Remove the booklet output tray



2. Reverse the removal steps to install the assembly. Also use the following special installation instructions.

 **NOTE:** Continue to reverse the removal steps to finish installing the assembly

Special installation instructions: booklet output tray

Position the tabs (callout 1) on the tray into the slots (callout 2) on the finisher.

Figure 5-773 Install the booklet output tray

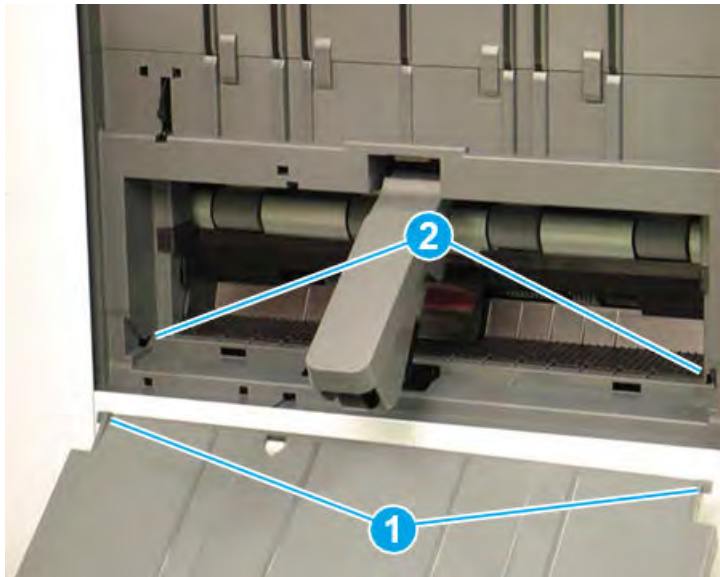

Remove the caster cover

Follow these steps to remove the caster cover.

1. Remove two screw caps and two self-tapping screws (callout 1). Remove two screw caps and two machine screws (callout 2).

Figure 5-774 Remove four screws

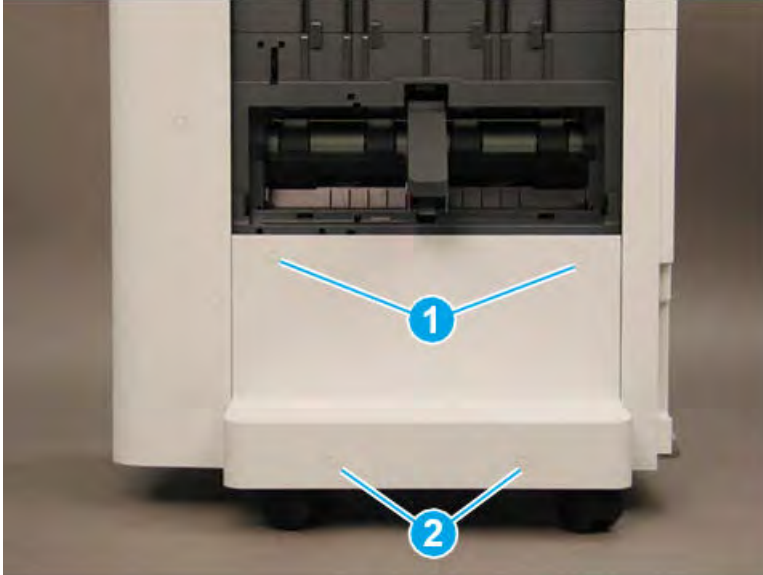

2. Rotate the left edge of the cover away from the finisher (callout 1), and then slide the cover to the left (callout 2) to remove it.

 **TIP:** Make sure that two tabs (callout 3) are positioned under the front lower cover when reinstalling the caster cover.

TIP: Reverse the removal steps to install the assembly

Figure 5-775 Remove the caster cover

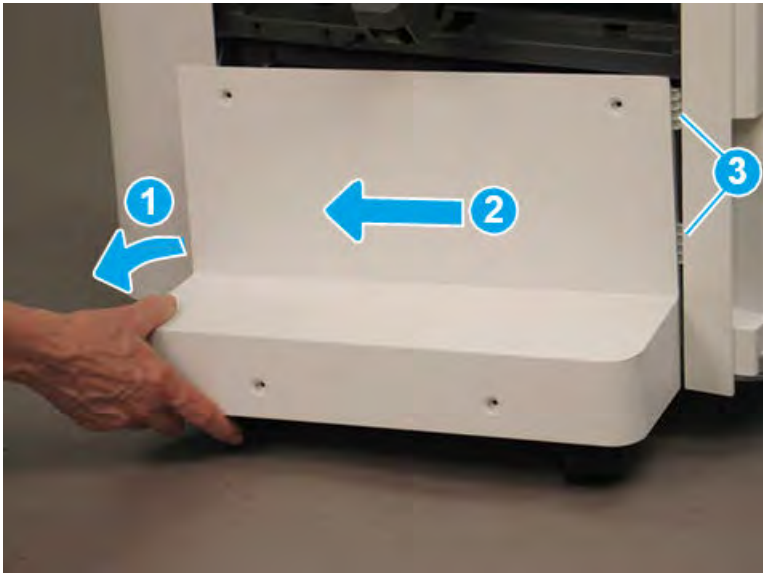

Remove the left lower cover (finisher)

Follow these steps to remove the left lower cover (finisher).

1. Remove four screws (callout 1).

 **NOTE:** Raise the lower output tray as needed to access the screws.

Figure 5-776 Remove four screws



2. Slide the shield down (callout 1) to release it from four tabs (callout 2), and then rotate it away from the finisher (callout 3).

⚠ CAUTION: The shield is still attached to the finisher. Do not attempt to completely remove the shield.

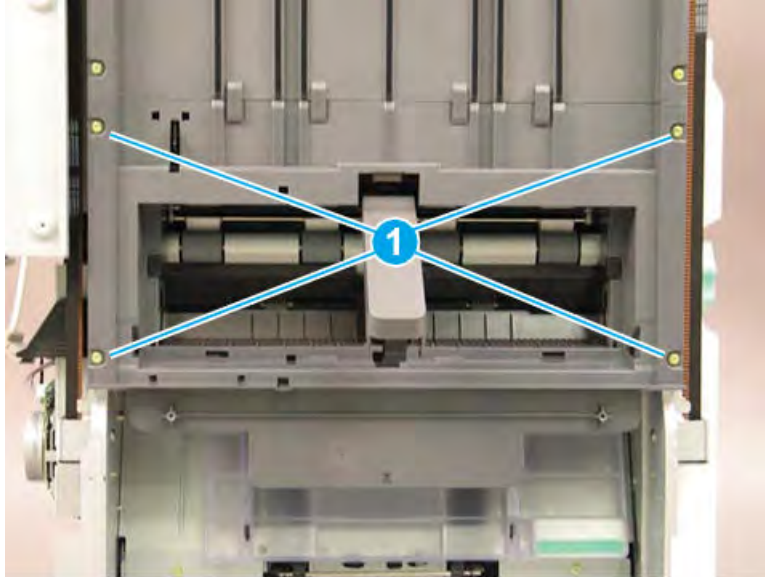
💡 TIP: Position the shield under the four tabs (callout 2) when reinstalling it.

Figure 5-777 Release the lower shield

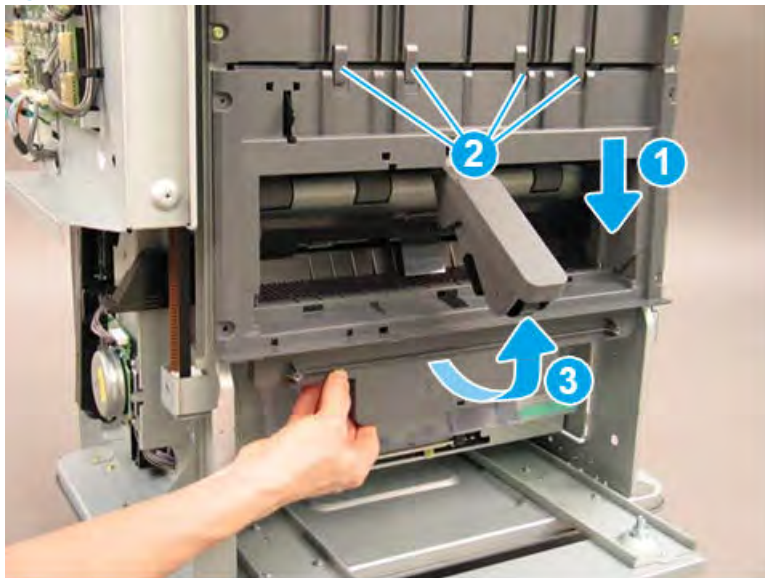

3. Disconnect two connectors (callout 1), and then remove the shield.

 **TIP:** Reverse the removal steps to install the assembly.

Figure 5-778 Disconnect two connectors



4. If you are replacing the left lower cover, locate three sensors (callout 1) on the back of the left lower cover. Remove these sensors and transfer them to the replacement part.

Figure 5-779 Remove the left lower cover

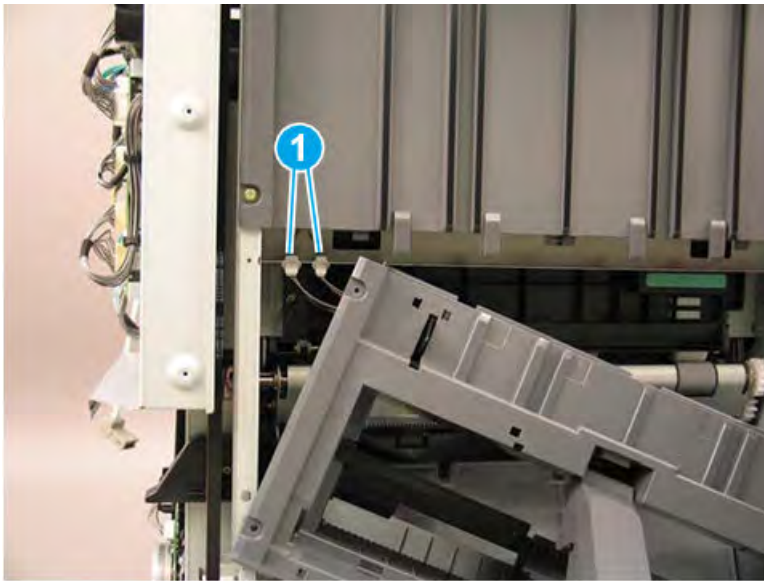
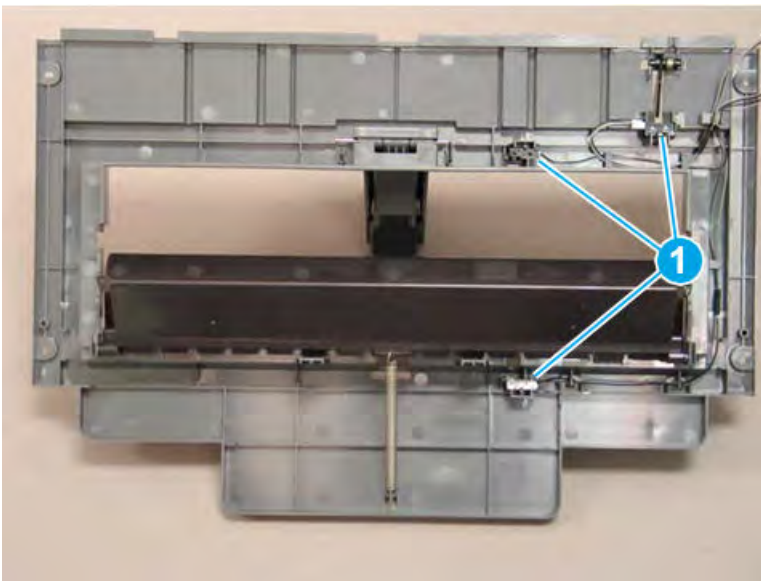

Remove the left upper cover (finisher)

Follow these steps to remove the left upper cover (finisher).

1. Bring the lower output tray down by positioning the shaft of a screwdriver on the clutch (callout 1) and gently pressing to the right to release the clutch. Hold the clutch in the released position and lower the tray (callout 2) to the lowest position.

Figure 5-780 Lower the output tray

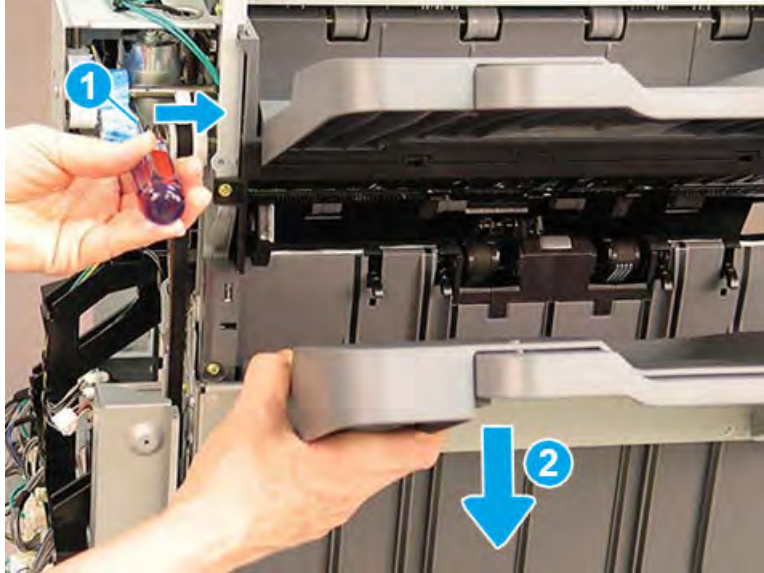

2. Remove six machine screws (callout 1).

Figure 5-781 Remove six screws

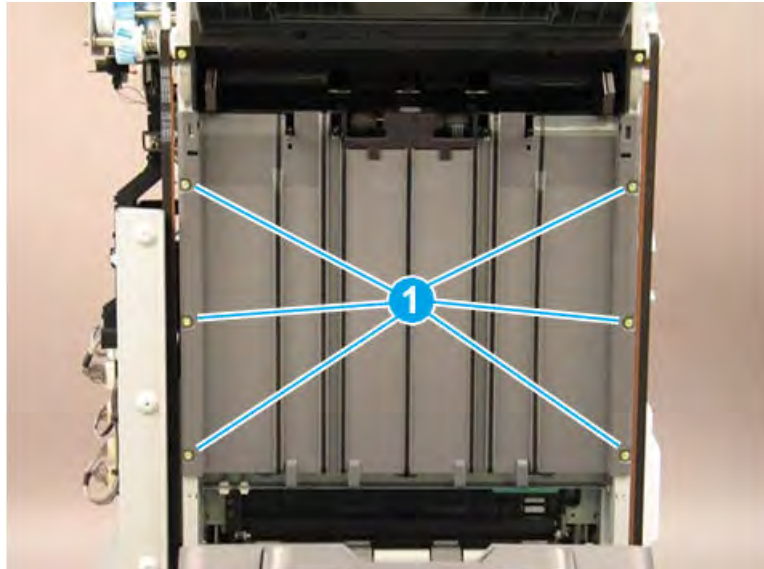

3. Rotate the lower edge of the shield away from the finisher (callout 1), and then slide the shield down (callout 2) to release it from two tabs (callout 3).

⚠ CAUTION: The shield is still attached to the finisher. Do not attempt to completely remove the shield.

💡 TIP: Position the shield under the two tabs (callout 3) when reinstalling it.

Figure 5-782 Release the shield

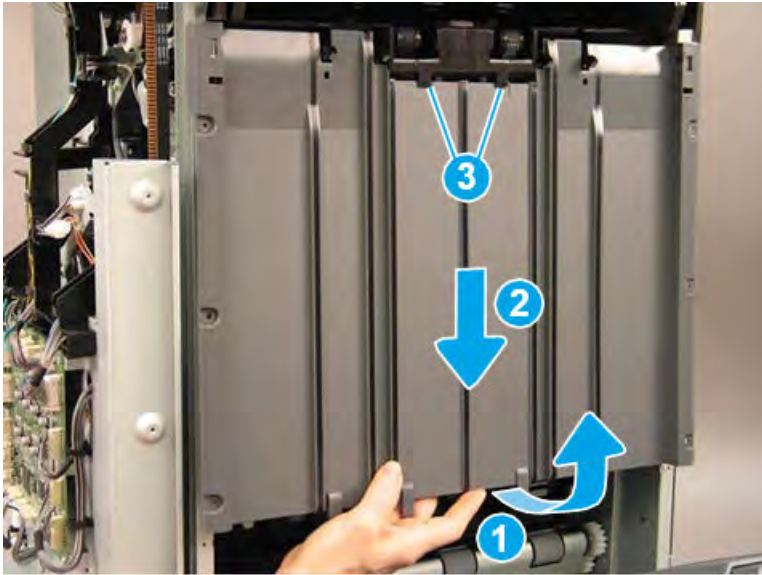

4. Disconnect one connector (callout 1), and then remove the upper shield assembly.

💡 TIP: Reverse the removal steps to install the assembly.

Figure 5-783 Disconnect one connector

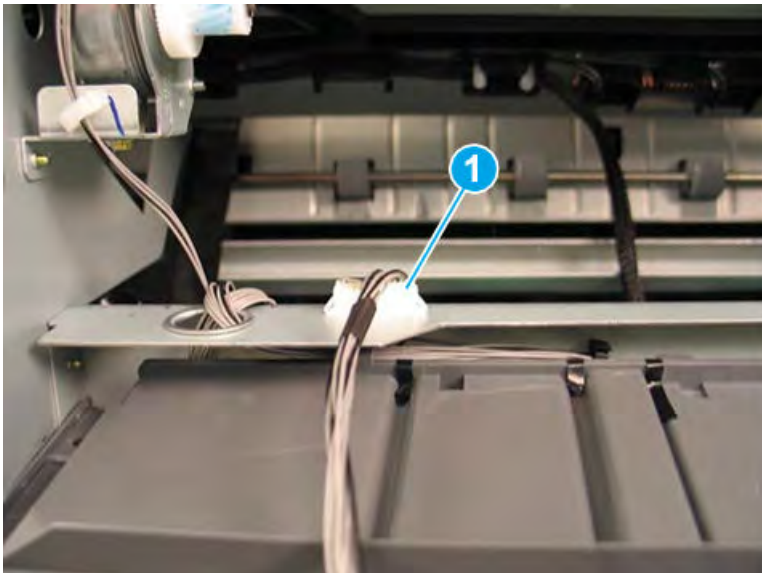

5. If you are replacing the left upper cover, locate three sensors (callout 1) on the back of the left upper cover. Remove these sensors and transfer them to the replacement part.

Figure 5-784 Remove the left upper cover

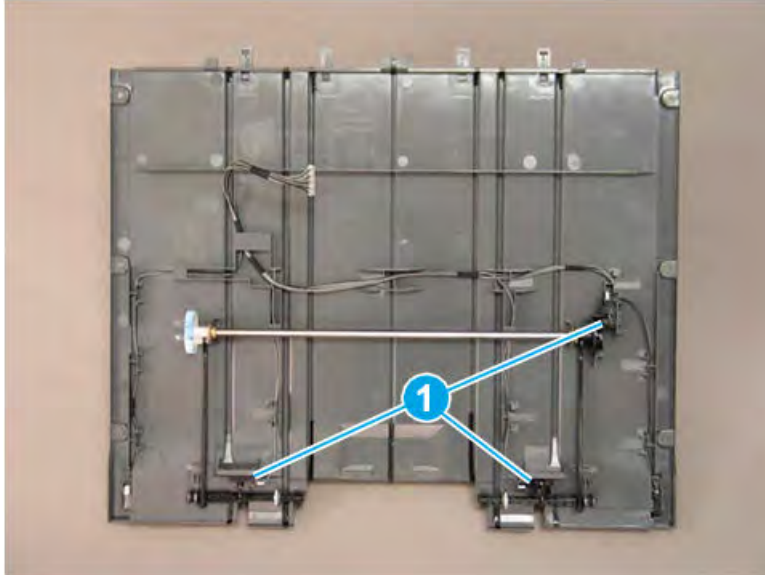

Remove the ejector unit (finisher)

Follow these steps to remove the ejector unit (finisher).

1. Rotate the green wheel to move the staple unit to the center of the finisher.

Figure 5-785 Move the staple unit to the center

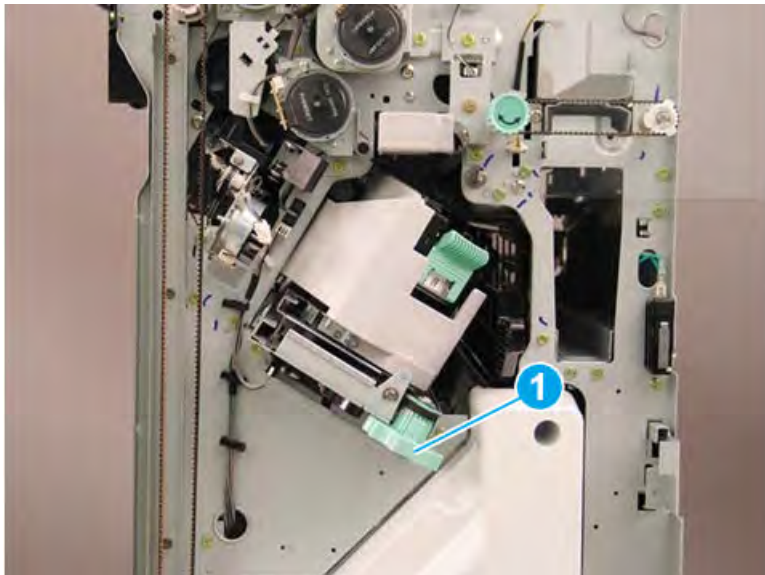

2. Release one retainer (callout 1), and then disconnect three connectors (callout 2).

Figure 5-786 Disconnect three connectors

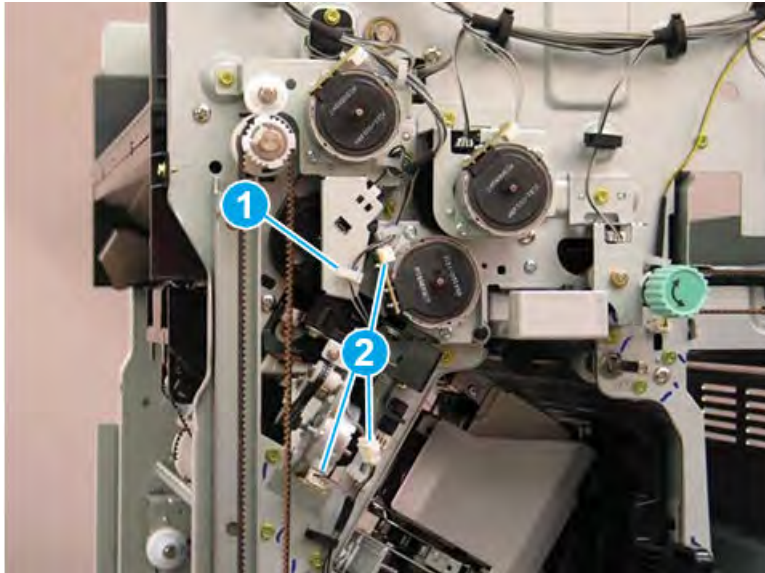

3. Remove two screws (callout 1).

Figure 5-787 Remove two screws

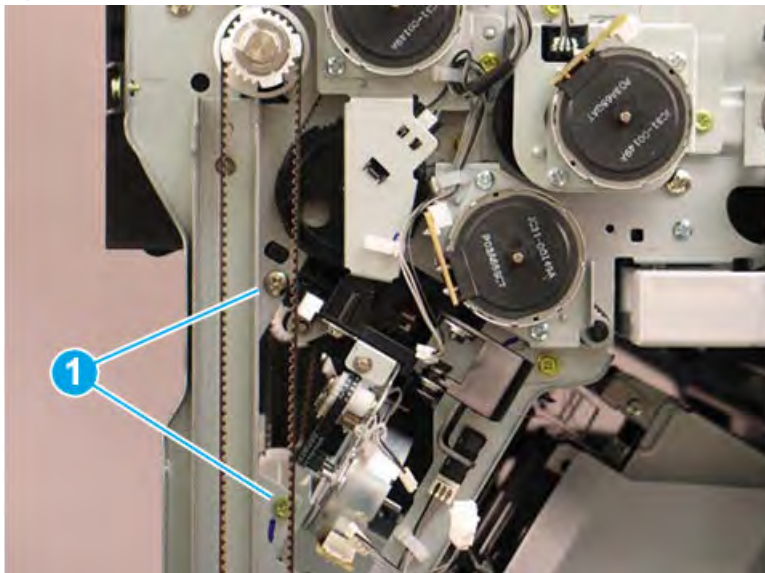

4. At the left side of the finisher, remove one screw (callout 1).

Figure 5-788 Remove one screw

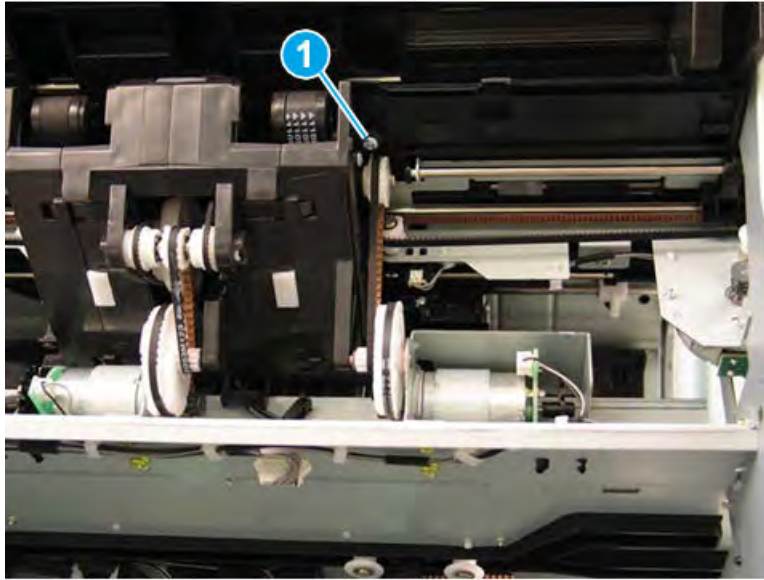

5. Press up on the hinge (callout 1), release one tab (callout 2), and then rotate the sensor away from the finisher (callout 3).

Figure 5-789 Rotate the sensor

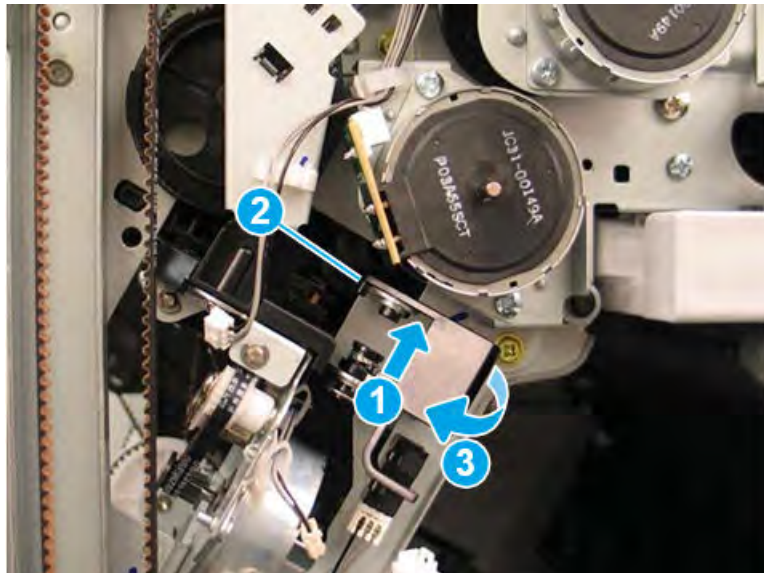

6. Remove one screw (callout 1).

Figure 5-790 Remove one screw

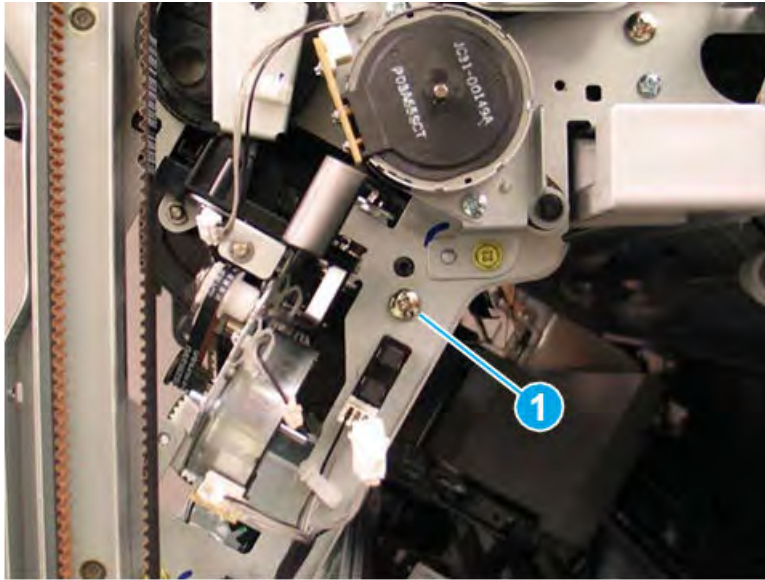

7. Look inside the finisher through the stapler opening in the front and pull down to release and remove one shaft (callout 1) on the front tamper unit.

Figure 5-791 Remove the front tamper shaft

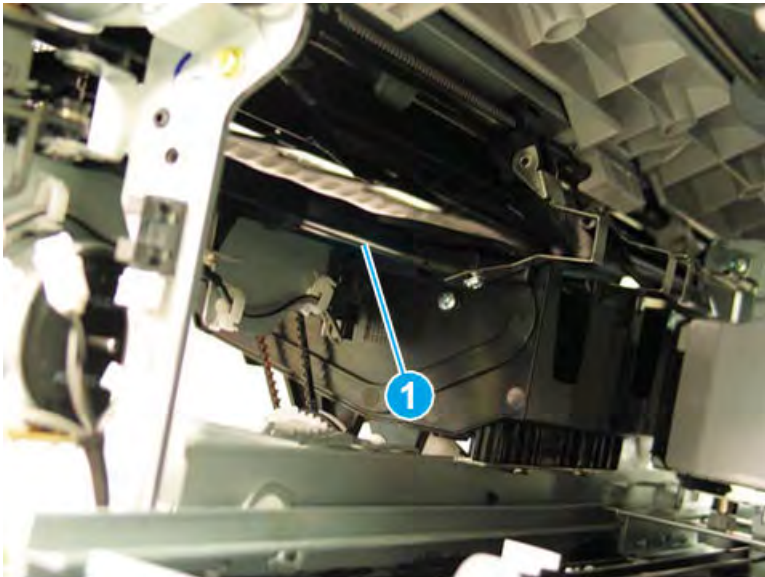

- At the rear of the finisher, disconnect two connectors (callout 1), and then remove three screws (callout 2).

Figure 5-792 Disconnect two connectors and remove three screws

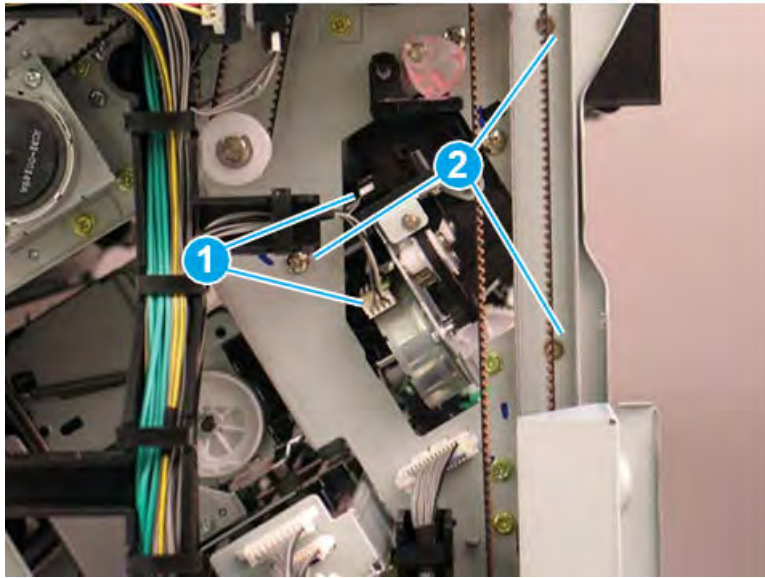

- At the left side of the finisher, remove one screw (callout 1).

Figure 5-793 Remove one screw

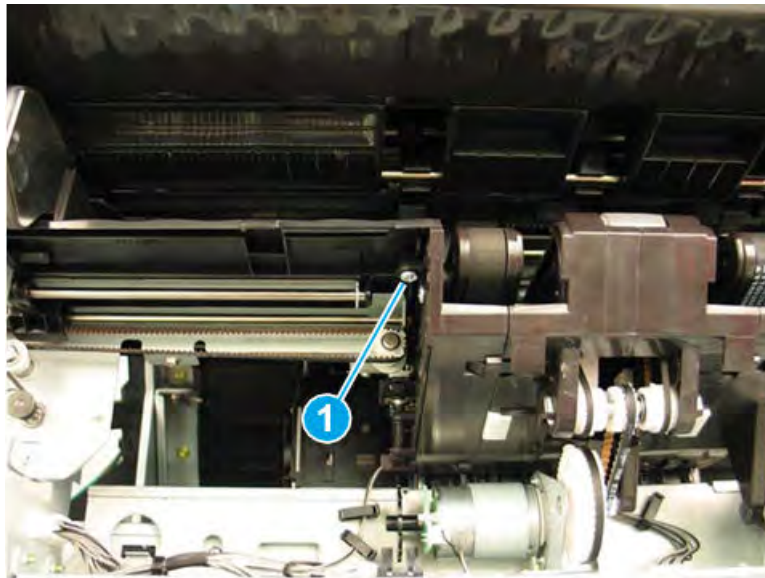

10. Look inside the finisher through the stapler opening in the rear and pull down to release and remove one shaft (callout 1) on the rear tamper unit.

Figure 5-794 Remove the rear tamper shaft

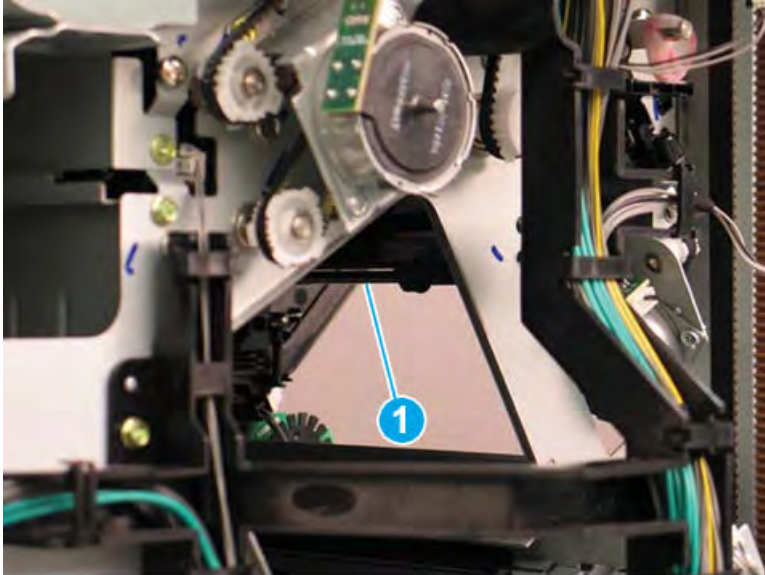

11. At the left side of the finisher, disconnect one connector (callout 1).

Figure 5-795 Disconnect one connector

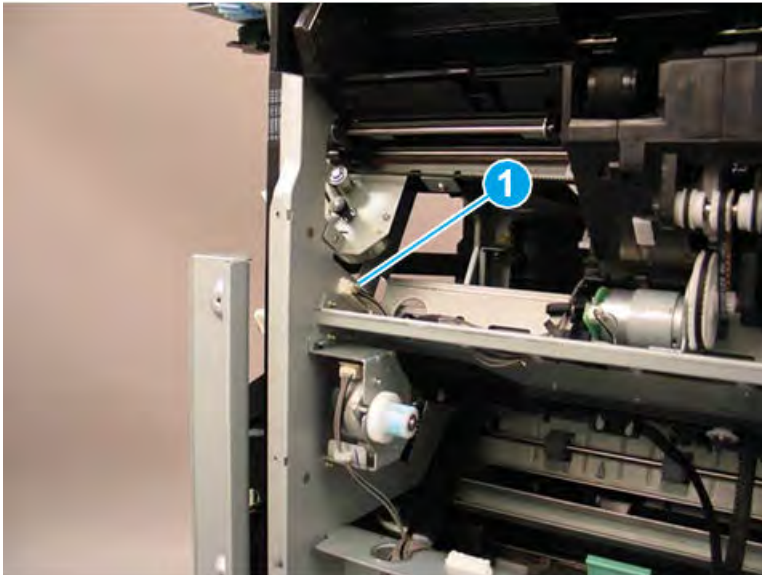

12. At the rear of the finisher, disconnect one connector (callout 1).

Figure 5-796 Disconnect one connector

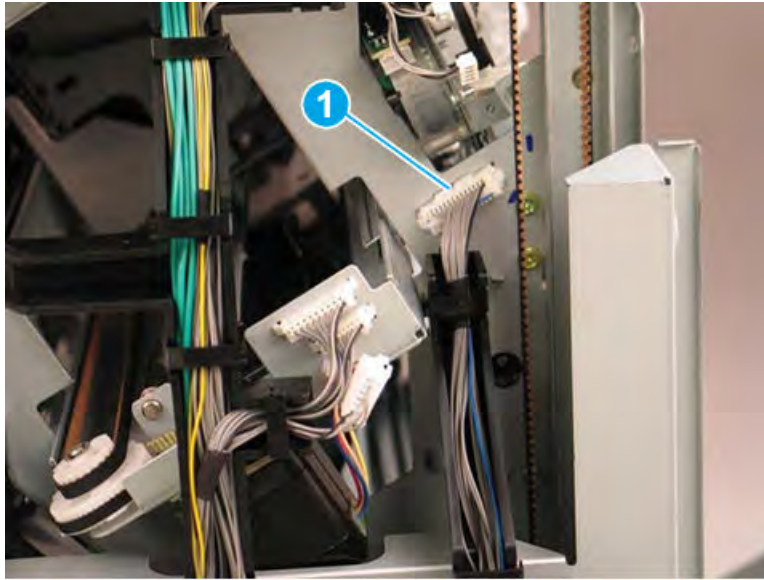

13. At the rear of the finisher, press the wire retainer to the right to access and remove two screws (callout 1).

Figure 5-797 Disconnect one connector

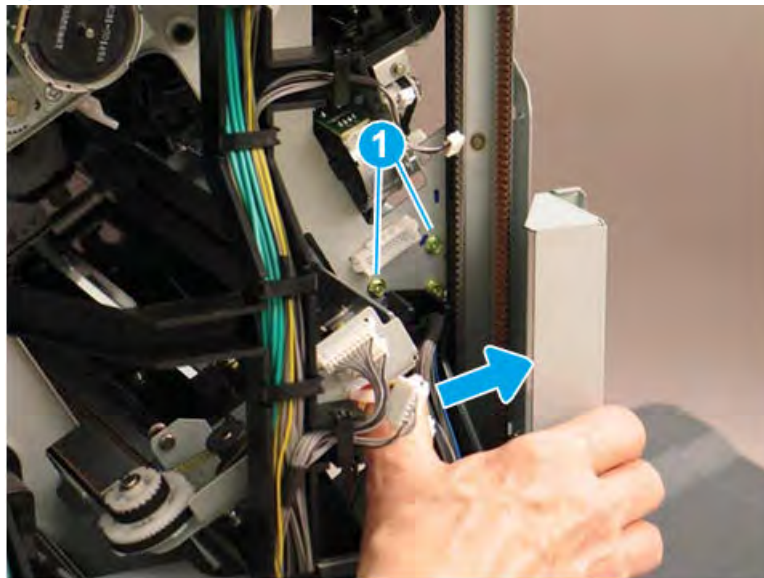

14. At the front of the finisher, remove two screws (callout 1).

Figure 5-798 Remove two screws

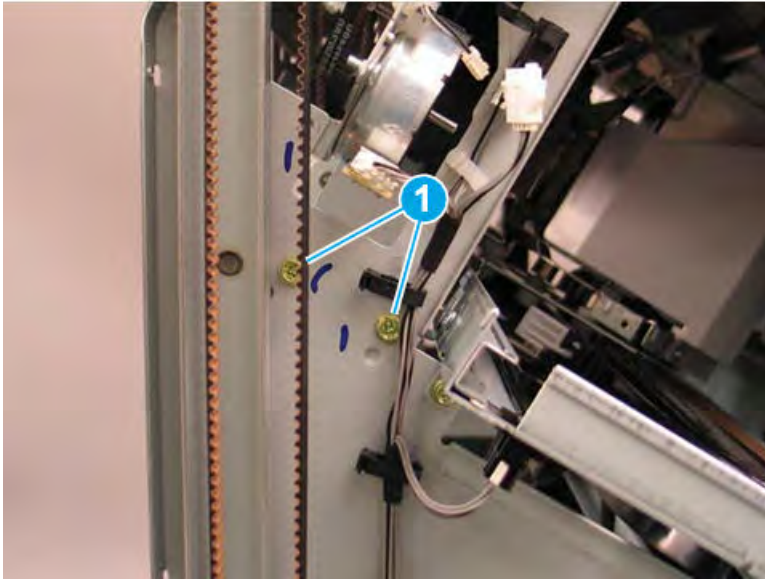

15. Lift the inside edges of the front and rear tampers up.

Figure 5-799 Lift the edges of the tampers

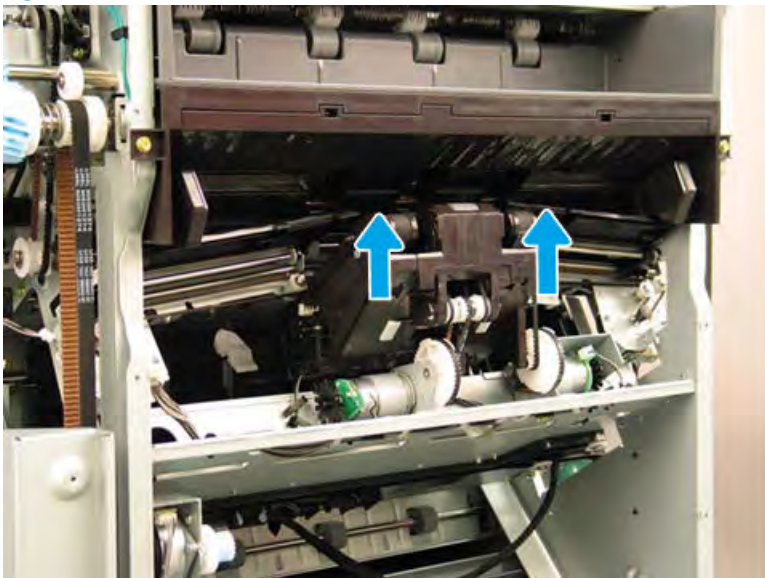

16. Rotate the rear edge of the ejector unit away from the finisher (callout 1), and then slide it toward the rear of the finisher (callout 2) to remove it. Make sure that the PCA (callout 3) stays clear of the sheet metal frame.

Figure 5-800 Remove the ejector unit

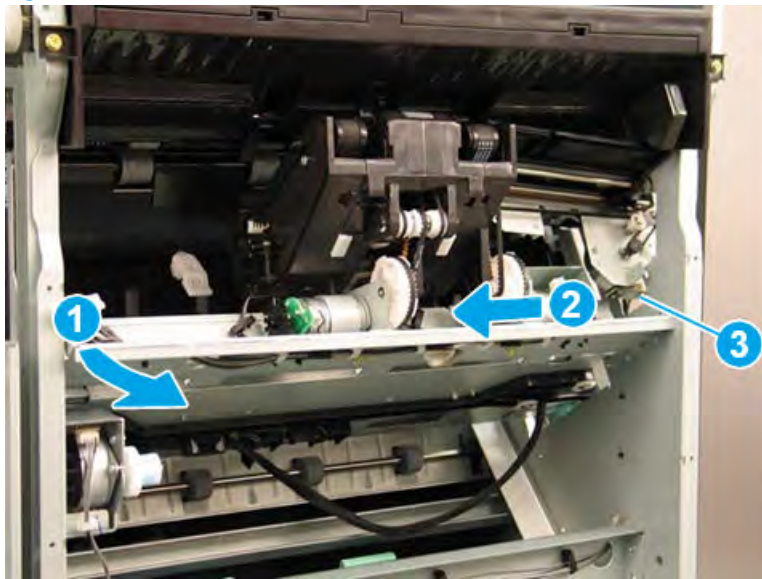

17. Reverse the removal steps to install the assembly. Also use the following special installation instructions.

 **NOTE:** Continue to reverse the removal steps to finish installing the assembly.

Special installation instructions: Ejector unit

- a. When the front tamper shaft is removed, the retainer arm that held the one end of the shaft will drop down. When reinstalling the shaft, raise the retainer arm and position the end of the shaft in the notch (callout 1).

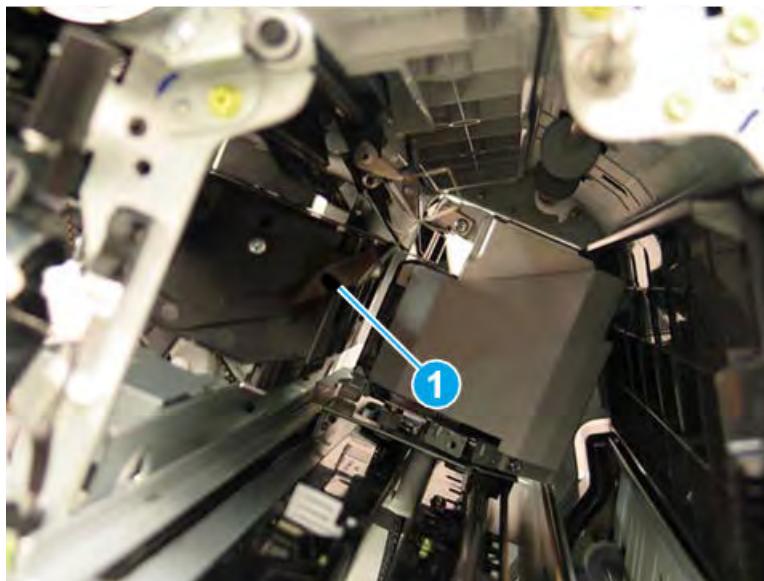

- b. When the rear tamper shaft is removed, the retainer arm that held the one end of the shaft will drop down. When reinstalling the shaft, raise the retainer arm and position the end of the shaft in the notch (callout 1).

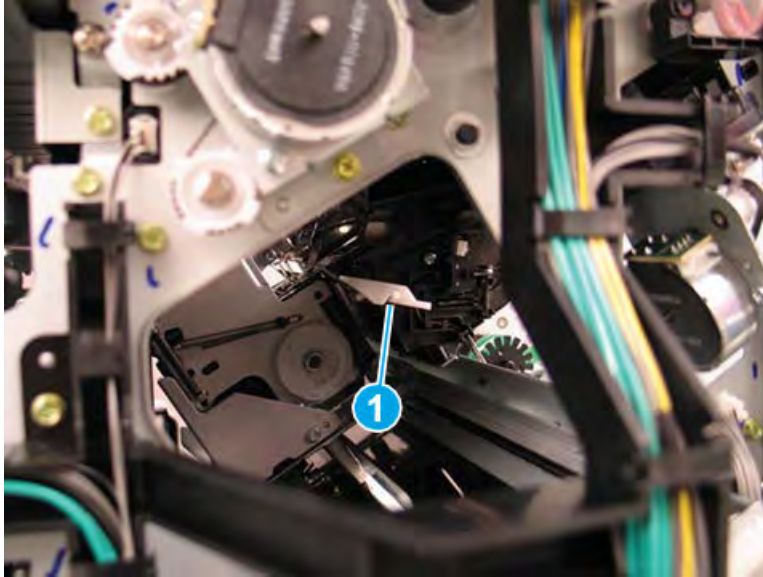

Remove the rear tamper unit

Follow these steps to remove the rear tamper unit.

- ▲ Lift the rear tamper away from the finisher to remove it

 **NOTE:** Reverse the removal steps to install the assembly.

Figure 5-801 Remove the rear tamper



Remove the rear tamper motor (M9)

Follow these steps to remove the rear tamper motor (M9).

1. Remove two screws (callout 1).

Figure 5-802 Remove two screws

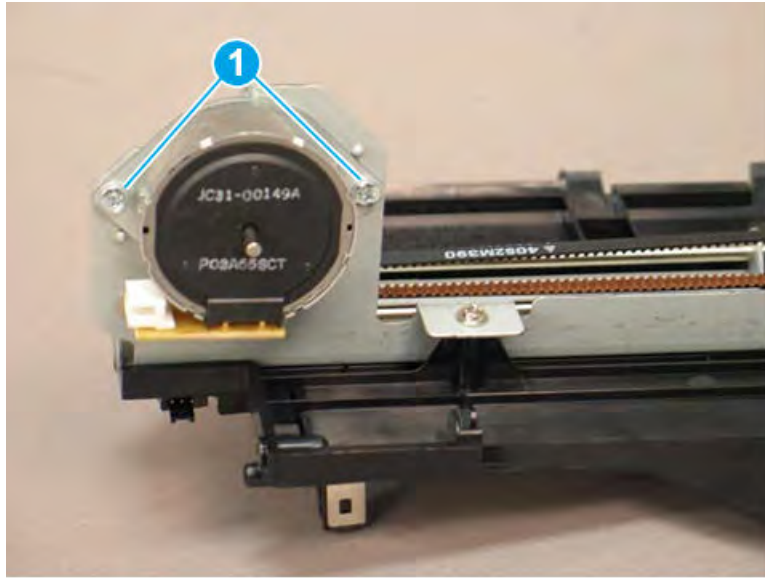

2. Release the belt (callout 1), and then remove the rear tamper motor.

 **TIP:** Make sure that the belt is routed correctly when reinstalling the motor.

TIP: Reverse the removal steps to install the assembly.

Figure 5-803 Release the belt and remove the motor

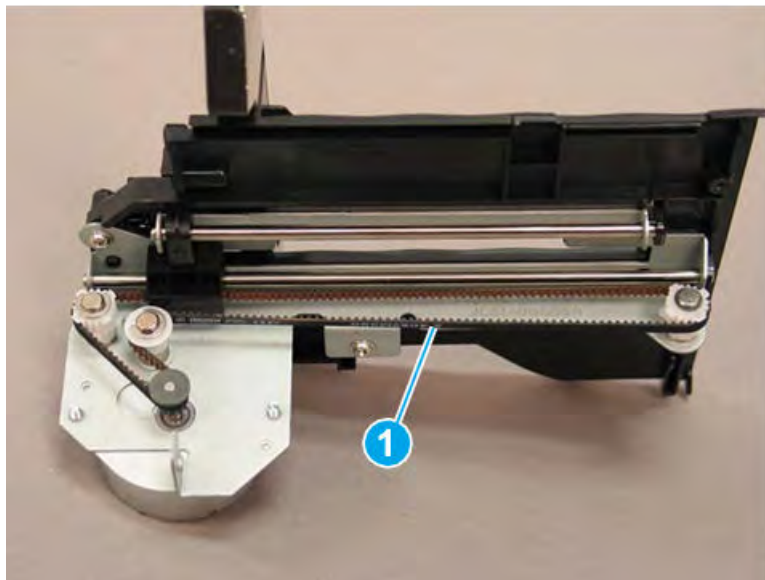

Unpack the replacement assembly

Follow these steps to unpack the replacement assembly.

1. Dispose of the defective part.

 **NOTE:** HP recommends responsible disposal of the defective part.

<http://www8.hp.com/us/en/hp-information/environment/product-recycling.html>

2. Unpack the replacement part from the packaging.



CAUTION:  Some parts are sensitive to electrostatic discharge (ESD). Always perform service work at an ESD-protected workstation or mat. If an ESD workstation or mat is not available, touch the sheet-metal chassis to provide a static ground before touching an ESD-sensitive assembly. Protect the ESD-sensitive assemblies by placing them in ESD pouches when they are out of the printer.

 **IMPORTANT:** Make sure that all of the shipping materials (for example shipping tape) are removed from the replacement part prior to installation.

 **NOTE:** If the replacement part is a roller or pad, avoid touching the spongy part of it. Skin oils on the roller or pad can cause paper pickup and/or print-quality problems. HP recommends using disposable gloves when handling rollers or pads or washing your hands before touching rollers or pads.

3. To install an assembly, reverse the removal steps.

 **NOTE:** When applicable, special installation instructions are provided for an assembly at the end of the removal procedure. Always completely read the removal instructions and follow all special installation instructions.

Stapler unit

Removal and replacement: Stapler unit

Learn how to remove and replace the stapler unit.

Introduction

This document provides the procedures to remove and replace the stapler unit on the finisher.



IMPORTANT: When applicable, special installation instructions are provided for an assembly at the end of the removal procedure. Always completely read the removal instructions and follow all special installation instructions.

Before performing service

- Turn the printer power off. A shutting-down message appears on the control-panel display.
- ⚠ **WARNING!** To avoid damage to the printer, turn the power off and wait until the printer shuts down before removing the power cable.
- Disconnect the printer power cable after the printer has completely shut down (the control-panel display is blank).
- Release the finisher from the printer by pulling out on the release latch inside the finisher door.
- Disconnect the cable from the bridge unit to the finisher.
- Disconnect the cable from the finisher to the printer.

Use the table below to identify the correct part number for your printer. To order the part, go to <https://parts.hp.com>.

Table 5-119 Part information

Part number	Part description
JC82-00894A	Stapler unit

Required tools

- #2 JIS screwdriver with a magnetic tip

After performing service

- Connect the cable from the finisher to the printer.
- Connect the cable from the bridge unit to the finisher.
- Attach the finisher to the printer, and then push in on the release latch inside the finisher door.
- Connect the printer power cable.
- Turn the printer power on.

Post service test

Process a job through the finisher and verify that the finisher works correctly.

Remove the right upper cover (finisher)

Follow these steps to remove the right upper cover (finisher).

- ▲ Remove one screw cap and three machine screws on the upper edge of the cover (callout 1). Remove three sheet metal screws (callout 2) on the lower portion of the cover. Rotate the right edge of the cover away from the finisher, and then slide the cover right to release three tabs (callout 3).

💡 **TIP:** The lower screws are shorter in length than the upper screws.

TIP: Reverse the removal steps to install the assembly.

Figure 5-804 Remove the right upper cover

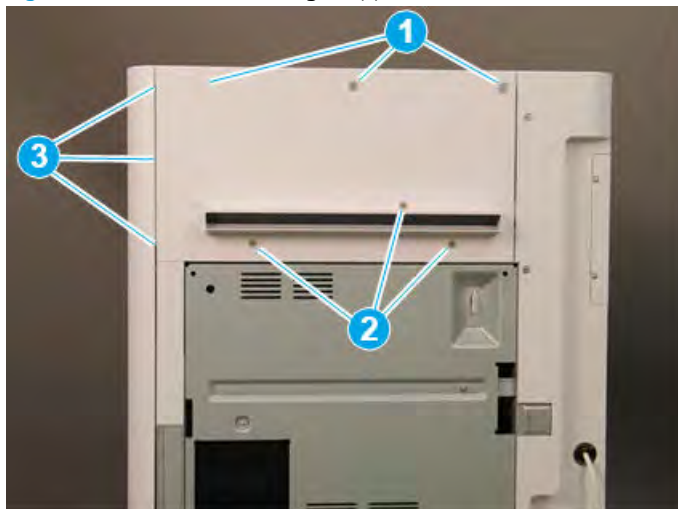

Remove the top cover (finisher)

Follow these steps to remove the top cover (finisher).

1. Remove three screw caps and three self-tapping screws at the top of the rear cover (callout 1), and then remove three machine screws (callout 2) on top of the cover.

Figure 5-805 Remove six screws

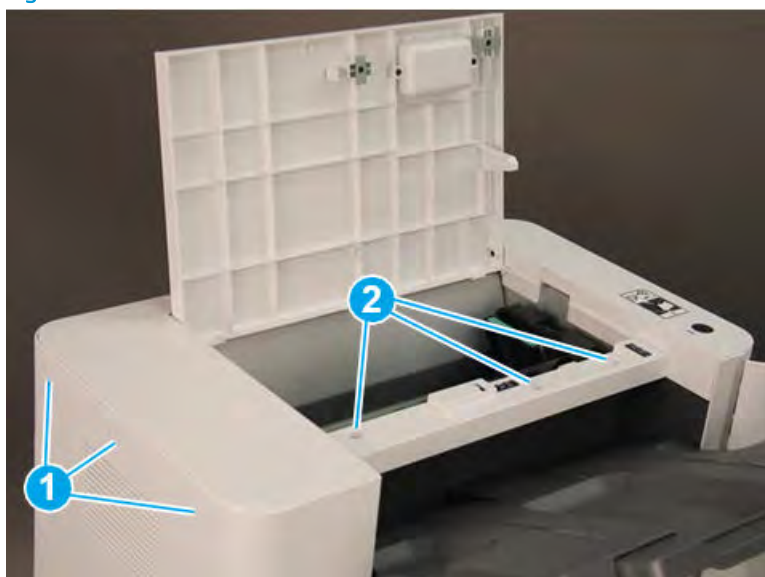

2. Remove three self-tapping screws at the top of the front cover (callout 1), and then remove two machine screws (callout 2) at the top of the right side.

Figure 5-806 Remove five screws

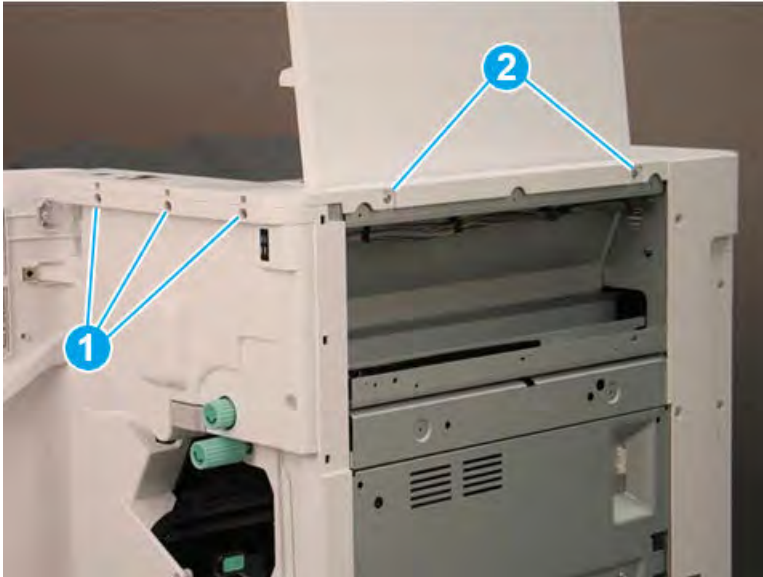

3. Lift the cover up slightly. Disconnect one in-line connector (callout 1), and then release one retainer (callout 2).

 **TIP:** Reverse the removal steps to install the assembly.

Figure 5-807 Disconnect one connector and release retainer

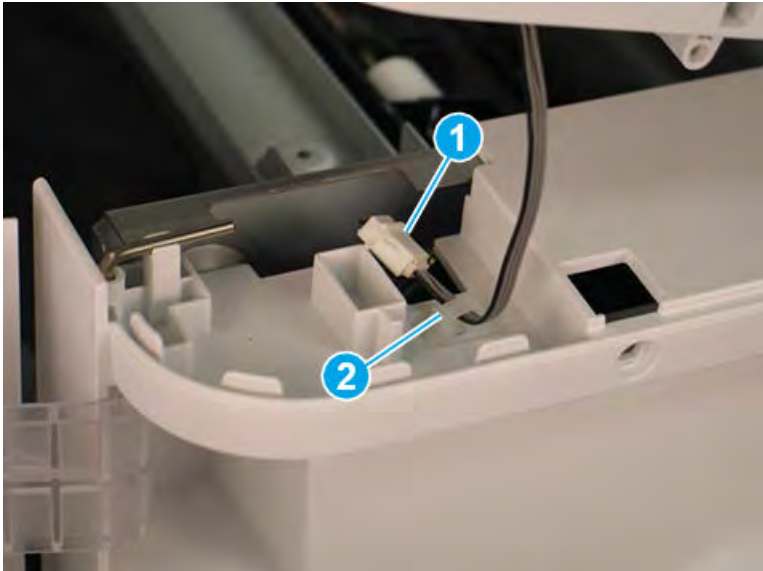

Remove the front door (finisher)

Follow these steps to remove the front door (finisher).

1. Lift the top hinge pin up to release it from the retainer.

Figure 5-808 Lift the top hinge pin

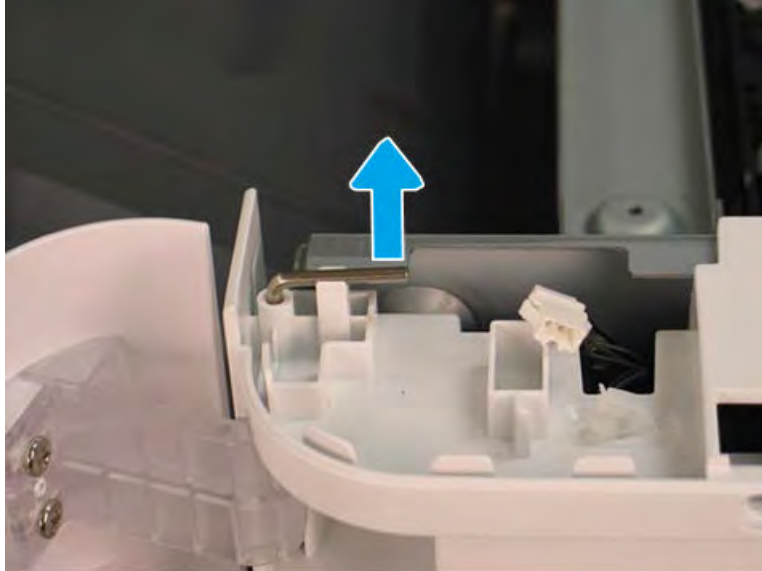

2. Pull the top hinge pin up to remove it.

Figure 5-809 Remove the top hinge pin

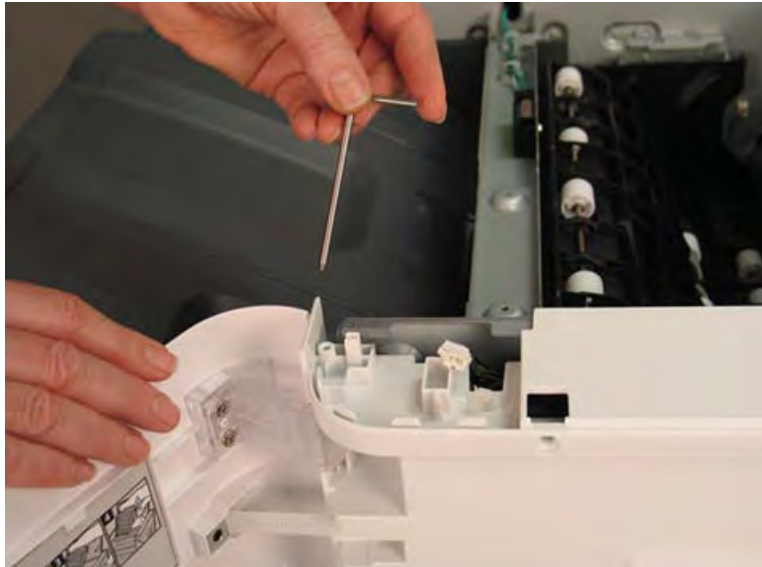

3. Use a small, flat-blade screwdriver to release the lower hinge pin from the retainer, and then rotate it away from the finisher.

Figure 5-810 Release the lower hinge pin



4. Support the door with one hand, and then pull the lower hinge pin straight up to remove it.

Figure 5-811 Remove the lower hinge pin



5. Support the door with one hand, and then remove one screw (callout 1) to release the strap. Remove the front door.

 **TIP:** Reverse the removal steps to install the assembly.

Figure 5-812 Remove the front door



Remove the front cover (finisher)

Follow these steps to remove the front cover (finisher).

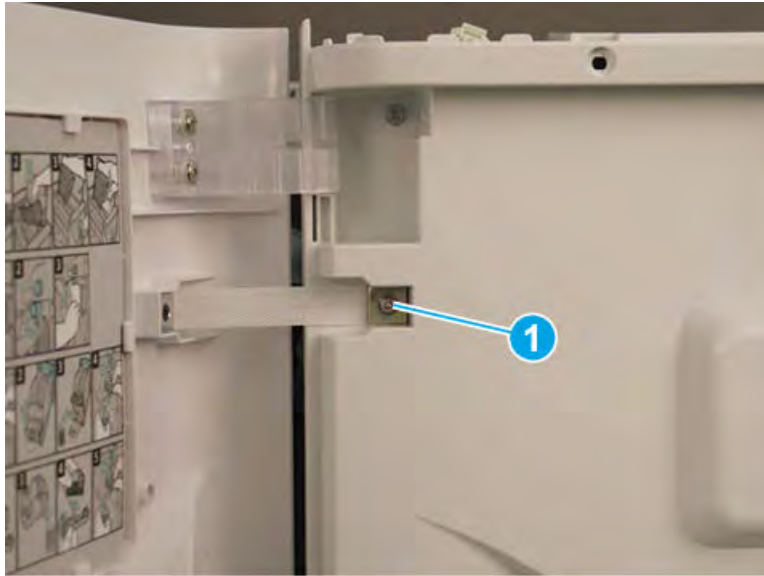
1. Release one tab (callout 1), and then pull the jam-access knob away from the finisher to remove it.

Figure 5-813 Remove the jam-access knob

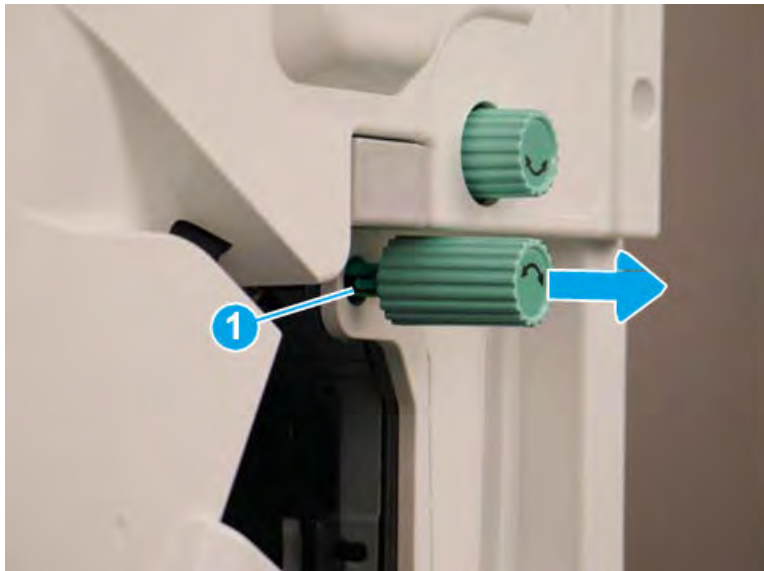

2. If the punch unit is installed, remove the punch waste bin (callout 1).

3. Remove one screw (callout 1) on top of the front cover.

Figure 5-814 Remove one screw



4. Remove five machine screws (callout 1), and then remove the front cover.

 **TIP:** Reverse the removal steps to install the assembly.

Figure 5-815 Remove the front cover



Remove the rear cover (finisher)

Follow these steps to remove the rear cover (finisher).

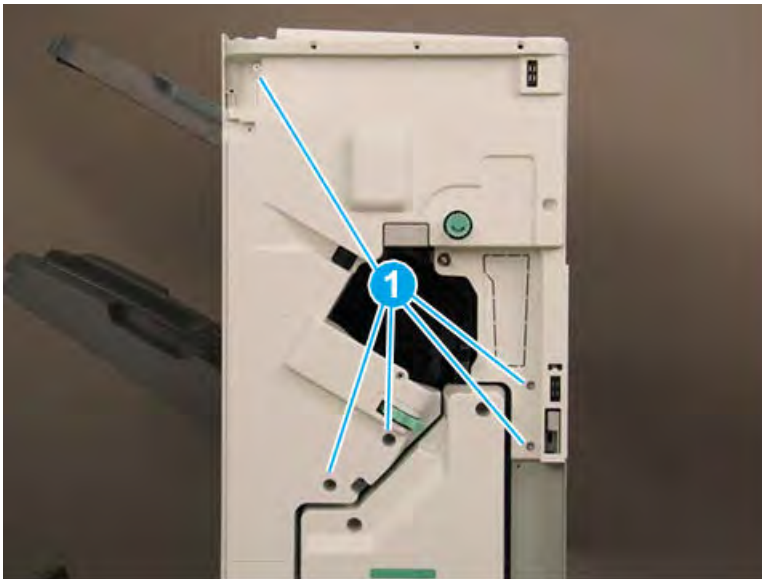
1. Remove two self-tapping screws (callout 1) on the top of the rear cover, and then remove five screw caps and five machine screws (callout 2) on the left side of the cover.

Figure 5-816 Remove seven screws

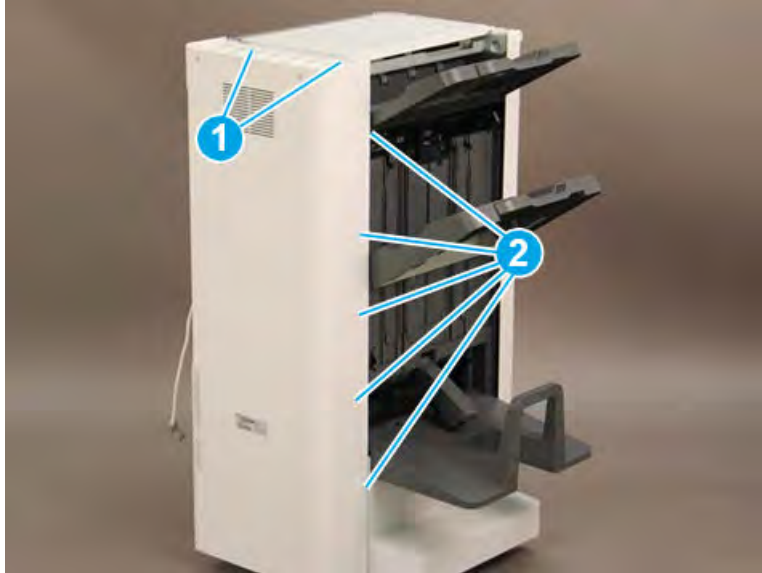

2. Remove one screw cap and four machine screws (callout 1) Remove the rear cover.

 **NOTE:** Make sure to thread the power cable (callout 2) through the opening in the cover.

 **TIP:** Reverse the removal steps to install the assembly

Figure 5-817 Remove the rear cover



Remove the stapler unit

Follow these steps to remove the stapler unit.

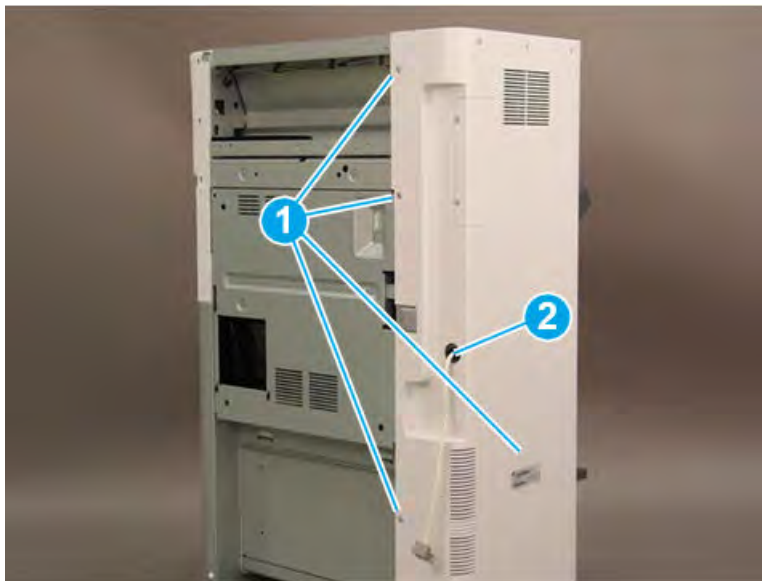
1. Rotate the green wheel to move the staple unit to the front until it stops.

Figure 5-818 Move the staple unit to the front

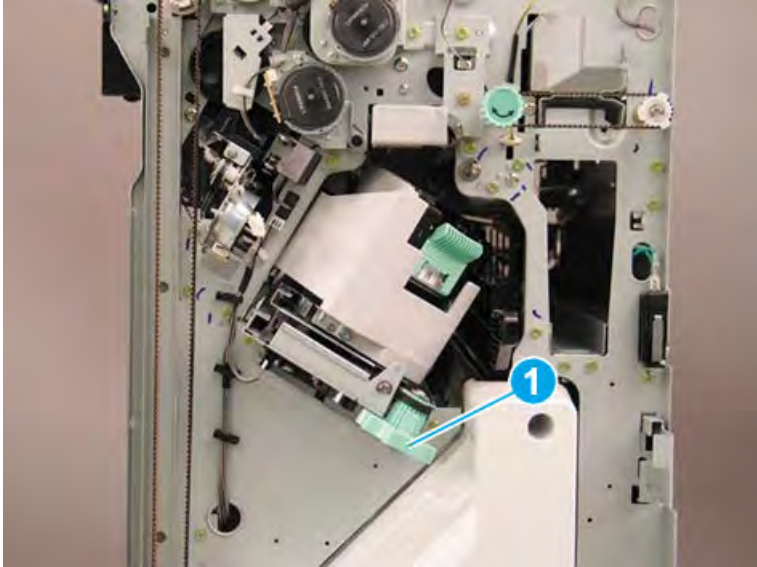

2. Lower the green latch (callout 1), and then slide the staple cartridge away from the finisher to remove it (callout 2).

Figure 5-819 Remove the staple cartridge

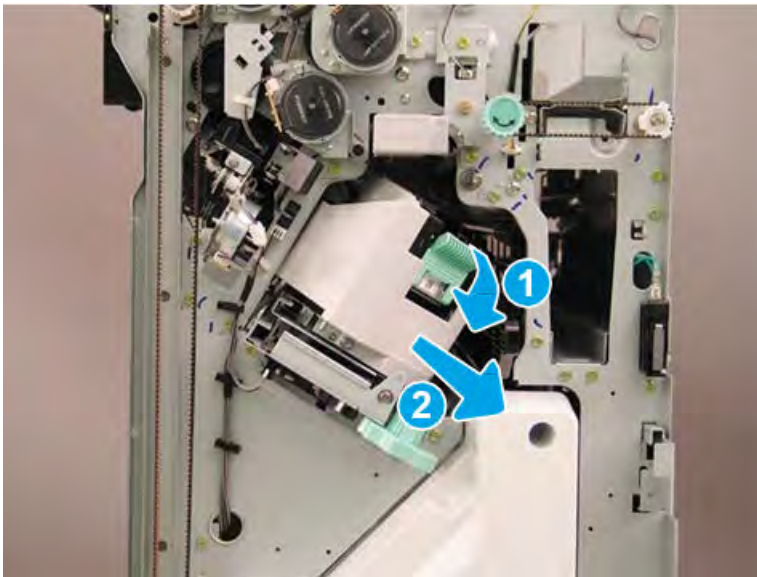

3. At the back of the finisher, release one retainer (callout 1), disconnect two connectors (callout 2), and then remove two screws (callout 3).

Figure 5-820 Disconnect three connectors and remove two screws

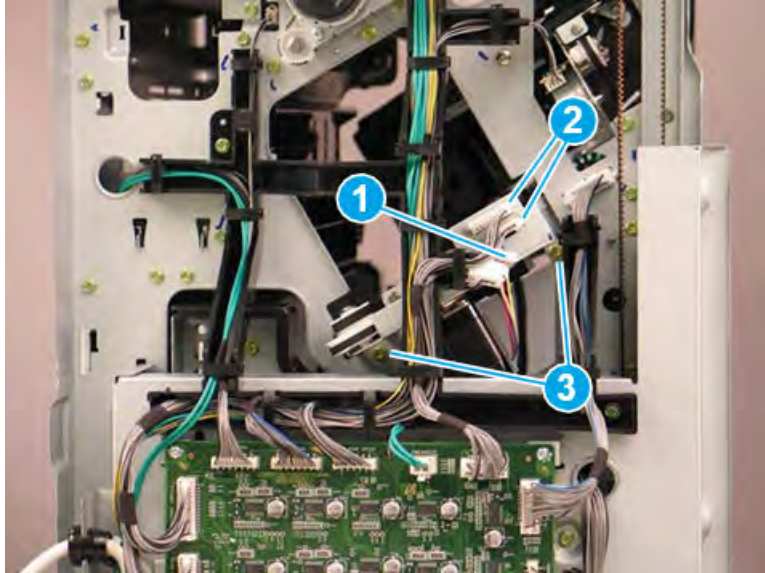

4. At the front of the finisher, disconnect one connector (callout 1), and then remove two screws (callout 2).

Figure 5-821 Disconnect one connector and remove two screws

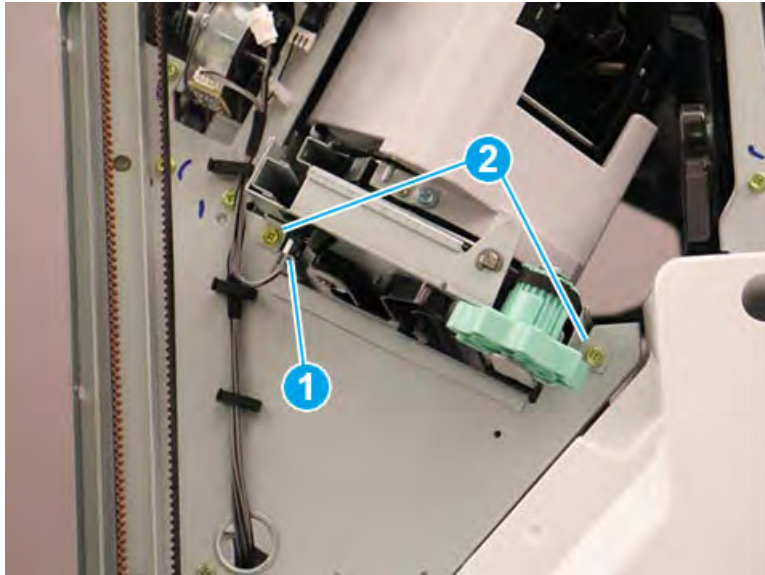

5. Lift up, and then slide the staple unit to the front of the finisher to remove it.

 **TIP:** Reverse the removal steps to install the assembly.

Figure 5-822 Remove the staple unit



Unpack the replacement assembly

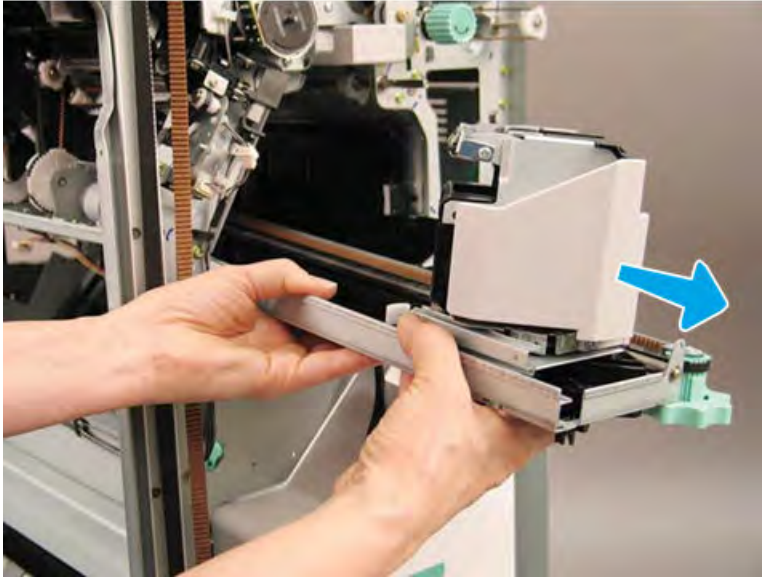

Follow these steps to unpack the replacement assembly.

1. Dispose of the defective part.

 **NOTE:** HP recommends responsible disposal of the defective part.

<http://www8.hp.com/us/en/hp-information/environment/product-recycling.html>

2. Unpack the replacement part from the packaging.

 **CAUTION:**  Some parts are sensitive to electrostatic discharge (ESD). Always perform service work at an ESD-protected workstation or mat. If an ESD workstation or mat is not available, touch the sheet-metal chassis to provide a static ground before touching an ESD-sensitive assembly. Protect the ESD-sensitive assemblies by placing them in ESD pouches when they are out of the printer.

 **IMPORTANT:** Make sure that all of the shipping materials (for example shipping tape) are removed from the replacement part prior to installation.

 **NOTE:** If the replacement part is a roller or pad, avoid touching the spongy part of it. Skin oils on the roller or pad can cause paper pickup and/or print-quality problems. HP recommends using disposable gloves when handling rollers or pads or washing your hands before touching rollers or pads.

3. To install an assembly, reverse the removal steps.

 **NOTE:** When applicable, special installation instructions are provided for an assembly at the end of the removal procedure. Always completely read the removal instructions and follow all special installation instructions.

Removal and replacement: Stapler front sensor (S21)

Learn how to remove and replace the stapler front sensor.

Introduction

This document provides the procedures to remove and replace the stapler front sensor on the finisher.



IMPORTANT: When applicable, special installation instructions are provided for an assembly at the end of the removal procedure. Always completely read the removal instructions and follow all special installation instructions.

Before performing service

- Turn the printer power off. A shutting-down message appears on the control-panel display.
- ⚠ **WARNING!** To avoid damage to the printer, turn the power off and wait until the printer shuts down before removing the power cable.
- Disconnect the printer power cable after the printer has completely shut down (the control-panel display is blank).
- Release the finisher from the printer by pulling out on the release latch inside the finisher door.
- Disconnect the cable from the bridge unit to the finisher.
- Disconnect the cable from the finisher to the printer.

Use the table below to identify the correct part number for your printer. To order the part, go to <https://parts.hp.com>.

Table 5-120 Part information

Part number	Part description
0604-001393	Stapler front sensor

Required tools

- #2 JIS screwdriver with a magnetic tip

After performing service

- Connect the cable from the finisher to the printer.
- Connect the cable from the bridge unit to the finisher.
- Attach the finisher to the printer, and then push in on the release latch inside the finisher door.
- Connect the printer power cable.
- Turn the printer power on.

Post service test

Process a job through the finisher and verify that the finisher works correctly.

Remove the right upper cover (finisher)

Follow these steps to remove the right upper cover (finisher).

- ▲ Remove one screw cap and three machine screws on the upper edge of the cover (callout 1). Remove three sheet metal screws (callout 2) on the lower portion of the cover. Rotate the right edge of the cover away from the finisher, and then slide the cover right to release three tabs (callout 3).

💡 **TIP:** The lower screws are shorter in length than the upper screws.

TIP: Reverse the removal steps to install the assembly.

Figure 5-823 Remove the right upper cover

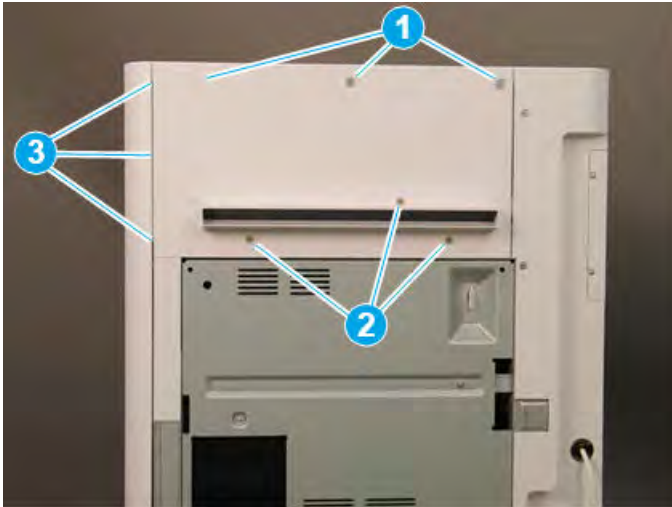

Remove the top cover (finisher)

Follow these steps to remove the top cover (finisher).

1. Remove three screw caps and three self-tapping screws at the top of the rear cover (callout 1), and then remove three machine screws (callout 2) on top of the cover.

Figure 5-824 Remove six screws

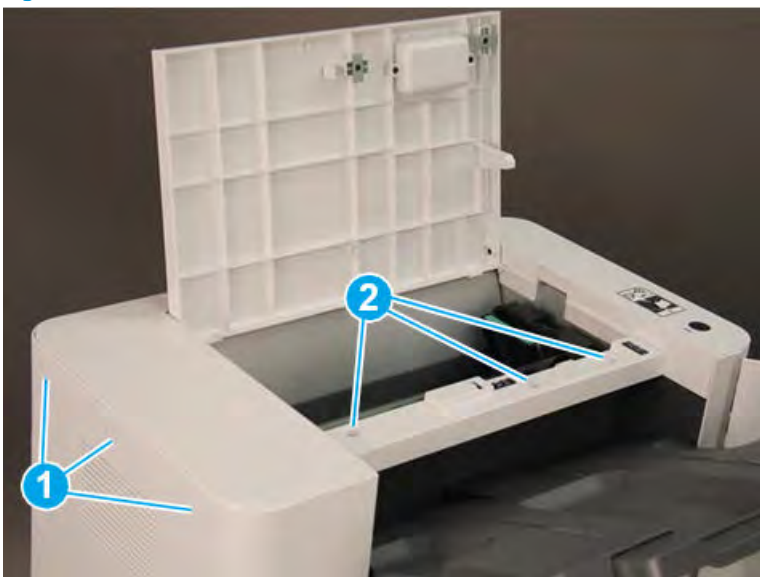

2. Remove three self-tapping screws at the top of the front cover (callout 1), and then remove two machine screws (callout 2) at the top of the right side.

Figure 5-825 Remove five screws

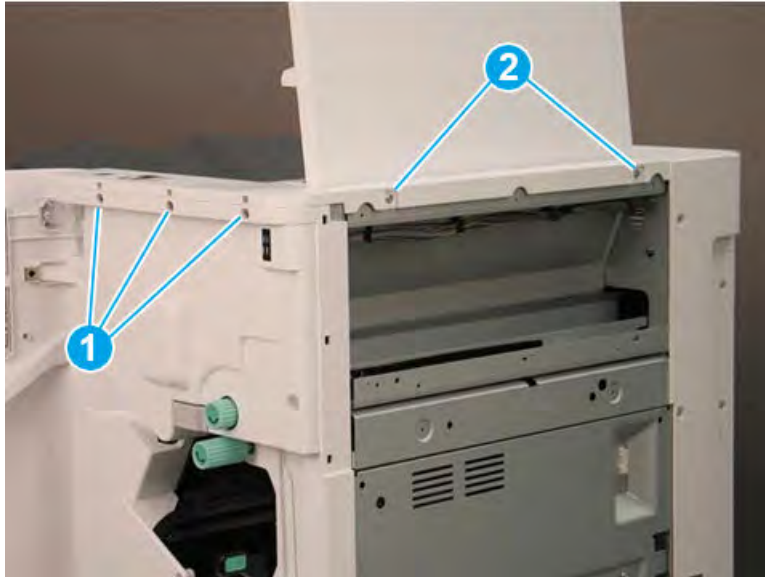

3. Lift the cover up slightly. Disconnect one in-line connector (callout 1), and then release one retainer (callout 2).

 **TIP:** Reverse the removal steps to install the assembly.

Figure 5-826 Disconnect one connector and release retainer



Remove the front door (finisher)

Follow these steps to remove the front door (finisher).

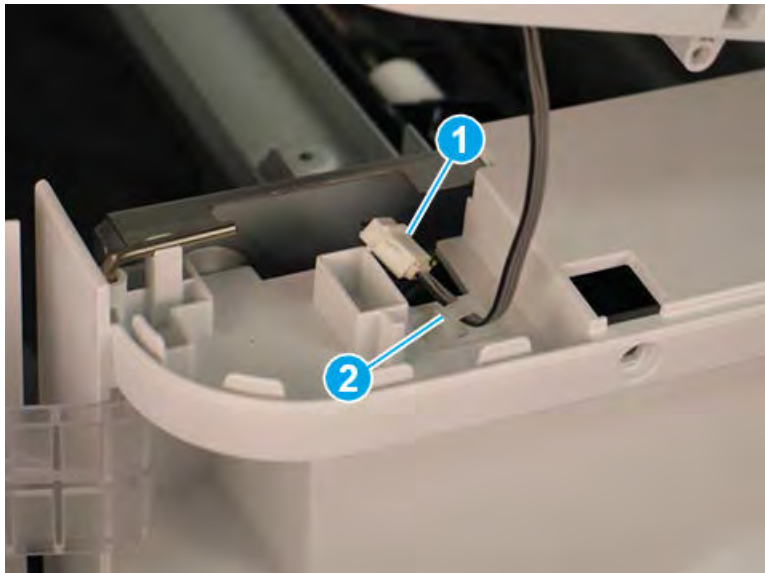
1. Lift the top hinge pin up to release it from the retainer.

Figure 5-827 Lift the top hinge pin

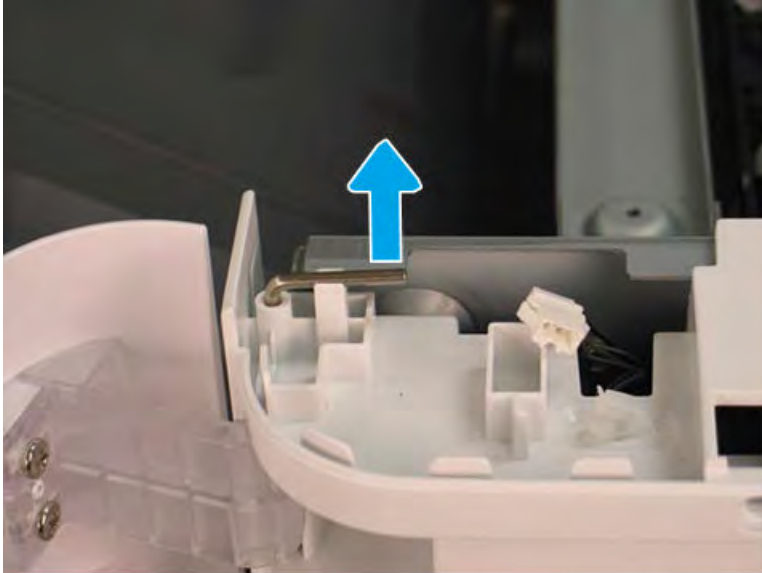

2. Pull the top hinge pin up to remove it.

Figure 5-828 Remove the top hinge pin

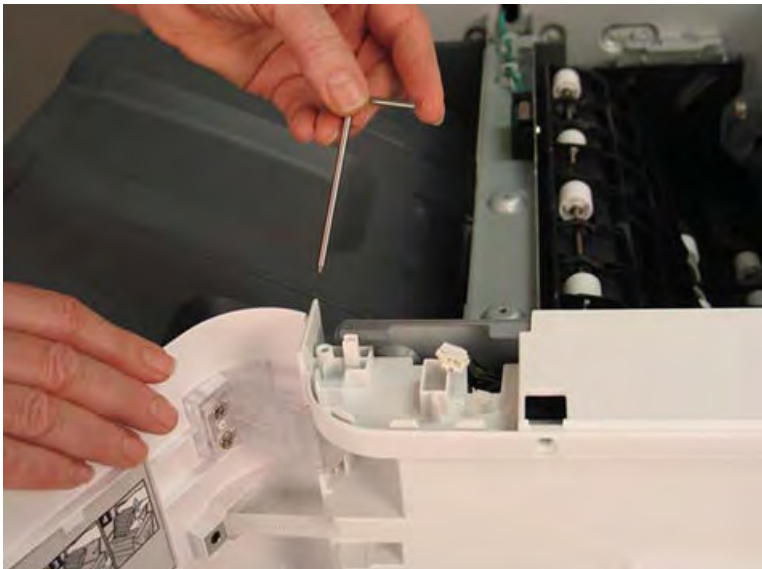

3. Use a small, flat-blade screwdriver to release the lower hinge pin from the retainer, and then rotate it away from the finisher.

Figure 5-829 Release the lower hinge pin



4. Support the door with one hand, and then pull the lower hinge pin straight up to remove it.

Figure 5-830 Remove the lower hinge pin



5. Support the door with one hand, and then remove one screw (callout 1) to release the strap. Remove the front door.

 **TIP:** Reverse the removal steps to install the assembly.

Figure 5-831 Remove the front door



Remove the front cover (finisher)

Follow these steps to remove the front cover (finisher).

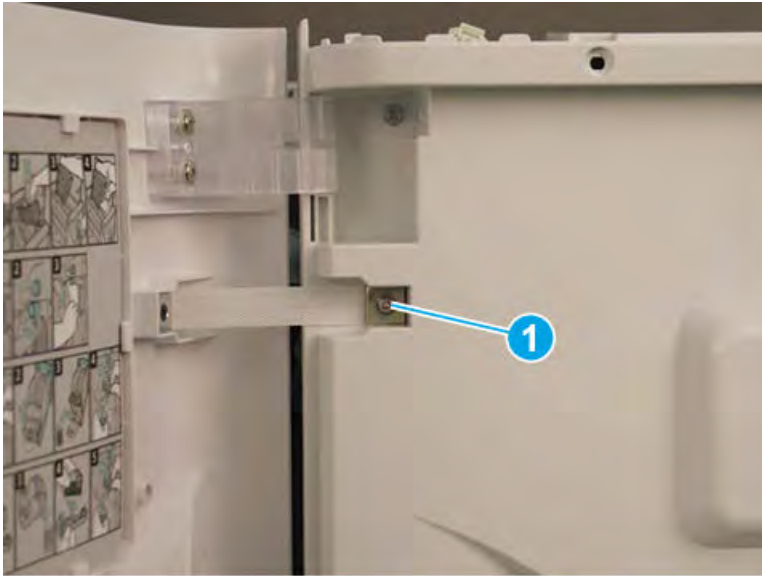
1. Release one tab (callout 1), and then pull the jam-access knob away from the finisher to remove it.

Figure 5-832 Remove the jam-access knob

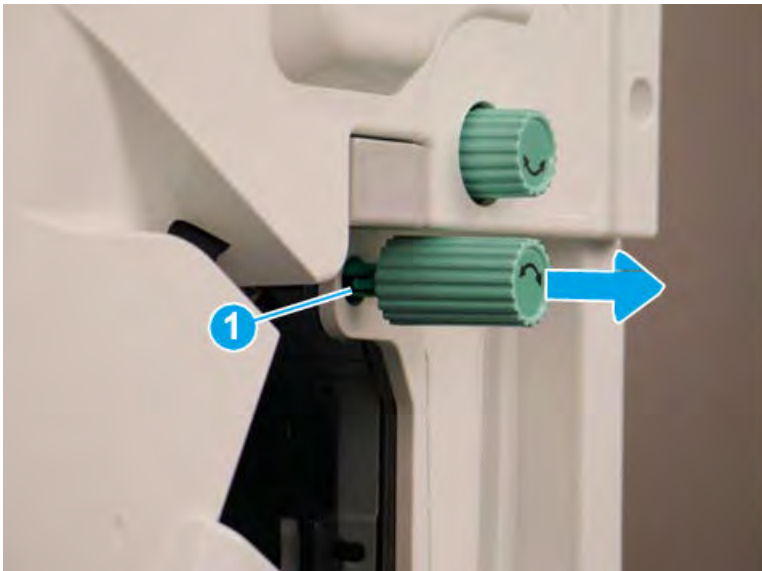

2. If the punch unit is installed, remove the punch waste bin (callout 1).

3. Remove one screw (callout 1) on top of the front cover.

Figure 5-833 Remove one screw



4. Remove five machine screws (callout 1), and then remove the front cover.

 **TIP:** Reverse the removal steps to install the assembly.

Figure 5-834 Remove the front cover

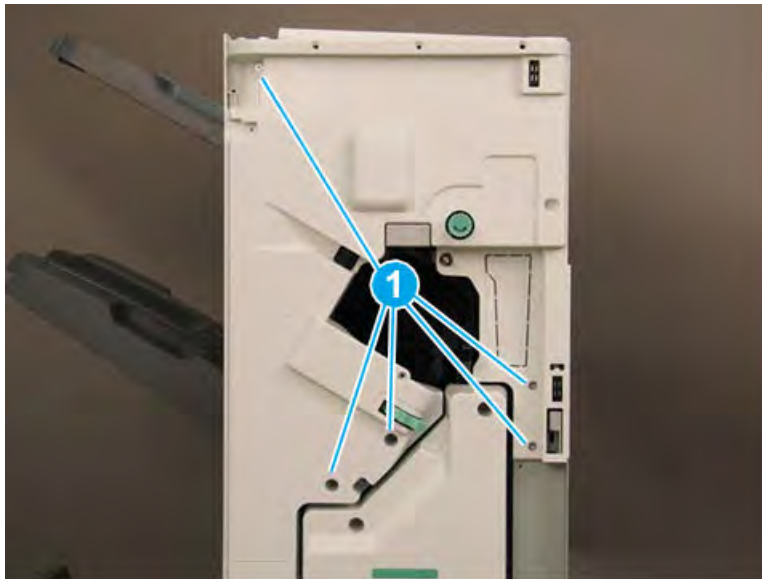

Remove the rear cover (finisher)

Follow these steps to remove the rear cover (finisher).

1. Remove two self-tapping screws (callout 1) on the top of the rear cover, and then remove five screw caps and five machine screws (callout 2) on the left side of the cover.

Figure 5-835 Remove seven screws

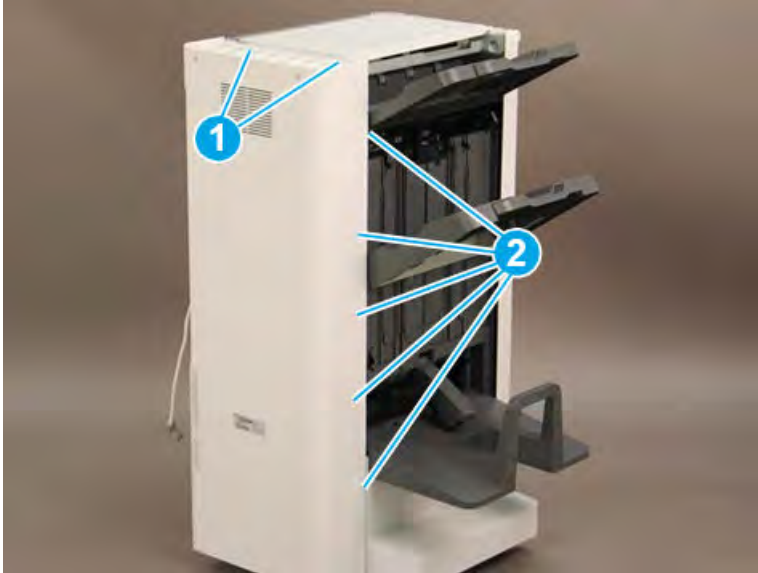

2. Remove one screw cap and four machine screws (callout 1) Remove the rear cover.

 **NOTE:** Make sure to thread the power cable (callout 2) through the opening in the cover.

 **TIP:** Reverse the removal steps to install the assembly

Figure 5-836 Remove the rear cover



Remove the stapler unit

Follow these steps to remove the stapler unit.

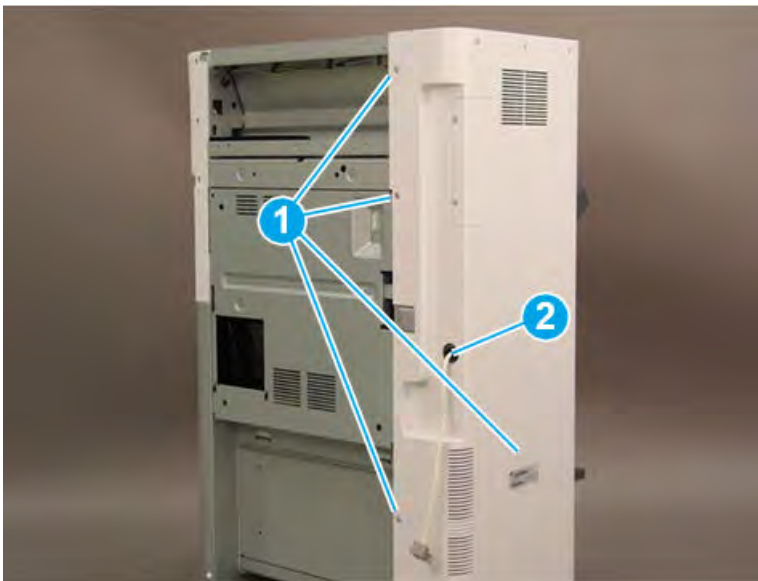
1. Rotate the green wheel to move the staple unit to the front until it stops.

Figure 5-837 Move the staple unit to the front

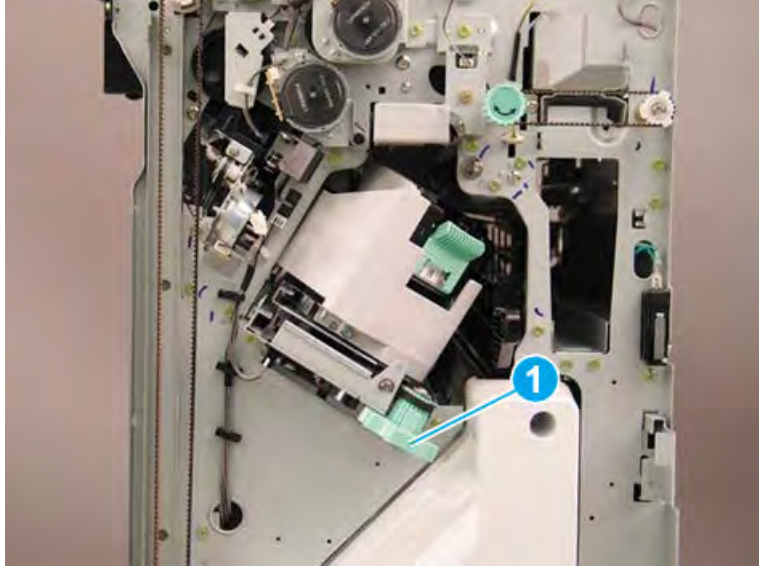

2. Lower the green latch (callout 1), and then slide the staple cartridge away from the finisher to remove it (callout 2).

Figure 5-838 Remove the staple cartridge

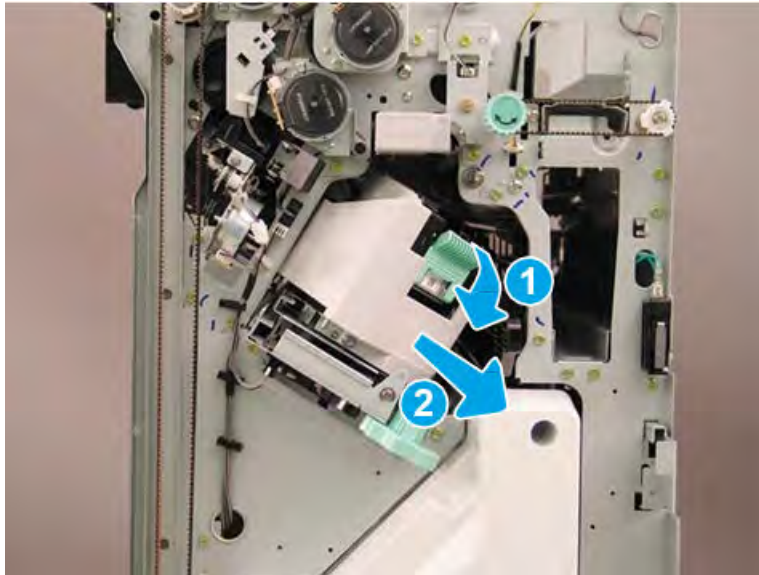

3. At the back of the finisher, release one retainer (callout 1), disconnect two connectors (callout 2), and then remove two screws (callout 3).

Figure 5-839 Disconnect three connectors and remove two screws

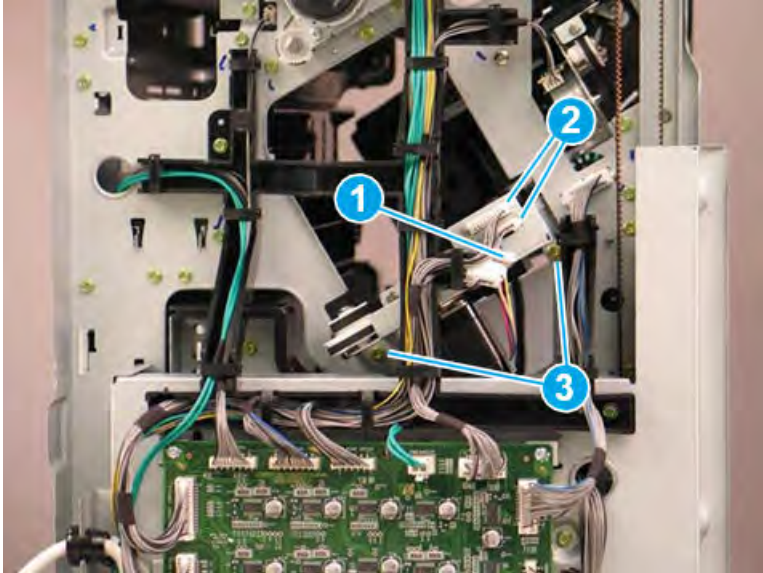

4. At the front of the finisher, disconnect one connector (callout 1), and then remove two screws (callout 2).

Figure 5-840 Disconnect one connector and remove two screws

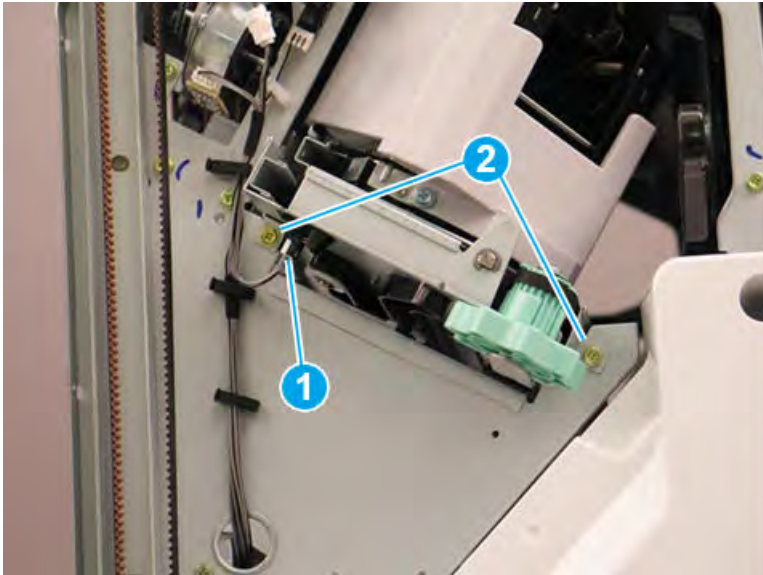

5. Lift up, and then slide the staple unit to the front of the finisher to remove it.

 **TIP:** Reverse the removal steps to install the assembly.

Figure 5-841 Remove the staple unit



Remove the stapler front sensor(S21)

Follow these steps to remove the stapler front sensor(S21).

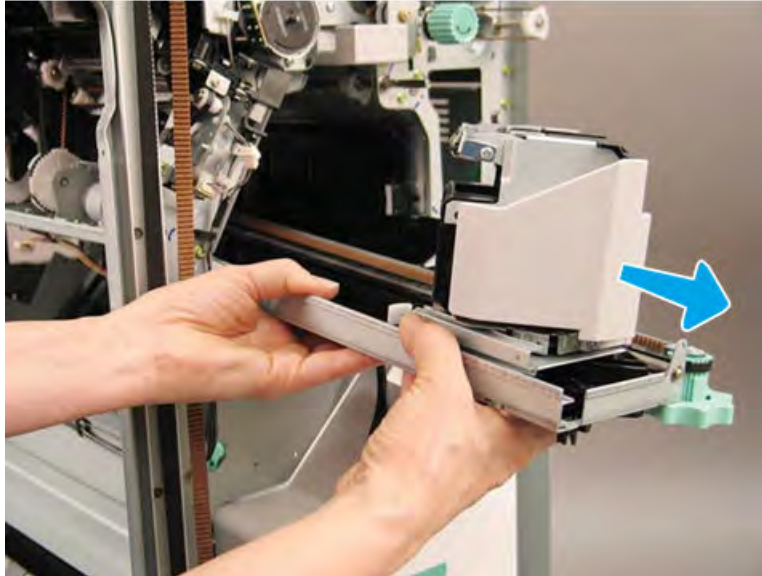
- ▲ Remove stapler front sensor from staple unit.

Figure 5-842 Remove the stapler front sensor

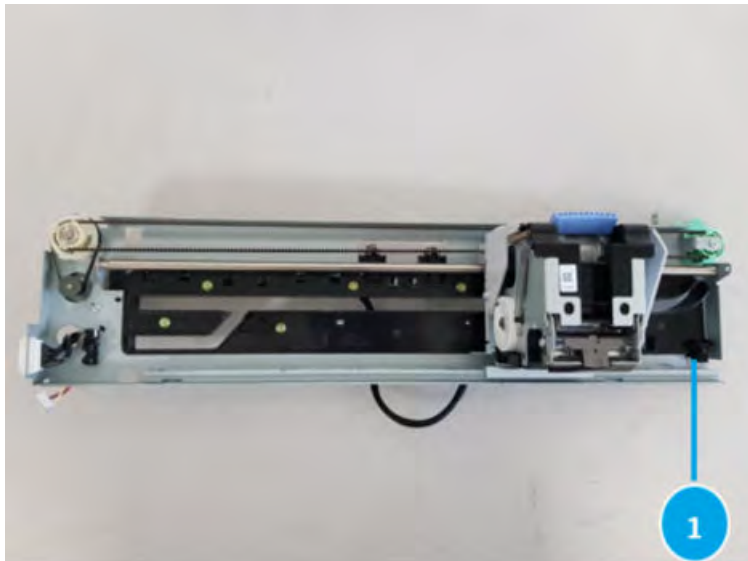

Unpack the replacement assembly

Follow these steps to unpack the replacement assembly.

1. Dispose of the defective part.

 **NOTE:** HP recommends responsible disposal of the defective part.

<http://www8.hp.com/us/en/hp-information/environment/product-recycling.html>

2. Unpack the replacement part from the packaging.



CAUTION:  Some parts are sensitive to electrostatic discharge (ESD). Always perform service work at an ESD-protected workstation or mat. If an ESD workstation or mat is not available, touch the sheet-metal chassis to provide a static ground before touching an ESD-sensitive assembly. Protect the ESD-sensitive assemblies by placing them in ESD pouches when they are out of the printer.

 **IMPORTANT:** Make sure that all of the shipping materials (for example shipping tape) are removed from the replacement part prior to installation.

 **NOTE:** If the replacement part is a roller or pad, avoid touching the spongy part of it. Skin oils on the roller or pad can cause paper pickup and/or print-quality problems. HP recommends using disposable gloves when handling rollers or pads or washing your hands before touching rollers or pads.

3. To install an assembly, reverse the removal steps.

 **NOTE:** When applicable, special installation instructions are provided for an assembly at the end of the removal procedure. Always completely read the removal instructions and follow all special installation instructions.

Removal and replacement: Stapler mid-front sensor (S24)

Learn how to remove and replace the stapler mid-front sensor.

Introduction

This document provides the procedures to remove and replace the stapler mid-front sensor on the finisher.



IMPORTANT: When applicable, special installation instructions are provided for an assembly at the end of the removal procedure. Always completely read the removal instructions and follow all special installation instructions.

Before performing service

- Turn the printer power off. A shutting-down message appears on the control-panel display.
- ⚠ **WARNING!** To avoid damage to the printer, turn the power off and wait until the printer shuts down before removing the power cable.
- Disconnect the printer power cable after the printer has completely shut down (the control-panel display is blank).
- Release the finisher from the printer by pulling out on the release latch inside the finisher door.
- Disconnect the cable from the bridge unit to the finisher.
- Disconnect the cable from the finisher to the printer.

Use the table below to identify the correct part number for your printer. To order the part, go to <https://parts.hp.com>.

Table 5-121 Part information

Part number	Part description
0604-001393	Stapler mid-front sensor

Required tools

- #2 JIS screwdriver with a magnetic tip

After performing service

- Connect the cable from the finisher to the printer.
- Connect the cable from the bridge unit to the finisher.
- Attach the finisher to the printer, and then push in on the release latch inside the finisher door.
- Connect the printer power cable.
- Turn the printer power on.

Post service test

Process a job through the finisher and verify that the finisher works correctly.

Remove the right upper cover (finisher)

Follow these steps to remove the right upper cover (finisher).

- ▲ Remove one screw cap and three machine screws on the upper edge of the cover (callout 1). Remove three sheet metal screws (callout 2) on the lower portion of the cover. Rotate the right edge of the cover away from the finisher, and then slide the cover right to release three tabs (callout 3).

💡 **TIP:** The lower screws are shorter in length than the upper screws.

TIP: Reverse the removal steps to install the assembly.

Figure 5-843 Remove the right upper cover

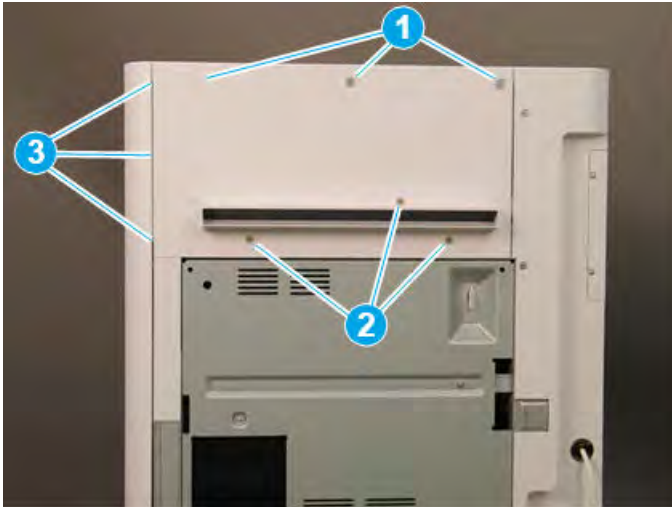

Remove the top cover (finisher)

Follow these steps to remove the top cover (finisher).

1. Remove three screw caps and three self-tapping screws at the top of the rear cover (callout 1), and then remove three machine screws (callout 2) on top of the cover.

Figure 5-844 Remove six screws

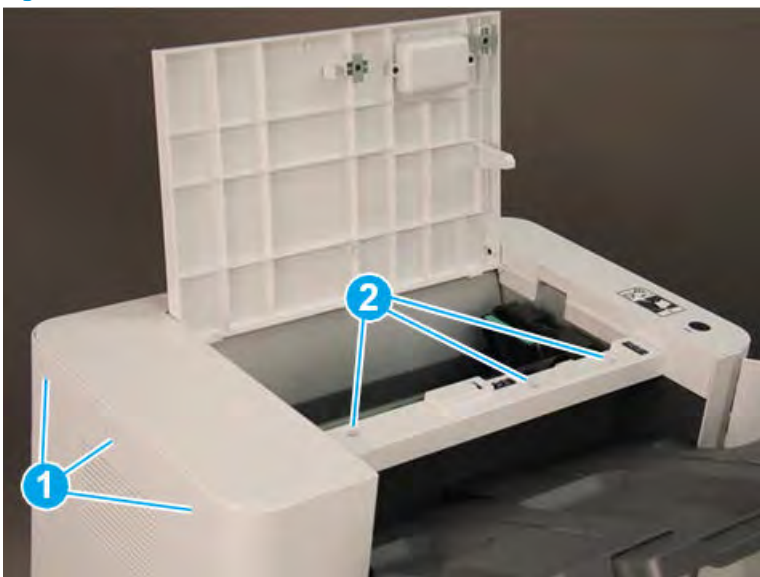

2. Remove three self-tapping screws at the top of the front cover (callout 1), and then remove two machine screws (callout 2) at the top of the right side.

Figure 5-845 Remove five screws

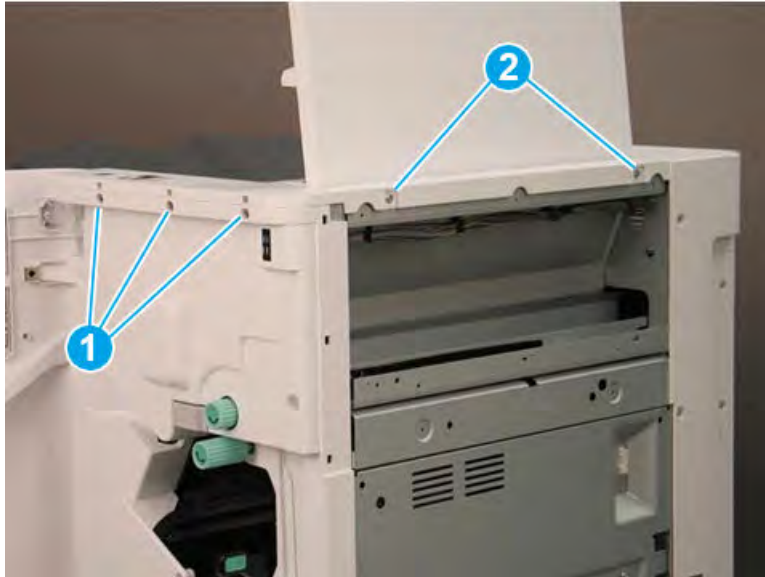

3. Lift the cover up slightly. Disconnect one in-line connector (callout 1), and then release one retainer (callout 2).

 **TIP:** Reverse the removal steps to install the assembly.

Figure 5-846 Disconnect one connector and release retainer



Remove the front door (finisher)

Follow these steps to remove the front door (finisher).

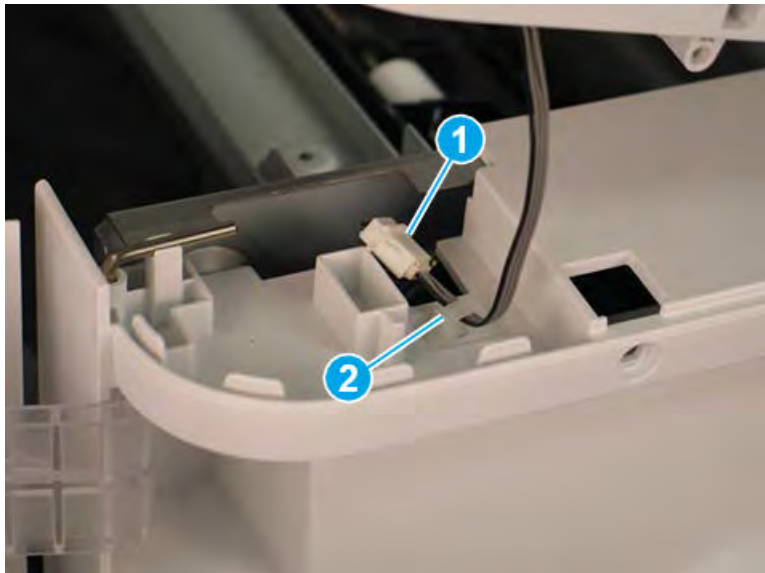
1. Lift the top hinge pin up to release it from the retainer.

Figure 5-847 Lift the top hinge pin

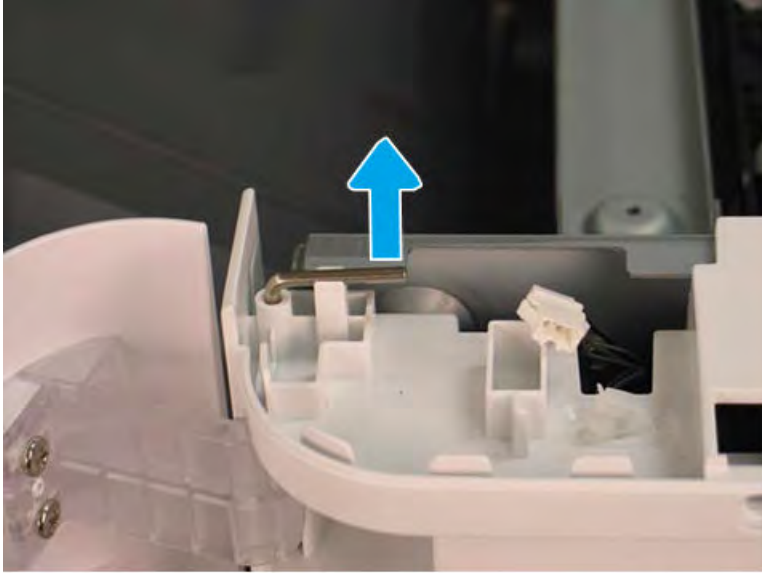

2. Pull the top hinge pin up to remove it.

Figure 5-848 Remove the top hinge pin

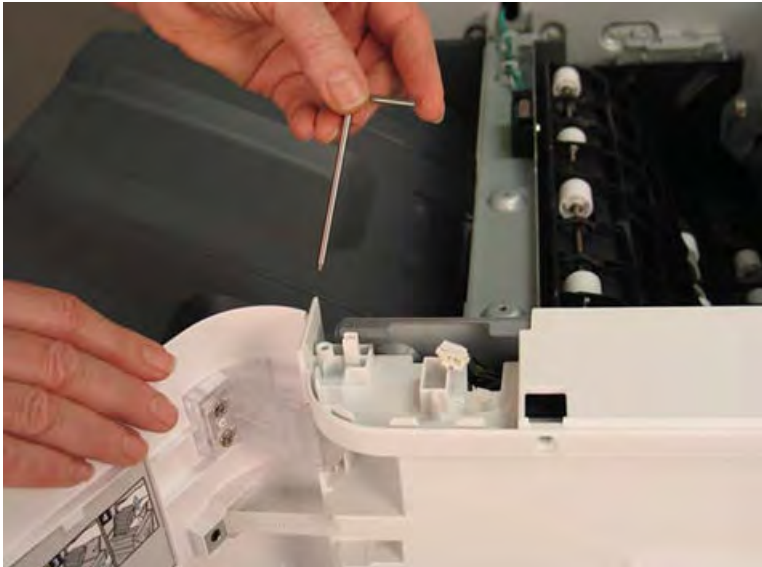

3. Use a small, flat-blade screwdriver to release the lower hinge pin from the retainer, and then rotate it away from the finisher.

Figure 5-849 Release the lower hinge pin



4. Support the door with one hand, and then pull the lower hinge pin straight up to remove it.

Figure 5-850 Remove the lower hinge pin



5. Support the door with one hand, and then remove one screw (callout 1) to release the strap. Remove the front door.

 **TIP:** Reverse the removal steps to install the assembly.

Figure 5-851 Remove the front door



Remove the front cover (finisher)

Follow these steps to remove the front cover (finisher).

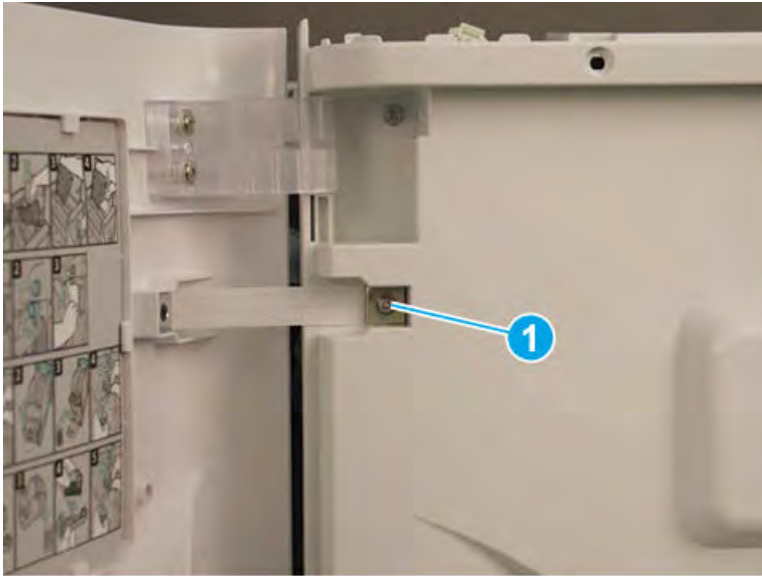
1. Release one tab (callout 1), and then pull the jam-access knob away from the finisher to remove it.

Figure 5-852 Remove the jam-access knob

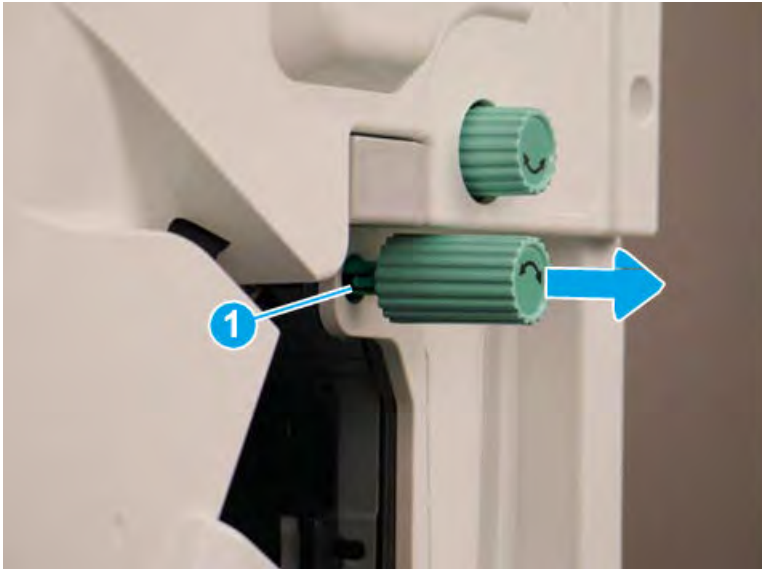

2. If the punch unit is installed, remove the punch waste bin (callout 1).

3. Remove one screw (callout 1) on top of the front cover.

Figure 5-853 Remove one screw



4. Remove five machine screws (callout 1), and then remove the front cover.

 **TIP:** Reverse the removal steps to install the assembly.

Figure 5-854 Remove the front cover



Remove the rear cover (finisher)

Follow these steps to remove the rear cover (finisher).

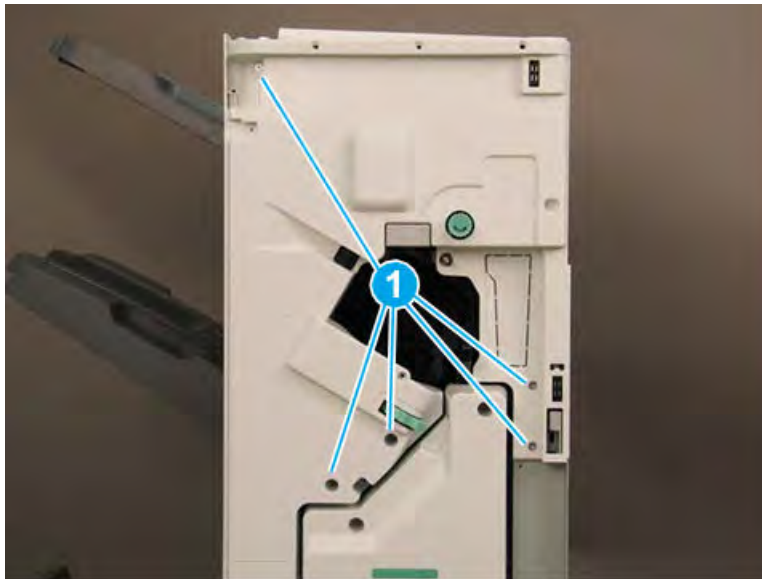
1. Remove two self-tapping screws (callout 1) on the top of the rear cover, and then remove five screw caps and five machine screws (callout 2) on the left side of the cover.

Figure 5-855 Remove seven screws



2. Remove one screw cap and four machine screws (callout 1) Remove the rear cover.

 **NOTE:** Make sure to thread the power cable (callout 2) through the opening in the cover.

 **TIP:** Reverse the removal steps to install the assembly

Figure 5-856 Remove the rear cover

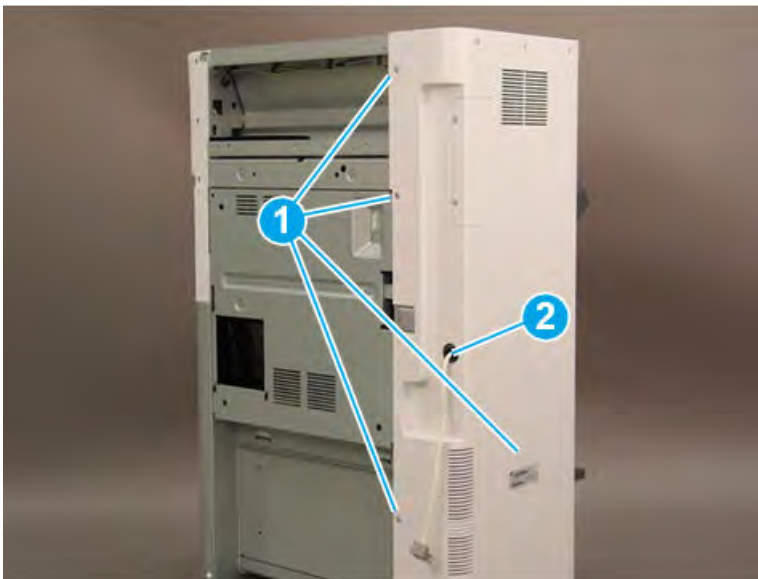

Remove the stapler unit

Follow these steps to remove the stapler unit.

1. Rotate the green wheel to move the stapler unit to the front until it stops.

Figure 5-857 Move the staple unit to the front

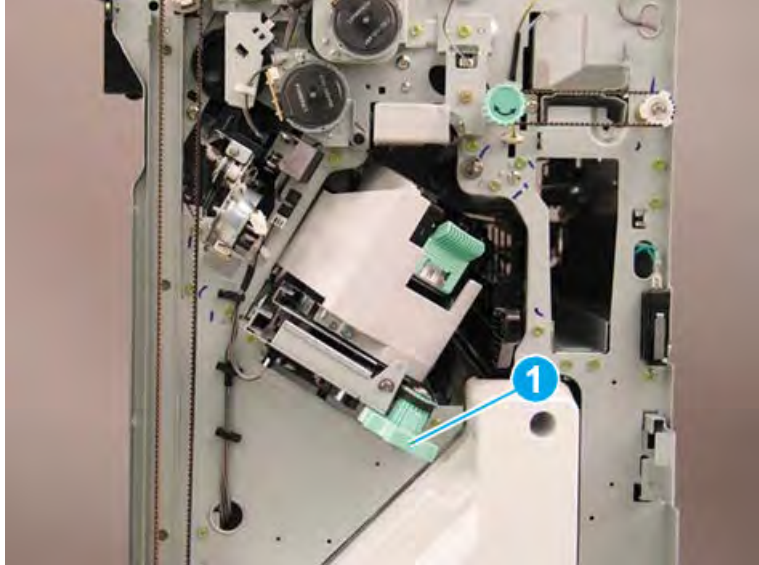

2. Lower the green latch (callout 1), and then slide the staple cartridge away from the finisher to remove it (callout 2).

Figure 5-858 Remove the staple cartridge

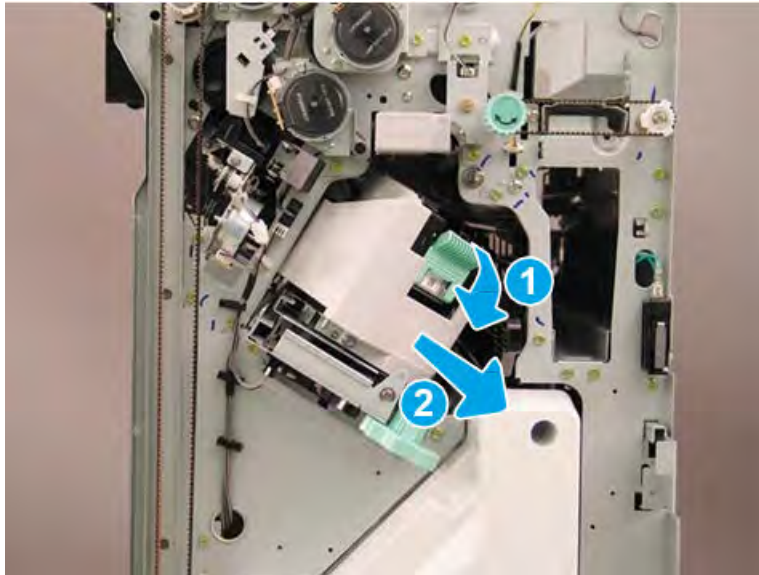

3. At the back of the finisher, release one retainer (callout 1), disconnect two connectors (callout 2), and then remove two screws (callout 3).

Figure 5-859 Disconnect three connectors and remove two screws

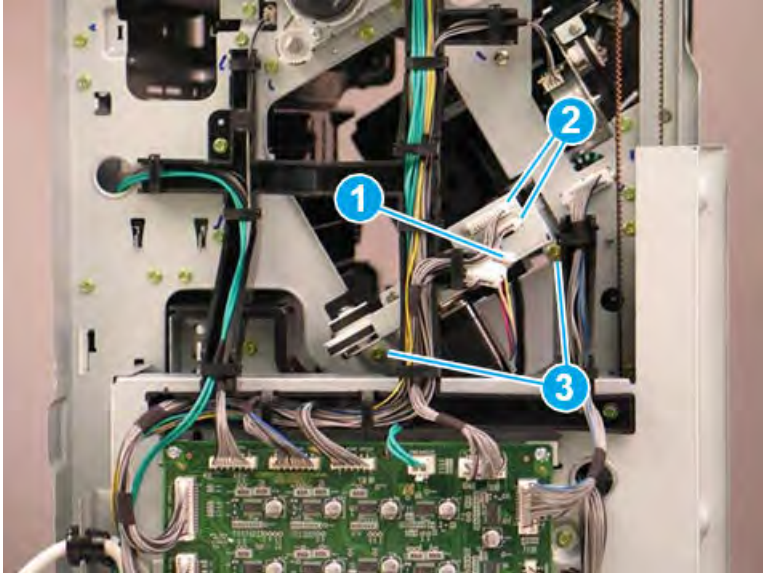

4. At the front of the finisher, disconnect one connector (callout 1), and then remove two screws (callout 2).

Figure 5-860 Disconnect one connector and remove two screws

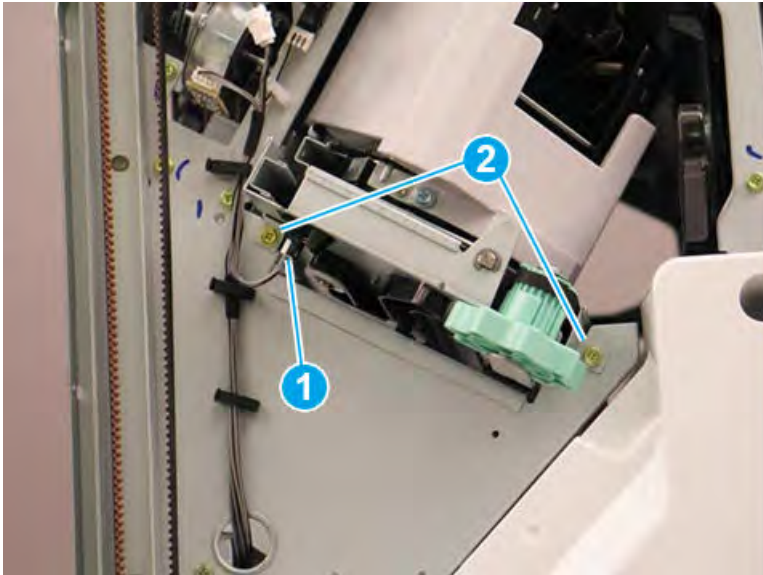

5. Lift up, and then slide the staple unit to the front of the finisher to remove it.

 **TIP:** Reverse the removal steps to install the assembly.

Figure 5-861 Remove the staple unit



Remove the stapler mid-front sensor(S24)

Follow these steps to remove the stapler mid-front sensor(S24).

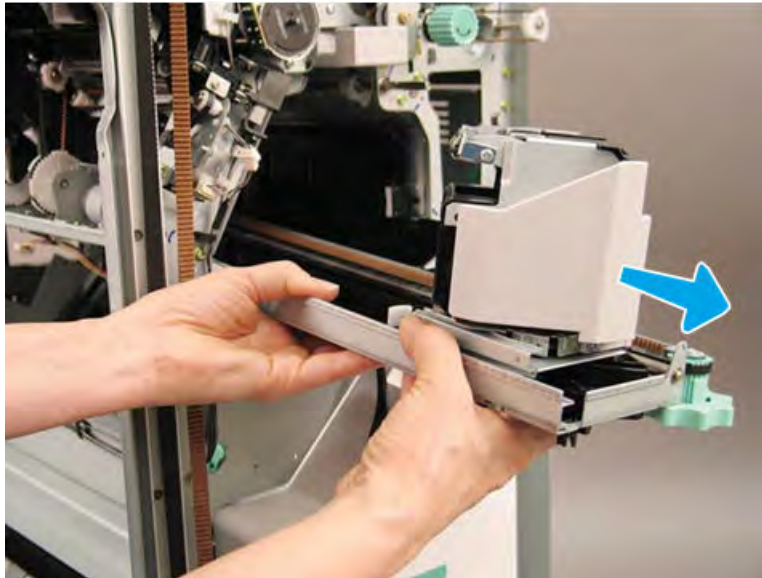
1. Turn over staple unit and disconnect the connector(callout 1)

Figure 5-862 Disconnect the connector

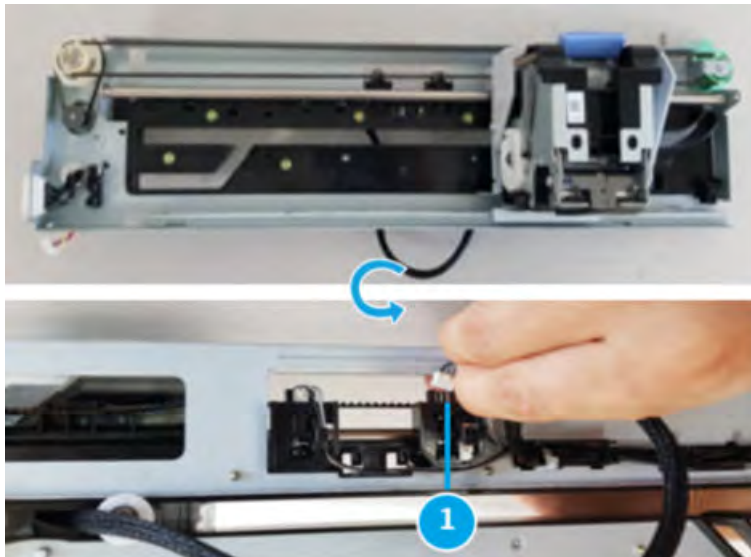

2. Remove stapler mid-rear sensor(S24, callout 1) from staple unit.

Figure 5-863 Remove stapler mid-rear sensor



Unpack the replacement assembly



Follow these steps to unpack the replacement assembly.

1. Dispose of the defective part.

 **NOTE:** HP recommends responsible disposal of the defective part.

<http://www8.hp.com/us/en/hp-information/environment/product-recycling.html>

2. Unpack the replacement part from the packaging.

 **CAUTION:**  Some parts are sensitive to electrostatic discharge (ESD). Always perform service work at an ESD-protected workstation or mat. If an ESD workstation or mat is not available, touch the sheet-metal chassis to provide a static ground before touching an ESD-sensitive assembly. Protect the ESD-sensitive assemblies by placing them in ESD pouches when they are out of the printer.

 **IMPORTANT:** Make sure that all of the shipping materials (for example shipping tape) are removed from the replacement part prior to installation.

 **NOTE:** If the replacement part is a roller or pad, avoid touching the spongy part of it. Skin oils on the roller or pad can cause paper pickup and/or print-quality problems. HP recommends using disposable gloves when handling rollers or pads or washing your hands before touching rollers or pads.

3. To install an assembly, reverse the removal steps.

 **NOTE:** When applicable, special installation instructions are provided for an assembly at the end of the removal procedure. Always completely read the removal instructions and follow all special installation instructions.

Removal and replacement: Stapler mid-rear sensor (S25)

Learn how to remove and replace the stapler mid-rear sensor.

Introduction

This document provides the procedures to remove and replace the stapler mid-rear sensor on the finisher.



IMPORTANT: When applicable, special installation instructions are provided for an assembly at the end of the removal procedure. Always completely read the removal instructions and follow all special installation instructions.

Before performing service

- Turn the printer power off. A shutting-down message appears on the control-panel display.
- ⚠ **WARNING!** To avoid damage to the printer, turn the power off and wait until the printer shuts down before removing the power cable.
- Disconnect the printer power cable after the printer has completely shut down (the control-panel display is blank).
- Release the finisher from the printer by pulling out on the release latch inside the finisher door.
- Disconnect the cable from the bridge unit to the finisher.
- Disconnect the cable from the finisher to the printer.

Use the table below to identify the correct part number for your printer. To order the part, go to <https://parts.hp.com>.

Table 5-122 Part information

Part number	Part description
0604-001393	Stapler mid-rear sensor

Required tools

- #2 JIS screwdriver with a magnetic tip

After performing service

- Connect the cable from the finisher to the printer.
- Connect the cable from the bridge unit to the finisher.
- Attach the finisher to the printer, and then push in on the release latch inside the finisher door.
- Connect the printer power cable.
- Turn the printer power on.

Post service test

Process a job through the finisher and verify that the finisher works correctly.

Remove the right upper cover (finisher)

Follow these steps to remove the right upper cover (finisher).

- ▲ Remove one screw cap and three machine screws on the upper edge of the cover (callout 1). Remove three sheet metal screws (callout 2) on the lower portion of the cover. Rotate the right edge of the cover away from the finisher, and then slide the cover right to release three tabs (callout 3).

💡 **TIP:** The lower screws are shorter in length than the upper screws.

TIP: Reverse the removal steps to install the assembly.

Figure 5-864 Remove the right upper cover

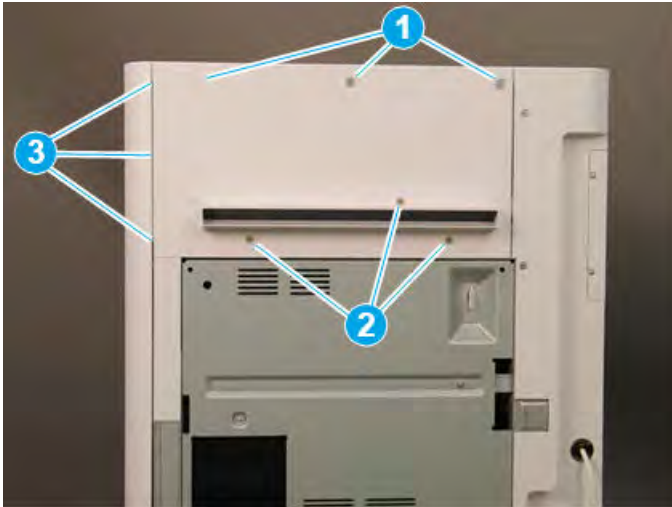

Remove the top cover (finisher)

Follow these steps to remove the top cover (finisher).

1. Remove three screw caps and three self-tapping screws at the top of the rear cover (callout 1), and then remove three machine screws (callout 2) on top of the cover.

Figure 5-865 Remove six screws

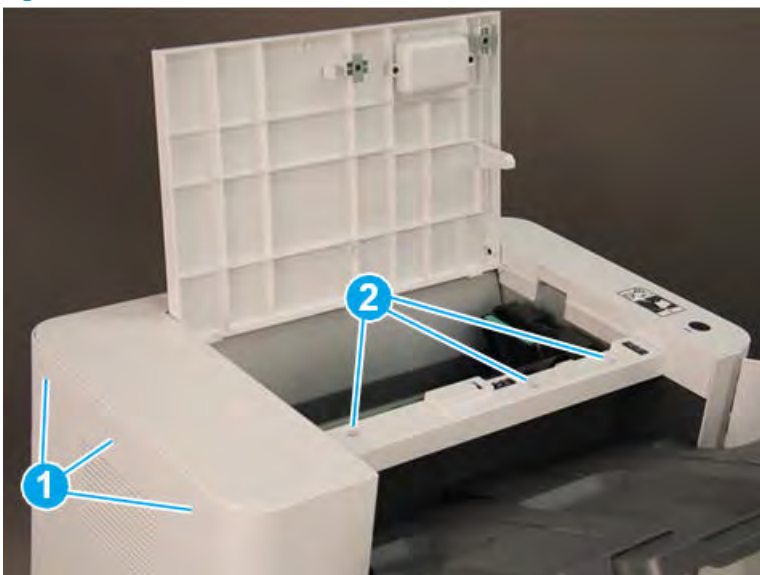

2. Remove three self-tapping screws at the top of the front cover (callout 1), and then remove two machine screws (callout 2) at the top of the right side.

Figure 5-866 Remove five screws

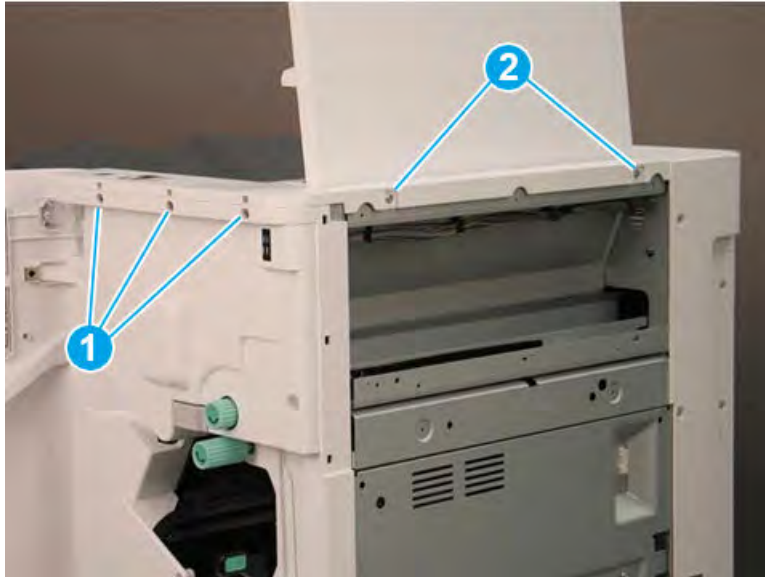

3. Lift the cover up slightly. Disconnect one in-line connector (callout 1), and then release one retainer (callout 2).

 **TIP:** Reverse the removal steps to install the assembly.

Figure 5-867 Disconnect one connector and release retainer



Remove the front door (finisher)

Follow these steps to remove the front door (finisher).

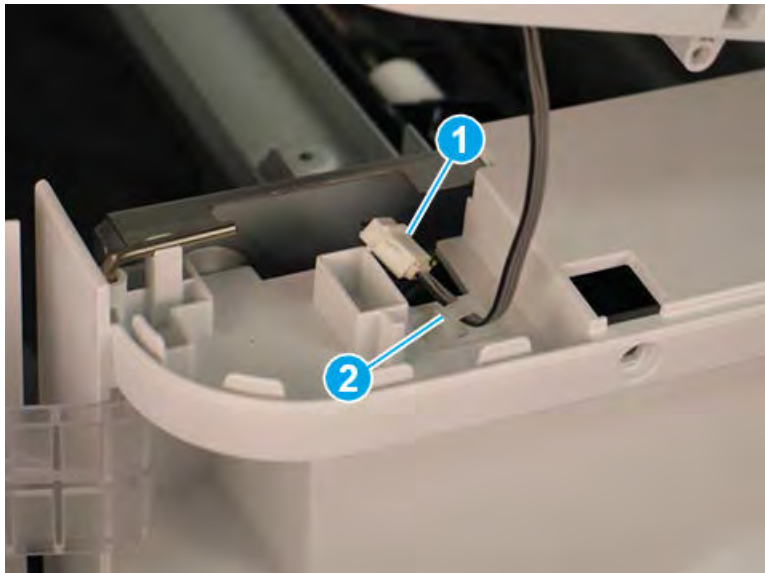
1. Lift the top hinge pin up to release it from the retainer.

Figure 5-868 Lift the top hinge pin

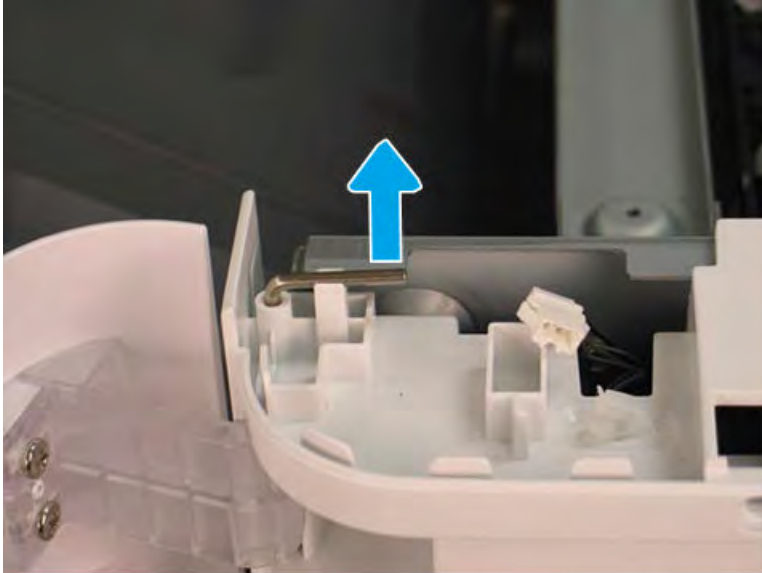

2. Pull the top hinge pin up to remove it.

Figure 5-869 Remove the top hinge pin

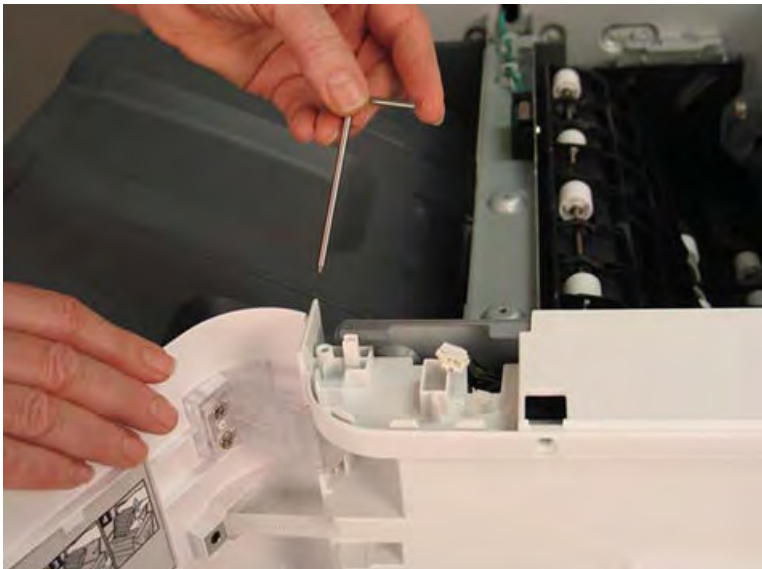

3. Use a small, flat-blade screwdriver to release the lower hinge pin from the retainer, and then rotate it away from the finisher.

Figure 5-870 Release the lower hinge pin



4. Support the door with one hand, and then pull the lower hinge pin straight up to remove it.

Figure 5-871 Remove the lower hinge pin



5. Support the door with one hand, and then remove one screw (callout 1) to release the strap. Remove the front door.

 **TIP:** Reverse the removal steps to install the assembly.

Figure 5-872 Remove the front door



Remove the front cover (finisher)

Follow these steps to remove the front cover (finisher).

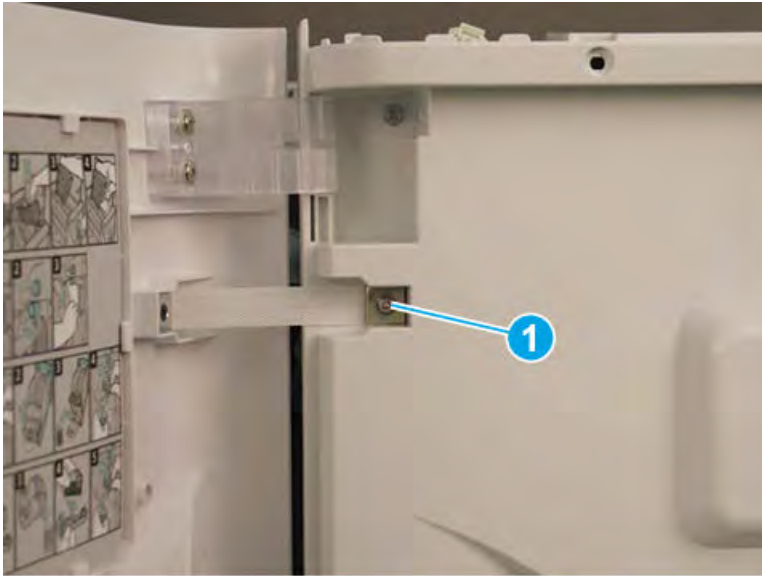
1. Release one tab (callout 1), and then pull the jam-access knob away from the finisher to remove it.

Figure 5-873 Remove the jam-access knob

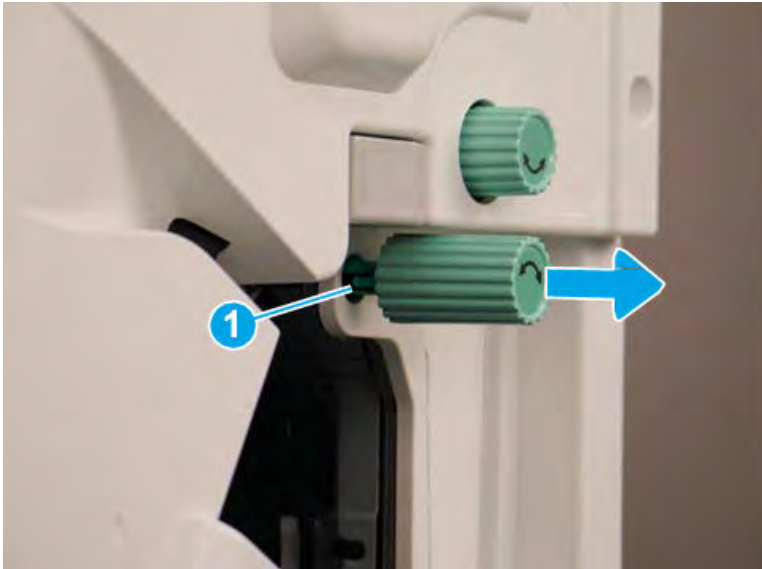

2. If the punch unit is installed, remove the punch waste bin (callout 1).

3. Remove one screw (callout 1) on top of the front cover.

Figure 5-874 Remove one screw



4. Remove five machine screws (callout 1), and then remove the front cover.

 **TIP:** Reverse the removal steps to install the assembly.

Figure 5-875 Remove the front cover



Remove the rear cover (finisher)

Follow these steps to remove the rear cover (finisher).

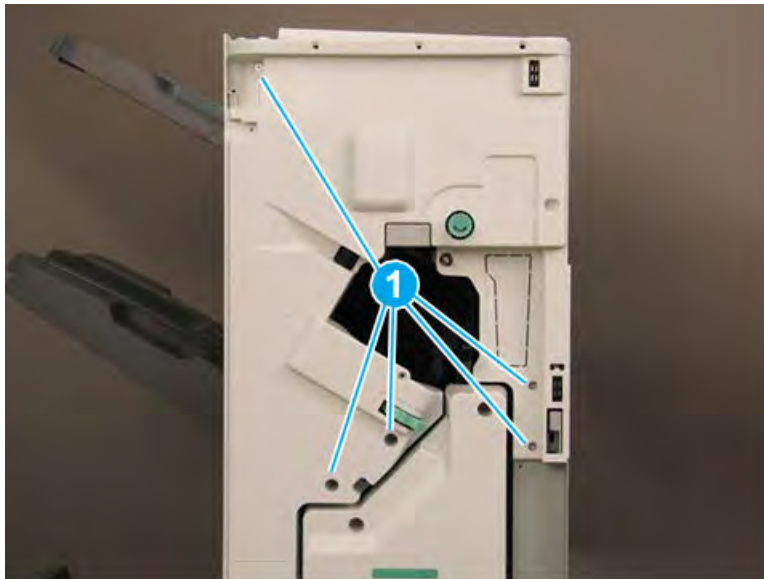
1. Remove two self-tapping screws (callout 1) on the top of the rear cover, and then remove five screw caps and five machine screws (callout 2) on the left side of the cover.

Figure 5-876 Remove seven screws

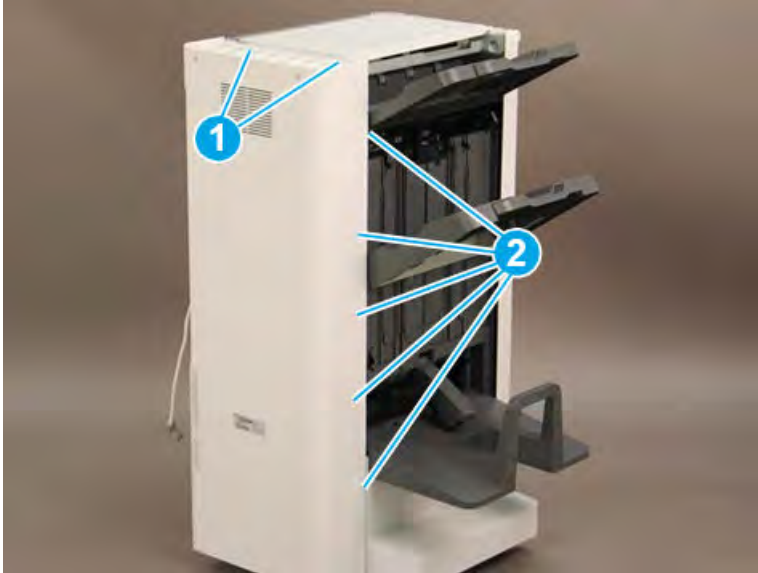

2. Remove one screw cap and four machine screws (callout 1) Remove the rear cover.

 **NOTE:** Make sure to thread the power cable (callout 2) through the opening in the cover.

 **TIP:** Reverse the removal steps to install the assembly

Figure 5-877 Remove the rear cover



Remove the stapler unit

Follow these steps to remove the stapler unit.

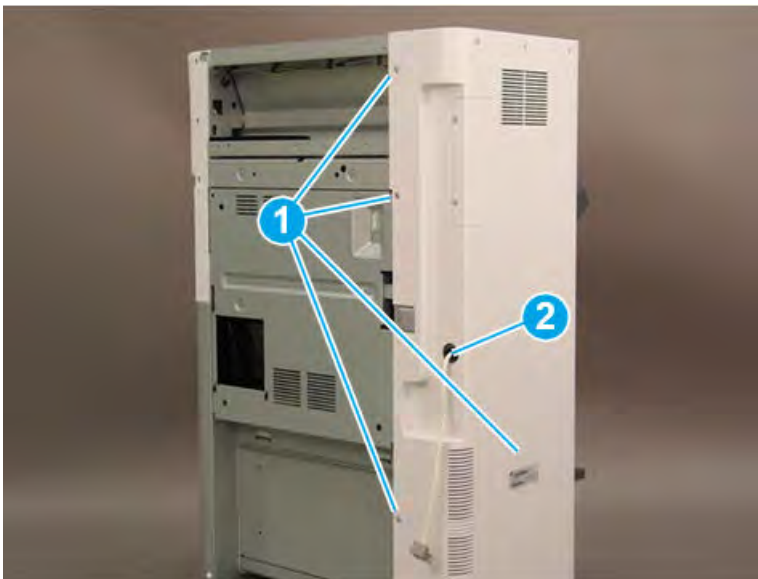
1. Rotate the green wheel to move the stapler unit to the front until it stops.

Figure 5-878 Move the staple unit to the front

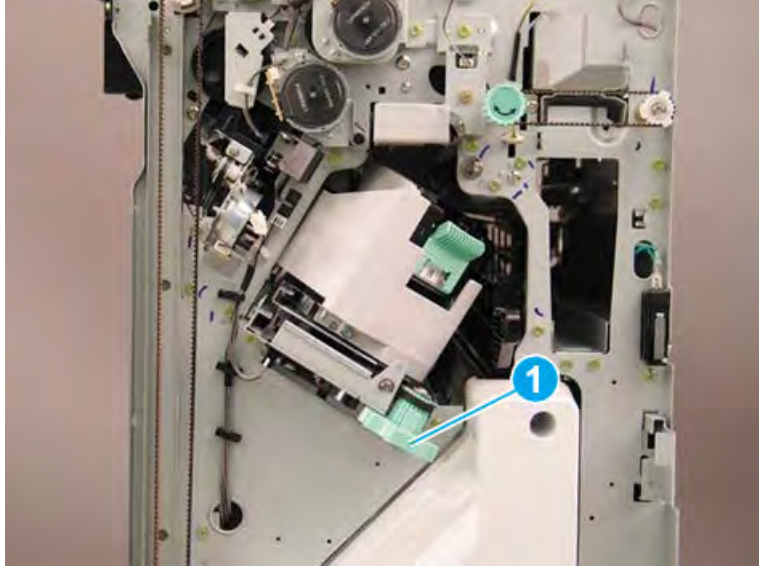

2. Lower the green latch (callout 1), and then slide the staple cartridge away from the finisher to remove it (callout 2).

Figure 5-879 Remove the staple cartridge

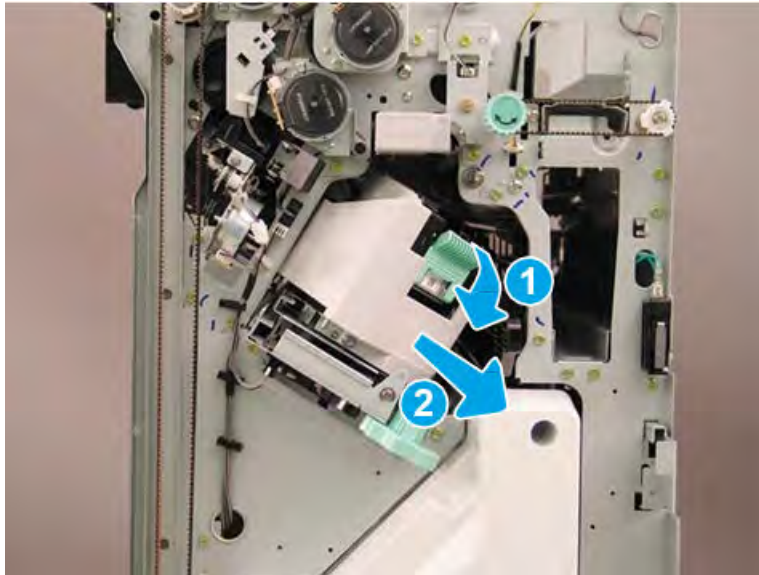

3. At the back of the finisher, release one retainer (callout 1), disconnect two connectors (callout 2), and then remove two screws (callout 3).

Figure 5-880 Disconnect three connectors and remove two screws

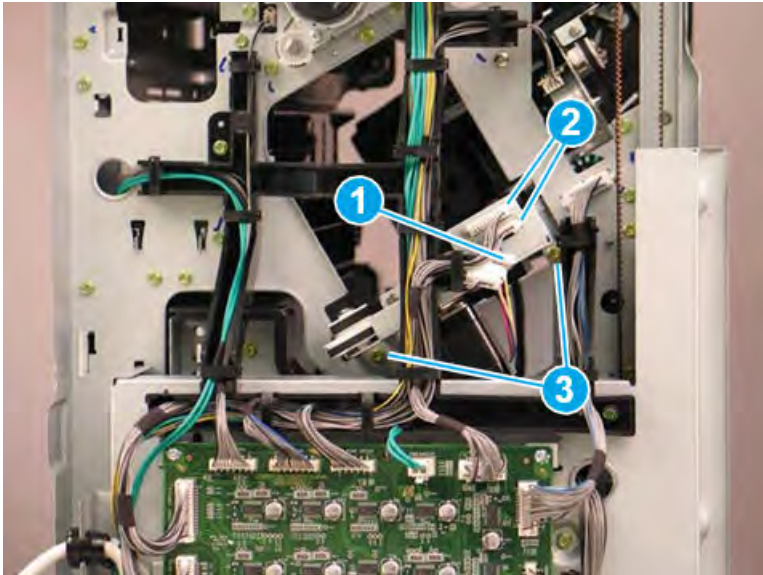

4. At the front of the finisher, disconnect one connector (callout 1), and then remove two screws (callout 2).

Figure 5-881 Disconnect one connector and remove two screws

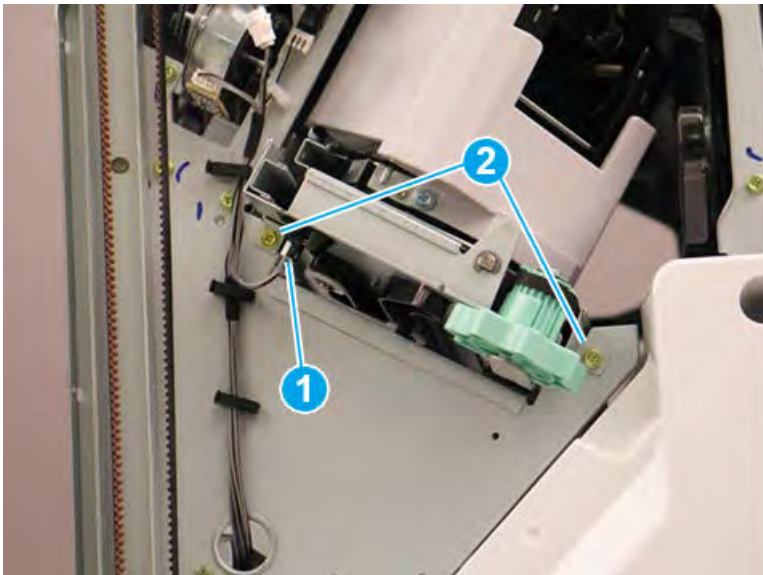

5. Lift up, and then slide the staple unit to the front of the finisher to remove it.

 **TIP:** Reverse the removal steps to install the assembly.

Figure 5-882 Remove the staple unit



Remove the stapler mid-rear sensor(S25)

Follow these steps to remove the stapler mid-rear sensor(S25).

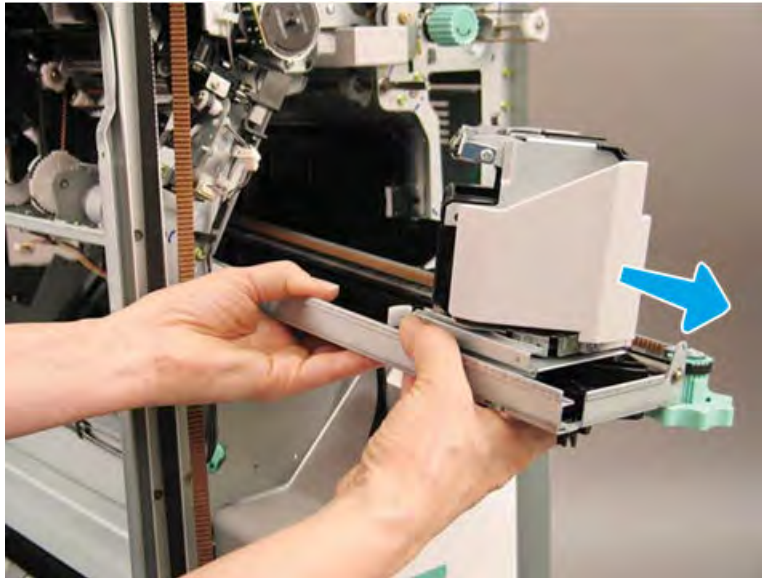
1. Turn over staple unit and disconnect the connector(callout 1)

Figure 5-883 Disconnect the connector

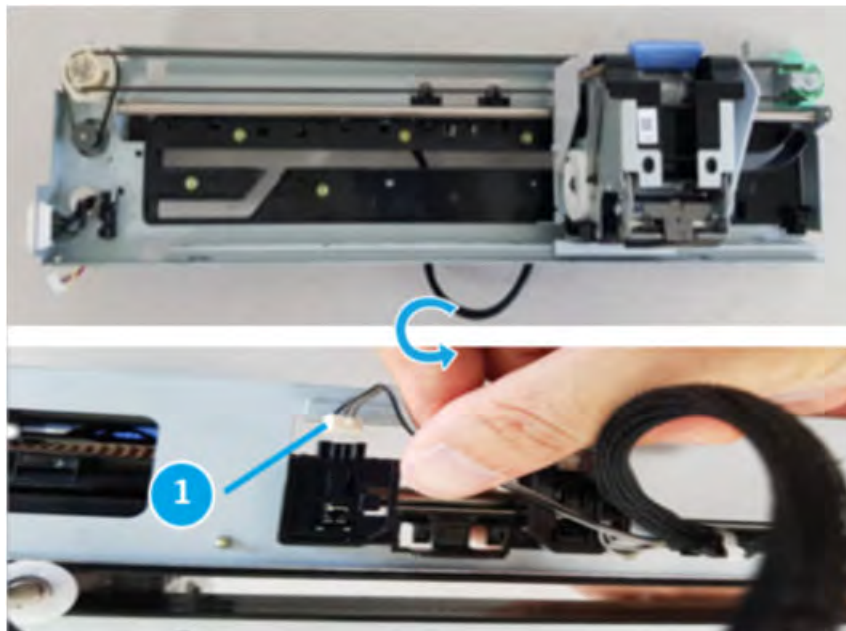

2. Remove stapler mid-rear sensor(S24, callout 1) from staple unit.

Figure 5-884 Remove stapler mid-rear sensor



Unpack the replacement assembly



Follow these steps to unpack the replacement assembly.

1. Dispose of the defective part.

 **NOTE:** HP recommends responsible disposal of the defective part.

<http://www8.hp.com/us/en/hp-information/environment/product-recycling.html>

2. Unpack the replacement part from the packaging.

 **CAUTION:**  Some parts are sensitive to electrostatic discharge (ESD). Always perform service work at an ESD-protected workstation or mat. If an ESD workstation or mat is not available, touch the sheet-metal chassis to provide a static ground before touching an ESD-sensitive assembly. Protect the ESD-sensitive assemblies by placing them in ESD pouches when they are out of the printer.

 **IMPORTANT:** Make sure that all of the shipping materials (for example shipping tape) are removed from the replacement part prior to installation.

 **NOTE:** If the replacement part is a roller or pad, avoid touching the spongy part of it. Skin oils on the roller or pad can cause paper pickup and/or print-quality problems. HP recommends using disposable gloves when handling rollers or pads or washing your hands before touching rollers or pads.

3. To install an assembly, reverse the removal steps.

 **NOTE:** When applicable, special installation instructions are provided for an assembly at the end of the removal procedure. Always completely read the removal instructions and follow all special installation instructions.

Removal and replacement: Stapler rear sensor (S30)

Learn how to remove and replace the stapler rear sensor.

Introduction

This document provides the procedures to remove and replace the stapler rear sensor on the finisher.

 **IMPORTANT:** When applicable, special installation instructions are provided for an assembly at the end of the removal procedure. Always completely read the removal instructions and follow all special installation instructions.

Before performing service

- Turn the printer power off. A shutting-down message appears on the control-panel display.
- ⚠ **WARNING!** To avoid damage to the printer, turn the power off and wait until the printer shuts down before removing the power cable.
- Disconnect the printer power cable after the printer has completely shut down (the control-panel display is blank).
- Release the finisher from the printer by pulling out on the release latch inside the finisher door.
- Disconnect the cable from the bridge unit to the finisher.
- Disconnect the cable from the finisher to the printer.

Use the table below to identify the correct part number for your printer. To order the part, go to <https://parts.hp.com>.

Table 5-123 Part information

Part number	Part description
0604-001393	Stapler rear sensor

Required tools

- #2 JIS screwdriver with a magnetic tip

After performing service

- Connect the cable from the finisher to the printer.
- Connect the cable from the bridge unit to the finisher.
- Attach the finisher to the printer, and then push in on the release latch inside the finisher door.
- Connect the printer power cable.
- Turn the printer power on.

Post service test

Process a job through the finisher and verify that the finisher works correctly.

Remove the right upper cover (finisher)

Follow these steps to remove the right upper cover (finisher).

- ▲ Remove one screw cap and three machine screws on the upper edge of the cover (callout 1). Remove three sheet metal screws (callout 2) on the lower portion of the cover. Rotate the right edge of the cover away from the finisher, and then slide the cover right to release three tabs (callout 3).

💡 **TIP:** The lower screws are shorter in length than the upper screws.

TIP: Reverse the removal steps to install the assembly.

Figure 5-885 Remove the right upper cover

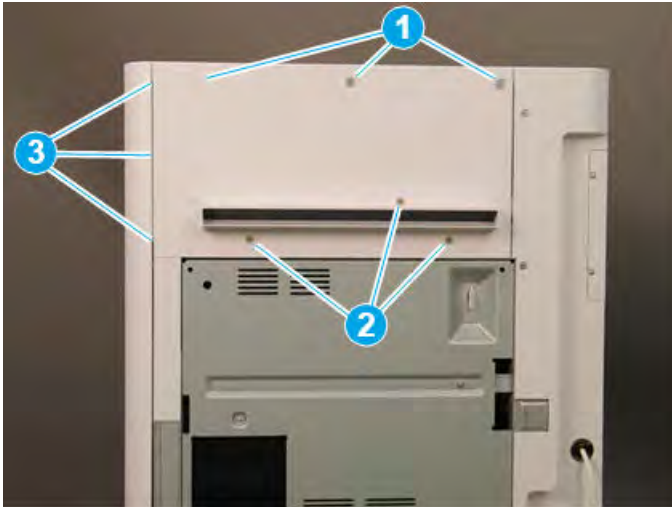

Remove the top cover (finisher)

Follow these steps to remove the top cover (finisher).

1. Remove three screw caps and three self-tapping screws at the top of the rear cover (callout 1), and then remove three machine screws (callout 2) on top of the cover.

Figure 5-886 Remove six screws

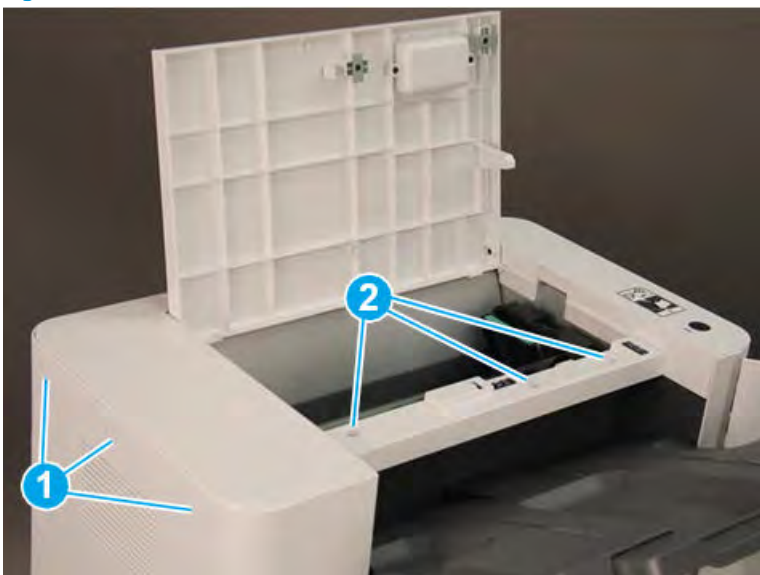

2. Remove three self-tapping screws at the top of the front cover (callout 1), and then remove two machine screws (callout 2) at the top of the right side.

Figure 5-887 Remove five screws

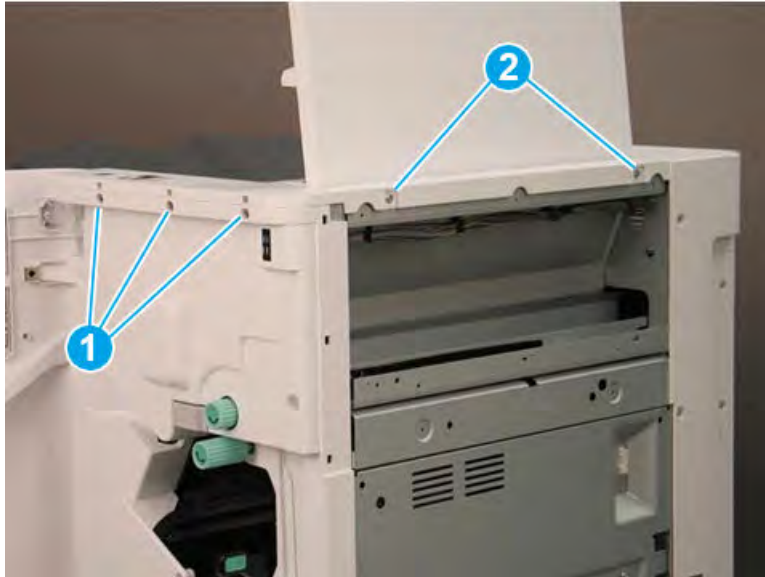

3. Lift the cover up slightly. Disconnect one in-line connector (callout 1), and then release one retainer (callout 2).

 **TIP:** Reverse the removal steps to install the assembly.

Figure 5-888 Disconnect one connector and release retainer



Remove the front door (finisher)

Follow these steps to remove the front door (finisher).

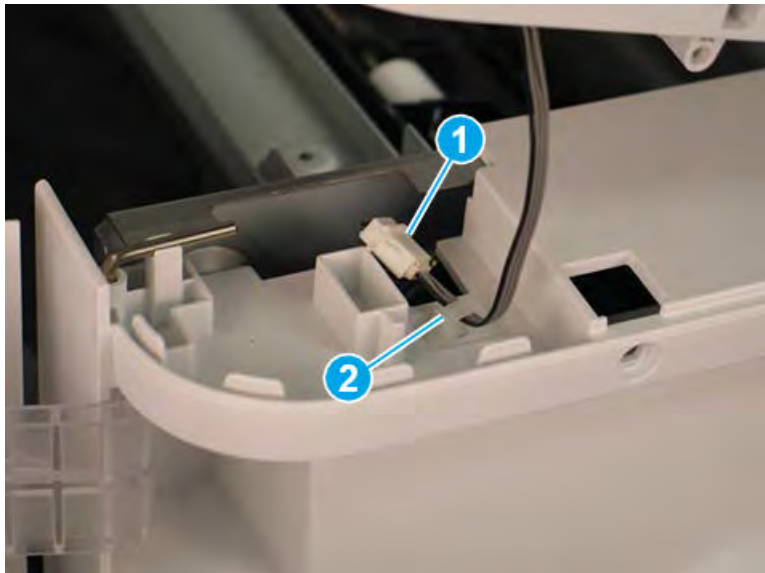
1. Lift the top hinge pin up to release it from the retainer.

Figure 5-889 Lift the top hinge pin

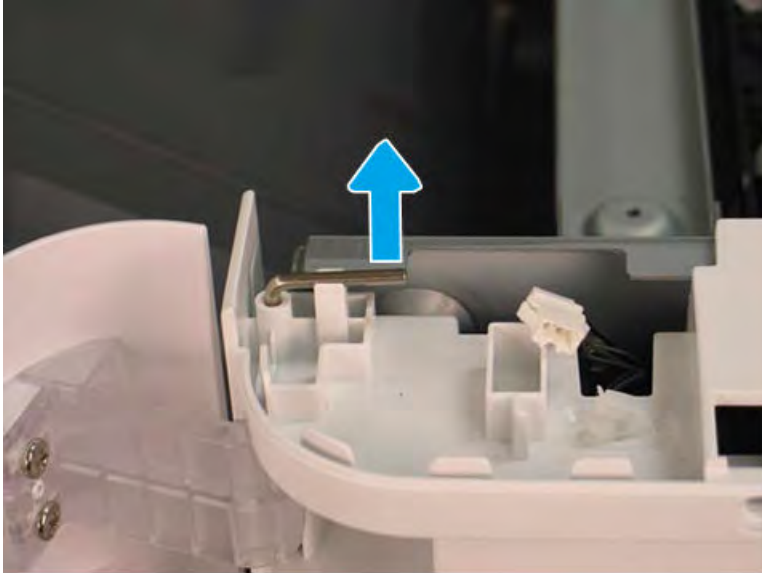

2. Pull the top hinge pin up to remove it.

Figure 5-890 Remove the top hinge pin

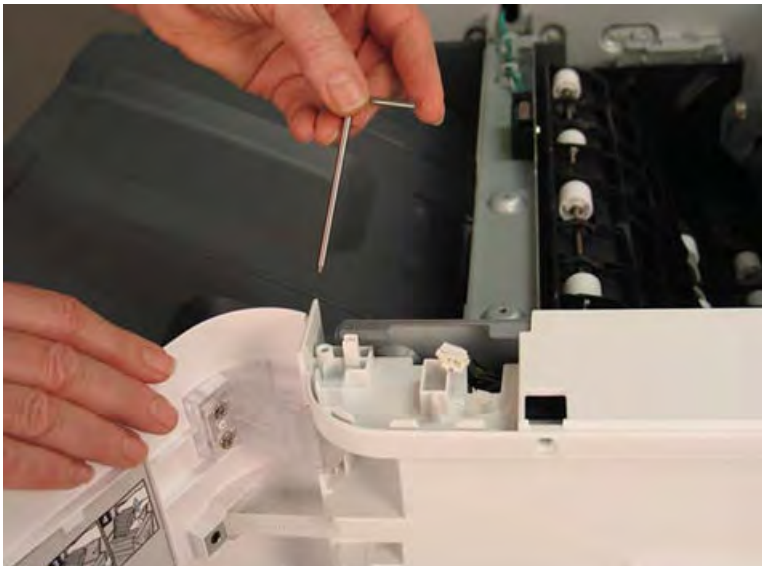

3. Use a small, flat-blade screwdriver to release the lower hinge pin from the retainer, and then rotate it away from the finisher.

Figure 5-891 Release the lower hinge pin



4. Support the door with one hand, and then pull the lower hinge pin straight up to remove it.

Figure 5-892 Remove the lower hinge pin



5. Support the door with one hand, and then remove one screw (callout 1) to release the strap. Remove the front door.

 **TIP:** Reverse the removal steps to install the assembly.

Figure 5-893 Remove the front door



Remove the front cover (finisher)

Follow these steps to remove the front cover (finisher).

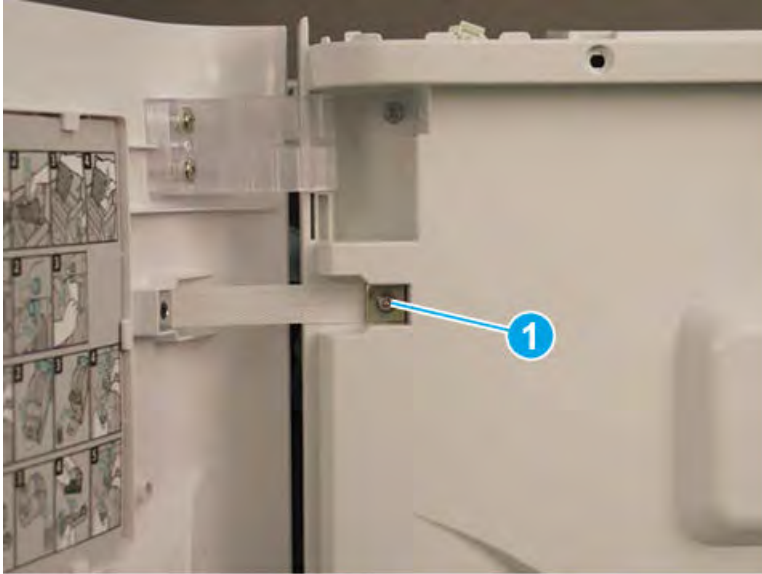
1. Release one tab (callout 1), and then pull the jam-access knob away from the finisher to remove it.

Figure 5-894 Remove the jam-access knob

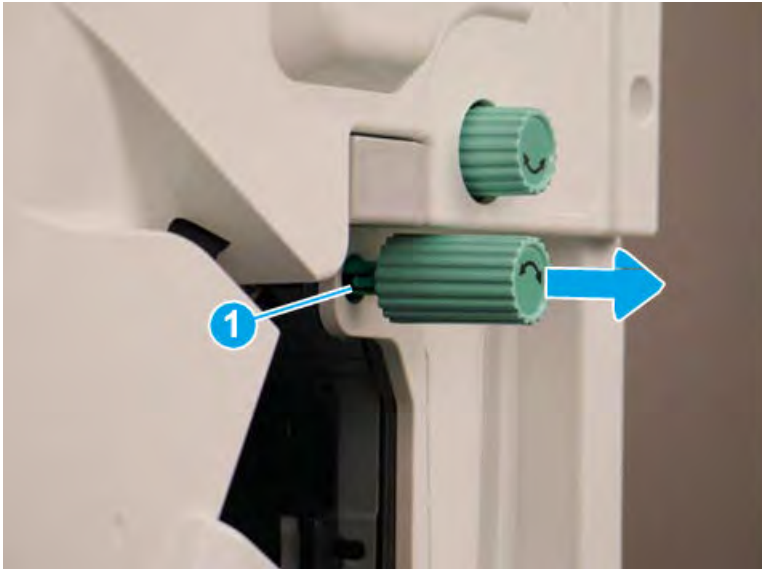

2. If the punch unit is installed, remove the punch waste bin (callout 1).

3. Remove one screw (callout 1) on top of the front cover.

Figure 5-895 Remove one screw



4. Remove five machine screws (callout 1), and then remove the front cover.

 **TIP:** Reverse the removal steps to install the assembly.

Figure 5-896 Remove the front cover



Remove the rear cover (finisher)

Follow these steps to remove the rear cover (finisher).

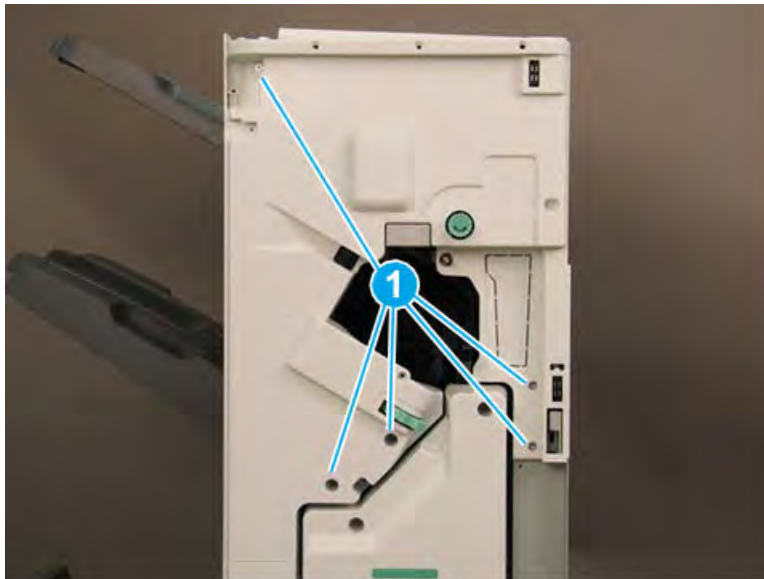
1. Remove two self-tapping screws (callout 1) on the top of the rear cover, and then remove five screw caps and five machine screws (callout 2) on the left side of the cover.

Figure 5-897 Remove seven screws



2. Remove one screw cap and four machine screws (callout 1) Remove the rear cover.

 **NOTE:** Make sure to thread the power cable (callout 2) through the opening in the cover.

 **TIP:** Reverse the removal steps to install the assembly

Figure 5-898 Remove the rear cover



Remove the stapler unit

Follow these steps to remove the stapler unit.

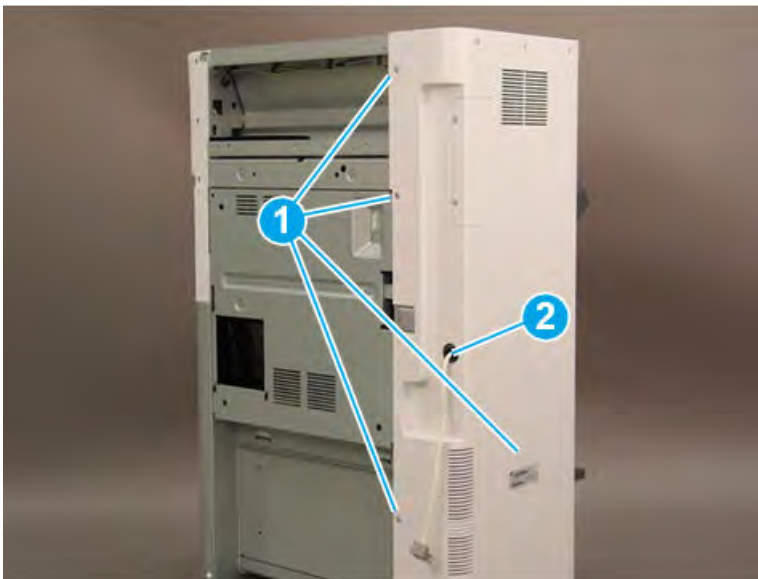
1. Rotate the green wheel to move the stapler unit to the front until it stops.

Figure 5-899 Move the staple unit to the front

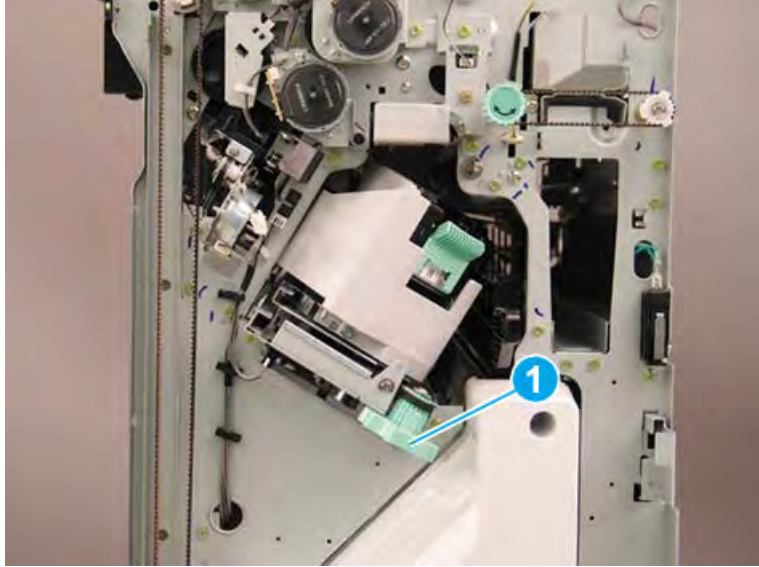

2. Lower the green latch (callout 1), and then slide the staple cartridge away from the finisher to remove it (callout 2).

Figure 5-900 Remove the staple cartridge

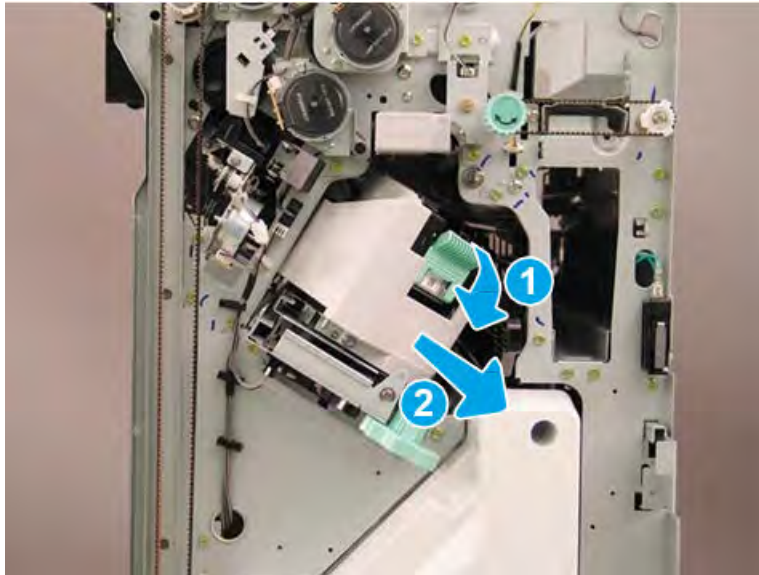

3. At the back of the finisher, release one retainer (callout 1), disconnect two connectors (callout 2), and then remove two screws (callout 3).

Figure 5-901 Disconnect three connectors and remove two screws

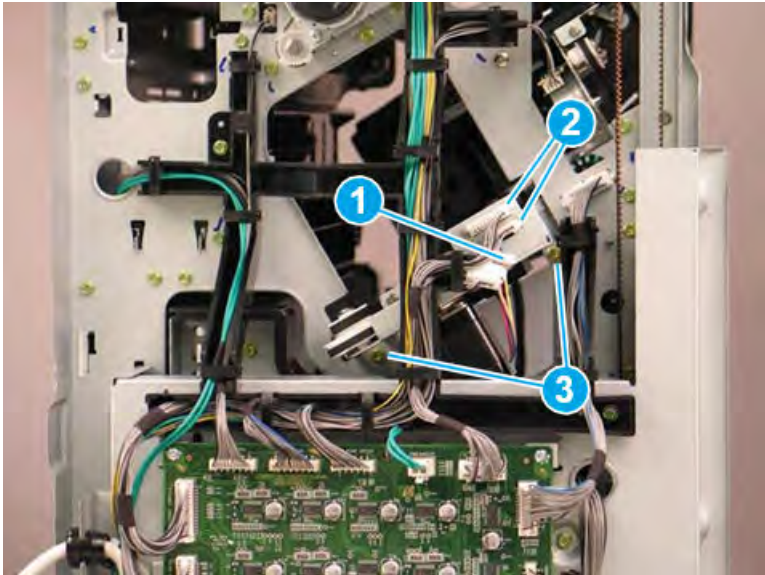

4. At the front of the finisher, disconnect one connector (callout 1), and then remove two screws (callout 2).

Figure 5-902 Disconnect one connector and remove two screws

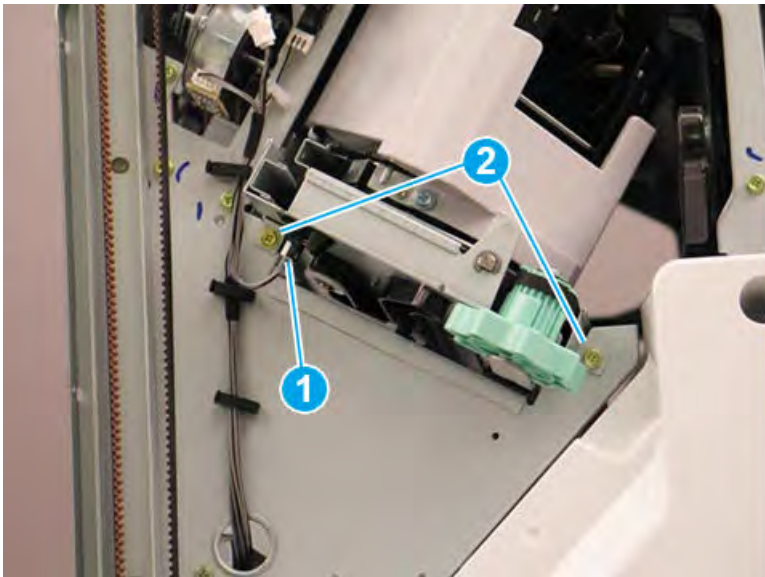

5. Lift up, and then slide the staple unit to the front of the finisher to remove it.

 **TIP:** Reverse the removal steps to install the assembly.

Figure 5-903 Remove the staple unit



Remove the stapler rear sensor(S30)

Follow these steps to remove the stapler rear sensor(S30).

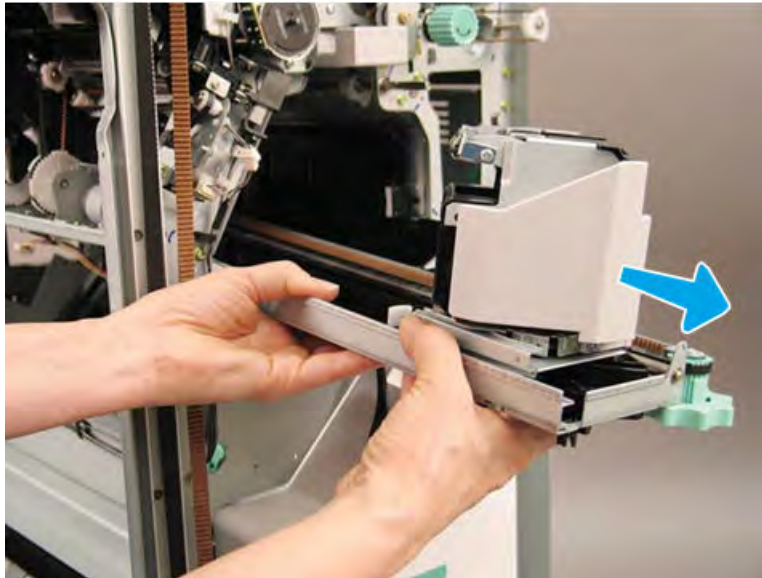
1. Remove stapler rear sensor(callout 1, S30) from staple unit.

Figure 5-904 Remove stapler rear sensor from staple unit.

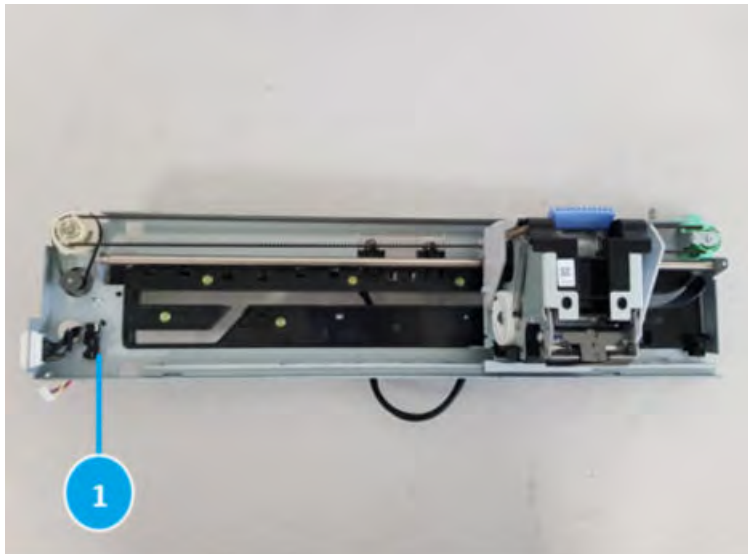

2. Disconnect the connector(callout 1) from stapler rear sensor.

Figure 5-905 Disconnect the connector from stapler rear sensor.

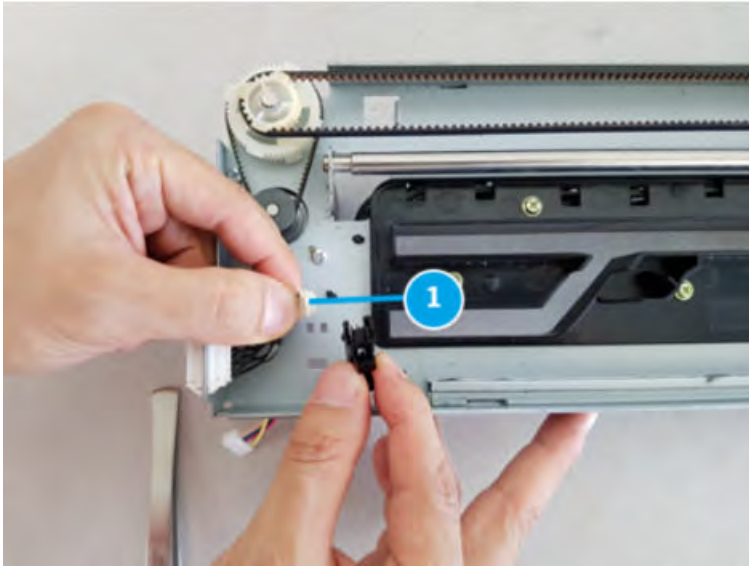

Unpack the replacement assembly



Follow these steps to unpack the replacement assembly.

1. Dispose of the defective part.

 **NOTE:** HP recommends responsible disposal of the defective part.

<http://www8.hp.com/us/en/hp-information/environment/product-recycling.html>

2. Unpack the replacement part from the packaging.

 **CAUTION:**  Some parts are sensitive to electrostatic discharge (ESD). Always perform service work at an ESD-protected workstation or mat. If an ESD workstation or mat is not available, touch the sheet-metal chassis to provide a static ground before touching an ESD-sensitive assembly. Protect the ESD-sensitive assemblies by placing them in ESD pouches when they are out of the printer.

 **IMPORTANT:** Make sure that all of the shipping materials (for example shipping tape) are removed from the replacement part prior to installation.

 **NOTE:** If the replacement part is a roller or pad, avoid touching the spongy part of it. Skin oils on the roller or pad can cause paper pickup and/or print-quality problems. HP recommends using disposable gloves when handling rollers or pads or washing your hands before touching rollers or pads.

3. To install an assembly, reverse the removal steps.

 **NOTE:** When applicable, special installation instructions are provided for an assembly at the end of the removal procedure. Always completely read the removal instructions and follow all special installation instructions.

Removal and replacement: Manual staple sensor (S19)

Learn how to remove and replace the manual staple sensor.

Introduction

This document provides the procedures to remove and replace the manual staple sensor for the finisher.

 **IMPORTANT:** When applicable, special installation instructions are provided for an assembly at the end of the removal procedure. Always completely read the removal instructions and follow all special installation instructions.

Before performing service

- Turn the printer power off. A shutting-down message appears on the control-panel display.
- ⚠ **WARNING!** To avoid damage to the printer, turn the power off and wait until the printer shuts down before removing the power cable.
- Disconnect the printer power cable after the printer has completely shut down (the control-panel display is blank).
- Release the finisher from the printer by pulling out on the release latch inside the finisher door.
- Disconnect the cable from the bridge unit to the finisher.
- Disconnect the cable from the finisher to the printer.

Use the table below to identify the correct part number for your printer. To order the part, go to <https://parts.hp.com>.

Table 5-124 Part information

Part number	Part description
0604-001415	Manual staple sensor

Required tools

- #2 JIS screwdriver with a magnetic tip
- Small, flat-blade screwdriver

After performing service

- Connect the cable from the finisher to the printer.
- Connect the cable from the bridge unit to the finisher.
- Attach the finisher to the printer, and then push in on the release latch inside the finisher door.
- Connect the printer power cable.
- Turn the printer power on.

Post service test

Process a job through the finisher and verify that the finisher works correctly.

Remove the right upper cover (finisher)

Follow these steps to remove the right upper cover (finisher).

- ▲ Remove one screw cap and three machine screws on the upper edge of the cover (callout 1). Remove three sheet metal screws (callout 2) on the lower portion of the cover. Rotate the right edge of the cover away from the finisher, and then slide the cover right to release three tabs (callout 3).

💡 **TIP:** The lower screws are shorter in length than the upper screws.

TIP: Reverse the removal steps to install the assembly.

Figure 5-906 Remove the right upper cover

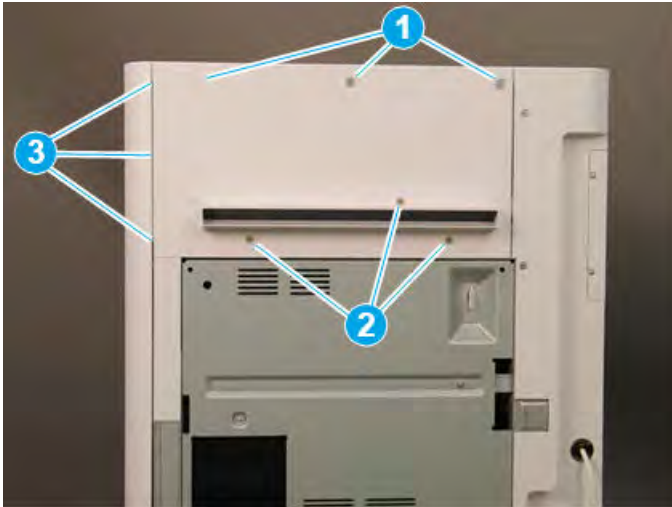

Remove the top cover (finisher)

Follow these steps to remove the top cover (finisher).

1. Remove three screw caps and three self-tapping screws at the top of the rear cover (callout 1), and then remove three machine screws (callout 2) on top of the cover.

Figure 5-907 Remove six screws

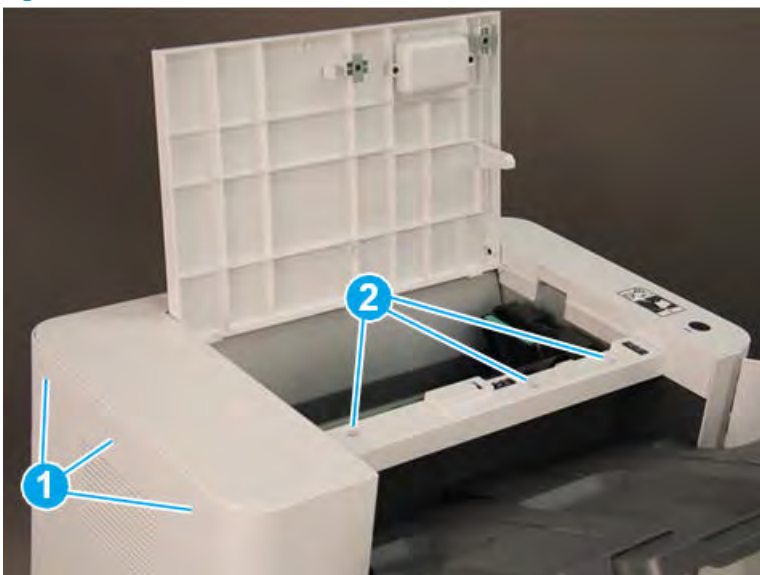

2. Remove three self-tapping screws at the top of the front cover (callout 1), and then remove two machine screws (callout 2) at the top of the right side.

Figure 5-908 Remove five screws

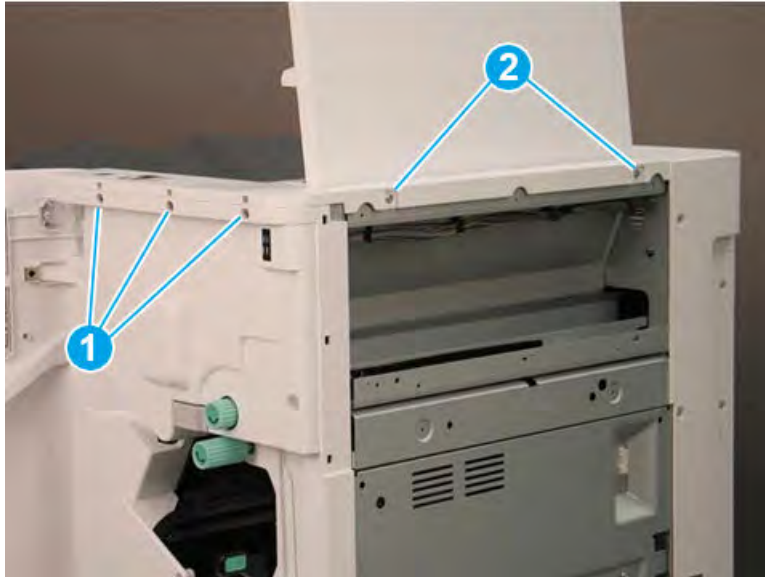

3. Lift the cover up slightly. Disconnect one in-line connector (callout 1), and then release one retainer (callout 2).

 **TIP:** Reverse the removal steps to install the assembly.

Figure 5-909 Disconnect one connector and release retainer



Remove the front door (finisher)

Follow these steps to remove the front door (finisher).

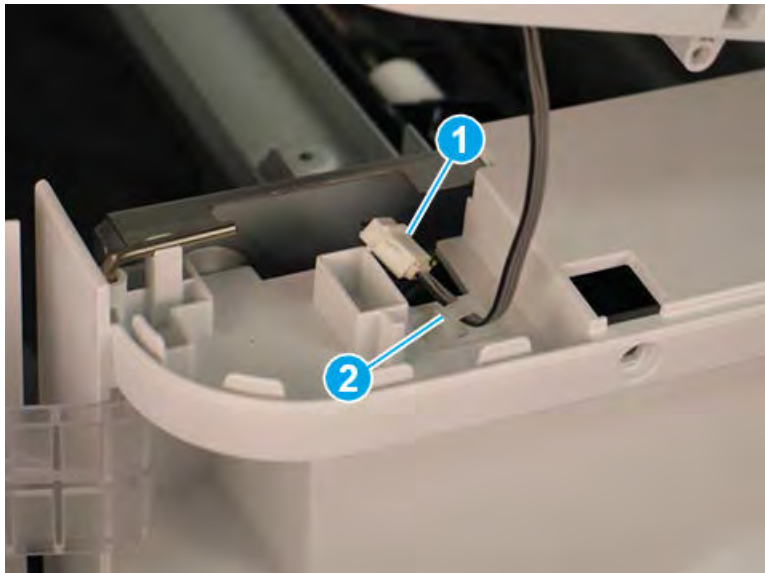
1. Lift the top hinge pin up to release it from the retainer.

Figure 5-910 Lift the top hinge pin

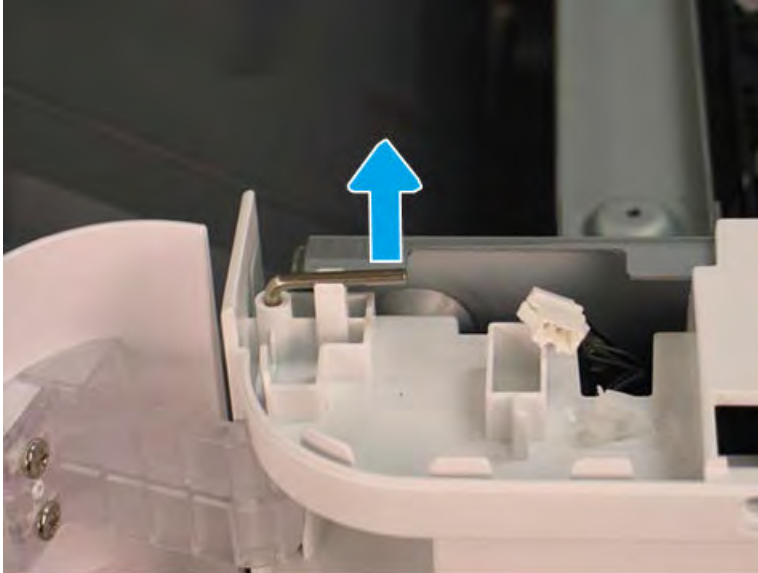

2. Pull the top hinge pin up to remove it.

Figure 5-911 Remove the top hinge pin

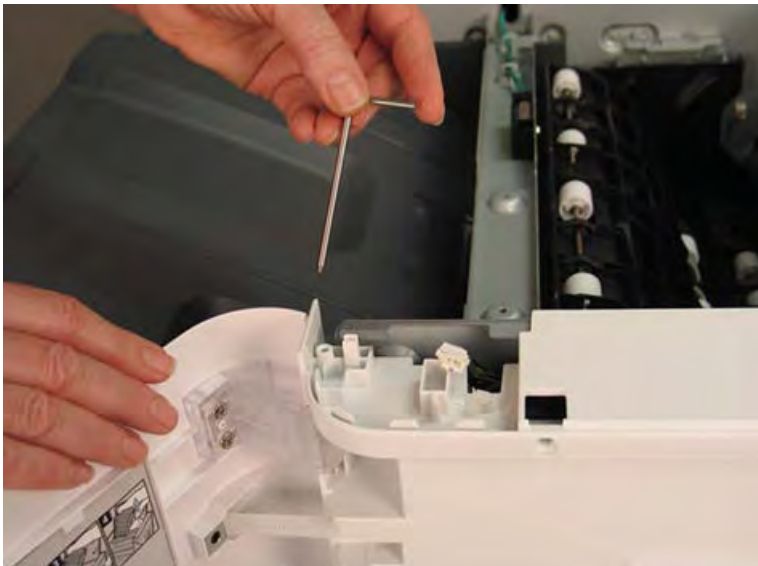

3. Use a small, flat-blade screwdriver to release the lower hinge pin from the retainer, and then rotate it away from the finisher.

Figure 5-912 Release the lower hinge pin



4. Support the door with one hand, and then pull the lower hinge pin straight up to remove it.

Figure 5-913 Remove the lower hinge pin



5. Support the door with one hand, and then remove one screw (callout 1) to release the strap. Remove the front door.

 **TIP:** Reverse the removal steps to install the assembly.

Figure 5-914 Remove the front door



Remove the front cover (finisher)

Follow these steps to remove the front cover (finisher).

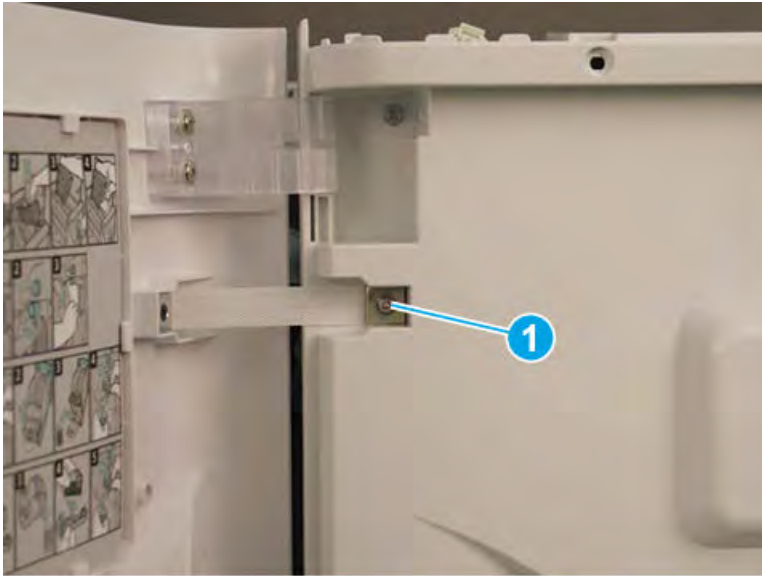
1. Release one tab (callout 1), and then pull the jam-access knob away from the finisher to remove it.

Figure 5-915 Remove the jam-access knob

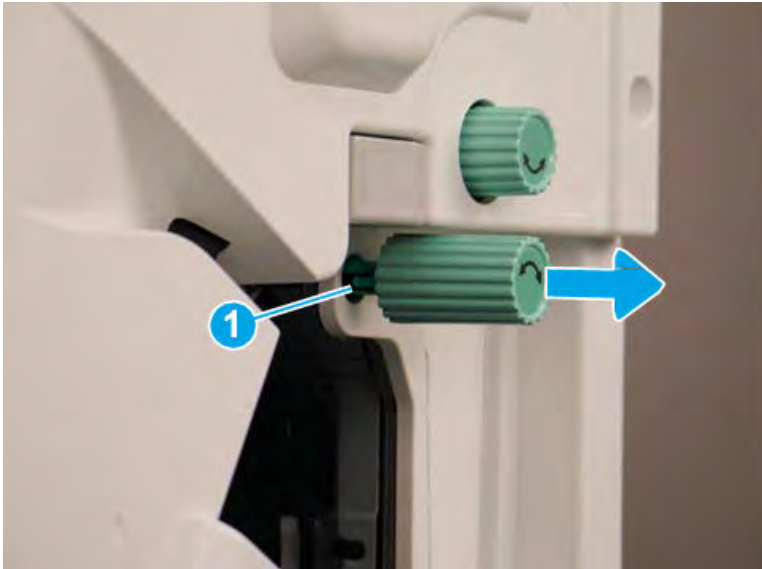

2. If the punch unit is installed, remove the punch waste bin (callout 1).

3. Remove one screw (callout 1) on top of the front cover.

Figure 5-916 Remove one screw



4. Remove five machine screws (callout 1), and then remove the front cover.

 **TIP:** Reverse the removal steps to install the assembly.

Figure 5-917 Remove the front cover



Remove the manual staple sensor(S19)

Follow these steps to remove the manual staple sensor(S19).

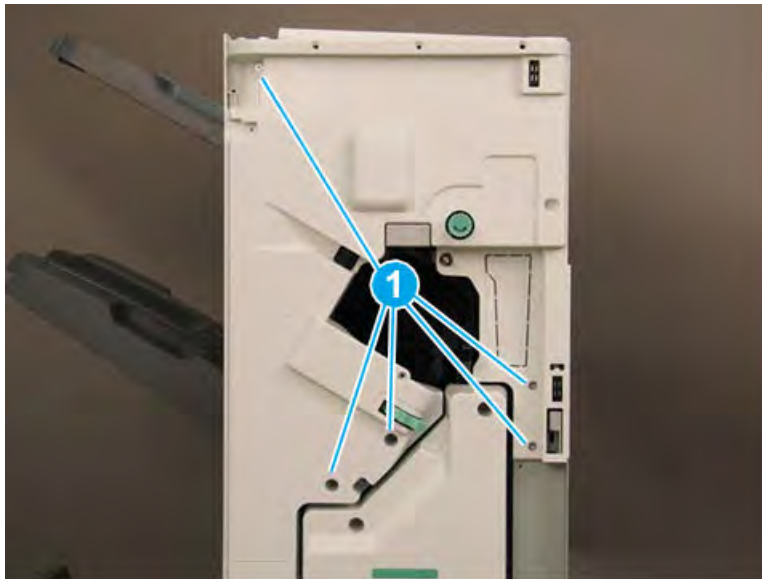
- ▲ At the front of the finisher, disconnect the connector(callout 1) and remove manual staple sensor(S19, callout 2).

Figure 5-918 Remove the manual staple sensor

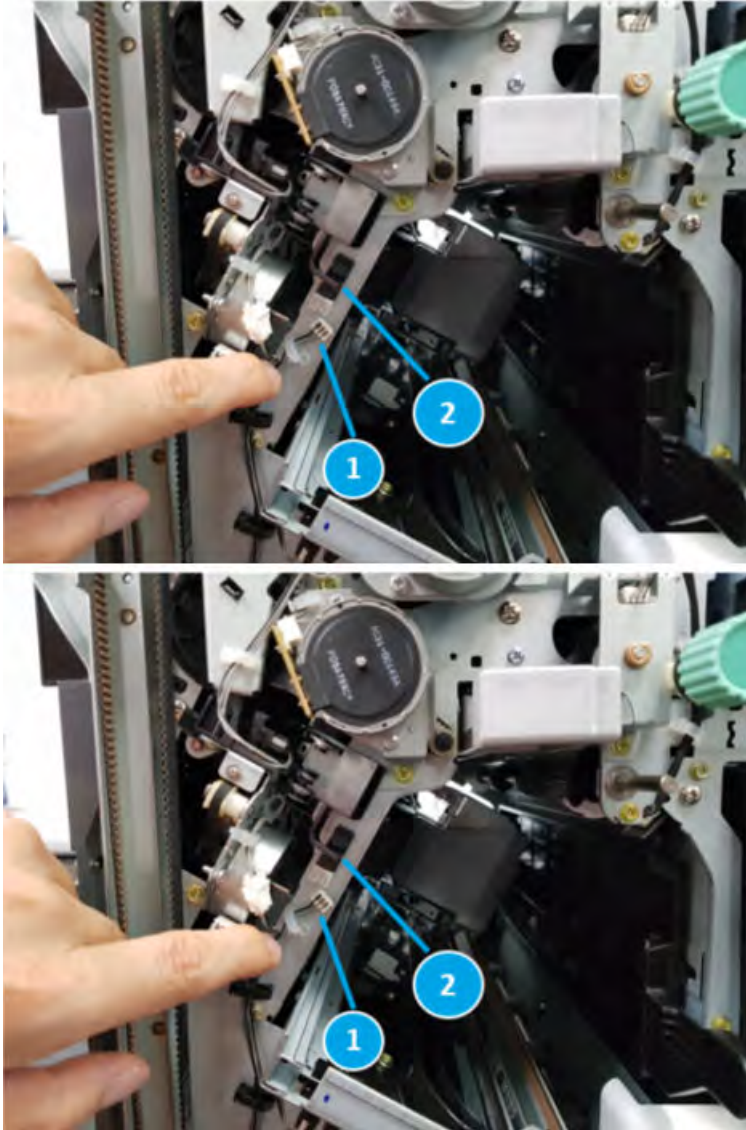

Unpack the replacement assembly

Follow these steps to unpack the replacement assembly.

1. Dispose of the defective part.

 **NOTE:** HP recommends responsible disposal of the defective part.

<http://www8.hp.com/us/en/hp-information/environment/product-recycling.html>

2. Unpack the replacement part from the packaging.



CAUTION:  Some parts are sensitive to electrostatic discharge (ESD). Always perform service work at an ESD-protected workstation or mat. If an ESD workstation or mat is not available, touch the sheet-metal chassis to provide a static ground before touching an ESD-sensitive assembly. Protect the ESD-sensitive assemblies by placing them in ESD pouches when they are out of the printer.



IMPORTANT: Make sure that all of the shipping materials (for example shipping tape) are removed from the replacement part prior to installation.



NOTE: If the replacement part is a roller or pad, avoid touching the spongy part of it. Skin oils on the roller or pad can cause paper pickup and/or print-quality problems. HP recommends using disposable gloves when handling rollers or pads or washing your hands before touching rollers or pads.

3. To install an assembly, reverse the removal steps.



NOTE: When applicable, special installation instructions are provided for an assembly at the end of the removal procedure. Always completely read the removal instructions and follow all special installation instructions.

Removal and replacement: Stapler position motor (M8)

Learn how to remove and replace the stapler position motor.

Introduction

This document provides the procedures to remove and replace the stapler position motor on the finisher.



IMPORTANT: When applicable, special installation instructions are provided for an assembly at the end of the removal procedure. Always completely read the removal instructions and follow all special installation instructions.

Before performing service

- Turn the printer power off. A shutting-down message appears on the control-panel display.
- ⚠ **WARNING!** To avoid damage to the printer, turn the power off and wait until the printer shuts down before removing the power cable.
- Disconnect the printer power cable after the printer has completely shut down (the control-panel display is blank).
- Release the finisher from the printer by pulling out on the release latch inside the finisher door.
- Disconnect the cable from the bridge unit to the finisher.
- Disconnect the cable from the finisher to the printer.

Use the table below to identify the correct part number for your printer. To order the part, go to <https://parts.hp.com>.

Table 5-125 Part information

Part number	Part description
JC31-00163A	Stapler position motor

Required tools

- #2 JIS screwdriver with a magnetic tip

After performing service

- Connect the cable from the finisher to the printer.
- Connect the cable from the bridge unit to the finisher.
- Attach the finisher to the printer, and then push in on the release latch inside the finisher door.
- Connect the printer power cable.
- Turn the printer power on.

Post service test

Process a job through the finisher and verify that the finisher works correctly.

Remove the right upper cover (finisher)

Follow these steps to remove the right upper cover (finisher).

- ▲ Remove one screw cap and three machine screws on the upper edge of the cover (callout 1). Remove three sheet metal screws (callout 2) on the lower portion of the cover. Rotate the right edge of the cover away from the finisher, and then slide the cover right to release three tabs (callout 3).

💡 **TIP:** The lower screws are shorter in length than the upper screws.

TIP: Reverse the removal steps to install the assembly.

Figure 5-919 Remove the right upper cover

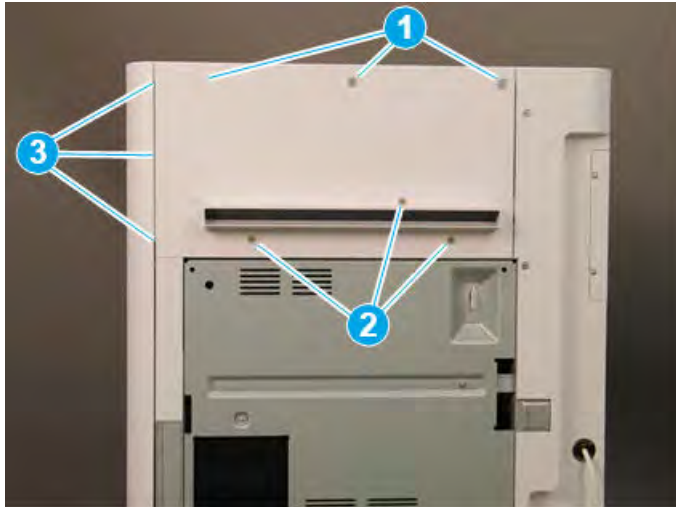

Remove the top cover (finisher)

Follow these steps to remove the top cover (finisher).

1. Remove three screw caps and three self-tapping screws at the top of the rear cover (callout 1), and then remove three machine screws (callout 2) on top of the cover.

Figure 5-920 Remove six screws

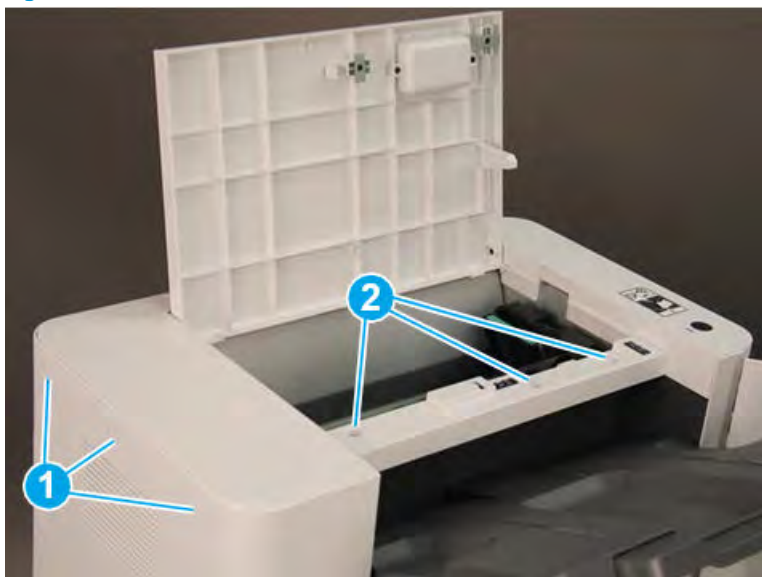

2. Remove three self-tapping screws at the top of the front cover (callout 1), and then remove two machine screws (callout 2) at the top of the right side.

Figure 5-921 Remove five screws

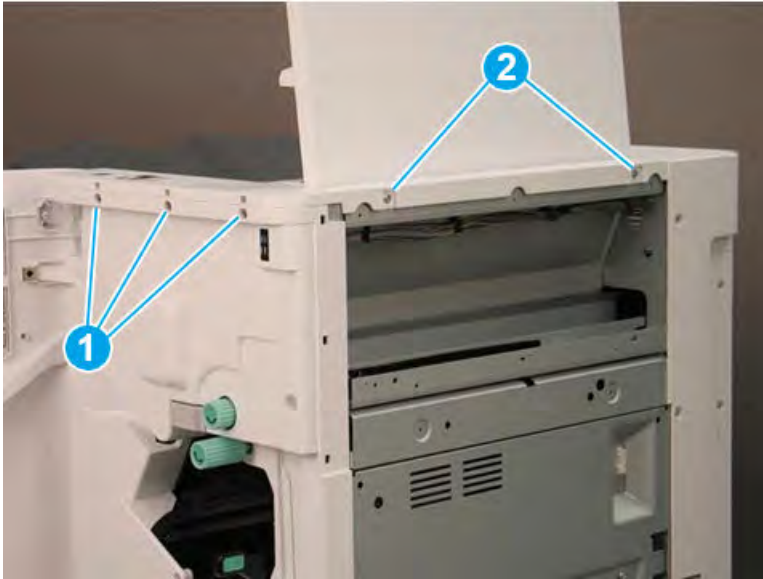

3. Lift the cover up slightly. Disconnect one in-line connector (callout 1), and then release one retainer (callout 2).

 **TIP:** Reverse the removal steps to install the assembly.

Figure 5-922 Disconnect one connector and release retainer

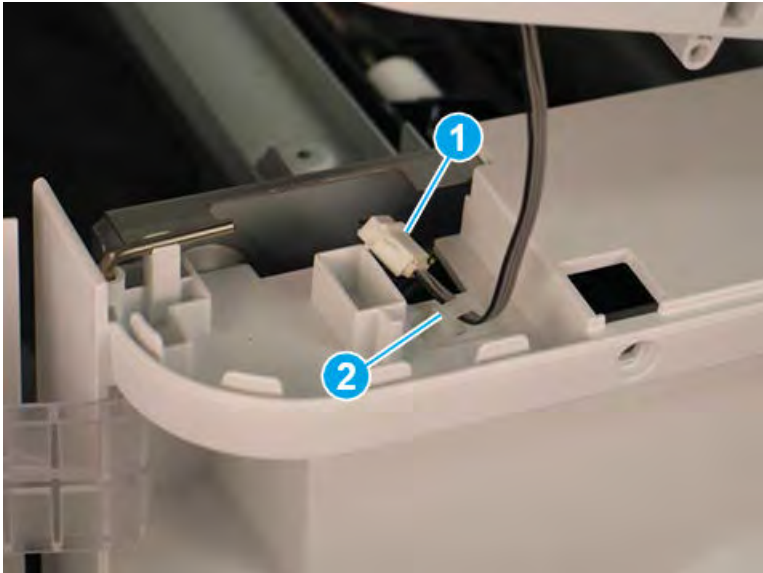

Remove the front door (finisher)

Follow these steps to remove the front door (finisher).

1. Lift the top hinge pin up to release it from the retainer.

Figure 5-923 Lift the top hinge pin

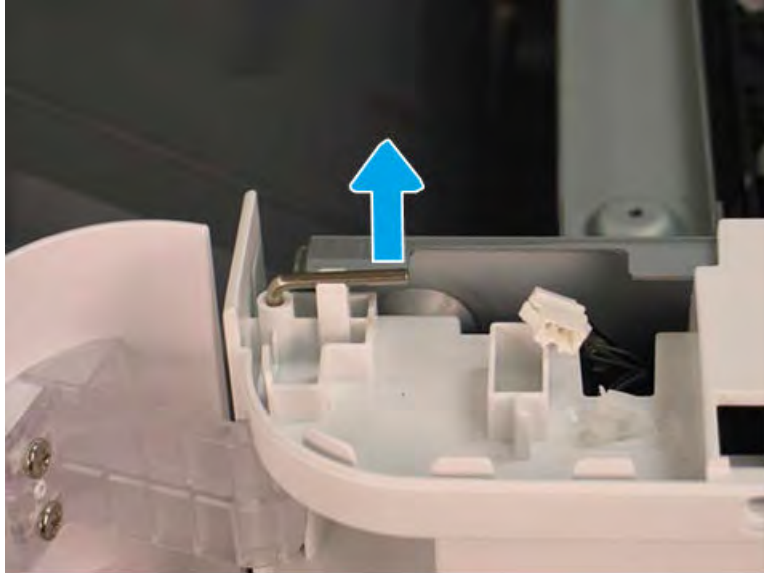

2. Pull the top hinge pin up to remove it.

Figure 5-924 Remove the top hinge pin

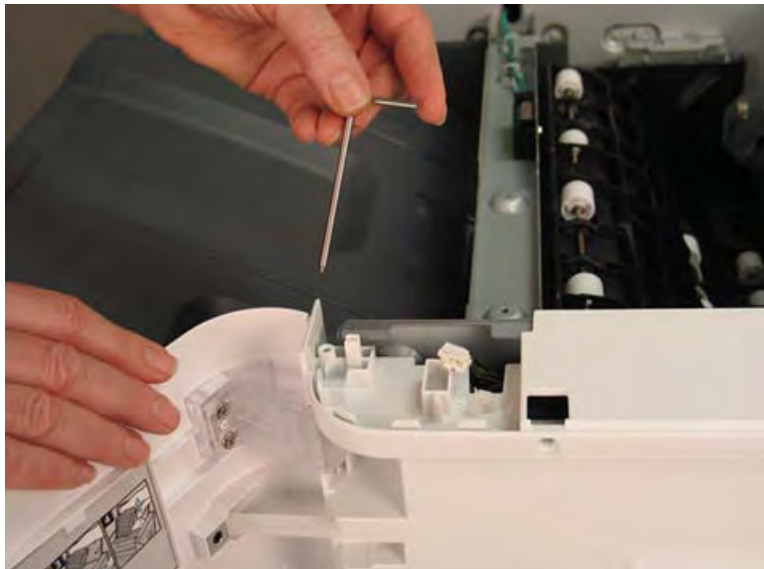

3. Use a small, flat-blade screwdriver to release the lower hinge pin from the retainer, and then rotate it away from the finisher.

Figure 5-925 Release the lower hinge pin



4. Support the door with one hand, and then pull the lower hinge pin straight up to remove it.

Figure 5-926 Remove the lower hinge pin



5. Support the door with one hand, and then remove one screw (callout 1) to release the strap. Remove the front door.

 **TIP:** Reverse the removal steps to install the assembly.

Figure 5-927 Remove the front door



Remove the front cover (finisher)

Follow these steps to remove the front cover (finisher).

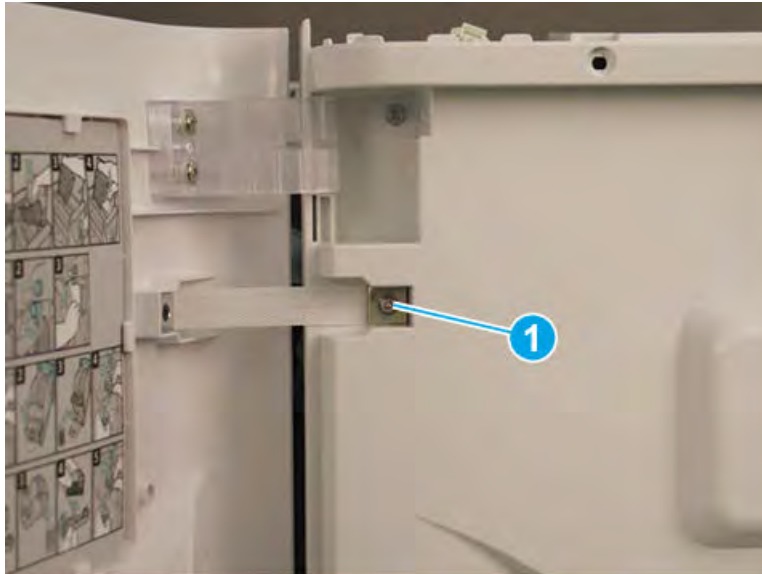
1. Release one tab (callout 1), and then pull the jam-access knob away from the finisher to remove it.

Figure 5-928 Remove the jam-access knob

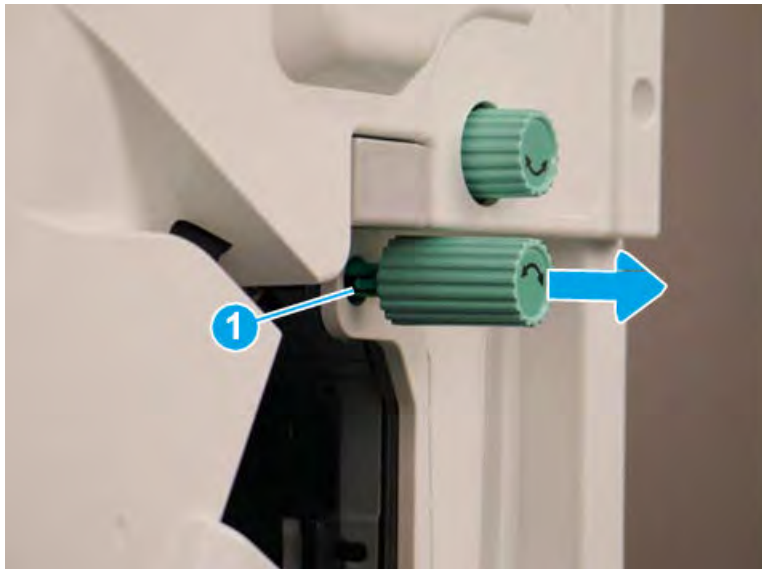

2. If the punch unit is installed, remove the punch waste bin (callout 1).

3. Remove one screw (callout 1) on top of the front cover.

Figure 5-929 Remove one screw



4. Remove five machine screws (callout 1), and then remove the front cover.

 **TIP:** Reverse the removal steps to install the assembly.

Figure 5-930 Remove the front cover



Remove the rear cover (finisher)

Follow these steps to remove the rear cover (finisher).

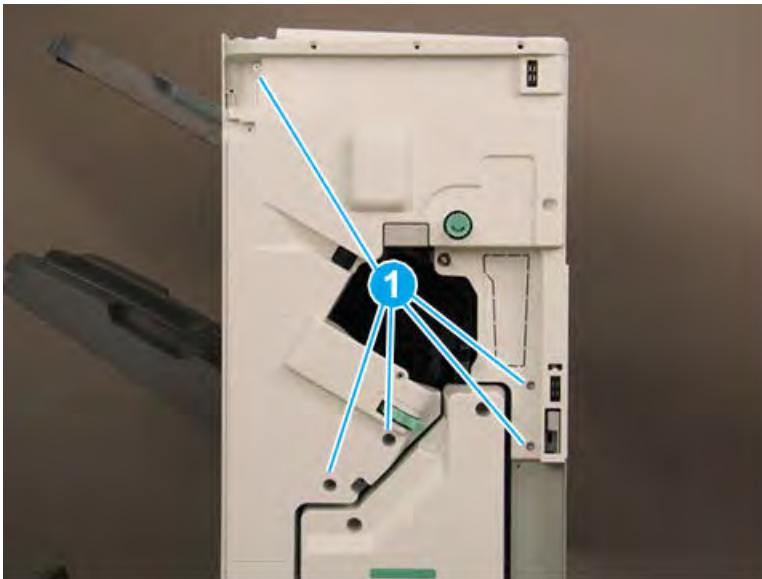
1. Remove two self-tapping screws (callout 1) on the top of the rear cover, and then remove five screw caps and five machine screws (callout 2) on the left side of the cover.

Figure 5-931 Remove seven screws

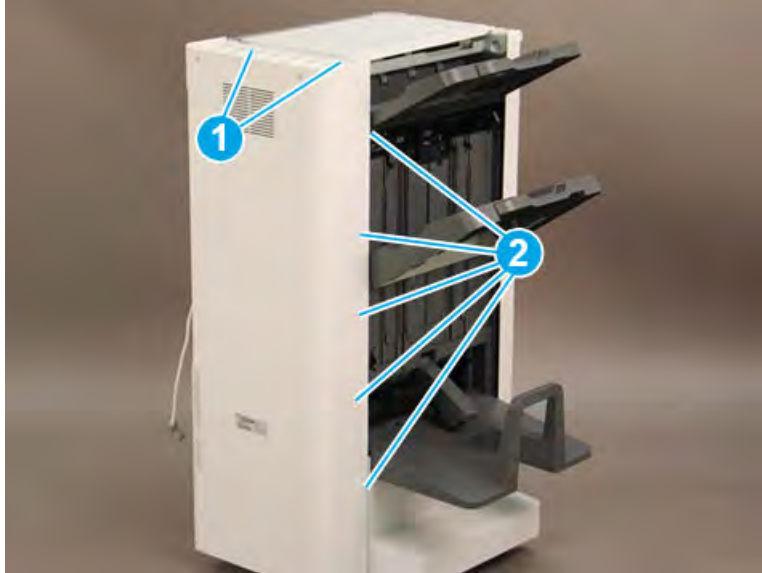

2. Remove one screw cap and four machine screws (callout 1) Remove the rear cover.

 **NOTE:** Make sure to thread the power cable (callout 2) through the opening in the cover.

 **TIP:** Reverse the removal steps to install the assembly

Figure 5-932 Remove the rear cover



Remove the stapler unit

Follow these steps to remove the stapler unit.

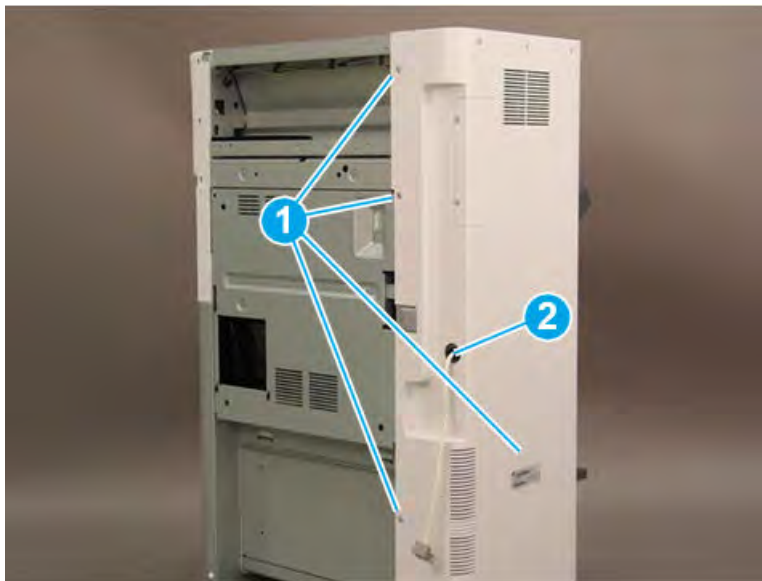
1. Rotate the green wheel to move the staple unit to the front until it stops.

Figure 5-933 Move the staple unit to the front

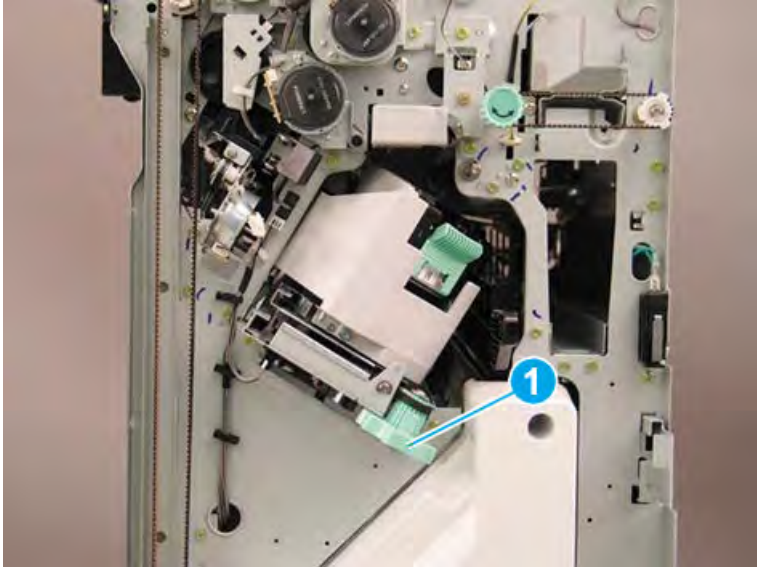

2. Lower the green latch (callout 1), and then slide the staple cartridge away from the finisher to remove it (callout 2).

Figure 5-934 Remove the staple cartridge

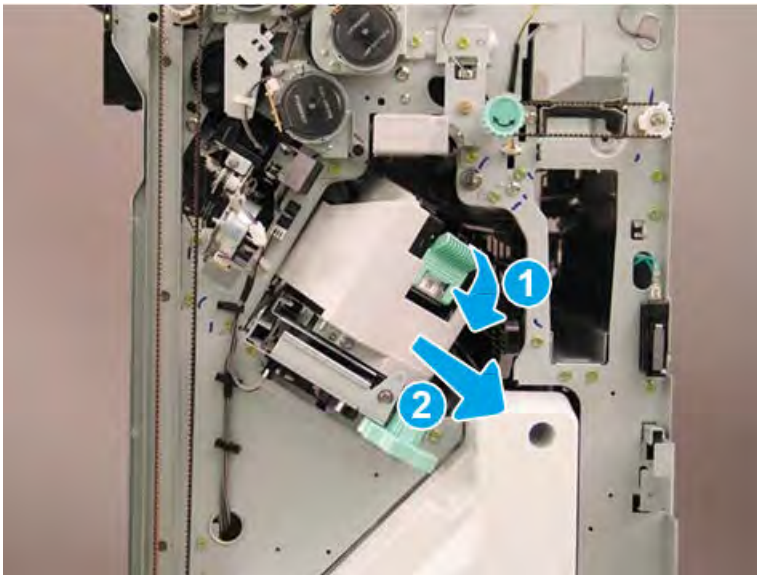

3. At the back of the finisher, release one retainer (callout 1), disconnect two connectors (callout 2), and then remove two screws (callout 3).

Figure 5-935 Disconnect three connectors and remove two screws

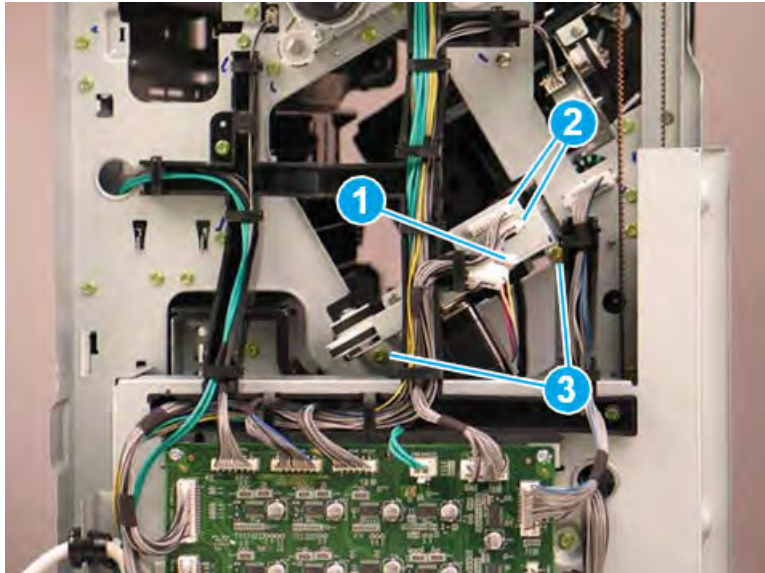

4. At the front of the finisher, disconnect one connector (callout 1), and then remove two screws (callout 2).

Figure 5-936 Disconnect one connector and remove two screws

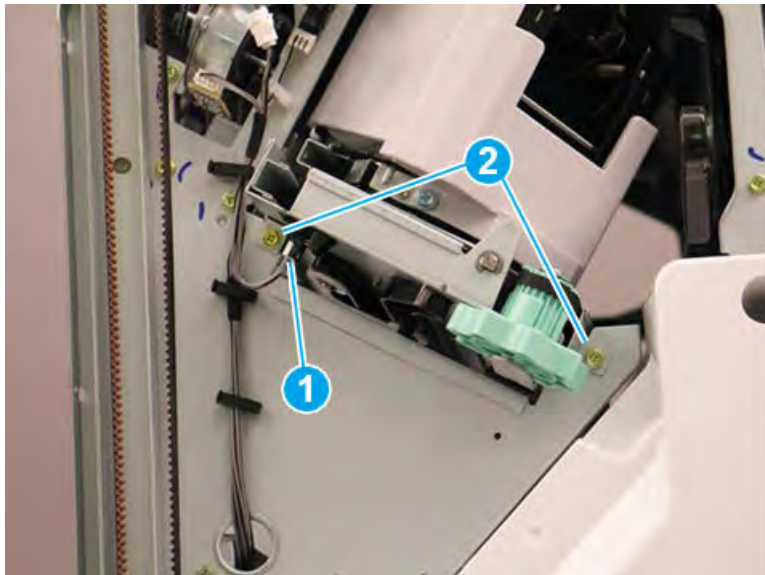

5. Lift up, and then slide the staple unit to the front of the finisher to remove it.

 **TIP:** Reverse the removal steps to install the assembly.

Figure 5-937 Remove the staple unit



Remove the stapler position motor(M8)

Follow these steps to remove the stapler position motor(M8).

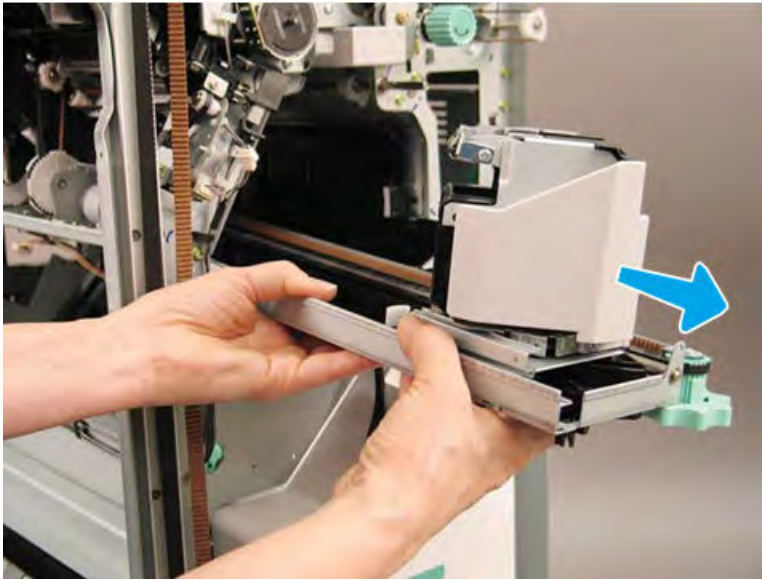
1. Remove two screws(callout 1)

Figure 5-938 Remove two screws

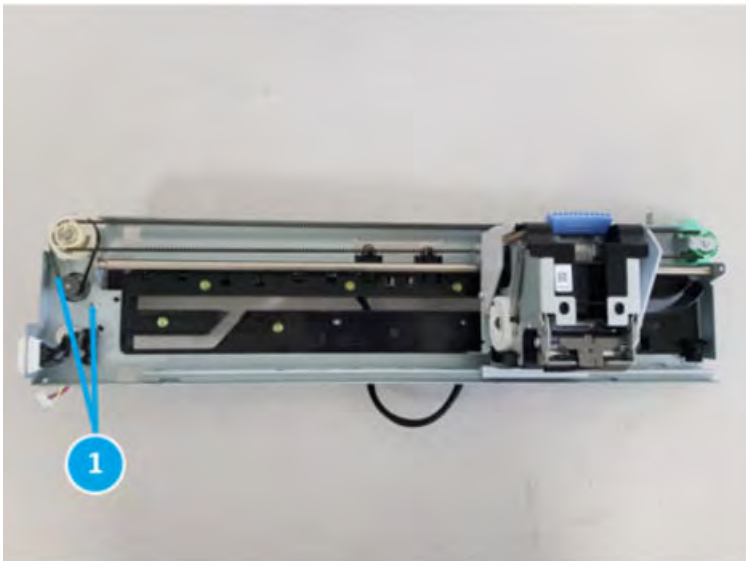

2. Remove stapler position motor(M8, callout1) from staple unit.

Figure 5-939 Remove stapler position motor

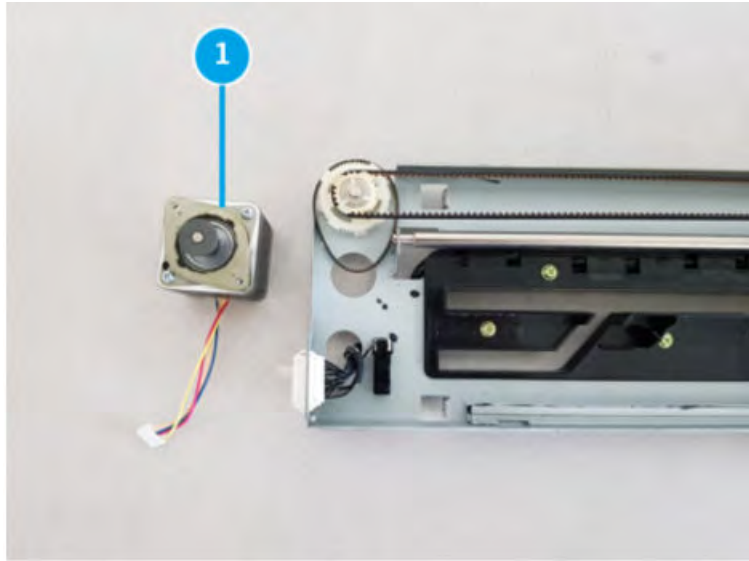

Unpack the replacement assembly



Follow these steps to unpack the replacement assembly.

1. Dispose of the defective part.

 **NOTE:** HP recommends responsible disposal of the defective part.

<http://www8.hp.com/us/en/hp-information/environment/product-recycling.html>

2. Unpack the replacement part from the packaging.

 **CAUTION:**  Some parts are sensitive to electrostatic discharge (ESD). Always perform service work at an ESD-protected workstation or mat. If an ESD workstation or mat is not available, touch the sheet-metal chassis to provide a static ground before touching an ESD-sensitive assembly. Protect the ESD-sensitive assemblies by placing them in ESD pouches when they are out of the printer.

 **IMPORTANT:** Make sure that all of the shipping materials (for example shipping tape) are removed from the replacement part prior to installation.

 **NOTE:** If the replacement part is a roller or pad, avoid touching the spongy part of it. Skin oils on the roller or pad can cause paper pickup and/or print-quality problems. HP recommends using disposable gloves when handling rollers or pads or washing your hands before touching rollers or pads.

3. To install an assembly, reverse the removal steps.

 **NOTE:** When applicable, special installation instructions are provided for an assembly at the end of the removal procedure. Always completely read the removal instructions and follow all special installation instructions.

Ejector unit

Removal and replacement: Ejector unit

Learn how to remove and replace the ejector unit.

Introduction

This document provides the procedures to remove and replace the ejector unit on the finisher.

 **IMPORTANT:** When applicable, special installation instructions are provided for an assembly at the end of the removal procedure. Always completely read the removal instructions and follow all special installation instructions.

Before performing service

- Turn the printer power off. A shutting-down message appears on the control-panel display.
- ⚠ **WARNING!** To avoid damage to the printer, turn the power off and wait until the printer shuts down before removing the power cable.
- Disconnect the printer power cable after the printer has completely shut down (the control-panel display is blank).
- Release the finisher from the printer by pulling out on the release latch inside the finisher door.
- Disconnect the cable from the bridge unit to the finisher.
- Disconnect the cable from the finisher to the printer.

Use the table below to identify the correct part number for your printer. To order the part, go to <https://parts.hp.com>.

Table 5-126 Part information

Part number	Part description
JC90-01409A	Ejector unit

Required tools

- #2 JIS screwdriver with a magnetic tip
- Small, flat-blade screwdriver

After performing service

- Connect the cable from the finisher to the printer.
- Connect the cable from the bridge unit to the finisher.
- Attach the finisher to the printer, and then push in on the release latch inside the finisher door.
- Connect the printer power cable.
- Turn the printer power on.

Post service test

Process a job through the finisher and verify that the finisher works correctly.

Remove the right upper cover (finisher)

Follow these steps to remove the right upper cover (finisher).

- ▲ Remove one screw cap and three machine screws on the upper edge of the cover (callout 1). Remove three sheet metal screws (callout 2) on the lower portion of the cover. Rotate the right edge of the cover away from the finisher, and then slide the cover right to release three tabs (callout 3).

💡 **TIP:** The lower screws are shorter in length than the upper screws.

TIP: Reverse the removal steps to install the assembly.

Figure 5-940 Remove the right upper cover

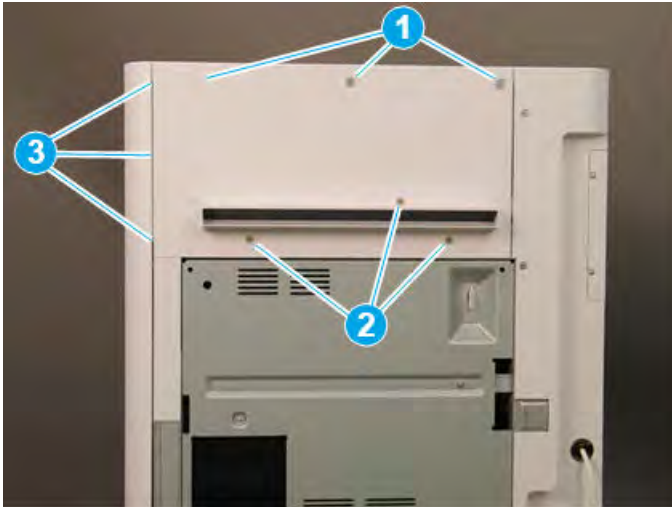

Remove the top cover (finisher)

Follow these steps to remove the top cover (finisher).

1. Remove three screw caps and three self-tapping screws at the top of the rear cover (callout 1), and then remove three machine screws (callout 2) on top of the cover.

Figure 5-941 Remove six screws

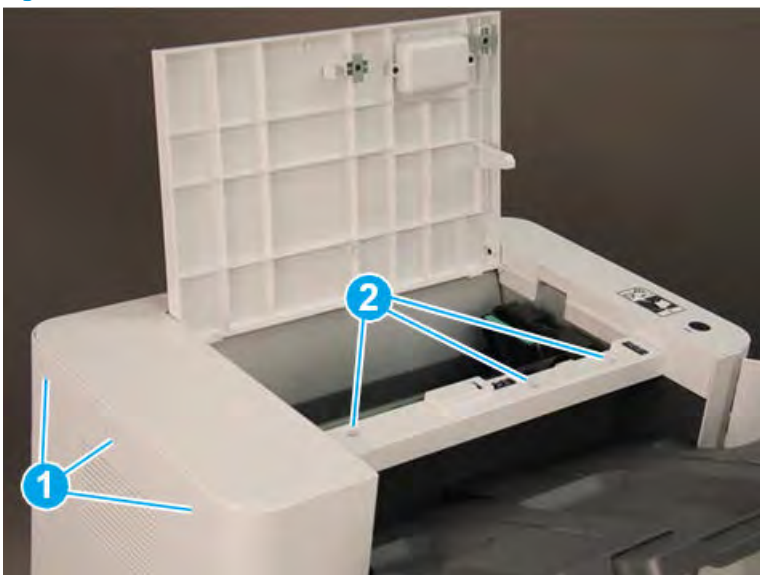

2. Remove three self-tapping screws at the top of the front cover (callout 1), and then remove two machine screws (callout 2) at the top of the right side.

Figure 5-942 Remove five screws

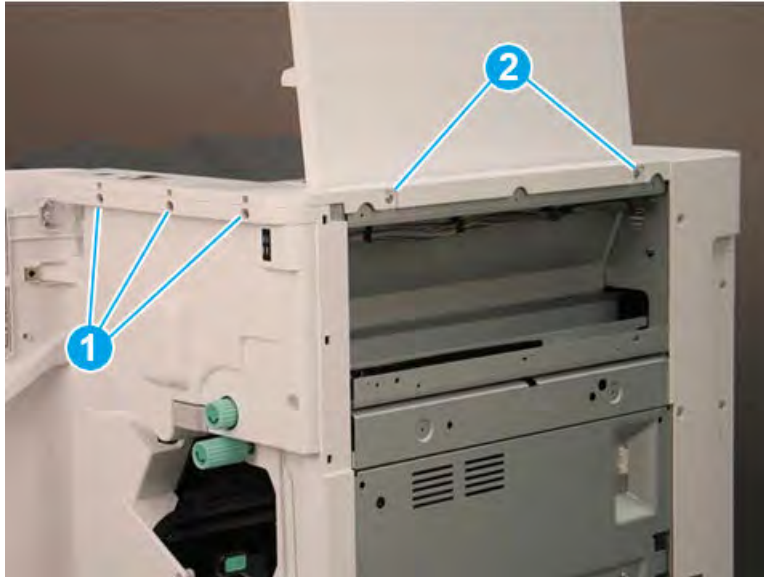

3. Lift the cover up slightly. Disconnect one in-line connector (callout 1), and then release one retainer (callout 2).

 **TIP:** Reverse the removal steps to install the assembly.

Figure 5-943 Disconnect one connector and release retainer



Remove the front door (finisher)

Follow these steps to remove the front door (finisher).

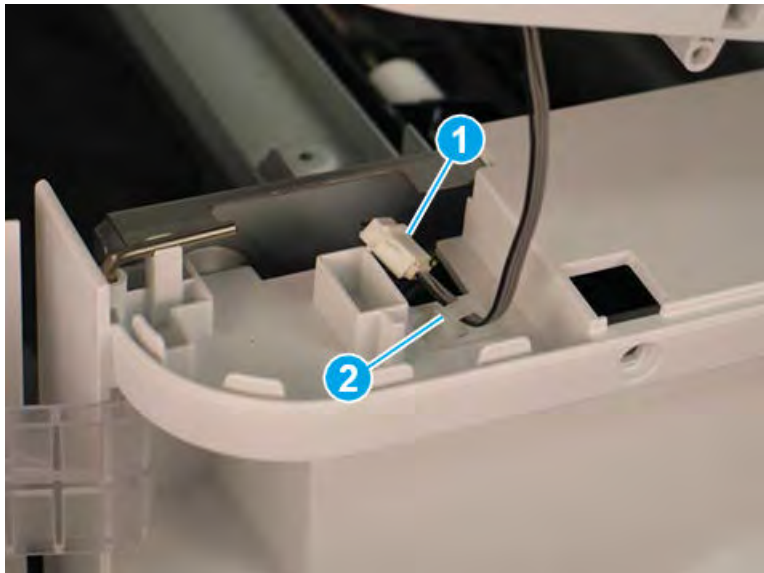
1. Lift the top hinge pin up to release it from the retainer.

Figure 5-944 Lift the top hinge pin

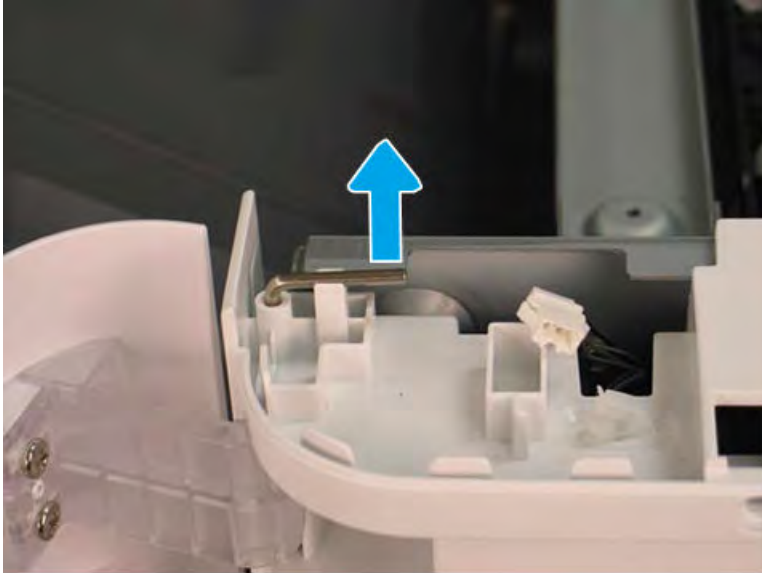

2. Pull the top hinge pin up to remove it.

Figure 5-945 Remove the top hinge pin

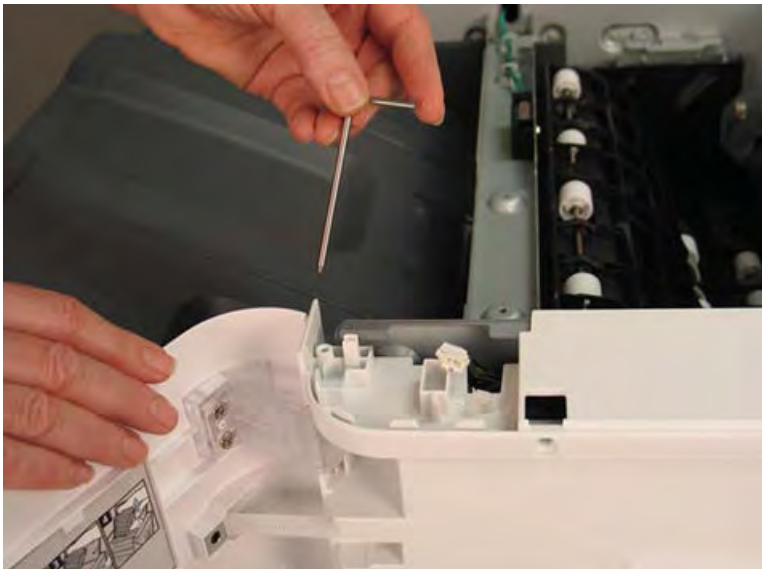

3. Use a small, flat-blade screwdriver to release the lower hinge pin from the retainer, and then rotate it away from the finisher.

Figure 5-946 Release the lower hinge pin



4. Support the door with one hand, and then pull the lower hinge pin straight up to remove it.

Figure 5-947 Remove the lower hinge pin



5. Support the door with one hand, and then remove one screw (callout 1) to release the strap. Remove the front door.

 **TIP:** Reverse the removal steps to install the assembly.

Figure 5-948 Remove the front door



Remove the front cover (finisher)

Follow these steps to remove the front cover (finisher).

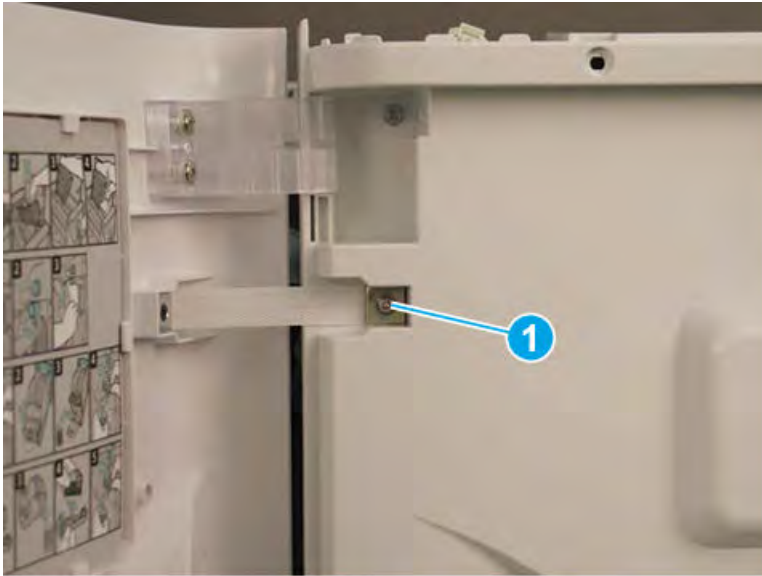
1. Release one tab (callout 1), and then pull the jam-access knob away from the finisher to remove it.

Figure 5-949 Remove the jam-access knob

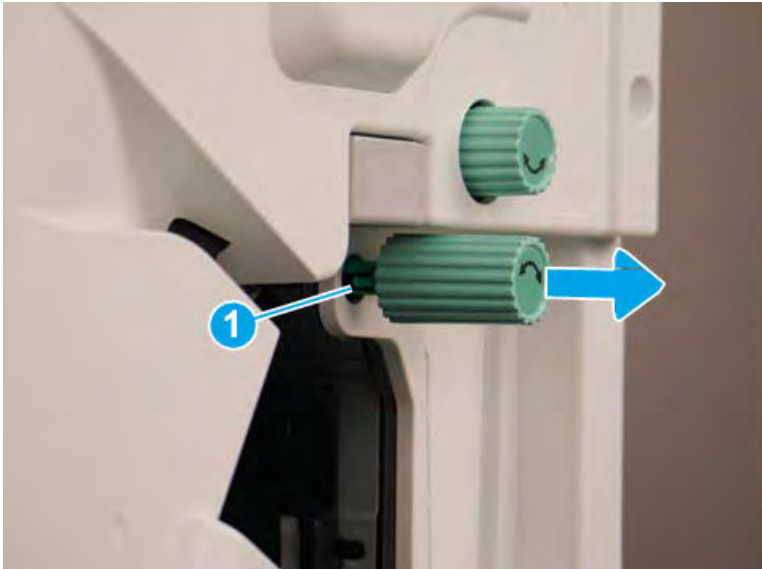

2. If the punch unit is installed, remove the punch waste bin (callout 1).

3. Remove one screw (callout 1) on top of the front cover.

Figure 5-950 Remove one screw



4. Remove five machine screws (callout 1), and then remove the front cover.

 **TIP:** Reverse the removal steps to install the assembly.

Figure 5-951 Remove the front cover

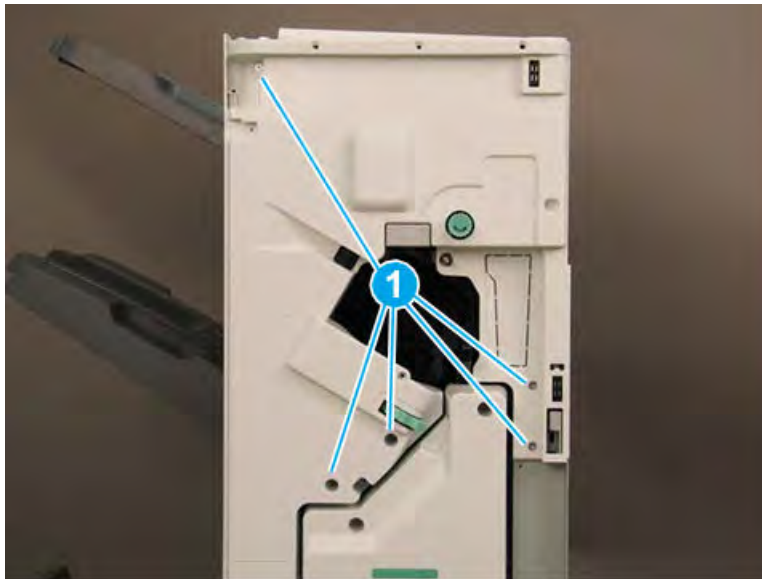

Remove the rear cover (finisher)

Follow these steps to remove the rear cover (finisher).

1. Remove two self-tapping screws (callout 1) on the top of the rear cover, and then remove five screw caps and five machine screws (callout 2) on the left side of the cover.

Figure 5-952 Remove seven screws



2. Remove one screw cap and four machine screws (callout 1) Remove the rear cover.

 **NOTE:** Make sure to thread the power cable (callout 2) through the opening in the cover.

 **TIP:** Reverse the removal steps to install the assembly

Figure 5-953 Remove the rear cover

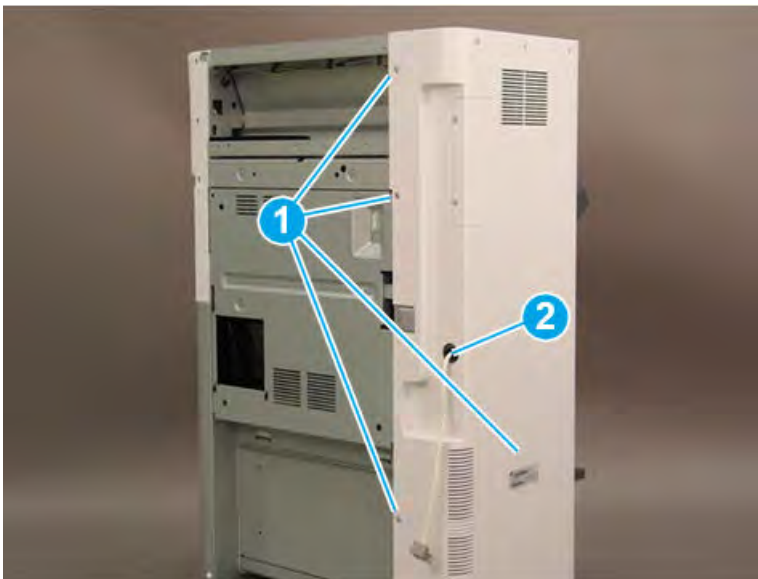

Remove the booklet output tray

Follow these steps to remove the booklet output tray.

1. Raise the booklet output tray up (callout 1), and then pull it away from the finisher (callout 2) to remove it.

Figure 5-954 Remove the booklet output tray



2. Reverse the removal steps to install the assembly. Also use the following special installation instructions.

 **NOTE:** Continue to reverse the removal steps to finish installing the assembly

Special installation instructions: booklet output tray

Position the tabs (callout 1) on the tray into the slots (callout 2) on the finisher.

Figure 5-955 Install the booklet output tray

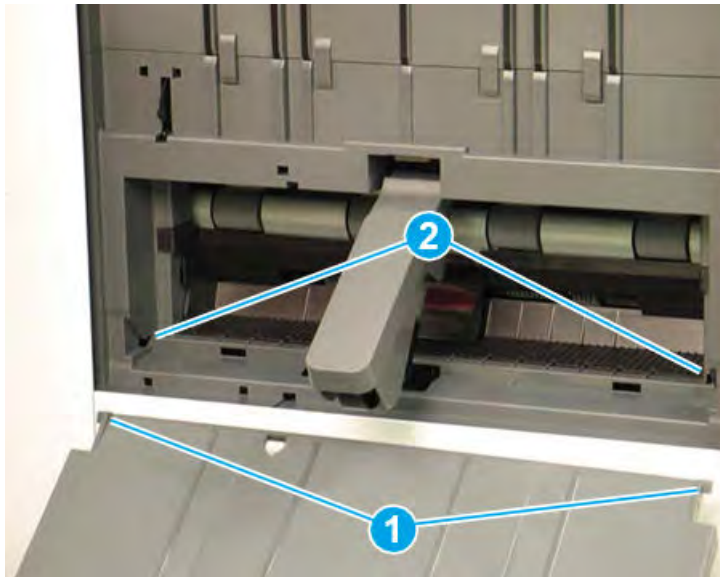

Remove the caster cover

Follow these steps to remove the caster cover.

1. Remove two screw caps and two self-tapping screws (callout 1). Remove two screw caps and two machine screws (callout 2).

Figure 5-956 Remove four screws

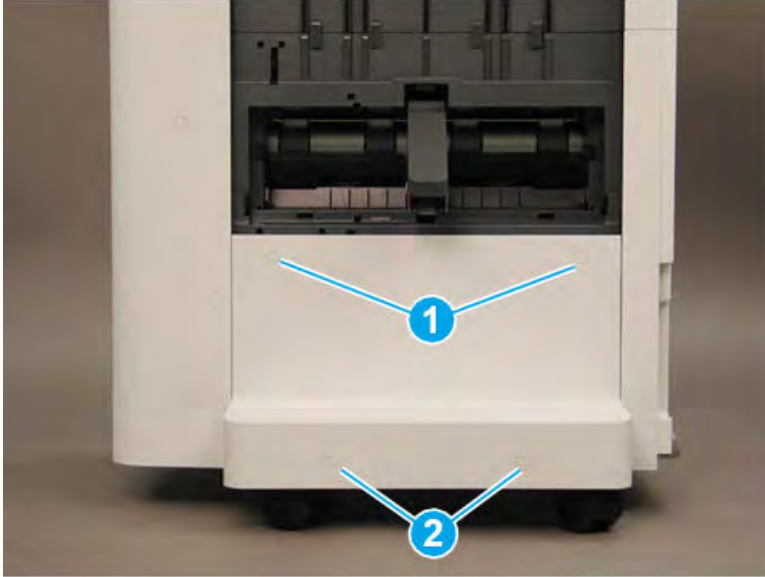

2. Rotate the left edge of the cover away from the finisher (callout 1), and then slide the cover to the left (callout 2) to remove it.

 **TIP:** Make sure that two tabs (callout 3) are positioned under the front lower cover when reinstalling the caster cover.

TIP: Reverse the removal steps to install the assembly

Figure 5-957 Remove the caster cover

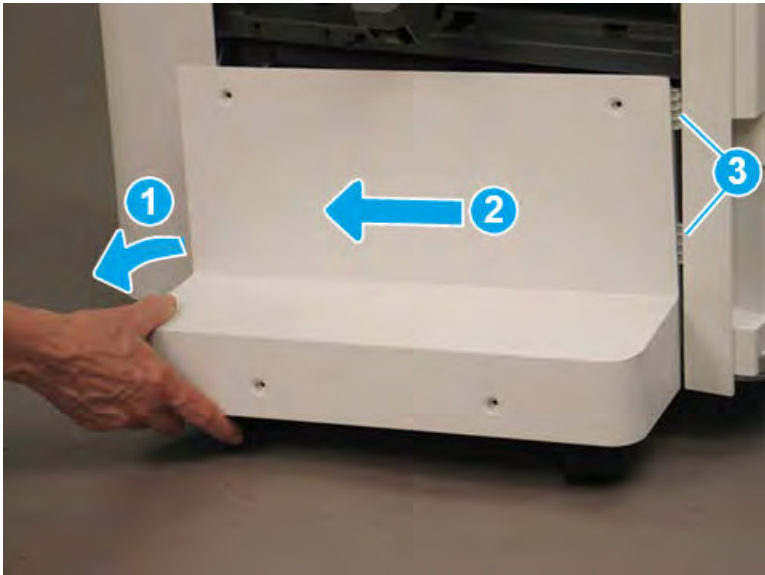

Remove the left lower cover (finisher)

Follow these steps to remove the left lower cover (finisher).

1. Remove four screws (callout 1).

 **NOTE:** Raise the lower output tray as needed to access the screws.

Figure 5-958 Remove four screws



2. Slide the shield down (callout 1) to release it from four tabs (callout 2), and then rotate it away from the finisher (callout 3).

⚠ CAUTION: The shield is still attached to the finisher. Do not attempt to completely remove the shield.

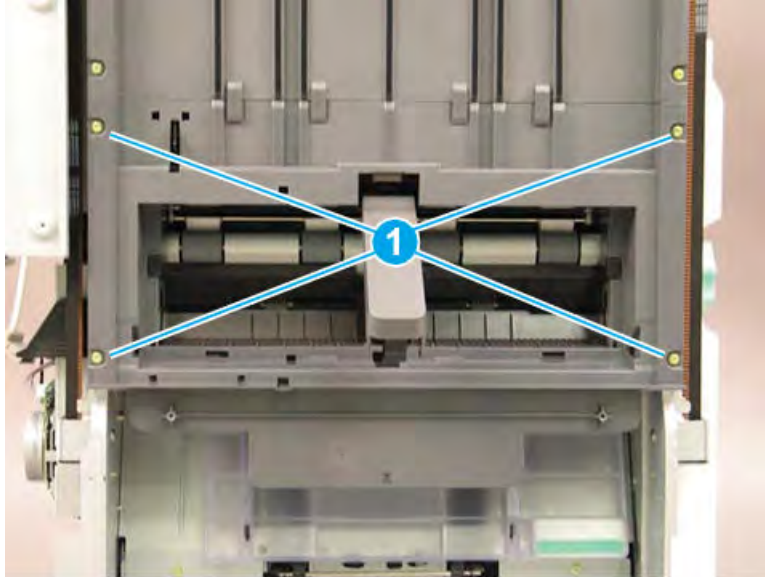
💡 TIP: Position the shield under the four tabs (callout 2) when reinstalling it.

Figure 5-959 Release the lower shield

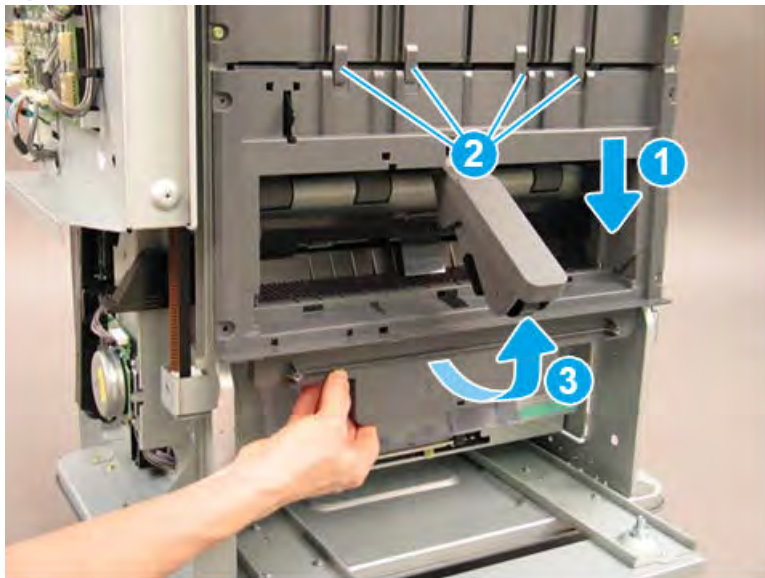

3. Disconnect two connectors (callout 1), and then remove the shield.

 **TIP:** Reverse the removal steps to install the assembly.

Figure 5-960 Disconnect two connectors



4. If you are replacing the left lower cover, locate three sensors (callout 1) on the back of the left lower cover. Remove these sensors and transfer them to the replacement part.

Figure 5-961 Remove the left lower cover

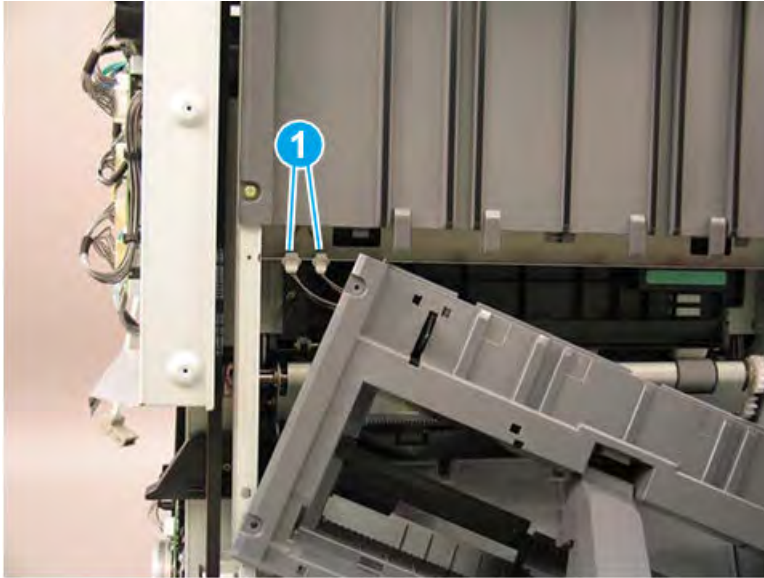
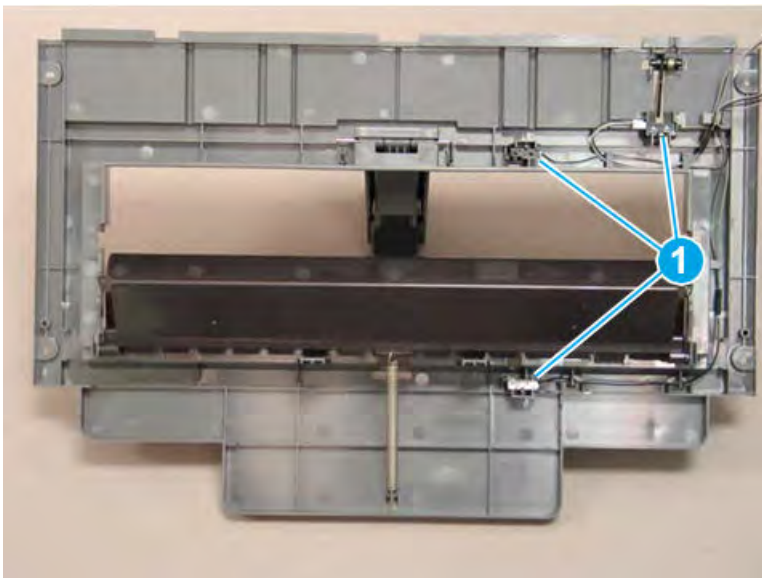

Remove the left upper cover (finisher)

Follow these steps to remove the left upper cover (finisher).

1. Bring the lower output tray down by positioning the shaft of a screwdriver on the clutch (callout 1) and gently pressing to the right to release the clutch. Hold the clutch in the released position and lower the tray (callout 2) to the lowest position.

Figure 5-962 Lower the output tray

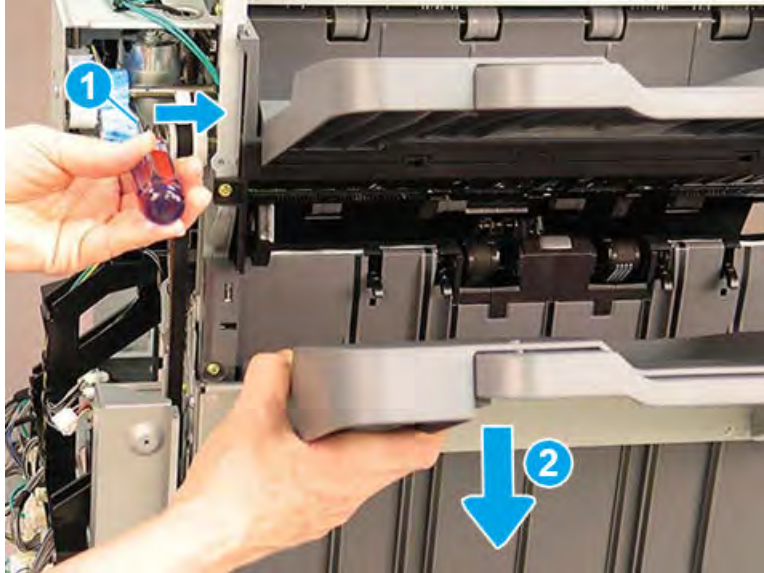

2. Remove six machine screws (callout 1).

Figure 5-963 Remove six screws

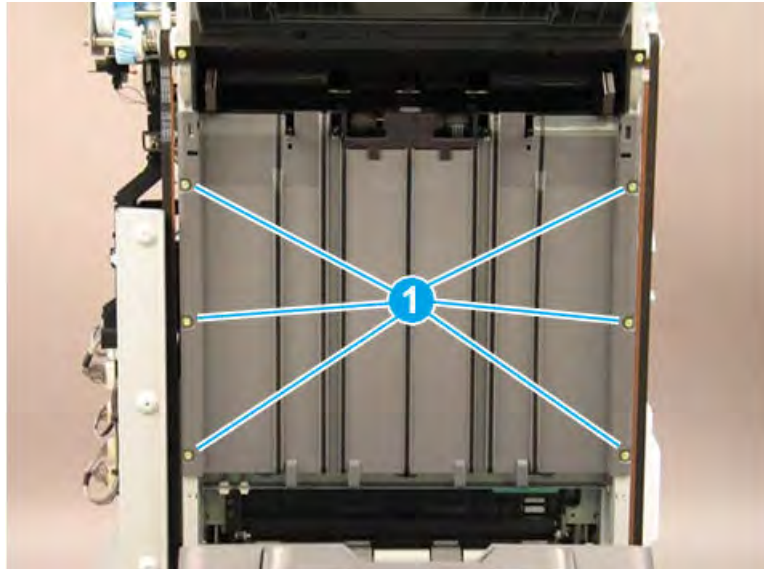

3. Rotate the lower edge of the shield away from the finisher (callout 1), and then slide the shield down (callout 2) to release it from two tabs (callout 3).

⚠ CAUTION: The shield is still attached to the finisher. Do not attempt to completely remove the shield.

💡 TIP: Position the shield under the two tabs (callout 3) when reinstalling it.

Figure 5-964 Release the shield

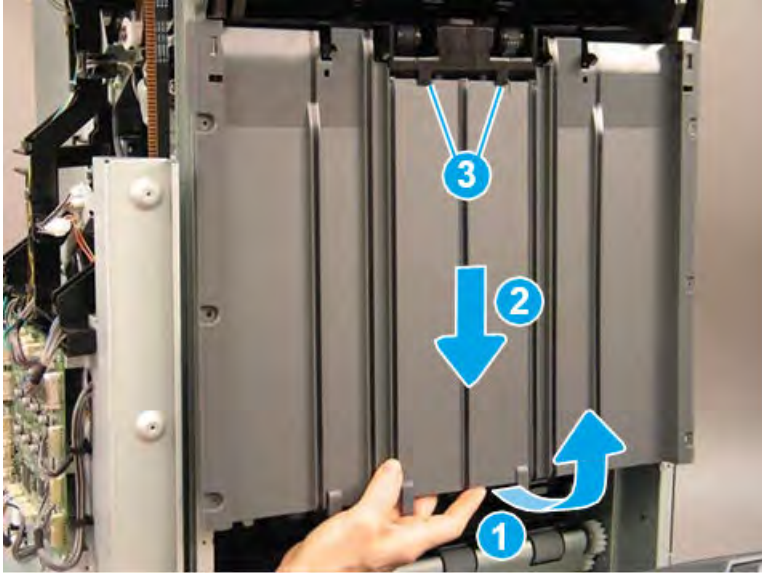

4. Disconnect one connector (callout 1), and then remove the upper shield assembly.

💡 TIP: Reverse the removal steps to install the assembly.

Figure 5-965 Disconnect one connector

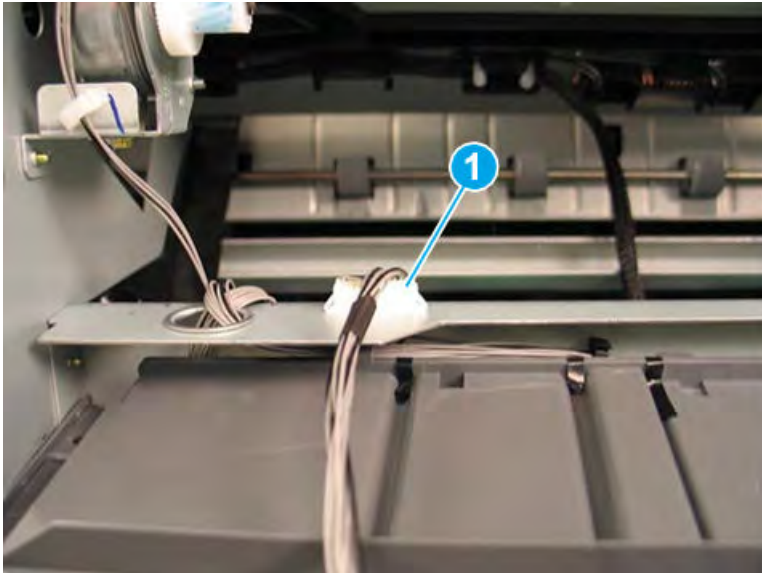

5. If you are replacing the left upper cover, locate three sensors (callout 1) on the back of the left upper cover. Remove these sensors and transfer them to the replacement part.

Figure 5-966 Remove the left upper cover

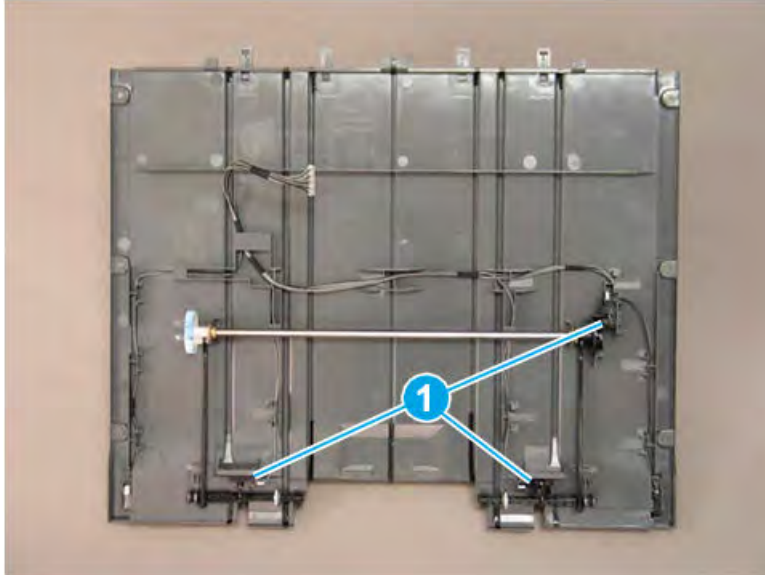

Remove the ejector unit (finisher)

Follow these steps to remove the ejector unit (finisher).

1. Rotate the green wheel to move the staple unit to the center of the finisher.

Figure 5-967 Move the staple unit to the center

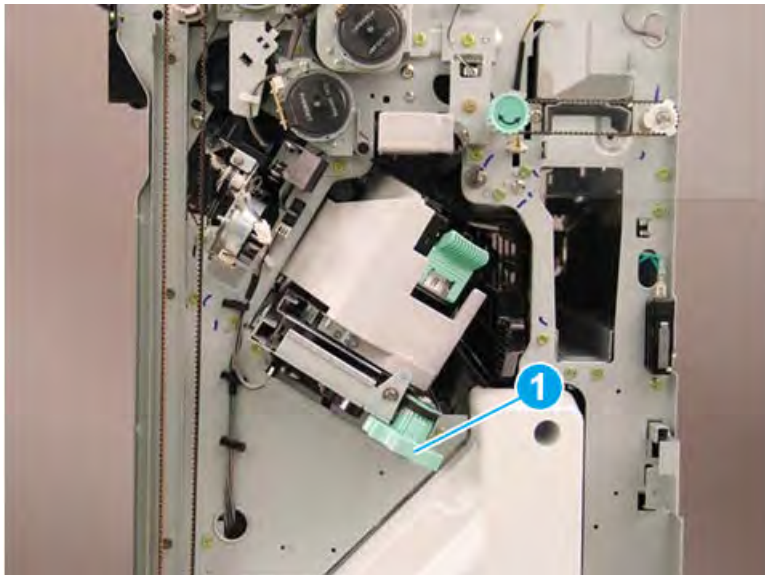

2. Release one retainer (callout 1), and then disconnect three connectors (callout 2).

Figure 5-968 Disconnect three connectors

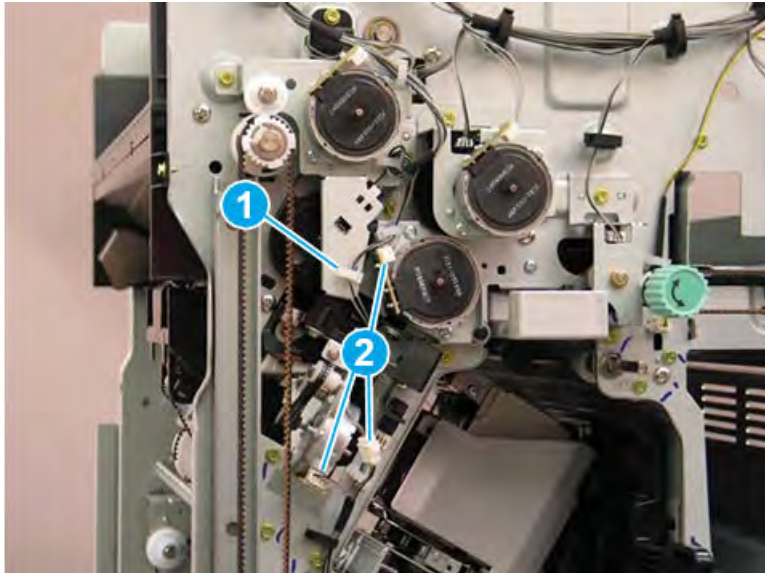

3. Remove two screws (callout 1).

Figure 5-969 Remove two screws

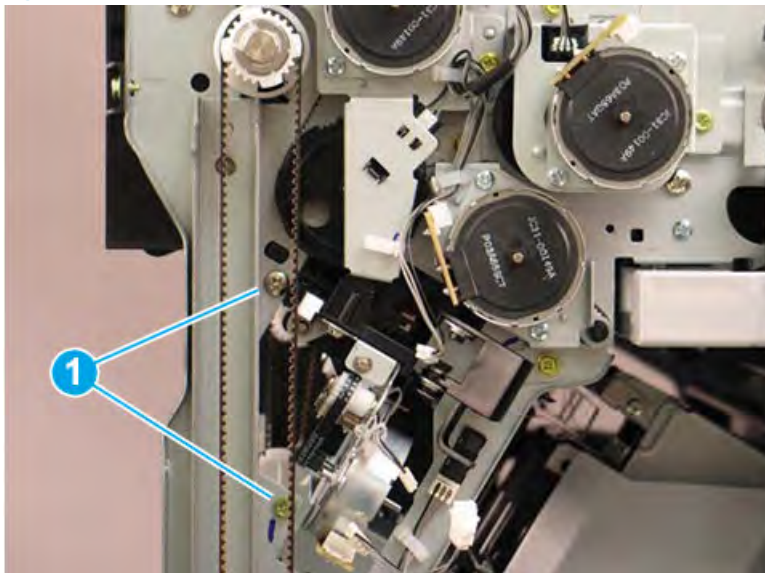

4. At the left side of the finisher, remove one screw (callout 1).

Figure 5-970 Remove one screw

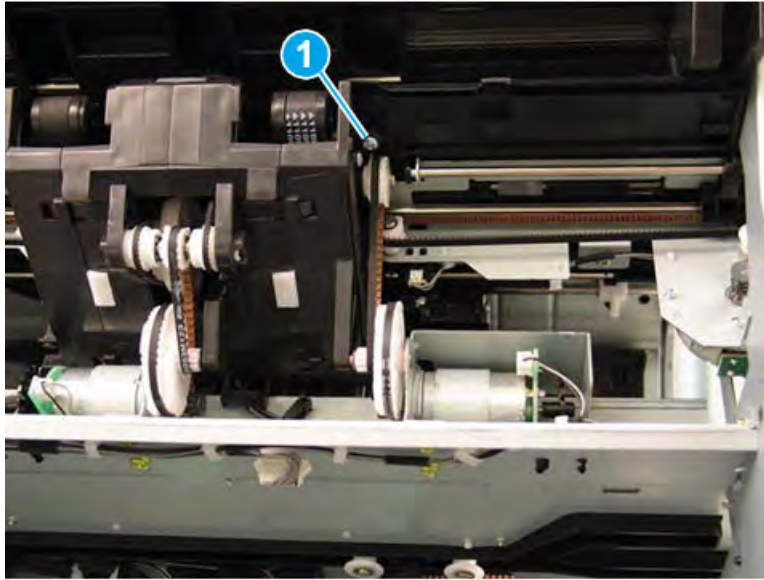

5. Press up on the hinge (callout 1), release one tab (callout 2), and then rotate the sensor away from the finisher (callout 3).

Figure 5-971 Rotate the sensor

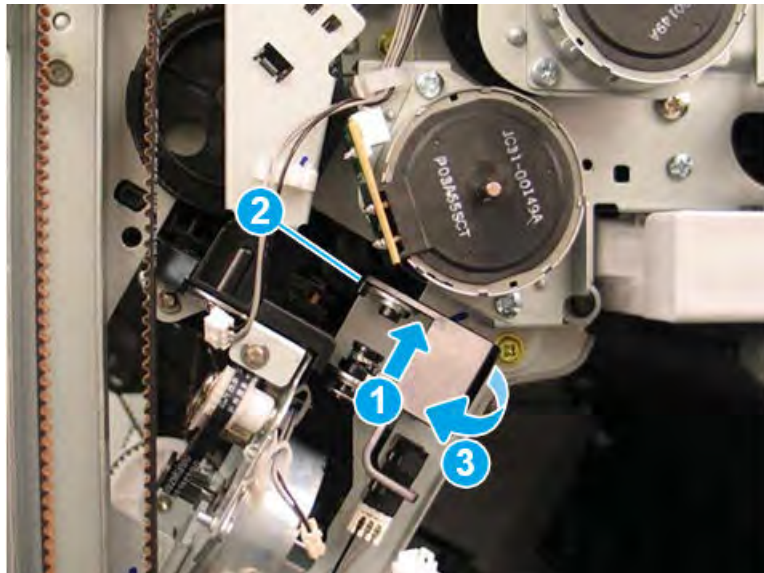

6. Remove one screw (callout 1).

Figure 5-972 Remove one screw

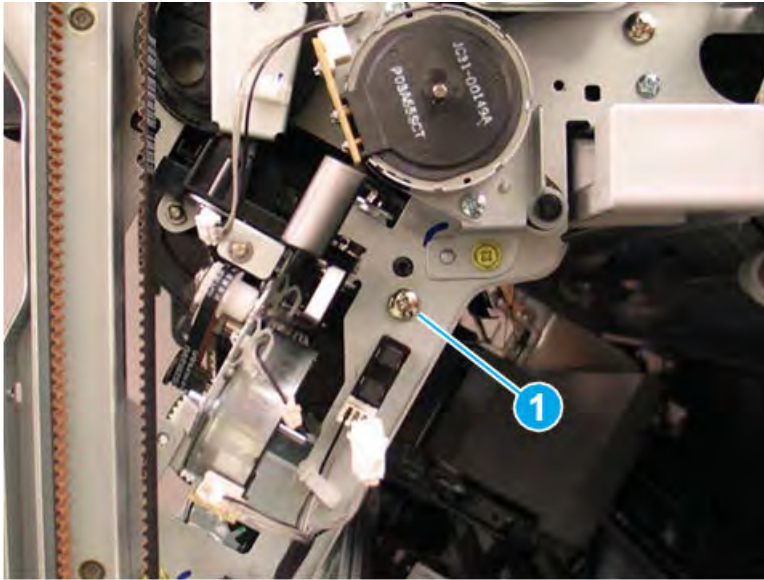

7. Look inside the finisher through the stapler opening in the front and pull down to release and remove one shaft (callout 1) on the front tamper unit.

Figure 5-973 Remove the front tamper shaft

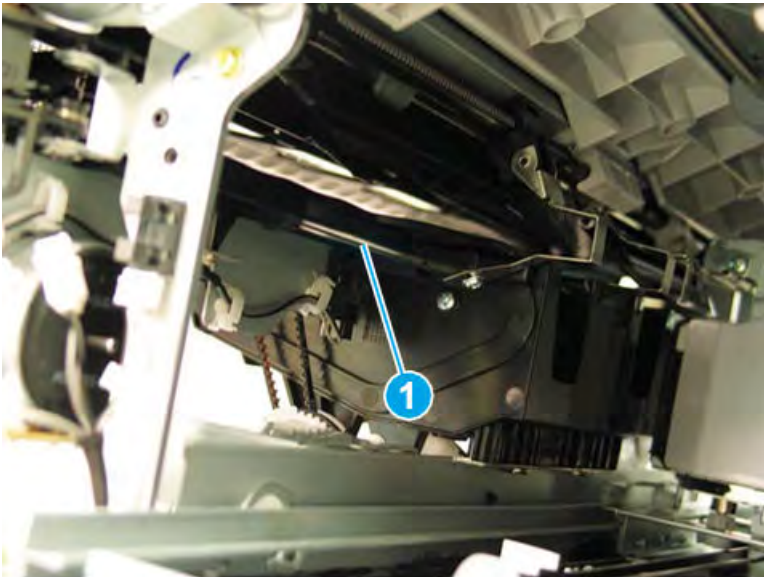

8. At the rear of the finisher, disconnect two connectors (callout 1), and then remove three screws (callout 2).

Figure 5-974 Disconnect two connectors and remove three screws

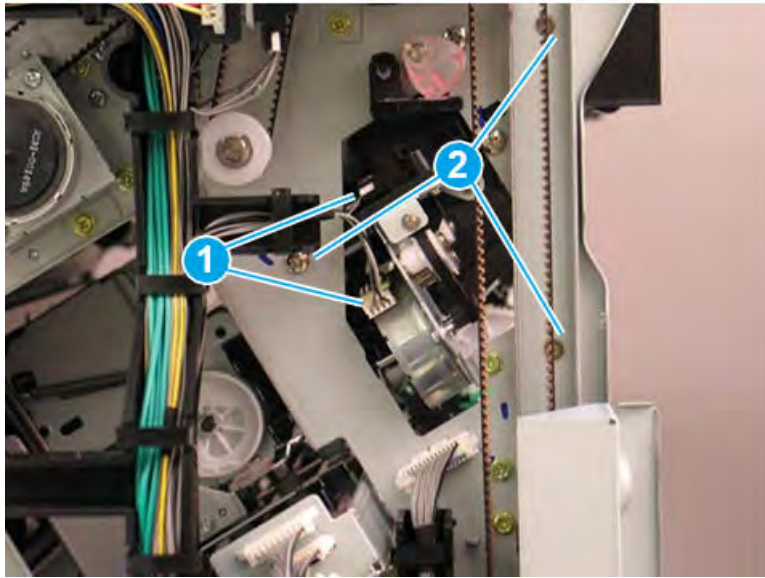

9. At the left side of the finisher, remove one screw (callout 1).

Figure 5-975 Remove one screw

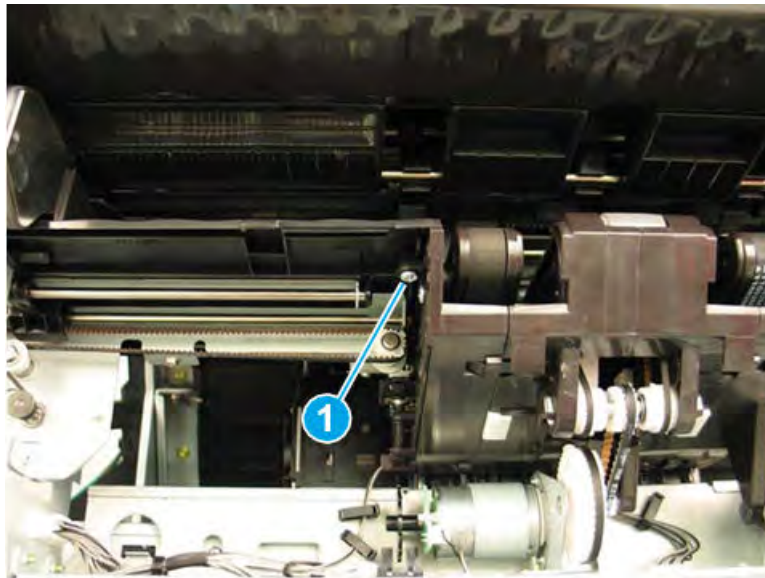

10. Look inside the finisher through the stapler opening in the rear and pull down to release and remove one shaft (callout 1) on the rear tamper unit.

Figure 5-976 Remove the rear tamper shaft

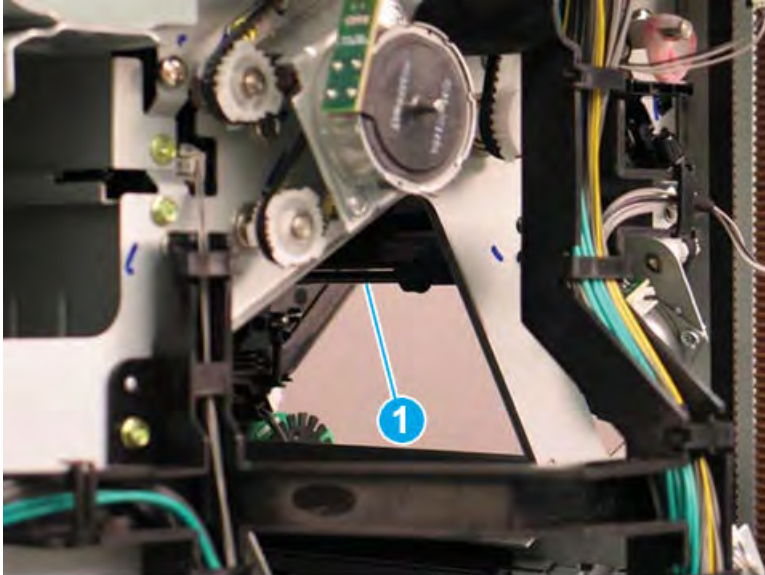

11. At the left side of the finisher, disconnect one connector (callout 1).

Figure 5-977 Disconnect one connector

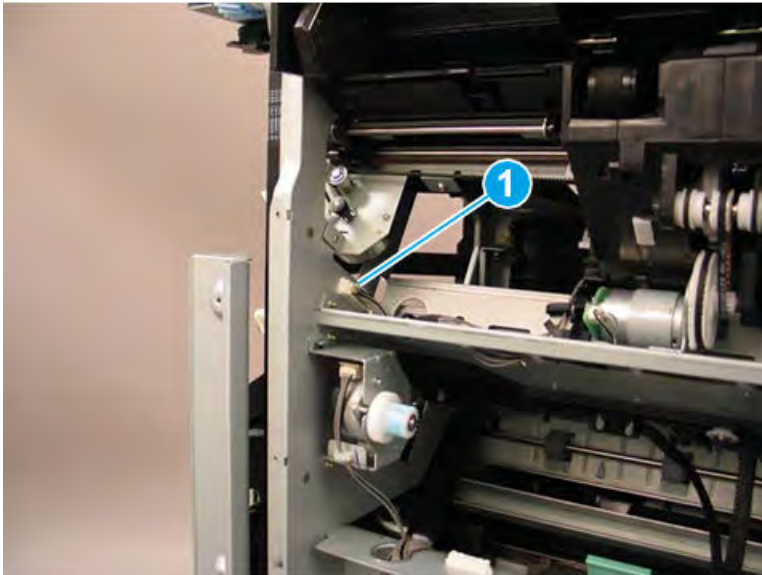

12. At the rear of the finisher, disconnect one connector (callout 1).

Figure 5-978 Disconnect one connector

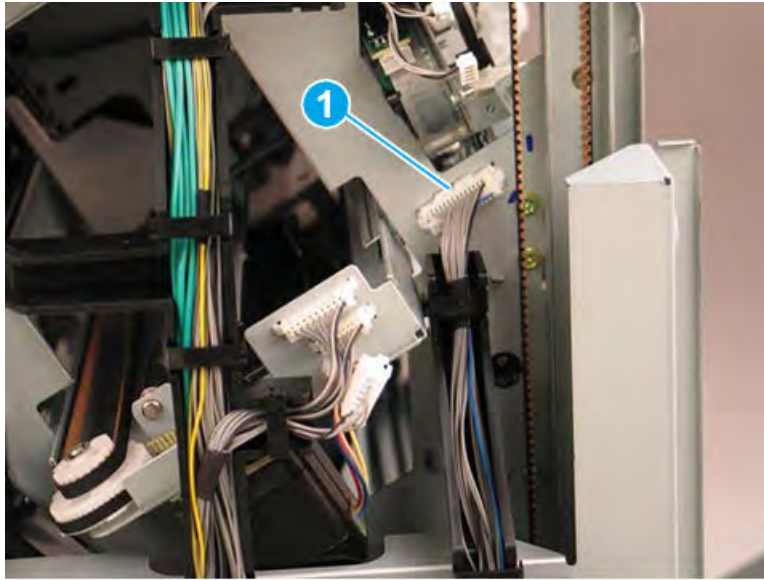

13. At the rear of the finisher, press the wire retainer to the right to access and remove two screws (callout 1).

Figure 5-979 Disconnect one connector

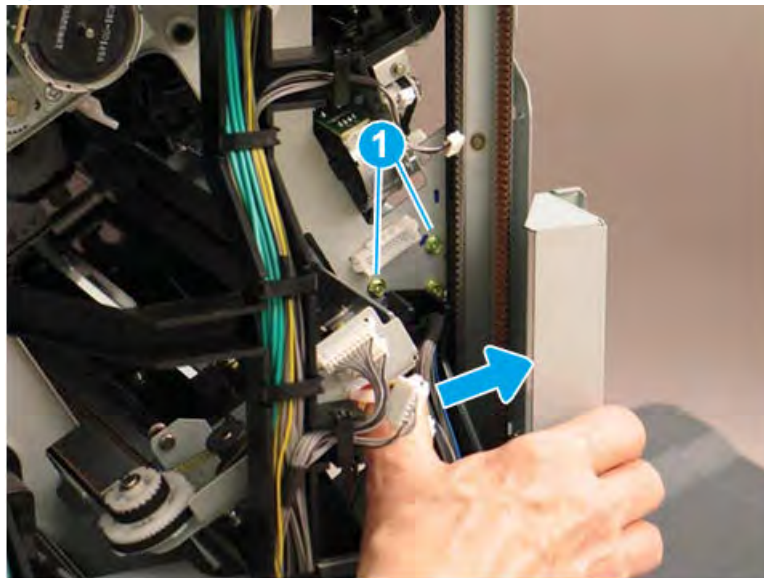

14. At the front of the finisher, remove two screws (callout 1).

Figure 5-980 Remove two screws



15. Lift the inside edges of the front and rear tampers up.

Figure 5-981 Lift the edges of the tampers

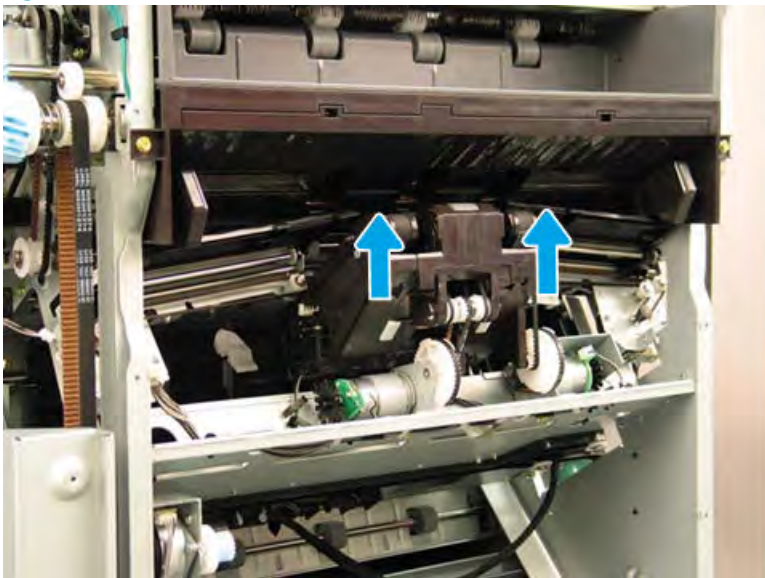

16. Rotate the rear edge of the ejector unit away from the finisher (callout 1), and then slide it toward the rear of the finisher (callout 2) to remove it. Make sure that the PCA (callout 3) stays clear of the sheet metal frame.

Figure 5-982 Remove the ejector unit

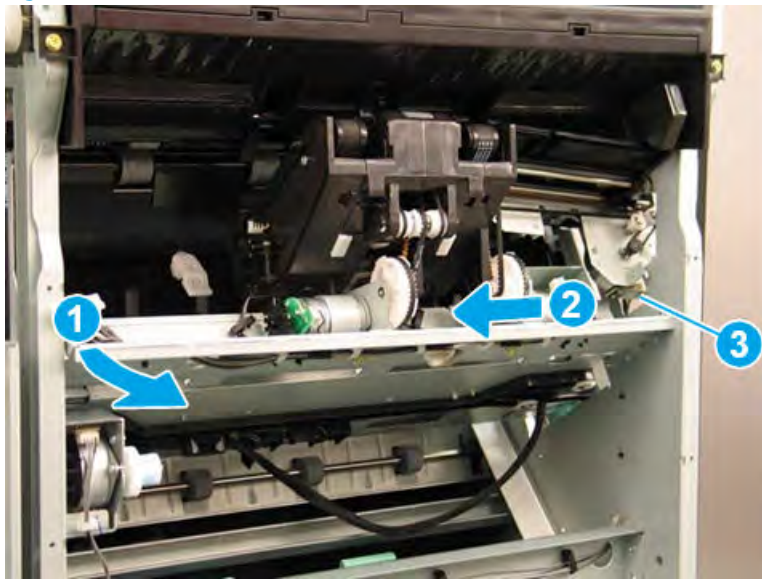

17. Reverse the removal steps to install the assembly. Also use the following special installation instructions.

 **NOTE:** Continue to reverse the removal steps to finish installing the assembly.

Special installation instructions: Ejector unit

- a. When the front tamper shaft is removed, the retainer arm that held the one end of the shaft will drop down. When reinstalling the shaft, raise the retainer arm and position the end of the shaft in the notch (callout 1).

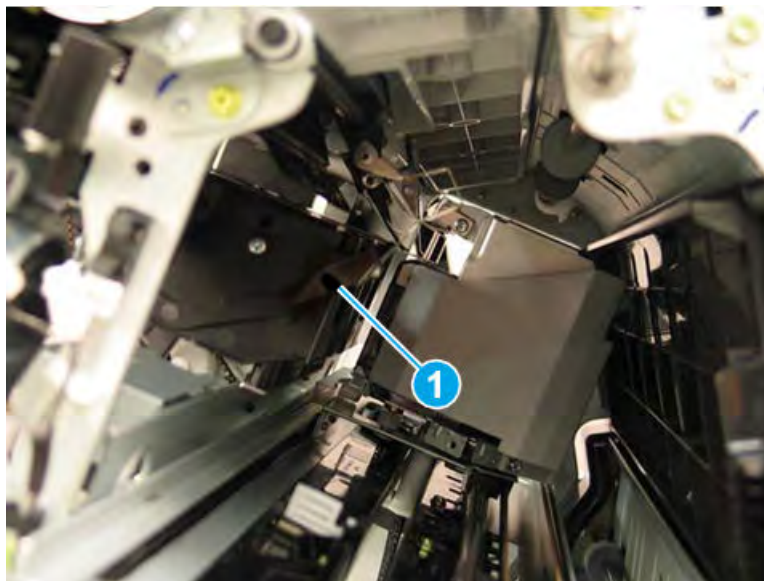

- b. When the rear tamper shaft is removed, the retainer arm that held the one end of the shaft will drop down. When reinstalling the shaft, raise the retainer arm and position the end of the shaft in the notch (callout 1).

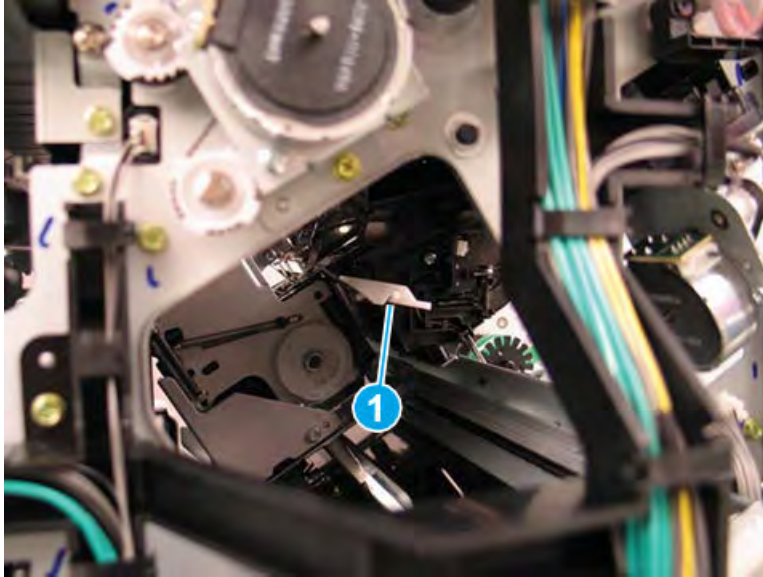

Unpack the replacement assembly



Follow these steps to unpack the replacement assembly.

1. Dispose of the defective part.

 **NOTE:** HP recommends responsible disposal of the defective part.

<http://www8.hp.com/us/en/hp-information/environment/product-recycling.html>

2. Unpack the replacement part from the packaging.

 **CAUTION:**  Some parts are sensitive to electrostatic discharge (ESD). Always perform service work at an ESD-protected workstation or mat. If an ESD workstation or mat is not available, touch the sheet-metal chassis to provide a static ground before touching an ESD-sensitive assembly. Protect the ESD-sensitive assemblies by placing them in ESD pouches when they are out of the printer.

 **IMPORTANT:** Make sure that all of the shipping materials (for example shipping tape) are removed from the replacement part prior to installation.

 **NOTE:** If the replacement part is a roller or pad, avoid touching the spongy part of it. Skin oils on the roller or pad can cause paper pickup and/or print-quality problems. HP recommends using disposable gloves when handling rollers or pads or washing your hands before touching rollers or pads.

3. To install an assembly, reverse the removal steps.

 **NOTE:** When applicable, special installation instructions are provided for an assembly at the end of the removal procedure. Always completely read the removal instructions and follow all special installation instructions.

Ejector1

Removal and replacement: Ejector1 motor sensor (S27)

Learn how to remove and replace the ejector1 motor sensor.

Introduction

This document provides the procedures to remove and replace the ejector1 motor sensor on the finisher.

 **IMPORTANT:** When applicable, special installation instructions are provided for an assembly at the end of the removal procedure. Always completely read the removal instructions and follow all special installation instructions.

Before performing service

- Turn the printer power off. A shutting-down message appears on the control-panel display.
-  **WARNING!** To avoid damage to the printer, turn the power off and wait until the printer shuts down before removing the power cable.
- Disconnect the printer power cable after the printer has completely shut down (the control-panel display is blank).
- Release the finisher from the printer by pulling out on the release latch inside the finisher door.
- Disconnect the cable from the bridge unit to the finisher.
- Disconnect the cable from the finisher to the printer.

Use the table below to identify the correct part number for your printer. To order the part, go to <https://parts.hp.com>.

Table 5-127 Part information

Part number	Part description
0604-001415	Ejector1 motor enor

Required tools

- #2 JIS screwdriver with a magnetic tip
- Small, flat-blade screwdriver

After performing service

- Connect the cable from the finisher to the printer.
- Connect the cable from the bridge unit to the finisher.
- Attach the finisher to the printer, and then push in on the release latch inside the finisher door.
- Connect the printer power cable.
- Turn the printer power on.

Post service test

Process a job through the finisher and verify that the finisher works correctly.

Remove the right upper cover (finisher)

Follow these steps to remove the right upper cover (finisher).

- ▲ Remove one screw cap and three machine screws on the upper edge of the cover (callout 1). Remove three sheet metal screws (callout 2) on the lower portion of the cover. Rotate the right edge of the cover away from the finisher, and then slide the cover right to release three tabs (callout 3).

💡 **TIP:** The lower screws are shorter in length than the upper screws.

TIP: Reverse the removal steps to install the assembly.

Figure 5-983 Remove the right upper cover

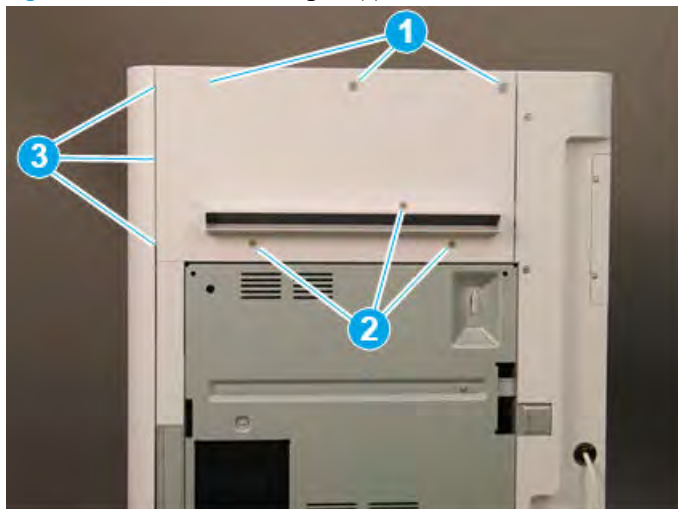

Remove the top cover (finisher)

Follow these steps to remove the top cover (finisher).

1. Remove three screw caps and three self-tapping screws at the top of the rear cover (callout 1), and then remove three machine screws (callout 2) on top of the cover.

Figure 5-984 Remove six screws

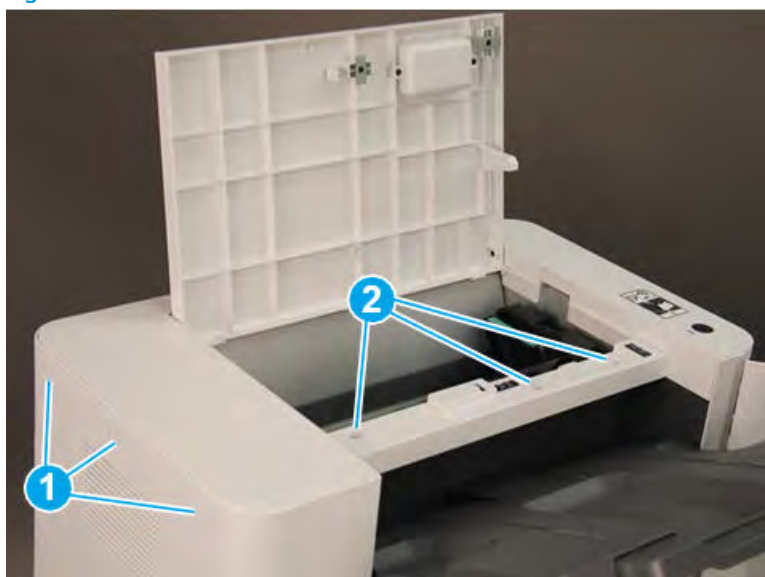

2. Remove three self-tapping screws at the top of the front cover (callout 1), and then remove two machine screws (callout 2) at the top of the right side.

Figure 5-985 Remove five screws

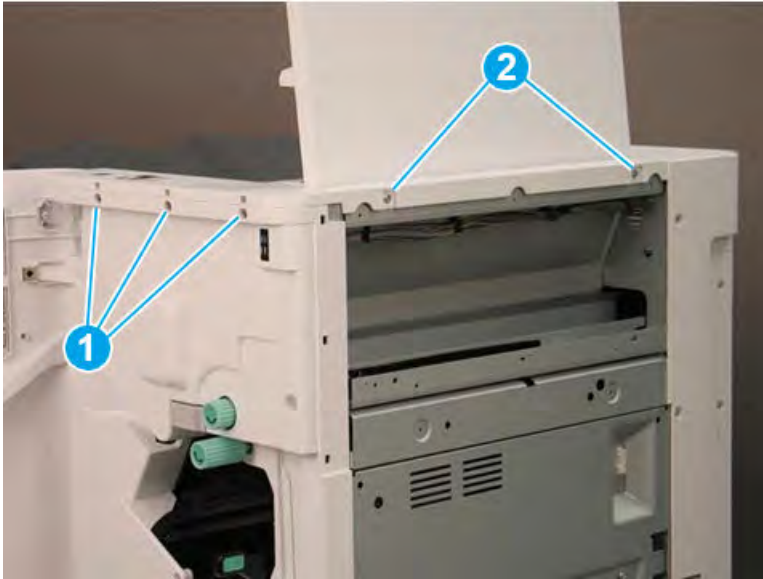

3. Lift the cover up slightly. Disconnect one in-line connector (callout 1), and then release one retainer (callout 2).

 **TIP:** Reverse the removal steps to install the assembly.

Figure 5-986 Disconnect one connector and release retainer



Remove the front door (finisher)

Follow these steps to remove the front door (finisher).

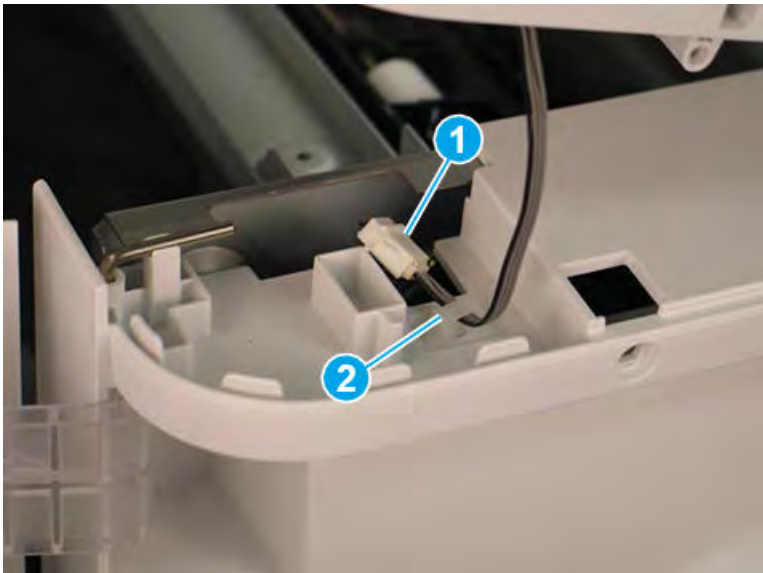
1. Lift the top hinge pin up to release it from the retainer.

Figure 5-987 Lift the top hinge pin

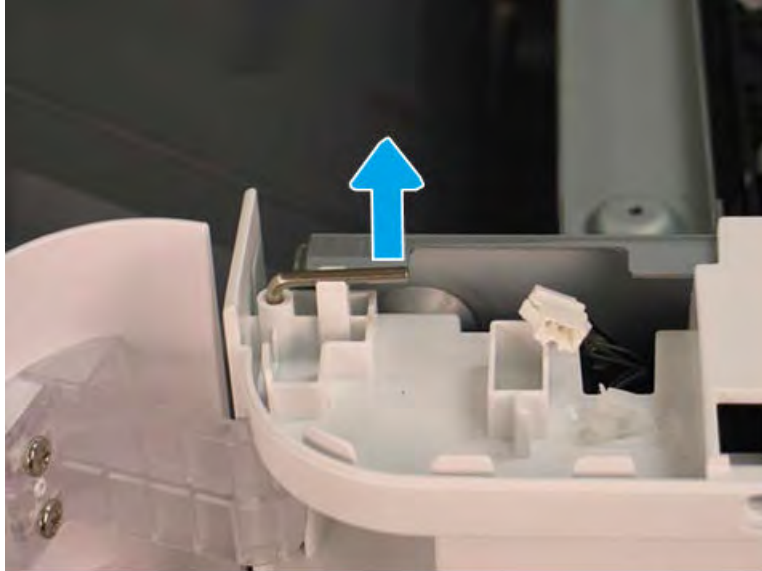

2. Pull the top hinge pin up to remove it.

Figure 5-988 Remove the top hinge pin

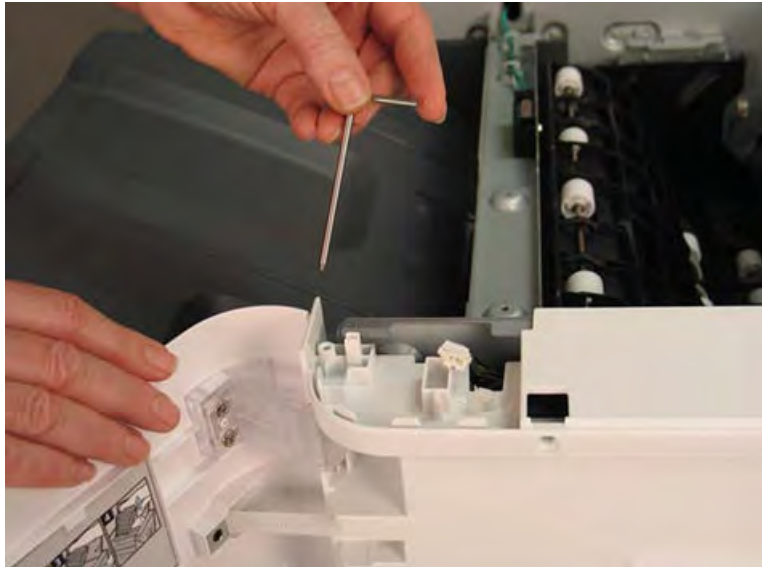

3. Use a small, flat-blade screwdriver to release the lower hinge pin from the retainer, and then rotate it away from the finisher.

Figure 5-989 Release the lower hinge pin



4. Support the door with one hand, and then pull the lower hinge pin straight up to remove it.

Figure 5-990 Remove the lower hinge pin



5. Support the door with one hand, and then remove one screw (callout 1) to release the strap. Remove the front door.

 **TIP:** Reverse the removal steps to install the assembly.

Figure 5-991 Remove the front door



Remove the front cover (finisher)

Follow these steps to remove the front cover (finisher).

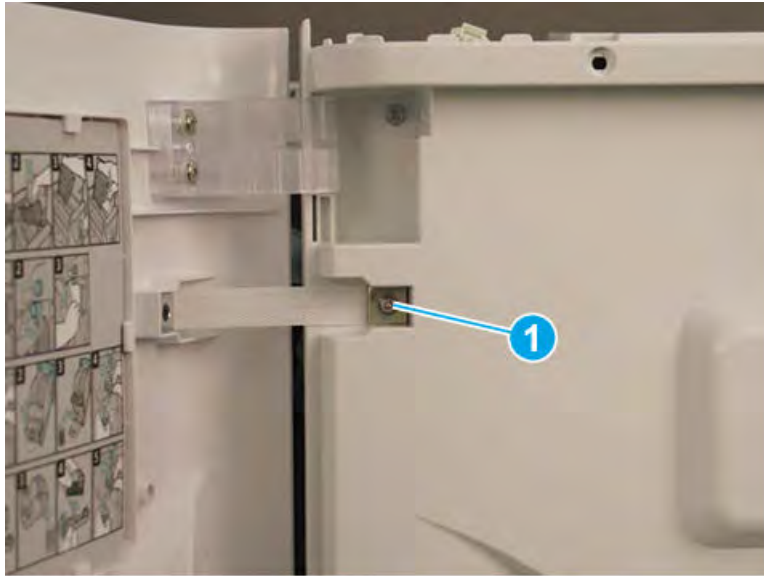
1. Release one tab (callout 1), and then pull the jam-access knob away from the finisher to remove it.

Figure 5-992 Remove the jam-access knob

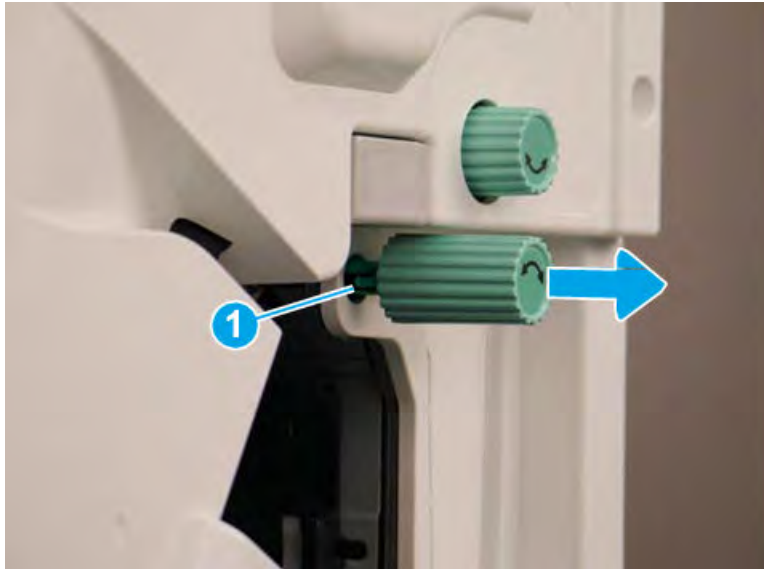

2. If the punch unit is installed, remove the punch waste bin (callout 1).

3. Remove one screw (callout 1) on top of the front cover.

Figure 5-993 Remove one screw



4. Remove five machine screws (callout 1), and then remove the front cover.

 **TIP:** Reverse the removal steps to install the assembly.

Figure 5-994 Remove the front cover



Remove the rear cover (finisher)

Follow these steps to remove the rear cover (finisher).

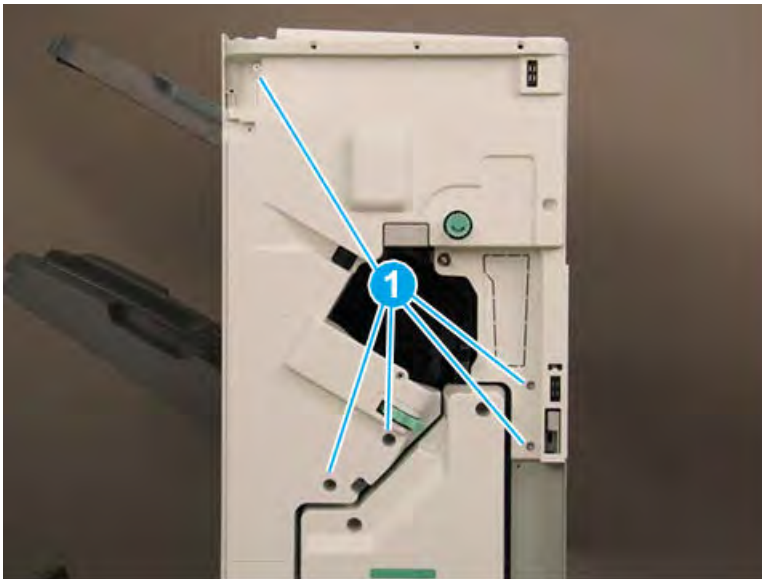
1. Remove two self-tapping screws (callout 1) on the top of the rear cover, and then remove five screw caps and five machine screws (callout 2) on the left side of the cover.

Figure 5-995 Remove seven screws

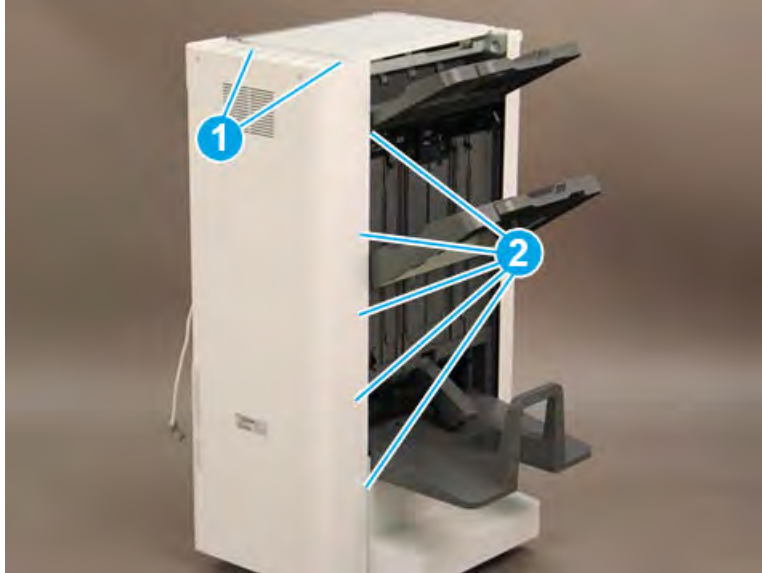

2. Remove one screw cap and four machine screws (callout 1) Remove the rear cover.

 **NOTE:** Make sure to thread the power cable (callout 2) through the opening in the cover.

 **TIP:** Reverse the removal steps to install the assembly

Figure 5-996 Remove the rear cover



Remove the booklet output tray

Follow these steps to remove the booklet output tray.

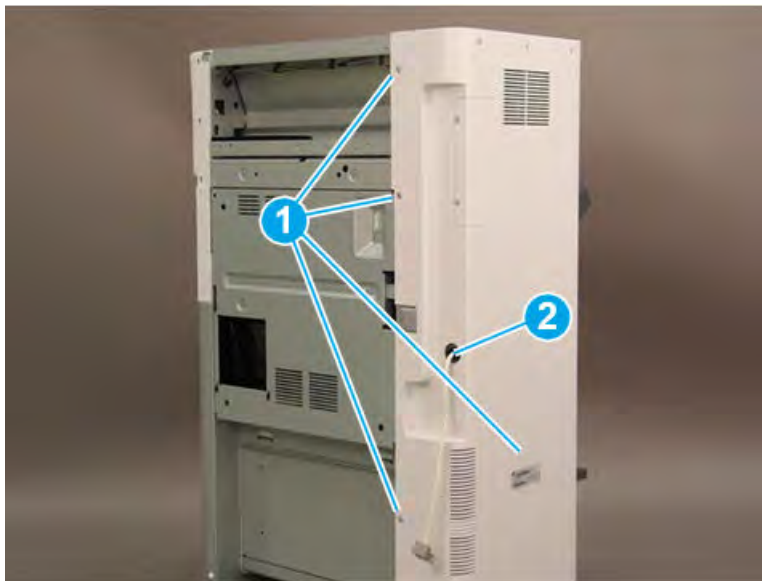
1. Raise the booklet output tray up (callout 1), and then pull it away from the finisher (callout 2) to remove it.

Figure 5-997 Remove the booklet output tray



2. Reverse the removal steps to install the assembly. Also use the following special installation instructions.

 **NOTE:** Continue to reverse the removal steps to finish installing the assembly

Special installation instructions: booklet output tray

Position the tabs (callout 1) on the tray into the slots (callout 2) on the finisher.

Figure 5-998 Install the booklet output tray

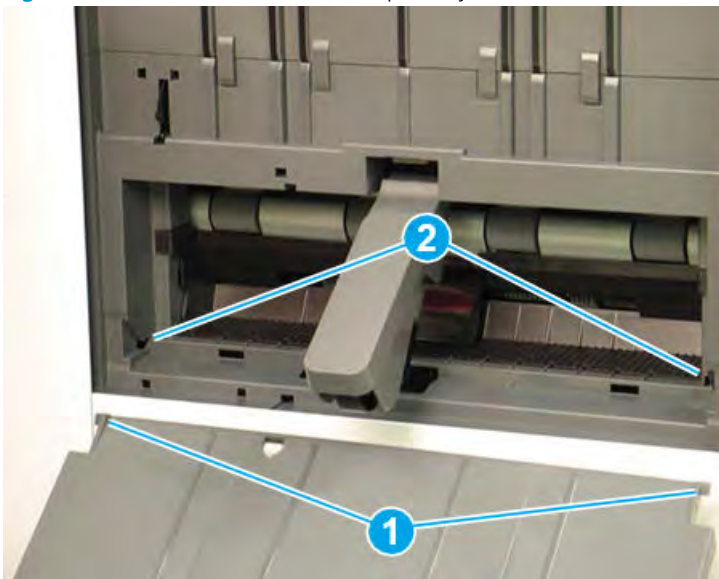

Remove the caster cover

Follow these steps to remove the caster cover.

1. Remove two screw caps and two self-tapping screws (callout 1). Remove two screw caps and two machine screws (callout 2).

Figure 5-999 Remove four screws

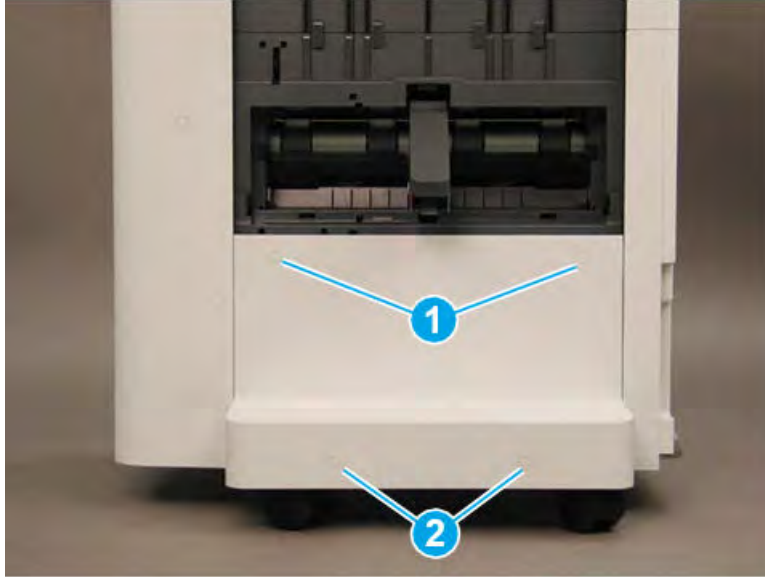

2. Rotate the left edge of the cover away from the finisher (callout 1), and then slide the cover to the left (callout 2) to remove it.

 **TIP:** Make sure that two tabs (callout 3) are positioned under the front lower cover when reinstalling the caster cover.

TIP: Reverse the removal steps to install the assembly

Figure 5-1000 Remove the caster cover

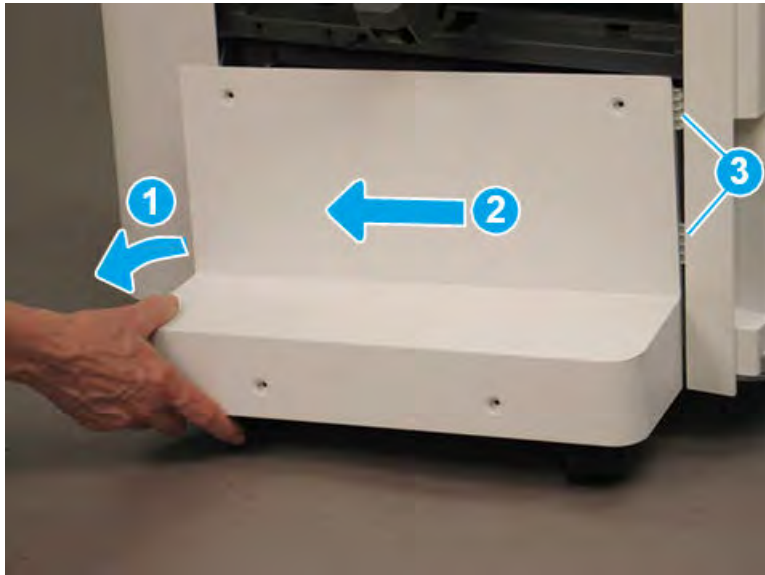

Remove the left lower cover (finisher)

Follow these steps to remove the left lower cover (finisher).

1. Remove four screws (callout 1).

 **NOTE:** Raise the lower output tray as needed to access the screws.

Figure 5-1001 Remove four screws



2. Slide the shield down (callout 1) to release it from four tabs (callout 2), and then rotate it away from the finisher (callout 3).

⚠ CAUTION: The shield is still attached to the finisher. Do not attempt to completely remove the shield.

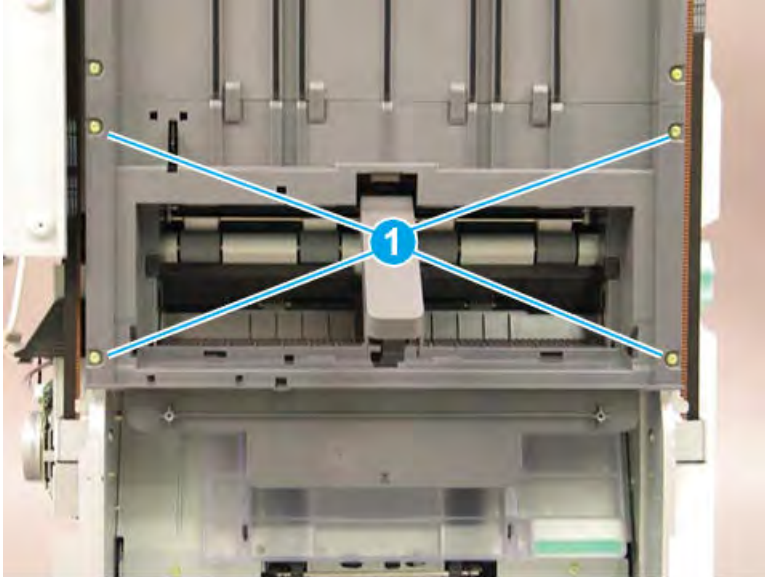
💡 TIP: Position the shield under the four tabs (callout 2) when reinstalling it.

Figure 5-1002 Release the lower shield

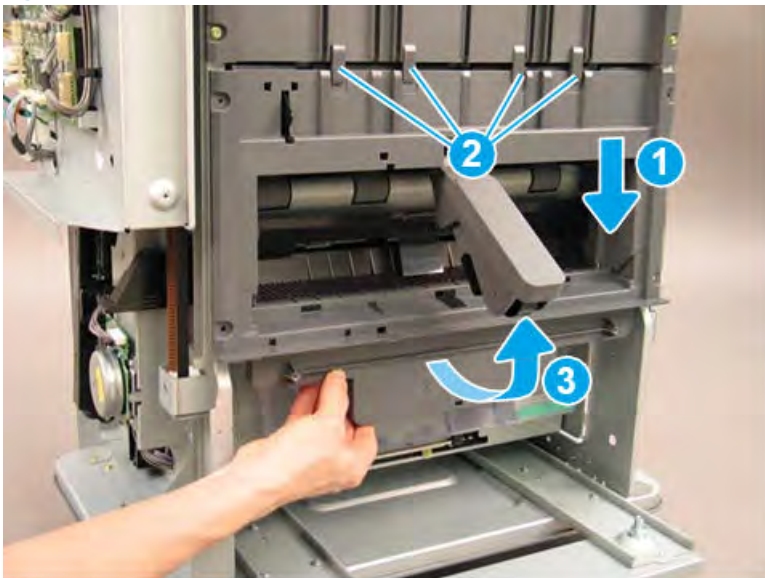

3. Disconnect two connectors (callout 1), and then remove the shield.

 **TIP:** Reverse the removal steps to install the assembly.

Figure 5-1003 Disconnect two connectors



4. If you are replacing the left lower cover, locate three sensors (callout 1) on the back of the left lower cover. Remove these sensors and transfer them to the replacement part.

Figure 5-1004 Remove the left lower cover

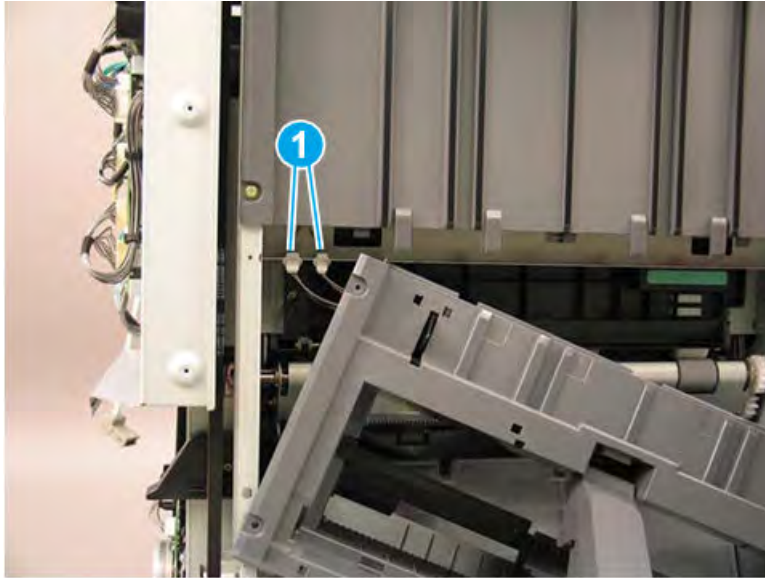
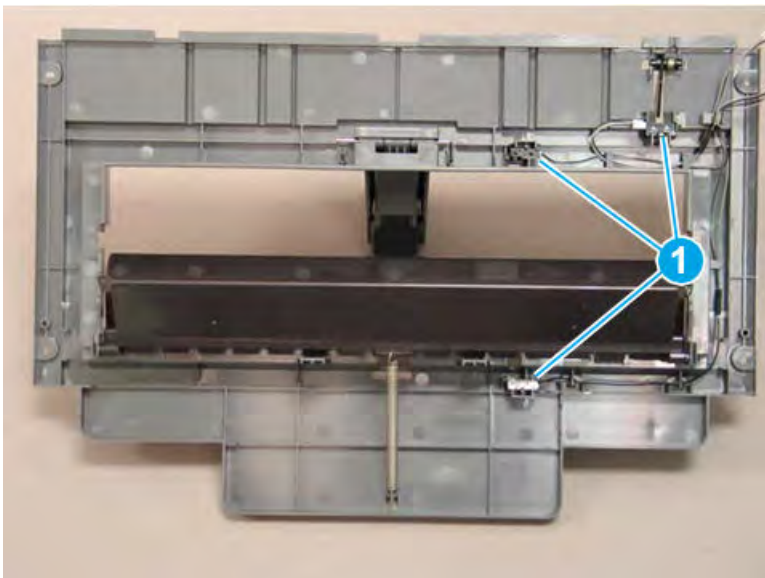

Remove the left upper cover (finisher)

Follow these steps to remove the left upper cover (finisher).

1. Bring the lower output tray down by positioning the shaft of a screwdriver on the clutch (callout 1) and gently pressing to the right to release the clutch. Hold the clutch in the released position and lower the tray (callout 2) to the lowest position.

Figure 5-1005 Lower the output tray

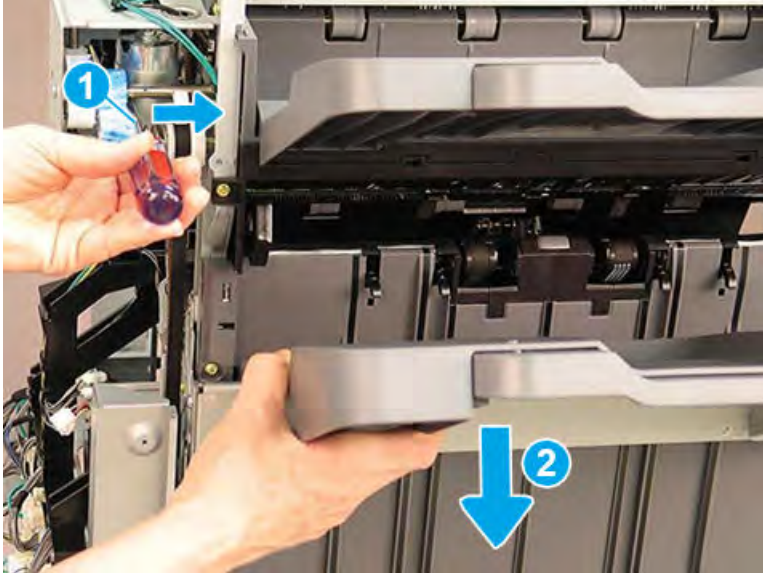

2. Remove six machine screws (callout 1).

Figure 5-1006 Remove six screws

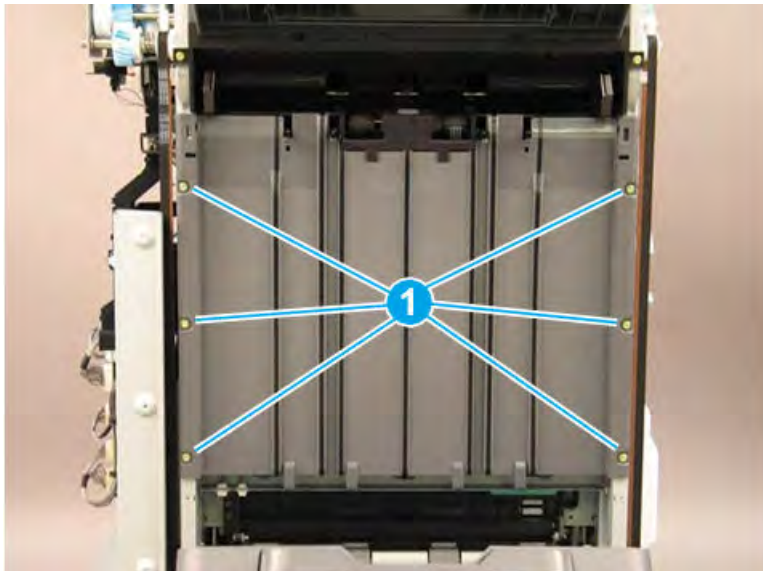

3. Rotate the lower edge of the shield away from the finisher (callout 1), and then slide the shield down (callout 2) to release it from two tabs (callout 3).

CAUTION: The shield is still attached to the finisher. Do not attempt to completely remove the shield.

TIP: Position the shield under the two tabs (callout 3) when reinstalling it.

Figure 5-1007 Release the shield

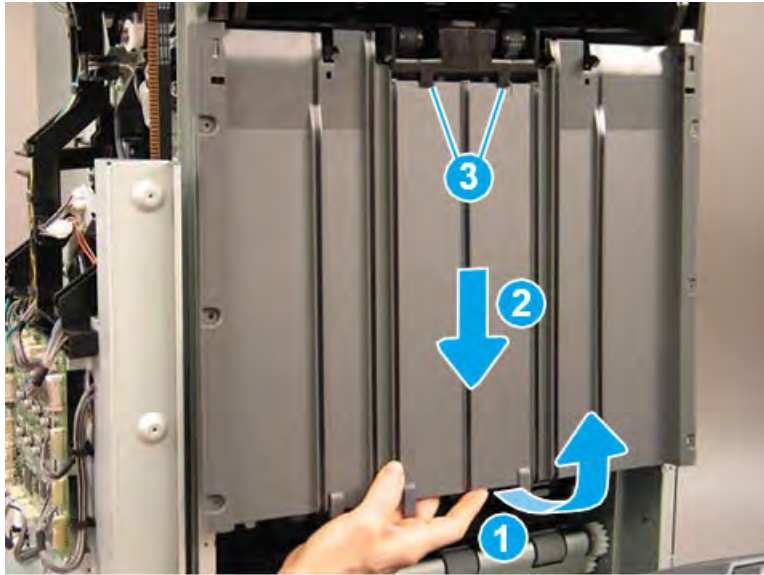

4. Disconnect one connector (callout 1), and then remove the upper shield assembly.

TIP: Reverse the removal steps to install the assembly.

Figure 5-1008 Disconnect one connector

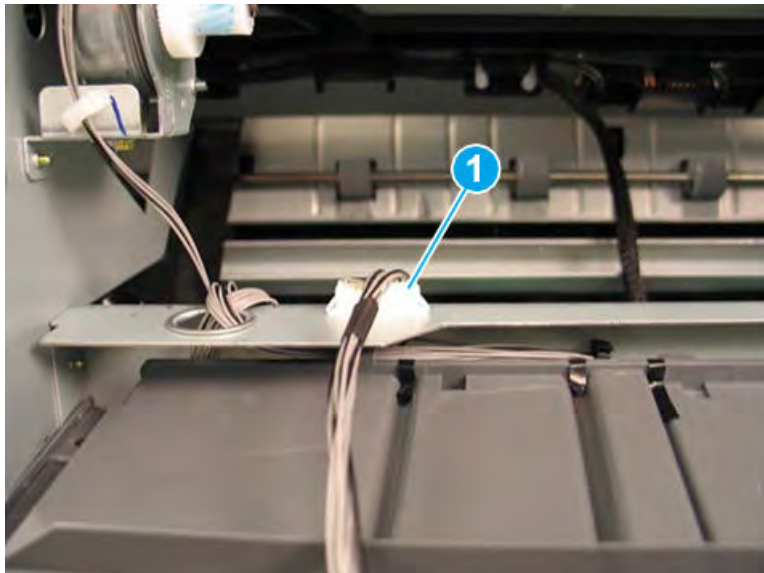

5. If you are replacing the left upper cover, locate three sensors (callout 1) on the back of the left upper cover. Remove these sensors and transfer them to the replacement part.

Figure 5-1009 Remove the left upper cover

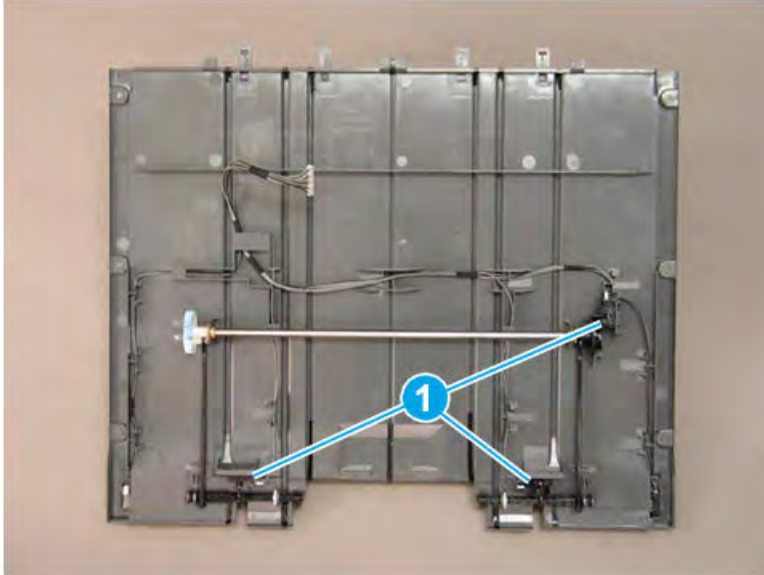

Remove the ejector unit (finisher)

Follow these steps to remove the ejector unit (finisher).

1. Rotate the green wheel to move the staple unit to the center of the finisher.

Figure 5-1010 Move the staple unit to the center

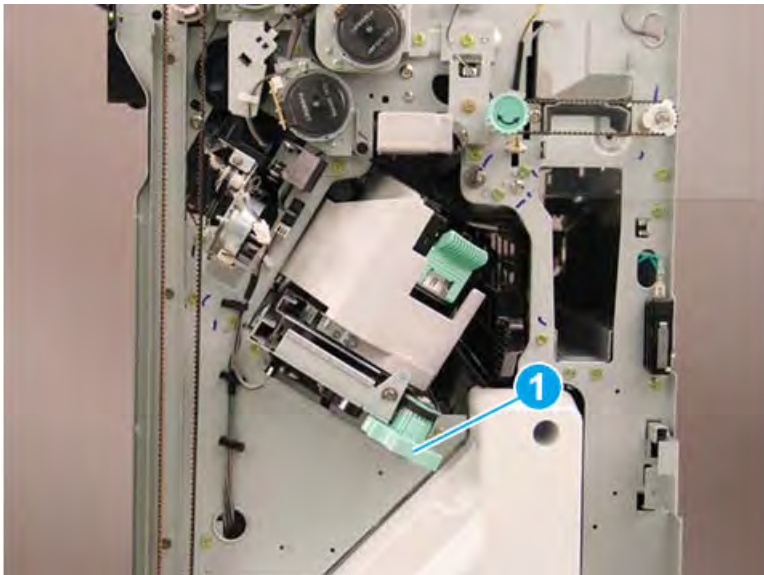

2. Release one retainer (callout 1), and then disconnect three connectors (callout 2).

Figure 5-1011 Disconnect three connectors

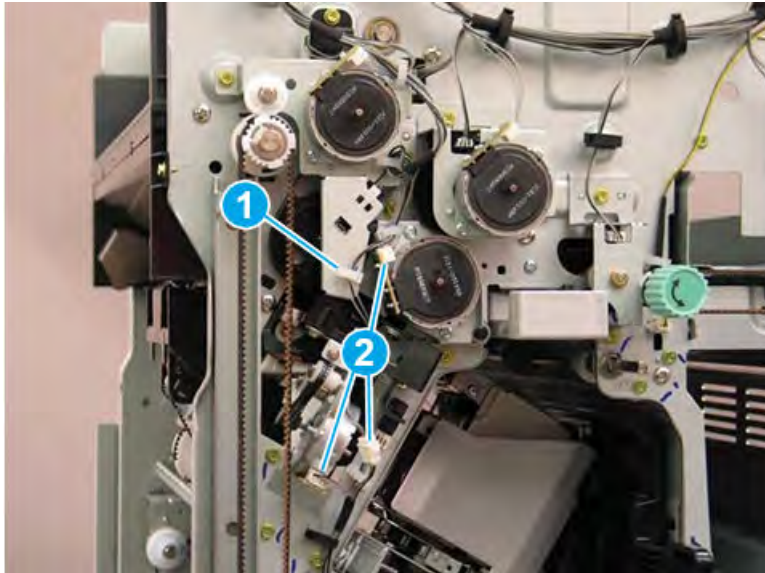

3. Remove two screws (callout 1).

Figure 5-1012 Remove two screws

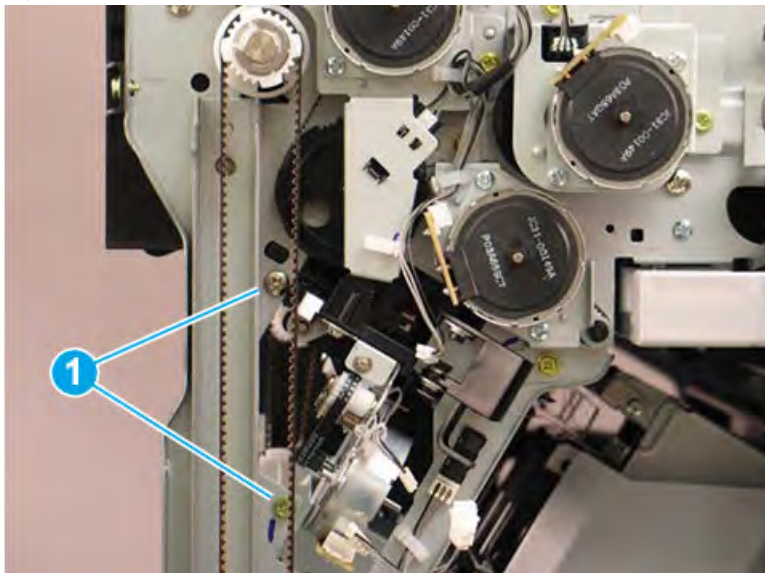

4. At the left side of the finisher, remove one screw (callout 1).

Figure 5-1013 Remove one screw

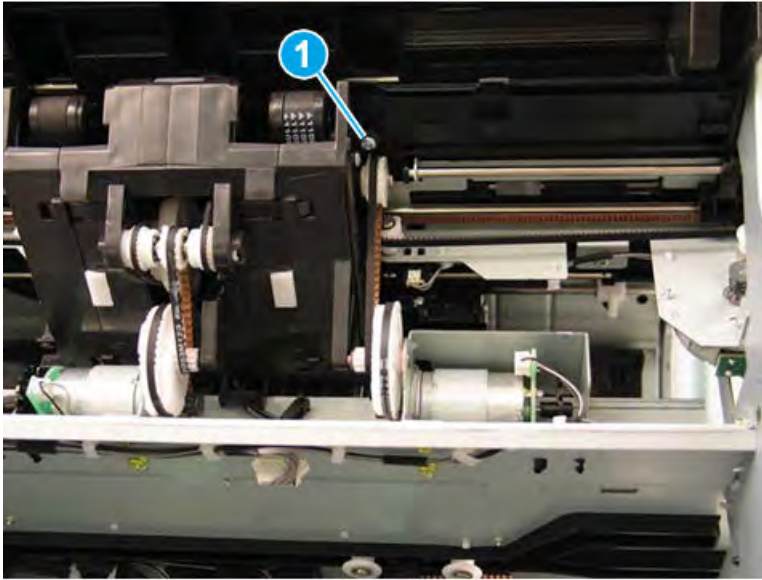

5. Press up on the hinge (callout 1), release one tab (callout 2), and then rotate the sensor away from the finisher (callout 3).

Figure 5-1014 Rotate the sensor

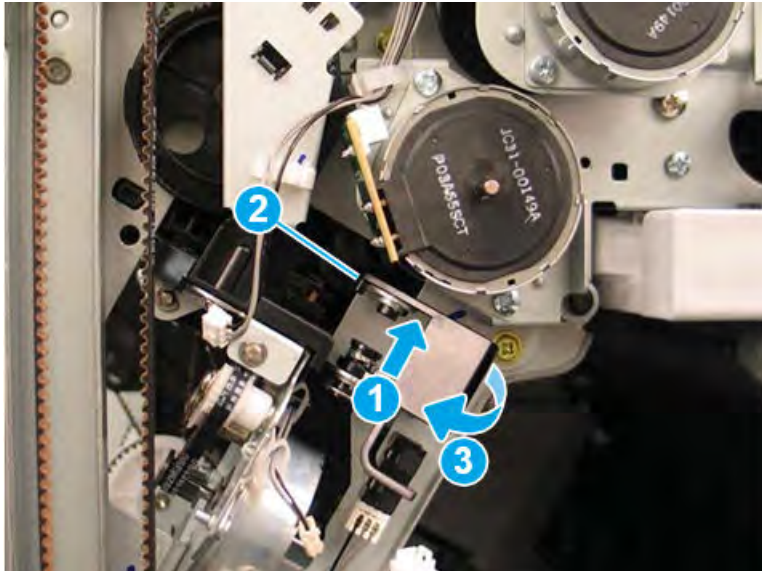

6. Remove one screw (callout 1).

Figure 5-1015 Remove one screw

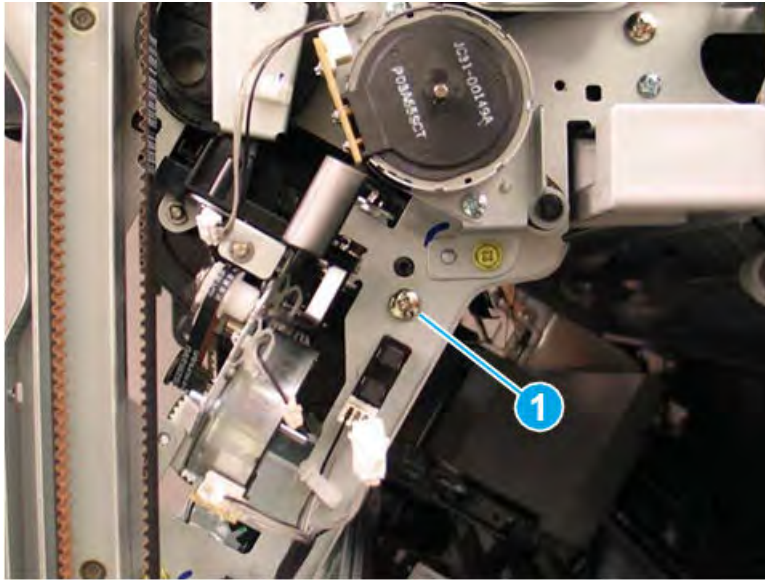

7. Look inside the finisher through the stapler opening in the front and pull down to release and remove one shaft (callout 1) on the front tamper unit.

Figure 5-1016 Remove the front tamper shaft

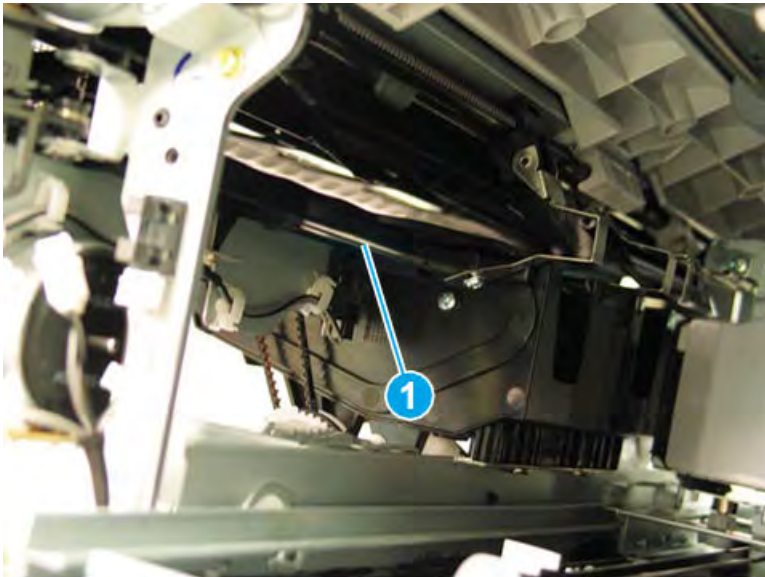

8. At the rear of the finisher, disconnect two connectors (callout 1), and then remove three screws (callout 2).

Figure 5-1017 Disconnect two connectors and remove three screws

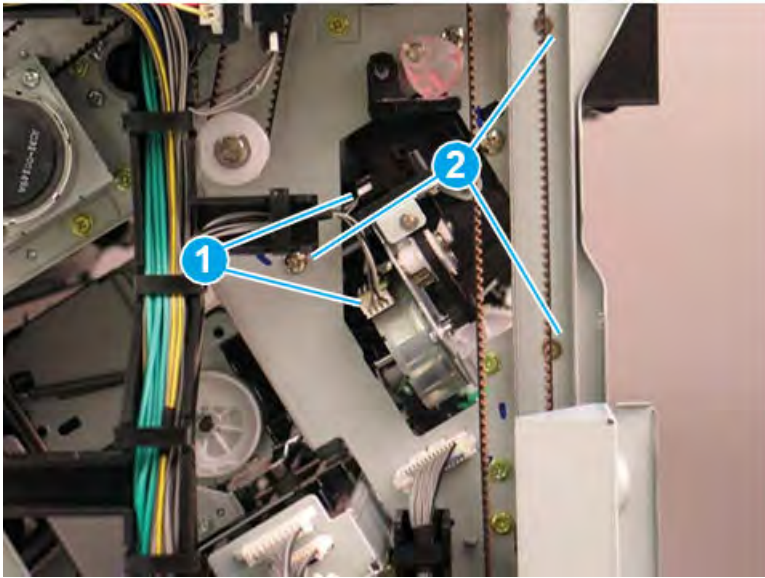

9. At the left side of the finisher, remove one screw (callout 1).

Figure 5-1018 Remove one screw

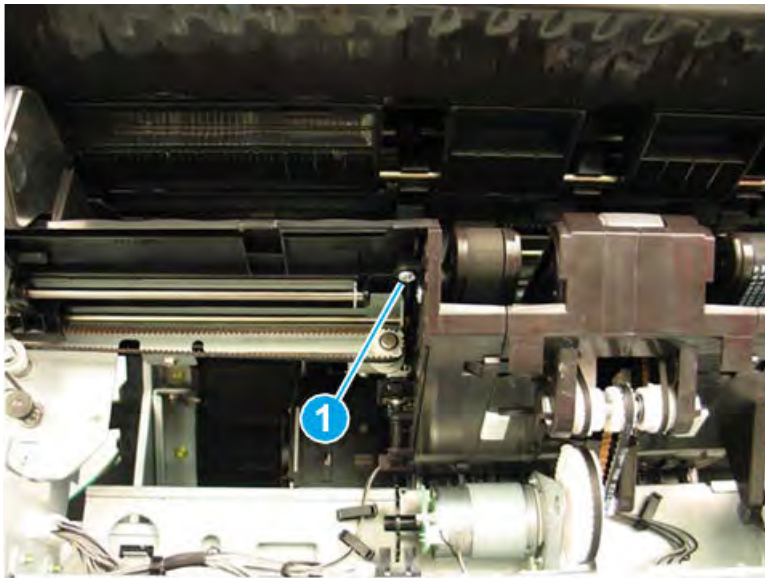

10. Look inside the finisher through the stapler opening in the rear and pull down to release and remove one shaft (callout 1) on the rear tamper unit.

Figure 5-1019 Remove the rear tamper shaft

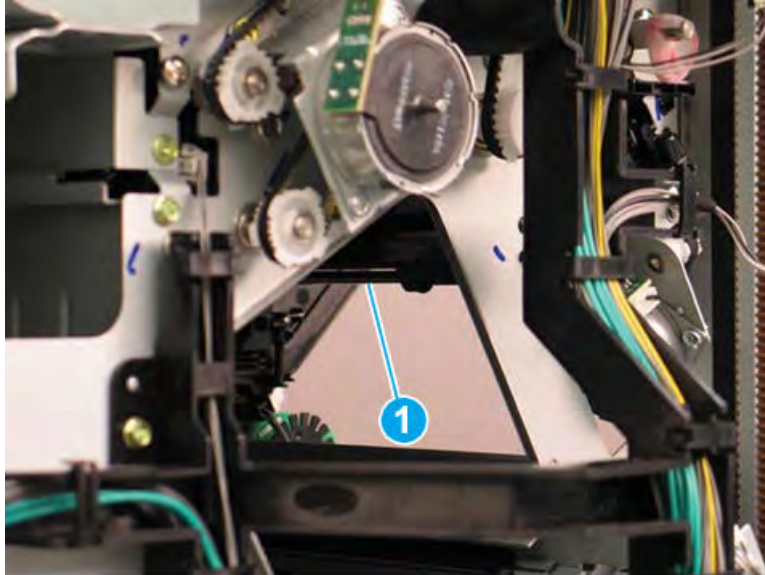

11. At the left side of the finisher, disconnect one connector (callout 1).

Figure 5-1020 Disconnect one connector

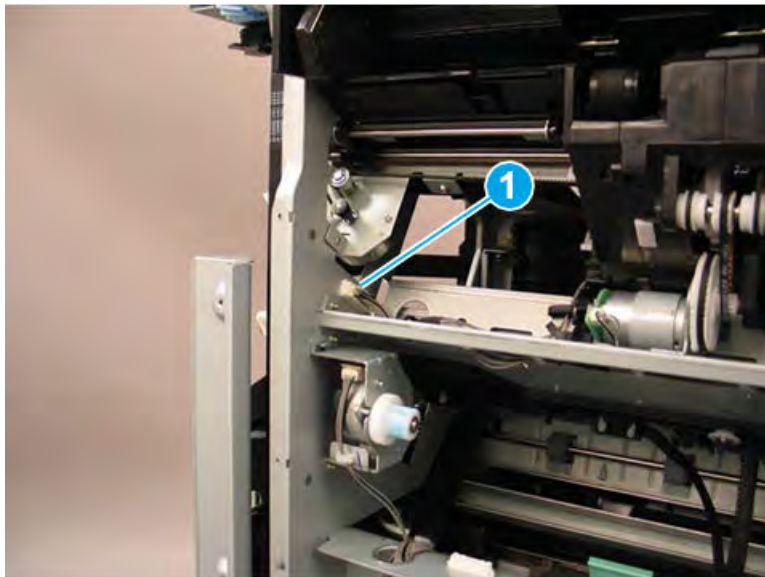

12. At the rear of the finisher, disconnect one connector (callout 1).

Figure 5-1021 Disconnect one connector

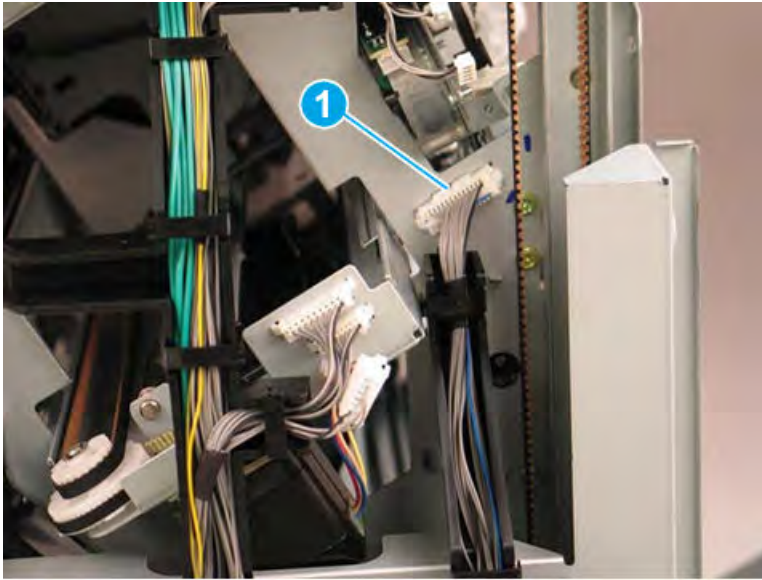

13. At the rear of the finisher, press the wire retainer to the right to access and remove two screws (callout 1).

Figure 5-1022 Disconnect one connector

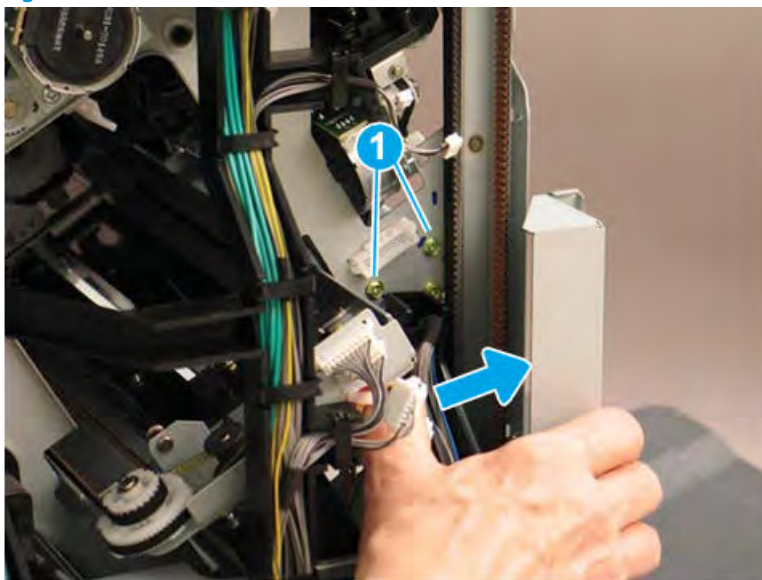

14. At the front of the finisher, remove two screws (callout 1).

Figure 5-1023 Remove two screws

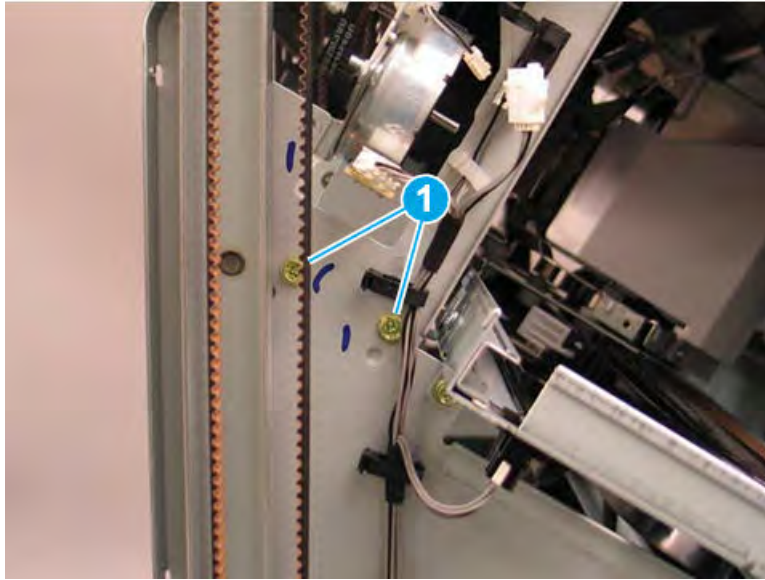

15. Lift the inside edges of the front and rear tampers up.

Figure 5-1024 Lift the edges of the tampers

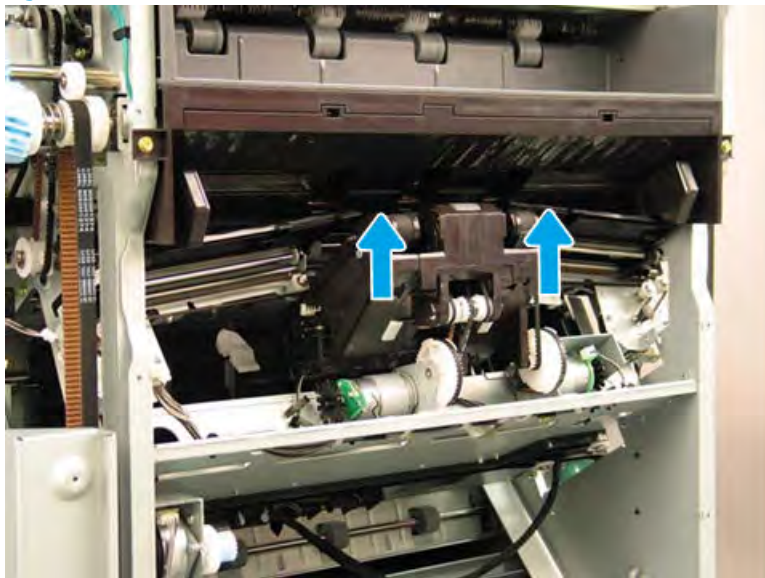

16. Rotate the rear edge of the ejector unit away from the finisher (callout 1), and then slide it toward the rear of the finisher (callout 2) to remove it. Make sure that the PCA (callout 3) stays clear of the sheet metal frame.

Figure 5-1025 Remove the ejector unit

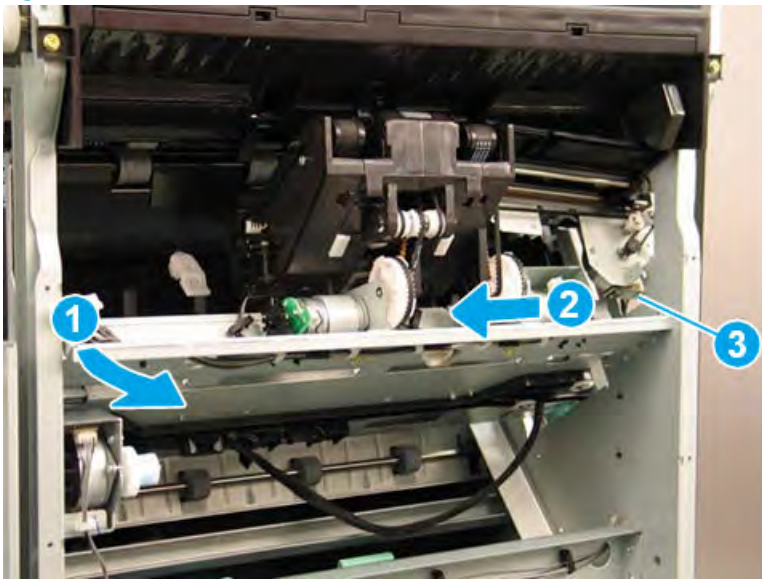

17. Reverse the removal steps to install the assembly. Also use the following special installation instructions.

 **NOTE:** Continue to reverse the removal steps to finish installing the assembly.

Special installation instructions: Ejector unit

- a. When the front tamper shaft is removed, the retainer arm that held the one end of the shaft will drop down. When reinstalling the shaft, raise the retainer arm and position the end of the shaft in the notch (callout 1).

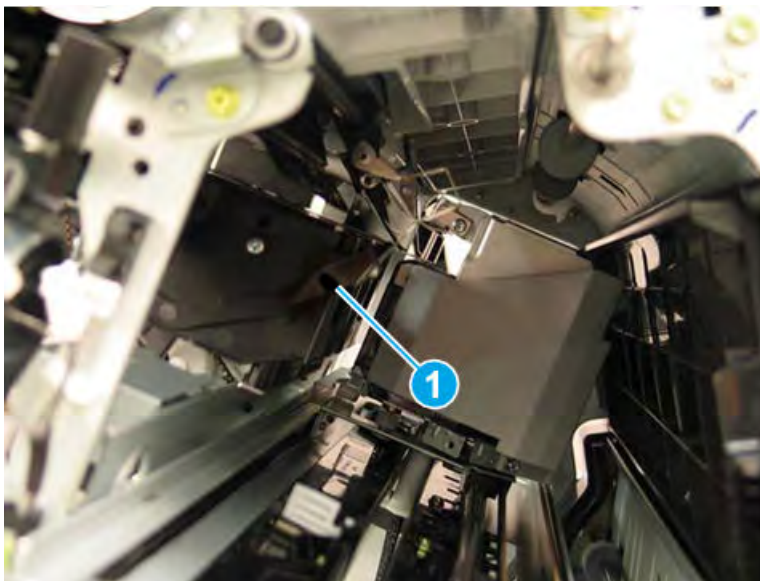

- b. When the rear tamper shaft is removed, the retainer arm that held the one end of the shaft will drop down. When reinstalling the shaft, raise the retainer arm and position the end of the shaft in the notch (callout 1).

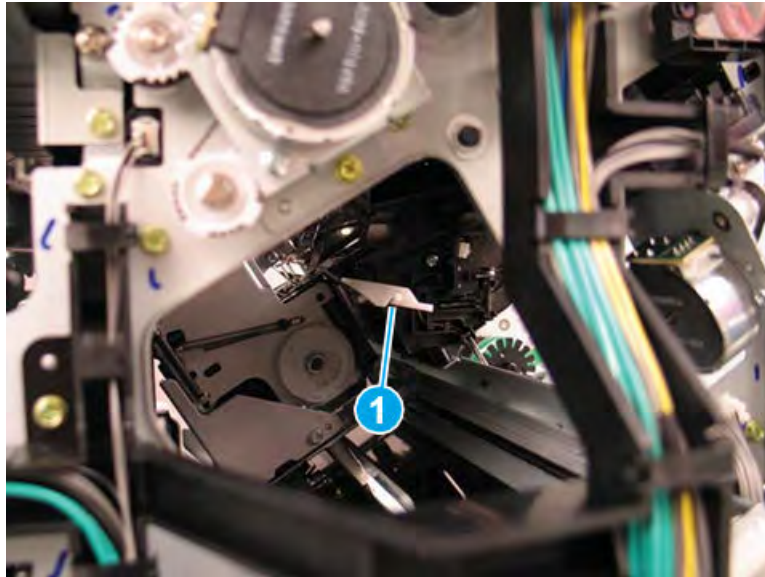

Remove the ejector1 motor sensor(S27)

Follow these steps to remove the ejector1 motor sensor(S27).

1. Disconnect the connector(callout 1) from ejector1 motor(callout 2, M6) of ejector unit.

Figure 5-1026 Disconnect the connector

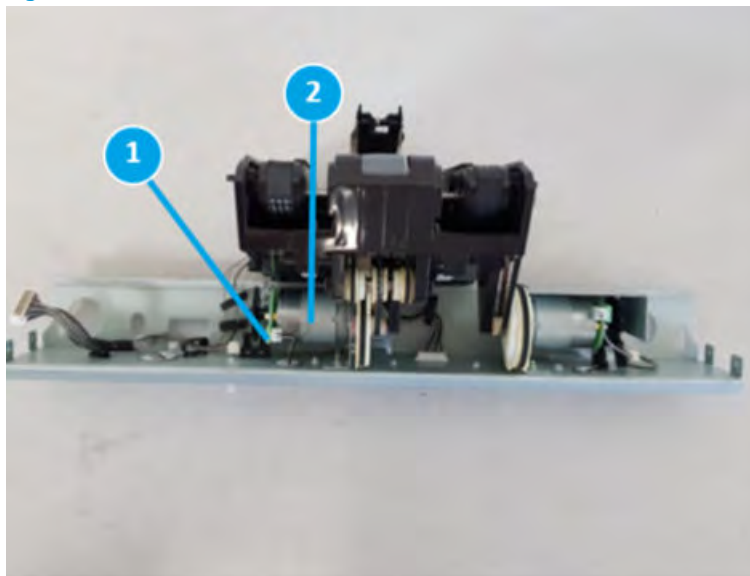

2. Remove two screws(callout 1).

Figure 5-1027 Remove two screws

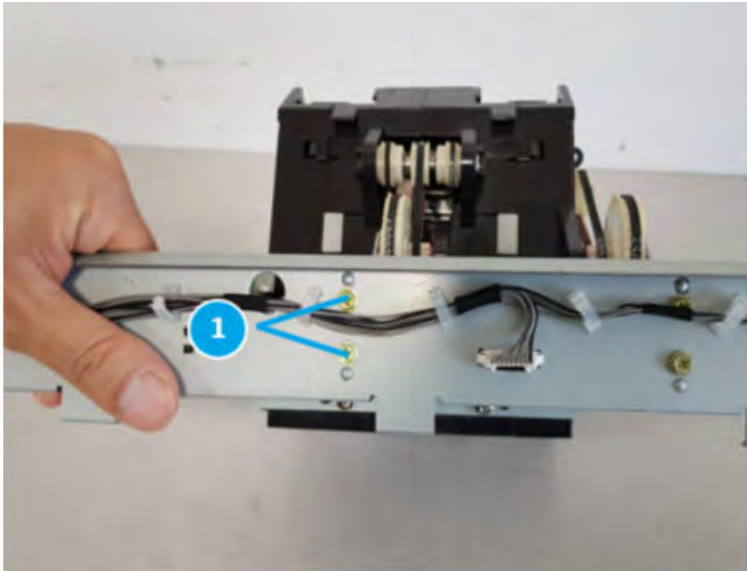

3. Remove the ejector1 motor from ejector unit, disconnect the connector(callout 1), and then remove the ejector1 motor sensor(S27, callout 2)

Figure 5-1028 Remove the ejector1 motor sensor

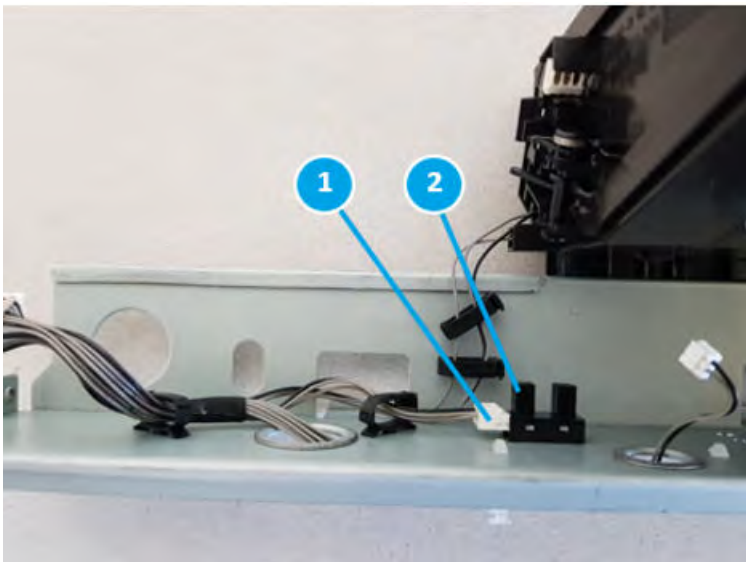

Unpack the replacement assembly

Follow these steps to unpack the replacement assembly.

1. Dispose of the defective part.

 **NOTE:** HP recommends responsible disposal of the defective part.

<http://www8.hp.com/us/en/hp-information/environment/product-recycling.html>

2. Unpack the replacement part from the packaging.



CAUTION:  Some parts are sensitive to electrostatic discharge (ESD). Always perform service work at an ESD-protected workstation or mat. If an ESD workstation or mat is not available, touch the sheet-metal chassis to provide a static ground before touching an ESD-sensitive assembly. Protect the ESD-sensitive assemblies by placing them in ESD pouches when they are out of the printer.

 **IMPORTANT:** Make sure that all of the shipping materials (for example shipping tape) are removed from the replacement part prior to installation.

 **NOTE:** If the replacement part is a roller or pad, avoid touching the spongy part of it. Skin oils on the roller or pad can cause paper pickup and/or print-quality problems. HP recommends using disposable gloves when handling rollers or pads or washing your hands before touching rollers or pads.

3. To install an assembly, reverse the removal steps.

 **NOTE:** When applicable, special installation instructions are provided for an assembly at the end of the removal procedure. Always completely read the removal instructions and follow all special installation instructions.

Removal and replacement: Ejector1 motor (M6)

Learn how to remove and replace the ejector1 motor.

Introduction

This document provides the procedures to remove and replace the ejector1 motor on the finisher.

 **IMPORTANT:** When applicable, special installation instructions are provided for an assembly at the end of the removal procedure. Always completely read the removal instructions and follow all special installation instructions.

Before performing service

- Turn the printer power off. A shutting-down message appears on the control-panel display.
-  **WARNING!** To avoid damage to the printer, turn the power off and wait until the printer shuts down before removing the power cable.
- Disconnect the printer power cable after the printer has completely shut down (the control-panel display is blank).
- Release the finisher from the printer by pulling out on the release latch inside the finisher door.
- Disconnect the cable from the bridge unit to the finisher.
- Disconnect the cable from the finisher to the printer.

Use the table below to identify the correct part number for your printer. To order the part, go to <https://parts.hp.com>.

Table 5-128 Part information

Part number	Part description
JC93-01168A	Ejector1 motor

Required tools

- #2 JIS screwdriver with a magnetic tip
- Small, flat-blade screwdriver

After performing service

- Connect the cable from the finisher to the printer.
- Connect the cable from the bridge unit to the finisher.
- Attach the finisher to the printer, and then push in on the release latch inside the finisher door.
- Connect the printer power cable.
- Turn the printer power on.

Post service test

Process a job through the finisher and verify that the finisher works correctly.

Remove the right upper cover (finisher)

Follow these steps to remove the right upper cover (finisher).

- ▲ Remove one screw cap and three machine screws on the upper edge of the cover (callout 1). Remove three sheet metal screws (callout 2) on the lower portion of the cover. Rotate the right edge of the cover away from the finisher, and then slide the cover right to release three tabs (callout 3).

💡 **TIP:** The lower screws are shorter in length than the upper screws.

TIP: Reverse the removal steps to install the assembly.

Figure 5-1029 Remove the right upper cover

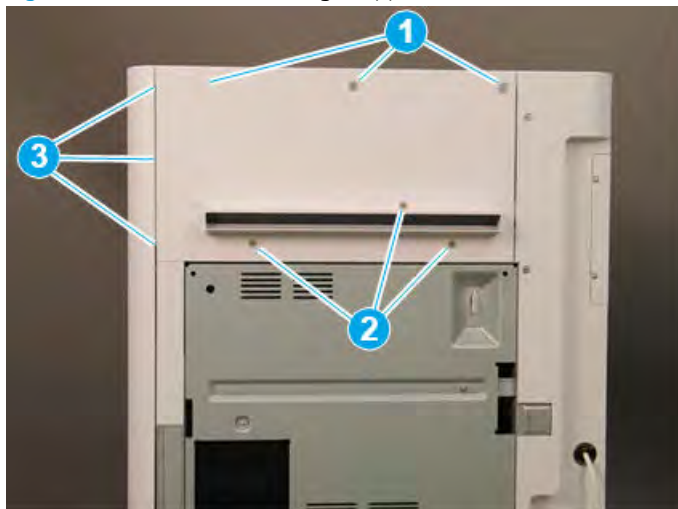

Remove the top cover (finisher)

Follow these steps to remove the top cover (finisher).

1. Remove three screw caps and three self-tapping screws at the top of the rear cover (callout 1), and then remove three machine screws (callout 2) on top of the cover.

Figure 5-1030 Remove six screws

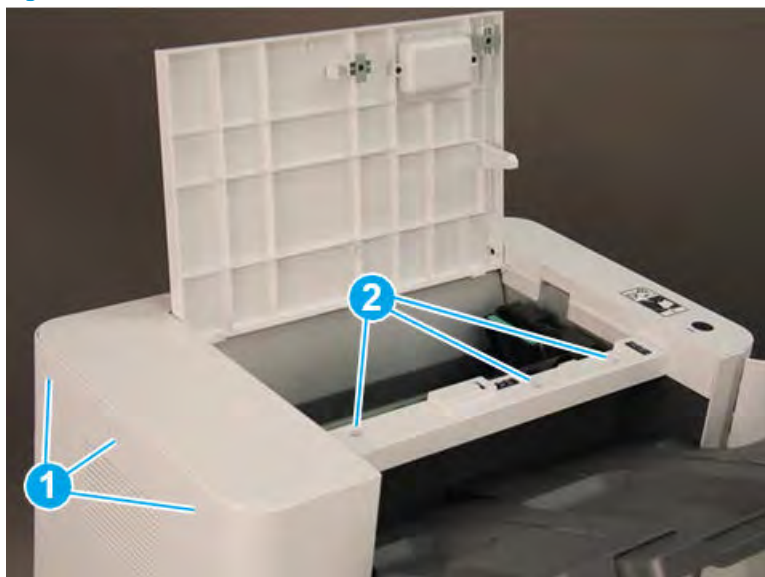

2. Remove three self-tapping screws at the top of the front cover (callout 1), and then remove two machine screws (callout 2) at the top of the right side.

Figure 5-1031 Remove five screws

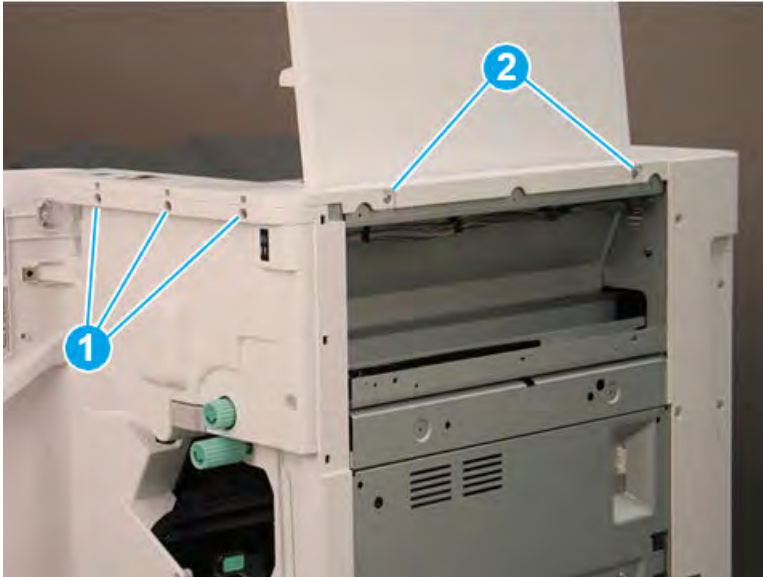

3. Lift the cover up slightly. Disconnect one in-line connector (callout 1), and then release one retainer (callout 2).

 **TIP:** Reverse the removal steps to install the assembly.

Figure 5-1032 Disconnect one connector and release retainer

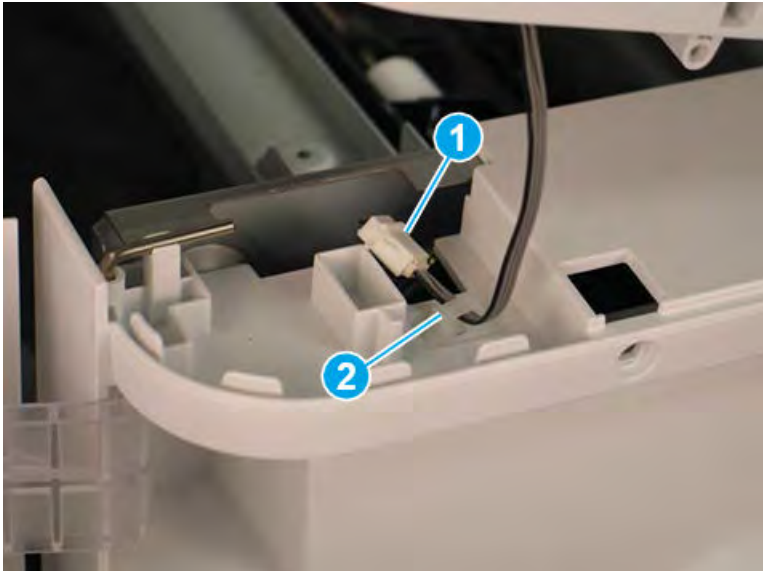

Remove the front door (finisher)

Follow these steps to remove the front door (finisher).

1. Lift the top hinge pin up to release it from the retainer.

Figure 5-1033 Lift the top hinge pin

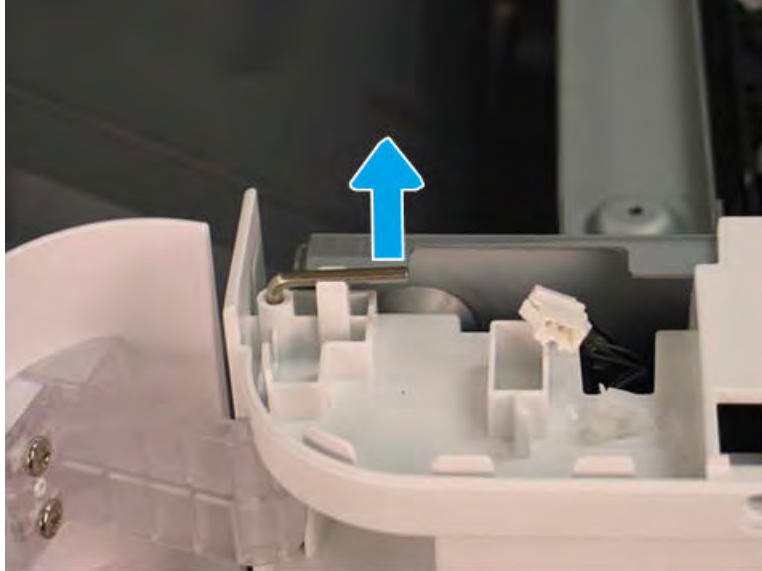

2. Pull the top hinge pin up to remove it.

Figure 5-1034 Remove the top hinge pin

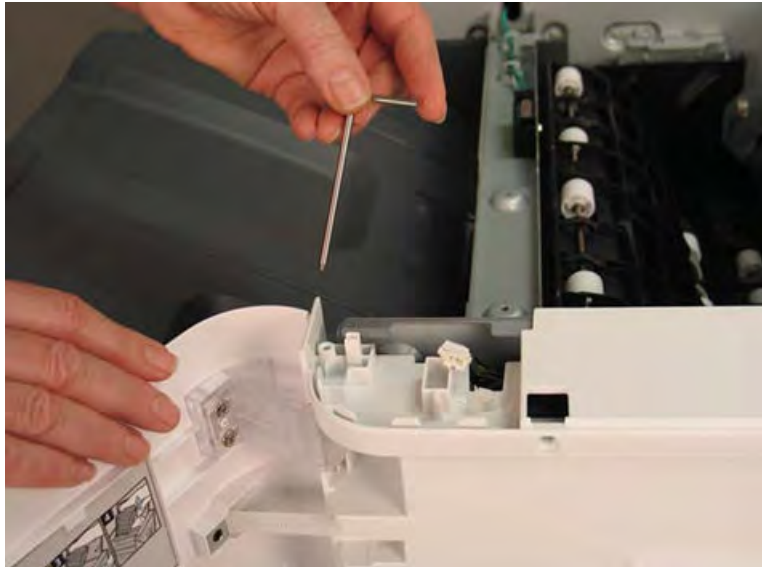

3. Use a small, flat-blade screwdriver to release the lower hinge pin from the retainer, and then rotate it away from the finisher.

Figure 5-1035 Release the lower hinge pin



4. Support the door with one hand, and then pull the lower hinge pin straight up to remove it.

Figure 5-1036 Remove the lower hinge pin



5. Support the door with one hand, and then remove one screw (callout 1) to release the strap. Remove the front door.

 **TIP:** Reverse the removal steps to install the assembly.

Figure 5-1037 Remove the front door



Remove the front cover (finisher)

Follow these steps to remove the front cover (finisher).

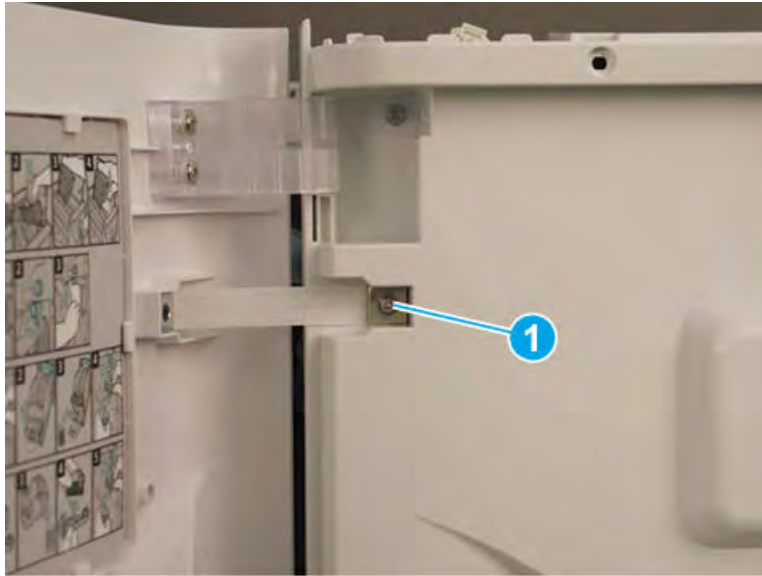
1. Release one tab (callout 1), and then pull the jam-access knob away from the finisher to remove it.

Figure 5-1038 Remove the jam-access knob

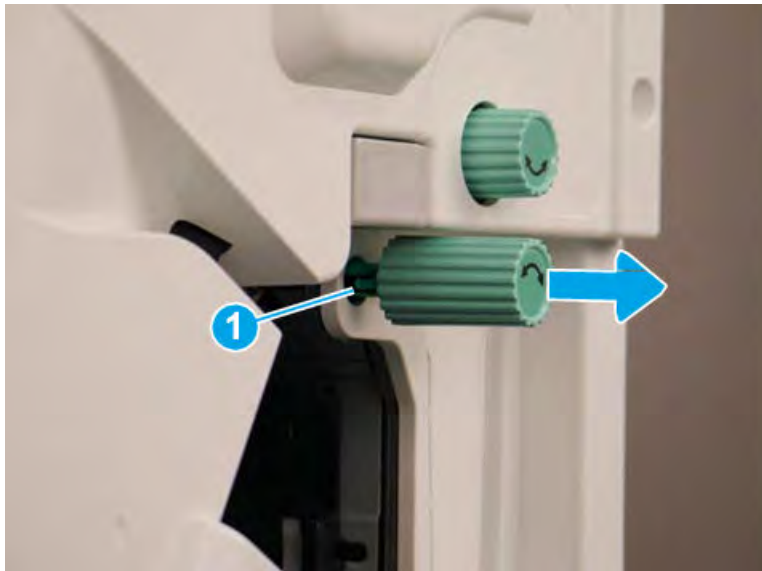

2. If the punch unit is installed, remove the punch waste bin (callout 1).

3. Remove one screw (callout 1) on top of the front cover.

Figure 5-1039 Remove one screw



4. Remove five machine screws (callout 1), and then remove the front cover.

 **TIP:** Reverse the removal steps to install the assembly.

Figure 5-1040 Remove the front cover



Remove the rear cover (finisher)

Follow these steps to remove the rear cover (finisher).

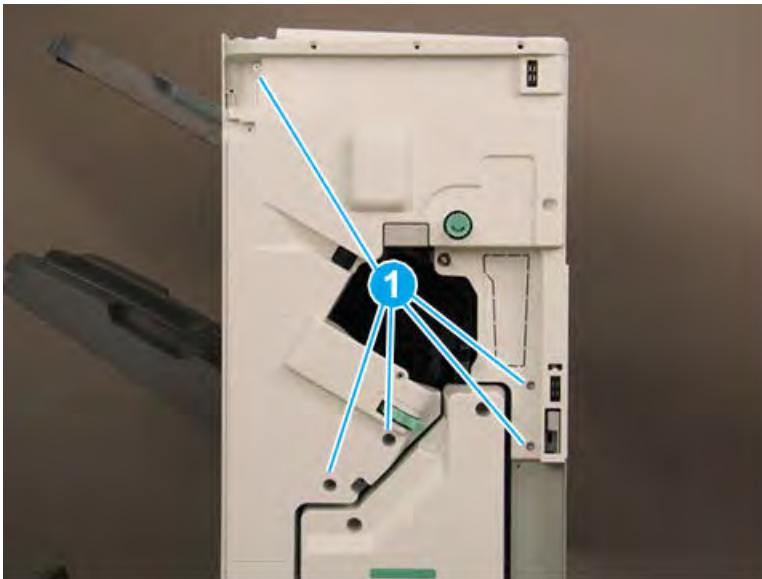
1. Remove two self-tapping screws (callout 1) on the top of the rear cover, and then remove five screw caps and five machine screws (callout 2) on the left side of the cover.

Figure 5-1041 Remove seven screws

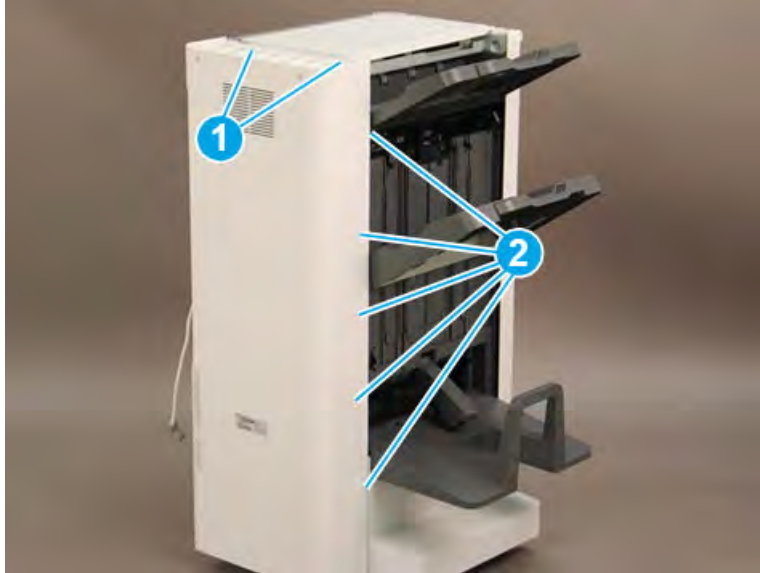

2. Remove one screw cap and four machine screws (callout 1) Remove the rear cover.

 **NOTE:** Make sure to thread the power cable (callout 2) through the opening in the cover.

 **TIP:** Reverse the removal steps to install the assembly

Figure 5-1042 Remove the rear cover



Remove the booklet output tray

Follow these steps to remove the booklet output tray.

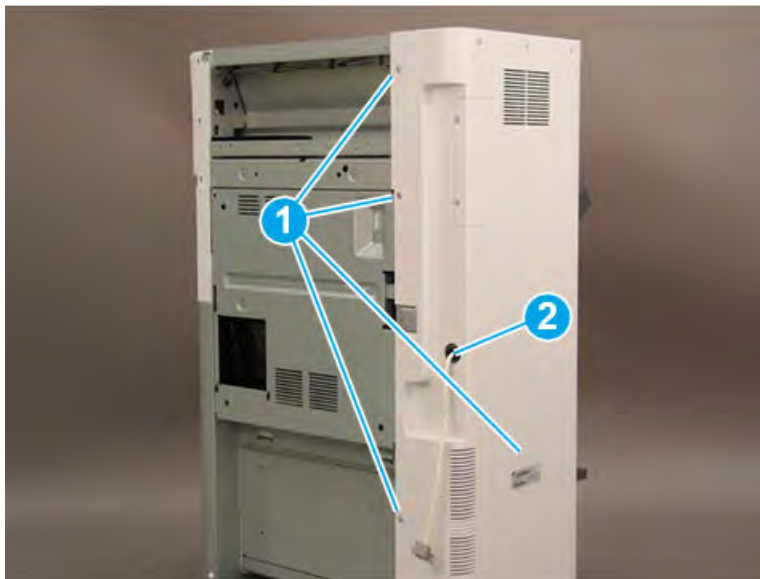
1. Raise the booklet output tray up (callout 1), and then pull it away from the finisher (callout 2) to remove it.

Figure 5-1043 Remove the booklet output tray



2. Reverse the removal steps to install the assembly. Also use the following special installation instructions.

 **NOTE:** Continue to reverse the removal steps to finish installing the assembly

Special installation instructions: booklet output tray

Position the tabs (callout 1) on the tray into the slots (callout 2) on the finisher.

Figure 5-1044 Install the booklet output tray

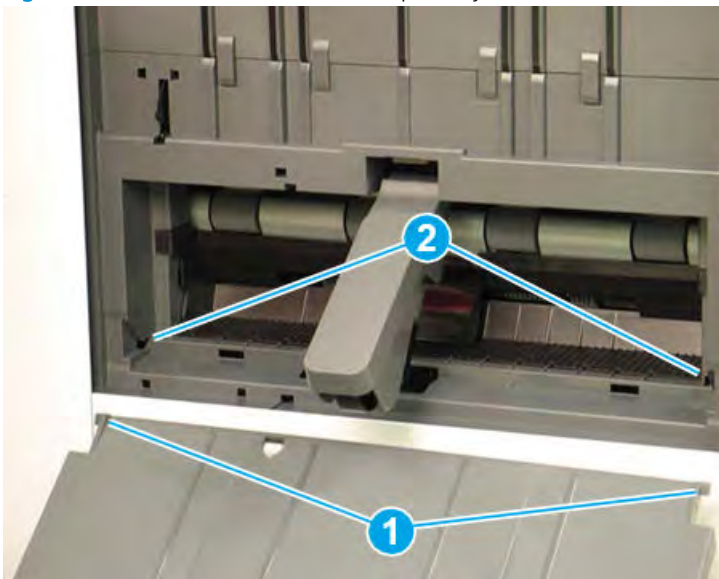

Remove the caster cover

Follow these steps to remove the caster cover.

1. Remove two screw caps and two self-tapping screws (callout 1). Remove two screw caps and two machine screws (callout 2).

Figure 5-1045 Remove four screws

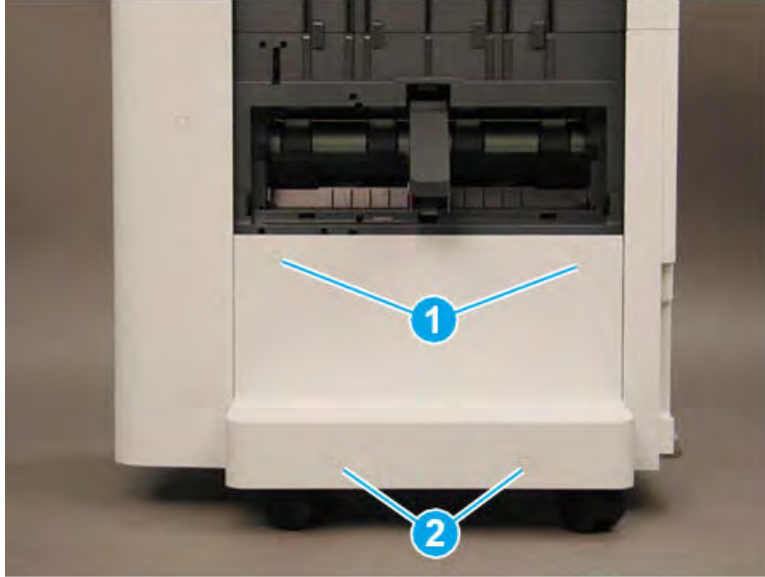

2. Rotate the left edge of the cover away from the finisher (callout 1), and then slide the cover to the left (callout 2) to remove it.

 **TIP:** Make sure that two tabs (callout 3) are positioned under the front lower cover when reinstalling the caster cover.

TIP: Reverse the removal steps to install the assembly

Figure 5-1046 Remove the caster cover

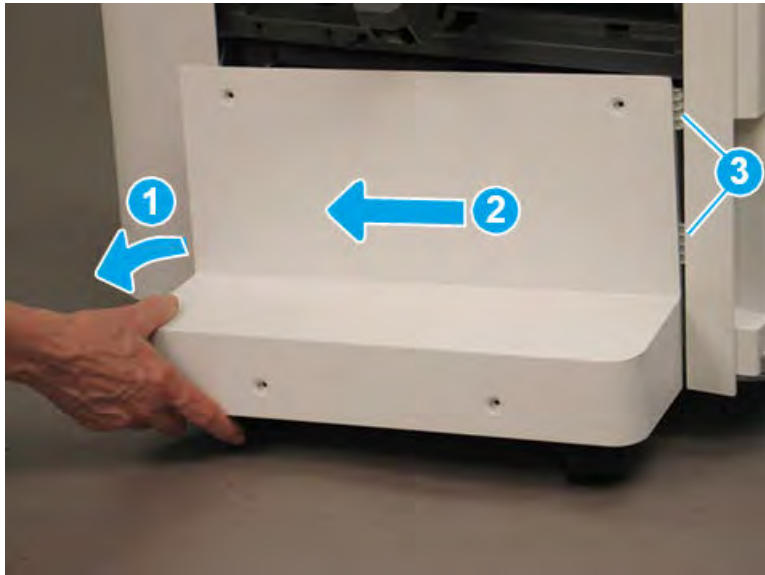

Remove the left lower cover (finisher)

Follow these steps to remove the left lower cover (finisher).

1. Remove four screws (callout 1).

 **NOTE:** Raise the lower output tray as needed to access the screws.

Figure 5-1047 Remove four screws



2. Slide the shield down (callout 1) to release it from four tabs (callout 2), and then rotate it away from the finisher (callout 3).

⚠ CAUTION: The shield is still attached to the finisher. Do not attempt to completely remove the shield.

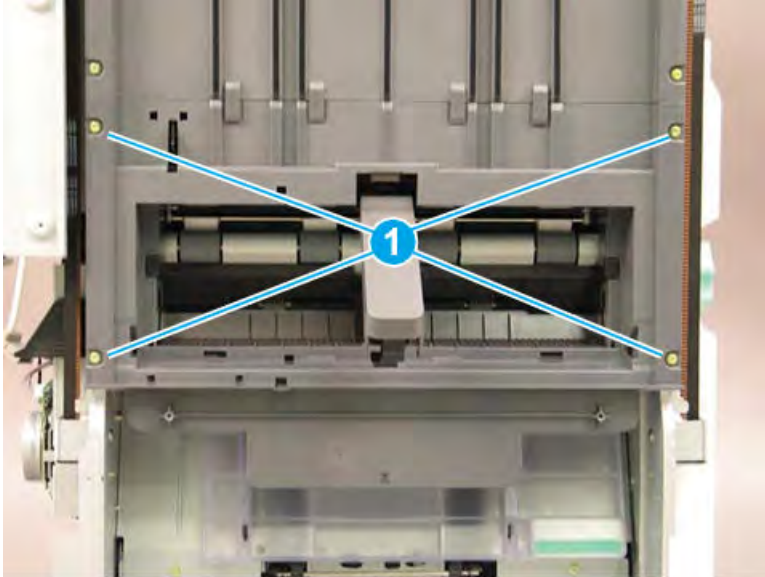
💡 TIP: Position the shield under the four tabs (callout 2) when reinstalling it.

Figure 5-1048 Release the lower shield

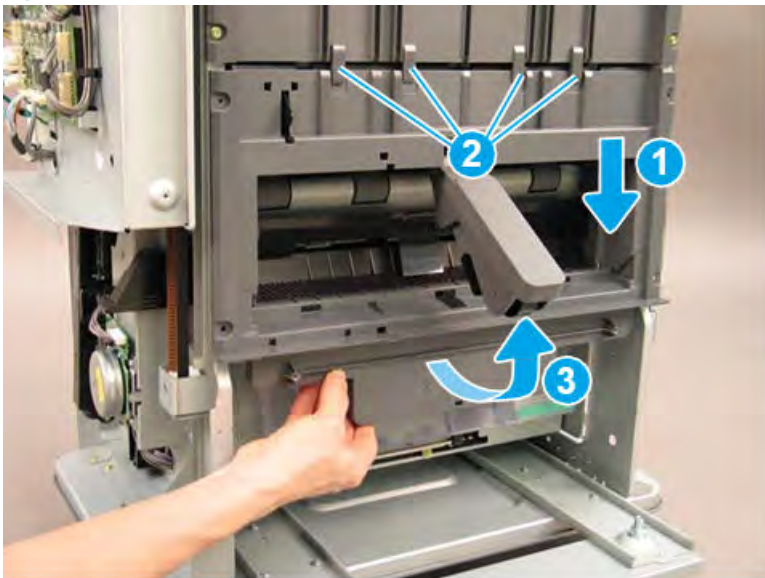

3. Disconnect two connectors (callout 1), and then remove the shield.

 **TIP:** Reverse the removal steps to install the assembly.

Figure 5-1049 Disconnect two connectors

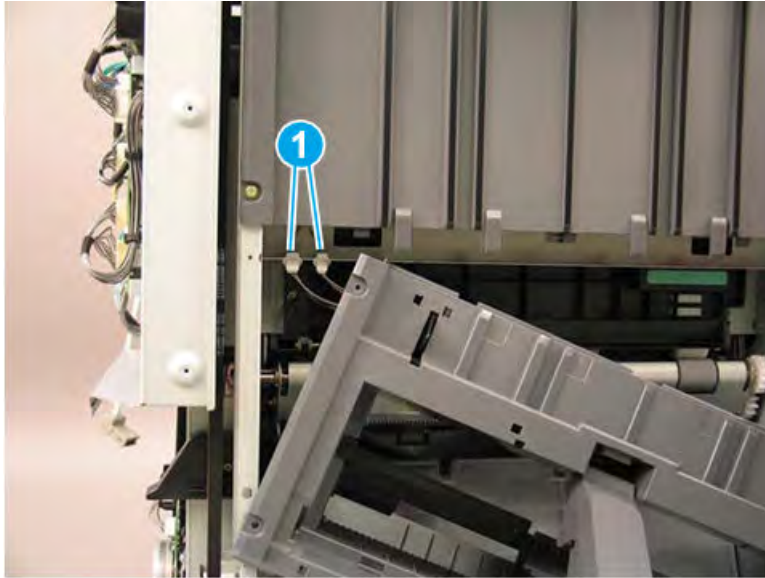

4. If you are replacing the left lower cover, locate three sensors (callout 1) on the back of the left lower cover. Remove these sensors and transfer them to the replacement part.

Figure 5-1050 Remove the left lower cover

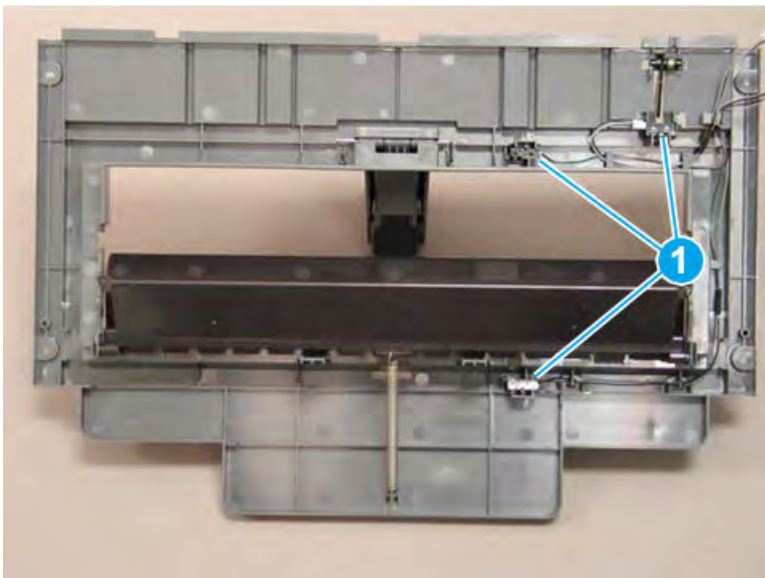

Remove the left upper cover (finisher)

Follow these steps to remove the left upper cover (finisher).

1. Bring the lower output tray down by positioning the shaft of a screwdriver on the clutch (callout 1) and gently pressing to the right to release the clutch. Hold the clutch in the released position and lower the tray (callout 2) to the lowest position.

Figure 5-1051 Lower the output tray

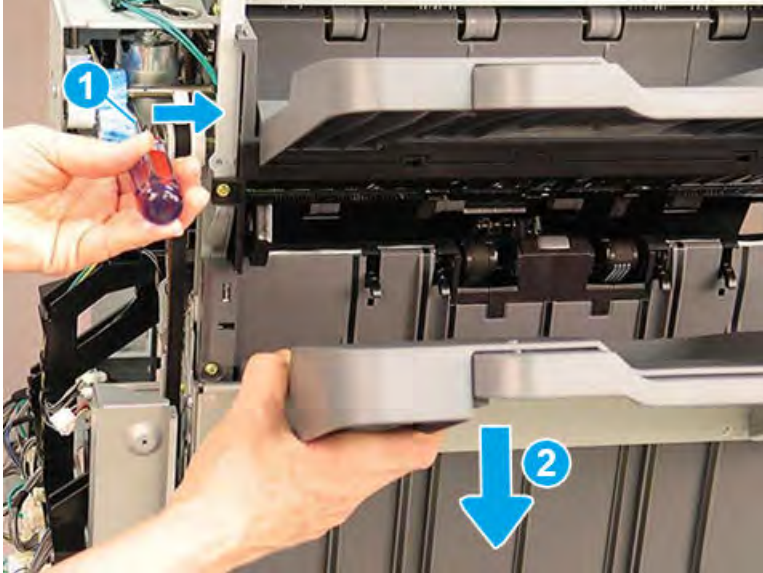

2. Remove six machine screws (callout 1).

Figure 5-1052 Remove six screws

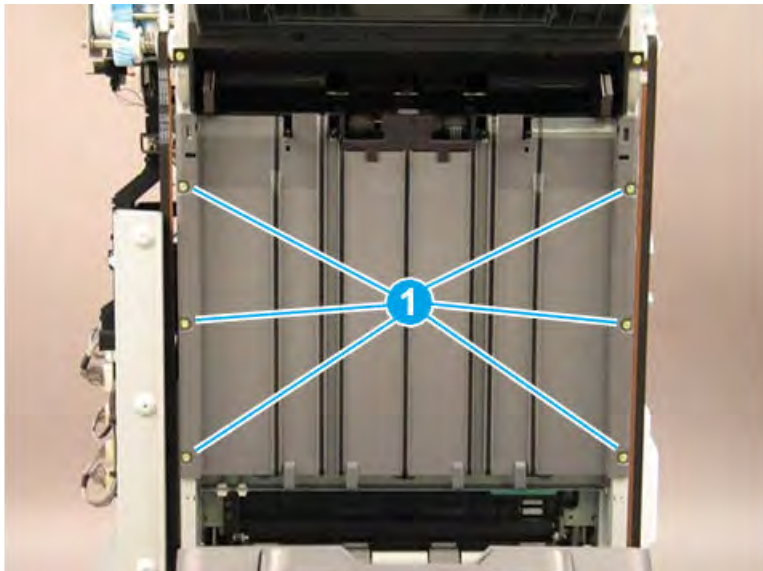

3. Rotate the lower edge of the shield away from the finisher (callout 1), and then slide the shield down (callout 2) to release it from two tabs (callout 3).

CAUTION: The shield is still attached to the finisher. Do not attempt to completely remove the shield.

TIP: Position the shield under the two tabs (callout 3) when reinstalling it.

Figure 5-1053 Release the shield

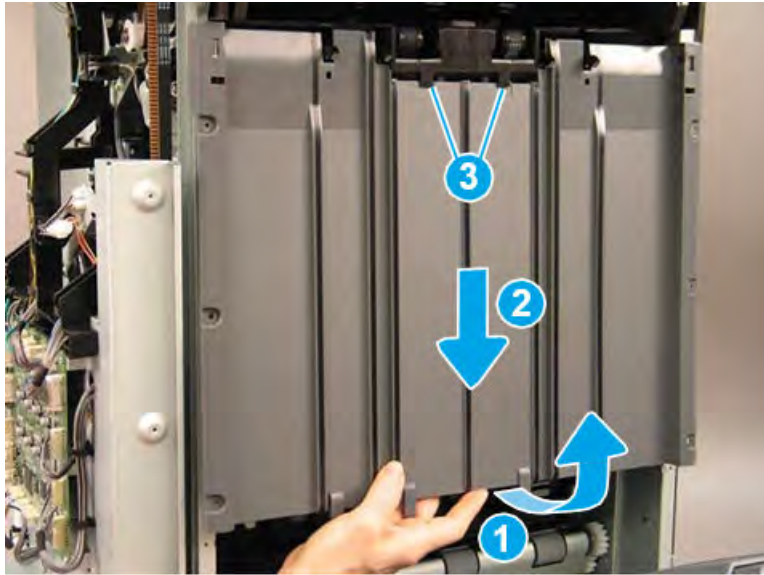

4. Disconnect one connector (callout 1), and then remove the upper shield assembly.

TIP: Reverse the removal steps to install the assembly.

Figure 5-1054 Disconnect one connector

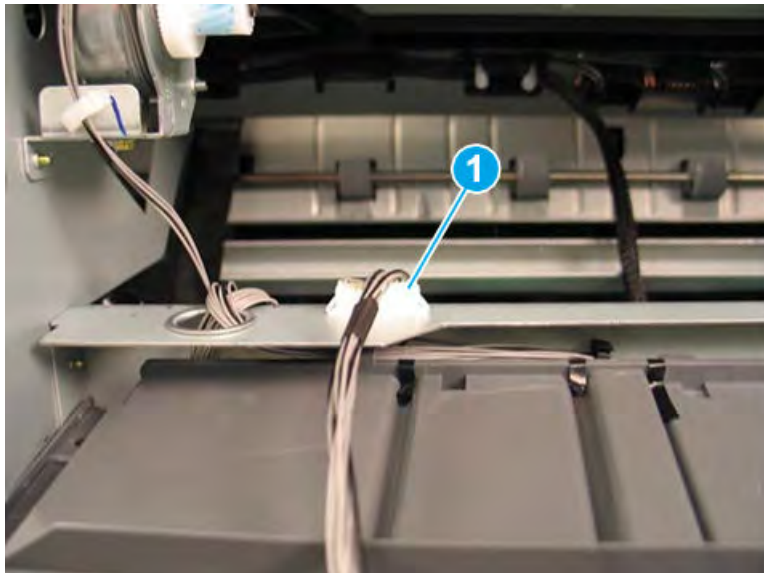

5. If you are replacing the left upper cover, locate three sensors (callout 1) on the back of the left upper cover. Remove these sensors and transfer them to the replacement part.

Figure 5-1055 Remove the left upper cover

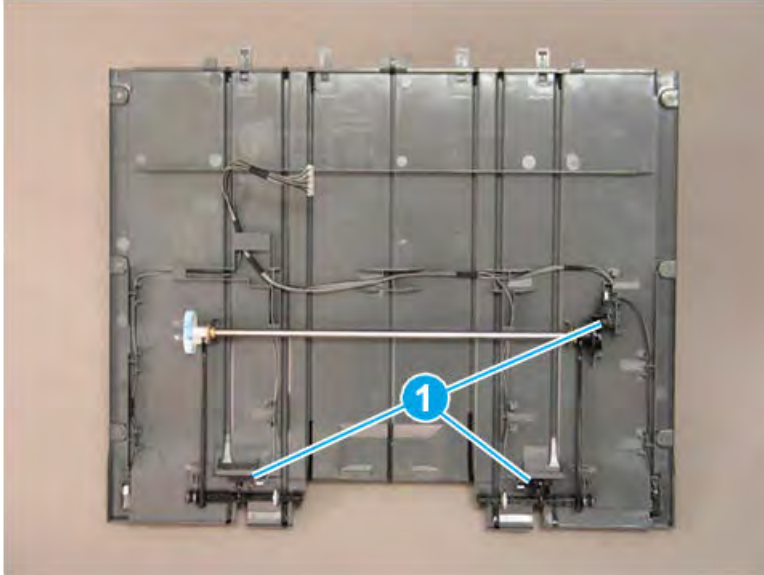

Remove the ejector unit (finisher)

Follow these steps to remove the ejector unit (finisher).

1. Rotate the green wheel to move the staple unit to the center of the finisher.

Figure 5-1056 Move the staple unit to the center

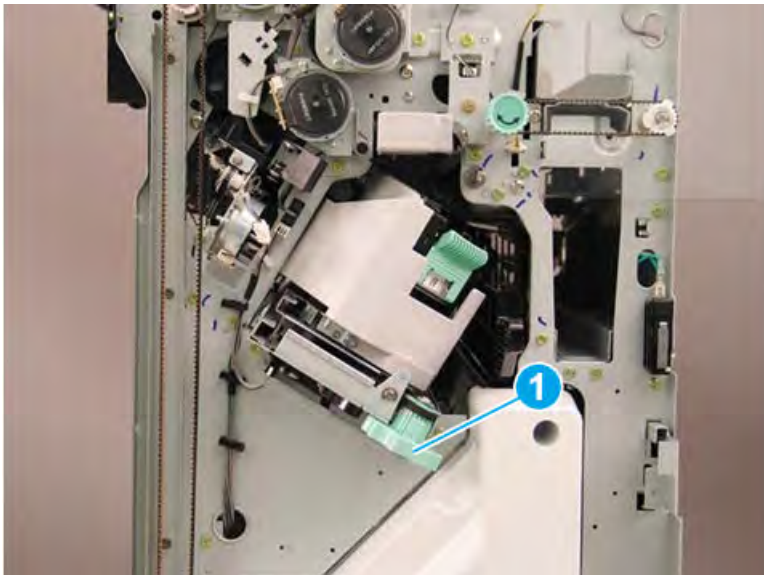

2. Release one retainer (callout 1), and then disconnect three connectors (callout 2).

Figure 5-1057 Disconnect three connectors

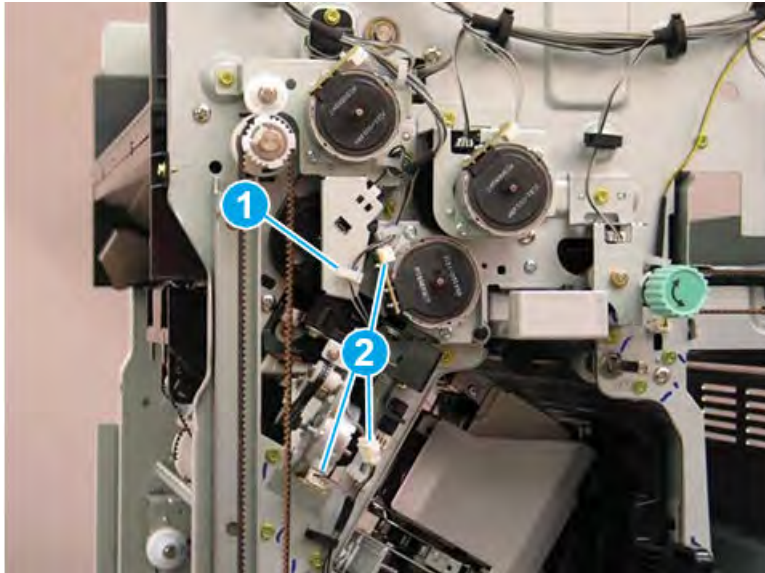

3. Remove two screws (callout 1).

Figure 5-1058 Remove two screws

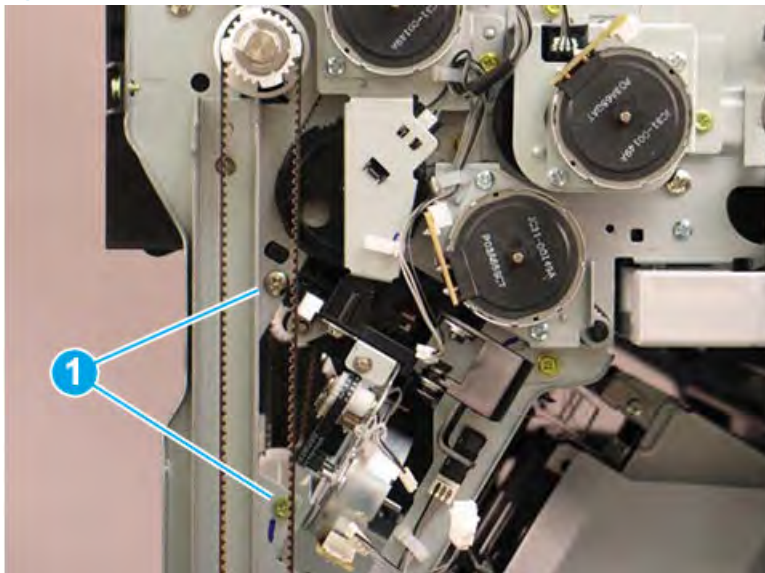

4. At the left side of the finisher, remove one screw (callout 1).

Figure 5-1059 Remove one screw

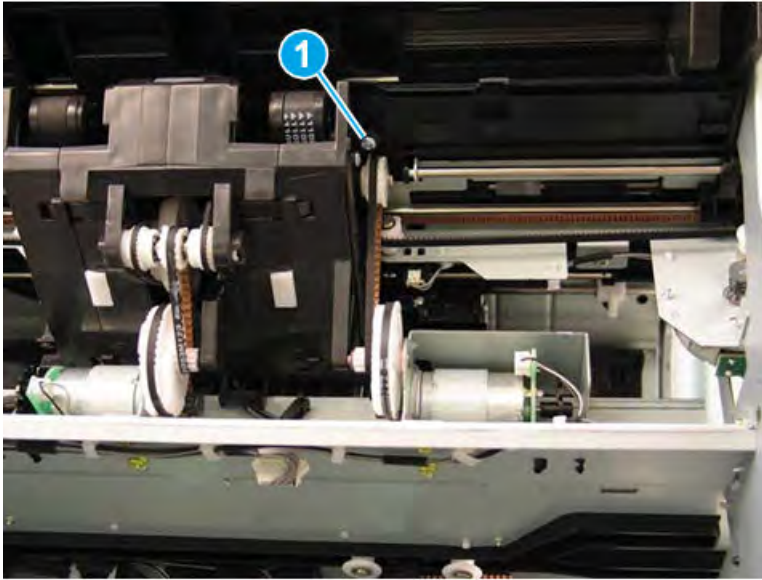

5. Press up on the hinge (callout 1), release one tab (callout 2), and then rotate the sensor away from the finisher (callout 3).

Figure 5-1060 Rotate the sensor

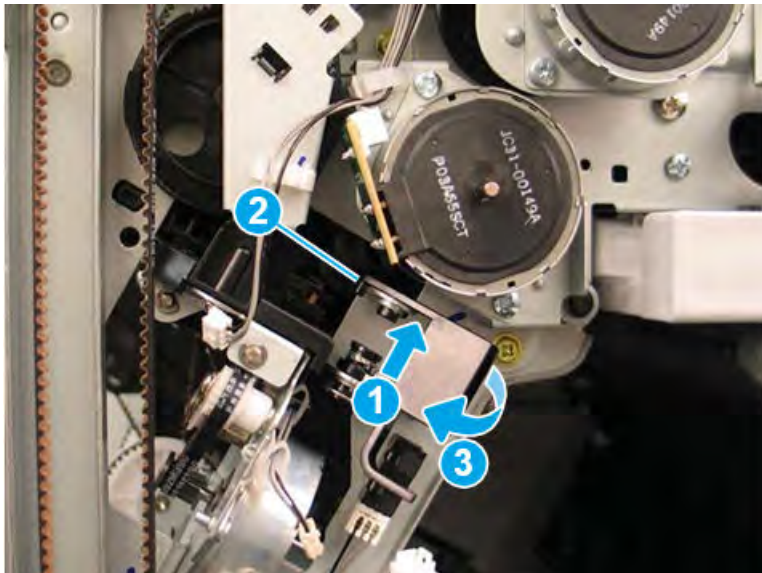

6. Remove one screw (callout 1).

Figure 5-1061 Remove one screw

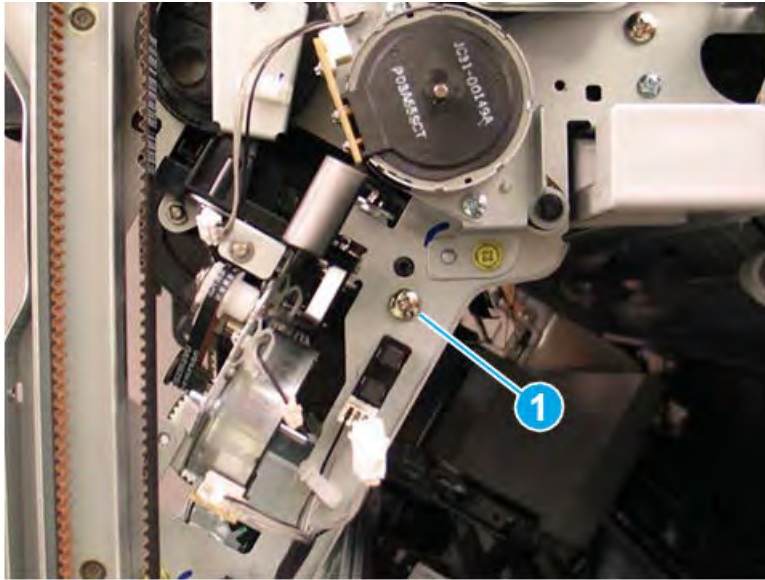

7. Look inside the finisher through the stapler opening in the front and pull down to release and remove one shaft (callout 1) on the front tamper unit.

Figure 5-1062 Remove the front tamper shaft

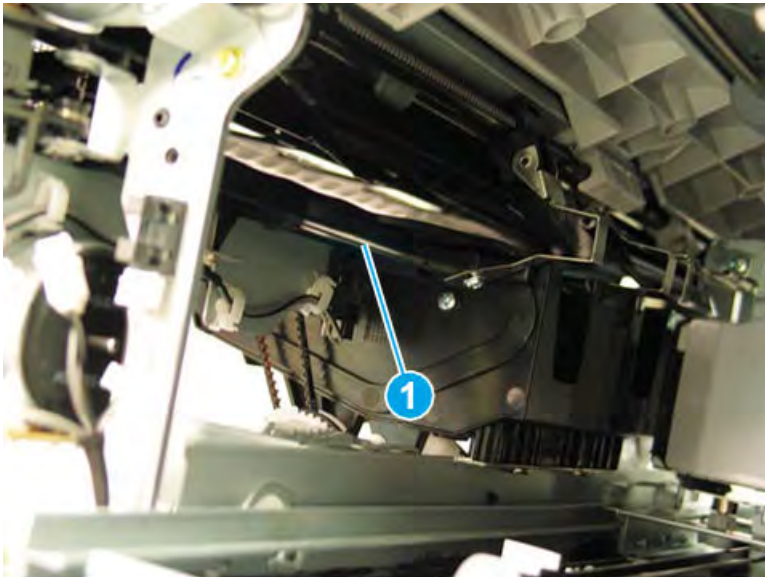

8. At the rear of the finisher, disconnect two connectors (callout 1), and then remove three screws (callout 2).

Figure 5-1063 Disconnect two connectors and remove three screws

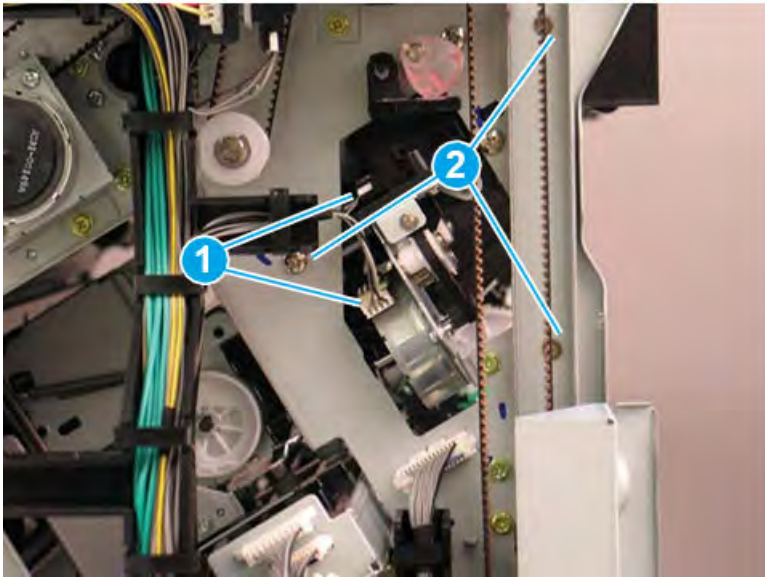

9. At the left side of the finisher, remove one screw (callout 1).

Figure 5-1064 Remove one screw

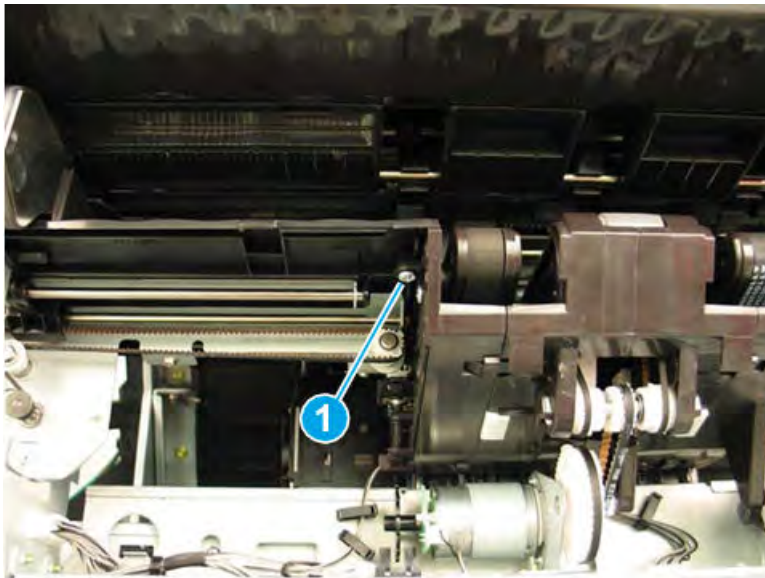

10. Look inside the finisher through the stapler opening in the rear and pull down to release and remove one shaft (callout 1) on the rear tamper unit.

Figure 5-1065 Remove the rear tamper shaft

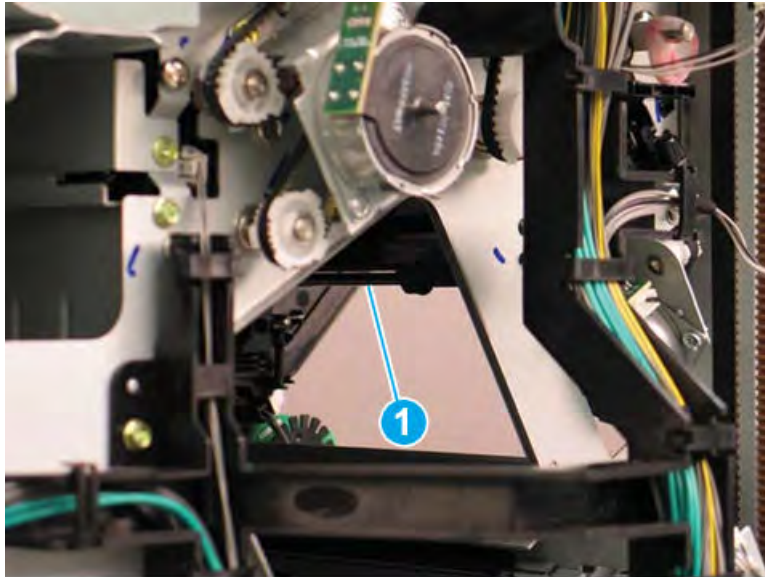

11. At the left side of the finisher, disconnect one connector (callout 1).

Figure 5-1066 Disconnect one connector

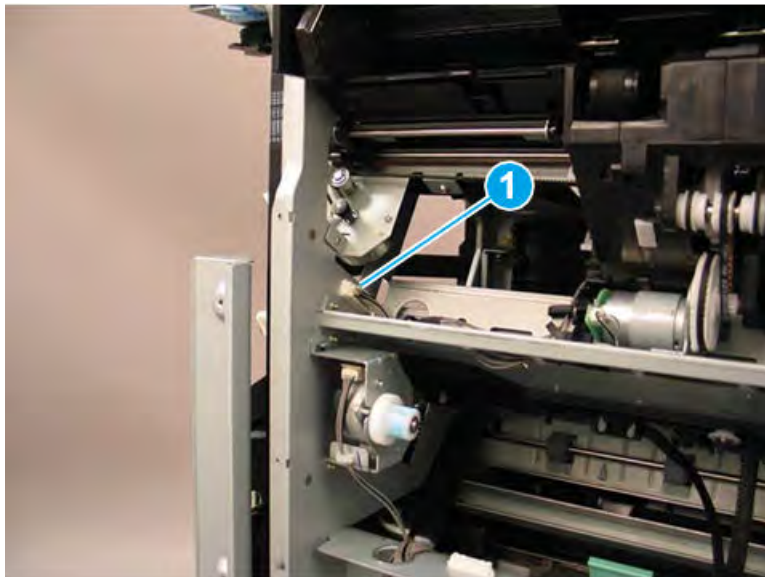

12. At the rear of the finisher, disconnect one connector (callout 1).

Figure 5-1067 Disconnect one connector

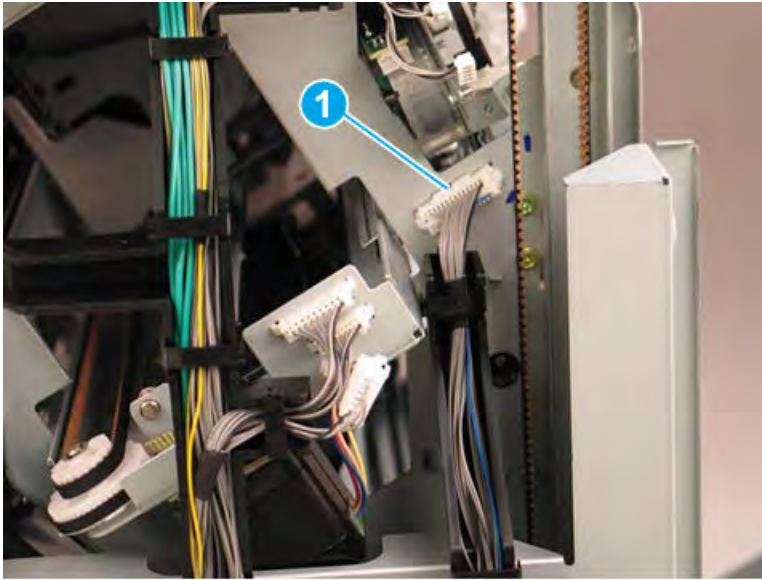

13. At the rear of the finisher, press the wire retainer to the right to access and remove two screws (callout 1).

Figure 5-1068 Disconnect one connector

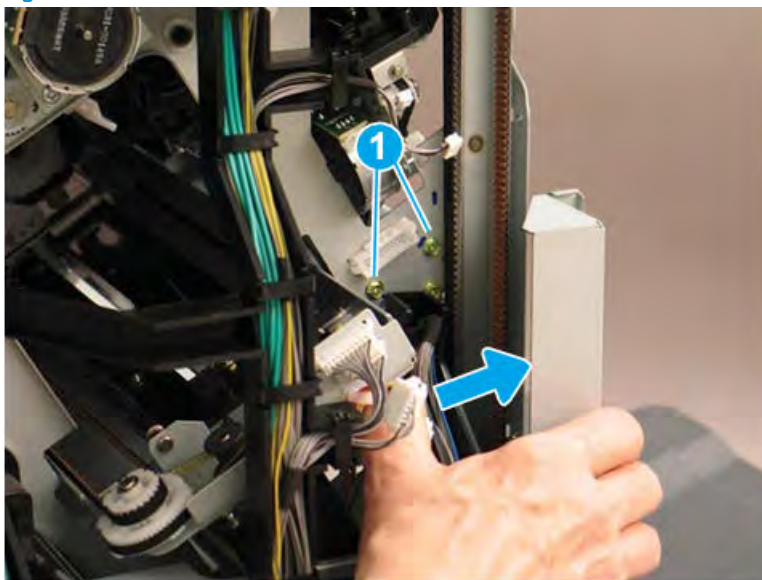

14. At the front of the finisher, remove two screws (callout 1).

Figure 5-1069 Remove two screws

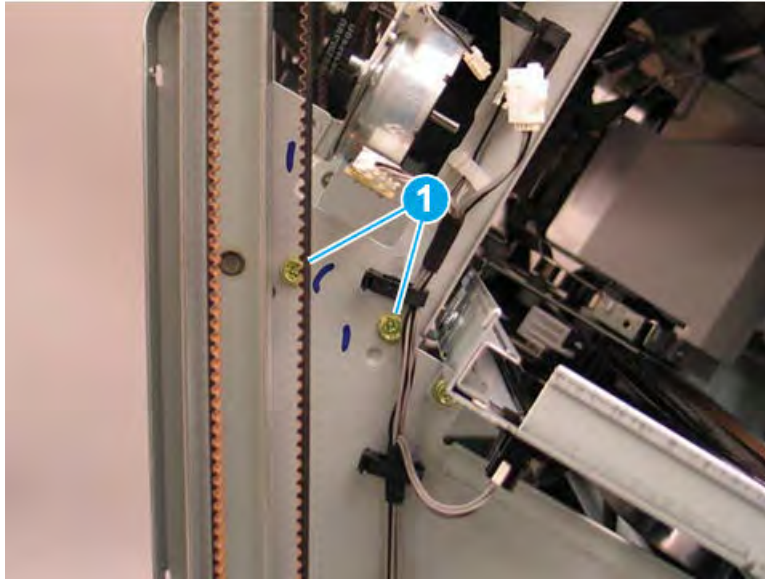

15. Lift the inside edges of the front and rear tampers up.

Figure 5-1070 Lift the edges of the tampers

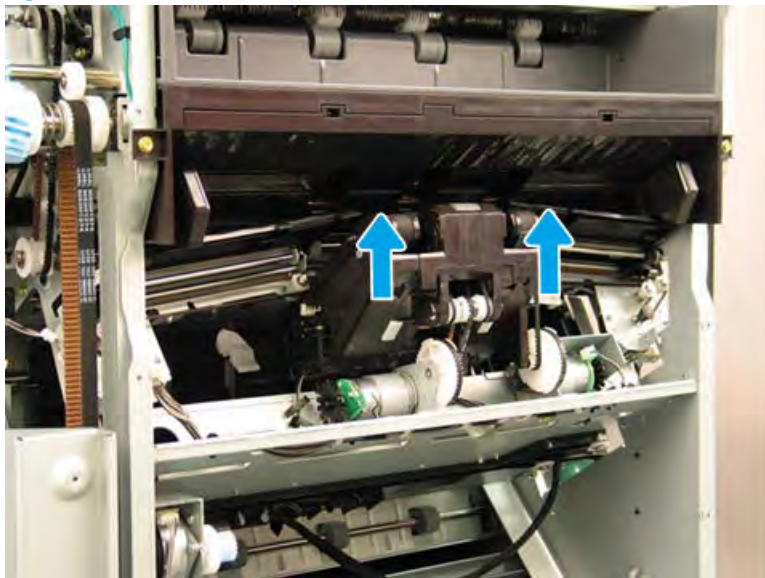

16. Rotate the rear edge of the ejector unit away from the finisher (callout 1), and then slide it toward the rear of the finisher (callout 2) to remove it. Make sure that the PCA (callout 3) stays clear of the sheet metal frame.

Figure 5-1071 Remove the ejector unit

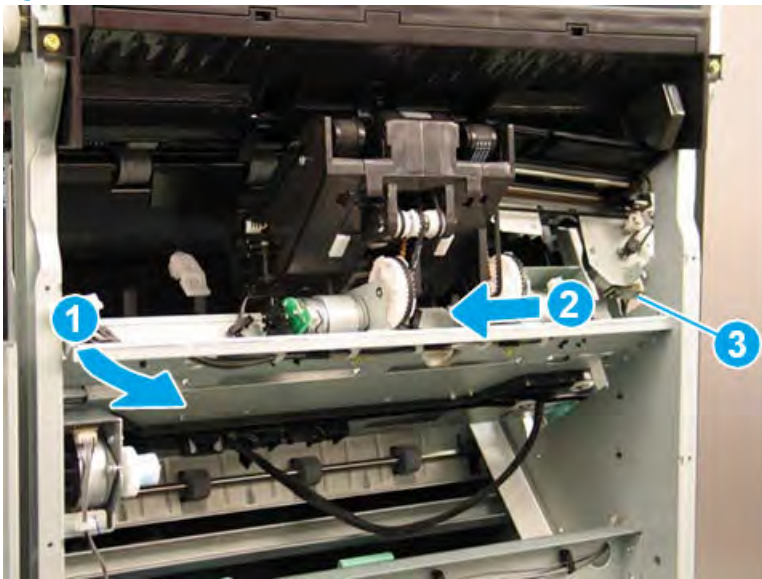

17. Reverse the removal steps to install the assembly. Also use the following special installation instructions.

 **NOTE:** Continue to reverse the removal steps to finish installing the assembly.

Special installation instructions: Ejector unit

- a. When the front tamper shaft is removed, the retainer arm that held the one end of the shaft will drop down. When reinstalling the shaft, raise the retainer arm and position the end of the shaft in the notch (callout 1).

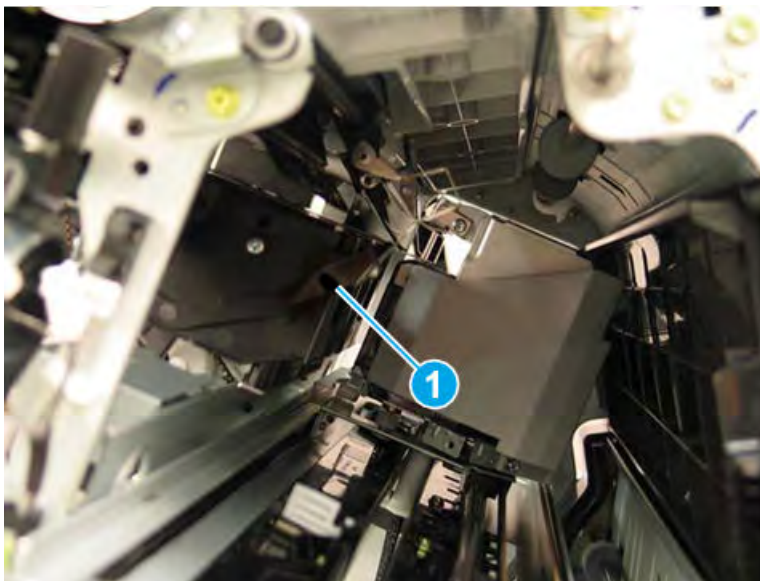

- b. When the rear tamper shaft is removed, the retainer arm that held the one end of the shaft will drop down. When reinstalling the shaft, raise the retainer arm and position the end of the shaft in the notch (callout 1).

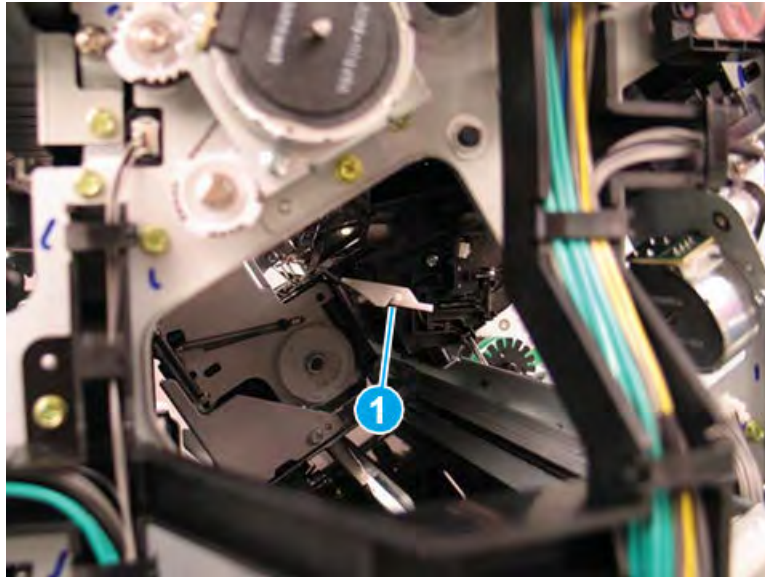

Remove the ejector1 motor(M6)

Follow these steps to remove the ejector1 motor(M6).

1. Disconnect the connector(callout 1) from ejector1 motor(M6, callout 2) of ejector unit.

Figure 5-1072 Disconnect the connector

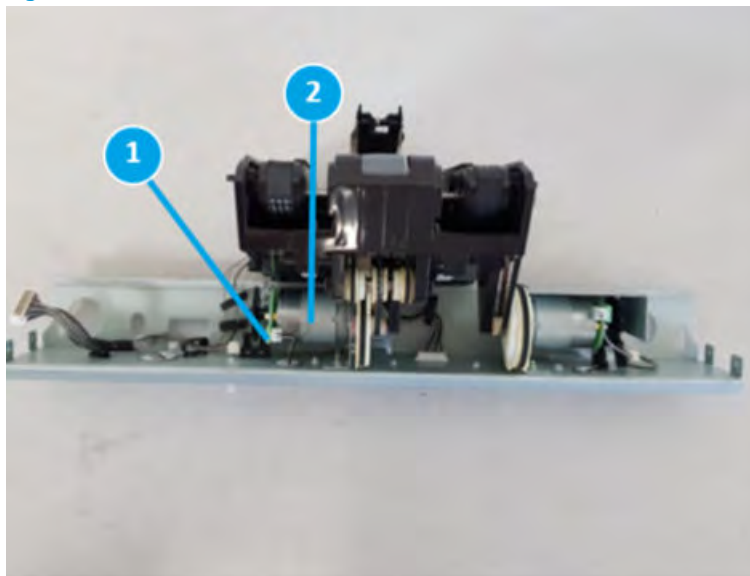

2. Remove two screws(callout 1).

Figure 5-1073 Remove two screws

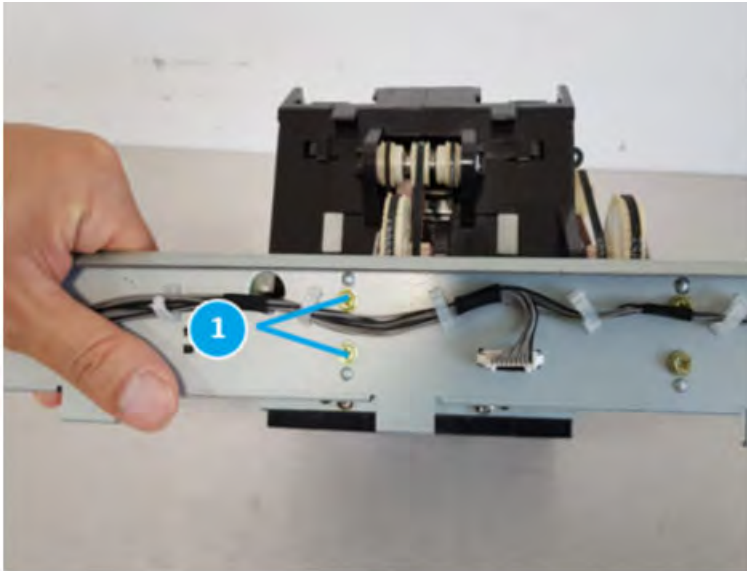

3. Remove the ejector1 motor from ejector unit and remove two screws(callout 1)

Figure 5-1074 Remove the ejector1 motor

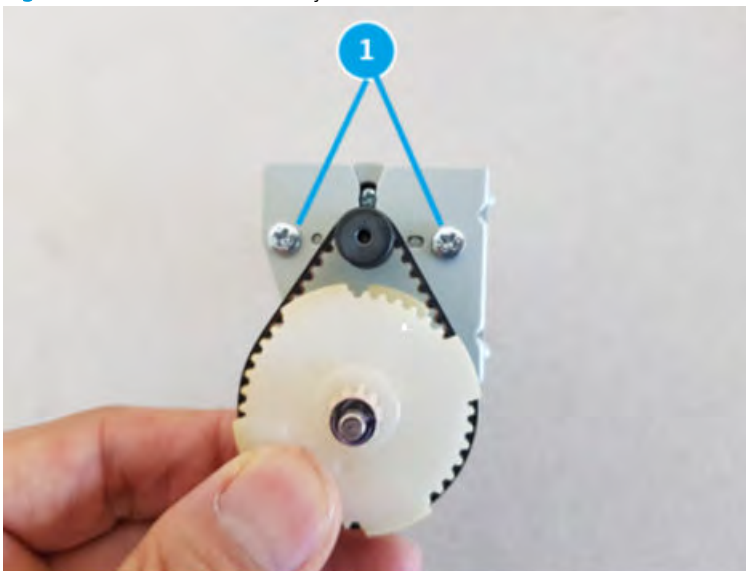

Unpack the replacement assembly

Follow these steps to unpack the replacement assembly.

1. Dispose of the defective part.

 **NOTE:** HP recommends responsible disposal of the defective part.

<http://www8.hp.com/us/en/hp-information/environment/product-recycling.html>

2. Unpack the replacement part from the packaging.



CAUTION:  Some parts are sensitive to electrostatic discharge (ESD). Always perform service work at an ESD-protected workstation or mat. If an ESD workstation or mat is not available, touch the sheet-metal chassis to provide a static ground before touching an ESD-sensitive assembly. Protect the ESD-sensitive assemblies by placing them in ESD pouches when they are out of the printer.

 **IMPORTANT:** Make sure that all of the shipping materials (for example shipping tape) are removed from the replacement part prior to installation.

 **NOTE:** If the replacement part is a roller or pad, avoid touching the spongy part of it. Skin oils on the roller or pad can cause paper pickup and/or print-quality problems. HP recommends using disposable gloves when handling rollers or pads or washing your hands before touching rollers or pads.

3. To install an assembly, reverse the removal steps.

 **NOTE:** When applicable, special installation instructions are provided for an assembly at the end of the removal procedure. Always completely read the removal instructions and follow all special installation instructions.

Ejector2 unit

Removal and replacement: Ejector2 home sensor (S32)

Learn how to remove and replace the ejector2 home sensor.

Introduction

This document provides the procedures to remove and replace the ejector2 home sensor on the finisher.

 **IMPORTANT:** When applicable, special installation instructions are provided for an assembly at the end of the removal procedure. Always completely read the removal instructions and follow all special installation instructions.

Before performing service

- Turn the printer power off. A shutting-down message appears on the control-panel display.
- ⚠ **WARNING!** To avoid damage to the printer, turn the power off and wait until the printer shuts down before removing the power cable.
- Disconnect the printer power cable after the printer has completely shut down (the control-panel display is blank).
- Release the finisher from the printer by pulling out on the release latch inside the finisher door.
- Disconnect the cable from the bridge unit to the finisher.
- Disconnect the cable from the finisher to the printer.

Use the table below to identify the correct part number for your printer. To order the part, go to <https://parts.hp.com>.

Table 5-129 Part information

Part number	Part description
0604-001415	Ejector2 home sensor

Required tools

- #2 JIS screwdriver with a magnetic tip
- Small, flat-blade screwdriver

After performing service

- Connect the cable from the finisher to the printer.
- Connect the cable from the bridge unit to the finisher.
- Attach the finisher to the printer, and then push in on the release latch inside the finisher door.
- Connect the printer power cable.
- Turn the printer power on.

Post service test

Process a job through the finisher and verify that the finisher works correctly.

Remove the right upper cover (finisher)

Follow these steps to remove the right upper cover (finisher).

- ▲ Remove one screw cap and three machine screws on the upper edge of the cover (callout 1). Remove three sheet metal screws (callout 2) on the lower portion of the cover. Rotate the right edge of the cover away from the finisher, and then slide the cover right to release three tabs (callout 3).

💡 **TIP:** The lower screws are shorter in length than the upper screws.

TIP: Reverse the removal steps to install the assembly.

Figure 5-1075 Remove the right upper cover

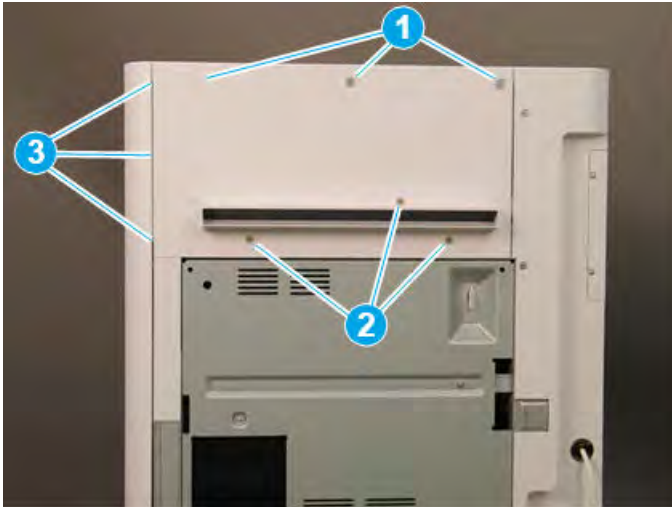

Remove the top cover (finisher)

Follow these steps to remove the top cover (finisher).

1. Remove three screw caps and three self-tapping screws at the top of the rear cover (callout 1), and then remove three machine screws (callout 2) on top of the cover.

Figure 5-1076 Remove six screws

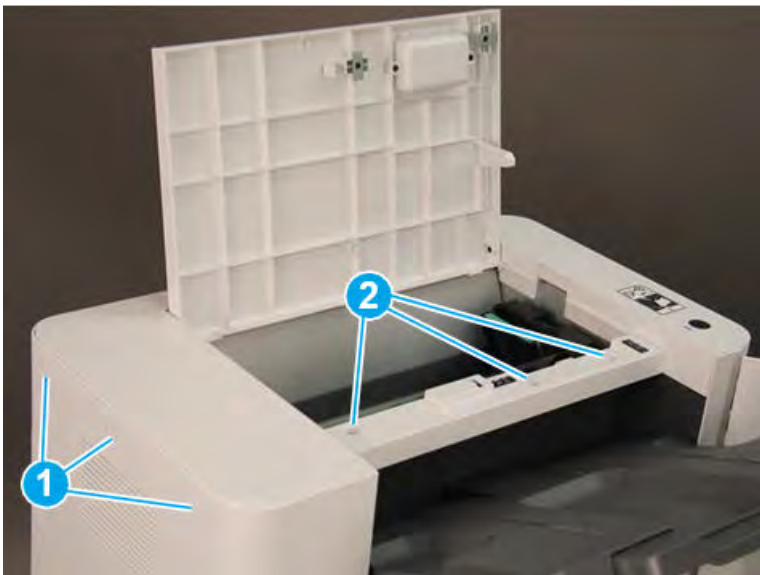

2. Remove three self-tapping screws at the top of the front cover (callout 1), and then remove two machine screws (callout 2) at the top of the right side.

Figure 5-1077 Remove five screws

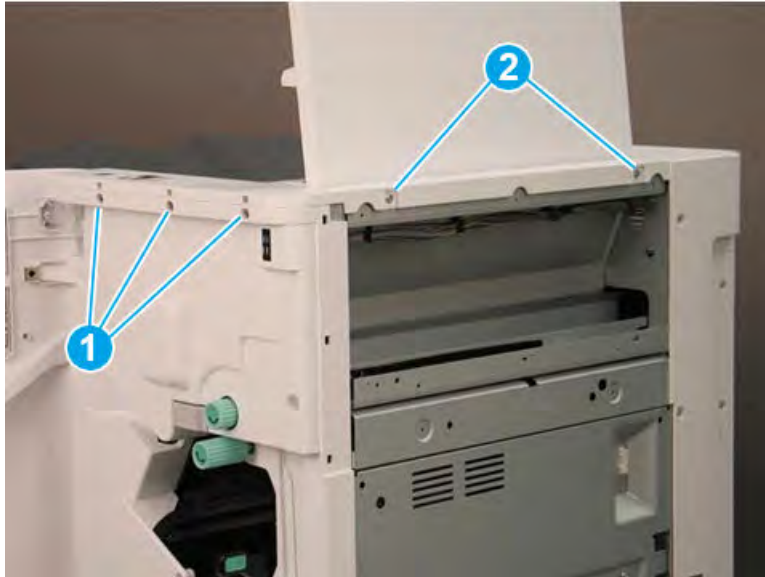

3. Lift the cover up slightly. Disconnect one in-line connector (callout 1), and then release one retainer (callout 2).

 **TIP:** Reverse the removal steps to install the assembly.

Figure 5-1078 Disconnect one connector and release retainer



Remove the front door (finisher)

Follow these steps to remove the front door (finisher).

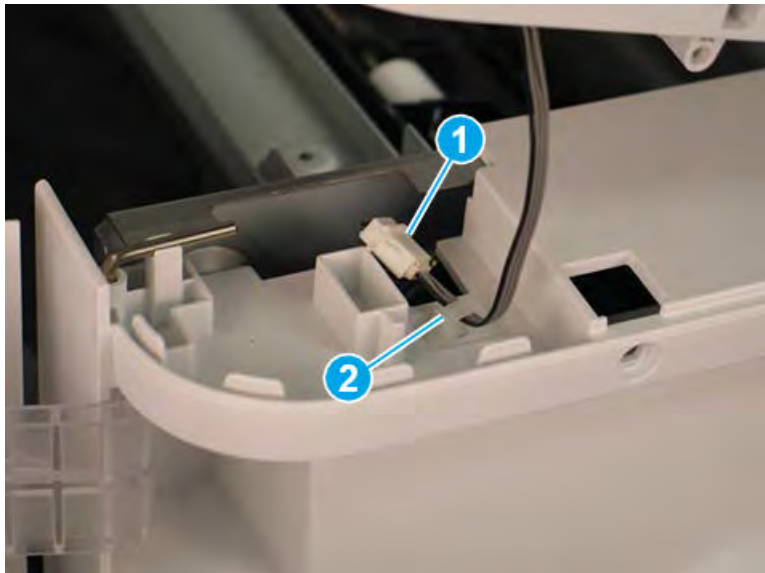
1. Lift the top hinge pin up to release it from the retainer.

Figure 5-1079 Lift the top hinge pin

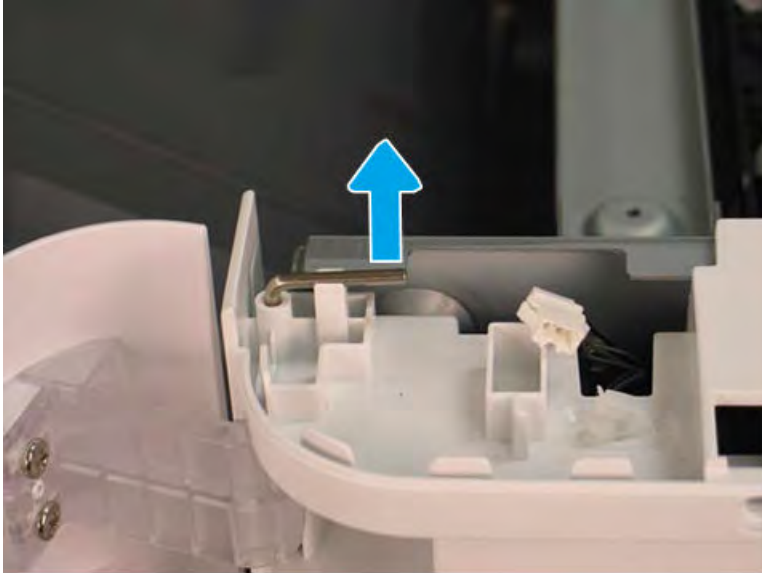

2. Pull the top hinge pin up to remove it.

Figure 5-1080 Remove the top hinge pin



3. Use a small, flat-blade screwdriver to release the lower hinge pin from the retainer, and then rotate it away from the finisher.

Figure 5-1081 Release the lower hinge pin



4. Support the door with one hand, and then pull the lower hinge pin straight up to remove it.

Figure 5-1082 Remove the lower hinge pin



5. Support the door with one hand, and then remove one screw (callout 1) to release the strap. Remove the front door.

 **TIP:** Reverse the removal steps to install the assembly.

Figure 5-1083 Remove the front door



Remove the front cover (finisher)

Follow these steps to remove the front cover (finisher).

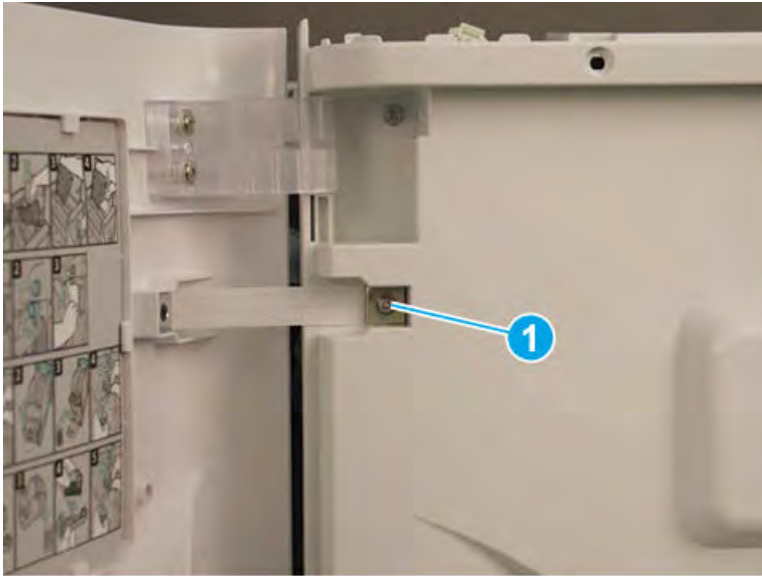
1. Release one tab (callout 1), and then pull the jam-access knob away from the finisher to remove it.

Figure 5-1084 Remove the jam-access knob

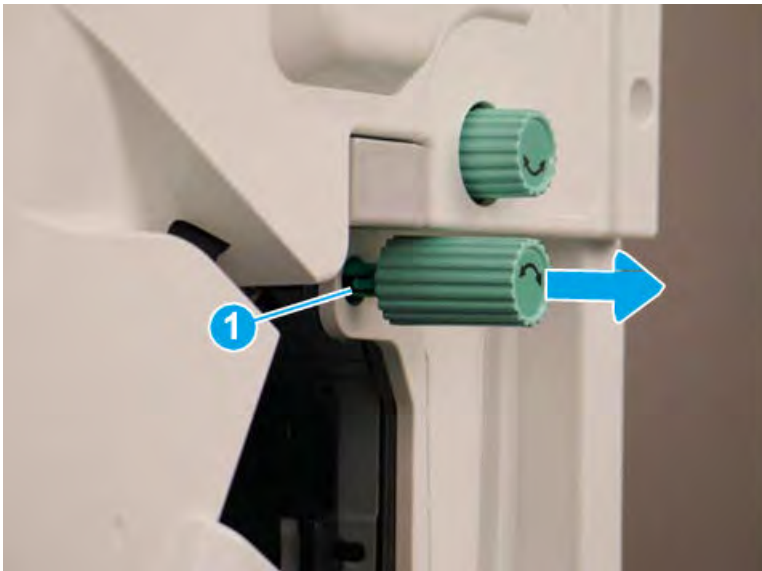

2. If the punch unit is installed, remove the punch waste bin (callout 1).

3. Remove one screw (callout 1) on top of the front cover.

Figure 5-1085 Remove one screw



4. Remove five machine screws (callout 1), and then remove the front cover.

 **TIP:** Reverse the removal steps to install the assembly.

Figure 5-1086 Remove the front cover



Remove the rear cover (finisher)

Follow these steps to remove the rear cover (finisher).

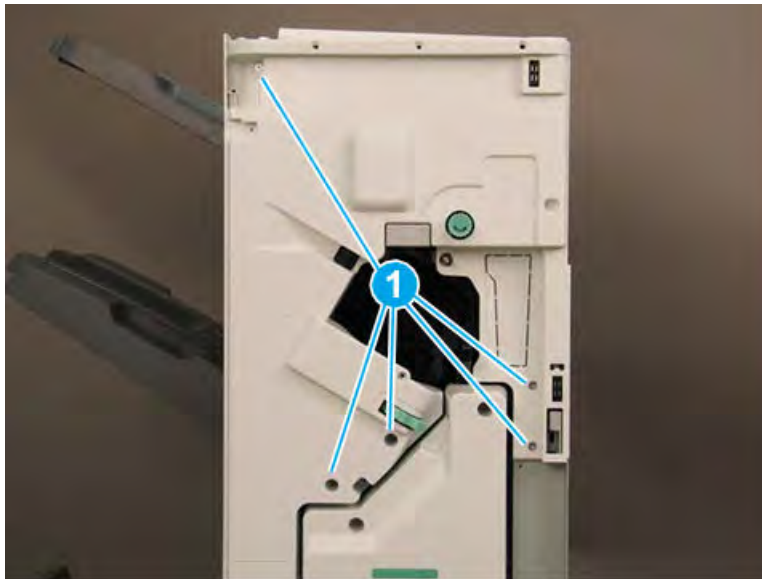
1. Remove two self-tapping screws (callout 1) on the top of the rear cover, and then remove five screw caps and five machine screws (callout 2) on the left side of the cover.

Figure 5-1087 Remove seven screws

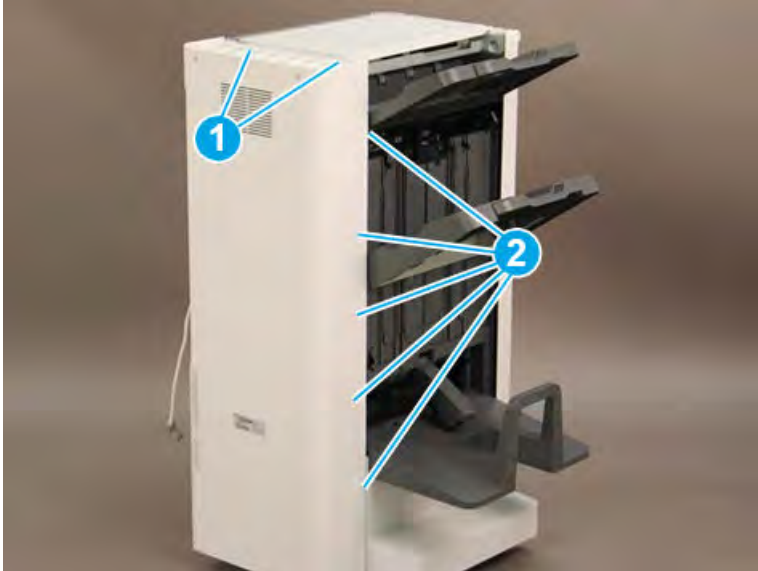

2. Remove one screw cap and four machine screws (callout 1) Remove the rear cover.

 **NOTE:** Make sure to thread the power cable (callout 2) through the opening in the cover.

 **TIP:** Reverse the removal steps to install the assembly

Figure 5-1088 Remove the rear cover



Remove the booklet output tray

Follow these steps to remove the booklet output tray.

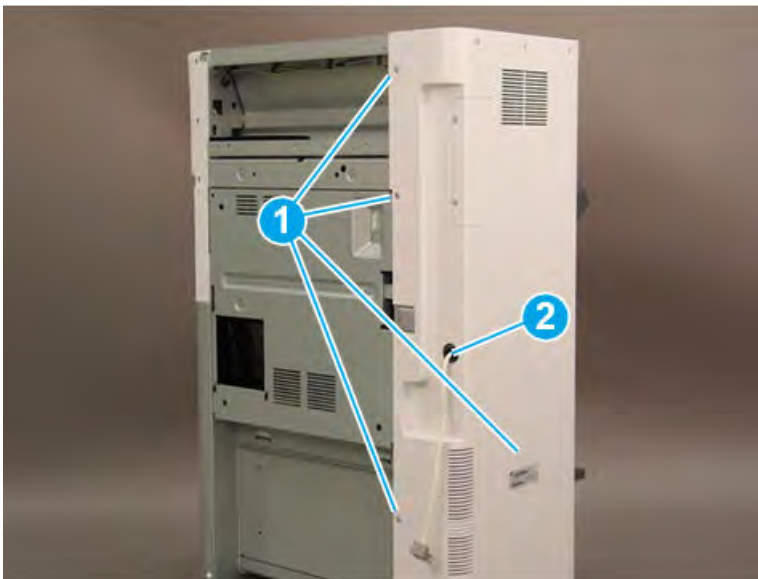
1. Raise the booklet output tray up (callout 1), and then pull it away from the finisher (callout 2) to remove it.

Figure 5-1089 Remove the booklet output tray



2. Reverse the removal steps to install the assembly. Also use the following special installation instructions.

 **NOTE:** Continue to reverse the removal steps to finish installing the assembly

Special installation instructions: booklet output tray

Position the tabs (callout 1) on the tray into the slots (callout 2) on the finisher.

Figure 5-1090 Install the booklet output tray

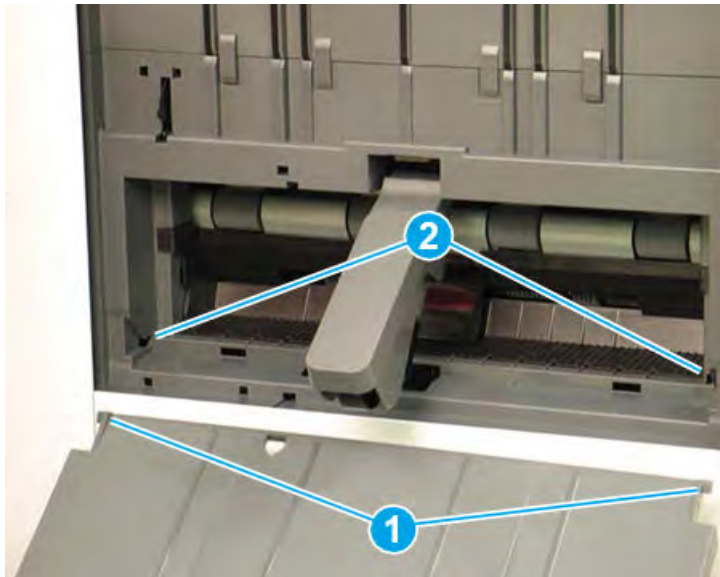

Remove the caster cover

Follow these steps to remove the caster cover.

1. Remove two screw caps and two self-tapping screws (callout 1). Remove two screw caps and two machine screws (callout 2).

Figure 5-1091 Remove four screws

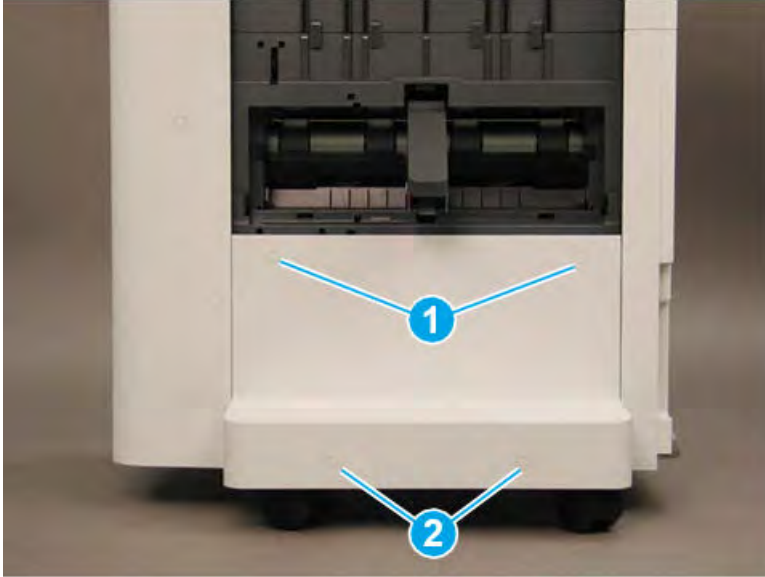

2. Rotate the left edge of the cover away from the finisher (callout 1), and then slide the cover to the left (callout 2) to remove it.

 **TIP:** Make sure that two tabs (callout 3) are positioned under the front lower cover when reinstalling the caster cover.

TIP: Reverse the removal steps to install the assembly

Figure 5-1092 Remove the caster cover

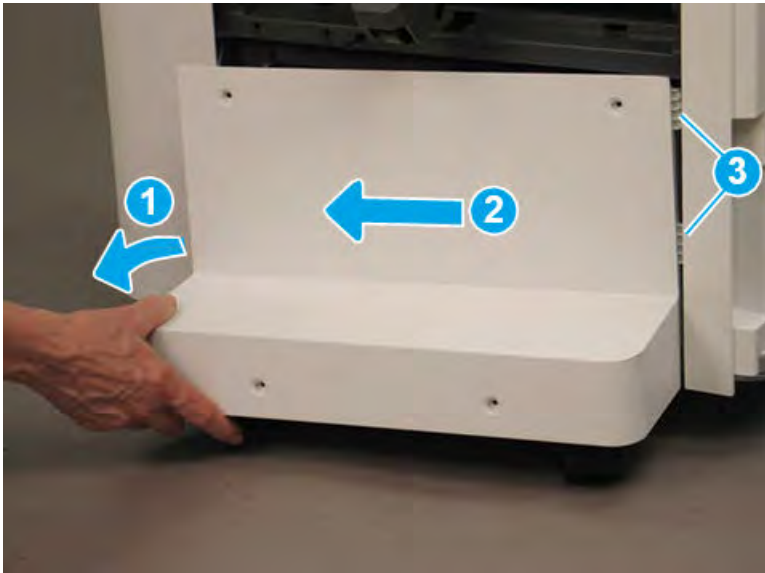

Remove the left lower cover (finisher)

Follow these steps to remove the left lower cover (finisher).

1. Remove four screws (callout 1).

 **NOTE:** Raise the lower output tray as needed to access the screws.

Figure 5-1093 Remove four screws



2. Slide the shield down (callout 1) to release it from four tabs (callout 2), and then rotate it away from the finisher (callout 3).

⚠ CAUTION: The shield is still attached to the finisher. Do not attempt to completely remove the shield.

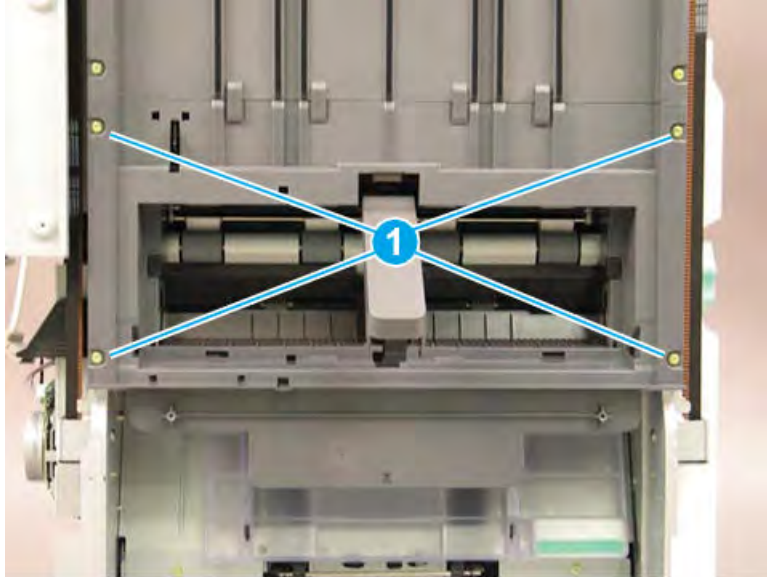
💡 TIP: Position the shield under the four tabs (callout 2) when reinstalling it.

Figure 5-1094 Release the lower shield

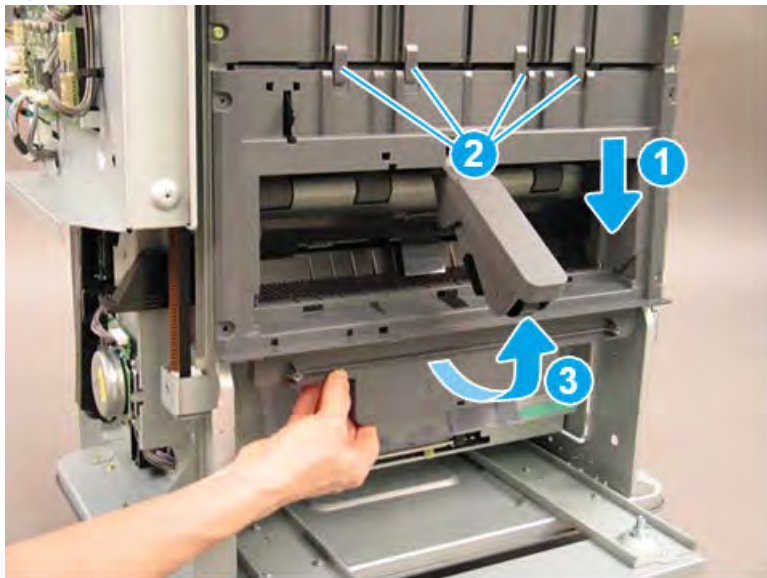

3. Disconnect two connectors (callout 1), and then remove the shield.

 **TIP:** Reverse the removal steps to install the assembly.

Figure 5-1095 Disconnect two connectors

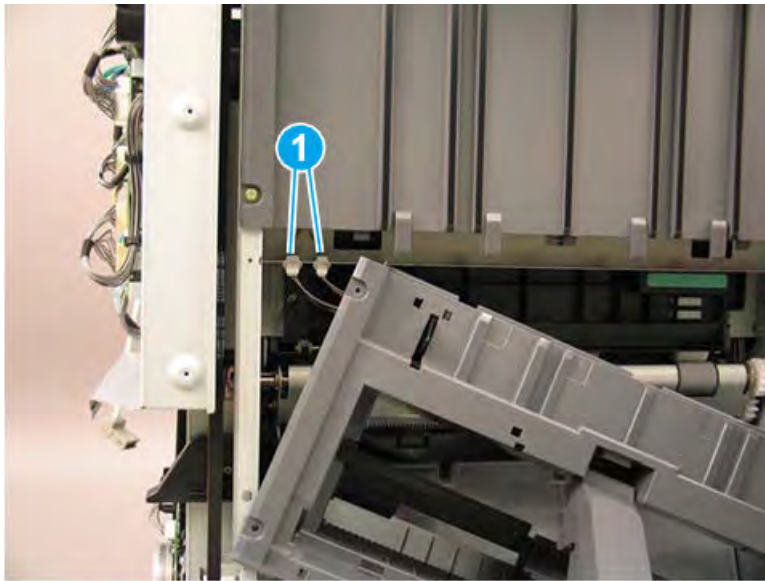

4. If you are replacing the left lower cover, locate three sensors (callout 1) on the back of the left lower cover. Remove these sensors and transfer them to the replacement part.

Figure 5-1096 Remove the left lower cover

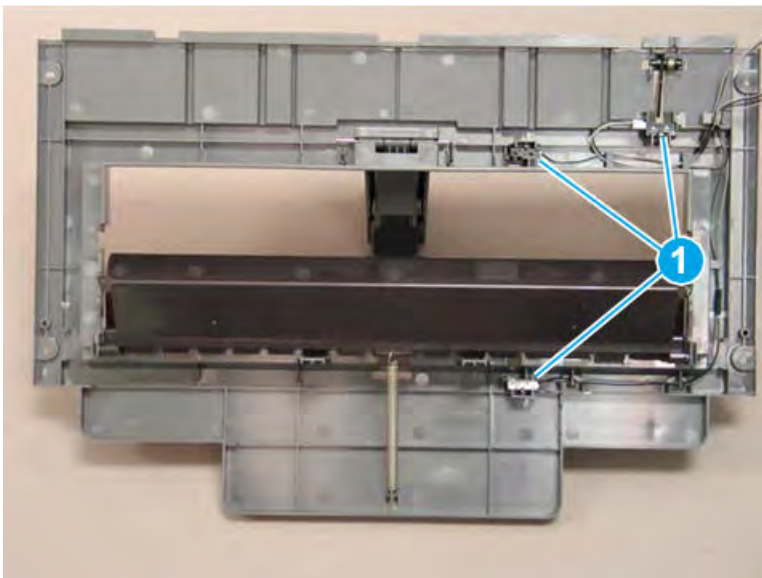

Remove the left upper cover (finisher)

Follow these steps to remove the left upper cover (finisher).

1. Bring the lower output tray down by positioning the shaft of a screwdriver on the clutch (callout 1) and gently pressing to the right to release the clutch. Hold the clutch in the released position and lower the tray (callout 2) to the lowest position.

Figure 5-1097 Lower the output tray

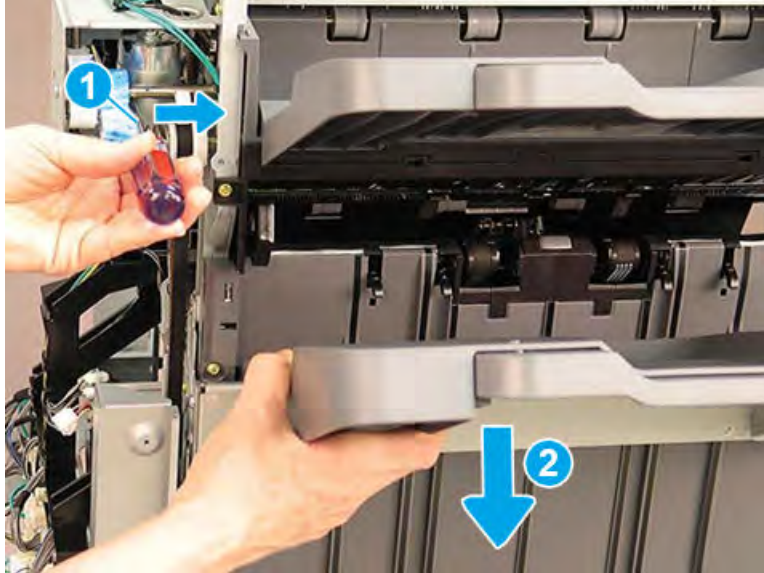

2. Remove six machine screws (callout 1).

Figure 5-1098 Remove six screws

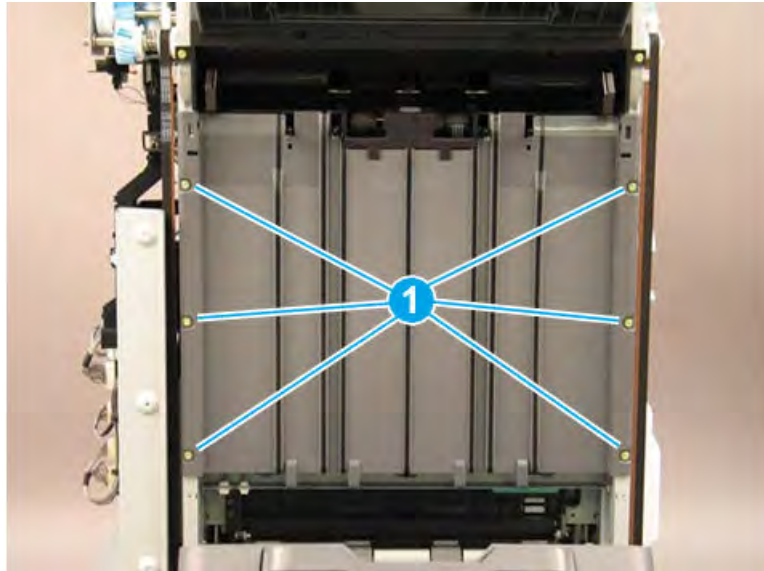

3. Rotate the lower edge of the shield away from the finisher (callout 1), and then slide the shield down (callout 2) to release it from two tabs (callout 3).

CAUTION: The shield is still attached to the finisher. Do not attempt to completely remove the shield.

TIP: Position the shield under the two tabs (callout 3) when reinstalling it.

Figure 5-1099 Release the shield

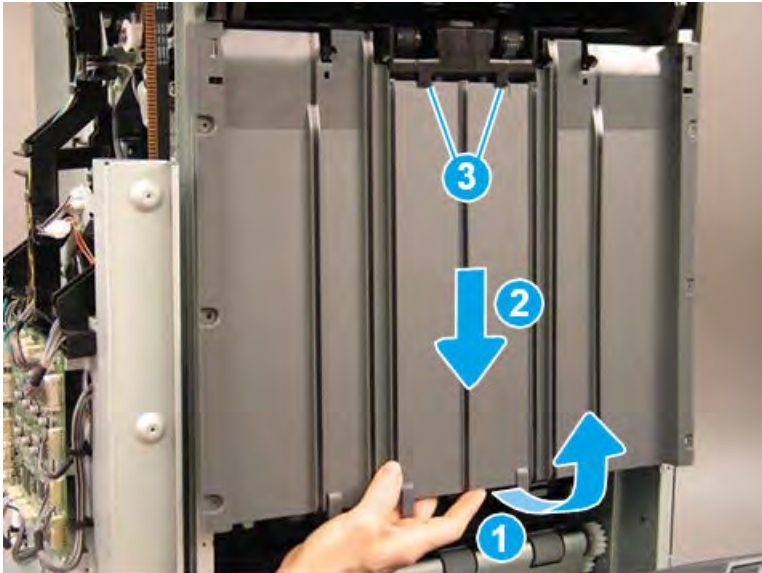

4. Disconnect one connector (callout 1), and then remove the upper shield assembly.

TIP: Reverse the removal steps to install the assembly.

Figure 5-1100 Disconnect one connector

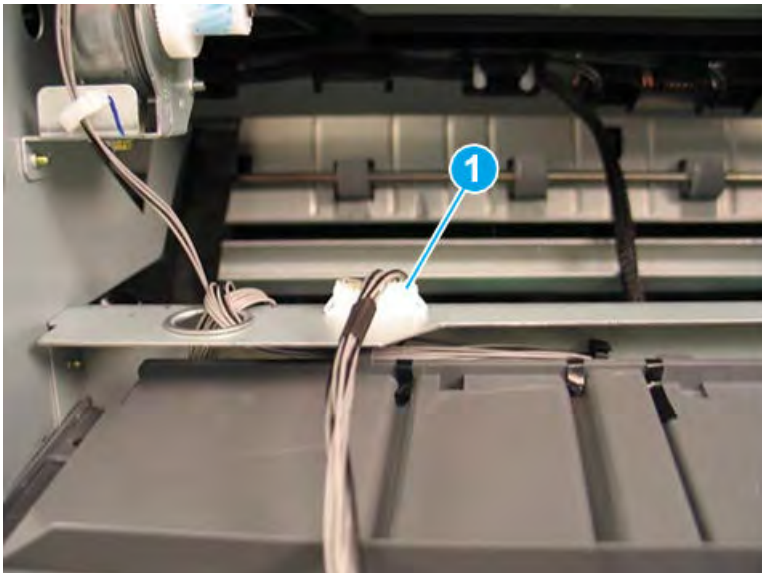

5. If you are replacing the left upper cover, locate three sensors (callout 1) on the back of the left upper cover. Remove these sensors and transfer them to the replacement part.

Figure 5-1101 Remove the left upper cover

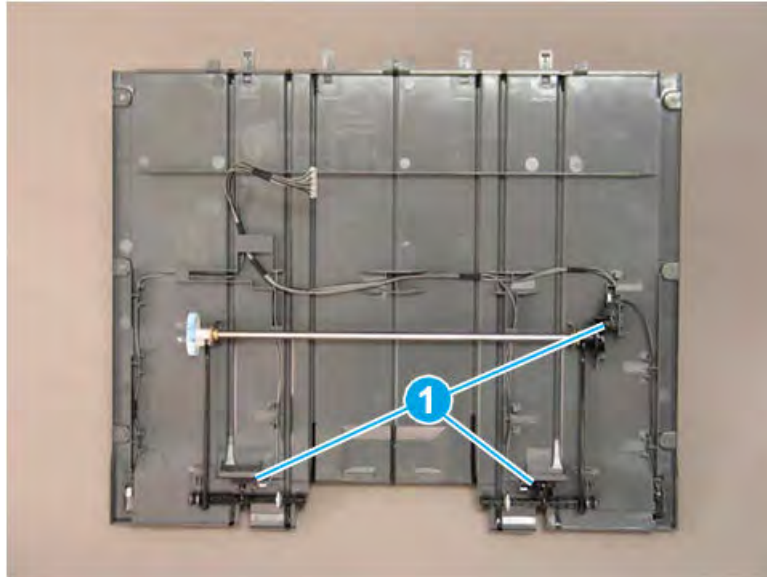

Remove the ejector unit (finisher)

Follow these steps to remove the ejector unit (finisher).

1. Rotate the green wheel to move the staple unit to the center of the finisher.

Figure 5-1102 Move the staple unit to the center

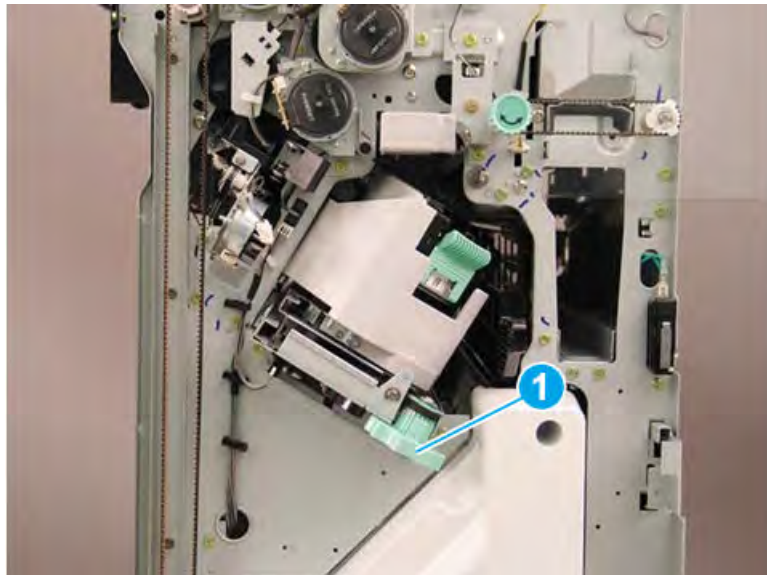

2. Release one retainer (callout 1), and then disconnect three connectors (callout 2).

Figure 5-1103 Disconnect three connectors

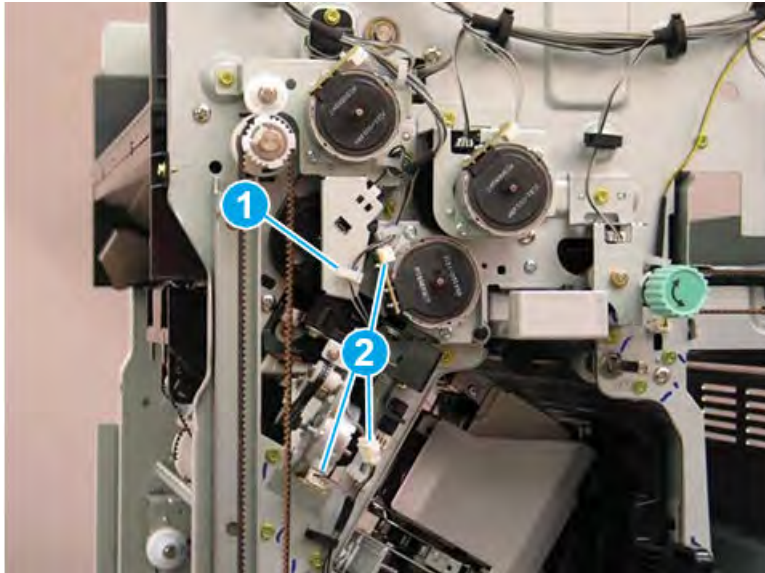

3. Remove two screws (callout 1).

Figure 5-1104 Remove two screws

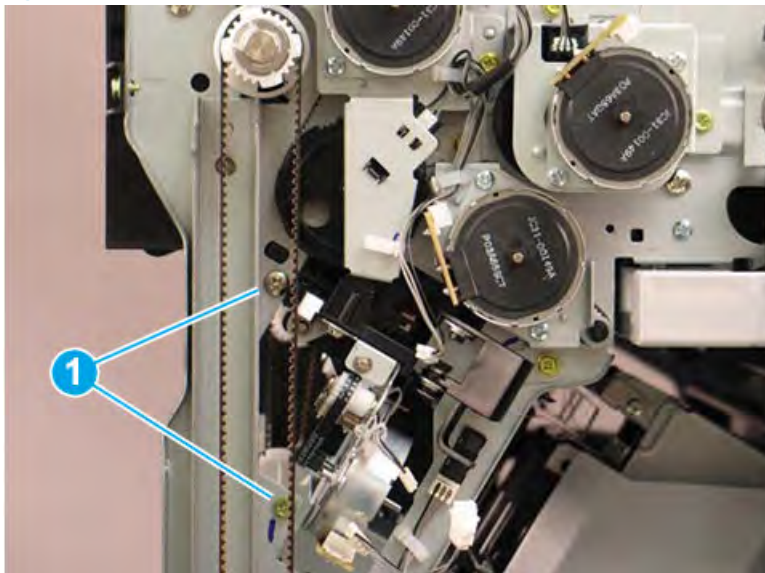

4. At the left side of the finisher, remove one screw (callout 1).

Figure 5-1105 Remove one screw

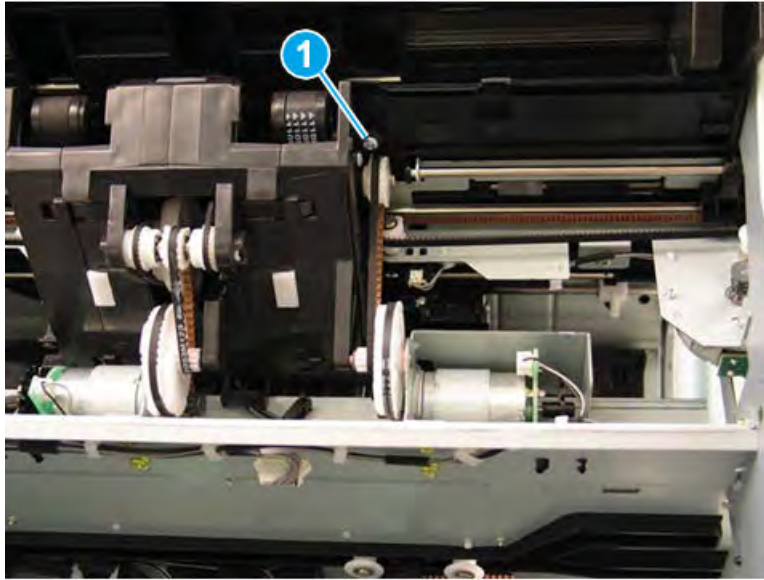

5. Press up on the hinge (callout 1), release one tab (callout 2), and then rotate the sensor away from the finisher (callout 3).

Figure 5-1106 Rotate the sensor

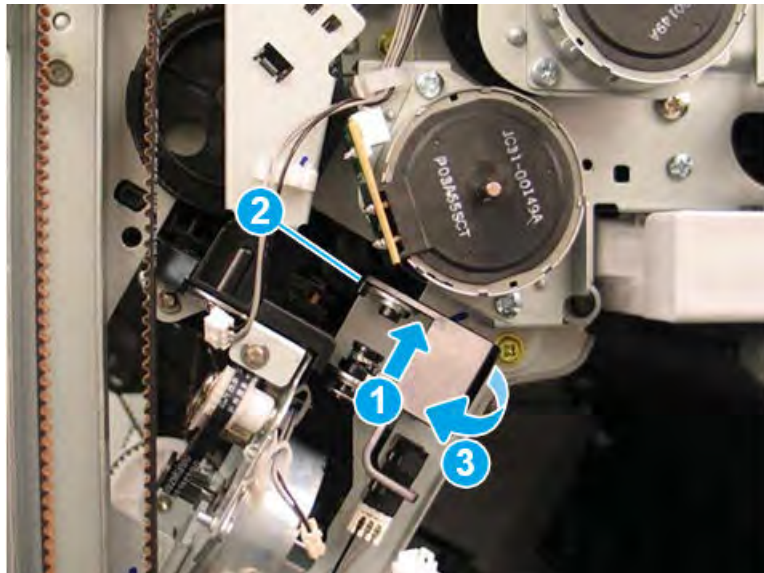

6. Remove one screw (callout 1).

Figure 5-1107 Remove one screw

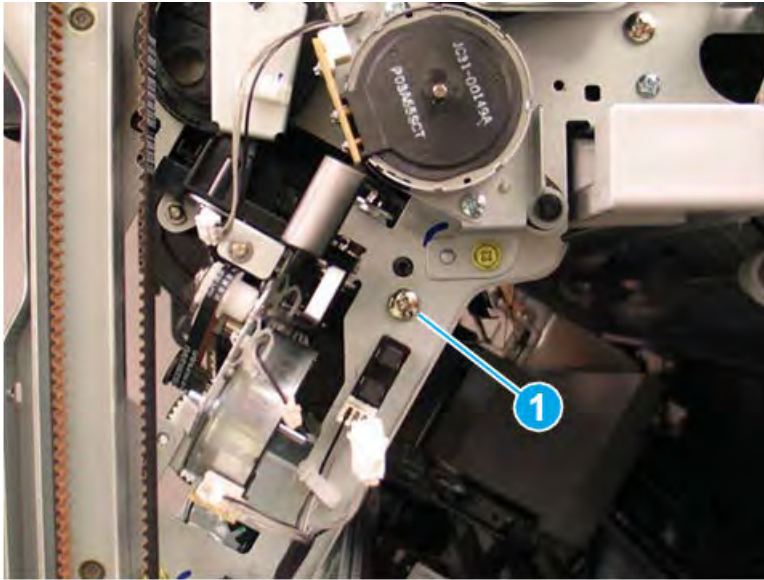

7. Look inside the finisher through the stapler opening in the front and pull down to release and remove one shaft (callout 1) on the front tamper unit.

Figure 5-1108 Remove the front tamper shaft

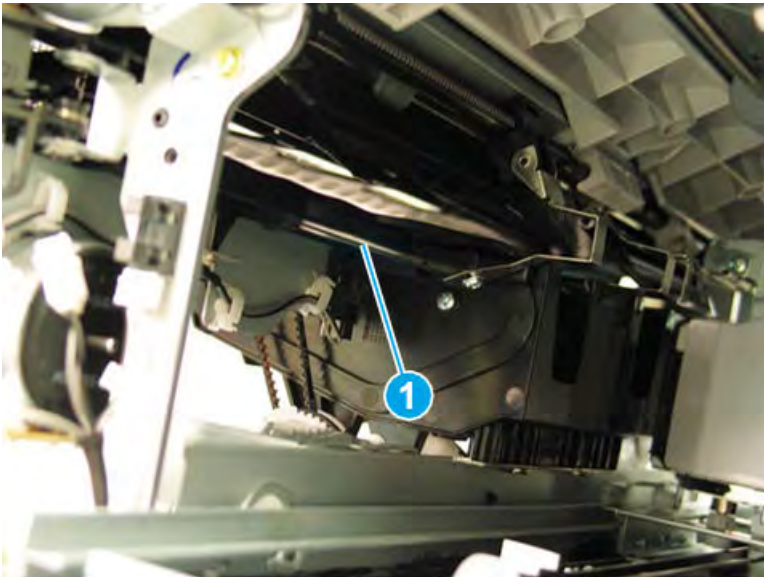

8. At the rear of the finisher, disconnect two connectors (callout 1), and then remove three screws (callout 2).

Figure 5-1109 Disconnect two connectors and remove three screws

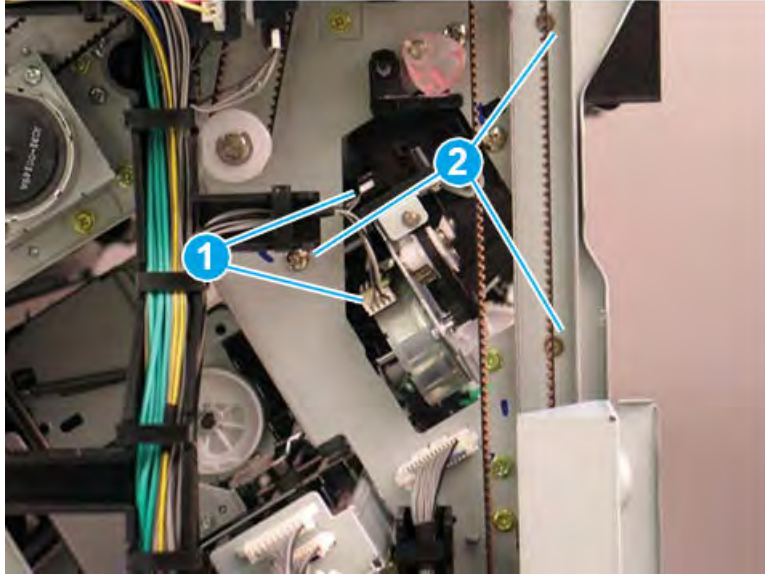

9. At the left side of the finisher, remove one screw (callout 1).

Figure 5-1110 Remove one screw

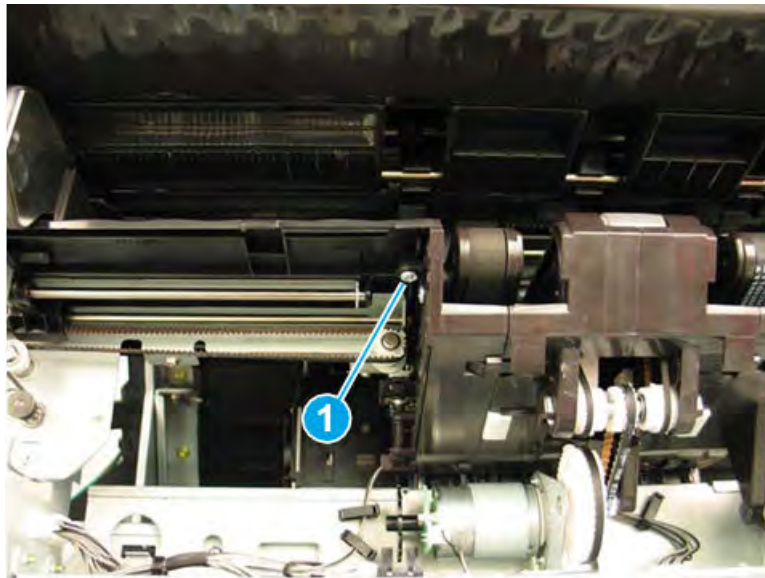

10. Look inside the finisher through the stapler opening in the rear and pull down to release and remove one shaft (callout 1) on the rear tamper unit.

Figure 5-1111 Remove the rear tamper shaft

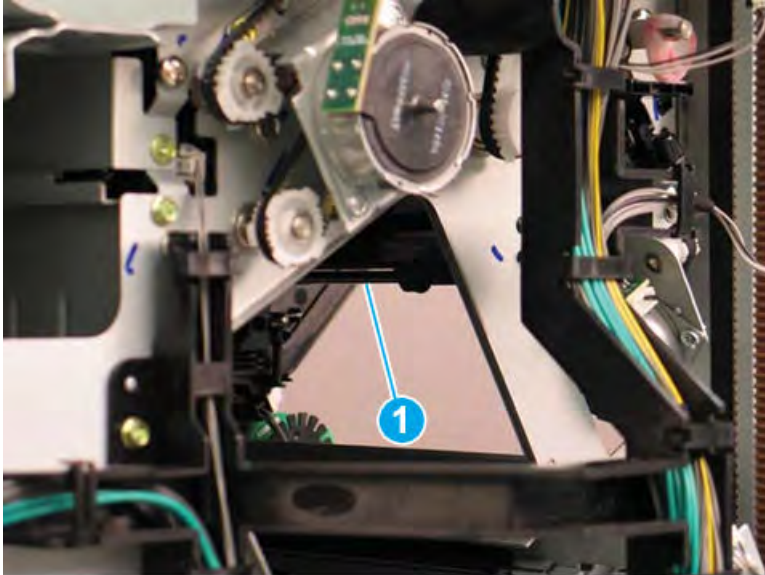

11. At the left side of the finisher, disconnect one connector (callout 1).

Figure 5-1112 Disconnect one connector

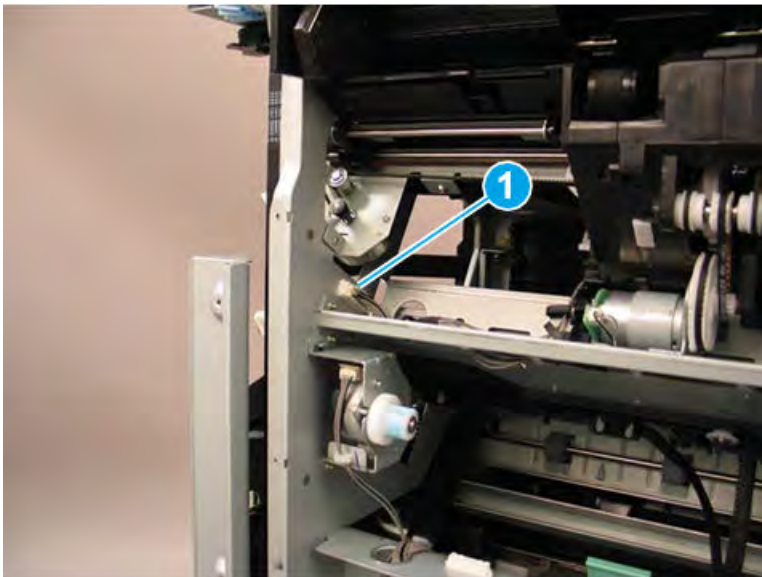

12. At the rear of the finisher, disconnect one connector (callout 1).

Figure 5-1113 Disconnect one connector

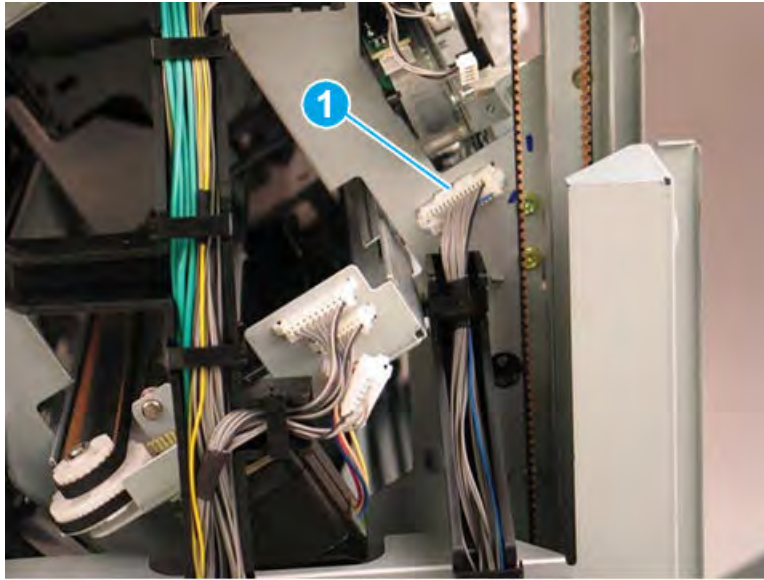

13. At the rear of the finisher, press the wire retainer to the right to access and remove two screws (callout 1).

Figure 5-1114 Disconnect one connector

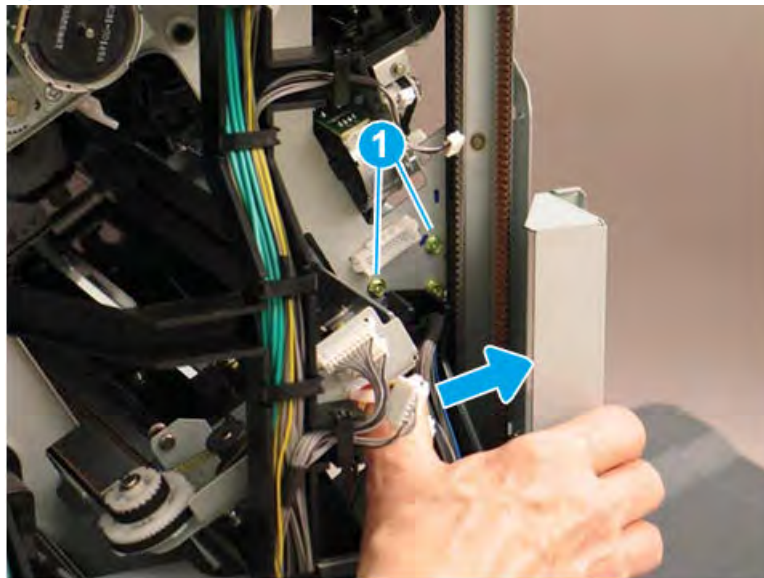

14. At the front of the finisher, remove two screws (callout 1).

Figure 5-1115 Remove two screws

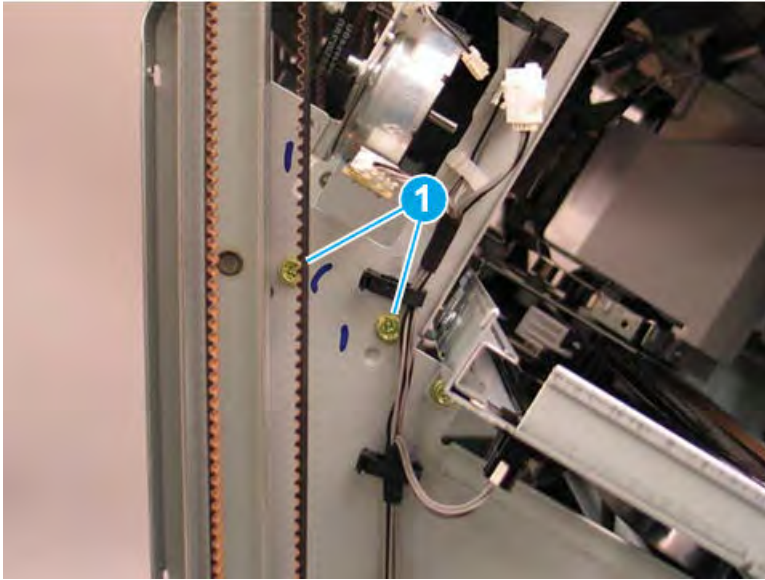

15. Lift the inside edges of the front and rear tampers up.

Figure 5-1116 Lift the edges of the tampers

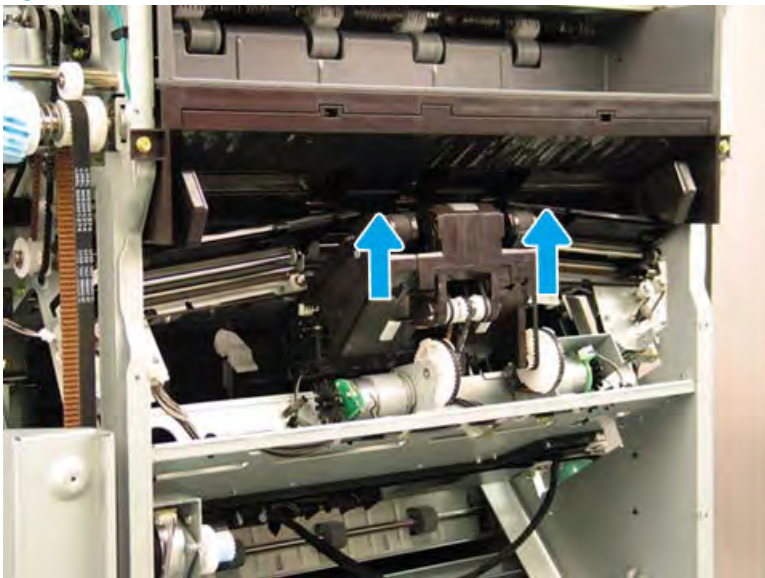

16. Rotate the rear edge of the ejector unit away from the finisher (callout 1), and then slide it toward the rear of the finisher (callout 2) to remove it. Make sure that the PCA (callout 3) stays clear of the sheet metal frame.

Figure 5-1117 Remove the ejector unit

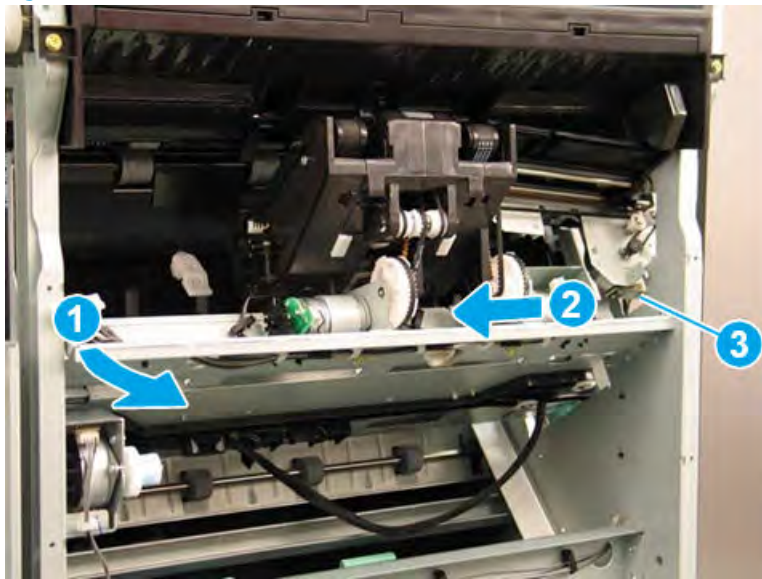

17. Reverse the removal steps to install the assembly. Also use the following special installation instructions.

 **NOTE:** Continue to reverse the removal steps to finish installing the assembly.

Special installation instructions: Ejector unit

- a. When the front tamper shaft is removed, the retainer arm that held the one end of the shaft will drop down. When reinstalling the shaft, raise the retainer arm and position the end of the shaft in the notch (callout 1).

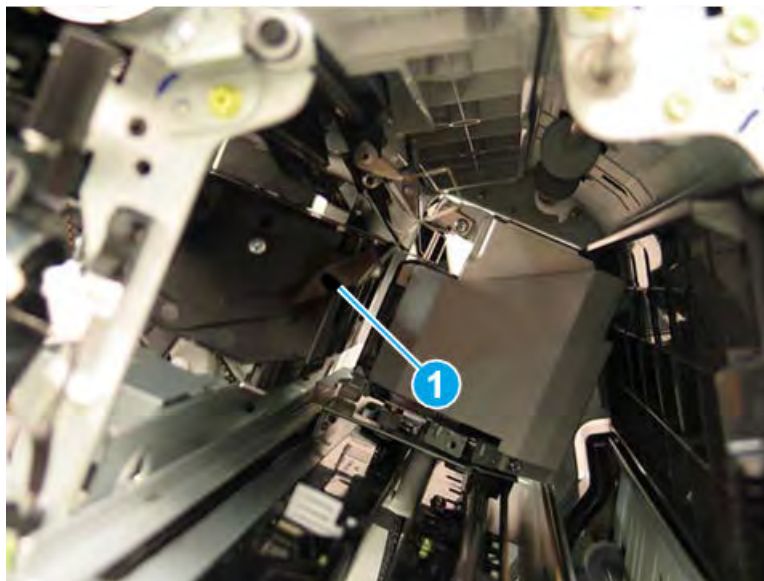

- b. When the rear tamper shaft is removed, the retainer arm that held the one end of the shaft will drop down. When reinstalling the shaft, raise the retainer arm and position the end of the shaft in the notch (callout 1).

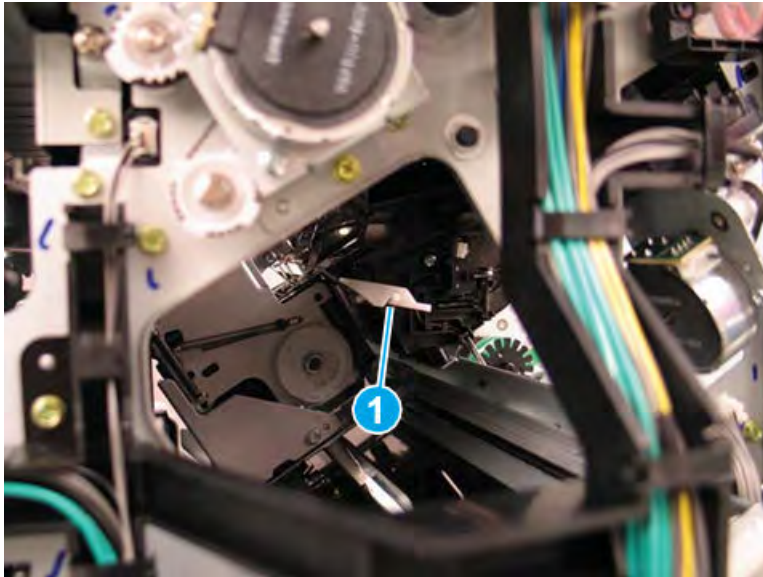

Remove the ejector2 home sensor(S32)

Follow these steps to remove the ejector2 home sensor(S32).

1. Remove sensor(callout 1, S32) using tweezers from the ejector unit.

Figure 5-1118 Remove sensor

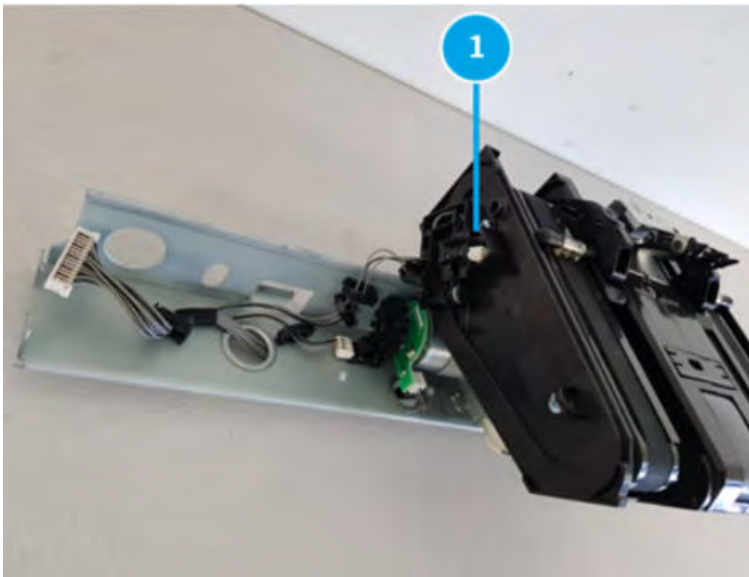

2. Disconnect the connector(callout 1) from ejector2 home sensor.

Figure 5-1119 Disconnect the connector from ejector2 home sensor



Unpack the replacement assembly



Follow these steps to unpack the replacement assembly.

1. Dispose of the defective part.

 **NOTE:** HP recommends responsible disposal of the defective part.

<http://www8.hp.com/us/en/hp-information/environment/product-recycling.html>

2. Unpack the replacement part from the packaging.

 **CAUTION:**  Some parts are sensitive to electrostatic discharge (ESD). Always perform service work at an ESD-protected workstation or mat. If an ESD workstation or mat is not available, touch the sheet-metal chassis to provide a static ground before touching an ESD-sensitive assembly. Protect the ESD-sensitive assemblies by placing them in ESD pouches when they are out of the printer.

 **IMPORTANT:** Make sure that all of the shipping materials (for example shipping tape) are removed from the replacement part prior to installation.

 **NOTE:** If the replacement part is a roller or pad, avoid touching the spongy part of it. Skin oils on the roller or pad can cause paper pickup and/or print-quality problems. HP recommends using disposable gloves when handling rollers or pads or washing your hands before touching rollers or pads.

3. To install an assembly, reverse the removal steps.

 **NOTE:** When applicable, special installation instructions are provided for an assembly at the end of the removal procedure. Always completely read the removal instructions and follow all special installation instructions.

Removal and replacement: Ejector2 motor sensor (S23)

Learn how to remove and replace the ejector2 motor sensor.

Introduction

This document provides the procedures to remove and replace the ejector2 motor sensor on the finisher.

 **IMPORTANT:** When applicable, special installation instructions are provided for an assembly at the end of the removal procedure. Always completely read the removal instructions and follow all special installation instructions.

Before performing service

- Turn the printer power off. A shutting-down message appears on the control-panel display.
-  **WARNING!** To avoid damage to the printer, turn the power off and wait until the printer shuts down before removing the power cable.
- Disconnect the printer power cable after the printer has completely shut down (the control-panel display is blank).
- Release the finisher from the printer by pulling out on the release latch inside the finisher door.
- Disconnect the cable from the bridge unit to the finisher.
- Disconnect the cable from the finisher to the printer.

Use the table below to identify the correct part number for your printer. To order the part, go to <https://parts.hp.com>.

Table 5-130 Part information

Part number	Part description
0604-001415	Ejector2 motor sensor

Required tools

- #2 JIS screwdriver with a magnetic tip
- Small, flat-blade screwdriver

After performing service

- Connect the cable from the finisher to the printer.
- Connect the cable from the bridge unit to the finisher.
- Attach the finisher to the printer, and then push in on the release latch inside the finisher door.
- Connect the printer power cable.
- Turn the printer power on.

Post service test

Process a job through the finisher and verify that the finisher works correctly.

Remove the right upper cover (finisher)

Follow these steps to remove the right upper cover (finisher).

- ▲ Remove one screw cap and three machine screws on the upper edge of the cover (callout 1). Remove three sheet metal screws (callout 2) on the lower portion of the cover. Rotate the right edge of the cover away from the finisher, and then slide the cover right to release three tabs (callout 3).

💡 **TIP:** The lower screws are shorter in length than the upper screws.

TIP: Reverse the removal steps to install the assembly.

Figure 5-1120 Remove the right upper cover

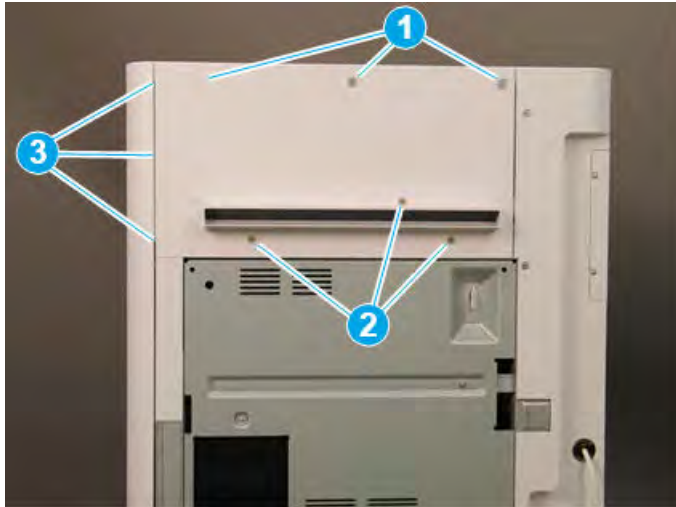

Remove the top cover (finisher)

Follow these steps to remove the top cover (finisher).

1. Remove three screw caps and three self-tapping screws at the top of the rear cover (callout 1), and then remove three machine screws (callout 2) on top of the cover.

Figure 5-1121 Remove six screws

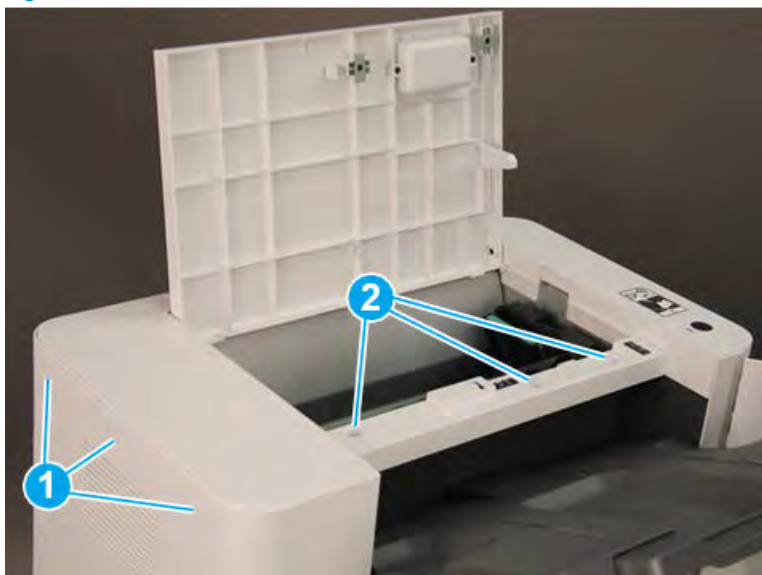

2. Remove three self-tapping screws at the top of the front cover (callout 1), and then remove two machine screws (callout 2) at the top of the right side.

Figure 5-1122 Remove five screws

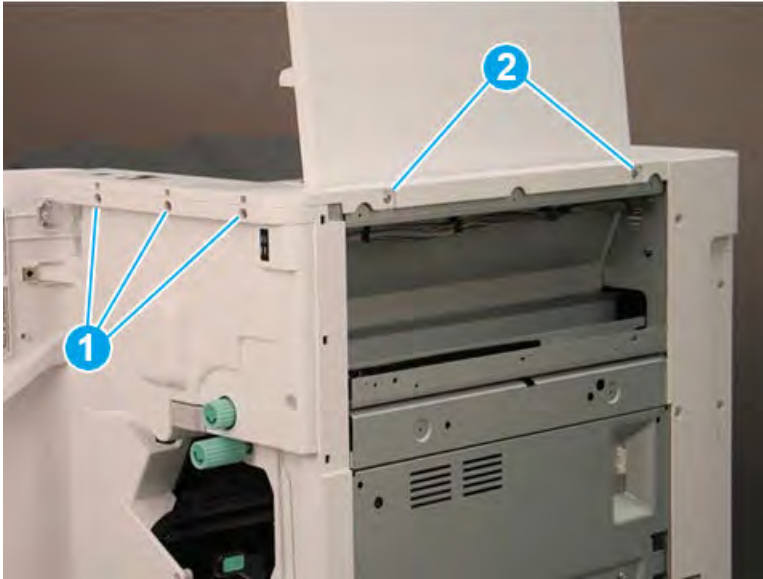

3. Lift the cover up slightly. Disconnect one in-line connector (callout 1), and then release one retainer (callout 2).

 **TIP:** Reverse the removal steps to install the assembly.

Figure 5-1123 Disconnect one connector and release retainer

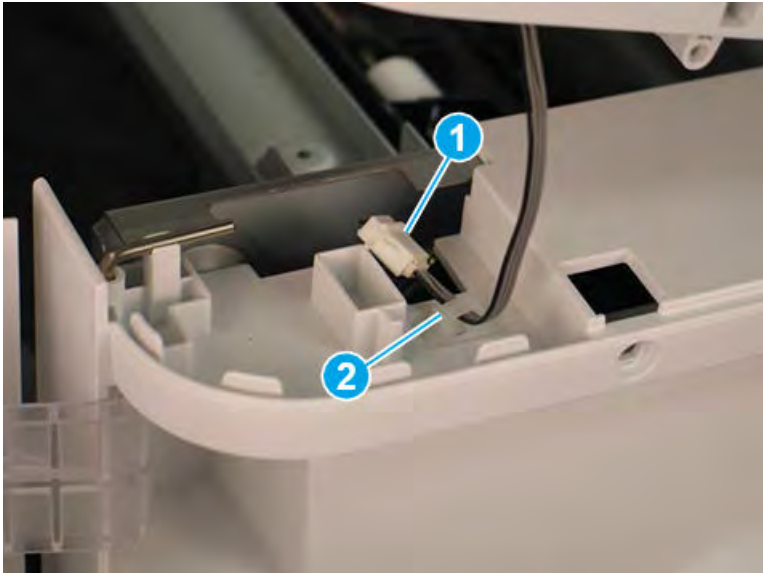

Remove the front door (finisher)

Follow these steps to remove the front door (finisher).

1. Lift the top hinge pin up to release it from the retainer.

Figure 5-1124 Lift the top hinge pin

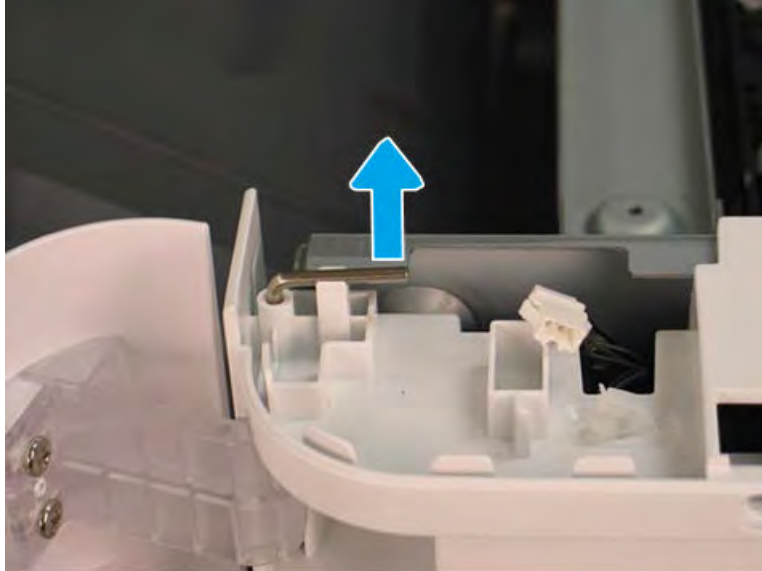

2. Pull the top hinge pin up to remove it.

Figure 5-1125 Remove the top hinge pin

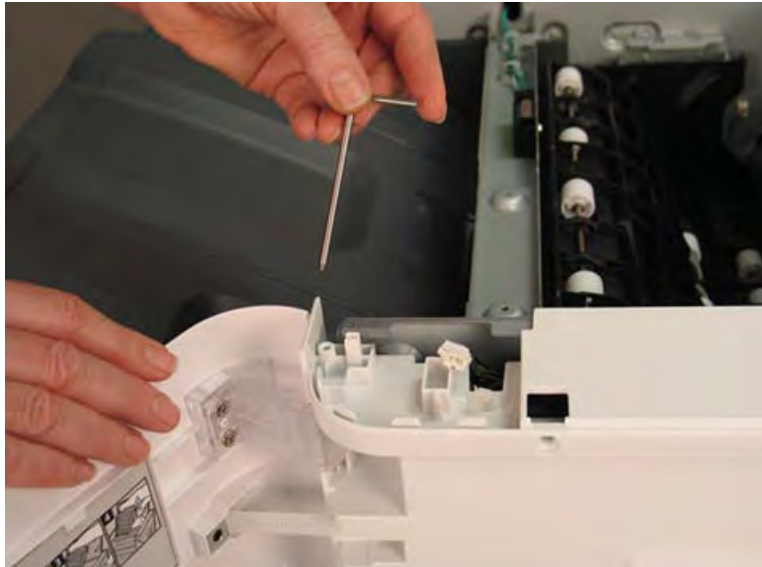

3. Use a small, flat-blade screwdriver to release the lower hinge pin from the retainer, and then rotate it away from the finisher.

Figure 5-1126 Release the lower hinge pin



4. Support the door with one hand, and then pull the lower hinge pin straight up to remove it.

Figure 5-1127 Remove the lower hinge pin



5. Support the door with one hand, and then remove one screw (callout 1) to release the strap. Remove the front door.

 **TIP:** Reverse the removal steps to install the assembly.

Figure 5-1128 Remove the front door



Remove the front cover (finisher)

Follow these steps to remove the front cover (finisher).

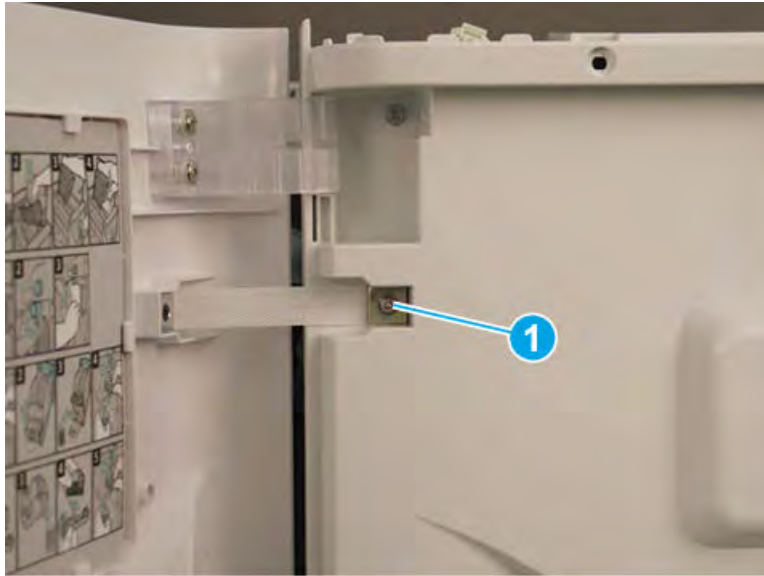
1. Release one tab (callout 1), and then pull the jam-access knob away from the finisher to remove it.

Figure 5-1129 Remove the jam-access knob

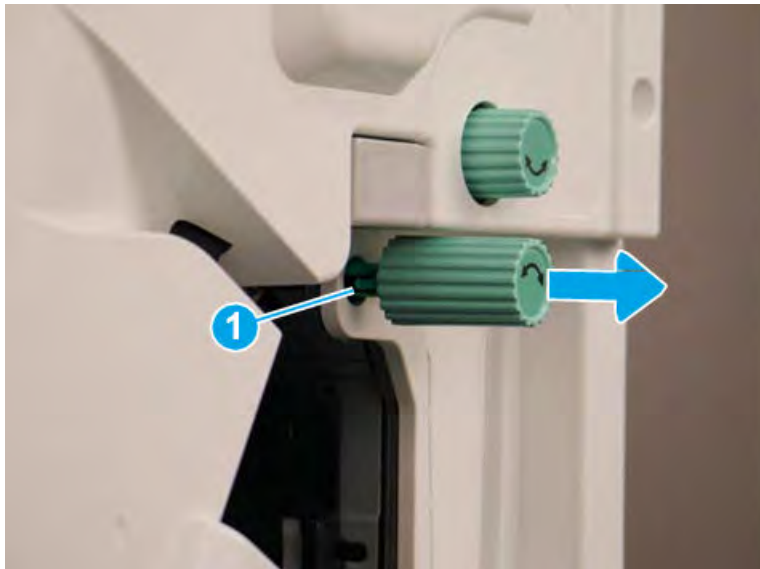

2. If the punch unit is installed, remove the punch waste bin (callout 1).

3. Remove one screw (callout 1) on top of the front cover.

Figure 5-1130 Remove one screw



4. Remove five machine screws (callout 1), and then remove the front cover.

 **TIP:** Reverse the removal steps to install the assembly.

Figure 5-1131 Remove the front cover



Remove the rear cover (finisher)

Follow these steps to remove the rear cover (finisher).

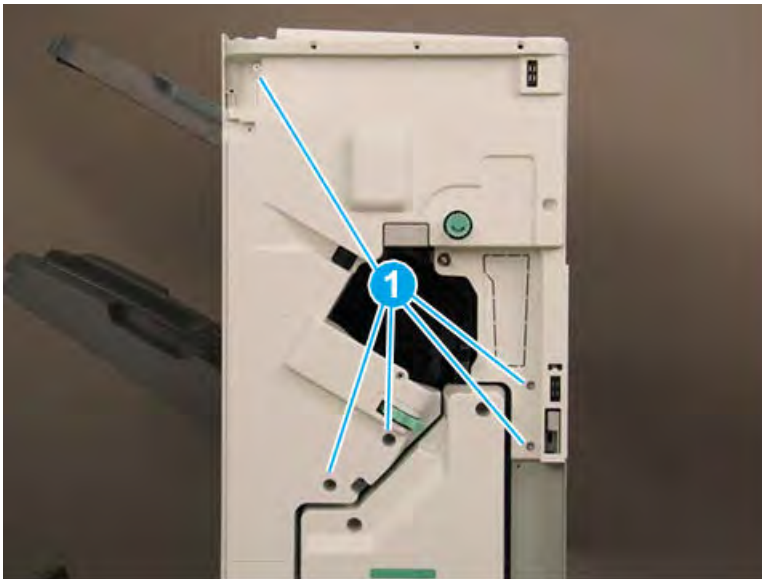
1. Remove two self-tapping screws (callout 1) on the top of the rear cover, and then remove five screw caps and five machine screws (callout 2) on the left side of the cover.

Figure 5-1132 Remove seven screws

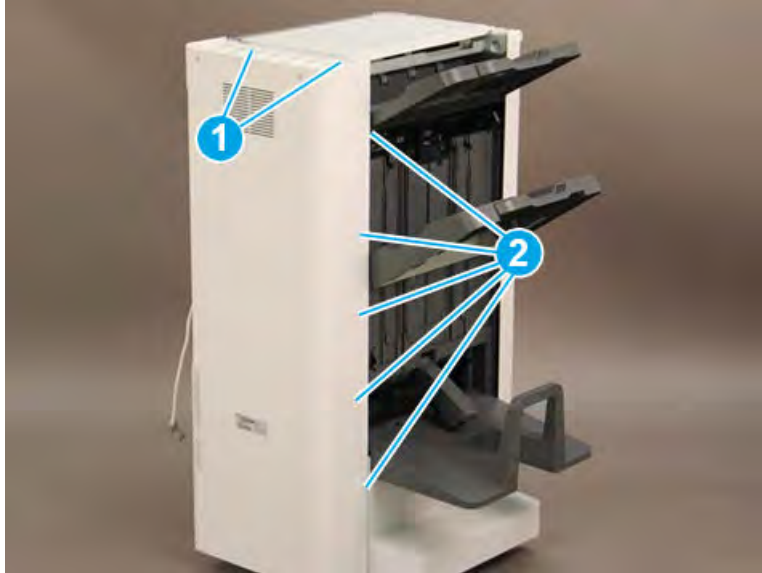

2. Remove one screw cap and four machine screws (callout 1) Remove the rear cover.

 **NOTE:** Make sure to thread the power cable (callout 2) through the opening in the cover.

 **TIP:** Reverse the removal steps to install the assembly

Figure 5-1133 Remove the rear cover



Remove the booklet output tray

Follow these steps to remove the booklet output tray.

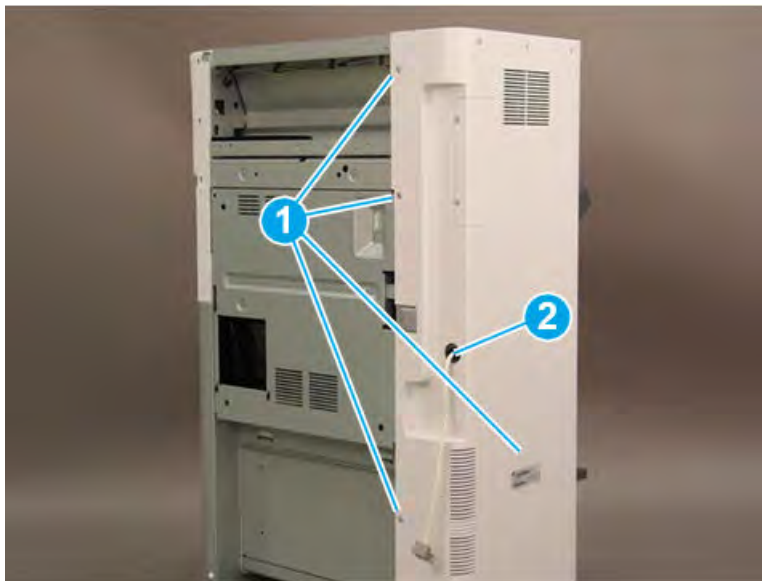
1. Raise the booklet output tray up (callout 1), and then pull it away from the finisher (callout 2) to remove it.

Figure 5-1134 Remove the booklet output tray



2. Reverse the removal steps to install the assembly. Also use the following special installation instructions.

 **NOTE:** Continue to reverse the removal steps to finish installing the assembly

Special installation instructions: booklet output tray

Position the tabs (callout 1) on the tray into the slots (callout 2) on the finisher.

Figure 5-1135 Install the booklet output tray

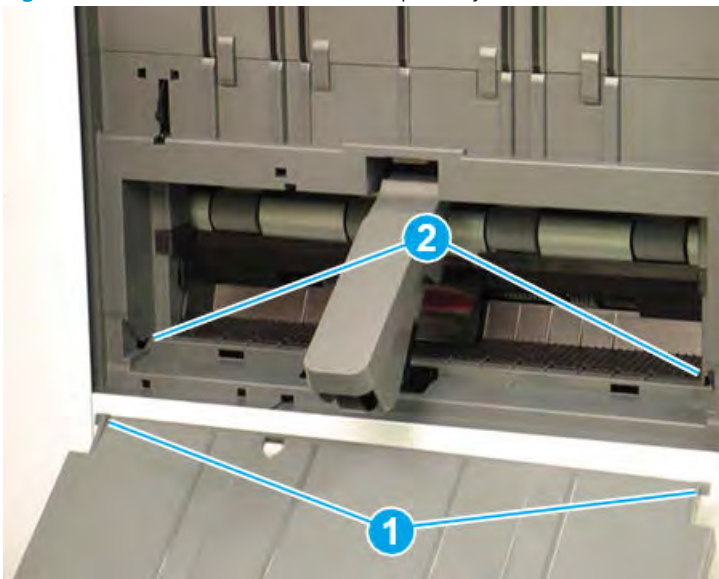

Remove the caster cover

Follow these steps to remove the caster cover.

1. Remove two screw caps and two self-tapping screws (callout 1). Remove two screw caps and two machine screws (callout 2).

Figure 5-1136 Remove four screws

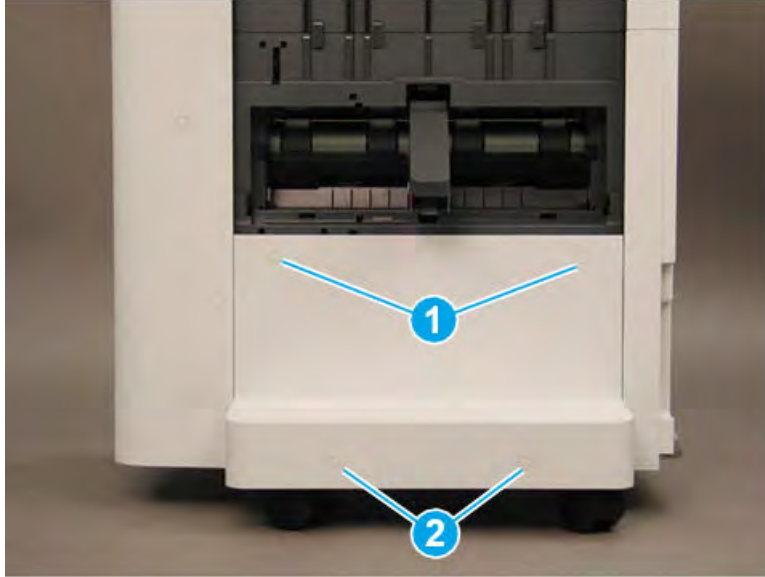

2. Rotate the left edge of the cover away from the finisher (callout 1), and then slide the cover to the left (callout 2) to remove it.

 **TIP:** Make sure that two tabs (callout 3) are positioned under the front lower cover when reinstalling the caster cover.

TIP: Reverse the removal steps to install the assembly

Figure 5-1137 Remove the caster cover

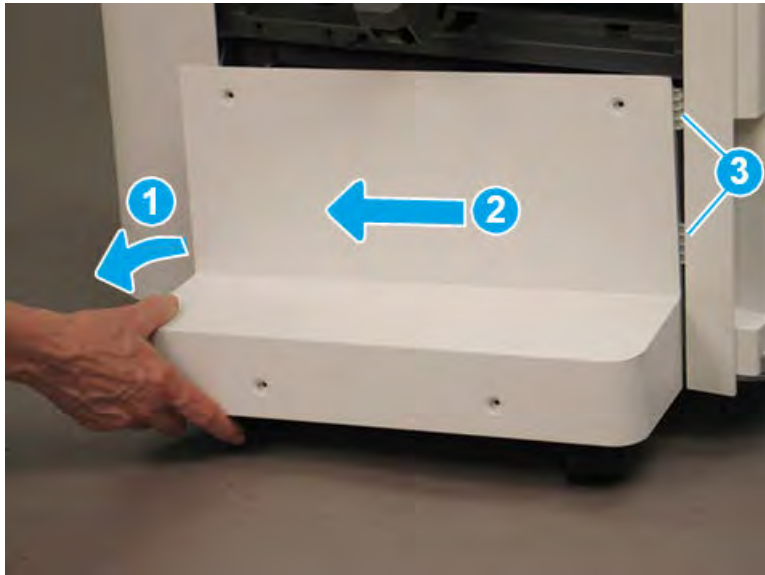

Remove the left lower cover (finisher)

Follow these steps to remove the left lower cover (finisher).

1. Remove four screws (callout 1).

 **NOTE:** Raise the lower output tray as needed to access the screws.

Figure 5-1138 Remove four screws



2. Slide the shield down (callout 1) to release it from four tabs (callout 2), and then rotate it away from the finisher (callout 3).

⚠ CAUTION: The shield is still attached to the finisher. Do not attempt to completely remove the shield.

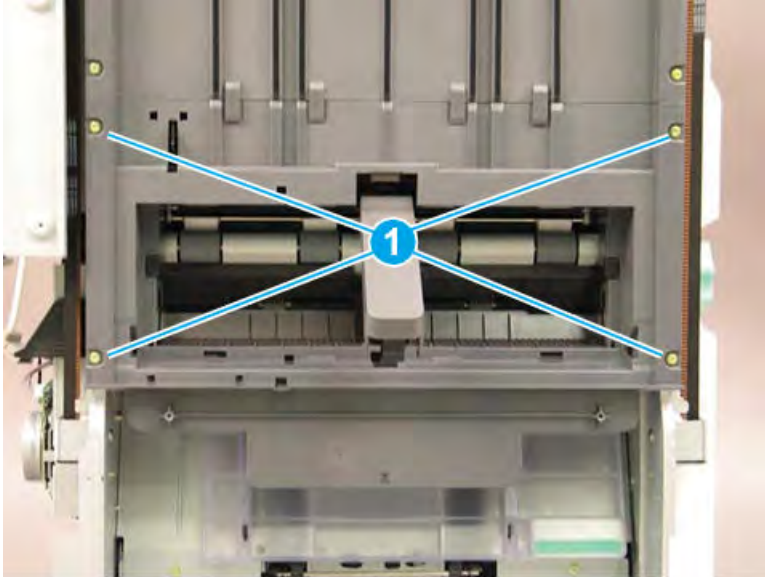
💡 TIP: Position the shield under the four tabs (callout 2) when reinstalling it.

Figure 5-1139 Release the lower shield

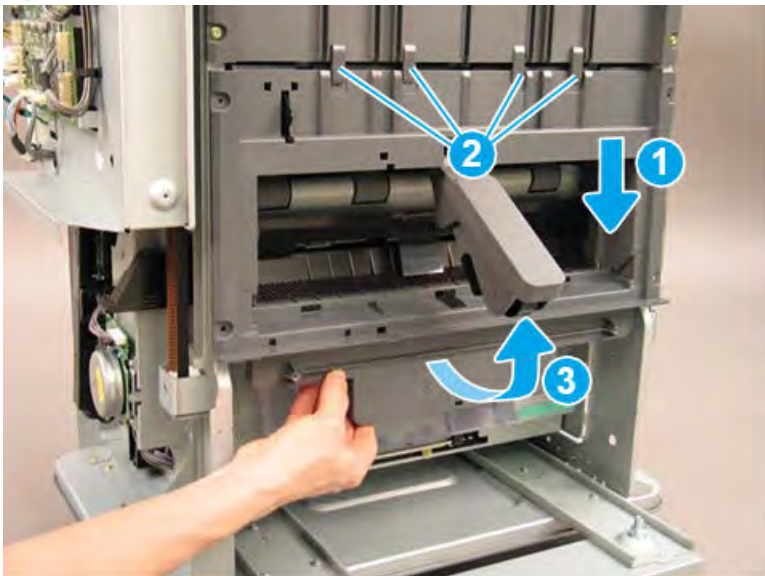

3. Disconnect two connectors (callout 1), and then remove the shield.

 **TIP:** Reverse the removal steps to install the assembly.

Figure 5-1140 Disconnect two connectors

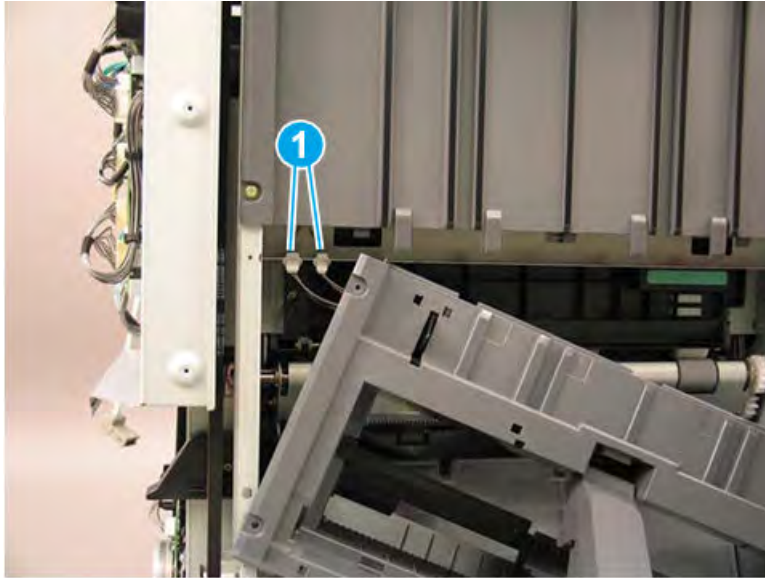

4. If you are replacing the left lower cover, locate three sensors (callout 1) on the back of the left lower cover. Remove these sensors and transfer them to the replacement part.

Figure 5-1141 Remove the left lower cover

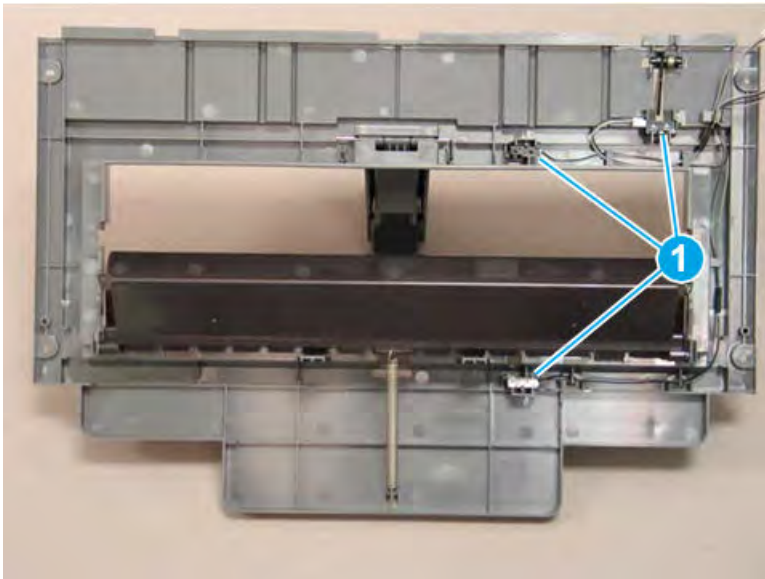

Remove the left upper cover (finisher)

Follow these steps to remove the left upper cover (finisher).

1. Bring the lower output tray down by positioning the shaft of a screwdriver on the clutch (callout 1) and gently pressing to the right to release the clutch. Hold the clutch in the released position and lower the tray (callout 2) to the lowest position.

Figure 5-1142 Lower the output tray

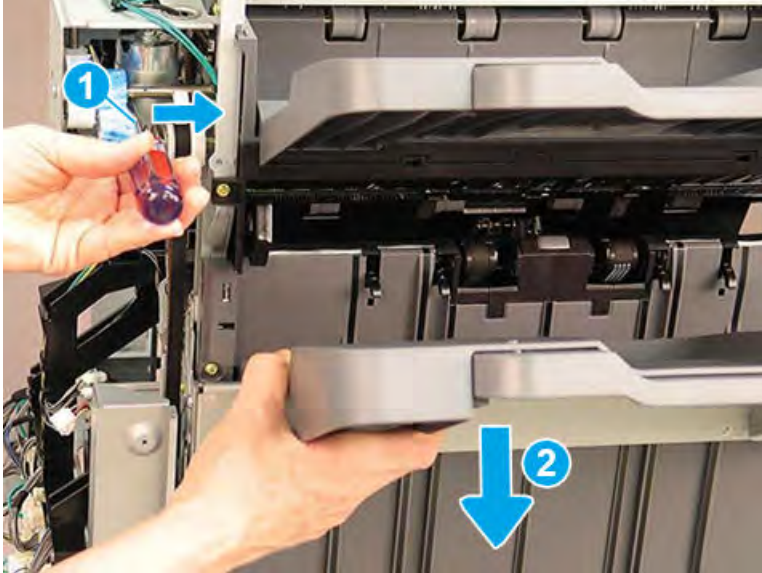

2. Remove six machine screws (callout 1).

Figure 5-1143 Remove six screws

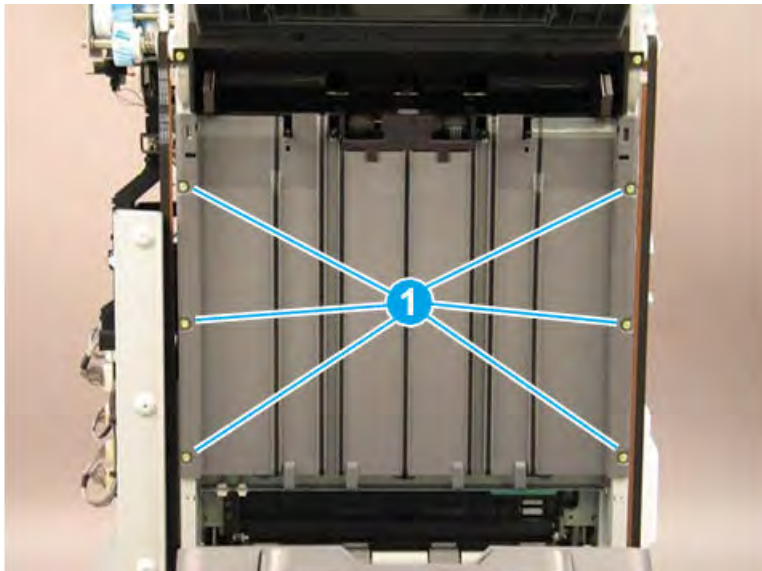

3. Rotate the lower edge of the shield away from the finisher (callout 1), and then slide the shield down (callout 2) to release it from two tabs (callout 3).

CAUTION: The shield is still attached to the finisher. Do not attempt to completely remove the shield.

TIP: Position the shield under the two tabs (callout 3) when reinstalling it.

Figure 5-1144 Release the shield

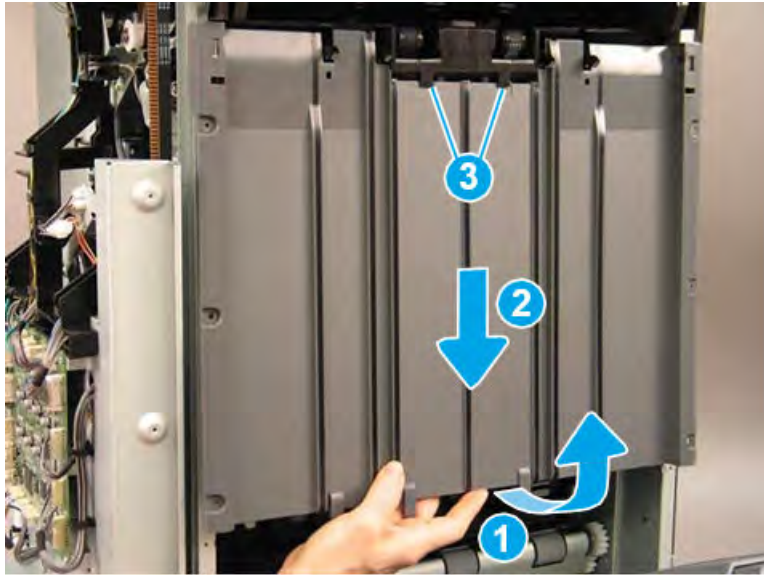

4. Disconnect one connector (callout 1), and then remove the upper shield assembly.

TIP: Reverse the removal steps to install the assembly.

Figure 5-1145 Disconnect one connector

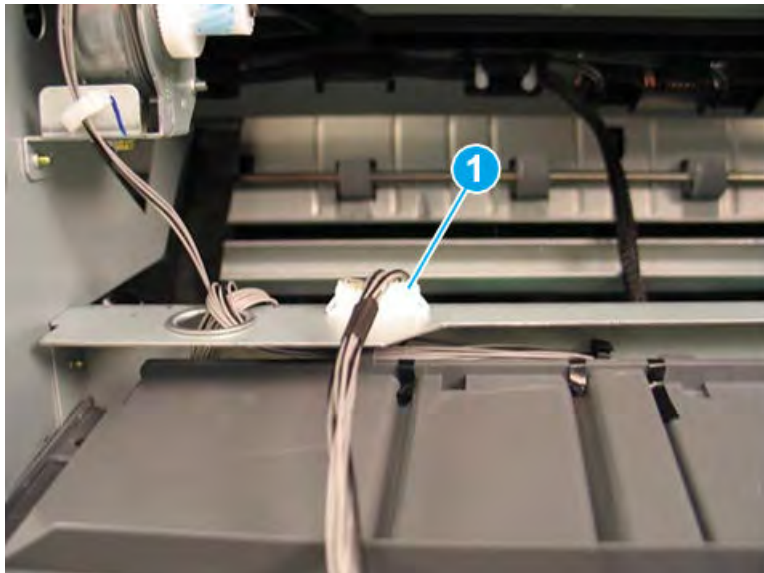

5. If you are replacing the left upper cover, locate three sensors (callout 1) on the back of the left upper cover. Remove these sensors and transfer them to the replacement part.

Figure 5-1146 Remove the left upper cover

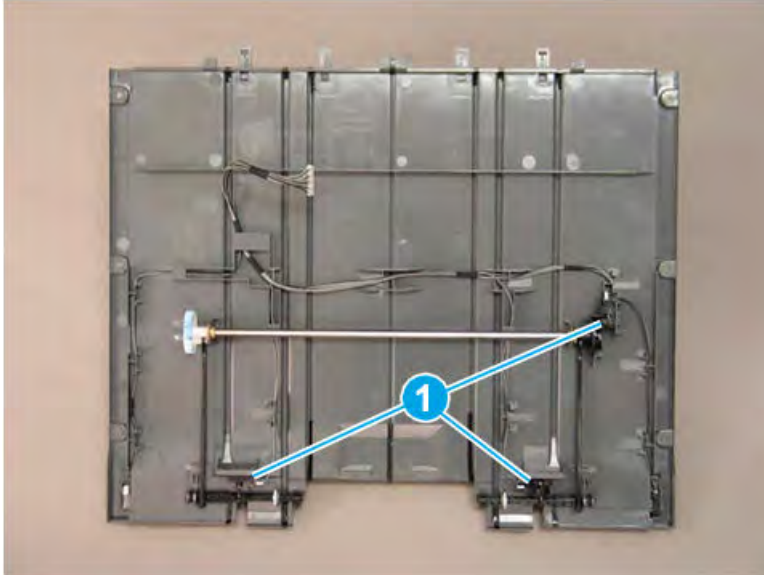

Remove the ejector unit (finisher)

Follow these steps to remove the ejector unit (finisher).

1. Rotate the green wheel to move the staple unit to the center of the finisher.

Figure 5-1147 Move the staple unit to the center

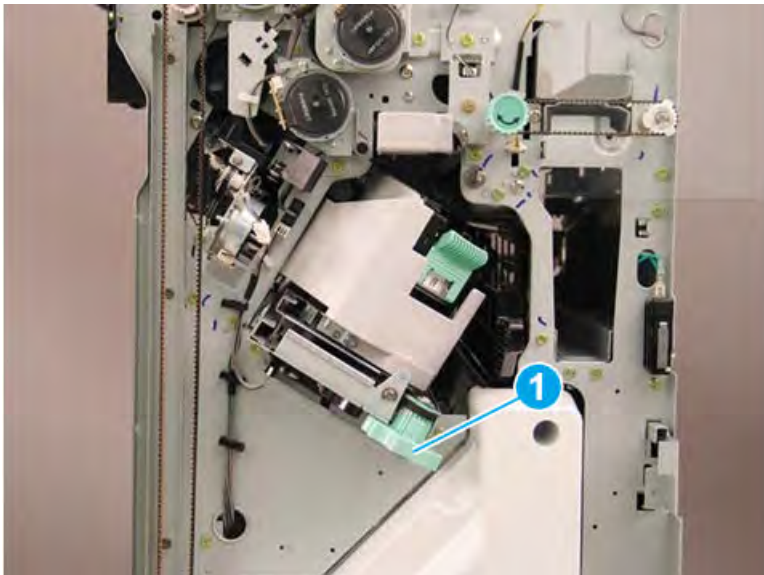

2. Release one retainer (callout 1), and then disconnect three connectors (callout 2).

Figure 5-1148 Disconnect three connectors

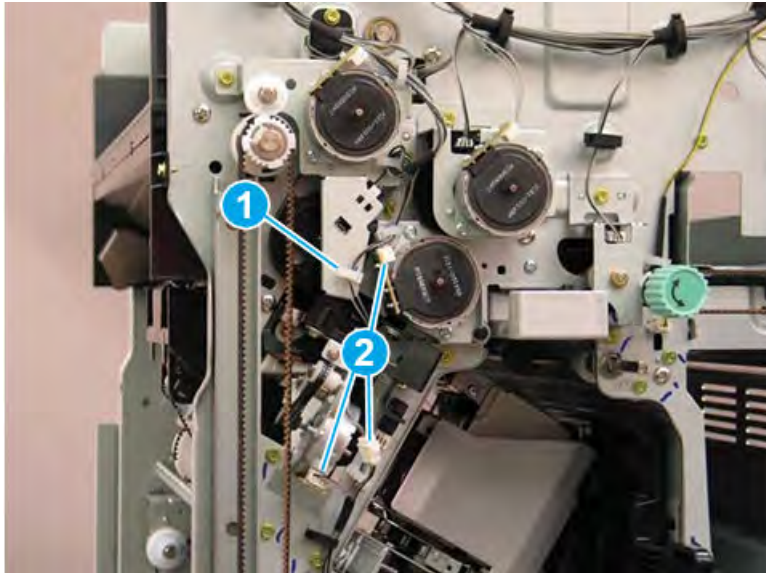

3. Remove two screws (callout 1).

Figure 5-1149 Remove two screws

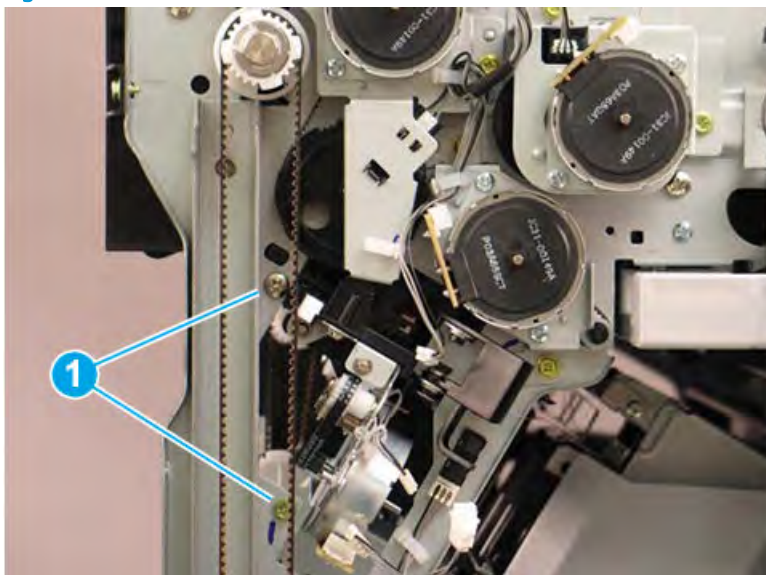

4. At the left side of the finisher, remove one screw (callout 1).

Figure 5-1150 Remove one screw

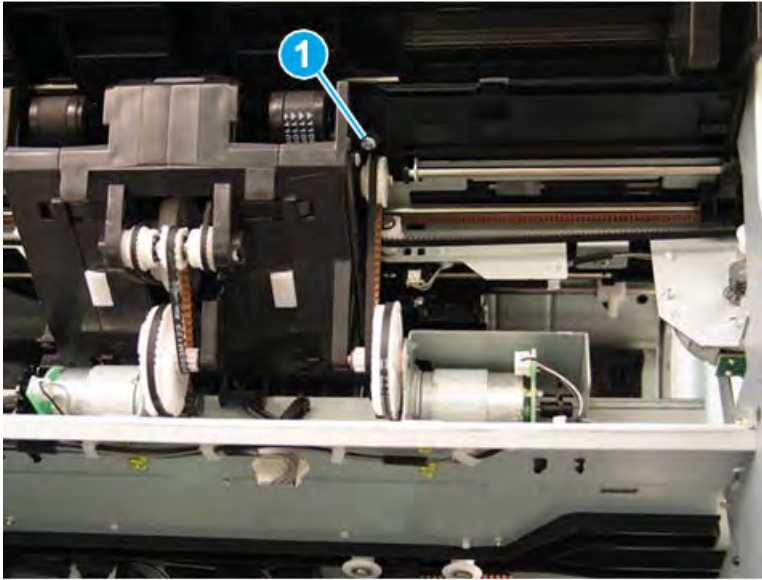

5. Press up on the hinge (callout 1), release one tab (callout 2), and then rotate the sensor away from the finisher (callout 3).

Figure 5-1151 Rotate the sensor

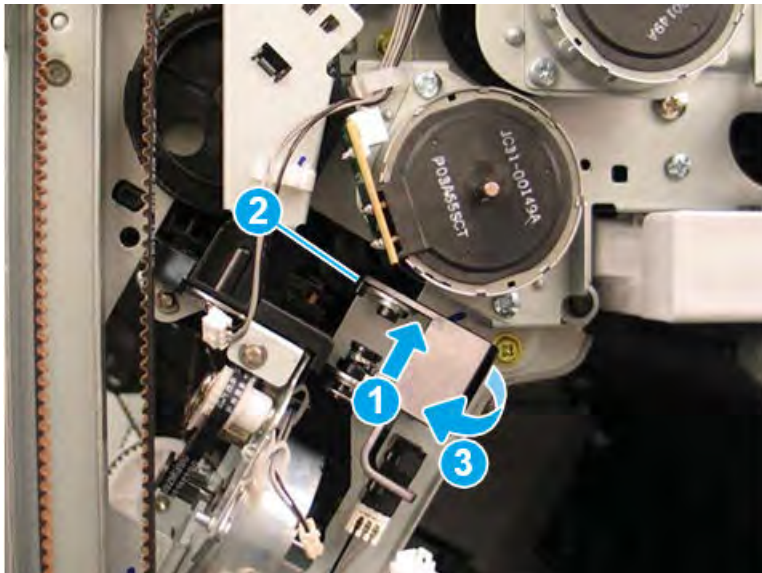

6. Remove one screw (callout 1).

Figure 5-1152 Remove one screw

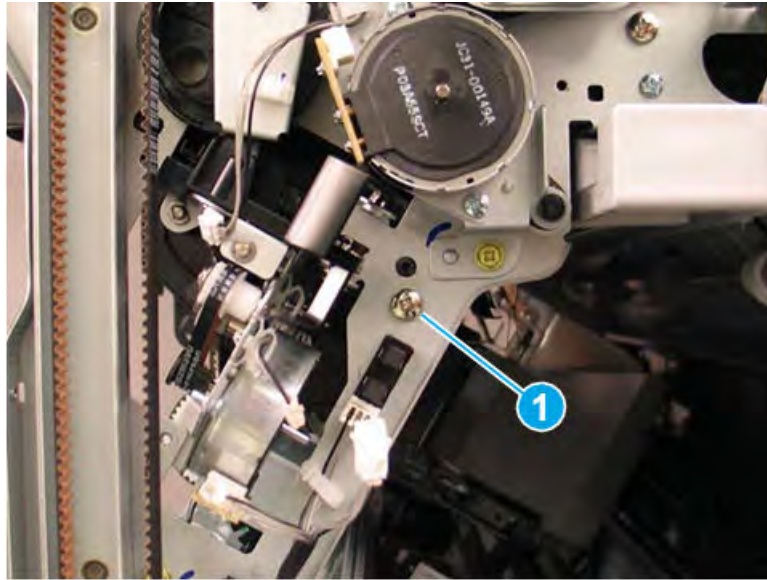

7. Look inside the finisher through the stapler opening in the front and pull down to release and remove one shaft (callout 1) on the front tamper unit.

Figure 5-1153 Remove the front tamper shaft

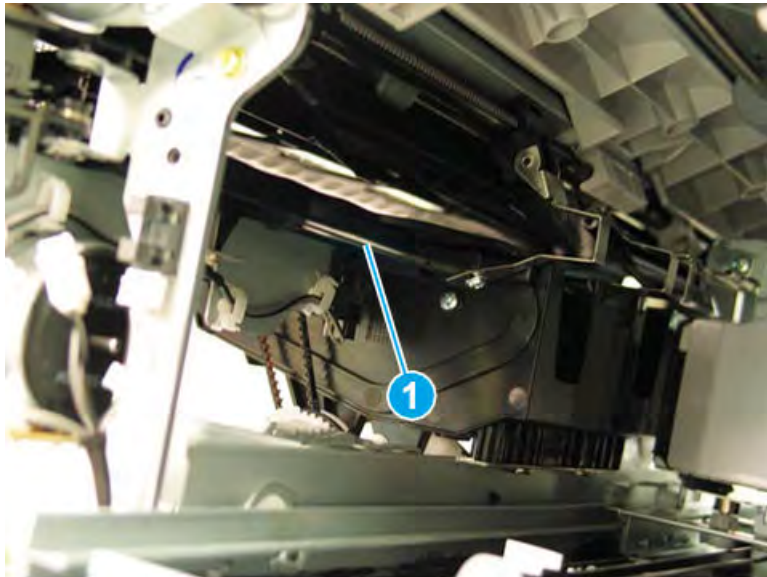

8. At the rear of the finisher, disconnect two connectors (callout 1), and then remove three screws (callout 2).

Figure 5-1154 Disconnect two connectors and remove three screws

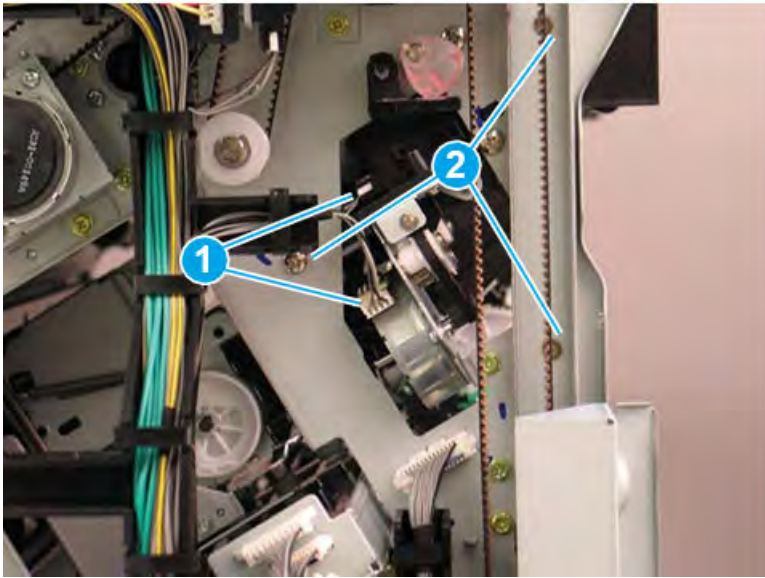

9. At the left side of the finisher, remove one screw (callout 1).

Figure 5-1155 Remove one screw

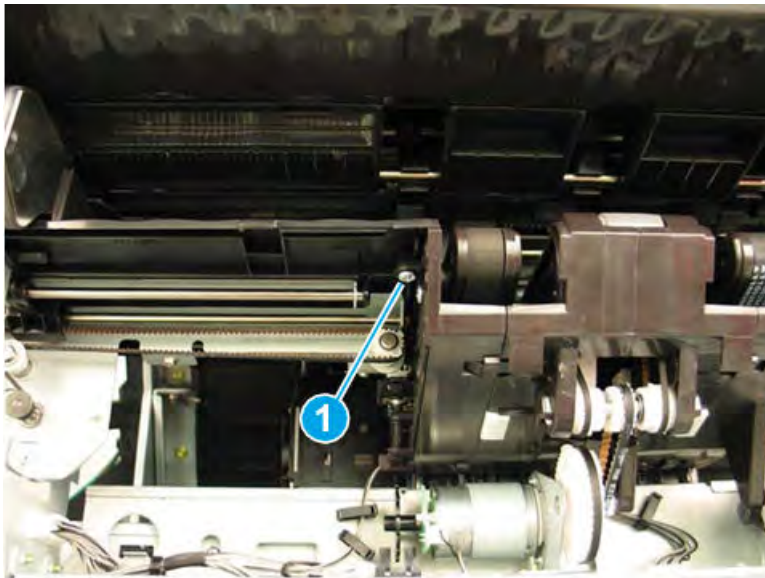

10. Look inside the finisher through the stapler opening in the rear and pull down to release and remove one shaft (callout 1) on the rear tamper unit.

Figure 5-1156 Remove the rear tamper shaft

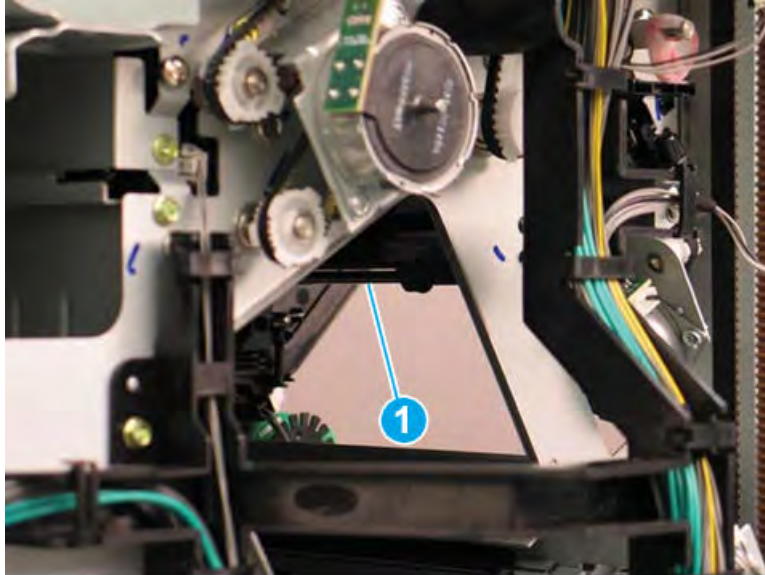

11. At the left side of the finisher, disconnect one connector (callout 1).

Figure 5-1157 Disconnect one connector

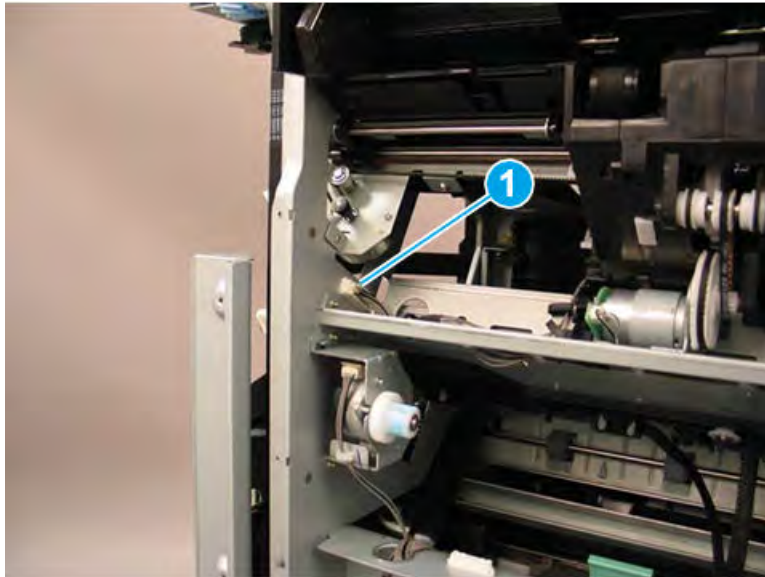

12. At the rear of the finisher, disconnect one connector (callout 1).

Figure 5-1158 Disconnect one connector

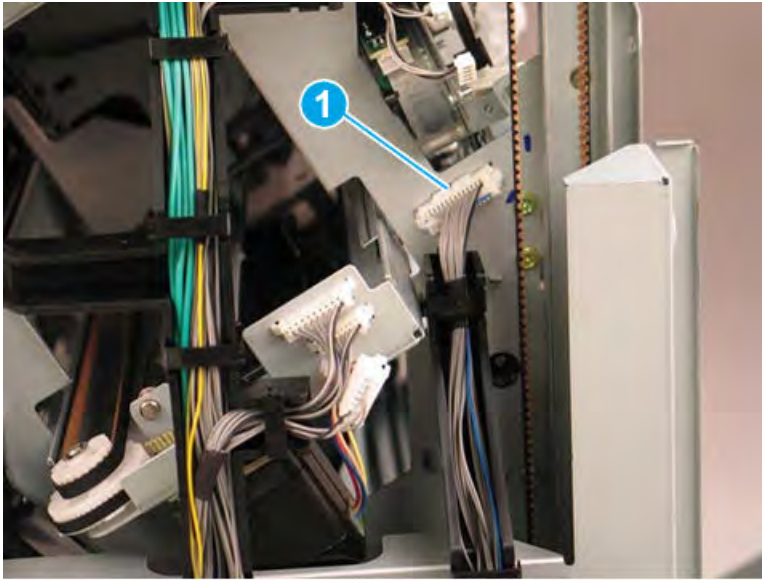

13. At the rear of the finisher, press the wire retainer to the right to access and remove two screws (callout 1).

Figure 5-1159 Disconnect one connector

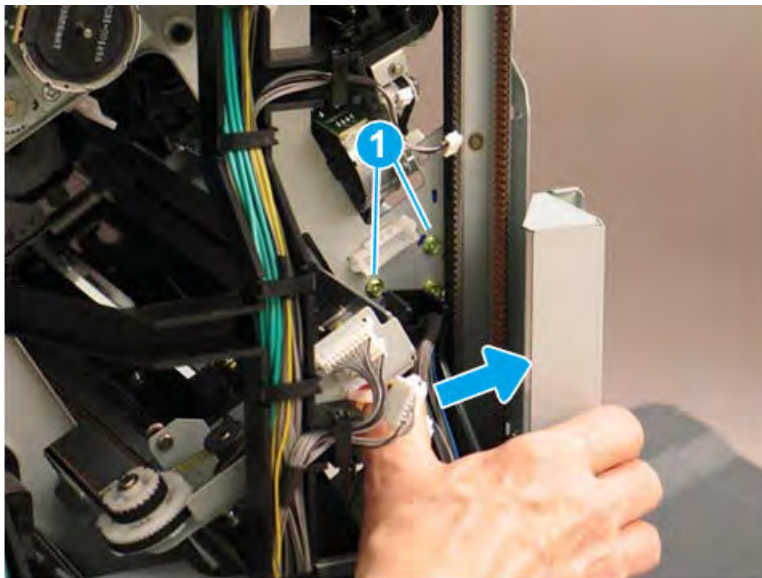

14. At the front of the finisher, remove two screws (callout 1).

Figure 5-1160 Remove two screws

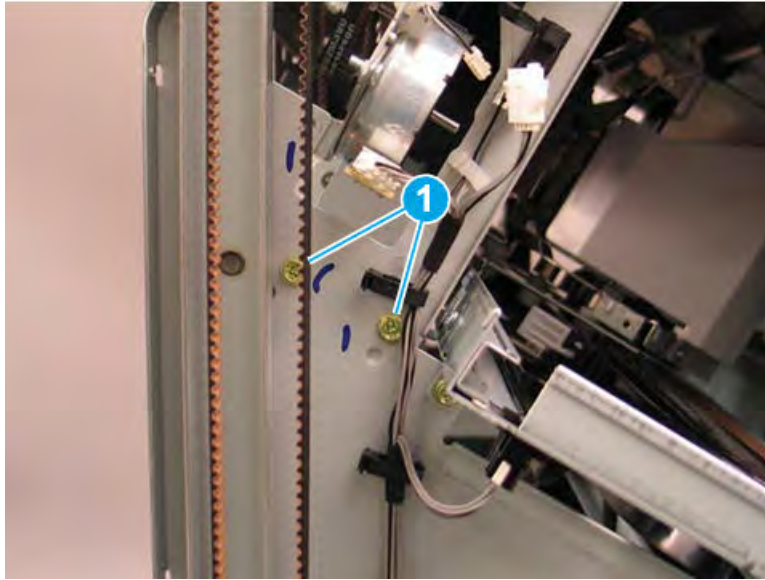

15. Lift the inside edges of the front and rear tampers up.

Figure 5-1161 Lift the edges of the tampers

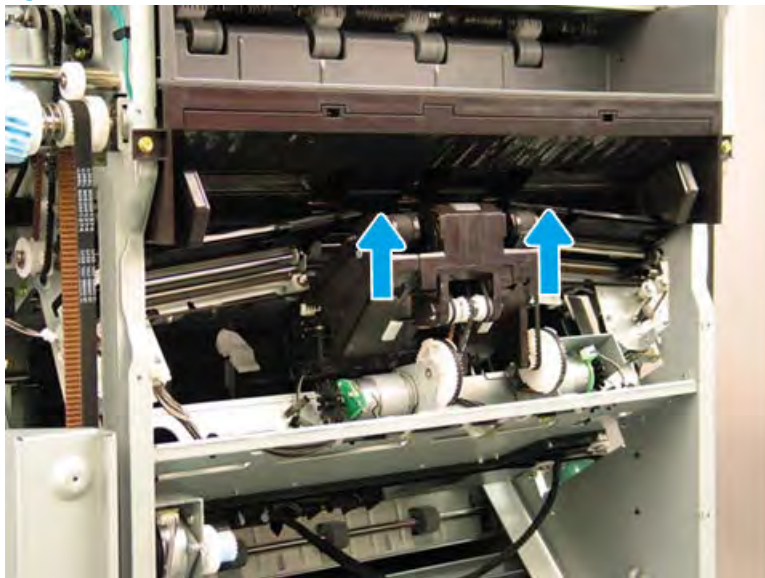

16. Rotate the rear edge of the ejector unit away from the finisher (callout 1), and then slide it toward the rear of the finisher (callout 2) to remove it. Make sure that the PCA (callout 3) stays clear of the sheet metal frame.

Figure 5-1162 Remove the ejector unit

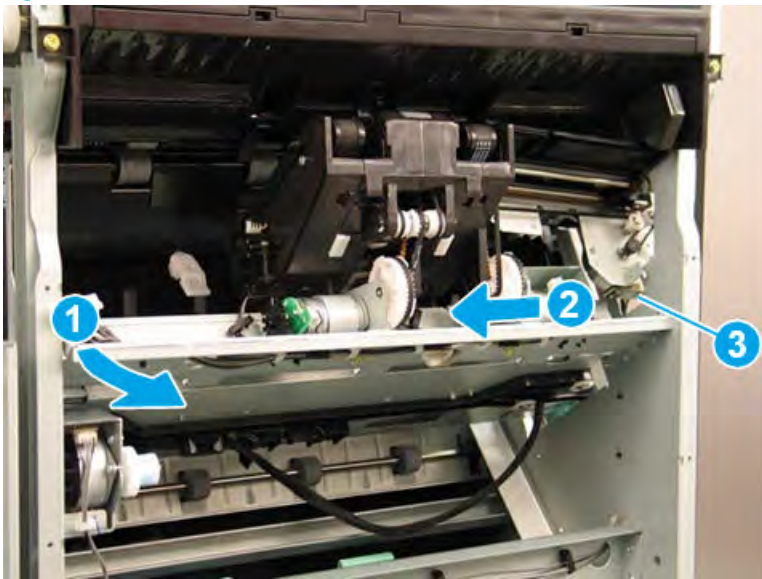

17. Reverse the removal steps to install the assembly. Also use the following special installation instructions.

 **NOTE:** Continue to reverse the removal steps to finish installing the assembly.

Special installation instructions: Ejector unit

- a. When the front tamper shaft is removed, the retainer arm that held the one end of the shaft will drop down. When reinstalling the shaft, raise the retainer arm and position the end of the shaft in the notch (callout 1).

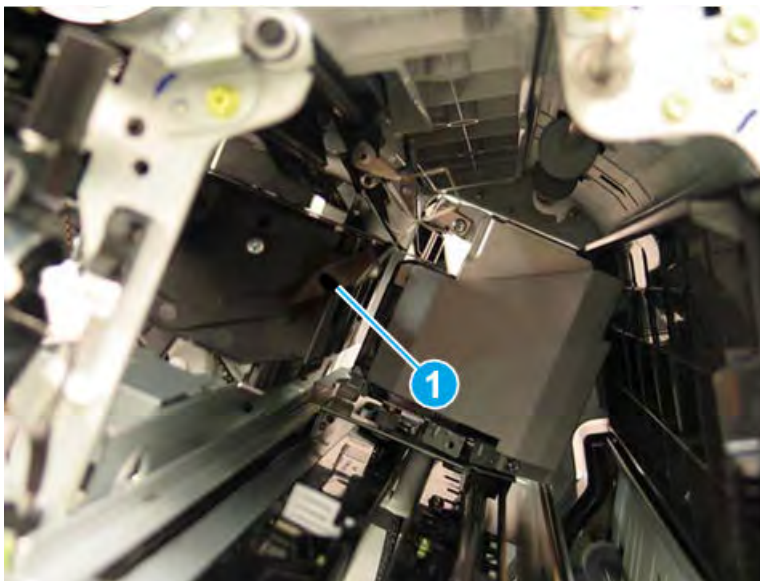

- b. When the rear tamper shaft is removed, the retainer arm that held the one end of the shaft will drop down. When reinstalling the shaft, raise the retainer arm and position the end of the shaft in the notch (callout 1).

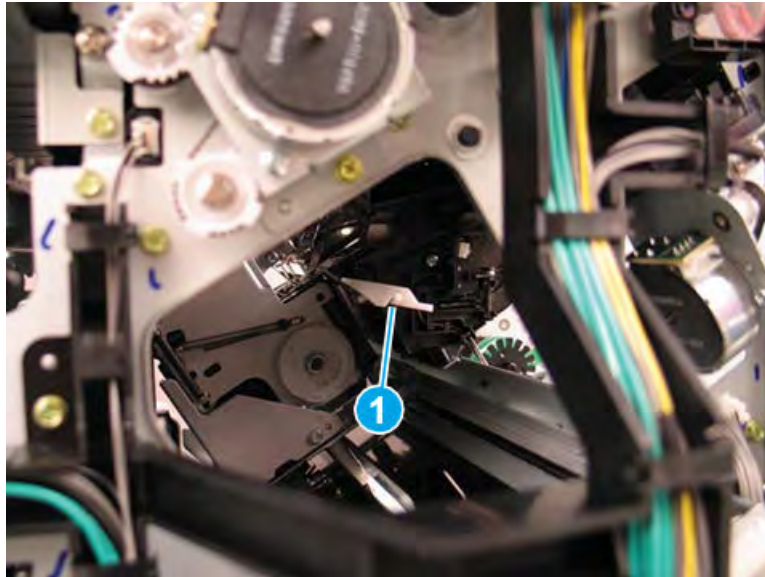

Remove the ejector2 motor sensor(S23)

Follow these steps to remove the ejector2 motor sensor(S23).

1. Disconnect the connector(callout 1) from ejector2 motor(M5, callout 2) of ejector unit.

Figure 5-1163 Disconnect the connector

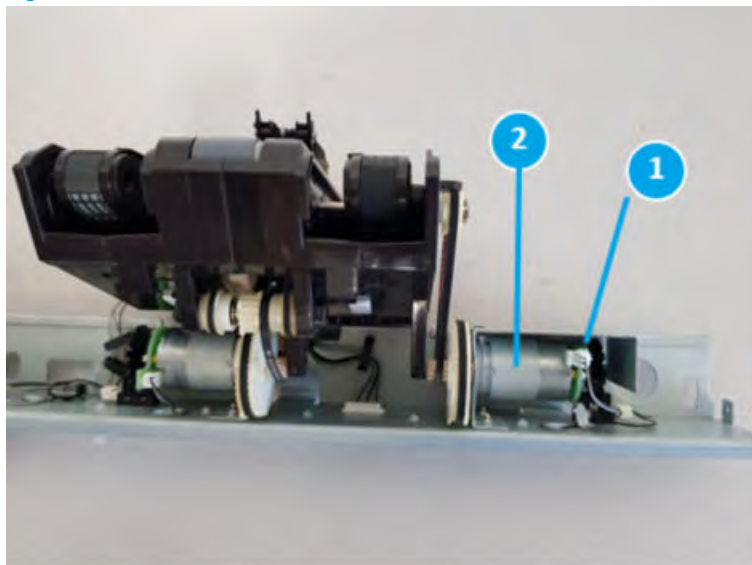

2. Remove two screws(callout 1).

Figure 5-1164 Remove two screws

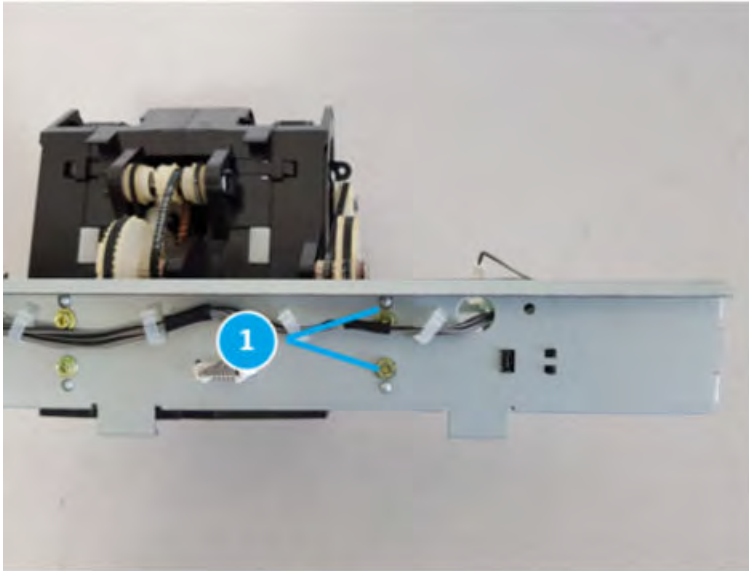

3. Remove the ejector2 motor from ejector unit, disconnect the connector(callout 1), and then remove the ejector2 motor sensor(S23, callout 2)

Figure 5-1165 Remove the ejector2 motor sensor

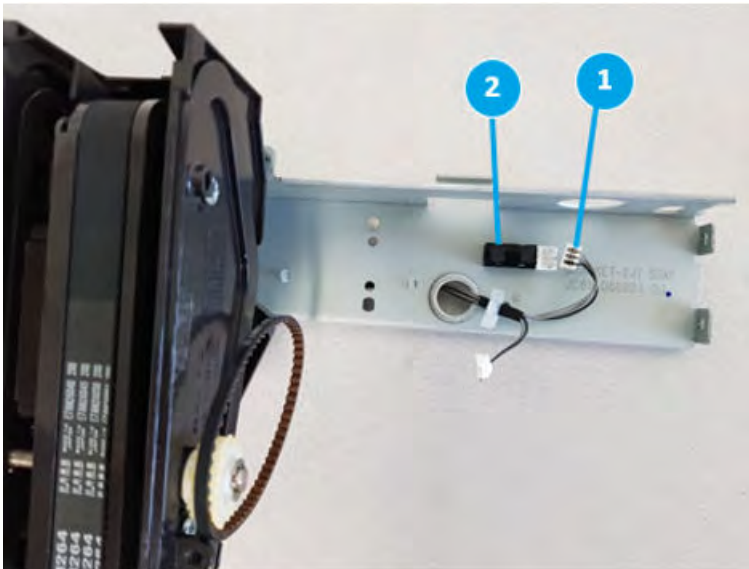

Unpack the replacement assembly

Follow these steps to unpack the replacement assembly.

1. Dispose of the defective part.

 **NOTE:** HP recommends responsible disposal of the defective part.

<http://www8.hp.com/us/en/hp-information/environment/product-recycling.html>

2. Unpack the replacement part from the packaging.



CAUTION:  Some parts are sensitive to electrostatic discharge (ESD). Always perform service work at an ESD-protected workstation or mat. If an ESD workstation or mat is not available, touch the sheet-metal chassis to provide a static ground before touching an ESD-sensitive assembly. Protect the ESD-sensitive assemblies by placing them in ESD pouches when they are out of the printer.

 **IMPORTANT:** Make sure that all of the shipping materials (for example shipping tape) are removed from the replacement part prior to installation.

 **NOTE:** If the replacement part is a roller or pad, avoid touching the spongy part of it. Skin oils on the roller or pad can cause paper pickup and/or print-quality problems. HP recommends using disposable gloves when handling rollers or pads or washing your hands before touching rollers or pads.

3. To install an assembly, reverse the removal steps.

 **NOTE:** When applicable, special installation instructions are provided for an assembly at the end of the removal procedure. Always completely read the removal instructions and follow all special installation instructions.

Removal and replacement: Ejector2 motor (M5)

Learn how to remove and replace the ejector2 motor.

Introduction

This document provides the procedures to remove and replace the ejector2 motor on the finisher.

 **IMPORTANT:** When applicable, special installation instructions are provided for an assembly at the end of the removal procedure. Always completely read the removal instructions and follow all special installation instructions.

Before performing service

- Turn the printer power off. A shutting-down message appears on the control-panel display.

 **WARNING!** To avoid damage to the printer, turn the power off and wait until the printer shuts down before removing the power cable.

- Disconnect the printer power cable after the printer has completely shut down (the control-panel display is blank).
- Release the finisher from the printer by pulling out on the release latch inside the finisher door.
- Disconnect the cable from the bridge unit to the finisher.
- Disconnect the cable from the finisher to the printer.

Use the table below to identify the correct part number for your printer. To order the part, go to <https://parts.hp.com>.

Table 5-131 Part information

Part number	Part description
JC93-01168A	Ejector2 motor

Required tools

- #2 JIS screwdriver with a magnetic tip
- Small, flat-blade screwdriver

After performing service

- Connect the cable from the finisher to the printer.
- Connect the cable from the bridge unit to the finisher.
- Attach the finisher to the printer, and then push in on the release latch inside the finisher door.
- Connect the printer power cable.
- Turn the printer power on.

Post service test

Process a job through the finisher and verify that the finisher works correctly.

Remove the right upper cover (finisher)

Follow these steps to remove the right upper cover (finisher).

- ▲ Remove one screw cap and three machine screws on the upper edge of the cover (callout 1). Remove three sheet metal screws (callout 2) on the lower portion of the cover. Rotate the right edge of the cover away from the finisher, and then slide the cover right to release three tabs (callout 3).

💡 **TIP:** The lower screws are shorter in length than the upper screws.

TIP: Reverse the removal steps to install the assembly.

Figure 5-1166 Remove the right upper cover

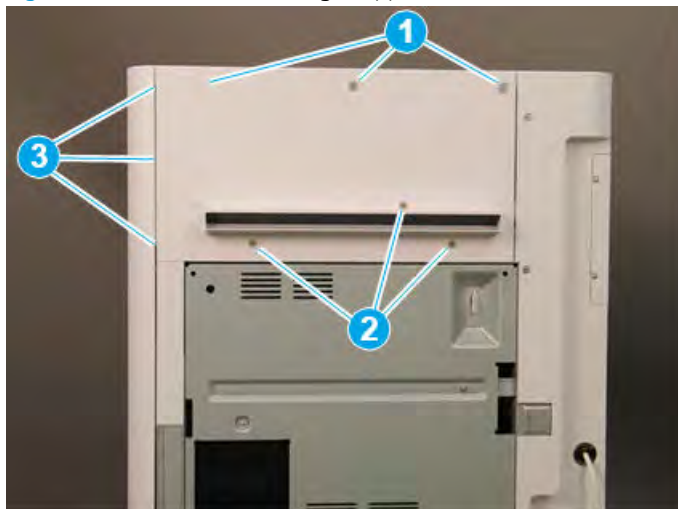

Remove the top cover (finisher)

Follow these steps to remove the top cover (finisher).

1. Remove three screw caps and three self-tapping screws at the top of the rear cover (callout 1), and then remove three machine screws (callout 2) on top of the cover.

Figure 5-1167 Remove six screws

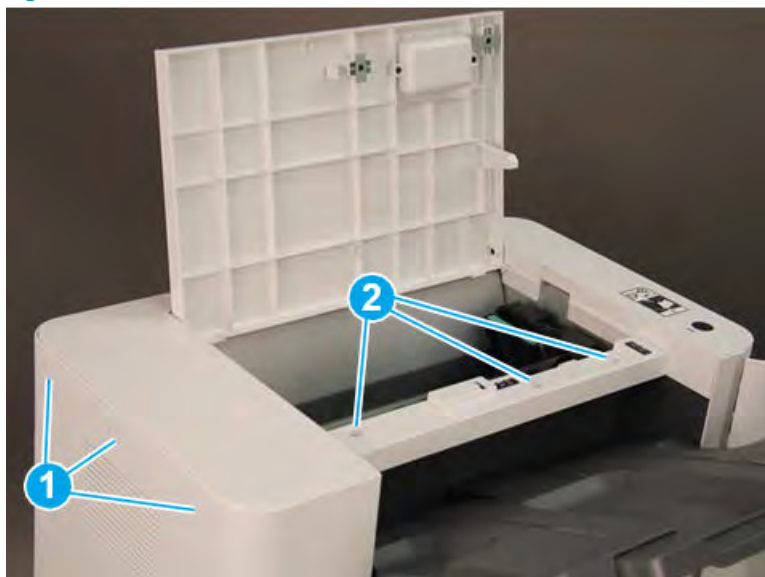

2. Remove three self-tapping screws at the top of the front cover (callout 1), and then remove two machine screws (callout 2) at the top of the right side.

Figure 5-1168 Remove five screws

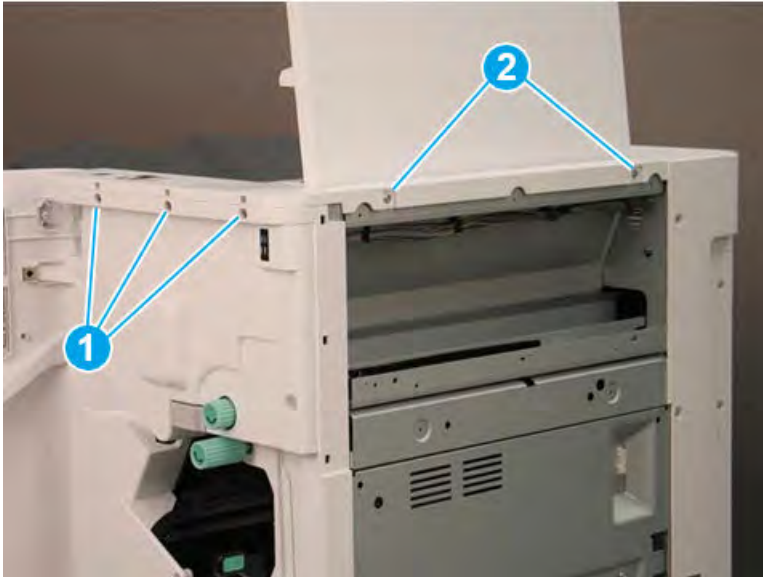

3. Lift the cover up slightly. Disconnect one in-line connector (callout 1), and then release one retainer (callout 2).

 **TIP:** Reverse the removal steps to install the assembly.

Figure 5-1169 Disconnect one connector and release retainer



Remove the front door (finisher)

Follow these steps to remove the front door (finisher).

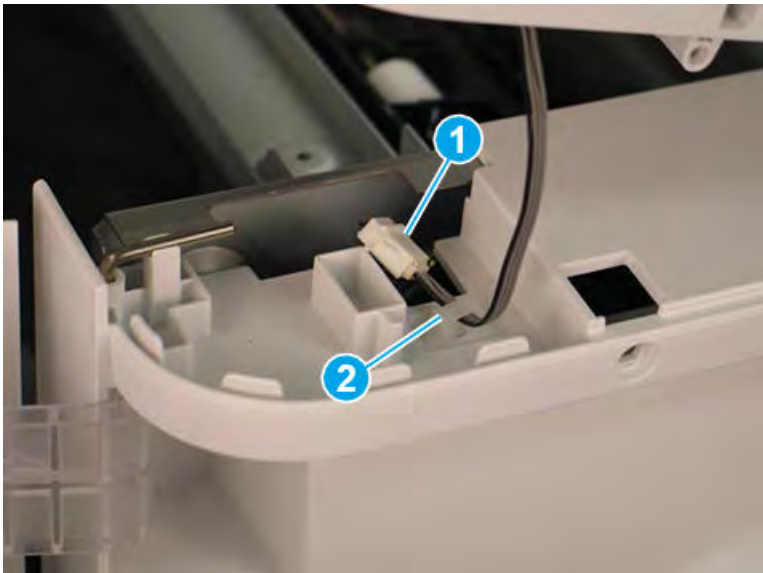
1. Lift the top hinge pin up to release it from the retainer.

Figure 5-1170 Lift the top hinge pin

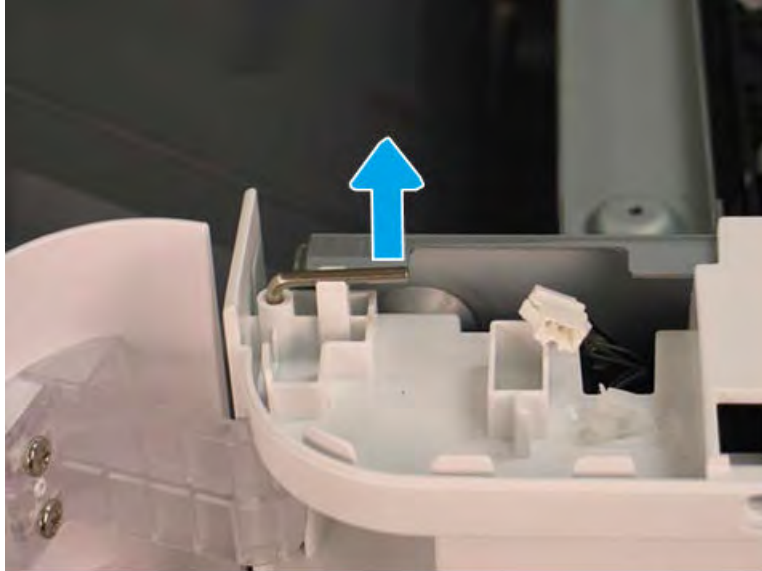

2. Pull the top hinge pin up to remove it.

Figure 5-1171 Remove the top hinge pin

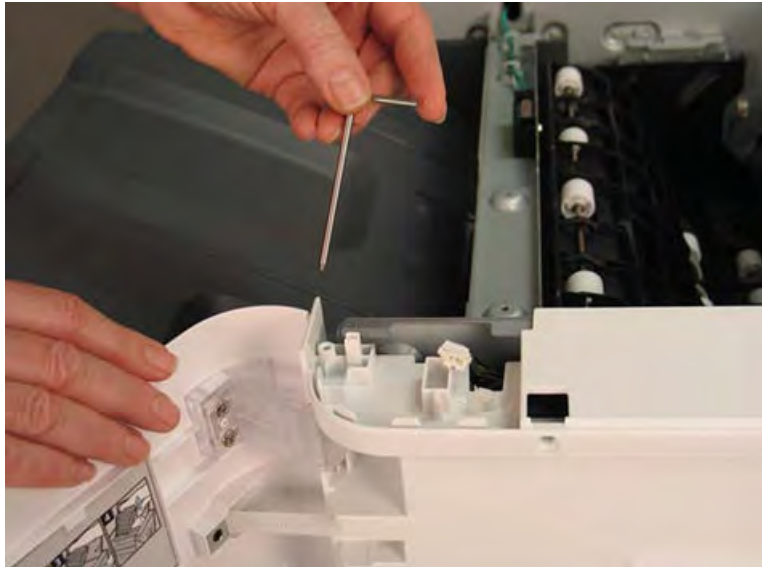

3. Use a small, flat-blade screwdriver to release the lower hinge pin from the retainer, and then rotate it away from the finisher.

Figure 5-1172 Release the lower hinge pin



4. Support the door with one hand, and then pull the lower hinge pin straight up to remove it.

Figure 5-1173 Remove the lower hinge pin



5. Support the door with one hand, and then remove one screw (callout 1) to release the strap. Remove the front door.

 **TIP:** Reverse the removal steps to install the assembly.

Figure 5-1174 Remove the front door



Remove the front cover (finisher)

Follow these steps to remove the front cover (finisher).

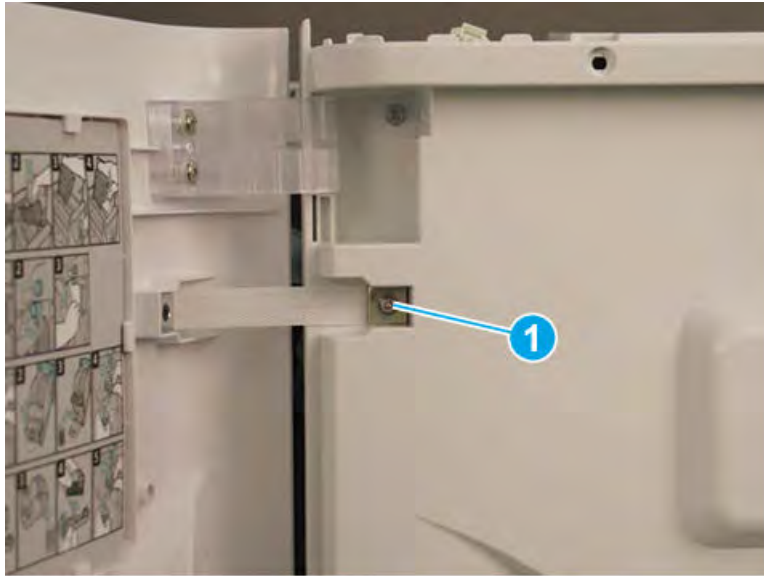
1. Release one tab (callout 1), and then pull the jam-access knob away from the finisher to remove it.

Figure 5-1175 Remove the jam-access knob

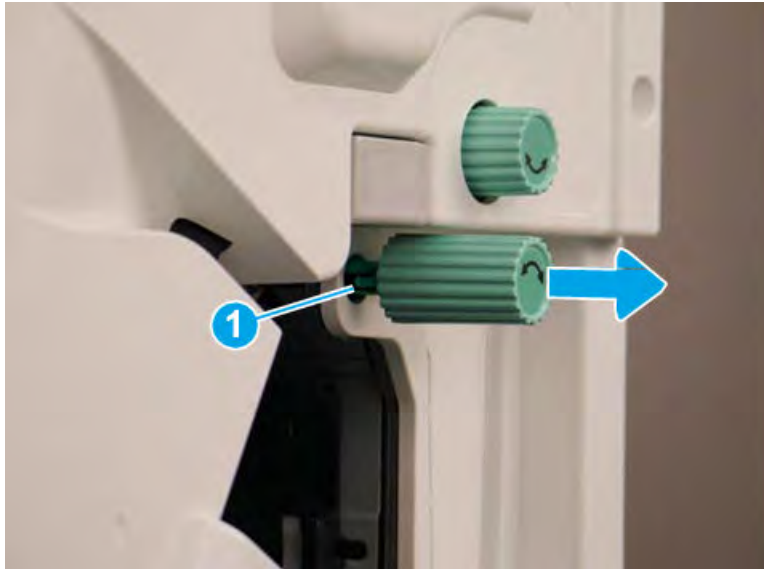

2. If the punch unit is installed, remove the punch waste bin (callout 1).

3. Remove one screw (callout 1) on top of the front cover.

Figure 5-1176 Remove one screw



4. Remove five machine screws (callout 1), and then remove the front cover.

 **TIP:** Reverse the removal steps to install the assembly.

Figure 5-1177 Remove the front cover



Remove the rear cover (finisher)

Follow these steps to remove the rear cover (finisher).

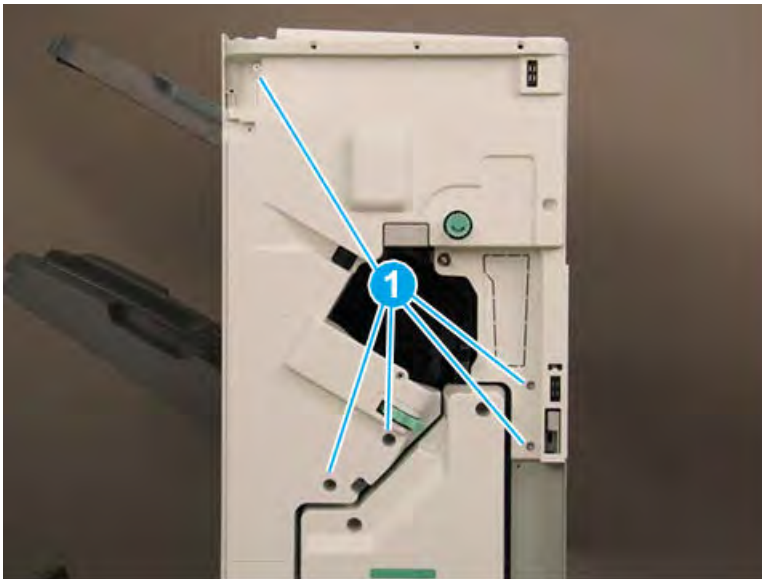
1. Remove two self-tapping screws (callout 1) on the top of the rear cover, and then remove five screw caps and five machine screws (callout 2) on the left side of the cover.

Figure 5-1178 Remove seven screws

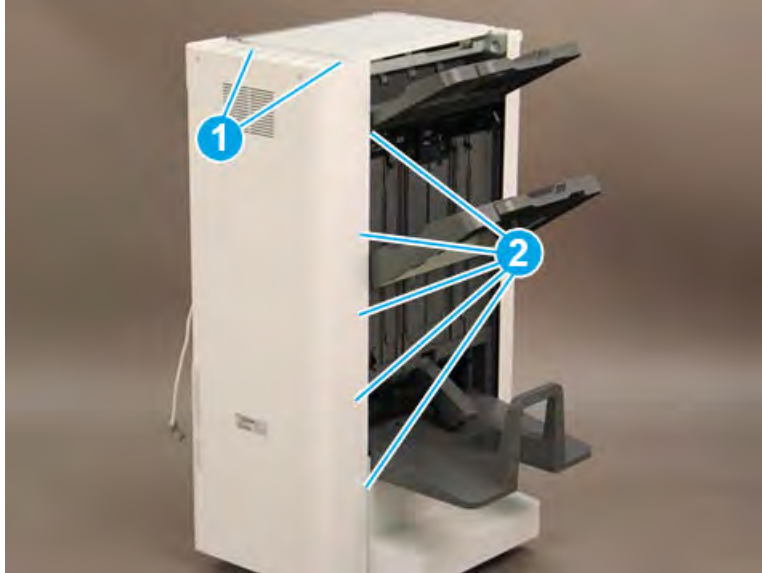

2. Remove one screw cap and four machine screws (callout 1) Remove the rear cover.

 **NOTE:** Make sure to thread the power cable (callout 2) through the opening in the cover.

 **TIP:** Reverse the removal steps to install the assembly

Figure 5-1179 Remove the rear cover



Remove the booklet output tray

Follow these steps to remove the booklet output tray.

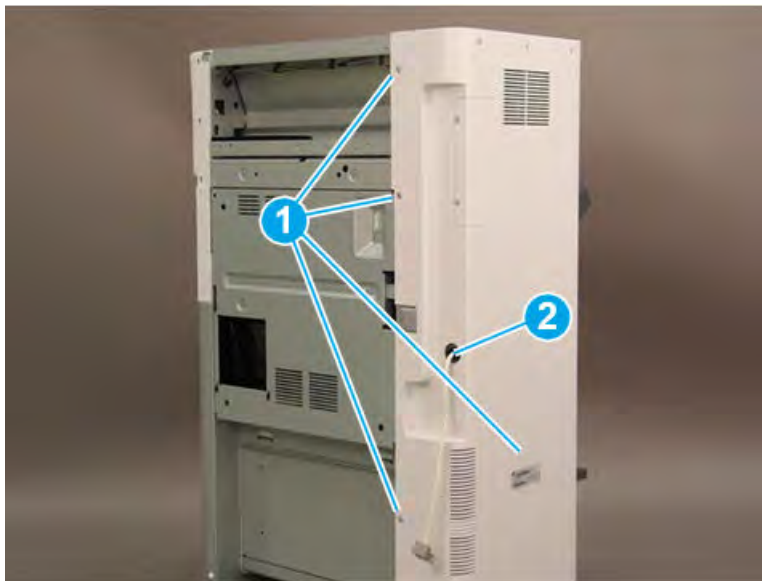
1. Raise the booklet output tray up (callout 1), and then pull it away from the finisher (callout 2) to remove it.

Figure 5-1180 Remove the booklet output tray



2. Reverse the removal steps to install the assembly. Also use the following special installation instructions.

 **NOTE:** Continue to reverse the removal steps to finish installing the assembly

Special installation instructions: booklet output tray

Position the tabs (callout 1) on the tray into the slots (callout 2) on the finisher.

Figure 5-1181 Install the booklet output tray

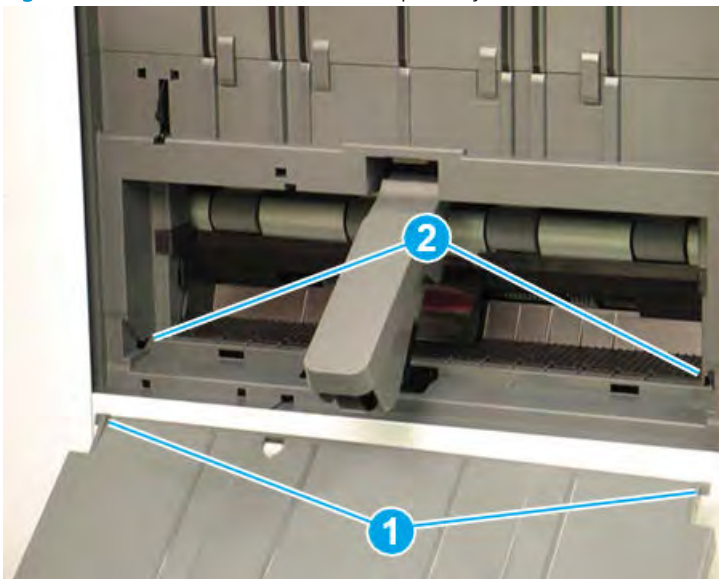

Remove the caster cover

Follow these steps to remove the caster cover.

1. Remove two screw caps and two self-tapping screws (callout 1). Remove two screw caps and two machine screws (callout 2).

Figure 5-1182 Remove four screws

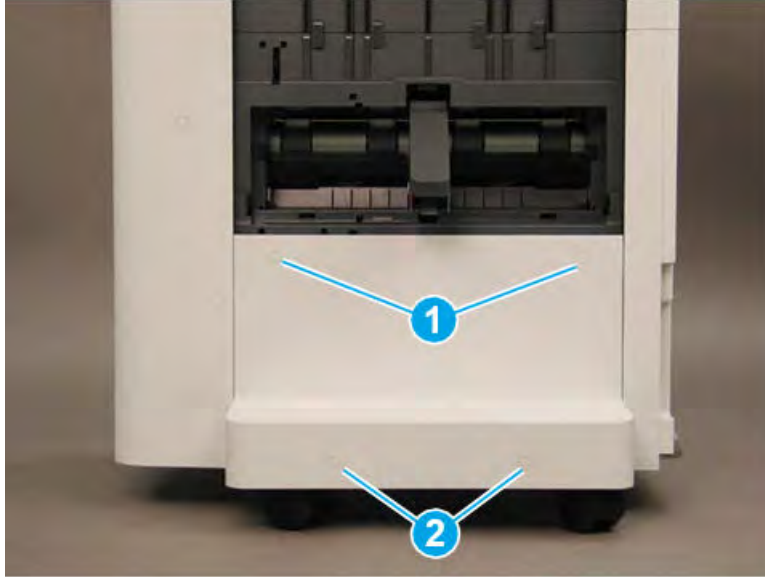

2. Rotate the left edge of the cover away from the finisher (callout 1), and then slide the cover to the left (callout 2) to remove it.

 **TIP:** Make sure that two tabs (callout 3) are positioned under the front lower cover when reinstalling the caster cover.

TIP: Reverse the removal steps to install the assembly

Figure 5-1183 Remove the caster cover

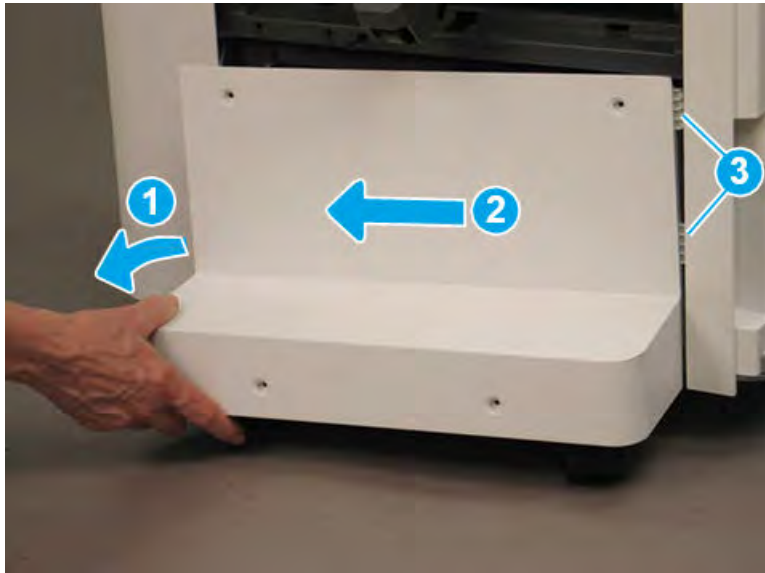

Remove the left lower cover (finisher)

Follow these steps to remove the left lower cover (finisher).

1. Remove four screws (callout 1).

 **NOTE:** Raise the lower output tray as needed to access the screws.

Figure 5-1184 Remove four screws



2. Slide the shield down (callout 1) to release it from four tabs (callout 2), and then rotate it away from the finisher (callout 3).

⚠ CAUTION: The shield is still attached to the finisher. Do not attempt to completely remove the shield.

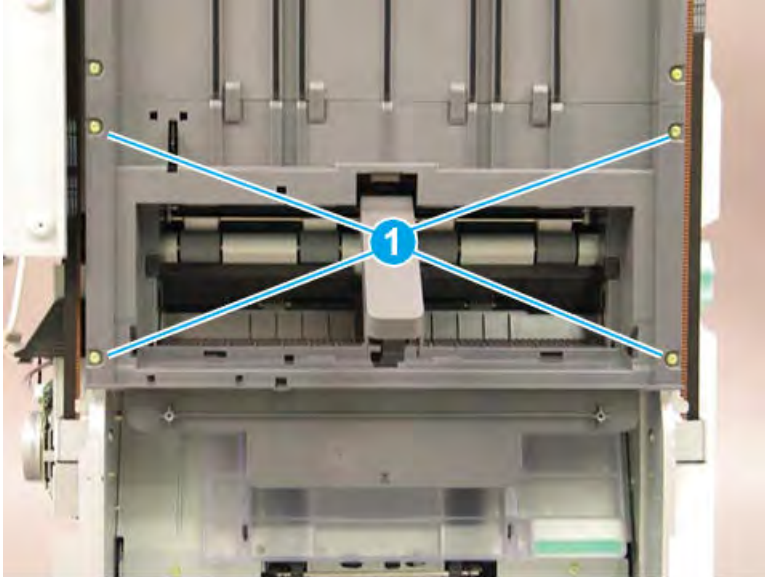
💡 TIP: Position the shield under the four tabs (callout 2) when reinstalling it.

Figure 5-1185 Release the lower shield

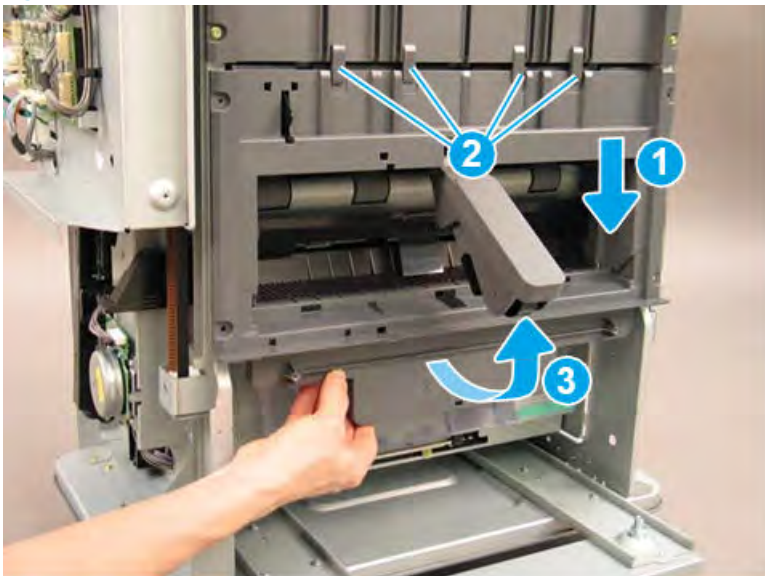

3. Disconnect two connectors (callout 1), and then remove the shield.

 **TIP:** Reverse the removal steps to install the assembly.

Figure 5-1186 Disconnect two connectors

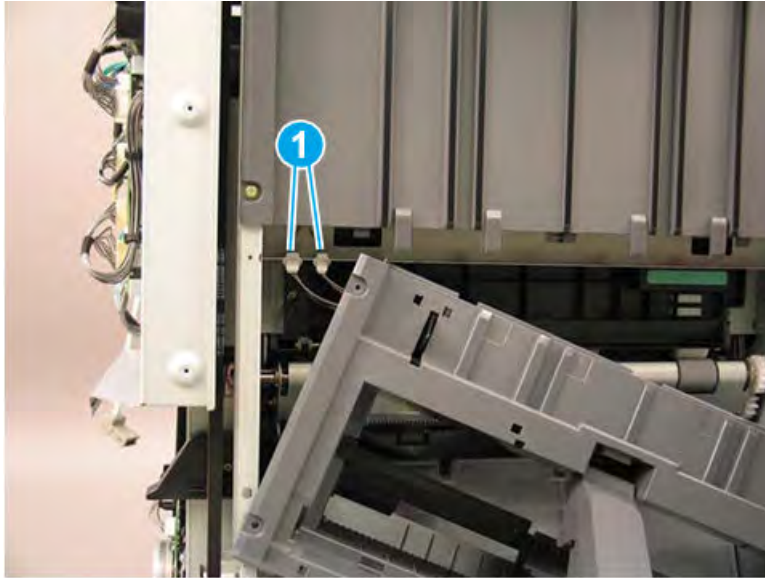

4. If you are replacing the left lower cover, locate three sensors (callout 1) on the back of the left lower cover. Remove these sensors and transfer them to the replacement part.

Figure 5-1187 Remove the left lower cover

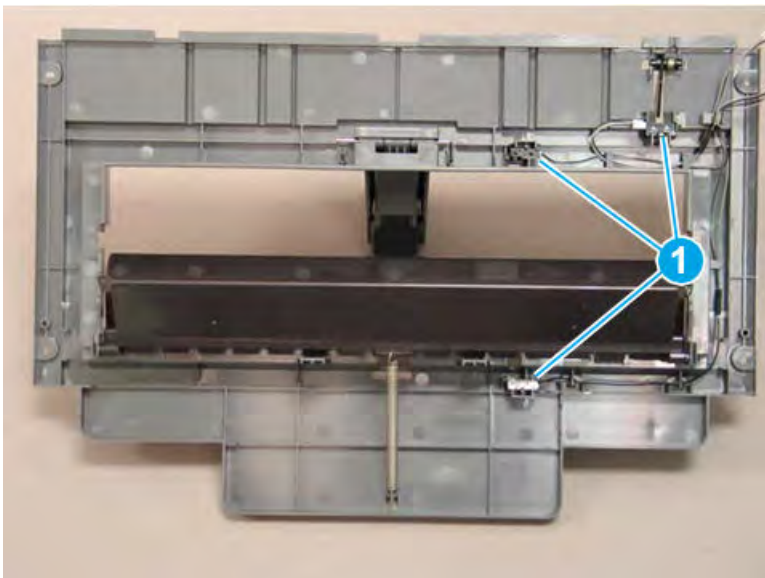

Remove the left upper cover (finisher)

Follow these steps to remove the left upper cover (finisher).

1. Bring the lower output tray down by positioning the shaft of a screwdriver on the clutch (callout 1) and gently pressing to the right to release the clutch. Hold the clutch in the released position and lower the tray (callout 2) to the lowest position.

Figure 5-1188 Lower the output tray

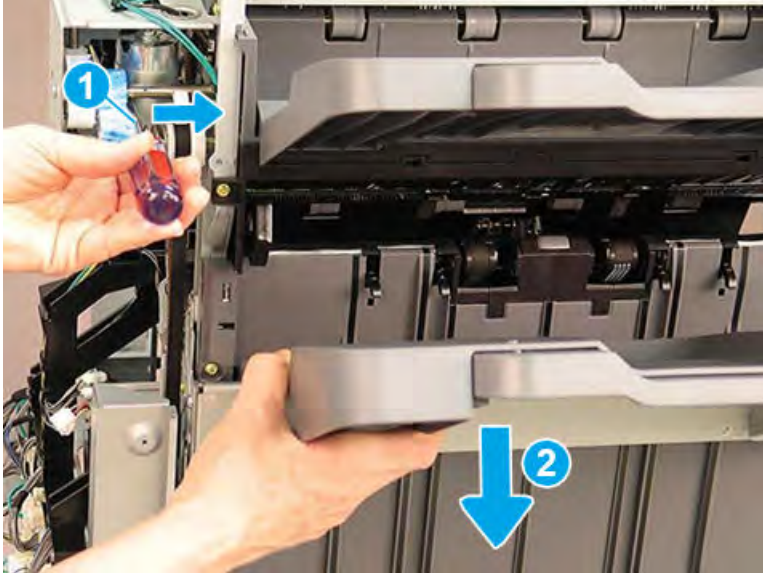

2. Remove six machine screws (callout 1).

Figure 5-1189 Remove six screws

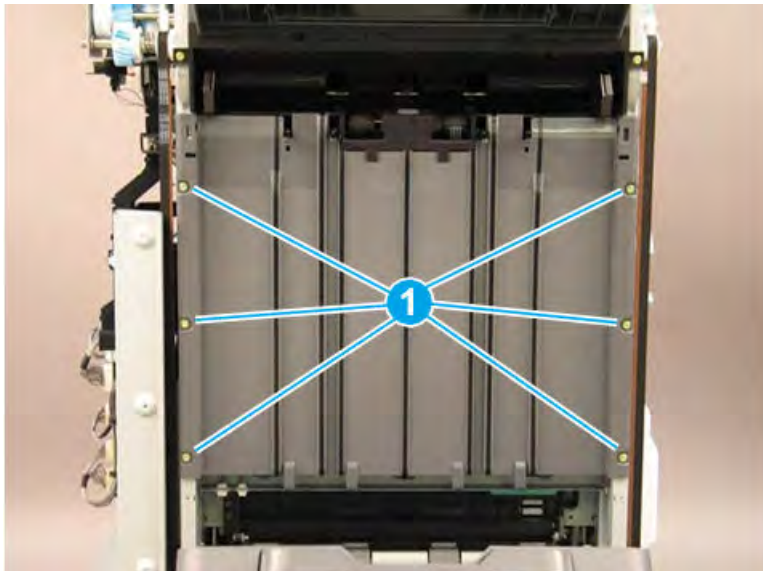

3. Rotate the lower edge of the shield away from the finisher (callout 1), and then slide the shield down (callout 2) to release it from two tabs (callout 3).

CAUTION: The shield is still attached to the finisher. Do not attempt to completely remove the shield.

TIP: Position the shield under the two tabs (callout 3) when reinstalling it.

Figure 5-1190 Release the shield

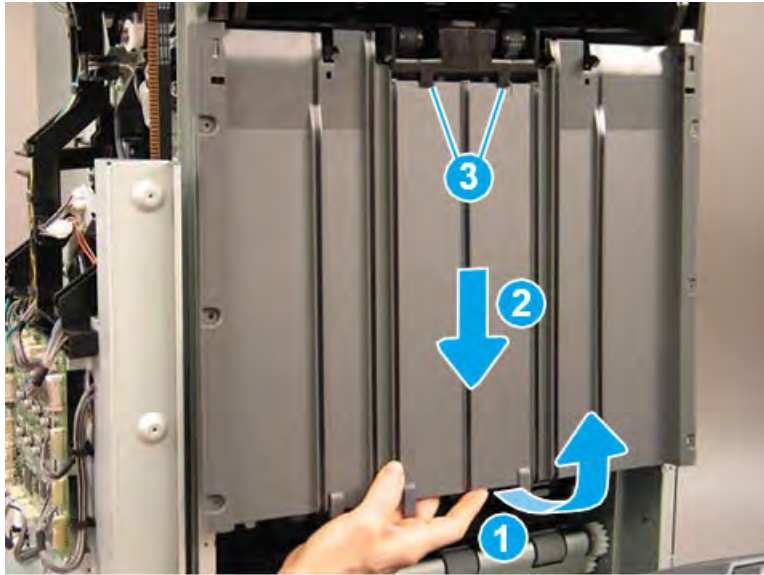

4. Disconnect one connector (callout 1), and then remove the upper shield assembly.

TIP: Reverse the removal steps to install the assembly.

Figure 5-1191 Disconnect one connector

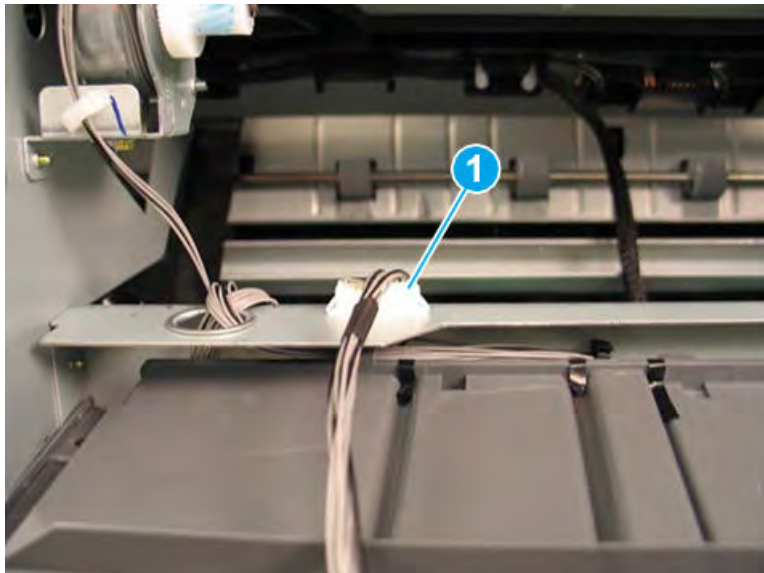

5. If you are replacing the left upper cover, locate three sensors (callout 1) on the back of the left upper cover. Remove these sensors and transfer them to the replacement part.

Figure 5-1192 Remove the left upper cover

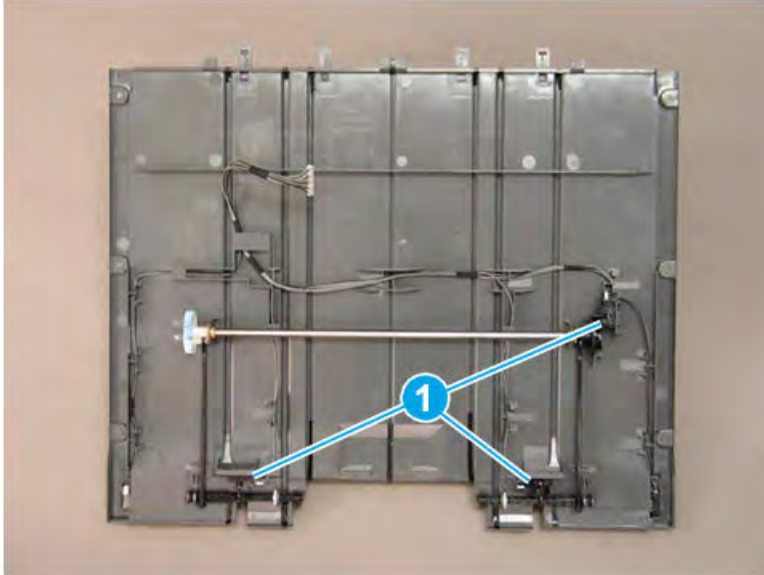

Remove the ejector unit (finisher)

Follow these steps to remove the ejector unit (finisher).

1. Rotate the green wheel to move the staple unit to the center of the finisher.

Figure 5-1193 Move the staple unit to the center

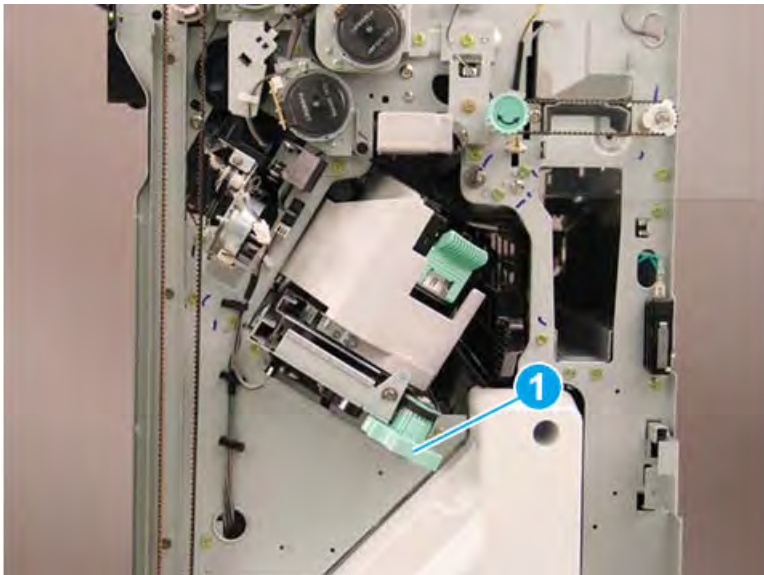

2. Release one retainer (callout 1), and then disconnect three connectors (callout 2).

Figure 5-1194 Disconnect three connectors

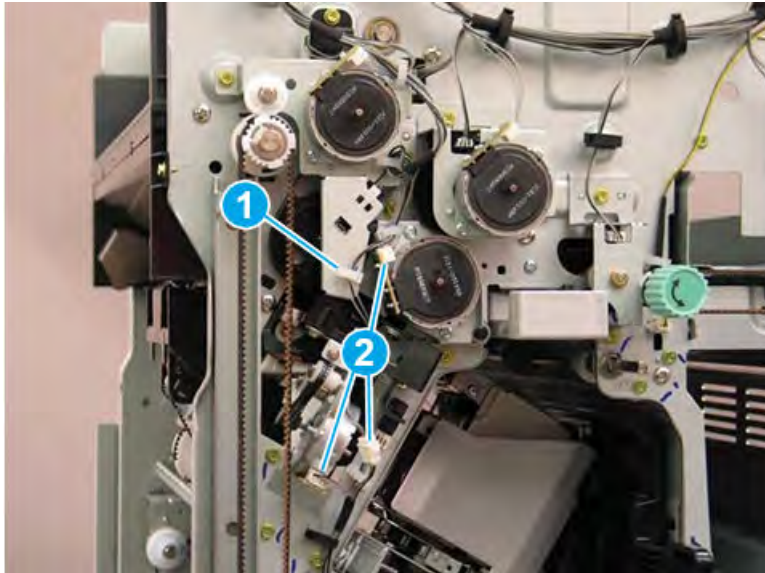

3. Remove two screws (callout 1).

Figure 5-1195 Remove two screws

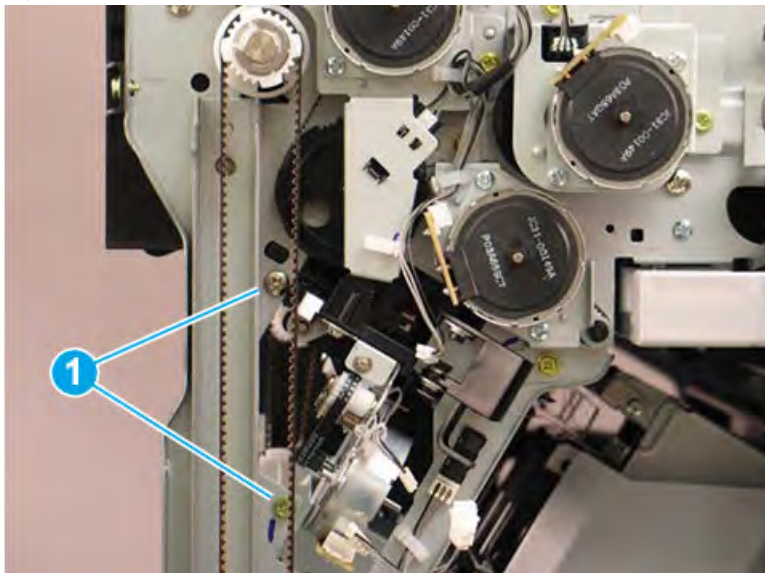

4. At the left side of the finisher, remove one screw (callout 1).

Figure 5-1196 Remove one screw

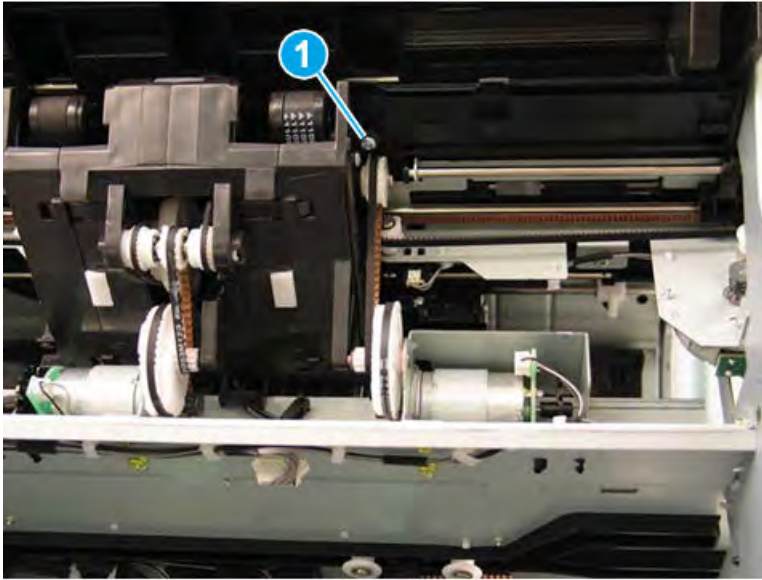

5. Press up on the hinge (callout 1), release one tab (callout 2), and then rotate the sensor away from the finisher (callout 3).

Figure 5-1197 Rotate the sensor

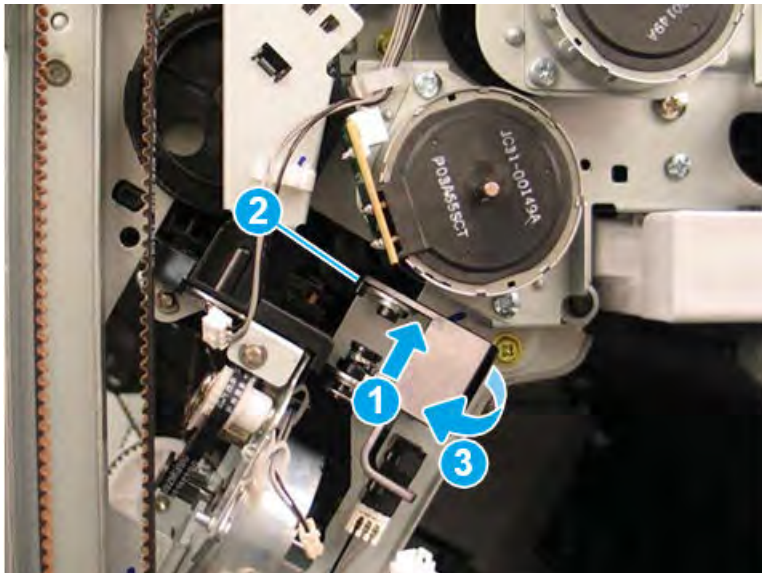

6. Remove one screw (callout 1).

Figure 5-1198 Remove one screw

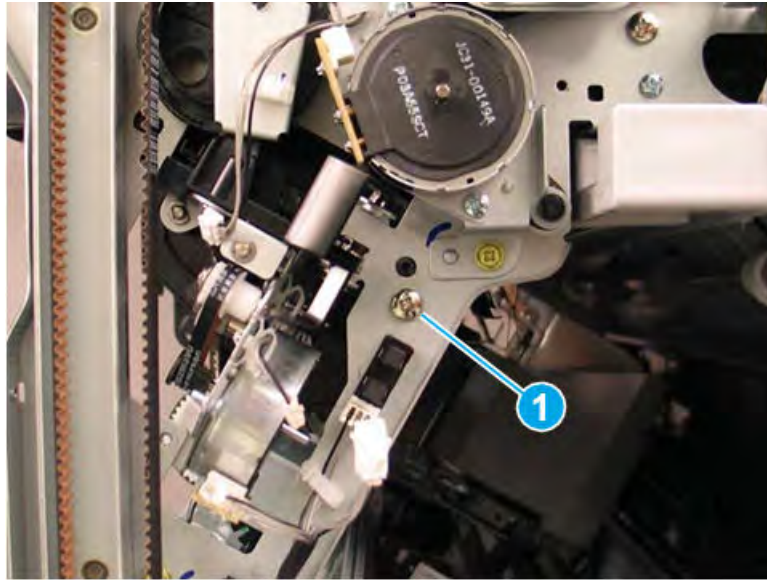

7. Look inside the finisher through the stapler opening in the front and pull down to release and remove one shaft (callout 1) on the front tamper unit.

Figure 5-1199 Remove the front tamper shaft

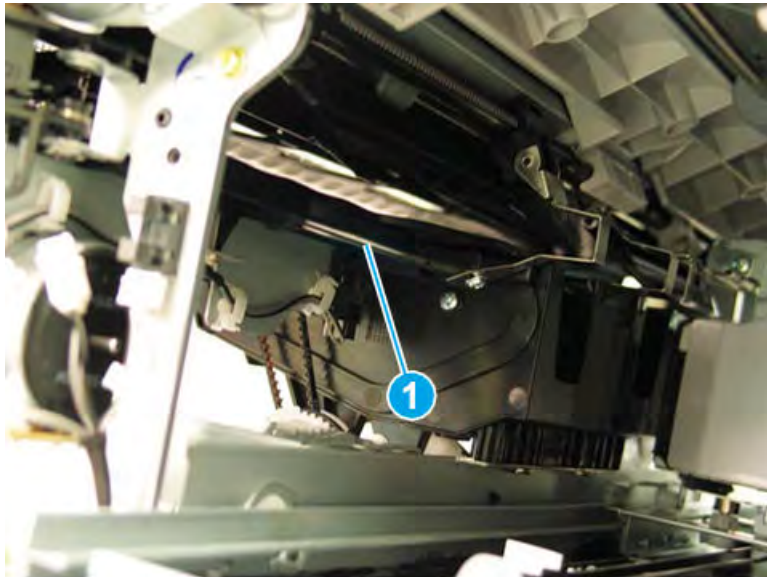

8. At the rear of the finisher, disconnect two connectors (callout 1), and then remove three screws (callout 2).

Figure 5-1200 Disconnect two connectors and remove three screws

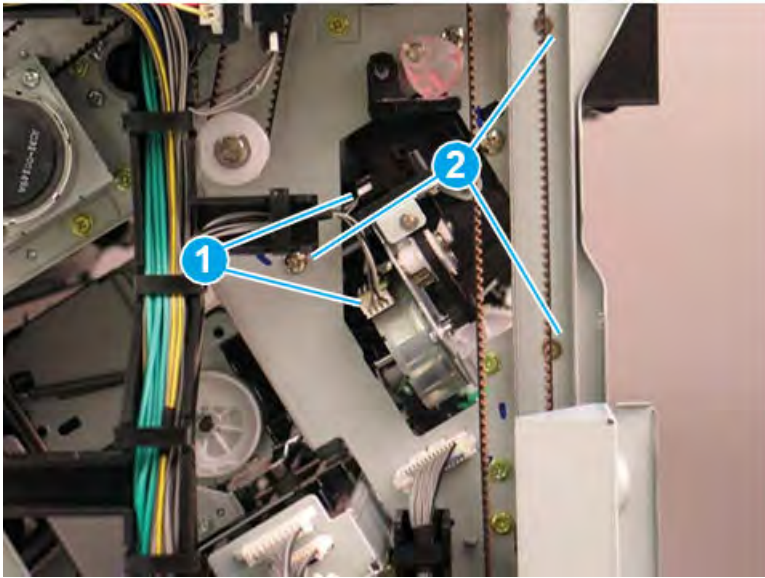

9. At the left side of the finisher, remove one screw (callout 1).

Figure 5-1201 Remove one screw

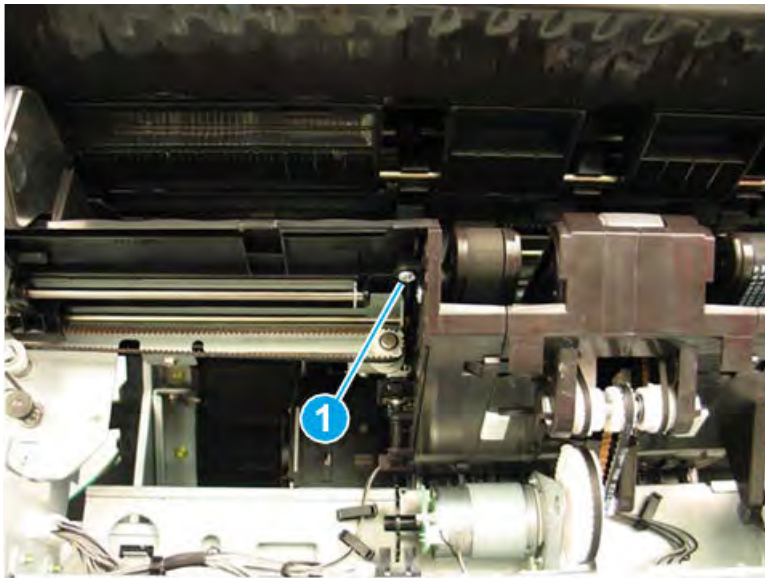

10. Look inside the finisher through the stapler opening in the rear and pull down to release and remove one shaft (callout 1) on the rear tamper unit.

Figure 5-1202 Remove the rear tamper shaft

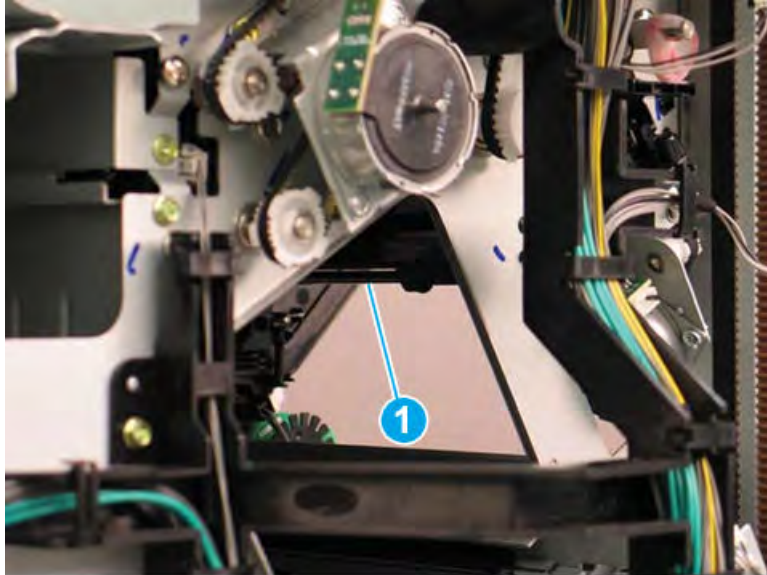

11. At the left side of the finisher, disconnect one connector (callout 1).

Figure 5-1203 Disconnect one connector

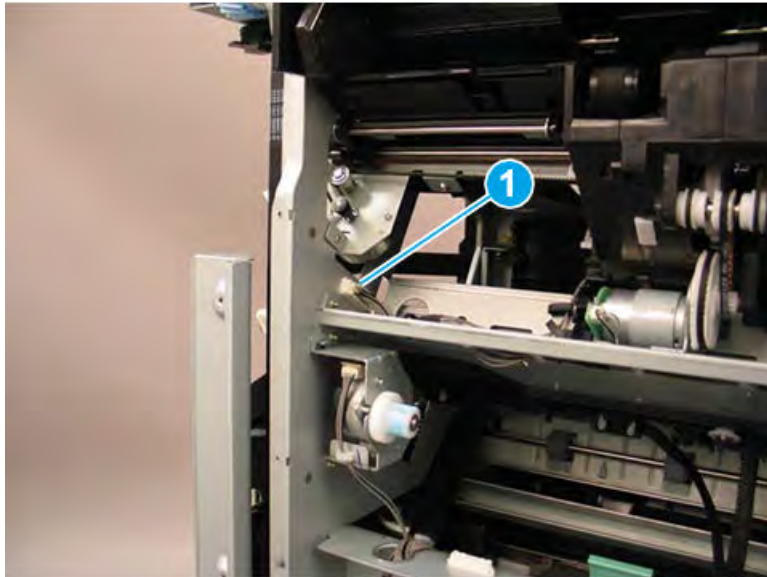

12. At the rear of the finisher, disconnect one connector (callout 1).

Figure 5-1204 Disconnect one connector

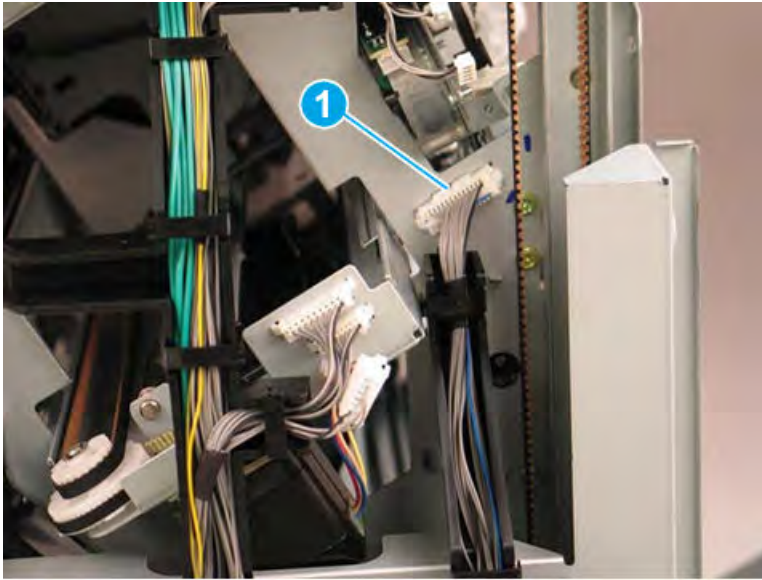

13. At the rear of the finisher, press the wire retainer to the right to access and remove two screws (callout 1).

Figure 5-1205 Disconnect one connector

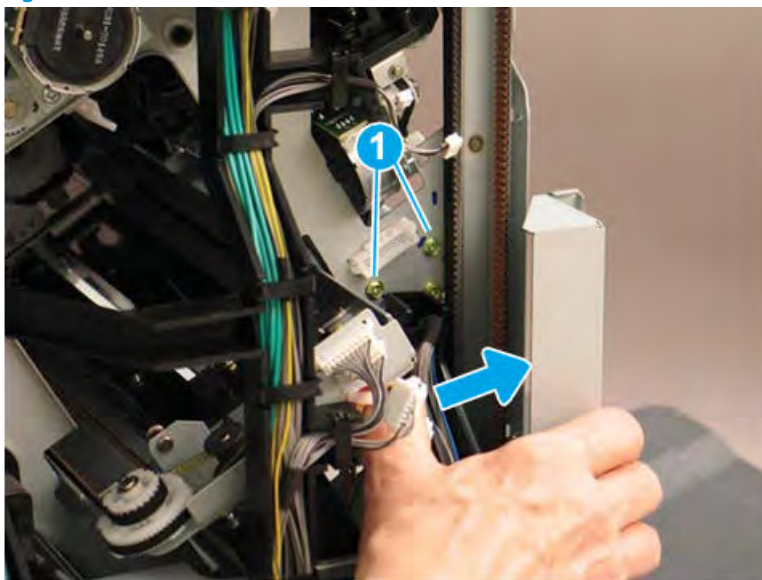

14. At the front of the finisher, remove two screws (callout 1).

Figure 5-1206 Remove two screws

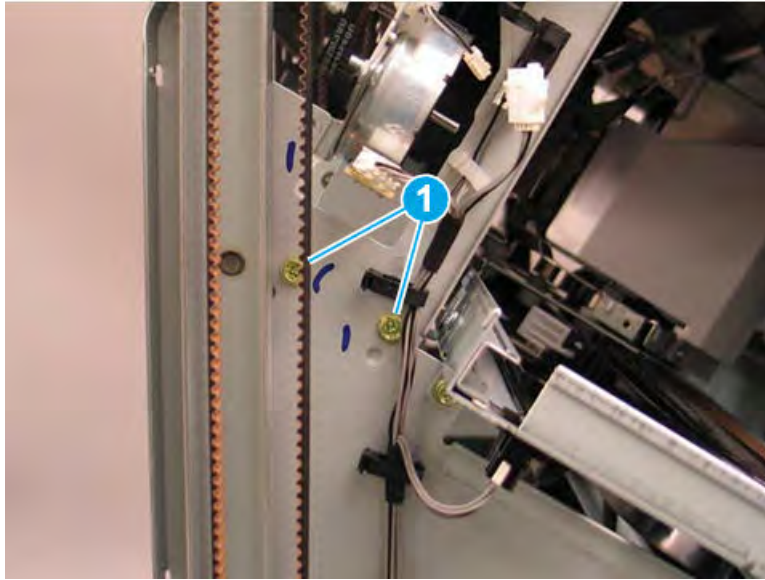

15. Lift the inside edges of the front and rear tampers up.

Figure 5-1207 Lift the edges of the tampers

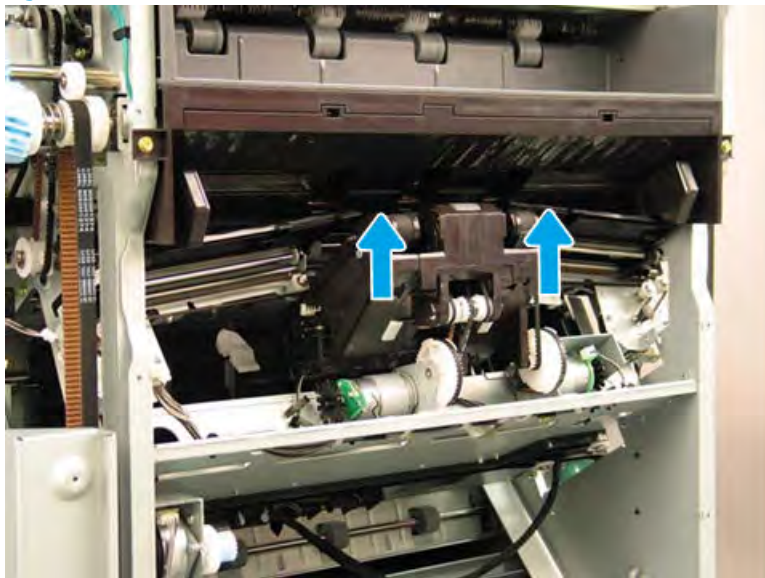

16. Rotate the rear edge of the ejector unit away from the finisher (callout 1), and then slide it toward the rear of the finisher (callout 2) to remove it. Make sure that the PCA (callout 3) stays clear of the sheet metal frame.

Figure 5-1208 Remove the ejector unit

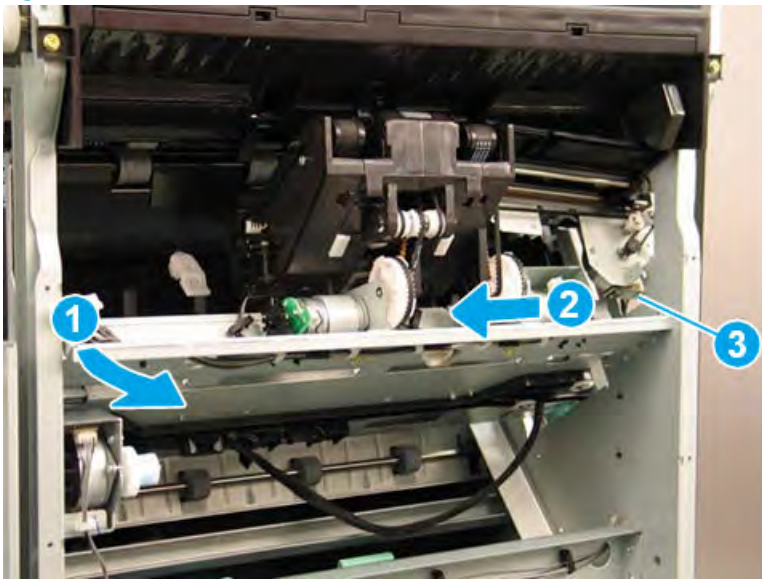

17. Reverse the removal steps to install the assembly. Also use the following special installation instructions.

 **NOTE:** Continue to reverse the removal steps to finish installing the assembly.

Special installation instructions: Ejector unit

- a. When the front tamper shaft is removed, the retainer arm that held the one end of the shaft will drop down. When reinstalling the shaft, raise the retainer arm and position the end of the shaft in the notch (callout 1).

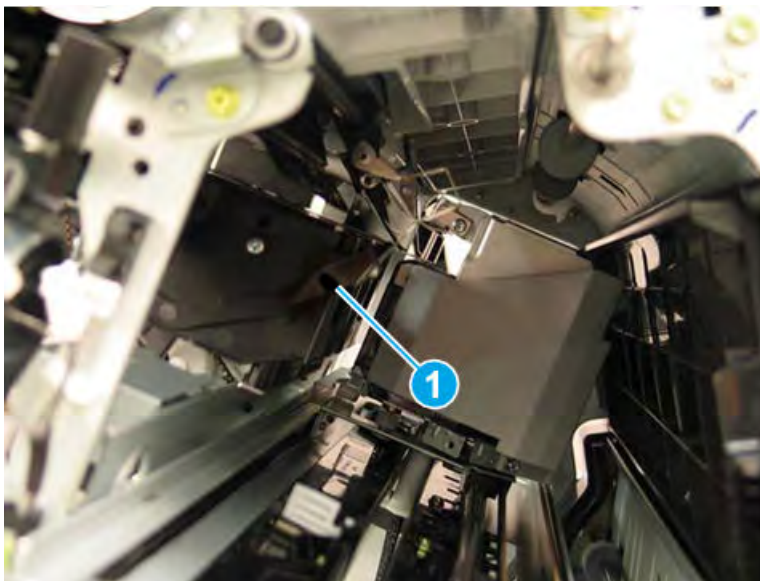

- b. When the rear tamper shaft is removed, the retainer arm that held the one end of the shaft will drop down. When reinstalling the shaft, raise the retainer arm and position the end of the shaft in the notch (callout 1).

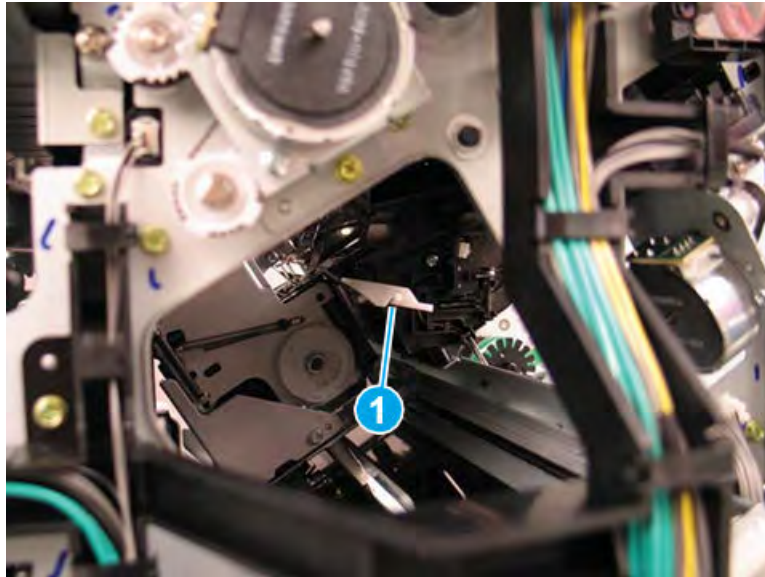

Remove the ejector2 motor(M5)

Follow these steps to remove the ejector2 motor(M5).

1. Disconnect the connector(callout 1) from ejector2 motor(M5, callout 2) of ejector unit.

Figure 5-1209 Disconnect the connector

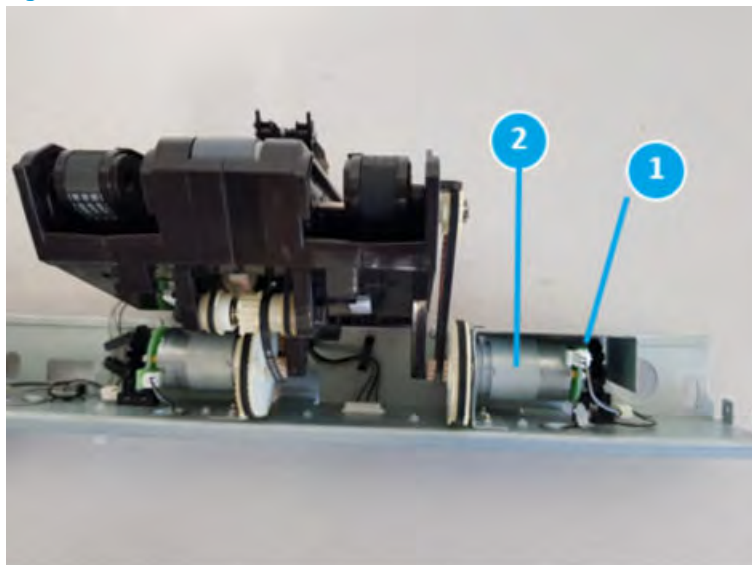

2. Remove two screws(callout 1).

Figure 5-1210 Remove two screws

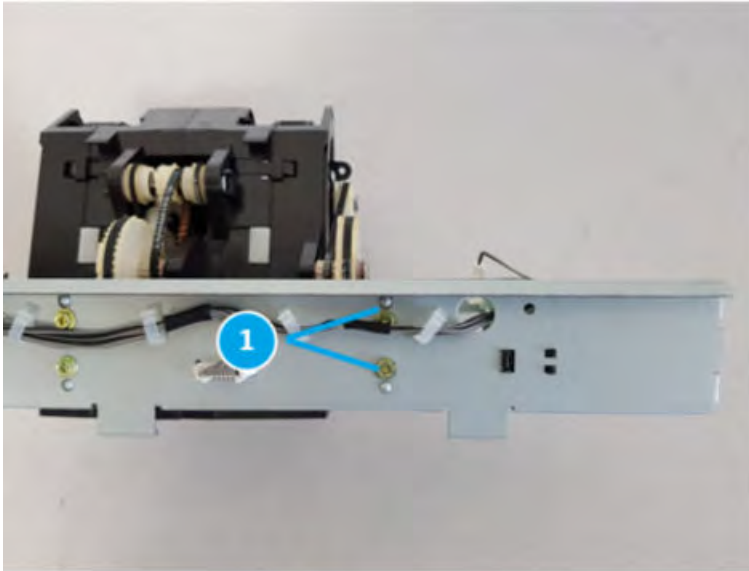

3. Remove the ejector2 motor from ejector unit and remove two screws(callout 1)

Figure 5-1211 Remove the ejector2 motor

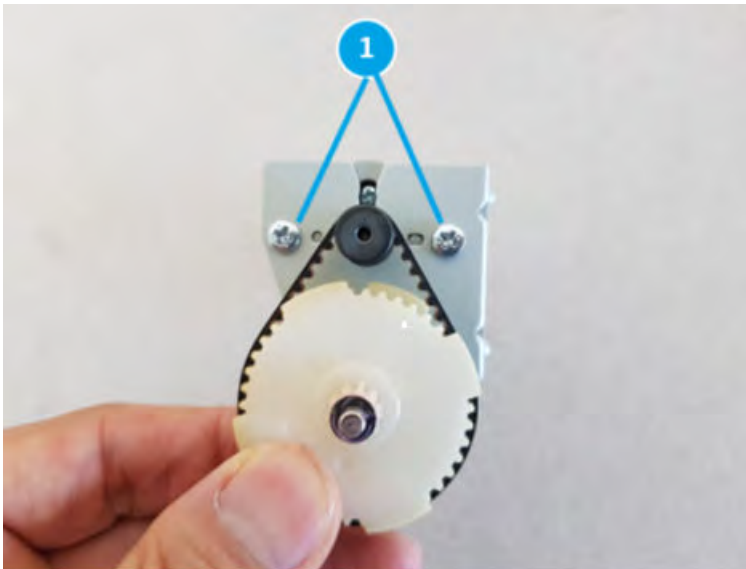

Unpack the replacement assembly

Follow these steps to unpack the replacement assembly.

1. Dispose of the defective part.

 **NOTE:** HP recommends responsible disposal of the defective part.

<http://www8.hp.com/us/en/hp-information/environment/product-recycling.html>

2. Unpack the replacement part from the packaging.



CAUTION:  Some parts are sensitive to electrostatic discharge (ESD). Always perform service work at an ESD-protected workstation or mat. If an ESD workstation or mat is not available, touch the sheet-metal chassis to provide a static ground before touching an ESD-sensitive assembly. Protect the ESD-sensitive assemblies by placing them in ESD pouches when they are out of the printer.

 **IMPORTANT:** Make sure that all of the shipping materials (for example shipping tape) are removed from the replacement part prior to installation.

 **NOTE:** If the replacement part is a roller or pad, avoid touching the spongy part of it. Skin oils on the roller or pad can cause paper pickup and/or print-quality problems. HP recommends using disposable gloves when handling rollers or pads or washing your hands before touching rollers or pads.

3. To install an assembly, reverse the removal steps.

 **NOTE:** When applicable, special installation instructions are provided for an assembly at the end of the removal procedure. Always completely read the removal instructions and follow all special installation instructions.

Main output tray unit

Removal and replacement: Main output tray top of stack sensor (S20)

Learn how to remove and replace the main output tray top of stack sensor.

Introduction

This document provides the procedures to remove and replace the main output tray top of stack sensor on the finisher.

 **IMPORTANT:** When applicable, special installation instructions are provided for an assembly at the end of the removal procedure. Always completely read the removal instructions and follow all special installation instructions.

Before performing service

- Turn the printer power off. A shutting-down message appears on the control-panel display.
- ⚠ **WARNING!** To avoid damage to the printer, turn the power off and wait until the printer shuts down before removing the power cable.
- Disconnect the printer power cable after the printer has completely shut down (the control-panel display is blank).
- Release the finisher from the printer by pulling out on the release latch inside the finisher door.
- Disconnect the cable from the bridge unit to the finisher.
- Disconnect the cable from the finisher to the printer.

Use the table below to identify the correct part number for your printer. To order the part, go to <https://parts.hp.com>.

Table 5-132 Part information

Part number	Part description
JC82-01039A	Main output tray top of stack sensor

Required tools

- #2 JIS screwdriver with a magnetic tip

After performing service

- Connect the cable from the finisher to the printer.
- Connect the cable from the bridge unit to the finisher.
- Attach the finisher to the printer, and then push in on the release latch inside the finisher door.
- Connect the printer power cable.
- Turn the printer power on.

Post service test

Process a job through the finisher and verify that the finisher works correctly.

Remove the right upper cover (finisher)

Follow these steps to remove the right upper cover (finisher).

- ▲ Remove one screw cap and three machine screws on the upper edge of the cover (callout 1). Remove three sheet metal screws (callout 2) on the lower portion of the cover. Rotate the right edge of the cover away from the finisher, and then slide the cover right to release three tabs (callout 3).

💡 **TIP:** The lower screws are shorter in length than the upper screws.

TIP: Reverse the removal steps to install the assembly.

Figure 5-1212 Remove the right upper cover

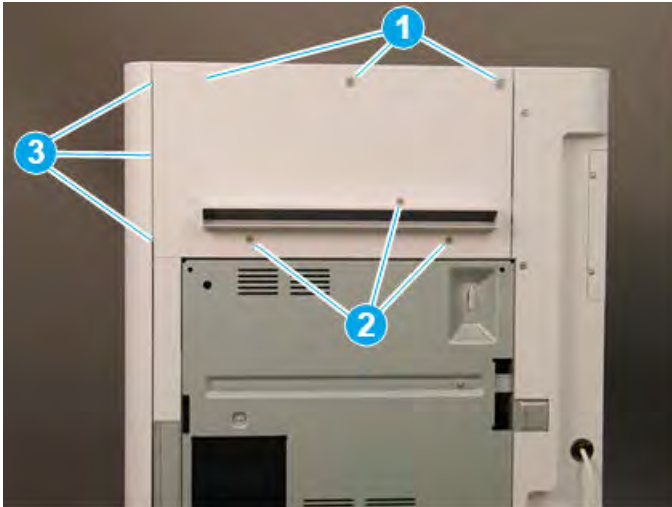

Remove the top cover (finisher)

Follow these steps to remove the top cover (finisher).

1. Remove three screw caps and three self-tapping screws at the top of the rear cover (callout 1), and then remove three machine screws (callout 2) on top of the cover.

Figure 5-1213 Remove six screws

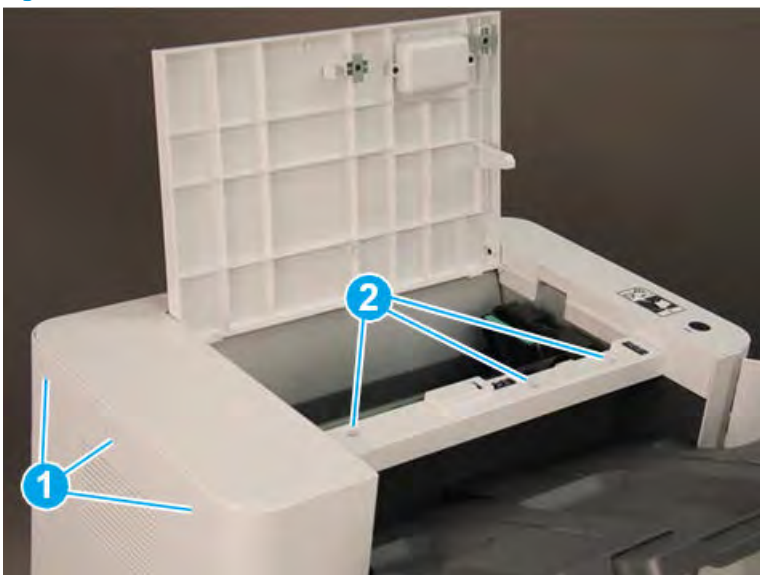

2. Remove three self-tapping screws at the top of the front cover (callout 1), and then remove two machine screws (callout 2) at the top of the right side.

Figure 5-1214 Remove five screws

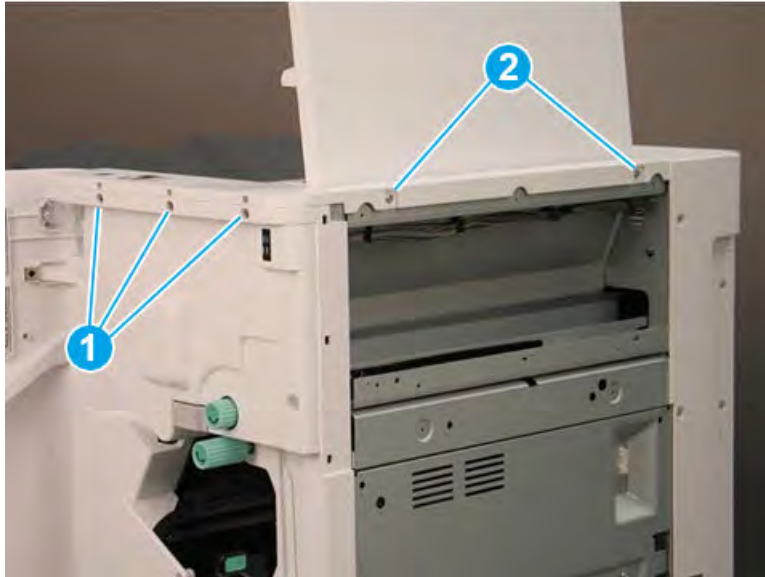

3. Lift the cover up slightly. Disconnect one in-line connector (callout 1), and then release one retainer (callout 2).

 **TIP:** Reverse the removal steps to install the assembly.

Figure 5-1215 Disconnect one connector and release retainer



Remove the front door (finisher)

Follow these steps to remove the front door (finisher).

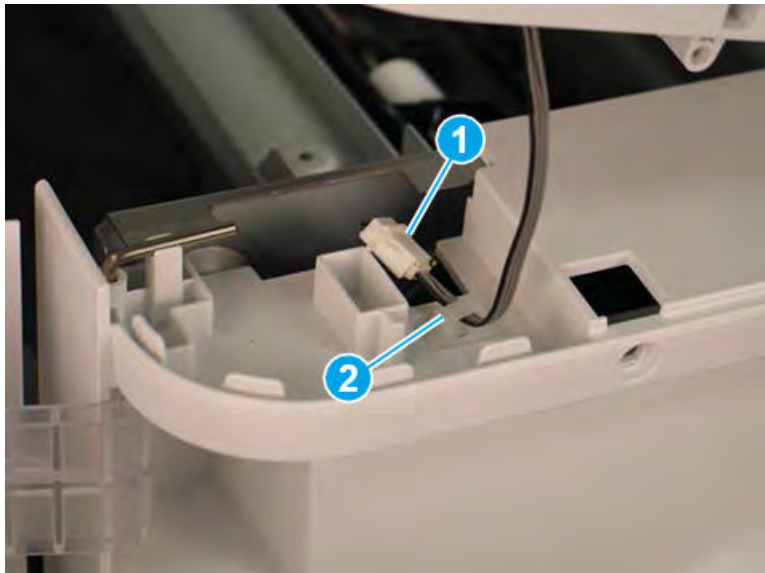
1. Lift the top hinge pin up to release it from the retainer.

Figure 5-1216 Lift the top hinge pin

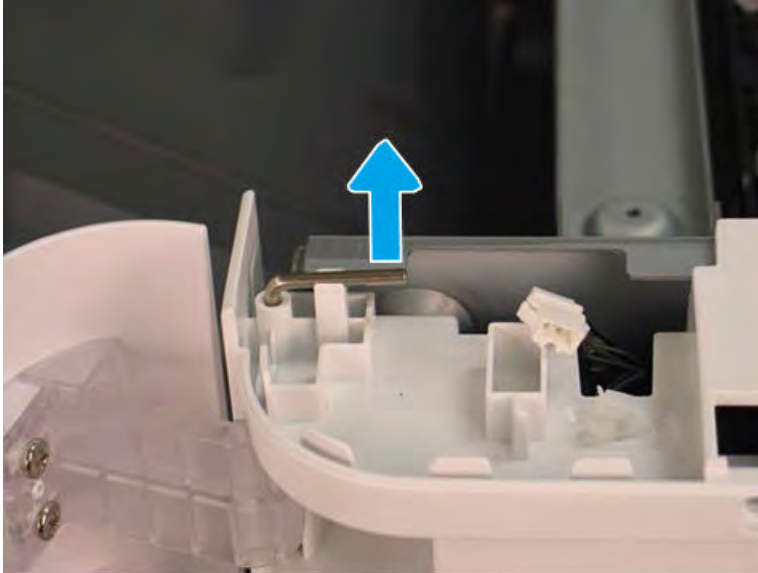

2. Pull the top hinge pin up to remove it.

Figure 5-1217 Remove the top hinge pin

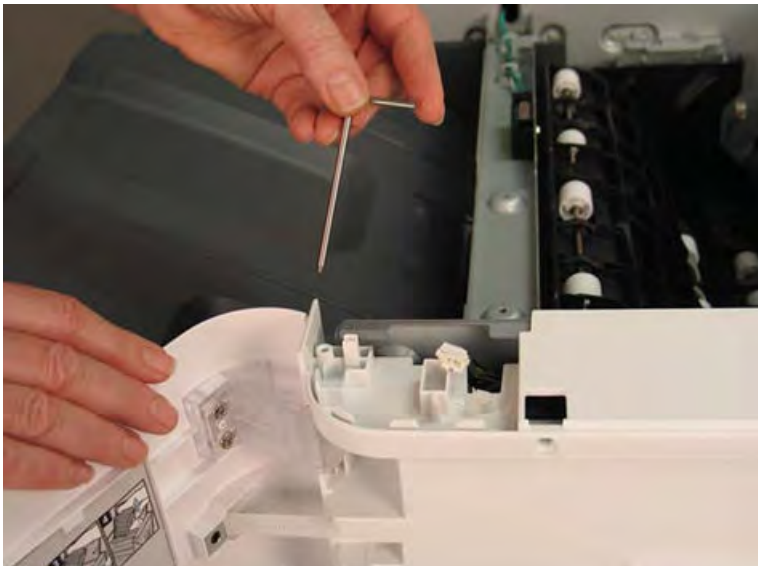

3. Use a small, flat-blade screwdriver to release the lower hinge pin from the retainer, and then rotate it away from the finisher.

Figure 5-1218 Release the lower hinge pin



4. Support the door with one hand, and then pull the lower hinge pin straight up to remove it.

Figure 5-1219 Remove the lower hinge pin



5. Support the door with one hand, and then remove one screw (callout 1) to release the strap. Remove the front door.

 **TIP:** Reverse the removal steps to install the assembly.

Figure 5-1220 Remove the front door



Remove the front cover (finisher)

Follow these steps to remove the front cover (finisher).

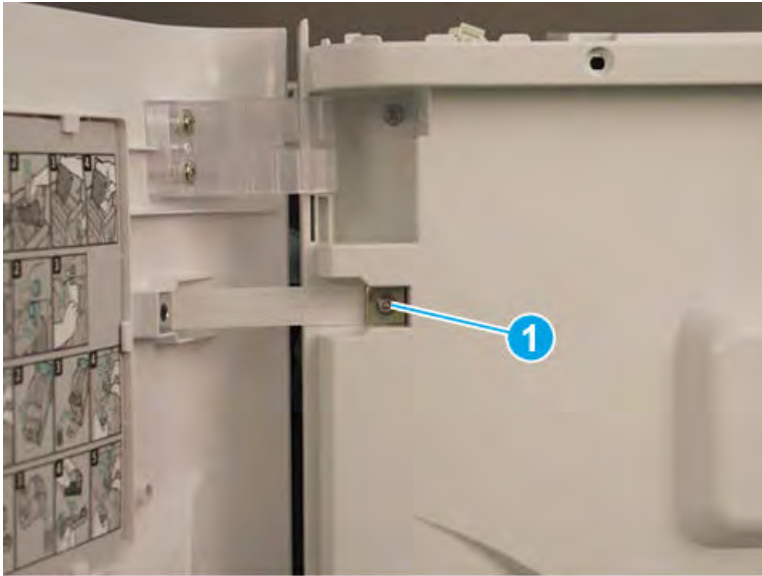
1. Release one tab (callout 1), and then pull the jam-access knob away from the finisher to remove it.

Figure 5-1221 Remove the jam-access knob

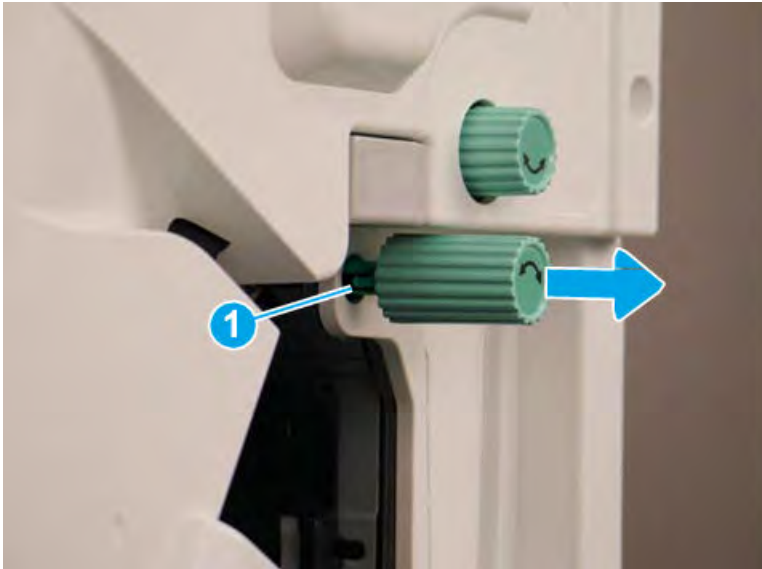

2. If the punch unit is installed, remove the punch waste bin (callout 1).

3. Remove one screw (callout 1) on top of the front cover.

Figure 5-1222 Remove one screw



4. Remove five machine screws (callout 1), and then remove the front cover.

 **TIP:** Reverse the removal steps to install the assembly.

Figure 5-1223 Remove the front cover



Remove the rear cover (finisher)

Follow these steps to remove the rear cover (finisher).

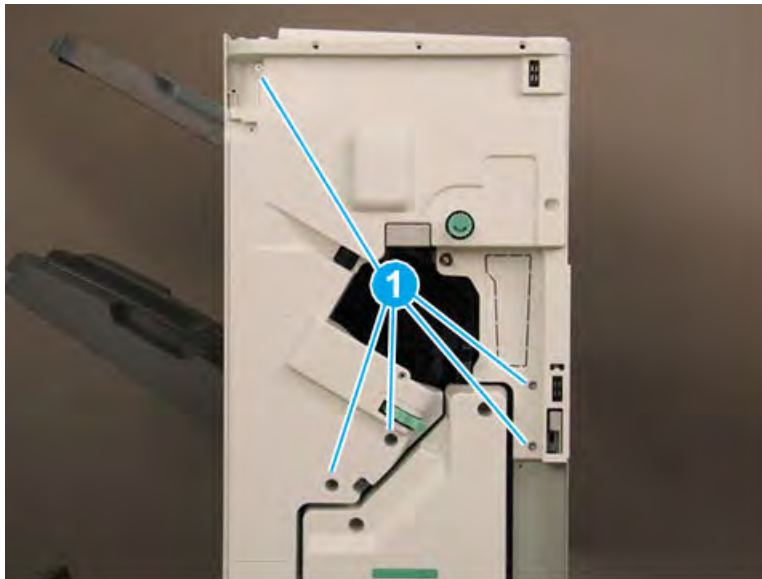
1. Remove two self-tapping screws (callout 1) on the top of the rear cover, and then remove five screw caps and five machine screws (callout 2) on the left side of the cover.

Figure 5-1224 Remove seven screws

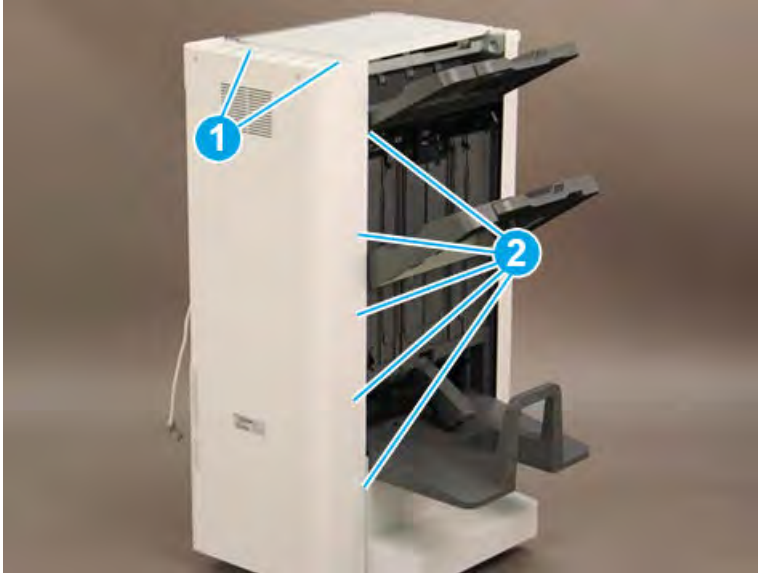

2. Remove one screw cap and four machine screws (callout 1) Remove the rear cover.

 **NOTE:** Make sure to thread the power cable (callout 2) through the opening in the cover.

 **TIP:** Reverse the removal steps to install the assembly

Figure 5-1225 Remove the rear cover



Remove the booklet output tray

Follow these steps to remove the booklet output tray.

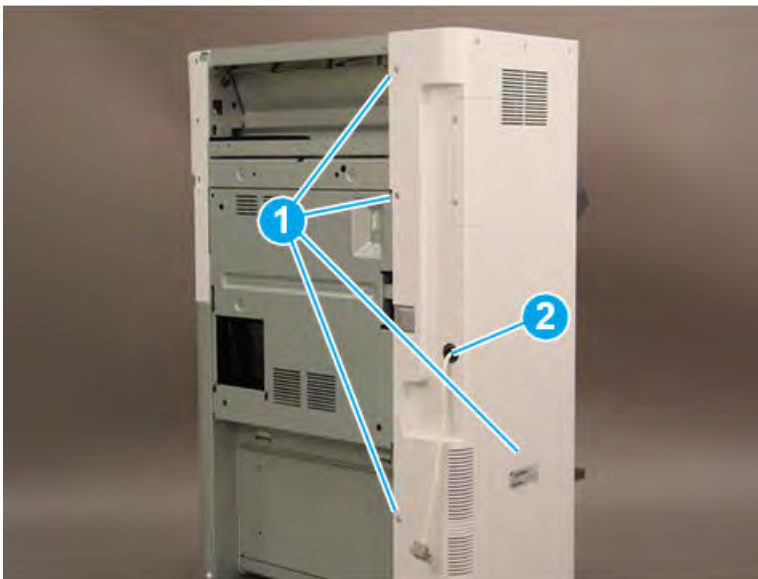
1. Raise the booklet output tray up (callout 1), and then pull it away from the finisher (callout 2) to remove it.

Figure 5-1226 Remove the booklet output tray



2. Reverse the removal steps to install the assembly. Also use the following special installation instructions.

 **NOTE:** Continue to reverse the removal steps to finish installing the assembly

Special installation instructions: booklet output tray

Position the tabs (callout 1) on the tray into the slots (callout 2) on the finisher.

Figure 5-1227 Install the booklet output tray

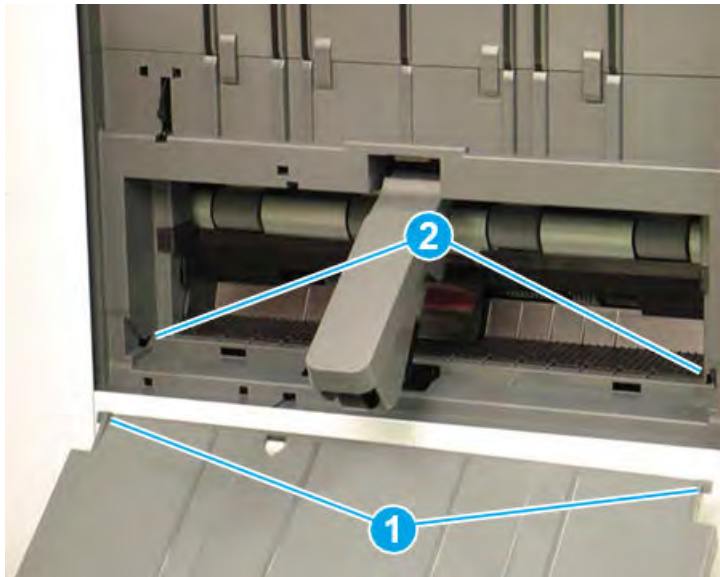

Remove the caster cover

Follow these steps to remove the caster cover.

1. Remove two screw caps and two self-tapping screws (callout 1). Remove two screw caps and two machine screws (callout 2).

Figure 5-1228 Remove four screws

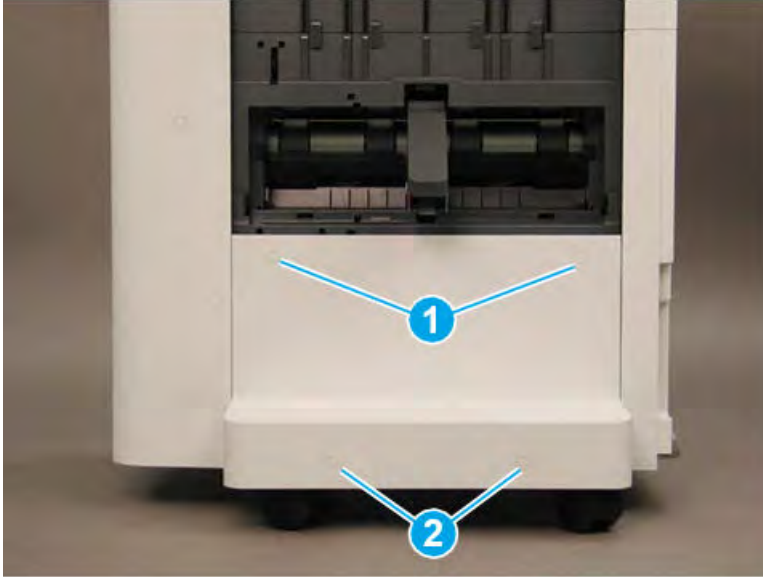

2. Rotate the left edge of the cover away from the finisher (callout 1), and then slide the cover to the left (callout 2) to remove it.

 **TIP:** Make sure that two tabs (callout 3) are positioned under the front lower cover when reinstalling the caster cover.

TIP: Reverse the removal steps to install the assembly

Figure 5-1229 Remove the caster cover

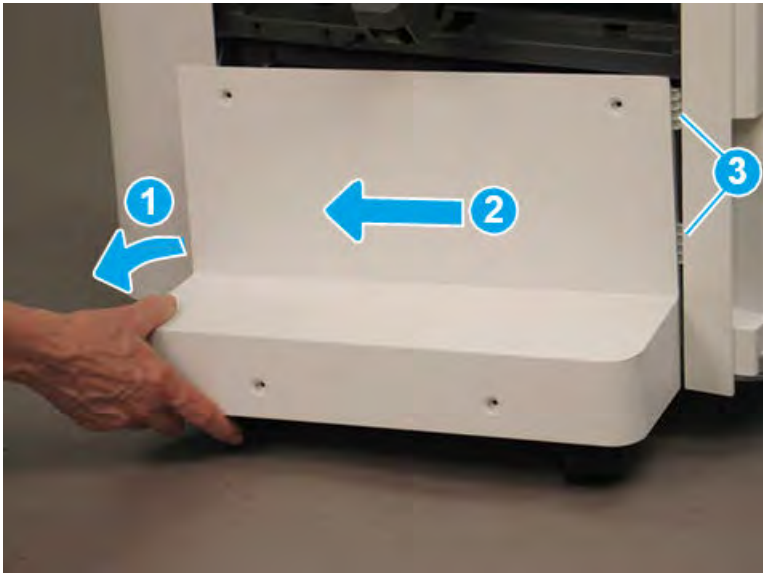

Remove the left lower cover (finisher)

Follow these steps to remove the left lower cover (finisher).

1. Remove four screws (callout 1).

 **NOTE:** Raise the lower output tray as needed to access the screws.

Figure 5-1230 Remove four screws



2. Slide the shield down (callout 1) to release it from four tabs (callout 2), and then rotate it away from the finisher (callout 3).

⚠ CAUTION: The shield is still attached to the finisher. Do not attempt to completely remove the shield.

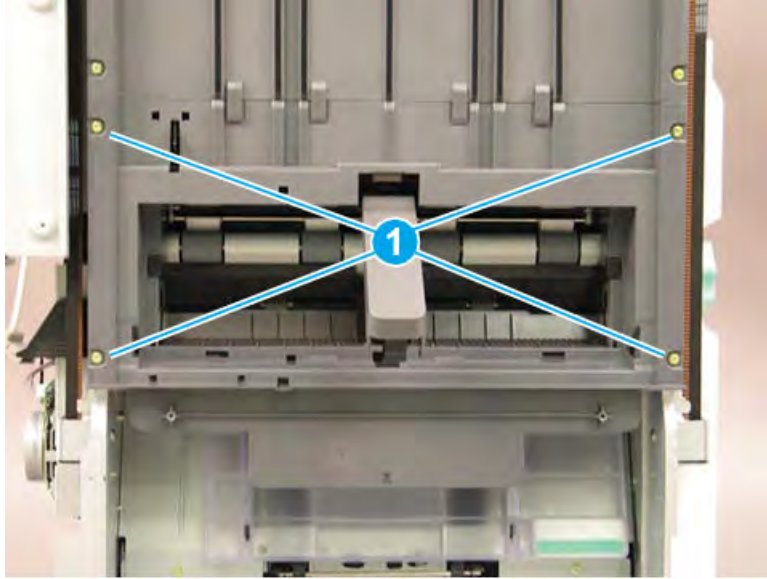
💡 TIP: Position the shield under the four tabs (callout 2) when reinstalling it.

Figure 5-1231 Release the lower shield

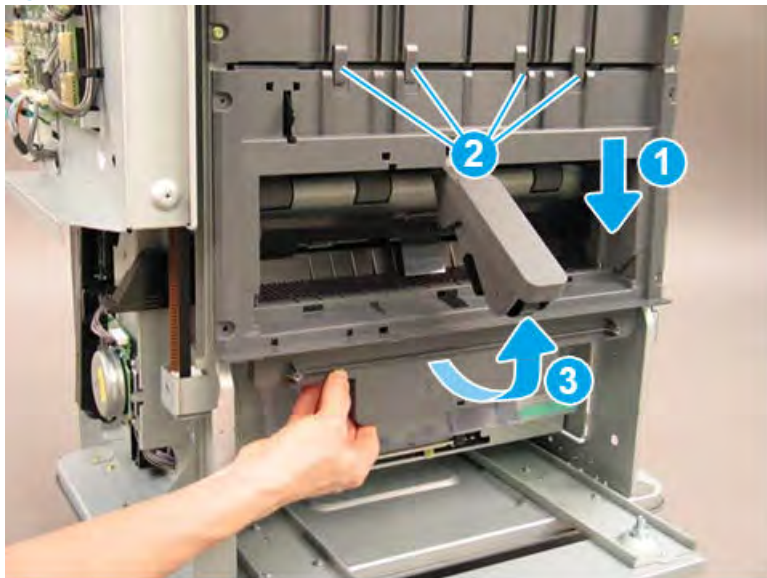

3. Disconnect two connectors (callout 1), and then remove the shield.

 **TIP:** Reverse the removal steps to install the assembly.

Figure 5-1232 Disconnect two connectors



4. If you are replacing the left lower cover, locate three sensors (callout 1) on the back of the left lower cover. Remove these sensors and transfer them to the replacement part.

Figure 5-1233 Remove the left lower cover

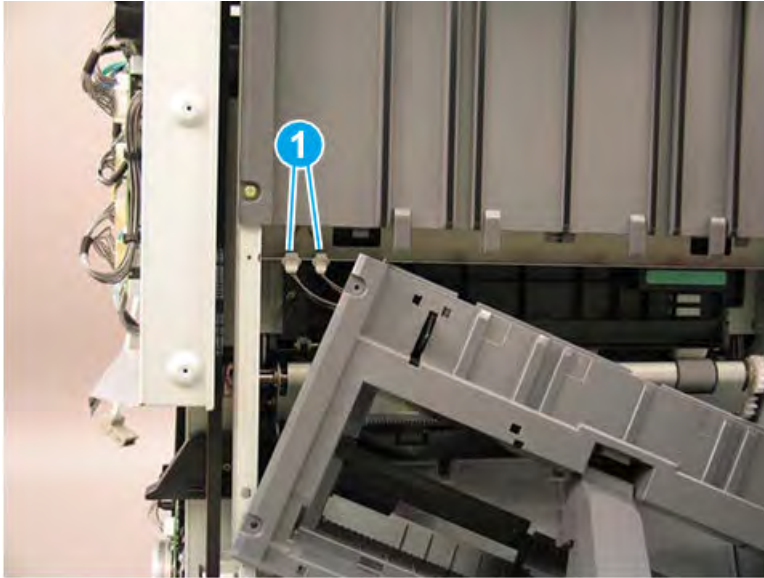
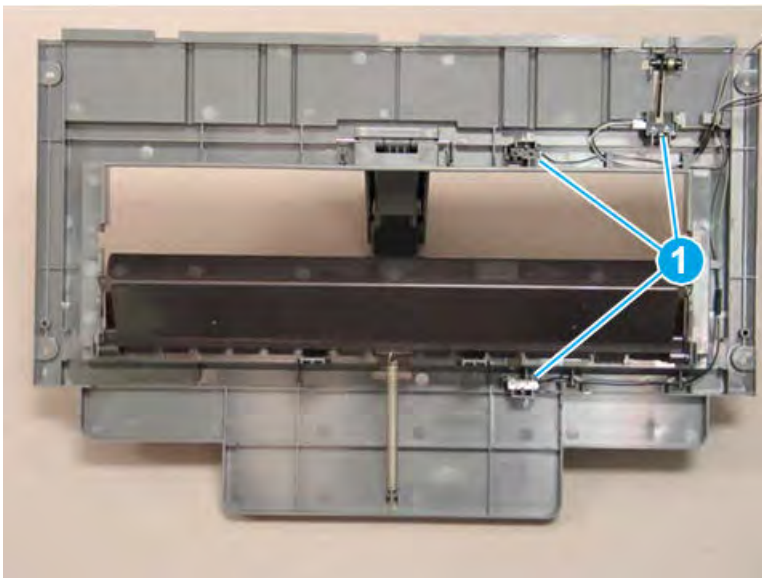

Remove the left upper cover (finisher)

Follow these steps to remove the left upper cover (finisher).

1. Bring the lower output tray down by positioning the shaft of a screwdriver on the clutch (callout 1) and gently pressing to the right to release the clutch. Hold the clutch in the released position and lower the tray (callout 2) to the lowest position.

Figure 5-1234 Lower the output tray

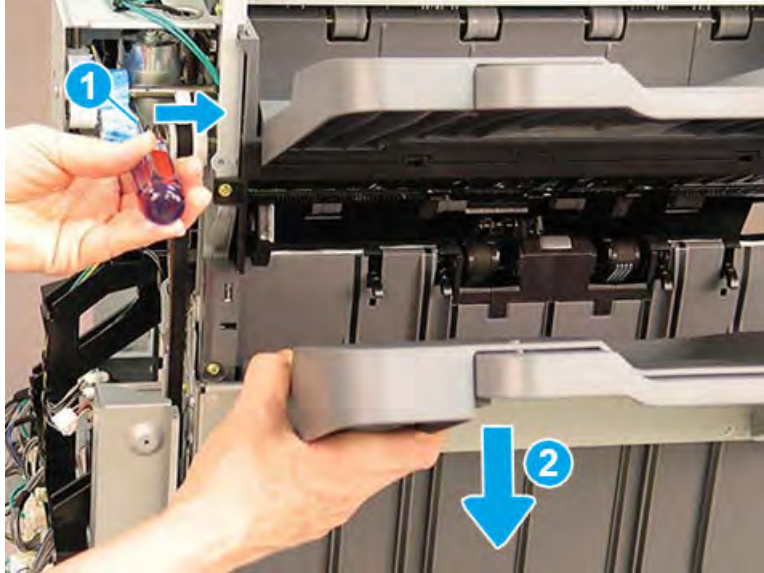

2. Remove six machine screws (callout 1).

Figure 5-1235 Remove six screws

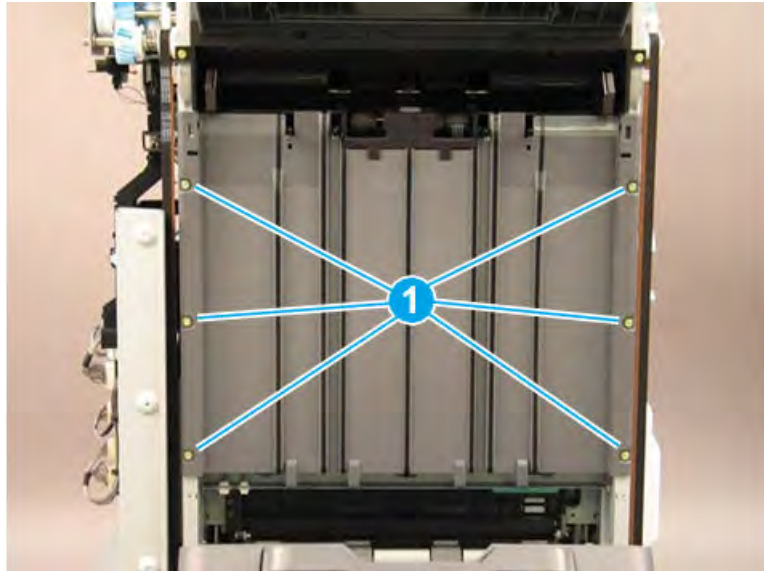

3. Rotate the lower edge of the shield away from the finisher (callout 1), and then slide the shield down (callout 2) to release it from two tabs (callout 3).

⚠ CAUTION: The shield is still attached to the finisher. Do not attempt to completely remove the shield.

💡 TIP: Position the shield under the two tabs (callout 3) when reinstalling it.

Figure 5-1236 Release the shield

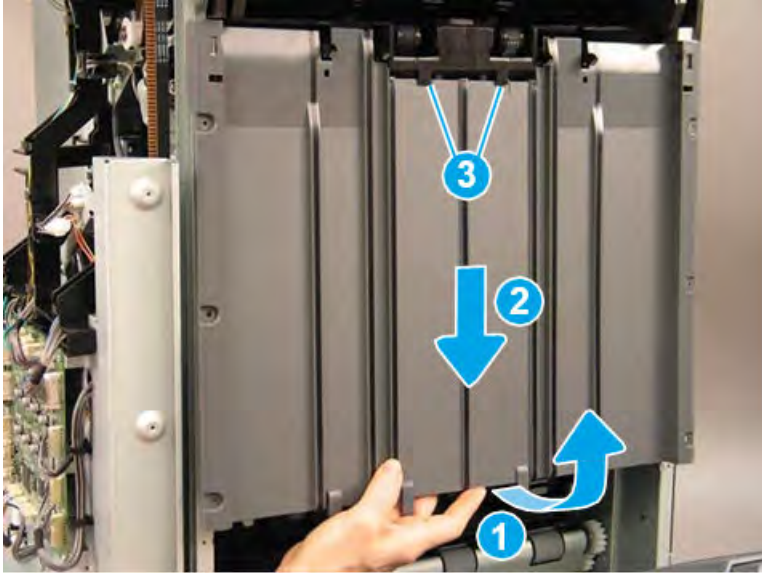

4. Disconnect one connector (callout 1), and then remove the upper shield assembly.

💡 TIP: Reverse the removal steps to install the assembly.

Figure 5-1237 Disconnect one connector

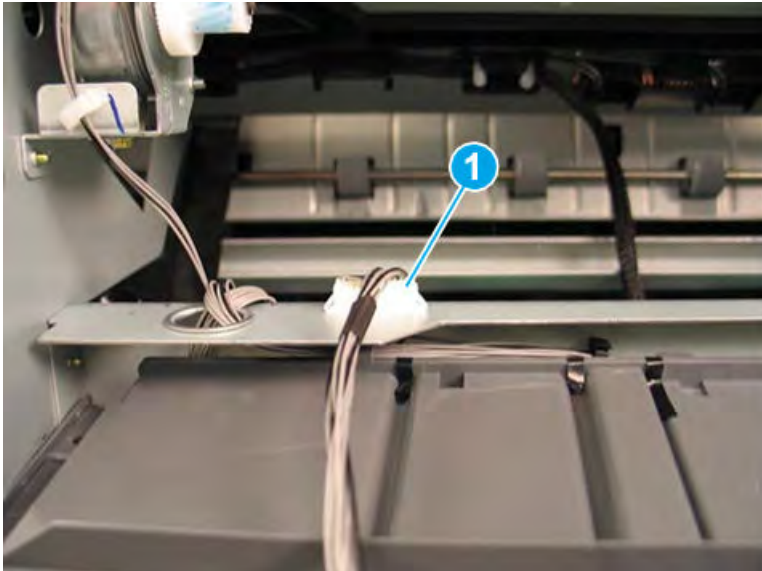

5. If you are replacing the left upper cover, locate three sensors (callout 1) on the back of the left upper cover. Remove these sensors and transfer them to the replacement part.

Figure 5-1238 Remove the left upper cover

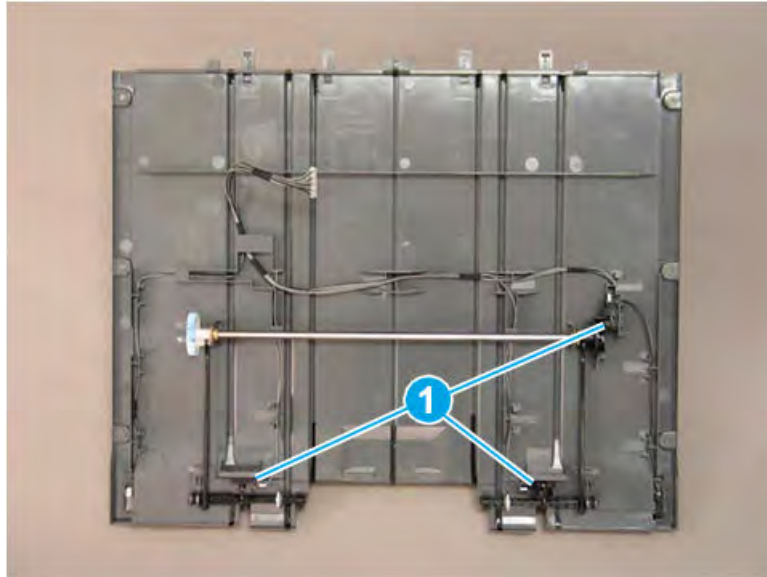

Remove the main output tray top of stack sensor(S20)

Follow these steps to remove the main output tray top of stack sensor(S20).

- ▲ Remove detector and emitter sensor(S20, callout 1)

Figure 5-1239 Remove detector and emitter sensor

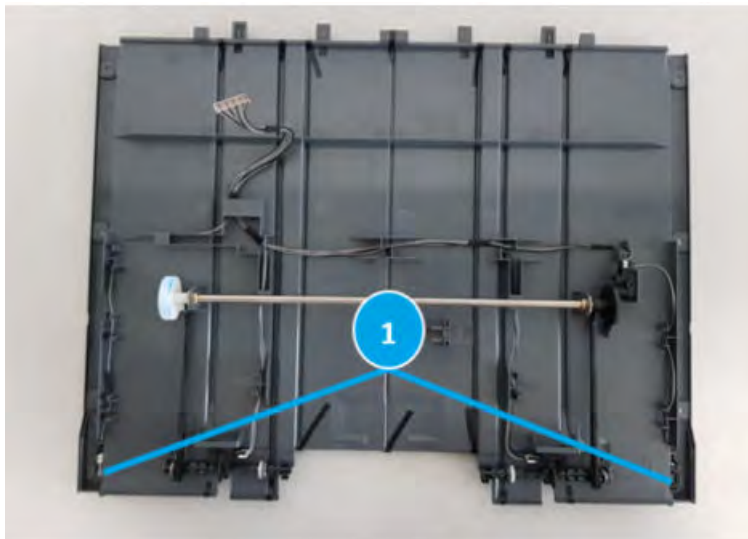

Unpack the replacement assembly



Follow these steps to unpack the replacement assembly.

1. Dispose of the defective part.

 **NOTE:** HP recommends responsible disposal of the defective part.

<http://www8.hp.com/us/en/hp-information/environment/product-recycling.html>

2. Unpack the replacement part from the packaging.

 **CAUTION:**  Some parts are sensitive to electrostatic discharge (ESD). Always perform service work at an ESD-protected workstation or mat. If an ESD workstation or mat is not available, touch the sheet-metal chassis to provide a static ground before touching an ESD-sensitive assembly. Protect the ESD-sensitive assemblies by placing them in ESD pouches when they are out of the printer.

 **IMPORTANT:** Make sure that all of the shipping materials (for example shipping tape) are removed from the replacement part prior to installation.

 **NOTE:** If the replacement part is a roller or pad, avoid touching the spongy part of it. Skin oils on the roller or pad can cause paper pickup and/or print-quality problems. HP recommends using disposable gloves when handling rollers or pads or washing your hands before touching rollers or pads.

3. To install an assembly, reverse the removal steps.

 **NOTE:** When applicable, special installation instructions are provided for an assembly at the end of the removal procedure. Always completely read the removal instructions and follow all special installation instructions.

Removal and replacement: Main output tray top of stack switch (S34)

Learn how to remove and replace the main output tray top of stack switch.

Introduction

This document provides the procedures to remove and replace the main output tray top of stack switch on the finisher.

 **IMPORTANT:** When applicable, special installation instructions are provided for an assembly at the end of the removal procedure. Always completely read the removal instructions and follow all special installation instructions.

Before performing service

- Turn the printer power off. A shutting-down message appears on the control-panel display.
- ⚠ **WARNING!** To avoid damage to the printer, turn the power off and wait until the printer shuts down before removing the power cable.
- Disconnect the printer power cable after the printer has completely shut down (the control-panel display is blank).
- Release the finisher from the printer by pulling out on the release latch inside the finisher door.
- Disconnect the cable from the bridge unit to the finisher.
- Disconnect the cable from the finisher to the printer.

Use the table below to identify the correct part number for your printer. To order the part, go to <https://parts.hp.com>.

Table 5-133 Part information

Part number	Part description
JC39-02316A	Main output tray top of stack switch

Required tools

- #2 JIS screwdriver with a magnetic tip
- Small, flat-blade screwdriver

After performing service

- Connect the cable from the finisher to the printer.
- Connect the cable from the bridge unit to the finisher.
- Attach the finisher to the printer, and then push in on the release latch inside the finisher door.
- Connect the printer power cable.
- Turn the printer power on.

Post service test

Process a job through the finisher and verify that the finisher works correctly.

Remove the right upper cover (finisher)

Follow these steps to remove the right upper cover (finisher).

- ▲ Remove one screw cap and three machine screws on the upper edge of the cover (callout 1). Remove three sheet metal screws (callout 2) on the lower portion of the cover. Rotate the right edge of the cover away from the finisher, and then slide the cover right to release three tabs (callout 3).

💡 **TIP:** The lower screws are shorter in length than the upper screws.

TIP: Reverse the removal steps to install the assembly.

Figure 5-1240 Remove the right upper cover

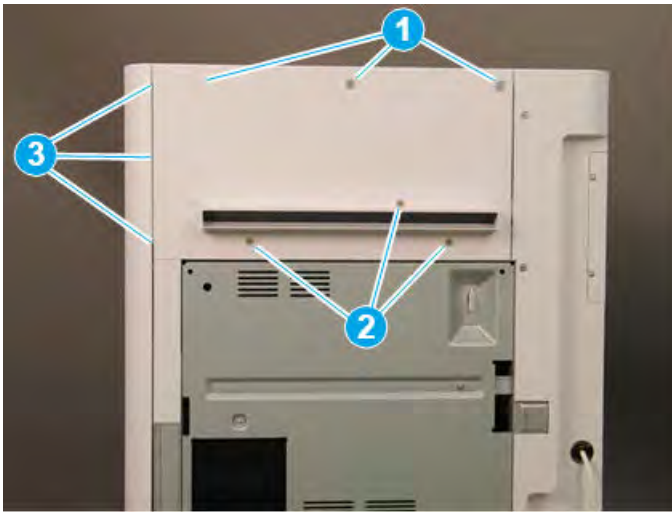

Remove the top cover (finisher)

Follow these steps to remove the top cover (finisher).

1. Remove three screw caps and three self-tapping screws at the top of the rear cover (callout 1), and then remove three machine screws (callout 2) on top of the cover.

Figure 5-1241 Remove six screws

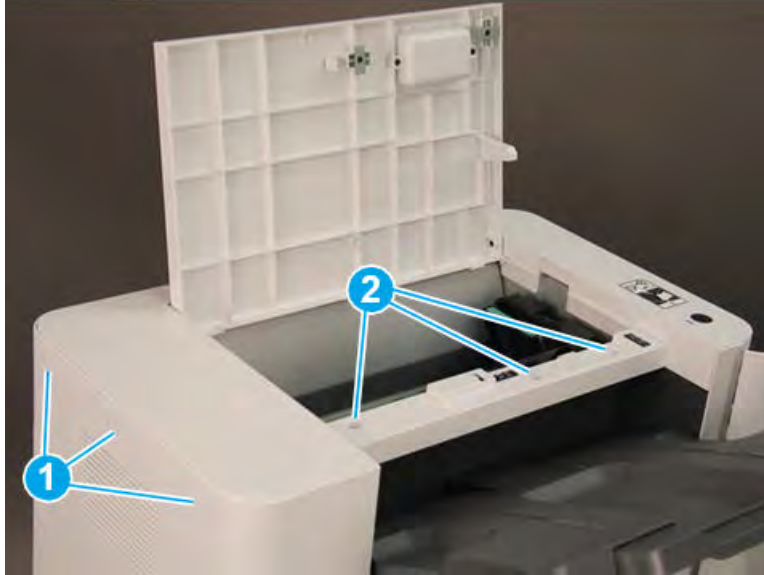

2. Remove three self-tapping screws at the top of the front cover (callout 1), and then remove two machine screws (callout 2) at the top of the right side.

Figure 5-1242 Remove five screws

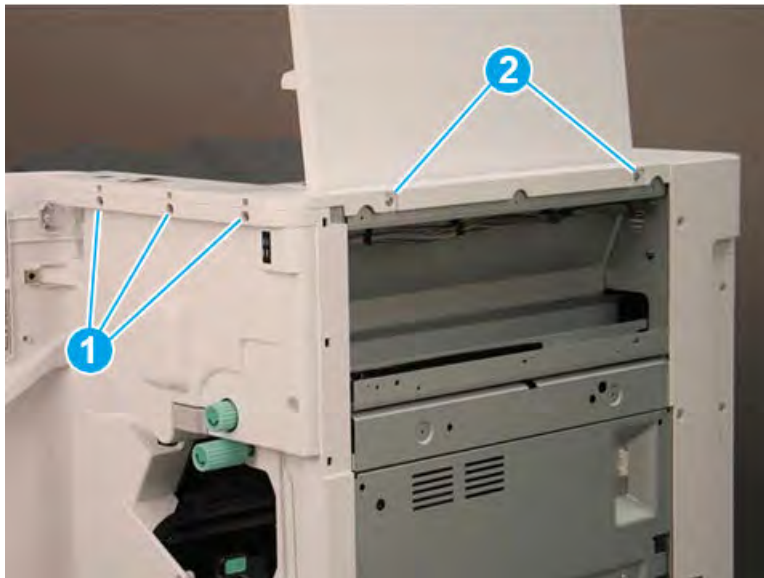

3. Lift the cover up slightly. Disconnect one in-line connector (callout 1), and then release one retainer (callout 2).

 **TIP:** Reverse the removal steps to install the assembly.

Figure 5-1243 Disconnect one connector and release retainer



Remove the front door (finisher)

Follow these steps to remove the front door (finisher).

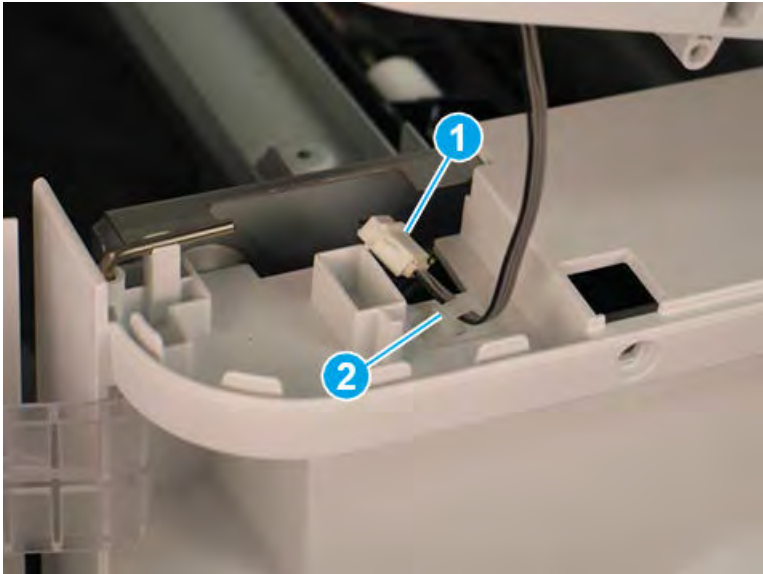
1. Lift the top hinge pin up to release it from the retainer.

Figure 5-1244 Lift the top hinge pin

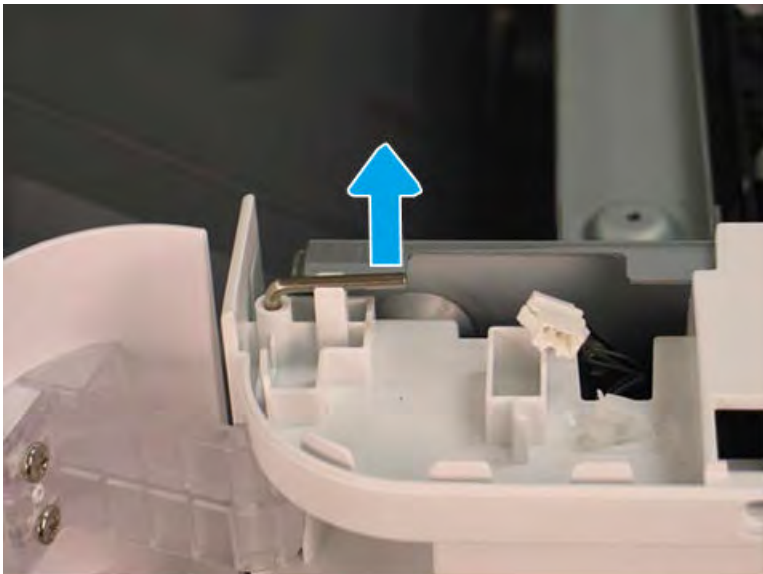

2. Pull the top hinge pin up to remove it.

Figure 5-1245 Remove the top hinge pin

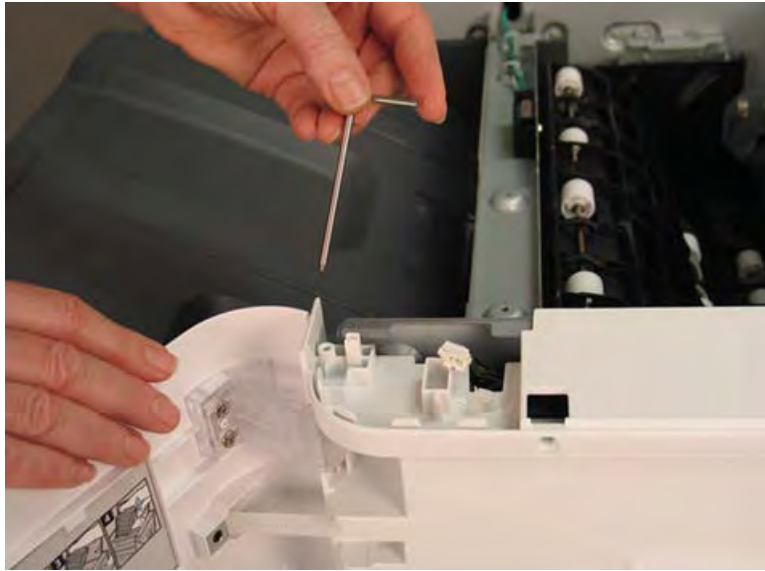

3. Use a small, flat-blade screwdriver to release the lower hinge pin from the retainer, and then rotate it away from the finisher.

Figure 5-1246 Release the lower hinge pin



4. Support the door with one hand, and then pull the lower hinge pin straight up to remove it.

Figure 5-1247 Remove the lower hinge pin



5. Support the door with one hand, and then remove one screw (callout 1) to release the strap. Remove the front door.

 **TIP:** Reverse the removal steps to install the assembly.

Figure 5-1248 Remove the front door



Remove the front cover (finisher)

Follow these steps to remove the front cover (finisher).

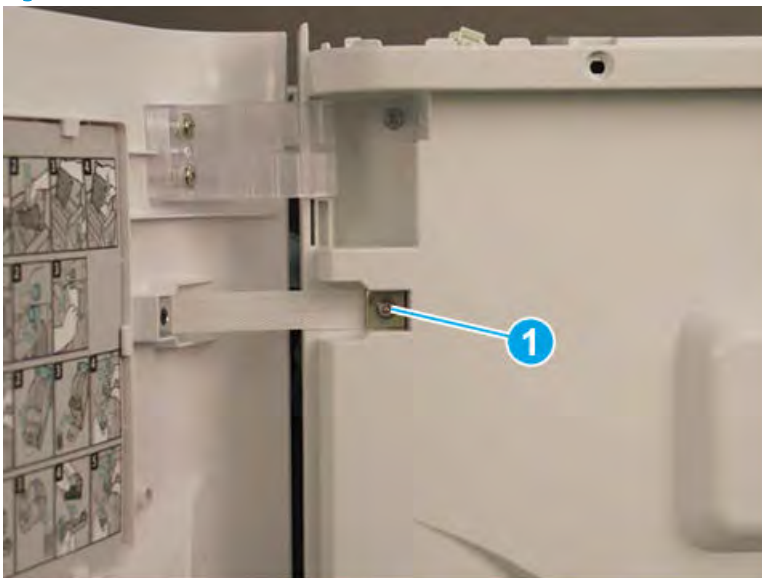
1. Release one tab (callout 1), and then pull the jam-access knob away from the finisher to remove it.

Figure 5-1249 Remove the jam-access knob

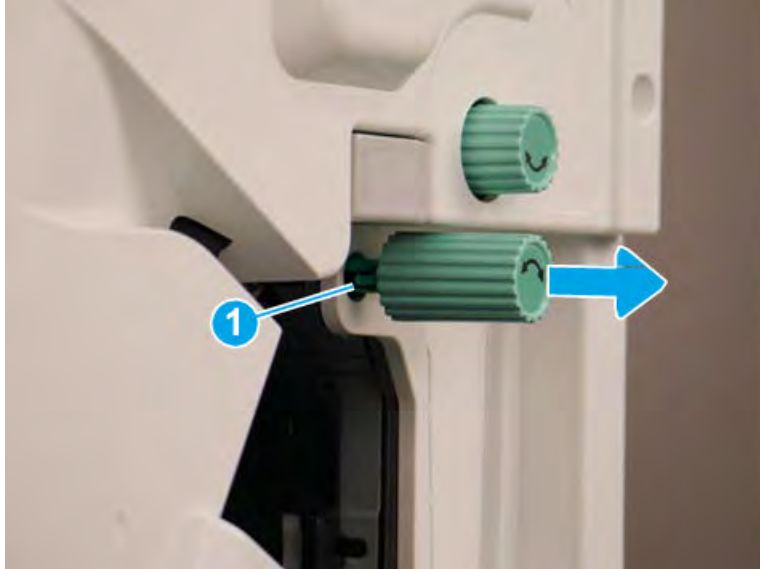

2. If the punch unit is installed, remove the punch waste bin (callout 1).
3. Remove one screw (callout 1) on top of the front cover.

Figure 5-1250 Remove one screw



4. Remove five machine screws (callout 1), and then remove the front cover.

 **TIP:** Reverse the removal steps to install the assembly.

Figure 5-1251 Remove the front cover



Remove the rear cover (finisher)

Follow these steps to remove the rear cover (finisher).

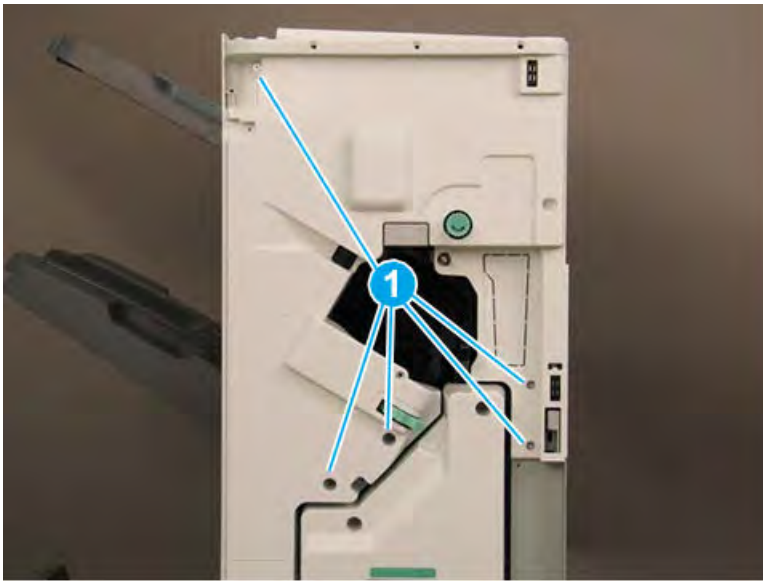
1. Remove two self-tapping screws (callout 1) on the top of the rear cover, and then remove five screw caps and five machine screws (callout 2) on the left side of the cover.

Figure 5-1252 Remove seven screws

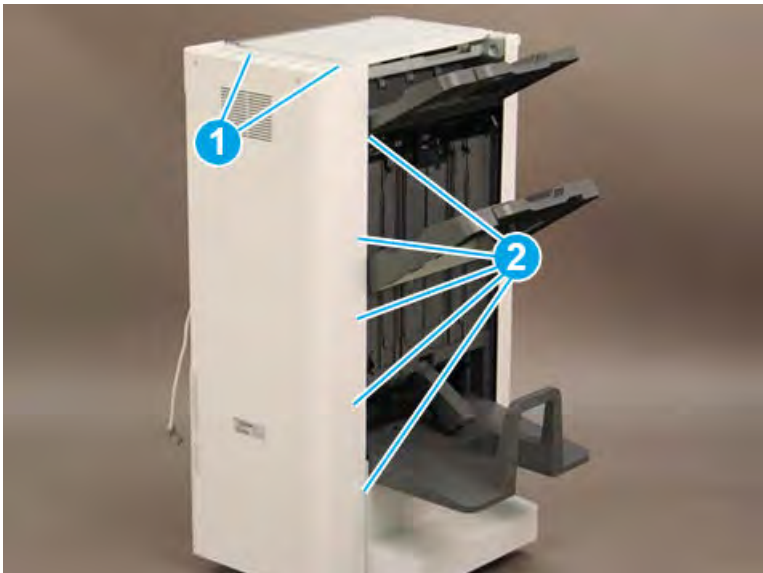

2. Remove one screw cap and four machine screws (callout 1) Remove the rear cover.

 **NOTE:** Make sure to thread the power cable (callout 2) through the opening in the cover.

 **TIP:** Reverse the removal steps to install the assembly

Figure 5-1253 Remove the rear cover



Remove the main output tray of stack switch(S34)

Follow these steps to remove the main output tray of stack switch(S34).

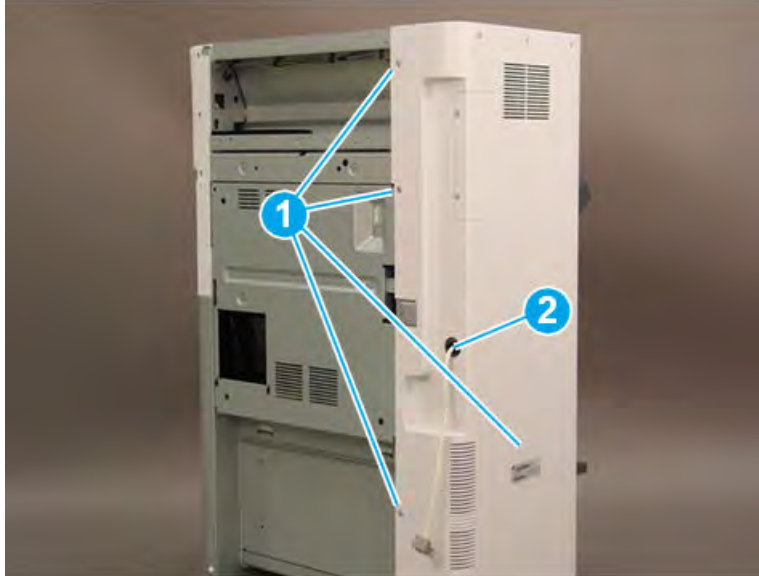
1. At the front of the finisher, remove two screws(callout 1).

Figure 5-1254 Remove two screws

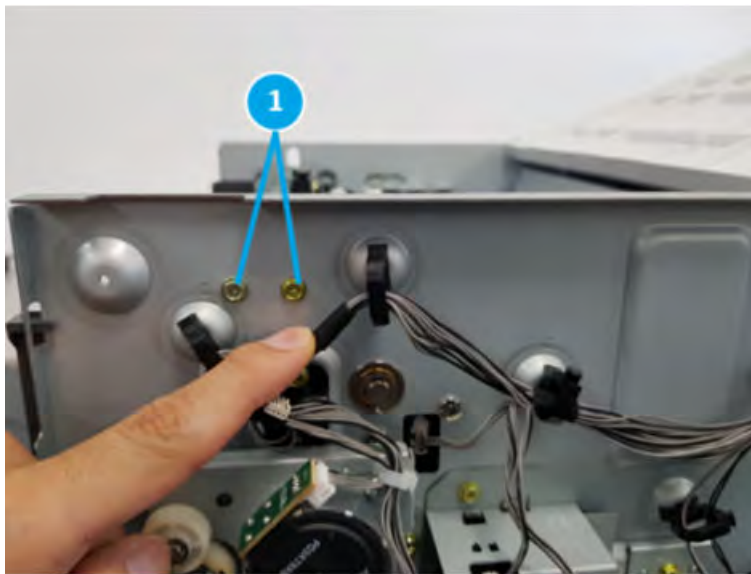

2. At the rear of the finisher, remove two screws(callout 1).

Figure 5-1255 Remove two screws

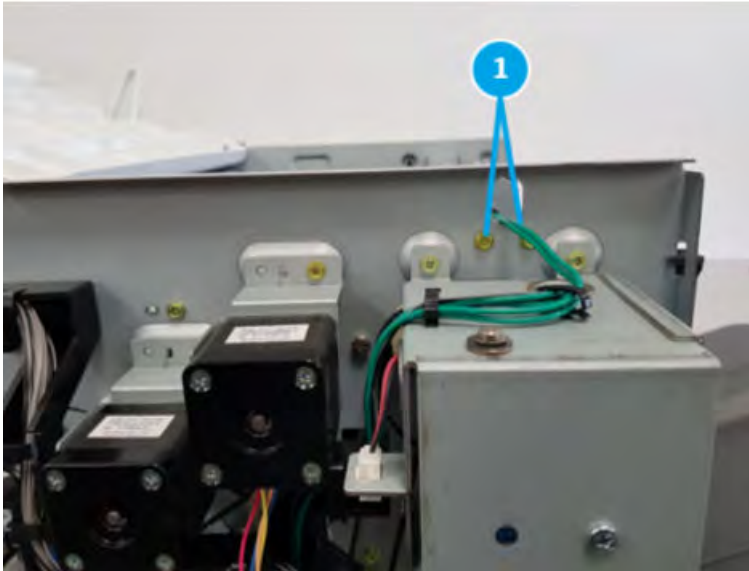

3. Do not remove the frame(callout 1) but pull it one side.

Figure 5-1256 Pull it one side

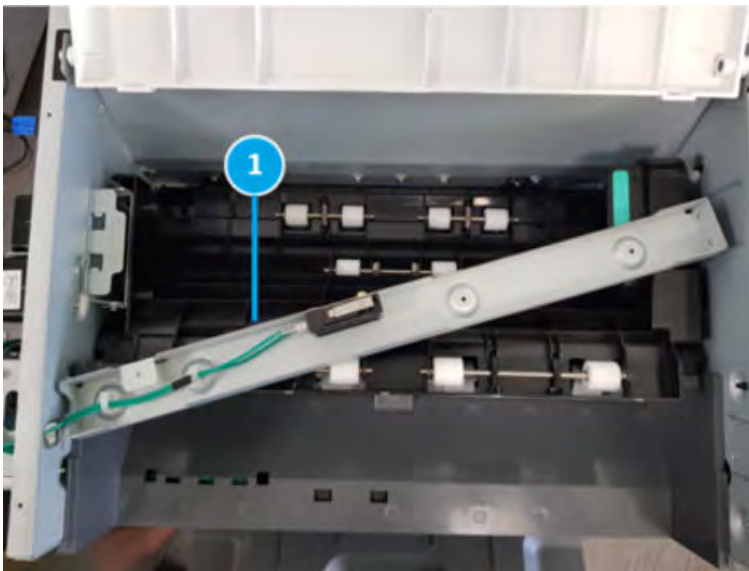

4. At the front of the finisher, remove two screws(callout 1)

Figure 5-1257 Remove two screws

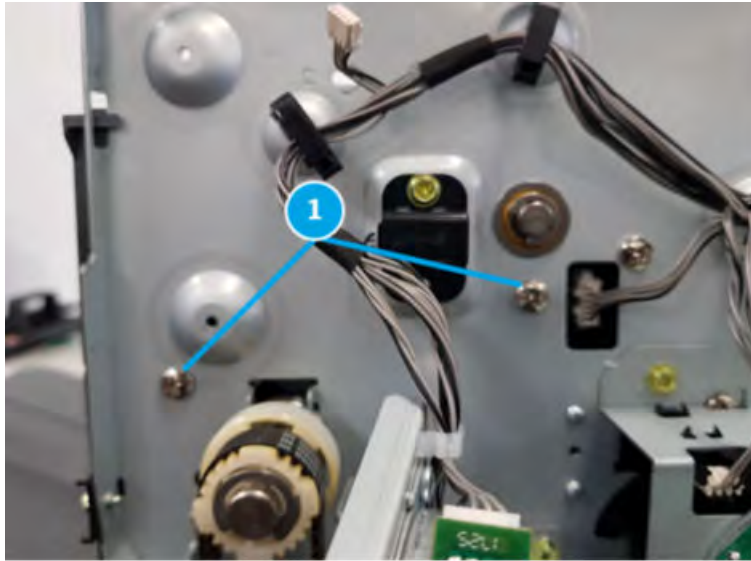

5. At the rear of the finisher, remove four screws(callout 1).

Figure 5-1258 Remove four screws

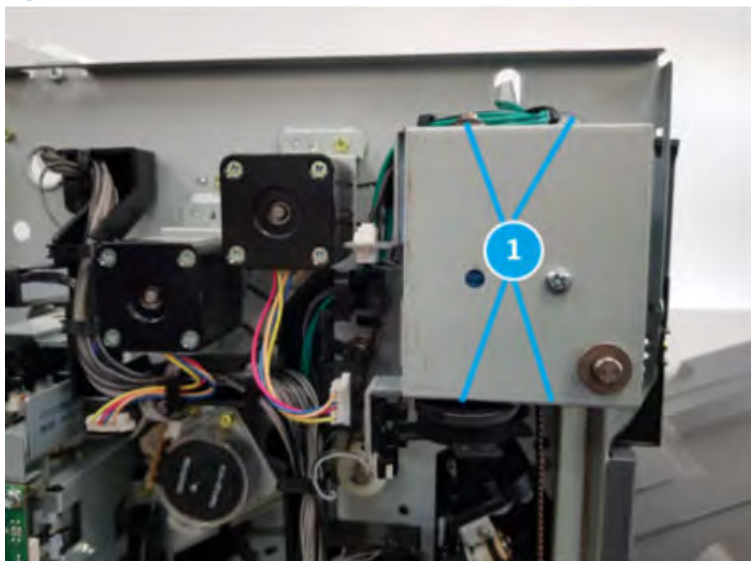

6. Bring the lower output tray down by positioning the shaft of a screwdriver or tweezers on the clutch (callout 1) and gently pressing to the right to release the clutch. Hold the clutch in the released position and lower the tray (callout 2) to the lowest position

Figure 5-1259 Pressing to the right to release the clutch

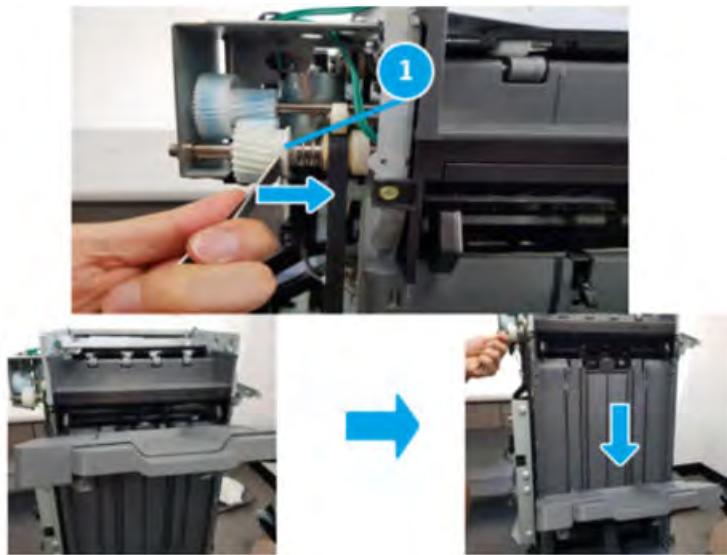

7. At the rear of the finisher, remove two screws (callout 1).

Figure 5-1260 Remove two screws

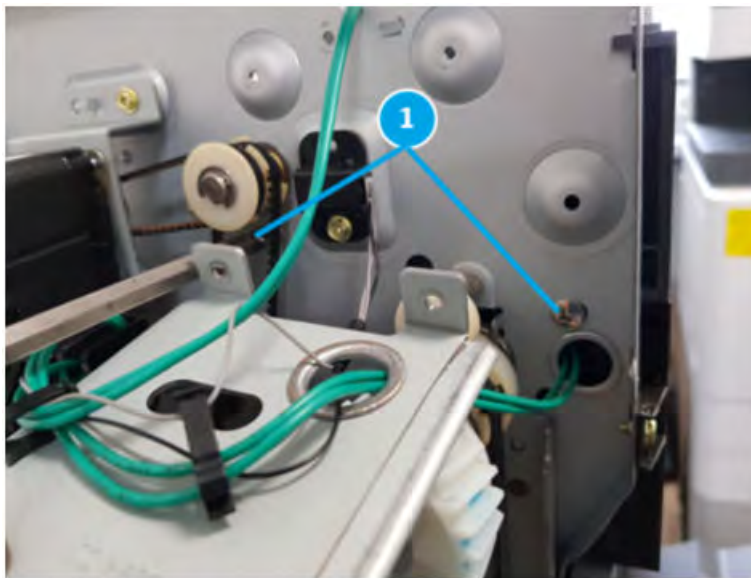

8. Remove two screws(callout 1)

Figure 5-1261 Remove two screws



9. Separate two parts (callout 1,callout 2)

Figure 5-1262 Separate two parts

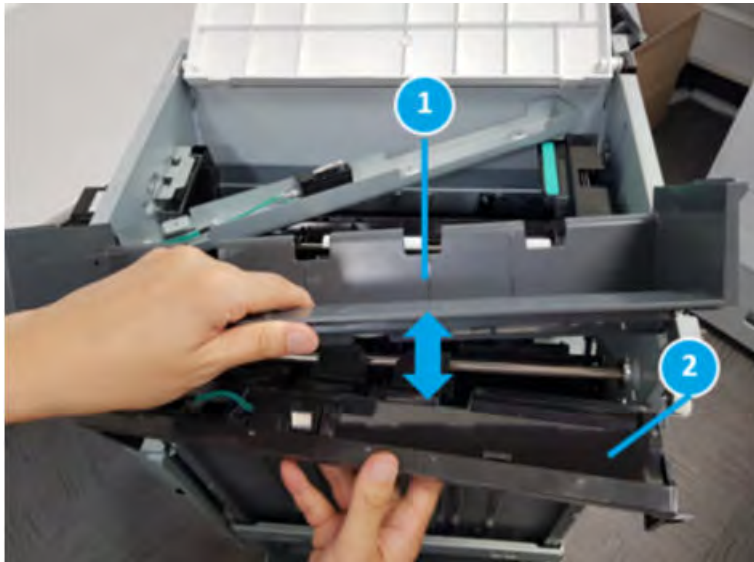

 **NOTE:** HP recommends responsible disposal of the defective part.

<http://www8.hp.com/us/en/hp-information/environment/product-recycling.html>

2. Unpack the replacement part from the packaging.



CAUTION:  Some parts are sensitive to electrostatic discharge (ESD). Always perform service work at an ESD-protected workstation or mat. If an ESD workstation or mat is not available, touch the sheet-metal chassis to provide a static ground before touching an ESD-sensitive assembly. Protect the ESD-sensitive assemblies by placing them in ESD pouches when they are out of the printer.



IMPORTANT: Make sure that all of the shipping materials (for example shipping tape) are removed from the replacement part prior to installation.



NOTE: If the replacement part is a roller or pad, avoid touching the spongy part of it. Skin oils on the roller or pad can cause paper pickup and/or print-quality problems. HP recommends using disposable gloves when handling rollers or pads or washing your hands before touching rollers or pads.

3. To install an assembly, reverse the removal steps.



NOTE: When applicable, special installation instructions are provided for an assembly at the end of the removal procedure. Always completely read the removal instructions and follow all special installation instructions.

Removal and replacement: Main output tray lower limit sensor (S26)

Learn how to remove and replace the main output tray lower limit sensor.

Introduction

This document provides the procedures to remove and replace the main output tray lower limit sensor on the finisher.



IMPORTANT: When applicable, special installation instructions are provided for an assembly at the end of the removal procedure. Always completely read the removal instructions and follow all special installation instructions.

Before performing service

- Turn the printer power off. A shutting-down message appears on the control-panel display.
-  **WARNING!** To avoid damage to the printer, turn the power off and wait until the printer shuts down before removing the power cable.
- Disconnect the printer power cable after the printer has completely shut down (the control-panel display is blank).
- Release the finisher from the printer by pulling out on the release latch inside the finisher door.
- Disconnect the cable from the bridge unit to the finisher.
- Disconnect the cable from the finisher to the printer.

Use the table below to identify the correct part number for your printer. To order the part, go to <https://parts.hp.com>.

Table 5-134 Part information

Part number	Part description
0604-001415	Main output tray lower limit sensor

Required tools

- #2 JIS screwdriver with a magnetic tip
- Small, flat-blade screwdriver

After performing service

- Connect the cable from the finisher to the printer.
- Connect the cable from the bridge unit to the finisher.
- Attach the finisher to the printer, and then push in on the release latch inside the finisher door.
- Connect the printer power cable.
- Turn the printer power on.

Post service test

Process a job through the finisher and verify that the finisher works correctly.

Remove the right upper cover (finisher)

Follow these steps to remove the right upper cover (finisher).

- ▲ Remove one screw cap and three machine screws on the upper edge of the cover (callout 1). Remove three sheet metal screws (callout 2) on the lower portion of the cover. Rotate the right edge of the cover away from the finisher, and then slide the cover right to release three tabs (callout 3).

💡 **TIP:** The lower screws are shorter in length than the upper screws.

TIP: Reverse the removal steps to install the assembly.

Figure 5-1265 Remove the right upper cover

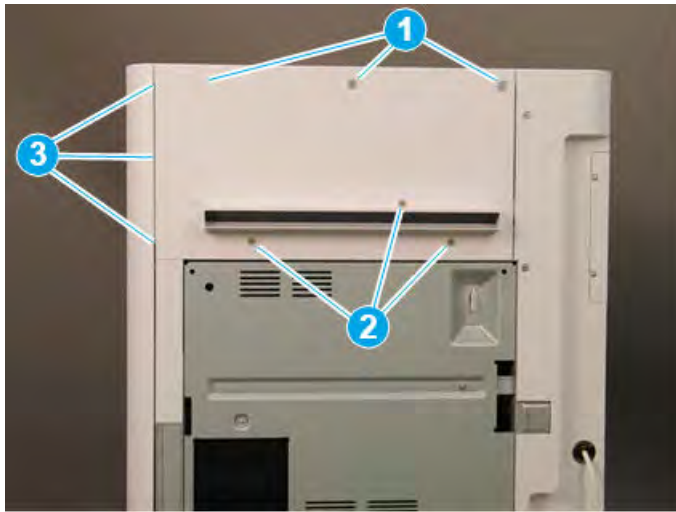

Remove the top cover (finisher)

Follow these steps to remove the top cover (finisher).

1. Remove three screw caps and three self-tapping screws at the top of the rear cover (callout 1), and then remove three machine screws (callout 2) on top of the cover.

Figure 5-1266 Remove six screws

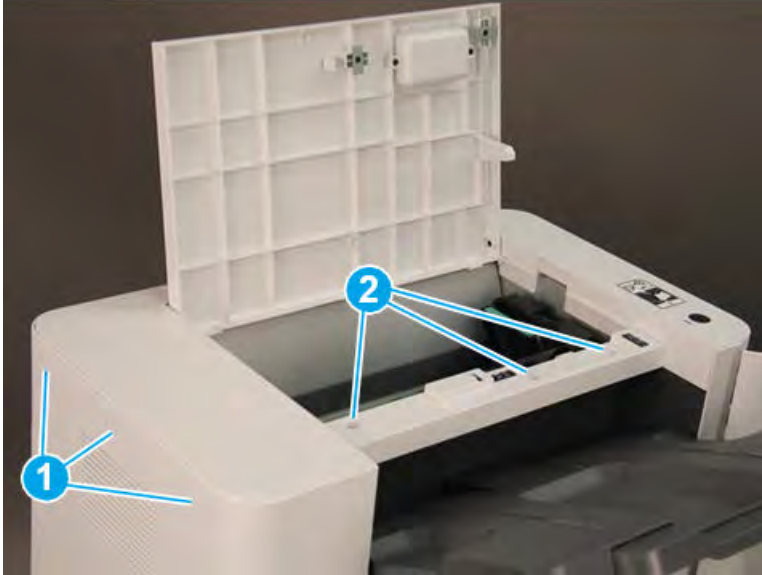

2. Remove three self-tapping screws at the top of the front cover (callout 1), and then remove two machine screws (callout 2) at the top of the right side.

Figure 5-1267 Remove five screws

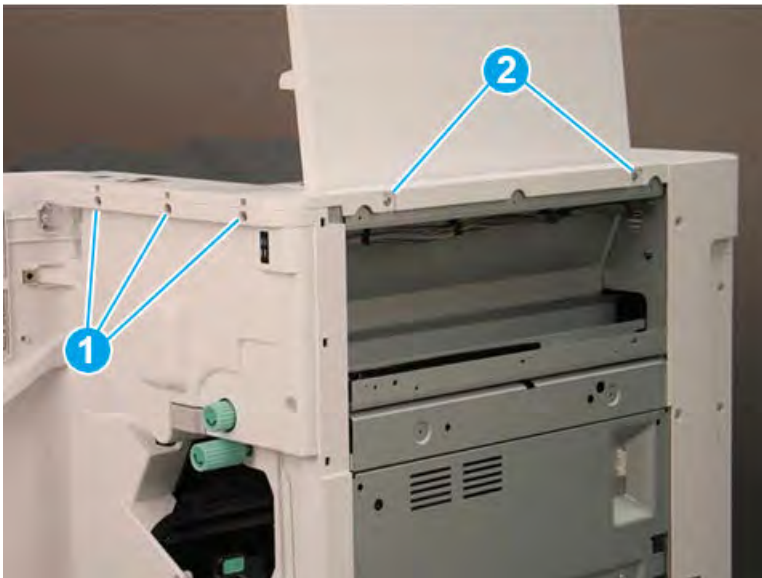

3. Lift the cover up slightly. Disconnect one in-line connector (callout 1), and then release one retainer (callout 2).

 **TIP:** Reverse the removal steps to install the assembly.

Figure 5-1268 Disconnect one connector and release retainer



Remove the front door (finisher)

Follow these steps to remove the front door (finisher).

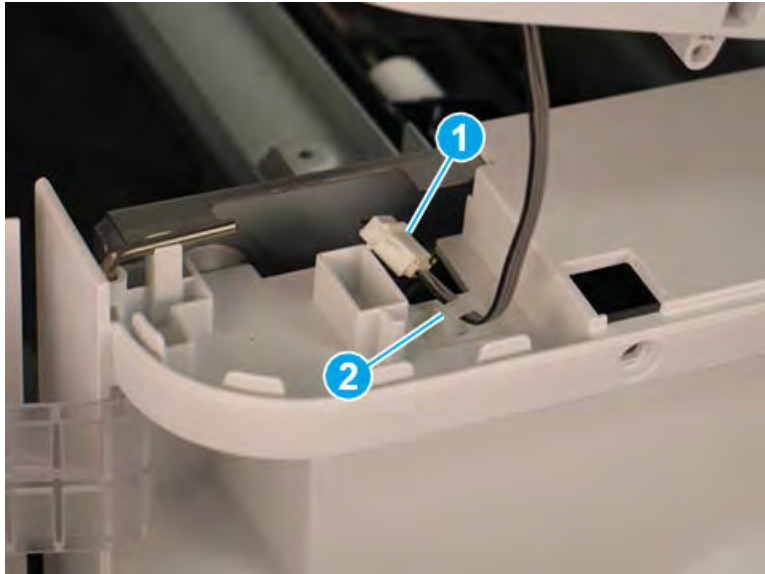
1. Lift the top hinge pin up to release it from the retainer.

Figure 5-1269 Lift the top hinge pin

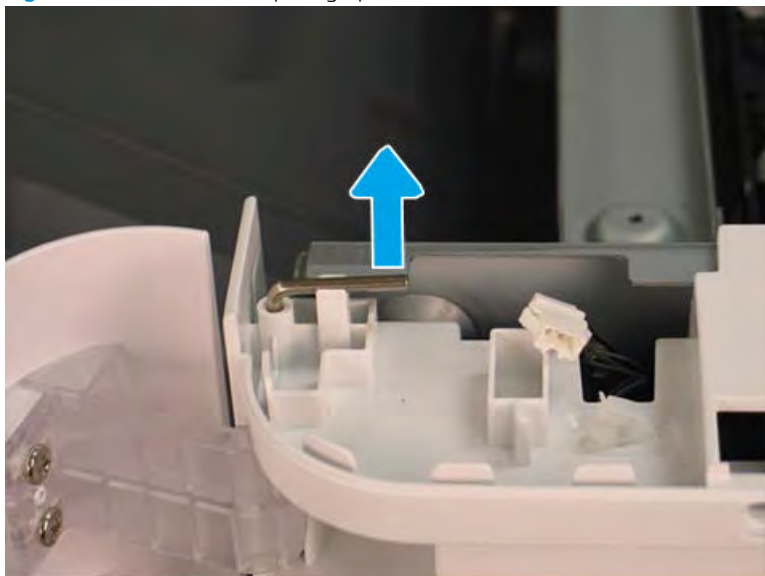

2. Pull the top hinge pin up to remove it.

Figure 5-1270 Remove the top hinge pin

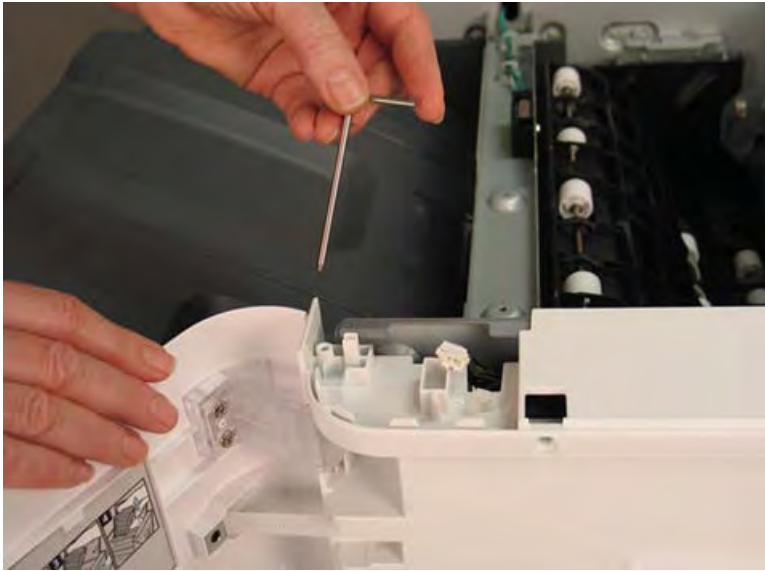

3. Use a small, flat-blade screwdriver to release the lower hinge pin from the retainer, and then rotate it away from the finisher.

Figure 5-1271 Release the lower hinge pin



4. Support the door with one hand, and then pull the lower hinge pin straight up to remove it.

Figure 5-1272 Remove the lower hinge pin



5. Support the door with one hand, and then remove one screw (callout 1) to release the strap. Remove the front door.

 **TIP:** Reverse the removal steps to install the assembly.

Figure 5-1273 Remove the front door



Remove the front cover (finisher)

Follow these steps to remove the front cover (finisher).

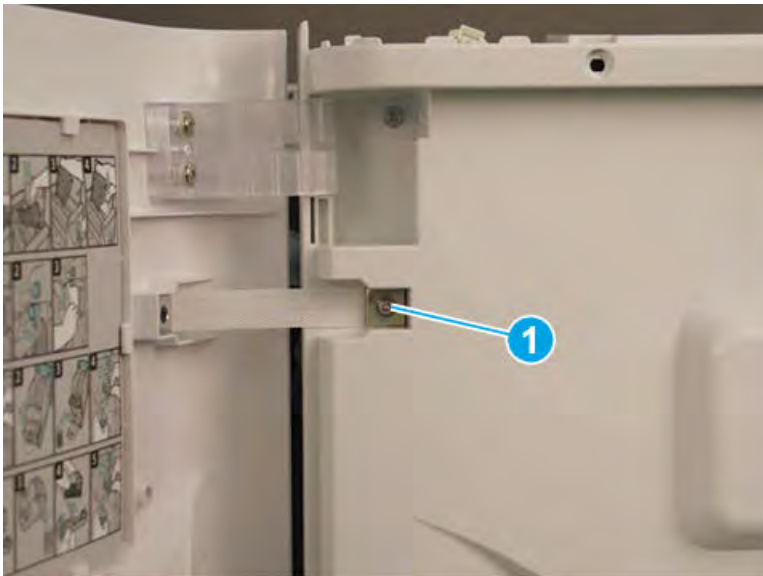
1. Release one tab (callout 1), and then pull the jam-access knob away from the finisher to remove it.

Figure 5-1274 Remove the jam-access knob

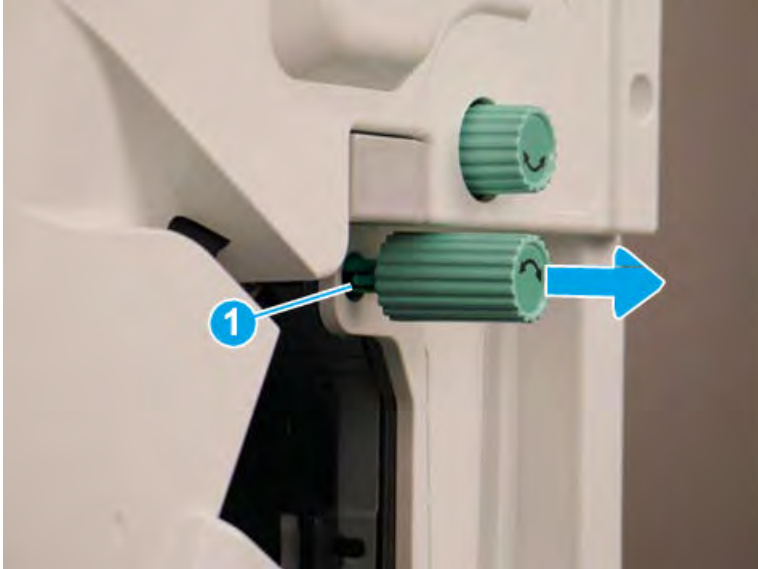

2. If the punch unit is installed, remove the punch waste bin (callout 1).
3. Remove one screw (callout 1) on top of the front cover.

Figure 5-1275 Remove one screw



4. Remove five machine screws (callout 1), and then remove the front cover.

 **TIP:** Reverse the removal steps to install the assembly.

Figure 5-1276 Remove the front cover



Remove the rear cover (finisher)

Follow these steps to remove the rear cover (finisher).

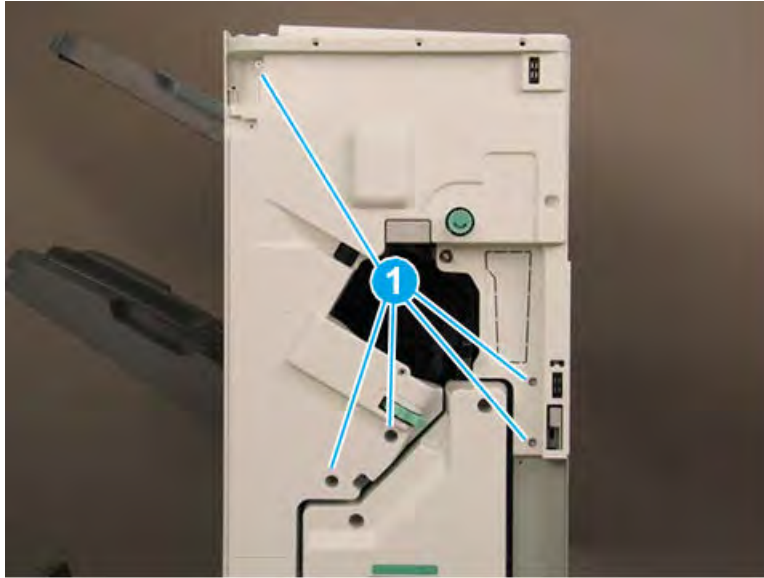
1. Remove two self-tapping screws (callout 1) on the top of the rear cover, and then remove five screw caps and five machine screws (callout 2) on the left side of the cover.

Figure 5-1277 Remove seven screws

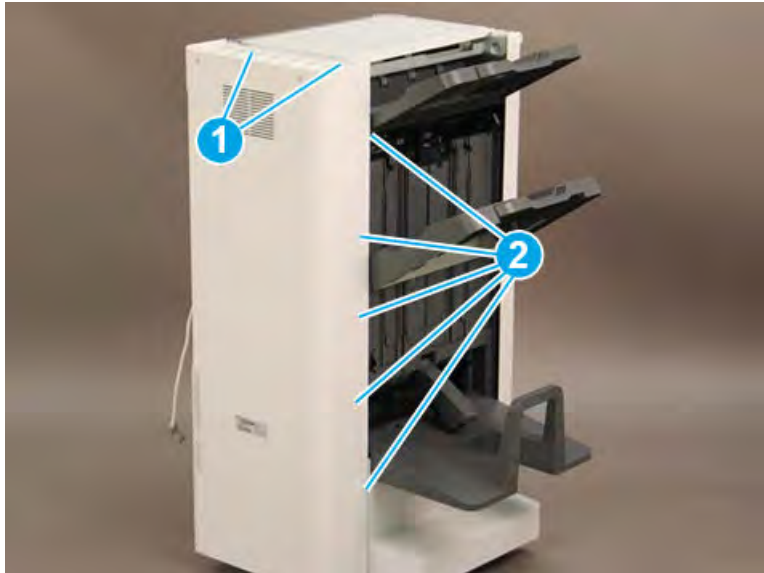

2. Remove one screw cap and four machine screws (callout 1) Remove the rear cover.

 **NOTE:** Make sure to thread the power cable (callout 2) through the opening in the cover.

 **TIP:** Reverse the removal steps to install the assembly

Figure 5-1278 Remove the rear cover



Remove the booklet output tray

Follow these steps to remove the booklet output tray.

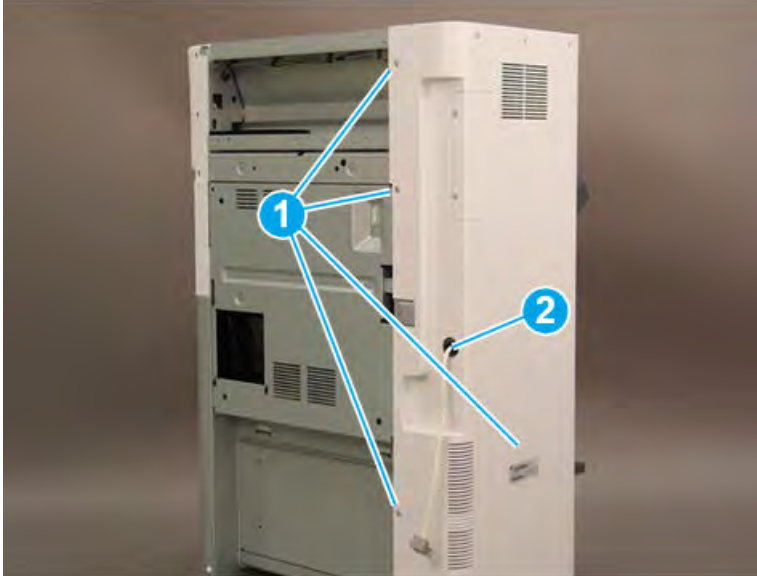
1. Raise the booklet output tray up (callout 1), and then pull it away from the finisher (callout 2) to remove it.

Figure 5-1279 Remove the booklet output tray

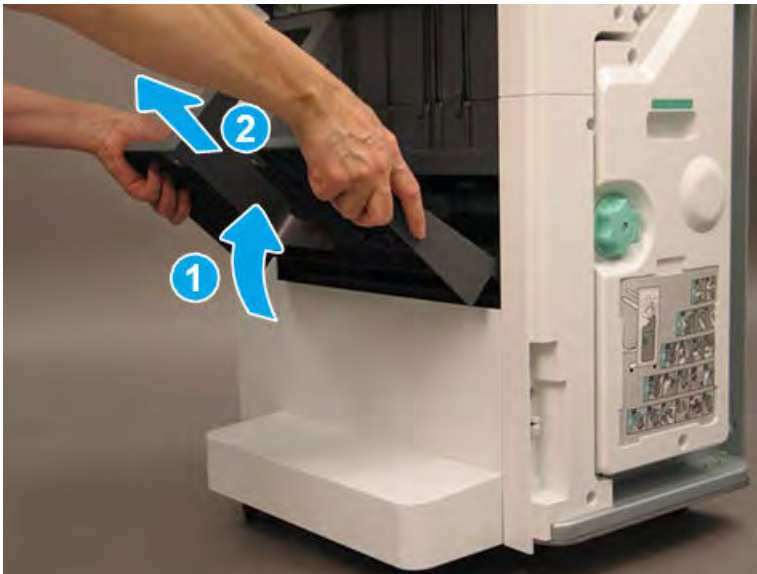

- Reverse the removal steps to install the assembly. Also use the following special installation instructions.

 **NOTE:** Continue to reverse the removal steps to finish installing the assembly

Special installation instructions: booklet output tray

Position the tabs (callout 1) on the tray into the slots (callout 2) on the finisher.

Figure 5-1280 Install the booklet output tray

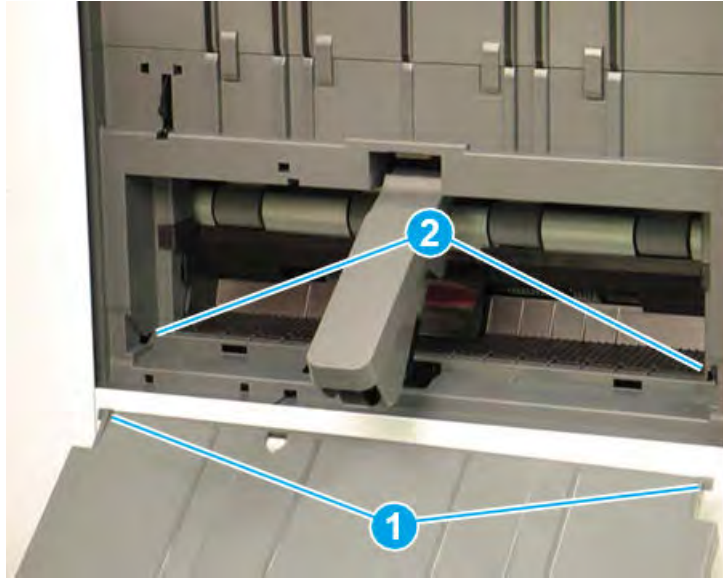

Remove the caster cover

Follow these steps to remove the caster cover.

- Remove two screw caps and two self-tapping screws (callout 1). Remove two screw caps and two machine screws (callout 2).

Figure 5-1281 Remove four screws

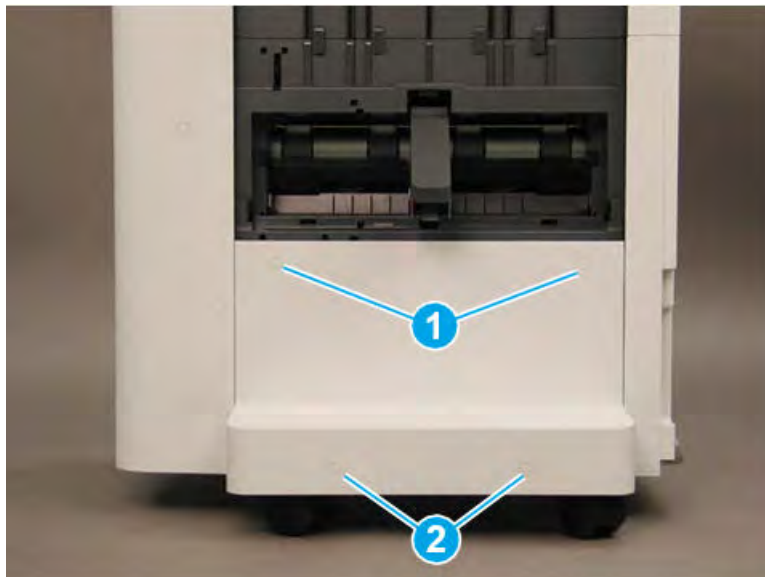

2. Rotate the left edge of the cover away from the finisher (callout 1), and then slide the cover to the left (callout 2) to remove it.

 **TIP:** Make sure that two tabs (callout 3) are positioned under the front lower cover when reinstalling the caster cover.

TIP: Reverse the removal steps to install the assembly

Figure 5-1282 Remove the caster cover

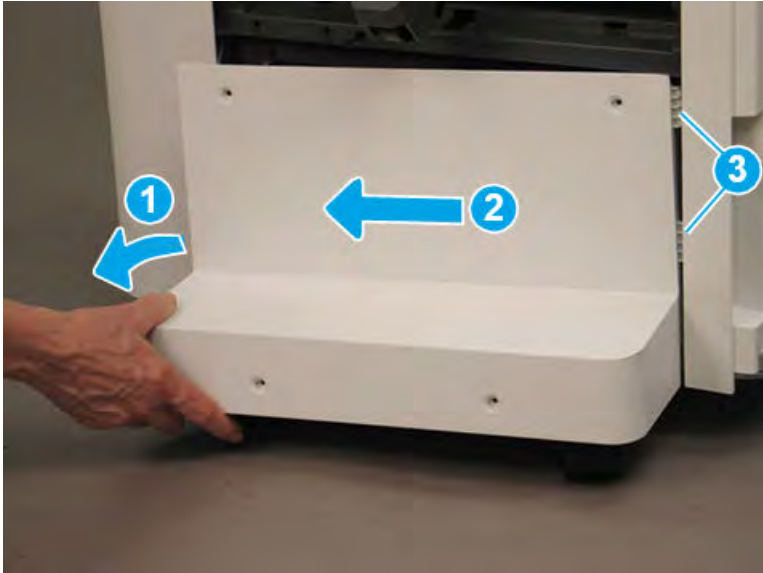

Remove the left lower cover (finisher)

Follow these steps to remove the left lower cover (finisher).

1. Remove four screws (callout 1).

 **NOTE:** Raise the lower output tray as needed to access the screws.

Figure 5-1283 Remove four screws

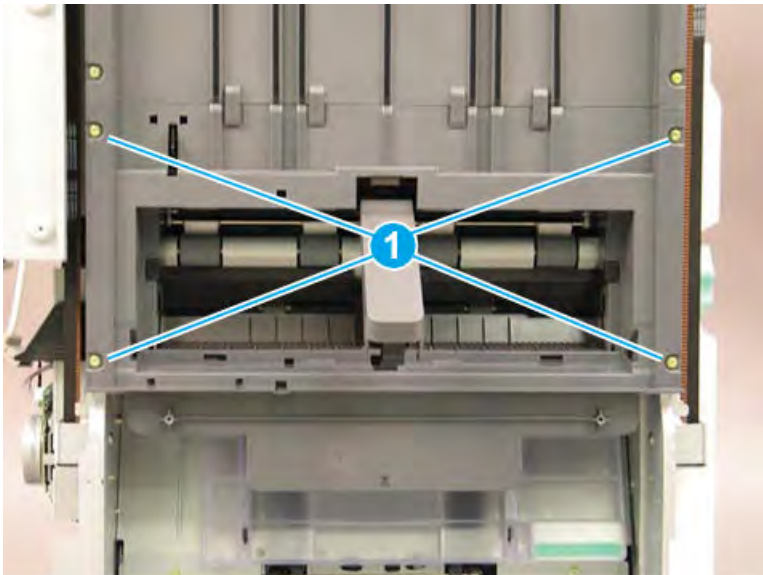

- Slide the shield down (callout 1) to release it from four tabs (callout 2), and then rotate it away from the finisher (callout 3).

CAUTION: The shield is still attached to the finisher. Do not attempt to completely remove the shield.

TIP: Position the shield under the four tabs (callout 2) when reinstalling it.

Figure 5-1284 Release the lower shield

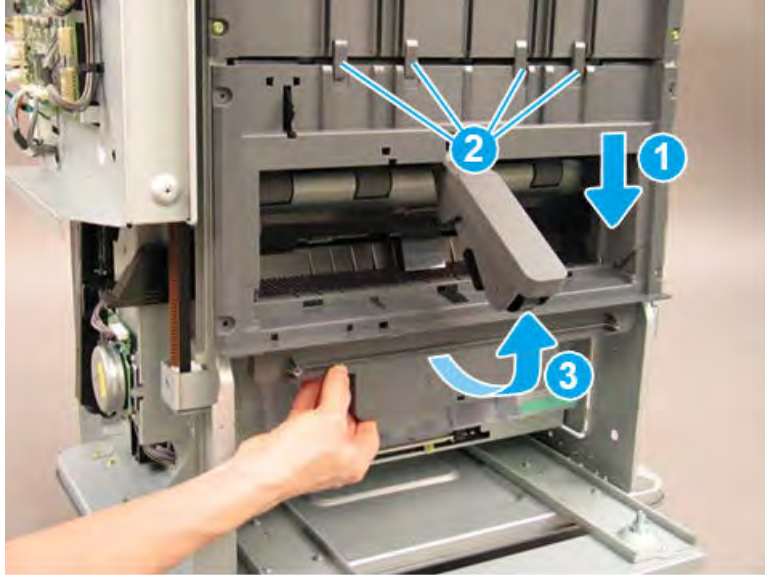

- Disconnect two connectors (callout 1), and then remove the shield.

TIP: Reverse the removal steps to install the assembly.

Figure 5-1285 Disconnect two connectors

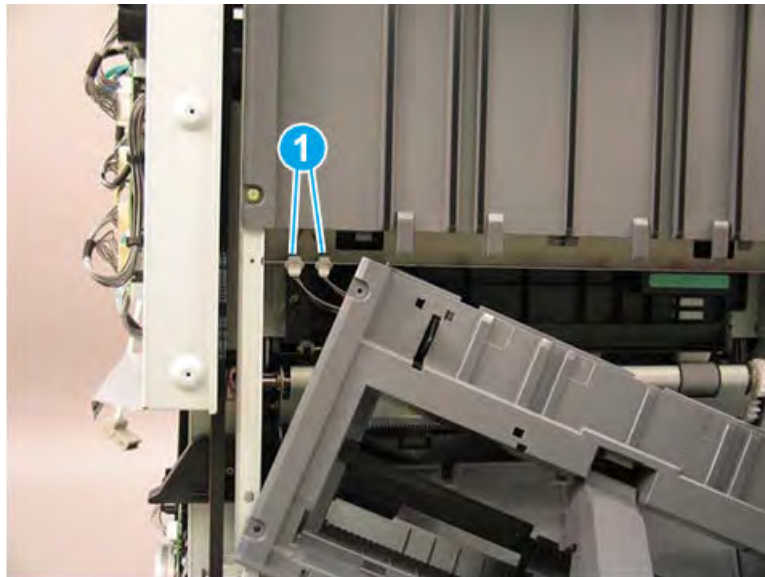

4. If you are replacing the left lower cover, locate three sensors (callout 1) on the back of the left lower cover. Remove these sensors and transfer them to the replacement part.

Figure 5-1286 Remove the left lower cover

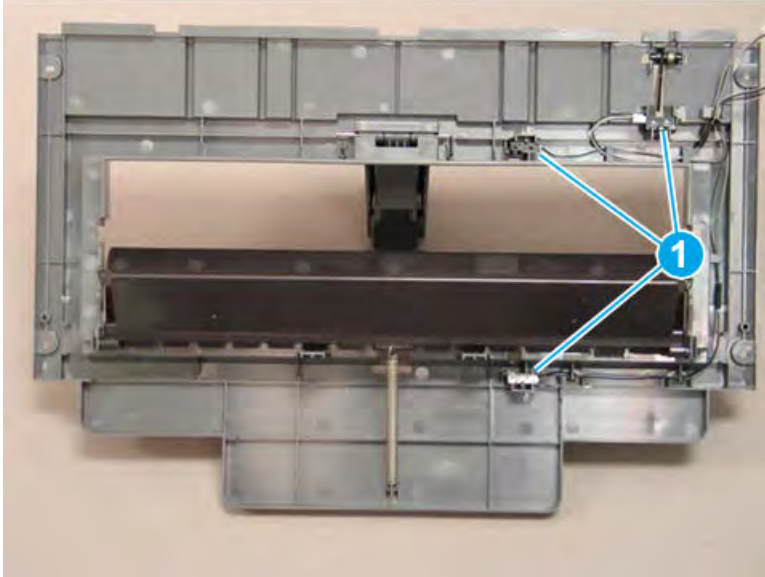

Remove the main output tray lower limit sensor(S26)

Follow these steps to remove the main output tray lower limit sensor(S26).

- ▲ Disconnect the connector(callout 1) and remove the sensor(S26, callout 2) from the lower shield assembly.

Figure 5-1287 Remove the main output tray lower limit sensor

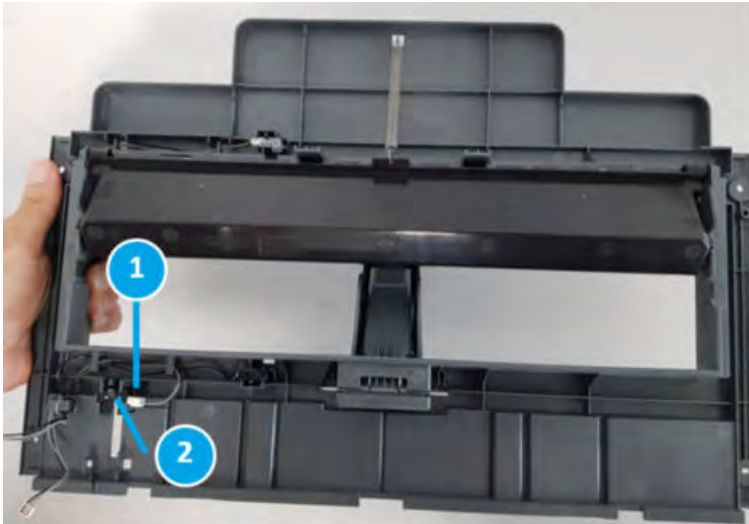

Unpack the replacement assembly

Follow these steps to unpack the replacement assembly.

1. Dispose of the defective part.

 **NOTE:** HP recommends responsible disposal of the defective part.

<http://www8.hp.com/us/en/hp-information/environment/product-recycling.html>

2. Unpack the replacement part from the packaging.



CAUTION:  Some parts are sensitive to electrostatic discharge (ESD). Always perform service work at an ESD-protected workstation or mat. If an ESD workstation or mat is not available, touch the sheet-metal chassis to provide a static ground before touching an ESD-sensitive assembly. Protect the ESD-sensitive assemblies by placing them in ESD pouches when they are out of the printer.

 **IMPORTANT:** Make sure that all of the shipping materials (for example shipping tape) are removed from the replacement part prior to installation.

 **NOTE:** If the replacement part is a roller or pad, avoid touching the spongy part of it. Skin oils on the roller or pad can cause paper pickup and/or print-quality problems. HP recommends using disposable gloves when handling rollers or pads or washing your hands before touching rollers or pads.

3. To install an assembly, reverse the removal steps.

 **NOTE:** When applicable, special installation instructions are provided for an assembly at the end of the removal procedure. Always completely read the removal instructions and follow all special installation instructions.

Removal and replacement: Main output tray motor sensor (S33)

Learn how to remove and replace the main output tray motor sensor.

Introduction

This document provides the procedures to remove and replace the main output tray motor sensor on the finisher.



IMPORTANT: When applicable, special installation instructions are provided for an assembly at the end of the removal procedure. Always completely read the removal instructions and follow all special installation instructions.

Before performing service

- Turn the printer power off. A shutting-down message appears on the control-panel display.
- ⚠ **WARNING!** To avoid damage to the printer, turn the power off and wait until the printer shuts down before removing the power cable.
- Disconnect the printer power cable after the printer has completely shut down (the control-panel display is blank).
- Release the finisher from the printer by pulling out on the release latch inside the finisher door.
- Disconnect the cable from the bridge unit to the finisher.
- Disconnect the cable from the finisher to the printer.

Use the table below to identify the correct part number for your printer. To order the part, go to <https://parts.hp.com>.

Table 5-135 Part information

Part number	Part description
0604-001393	Main output tray motor sensor

Required tools

- #2 JIS screwdriver with a magnetic tip

After performing service

- Connect the cable from the finisher to the printer.
- Connect the cable from the bridge unit to the finisher.
- Attach the finisher to the printer, and then push in on the release latch inside the finisher door.
- Connect the printer power cable.
- Turn the printer power on.

Post service test

Process a job through the finisher and verify that the finisher works correctly.

Remove the right upper cover (finisher)

Follow these steps to remove the right upper cover (finisher).

- ▲ Remove one screw cap and three machine screws on the upper edge of the cover (callout 1). Remove three sheet metal screws (callout 2) on the lower portion of the cover. Rotate the right edge of the cover away from the finisher, and then slide the cover right to release three tabs (callout 3).

💡 **TIP:** The lower screws are shorter in length than the upper screws.

TIP: Reverse the removal steps to install the assembly.

Figure 5-1288 Remove the right upper cover

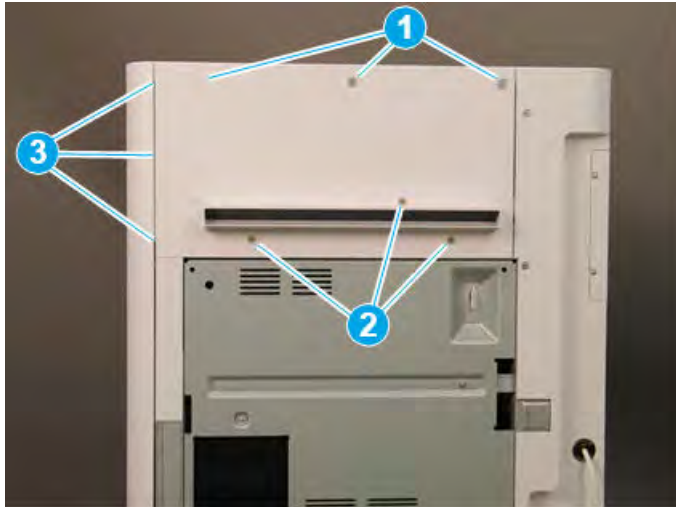

Remove the top cover (finisher)

Follow these steps to remove the top cover (finisher).

1. Remove three screw caps and three self-tapping screws at the top of the rear cover (callout 1), and then remove three machine screws (callout 2) on top of the cover.

Figure 5-1289 Remove six screws

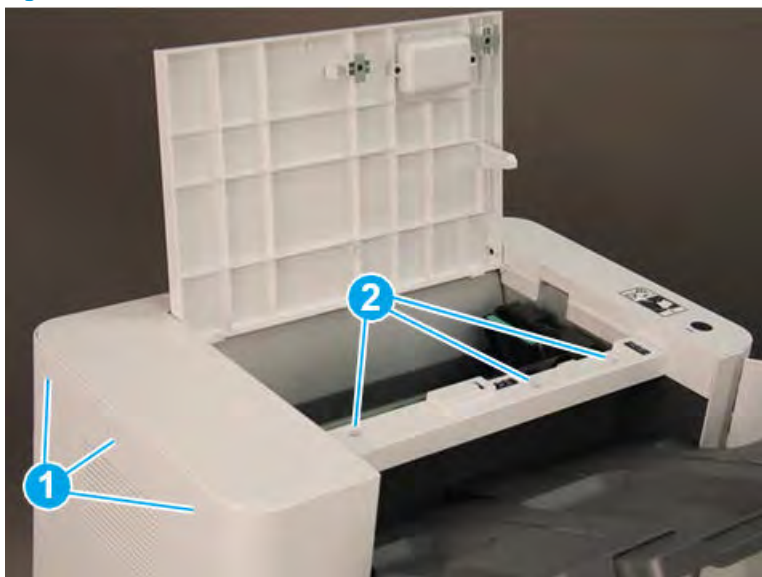

2. Remove three self-tapping screws at the top of the front cover (callout 1), and then remove two machine screws (callout 2) at the top of the right side.

Figure 5-1290 Remove five screws

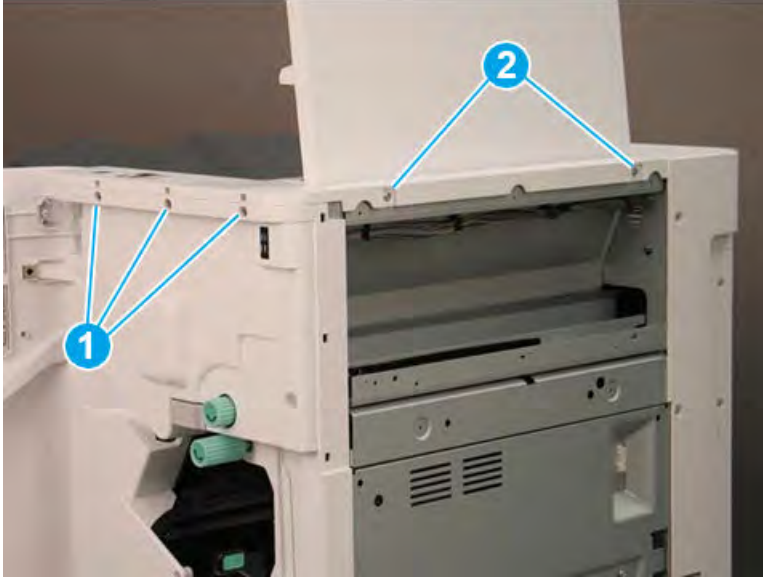

3. Lift the cover up slightly. Disconnect one in-line connector (callout 1), and then release one retainer (callout 2).

 **TIP:** Reverse the removal steps to install the assembly.

Figure 5-1291 Disconnect one connector and release retainer



Remove the rear cover (finisher)

Follow these steps to remove the rear cover (finisher).

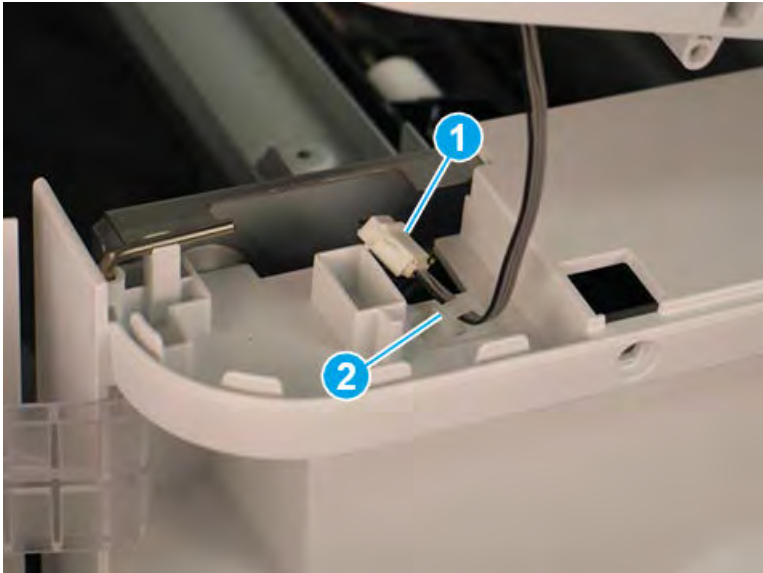
1. Remove two self-tapping screws (callout 1) on the top of the rear cover, and then remove five screw caps and five machine screws (callout 2) on the left side of the cover.

Figure 5-1292 Remove seven screws



2. Remove one screw cap and four machine screws (callout 1) Remove the rear cover.

 **NOTE:** Make sure to thread the power cable (callout 2) through the opening in the cover.

 **TIP:** Reverse the removal steps to install the assembly

Figure 5-1293 Remove the rear cover

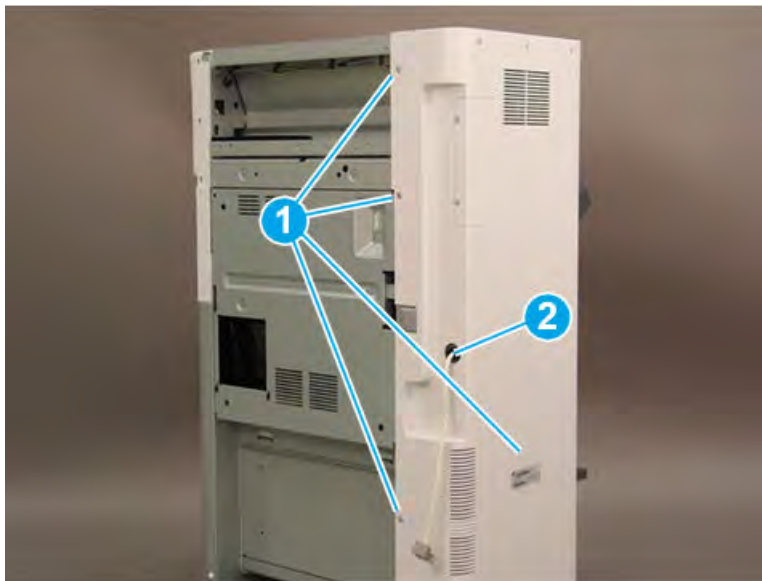

Remove the main output tray motor sensor (S33)

Follow these steps to remove the main output tray motor sensor (S33).

1. Disconnect the connector (callout 1)

Figure 5-1294 Disconnect the connector

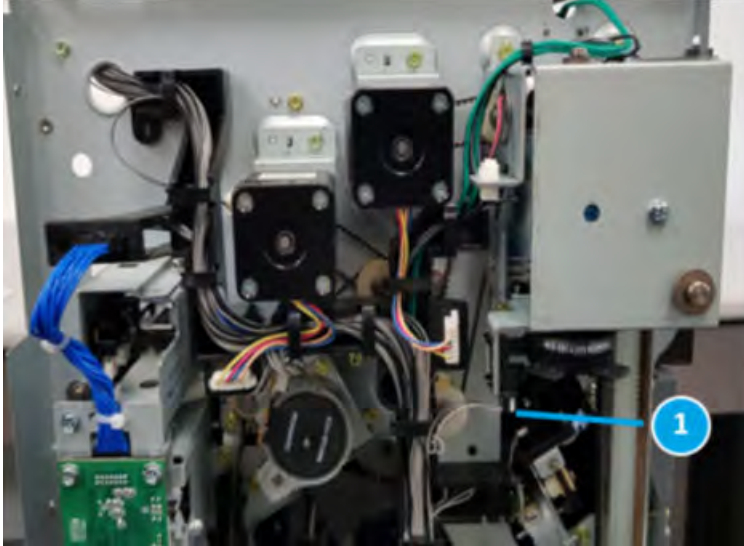

2. Remove the tape using tweezers and remove the sensor (S33, callout 1).

Figure 5-1295 Remove the sensor

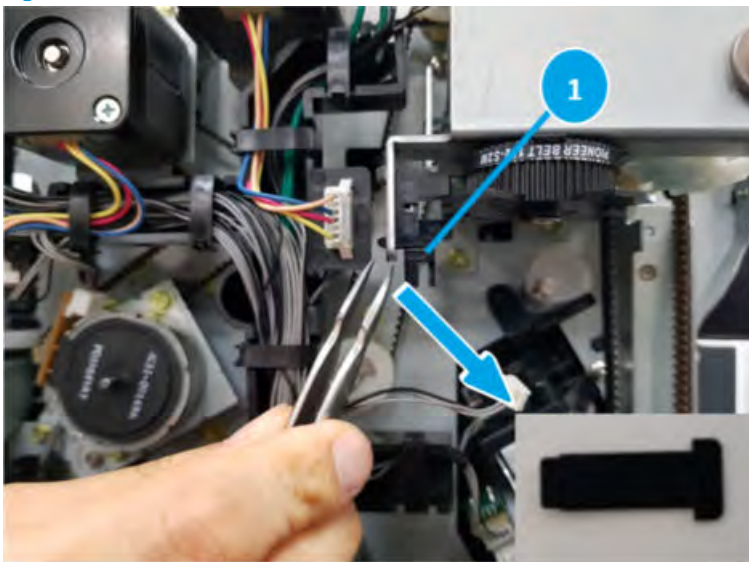

Unpack the replacement assembly

Follow these steps to unpack the replacement assembly.

1. Dispose of the defective part.

 **NOTE:** HP recommends responsible disposal of the defective part.

<http://www8.hp.com/us/en/hp-information/environment/product-recycling.html>

2. Unpack the replacement part from the packaging.



CAUTION:  Some parts are sensitive to electrostatic discharge (ESD). Always perform service work at an ESD-protected workstation or mat. If an ESD workstation or mat is not available, touch the sheet-metal chassis to provide a static ground before touching an ESD-sensitive assembly. Protect the ESD-sensitive assemblies by placing them in ESD pouches when they are out of the printer.



IMPORTANT: Make sure that all of the shipping materials (for example shipping tape) are removed from the replacement part prior to installation.



NOTE: If the replacement part is a roller or pad, avoid touching the spongy part of it. Skin oils on the roller or pad can cause paper pickup and/or print-quality problems. HP recommends using disposable gloves when handling rollers or pads or washing your hands before touching rollers or pads.

3. To install an assembly, reverse the removal steps.



NOTE: When applicable, special installation instructions are provided for an assembly at the end of the removal procedure. Always completely read the removal instructions and follow all special installation instructions.

HP LaserJet Managed MFP E82540-E82560, E87640-E87660, E82540du-E82560du, E87640du-E87660du, E72525-E72535, E77822-E77830 - Removal and replacement: Main output tray motor (M11)

Learn how to remove and replace the main output tray motor.

Introduction

This document provides the procedures to remove and replace the main output tray motor on the finisher.



IMPORTANT: When applicable, special installation instructions are provided for an assembly at the end of the removal procedure. Always completely read the removal instructions and follow all special installation instructions.

Before performing service

- Turn the printer power off. A shutting-down message appears on the control-panel display.
- ⚠ **WARNING!** To avoid damage to the printer, turn the power off and wait until the printer shuts down before removing the power cable.
- Disconnect the printer power cable after the printer has completely shut down (the control-panel display is blank).
- Release the finisher from the printer by pulling out on the release latch inside the finisher door.
- Disconnect the cable from the bridge unit to the finisher.
- Disconnect the cable from the finisher to the printer.

Use the table below to identify the correct part number for your printer. To order the part, go to <https://parts.hp.com>.

Table 5-136 Part information

Part number	Part description
JC90-01415B	Main output tray motor assembly

Required tools

- #2 JIS screwdriver with a magnetic tip

After performing service

- Connect the cable from the finisher to the printer.
- Connect the cable from the bridge unit to the finisher.
- Attach the finisher to the printer, and then push in on the release latch inside the finisher door.
- Connect the printer power cable.
- Turn the printer power on.

Post service test

Process a job through the finisher and verify that the finisher works correctly.

Remove the right upper cover (finisher)

Follow these steps to remove the right upper cover (finisher).

- ▲ Remove one screw cap and three machine screws on the upper edge of the cover (callout 1). Remove three sheet metal screws (callout 2) on the lower portion of the cover. Rotate the right edge of the cover away from the finisher, and then slide the cover right to release three tabs (callout 3).

💡 **TIP:** The lower screws are shorter in length than the upper screws.

TIP: Reverse the removal steps to install the assembly.

Figure 5-1296 Remove the right upper cover

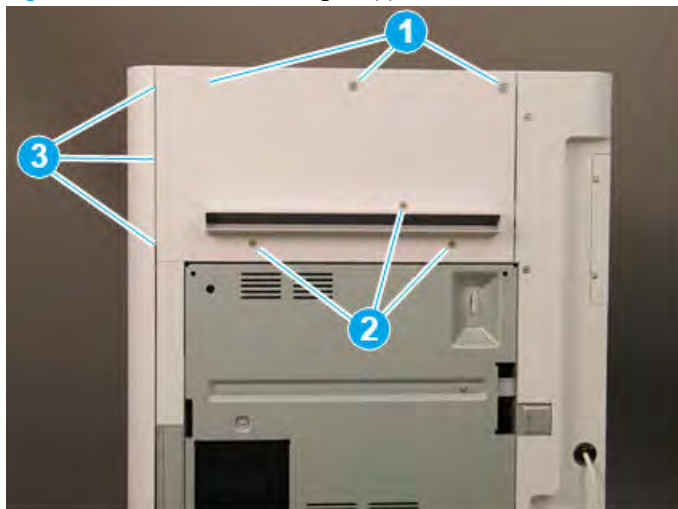

Remove the top cover (finisher)

Follow these steps to remove the top cover (finisher).

1. Remove three screw caps and three self-tapping screws at the top of the rear cover (callout 1), and then remove three machine screws (callout 2) on top of the cover.

Figure 5-1297 Remove six screws

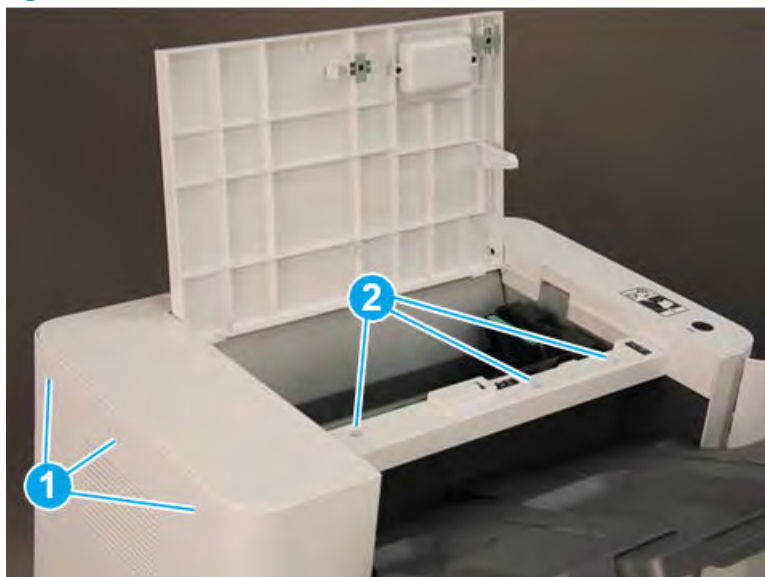

2. Remove three self-tapping screws at the top of the front cover (callout 1), and then remove two machine screws (callout 2) at the top of the right side.

Figure 5-1298 Remove five screws

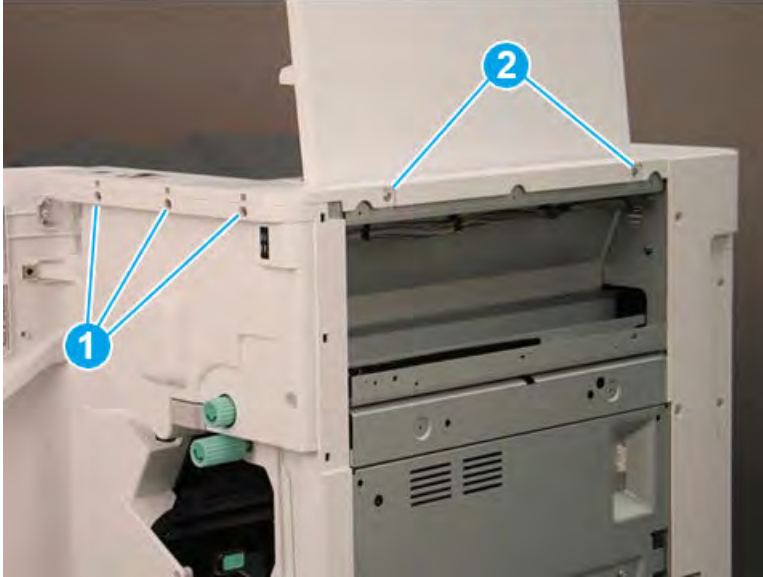

3. Lift the cover up slightly. Disconnect one in-line connector (callout 1), and then release one retainer (callout 2).

 **TIP:** Reverse the removal steps to install the assembly.

Figure 5-1299 Disconnect one connector and release retainer

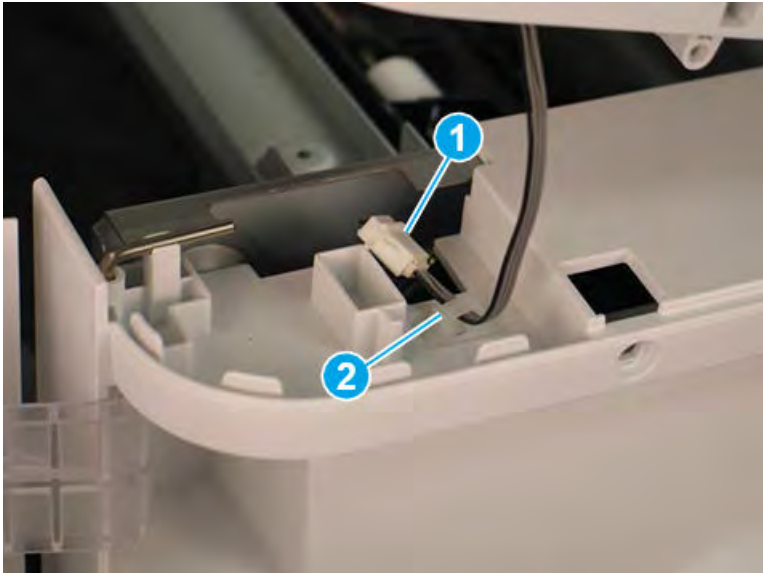

Remove the rear cover (finisher)

Follow these steps to remove the rear cover (finisher).

1. Remove two self-tapping screws (callout 1) on the top of the rear cover, and then remove five screw caps and five machine screws (callout 2) on the left side of the cover.

Figure 5-1300 Remove seven screws

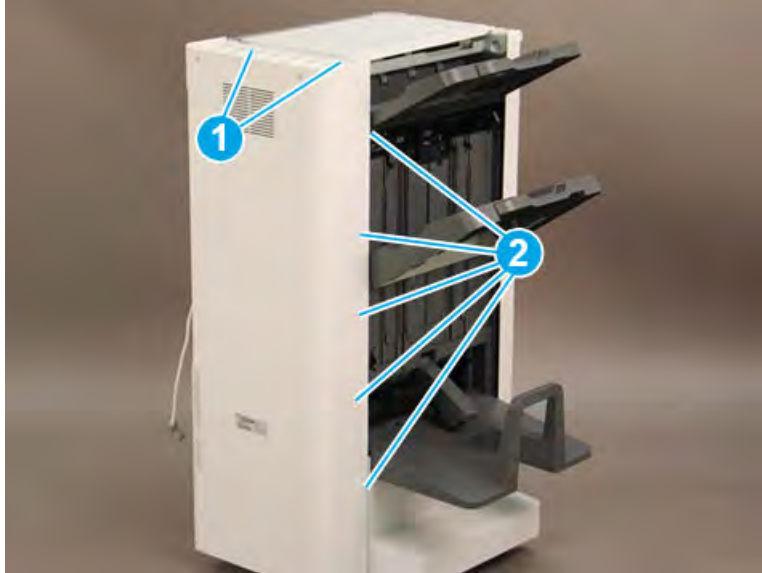

2. Remove one screw cap and four machine screws (callout 1) Remove the rear cover.

 **NOTE:** Make sure to thread the power cable (callout 2) through the opening in the cover.

 **TIP:** Reverse the removal steps to install the assembly

Figure 5-1301 Remove the rear cover



Remove the main output tray motor (M11)

Follow these steps to remove the main output tray motor (M11).

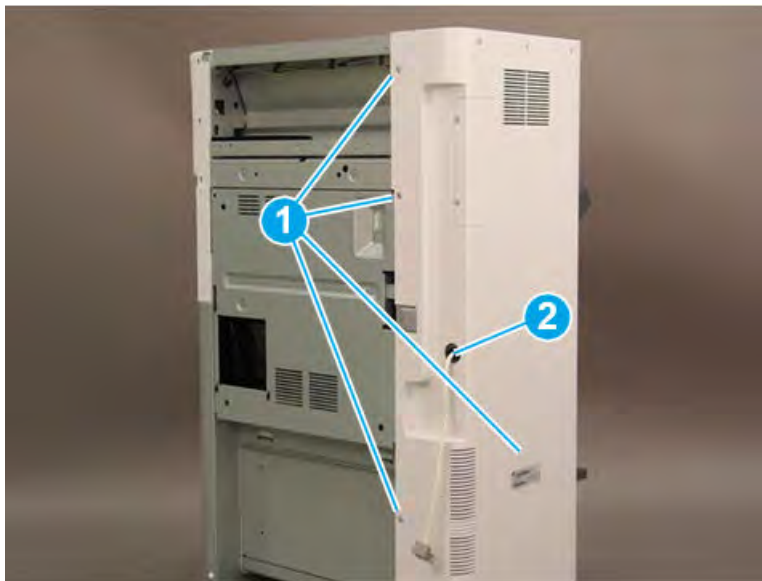
1. Bring the lower output tray down by positioning the shaft of a screwdriver on the clutch (callout 1) and gently pressing to the right to release the clutch. Hold the clutch in the released position and lower the tray (callout 2) to the lowest position

Figure 5-1302 Lower the output tray

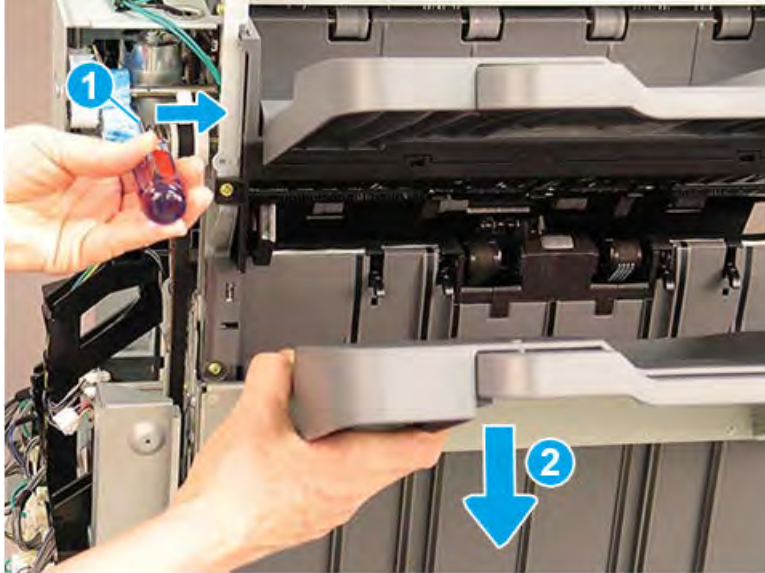

2. Open two retainers (callout 1), and then release the green wires (callout 2).

Figure 5-1303 Open two retainers

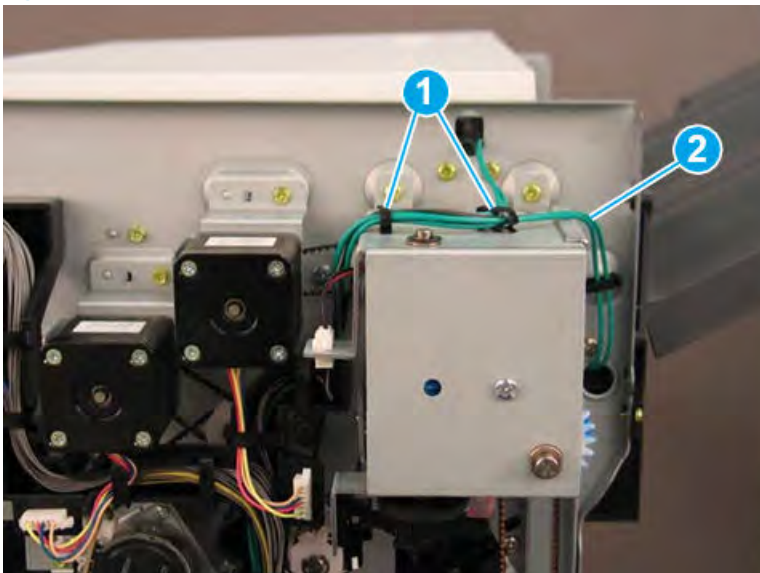

3. Disconnect three connectors (callout 1).

Figure 5-1304 Disconnect three connectors

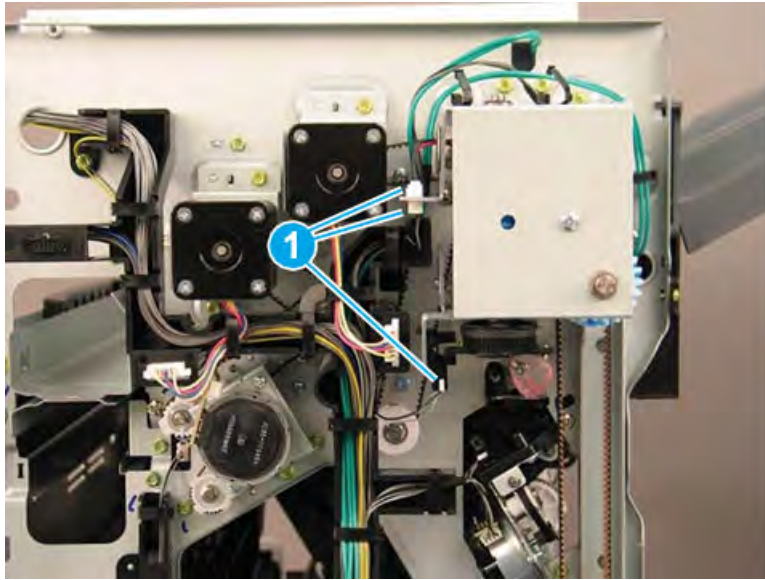

4. Disconnect one connector (callout 1), and then thread the cable up through the opening in the top of the bracket.

Figure 5-1305 Disconnect one connector

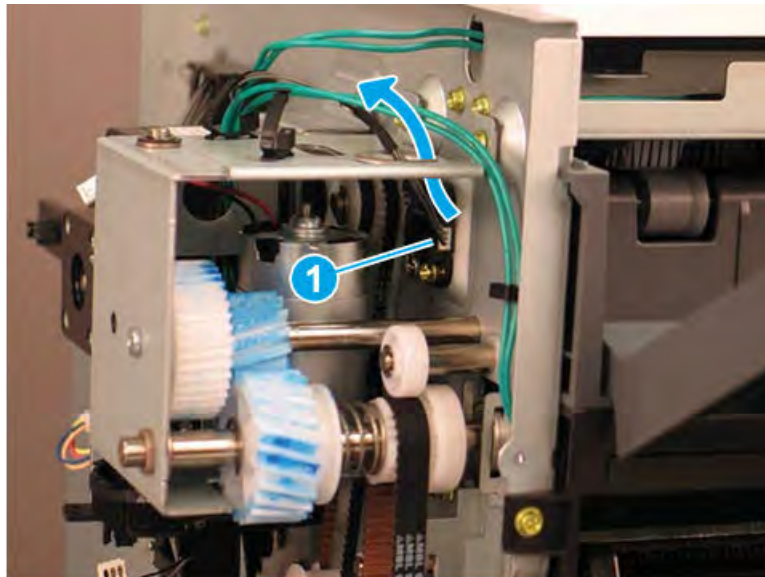

5. Remove four screws (callout 1), and then remove the motor assembly.

Figure 5-1306 Remove four screws and the motor assembly

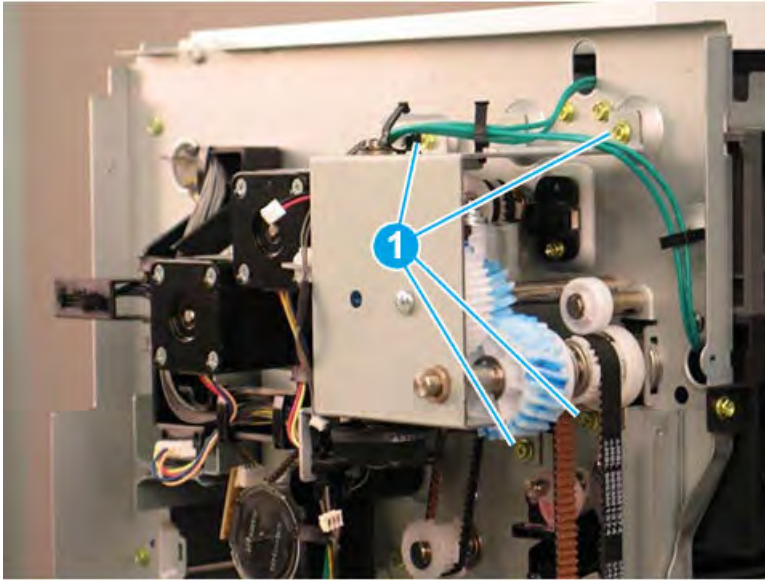

6. Carefully pull the motor assembly away from the printer to remove it.

Figure 5-1307 Remove the motor assembly

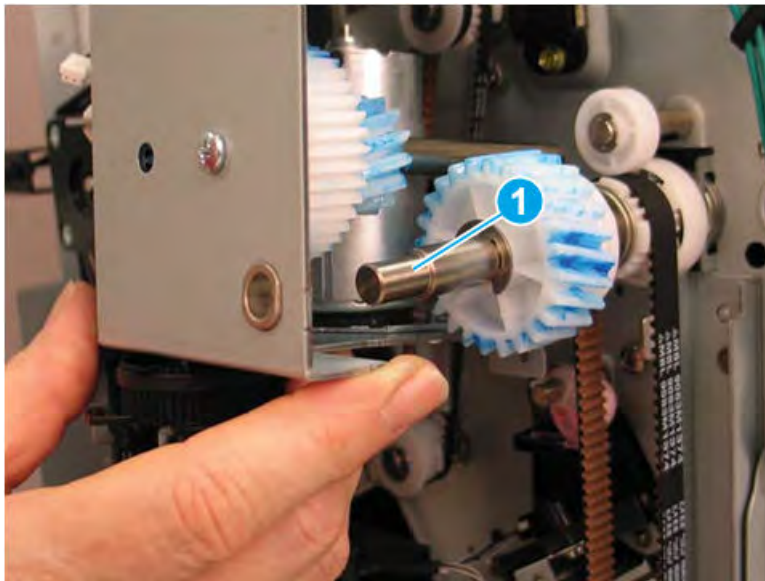

7. Reverse the removal steps to install the assembly. Also use the following special installation instructions.

 **NOTE:** Continue to reverse the removal steps to finish installing the assembly.

Special installation instructions: Main tray moving motor (M11)

- a. Before installing the motor assembly, slide the bushing (callout 1) off of the shaft.

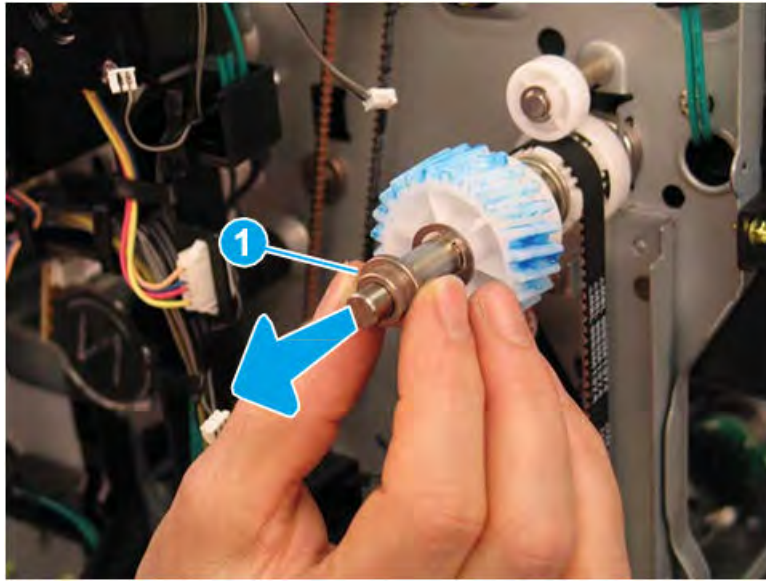

- b. Align the flat edges on the bushing with the flat edges on the opening in the motor assembly bracket, and then install the bushing.



- c. Position the bushing over the shaft, and then install the motor assembly.

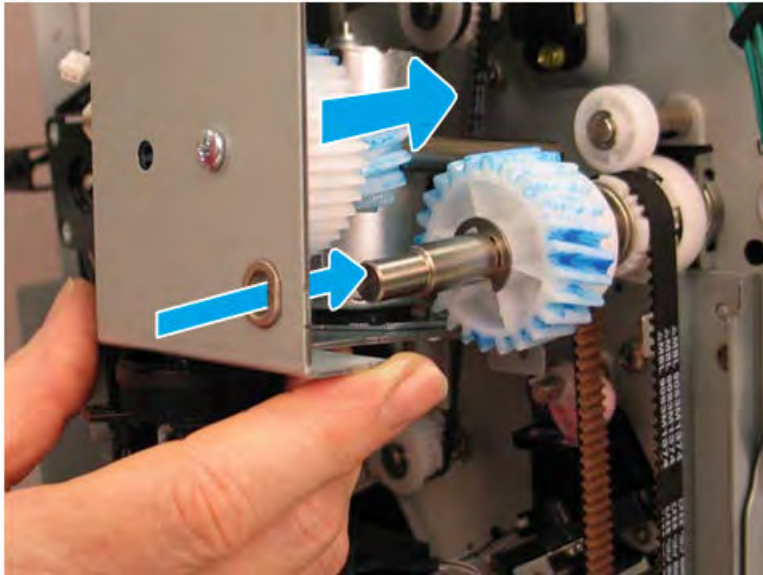

Unpack the replacement assembly



Follow these steps to unpack the replacement assembly.

1. Dispose of the defective part.

 **NOTE:** HP recommends responsible disposal of the defective part.

<http://www8.hp.com/us/en/hp-information/environment/product-recycling.html>

2. Unpack the replacement part from the packaging.

 **CAUTION:**  Some parts are sensitive to electrostatic discharge (ESD). Always perform service work at an ESD-protected workstation or mat. If an ESD workstation or mat is not available, touch the sheet-metal chassis to provide a static ground before touching an ESD-sensitive assembly. Protect the ESD-sensitive assemblies by placing them in ESD pouches when they are out of the printer.

 **IMPORTANT:** Make sure that all of the shipping materials (for example shipping tape) are removed from the replacement part prior to installation.

 **NOTE:** If the replacement part is a roller or pad, avoid touching the spongy part of it. Skin oils on the roller or pad can cause paper pickup and/or print-quality problems. HP recommends using disposable gloves when handling rollers or pads or washing your hands before touching rollers or pads.

3. To install an assembly, reverse the removal steps.

 **NOTE:** When applicable, special installation instructions are provided for an assembly at the end of the removal procedure. Always completely read the removal instructions and follow all special installation instructions.

Paper holding unit

Removal and replacement: Paper holding home sensor (S22)

Learn how to remove and replace the paper holding home sensor.

Introduction

This document provides the procedures to remove and replace the paper holding home sensor on the finisher.



IMPORTANT: When applicable, special installation instructions are provided for an assembly at the end of the removal procedure. Always completely read the removal instructions and follow all special installation instructions.

Before performing service

- Turn the printer power off. A shutting-down message appears on the control-panel display.
- ⚠ **WARNING!** To avoid damage to the printer, turn the power off and wait until the printer shuts down before removing the power cable.
- Disconnect the printer power cable after the printer has completely shut down (the control-panel display is blank).
- Release the finisher from the printer by pulling out on the release latch inside the finisher door.
- Disconnect the cable from the bridge unit to the finisher.
- Disconnect the cable from the finisher to the printer.

Use the table below to identify the correct part number for your printer. To order the part, go to <https://parts.hp.com>.

Table 5-137 Part information

Part number	Part description
0604-001393	Paper holding home sensor

Required tools

- #2 JIS screwdriver with a magnetic tip

After performing service

- Connect the cable from the finisher to the printer.
- Connect the cable from the bridge unit to the finisher.
- Attach the finisher to the printer, and then push in on the release latch inside the finisher door.
- Connect the printer power cable.
- Turn the printer power on.

Post service test

Process a job through the finisher and verify that the finisher works correctly.

Remove the right upper cover (finisher)

Follow these steps to remove the right upper cover (finisher).

- ▲ Remove one screw cap and three machine screws on the upper edge of the cover (callout 1). Remove three sheet metal screws (callout 2) on the lower portion of the cover. Rotate the right edge of the cover away from the finisher, and then slide the cover right to release three tabs (callout 3).

💡 **TIP:** The lower screws are shorter in length than the upper screws.

TIP: Reverse the removal steps to install the assembly.

Figure 5-1308 Remove the right upper cover

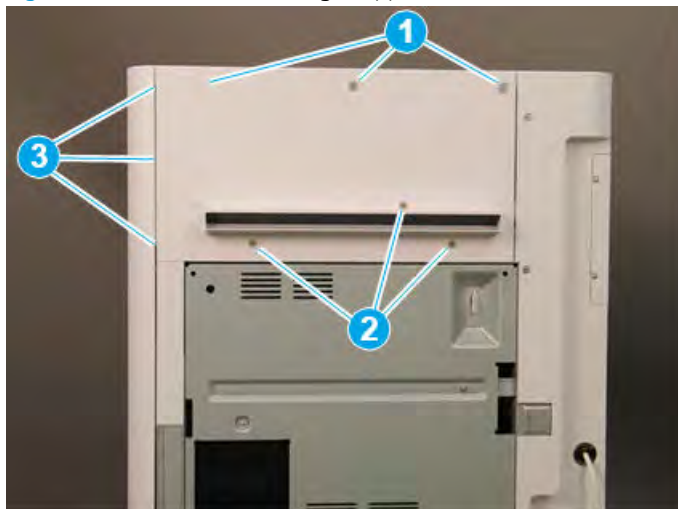

Remove the top cover (finisher)

Follow these steps to remove the top cover (finisher).

1. Remove three screw caps and three self-tapping screws at the top of the rear cover (callout 1), and then remove three machine screws (callout 2) on top of the cover.

Figure 5-1309 Remove six screws

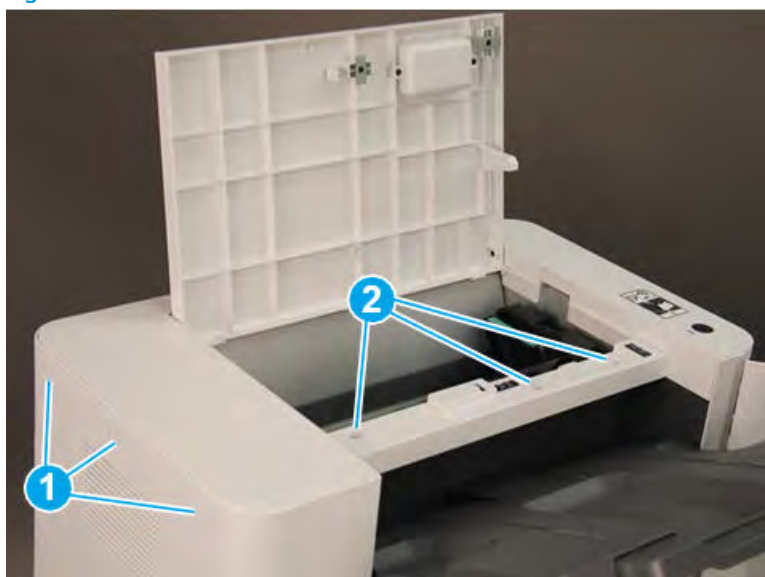

2. Remove three self-tapping screws at the top of the front cover (callout 1), and then remove two machine screws (callout 2) at the top of the right side.

Figure 5-1310 Remove five screws

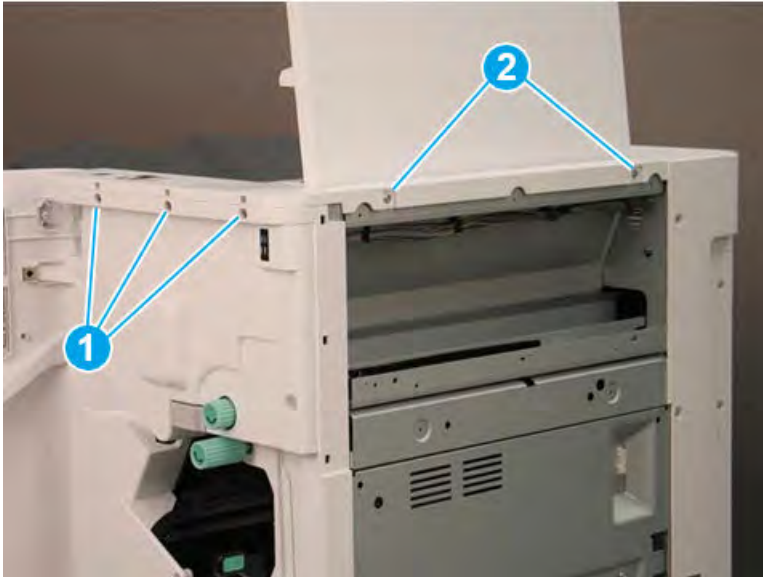

3. Lift the cover up slightly. Disconnect one in-line connector (callout 1), and then release one retainer (callout 2).

 **TIP:** Reverse the removal steps to install the assembly.

Figure 5-1311 Disconnect one connector and release retainer



Remove the front door (finisher)

Follow these steps to remove the front door (finisher).

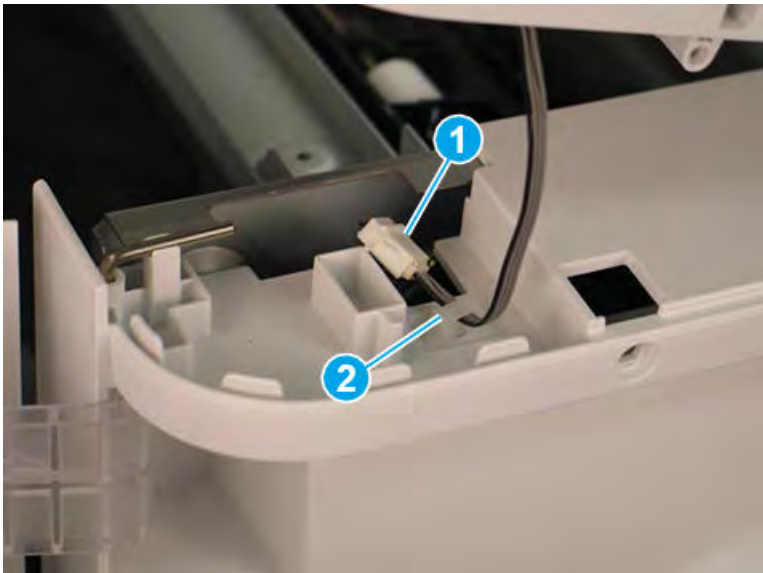
1. Lift the top hinge pin up to release it from the retainer.

Figure 5-1312 Lift the top hinge pin

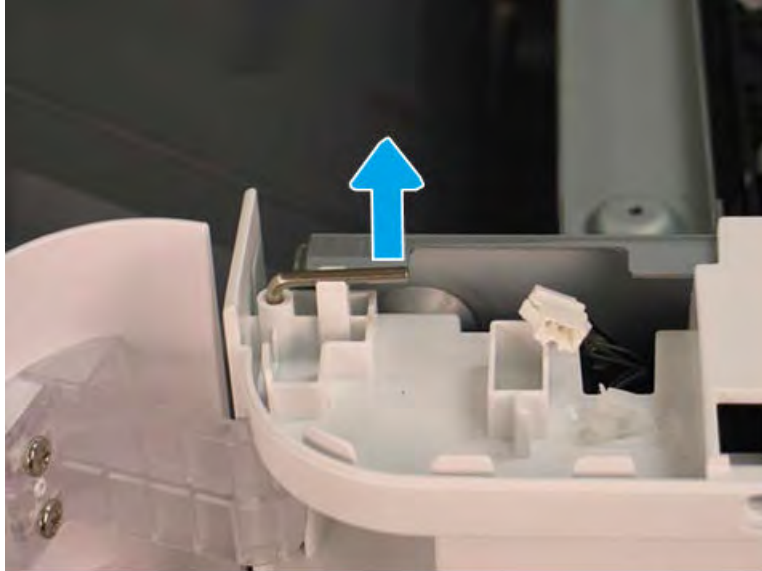

2. Pull the top hinge pin up to remove it.

Figure 5-1313 Remove the top hinge pin

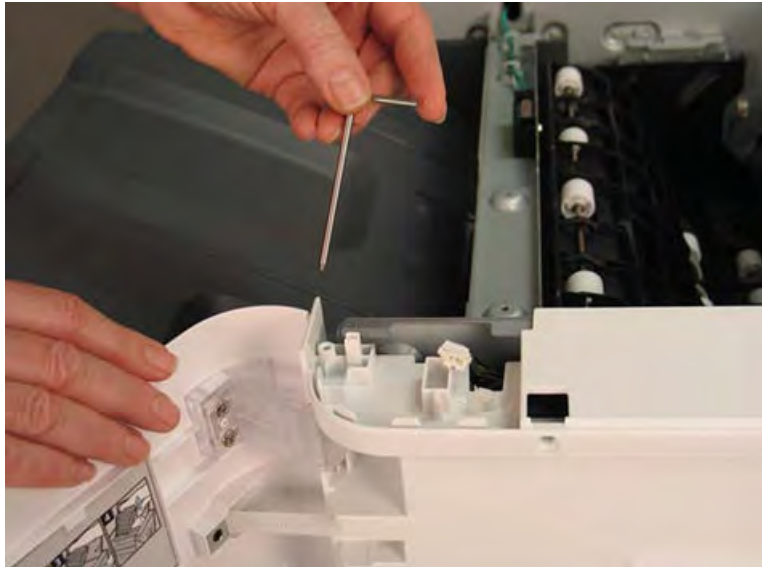

3. Use a small, flat-blade screwdriver to release the lower hinge pin from the retainer, and then rotate it away from the finisher.

Figure 5-1314 Release the lower hinge pin



4. Support the door with one hand, and then pull the lower hinge pin straight up to remove it.

Figure 5-1315 Remove the lower hinge pin



5. Support the door with one hand, and then remove one screw (callout 1) to release the strap. Remove the front door.

 **TIP:** Reverse the removal steps to install the assembly.

Figure 5-1316 Remove the front door



Remove the front cover (finisher)

Follow these steps to remove the front cover (finisher).

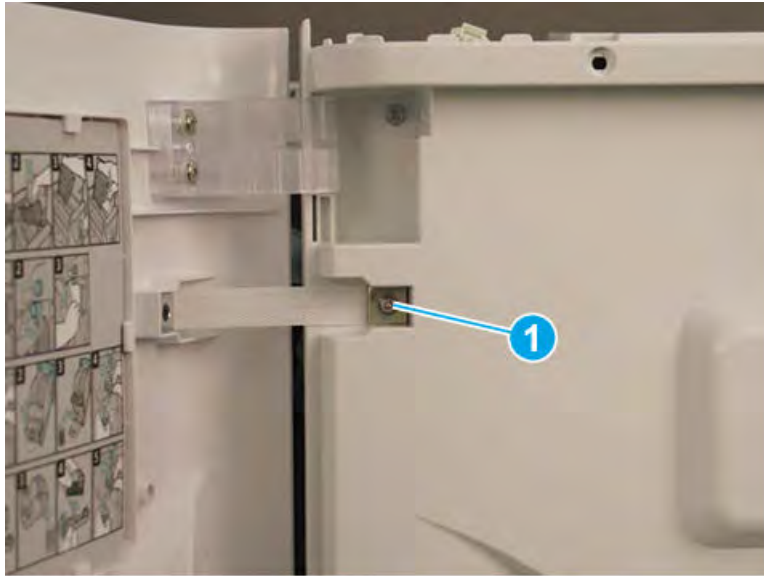
1. Release one tab (callout 1), and then pull the jam-access knob away from the finisher to remove it.

Figure 5-1317 Remove the jam-access knob

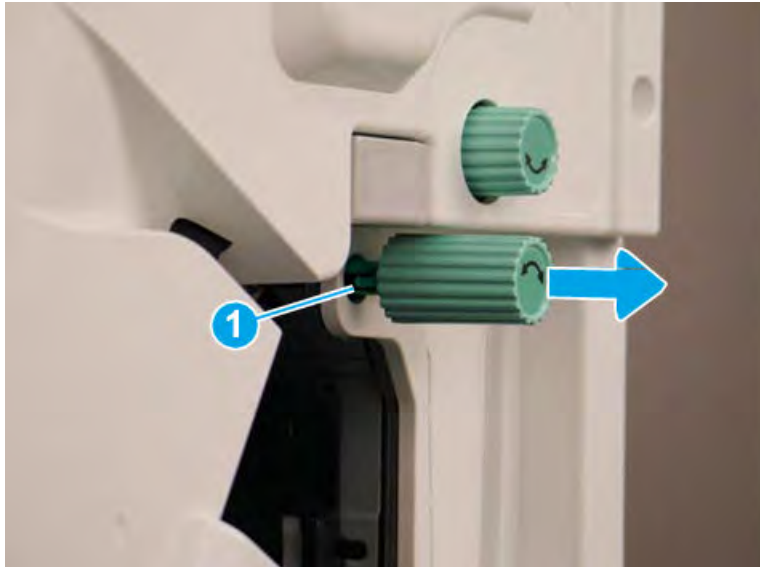

2. If the punch unit is installed, remove the punch waste bin (callout 1).

3. Remove one screw (callout 1) on top of the front cover.

Figure 5-1318 Remove one screw



4. Remove five machine screws (callout 1), and then remove the front cover.

 **TIP:** Reverse the removal steps to install the assembly.

Figure 5-1319 Remove the front cover



Remove the rear cover (finisher)

Follow these steps to remove the rear cover (finisher).

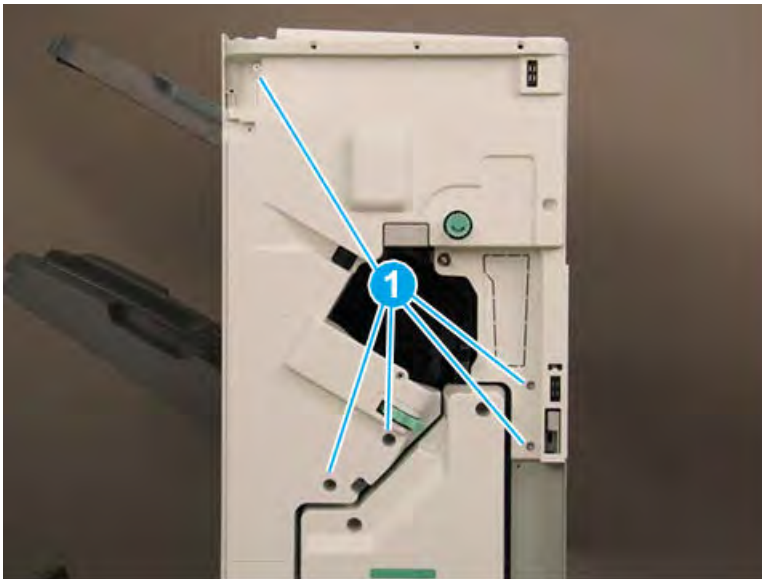
1. Remove two self-tapping screws (callout 1) on the top of the rear cover, and then remove five screw caps and five machine screws (callout 2) on the left side of the cover.

Figure 5-1320 Remove seven screws

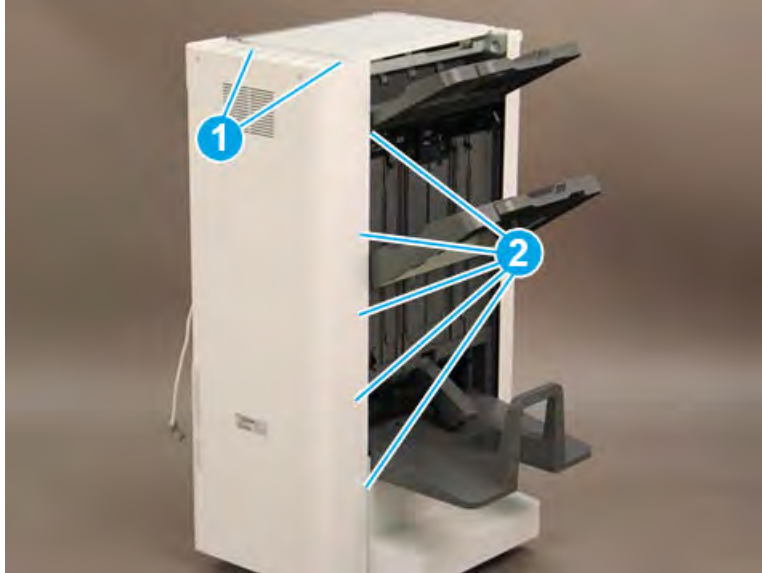

2. Remove one screw cap and four machine screws (callout 1) Remove the rear cover.

 **NOTE:** Make sure to thread the power cable (callout 2) through the opening in the cover.

 **TIP:** Reverse the removal steps to install the assembly

Figure 5-1321 Remove the rear cover



Remove the booklet output tray

Follow these steps to remove the booklet output tray.

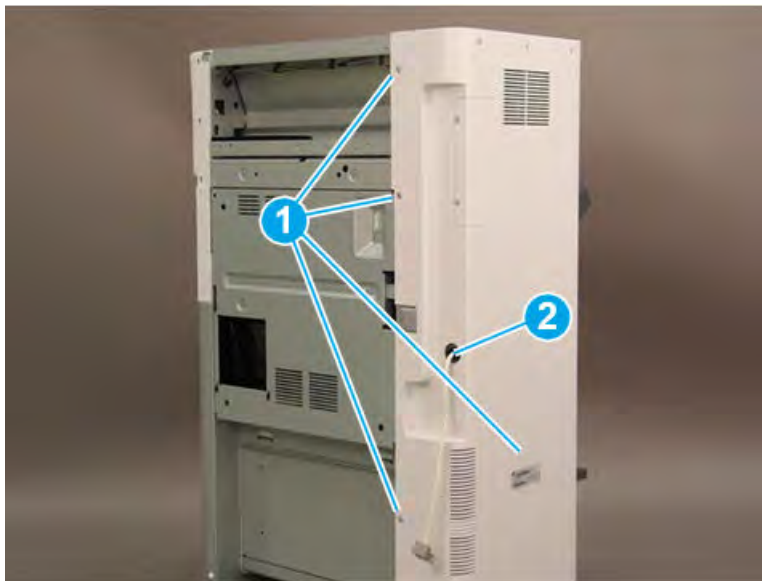
1. Raise the booklet output tray up (callout 1), and then pull it away from the finisher (callout 2) to remove it.

Figure 5-1322 Remove the booklet output tray



2. Reverse the removal steps to install the assembly. Also use the following special installation instructions.

 **NOTE:** Continue to reverse the removal steps to finish installing the assembly

Special installation instructions: booklet output tray

Position the tabs (callout 1) on the tray into the slots (callout 2) on the finisher.

Figure 5-1323 Install the booklet output tray

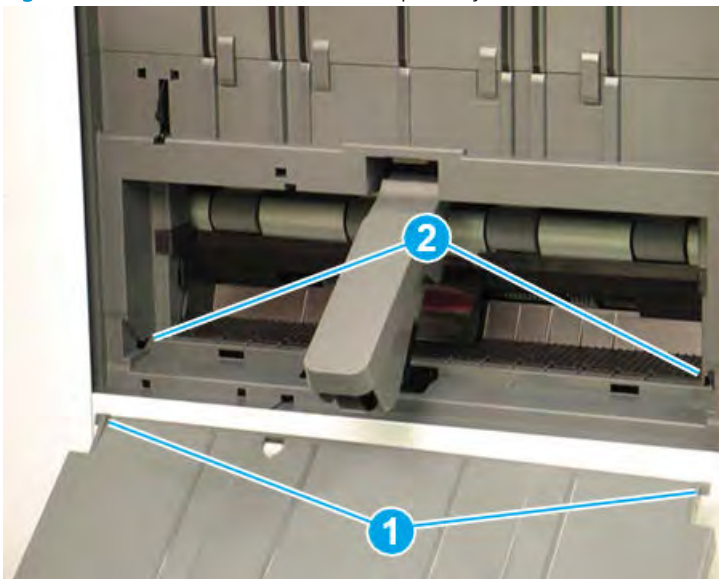

Remove the caster cover

Follow these steps to remove the caster cover.

1. Remove two screw caps and two self-tapping screws (callout 1). Remove two screw caps and two machine screws (callout 2).

Figure 5-1324 Remove four screws

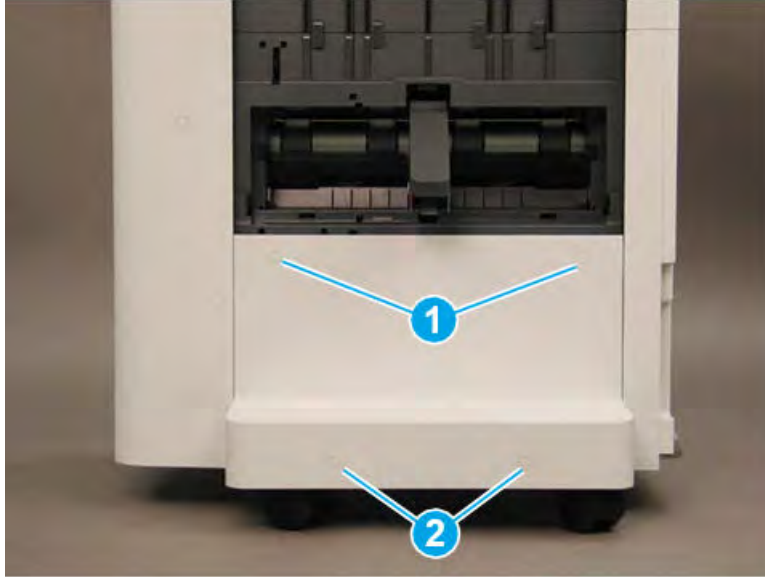

2. Rotate the left edge of the cover away from the finisher (callout 1), and then slide the cover to the left (callout 2) to remove it.

 **TIP:** Make sure that two tabs (callout 3) are positioned under the front lower cover when reinstalling the caster cover.

TIP: Reverse the removal steps to install the assembly

Figure 5-1325 Remove the caster cover

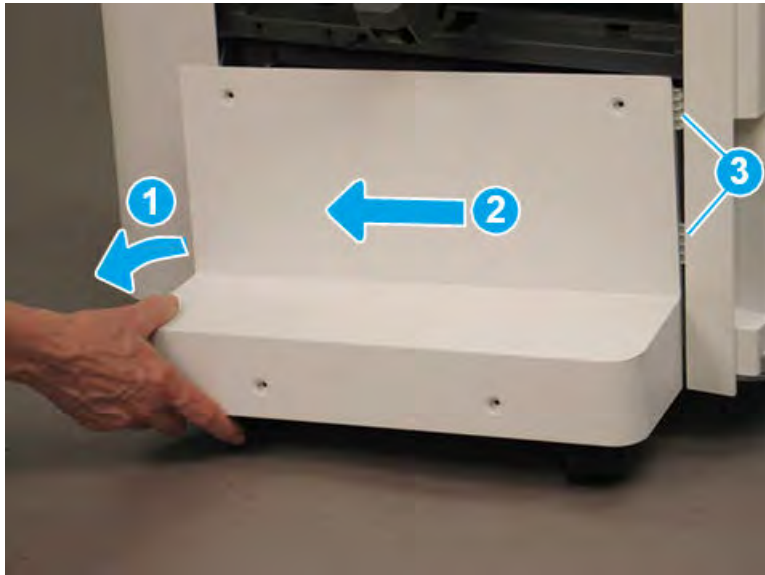

Remove the left lower cover (finisher)

Follow these steps to remove the left lower cover (finisher).

1. Remove four screws (callout 1).

 **NOTE:** Raise the lower output tray as needed to access the screws.

Figure 5-1326 Remove four screws



2. Slide the shield down (callout 1) to release it from four tabs (callout 2), and then rotate it away from the finisher (callout 3).

⚠ CAUTION: The shield is still attached to the finisher. Do not attempt to completely remove the shield.

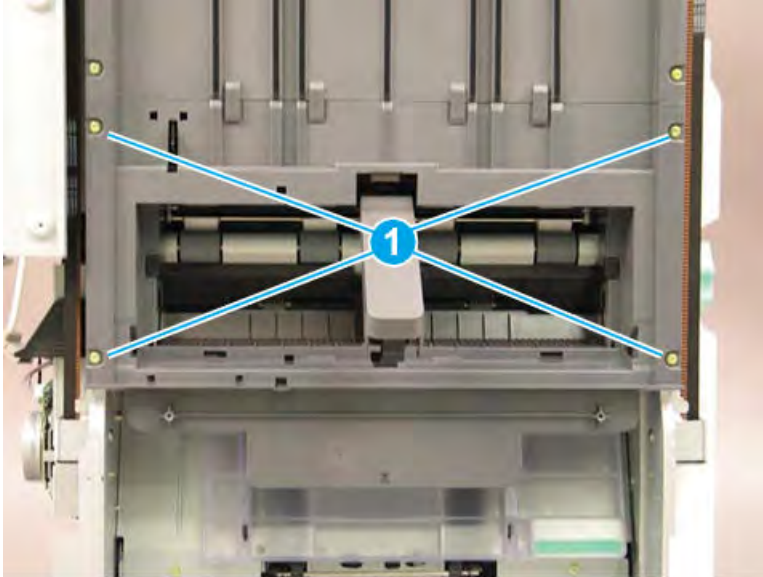
💡 TIP: Position the shield under the four tabs (callout 2) when reinstalling it.

Figure 5-1327 Release the lower shield

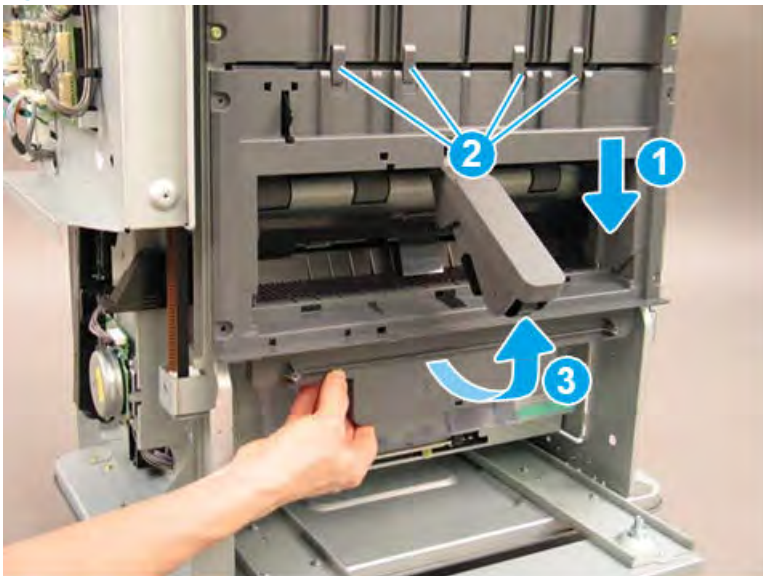

3. Disconnect two connectors (callout 1), and then remove the shield.

 **TIP:** Reverse the removal steps to install the assembly.

Figure 5-1328 Disconnect two connectors



4. If you are replacing the left lower cover, locate three sensors (callout 1) on the back of the left lower cover. Remove these sensors and transfer them to the replacement part.

Figure 5-1329 Remove the left lower cover

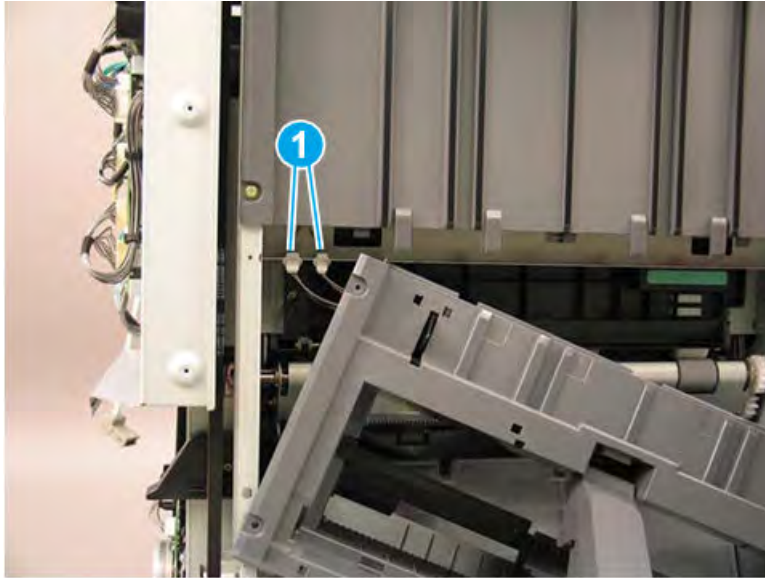
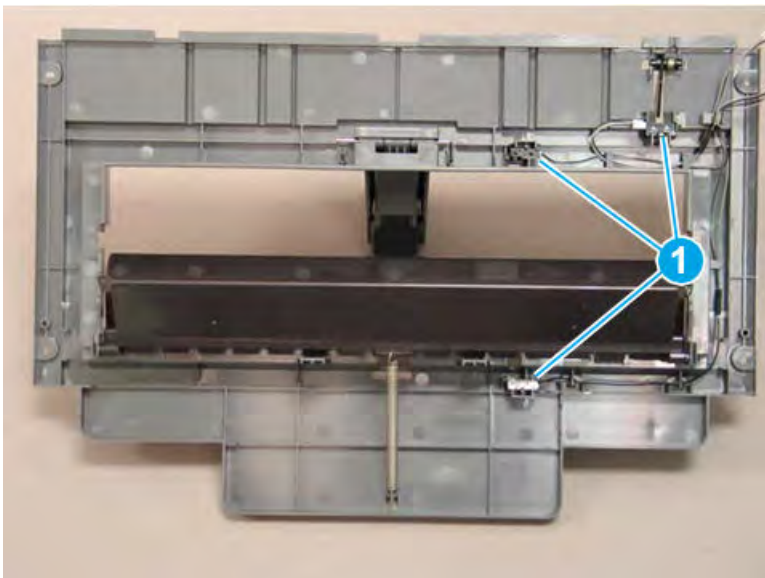

Remove the left upper cover (finisher)

Follow these steps to remove the left upper cover (finisher).

1. Bring the lower output tray down by positioning the shaft of a screwdriver on the clutch (callout 1) and gently pressing to the right to release the clutch. Hold the clutch in the released position and lower the tray (callout 2) to the lowest position.

Figure 5-1330 Lower the output tray

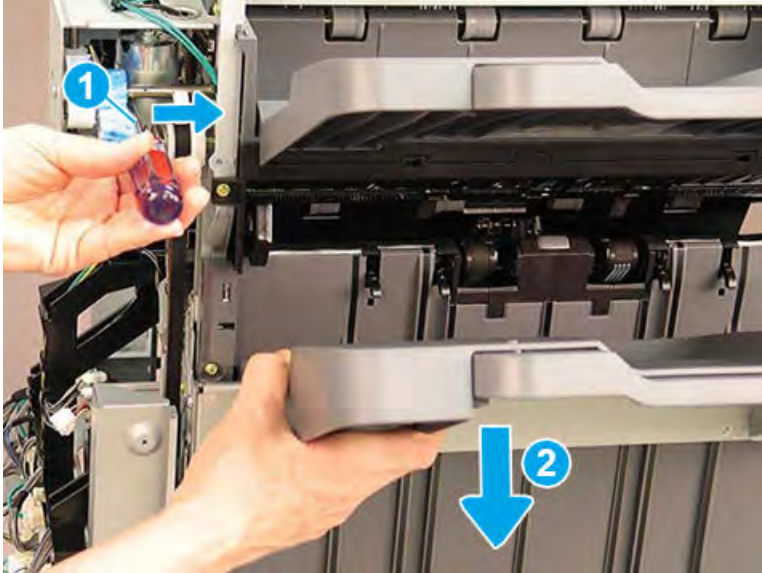

2. Remove six machine screws (callout 1).

Figure 5-1331 Remove six screws

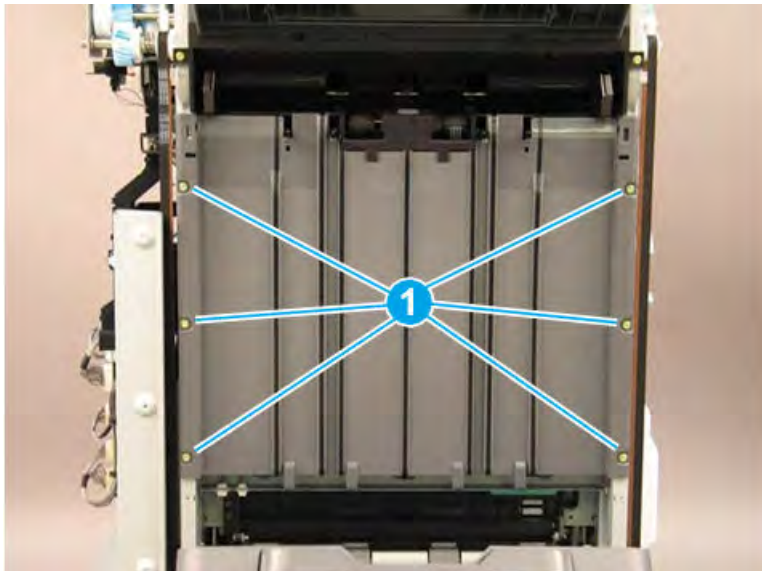

3. Rotate the lower edge of the shield away from the finisher (callout 1), and then slide the shield down (callout 2) to release it from two tabs (callout 3).

CAUTION: The shield is still attached to the finisher. Do not attempt to completely remove the shield.

TIP: Position the shield under the two tabs (callout 3) when reinstalling it.

Figure 5-1332 Release the shield

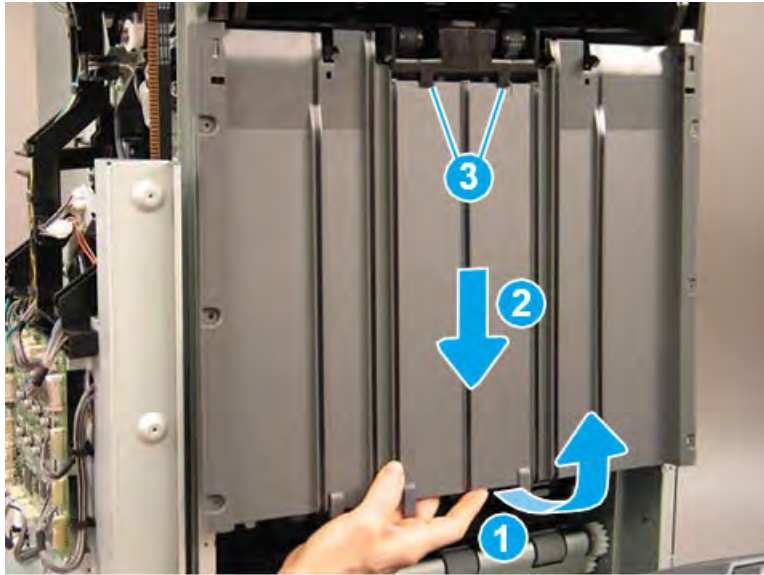

4. Disconnect one connector (callout 1), and then remove the upper shield assembly.

TIP: Reverse the removal steps to install the assembly.

Figure 5-1333 Disconnect one connector

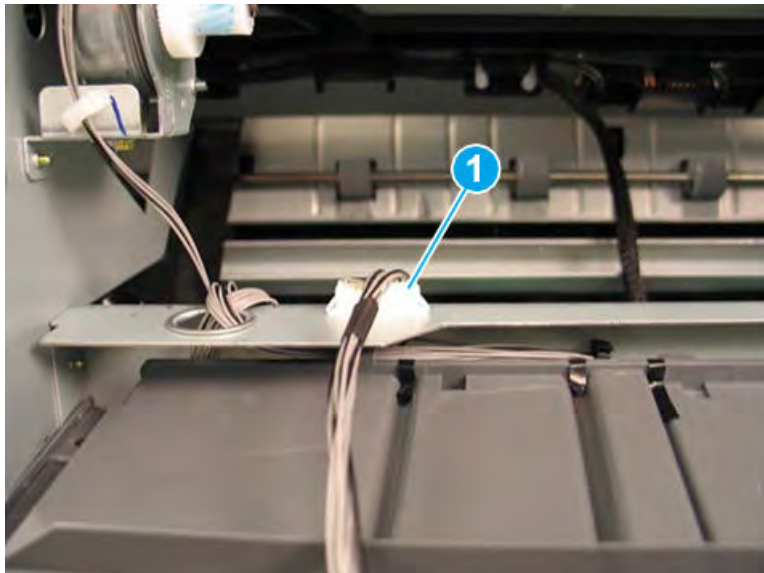

5. If you are replacing the left upper cover, locate three sensors (callout 1) on the back of the left upper cover. Remove these sensors and transfer them to the replacement part.

Figure 5-1334 Remove the left upper cover

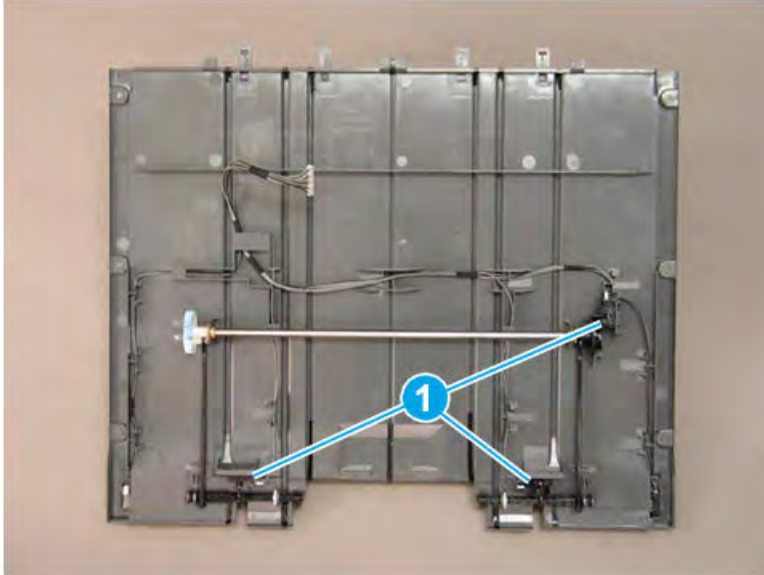

Remove the paper holding home sensor(S22)

Follow these steps to remove the paper holding home sensor(S22).

- ▲ Disconnect the connector(callout 1) and remove the sensor(S22, callout 2) from the upper shield assembly.

Figure 5-1335 Remove the paper holding home sensor

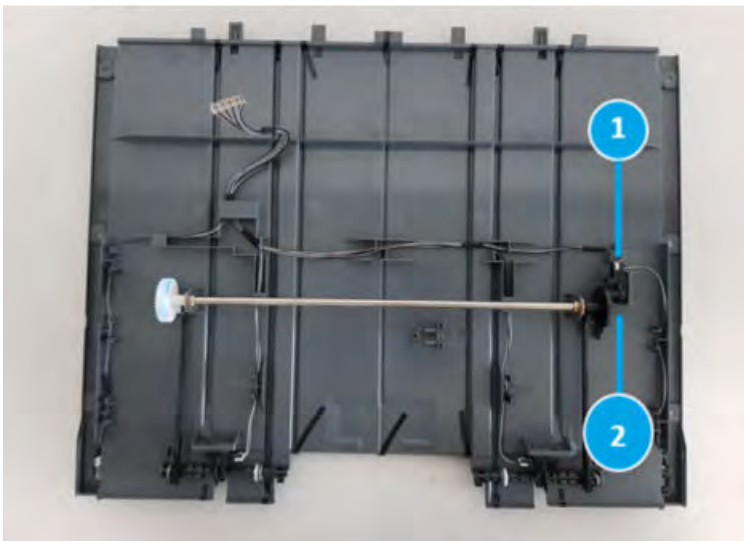

Unpack the replacement assembly

Follow these steps to unpack the replacement assembly.

1. Dispose of the defective part.

 **NOTE:** HP recommends responsible disposal of the defective part.

<http://www8.hp.com/us/en/hp-information/environment/product-recycling.html>

2. Unpack the replacement part from the packaging.



CAUTION:  Some parts are sensitive to electrostatic discharge (ESD). Always perform service work at an ESD-protected workstation or mat. If an ESD workstation or mat is not available, touch the sheet-metal chassis to provide a static ground before touching an ESD-sensitive assembly. Protect the ESD-sensitive assemblies by placing them in ESD pouches when they are out of the printer.

 **IMPORTANT:** Make sure that all of the shipping materials (for example shipping tape) are removed from the replacement part prior to installation.

 **NOTE:** If the replacement part is a roller or pad, avoid touching the spongy part of it. Skin oils on the roller or pad can cause paper pickup and/or print-quality problems. HP recommends using disposable gloves when handling rollers or pads or washing your hands before touching rollers or pads.

3. To install an assembly, reverse the removal steps.

 **NOTE:** When applicable, special installation instructions are provided for an assembly at the end of the removal procedure. Always completely read the removal instructions and follow all special installation instructions.

Removal and replacement: Paper holding front sensor (S17)

Learn how to remove and replace the front paper holding sensor.

Introduction

This document provides the procedures to remove and replace the front paper holding sensor on the finisher.



IMPORTANT: When applicable, special installation instructions are provided for an assembly at the end of the removal procedure. Always completely read the removal instructions and follow all special installation instructions.

Before performing service

- Turn the printer power off. A shutting-down message appears on the control-panel display.
- ⚠ **WARNING!** To avoid damage to the printer, turn the power off and wait until the printer shuts down before removing the power cable.
- Disconnect the printer power cable after the printer has completely shut down (the control-panel display is blank).
- Release the finisher from the printer by pulling out on the release latch inside the finisher door.
- Disconnect the cable from the bridge unit to the finisher.
- Disconnect the cable from the finisher to the printer.

Use the table below to identify the correct part number for your printer. To order the part, go to <https://parts.hp.com>.

Table 5-138 Part information

Part number	Part description
0604-001393	Front paper holding sensor

Required tools

- #2 JIS screwdriver with a magnetic tip

After performing service

- Connect the cable from the finisher to the printer.
- Connect the cable from the bridge unit to the finisher.
- Attach the finisher to the printer, and then push in on the release latch inside the finisher door.
- Connect the printer power cable.
- Turn the printer power on.

Post service test

Process a job through the finisher and verify that the finisher works correctly.

Remove the right upper cover (finisher)

Follow these steps to remove the right upper cover (finisher).

- ▲ Remove one screw cap and three machine screws on the upper edge of the cover (callout 1). Remove three sheet metal screws (callout 2) on the lower portion of the cover. Rotate the right edge of the cover away from the finisher, and then slide the cover right to release three tabs (callout 3).

💡 **TIP:** The lower screws are shorter in length than the upper screws.

TIP: Reverse the removal steps to install the assembly.

Figure 5-1336 Remove the right upper cover

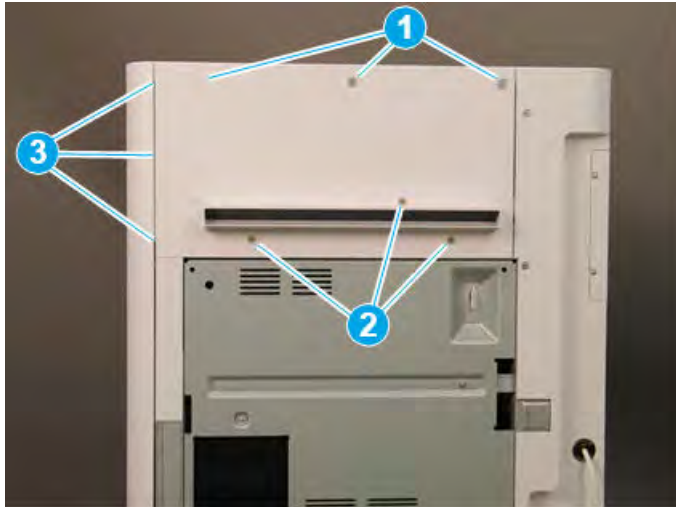

Remove the top cover (finisher)

Follow these steps to remove the top cover (finisher).

1. Remove three screw caps and three self-tapping screws at the top of the rear cover (callout 1), and then remove three machine screws (callout 2) on top of the cover.

Figure 5-1337 Remove six screws

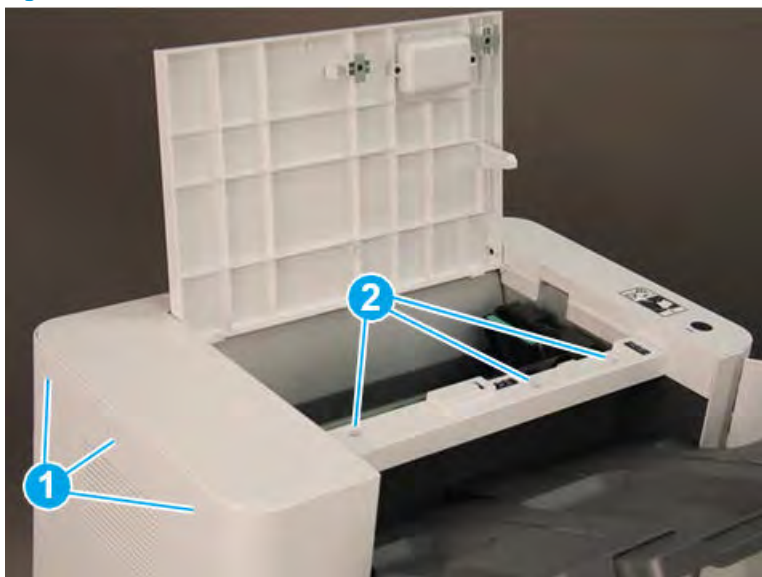

2. Remove three self-tapping screws at the top of the front cover (callout 1), and then remove two machine screws (callout 2) at the top of the right side.

Figure 5-1338 Remove five screws

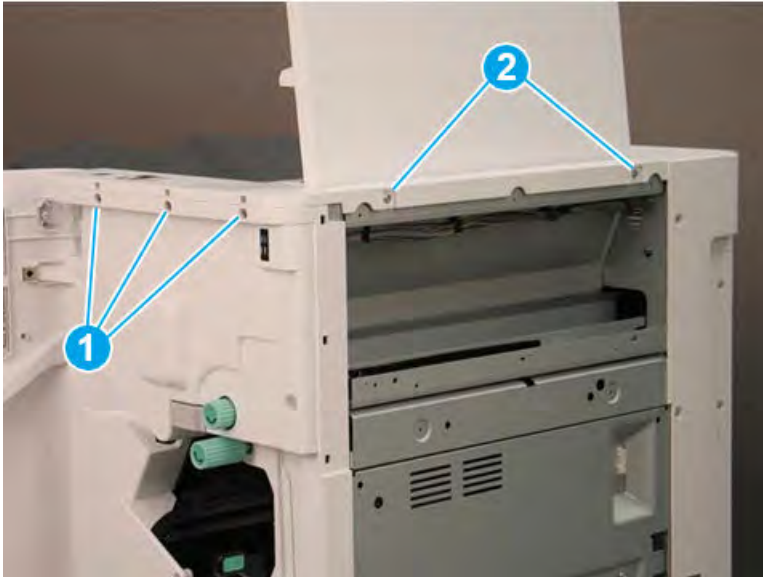

3. Lift the cover up slightly. Disconnect one in-line connector (callout 1), and then release one retainer (callout 2).

 **TIP:** Reverse the removal steps to install the assembly.

Figure 5-1339 Disconnect one connector and release retainer



Remove the front door (finisher)

Follow these steps to remove the front door (finisher).

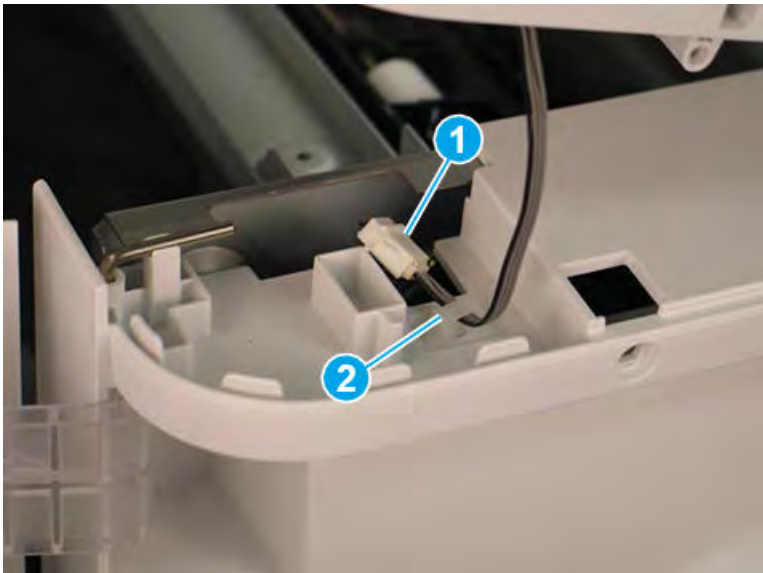
1. Lift the top hinge pin up to release it from the retainer.

Figure 5-1340 Lift the top hinge pin

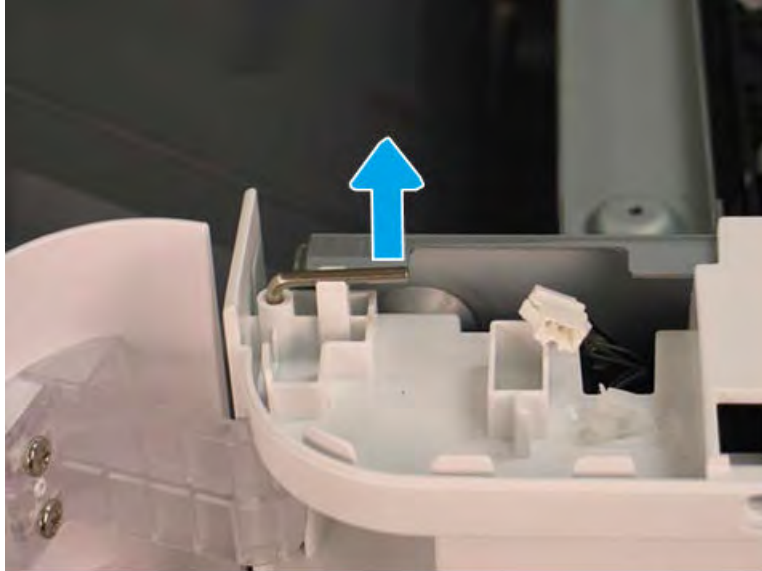

2. Pull the top hinge pin up to remove it.

Figure 5-1341 Remove the top hinge pin

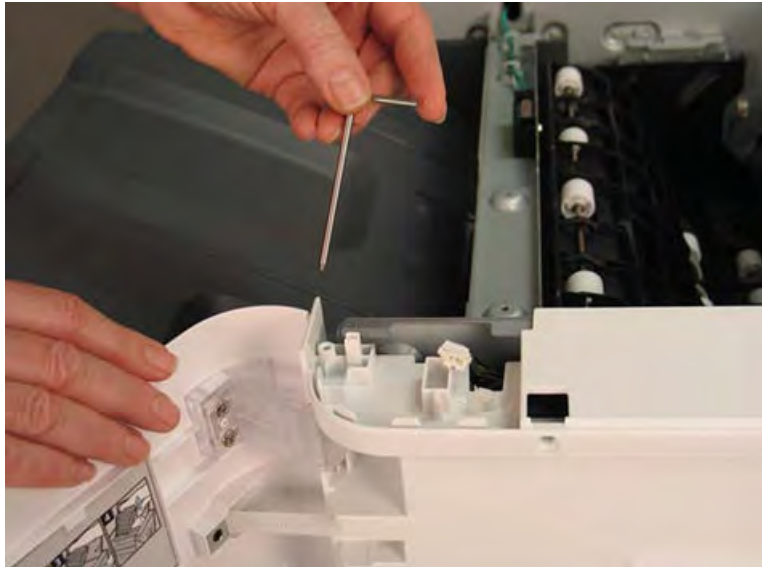

3. Use a small, flat-blade screwdriver to release the lower hinge pin from the retainer, and then rotate it away from the finisher.

Figure 5-1342 Release the lower hinge pin



4. Support the door with one hand, and then pull the lower hinge pin straight up to remove it.

Figure 5-1343 Remove the lower hinge pin



5. Support the door with one hand, and then remove one screw (callout 1) to release the strap. Remove the front door.

 **TIP:** Reverse the removal steps to install the assembly.

Figure 5-1344 Remove the front door



Remove the front cover (finisher)

Follow these steps to remove the front cover (finisher).

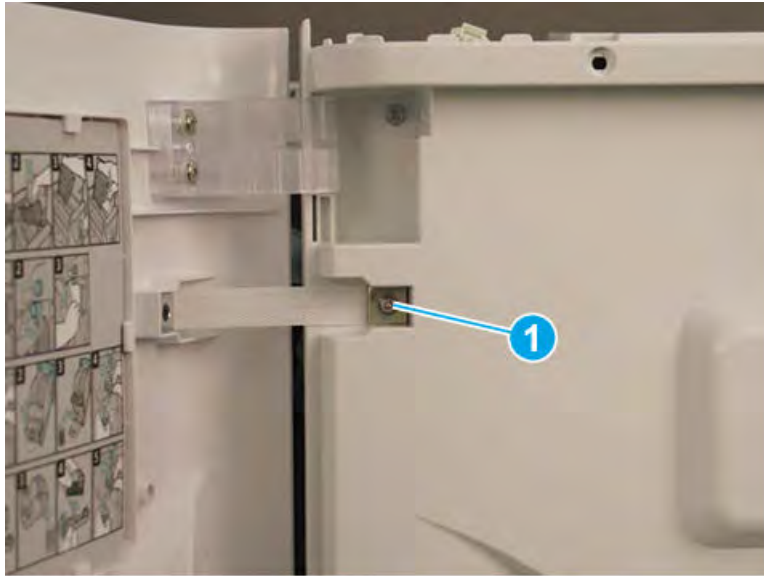
1. Release one tab (callout 1), and then pull the jam-access knob away from the finisher to remove it.

Figure 5-1345 Remove the jam-access knob

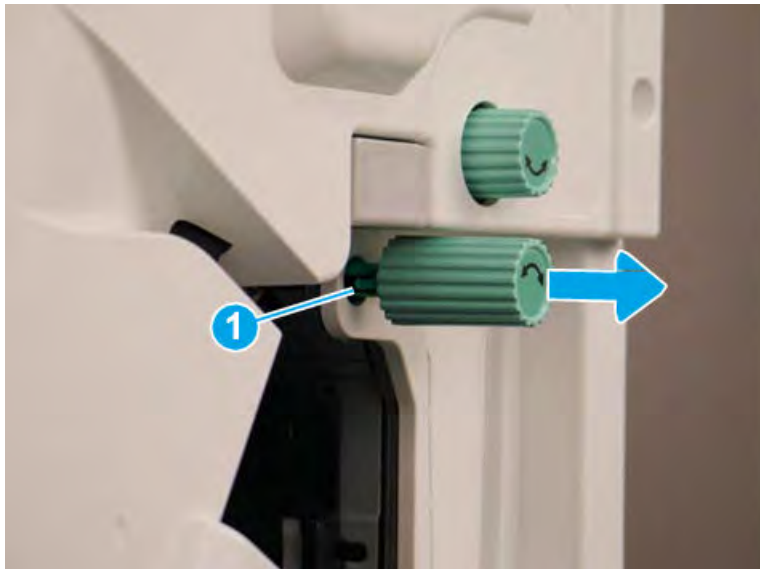

2. If the punch unit is installed, remove the punch waste bin (callout 1).

3. Remove one screw (callout 1) on top of the front cover.

Figure 5-1346 Remove one screw



4. Remove five machine screws (callout 1), and then remove the front cover.

 **TIP:** Reverse the removal steps to install the assembly.

Figure 5-1347 Remove the front cover



Remove the rear cover (finisher)

Follow these steps to remove the rear cover (finisher).

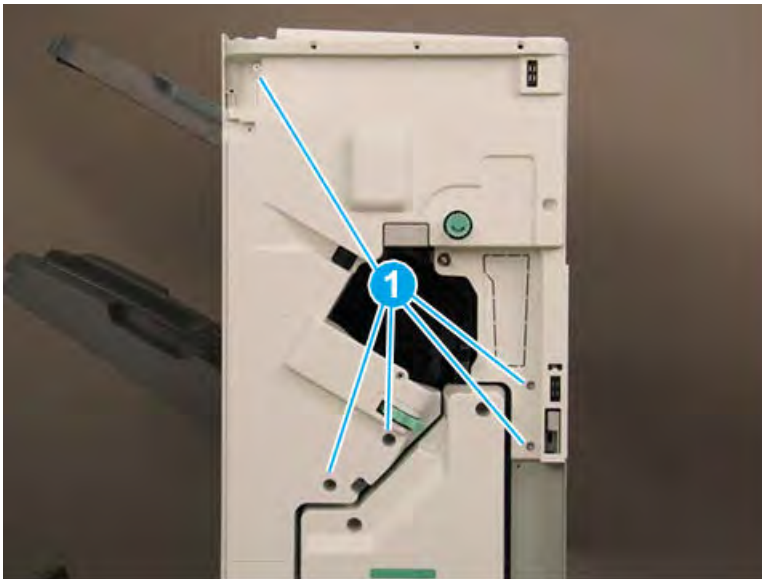
1. Remove two self-tapping screws (callout 1) on the top of the rear cover, and then remove five screw caps and five machine screws (callout 2) on the left side of the cover.

Figure 5-1348 Remove seven screws

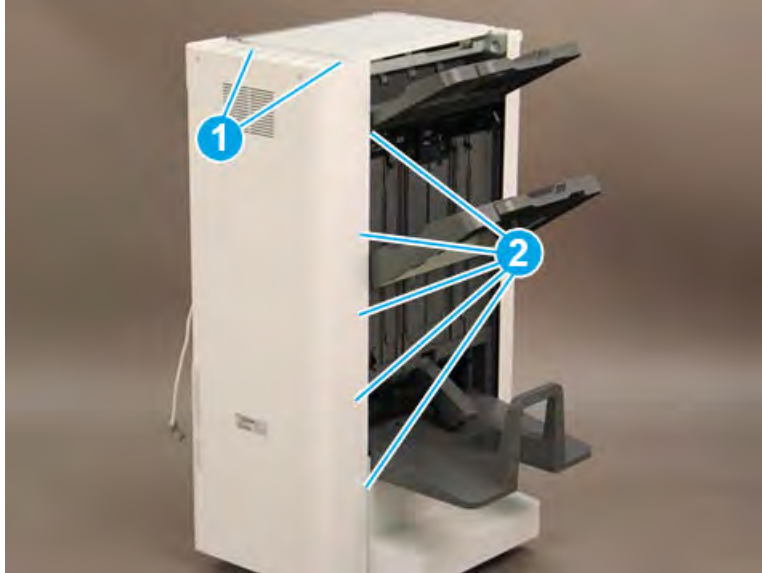

2. Remove one screw cap and four machine screws (callout 1) Remove the rear cover.

 **NOTE:** Make sure to thread the power cable (callout 2) through the opening in the cover.

 **TIP:** Reverse the removal steps to install the assembly

Figure 5-1349 Remove the rear cover



Remove the booklet output tray

Follow these steps to remove the booklet output tray.

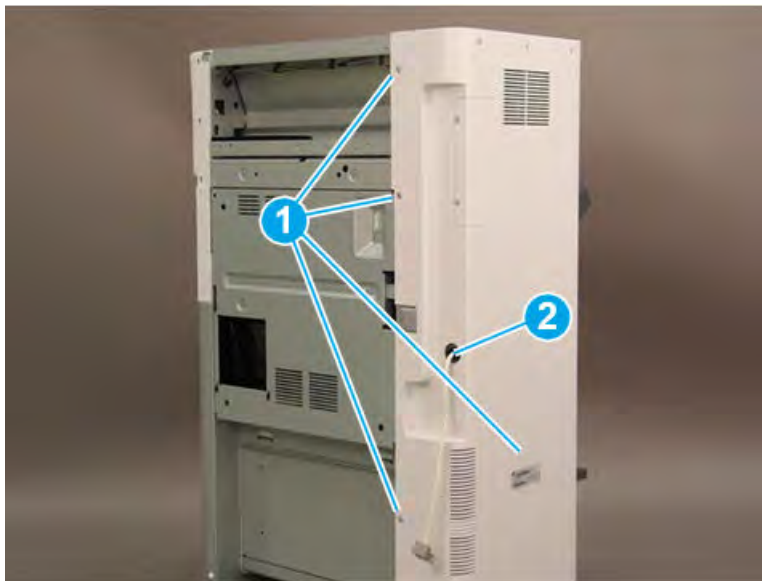
1. Raise the booklet output tray up (callout 1), and then pull it away from the finisher (callout 2) to remove it.

Figure 5-1350 Remove the booklet output tray



2. Reverse the removal steps to install the assembly. Also use the following special installation instructions.

 **NOTE:** Continue to reverse the removal steps to finish installing the assembly

Special installation instructions: booklet output tray

Position the tabs (callout 1) on the tray into the slots (callout 2) on the finisher.

Figure 5-1351 Install the booklet output tray

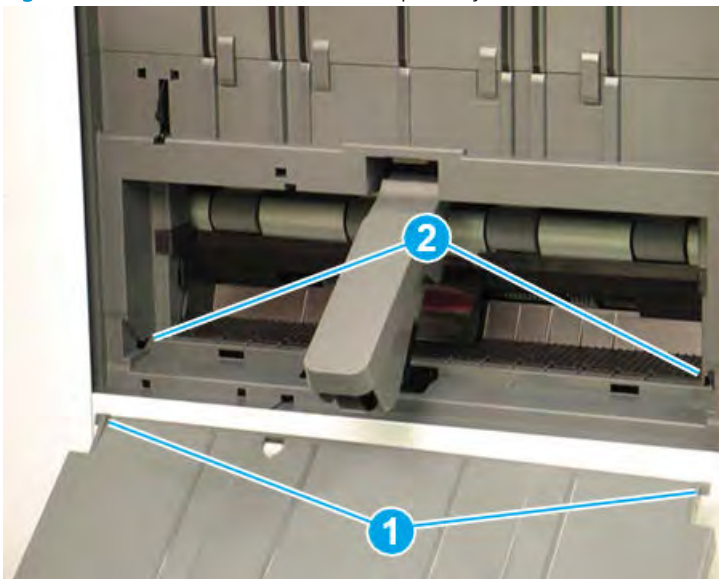

Remove the caster cover

Follow these steps to remove the caster cover.

1. Remove two screw caps and two self-tapping screws (callout 1). Remove two screw caps and two machine screws (callout 2).

Figure 5-1352 Remove four screws

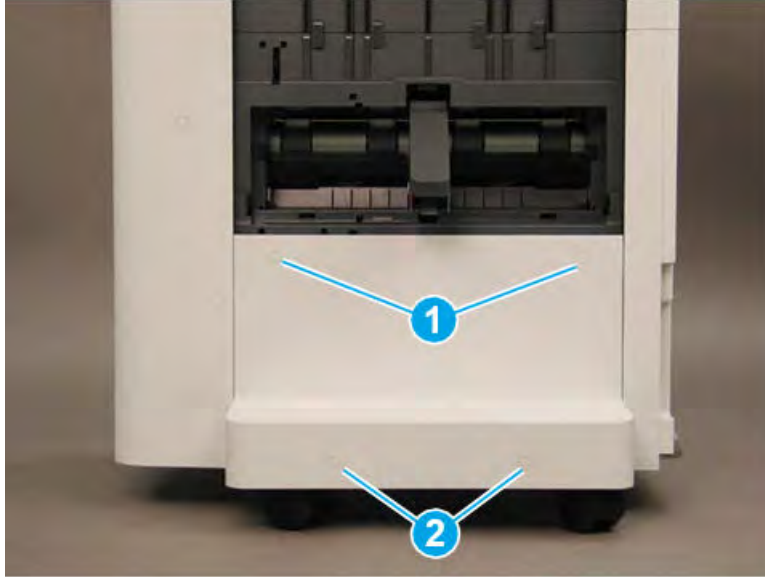

2. Rotate the left edge of the cover away from the finisher (callout 1), and then slide the cover to the left (callout 2) to remove it.

 **TIP:** Make sure that two tabs (callout 3) are positioned under the front lower cover when reinstalling the caster cover.

TIP: Reverse the removal steps to install the assembly

Figure 5-1353 Remove the caster cover

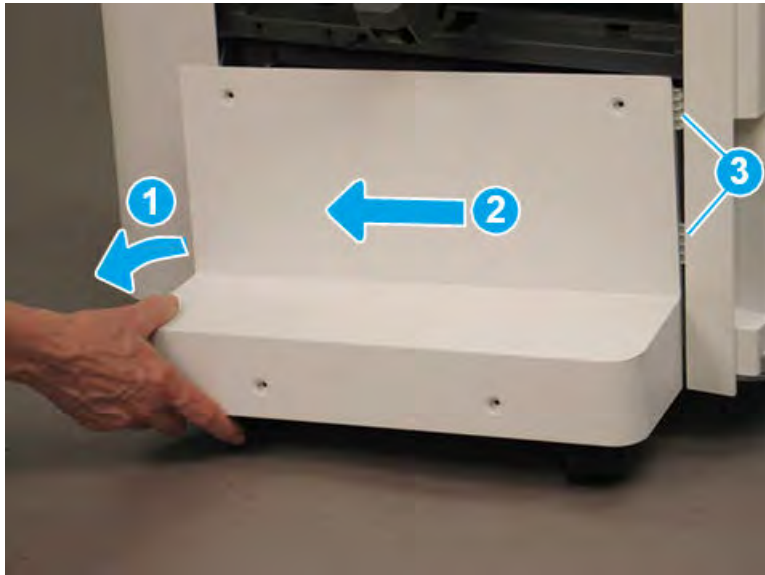

Remove the left lower cover (finisher)

Follow these steps to remove the left lower cover (finisher).

1. Remove four screws (callout 1).

 **NOTE:** Raise the lower output tray as needed to access the screws.

Figure 5-1354 Remove four screws



2. Slide the shield down (callout 1) to release it from four tabs (callout 2), and then rotate it away from the finisher (callout 3).

⚠ CAUTION: The shield is still attached to the finisher. Do not attempt to completely remove the shield.

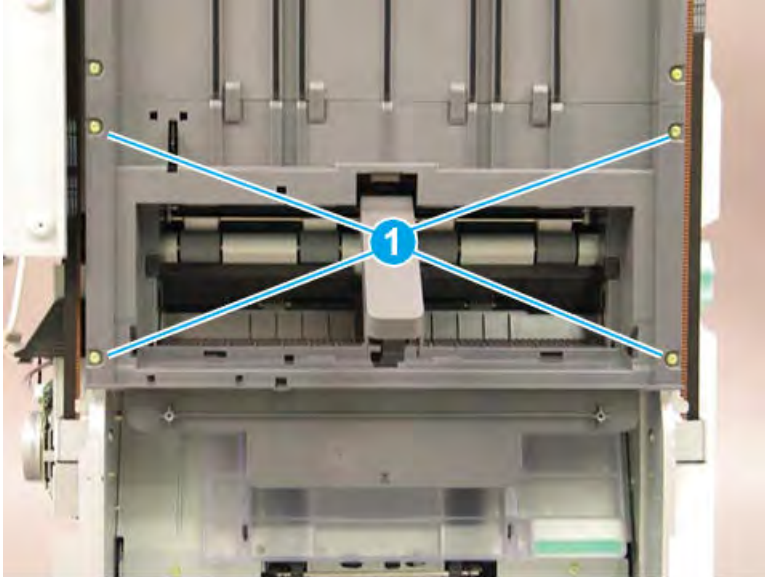
💡 TIP: Position the shield under the four tabs (callout 2) when reinstalling it.

Figure 5-1355 Release the lower shield

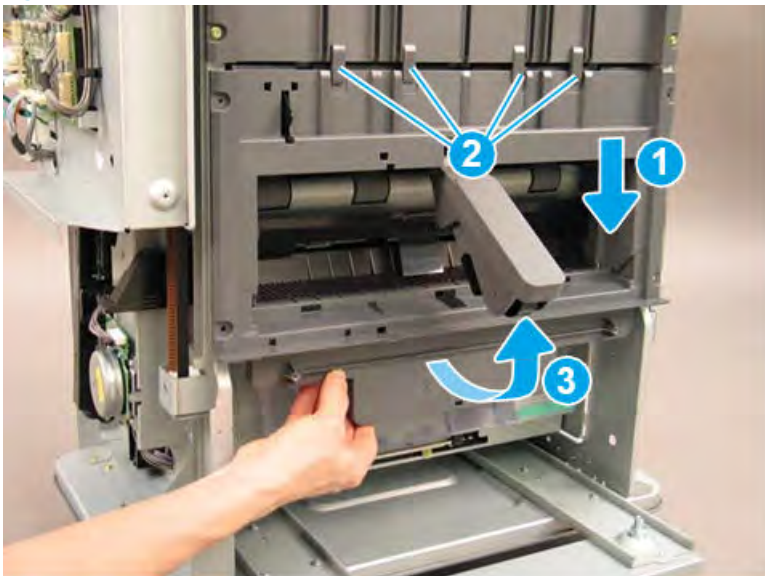

3. Disconnect two connectors (callout 1), and then remove the shield.

 **TIP:** Reverse the removal steps to install the assembly.

Figure 5-1356 Disconnect two connectors

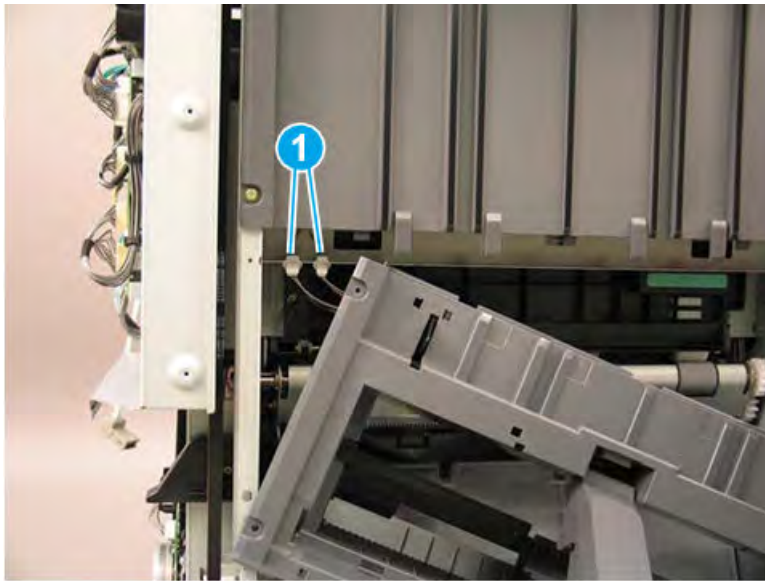

4. If you are replacing the left lower cover, locate three sensors (callout 1) on the back of the left lower cover. Remove these sensors and transfer them to the replacement part.

Figure 5-1357 Remove the left lower cover

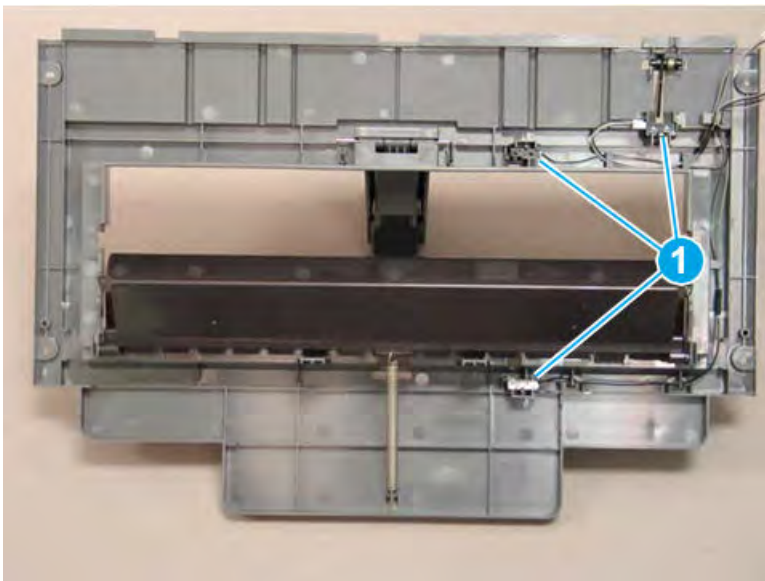

Remove the paper holding sensor (S17)

Follow these steps to remove the paper holding sensor (S17).

- ▲ Remove the sensor (callout 1, S17) from the upper shield assembly.

Figure 5-1358 Remove the paper holding sensor

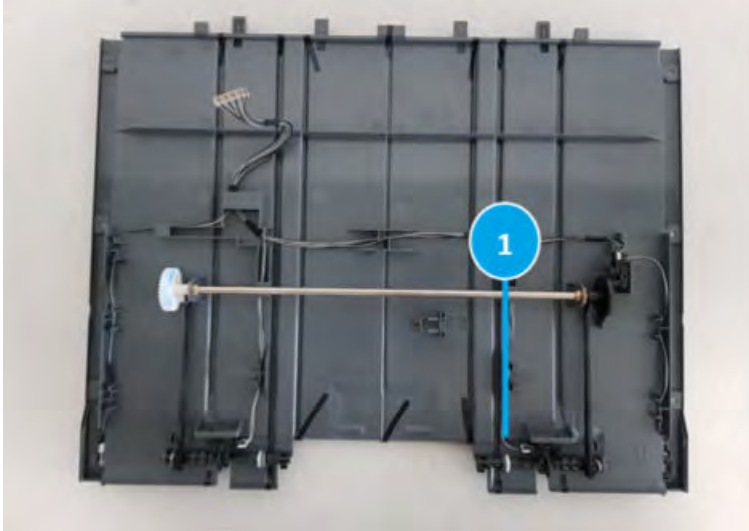

Unpack the replacement assembly

Follow these steps to unpack the replacement assembly.

1. Dispose of the defective part.



NOTE: HP recommends responsible disposal of the defective part.

<http://www8.hp.com/us/en/hp-information/environment/product-recycling.html>

2. Unpack the replacement part from the packaging.



CAUTION:  Some parts are sensitive to electrostatic discharge (ESD). Always perform service work at an ESD-protected workstation or mat. If an ESD workstation or mat is not available, touch the sheet-metal chassis to provide a static ground before touching an ESD-sensitive assembly. Protect the ESD-sensitive assemblies by placing them in ESD pouches when they are out of the printer.



IMPORTANT: Make sure that all of the shipping materials (for example shipping tape) are removed from the replacement part prior to installation.



NOTE: If the replacement part is a roller or pad, avoid touching the spongy part of it. Skin oils on the roller or pad can cause paper pickup and/or print-quality problems. HP recommends using disposable gloves when handling rollers or pads or washing your hands before touching rollers or pads.

3. To install an assembly, reverse the removal steps.



NOTE: When applicable, special installation instructions are provided for an assembly at the end of the removal procedure. Always completely read the removal instructions and follow all special installation instructions.

Removal and replacement: Paper holding rear sensor (S31)

Learn how to remove and replace the rear paper holding sensor.

Introduction

This document provides the procedures to remove and replace the rear paper holding sensor on the finisher.



IMPORTANT: When applicable, special installation instructions are provided for an assembly at the end of the removal procedure. Always completely read the removal instructions and follow all special installation instructions.

Before performing service

- Turn the printer power off. A shutting-down message appears on the control-panel display.
- ⚠ **WARNING!** To avoid damage to the printer, turn the power off and wait until the printer shuts down before removing the power cable.
- Disconnect the printer power cable after the printer has completely shut down (the control-panel display is blank).
- Release the finisher from the printer by pulling out on the release latch inside the finisher door.
- Disconnect the cable from the bridge unit to the finisher.
- Disconnect the cable from the finisher to the printer.

Use the table below to identify the correct part number for your printer. To order the part, go to <https://parts.hp.com>.

Table 5-139 Part information

Part number	Part description
0604-001393	Rear paper holding sensor

Required tools

- #2 JIS screwdriver with a magnetic tip

After performing service

- Connect the cable from the finisher to the printer.
- Connect the cable from the bridge unit to the finisher.
- Attach the finisher to the printer, and then push in on the release latch inside the finisher door.
- Connect the printer power cable.
- Turn the printer power on.

Post service test

Process a job through the finisher and verify that the finisher works correctly.

Remove the right upper cover (finisher)

Follow these steps to remove the right upper cover (finisher).

- ▲ Remove one screw cap and three machine screws on the upper edge of the cover (callout 1). Remove three sheet metal screws (callout 2) on the lower portion of the cover. Rotate the right edge of the cover away from the finisher, and then slide the cover right to release three tabs (callout 3).

💡 **TIP:** The lower screws are shorter in length than the upper screws.

TIP: Reverse the removal steps to install the assembly.

Figure 5-1359 Remove the right upper cover

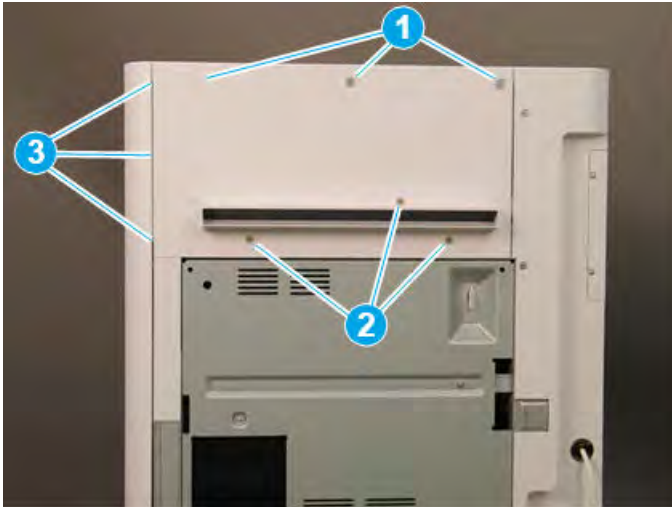

Remove the top cover (finisher)

Follow these steps to remove the top cover (finisher).

1. Remove three screw caps and three self-tapping screws at the top of the rear cover (callout 1), and then remove three machine screws (callout 2) on top of the cover.

Figure 5-1360 Remove six screws

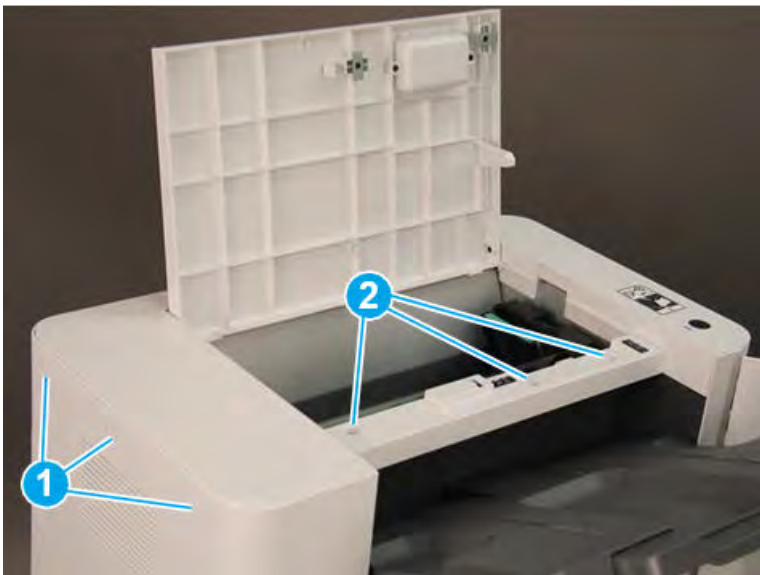

2. Remove three self-tapping screws at the top of the front cover (callout 1), and then remove two machine screws (callout 2) at the top of the right side.

Figure 5-1361 Remove five screws

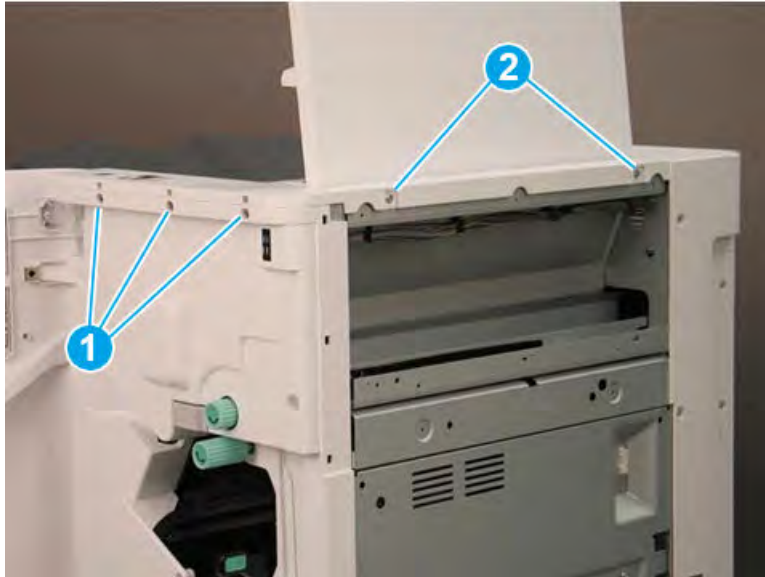

3. Lift the cover up slightly. Disconnect one in-line connector (callout 1), and then release one retainer (callout 2).

 **TIP:** Reverse the removal steps to install the assembly.

Figure 5-1362 Disconnect one connector and release retainer



Remove the front door (finisher)

Follow these steps to remove the front door (finisher).

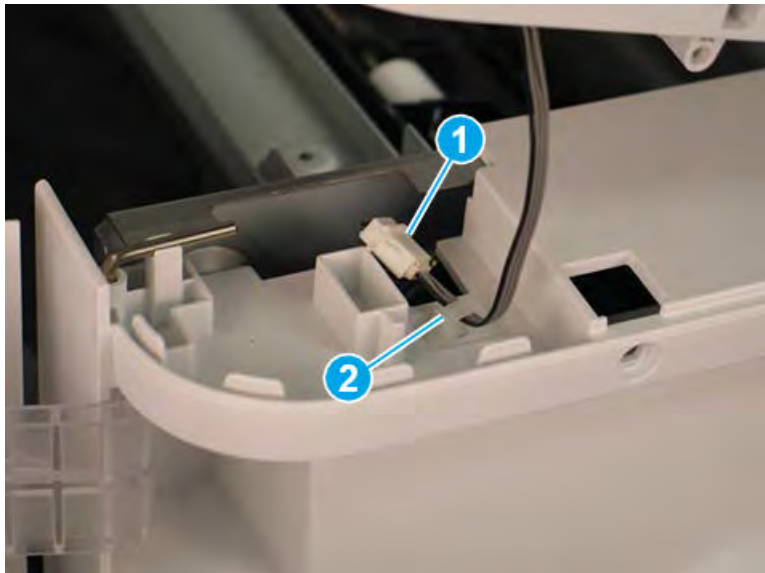
1. Lift the top hinge pin up to release it from the retainer.

Figure 5-1363 Lift the top hinge pin

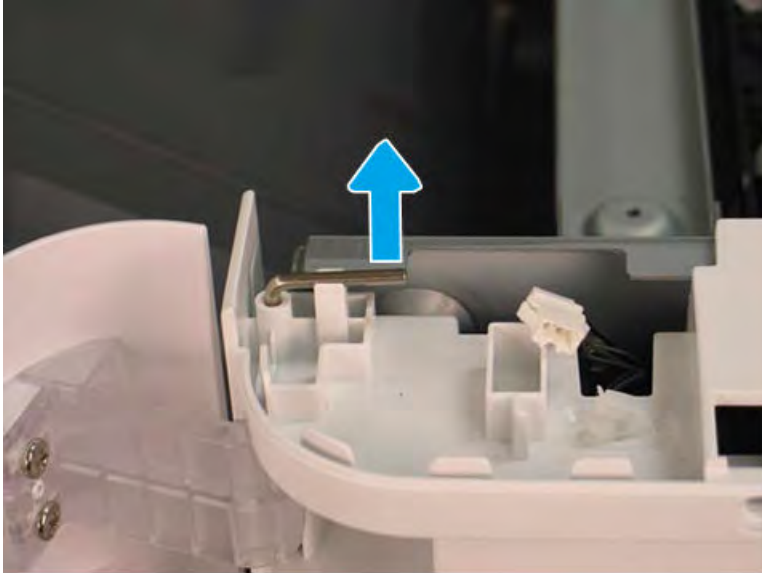

2. Pull the top hinge pin up to remove it.

Figure 5-1364 Remove the top hinge pin



3. Use a small, flat-blade screwdriver to release the lower hinge pin from the retainer, and then rotate it away from the finisher.

Figure 5-1365 Release the lower hinge pin

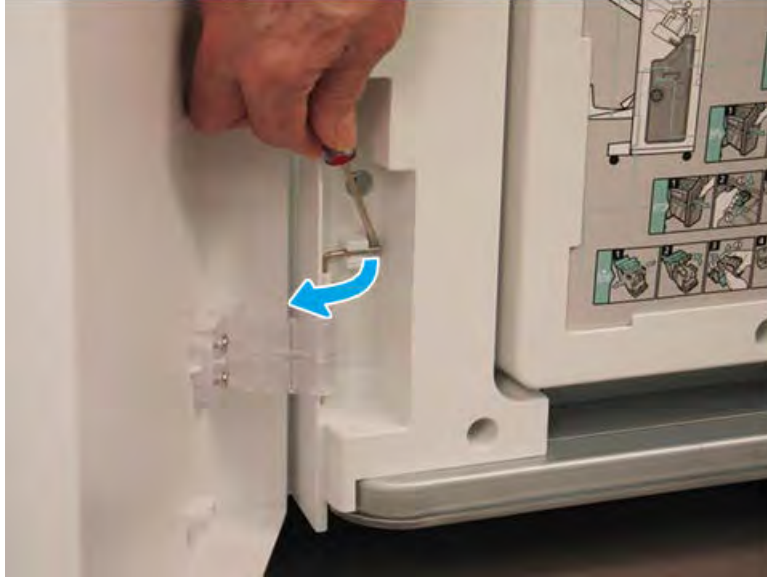

4. Support the door with one hand, and then pull the lower hinge pin straight up to remove it.

Figure 5-1366 Remove the lower hinge pin



5. Support the door with one hand, and then remove one screw (callout 1) to release the strap. Remove the front door.

 **TIP:** Reverse the removal steps to install the assembly.

Figure 5-1367 Remove the front door



Remove the front cover (finisher)

Follow these steps to remove the front cover (finisher).

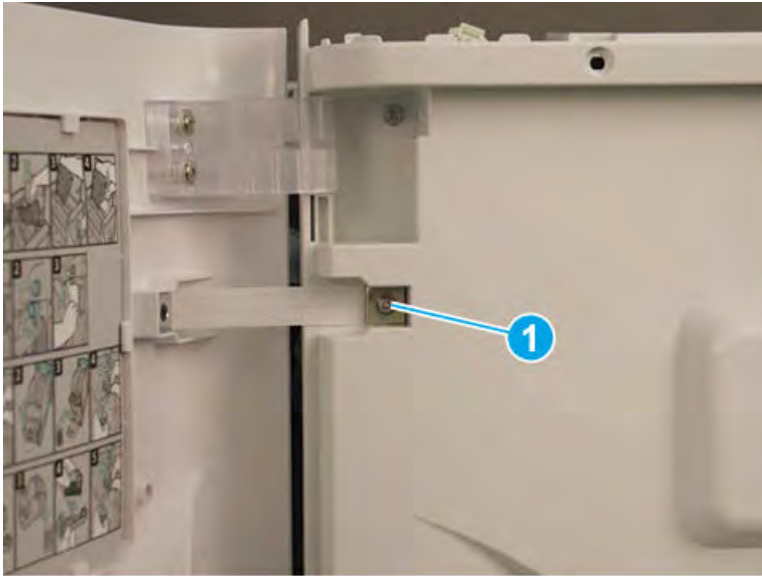
1. Release one tab (callout 1), and then pull the jam-access knob away from the finisher to remove it.

Figure 5-1368 Remove the jam-access knob

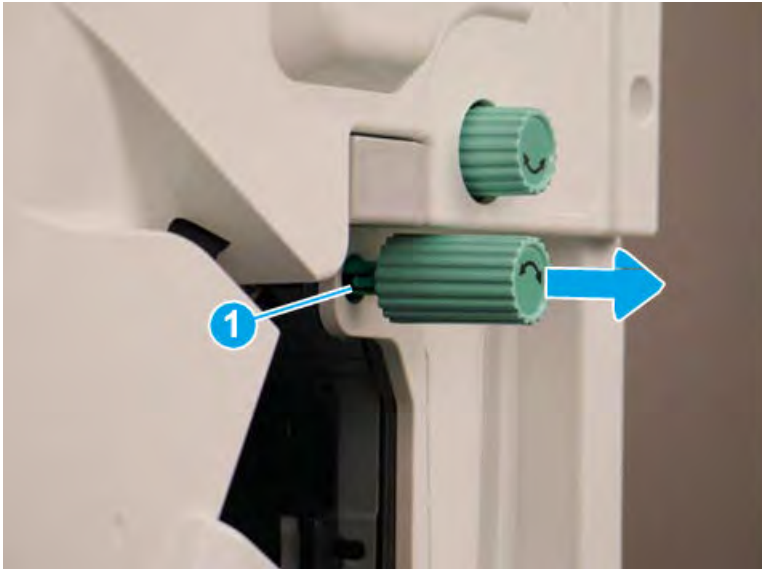

2. If the punch unit is installed, remove the punch waste bin (callout 1).

3. Remove one screw (callout 1) on top of the front cover.

Figure 5-1369 Remove one screw



4. Remove five machine screws (callout 1), and then remove the front cover.

 **TIP:** Reverse the removal steps to install the assembly.

Figure 5-1370 Remove the front cover



Remove the rear cover (finisher)

Follow these steps to remove the rear cover (finisher).

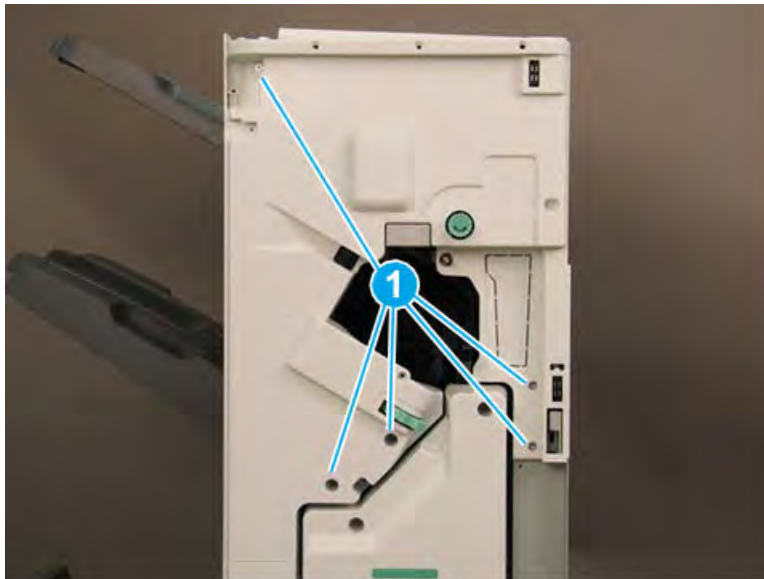
1. Remove two self-tapping screws (callout 1) on the top of the rear cover, and then remove five screw caps and five machine screws (callout 2) on the left side of the cover.

Figure 5-1371 Remove seven screws



2. Remove one screw cap and four machine screws (callout 1) Remove the rear cover.

 **NOTE:** Make sure to thread the power cable (callout 2) through the opening in the cover.

 **TIP:** Reverse the removal steps to install the assembly

Figure 5-1372 Remove the rear cover



Remove the booklet output tray

Follow these steps to remove the booklet output tray.

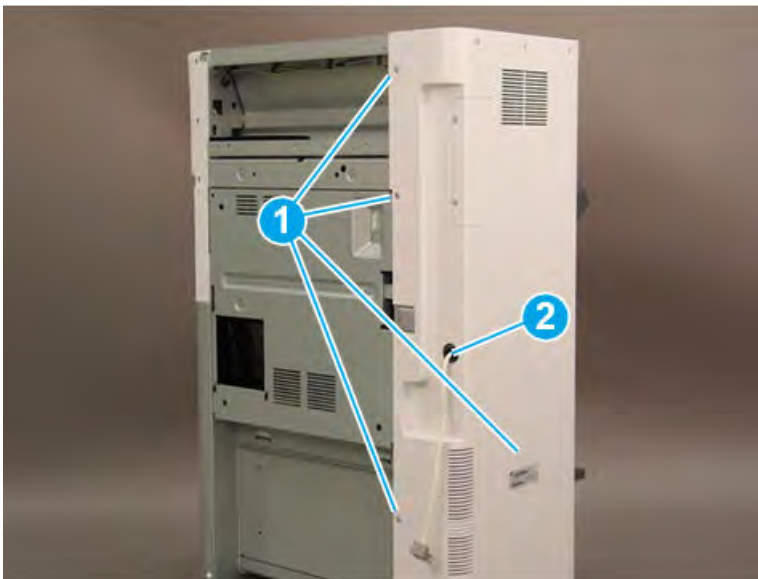
1. Raise the booklet output tray up (callout 1), and then pull it away from the finisher (callout 2) to remove it.

Figure 5-1373 Remove the booklet output tray



2. Reverse the removal steps to install the assembly. Also use the following special installation instructions.

 **NOTE:** Continue to reverse the removal steps to finish installing the assembly

Special installation instructions: booklet output tray

Position the tabs (callout 1) on the tray into the slots (callout 2) on the finisher.

Figure 5-1374 Install the booklet output tray

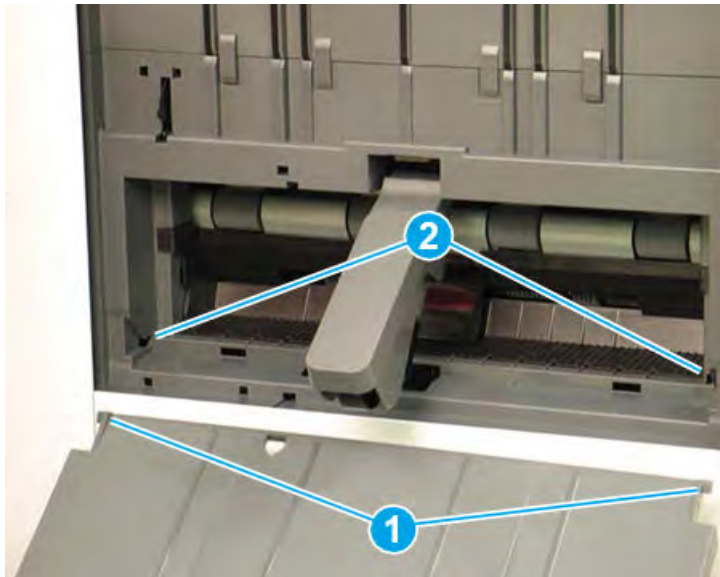

Remove the caster cover

Follow these steps to remove the caster cover.

1. Remove two screw caps and two self-tapping screws (callout 1). Remove two screw caps and two machine screws (callout 2).

Figure 5-1375 Remove four screws

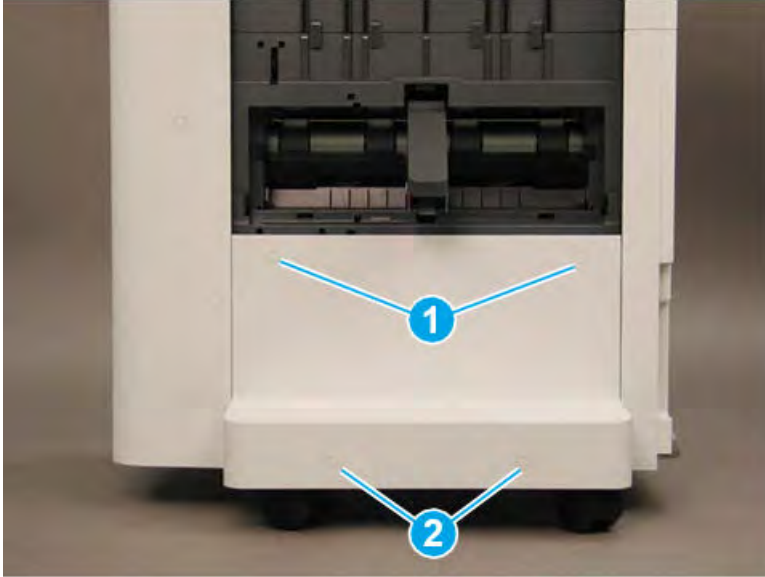

2. Rotate the left edge of the cover away from the finisher (callout 1), and then slide the cover to the left (callout 2) to remove it.

 **TIP:** Make sure that two tabs (callout 3) are positioned under the front lower cover when reinstalling the caster cover.

TIP: Reverse the removal steps to install the assembly

Figure 5-1376 Remove the caster cover

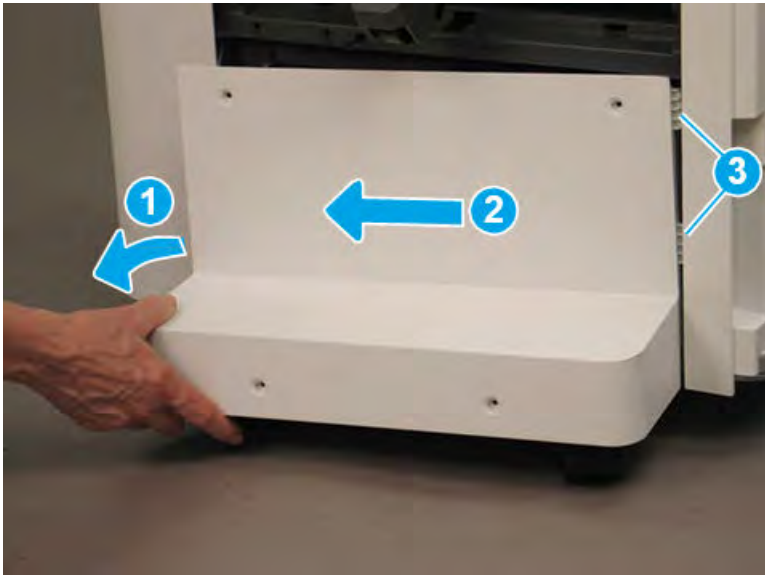

Remove the left lower cover (finisher)

Follow these steps to remove the left lower cover (finisher).

1. Remove four screws (callout 1).

 **NOTE:** Raise the lower output tray as needed to access the screws.

Figure 5-1377 Remove four screws



2. Slide the shield down (callout 1) to release it from four tabs (callout 2), and then rotate it away from the finisher (callout 3).

⚠ CAUTION: The shield is still attached to the finisher. Do not attempt to completely remove the shield.

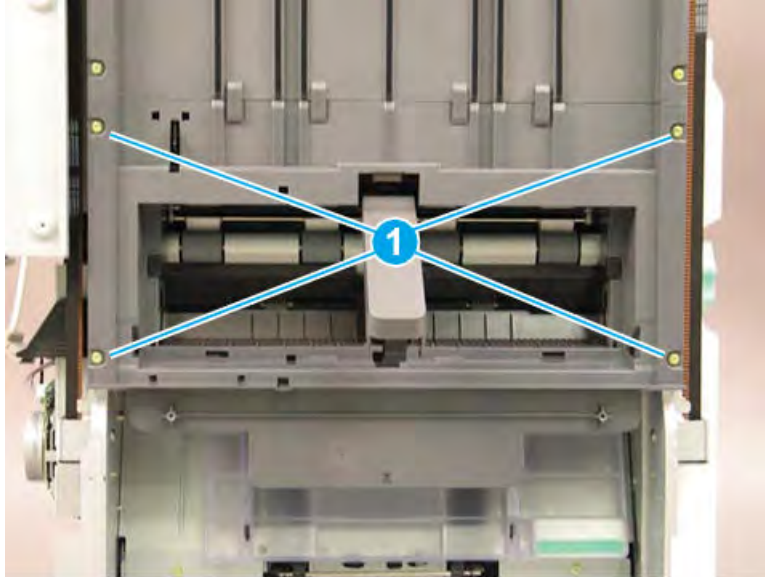
💡 TIP: Position the shield under the four tabs (callout 2) when reinstalling it.

Figure 5-1378 Release the lower shield

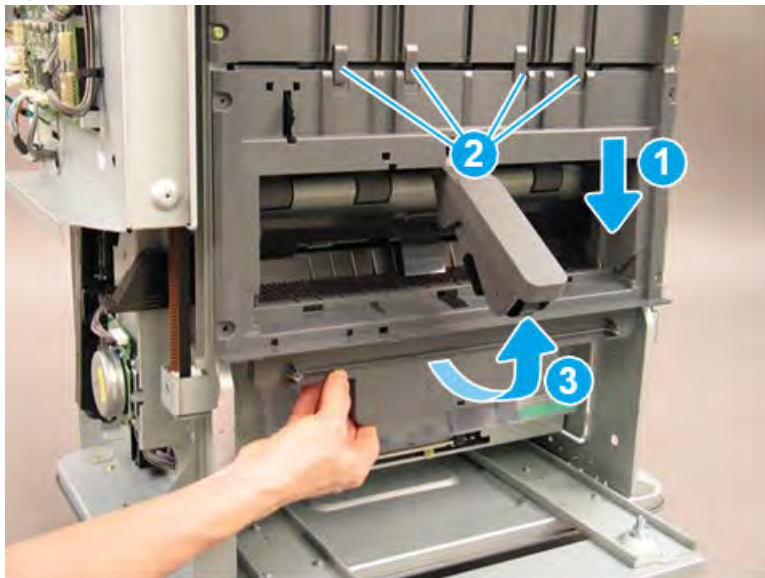

3. Disconnect two connectors (callout 1), and then remove the shield.

 **TIP:** Reverse the removal steps to install the assembly.

Figure 5-1379 Disconnect two connectors



4. If you are replacing the left lower cover, locate three sensors (callout 1) on the back of the left lower cover. Remove these sensors and transfer them to the replacement part.

Figure 5-1380 Remove the left lower cover

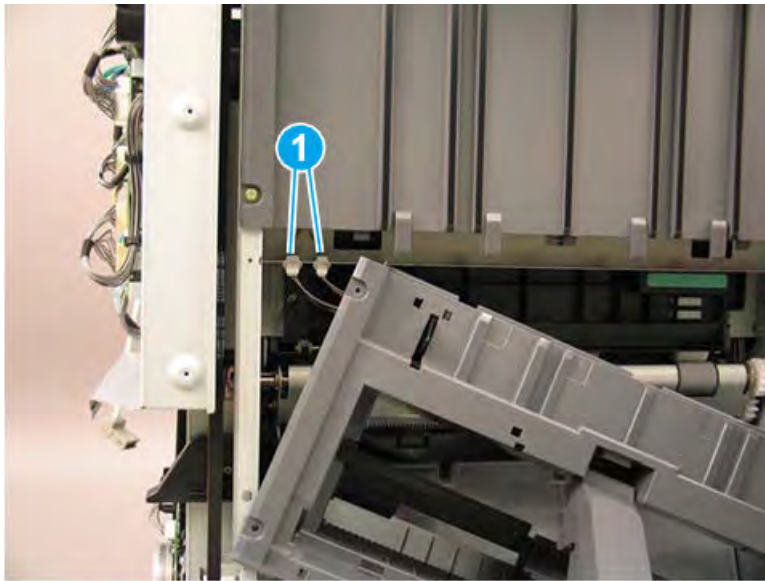
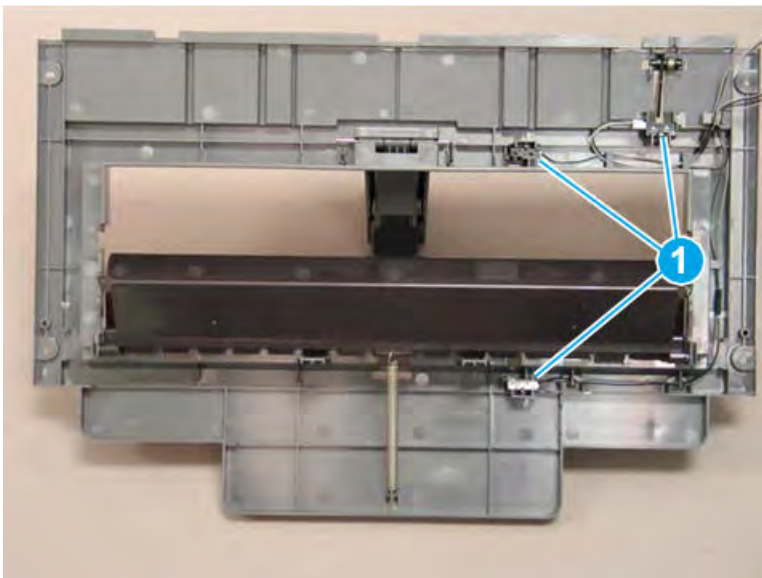

Remove the rear paper holding sensor(S31)

Follow these steps to remove the rear paper holding sensor(S31).

- ▲ Remove the sensor(S31, callout 1) from the upper shield assembly.

Figure 5-1381 Remove the rear paper holding sensor

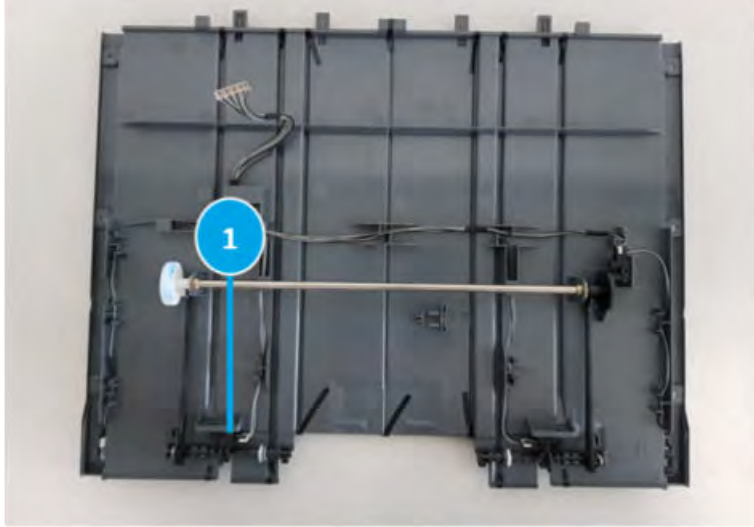

Unpack the replacement assembly

Follow these steps to unpack the replacement assembly.

1. Dispose of the defective part.



NOTE: HP recommends responsible disposal of the defective part.

<http://www8.hp.com/us/en/hp-information/environment/product-recycling.html>

2. Unpack the replacement part from the packaging.



CAUTION:  Some parts are sensitive to electrostatic discharge (ESD). Always perform service work at an ESD-protected workstation or mat. If an ESD workstation or mat is not available, touch the sheet-metal chassis to provide a static ground before touching an ESD-sensitive assembly. Protect the ESD-sensitive assemblies by placing them in ESD pouches when they are out of the printer.



IMPORTANT: Make sure that all of the shipping materials (for example shipping tape) are removed from the replacement part prior to installation.



NOTE: If the replacement part is a roller or pad, avoid touching the spongy part of it. Skin oils on the roller or pad can cause paper pickup and/or print-quality problems. HP recommends using disposable gloves when handling rollers or pads or washing your hands before touching rollers or pads.

3. To install an assembly, reverse the removal steps.



NOTE: When applicable, special installation instructions are provided for an assembly at the end of the removal procedure. Always completely read the removal instructions and follow all special installation instructions.

Removal and replacement: Paper holding Motor (M7)

Learn how to remove and replace the paper holding Motor.

Introduction

This document provides the procedures to remove and replace the paper holding Motor on the finisher.



IMPORTANT: When applicable, special installation instructions are provided for an assembly at the end of the removal procedure. Always completely read the removal instructions and follow all special installation instructions.

Before performing service

- Turn the printer power off. A shutting-down message appears on the control-panel display.
- ⚠ **WARNING!** To avoid damage to the printer, turn the power off and wait until the printer shuts down before removing the power cable.
- Disconnect the printer power cable after the printer has completely shut down (the control-panel display is blank).
- Release the finisher from the printer by pulling out on the release latch inside the finisher door.
- Disconnect the cable from the bridge unit to the finisher.
- Disconnect the cable from the finisher to the printer.

Use the table below to identify the correct part number for your printer. To order the part, go to <https://parts.hp.com>.

Table 5-140 Part information

Part number	Part description
JC90-01414A	Paper holding motor assembly
JC93-01156A	Paper holding motor

Required tools

- #2 JIS screwdriver with a magnetic tip

After performing service

- Connect the cable from the finisher to the printer.
- Connect the cable from the bridge unit to the finisher.
- Attach the finisher to the printer, and then push in on the release latch inside the finisher door.
- Connect the printer power cable.
- Turn the printer power on.

Post service test

Process a job through the finisher and verify that the finisher works correctly.

Remove the right upper cover (finisher)

Follow these steps to remove the right upper cover (finisher).

- ▲ Remove one screw cap and three machine screws on the upper edge of the cover (callout 1). Remove three sheet metal screws (callout 2) on the lower portion of the cover. Rotate the right edge of the cover away from the finisher, and then slide the cover right to release three tabs (callout 3).

💡 **TIP:** The lower screws are shorter in length than the upper screws.

TIP: Reverse the removal steps to install the assembly.

Figure 5-1382 Remove the right upper cover

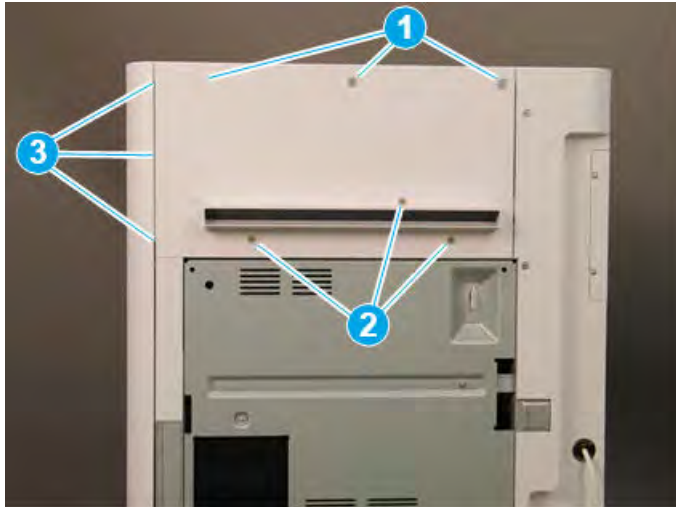

Remove the top cover (finisher)

Follow these steps to remove the top cover (finisher).

1. Remove three screw caps and three self-tapping screws at the top of the rear cover (callout 1), and then remove three machine screws (callout 2) on top of the cover.

Figure 5-1383 Remove six screws

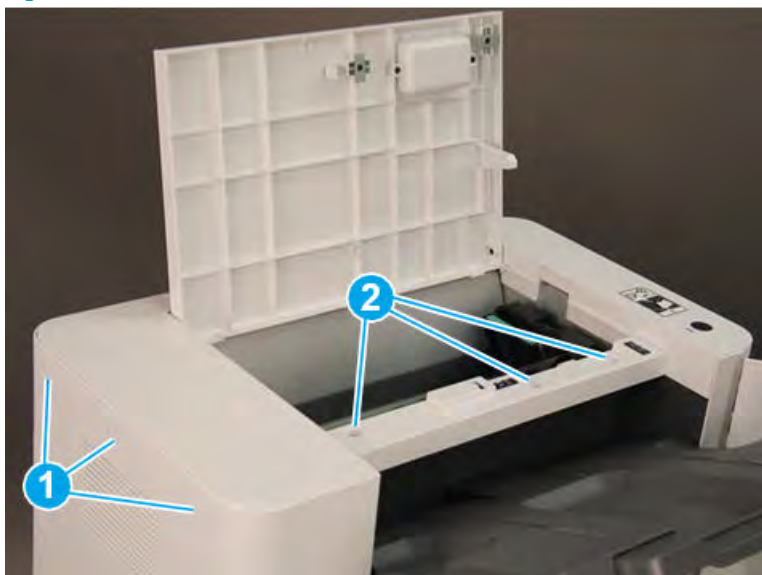

2. Remove three self-tapping screws at the top of the front cover (callout 1), and then remove two machine screws (callout 2) at the top of the right side.

Figure 5-1384 Remove five screws

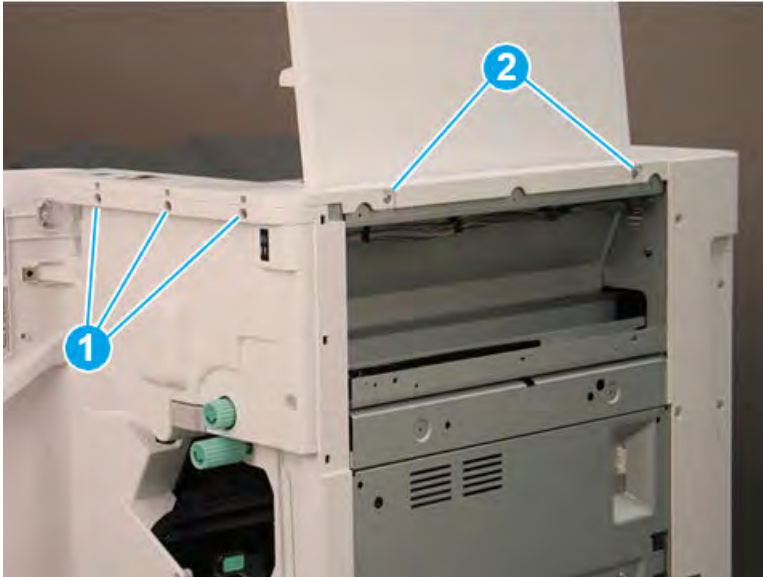

3. Lift the cover up slightly. Disconnect one in-line connector (callout 1), and then release one retainer (callout 2).

 **TIP:** Reverse the removal steps to install the assembly.

Figure 5-1385 Disconnect one connector and release retainer



Remove the front door (finisher)

Follow these steps to remove the front door (finisher).

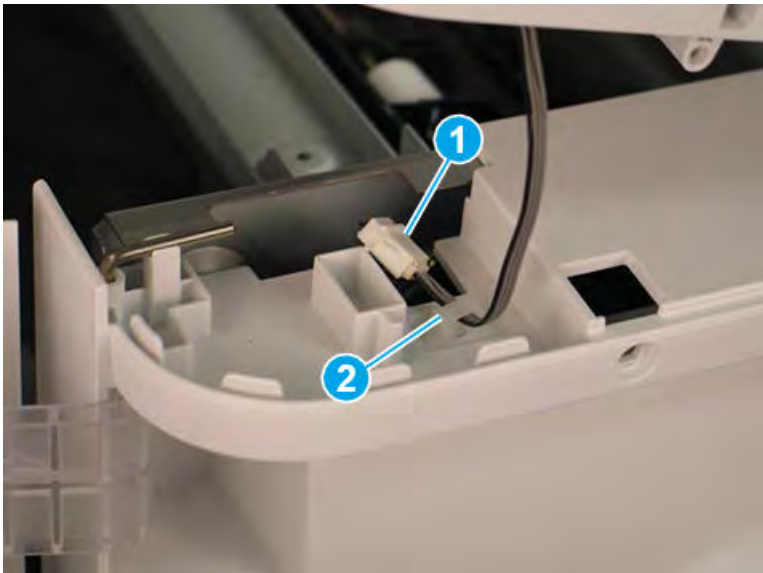
1. Lift the top hinge pin up to release it from the retainer.

Figure 5-1386 Lift the top hinge pin

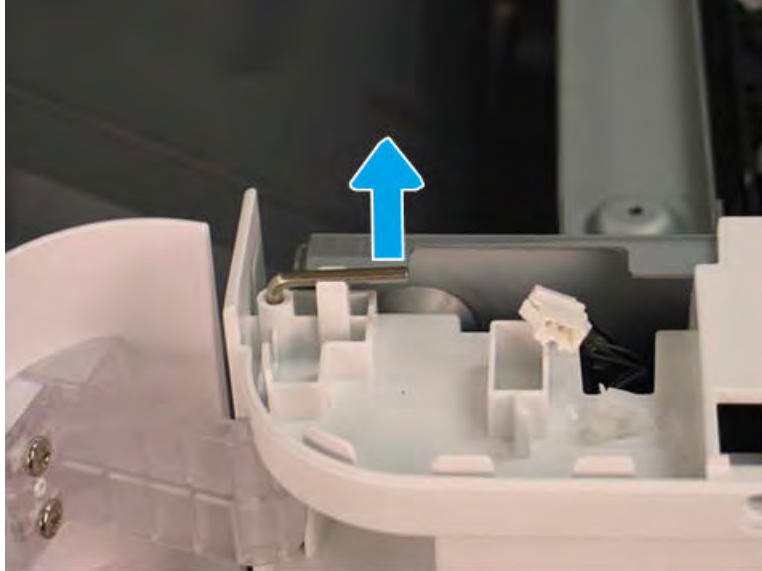

2. Pull the top hinge pin up to remove it.

Figure 5-1387 Remove the top hinge pin

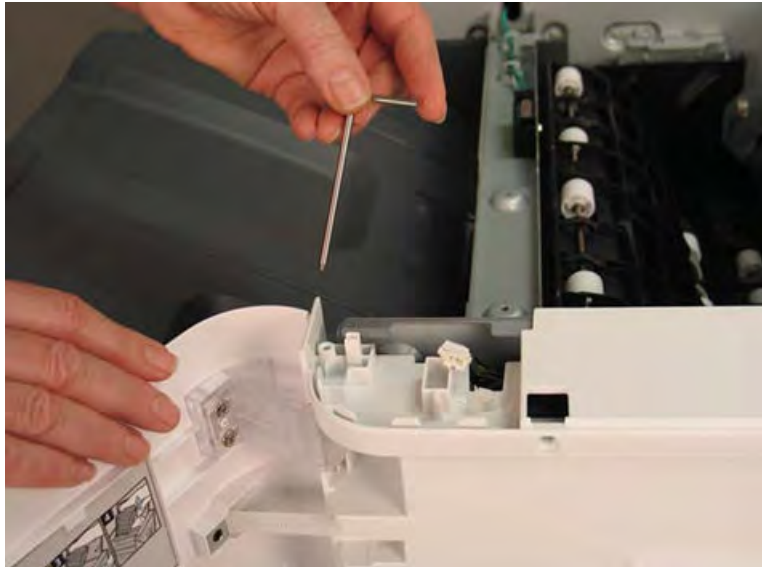

3. Use a small, flat-blade screwdriver to release the lower hinge pin from the retainer, and then rotate it away from the finisher.

Figure 5-1388 Release the lower hinge pin



4. Support the door with one hand, and then pull the lower hinge pin straight up to remove it.

Figure 5-1389 Remove the lower hinge pin



5. Support the door with one hand, and then remove one screw (callout 1) to release the strap. Remove the front door.

 **TIP:** Reverse the removal steps to install the assembly.

Figure 5-1390 Remove the front door



Remove the front cover (finisher)

Follow these steps to remove the front cover (finisher).

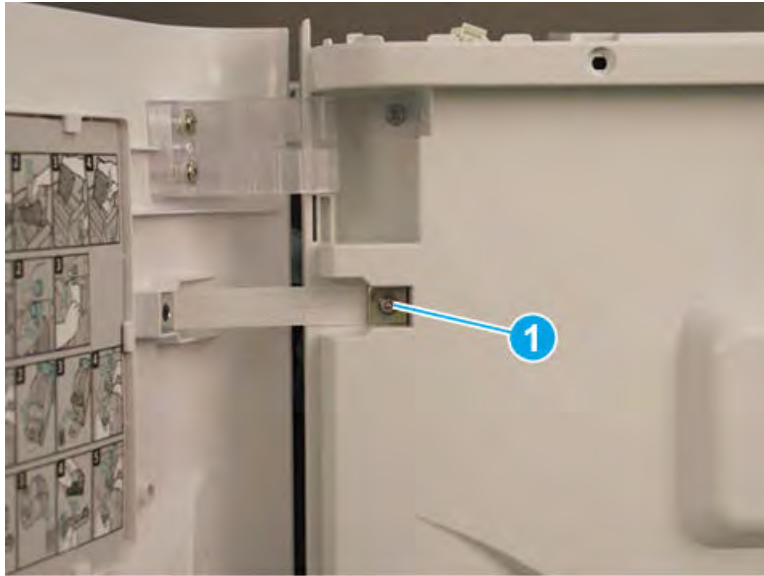
1. Release one tab (callout 1), and then pull the jam-access knob away from the finisher to remove it.

Figure 5-1391 Remove the jam-access knob

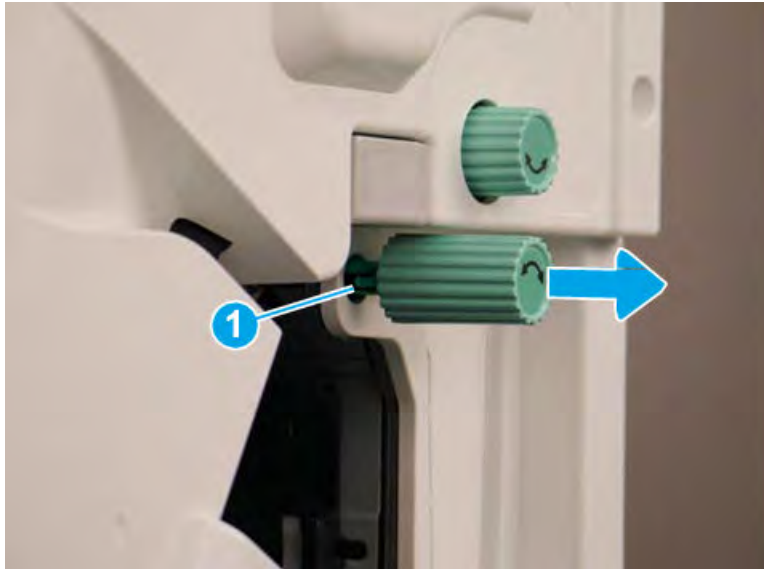

2. If the punch unit is installed, remove the punch waste bin (callout 1).

3. Remove one screw (callout 1) on top of the front cover.

Figure 5-1392 Remove one screw



4. Remove five machine screws (callout 1), and then remove the front cover.

 **TIP:** Reverse the removal steps to install the assembly.

Figure 5-1393 Remove the front cover



Remove the rear cover (finisher)

Follow these steps to remove the rear cover (finisher).

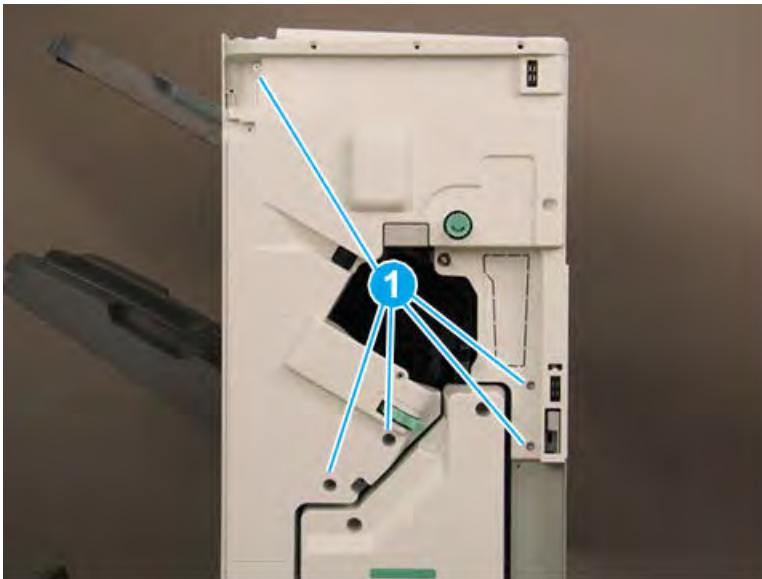
1. Remove two self-tapping screws (callout 1) on the top of the rear cover, and then remove five screw caps and five machine screws (callout 2) on the left side of the cover.

Figure 5-1394 Remove seven screws

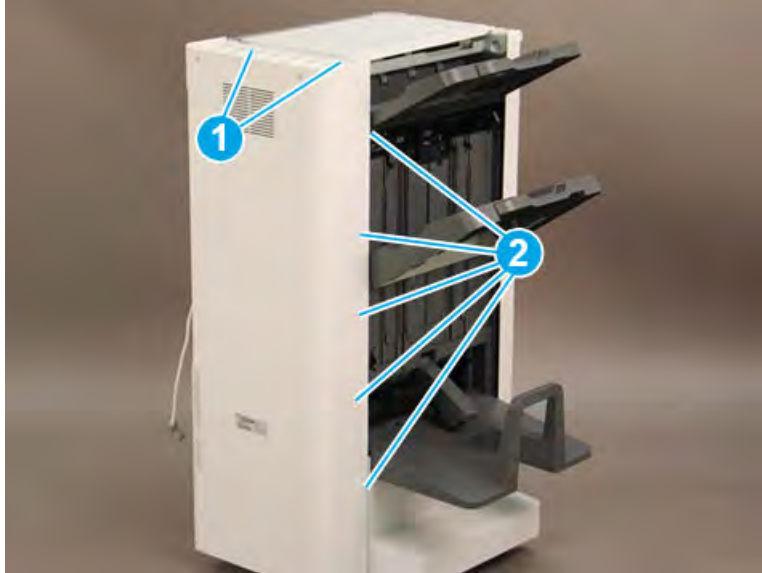

2. Remove one screw cap and four machine screws (callout 1) Remove the rear cover.

 **NOTE:** Make sure to thread the power cable (callout 2) through the opening in the cover.

 **TIP:** Reverse the removal steps to install the assembly

Figure 5-1395 Remove the rear cover



Remove the booklet output tray

Follow these steps to remove the booklet output tray.

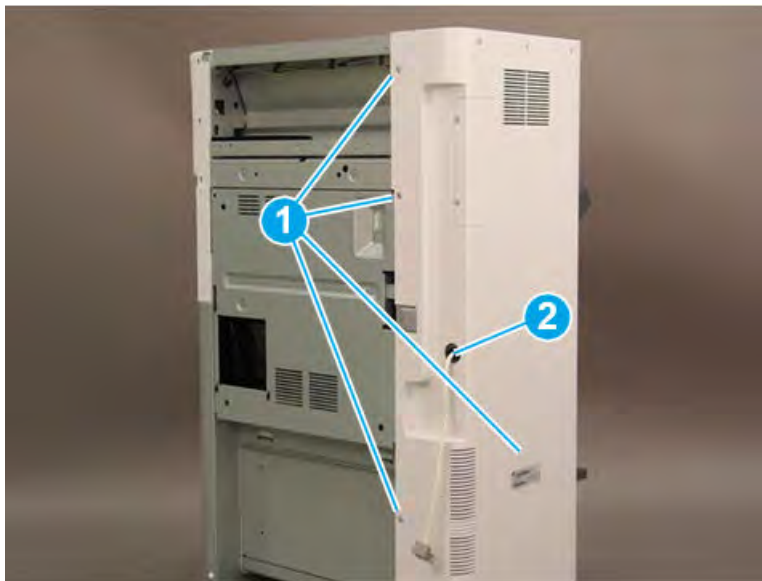
1. Raise the booklet output tray up (callout 1), and then pull it away from the finisher (callout 2) to remove it.

Figure 5-1396 Remove the booklet output tray



2. Reverse the removal steps to install the assembly. Also use the following special installation instructions.

 **NOTE:** Continue to reverse the removal steps to finish installing the assembly

Special installation instructions: booklet output tray

Position the tabs (callout 1) on the tray into the slots (callout 2) on the finisher.

Figure 5-1397 Install the booklet output tray

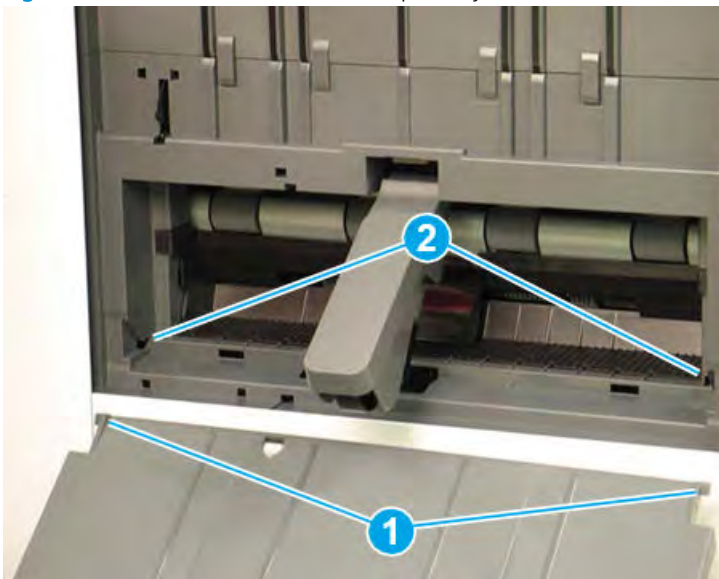

Remove the caster cover

Follow these steps to remove the caster cover.

1. Remove two screw caps and two self-tapping screws (callout 1). Remove two screw caps and two machine screws (callout 2).

Figure 5-1398 Remove four screws

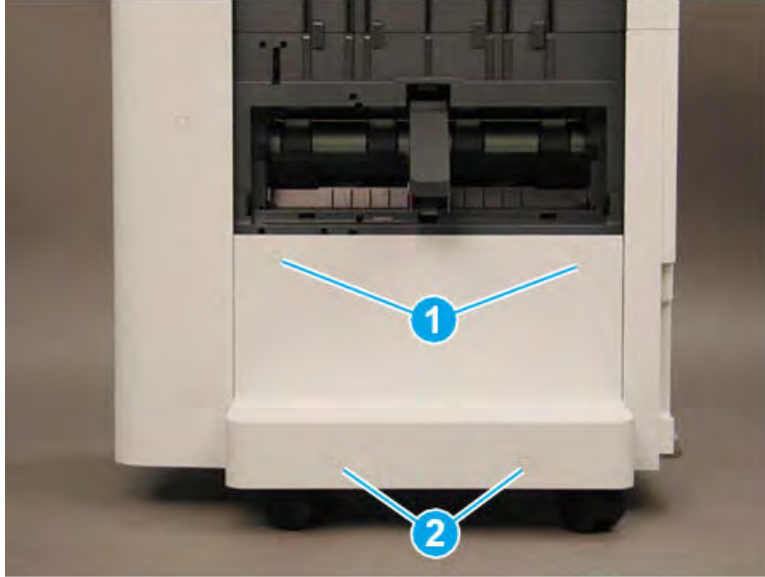

2. Rotate the left edge of the cover away from the finisher (callout 1), and then slide the cover to the left (callout 2) to remove it.

 **TIP:** Make sure that two tabs (callout 3) are positioned under the front lower cover when reinstalling the caster cover.

TIP: Reverse the removal steps to install the assembly

Figure 5-1399 Remove the caster cover

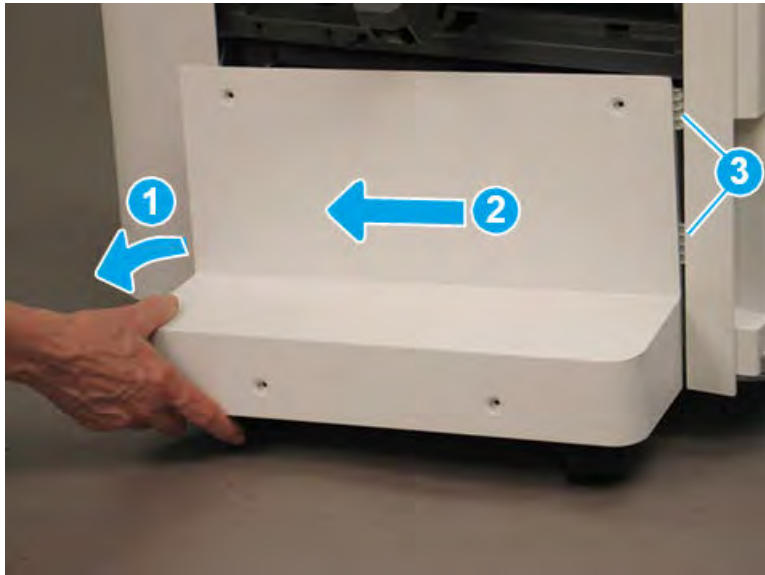

Remove the left lower cover (finisher)

Follow these steps to remove the left lower cover (finisher).

1. Remove four screws (callout 1).

 **NOTE:** Raise the lower output tray as needed to access the screws.

Figure 5-1400 Remove four screws



2. Slide the shield down (callout 1) to release it from four tabs (callout 2), and then rotate it away from the finisher (callout 3).

⚠ CAUTION: The shield is still attached to the finisher. Do not attempt to completely remove the shield.

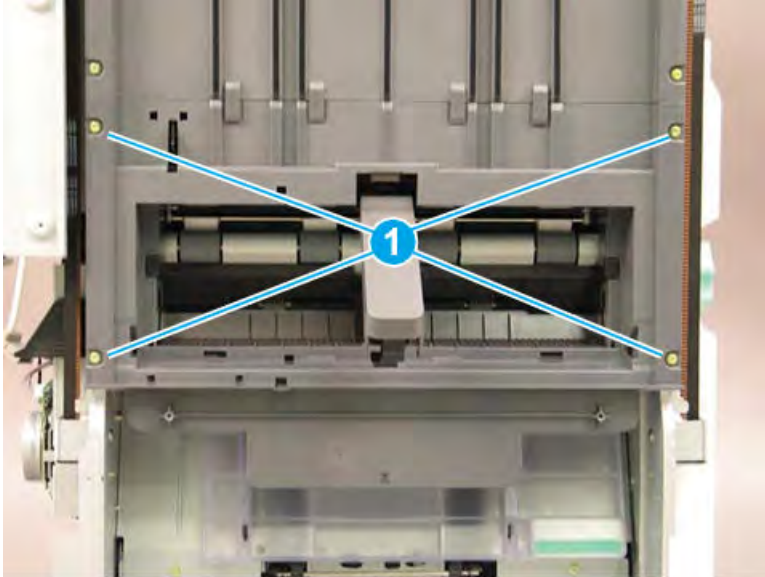
💡 TIP: Position the shield under the four tabs (callout 2) when reinstalling it.

Figure 5-1401 Release the lower shield

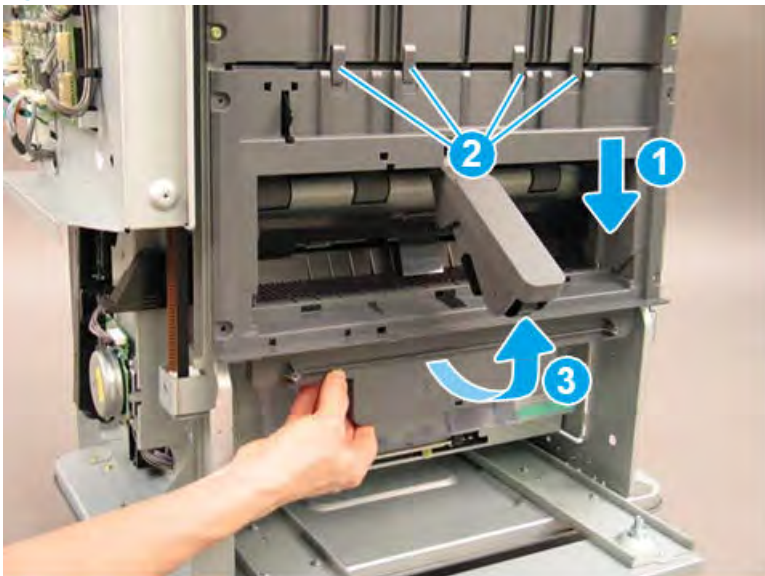

3. Disconnect two connectors (callout 1), and then remove the shield.

 **TIP:** Reverse the removal steps to install the assembly.

Figure 5-1402 Disconnect two connectors



4. If you are replacing the left lower cover, locate three sensors (callout 1) on the back of the left lower cover. Remove these sensors and transfer them to the replacement part.

Figure 5-1403 Remove the left lower cover

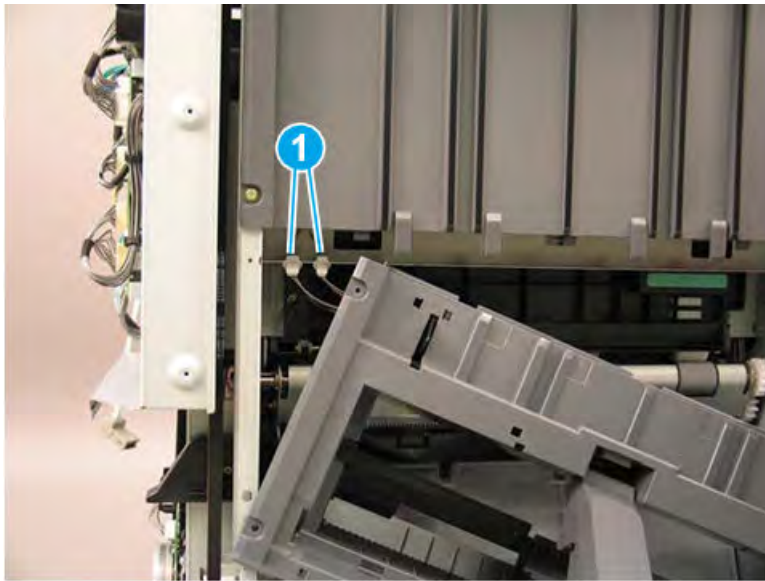
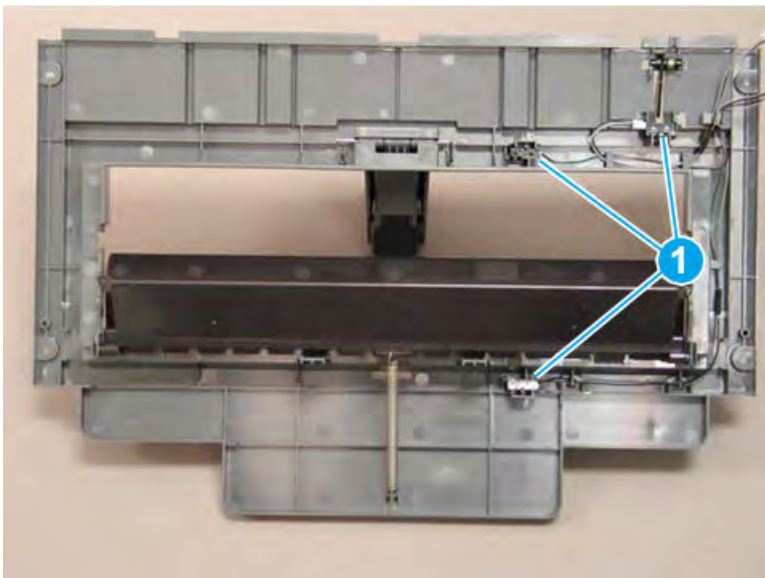

Remove the paper holding Motor (M7)

Follow these steps to remove the paper holding Motor (M7).

1. Release one retainer (callout 1), and then disconnect one connector (callout 2).

Figure 5-1404 Disconnect one connector

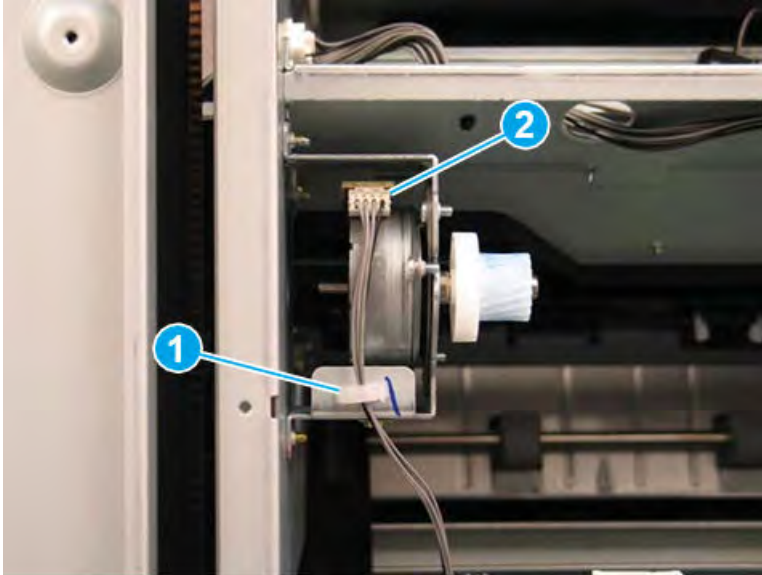

2. Remove two screws (callout 1), and then remove the motor and bracket.

Figure 5-1405 Remove two screws

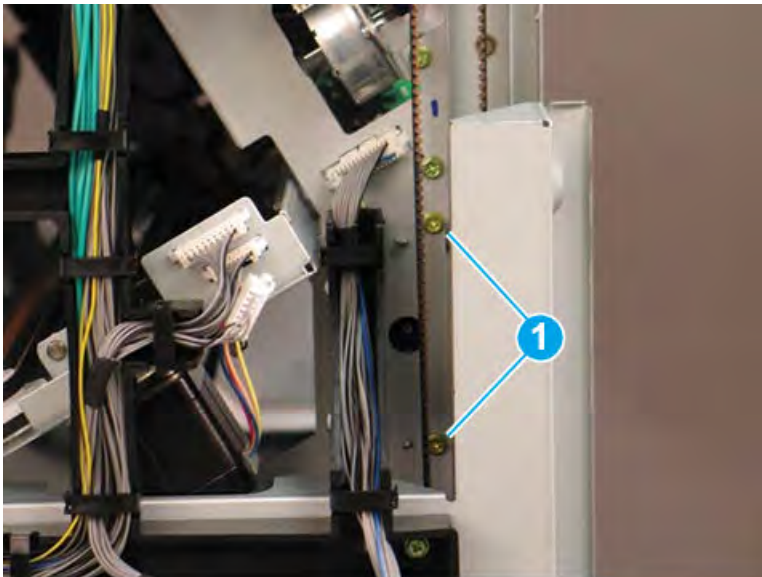

3. Remove two screws (callout 1), and then remove the motor.

Figure 5-1406 Remove two screws and the motor

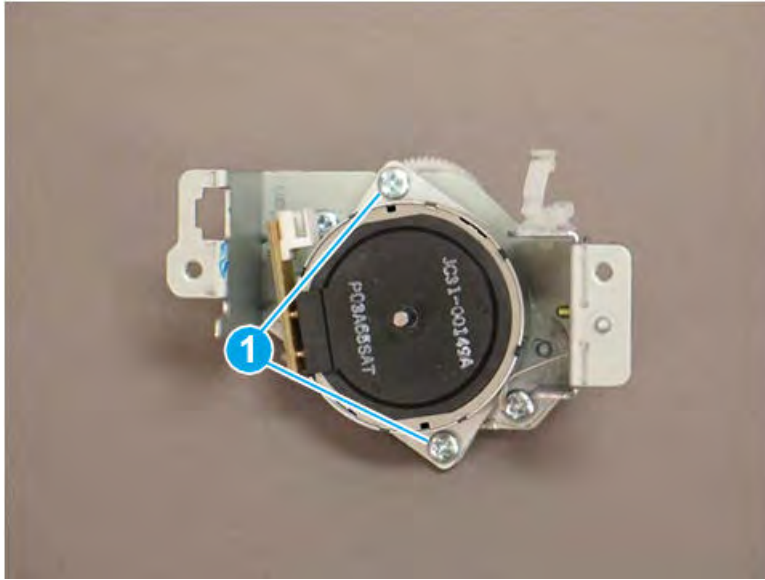

4. Reverse the removal steps to install the assembly. Also use the following special installation instructions.

 **NOTE:** Continue to reverse the removal steps to finish installing the assembly

Special installation instructions: paper holding Motor (M10)

When installing the motor and bracket, align the tab and slot on the motor bracket with the tab and slot in the printer.

Figure 5-1407 Install the motor and bracket

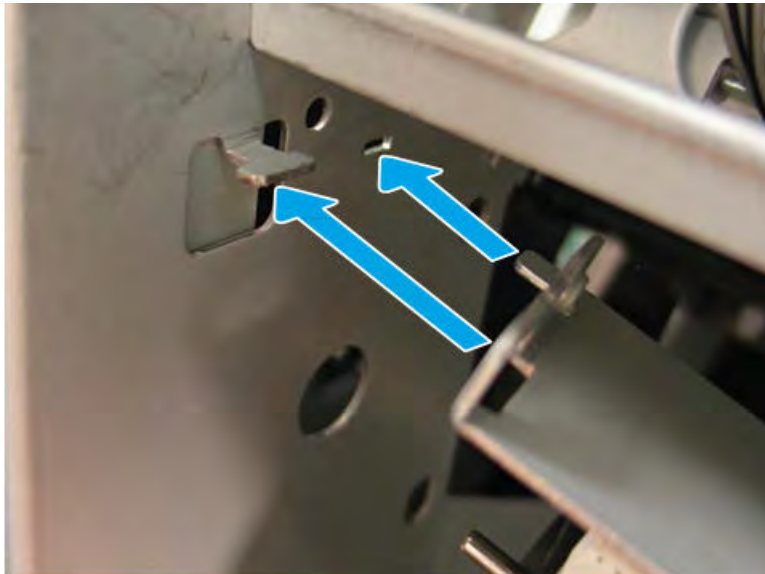

Unpack the replacement assembly



Follow these steps to unpack the replacement assembly.

1. Dispose of the defective part.

 **NOTE:** HP recommends responsible disposal of the defective part.

<http://www8.hp.com/us/en/hp-information/environment/product-recycling.html>

2. Unpack the replacement part from the packaging.

 **CAUTION:**  Some parts are sensitive to electrostatic discharge (ESD). Always perform service work at an ESD-protected workstation or mat. If an ESD workstation or mat is not available, touch the sheet-metal chassis to provide a static ground before touching an ESD-sensitive assembly. Protect the ESD-sensitive assemblies by placing them in ESD pouches when they are out of the printer.

 **IMPORTANT:** Make sure that all of the shipping materials (for example shipping tape) are removed from the replacement part prior to installation.

 **NOTE:** If the replacement part is a roller or pad, avoid touching the spongy part of it. Skin oils on the roller or pad can cause paper pickup and/or print-quality problems. HP recommends using disposable gloves when handling rollers or pads or washing your hands before touching rollers or pads.

3. To install an assembly, reverse the removal steps.

 **NOTE:** When applicable, special installation instructions are provided for an assembly at the end of the removal procedure. Always completely read the removal instructions and follow all special installation instructions.

Buffer unit

Removal and replacement: Buffer motor (M10)

Learn how to remove and replace the buffer motor.

Introduction

This document provides the procedures to remove and replace the buffer motor on the finisher.



IMPORTANT: When applicable, special installation instructions are provided for an assembly at the end of the removal procedure. Always completely read the removal instructions and follow all special installation instructions.

Before performing service

- Turn the printer power off. A shutting-down message appears on the control-panel display.
- ⚠ **WARNING!** To avoid damage to the printer, turn the power off and wait until the printer shuts down before removing the power cable.
- Disconnect the printer power cable after the printer has completely shut down (the control-panel display is blank).
- Release the finisher from the printer by pulling out on the release latch inside the finisher door.
- Disconnect the cable from the bridge unit to the finisher.
- Disconnect the cable from the finisher to the printer.

Use the table below to identify the correct part number for your printer. To order the part, go to <https://parts.hp.com>.

Table 5-141 Part information

Part number	Part description
JC93-01152A	Buffer motor

Required tools

- #2 JIS screwdriver with a magnetic tip

After performing service

- Connect the cable from the finisher to the printer.
- Connect the cable from the bridge unit to the finisher.
- Attach the finisher to the printer, and then push in on the release latch inside the finisher door.
- Connect the printer power cable.
- Turn the printer power on.

Post service test

Process a job through the finisher and verify that the finisher works correctly.

Remove the right upper cover (finisher)

Follow these steps to remove the right upper cover (finisher).

- ▲ Remove one screw cap and three machine screws on the upper edge of the cover (callout 1). Remove three sheet metal screws (callout 2) on the lower portion of the cover. Rotate the right edge of the cover away from the finisher, and then slide the cover right to release three tabs (callout 3).

💡 **TIP:** The lower screws are shorter in length than the upper screws.

TIP: Reverse the removal steps to install the assembly.

Figure 5-1408 Remove the right upper cover

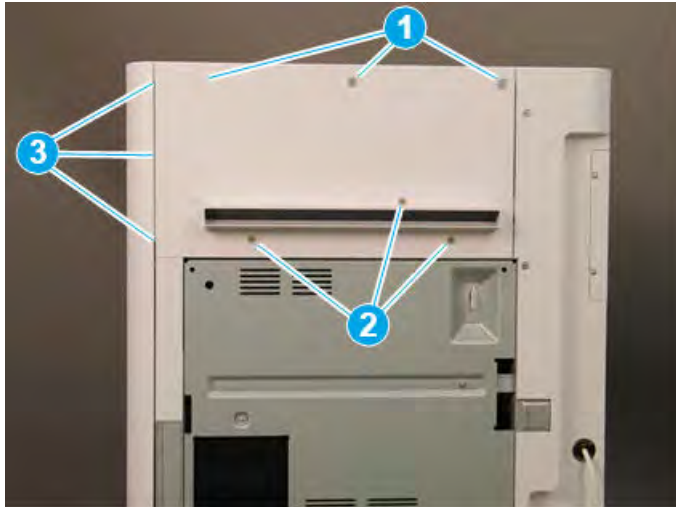

Remove the top cover (finisher)

Follow these steps to remove the top cover (finisher).

1. Remove three screw caps and three self-tapping screws at the top of the rear cover (callout 1), and then remove three machine screws (callout 2) on top of the cover.

Figure 5-1409 Remove six screws

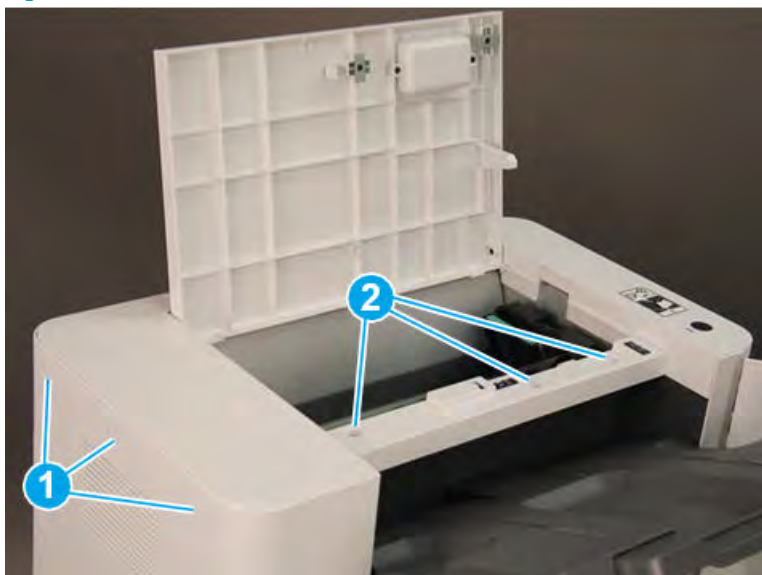

2. Remove three self-tapping screws at the top of the front cover (callout 1), and then remove two machine screws (callout 2) at the top of the right side.

Figure 5-1410 Remove five screws

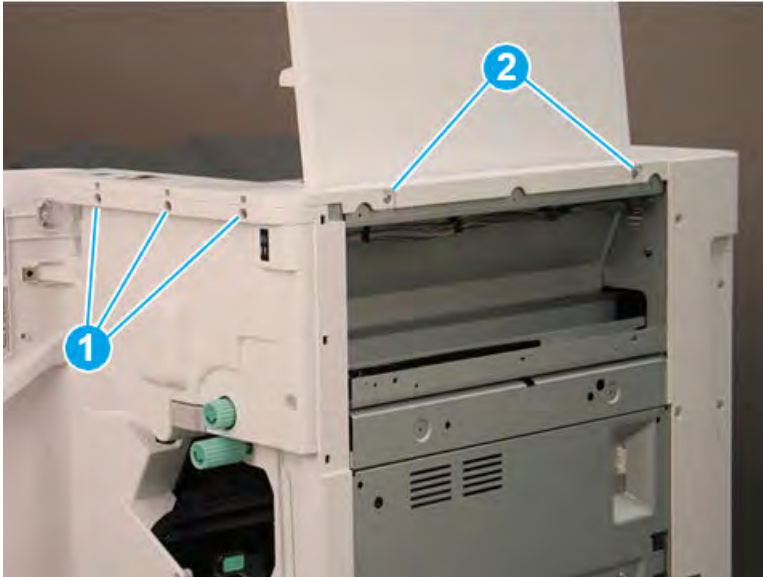

3. Lift the cover up slightly. Disconnect one in-line connector (callout 1), and then release one retainer (callout 2).

 **TIP:** Reverse the removal steps to install the assembly.

Figure 5-1411 Disconnect one connector and release retainer



Remove the rear cover (finisher)

Follow these steps to remove the rear cover (finisher).

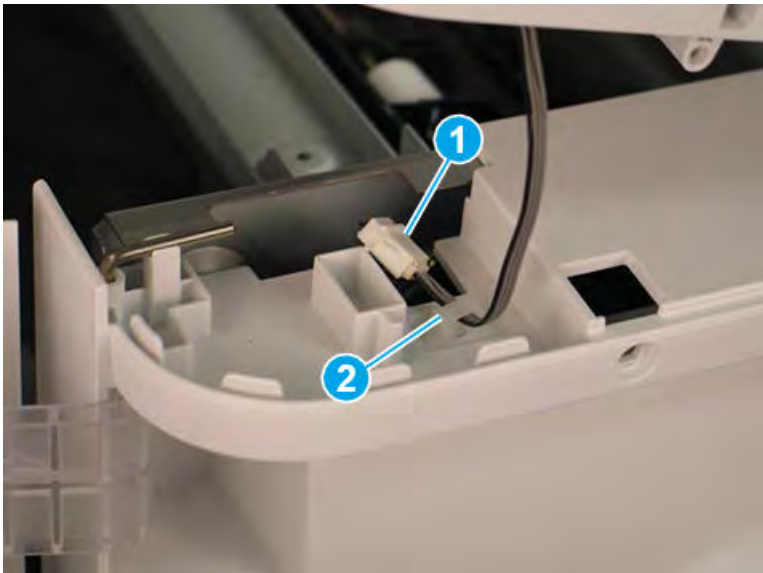
1. Remove two self-tapping screws (callout 1) on the top of the rear cover, and then remove five screw caps and five machine screws (callout 2) on the left side of the cover.

Figure 5-1412 Remove seven screws

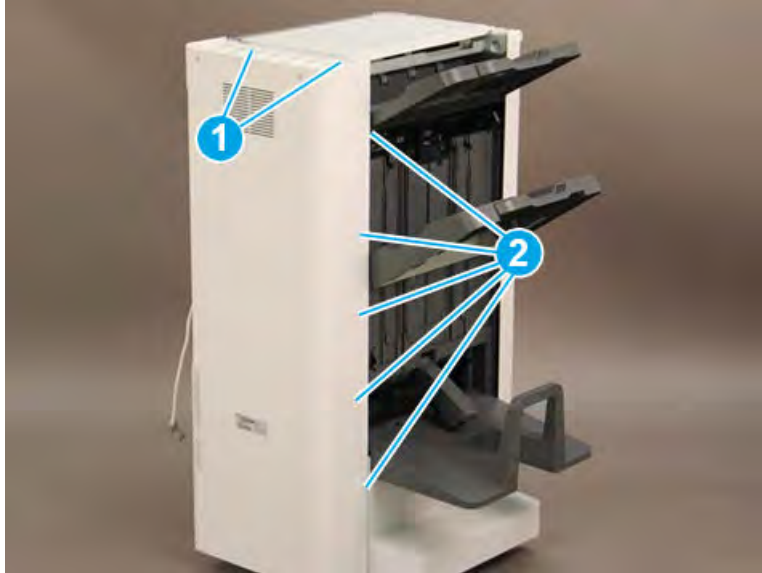

2. Remove one screw cap and four machine screws (callout 1) Remove the rear cover.

 **NOTE:** Make sure to thread the power cable (callout 2) through the opening in the cover.

 **TIP:** Reverse the removal steps to install the assembly

Figure 5-1413 Remove the rear cover



Remove the main exit cam motor(M10)

Follow these steps to remove the main exit cam motor(M10).

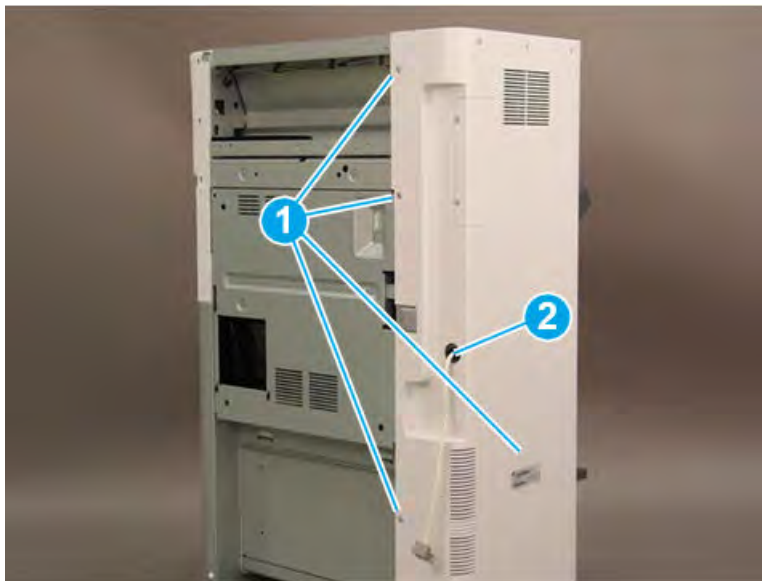
1. At the rear of the finisher, remove two screws(callout 1).

Figure 5-1414 Remove two screws

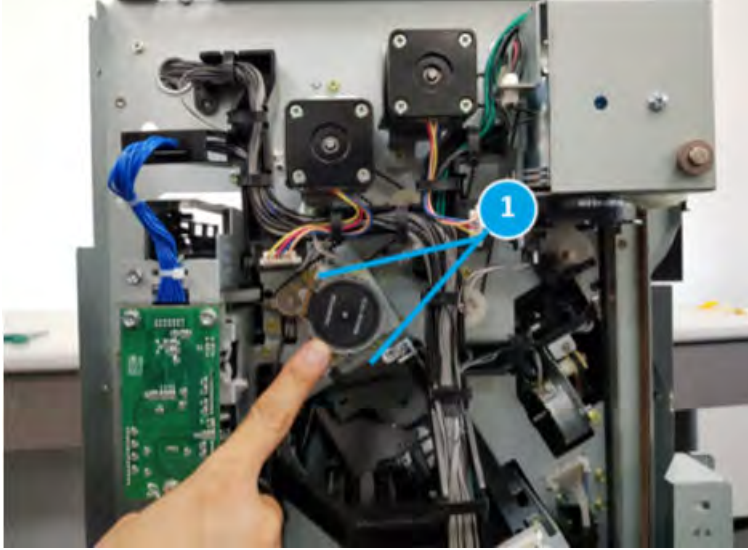

2. Disconnect the connector(callout 1)

Figure 5-1415 Disconnect the connector

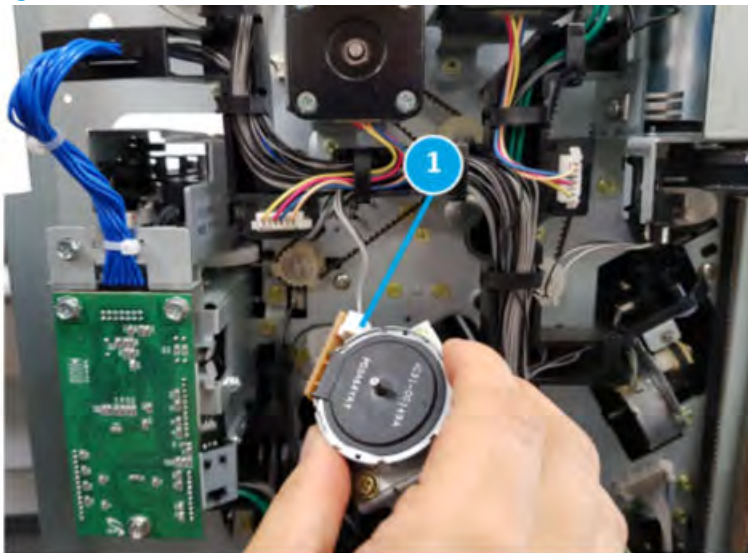

Unpack the replacement assembly

Follow these steps to unpack the replacement assembly.

1. Dispose of the defective part.

 **NOTE:** HP recommends responsible disposal of the defective part.

<http://www8.hp.com/us/en/hp-information/environment/product-recycling.html>

2. Unpack the replacement part from the packaging.



CAUTION:  Some parts are sensitive to electrostatic discharge (ESD). Always perform service work at an ESD-protected workstation or mat. If an ESD workstation or mat is not available, touch the sheet-metal chassis to provide a static ground before touching an ESD-sensitive assembly. Protect the ESD-sensitive assemblies by placing them in ESD pouches when they are out of the printer.

 **IMPORTANT:** Make sure that all of the shipping materials (for example shipping tape) are removed from the replacement part prior to installation.

 **NOTE:** If the replacement part is a roller or pad, avoid touching the spongy part of it. Skin oils on the roller or pad can cause paper pickup and/or print-quality problems. HP recommends using disposable gloves when handling rollers or pads or washing your hands before touching rollers or pads.

3. To install an assembly, reverse the removal steps.

 **NOTE:** When applicable, special installation instructions are provided for an assembly at the end of the removal procedure. Always completely read the removal instructions and follow all special installation instructions.

Removal and replacement: Buffer solenoid (SL1)

Learn how to remove and replace the buffer solenoid.

Introduction

This document provides the procedures to remove and replace the buffer solenoid on the finisher.



IMPORTANT: When applicable, special installation instructions are provided for an assembly at the end of the removal procedure. Always completely read the removal instructions and follow all special installation instructions.

Before performing service

- Turn the printer power off. A shutting-down message appears on the control-panel display.
- ⚠ **WARNING!** To avoid damage to the printer, turn the power off and wait until the printer shuts down before removing the power cable.
- Disconnect the printer power cable after the printer has completely shut down (the control-panel display is blank).
- Release the finisher from the printer by pulling out on the release latch inside the finisher door.
- Disconnect the cable from the bridge unit to the finisher.
- Disconnect the cable from the finisher to the printer.

Use the table below to identify the correct part number for your printer. To order the part, go to <https://parts.hp.com>.

Table 5-142 Part information

Part number	Part description
JC90-01675A	Buffer solenoid

Required tools

- #2 JIS screwdriver with a magnetic tip

After performing service

- Connect the cable from the finisher to the printer.
- Connect the cable from the bridge unit to the finisher.
- Attach the finisher to the printer, and then push in on the release latch inside the finisher door.
- Connect the printer power cable.
- Turn the printer power on.

Post service test

Process a job through the finisher and verify that the finisher works correctly.

Remove the right upper cover (finisher)

Follow these steps to remove the right upper cover (finisher).

- ▲ Remove one screw cap and three machine screws on the upper edge of the cover (callout 1). Remove three sheet metal screws (callout 2) on the lower portion of the cover. Rotate the right edge of the cover away from the finisher, and then slide the cover right to release three tabs (callout 3).

💡 **TIP:** The lower screws are shorter in length than the upper screws.

TIP: Reverse the removal steps to install the assembly.

Figure 5-1416 Remove the right upper cover

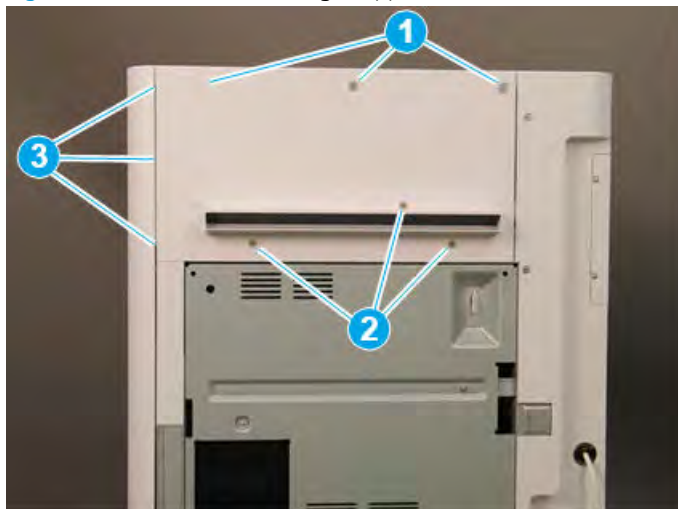

Remove the top cover (finisher)

Follow these steps to remove the top cover (finisher).

1. Remove three screw caps and three self-tapping screws at the top of the rear cover (callout 1), and then remove three machine screws (callout 2) on top of the cover.

Figure 5-1417 Remove six screws

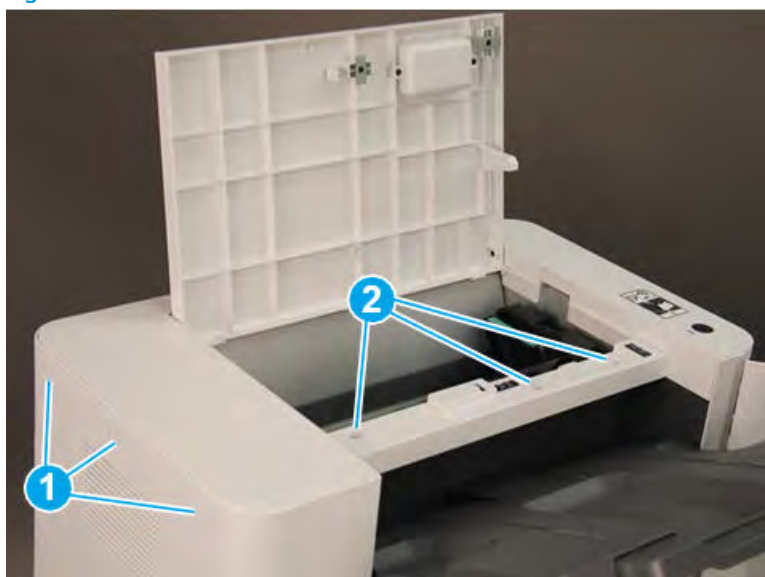

2. Remove three self-tapping screws at the top of the front cover (callout 1), and then remove two machine screws (callout 2) at the top of the right side.

Figure 5-1418 Remove five screws

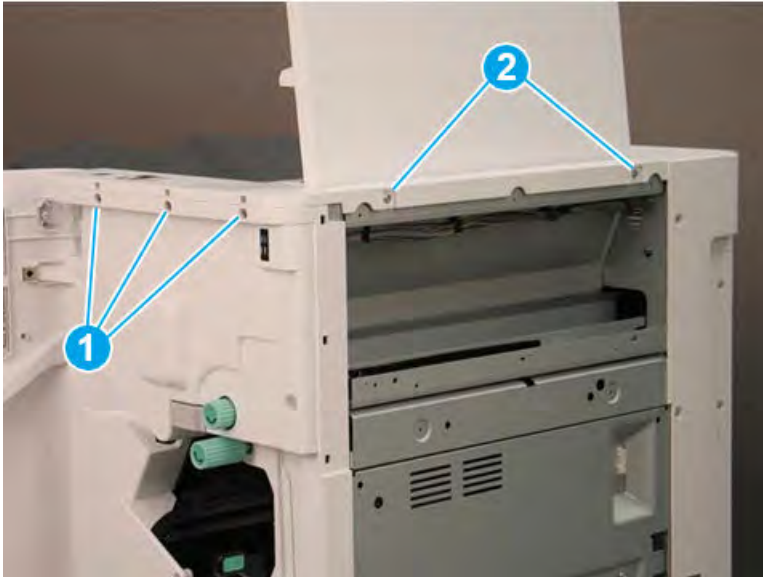

3. Lift the cover up slightly. Disconnect one in-line connector (callout 1), and then release one retainer (callout 2).

 **TIP:** Reverse the removal steps to install the assembly.

Figure 5-1419 Disconnect one connector and release retainer



Remove the rear cover (finisher)

Follow these steps to remove the rear cover (finisher).

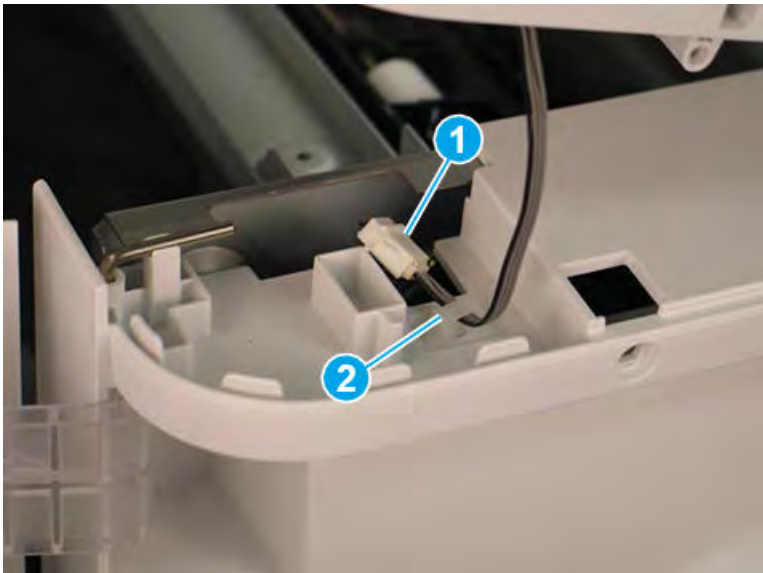
1. Remove two self-tapping screws (callout 1) on the top of the rear cover, and then remove five screw caps and five machine screws (callout 2) on the left side of the cover.

Figure 5-1420 Remove seven screws



2. Remove one screw cap and four machine screws (callout 1) Remove the rear cover.

 **NOTE:** Make sure to thread the power cable (callout 2) through the opening in the cover.

 **TIP:** Reverse the removal steps to install the assembly

Figure 5-1421 Remove the rear cover

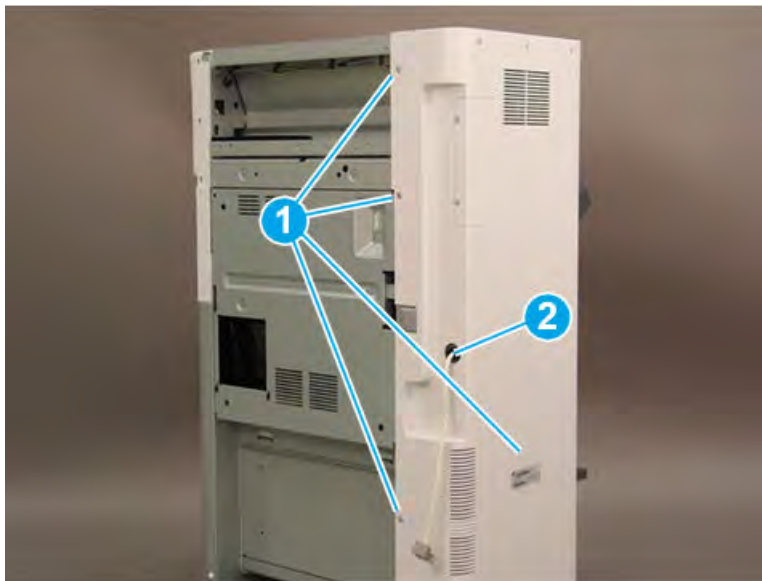

Remove the buffer solenoid(SL1)

Follow these steps to remove the buffer solenoid(SL1).

1. At the rear of the finisher, remove two screws(Callout 1)

Figure 5-1422 Remove two screws

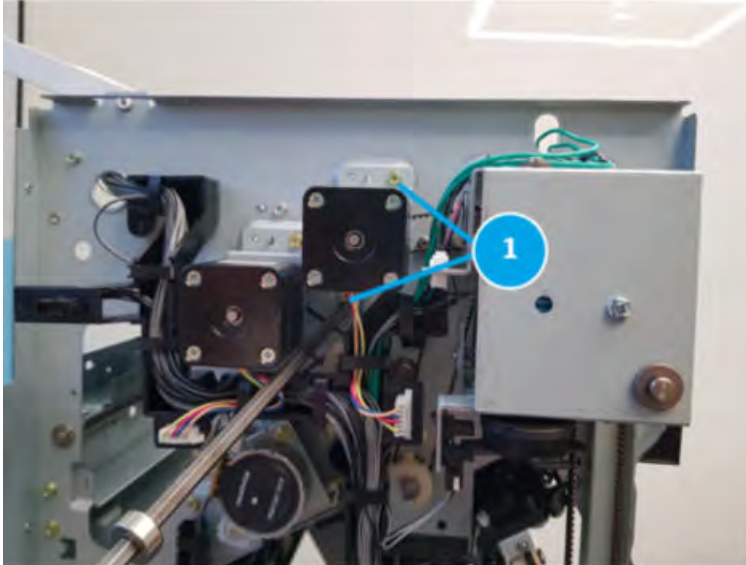

2. At the rear of the finisher, remove two screws(Callout 1)

Figure 5-1423 Remove two screws

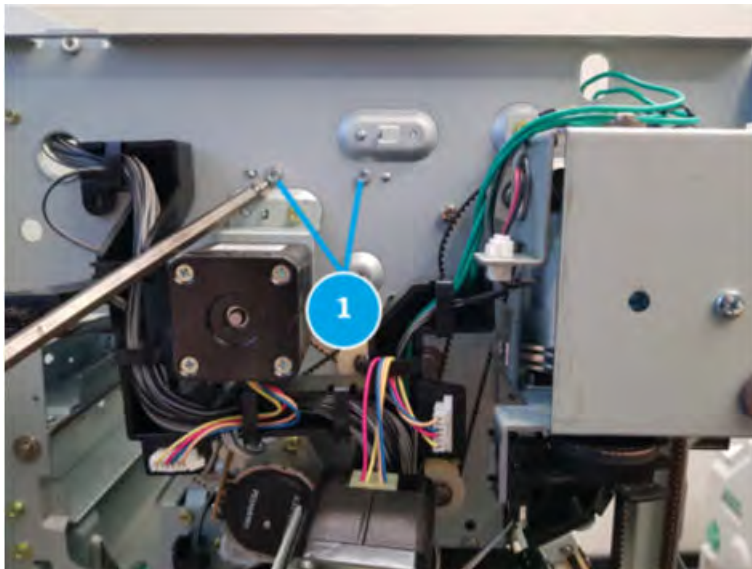

3. Remove top jam cover assembly (Callout 1)

Figure 5-1424 Remove top jam cover assembly

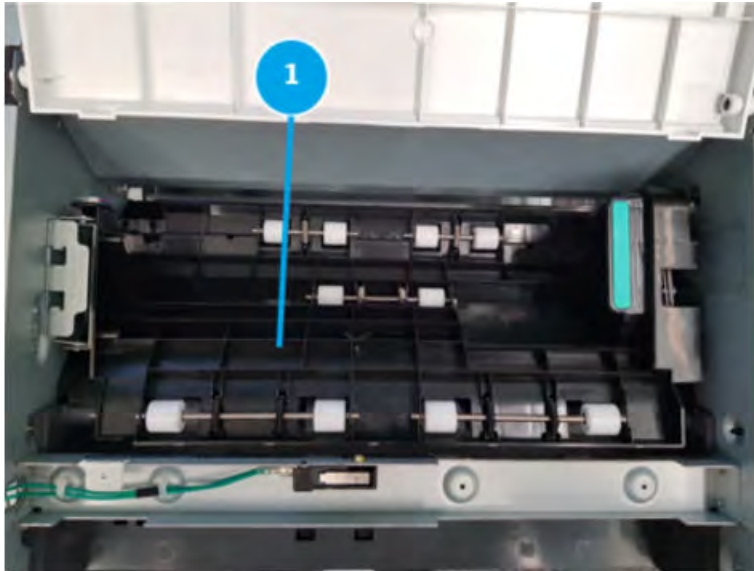

4. At the rear of the finisher, remove two screws (Callout 1)

Figure 5-1425 Remove two screws

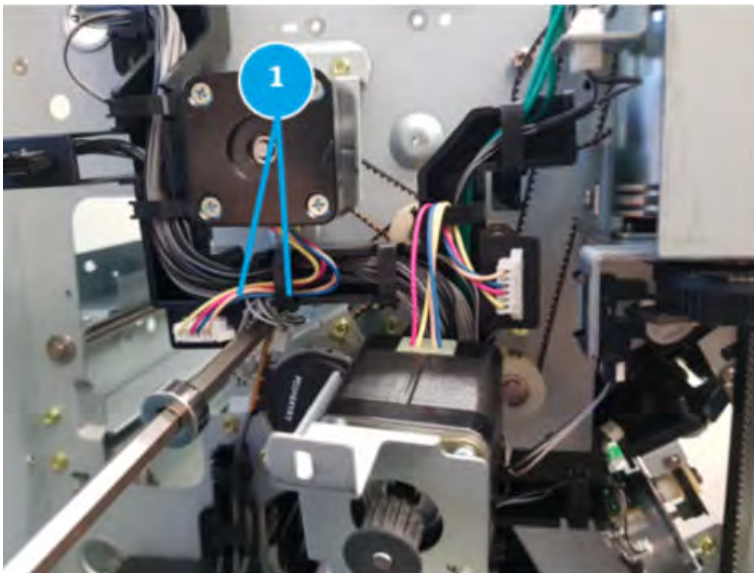

5. Disconnect the connector(Callout 1) and remove the buffer solenoid(Callout 2)

Figure 5-1426 Remove the buffer solenoid

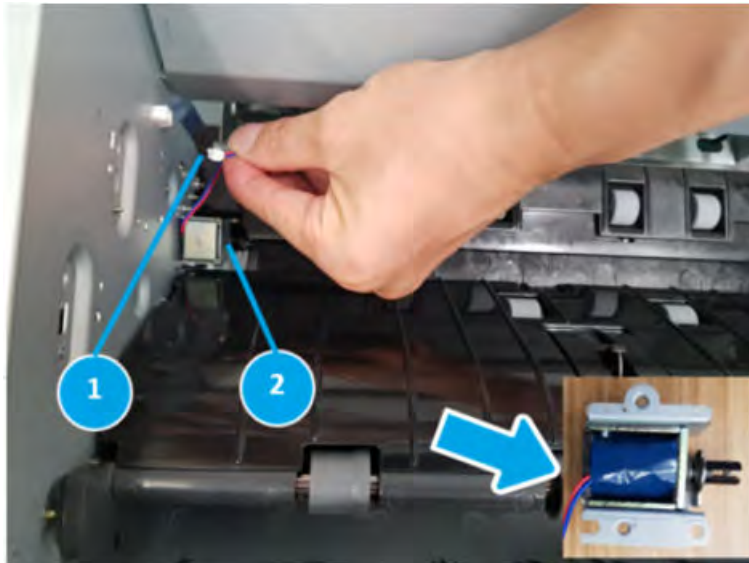

Unpack the replacement assembly



Follow these steps to unpack the replacement assembly.

1. Dispose of the defective part.

 **NOTE:** HP recommends responsible disposal of the defective part.

<http://www8.hp.com/us/en/hp-information/environment/product-recycling.html>

2. Unpack the replacement part from the packaging.

 **CAUTION:**  Some parts are sensitive to electrostatic discharge (ESD). Always perform service work at an ESD-protected workstation or mat. If an ESD workstation or mat is not available, touch the sheet-metal chassis to provide a static ground before touching an ESD-sensitive assembly. Protect the ESD-sensitive assemblies by placing them in ESD pouches when they are out of the printer.

 **IMPORTANT:** Make sure that all of the shipping materials (for example shipping tape) are removed from the replacement part prior to installation.

 **NOTE:** If the replacement part is a roller or pad, avoid touching the spongy part of it. Skin oils on the roller or pad can cause paper pickup and/or print-quality problems. HP recommends using disposable gloves when handling rollers or pads or washing your hands before touching rollers or pads.

3. To install an assembly, reverse the removal steps.

 **NOTE:** When applicable, special installation instructions are provided for an assembly at the end of the removal procedure. Always completely read the removal instructions and follow all special installation instructions.

Booklet maker

Removal and replacement: Booklet finisher

Learn how to remove and replace the booklet maker.

Introduction

This document provides the procedures to remove and replace the booklet maker on the finisher.



IMPORTANT: When applicable, special installation instructions are provided for an assembly at the end of the removal procedure. Always completely read the removal instructions and follow all special installation instructions.

Before performing service

- Turn the printer power off. A shutting-down message appears on the control-panel display.
- ⚠ **WARNING!** To avoid damage to the printer, turn the power off and wait until the printer shuts down before removing the power cable.
- Disconnect the printer power cable after the printer has completely shut down (the control-panel display is blank).
- Release the finisher from the printer by pulling out on the release latch inside the finisher door.
- Disconnect the cable from the bridge unit to the finisher.
- Disconnect the cable from the finisher to the printer.

Use the table below to identify the correct part number for your printer. To order the part, go to <https://parts.hp.com>.

Table 5-143 Part information

Part number	Part description
JC82-00905A	Booklet maker

Required tools

- #2 JIS screwdriver with a magnetic tip

After performing service

- Connect the cable from the finisher to the printer.
- Connect the cable from the bridge unit to the finisher.
- Attach the finisher to the printer, and then push in on the release latch inside the finisher door.
- Connect the printer power cable.
- Turn the printer power on.

Post service test

Process a job through the finisher and verify that the finisher works correctly.

Remove the right upper cover (finisher)

Follow these steps to remove the right upper cover (finisher).

- ▲ Remove one screw cap and three machine screws on the upper edge of the cover (callout 1). Remove three sheet metal screws (callout 2) on the lower portion of the cover. Rotate the right edge of the cover away from the finisher, and then slide the cover right to release three tabs (callout 3).

💡 **TIP:** The lower screws are shorter in length than the upper screws.

TIP: Reverse the removal steps to install the assembly.

Figure 5-1427 Remove the right upper cover

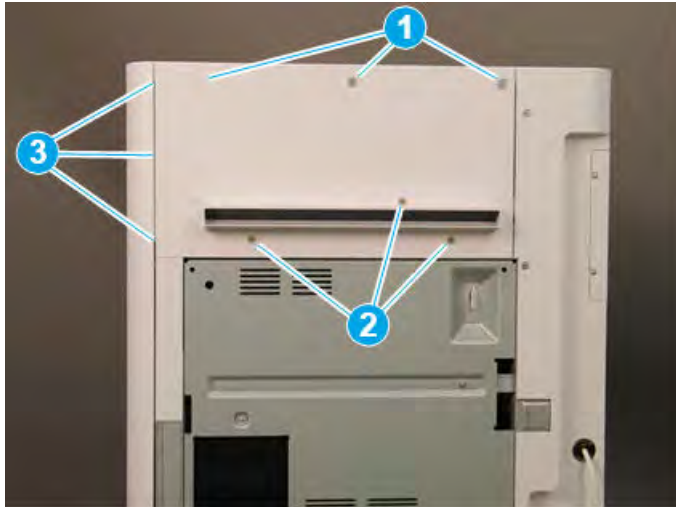

Remove the top cover (finisher)

Follow these steps to remove the top cover (finisher).

1. Remove three screw caps and three self-tapping screws at the top of the rear cover (callout 1), and then remove three machine screws (callout 2) on top of the cover.

Figure 5-1428 Remove six screws

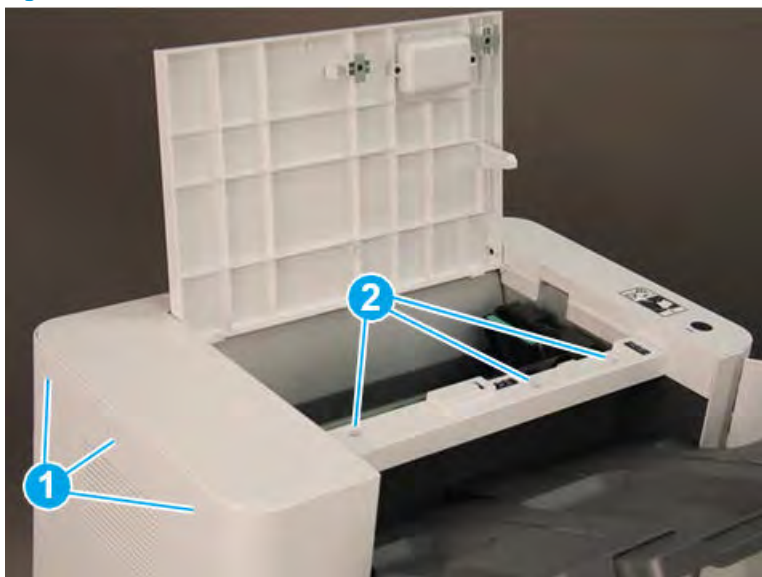

2. Remove three self-tapping screws at the top of the front cover (callout 1), and then remove two machine screws (callout 2) at the top of the right side.

Figure 5-1429 Remove five screws

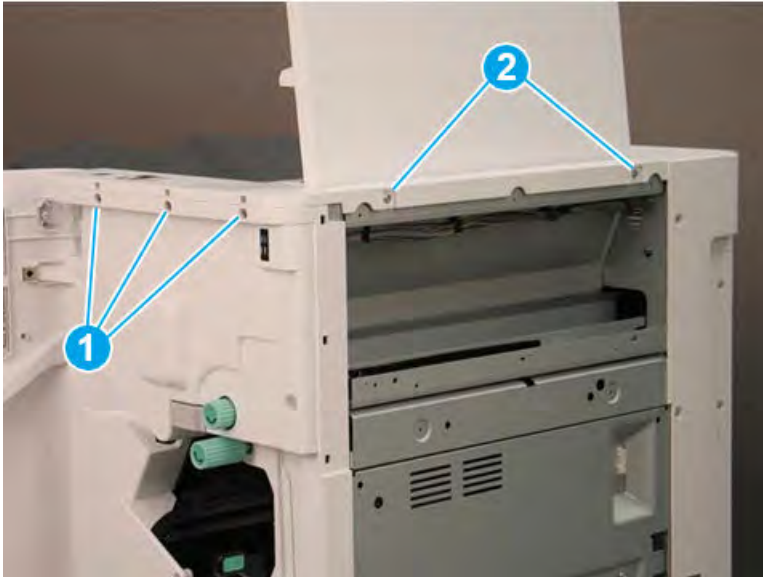

3. Lift the cover up slightly. Disconnect one in-line connector (callout 1), and then release one retainer (callout 2).

 **TIP:** Reverse the removal steps to install the assembly.

Figure 5-1430 Disconnect one connector and release retainer



Remove the rear cover (finisher)

Follow these steps to remove the rear cover (finisher).

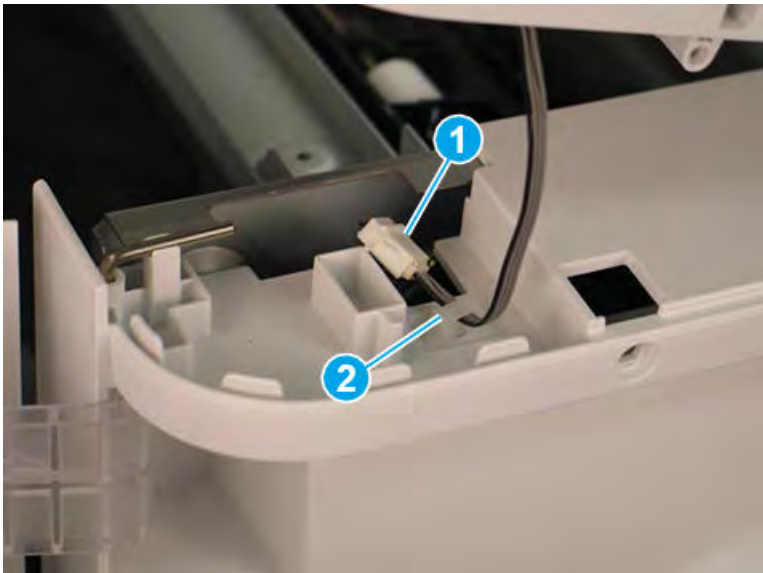
1. Remove two self-tapping screws (callout 1) on the top of the rear cover, and then remove five screw caps and five machine screws (callout 2) on the left side of the cover.

Figure 5-1431 Remove seven screws



2. Remove one screw cap and four machine screws (callout 1) Remove the rear cover.

 **NOTE:** Make sure to thread the power cable (callout 2) through the opening in the cover.

 **TIP:** Reverse the removal steps to install the assembly

Figure 5-1432 Remove the rear cover



Remove the booklet maker

Follow these steps to remove the booklet maker.

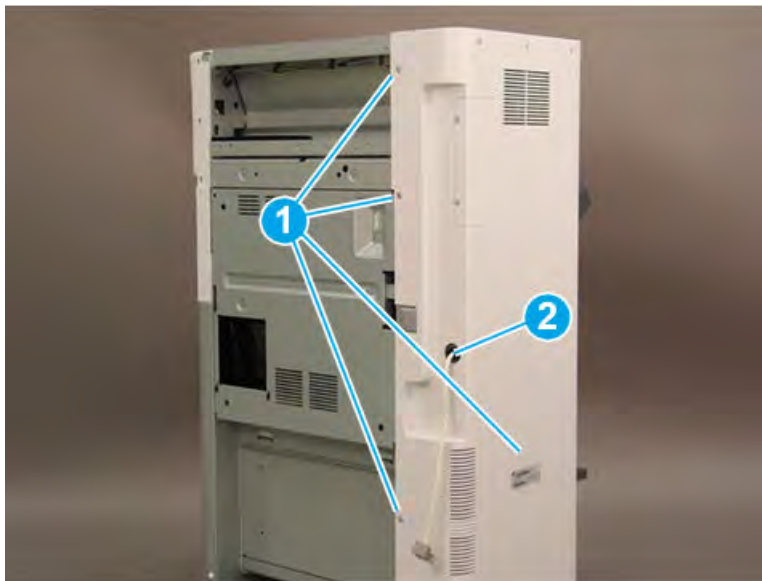
1. Slide the booklet maker away from the finisher.

Figure 5-1433 Slide the booklet maker away from the finisher



2. At the Disconnect one connector (callout 1), and then remove one screw (callout 2).

Figure 5-1434 Disconnect one connector and remove one screw

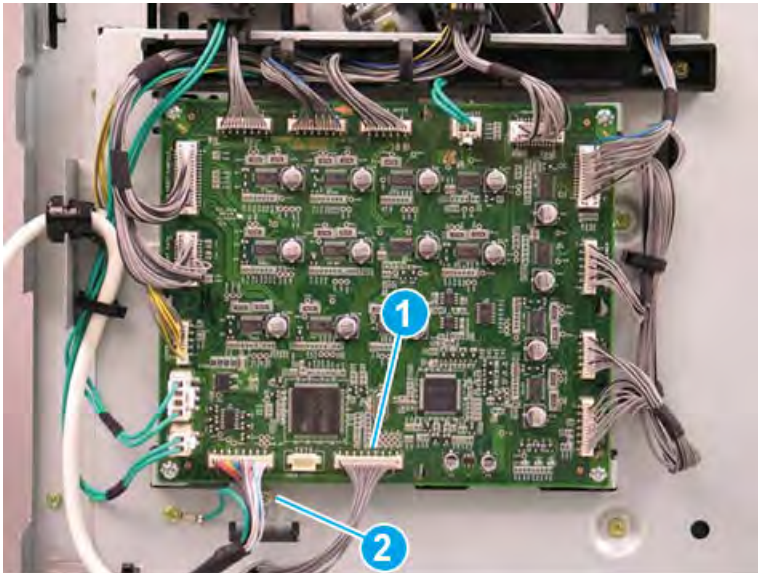

3. Release the metal bracket through the opening in the sheet metal.

Figure 5-1435 Release the metal bracket

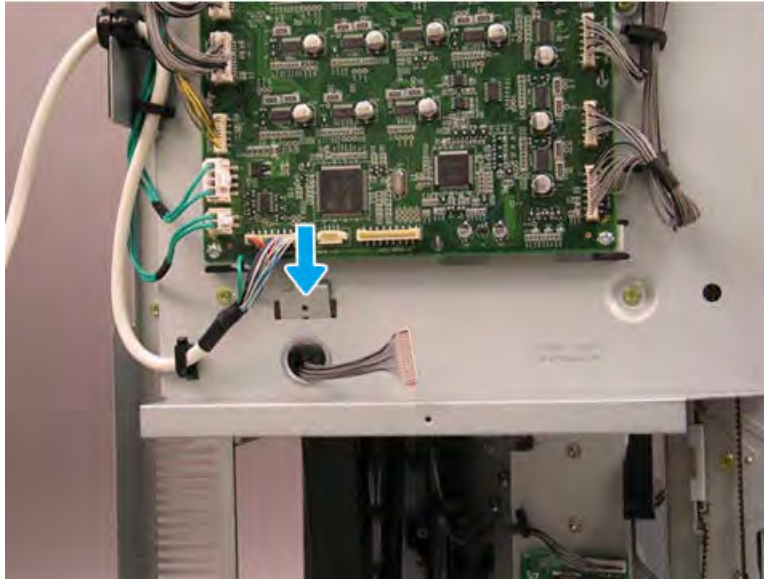

4. Remove one star-washer screw (callout 1), and then release the alignment pin (callout 2) on the right side of the booklet maker.

Figure 5-1436 Remove one screw

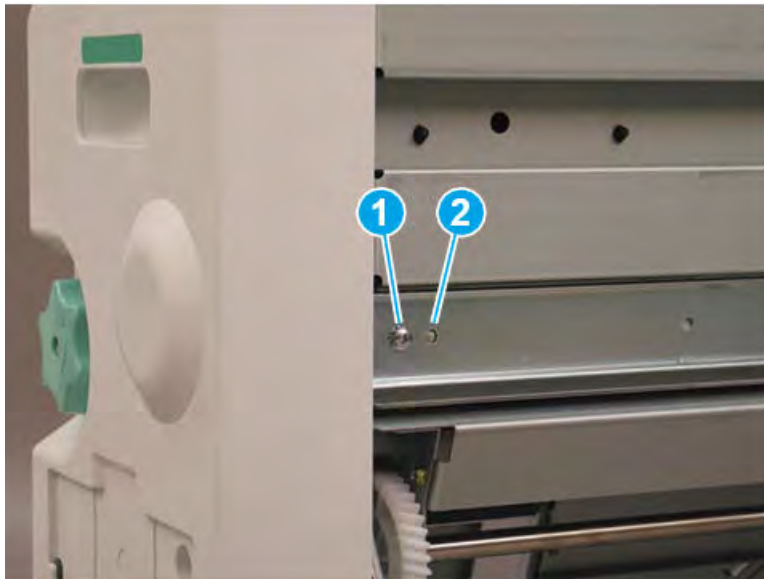

5. Slide the right rail toward the finisher.

Figure 5-1437 Slide the right rail

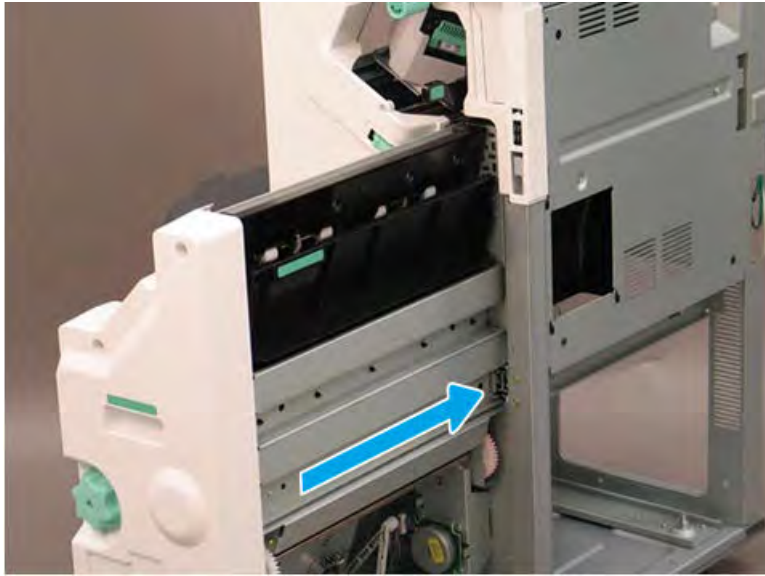

6. Remove one star-washer screw (callout 1) on the left side of the booklet maker.

Figure 5-1438 Remove one screw



7. Lift the booklet maker up on the left side while squeezing the right rail away from the finisher slightly to clear the sheet metal. Remove the booklet maker.

Figure 5-1439 Remove the booklet maker

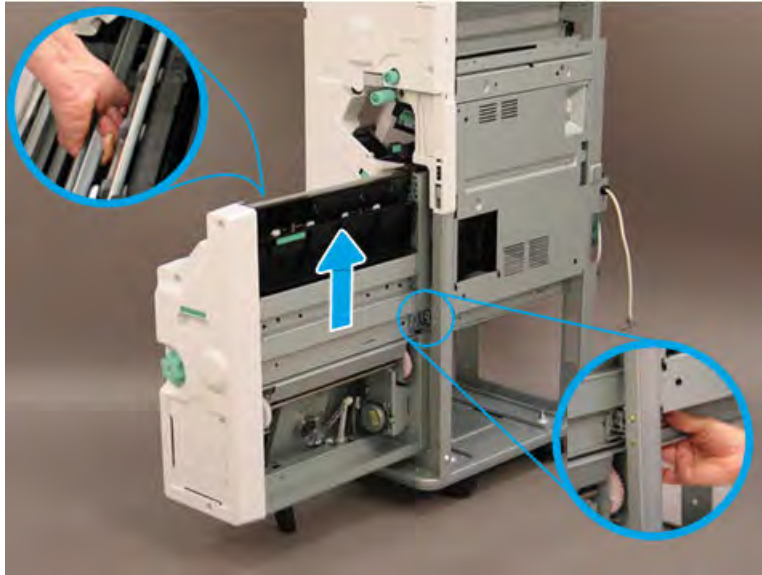

8. Reverse the removal steps to install the assembly. Also use the following special installation instructions.

 **NOTE:** Continue to reverse the removal steps to finish installing the assembly.

Special installation instructions: booklet maker

When installing the booklet maker, position the hooks on the rail under the slots on the booklet maker.

Figure 5-1440 Position the hooks

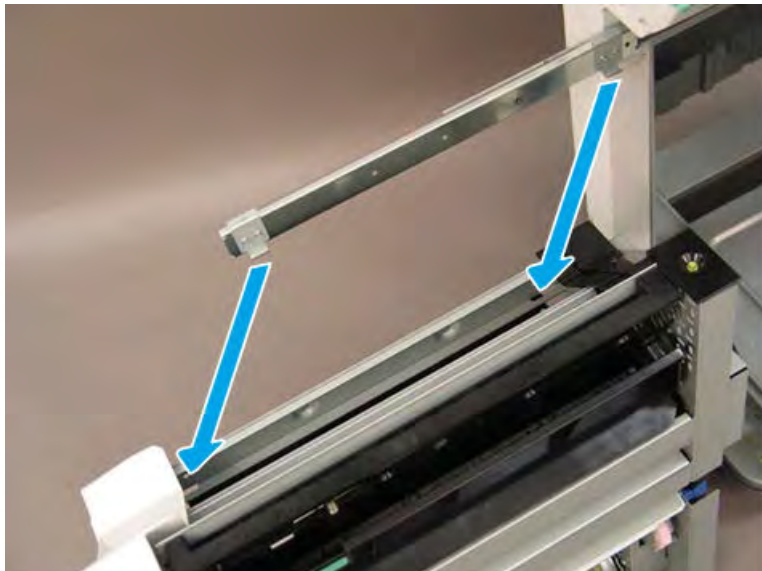

9. When installed correctly, the arrow on the front of the booklet maker aligns with the arrow on the finisher rail.

Figure 5-1441 Align arrows

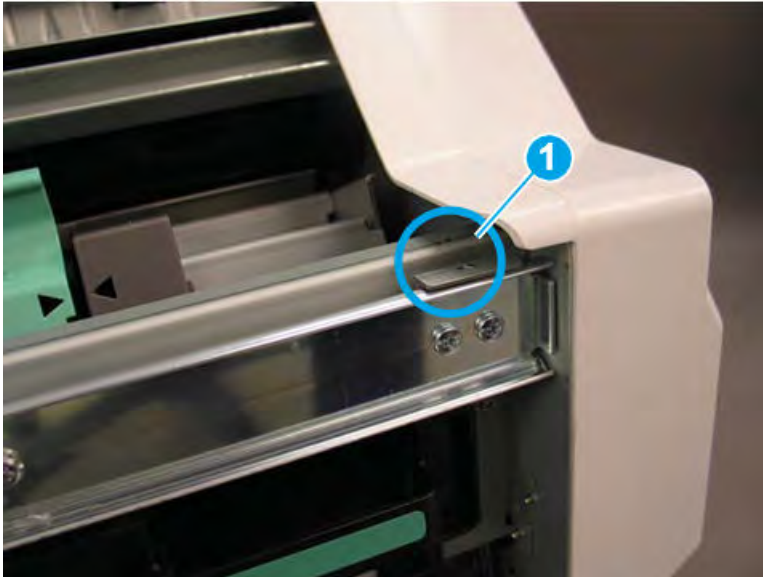

10. When installed correctly, the arrow on the back of the booklet maker aligns with the arrow on the finisher rail.

Figure 5-1442 Align arrows

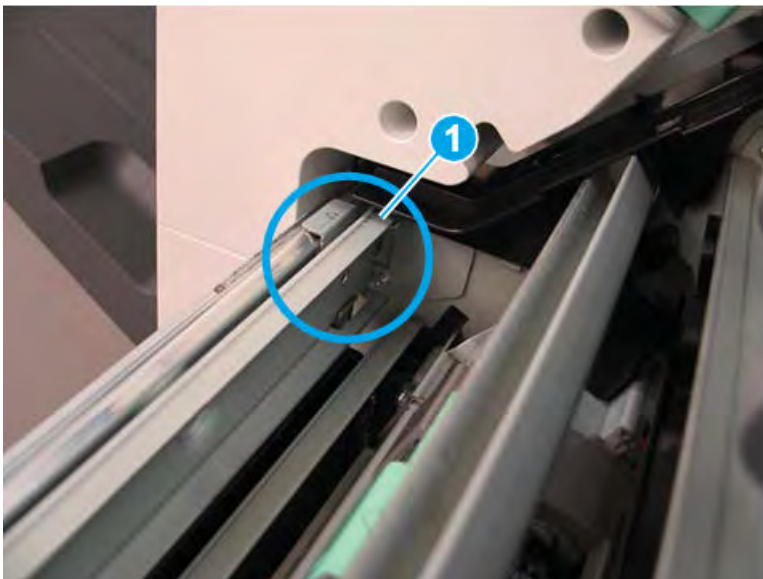

11. Extend the right rail away from the finisher and position it in the booklet maker slot.

Figure 5-1443 Extend the right rail



Unpack the replacement assembly



Follow these steps to unpack the replacement assembly.

1. Dispose of the defective part.

 **NOTE:** HP recommends responsible disposal of the defective part.

<http://www8.hp.com/us/en/hp-information/environment/product-recycling.html>

2. Unpack the replacement part from the packaging.

 **CAUTION:**  Some parts are sensitive to electrostatic discharge (ESD). Always perform service work at an ESD-protected workstation or mat. If an ESD workstation or mat is not available, touch the sheet-metal chassis to provide a static ground before touching an ESD-sensitive assembly. Protect the ESD-sensitive assemblies by placing them in ESD pouches when they are out of the printer.

 **IMPORTANT:** Make sure that all of the shipping materials (for example shipping tape) are removed from the replacement part prior to installation.

 **NOTE:** If the replacement part is a roller or pad, avoid touching the spongy part of it. Skin oils on the roller or pad can cause paper pickup and/or print-quality problems. HP recommends using disposable gloves when handling rollers or pads or washing your hands before touching rollers or pads.

3. To install an assembly, reverse the removal steps.

 **NOTE:** When applicable, special installation instructions are provided for an assembly at the end of the removal procedure. Always completely read the removal instructions and follow all special installation instructions.

Booklet entrance unit

Removal and replacement: Booklet entrance motor (M15)

Learn how to remove and replace the booklet entrance motor.

Introduction

This document provides the procedures to remove and replace the booklet entrance motor on the finisher.



IMPORTANT: When applicable, special installation instructions are provided for an assembly at the end of the removal procedure. Always completely read the removal instructions and follow all special installation instructions.

Before performing service

- Turn the printer power off. A shutting-down message appears on the control-panel display.
- ⚠ **WARNING!** To avoid damage to the printer, turn the power off and wait until the printer shuts down before removing the power cable.
- Disconnect the printer power cable after the printer has completely shut down (the control-panel display is blank).
- Release the finisher from the printer by pulling out on the release latch inside the finisher door.
- Disconnect the cable from the bridge unit to the finisher.
- Disconnect the cable from the finisher to the printer.

Use the table below to identify the correct part number for your printer. To order the part, go to <https://parts.hp.com>.

Table 5-144 Part information

Part number	Part description
JC93-01152A	Booklet entrance motor

Required tools

- #2 JIS screwdriver with a magnetic tip

After performing service

- Connect the cable from the finisher to the printer.
- Connect the cable from the bridge unit to the finisher.
- Attach the finisher to the printer, and then push in on the release latch inside the finisher door.
- Connect the printer power cable.
- Turn the printer power on.

Post service test

Process a job through the finisher and verify that the finisher works correctly.

Remove the booklet front cover

Follow these steps to remove the booklet front cover.

- ▲ Slide the booklet maker slightly away from the finisher (callout 1). Remove one screw (callout 2), and then slide the green knob away from the booklet maker to remove it (callout 3). Remove four screws (callout 4), and then remove the booklet front cover.

💡 **TIP:** Reverse the removal steps to install the assembly

Figure 5-1444 Remove five screws and the cover

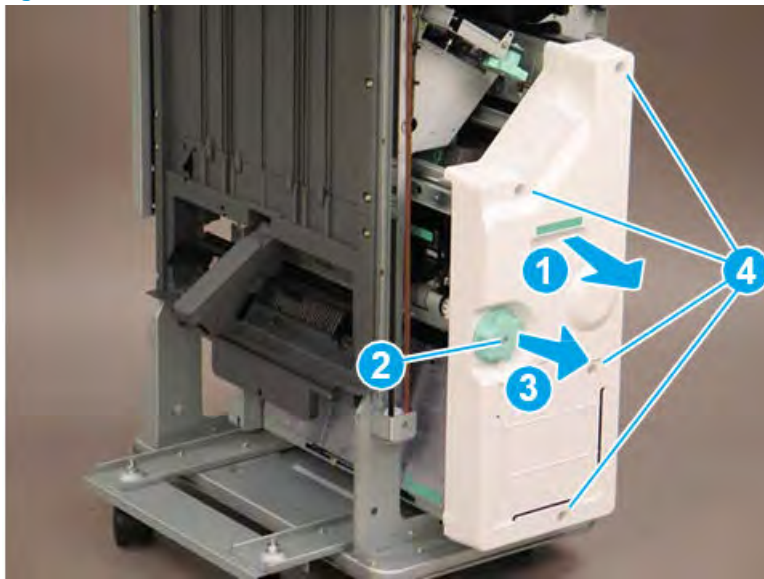

Remove the booklet entrance motor (M15)

Follow these steps to remove the booklet entrance motor (M15).

- ▲ Disconnect one connector (callout 1), and then remove two screws (callout 2). Lift the motor away from the booklet maker and release the belt (callout 3) from the back of the motor.

💡 **TIP:** Reverse the removal steps to install the assembly.

Figure 5-1445 Remove the booklet entrance motor

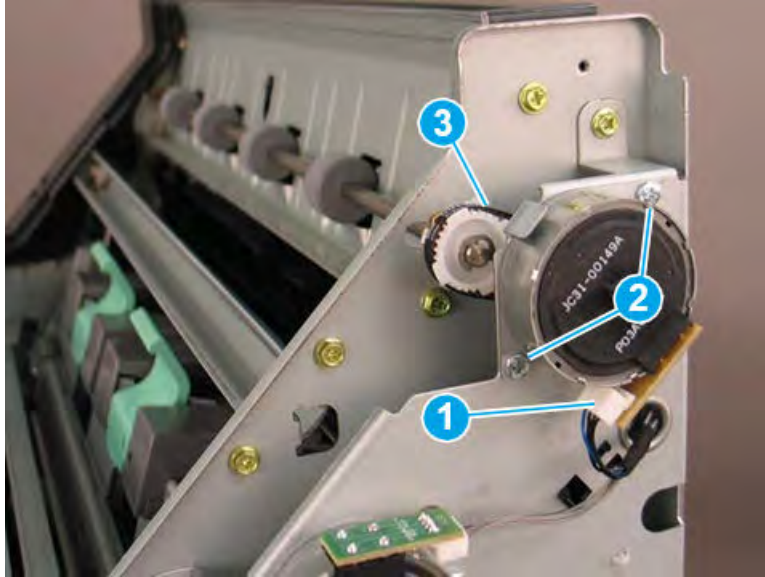

Unpack the replacement assembly



Follow these steps to unpack the replacement assembly.

1. Dispose of the defective part.

 **NOTE:** HP recommends responsible disposal of the defective part.

<http://www8.hp.com/us/en/hp-information/environment/product-recycling.html>

2. Unpack the replacement part from the packaging.

 **CAUTION:**  Some parts are sensitive to electrostatic discharge (ESD). Always perform service work at an ESD-protected workstation or mat. If an ESD workstation or mat is not available, touch the sheet-metal chassis to provide a static ground before touching an ESD-sensitive assembly. Protect the ESD-sensitive assemblies by placing them in ESD pouches when they are out of the printer.

 **IMPORTANT:** Make sure that all of the shipping materials (for example shipping tape) are removed from the replacement part prior to installation.

 **NOTE:** If the replacement part is a roller or pad, avoid touching the spongy part of it. Skin oils on the roller or pad can cause paper pickup and/or print-quality problems. HP recommends using disposable gloves when handling rollers or pads or washing your hands before touching rollers or pads.

3. To install an assembly, reverse the removal steps.

 **NOTE:** When applicable, special installation instructions are provided for an assembly at the end of the removal procedure. Always completely read the removal instructions and follow all special installation instructions.

Removal and replacement: Booklet entrance sensor (S36)

Learn how to remove and replace the booklet entrance sensor.

Introduction

This document provides the procedures to remove and replace the booklet entrance sensor on the finisher.



IMPORTANT: When applicable, special installation instructions are provided for an assembly at the end of the removal procedure. Always completely read the removal instructions and follow all special installation instructions.

Before performing service

- Turn the printer power off. A shutting-down message appears on the control-panel display.
- ⚠ **WARNING!** To avoid damage to the printer, turn the power off and wait until the printer shuts down before removing the power cable.
- Disconnect the printer power cable after the printer has completely shut down (the control-panel display is blank).
- Release the finisher from the printer by pulling out on the release latch inside the finisher door.
- Disconnect the cable from the bridge unit to the finisher.
- Disconnect the cable from the finisher to the printer.

Use the table below to identify the correct part number for your printer. To order the part, go to <https://parts.hp.com>.

Table 5-145 Part information

Part number	Part description
0604-001415	Booklet entrance sensor

Required tools

- #2 JIS screwdriver with a magnetic tip

After performing service

- Connect the cable from the finisher to the printer.
- Connect the cable from the bridge unit to the finisher.
- Attach the finisher to the printer, and then push in on the release latch inside the finisher door.
- Connect the printer power cable.
- Turn the printer power on.

Post service test

Process a job through the finisher and verify that the finisher works correctly.

Remove the right upper cover (finisher)

Follow these steps to remove the right upper cover (finisher).

- ▲ Remove one screw cap and three machine screws on the upper edge of the cover (callout 1). Remove three sheet metal screws (callout 2) on the lower portion of the cover. Rotate the right edge of the cover away from the finisher, and then slide the cover right to release three tabs (callout 3).

💡 **TIP:** The lower screws are shorter in length than the upper screws.

TIP: Reverse the removal steps to install the assembly.

Figure 5-1446 Remove the right upper cover

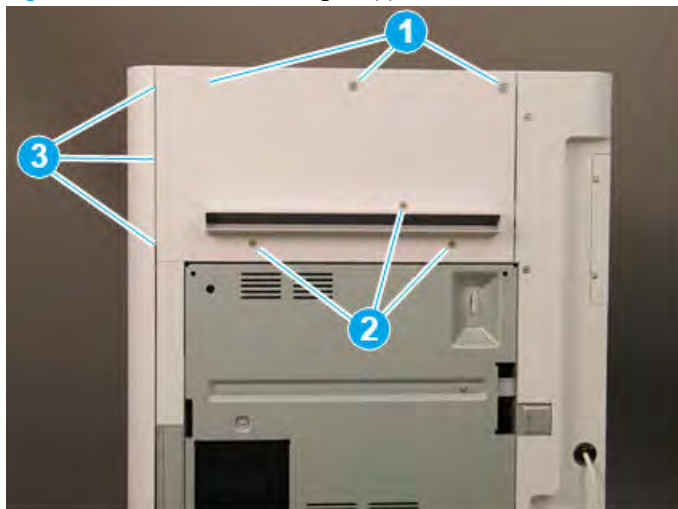

Remove the top cover (finisher)

Follow these steps to remove the top cover (finisher).

1. Remove three screw caps and three self-tapping screws at the top of the rear cover (callout 1), and then remove three machine screws (callout 2) on top of the cover.

Figure 5-1447 Remove six screws

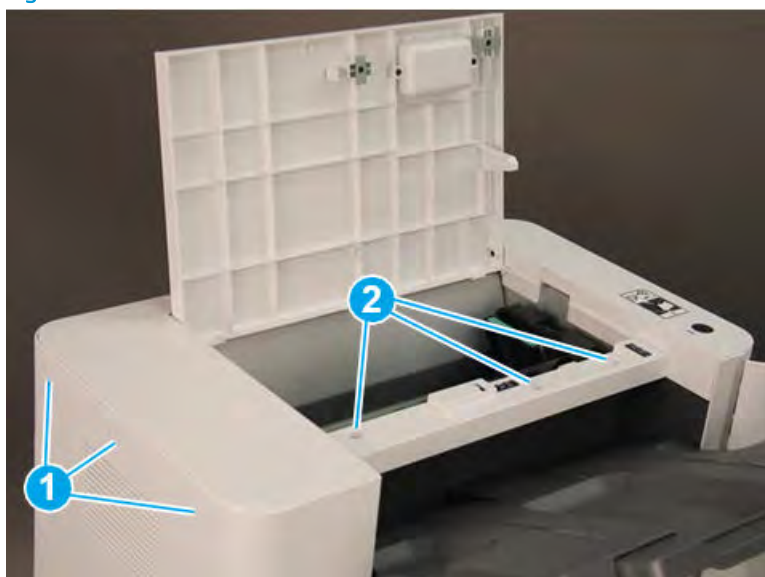

2. Remove three self-tapping screws at the top of the front cover (callout 1), and then remove two machine screws (callout 2) at the top of the right side.

Figure 5-1448 Remove five screws

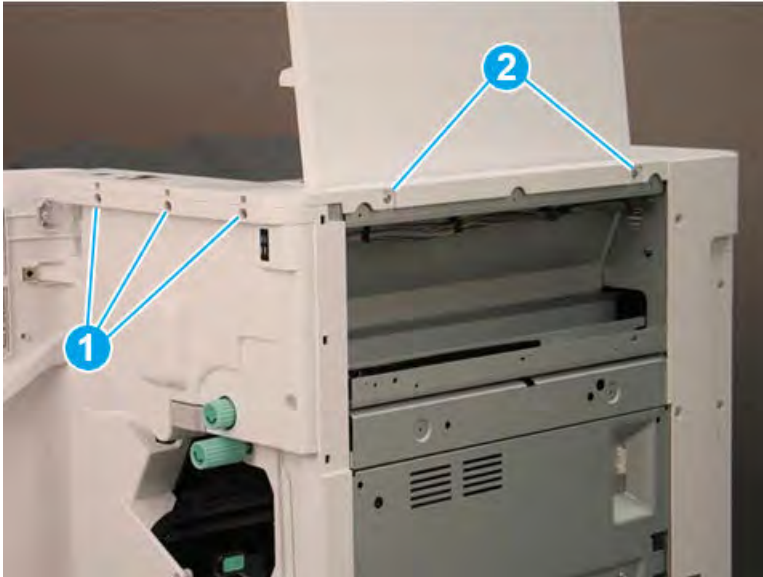

3. Lift the cover up slightly. Disconnect one in-line connector (callout 1), and then release one retainer (callout 2).

 **TIP:** Reverse the removal steps to install the assembly.

Figure 5-1449 Disconnect one connector and release retainer



Remove the rear cover (finisher)

Follow these steps to remove the rear cover (finisher).

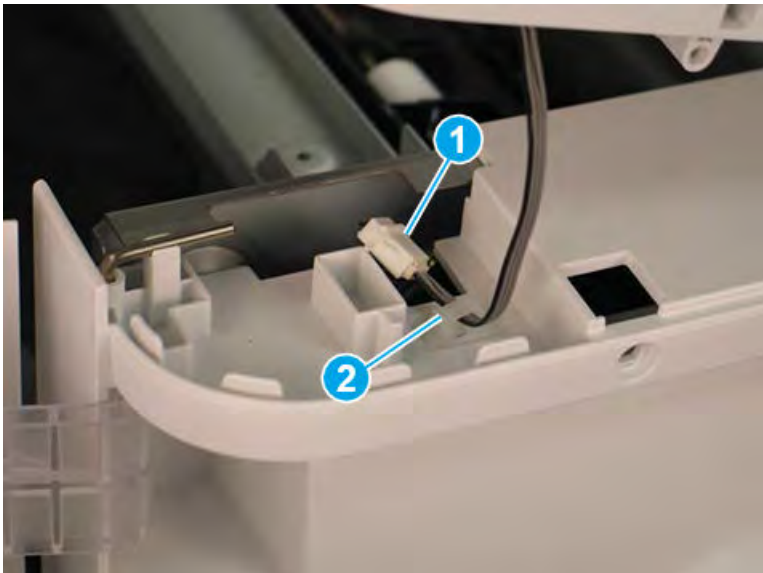
1. Remove two self-tapping screws (callout 1) on the top of the rear cover, and then remove five screw caps and five machine screws (callout 2) on the left side of the cover.

Figure 5-1450 Remove seven screws

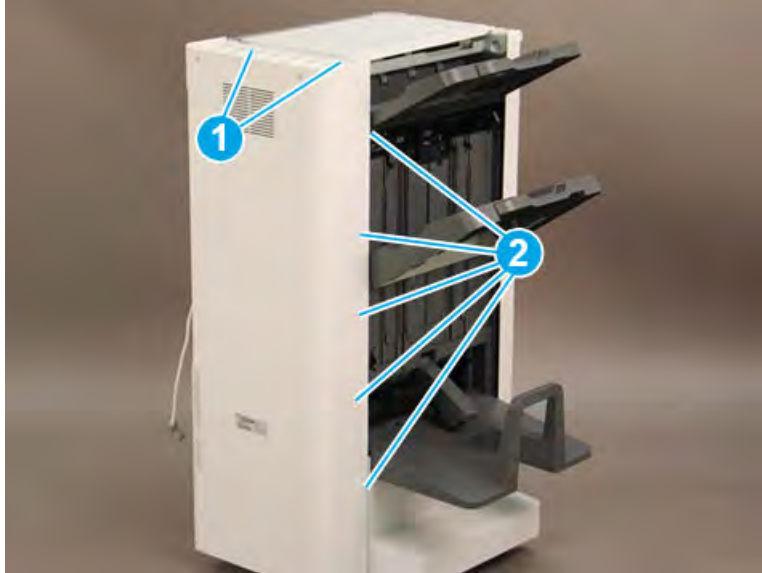

2. Remove one screw cap and four machine screws (callout 1) Remove the rear cover.

 **NOTE:** Make sure to thread the power cable (callout 2) through the opening in the cover.

 **TIP:** Reverse the removal steps to install the assembly

Figure 5-1451 Remove the rear cover



Remove the booklet maker

Follow these steps to remove the booklet maker.

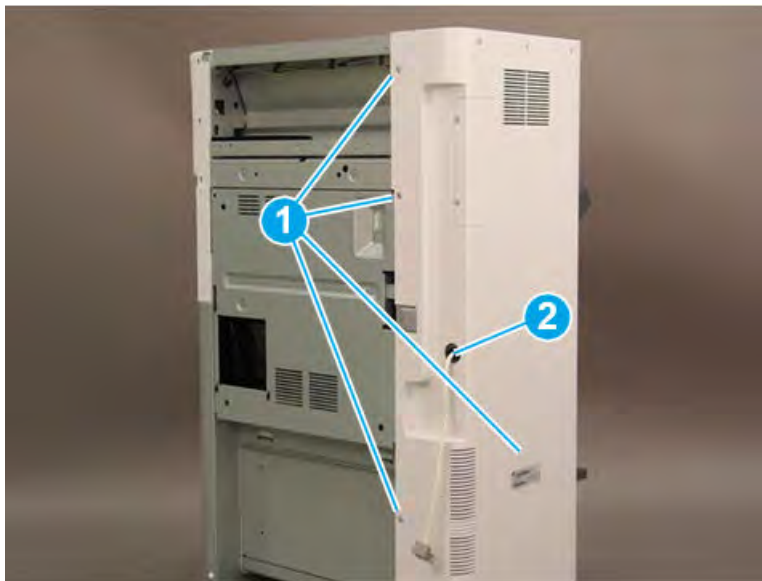
1. Slide the booklet maker away from the finisher.

Figure 5-1452 Slide the booklet maker away from the finisher



2. At the Disconnect one connector (callout 1), and then remove one screw (callout 2).

Figure 5-1453 Disconnect one connector and remove one screw

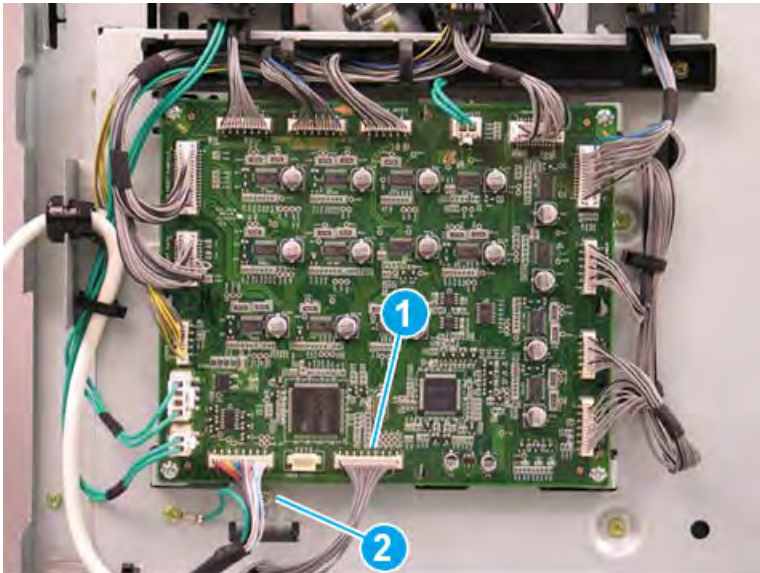

3. Release the metal bracket through the opening in the sheet metal.

Figure 5-1454 Release the metal bracket

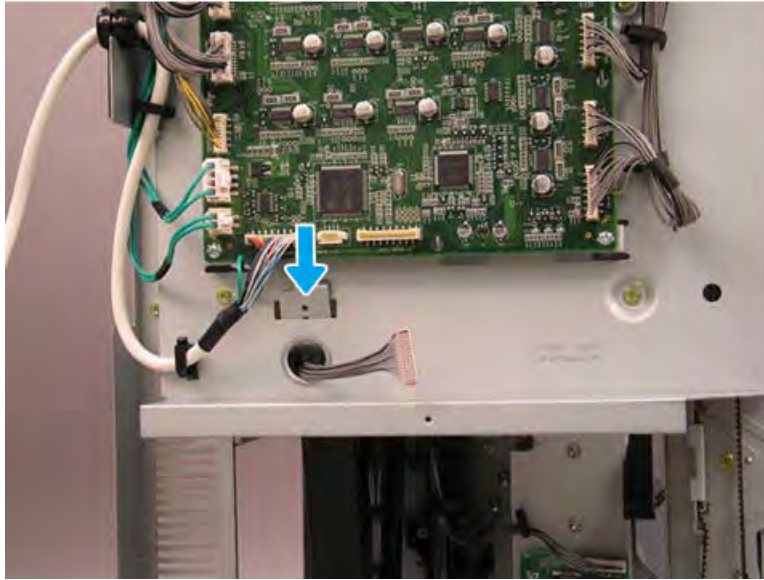

4. Remove one star-washer screw (callout 1), and then release the alignment pin (callout 2) on the right side of the booklet maker.

Figure 5-1455 Remove one screw

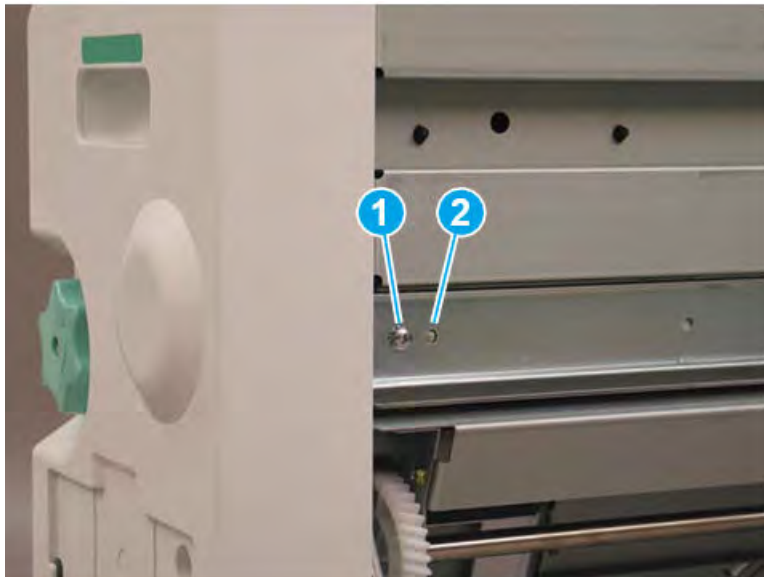

5. Slide the right rail toward the finisher.

Figure 5-1456 Slide the right rail

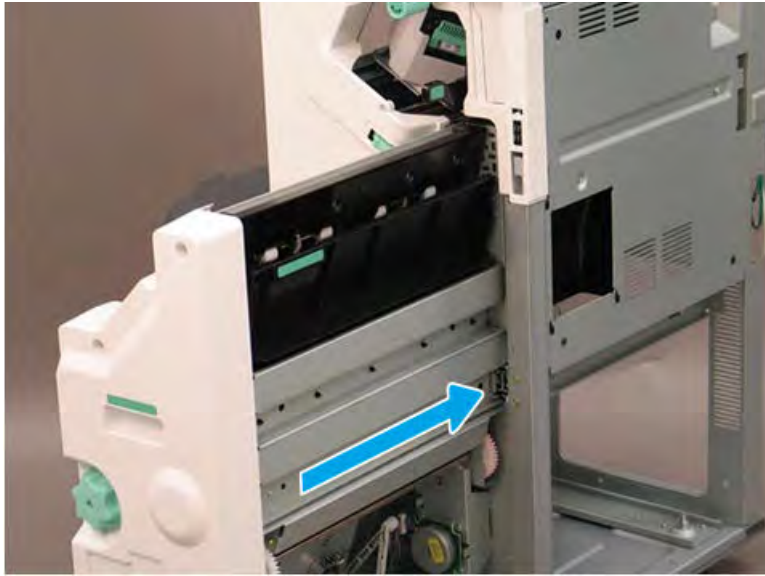

6. Remove one star-washer screw (callout 1) on the left side of the booklet maker.

Figure 5-1457 Remove one screw

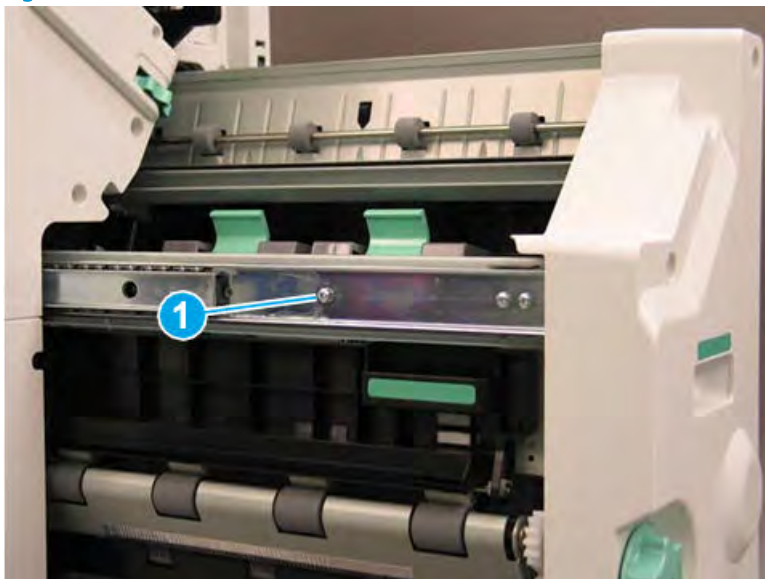

7. Lift the booklet maker up on the left side while squeezing the right rail away from the finisher slightly to clear the sheet metal. Remove the booklet maker.

Figure 5-1458 Remove the booklet maker

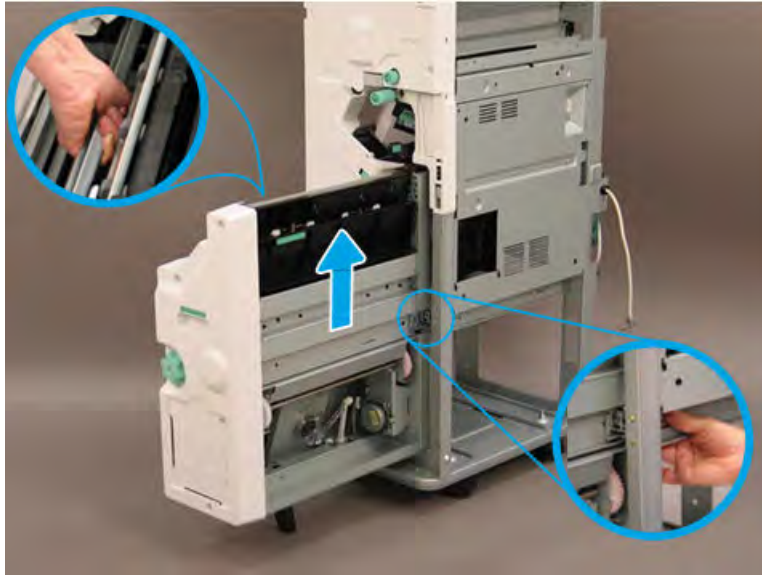

8. Reverse the removal steps to install the assembly. Also use the following special installation instructions.

 **NOTE:** Continue to reverse the removal steps to finish installing the assembly.

Special installation instructions: booklet maker

When installing the booklet maker, position the hooks on the rail under the slots on the booklet maker.

Figure 5-1459 Position the hooks

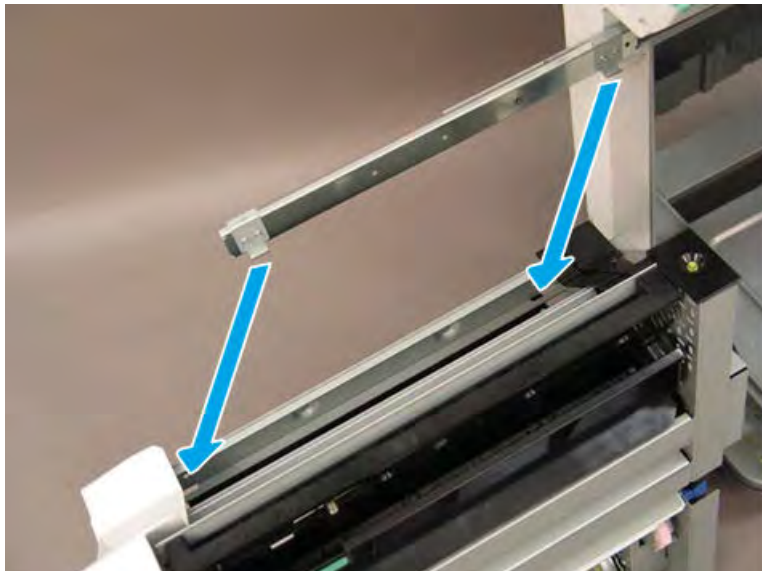

9. When installed correctly, the arrow on the front of the booklet maker aligns with the arrow on the finisher rail.

Figure 5-1460 Align arrows

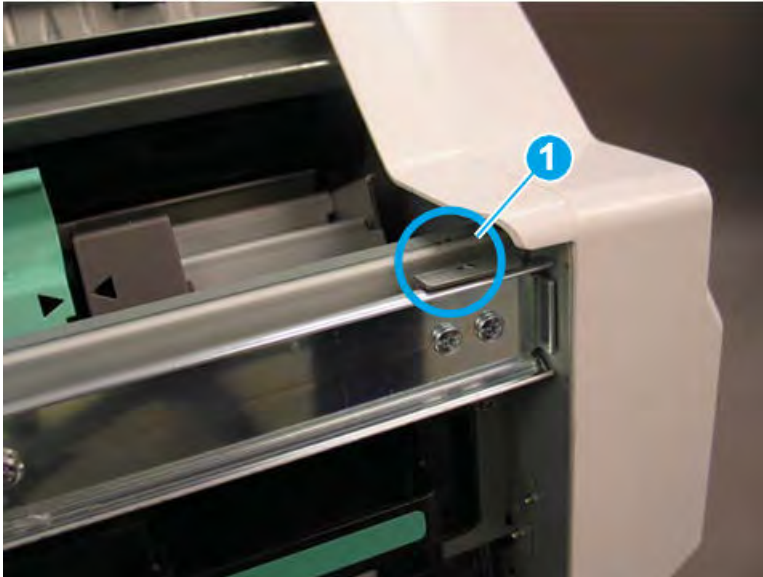

10. When installed correctly, the arrow on the back of the booklet maker aligns with the arrow on the finisher rail.

Figure 5-1461 Align arrows

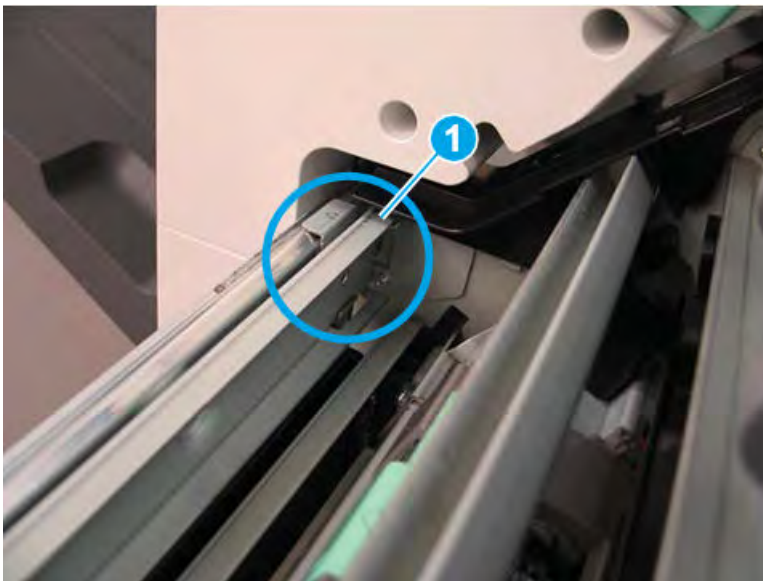

11. Extend the right rail away from the finisher and position it in the booklet maker slot.

Figure 5-1462 Extend the right rail



Remove the booklet entrance unit

Follow these steps to remove the booklet entrance unit.

1. Remove two screws (callout 1) then remove the black cover (callout 2)

Figure 5-1463 Remove two screws then remove the black cover

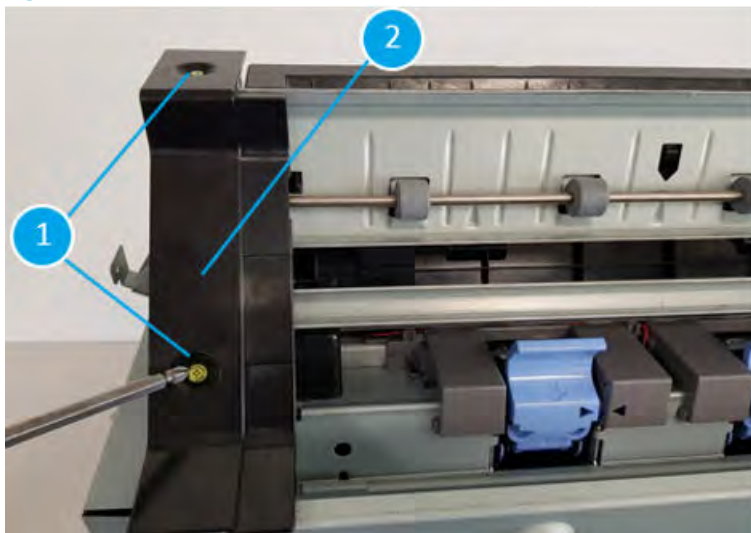

2. Remove two screws(callout 1) and disconnect one connector(callout 2)

Figure 5-1464 Remove two screws and disconnect one connector

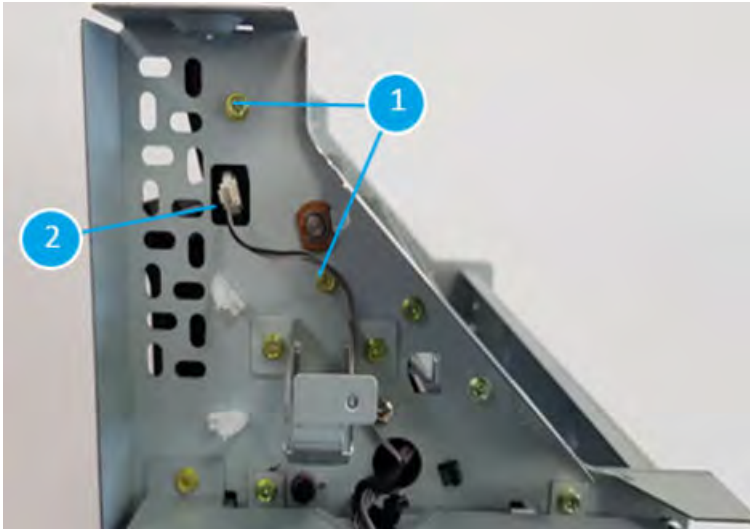

3. Remove two screws(callout 1)

Figure 5-1465 Remove two screws

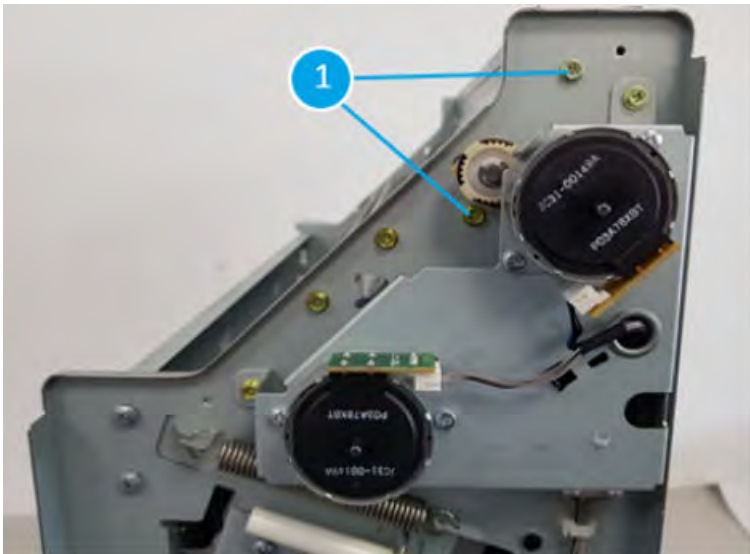

4. Remove two screws (callout 1) to make it easy to pull off the booklet entrance unit (callout 2)

Figure 5-1466 Remove two screws to make it easy to pull off the booklet entrance unit

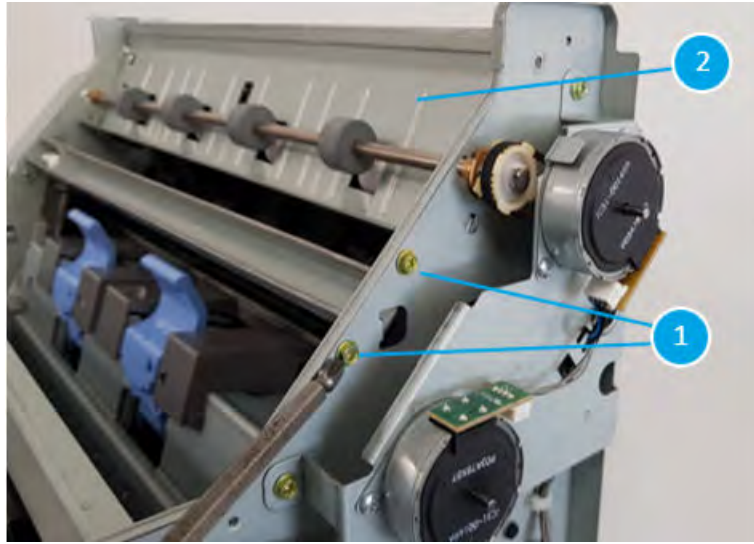

5. Remove the booklet entrance unit (callout 1)

Figure 5-1467 Remove the booklet entrance unit

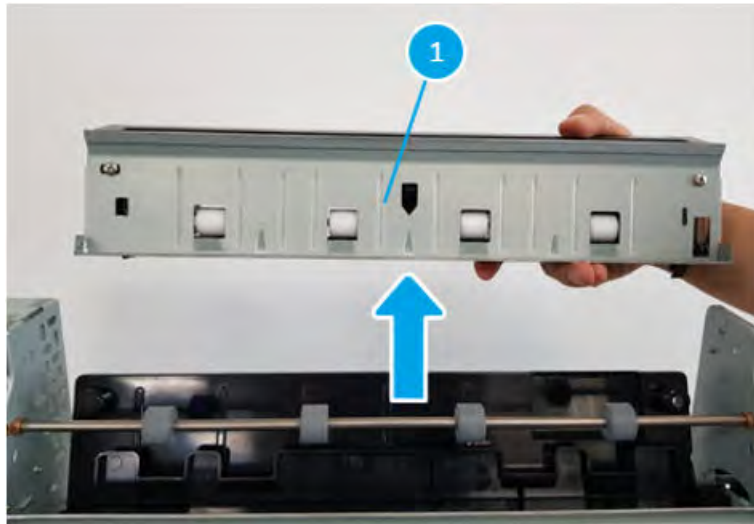

Remove the booklet entrance sensor (S36)

Follow these steps to remove the booklet entrance sensor (S36).

1. Entrance unit (callout 1)

Figure 5-1468 Entrance unit

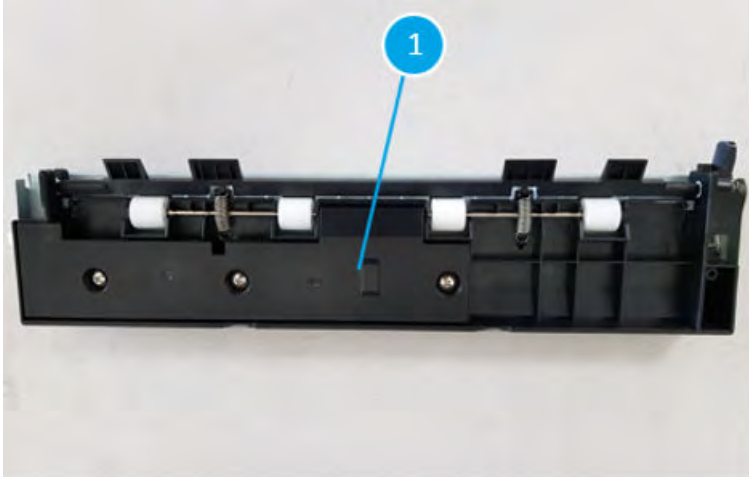

2. Unplug one connector (callout 1)

Figure 5-1469 Unplug one connector

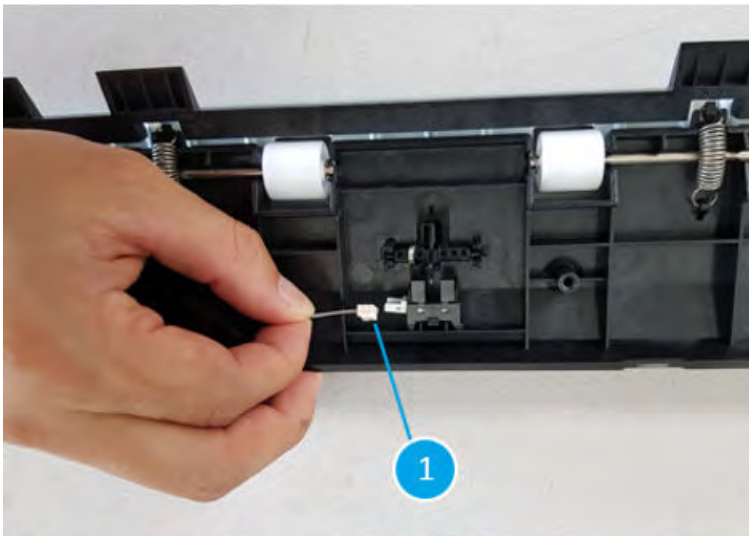

3. Use a tweezer to remove the entrance sensor (S36, callout1)

Figure 5-1470 Remove the entrance sensor

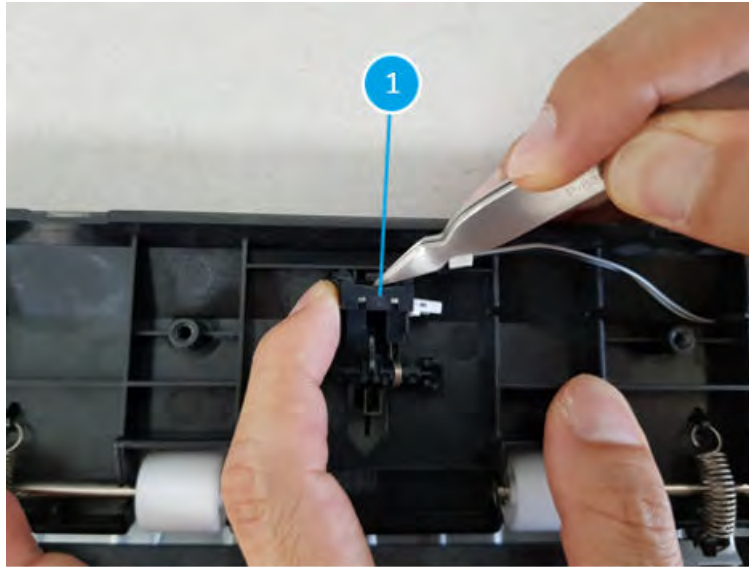

Unpack the replacement assembly

Follow these steps to unpack the replacement assembly.

1. Dispose of the defective part.



NOTE: HP recommends responsible disposal of the defective part.

<http://www8.hp.com/us/en/hp-information/environment/product-recycling.html>

2. Unpack the replacement part from the packaging.



CAUTION:  Some parts are sensitive to electrostatic discharge (ESD). Always perform service work at an ESD-protected workstation or mat. If an ESD workstation or mat is not available, touch the sheet-metal chassis to provide a static ground before touching an ESD-sensitive assembly. Protect the ESD-sensitive assemblies by placing them in ESD pouches when they are out of the printer.



IMPORTANT: Make sure that all of the shipping materials (for example shipping tape) are removed from the replacement part prior to installation.



NOTE: If the replacement part is a roller or pad, avoid touching the spongy part of it. Skin oils on the roller or pad can cause paper pickup and/or print-quality problems. HP recommends using disposable gloves when handling rollers or pads or washing your hands before touching rollers or pads.

3. To install an assembly, reverse the removal steps.



NOTE: When applicable, special installation instructions are provided for an assembly at the end of the removal procedure. Always completely read the removal instructions and follow all special installation instructions.

Booklet paddle unit

Removal and replacement: Booklet paddle motor (M19)

Learn how to remove and replace the booklet paddle motor.

Introduction

This document provides the procedures to remove and replace the booklet paddle motor on the finisher.



IMPORTANT: When applicable, special installation instructions are provided for an assembly at the end of the removal procedure. Always completely read the removal instructions and follow all special installation instructions.

Before performing service

- Turn the printer power off. A shutting-down message appears on the control-panel display.
- ⚠ **WARNING!** To avoid damage to the printer, turn the power off and wait until the printer shuts down before removing the power cable.
- Disconnect the printer power cable after the printer has completely shut down (the control-panel display is blank).
- Release the finisher from the printer by pulling out on the release latch inside the finisher door.
- Disconnect the cable from the bridge unit to the finisher.
- Disconnect the cable from the finisher to the printer.

Use the table below to identify the correct part number for your printer. To order the part, go to <https://parts.hp.com>.

Table 5-146 Part information

Part number	Part description
JC93-01001A	Booklet paddle motor
JC90-01430A	Booklet paddle motor assembly

Required tools

- #2 JIS screwdriver with a magnetic tip

After performing service

- Connect the cable from the finisher to the printer.
- Connect the cable from the bridge unit to the finisher.
- Attach the finisher to the printer, and then push in on the release latch inside the finisher door.
- Connect the printer power cable.
- Turn the printer power on.

Post service test

Process a job through the finisher and verify that the finisher works correctly.

Remove the booklet front cover

Follow these steps to remove the booklet front cover.

- ▲ Slide the booklet maker slightly away from the finisher (callout 1). Remove one screw (callout 2), and then slide the green knob away from the booklet maker to remove it (callout 3). Remove four screws (callout 4), and then remove the booklet front cover.

 **TIP:** Reverse the removal steps to install the assembly

Figure 5-1471 Remove five screws and the cover



Remove the booklet paddle motor (M19)

Follow these steps to remove the booklet paddle motor (M19).

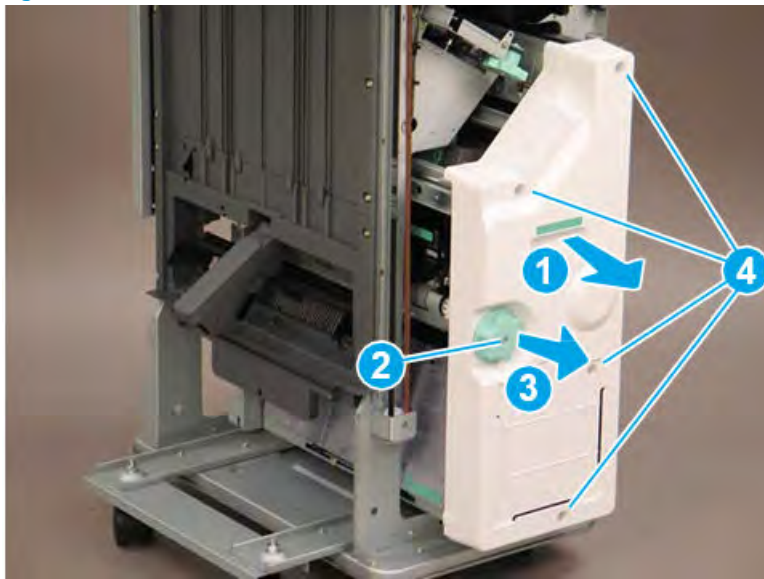
1. Remove two screws (callout 1)

Figure 5-1472 Remove two screws

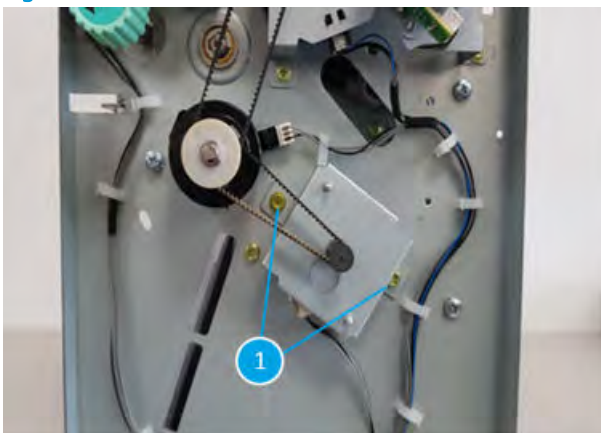

2. Remove the booklet paddle motor (M19, callout 1) and unplug one connector (callout 2)

Figure 5-1473 Remove the booklet paddle motor and unplug one connector

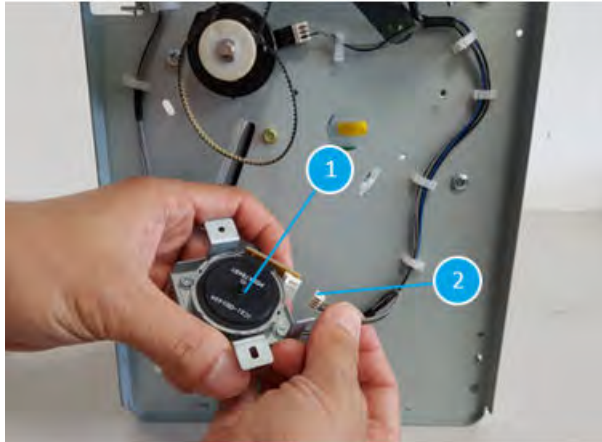

Unpack the replacement assembly



Follow these steps to unpack the replacement assembly.

1. Dispose of the defective part.

 **NOTE:** HP recommends responsible disposal of the defective part.

<http://www8.hp.com/us/en/hp-information/environment/product-recycling.html>

2. Unpack the replacement part from the packaging.

 **CAUTION:**  Some parts are sensitive to electrostatic discharge (ESD). Always perform service work at an ESD-protected workstation or mat. If an ESD workstation or mat is not available, touch the sheet-metal chassis to provide a static ground before touching an ESD-sensitive assembly. Protect the ESD-sensitive assemblies by placing them in ESD pouches when they are out of the printer.

 **IMPORTANT:** Make sure that all of the shipping materials (for example shipping tape) are removed from the replacement part prior to installation.

 **NOTE:** If the replacement part is a roller or pad, avoid touching the spongy part of it. Skin oils on the roller or pad can cause paper pickup and/or print-quality problems. HP recommends using disposable gloves when handling rollers or pads or washing your hands before touching rollers or pads.

3. To install an assembly, reverse the removal steps.

 **NOTE:** When applicable, special installation instructions are provided for an assembly at the end of the removal procedure. Always completely read the removal instructions and follow all special installation instructions.

Removal and replacement: Booklet paddle home sensor (S41)

Learn how to remove and replace the booklet paddle home sensor.

Introduction

This document provides the procedures to remove and replace the booklet paddle home sensor on the finisher.



IMPORTANT: When applicable, special installation instructions are provided for an assembly at the end of the removal procedure. Always completely read the removal instructions and follow all special installation instructions.

Before performing service

- Turn the printer power off. A shutting-down message appears on the control-panel display.
- ⚠ **WARNING!** To avoid damage to the printer, turn the power off and wait until the printer shuts down before removing the power cable.
- Disconnect the printer power cable after the printer has completely shut down (the control-panel display is blank).
- Release the finisher from the printer by pulling out on the release latch inside the finisher door.
- Disconnect the cable from the bridge unit to the finisher.
- Disconnect the cable from the finisher to the printer.

Use the table below to identify the correct part number for your printer. To order the part, go to <https://parts.hp.com>.

Table 5-147 Part information

Part number	Part description
0604-001393	Booklet paddle home sensor

Required tools

- #2 JIS screwdriver with a magnetic tip

After performing service

- Connect the cable from the finisher to the printer.
- Connect the cable from the bridge unit to the finisher.
- Attach the finisher to the printer, and then push in on the release latch inside the finisher door.
- Connect the printer power cable.
- Turn the printer power on.

Post service test

Process a job through the finisher and verify that the finisher works correctly.

Remove the right upper cover (finisher)

Follow these steps to remove the right upper cover (finisher).

- ▲ Remove one screw cap and three machine screws on the upper edge of the cover (callout 1). Remove three sheet metal screws (callout 2) on the lower portion of the cover. Rotate the right edge of the cover away from the finisher, and then slide the cover right to release three tabs (callout 3).

💡 **TIP:** The lower screws are shorter in length than the upper screws.

TIP: Reverse the removal steps to install the assembly.

Figure 5-1474 Remove the right upper cover

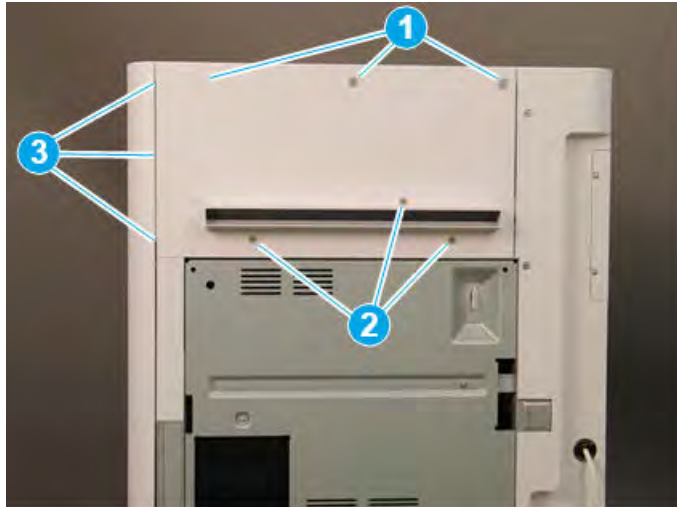

Remove the top cover (finisher)

Follow these steps to remove the top cover (finisher).

1. Remove three screw caps and three self-tapping screws at the top of the rear cover (callout 1), and then remove three machine screws (callout 2) on top of the cover.

Figure 5-1475 Remove six screws

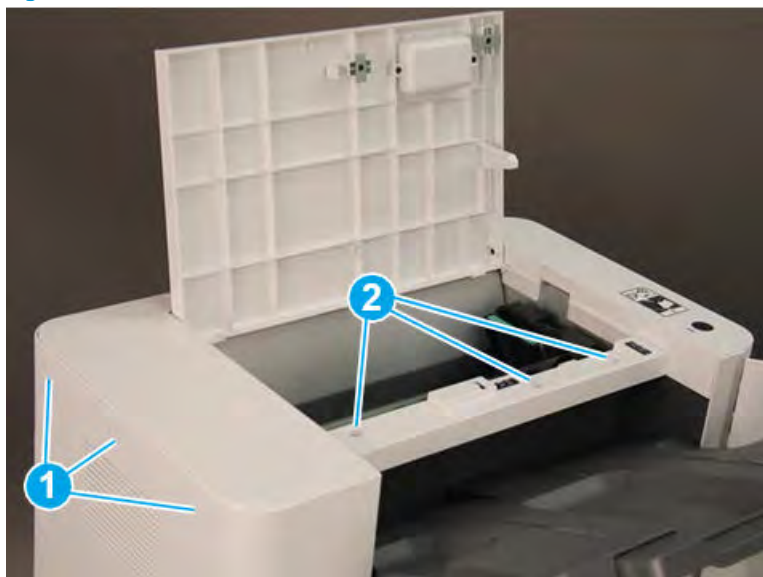

2. Remove three self-tapping screws at the top of the front cover (callout 1), and then remove two machine screws (callout 2) at the top of the right side.

Figure 5-1476 Remove five screws

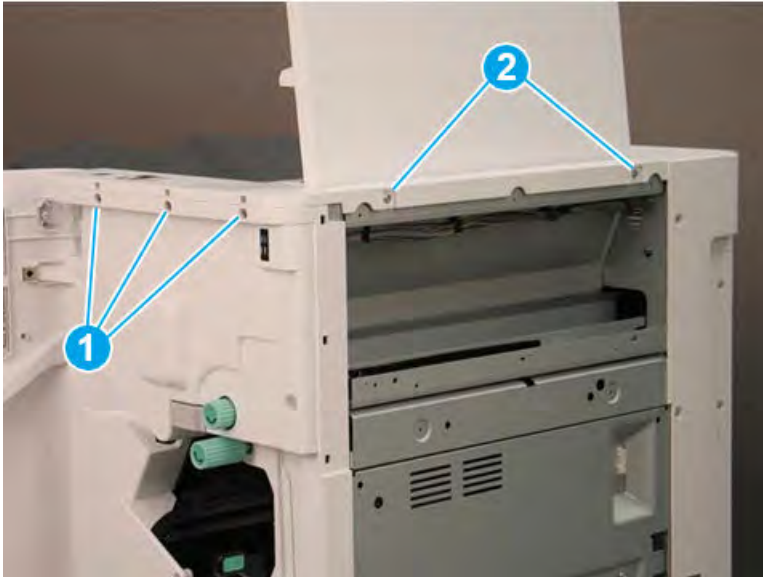

3. Lift the cover up slightly. Disconnect one in-line connector (callout 1), and then release one retainer (callout 2).

 **TIP:** Reverse the removal steps to install the assembly.

Figure 5-1477 Disconnect one connector and release retainer



Remove the rear cover (finisher)

Follow these steps to remove the rear cover (finisher).

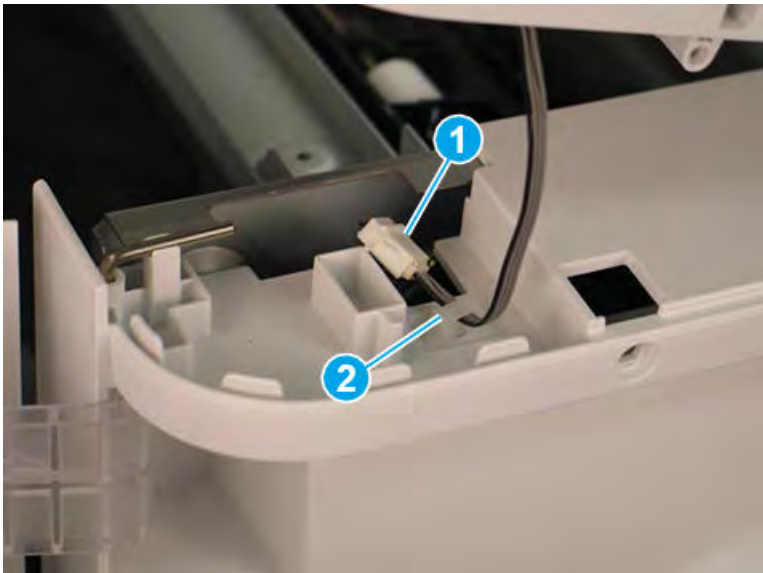
1. Remove two self-tapping screws (callout 1) on the top of the rear cover, and then remove five screw caps and five machine screws (callout 2) on the left side of the cover.

Figure 5-1478 Remove seven screws

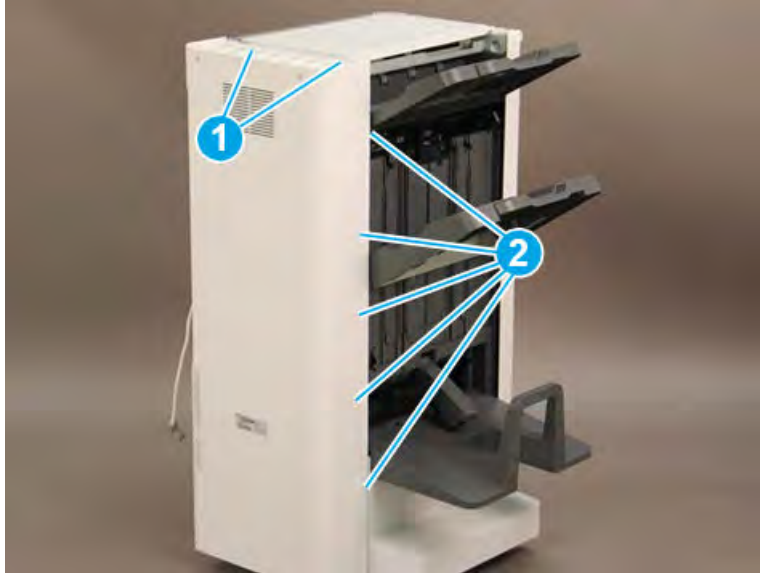

2. Remove one screw cap and four machine screws (callout 1) Remove the rear cover.

 **NOTE:** Make sure to thread the power cable (callout 2) through the opening in the cover.

 **TIP:** Reverse the removal steps to install the assembly

Figure 5-1479 Remove the rear cover

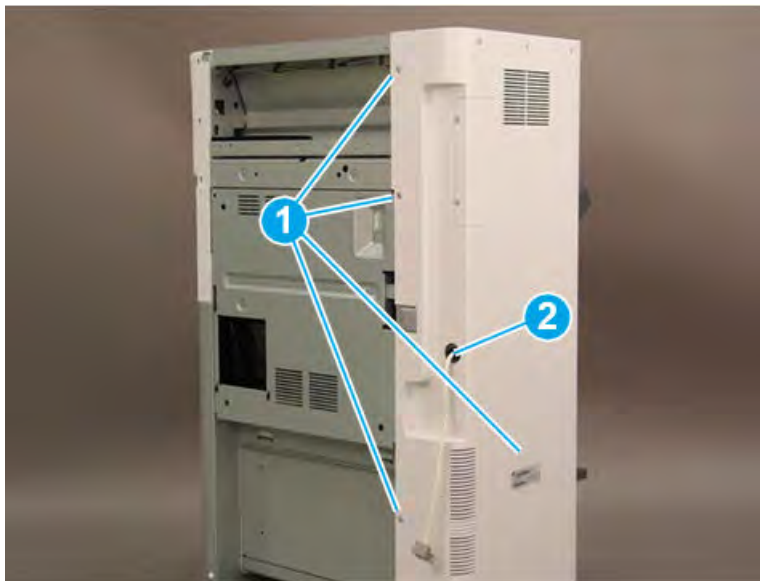

Remove the booklet front cover

Follow these steps to remove the booklet front cover.

- ▲ Slide the booklet maker slightly away from the finisher (callout 1). Remove one screw (callout 2), and then slide the green knob away from the booklet maker to remove it (callout 3). Remove four screws (callout 4), and then remove the booklet front cover.

 **TIP:** Reverse the removal steps to install the assembly

Figure 5-1480 Remove five screws and the cover



Remove the booklet right lower shield

Follow these steps to remove the booklet right lower shield.

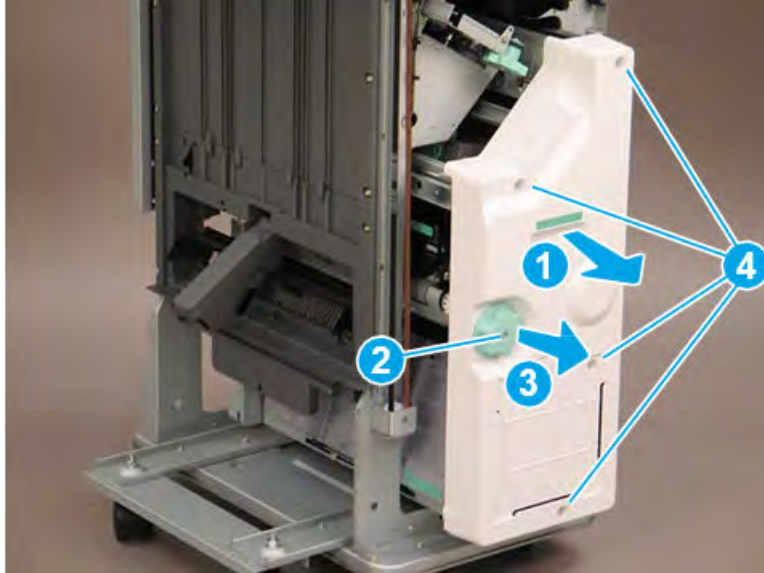
1. Remove two screws at the front of the booklet maker (callout 1).

Figure 5-1481 Remove two screws

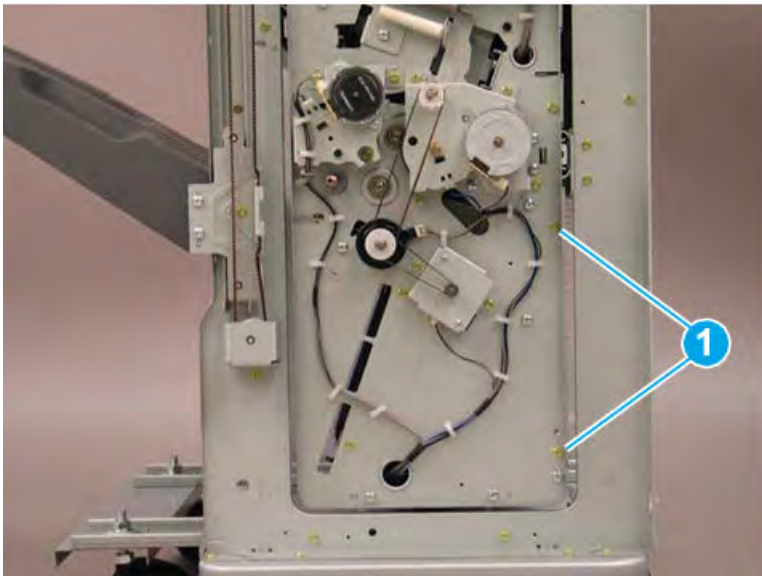

2. Remove two screws at the back of the booklet maker (callout 1).

Figure 5-1482 Remove two screws

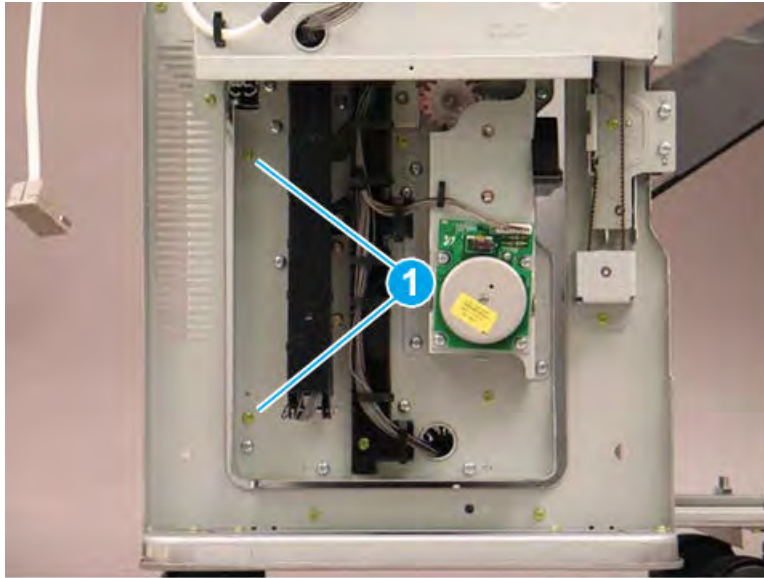

3. Slide the booklet maker out of the finisher (callout 1), and then rotate the top of the right lower shield (callout 2) away from the booklet maker to remove it.

Figure 5-1483 Remove the right lower shield

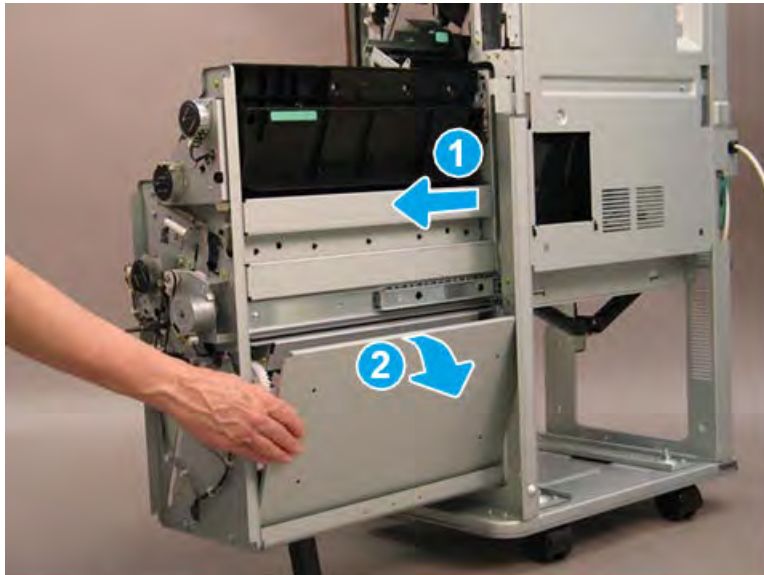

Remove the booklet paddle motor (M19)

Follow these steps to remove the booklet paddle motor (M19).

1. Remove two screws (callout 1)

Figure 5-1484 Remove two screws

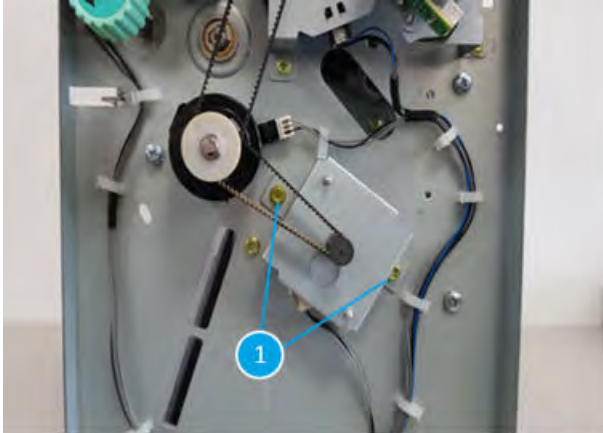

2. Remove the booklet paddle motor (M19, callout 1) and unplug one connector (callout 2)

Figure 5-1485 Remove the booklet paddle motor and unplug one connector

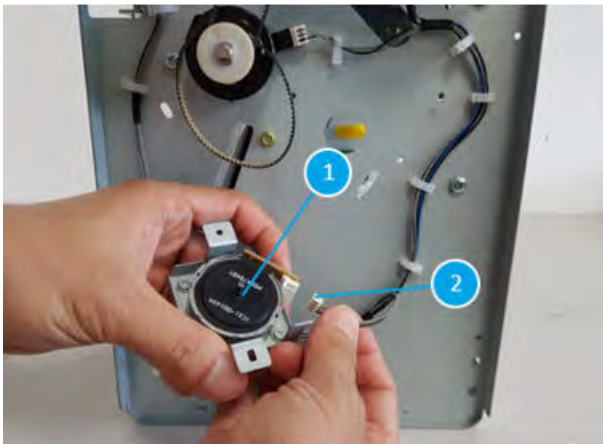

Remove the booklet paddle home sensor (S41)

Follow these steps to remove the booklet paddle home sensor (S41).

1. Remove one e-clip on top of the white washer and then remove the white washer (callout 1)

Figure 5-1486 Remove white washer



2. Remove two belts (callout 1)

Figure 5-1487 Remove two belts

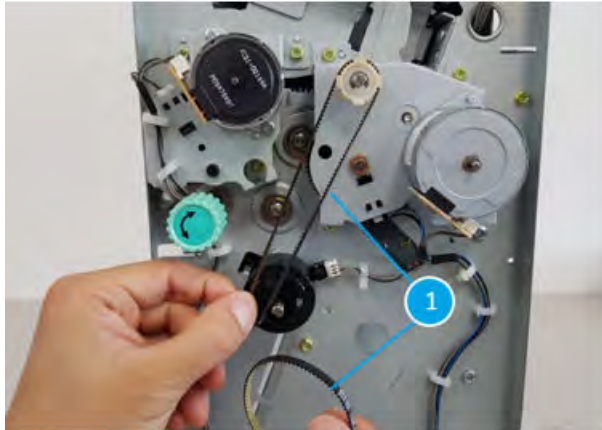

3. Remove the black actuator (callout 1)

Figure 5-1488 Remove the black actuator

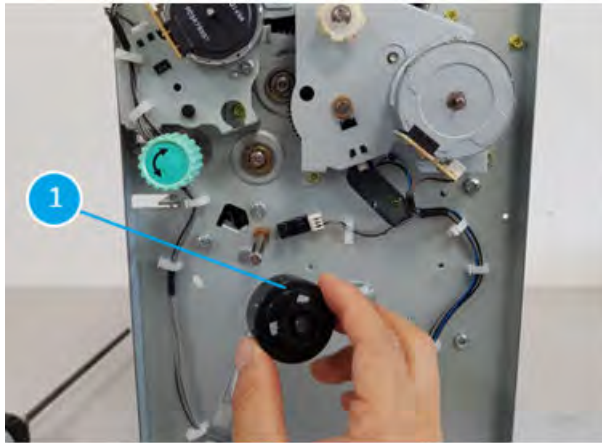

4. Unplug one connector (callout 1)

Figure 5-1489 Unplug one connector

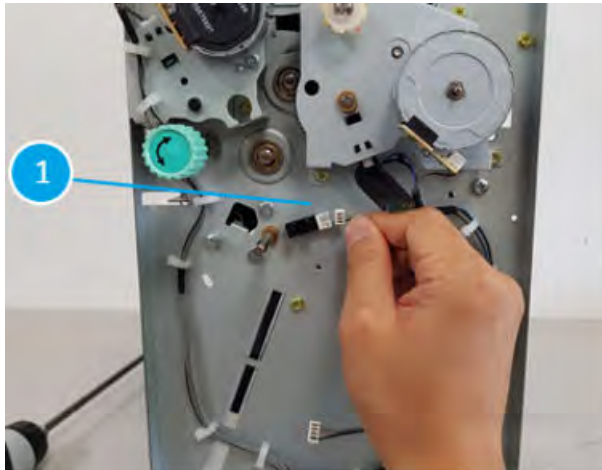

5. Use a tweezer to remove the Booklet paddle home sensor (S41, callout 1) from the left side

Figure 5-1490 Use a tweezer to remove the Booklet paddle home sensor



Unpack the replacement assembly



Follow these steps to unpack the replacement assembly.

1. Dispose of the defective part.

 **NOTE:** HP recommends responsible disposal of the defective part.

<http://www8.hp.com/us/en/hp-information/environment/product-recycling.html>

2. Unpack the replacement part from the packaging.

 **CAUTION:**  Some parts are sensitive to electrostatic discharge (ESD). Always perform service work at an ESD-protected workstation or mat. If an ESD workstation or mat is not available, touch the sheet-metal chassis to provide a static ground before touching an ESD-sensitive assembly. Protect the ESD-sensitive assemblies by placing them in ESD pouches when they are out of the printer.

 **IMPORTANT:** Make sure that all of the shipping materials (for example shipping tape) are removed from the replacement part prior to installation.

 **NOTE:** If the replacement part is a roller or pad, avoid touching the spongy part of it. Skin oils on the roller or pad can cause paper pickup and/or print-quality problems. HP recommends using disposable gloves when handling rollers or pads or washing your hands before touching rollers or pads.

3. To install an assembly, reverse the removal steps.

 **NOTE:** When applicable, special installation instructions are provided for an assembly at the end of the removal procedure. Always completely read the removal instructions and follow all special installation instructions.

Booklet end fence unit

Removal and replacement: Booklet end fence unit

Learn how to remove and replace the booklet end fence.

Introduction

This document provides the procedures to remove and replace the booklet end fence on the finisher.



IMPORTANT: When applicable, special installation instructions are provided for an assembly at the end of the removal procedure. Always completely read the removal instructions and follow all special installation instructions.

Before performing service

- Turn the printer power off. A shutting-down message appears on the control-panel display.
- ⚠ **WARNING!** To avoid damage to the printer, turn the power off and wait until the printer shuts down before removing the power cable.
- Disconnect the printer power cable after the printer has completely shut down (the control-panel display is blank).
- Release the finisher from the printer by pulling out on the release latch inside the finisher door.
- Disconnect the cable from the bridge unit to the finisher.
- Disconnect the cable from the finisher to the printer.

Use the table below to identify the correct part number for your printer. To order the part, go to <https://parts.hp.com>.

Table 5-148 Part information

Part number	Part description
JC90-01432A	Booklet end fence unit

Required tools

- #2 JIS screwdriver with a magnetic tip

After performing service

- Connect the cable from the finisher to the printer.
- Connect the cable from the bridge unit to the finisher.
- Attach the finisher to the printer, and then push in on the release latch inside the finisher door.
- Connect the printer power cable.
- Turn the printer power on.

Post service test

Process a job through the finisher and verify that the finisher works correctly.

Remove the right upper cover (finisher)

Follow these steps to remove the right upper cover (finisher).

- ▲ Remove one screw cap and three machine screws on the upper edge of the cover (callout 1). Remove three sheet metal screws (callout 2) on the lower portion of the cover. Rotate the right edge of the cover away from the finisher, and then slide the cover right to release three tabs (callout 3).

💡 **TIP:** The lower screws are shorter in length than the upper screws.

TIP: Reverse the removal steps to install the assembly.

Figure 5-1491 Remove the right upper cover

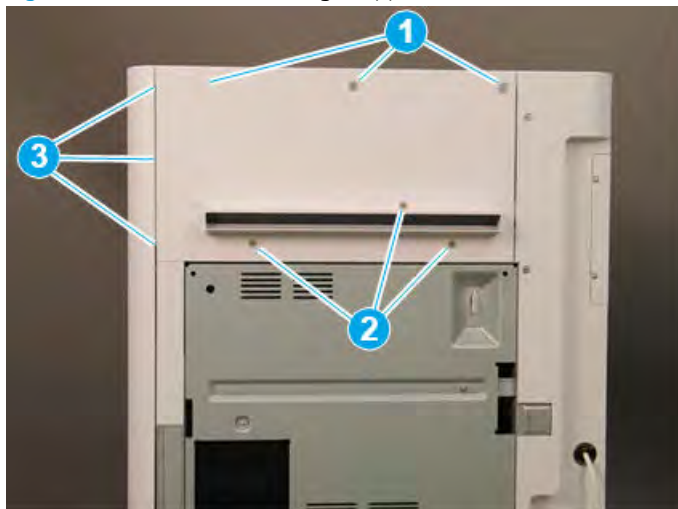

Remove the top cover (finisher)

Follow these steps to remove the top cover (finisher).

1. Remove three screw caps and three self-tapping screws at the top of the rear cover (callout 1), and then remove three machine screws (callout 2) on top of the cover.

Figure 5-1492 Remove six screws

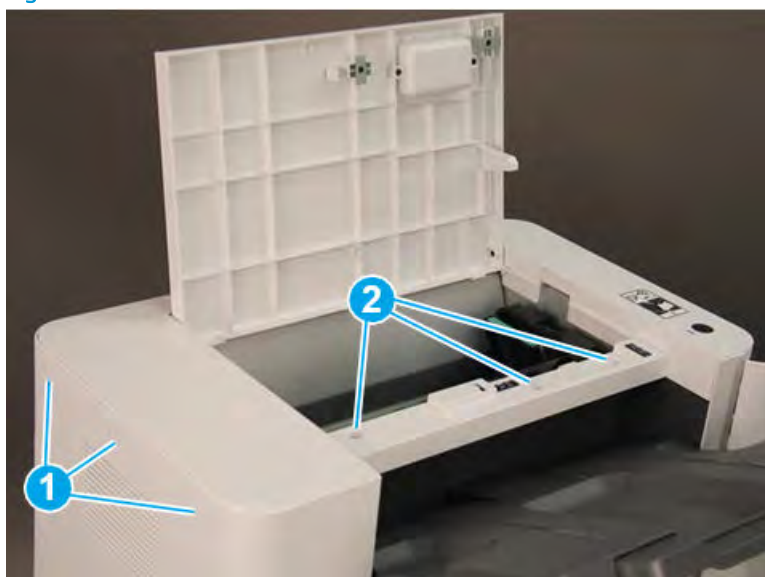

2. Remove three self-tapping screws at the top of the front cover (callout 1), and then remove two machine screws (callout 2) at the top of the right side.

Figure 5-1493 Remove five screws

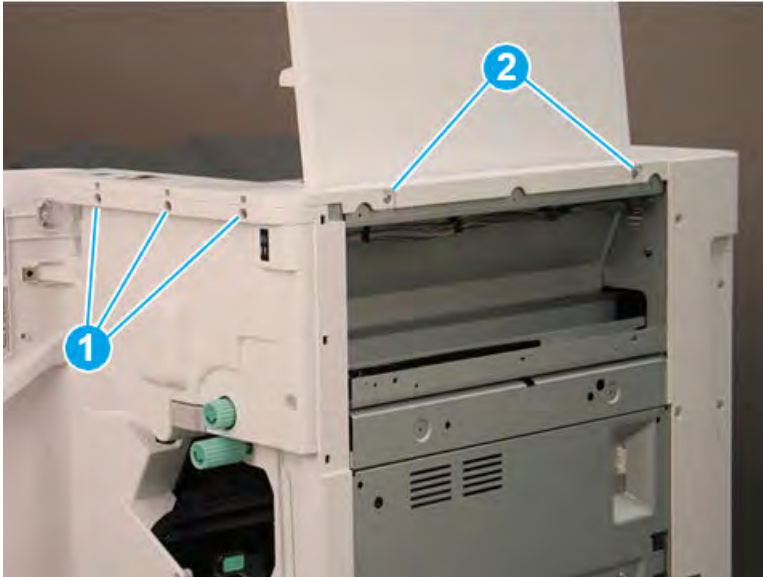

3. Lift the cover up slightly. Disconnect one in-line connector (callout 1), and then release one retainer (callout 2).

 **TIP:** Reverse the removal steps to install the assembly.

Figure 5-1494 Disconnect one connector and release retainer



Remove the rear cover (finisher)

Follow these steps to remove the rear cover (finisher).

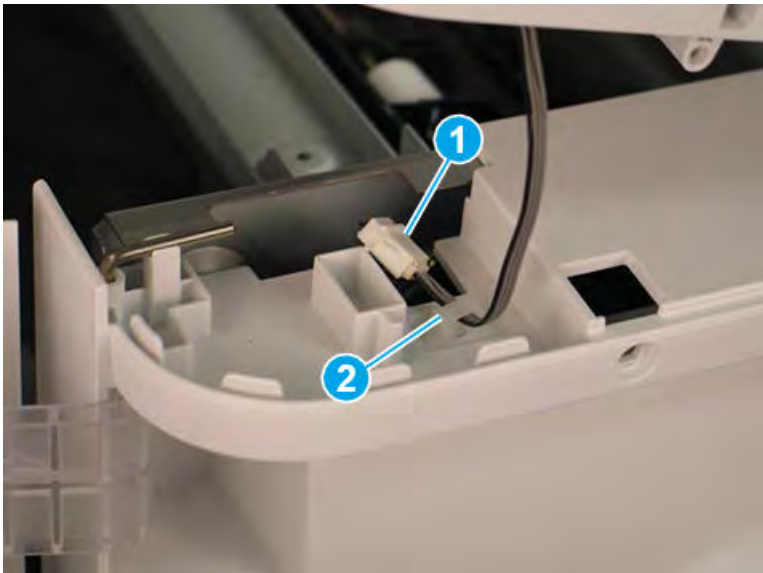
1. Remove two self-tapping screws (callout 1) on the top of the rear cover, and then remove five screw caps and five machine screws (callout 2) on the left side of the cover.

Figure 5-1495 Remove seven screws

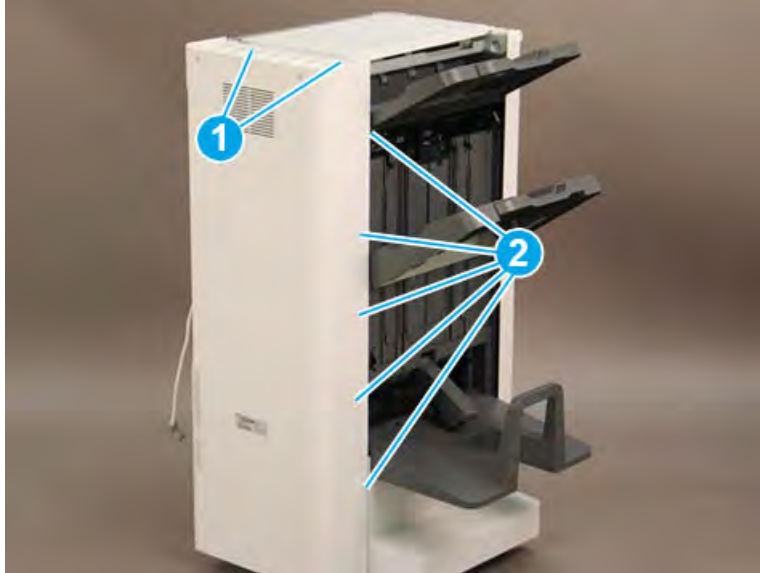

2. Remove one screw cap and four machine screws (callout 1) Remove the rear cover.

 **NOTE:** Make sure to thread the power cable (callout 2) through the opening in the cover.

 **TIP:** Reverse the removal steps to install the assembly

Figure 5-1496 Remove the rear cover



Remove the booklet front cover

Follow these steps to remove the booklet front cover.

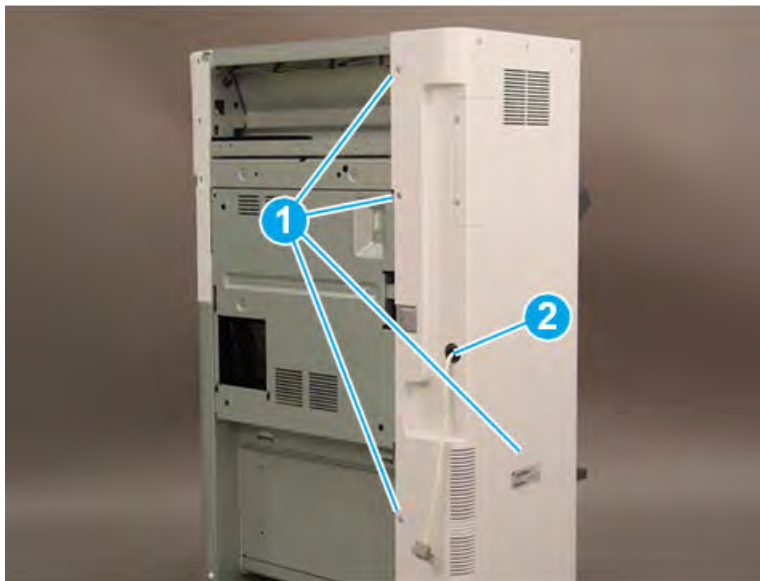
- ▲ Slide the booklet maker slightly away from the finisher (callout 1). Remove one screw (callout 2), and then slide the green knob away from the booklet maker to remove it (callout 3). Remove four screws (callout 4), and then remove the booklet front cover.

 **TIP:** Reverse the removal steps to install the assembly

Figure 5-1497 Remove five screws and the cover



Remove the booklet right lower shield

Follow these steps to remove the booklet right lower shield.

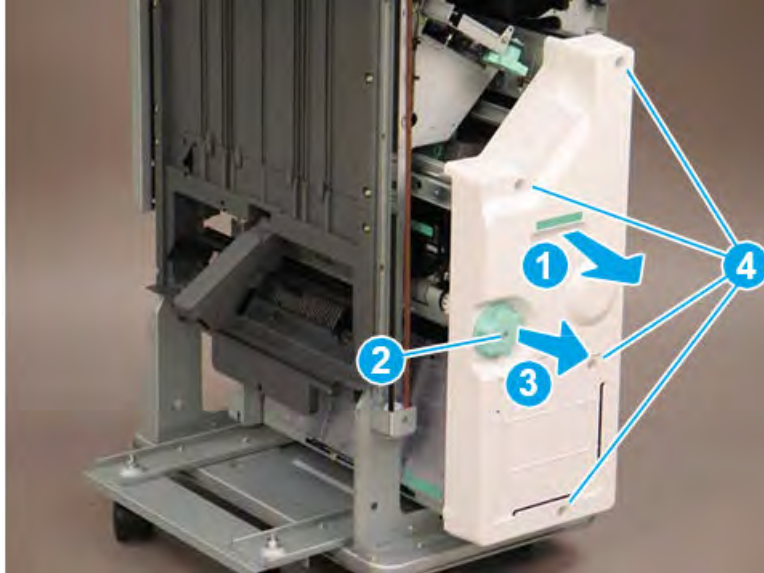
1. Remove two screws at the front of the booklet maker (callout 1).

Figure 5-1498 Remove two screws

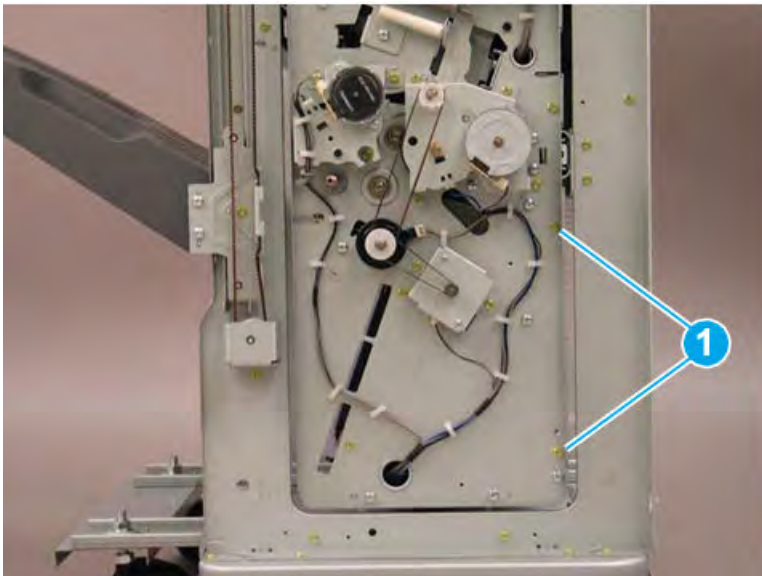

2. Remove two screws at the back of the booklet maker (callout 1).

Figure 5-1499 Remove two screws

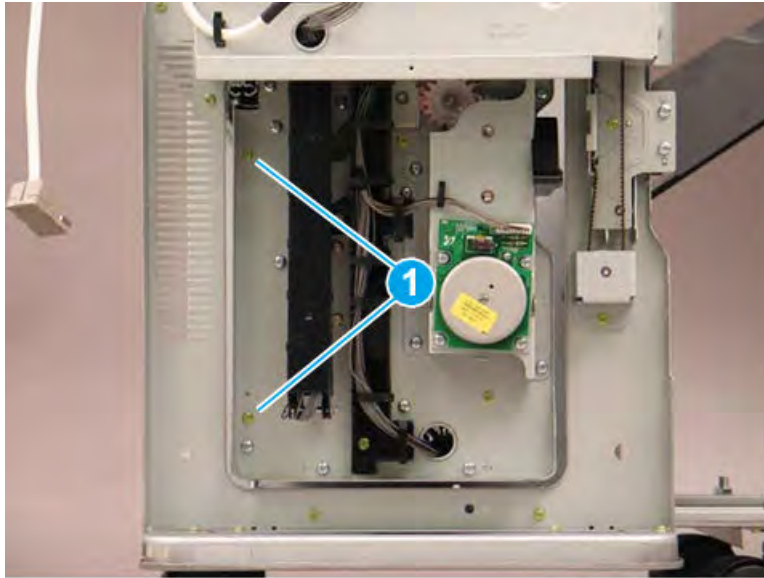

3. Slide the booklet maker out of the finisher (callout 1), and then rotate the top of the right lower shield (callout 2) away from the booklet maker to remove it.

Figure 5-1500 Remove the right lower shield

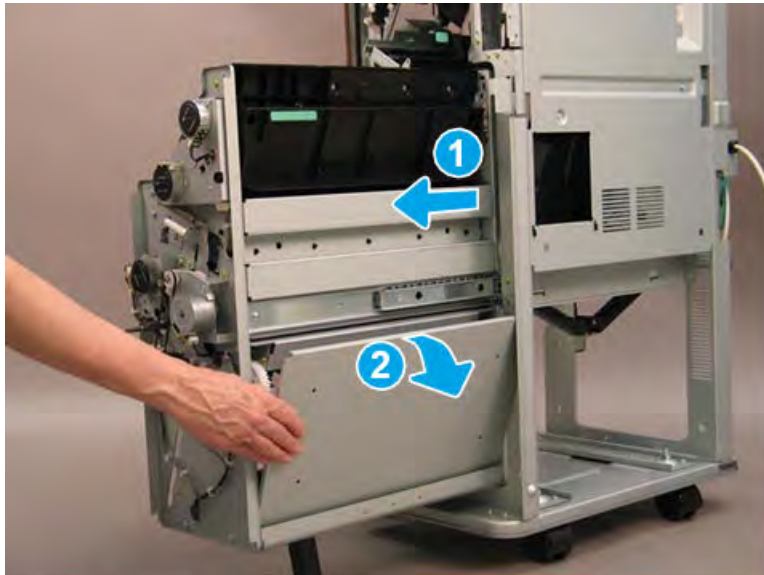

Remove the fold stopper unit

Follow these steps to remove the fold stopper unit.

1. On the left side of the booklet maker, remove two screws through access openings in the jam access cover (callout 1).

Figure 5-1501 Remove two screws

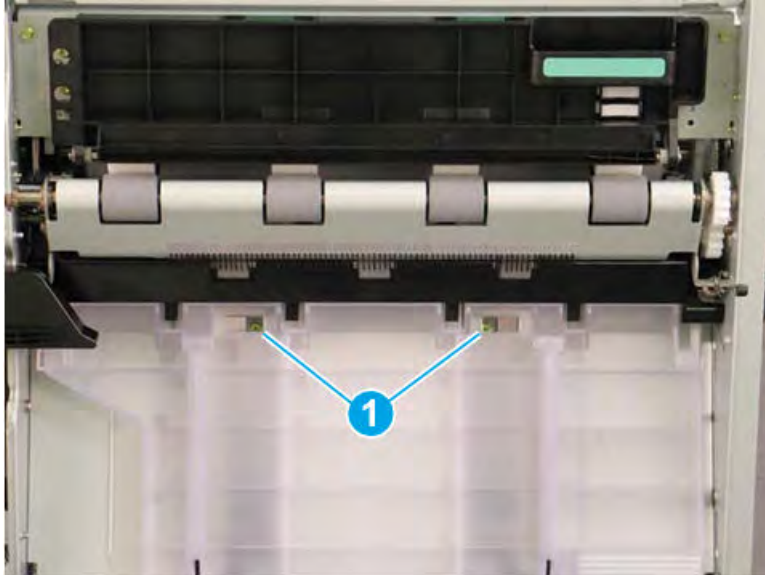

2. Raise the jam access cover.

Figure 5-1502 Raise the jam access cover



3. Raise the booklet width guide.

Figure 5-1503 Raise the booklet width guide.

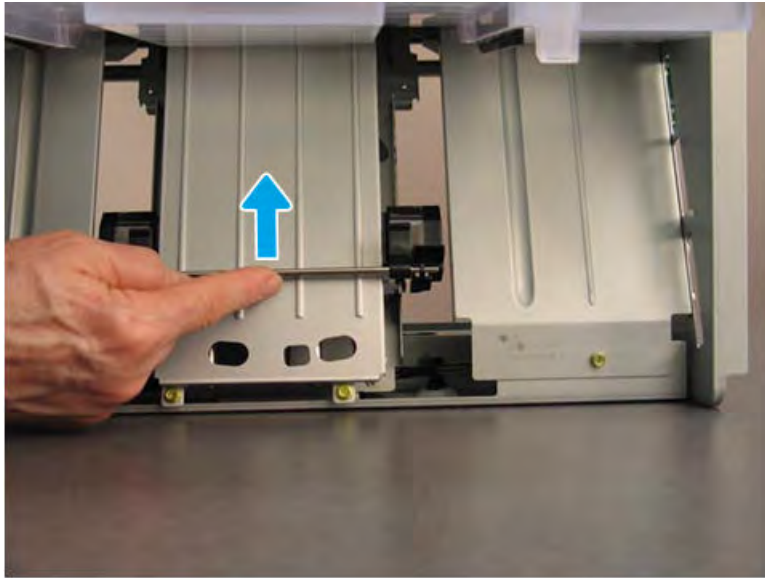

4. On the right side of the booklet maker, open two retainers (callout 1), and then disconnect three connectors (callout 2).

Figure 5-1504 Disconnect three connectors

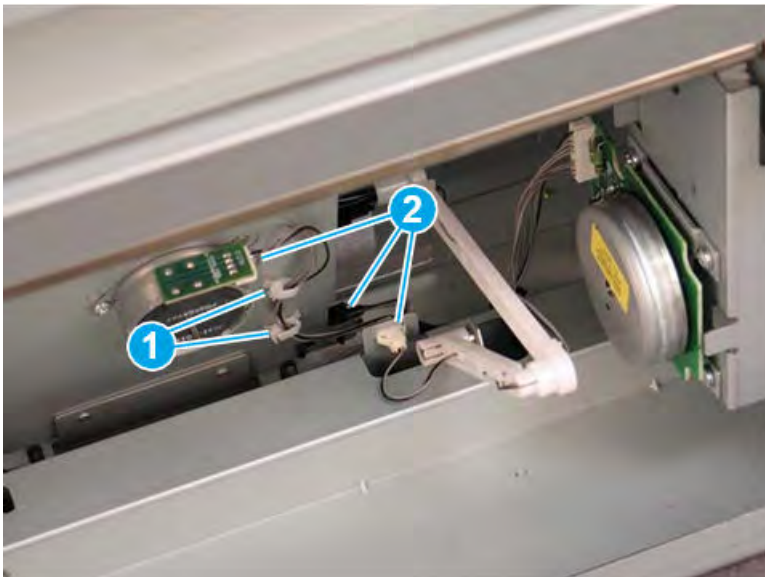

5. Remove two screws (callout 1).

Figure 5-1505 Remove two screws

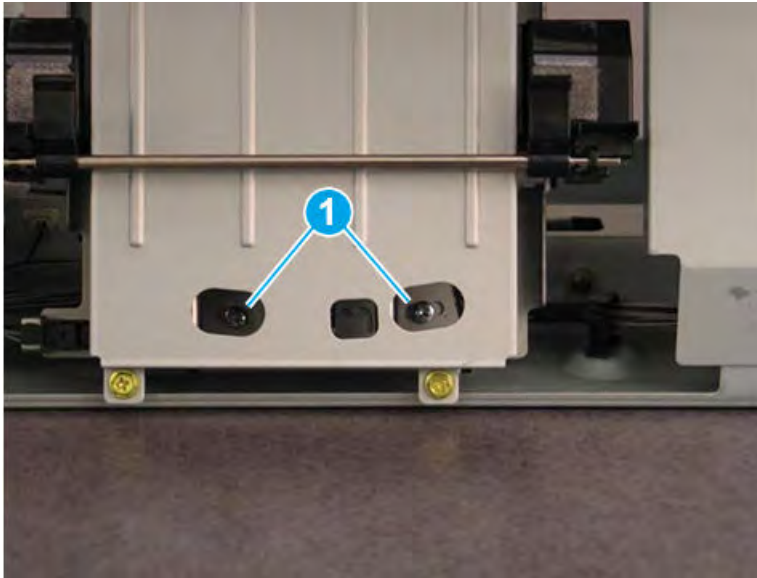

6. Release the tab (callout 1) on the guide arm, and then slide the guide off of the shaft (callout 2) to remove it.

Figure 5-1506 Release the guide arm

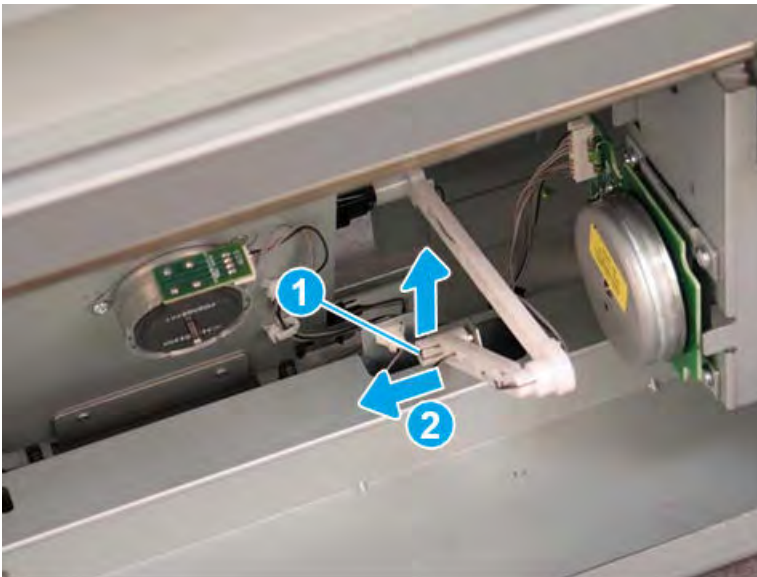

7. Lower the width guide to the lowest position.

Figure 5-1507 Lower the width guide

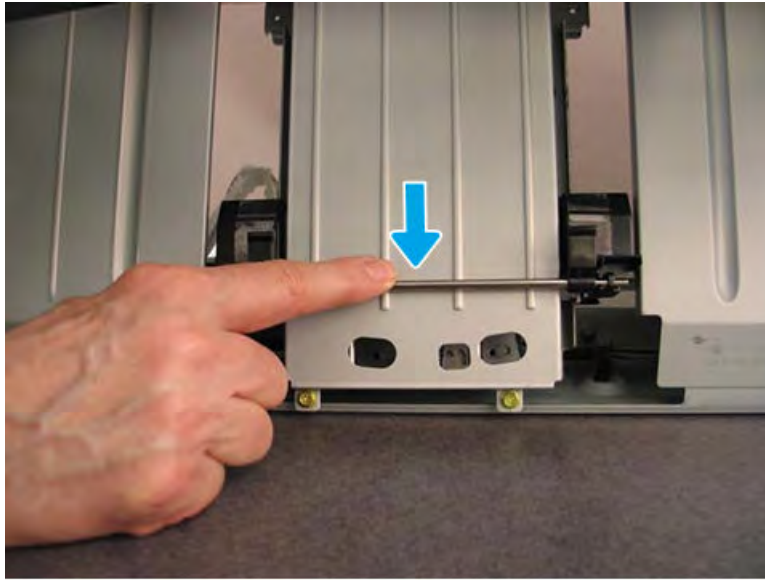

8. On the right side of the booklet maker, remove one screw (callout 1).

Figure 5-1508 Remove one screw

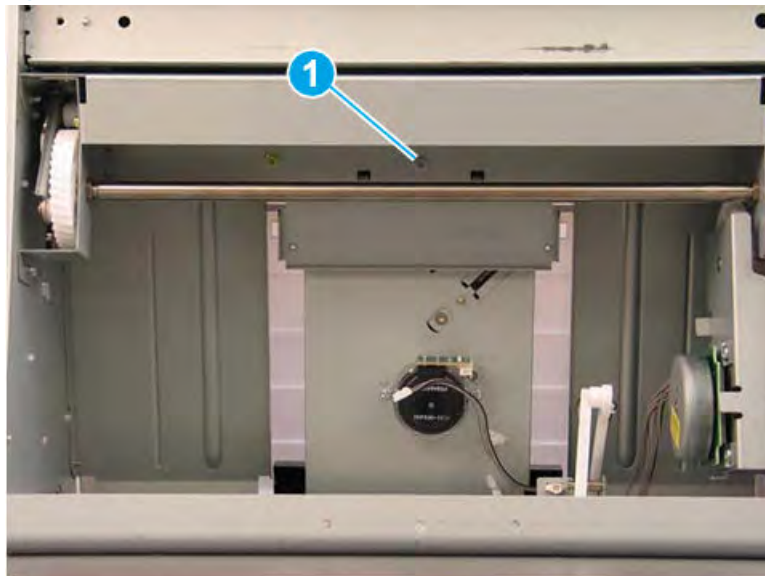

9. Lift the right lower corner (callout 1) to clear the cable guide, and then slide the assembly to the right (callout 2) to remove it.

Figure 5-1509 Remove the fold stopper unit

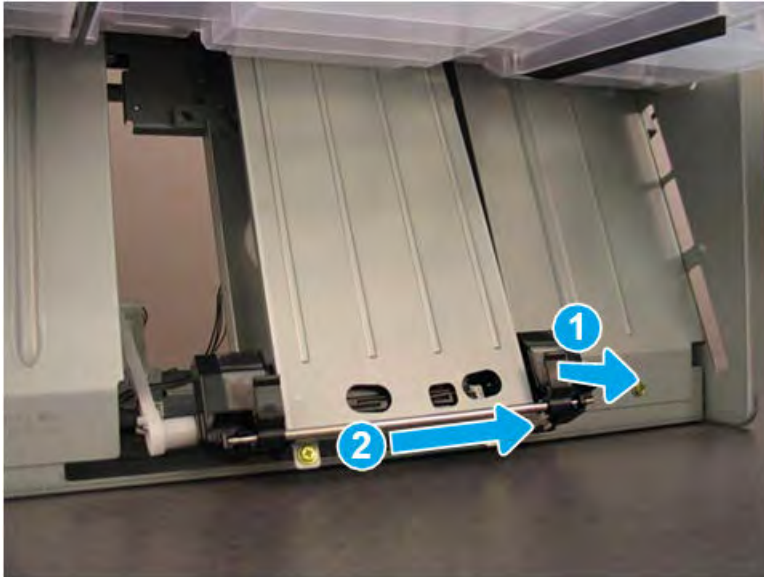

10. Reverse the removal steps to install the assembly. Also use the following special installation instructions.

 **NOTE:** Continue to reverse the removal steps to finish installing the assembly.

Special installation instructions: Fold stopper unit

Loosen the two alignment screws (callout 1) and move the fold unit side to side until the alignment gauge is positioned on the center line. Tighten the screws and run a folded job through the finisher and verify that the fold is correct. If the fold is not correct, loosen the screws, adjust the alignment, and run another fold job. Continue this process until the fold is correct.

Figure 5-1510 Adjust the alignment gauge

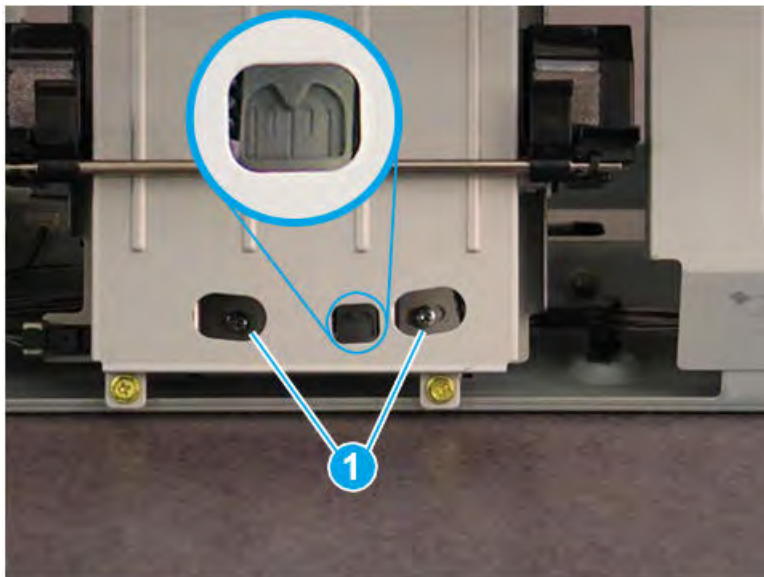

Unpack the replacement assembly

Follow these steps to unpack the replacement assembly.

1. Dispose of the defective part.



NOTE: HP recommends responsible disposal of the defective part.

<http://www8.hp.com/us/en/hp-information/environment/product-recycling.html>

2. Unpack the replacement part from the packaging.



CAUTION:  Some parts are sensitive to electrostatic discharge (ESD). Always perform service work at an ESD-protected workstation or mat. If an ESD workstation or mat is not available, touch the sheet-metal chassis to provide a static ground before touching an ESD-sensitive assembly. Protect the ESD-sensitive assemblies by placing them in ESD pouches when they are out of the printer.



IMPORTANT: Make sure that all of the shipping materials (for example shipping tape) are removed from the replacement part prior to installation.



NOTE: If the replacement part is a roller or pad, avoid touching the spongy part of it. Skin oils on the roller or pad can cause paper pickup and/or print-quality problems. HP recommends using disposable gloves when handling rollers or pads or washing your hands before touching rollers or pads.

3. To install an assembly, reverse the removal steps.



NOTE: When applicable, special installation instructions are provided for an assembly at the end of the removal procedure. Always completely read the removal instructions and follow all special installation instructions.

Removal and replacement: End fence motor (M3)

Learn how to remove and replace the booklet end fence motor.

Introduction

This document provides the procedures to remove and replace the booklet end fence motor on the finisher.



IMPORTANT: When applicable, special installation instructions are provided for an assembly at the end of the removal procedure. Always completely read the removal instructions and follow all special installation instructions.

Before performing service

- Turn the printer power off. A shutting-down message appears on the control-panel display.
- ⚠ **WARNING!** To avoid damage to the printer, turn the power off and wait until the printer shuts down before removing the power cable.
- Disconnect the printer power cable after the printer has completely shut down (the control-panel display is blank).
- Release the finisher from the printer by pulling out on the release latch inside the finisher door.
- Disconnect the cable from the bridge unit to the finisher.
- Disconnect the cable from the finisher to the printer.

Use the table below to identify the correct part number for your printer. To order the part, go to <https://parts.hp.com>.

Table 5-149 Part information

Part number	Part description
JC93-01155A	Booklet end fence motor

Required tools

- #2 JIS screwdriver with a magnetic tip

After performing service

- Connect the cable from the finisher to the printer.
- Connect the cable from the bridge unit to the finisher.
- Attach the finisher to the printer, and then push in on the release latch inside the finisher door.
- Connect the printer power cable.
- Turn the printer power on.

Post service test

Process a job through the finisher and verify that the finisher works correctly.

Remove the booklet front cover

Follow these steps to remove the booklet front cover.

- ▲ Slide the booklet maker slightly away from the finisher (callout 1). Remove one screw (callout 2), and then slide the green knob away from the booklet maker to remove it (callout 3). Remove four screws (callout 4), and then remove the booklet front cover.

 **TIP:** Reverse the removal steps to install the assembly

Figure 5-1511 Remove five screws and the cover



Remove the booklet right lower shield

Follow these steps to remove the booklet right lower shield.

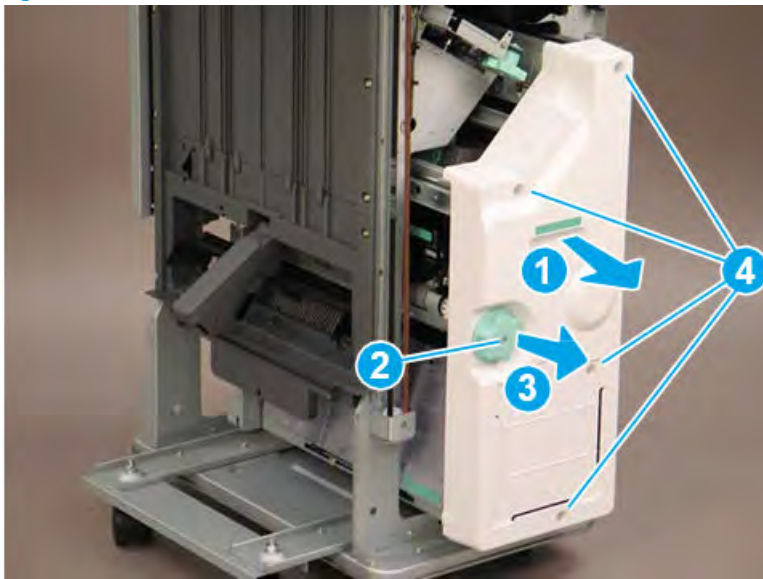
1. Remove two screws at the front of the booklet maker (callout 1).

Figure 5-1512 Remove two screws

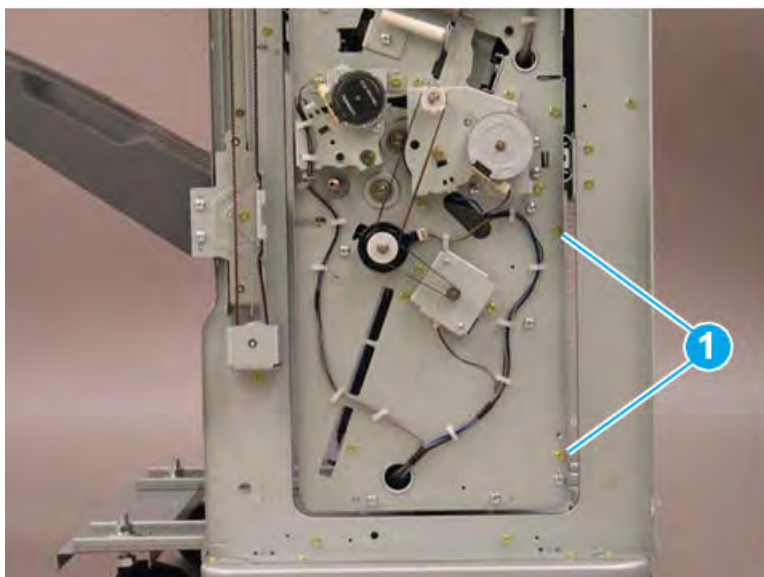

2. Remove two screws at the back of the booklet maker (callout 1).

Figure 5-1513 Remove two screws

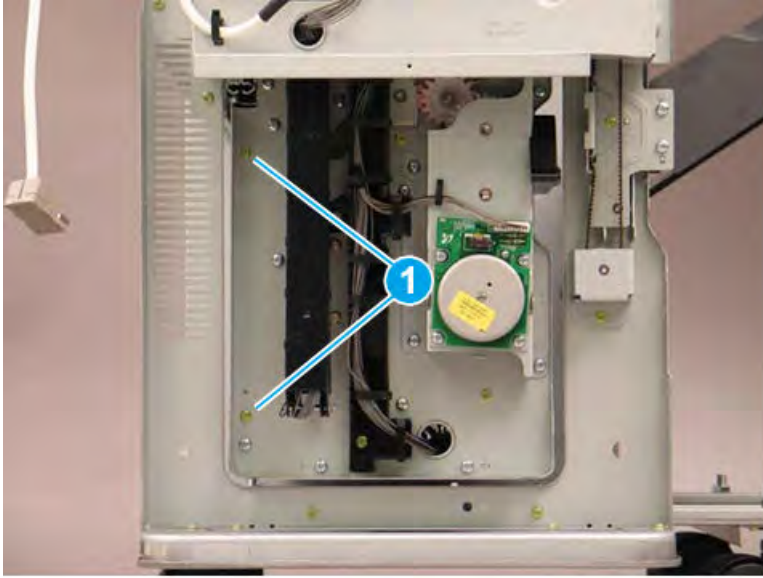

3. Slide the booklet maker out of the finisher (callout 1), and then rotate the top of the right lower shield (callout 2) away from the booklet maker to remove it.

Figure 5-1514 Remove the right lower shield

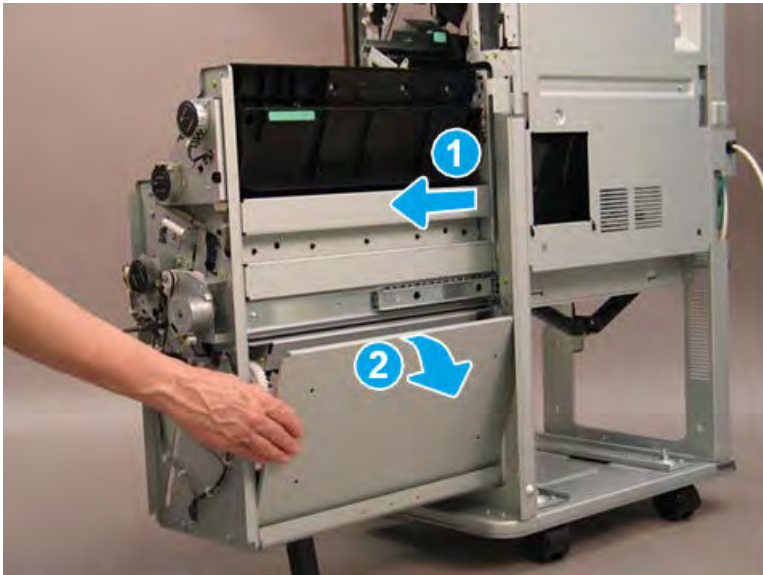

Remove the booklet end fence motor (M20)

Follow these steps to remove the booklet end fence motor (M20).

- ▲ Disconnect one connector (callout 1), remove two screws (callout 2), and then remove the booklet end fence motor.

 **TIP:** Reverse the removal steps to install the assembly.

Figure 5-1515 Remove the booklet end fence motor



Unpack the replacement assembly

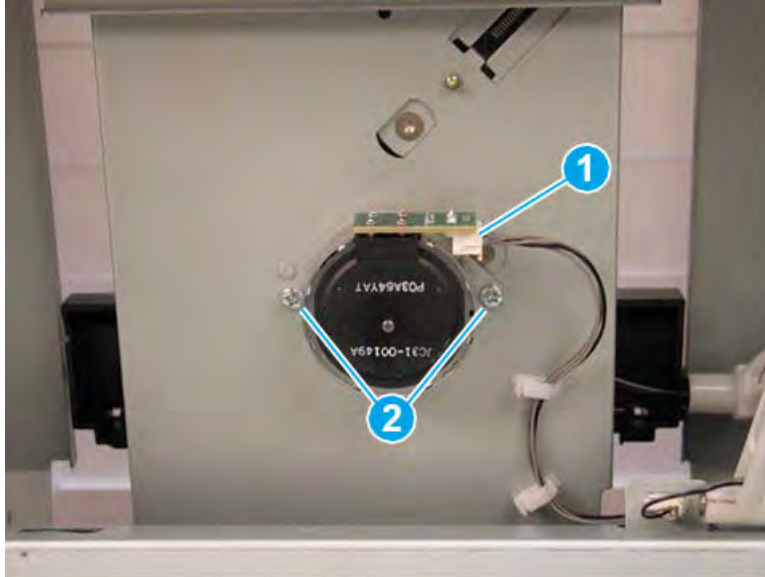

Follow these steps to unpack the replacement assembly.

1. Dispose of the defective part.

 **NOTE:** HP recommends responsible disposal of the defective part.

<http://www8.hp.com/us/en/hp-information/environment/product-recycling.html>

2. Unpack the replacement part from the packaging.

 **CAUTION:**  Some parts are sensitive to electrostatic discharge (ESD). Always perform service work at an ESD-protected workstation or mat. If an ESD workstation or mat is not available, touch the sheet-metal chassis to provide a static ground before touching an ESD-sensitive assembly. Protect the ESD-sensitive assemblies by placing them in ESD pouches when they are out of the printer.

 **IMPORTANT:** Make sure that all of the shipping materials (for example shipping tape) are removed from the replacement part prior to installation.

 **NOTE:** If the replacement part is a roller or pad, avoid touching the spongy part of it. Skin oils on the roller or pad can cause paper pickup and/or print-quality problems. HP recommends using disposable gloves when handling rollers or pads or washing your hands before touching rollers or pads.

3. To install an assembly, reverse the removal steps.

 **NOTE:** When applicable, special installation instructions are provided for an assembly at the end of the removal procedure. Always completely read the removal instructions and follow all special installation instructions.

Removal and replacement: Booklet end fence home sensor (S42)

Learn how to remove and replace the booklet end fence home sensor.

Introduction

This document provides the procedures to remove and replace the booklet end fence home sensor on the finisher.



IMPORTANT: When applicable, special installation instructions are provided for an assembly at the end of the removal procedure. Always completely read the removal instructions and follow all special installation instructions.

Before performing service

- Turn the printer power off. A shutting-down message appears on the control-panel display.
- ⚠ **WARNING!** To avoid damage to the printer, turn the power off and wait until the printer shuts down before removing the power cable.
- Disconnect the printer power cable after the printer has completely shut down (the control-panel display is blank).
- Release the finisher from the printer by pulling out on the release latch inside the finisher door.
- Disconnect the cable from the bridge unit to the finisher.
- Disconnect the cable from the finisher to the printer.

Use the table below to identify the correct part number for your printer. To order the part, go to <https://parts.hp.com>.

Table 5-150 Part information

Part number	Part description
0604-001393	Booklet end fence home sensor

Required tools

- #2 JIS screwdriver with a magnetic tip

After performing service

- Connect the cable from the finisher to the printer.
- Connect the cable from the bridge unit to the finisher.
- Attach the finisher to the printer, and then push in on the release latch inside the finisher door.
- Connect the printer power cable.
- Turn the printer power on.

Post service test

Process a job through the finisher and verify that the finisher works correctly.

Remove the booklet front cover

Follow these steps to remove the booklet front cover.

- ▲ Slide the booklet maker slightly away from the finisher (callout 1). Remove one screw (callout 2), and then slide the green knob away from the booklet maker to remove it (callout 3). Remove four screws (callout 4), and then remove the booklet front cover.

 **TIP:** Reverse the removal steps to install the assembly

Figure 5-1516 Remove five screws and the cover



Remove the booklet right lower shield

Follow these steps to remove the booklet right lower shield.

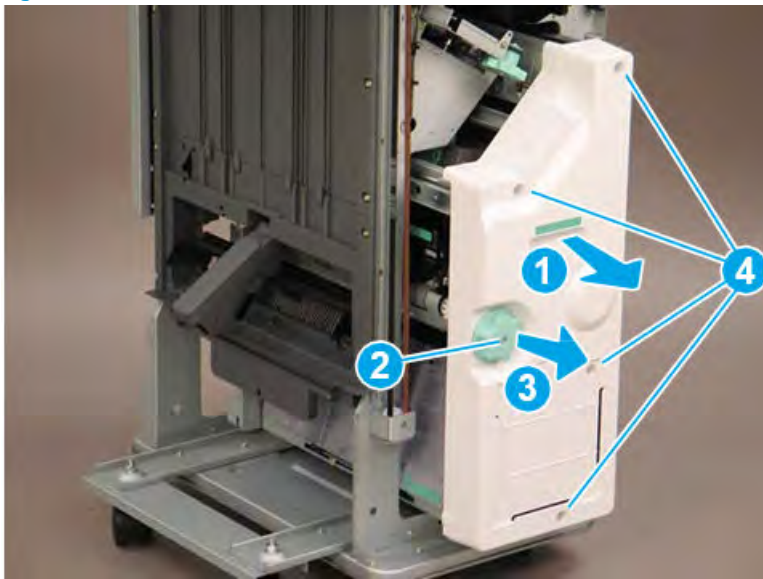
1. Remove two screws at the front of the booklet maker (callout 1).

Figure 5-1517 Remove two screws

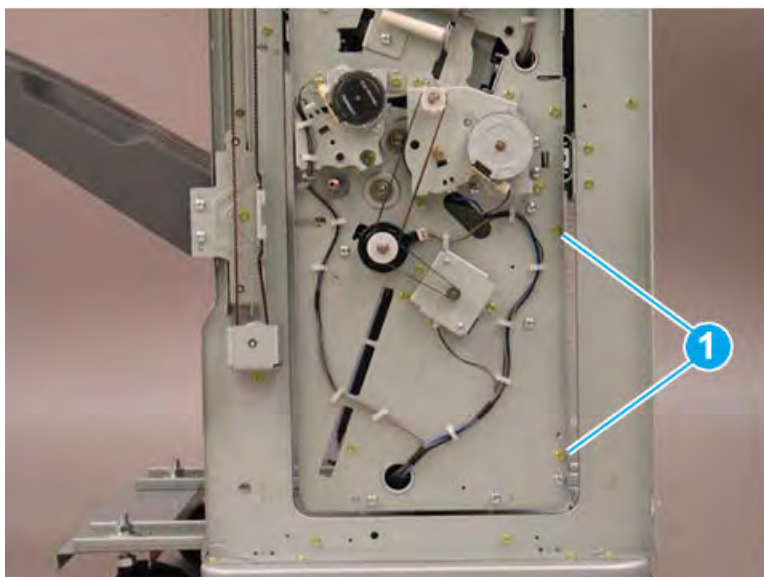

2. Remove two screws at the back of the booklet maker (callout 1).

Figure 5-1518 Remove two screws

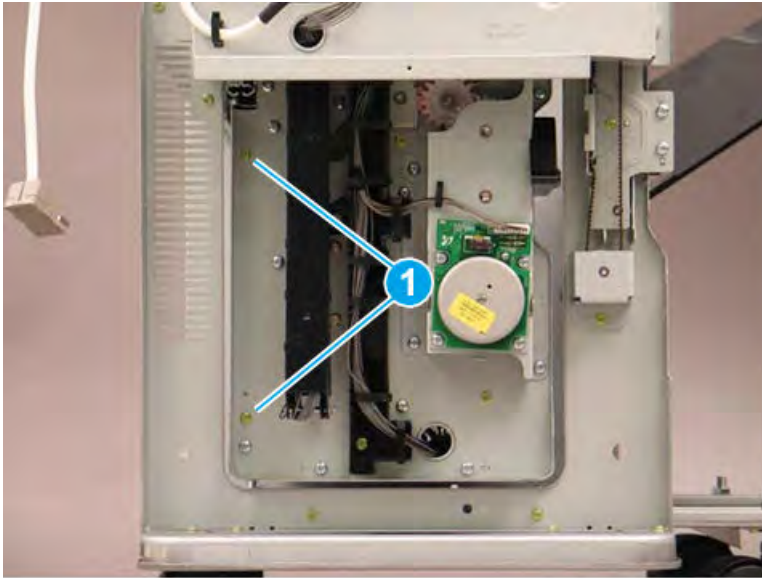

3. Slide the booklet maker out of the finisher (callout 1), and then rotate the top of the right lower shield (callout 2) away from the booklet maker to remove it.

Figure 5-1519 Remove the right lower shield

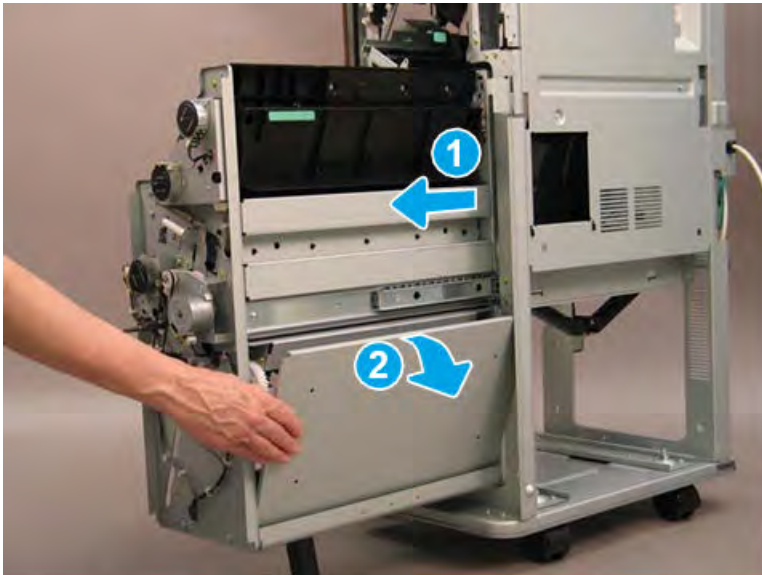

Remove the Booklet end fence home sensor (S42)

Follow these steps to remove the Booklet end fence home sensor (S42).

1. Unplug one connector (callout 1) at the left of the booklet maker

Figure 5-1520 Unplug one connector

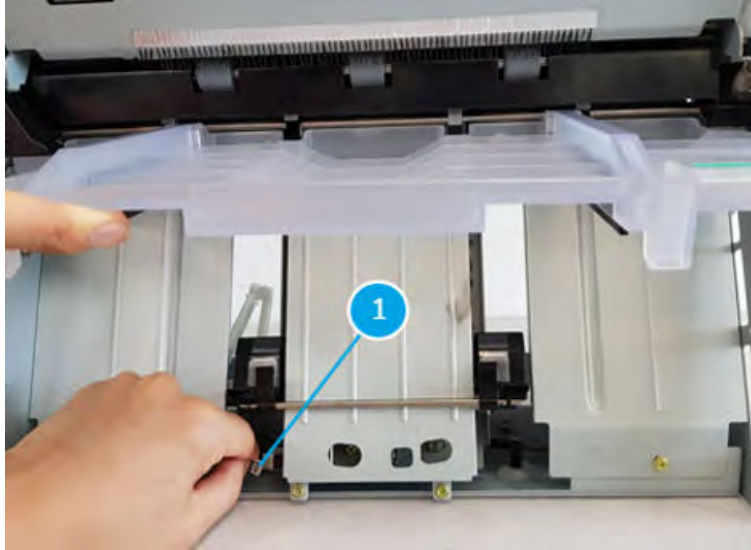

2. Remove the Booklet end fence home sensor (S42, callout 1) at the right of the booklet maker.

Figure 5-1521 Remove the Booklet end fence home sensor



Unpack the replacement assembly

Follow these steps to unpack the replacement assembly.

1. Dispose of the defective part.

 **NOTE:** HP recommends responsible disposal of the defective part.

<http://www8.hp.com/us/en/hp-information/environment/product-recycling.html>

2. Unpack the replacement part from the packaging.



CAUTION:  Some parts are sensitive to electrostatic discharge (ESD). Always perform service work at an ESD-protected workstation or mat. If an ESD workstation or mat is not available, touch the sheet-metal chassis to provide a static ground before touching an ESD-sensitive assembly. Protect the ESD-sensitive assemblies by placing them in ESD pouches when they are out of the printer.

 **IMPORTANT:** Make sure that all of the shipping materials (for example shipping tape) are removed from the replacement part prior to installation.

 **NOTE:** If the replacement part is a roller or pad, avoid touching the spongy part of it. Skin oils on the roller or pad can cause paper pickup and/or print-quality problems. HP recommends using disposable gloves when handling rollers or pads or washing your hands before touching rollers or pads.

3. To install an assembly, reverse the removal steps.

 **NOTE:** When applicable, special installation instructions are provided for an assembly at the end of the removal procedure. Always completely read the removal instructions and follow all special installation instructions.

Booklet presser unit

Removal and replacement: Booklet presser

Learn how to remove and replace the booklet presser.

Introduction

This document provides the procedures to remove and replace the booklet presser on the finisher.



IMPORTANT: When applicable, special installation instructions are provided for an assembly at the end of the removal procedure. Always completely read the removal instructions and follow all special installation instructions.

Before performing service

- Turn the printer power off. A shutting-down message appears on the control-panel display.
- ⚠ **WARNING!** To avoid damage to the printer, turn the power off and wait until the printer shuts down before removing the power cable.
- Disconnect the printer power cable after the printer has completely shut down (the control-panel display is blank).
- Release the finisher from the printer by pulling out on the release latch inside the finisher door.
- Disconnect the cable from the bridge unit to the finisher.
- Disconnect the cable from the finisher to the printer.

Use the table below to identify the correct part number for your printer. To order the part, go to <https://parts.hp.com>.

Table 5-151 Part information

Part number	Part description
JC61-07237A	Booklet presser

Required tools

- #2 JIS screwdriver with a magnetic tip

After performing service

- Connect the cable from the finisher to the printer.
- Connect the cable from the bridge unit to the finisher.
- Attach the finisher to the printer, and then push in on the release latch inside the finisher door.
- Connect the printer power cable.
- Turn the printer power on.

Post service test

Process a job through the finisher and verify that the finisher works correctly.

Remove the right upper cover (finisher)

Follow these steps to remove the right upper cover (finisher).

- ▲ Remove one screw cap and three machine screws on the upper edge of the cover (callout 1). Remove three sheet metal screws (callout 2) on the lower portion of the cover. Rotate the right edge of the cover away from the finisher, and then slide the cover right to release three tabs (callout 3).

💡 **TIP:** The lower screws are shorter in length than the upper screws.

TIP: Reverse the removal steps to install the assembly.

Figure 5-1522 Remove the right upper cover

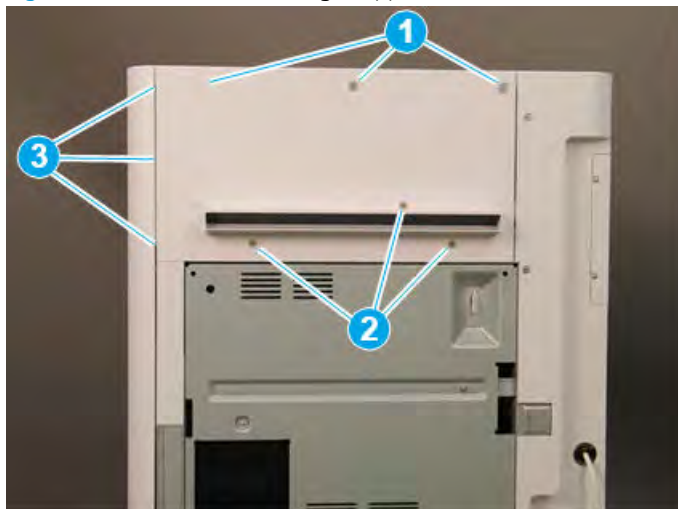

Remove the top cover (finisher)

Follow these steps to remove the top cover (finisher).

1. Remove three screw caps and three self-tapping screws at the top of the rear cover (callout 1), and then remove three machine screws (callout 2) on top of the cover.

Figure 5-1523 Remove six screws

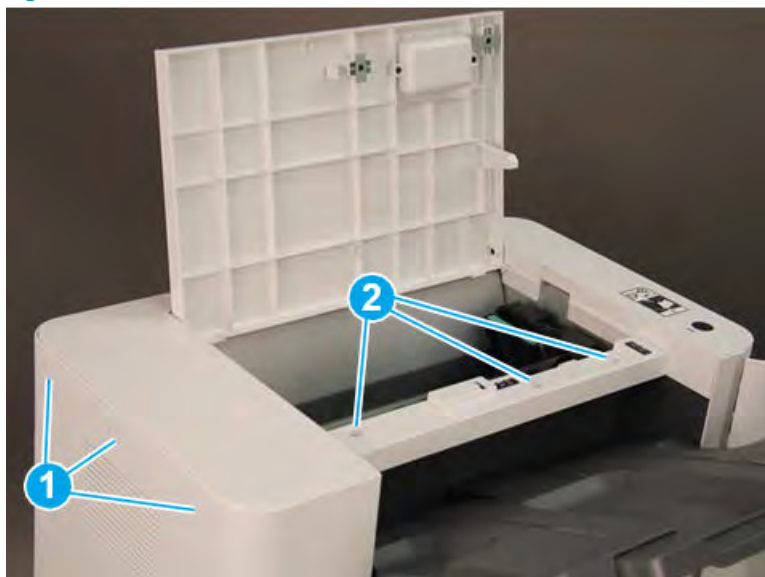

2. Remove three self-tapping screws at the top of the front cover (callout 1), and then remove two machine screws (callout 2) at the top of the right side.

Figure 5-1524 Remove five screws

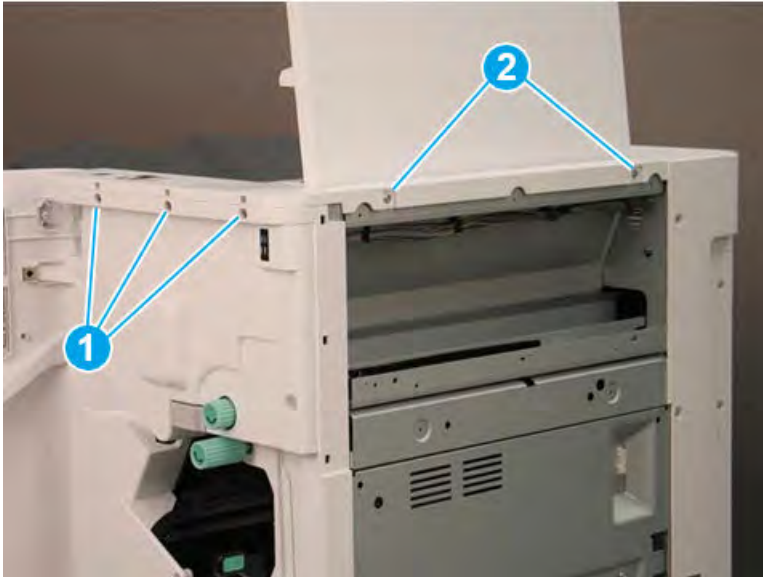

3. Lift the cover up slightly. Disconnect one in-line connector (callout 1), and then release one retainer (callout 2).

 **TIP:** Reverse the removal steps to install the assembly.

Figure 5-1525 Disconnect one connector and release retainer



Remove the rear cover (finisher)

Follow these steps to remove the rear cover (finisher).

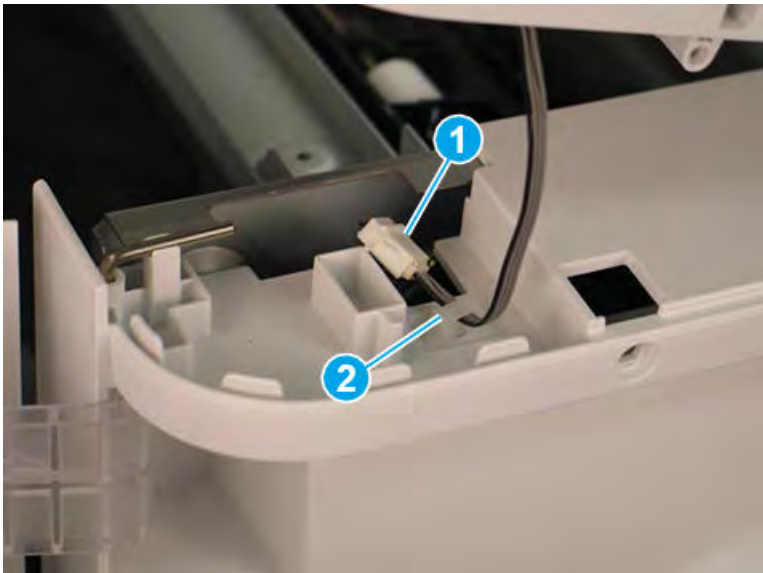
1. Remove two self-tapping screws (callout 1) on the top of the rear cover, and then remove five screw caps and five machine screws (callout 2) on the left side of the cover.

Figure 5-1526 Remove seven screws

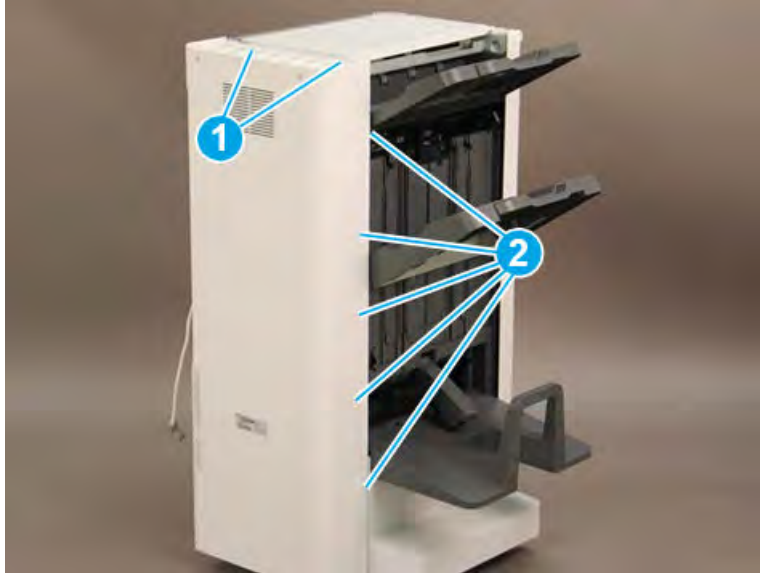

2. Remove one screw cap and four machine screws (callout 1) Remove the rear cover.

 **NOTE:** Make sure to thread the power cable (callout 2) through the opening in the cover.

 **TIP:** Reverse the removal steps to install the assembly

Figure 5-1527 Remove the rear cover

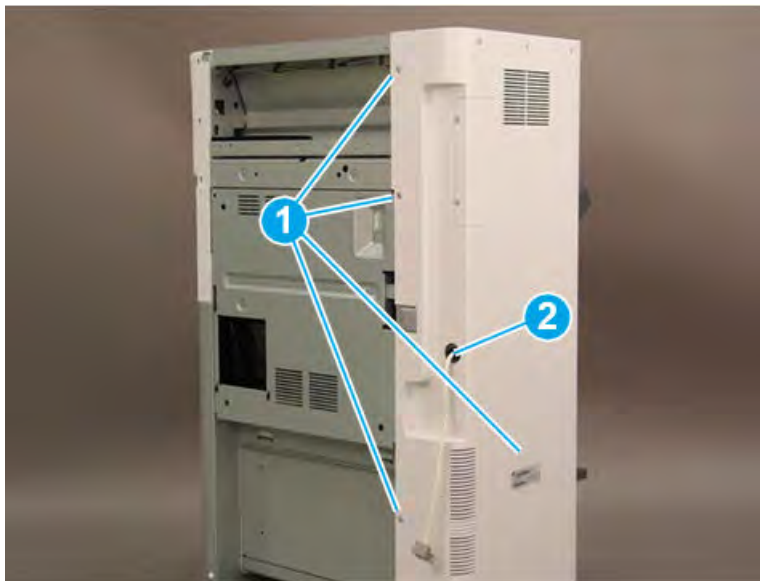

Remove the booklet maker

Follow these steps to remove the booklet maker.

1. Slide the booklet maker away from the finisher.

Figure 5-1528 Slide the booklet maker away from the finisher



2. At the Disconnect one connector (callout 1), and then remove one screw (callout 2).

Figure 5-1529 Disconnect one connector and remove one screw

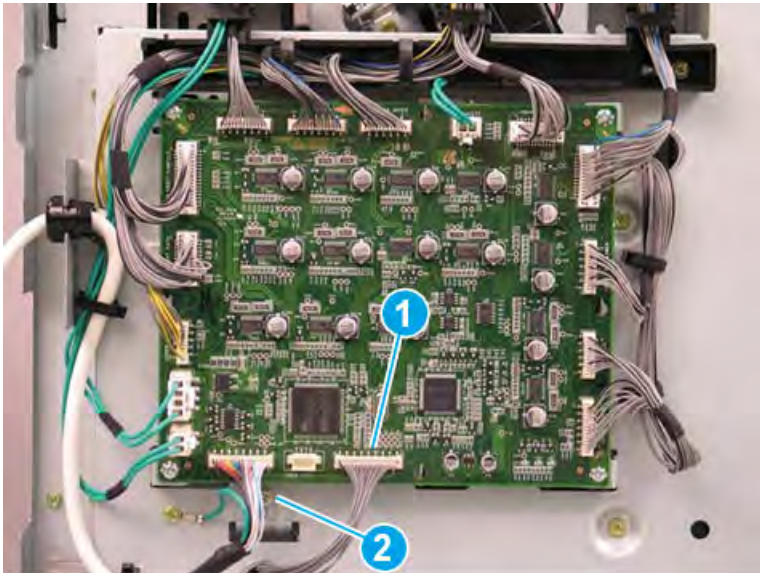

3. Release the metal bracket through the opening in the sheet metal.

Figure 5-1530 Release the metal bracket

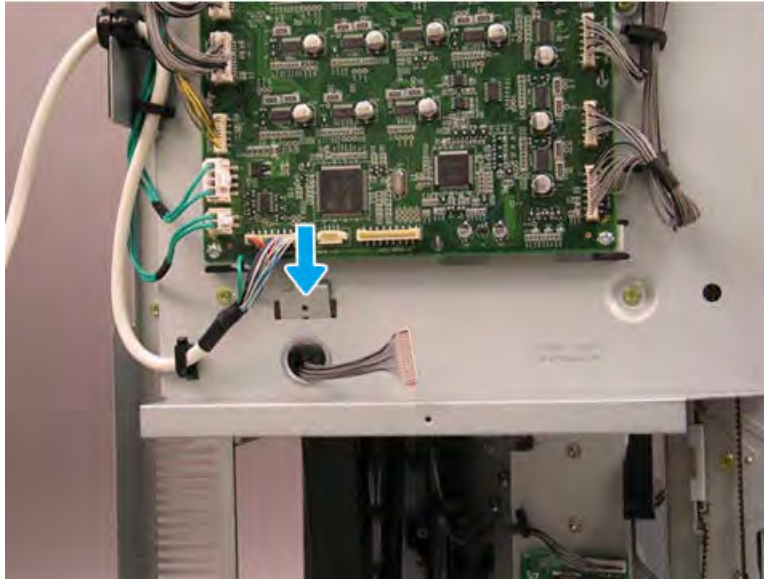

4. Remove one star-washer screw (callout 1), and then release the alignment pin (callout 2) on the right side of the booklet maker.

Figure 5-1531 Remove one screw

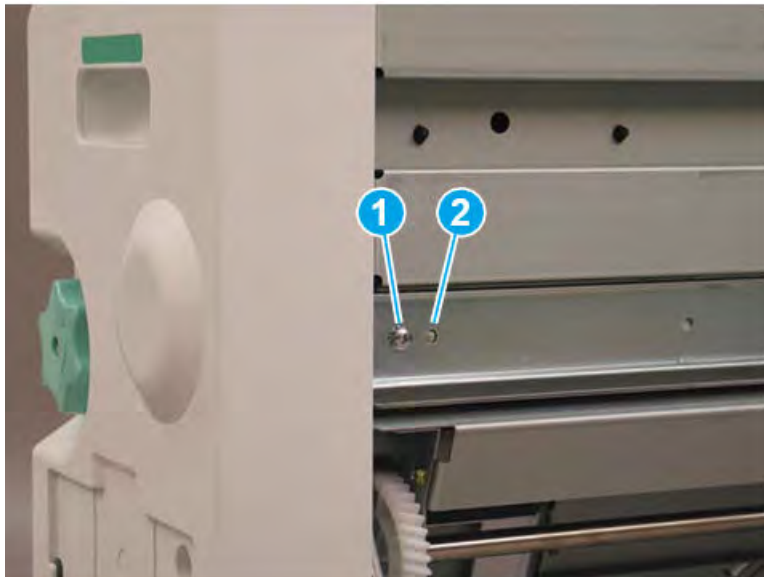

5. Slide the right rail toward the finisher.

Figure 5-1532 Slide the right rail

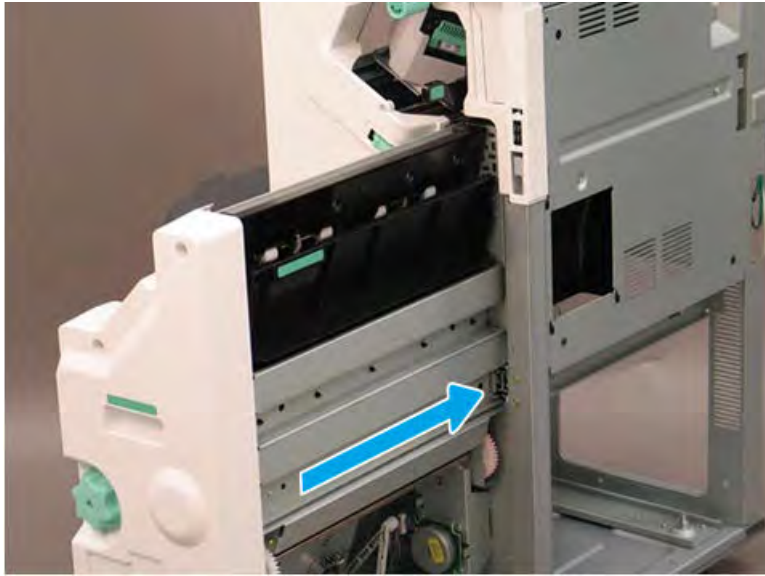

6. Remove one star-washer screw (callout 1) on the left side of the booklet maker.

Figure 5-1533 Remove one screw



7. Lift the booklet maker up on the left side while squeezing the right rail away from the finisher slightly to clear the sheet metal. Remove the booklet maker.

Figure 5-1534 Remove the booklet maker

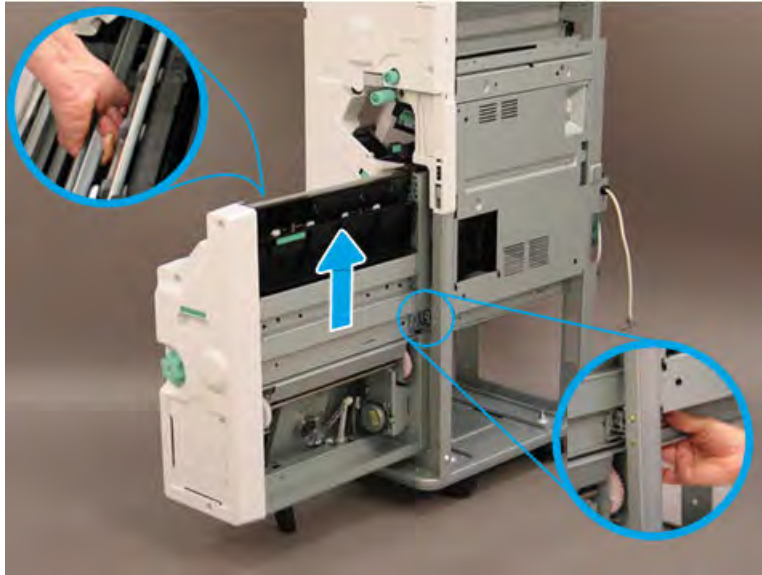

8. Reverse the removal steps to install the assembly. Also use the following special installation instructions.

 **NOTE:** Continue to reverse the removal steps to finish installing the assembly.

Special installation instructions: booklet maker

When installing the booklet maker, position the hooks on the rail under the slots on the booklet maker.

Figure 5-1535 Position the hooks

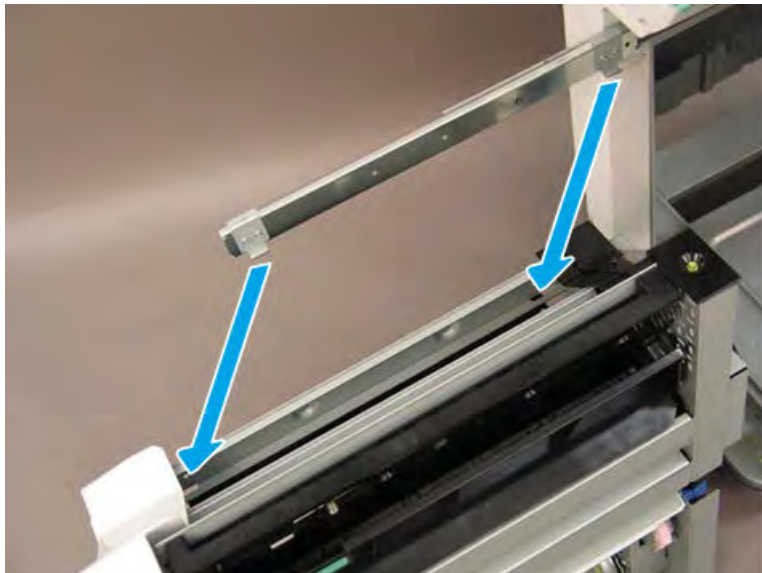

9. When installed correctly, the arrow on the front of the booklet maker aligns with the arrow on the finisher rail.

Figure 5-1536 Align arrows

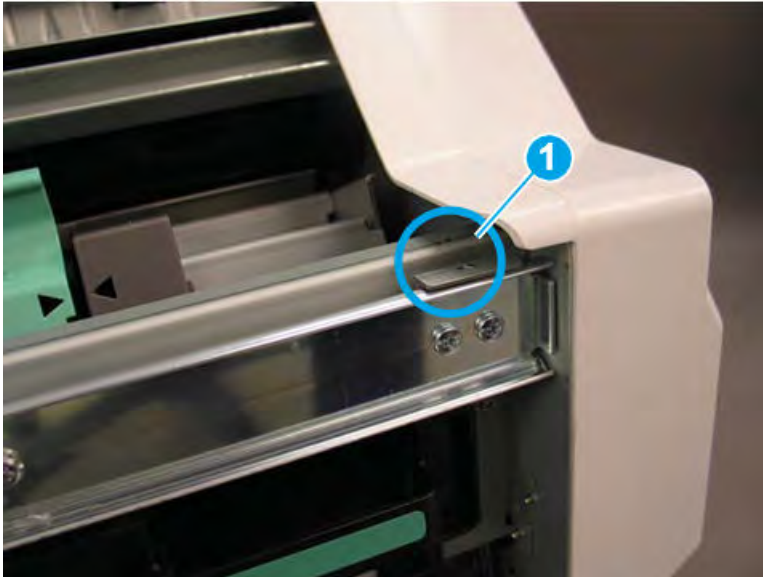

10. When installed correctly, the arrow on the back of the booklet maker aligns with the arrow on the finisher rail.

Figure 5-1537 Align arrows

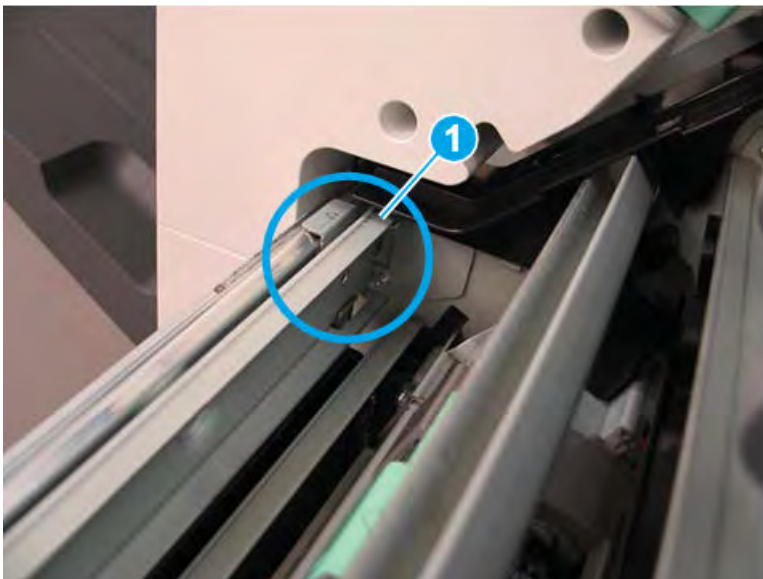

11. Extend the right rail away from the finisher and position it in the booklet maker slot.

Figure 5-1538 Extend the right rail



Remove the booklet entrance unit

Follow these steps to remove the booklet entrance unit.

1. Remove two screws (callout 1) then remove the black cover (callout 2)

Figure 5-1539 Remove two screws then remove the black cover

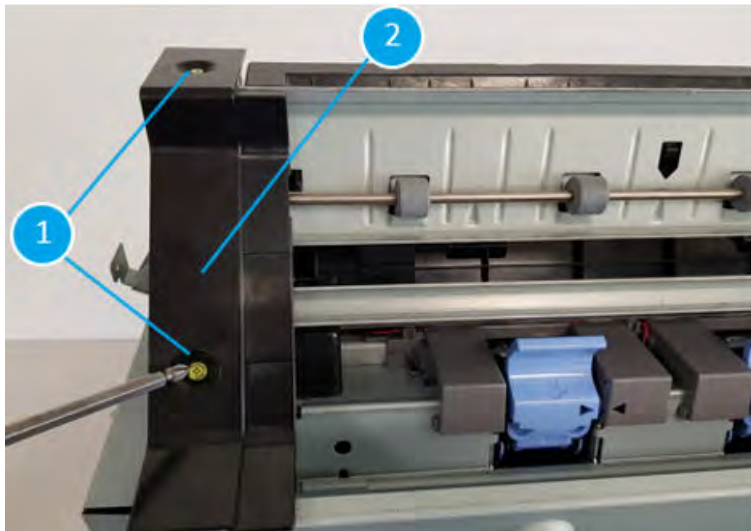

2. Remove two screws(callout 1) and disconnect one connector(callout 2)

Figure 5-1540 Remove two screws and disconnect one connector

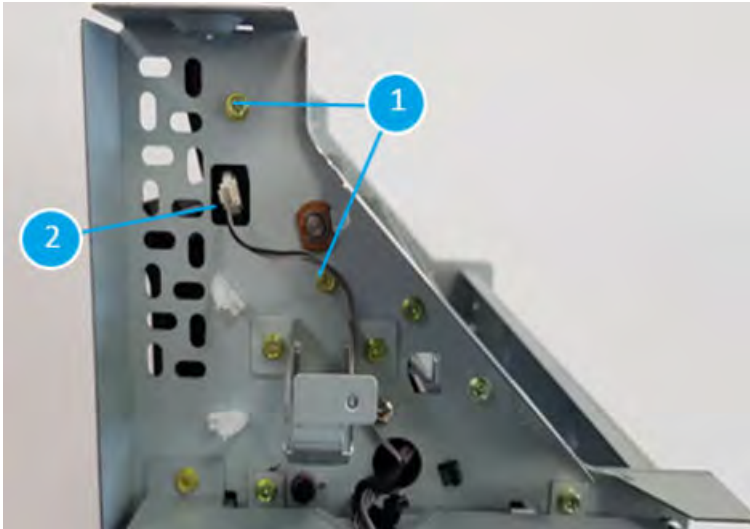

3. Remove two screws(callout 1)

Figure 5-1541 Remove two screws

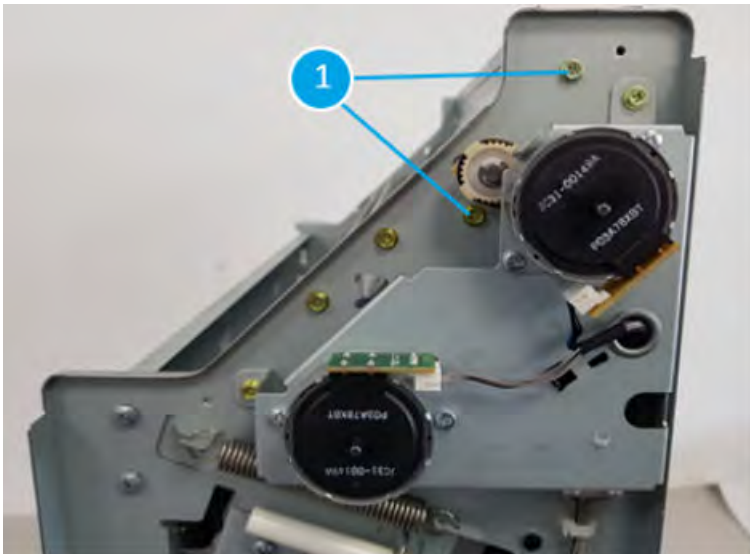

4. Remove two screws (callout 1) to make it easy to pull off the booklet entrance unit (callout 2)

Figure 5-1542 Remove two screws to make it easy to pull off the booklet entrance unit

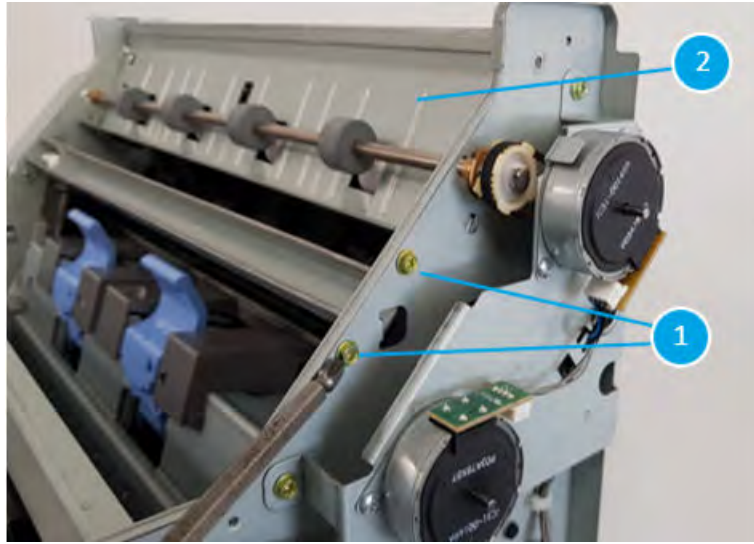

5. Remove the booklet entrance unit (callout 1)

Figure 5-1543 Remove the booklet entrance unit

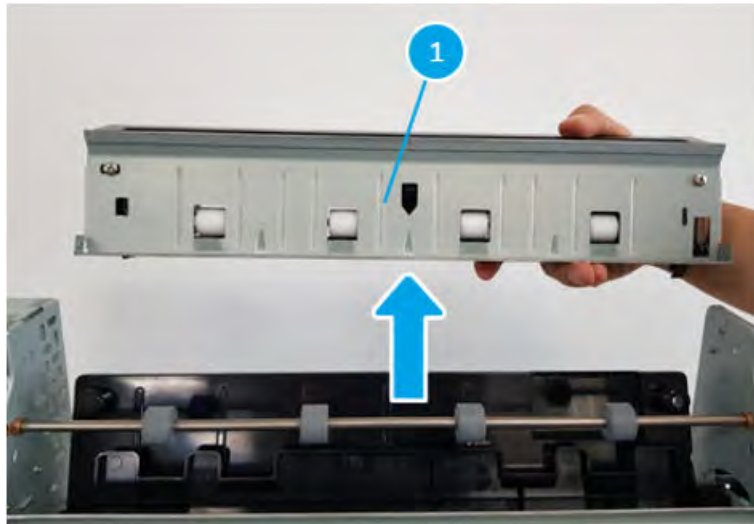

Remove the booklet presser

Follow these steps to remove the booklet presser.

1. Remove three screws (callout 1)

Figure 5-1544 Remove three screws



2. Disconnect one connector (callout 1) and remove the motor unit (callout 2)

Figure 5-1545 Disconnect one connector and remove the motor unit

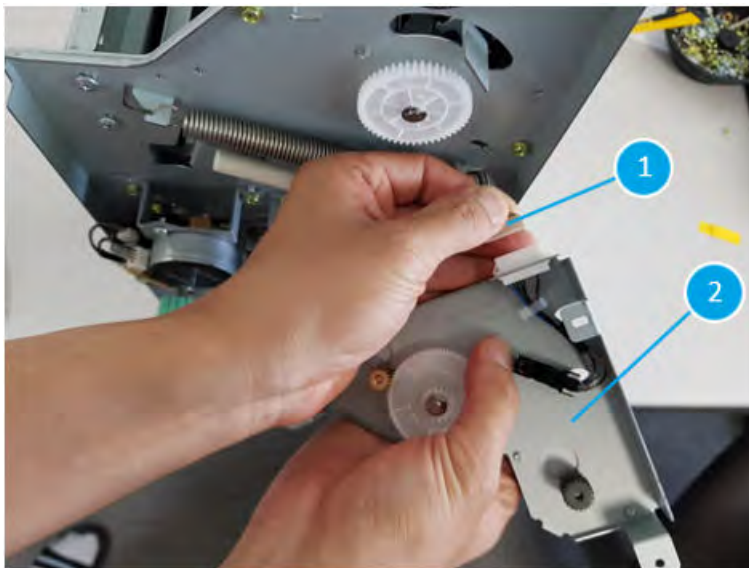

3. Remove one e-clip on top of the white gear then remove the white gear (callout 1)

Figure 5-1546 Remove one e-clip on top of the white gear then remove the white gear



4. Remove one e-clip on top of the bush then remove the bush (callout 1)

Figure 5-1547 Remove one e-clip on top of the bush then remove the bush



5. Band (callout2) the booklet presser (callout 1) out to make it easy to pull out (callout 3)

Figure 5-1548 Band the booklet presser out to make it easy to pull out

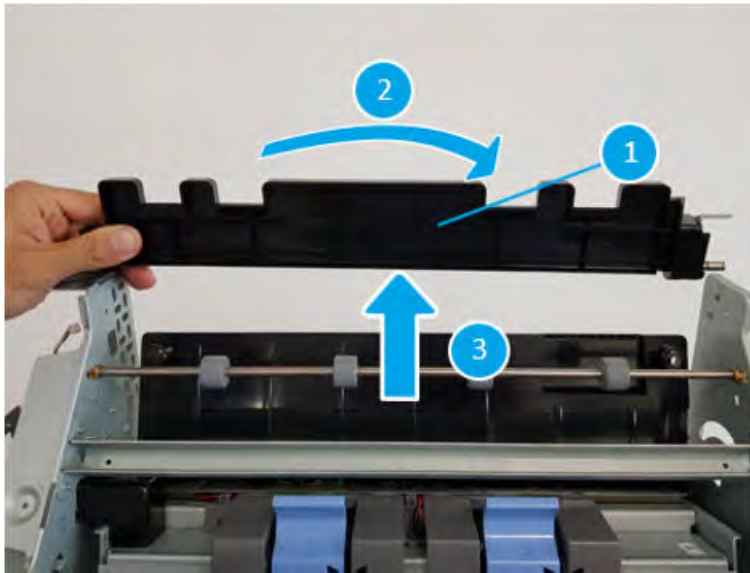

Unpack the replacement assembly

Follow these steps to unpack the replacement assembly.

1. Dispose of the defective part.



NOTE: HP recommends responsible disposal of the defective part.

<http://www8.hp.com/us/en/hp-information/environment/product-recycling.html>

2. Unpack the replacement part from the packaging.



CAUTION:  Some parts are sensitive to electrostatic discharge (ESD). Always perform service work at an ESD-protected workstation or mat. If an ESD workstation or mat is not available, touch the sheet-metal chassis to provide a static ground before touching an ESD-sensitive assembly. Protect the ESD-sensitive assemblies by placing them in ESD pouches when they are out of the printer.



IMPORTANT: Make sure that all of the shipping materials (for example shipping tape) are removed from the replacement part prior to installation.



NOTE: If the replacement part is a roller or pad, avoid touching the spongy part of it. Skin oils on the roller or pad can cause paper pickup and/or print-quality problems. HP recommends using disposable gloves when handling rollers or pads or washing your hands before touching rollers or pads.

3. To install an assembly, reverse the removal steps.



NOTE: When applicable, special installation instructions are provided for an assembly at the end of the removal procedure. Always completely read the removal instructions and follow all special installation instructions.

Removal and replacement: Booklet presser home sensor (S37)

Learn how to remove and replace the booklet presser home sensor.

Introduction

This document provides the procedures to remove and replace the booklet presser home sensor on the finisher.

 **IMPORTANT:** When applicable, special installation instructions are provided for an assembly at the end of the removal procedure. Always completely read the removal instructions and follow all special installation instructions.

Before performing service

- Turn the printer power off. A shutting-down message appears on the control-panel display.
- ⚠ **WARNING!** To avoid damage to the printer, turn the power off and wait until the printer shuts down before removing the power cable.
- Disconnect the printer power cable after the printer has completely shut down (the control-panel display is blank).
- Release the finisher from the printer by pulling out on the release latch inside the finisher door.
- Disconnect the cable from the bridge unit to the finisher.
- Disconnect the cable from the finisher to the printer.

Use the table below to identify the correct part number for your printer. To order the part, go to <https://parts.hp.com>.

Table 5-152 Part information

Part number	Part description
0604-001393	Booklet presser home sensor

Required tools

- #2 JIS screwdriver with a magnetic tip

After performing service

- Connect the cable from the finisher to the printer.
- Connect the cable from the bridge unit to the finisher.
- Attach the finisher to the printer, and then push in on the release latch inside the finisher door.
- Connect the printer power cable.
- Turn the printer power on.

Post service test

Process a job through the finisher and verify that the finisher works correctly.

Remove the booklet front cover

Follow these steps to remove the booklet front cover.

- ▲ Slide the booklet maker slightly away from the finisher (callout 1). Remove one screw (callout 2), and then slide the green knob away from the booklet maker to remove it (callout 3). Remove four screws (callout 4), and then remove the booklet front cover.

 **TIP:** Reverse the removal steps to install the assembly

Figure 5-1549 Remove five screws and the cover



Remove the booklet presser home sensor (S37)

Follow these steps to remove the booklet presser home sensor (S37).

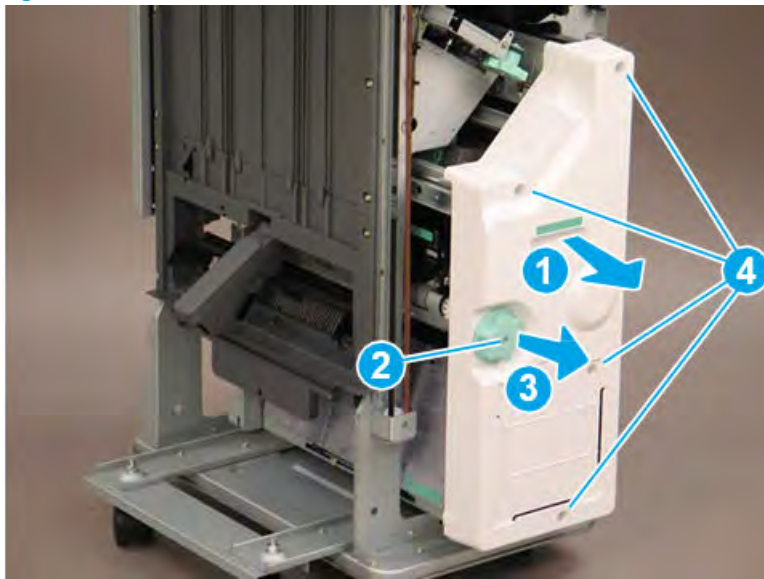
1. Remove three screws (callout 1)

Figure 5-1550 Remove three screws



2. Use a tweezer to remove booklet presser home sensor (S37, callout 1)

Figure 5-1551 Remove booklet presser home sensor

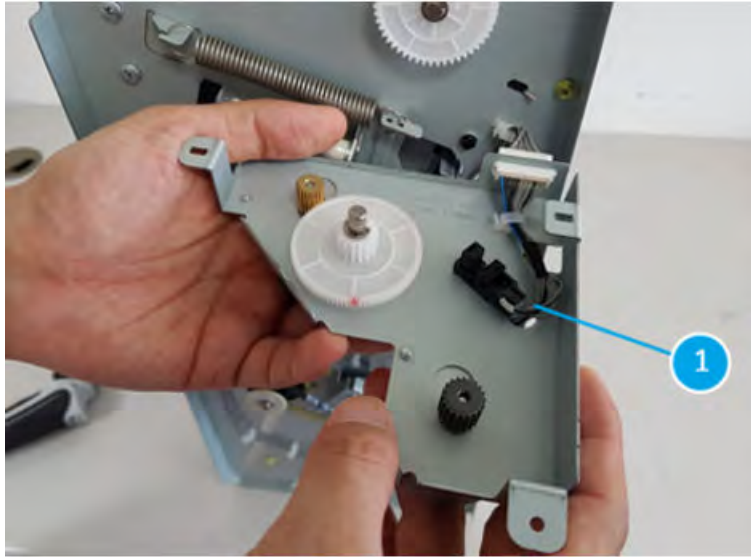

3. Unplug one connector (callout 1)

Figure 5-1552 Unplug one connector

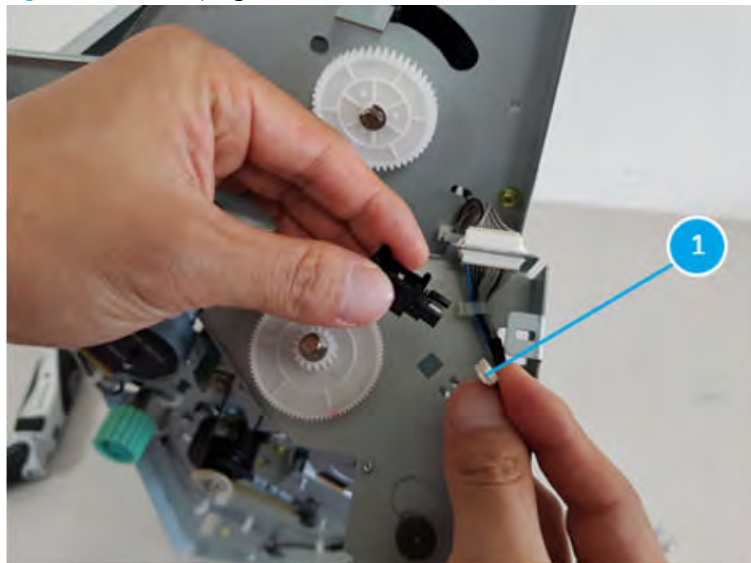

Unpack the replacement assembly

Follow these steps to unpack the replacement assembly.

1. Dispose of the defective part.

 **NOTE:** HP recommends responsible disposal of the defective part.

<http://www8.hp.com/us/en/hp-information/environment/product-recycling.html>

2. Unpack the replacement part from the packaging.



CAUTION:  Some parts are sensitive to electrostatic discharge (ESD). Always perform service work at an ESD-protected workstation or mat. If an ESD workstation or mat is not available, touch the sheet-metal chassis to provide a static ground before touching an ESD-sensitive assembly. Protect the ESD-sensitive assemblies by placing them in ESD pouches when they are out of the printer.

 **IMPORTANT:** Make sure that all of the shipping materials (for example shipping tape) are removed from the replacement part prior to installation.

 **NOTE:** If the replacement part is a roller or pad, avoid touching the spongy part of it. Skin oils on the roller or pad can cause paper pickup and/or print-quality problems. HP recommends using disposable gloves when handling rollers or pads or washing your hands before touching rollers or pads.

3. To install an assembly, reverse the removal steps.

 **NOTE:** When applicable, special installation instructions are provided for an assembly at the end of the removal procedure. Always completely read the removal instructions and follow all special installation instructions.

Removal and replacement: Booklet presser motor (M16)

Learn how to remove and replace the booklet presser motor.

Introduction

This document provides the procedures to remove and replace the booklet presser motor on the finisher.

 **IMPORTANT:** When applicable, special installation instructions are provided for an assembly at the end of the removal procedure. Always completely read the removal instructions and follow all special installation instructions.

Before performing service

- Turn the printer power off. A shutting-down message appears on the control-panel display.
- ⚠ **WARNING!** To avoid damage to the printer, turn the power off and wait until the printer shuts down before removing the power cable.
- Disconnect the printer power cable after the printer has completely shut down (the control-panel display is blank).
- Release the finisher from the printer by pulling out on the release latch inside the finisher door.
- Disconnect the cable from the bridge unit to the finisher.
- Disconnect the cable from the finisher to the printer.

Use the table below to identify the correct part number for your printer. To order the part, go to <https://parts.hp.com>.

Table 5-153 Part information

Part number	Part description
JC93-01155A	Booklet presser motor

Required tools

- #2 JIS screwdriver with a magnetic tip

After performing service

- Connect the cable from the finisher to the printer.
- Connect the cable from the bridge unit to the finisher.
- Attach the finisher to the printer, and then push in on the release latch inside the finisher door.
- Connect the printer power cable.
- Turn the printer power on.

Post service test

Process a job through the finisher and verify that the finisher works correctly.

Remove the booklet front cover

Follow these steps to remove the booklet front cover.

- ▲ Slide the booklet maker slightly away from the finisher (callout 1). Remove one screw (callout 2), and then slide the green knob away from the booklet maker to remove it (callout 3). Remove four screws (callout 4), and then remove the booklet front cover.

💡 **TIP:** Reverse the removal steps to install the assembly

Figure 5-1553 Remove five screws and the cover

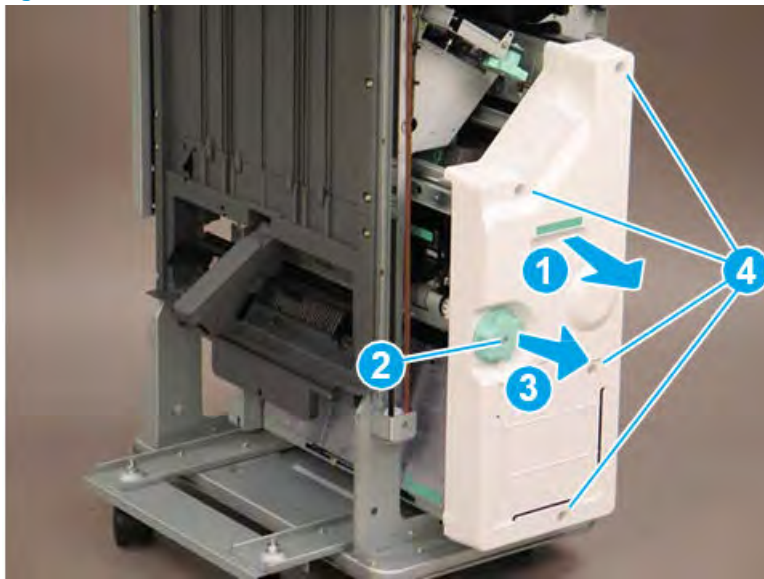

Remove the booklet presser motor (M16)

Follow these steps to remove the booklet presser motor (M16).

- ▲ Disconnect one connector (callout 1), remove two screws (callout 2), and then remove the booklet presser motor.

💡 **TIP:** Reverse the removal steps to install the assembly.

Figure 5-1554 Remove the booklet presser motor



Unpack the replacement assembly



Follow these steps to unpack the replacement assembly.

1. Dispose of the defective part.

 **NOTE:** HP recommends responsible disposal of the defective part.

<http://www8.hp.com/us/en/hp-information/environment/product-recycling.html>

2. Unpack the replacement part from the packaging.

 **CAUTION:**  Some parts are sensitive to electrostatic discharge (ESD). Always perform service work at an ESD-protected workstation or mat. If an ESD workstation or mat is not available, touch the sheet-metal chassis to provide a static ground before touching an ESD-sensitive assembly. Protect the ESD-sensitive assemblies by placing them in ESD pouches when they are out of the printer.

 **IMPORTANT:** Make sure that all of the shipping materials (for example shipping tape) are removed from the replacement part prior to installation.

 **NOTE:** If the replacement part is a roller or pad, avoid touching the spongy part of it. Skin oils on the roller or pad can cause paper pickup and/or print-quality problems. HP recommends using disposable gloves when handling rollers or pads or washing your hands before touching rollers or pads.

3. To install an assembly, reverse the removal steps.

 **NOTE:** When applicable, special installation instructions are provided for an assembly at the end of the removal procedure. Always completely read the removal instructions and follow all special installation instructions.

Booklet tamper unit

Removal and replacement: Booklet tamper unit

Learn how to remove and replace the tray booklet tamper unit.

Introduction

This document provides the procedures to remove and replace the booklet tamper unit on the finisher.

 **IMPORTANT:** When applicable, special installation instructions are provided for an assembly at the end of the removal procedure. Always completely read the removal instructions and follow all special installation instructions.

Before performing service

- Turn the printer power off. A shutting-down message appears on the control-panel display.
- ⚠ **WARNING!** To avoid damage to the printer, turn the power off and wait until the printer shuts down before removing the power cable.
- Disconnect the printer power cable after the printer has completely shut down (the control-panel display is blank).
- Release the finisher from the printer by pulling out on the release latch inside the finisher door.
- Disconnect the cable from the bridge unit to the finisher.
- Disconnect the cable from the finisher to the printer.

Use the table below to identify the correct part number for your printer. To order the part, go to <https://parts.hp.com>.

Table 5-154 Part information

Part number	Part description
JC90-01431A	Booklet tamper unit

Required tools

- #2 JIS screwdriver with a magnetic tip

After performing service

- Connect the cable from the finisher to the printer.
- Connect the cable from the bridge unit to the finisher.
- Attach the finisher to the printer, and then push in on the release latch inside the finisher door.
- Connect the printer power cable.
- Turn the printer power on.

Post service test

Process a job through the finisher and verify that the finisher works correctly.

Remove the right upper cover (finisher)

Follow these steps to remove the right upper cover (finisher).

- ▲ Remove one screw cap and three machine screws on the upper edge of the cover (callout 1). Remove three sheet metal screws (callout 2) on the lower portion of the cover. Rotate the right edge of the cover away from the finisher, and then slide the cover right to release three tabs (callout 3).

💡 **TIP:** The lower screws are shorter in length than the upper screws.

TIP: Reverse the removal steps to install the assembly.

Figure 5-1555 Remove the right upper cover

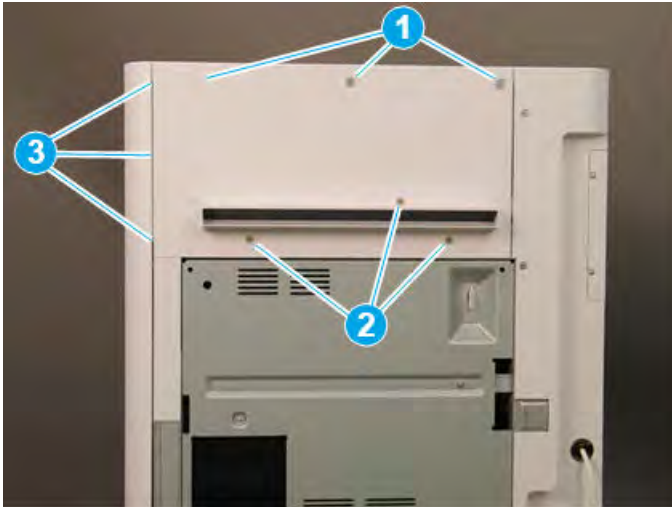

Remove the top cover (finisher)

Follow these steps to remove the top cover (finisher).

1. Remove three screw caps and three self-tapping screws at the top of the rear cover (callout 1), and then remove three machine screws (callout 2) on top of the cover.

Figure 5-1556 Remove six screws

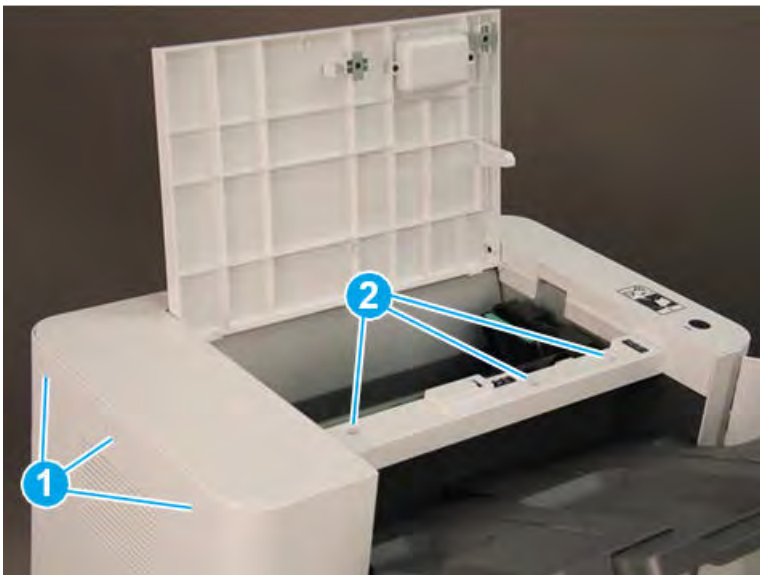

2. Remove three self-tapping screws at the top of the front cover (callout 1), and then remove two machine screws (callout 2) at the top of the right side.

Figure 5-1557 Remove five screws

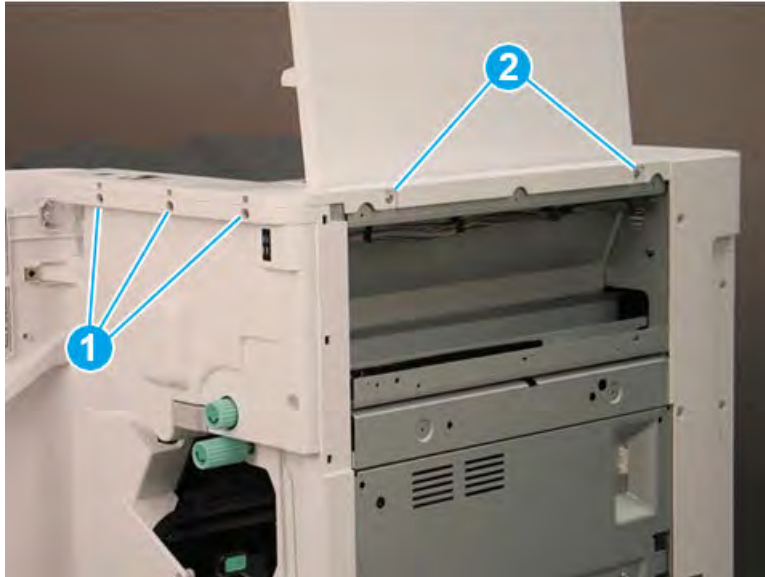

3. Lift the cover up slightly. Disconnect one in-line connector (callout 1), and then release one retainer (callout 2).

 **TIP:** Reverse the removal steps to install the assembly.

Figure 5-1558 Disconnect one connector and release retainer



Remove the rear cover (finisher)

Follow these steps to remove the rear cover (finisher).

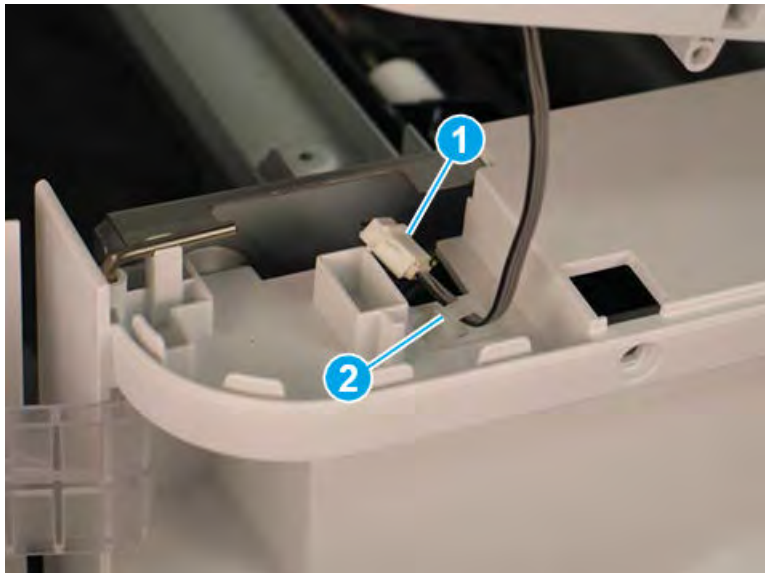
1. Remove two self-tapping screws (callout 1) on the top of the rear cover, and then remove five screw caps and five machine screws (callout 2) on the left side of the cover.

Figure 5-1559 Remove seven screws

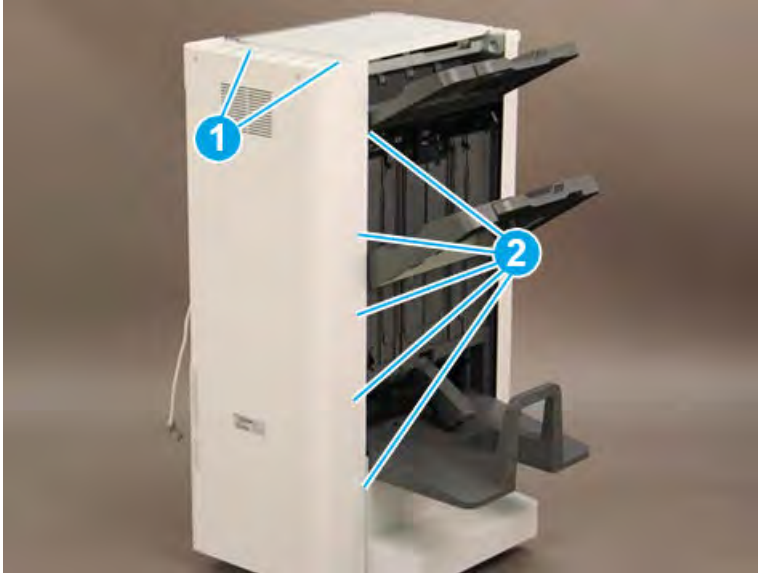

2. Remove one screw cap and four machine screws (callout 1) Remove the rear cover.

 **NOTE:** Make sure to thread the power cable (callout 2) through the opening in the cover.

 **TIP:** Reverse the removal steps to install the assembly

Figure 5-1560 Remove the rear cover



Remove the booklet maker

Follow these steps to remove the booklet maker.

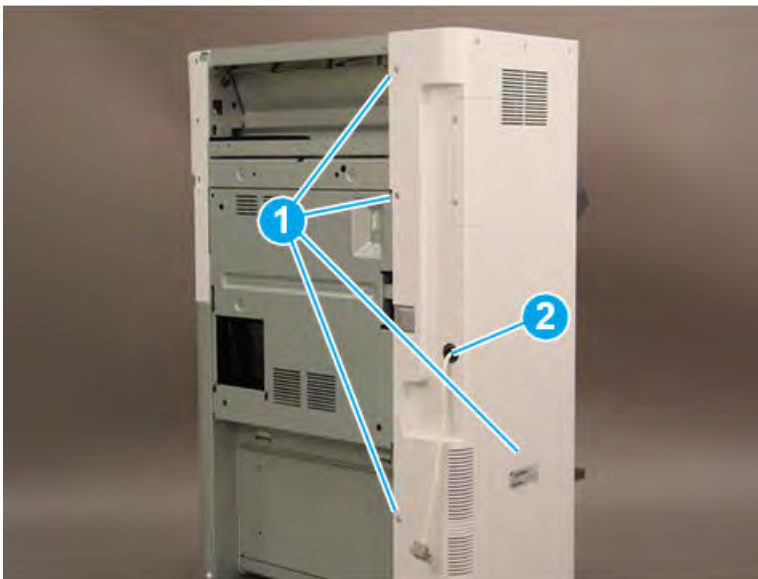
1. Slide the booklet maker away from the finisher.

Figure 5-1561 Slide the booklet maker away from the finisher



2. At the Disconnect one connector (callout 1), and then remove one screw (callout 2).

Figure 5-1562 Disconnect one connector and remove one screw

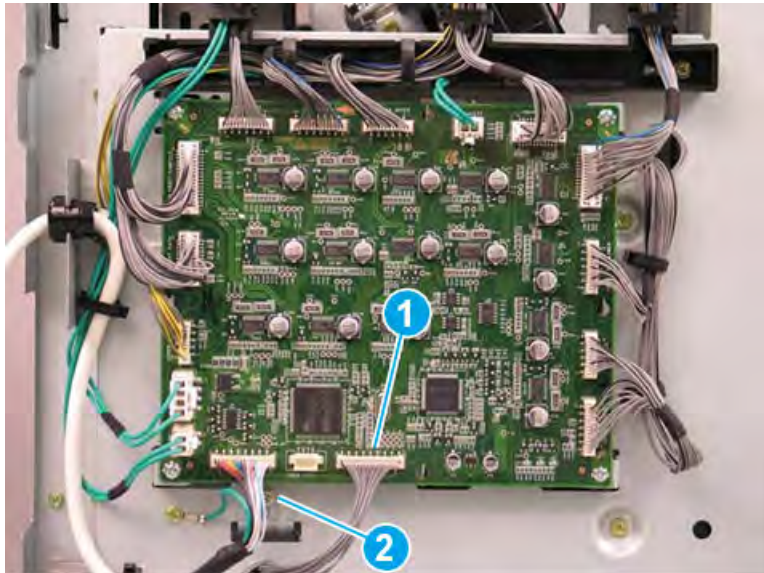

3. Release the metal bracket through the opening in the sheet metal.

Figure 5-1563 Release the metal bracket

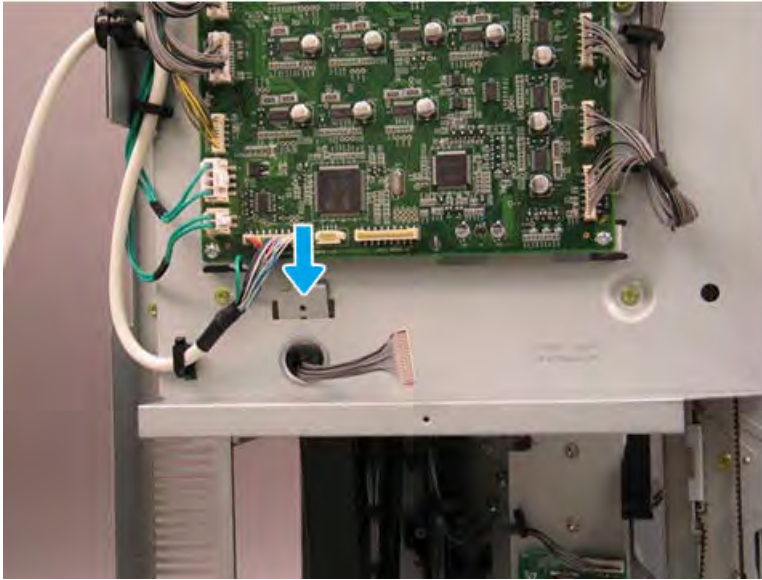

4. Remove one star-washer screw (callout 1), and then release the alignment pin (callout 2) on the right side of the booklet maker.

Figure 5-1564 Remove one screw

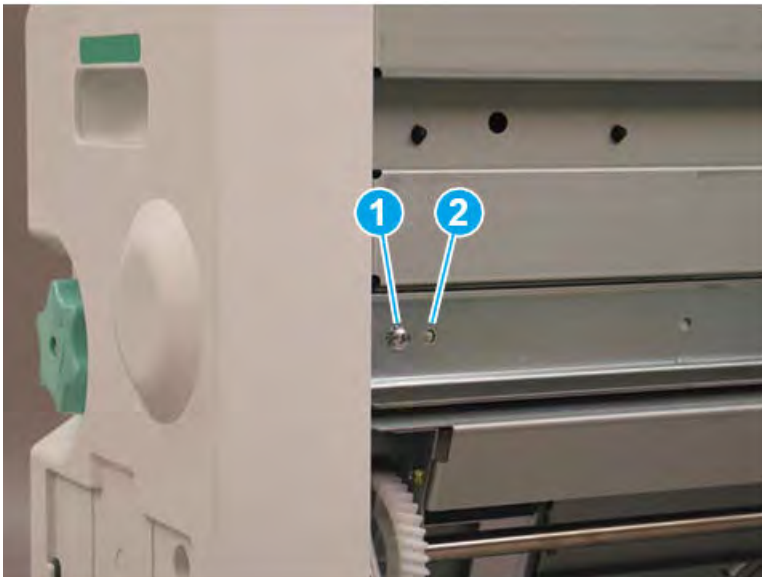

5. Slide the right rail toward the finisher.

Figure 5-1565 Slide the right rail

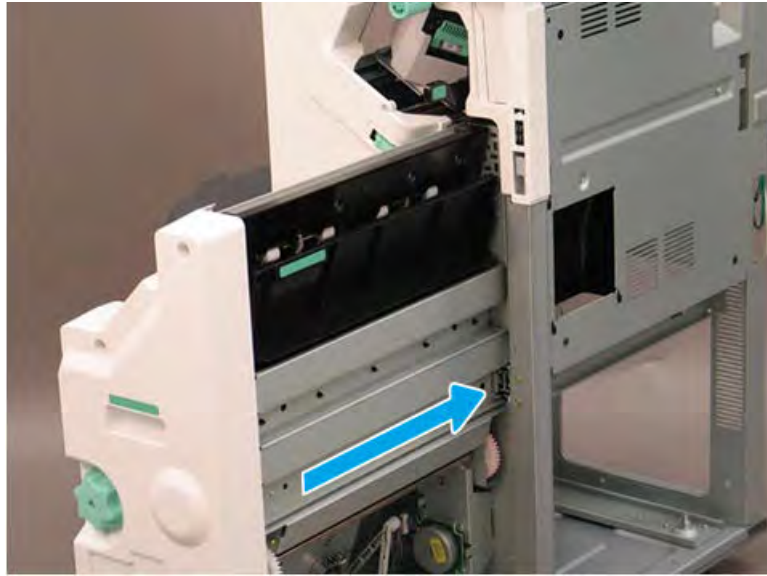

6. Remove one star-washer screw (callout 1) on the left side of the booklet maker.

Figure 5-1566 Remove one screw

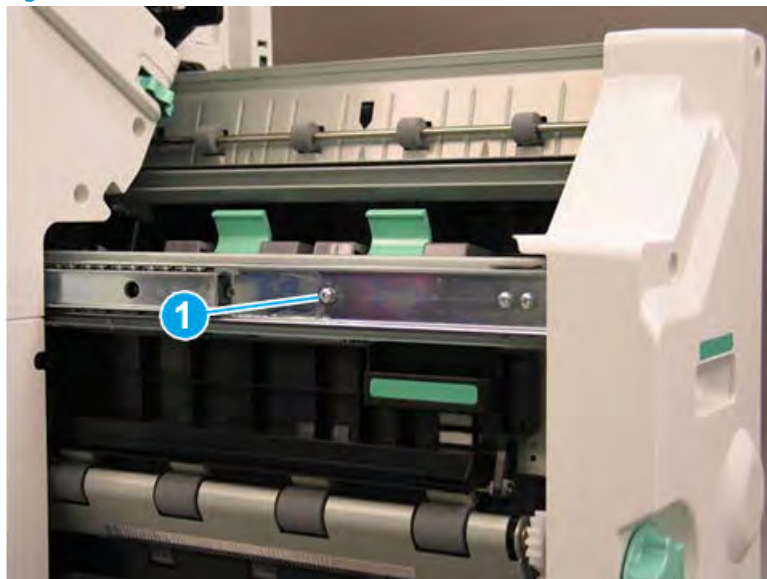

7. Lift the booklet maker up on the left side while squeezing the right rail away from the finisher slightly to clear the sheet metal. Remove the booklet maker.

Figure 5-1567 Remove the booklet maker

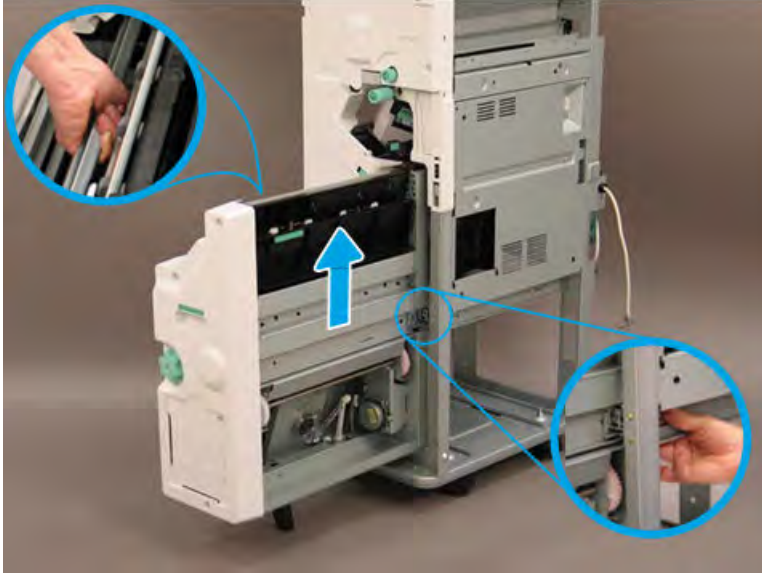

8. Reverse the removal steps to install the assembly. Also use the following special installation instructions.

 **NOTE:** Continue to reverse the removal steps to finish installing the assembly.

Special installation instructions: booklet maker

When installing the booklet maker, position the hooks on the rail under the slots on the booklet maker.

Figure 5-1568 Position the hooks

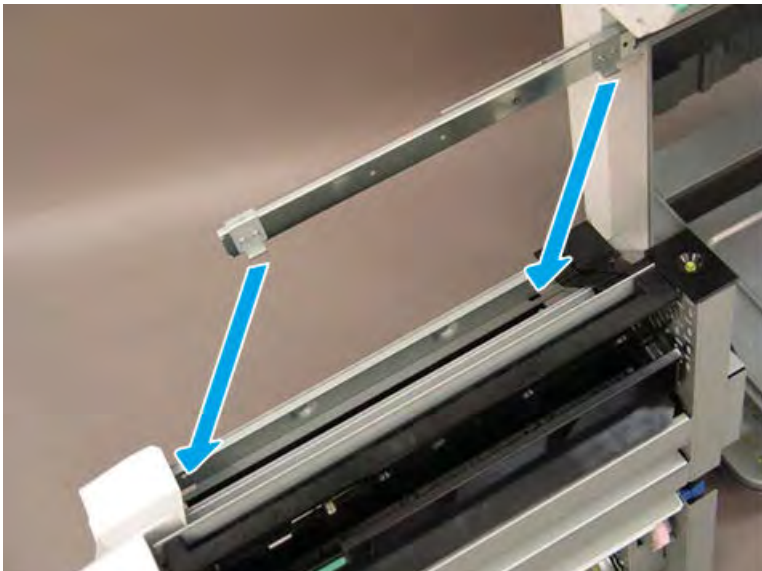

9. When installed correctly, the arrow on the front of the booklet maker aligns with the arrow on the finisher rail.

Figure 5-1569 Align arrows



10. When installed correctly, the arrow on the back of the booklet maker aligns with the arrow on the finisher rail.

Figure 5-1570 Align arrows

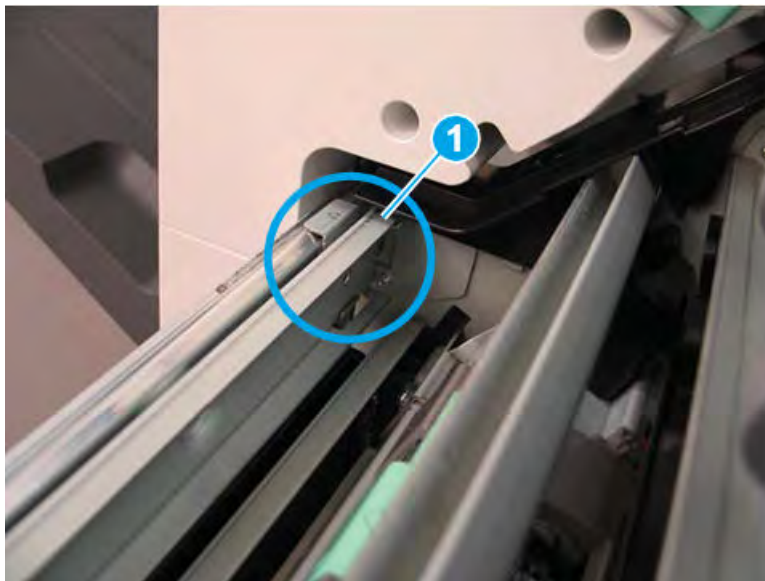

11. Extend the right rail away from the finisher and position it in the booklet maker slot.

Figure 5-1571 Extend the right rail



Remove the booklet front cover

Follow these steps to remove the booklet front cover.

- ▲ Slide the booklet maker slightly away from the finisher (callout 1). Remove one screw (callout 2), and then slide the green knob away from the booklet maker to remove it (callout 3). Remove four screws (callout 4), and then remove the booklet front cover.

 **TIP:** Reverse the removal steps to install the assembly

Figure 5-1572 Remove five screws and the cover



Remove the booklet right lower shield

Follow these steps to remove the booklet right lower shield.

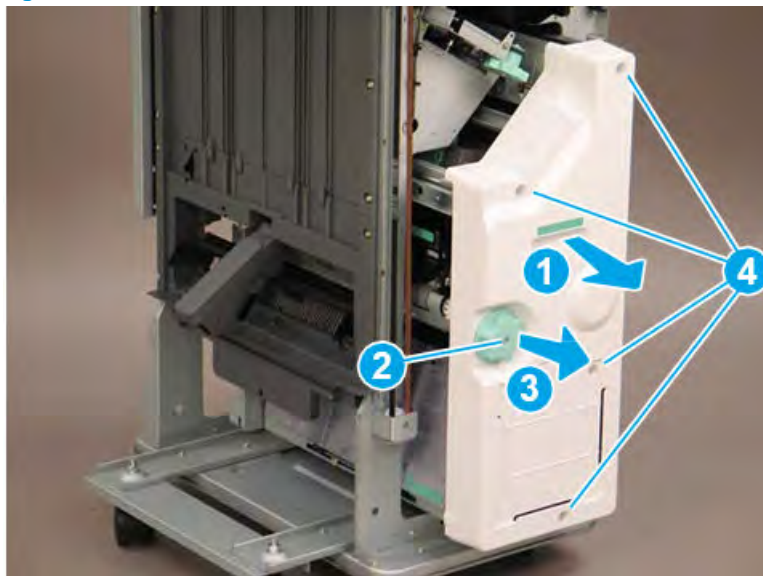
1. Remove two screws at the front of the booklet maker (callout 1).

Figure 5-1573 Remove two screws

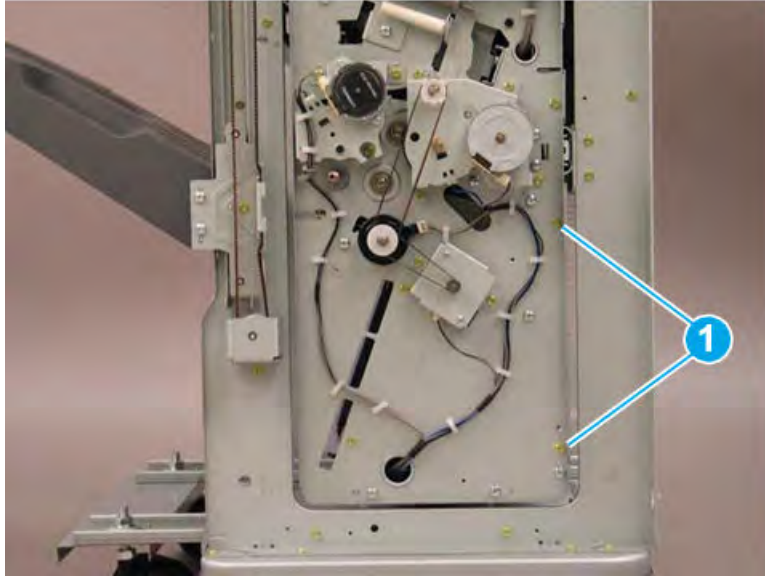

2. Remove two screws at the back of the booklet maker (callout 1).

Figure 5-1574 Remove two screws

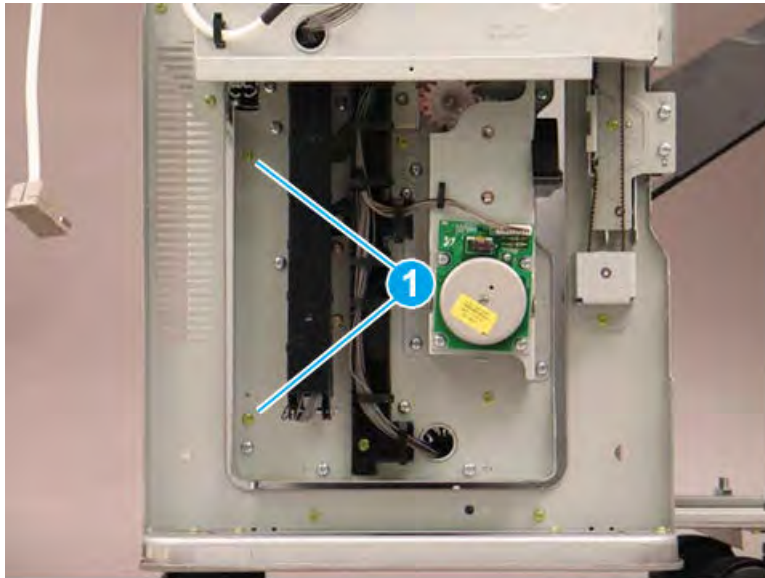

3. Slide the booklet maker out of the finisher (callout 1), and then rotate the top of the right lower shield (callout 2) away from the booklet maker to remove it.

Figure 5-1575 Remove the right lower shield

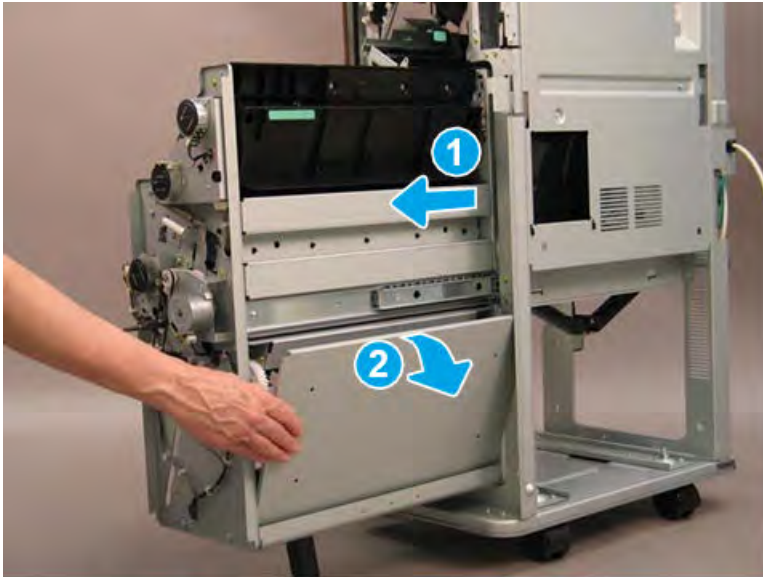

Remove the booklet maker middle right shield

Follow these steps to remove the booklet maker middle right shield.

1. Remove two screws at the front of the booklet maker (callout 1).

Figure 5-1576 Remove two screws at the front of the booklet maker

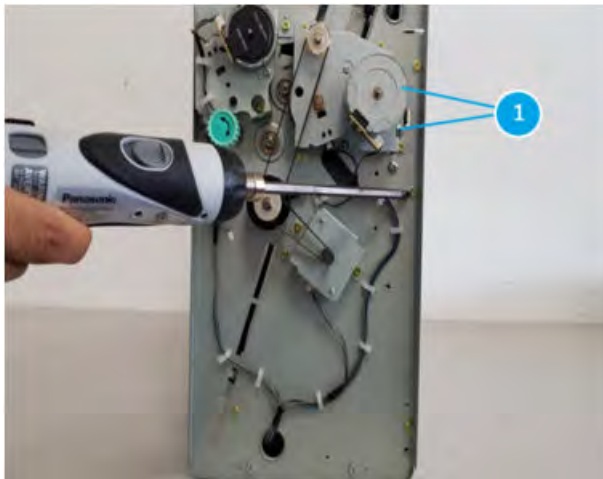

2. Remove two screws at the back of the booklet maker (callout 1).

Figure 5-1577 Remove two screws at the back of the booklet maker

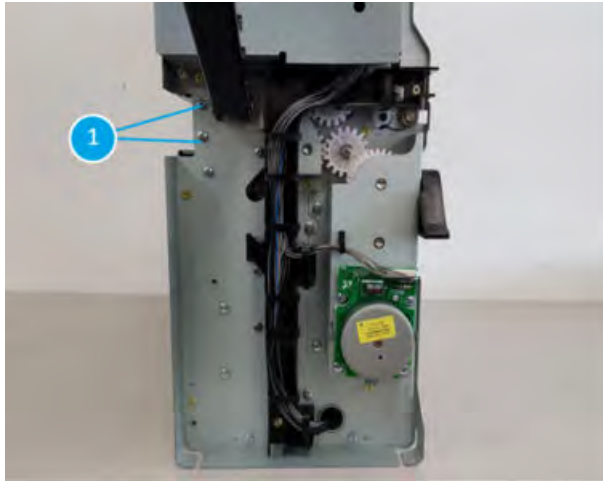

Remove the booklet finisher upper right shield

Follow these steps to remove the booklet finisher upper right shield.

1. Remove two screws at the front of the booklet maker (callout 1)

Figure 5-1578 Remove two screws at the front of the booklet maker



2. Remove two screws(callout 1) and one screw(callout 2) at the back of the booklet maker and then remove the board cover.

Figure 5-1579 Remove the board cover

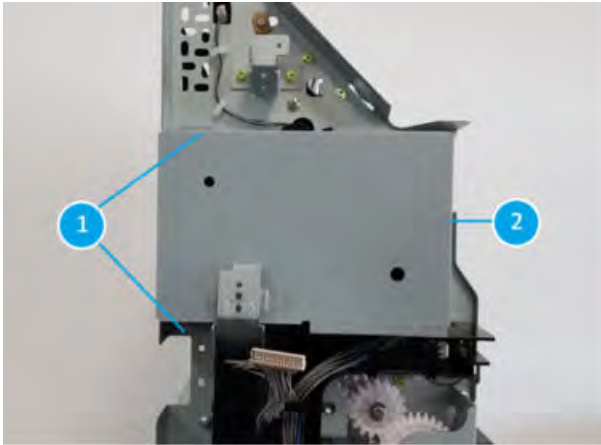

3. Remove two screws at the back of the booklet maker (callout 1).

Figure 5-1580 Remove two screws

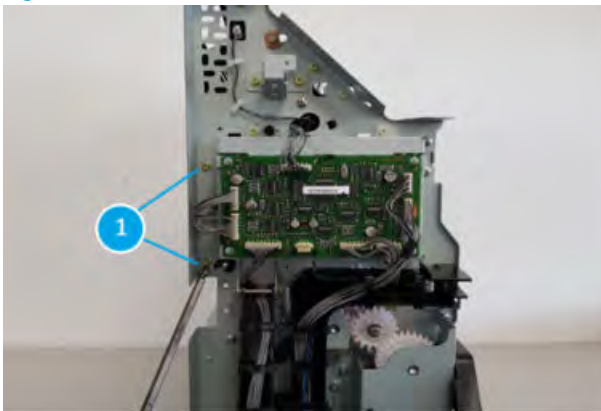

4. Disconnect one connector at the front of the booklet maker (callout 1).

Figure 5-1581 Disconnect one connector



5. Disconnect one connector at the right of the booklet maker (callout 1).

Figure 5-1582 Disconnect one connector



Remove the booklet tamper and fold unit

Follow these steps to remove the booklet tamper and fold unit.

1. Remove two screws at the left of the booklet maker (callout 1).

Figure 5-1583 Remove two screws at the left of the booklet maker



2. Remove three screws at the right of the booklet maker (callout 1).

Figure 5-1584 Remove three screws at the right of the booklet maker

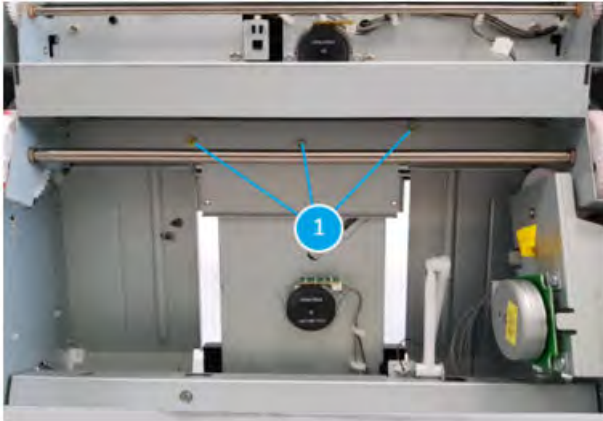

3. Remove two screws at the front of the booklet maker (callout 1).

Figure 5-1585 Remove two screws at the front of the booklet maker

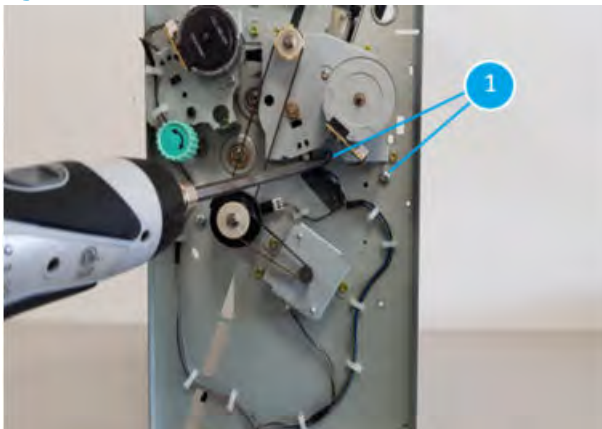

4. Remove two screws at the back of the booklet maker (callout 1).

Figure 5-1586 Remove two screws at the back of the booklet maker

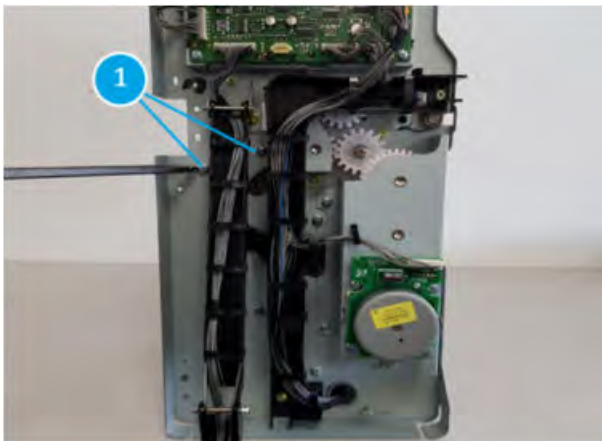

5. Disconnect one connector at the right of the booklet maker (callout 1).

Figure 5-1587 Disconnect one connector



Remove the booklet tamper unit

Follow these steps to remove the booklet tamper unit.

1. Remove two screws and disconnect one connector (callout 2)

Figure 5-1588 Remove two screws

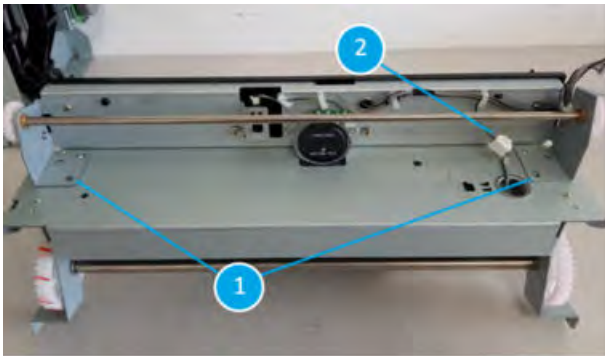

2. Booklet tamper unit (callout 1)

Figure 5-1589 Booklet tamper unit



Unpack the replacement assembly

Follow these steps to unpack the replacement assembly.

1. Dispose of the defective part.

 **NOTE:** HP recommends responsible disposal of the defective part.

<http://www8.hp.com/us/en/hp-information/environment/product-recycling.html>

2. Unpack the replacement part from the packaging.



CAUTION:  Some parts are sensitive to electrostatic discharge (ESD). Always perform service work at an ESD-protected workstation or mat. If an ESD workstation or mat is not available, touch the sheet-metal chassis to provide a static ground before touching an ESD-sensitive assembly. Protect the ESD-sensitive assemblies by placing them in ESD pouches when they are out of the printer.

 **IMPORTANT:** Make sure that all of the shipping materials (for example shipping tape) are removed from the replacement part prior to installation.

 **NOTE:** If the replacement part is a roller or pad, avoid touching the spongy part of it. Skin oils on the roller or pad can cause paper pickup and/or print-quality problems. HP recommends using disposable gloves when handling rollers or pads or washing your hands before touching rollers or pads.

3. To install an assembly, reverse the removal steps.

 **NOTE:** When applicable, special installation instructions are provided for an assembly at the end of the removal procedure. Always completely read the removal instructions and follow all special installation instructions.

Removal and replacement: Booklet presser home sensor (S37)

Learn how to remove and replace the tray booklet tamper home sensor.

Introduction

This document provides the procedures to remove and replace the booklet tamper home sensor on the finisher.



IMPORTANT: When applicable, special installation instructions are provided for an assembly at the end of the removal procedure. Always completely read the removal instructions and follow all special installation instructions.

Before performing service

- Turn the printer power off. A shutting-down message appears on the control-panel display.
- ⚠ **WARNING!** To avoid damage to the printer, turn the power off and wait until the printer shuts down before removing the power cable.
- Disconnect the printer power cable after the printer has completely shut down (the control-panel display is blank).
- Release the finisher from the printer by pulling out on the release latch inside the finisher door.
- Disconnect the cable from the bridge unit to the finisher.
- Disconnect the cable from the finisher to the printer.

Use the table below to identify the correct part number for your printer. To order the part, go to <https://parts.hp.com>.

Table 5-155 Part information

Part number	Part description
0604-001393	Booklet tamper home sensor

Required tools

- #2 JIS screwdriver with a magnetic tip

After performing service

- Connect the cable from the finisher to the printer.
- Connect the cable from the bridge unit to the finisher.
- Attach the finisher to the printer, and then push in on the release latch inside the finisher door.
- Connect the printer power cable.
- Turn the printer power on.

Post service test

Process a job through the finisher and verify that the finisher works correctly.

Remove the right upper cover (finisher)

Follow these steps to remove the right upper cover (finisher).

- ▲ Remove one screw cap and three machine screws on the upper edge of the cover (callout 1). Remove three sheet metal screws (callout 2) on the lower portion of the cover. Rotate the right edge of the cover away from the finisher, and then slide the cover right to release three tabs (callout 3).

💡 **TIP:** The lower screws are shorter in length than the upper screws.

TIP: Reverse the removal steps to install the assembly.

Figure 5-1590 Remove the right upper cover

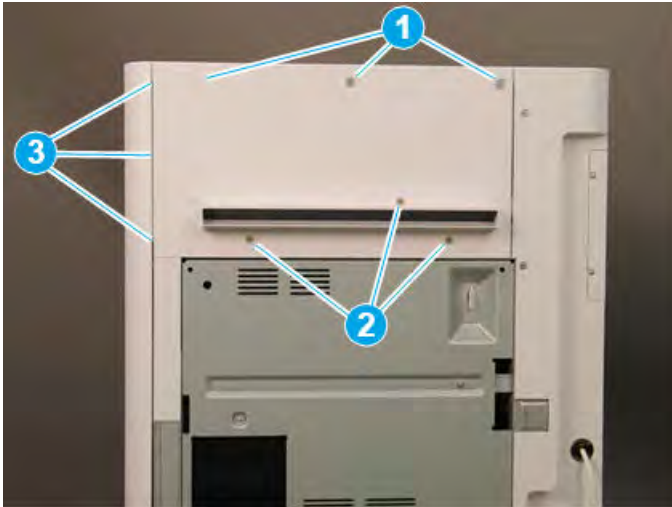

Remove the top cover (finisher)

Follow these steps to remove the top cover (finisher).

1. Remove three screw caps and three self-tapping screws at the top of the rear cover (callout 1), and then remove three machine screws (callout 2) on top of the cover.

Figure 5-1591 Remove six screws

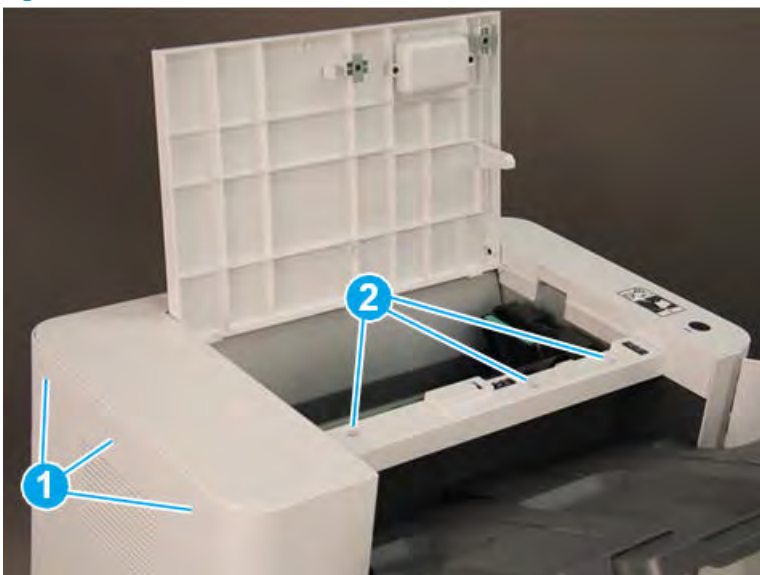

2. Remove three self-tapping screws at the top of the front cover (callout 1), and then remove two machine screws (callout 2) at the top of the right side.

Figure 5-1592 Remove five screws

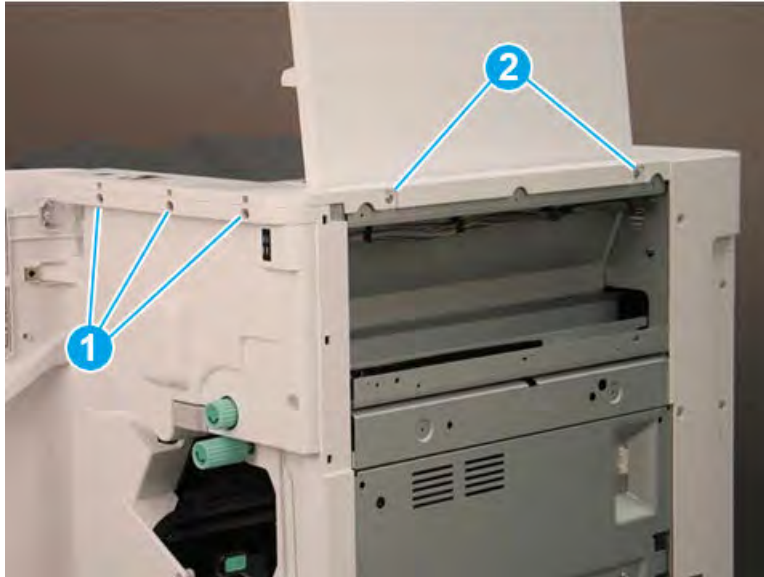

3. Lift the cover up slightly. Disconnect one in-line connector (callout 1), and then release one retainer (callout 2).

 **TIP:** Reverse the removal steps to install the assembly.

Figure 5-1593 Disconnect one connector and release retainer



Remove the rear cover (finisher)

Follow these steps to remove the rear cover (finisher).

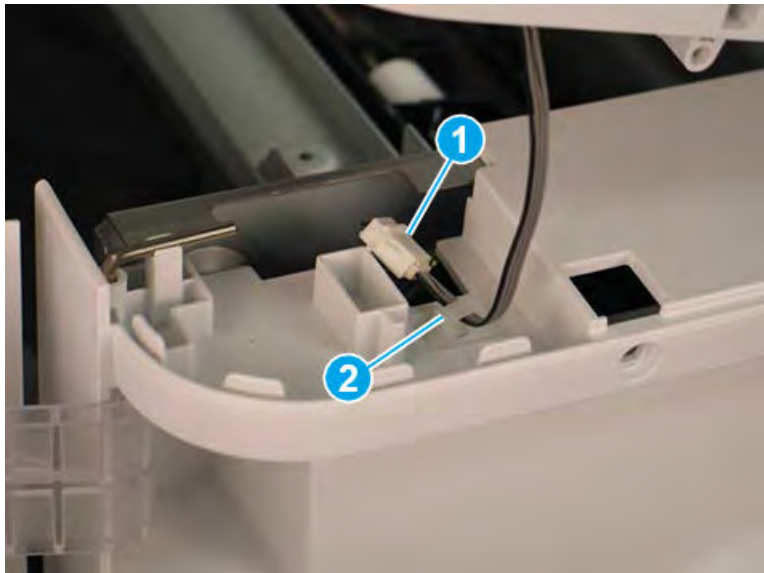
1. Remove two self-tapping screws (callout 1) on the top of the rear cover, and then remove five screw caps and five machine screws (callout 2) on the left side of the cover.

Figure 5-1594 Remove seven screws



2. Remove one screw cap and four machine screws (callout 1) Remove the rear cover.

 **NOTE:** Make sure to thread the power cable (callout 2) through the opening in the cover.

 **TIP:** Reverse the removal steps to install the assembly

Figure 5-1595 Remove the rear cover

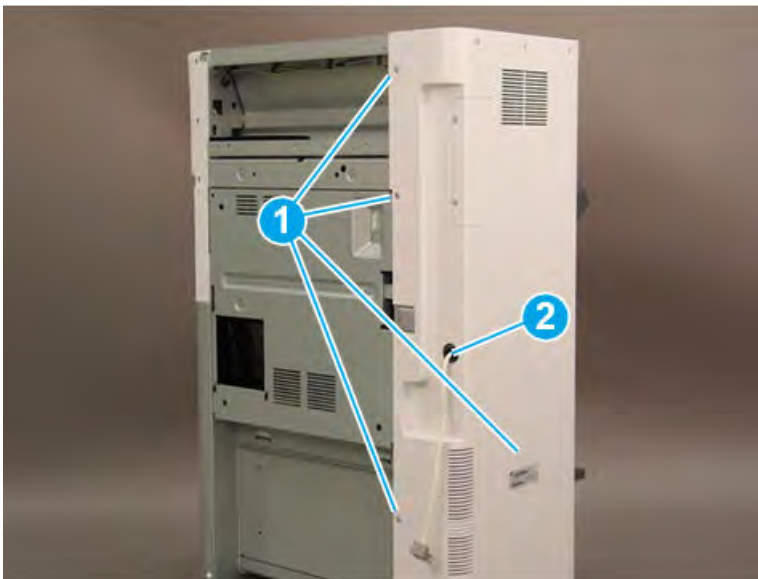

Remove the booklet maker

Follow these steps to remove the booklet maker.

1. Slide the booklet maker away from the finisher.

Figure 5-1596 Slide the booklet maker away from the finisher



2. At the Disconnect one connector (callout 1), and then remove one screw (callout 2).

Figure 5-1597 Disconnect one connector and remove one screw

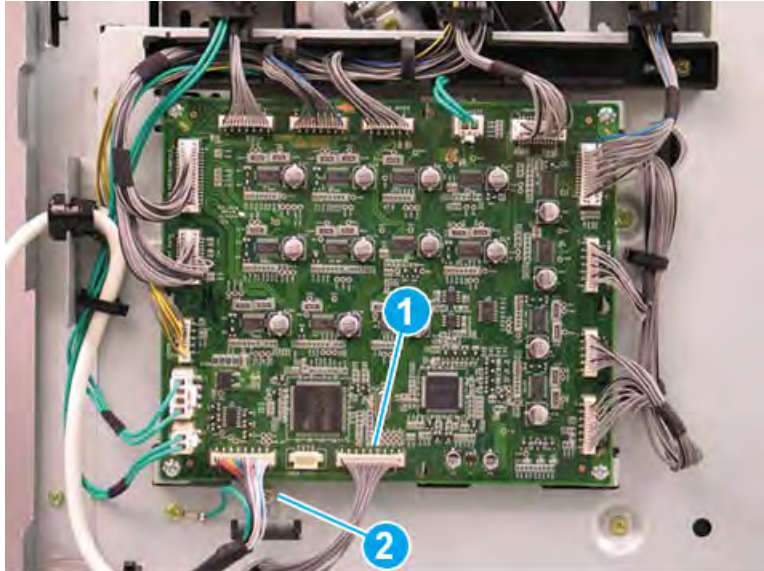

3. Release the metal bracket through the opening in the sheet metal.

Figure 5-1598 Release the metal bracket

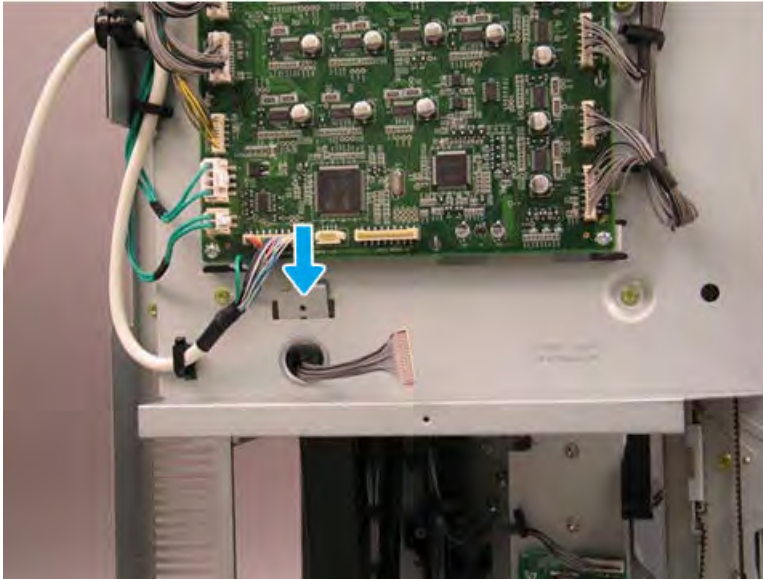

4. Remove one star-washer screw (callout 1), and then release the alignment pin (callout 2) on the right side of the booklet maker.

Figure 5-1599 Remove one screw

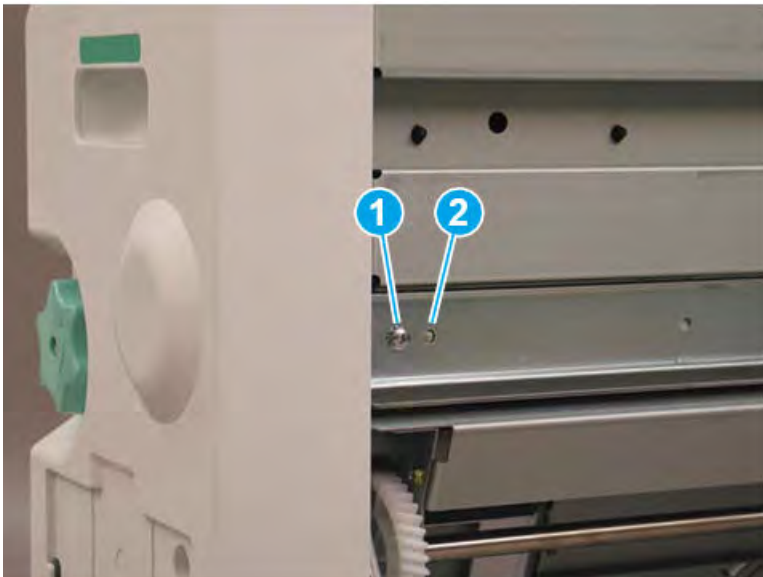

5. Slide the right rail toward the finisher.

Figure 5-1600 Slide the right rail

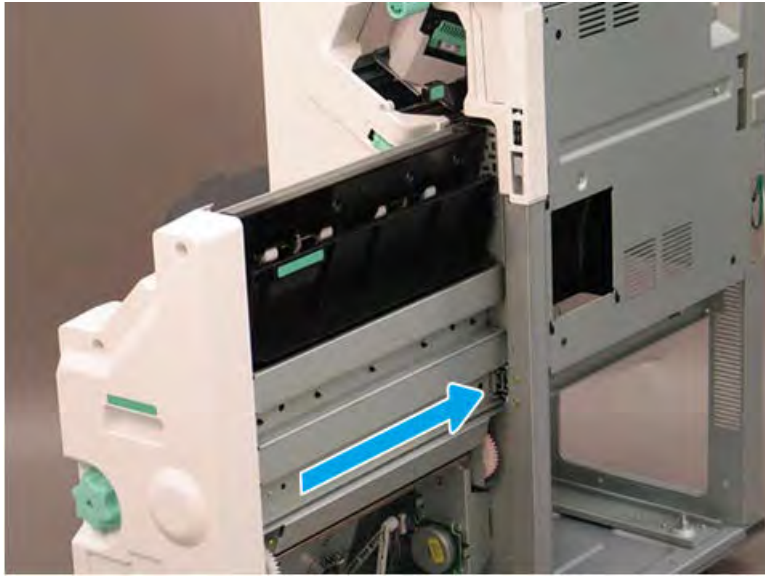

6. Remove one star-washer screw (callout 1) on the left side of the booklet maker.

Figure 5-1601 Remove one screw

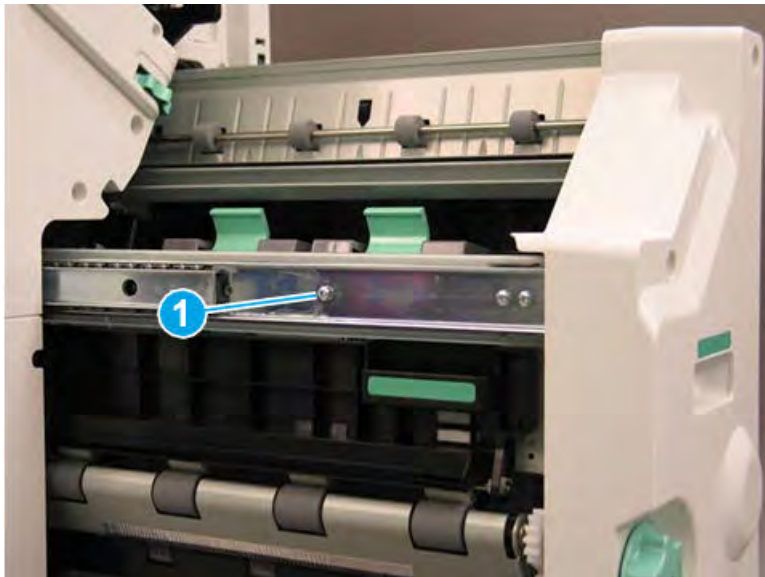

7. Lift the booklet maker up on the left side while squeezing the right rail away from the finisher slightly to clear the sheet metal. Remove the booklet maker.

Figure 5-1602 Remove the booklet maker

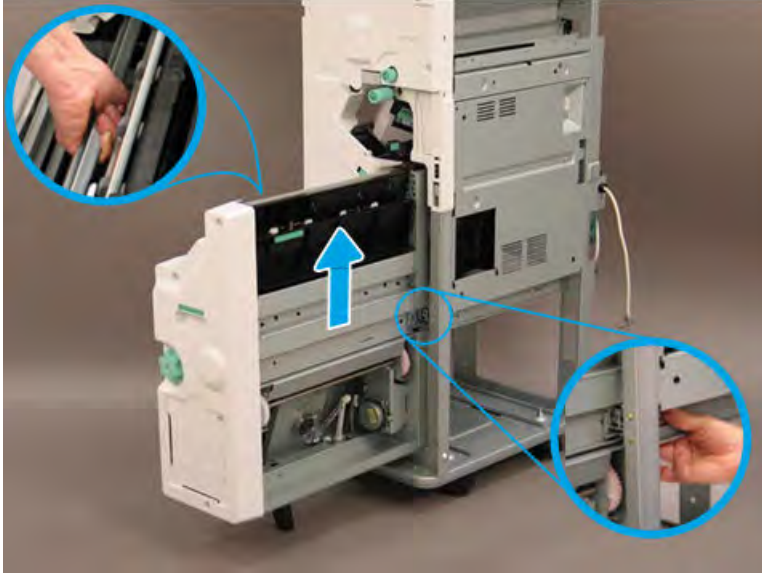

8. Reverse the removal steps to install the assembly. Also use the following special installation instructions.

 **NOTE:** Continue to reverse the removal steps to finish installing the assembly.

Special installation instructions: booklet maker

When installing the booklet maker, position the hooks on the rail under the slots on the booklet maker.

Figure 5-1603 Position the hooks

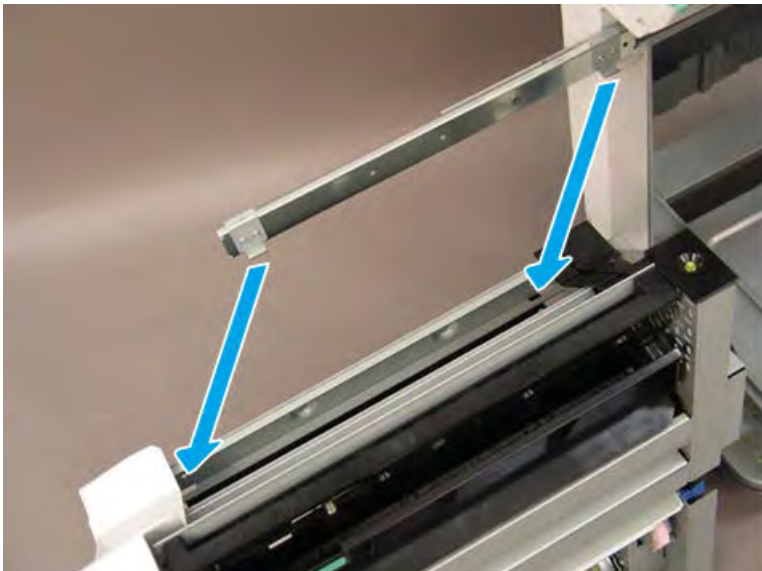

9. When installed correctly, the arrow on the front of the booklet maker aligns with the arrow on the finisher rail.

Figure 5-1604 Align arrows

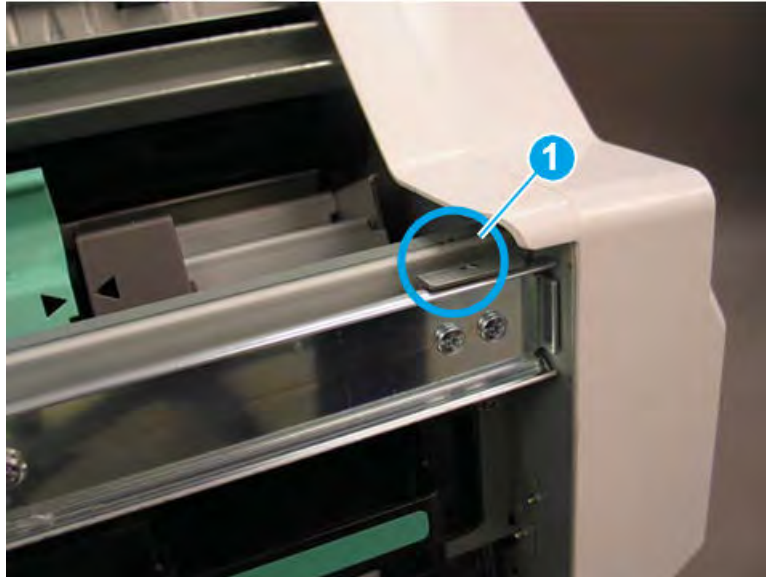

10. When installed correctly, the arrow on the back of the booklet maker aligns with the arrow on the finisher rail.

Figure 5-1605 Align arrows

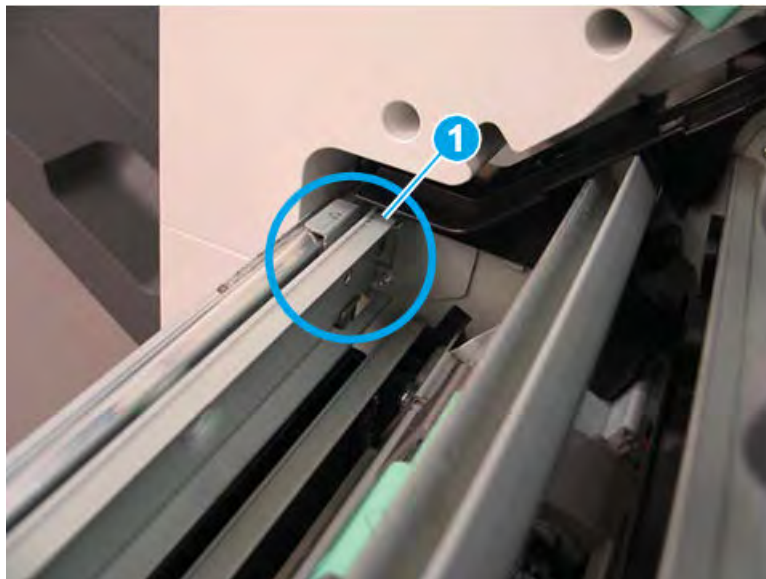

11. Extend the right rail away from the finisher and position it in the booklet maker slot.

Figure 5-1606 Extend the right rail



Remove the booklet front cover

Follow these steps to remove the booklet front cover.

- ▲ Slide the booklet maker slightly away from the finisher (callout 1). Remove one screw (callout 2), and then slide the green knob away from the booklet maker to remove it (callout 3). Remove four screws (callout 4), and then remove the booklet front cover.

 **TIP:** Reverse the removal steps to install the assembly

Figure 5-1607 Remove five screws and the cover

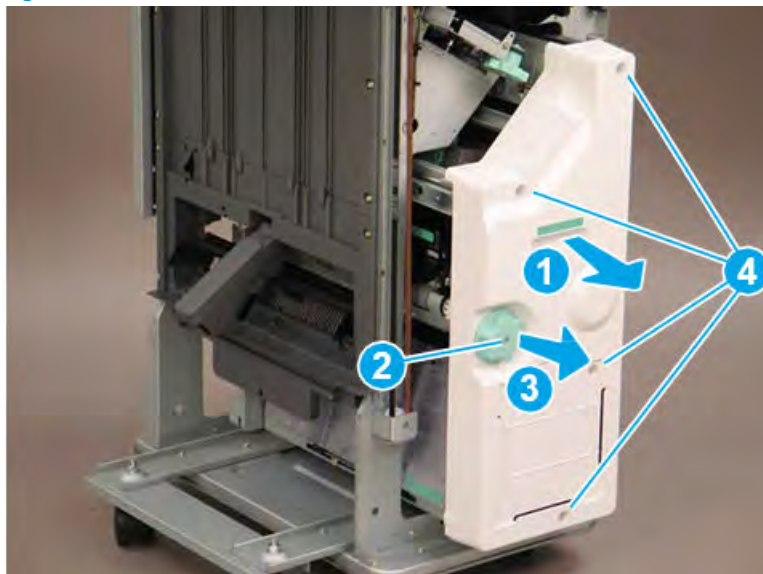

Remove the booklet right lower shield

Follow these steps to remove the booklet right lower shield.

1. Remove two screws at the front of the booklet maker (callout 1).

Figure 5-1608 Remove two screws

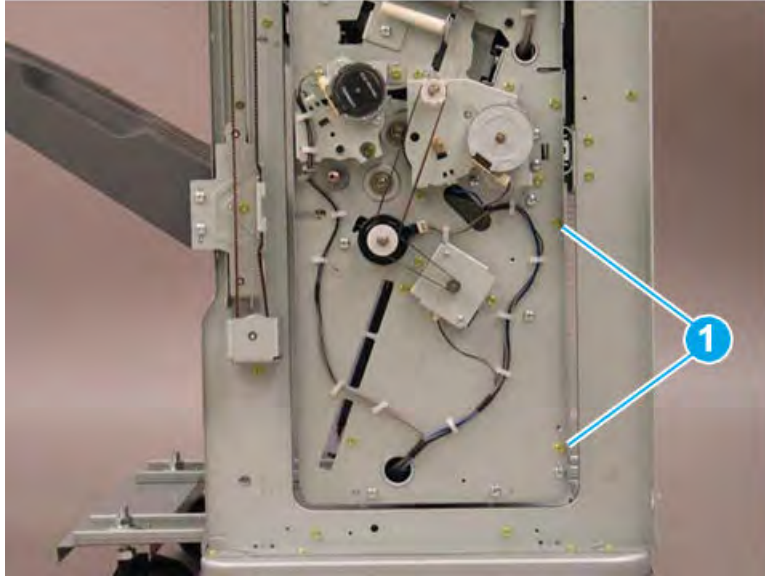

2. Remove two screws at the back of the booklet maker (callout 1).

Figure 5-1609 Remove two screws

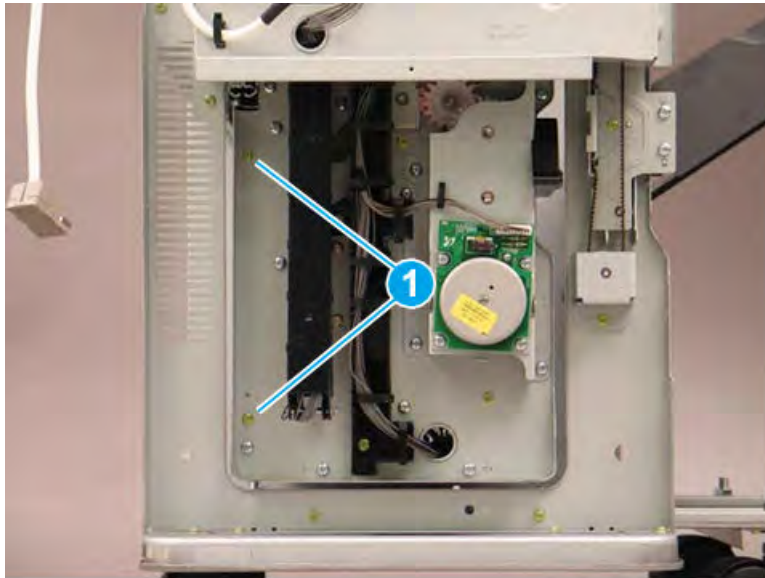

3. Slide the booklet maker out of the finisher (callout 1), and then rotate the top of the right lower shield (callout 2) away from the booklet maker to remove it.

Figure 5-1610 Remove the right lower shield

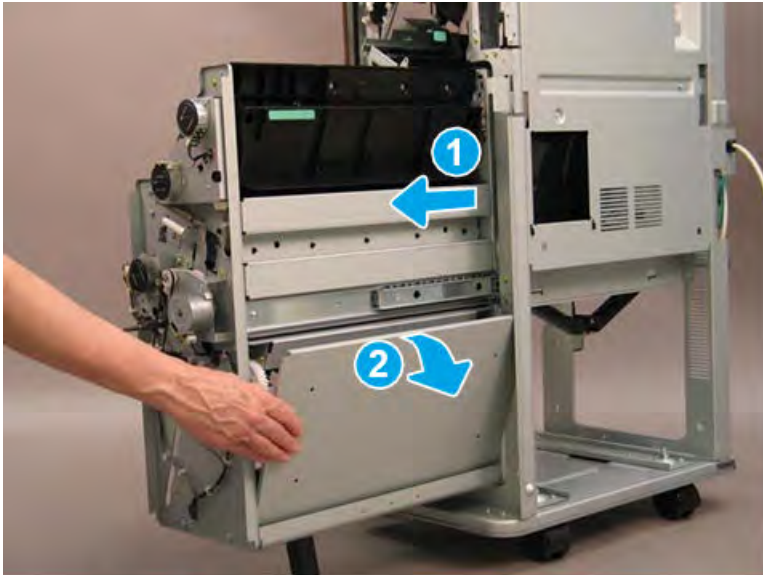

Remove the booklet maker middle right shield

Follow these steps to remove the booklet maker middle right shield.

1. Remove two screws at the front of the booklet maker (callout 1).

Figure 5-1611 Remove two screws at the front of the booklet maker

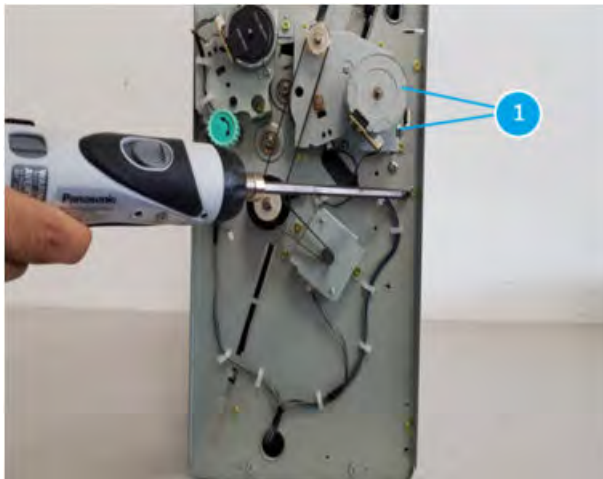

2. Remove two screws at the back of the booklet maker (callout 1).

Figure 5-1612 Remove two screws at the back of the booklet maker

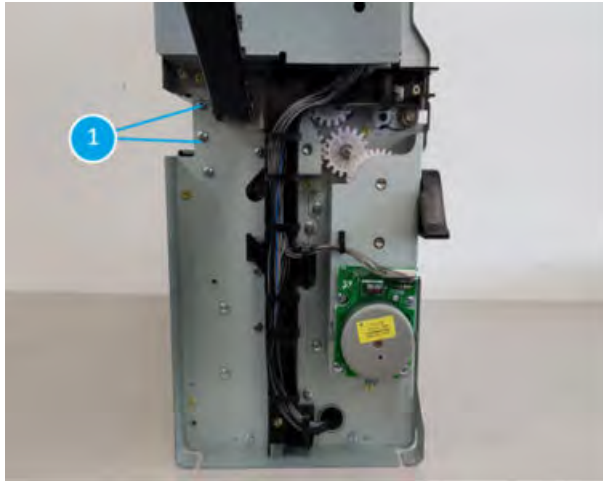

Remove the booklet finisher upper right shield

Follow these steps to remove the booklet finisher upper right shield.

1. Remove two screws at the front of the booklet maker (callout 1)

Figure 5-1613 Remove two screws at the front of the booklet maker

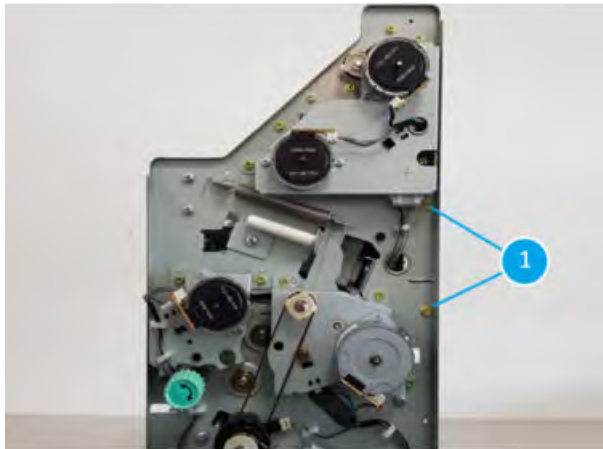

2. Remove two screws(callout 1) and one screw(callout 2) at the back of the booklet maker and then remove the board cover.

Figure 5-1614 Remove the board cover

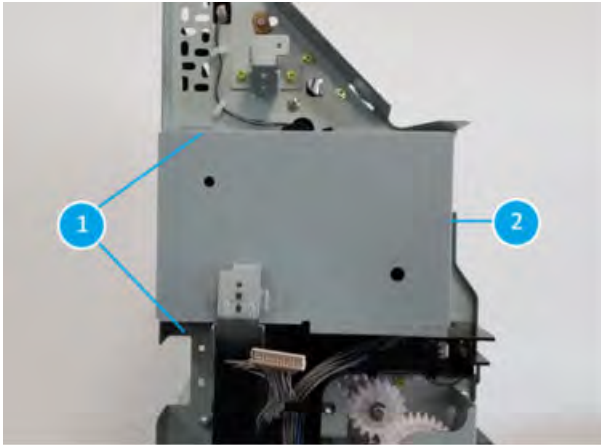

3. Remove two screws at the back of the booklet maker (callout 1).

Figure 5-1615 Remove two screws

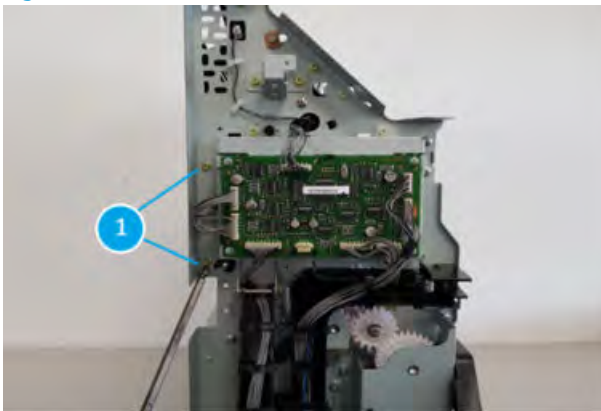

4. Disconnect one connector at the front of the booklet maker (callout 1).

Figure 5-1616 Disconnect one connector



5. Disconnect one connector at the right of the booklet maker (callout 1).

Figure 5-1617 Disconnect one connector



Remove the booklet tamper and fold unit

Follow these steps to remove the booklet tamper and fold unit.

1. Remove two screws at the left of the booklet maker (callout 1).

Figure 5-1618 Remove two screws at the left of the booklet maker



2. Remove three screws at the right of the booklet maker (callout 1).

Figure 5-1619 Remove three screws at the right of the booklet maker

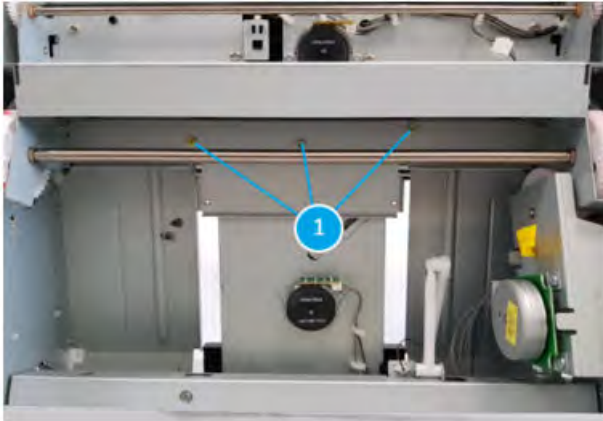

3. Remove two screws at the front of the booklet maker (callout 1).

Figure 5-1620 Remove two screws at the front of the booklet maker

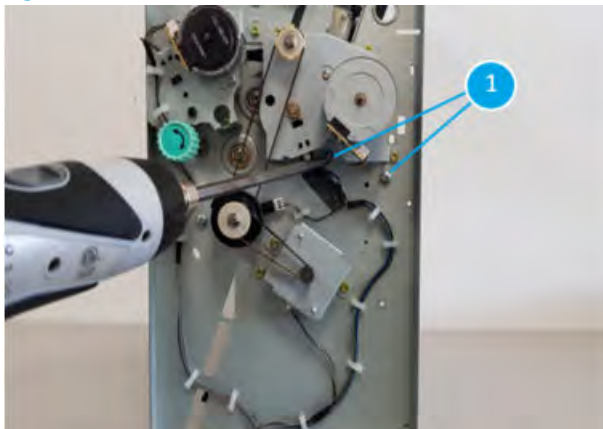

4. Remove two screws at the back of the booklet maker (callout 1).

Figure 5-1621 Remove two screws at the back of the booklet maker

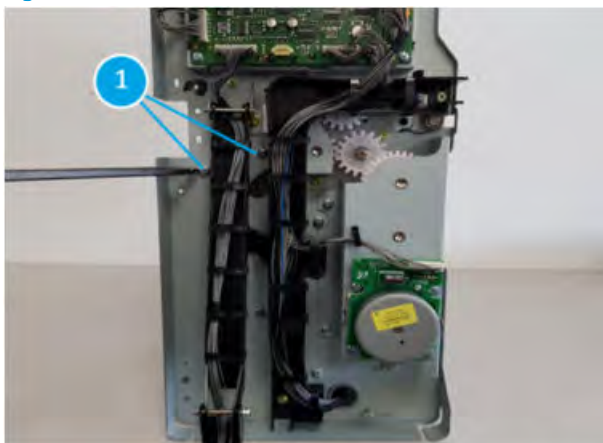

5. Disconnect one connector at the right of the booklet maker (callout 1).

Figure 5-1622 Disconnect one connector



Remove the booklet tamper unit

Follow these steps to remove the booklet tamper unit.

1. Remove two screws and disconnect one connector (callout 2)

Figure 5-1623 Remove two screws

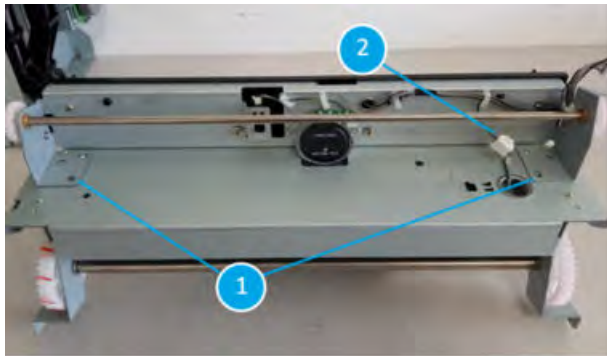

2. Booklet tamper unit (callout 1)

Figure 5-1624 Booklet tamper unit



Remove the booklet tamper home sensor (S38)

Follow these steps to remove the booklet tamper home sensor (S38).

1. Remove four screws (callout 1) and unplug one connector (callout 2)

Figure 5-1625 Remove four screws

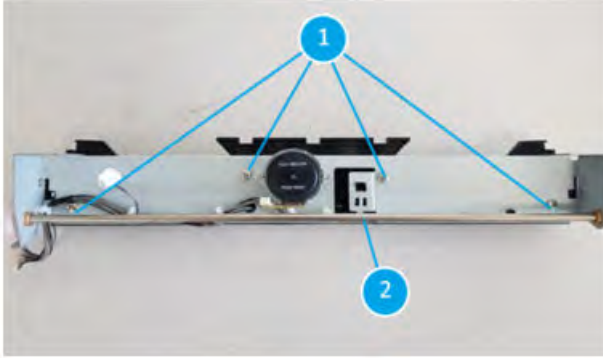

2. Use a tweezer to remove the booklet tamper home sensor (S38, callout 1)

Figure 5-1626 Remove booklet tamper home sensor



Unpack the replacement assembly



Follow these steps to unpack the replacement assembly.

1. Dispose of the defective part.

 **NOTE:** HP recommends responsible disposal of the defective part.

<http://www8.hp.com/us/en/hp-information/environment/product-recycling.html>

2. Unpack the replacement part from the packaging.

 **CAUTION:**  Some parts are sensitive to electrostatic discharge (ESD). Always perform service work at an ESD-protected workstation or mat. If an ESD workstation or mat is not available, touch the sheet-metal chassis to provide a static ground before touching an ESD-sensitive assembly. Protect the ESD-sensitive assemblies by placing them in ESD pouches when they are out of the printer.

 **IMPORTANT:** Make sure that all of the shipping materials (for example shipping tape) are removed from the replacement part prior to installation.

 **NOTE:** If the replacement part is a roller or pad, avoid touching the spongy part of it. Skin oils on the roller or pad can cause paper pickup and/or print-quality problems. HP recommends using disposable gloves when handling rollers or pads or washing your hands before touching rollers or pads.

3. To install an assembly, reverse the removal steps.



NOTE: When applicable, special installation instructions are provided for an assembly at the end of the removal procedure. Always completely read the removal instructions and follow all special installation instructions.

Removal and replacement: Booklet tamper motor (M23)

Learn how to remove and replace the tray booklet tamper motor.

Introduction

This document provides the procedures to remove and replace the booklet tamper motor on the finisher.



IMPORTANT: When applicable, special installation instructions are provided for an assembly at the end of the removal procedure. Always completely read the removal instructions and follow all special installation instructions.

Before performing service

- Turn the printer power off. A shutting-down message appears on the control-panel display.
- ⚠ **WARNING!** To avoid damage to the printer, turn the power off and wait until the printer shuts down before removing the power cable.
- Disconnect the printer power cable after the printer has completely shut down (the control-panel display is blank).
- Release the finisher from the printer by pulling out on the release latch inside the finisher door.
- Disconnect the cable from the bridge unit to the finisher.
- Disconnect the cable from the finisher to the printer.

Use the table below to identify the correct part number for your printer. To order the part, go to <https://parts.hp.com>.

Table 5-156 Part information

Part number	Part description
JC93-01155A	Booklet tamper motor

Required tools

- #2 JIS screwdriver with a magnetic tip

After performing service

- Connect the cable from the finisher to the printer.
- Connect the cable from the bridge unit to the finisher.
- Attach the finisher to the printer, and then push in on the release latch inside the finisher door.
- Connect the printer power cable.
- Turn the printer power on.

Post service test

Process a job through the finisher and verify that the finisher works correctly.

Remove the right upper cover (finisher)

Follow these steps to remove the right upper cover (finisher).

- ▲ Remove one screw cap and three machine screws on the upper edge of the cover (callout 1). Remove three sheet metal screws (callout 2) on the lower portion of the cover. Rotate the right edge of the cover away from the finisher, and then slide the cover right to release three tabs (callout 3).

💡 **TIP:** The lower screws are shorter in length than the upper screws.

TIP: Reverse the removal steps to install the assembly.

Figure 5-1627 Remove the right upper cover

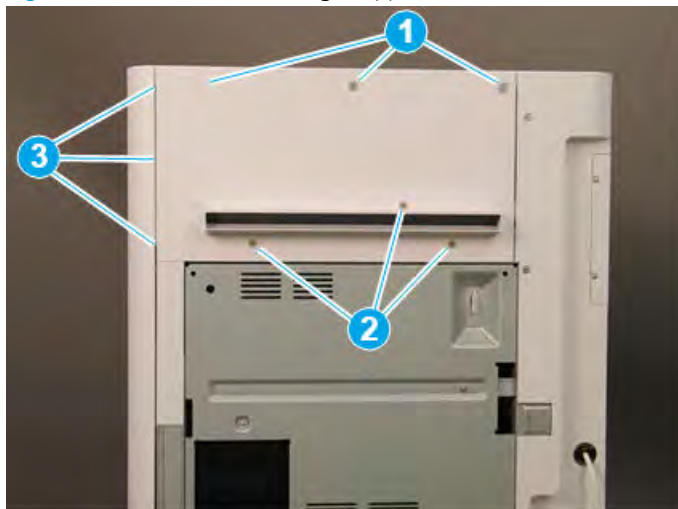

Remove the top cover (finisher)

Follow these steps to remove the top cover (finisher).

1. Remove three screw caps and three self-tapping screws at the top of the rear cover (callout 1), and then remove three machine screws (callout 2) on top of the cover.

Figure 5-1628 Remove six screws

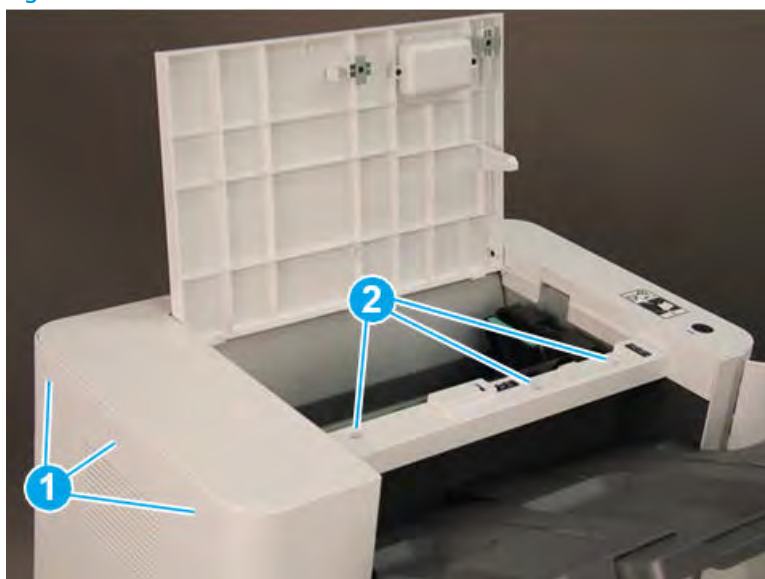

2. Remove three self-tapping screws at the top of the front cover (callout 1), and then remove two machine screws (callout 2) at the top of the right side.

Figure 5-1629 Remove five screws

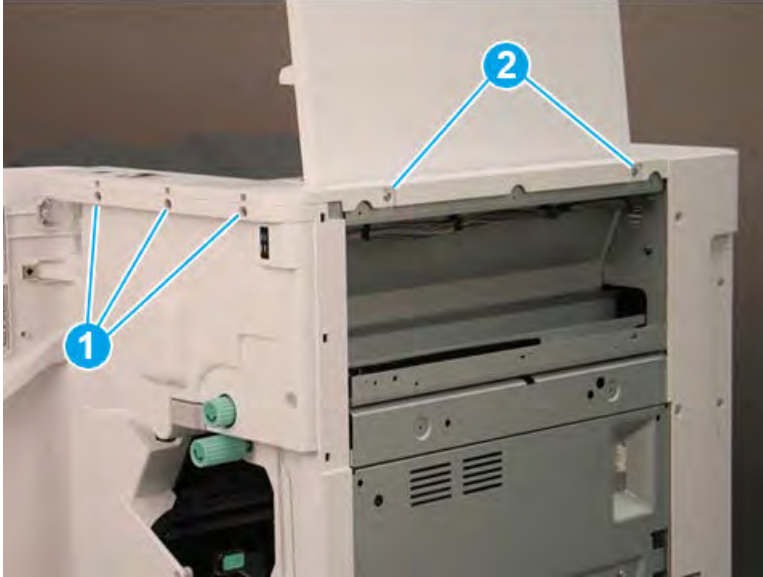

3. Lift the cover up slightly. Disconnect one in-line connector (callout 1), and then release one retainer (callout 2).

 **TIP:** Reverse the removal steps to install the assembly.

Figure 5-1630 Disconnect one connector and release retainer

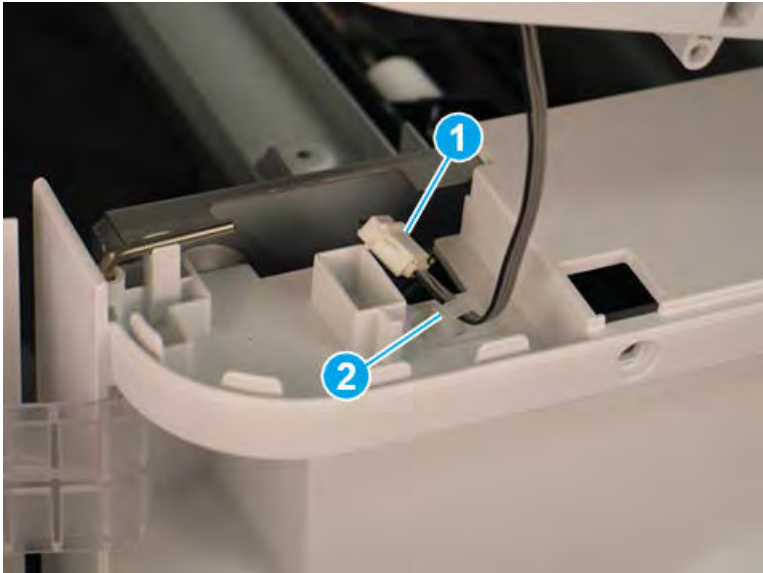

Remove the rear cover (finisher)

Follow these steps to remove the rear cover (finisher).

1. Remove two self-tapping screws (callout 1) on the top of the rear cover, and then remove five screw caps and five machine screws (callout 2) on the left side of the cover.

Figure 5-1631 Remove seven screws

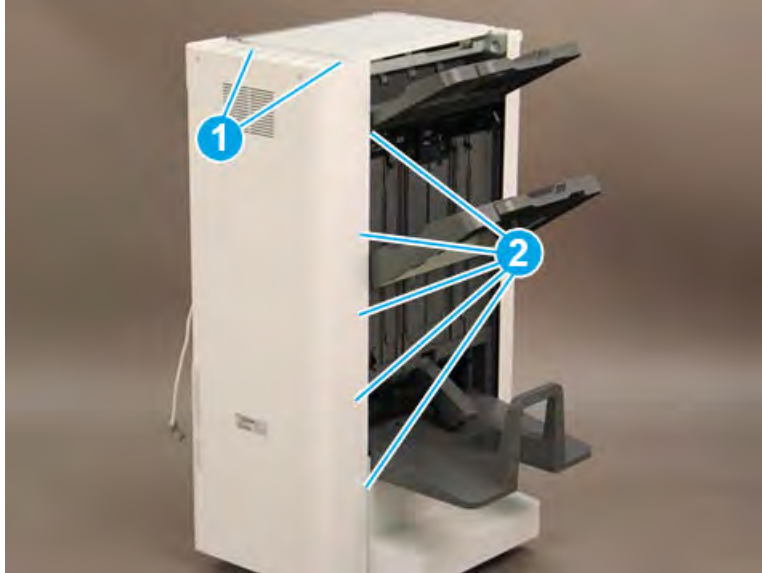

2. Remove one screw cap and four machine screws (callout 1) Remove the rear cover.

 **NOTE:** Make sure to thread the power cable (callout 2) through the opening in the cover.

 **TIP:** Reverse the removal steps to install the assembly

Figure 5-1632 Remove the rear cover



Remove the booklet maker

Follow these steps to remove the booklet maker.

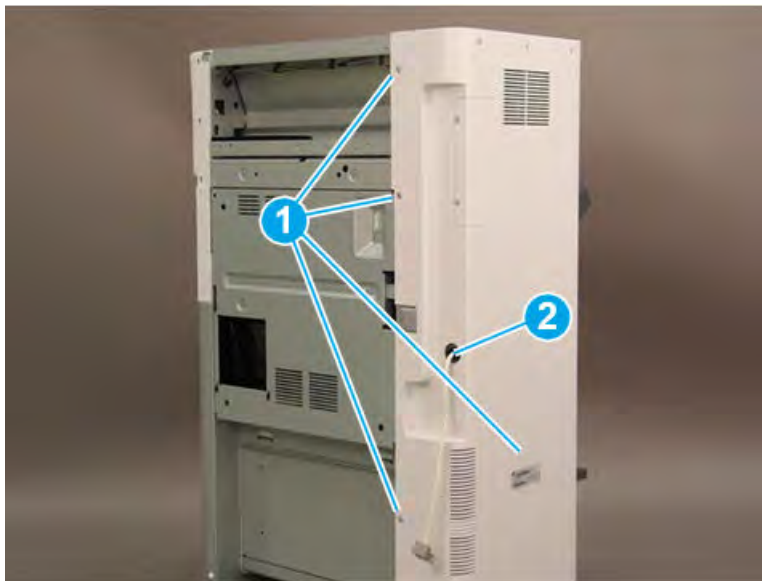
1. Slide the booklet maker away from the finisher.

Figure 5-1633 Slide the booklet maker away from the finisher



2. At the Disconnect one connector (callout 1), and then remove one screw (callout 2).

Figure 5-1634 Disconnect one connector and remove one screw

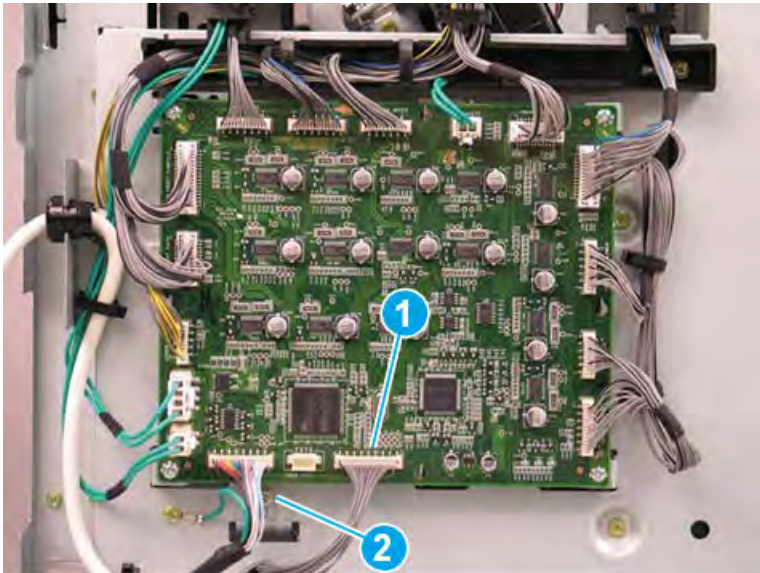

3. Release the metal bracket through the opening in the sheet metal.

Figure 5-1635 Release the metal bracket

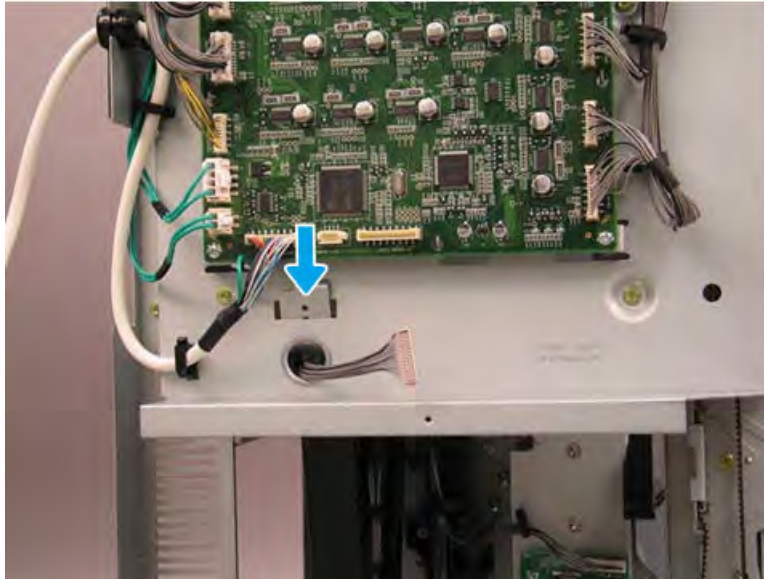

4. Remove one star-washer screw (callout 1), and then release the alignment pin (callout 2) on the right side of the booklet maker.

Figure 5-1636 Remove one screw

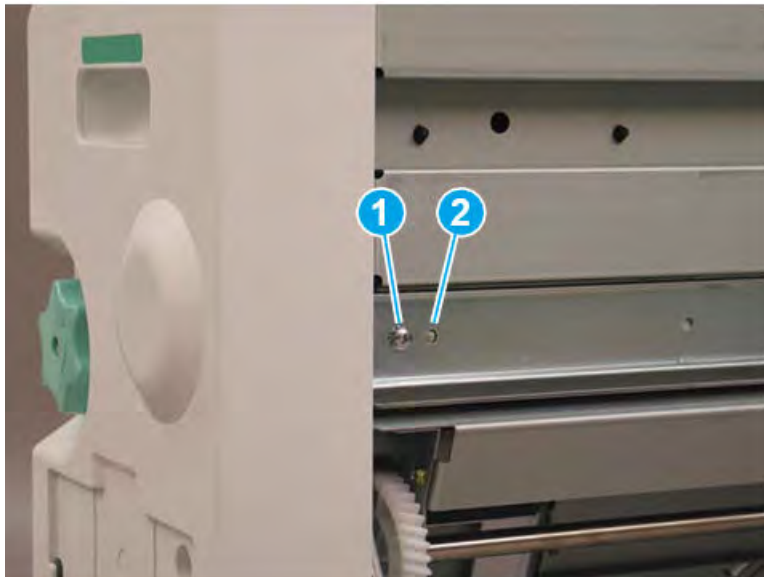

5. Slide the right rail toward the finisher.

Figure 5-1637 Slide the right rail

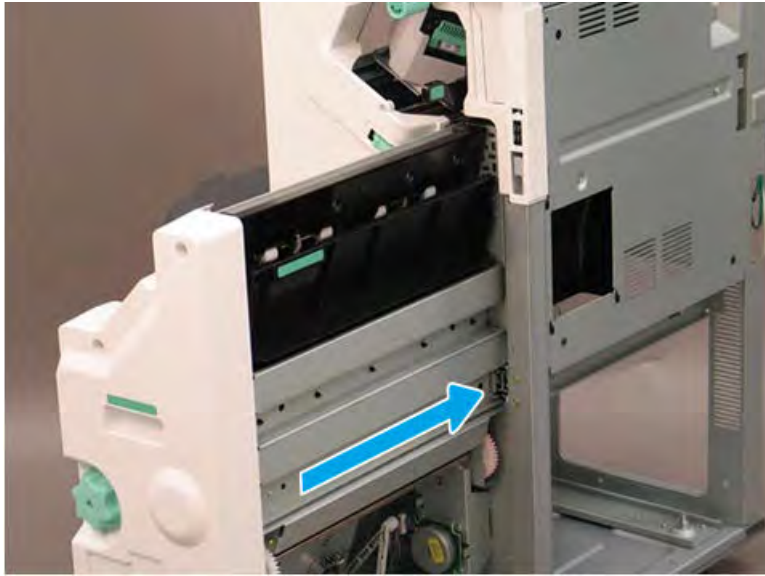

6. Remove one star-washer screw (callout 1) on the left side of the booklet maker.

Figure 5-1638 Remove one screw



7. Lift the booklet maker up on the left side while squeezing the right rail away from the finisher slightly to clear the sheet metal. Remove the booklet maker.

Figure 5-1639 Remove the booklet maker

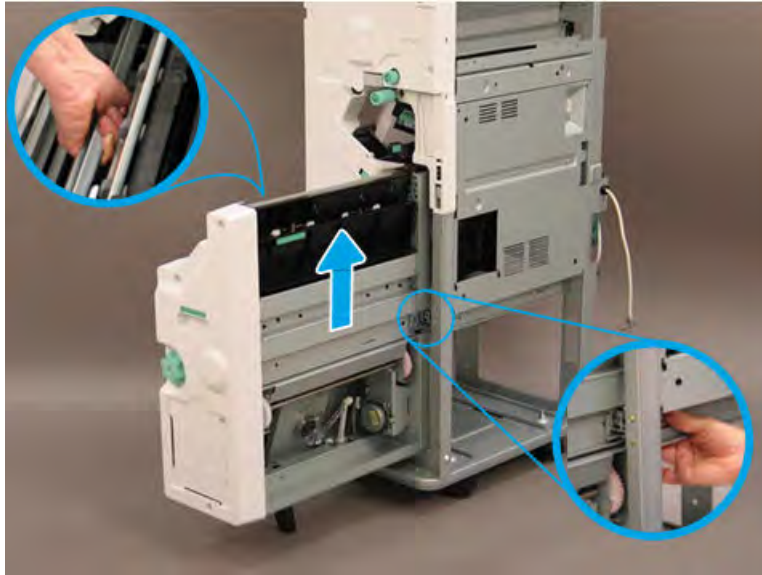

8. Reverse the removal steps to install the assembly. Also use the following special installation instructions.

 **NOTE:** Continue to reverse the removal steps to finish installing the assembly.

Special installation instructions: booklet maker

When installing the booklet maker, position the hooks on the rail under the slots on the booklet maker.

Figure 5-1640 Position the hooks

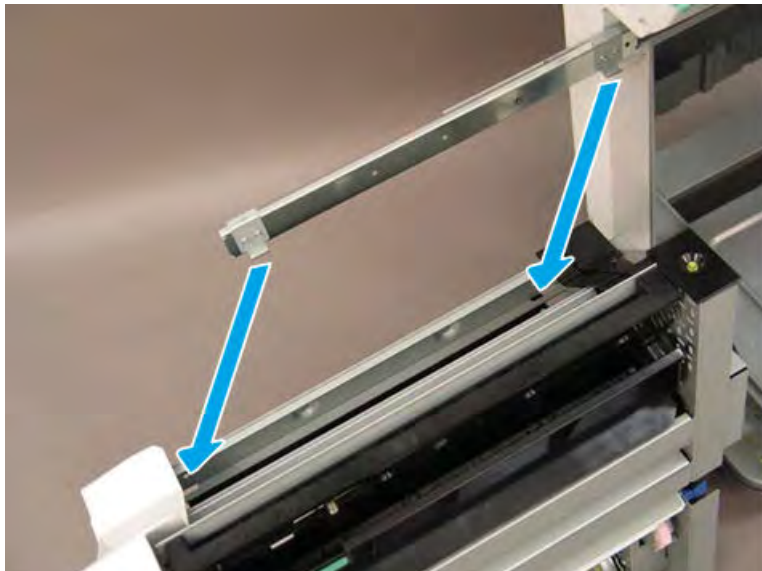

9. When installed correctly, the arrow on the front of the booklet maker aligns with the arrow on the finisher rail.

Figure 5-1641 Align arrows

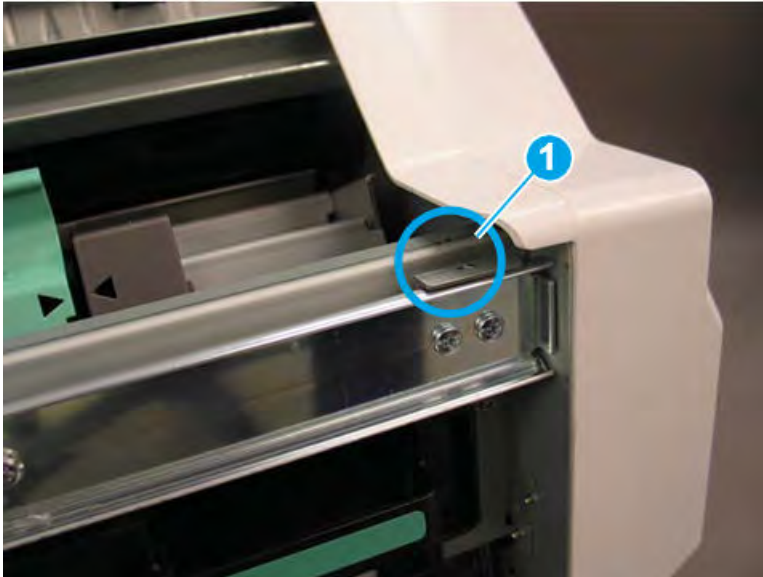

10. When installed correctly, the arrow on the back of the booklet maker aligns with the arrow on the finisher rail.

Figure 5-1642 Align arrows

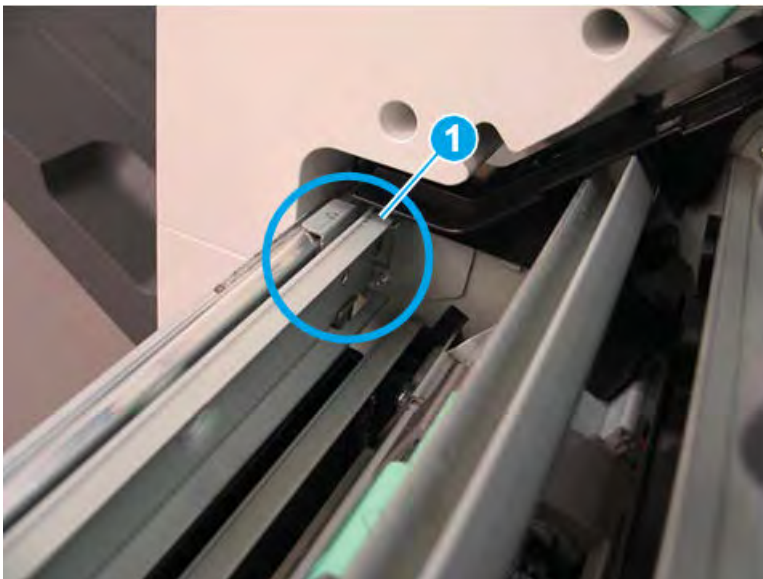

11. Extend the right rail away from the finisher and position it in the booklet maker slot.

Figure 5-1643 Extend the right rail



Remove the booklet front cover

Follow these steps to remove the booklet front cover.

- ▲ Slide the booklet maker slightly away from the finisher (callout 1). Remove one screw (callout 2), and then slide the green knob away from the booklet maker to remove it (callout 3). Remove four screws (callout 4), and then remove the booklet front cover.

💡 **TIP:** Reverse the removal steps to install the assembly

Figure 5-1644 Remove five screws and the cover

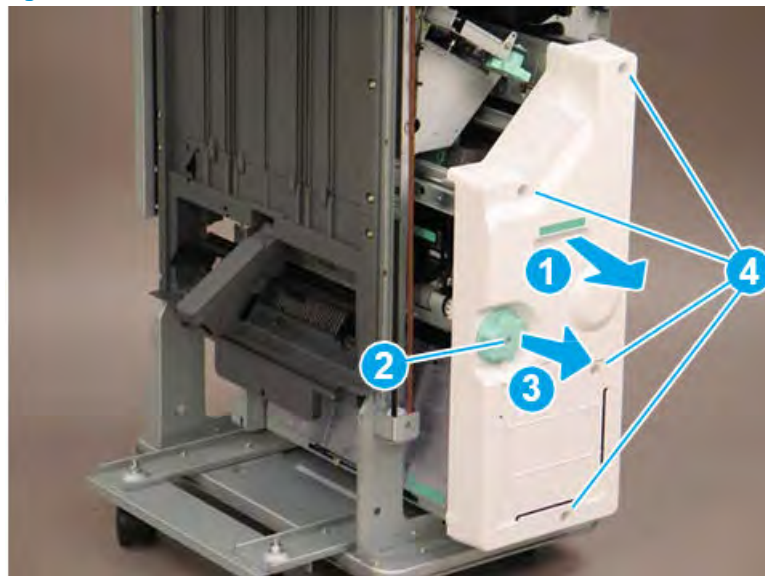

Remove the booklet right lower shield

Follow these steps to remove the booklet right lower shield.

1. Remove two screws at the front of the booklet maker (callout 1).

Figure 5-1645 Remove two screws

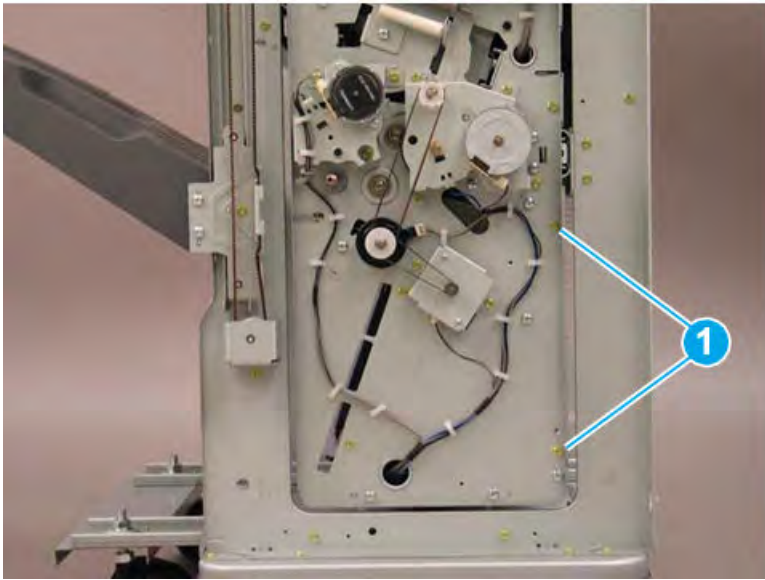

2. Remove two screws at the back of the booklet maker (callout 1).

Figure 5-1646 Remove two screws

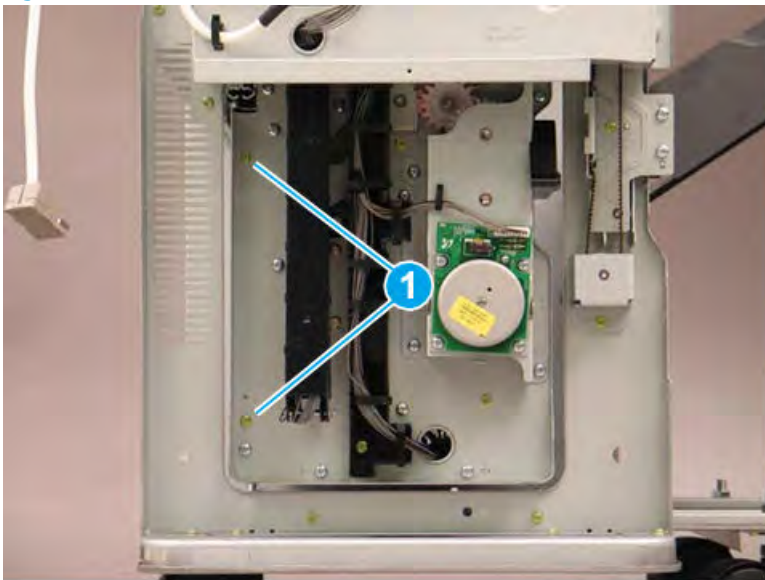

3. Slide the booklet maker out of the finisher (callout 1), and then rotate the top of the right lower shield (callout 2) away from the booklet maker to remove it.

Figure 5-1647 Remove the right lower shield

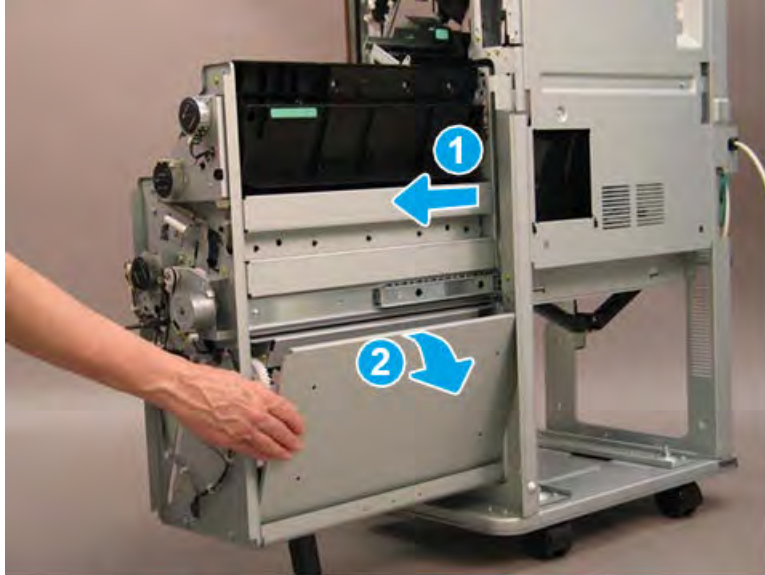

Remove the booklet maker middle right shield

Follow these steps to remove the booklet maker middle right shield.

1. Remove two screws at the front of the booklet maker (callout 1).

Figure 5-1648 Remove two screws at the front of the booklet maker

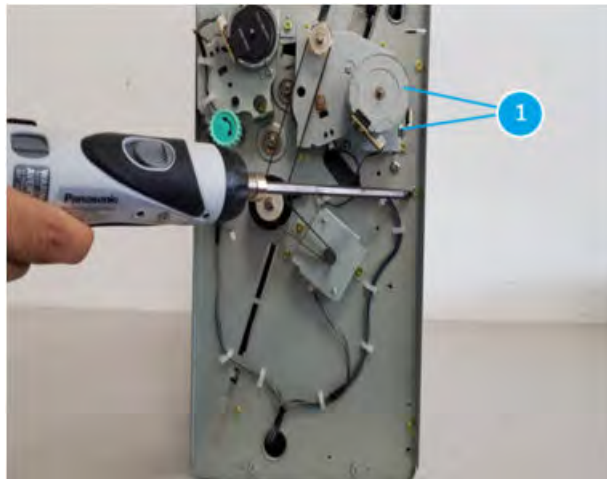

2. Remove two screws at the back of the booklet maker (callout 1).

Figure 5-1649 Remove two screws at the back of the booklet maker

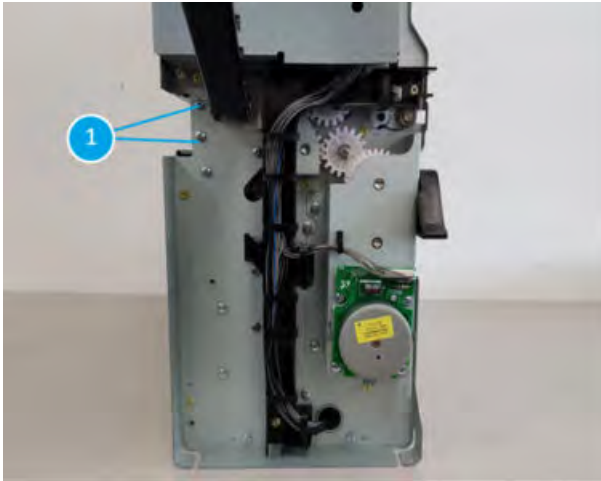

Remove the booklet finisher upper right shield

Follow these steps to remove the booklet finisher upper right shield.

1. Remove two screws at the front of the booklet maker (callout 1)

Figure 5-1650 Remove two screws at the front of the booklet maker



2. Remove two screws(callout 1) and one screw(callout 2) at the back of the booklet maker and then remove the board cover.

Figure 5-1651 Remove the board cover

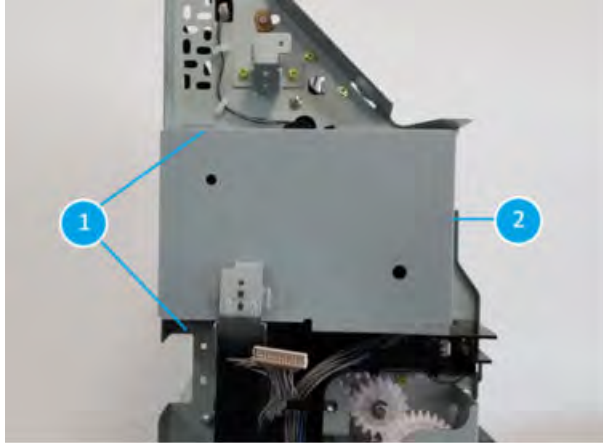

3. Remove two screws at the back of the booklet maker (callout 1).

Figure 5-1652 Remove two screws

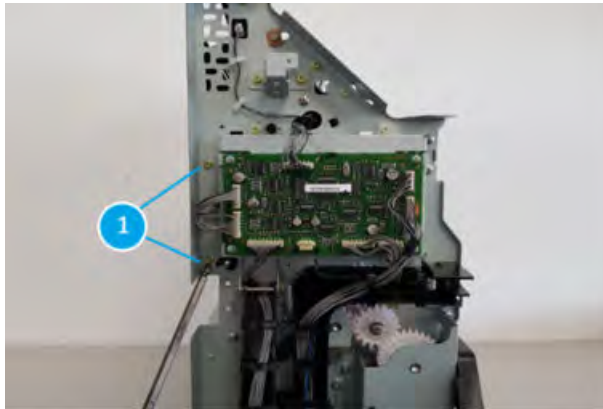

4. Disconnect one connector at the front of the booklet maker (callout 1).

Figure 5-1653 Disconnect one connector



5. Disconnect one connector at the right of the booklet maker (callout 1).

Figure 5-1654 Disconnect one connector



Remove the booklet tamper and fold unit

Follow these steps to remove the booklet tamper and fold unit.

1. Remove two screws at the left of the booklet maker (callout 1).

Figure 5-1655 Remove two screws at the left of the booklet maker



2. Remove three screws at the right of the booklet maker (callout 1).

Figure 5-1656 Remove three screws at the right of the booklet maker

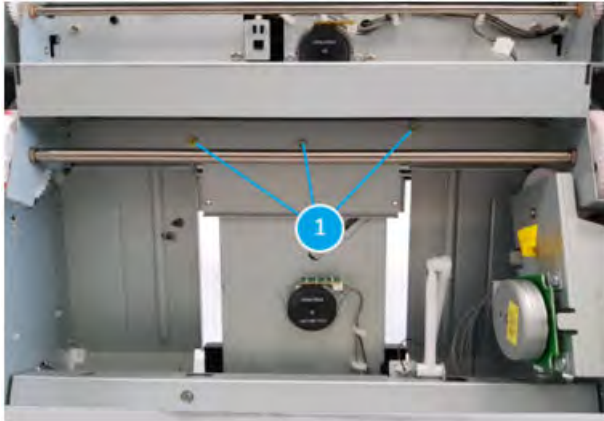

3. Remove two screws at the front of the booklet maker (callout 1).

Figure 5-1657 Remove two screws at the front of the booklet maker

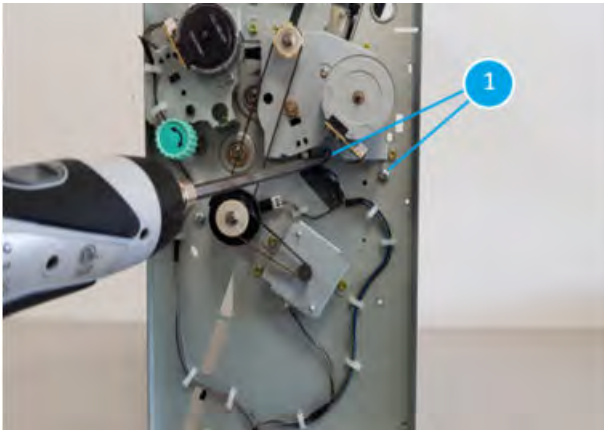

4. Remove two screws at the back of the booklet maker (callout 1).

Figure 5-1658 Remove two screws at the back of the booklet maker

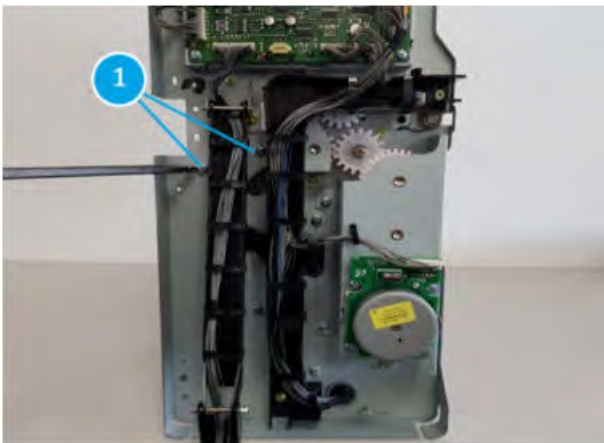

5. Disconnect one connector at the right of the booklet maker (callout 1).

Figure 5-1659 Disconnect one connector



Remove the booklet tamper unit

Follow these steps to remove the booklet tamper unit.

1. Remove two screws and disconnect one connector (callout 2)

Figure 5-1660 Remove two screws

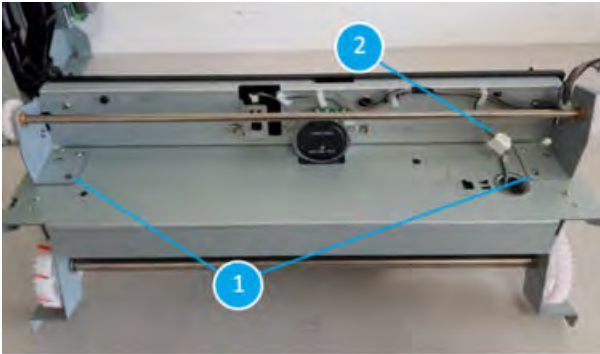

2. Booklet tamper unit (callout 1)

Figure 5-1661 Booklet tamper unit



Remove the booklet tamper motor (M23)

Follow these steps to remove the booklet tamper motor (M23).

1. Remove two screws (callout 1) and unplug one connector (callout 2)

Figure 5-1662 Remove two screws and unplug one connector

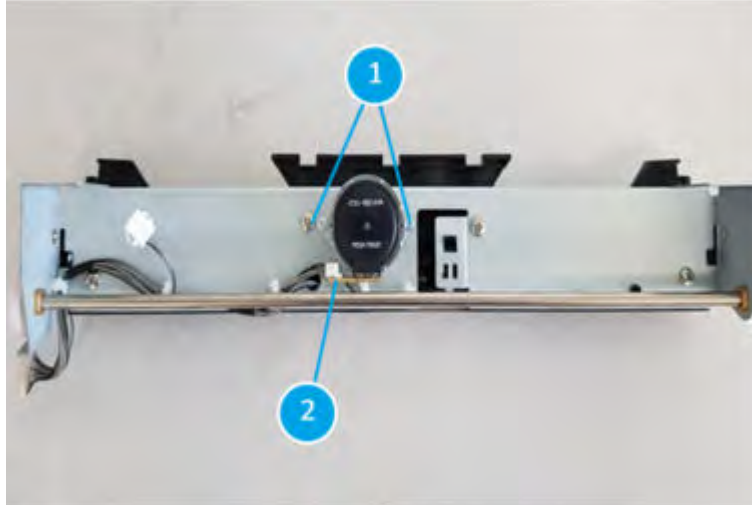

2. Remove the booklet tamper motor (M23, callout 1)

Figure 5-1663 Remove the booklet tamper motor

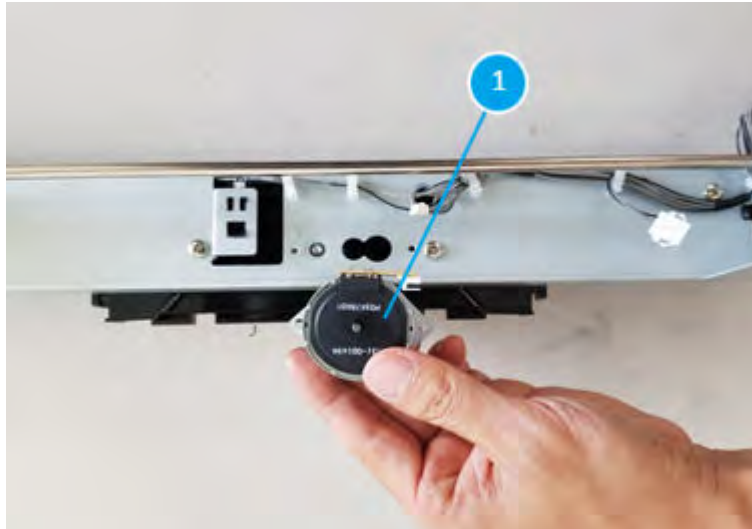

Unpack the replacement assembly

Follow these steps to unpack the replacement assembly.

1. Dispose of the defective part.

 **NOTE:** HP recommends responsible disposal of the defective part.

<http://www8.hp.com/us/en/hp-information/environment/product-recycling.html>

2. Unpack the replacement part from the packaging.



CAUTION:  Some parts are sensitive to electrostatic discharge (ESD). Always perform service work at an ESD-protected workstation or mat. If an ESD workstation or mat is not available, touch the sheet-metal chassis to provide a static ground before touching an ESD-sensitive assembly. Protect the ESD-sensitive assemblies by placing them in ESD pouches when they are out of the printer.

 **IMPORTANT:** Make sure that all of the shipping materials (for example shipping tape) are removed from the replacement part prior to installation.

 **NOTE:** If the replacement part is a roller or pad, avoid touching the spongy part of it. Skin oils on the roller or pad can cause paper pickup and/or print-quality problems. HP recommends using disposable gloves when handling rollers or pads or washing your hands before touching rollers or pads.

3. To install an assembly, reverse the removal steps.

 **NOTE:** When applicable, special installation instructions are provided for an assembly at the end of the removal procedure. Always completely read the removal instructions and follow all special installation instructions.

Booklet stapler unit

Removal and replacement: Booklet stapler unit

Learn how to remove and replace the tray booklet stapler unit.

Introduction

This document provides the procedures to remove and replace the booklet stapler unit on the finisher.



IMPORTANT: When applicable, special installation instructions are provided for an assembly at the end of the removal procedure. Always completely read the removal instructions and follow all special installation instructions.

Before performing service

- Turn the printer power off. A shutting-down message appears on the control-panel display.
- ⚠ **WARNING!** To avoid damage to the printer, turn the power off and wait until the printer shuts down before removing the power cable.
- Disconnect the printer power cable after the printer has completely shut down (the control-panel display is blank).
- Release the finisher from the printer by pulling out on the release latch inside the finisher door.
- Disconnect the cable from the bridge unit to the finisher.
- Disconnect the cable from the finisher to the printer.

Use the table below to identify the correct part number for your printer. To order the part, go to <https://parts.hp.com>.

Table 5-157 Part information

Part number	Part description
JCB1-08274B	Booklet stapler unit

Required tools

- #2 JIS screwdriver with a magnetic tip

After performing service

- Connect the cable from the finisher to the printer.
- Connect the cable from the bridge unit to the finisher.
- Attach the finisher to the printer, and then push in on the release latch inside the finisher door.
- Connect the printer power cable.
- Turn the printer power on.

Post service test

Process a job through the finisher and verify that the finisher works correctly.

Remove the right upper cover (finisher)

Follow these steps to remove the right upper cover (finisher).

- ▲ Remove one screw cap and three machine screws on the upper edge of the cover (callout 1). Remove three sheet metal screws (callout 2) on the lower portion of the cover. Rotate the right edge of the cover away from the finisher, and then slide the cover right to release three tabs (callout 3).

💡 **TIP:** The lower screws are shorter in length than the upper screws.

TIP: Reverse the removal steps to install the assembly.

Figure 5-1664 Remove the right upper cover

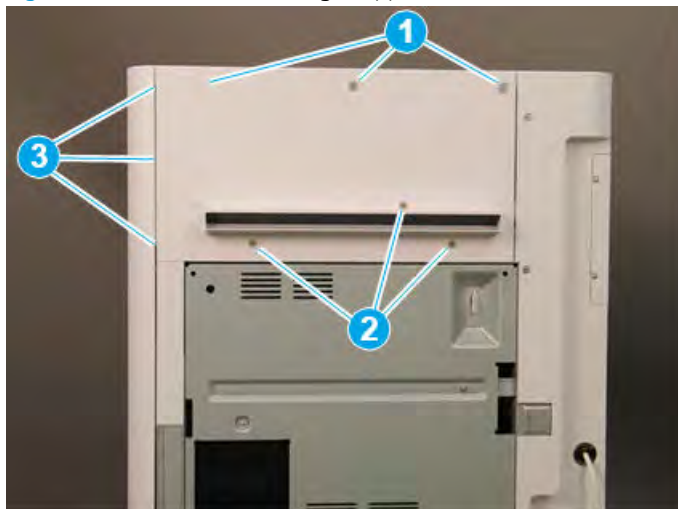

Remove the top cover (finisher)

Follow these steps to remove the top cover (finisher).

1. Remove three screw caps and three self-tapping screws at the top of the rear cover (callout 1), and then remove three machine screws (callout 2) on top of the cover.

Figure 5-1665 Remove six screws

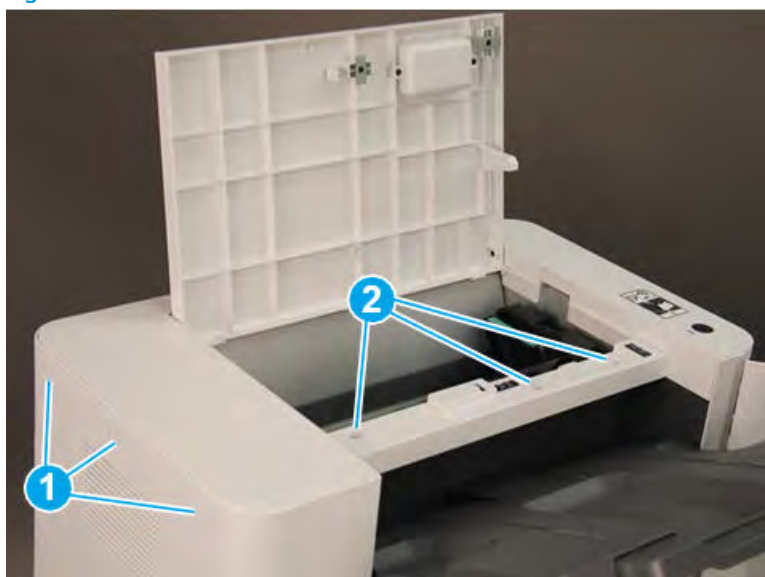

2. Remove three self-tapping screws at the top of the front cover (callout 1), and then remove two machine screws (callout 2) at the top of the right side.

Figure 5-1666 Remove five screws

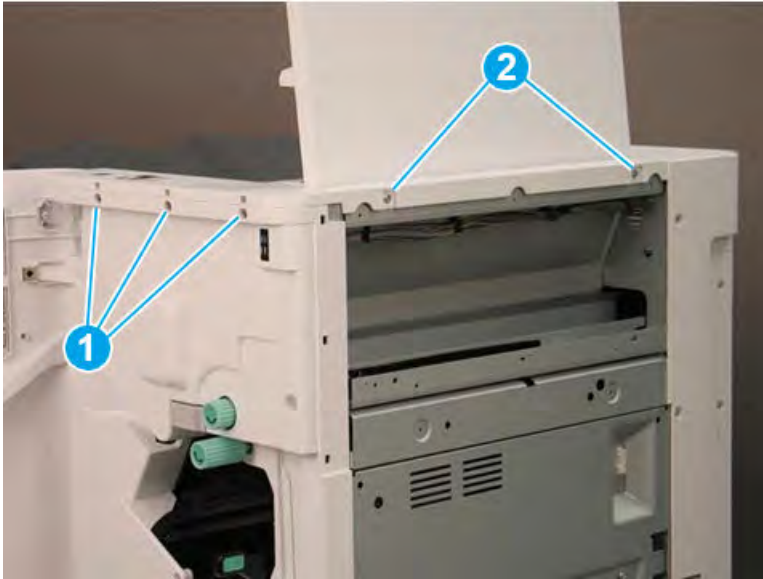

3. Lift the cover up slightly. Disconnect one in-line connector (callout 1), and then release one retainer (callout 2).

 **TIP:** Reverse the removal steps to install the assembly.

Figure 5-1667 Disconnect one connector and release retainer

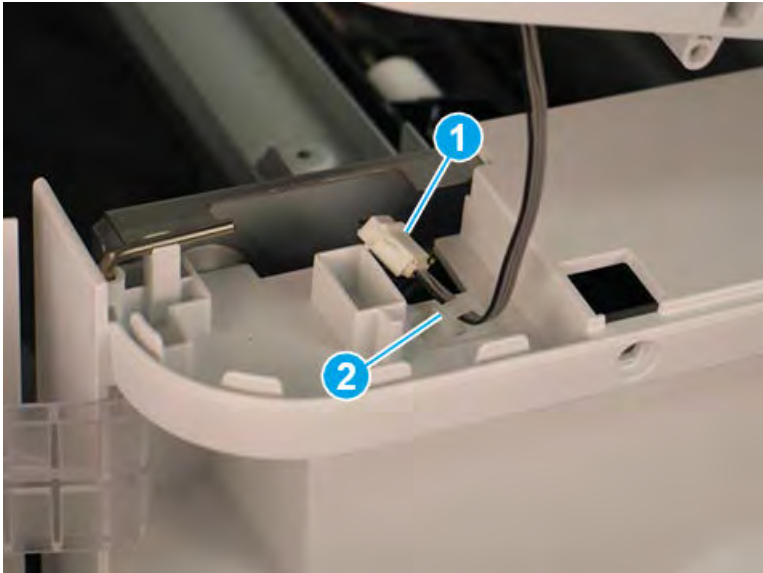

Remove the rear cover (finisher)

Follow these steps to remove the rear cover (finisher).

1. Remove two self-tapping screws (callout 1) on the top of the rear cover, and then remove five screw caps and five machine screws (callout 2) on the left side of the cover.

Figure 5-1668 Remove seven screws



2. Remove one screw cap and four machine screws (callout 1) Remove the rear cover.

 **NOTE:** Make sure to thread the power cable (callout 2) through the opening in the cover.

 **TIP:** Reverse the removal steps to install the assembly

Figure 5-1669 Remove the rear cover

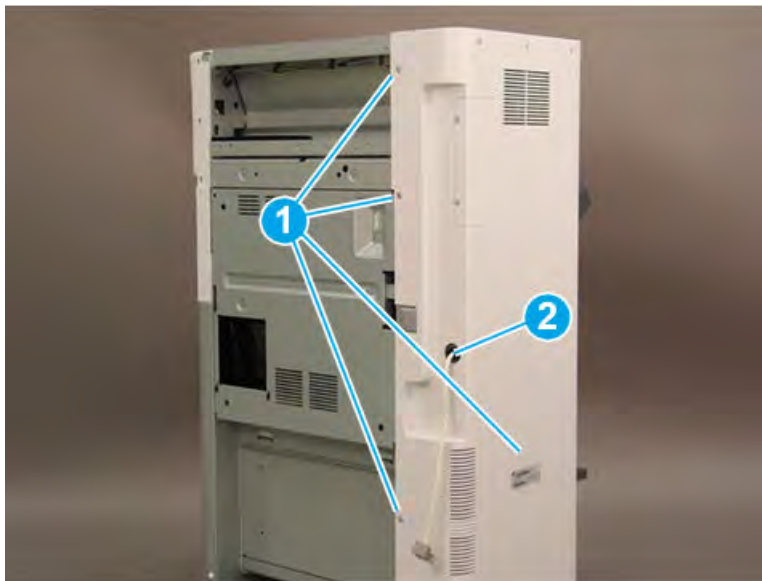

Remove the booklet maker

Follow these steps to remove the booklet maker.

1. Slide the booklet maker away from the finisher.

Figure 5-1670 Slide the booklet maker away from the finisher



2. At the Disconnect one connector (callout 1), and then remove one screw (callout 2).

Figure 5-1671 Disconnect one connector and remove one screw

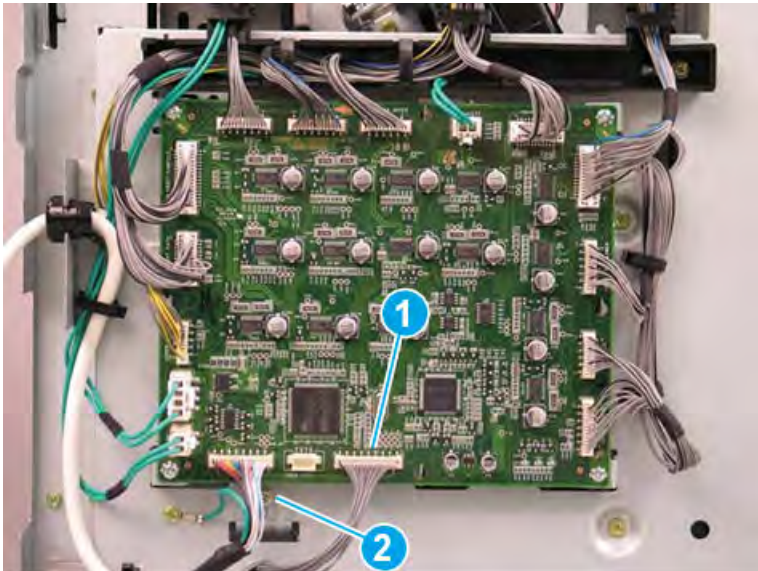

3. Release the metal bracket through the opening in the sheet metal.

Figure 5-1672 Release the metal bracket

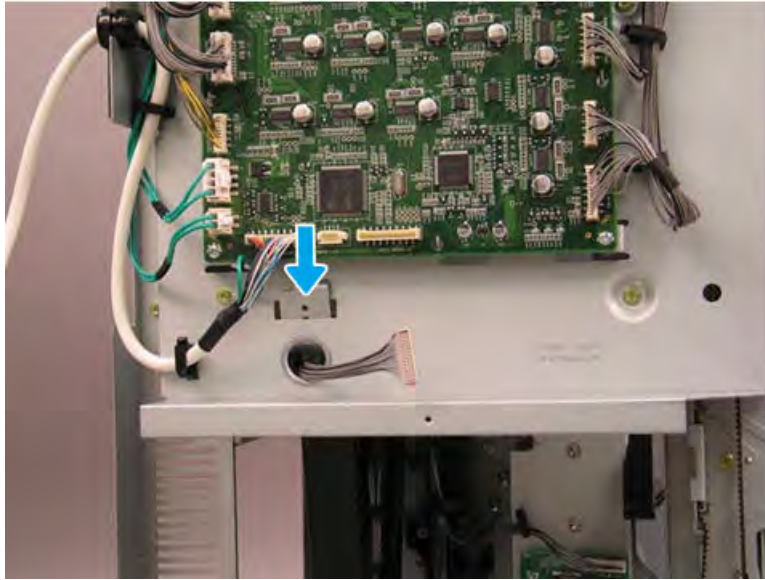

4. Remove one star-washer screw (callout 1), and then release the alignment pin (callout 2) on the right side of the booklet maker.

Figure 5-1673 Remove one screw

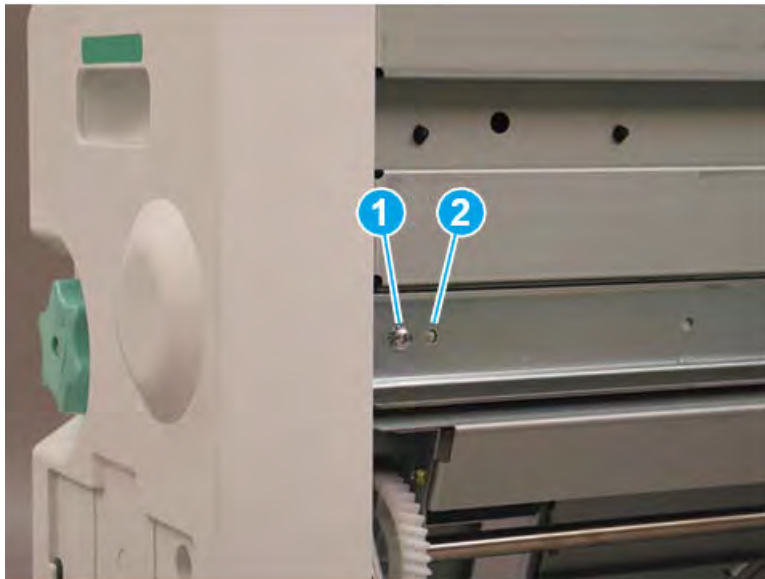

5. Slide the right rail toward the finisher.

Figure 5-1674 Slide the right rail

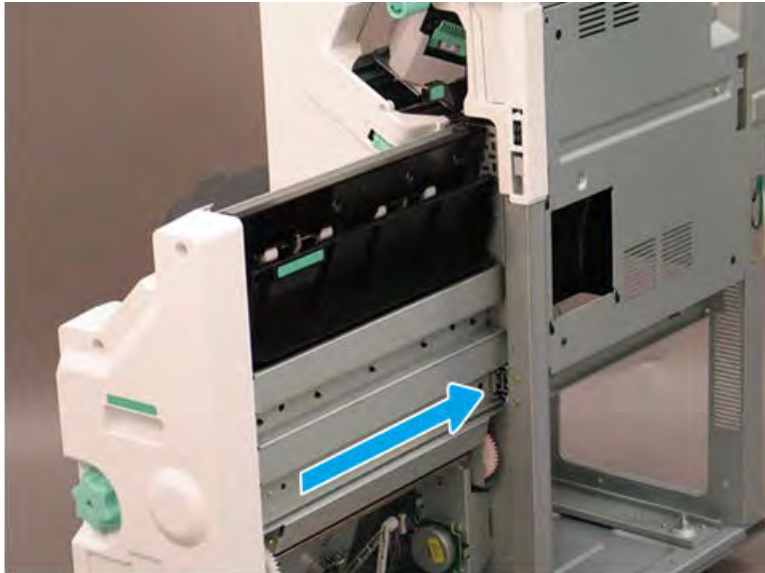

6. Remove one star-washer screw (callout 1) on the left side of the booklet maker.

Figure 5-1675 Remove one screw



7. Lift the booklet maker up on the left side while squeezing the right rail away from the finisher slightly to clear the sheet metal. Remove the booklet maker.

Figure 5-1676 Remove the booklet maker

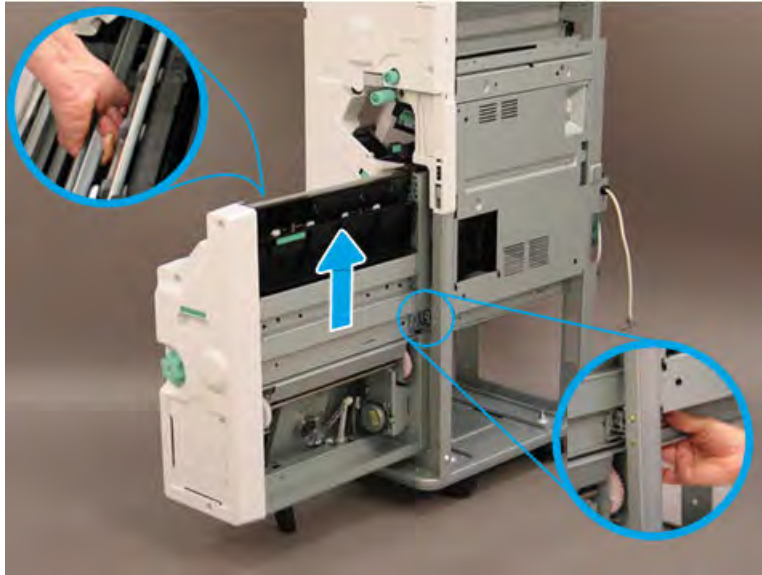

8. Reverse the removal steps to install the assembly. Also use the following special installation instructions.

 **NOTE:** Continue to reverse the removal steps to finish installing the assembly.

Special installation instructions: booklet maker

When installing the booklet maker, position the hooks on the rail under the slots on the booklet maker.

Figure 5-1677 Position the hooks

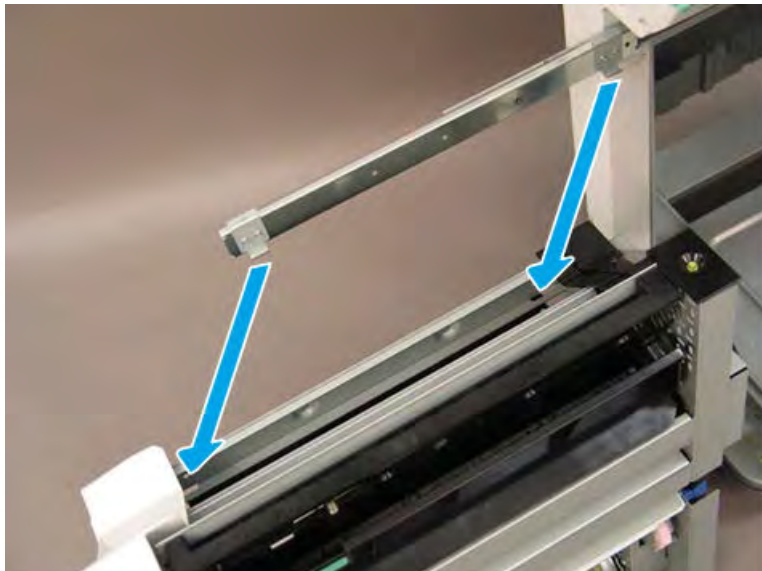

9. When installed correctly, the arrow on the front of the booklet maker aligns with the arrow on the finisher rail.

Figure 5-1678 Align arrows

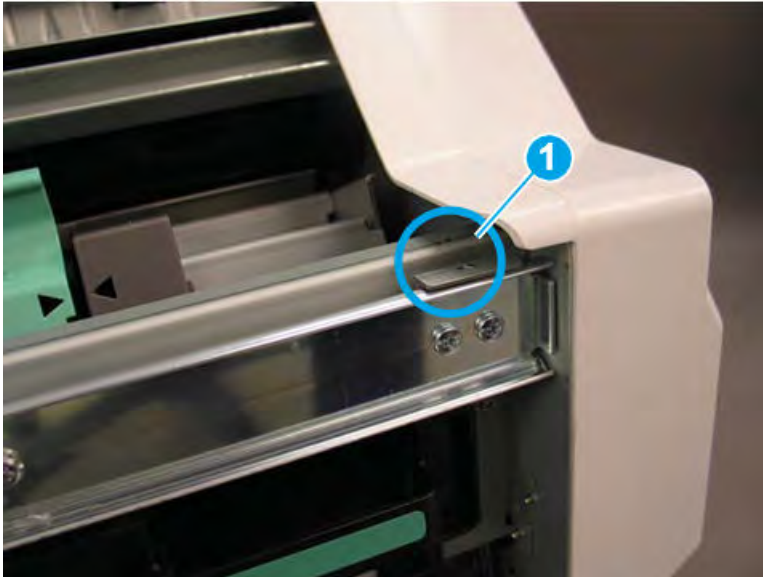

10. When installed correctly, the arrow on the back of the booklet maker aligns with the arrow on the finisher rail.

Figure 5-1679 Align arrows

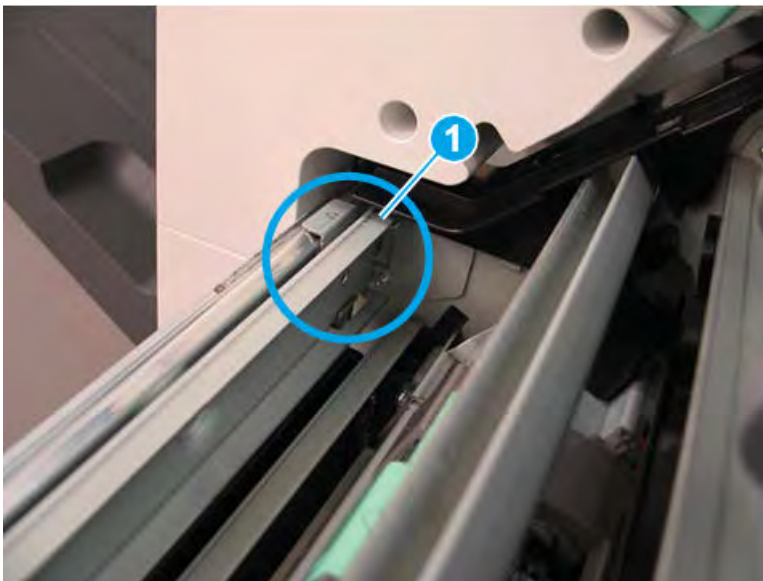

11. Extend the right rail away from the finisher and position it in the booklet maker slot.

Figure 5-1680 Extend the right rail



Remove the booklet front cover

Follow these steps to remove the booklet front cover.

- ▲ Slide the booklet maker slightly away from the finisher (callout 1). Remove one screw (callout 2), and then slide the green knob away from the booklet maker to remove it (callout 3). Remove four screws (callout 4), and then remove the booklet front cover.

 **TIP:** Reverse the removal steps to install the assembly

Figure 5-1681 Remove five screws and the cover



Remove the Booklet c-fold blade unit

Follow these steps to remove the Booklet c-fold blade unit.

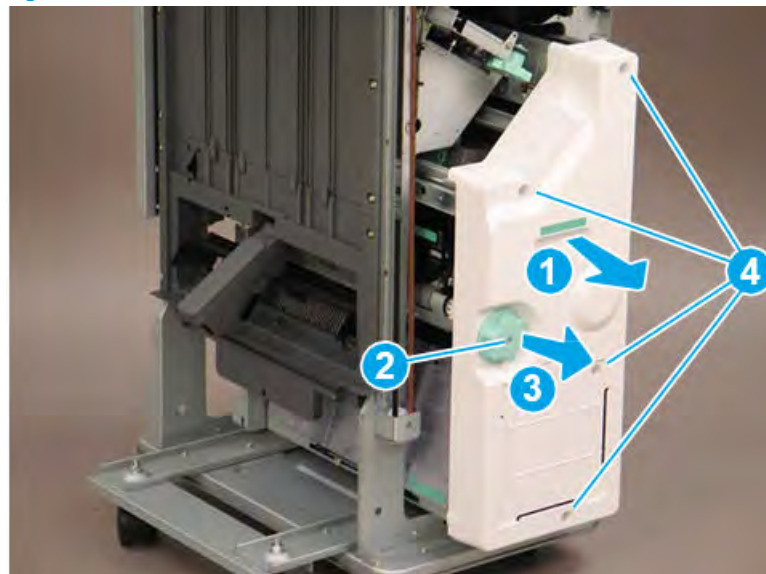
1. Remove two screws(callout 1) at the left of the booklet maker

Figure 5-1682 Remove two screws at the left of the booklet maker

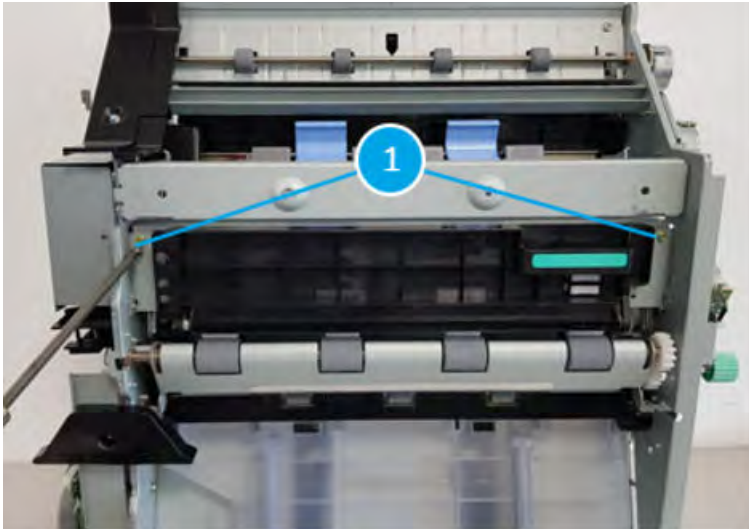

2. Remove three screws(callout 1) at the front of the booklet maker to remove motor unit(callout 2) to reach out to the screw.

Figure 5-1683 Remove three screws to remove motor unit to reach out to the screw

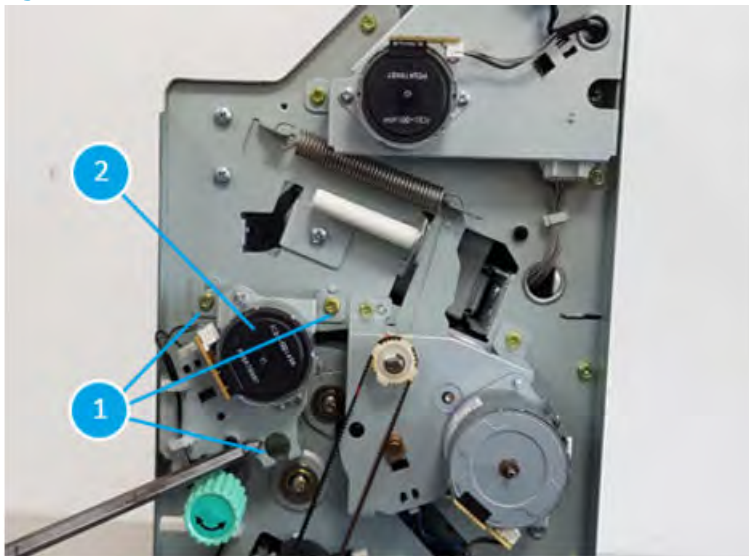

3. Remove one screw(callout 1) at the front of the booklet maker.

Figure 5-1684 Remove one screw at the front of the booklet maker



4. Remove one screw(callout 1) at the rear of the booklet maker.

Figure 5-1685 Remove one screw at the rear of the booklet maker

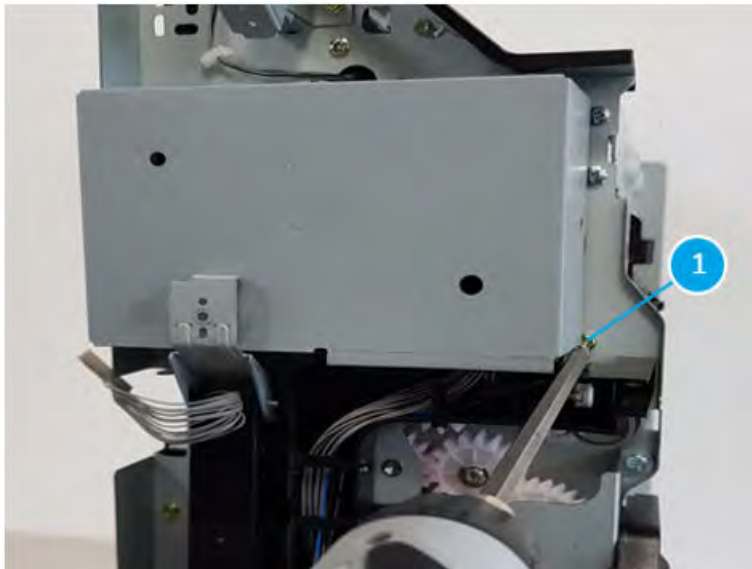

5. Take the booklet c-fold blade unit out from the booklet maker.

Figure 5-1686 Take the booklet c-fold blade unit out from the booklet maker

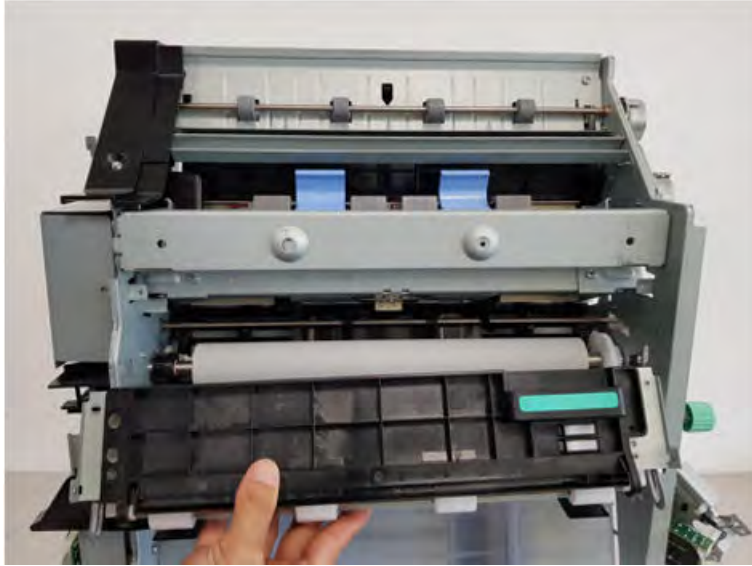

Remove the booklet stapler unit

Follow these steps to remove the booklet stapler unit.

1. Remove two screws (callout 1) at the front of the booklet maker.

Figure 5-1687 Remove two screws

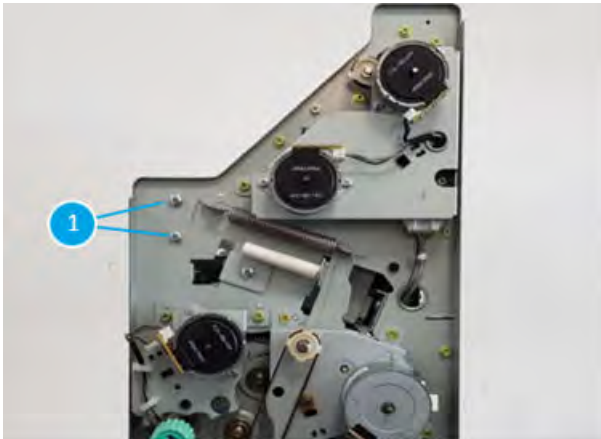

2. Remove two screws (callout 1) at the rear of the booklet maker.

Figure 5-1688 Remove two screws



3. Remove the metal frame (callout 1)

Figure 5-1689 Remove the metal frame



4. Remove two screws (callout 1) at the rear of the booklet maker to remove the board cover (callout 2)

Figure 5-1690 Remove the board cover

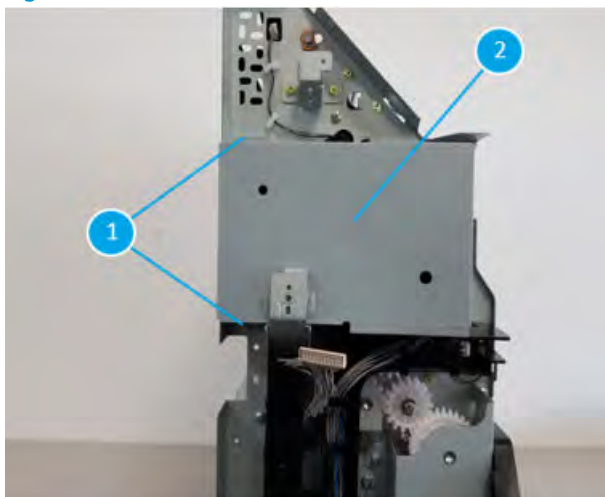

5. Remove four screws (callout 1) and unplug the connector (callout 2) at the rear of the booklet maker.

Figure 5-1691 Remove four screws and unplug the connector

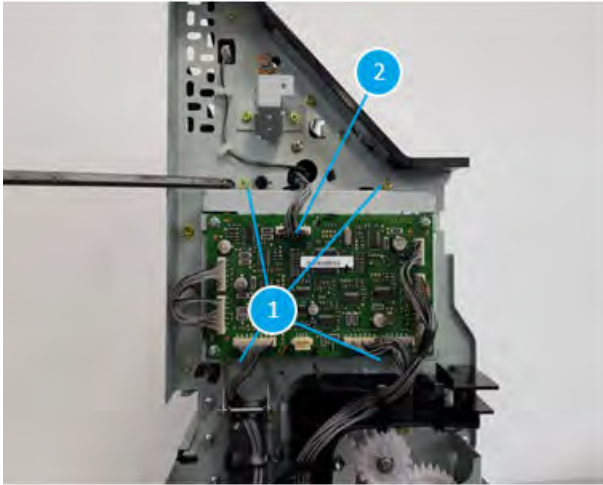

6. Remove one screw (callout 1).

Figure 5-1692 Remove one screw

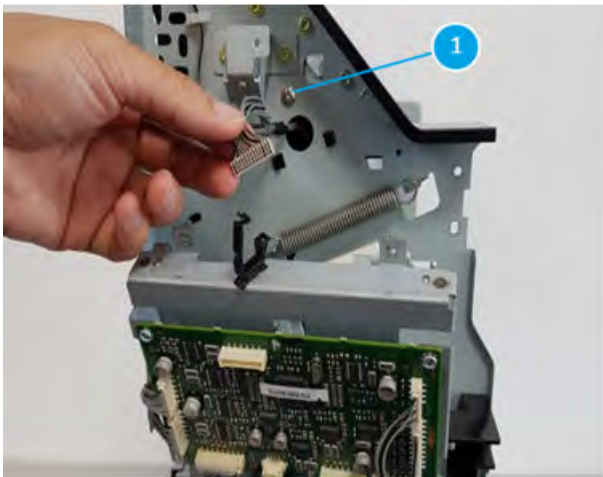

7. Remove the connector cover (callout 1).

Figure 5-1693 Remove the connector cover

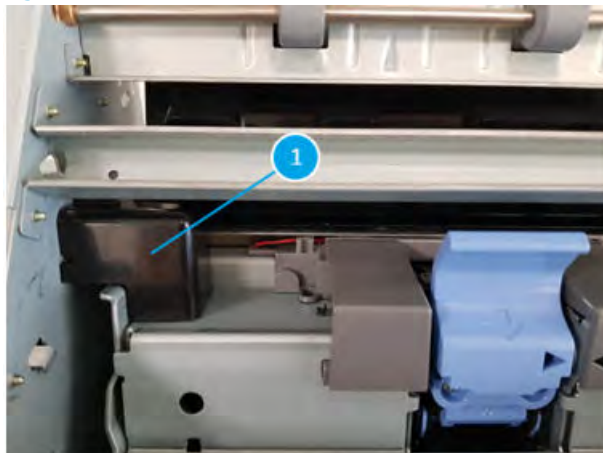

8. Remove one screw(callout 1) at the front of the booklet maker.

Figure 5-1694 Remove one screw



9. Remove one screw(callout 1) at the rear of the booklet maker.

Figure 5-1695 Remove one screw



10. Remove two screws (callout 1) at the left of the booklet maker and pull the metal bracket (callout 2) out each side.

Figure 5-1696 Remove two screws

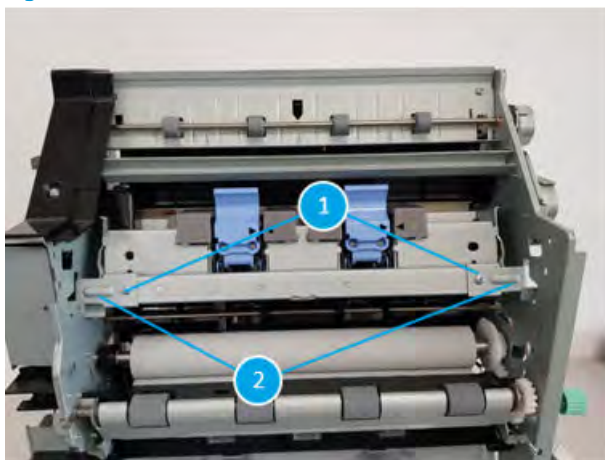

11. Remove one screw(callout 1) and remove one screw(callout 2) (Remove two screws each side)

Figure 5-1697 Remove two screws each side

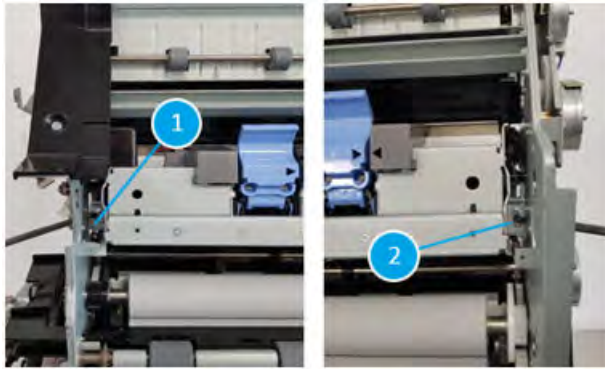

12. Remove two screws (callout 1) and remove the black cover (callout 2) and pull the stapler unit (callout 3) out

Figure 5-1698 Pull the stapler unit

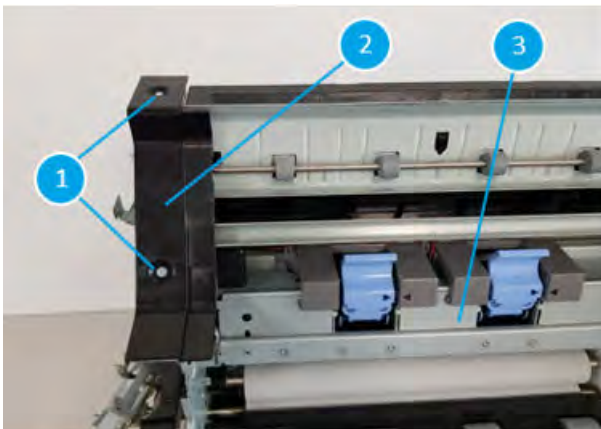

Unpack the replacement assembly

Follow these steps to unpack the replacement assembly.

1. Dispose of the defective part.

 **NOTE:** HP recommends responsible disposal of the defective part.

<http://www8.hp.com/us/en/hp-information/environment/product-recycling.html>

2. Unpack the replacement part from the packaging.



CAUTION:  Some parts are sensitive to electrostatic discharge (ESD). Always perform service work at an ESD-protected workstation or mat. If an ESD workstation or mat is not available, touch the sheet-metal chassis to provide a static ground before touching an ESD-sensitive assembly. Protect the ESD-sensitive assemblies by placing them in ESD pouches when they are out of the printer.

 **IMPORTANT:** Make sure that all of the shipping materials (for example shipping tape) are removed from the replacement part prior to installation.

 **NOTE:** If the replacement part is a roller or pad, avoid touching the spongy part of it. Skin oils on the roller or pad can cause paper pickup and/or print-quality problems. HP recommends using disposable gloves when handling rollers or pads or washing your hands before touching rollers or pads.

3. To install an assembly, reverse the removal steps.

 **NOTE:** When applicable, special installation instructions are provided for an assembly at the end of the removal procedure. Always completely read the removal instructions and follow all special installation instructions.

Booklet fold unit

Removal and replacement: Booklet blade

Learn how to remove and replace the tray booklet blade.

Introduction

This document provides the procedures to remove and replace the booklet blade on the finisher.



IMPORTANT: When applicable, special installation instructions are provided for an assembly at the end of the removal procedure. Always completely read the removal instructions and follow all special installation instructions.

Before performing service

- Turn the printer power off. A shutting-down message appears on the control-panel display.
- ⚠ **WARNING!** To avoid damage to the printer, turn the power off and wait until the printer shuts down before removing the power cable.
- Disconnect the printer power cable after the printer has completely shut down (the control-panel display is blank).
- Release the finisher from the printer by pulling out on the release latch inside the finisher door.
- Disconnect the cable from the bridge unit to the finisher.
- Disconnect the cable from the finisher to the printer.

Use the table below to identify the correct part number for your printer. To order the part, go to <https://parts.hp.com>.

Table 5-158 Part information

Part number	Part description
JC93-01163A	Booklet blade

Required tools

- #2 JIS screwdriver with a magnetic tip

After performing service

- Connect the cable from the finisher to the printer.
- Connect the cable from the bridge unit to the finisher.
- Attach the finisher to the printer, and then push in on the release latch inside the finisher door.
- Connect the printer power cable.
- Turn the printer power on.

Post service test

Process a job through the finisher and verify that the finisher works correctly.

Remove the right upper cover (finisher)

Follow these steps to remove the right upper cover (finisher).

- ▲ Remove one screw cap and three machine screws on the upper edge of the cover (callout 1). Remove three sheet metal screws (callout 2) on the lower portion of the cover. Rotate the right edge of the cover away from the finisher, and then slide the cover right to release three tabs (callout 3).

💡 **TIP:** The lower screws are shorter in length than the upper screws.

TIP: Reverse the removal steps to install the assembly.

Figure 5-1699 Remove the right upper cover

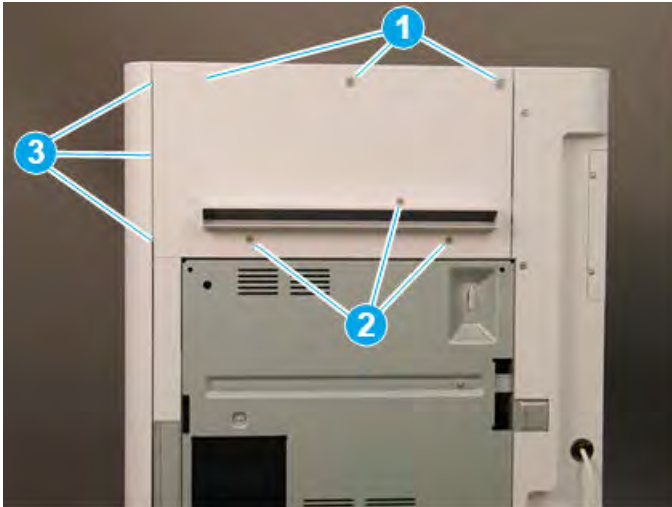

Remove the top cover (finisher)

Follow these steps to remove the top cover (finisher).

1. Remove three screw caps and three self-tapping screws at the top of the rear cover (callout 1), and then remove three machine screws (callout 2) on top of the cover.

Figure 5-1700 Remove six screws

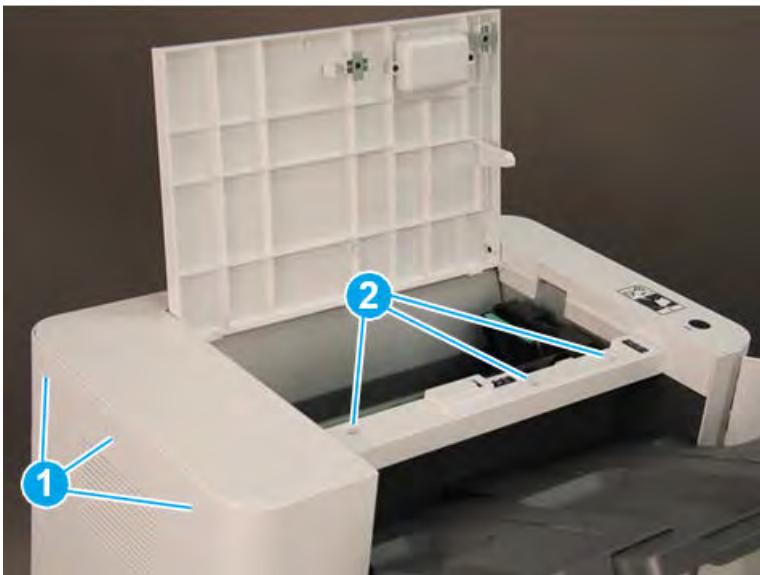

2. Remove three self-tapping screws at the top of the front cover (callout 1), and then remove two machine screws (callout 2) at the top of the right side.

Figure 5-1701 Remove five screws

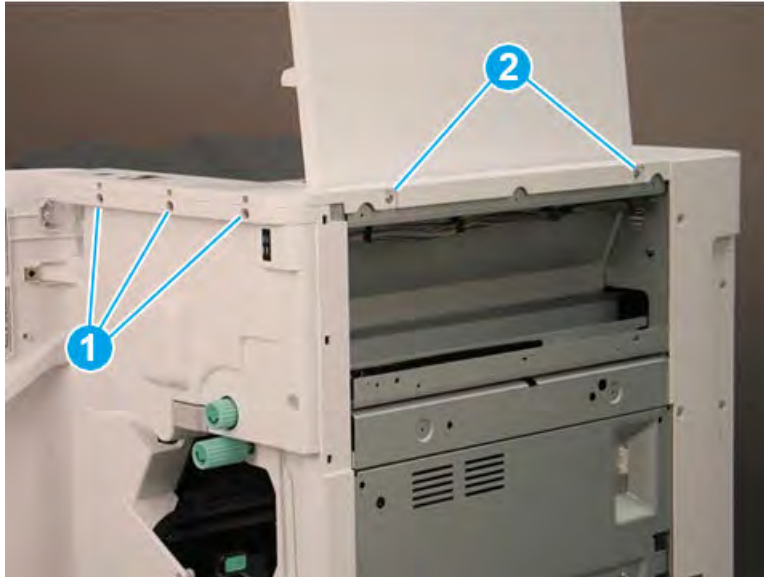

3. Lift the cover up slightly. Disconnect one in-line connector (callout 1), and then release one retainer (callout 2).

 **TIP:** Reverse the removal steps to install the assembly.

Figure 5-1702 Disconnect one connector and release retainer



Remove the rear cover (finisher)

Follow these steps to remove the rear cover (finisher).

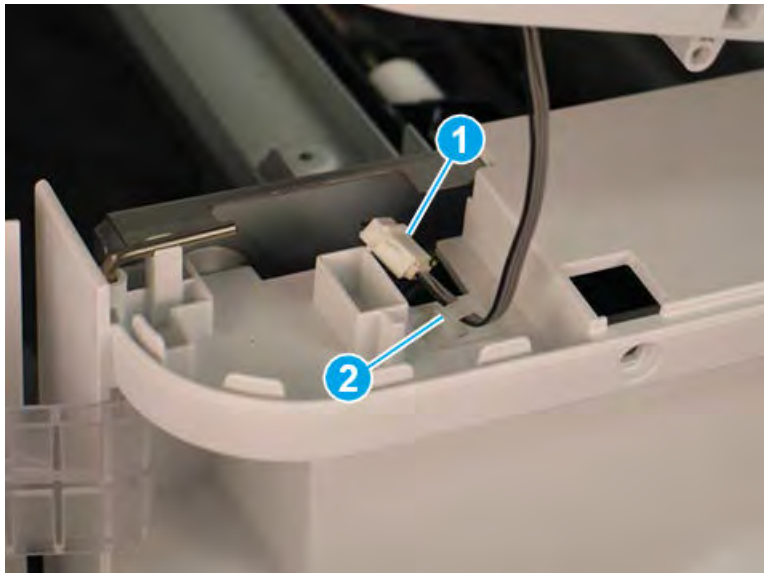
1. Remove two self-tapping screws (callout 1) on the top of the rear cover, and then remove five screw caps and five machine screws (callout 2) on the left side of the cover.

Figure 5-1703 Remove seven screws



2. Remove one screw cap and four machine screws (callout 1) Remove the rear cover.

 **NOTE:** Make sure to thread the power cable (callout 2) through the opening in the cover.

 **TIP:** Reverse the removal steps to install the assembly

Figure 5-1704 Remove the rear cover

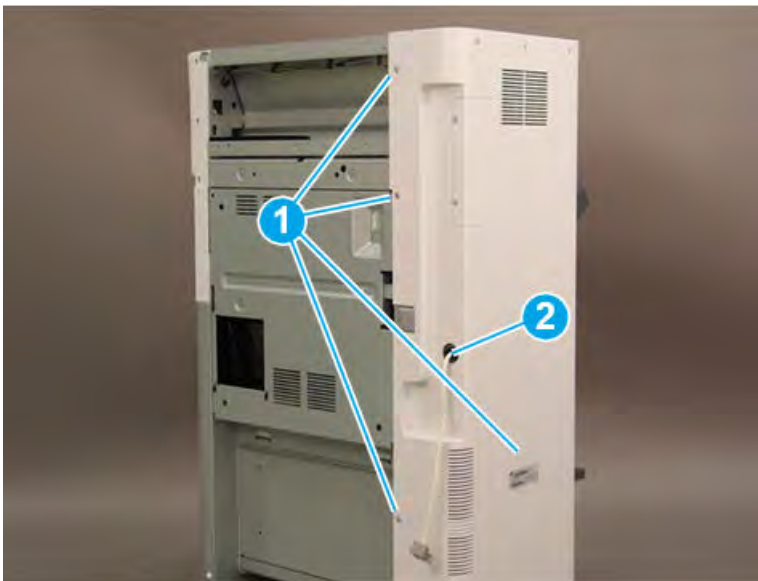

Remove the booklet maker

Follow these steps to remove the booklet maker.

1. Slide the booklet maker away from the finisher.

Figure 5-1705 Slide the booklet maker away from the finisher



2. At the Disconnect one connector (callout 1), and then remove one screw (callout 2).

Figure 5-1706 Disconnect one connector and remove one screw

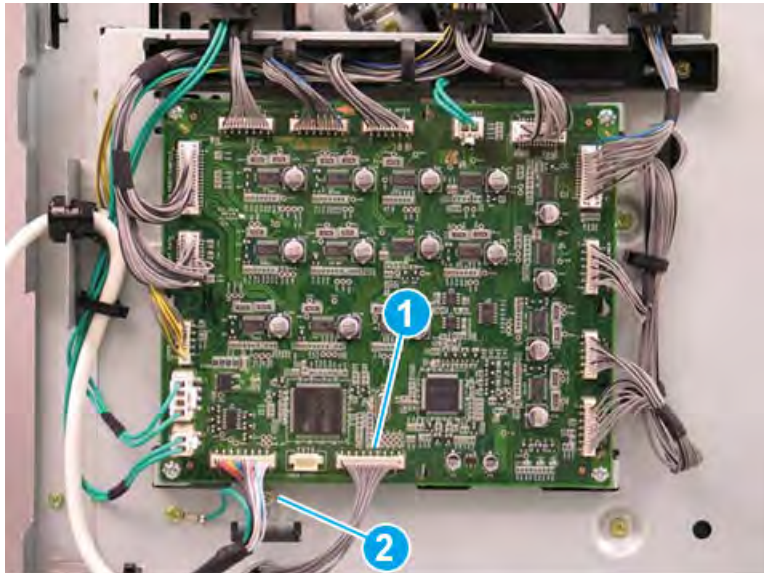

3. Release the metal bracket through the opening in the sheet metal.

Figure 5-1707 Release the metal bracket

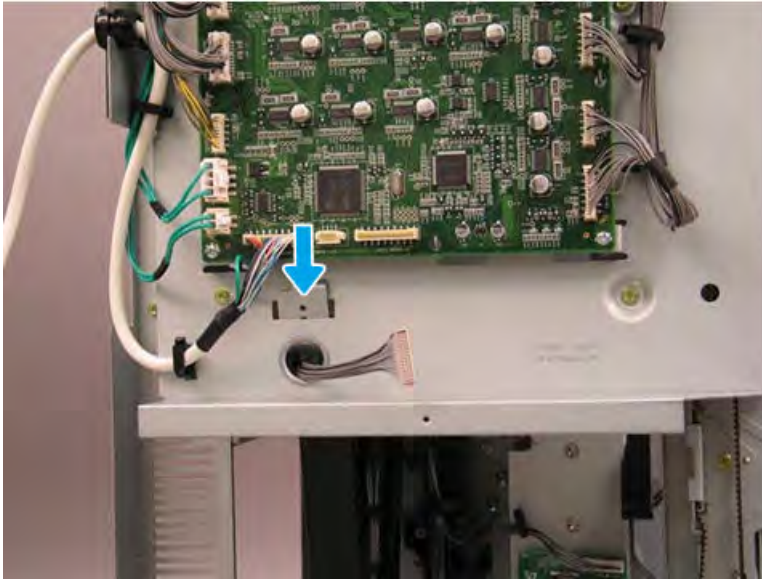

4. Remove one star-washer screw (callout 1), and then release the alignment pin (callout 2) on the right side of the booklet maker.

Figure 5-1708 Remove one screw

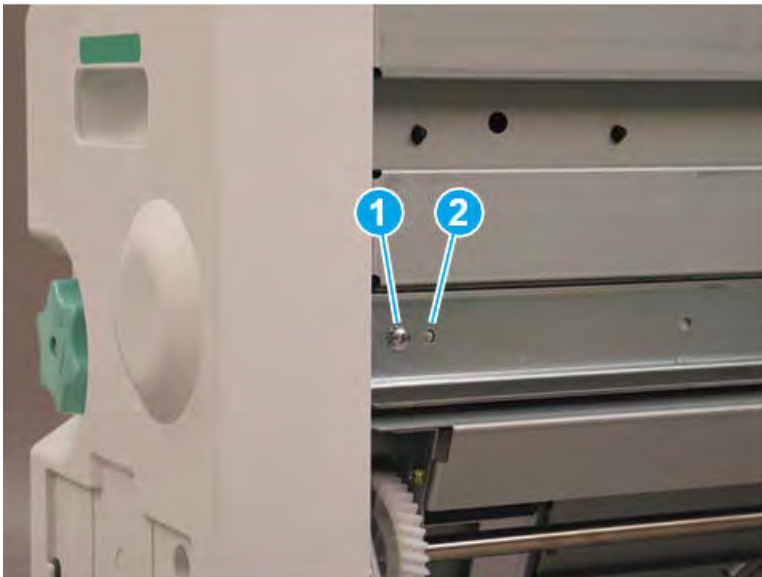

5. Slide the right rail toward the finisher.

Figure 5-1709 Slide the right rail

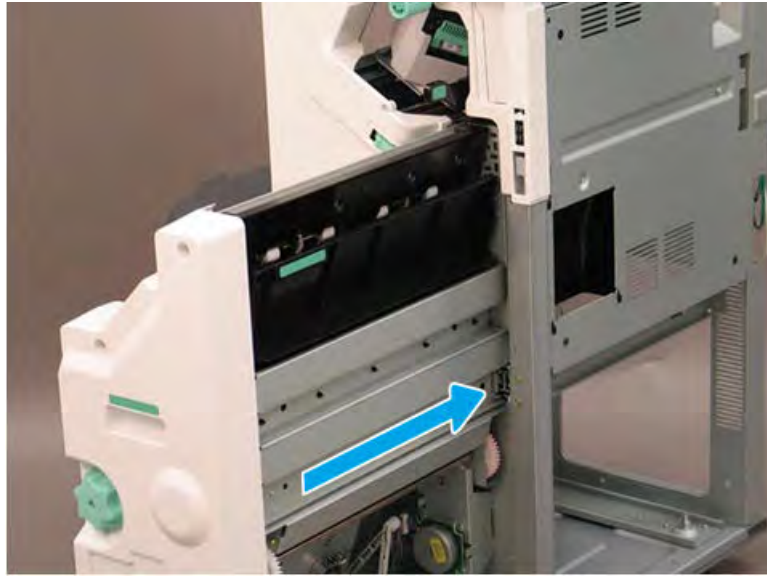

6. Remove one star-washer screw (callout 1) on the left side of the booklet maker.

Figure 5-1710 Remove one screw

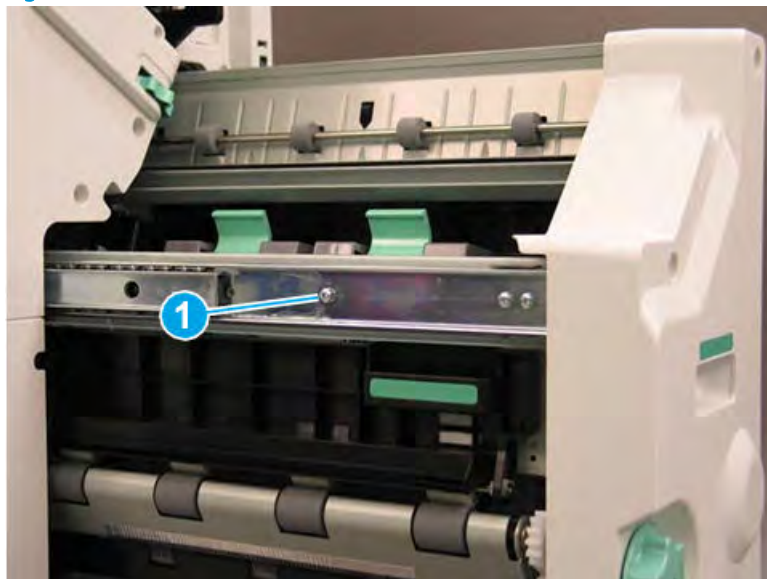

7. Lift the booklet maker up on the left side while squeezing the right rail away from the finisher slightly to clear the sheet metal. Remove the booklet maker.

Figure 5-1711 Remove the booklet maker

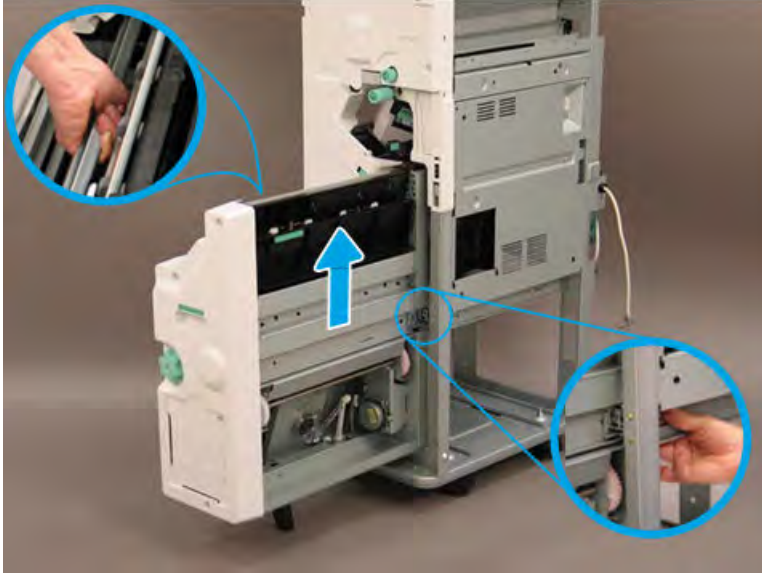

8. Reverse the removal steps to install the assembly. Also use the following special installation instructions.

 **NOTE:** Continue to reverse the removal steps to finish installing the assembly.

Special installation instructions: booklet maker

When installing the booklet maker, position the hooks on the rail under the slots on the booklet maker.

Figure 5-1712 Position the hooks

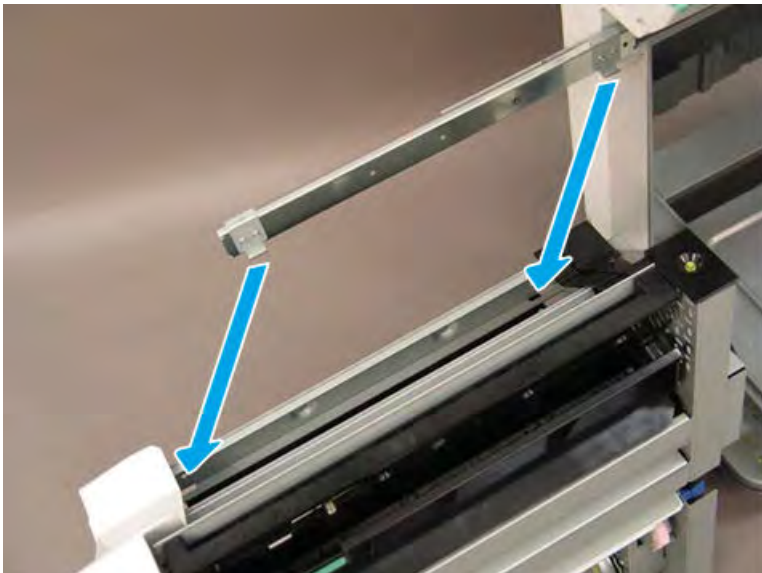

9. When installed correctly, the arrow on the front of the booklet maker aligns with the arrow on the finisher rail.

Figure 5-1713 Align arrows

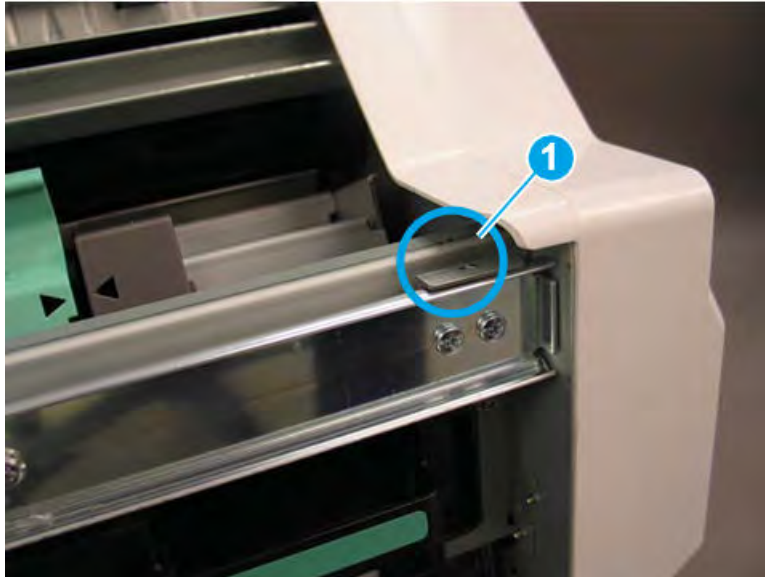

10. When installed correctly, the arrow on the back of the booklet maker aligns with the arrow on the finisher rail.

Figure 5-1714 Align arrows

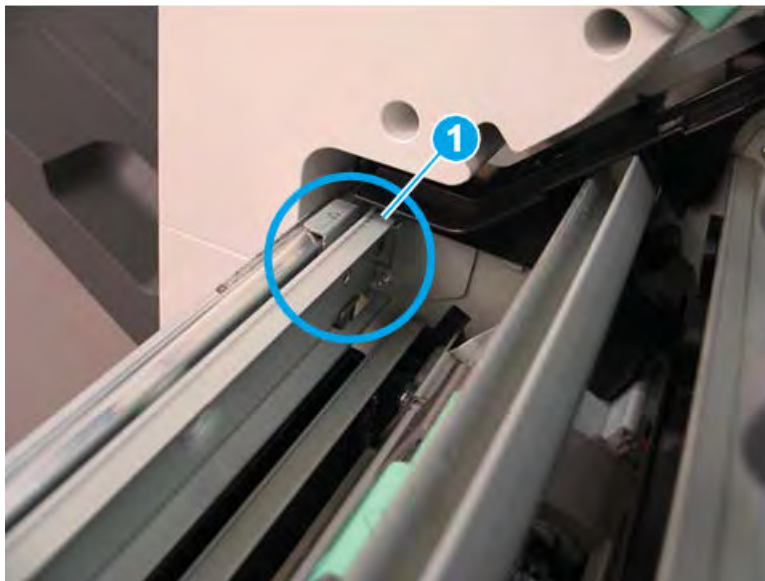

11. Extend the right rail away from the finisher and position it in the booklet maker slot.

Figure 5-1715 Extend the right rail



Remove the booklet front cover

Follow these steps to remove the booklet front cover.

- ▲ Slide the booklet maker slightly away from the finisher (callout 1). Remove one screw (callout 2), and then slide the green knob away from the booklet maker to remove it (callout 3). Remove four screws (callout 4), and then remove the booklet front cover.

 **TIP:** Reverse the removal steps to install the assembly

Figure 5-1716 Remove five screws and the cover

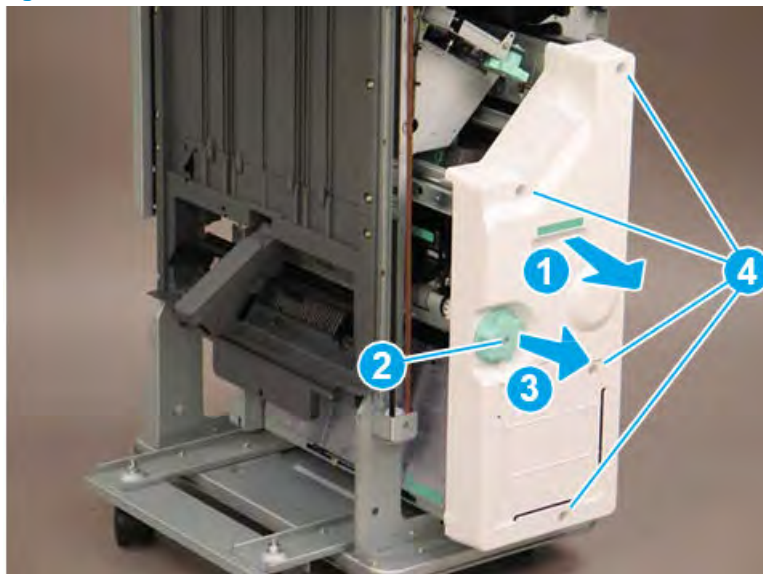

Remove the booklet right lower shield

Follow these steps to remove the booklet right lower shield.

1. Remove two screws at the front of the booklet maker (callout 1).

Figure 5-1717 Remove two screws

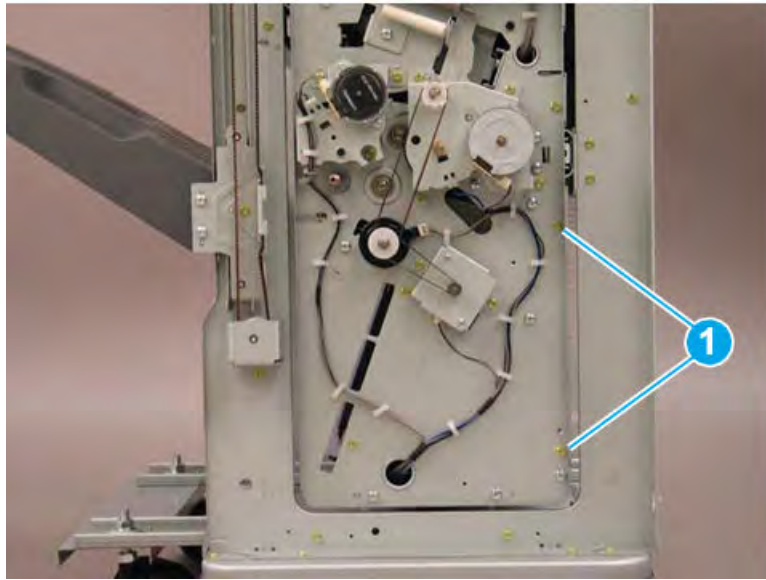

2. Remove two screws at the back of the booklet maker (callout 1).

Figure 5-1718 Remove two screws

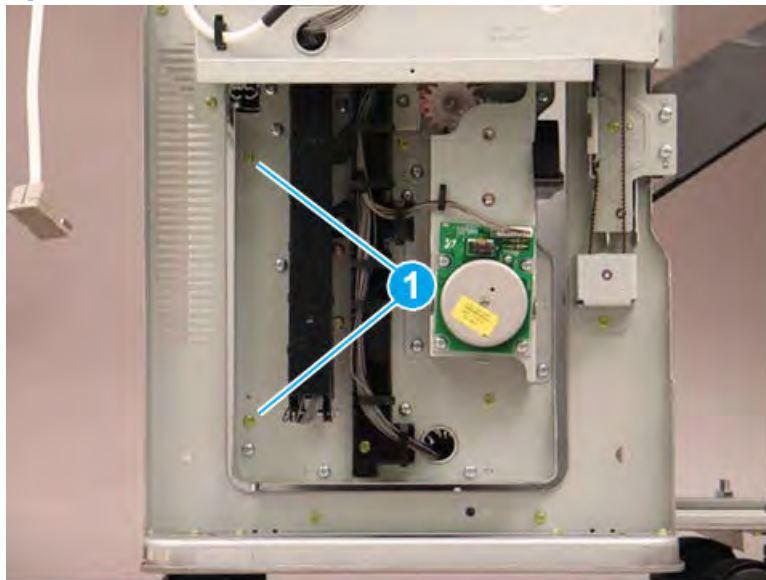

3. Slide the booklet maker out of the finisher (callout 1), and then rotate the top of the right lower shield (callout 2) away from the booklet maker to remove it.

Figure 5-1719 Remove the right lower shield

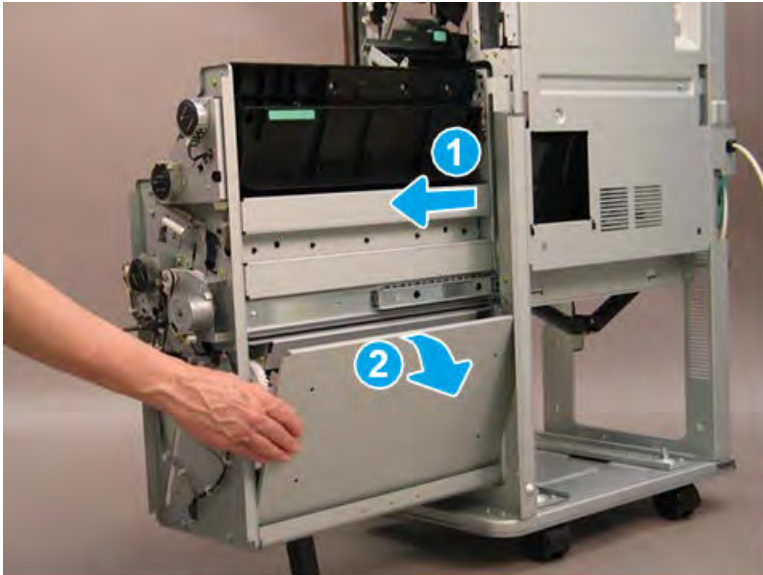

Remove the booklet maker middle right shield

Follow these steps to remove the booklet maker middle right shield.

1. Remove two screws at the front of the booklet maker (callout 1).

Figure 5-1720 Remove two screws at the front of the booklet maker



2. Remove two screws at the back of the booklet maker (callout 1).

Figure 5-1721 Remove two screws at the back of the booklet maker

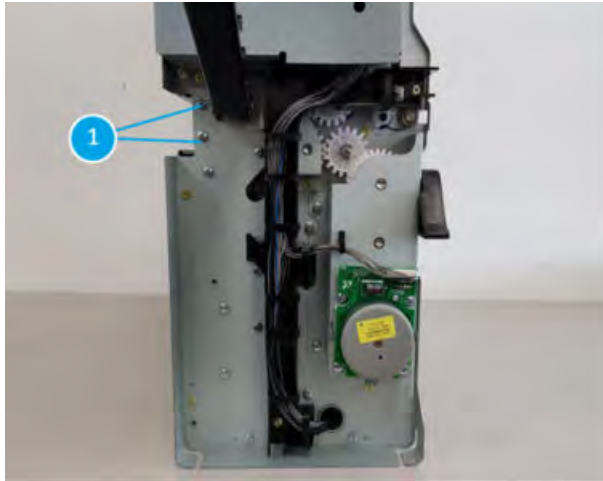

Remove the booklet finisher upper right shield

Follow these steps to remove the booklet finisher upper right shield.

1. Remove two screws at the front of the booklet maker (callout 1)

Figure 5-1722 Remove two screws at the front of the booklet maker



2. Remove two screws(callout 1) and one screw(callout 2) at the back of the booklet maker and then remove the board cover.

Figure 5-1723 Remove the board cover

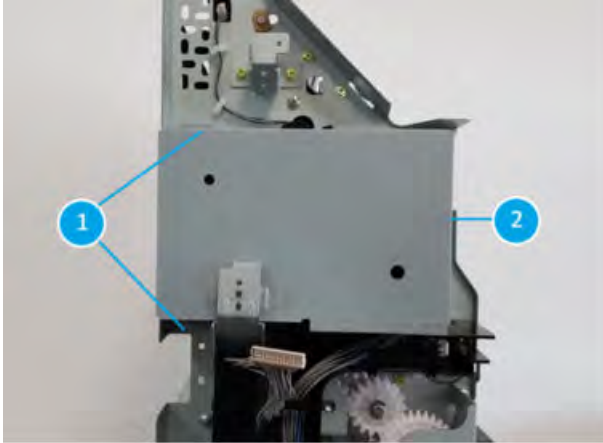

3. Remove two screws at the back of the booklet maker (callout 1).

Figure 5-1724 Remove two screws

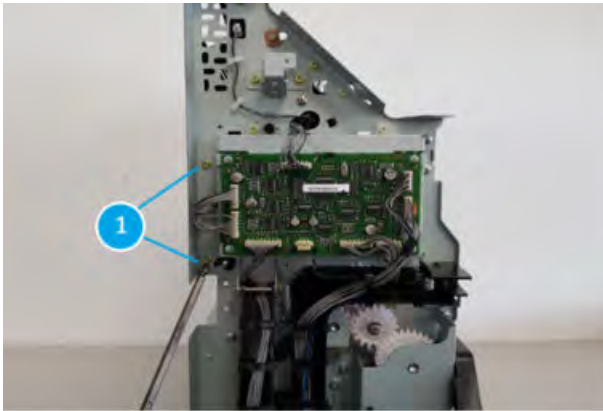

4. Disconnect one connector at the front of the booklet maker (callout 1).

Figure 5-1725 Disconnect one connector



5. Disconnect one connector at the right of the booklet maker (callout 1).

Figure 5-1726 Disconnect one connector



Remove the booklet tamper and fold unit

Follow these steps to remove the booklet tamper and fold unit.

1. Remove two screws at the left of the booklet maker (callout 1).

Figure 5-1727 Remove two screws at the left of the booklet maker



2. Remove three screws at the right of the booklet maker (callout 1).

Figure 5-1728 Remove three screws at the right of the booklet maker

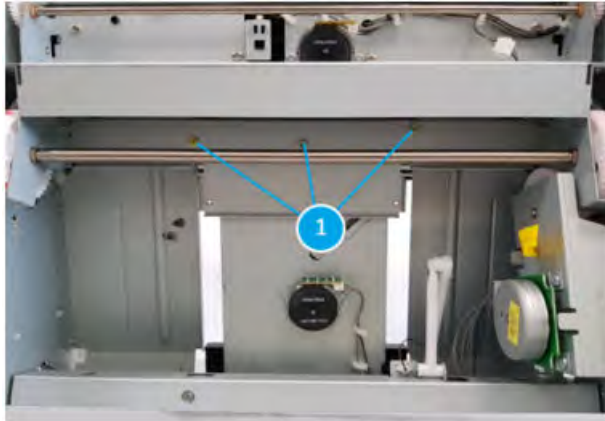

3. Remove two screws at the front of the booklet maker (callout 1).

Figure 5-1729 Remove two screws at the front of the booklet maker

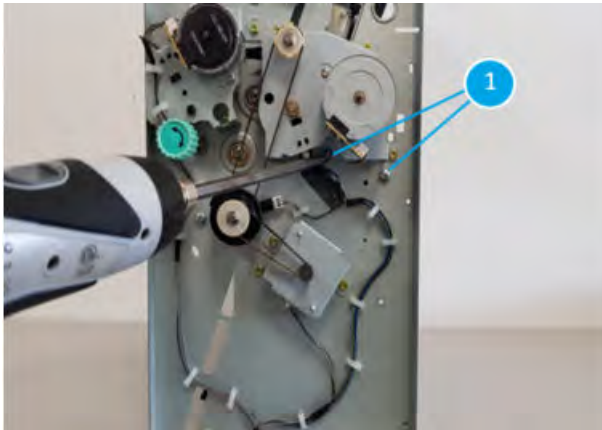

4. Remove two screws at the back of the booklet maker (callout 1).

Figure 5-1730 Remove two screws at the back of the booklet maker

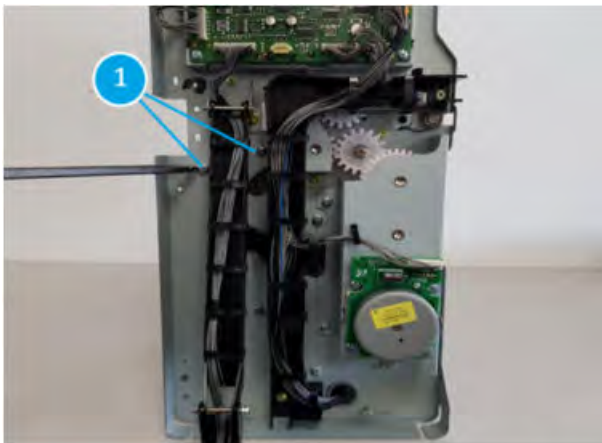

5. Disconnect one connector at the right of the booklet maker (callout 1).

Figure 5-1731 Disconnect one connector



Remove the booklet blade

Follow these steps to remove the booklet blade.

1. Remove two screws (callout 1) and disconnect one connector (callout 2)

Figure 5-1732 Remove two screws and disconnect one connector

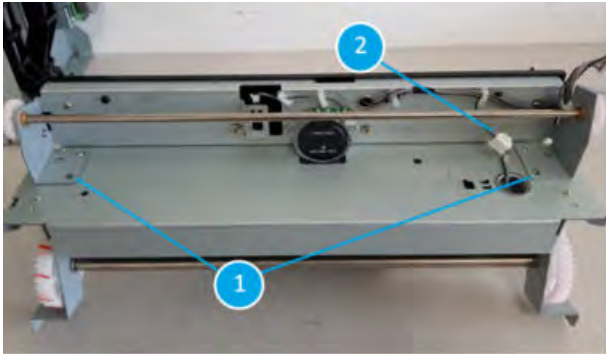

2. Remove 7 screws (callout 1) and remove the booklet blade (callout 2)

Figure 5-1733 Remove 7 screws and remove the booklet blade

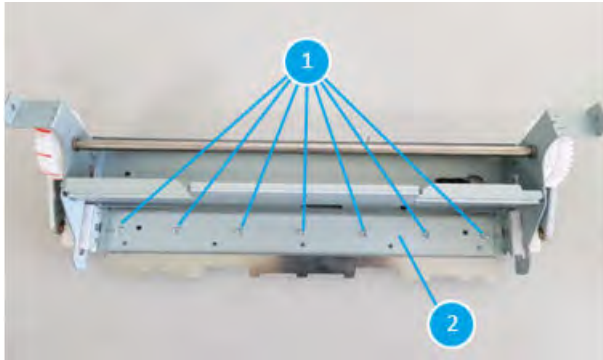

 **NOTE:** Be sure to make the scale when you reassemble with the new blade



Unpack the replacement assembly



Follow these steps to unpack the replacement assembly.

1. Dispose of the defective part.

 **NOTE:** HP recommends responsible disposal of the defective part.

<http://www8.hp.com/us/en/hp-information/environment/product-recycling.html>

2. Unpack the replacement part from the packaging.

 **CAUTION:**  Some parts are sensitive to electrostatic discharge (ESD). Always perform service work at an ESD-protected workstation or mat. If an ESD workstation or mat is not available, touch the sheet-metal chassis to provide a static ground before touching an ESD-sensitive assembly. Protect the ESD-sensitive assemblies by placing them in ESD pouches when they are out of the printer.

 **IMPORTANT:** Make sure that all of the shipping materials (for example shipping tape) are removed from the replacement part prior to installation.

 **NOTE:** If the replacement part is a roller or pad, avoid touching the spongy part of it. Skin oils on the roller or pad can cause paper pickup and/or print-quality problems. HP recommends using disposable gloves when handling rollers or pads or washing your hands before touching rollers or pads.

3. To install an assembly, reverse the removal steps.



NOTE: When applicable, special installation instructions are provided for an assembly at the end of the removal procedure. Always completely read the removal instructions and follow all special installation instructions.

Removal and replacement: Booklet blade home sensor (S45)

Learn how to remove and replace the tray booklet blade home sensor.

Introduction

This document provides the procedures to remove and replace the booklet blade home sensor on the finisher.



IMPORTANT: When applicable, special installation instructions are provided for an assembly at the end of the removal procedure. Always completely read the removal instructions and follow all special installation instructions.

Before performing service

- Turn the printer power off. A shutting-down message appears on the control-panel display.
- ⚠ **WARNING!** To avoid damage to the printer, turn the power off and wait until the printer shuts down before removing the power cable.
- Disconnect the printer power cable after the printer has completely shut down (the control-panel display is blank).
- Release the finisher from the printer by pulling out on the release latch inside the finisher door.
- Disconnect the cable from the bridge unit to the finisher.
- Disconnect the cable from the finisher to the printer.

Use the table below to identify the correct part number for your printer. To order the part, go to <https://parts.hp.com>.

Table 5-159 Part information

Part number	Part description
0604-001393	Booklet blade home sensor

Required tools

- #2 JIS screwdriver with a magnetic tip

After performing service

- Connect the cable from the finisher to the printer.
- Connect the cable from the bridge unit to the finisher.
- Attach the finisher to the printer, and then push in on the release latch inside the finisher door.
- Connect the printer power cable.
- Turn the printer power on.

Post service test

Process a job through the finisher and verify that the finisher works correctly.

Remove the right upper cover (finisher)

Follow these steps to remove the right upper cover (finisher).

- ▲ Remove one screw cap and three machine screws on the upper edge of the cover (callout 1). Remove three sheet metal screws (callout 2) on the lower portion of the cover. Rotate the right edge of the cover away from the finisher, and then slide the cover right to release three tabs (callout 3).

 **TIP:** The lower screws are shorter in length than the upper screws.

TIP: Reverse the removal steps to install the assembly.

Figure 5-1734 Remove the right upper cover

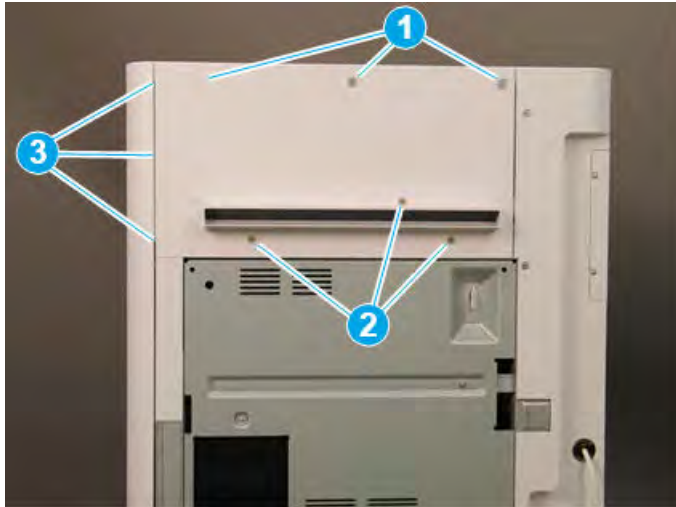

Remove the top cover (finisher)

Follow these steps to remove the top cover (finisher).

1. Remove three screw caps and three self-tapping screws at the top of the rear cover (callout 1), and then remove three machine screws (callout 2) on top of the cover.

Figure 5-1735 Remove six screws

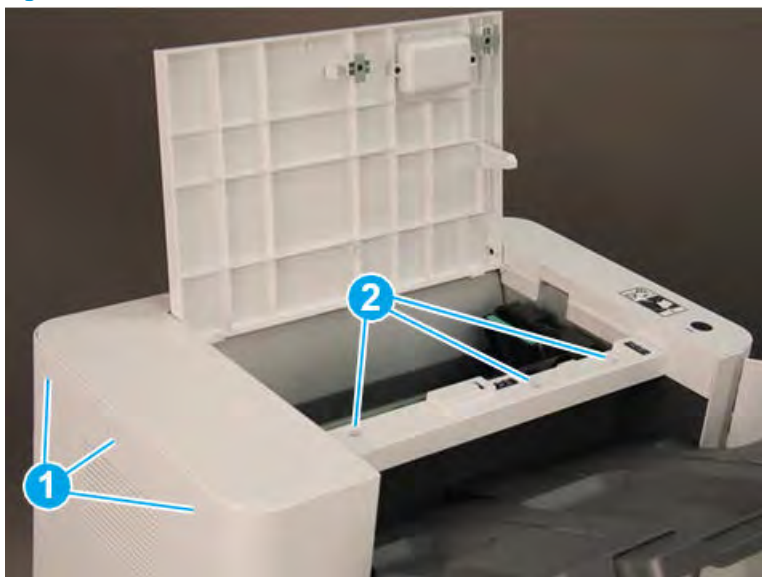

2. Remove three self-tapping screws at the top of the front cover (callout 1), and then remove two machine screws (callout 2) at the top of the right side.

Figure 5-1736 Remove five screws

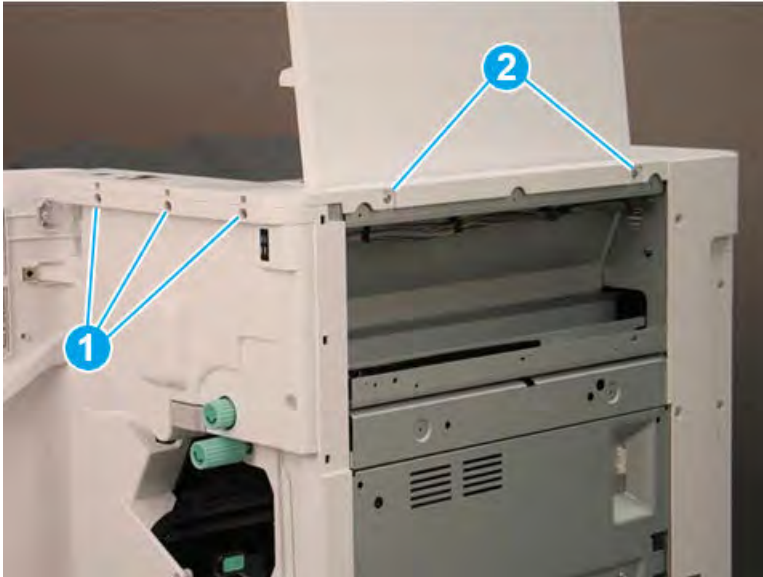

3. Lift the cover up slightly. Disconnect one in-line connector (callout 1), and then release one retainer (callout 2).

 **TIP:** Reverse the removal steps to install the assembly.

Figure 5-1737 Disconnect one connector and release retainer



Remove the rear cover (finisher)

Follow these steps to remove the rear cover (finisher).

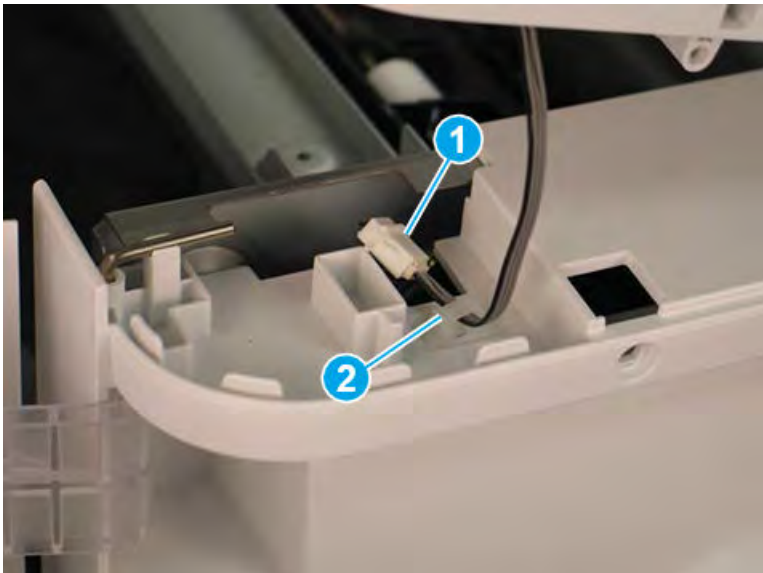
1. Remove two self-tapping screws (callout 1) on the top of the rear cover, and then remove five screw caps and five machine screws (callout 2) on the left side of the cover.

Figure 5-1738 Remove seven screws

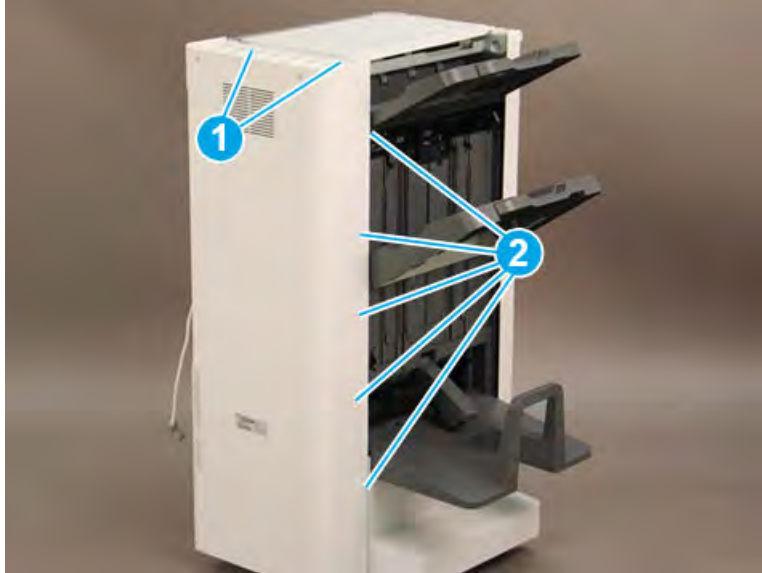

2. Remove one screw cap and four machine screws (callout 1) Remove the rear cover.

 **NOTE:** Make sure to thread the power cable (callout 2) through the opening in the cover.

 **TIP:** Reverse the removal steps to install the assembly

Figure 5-1739 Remove the rear cover



Remove the booklet maker

Follow these steps to remove the booklet maker.

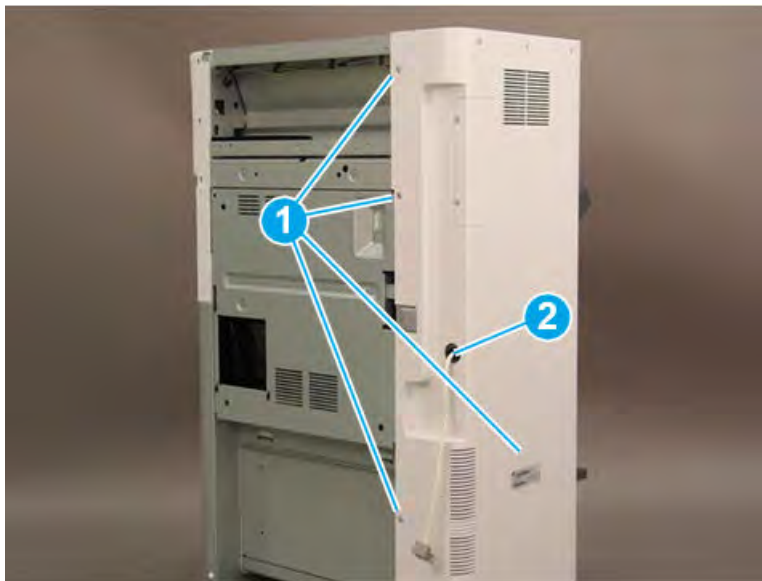
1. Slide the booklet maker away from the finisher.

Figure 5-1740 Slide the booklet maker away from the finisher



2. At the Disconnect one connector (callout 1), and then remove one screw (callout 2).

Figure 5-1741 Disconnect one connector and remove one screw

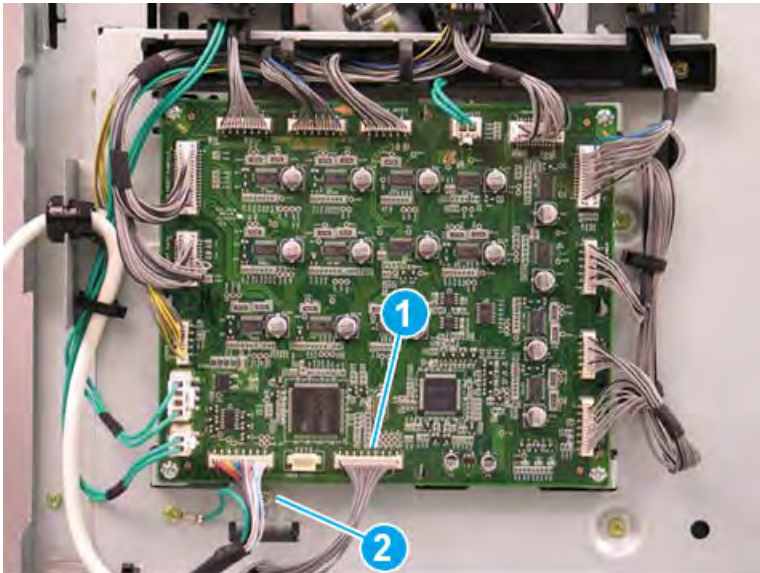

3. Release the metal bracket through the opening in the sheet metal.

Figure 5-1742 Release the metal bracket

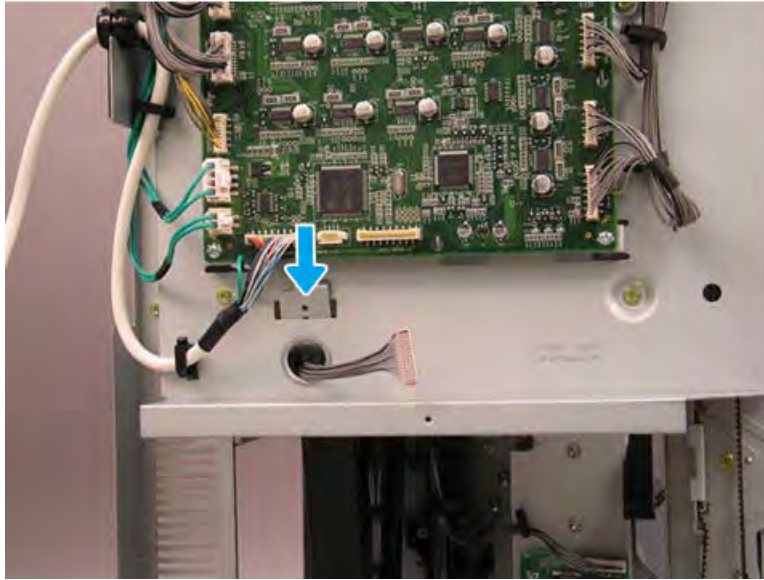

4. Remove one star-washer screw (callout 1), and then release the alignment pin (callout 2) on the right side of the booklet maker.

Figure 5-1743 Remove one screw

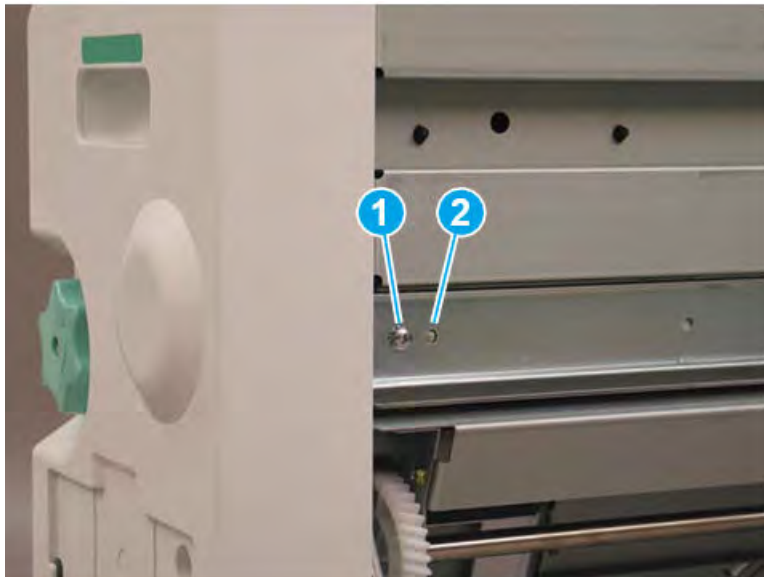

5. Slide the right rail toward the finisher.

Figure 5-1744 Slide the right rail

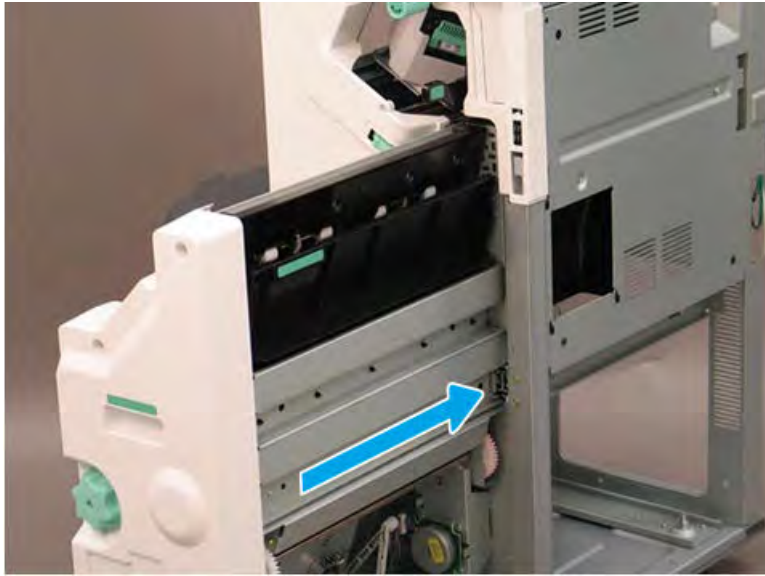

6. Remove one star-washer screw (callout 1) on the left side of the booklet maker.

Figure 5-1745 Remove one screw

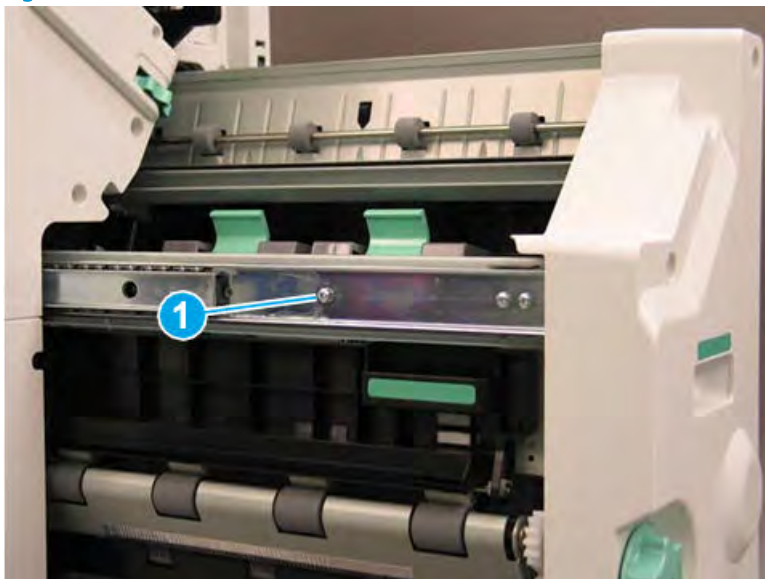

7. Lift the booklet maker up on the left side while squeezing the right rail away from the finisher slightly to clear the sheet metal. Remove the booklet maker.

Figure 5-1746 Remove the booklet maker

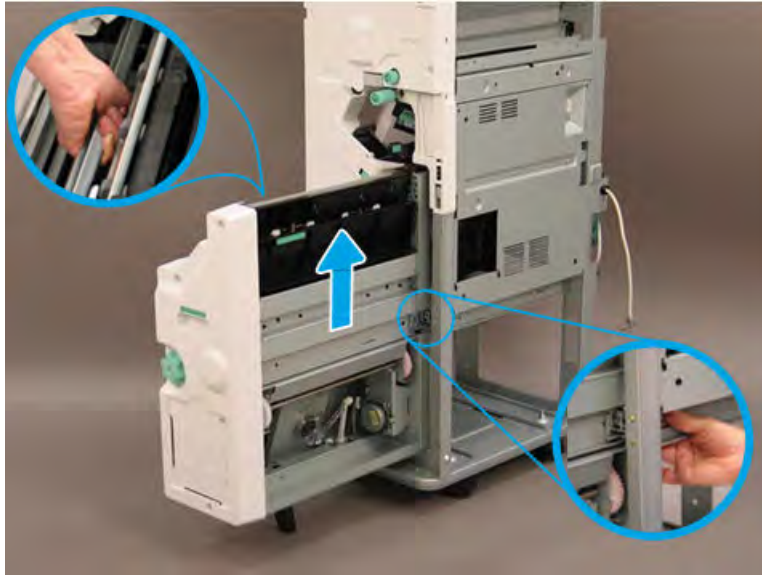

8. Reverse the removal steps to install the assembly. Also use the following special installation instructions.

 **NOTE:** Continue to reverse the removal steps to finish installing the assembly.

Special installation instructions: booklet maker

When installing the booklet maker, position the hooks on the rail under the slots on the booklet maker.

Figure 5-1747 Position the hooks

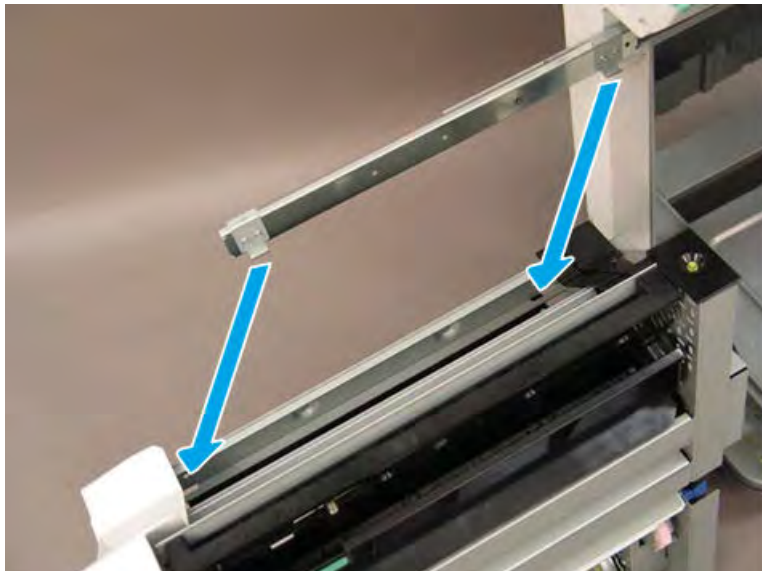

9. When installed correctly, the arrow on the front of the booklet maker aligns with the arrow on the finisher rail.

Figure 5-1748 Align arrows

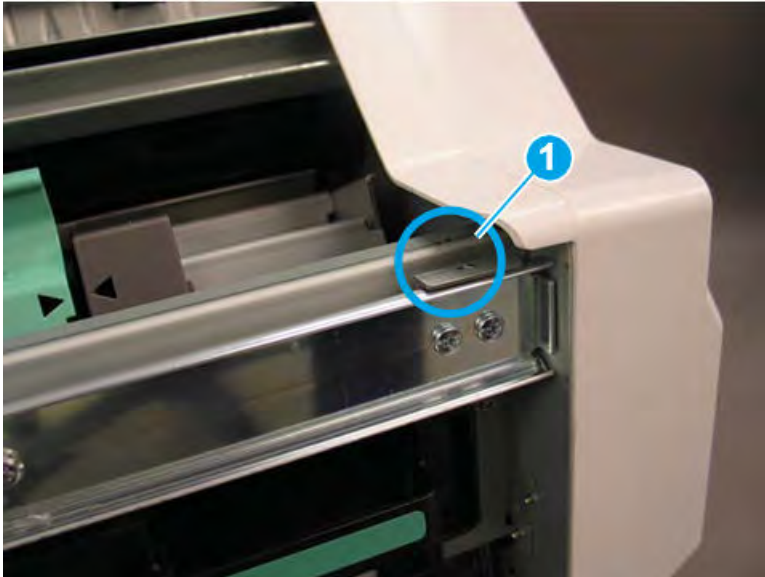

10. When installed correctly, the arrow on the back of the booklet maker aligns with the arrow on the finisher rail.

Figure 5-1749 Align arrows

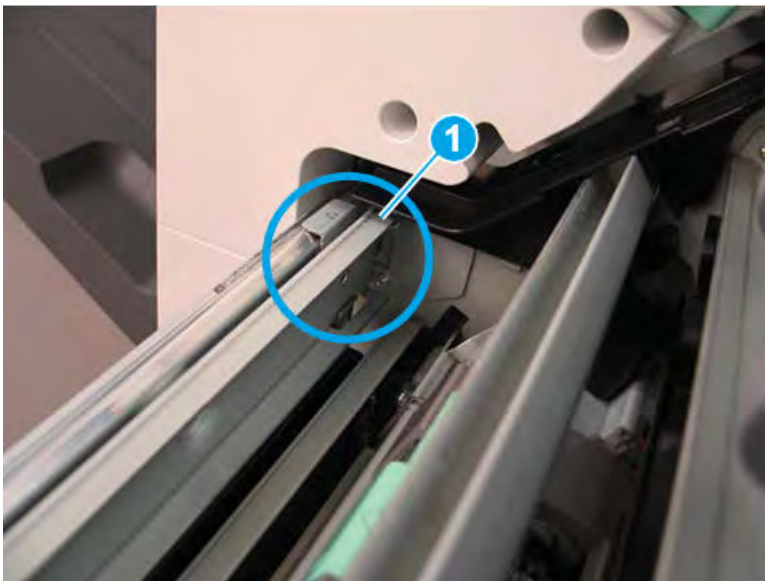

11. Extend the right rail away from the finisher and position it in the booklet maker slot.

Figure 5-1750 Extend the right rail

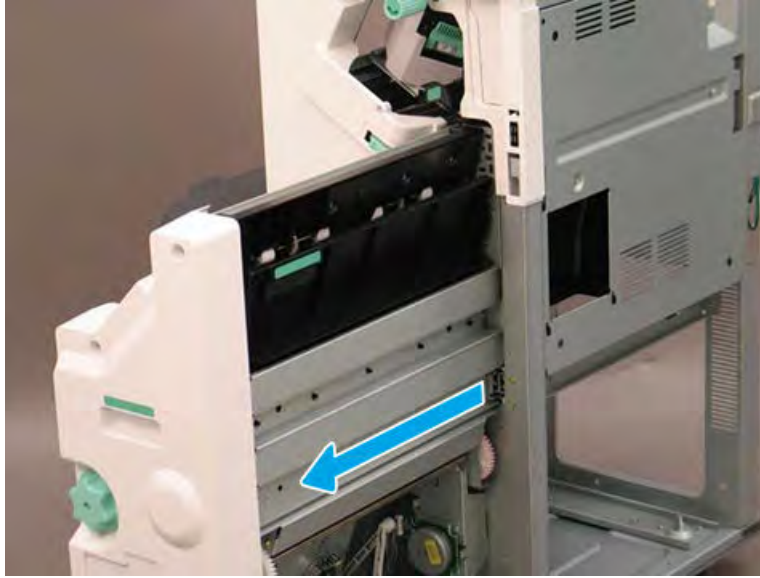

Remove the booklet front cover

Follow these steps to remove the booklet front cover.

- ▲ Slide the booklet maker slightly away from the finisher (callout 1). Remove one screw (callout 2), and then slide the green knob away from the booklet maker to remove it (callout 3). Remove four screws (callout 4), and then remove the booklet front cover.

 **TIP:** Reverse the removal steps to install the assembly

Figure 5-1751 Remove five screws and the cover



Remove the booklet right lower shield

Follow these steps to remove the booklet right lower shield.

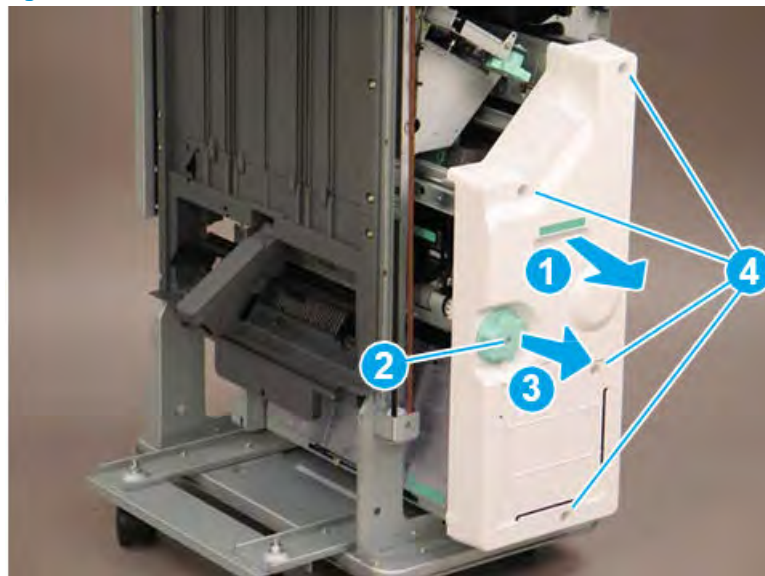
1. Remove two screws at the front of the booklet maker (callout 1).

Figure 5-1752 Remove two screws

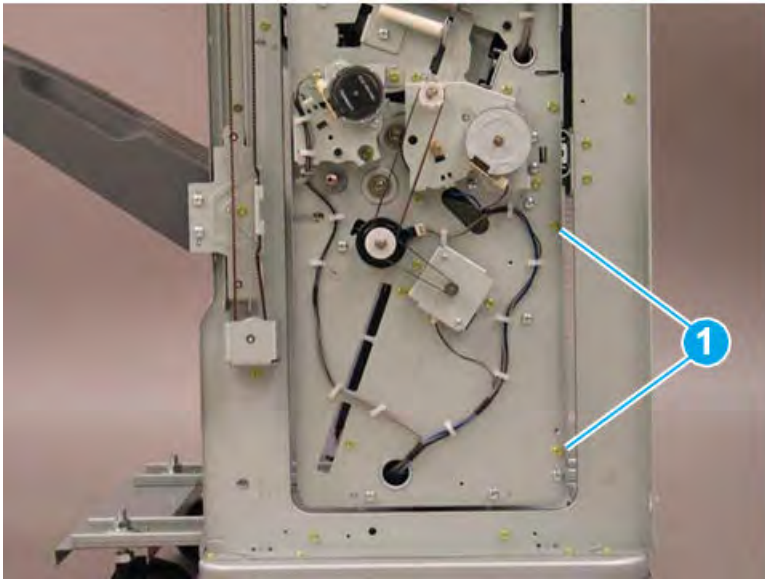

2. Remove two screws at the back of the booklet maker (callout 1).

Figure 5-1753 Remove two screws

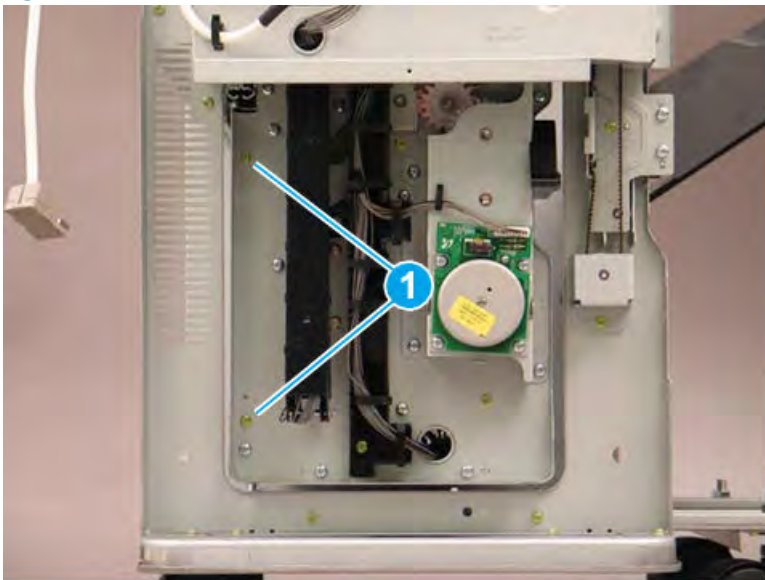

3. Slide the booklet maker out of the finisher (callout 1), and then rotate the top of the right lower shield (callout 2) away from the booklet maker to remove it.

Figure 5-1754 Remove the right lower shield

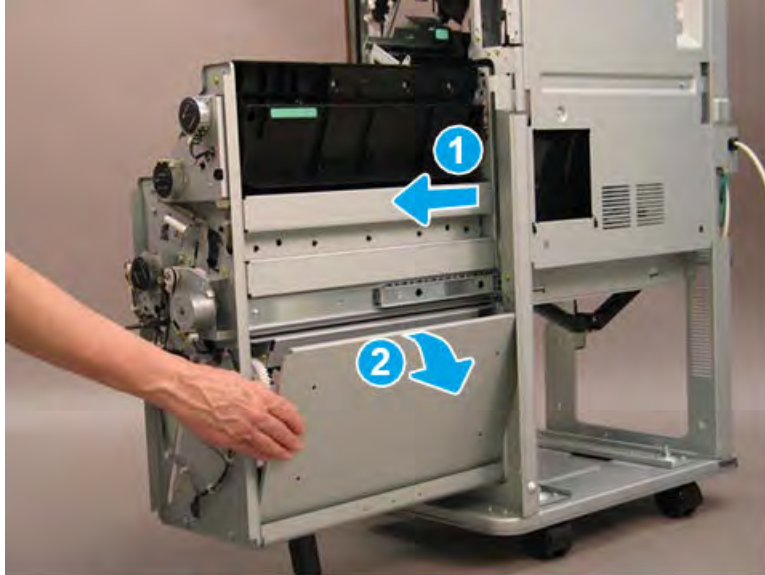

Remove the booklet maker middle right shield

Follow these steps to remove the booklet maker middle right shield.

1. Remove two screws at the front of the booklet maker (callout 1).

Figure 5-1755 Remove two screws at the front of the booklet maker

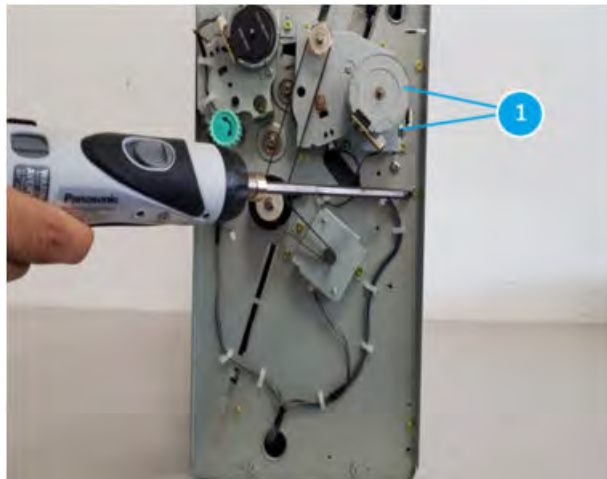

2. Remove two screws at the back of the booklet maker (callout 1).

Figure 5-1756 Remove two screws at the back of the booklet maker

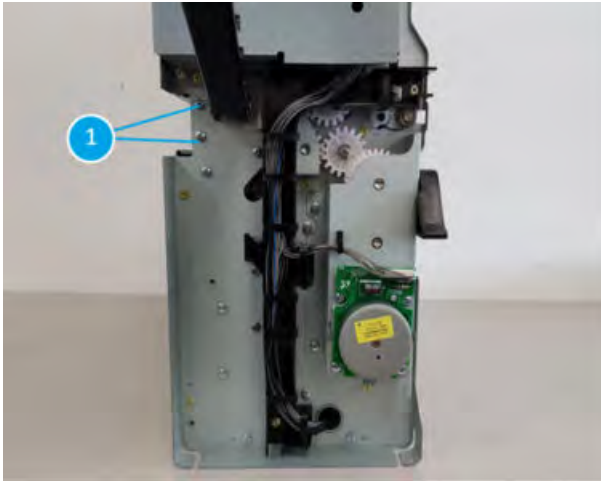

Remove the booklet finisher upper right shield

Follow these steps to remove the booklet finisher upper right shield.

1. Remove two screws at the front of the booklet maker (callout 1)

Figure 5-1757 Remove two screws at the front of the booklet maker



2. Remove two screws(callout 1) and one screw(callout 2) at the back of the booklet maker and then remove the board cover.

Figure 5-1758 Remove the board cover

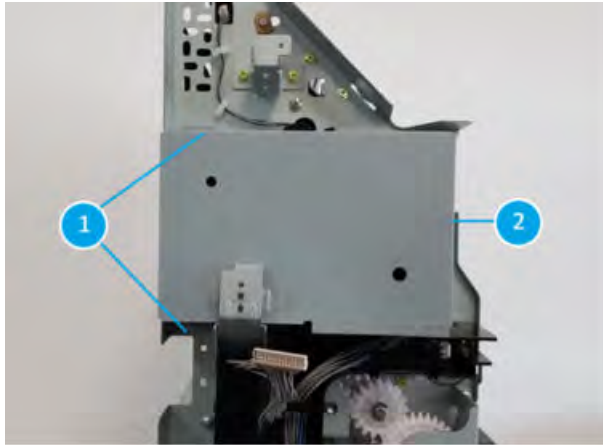

3. Remove two screws at the back of the booklet maker (callout 1).

Figure 5-1759 Remove two screws

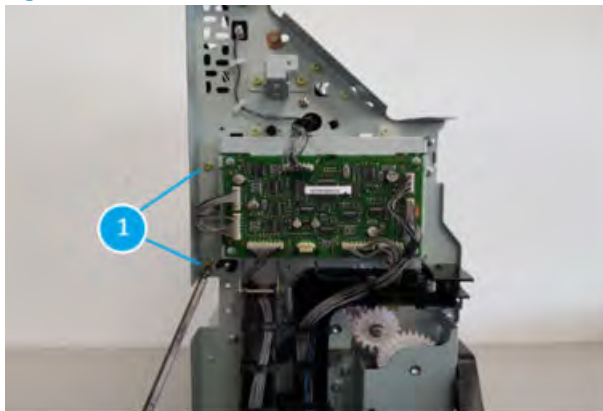

4. Disconnect one connector at the front of the booklet maker (callout 1).

Figure 5-1760 Disconnect one connector

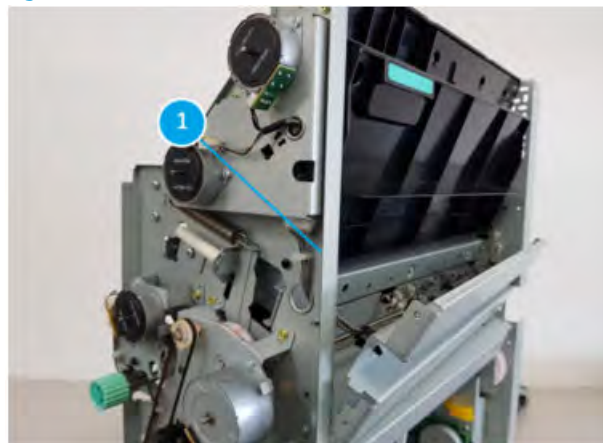

5. Disconnect one connector at the right of the booklet maker (callout 1).

Figure 5-1761 Disconnect one connector



Remove the booklet tamper and fold unit

Follow these steps to remove the booklet tamper and fold unit.

1. Remove two screws at the left of the booklet maker (callout 1).

Figure 5-1762 Remove two screws at the left of the booklet maker



2. Remove three screws at the right of the booklet maker (callout 1).

Figure 5-1763 Remove three screws at the right of the booklet maker

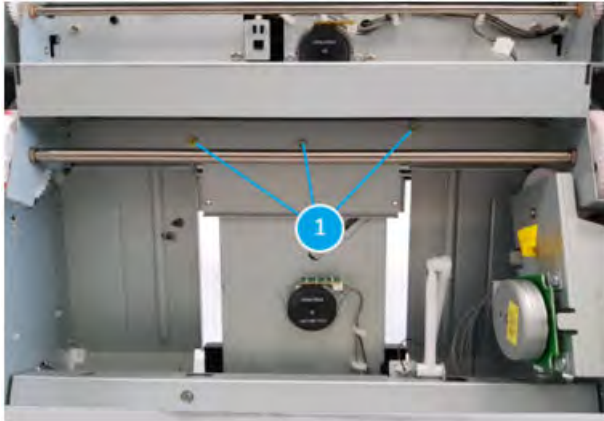

3. Remove two screws at the front of the booklet maker (callout 1).

Figure 5-1764 Remove two screws at the front of the booklet maker

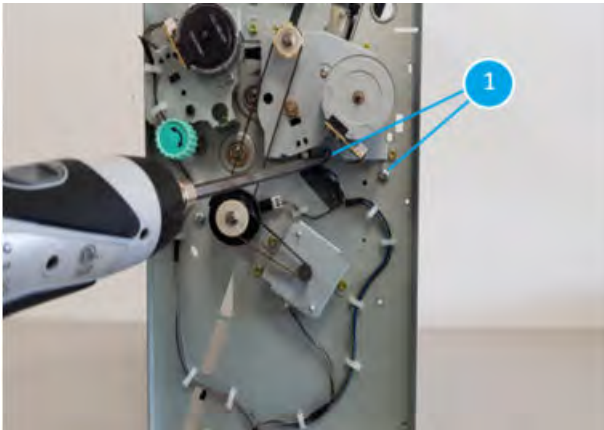

4. Remove two screws at the back of the booklet maker (callout 1).

Figure 5-1765 Remove two screws at the back of the booklet maker

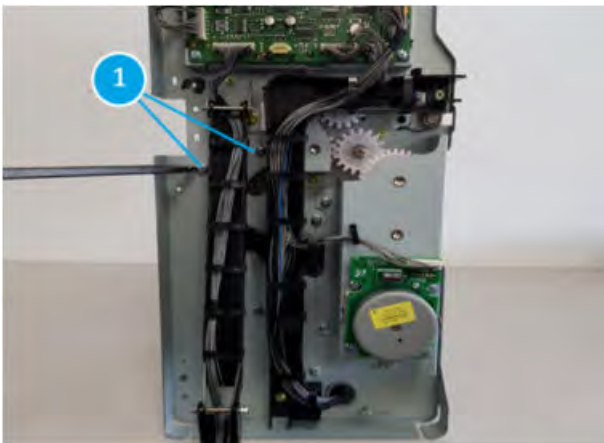

5. Disconnect one connector at the right of the booklet maker (callout 1).

Figure 5-1766 Disconnect one connector



Remove the booklet blade home sensor (S45)

Follow these steps to remove the booklet blade home sensor (S45).

- ▲ Disconnect one connector (callout 1) and remove the Booklet blade home sensor (S45, callout 2)

Figure 5-1767 Disconnect one connector and remove the Booklet blade home sensor

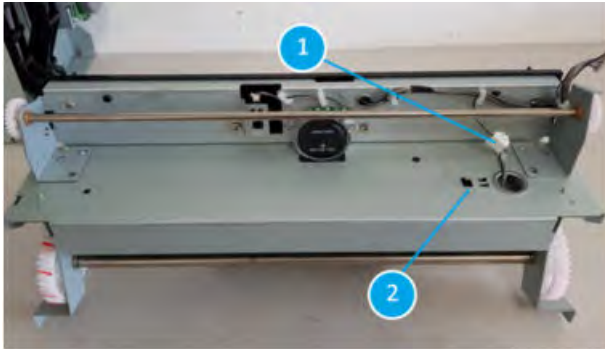

Unpack the replacement assembly

Follow these steps to unpack the replacement assembly.

1. Dispose of the defective part.

 **NOTE:** HP recommends responsible disposal of the defective part.

<http://www8.hp.com/us/en/hp-information/environment/product-recycling.html>

2. Unpack the replacement part from the packaging.



CAUTION:  Some parts are sensitive to electrostatic discharge (ESD). Always perform service work at an ESD-protected workstation or mat. If an ESD workstation or mat is not available, touch the sheet-metal chassis to provide a static ground before touching an ESD-sensitive assembly. Protect the ESD-sensitive assemblies by placing them in ESD pouches when they are out of the printer.



IMPORTANT: Make sure that all of the shipping materials (for example shipping tape) are removed from the replacement part prior to installation.



NOTE: If the replacement part is a roller or pad, avoid touching the spongy part of it. Skin oils on the roller or pad can cause paper pickup and/or print-quality problems. HP recommends using disposable gloves when handling rollers or pads or washing your hands before touching rollers or pads.

3. To install an assembly, reverse the removal steps.



NOTE: When applicable, special installation instructions are provided for an assembly at the end of the removal procedure. Always completely read the removal instructions and follow all special installation instructions.

Removal and replacement: Booklet blade motor (M22)

Learn how to remove and replace the booklet blade motor.

Introduction

This document provides the procedures to remove and replace the booklet blade motor on the finisher.



IMPORTANT: When applicable, special installation instructions are provided for an assembly at the end of the removal procedure. Always completely read the removal instructions and follow all special installation instructions.

Before performing service

- Turn the printer power off. A shutting-down message appears on the control-panel display.
- ⚠ **WARNING!** To avoid damage to the printer, turn the power off and wait until the printer shuts down before removing the power cable.
- Disconnect the printer power cable after the printer has completely shut down (the control-panel display is blank).
- Release the finisher from the printer by pulling out on the release latch inside the finisher door.
- Disconnect the cable from the bridge unit to the finisher.
- Disconnect the cable from the finisher to the printer.

Use the table below to identify the correct part number for your printer. To order the part, go to <https://parts.hp.com>.

Table 5-160 Part information

Part number	Part description
JC90-01435A	Booklet blade motor assembly
JC31-00144A	Booklet blade motor

Required tools

- #2 JIS screwdriver with a magnetic tip

After performing service

- Connect the cable from the finisher to the printer.
- Connect the cable from the bridge unit to the finisher.
- Attach the finisher to the printer, and then push in on the release latch inside the finisher door.
- Connect the printer power cable.
- Turn the printer power on.

Post service test

Process a job through the finisher and verify that the finisher works correctly.

Remove the booklet front cover

Follow these steps to remove the booklet front cover.

- ▲ Slide the booklet maker slightly away from the finisher (callout 1). Remove one screw (callout 2), and then slide the green knob away from the booklet maker to remove it (callout 3). Remove four screws (callout 4), and then remove the booklet front cover.

 **TIP:** Reverse the removal steps to install the assembly

Figure 5-1768 Remove five screws and the cover



Remove the booklet right lower shield

Follow these steps to remove the booklet right lower shield.

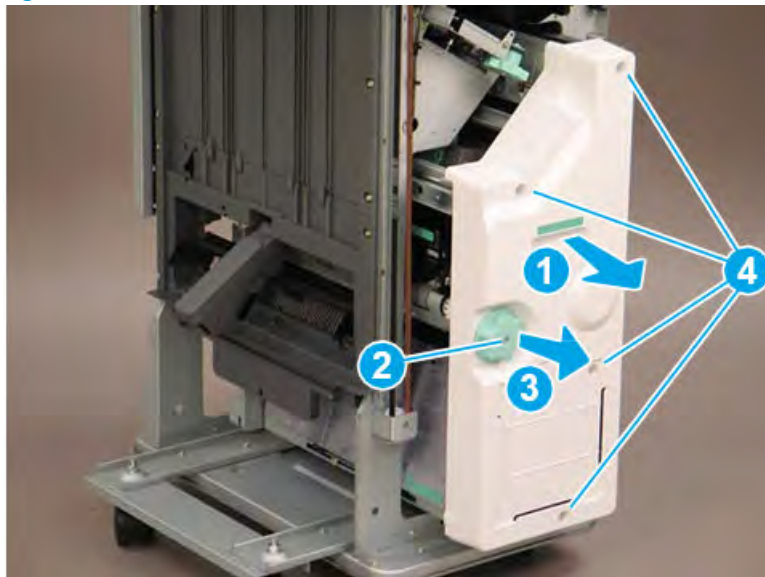
1. Remove two screws at the front of the booklet maker (callout 1).

Figure 5-1769 Remove two screws

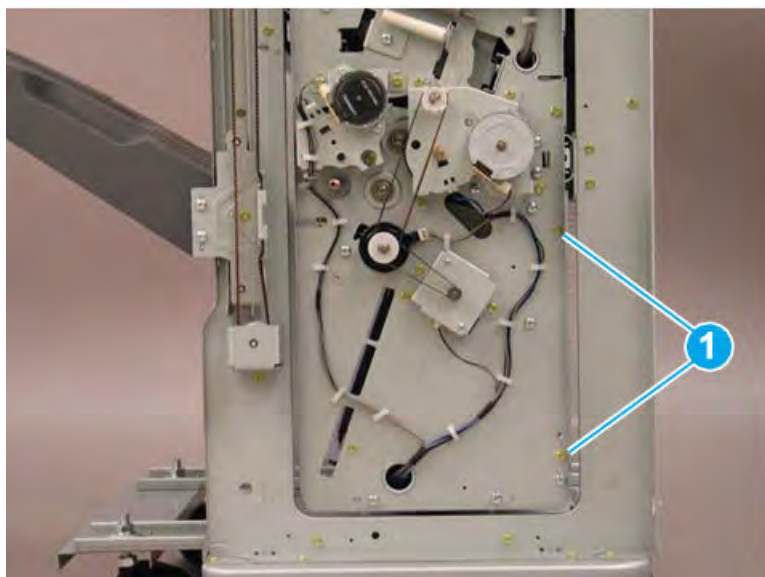

2. Remove two screws at the back of the booklet maker (callout 1).

Figure 5-1770 Remove two screws

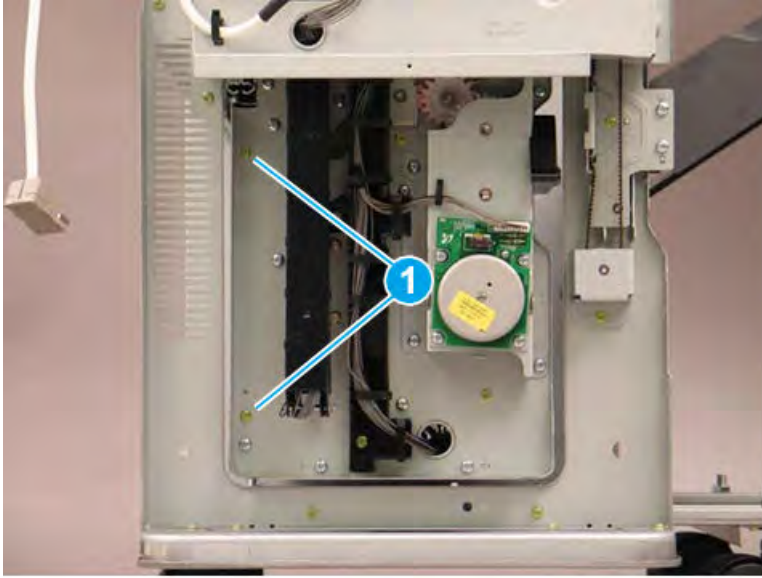

3. Slide the booklet maker out of the finisher (callout 1), and then rotate the top of the right lower shield (callout 2) away from the booklet maker to remove it.

Figure 5-1771 Remove the right lower shield

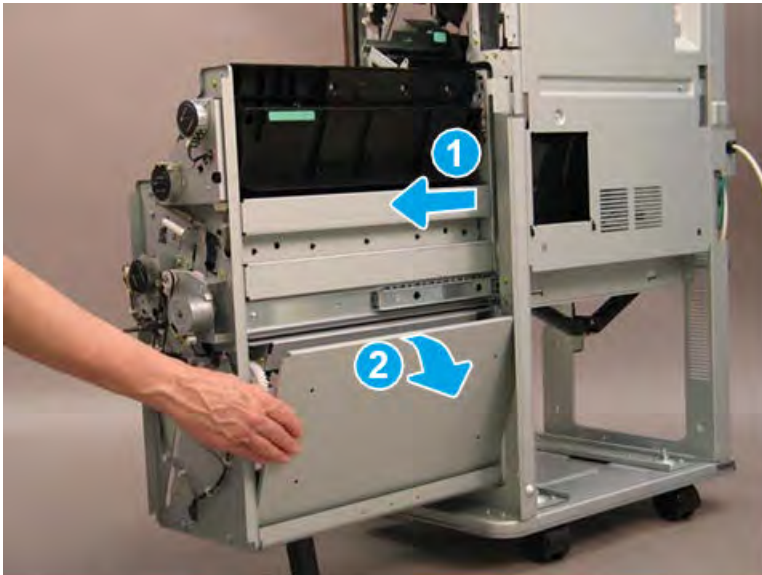

Remove the booklet blade motor (M22)

Follow these steps to remove the booklet blade motor (M22).

- ▲ Disconnect one connector (callout 1), remove four screws (callout 2), and then remove the booklet blade motor.

💡 **TIP:** Reverse the removal steps to install the assembly.

Figure 5-1772 Remove the booklet blade motor

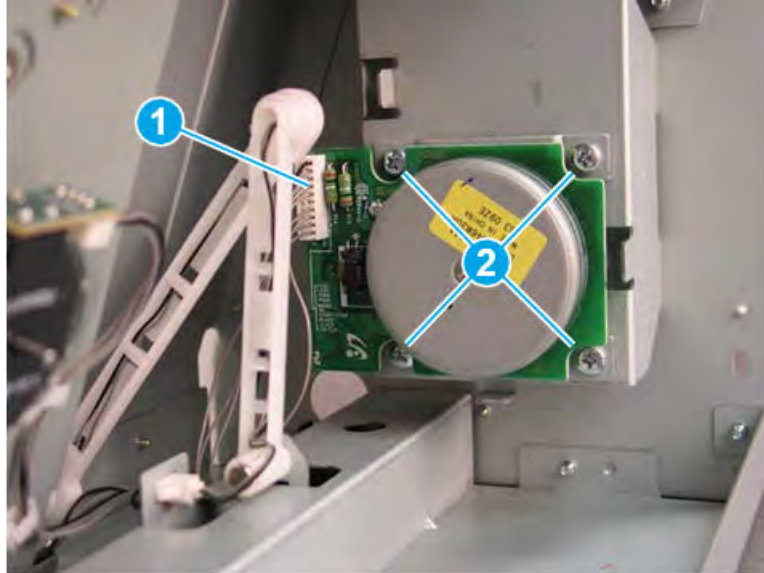

Unpack the replacement assembly



Follow these steps to unpack the replacement assembly.

1. Dispose of the defective part.

 **NOTE:** HP recommends responsible disposal of the defective part.

<http://www8.hp.com/us/en/hp-information/environment/product-recycling.html>

2. Unpack the replacement part from the packaging.

 **CAUTION:**  Some parts are sensitive to electrostatic discharge (ESD). Always perform service work at an ESD-protected workstation or mat. If an ESD workstation or mat is not available, touch the sheet-metal chassis to provide a static ground before touching an ESD-sensitive assembly. Protect the ESD-sensitive assemblies by placing them in ESD pouches when they are out of the printer.

 **IMPORTANT:** Make sure that all of the shipping materials (for example shipping tape) are removed from the replacement part prior to installation.

 **NOTE:** If the replacement part is a roller or pad, avoid touching the spongy part of it. Skin oils on the roller or pad can cause paper pickup and/or print-quality problems. HP recommends using disposable gloves when handling rollers or pads or washing your hands before touching rollers or pads.

3. To install an assembly, reverse the removal steps.

 **NOTE:** When applicable, special installation instructions are provided for an assembly at the end of the removal procedure. Always completely read the removal instructions and follow all special installation instructions.

Removal and replacement: Booklet fold motor (M21)

Learn how to remove and replace the booklet fold motor.

Introduction

This document provides the procedures to remove and replace the booklet fold motor on the finisher.



IMPORTANT: When applicable, special installation instructions are provided for an assembly at the end of the removal procedure. Always completely read the removal instructions and follow all special installation instructions.

Before performing service

- Turn the printer power off. A shutting-down message appears on the control-panel display.
- ⚠ **WARNING!** To avoid damage to the printer, turn the power off and wait until the printer shuts down before removing the power cable.
- Disconnect the printer power cable after the printer has completely shut down (the control-panel display is blank).
- Release the finisher from the printer by pulling out on the release latch inside the finisher door.
- Disconnect the cable from the bridge unit to the finisher.
- Disconnect the cable from the finisher to the printer.

Use the table below to identify the correct part number for your printer. To order the part, go to <https://parts.hp.com>.

Table 5-161 Part information

Part number	Part description
JC90-01436A	Booklet fold motor assembly
JC31-00144A	Booklet fold motor

Required tools

- #2 JIS screwdriver with a magnetic tip

After performing service

- Connect the cable from the finisher to the printer.
- Connect the cable from the bridge unit to the finisher.
- Attach the finisher to the printer, and then push in on the release latch inside the finisher door.
- Connect the printer power cable.
- Turn the printer power on.

Post service test

Process a job through the finisher and verify that the finisher works correctly.

Remove the right upper cover (finisher)

Follow these steps to remove the right upper cover (finisher).

- ▲ Remove one screw cap and three machine screws on the upper edge of the cover (callout 1). Remove three sheet metal screws (callout 2) on the lower portion of the cover. Rotate the right edge of the cover away from the finisher, and then slide the cover right to release three tabs (callout 3).

💡 **TIP:** The lower screws are shorter in length than the upper screws.

TIP: Reverse the removal steps to install the assembly.

Figure 5-1773 Remove the right upper cover

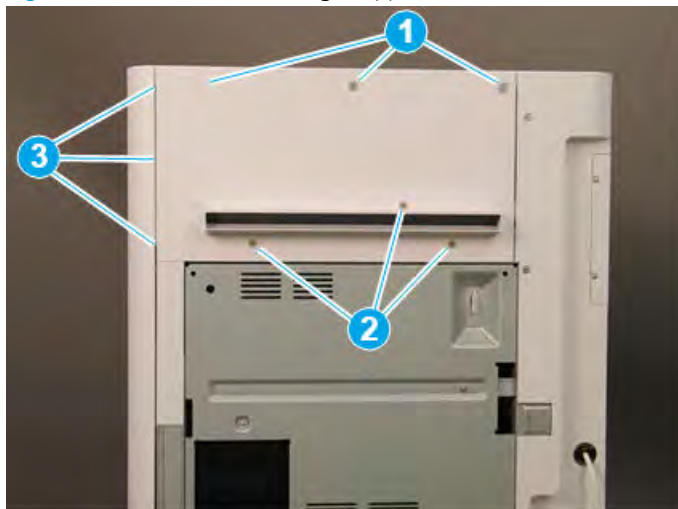

Remove the top cover (finisher)

Follow these steps to remove the top cover (finisher).

1. Remove three screw caps and three self-tapping screws at the top of the rear cover (callout 1), and then remove three machine screws (callout 2) on top of the cover.

Figure 5-1774 Remove six screws

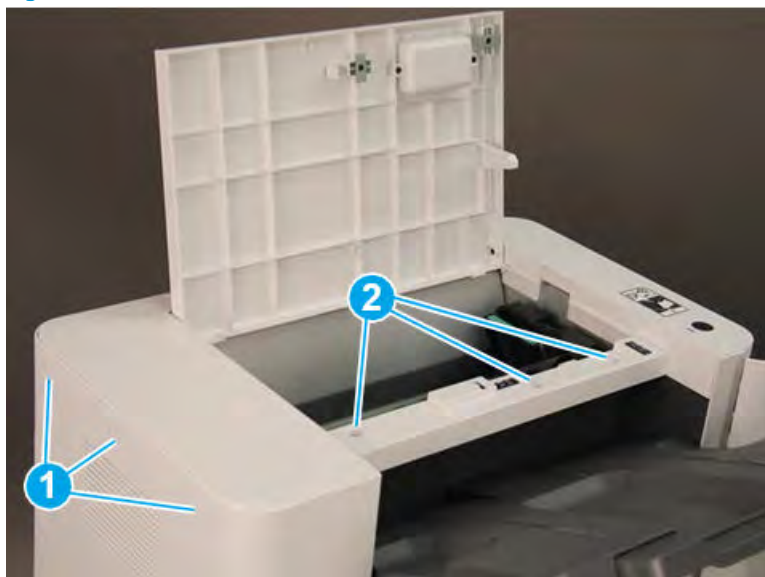

2. Remove three self-tapping screws at the top of the front cover (callout 1), and then remove two machine screws (callout 2) at the top of the right side.

Figure 5-1775 Remove five screws

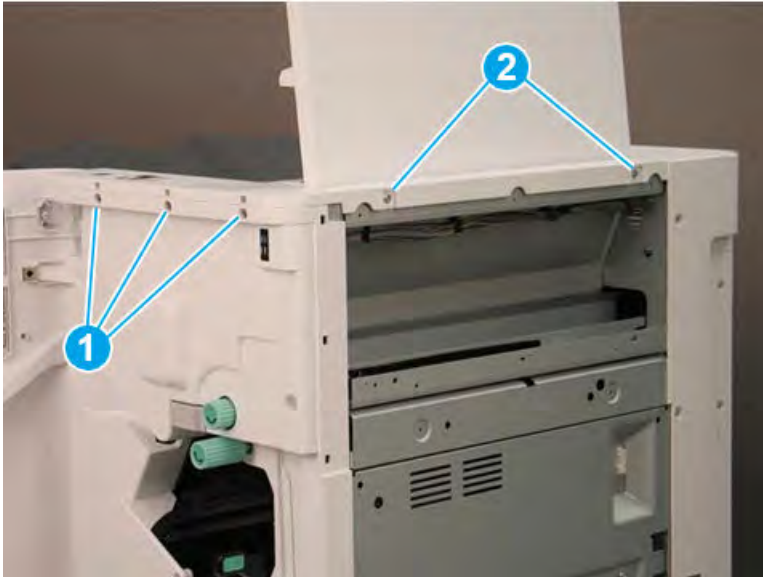

3. Lift the cover up slightly. Disconnect one in-line connector (callout 1), and then release one retainer (callout 2).

 **TIP:** Reverse the removal steps to install the assembly.

Figure 5-1776 Disconnect one connector and release retainer



Remove the rear cover (finisher)

Follow these steps to remove the rear cover (finisher).

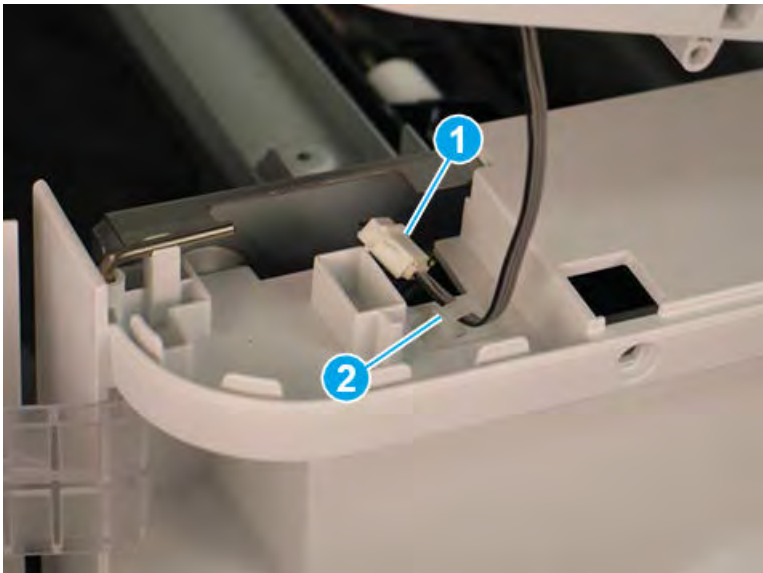
1. Remove two self-tapping screws (callout 1) on the top of the rear cover, and then remove five screw caps and five machine screws (callout 2) on the left side of the cover.

Figure 5-1777 Remove seven screws

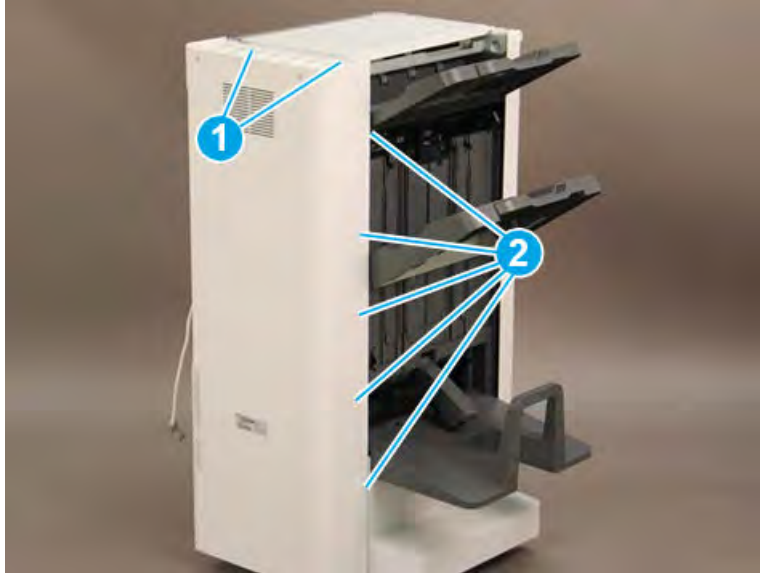

2. Remove one screw cap and four machine screws (callout 1) Remove the rear cover.

 **NOTE:** Make sure to thread the power cable (callout 2) through the opening in the cover.

 **TIP:** Reverse the removal steps to install the assembly

Figure 5-1778 Remove the rear cover



Remove the booklet fold motor (M21)

Follow these steps to remove the booklet fold motor (M21).

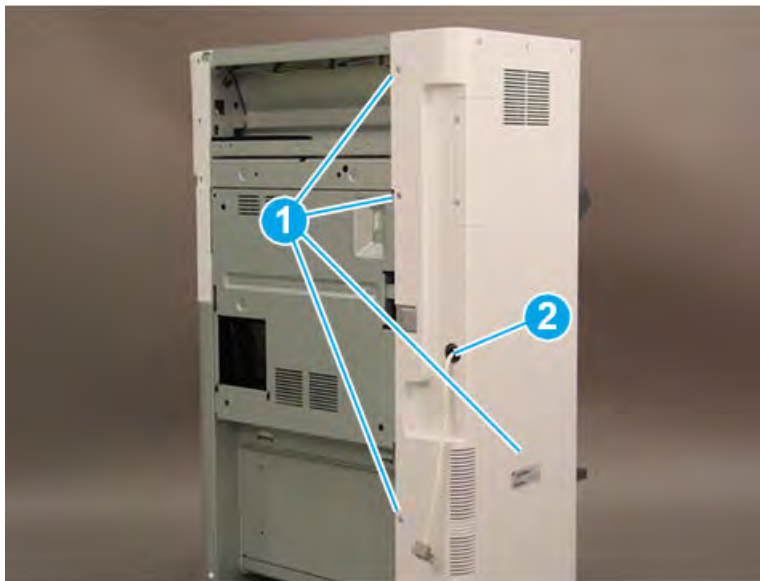
- ▲ Disconnect one connector (callout 1), remove four screws (callout 2), and then remove the folding roller motor.

 **TIP:** Reverse the removal steps to install the assembly.

Figure 5-1779 Remove the booklet fold motor



Unpack the replacement assembly

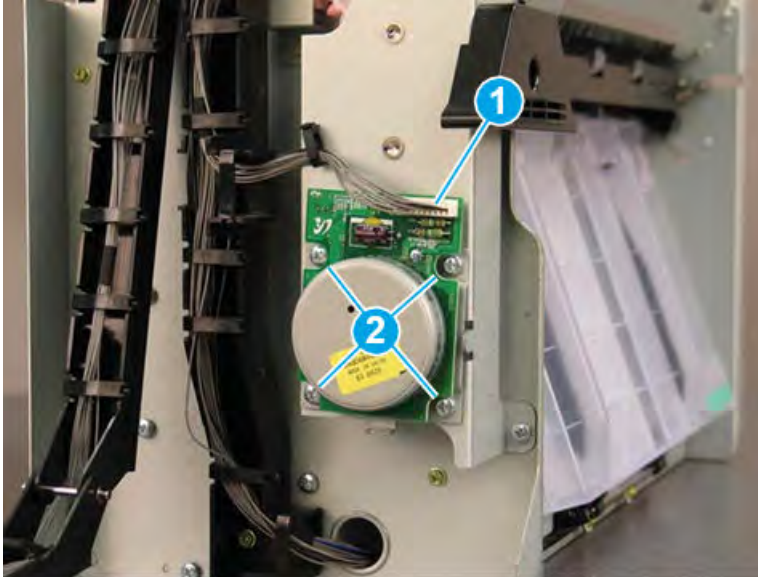

Follow these steps to unpack the replacement assembly.

1. Dispose of the defective part.

 **NOTE:** HP recommends responsible disposal of the defective part.

<http://www8.hp.com/us/en/hp-information/environment/product-recycling.html>

2. Unpack the replacement part from the packaging.

 **CAUTION:**  Some parts are sensitive to electrostatic discharge (ESD). Always perform service work at an ESD-protected workstation or mat. If an ESD workstation or mat is not available, touch the sheet-metal chassis to provide a static ground before touching an ESD-sensitive assembly. Protect the ESD-sensitive assemblies by placing them in ESD pouches when they are out of the printer.

 **IMPORTANT:** Make sure that all of the shipping materials (for example shipping tape) are removed from the replacement part prior to installation.

 **NOTE:** If the replacement part is a roller or pad, avoid touching the spongy part of it. Skin oils on the roller or pad can cause paper pickup and/or print-quality problems. HP recommends using disposable gloves when handling rollers or pads or washing your hands before touching rollers or pads.

3. To install an assembly, reverse the removal steps.

 **NOTE:** When applicable, special installation instructions are provided for an assembly at the end of the removal procedure. Always completely read the removal instructions and follow all special installation instructions.

Removal and replacement: Booklet c-fold blade

Learn how to remove and replace the booklet c-fold blade.

Introduction

This document provides the procedures to remove and replace the booklet c-fold blade on the finisher.



IMPORTANT: When applicable, special installation instructions are provided for an assembly at the end of the removal procedure. Always completely read the removal instructions and follow all special installation instructions.

Before performing service

- Turn the printer power off. A shutting-down message appears on the control-panel display.
- ⚠ **WARNING!** To avoid damage to the printer, turn the power off and wait until the printer shuts down before removing the power cable.
- Disconnect the printer power cable after the printer has completely shut down (the control-panel display is blank).
- Release the finisher from the printer by pulling out on the release latch inside the finisher door.
- Disconnect the cable from the bridge unit to the finisher.
- Disconnect the cable from the finisher to the printer.

Use the table below to identify the correct part number for your printer. To order the part, go to <https://parts.hp.com>.

Table 5-162 Part information

Part number	Part description
JC61-07366A	Booklet c-fold blade

Required tools

- #2 JIS screwdriver with a magnetic tip

After performing service

- Connect the cable from the finisher to the printer.
- Connect the cable from the bridge unit to the finisher.
- Attach the finisher to the printer, and then push in on the release latch inside the finisher door.
- Connect the printer power cable.
- Turn the printer power on.

Post service test

Process a job through the finisher and verify that the finisher works correctly.

Remove the right upper cover (finisher)

Follow these steps to remove the right upper cover (finisher).

- ▲ Remove one screw cap and three machine screws on the upper edge of the cover (callout 1). Remove three sheet metal screws (callout 2) on the lower portion of the cover. Rotate the right edge of the cover away from the finisher, and then slide the cover right to release three tabs (callout 3).

💡 **TIP:** The lower screws are shorter in length than the upper screws.

TIP: Reverse the removal steps to install the assembly.

Figure 5-1780 Remove the right upper cover

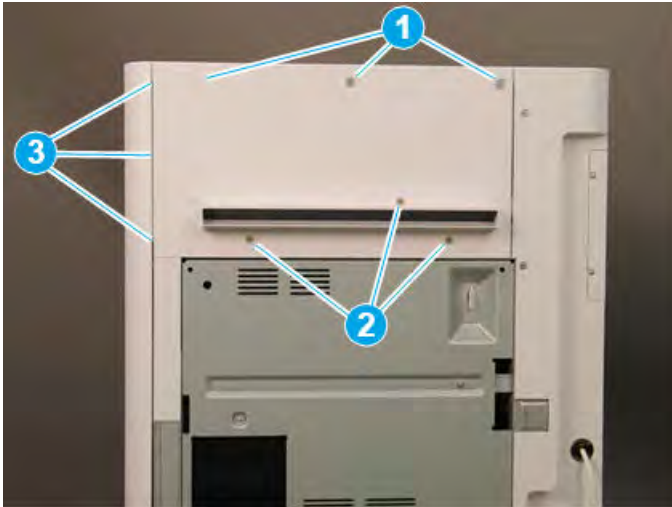

Remove the top cover (finisher)

Follow these steps to remove the top cover (finisher).

1. Remove three screw caps and three self-tapping screws at the top of the rear cover (callout 1), and then remove three machine screws (callout 2) on top of the cover.

Figure 5-1781 Remove six screws

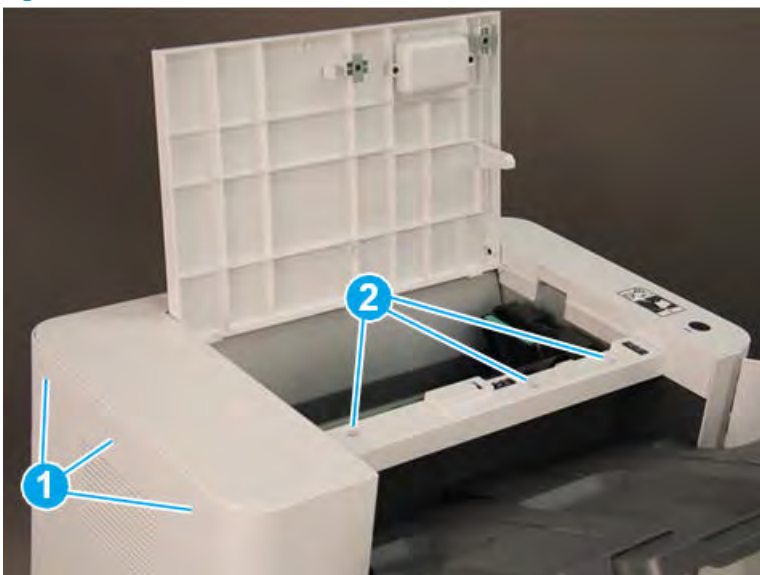

2. Remove three self-tapping screws at the top of the front cover (callout 1), and then remove two machine screws (callout 2) at the top of the right side.

Figure 5-1782 Remove five screws

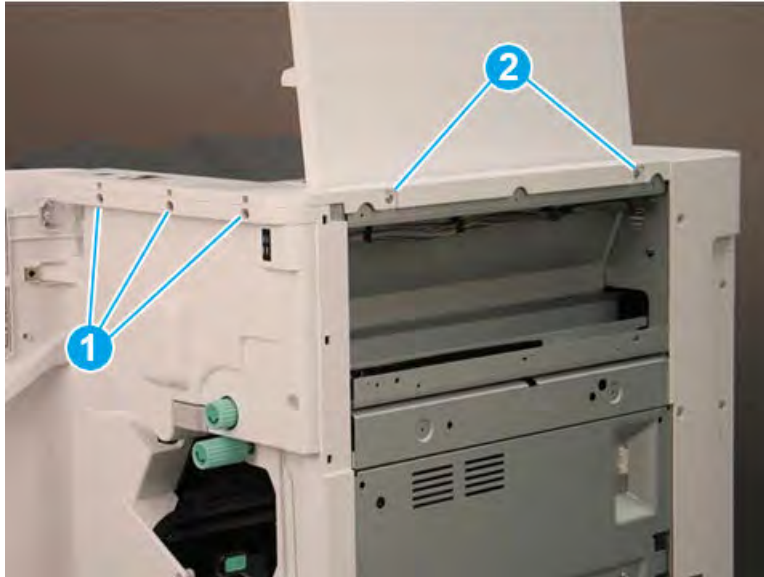

3. Lift the cover up slightly. Disconnect one in-line connector (callout 1), and then release one retainer (callout 2).

 **TIP:** Reverse the removal steps to install the assembly.

Figure 5-1783 Disconnect one connector and release retainer



Remove the rear cover (finisher)

Follow these steps to remove the rear cover (finisher).

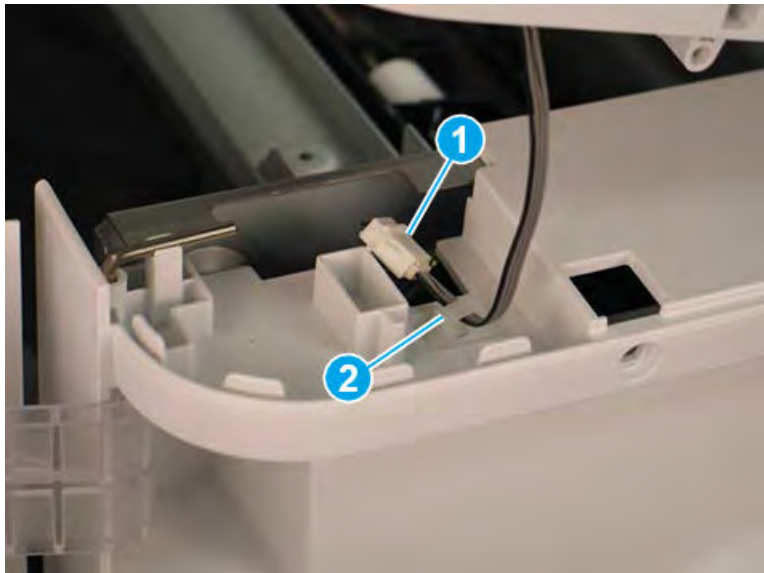
1. Remove two self-tapping screws (callout 1) on the top of the rear cover, and then remove five screw caps and five machine screws (callout 2) on the left side of the cover.

Figure 5-1784 Remove seven screws



2. Remove one screw cap and four machine screws (callout 1) Remove the rear cover.

 **NOTE:** Make sure to thread the power cable (callout 2) through the opening in the cover.

 **TIP:** Reverse the removal steps to install the assembly

Figure 5-1785 Remove the rear cover

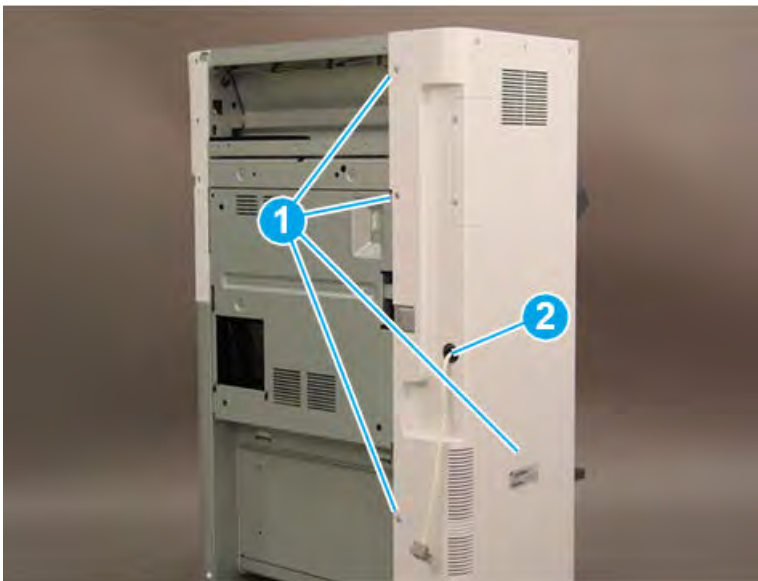

Remove the booklet maker

Follow these steps to remove the booklet maker.

1. Slide the booklet maker away from the finisher.

Figure 5-1786 Slide the booklet maker away from the finisher



2. At the Disconnect one connector (callout 1), and then remove one screw (callout 2).

Figure 5-1787 Disconnect one connector and remove one screw

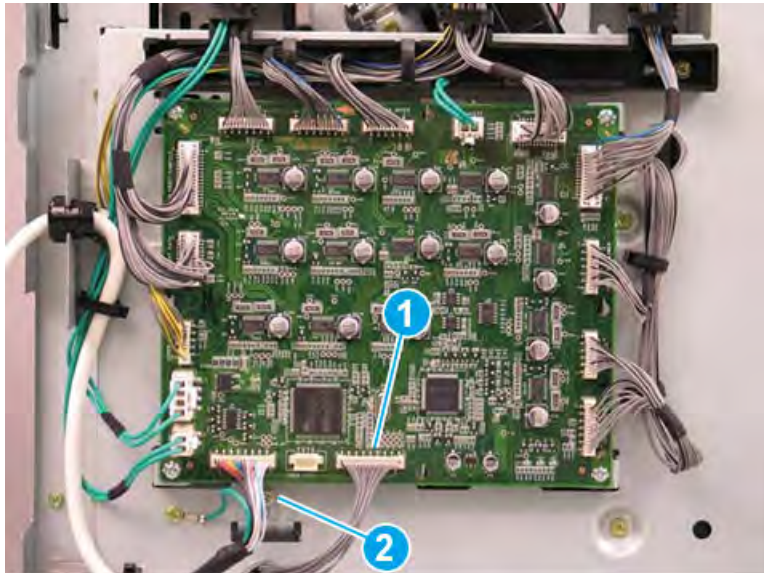

3. Release the metal bracket through the opening in the sheet metal.

Figure 5-1788 Release the metal bracket

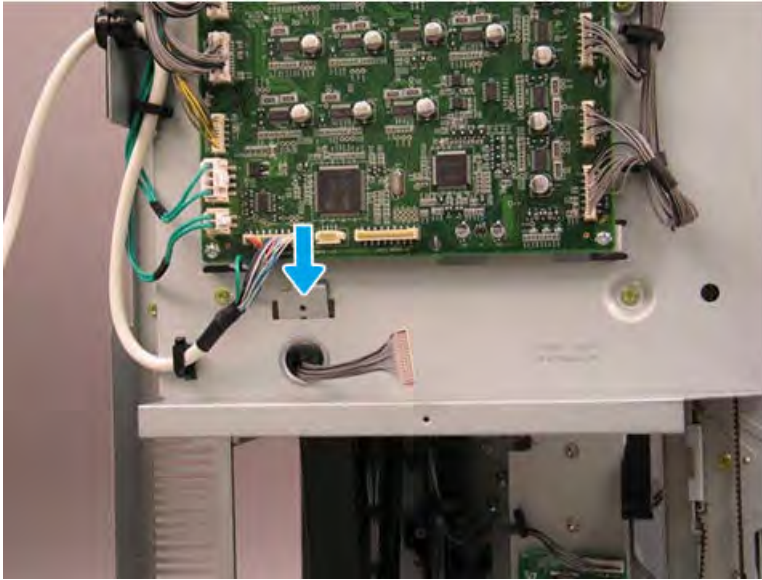

4. Remove one star-washer screw (callout 1), and then release the alignment pin (callout 2) on the right side of the booklet maker.

Figure 5-1789 Remove one screw

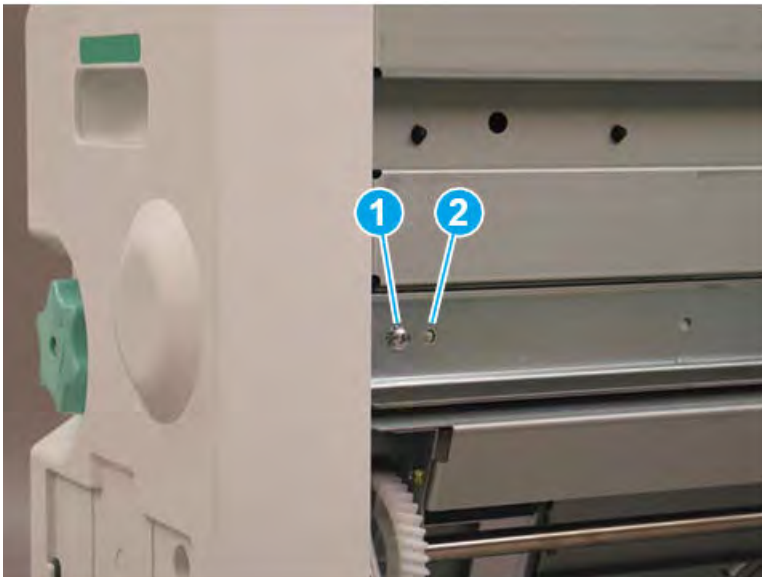

5. Slide the right rail toward the finisher.

Figure 5-1790 Slide the right rail

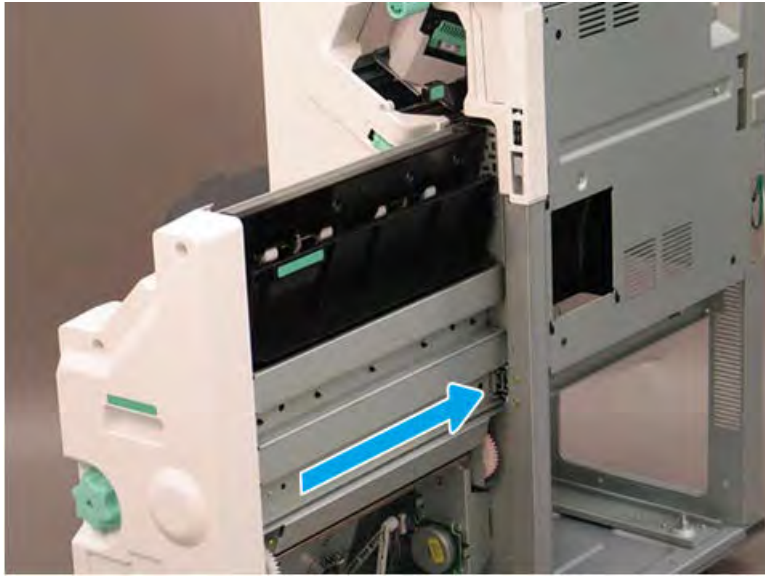

6. Remove one star-washer screw (callout 1) on the left side of the booklet maker.

Figure 5-1791 Remove one screw

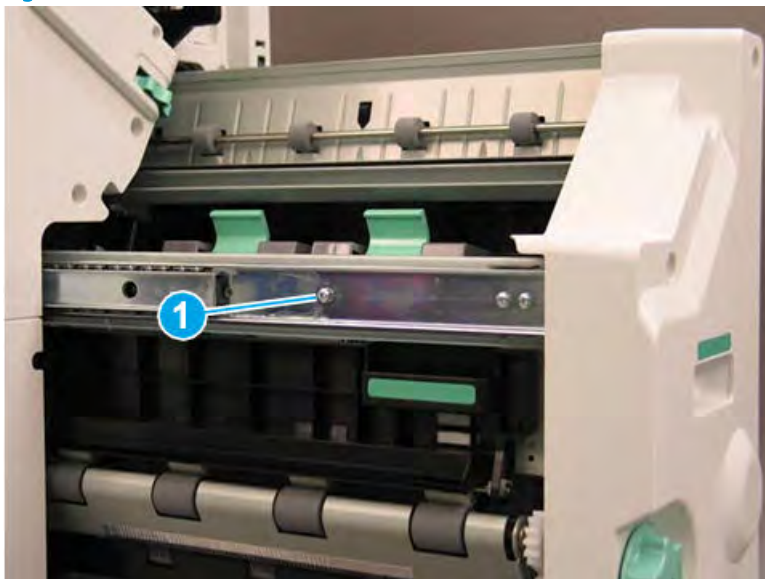

7. Lift the booklet maker up on the left side while squeezing the right rail away from the finisher slightly to clear the sheet metal. Remove the booklet maker.

Figure 5-1792 Remove the booklet maker

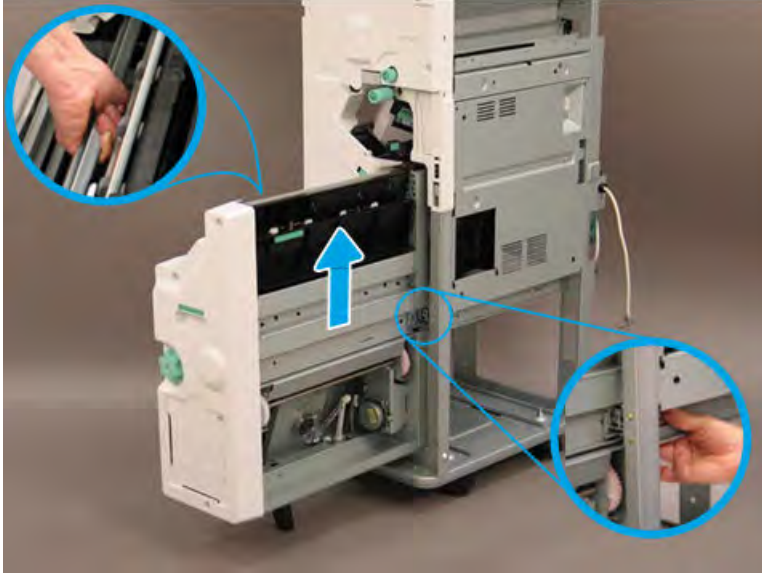

8. Reverse the removal steps to install the assembly. Also use the following special installation instructions.

 **NOTE:** Continue to reverse the removal steps to finish installing the assembly.

Special installation instructions: booklet maker

When installing the booklet maker, position the hooks on the rail under the slots on the booklet maker.

Figure 5-1793 Position the hooks

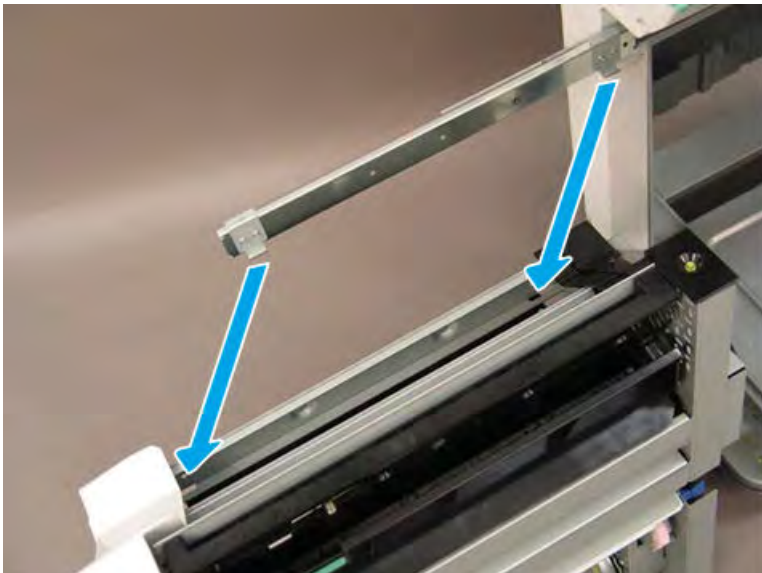

9. When installed correctly, the arrow on the front of the booklet maker aligns with the arrow on the finisher rail.

Figure 5-1794 Align arrows



10. When installed correctly, the arrow on the back of the booklet maker aligns with the arrow on the finisher rail.

Figure 5-1795 Align arrows

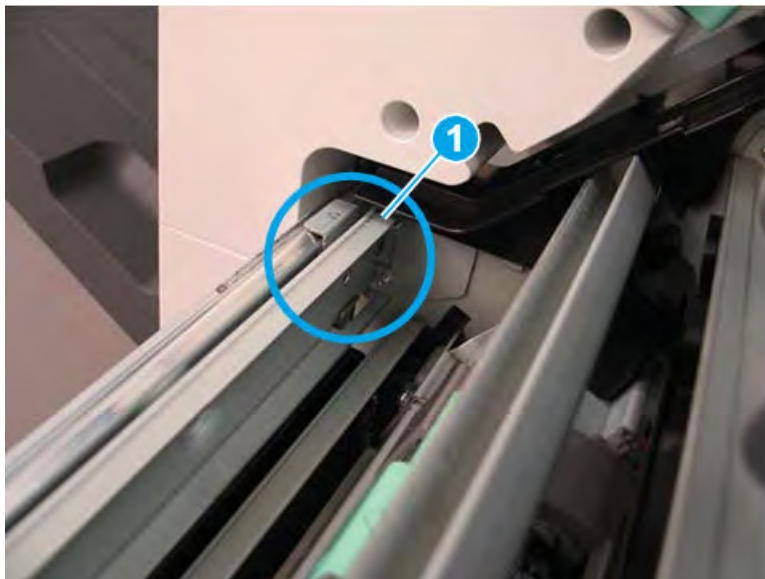

11. Extend the right rail away from the finisher and position it in the booklet maker slot.

Figure 5-1796 Extend the right rail



Remove the booklet front cover

Follow these steps to remove the booklet front cover.

- ▲ Slide the booklet maker slightly away from the finisher (callout 1). Remove one screw (callout 2), and then slide the green knob away from the booklet maker to remove it (callout 3). Remove four screws (callout 4), and then remove the booklet front cover.

 **TIP:** Reverse the removal steps to install the assembly

Figure 5-1797 Remove five screws and the cover



Remove the Booklet c-fold blade unit

Follow these steps to remove the Booklet c-fold blade unit.

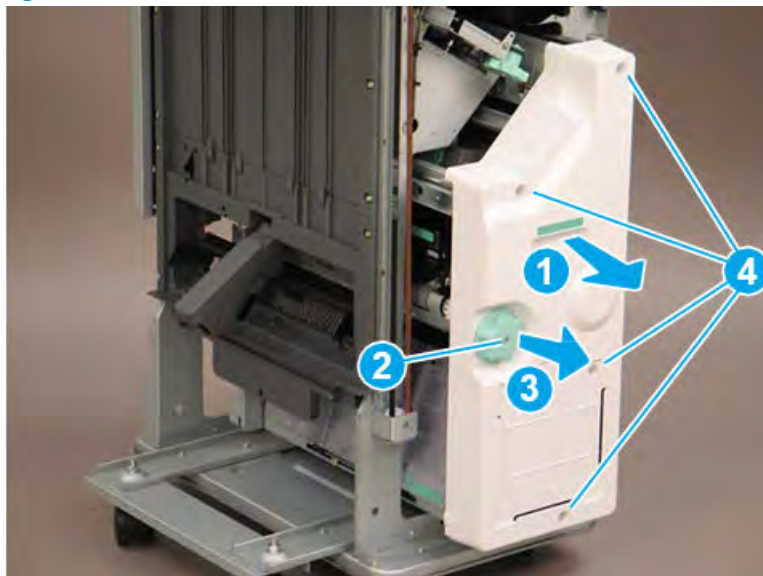
1. Remove two screws(callout 1) at the left of the booklet maker

Figure 5-1798 Remove two screws at the left of the booklet maker

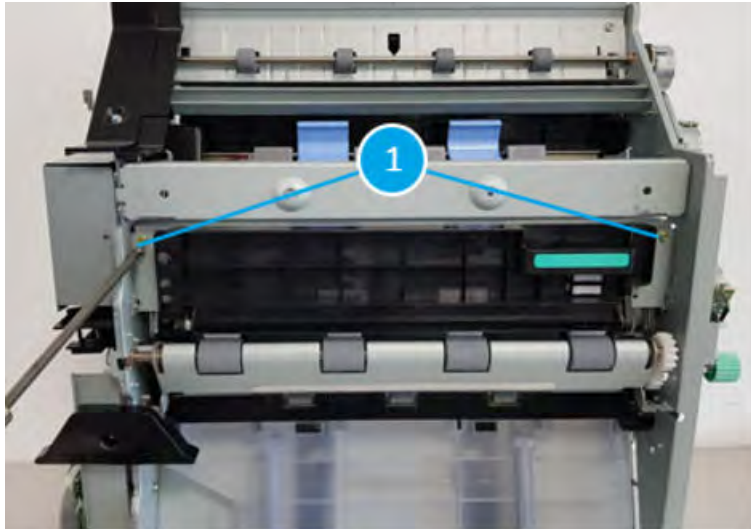

2. Remove three screws(callout 1) at the front of the booklet maker to remove motor unit(callout 2) to reach out to the screw.

Figure 5-1799 Remove three screws to remove motor unit to reach out to the screw

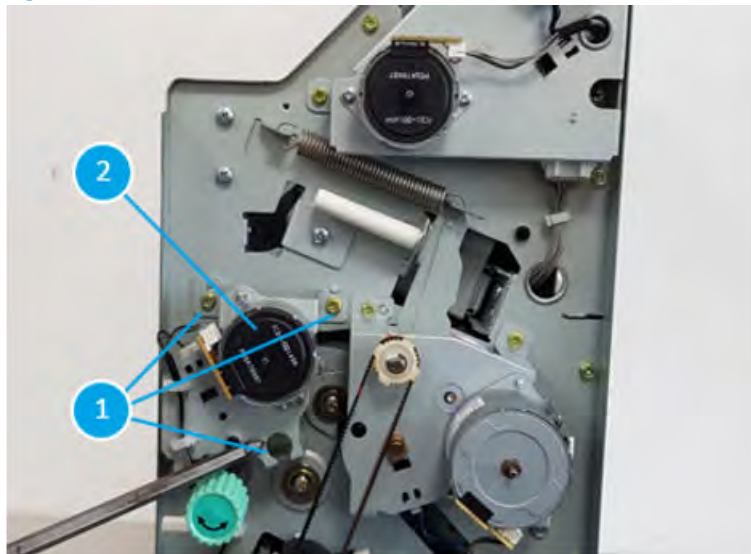

3. Remove one screw(callout 1) at the front of the booklet maker.

Figure 5-1800 Remove one screw at the front of the booklet maker



4. Remove one screw(callout 1) at the rear of the booklet maker.

Figure 5-1801 Remove one screw at the rear of the booklet maker

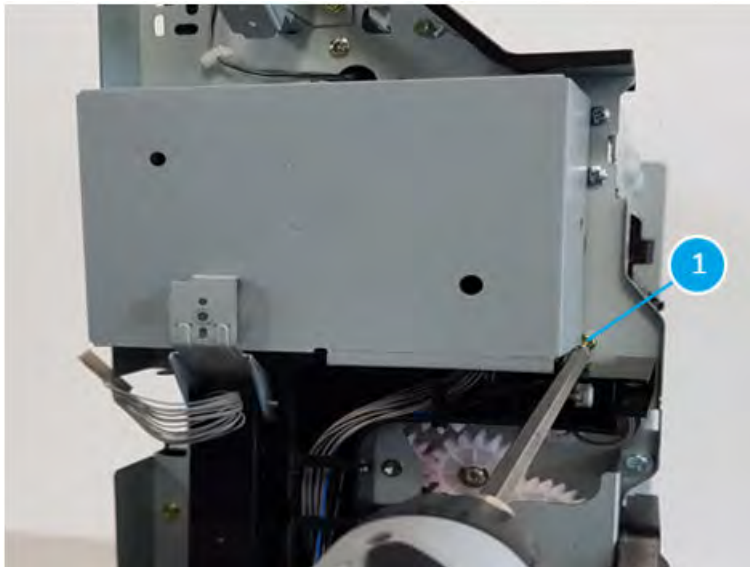

5. Take the booklet c-fold blade unit out from the booklet maker.

Figure 5-1802 Take the booklet c-fold blade unit out from the booklet maker

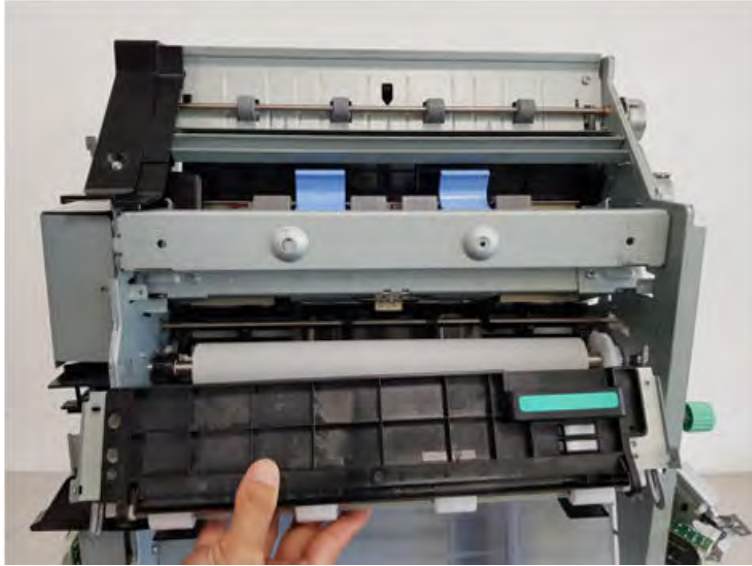

Remove the Booklet c-fold blade

Follow these steps to remove the Booklet c-fold blade.

- ▲ Remove four screws (callout 1) to remove the booklet c-fold blade

Figure 5-1803 Remove four screws to remove the booklet c-fold blade

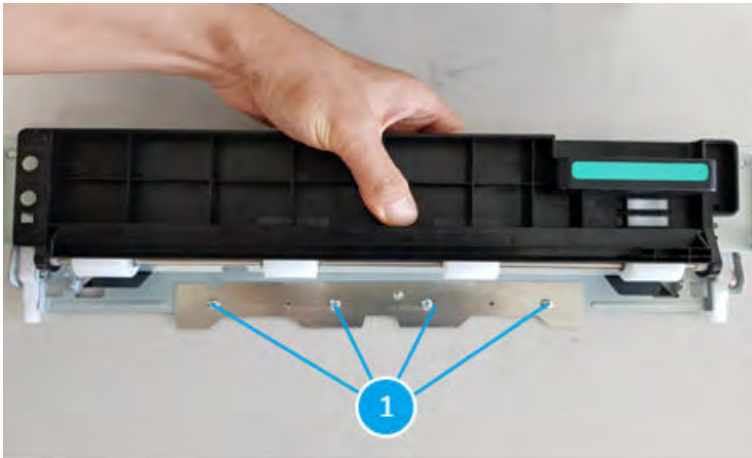

 **NOTE:**

- Reverse the removal steps to install the assembly.
- Make sure the metal is located on the home position when you reassemble the unit.
You can make it by rotating the gear to the left direction.

 **TIP:** Rotate the white gear (callout 1) to the left direction to make the metal (callout 2) to the home position.



Unpack the replacement assembly

Follow these steps to unpack the replacement assembly.

1. Dispose of the defective part.

 **NOTE:** HP recommends responsible disposal of the defective part.

<http://www8.hp.com/us/en/hp-information/environment/product-recycling.html>

2. Unpack the replacement part from the packaging.



CAUTION:  Some parts are sensitive to electrostatic discharge (ESD). Always perform service work at an ESD-protected workstation or mat. If an ESD workstation or mat is not available, touch the sheet-metal chassis to provide a static ground before touching an ESD-sensitive assembly. Protect the ESD-sensitive assemblies by placing them in ESD pouches when they are out of the printer.



IMPORTANT: Make sure that all of the shipping materials (for example shipping tape) are removed from the replacement part prior to installation.



NOTE: If the replacement part is a roller or pad, avoid touching the spongy part of it. Skin oils on the roller or pad can cause paper pickup and/or print-quality problems. HP recommends using disposable gloves when handling rollers or pads or washing your hands before touching rollers or pads.

3. To install an assembly, reverse the removal steps.



NOTE: When applicable, special installation instructions are provided for an assembly at the end of the removal procedure. Always completely read the removal instructions and follow all special installation instructions.

Removal and replacement: Booklet c-fold blade home sensor (S39)

Learn how to remove and replace the booklet c-fold blade home sensor.

Introduction

This document provides the procedures to remove and replace the booklet c-fold blade home sensor on the finisher.



IMPORTANT: When applicable, special installation instructions are provided for an assembly at the end of the removal procedure. Always completely read the removal instructions and follow all special installation instructions.

Before performing service

- Turn the printer power off. A shutting-down message appears on the control-panel display.
- **WARNING!** To avoid damage to the printer, turn the power off and wait until the printer shuts down before removing the power cable.
- Disconnect the printer power cable after the printer has completely shut down (the control-panel display is blank).
- Release the finisher from the printer by pulling out on the release latch inside the finisher door.
- Disconnect the cable from the bridge unit to the finisher.
- Disconnect the cable from the finisher to the printer.

Use the table below to identify the correct part number for your printer. To order the part, go to <https://parts.hp.com>.

Table 5-163 Part information

Part number	Part description
0604-001393	Booklet c-fold blade home sensor

Required tools

- #2 JIS screwdriver with a magnetic tip

After performing service

- Connect the cable from the finisher to the printer.
- Connect the cable from the bridge unit to the finisher.
- Attach the finisher to the printer, and then push in on the release latch inside the finisher door.
- Connect the printer power cable.
- Turn the printer power on.

Post service test

Process a job through the finisher and verify that the finisher works correctly.

Remove the right upper cover (finisher)

Follow these steps to remove the right upper cover (finisher).

- ▲ Remove one screw cap and three machine screws on the upper edge of the cover (callout 1). Remove three sheet metal screws (callout 2) on the lower portion of the cover. Rotate the right edge of the cover away from the finisher, and then slide the cover right to release three tabs (callout 3).

💡 **TIP:** The lower screws are shorter in length than the upper screws.

TIP: Reverse the removal steps to install the assembly.

Figure 5-1804 Remove the right upper cover

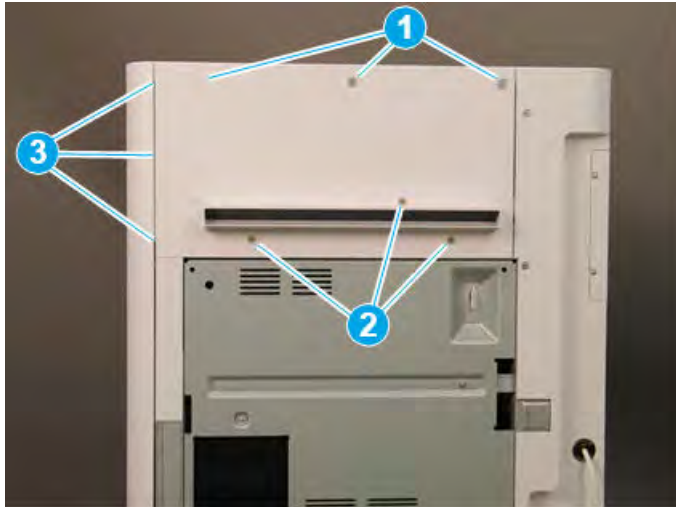

Remove the top cover (finisher)

Follow these steps to remove the top cover (finisher).

1. Remove three screw caps and three self-tapping screws at the top of the rear cover (callout 1), and then remove three machine screws (callout 2) on top of the cover.

Figure 5-1805 Remove six screws

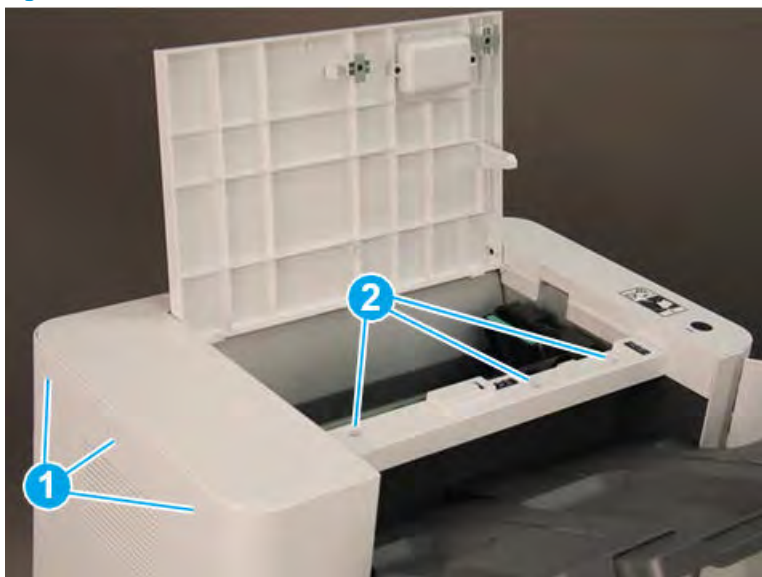

2. Remove three self-tapping screws at the top of the front cover (callout 1), and then remove two machine screws (callout 2) at the top of the right side.

Figure 5-1806 Remove five screws

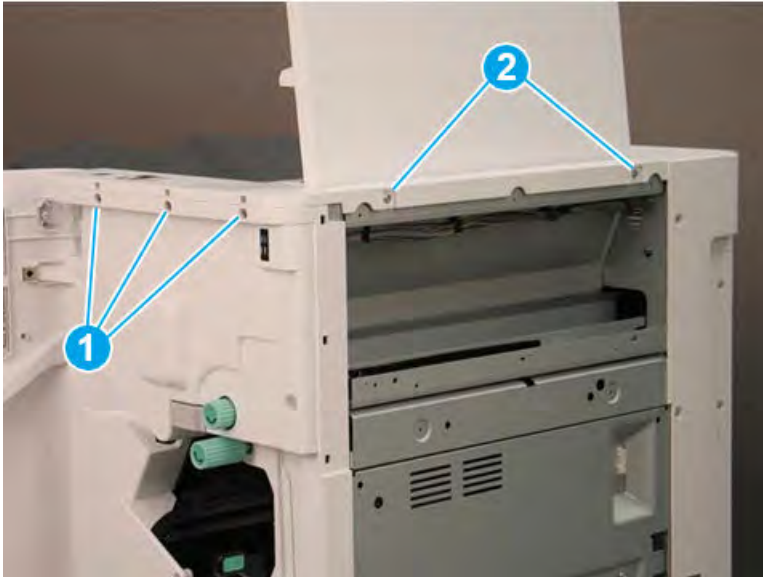

3. Lift the cover up slightly. Disconnect one in-line connector (callout 1), and then release one retainer (callout 2).

 **TIP:** Reverse the removal steps to install the assembly.

Figure 5-1807 Disconnect one connector and release retainer



Remove the rear cover (finisher)

Follow these steps to remove the rear cover (finisher).

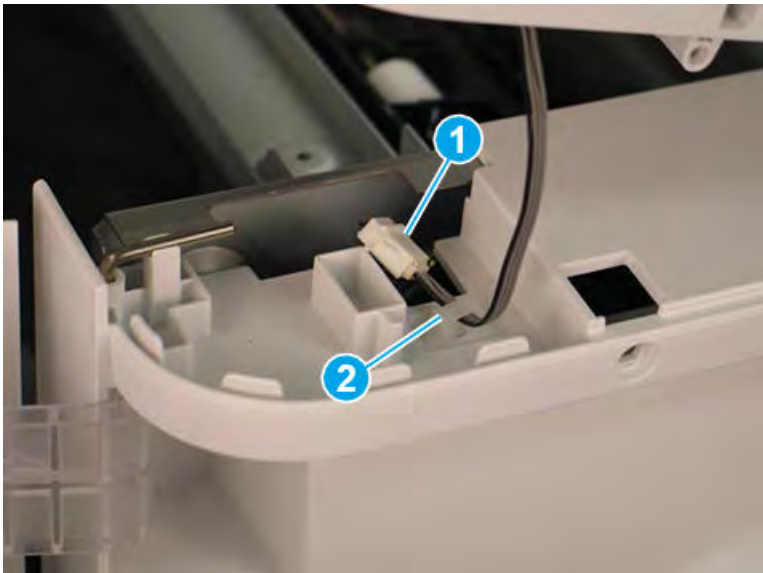
1. Remove two self-tapping screws (callout 1) on the top of the rear cover, and then remove five screw caps and five machine screws (callout 2) on the left side of the cover.

Figure 5-1808 Remove seven screws



2. Remove one screw cap and four machine screws (callout 1) Remove the rear cover.

 **NOTE:** Make sure to thread the power cable (callout 2) through the opening in the cover.

 **TIP:** Reverse the removal steps to install the assembly

Figure 5-1809 Remove the rear cover

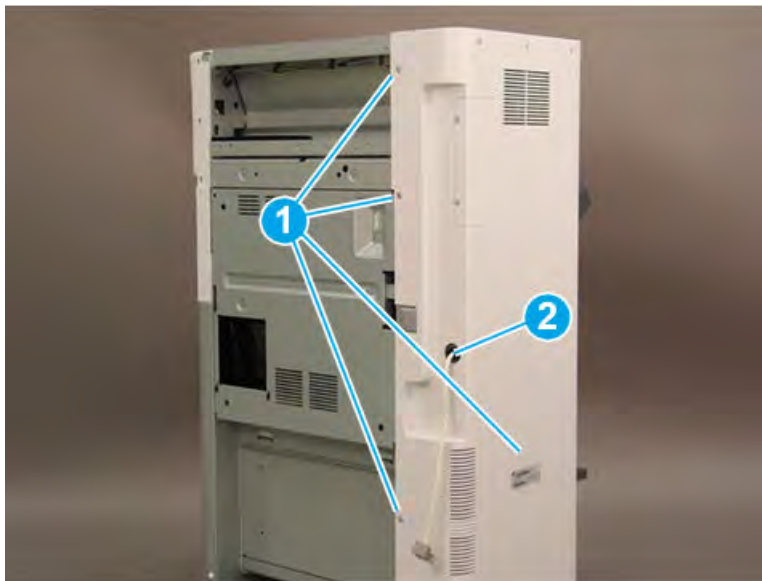

Remove the booklet maker

Follow these steps to remove the booklet maker.

1. Slide the booklet maker away from the finisher.

Figure 5-1810 Slide the booklet maker away from the finisher



2. At the Disconnect one connector (callout 1), and then remove one screw (callout 2).

Figure 5-1811 Disconnect one connector and remove one screw

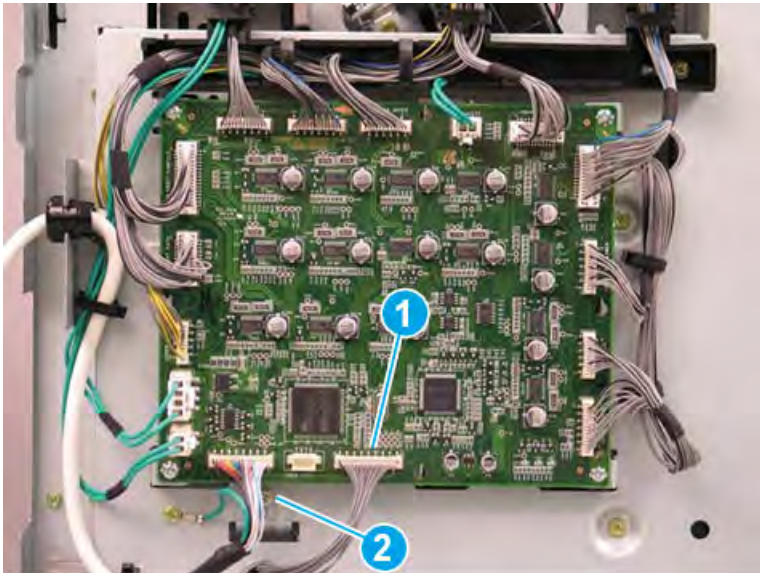

3. Release the metal bracket through the opening in the sheet metal.

Figure 5-1812 Release the metal bracket

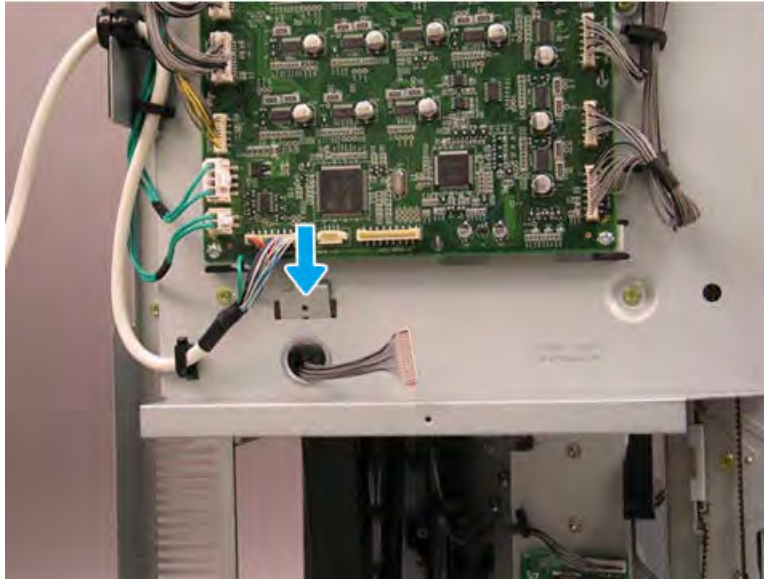

4. Remove one star-washer screw (callout 1), and then release the alignment pin (callout 2) on the right side of the booklet maker.

Figure 5-1813 Remove one screw

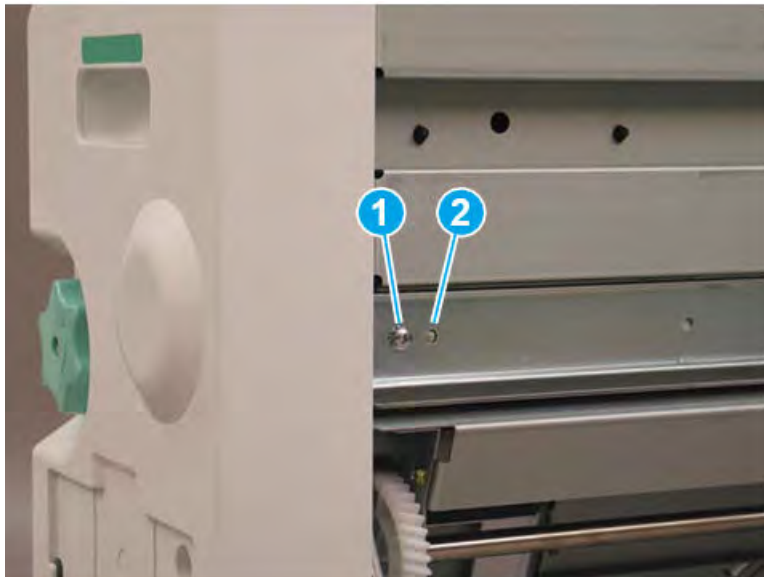

5. Slide the right rail toward the finisher.

Figure 5-1814 Slide the right rail

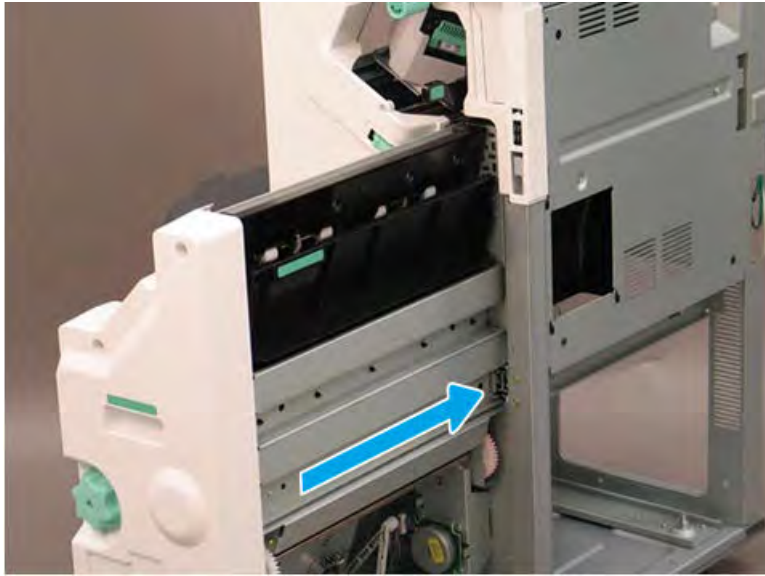

6. Remove one star-washer screw (callout 1) on the left side of the booklet maker.

Figure 5-1815 Remove one screw



7. Lift the booklet maker up on the left side while squeezing the right rail away from the finisher slightly to clear the sheet metal. Remove the booklet maker.

Figure 5-1816 Remove the booklet maker

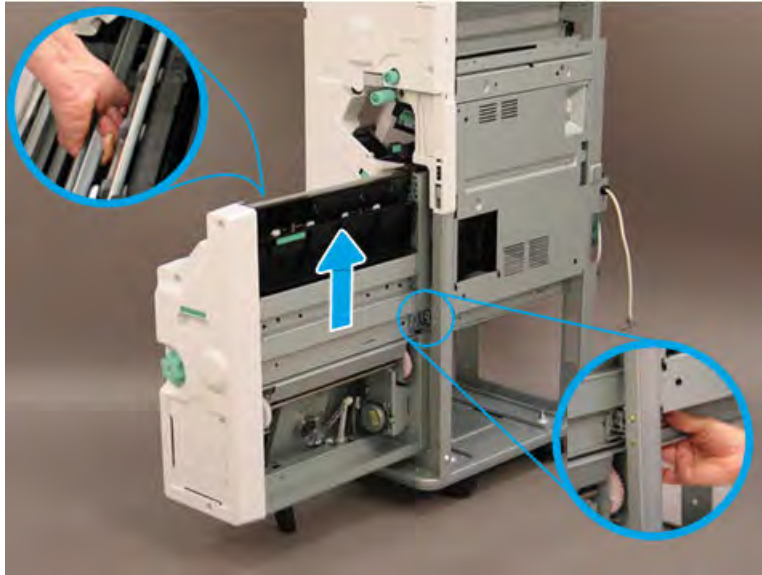

8. Reverse the removal steps to install the assembly. Also use the following special installation instructions.

 **NOTE:** Continue to reverse the removal steps to finish installing the assembly.

Special installation instructions: booklet maker

When installing the booklet maker, position the hooks on the rail under the slots on the booklet maker.

Figure 5-1817 Position the hooks

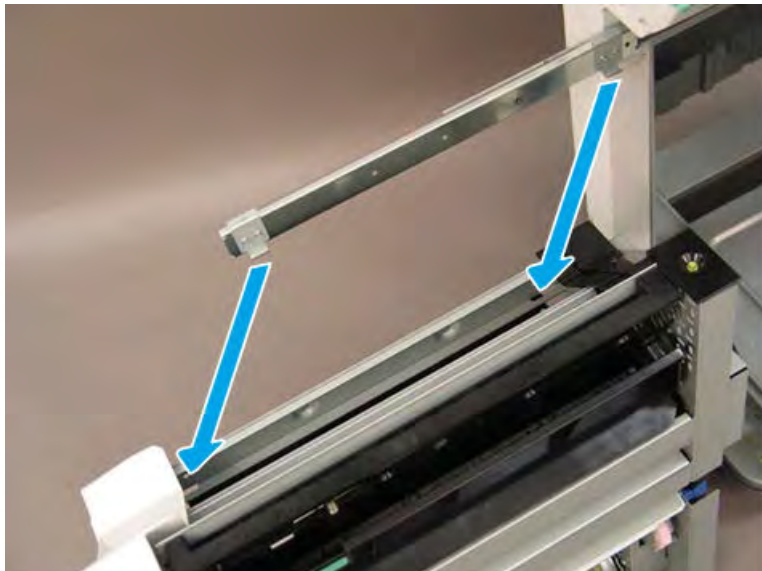

9. When installed correctly, the arrow on the front of the booklet maker aligns with the arrow on the finisher rail.

Figure 5-1818 Align arrows

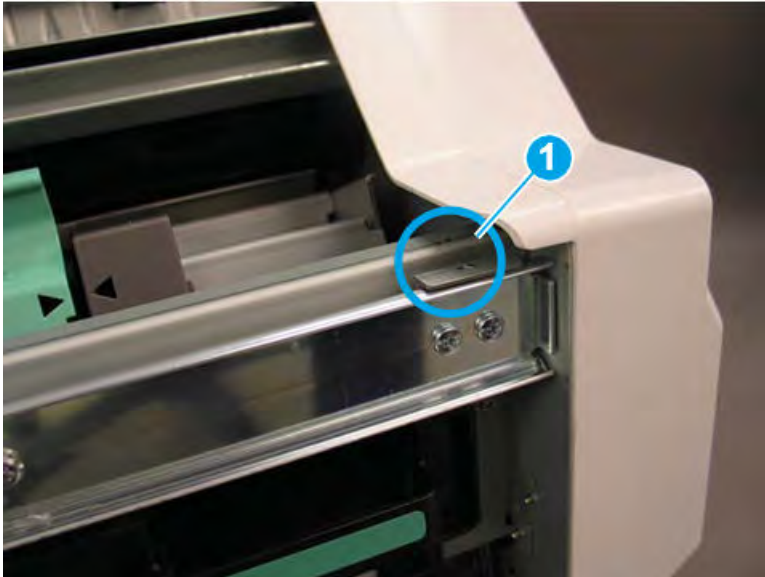

10. When installed correctly, the arrow on the back of the booklet maker aligns with the arrow on the finisher rail.

Figure 5-1819 Align arrows

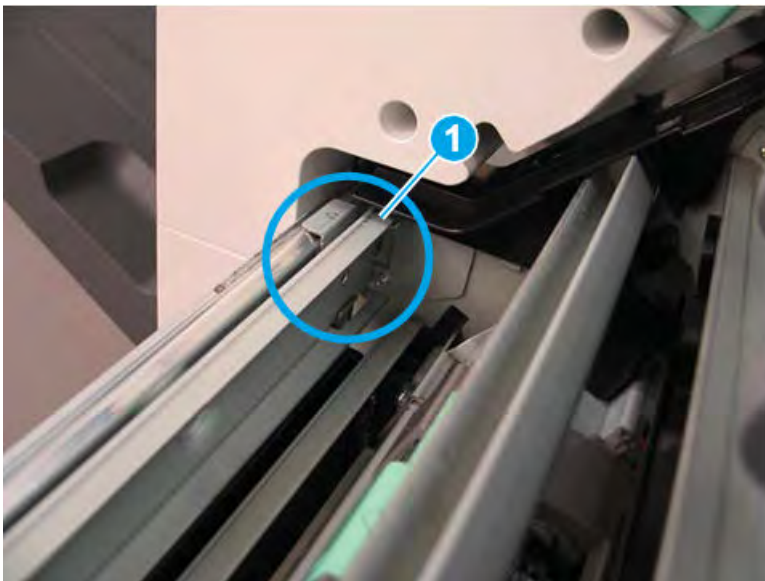

11. Extend the right rail away from the finisher and position it in the booklet maker slot.

Figure 5-1820 Extend the right rail

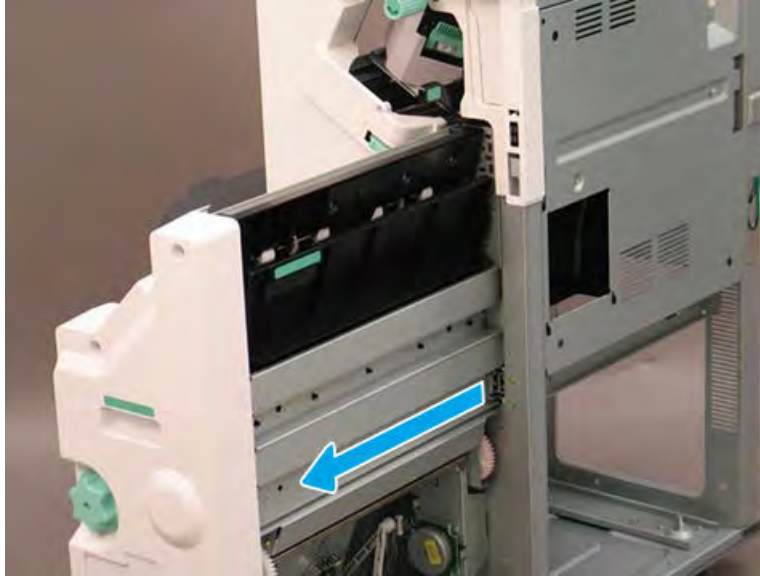

Remove the booklet front cover

Follow these steps to remove the booklet front cover.

- ▲ Slide the booklet maker slightly away from the finisher (callout 1). Remove one screw (callout 2), and then slide the green knob away from the booklet maker to remove it (callout 3). Remove four screws (callout 4), and then remove the booklet front cover.

 **TIP:** Reverse the removal steps to install the assembly

Figure 5-1821 Remove five screws and the cover



Remove the Booklet c-fold blade unit

Follow these steps to remove the Booklet c-fold blade unit.

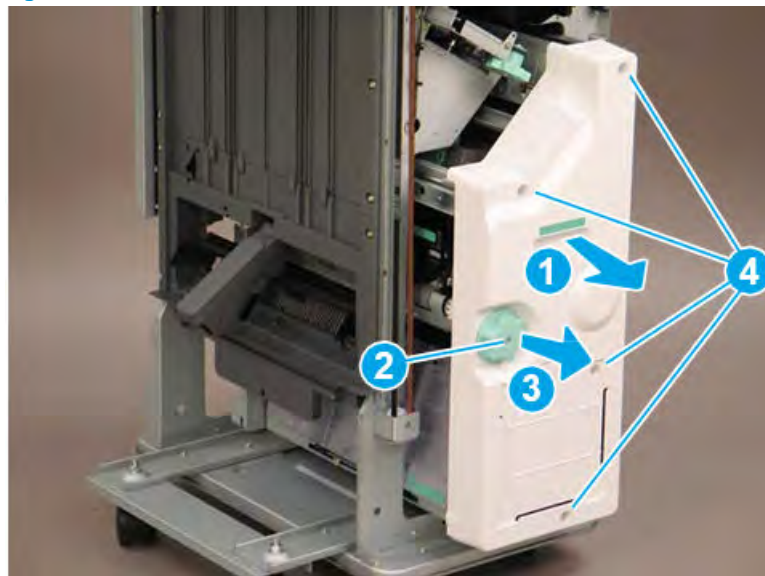
1. Remove two screws(callout 1) at the left of the booklet maker

Figure 5-1822 Remove two screws at the left of the booklet maker

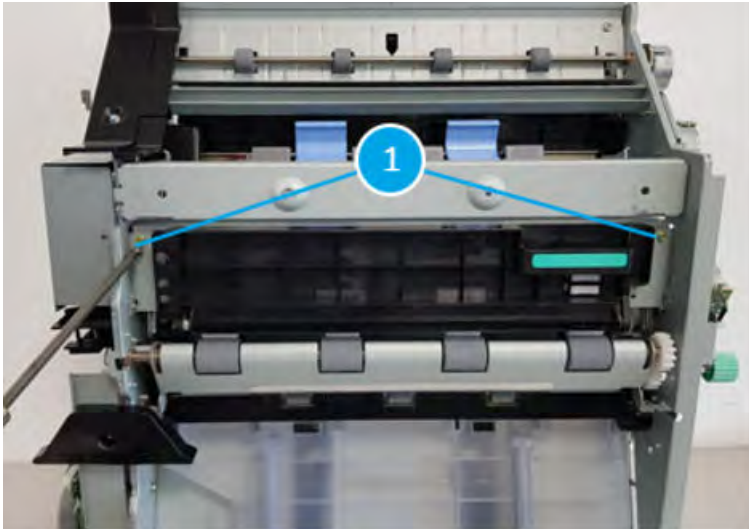

2. Remove three screws(callout 1) at the front of the booklet maker to remove motor unit(callout 2) to reach out to the screw.

Figure 5-1823 Remove three screws to remove motor unit to reach out to the screw

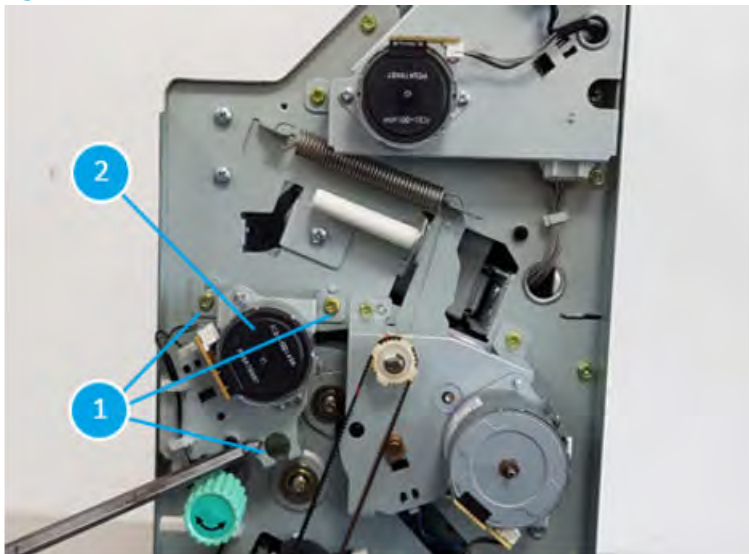

3. Remove one screw(callout 1) at the front of the booklet maker.

Figure 5-1824 Remove one screw at the front of the booklet maker



4. Remove one screw(callout 1) at the rear of the booklet maker.

Figure 5-1825 Remove one screw at the rear of the booklet maker

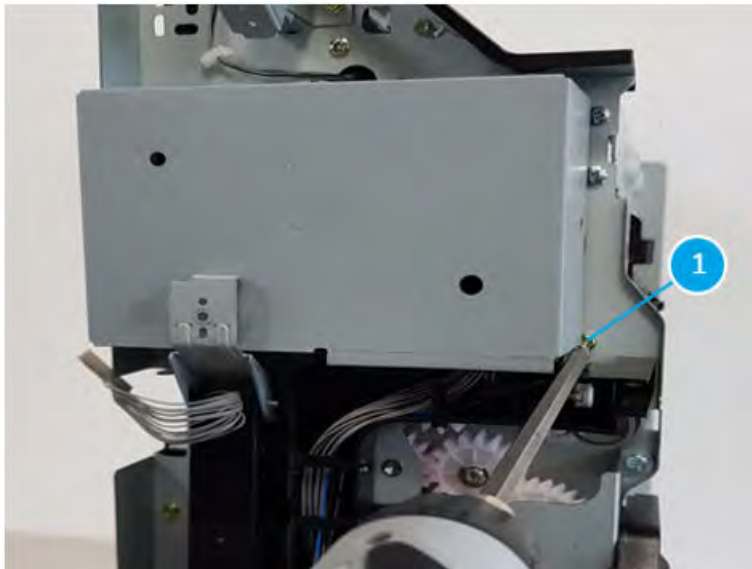

5. Take the booklet c-fold blade unit out from the booklet maker.

Figure 5-1826 Take the booklet c-fold blade unit out from the booklet maker



Remove the booklet c-fold blade home sensor (S39)

Follow these steps to remove the booklet c-fold blade home sensor (S39).

1. Remove three screws (callout 1) at the front of the booklet maker.

Figure 5-1827 Remove three screws at the front of the booklet maker

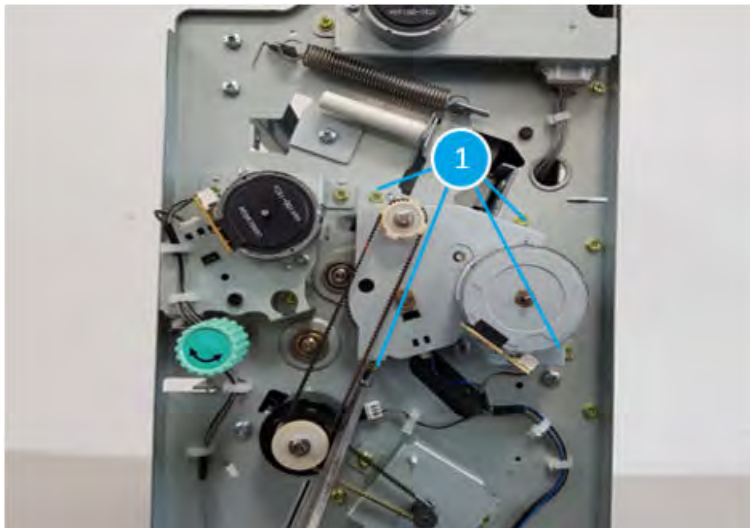

2. Take motor unit (callout 1) out from the booklet maker and unplug one connector (callout 2)

Figure 5-1828 Take motor unit out from the booklet maker and unplug one connector

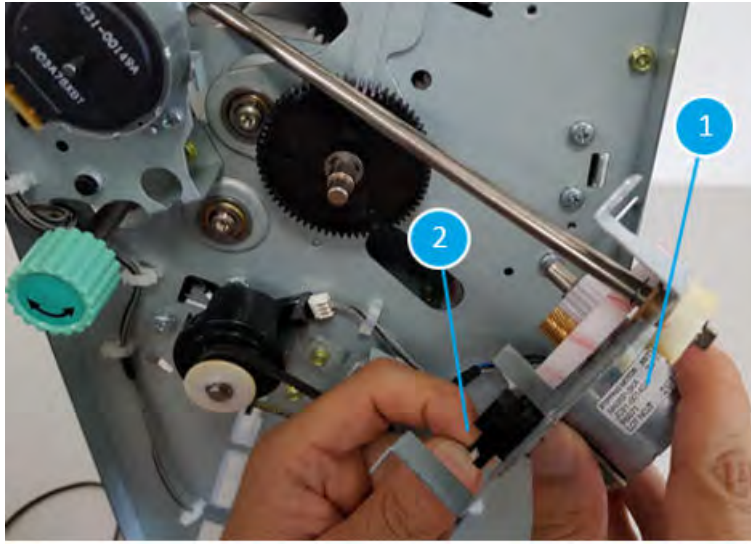

3. Remove the booklet c-fold blade home sensor (S39, callout 1)

Figure 5-1829 Remove the booklet c-fold blade home sensor

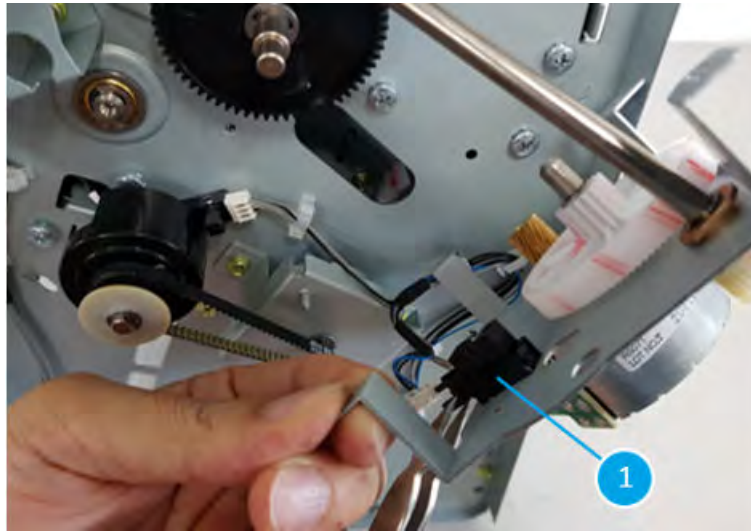

Unpack the replacement assembly

Follow these steps to unpack the replacement assembly.

1. Dispose of the defective part.

 **NOTE:** HP recommends responsible disposal of the defective part.

<http://www8.hp.com/us/en/hp-information/environment/product-recycling.html>

2. Unpack the replacement part from the packaging.



CAUTION:  Some parts are sensitive to electrostatic discharge (ESD). Always perform service work at an ESD-protected workstation or mat. If an ESD workstation or mat is not available, touch the sheet-metal chassis to provide a static ground before touching an ESD-sensitive assembly. Protect the ESD-sensitive assemblies by placing them in ESD pouches when they are out of the printer.

 **IMPORTANT:** Make sure that all of the shipping materials (for example shipping tape) are removed from the replacement part prior to installation.

 **NOTE:** If the replacement part is a roller or pad, avoid touching the spongy part of it. Skin oils on the roller or pad can cause paper pickup and/or print-quality problems. HP recommends using disposable gloves when handling rollers or pads or washing your hands before touching rollers or pads.

3. To install an assembly, reverse the removal steps.

 **NOTE:** When applicable, special installation instructions are provided for an assembly at the end of the removal procedure. Always completely read the removal instructions and follow all special installation instructions.

Removal and replacement: Booklet c-fold blade motor (M17)

Learn how to remove and replace the booklet c-fold blade motor.

Introduction

This document provides the procedures to remove and replace the booklet c-fold blade motor on the finisher.



IMPORTANT: When applicable, special installation instructions are provided for an assembly at the end of the removal procedure. Always completely read the removal instructions and follow all special installation instructions.

Before performing service

- Turn the printer power off. A shutting-down message appears on the control-panel display.
- ⚠ **WARNING!** To avoid damage to the printer, turn the power off and wait until the printer shuts down before removing the power cable.
- Disconnect the printer power cable after the printer has completely shut down (the control-panel display is blank).
- Release the finisher from the printer by pulling out on the release latch inside the finisher door.
- Disconnect the cable from the bridge unit to the finisher.
- Disconnect the cable from the finisher to the printer.

Use the table below to identify the correct part number for your printer. To order the part, go to <https://parts.hp.com>.

Table 5-164 Part information

Part number	Part description
JC93-01154A	Booklet c-fold blade motor
JC90-01396A	Booklet c-fold blade motor assembly

Required tools

- #2 JIS screwdriver with a magnetic tip

After performing service

- Connect the cable from the finisher to the printer.
- Connect the cable from the bridge unit to the finisher.
- Attach the finisher to the printer, and then push in on the release latch inside the finisher door.
- Connect the printer power cable.
- Turn the printer power on.

Post service test

Process a job through the finisher and verify that the finisher works correctly.

Remove the booklet front cover

Follow these steps to remove the booklet front cover.

- ▲ Slide the booklet maker slightly away from the finisher (callout 1). Remove one screw (callout 2), and then slide the green knob away from the booklet maker to remove it (callout 3). Remove four screws (callout 4), and then remove the booklet front cover.

 **TIP:** Reverse the removal steps to install the assembly

Figure 5-1830 Remove five screws and the cover



Remove the booklet c-fold blade motor (M17)

Follow these steps to remove the booklet c-fold blade motor (M17).

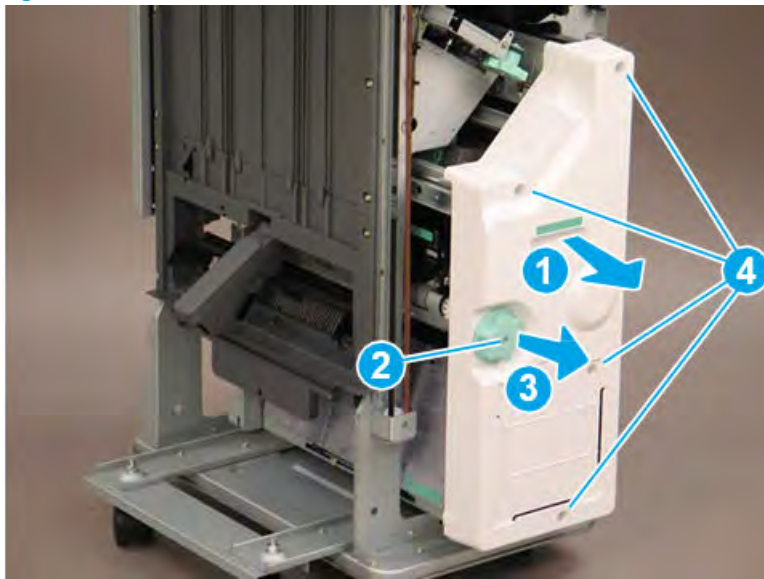
1. Note the position of the alignment arrows on the upper white gear and the lower motor (callout 1). These arrows must be aligned in these positions when the motor is reinstalled.

Figure 5-1831 Check arrow alignment

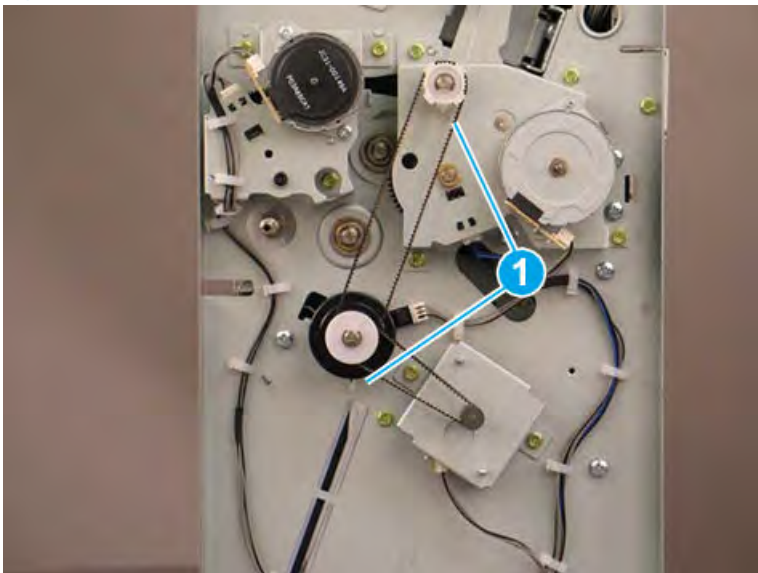

2. Disconnect two connectors (callout 1).

Figure 5-1832 Disconnect two connectors

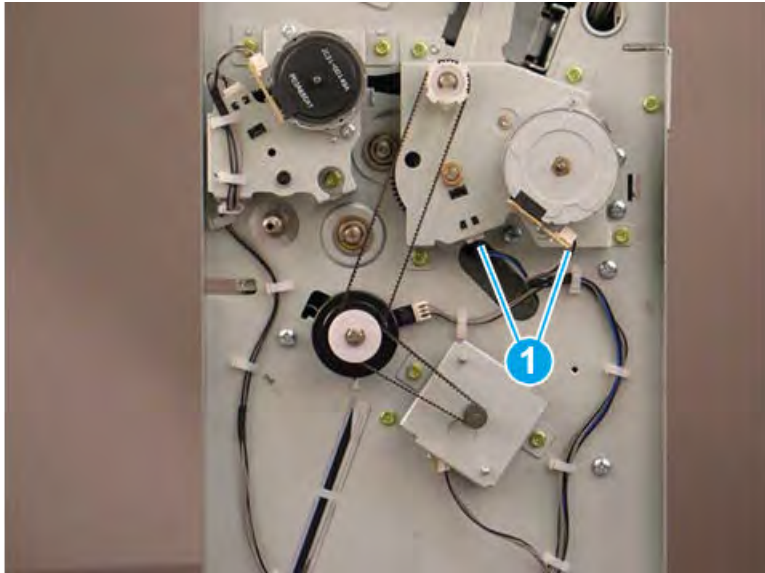

3. Remove four screws (callout 1).

Figure 5-1833 Remove four screws (callout 1).

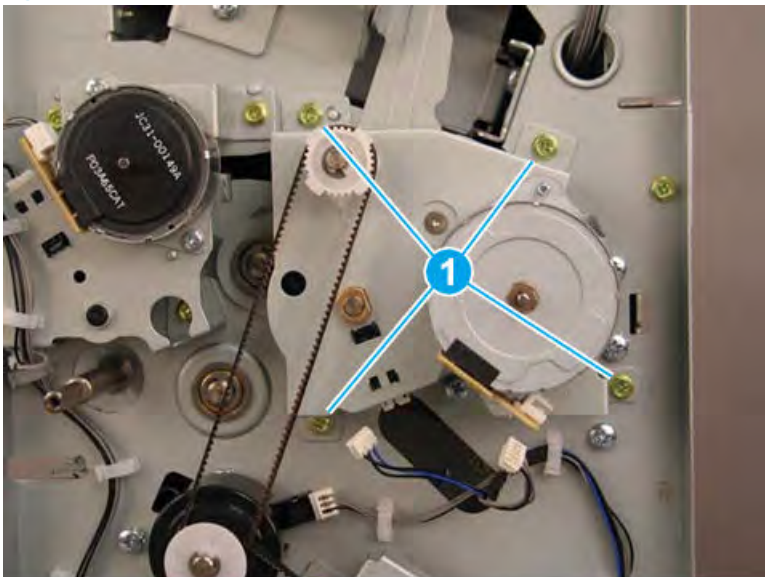

4. Remove one e-clip (callout 1) on top of the white gear. Remove the white gear (callout 2) and release the belt (callout 3).

Figure 5-1834 Remove one e-clip, gear, and belt

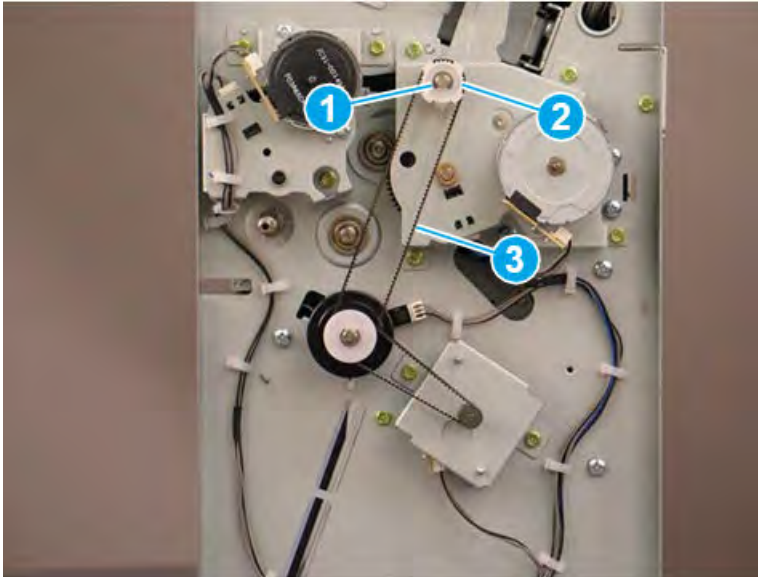

5. Remove the bracket and motor from the booklet maker.

⚠ CAUTION: Do not pull on the shaft (callout 1) while removing the bracket and motor. The shaft might become dislodged at the other end. If the shaft becomes dislodged, remove the booklet maker PCA shield and PCA bracket to reinstall the shaft.

Figure 5-1835 Remove the bracket and motor

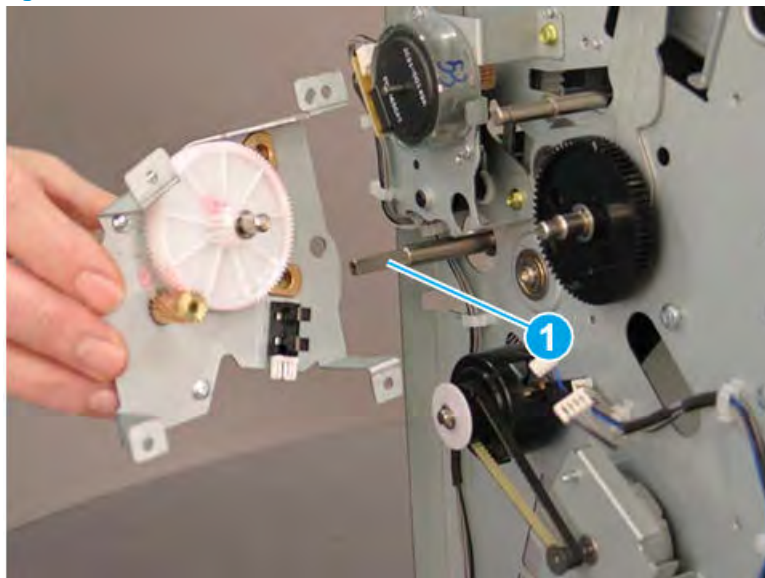

6. Remove two screws (callout 1), and then remove the C fold motor.

Figure 5-1836 Remove two screws

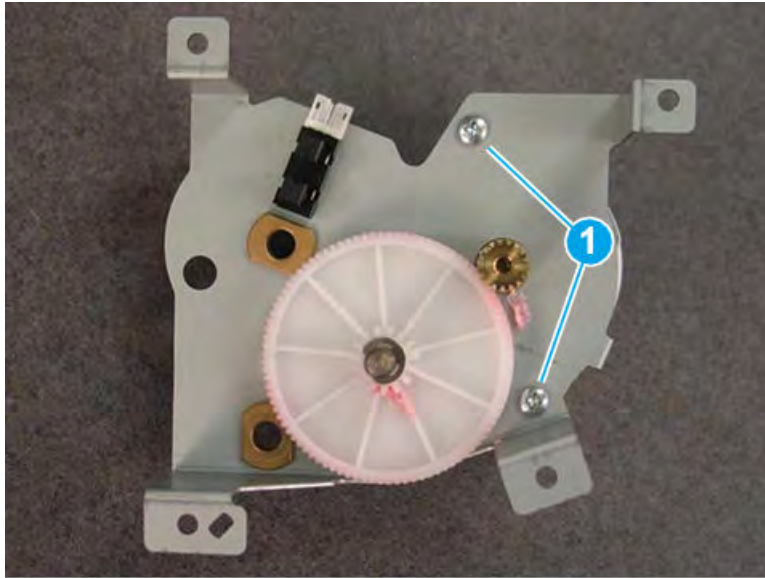

7. Reverse the removal steps to install the assembly. Also use the following special installation instructions.

 **NOTE:** Continue to reverse the removal steps to finish installing the assembly.

Special installation instructions: C fold motor

- a. When installing the motor, install one screw (callout 1) to hold the bracket in place while installing the gear and belt.

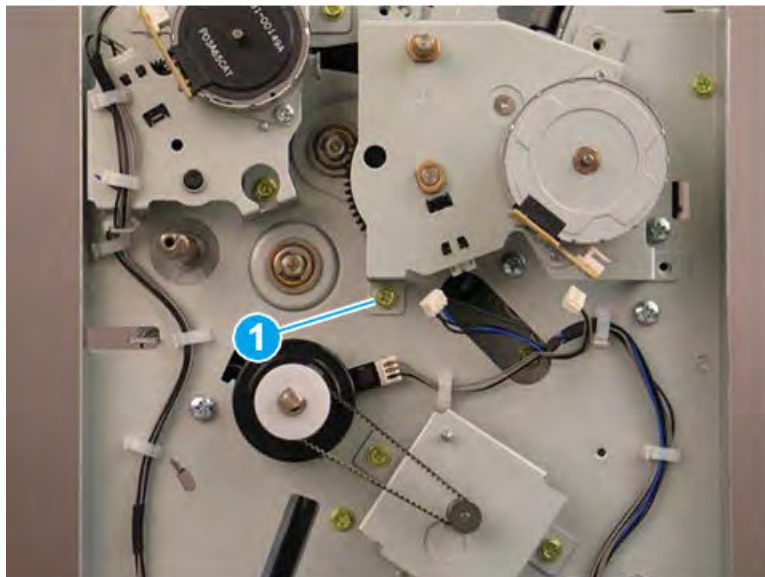

- b. Check the position of the alignment arrows on the upper white gear and the lower motor (callout 1).

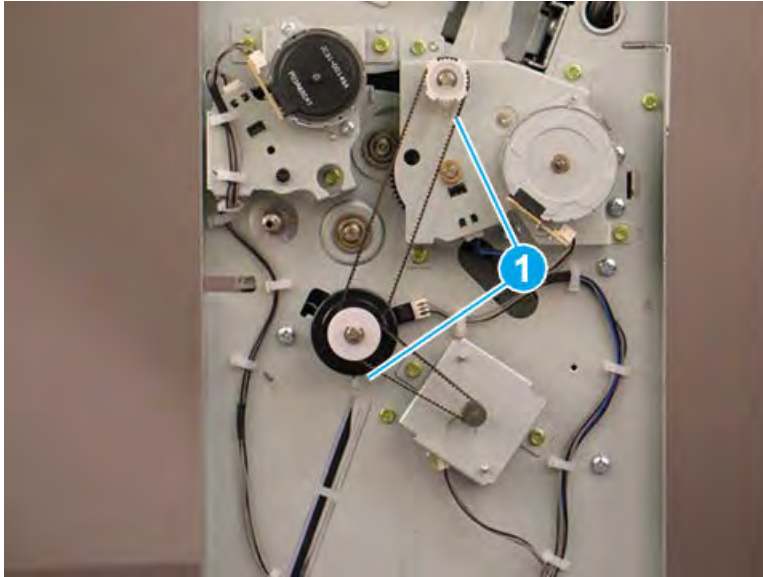

- c. If the arrows are not aligned, slightly pull up on the belt to create some slack around the gear (callout 1), and then rotate the gear (callout 2) until the arrows align.

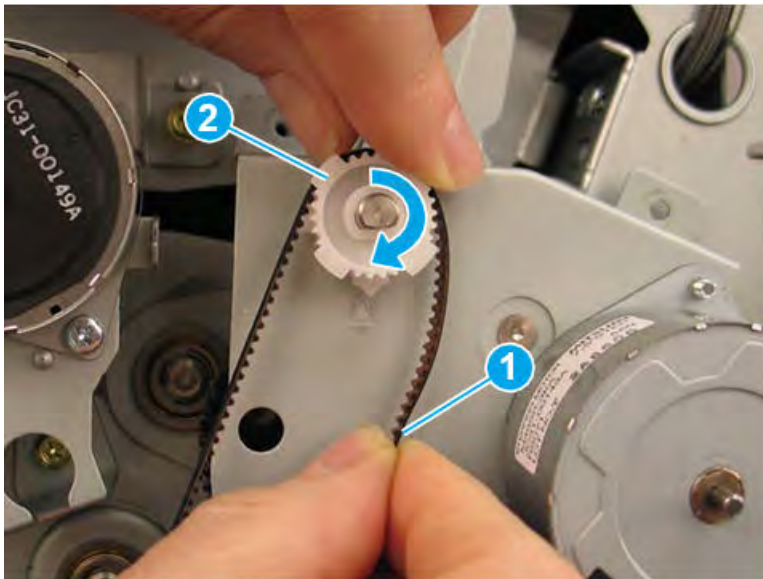

Unpack the replacement assembly

Follow these steps to unpack the replacement assembly.

1. Dispose of the defective part.

 **NOTE:** HP recommends responsible disposal of the defective part.

<http://www8.hp.com/us/en/hp-information/environment/product-recycling.html>

2. Unpack the replacement part from the packaging.



CAUTION:  Some parts are sensitive to electrostatic discharge (ESD). Always perform service work at an ESD-protected workstation or mat. If an ESD workstation or mat is not available, touch the sheet-metal chassis to provide a static ground before touching an ESD-sensitive assembly. Protect the ESD-sensitive assemblies by placing them in ESD pouches when they are out of the printer.

 **IMPORTANT:** Make sure that all of the shipping materials (for example shipping tape) are removed from the replacement part prior to installation.

 **NOTE:** If the replacement part is a roller or pad, avoid touching the spongy part of it. Skin oils on the roller or pad can cause paper pickup and/or print-quality problems. HP recommends using disposable gloves when handling rollers or pads or washing your hands before touching rollers or pads.

3. To install an assembly, reverse the removal steps.

 **NOTE:** When applicable, special installation instructions are provided for an assembly at the end of the removal procedure. Always completely read the removal instructions and follow all special installation instructions.

Booklet diverter unit

Removal and replacement: Booklet diverter

Learn how to remove and replace the booklet diverter.

Introduction

This document provides the procedures to remove and replace the booklet diverter on the finisher.

 **IMPORTANT:** When applicable, special installation instructions are provided for an assembly at the end of the removal procedure. Always completely read the removal instructions and follow all special installation instructions.

Before performing service

- Turn the printer power off. A shutting-down message appears on the control-panel display.
- ⚠ **WARNING!** To avoid damage to the printer, turn the power off and wait until the printer shuts down before removing the power cable.
- Disconnect the printer power cable after the printer has completely shut down (the control-panel display is blank).
- Release the finisher from the printer by pulling out on the release latch inside the finisher door.
- Disconnect the cable from the bridge unit to the finisher.
- Disconnect the cable from the finisher to the printer.

Use the table below to identify the correct part number for your printer. To order the part, go to <https://parts.hp.com>.

Table 5-165 Part information

Part number	Part description
JC90-01398A	Booklet diverter

Required tools

- #2 JIS screwdriver with a magnetic tip

After performing service

- Connect the cable from the finisher to the printer.
- Connect the cable from the bridge unit to the finisher.
- Attach the finisher to the printer, and then push in on the release latch inside the finisher door.
- Connect the printer power cable.
- Turn the printer power on.

Post service test

Process a job through the finisher and verify that the finisher works correctly.

Remove the right upper cover (finisher)

Follow these steps to remove the right upper cover (finisher).

- ▲ Remove one screw cap and three machine screws on the upper edge of the cover (callout 1). Remove three sheet metal screws (callout 2) on the lower portion of the cover. Rotate the right edge of the cover away from the finisher, and then slide the cover right to release three tabs (callout 3).

💡 **TIP:** The lower screws are shorter in length than the upper screws.

TIP: Reverse the removal steps to install the assembly.

Figure 5-1837 Remove the right upper cover

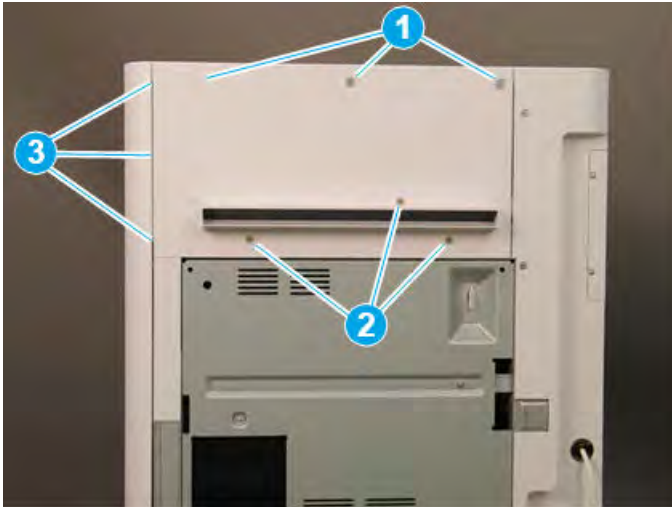

Remove the top cover (finisher)

Follow these steps to remove the top cover (finisher).

1. Remove three screw caps and three self-tapping screws at the top of the rear cover (callout 1), and then remove three machine screws (callout 2) on top of the cover.

Figure 5-1838 Remove six screws

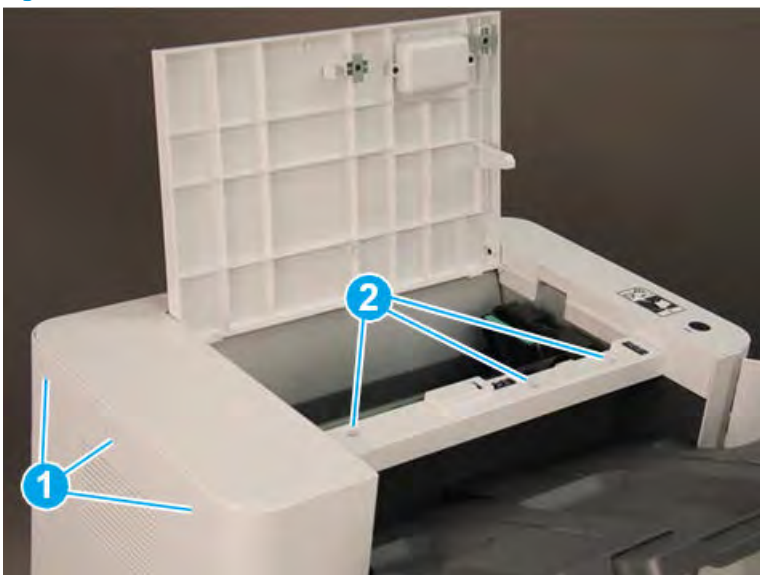

2. Remove three self-tapping screws at the top of the front cover (callout 1), and then remove two machine screws (callout 2) at the top of the right side.

Figure 5-1839 Remove five screws

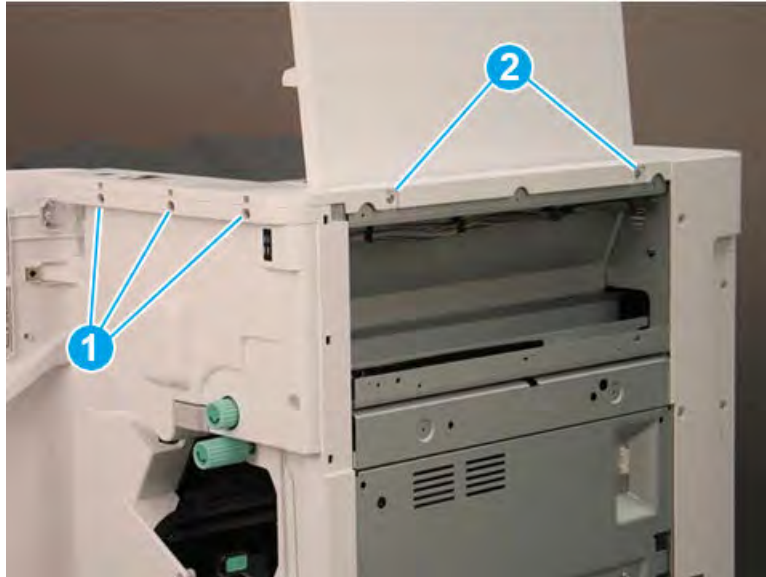

3. Lift the cover up slightly. Disconnect one in-line connector (callout 1), and then release one retainer (callout 2).

 **TIP:** Reverse the removal steps to install the assembly.

Figure 5-1840 Disconnect one connector and release retainer



Remove the rear cover (finisher)

Follow these steps to remove the rear cover (finisher).

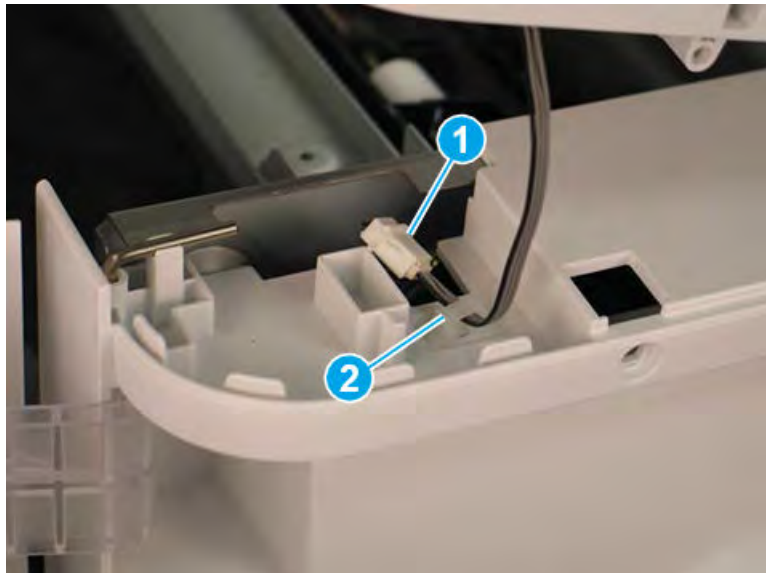
1. Remove two self-tapping screws (callout 1) on the top of the rear cover, and then remove five screw caps and five machine screws (callout 2) on the left side of the cover.

Figure 5-1841 Remove seven screws

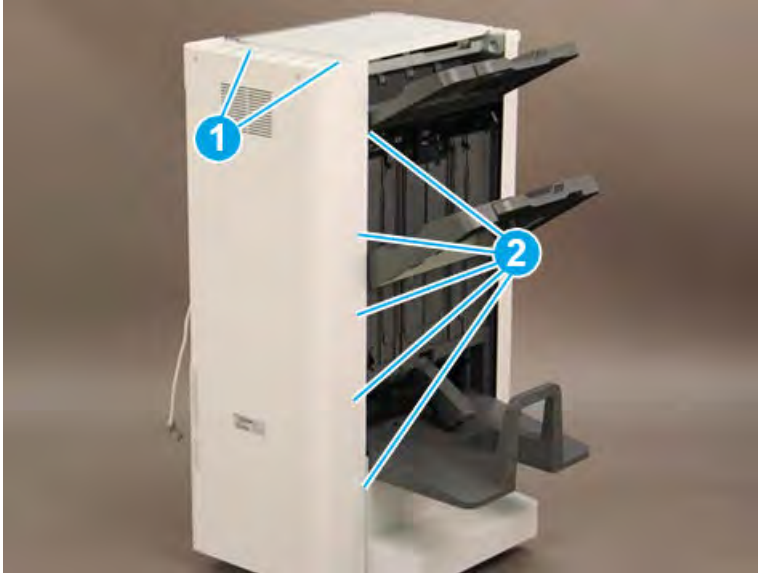

2. Remove one screw cap and four machine screws (callout 1) Remove the rear cover.

 **NOTE:** Make sure to thread the power cable (callout 2) through the opening in the cover.

 **TIP:** Reverse the removal steps to install the assembly

Figure 5-1842 Remove the rear cover



Remove the booklet maker

Follow these steps to remove the booklet maker.

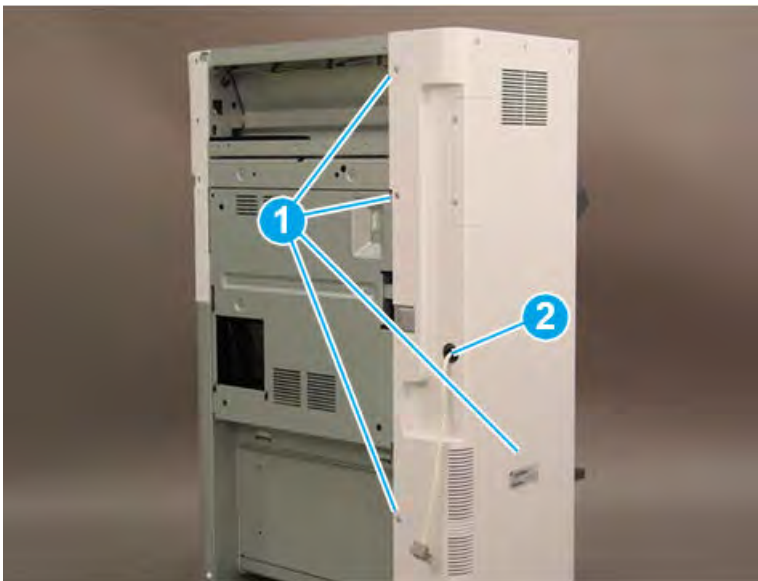
1. Slide the booklet maker away from the finisher.

Figure 5-1843 Slide the booklet maker away from the finisher



2. At the Disconnect one connector (callout 1), and then remove one screw (callout 2).

Figure 5-1844 Disconnect one connector and remove one screw

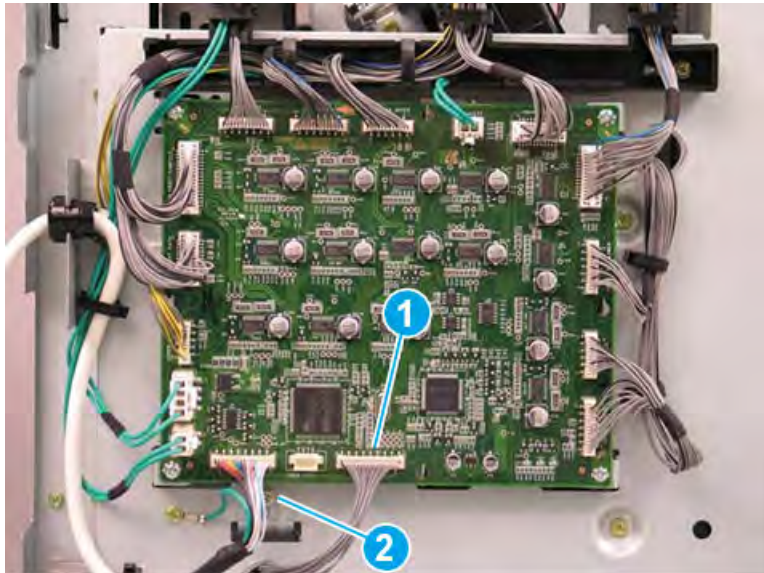

3. Release the metal bracket through the opening in the sheet metal.

Figure 5-1845 Release the metal bracket

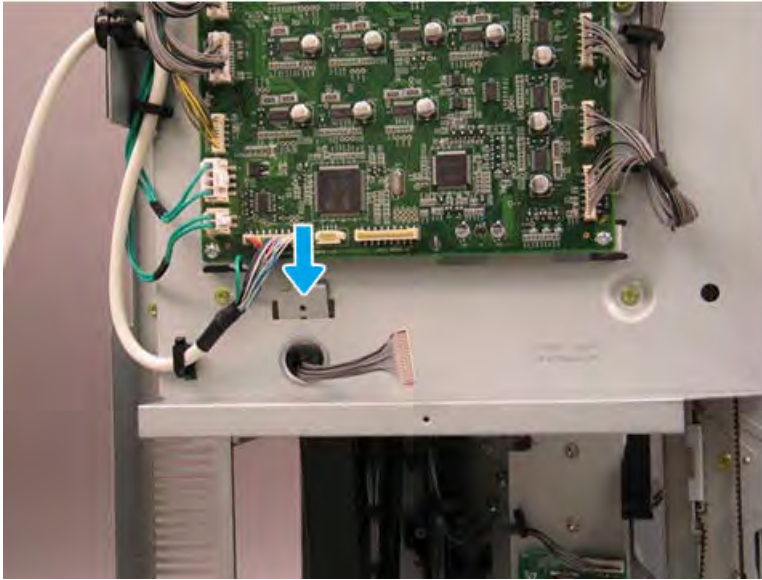

4. Remove one star-washer screw (callout 1), and then release the alignment pin (callout 2) on the right side of the booklet maker.

Figure 5-1846 Remove one screw

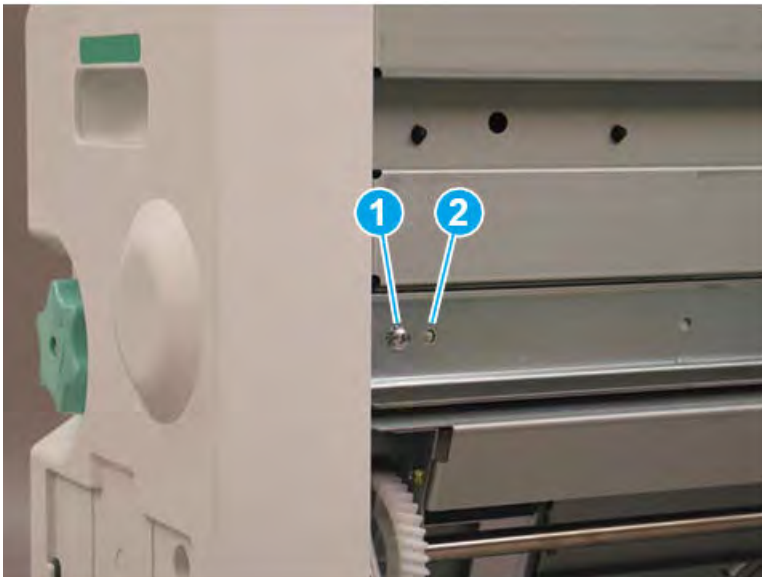

5. Slide the right rail toward the finisher.

Figure 5-1847 Slide the right rail

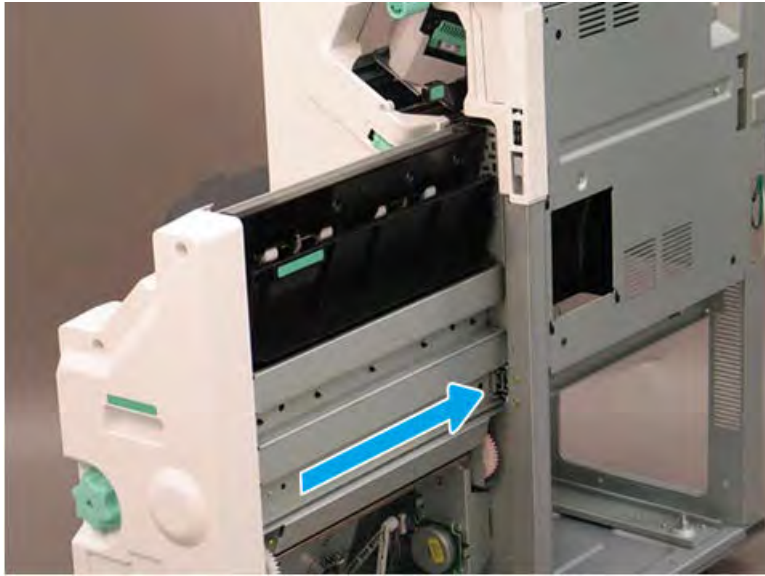

6. Remove one star-washer screw (callout 1) on the left side of the booklet maker.

Figure 5-1848 Remove one screw

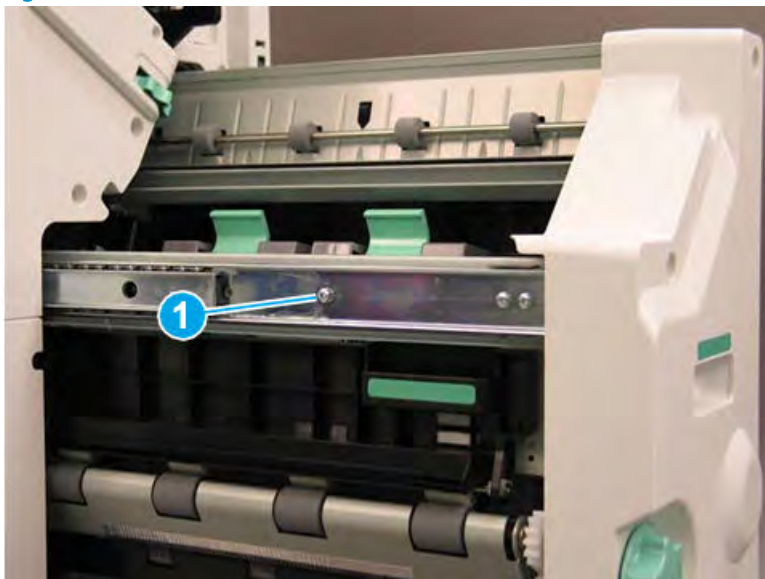

7. Lift the booklet maker up on the left side while squeezing the right rail away from the finisher slightly to clear the sheet metal. Remove the booklet maker.

Figure 5-1849 Remove the booklet maker

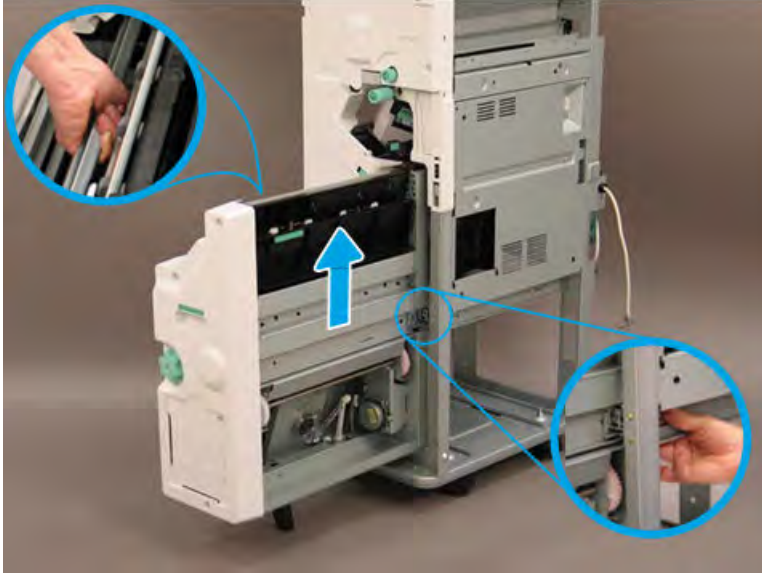

8. Reverse the removal steps to install the assembly. Also use the following special installation instructions.

 **NOTE:** Continue to reverse the removal steps to finish installing the assembly.

Special installation instructions: booklet maker

When installing the booklet maker, position the hooks on the rail under the slots on the booklet maker.

Figure 5-1850 Position the hooks

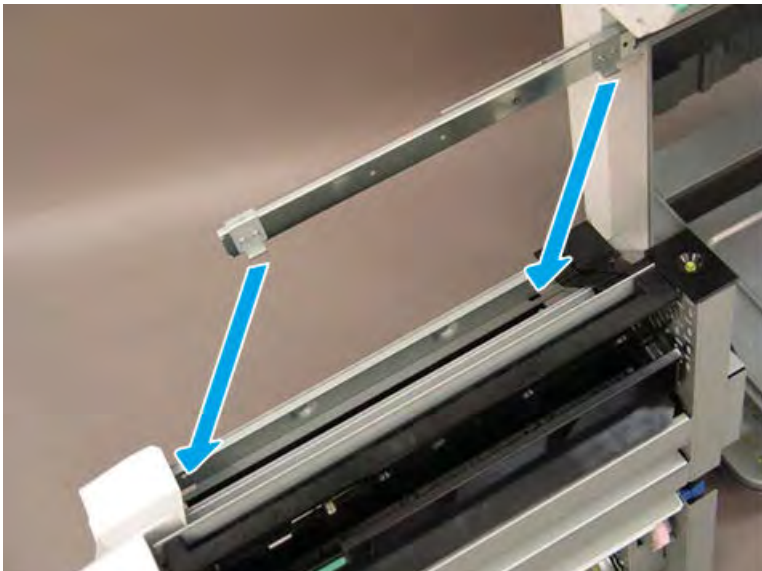

9. When installed correctly, the arrow on the front of the booklet maker aligns with the arrow on the finisher rail.

Figure 5-1851 Align arrows



10. When installed correctly, the arrow on the back of the booklet maker aligns with the arrow on the finisher rail.

Figure 5-1852 Align arrows

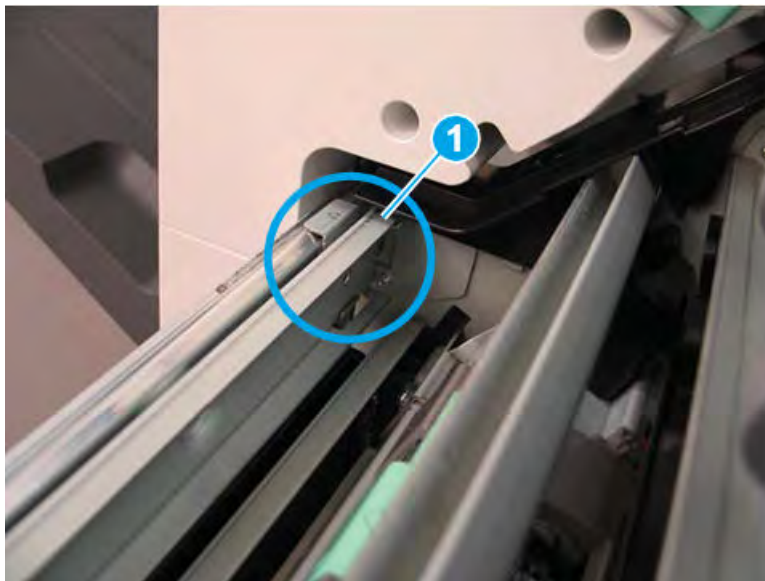

11. Extend the right rail away from the finisher and position it in the booklet maker slot.

Figure 5-1853 Extend the right rail



Remove the booklet front cover

Follow these steps to remove the booklet front cover.

- ▲ Slide the booklet maker slightly away from the finisher (callout 1). Remove one screw (callout 2), and then slide the green knob away from the booklet maker to remove it (callout 3). Remove four screws (callout 4), and then remove the booklet front cover.

 **TIP:** Reverse the removal steps to install the assembly

Figure 5-1854 Remove five screws and the cover

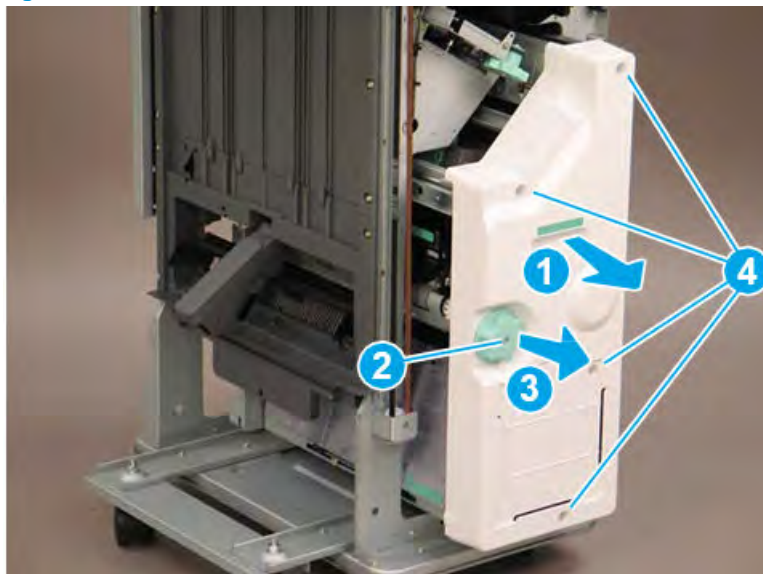

Remove the Booklet c-fold blade unit

Follow these steps to remove the Booklet c-fold blade unit.

1. Remove two screws(callout 1) at the left of the booklet maker

Figure 5-1855 Remove two screws at the left of the booklet maker

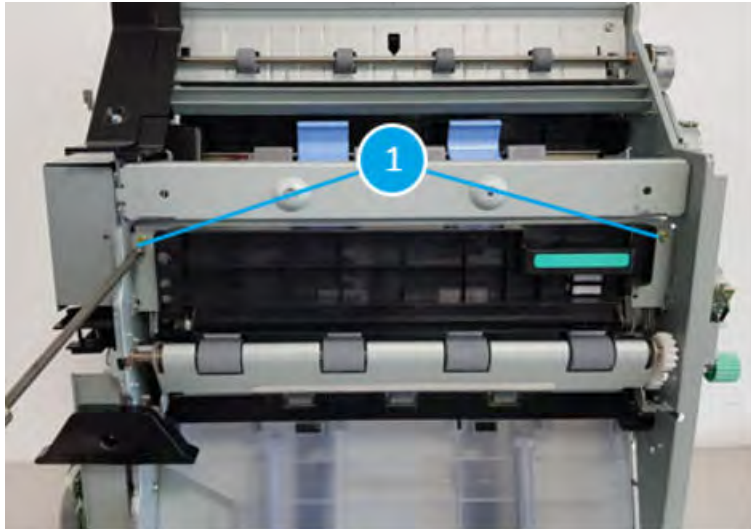

2. Remove three screws(callout 1) at the front of the booklet maker to remove motor unit(callout 2) to reach out to the screw.

Figure 5-1856 Remove three screws to remove motor unit to reach out to the screw

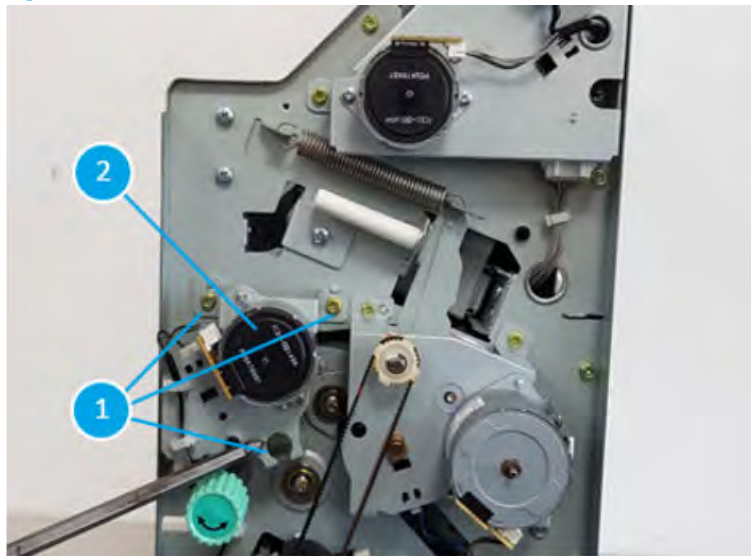

3. Remove one screw(callout 1) at the front of the booklet maker.

Figure 5-1857 Remove one screw at the front of the booklet maker



4. Remove one screw(callout 1) at the rear of the booklet maker.

Figure 5-1858 Remove one screw at the rear of the booklet maker

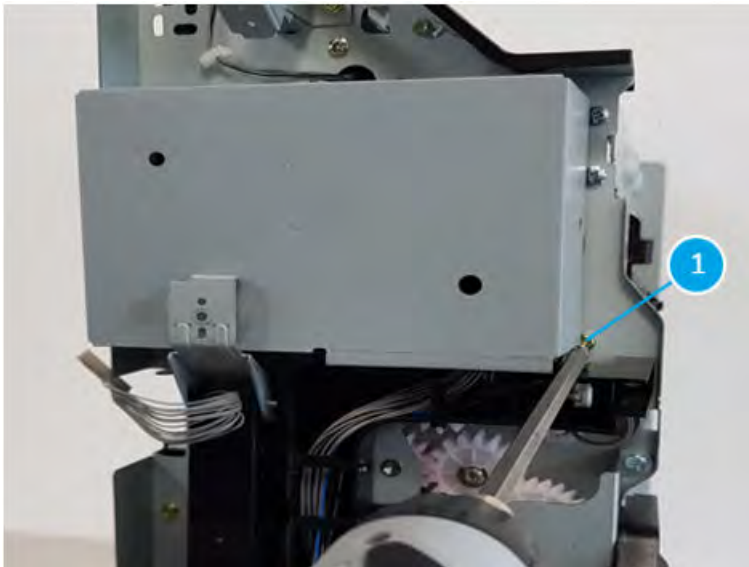

5. Take the booklet c-fold blade unit out from the booklet maker.

Figure 5-1859 Take the booklet c-fold blade unit out from the booklet maker

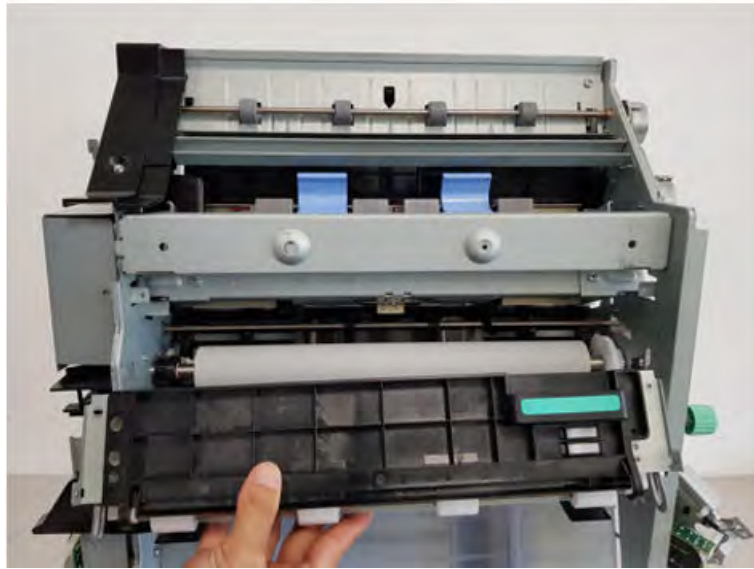

Remove the booklet diverter

Follow these steps to remove the booklet diverter.

1. Remove two screws (callout 1) at the rear of the booklet maker and remove the PCA cover (callout 2).

Figure 5-1860 Remove two screws at the rear of the booklet maker and remove the PCA cover

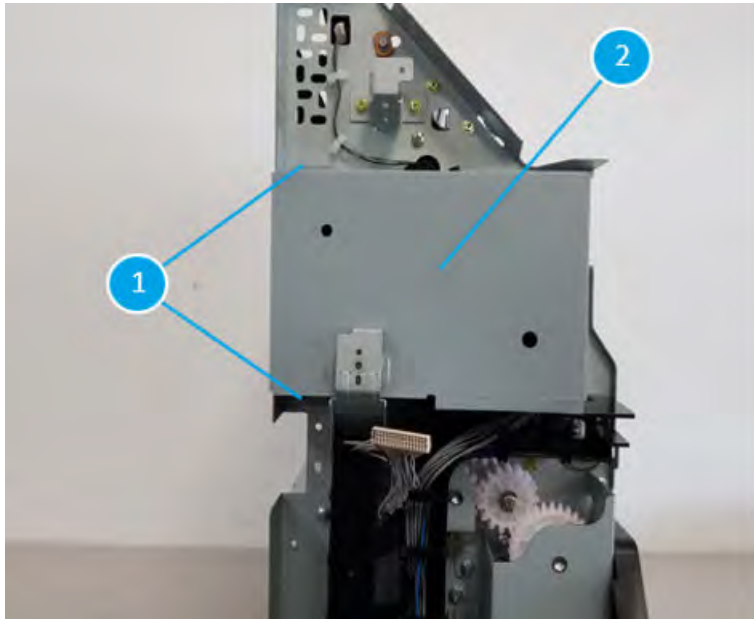

2. Remove one screw(callout 1) at the rear of the booklet maker to make it easy to disconnect the connector.

Figure 5-1861 Remove one screw at the rear of the booklet maker

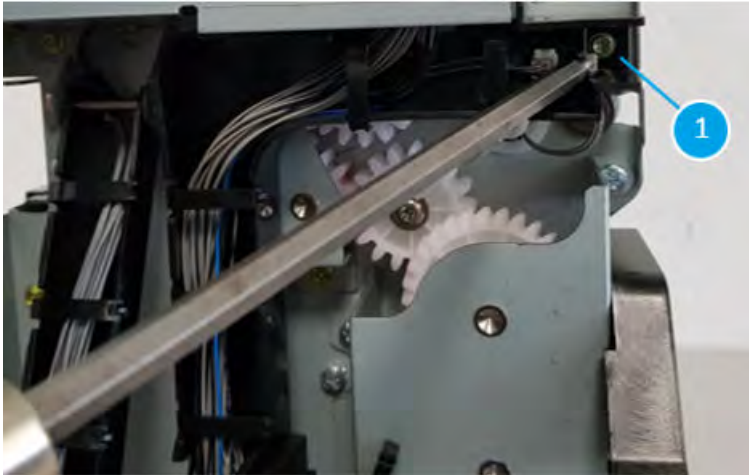

3. Pull the connector cover (callout 1) and disconnect the one connector (callout 2)

Figure 5-1862 Pull the connector cover and disconnect the one connector

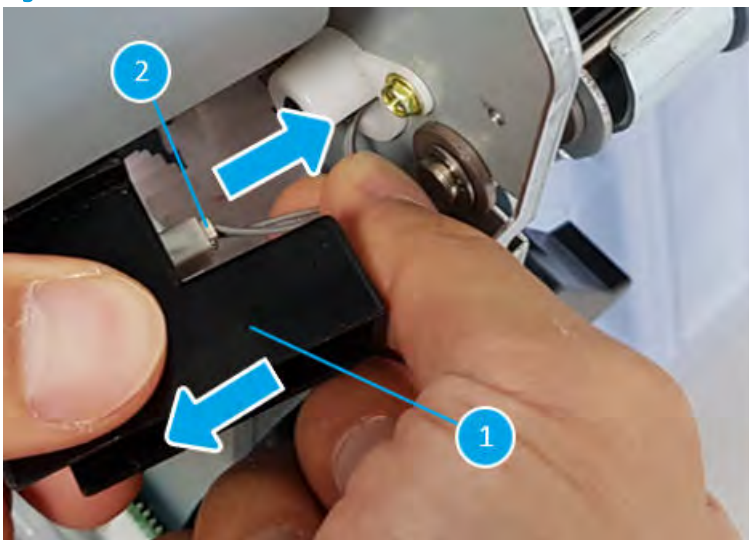

4. Remove two screws(callout 1)

Figure 5-1863 Remove two screws

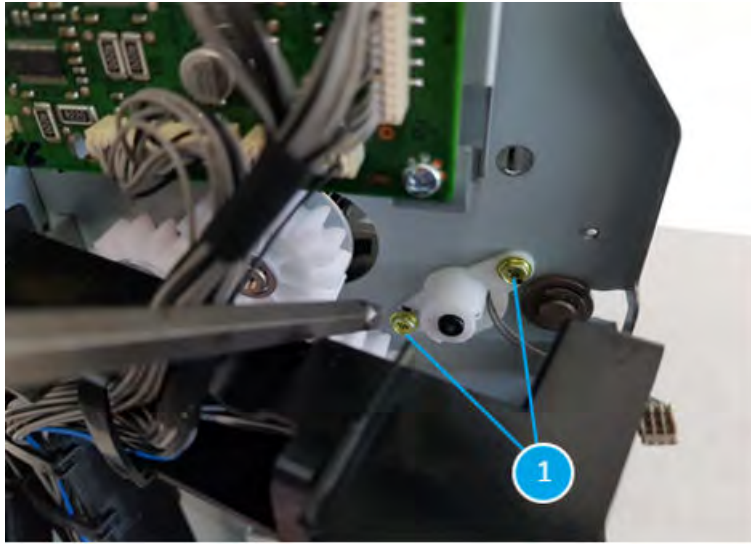

5. Remove the white bush

Figure 5-1864 Remove the white bush

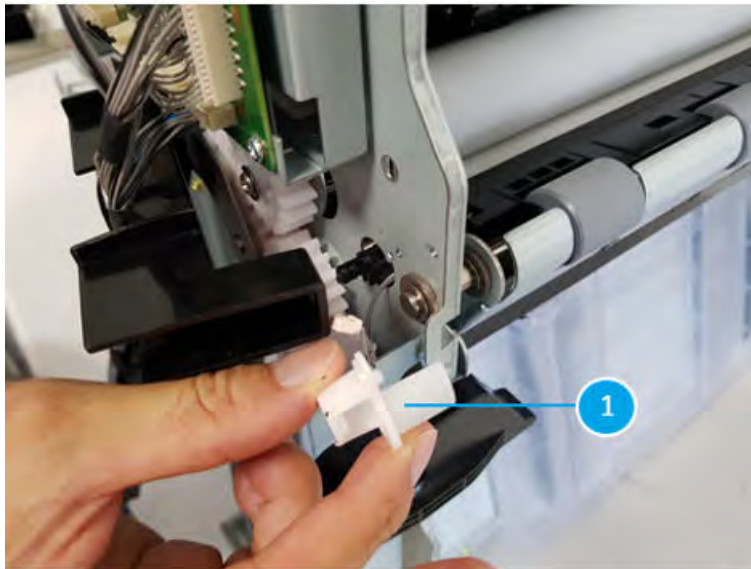

6. Remove one e-clip on top of the black actuator (callout 1) and remove the black actuator and make sure not to lose the pin (callout 2) when you pull out the black actuator.

Figure 5-1865 Remove one e-clip on top of the black actuator (callout 1) and remove the black actuator

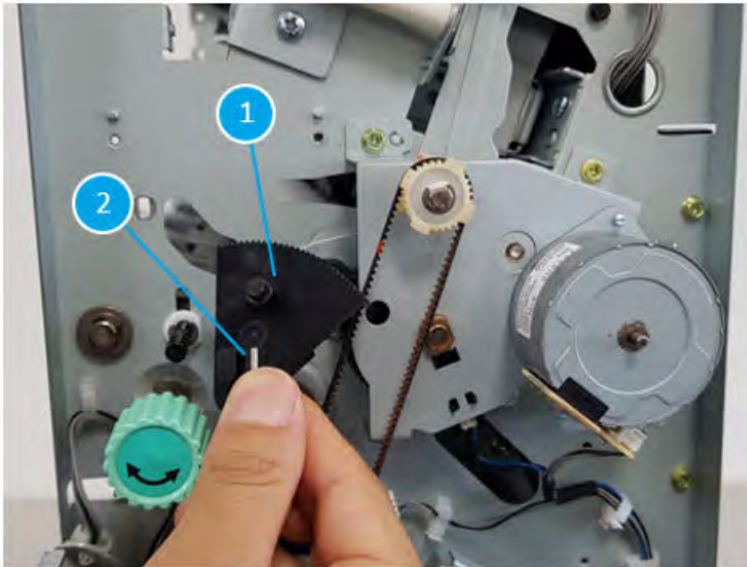

7. Remove the white bush (callout 1).

Figure 5-1866 Remove the white bush

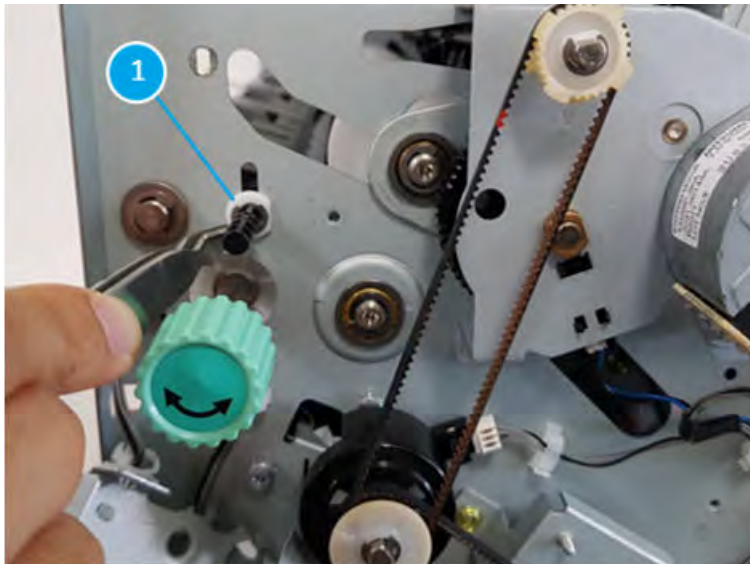

8. Pull the booklet diverter out from the booklet maker.

Figure 5-1867 Pull the booklet diverter out from the booklet maker

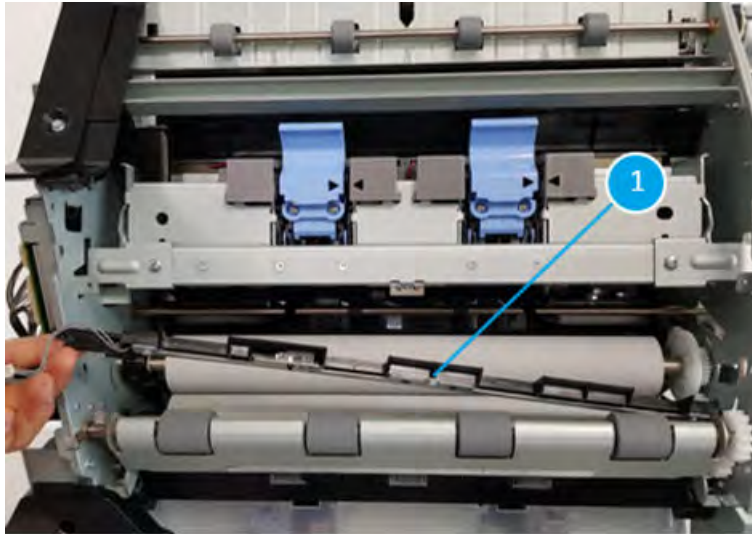

Unpack the replacement assembly



Follow these steps to unpack the replacement assembly.

1. Dispose of the defective part.

 **NOTE:** HP recommends responsible disposal of the defective part.

<http://www8.hp.com/us/en/hp-information/environment/product-recycling.html>

2. Unpack the replacement part from the packaging.

 **CAUTION:**  Some parts are sensitive to electrostatic discharge (ESD). Always perform service work at an ESD-protected workstation or mat. If an ESD workstation or mat is not available, touch the sheet-metal chassis to provide a static ground before touching an ESD-sensitive assembly. Protect the ESD-sensitive assemblies by placing them in ESD pouches when they are out of the printer.

 **IMPORTANT:** Make sure that all of the shipping materials (for example shipping tape) are removed from the replacement part prior to installation.

 **NOTE:** If the replacement part is a roller or pad, avoid touching the spongy part of it. Skin oils on the roller or pad can cause paper pickup and/or print-quality problems. HP recommends using disposable gloves when handling rollers or pads or washing your hands before touching rollers or pads.

3. To install an assembly, reverse the removal steps.

 **NOTE:** When applicable, special installation instructions are provided for an assembly at the end of the removal procedure. Always completely read the removal instructions and follow all special installation instructions.

Removal and replacement: Booklet diverter home sensor (S40)

Learn how to remove and replace the booklet diverter home sensor.

Introduction

This document provides the procedures to remove and replace the booklet diverter home sensor on the finisher.



IMPORTANT: When applicable, special installation instructions are provided for an assembly at the end of the removal procedure. Always completely read the removal instructions and follow all special installation instructions.

Before performing service

- Turn the printer power off. A shutting-down message appears on the control-panel display.
- ⚠ **WARNING!** To avoid damage to the printer, turn the power off and wait until the printer shuts down before removing the power cable.
- Disconnect the printer power cable after the printer has completely shut down (the control-panel display is blank).
- Release the finisher from the printer by pulling out on the release latch inside the finisher door.
- Disconnect the cable from the bridge unit to the finisher.
- Disconnect the cable from the finisher to the printer.

Use the table below to identify the correct part number for your printer. To order the part, go to <https://parts.hp.com>.

Table 5-166 Part information

Part number	Part description
0604-001415	Booklet diverter home sensor

Required tools

- #2 JIS screwdriver with a magnetic tip

After performing service

- Connect the cable from the finisher to the printer.
- Connect the cable from the bridge unit to the finisher.
- Attach the finisher to the printer, and then push in on the release latch inside the finisher door.
- Connect the printer power cable.
- Turn the printer power on.

Post service test

Process a job through the finisher and verify that the finisher works correctly.

Remove the booklet front cover

Follow these steps to remove the booklet front cover.

- ▲ Slide the booklet maker slightly away from the finisher (callout 1). Remove one screw (callout 2), and then slide the green knob away from the booklet maker to remove it (callout 3). Remove four screws (callout 4), and then remove the booklet front cover.

 **TIP:** Reverse the removal steps to install the assembly

Figure 5-1868 Remove five screws and the cover



Remove the booklet diverter home sensor (S40)

Follow these steps to remove the booklet diverter home sensor (S40).

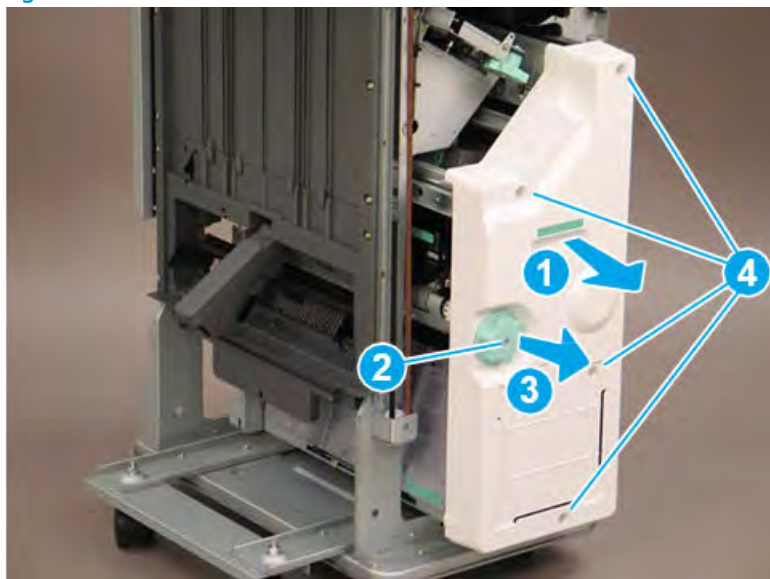
1. Remove three screws (callout 1)

Figure 5-1869 Remove three screws

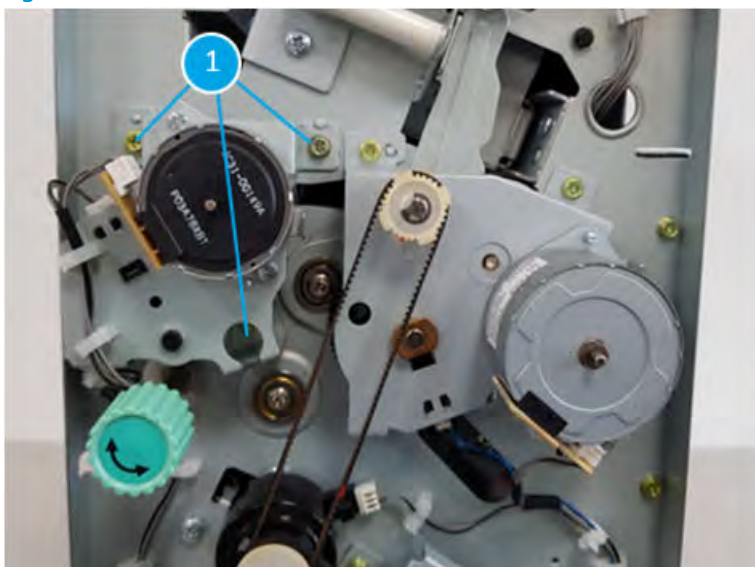

2. Unplug one connector (callout 1) and remove the booklet diverter home sensor (S40, callout 2)

Figure 5-1870 Remove the booklet diverter home sensor

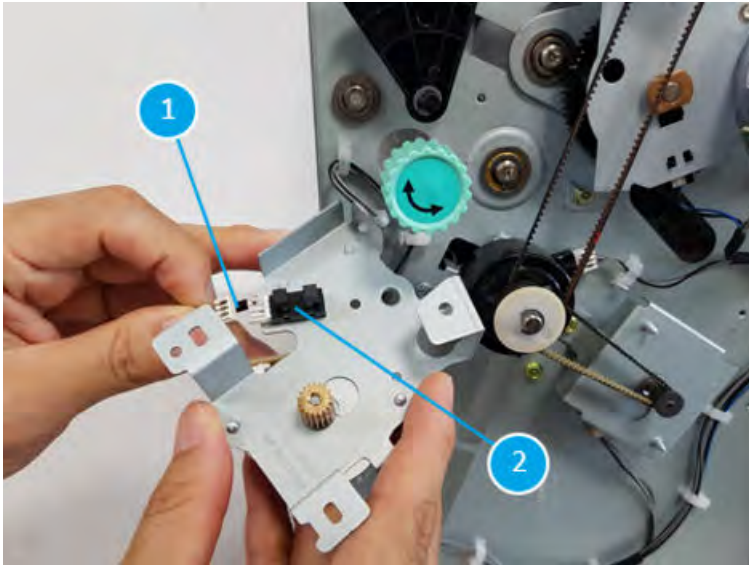

Unpack the replacement assembly



Follow these steps to unpack the replacement assembly.

1. Dispose of the defective part.

 **NOTE:** HP recommends responsible disposal of the defective part.

<http://www8.hp.com/us/en/hp-information/environment/product-recycling.html>

2. Unpack the replacement part from the packaging.

 **CAUTION:**  Some parts are sensitive to electrostatic discharge (ESD). Always perform service work at an ESD-protected workstation or mat. If an ESD workstation or mat is not available, touch the sheet-metal chassis to provide a static ground before touching an ESD-sensitive assembly. Protect the ESD-sensitive assemblies by placing them in ESD pouches when they are out of the printer.

 **IMPORTANT:** Make sure that all of the shipping materials (for example shipping tape) are removed from the replacement part prior to installation.

 **NOTE:** If the replacement part is a roller or pad, avoid touching the spongy part of it. Skin oils on the roller or pad can cause paper pickup and/or print-quality problems. HP recommends using disposable gloves when handling rollers or pads or washing your hands before touching rollers or pads.

3. To install an assembly, reverse the removal steps.

 **NOTE:** When applicable, special installation instructions are provided for an assembly at the end of the removal procedure. Always completely read the removal instructions and follow all special installation instructions.

Removal and replacement: Booklet diverter motor (M18)

Learn how to remove and replace the booklet diverter motor.

Introduction

This document provides the procedures to remove and replace the booklet diverter motor on the finisher.

 **IMPORTANT:** When applicable, special installation instructions are provided for an assembly at the end of the removal procedure. Always completely read the removal instructions and follow all special installation instructions.

Before performing service

- Turn the printer power off. A shutting-down message appears on the control-panel display.
- ⚠ **WARNING!** To avoid damage to the printer, turn the power off and wait until the printer shuts down before removing the power cable.
- Disconnect the printer power cable after the printer has completely shut down (the control-panel display is blank).
- Release the finisher from the printer by pulling out on the release latch inside the finisher door.
- Disconnect the cable from the bridge unit to the finisher.
- Disconnect the cable from the finisher to the printer.

Use the table below to identify the correct part number for your printer. To order the part, go to <https://parts.hp.com>.

Table 5-167 Part information

Part number	Part description
JC90-01397A	Booklet diverter motor assembly
JC93-01153A	Booklet diverter motor

Required tools

- #2 JIS screwdriver with a magnetic tip

After performing service

- Connect the cable from the finisher to the printer.
- Connect the cable from the bridge unit to the finisher.
- Attach the finisher to the printer, and then push in on the release latch inside the finisher door.
- Connect the printer power cable.
- Turn the printer power on.

Post service test

Process a job through the finisher and verify that the finisher works correctly.

Remove the booklet front cover

Follow these steps to remove the booklet front cover.

- ▲ Slide the booklet maker slightly away from the finisher (callout 1). Remove one screw (callout 2), and then slide the green knob away from the booklet maker to remove it (callout 3). Remove four screws (callout 4), and then remove the booklet front cover.

💡 **TIP:** Reverse the removal steps to install the assembly

Figure 5-1871 Remove five screws and the cover

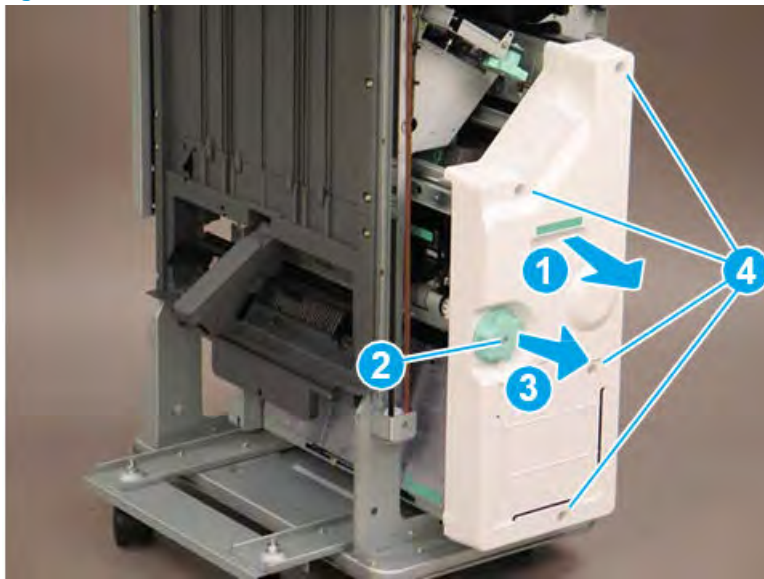

Remove the booklet diverter motor (M18)

Follow these steps to remove the booklet diverter motor (M18).

- ▲ Disconnect one connector (callout 1), remove two screws (callout 2), and then remove the booklet diverter motor.

💡 **TIP:** Reverse the removal steps to install the assembly.

Figure 5-1872 Remove the separate pawl motor

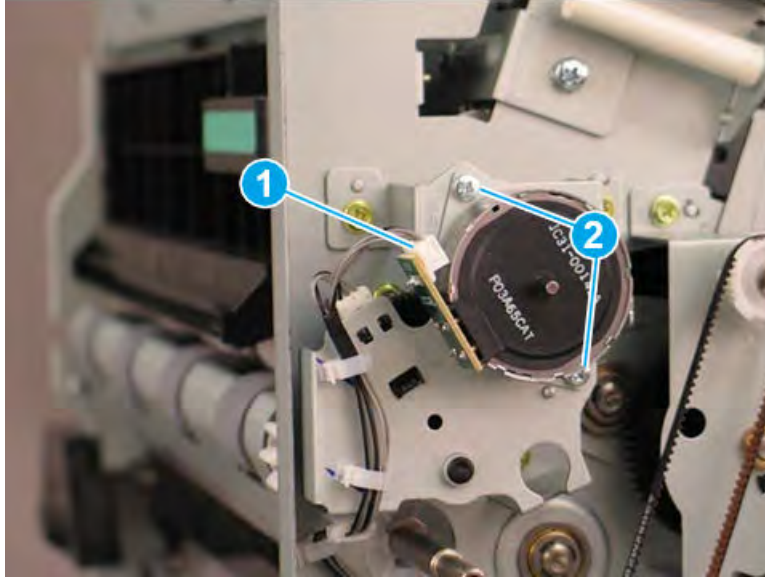

Unpack the replacement assembly



Follow these steps to unpack the replacement assembly.

1. Dispose of the defective part.

 **NOTE:** HP recommends responsible disposal of the defective part.

<http://www8.hp.com/us/en/hp-information/environment/product-recycling.html>

2. Unpack the replacement part from the packaging.

 **CAUTION:**  Some parts are sensitive to electrostatic discharge (ESD). Always perform service work at an ESD-protected workstation or mat. If an ESD workstation or mat is not available, touch the sheet-metal chassis to provide a static ground before touching an ESD-sensitive assembly. Protect the ESD-sensitive assemblies by placing them in ESD pouches when they are out of the printer.

 **IMPORTANT:** Make sure that all of the shipping materials (for example shipping tape) are removed from the replacement part prior to installation.

 **NOTE:** If the replacement part is a roller or pad, avoid touching the spongy part of it. Skin oils on the roller or pad can cause paper pickup and/or print-quality problems. HP recommends using disposable gloves when handling rollers or pads or washing your hands before touching rollers or pads.

3. To install an assembly, reverse the removal steps.

 **NOTE:** When applicable, special installation instructions are provided for an assembly at the end of the removal procedure. Always completely read the removal instructions and follow all special installation instructions.

Booklet exit unit

Removal and replacement: Booklet exit sensor (S44)

Learn how to remove and replace the tray booklet exit sensor.

Introduction

This document provides the procedures to remove and replace the booklet exit sensor on the finisher.

 **IMPORTANT:** When applicable, special installation instructions are provided for an assembly at the end of the removal procedure. Always completely read the removal instructions and follow all special installation instructions.

Before performing service

- Turn the printer power off. A shutting-down message appears on the control-panel display.
- ⚠ **WARNING!** To avoid damage to the printer, turn the power off and wait until the printer shuts down before removing the power cable.
- Disconnect the printer power cable after the printer has completely shut down (the control-panel display is blank).
- Release the finisher from the printer by pulling out on the release latch inside the finisher door.
- Disconnect the cable from the bridge unit to the finisher.
- Disconnect the cable from the finisher to the printer.

Use the table below to identify the correct part number for your printer. To order the part, go to <https://parts.hp.com>.

Table 5-168 Part information

Part number	Part description
JC32-00020A	Booklet exit sensor

Required tools

- #2 JIS screwdriver with a magnetic tip

After performing service

- Connect the cable from the finisher to the printer.
- Connect the cable from the bridge unit to the finisher.
- Attach the finisher to the printer, and then push in on the release latch inside the finisher door.
- Connect the printer power cable.
- Turn the printer power on.

Post service test

Process a job through the finisher and verify that the finisher works correctly.

Remove the right upper cover (finisher)

Follow these steps to remove the right upper cover (finisher).

- ▲ Remove one screw cap and three machine screws on the upper edge of the cover (callout 1). Remove three sheet metal screws (callout 2) on the lower portion of the cover. Rotate the right edge of the cover away from the finisher, and then slide the cover right to release three tabs (callout 3).

💡 **TIP:** The lower screws are shorter in length than the upper screws.

TIP: Reverse the removal steps to install the assembly.

Figure 5-1873 Remove the right upper cover

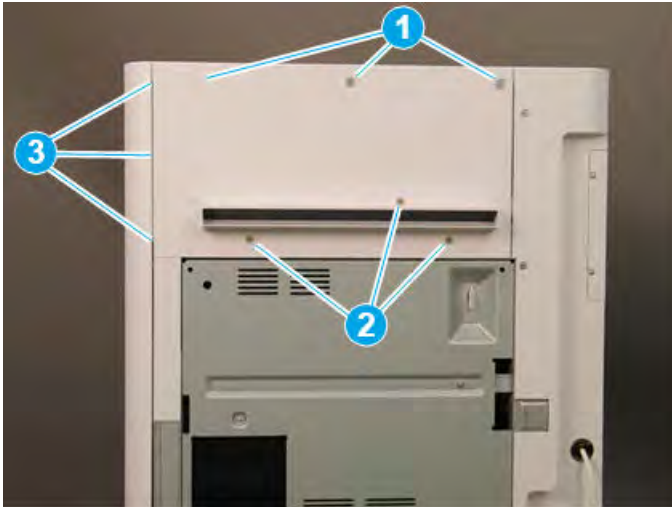

Remove the top cover (finisher)

Follow these steps to remove the top cover (finisher).

1. Remove three screw caps and three self-tapping screws at the top of the rear cover (callout 1), and then remove three machine screws (callout 2) on top of the cover.

Figure 5-1874 Remove six screws

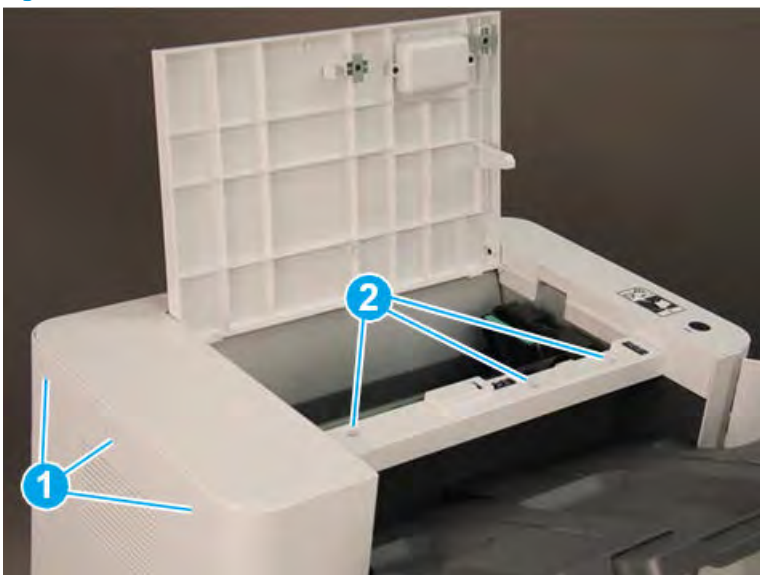

2. Remove three self-tapping screws at the top of the front cover (callout 1), and then remove two machine screws (callout 2) at the top of the right side.

Figure 5-1875 Remove five screws

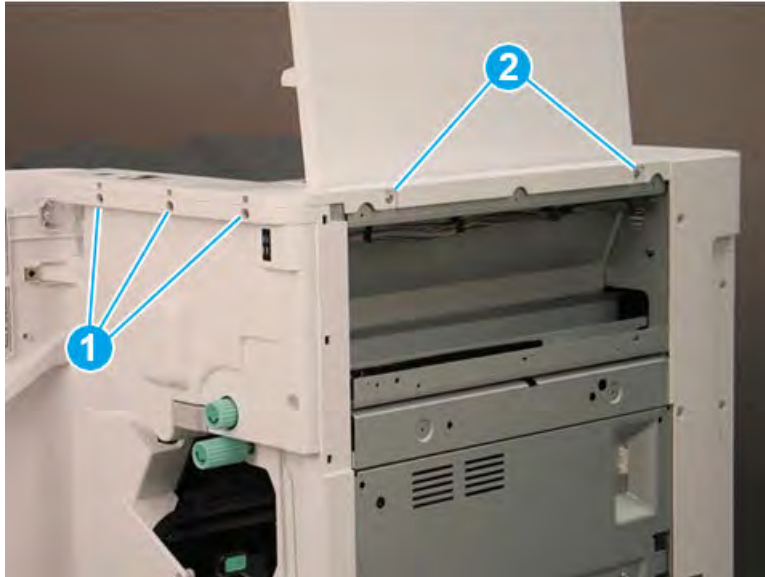

3. Lift the cover up slightly. Disconnect one in-line connector (callout 1), and then release one retainer (callout 2).

 **TIP:** Reverse the removal steps to install the assembly.

Figure 5-1876 Disconnect one connector and release retainer



Remove the rear cover (finisher)

Follow these steps to remove the rear cover (finisher).

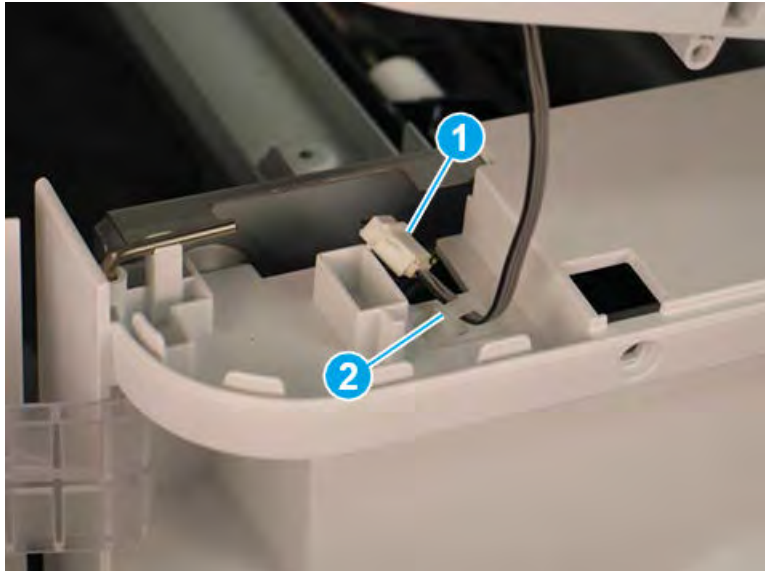
1. Remove two self-tapping screws (callout 1) on the top of the rear cover, and then remove five screw caps and five machine screws (callout 2) on the left side of the cover.

Figure 5-1877 Remove seven screws

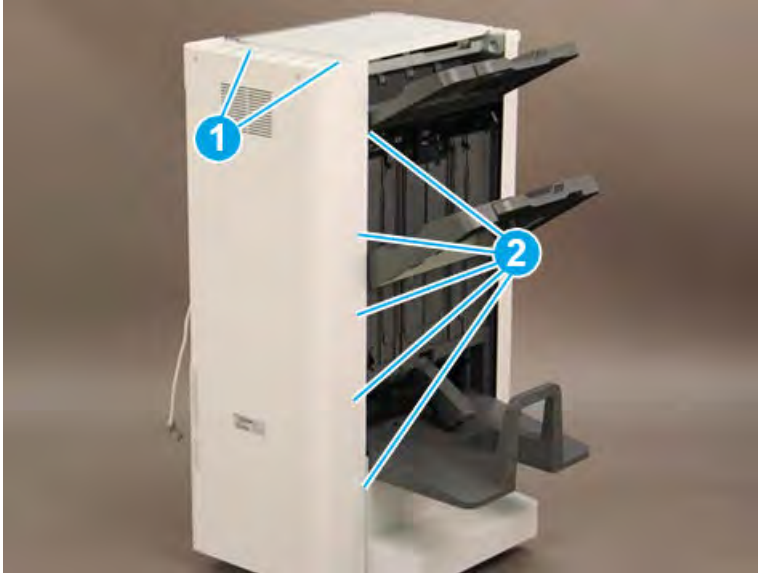

2. Remove one screw cap and four machine screws (callout 1) Remove the rear cover.

 **NOTE:** Make sure to thread the power cable (callout 2) through the opening in the cover.

 **TIP:** Reverse the removal steps to install the assembly

Figure 5-1878 Remove the rear cover



Remove the booklet maker

Follow these steps to remove the booklet maker.

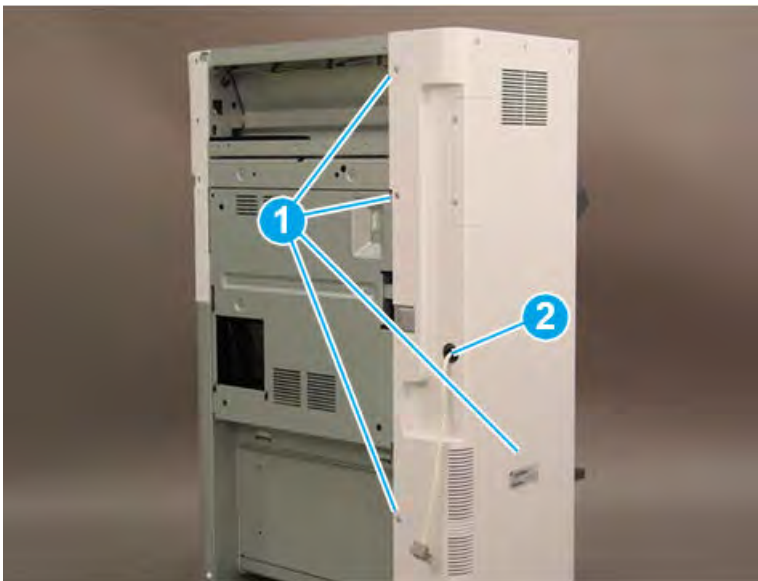
1. Slide the booklet maker away from the finisher.

Figure 5-1879 Slide the booklet maker away from the finisher



2. At the Disconnect one connector (callout 1), and then remove one screw (callout 2).

Figure 5-1880 Disconnect one connector and remove one screw

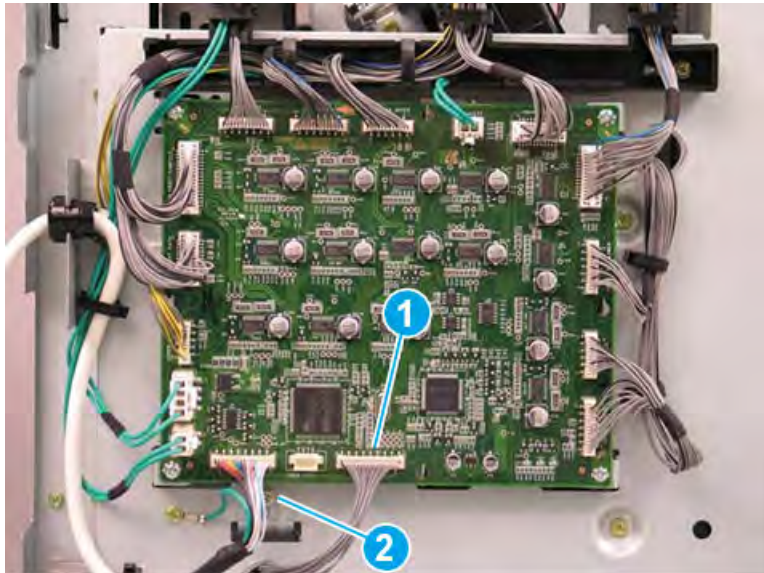

3. Release the metal bracket through the opening in the sheet metal.

Figure 5-1881 Release the metal bracket

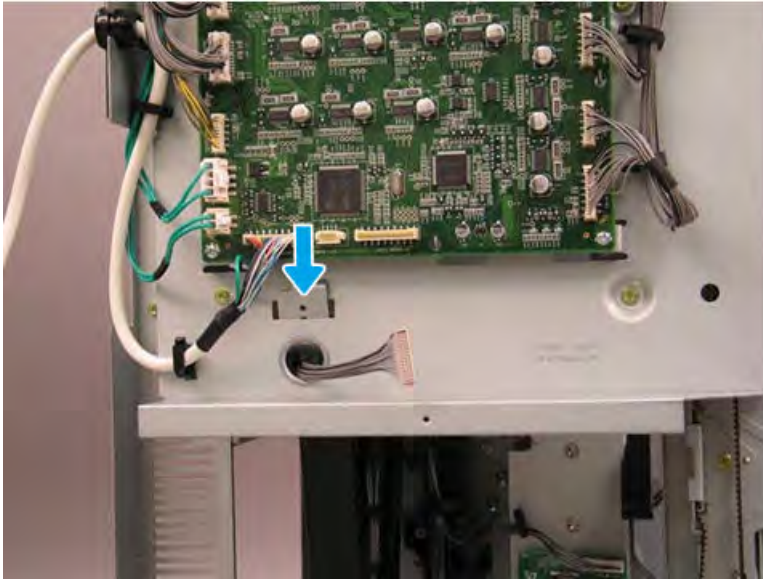

4. Remove one star-washer screw (callout 1), and then release the alignment pin (callout 2) on the right side of the booklet maker.

Figure 5-1882 Remove one screw

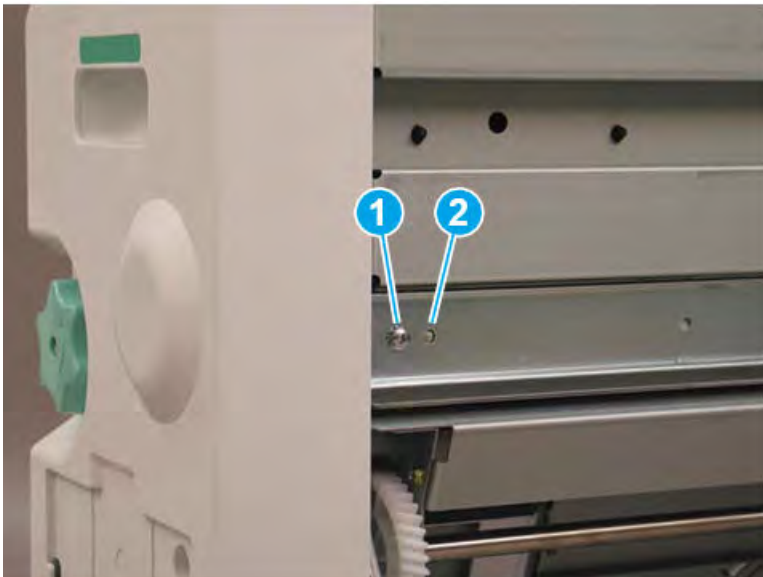

5. Slide the right rail toward the finisher.

Figure 5-1883 Slide the right rail

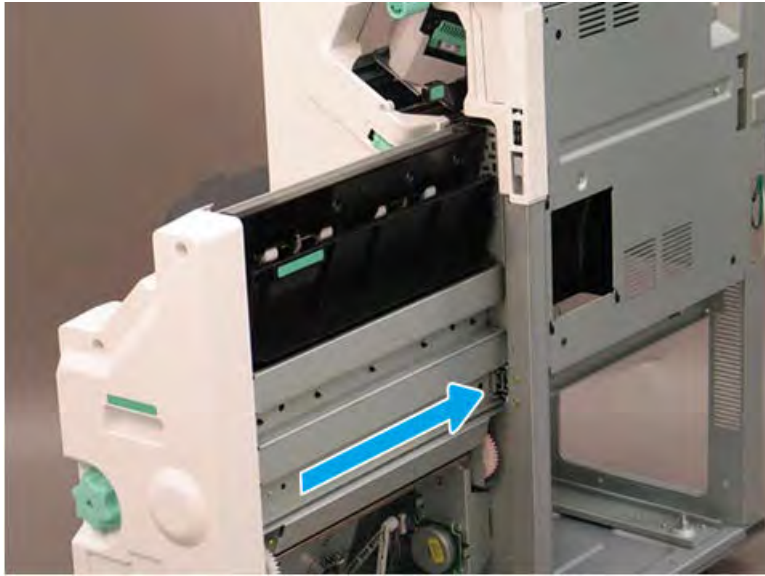

6. Remove one star-washer screw (callout 1) on the left side of the booklet maker.

Figure 5-1884 Remove one screw

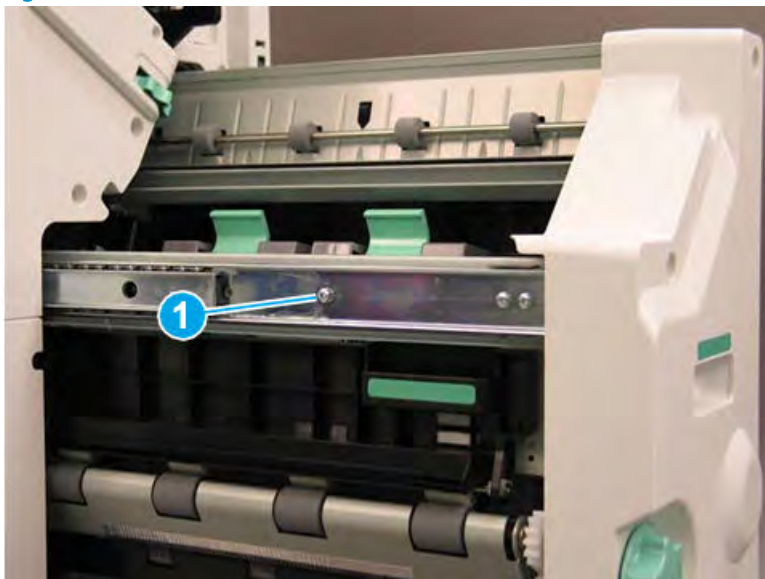

7. Lift the booklet maker up on the left side while squeezing the right rail away from the finisher slightly to clear the sheet metal. Remove the booklet maker.

Figure 5-1885 Remove the booklet maker

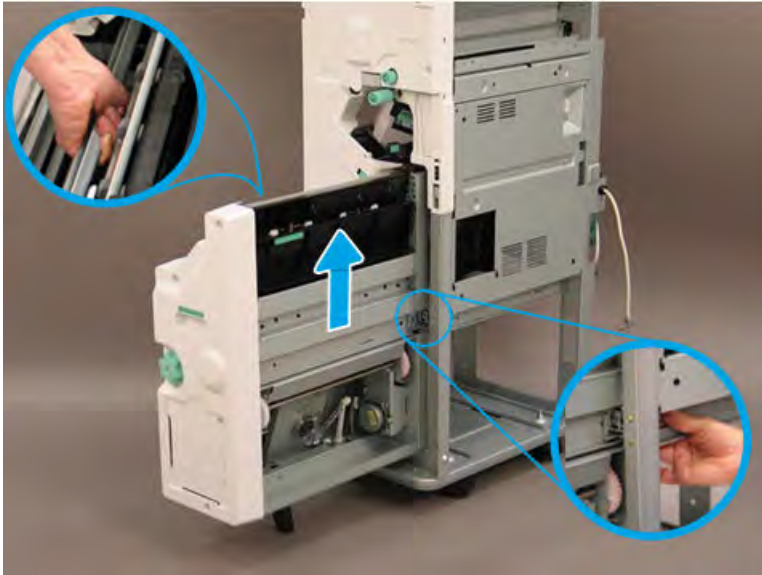

8. Reverse the removal steps to install the assembly. Also use the following special installation instructions.

 **NOTE:** Continue to reverse the removal steps to finish installing the assembly.

Special installation instructions: booklet maker

When installing the booklet maker, position the hooks on the rail under the slots on the booklet maker.

Figure 5-1886 Position the hooks

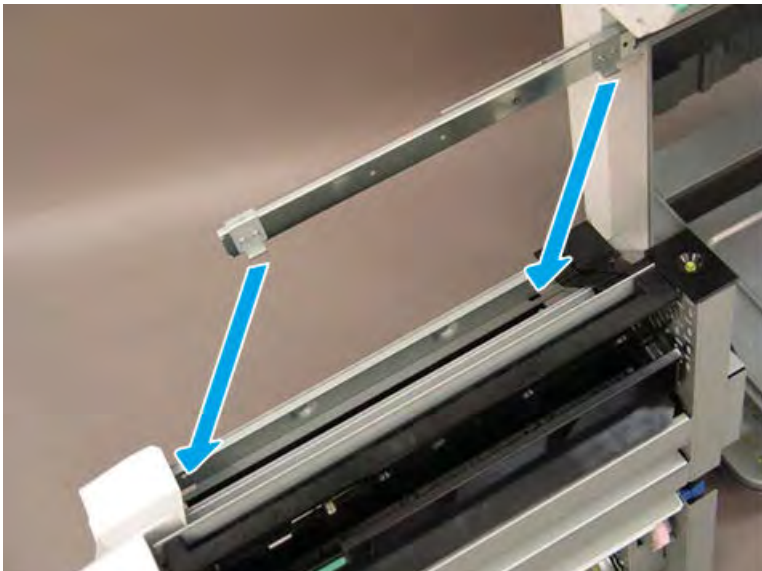

9. When installed correctly, the arrow on the front of the booklet maker aligns with the arrow on the finisher rail.

Figure 5-1887 Align arrows



10. When installed correctly, the arrow on the back of the booklet maker aligns with the arrow on the finisher rail.

Figure 5-1888 Align arrows

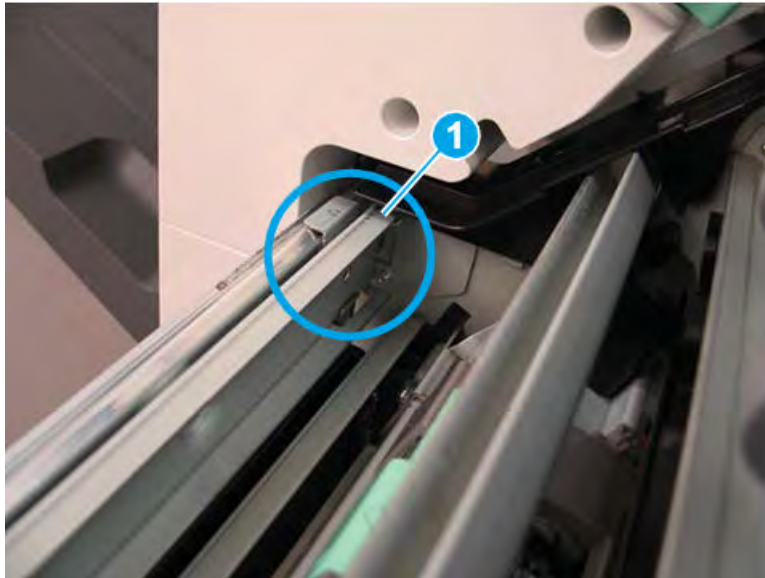

11. Extend the right rail away from the finisher and position it in the booklet maker slot.

Figure 5-1889 Extend the right rail



Remove the booklet front cover

Follow these steps to remove the booklet front cover.

- ▲ Slide the booklet maker slightly away from the finisher (callout 1). Remove one screw (callout 2), and then slide the green knob away from the booklet maker to remove it (callout 3). Remove four screws (callout 4), and then remove the booklet front cover.

 **TIP:** Reverse the removal steps to install the assembly

Figure 5-1890 Remove five screws and the cover

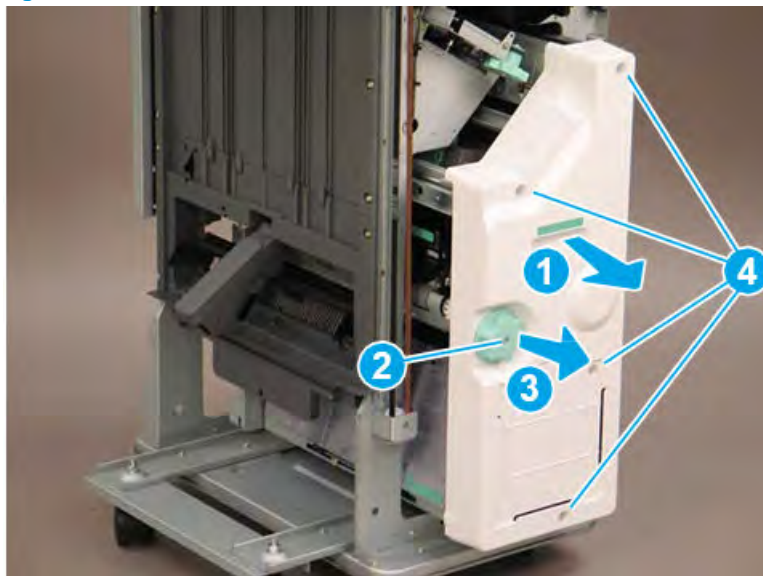

Remove the Booklet c-fold blade unit

Follow these steps to remove the Booklet c-fold blade unit.

1. Remove two screws(callout 1) at the left of the booklet maker

Figure 5-1891 Remove two screws at the left of the booklet maker

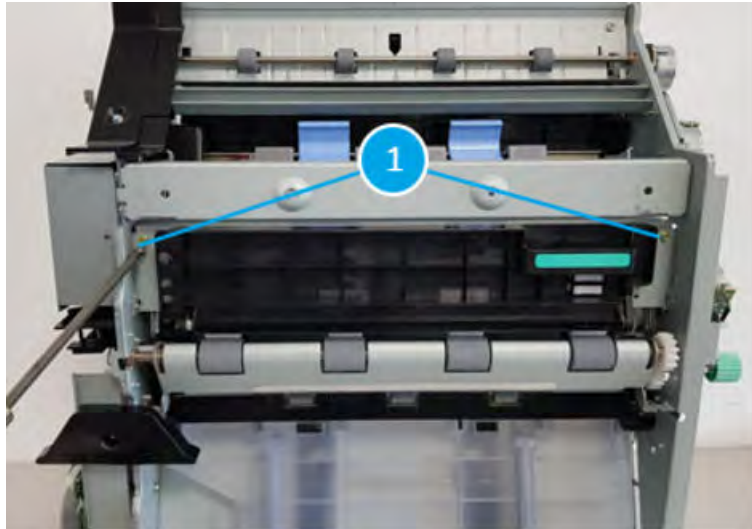

2. Remove three screws(callout 1) at the front of the booklet maker to remove motor unit(callout 2) to reach out to the screw.

Figure 5-1892 Remove three screws to remove motor unit to reach out to the screw

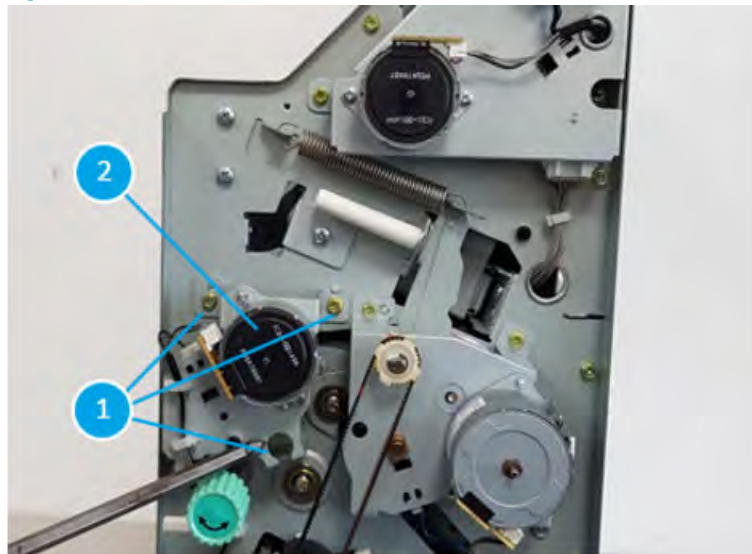

3. Remove one screw(callout 1) at the front of the booklet maker.

Figure 5-1893 Remove one screw at the front of the booklet maker



4. Remove one screw(callout 1) at the rear of the booklet maker.

Figure 5-1894 Remove one screw at the rear of the booklet maker

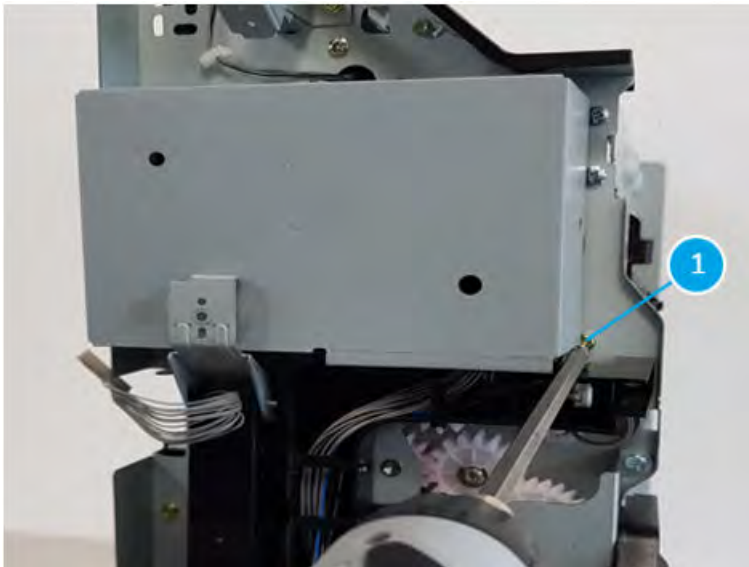

5. Take the booklet c-fold blade unit out from the booklet maker.

Figure 5-1895 Take the booklet c-fold blade unit out from the booklet maker

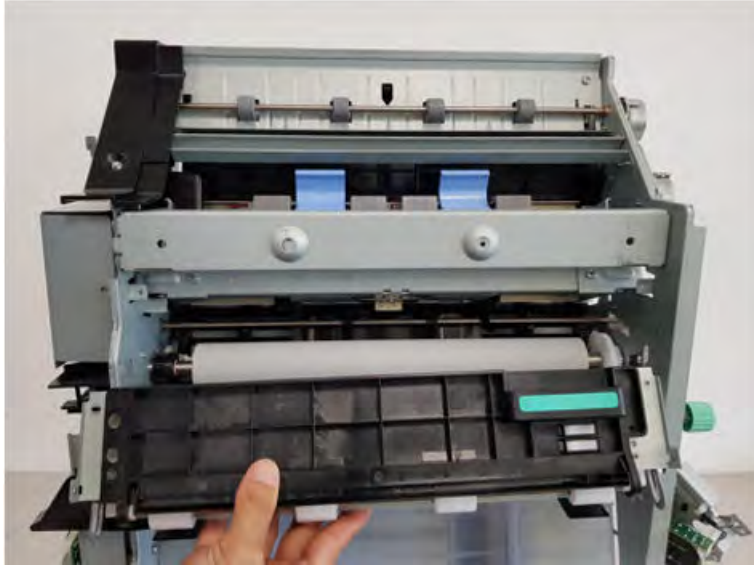

Remove the booklet diverter

Follow these steps to remove the booklet diverter.

1. Remove two screws (callout 1) at the rear of the booklet maker and remove the PCA cover (callout 2).

Figure 5-1896 Remove two screws at the rear of the booklet maker and remove the PCA cover

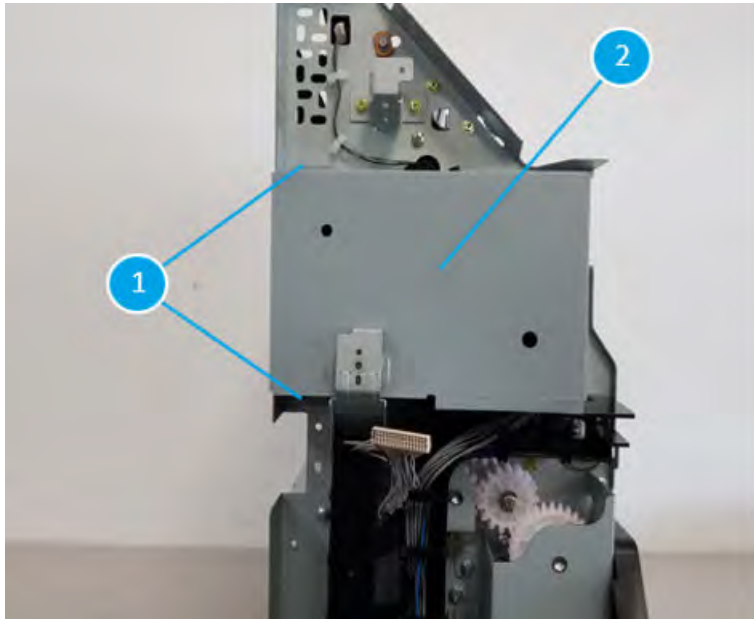

2. Remove one screw(callout 1) at the rear of the booklet maker to make it easy to disconnect the connector.

Figure 5-1897 Remove one screw at the rear of the booklet maker

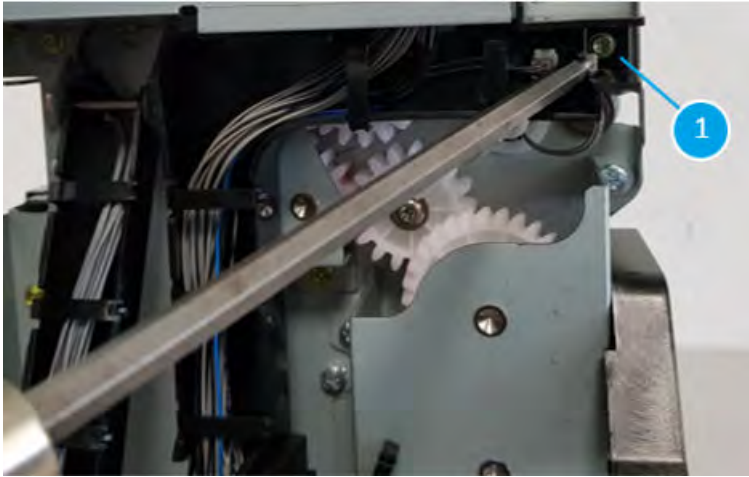

3. Pull the connector cover (callout 1) and disconnect the one connector (callout 2)

Figure 5-1898 Pull the connector cover and disconnect the one connector

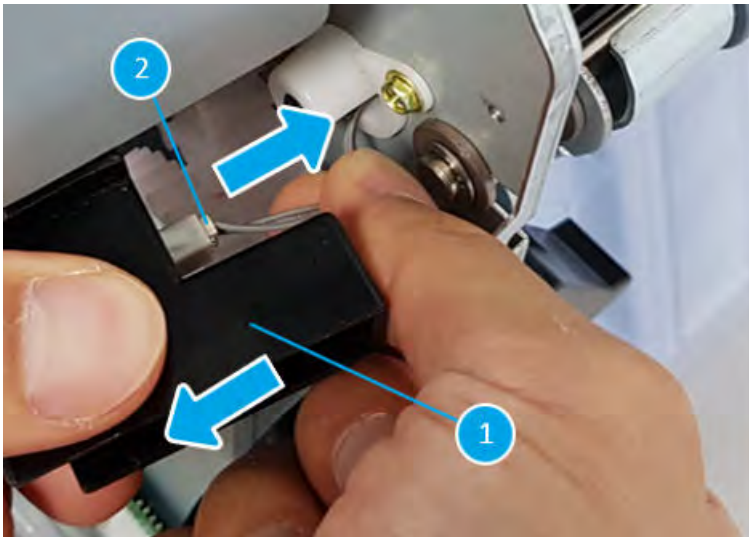

4. Remove two screws(callout 1)

Figure 5-1899 Remove two screws

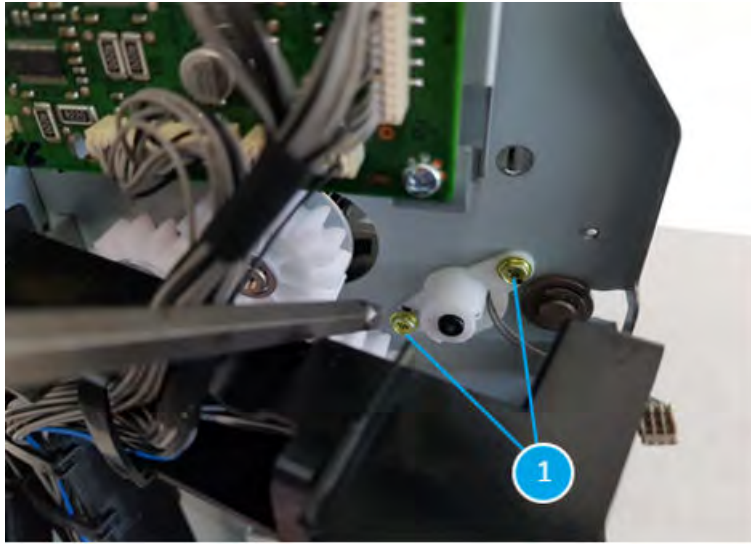

5. Remove the white bush

Figure 5-1900 Remove the white bush

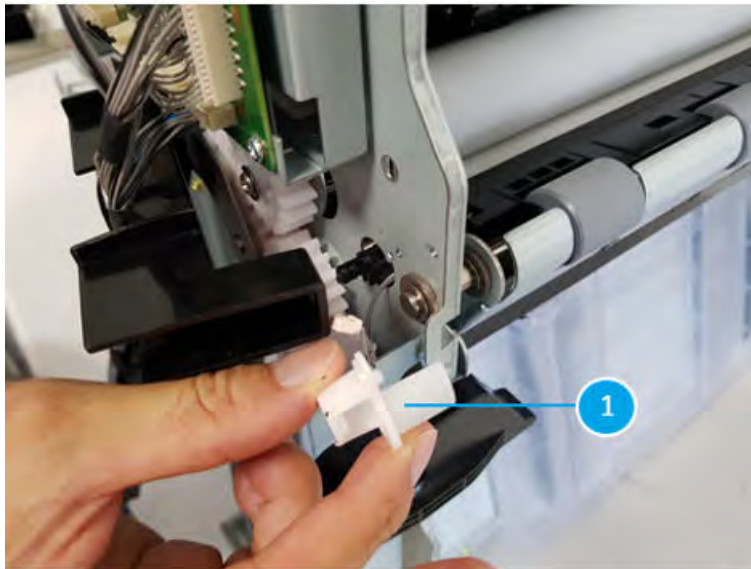

6. Remove one e-clip on top of the black actuator (callout 1) and remove the black actuator and make sure not to lose the pin (callout 2) when you pull out the black actuator.

Figure 5-1901 Remove one e-clip on top of the black actuator (callout 1) and remove the black actuator

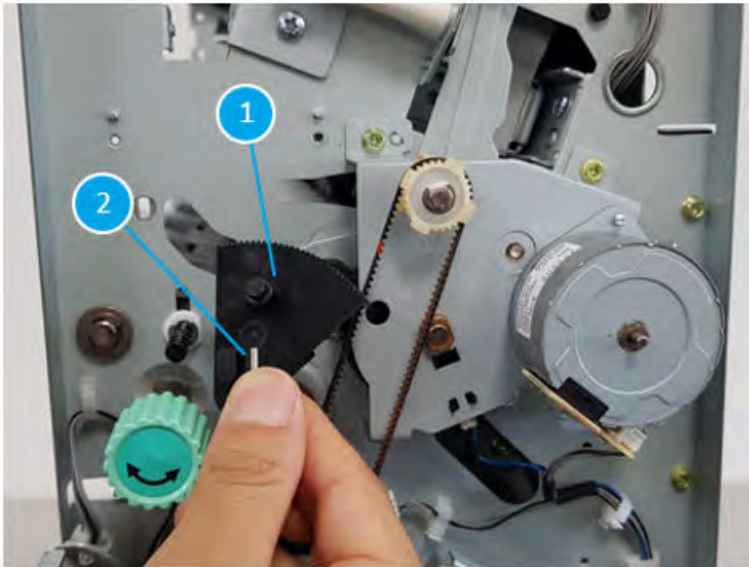

7. Remove the white bush (callout 1).

Figure 5-1902 Remove the white bush

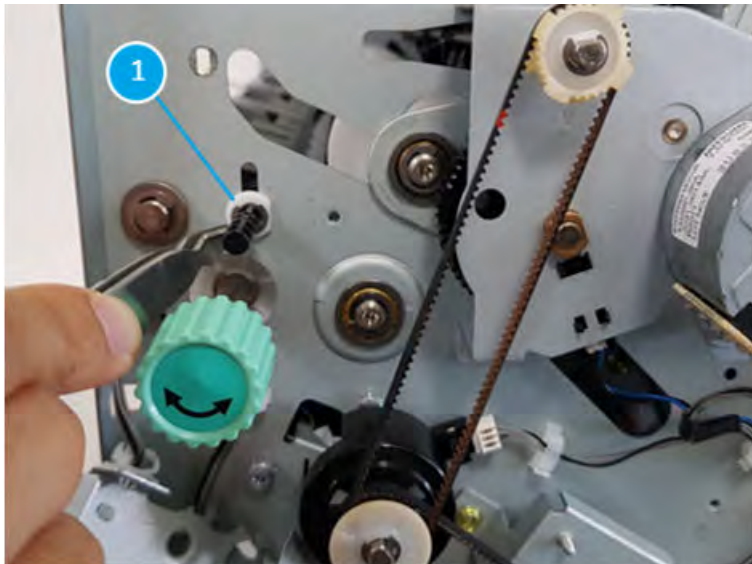

8. Pull the booklet diverter out from the booklet maker.

Figure 5-1903 Pull the booklet diverter out from the booklet maker

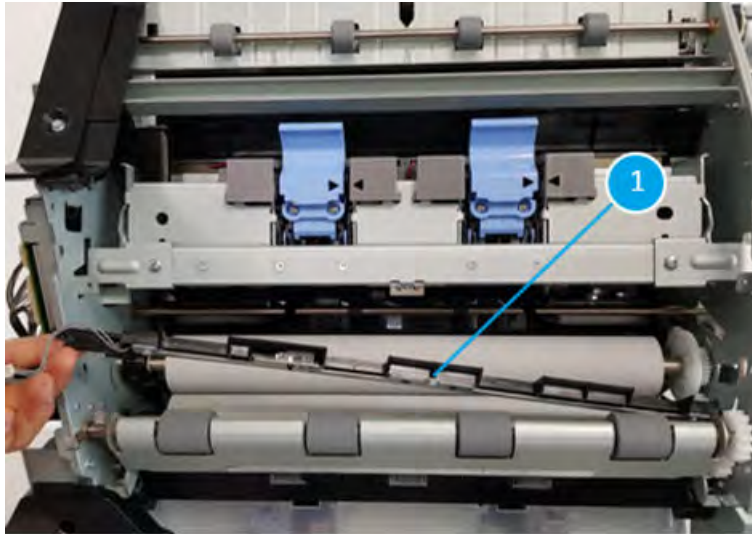

Remove the booklet exit sensor (S44)

Follow these steps to remove the booklet exit sensor (S44).

1. Remove three screws (callout 1)

Figure 5-1904 Remove three screws

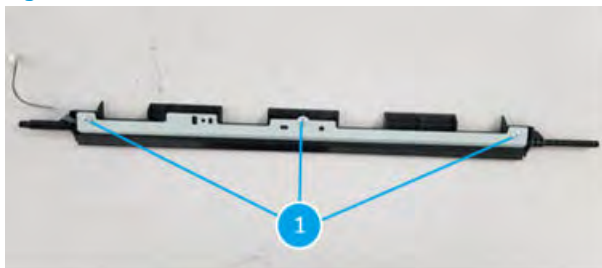

2. Unplug one connector (callout 1)

Figure 5-1905 Unplug one connector



3. Remove the booklet exit sensor (S44, callout 1)

Figure 5-1906 Remove the booklet exit sensor



Unpack the replacement assembly

Follow these steps to unpack the replacement assembly.

1. Dispose of the defective part.



NOTE: HP recommends responsible disposal of the defective part.

<http://www8.hp.com/us/en/hp-information/environment/product-recycling.html>

2. Unpack the replacement part from the packaging.



CAUTION:  Some parts are sensitive to electrostatic discharge (ESD). Always perform service work at an ESD-protected workstation or mat. If an ESD workstation or mat is not available, touch the sheet-metal chassis to provide a static ground before touching an ESD-sensitive assembly. Protect the ESD-sensitive assemblies by placing them in ESD pouches when they are out of the printer.



IMPORTANT: Make sure that all of the shipping materials (for example shipping tape) are removed from the replacement part prior to installation.



NOTE: If the replacement part is a roller or pad, avoid touching the spongy part of it. Skin oils on the roller or pad can cause paper pickup and/or print-quality problems. HP recommends using disposable gloves when handling rollers or pads or washing your hands before touching rollers or pads.

3. To install an assembly, reverse the removal steps.



NOTE: When applicable, special installation instructions are provided for an assembly at the end of the removal procedure. Always completely read the removal instructions and follow all special installation instructions.

Booklet output tray unit

Removal and replacement: Booklet output tray

Learn how to remove and replace the booklet output tray.

Introduction

This document provides the procedures to remove and replace the booklet output tray on the finisher.



IMPORTANT: When applicable, special installation instructions are provided for an assembly at the end of the removal procedure. Always completely read the removal instructions and follow all special installation instructions.

Before performing service

- Turn the printer power off. A shutting-down message appears on the control-panel display.
- ⚠ **WARNING!** To avoid damage to the printer, turn the power off and wait until the printer shuts down before removing the power cable.
- Disconnect the printer power cable after the printer has completely shut down (the control-panel display is blank).
- Release the finisher from the printer by pulling out on the release latch inside the finisher door.
- Disconnect the cable from the bridge unit to the finisher.
- Disconnect the cable from the finisher to the printer.

Use the table below to identify the correct part number for your printer. To order the part, go to <https://parts.hp.com>.

Table 5-169 Part information

Part number	Part description
JC61-07253B	Booklet output tray
JC63-04978B	Booklet output tray cover

Required tools

- #2 JIS screwdriver with a magnetic tip

After performing service

- Connect the cable from the finisher to the printer.
- Connect the cable from the bridge unit to the finisher.
- Attach the finisher to the printer, and then push in on the release latch inside the finisher door.
- Connect the printer power cable.
- Turn the printer power on.

Post service test

Process a job through the finisher and verify that the finisher works correctly.

Remove the booklet output tray

Follow these steps to remove the booklet output tray.

1. Raise the booklet output tray up (callout 1), and then pull it away from the finisher (callout 2) to remove it.

Figure 5-1907 Remove the booklet output tray

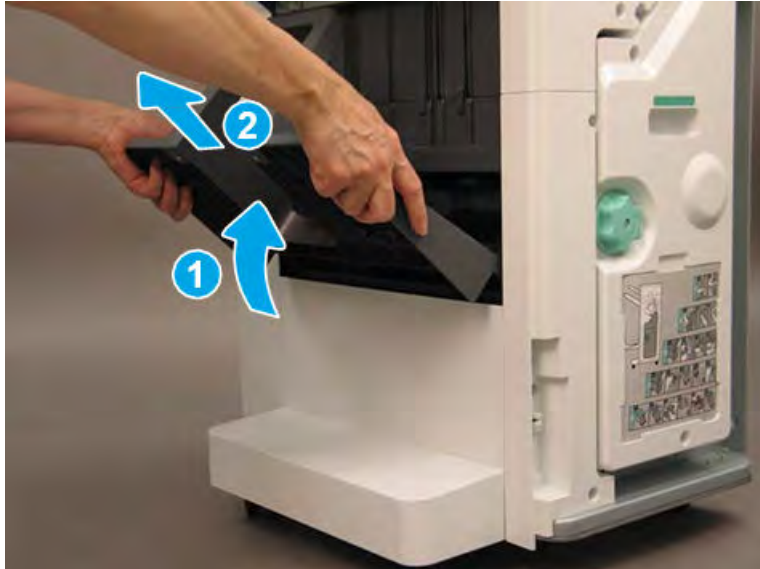

2. Reverse the removal steps to install the assembly. Also use the following special installation instructions.

 **NOTE:** Continue to reverse the removal steps to finish installing the assembly

Special installation instructions: booklet output tray

Position the tabs (callout 1) on the tray into the slots (callout 2) on the finisher.

Figure 5-1908 Install the booklet output tray

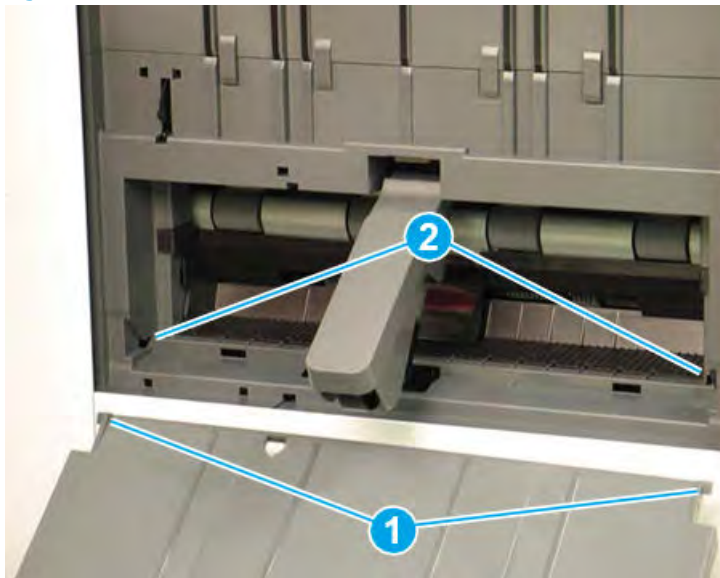

Unpack the replacement assembly



Follow these steps to unpack the replacement assembly.

1. Dispose of the defective part.

 **NOTE:** HP recommends responsible disposal of the defective part.

<http://www8.hp.com/us/en/hp-information/environment/product-recycling.html>

2. Unpack the replacement part from the packaging.

 **CAUTION:**  Some parts are sensitive to electrostatic discharge (ESD). Always perform service work at an ESD-protected workstation or mat. If an ESD workstation or mat is not available, touch the sheet-metal chassis to provide a static ground before touching an ESD-sensitive assembly. Protect the ESD-sensitive assemblies by placing them in ESD pouches when they are out of the printer.

 **IMPORTANT:** Make sure that all of the shipping materials (for example shipping tape) are removed from the replacement part prior to installation.

 **NOTE:** If the replacement part is a roller or pad, avoid touching the spongy part of it. Skin oils on the roller or pad can cause paper pickup and/or print-quality problems. HP recommends using disposable gloves when handling rollers or pads or washing your hands before touching rollers or pads.

3. To install an assembly, reverse the removal steps.

 **NOTE:** When applicable, special installation instructions are provided for an assembly at the end of the removal procedure. Always completely read the removal instructions and follow all special installation instructions.

PCA

Removal and replacement: Main PCA

Learn how to remove and replace the main PCA.

Introduction

This document provides the procedures to remove and replace the main PCA on the finisher.



IMPORTANT: When applicable, special installation instructions are provided for an assembly at the end of the removal procedure. Always completely read the removal instructions and follow all special installation instructions.

Before performing service

- Turn the printer power off. A shutting-down message appears on the control-panel display.
- ⚠ **WARNING!** To avoid damage to the printer, turn the power off and wait until the printer shuts down before removing the power cable.
- Disconnect the printer power cable after the printer has completely shut down (the control-panel display is blank).
- Release the finisher from the printer by pulling out on the release latch inside the finisher door.
- Disconnect the cable from the bridge unit to the finisher.
- Disconnect the cable from the finisher to the printer.

Use the table below to identify the correct part number for your printer. To order the part, go to <https://parts.hp.com>.

Table 5-170 Part information

Part number	Part description
JC92-02968A	Finisher mainPCA

Required tools

- #2 JIS screwdriver with a magnetic tip

After performing service

- Connect the cable from the finisher to the printer.
- Connect the cable from the bridge unit to the finisher.
- Attach the finisher to the printer, and then push in on the release latch inside the finisher door.
- Connect the printer power cable.
- Turn the printer power on.

Post service test

Process a job through the finisher and verify that the finisher works correctly.

Remove the right upper cover (finisher)

Follow these steps to remove the right upper cover (finisher).

- ▲ Remove one screw cap and three machine screws on the upper edge of the cover (callout 1). Remove three sheet metal screws (callout 2) on the lower portion of the cover. Rotate the right edge of the cover away from the finisher, and then slide the cover right to release three tabs (callout 3).

💡 **TIP:** The lower screws are shorter in length than the upper screws.

TIP: Reverse the removal steps to install the assembly.

Figure 5-1909 Remove the right upper cover

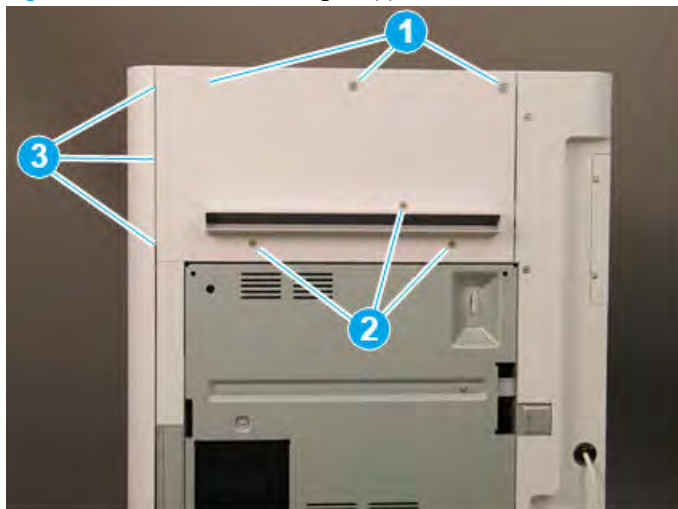

Remove the top cover (finisher)

Follow these steps to remove the top cover (finisher).

1. Remove three screw caps and three self-tapping screws at the top of the rear cover (callout 1), and then remove three machine screws (callout 2) on top of the cover.

Figure 5-1910 Remove six screws

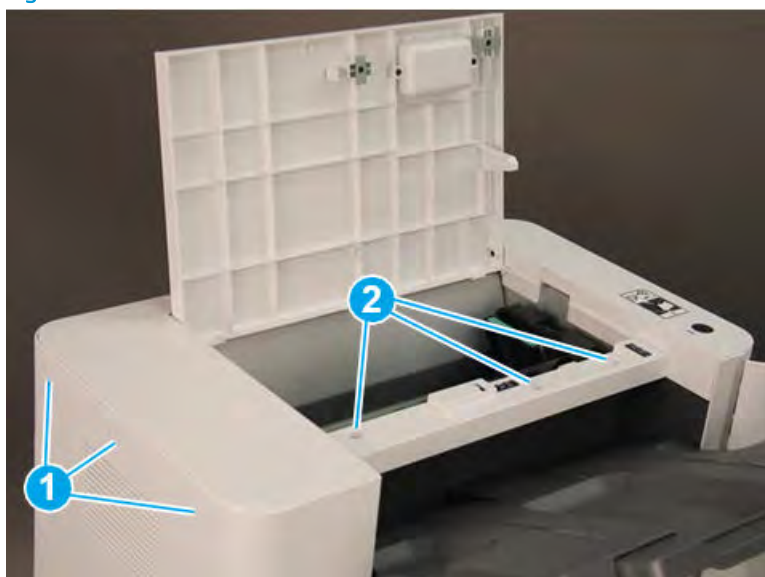

2. Remove three self-tapping screws at the top of the front cover (callout 1), and then remove two machine screws (callout 2) at the top of the right side.

Figure 5-1911 Remove five screws

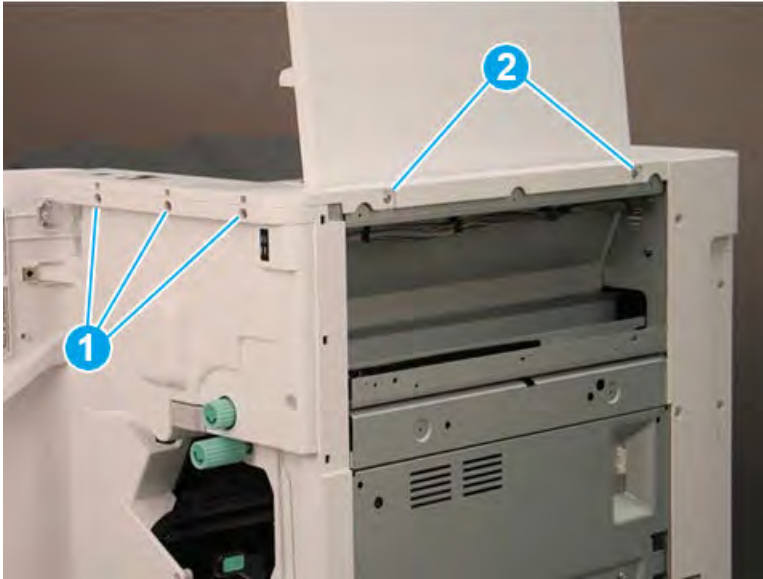

3. Lift the cover up slightly. Disconnect one in-line connector (callout 1), and then release one retainer (callout 2).

 **TIP:** Reverse the removal steps to install the assembly.

Figure 5-1912 Disconnect one connector and release retainer

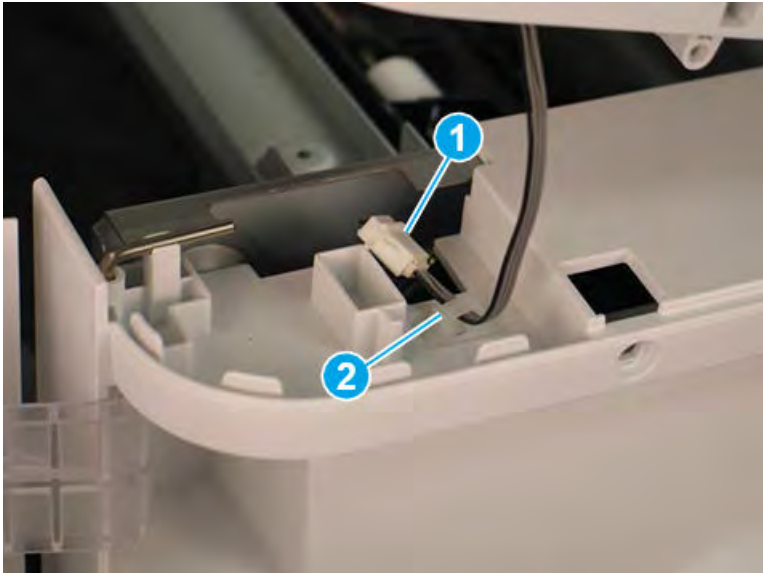

Remove the rear cover (finisher)

Follow these steps to remove the rear cover (finisher).

1. Remove two self-tapping screws (callout 1) on the top of the rear cover, and then remove five screw caps and five machine screws (callout 2) on the left side of the cover.

Figure 5-1913 Remove seven screws

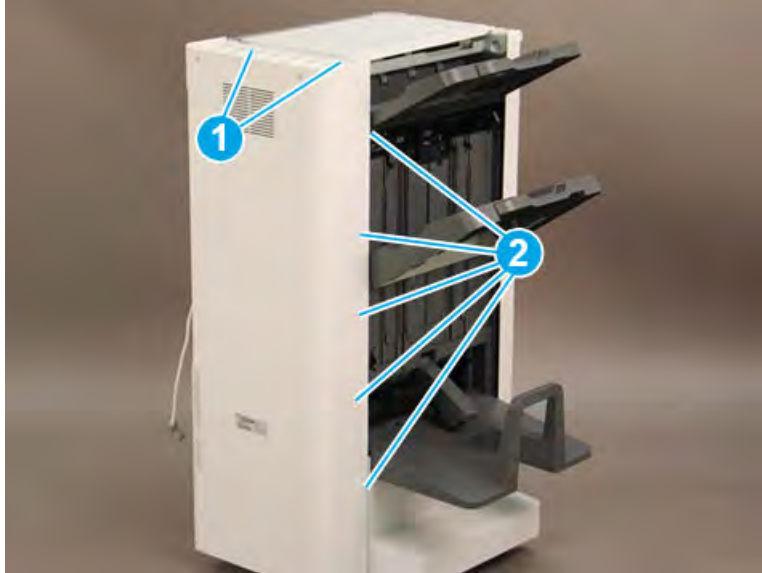

2. Remove one screw cap and four machine screws (callout 1) Remove the rear cover.

 **NOTE:** Make sure to thread the power cable (callout 2) through the opening in the cover.

 **TIP:** Reverse the removal steps to install the assembly

Figure 5-1914 Remove the rear cover



Remove the controller PCA

Follow these steps to remove the controller PCA.

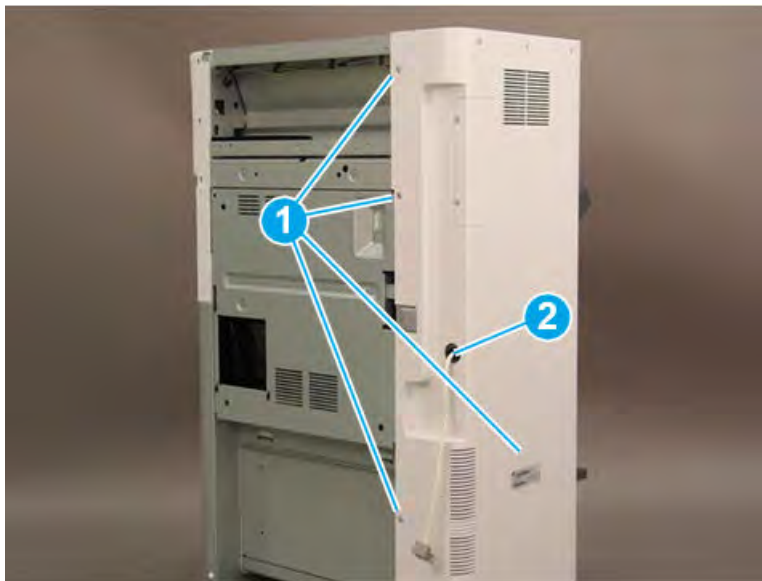
- ▲ Disconnect all of the connectors, remove four screws (callout 1), and then remove the controller PCA.

 **TIP:** Refer to the figure below for correct positioning and connection of the cables.

TIP: Reverse the removal steps to install the assembly.

Figure 5-1915 Remove the controller PCA

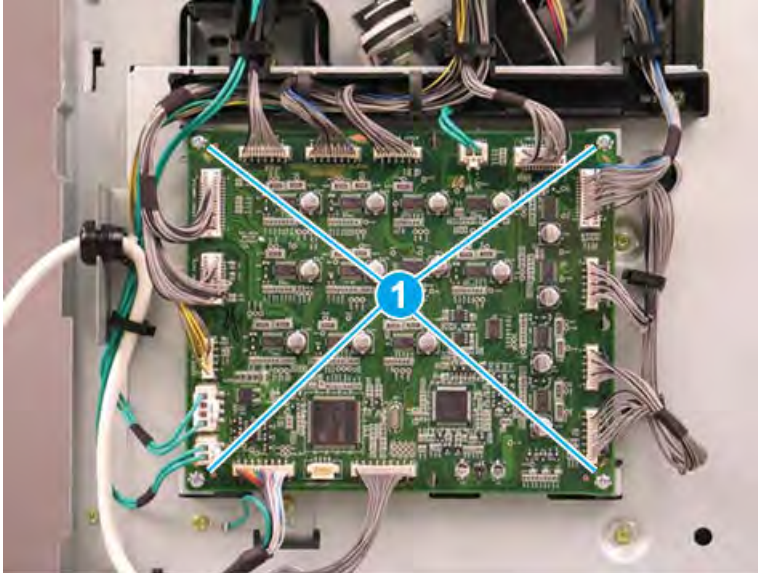

Unpack the replacement assembly



Follow these steps to unpack the replacement assembly.

1. Dispose of the defective part.

 **NOTE:** HP recommends responsible disposal of the defective part.

<http://www8.hp.com/us/en/hp-information/environment/product-recycling.html>

2. Unpack the replacement part from the packaging.

 **CAUTION:**  Some parts are sensitive to electrostatic discharge (ESD). Always perform service work at an ESD-protected workstation or mat. If an ESD workstation or mat is not available, touch the sheet-metal chassis to provide a static ground before touching an ESD-sensitive assembly. Protect the ESD-sensitive assemblies by placing them in ESD pouches when they are out of the printer.

 **IMPORTANT:** Make sure that all of the shipping materials (for example shipping tape) are removed from the replacement part prior to installation.

 **NOTE:** If the replacement part is a roller or pad, avoid touching the spongy part of it. Skin oils on the roller or pad can cause paper pickup and/or print-quality problems. HP recommends using disposable gloves when handling rollers or pads or washing your hands before touching rollers or pads.

3. To install an assembly, reverse the removal steps.

 **NOTE:** When applicable, special installation instructions are provided for an assembly at the end of the removal procedure. Always completely read the removal instructions and follow all special installation instructions.

Removal and replacement: Booklet finisher PCA

Learn how to remove and replace the booklet maker PCA.

Introduction

This document provides the procedures to remove and replace the booklet maker PCA on the finisher.



IMPORTANT: When applicable, special installation instructions are provided for an assembly at the end of the removal procedure. Always completely read the removal instructions and follow all special installation instructions.

Before performing service

- Turn the printer power off. A shutting-down message appears on the control-panel display.
- ⚠ **WARNING!** To avoid damage to the printer, turn the power off and wait until the printer shuts down before removing the power cable.
- Disconnect the printer power cable after the printer has completely shut down (the control-panel display is blank).
- Release the finisher from the printer by pulling out on the release latch inside the finisher door.
- Disconnect the cable from the bridge unit to the finisher.
- Disconnect the cable from the finisher to the printer.

Use the table below to identify the correct part number for your printer. To order the part, go to <https://parts.hp.com>.

Table 5-171 Part information

Part number	Part description
JC92-02789B	Booklet finisher PCA

Required tools

- #2 JIS screwdriver with a magnetic tip

After performing service

- Connect the cable from the finisher to the printer.
- Connect the cable from the bridge unit to the finisher.
- Attach the finisher to the printer, and then push in on the release latch inside the finisher door.
- Connect the printer power cable.
- Turn the printer power on.

Post service test

Process a job through the finisher and verify that the finisher works correctly.

Remove the right upper cover (finisher)

Follow these steps to remove the right upper cover (finisher).

- ▲ Remove one screw cap and three machine screws on the upper edge of the cover (callout 1). Remove three sheet metal screws (callout 2) on the lower portion of the cover. Rotate the right edge of the cover away from the finisher, and then slide the cover right to release three tabs (callout 3).

💡 **TIP:** The lower screws are shorter in length than the upper screws.

TIP: Reverse the removal steps to install the assembly.

Figure 5-1916 Remove the right upper cover

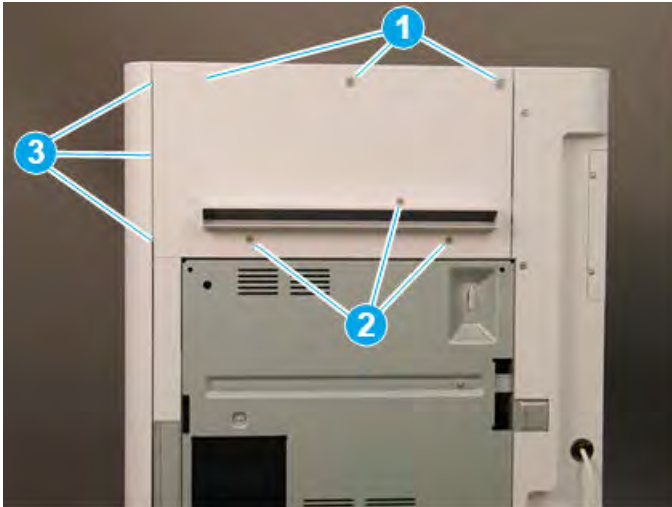

Remove the top cover (finisher)

Follow these steps to remove the top cover (finisher).

1. Remove three screw caps and three self-tapping screws at the top of the rear cover (callout 1), and then remove three machine screws (callout 2) on top of the cover.

Figure 5-1917 Remove six screws

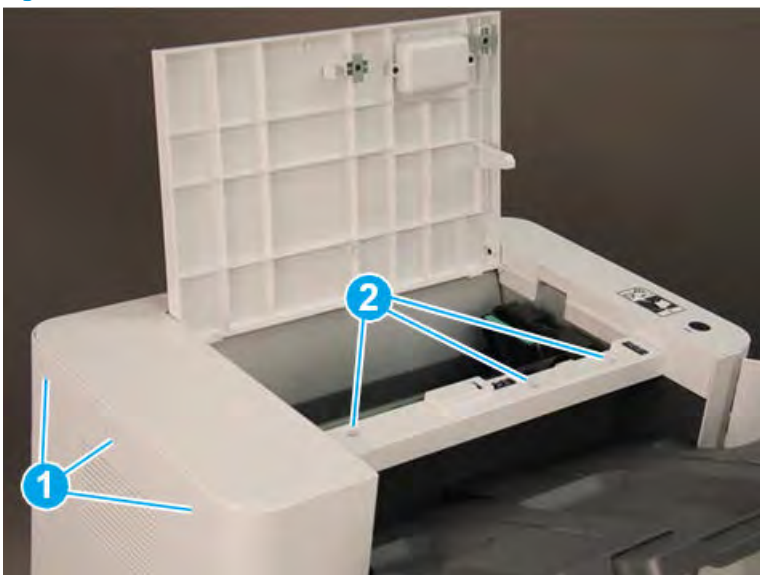

2. Remove three self-tapping screws at the top of the front cover (callout 1), and then remove two machine screws (callout 2) at the top of the right side.

Figure 5-1918 Remove five screws

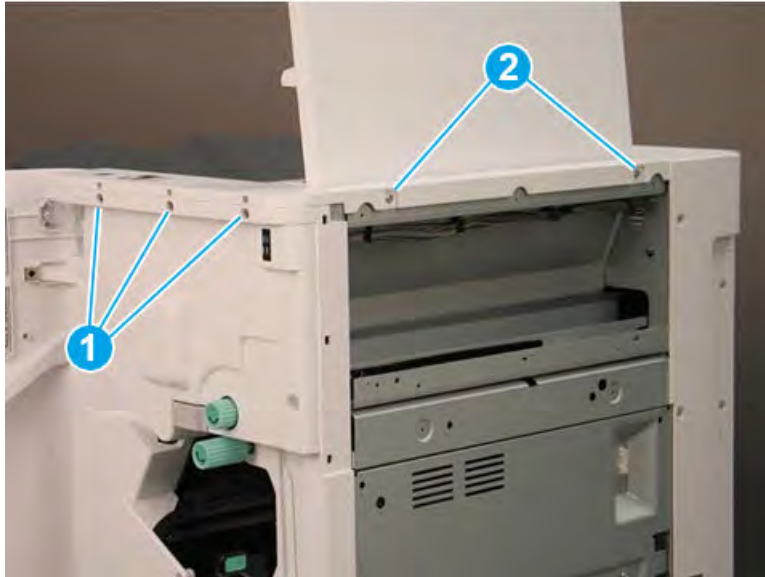

3. Lift the cover up slightly. Disconnect one in-line connector (callout 1), and then release one retainer (callout 2).

 **TIP:** Reverse the removal steps to install the assembly.

Figure 5-1919 Disconnect one connector and release retainer



Remove the rear cover (finisher)

Follow these steps to remove the rear cover (finisher).

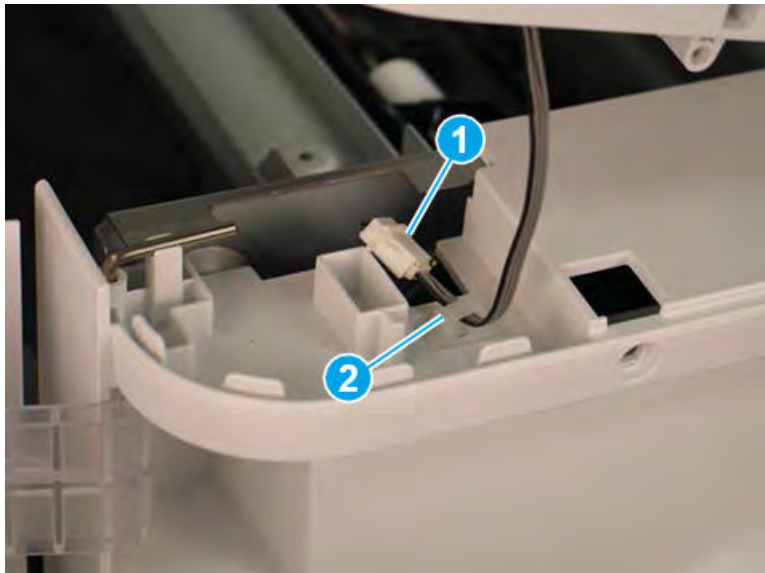
1. Remove two self-tapping screws (callout 1) on the top of the rear cover, and then remove five screw caps and five machine screws (callout 2) on the left side of the cover.

Figure 5-1920 Remove seven screws

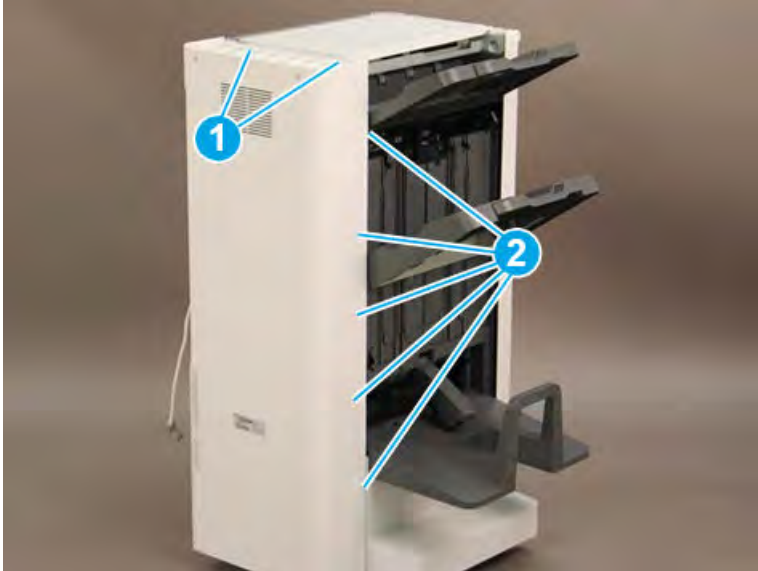

2. Remove one screw cap and four machine screws (callout 1) Remove the rear cover.

 **NOTE:** Make sure to thread the power cable (callout 2) through the opening in the cover.

 **TIP:** Reverse the removal steps to install the assembly

Figure 5-1921 Remove the rear cover



Remove the booklet maker

Follow these steps to remove the booklet maker.

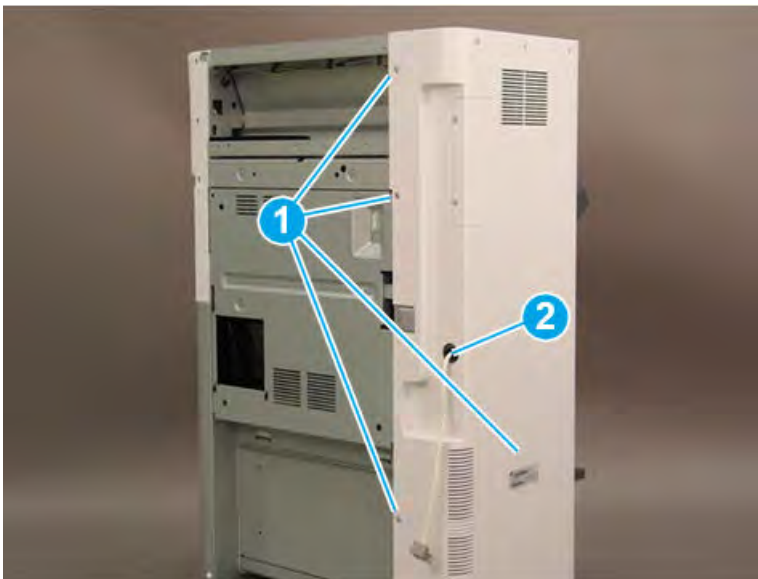
1. Slide the booklet maker away from the finisher.

Figure 5-1922 Slide the booklet maker away from the finisher



2. At the Disconnect one connector (callout 1), and then remove one screw (callout 2).

Figure 5-1923 Disconnect one connector and remove one screw

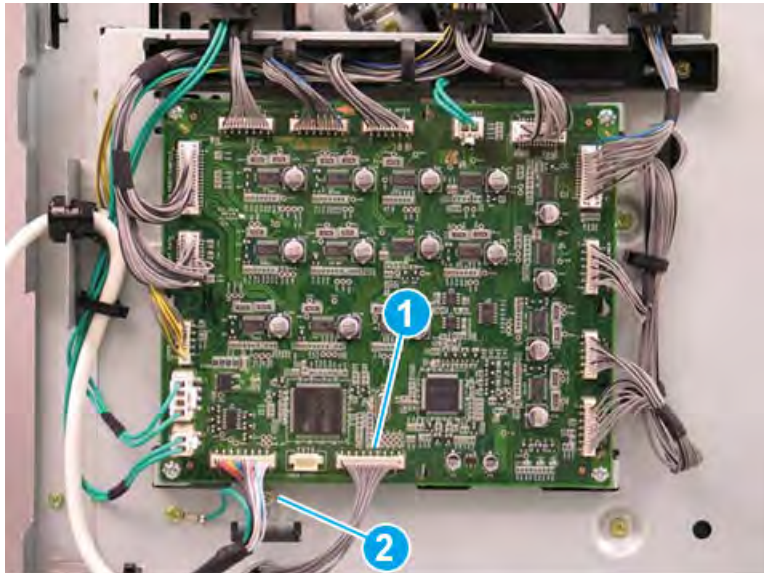

3. Release the metal bracket through the opening in the sheet metal.

Figure 5-1924 Release the metal bracket

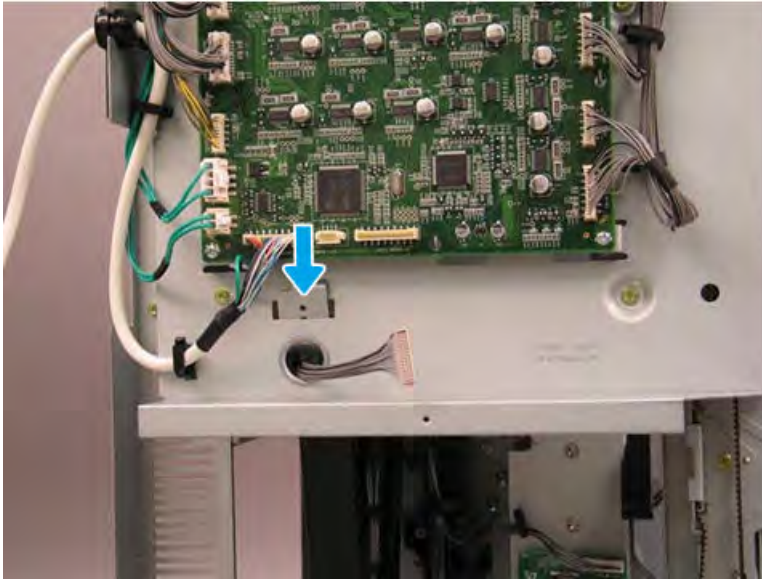

4. Remove one star-washer screw (callout 1), and then release the alignment pin (callout 2) on the right side of the booklet maker.

Figure 5-1925 Remove one screw

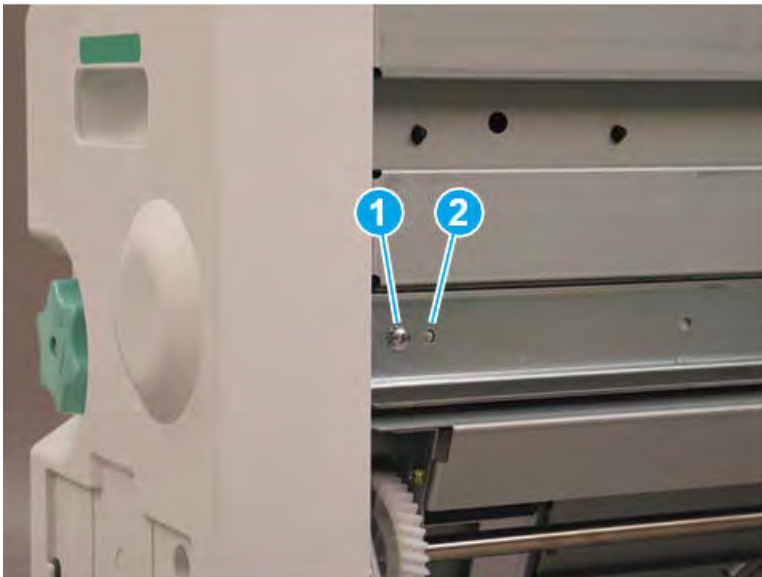

5. Slide the right rail toward the finisher.

Figure 5-1926 Slide the right rail

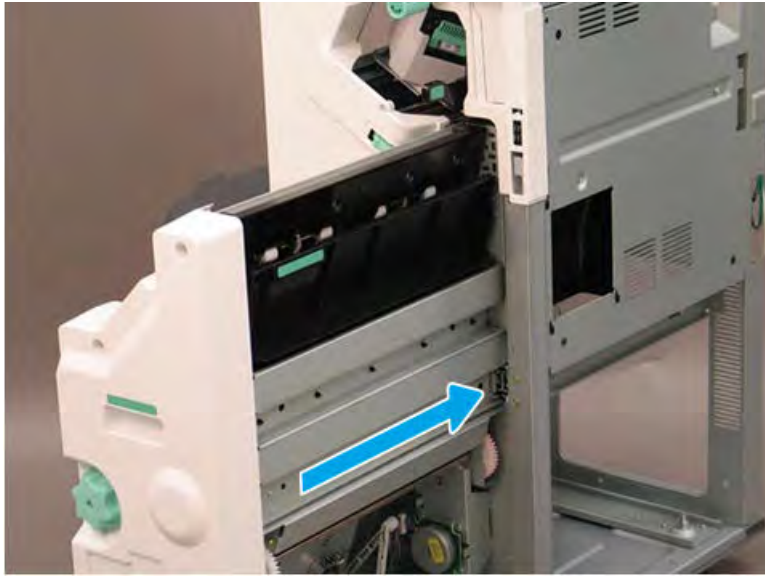

6. Remove one star-washer screw (callout 1) on the left side of the booklet maker.

Figure 5-1927 Remove one screw



7. Lift the booklet maker up on the left side while squeezing the right rail away from the finisher slightly to clear the sheet metal. Remove the booklet maker.

Figure 5-1928 Remove the booklet maker

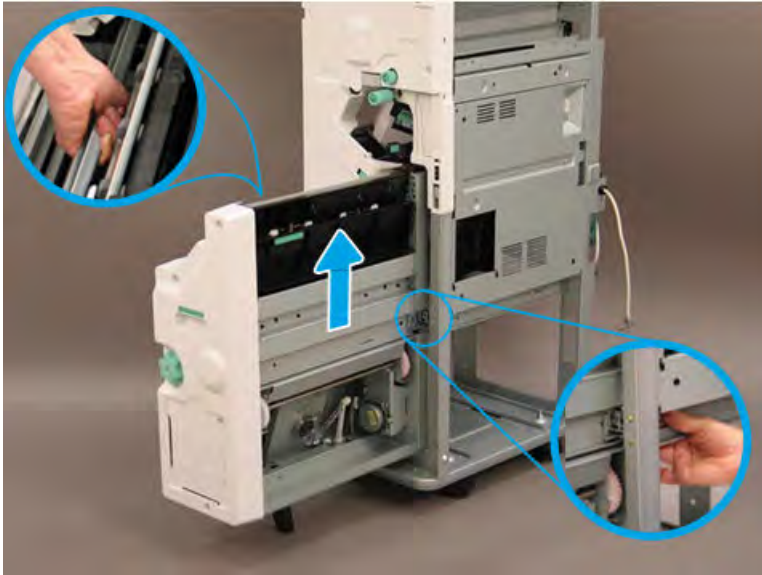

8. Reverse the removal steps to install the assembly. Also use the following special installation instructions.

 **NOTE:** Continue to reverse the removal steps to finish installing the assembly.

Special installation instructions: booklet maker

When installing the booklet maker, position the hooks on the rail under the slots on the booklet maker.

Figure 5-1929 Position the hooks

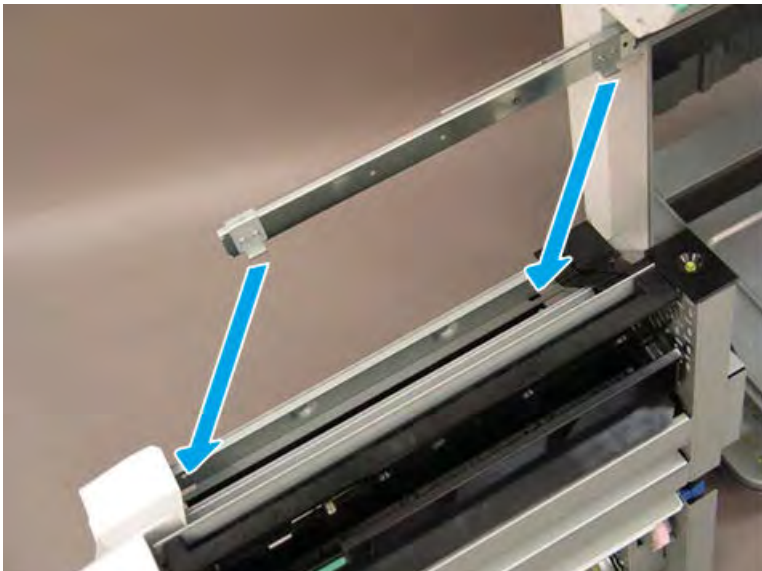

9. When installed correctly, the arrow on the front of the booklet maker aligns with the arrow on the finisher rail.

Figure 5-1930 Align arrows

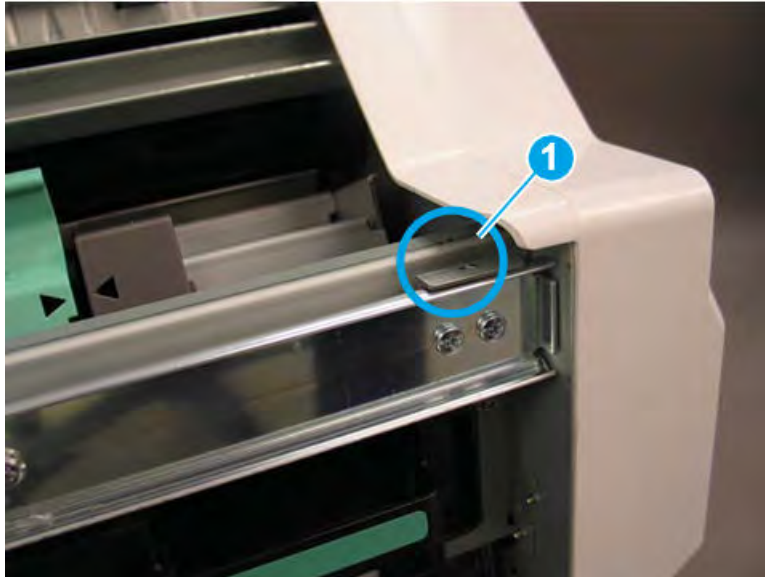

10. When installed correctly, the arrow on the back of the booklet maker aligns with the arrow on the finisher rail.

Figure 5-1931 Align arrows

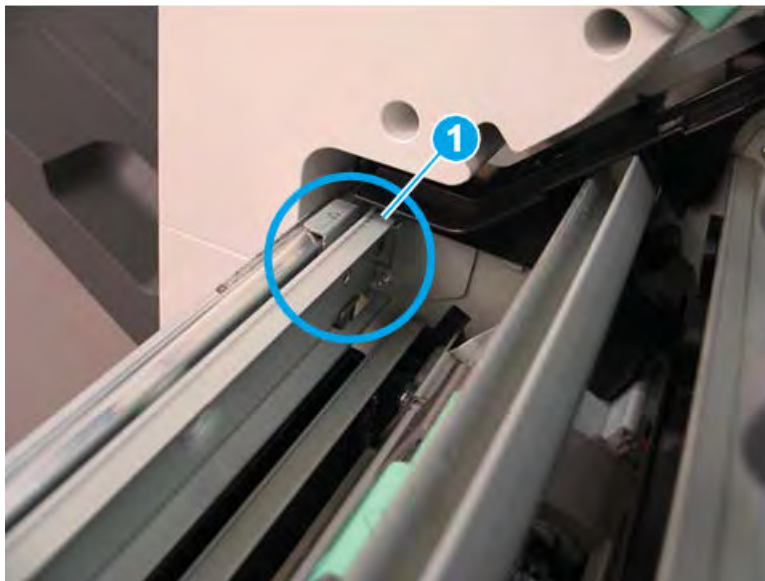

11. Extend the right rail away from the finisher and position it in the booklet maker slot.

Figure 5-1932 Extend the right rail



Remove the booklet maker PCA

Follow these steps to remove the booklet maker PCA.

1. Remove two screws (callout 1).

Figure 5-1933 Remove two screws

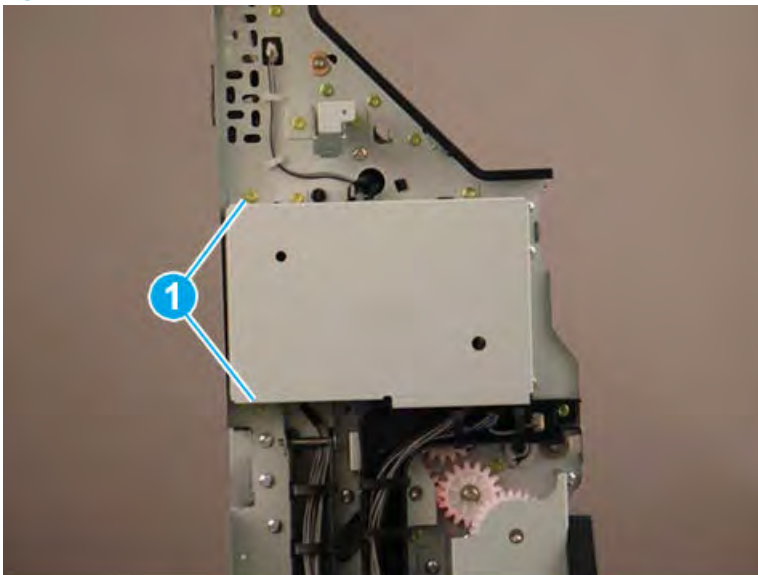

2. Remove one screw (callout 1), and then remove the metal cover.

Figure 5-1934 Remove one screw and the metal cover

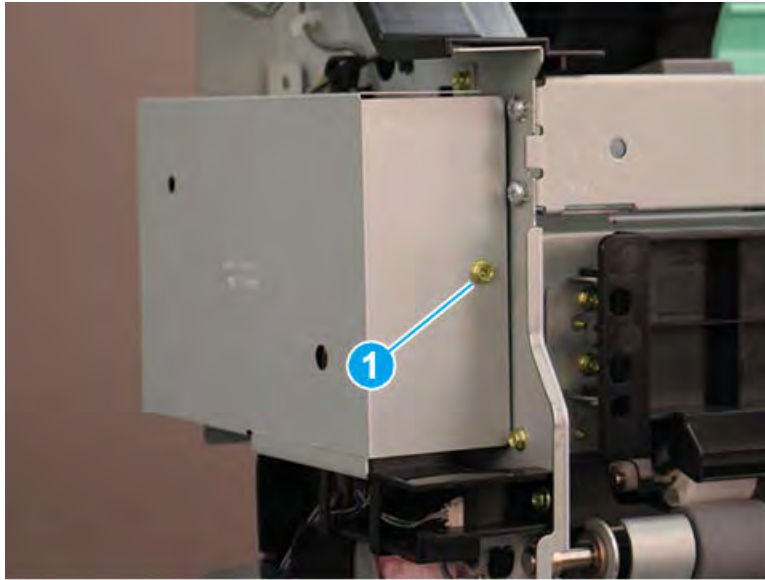

3. Disconnect all of the connectors, remove four screws (callout 1), and then remove the booklet maker PCA.

 **TIP:** Reverse the removal steps to install the assembly.

Figure 5-1935 Remove four screws and the PCA



Unpack the replacement assembly

Follow these steps to unpack the replacement assembly.

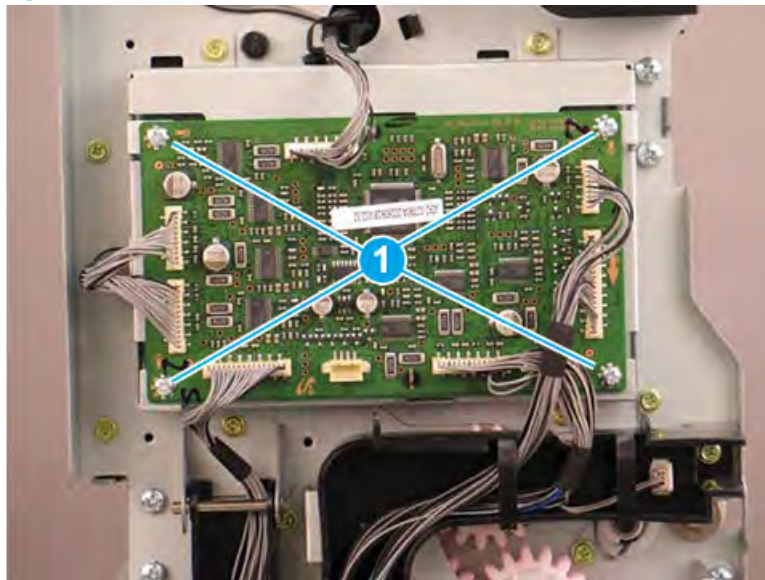
1. Dispose of the defective part.

 **NOTE:** HP recommends responsible disposal of the defective part.

<http://www8.hp.com/us/en/hp-information/environment/product-recycling.html>

2. Unpack the replacement part from the packaging.



CAUTION:  Some parts are sensitive to electrostatic discharge (ESD). Always perform service work at an ESD-protected workstation or mat. If an ESD workstation or mat is not available, touch the sheet-metal chassis to provide a static ground before touching an ESD-sensitive assembly. Protect the ESD-sensitive assemblies by placing them in ESD pouches when they are out of the printer.

 **IMPORTANT:** Make sure that all of the shipping materials (for example shipping tape) are removed from the replacement part prior to installation.

 **NOTE:** If the replacement part is a roller or pad, avoid touching the spongy part of it. Skin oils on the roller or pad can cause paper pickup and/or print-quality problems. HP recommends using disposable gloves when handling rollers or pads or washing your hands before touching rollers or pads.

3. To install an assembly, reverse the removal steps.

 **NOTE:** When applicable, special installation instructions are provided for an assembly at the end of the removal procedure. Always completely read the removal instructions and follow all special installation instructions.

Problem solving

Learn about problem solving.

Control panel message document (CPMD)

Learn about the control panel message document (CPMD).

Refer to [Error codes on page 674](#) for more details.

Clear paper jams

Learn about clearing paper jams.

Clear paper jams in the Booklet maker

Learn how to clear paper jams in the Booklet maker.

Clear jams in the top output area

Learn how to clear jams in the top output area.

1. Open the top cover.



2. Lift the TF feeder, and then turn the knob while the TF feeder is lifted.



3. Remove any jammed paper.

Clear jams in the booklet maker paper path

Learn how to clear jams in the booklet maker paper path.

1. Open the booklet maker door.



2. Release the lever.

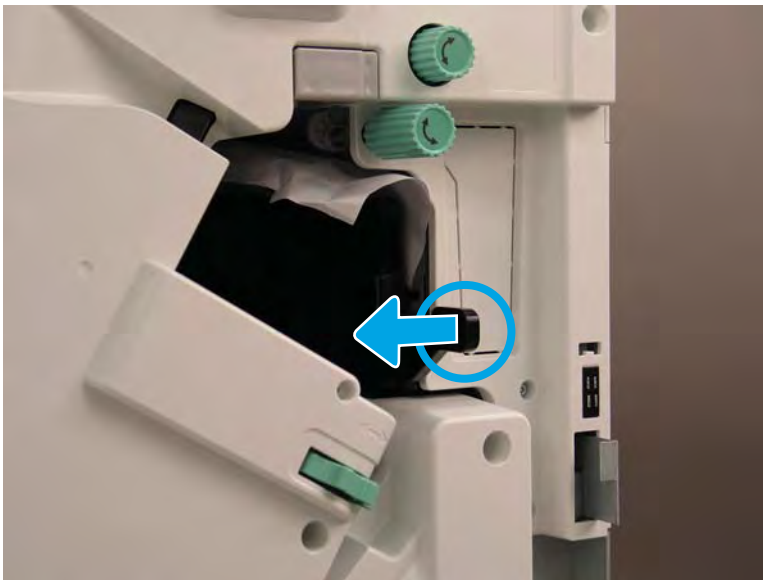

3. Turn the knob.



4. Remove the jammed paper.

Clear jams in the booklet maker booklet output area

Learn how to clear jams in the booklet maker booklet output area.

1. Open the booklet maker door.



2. Pull out the booklet maker assembly until it stops.



3. Turn the knob to advance the jammed paper.



4. Remove the jammed paper/booklet from the output area.

Clear jams in the booklet maker assembly-right-upper area

Learn how to clear paper jams in the booklet maker assembly-right-upper-area.

1. Open the booklet maker door.

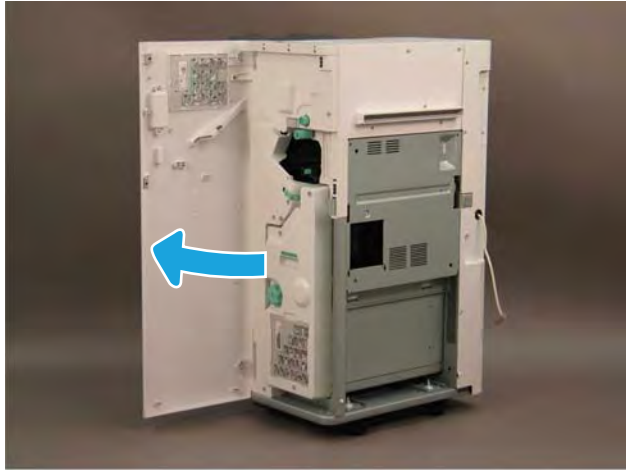

2. Pull out the booklet maker assembly until it stops.



3. Open the vertical tray by pulling outward on the green tab.

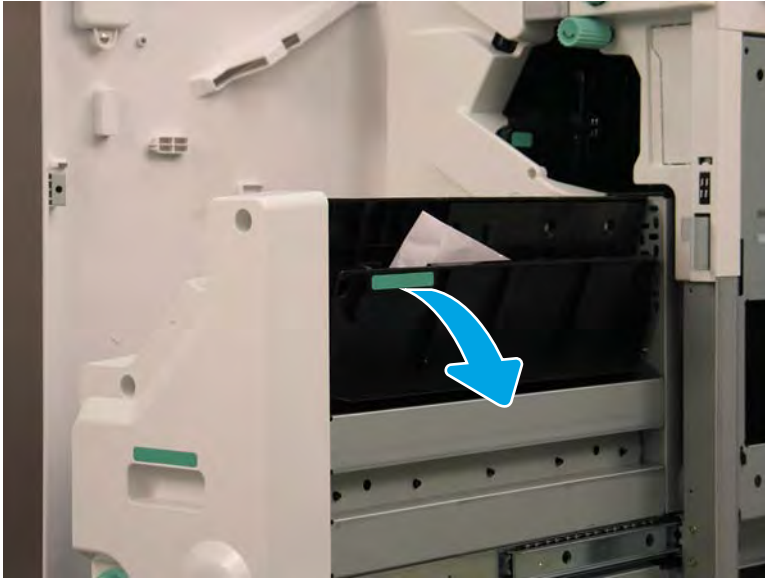

4. Remove the jammed paper.

Clear jams in the booklet maker assembly left middle area

Learn how to clear jams in the booklet maker assembly left-middle-area.

1. Open the booklet maker door.

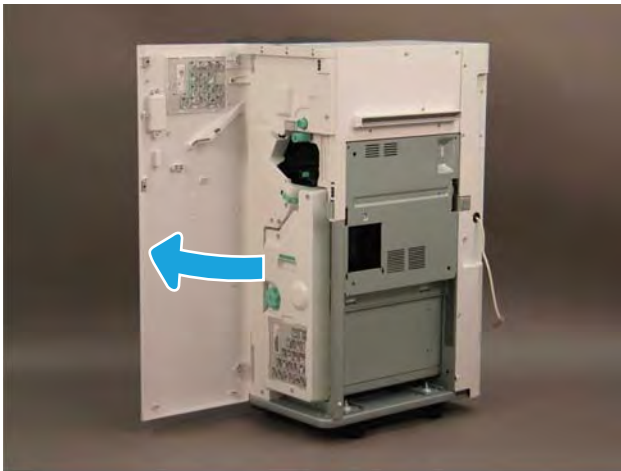

2. Pull out the booklet maker assembly until it stops.

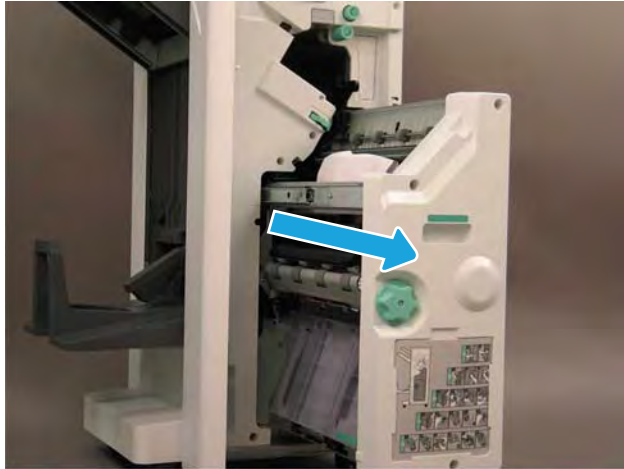

3. Pull the green tab.

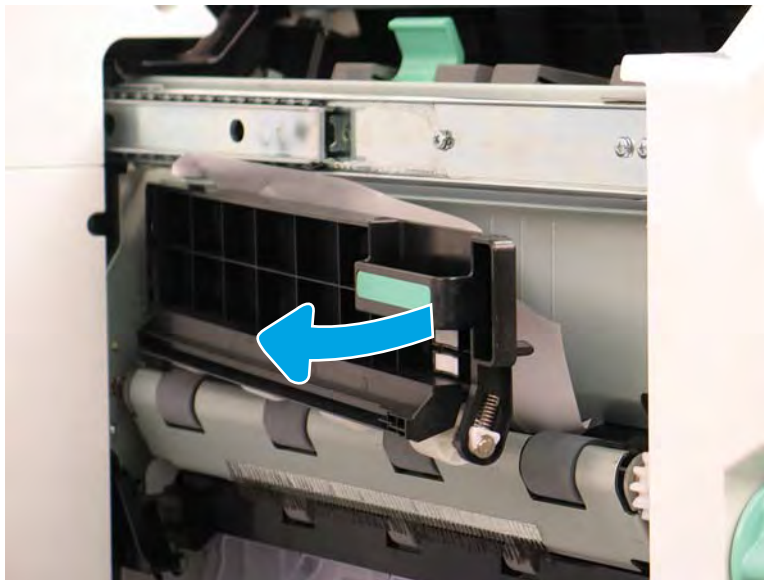

4. Remove the jammed paper.

5. Open the clear plastic door at the left bottom.



6. Remove the jammed paper.

Clear jams in the booklet maker assembly left lower area

Learn how to clear jams in the booklet maker assembly left-lower area.

1. Open the booklet maker door.

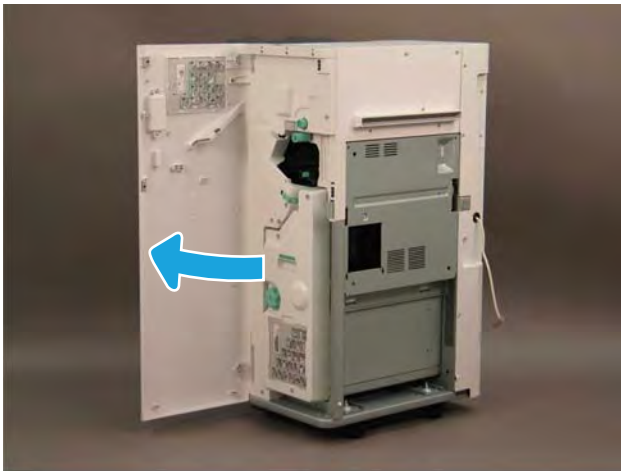

2. Pull out the booklet maker assembly until it stops.



3. Open the roller door.
4. Remove the jammed paper.
5. Open the clear plastic door at the left bottom.



6. Remove the jammed paper.

Clear jams in the IPTU

Learn how to clear jams in the IPTU.

1. Lift the IPTU cover and clear any jammed paper inside the IPTU.



2. Close the IPTU cover.

Clear jams in the inner finisher (IF)

Learn how to clear jams in the inner finisher (IF).

1. Open the staple cartridge access door.



2. Rotate the lever to the left to release the hooks that secure the inner finisher (they hold the IF in place).

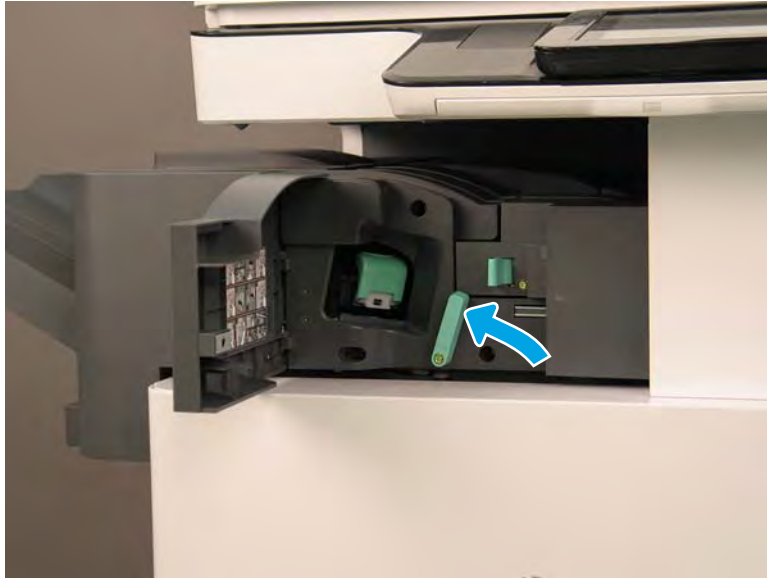

3. Slide the inner finisher partially out.
4. Release the lever to open the right cover on the inner finisher.

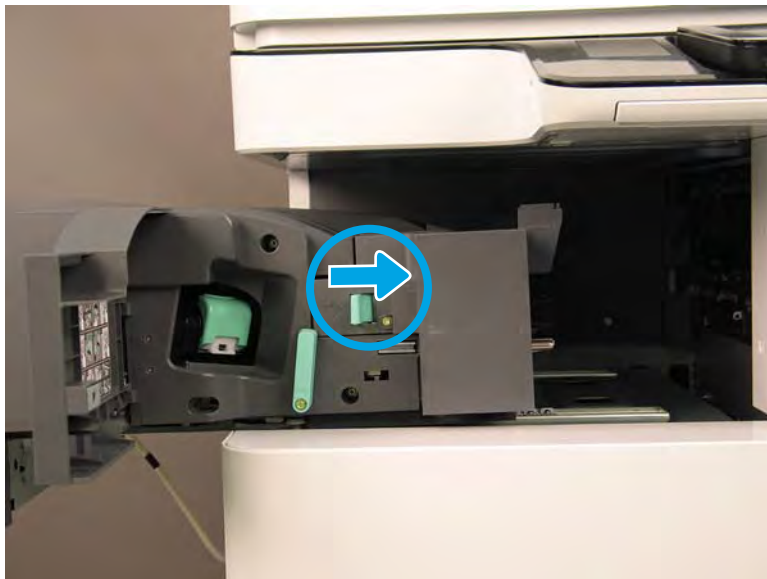

5. Lift the inner finisher jam access cover, and then remove any jammed paper inside the rear of the inner finisher.

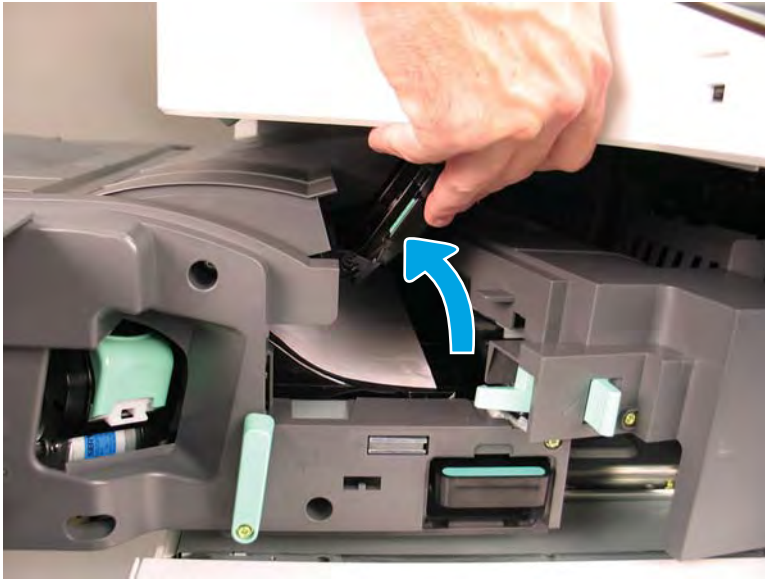

6. Close the inner finisher jam access cover.
7. Close the inner finisher right cover.
8. Open the output side jam access cover, and then remove any jammed paper.



9. Close the output side jam access cover.
10. Slide the inner finisher in until it clicks into place.
11. Close the staple cartridge access door.

Clear paper jams in the High-volume finisher

Learn how to clear paper jams in the High-volume finisher.

1. Open the top cover.



2. Lift the TF feeder, and then turn the knob while the TF feeder is lifted.



3. Remove any jammed paper.

Finisher system diagram

Learn about the finisher system diagram.

Finisher system consists of the FINISHER PCA, BOOKLET MAKER PCA, SWITCH PCA, and HOLE PUNCH PCA.

Figure 5-1936 Finisher system diagram

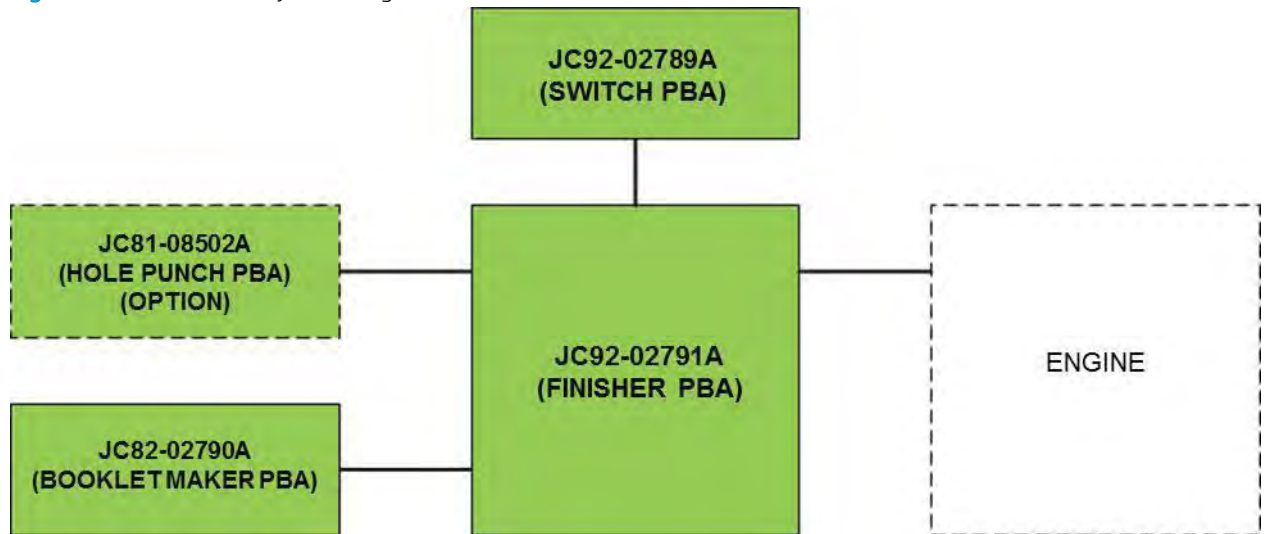

PCA function

- **FINISHER PCA**
This PCA controls the finisher modules and consists of the micro-controller and driver ICs.
- **SWITCH PCA**
This PCA shows the manual stapling condition and accepts the button input for manual staple operation.
- **BOOKLET MAKER PCA**
This PCA controls the booklet maker module and consists of the micro-controller and driver ICs.
- **HOLE PUNCH PCA**
This PCA controls the hole punch module and consists of the micro-controller and driver ICs.

6 Diagrams

Learn about the electrical-mechanical diagrams.

Diagrams (connection)

Learn about the connection diagram.

NOTE: The connection diagram includes the harness part code as shown below.

- Blue text harness codes are for both color and mono models.
- Green text harness codes are for mono models.
- Red text harness codes are for color models.

Figure 6-1 Connection diagram

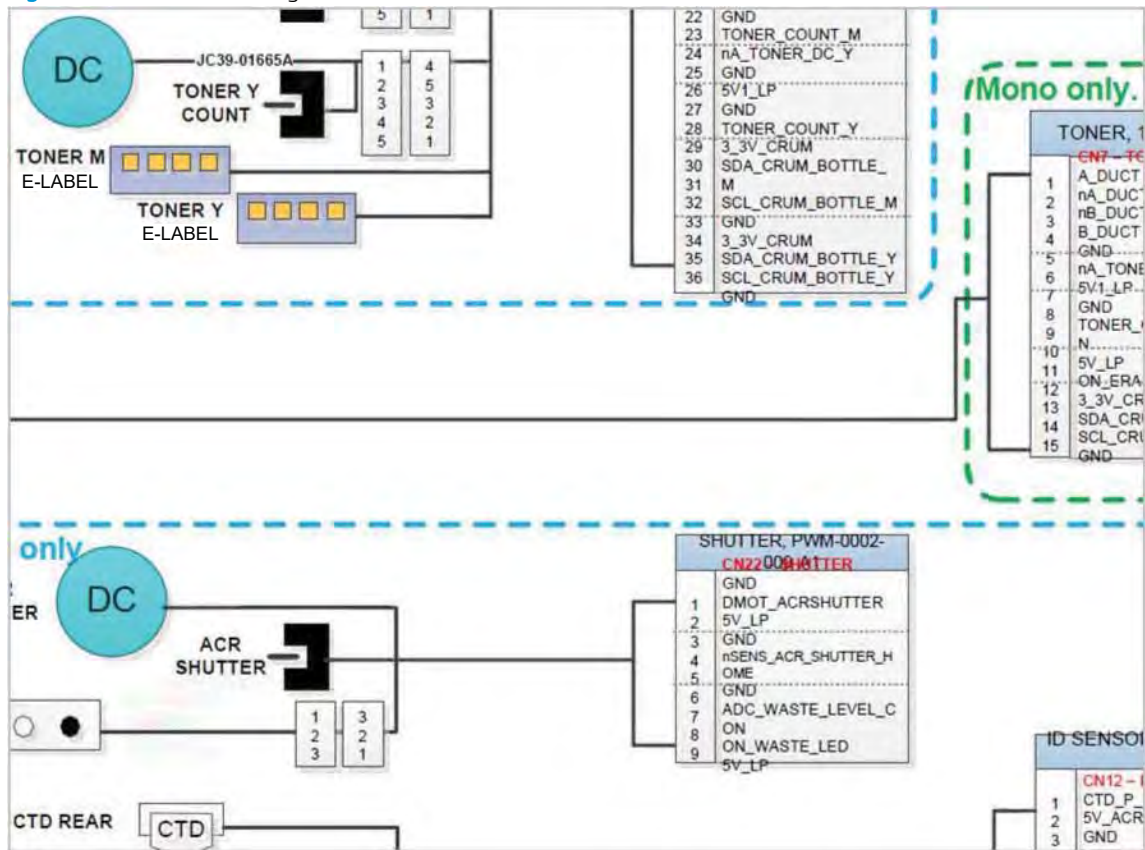
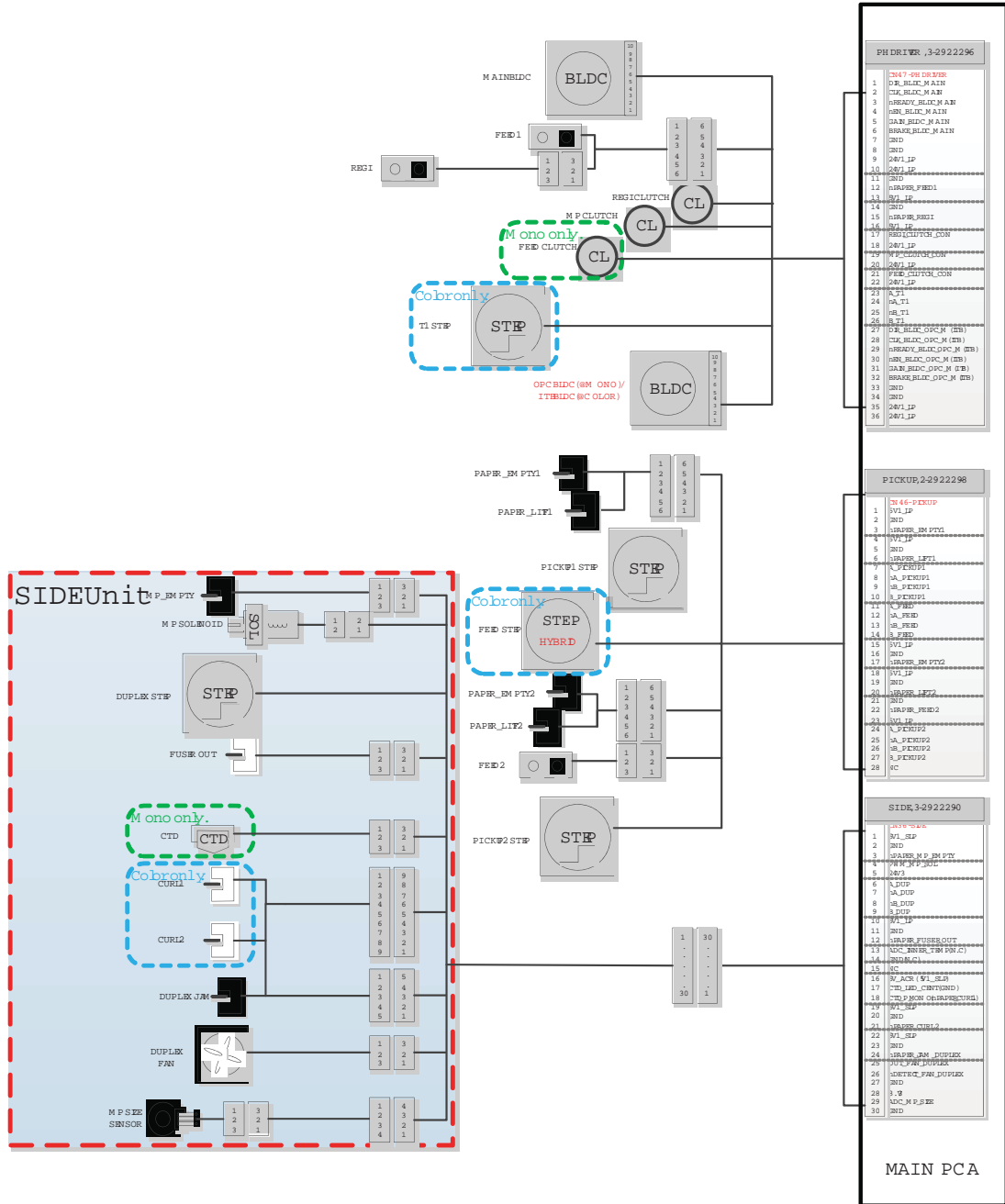

Figure 6-3 Pickup/PH drive/side diagram



Diagrams (laser scanner assembly/HVPS)

Learn about the laser scanner assembly/HVPS diagram.

Figure 6-4 Laser scanner assembly/HVPS diagram

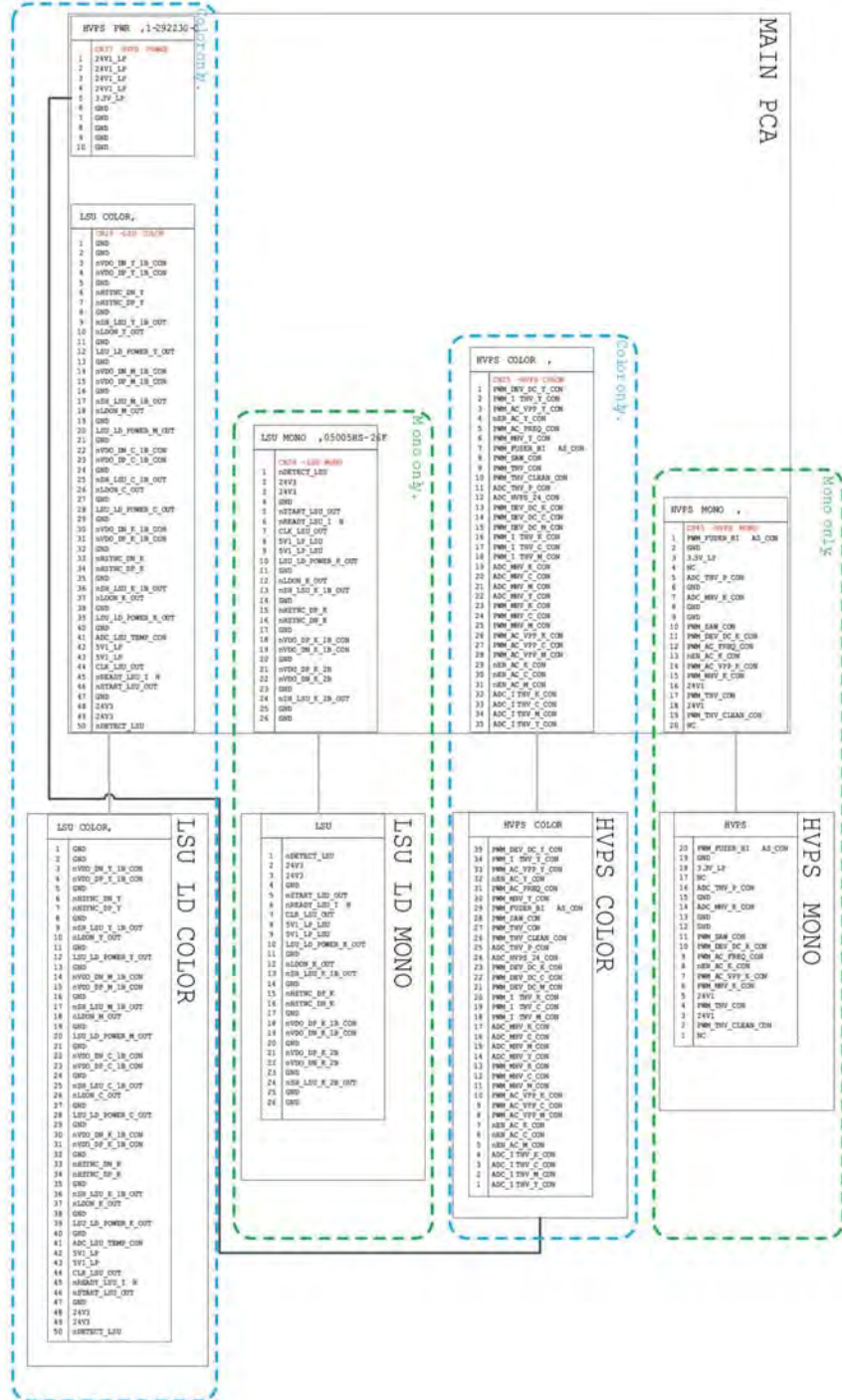

Diagrams (toner)

Learn about the toner diagram.

Figure 6-5 Toner diagram

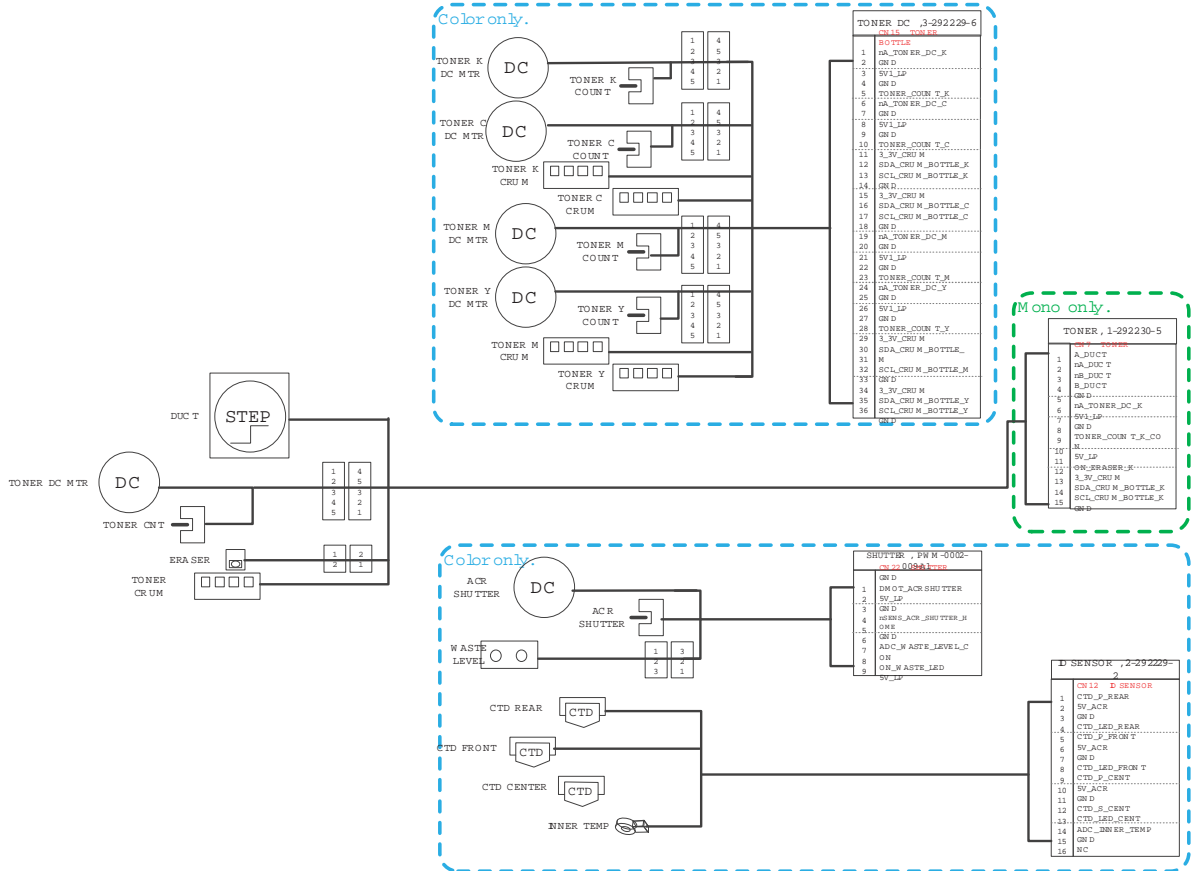

Diagrams (FDB/LVPS)

Learn about the FDB/LVPS diagram.

Figure 6-7 UI diagram

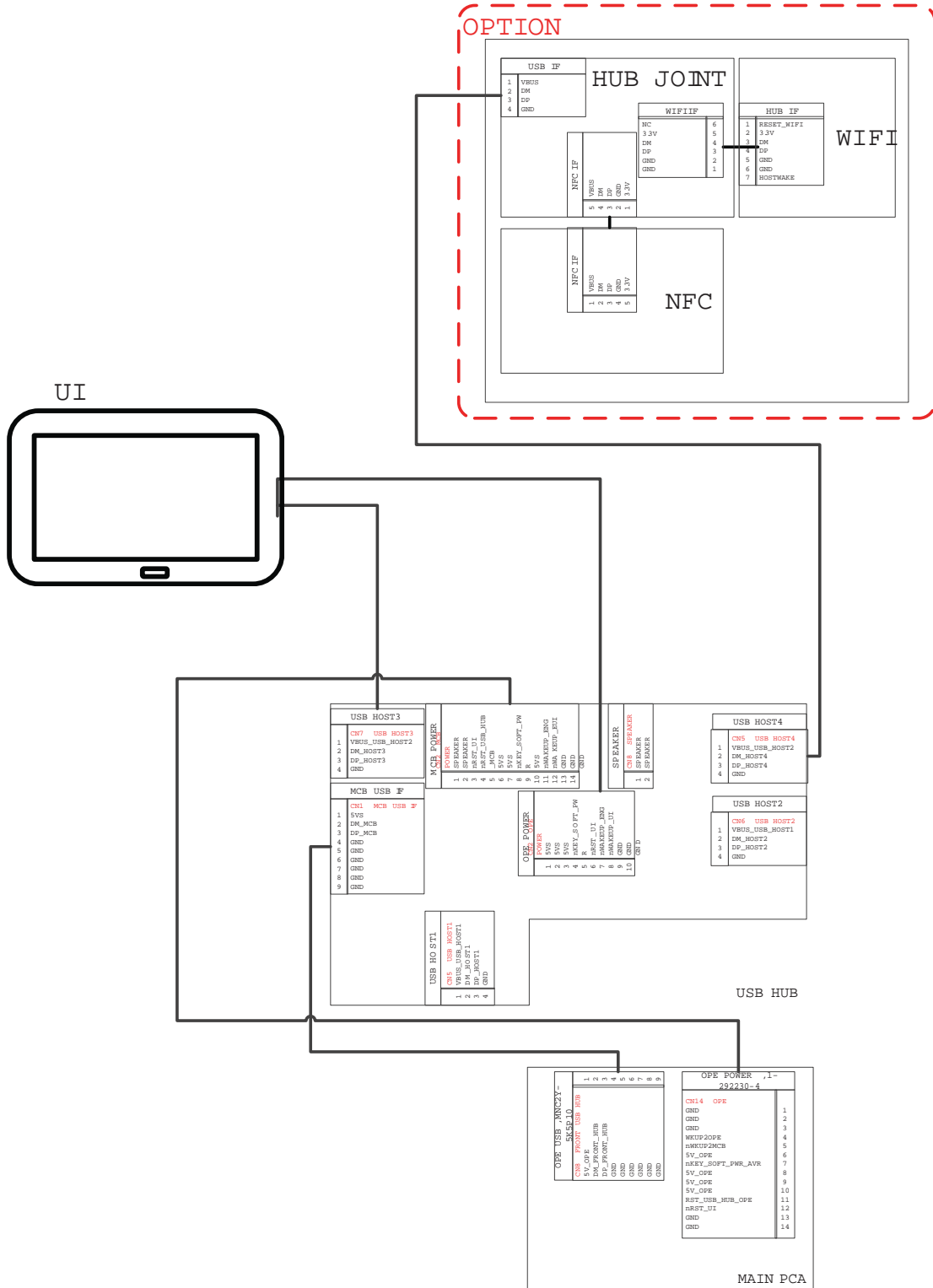

Diagrams (FRONT/OPC)

Learn about the front OPC diagram.

Figure 6-8 Front/OPC diagram

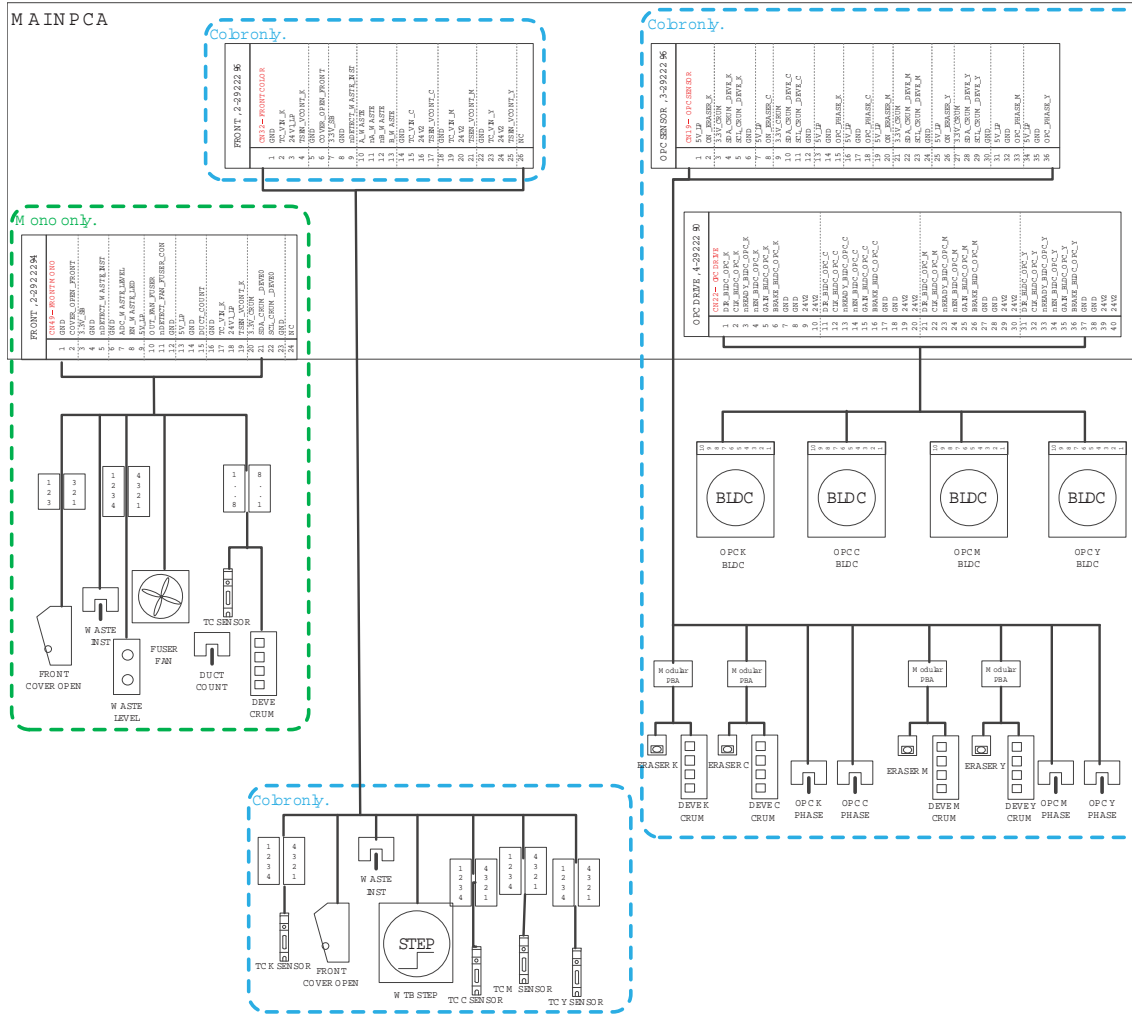

Diagrams (scanner)

Learn about the scanner diagram.

Figure 6-9 Scanner diagram

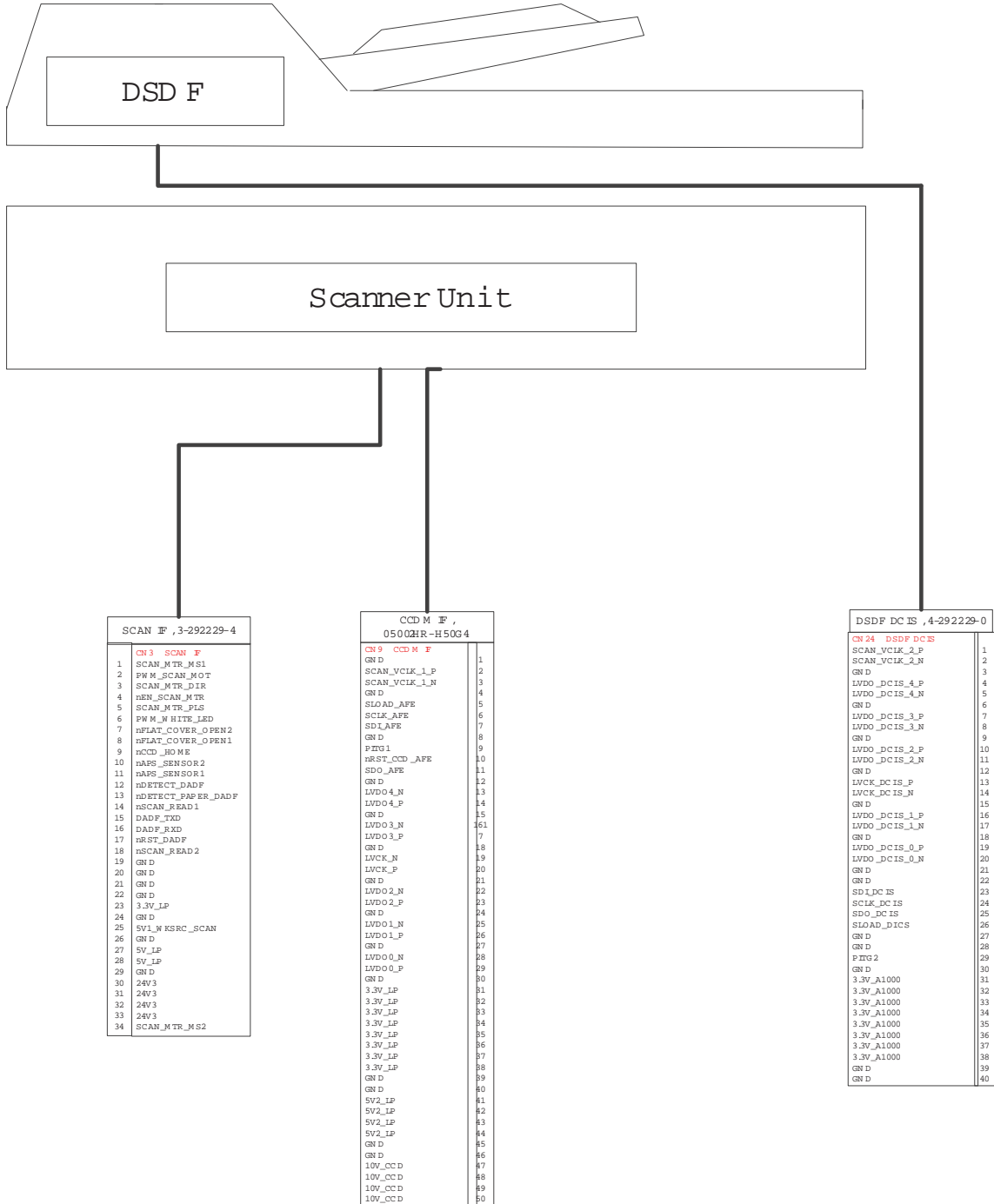

Diagrams (Dual Cassette Feeder)

Learn about the Dual Cassette Feeder diagram.

7 Inner finisher

Learn more about the inner finisher.

Product specification and description

Learn about product specifications and descriptions.

Inner finisher view

Learn about the front view and rear view of the inner finisher.

Front & rear view

Figure 7-1 Inner finisher system - front view

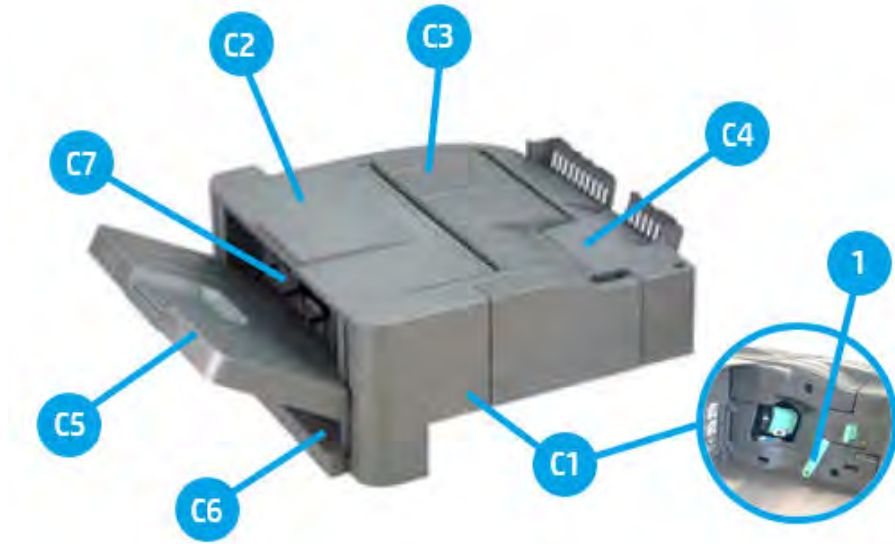

Figure 7-2 Inner finisher system - rear view



Table 7-1 Inner finisher system - entrance unit parts information

Item	Part name	Part number	Orderable ^(*)
C1	Front cover	JC90-01321B	(*)
C2	Top cover	JC90-01323B	(*)
C3	Middle cover	JC90-01322B	(*)
C4	Punch cover	JC90-01343B	(*)

Table 7-1 Inner finisher system - entrance unit parts information (continued)

Item	Part name	Part number	Orderable ^(*)
C5	Output tray	JC90-01337B	(*)
C6	PCA cover	JC63-04792B	(*)
C7	Left cover	JC90-01324B	(*)
C8	Rear cover	JC63-04750B	(*)
1	Lock release handle	JC66-04233A	(*)
2	Main interface harness	JC39-02169A	(*)
Not shown	Exit bin full	JC90-01546A	(*)

(*) This part is in ordering system.

 **NOTE:** Exit bin full is included in the box



Specification

Learn about the specifications of the inner finisher.

Table 7-2 General specifications

Item	Description
Capacity	550 Sheets (Main 500, Top 50) @ 80gsm
Sensing	Paper Jam/Tray Sensing/Stapler/Cover Open
Media Sizes	<ul style="list-style-type: none"> Main: 98mm - 320mm x 139.7mm - 457.2mm (3.86in - 12.59in x 5.5in - 18in) Top: 98mm - 320mm x 148.0mm - 430.0mm(3.86in - 12.59in x 5.83in - 16.93in)
Media types	Plain/Thick/Heavy weight/Thin/Cotton/Colored/Recycled/Bond/Archive/Pre-Punched/Cardstock/Glossy/Envelope
Media Weight	<ul style="list-style-type: none"> Main: 52-256 gsm (13.9-68.3 lb.) Top: 52-325 gsm (13.9-86.7 lb.)
Number of Bin	2 (Main/Top)
Dimension (W X D X H)	458 x 491 x 173 mm (18.0 X 19.3 X 6.8 inch)
Weight	15 kg (33 lb.)
Tray1 Finishing Capacity	50 Sheets @ 80gsm

Table 7-2 General specifications (continued)

Item	Description
Tray1 Finishing Mode	Stapling (Left, Right, Center)/Punch (2/3, 2/4, Swedish)
Tray2 Finishing Capacity	500 Sheets @ 80 gsm

Table 7-3 Paper Size Specification

Name	Paper size		Orientation Direction	Output			Staple position		
	mm	Inches		Main tray	Top tray	Corner		DUAL	
			52-256 g			Offset	52-325 g		45°
A5	210 x 148	8.3 x 5.8	LEF	0	0	0	X	F/R ¹	0
Statement	216 x 140	8.5 x 5.5	LEF	0	0	0	X	F/R ¹	0
Lt	279 x 216	11 x 8.5	LEF	0	0	0	F/R ¹	X	0
A4	297 x 210	8.3 x 11.7	LEF	0	0	0	F/R ¹	X	0
B5(JIS)	257 x 182	10.1 x 7.2	LEF	0	0	0	F/R ¹	X	0
B5(ISO)	250 x 176	9.8 x 6.9	LEF	0	0	0	F/R ¹	X	0
Executive	267 x 184	10.5 x 7.3	LEF	0	0	0	F/R ¹	X	0
No 9 Env	98 x 225	3.9 x 8.9	SEF	X	X	0	X	X	X
Monarch Env	98.4 x 190.5	3.9 x 7.5	SEF	X	X	0	X	X	X
PostCard 4X6	101.6 x 152.4	4.0 x 6.0	SEF	X	X	0	X	X	X
A6	105 x 148	4.1 x 5.8	SEF	X	X	0	X	X	X
No 10 Env	105 x 241	4.1 x 9.5	SEF	X	X	0	X	X	X
DL Env	110 x 220	4.3 x 8.7	SEF	X	X	0	X	X	X
C6 Env	114 x 162	4.5 x 6.4	SEF	X	X	0	X	X	X
B6	128 x 182	5.0 x 7.2	SEF	X	X	0	X	X	X
Statement	140 x 216	5.5 x 8.5	SEF	X	X	0	X	X	X
A5	148 x 210	5.8 x 8.3	SEF	0	X	0	X	X	X
C5 Env	162 x 229	6.4 x 9.0	SEF	X	X	0	X	X	X
B5(ISO)	176 x 250	6.9 x 9.8	SEF	0	0	0	X	F/R ¹	X
B5(JIS)	182 x 257	6.9 x 9.8	SEF	0	0	0	X	F/R ¹	X
Executive	184 x 267	7.3 x 10.5	SEF	0	0	0	X	F/R ¹	X
16k	195 x 270	7.7 x 10.6	SEF	0	0	0	X	F/R ¹	0
A4	210 x 297	8.3 x 11.7	SEF	0	0	0	X	F/R ¹	0
Legal	216 x 356	8.5 x 14	SEF	0	0	0	X	F/R ¹	0

Table 7-3 Paper Size Specification (continued)

Name	Paper size		Orientation	Output			Staple position		
	mm	Inches		Direction	Main tray		Top tray	Corner	
			52-256 g		Offset	52-325 g	45°	Flat	
Letter	216 x 279	8.5 x 11	SEF	0	0	0	X	F/R ¹	0
Folio	216 x 330	8.5 x 13	SEF	0	0	0	X	F/R ¹	0
Oficio	215.9 x 342.9	8.5 x 13.5	SEF	0	0	0	X	F/R ¹	0
C4	229 x 324	9.1 x 12.8	SEF	X	X	0	X	X	X
Tabloid	254 x 374	10 x 14.7	SEF	0	0	0	F/R ¹	X	0
B4	257 x 364	10 x 14.3	SEF	0	0	0	F/R ¹	X	0
8K	270 x 390	10.6 x 15.4	SEF	0	0	0	F/R ¹	X	0
Ledger	279 x 432	11 x 17	SEF	0	0	0	F/R ¹	X	0
A3	297 x 420	11.7 x 16.5	SEF	0	0	0	F/R ¹	X	0
Tabloid Extra	304.8 x 457.2	12 x 18	SEF	0	X	X	X	X	X
SRA3	320 x 450	12.6 x 17.7	SEF	0	0	X	X	X	X
Custom	W 98-320 ~ L 139.7-457. 2	W3.86-12. 59 ~ L 5.5-18	—	0	X	0	X	X	X

¹ "F/R" means front side and rear side can be supported.

Table 7-4 Punch specifications

Name	Paper size		Orientation	Punch				
	mm	Inches		Direction	NA 2/3		EU 2/4H	
			2H		3H	2H	4H	4H
A5	210 x 148	8.3 x 5.8	LEF	0	X	0	X	0
Statement	216 x 140	8.5 x 5.5	LEF	0	X	0	X	0
Lt	279 x 216	11 x 8.5	LEF	0	0	0	0	0
A4	297 x 210	8.3 x 11.7	LEF	0	0	0	0	0
B5 (JIS)	257 x 182	10.1 x 7.2	LEF	0	0	0	X	0
B5 (ISO)	250 x 176	9.8 x 6.9	LEF	0	0	0	X	0
Executive	267 x 184	10.5 x 7.3	LEF	0	0	0	0	0
No 9 Env	98 x 225	3.9 x 8.9	SEF	X	X	X	X	X
Monarch Env	98.4 x 190.5	3.9 x 7.5	SEF	X	X	X	X	X

Table 7-4 Punch specifications (continued)

Name	Paper size		Orientation	Punch				
	mm	Inches		Direction	NA 2/3		EU 2/4H	
			2H		3H	2H	4H	4H
PostCard 4X6	101.6 x 152.4	4.0 x 6.0	SEF	X	X	X	X	X
A6	105 x 148	4.1 x 5.8	SEF	X	X	X	X	X
No 10 Env	105 x 241	4.1 x 9.5	SEF	X	X	X	X	X
DL Env	110 x 220	4.3 x 8.7	SEF	X	X	X	X	X
C6 Env	114 x 162	4.5 x 6.4	SEF	X	X	X	X	X
B6	128 x 182	5.0 x 7.2	SEF	X	X	X	X	X
Statement	140 x 216	5.5 x 8.5	SEF	X	X	X	X	X
A5	148 x 210	5.8 x 8.3	SEF	0	X	0	X	0
C5 Env	162 x 229	6.4 x 9.0	SEF	X	X	X	X	X
B5(ISO)	176 x 250	6.9 x 9.8	SEF	0	X	0	X	0
B5(JIS)	182 x 257	6.9 x 9.8	SEF	0	X	0	X	0
Executive	184 x 267	7.3 x 10.5	SEF	0	X	0	X	0
16k	195 x 270	7.7 x 10.6	SEF	0	X	0	X	0
A4	210 x 297	8.3 x 11.7	SEF	0	X	0	X	0
Legal	216 x 356	8.5 x 14	SEF	0	X	0	X	0
Letter	216 x 279	8.5 x 11	SEF	0	X	0	X	0
Folio	216 x 330	8.5 x 13	SEF	0	X	0	X	0
Oficio	215.9 x 342.9	8.5 x 13.5	SEF	0	X	0	X	0
C4	229 x 324	9.1 x 12.8	SEF	X	X	X	X	X
Tabloid	254 x 374	10 x 14.7	SEF	0	0	0	X	0
B4	257 x 364	10 x 14.3	SEF	0	0	0	X	0
8K	270 x 390	10.6 x 15.4	SEF	0		0	0	0
Ledger	279 x 432	11 x 17	SEF	0	0	0	0	0
A3	297 x 420	11.7 x 16.5	SEF	0	0	0	0	0
Tabloid Extra	304.8 x 457.2	12 x 18	SEF	X	X	X	X	X
SRA3	320 x 450	12.6 x 17.7	SEF	X	X	X	X	X
Custom	W 98-320 ~ L 140-1200	W3.9-12.6 ~ L 5.5-47	-	X	X	X	X	X

Table 7-5 Media performance

Paper Type	Function			
	Main Tray	Top Tray	Staple	Punch
Plain (71-90 g/m ²)	0	0	0	0
Thick (91-105 g/m ²)	0	0	0	0
Heavy weight (106-175 g/m ²)	0	0	0	0
Extra Heavy weight 1 (176-216 g/m ²)	0	0	0	0
Extra Heavy weight 2 (217-256 g/m ²)	0	0	0	0
Extra Heavy weight 3 (257-300 g/m ²)	X	0	X	X
Extra Heavy weight 4 (301-325 g/m ²)	X	0	X	X
Thin (60-70 g/m ²)	0	0	0	0
Cotton (75-90 g/m ²)	0	0	0	0
Colored (75-90 g/m ²)	0	0	0	0
Pre-Printed (75-90 g/m ²)	0	0	0	0
Recycled (60-90 g/m ²)	0	0	0	0
Bond	0	0	0	0
Archive (75-105 g/m ²)	0	0	0	0
LetterHead	0	0	0	0
Pre-Punched	0	0	0	X
Thin Cardstock (105-163 g/m ²)	0	0	0	0
Thick Cardstock (170-216 g/m ²)	0	0	0	X
Heavy Cardstock (217-256 g/m ²)	0	0	0	X
Extra Heavy Cardstock 1 (257-300 g/m ²)	X	0	X	X
Extra Heavy Cardstock 2 (301-325 g/m ²)	X	0	X	X
Thin Glossy (106-169 g/m ²)	0	0	0	0
Thick Glossy (170-216 g/m ²)	0	0	0	X
Heavy Glossy (217-256 g/m ²)	0	X	X	X
Envelope (75-90 g/m ²)	X	0	X	X
Thick Envelope (217-256 g/m ²)	0	X	X	X
Tab	0	X	X	0
Perforated Paper (75-90 g/m ²)	X	0	X	X

Inner finisher system

Learn about the inner finisher system.

Overview

Learn about the overview of the inner finisher.

Work flow

Figure 7-3 Inner finisher system - work flow overview

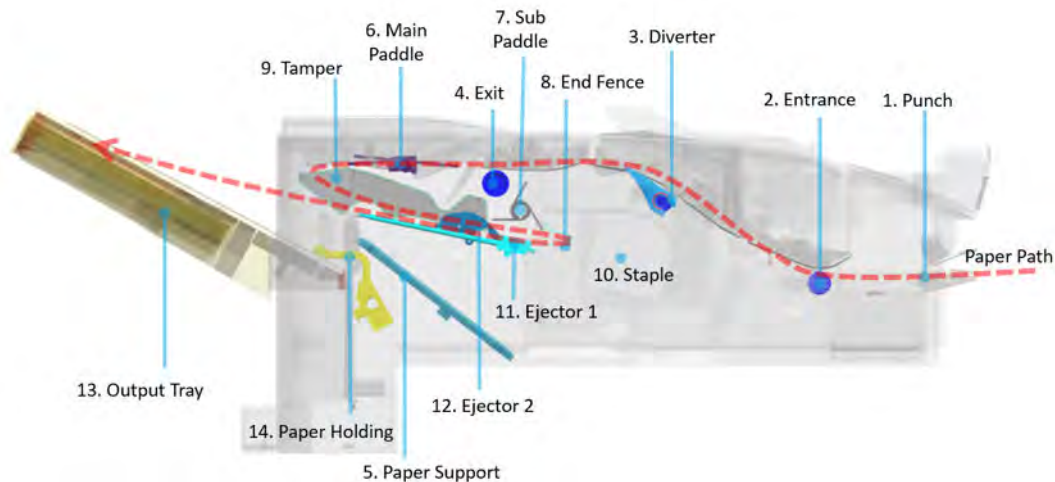

Table 7-6 Inner finisher system - work flow overview

Item	Unit	Description
1	Punch unit	holes in a specific location on a sheet of paper
2	Entrance unit	allows paper to move into the finisher
3	Diverter unit	holds paper so that the newly printed paper can stay out for seconds while the stapled bundle of paper moves to the output tray
4	Exit unit	moves paper from the diverter unit to the ejector unit
5	Paper support unit	prevents paper from being fallen down or bent when the long length paper such as A3 is ejected from the exit unit
6	Main paddle unit	moves paper to the sub paddle
7	Sub paddle unit	moves paper to the end fence
8	End fence unit	sets the standard position of the paper to be aligned towards top and bottom of the paper
9	Tamper unit	aligns the paper on the right and left side of the paper
10	Stapler unit	performs stapling to a bundle of aligned documents
11	Ejector 1 unit	transfers a stapled paper loaded at the end fence unit to the ejector2 unit
12	Ejector 2 unit	grips a stack of paper up and ejects it onto the output tray
13	Output tray unit	stacks the job ended paper
14	Paper holding unit	controls the output tray movement

Figure 7-4 Inner finisher system - sensor

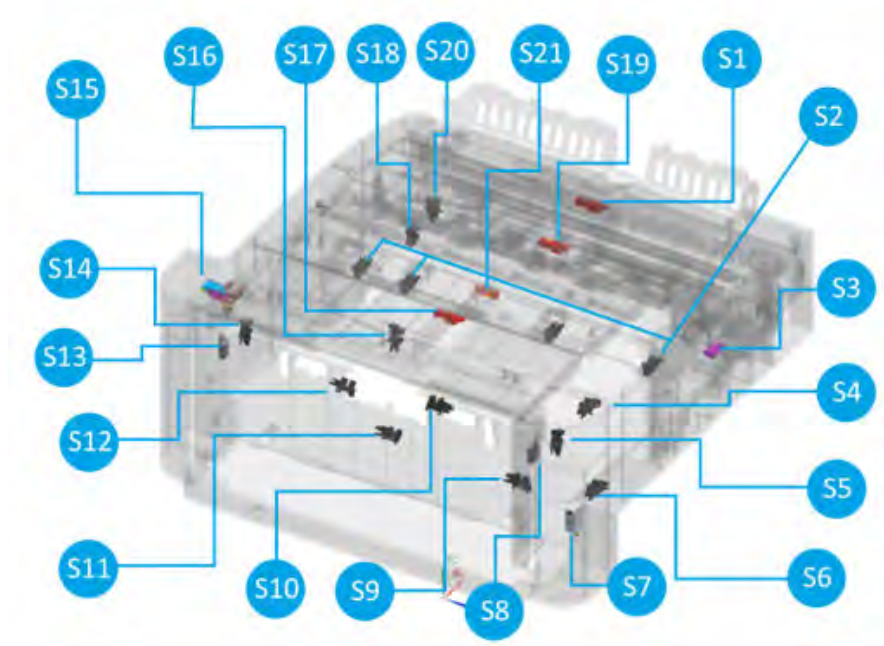

Table 7-7 Inner finisher system - sensor

No	Name	Part number	Orderable ^(*)	Diagnostics	Type	Description
S1	Entrance sensor	0604-001381	(*)	113-0350	Photo emitter, detector	Checks paper comes into the entrance unit
S2	Stapler position sensor	0604-001393		113-0491 113-0492	Photo interrupter	Makes the stapler be positioned in the exact stapling position
S3	Front cover switch	JC39-01610A		113-0410	Cover open switch	Checks whether the front cover is closed or opened
S4	Main paddle home sensor	0604-001393		113-0370	Photo interrupter	Checks the main paddle locates at the home position
S5	Front tamper home sensor	0604-001393		113-0390	Photo interrupter	Checks the front tamper locates at the home position
S6	Output tray motor sensor	0604-001393		113-0473	Photo interrupter	Checks the output tray motor is operational
S7	Output tray lower limit switch	JC90-01320A	(*)	113-0472	Lower limit switch assembly	Checks the lower limit (=Output tray is full) of the output tray
S8	Output tray top of stack sensor (receiver)	0603-001309	(*)	113-0471	Photo TR	Checks the upper limit of output tray
S9	Paper holding sensor	0604-001393		113-0470	Photo interrupter	Checks the location of the paper holding actuator
S10	Ejector 2 home sensor	0604-001393		113-0462	Photo interrupter	Checks the ejector 2 locates at the home position.
S11	Ejector 2 motor sensor	0604-001393		113-0463	Photo interrupter	Checks the ejector 2 motor is operational

Table 7-7 Inner finisher system - sensor (continued)

No	Name	Part number	Orderable ^(*)	Diagnostics	Type	Description
S12	Paper support home sensor	0604-001393		113-0481	Photo interrupter	Checks the paper support locates at the home position
S13	Output tray top of stack sensor (led)	0601-003440		113-0471	LED IR	Checks the upper limit of output tray
S14	Rear tamper home sensor	0604-001393		113-0380	Photo interrupter	Checks the rear tamper locates at the home position
S15	Top cover switch	JC39-01610A	(*)	113-0420	Cover open switch	Checks whether the top cover is closed or opened
S16	Ejector 1 home sensor	0604-001393		113-0461	Photo interrupter	Checks the ejector 1 locates at the home position
S17	End fence sensor	0604-001381	(*)	113-0361	Photo emitter, detector	Check paper comes into the end fence unit
S18	Punch waste box sensor	0604-001393		113-0620	Photo interrupter	Detects the punch waste box is installed
S19	Punch waste full sensor	0604-001381	(*)	113-0621	Photo emitter, detector	Checks the punch waste box is full
S20	Finisher docking sensor	0604-001393		113-0000	Photo interrupter	Checks the finisher is installed
S21	Exit sensor	0604-001415	(*)	113-0360	Photo interrupter	Checks paper comes into the exit unit

^(*) This part is in ordering system.

Figure 7-5 Inner finisher system - Photo interrupter (0604-001393)

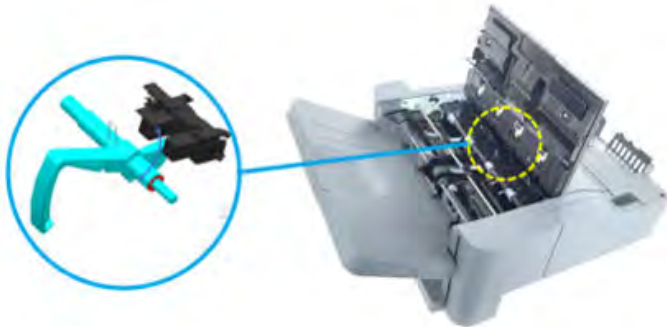

Figure 7-6 Inner finisher system - Photo emitter, detector (0604-001381)



Motor and solenoid

Figure 7-7 Inner finisher system - motor, solenoid

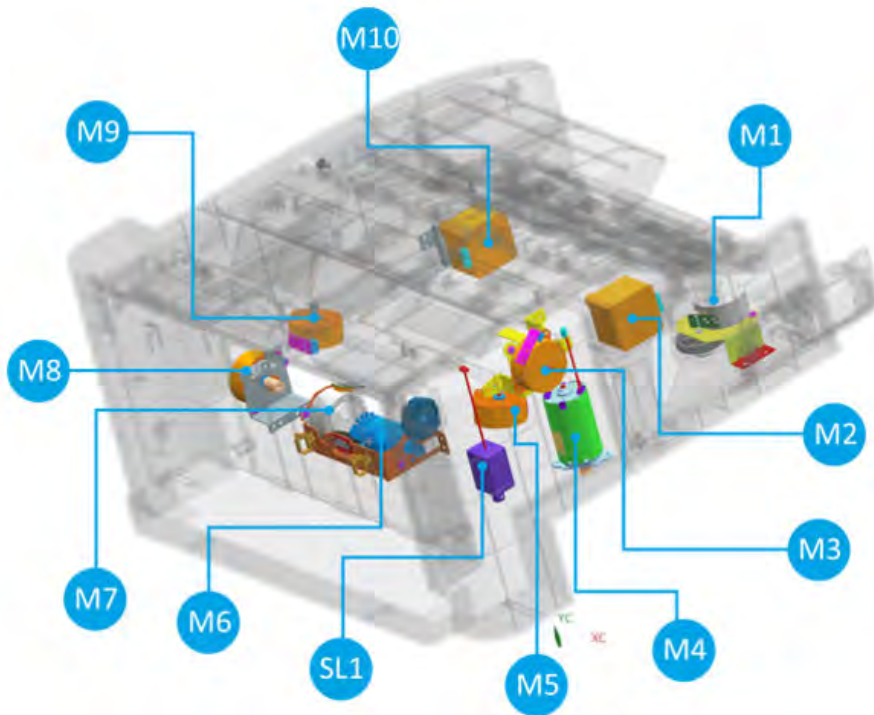

Table 7-8 Inner finisher system - motor, solenoid

No	Name	Part number	Orderable ^(*)	Diagnostics	Type	Motor sensor	Description
M1	Stapler position motor	JC93-00999A	(*)	113-0581	Step motor		Drives the stapler unit
M2	Exit motor	JC31-00169B	(*)	113-0502	Step motor		Drives the exit roller and the sub paddle unit
M3	Main paddle motor assembly	JC93-01001A	(*)	113-0510	Step motor	Home	Drives the main paddle unit
M4	Output tray motor assembly	JC90-01334B	(*)	113-0570	DC Motor	Encoder	Drives the output tray unit
M5	Rear tamper motor assembly	JC93-01001A	(*)	113-0520	Step motor	Home	Drives the rear tamper unit
M6	Ejector2 motor assembly	JC93-01168A		113-0562	DC Motor	Home, encoder	Drives the ejector 2 unit
M7	Ejector1 motor assembly	JC93-00998A		113-0561	Step Motor	Home	Drives the ejector 1 unit
M8	Paper support motor assembly	JC93-00802B		113-0571	Step Motor	Home	Drives paper support unit

Table 7-8 Inner finisher system - motor, solenoid (continued)

No	Name	Part number	Orderable ^(*)	Diagnostics	Type	Motor sensor	Description
M9	Front tamper motor assembly	JC93-01001A	(*)	113-0530	Step Motor	Home	Drives the front tamper unit
M10	Entrance motor assembly	JC90-01344A	(*)	113-0501	Step Motor		Drives the entrance roller and the middle roller
SL1	Paper holding solenoid	JC33-00037A	(*)	113-0591	Solenoid		Drives paper holding unit

^(*) This part is in ordering system.

The sensor mounted at the driving motor detects motor operation. If a motor doesn't work properly, an event code only for the motor will pop up.

Figure 7-8 Inner finisher system - motor sensor

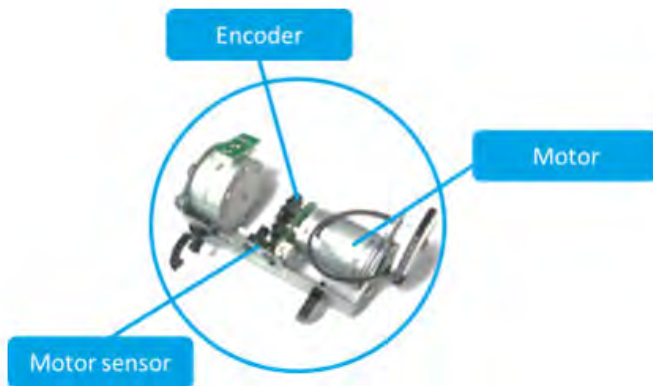

The home position sensor is installed for the purpose of checking the reference point when the specific unit is operating.

Figure 7-9 Inner finisher system - home sensor

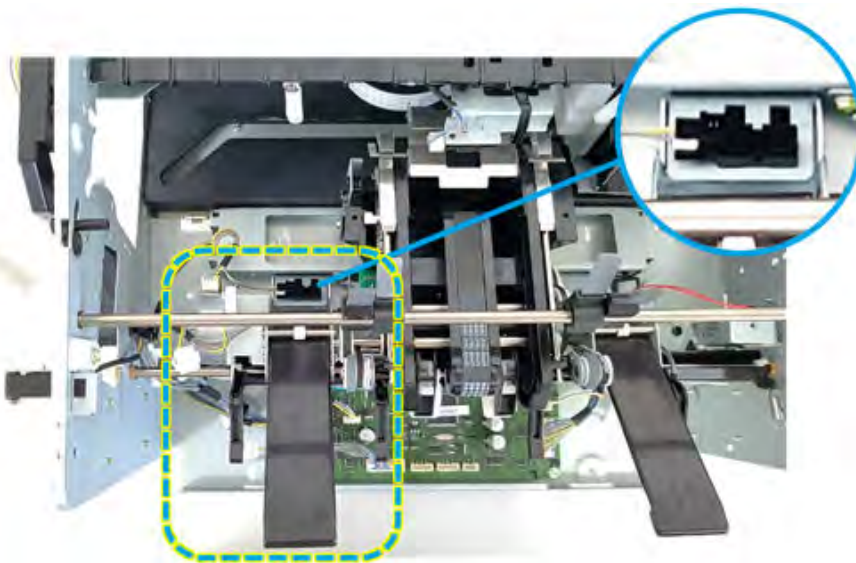

Roller

Figure 7-10 Inner finisher system - roller

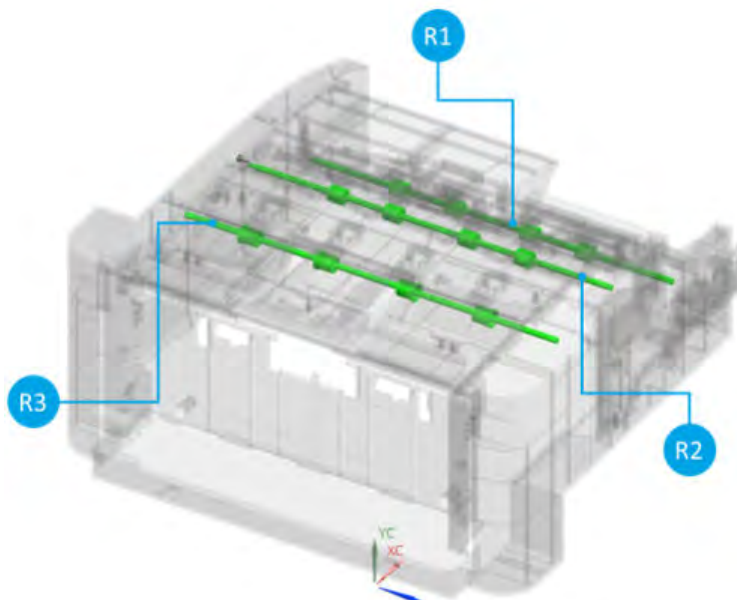

Table 7-9 Inner finisher system - roller

No	Name	Part number	Orderable ^(*)	Diagnostics	Type	Description
R1	Entrance roller	JC66-04243A	(*)		Roller	Moves paper forward
R2	Middle roller	JC66-04243A	(*)		Roller	Moves paper forward
R3	Exit roller	JC66-04244A	(*)		Roller	Moves paper forward

^(*) This part is in ordering system.

Figure 7-11 Inner finisher system - PCA

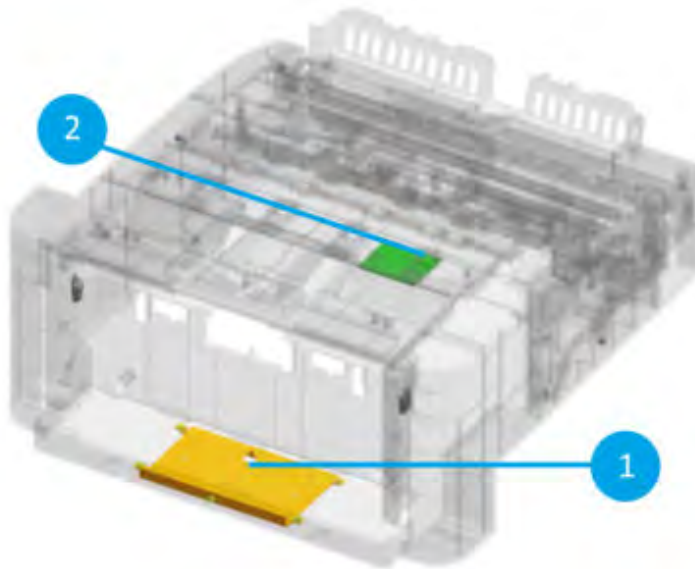

Table 7-10 Inner finisher system - roller

No	Name	Part number	Orderable ^(*)	Diagnostics	Type	Description
1	Main PCA	JC92-02774B	(*)			
2	Rear joint PCA	JC92-02780A	(*)			Joint PCA between main PCA and several parts punch, stapler, entrance, and front door

(*) This part is in ordering system.

Punch unit (optional)

Learn about the punch unit of the inner finisher.

The punch unit is a device that punches holes in a specific location on a sheet of paper. The punch unit is located immediately before the entrance unit and punches holes onto a paper.

- HP LaserJet Inner Finisher Hole2/3 Punch : Y1G02-67901
- HP LaserJet Inner Finisher Hole2/4 Punch : Y1G03-67901
- HP LaserJet Inner Finisher Swedish Punch : Y1G04-67901

 **NOTE:** Puncher types vary depending on the country/region.

In case of 2/3 hole punch, the 5 hole-punches are mounted in the punch unit. As the punch motor rotates clockwise, the inner gear moves to the right and the 3 hole-punches are moved downward to make holes. When making 2 holes, the motor rotates in the counterclockwise direction and the inner gear rotates to the left to drill two holes. The travel distance and position of the motor are detected and controlled by the hole punch home sensor and the hole punch motor sensor.

Figure 7-12 Inner finisher system - punched hole location and pair

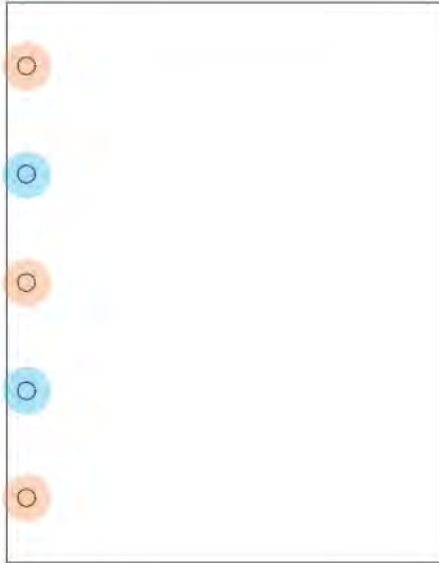

For more information, go to the HP WISE support portal and search for *HP LaserJet Managed MFP - How to use the hole punch* (c05450959).

Figure 7-13 Inner finisher system - punch unit overview

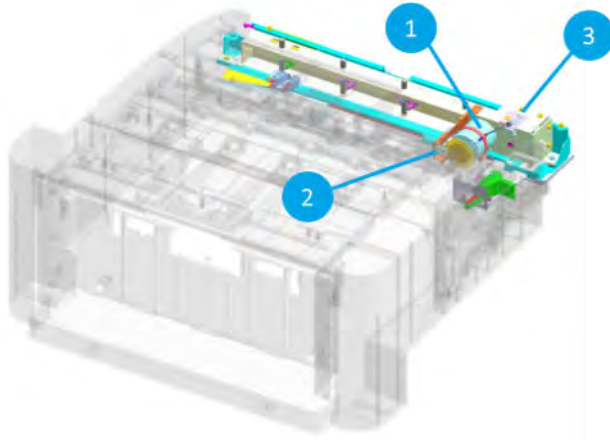

Figure 7-14 Inner finisher system - punch unit detail view

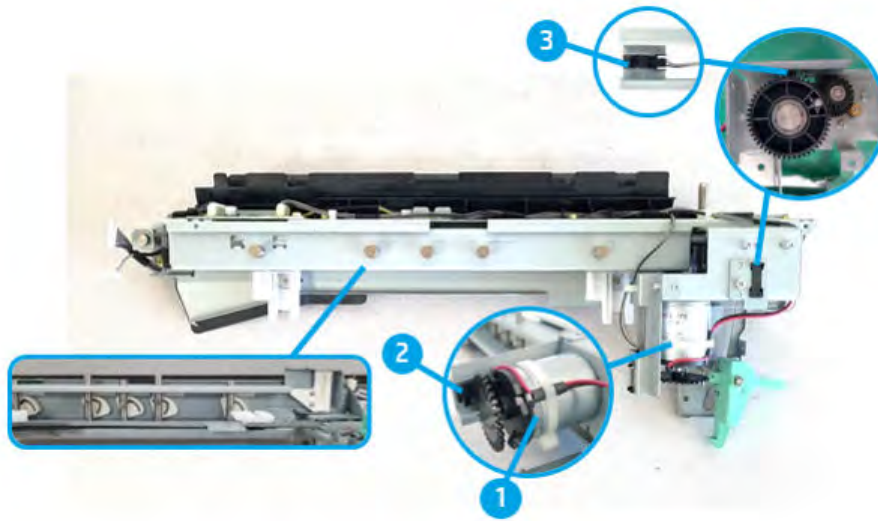

Table 7-11 Inner finisher system - punch unit parts information

Item	Part name	Part number	Orderable ^(*)	Diagnostics	Description
-	Hole 2/3 Punch	Y1G02-67901	(*)		Punch unit assembly for hole 2/3
	Hole 2/4 Punch	Y1G03-67901			Punch unit assembly for hole 2/4
	Swedish Punch	Y1G04-67901			Punch unit assembly for Swedish
	Punch cover	JC90-01343B			Punch cover (for the finisher punch is not installed)
1	Punch motor	-		113-0610	Drives the entrance roller connected by a belt
2	Punch motor sensor	-		113-0600	Detects punch motor operation
3	Punch home sensor	-		113-0612	Detects punchers' home position
Not shown	Punch PBA 2-4 hole	SS465-67001	(*)		
Not shown	Punch PBA 2-3 hole	SS467-67001	(*)		
Not shown	Punch PBA Swedish	SS466-67001	(*)		

(*) This part is in system.

Figure 7-15 Inner finisher system - punch unit operation (3 holes)

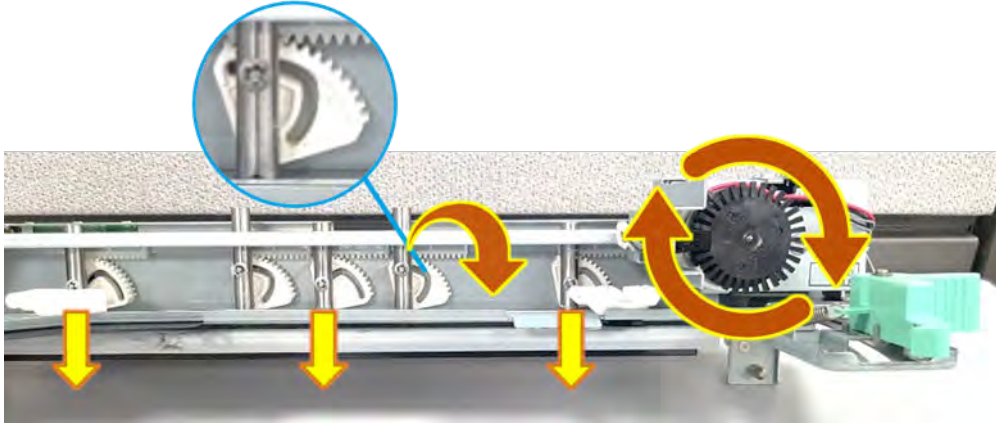
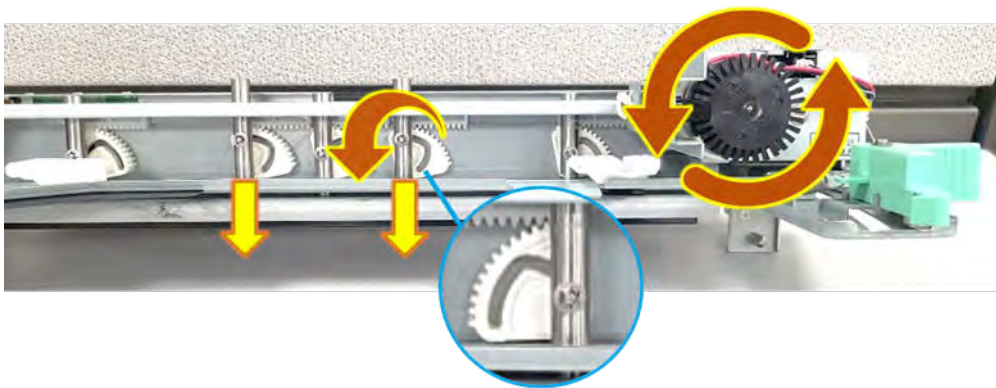

Figure 7-16 Inner finisher system - punch unit operation (2 holes)



Entrance unit

Learn about the entrance unit of the inner finisher.

The entrance unit is located right after the punch unit. This unit is driven by entrance motor which is installed on the rear of the finisher. This motor is connected to the entrance roller by a belt, which transfers driving force to move paper from the printer to the finisher inside. If an error such as paper jam occurs in the entrance unit, the entrance sensor detects the error and generates an event code (13.60.xx).

Figure 7-17 Inner finisher system - entrance unit overview

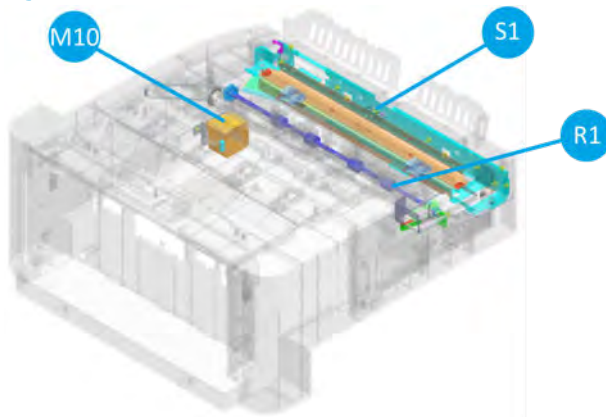

Figure 7-18 Inner finisher system - entrance unit detail view

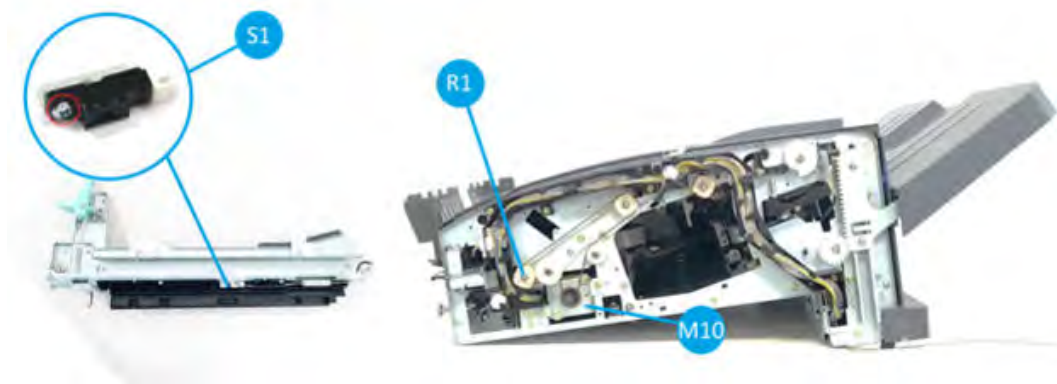

Table 7-12 Inner finisher system - entrance unit parts information

Item	Part name	Part number	Orderable ^(*)	Diagnostics	Description
S1	Entrance sensor	0604-001381	(*)	113-0350	Detects paper if it comes into the entrance unit
M10	Entrance motor assembly	JC90-01344A	(*)	113-0501	Drives the entrance roller connected by a belt
-	Entrance motor	JC31-00169B	(*)		
R1	Entrance roller	JC66-04243A	(*)		Moves paper forward

(*) This part is in ordering system.

Diverter unit

Learn about the diverter unit of the inner finisher.

The diverter unit holds paper so that the newly printed paper can wait for a few seconds until the stapled bundle moves to the output tray. The diverter unit is used to change paper path, which is done by a spring mounted on the diverter unit. When paper exit from the unit, it goes through the upper path of the diverter. When the paper rolls back, it passes the lower paper path created by the diverter. Here, the paper sits for a while until the next paper is ready to come out together.

Figure 7-19 Inner finisher system - diverter unit overview

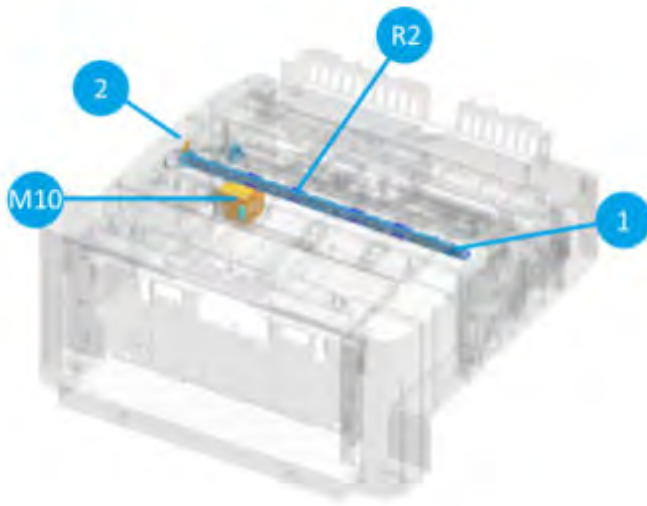

Figure 7-20 Inner finisher system - diverter unit detail view

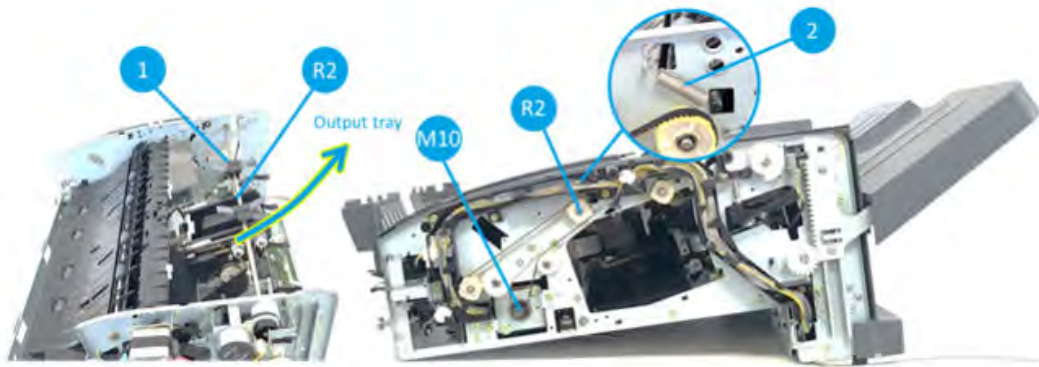

Table 7-13 Inner finisher system - diverter unit parts information

Item	Part name	Part number	Orderable ^(*)	Diagnostics	Description
M10	Entrance motor assembly	JC90-01344A	(*)	113-501	Drives the feed roller connected by a belt
	Entrance motor	JC31-00169B	(*)		
R2	Middle roller	JC66-04243A	(*)		Drives paper forward installed in front of the diverter
1	Diverter	JC61-06392A			Changes paper path when paper goes backward
2	Diverter spring	JC61-07269A			Pulls the diverter to upward so that it makes paper path to the lower of the diverter

(*) This part is in ordering system.

Diverter unit operation

1. Paper goes forward to the output tray.

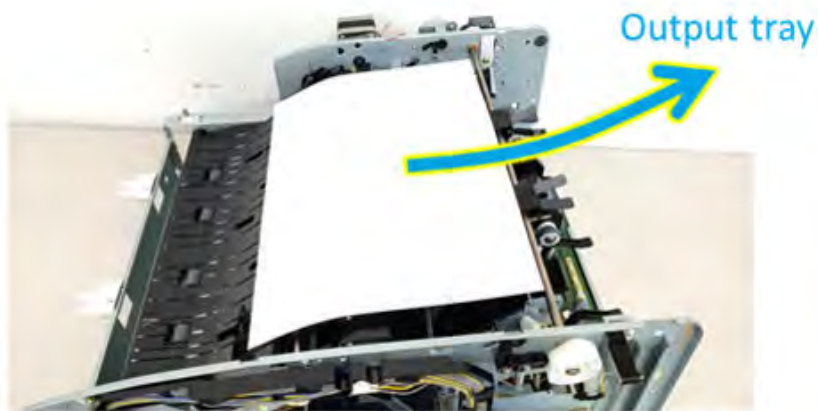

2. Exit roller stops after paper passes by the diverter unit.

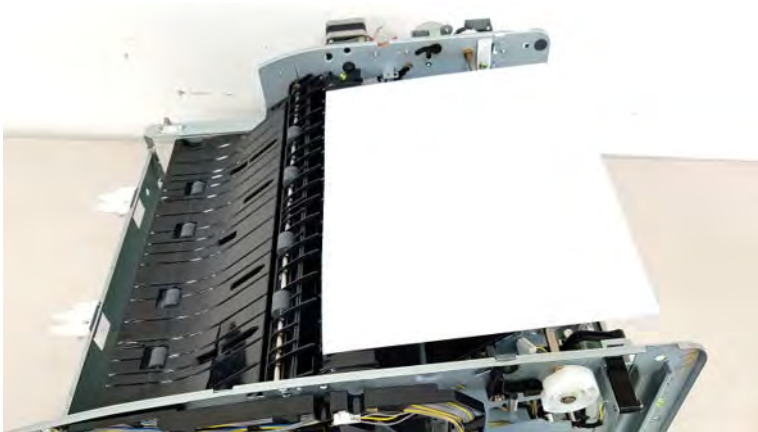

3. Paper goes backward under the diverter unit.

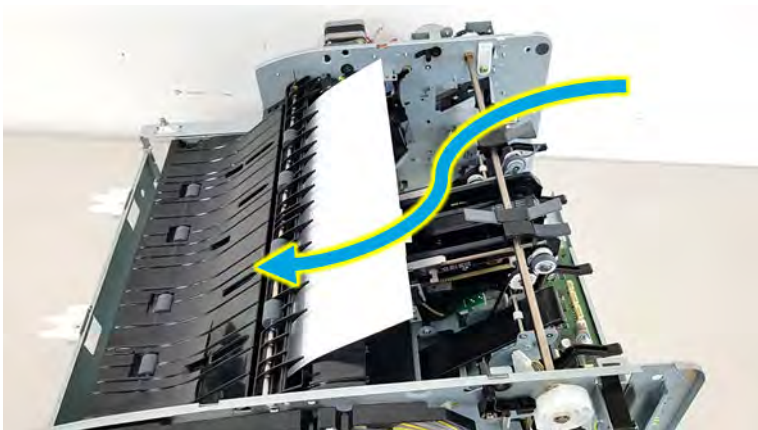

Exit unit

Learn about the exit unit of the inner finisher.

The exit unit is the part that moves paper from the diverter unit to the ejector unit. The exit unit is powered by an exit motor installed on the front of the finisher. The motor and the exit roller are connected by a single belt. The exit motor rotates in both the forward and reverse directions, since it serves to return paper to a new paper path

created by the diverter unit. The exit sensor is installed right in front of exit roller. It generates an event code when a paper jam occurred.

Figure 7-21 Inner finisher system - exit unit overview

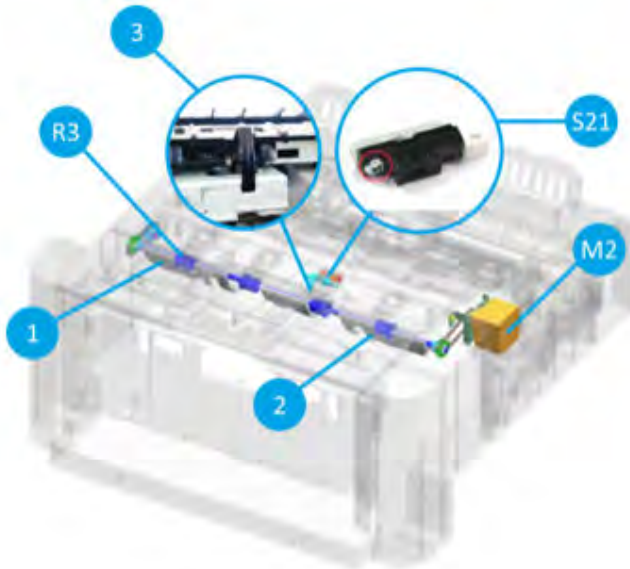

Figure 7-22 Inner finisher system - exit unit detail view

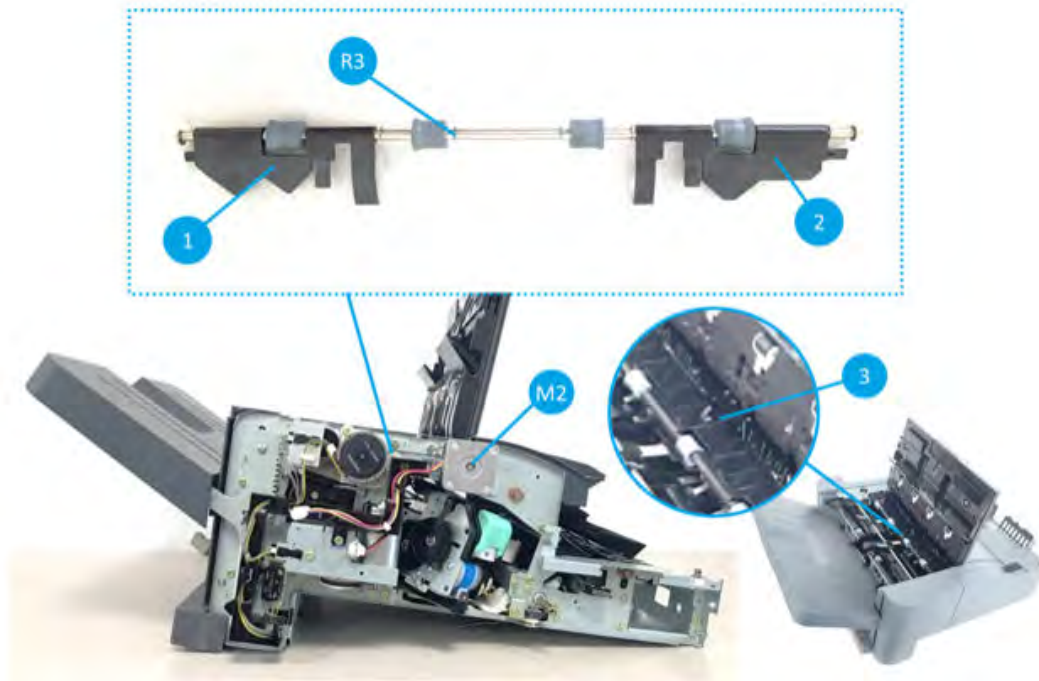

Table 7-14 Inner finisher system - exit unit parts information

Item	Part name	Part number	Orderable ^(*)	Diagnostics	Description
1	Rear compile guide	JC61-07450A	(*)		Guides to help paper move through the paper path
2	Front compile guide	JC61-07449A	(*)		Guides to help paper move through the paper path

Table 7-14 Inner finisher system - exit unit parts information (continued)

Item	Part name	Part number	Orderable ^(*)	Diagnostics	Description
3	Exit sensor actuator	JC66-04199A	(*)	113-0360	Makes the sensor on and off by checking paper
S21	Exit sensor	0604-001415	(*)	113-0360	Detects paper if it passes through the exit unit
M2	Exit motor assembly	JC90-01331A		113-0502	Drives the exit roller connected by a belt
	Exit motor	JC31-00169B	(*)		
R3	Exit roller	JC66-04244A	(*)		Moves paper to the ejector unit

^(*) This part is in ordering system.

Exit unit operation

1. When rotating the exit motor counter clockwise, paper goes forward to the output tray.

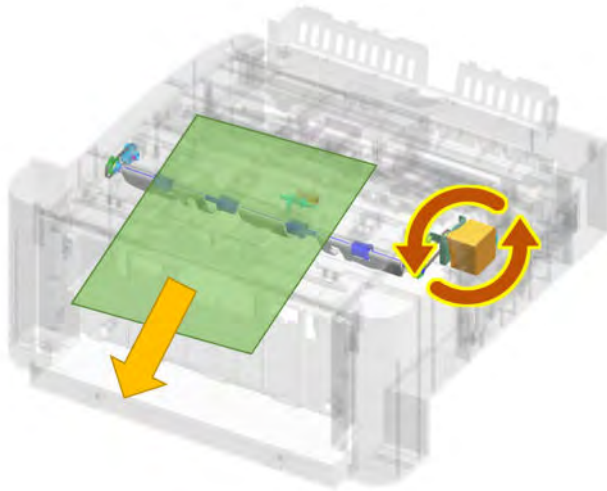

2. When rotating the exit motor clockwise, paper goes backward to the end fence unit.

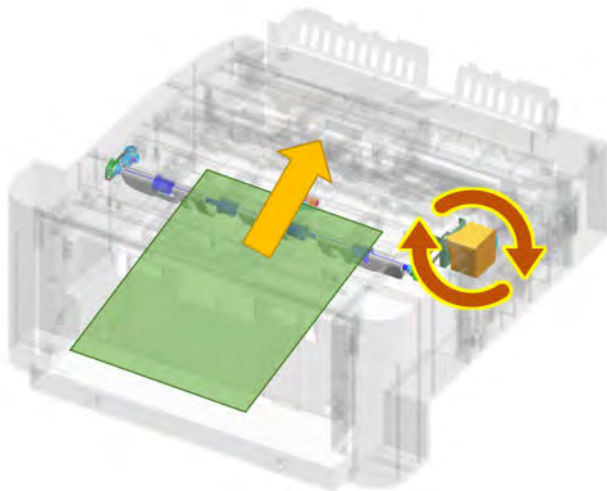

Paper support unit

Learn about the paper support unit of the inner finisher.

Paper support unit works to prevent the paper from falling out or being folded. Also, the newly printed paper will not scatter papers already sitting on the output tray. Paper guides are installed on each front and rear side of the finisher, these guides move towards the output tray when the paper exits, then the guides return to the original position after the support operation is completed. The paper support home sensor confirms the original position of the guide.

Figure 7-23 Inner finisher system - paper support unit overview

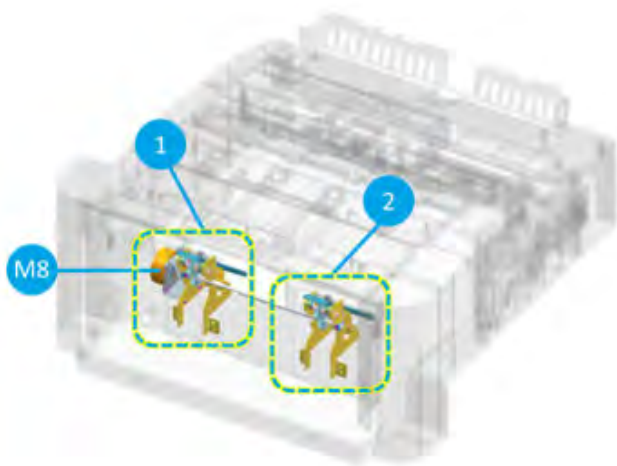

Figure 7-24 Inner finisher system - paper support unit detail view

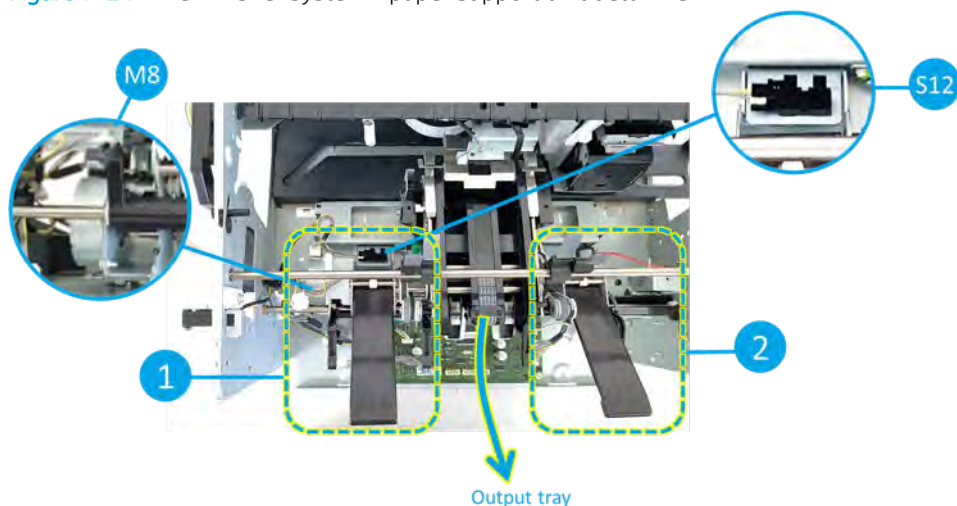

Table 7-15 Inner finisher system - paper support unit parts information

Item	Part name	Part number	Orderable ^(*)	Diagnostics	Description
1	Rear paper support	JC90-01311A	(*)		Supports paper not to be bended
2	Front paper support	JC90-01310A	(*)		Supports paper not to be bended
S12	Paper support home sensor	0604-001393		113-0481	Detects the paper support guides locate at the home position

Table 7-15 Inner finisher system - paper support unit parts information (continued)

Item	Part name	Part number	Orderable ^(*)	Diagnostics	Description
M8	Paper support motor assembly	JC93-00802B		113-0571	Drives paper support guides from the home position to the forward direction
	Paper support motor	JC31-00149A			

^(*) This part is in ordering system.

Paper support unit operation

Paper support unit is extended to the arrow direction to help paper is bent of fallen to the output tray.

Figure 7-25 Inner finisher system - paper support unit operation



Paddle unit

Learn about the paddle unit of the inner finisher.

The paddle unit consists of two paddle systems, a main paddle and a sub paddle. First, when paper is discharged from the exit unit, the main paddle unit moves paper to the sub paddle. Then the sub paddle unit moves paper to the end fence unit so that it can be ready to be stapled.

The main paddle unit is operated by the main paddle motor. The main paddle sensor detects the main paddle position. The sub paddle unit rotates by the exit motor.

Figure 7-26 Inner finisher system - paddle unit driving system overview (main paddle unit)

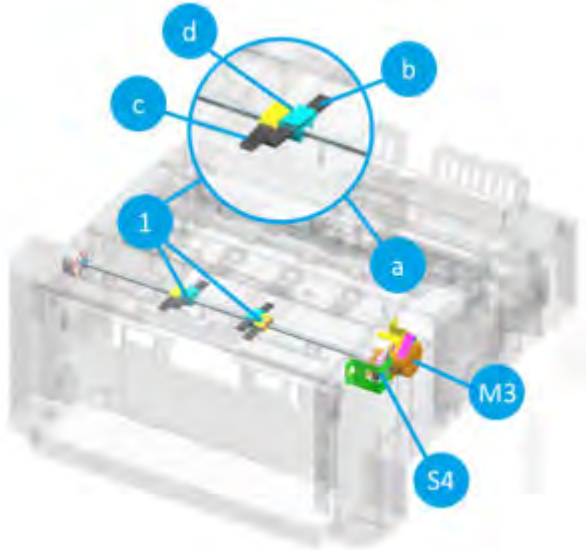

Figure 7-27 Inner finisher system - paddle unit driving system overview (sub paddle unit)

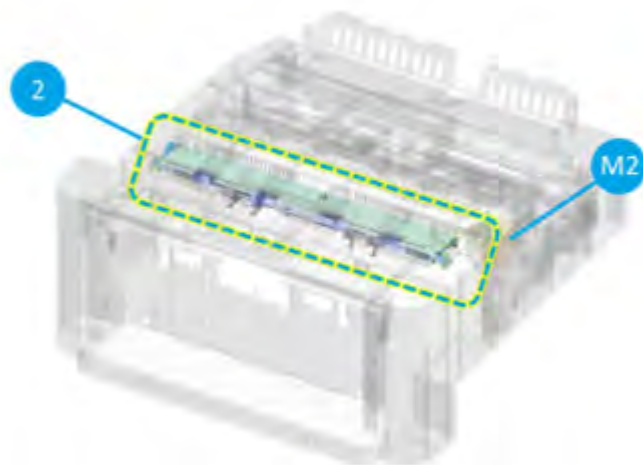

Figure 7-28 Inner finisher system - paddle unit driving system detail view (1/2)

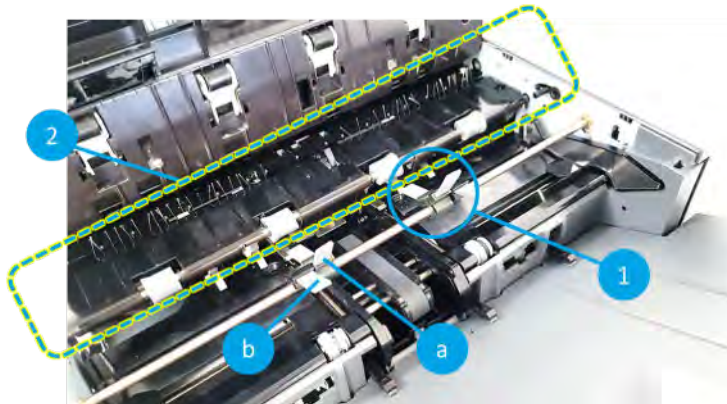

Figure 7-29 Inner finisher system - paddle unit driving system detail view (2/2)

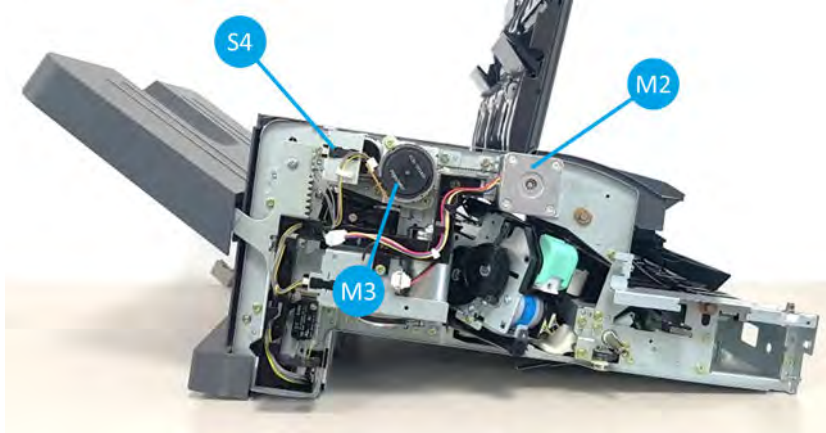

Table 7-16 Inner finisher system - paddle unit parts information

Item	Part name	Part number	Orderable ^(*)	Diagnostics	Description
1	Main paddle	JC90-01327A	(*)		Moves paper to the sub paddle unit
1-a	Main paddle kit	JC82-01038A	(*)		
1-b	Main paddle A	JC63-04957A	(*)		
1-c	Main paddle B	JC63-04958A	(*)		
1-d	Main paddle holder	JC81-07560A	(*)		
2	Sub paddle	JC90-01336A	(*)		Gets paper move to the end fence and arrange them to be stapled correctly
S4	Main paddle home sensor	0604-001393		113-0370	Detects the home position of the main paddle
M3	Main paddle motor assembly	JC90-01331A	(*)	113-0510	Drives the main paddle unit connected by a belt
	Main paddle motor	JC31-00149A			
M2	Exit motor	JC31-00169B	(*)	113-0502	Drives the sub paddle unit connected by a belt

^(*) This part is in ordering system.

Paddle unit operation

1. Main paddles get paper moves to the sub paddle unit.



2. Sub paddle unit gets paper goes to the end fence unit.

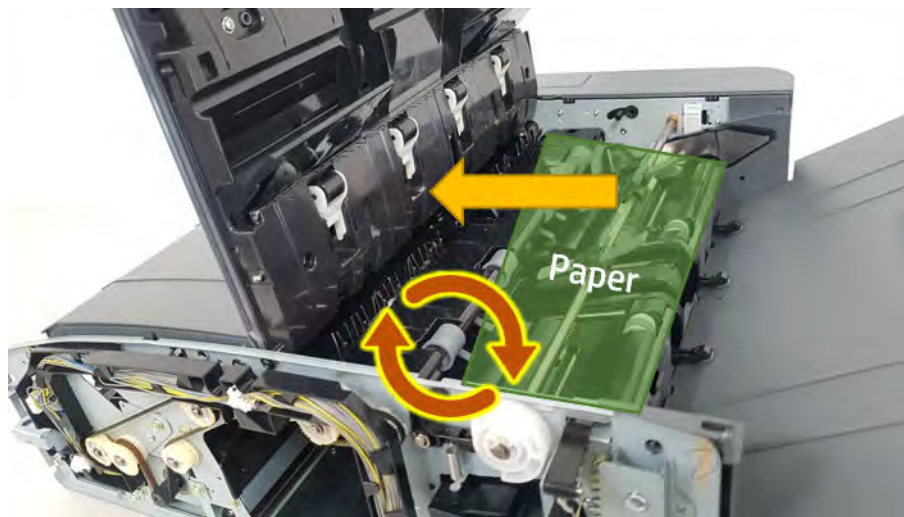

Tamper unit

Learn about the tamper unit of the inner finisher.

The tamper unit functions to align the left and right sides of a bundle of paper in order to staple it to the correct position. When a certain amount of paper for stapling is collected after printing, the tamper unit hits the left and right ends of the paper to align the paper correctly.

Each temper has a motor on the back side that delivers driving force to move. The temper unit sensors are mounted on the back side of the unit, to check the position of the temper unit.

Figure 7-30 Inner finisher system - tamper unit overview

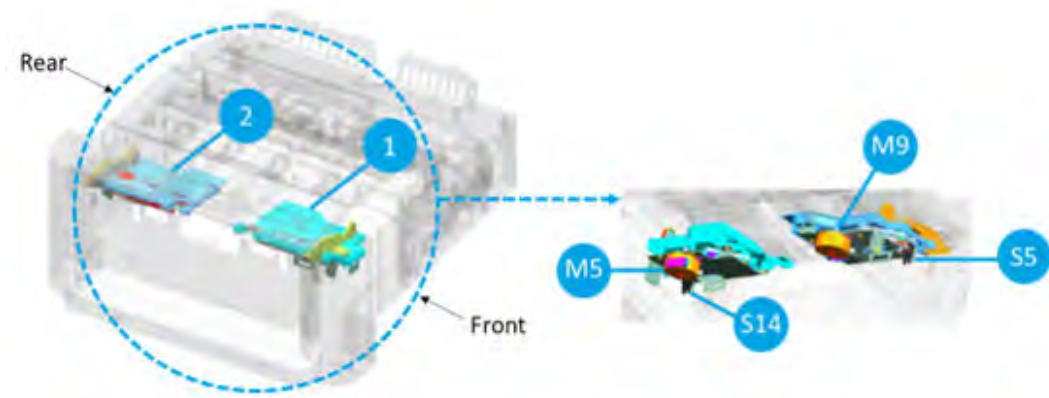

Figure 7-31 Inner finisher system - tamper unit detail view (1/3)

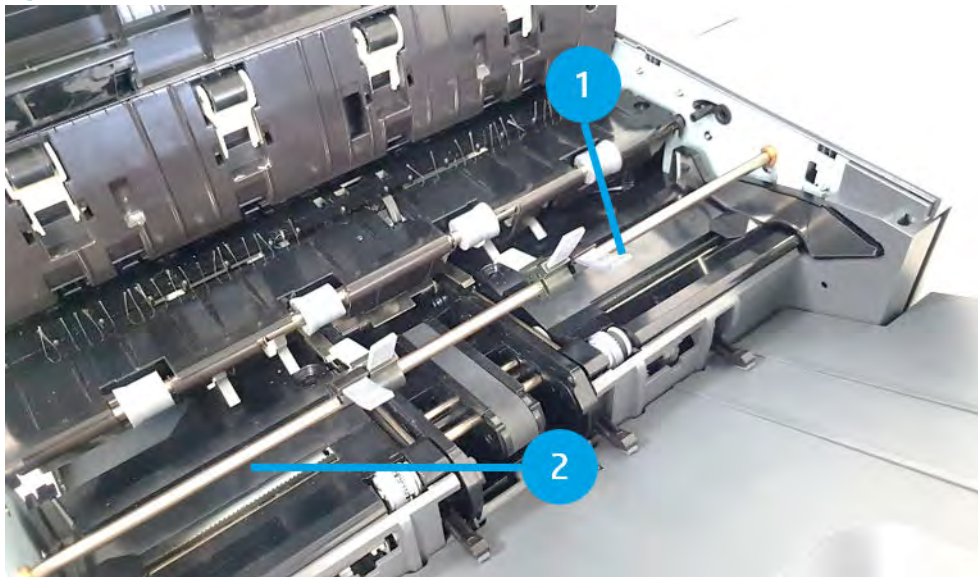

Figure 7-32 Inner finisher system - tamper unit detail view (rear) (2/3)

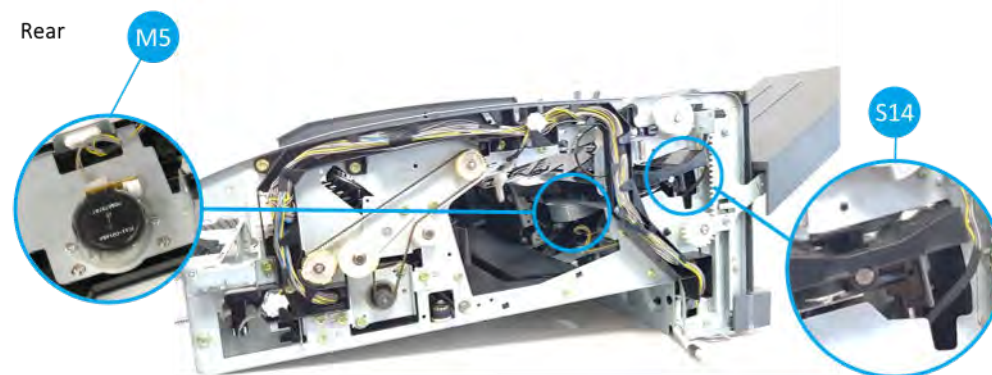

Figure 7-33 Inner finisher system - tamper unit detail view (front) (3/3)

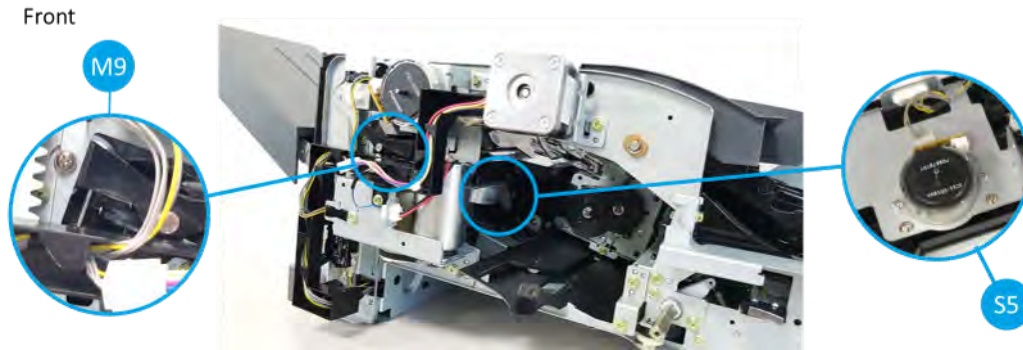

Table 7-17 Inner finisher system - tamper unit parts information

Item	Part name	Part number	Orderable ^(*)	Diagnostics	Description
1	Front tamper	JC82-00899A	(*)		Aligns left and right side of paper
2	Rear tamper	JC82-00900A	(*)		Aligns left and right side of paper
M5	Rear tamper motor assembly	JC93-01001A	(*)	113-0520	Drives the rear tamper unit
	Rear tamper motor	JC31-00149A			
S14	Rear tamper home sensor	0604-001393		113-0380	Detects the reference position of the tamper unit
M9	Front tamper motor assembly	JC93-01001A	(*)	113-0530	Drives the front tamper unit
	Front tamper motor	JC31-00149A			
S5	Front tamper home sensor	0604-001393		113-0390	Detects the reference position of the tamper unit

(*) This part is in ordering system.

Tamper unit operation

1. Paper is arranged at the end of the end fence unit.



2. The left and right tampers arrange a stack of paper.

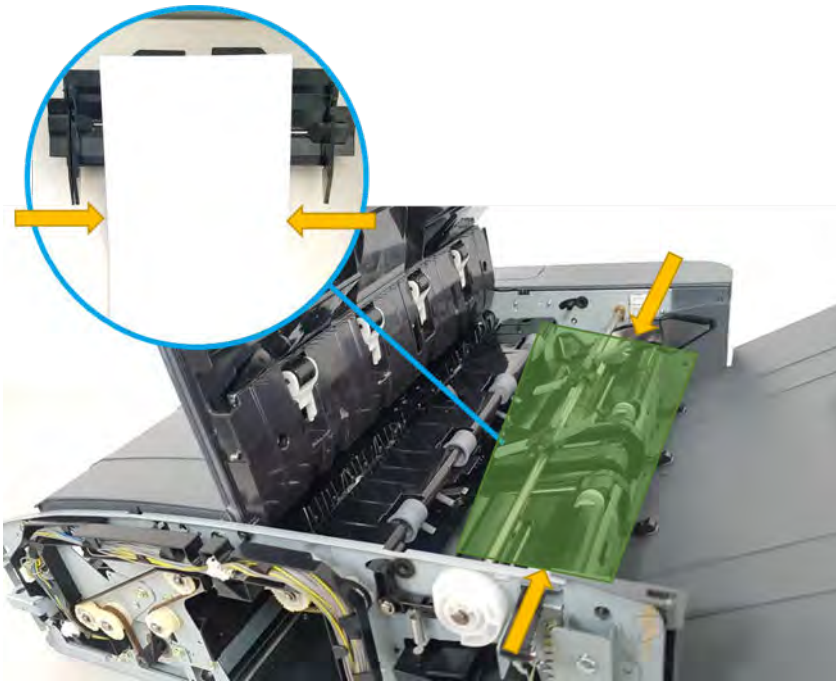

End fence unit

Learn about the end fence unit of the inner finisher.

The paddle unit moves paper to the end fence unit. The end fence unit sets the standard position of the paper to be aligned towards top and bottom of the paper. The end fence is fixed onto the finisher, and the end fence sensor can sense any paper entering the end fence unit.

Figure 7-34 Inner finisher system - end fence unit overview

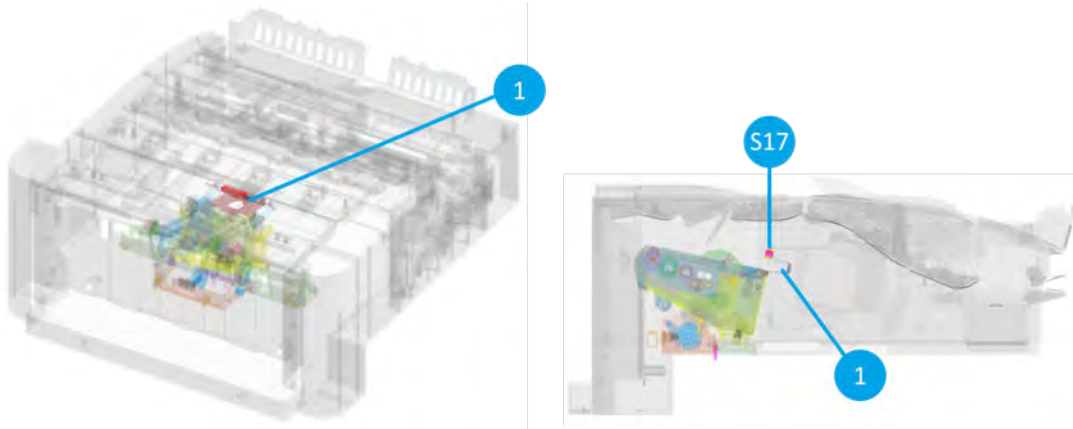

Figure 7-35 Inner finisher system - end fence unit detail view

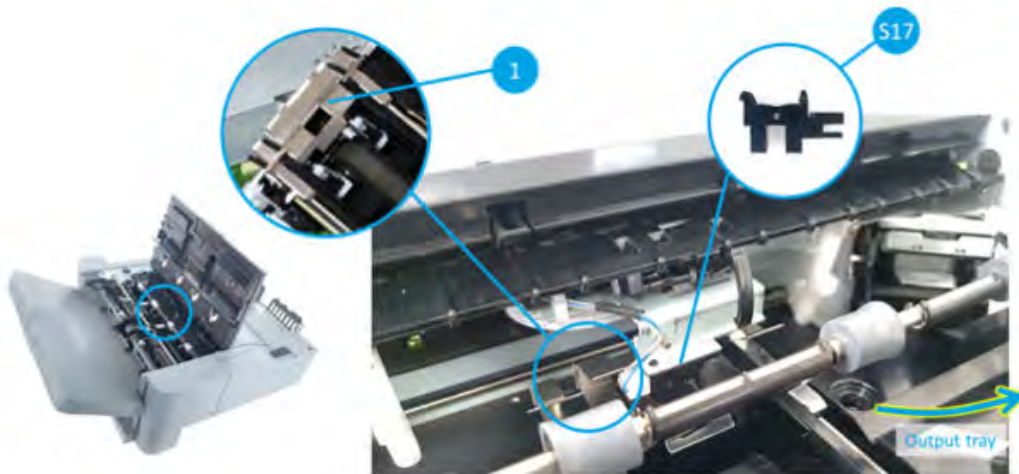

Table 7-18 Inner finisher system - end fence unit parts information

Item	Part name	Part number	Orderable ^(*)	Diagnostics	Description
1	End fence	JC61-06428A			Aligns paper toward top and bottom direction
2	End fence sensor	0604-001381	(*)	113-0361	Detects paper whether paper exists in the end fence unit

(*) This part is in ordering system.

End fence unit operation

1. Paper goes into the end fence unit through the main paddle unit and sub paddle unit. At the same time the end fence unit is aligned paper to the direction of yellow line.



2. The end fence sensor is checking whether paper goes into the end fence sensor.

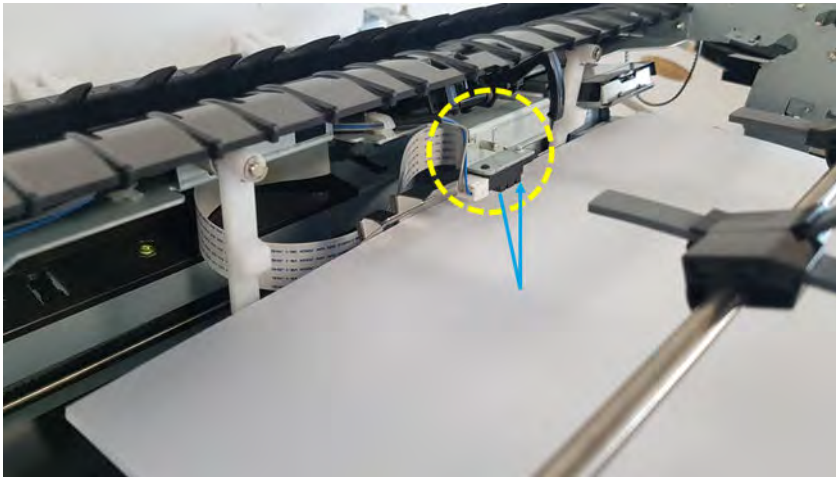

Stapler unit

Learn about the stapler unit of the inner finisher.

Stapler unit is a device installed inside the finisher that staples a bundle of aligned documents. Documents are collected as a bundle by the tamper unit and the end fence unit for stapling, then stapler assembly staples the bundle. There are 6 options to make a bundle.

Figure 7-36 Inner finisher system - stapling options



The stapler unit moves using the stapler motor installed inside. The four stapler position sensors are mounted so that the stapler can be positioned in the exact stapling position whether it is stapled on the left, the right, or at the center of the document. Stapling is done by the motor inside the stapler assembly.

Figure 7-37 Inner finisher system - stapler unit overview

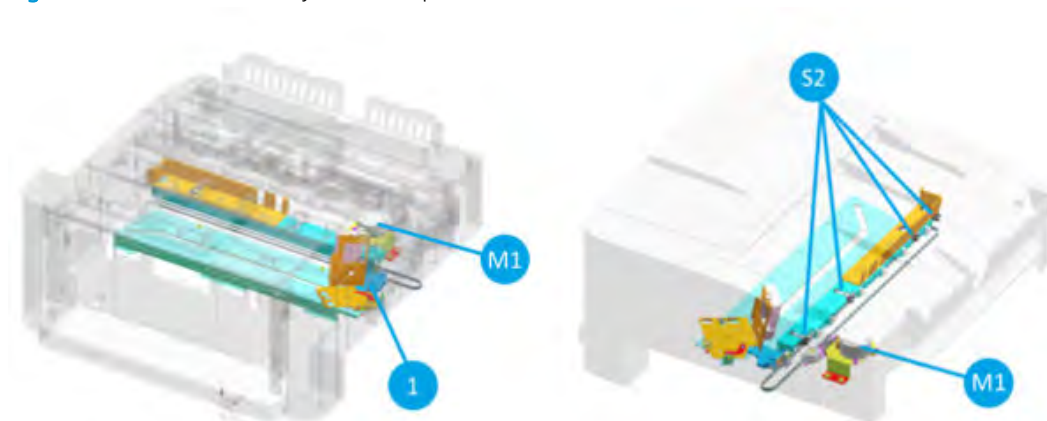

Figure 7-38 Inner finisher system - stapler unit detail view (1/2)

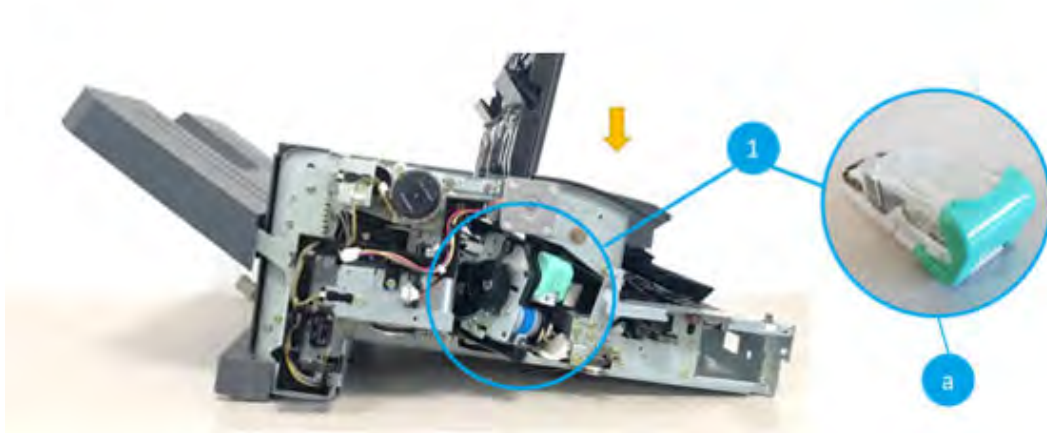

Figure 7-39 Inner finisher system - stapler unit detail view (2/2)

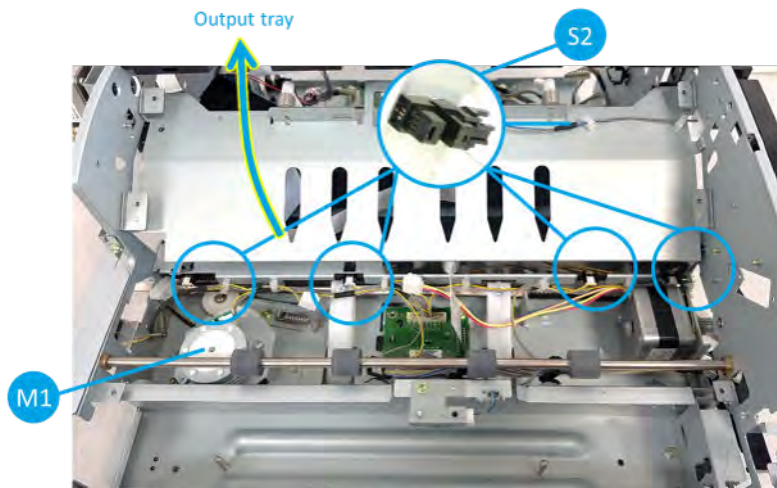

Table 7-19 Inner finisher system - stapler unit parts information

Item	Part name	Part number	Orderable ^(*)	Diagnostics	Description
1	Stapler assembly	JC59-00040A	(*)		Staples a bundle of paper
1-a	Staple cartridge	JC81-07408B	(*)		Staple cartridge
S2	Stapler position sensor	0604-001393	(*)	113-0491 113-0492	Detects and moves the staple assembly position to make a bundle of paper at the exact location
M1	Stapler position motor	JC93-00999A	(*)	113-0581	Gets the staple assembly move toward top and down direction of paper

(*) This part is in ordering system.

Stapler unit operation

1. The stapler position motor delivers the stapler assembly to the horizontal direction (yellow line).

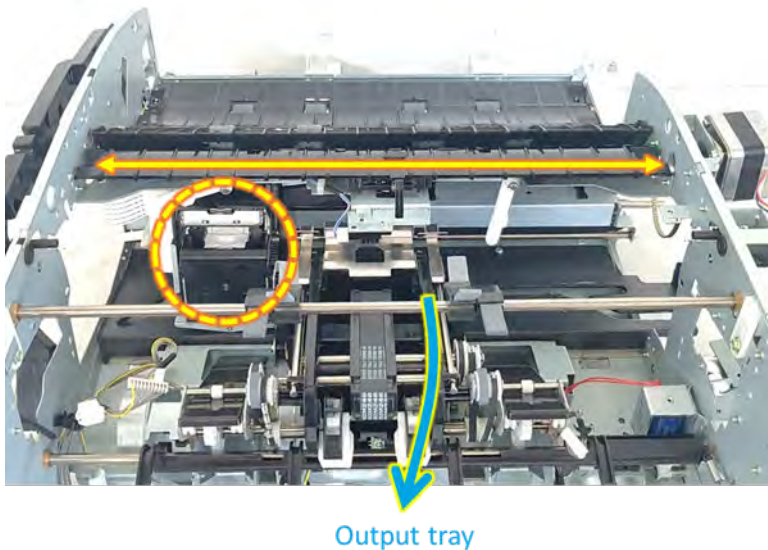

2. The stapler assembly checks front and rear home position and moves where the stapler position sensors are located depending on stapling types.

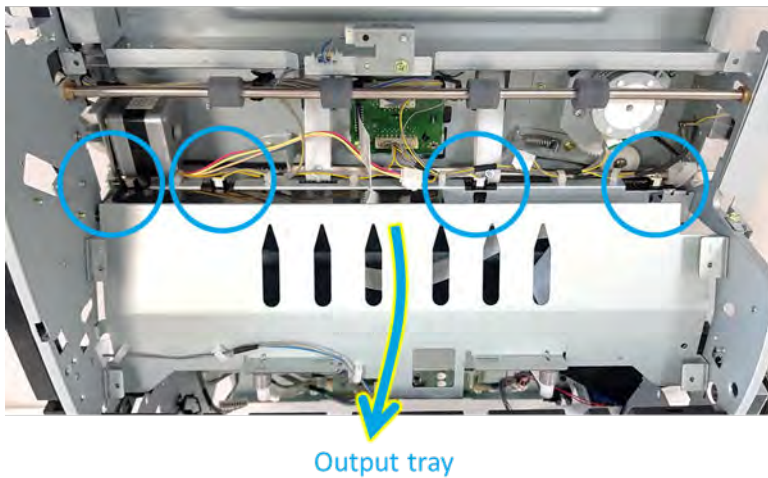

Ejector unit

Learn about the ejector unit of the inner finisher.

The ejector unit moves a bundle of stapled paper out. The ejector unit consists of ejector1 and ejector2. The Ejector1 transfers a stapled paper loaded at the end fence unit to the ejector2 unit. During this process, the ejector1 motor transmits the driving force to the ejector1 unit. And the ejector1 home position sensor controls the movement of the ejector1. When the paper arrives at the ejector2 unit, the ejector2 grabs a stack of paper and ejects it onto the output tray. The ejector2 motor is responsible for this process, and the ejector2 motor sensor helps it to be controlled correctly. In addition, the ejector2 home position sensor is mounted to check the location of the ejector2.

Figure 7-40 Inner finisher system - ejector unit overview

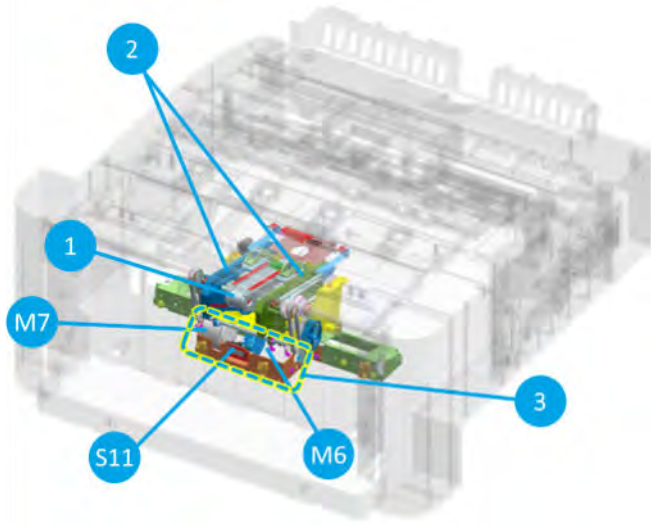

Figure 7-41 Inner finisher system - ejector unit detail view (1/3)

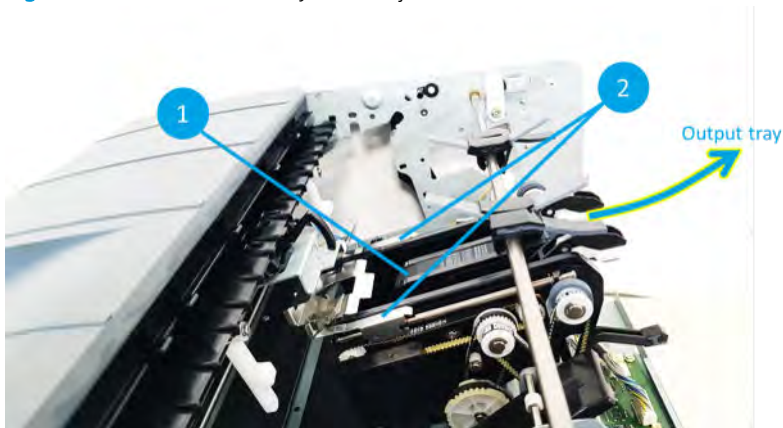

Figure 7-42 Inner finisher system - ejector unit detail view (2/3)



Figure 7-43 Inner finisher system - ejector unit detail view (3/3)

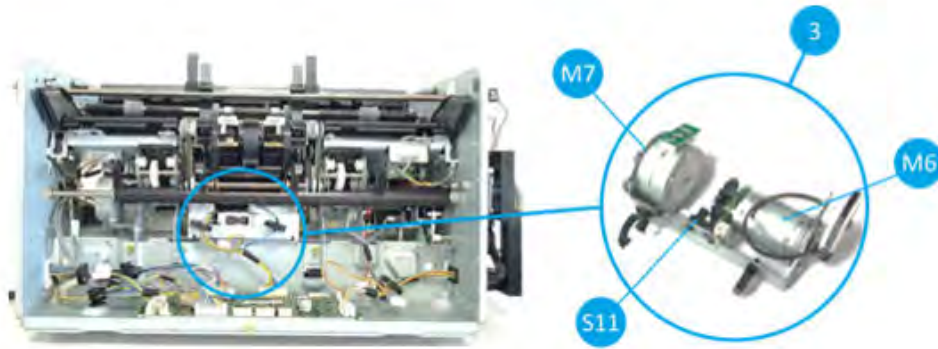

Table 7-20 Inner finisher system - ejector unit parts information

Item	Part name	Part number	Orderable ^(*)	Diagnostics	Description
NA	Ejector	SS456-61001	(*)		
1	Ejector2	Not applicable			Moves paper from the ejector 1 to the output tray
2	Ejector1	Not applicable			Moves the stack of paper from the end fence to the ejector2
S10	Ejector2 home sensor	0604-001393	(*)	113-0462	Detects the home position of the ejector2
S16	Ejector1 home sensor	0604-001393	(*)	113-0461	Detects the home position of the ejector1
3	Ejector motor assembly	JC90-01309A			Moves the ejector1 and ejector2
M6	Ejector2 motor assembly	JC93-01168A	(*)	113-0562	Moves the ejector2 forward and backward
	Ejector2 motor	JC31-00175A			Detects the ejector2 motor rotation
S11	Ejector2 motor sensor	0604-001393	(*)	113-0463	
M7	Ejector1 motor assembly	JC93-00998A	(*)	113-0561	Grabs a stack of paper, then move it to the output tray
	Ejector1 motor	JC31-00009C			

(*) This part is in ordering system.

Ejector unit operation

1. Ejector 1 pushes aligned paper at the end fence unit to ejector 2 unit.



2. Ejector 2 grabs paper, then moves forward to the output tray unit direction.

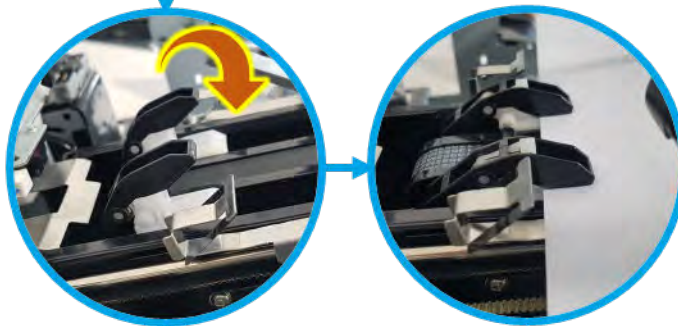

3. Ejector2 draws off paper on the output tray.



Output tray & paper holding unit

Learn about the output tray & paper holding unit of the inner finisher.

The output tray moves up and down along the rails inside the finisher, and the output tray motor controls those movement according to the signals sent from the paper holding sensor. As paper stacks up on the output tray, the paper holding unit is lifted by papers. When the paper holding sensor is touched, the output tray moves downward.

The machine detects when the output tray is full as the output tray hits the lower limit switch. The output tray top of stack sensor is mounted on both left and right sides for the case that the paper holding sensor breaks down.

The paper holding solenoid lifts the paper holding actuator up when a new bundle of paper come to the output tray.

Figure 7-44 Inner finisher system - output tray unit overview

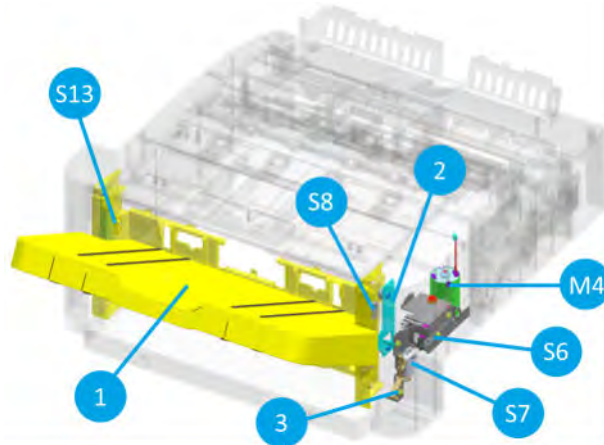

Figure 7-45 Inner finisher system - output tray unit detail view (1/2)

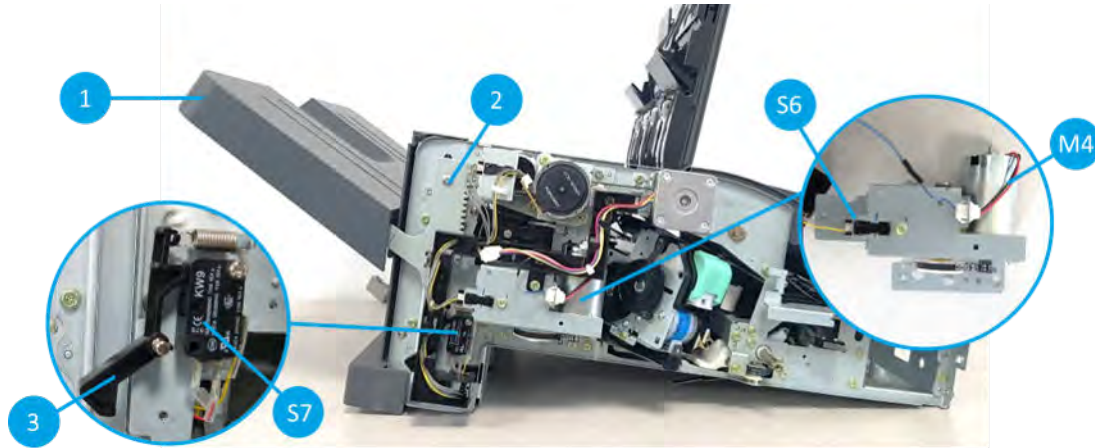

Figure 7-46 Inner finisher system - output tray unit detail view (2/2)

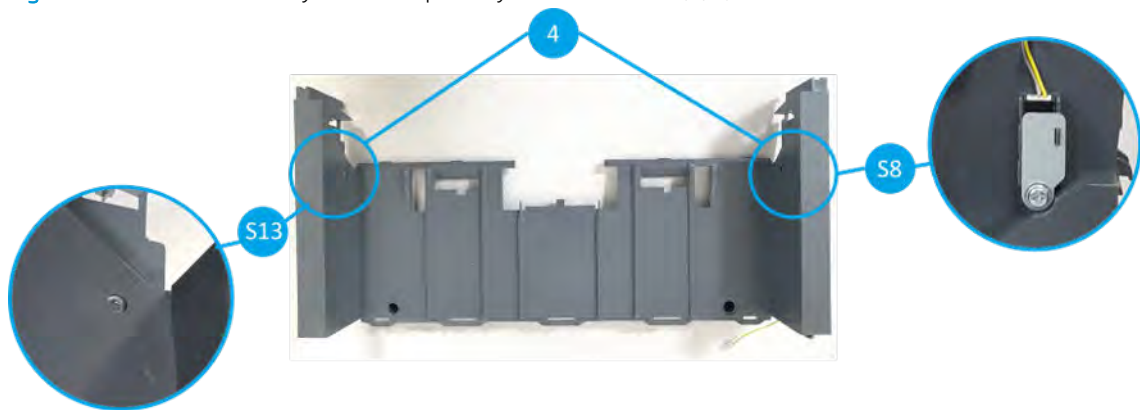

Table 7-21 Inner finisher system - output tray unit parts information

Item	Part name	Part number	Orderable ^(*)	Diagnostics	Description
1	Output tray	JC90-01337B	(*)		Stacking plate for ejected paper
M4	Output tray motor assembly	JC90-01334B	(*)	113-0570	Moves the output tray up and down
	Output tray motor	JC31-00178B	(*)		
S6	Output tray motor sensor	0604-001393		113-0473	Detects if the output tray motor is operational
2	Output tray frame	JC90-01319A	(*)		
S7	Output tray lower limit switch	JC90-01320A	(*)	113-0472	Detects the lowest position of the output tray
3	Output tray lower actuator	JC66-04200A	(*)	113-0472	Detects the lowest position of the output tray
4	Output tray top of stack sensor kit	JC82-01039A	(*)	113-0471	Detects abnormal movement of output tray (Output tray top of stack sensor receiver + led)
S8	Output tray top of stack sensor (receiver)	0603-001309	(*)		

Table 7-21 Inner finisher system - output tray unit parts information (continued)

Item	Part name	Part number	Orderable ^(*)	Diagnostics	Description
S13	Output tray top of stack sensor (led)	0601-003440			

^(*) This part is in ordering system.

Figure 7-47 Inner finisher system - paper holding unit overview

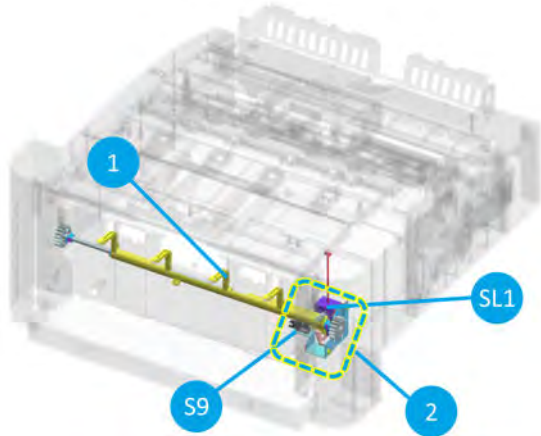

Figure 7-48 Inner finisher system - paper holding unit detail view

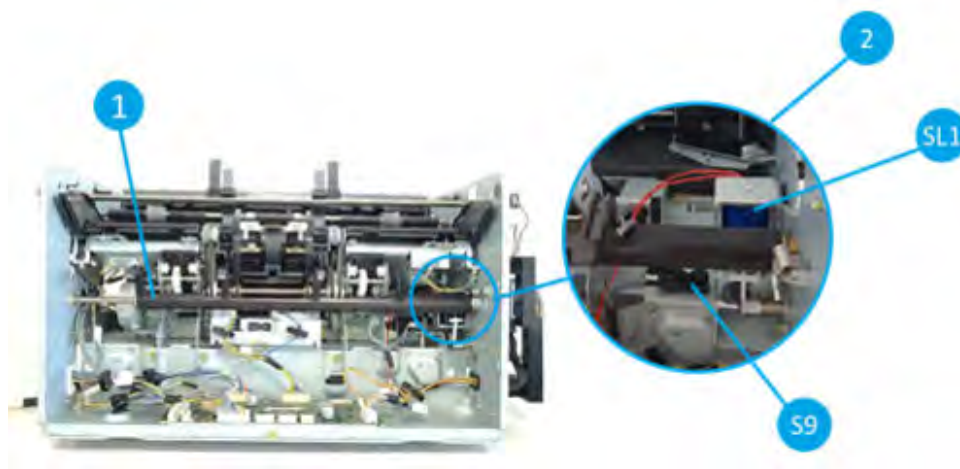

Table 7-22 Inner finisher system - output tray unit parts information

Item	Part name	Part number	Orderable ^(*)	Diagnostics	Description
1	Paper holding actuator	JC90-01313A	(*)		Controls the output tray height, and grabs stacked paper not to be scattered
2	Paper holding kit	JC90-01314A	(*)		Paper holding solenoid + Paper holding sensor
SL1	Paper holding solenoid	JC33-00037A	(*)	113-0591	Moves paper holding actuator up when paper goes out to the output tray

Table 7-22 Inner finisher system - output tray unit parts information (continued)

Item	Part name	Part number	Orderable ^(*)	Diagnostics	Description
S9	Paper holding sensor	0604-001393		113-0470	Detects stacked paper position

(*) This part is in ordering system.

Inner finisher system - output tray & paper holding unit operation

1. Paper holding unit helps paper stores stable on the output tray. Besides it detects amount of stacked paper and get the output tray moves downward.

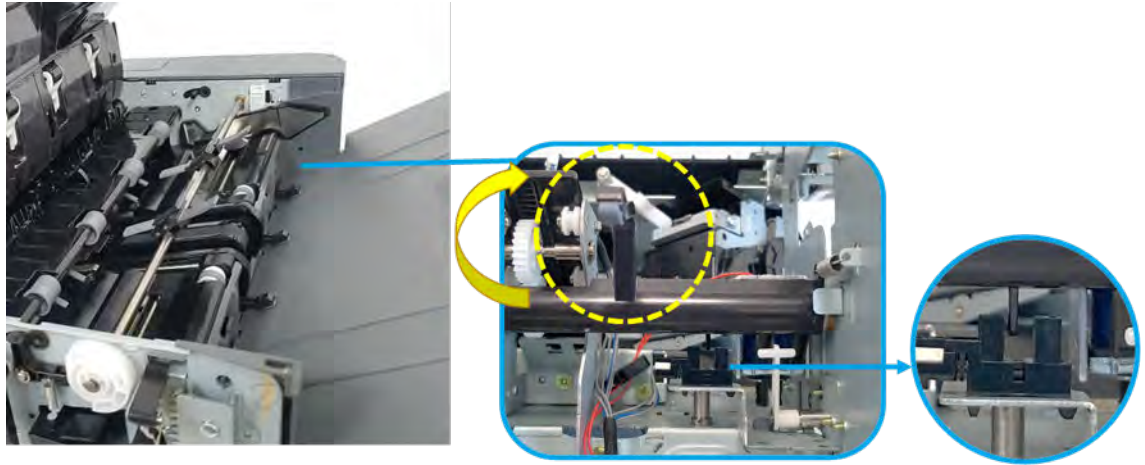

2. When paper goes out to the output tray, paper holding solenoid forcibly make paper holding actuator goes upward to create the paper passage not to be jammed by the paper holding actuator.

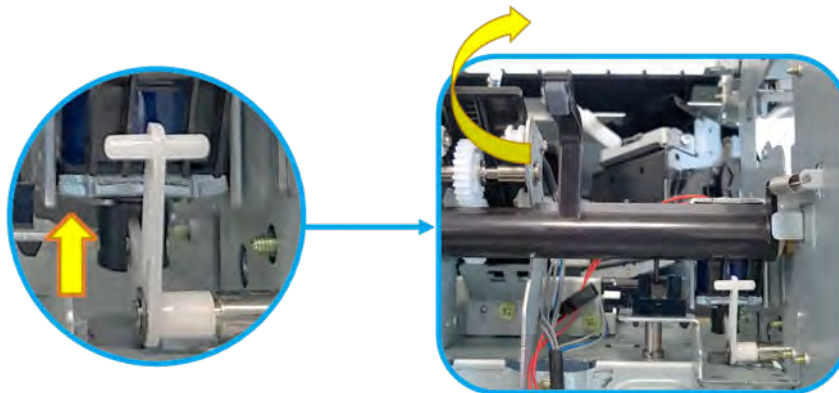

3. As the paper accumulates, output tray moves downward. When it reaches at the end of the moving range, output tray lower limit switch is pressed. The switch detects paper stacks full on the output tray.

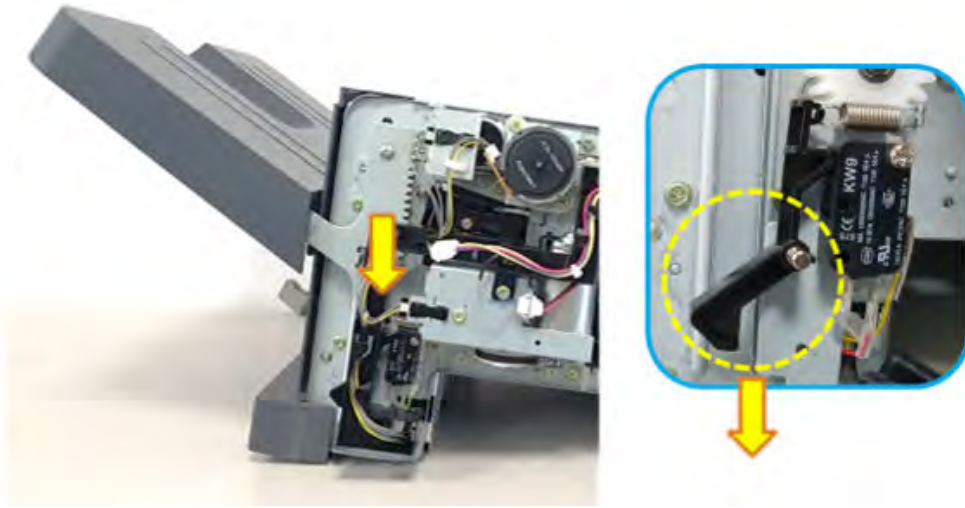

4. In case of fatal error in the output tray unit and paper holding unit, output tray top of stack sensor makes the machine emergency stop so that output tray unit does not move upward.

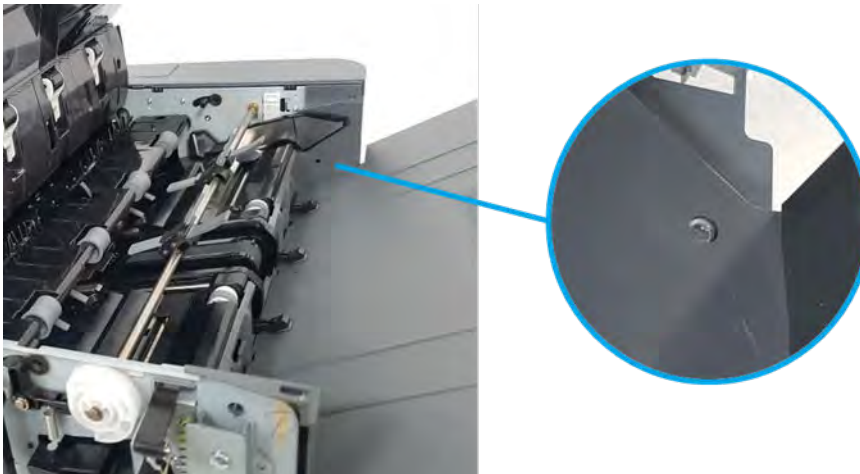

PCA connection information

Learn about the PCA connection information.

Figure 7-49 Inner finisher system - PCA connection information

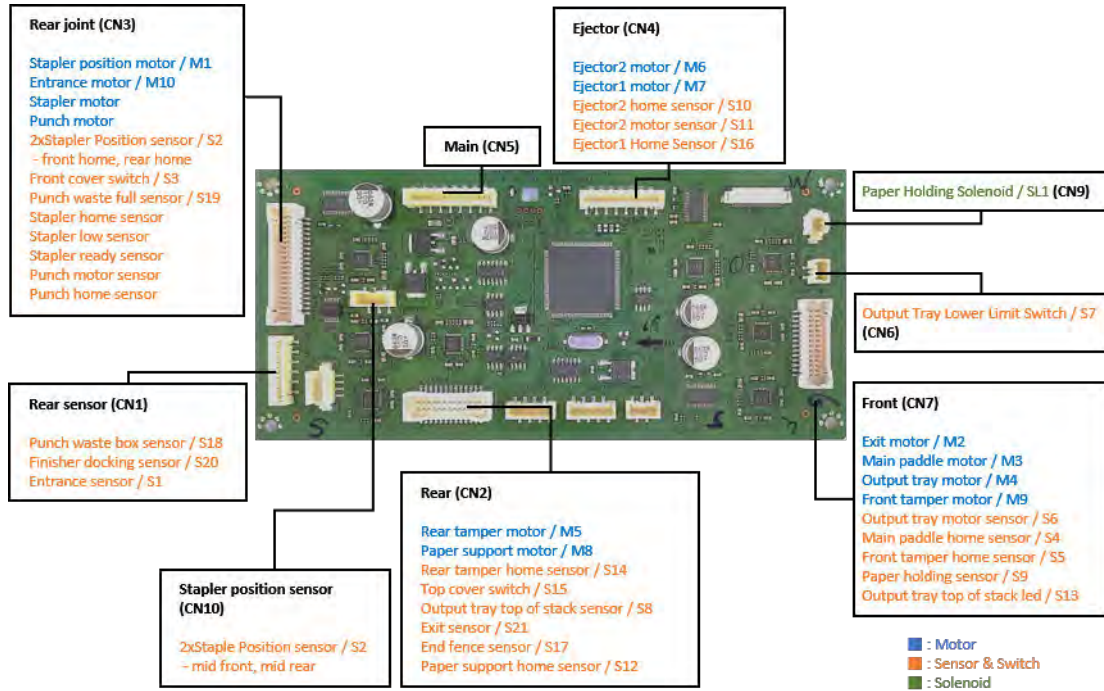

Table 7-23 Inner finisher system - PCA connectors, parts, and diagnostics information

CN No.	Connector name	Motor (Diagnostics)	Sensor (Diagnostics)	Switch & Solenoid (Diagnostics)
CN1	Rear sensor		<ul style="list-style-type: none"> Punch waste box sensor (113-0620) Finisher docking sensor (113-0000) Entrance sensor (113-0350) 	
CN2	Rear	<ul style="list-style-type: none"> Rear tamper motor (113-0520) Paper support motor (113-0571) 	<ul style="list-style-type: none"> Rear tamper home sensor (113-0380) Output tray top of stack sensor (113-0471) Exit sensor (113-0360) End fence sensor (113-0361) Paper support home sensor (113-0481) 	<ul style="list-style-type: none"> Top cover switch (113-0420)

Table 7-23 Inner finisher system - PCA connectors, parts, and diagnostics information (continued)

CN No.	Connector name	Motor (Diagnostics)	Sensor (Diagnostics)	Switch & Solenoid (Diagnostics)
CN3	Rear joint	<ul style="list-style-type: none"> • Stapler motor (113-0550) • Stapler position motor (113-0581) • Entrance motor (113-0501) • Punch motor (113-0610) 	<ul style="list-style-type: none"> • Stapler low sensor(113-0440) • Stapler ready sensor (113-0451) • Stapler home sensor(113-0430) • Stapler position sensor (front home) (113-0491) • Stapler position sensor (rear home) (113-0492) • Punch waste full sensor (113-0621) • Punch motor sensor(113-0600) • Punch home sensor (113-0612) 	<ul style="list-style-type: none"> • Front cover switch (113-0420)
CN4	Ejector	<ul style="list-style-type: none"> • Ejector2 motor (113-0562) • Ejector1 motor (113-0561) 	<ul style="list-style-type: none"> • Ejector2 motor sensor (113-0463) • Ejector2 home sensor (113-0462) • Ejector1 home sensor (113-0461) 	
CN5	Main (to the main PBA)			
CN6	Output tray lower limit switch			<ul style="list-style-type: none"> • Output tray lower limit switch (113-0472)
CN7	Front	<ul style="list-style-type: none"> • Exit motor (113-0502) • Main paddle motor (113-0510) • Output tray motor (113-0570) • Front tamper motor (113-0530) 	<ul style="list-style-type: none"> • Output tray motor sensor (113-0473) • Main paddle home sensor (113-0370) • Front tamper home sensor (113-0390) • Paper holding sensor (113-0470) • Output tray top of stack sensor (113-0471) 	

Table 7-23 Inner finisher system - PCA connectors, parts, and diagnostics information (continued)

CN No.	Connector name	Motor (Diagnostics)	Sensor (Diagnostics)	Switch & Solenoid (Diagnostics)
CN9	Paper holding solenoid			<ul style="list-style-type: none"> • Paper holding solenoid (113-0591)
CN10	Stapler position sensor		<ul style="list-style-type: none"> • Stapler position sensor (mid front) (-) • Stapler position sensor (mid rear) (-) 	

Service approach

Learn about the service approach of the inner finisher.

 **CAUTION:** When working on the product, do not pick up the unit by the output tray, which will detach under the weight of the product.

Precautions when replacing parts

Learn about precautions when replacing parts.

Precautions when replacing parts

Learn about precautions when replacing parts.

Precautions when assembling and disassembling

- Use only HP approved replacement parts. Make sure that the part number, product name, voltage, and current or temperature ratings are correct. Failure to do so might result in damage to the machine, circuit overload, fire, or electric shock.
- Do not make unauthorized changes or additions to the printer. Unauthorized changes might cause the printer to malfunction and create electric shock or fire hazards.
- Use caution when dismantling the unit. Take note of the location of each screw or other part. This printer contains different kinds of screws. Using the wrong screw might lead to system failure, short circuit or electric shock.
- Do not disassemble the laser scanner assembly. Once the laser scanner assembly is disassembled, dust might enter the mirror chamber and will seriously degrade print quality. There are no serviceable parts inside the laser scanner assembly.
- Regularly check the condition of the power cable, plug and socket. Bad contacts might lead to overheating and fire. Damaged cables might lead to electric shock or unit malfunction.

Precautions when handling PCAs

Static electricity might damage a PCA. Use approved, anti-static precautions when handling or storing a PCA. Service personnel should use grounded ESD straps and/or mats when handling PCAs.

- Precautions when moving and storing a PCA
 - Keep PCA in a conductive case, anti-static bag, or wrapped in aluminum foil.
 - Do not store a PCA where it is exposed to direct sunlight.
- Precautions when replacing a PCA
 - Disconnect power cables before disconnecting other cables.
 - Do not touch any soldered connections, connector terminals, or other electronic parts when handling insulated parts.
- Precautions when checking a PCA
 - Touch a grounded area of the printer chassis to discharge static electric charge before touching a PCA.
 - Do not touch a PCA with bare hands or metal objects. Doing so might create a short circuit or cause electric shock. Use caution when handling a PCA with moving parts such as sensors, motors, or lamps, as they might become very hot.

- Use caution when fitting and removing screws. Watch for hidden screens. Make sure that the correct screw is used and make sure that when toothed washers are removed, they are refitted in their original positions.
- Place the product on an ESD workstation or mat, or use an ESD strap (if one is available). If an ESD workstation, mat, or strap is not available, ground yourself by touching the sheet-metal chassis *before* touching an ESD-sensitive part.

Releasing plastic latches

Many of the parts are held in place with plastic latches. The latches might easily break. Be careful when releasing them. To remove such parts, press the hook end of the latch away from the part to which it is latched.

Precautions when handling PCA

Static electric might damage a PCA. Use approved, anti-static precautions when handling or storing a PCA. Service personnel should use grounded ESD straps and/or mats when handling PCAs.

- Precautions when moving and storing a PCA
 - Keep PCA in a conductive case, anti-static bag, or wrapped in aluminum foil.
 - Do not store a PCA where it is exposed to direct sunlight.
- Precautions when replacing a PCA
 - Disconnect power cables before disconnecting other cables.
 - Do not touch any soldered connections, connector terminals, or other electronic parts when handling insulated parts.
- Precautions when checking a PCA
 - Touch a grounded area of the printer chassis to discharge static electric charge before touching a PCA.
 - Do not touch a PCA with bare hands or metal objects. Doing so might create a short circuit or cause electric shock. Use caution when handling a PCA with moving parts such as sensors, motors, or lamps, as they might become very hot.
 - Use caution when fitting and removing screws. Watch for hidden screens. Make sure that the correct screw is used and make sure that when toothed washers are removed, they are refitted in their original positions.
 - Place the product on an ESD workstation or mat, or use an ESD strap (if one is available). If an ESD workstation, mat, or strap is not available, ground yourself by touching the sheet-metal chassis *before* touching an ESD-sensitive part.

Releasing plastic latches

Learn about releasing plastic latches.

Many of the parts are held in place with plastic latches. The latches can break easily; release them carefully. To remove such parts, press the hook end of the latch away from the part to which it is latched.

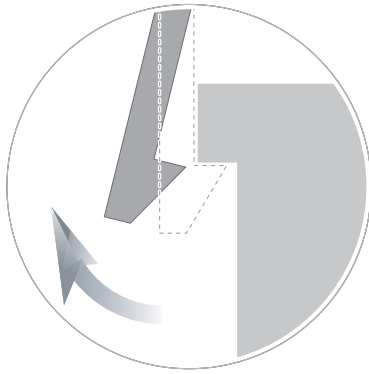

Before performing service

Learn what to do before performing service.

- Remove all paper from the product.
- Turn off the power using the power button.
- Unplug the power cable and interface cable or cables.
- Place the product on an ESD workstation or mat, or use an ESD strap (if one is available). If an ESD workstation, mat, or strap is not available, ground yourself by touching the sheet-metal chassis *before* touching an ESD-sensitive part.
- Remove the toner cartridges.
- Remove the Tray 2 cassette.

ESD precautions

Learn the importance of electrostatic discharge.



CAUTION:



Some parts are sensitive to electrostatic discharge (ESD). Look for the ESD reminder when removing printer parts. Always perform service work at an ESD-protected workstation or mat. If an ESD workstation or mat is not available, touch the sheet-metal chassis to provide a static ground *before* touching an ESD-sensitive assembly.

Protect the ESD-sensitive assemblies by placing them in ESD pouches when they are out of the printer.

After performing service

Learn what to do after performing service.

- Verify that the service performed was successful.
- Verify that the most recent firmware is installed on the printer.
- Verify that all parts are correctly reinstalled and are properly working.
- Print any pages necessary to verify that the repair resolved the issue and did not create any new issues.
- Verify that the printer is in better condition than when you arrived, cosmetically and electrically.

Post-service test

Perform the following tests to verify that the repair or replacement was successful:

Print-quality test

Learn about the print-quality test.

1. Verify that you have completed the necessary reassembly steps.
2. Make sure that the tray contains clean, unmarked paper.
3. Attach the power cord and interface cable or interface cables, and then turn on the product.
4. Print a configuration page.
5. Print a print quality page, and then verify that there are no lines, streaks, banding, or other print quality defects.
6. Send a print job from the host computer, and then verify that the output meets expectations.

Order parts by authorized service providers

Find information about ordering parts and supplies for the printer.

Ordering

Order parts by authorized service providers.

Table 7-24 Ordering

Item or provider	Description
Order supplies and paper	www.hp.com/go/suresupply
Order parts from authorized service providers	www.hp.com/buy/parts or partsurfer.hp.com
Order through service or support providers	Contact an HP-authorized service or support provider.
Order using the HP Embedded Web Server (EWS)	To access, in a supported web browser on your computer, enter the printer IP address or host name in the address/URL field. The EWS contains a link to the HP SureSupply web site, which provides options for purchasing Original HP supplies.

Orderable parts

Not all of the parts shown in the exploded assembly diagrams are orderable parts.

Refer to the tables following the diagrams or the alphabetical/numerical parts lists to determine if a part is orderable.

Parts, diagrams, removal and replacement (inner finisher)

Learn about parts, diagrams, removal and replacement (inner finisher)



NOTE:



Some parts are sensitive to electrostatic discharge (ESD). Always perform service work at an ESD-protected workstation or mat. If an ESD workstation or mat is not available, touch the sheet-metal chassis to provide a static ground before touching an ESD-sensitive assembly. Protect the ESD-sensitive assemblies by placing them in ESD pouches when they are out of the printer.

Parts and diagrams (inner finisher)

View inner finisher exploded diagrams and parts lists.

Inner finisher (main)

Parts diagram and parts list for the inner finisher (main).

Figure 7-50 Inner finisher (main)

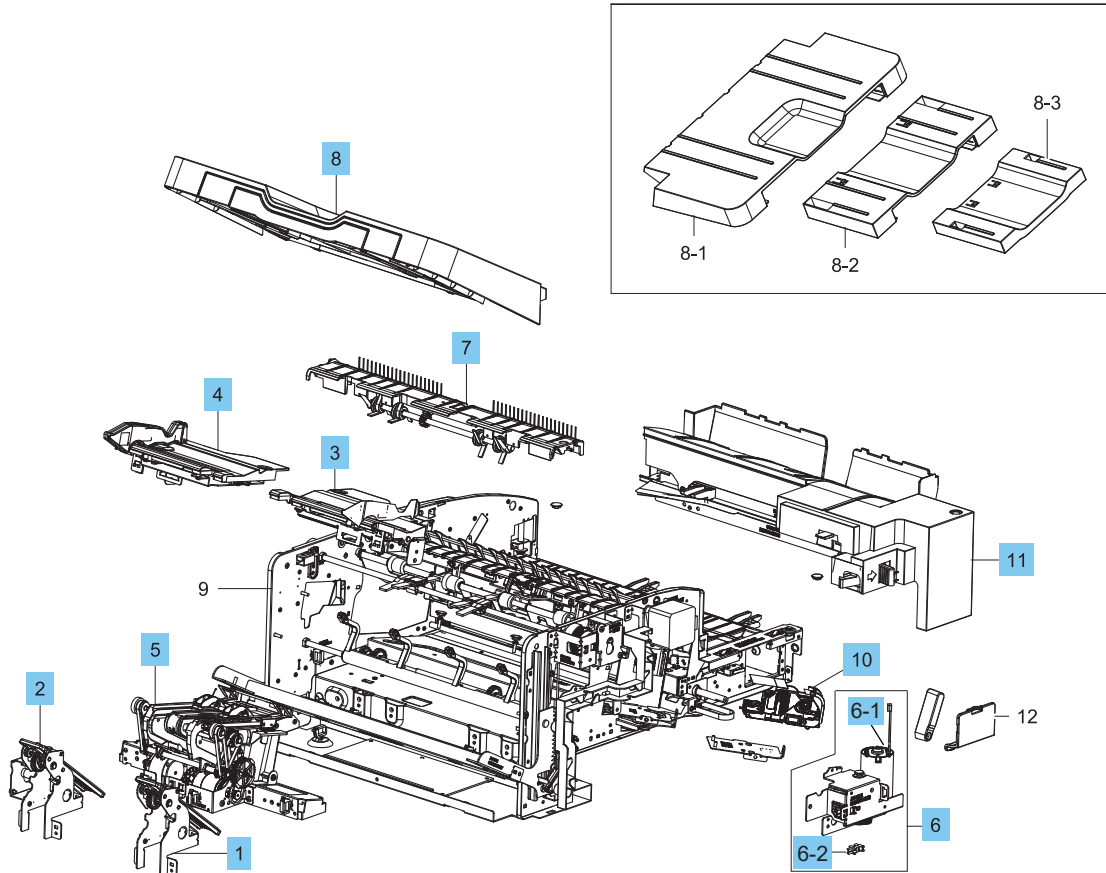

Table 7-25 Inner finisher (main)

Ref	Part number	Description	Qty
Complete	Y1G00-67901	Inner finisher whole unit	1
1	JC90-01310A	Front paper support	1
2	JC90-01311A	Rear paper support	1
3	JC82-00899A	Front tamper unit assembly	1
4	JC82-00900A	Rear tamper unit assembly	1
5	SS456-61001	Ejector	1
6	JC90-01334B	Output tray motor assembly	1
6-1	JC31-00178B	Output tray motor	1
6-2	0604-001393	Output tray motor sensor	1
7	JC90-01336A	Sub paddle unit	1
8	JC90-01337B	Output tray	1
10	JC81-07408B	Staple cartridge	1
11	JC90-01343B	Punch cover	1
Not shown	JC39-02169A	Main interface harness	1

Inner finisher (covers)

Parts diagram and parts list for the inner finisher (covers)

Figure 7-51 Inner finisher (covers)

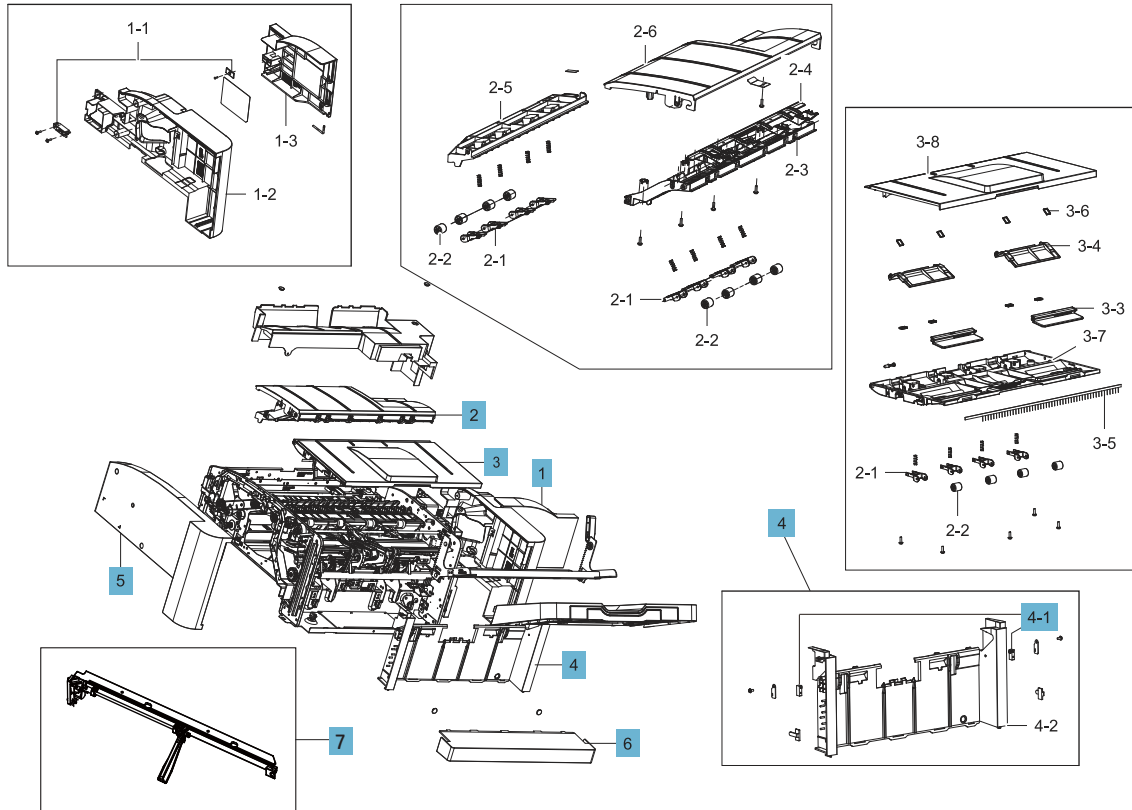

Table 7-26 Inner finisher (covers)

Ref	Part number	Description	Qty
1	JC90-01321B	Front cover	1
2	JC90-01322B	Middle cover	1
3	JC90-01323B	Top cover	1
4	JC90-01324B	Left cover	1
4-1	JC82-01039A	Output tray top of stack sensor kit	1
5	JC63-04750B	Rear cover	1
6	JC63-04792B	PCA cover	1
7	JC90-01546A	Exit bin full	1

Inner finisher (main paddle unit, entrance unit, exit unit, paper holding unit, and output tray unit)

Parts diagram and parts list for the inner finisher (main paddle unit, entrance unit, exit unit, paper holding unit, and output tray unit).

Figure 7-52 Inner finisher (main paddle unit, entrance unit, exit unit, paper holding unit, and output tray unit)

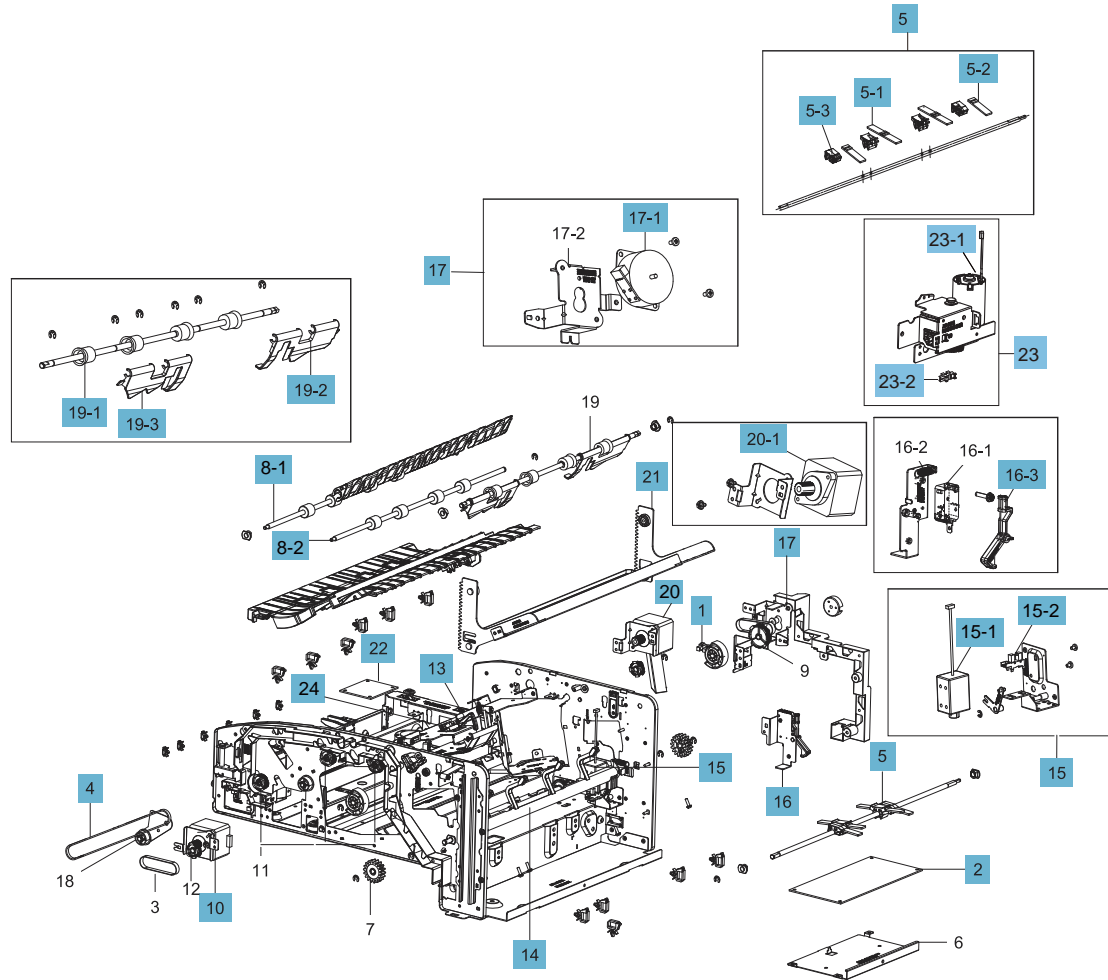

Table 7-27 Inner finisher (main paddle unit, entrance unit, exit unit, paper holding unit, and output tray unit)

Ref	Part number	Description	Qty
1	0604-001393	Main paddle home sensor	2
2	JC92-02774B	Main PCA	1
4	6602-003644	Entrance motor timing belt	1
5	JC82-01038A	Paddle kit	1
5-1	JC63-04957A	Paddle A	2
5-2	JC63-04958A	Paddle B	2
5-3	JC81-07560A	Paddle holder	4
8-1	JC66-04243A	Entrance roller	1
8-2	JC66-04243A	Middle roller	1
10	JC90-01344A	Entrance motor assembly	1
13	JC66-04199A	Exit sensor actuator	1
14	JC90-01313A	Paper holding actuator	1
15	JC90-01314A	Paper holding kit	1
15-1	JC33-00037A	Paper holding solenoid	1
15-2	0604-001393	Paper holding sensor	1
16	JC90-01320A	Output tray lower limit switch	1
16-3	JC66-04200A	Output tray lower limit switch actuator	1
17	JC93-01001A	Main paddle motor assembly	1
17-1	JC31-00149A	Main paddle motor	1
19-1	JC66-04244A	Exit roller	1
19-2	JC61-07449A	Front compile guide	1
19-3	JC61-07450A	Rear compile guide	1
20	JC90-01331A	Exit motor assembly	1
20-1	JC31-00169B	Exit motor	1
21	JC90-01319A	Output tray frame	1
22	JC92-02780A	Rear joint PCA	1
23 shown	JC90-01334B	Output tray motor assembly	1
23-1	JC31-00178B	Output tray motor	1
23-2	0604-001393	Output tray motor sensor	1
24	0604-001415	Exit sensor	1

Inner finisher (paper support unit)

Parts diagram and parts list for the inner finisher (paper support unit).

Figure 7-53 Inner finisher (paper support unit)

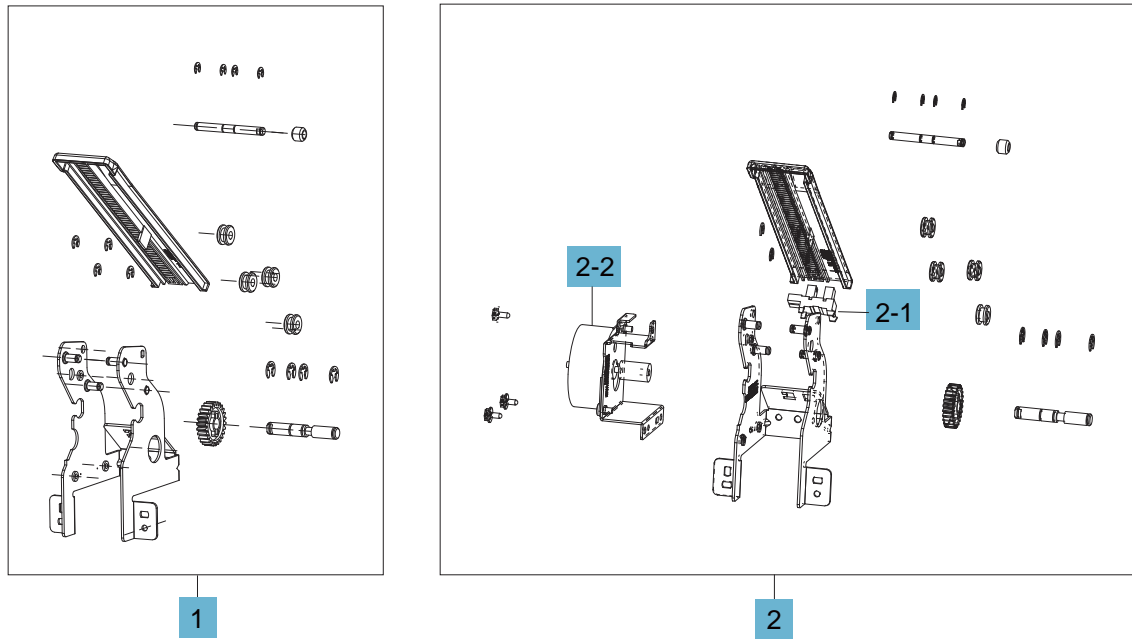

Table 7-28 Inner finisher (paper support unit)

Ref	Part number	Description	Qty
1	JC90-01310A	Front paper support	1
2	JC90-01311A	Rear paper support	1
2-1	0604-001393	Paper support home sensor	1
2-2	JC93-00802B	Paper support motor assembly	1

Inner finisher (tamper unit)

Parts diagram and parts list for the inner finisher (tamper unit).

Figure 7-54 Inner finisher (tamper unit)

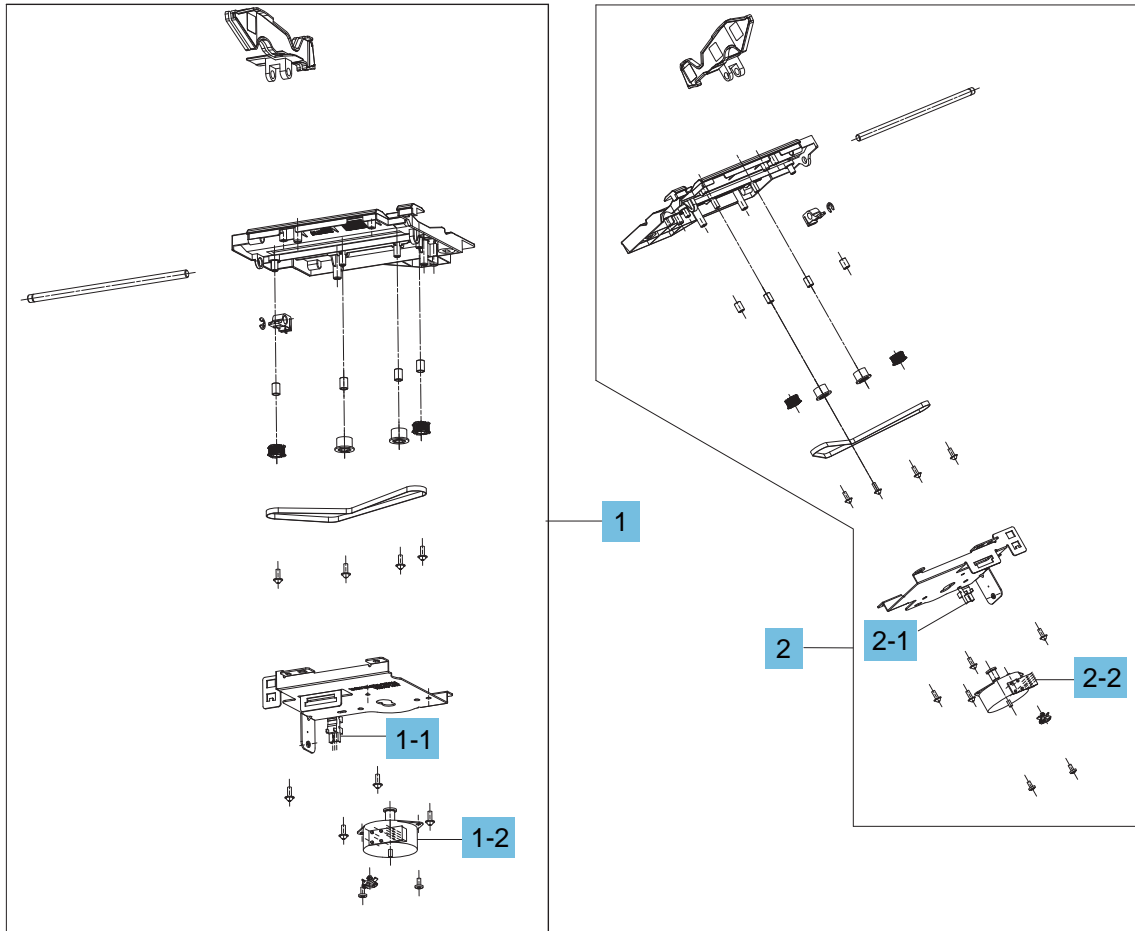

Table 7-29 Inner finisher (tamper unit)

Ref	Part number	Description	Qty
1	JC82-00900A	Rear tamper unit	1
1-1	0604-001393	Rear tamper home sensor	1
1-2	JC93-01001A	Rear tamper motor assembly	1
2	JC82-00899A	Front tamper unit	1
2-1	0604-001393	Front tamper home sensor	1
2-2	JC93-01001A	Front tamper motor assembly	1

Inner finisher (stapler unit, end fence unit)

Parts diagram and parts list for the inner finisher (stapler unit, end fence unit).

Figure 7-55 Inner finisher (stapler unit, end fence unit)

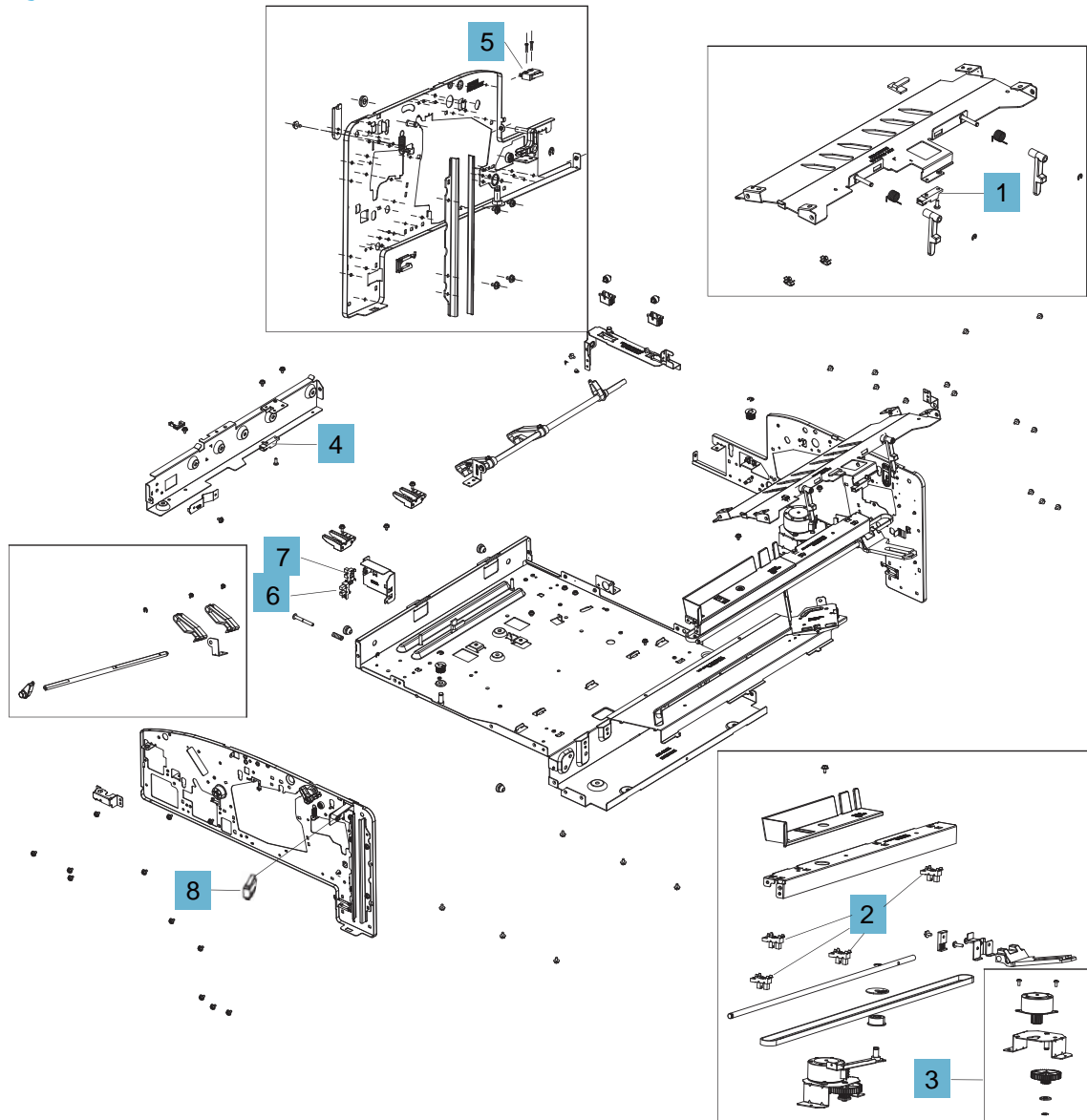

Table 7-30 Inner finisher (stapler unit, end fence unit)

Ref	Part number	Description	Qty
1	0604-001381	End fence sensor	1
2	0604-001393	Stapler position sensor	1
3	JC93-00999A	Stapler position motor	1
4	0604-001381	Punch waste full sensor	1
5	JC39-01610A	Top cover switch	1
6	0604-001393	Finisher docking sensor	1
7	0604-001393	Punch waste box sensor	1
8	JC39-01610A	Compile cover switch	1

Inner finisher (stapler assembly, entrance unit)

Parts diagram and parts list for the inner finisher (stapler assembly, entrance unit).

Figure 7-56 Inner finisher (stapler assembly, entrance unit)

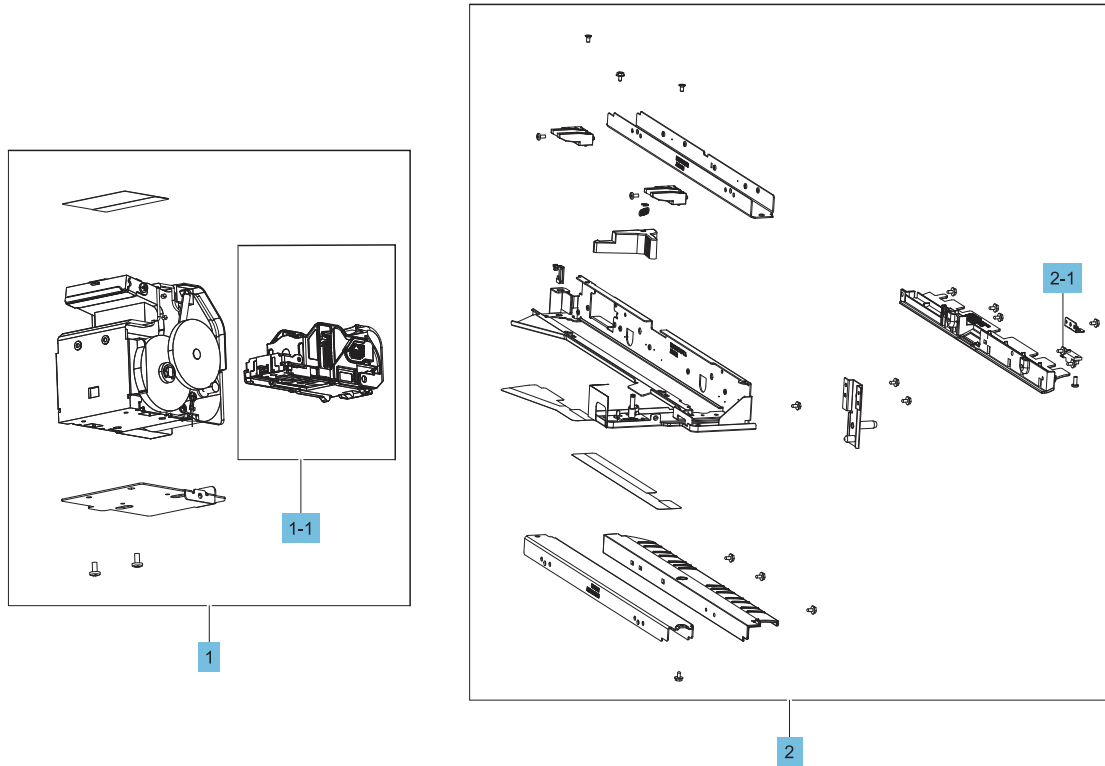

Table 7-31 Inner finisher (stapler assembly, entrance unit)

Ref	Part number	Description	Qty
1	JC59-00040A	Stapler assembly	1
1-1	JC81-07408B	Staple cartridge	1
2	JC90-01343B	Punch cover	1
2-1	0604-001381	Entrance sensor	1
Not shown	SS465-67001	Punch PBA 2-4 hole	1
Not shown	SS467-67001	Punch PBA 2-3 hole	1
Not shown	SS466-67001	Punch PBA Swedish	1

Inner finisher (ejector unit)

Parts diagram and parts list for the inner finisher (ejector unit).

Figure 7-57 Inner finisher (ejector unit)

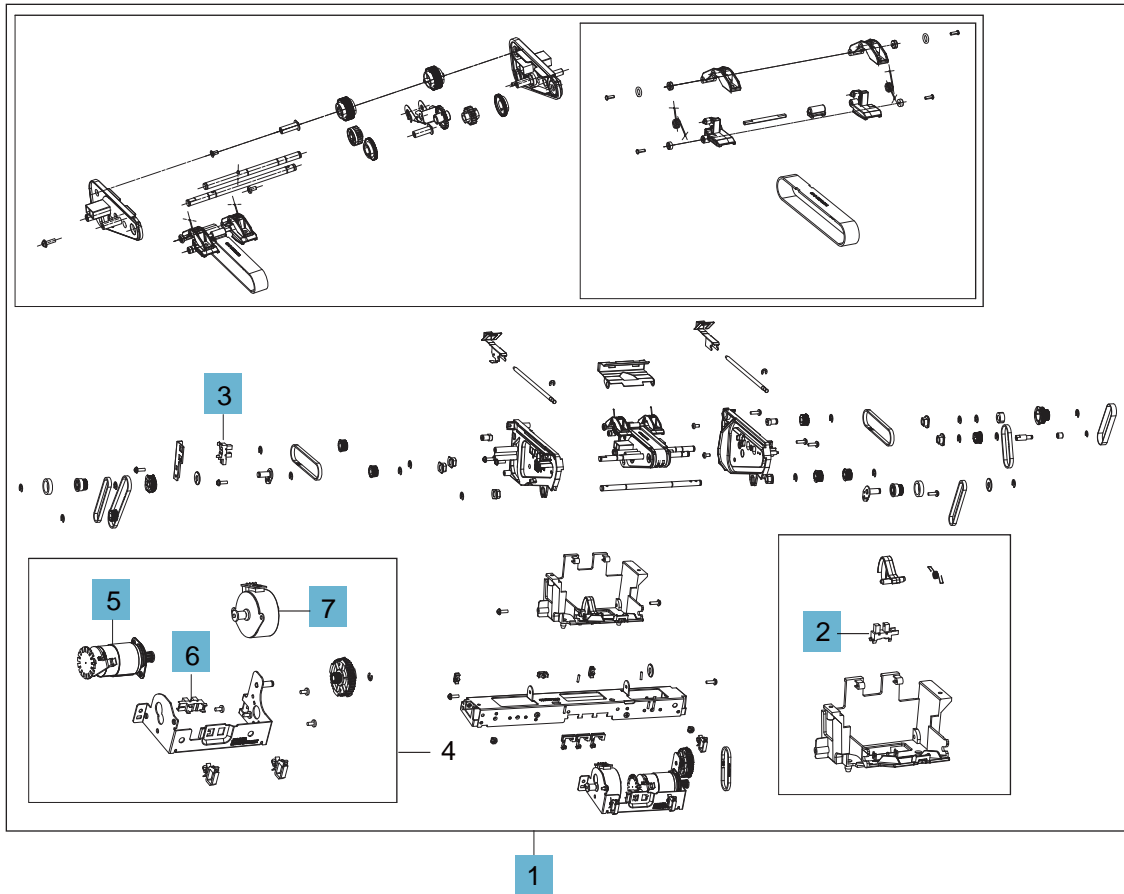

Table 7-32 Inner finisher (ejector unit)

Ref	Part number	Description	Qty
1	SS456-61001	Ejector	1
2	0604-001393	Ejector2 home sensor	1
3	0604-001393	Ejector1 home sensor	1
4	JC90-01309A	Ejector motor assembly	1
5	JC93-01168A	Ejector2 motor assembly	1
6	0604-001393	Ejector2 motor sensor	1
7	JC93-00998A	Ejector1 motor assembly	1

Covers

Removal and replacement: Front cover (C1)

Learn how to remove and replace the front cover.

To view tear down and reassembling video of the inner finisher, click the link below.



[View a tear down video of the inner finisher.](#)



[View a reassembling video of the inner finisher.](#)



IMPORTANT: When applicable, special installation instructions are provided for an assembly at the end of the removal procedure. Always completely read the removal instructions and follow all special installation instructions.

Mean time to repair:

Service level:

Before performing service

Turn the printer power off

- Press the power button on the front of the printer, and then turn off the power switch next to the power cable.
- A shutting-down message appears on the control-panel display.



WARNING! To avoid damage to the printer, turn the power off and wait until the printer shuts down before removing the power cable.

- Disconnect the printer power cable after the printer has completely shut down (the control-panel display is blank).

Use the table below to identify the correct part number for your printer. To order the part, go to <http://www.hp.com/buy/parts>.

Table 7-33 Part information

Part number	Part description
JC90-01321B	Front cover

Required tools

- #2 JIS screwdriver with a magnetic tip

After performing service

Turn the printer power on

- Connect the power cable.
- Use the power switch to turn the power on.

Post service test

Print any pages necessary to verify that the repair resolved the issue and did not create any new issues.

Remove the front cover

Follow these steps to remove the front cover.

1. Open the front door and open the punch cover.
2. Remove three screws in the front.
3. Remove the lever.
4. Open the top cover.
5. From the right side of the front cover, carefully lift and pry toward the top-left corner to remove the front cover.

Figure 7-58 Remove the front cover

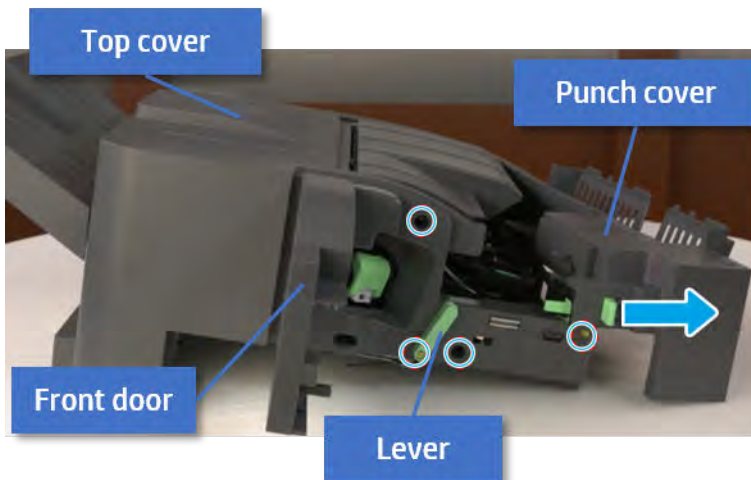

Unpack the replacement assembly

Follow these steps to unpack the replacement assembly.

1. Dispose of the defective part.

 **NOTE:** HP recommends responsible disposal of the defective part.

<http://www8.hp.com/us/en/hp-information/environment/product-recycling.html>

2. Unpack the replacement part from the packaging.



CAUTION:  Some parts are sensitive to electrostatic discharge (ESD). Always perform service work at an ESD-protected workstation or mat. If an ESD workstation or mat is not available, touch the sheet-metal chassis to provide a static ground before touching an ESD-sensitive assembly. Protect the ESD-sensitive assemblies by placing them in ESD pouches when they are out of the printer.

 **IMPORTANT:** Make sure that all of the shipping materials (for example shipping tape) are removed from the replacement part prior to installation.

 **NOTE:** If the replacement part is a roller or pad, avoid touching the spongy part of it. Skin oils on the roller or pad can cause paper pickup and/or print-quality problems. HP recommends using disposable gloves when handling rollers or pads or washing your hands before touching rollers or pads.

3. To install an assembly, reverse the removal steps.

 **NOTE:** When applicable, special installation instructions are provided for an assembly at the end of the removal procedure. Always completely read the removal instructions and follow all special installation instructions.

Removal and replacement: Rear cover (C8)

Learn how to remove and replace the rear cover.

To view teardown and reassembling video of the inner finisher, click the link below.



[View a teardown video of the inner finisher.](#)



[View a reassembling video of the inner finisher.](#)



IMPORTANT: When applicable, special installation instructions are provided for an assembly at the end of the removal procedure. Always completely read the removal instructions and follow all special installation instructions.

Mean time to repair:

Service level:

Before performing service

Turn the printer power off

- Press the power button on the front of the printer, and then turn off the power switch next to the power cable.
- A shutting-down message appears on the control-panel display.



WARNING! To avoid damage to the printer, turn the power off and wait until the printer shuts down before removing the power cable.

- Disconnect the printer power cable after the printer has completely shut down (the control-panel display is blank).

Use the table below to identify the correct part number for your printer. To order the part, go to <http://www.hp.com/buy/parts>.

Table 7-34 Part information

Part number	Part description
JC63-04750B	Rear cover

Required tools

- #2 JIS screwdriver with a magnetic tip

After performing service

Turn the printer power on

- Connect the power cable.
- Use the power switch to turn the power on.

Post service test

Print any pages necessary to verify that the repair resolved the issue and did not create any new issues.

Remove the rear cover

Follow these steps to remove the rear cover.

1. Open the top cover.

Figure 7-59 Open the top cover

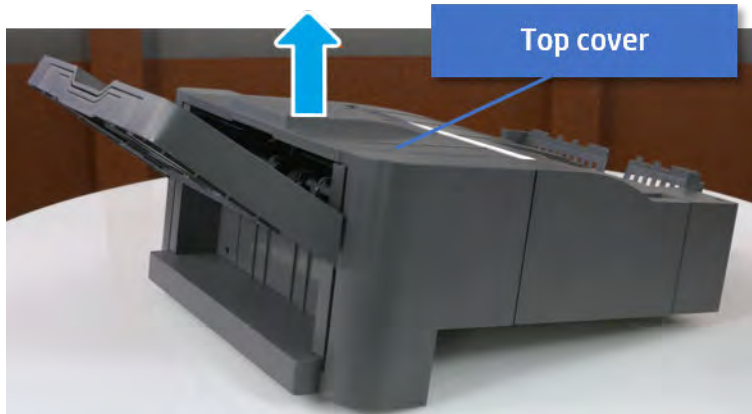

2. Remove three screws.
3. Release hooks carefully and remove the rear cover.

Figure 7-60 Remove the rear cover

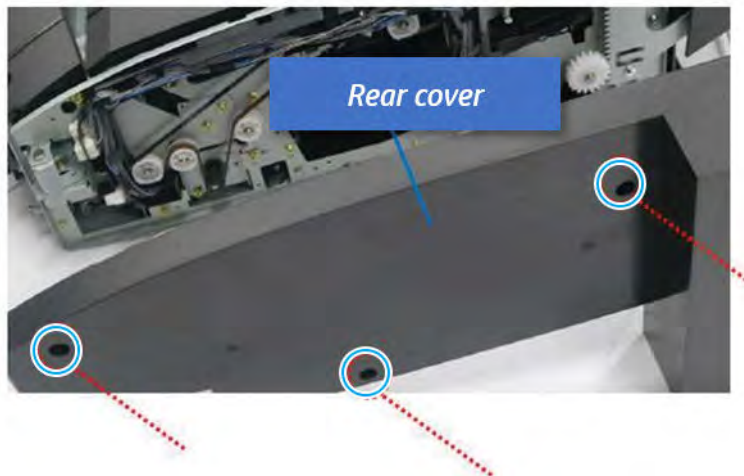

Unpack the replacement assembly

Follow these steps to unpack the replacement assembly.

1. Dispose of the defective part.

 **NOTE:** HP recommends responsible disposal of the defective part.

<http://www8.hp.com/us/en/hp-information/environment/product-recycling.html>

2. Unpack the replacement part from the packaging.



CAUTION:  Some parts are sensitive to electrostatic discharge (ESD). Always perform service work at an ESD-protected workstation or mat. If an ESD workstation or mat is not available, touch the sheet-metal chassis to provide a static ground before touching an ESD-sensitive assembly. Protect the ESD-sensitive assemblies by placing them in ESD pouches when they are out of the printer.

 **IMPORTANT:** Make sure that all of the shipping materials (for example shipping tape) are removed from the replacement part prior to installation.

 **NOTE:** If the replacement part is a roller or pad, avoid touching the spongy part of it. Skin oils on the roller or pad can cause paper pickup and/or print-quality problems. HP recommends using disposable gloves when handling rollers or pads or washing your hands before touching rollers or pads.

3. To install an assembly, reverse the removal steps.

 **NOTE:** When applicable, special installation instructions are provided for an assembly at the end of the removal procedure. Always completely read the removal instructions and follow all special installation instructions.

Removal and replacement: Middle cover (C3)

Learn how to remove and replace the middle cover.

To view teardown and reassembling video of the inner finisher, click the link below.



[View a teardown video of the inner finisher.](#)



[View a reassembling video of the inner finisher.](#)



IMPORTANT: When applicable, special installation instructions are provided for an assembly at the end of the removal procedure. Always completely read the removal instructions and follow all special installation instructions.

Mean time to repair:

Service level:

Before performing service

Turn the printer power off

- Press the power button on the front of the printer, and then turn off the power switch next to the power cable.
- A shutting-down message appears on the control-panel display.



WARNING! To avoid damage to the printer, turn the power off and wait until the printer shuts down before removing the power cable.

- Disconnect the printer power cable after the printer has completely shut down (the control-panel display is blank).

Use the table below to identify the correct part number for your printer. To order the part, go to <http://www.hp.com/buy/parts>.

Table 7-35 Part information

Part number	Part description
JC90-01322B	Middle cover

Required tools

- #2 JIS screwdriver with a magnetic tip

After performing service

Turn the printer power on

- Connect the power cable.
- Use the power switch to turn the power on.

Post service test

Print any pages necessary to verify that the repair resolved the issue and did not create any new issues.

Remove the rear cover

Follow these steps to remove the rear cover.

1. Open the top cover.

Figure 7-61 Open the top cover

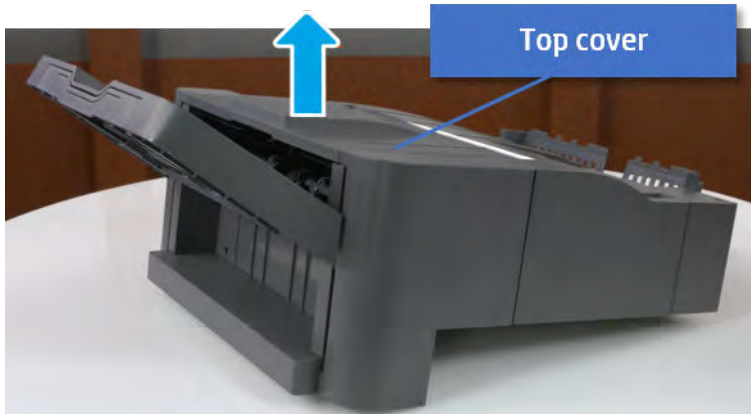

2. Remove three screws.
3. Release hooks carefully and remove the rear cover.

Figure 7-62 Remove the rear cover

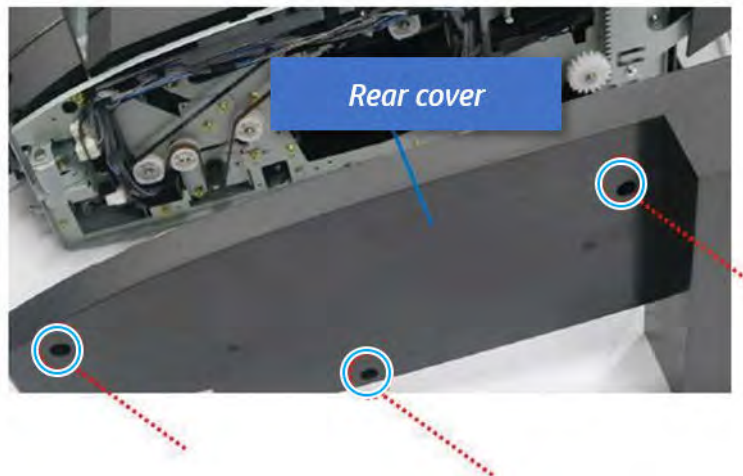

Remove the middle cover

Follow these steps to remove the middle cover.

1. Open the front door and then open the punch cover.

Figure 7-63 Open the front door and punch cover

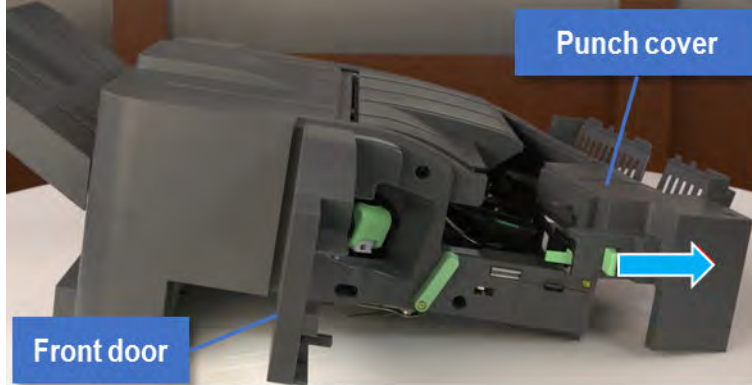

2. Remove left-side one screw at the rear of the inner finisher, and then remove the middle cover by lifting off the hinge pins at the front.

Figure 7-64 Remove the middle cover

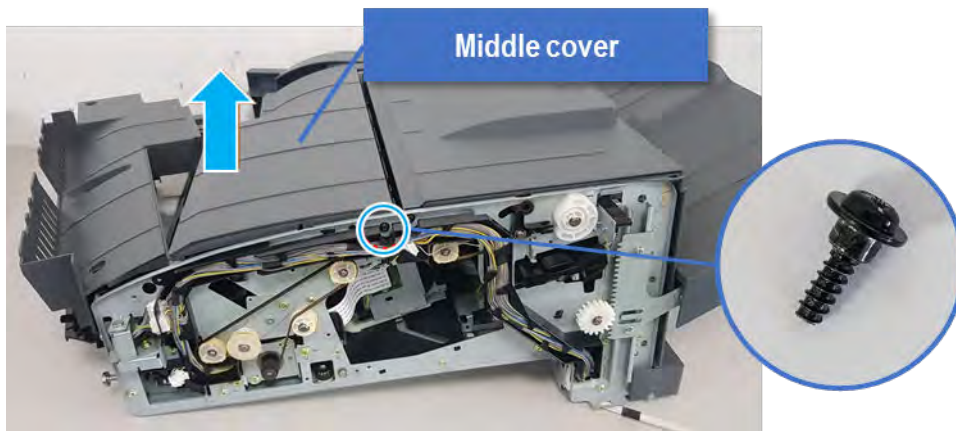

Unpack the replacement assembly

Follow these steps to unpack the replacement assembly.

1. Dispose of the defective part.

 **NOTE:** HP recommends responsible disposal of the defective part.

<http://www8.hp.com/us/en/hp-information/environment/product-recycling.html>

2. Unpack the replacement part from the packaging.



CAUTION:



Some parts are sensitive to electrostatic discharge (ESD). Always perform service work at an ESD-protected workstation or mat. If an ESD workstation or mat is not available, touch the sheet-metal chassis to provide a static ground before touching an ESD-sensitive assembly. Protect the ESD-sensitive assemblies by placing them in ESD pouches when they are out of the printer.



IMPORTANT: Make sure that all of the shipping materials (for example shipping tape) are removed from the replacement part prior to installation.



NOTE: If the replacement part is a roller or pad, avoid touching the spongy part of it. Skin oils on the roller or pad can cause paper pickup and/or print-quality problems. HP recommends using disposable gloves when handling rollers or pads or washing your hands before touching rollers or pads.

3. To install an assembly, reverse the removal steps.



NOTE: When applicable, special installation instructions are provided for an assembly at the end of the removal procedure. Always completely read the removal instructions and follow all special installation instructions.

Removal and replacement: Top cover (C2)

Learn how to remove and replace the top cover.

To view teardown and reassembling video of the inner finisher, click the link below.



[View a teardown video of the inner finisher.](#)



[View a reassembling video of the inner finisher.](#)



IMPORTANT: When applicable, special installation instructions are provided for an assembly at the end of the removal procedure. Always completely read the removal instructions and follow all special installation instructions.

Mean time to repair:

Service level:

Before performing service

Turn the printer power off

- Press the power button on the front of the printer, and then turn off the power switch next to the power cable.
- A shutting-down message appears on the control-panel display.



WARNING! To avoid damage to the printer, turn the power off and wait until the printer shuts down before removing the power cable.

- Disconnect the printer power cable after the printer has completely shut down (the control-panel display is blank).

Use the table below to identify the correct part number for your printer. To order the part, go to <http://www.hp.com/buy/parts>.

Table 7-36 Part information

Part number	Part description
JC90-01323B	Top cover

Required tools

- #2 JIS screwdriver with a magnetic tip

After performing service

Turn the printer power on

- Connect the power cable.
- Use the power switch to turn the power on.

Post service test

Print any pages necessary to verify that the repair resolved the issue and did not create any new issues.

Remove the rear cover

Follow these steps to remove the rear cover.

1. Open the top cover.

Figure 7-65 Open the top cover

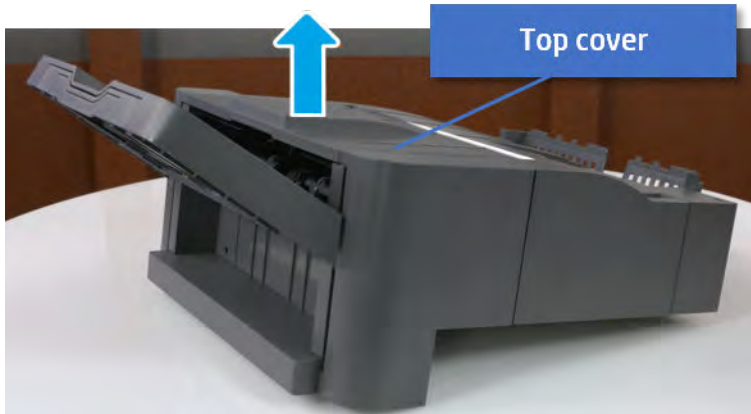

2. Remove three screws.
3. Release hooks carefully and remove the rear cover.

Figure 7-66 Remove the rear cover

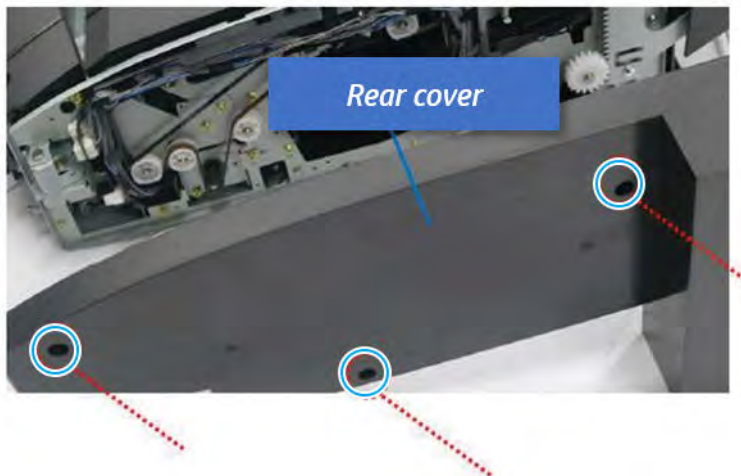

Remove the top cover

Follow these steps to remove the top cover.

Figure 7-67 Remove the top cover

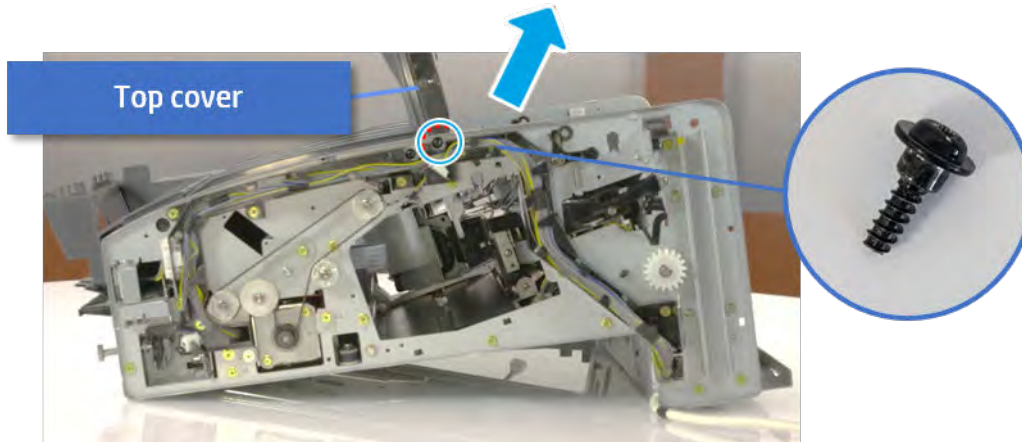

- ▲ Remove one screw at the rear of the inner finisher, and then remove the top cover by lifting off the hinge pins at the front.

Unpack the replacement assembly

Follow these steps to unpack the replacement assembly.

1. Dispose of the defective part.



NOTE: HP recommends responsible disposal of the defective part.

<http://www8.hp.com/us/en/hp-information/environment/product-recycling.html>

2. Unpack the replacement part from the packaging.



CAUTION:  Some parts are sensitive to electrostatic discharge (ESD). Always perform service work at an ESD-protected workstation or mat. If an ESD workstation or mat is not available, touch the sheet-metal chassis to provide a static ground before touching an ESD-sensitive assembly. Protect the ESD-sensitive assemblies by placing them in ESD pouches when they are out of the printer.



IMPORTANT: Make sure that all of the shipping materials (for example shipping tape) are removed from the replacement part prior to installation.



NOTE: If the replacement part is a roller or pad, avoid touching the spongy part of it. Skin oils on the roller or pad can cause paper pickup and/or print-quality problems. HP recommends using disposable gloves when handling rollers or pads or washing your hands before touching rollers or pads.

3. To install an assembly, reverse the removal steps.



NOTE: When applicable, special installation instructions are provided for an assembly at the end of the removal procedure. Always completely read the removal instructions and follow all special installation instructions.

Removal and replacement: PCA cover (C6)

Learn how to remove and replace the PCA cover.

To view teardown and reassembling video of the inner finisher, click the link below.



[View a teardown video of the inner finisher.](#)



[View a reassembling video of the inner finisher.](#)



IMPORTANT: When applicable, special installation instructions are provided for an assembly at the end of the removal procedure. Always completely read the removal instructions and follow all special installation instructions.

Mean time to repair:

Service level:

Before performing service

Turn the printer power off

- Press the power button on the front of the printer, and then turn off the power switch next to the power cable.
- A shutting-down message appears on the control-panel display.



WARNING! To avoid damage to the printer, turn the power off and wait until the printer shuts down before removing the power cable.

- Disconnect the printer power cable after the printer has completely shut down (the control-panel display is blank).

Use the table below to identify the correct part number for your printer. To order the part, go to <http://www.hp.com/buy/parts>.

Table 7-37 Part information

Part number	Part description
JC63-04792B	PCA cover

Required tools

- #2 JIS screwdriver with a magnetic tip

After performing service

Turn the printer power on

- Connect the power cable.
- Use the power switch to turn the power on.

Post service test

Print any pages necessary to verify that the repair resolved the issue and did not create any new issues.

Remove the PCA cover

Follow these steps to remove the PCA cover.

- ▲ Remove two screws, and then remove the PCA cover.

Figure 7-68 Remove the PCA cover

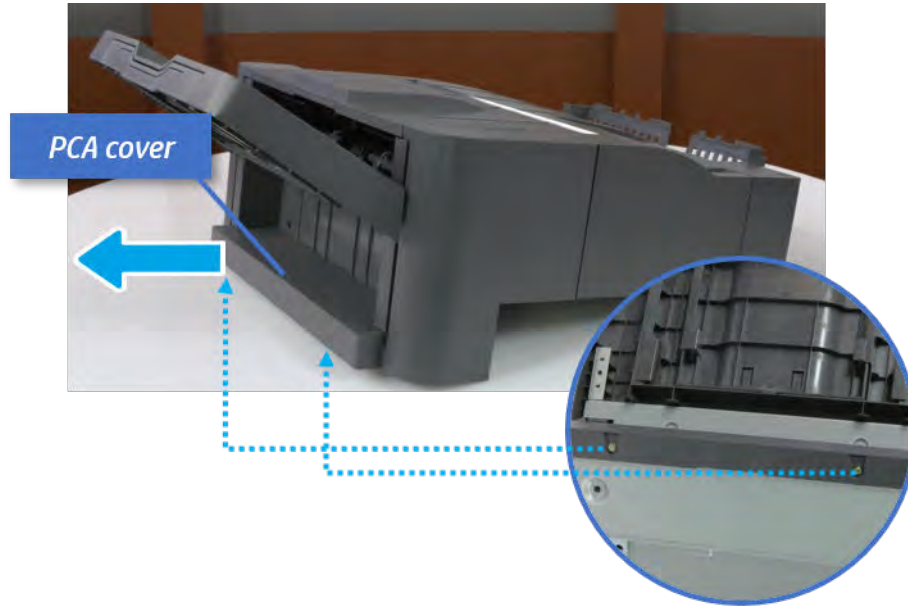

Unpack the replacement assembly

Follow these steps to unpack the replacement assembly.

1. Dispose of the defective part.



NOTE: HP recommends responsible disposal of the defective part.

<http://www8.hp.com/us/en/hp-information/environment/product-recycling.html>

2. Unpack the replacement part from the packaging.



CAUTION:  Some parts are sensitive to electrostatic discharge (ESD). Always perform service work at an ESD-protected workstation or mat. If an ESD workstation or mat is not available, touch the sheet-metal chassis to provide a static ground before touching an ESD-sensitive assembly. Protect the ESD-sensitive assemblies by placing them in ESD pouches when they are out of the printer.



IMPORTANT: Make sure that all of the shipping materials (for example shipping tape) are removed from the replacement part prior to installation.



NOTE: If the replacement part is a roller or pad, avoid touching the spongy part of it. Skin oils on the roller or pad can cause paper pickup and/or print-quality problems. HP recommends using disposable gloves when handling rollers or pads or washing your hands before touching rollers or pads.

3. To install an assembly, reverse the removal steps.

 **NOTE:** When applicable, special installation instructions are provided for an assembly at the end of the removal procedure. Always completely read the removal instructions and follow all special installation instructions.

Removal and replacement: Left cover (C7)

Learn how to remove and replace the left cover.

To view teardown and reassembling video of the inner finisher, click the link below.



[View a teardown video of the inner finisher.](#)



[View a reassembling video of the inner finisher.](#)



IMPORTANT: When applicable, special installation instructions are provided for an assembly at the end of the removal procedure. Always completely read the removal instructions and follow all special installation instructions.

Mean time to repair:

Service level:

Before performing service

Turn the printer power off

- Press the power button on the front of the printer, and then turn off the power switch next to the power cable.
- A shutting-down message appears on the control-panel display.



WARNING! To avoid damage to the printer, turn the power off and wait until the printer shuts down before removing the power cable.

- Disconnect the printer power cable after the printer has completely shut down (the control-panel display is blank).

Use the table below to identify the correct part number for your printer. To order the part, go to <http://www.hp.com/buy/parts>.

Table 7-38 Part information

Part number	Part description
JC90-01324B	Left cover

Required tools

- #2 JIS screwdriver with a magnetic tip

After performing service

Turn the printer power on

- Connect the power cable.
- Use the power switch to turn the power on.

Post service test

Print any pages necessary to verify that the repair resolved the issue and did not create any new issues.

Remove the front cover

Follow these steps to remove the front cover.

1. Open the front door and open the punch cover.
2. Remove three screws in the front.
3. Remove the lever.
4. Open the top cover.
5. From the right side of the front cover, carefully lift and pry toward the top-left corner to remove the front cover.

Figure 7-69 Remove the front cover

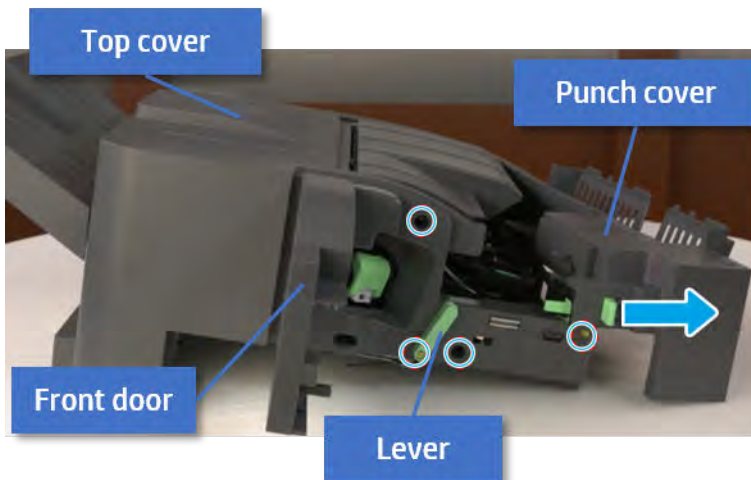

Remove the rear cover

Follow these steps to remove the rear cover.

1. Open the top cover.

Figure 7-70 Open the top cover

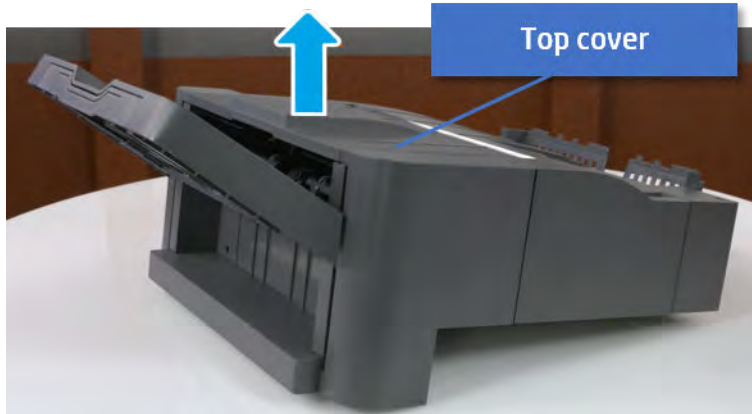

2. Remove three screws.
3. Release hooks carefully and remove the rear cover.

Figure 7-71 Remove the rear cover

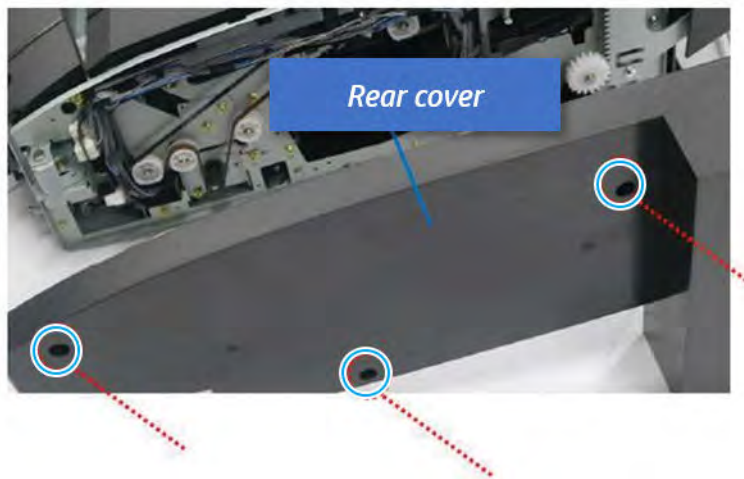

Remove the output tray

Follow these steps to remove the output tray.

1. Remove four screws.

Figure 7-72 Remove four screws

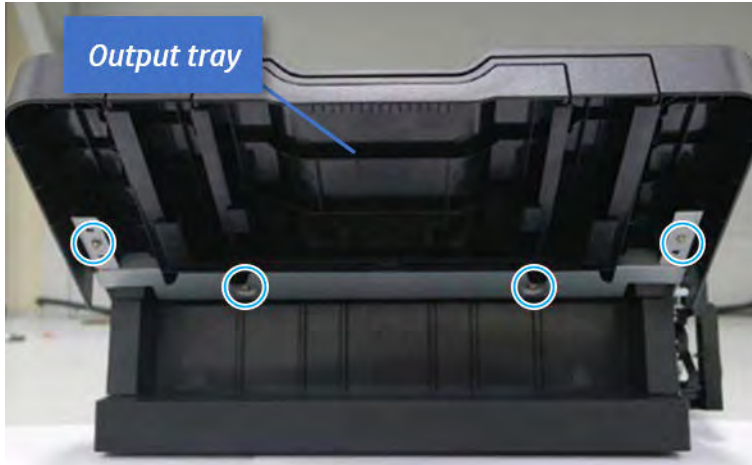

2. Push the paper holding actuator into the inner finisher, and then remove the output tray.

Figure 7-73 Remove the output tray.



Remove the output tray frame

Follow these steps to remove the output tray frame.

1. Rotate the pulley until the output tray frame depart from the gear.

Figure 7-74 Remove the pulley

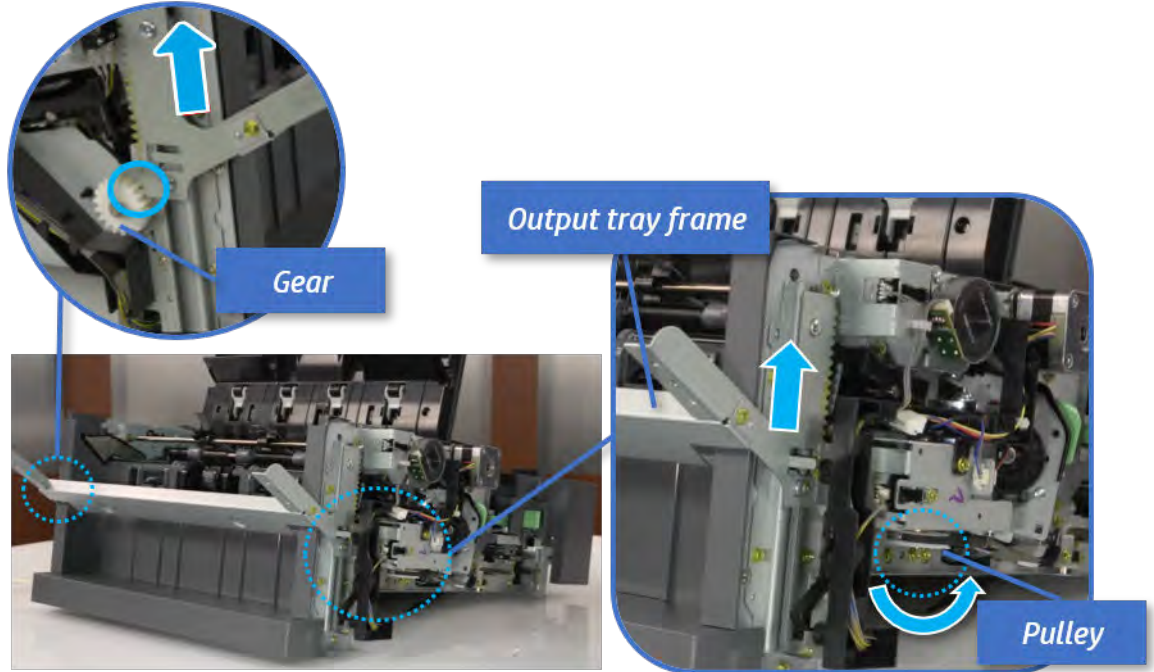

2. Push the paper holding actuator into the inner finisher, and then remove the output tray frame.

Figure 7-75 Remove the output tray frame

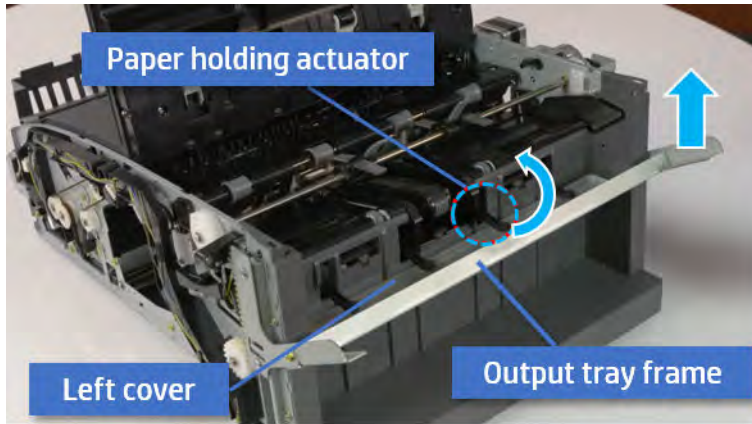

 **TIP:** Push the paper holding actuator into the inner finisher when reassembling. Be sure to level the output tray.

- a. Position the first wheel into the channel on both sides while pushing the paper holding actuator.

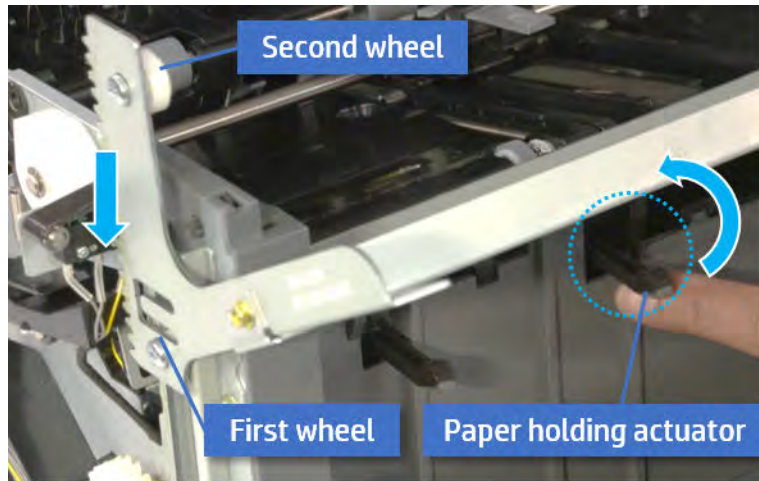

- b. Let the second wheel rest on the channel on both sides simultaneously.
- c. Gently squeeze the wheels into channel until the output tray frame meet the gear.

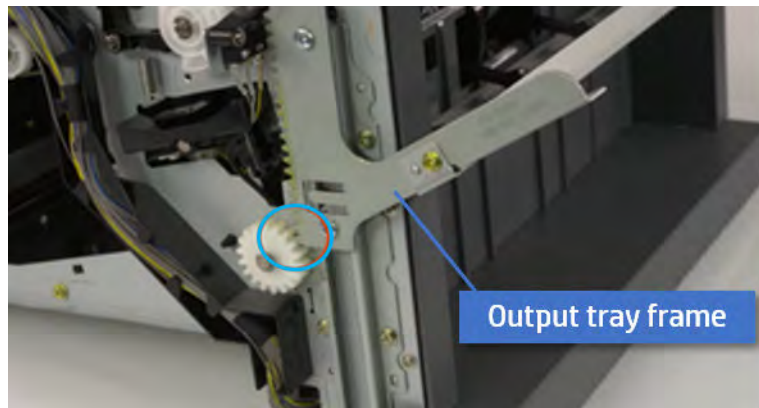

- d. Rotate the pulley until the output tray frame is no longer lifted. It can make to level the output tray frame.

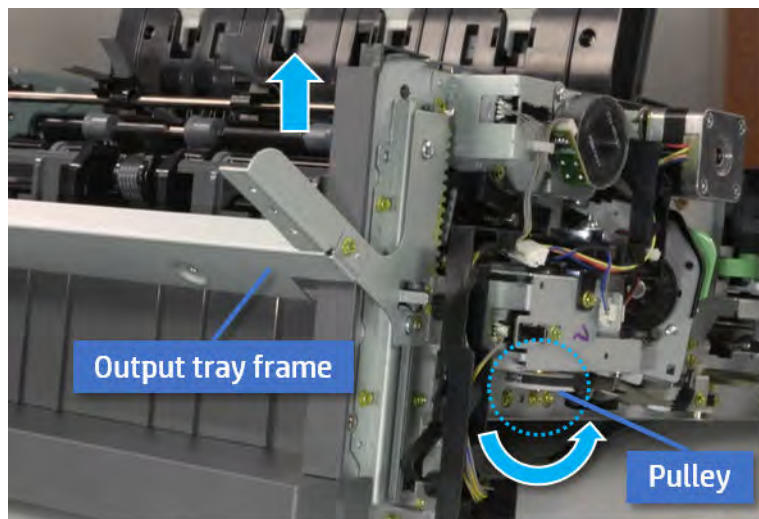

- e. Rotate the pulley in the opposite direction.

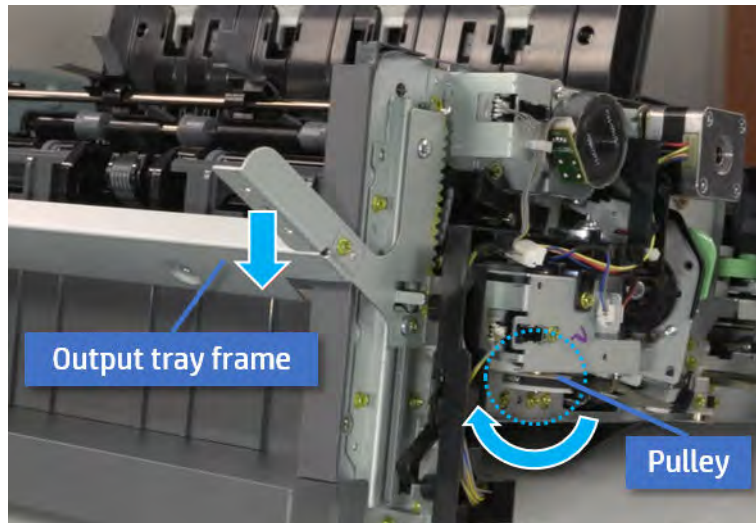

Remove the PCA cover

Follow these steps to remove the PCA cover.

- ▲ Remove two screws, and then remove the PCA cover.

Figure 7-76 Remove the PCA cover

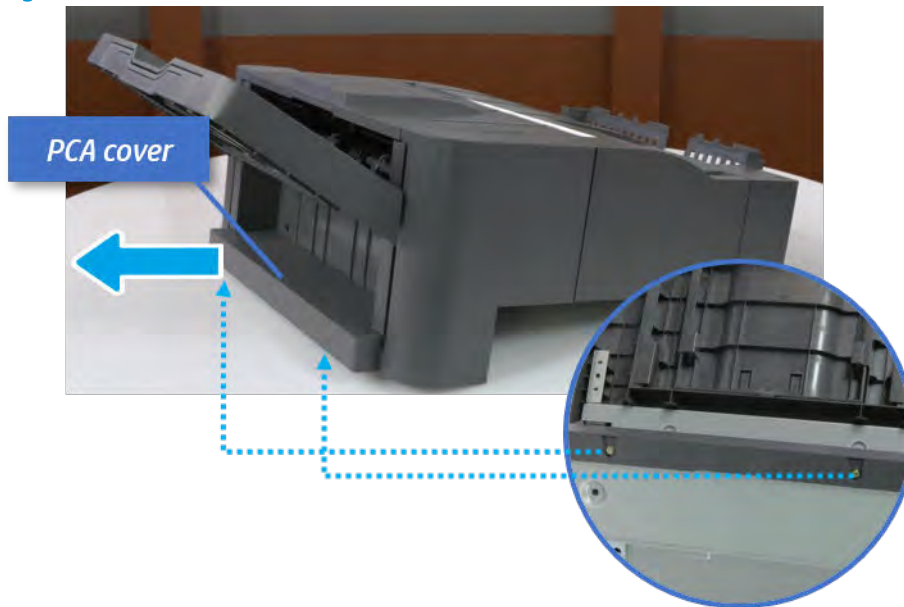

Remove the left cover

Follow these steps to remove the left cover.

1. Remove two screws.

Figure 7-77 Remove two screws

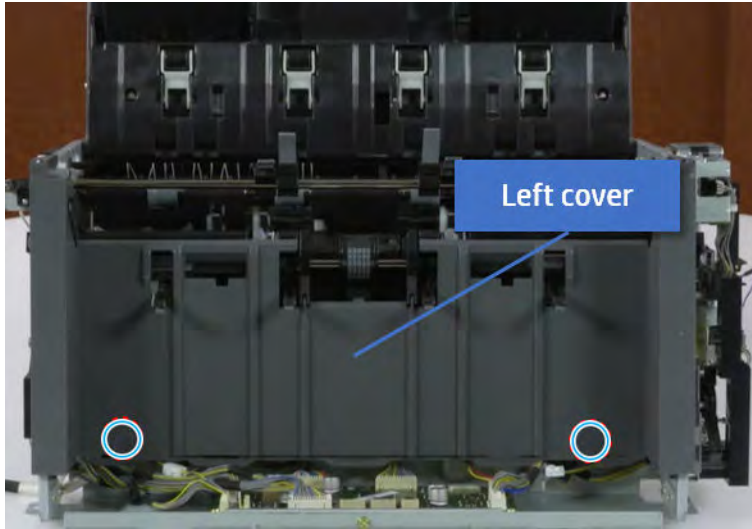

2. Remove four screws from both front and rear sides.

Figure 7-78 Remove four screws

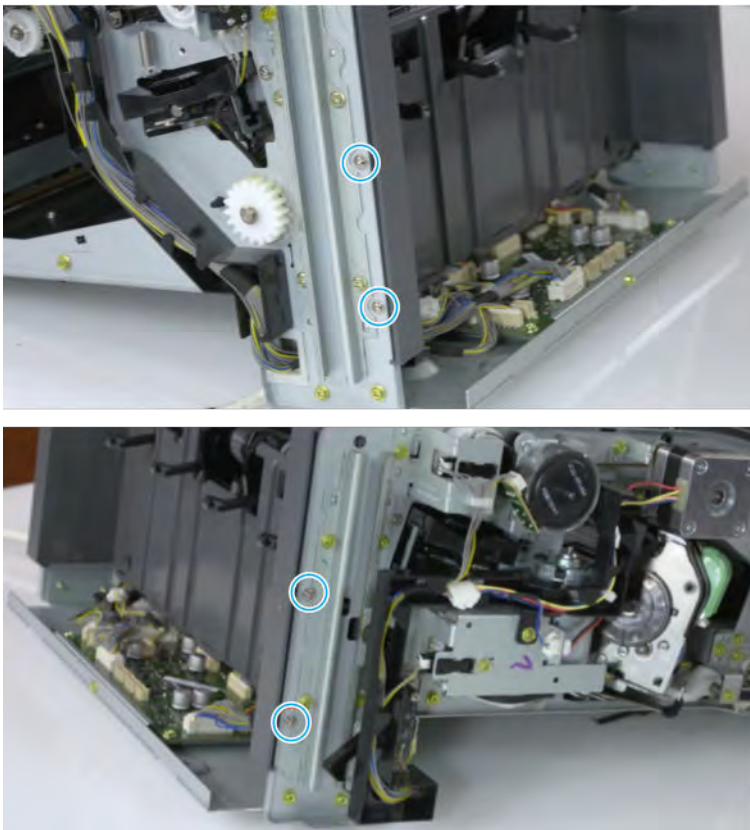

3. Unplug two inline connectors, and then remove the left cover.

Figure 7-79 Unplug two connectors

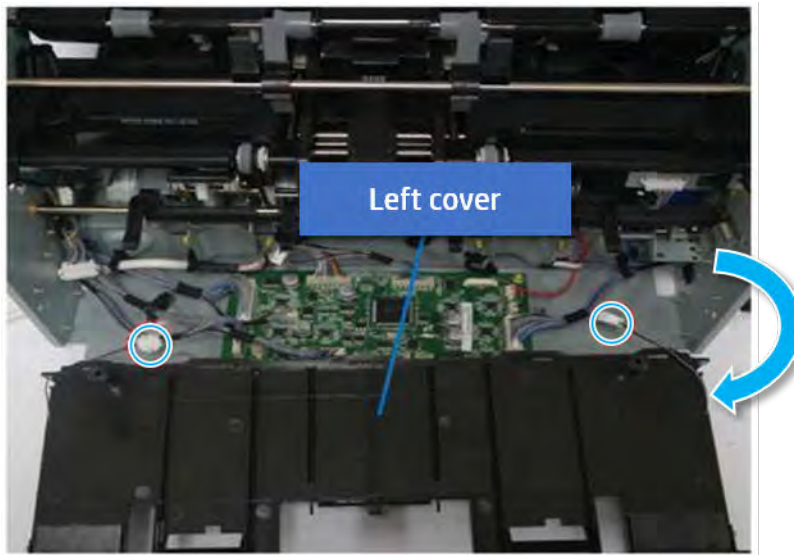

 **TIP:** Be sure to check the hook when reassembling.

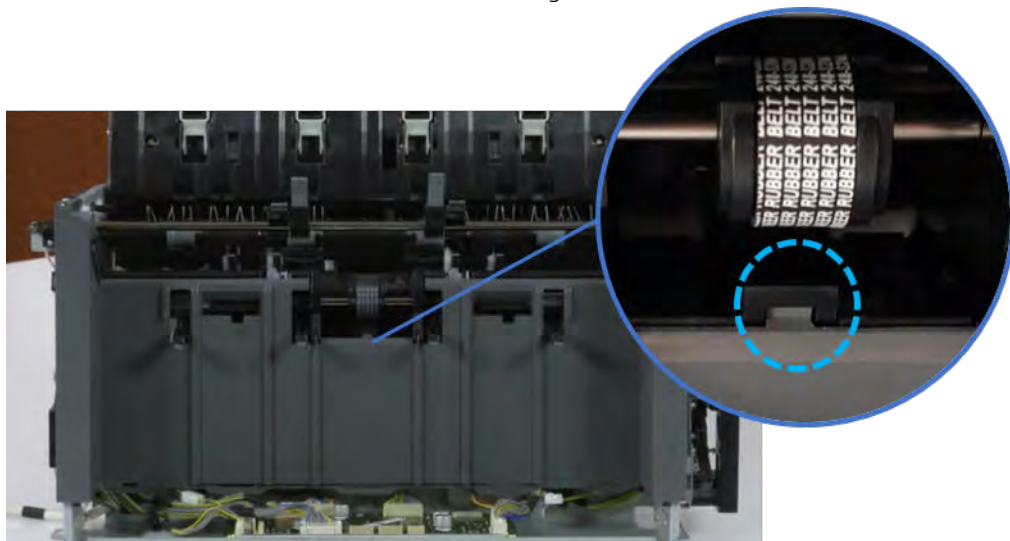

Unpack the replacement assembly

Follow these steps to unpack the replacement assembly.

1. Dispose of the defective part.

 **NOTE:** HP recommends responsible disposal of the defective part.

<http://www8.hp.com/us/en/hp-information/environment/product-recycling.html>

2. Unpack the replacement part from the packaging.



CAUTION:  Some parts are sensitive to electrostatic discharge (ESD). Always perform service work at an ESD-protected workstation or mat. If an ESD workstation or mat is not available, touch the sheet-metal chassis to provide a static ground before touching an ESD-sensitive assembly. Protect the ESD-sensitive assemblies by placing them in ESD pouches when they are out of the printer.

 **IMPORTANT:** Make sure that all of the shipping materials (for example shipping tape) are removed from the replacement part prior to installation.

 **NOTE:** If the replacement part is a roller or pad, avoid touching the spongy part of it. Skin oils on the roller or pad can cause paper pickup and/or print-quality problems. HP recommends using disposable gloves when handling rollers or pads or washing your hands before touching rollers or pads.

3. To install an assembly, reverse the removal steps.

 **NOTE:** When applicable, special installation instructions are provided for an assembly at the end of the removal procedure. Always completely read the removal instructions and follow all special installation instructions.

Entrance unit

Removal and replacement: Entrance sensor (S1)

Learn how to remove and replace the entrance sensor.

To view teardown and reassembling video of the inner finisher, click the link below.



[View a teardown video of the inner finisher.](#)



[View a reassembling video of the inner finisher.](#)



IMPORTANT: When applicable, special installation instructions are provided for an assembly at the end of the removal procedure. Always completely read the removal instructions and follow all special installation instructions.

Mean time to repair:

Service level:

Before performing service

Turn the printer power off

- Press the power button on the front of the printer, and then turn off the power switch next to the power cable.
- A shutting-down message appears on the control-panel display.



WARNING! To avoid damage to the printer, turn the power off and wait until the printer shuts down before removing the power cable.

- Disconnect the printer power cable after the printer has completely shut down (the control-panel display is blank).

Use the table below to identify the correct part number for your printer. To order the part, go to www.hp.com/buy/parts.

Table 7-39 Part information

Part number	Part description
0604-001381	Entrance sensor

Required tools

- #2 JIS screwdriver with a magnetic tip

After performing service

Turn the printer power on

- Connect the power cable.
- Use the power switch to turn the power on.

Post service test

Print any pages necessary to verify that the repair resolved the issue and did not create any new issues.

Remove the rear cover

Follow these steps to remove the rear cover.

1. Open the top cover.

Figure 7-80 Open the top cover

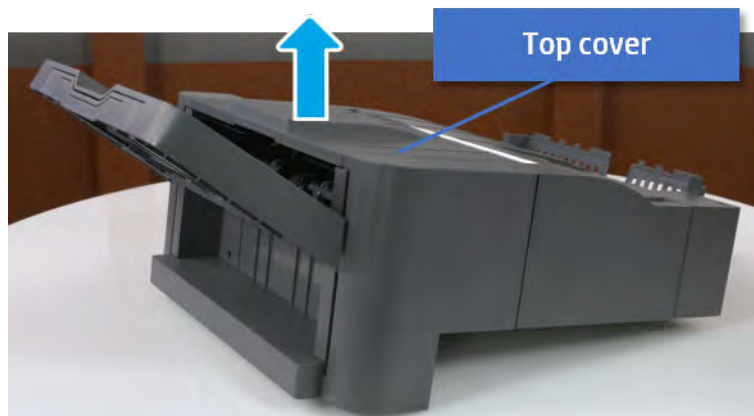

2. Remove three screws.
3. Release hooks carefully and remove the rear cover.

Figure 7-81 Remove the rear cover

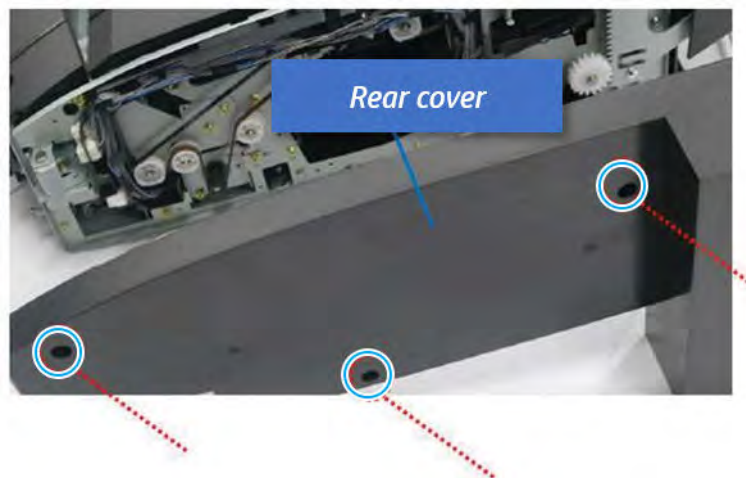

Remove the punch cover

Follow these steps to remove the punch cover.

1. Unplug the connector. Remove the e-ring, and then remove the slide shaft at the rear of the inner finisher.

Figure 7-82 Remove the slide shaft

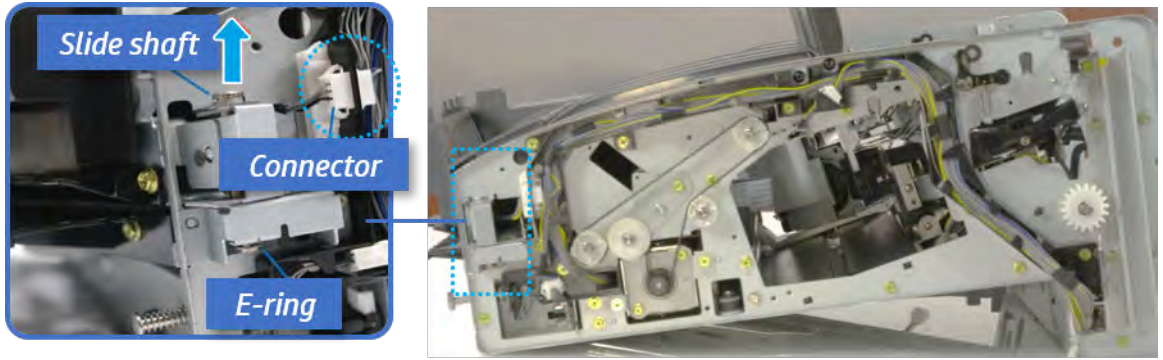

2. Open the punch cover.

Figure 7-83 Open the punch cover

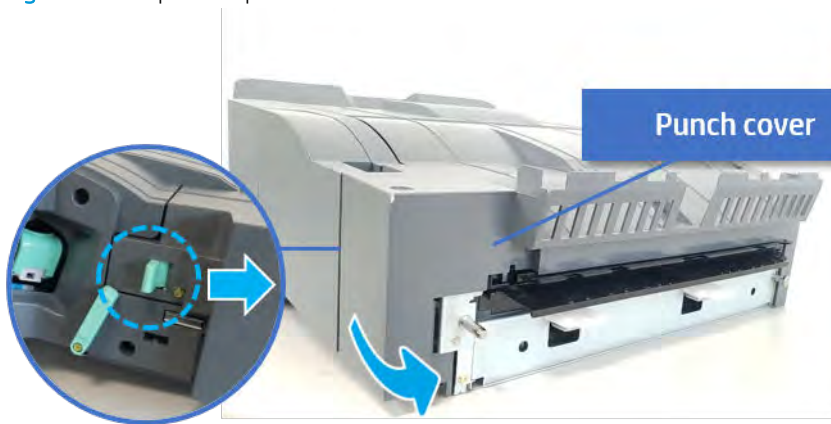

3. Remove the front punch sheet, and then remove the e-ring and the washer. And then remove the punch cover.

Figure 7-84 Remove the punch cover

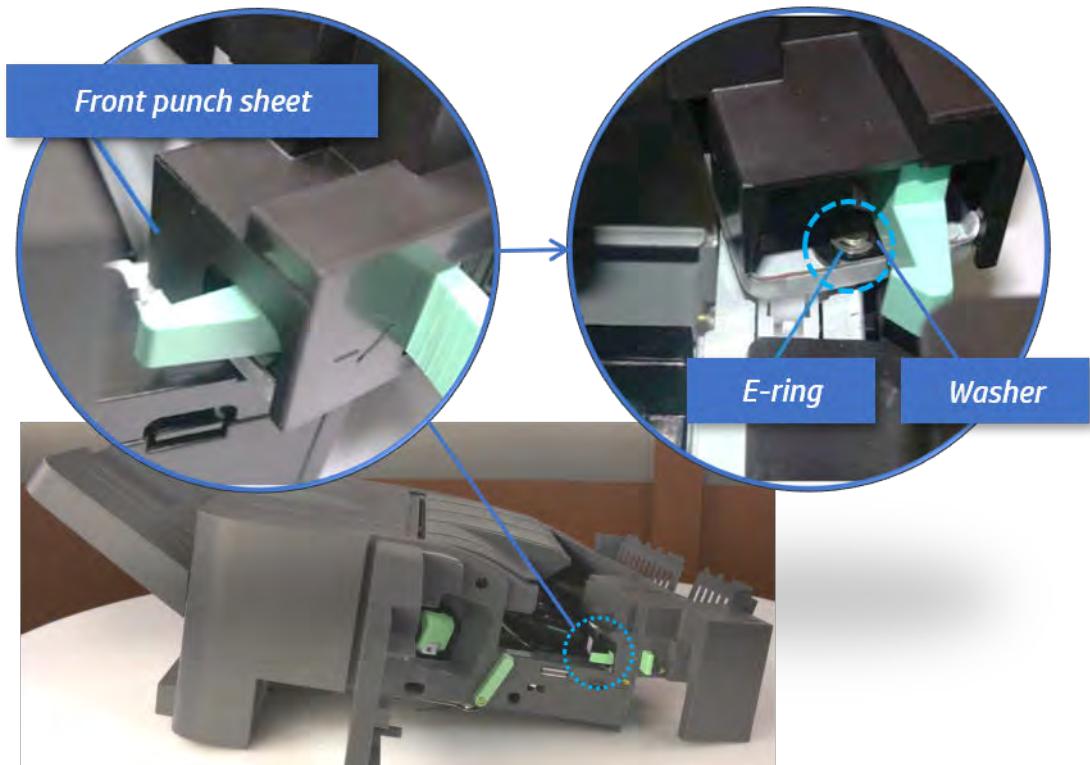

Remove the entrance sensor

Follow these steps to remove the entrance sensor.

1. Loosen the adhesive tape around, and then remove four screws. And then remove the punch cover.

Figure 7-85 Remove the punch cover

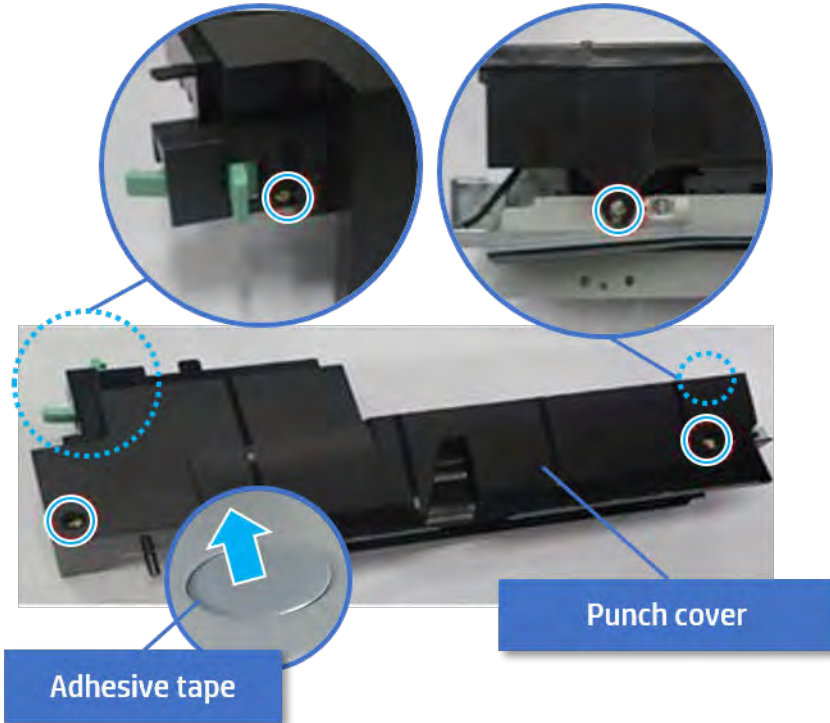

2. Remove one screw, unplug the connector, and then remove the entrance sensor bracket.

Figure 7-86 Remove the entrance sensor bracket

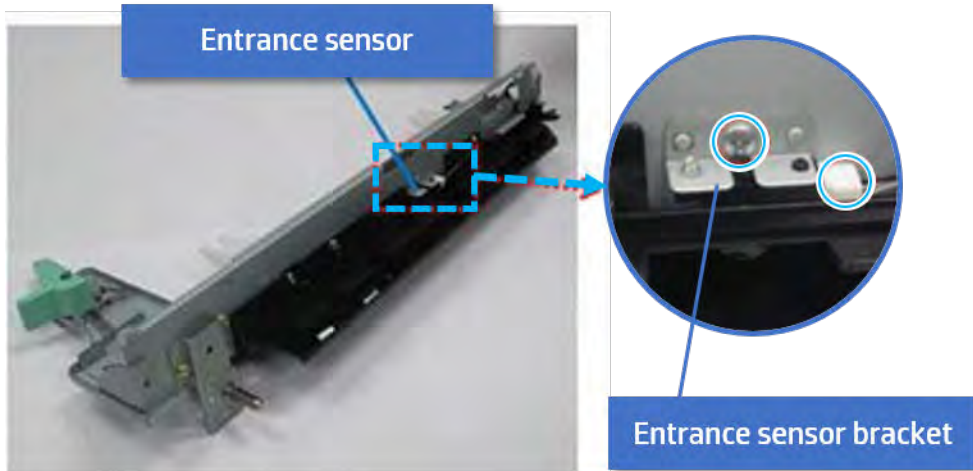

3. Remove one screw, and then remove the sensor.

Figure 7-87 Remove the entrance sensor

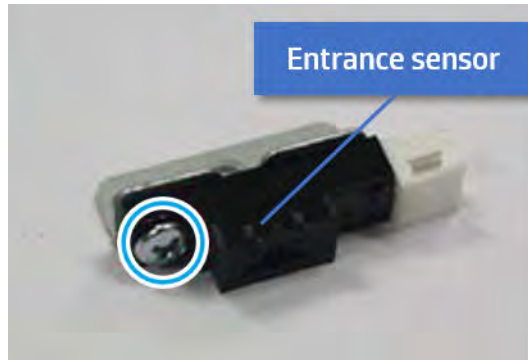

Unpack the replacement assembly



Follow these steps to unpack the replacement assembly.

1. Dispose of the defective part.

 **NOTE:** HP recommends responsible disposal of the defective part.

<http://www8.hp.com/us/en/hp-information/environment/product-recycling.html>

2. Unpack the replacement part from the packaging.

 **CAUTION:**  Some parts are sensitive to electrostatic discharge (ESD). Always perform service work at an ESD-protected workstation or mat. If an ESD workstation or mat is not available, touch the sheet-metal chassis to provide a static ground before touching an ESD-sensitive assembly. Protect the ESD-sensitive assemblies by placing them in ESD pouches when they are out of the printer.

 **IMPORTANT:** Make sure that all of the shipping materials (for example shipping tape) are removed from the replacement part prior to installation.

 **NOTE:** If the replacement part is a roller or pad, avoid touching the spongy part of it. Skin oils on the roller or pad can cause paper pickup and/or print-quality problems. HP recommends using disposable gloves when handling rollers or pads or washing your hands before touching rollers or pads.

3. To install an assembly, reverse the removal steps.

 **NOTE:** When applicable, special installation instructions are provided for an assembly at the end of the removal procedure. Always completely read the removal instructions and follow all special installation instructions.

Removal and replacement: Entrance motor (M10)

Learn how to remove and replace the entrance motor.

To view teardown and reassembling video of the inner finisher, click the link below.



[View a teardown video of the inner finisher.](#)



[View a reassembling video of the inner finisher.](#)



IMPORTANT: When applicable, special installation instructions are provided for an assembly at the end of the removal procedure. Always completely read the removal instructions and follow all special installation instructions.

Mean time to repair:

Service level:

Before performing service

Turn the printer power off

- Press the power button on the front of the printer, and then turn off the power switch next to the power cable.
- A shutting-down message appears on the control-panel display.



WARNING! To avoid damage to the printer, turn the power off and wait until the printer shuts down before removing the power cable.

- Disconnect the printer power cable after the printer has completely shut down (the control-panel display is blank).

Use the table below to identify the correct part number for your printer. To order the part, go to www.hp.com/buy/parts.

Table 7-40 Part information

Part number	Part description
JC90-01344A	Entrance motor assembly

Required tools

- #2 JIS screwdriver with a magnetic tip

After performing service

Turn the printer power on

- Connect the power cable.
- Use the power switch to turn the power on.

Post service test

Print any pages necessary to verify that the repair resolved the issue and did not create any new issues.

Remove the front cover

Follow these steps to remove the front cover.

1. Open the front door and open the punch cover.
2. Remove three screws in the front.
3. Remove the lever.
4. Open the top cover.
5. From the right side of the front cover, carefully lift and pry toward the top-left corner to remove the front cover.

Figure 7-88 Remove the front cover

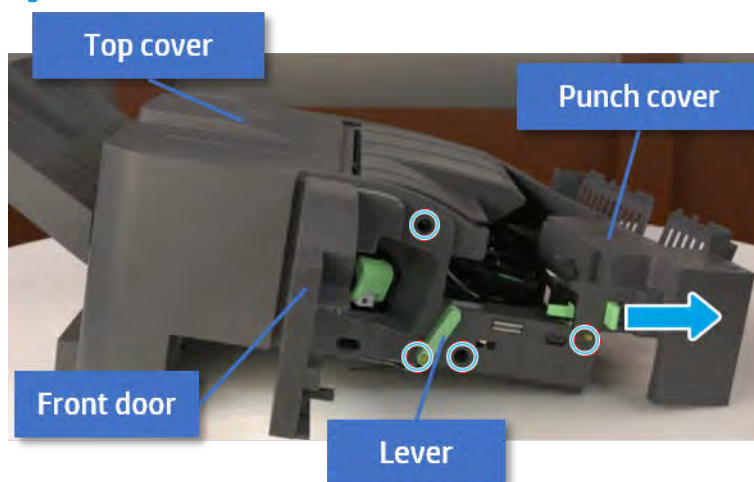

Remove the rear cover

Follow these steps to remove the rear cover.

1. Open the top cover.

Figure 7-89 Open the top cover

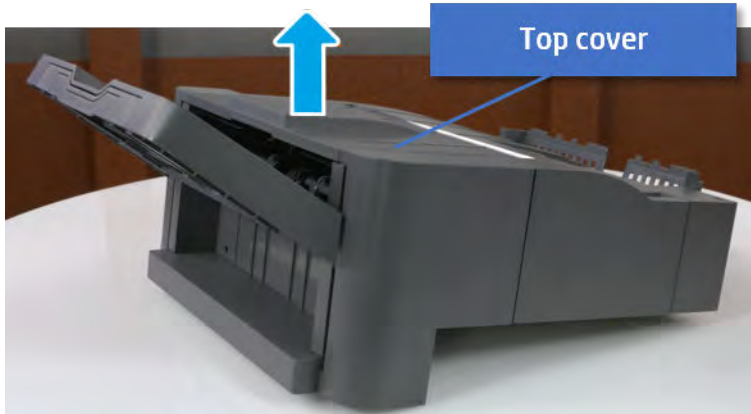

2. Remove three screws.
3. Release hooks carefully and remove the rear cover.

Figure 7-90 Remove the rear cover

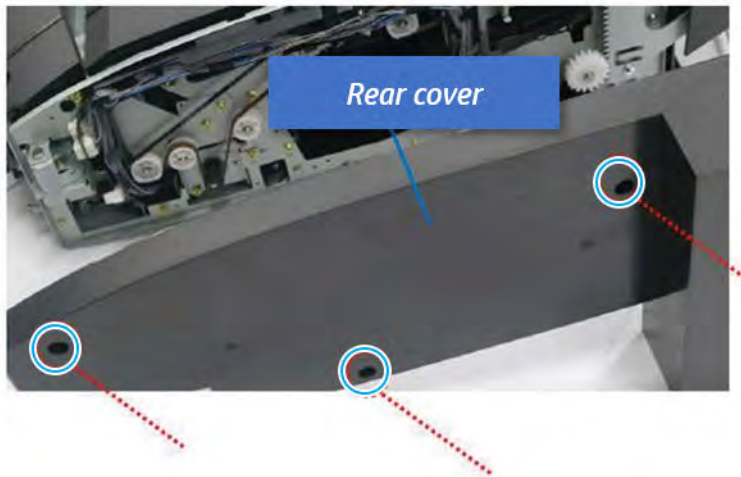

Remove the middle cover

Follow these steps to remove the middle cover.

1. Open the front door and then open the punch cover.

Figure 7-91 Open the front door and punch cover

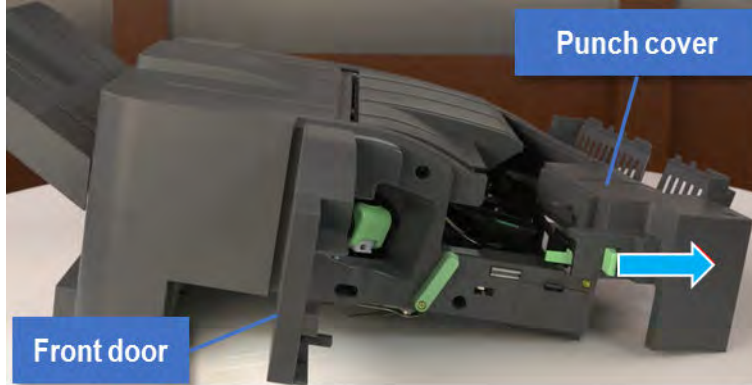

2. Remove left-side one screw at the rear of the inner finisher, and then remove the middle cover by lifting off the hinge pins at the front.

Figure 7-92 Remove the middle cover

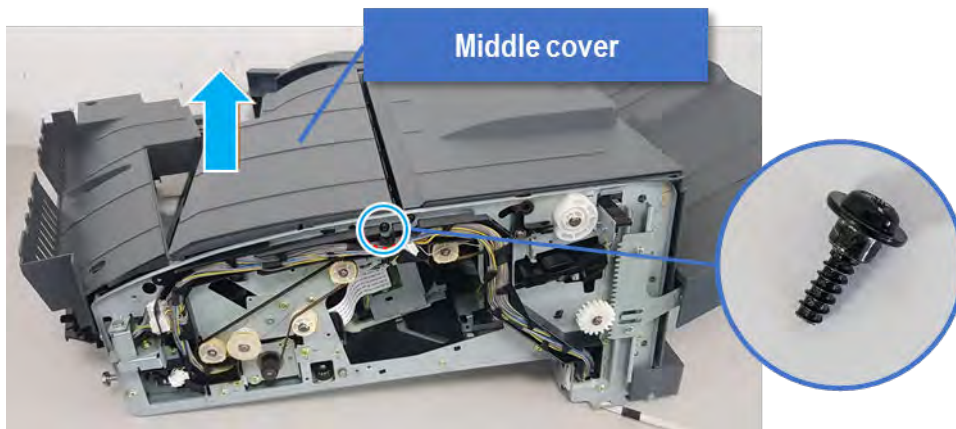

Remove the punch cover

Follow these steps to remove the punch cover.

1. Unplug the connector. Remove the e-ring, and then remove the slide shaft at the rear of the inner finisher.

Figure 7-93 Remove the slide shaft

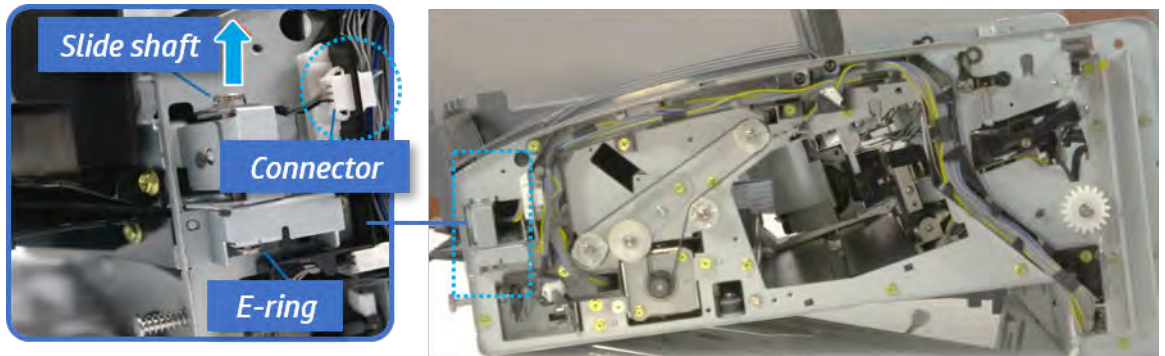

2. Open the punch cover.

Figure 7-94 Open the punch cover

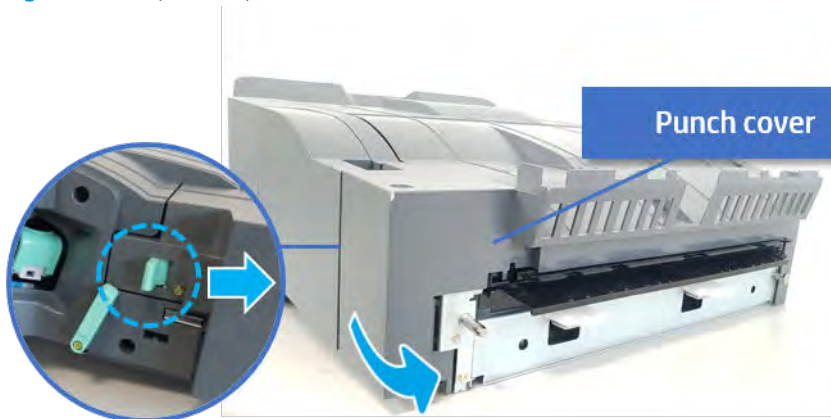

3. Remove the front punch sheet, and then remove the e-ring and the washer. And then remove the punch cover.

Figure 7-95 Remove the punch cover

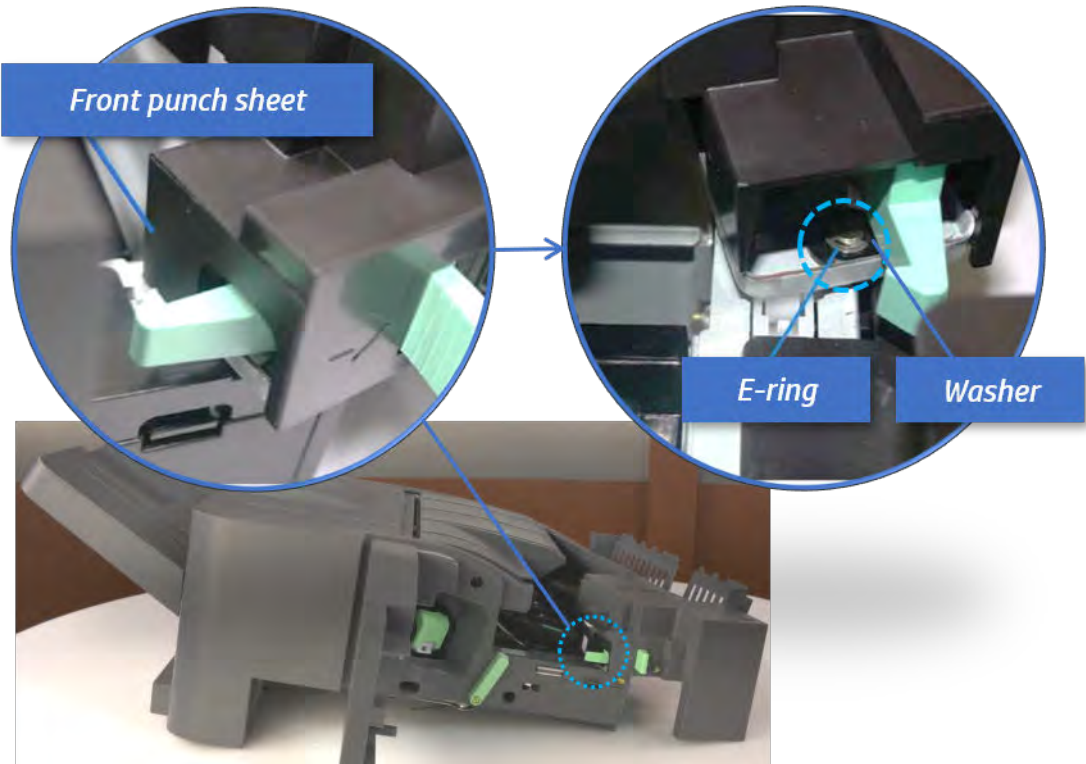

Remove the diverter guide and the middle roller

Follow these steps to remove the diverter guide and the middle roller.

1. On the front of the inner finisher, remove the e-ring and bushing.

Figure 7-96 Remove the e-ring and bushing

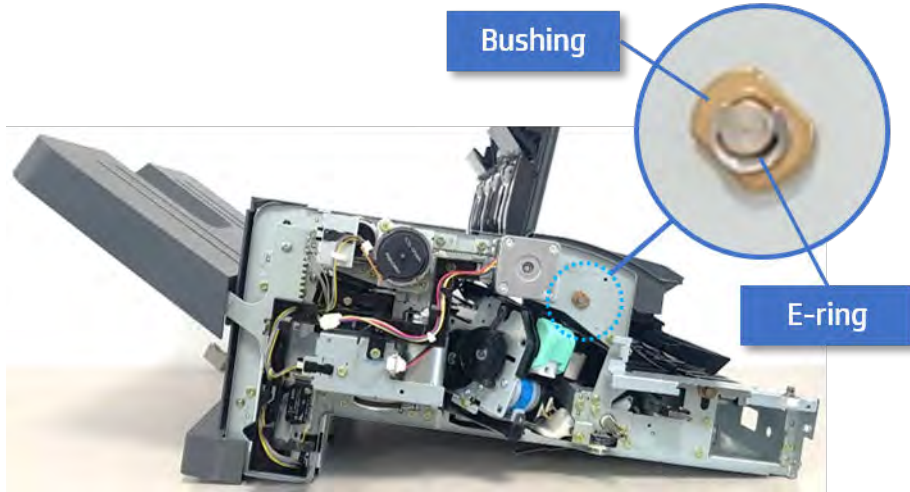

2. On the rear of the inner finisher, remove the e-ring, pulley, bushing, belt, and spring (slightly hidden from view).

Figure 7-97 Remove the e-ring, pulley, bushing, belt, and spring

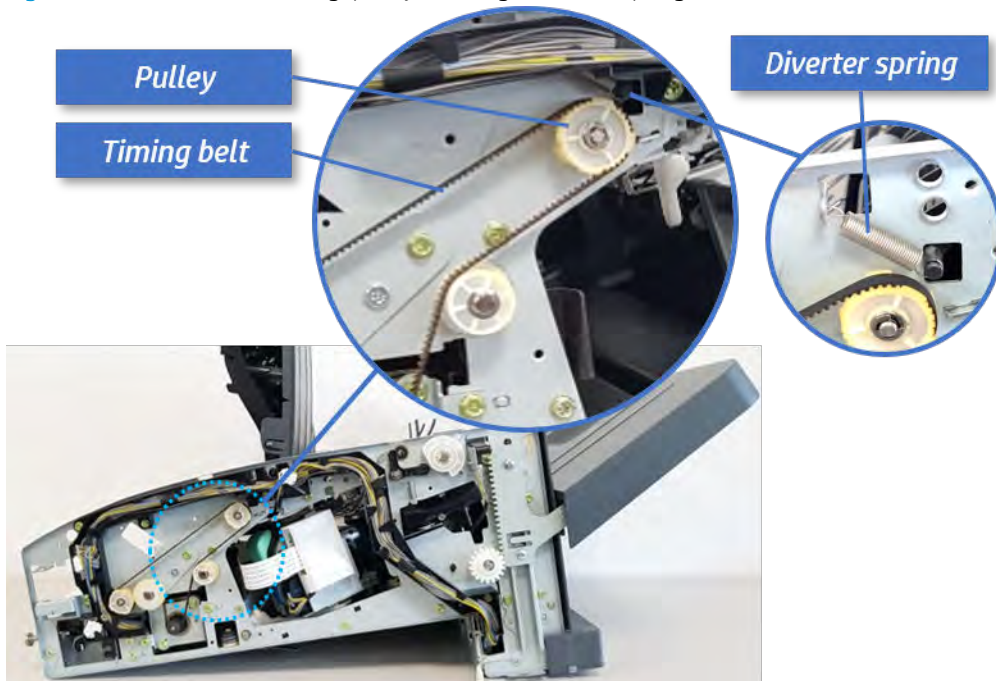

3. Remove the diverter guide and the middle roller.

Figure 7-98 Remove the diverter guide and the middle roller

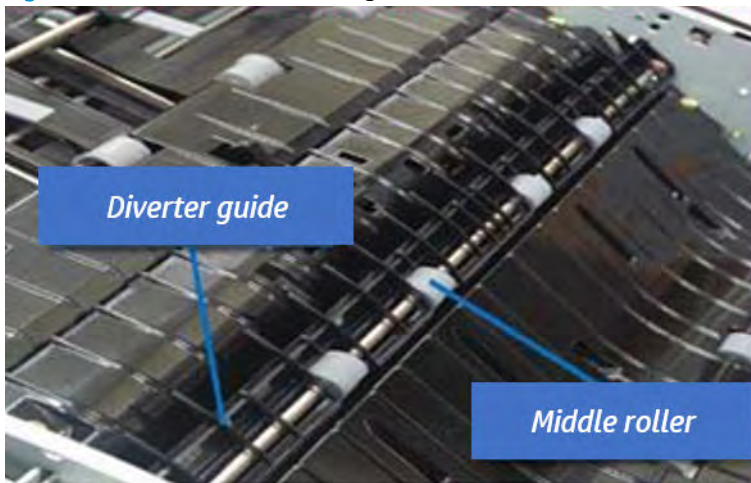



Remove the middle paper guide

Follow these steps to remove the middle paper guide.

1. Remove six screws, and then open the middle paper guide in the direction of the arrow.

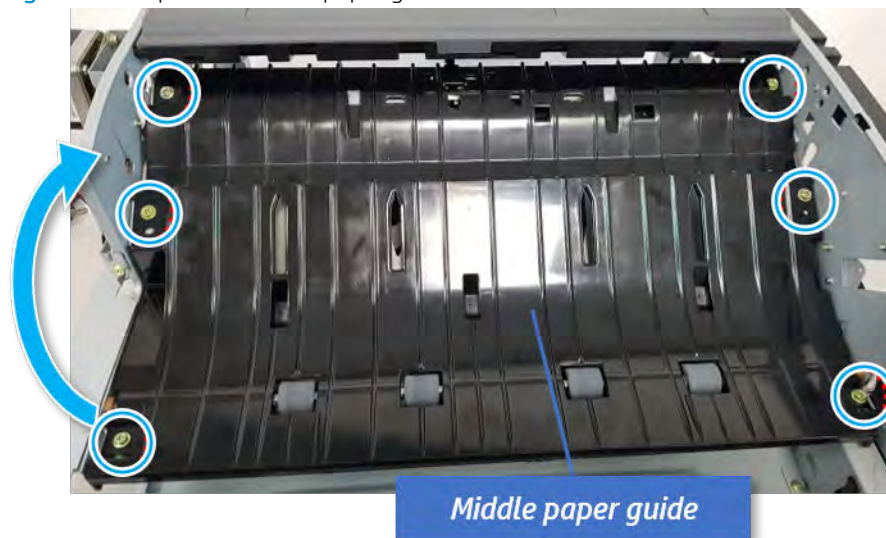
Figure 7-99 Open the middle paper guide



 **NOTE:** Be careful not to damage the sensor connector.

2. Unplug the connector under the middle paper guide. And then, remove the middle paper guide.

Figure 7-100 Remove the middle paper guide

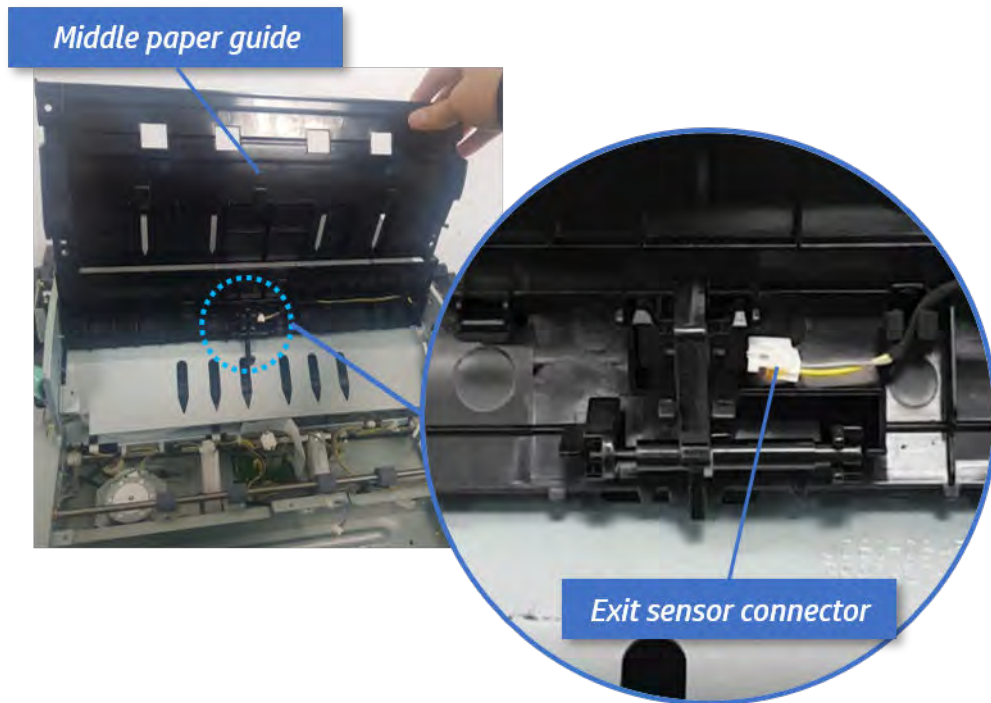

Remove the entrance motor

Follow these steps to remove the entrance motor.

1. Remove two screws.

Figure 7-101 Remove two screws

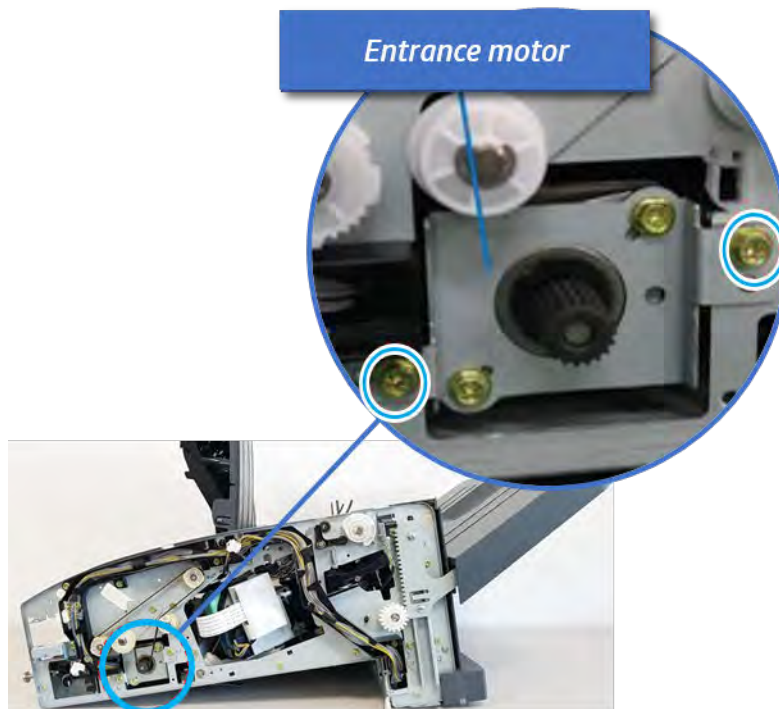

2. Open the clamps, and then unplug the connector.

Figure 7-102 Unplug the connector

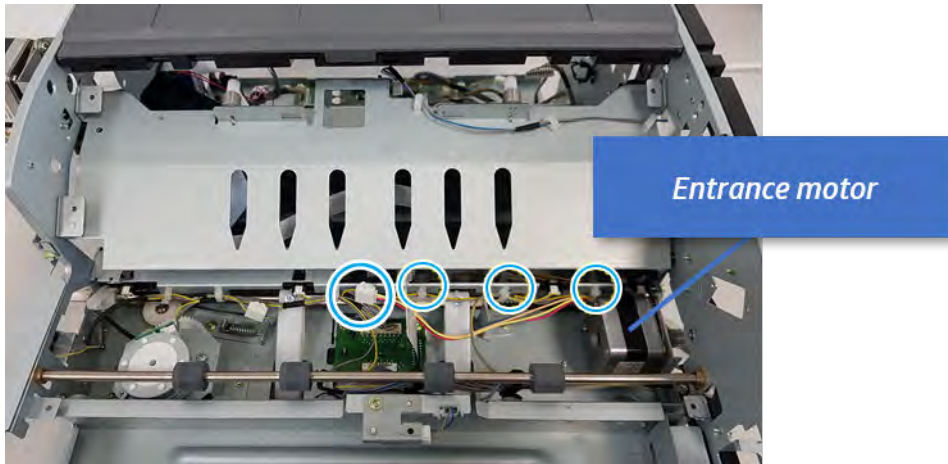

3. Remove two screws, and then remove the motor.

Figure 7-103 Remove the entrance motor

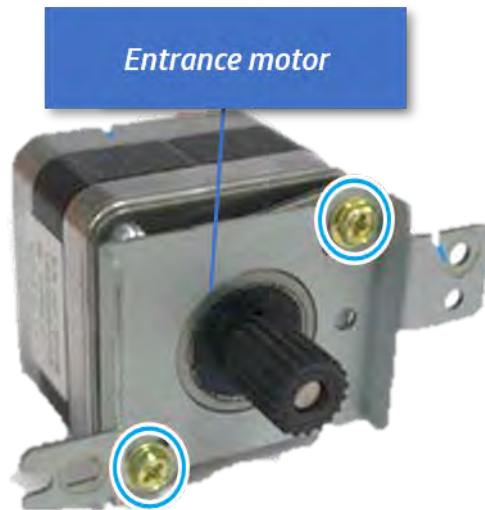

Unpack the replacement assembly

Follow these steps to unpack the replacement assembly.

1. Dispose of the defective part.

 **NOTE:** HP recommends responsible disposal of the defective part.

<http://www8.hp.com/us/en/hp-information/environment/product-recycling.html>

2. Unpack the replacement part from the packaging.



CAUTION:  Some parts are sensitive to electrostatic discharge (ESD). Always perform service work at an ESD-protected workstation or mat. If an ESD workstation or mat is not available, touch the sheet-metal chassis to provide a static ground before touching an ESD-sensitive assembly. Protect the ESD-sensitive assemblies by placing them in ESD pouches when they are out of the printer.

 **IMPORTANT:** Make sure that all of the shipping materials (for example shipping tape) are removed from the replacement part prior to installation.

 **NOTE:** If the replacement part is a roller or pad, avoid touching the spongy part of it. Skin oils on the roller or pad can cause paper pickup and/or print-quality problems. HP recommends using disposable gloves when handling rollers or pads or washing your hands before touching rollers or pads.

3. To install an assembly, reverse the removal steps.

 **NOTE:** When applicable, special installation instructions are provided for an assembly at the end of the removal procedure. Always completely read the removal instructions and follow all special installation instructions.

Exit unit

Removal and replacement: Exit roller (R3)

Learn how to remove and replace the exit roller.

To view teardown and reassembling video of the inner finisher, click the link below.



[View a teardown video of the inner finisher.](#)



[View a reassembling video of the inner finisher.](#)



IMPORTANT: When applicable, special installation instructions are provided for an assembly at the end of the removal procedure. Always completely read the removal instructions and follow all special installation instructions.

Mean time to repair:

Service level:

Before performing service

Turn the printer power off

- Press the power button on the front of the printer, and then turn off the power switch next to the power cable.
- A shutting-down message appears on the control-panel display.



WARNING! To avoid damage to the printer, turn the power off and wait until the printer shuts down before removing the power cable.

- Disconnect the printer power cable after the printer has completely shut down (the control-panel display is blank).

Use the table below to identify the correct part number for your printer. To order the part, go to <http://www.hp.com/buy/parts>.

Table 7-41 Part information

Part number	Part description
JC66-04244A	Exit roller
JC61-07449A	Front compile guide
JC61-07450A	Rear compile guide

Required tools

- #2 JIS screwdriver with a magnetic tip

After performing service

Turn the printer power on

- Connect the power cable.
- Use the power switch to turn the power on.

Post service test

Print any pages necessary to verify that the repair resolved the issue and did not create any new issues.

Remove the front cover

Follow these steps to remove the front cover.

1. Open the front door and open the punch cover.
2. Remove three screws in the front.
3. Remove the lever.
4. Open the top cover.
5. From the right side of the front cover, carefully lift and pry toward the top-left corner to remove the front cover.

Figure 7-104 Remove the front cover

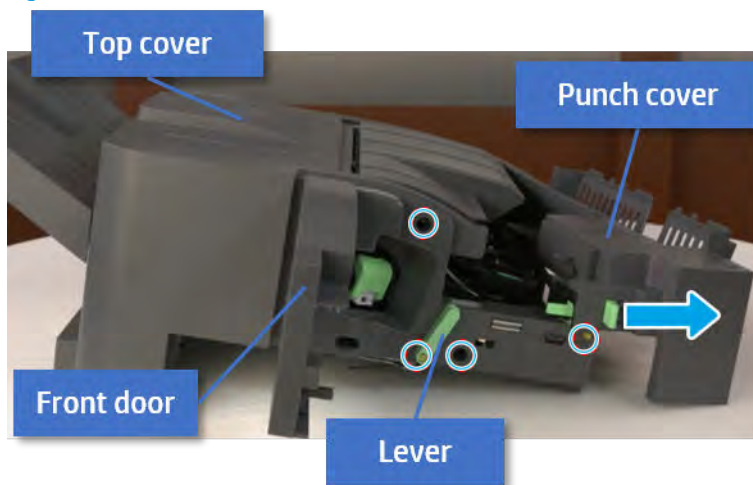

Remove the rear cover

Follow these steps to remove the rear cover.

1. Open the top cover.

Figure 7-105 Open the top cover

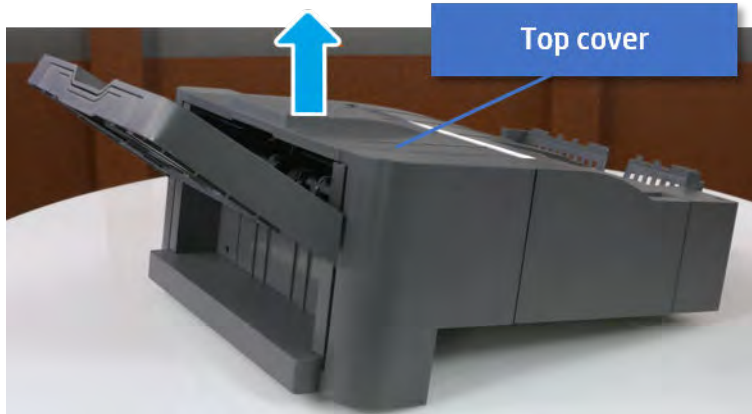

2. Remove three screws.
3. Release hooks carefully and remove the rear cover.

Figure 7-106 Remove the rear cover

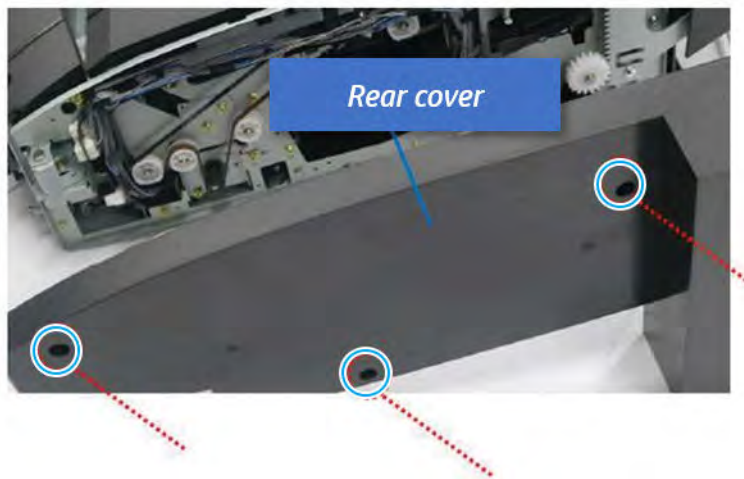

Remove the sub paddle unit

Follow these steps to remove the sub paddle unit.

1. Open the top cover, and then remove one screw securing the sub paddle unit.

Figure 7-107 Remove one screw

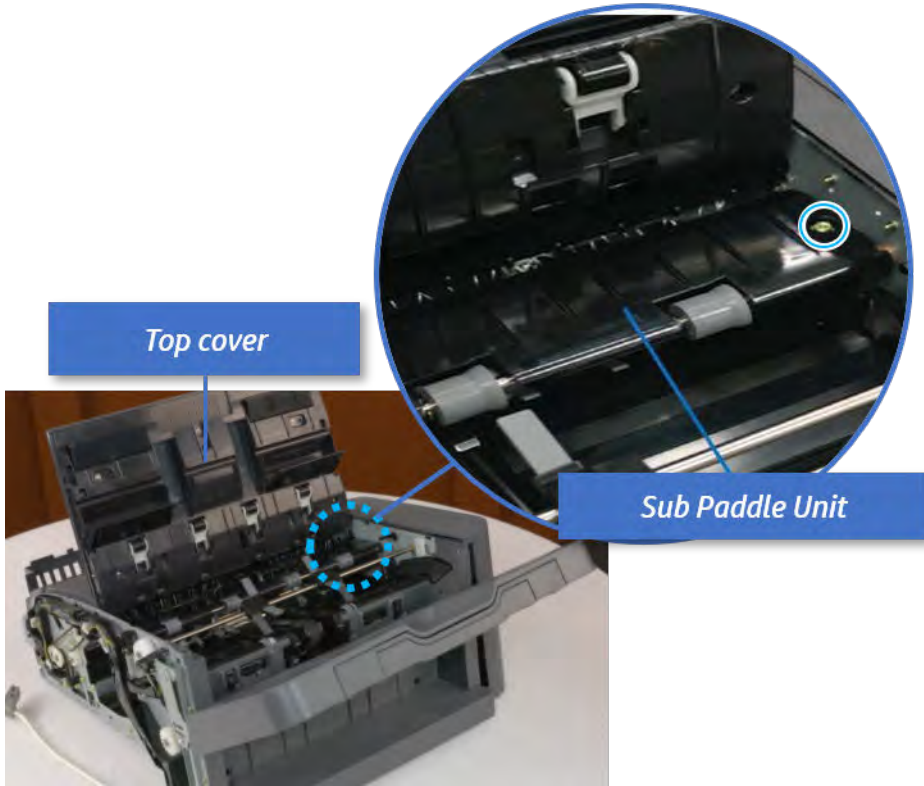

2. Remove the e-ring, and then remove the pulley and timing belt. And then remove the e-ring and the bushing.

Figure 7-108 Remove the e-ring, pulley, timing belt, and bushing

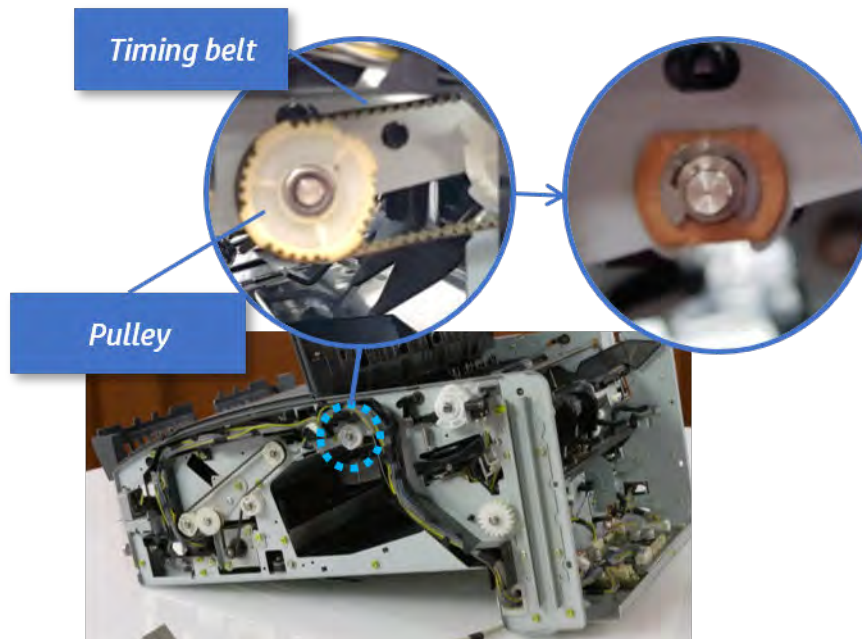

3. Lift up and remove the sub paddle unit.

Figure 7-109 Remove the sub paddle unit

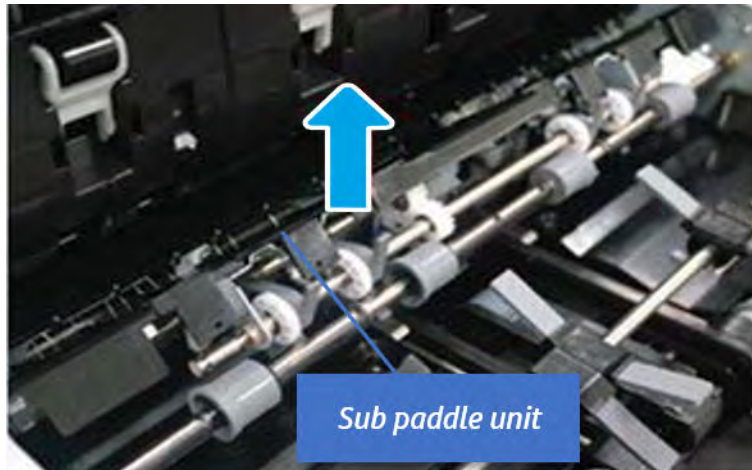

Remove the exit roller

Follow these steps to remove the exit roller.

1. Remove the guide on the center of the exit roller.

Figure 7-110 Remove the guide

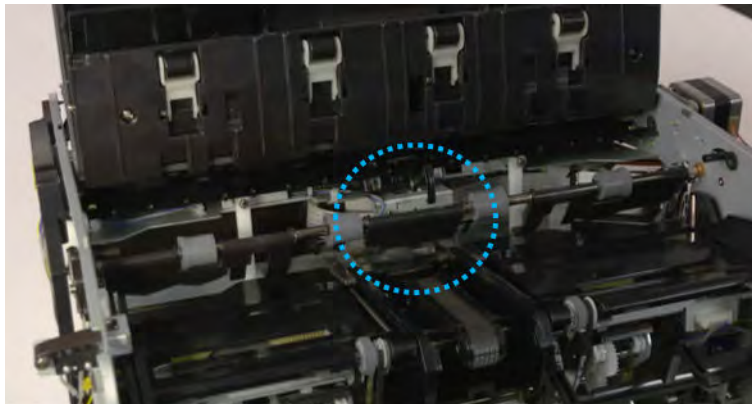

2. On the front of the inner finisher, release the timing belt connected to the exit motor.

Figure 7-111 Release the timing belt

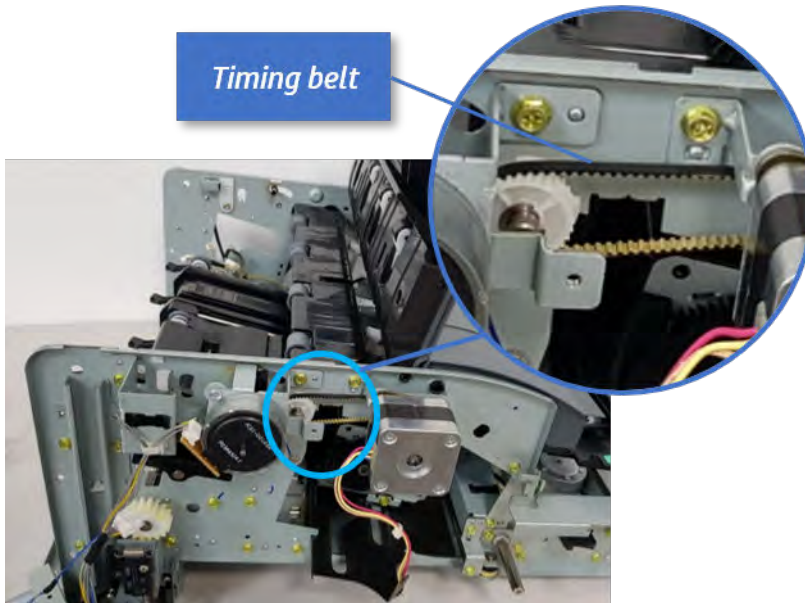

3. Remove five screws securing the rear harness guide.

Figure 7-112 Remove five screws

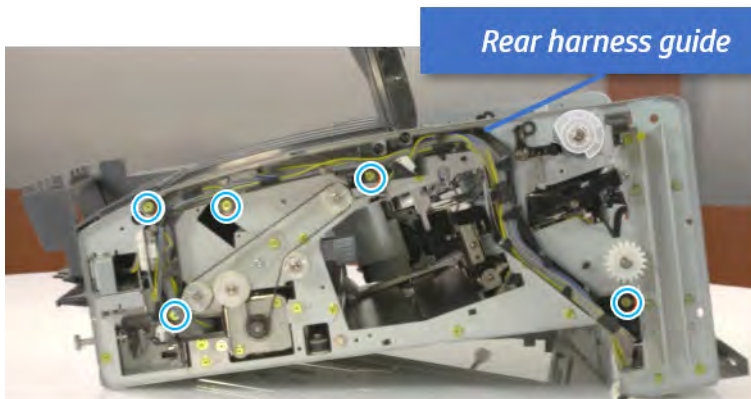

4. On the rear of the inner finisher, remove the e-ring and the pulley and then remove the e-ring and the bushing.

Figure 7-113 Remove e-ring, pulley, and bushing

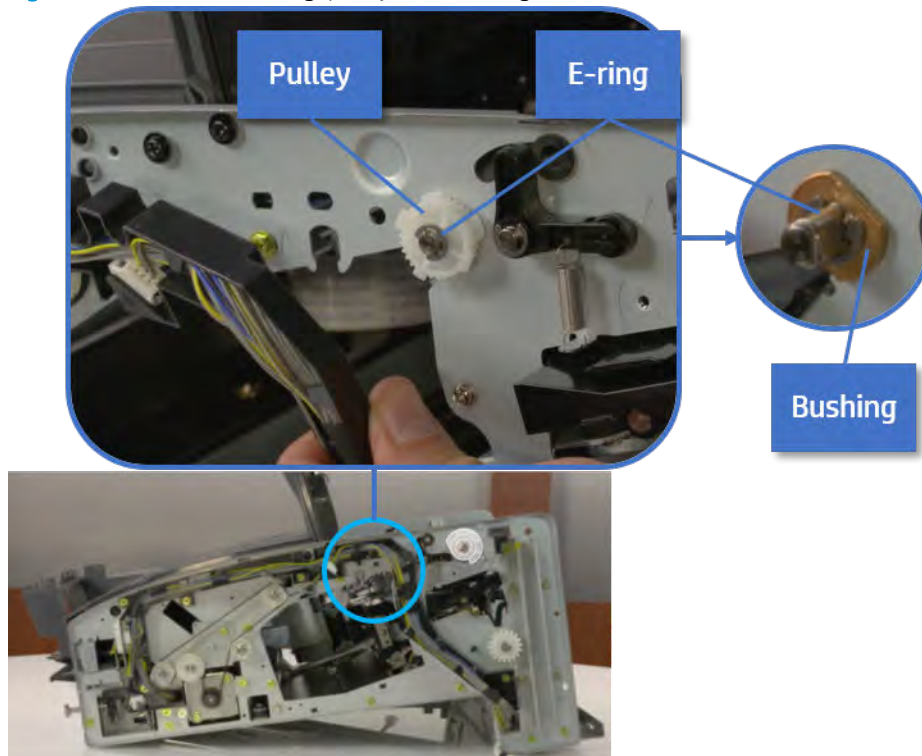

5. Push the bushing to detach it, and then remove the exit roller.

Figure 7-114 Remove the exit roller

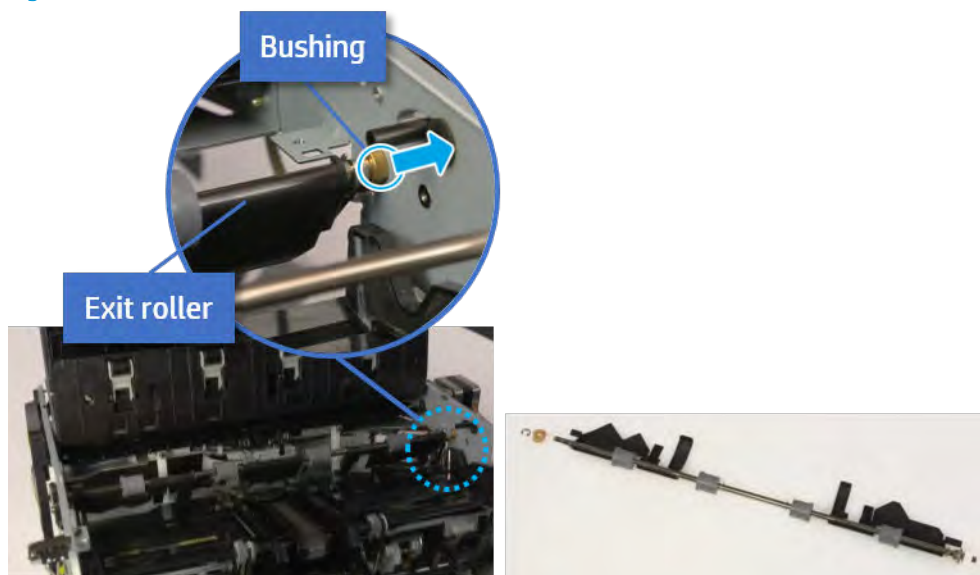

Unpack the replacement assembly

Follow these steps to unpack the replacement assembly.

1. Dispose of the defective part.

 **NOTE:** HP recommends responsible disposal of the defective part.

<http://www8.hp.com/us/en/hp-information/environment/product-recycling.html>

2. Unpack the replacement part from the packaging.



CAUTION:  Some parts are sensitive to electrostatic discharge (ESD). Always perform service work at an ESD-protected workstation or mat. If an ESD workstation or mat is not available, touch the sheet-metal chassis to provide a static ground before touching an ESD-sensitive assembly. Protect the ESD-sensitive assemblies by placing them in ESD pouches when they are out of the printer.

 **IMPORTANT:** Make sure that all of the shipping materials (for example shipping tape) are removed from the replacement part prior to installation.

 **NOTE:** If the replacement part is a roller or pad, avoid touching the spongy part of it. Skin oils on the roller or pad can cause paper pickup and/or print-quality problems. HP recommends using disposable gloves when handling rollers or pads or washing your hands before touching rollers or pads.

3. To install an assembly, reverse the removal steps.

 **NOTE:** When applicable, special installation instructions are provided for an assembly at the end of the removal procedure. Always completely read the removal instructions and follow all special installation instructions.

Removal and replacement: Exit sensor (S21)

Learn how to remove and replace the exit sensor.

To view teardown and reassembling video of the inner finisher, click the link below.



[View a teardown video of the inner finisher.](#)



[View a reassembling video of the inner finisher.](#)



IMPORTANT: When applicable, special installation instructions are provided for an assembly at the end of the removal procedure. Always completely read the removal instructions and follow all special installation instructions.

Mean time to repair:

Service level:

Before performing service

Turn the printer power off

- Press the power button on the front of the printer, and then turn off the power switch next to the power cable.
- A shutting-down message appears on the control-panel display.



WARNING! To avoid damage to the printer, turn the power off and wait until the printer shuts down before removing the power cable.

- Disconnect the printer power cable after the printer has completely shut down (the control-panel display is blank).

Use the table below to identify the correct part number for your printer. To order the part, go to www.hp.com/buy/parts.

Table 7-42 Part information

Part number	Part description
0604-001415	Exit sensor

Required tools

- #2 JIS screwdriver with a magnetic tip

After performing service

Turn the printer power on

- Connect the power cable.
- Use the power switch to turn the power on.

Post service test

Print any pages necessary to verify that the repair resolved the issue and did not create any new issues.

Remove the front cover

Follow these steps to remove the front cover.

1. Open the front door and open the punch cover.
2. Remove three screws in the front.
3. Remove the lever.
4. Open the top cover.
5. From the right side of the front cover, carefully lift and pry toward the top-left corner to remove the front cover.

Figure 7-115 Remove the front cover

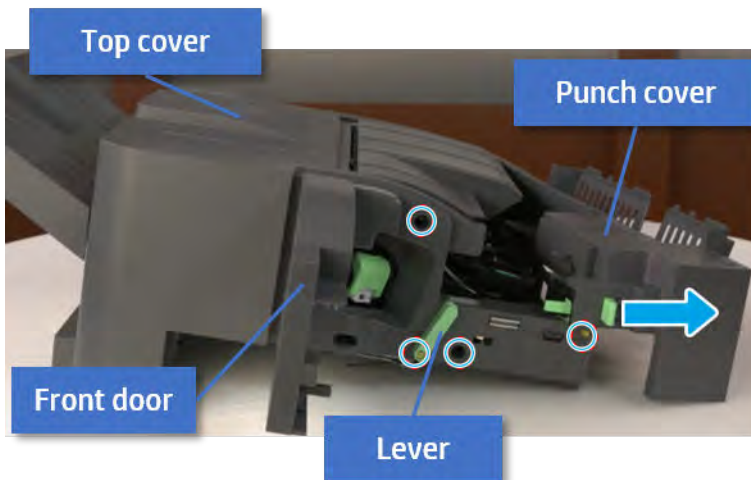

Remove the rear cover

Follow these steps to remove the rear cover.

1. Open the top cover.

Figure 7-116 Open the top cover

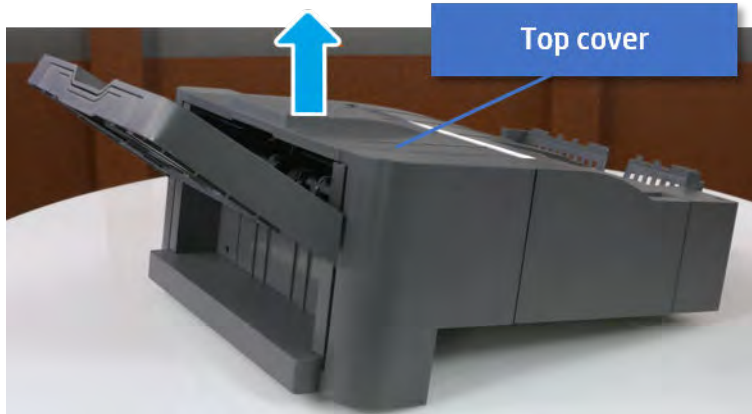

2. Remove three screws.
3. Release hooks carefully and remove the rear cover.

Figure 7-117 Remove the rear cover

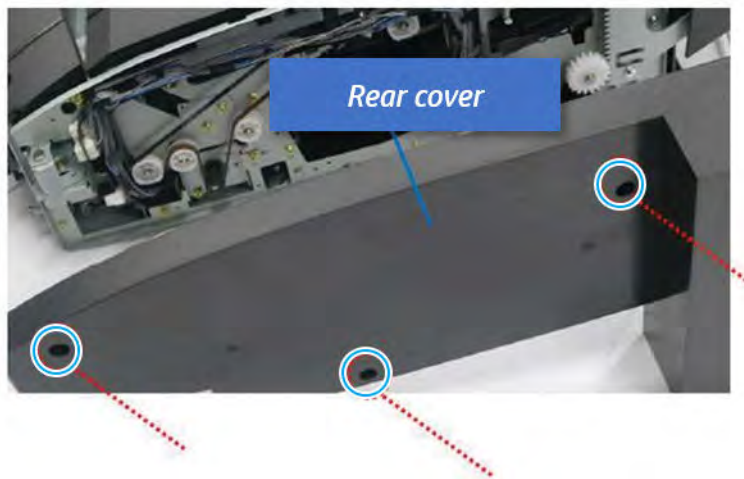

Remove the middle cover

Follow these steps to remove the middle cover.

1. Open the front door and then open the punch cover.

Figure 7-118 Open the front door and punch cover

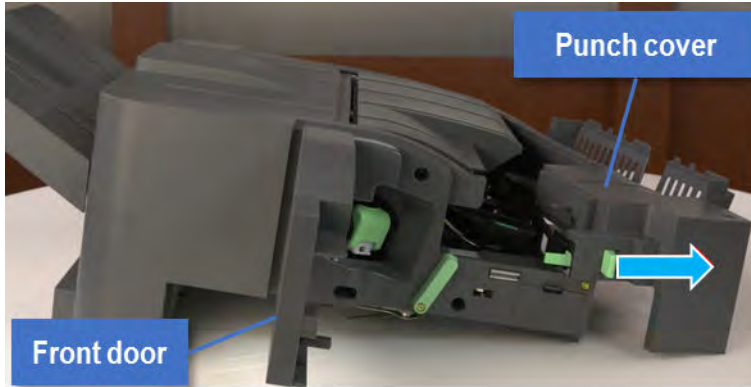

2. Remove left-side one screw at the rear of the inner finisher, and then remove the middle cover by lifting off the hinge pins at the front.

Figure 7-119 Remove the middle cover

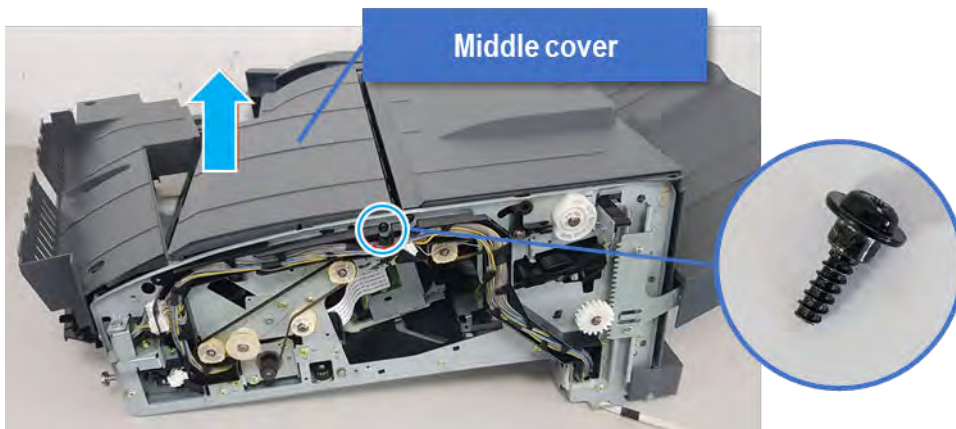

Remove the punch cover

Follow these steps to remove the punch cover.

1. Unplug the connector. Remove the e-ring, and then remove the slide shaft at the rear of the inner finisher.

Figure 7-120 Remove the slide shaft

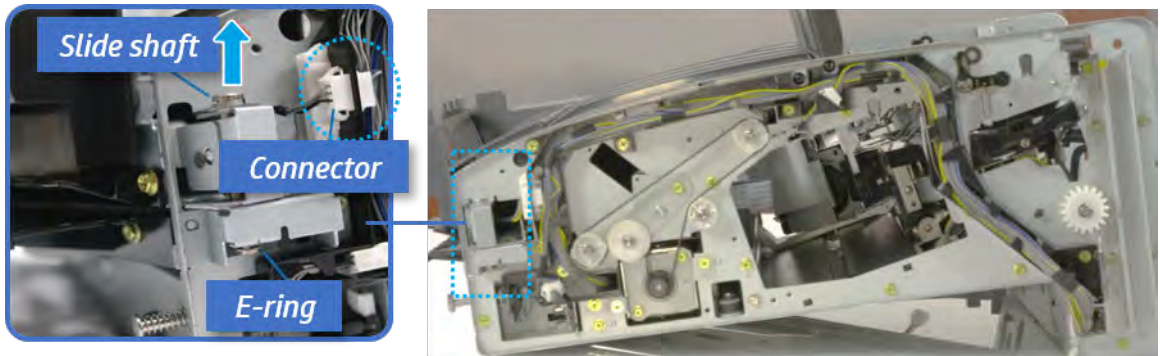

2. Open the punch cover.

Figure 7-121 Open the punch cover

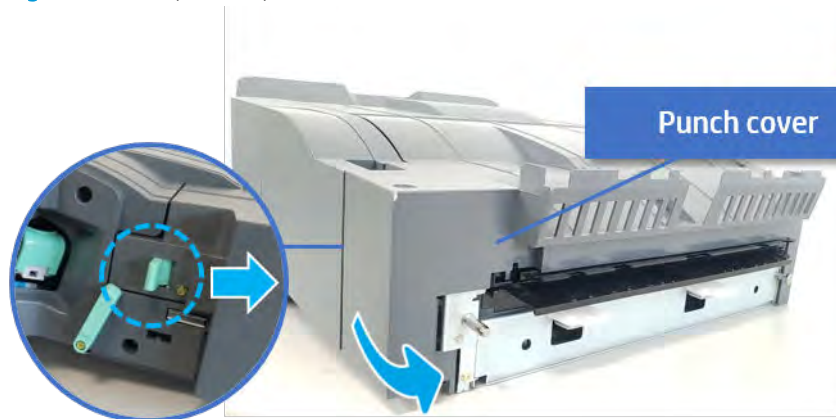

3. Remove the front punch sheet, and then remove the e-ring and the washer. And then remove the punch cover.

Figure 7-122 Remove the punch cover

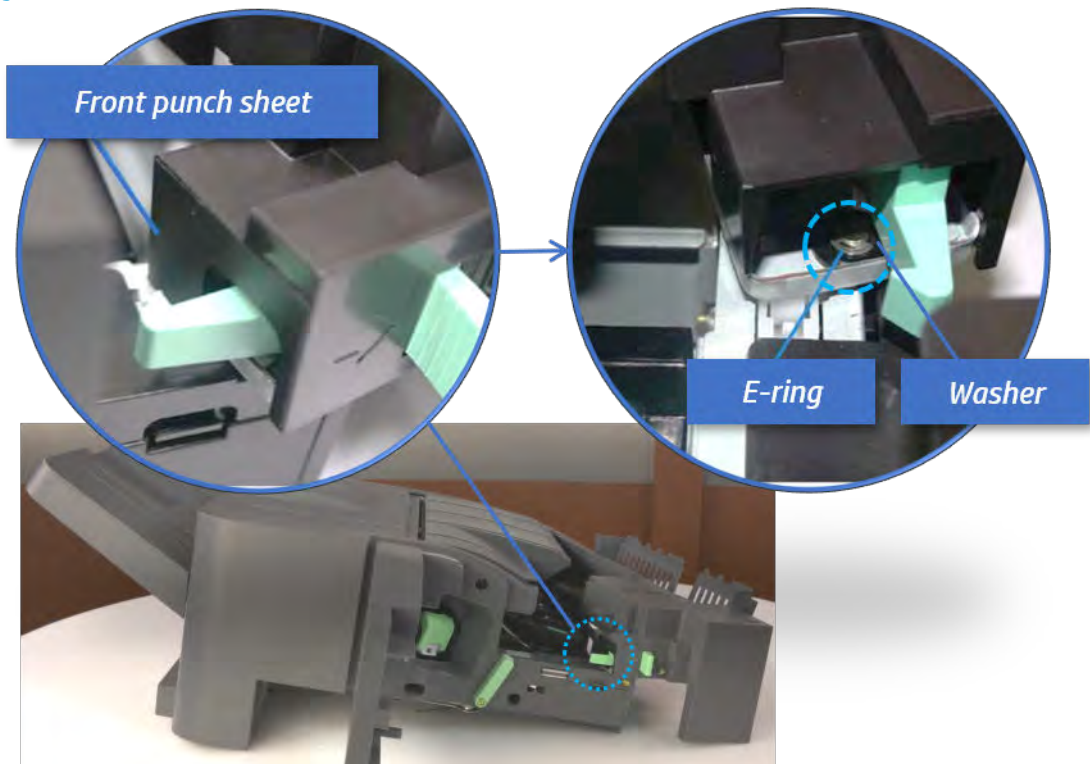

Remove the diverter guide and the middle roller

Follow these steps to remove the diverter guide and the middle roller.

1. On the front of the inner finisher, remove the e-ring and bushing.

Figure 7-123 Remove the e-ring and bushing

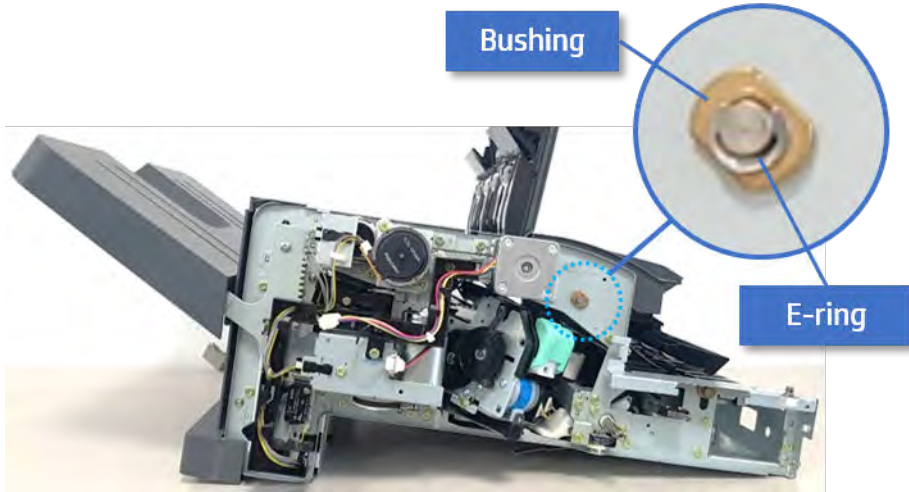

2. On the rear of the inner finisher, remove the e-ring, pulley, bushing, belt, and spring (slightly hidden from view).

Figure 7-124 Remove the e-ring, pulley, bushing, belt, and spring

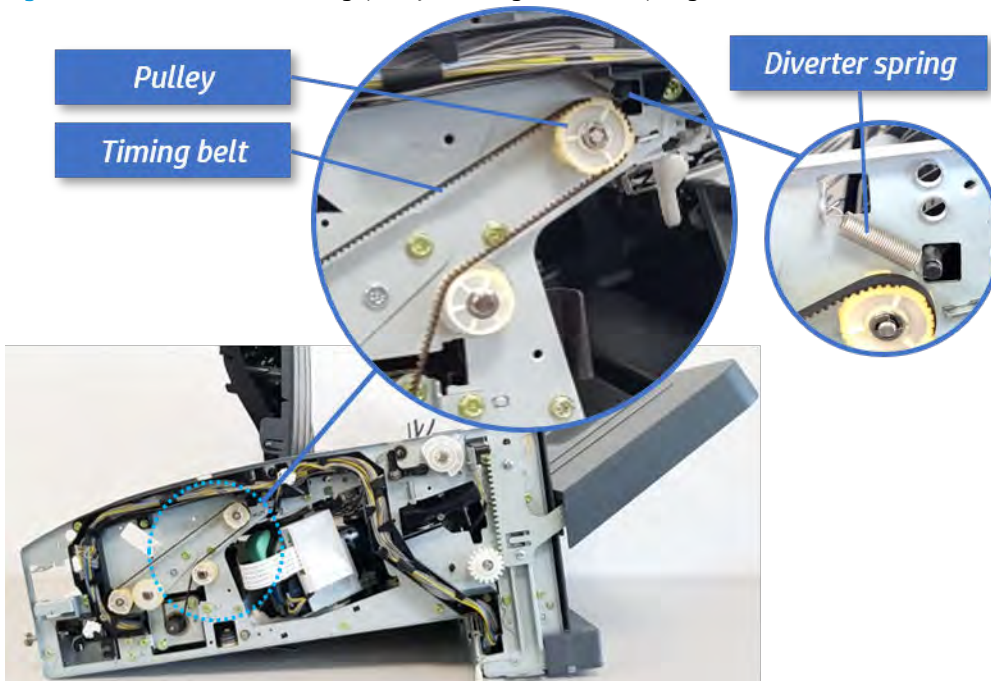

3. Remove the diverter guide and the middle roller.

Figure 7-125 Remove the diverter guide and the middle roller

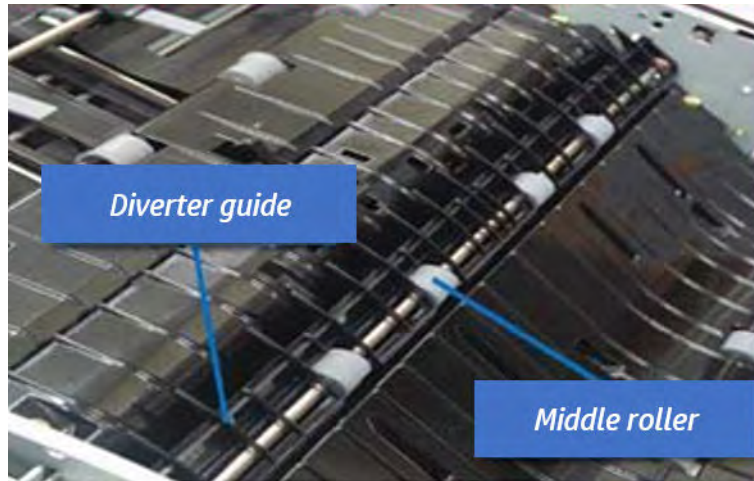

Remove the middle paper guide

Follow these steps to remove the middle paper guide.

1. Remove six screws, and then open the middle paper guide in the direction of the arrow.

Figure 7-126 Open the middle paper guide

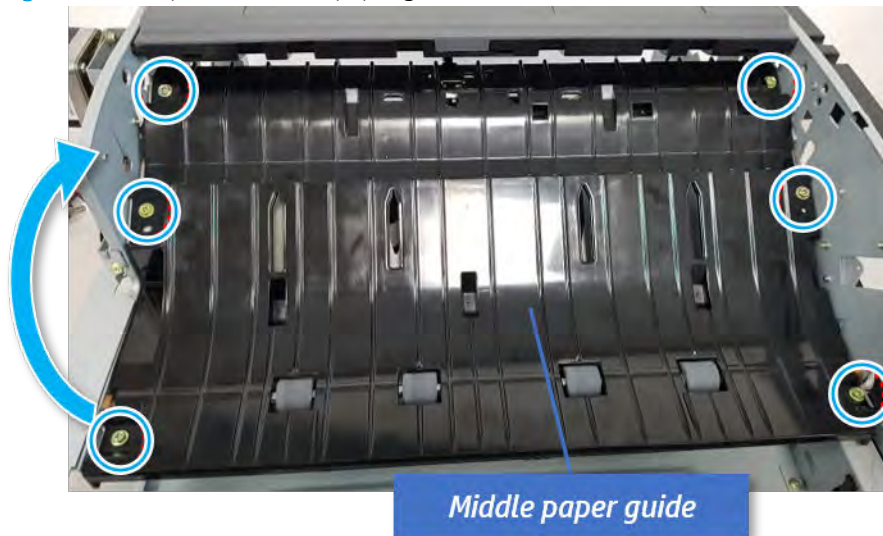

 **NOTE:** Be careful not to damage the sensor connector.

2. Unplug the connector under the middle paper guide. And then, remove the middle paper guide.

Figure 7-127 Remove the middle paper guide

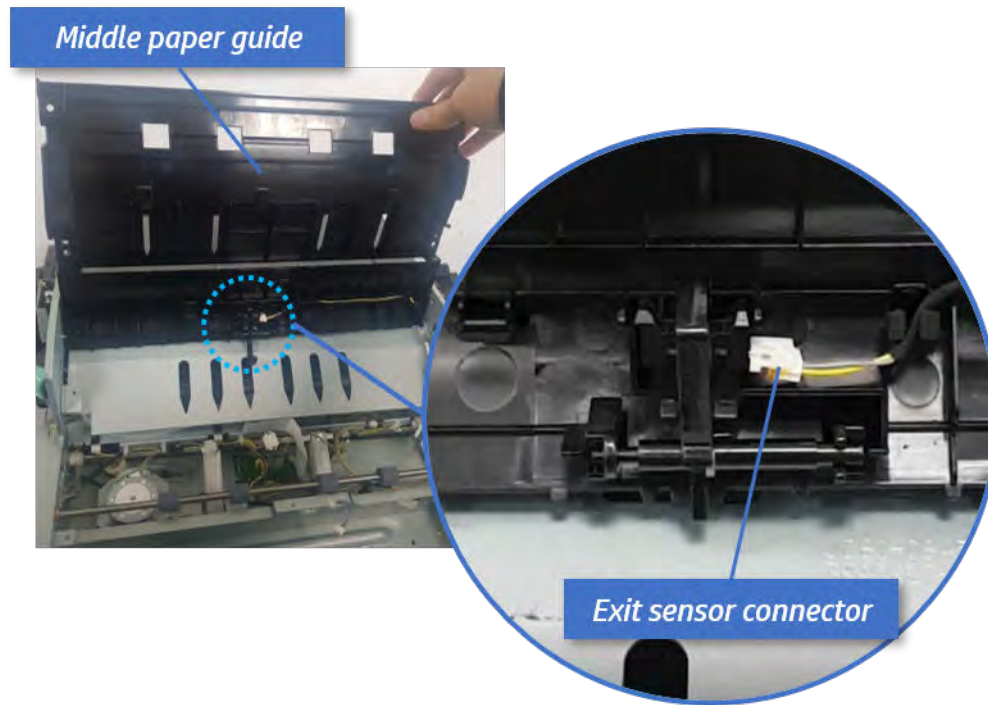

Remove the exit sensor

Follow these steps to remove the exit sensor.

- ▲ Remove the exit sensor from the middle paper guide.

Figure 7-128 Remove the exit sensor

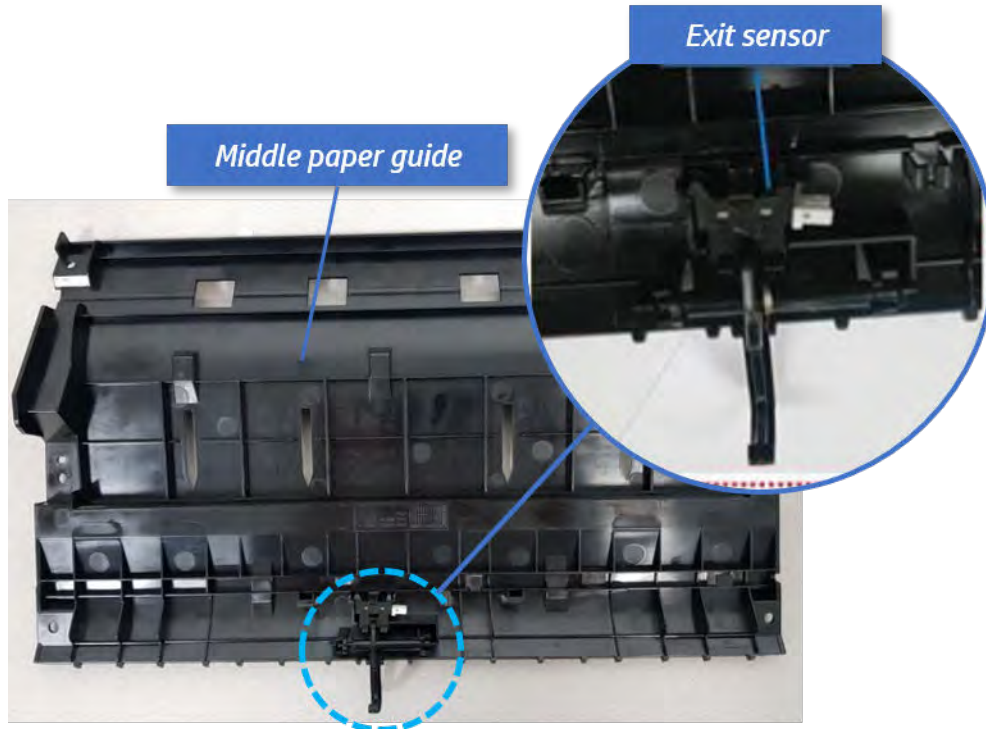

Unpack the replacement assembly

Follow these steps to unpack the replacement assembly.

1. Dispose of the defective part.



NOTE: HP recommends responsible disposal of the defective part.

<http://www8.hp.com/us/en/hp-information/environment/product-recycling.html>

2. Unpack the replacement part from the packaging.



CAUTION:  Some parts are sensitive to electrostatic discharge (ESD). Always perform service work at an ESD-protected workstation or mat. If an ESD workstation or mat is not available, touch the sheet-metal chassis to provide a static ground before touching an ESD-sensitive assembly. Protect the ESD-sensitive assemblies by placing them in ESD pouches when they are out of the printer.



IMPORTANT: Make sure that all of the shipping materials (for example shipping tape) are removed from the replacement part prior to installation.



NOTE: If the replacement part is a roller or pad, avoid touching the spongy part of it. Skin oils on the roller or pad can cause paper pickup and/or print-quality problems. HP recommends using disposable gloves when handling rollers or pads or washing your hands before touching rollers or pads.

3. To install an assembly, reverse the removal steps.



NOTE: When applicable, special installation instructions are provided for an assembly at the end of the removal procedure. Always completely read the removal instructions and follow all special installation instructions.

Removal and replacement: Exit motor (M2)

Learn how to remove and replace the exit motor.

To view teardown and reassembling video of the inner finisher, click the link below.



[View a teardown video of the inner finisher.](#)



[View a reassembling video of the inner finisher.](#)



IMPORTANT: When applicable, special installation instructions are provided for an assembly at the end of the removal procedure. Always completely read the removal instructions and follow all special installation instructions.

Mean time to repair:

Service level:

Before performing service

Turn the printer power off

- Press the power button on the front of the printer, and then turn off the power switch next to the power cable.
- A shutting-down message appears on the control-panel display.



WARNING! To avoid damage to the printer, turn the power off and wait until the printer shuts down before removing the power cable.

- Disconnect the printer power cable after the printer has completely shut down (the control-panel display is blank).

Use the table below to identify the correct part number for your printer. To order the part, go to www.hp.com/buy/parts.

Table 7-43 Part information

Part number	Part description
JC31-00169B	Exit motor

Required tools

- #2 JIS screwdriver with a magnetic tip

After performing service

Turn the printer power on

- Connect the power cable.
- Use the power switch to turn the power on.

Post service test

Print any pages necessary to verify that the repair resolved the issue and did not create any new issues.

Remove the front cover

Follow these steps to remove the front cover.

1. Open the front door and open the punch cover.
2. Remove three screws in the front.
3. Remove the lever.
4. Open the top cover.
5. From the right side of the front cover, carefully lift and pry toward the top-left corner to remove the front cover.

Figure 7-129 Remove the front cover

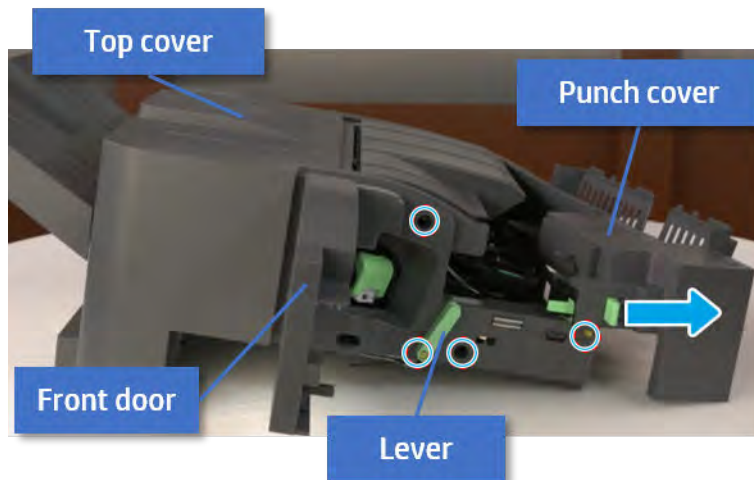

Remove the exit motor bracket

Follow these steps to remove the exit motor bracket.

- ▲ Remove two screws, unplug the motor connector. And then remove exit motor bracket.

Figure 7-130 Remove the exit motor bracket

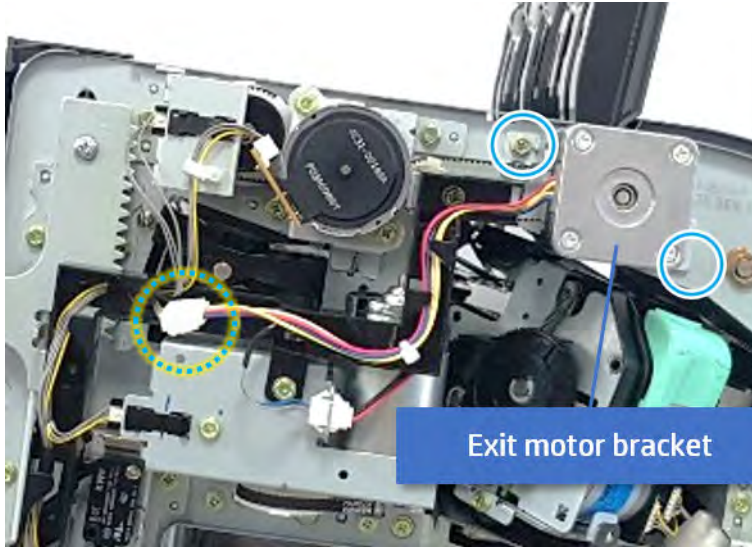

Remove the exit motor

Follow these steps to remove the exit motor.

- ▲ Remove two screws, and then remove the exit motor from the bracket.

Figure 7-131 Remove the exit motor

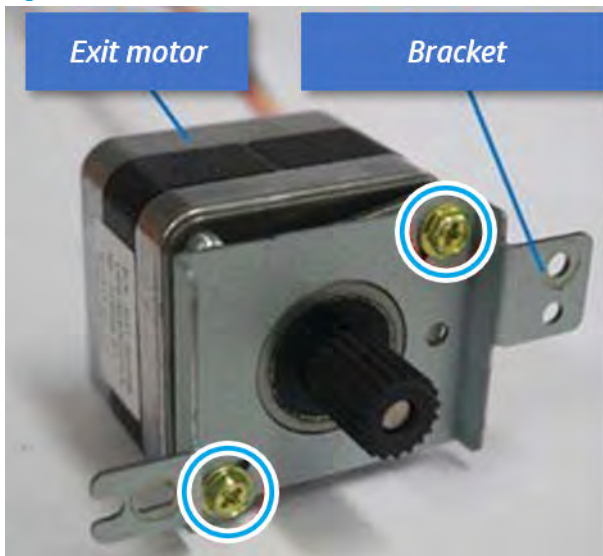

Unpack the replacement assembly

Follow these steps to unpack the replacement assembly.

1. Dispose of the defective part.

 **NOTE:** HP recommends responsible disposal of the defective part.

<http://www8.hp.com/us/en/hp-information/environment/product-recycling.html>

2. Unpack the replacement part from the packaging.



CAUTION:  Some parts are sensitive to electrostatic discharge (ESD). Always perform service work at an ESD-protected workstation or mat. If an ESD workstation or mat is not available, touch the sheet-metal chassis to provide a static ground before touching an ESD-sensitive assembly. Protect the ESD-sensitive assemblies by placing them in ESD pouches when they are out of the printer.

 **IMPORTANT:** Make sure that all of the shipping materials (for example shipping tape) are removed from the replacement part prior to installation.

 **NOTE:** If the replacement part is a roller or pad, avoid touching the spongy part of it. Skin oils on the roller or pad can cause paper pickup and/or print-quality problems. HP recommends using disposable gloves when handling rollers or pads or washing your hands before touching rollers or pads.

3. To install an assembly, reverse the removal steps.

 **NOTE:** When applicable, special installation instructions are provided for an assembly at the end of the removal procedure. Always completely read the removal instructions and follow all special installation instructions.

Paper support unit

Removal and replacement: Front paper support

Learn how to remove and replace the front paper support.

To view teardown and reassembling video of the inner finisher, click the link below.



[View a teardown video of the inner finisher.](#)



[View a reassembling video of the inner finisher.](#)



IMPORTANT: When applicable, special installation instructions are provided for an assembly at the end of the removal procedure. Always completely read the removal instructions and follow all special installation instructions.

Mean time to repair:

Service level:

Before performing service

Turn the printer power off

- Press the power button on the front of the printer, and then turn off the power switch next to the power cable.
- A shutting-down message appears on the control-panel display.



WARNING! To avoid damage to the printer, turn the power off and wait until the printer shuts down before removing the power cable.

- Disconnect the printer power cable after the printer has completely shut down (the control-panel display is blank).

Use the table below to identify the correct part number for your printer. To order the part, go to <http://www.hp.com/buy/parts>.

Table 7-44 Part information

Part number	Part description
JC90-01310A	Front paper support

Required tools

- #2 JIS screwdriver with a magnetic tip

After performing service

Turn the printer power on

- Connect the power cable.
- Use the power switch to turn the power on.

Post service test

Print any pages necessary to verify that the repair resolved the issue and did not create any new issues.

Remove the front cover

Follow these steps to remove the front cover.

1. Open the front door and open the punch cover.
2. Remove three screws in the front.
3. Remove the lever.
4. Open the top cover.
5. From the right side of the front cover, carefully lift and pry toward the top-left corner to remove the front cover.

Figure 7-132 Remove the front cover

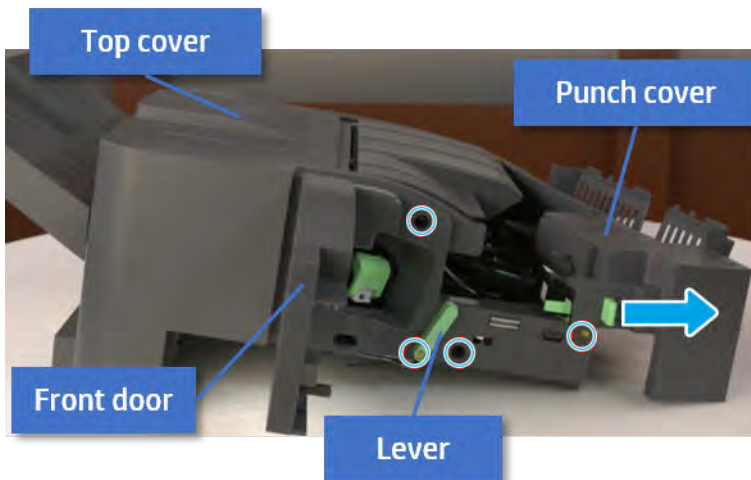

Remove the rear cover

Follow these steps to remove the rear cover.

1. Open the top cover.

Figure 7-133 Open the top cover

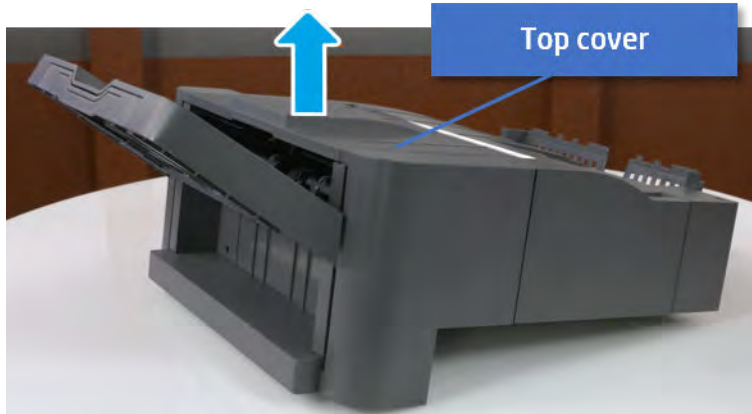

2. Remove three screws.
3. Release hooks carefully and remove the rear cover.

Figure 7-134 Remove the rear cover

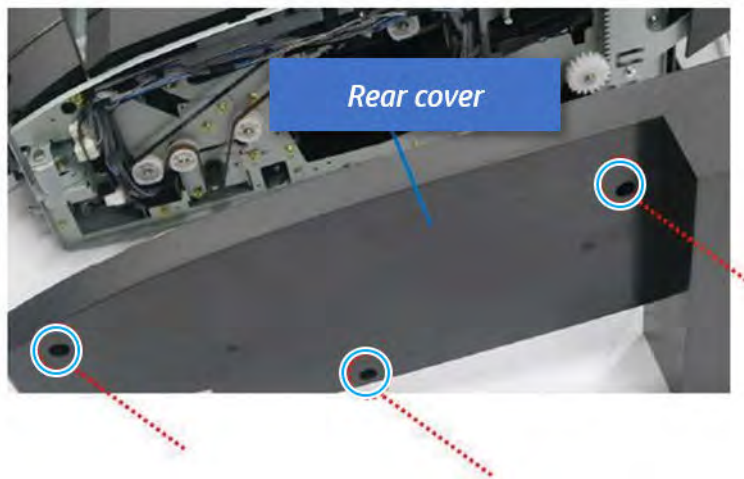

Remove the output tray

Follow these steps to remove the output tray.

1. Remove four screws.

Figure 7-135 Remove four screws

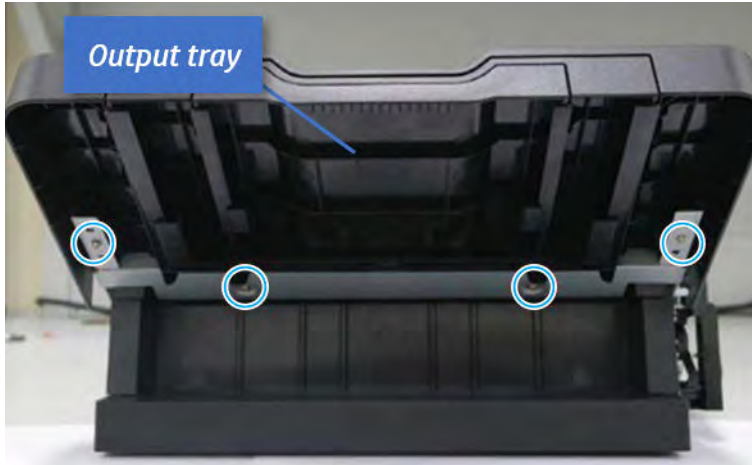

2. Push the paper holding actuator into the inner finisher, and then remove the output tray.

Figure 7-136 Remove the output tray.



Remove the output tray frame

Follow these steps to remove the output tray frame.

1. Rotate the pulley until the output tray frame depart from the gear.

Figure 7-137 Remove the pulley

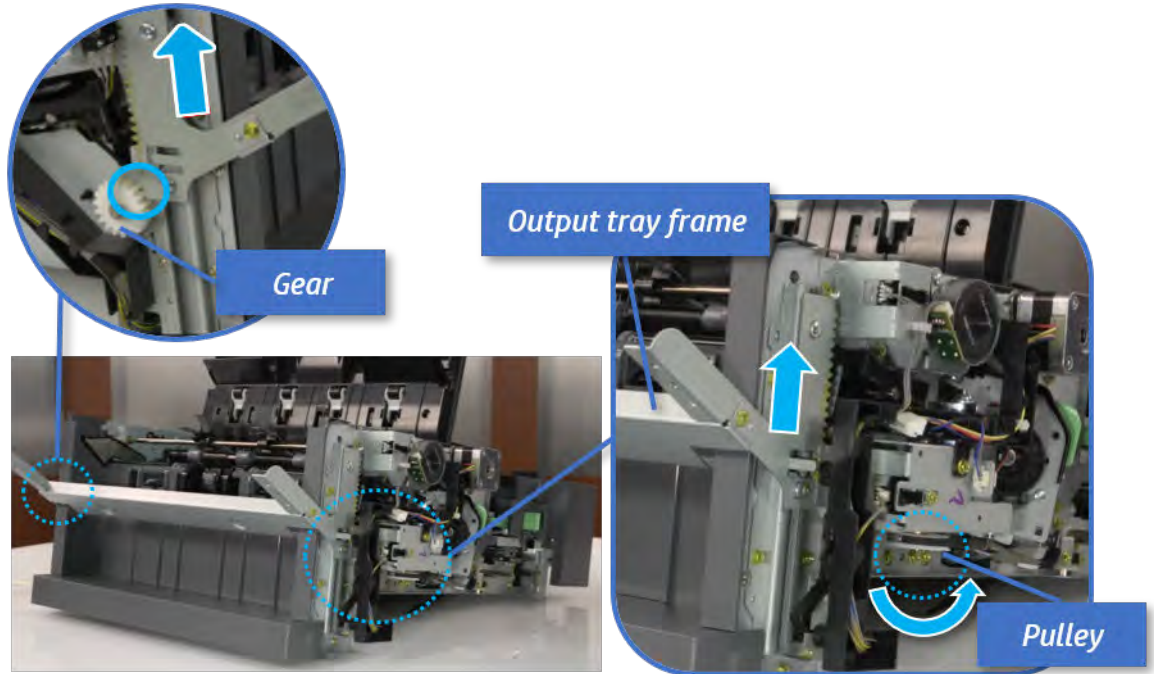

2. Push the paper holding actuator into the inner finisher, and then remove the output tray frame.

Figure 7-138 Remove the output tray frame

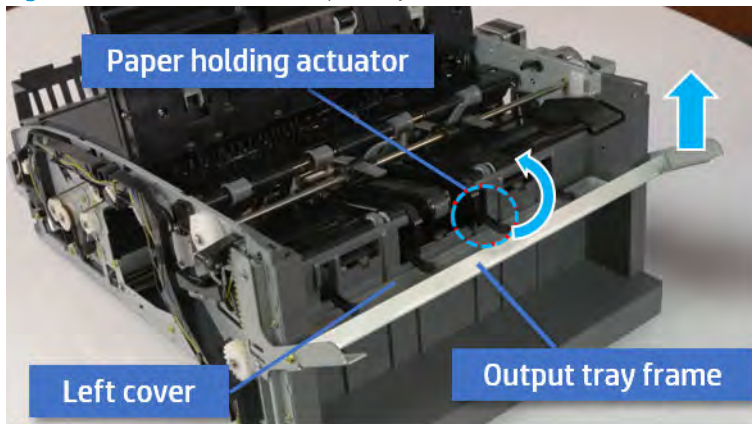

TIP: Push the paper holding actuator into the inner finisher when reassembling. Be sure to level the output tray.

- a. Position the first wheel into the channel on both sides while pushing the paper holding actuator.

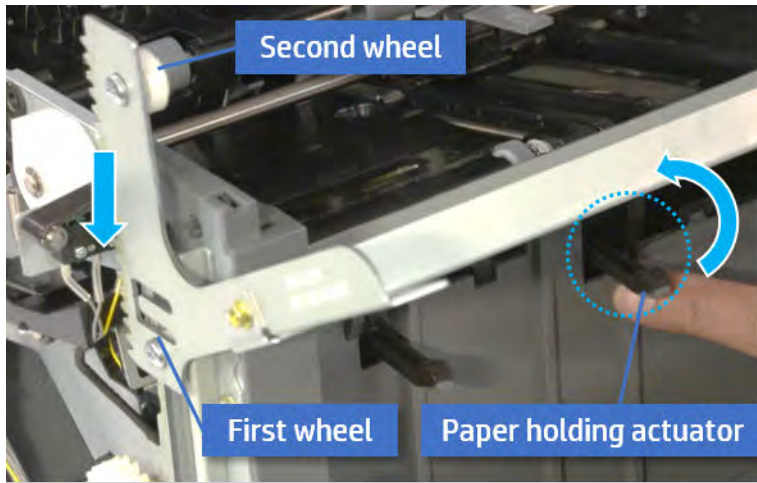

- b. Let the second wheel rest on the channel on both sides simultaneously.
- c. Gently squeeze the wheels into channel until the output tray frame meet the gear.

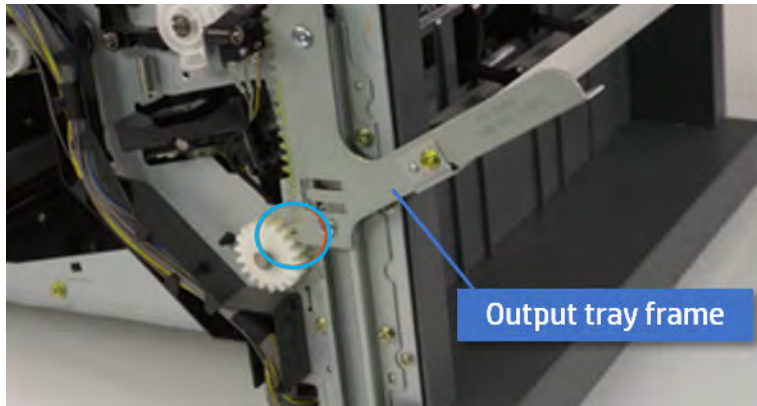

- d. Rotate the pulley until the output tray frame is no longer lifted. It can make to level the output tray frame.

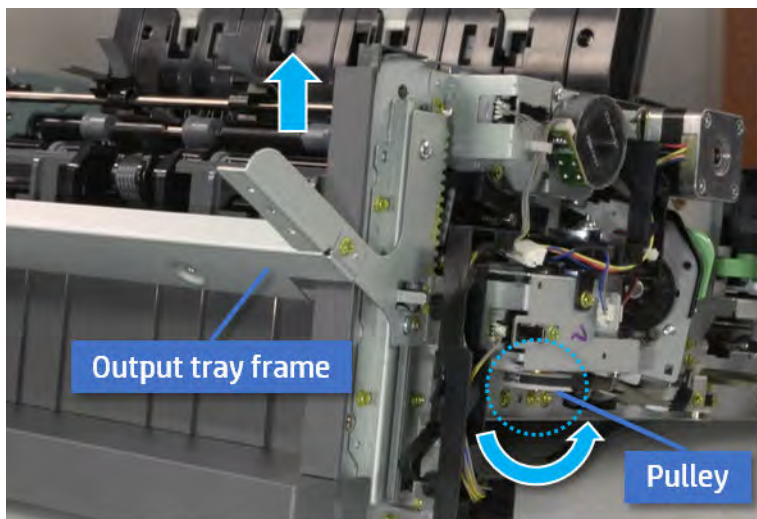

- e. Rotate the pulley in the opposite direction.

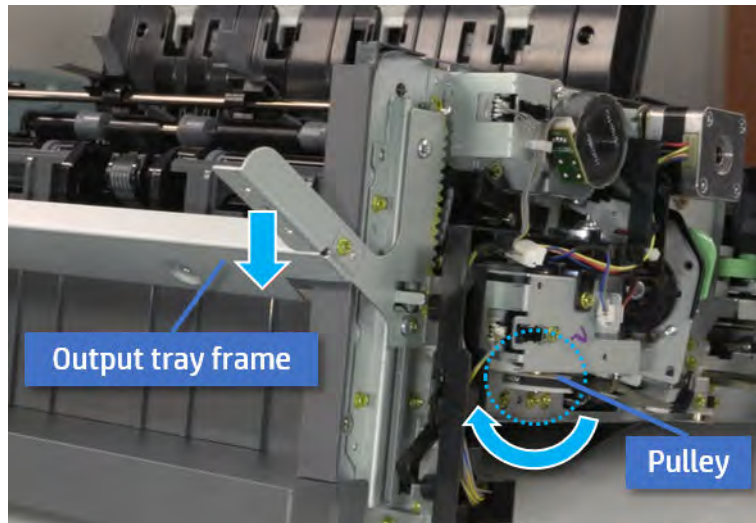

Remove the PCA cover

Follow these steps to remove the PCA cover.

- ▲ Remove two screws, and then remove the PCA cover.

Figure 7-139 Remove the PCA cover

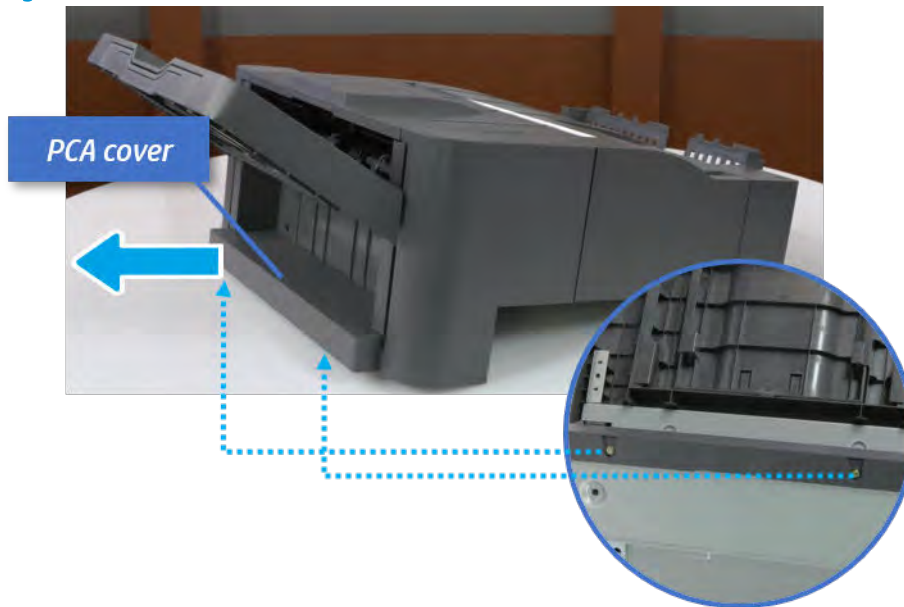

Remove the left cover

Follow these steps to remove the left cover.

1. Remove two screws.

Figure 7-140 Remove two screws

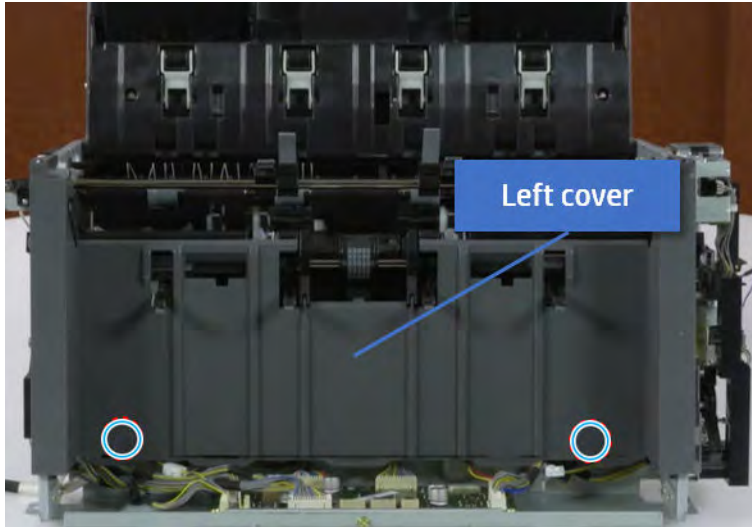

2. Remove four screws from both front and rear sides.

Figure 7-141 Remove four screws

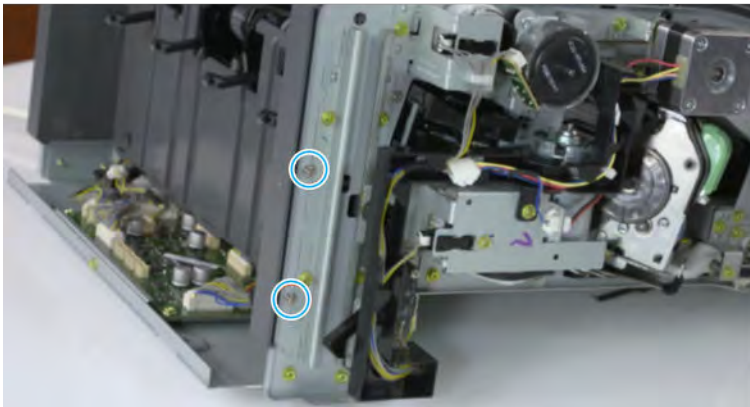
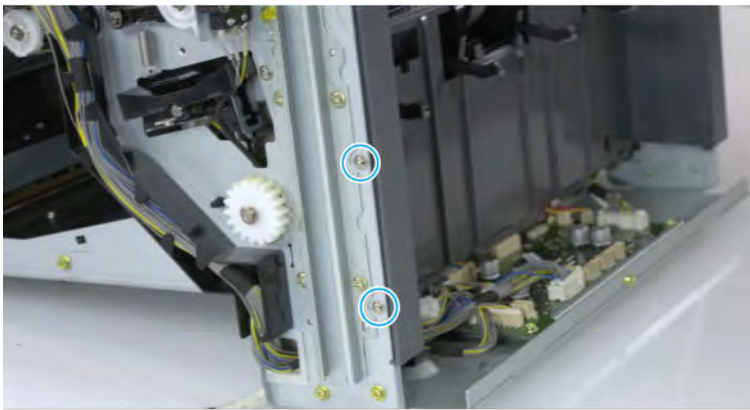

3. Unplug two inline connectors, and then remove the left cover.

Figure 7-142 Unplug two connectors

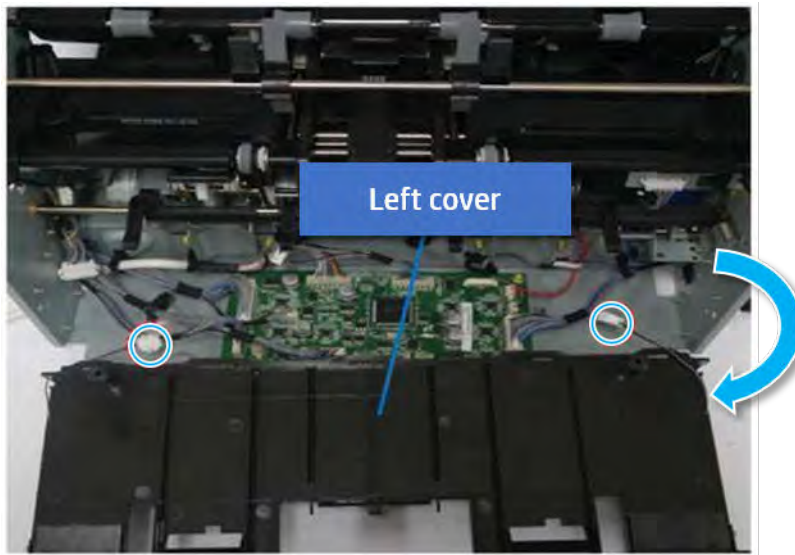

 **TIP:** Be sure to check the hook when reassembling.

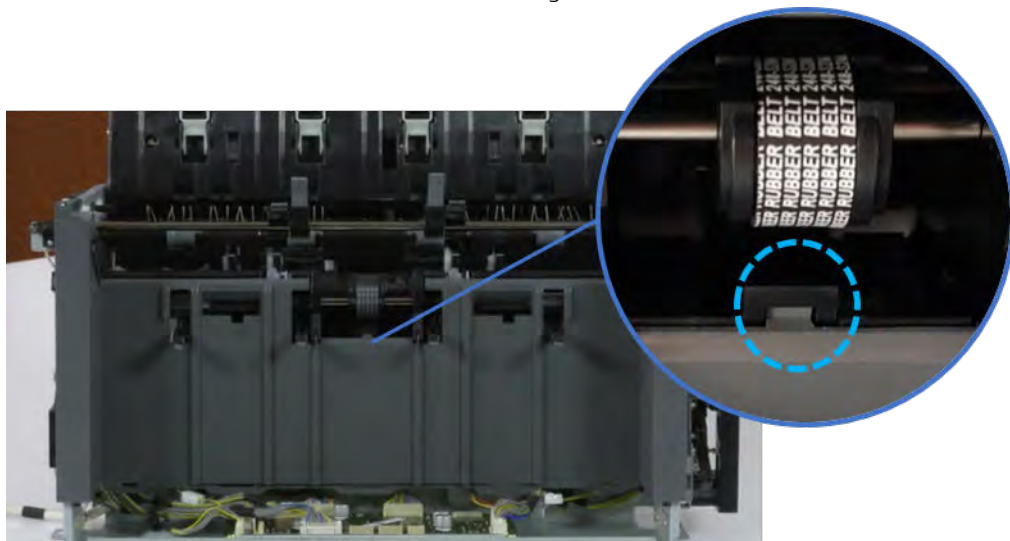

Remove the front harness guide

Follow these steps to remove the front harness guide.

1. Open one clamp and unplug five connectors, and then remove the wire harness from the front harness guide.

2. Remove four screws, and then remove the front harness guide.

Figure 7-143 Remove the front harness guide

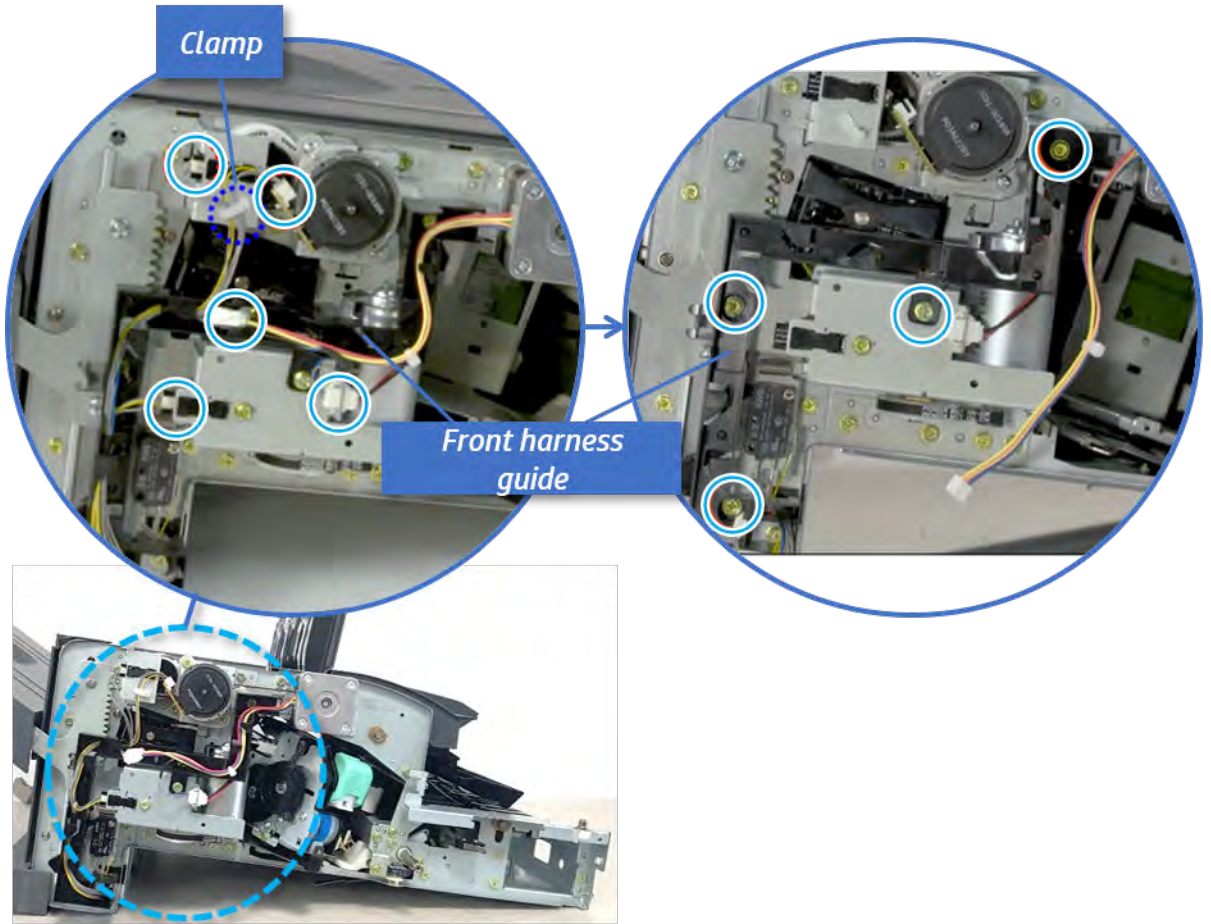

Remove the output tray motor assembly

Follow these steps to remove the output tray motor assembly.

- ▲ Remove three screws, and then remove the output tray motor assembly.

Figure 7-144 Remove the output tray motor assembly

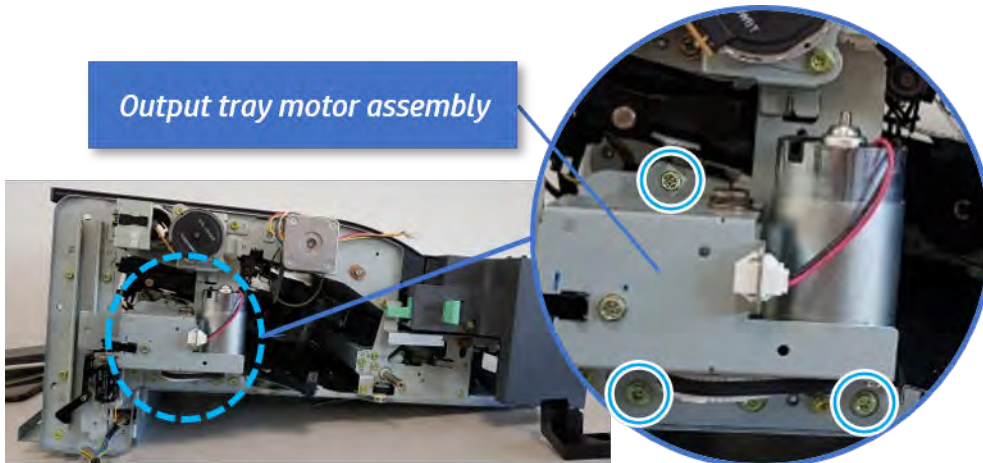

Remove the output tray lower limit switch

Follow these steps to remove the output tray lower limit switch.

- ▲ Remove one screw, and then remove the output tray lower limit switch.

Figure 7-145 Remove the output tray lower limit switch

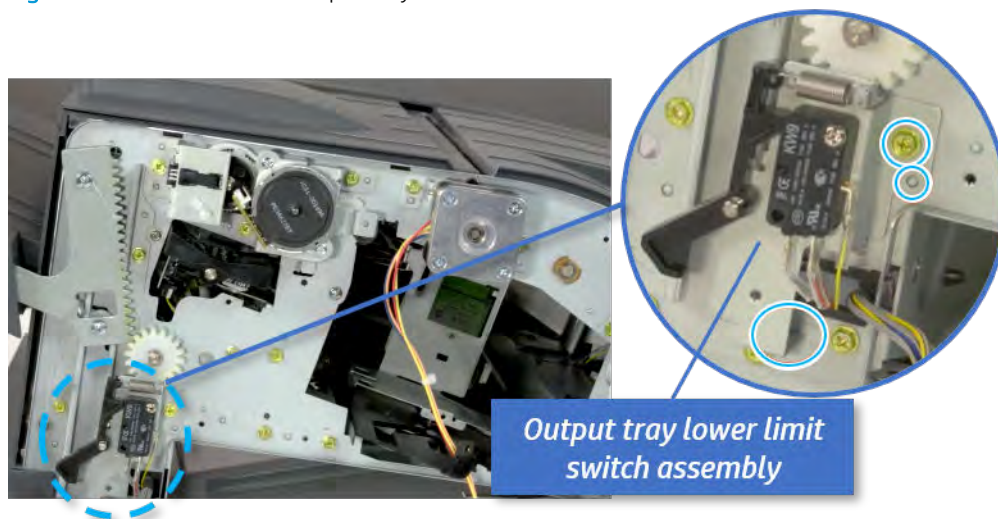

Remove the paper holding

Follow these steps to remove the paper holding.

1. Remove the paper holding actuator spring.

Figure 7-146 Remove the paper holding actuator spring

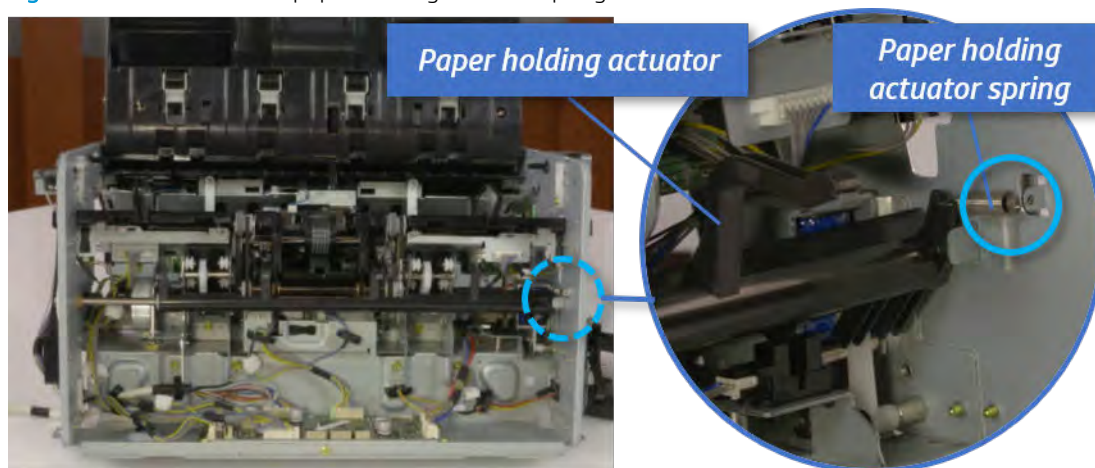

2. Remove the e-ring and the rack pinion gear. And then remove the pin and the e-ring, and then remove the bushing.

Figure 7-147 Remove e-ring, rack pinion gear, pin, and bushing

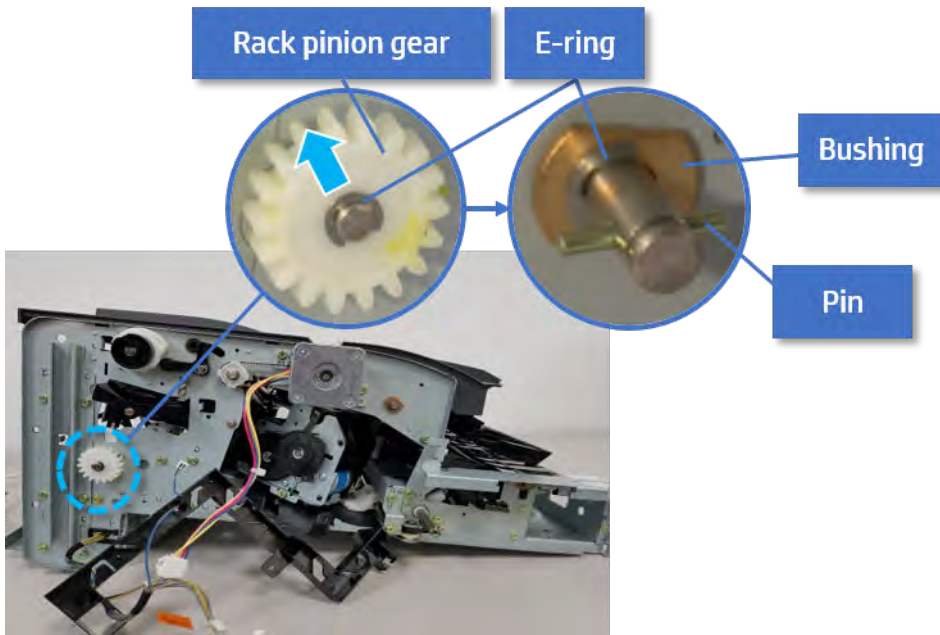

 **NOTE:** Be sure not to lose the pin.

3. Carefully remove the paper holding shaft and the actuator.

Figure 7-148 Remove the paper holding shaft and the actuator

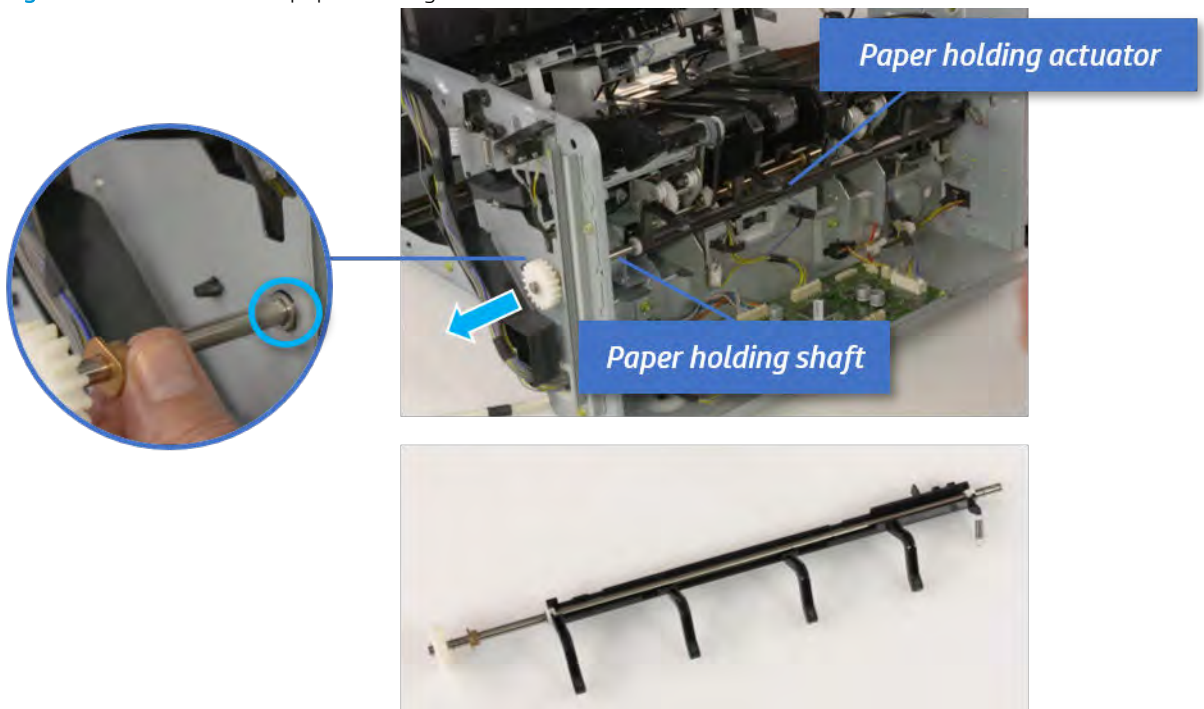

Remove the sub paddle unit

Follow these steps to remove the sub paddle unit.

1. Open the top cover, and then remove one screw securing the sub paddle unit.

Figure 7-149 Remove one screw

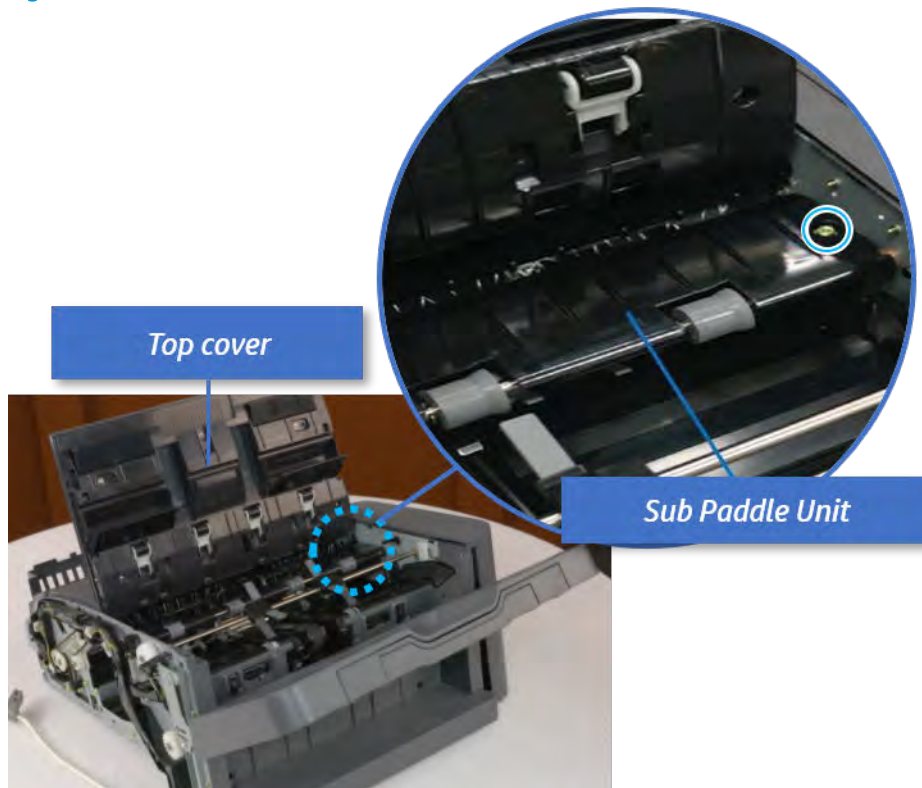

2. Remove the e-ring, and then remove the pulley and timing belt. And then remove the e-ring and the bushing.

Figure 7-150 Remove the e-ring, pulley, timing belt, and bushing

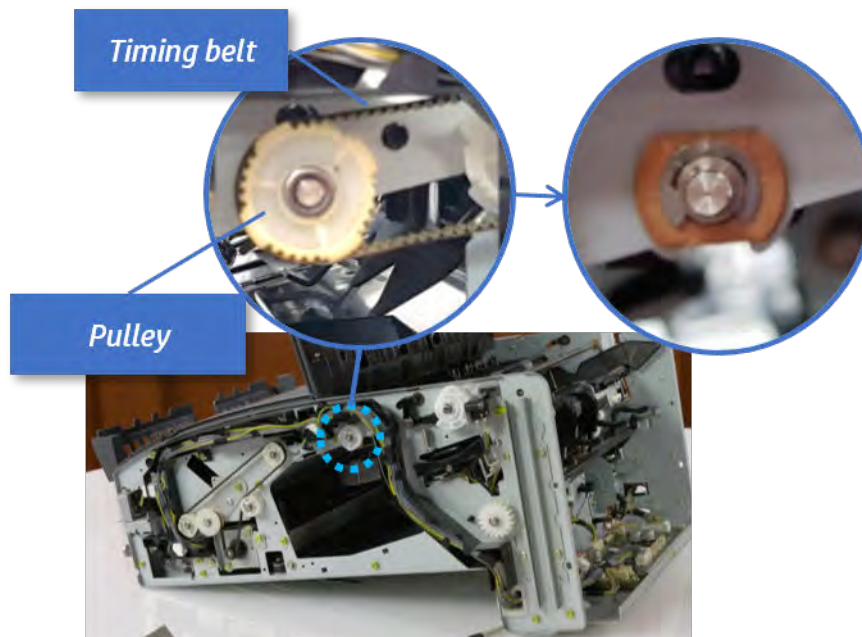

3. Lift up and remove the sub paddle unit.

Figure 7-151 Remove the sub paddle unit

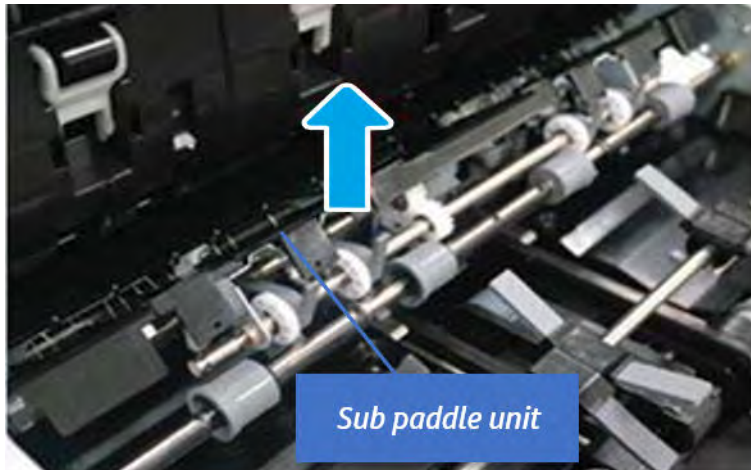

Remove the exit roller

Follow these steps to remove the exit roller.

1. Remove the guide on the center of the exit roller.

Figure 7-152 Remove the guide

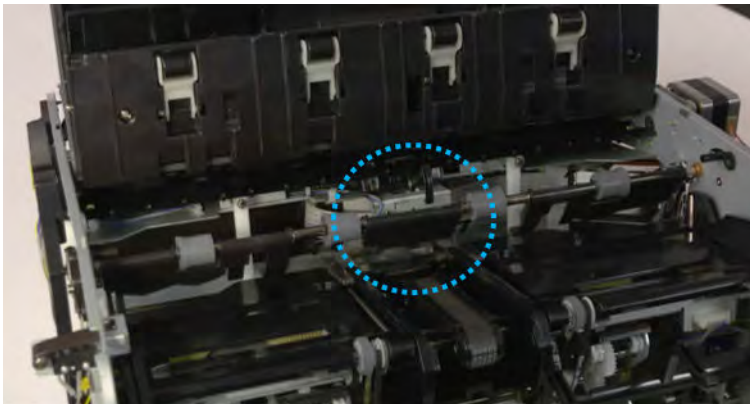

2. On the front of the inner finisher, release the timing belt connected to the exit motor.

Figure 7-153 Release the timing belt

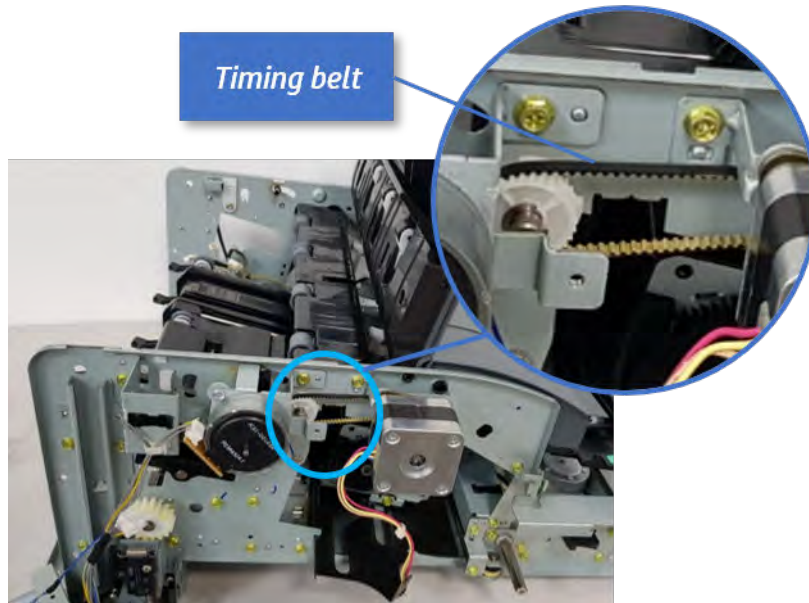

3. Remove five screws securing the rear harness guide.

Figure 7-154 Remove five screws

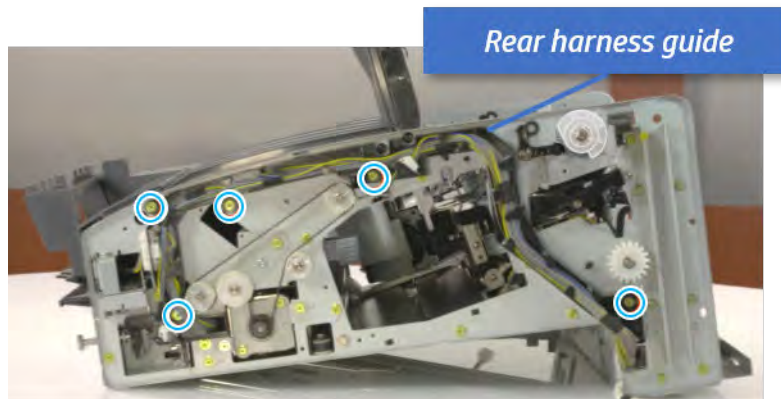

4. On the rear of the inner finisher, remove the e-ring and the pulley and then remove the e-ring and the bushing.

Figure 7-155 Remove e-ring, pulley, and bushing

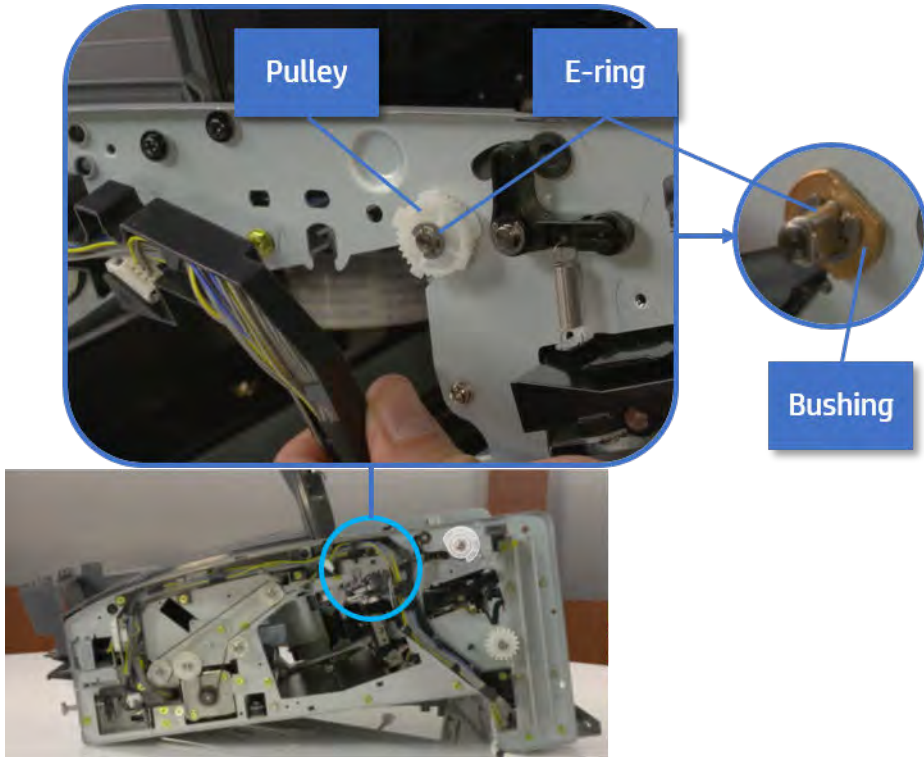

5. Push the bushing to detach it, and then remove the exit roller.

Figure 7-156 Remove the exit roller

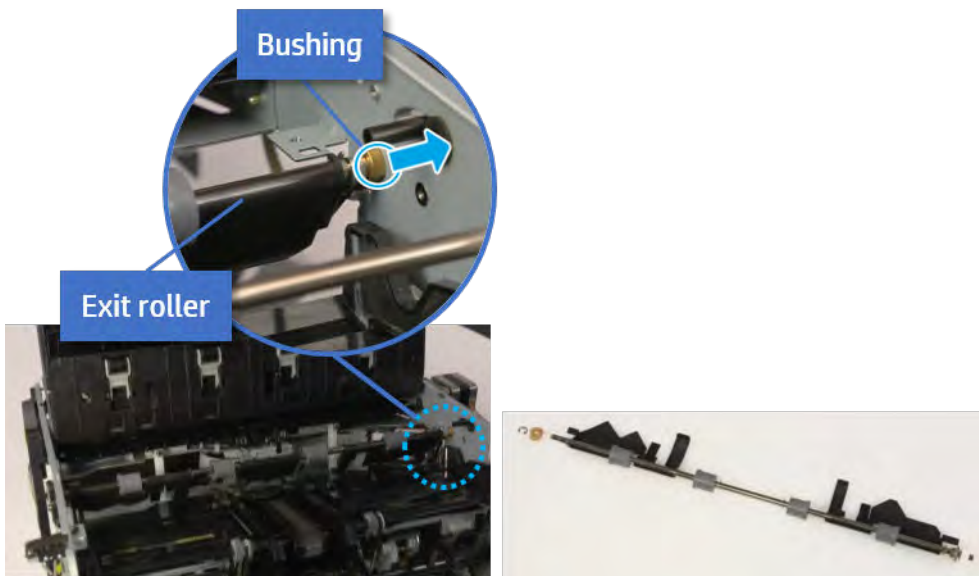

Remove the front tamper

Follow these steps to remove the front tamper.

1. Remove four screws.

Figure 7-157 Remove four screws

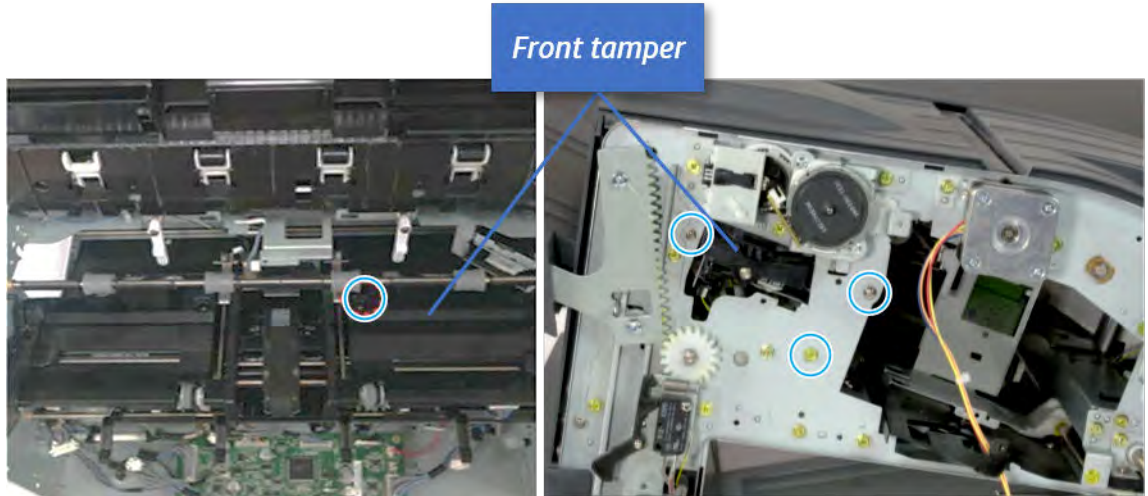

2. Unplug the connector and release the hook, and then pull the front tamper up to remove.

Figure 7-158 Remove the front tamper

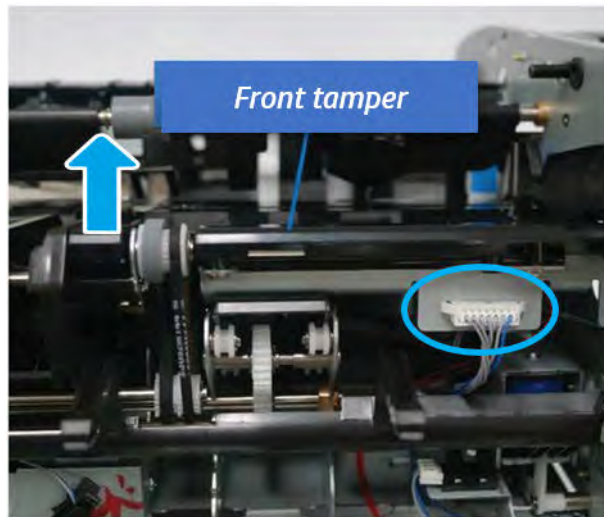

Remove the rear tamper

Follow these steps to remove the rear tamper.

1. Remove four screws.

 **NOTE:** Move cable guideout of position to access the screws.

Figure 7-159 Remove four screws



2. Unplug two connectors and release the hook, and then remove the rear tamper.

Figure 7-160 Remove the rear tamper

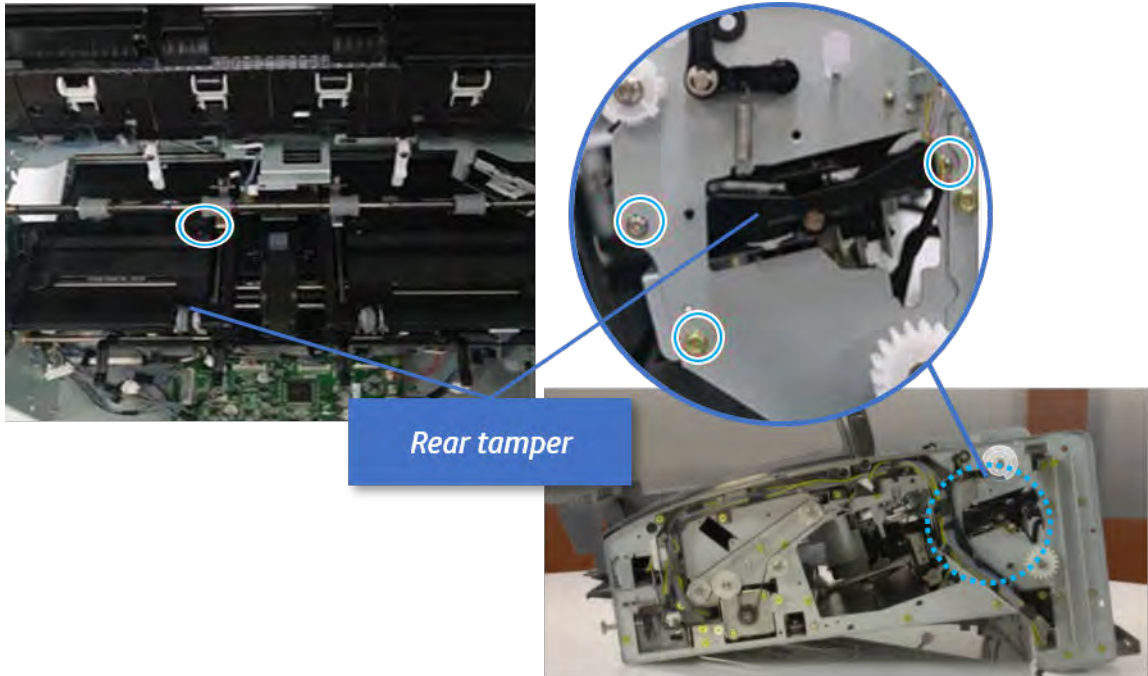
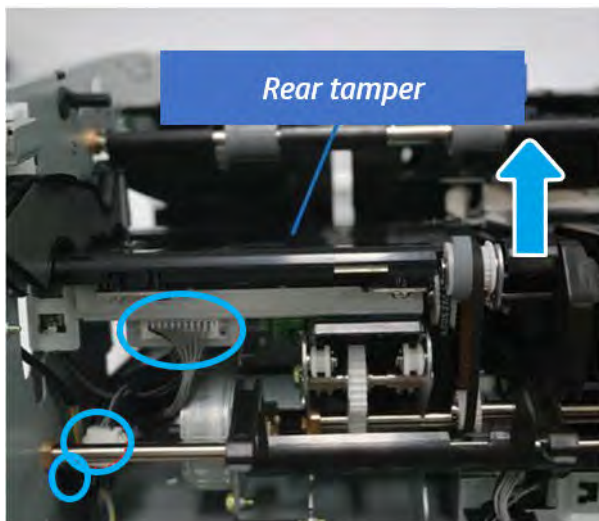

Remove the ejector & paper support assembly

Follow these steps to remove the ejector & paper support assembly.

1. Open one clamp, disconnect one connector.

Figure 7-161 Disconnect one connector

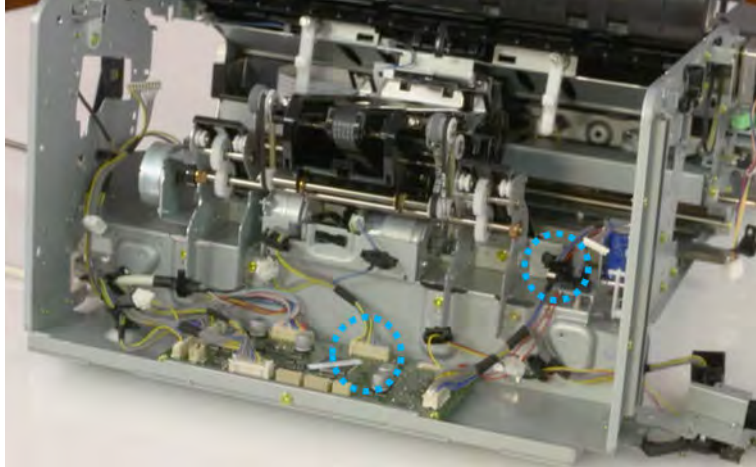

2. Pull the rear paper support up, and then release one clamp and disconnect two connectors.

Figure 7-162 Disconnect two connector

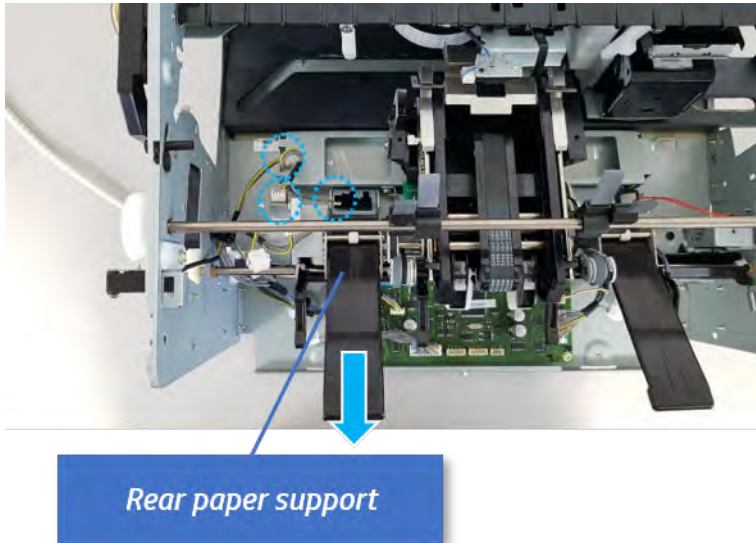

3. Remove four screws, and then remove the ejector & paper support assembly.

Figure 7-163 Remove the ejector & paper support assembly

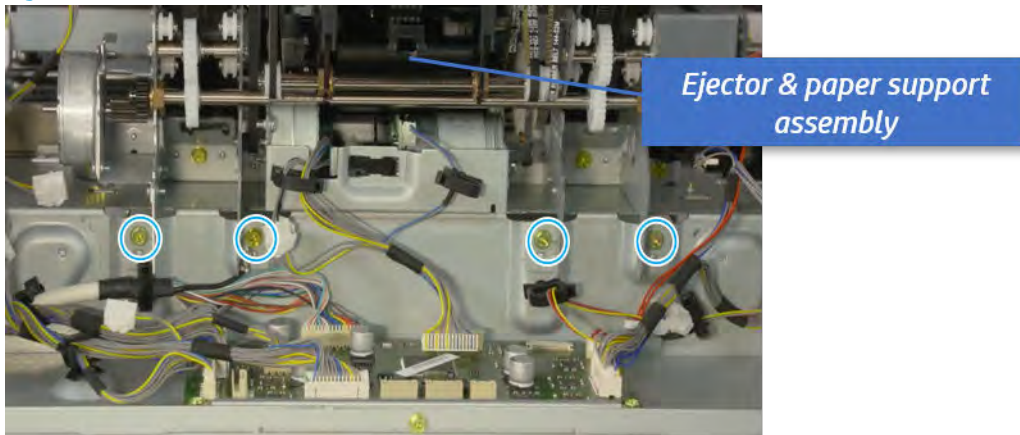

Remove the front paper support

Follow these steps to remove the front paper support.

1. Remove the e-ring and the bushing, and then pull and remove the drive shaft.

Figure 7-164 Remove the drive shaft

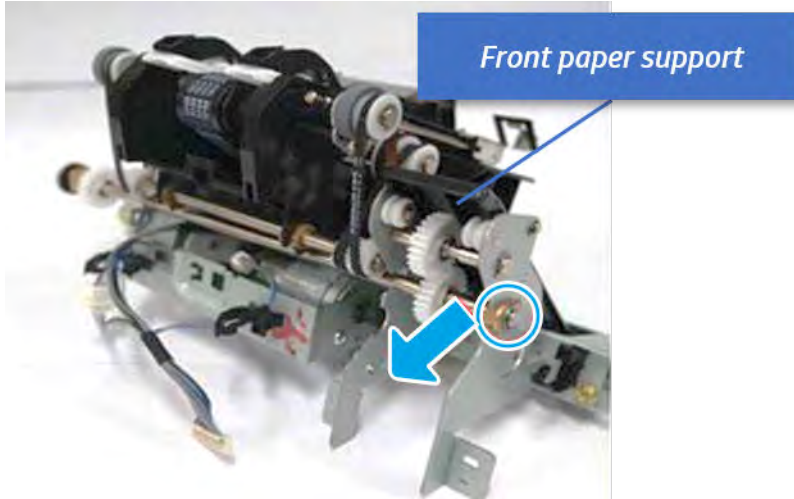

TIP: When reassembling the drive shaft, ensure the paper supports are in the full down position (against the stops).

2. Remove one screw, and then remove the front paper support.

Figure 7-165 Remove the front paper support

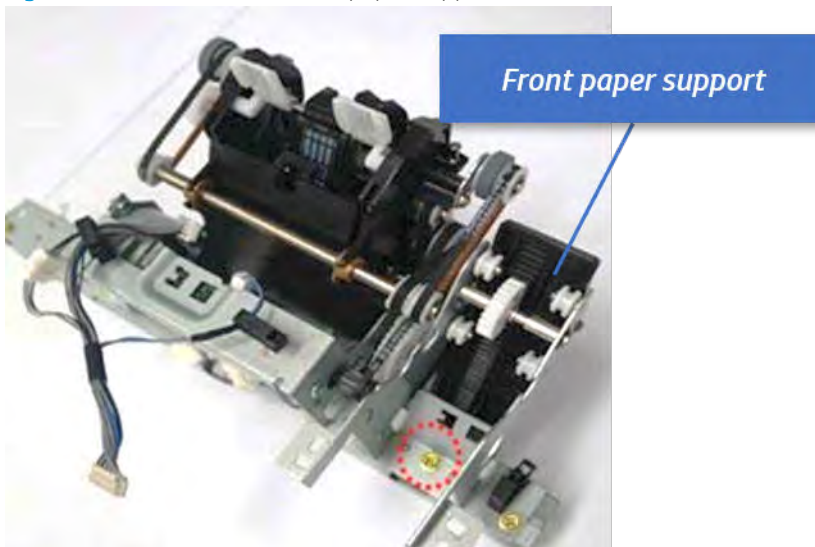

Unpack the replacement assembly

Follow these steps to unpack the replacement assembly.

1. Dispose of the defective part.

 **NOTE:** HP recommends responsible disposal of the defective part.

<http://www8.hp.com/us/en/hp-information/environment/product-recycling.html>

2. Unpack the replacement part from the packaging.



CAUTION:  Some parts are sensitive to electrostatic discharge (ESD). Always perform service work at an ESD-protected workstation or mat. If an ESD workstation or mat is not available, touch the sheet-metal chassis to provide a static ground before touching an ESD-sensitive assembly. Protect the ESD-sensitive assemblies by placing them in ESD pouches when they are out of the printer.

 **IMPORTANT:** Make sure that all of the shipping materials (for example shipping tape) are removed from the replacement part prior to installation.

 **NOTE:** If the replacement part is a roller or pad, avoid touching the spongy part of it. Skin oils on the roller or pad can cause paper pickup and/or print-quality problems. HP recommends using disposable gloves when handling rollers or pads or washing your hands before touching rollers or pads.

3. To install an assembly, reverse the removal steps.

 **NOTE:** When applicable, special installation instructions are provided for an assembly at the end of the removal procedure. Always completely read the removal instructions and follow all special installation instructions.

Rear paper support

Removal and replacement: Rear paper support

Learn how to remove and replace the rear paper support.

To view teardown and reassembling video of the inner finisher, click the link below.



[View a teardown video of the inner finisher.](#)



[View a reassembling video of the inner finisher.](#)

IMPORTANT: When applicable, special installation instructions are provided for an assembly at the end of the removal procedure. Always completely read the removal instructions and follow all special installation instructions.

Mean time to repair:

Service level:

Before performing service

Turn the printer power off

- Press the power button on the front of the printer, and then turn off the power switch next to the power cable.
- A shutting-down message appears on the control-panel display.

WARNING! To avoid damage to the printer, turn the power off and wait until the printer shuts down before removing the power cable.

- Disconnect the printer power cable after the printer has completely shut down (the control-panel display is blank).

Use the table below to identify the correct part number for your printer. To order the part, go to <http://www.hp.com/buy/parts>.

Table 7-45 Part information

Part number	Part description
JC90-01311A	Rear paper support

Required tools

- #2 JIS screwdriver with a magnetic tip

After performing service

Turn the printer power on

- Connect the power cable.
- Use the power switch to turn the power on.

Post service test

Print any pages necessary to verify that the repair resolved the issue and did not create any new issues.

Remove the front cover

Follow these steps to remove the front cover.

1. Open the front door and open the punch cover.
2. Remove three screws in the front.
3. Remove the lever.
4. Open the top cover.
5. From the right side of the front cover, carefully lift and pry toward the top-left corner to remove the front cover.

Figure 7-166 Remove the front cover

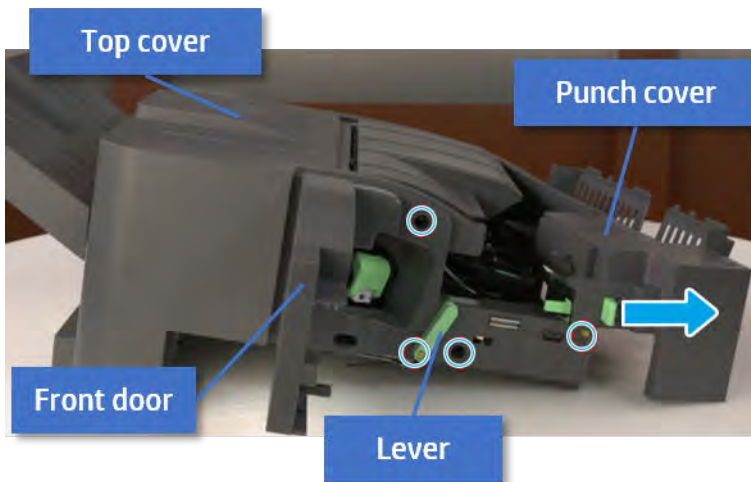

Remove the rear cover

Follow these steps to remove the rear cover.

1. Open the top cover.

Figure 7-167 Open the top cover

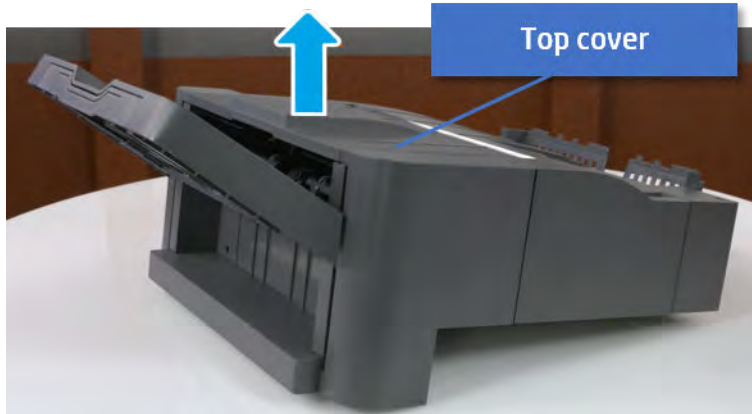

2. Remove three screws.
3. Release hooks carefully and remove the rear cover.

Figure 7-168 Remove the rear cover

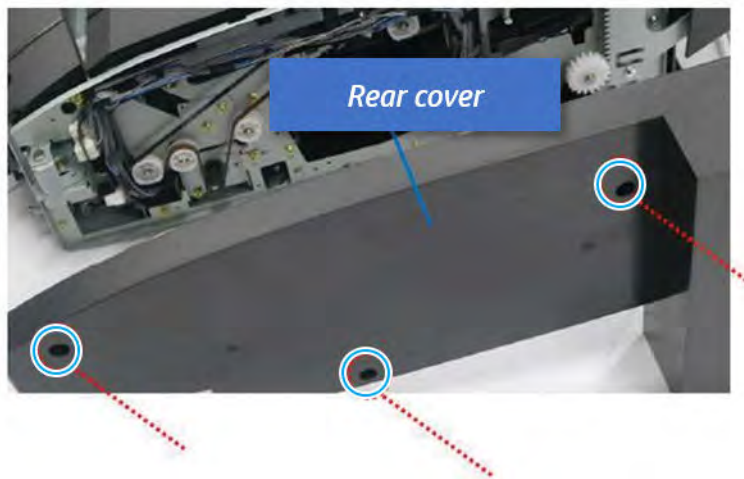

Remove the output tray

Follow these steps to remove the output tray.

1. Remove four screws.

Figure 7-169 Remove four screws

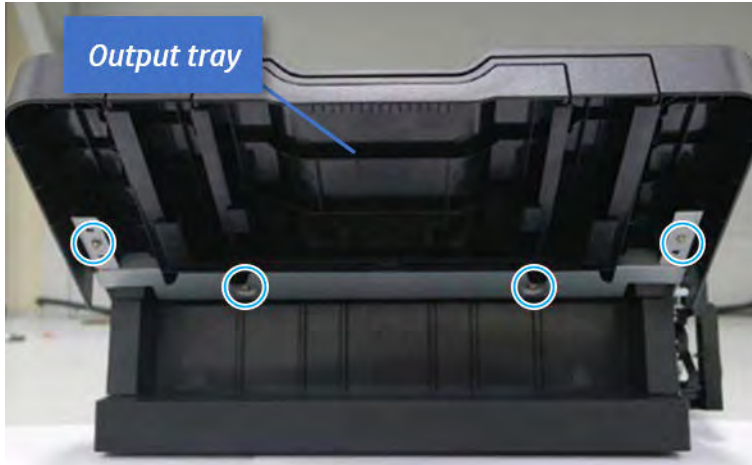

2. Push the paper holding actuator into the inner finisher, and then remove the output tray.

Figure 7-170 Remove the output tray.



Remove the output tray frame

Follow these steps to remove the output tray frame.

1. Rotate the pulley until the output tray frame depart from the gear.

Figure 7-171 Remove the pulley

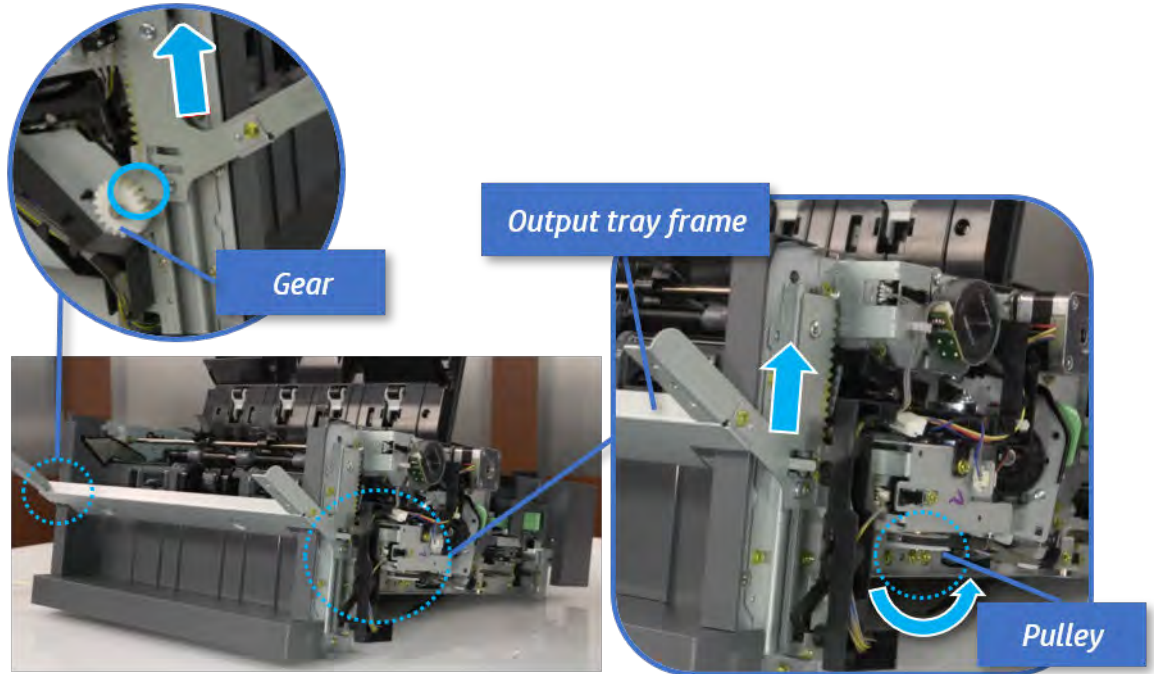

2. Push the paper holding actuator into the inner finisher, and then remove the output tray frame.

Figure 7-172 Remove the output tray frame

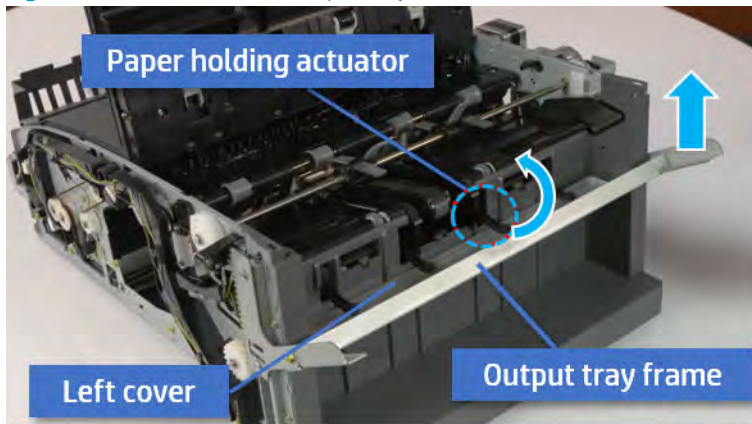

 **TIP:** Push the paper holding actuator into the inner finisher when reassembling. Be sure to level the output tray.

- a. Position the first wheel into the channel on both sides while pushing the paper holding actuator.

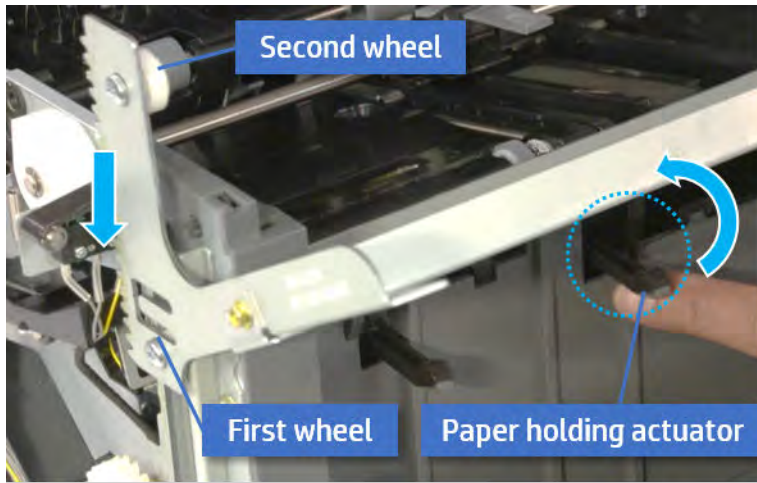

- b. Let the second wheel rest on the channel on both sides simultaneously.
- c. Gently squeeze the wheels into channel until the output tray frame meet the gear.

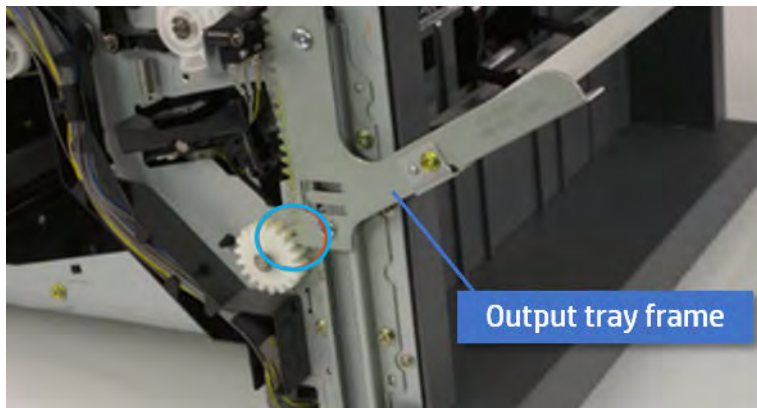

- d. Rotate the pulley until the output tray frame is no longer lifted. It can make to level the output tray frame.

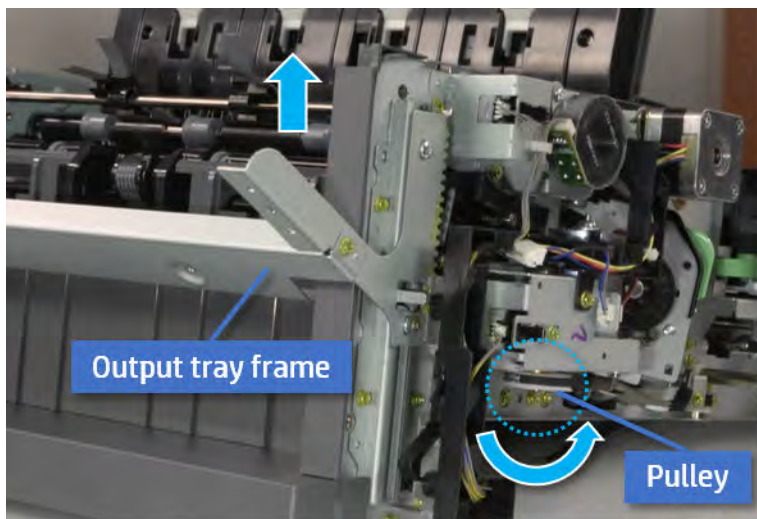

- e. Rotate the pulley in the opposite direction.

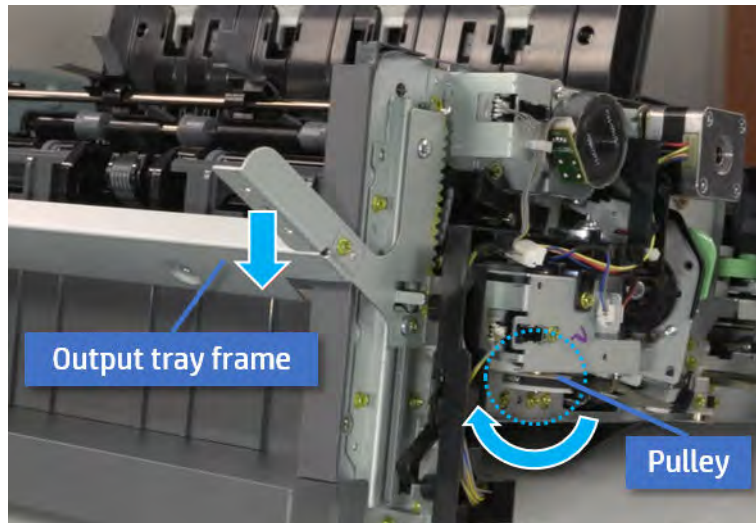

Remove the PCA cover

Follow these steps to remove the PCA cover.

- ▲ Remove two screws, and then remove the PCA cover.

Figure 7-173 Remove the PCA cover

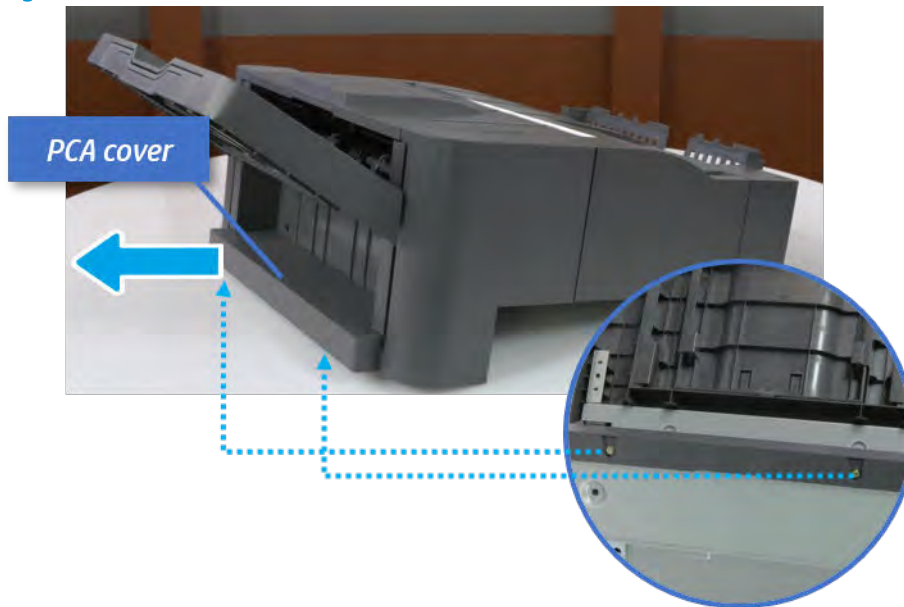

Remove the left cover

Follow these steps to remove the left cover.

1. Remove two screws.

Figure 7-174 Remove two screws

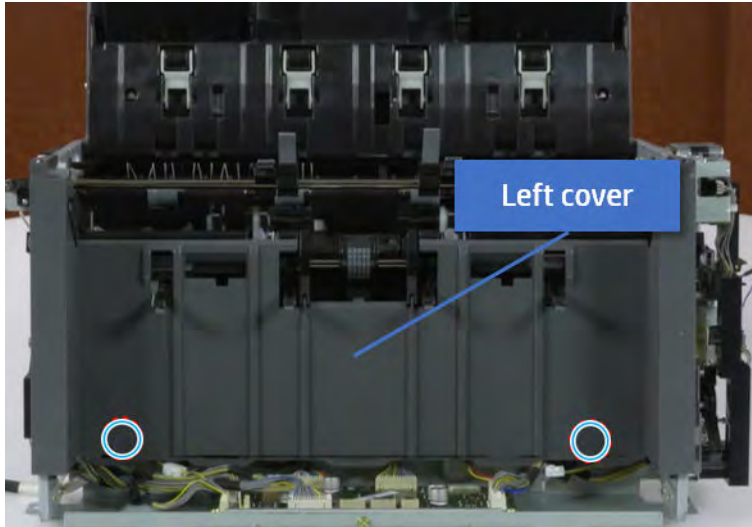

2. Remove four screws from both front and rear sides.

Figure 7-175 Remove four screws

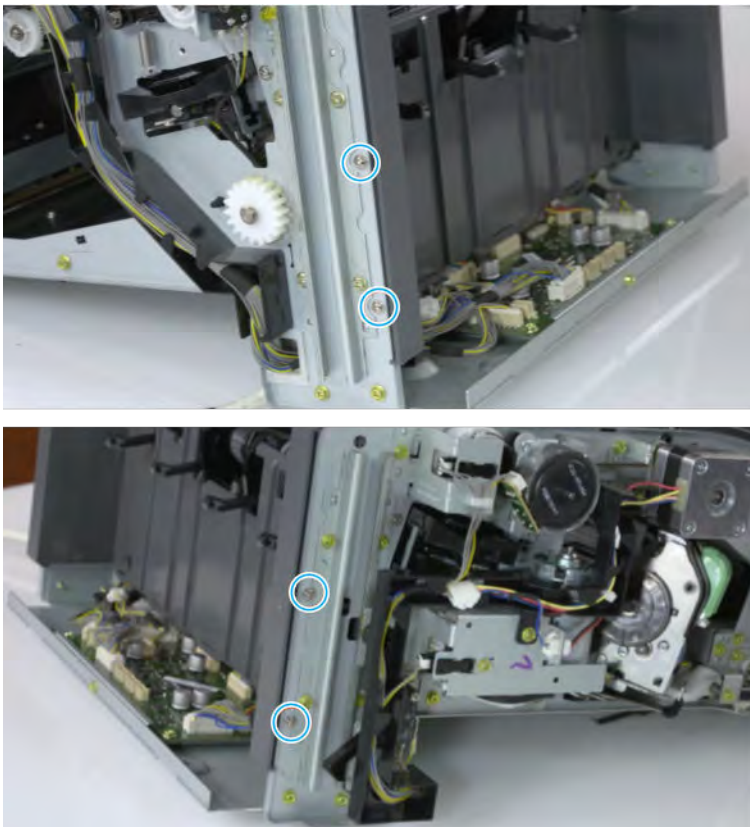

3. Unplug two inline connectors, and then remove the left cover.

Figure 7-176 Unplug two connectors

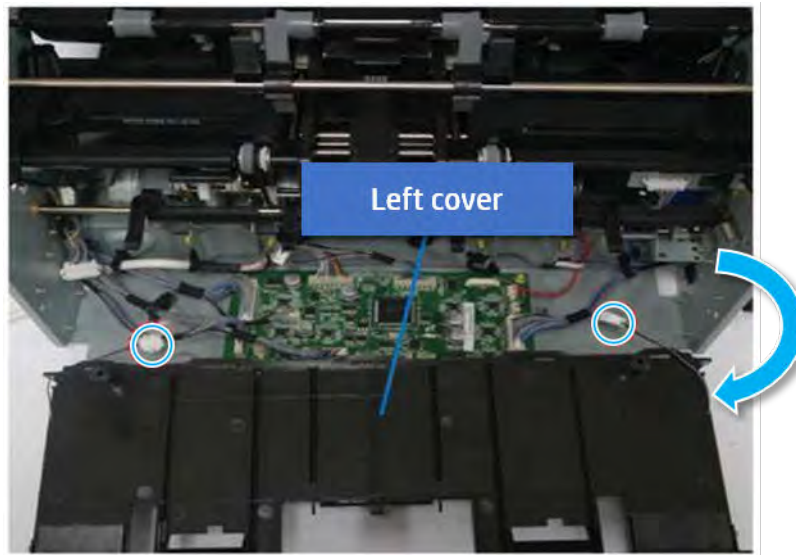

 **TIP:** Be sure to check the hook when reassembling.

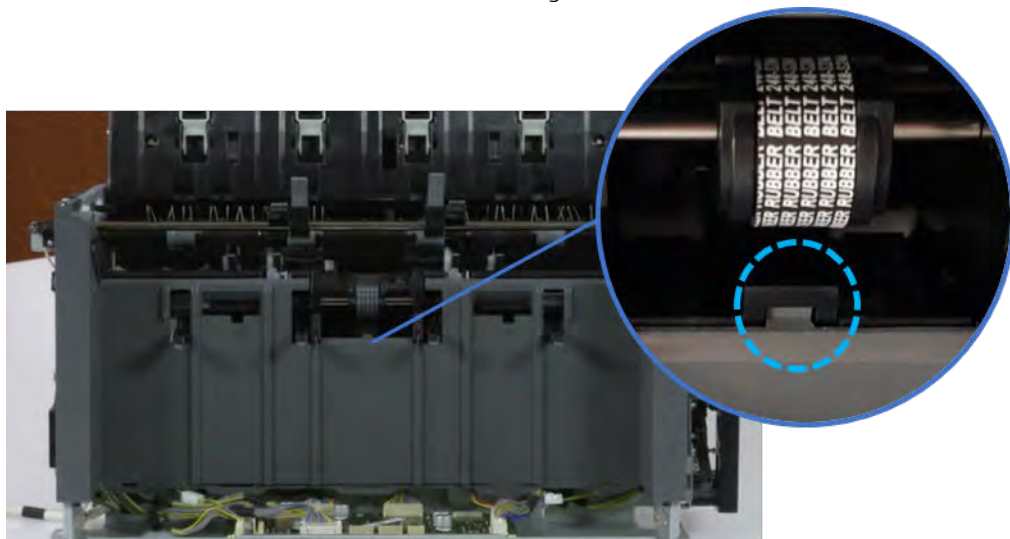

Remove the front harness guide

Follow these steps to remove the front harness guide.

1. Open one clamp and unplug five connectors, and then remove the wire harness from the front harness guide.

2. Remove four screws, and then remove the front harness guide.

Figure 7-177 Remove the front harness guide

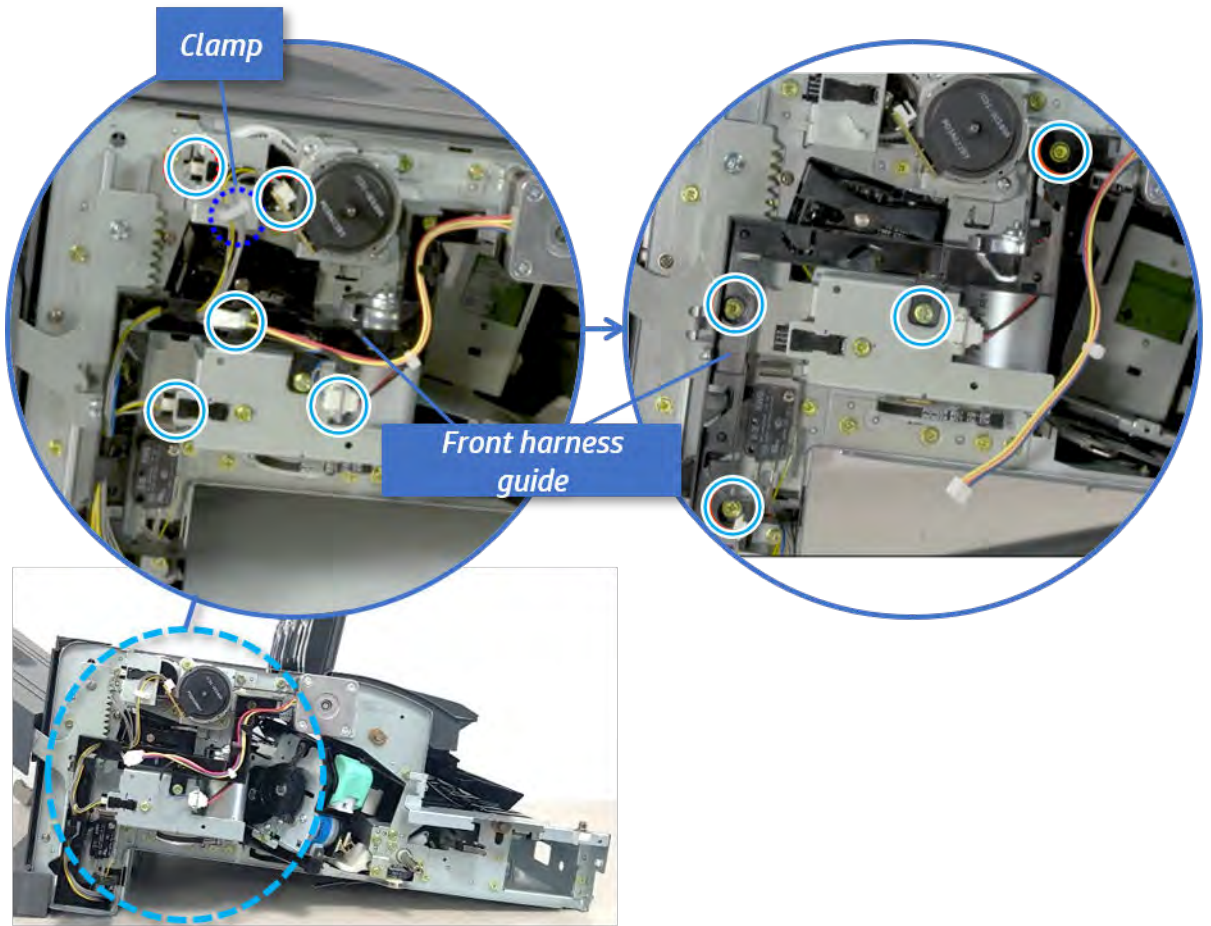

Remove the output tray motor assembly

Follow these steps to remove the output tray motor assembly.

- ▲ Remove three screws, and then remove the output tray motor assembly.

Figure 7-178 Remove the output tray motor assembly

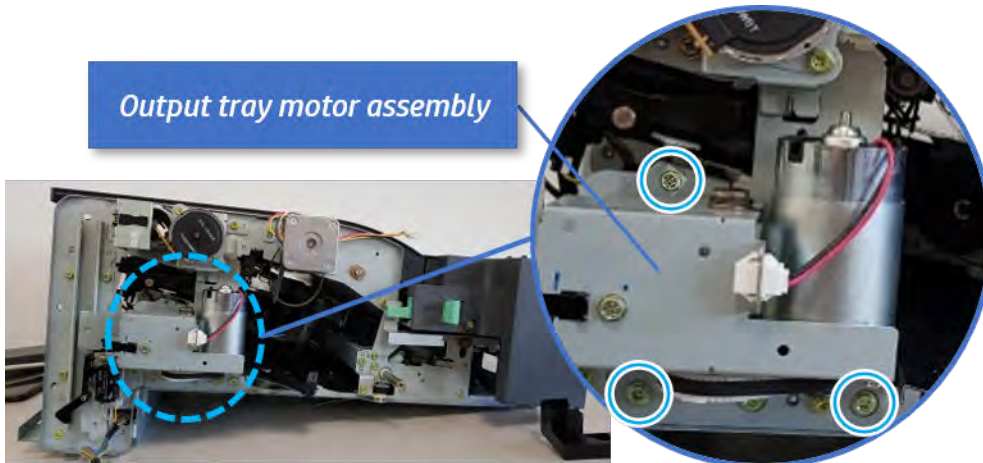

Remove the output tray lower limit switch

Follow these steps to remove the output tray lower limit switch.

- ▲ Remove one screw, and then remove the output tray lower limit switch.

Figure 7-179 Remove the output tray lower limit switch

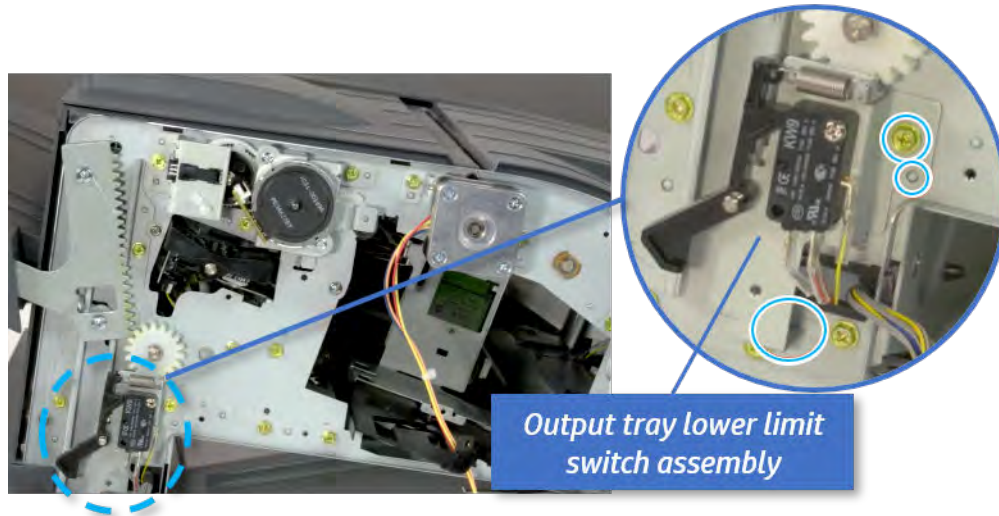

Remove the paper holding

Follow these steps to remove the paper holding.

1. Remove the paper holding actuator spring.

Figure 7-180 Remove the paper holding actuator spring

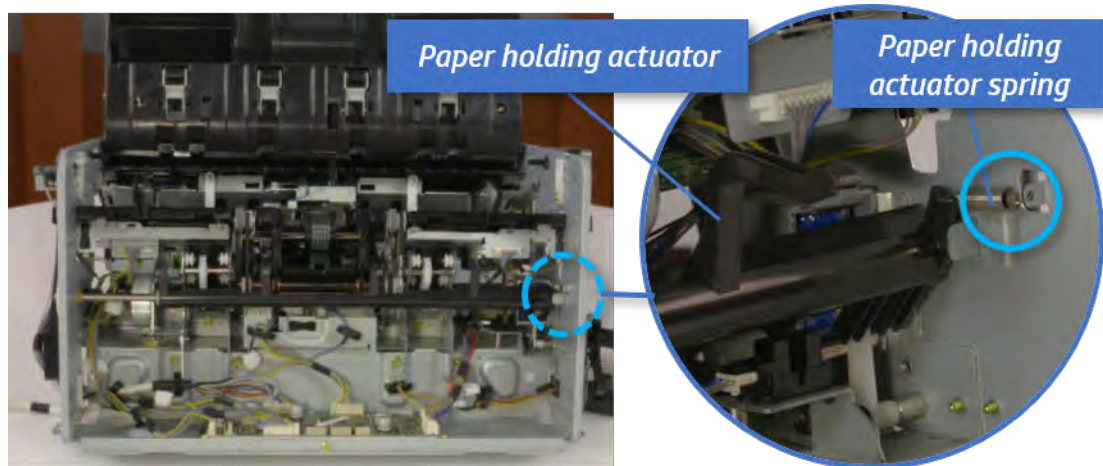

2. Remove the e-ring and the rack pinion gear. And then remove the pin and the e-ring, and then remove the bushing.

Figure 7-181 Remove e-ring, rack pinion gear, pin, and bushing

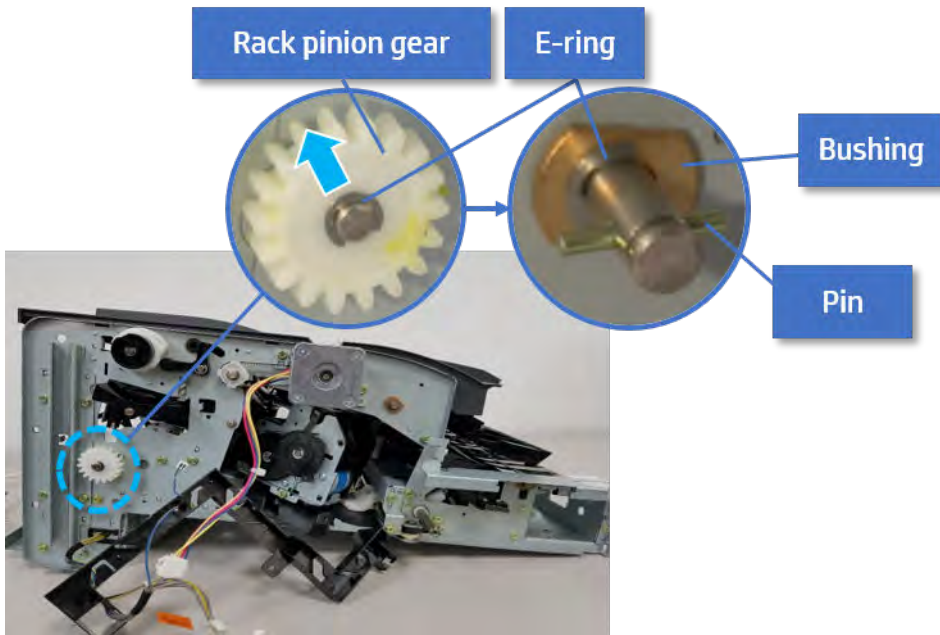

 **NOTE:** Be sure not to lose the pin.

3. Carefully remove the paper holding shaft and the actuator.

Figure 7-182 Remove the paper holding shaft and the actuator

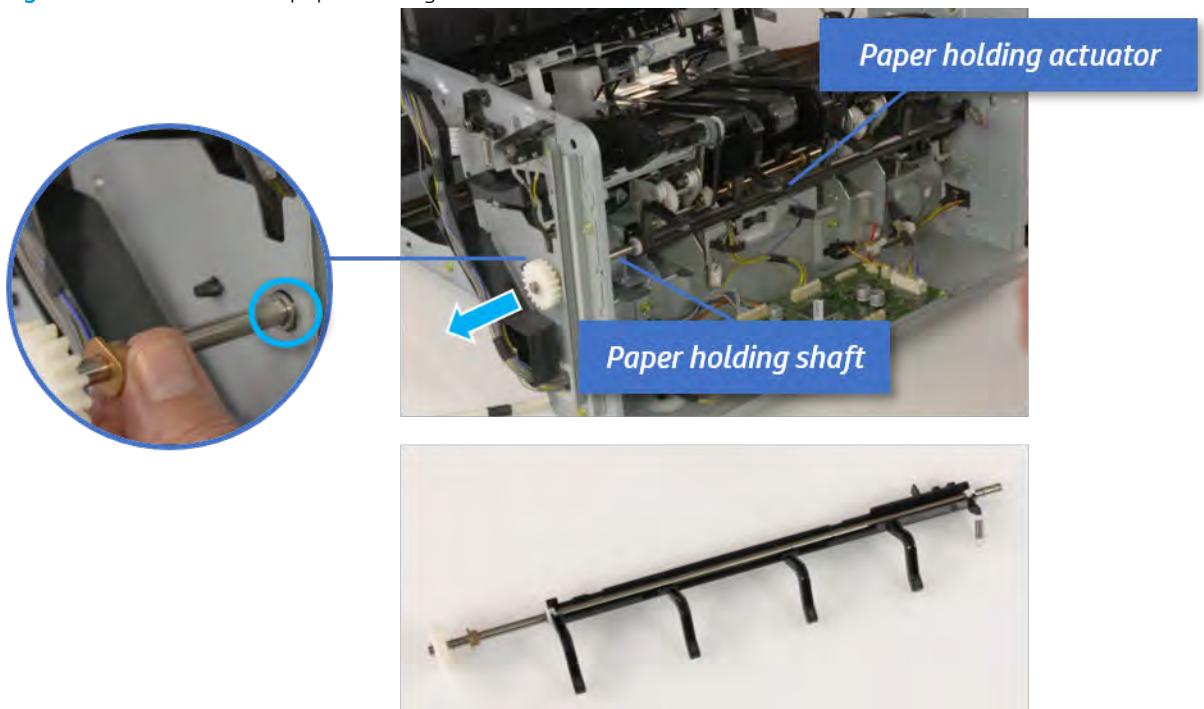

Remove the sub paddle unit

Follow these steps to remove the sub paddle unit.

1. Open the top cover, and then remove one screw securing the sub paddle unit.

Figure 7-183 Remove one screw

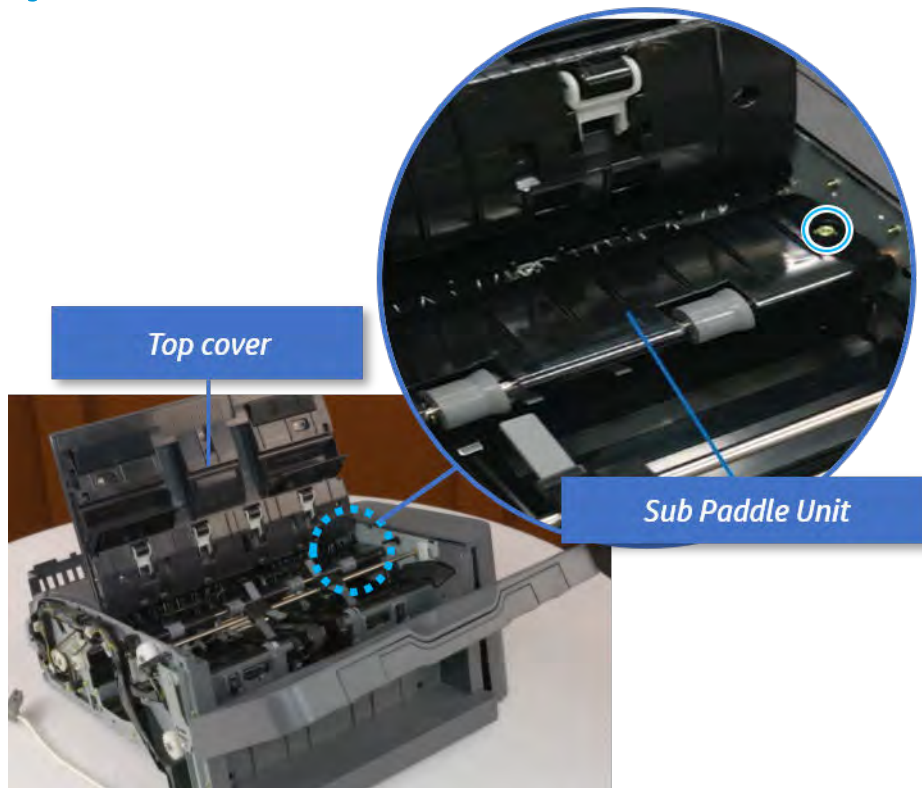

2. Remove the e-ring, and then remove the pulley and timing belt. And then remove the e-ring and the bushing.

Figure 7-184 Remove the e-ring, pulley, timing belt, and bushing

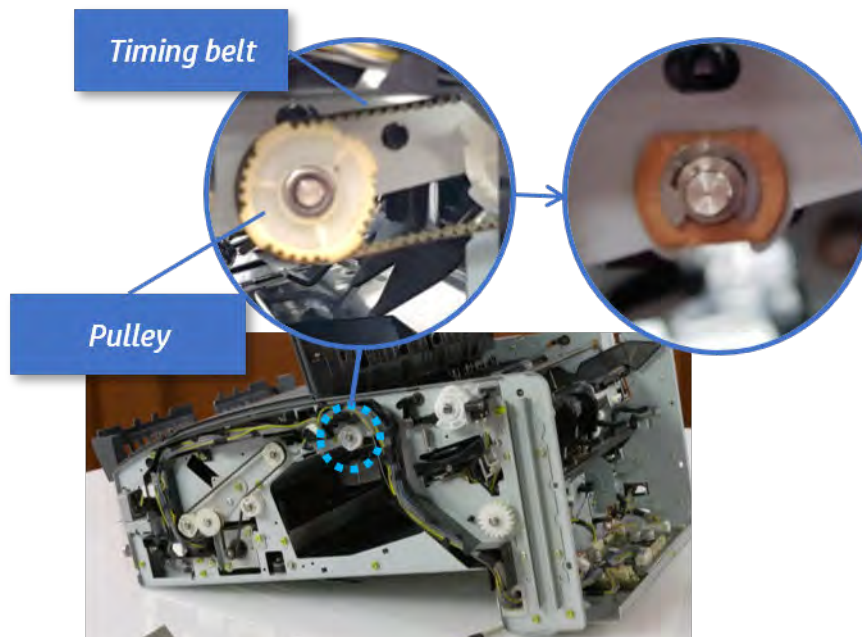

3. Lift up and remove the sub paddle unit.

Figure 7-185 Remove the sub paddle unit

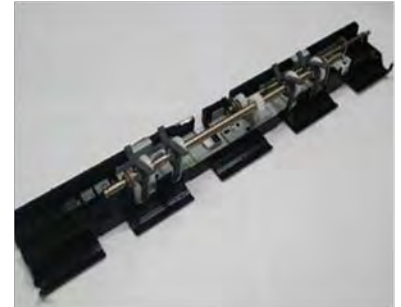
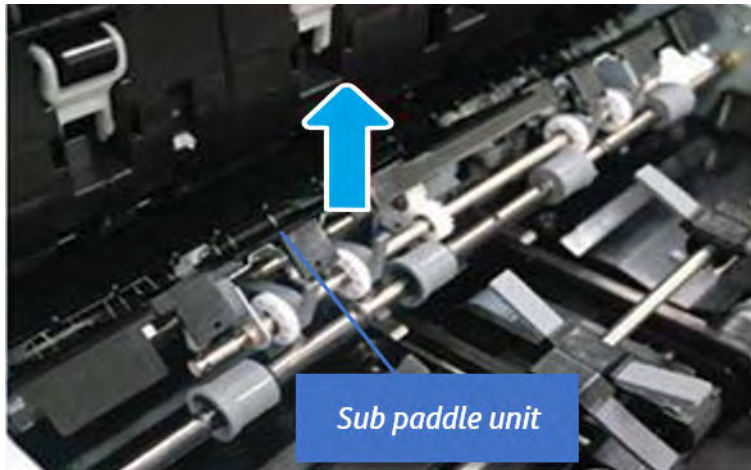

Remove the exit roller

Follow these steps to remove the exit roller.

1. Remove the guide on the center of the exit roller.

Figure 7-186 Remove the guide

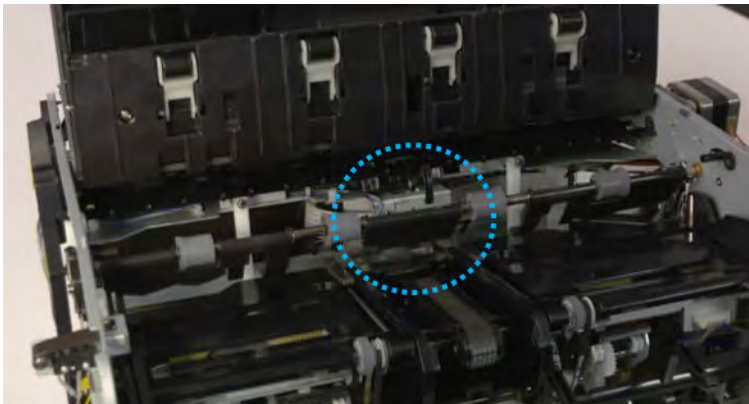

2. On the front of the inner finisher, release the timing belt connected to the exit motor.

Figure 7-187 Release the timing belt

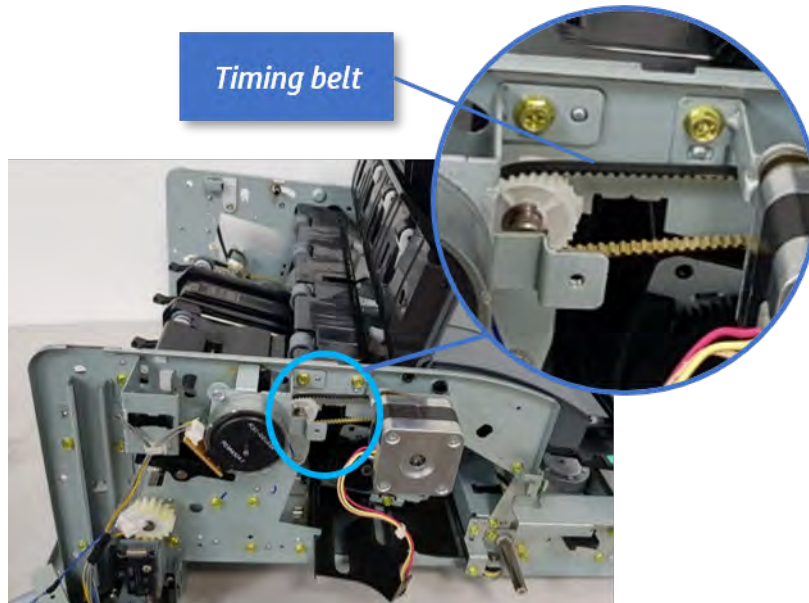

3. Remove five screws securing the rear harness guide.

Figure 7-188 Remove five screws

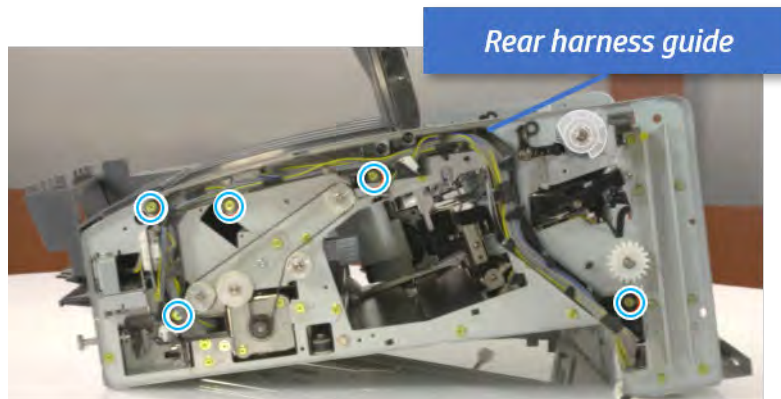

4. On the rear of the inner finisher, remove the e-ring and the pulley and then remove the e-ring and the bushing.

Figure 7-189 Remove e-ring, pulley, and bushing

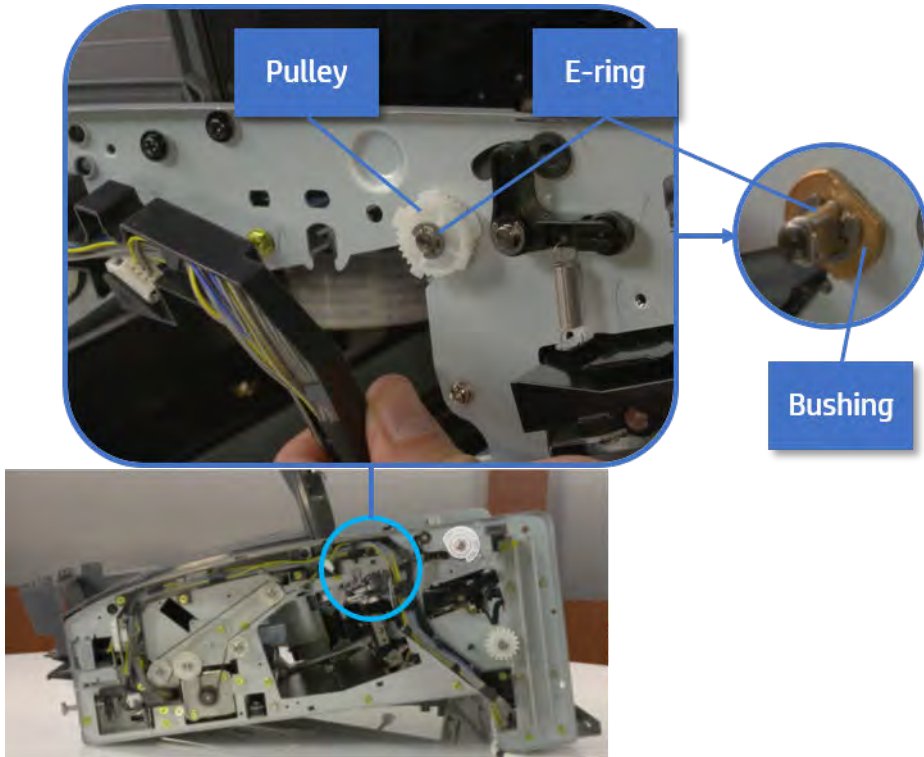

5. Push the bushing to detach it, and then remove the exit roller.

Figure 7-190 Remove the exit roller

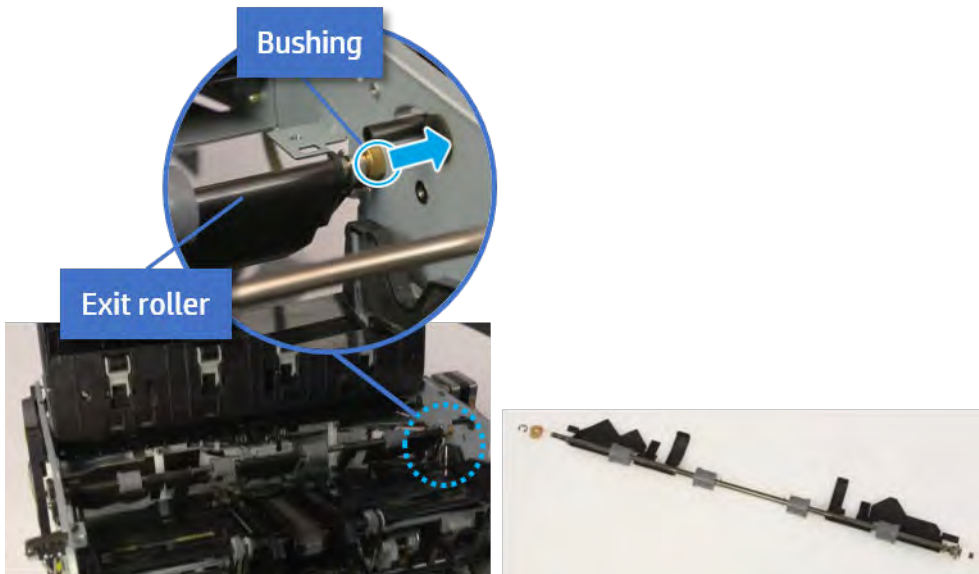

Remove the front tamper

Follow these steps to remove the front tamper.

1. Remove four screws.

Figure 7-191 Remove four screws

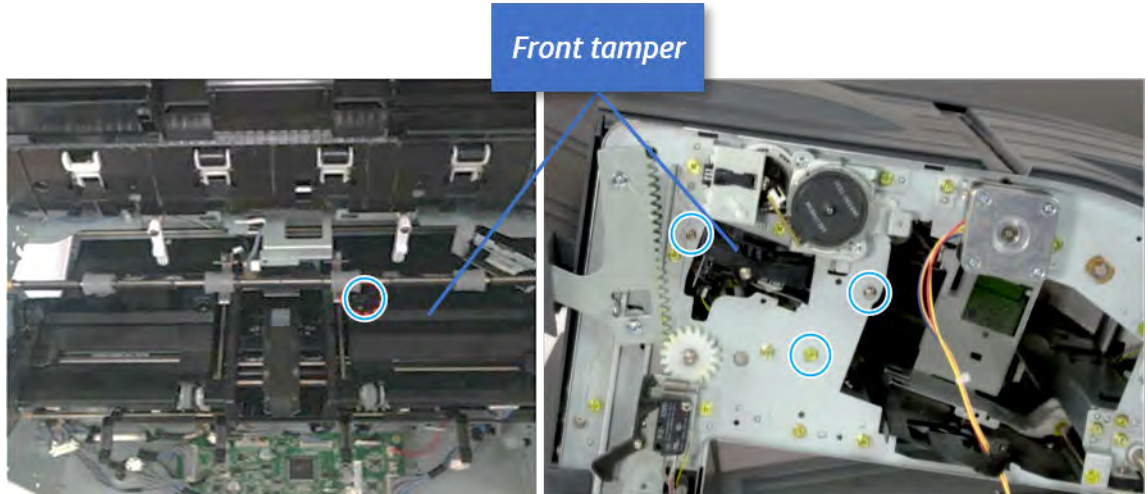

2. Unplug the connector and release the hook, and then pull the front tamper up to remove.

Figure 7-192 Remove the front tamper

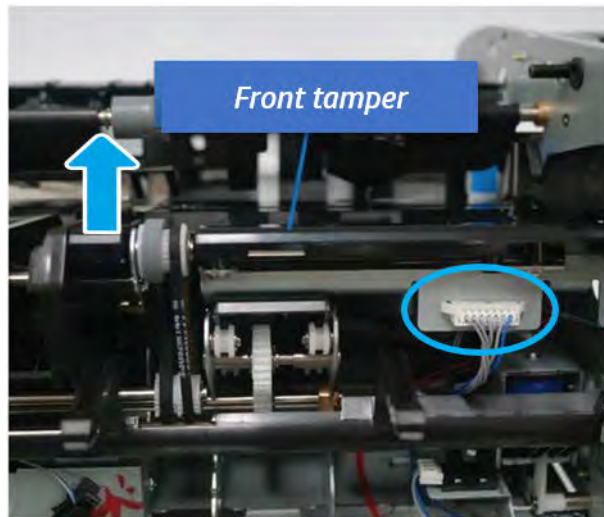

Remove the rear tamper

Follow these steps to remove the rear tamper.

1. Remove four screws.

 **NOTE:** Move cable guideout of position to access the screws.

Figure 7-193 Remove four screws



2. Unplug two connectors and release the hook, and then remove the rear tamper.

Figure 7-194 Remove the rear tamper

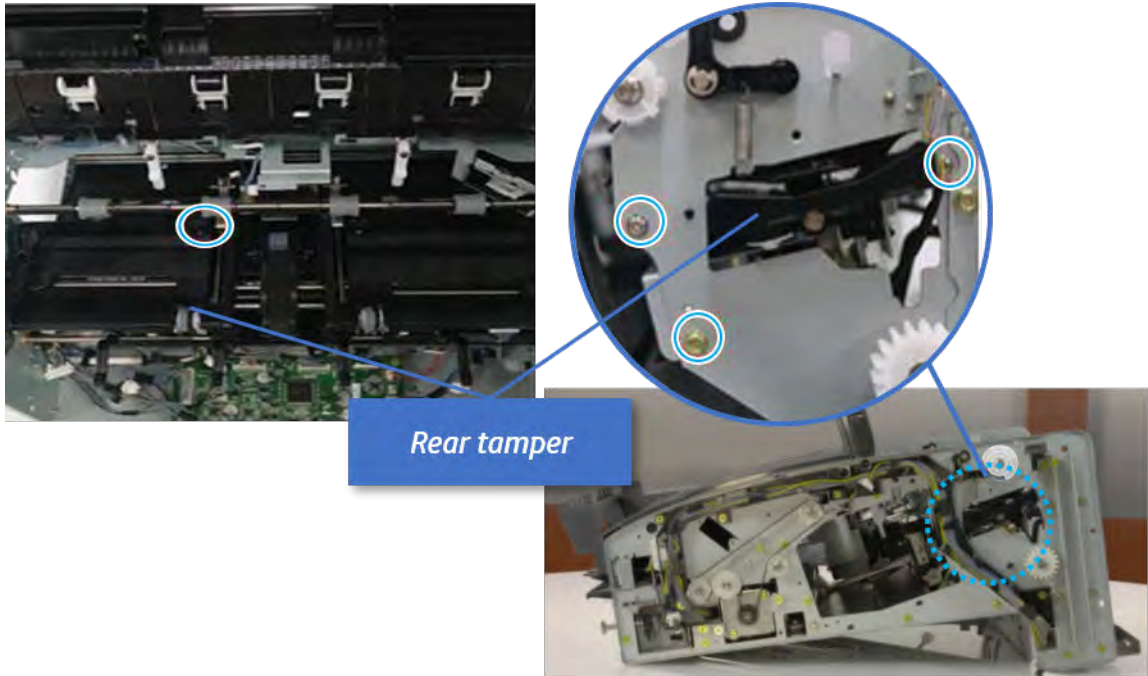
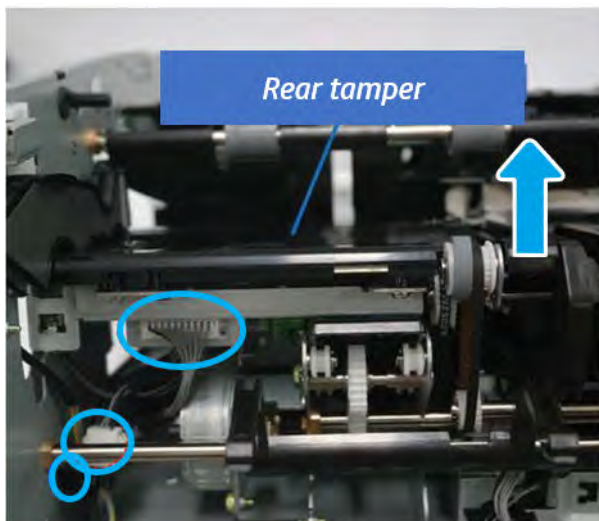

Remove the ejector & paper support assembly

Follow these steps to remove the ejector & paper support assembly.

1. Open one clamp, disconnect one connector.

Figure 7-195 Disconnect one connector

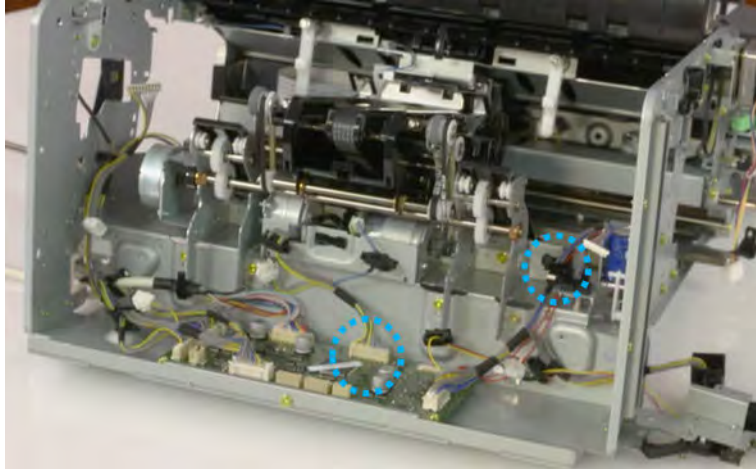

2. Pull the rear paper support up, and then release one clamp and disconnect two connectors.

Figure 7-196 Disconnect two connector

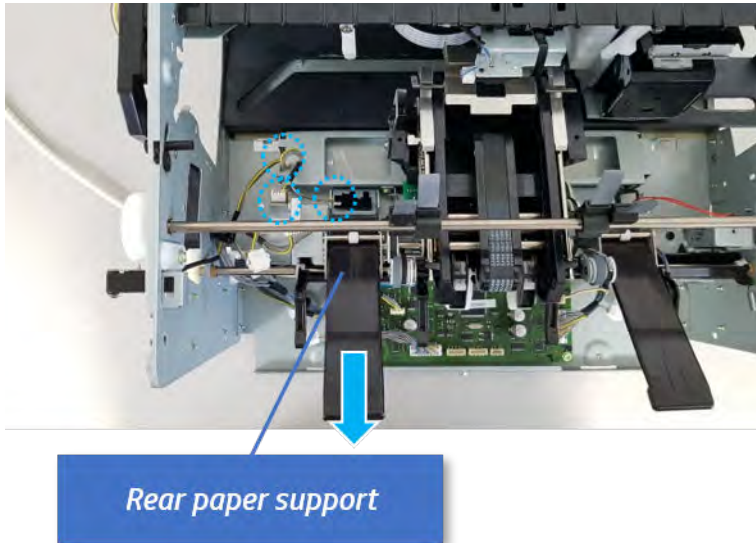

3. Remove four screws, and then remove the ejector & paper support assembly.

Figure 7-197 Remove the ejector & paper support assembly

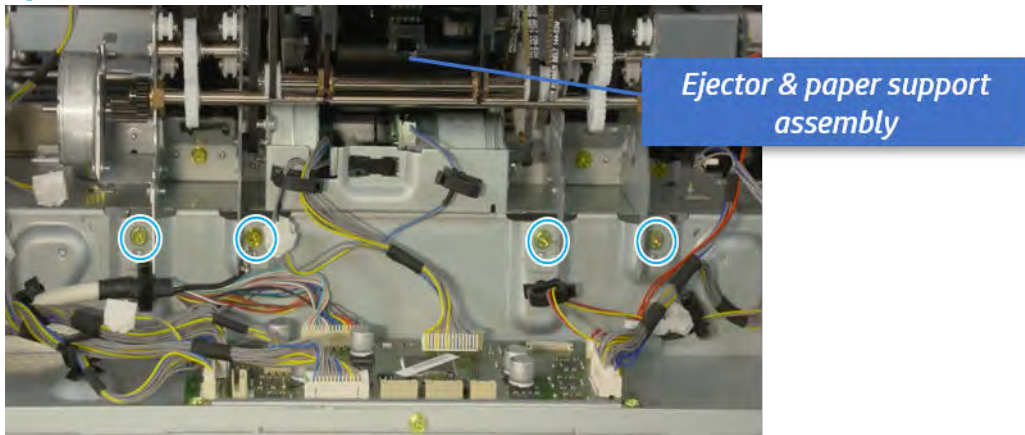

Remove the rear paper support

Follow these steps to remove the rear paper support.

1. Remove one screw.

Figure 7-198 Remove one screw

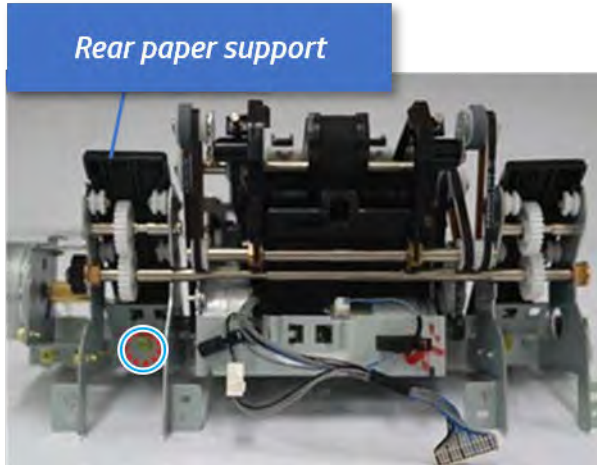

2. Remove the shaft while pulling the bushing in the direction of the arrow.

Figure 7-199 Remove the shaft

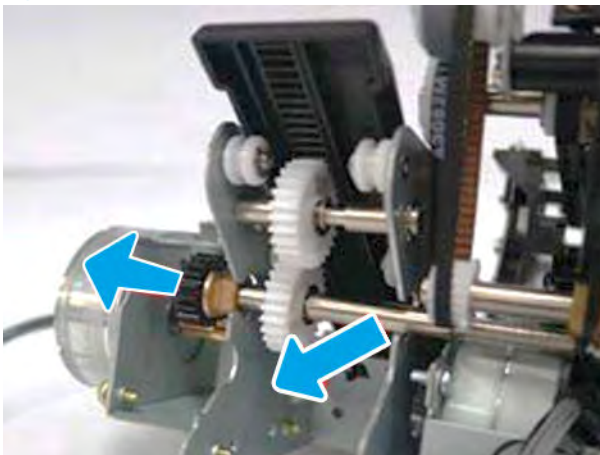

3. Remove the rear paper support with attention for pinion.

Figure 7-200 Remove the rear paper support



Unpack the replacement assembly



Follow these steps to unpack the replacement assembly.

1. Dispose of the defective part.

 **NOTE:** HP recommends responsible disposal of the defective part.

<http://www8.hp.com/us/en/hp-information/environment/product-recycling.html>

2. Unpack the replacement part from the packaging.

 **CAUTION:**  Some parts are sensitive to electrostatic discharge (ESD). Always perform service work at an ESD-protected workstation or mat. If an ESD workstation or mat is not available, touch the sheet-metal chassis to provide a static ground before touching an ESD-sensitive assembly. Protect the ESD-sensitive assemblies by placing them in ESD pouches when they are out of the printer.

 **IMPORTANT:** Make sure that all of the shipping materials (for example shipping tape) are removed from the replacement part prior to installation.

 **NOTE:** If the replacement part is a roller or pad, avoid touching the spongy part of it. Skin oils on the roller or pad can cause paper pickup and/or print-quality problems. HP recommends using disposable gloves when handling rollers or pads or washing your hands before touching rollers or pads.

3. To install an assembly, reverse the removal steps.

 **NOTE:** When applicable, special installation instructions are provided for an assembly at the end of the removal procedure. Always completely read the removal instructions and follow all special installation instructions.

Removal and replacement: Paper support home sensor (S12)

Learn how to remove and replace the paper support home sensor.

To view teardown and reassembling video of the inner finisher, click the link below.



[View a teardown video of the inner finisher.](#)



[View a reassembling video of the inner finisher.](#)



IMPORTANT: When applicable, special installation instructions are provided for an assembly at the end of the removal procedure. Always completely read the removal instructions and follow all special installation instructions.

Mean time to repair:

Service level:

Before performing service

Turn the printer power off

- Press the power button on the front of the printer, and then turn off the power switch next to the power cable.
- A shutting-down message appears on the control-panel display.



WARNING! To avoid damage to the printer, turn the power off and wait until the printer shuts down before removing the power cable.

- Disconnect the printer power cable after the printer has completely shut down (the control-panel display is blank).

Use the table below to identify the correct part number for your printer. To order the part, go to www.hp.com/buy/parts.

Table 7-46 Part information

Part number	Part description
0604-001393	Paper support home sensor

Required tools

- #2 JIS screwdriver with a magnetic tip

After performing service

Turn the printer power on

- Connect the power cable.
- Use the power switch to turn the power on.

Post service test

Print any pages necessary to verify that the repair resolved the issue and did not create any new issues.

Remove the front cover

Follow these steps to remove the front cover.

1. Open the front door and open the punch cover.
2. Remove three screws in the front.
3. Remove the lever.
4. Open the top cover.
5. From the right side of the front cover, carefully lift and pry toward the top-left corner to remove the front cover.

Figure 7-201 Remove the front cover

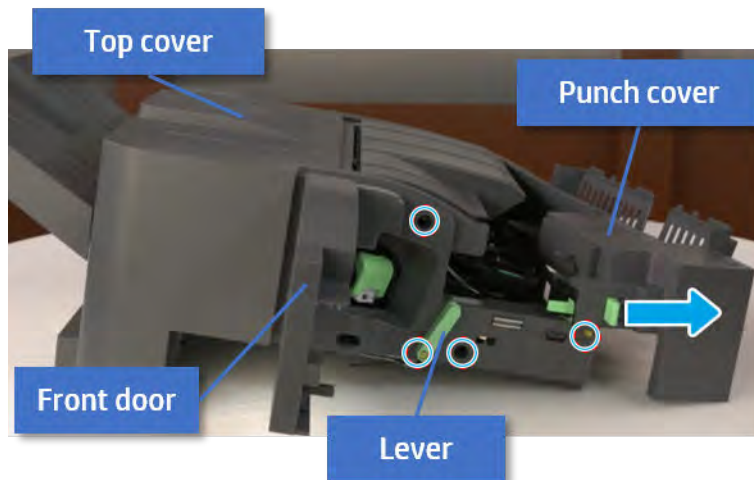

Remove the rear cover

Follow these steps to remove the rear cover.

1. Open the top cover.

Figure 7-202 Open the top cover

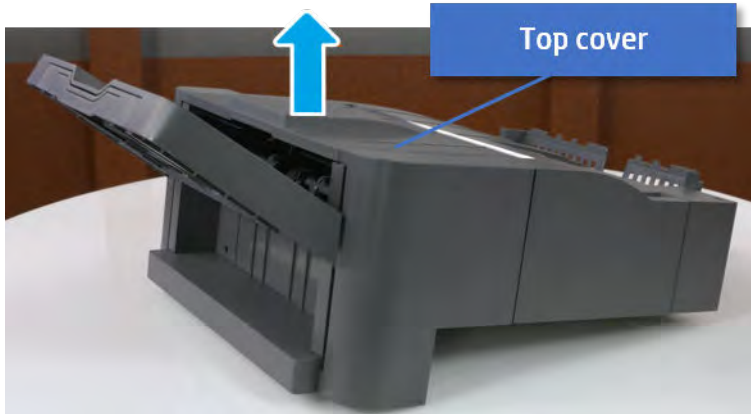

2. Remove three screws.
3. Release hooks carefully and remove the rear cover.

Figure 7-203 Remove the rear cover

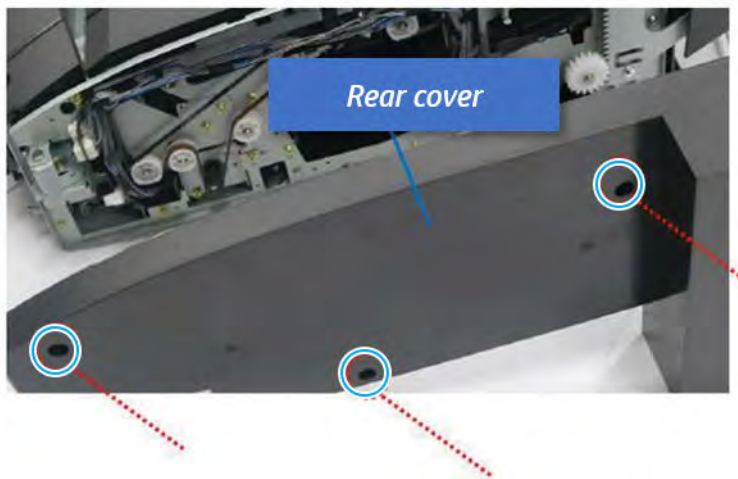

Remove the output tray

Follow these steps to remove the output tray.

1. Remove four screws.

Figure 7-204 Remove four screws

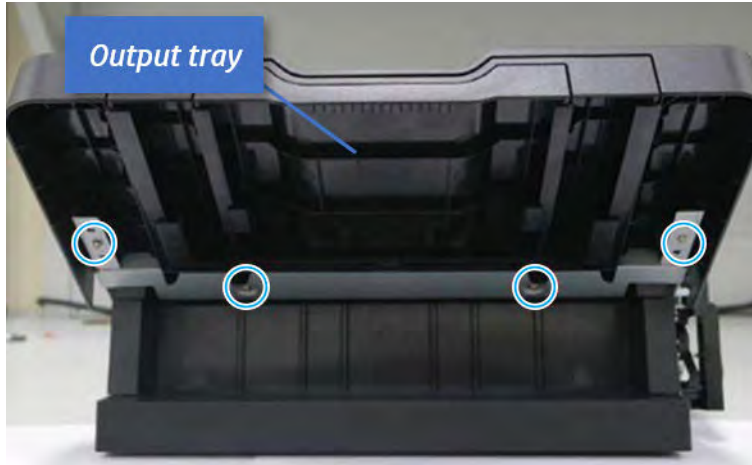

2. Push the paper holding actuator into the inner finisher, and then remove the output tray.

Figure 7-205 Remove the output tray.



Remove the output tray frame

Follow these steps to remove the output tray frame.

1. Rotate the pulley until the output tray frame depart from the gear.

Figure 7-206 Remove the pulley

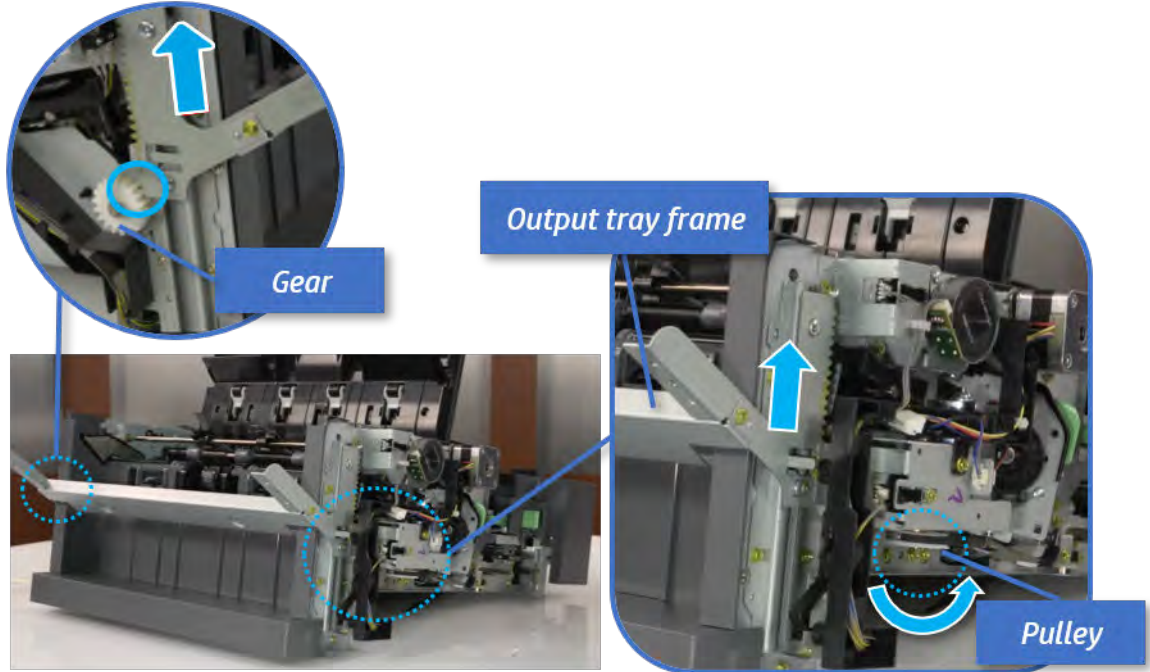

2. Push the paper holding actuator into the inner finisher, and then remove the output tray frame.

Figure 7-207 Remove the output tray frame

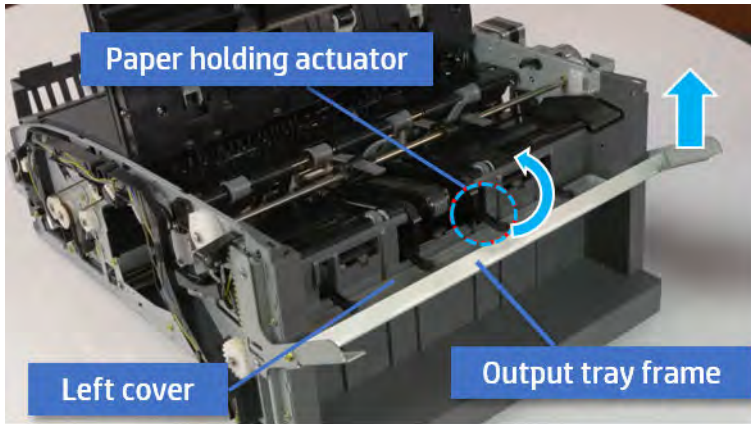

 **TIP:** Push the paper holding actuator into the inner finisher when reassembling. Be sure to level the output tray.

- a. Position the first wheel into the channel on both sides while pushing the paper holding actuator.

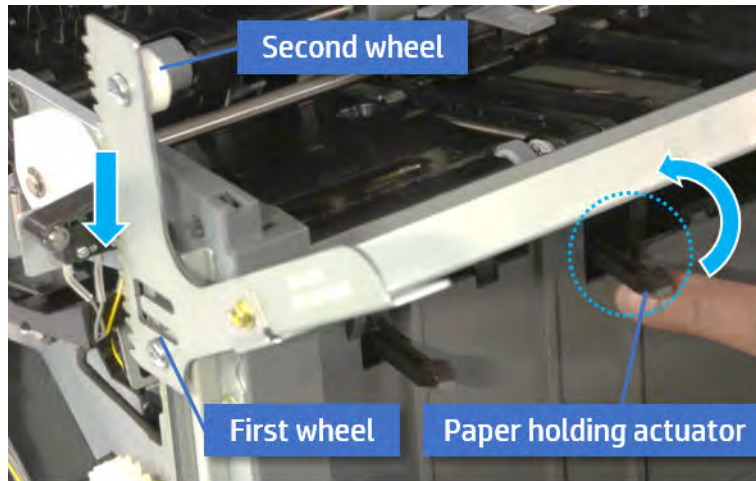

- b. Let the second wheel rest on the channel on both sides simultaneously.
- c. Gently squeeze the wheels into channel until the output tray frame meet the gear.

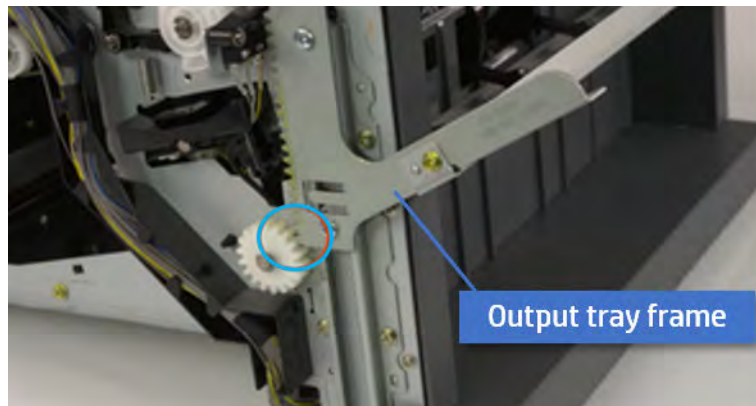

- d. Rotate the pulley until the output tray frame is no longer lifted. It can make to level the output tray frame.

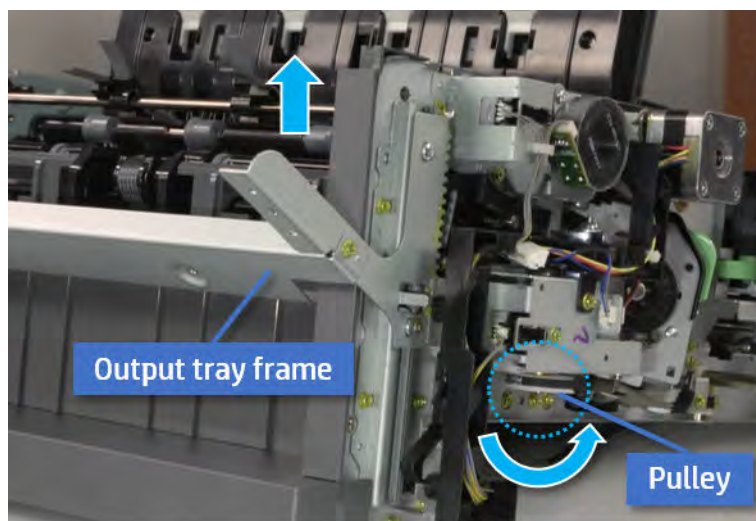

- e. Rotate the pulley in the opposite direction.

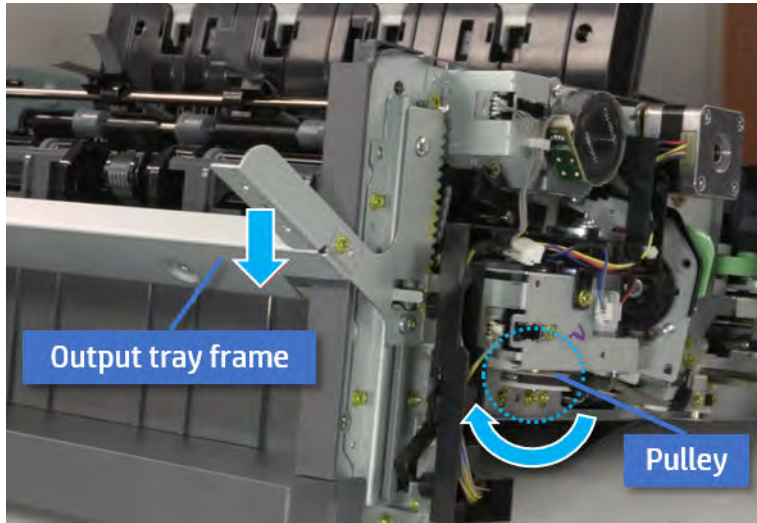

Remove the PCA cover

Follow these steps to remove the PCA cover.

- ▲ Remove two screws, and then remove the PCA cover.

Figure 7-208 Remove the PCA cover

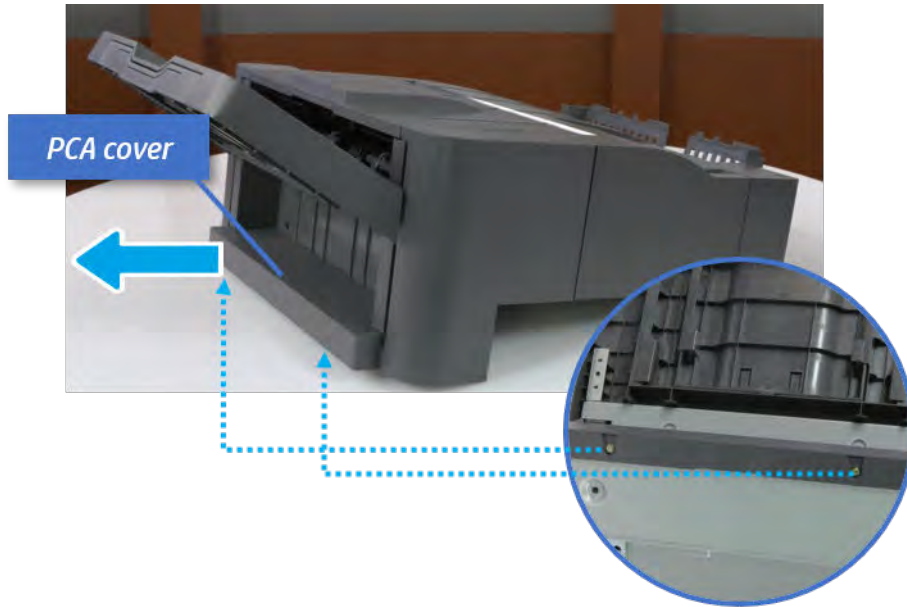

Remove the left cover

Follow these steps to remove the left cover.

1. Remove two screws.

Figure 7-209 Remove two screws

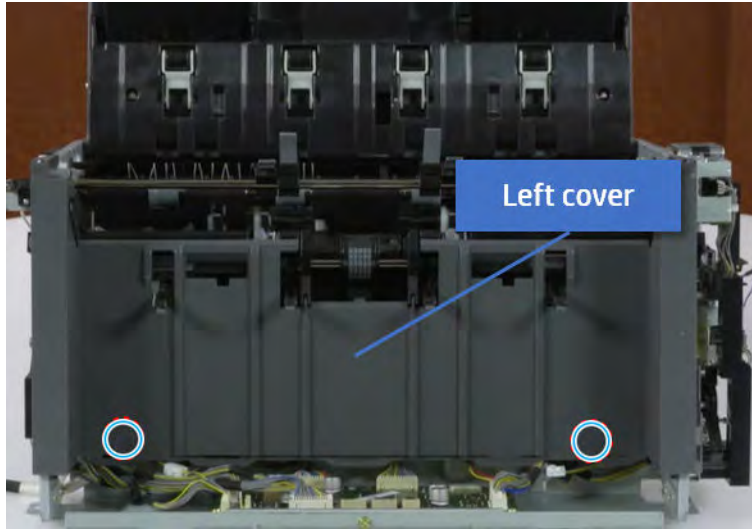

2. Remove four screws from both front and rear sides.

Figure 7-210 Remove four screws

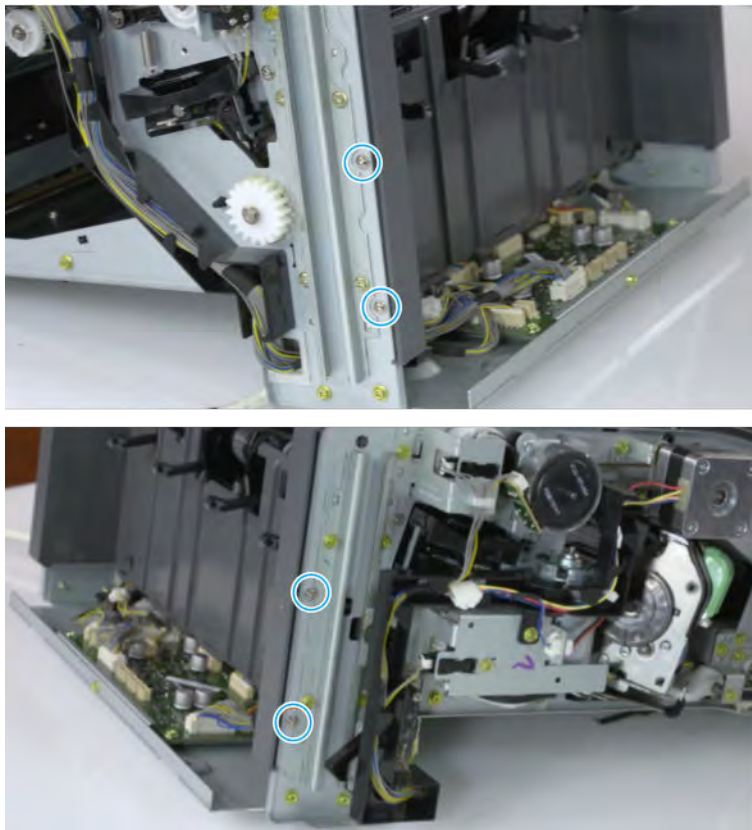

3. Unplug two inline connectors, and then remove the left cover.

Figure 7-211 Unplug two connectors

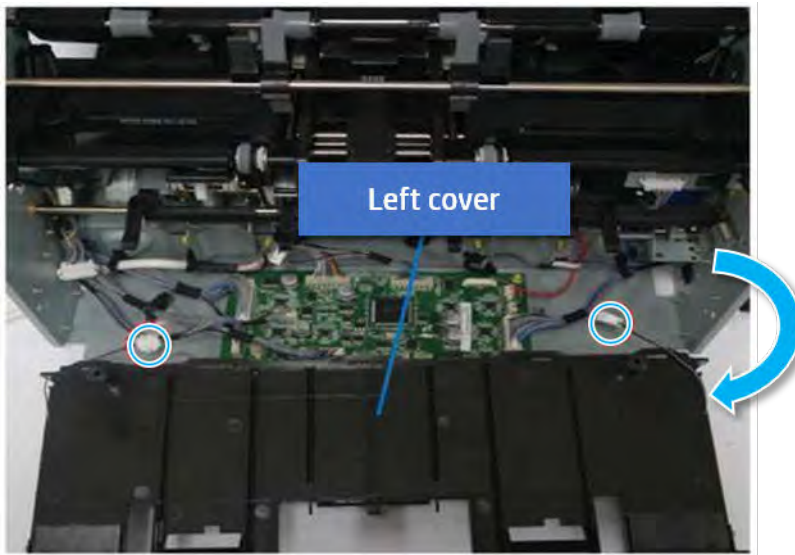

 **TIP:** Be sure to check the hook when reassembling.

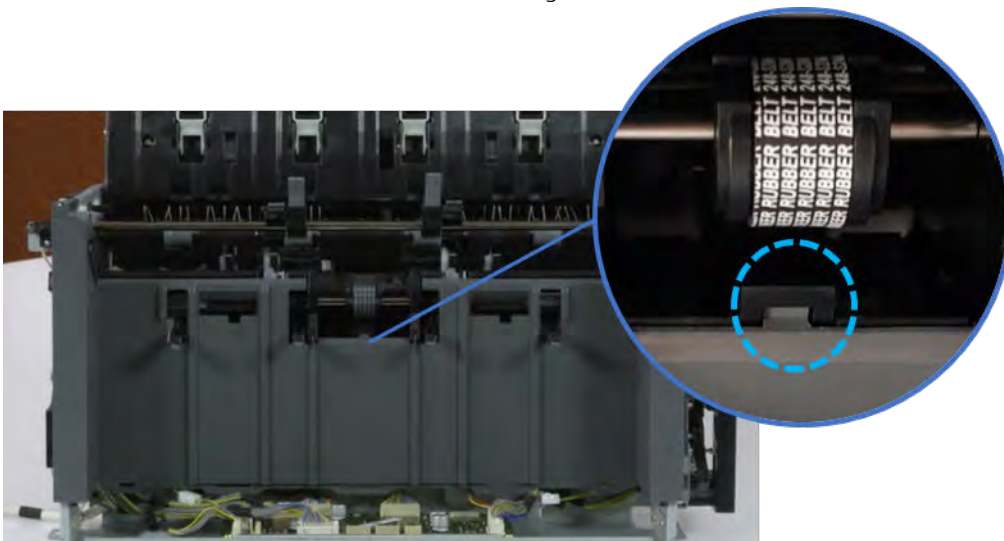

Remove the front harness guide

Follow these steps to remove the front harness guide.

1. Open one clamp and unplug five connectors, and then remove the wire harness from the front harness guide.

2. Remove four screws, and then remove the front harness guide.

Figure 7-212 Remove the front harness guide

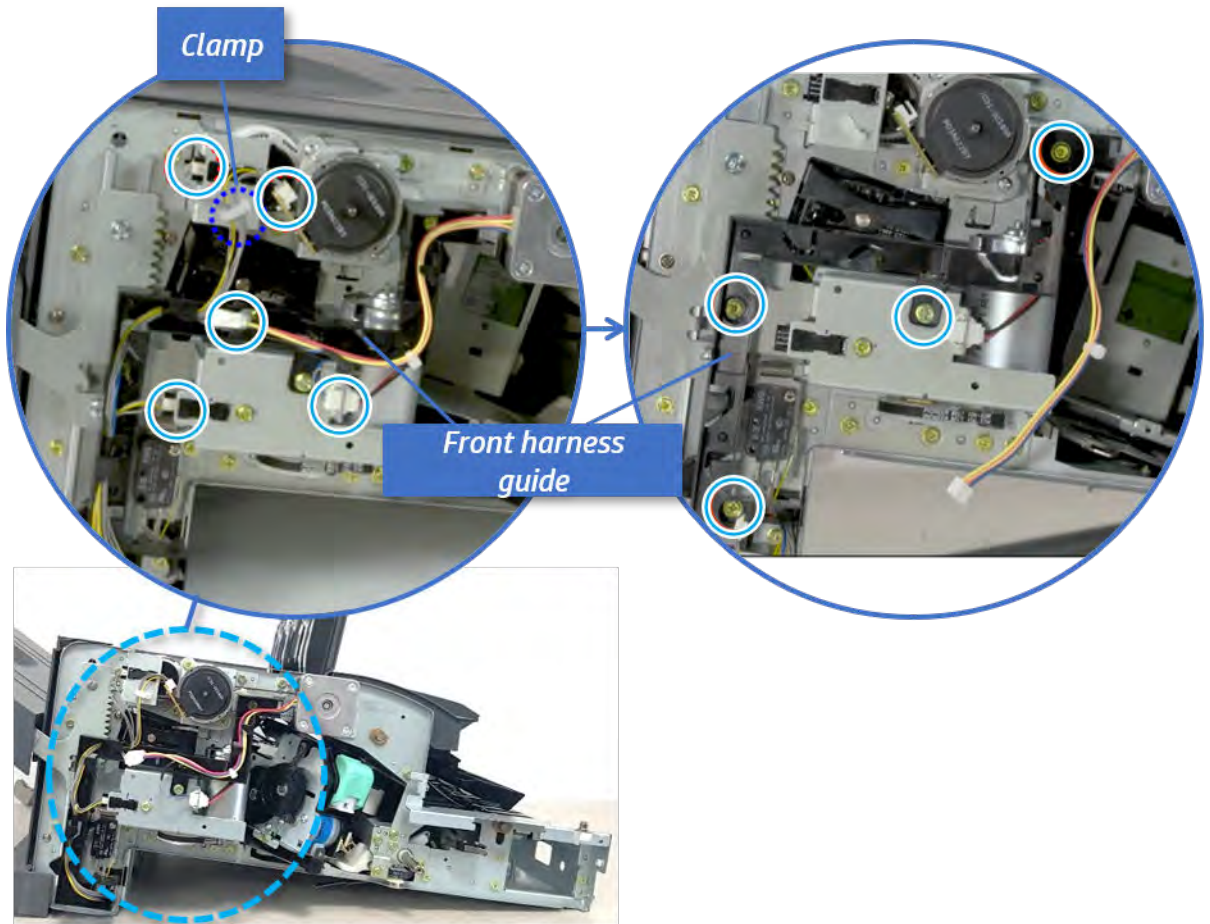

Remove the output tray motor assembly

Follow these steps to remove the output tray motor assembly.

- ▲ Remove three screws, and then remove the output tray motor assembly.

Figure 7-213 Remove the output tray motor assembly

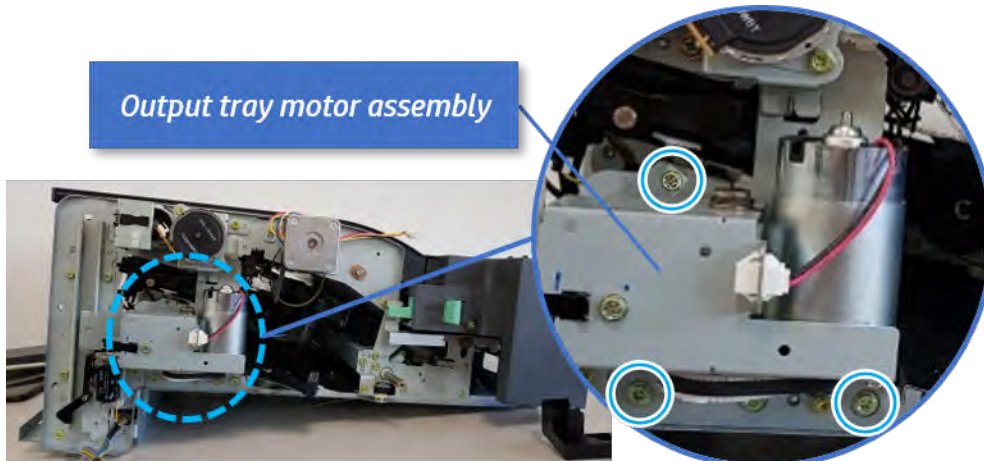

Remove the output tray lower limit switch

Follow these steps to remove the output tray lower limit switch.

- ▲ Remove one screw, and then remove the output tray lower limit switch.

Figure 7-214 Remove the output tray lower limit switch

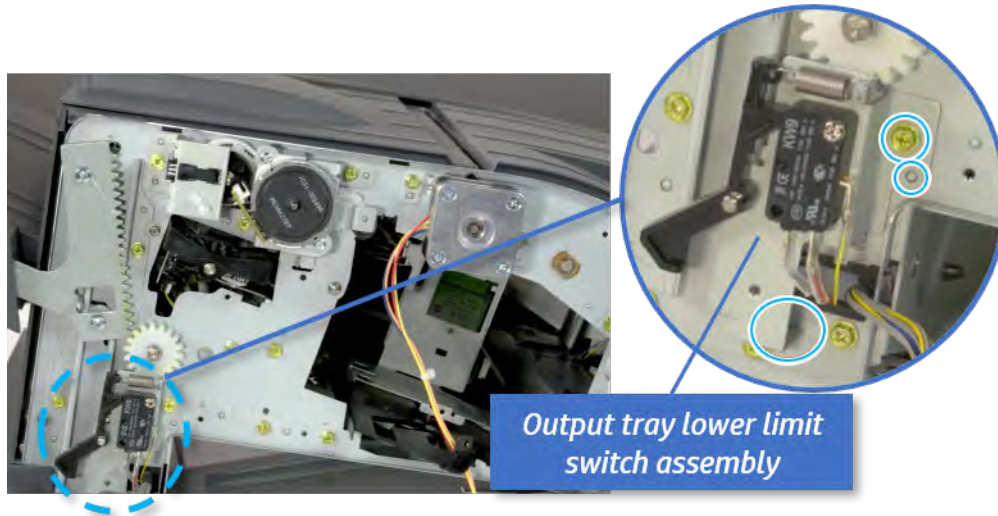

Remove the paper holding

Follow these steps to remove the paper holding.

1. Remove the paper holding actuator spring.

Figure 7-215 Remove the paper holding actuator spring

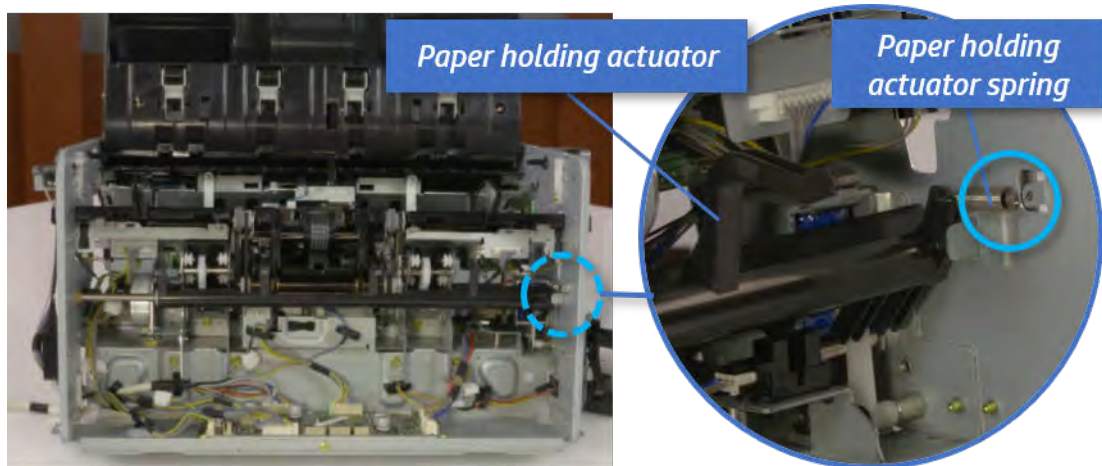

2. Remove the e-ring and the rack pinion gear. And then remove the pin and the e-ring, and then remove the bushing.

Figure 7-216 Remove e-ring, rack pinion gear, pin, and bushing

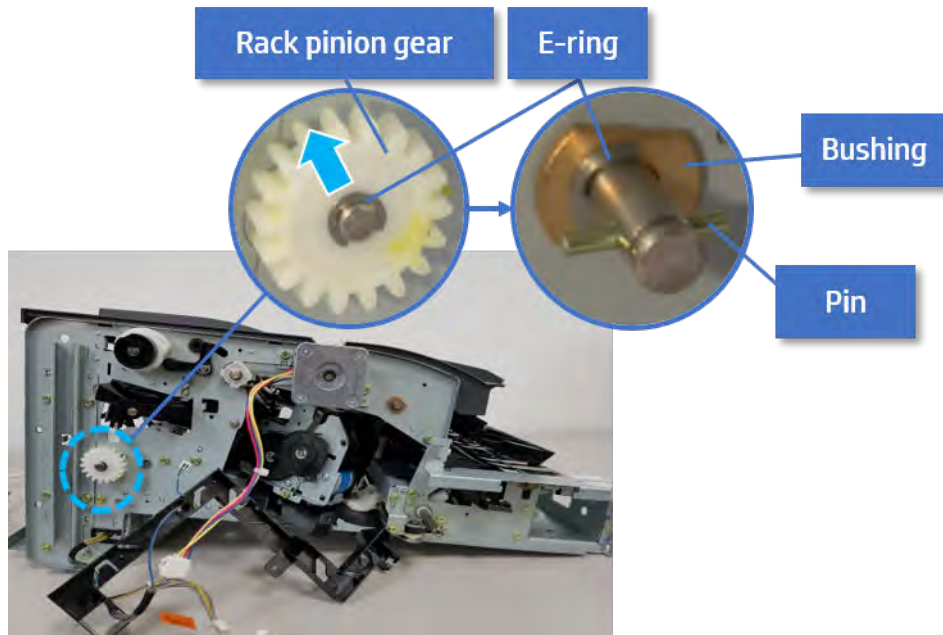

 **NOTE:** Be sure not to lose the pin.

3. Carefully remove the paper holding shaft and the actuator.

Figure 7-217 Remove the paper holding shaft and the actuator

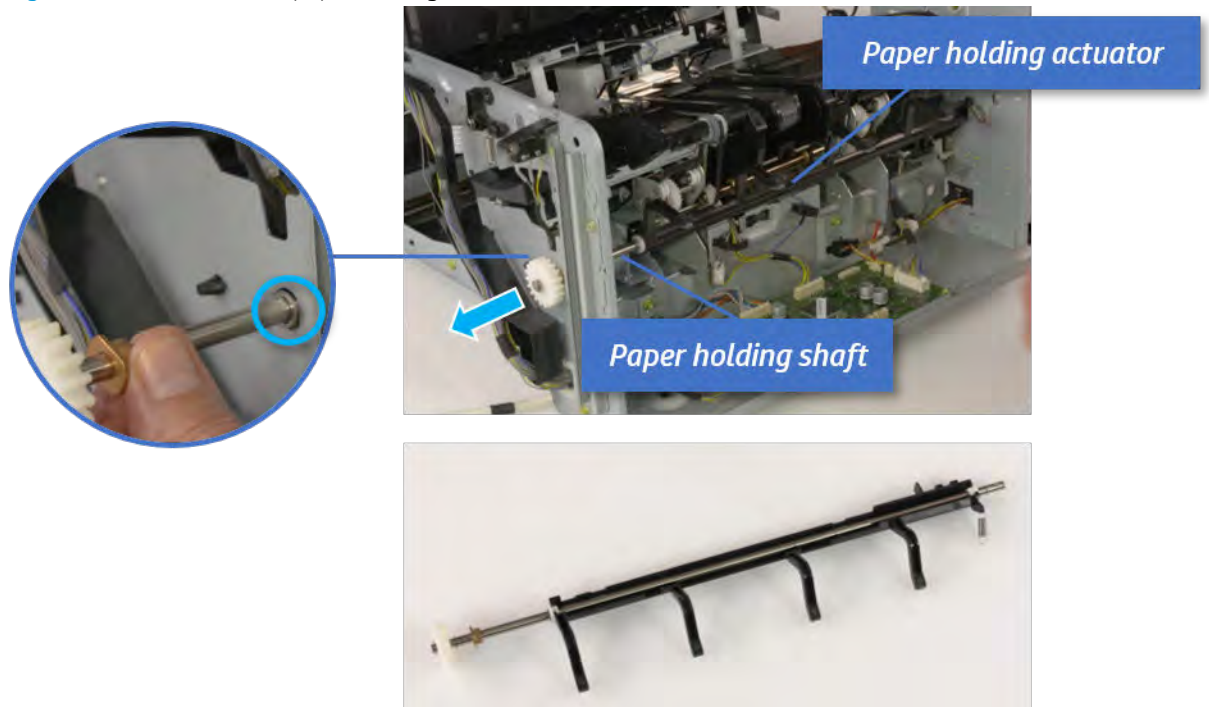

Remove the sub paddle unit

Follow these steps to remove the sub paddle unit.

1. Open the top cover, and then remove one screw securing the sub paddle unit.

Figure 7-218 Remove one screw

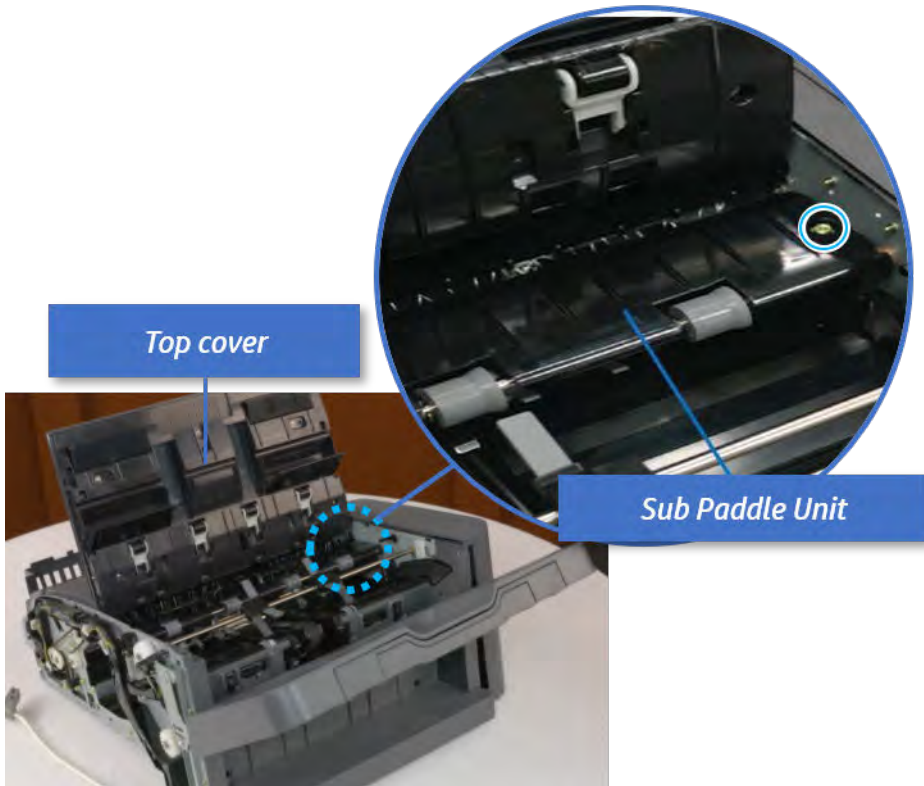

2. Remove the e-ring, and then remove the pulley and timing belt. And then remove the e-ring and the bushing.

Figure 7-219 Remove the e-ring, pulley, timing belt, and bushing

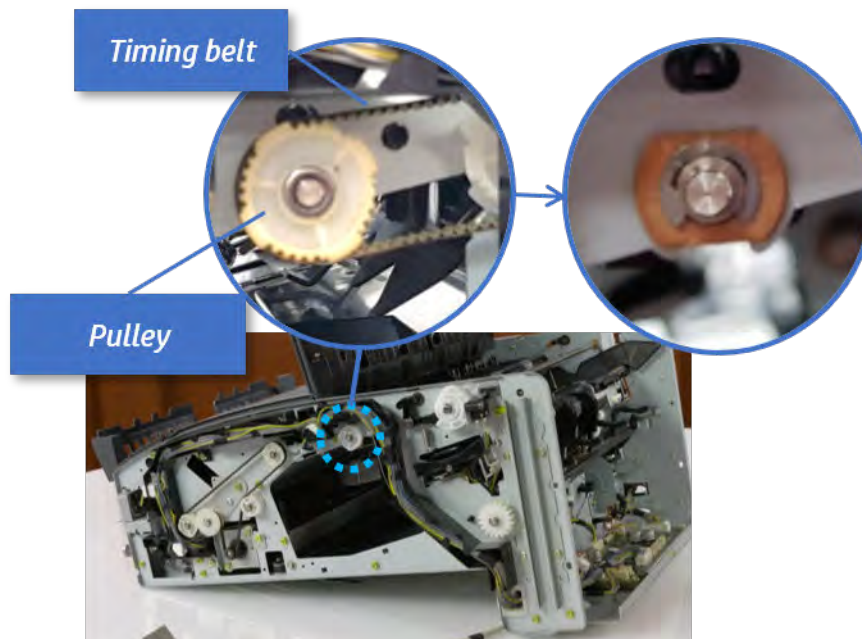

3. Lift up and remove the sub paddle unit.

Figure 7-220 Remove the sub paddle unit

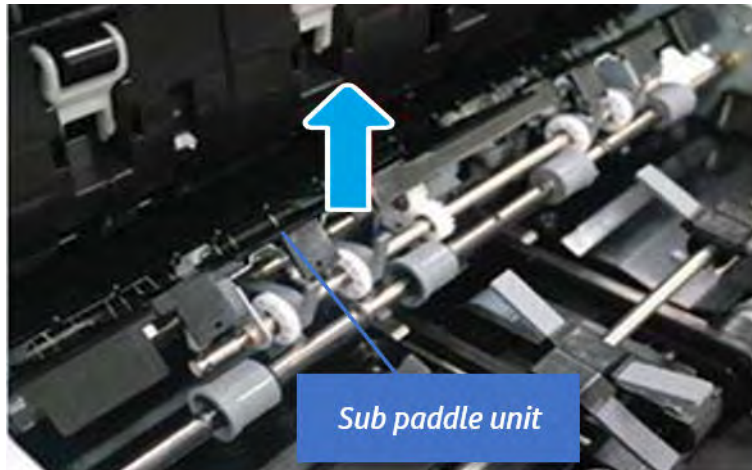

Remove the exit roller

Follow these steps to remove the exit roller.

1. Remove the guide on the center of the exit roller.

Figure 7-221 Remove the guide

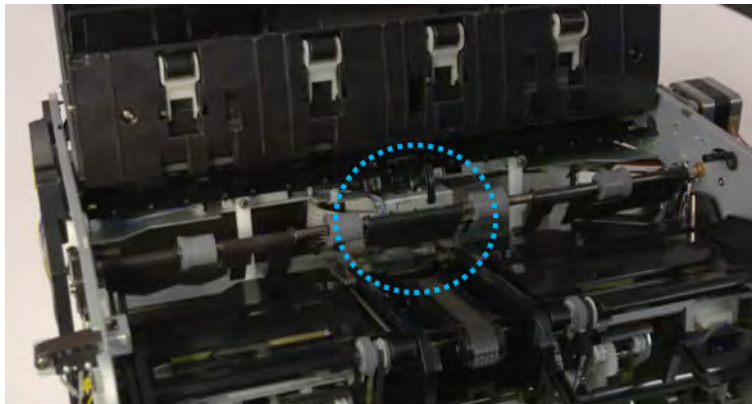

2. On the front of the inner finisher, release the timing belt connected to the exit motor.

Figure 7-222 Release the timing belt

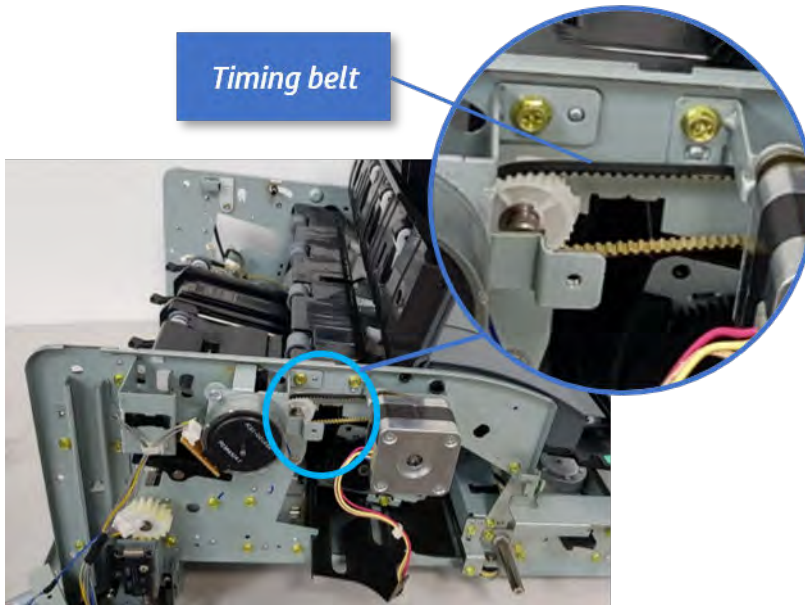

3. Remove five screws securing the rear harness guide.

Figure 7-223 Remove five screws

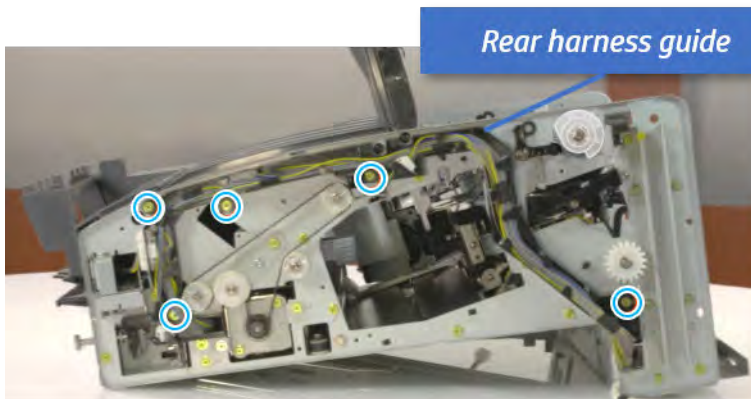

4. On the rear of the inner finisher, remove the e-ring and the pulley and then remove the e-ring and the bushing.

Figure 7-224 Remove e-ring, pulley, and bushing

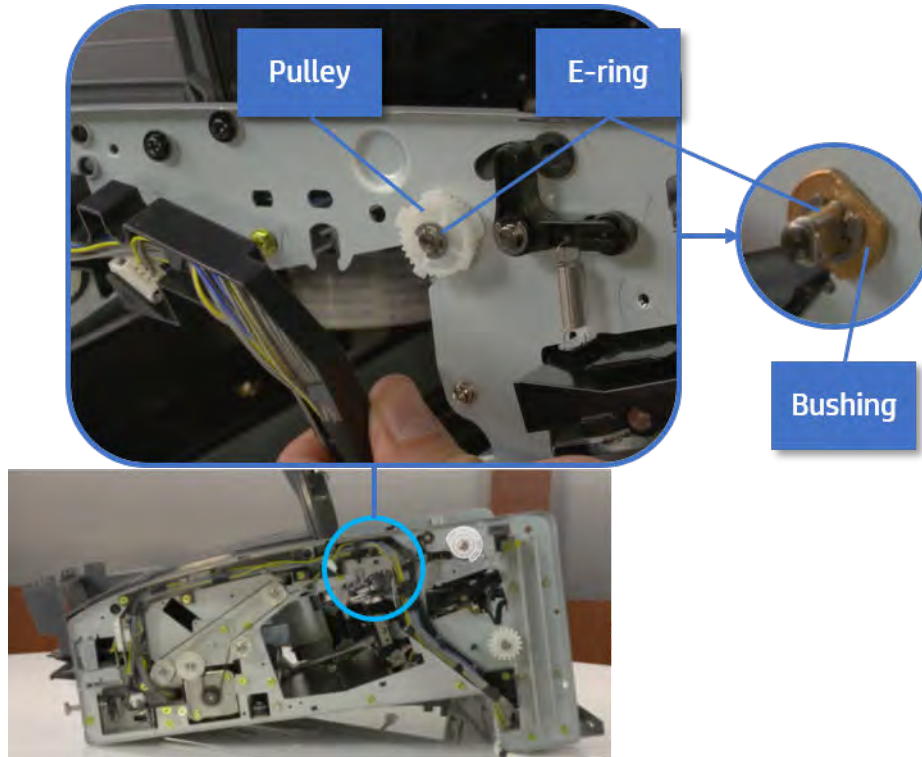

5. Push the bushing to detach it, and then remove the exit roller.

Figure 7-225 Remove the exit roller

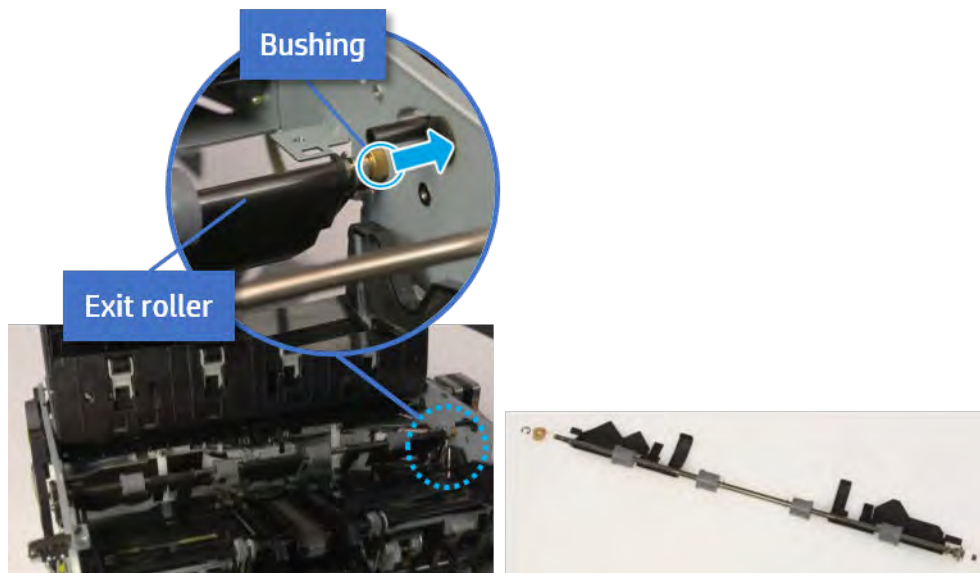

Remove the front tamper

Follow these steps to remove the front tamper.

1. Remove four screws.

Figure 7-226 Remove four screws

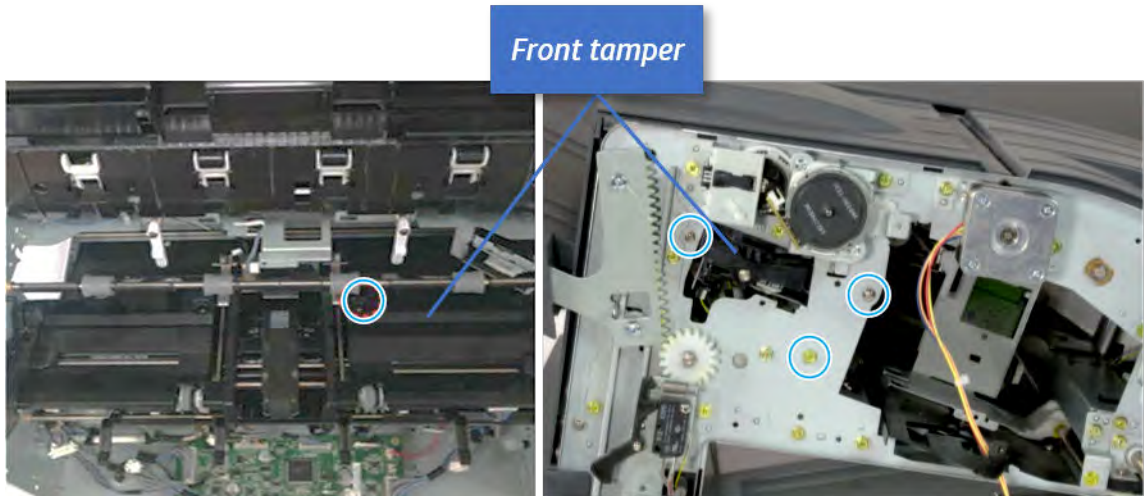

2. Unplug the connector and release the hook, and then pull the front tamper up to remove.

Figure 7-227 Remove the front tamper

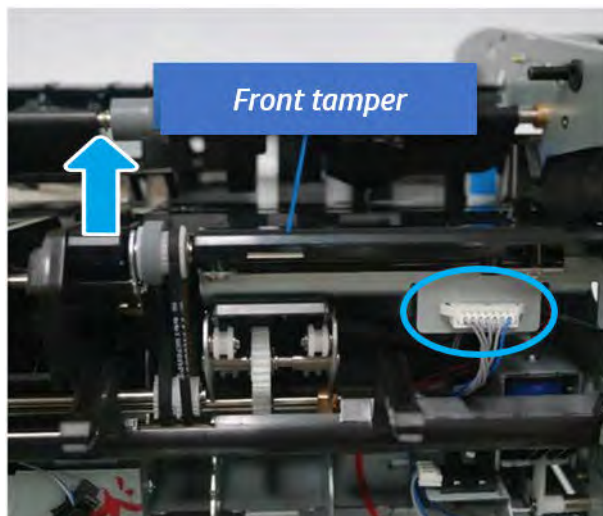

Remove the rear tamper

Follow these steps to remove the rear tamper.

1. Remove four screws.

 **NOTE:** Move cable guide out of position to access the screws.

Figure 7-228 Remove four screws



2. Unplug two connectors and release the hook, and then remove the rear tamper.

Figure 7-229 Remove the rear tamper

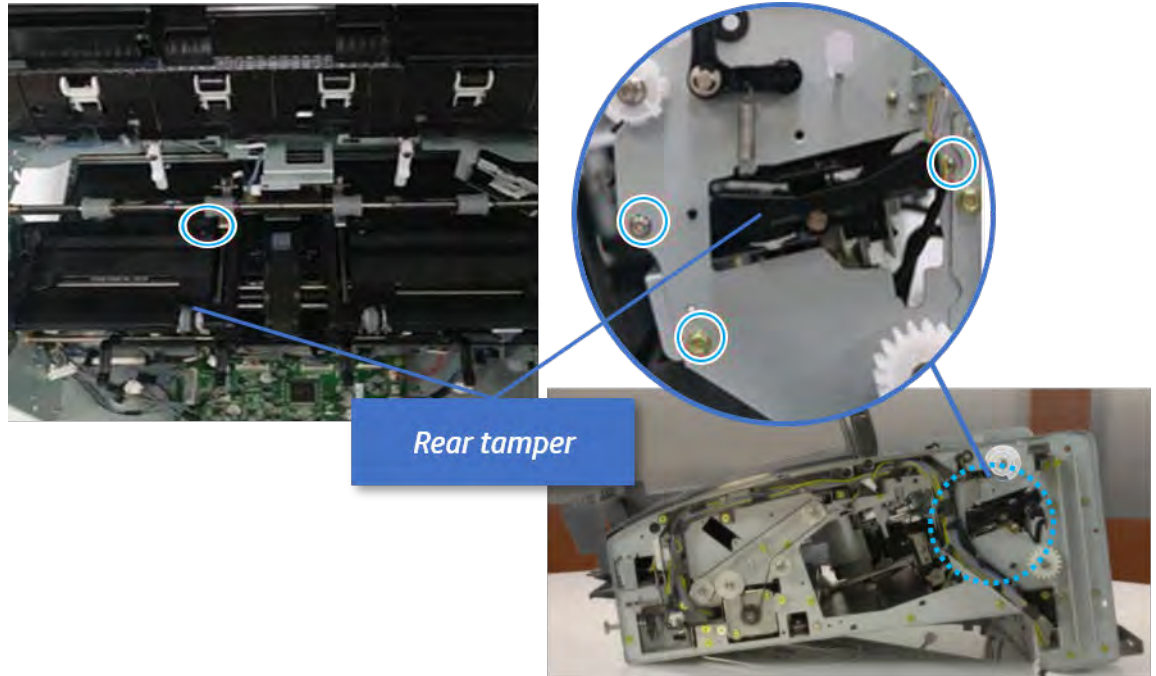
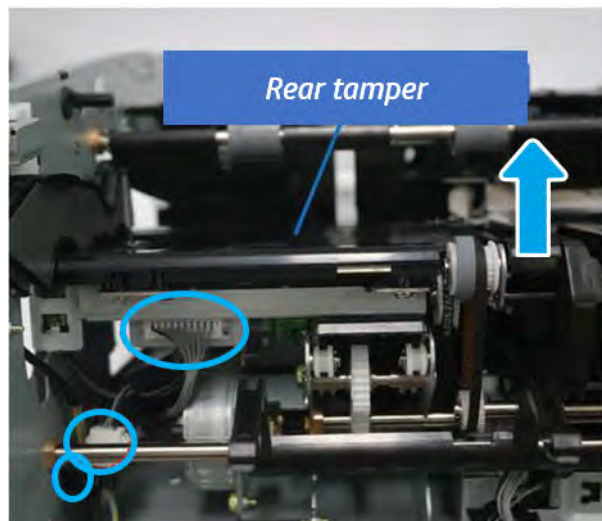

Remove the ejector & paper support assembly

Follow these steps to remove the ejector & paper support assembly.

1. Open one clamp, disconnect one connector.

Figure 7-230 Disconnect one connector

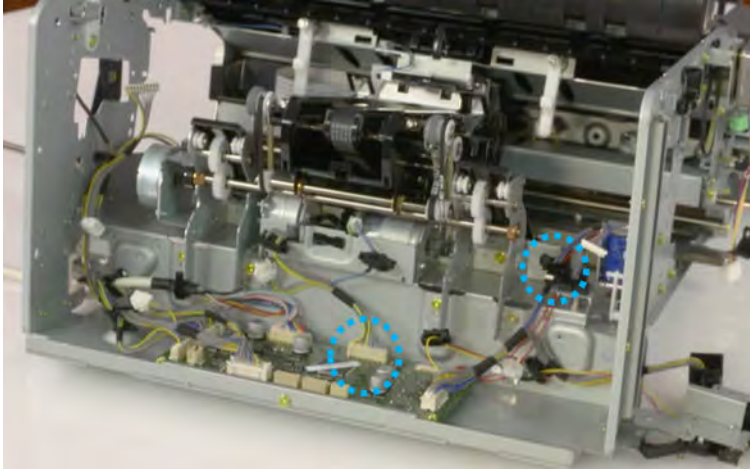

2. Pull the rear paper support up, and then release one clamp and disconnect two connectors.

Figure 7-231 Disconnect two connector

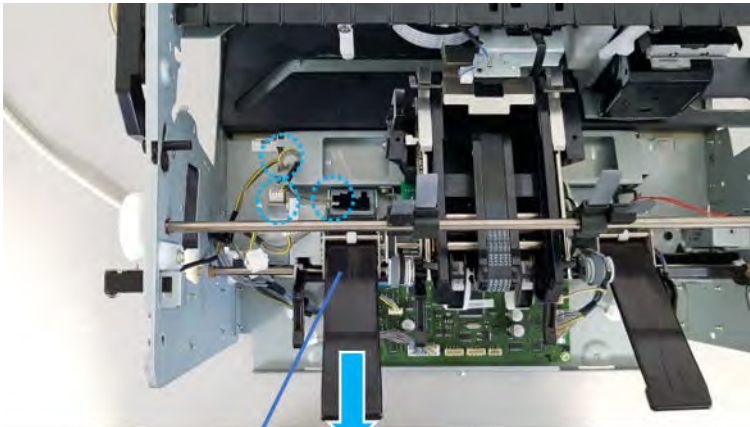

Rear paper support

3. Remove four screws, and then remove the ejector & paper support assembly.

Figure 7-232 Remove the ejector & paper support assembly

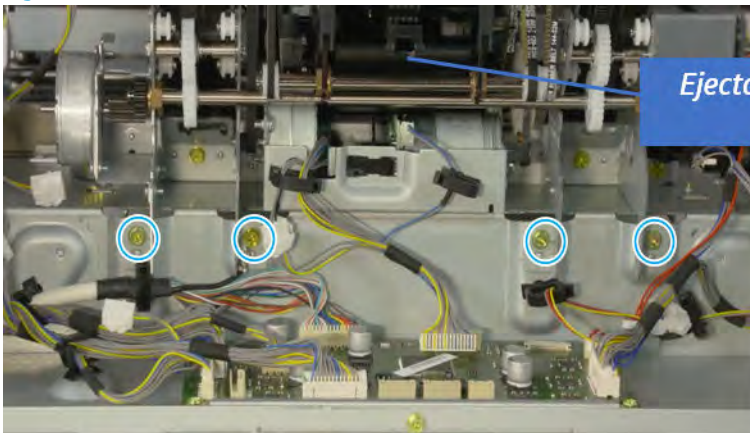

*Ejector & paper support
assembly*

Remove the rear paper support

Follow these steps to remove the rear paper support.

1. Remove one screw.

Figure 7-233 Remove one screw

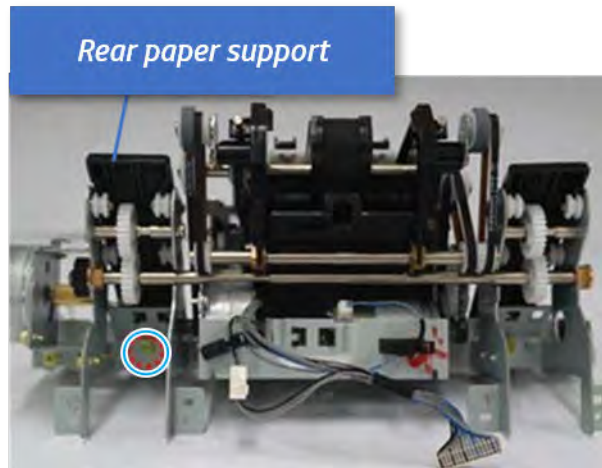

2. Remove the shaft while pulling the bushing in the direction of the arrow.

Figure 7-234 Remove the shaft

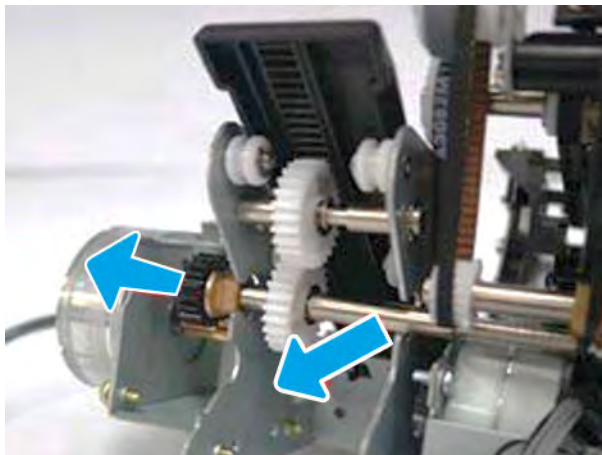

3. Remove the rear paper support with attention for pinion.

Figure 7-235 Remove the rear paper support



Remove the paper support home sensor

Follow these steps to remove the paper support home sensor.

- ▲ Remove the sensor from the rear paper support.

Figure 7-236 Remove the paper support home sensor



Unpack the replacement assembly

Follow these steps to unpack the replacement assembly.

1. Dispose of the defective part.

 **NOTE:** HP recommends responsible disposal of the defective part.

<http://www8.hp.com/us/en/hp-information/environment/product-recycling.html>

2. Unpack the replacement part from the packaging.



CAUTION:  Some parts are sensitive to electrostatic discharge (ESD). Always perform service work at an ESD-protected workstation or mat. If an ESD workstation or mat is not available, touch the sheet-metal chassis to provide a static ground before touching an ESD-sensitive assembly. Protect the ESD-sensitive assemblies by placing them in ESD pouches when they are out of the printer.

 **IMPORTANT:** Make sure that all of the shipping materials (for example shipping tape) are removed from the replacement part prior to installation.

 **NOTE:** If the replacement part is a roller or pad, avoid touching the spongy part of it. Skin oils on the roller or pad can cause paper pickup and/or print-quality problems. HP recommends using disposable gloves when handling rollers or pads or washing your hands before touching rollers or pads.

3. To install an assembly, reverse the removal steps.

 **NOTE:** When applicable, special installation instructions are provided for an assembly at the end of the removal procedure. Always completely read the removal instructions and follow all special installation instructions.

Removal and replacement: Paper support motor (M8)

Learn how to remove and replace the paper support motor.

To view teardown and reassembling video of the inner finisher, click the link below.



[View a teardown video of the inner finisher.](#)



[View a reassembling video of the inner finisher.](#)



IMPORTANT: When applicable, special installation instructions are provided for an assembly at the end of the removal procedure. Always completely read the removal instructions and follow all special installation instructions.

Mean time to repair:

Service level:

Before performing service

Turn the printer power off

- Press the power button on the front of the printer, and then turn off the power switch next to the power cable.
- A shutting-down message appears on the control-panel display.



WARNING! To avoid damage to the printer, turn the power off and wait until the printer shuts down before removing the power cable.

- Disconnect the printer power cable after the printer has completely shut down (the control-panel display is blank).

Use the table below to identify the correct part number for your printer. To order the part, go to www.hp.com/buy/parts.

Table 7-47 Part information

Part number	Part description
JC93-00802B (not orderable)	Paper support motor assembly
JC31-00149A (not orderable)	Paper support motor

Required tools

- #2 JIS screwdriver with a magnetic tip

After performing service

Turn the printer power on

- Connect the power cable.
- Use the power switch to turn the power on.

Post service test

Print any pages necessary to verify that the repair resolved the issue and did not create any new issues.

Remove the front cover

Follow these steps to remove the front cover.

1. Open the front door and open the punch cover.
2. Remove three screws in the front.
3. Remove the lever.
4. Open the top cover.
5. From the right side of the front cover, carefully lift and pry toward the top-left corner to remove the front cover.

Figure 7-237 Remove the front cover

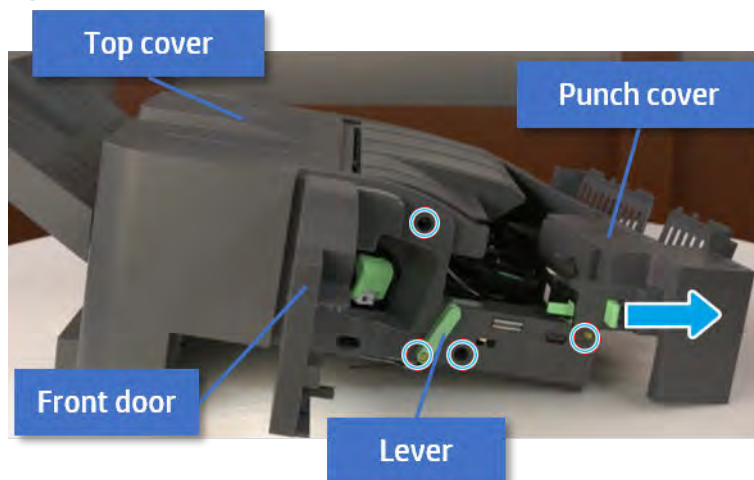

Remove the rear cover

Follow these steps to remove the rear cover.

1. Open the top cover.

Figure 7-238 Open the top cover

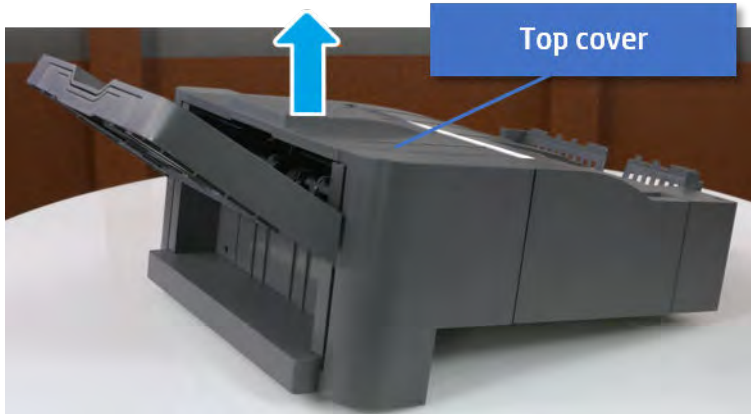

2. Remove three screws.
3. Release hooks carefully and remove the rear cover.

Figure 7-239 Remove the rear cover

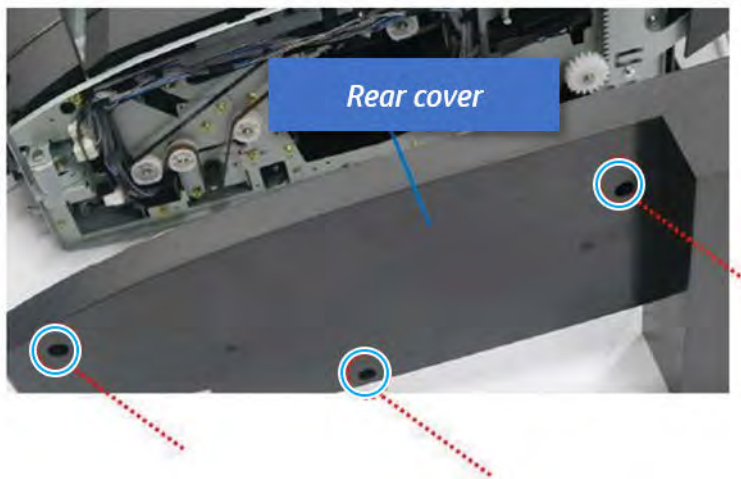

Remove the output tray

Follow these steps to remove the output tray.

1. Remove four screws.

Figure 7-240 Remove four screws

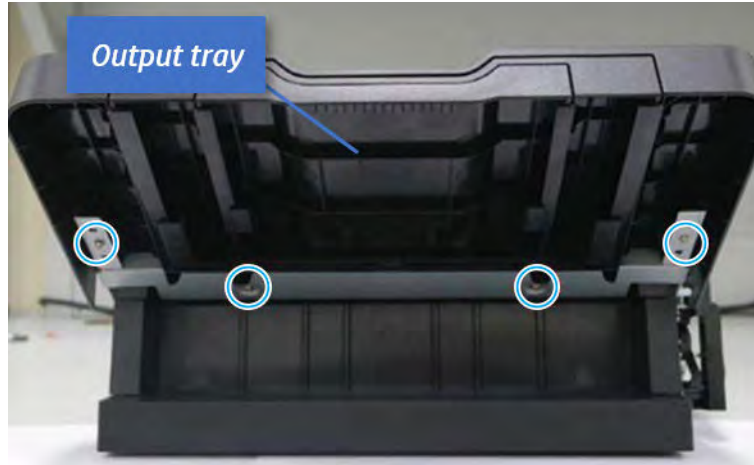

2. Push the paper holding actuator into the inner finisher, and then remove the output tray.

Figure 7-241 Remove the output tray.



Remove the output tray frame

Follow these steps to remove the output tray frame.

1. Rotate the pulley until the output tray frame depart from the gear.

Figure 7-242 Remove the pulley

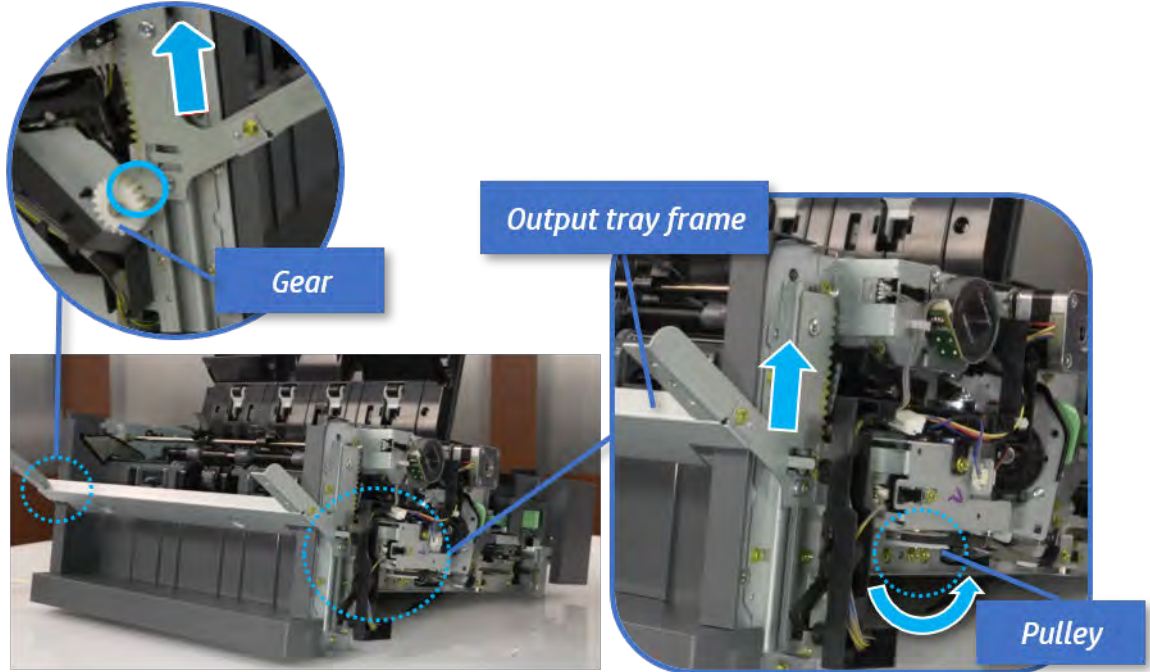

2. Push the paper holding actuator into the inner finisher, and then remove the output tray frame.

Figure 7-243 Remove the output tray frame

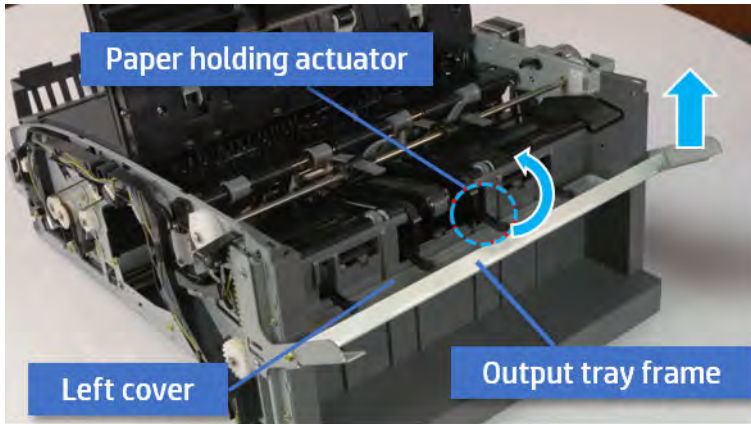

 **TIP:** Push the paper holding actuator into the inner finisher when reassembling. Be sure to level the output tray.

- a. Position the first wheel into the channel on both sides while pushing the paper holding actuator.

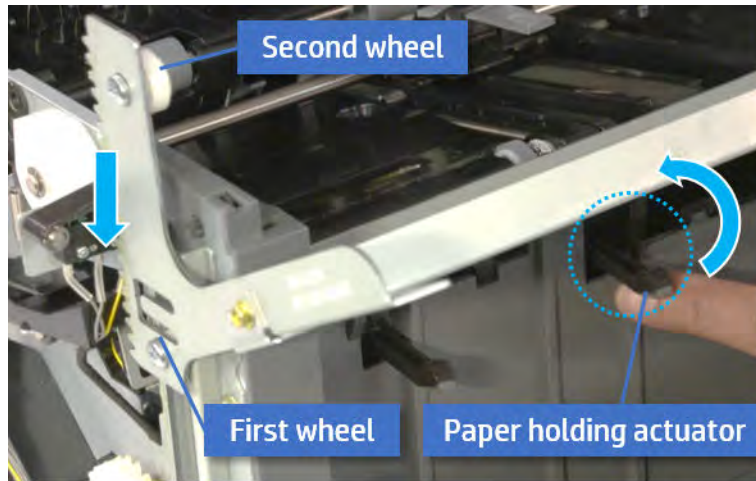

- b. Let the second wheel rest on the channel on both sides simultaneously.
- c. Gently squeeze the wheels into channel until the output tray frame meet the gear.

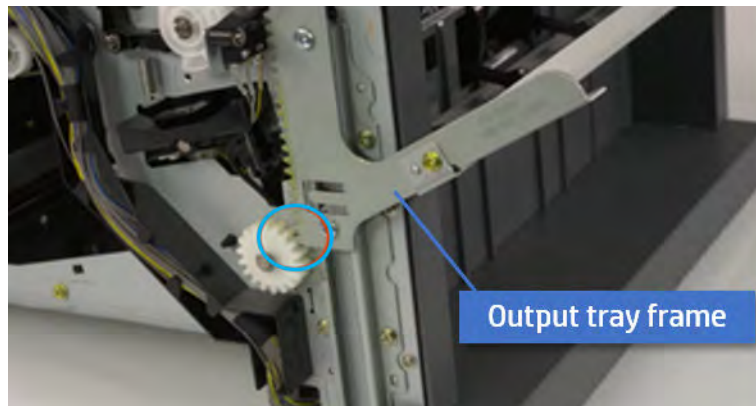

- d. Rotate the pulley until the output tray frame is no longer lifted. It can make to level the output tray frame.

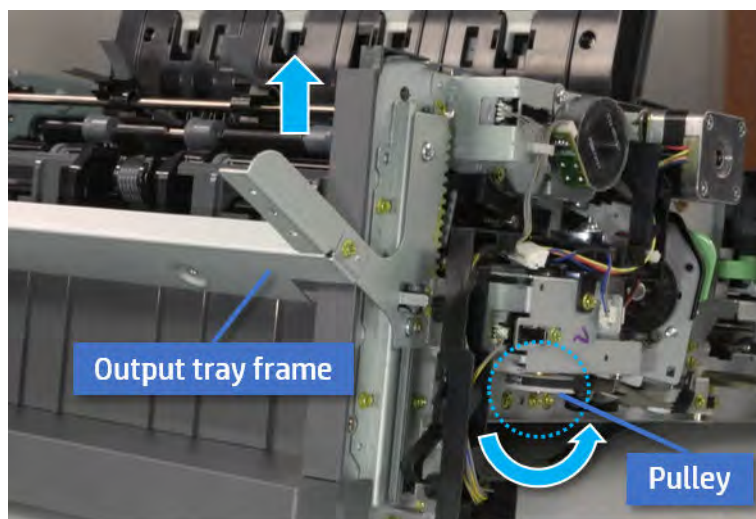

- e. Rotate the pulley in the opposite direction.

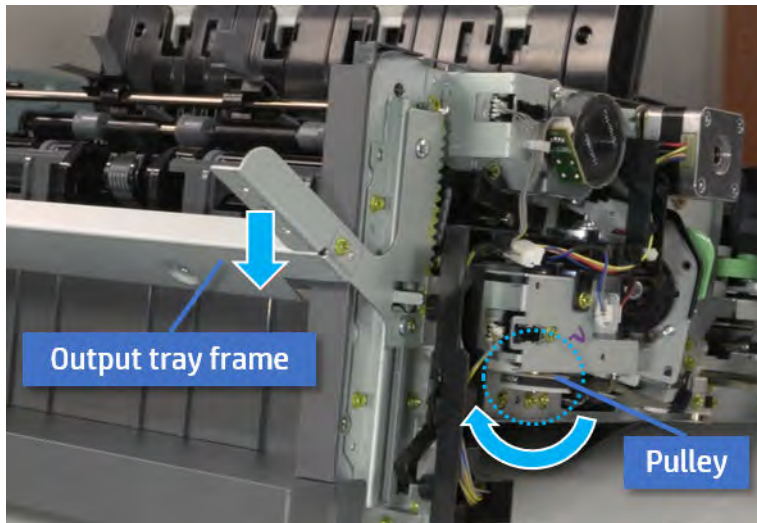

Remove the PCA cover

Follow these steps to remove the PCA cover.

- ▲ Remove two screws, and then remove the PCA cover.

Figure 7-244 Remove the PCA cover

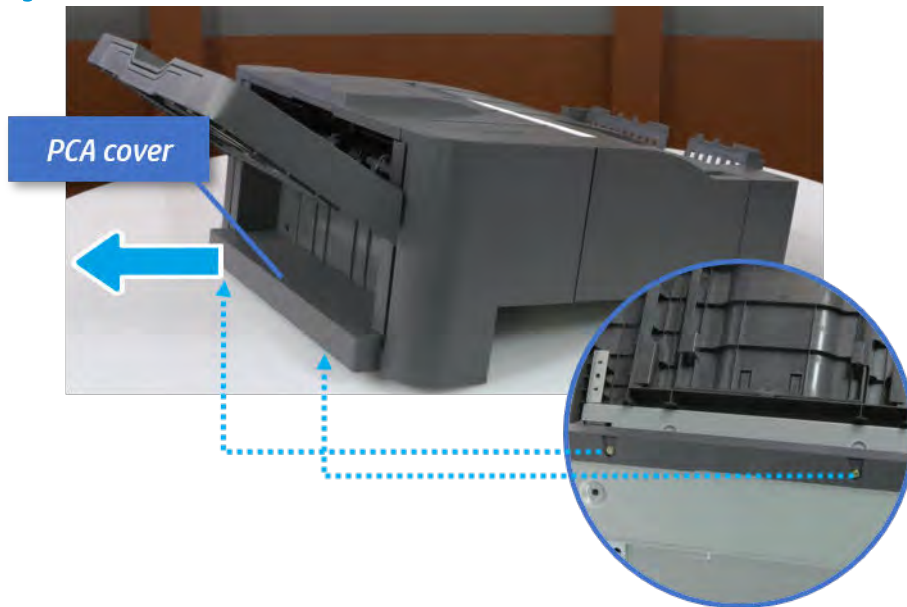

Remove the left cover

Follow these steps to remove the left cover.

1. Remove two screws.

Figure 7-245 Remove two screws

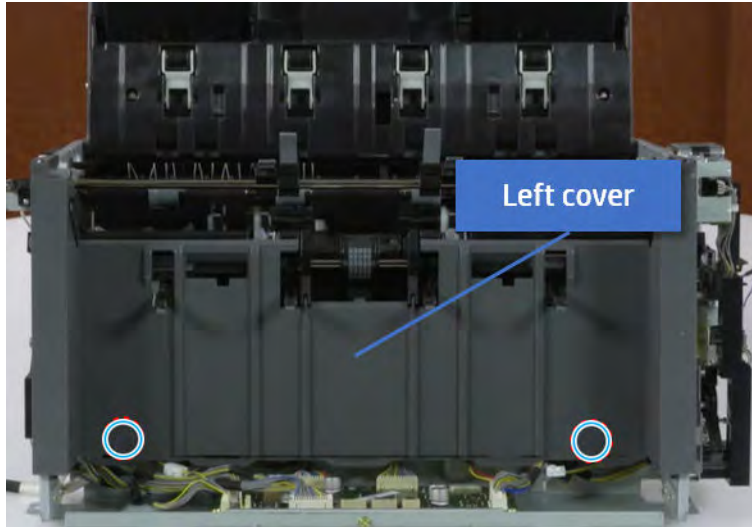

2. Remove four screws from both front and rear sides.

Figure 7-246 Remove four screws

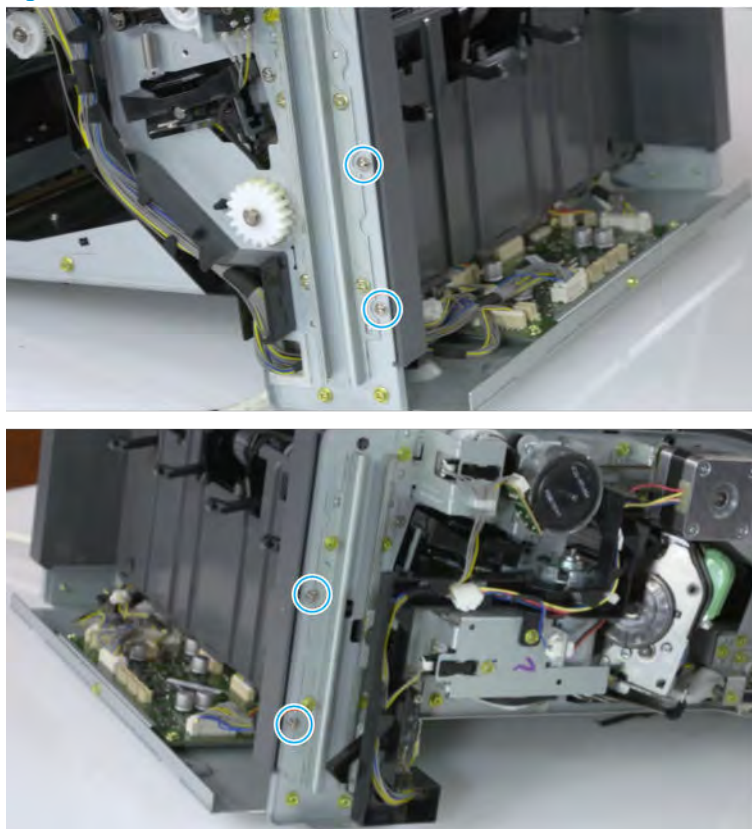

3. Unplug two inline connectors, and then remove the left cover.

Figure 7-247 Unplug two connectors

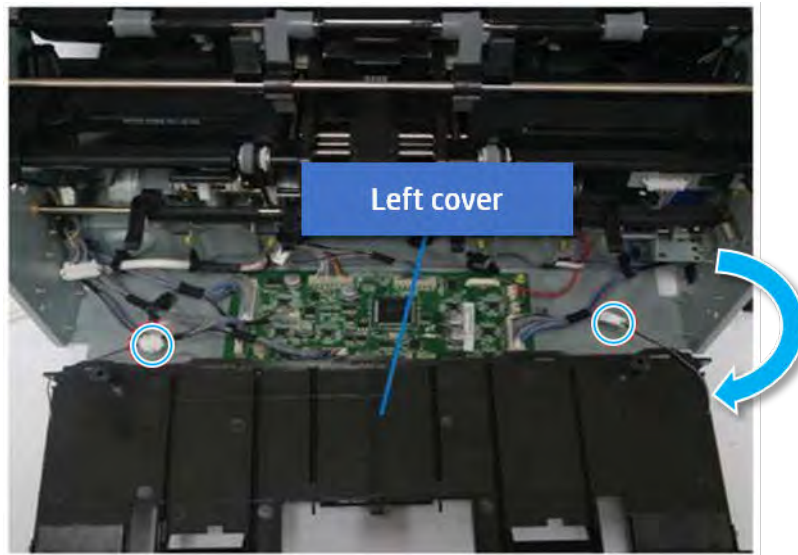

 **TIP:** Be sure to check the hook when reassembling.

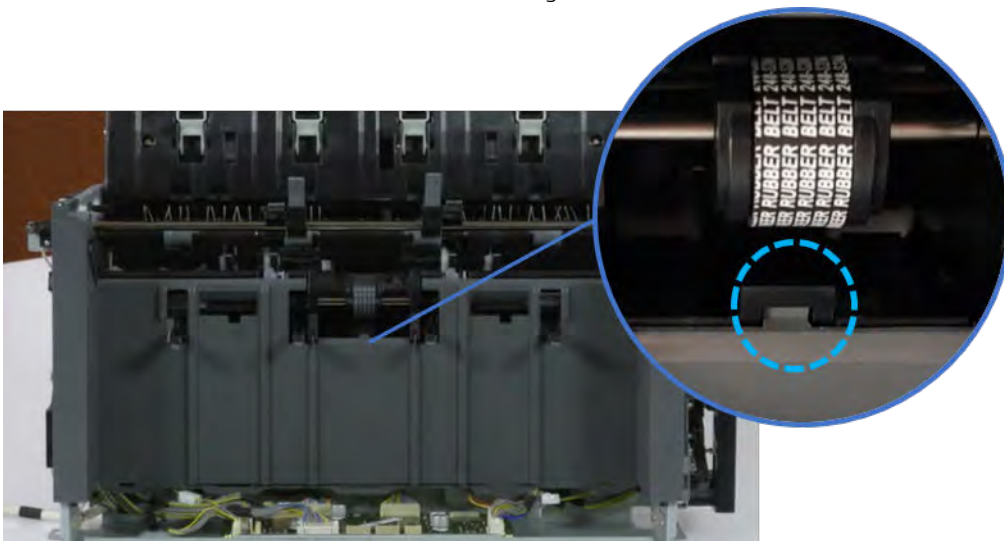

Remove the front harness guide

Follow these steps to remove the front harness guide.

1. Open one clamp and unplug five connectors, and then remove the wire harness from the front harness guide.

2. Remove four screws, and then remove the front harness guide.

Figure 7-248 Remove the front harness guide

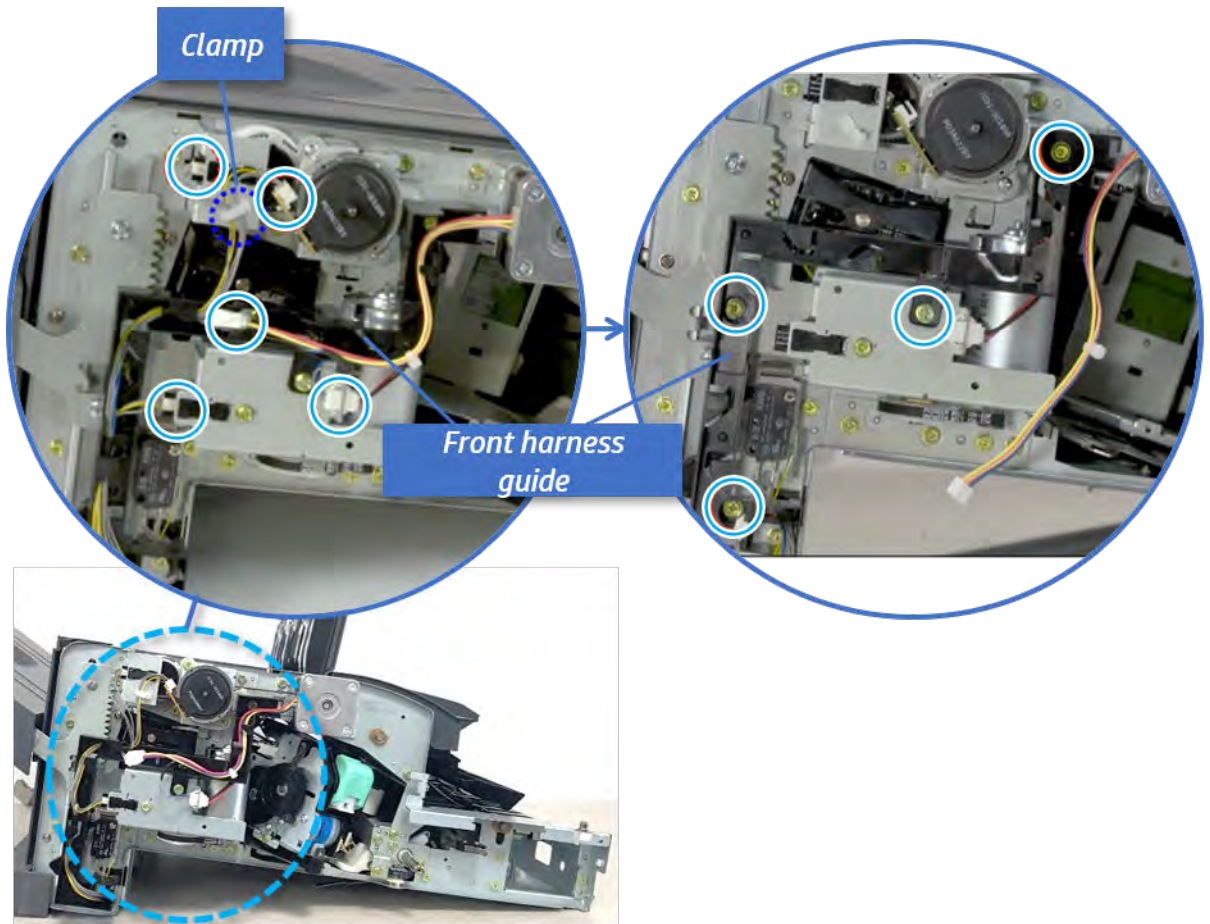

Remove the output tray motor assembly

Follow these steps to remove the output tray motor assembly.

- ▲ Remove three screws, and then remove the output tray motor assembly.

Figure 7-249 Remove the output tray motor assembly

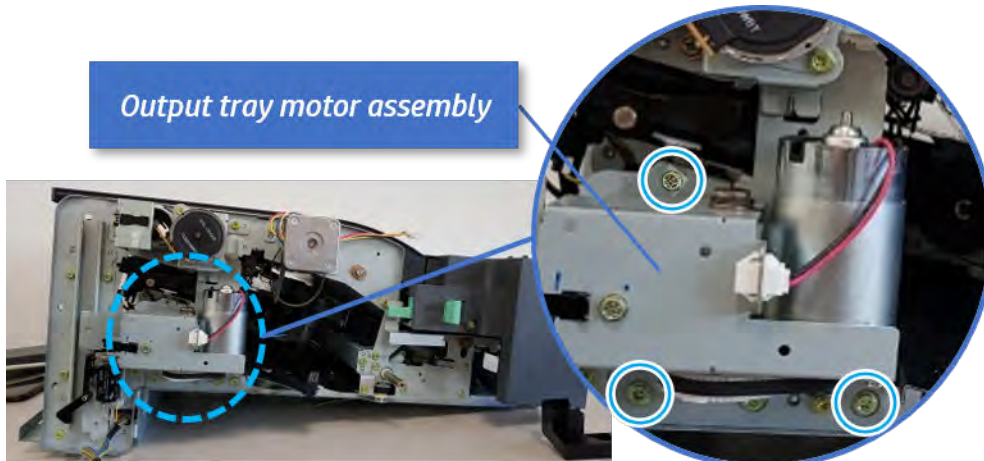

Remove the output tray lower limit switch

Follow these steps to remove the output tray lower limit switch.

- ▲ Remove one screw, and then remove the output tray lower limit switch.

Figure 7-250 Remove the output tray lower limit switch

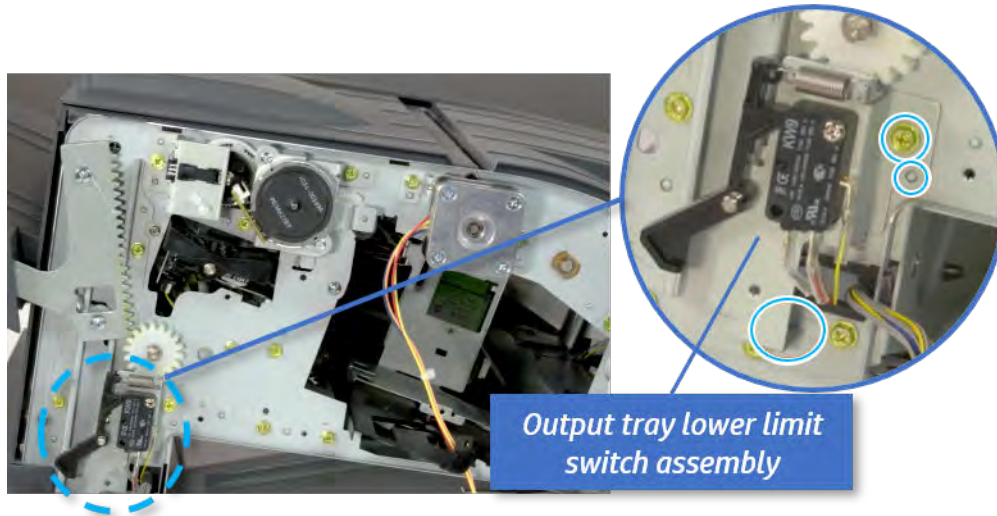

Remove the paper holding

Follow these steps to remove the paper holding.

1. Remove the paper holding actuator spring.

Figure 7-251 Remove the paper holding actuator spring

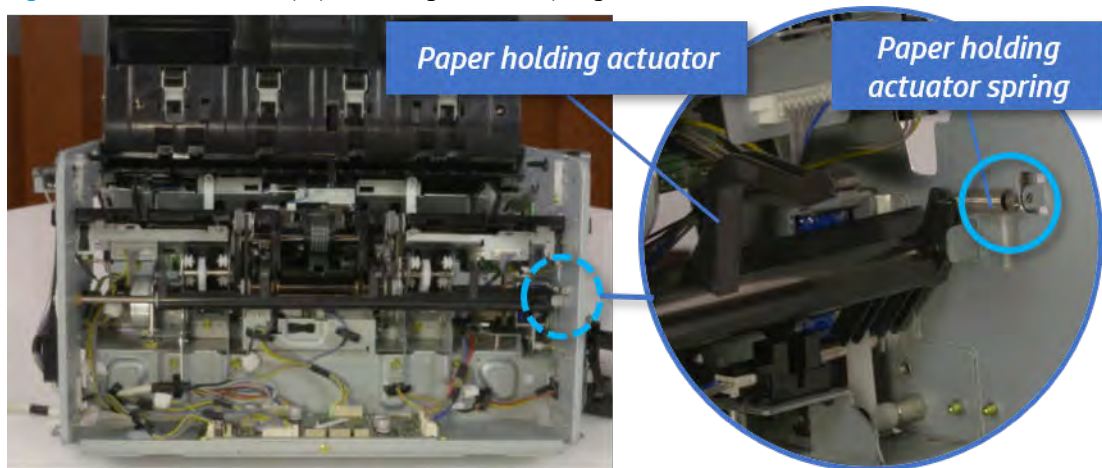

2. Remove the e-ring and the rack pinion gear. And then remove the pin and the e-ring, and then remove the bushing.

Figure 7-252 Remove e-ring, rack pinion gear, pin, and bushing

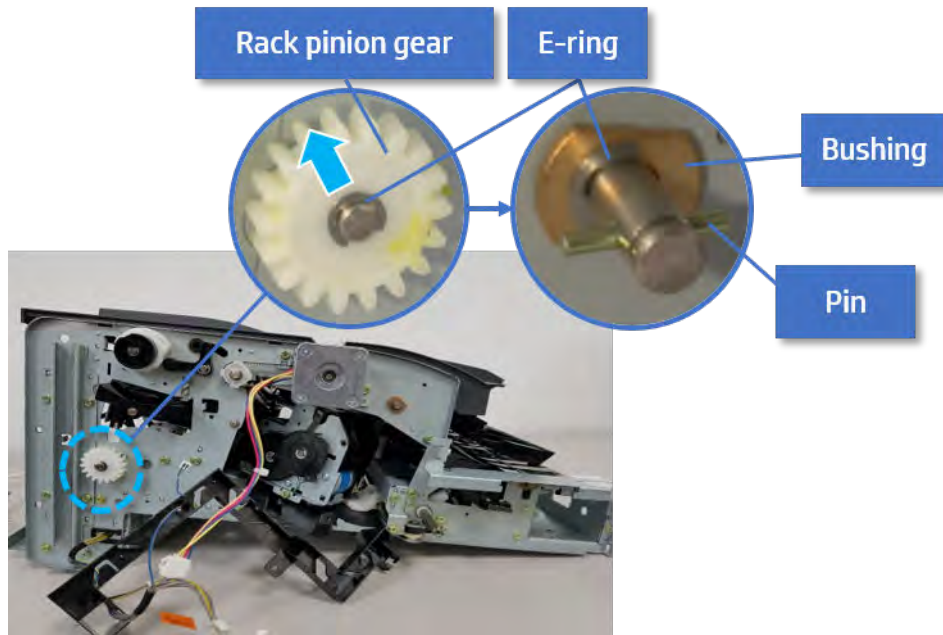

 **NOTE:** Be sure not to lose the pin.

3. Carefully remove the paper holding shaft and the actuator.

Figure 7-253 Remove the paper holding shaft and the actuator

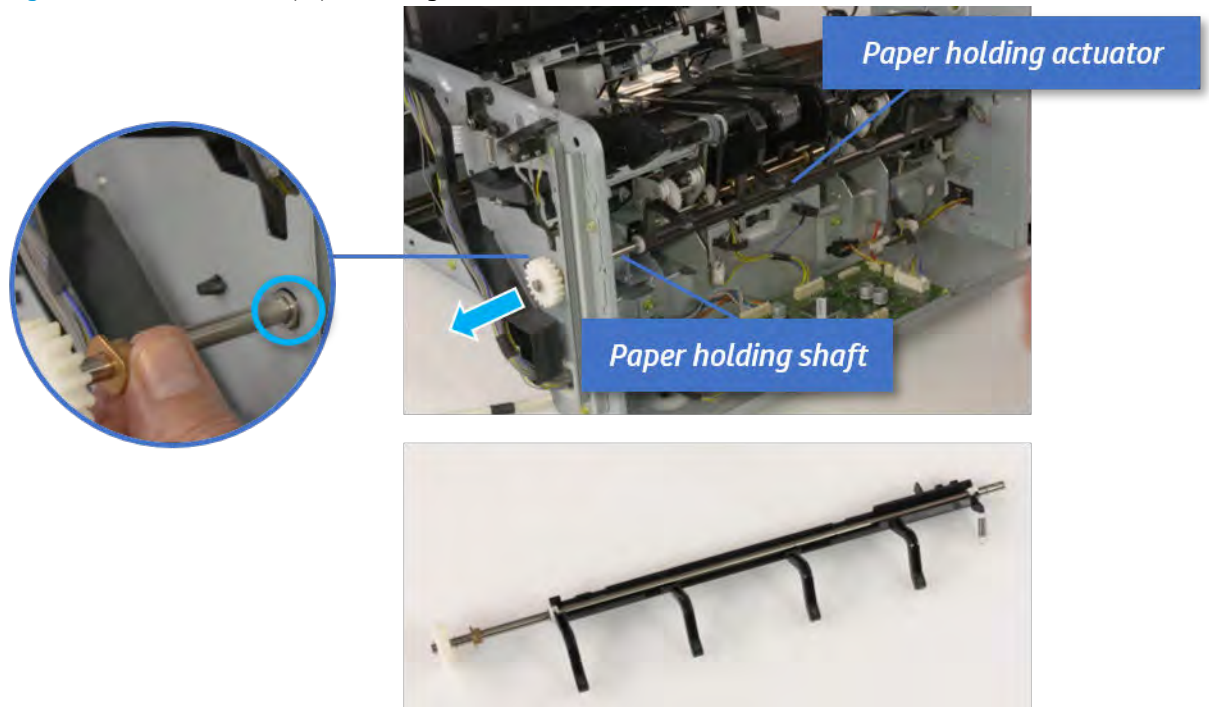

Remove the sub paddle unit

Follow these steps to remove the sub paddle unit.

1. Open the top cover, and then remove one screw securing the sub paddle unit.

Figure 7-254 Remove one screw

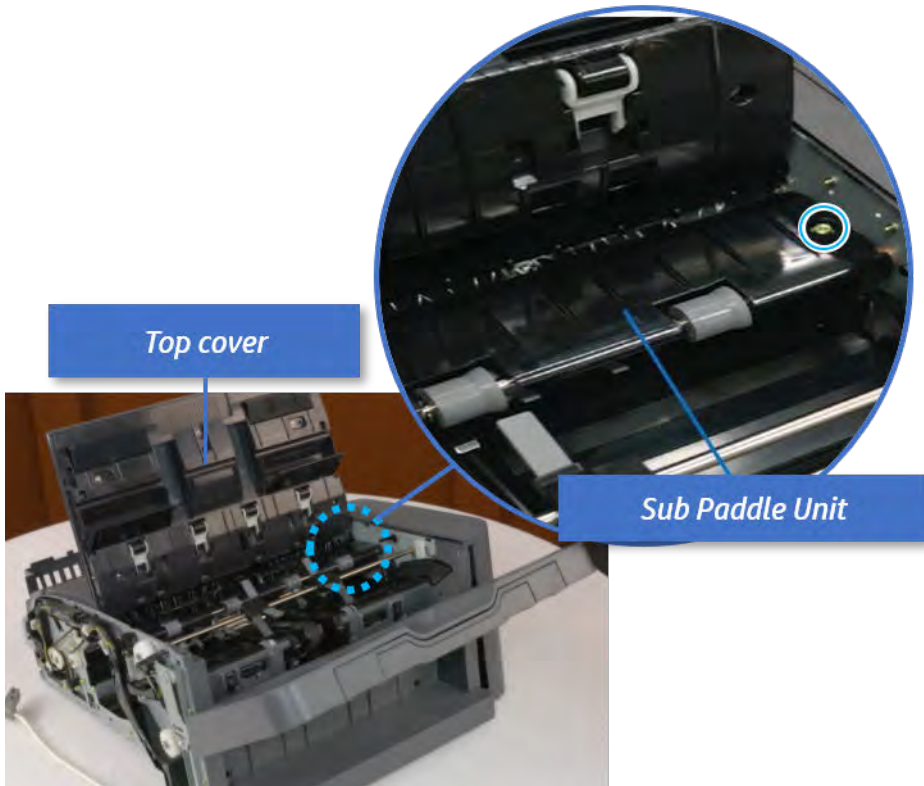

2. Remove the e-ring, and then remove the pulley and timing belt. And then remove the e-ring and the bushing.

Figure 7-255 Remove the e-ring, pulley, timing belt, and bushing

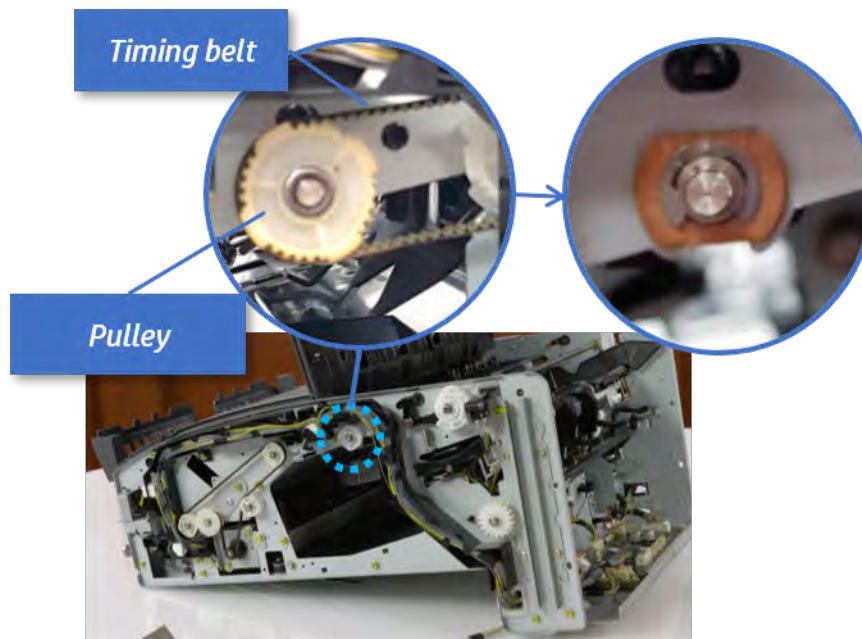

3. Lift up and remove the sub paddle unit.

Figure 7-256 Remove the sub paddle unit

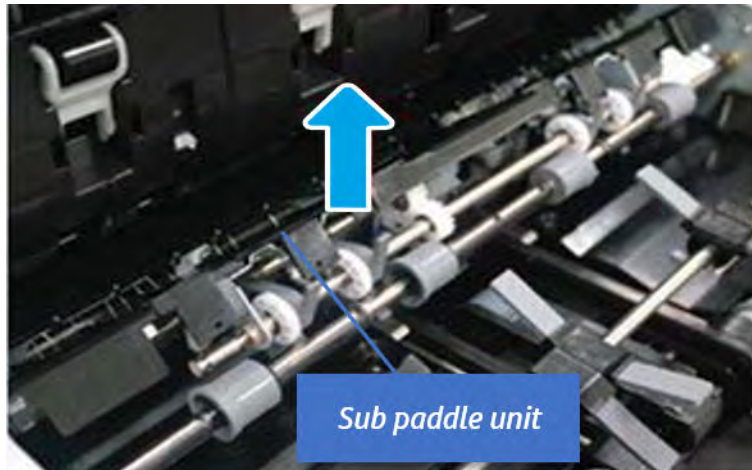

Remove the exit roller

Follow these steps to remove the exit roller.

1. Remove the guide on the center of the exit roller.

Figure 7-257 Remove the guide

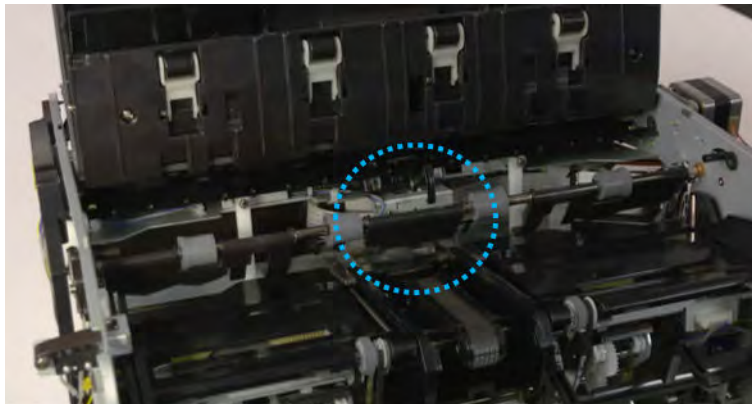

2. On the front of the inner finisher, release the timing belt connected to the exit motor.

Figure 7-258 Release the timing belt

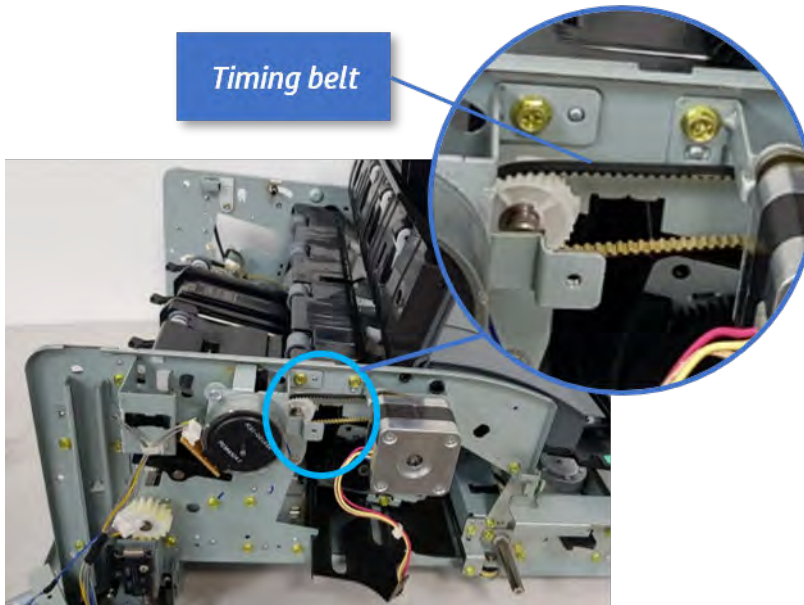

3. Remove five screws securing the rear harness guide.

Figure 7-259 Remove five screws

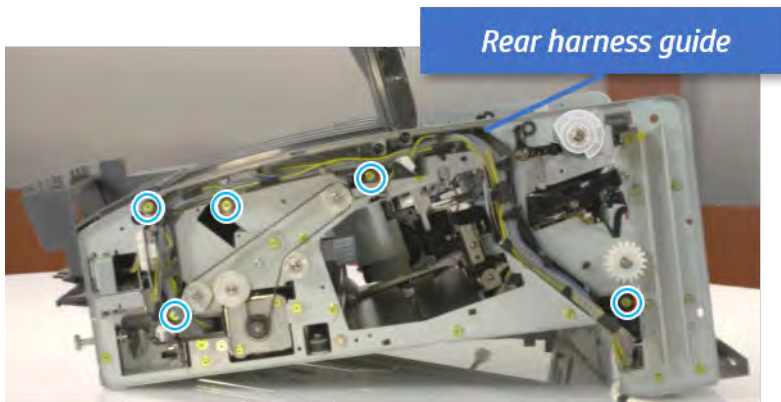

4. On the rear of the inner finisher, remove the e-ring and the pulley and then remove the e-ring and the bushing.

Figure 7-260 Remove e-ring, pulley, and bushing

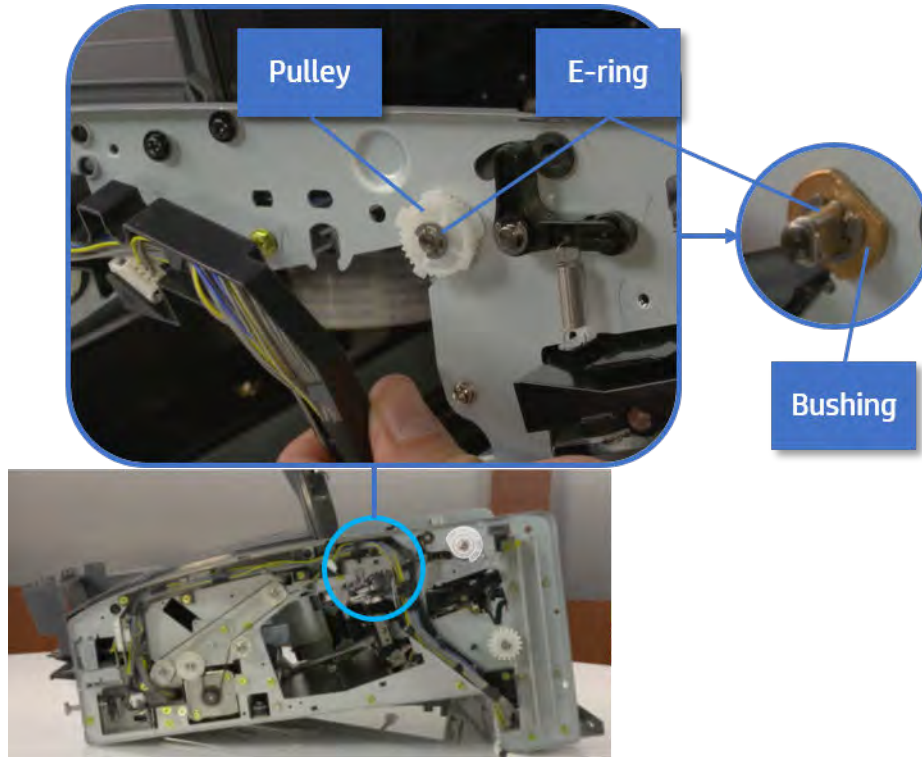

5. Push the bushing to detach it, and then remove the exit roller.

Figure 7-261 Remove the exit roller

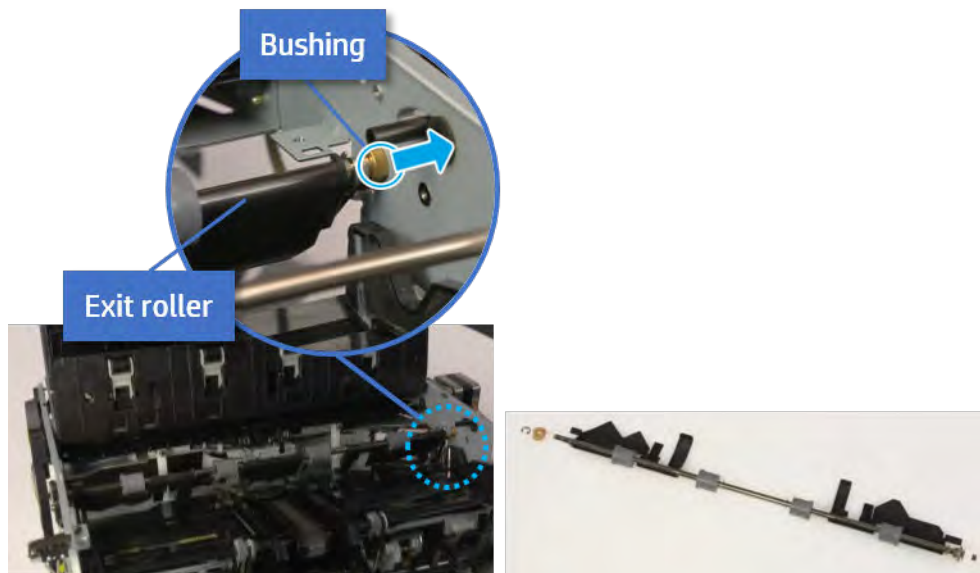

Remove the front tamper

Follow these steps to remove the front tamper.

1. Remove four screws.

Figure 7-262 Remove four screws

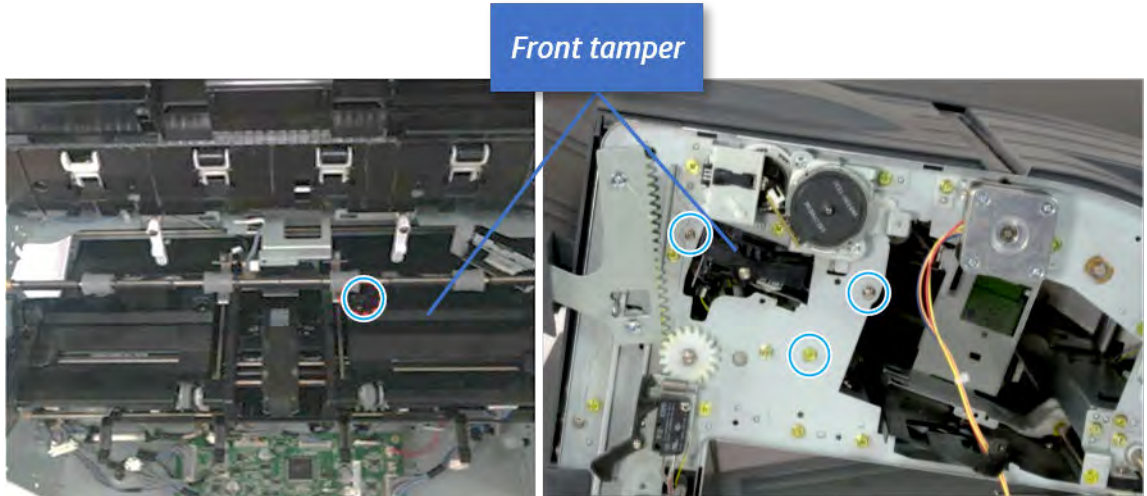

2. Unplug the connector and release the hook, and then pull the front tamper up to remove.

Figure 7-263 Remove the front tamper

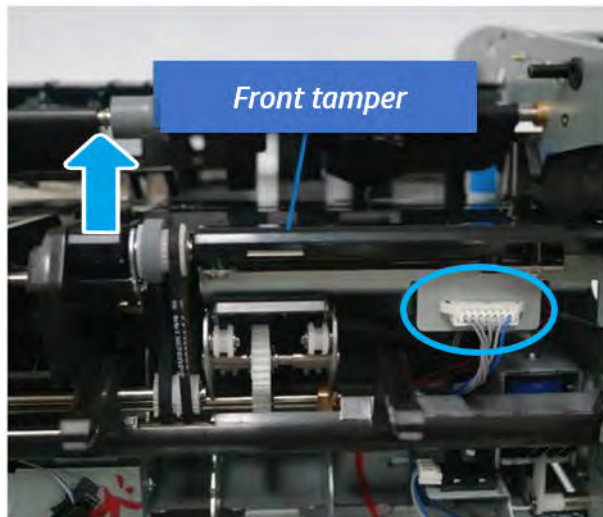

Remove the rear tamper

Follow these steps to remove the rear tamper.

1. Remove four screws.

 **NOTE:** Move cable guide out of position to access the screws.

Figure 7-264 Remove four screws



2. Unplug two connectors and release the hook, and then remove the rear tamper.

Figure 7-265 Remove the rear tamper

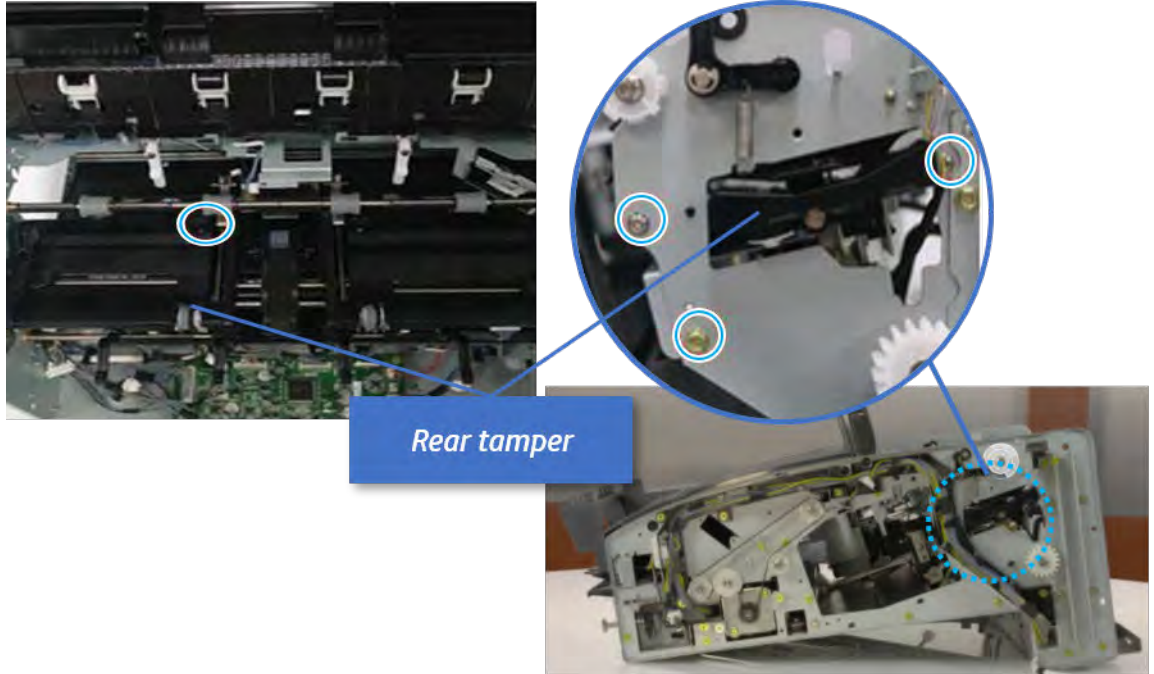
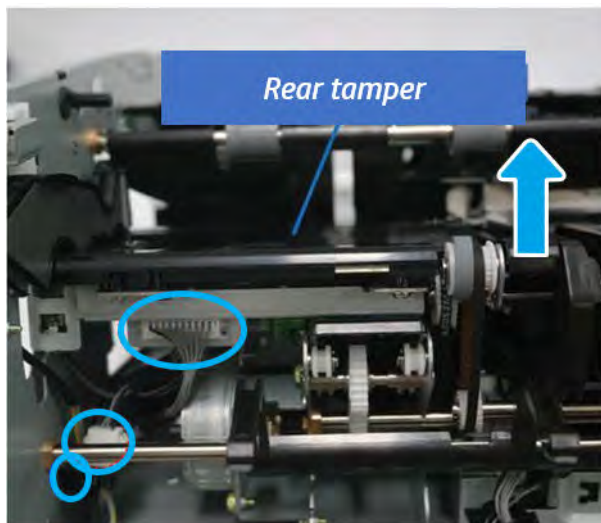

Remove the ejector & paper support assembly

Follow these steps to remove the ejector & paper support assembly.

1. Open one clamp, disconnect one connector.

Figure 7-266 Disconnect one connector

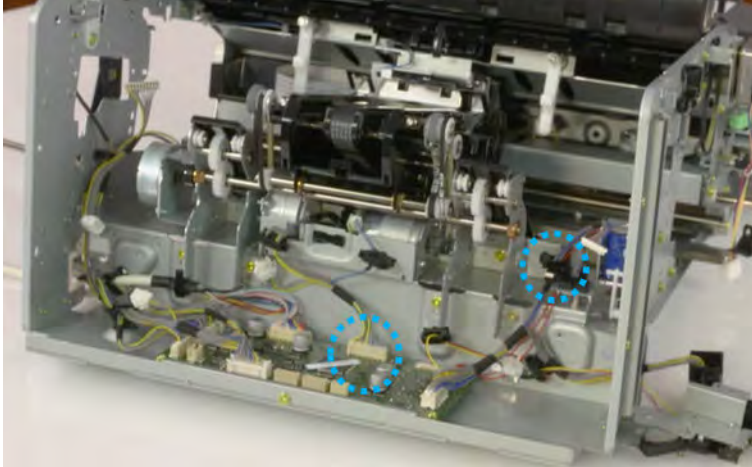

2. Pull the rear paper support up, and then release one clamp and disconnect two connectors.

Figure 7-267 Disconnect two connector

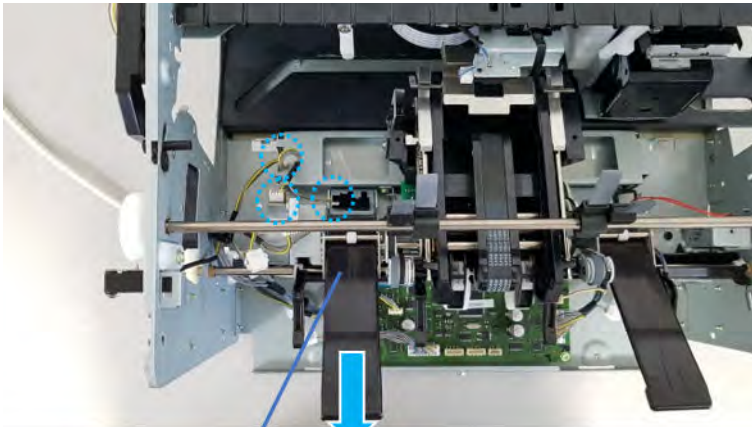

Rear paper support

3. Remove four screws, and then remove the ejector & paper support assembly.

Figure 7-268 Remove the ejector & paper support assembly

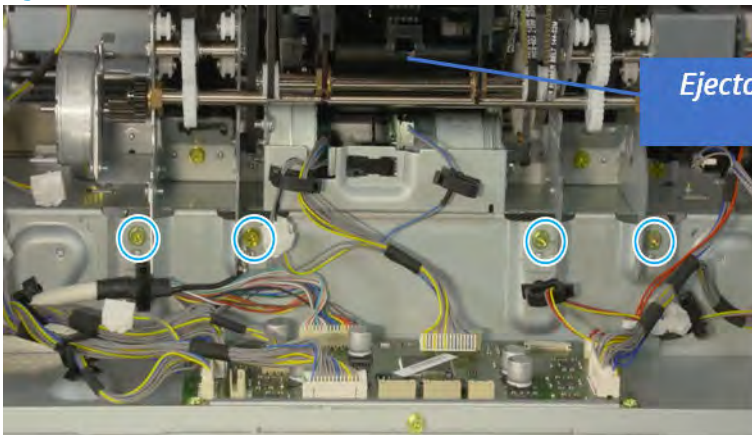

Ejector & paper support assembly

Remove the paper support motor

Follow these steps to remove the paper support motor.

- ▲ Remove two screws, disconnect one connect, and then remove the paper support motor.

Figure 7-269 Remove the paper support motor

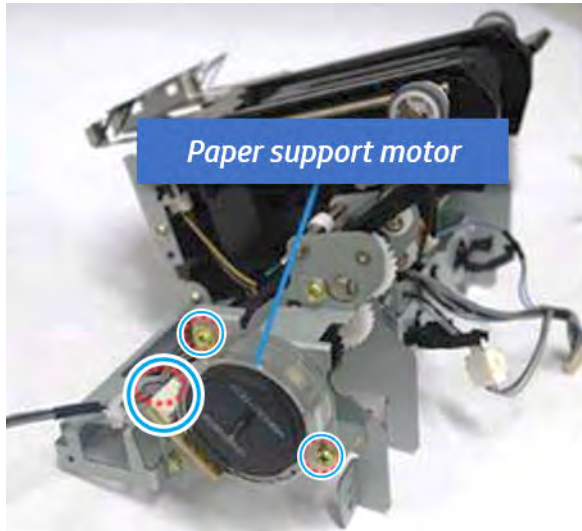

Unpack the replacement assembly



Follow these steps to unpack the replacement assembly.

1. Dispose of the defective part.

 **NOTE:** HP recommends responsible disposal of the defective part.

<http://www8.hp.com/us/en/hp-information/environment/product-recycling.html>

2. Unpack the replacement part from the packaging.

 **CAUTION:**  Some parts are sensitive to electrostatic discharge (ESD). Always perform service work at an ESD-protected workstation or mat. If an ESD workstation or mat is not available, touch the sheet-metal chassis to provide a static ground before touching an ESD-sensitive assembly. Protect the ESD-sensitive assemblies by placing them in ESD pouches when they are out of the printer.

 **IMPORTANT:** Make sure that all of the shipping materials (for example shipping tape) are removed from the replacement part prior to installation.

 **NOTE:** If the replacement part is a roller or pad, avoid touching the spongy part of it. Skin oils on the roller or pad can cause paper pickup and/or print-quality problems. HP recommends using disposable gloves when handling rollers or pads or washing your hands before touching rollers or pads.

3. To install an assembly, reverse the removal steps.

 **NOTE:** When applicable, special installation instructions are provided for an assembly at the end of the removal procedure. Always completely read the removal instructions and follow all special installation instructions.

Paddle unit

Removal and replacement: Main paddle

Learn how to remove and replace the main paddle.

To view teardown and reassembling video of the inner finisher, click the link below.



[View a teardown video of the inner finisher.](#)



[View a reassembling video of the inner finisher.](#)

IMPORTANT: When applicable, special installation instructions are provided for an assembly at the end of the removal procedure. Always completely read the removal instructions and follow all special installation instructions.

Mean time to repair:

Service level:

Before performing service

Turn the printer power off

- Press the power button on the front of the printer, and then turn off the power switch next to the power cable.
- A shutting-down message appears on the control-panel display.

WARNING! To avoid damage to the printer, turn the power off and wait until the printer shuts down before removing the power cable.

- Disconnect the printer power cable after the printer has completely shut down (the control-panel display is blank).

Use the table below to identify the correct part number for your printer. To order the part, go to www.hp.com/buy/parts.

Table 7-48 Part information

Part number	Part description
JC90-01327A	Main paddle
JC82-01038A	Main paddle kit
JC63-04957A	Main paddle A
JC63-04958A	Main paddle B
JC81-07560A	Main paddle holder

Required tools

- #2 JIS screwdriver with a magnetic tip

After performing service

Turn the printer power on

- Connect the power cable.
- Use the power switch to turn the power on.

Post service test

Print any pages necessary to verify that the repair resolved the issue and did not create any new issues.

Remove the main paddle

Follow these steps to remove the main paddle.

1. Open the top cover.
2. Rotate the main paddle shaft to see the lower side of the main paddle.

Figure 7-270 Rotate the main paddle shaft

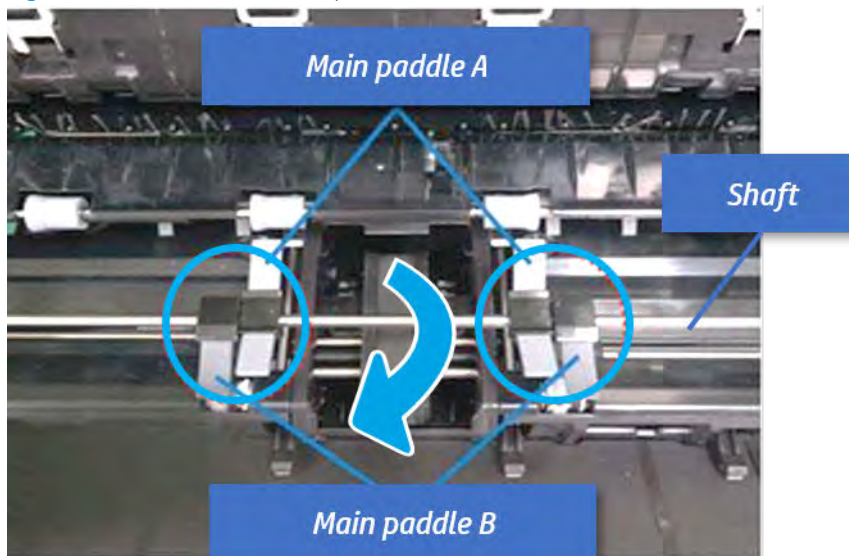

3. Remove the main paddle by pushing both sides.

Figure 7-271 Remove the main paddle

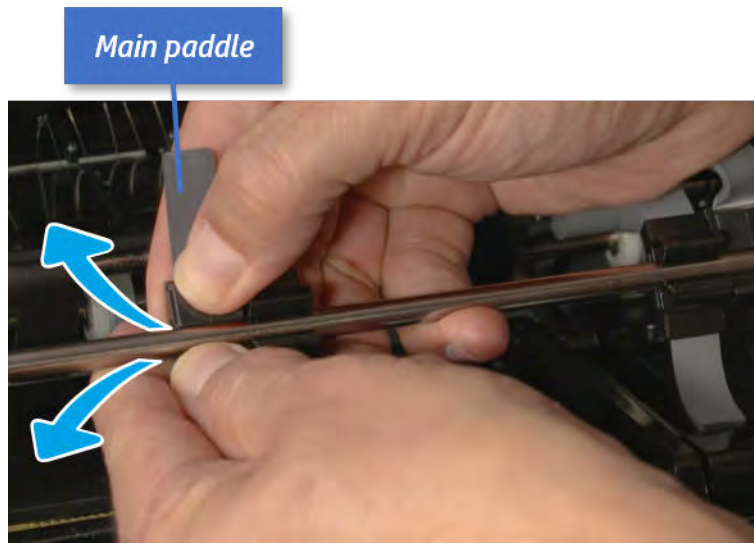

 **TIP:** When reassembling the main paddle, check the pin position of the paddle and the hole position of the shaft, and then assemble them.

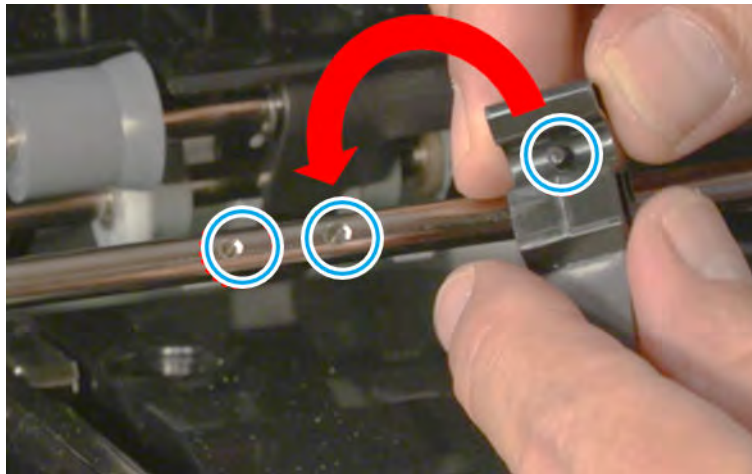

Unpack the replacement assembly

Follow these steps to unpack the replacement assembly.

1. Dispose of the defective part.

 **NOTE:** HP recommends responsible disposal of the defective part.

<http://www8.hp.com/us/en/hp-information/environment/product-recycling.html>

2. Unpack the replacement part from the packaging.



CAUTION:  Some parts are sensitive to electrostatic discharge (ESD). Always perform service work at an ESD-protected workstation or mat. If an ESD workstation or mat is not available, touch the sheet-metal chassis to provide a static ground before touching an ESD-sensitive assembly. Protect the ESD-sensitive assemblies by placing them in ESD pouches when they are out of the printer.

 **IMPORTANT:** Make sure that all of the shipping materials (for example shipping tape) are removed from the replacement part prior to installation.

 **NOTE:** If the replacement part is a roller or pad, avoid touching the spongy part of it. Skin oils on the roller or pad can cause paper pickup and/or print-quality problems. HP recommends using disposable gloves when handling rollers or pads or washing your hands before touching rollers or pads.

3. To install an assembly, reverse the removal steps.

 **NOTE:** When applicable, special installation instructions are provided for an assembly at the end of the removal procedure. Always completely read the removal instructions and follow all special installation instructions.

Removal and replacement: Main paddle home sensor (S4)

Learn how to remove and replace the main paddle home sensor.

To view teardown and reassembling video of the inner finisher, click the link below.



[View a teardown video of the inner finisher.](#)



[View a reassembling video of the inner finisher.](#)



IMPORTANT: When applicable, special installation instructions are provided for an assembly at the end of the removal procedure. Always completely read the removal instructions and follow all special installation instructions.

Mean time to repair:

Service level:

Before performing service

Turn the printer power off

- Press the power button on the front of the printer, and then turn off the power switch next to the power cable.
- A shutting-down message appears on the control-panel display.



WARNING! To avoid damage to the printer, turn the power off and wait until the printer shuts down before removing the power cable.

- Disconnect the printer power cable after the printer has completely shut down (the control-panel display is blank).

Use the table below to identify the correct part number for your printer. To order the part, go to www.hp.com/buy/parts.

Table 7-49 Part information

Part number	Part description
0604-001393	Main paddle home sensor

Required tools

- #2 JIS screwdriver with a magnetic tip

After performing service

Turn the printer power on

- Connect the power cable.
- Use the power switch to turn the power on.

Post service test

Print any pages necessary to verify that the repair resolved the issue and did not create any new issues.

Remove the front cover

Follow these steps to remove the front cover.

1. Open the front door and open the punch cover.
2. Remove three screws in the front.
3. Remove the lever.
4. Open the top cover.
5. From the right side of the front cover, carefully lift and pry toward the top-left corner to remove the front cover.

Figure 7-272 Remove the front cover

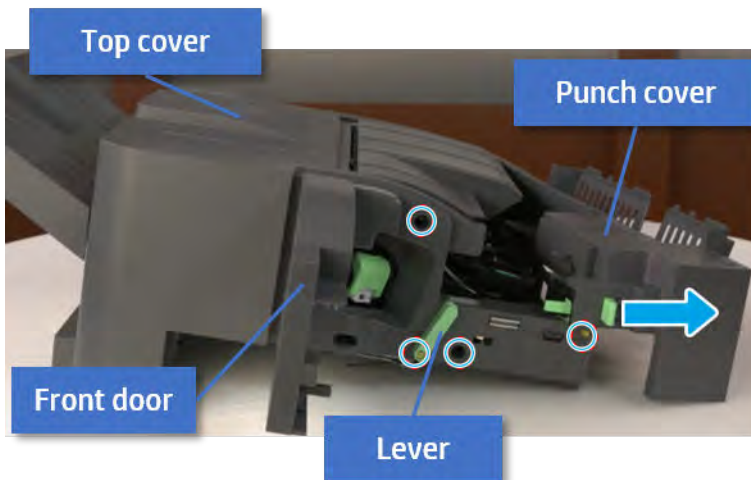

Remove the main paddle home sensor

Follow these steps to remove the main paddle home sensor.

1. Remove one screw. Open the clamp and unplug one connector, and then remove the main paddle home sensor bracket.

Figure 7-273 Remove the main paddle home sensor bracket

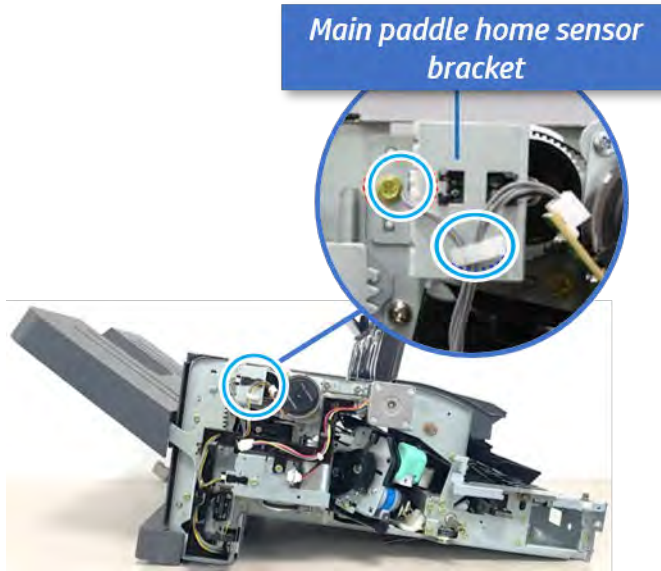

2. Remove the main paddle home sensor from the bracket.

Figure 7-274 Remove the main paddle home sensor

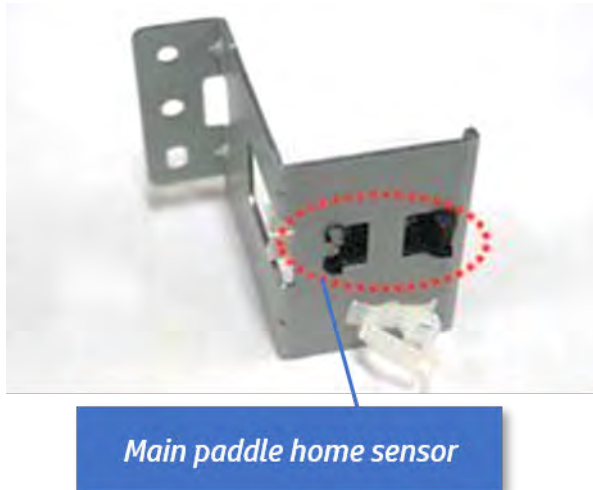

Unpack the replacement assembly

Follow these steps to unpack the replacement assembly.

1. Dispose of the defective part.

 **NOTE:** HP recommends responsible disposal of the defective part.

<http://www8.hp.com/us/en/hp-information/environment/product-recycling.html>

2. Unpack the replacement part from the packaging.



CAUTION:  Some parts are sensitive to electrostatic discharge (ESD). Always perform service work at an ESD-protected workstation or mat. If an ESD workstation or mat is not available, touch the sheet-metal chassis to provide a static ground before touching an ESD-sensitive assembly. Protect the ESD-sensitive assemblies by placing them in ESD pouches when they are out of the printer.

 **IMPORTANT:** Make sure that all of the shipping materials (for example shipping tape) are removed from the replacement part prior to installation.

 **NOTE:** If the replacement part is a roller or pad, avoid touching the spongy part of it. Skin oils on the roller or pad can cause paper pickup and/or print-quality problems. HP recommends using disposable gloves when handling rollers or pads or washing your hands before touching rollers or pads.

3. To install an assembly, reverse the removal steps.

 **NOTE:** When applicable, special installation instructions are provided for an assembly at the end of the removal procedure. Always completely read the removal instructions and follow all special installation instructions.

Removal and replacement: Main paddle motor (M3)

Learn how to remove and replace the main paddle motor.

To view teardown and reassembling video of the inner finisher, click the link below.



[View a teardown video of the inner finisher.](#)



[View a reassembling video of the inner finisher.](#)



IMPORTANT: When applicable, special installation instructions are provided for an assembly at the end of the removal procedure. Always completely read the removal instructions and follow all special installation instructions.

Mean time to repair:

Service level:

Before performing service

Turn the printer power off

- Press the power button on the front of the printer, and then turn off the power switch next to the power cable.
- A shutting-down message appears on the control-panel display.



WARNING! To avoid damage to the printer, turn the power off and wait until the printer shuts down before removing the power cable.

- Disconnect the printer power cable after the printer has completely shut down (the control-panel display is blank).

Use the table below to identify the correct part number for your printer. To order the part, go to www.hp.com/buy/parts.

Table 7-50 Part information

Part number	Part description
JC93-01001A	Main paddle motor assembly

Required tools

- #2 JIS screwdriver with a magnetic tip

After performing service

Turn the printer power on

- Connect the power cable.
- Use the power switch to turn the power on.

Post service test

Print any pages necessary to verify that the repair resolved the issue and did not create any new issues.

Remove the front cover

Follow these steps to remove the front cover.

1. Open the front door and open the punch cover.
2. Remove three screws in the front.
3. Remove the lever.
4. Open the top cover.
5. From the right side of the front cover, carefully lift and pry toward the top-left corner to remove the front cover.

Figure 7-275 Remove the front cover

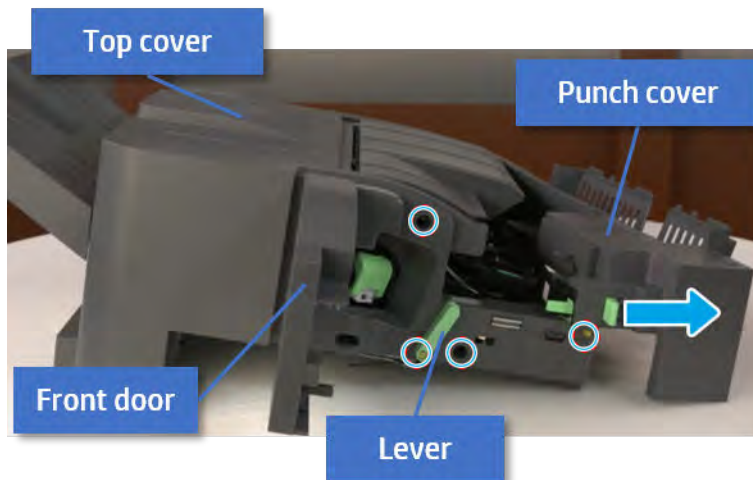

Remove the main paddle motor

Follow these steps to remove the main paddle motor.

1. Remove three screws, unplug the connector, and then remove the main paddle motor bracket.

Figure 7-276 Remove the main paddle motor bracket

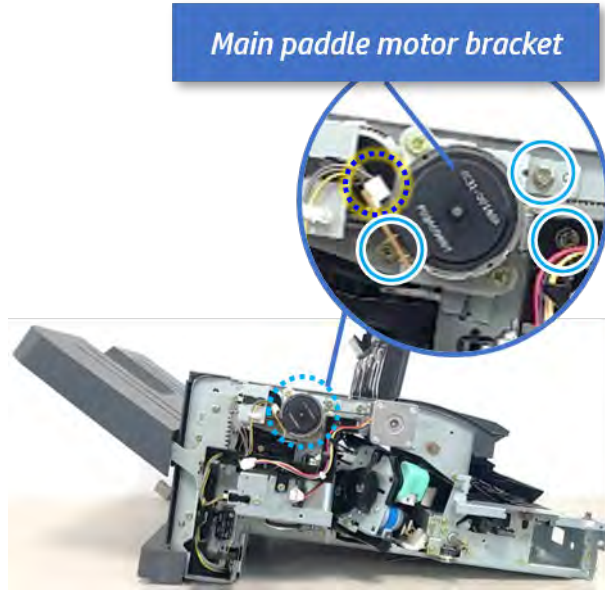

2. Remove two screws, and then remove the motor from the bracket.

Figure 7-277 Remove the main paddle motor



Unpack the replacement assembly

Follow these steps to unpack the replacement assembly.

1. Dispose of the defective part.

 **NOTE:** HP recommends responsible disposal of the defective part.

<http://www8.hp.com/us/en/hp-information/environment/product-recycling.html>

2. Unpack the replacement part from the packaging.



CAUTION:



Some parts are sensitive to electrostatic discharge (ESD). Always perform service work at an ESD-protected workstation or mat. If an ESD workstation or mat is not available, touch the sheet-metal chassis to provide a static ground before touching an ESD-sensitive assembly. Protect the ESD-sensitive assemblies by placing them in ESD pouches when they are out of the printer.



IMPORTANT: Make sure that all of the shipping materials (for example shipping tape) are removed from the replacement part prior to installation.



NOTE: If the replacement part is a roller or pad, avoid touching the spongy part of it. Skin oils on the roller or pad can cause paper pickup and/or print-quality problems. HP recommends using disposable gloves when handling rollers or pads or washing your hands before touching rollers or pads.

3. To install an assembly, reverse the removal steps.



NOTE: When applicable, special installation instructions are provided for an assembly at the end of the removal procedure. Always completely read the removal instructions and follow all special installation instructions.

Removal and replacement: Main paddle assembly

Learn how to remove and replace the main paddle assembly.

To view teardown and reassembling video of the inner finisher, click the link below.



[View a teardown video of the inner finisher.](#)



[View a reassembling video of the inner finisher.](#)



IMPORTANT: When applicable, special installation instructions are provided for an assembly at the end of the removal procedure. Always completely read the removal instructions and follow all special installation instructions.

Mean time to repair:

Service level:

Before performing service

Turn the printer power off

- Press the power button on the front of the printer, and then turn off the power switch next to the power cable.
- A shutting-down message appears on the control-panel display.



WARNING! To avoid damage to the printer, turn the power off and wait until the printer shuts down before removing the power cable.

- Disconnect the printer power cable after the printer has completely shut down (the control-panel display is blank).

Use the table below to identify the correct part number for your printer. To order the part, go to <http://www.hp.com/buy/parts>.

Table 7-51 Part information

Part number	Part description
JC90-01327A (not orderable)	Main paddle assembly

Required tools

- #2 JIS screwdriver with a magnetic tip

After performing service

Turn the printer power on

- Connect the power cable.
- Use the power switch to turn the power on.

Post service test

Print any pages necessary to verify that the repair resolved the issue and did not create any new issues.

Remove the front cover

Follow these steps to remove the front cover.

1. Open the front door and open the punch cover.
2. Remove three screws in the front.
3. Remove the lever.
4. Open the top cover.
5. From the right side of the front cover, carefully lift and pry toward the top-left corner to remove the front cover.

Figure 7-278 Remove the front cover

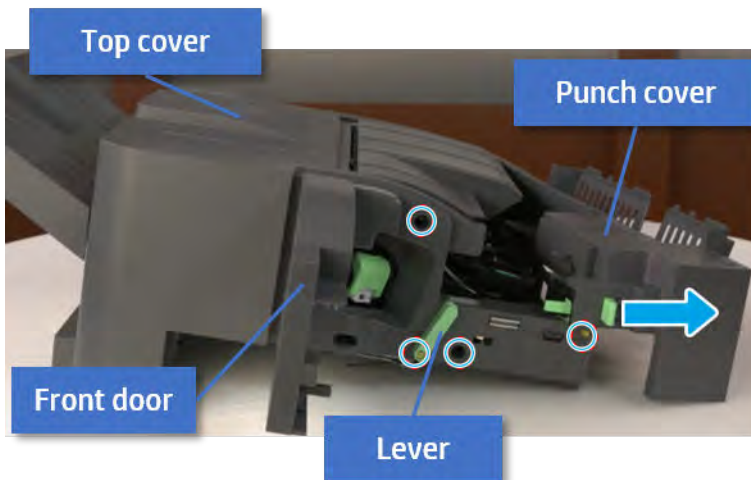

Remove the rear cover

Follow these steps to remove the rear cover.

1. Open the top cover.

Figure 7-279 Open the top cover

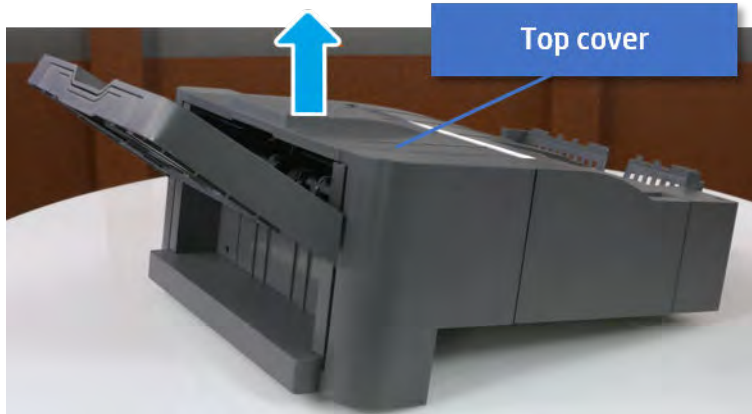

2. Remove three screws.
3. Release hooks carefully and remove the rear cover.

Figure 7-280 Remove the rear cover

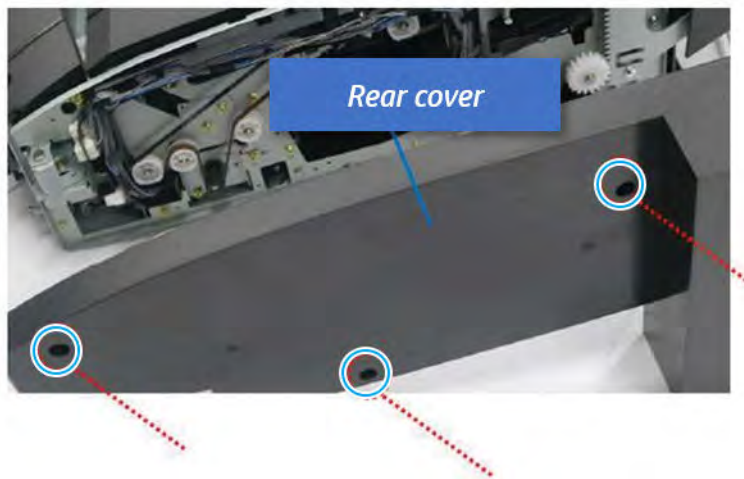

Remove the main paddle home sensor bracket

Follow these steps to remove the main paddle home sensor bracket.

- ▲ Remove one screw. Open the clamp and unplug one connector, and then remove the main paddle home sensor bracket.

Figure 7-281 Remove the main paddle home sensor bracket

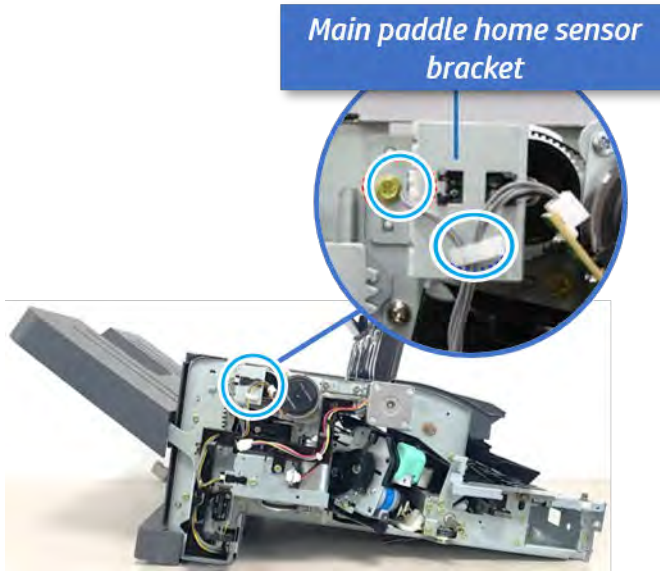

Remove the main paddle motor bracket

Follow these steps to remove the main paddle motor bracket.

- ▲ Remove three screws, unplug the connector, and then remove the main paddle motor bracket.

Figure 7-282 Remove the main paddle motor bracket

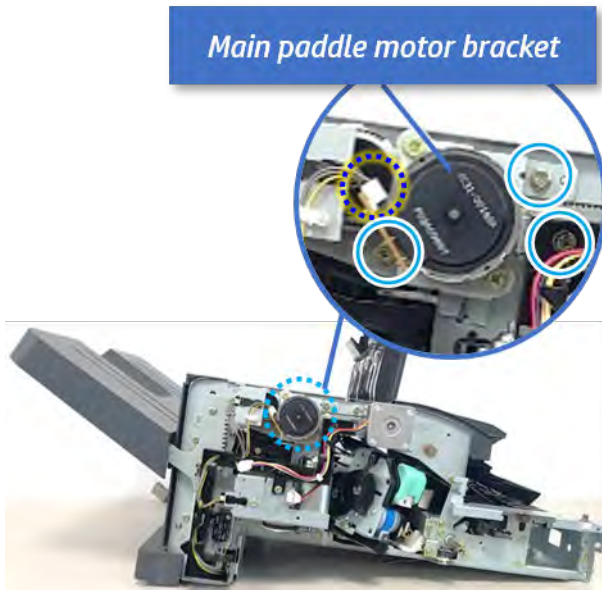

Remove the main paddle

Follow these steps to remove the main paddle.

1. Open the top cover.

2. Rotate the main paddle shaft to see the lower side of the main paddle.

Figure 7-283 Rotate the main paddle shaft

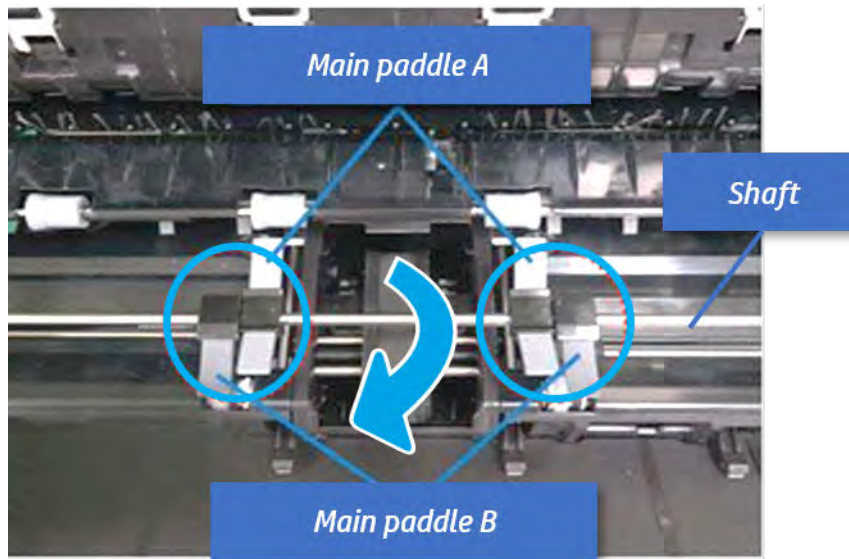

3. Remove the main paddle by pushing both sides.

Figure 7-284 Remove the main paddle

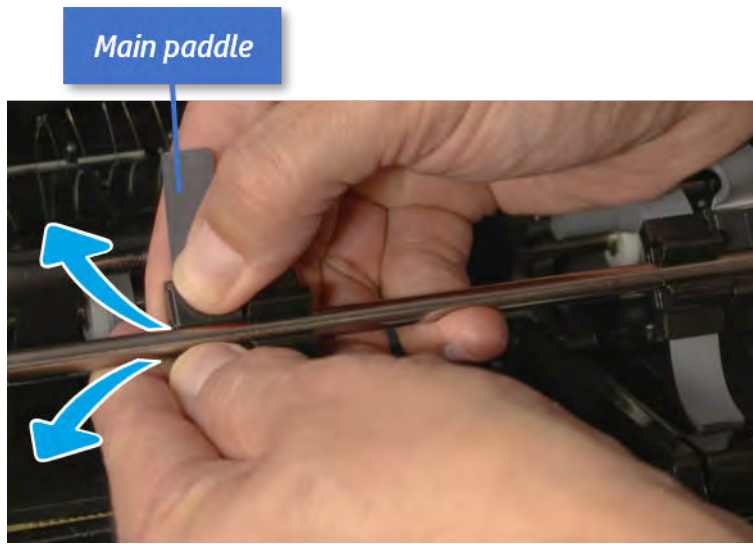

 **TIP:** When reassembling the main paddle, check the pin position of the paddle and the hole position of the shaft, and then assemble them.

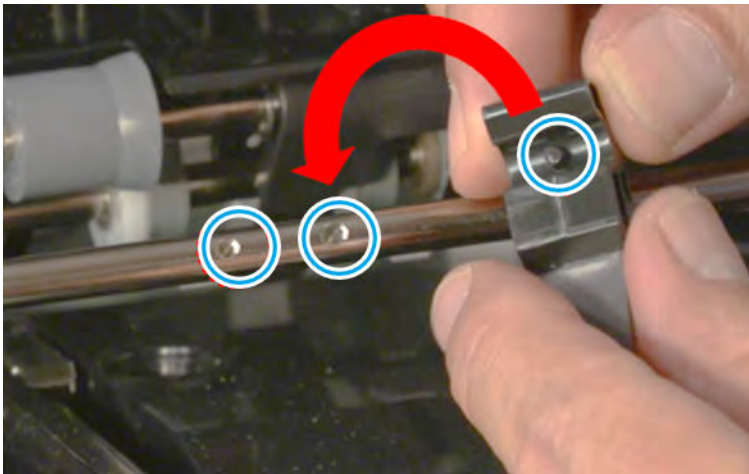

Remove the main paddle assembly

Follow these steps to remove the main paddle assembly.

1. Remove the belt in the front.

Figure 7-285 Remove the belt

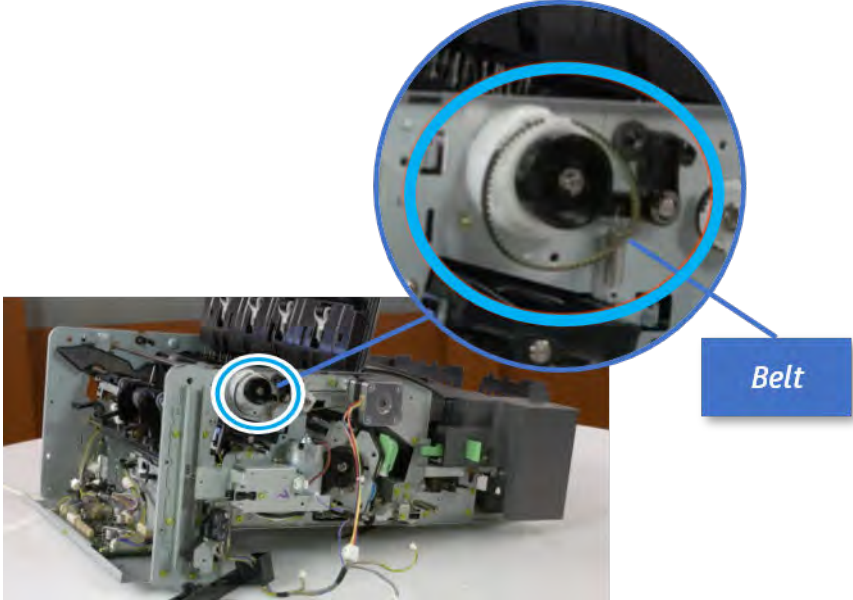

- 2. Remove the e-ring and the main paddle CAM in the rear. And then remove the e-ring and the bushing.

Figure 7-286 Remove the e-ring, cam, and bushing

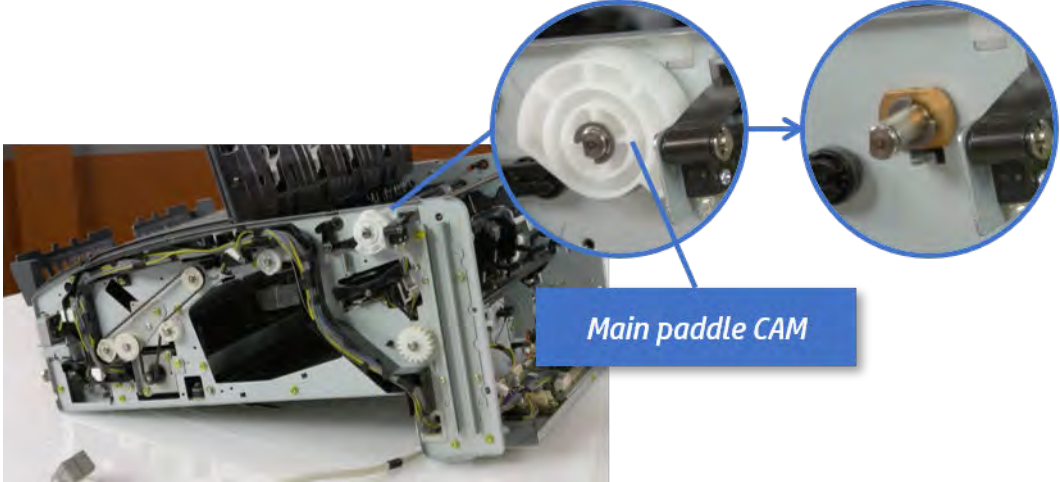

3. Push the shaft to remove the main paddle shaft.

Figure 7-287 Remove the main paddle shaft



Main paddle shaft



Unpack the replacement assembly



Follow these steps to unpack the replacement assembly.

1. Dispose of the defective part.

 **NOTE:** HP recommends responsible disposal of the defective part.

<http://www8.hp.com/us/en/hp-information/environment/product-recycling.html>

2. Unpack the replacement part from the packaging.

 **CAUTION:**  Some parts are sensitive to electrostatic discharge (ESD). Always perform service work at an ESD-protected workstation or mat. If an ESD workstation or mat is not available, touch the sheet-metal chassis to provide a static ground before touching an ESD-sensitive assembly. Protect the ESD-sensitive assemblies by placing them in ESD pouches when they are out of the printer.

 **IMPORTANT:** Make sure that all of the shipping materials (for example shipping tape) are removed from the replacement part prior to installation.

 **NOTE:** If the replacement part is a roller or pad, avoid touching the spongy part of it. Skin oils on the roller or pad can cause paper pickup and/or print-quality problems. HP recommends using disposable gloves when handling rollers or pads or washing your hands before touching rollers or pads.

3. To install an assembly, reverse the removal steps.

 **NOTE:** When applicable, special installation instructions are provided for an assembly at the end of the removal procedure. Always completely read the removal instructions and follow all special installation instructions.

Removal and replacement: Sub paddle unit

Learn how to remove and replace the sub paddle unit.

To view teardown and reassembling video of the inner finisher, click the link below.



[View a teardown video of the inner finisher.](#)



[View a reassembling video of the inner finisher.](#)



IMPORTANT: When applicable, special installation instructions are provided for an assembly at the end of the removal procedure. Always completely read the removal instructions and follow all special installation instructions.

Mean time to repair:

Service level:

Before performing service

Turn the printer power off

- Press the power button on the front of the printer, and then turn off the power switch next to the power cable.
- A shutting-down message appears on the control-panel display.



WARNING! To avoid damage to the printer, turn the power off and wait until the printer shuts down before removing the power cable.

- Disconnect the printer power cable after the printer has completely shut down (the control-panel display is blank).

Use the table below to identify the correct part number for your printer. To order the part, go to <http://www.hp.com/buy/parts>.

Table 7-52 Part information

Part number	Part description
JC90-01336A	Sub paddle unit

Required tools

- #2 JIS screwdriver with a magnetic tip

After performing service

Turn the printer power on

- Connect the power cable.
- Use the power switch to turn the power on.

Post service test

Print any pages necessary to verify that the repair resolved the issue and did not create any new issues.

Remove the rear cover

Follow these steps to remove the rear cover.

1. Open the top cover.

Figure 7-288 Open the top cover

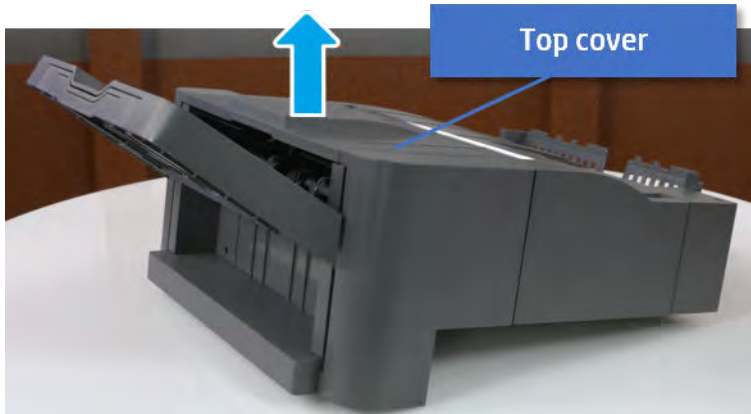

2. Remove three screws.
3. Release hooks carefully and remove the rear cover.

Figure 7-289 Remove the rear cover

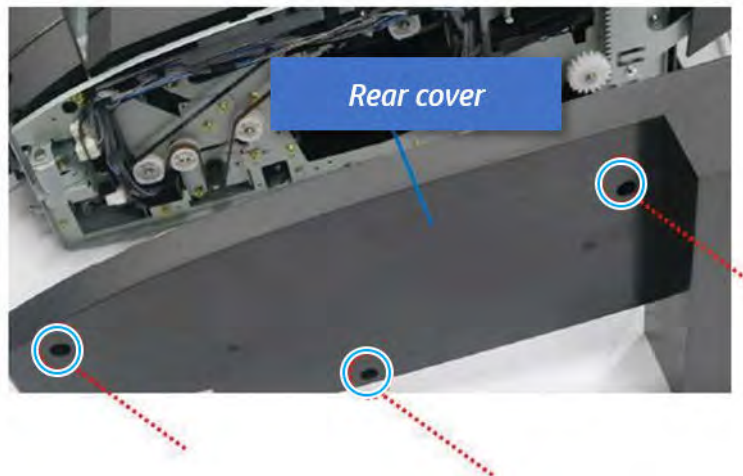

Remove the sub paddle unit

Follow these steps to remove the sub paddle unit.

1. Open the top cover, and then remove one screw securing the sub paddle unit.

Figure 7-290 Remove one screw

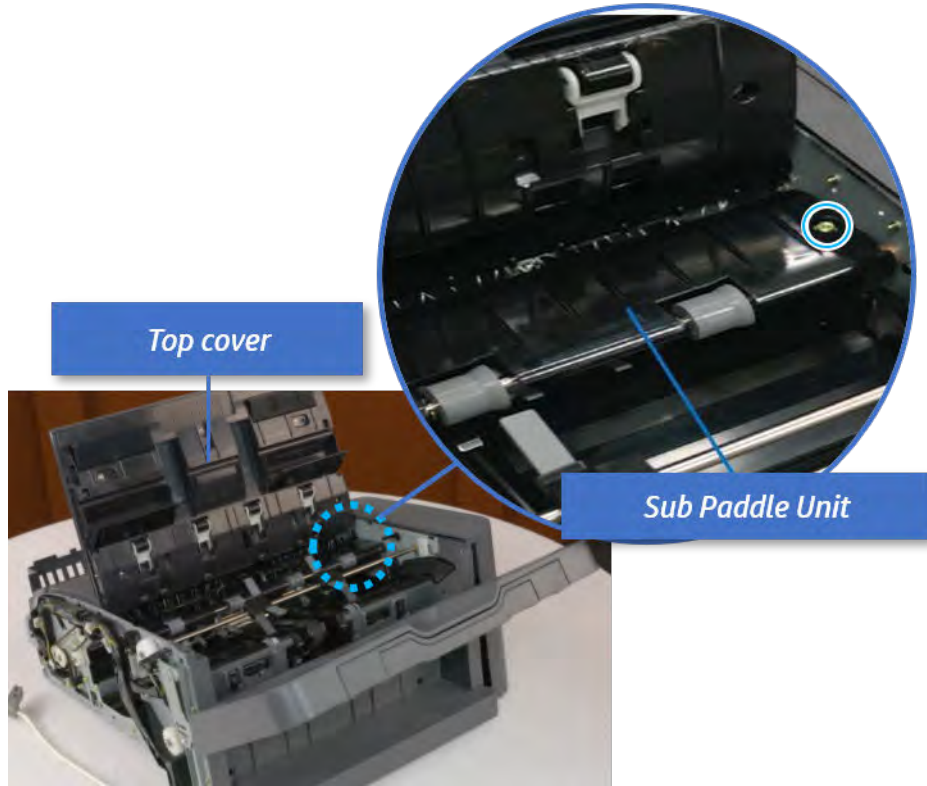

2. Remove the e-ring, and then remove the pulley and timing belt. And then remove the e-ring and the bushing.

Figure 7-291 Remove the e-ring, pulley, timing belt, and bushing

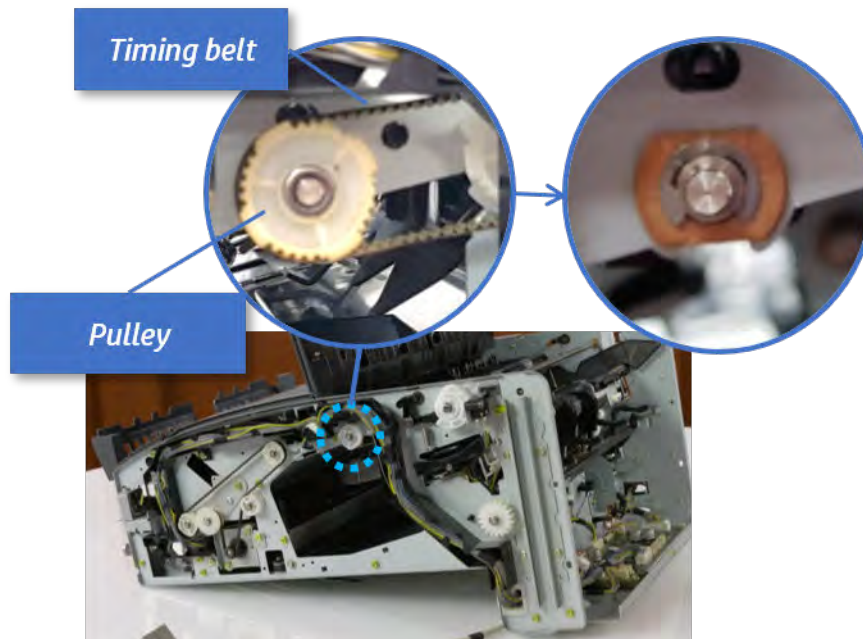

3. Lift up and remove the sub paddle unit.

Figure 7-292 Remove the sub paddle unit

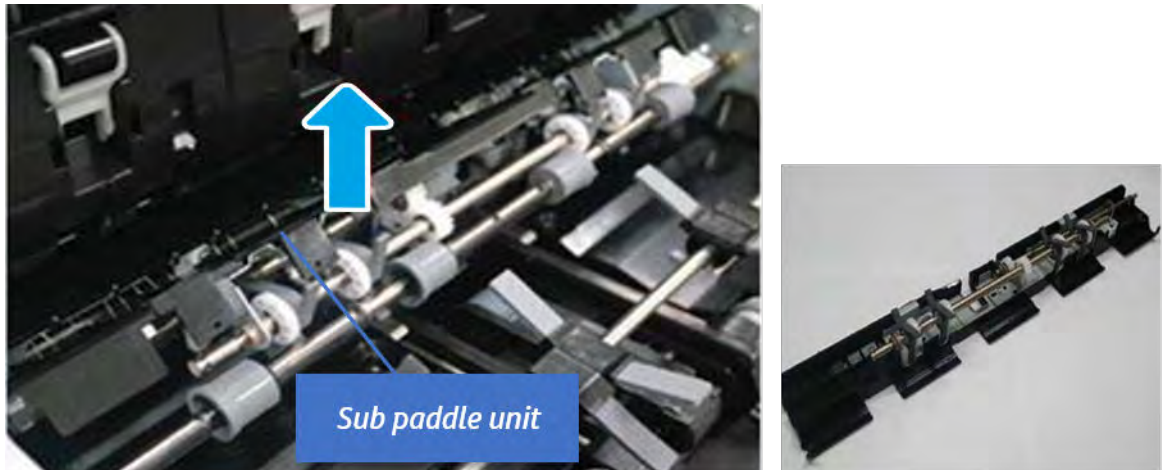

Unpack the replacement assembly

Follow these steps to unpack the replacement assembly.

1. Dispose of the defective part.



NOTE: HP recommends responsible disposal of the defective part.

<http://www8.hp.com/us/en/hp-information/environment/product-recycling.html>

2. Unpack the replacement part from the packaging.



CAUTION:  Some parts are sensitive to electrostatic discharge (ESD). Always perform service work at an ESD-protected workstation or mat. If an ESD workstation or mat is not available, touch the sheet-metal chassis to provide a static ground before touching an ESD-sensitive assembly. Protect the ESD-sensitive assemblies by placing them in ESD pouches when they are out of the printer.



IMPORTANT: Make sure that all of the shipping materials (for example shipping tape) are removed from the replacement part prior to installation.



NOTE: If the replacement part is a roller or pad, avoid touching the spongy part of it. Skin oils on the roller or pad can cause paper pickup and/or print-quality problems. HP recommends using disposable gloves when handling rollers or pads or washing your hands before touching rollers or pads.

3. To install an assembly, reverse the removal steps.



NOTE: When applicable, special installation instructions are provided for an assembly at the end of the removal procedure. Always completely read the removal instructions and follow all special installation instructions.

Tamper unit

Front tamper

Removal and replacement: Front tamper

Learn how to remove and replace the front tamper.

To view teardown and reassembling video of the inner finisher, click the link below.



[View a teardown video of the inner finisher.](#)



[View a reassembling video of the inner finisher.](#)



IMPORTANT: When applicable, special installation instructions are provided for an assembly at the end of the removal procedure. Always completely read the removal instructions and follow all special installation instructions.

Mean time to repair:

Service level:

Before performing service

Turn the printer power off

- Press the power button on the front of the printer, and then turn off the power switch next to the power cable.
- A shutting-down message appears on the control-panel display.



WARNING! To avoid damage to the printer, turn the power off and wait until the printer shuts down before removing the power cable.

- Disconnect the printer power cable after the printer has completely shut down (the control-panel display is blank).

Use the table below to identify the correct part number for your printer. To order the part, go to <http://www.hp.com/buy/parts>.

Table 7-53 Part information

Part number	Part description
JC82-00899A	Front tamper

Required tools

- #2 JIS screwdriver with a magnetic tip

After performing service

Turn the printer power on

- Connect the power cable.
- Use the power switch to turn the power on.

Post service test

Print any pages necessary to verify that the repair resolved the issue and did not create any new issues.

Remove the front cover

Follow these steps to remove the front cover.

1. Open the front door and open the punch cover.
2. Remove three screws in the front.
3. Remove the lever.
4. Open the top cover.
5. From the right side of the front cover, carefully lift and pry toward the top-left corner to remove the front cover.

Figure 7-293 Remove the front cover

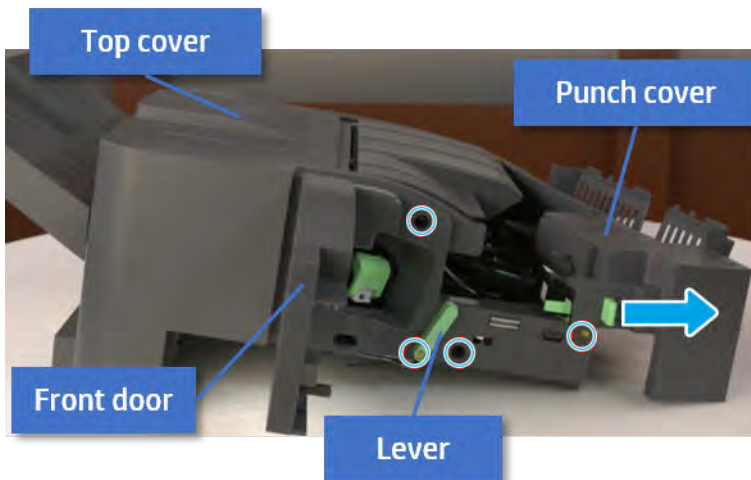

Remove the rear cover

Follow these steps to remove the rear cover.

1. Open the top cover.

Figure 7-294 Open the top cover

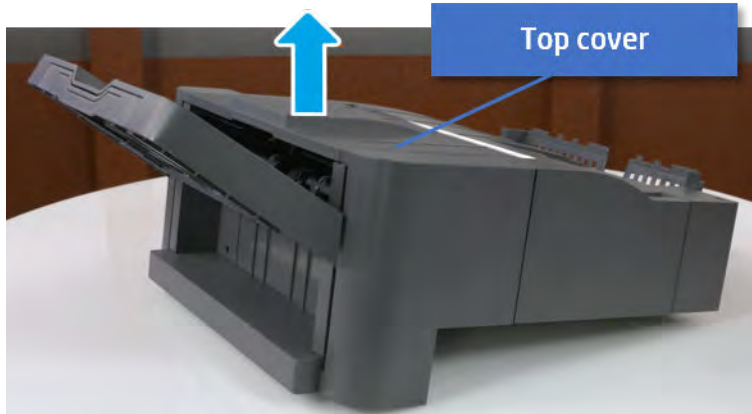

2. Remove three screws.
3. Release hooks carefully and remove the rear cover.

Figure 7-295 Remove the rear cover

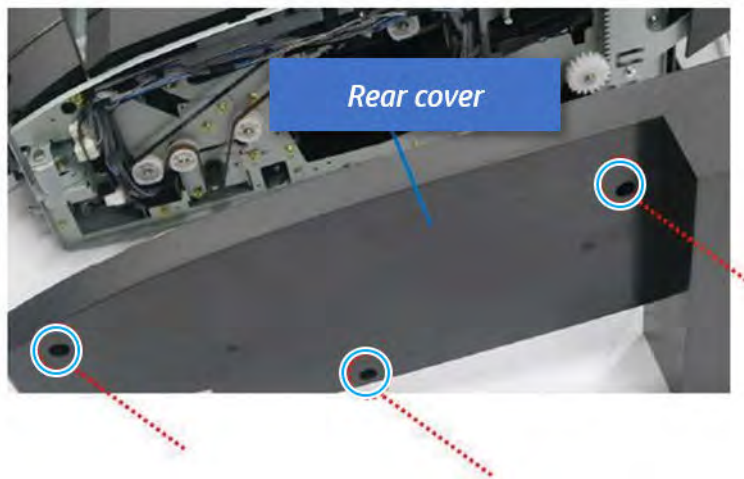

Remove the output tray

Follow these steps to remove the output tray.

1. Remove four screws.

Figure 7-296 Remove four screws

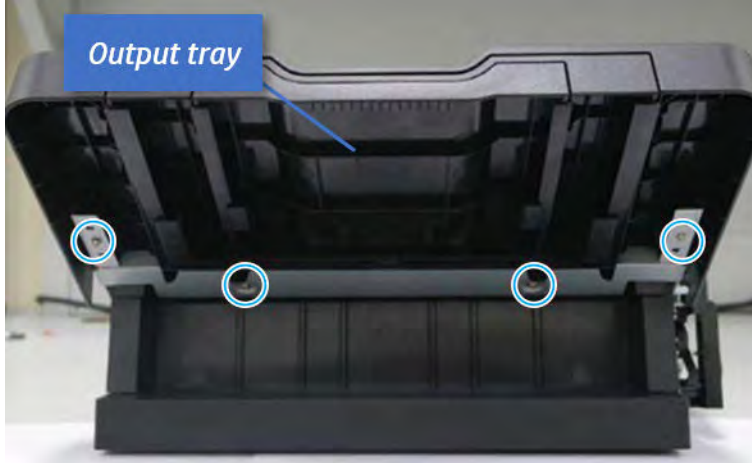

2. Push the paper holding actuator into the inner finisher, and then remove the output tray.

Figure 7-297 Remove the output tray.



Remove the output tray frame

Follow these steps to remove the output tray frame.

1. Rotate the pulley until the output tray frame depart from the gear.

Figure 7-298 Remove the pulley

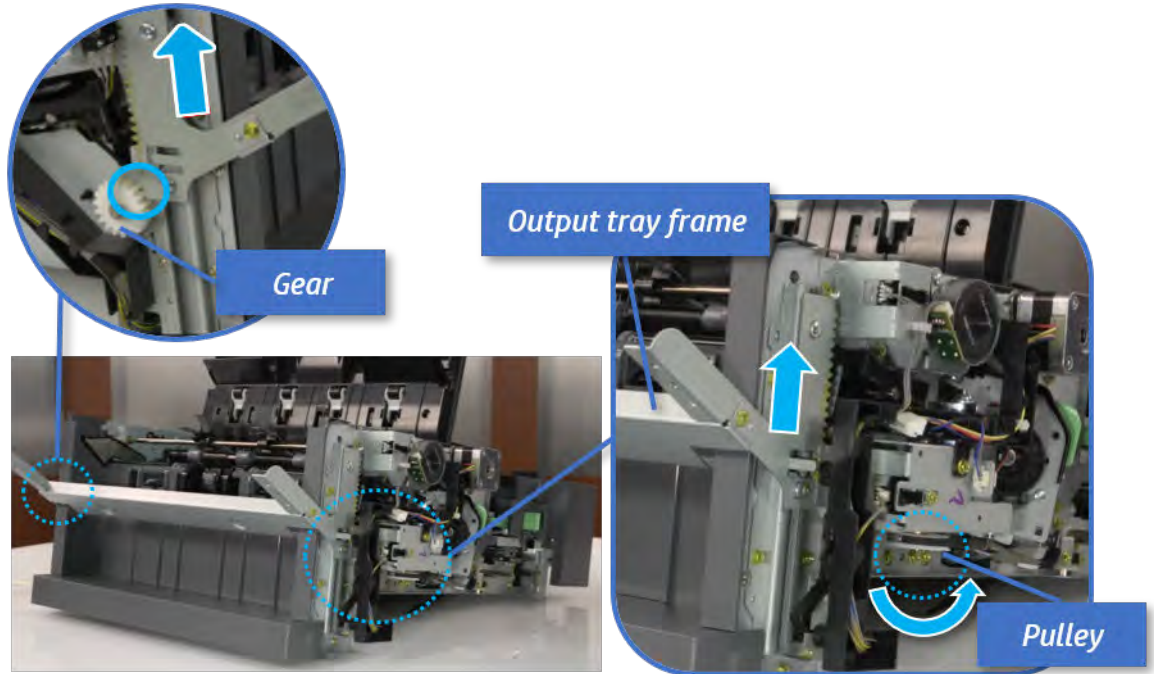

2. Push the paper holding actuator into the inner finisher, and then remove the output tray frame.

Figure 7-299 Remove the output tray frame

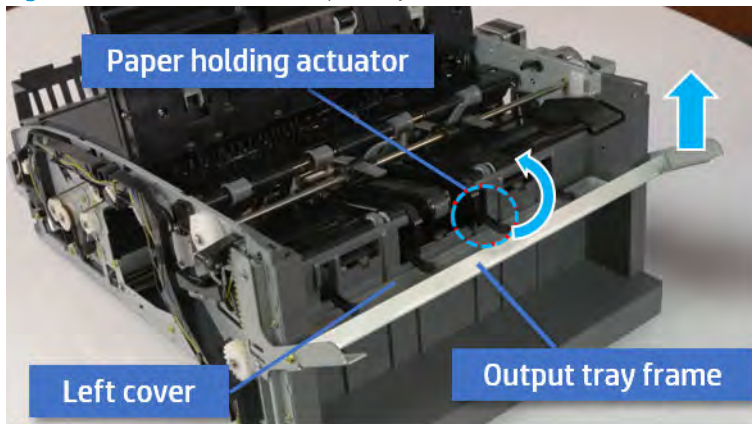

 **TIP:** Push the paper holding actuator into the inner finisher when reassembling. Be sure to level the output tray.

- a. Position the first wheel into the channel on both sides while pushing the paper holding actuator.

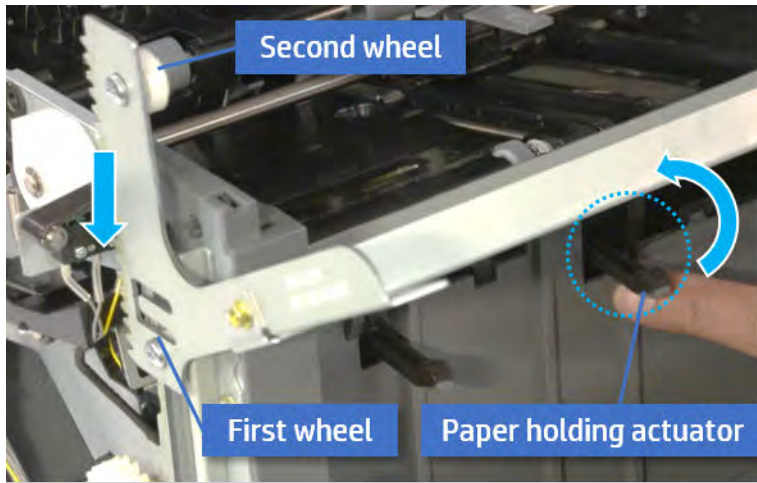

- b. Let the second wheel rest on the channel on both sides simultaneously.
- c. Gently squeeze the wheels into channel until the output tray frame meet the gear.

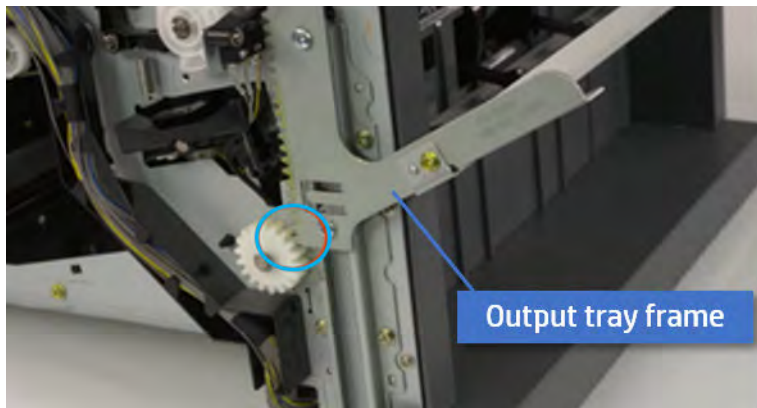

- d. Rotate the pulley until the output tray frame is no longer lifted. It can make to level the output tray frame.

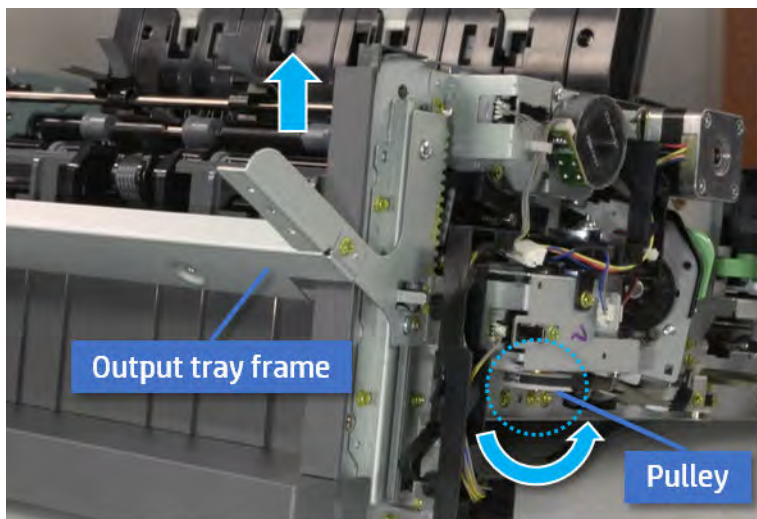

- e. Rotate the pulley in the opposite direction.

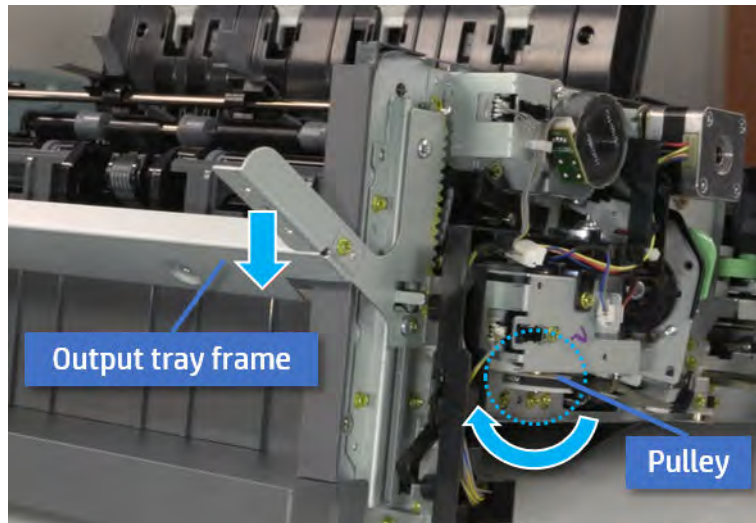

Remove the PCA cover

Follow these steps to remove the PCA cover.

- ▲ Remove two screws, and then remove the PCA cover.

Figure 7-300 Remove the PCA cover

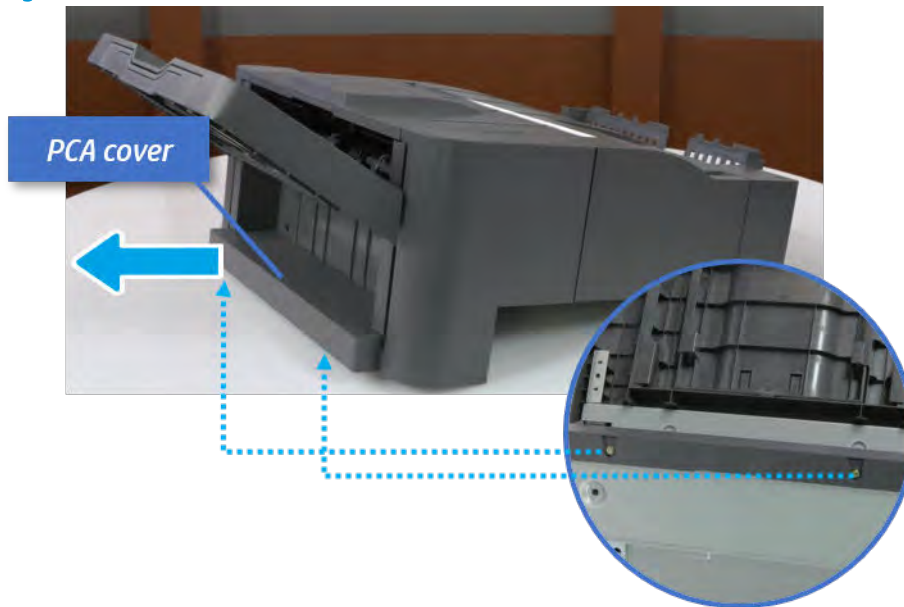

Remove the left cover

Follow these steps to remove the left cover.

1. Remove two screws.

Figure 7-301 Remove two screws

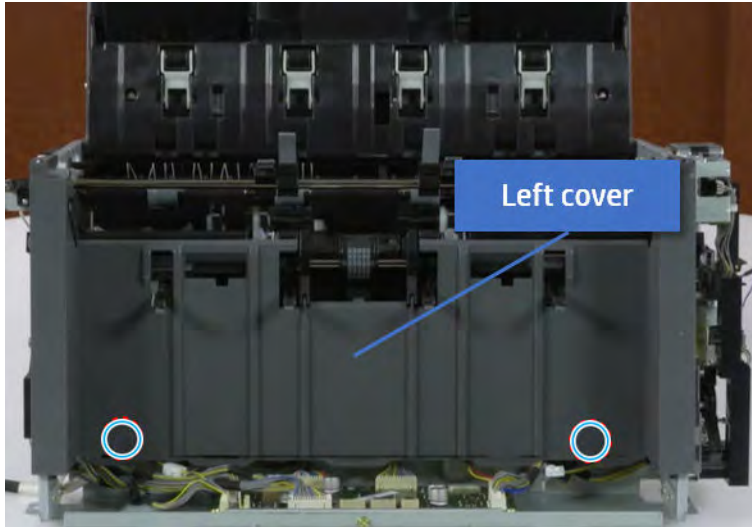

2. Remove four screws from both front and rear sides.

Figure 7-302 Remove four screws

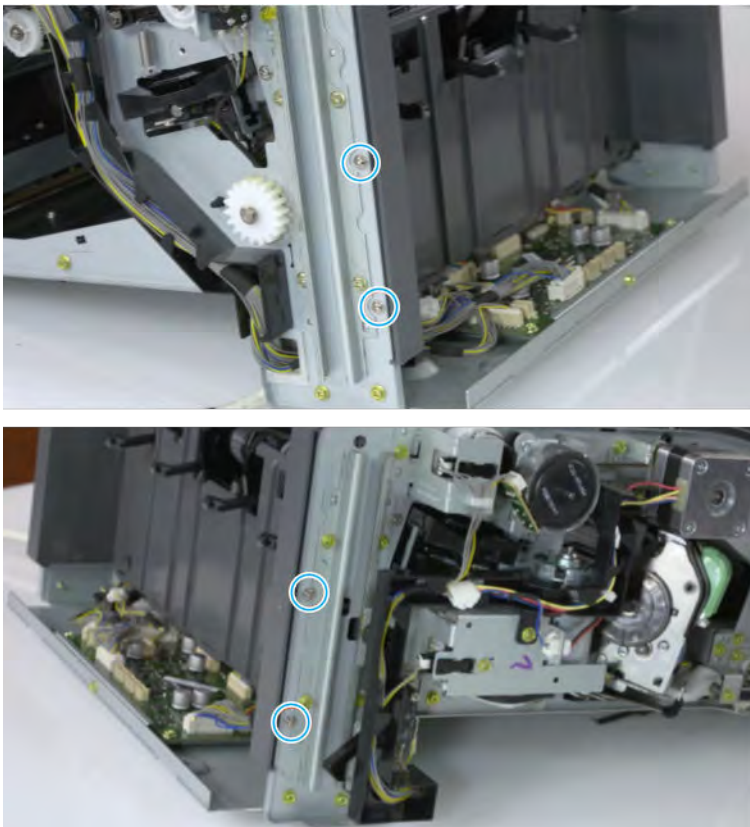

3. Unplug two inline connectors, and then remove the left cover.

Figure 7-303 Unplug two connectors

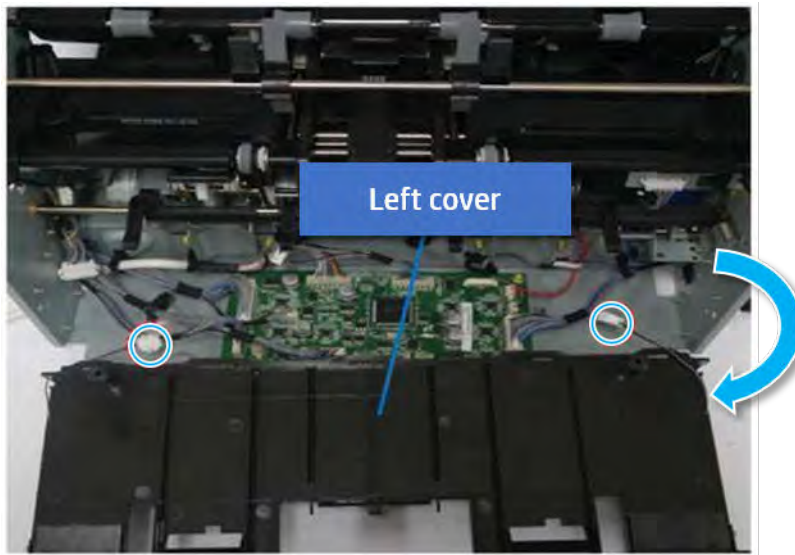

 **TIP:** Be sure to check the hook when reassembling.

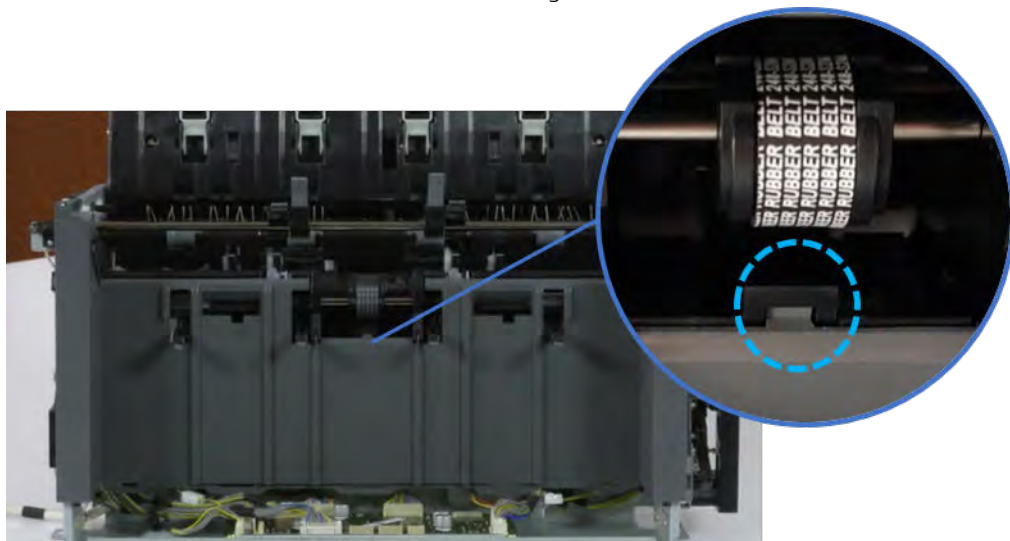

Remove the front harness guide

Follow these steps to remove the front harness guide.

1. Open one clamp and unplug five connectors, and then remove the wire harness from the front harness guide.

2. Remove four screws, and then remove the front harness guide.

Figure 7-304 Remove the front harness guide

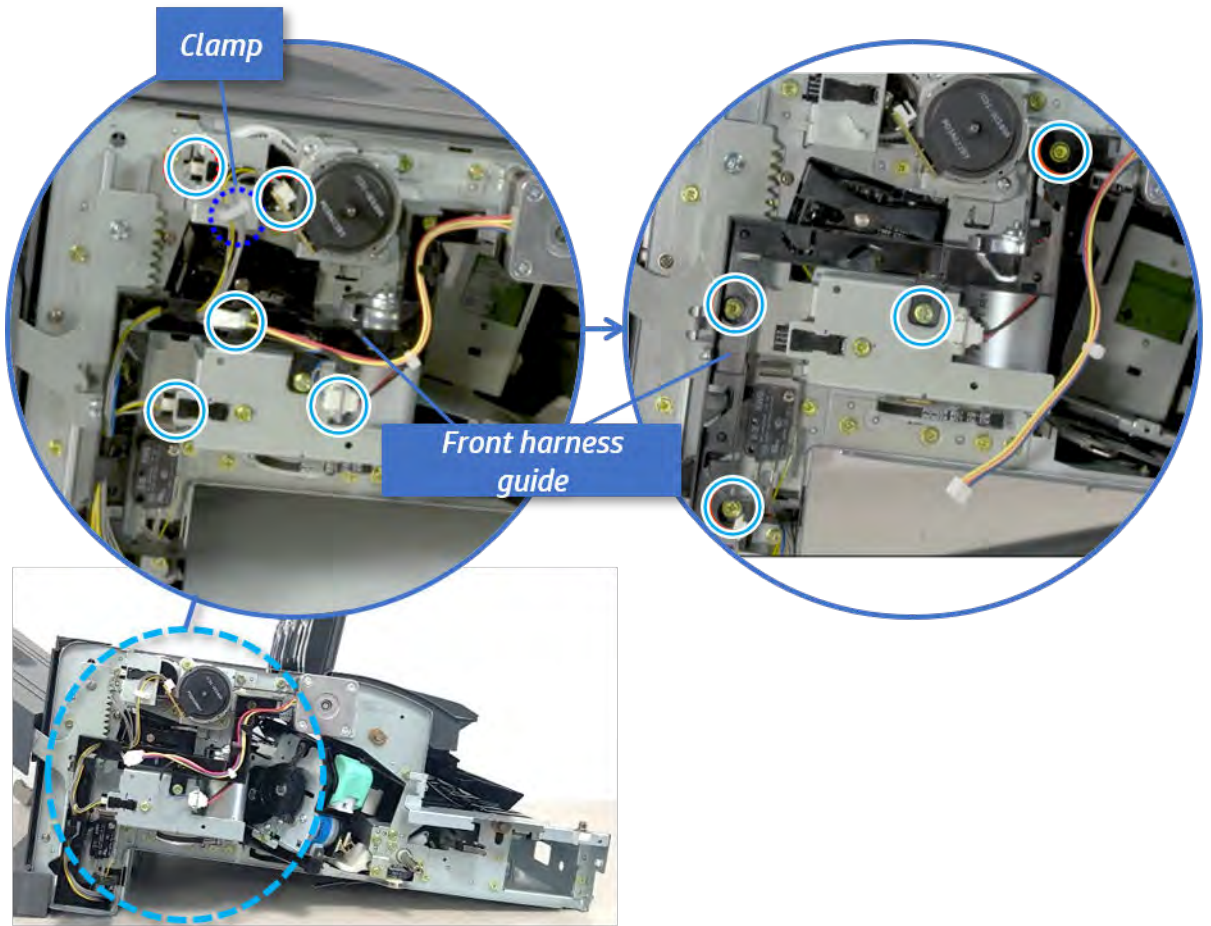

Remove the output tray motor assembly

Follow these steps to remove the output tray motor assembly.

- ▲ Remove three screws, and then remove the output tray motor assembly.

Figure 7-305 Remove the output tray motor assembly

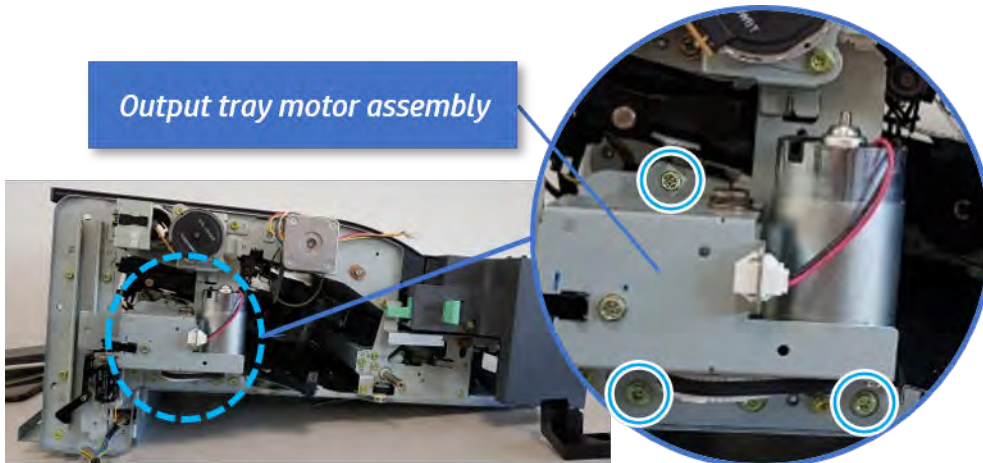

Remove the output tray lower limit switch

Follow these steps to remove the output tray lower limit switch.

- ▲ Remove one screw, and then remove the output tray lower limit switch.

Figure 7-306 Remove the output tray lower limit switch

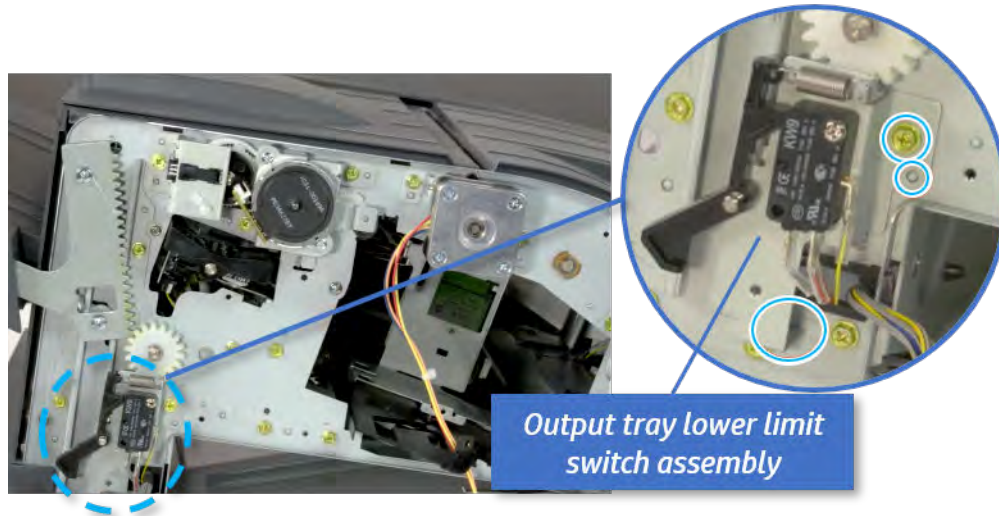

Remove the paper holding

Follow these steps to remove the paper holding.

1. Remove the paper holding actuator spring.

Figure 7-307 Remove the paper holding actuator spring

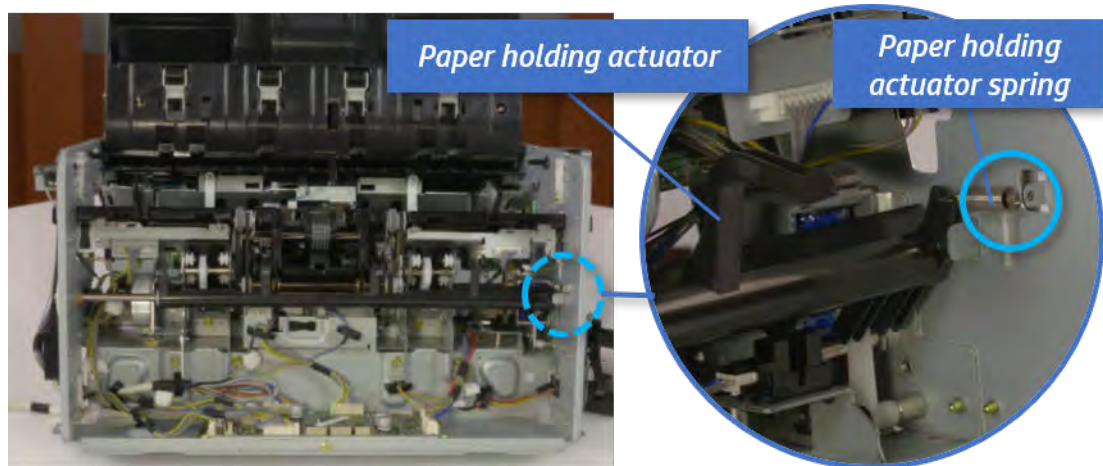

2. Remove the e-ring and the rack pinion gear. And then remove the pin and the e-ring, and then remove the bushing.

Figure 7-308 Remove e-ring, rack pinion gear, pin, and bushing

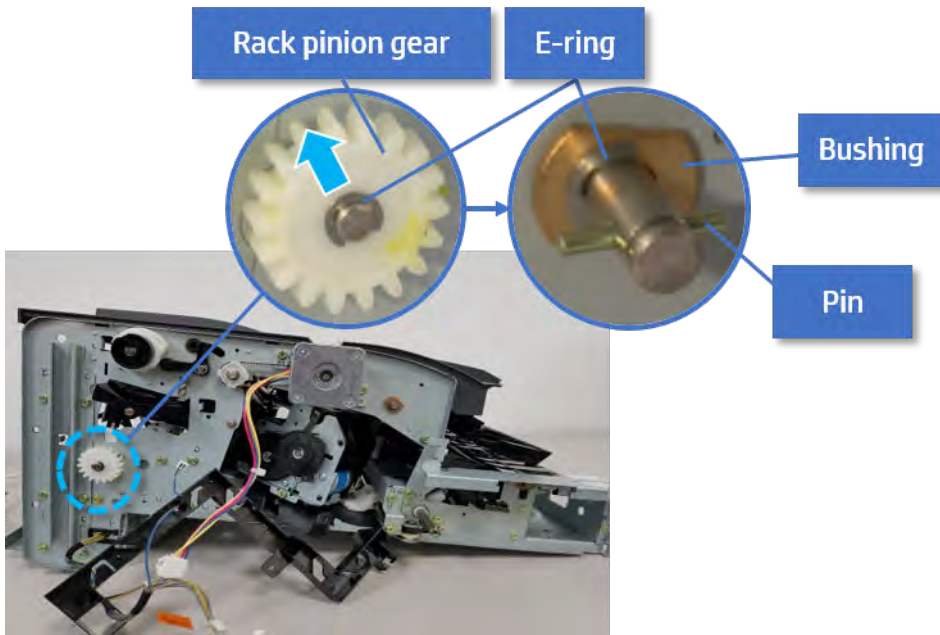

 **NOTE:** Be sure not to lose the pin.

3. Carefully remove the paper holding shaft and the actuator.

Figure 7-309 Remove the paper holding shaft and the actuator

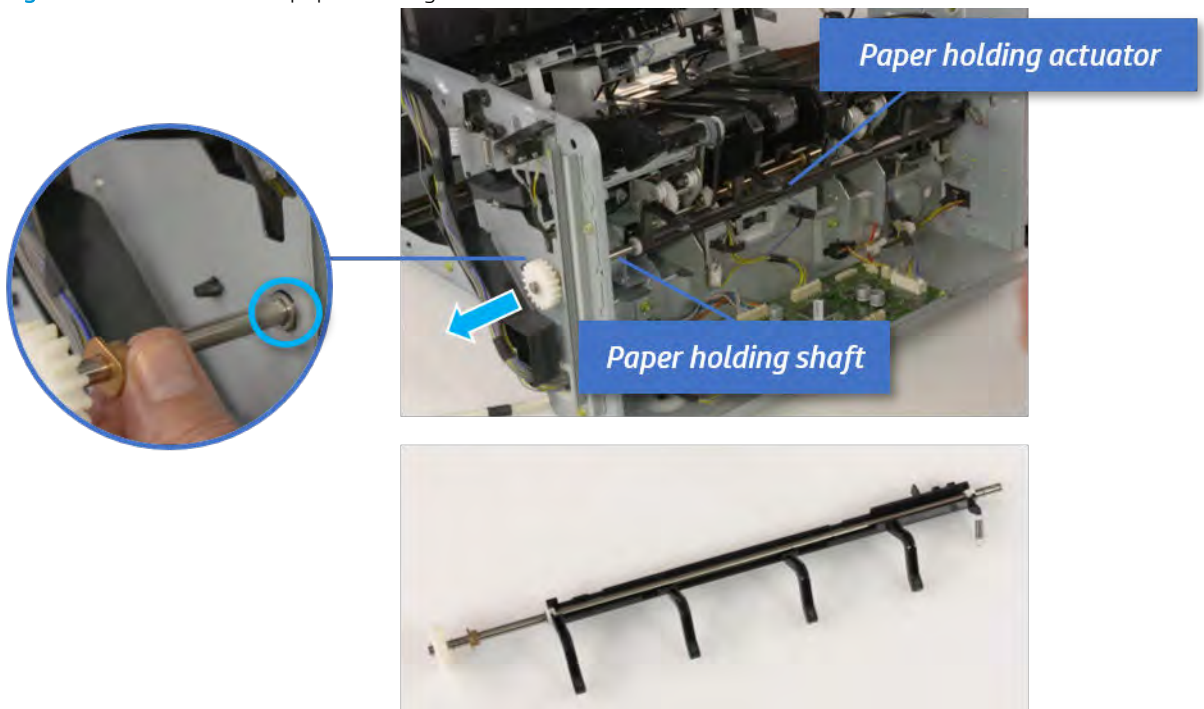

Remove the sub paddle unit

Follow these steps to remove the sub paddle unit.

1. Open the top cover, and then remove one screw securing the sub paddle unit.

Figure 7-310 Remove one screw

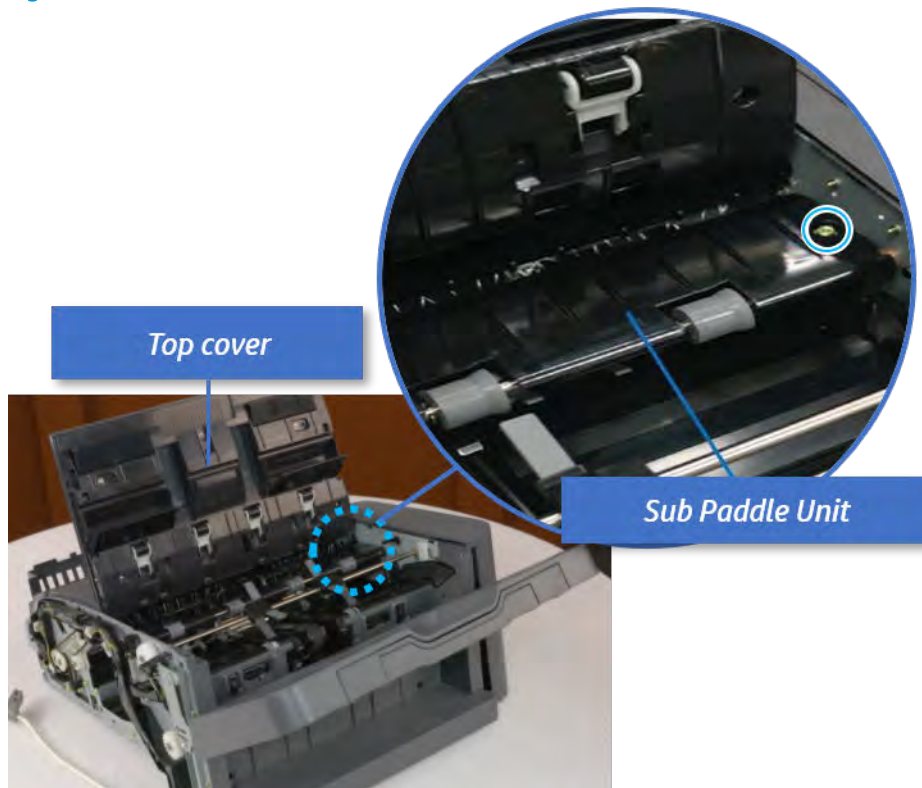

2. Remove the e-ring, and then remove the pulley and timing belt. And then remove the e-ring and the bushing.

Figure 7-311 Remove the e-ring, pulley, timing belt, and bushing

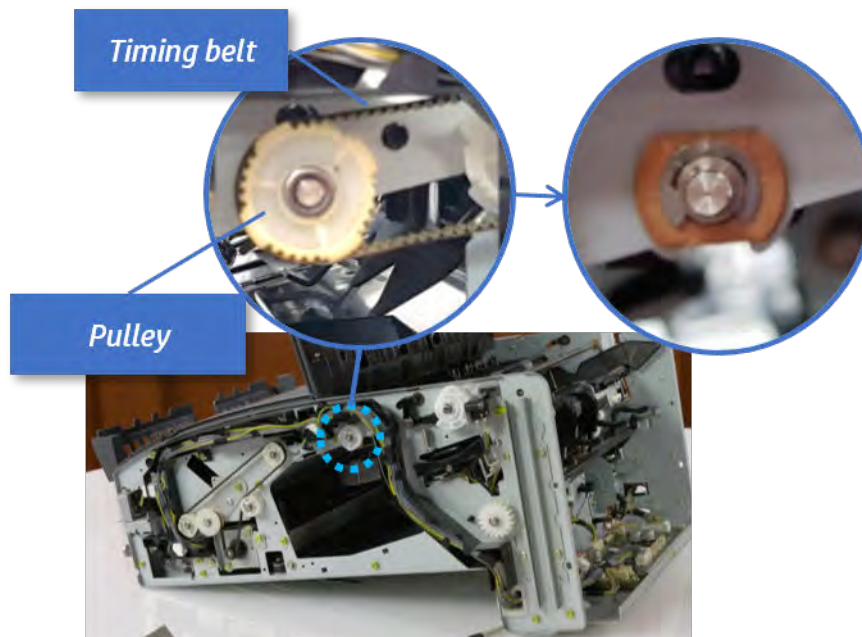

3. Lift up and remove the sub paddle unit.

Figure 7-312 Remove the sub paddle unit

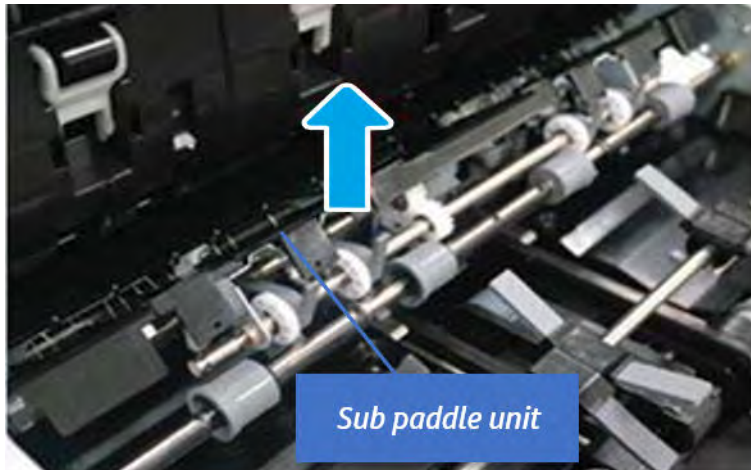

Remove the exit roller

Follow these steps to remove the exit roller.

1. Remove the guide on the center of the exit roller.

Figure 7-313 Remove the guide

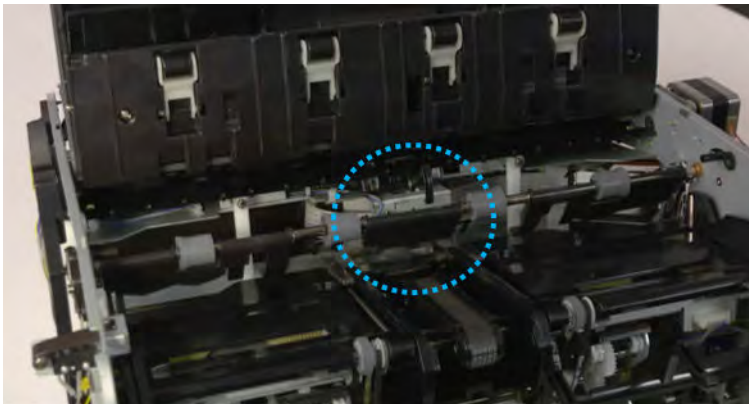

2. On the front of the inner finisher, release the timing belt connected to the exit motor.

Figure 7-314 Release the timing belt

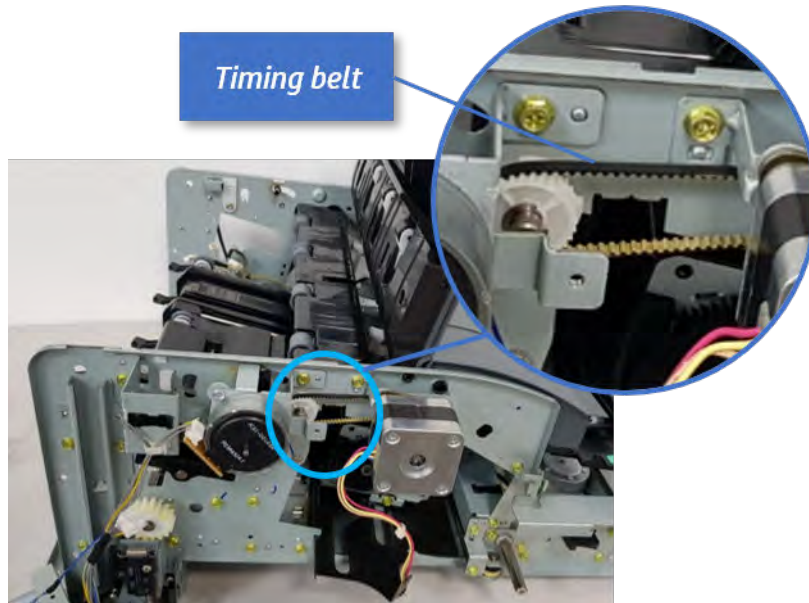

3. Remove five screws securing the rear harness guide.

Figure 7-315 Remove five screws

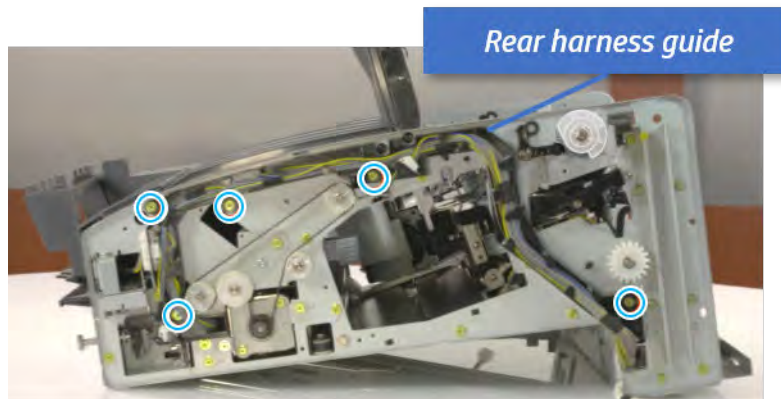

4. On the rear of the inner finisher, remove the e-ring and the pulley and then remove the e-ring and the bushing.

Figure 7-316 Remove e-ring, pulley, and bushing

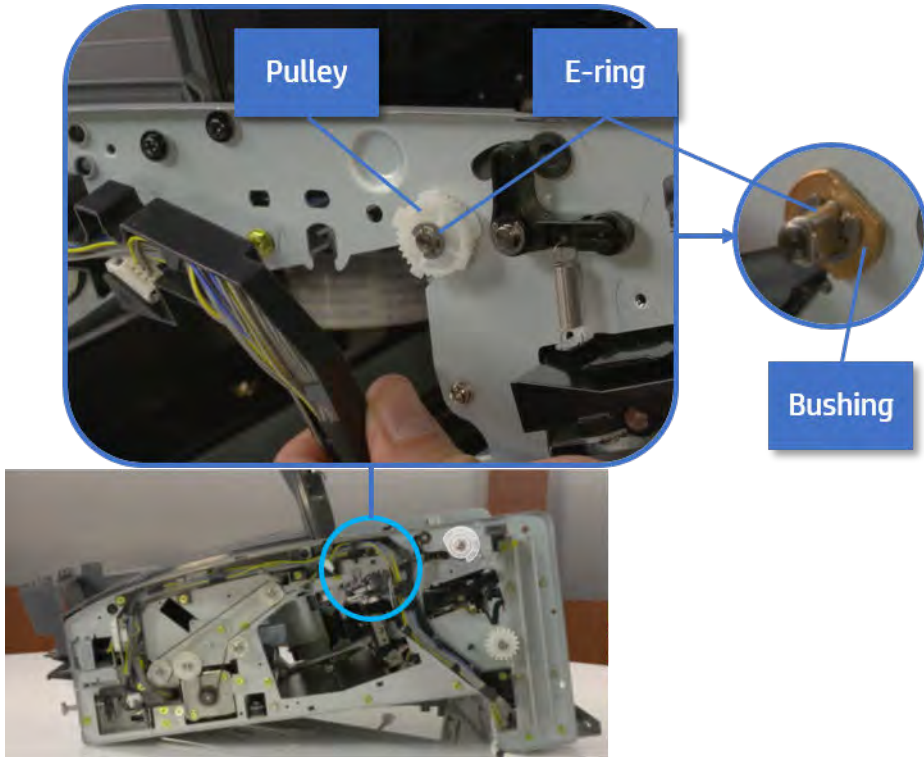

5. Push the bushing to detach it, and then remove the exit roller.

Figure 7-317 Remove the exit roller

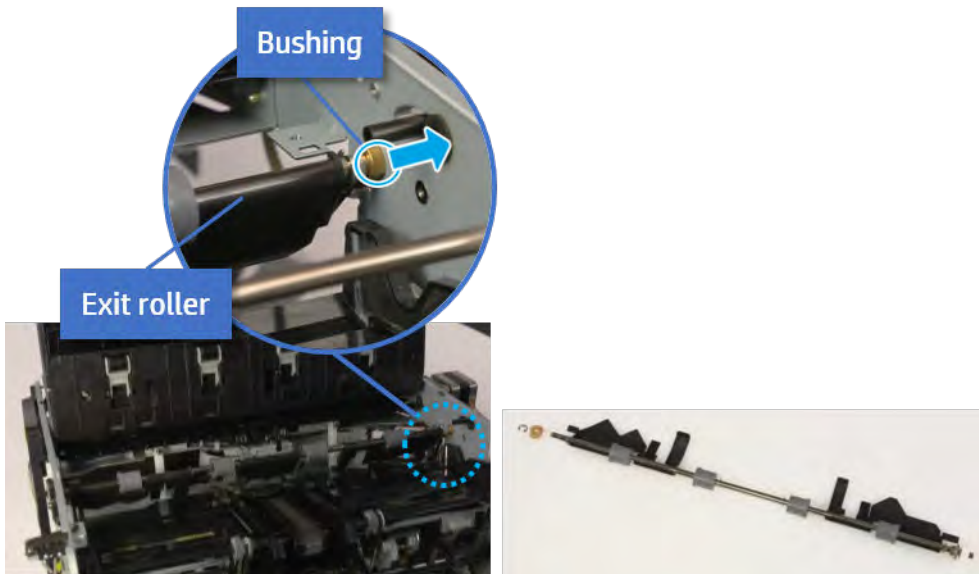

Remove the front tamper

Follow these steps to remove the front tamper.

1. Remove four screws.

Figure 7-318 Remove four screws

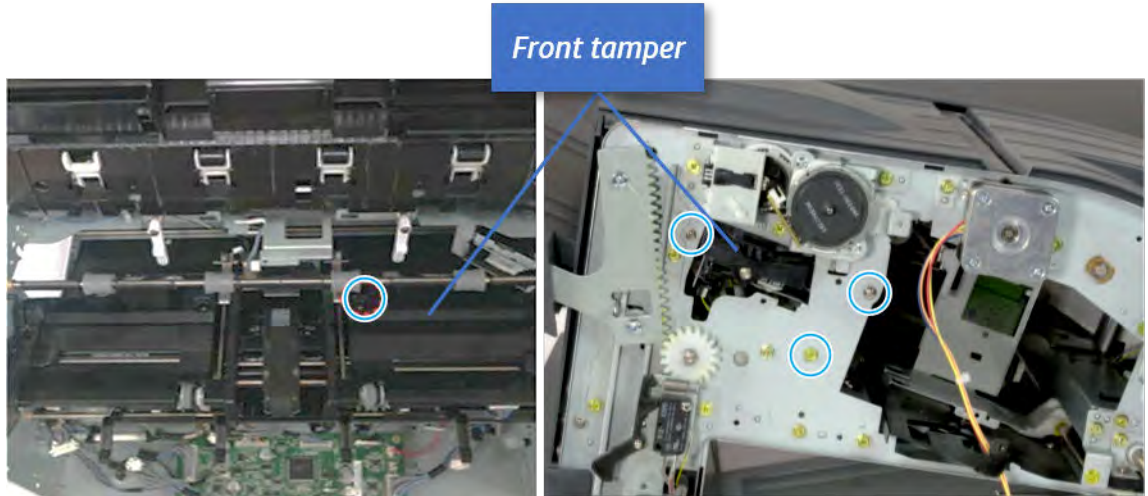

2. Unplug the connector and release the hook, and then pull the front tamper up to remove.

Figure 7-319 Remove the front tamper

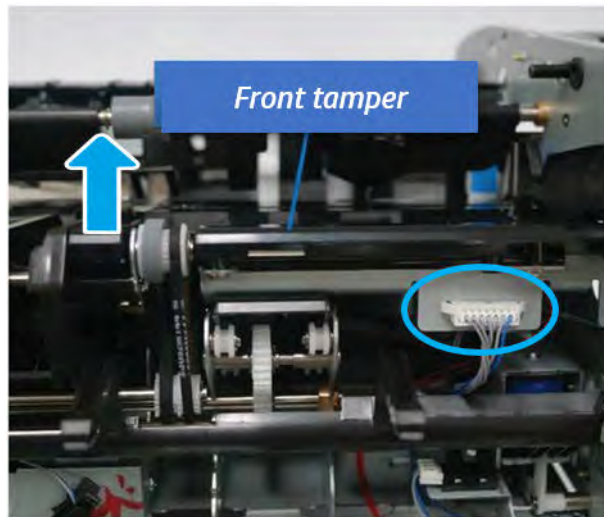

Unpack the replacement assembly

Follow these steps to unpack the replacement assembly.

1. Dispose of the defective part.

 **NOTE:** HP recommends responsible disposal of the defective part.

<http://www8.hp.com/us/en/hp-information/environment/product-recycling.html>

2. Unpack the replacement part from the packaging.



CAUTION:  Some parts are sensitive to electrostatic discharge (ESD). Always perform service work at an ESD-protected workstation or mat. If an ESD workstation or mat is not available, touch the sheet-metal chassis to provide a static ground before touching an ESD-sensitive assembly. Protect the ESD-sensitive assemblies by placing them in ESD pouches when they are out of the printer.

 **IMPORTANT:** Make sure that all of the shipping materials (for example shipping tape) are removed from the replacement part prior to installation.

 **NOTE:** If the replacement part is a roller or pad, avoid touching the spongy part of it. Skin oils on the roller or pad can cause paper pickup and/or print-quality problems. HP recommends using disposable gloves when handling rollers or pads or washing your hands before touching rollers or pads.

3. To install an assembly, reverse the removal steps.

 **NOTE:** When applicable, special installation instructions are provided for an assembly at the end of the removal procedure. Always completely read the removal instructions and follow all special installation instructions.

Removal and replacement: Front tamper home sensor (S5)

Learn how to remove and replace the front tamper home sensor.

To view teardown and reassembling video of the inner finisher, click the link below.



[View a teardown video of the inner finisher.](#)



[View a reassembling video of the inner finisher.](#)



IMPORTANT: When applicable, special installation instructions are provided for an assembly at the end of the removal procedure. Always completely read the removal instructions and follow all special installation instructions.

Mean time to repair:

Service level:

Before performing service

Turn the printer power off

- Press the power button on the front of the printer, and then turn off the power switch next to the power cable.
- A shutting-down message appears on the control-panel display.



WARNING! To avoid damage to the printer, turn the power off and wait until the printer shuts down before removing the power cable.

- Disconnect the printer power cable after the printer has completely shut down (the control-panel display is blank).

Use the table below to identify the correct part number for your printer. To order the part, go to www.hp.com/buy/parts.

Table 7-54 Part information

Part number	Part description
0604-001393	Front tamper home sensor

Required tools

- #2 JIS screwdriver with a magnetic tip

After performing service

Turn the printer power on

- Connect the power cable.
- Use the power switch to turn the power on.

Post service test

Print any pages necessary to verify that the repair resolved the issue and did not create any new issues.

Remove the front cover

Follow these steps to remove the front cover.

1. Open the front door and open the punch cover.
2. Remove three screws in the front.
3. Remove the lever.
4. Open the top cover.
5. From the right side of the front cover, carefully lift and pry toward the top-left corner to remove the front cover.

Figure 7-320 Remove the front cover

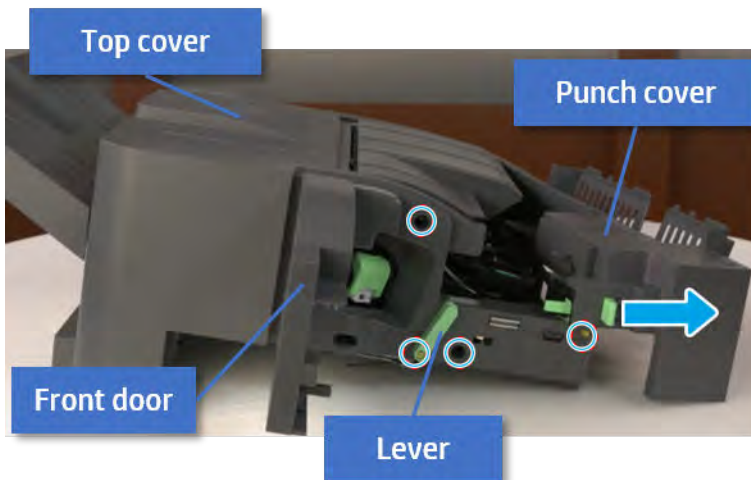

Remove the rear cover

Follow these steps to remove the rear cover.

1. Open the top cover.

Figure 7-321 Open the top cover

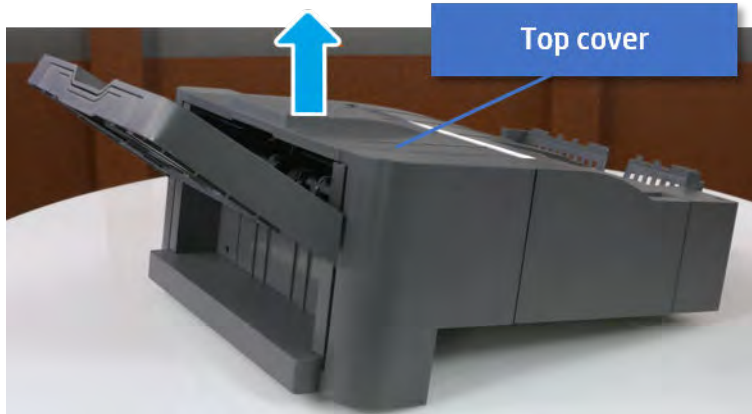

2. Remove three screws.
3. Release hooks carefully and remove the rear cover.

Figure 7-322 Remove the rear cover

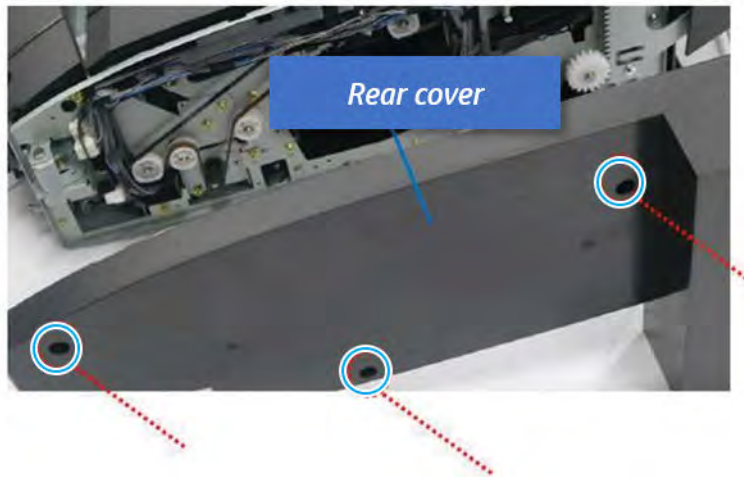

Remove the output tray

Follow these steps to remove the output tray.

1. Remove four screws.

Figure 7-323 Remove four screws

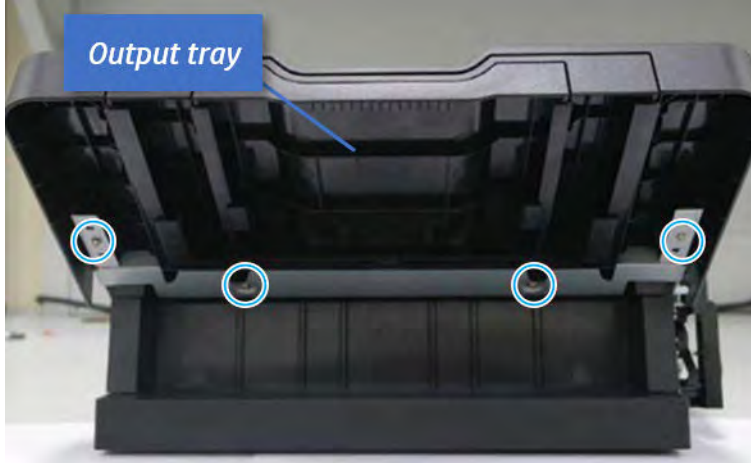

2. Push the paper holding actuator into the inner finisher, and then remove the output tray.

Figure 7-324 Remove the output tray.



Remove the output tray frame

Follow these steps to remove the output tray frame.

1. Rotate the pulley until the output tray frame depart from the gear.

Figure 7-325 Remove the pulley

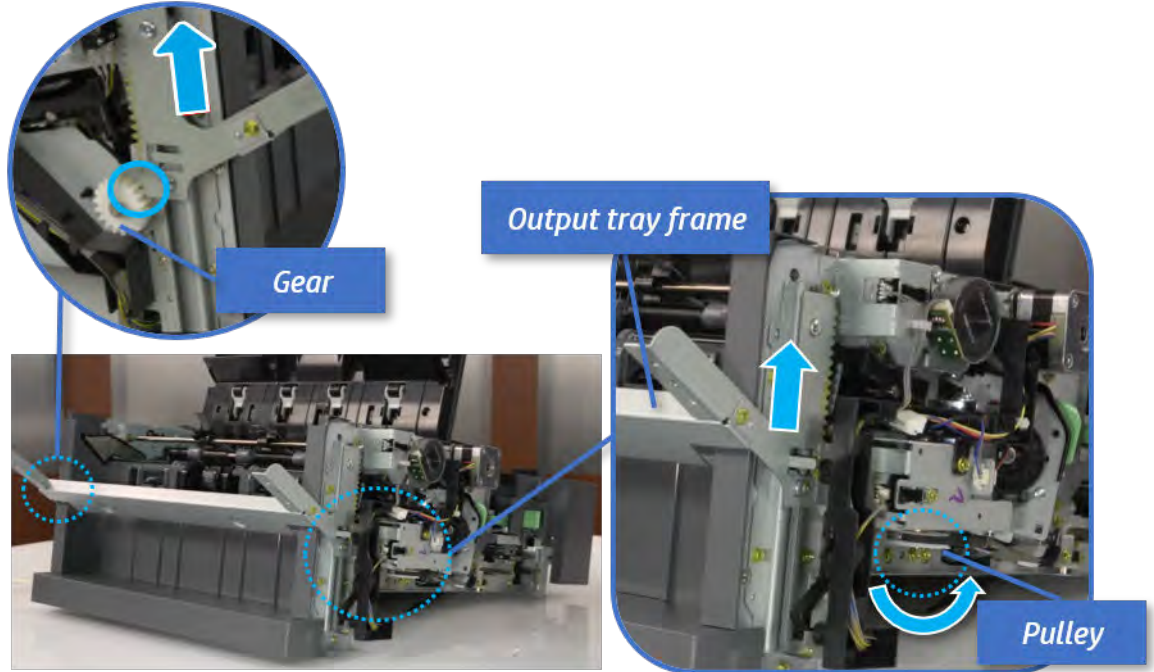

2. Push the paper holding actuator into the inner finisher, and then remove the output tray frame.

Figure 7-326 Remove the output tray frame

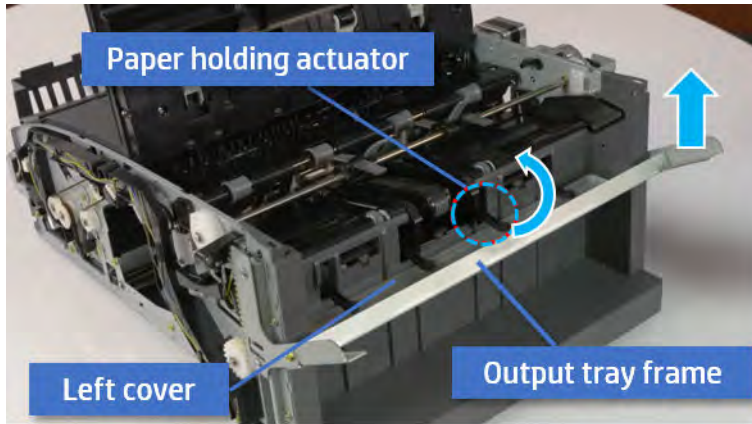

TIP: Push the paper holding actuator into the inner finisher when reassembling. Be sure to level the output tray.

- a. Position the first wheel into the channel on both sides while pushing the paper holding actuator.

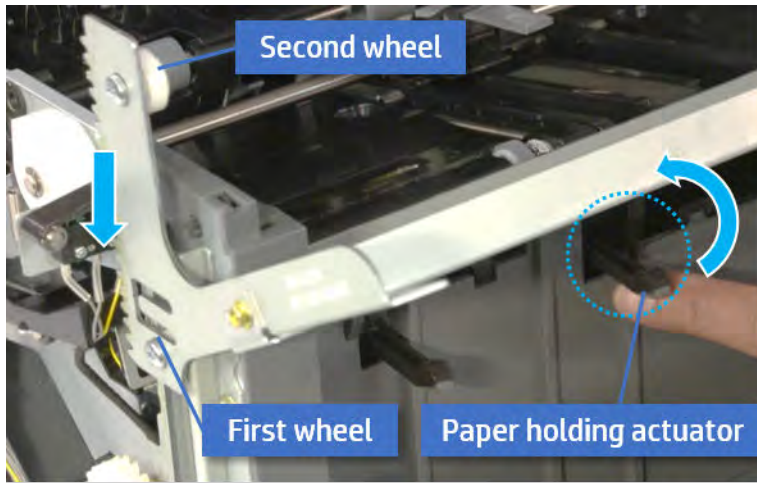

- b. Let the second wheel rest on the channel on both sides simultaneously.
- c. Gently squeeze the wheels into channel until the output tray frame meet the gear.

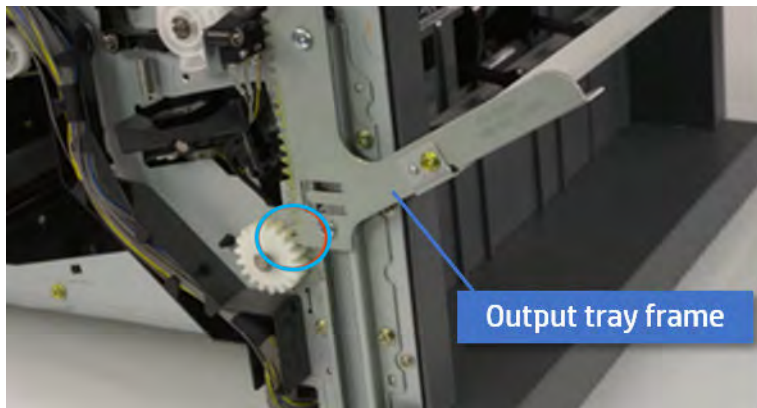

- d. Rotate the pulley until the output tray frame is no longer lifted. It can make to level the output tray frame.

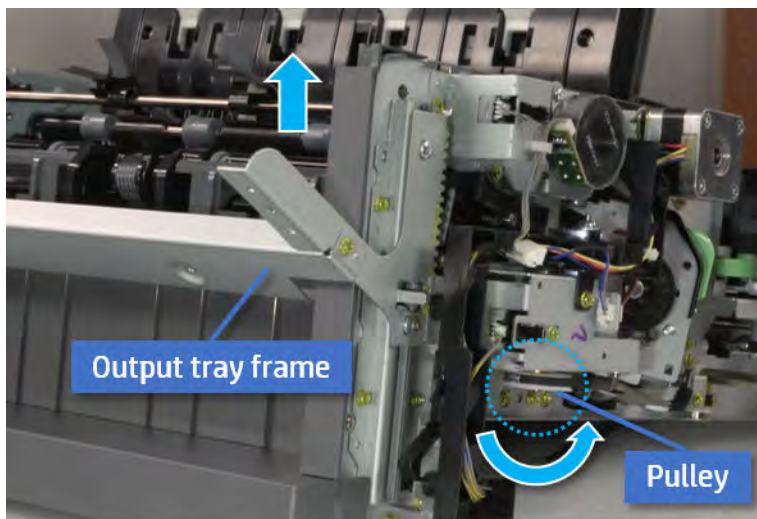

- e. Rotate the pulley in the opposite direction.

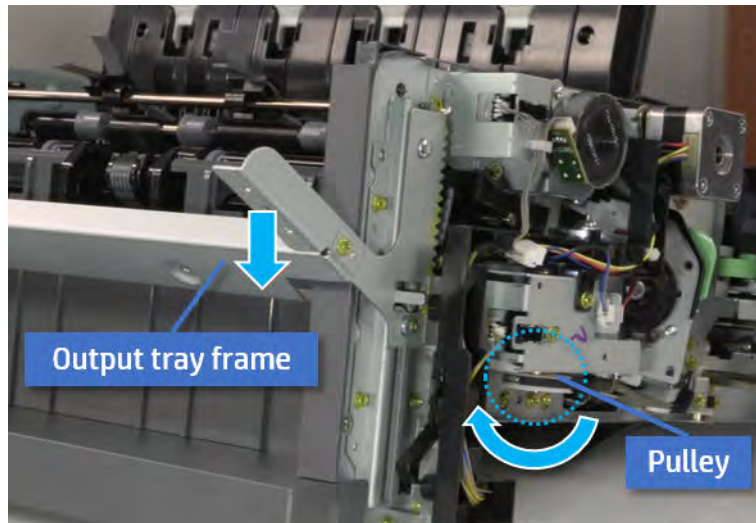

Remove the PCA cover

Follow these steps to remove the PCA cover.

- ▲ Remove two screws, and then remove the PCA cover.

Figure 7-327 Remove the PCA cover

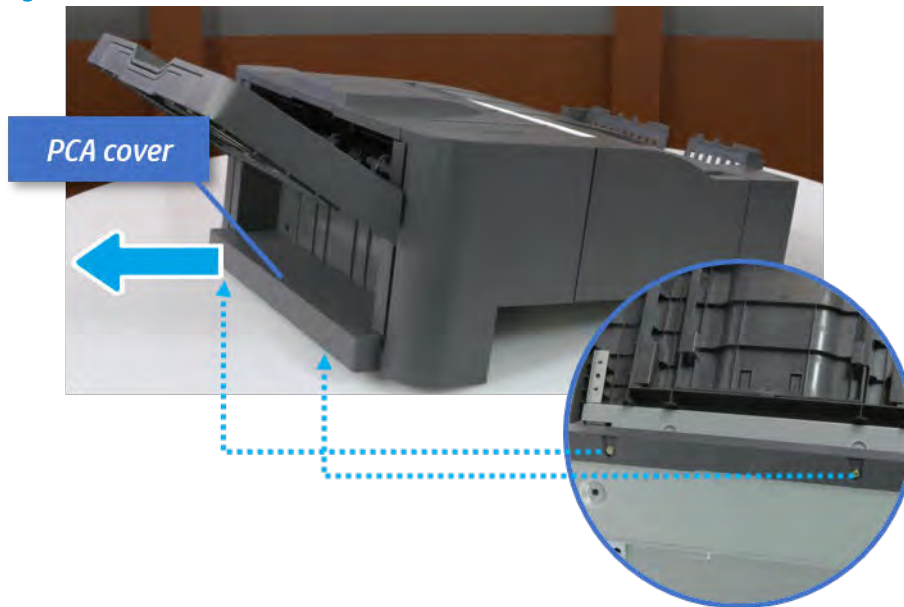

Remove the left cover

Follow these steps to remove the left cover.

1. Remove two screws.

Figure 7-328 Remove two screws

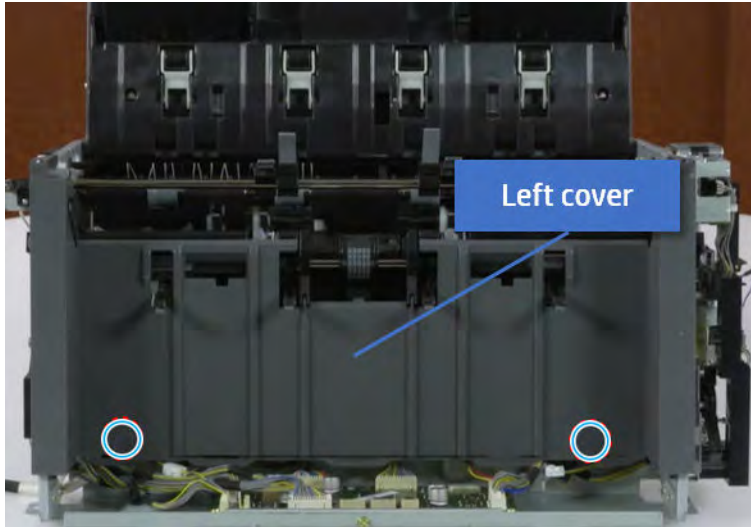

2. Remove four screws from both front and rear sides.

Figure 7-329 Remove four screws

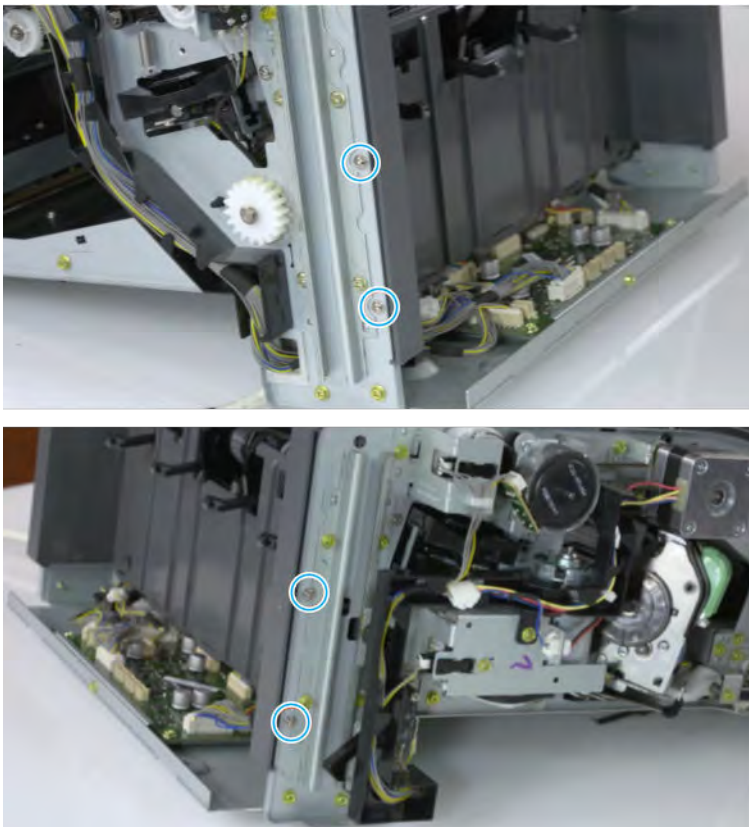

3. Unplug two inline connectors, and then remove the left cover.

Figure 7-330 Unplug two connectors

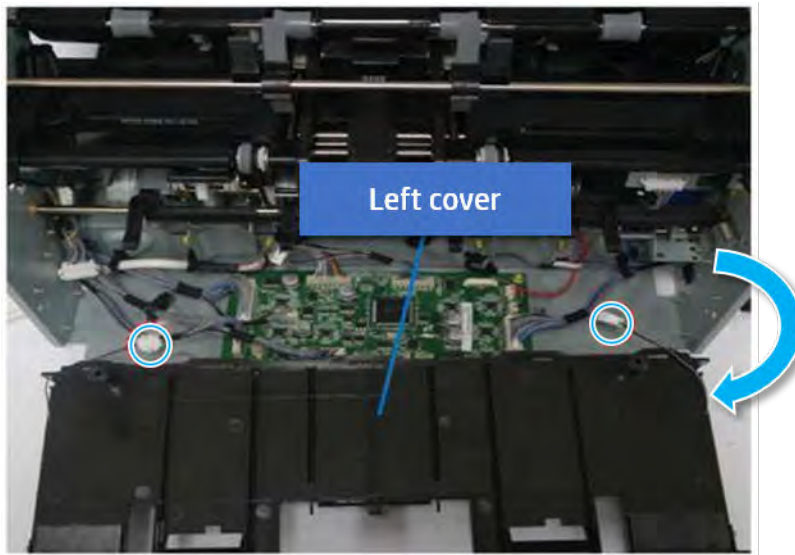

 **TIP:** Be sure to check the hook when reassembling.

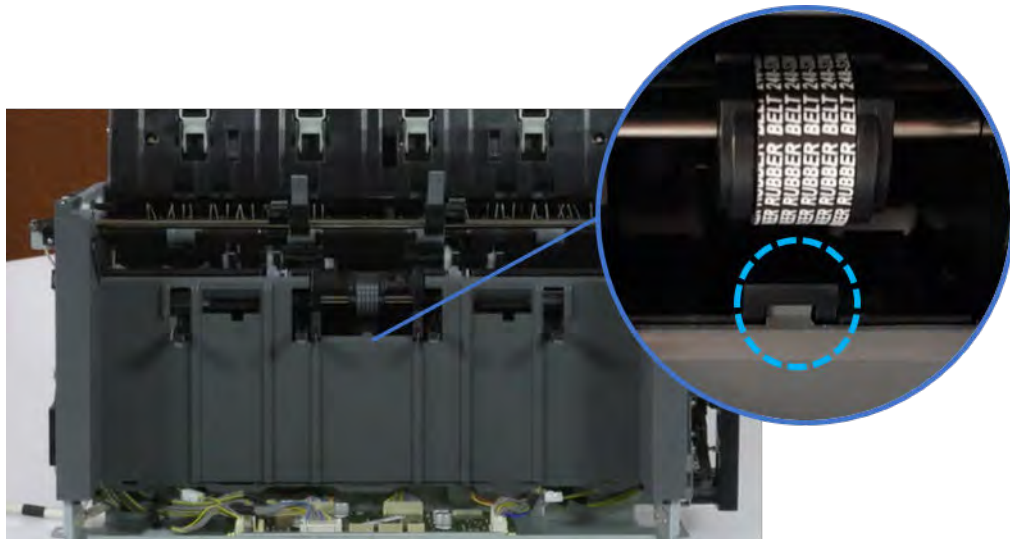

Remove the front harness guide

Follow these steps to remove the front harness guide.

1. Open one clamp and unplug five connectors, and then remove the wire harness from the front harness guide.

2. Remove four screws, and then remove the front harness guide.

Figure 7-331 Remove the front harness guide

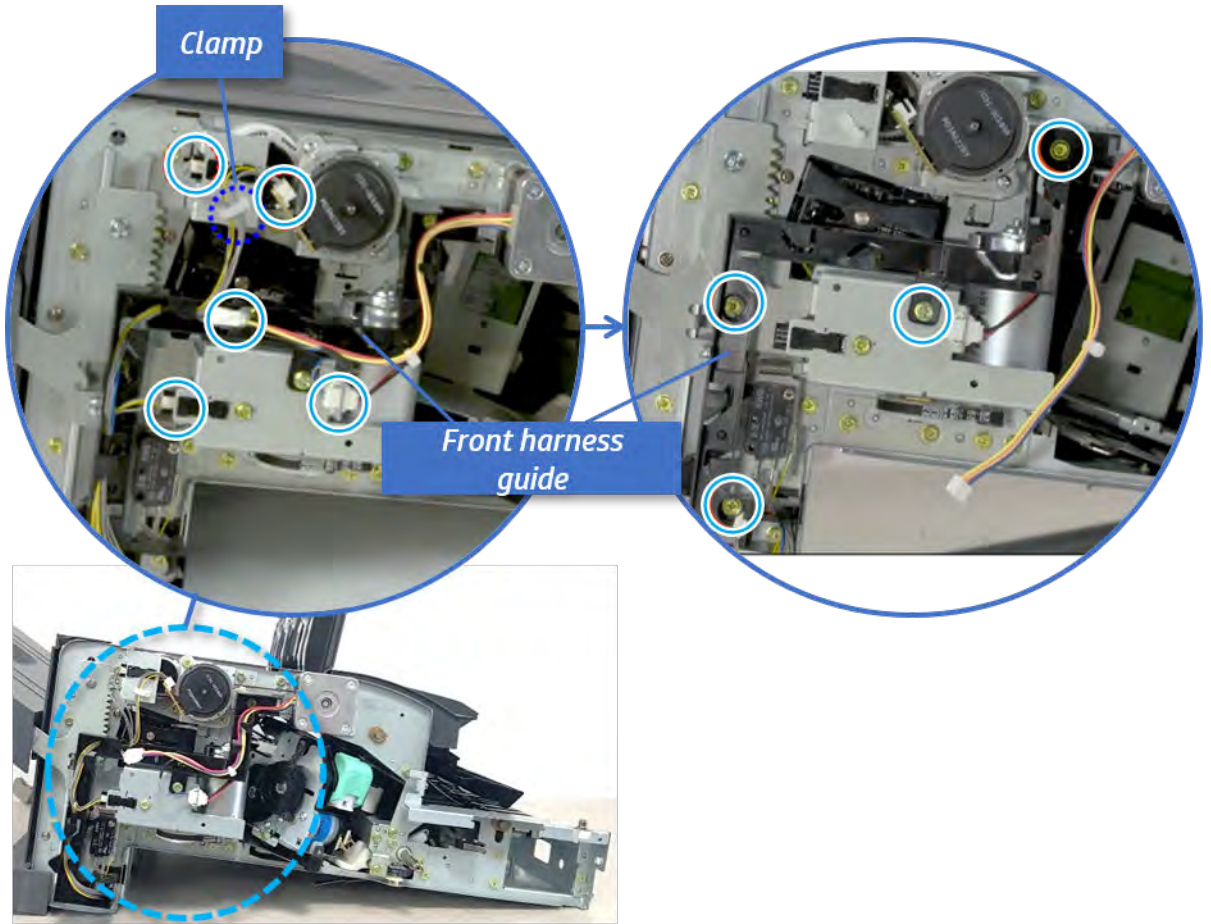

Remove the output tray motor assembly

Follow these steps to remove the output tray motor assembly.

- ▲ Remove three screws, and then remove the output tray motor assembly.

Figure 7-332 Remove the output tray motor assembly

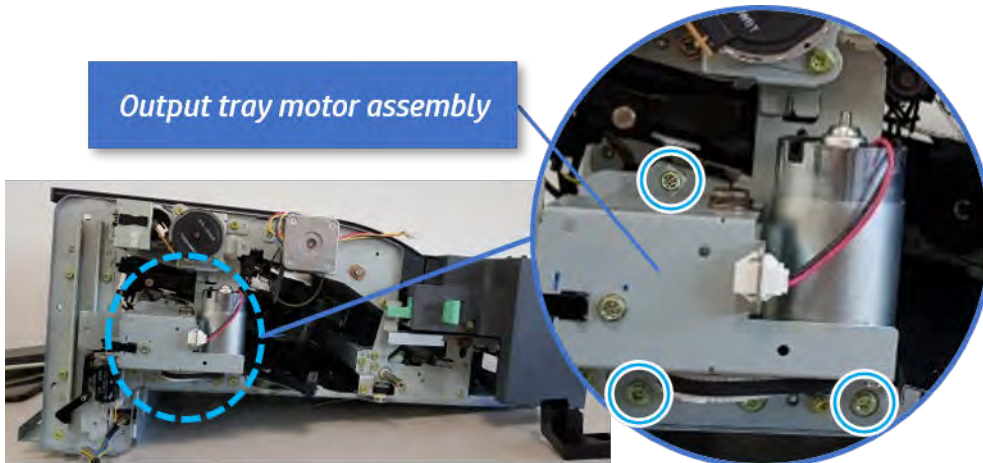

Remove the output tray lower limit switch

Follow these steps to remove the output tray lower limit switch.

- ▲ Remove one screw, and then remove the output tray lower limit switch.

Figure 7-333 Remove the output tray lower limit switch

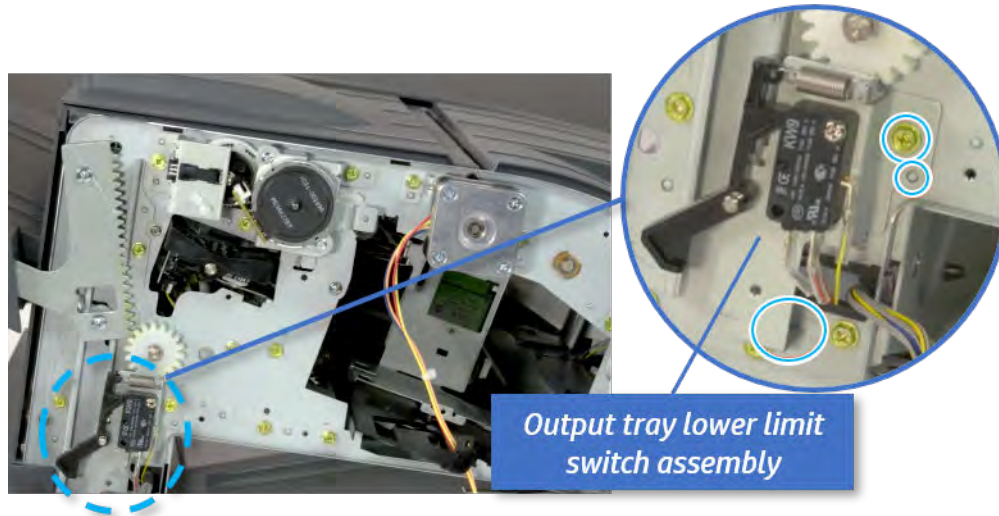

Remove the paper holding

Follow these steps to remove the paper holding.

1. Remove the paper holding actuator spring.

Figure 7-334 Remove the paper holding actuator spring

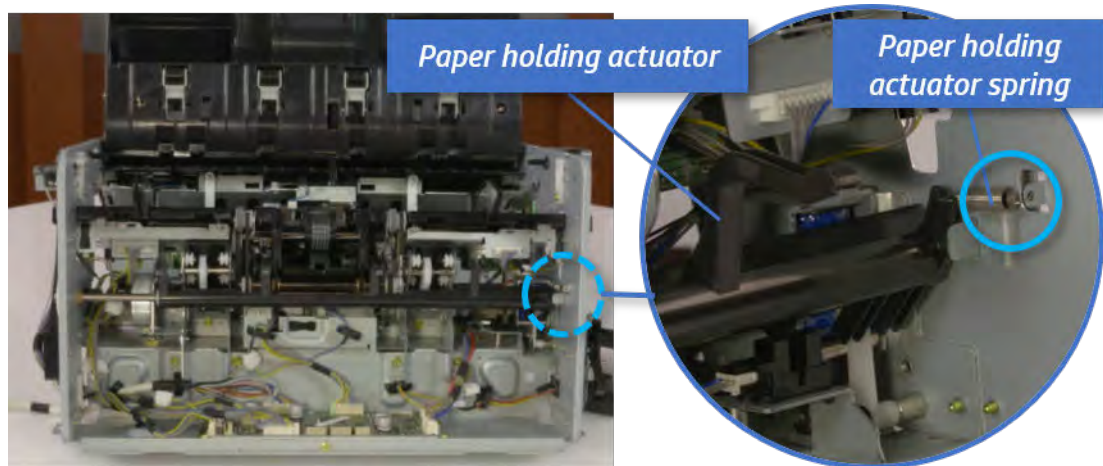

2. Remove the e-ring and the rack pinion gear. And then remove the pin and the e-ring, and then remove the bushing.

Figure 7-335 Remove e-ring, rack pinion gear, pin, and bushing

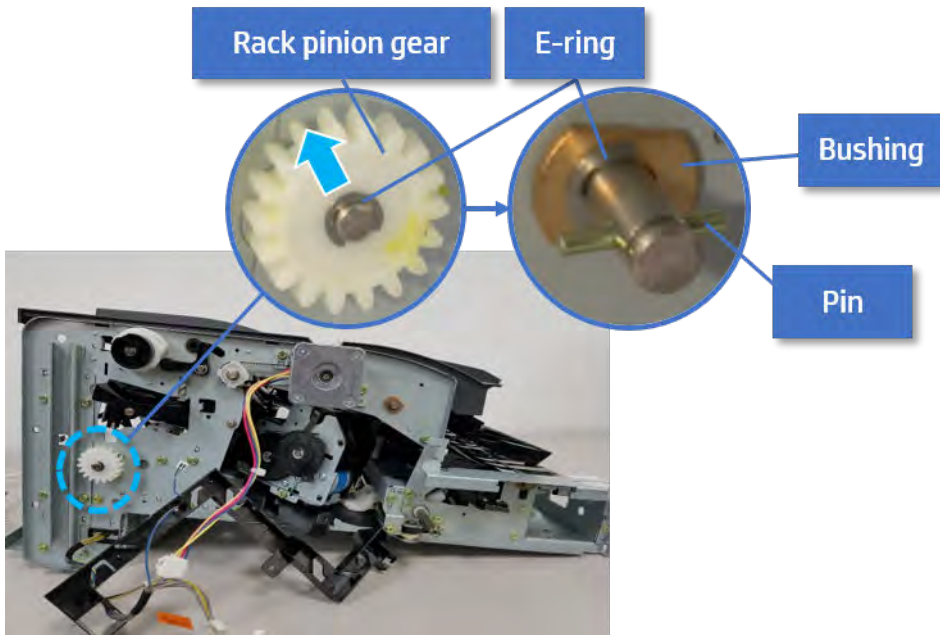

 **NOTE:** Be sure not to lose the pin.

3. Carefully remove the paper holding shaft and the actuator.

Figure 7-336 Remove the paper holding shaft and the actuator

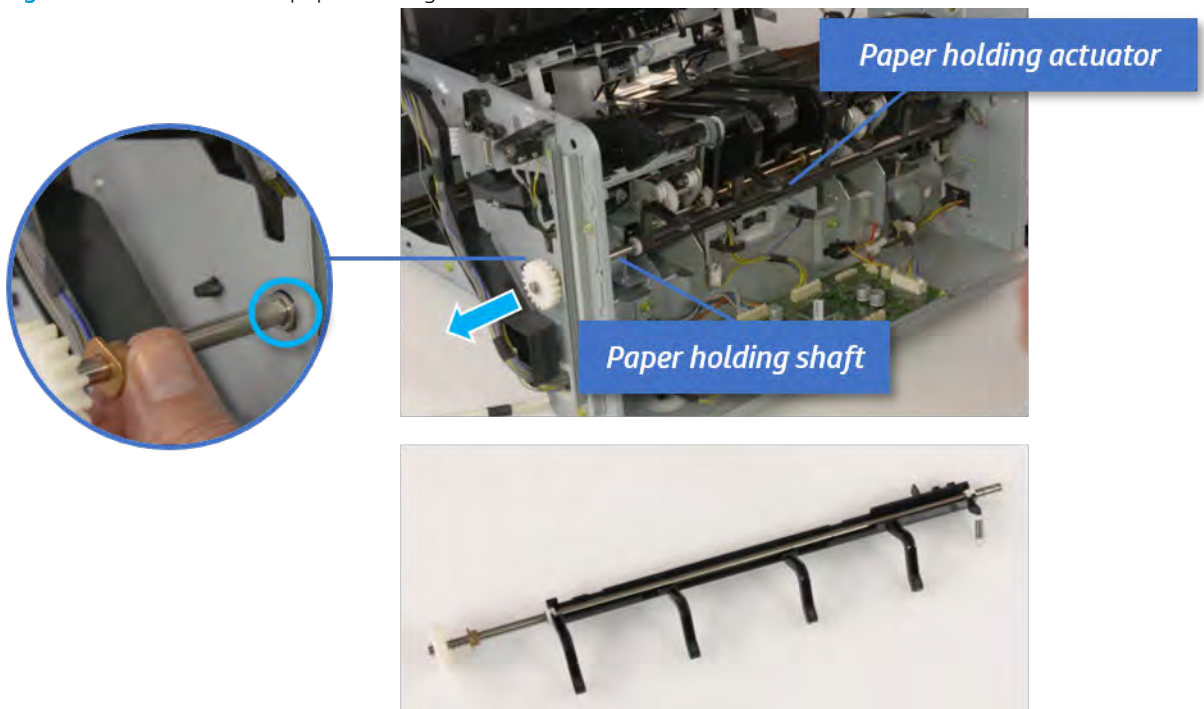

Remove the sub paddle unit

Follow these steps to remove the sub paddle unit.

1. Open the top cover, and then remove one screw securing the sub paddle unit.

Figure 7-337 Remove one screw

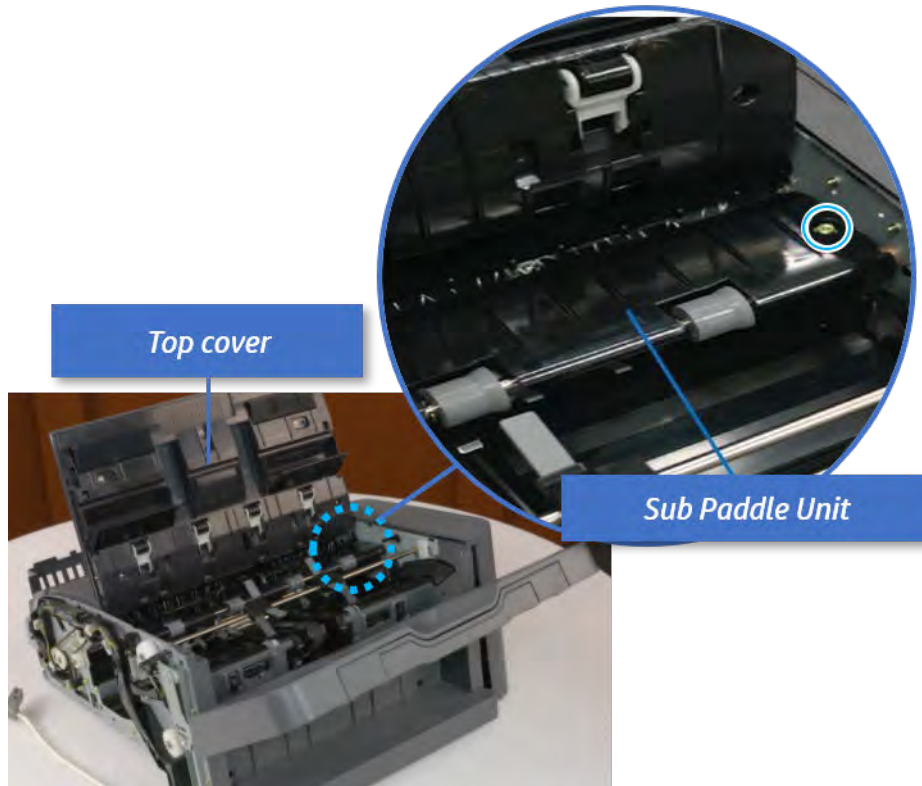

2. Remove the e-ring, and then remove the pulley and timing belt. And then remove the e-ring and the bushing.

Figure 7-338 Remove the e-ring, pulley, timing belt, and bushing

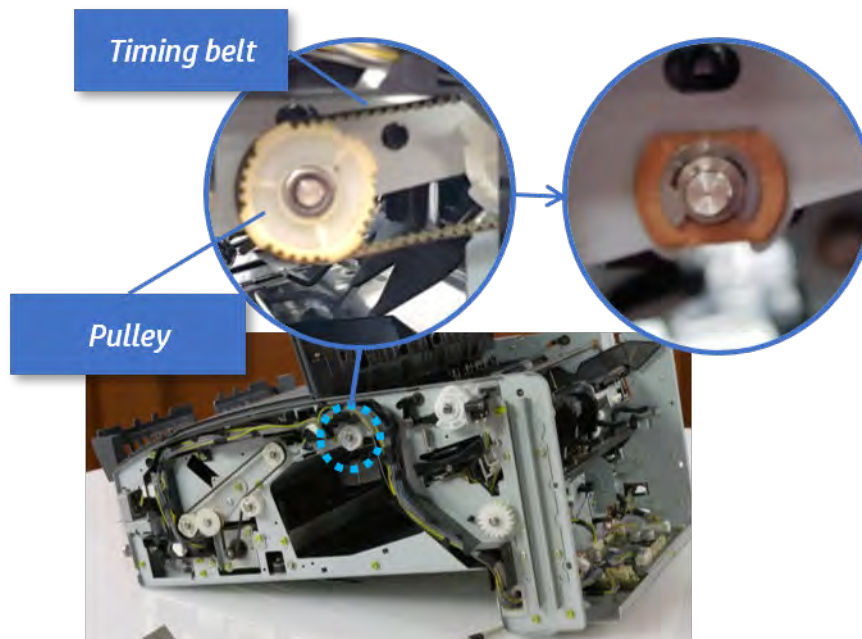

3. Lift up and remove the sub paddle unit.

Figure 7-339 Remove the sub paddle unit

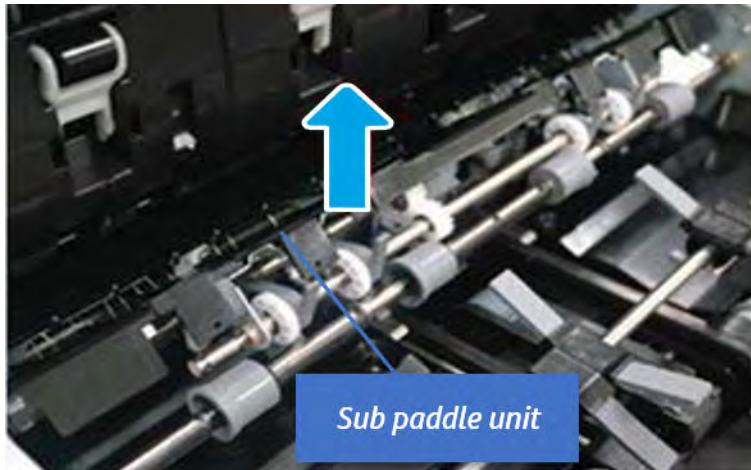

Remove the exit roller

Follow these steps to remove the exit roller.

1. Remove the guide on the center of the exit roller.

Figure 7-340 Remove the guide

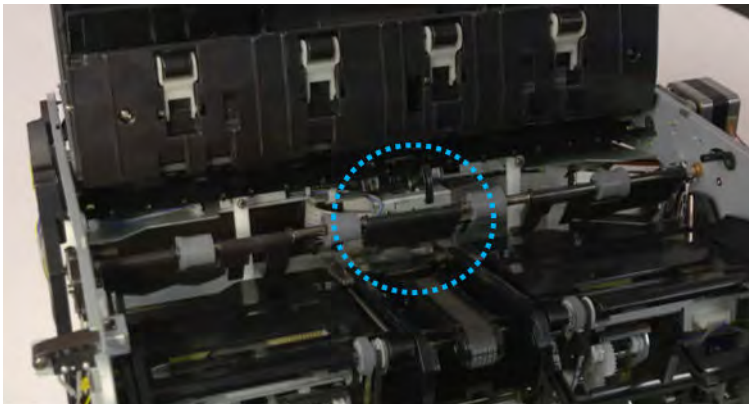

2. On the front of the inner finisher, release the timing belt connected to the exit motor.

Figure 7-341 Release the timing belt

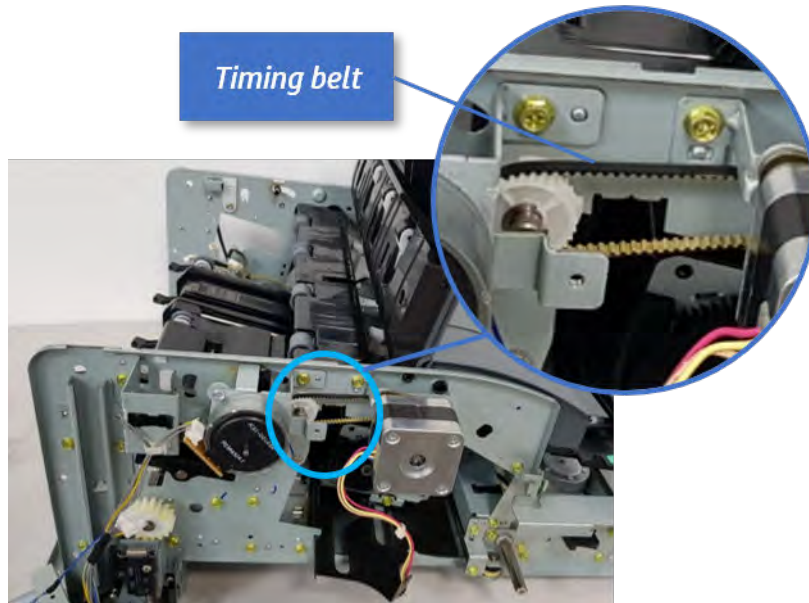

3. Remove five screws securing the rear harness guide.

Figure 7-342 Remove five screws

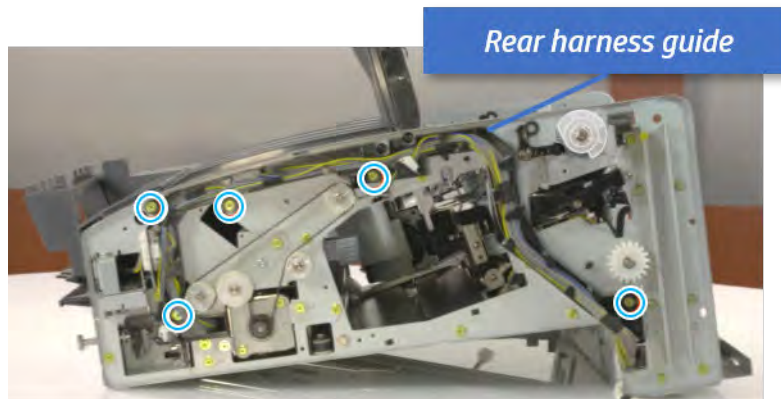

4. On the rear of the inner finisher, remove the e-ring and the pulley and then remove the e-ring and the bushing.

Figure 7-343 Remove e-ring, pulley, and bushing

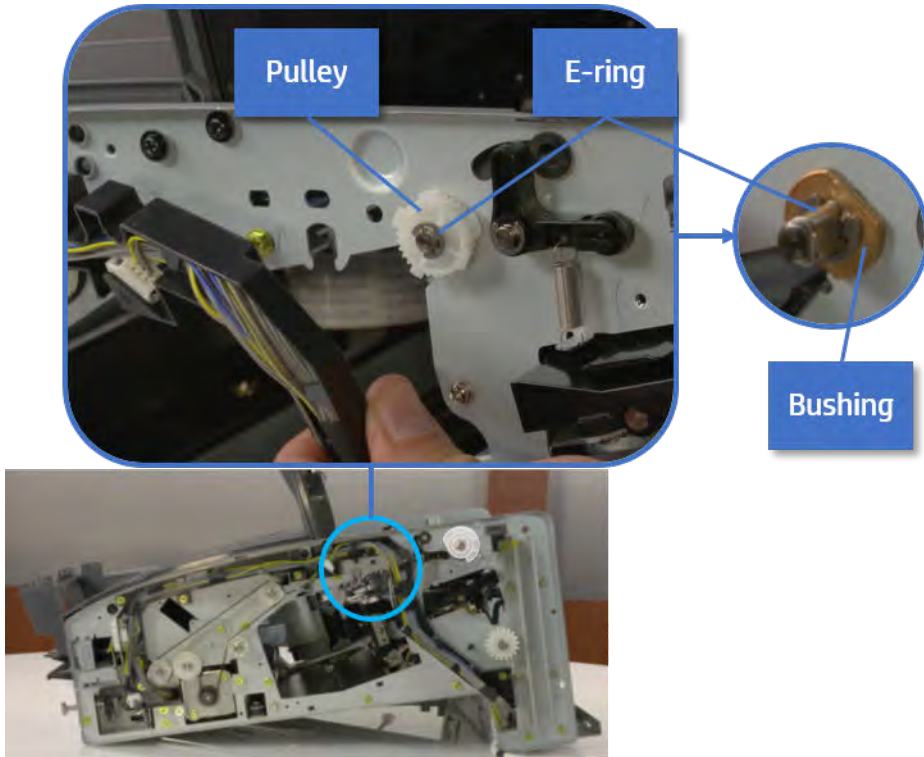

5. Push the bushing to detach it, and then remove the exit roller.

Figure 7-344 Remove the exit roller

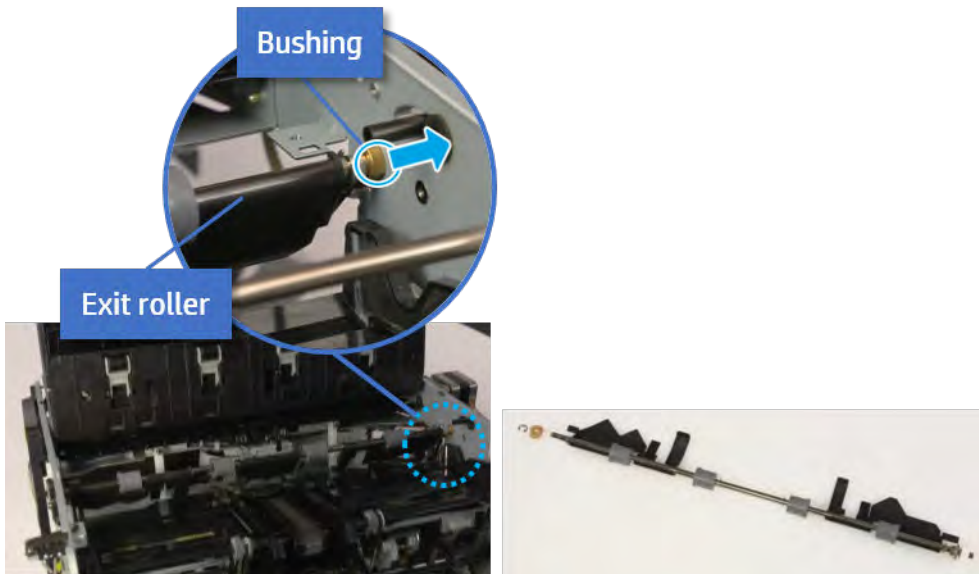

Remove the front tamper

Follow these steps to remove the front tamper.

1. Remove four screws.

Figure 7-345 Remove four screws

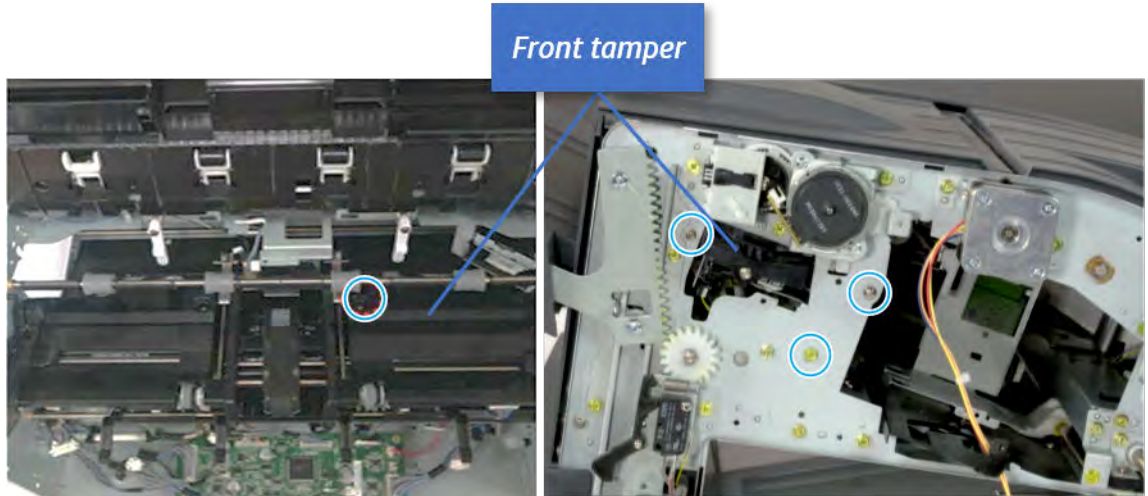

2. Unplug the connector and release the hook, and then pull the front tamper up to remove.

Figure 7-346 Remove the front tamper

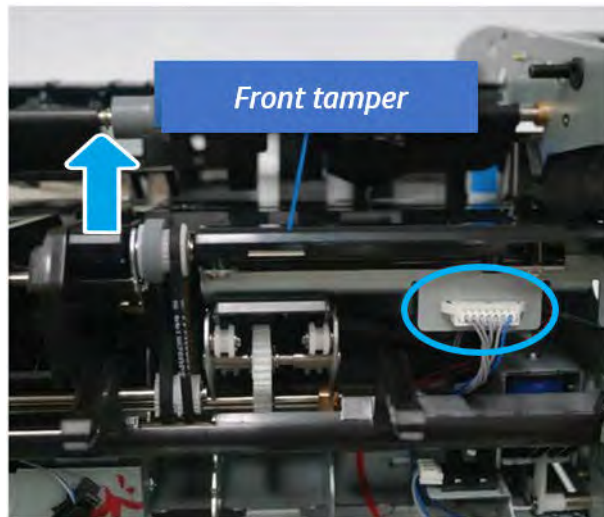

Remove the front tamper home sensor

Follow these steps to remove the front tamper home sensor.

- ▲ Unplug the connector, and then remove the front tamper home sensor.

Figure 7-347 Remove the front tamper home sensor

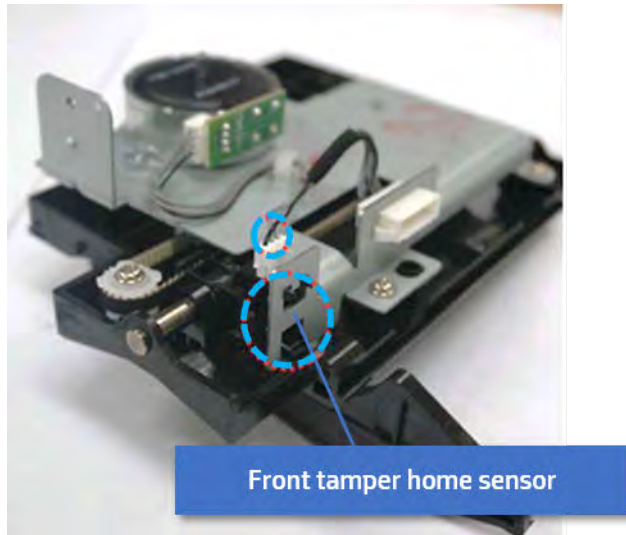

Unpack the replacement assembly



Follow these steps to unpack the replacement assembly.

1. Dispose of the defective part.

 **NOTE:** HP recommends responsible disposal of the defective part.

<http://www8.hp.com/us/en/hp-information/environment/product-recycling.html>

2. Unpack the replacement part from the packaging.

 **CAUTION:**  Some parts are sensitive to electrostatic discharge (ESD). Always perform service work at an ESD-protected workstation or mat. If an ESD workstation or mat is not available, touch the sheet-metal chassis to provide a static ground before touching an ESD-sensitive assembly. Protect the ESD-sensitive assemblies by placing them in ESD pouches when they are out of the printer.

 **IMPORTANT:** Make sure that all of the shipping materials (for example shipping tape) are removed from the replacement part prior to installation.

 **NOTE:** If the replacement part is a roller or pad, avoid touching the spongy part of it. Skin oils on the roller or pad can cause paper pickup and/or print-quality problems. HP recommends using disposable gloves when handling rollers or pads or washing your hands before touching rollers or pads.

3. To install an assembly, reverse the removal steps.

 **NOTE:** When applicable, special installation instructions are provided for an assembly at the end of the removal procedure. Always completely read the removal instructions and follow all special installation instructions.

Removal and replacement: Front tamper motor (M9)

Learn how to remove and replace the front tamper motor.

To view teardown and reassembling video of the inner finisher, click the link below.



[View a teardown video of the inner finisher.](#)



[View a reassembling video of the inner finisher.](#)



IMPORTANT: When applicable, special installation instructions are provided for an assembly at the end of the removal procedure. Always completely read the removal instructions and follow all special installation instructions.

Mean time to repair:

Service level:

Before performing service

Turn the printer power off

- Press the power button on the front of the printer, and then turn off the power switch next to the power cable.
- A shutting-down message appears on the control-panel display.



WARNING! To avoid damage to the printer, turn the power off and wait until the printer shuts down before removing the power cable.

- Disconnect the printer power cable after the printer has completely shut down (the control-panel display is blank).

Use the table below to identify the correct part number for your printer. To order the part, go to www.hp.com/buy/parts.

Table 7-55 Part information

Part number	Part description
JC93-01001A	Front tamper motor assembly

Required tools

- #2 JIS screwdriver with a magnetic tip

After performing service

Turn the printer power on

- Connect the power cable.
- Use the power switch to turn the power on.

Post service test

Print any pages necessary to verify that the repair resolved the issue and did not create any new issues.

Remove the front cover

Follow these steps to remove the front cover.

1. Open the front door and open the punch cover.
2. Remove three screws in the front.
3. Remove the lever.
4. Open the top cover.
5. From the right side of the front cover, carefully lift and pry toward the top-left corner to remove the front cover.

Figure 7-348 Remove the front cover

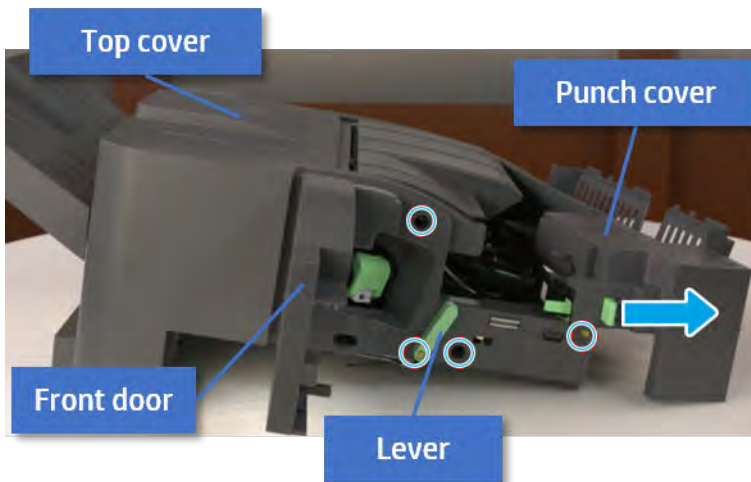

Remove the rear cover

Follow these steps to remove the rear cover.

1. Open the top cover.

Figure 7-349 Open the top cover

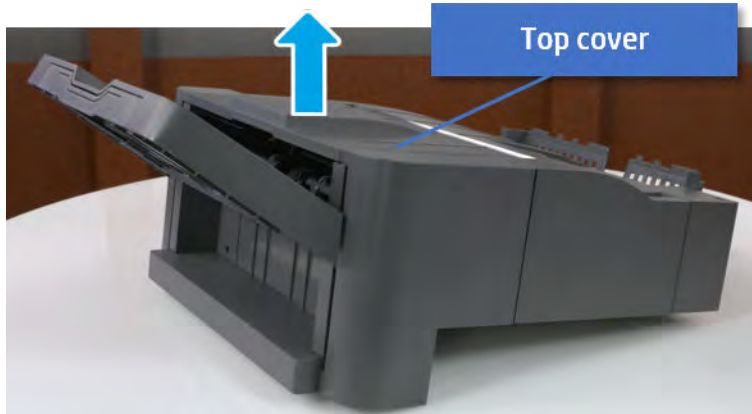

2. Remove three screws.
3. Release hooks carefully and remove the rear cover.

Figure 7-350 Remove the rear cover

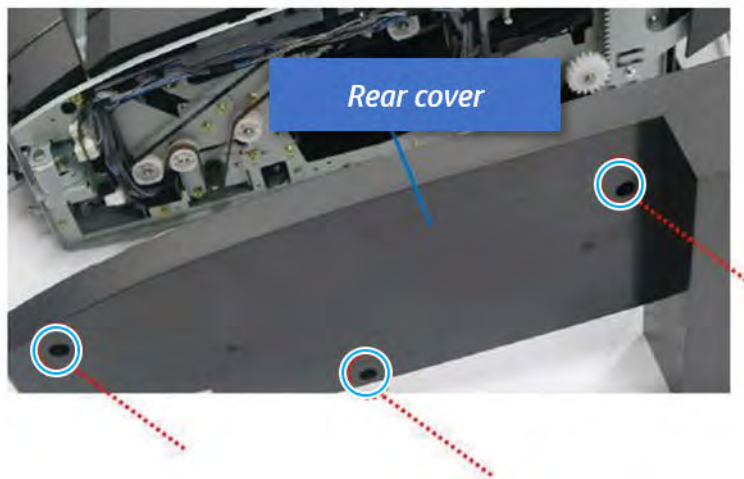

Remove the output tray

Follow these steps to remove the output tray.

1. Remove four screws.

Figure 7-351 Remove four screws

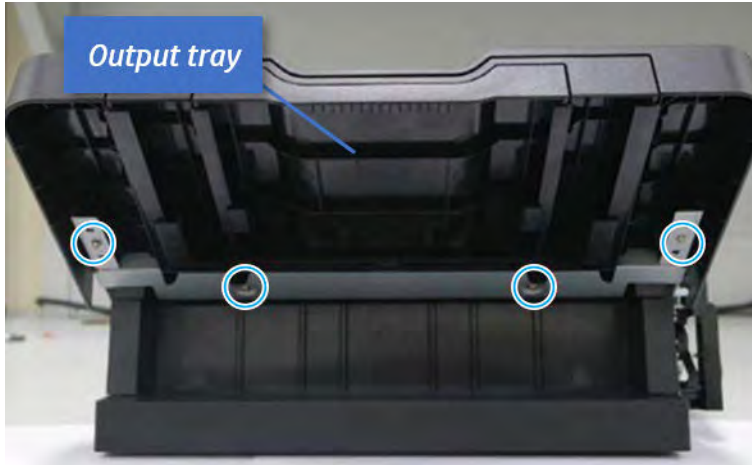

2. Push the paper holding actuator into the inner finisher, and then remove the output tray.

Figure 7-352 Remove the output tray.



Remove the output tray frame

Follow these steps to remove the output tray frame.

1. Rotate the pulley until the output tray frame depart from the gear.

Figure 7-353 Remove the pulley

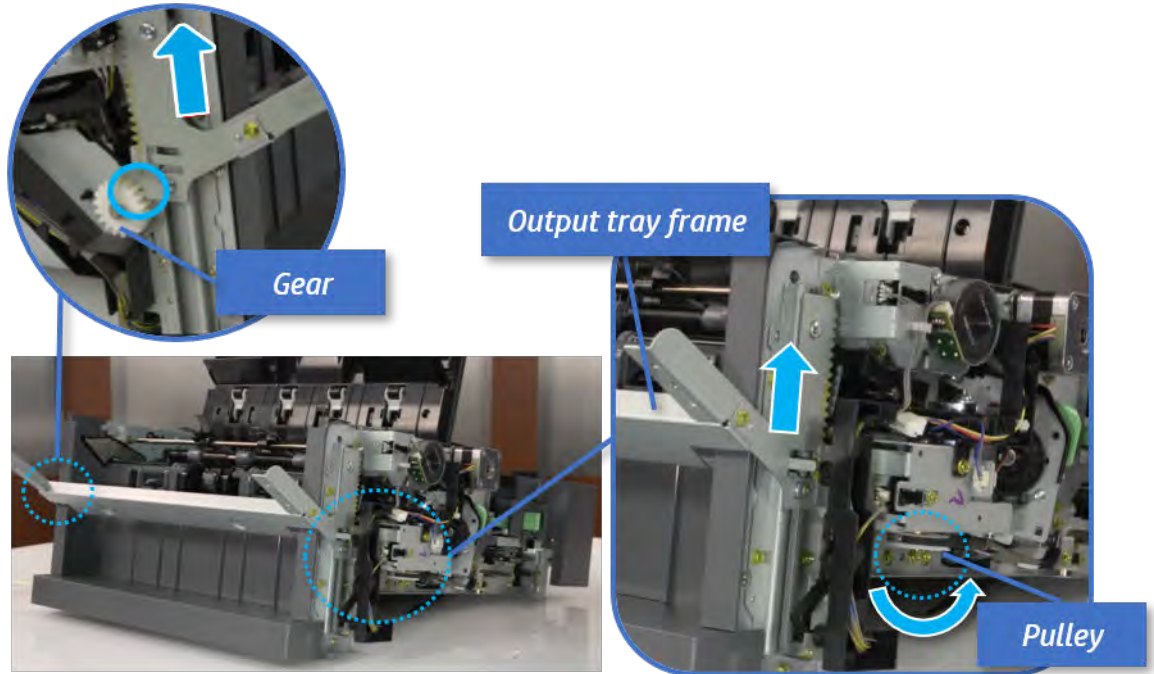

2. Push the paper holding actuator into the inner finisher, and then remove the output tray frame.

Figure 7-354 Remove the output tray frame

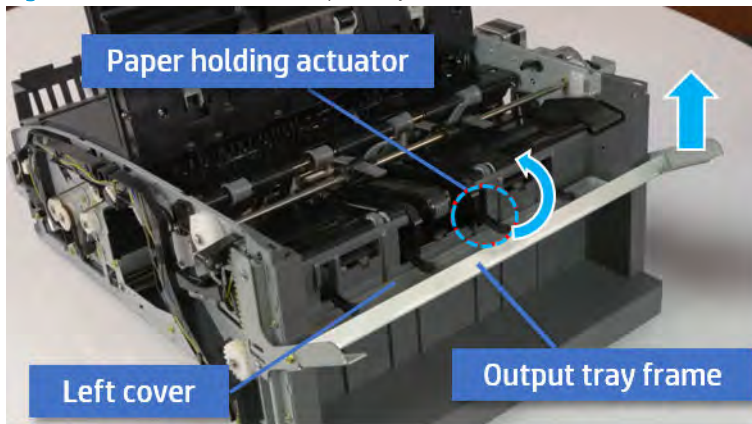

TIP: Push the paper holding actuator into the inner finisher when reassembling. Be sure to level the output tray.

- a. Position the first wheel into the channel on both sides while pushing the paper holding actuator.

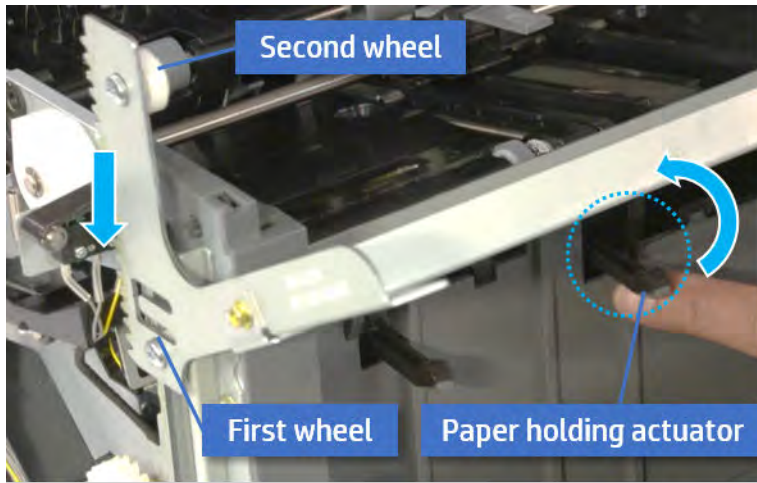

- b. Let the second wheel rest on the channel on both sides simultaneously.
- c. Gently squeeze the wheels into channel until the output tray frame meet the gear.

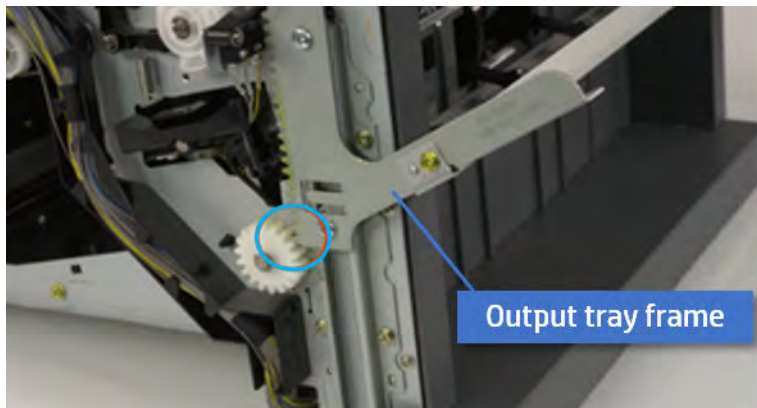

- d. Rotate the pulley until the output tray frame is no longer lifted. It can make to level the output tray frame.

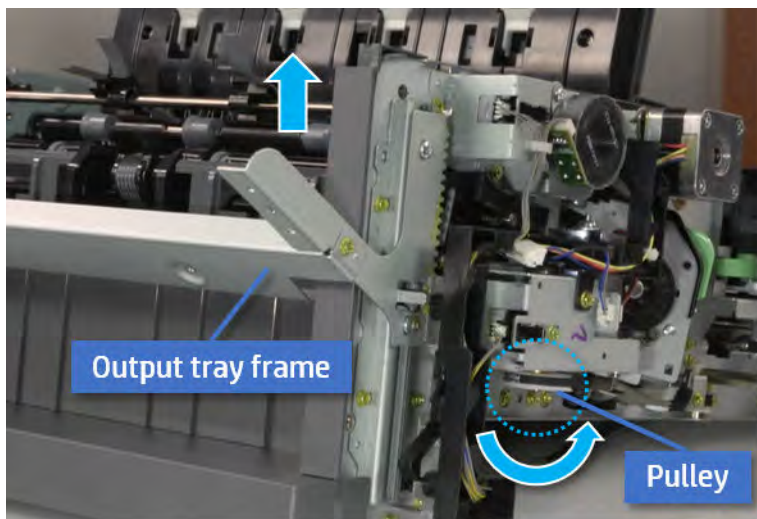

- e. Rotate the pulley in the opposite direction.

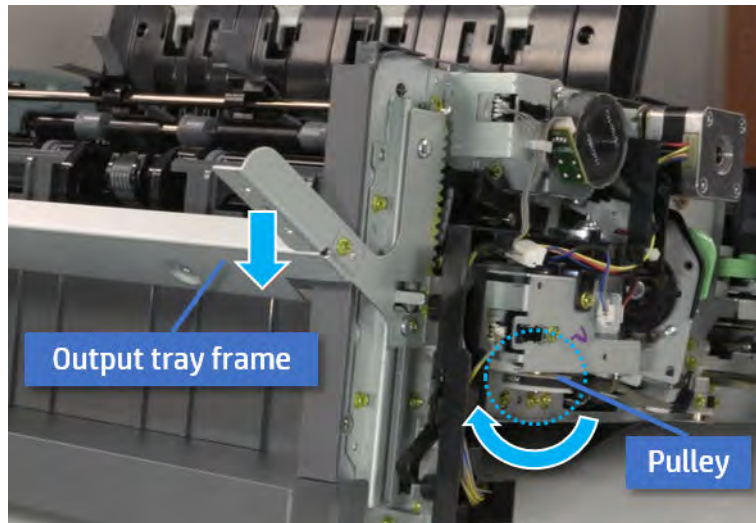

Remove the PCA cover

Follow these steps to remove the PCA cover.

- ▲ Remove two screws, and then remove the PCA cover.

Figure 7-355 Remove the PCA cover

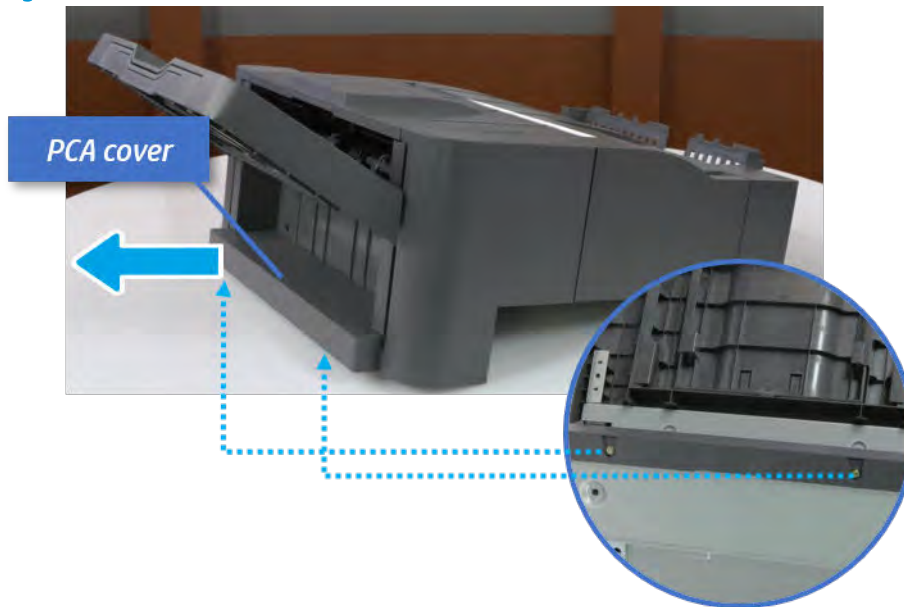

Remove the left cover

Follow these steps to remove the left cover.

1. Remove two screws.

Figure 7-356 Remove two screws

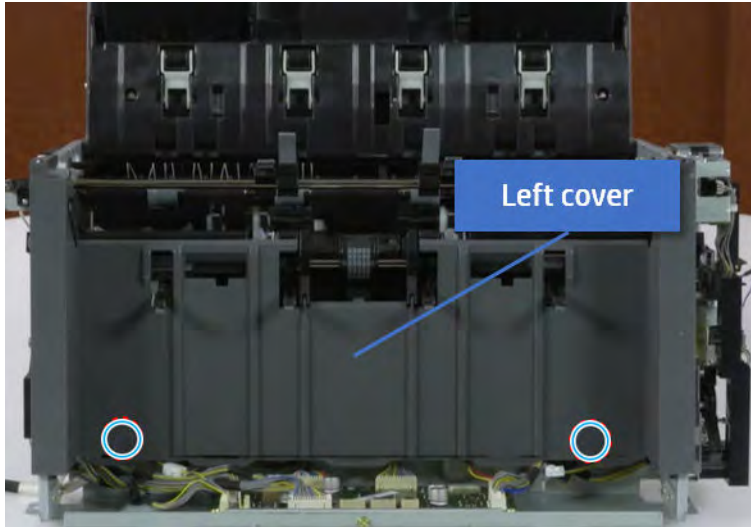

2. Remove four screws from both front and rear sides.

Figure 7-357 Remove four screws

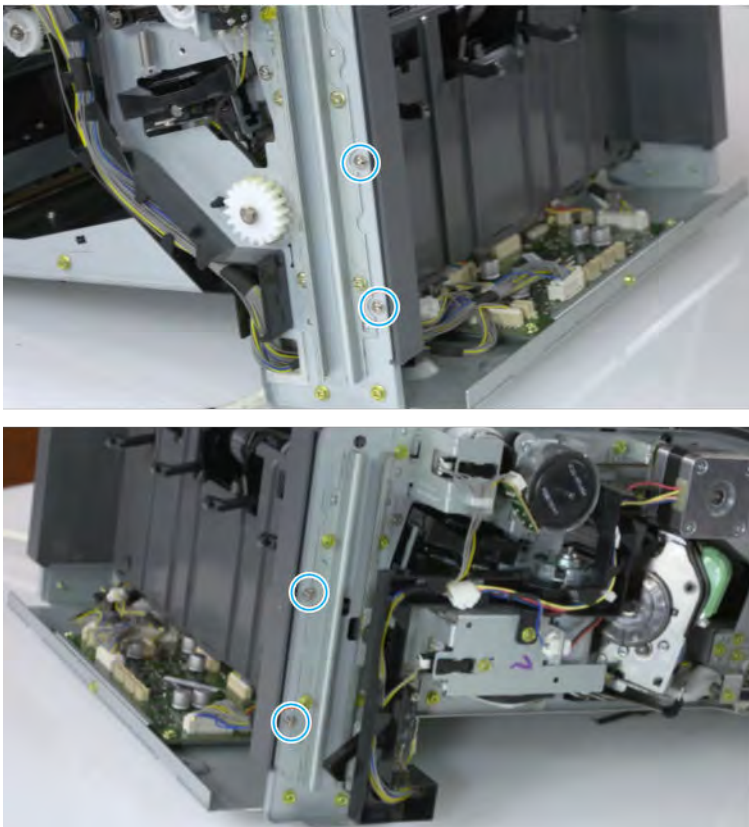

3. Unplug two inline connectors, and then remove the left cover.

Figure 7-358 Unplug two connectors

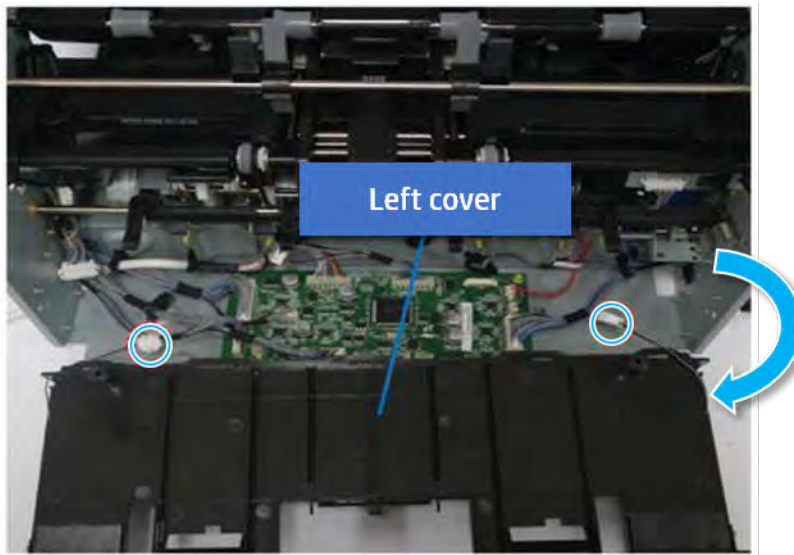

 **TIP:** Be sure to check the hook when reassembling.

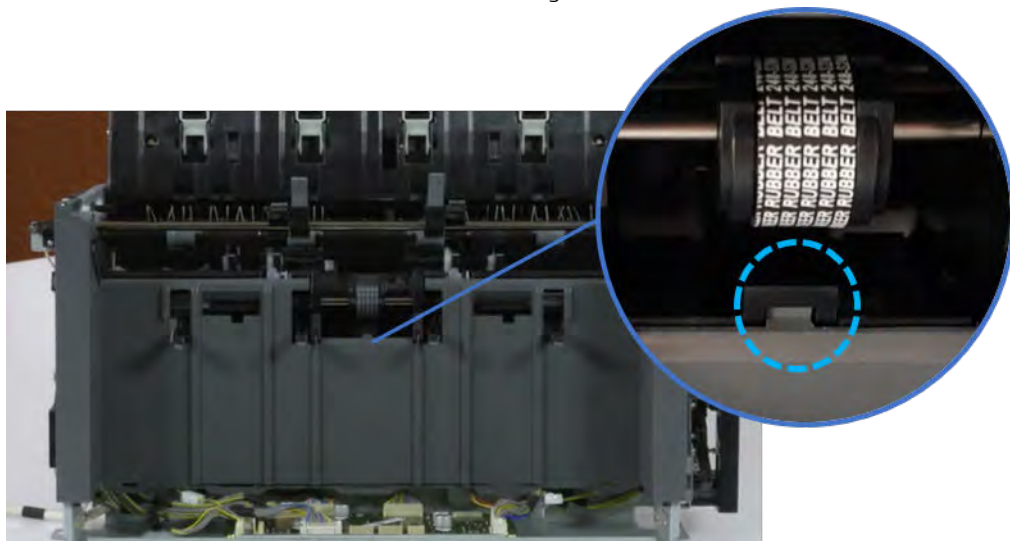

Remove the front harness guide

Follow these steps to remove the front harness guide.

1. Open one clamp and unplug five connectors, and then remove the wire harness from the front harness guide.

2. Remove four screws, and then remove the front harness guide.

Figure 7-359 Remove the front harness guide

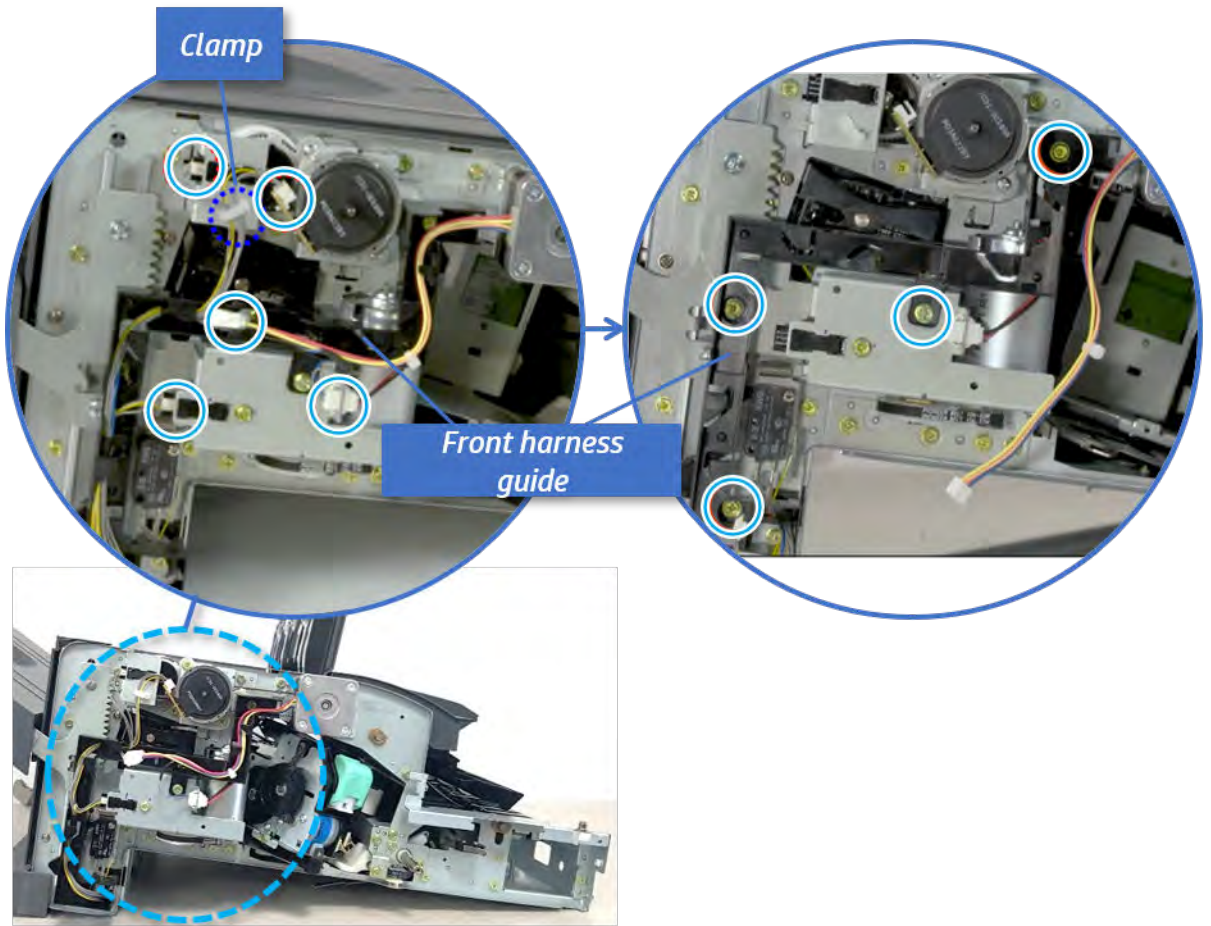

Remove the output tray motor assembly

Follow these steps to remove the output tray motor assembly.

- ▲ Remove three screws, and then remove the output tray motor assembly.

Figure 7-360 Remove the output tray motor assembly

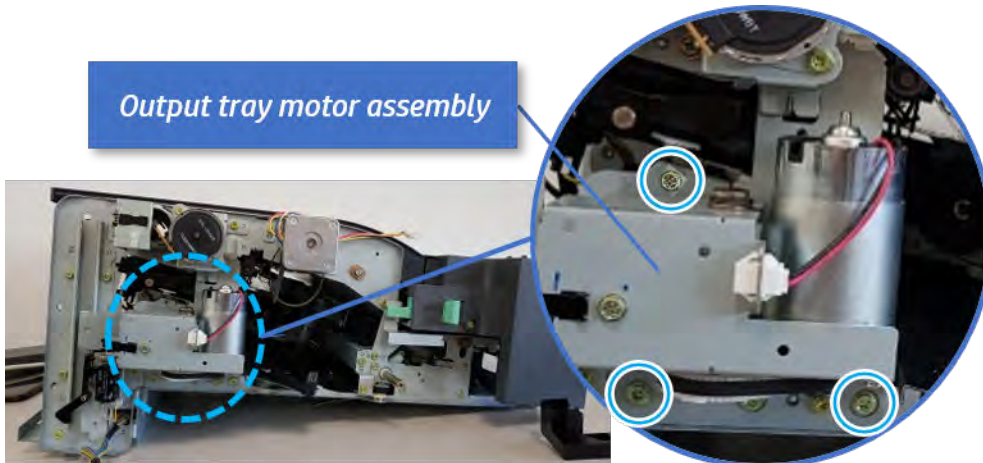

Remove the output tray lower limit switch

Follow these steps to remove the output tray lower limit switch.

- ▲ Remove one screw, and then remove the output tray lower limit switch.

Figure 7-361 Remove the output tray lower limit switch

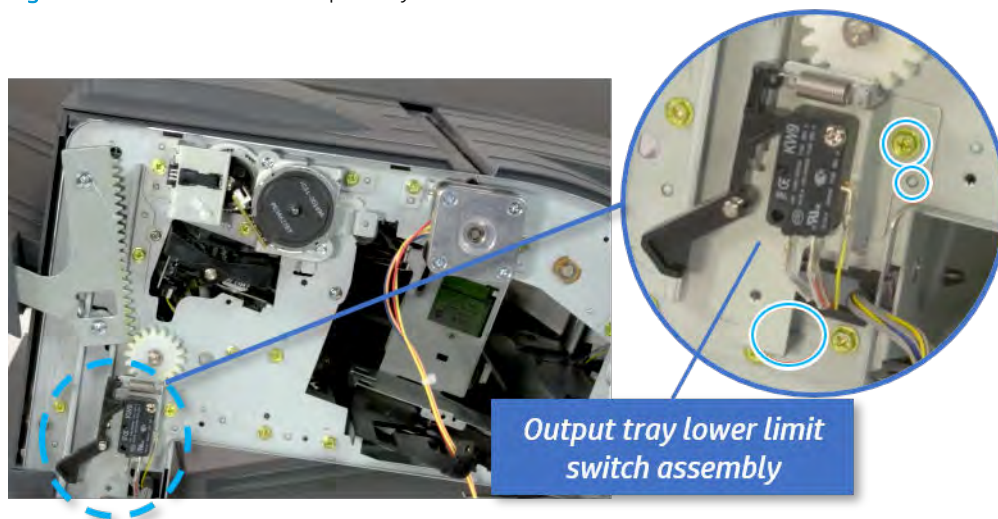

Remove the paper holding

Follow these steps to remove the paper holding.

1. Remove the paper holding actuator spring.

Figure 7-362 Remove the paper holding actuator spring

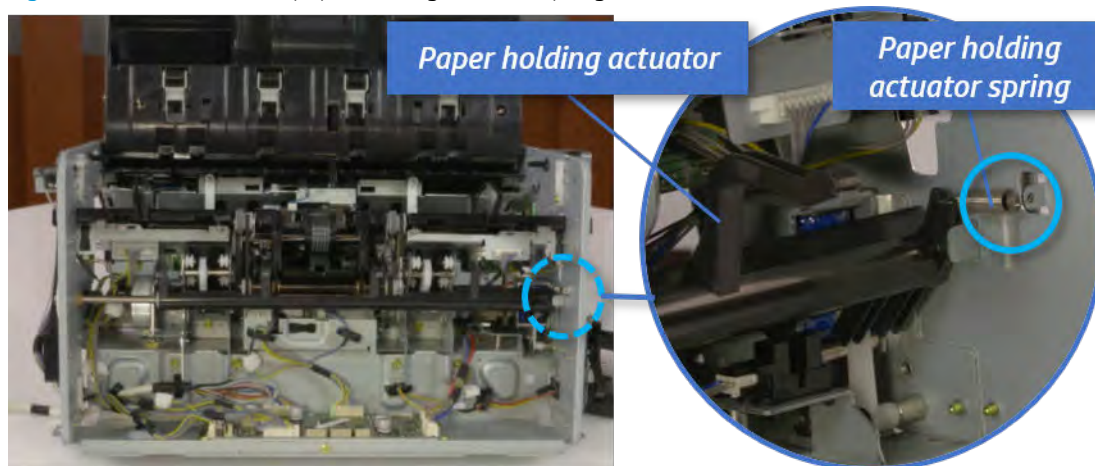

2. Remove the e-ring and the rack pinion gear. And then remove the pin and the e-ring, and then remove the bushing.

Figure 7-363 Remove e-ring, rack pinion gear, pin, and bushing

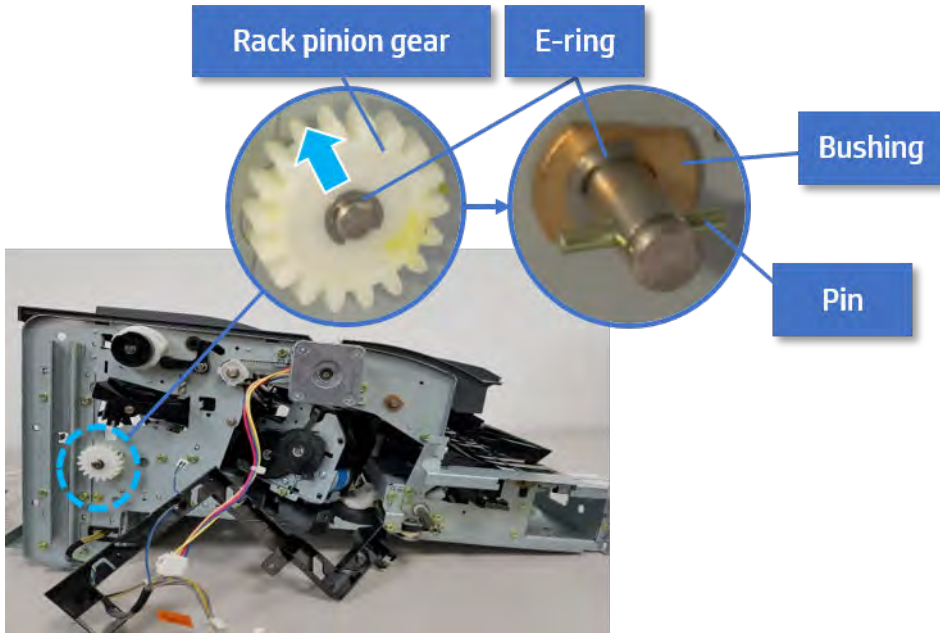

 **NOTE:** Be sure not to lose the pin.

3. Carefully remove the paper holding shaft and the actuator.

Figure 7-364 Remove the paper holding shaft and the actuator

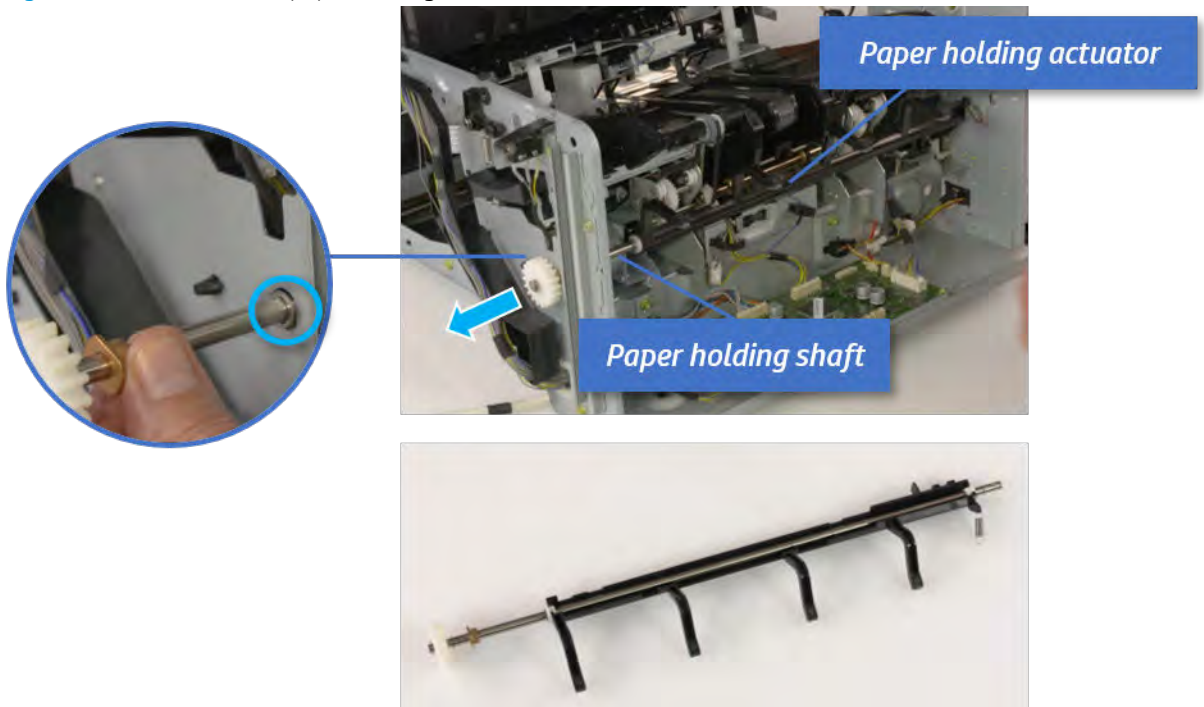

Remove the sub paddle unit

Follow these steps to remove the sub paddle unit.

1. Open the top cover, and then remove one screw securing the sub paddle unit.

Figure 7-365 Remove one screw

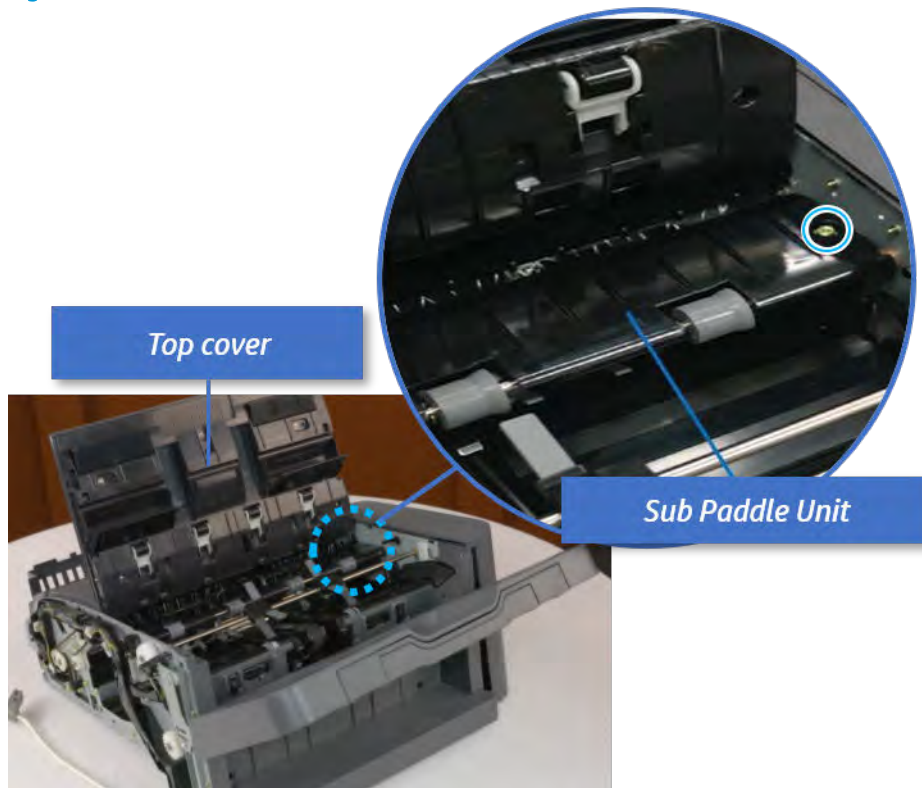

2. Remove the e-ring, and then remove the pulley and timing belt. And then remove the e-ring and the bushing.

Figure 7-366 Remove the e-ring, pulley, timing belt, and bushing

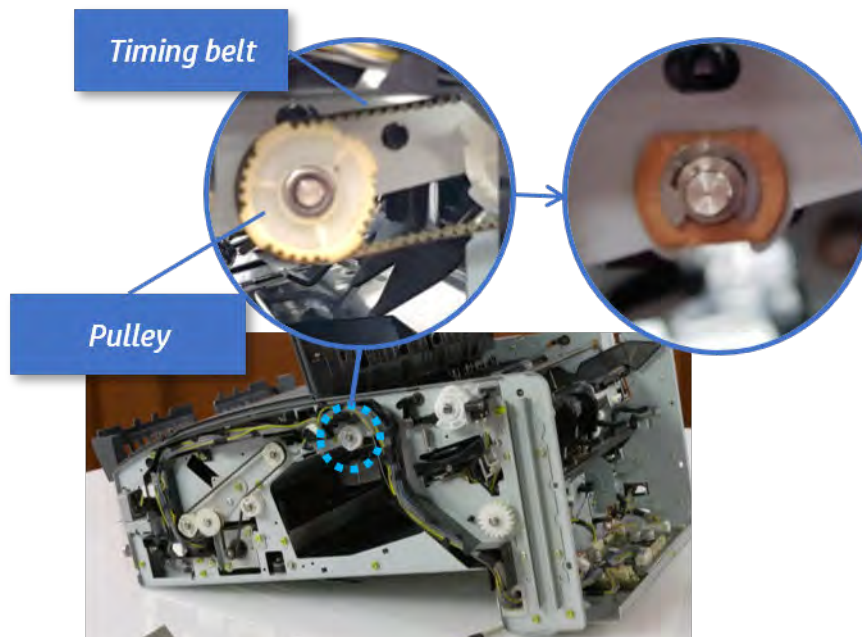

3. Lift up and remove the sub paddle unit.

Figure 7-367 Remove the sub paddle unit

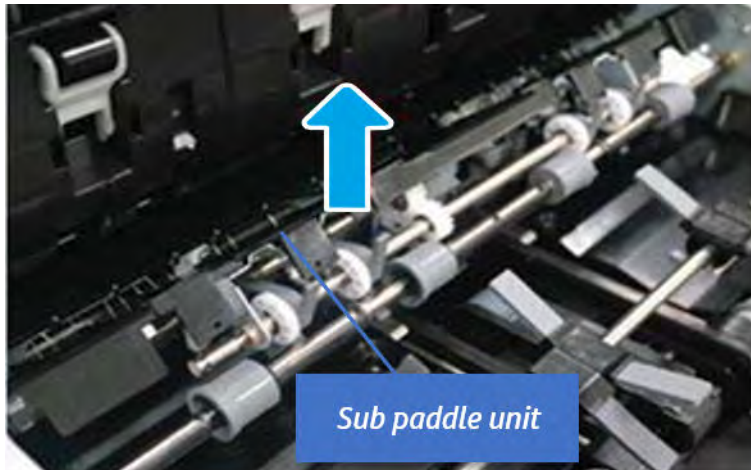

Remove the exit roller

Follow these steps to remove the exit roller.

1. Remove the guide on the center of the exit roller.

Figure 7-368 Remove the guide

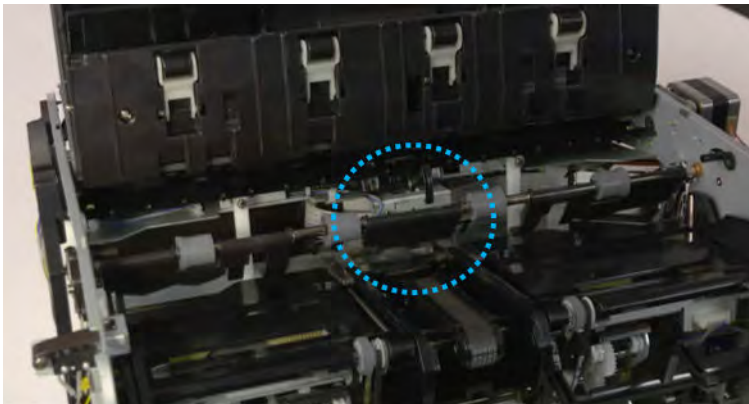

2. On the front of the inner finisher, release the timing belt connected to the exit motor.

Figure 7-369 Release the timing belt

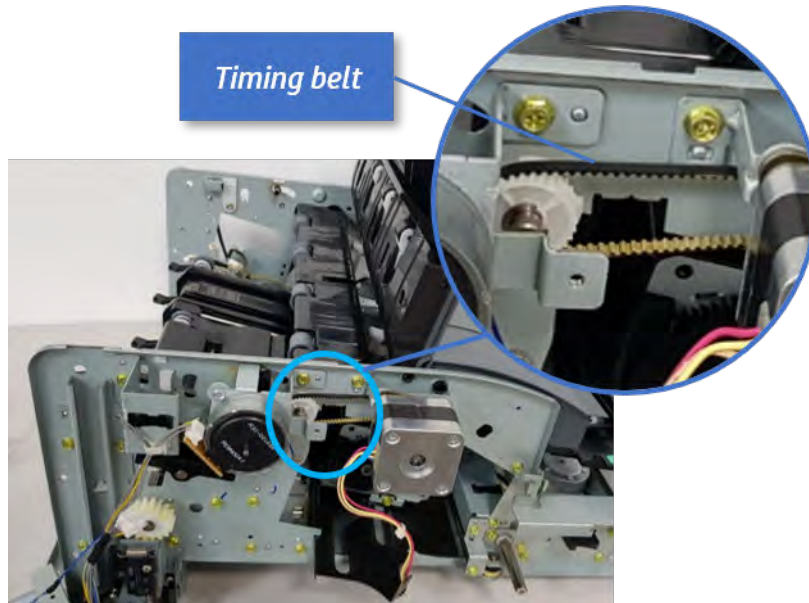

3. Remove five screws securing the rear harness guide.

Figure 7-370 Remove five screws

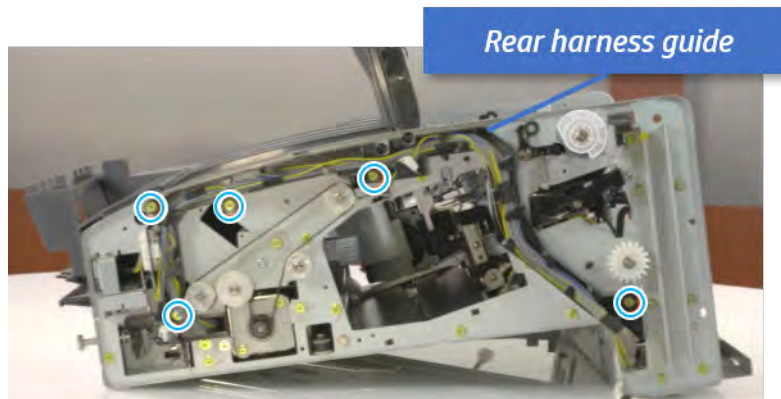

4. On the rear of the inner finisher, remove the e-ring and the pulley and then remove the e-ring and the bushing.

Figure 7-371 Remove e-ring, pulley, and bushing

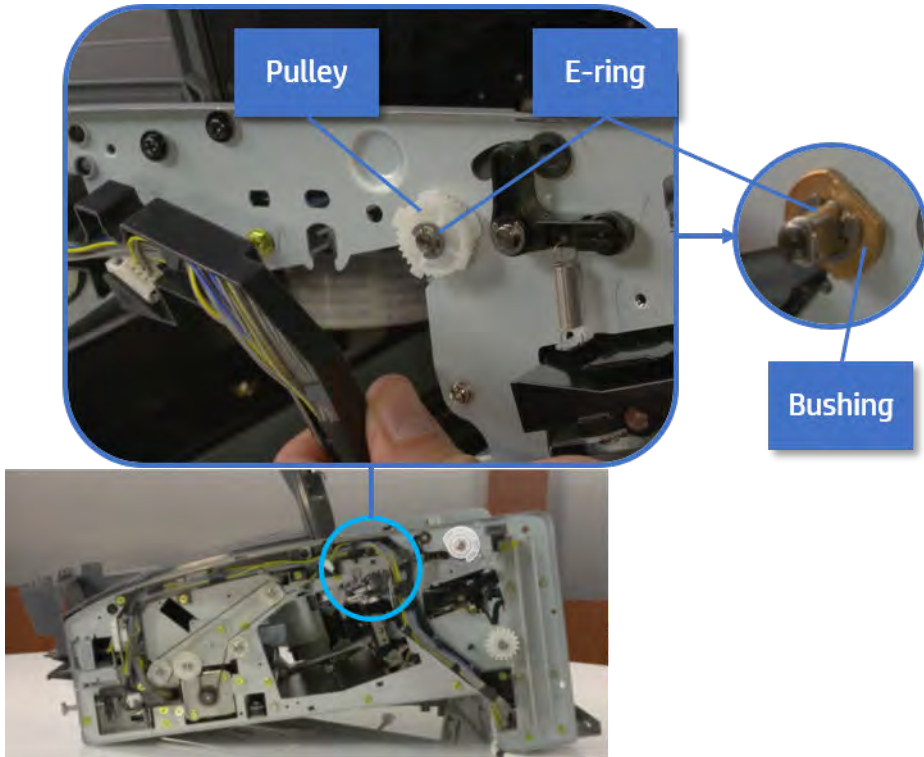

5. Push the bushing to detach it, and then remove the exit roller.

Figure 7-372 Remove the exit roller

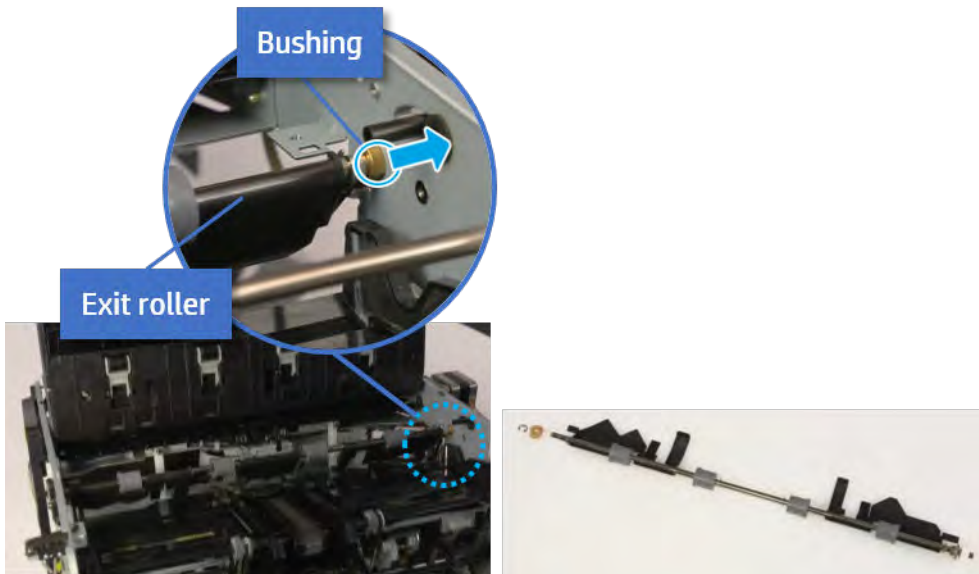

Remove the front tamper

Follow these steps to remove the front tamper.

1. Remove four screws.

Figure 7-373 Remove four screws

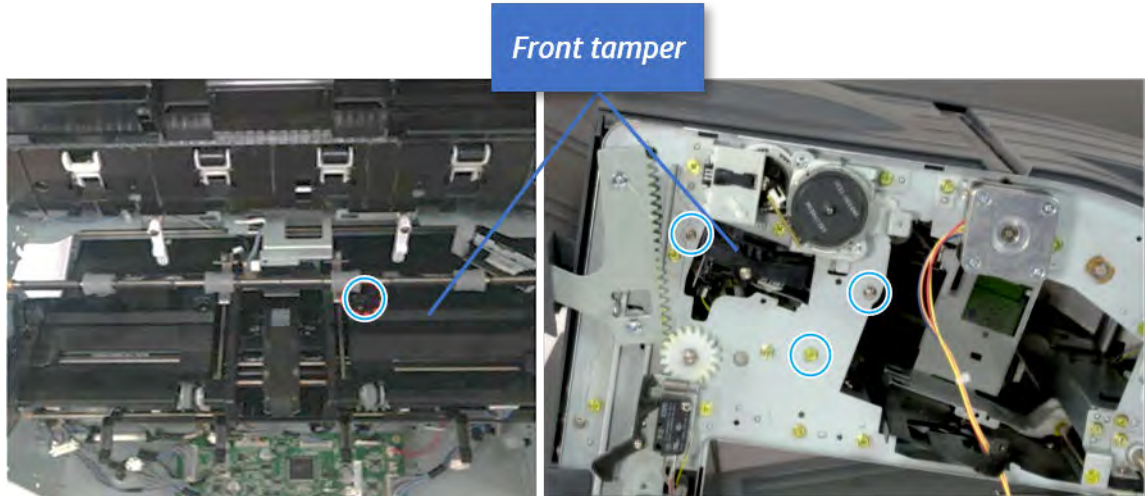

2. Unplug the connector and release the hook, and then pull the front tamper up to remove.

Figure 7-374 Remove the front tamper

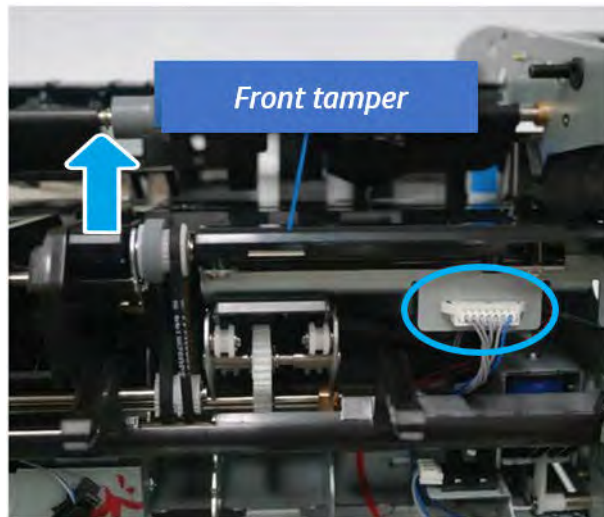

Remove the front tamper motor

Follow these steps to remove the front tamper motor.

- ▲ Remove two screws, unplug the connector, and then remove the motor.

Figure 7-375 Remove the front tamper motor

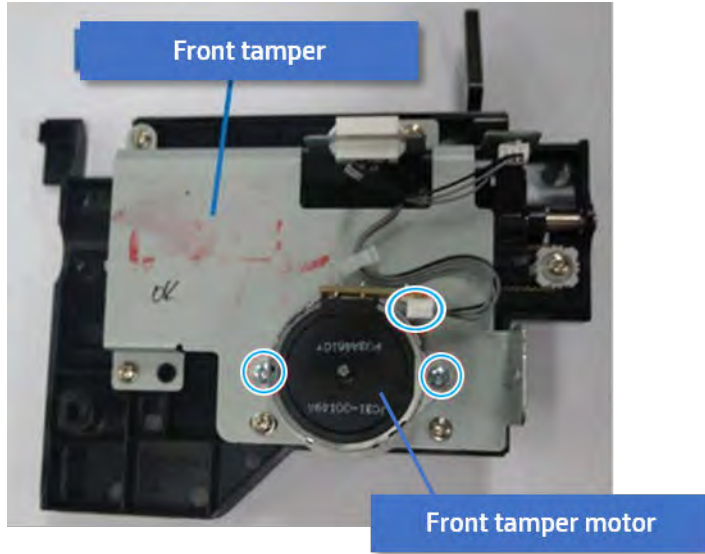

Unpack the replacement assembly



Follow these steps to unpack the replacement assembly.

1. Dispose of the defective part.

 **NOTE:** HP recommends responsible disposal of the defective part.

<http://www8.hp.com/us/en/hp-information/environment/product-recycling.html>

2. Unpack the replacement part from the packaging.

 **CAUTION:**  Some parts are sensitive to electrostatic discharge (ESD). Always perform service work at an ESD-protected workstation or mat. If an ESD workstation or mat is not available, touch the sheet-metal chassis to provide a static ground before touching an ESD-sensitive assembly. Protect the ESD-sensitive assemblies by placing them in ESD pouches when they are out of the printer.

 **IMPORTANT:** Make sure that all of the shipping materials (for example shipping tape) are removed from the replacement part prior to installation.

 **NOTE:** If the replacement part is a roller or pad, avoid touching the spongy part of it. Skin oils on the roller or pad can cause paper pickup and/or print-quality problems. HP recommends using disposable gloves when handling rollers or pads or washing your hands before touching rollers or pads.

3. To install an assembly, reverse the removal steps.

 **NOTE:** When applicable, special installation instructions are provided for an assembly at the end of the removal procedure. Always completely read the removal instructions and follow all special installation instructions.

Rear tamper

Removal and replacement: Rear tamper

Learn how to remove and replace the rear tamper.

To view teardown and reassembling video of the inner finisher, click the link below.



[View a teardown video of the inner finisher.](#)



[View a reassembling video of the inner finisher.](#)



IMPORTANT: When applicable, special installation instructions are provided for an assembly at the end of the removal procedure. Always completely read the removal instructions and follow all special installation instructions.

Mean time to repair:

Service level:

Before performing service

Turn the printer power off

- Press the power button on the front of the printer, and then turn off the power switch next to the power cable.
- A shutting-down message appears on the control-panel display.



WARNING! To avoid damage to the printer, turn the power off and wait until the printer shuts down before removing the power cable.

- Disconnect the printer power cable after the printer has completely shut down (the control-panel display is blank).

Use the table below to identify the correct part number for your printer. To order the part, go to <http://www.hp.com/buy/parts>.

Table 7-56 Part information

Part number	Part description
JC82-00900A	Rear tamper

Required tools

- #2 JIS screwdriver with a magnetic tip

After performing service

Turn the printer power on

- Connect the power cable.
- Use the power switch to turn the power on.

Post service test

Print any pages necessary to verify that the repair resolved the issue and did not create any new issues.

Remove the front cover

Follow these steps to remove the front cover.

1. Open the front door and open the punch cover.
2. Remove three screws in the front.
3. Remove the lever.
4. Open the top cover.
5. From the right side of the front cover, carefully lift and pry toward the top-left corner to remove the front cover.

Figure 7-376 Remove the front cover

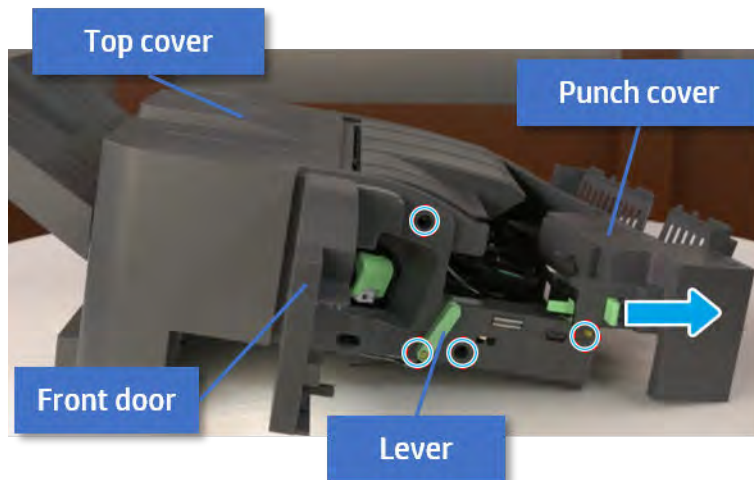

Remove the rear cover

Follow these steps to remove the rear cover.

1. Open the top cover.

Figure 7-377 Open the top cover

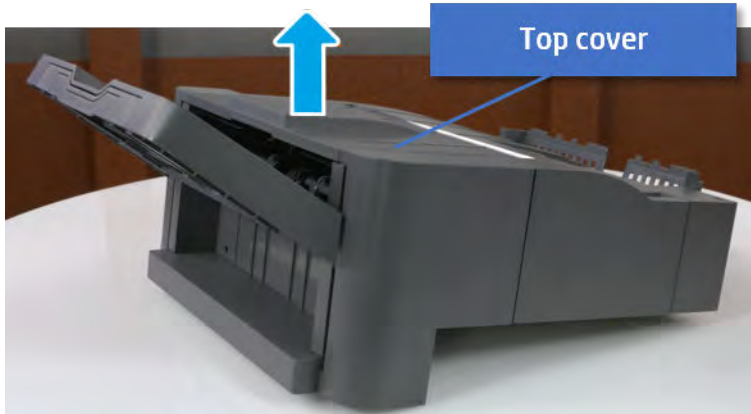

2. Remove three screws.
3. Release hooks carefully and remove the rear cover.

Figure 7-378 Remove the rear cover

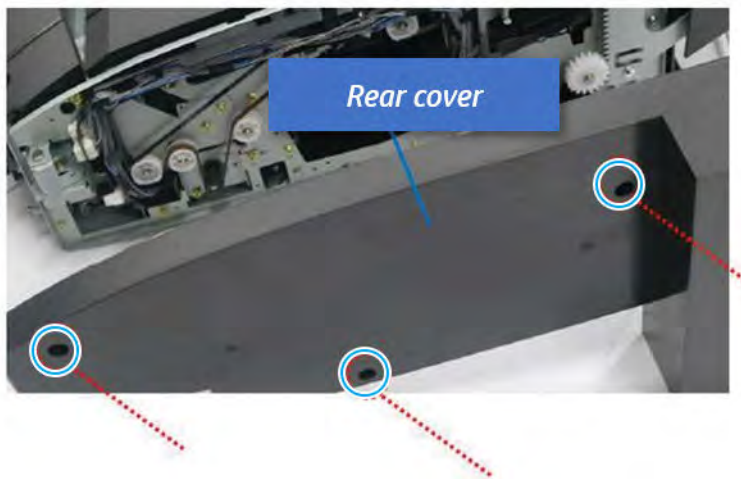

Remove the output tray

Follow these steps to remove the output tray.

1. Remove four screws.

Figure 7-379 Remove four screws

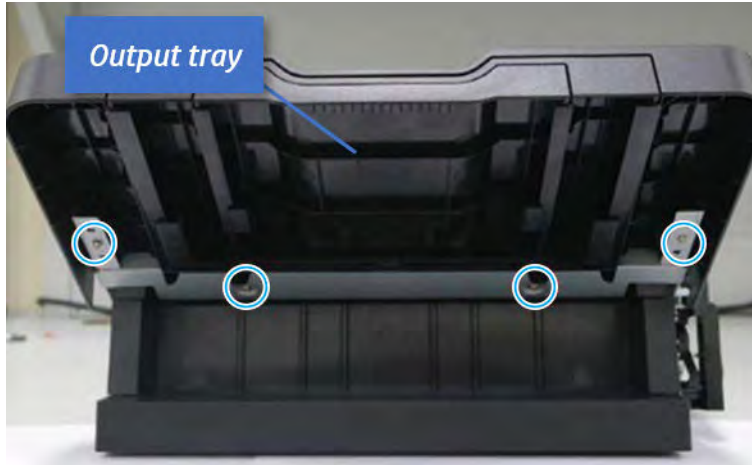

2. Push the paper holding actuator into the inner finisher, and then remove the output tray.

Figure 7-380 Remove the output tray.



Remove the output tray frame

Follow these steps to remove the output tray frame.

1. Rotate the pulley until the output tray frame depart from the gear.

Figure 7-381 Remove the pulley

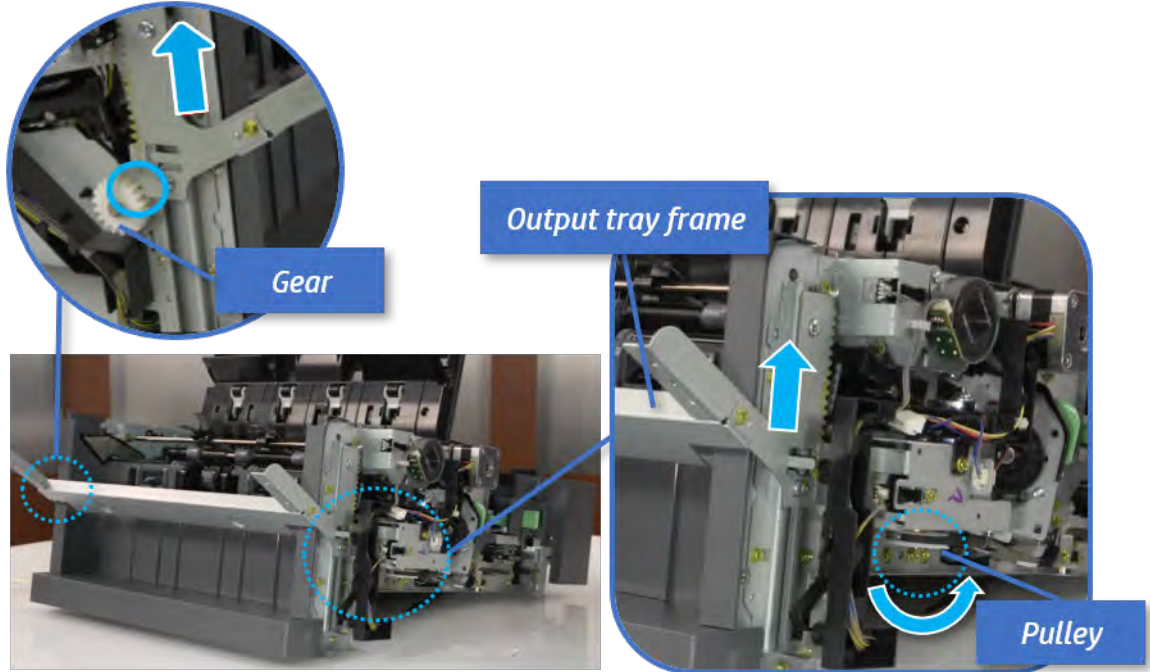

2. Push the paper holding actuator into the inner finisher, and then remove the output tray frame.

Figure 7-382 Remove the output tray frame

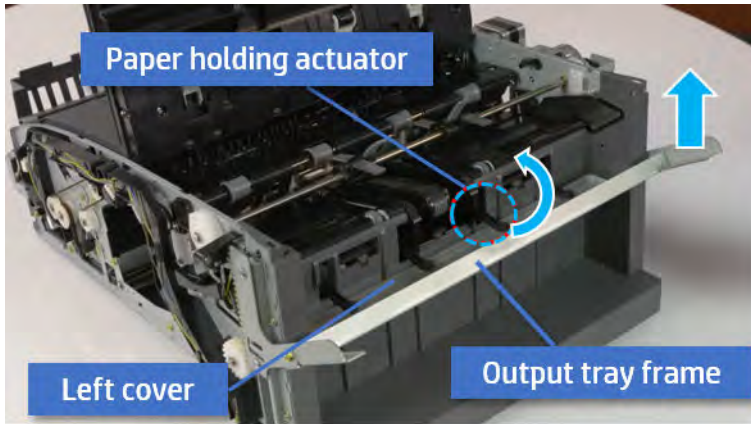

TIP: Push the paper holding actuator into the inner finisher when reassembling. Be sure to level the output tray.

- a. Position the first wheel into the channel on both sides while pushing the paper holding actuator.

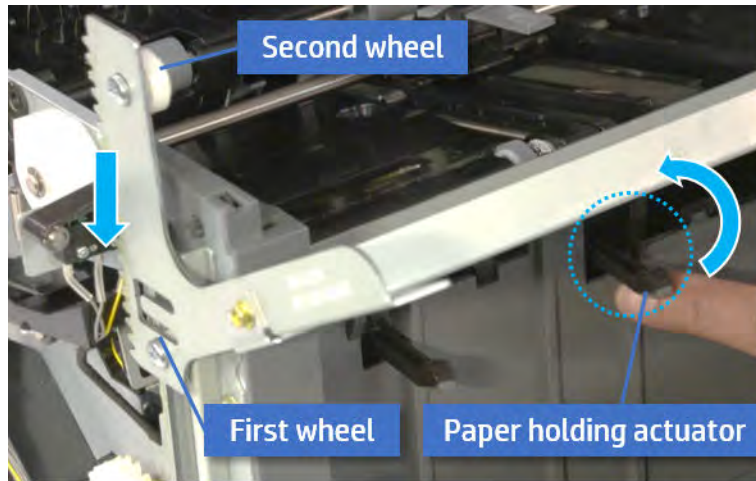

- b. Let the second wheel rest on the channel on both sides simultaneously.
- c. Gently squeeze the wheels into channel until the output tray frame meet the gear.

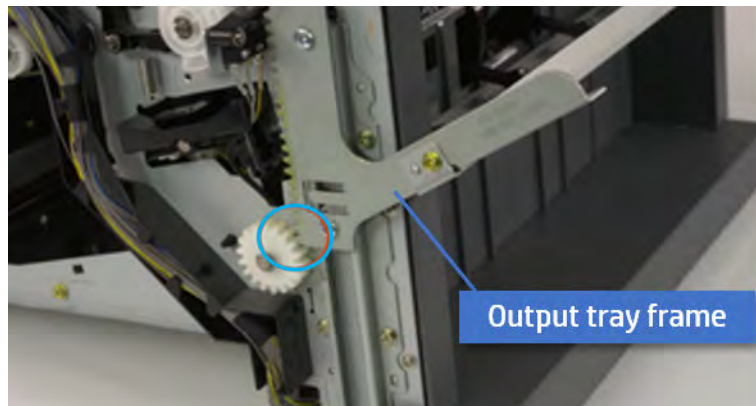

- d. Rotate the pulley until the output tray frame is no longer lifted. It can make to level the output tray frame.

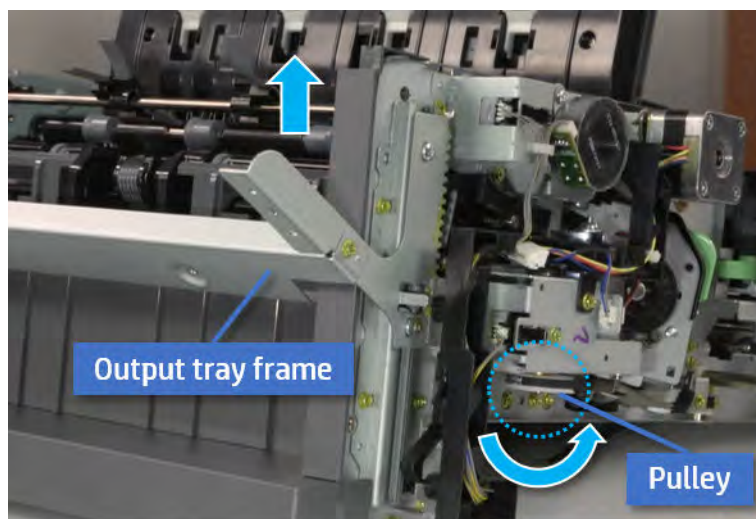

- e. Rotate the pulley in the opposite direction.

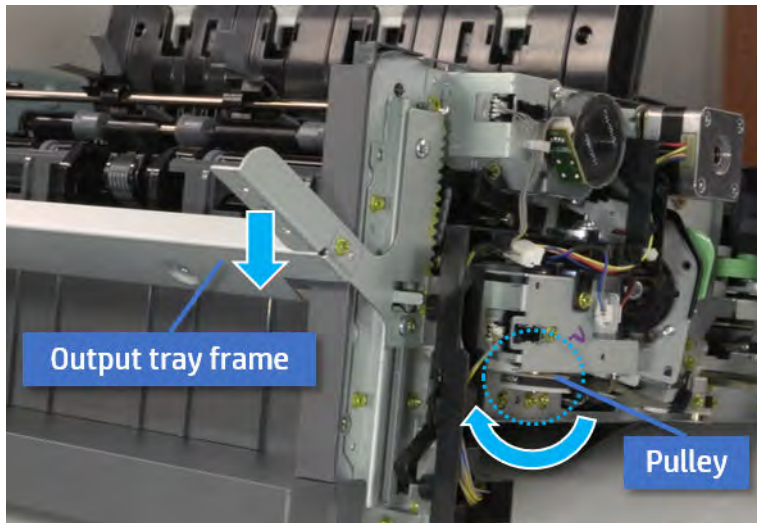

Remove the PCA cover

Follow these steps to remove the PCA cover.

- ▲ Remove two screws, and then remove the PCA cover.

Figure 7-383 Remove the PCA cover

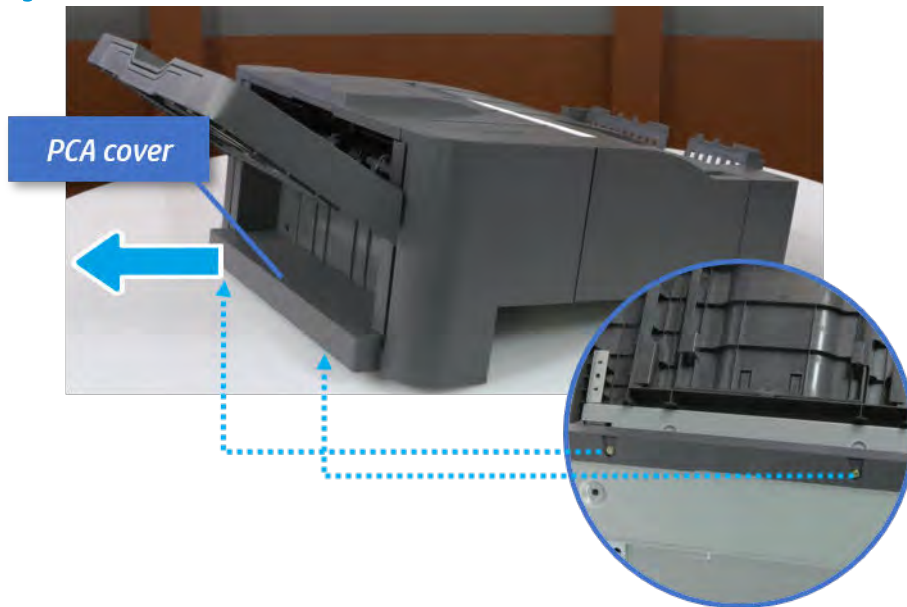

Remove the left cover

Follow these steps to remove the left cover.

1. Remove two screws.

Figure 7-384 Remove two screws

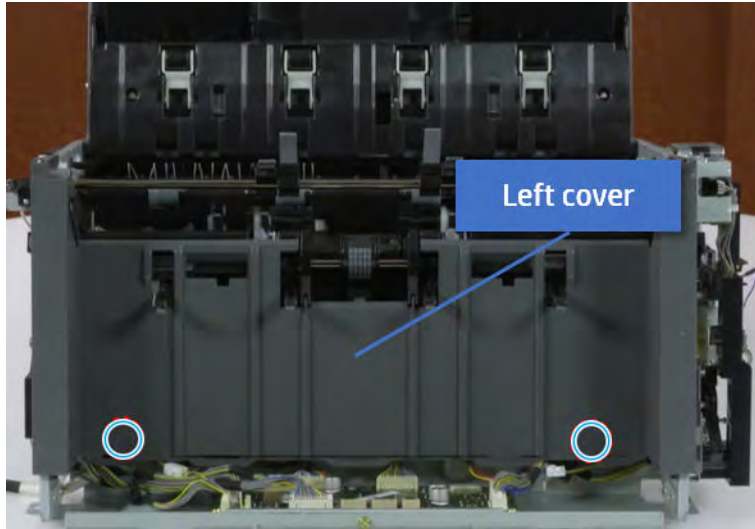

2. Remove four screws from both front and rear sides.

Figure 7-385 Remove four screws

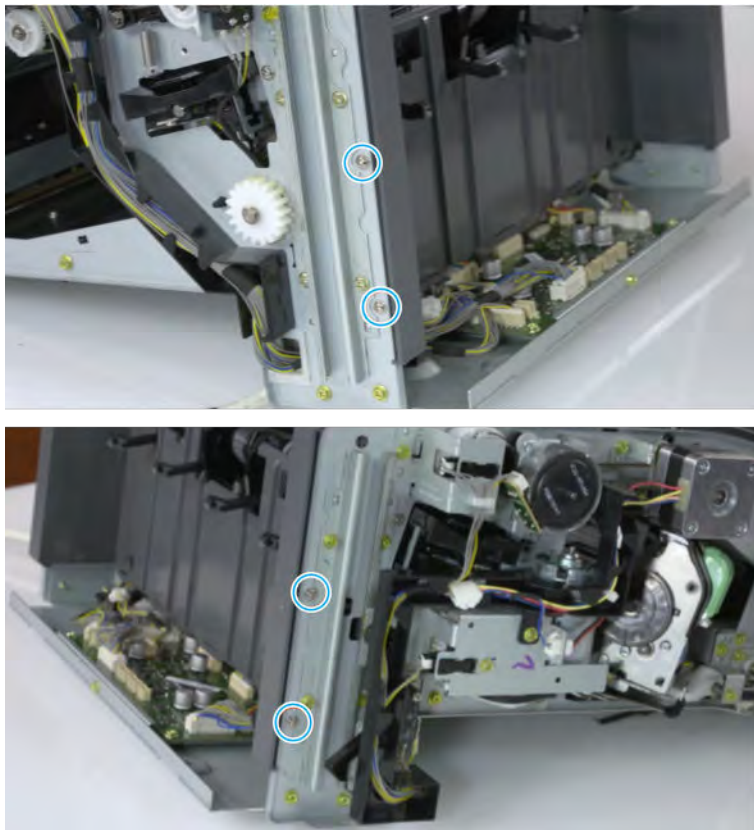

3. Unplug two inline connectors, and then remove the left cover.

Figure 7-386 Unplug two connectors

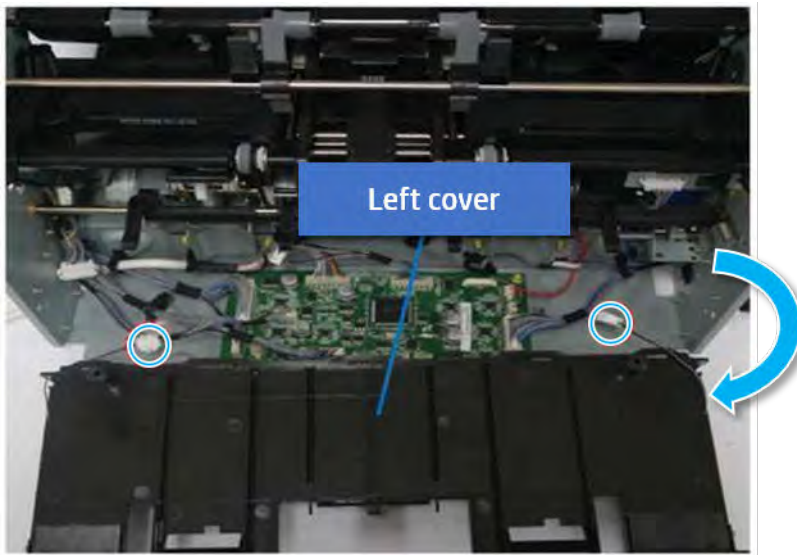

 **TIP:** Be sure to check the hook when reassembling.

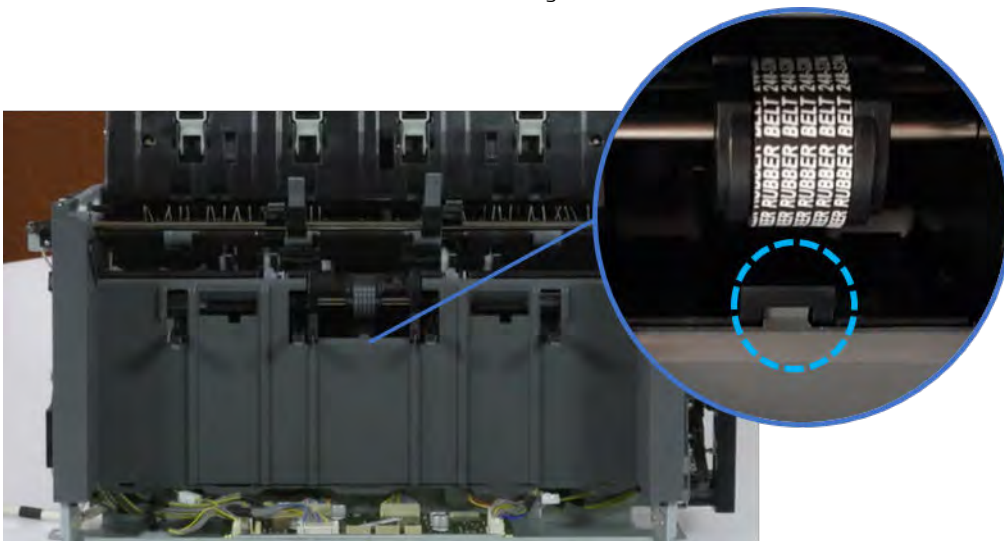

Remove the front harness guide

Follow these steps to remove the front harness guide.

1. Open one clamp and unplug five connectors, and then remove the wire harness from the front harness guide.

2. Remove four screws, and then remove the front harness guide.

Figure 7-387 Remove the front harness guide

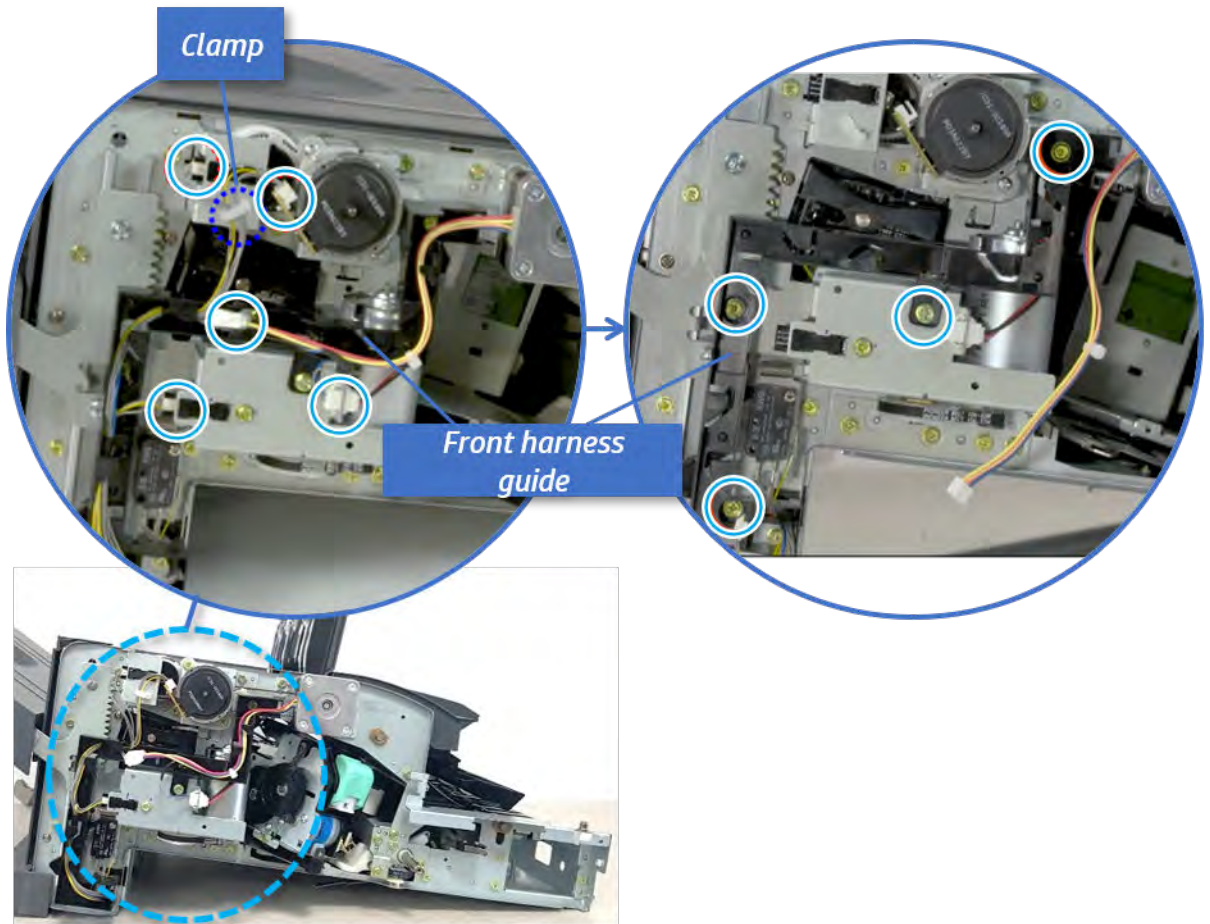

Remove the output tray motor assembly

Follow these steps to remove the output tray motor assembly.

- ▲ Remove three screws, and then remove the output tray motor assembly.

Figure 7-388 Remove the output tray motor assembly

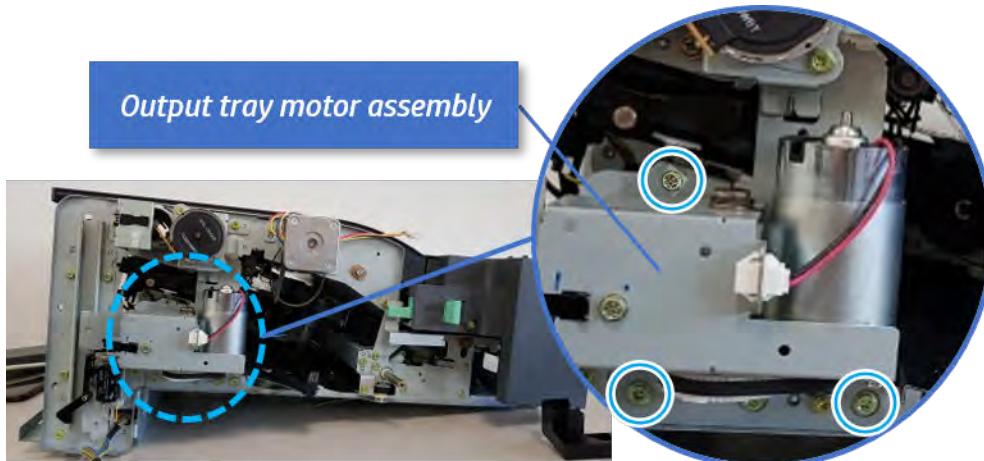

Remove the output tray lower limit switch

Follow these steps to remove the output tray lower limit switch.

- ▲ Remove one screw, and then remove the output tray lower limit switch.

Figure 7-389 Remove the output tray lower limit switch

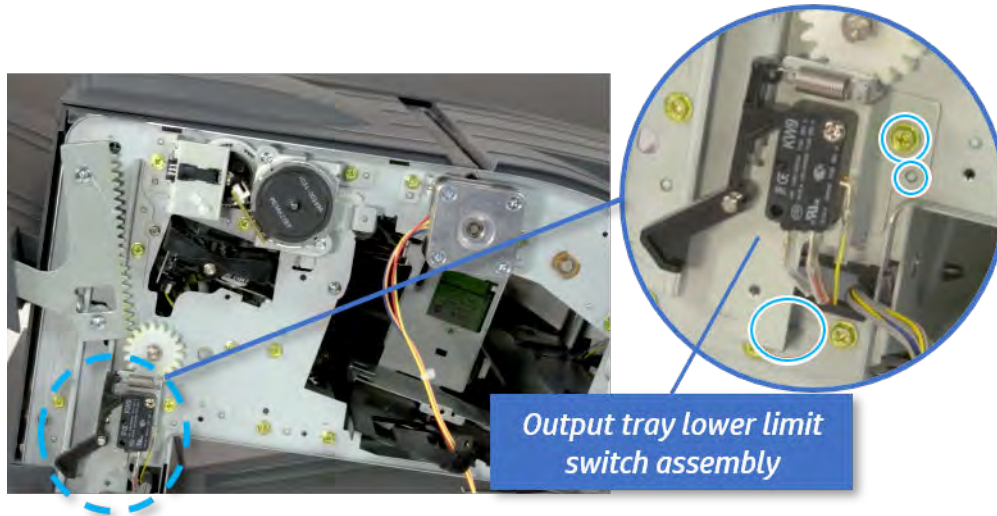

Remove the paper holding

Follow these steps to remove the paper holding.

1. Remove the paper holding actuator spring.

Figure 7-390 Remove the paper holding actuator spring

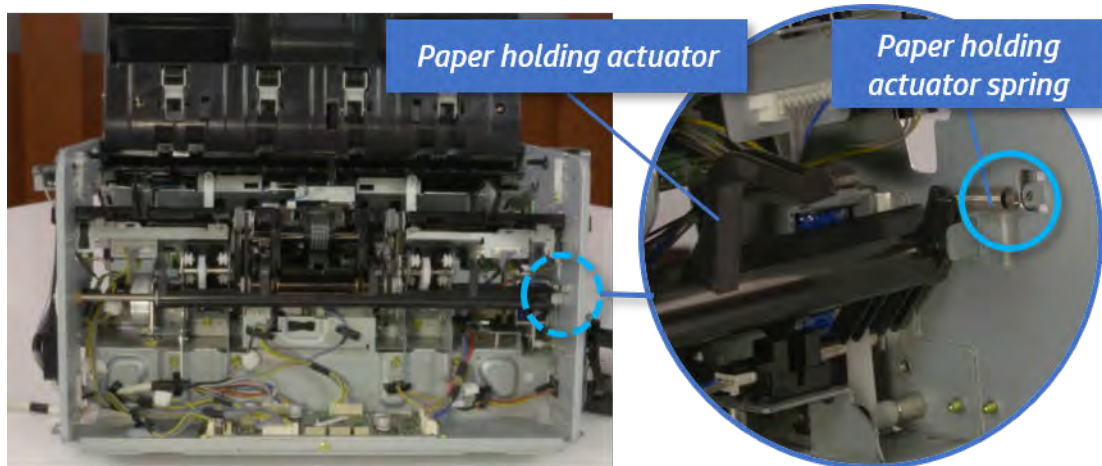

2. Remove the e-ring and the rack pinion gear. And then remove the pin and the e-ring, and then remove the bushing.

Figure 7-391 Remove e-ring, rack pinion gear, pin, and bushing

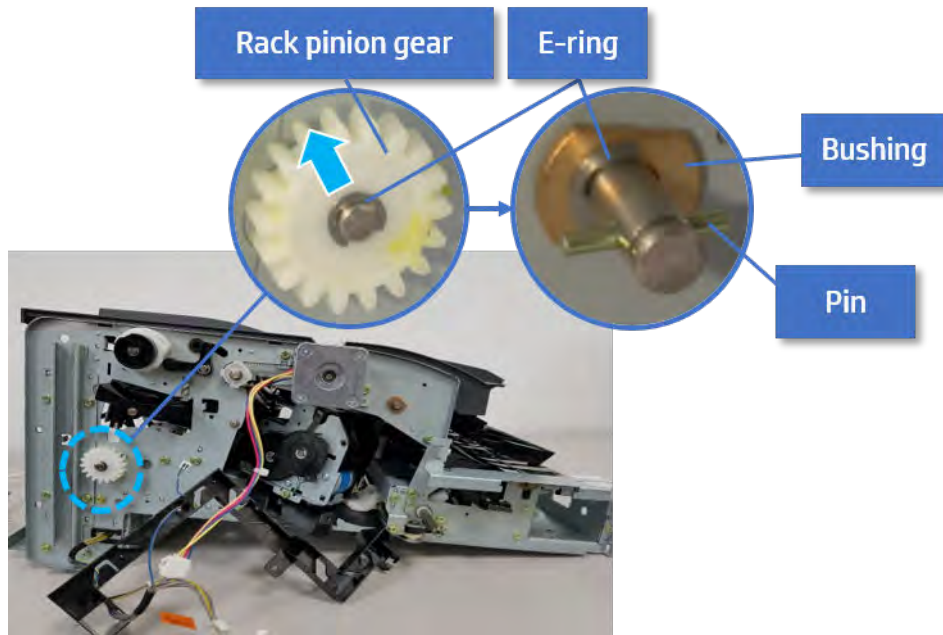

 **NOTE:** Be sure not to lose the pin.

3. Carefully remove the paper holding shaft and the actuator.

Figure 7-392 Remove the paper holding shaft and the actuator

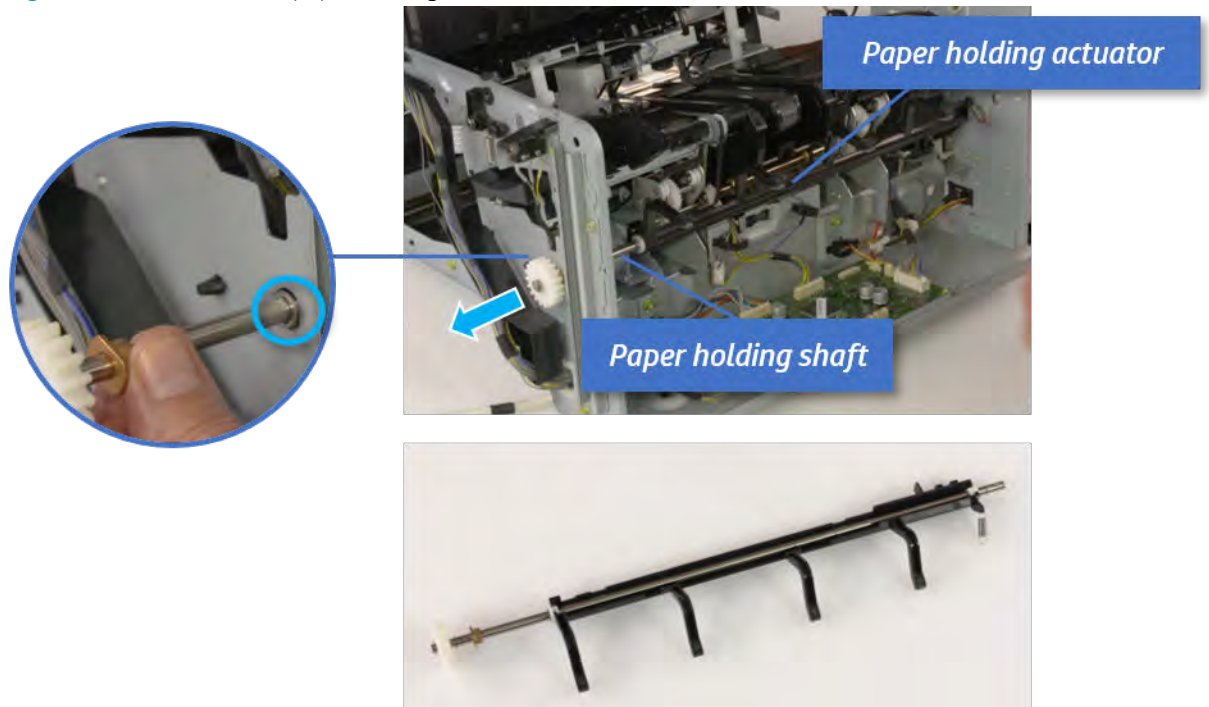

Remove the sub paddle unit

Follow these steps to remove the sub paddle unit.

1. Open the top cover, and then remove one screw securing the sub paddle unit.

Figure 7-393 Remove one screw

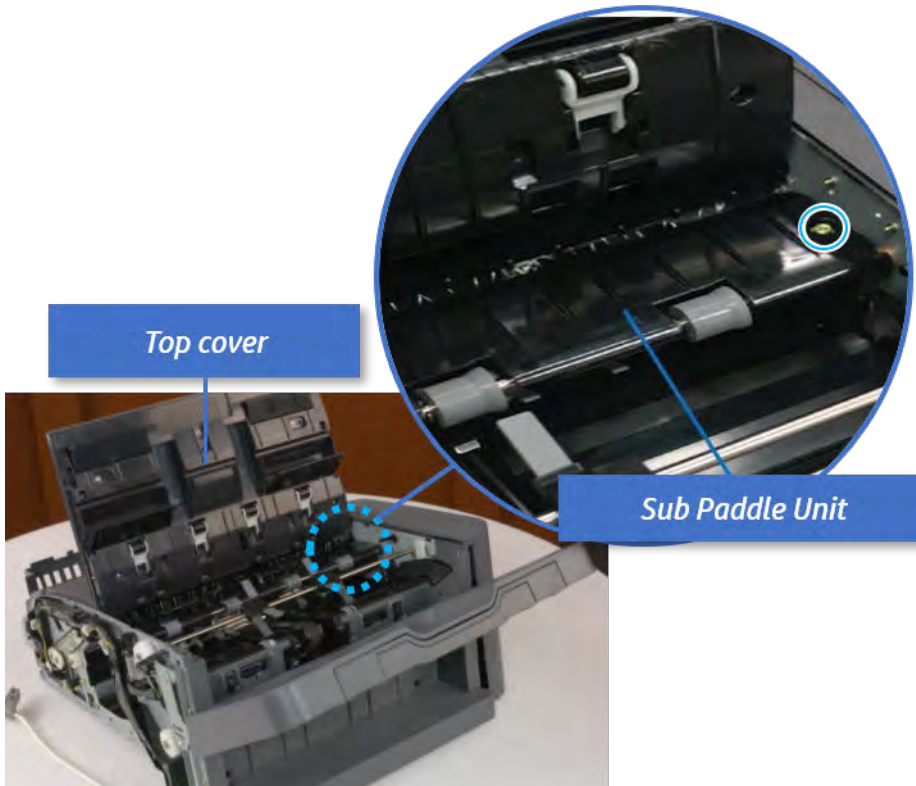

2. Remove the e-ring, and then remove the pulley and timing belt. And then remove the e-ring and the bushing.

Figure 7-394 Remove the e-ring, pulley, timing belt, and bushing

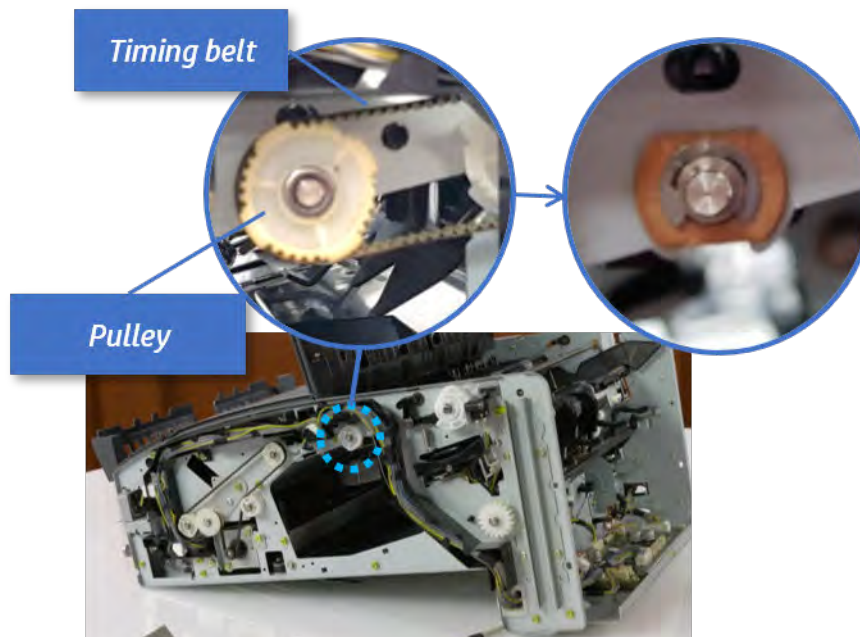

3. Lift up and remove the sub paddle unit.

Figure 7-395 Remove the sub paddle unit

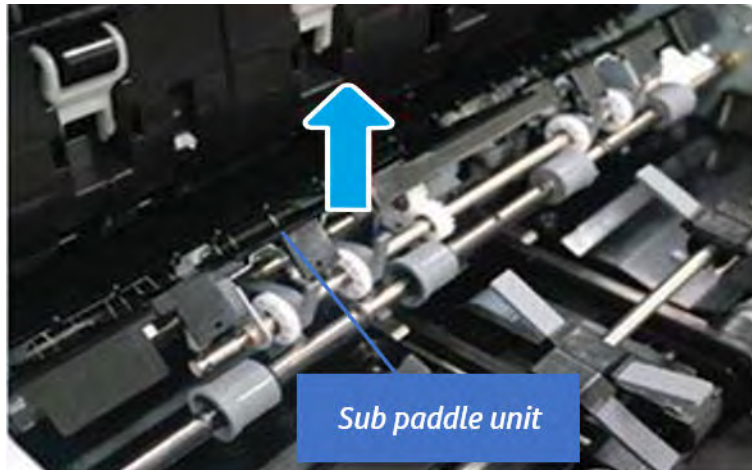

Remove the exit roller

Follow these steps to remove the exit roller.

1. Remove the guide on the center of the exit roller.

Figure 7-396 Remove the guide

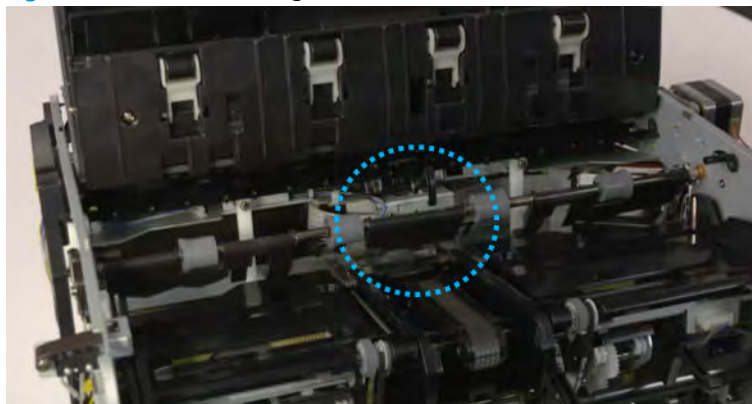

2. On the front of the inner finisher, release the timing belt connected to the exit motor.

Figure 7-397 Release the timing belt

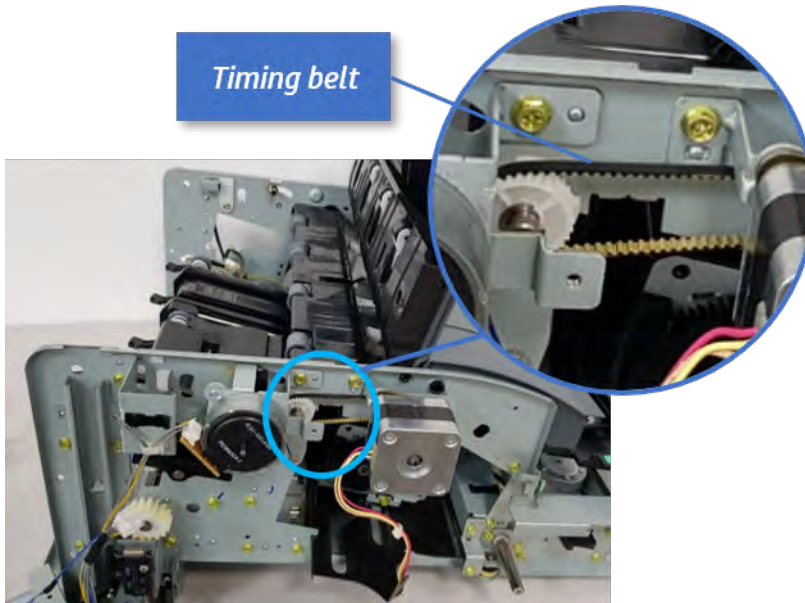

3. Remove five screws securing the rear harness guide.

Figure 7-398 Remove five screws

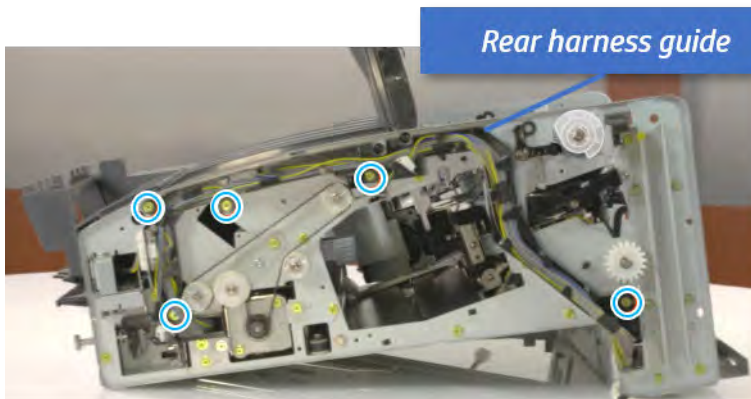

4. On the rear of the inner finisher, remove the e-ring and the pulley and then remove the e-ring and the bushing.

Figure 7-399 Remove e-ring, pulley, and bushing

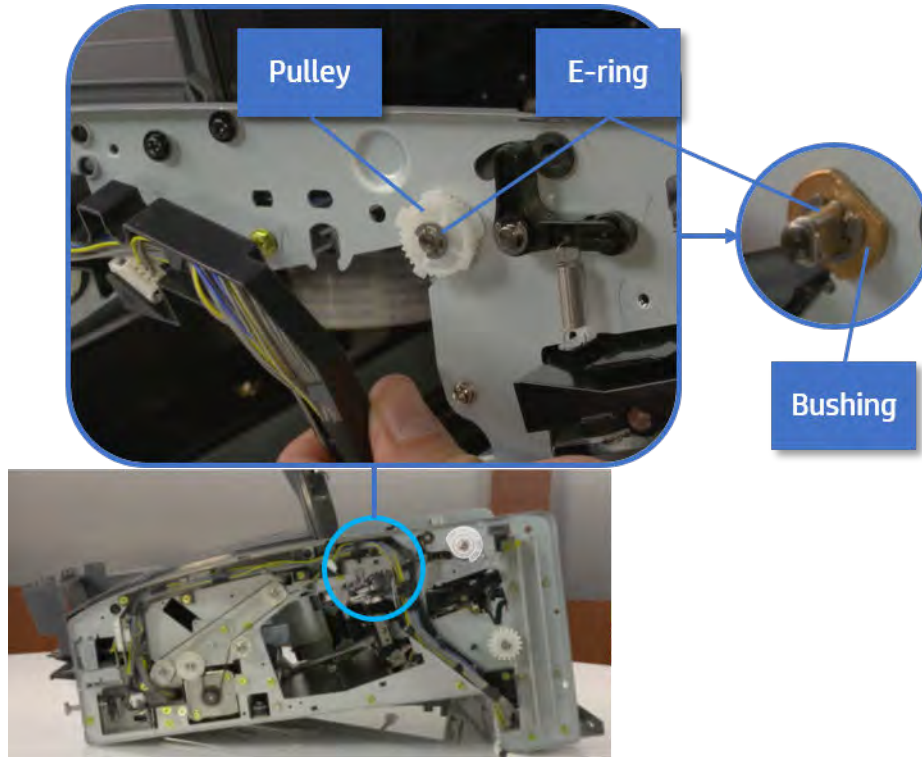

5. Push the bushing to detach it, and then remove the exit roller.

Figure 7-400 Remove the exit roller

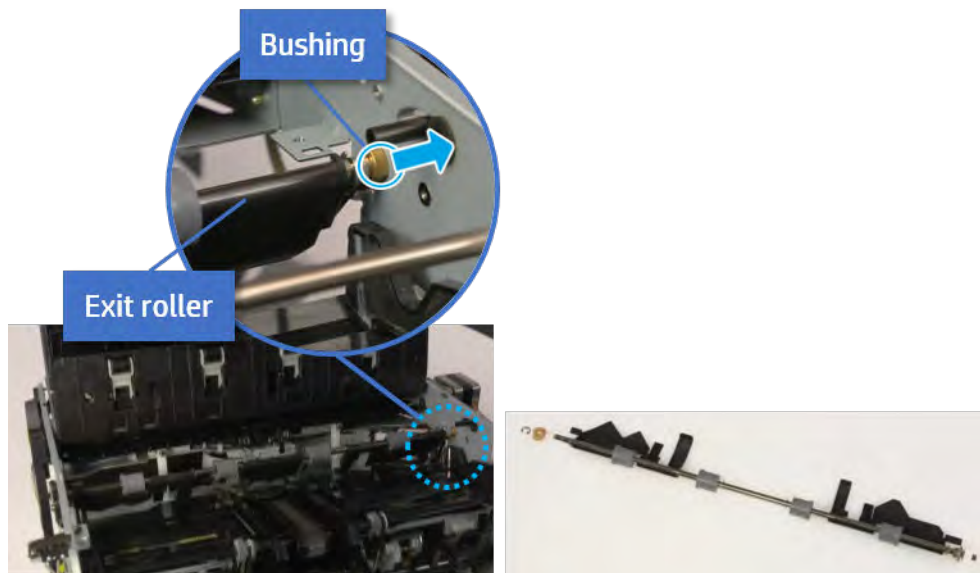

Remove the rear tamper

Follow these steps to remove the rear tamper.

1. Remove four screws.

 **NOTE:** Move cable guideout of position to access the screws.

Figure 7-401 Remove four screws



2. Unplug two connectors and release the hook, and then remove the rear tamper.

Figure 7-402 Remove the rear tamper

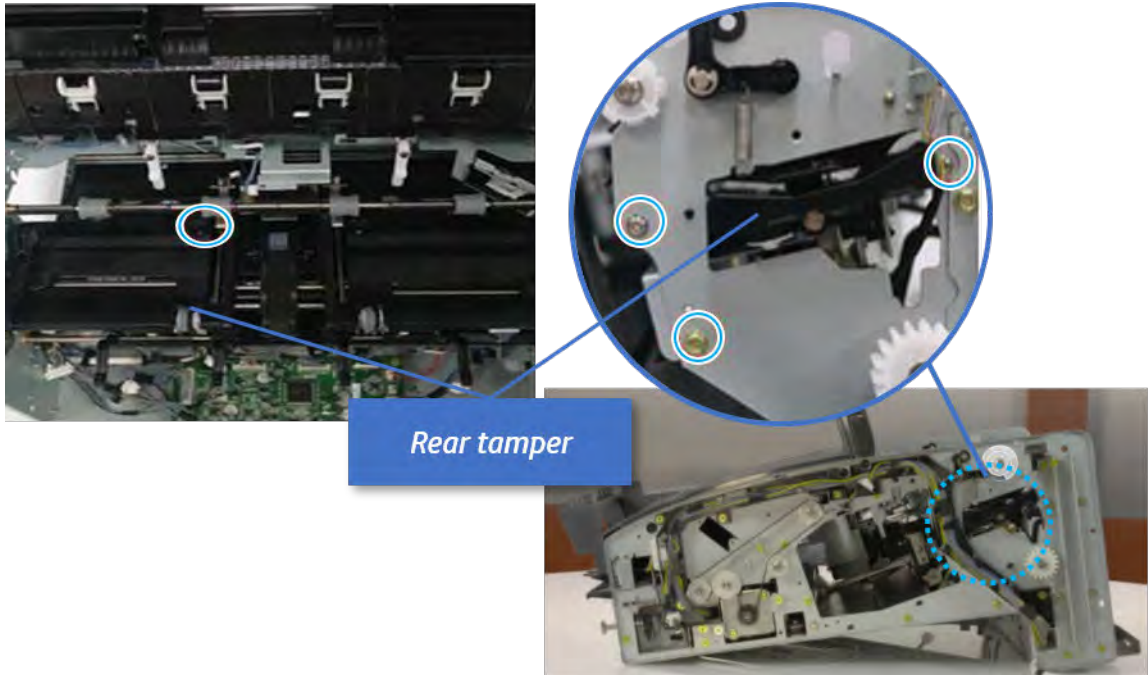
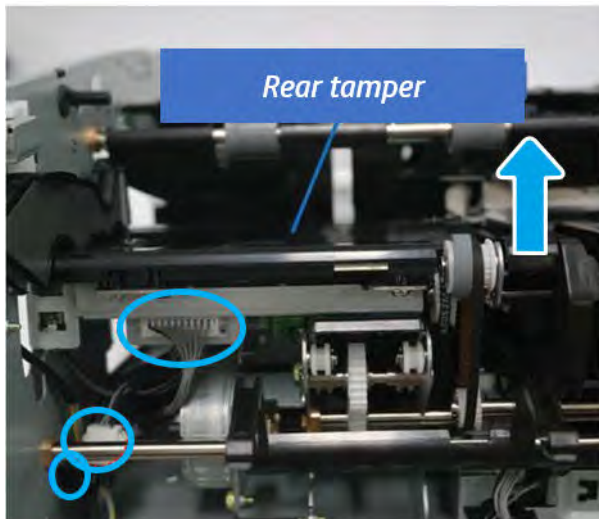

Unpack the replacement assembly

Follow these steps to unpack the replacement assembly.

1. Dispose of the defective part.

 **NOTE:** HP recommends responsible disposal of the defective part.

<http://www8.hp.com/us/en/hp-information/environment/product-recycling.html>

2. Unpack the replacement part from the packaging.



CAUTION:  Some parts are sensitive to electrostatic discharge (ESD). Always perform service work at an ESD-protected workstation or mat. If an ESD workstation or mat is not available, touch the sheet-metal chassis to provide a static ground before touching an ESD-sensitive assembly. Protect the ESD-sensitive assemblies by placing them in ESD pouches when they are out of the printer.

 **IMPORTANT:** Make sure that all of the shipping materials (for example shipping tape) are removed from the replacement part prior to installation.

 **NOTE:** If the replacement part is a roller or pad, avoid touching the spongy part of it. Skin oils on the roller or pad can cause paper pickup and/or print-quality problems. HP recommends using disposable gloves when handling rollers or pads or washing your hands before touching rollers or pads.

3. To install an assembly, reverse the removal steps.

 **NOTE:** When applicable, special installation instructions are provided for an assembly at the end of the removal procedure. Always completely read the removal instructions and follow all special installation instructions.

Removal and replacement: Rear tamper home sensor (S14)

Learn how to remove and replace the rear tamper home sensor.

To view teardown and reassembling video of the inner finisher, click the link below.



[View a teardown video of the inner finisher.](#)



[View a reassembling video of the inner finisher.](#)



IMPORTANT: When applicable, special installation instructions are provided for an assembly at the end of the removal procedure. Always completely read the removal instructions and follow all special installation instructions.

Mean time to repair:

Service level:

Before performing service

Turn the printer power off

- Press the power button on the front of the printer, and then turn off the power switch next to the power cable.
- A shutting-down message appears on the control-panel display.



WARNING! To avoid damage to the printer, turn the power off and wait until the printer shuts down before removing the power cable.

- Disconnect the printer power cable after the printer has completely shut down (the control-panel display is blank).

Use the table below to identify the correct part number for your printer. To order the part, go to www.hp.com/buy/parts.

Table 7-57 Part information

Part number	Part description
0604-001393	Rear tamper home sensor

Required tools

- #2 JIS screwdriver with a magnetic tip

After performing service

Turn the printer power on

- Connect the power cable.
- Use the power switch to turn the power on.

Post service test

Print any pages necessary to verify that the repair resolved the issue and did not create any new issues.

Remove the front cover

Follow these steps to remove the front cover.

1. Open the front door and open the punch cover.
2. Remove three screws in the front.
3. Remove the lever.
4. Open the top cover.
5. From the right side of the front cover, carefully lift and pry toward the top-left corner to remove the front cover.

Figure 7-403 Remove the front cover

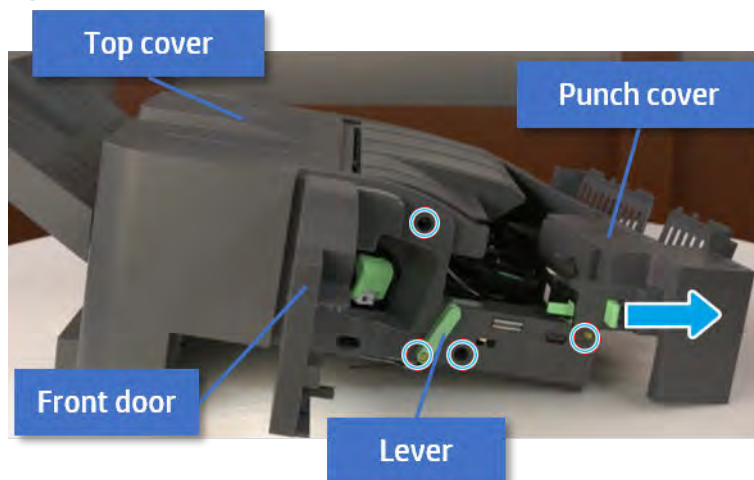

Remove the rear cover

Follow these steps to remove the rear cover.

1. Open the top cover.

Figure 7-404 Open the top cover

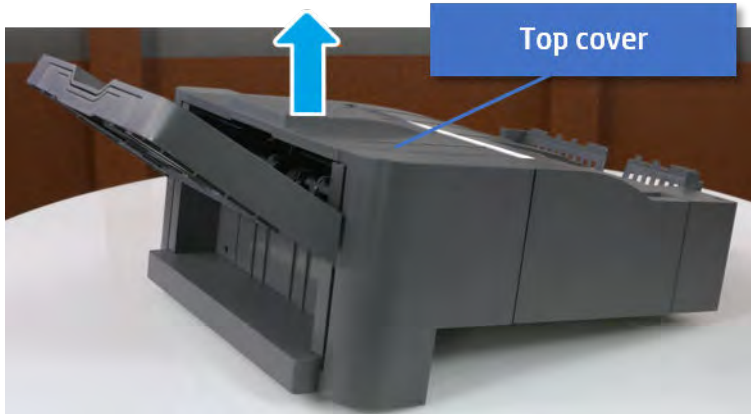

2. Remove three screws.
3. Release hooks carefully and remove the rear cover.

Figure 7-405 Remove the rear cover

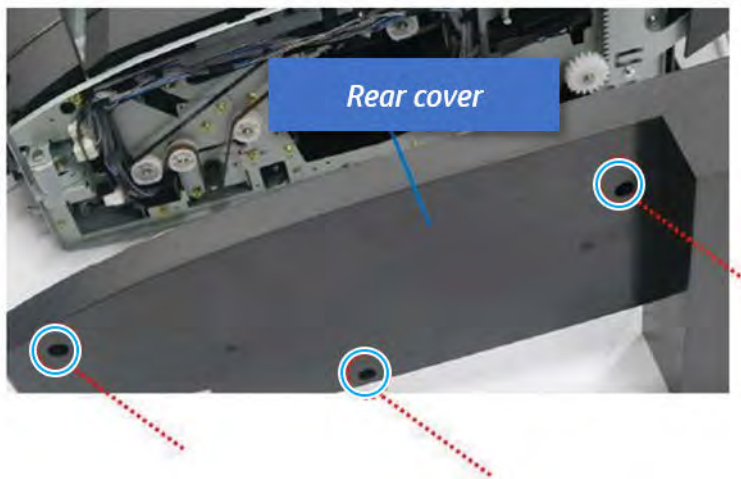

Remove the output tray

Follow these steps to remove the output tray.

1. Remove four screws.

Figure 7-406 Remove four screws

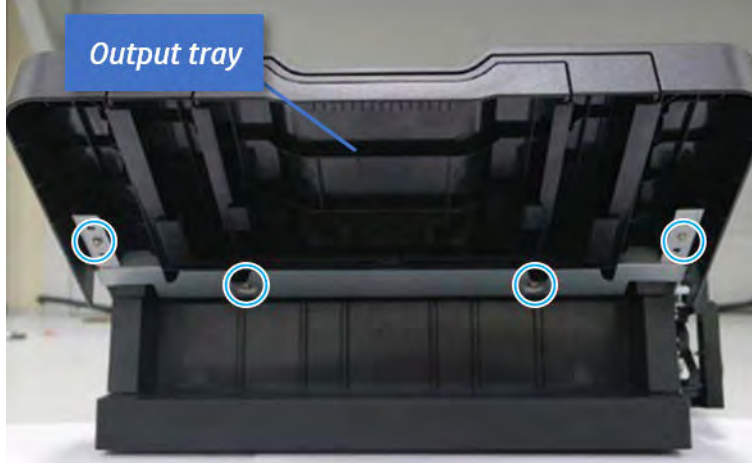

2. Push the paper holding actuator into the inner finisher, and then remove the output tray.

Figure 7-407 Remove the output tray.



Remove the output tray frame

Follow these steps to remove the output tray frame.

1. Rotate the pulley until the output tray frame depart from the gear.

Figure 7-408 Remove the pulley

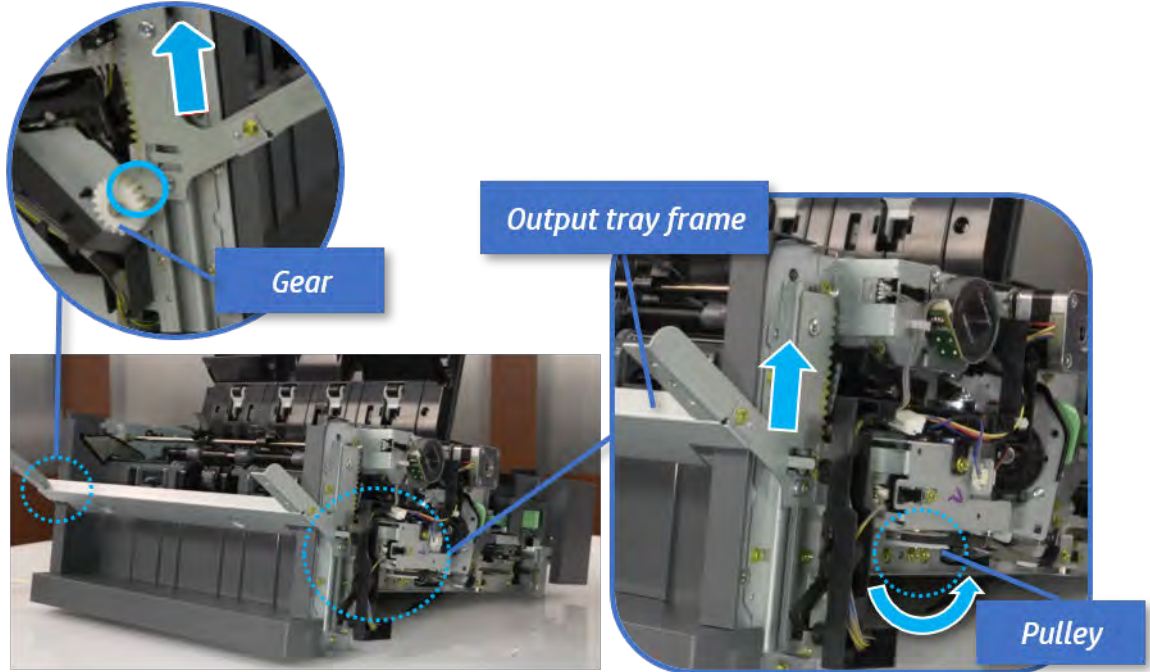

2. Push the paper holding actuator into the inner finisher, and then remove the output tray frame.

Figure 7-409 Remove the output tray frame

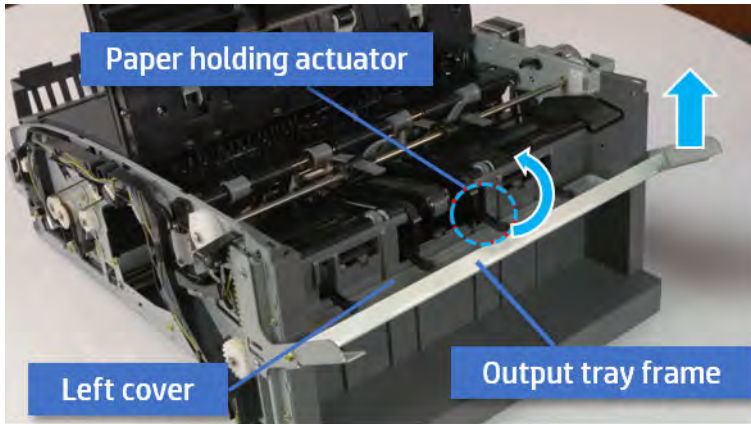

 **TIP:** Push the paper holding actuator into the inner finisher when reassembling. Be sure to level the output tray.

- a. Position the first wheel into the channel on both sides while pushing the paper holding actuator.

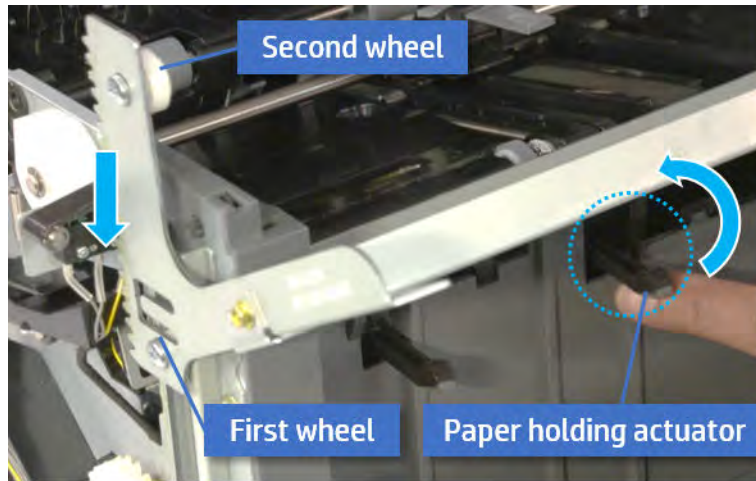

- b. Let the second wheel rest on the channel on both sides simultaneously.
- c. Gently squeeze the wheels into channel until the output tray frame meet the gear.

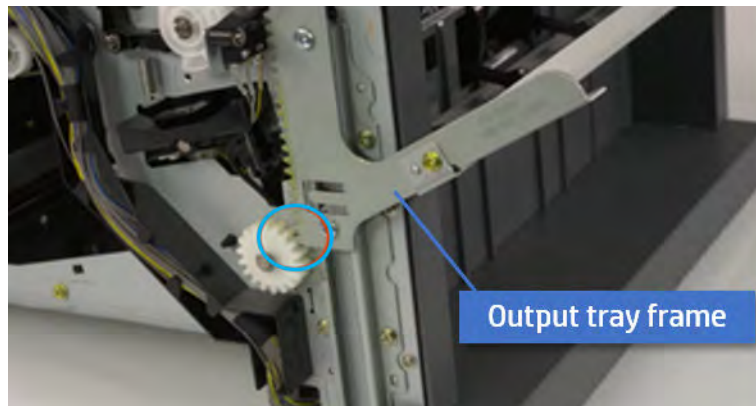

- d. Rotate the pulley until the output tray frame is no longer lifted. It can make to level the output tray frame.

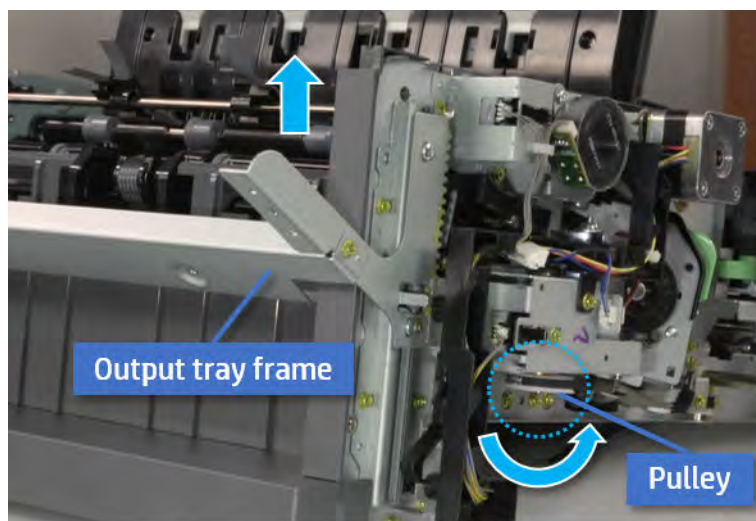

- e. Rotate the pulley in the opposite direction.

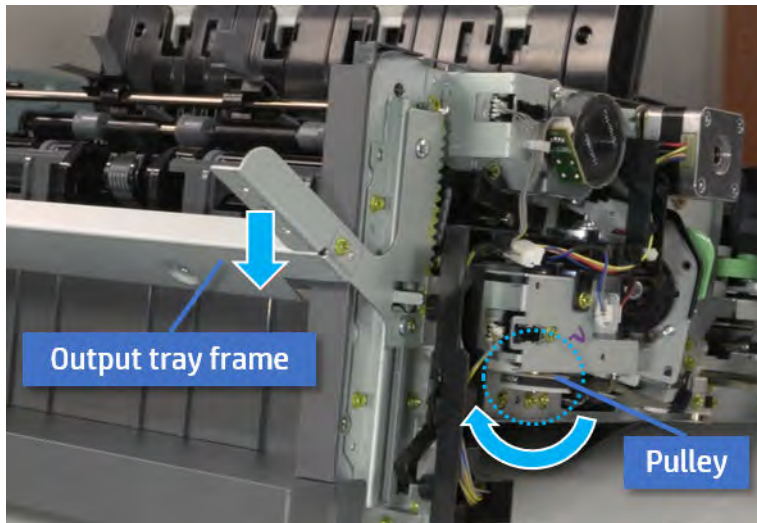

Remove the PCA cover

Follow these steps to remove the PCA cover.

- ▲ Remove two screws, and then remove the PCA cover.

Figure 7-410 Remove the PCA cover

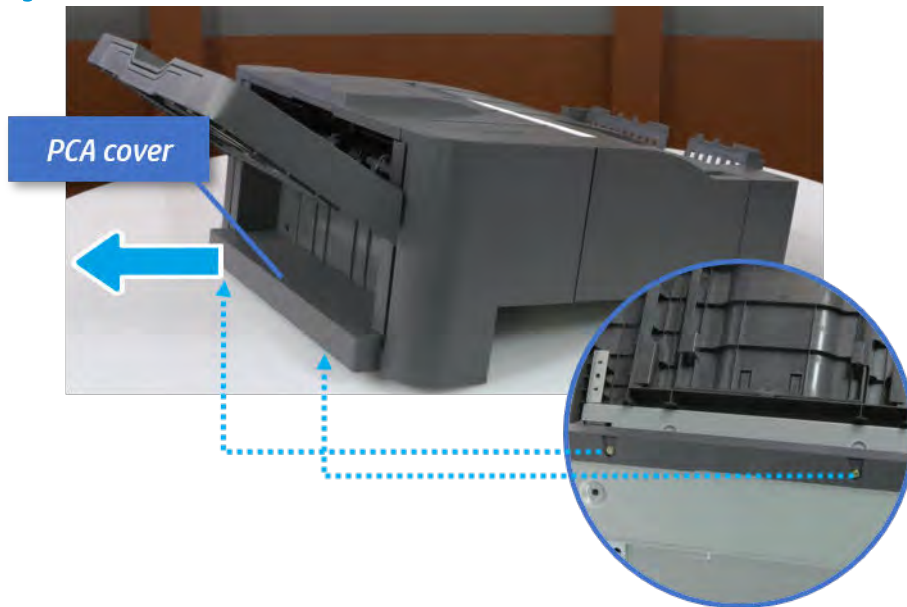

Remove the left cover

Follow these steps to remove the left cover.

1. Remove two screws.

Figure 7-411 Remove two screws

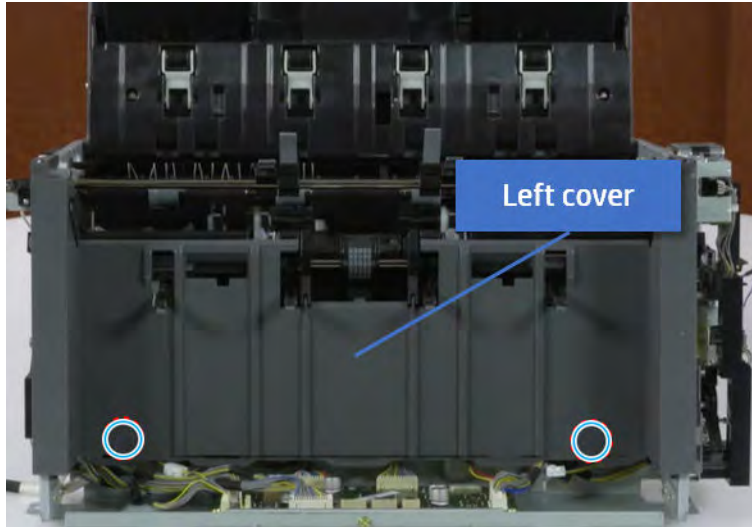

2. Remove four screws from both front and rear sides.

Figure 7-412 Remove four screws

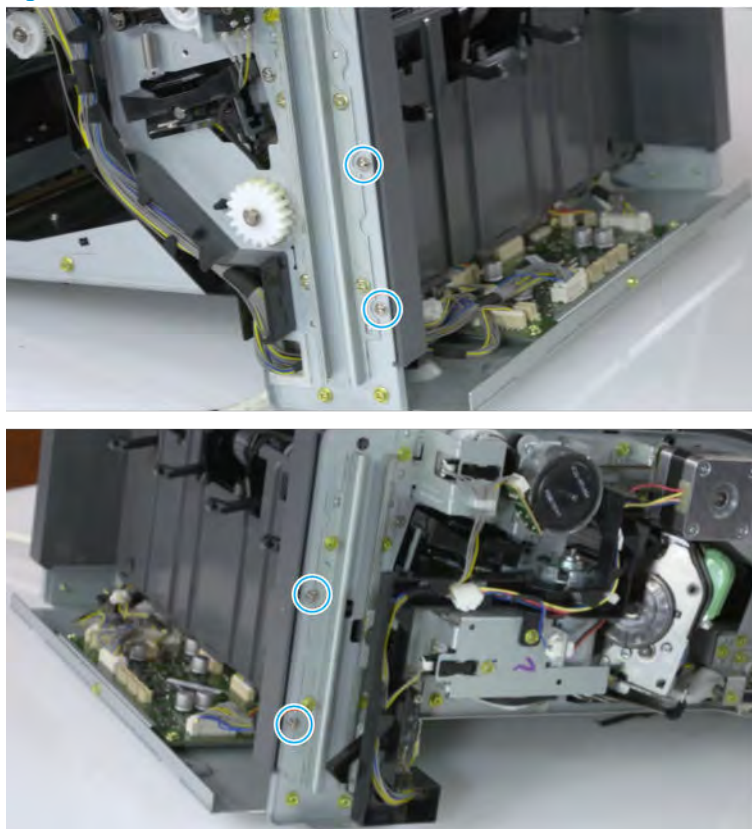

3. Unplug two inline connectors, and then remove the left cover.

Figure 7-413 Unplug two connectors

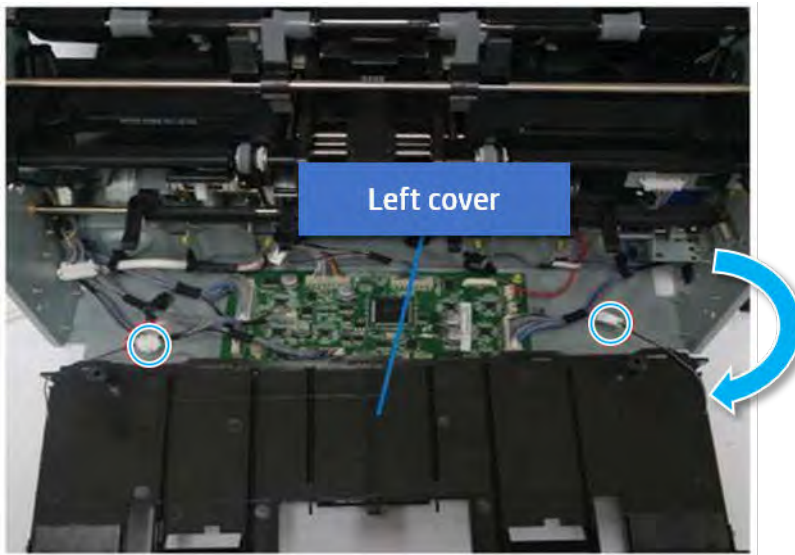

 **TIP:** Be sure to check the hook when reassembling.

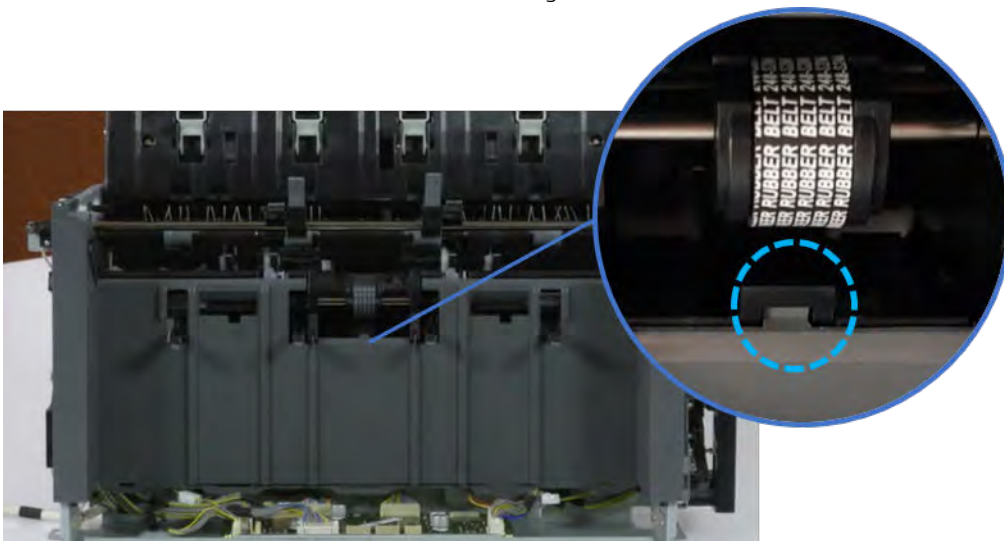

Remove the front harness guide

Follow these steps to remove the front harness guide.

1. Open one clamp and unplug five connectors, and then remove the wire harness from the front harness guide.

2. Remove four screws, and then remove the front harness guide.

Figure 7-414 Remove the front harness guide

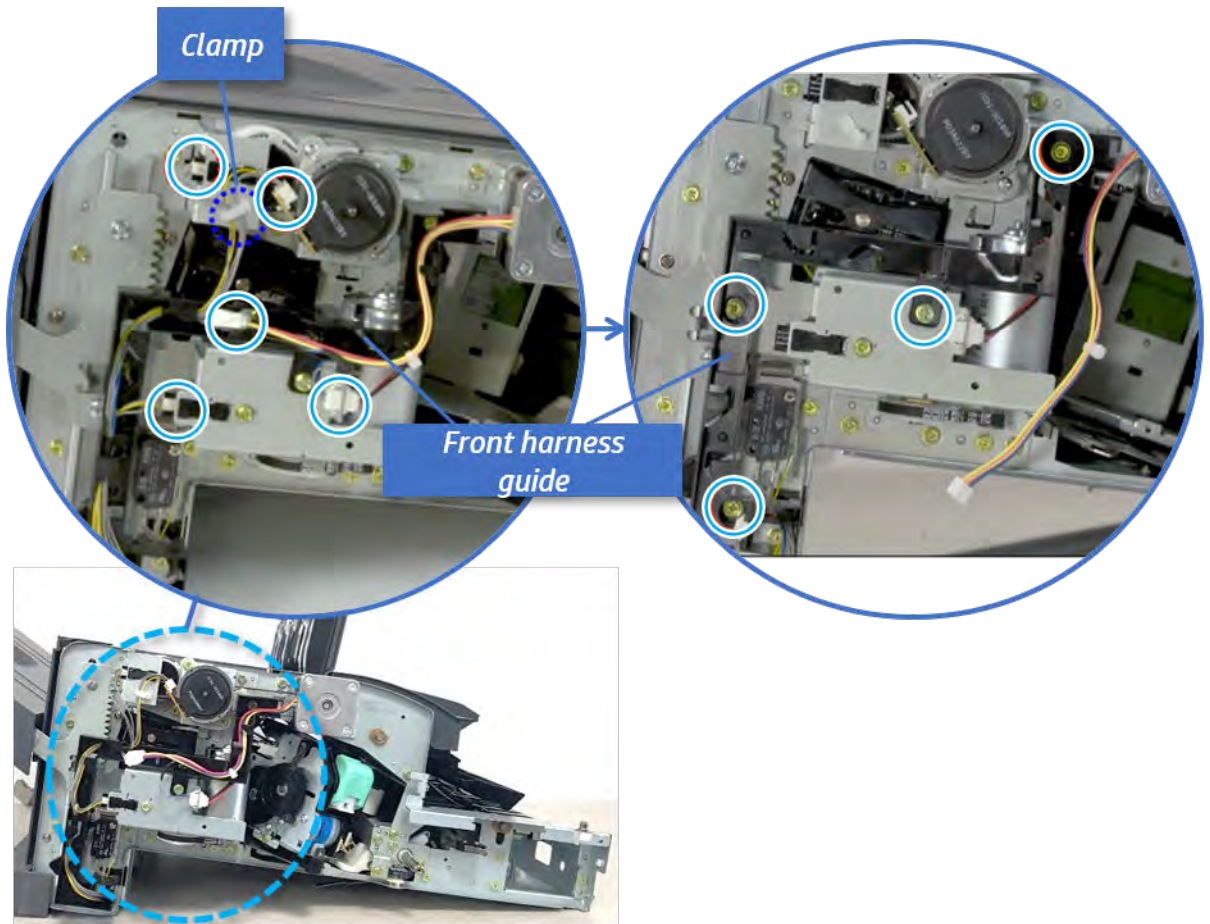

Remove the output tray motor assembly

Follow these steps to remove the output tray motor assembly.

- ▲ Remove three screws, and then remove the output tray motor assembly.

Figure 7-415 Remove the output tray motor assembly

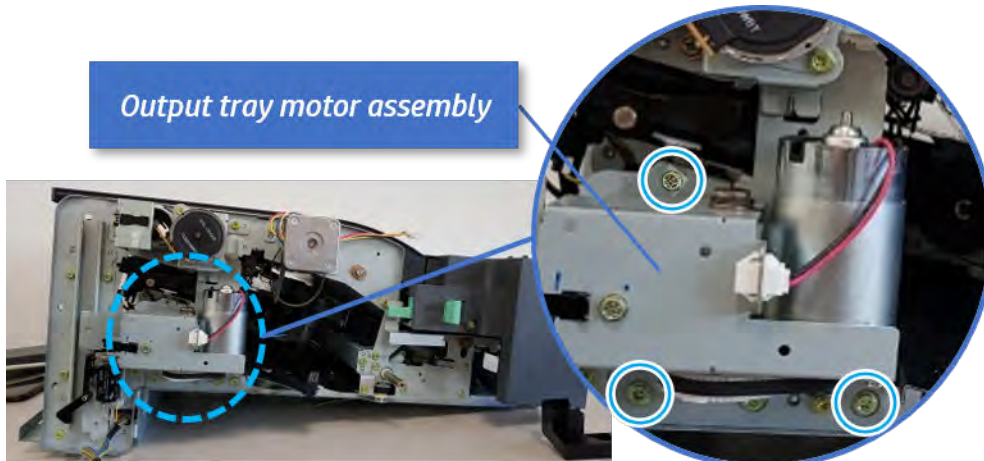

Remove the output tray lower limit switch

Follow these steps to remove the output tray lower limit switch.

- ▲ Remove one screw, and then remove the output tray lower limit switch.

Figure 7-416 Remove the output tray lower limit switch

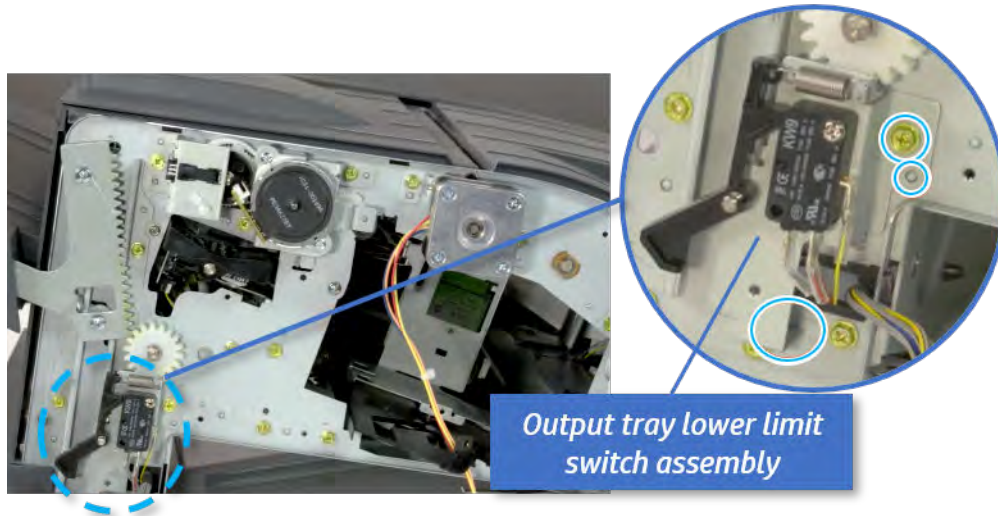

Remove the paper holding

Follow these steps to remove the paper holding.

1. Remove the paper holding actuator spring.

Figure 7-417 Remove the paper holding actuator spring

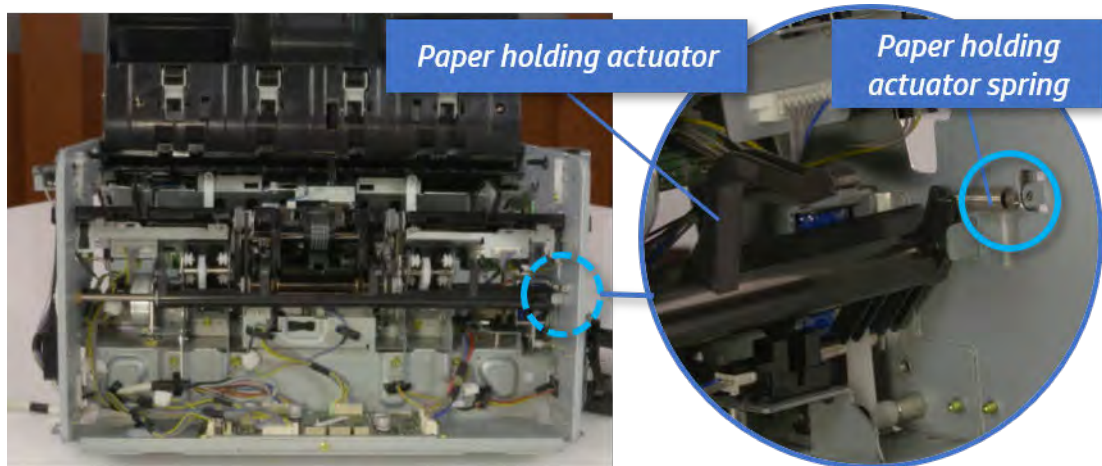

2. Remove the e-ring and the rack pinion gear. And then remove the pin and the e-ring, and then remove the bushing.

Figure 7-418 Remove e-ring, rack pinion gear, pin, and bushing

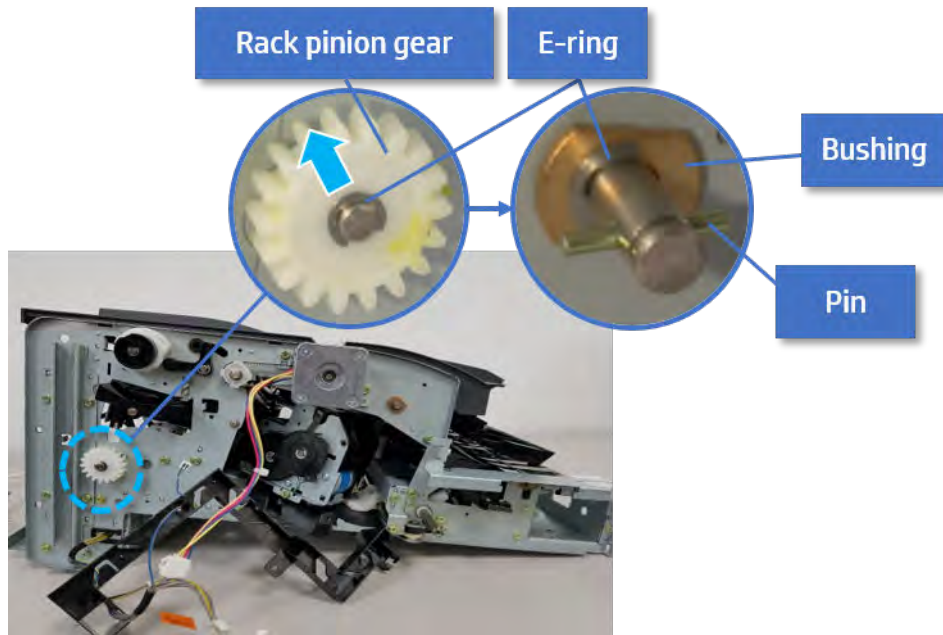

 **NOTE:** Be sure not to lose the pin.

3. Carefully remove the paper holding shaft and the actuator.

Figure 7-419 Remove the paper holding shaft and the actuator

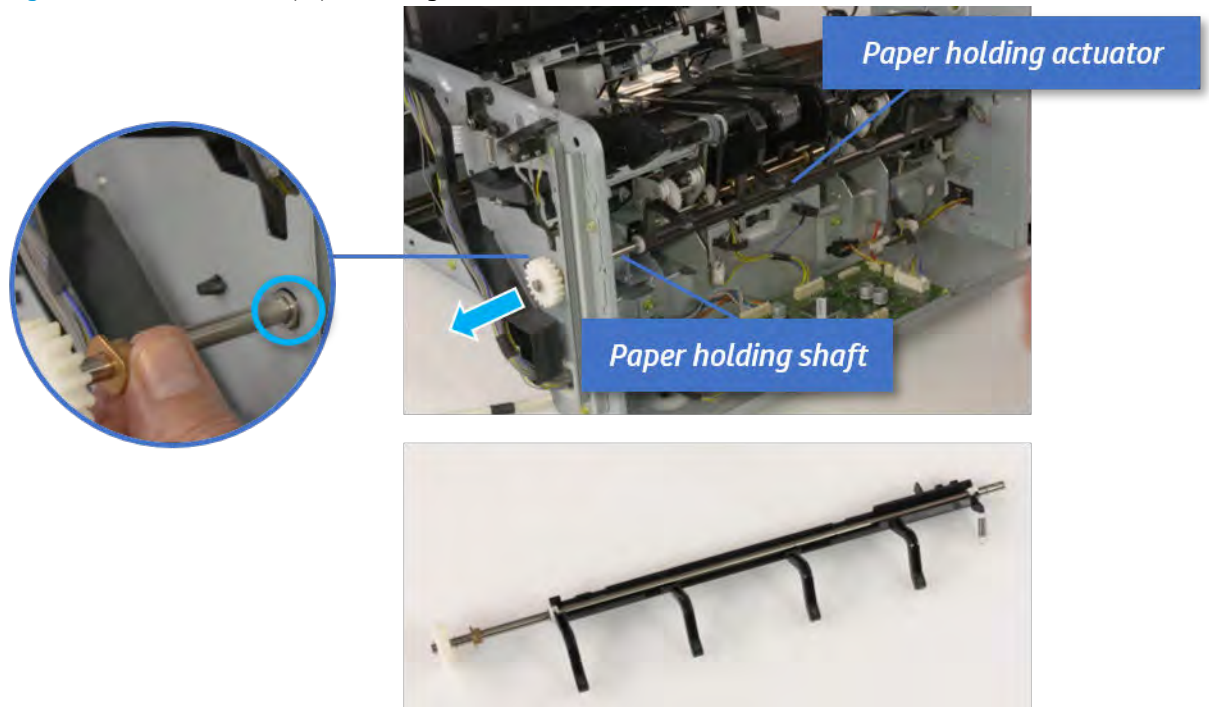

Remove the sub paddle unit

Follow these steps to remove the sub paddle unit.

1. Open the top cover, and then remove one screw securing the sub paddle unit.

Figure 7-420 Remove one screw

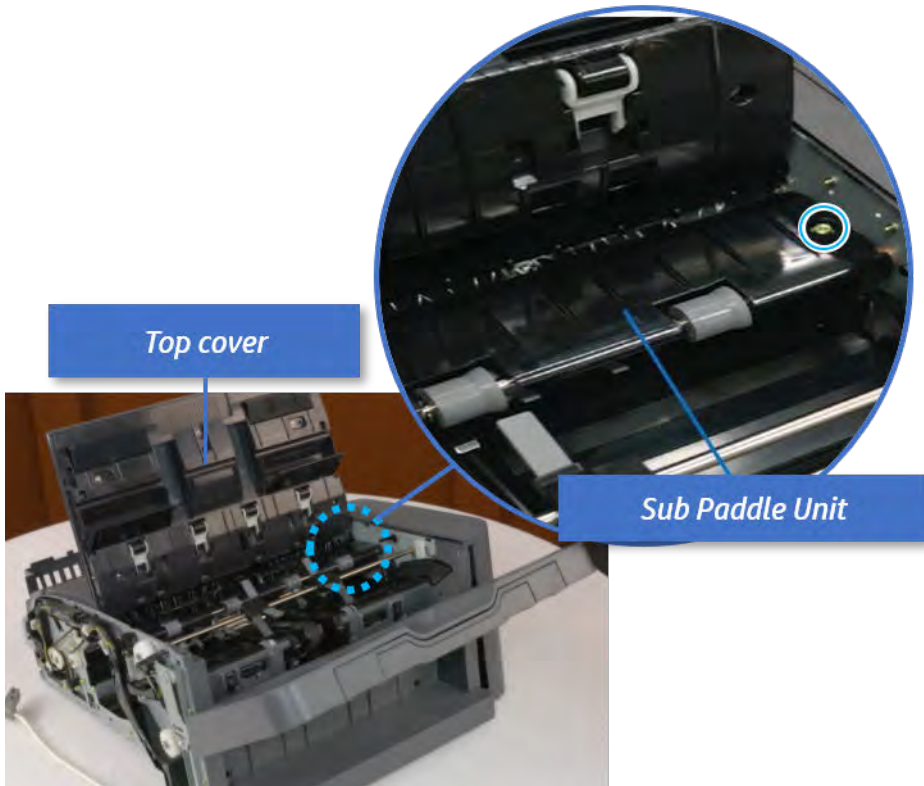

2. Remove the e-ring, and then remove the pulley and timing belt. And then remove the e-ring and the bushing.

Figure 7-421 Remove the e-ring, pulley, timing belt, and bushing

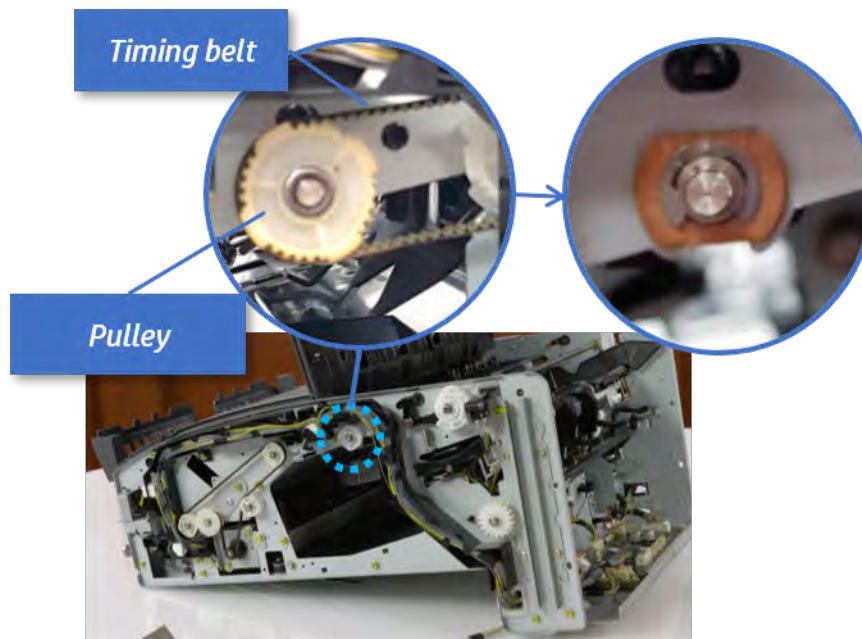

3. Lift up and remove the sub paddle unit.

Figure 7-422 Remove the sub paddle unit

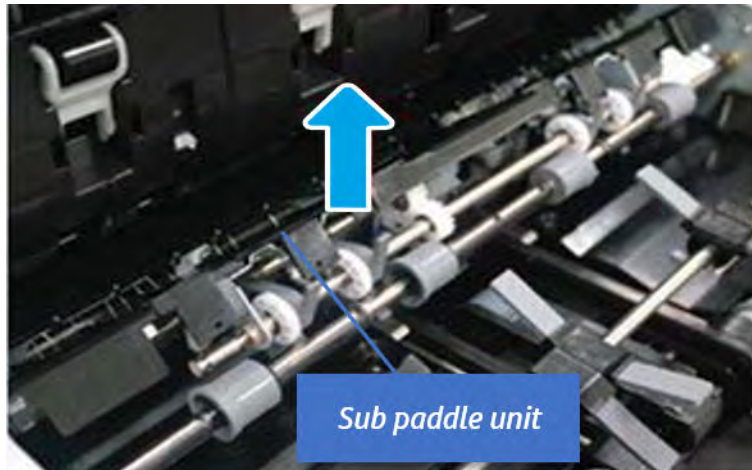

Remove the exit roller

Follow these steps to remove the exit roller.

1. Remove the guide on the center of the exit roller.

Figure 7-423 Remove the guide

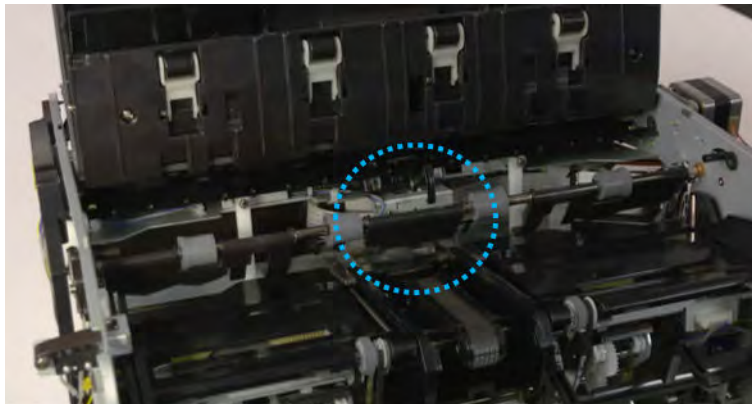

2. On the front of the inner finisher, release the timing belt connected to the exit motor.

Figure 7-424 Release the timing belt

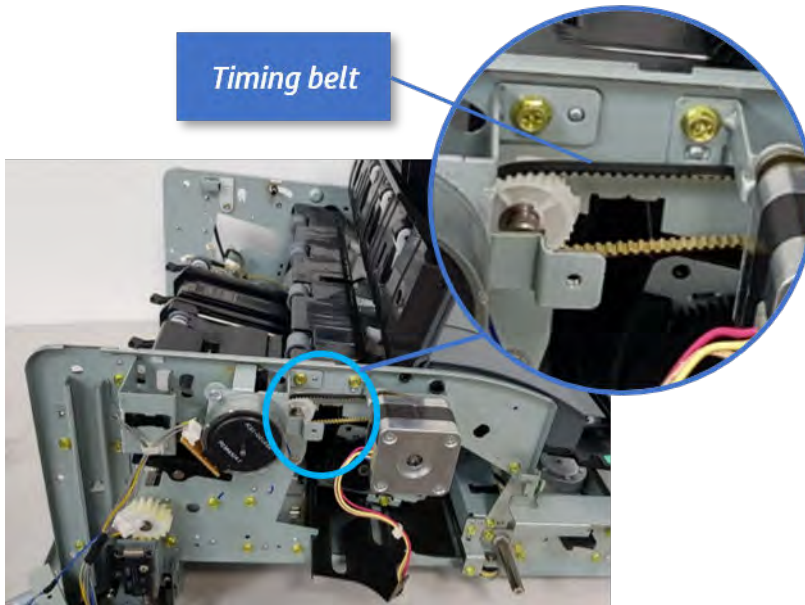

3. Remove five screws securing the rear harness guide.

Figure 7-425 Remove five screws

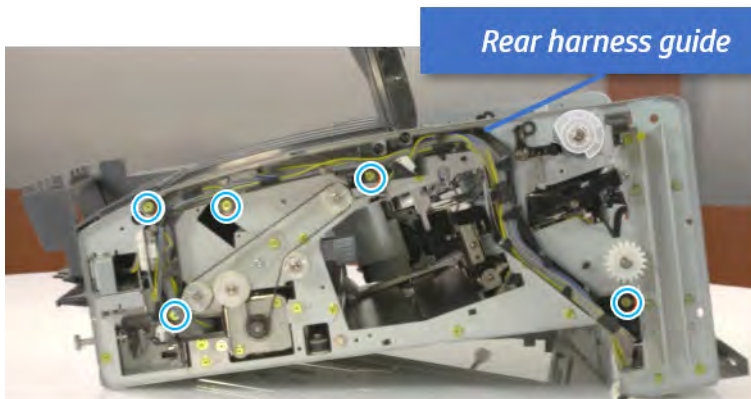

4. On the rear of the inner finisher, remove the e-ring and the pulley and then remove the e-ring and the bushing.

Figure 7-426 Remove e-ring, pulley, and bushing

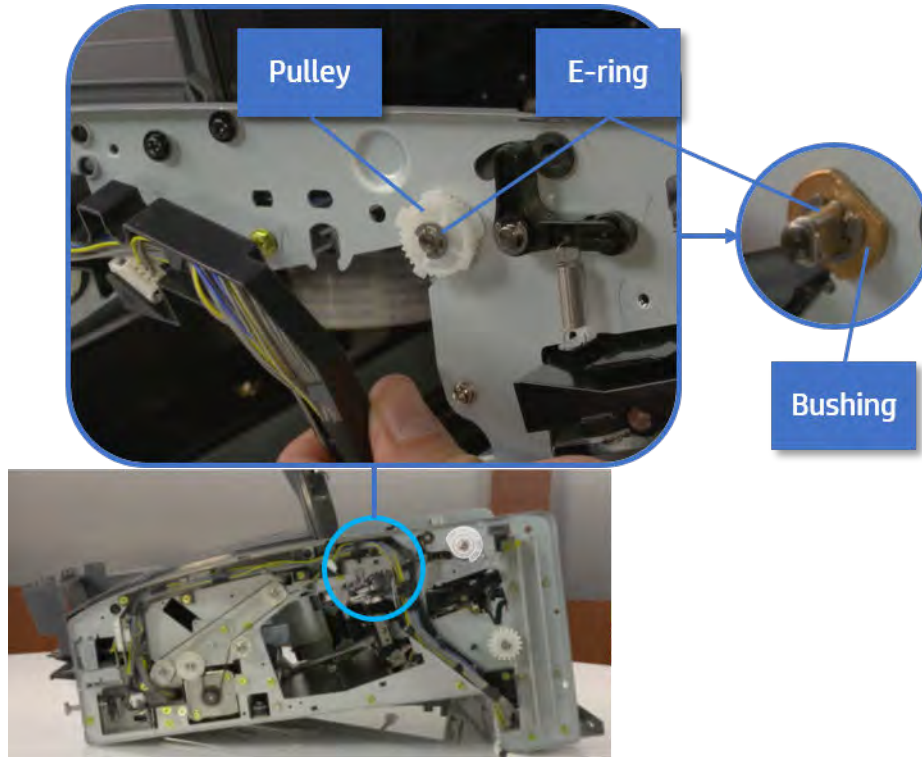

5. Push the bushing to detach it, and then remove the exit roller.

Figure 7-427 Remove the exit roller

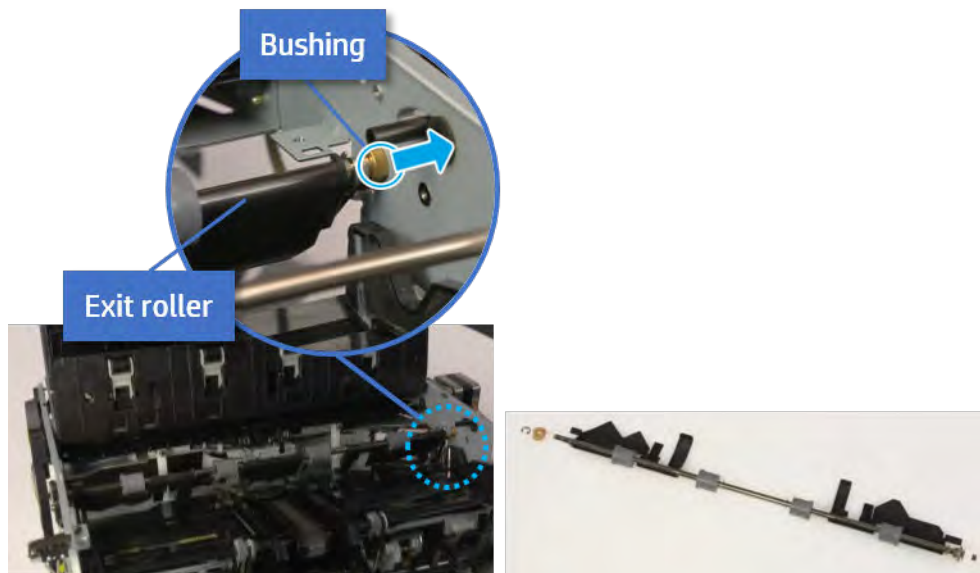

Remove the rear tamper

Follow these steps to remove the rear tamper.

1. Remove four screws.

 **NOTE:** Move cable guideout of position to access the screws.

Figure 7-428 Remove four screws



2. Unplug two connectors and release the hook, and then remove the rear tamper.

Figure 7-429 Remove the rear tamper

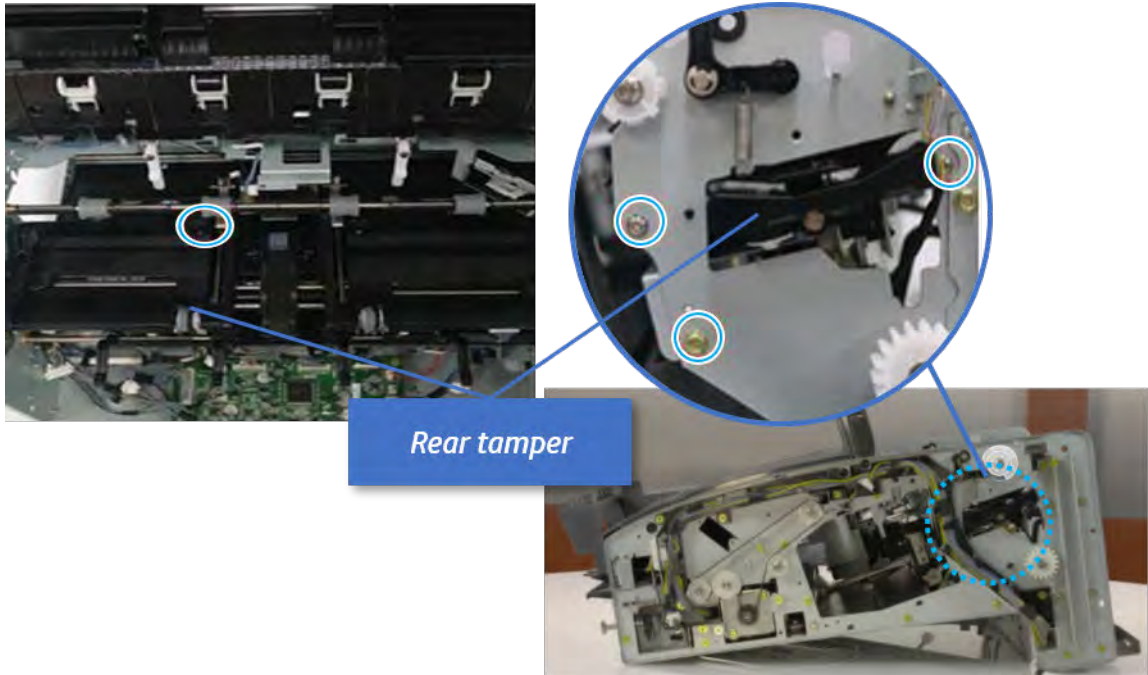
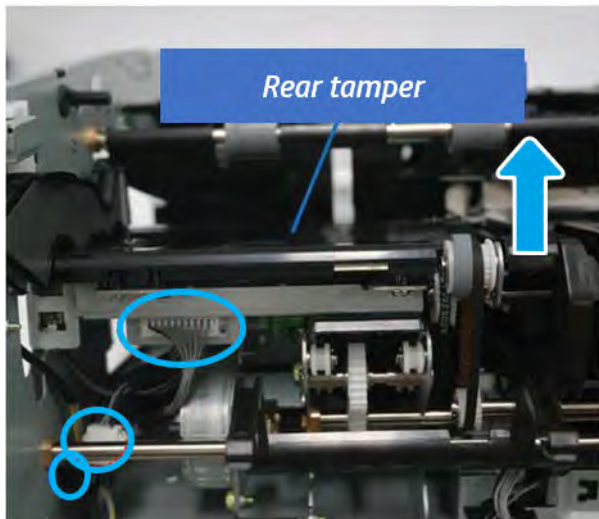

Remove the rear tamper home sensor

Follow these steps to remove the rear tamper home sensor.

- ▲ Unplug the connector, and then remove the rear tamper home sensor.

Figure 7-430 Remove the rear tamper home sensor

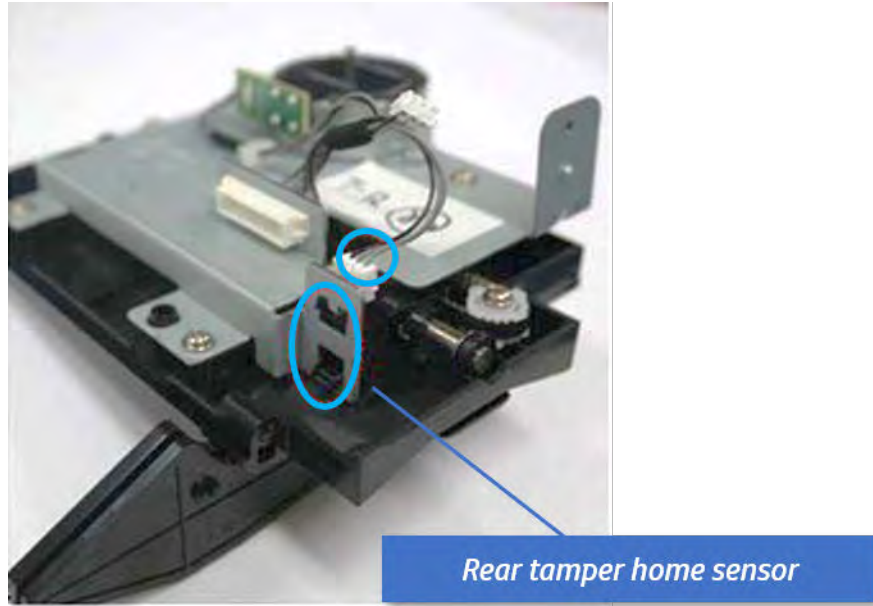

Unpack the replacement assembly



Follow these steps to unpack the replacement assembly.

1. Dispose of the defective part.

 **NOTE:** HP recommends responsible disposal of the defective part.

<http://www8.hp.com/us/en/hp-information/environment/product-recycling.html>

2. Unpack the replacement part from the packaging.

 **CAUTION:**  Some parts are sensitive to electrostatic discharge (ESD). Always perform service work at an ESD-protected workstation or mat. If an ESD workstation or mat is not available, touch the sheet-metal chassis to provide a static ground before touching an ESD-sensitive assembly. Protect the ESD-sensitive assemblies by placing them in ESD pouches when they are out of the printer.

 **IMPORTANT:** Make sure that all of the shipping materials (for example shipping tape) are removed from the replacement part prior to installation.

 **NOTE:** If the replacement part is a roller or pad, avoid touching the spongy part of it. Skin oils on the roller or pad can cause paper pickup and/or print-quality problems. HP recommends using disposable gloves when handling rollers or pads or washing your hands before touching rollers or pads.

3. To install an assembly, reverse the removal steps.

 **NOTE:** When applicable, special installation instructions are provided for an assembly at the end of the removal procedure. Always completely read the removal instructions and follow all special installation instructions.

Removal and replacement: Rear tamper motor (M5)

Learn how to remove and replace the rear tamper motor.

To view teardown and reassembling video of the inner finisher, click the link below.



[View a teardown video of the inner finisher.](#)



[View a reassembling video of the inner finisher.](#)



IMPORTANT: When applicable, special installation instructions are provided for an assembly at the end of the removal procedure. Always completely read the removal instructions and follow all special installation instructions.

Mean time to repair:

Service level:

Before performing service

Turn the printer power off

- Press the power button on the front of the printer, and then turn off the power switch next to the power cable.
- A shutting-down message appears on the control-panel display.



WARNING! To avoid damage to the printer, turn the power off and wait until the printer shuts down before removing the power cable.

- Disconnect the printer power cable after the printer has completely shut down (the control-panel display is blank).

Use the table below to identify the correct part number for your printer. To order the part, go to www.hp.com/buy/parts.

Table 7-58 Part information

Part number	Part description
JC93-01001A	Rear tamper motor assembly

Required tools

- #2 JIS screwdriver with a magnetic tip

After performing service

Turn the printer power on

- Connect the power cable.
- Use the power switch to turn the power on.

Post service test

Print any pages necessary to verify that the repair resolved the issue and did not create any new issues.

Remove the front cover

Follow these steps to remove the front cover.

1. Open the front door and open the punch cover.
2. Remove three screws in the front.
3. Remove the lever.
4. Open the top cover.
5. From the right side of the front cover, carefully lift and pry toward the top-left corner to remove the front cover.

Figure 7-431 Remove the front cover

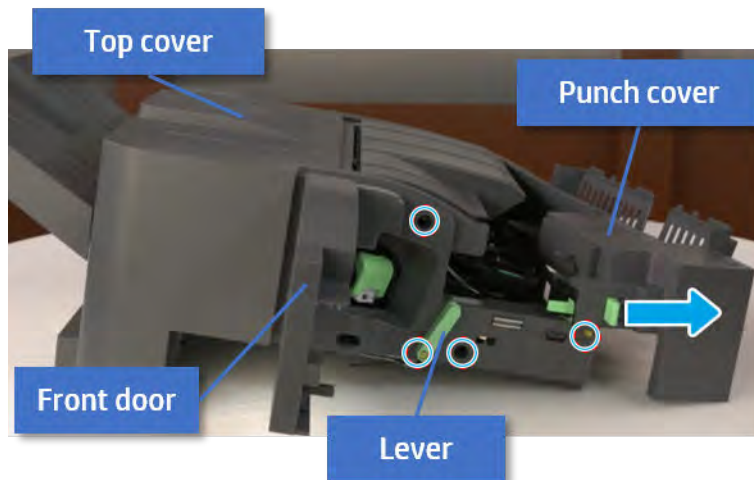

Remove the rear cover

Follow these steps to remove the rear cover.

1. Open the top cover.

Figure 7-432 Open the top cover

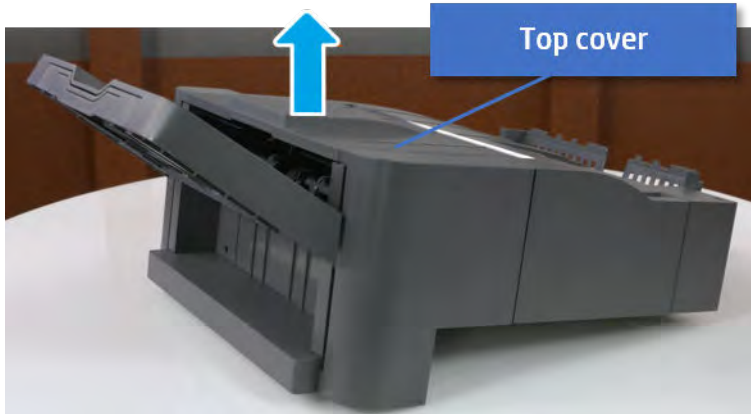

2. Remove three screws.
3. Release hooks carefully and remove the rear cover.

Figure 7-433 Remove the rear cover

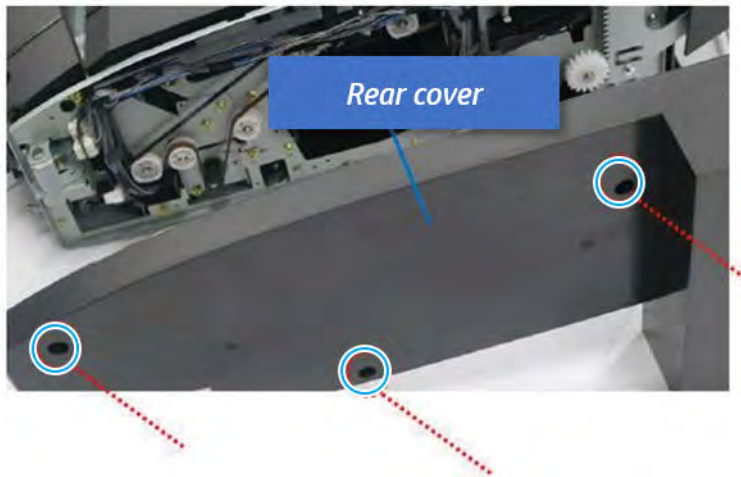

Remove the output tray

Follow these steps to remove the output tray.

1. Remove four screws.

Figure 7-434 Remove four screws

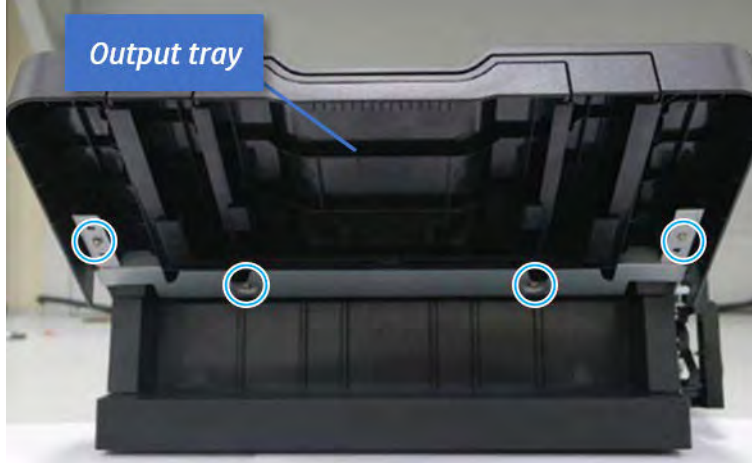

2. Push the paper holding actuator into the inner finisher, and then remove the output tray.

Figure 7-435 Remove the output tray.



Remove the output tray frame

Follow these steps to remove the output tray frame.

1. Rotate the pulley until the output tray frame depart from the gear.

Figure 7-436 Remove the pulley

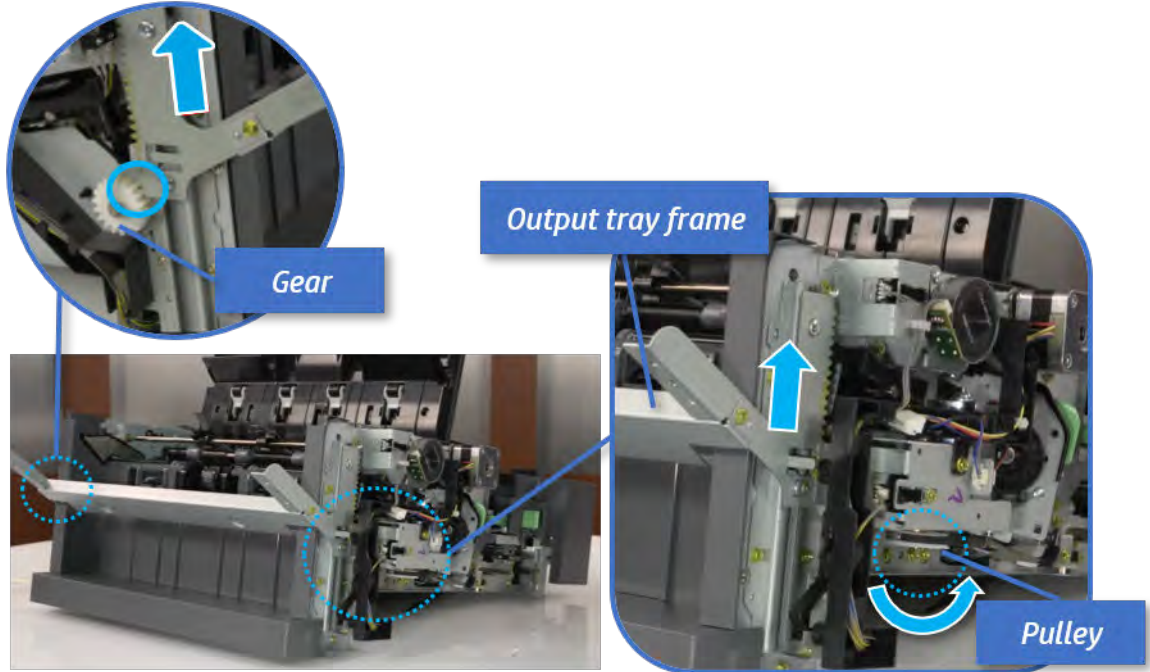

2. Push the paper holding actuator into the inner finisher, and then remove the output tray frame.

Figure 7-437 Remove the output tray frame

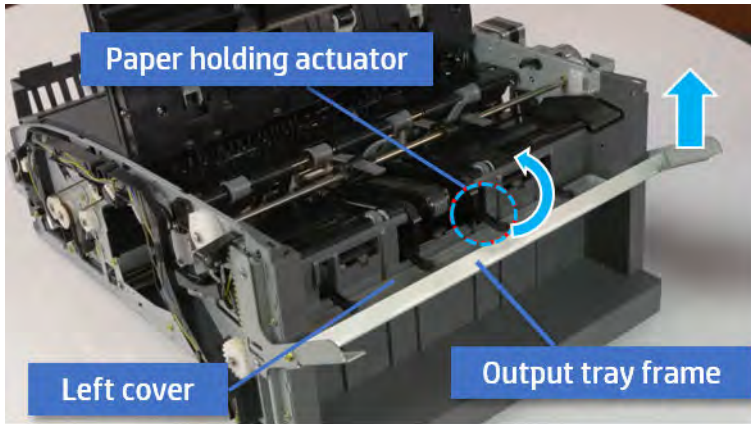

 **TIP:** Push the paper holding actuator into the inner finisher when reassembling. Be sure to level the output tray.

- a. Position the first wheel into the channel on both sides while pushing the paper holding actuator.

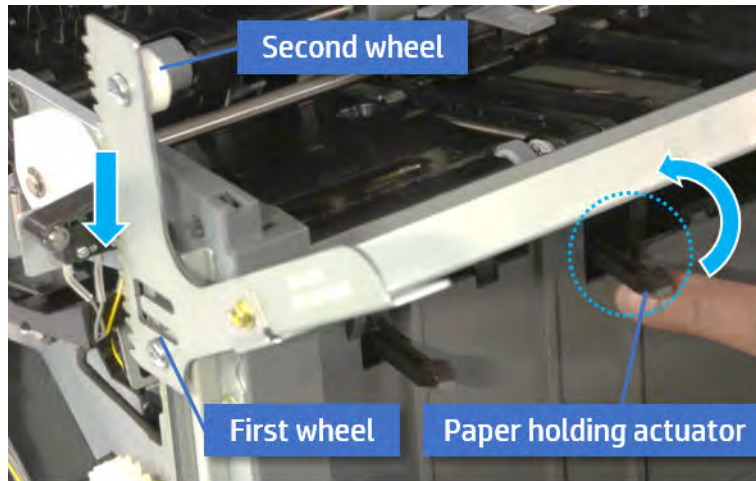

- b. Let the second wheel rest on the channel on both sides simultaneously.
- c. Gently squeeze the wheels into channel until the output tray frame meet the gear.

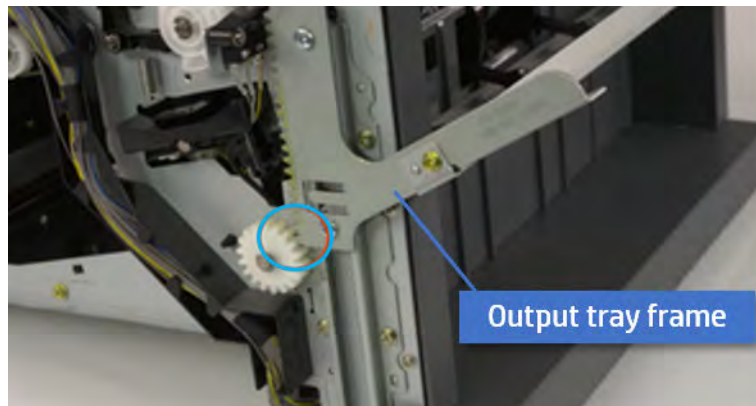

- d. Rotate the pulley until the output tray frame is no longer lifted. It can make to level the output tray frame.

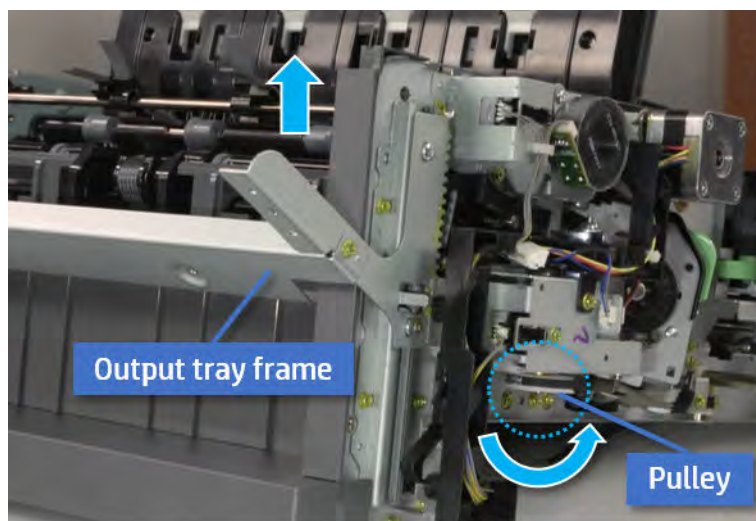

- e. Rotate the pulley in the opposite direction.

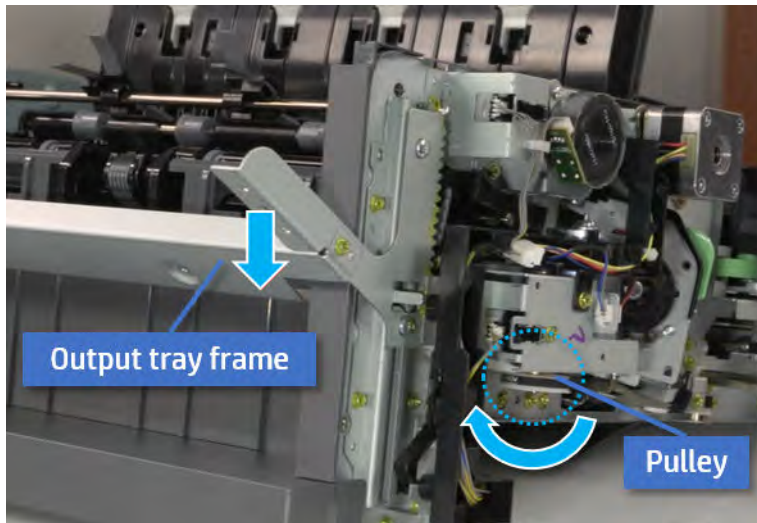

Remove the PCA cover

Follow these steps to remove the PCA cover.

- ▲ Remove two screws, and then remove the PCA cover.

Figure 7-438 Remove the PCA cover

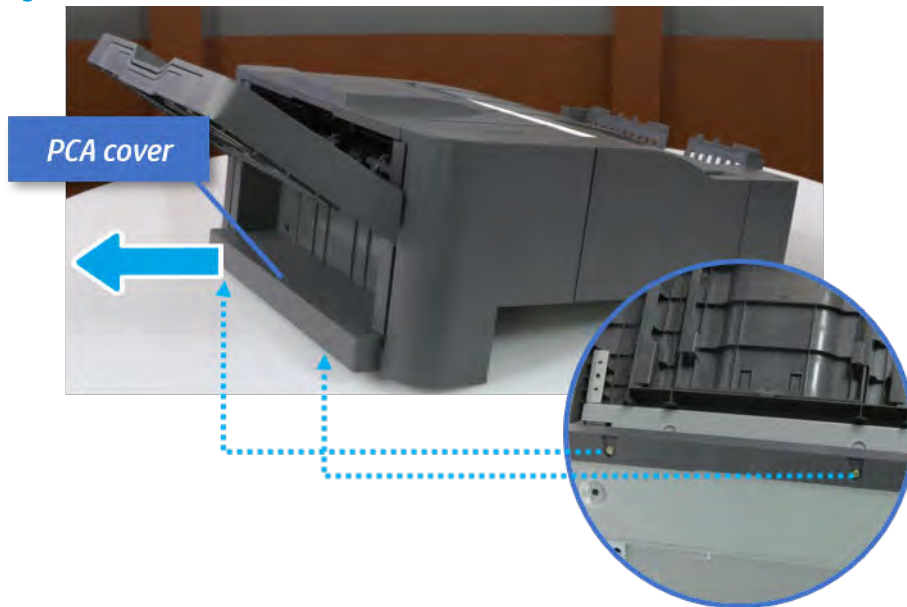

Remove the left cover

Follow these steps to remove the left cover.

1. Remove two screws.

Figure 7-439 Remove two screws

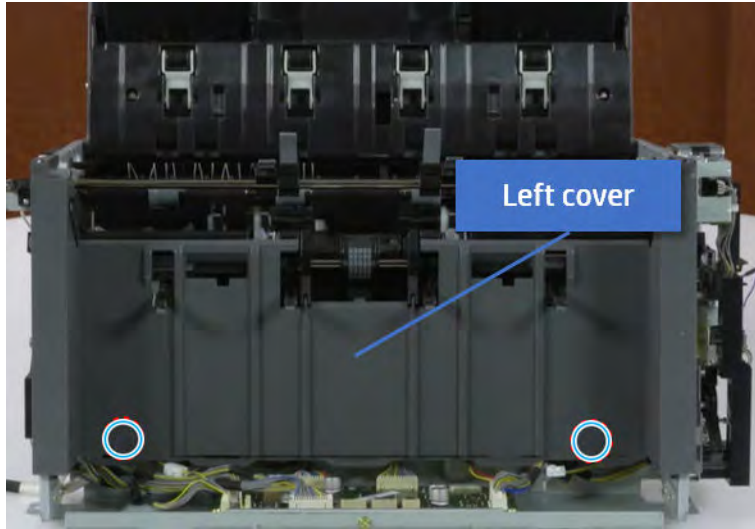

2. Remove four screws from both front and rear sides.

Figure 7-440 Remove four screws

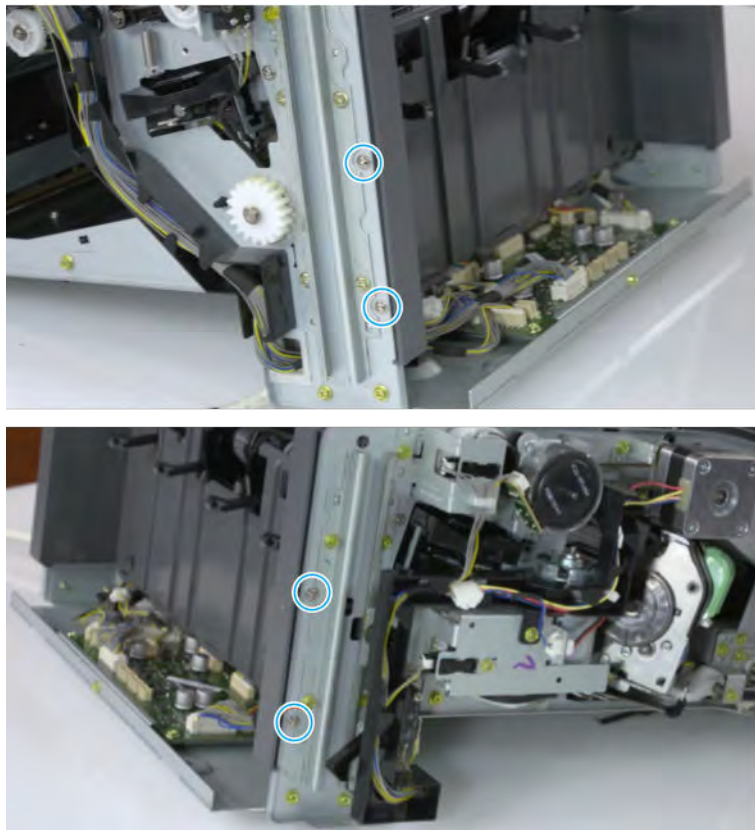

3. Unplug two inline connectors, and then remove the left cover.

Figure 7-441 Unplug two connectors

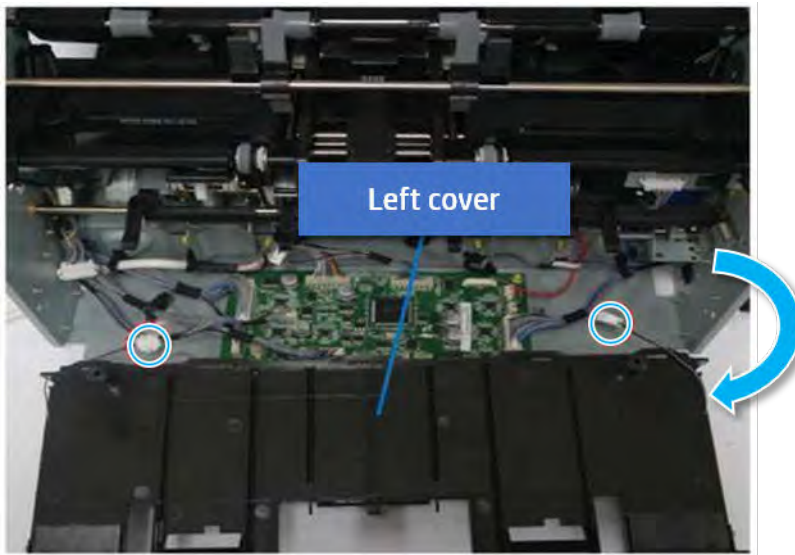

 **TIP:** Be sure to check the hook when reassembling.

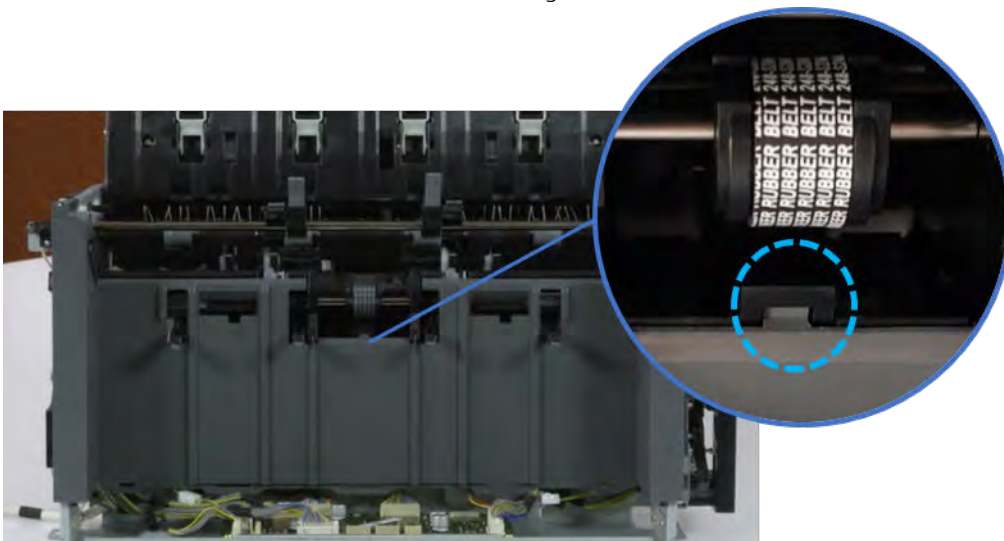

Remove the front harness guide

Follow these steps to remove the front harness guide.

1. Open one clamp and unplug five connectors, and then remove the wire harness from the front harness guide.

2. Remove four screws, and then remove the front harness guide.

Figure 7-442 Remove the front harness guide

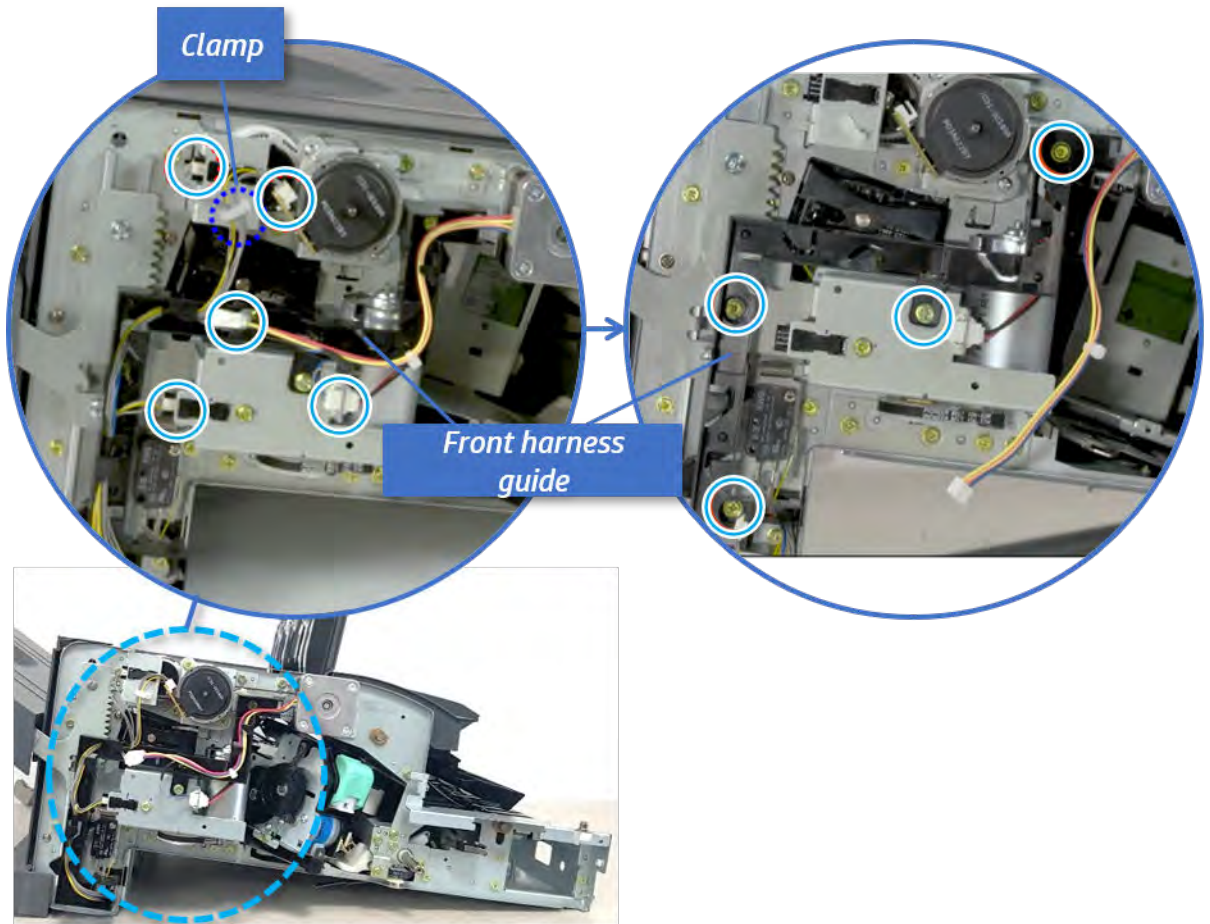

Remove the output tray motor assembly

Follow these steps to remove the output tray motor assembly.

- ▲ Remove three screws, and then remove the output tray motor assembly.

Figure 7-443 Remove the output tray motor assembly

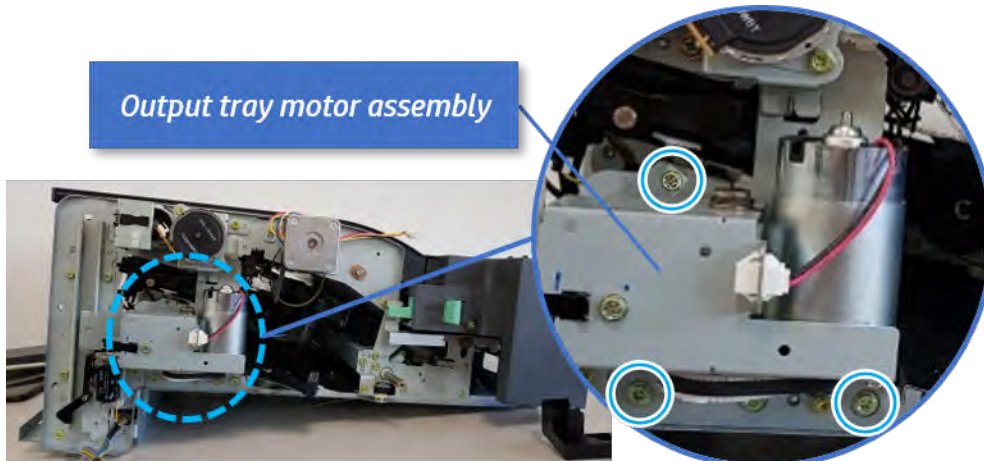

Remove the output tray lower limit switch

Follow these steps to remove the output tray lower limit switch.

- ▲ Remove one screw, and then remove the output tray lower limit switch.

Figure 7-444 Remove the output tray lower limit switch

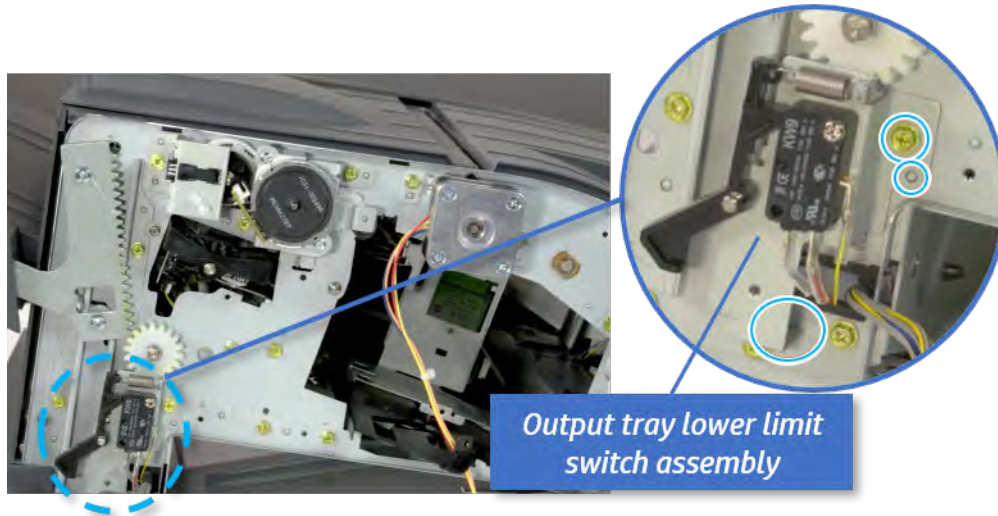

Remove the paper holding

Follow these steps to remove the paper holding.

1. Remove the paper holding actuator spring.

Figure 7-445 Remove the paper holding actuator spring

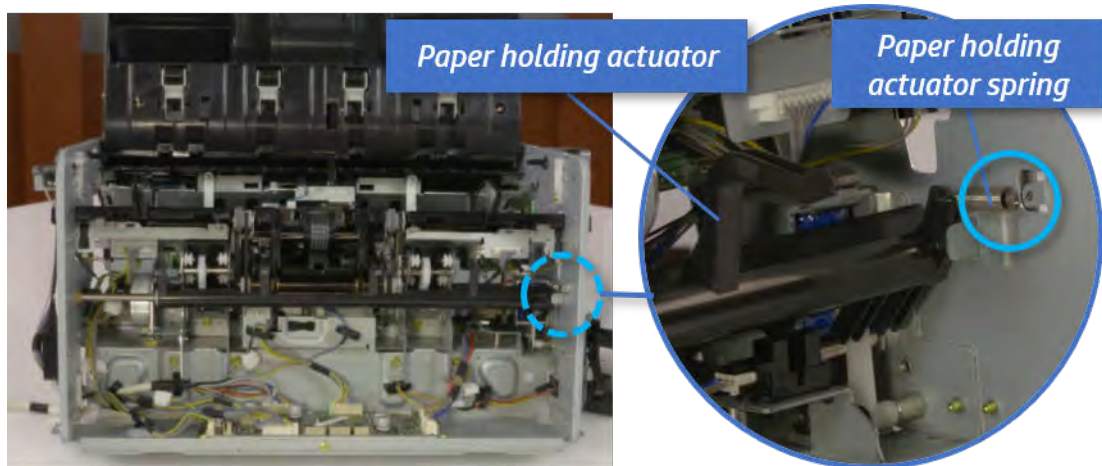

2. Remove the e-ring and the rack pinion gear. And then remove the pin and the e-ring, and then remove the bushing.

Figure 7-446 Remove e-ring, rack pinion gear, pin, and bushing

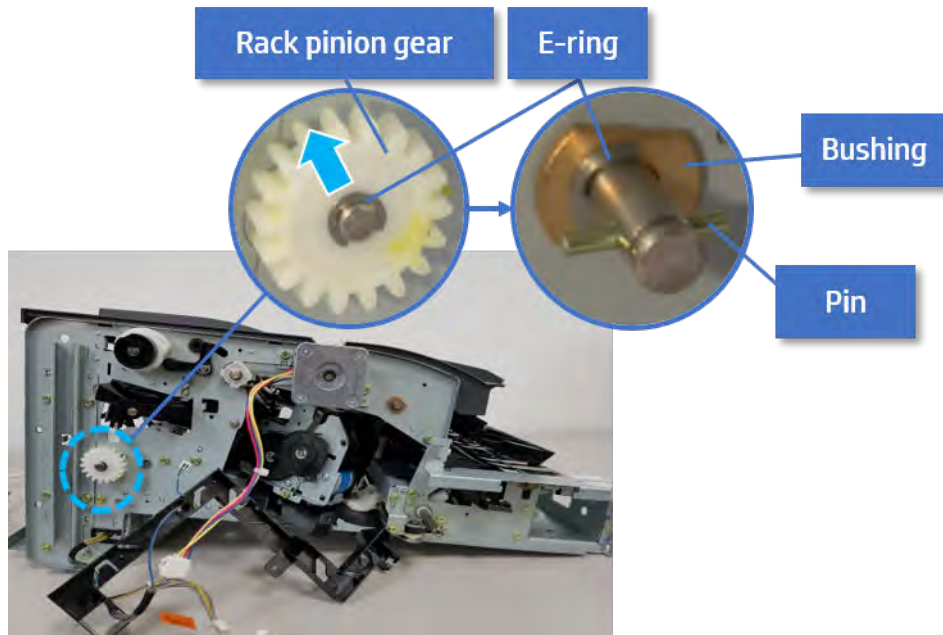

 **NOTE:** Be sure not to lose the pin.

3. Carefully remove the paper holding shaft and the actuator.

Figure 7-447 Remove the paper holding shaft and the actuator

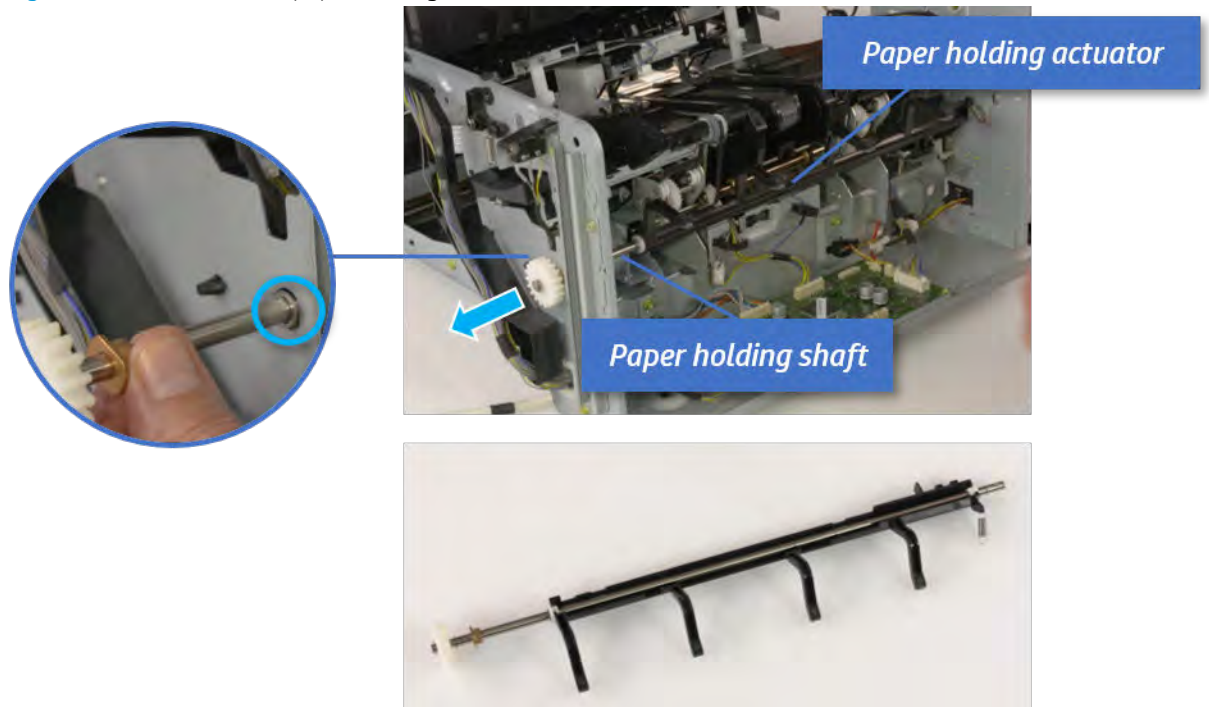

Remove the sub paddle unit

Follow these steps to remove the sub paddle unit.

1. Open the top cover, and then remove one screw securing the sub paddle unit.

Figure 7-448 Remove one screw

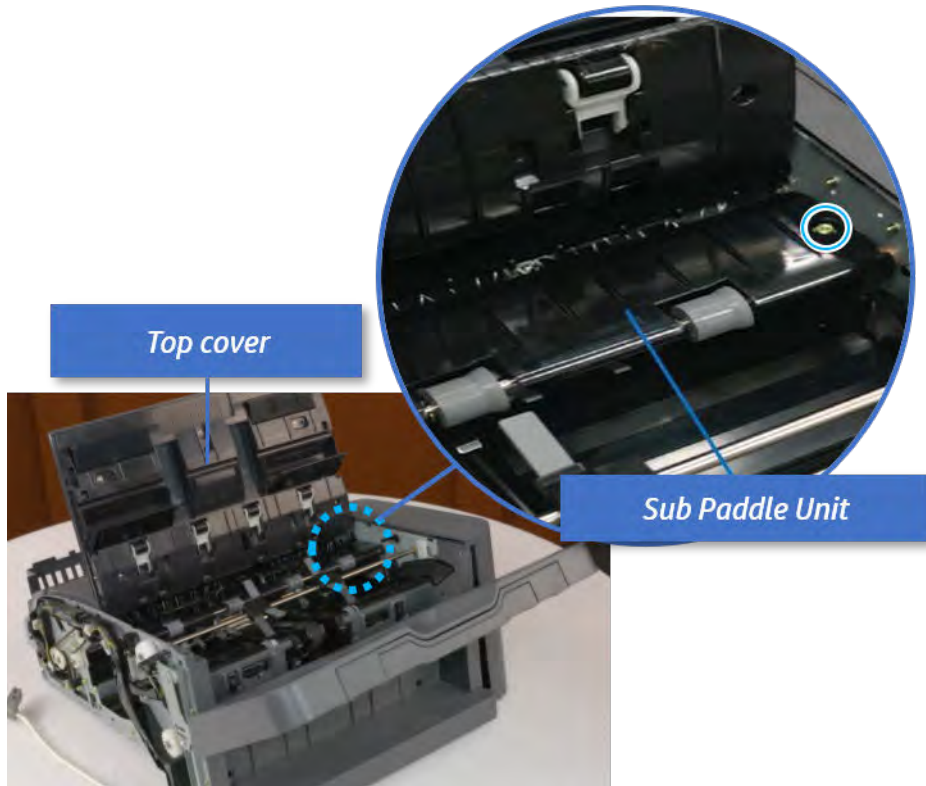

2. Remove the e-ring, and then remove the pulley and timing belt. And then remove the e-ring and the bushing.

Figure 7-449 Remove the e-ring, pulley, timing belt, and bushing

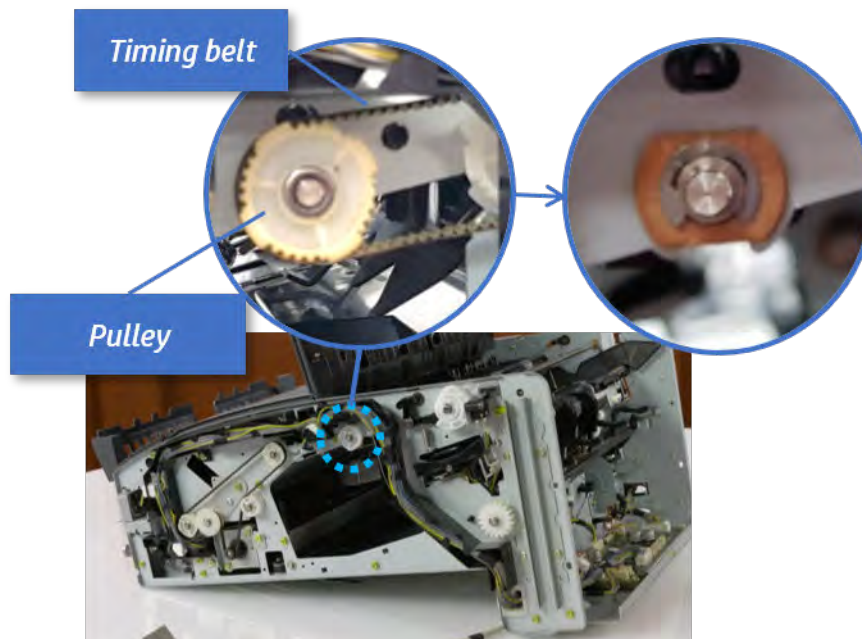

3. Lift up and remove the sub paddle unit.

Figure 7-450 Remove the sub paddle unit

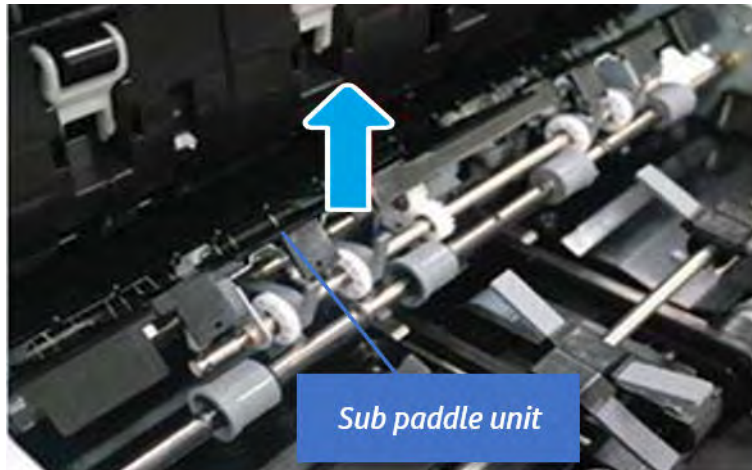

Remove the exit roller

Follow these steps to remove the exit roller.

1. Remove the guide on the center of the exit roller.

Figure 7-451 Remove the guide

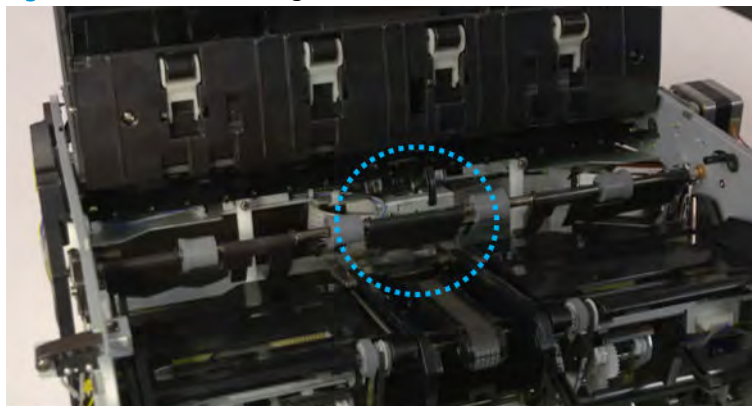

2. On the front of the inner finisher, release the timing belt connected to the exit motor.

Figure 7-452 Release the timing belt

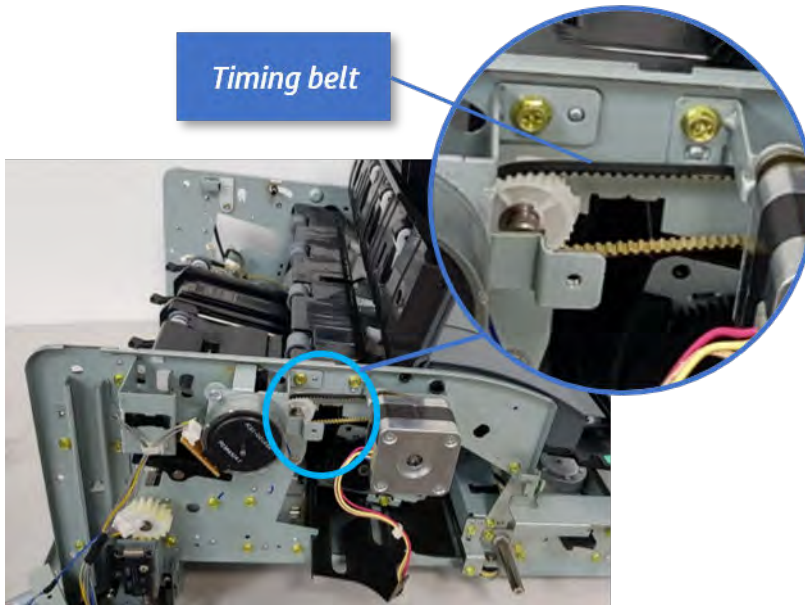

3. Remove five screws securing the rear harness guide.

Figure 7-453 Remove five screws

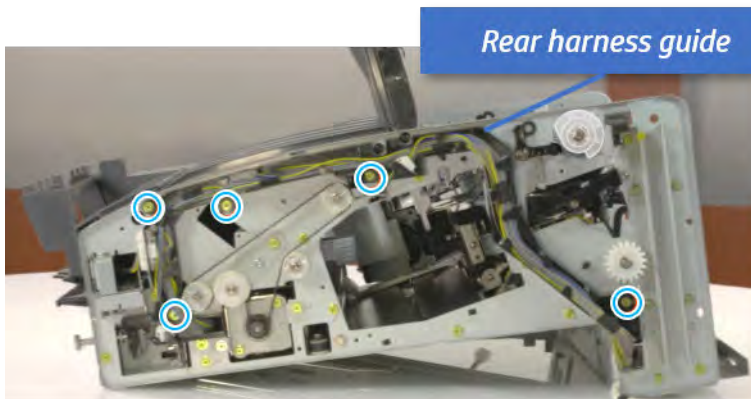

4. On the rear of the inner finisher, remove the e-ring and the pulley and then remove the e-ring and the bushing.

Figure 7-454 Remove e-ring, pulley, and bushing

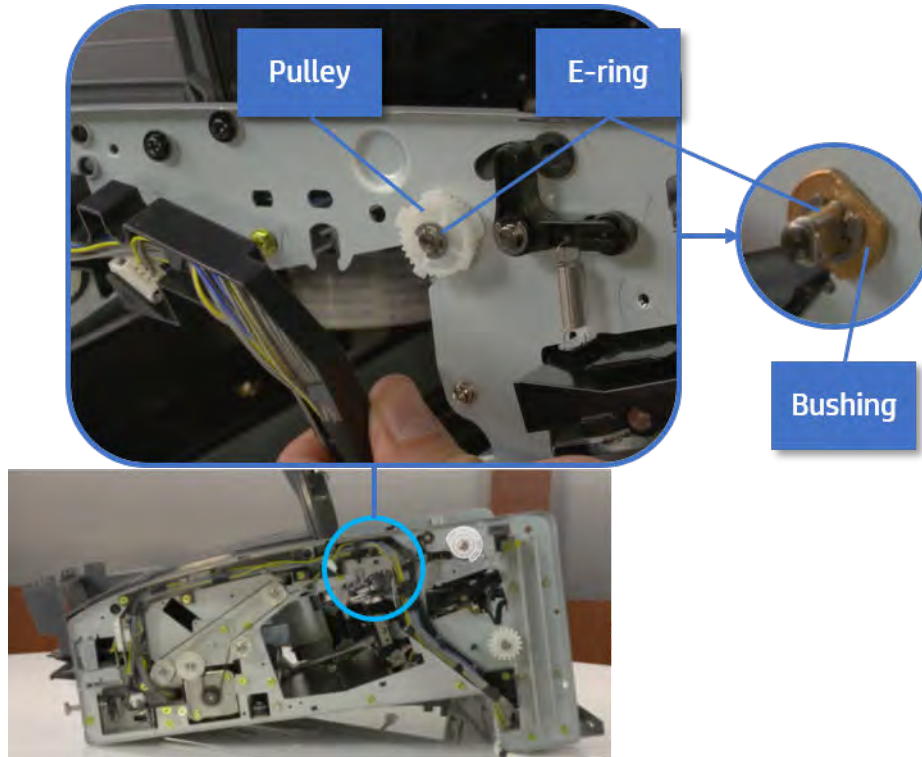

5. Push the bushing to detach it, and then remove the exit roller.

Figure 7-455 Remove the exit roller

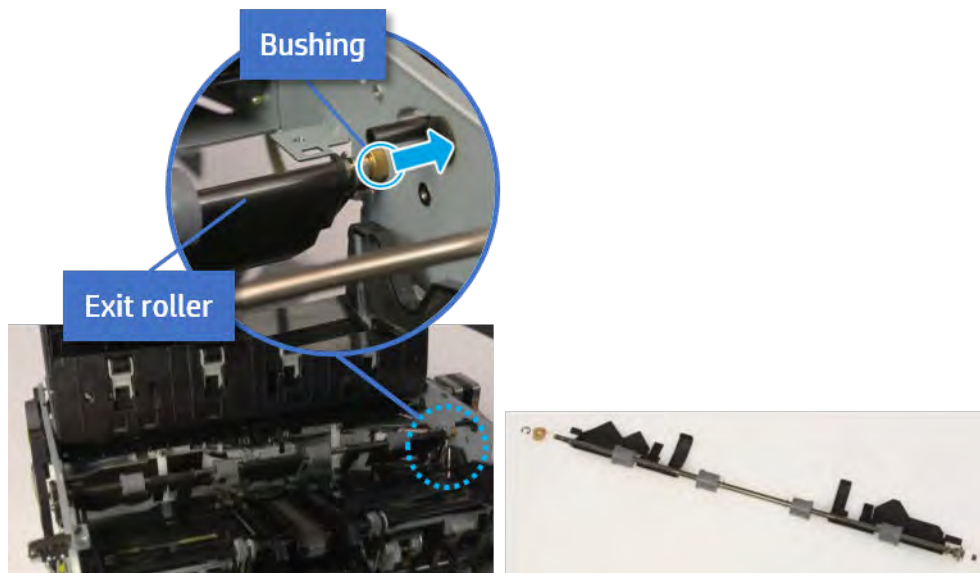

Remove the rear tamper

Follow these steps to remove the rear tamper.

1. Remove four screws.

 **NOTE:** Move cable guideout of position to access the screws.

Figure 7-456 Remove four screws



2. Unplug two connectors and release the hook, and then remove the rear tamper.

Figure 7-457 Remove the rear tamper

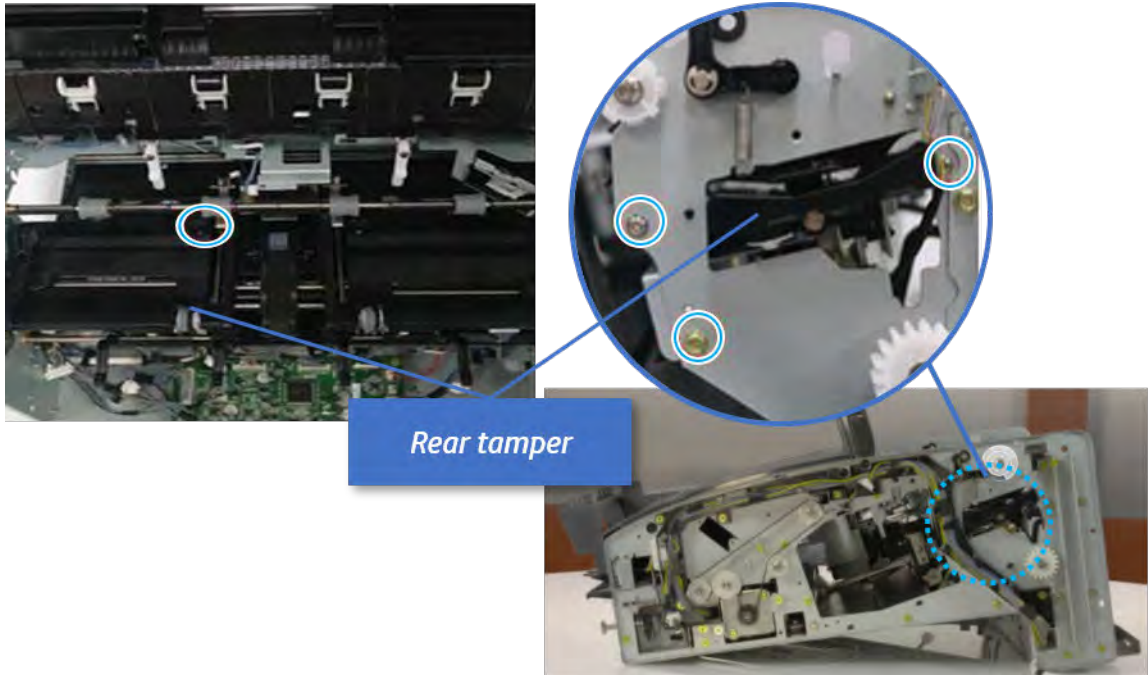
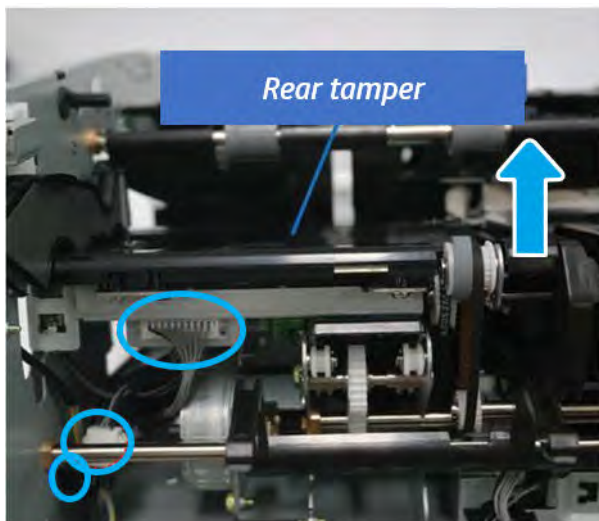

Remove the rear tamper motor

Follow these steps to remove the rear tamper motor.

- ▲ Remove two screws, unplug the connector, and then remove the motor.

Figure 7-458 Remove the rear tamper motor

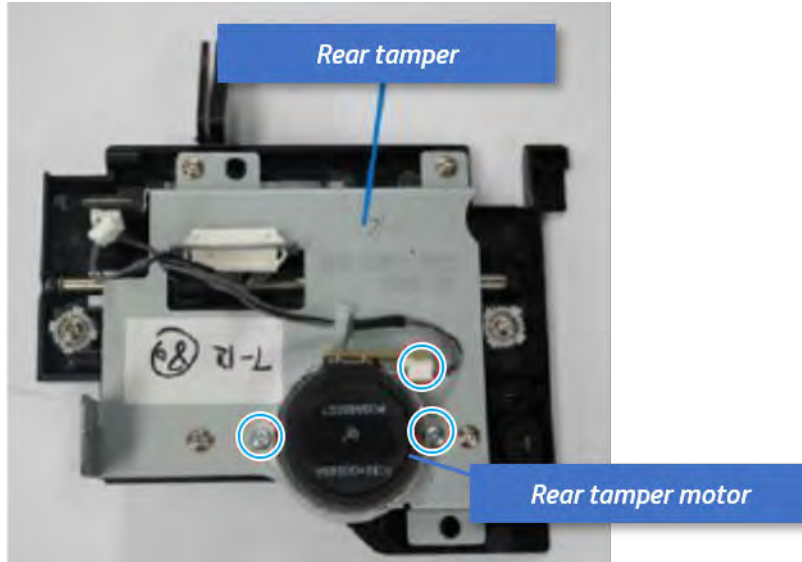

Unpack the replacement assembly

Follow these steps to unpack the replacement assembly.

1. Dispose of the defective part.



NOTE: HP recommends responsible disposal of the defective part.

<http://www8.hp.com/us/en/hp-information/environment/product-recycling.html>

2. Unpack the replacement part from the packaging.



CAUTION:  Some parts are sensitive to electrostatic discharge (ESD). Always perform service work at an ESD-protected workstation or mat. If an ESD workstation or mat is not available, touch the sheet-metal chassis to provide a static ground before touching an ESD-sensitive assembly. Protect the ESD-sensitive assemblies by placing them in ESD pouches when they are out of the printer.



IMPORTANT: Make sure that all of the shipping materials (for example shipping tape) are removed from the replacement part prior to installation.



NOTE: If the replacement part is a roller or pad, avoid touching the spongy part of it. Skin oils on the roller or pad can cause paper pickup and/or print-quality problems. HP recommends using disposable gloves when handling rollers or pads or washing your hands before touching rollers or pads.

3. To install an assembly, reverse the removal steps.



NOTE: When applicable, special installation instructions are provided for an assembly at the end of the removal procedure. Always completely read the removal instructions and follow all special installation instructions.

Stapler unit

Removal and replacement: Stapler

Learn how to remove and replace the stapler.

To view teardown and reassembling video of the inner finisher, click the link below.



[View a teardown video of the inner finisher.](#)



[View a reassembling video of the inner finisher.](#)

IMPORTANT: When applicable, special installation instructions are provided for an assembly at the end of the removal procedure. Always completely read the removal instructions and follow all special installation instructions.

Mean time to repair:

Service level:

Before performing service

Turn the printer power off

- Press the power button on the front of the printer, and then turn off the power switch next to the power cable.
- A shutting-down message appears on the control-panel display.

WARNING! To avoid damage to the printer, turn the power off and wait until the printer shuts down before removing the power cable.

- Disconnect the printer power cable after the printer has completely shut down (the control-panel display is blank).

Use the table below to identify the correct part number for your printer. To order the part, go to www.hp.com/buy/parts.

Table 7-59 Part information

Part number	Part description
JC90-01342A	Stapler assembly

Required tools

- #2 JIS screwdriver with a magnetic tip

After performing service

Turn the printer power on

- Connect the power cable.
- Use the power switch to turn the power on.

Post service test

Print any pages necessary to verify that the repair resolved the issue and did not create any new issues.

Remove the front cover

Follow these steps to remove the front cover.

1. Open the front door and open the punch cover.
2. Remove three screws in the front.
3. Remove the lever.
4. Open the top cover.
5. From the right side of the front cover, carefully lift and pry toward the top-left corner to remove the front cover.

Figure 7-459 Remove the front cover

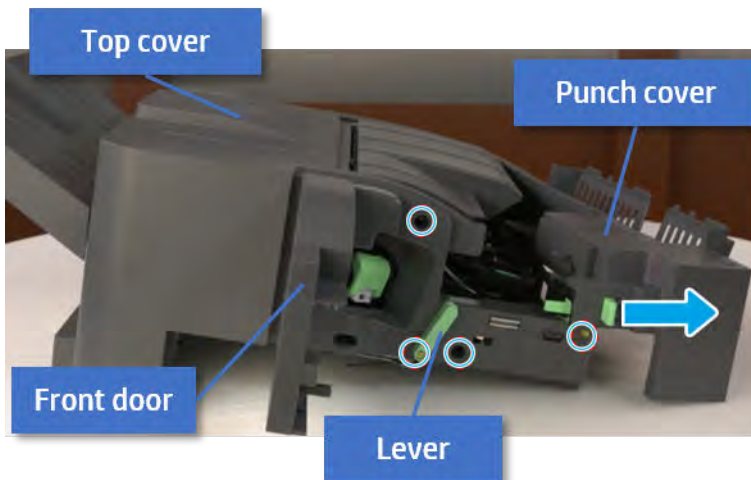

Remove the rear cover

Follow these steps to remove the rear cover.

1. Open the top cover.

Figure 7-460 Open the top cover

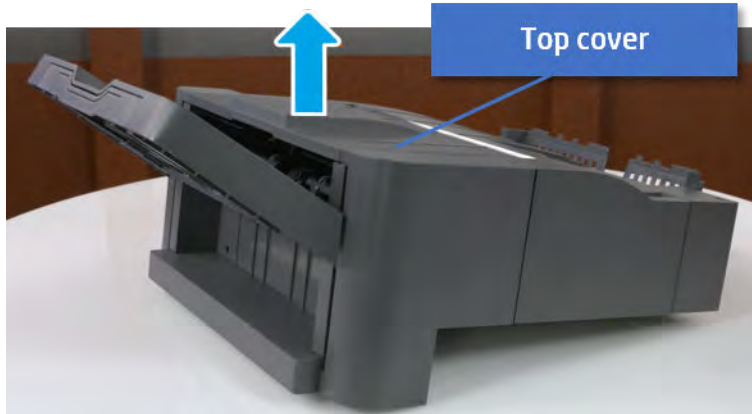

2. Remove three screws.
3. Release hooks carefully and remove the rear cover.

Figure 7-461 Remove the rear cover

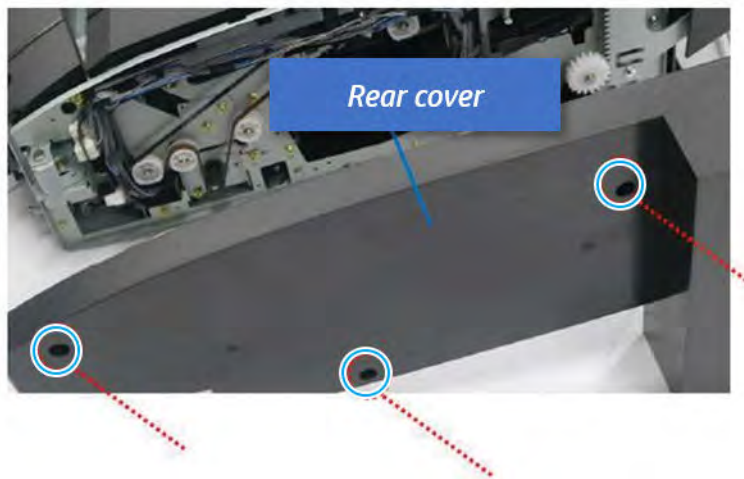

Remove the exit motor bracket

Follow these steps to remove the exit motor bracket.

- ▲ Remove two screws, unplug the motor connector. And then remove exit motor bracket.

Figure 7-462 Remove the exit motor bracket

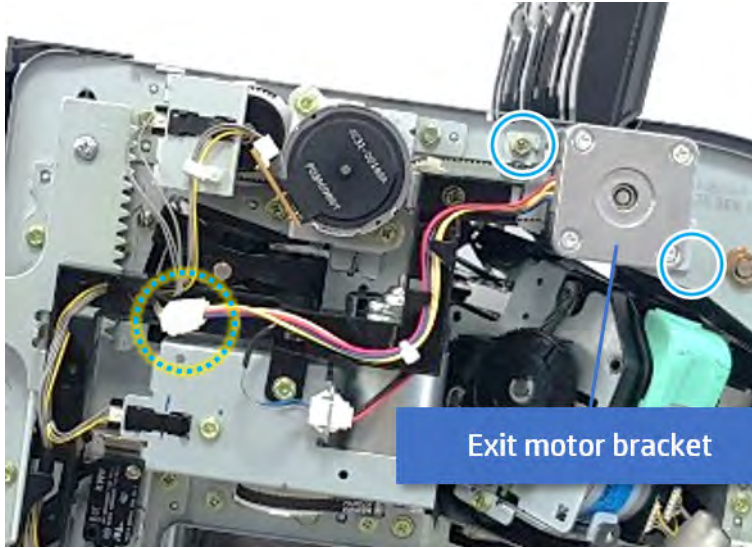

Remove the stapler

Follow these steps to remove the stapler.

1. Push the stapler from the rear-side to the front-side.

Figure 7-463 Push the stapler

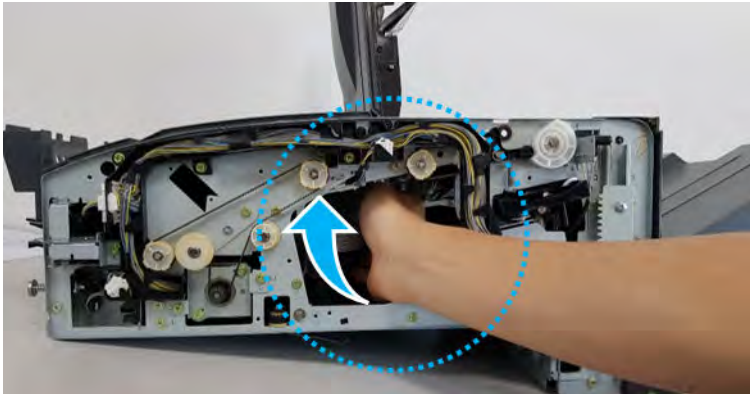

2. Remove one screw, unplug two connectors, and then remove the stapler assembly.

Figure 7-464 Remove the stapler assembly

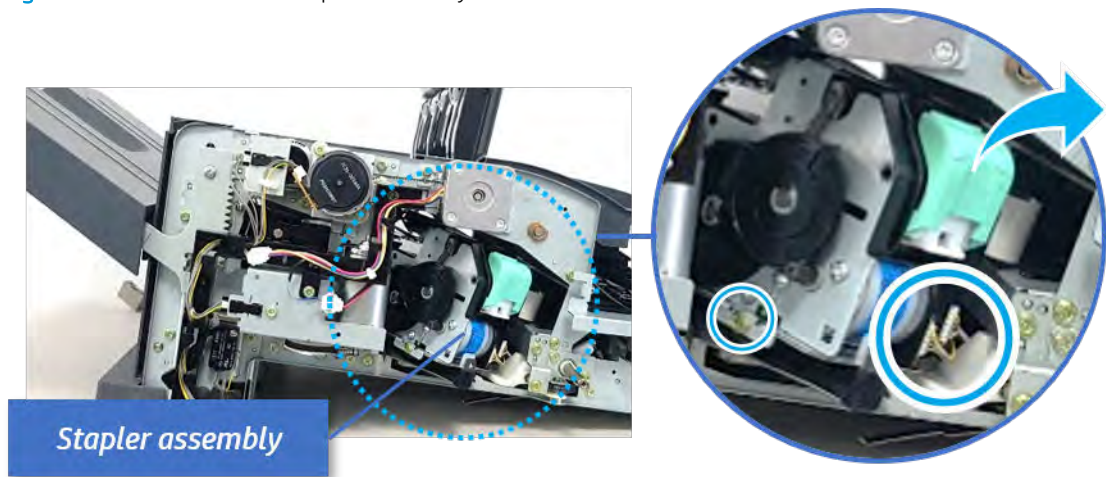

3. Remove two screws, and then remove the stapler.

Figure 7-465 Remove the stapler

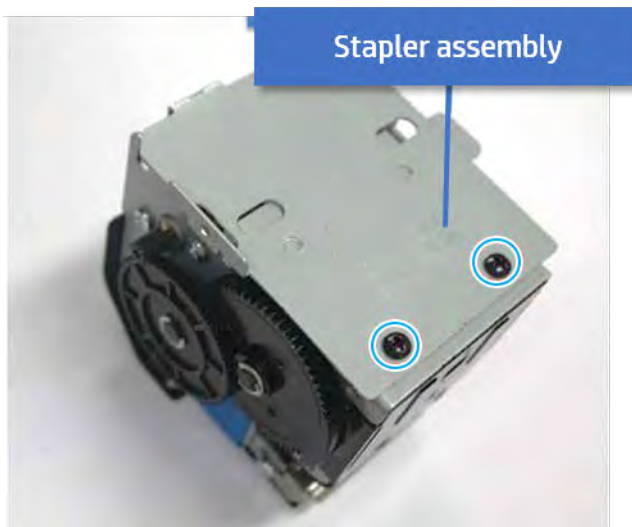

Unpack the replacement assembly

Follow these steps to unpack the replacement assembly.

1. Dispose of the defective part.

 **NOTE:** HP recommends responsible disposal of the defective part.

<http://www8.hp.com/us/en/hp-information/environment/product-recycling.html>

2. Unpack the replacement part from the packaging.



CAUTION:  Some parts are sensitive to electrostatic discharge (ESD). Always perform service work at an ESD-protected workstation or mat. If an ESD workstation or mat is not available, touch the sheet-metal chassis to provide a static ground before touching an ESD-sensitive assembly. Protect the ESD-sensitive assemblies by placing them in ESD pouches when they are out of the printer.

 **IMPORTANT:** Make sure that all of the shipping materials (for example shipping tape) are removed from the replacement part prior to installation.

 **NOTE:** If the replacement part is a roller or pad, avoid touching the spongy part of it. Skin oils on the roller or pad can cause paper pickup and/or print-quality problems. HP recommends using disposable gloves when handling rollers or pads or washing your hands before touching rollers or pads.

3. To install an assembly, reverse the removal steps.

 **NOTE:** When applicable, special installation instructions are provided for an assembly at the end of the removal procedure. Always completely read the removal instructions and follow all special installation instructions.

Removal and replacement: Stapler position sensor (S2)

Learn how to remove and replace the stapler position sensor.

To view teardown and reassembling video of the inner finisher, click the link below.



[View a teardown video of the inner finisher.](#)



[View a reassembling video of the inner finisher.](#)



IMPORTANT: When applicable, special installation instructions are provided for an assembly at the end of the removal procedure. Always completely read the removal instructions and follow all special installation instructions.

Mean time to repair:

Service level:

Before performing service

Turn the printer power off

- Press the power button on the front of the printer, and then turn off the power switch next to the power cable.
- A shutting-down message appears on the control-panel display.



WARNING! To avoid damage to the printer, turn the power off and wait until the printer shuts down before removing the power cable.

- Disconnect the printer power cable after the printer has completely shut down (the control-panel display is blank).

Use the table below to identify the correct part number for your printer. To order the part, go to www.hp.com/buy/parts.

Table 7-60 Part information

Part number	Part description
0604-001393	Stapler position sensor

Required tools

- #2 JIS screwdriver with a magnetic tip

After performing service

Turn the printer power on

- Connect the power cable.
- Use the power switch to turn the power on.

Post service test

Print any pages necessary to verify that the repair resolved the issue and did not create any new issues.

Remove the front cover

Follow these steps to remove the front cover.

1. Open the front door and open the punch cover.
2. Remove three screws in the front.
3. Remove the lever.
4. Open the top cover.
5. From the right side of the front cover, carefully lift and pry toward the top-left corner to remove the front cover.

Figure 7-466 Remove the front cover

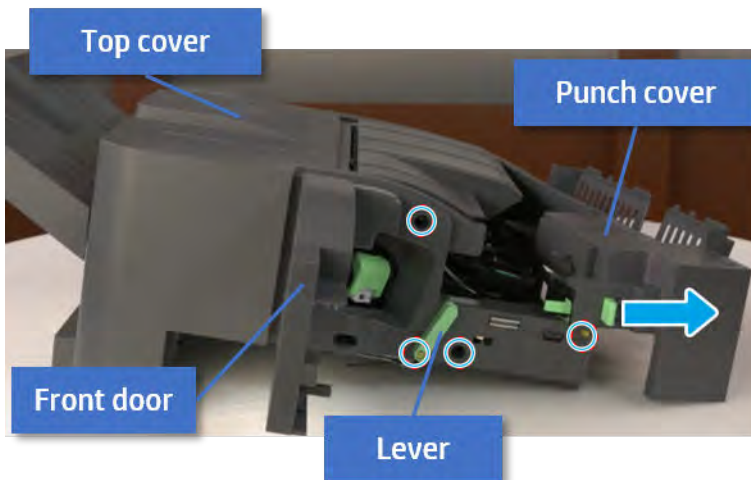

Remove the rear cover

Follow these steps to remove the rear cover.

1. Open the top cover.

Figure 7-467 Open the top cover

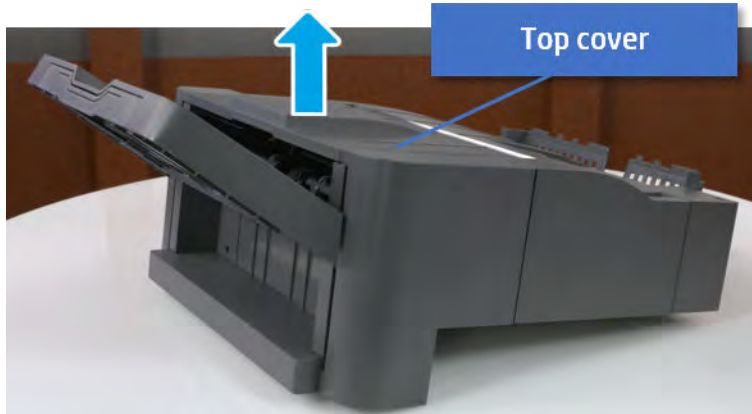

2. Remove three screws.
3. Release hooks carefully and remove the rear cover.

Figure 7-468 Remove the rear cover

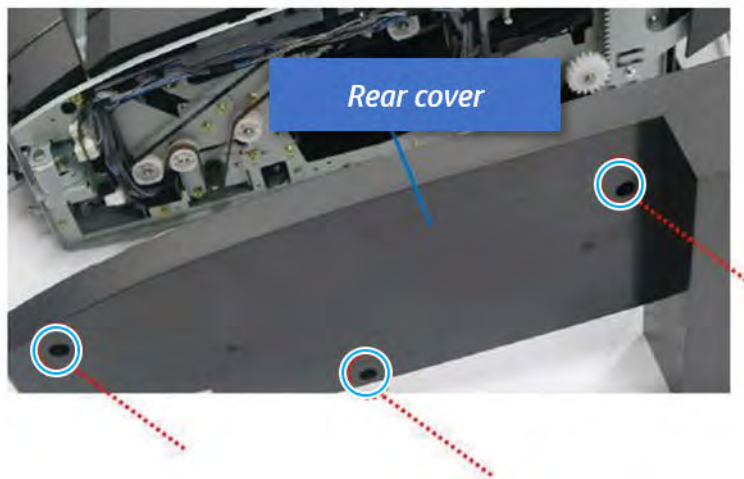

Remove the middle cover

Follow these steps to remove the middle cover.

1. Open the front door and then open the punch cover.

Figure 7-469 Open the front door and punch cover

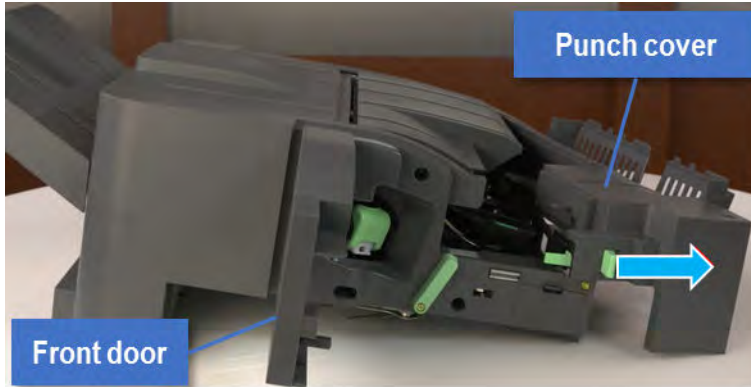

2. Remove left-side one screw at the rear of the inner finisher, and then remove the middle cover by lifting off the hinge pins at the front.

Figure 7-470 Remove the middle cover

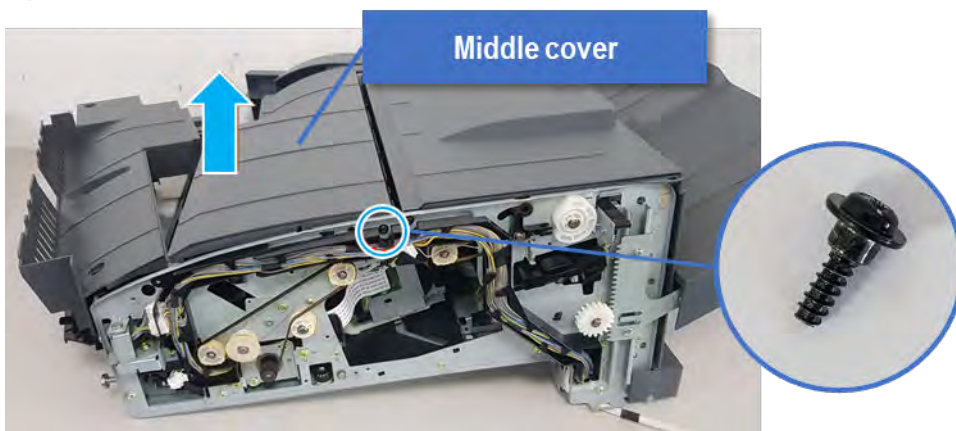

Remove the punch cover

Follow these steps to remove the punch cover.

1. Unplug the connector. Remove the e-ring, and then remove the slide shaft at the rear of the inner finisher.

Figure 7-471 Remove the slide shaft

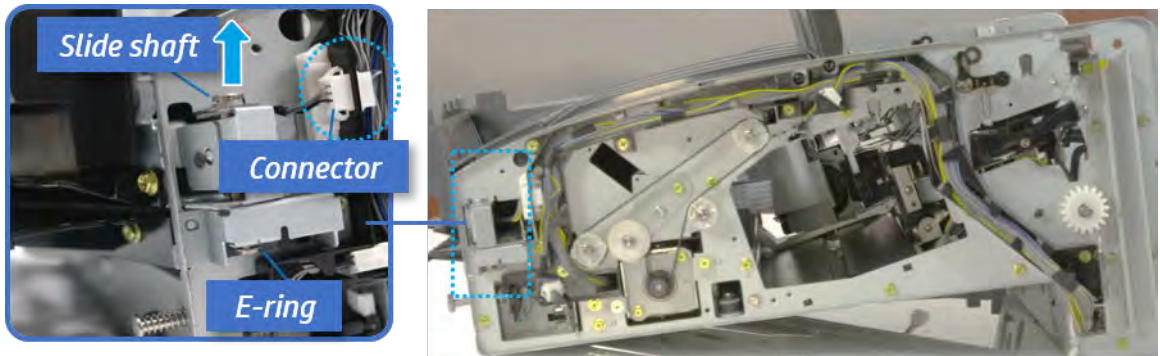

2. Open the punch cover.

Figure 7-472 Open the punch cover

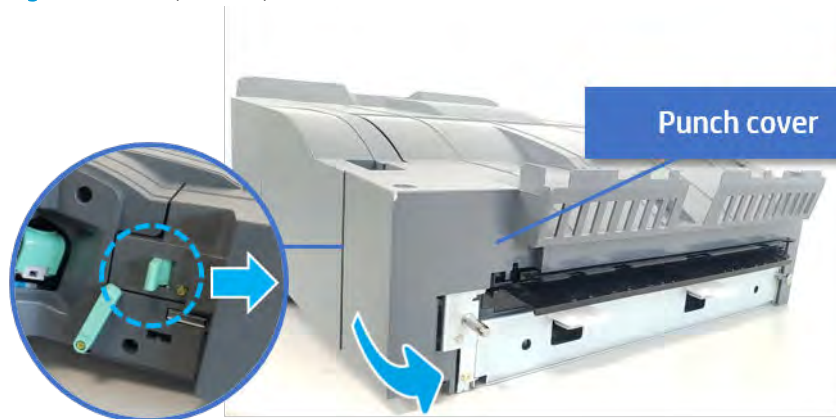

3. Remove the front punch sheet, and then remove the e-ring and the washer. And then remove the punch cover.

Figure 7-473 Remove the punch cover

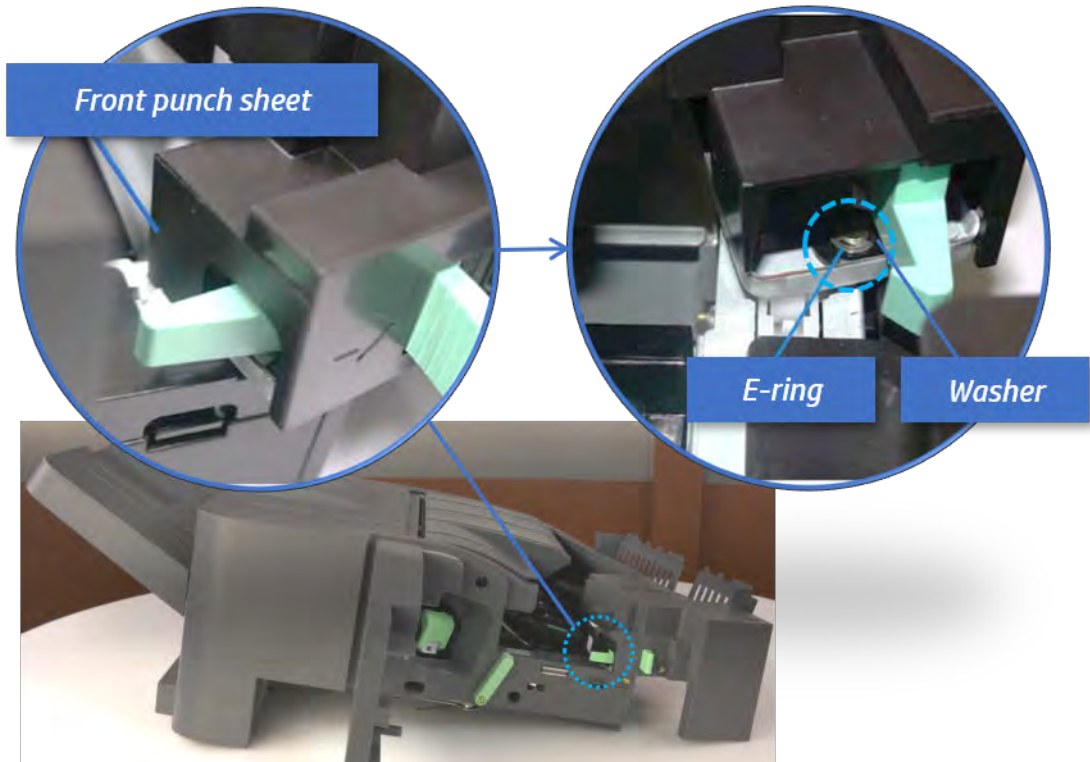

Remove the diverter guide and the middle roller

Follow these steps to remove the diverter guide and the middle roller.

1. On the front of the inner finisher, remove the e-ring and bushing.

Figure 7-474 Remove the e-ring and bushing

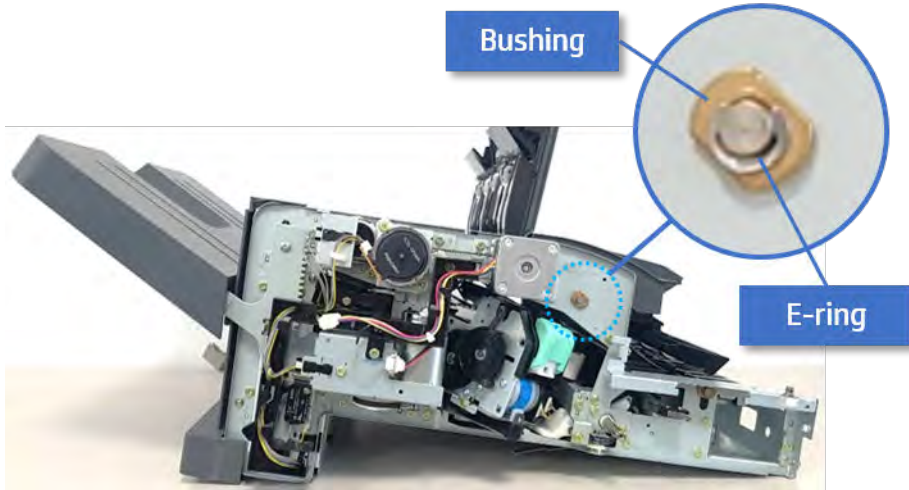

2. On the rear of the inner finisher, remove the e-ring, pulley, bushing, belt, and spring (slightly hidden from view).

Figure 7-475 Remove the e-ring, pulley, bushing, belt, and spring

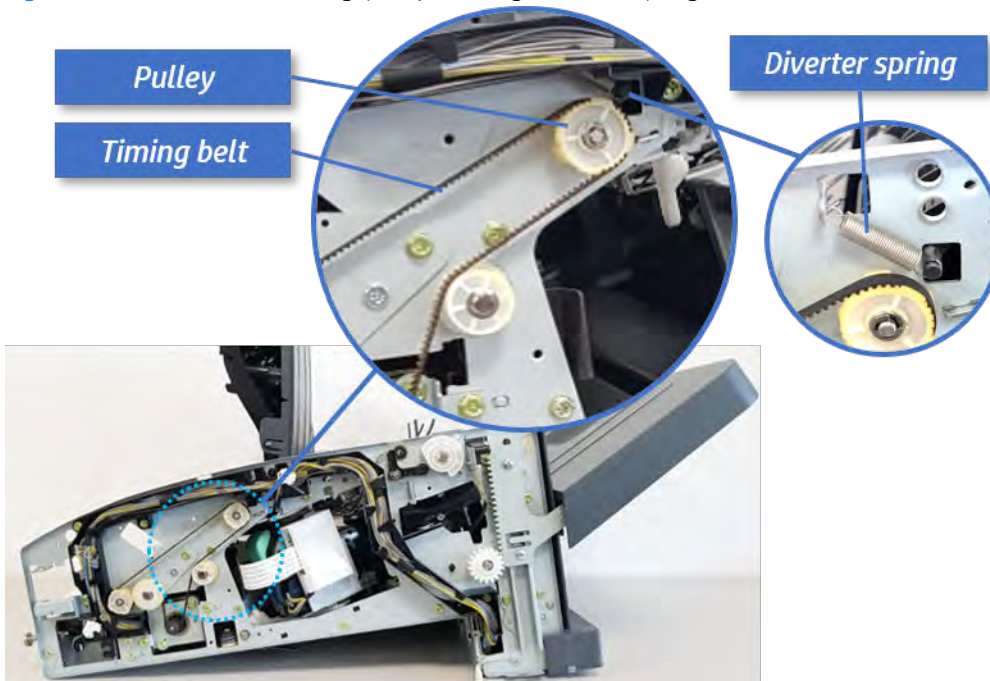

3. Remove the diverter guide and the middle roller.

Figure 7-476 Remove the diverter guide and the middle roller

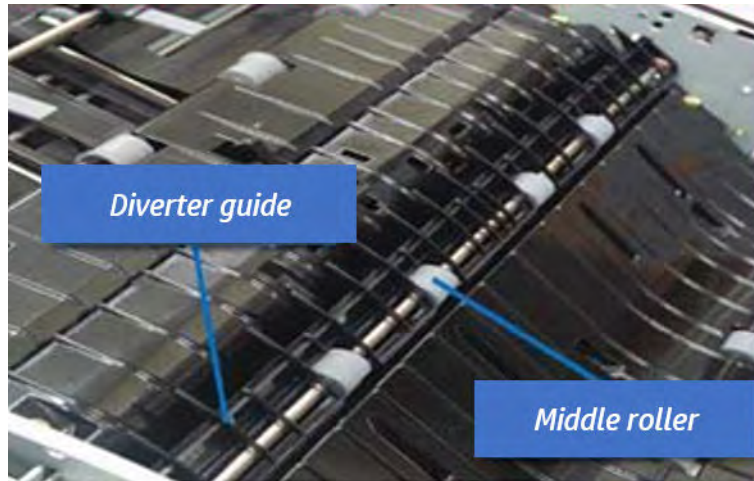

Remove the middle paper guide

Follow these steps to remove the middle paper guide.

1. Remove six screws, and then open the middle paper guide in the direction of the arrow.

Figure 7-477 Open the middle paper guide

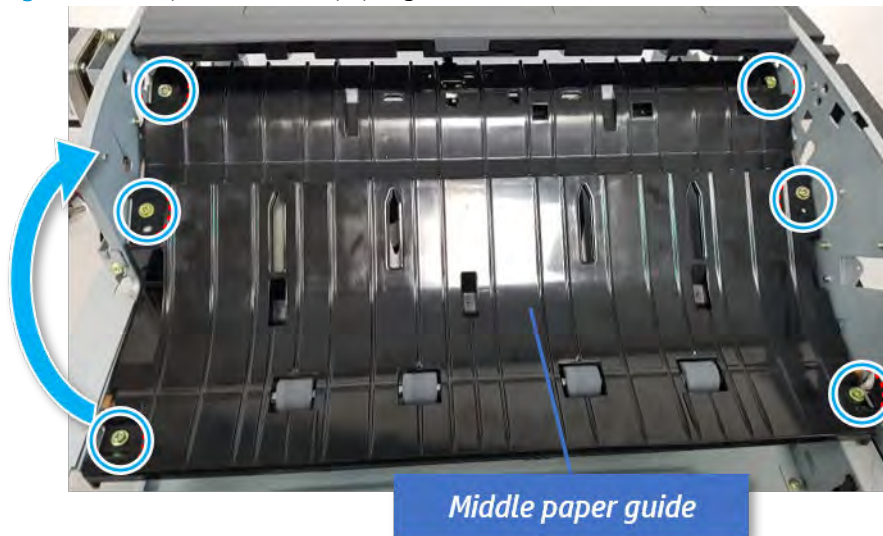

 **NOTE:** Be careful not to damage the sensor connector.

2. Unplug the connector under the middle paper guide. And then, remove the middle paper guide.

Figure 7-478 Remove the middle paper guide

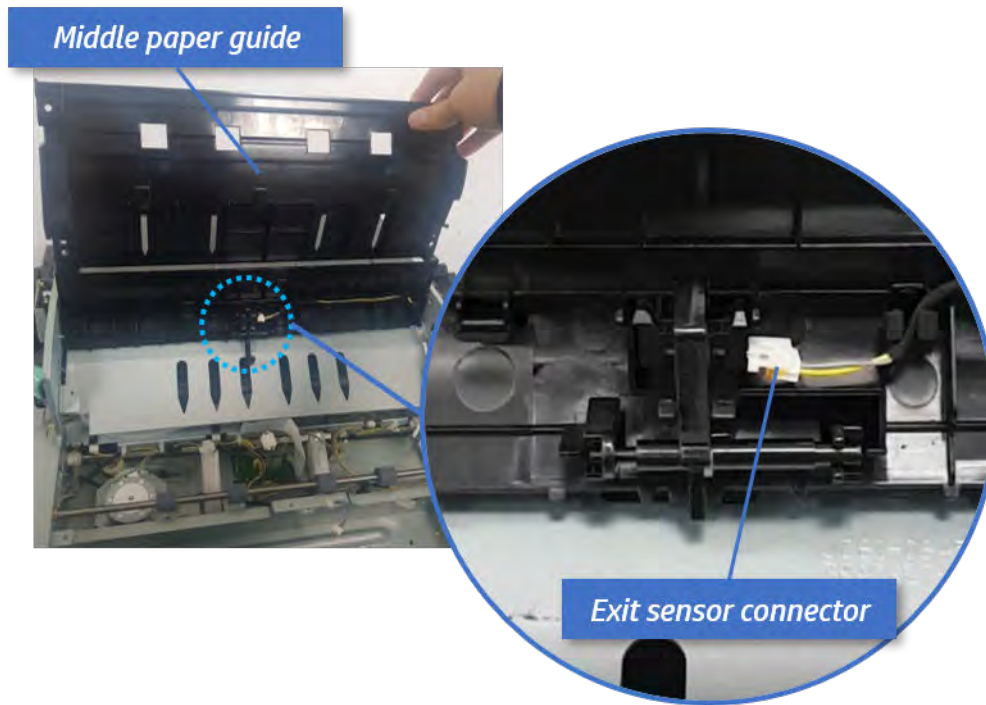

Remove the exit motor bracket

Follow these steps to remove the exit motor bracket.

- ▲ Remove two screws, unplug the motor connector. And then remove exit motor bracket.

Figure 7-479 Remove the exit motor bracket

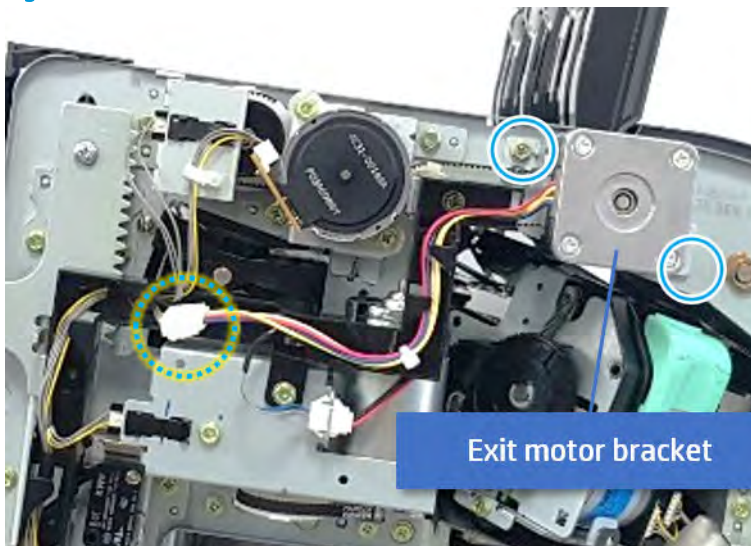

Remove the end fence sensor bracket

Follow these steps to remove the end fence sensor bracket.

1. Remove three screws at the front of the inner finisher, and then remove the bracket.

Figure 7-480 Remove the bracket

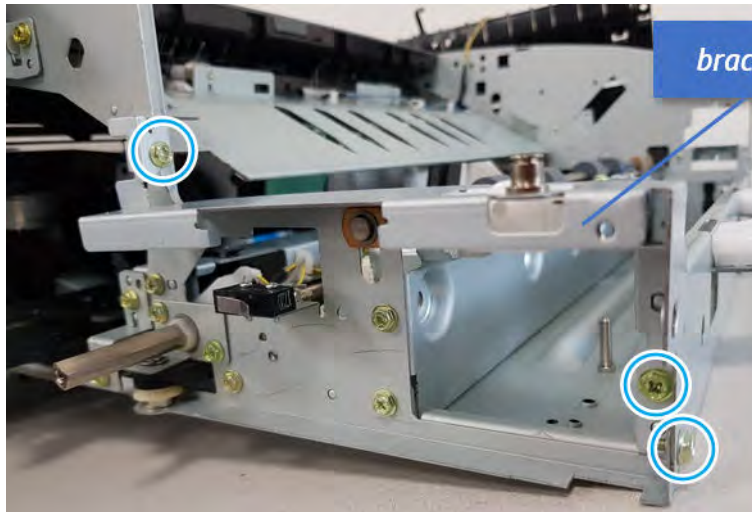

2. Remove two screws at the front of the inner finisher.

Figure 7-481 Remove two screws

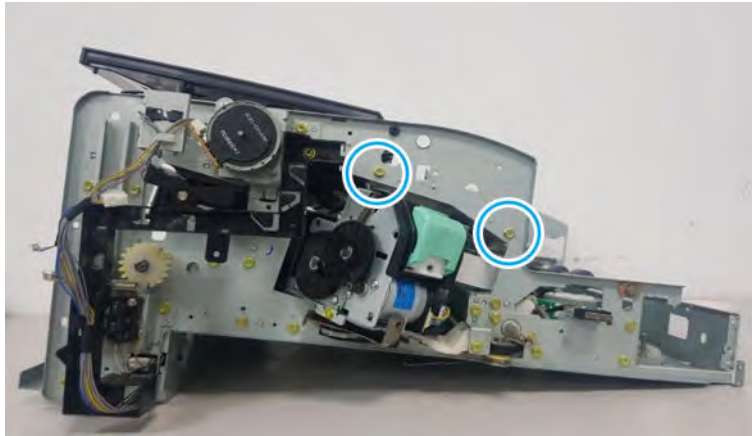

3. Remove two screws at the rear of the inner finisher.

Figure 7-482 Remove two screws

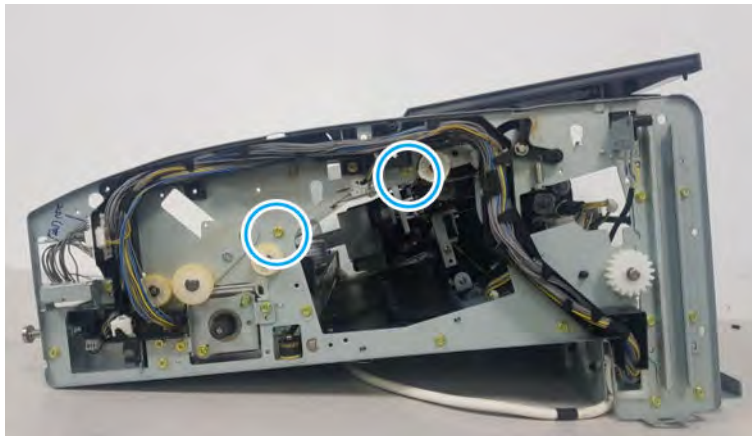

4. Loosen three cable clamps. Unplug the connector at the sensor, and then remove the end fence sensor bracket.

Figure 7-483 Remove the end fence sensor bracket

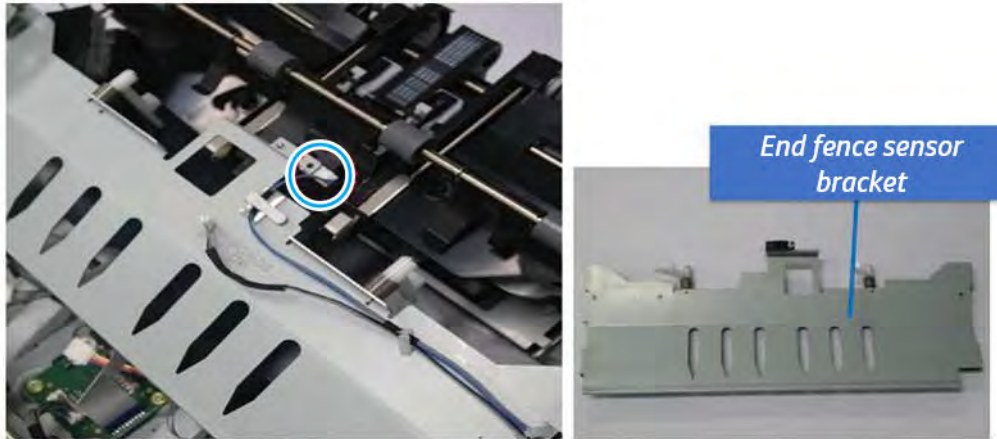

Remove the stapler position sensor

Follow these steps to remove the stapler position sensor.

1. Remove one screw from the front of the inner finisher.

Figure 7-484 Remove one screw

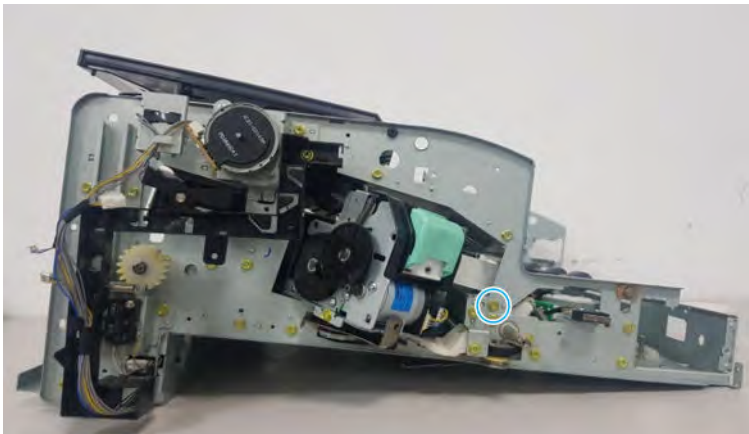

2. Remove one screw from the rear of the inner finisher.

Figure 7-485 Remove one screw

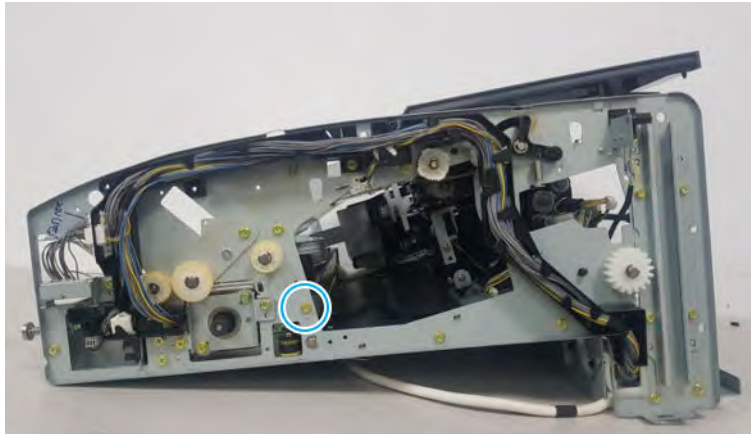

3. Unplug four photo-sensor connectors. Open the six cable clamps.

Figure 7-486 Unplug connectors

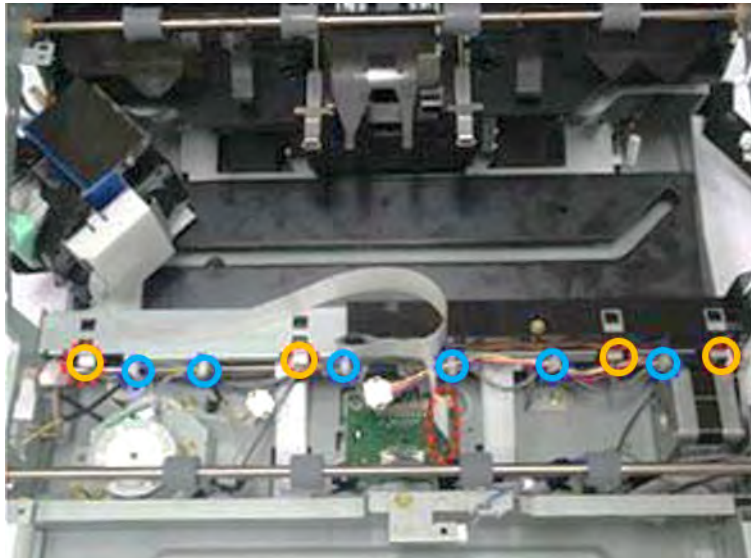

4. Remove the assembly, and then remove the sensor.

Figure 7-487 Remove the stapler position sensor

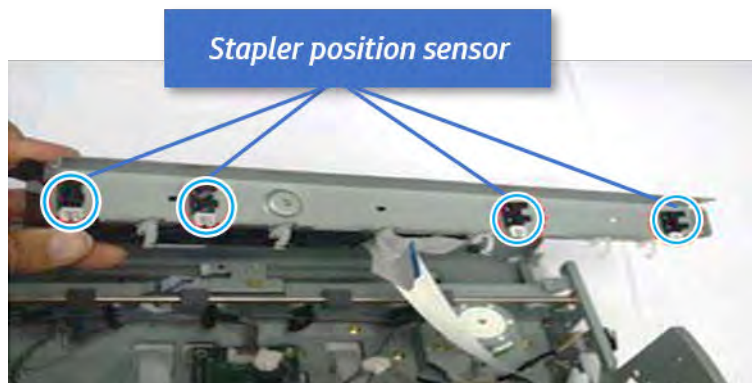

Unpack the replacement assembly



Follow these steps to unpack the replacement assembly.

1. Dispose of the defective part.

 **NOTE:** HP recommends responsible disposal of the defective part.

<http://www8.hp.com/us/en/hp-information/environment/product-recycling.html>

2. Unpack the replacement part from the packaging.

 **CAUTION:**  Some parts are sensitive to electrostatic discharge (ESD). Always perform service work at an ESD-protected workstation or mat. If an ESD workstation or mat is not available, touch the sheet-metal chassis to provide a static ground before touching an ESD-sensitive assembly. Protect the ESD-sensitive assemblies by placing them in ESD pouches when they are out of the printer.

 **IMPORTANT:** Make sure that all of the shipping materials (for example shipping tape) are removed from the replacement part prior to installation.

 **NOTE:** If the replacement part is a roller or pad, avoid touching the spongy part of it. Skin oils on the roller or pad can cause paper pickup and/or print-quality problems. HP recommends using disposable gloves when handling rollers or pads or washing your hands before touching rollers or pads.

3. To install an assembly, reverse the removal steps.

 **NOTE:** When applicable, special installation instructions are provided for an assembly at the end of the removal procedure. Always completely read the removal instructions and follow all special installation instructions.

Removal and replacement: Stapler position motor (M1)

Learn how to remove and replace the stapler position motor.

To view teardown and reassembling video of the inner finisher, click the link below.



[View a teardown video of the inner finisher.](#)



[View a reassembling video of the inner finisher.](#)



IMPORTANT: When applicable, special installation instructions are provided for an assembly at the end of the removal procedure. Always completely read the removal instructions and follow all special installation instructions.

Mean time to repair:

Service level:

Before performing service

Turn the printer power off

- Press the power button on the front of the printer, and then turn off the power switch next to the power cable.
- A shutting-down message appears on the control-panel display.



WARNING! To avoid damage to the printer, turn the power off and wait until the printer shuts down before removing the power cable.

- Disconnect the printer power cable after the printer has completely shut down (the control-panel display is blank).

Use the table below to identify the correct part number for your printer. To order the part, go to <http://www.hp.com/buy/parts>.

Table 7-61 Part information

Part number	Part description
JC93-00999A	Stapler position motor

Required tools

- #2 JIS screwdriver with a magnetic tip

After performing service

Turn the printer power on

- Connect the power cable.
- Use the power switch to turn the power on.

Post service test

Print any pages necessary to verify that the repair resolved the issue and did not create any new issues.

Remove the front cover

Follow these steps to remove the front cover.

1. Open the front door and open the punch cover.
2. Remove three screws in the front.
3. Remove the lever.
4. Open the top cover.
5. From the right side of the front cover, carefully lift and pry toward the top-left corner to remove the front cover.

Figure 7-488 Remove the front cover

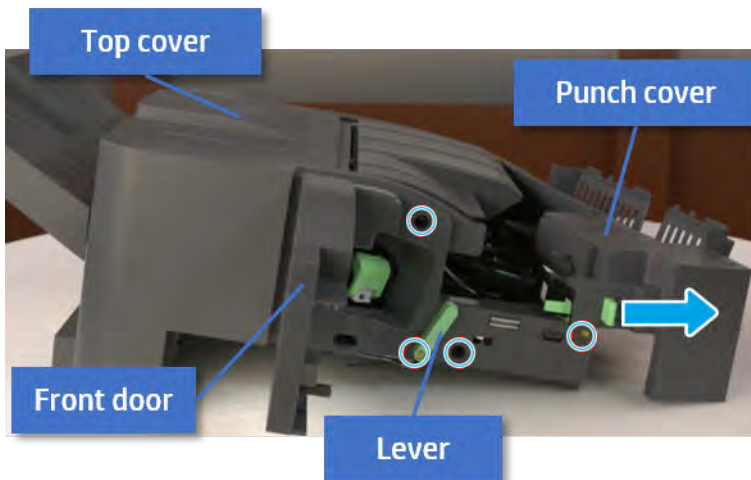

Remove the rear cover

Follow these steps to remove the rear cover.

1. Open the top cover.

Figure 7-489 Open the top cover

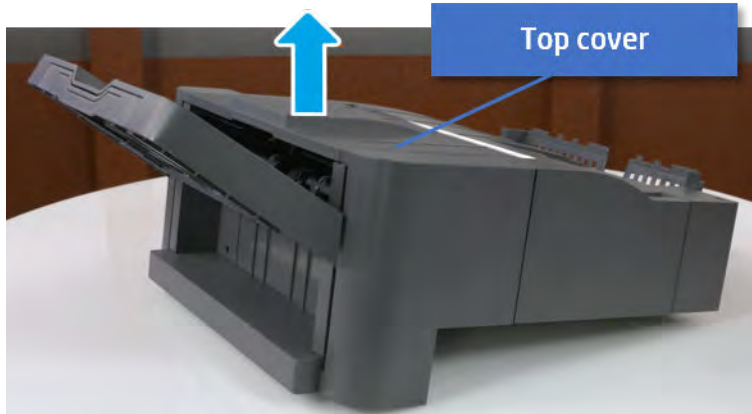

2. Remove three screws.
3. Release hooks carefully and remove the rear cover.

Figure 7-490 Remove the rear cover

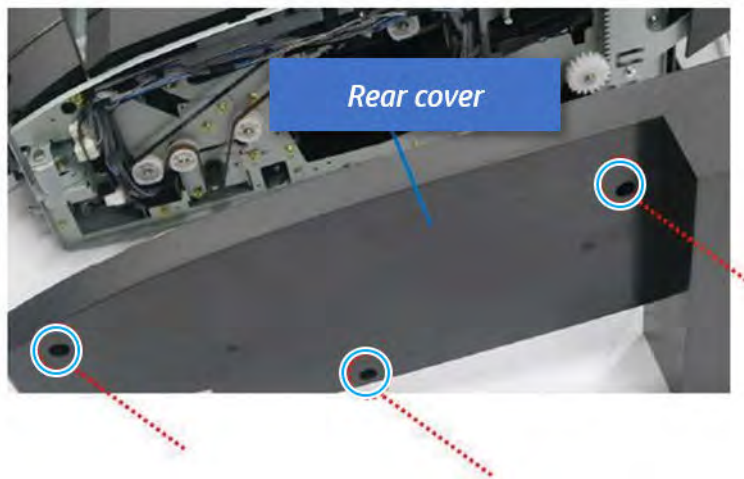

Remove the middle cover

Follow these steps to remove the middle cover.

1. Open the front door and then open the punch cover.

Figure 7-491 Open the front door and punch cover

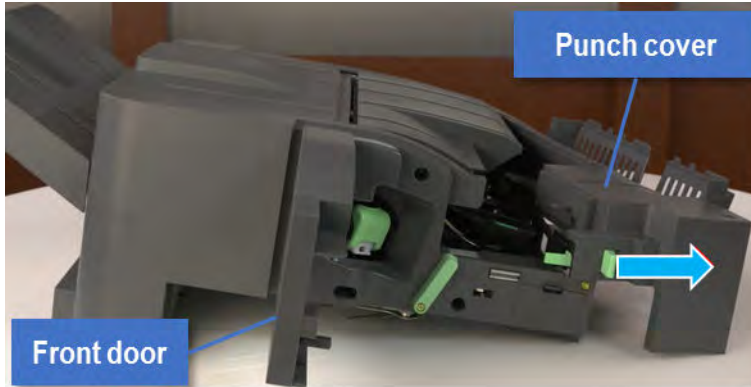

2. Remove left-side one screw at the rear of the inner finisher, and then remove the middle cover by lifting off the hinge pins at the front.

Figure 7-492 Remove the middle cover



Remove the punch cover

Follow these steps to remove the punch cover.

1. Unplug the connector. Remove the e-ring, and then remove the slide shaft at the rear of the inner finisher.

Figure 7-493 Remove the slide shaft

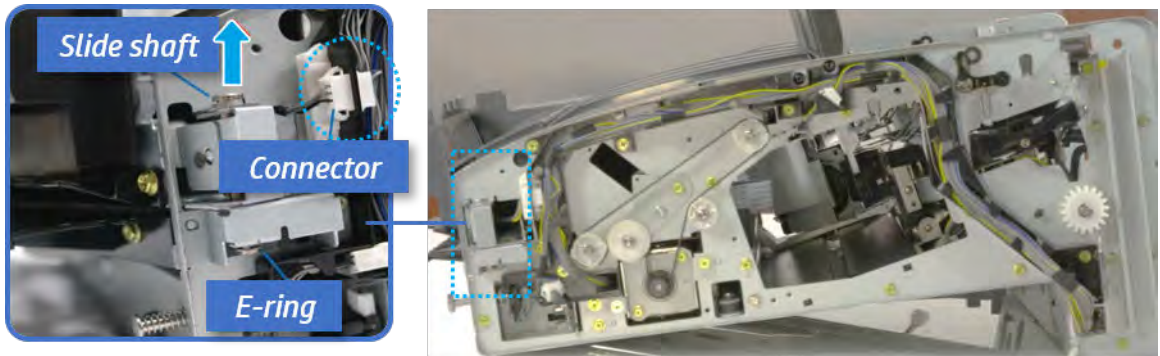

2. Open the punch cover.

Figure 7-494 Open the punch cover

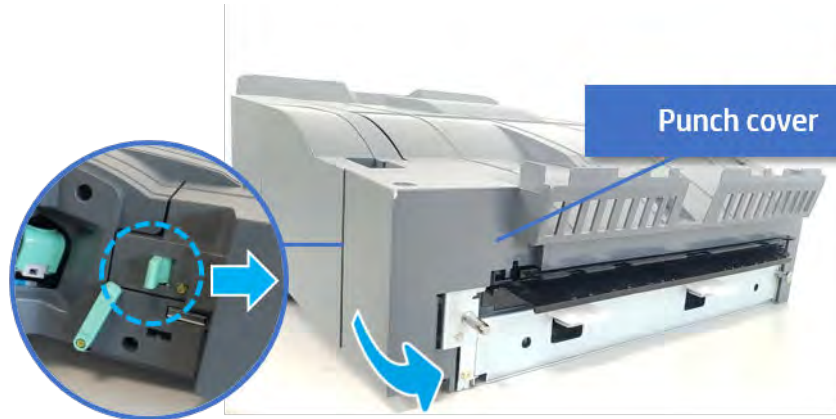

3. Remove the front punch sheet, and then remove the e-ring and the washer. And then remove the punch cover.

Figure 7-495 Remove the punch cover

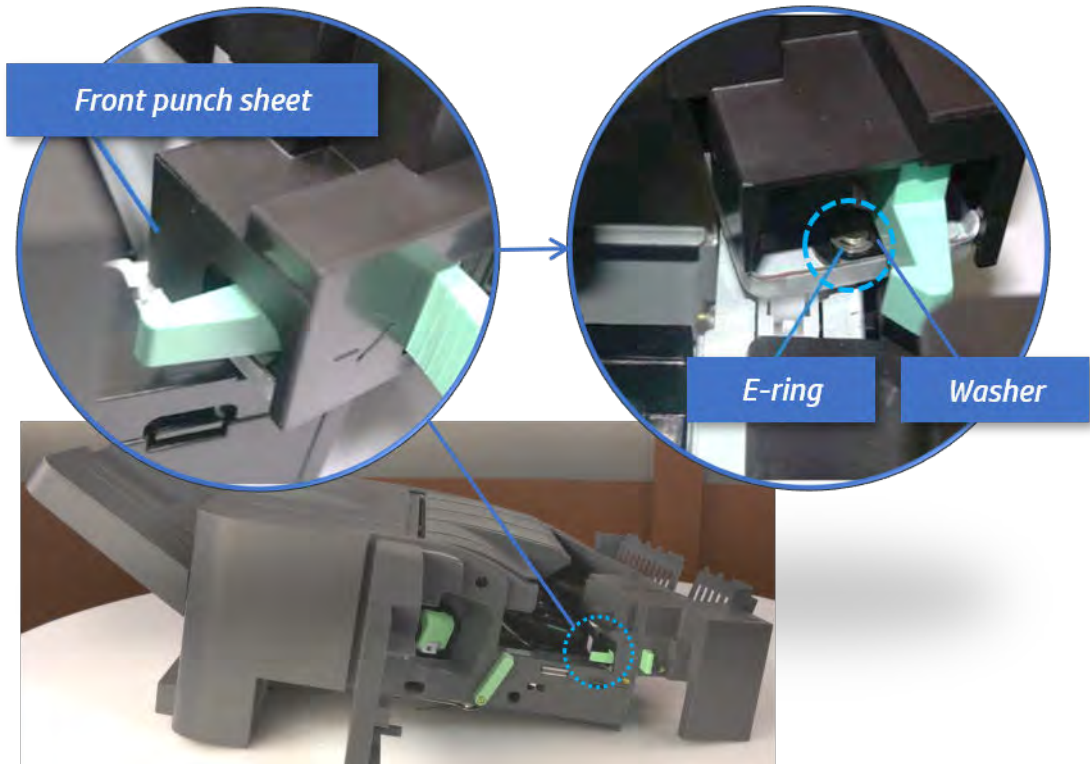

Remove the diverter guide and the middle roller

Follow these steps to remove the diverter guide and the middle roller.

1. On the front of the inner finisher, remove the e-ring and bushing.

Figure 7-496 Remove the e-ring and bushing

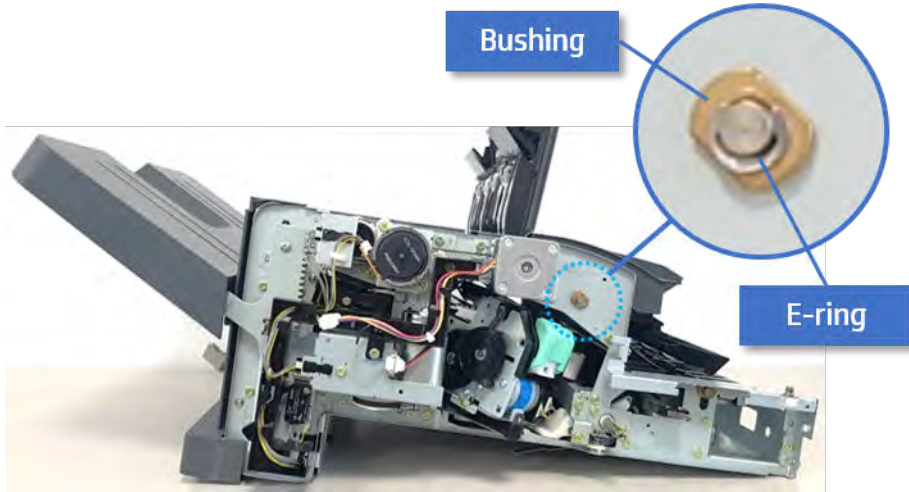

2. On the rear of the inner finisher, remove the e-ring, pulley, bushing, belt, and spring (slightly hidden from view).

Figure 7-497 Remove the e-ring, pulley, bushing, belt, and spring

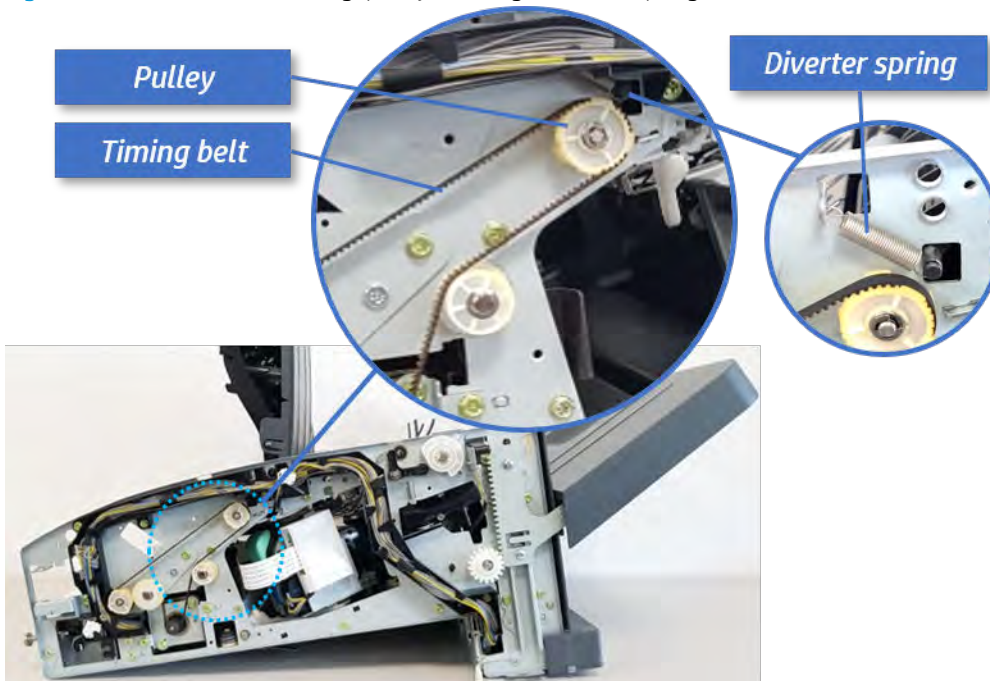

3. Remove the diverter guide and the middle roller.

Figure 7-498 Remove the diverter guide and the middle roller

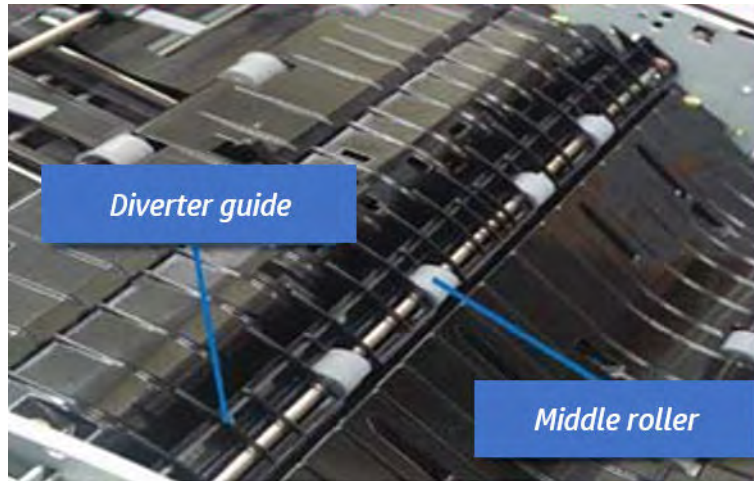

Remove the middle paper guide

Follow these steps to remove the middle paper guide.

1. Remove six screws, and then open the middle paper guide in the direction of the arrow.

Figure 7-499 Open the middle paper guide

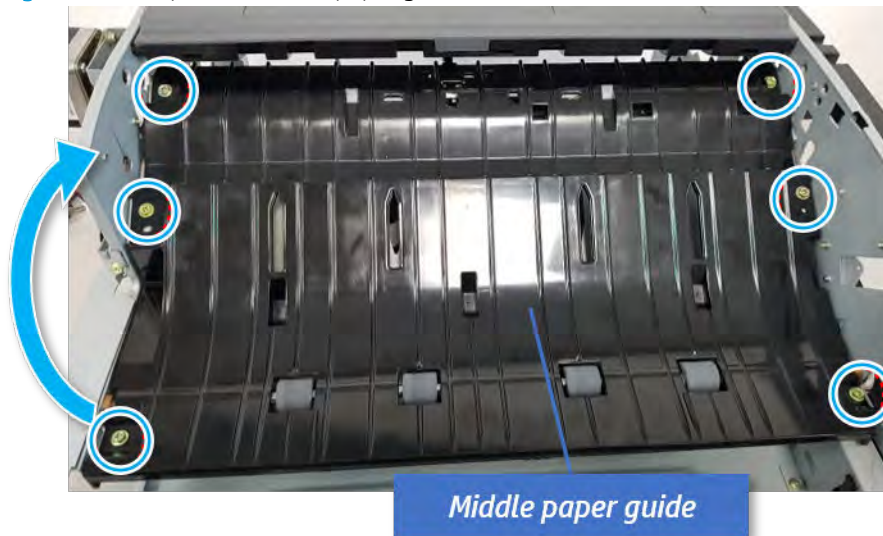

 **NOTE:** Be careful not to damage the sensor connector.

2. Unplug the connector under the middle paper guide. And then, remove the middle paper guide.

Figure 7-500 Remove the middle paper guide

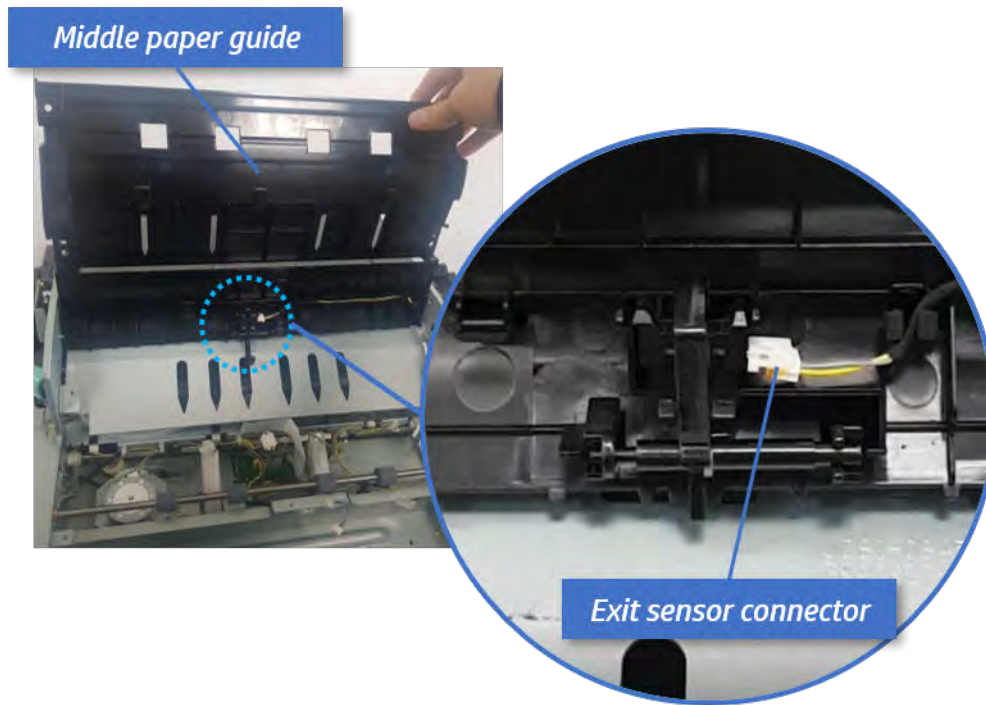

Remove the stapler position motor

Follow these steps to remove the stapler position motor.

1. Remove three screws, unplug the motor connector, and then remove the stapler position motor bracket.

Figure 7-501 Remove the stapler position motor bracket

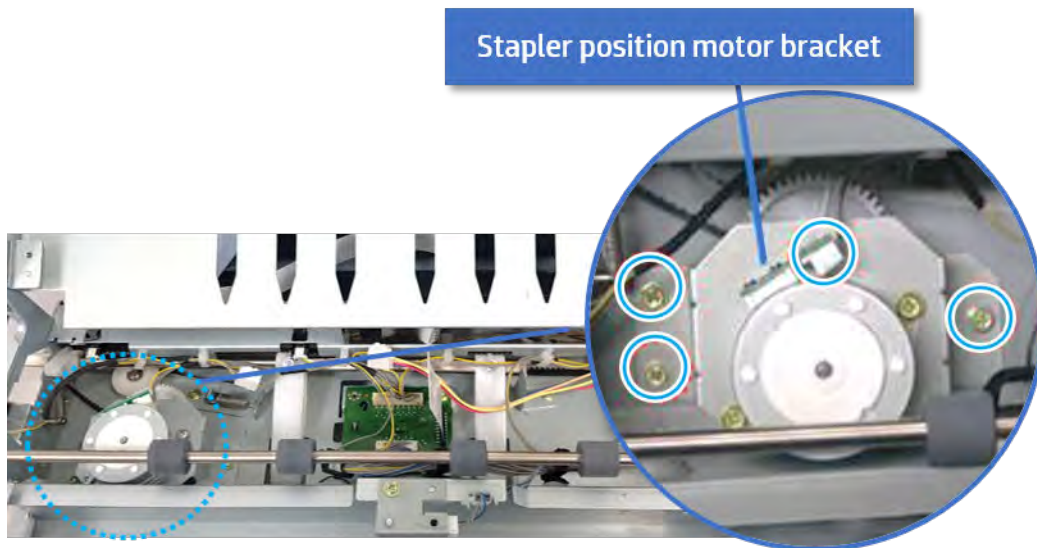

2. Remove two screws, and then remove the motor from the bracket.

Figure 7-502 Remove the stapler position motor

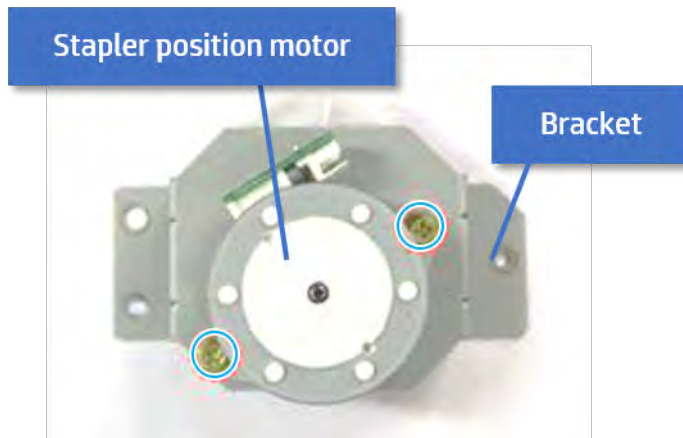

 **TIP:** Use the following steps when reinstalling the stapler position motor.

Release the spring tension screw.

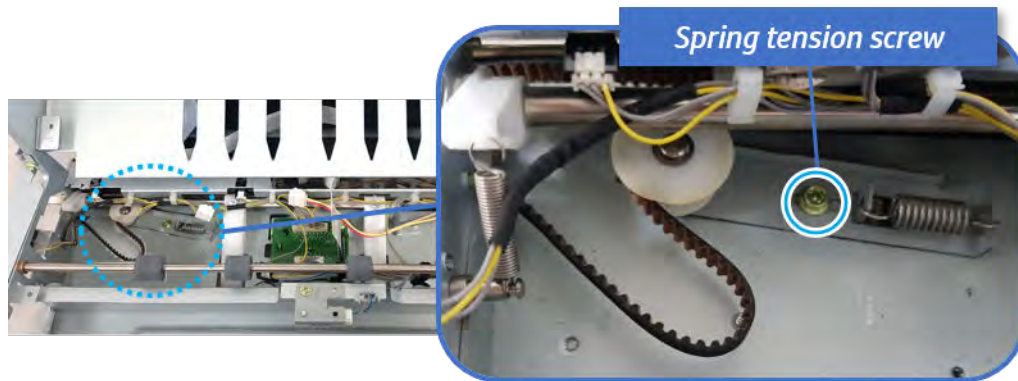

Apply tension to the spring by pulling the belt, and then tighten the spring tension screw. Tightening the screw puts maximum slack in the belt.

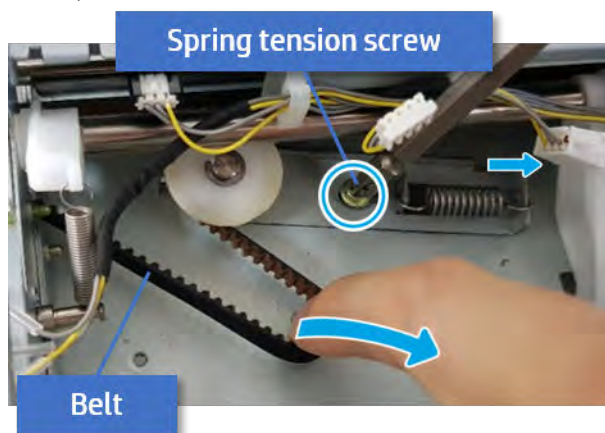

Lower the stapler position motor while placing the belt on the motor pulley, and then secure the bracket with three screws.

Release the spring tension screw to allow the spring to apply tension to the belt, and then tighten it again

Unpack the replacement assembly



Follow these steps to unpack the replacement assembly.

1. Dispose of the defective part.

 **NOTE:** HP recommends responsible disposal of the defective part.

<http://www8.hp.com/us/en/hp-information/environment/product-recycling.html>

2. Unpack the replacement part from the packaging.

 **CAUTION:**  Some parts are sensitive to electrostatic discharge (ESD). Always perform service work at an ESD-protected workstation or mat. If an ESD workstation or mat is not available, touch the sheet-metal chassis to provide a static ground before touching an ESD-sensitive assembly. Protect the ESD-sensitive assemblies by placing them in ESD pouches when they are out of the printer.

 **IMPORTANT:** Make sure that all of the shipping materials (for example shipping tape) are removed from the replacement part prior to installation.

 **NOTE:** If the replacement part is a roller or pad, avoid touching the spongy part of it. Skin oils on the roller or pad can cause paper pickup and/or print-quality problems. HP recommends using disposable gloves when handling rollers or pads or washing your hands before touching rollers or pads.

3. To install an assembly, reverse the removal steps.

 **NOTE:** When applicable, special installation instructions are provided for an assembly at the end of the removal procedure. Always completely read the removal instructions and follow all special installation instructions.

Ejector unit

Removal and replacement: Ejector & paper support assembly

Learn how to remove and replace the ejector & paper support assembly.

To view teardown and reassembling video of the inner finisher, click the link below.



[View a teardown video of the inner finisher.](#)



[View a reassembling video of the inner finisher.](#)



IMPORTANT: When applicable, special installation instructions are provided for an assembly at the end of the removal procedure. Always completely read the removal instructions and follow all special installation instructions.

Mean time to repair:

Service level:

Before performing service

Turn the printer power off

- Press the power button on the front of the printer, and then turn off the power switch next to the power cable.
- A shutting-down message appears on the control-panel display.



WARNING! To avoid damage to the printer, turn the power off and wait until the printer shuts down before removing the power cable.

- Disconnect the printer power cable after the printer has completely shut down (the control-panel display is blank).

Use the table below to identify the correct part number for your printer. To order the part, go to <http://www.hp.com/buy/parts>.

Table 7-62 Part information

Part number	Part description
SS456-61001	Ejector
JC90-01310A	Front paper support
JC90-01311A	Rear paper support

Required tools

- #2 JIS screwdriver with a magnetic tip

After performing service

Turn the printer power on

- Connect the power cable.
- Use the power switch to turn the power on.

Post service test

Print any pages necessary to verify that the repair resolved the issue and did not create any new issues.

Remove the front cover

Follow these steps to remove the front cover.

1. Open the front door and open the punch cover.
2. Remove three screws in the front.
3. Remove the lever.
4. Open the top cover.
5. From the right side of the front cover, carefully lift and pry toward the top-left corner to remove the front cover.

Figure 7-503 Remove the front cover

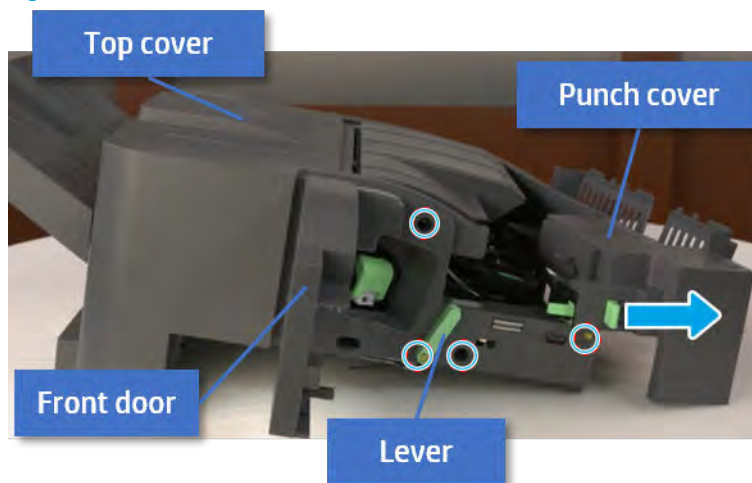

Remove the rear cover

Follow these steps to remove the rear cover.

1. Open the top cover.

Figure 7-504 Open the top cover

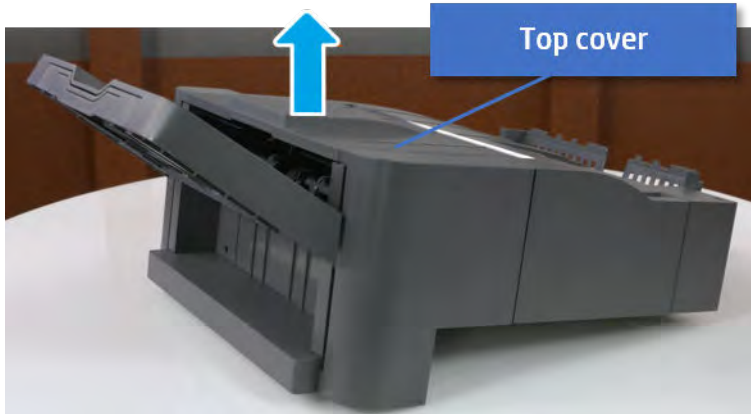

2. Remove three screws.
3. Release hooks carefully and remove the rear cover.

Figure 7-505 Remove the rear cover

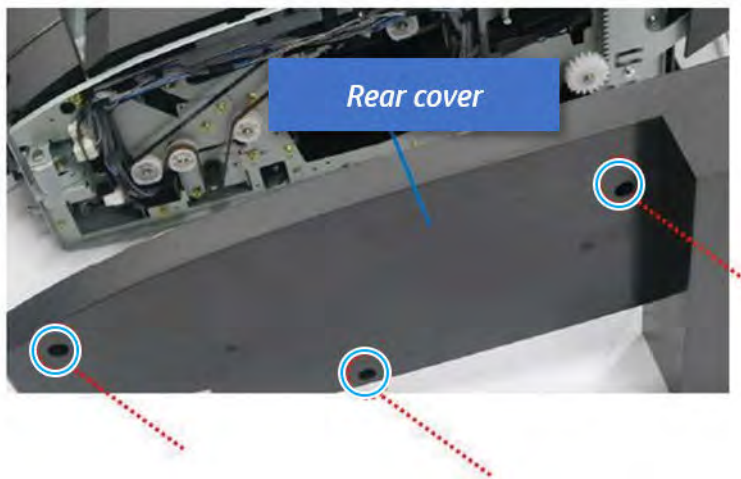

Remove the output tray

Follow these steps to remove the output tray.

1. Remove four screws.

Figure 7-506 Remove four screws

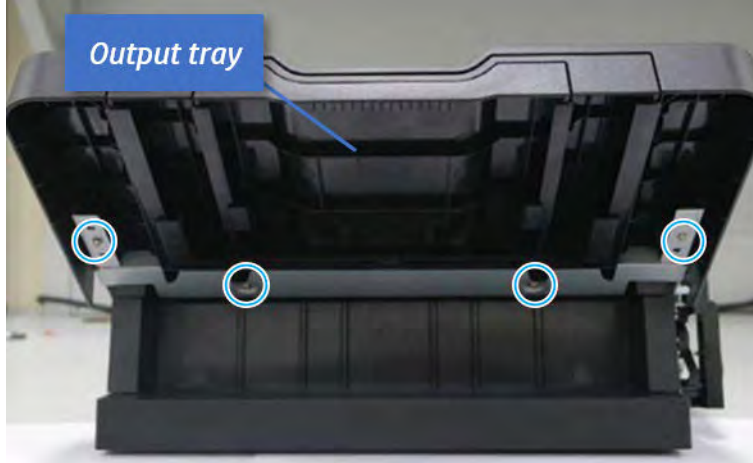

2. Push the paper holding actuator into the inner finisher, and then remove the output tray.

Figure 7-507 Remove the output tray.



Remove the output tray frame

Follow these steps to remove the output tray frame.

1. Rotate the pulley until the output tray frame depart from the gear.

Figure 7-508 Remove the pulley

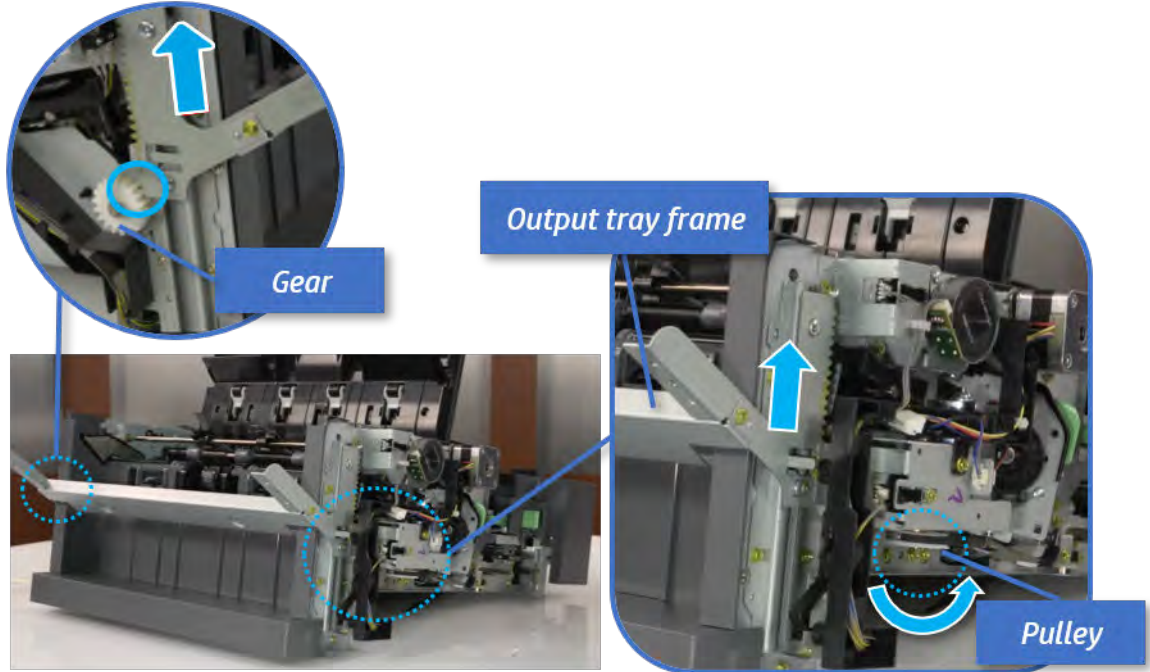

2. Push the paper holding actuator into the inner finisher, and then remove the output tray frame.

Figure 7-509 Remove the output tray frame

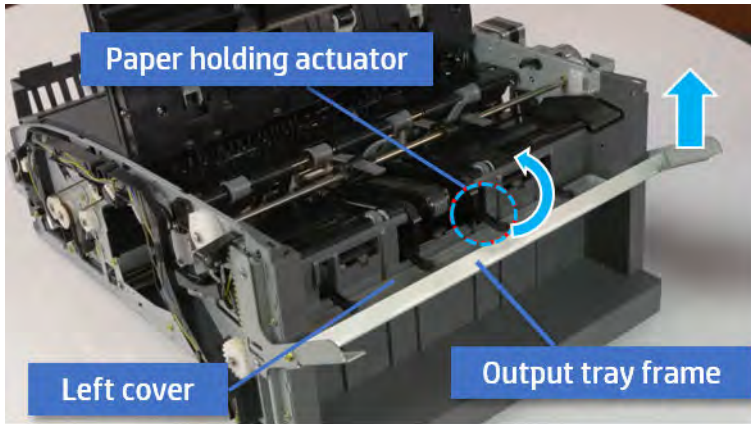

 **TIP:** Push the paper holding actuator into the inner finisher when reassembling. Be sure to level the output tray.

- a. Position the first wheel into the channel on both sides while pushing the paper holding actuator.

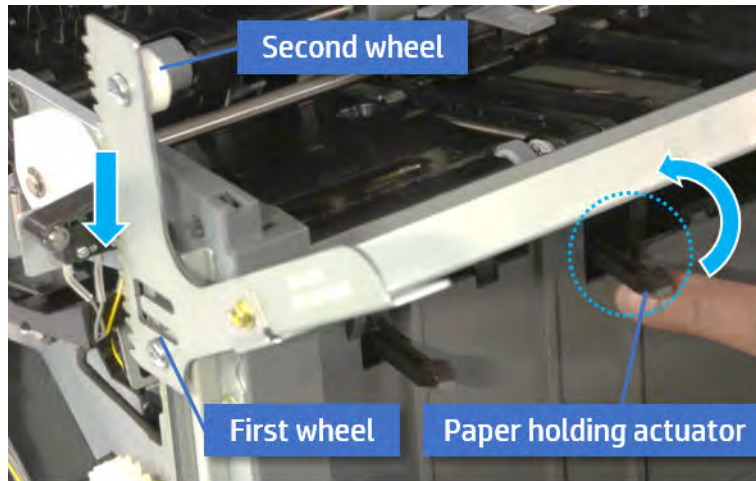

- b. Let the second wheel rest on the channel on both sides simultaneously.
- c. Gently squeeze the wheels into channel until the output tray frame meet the gear.

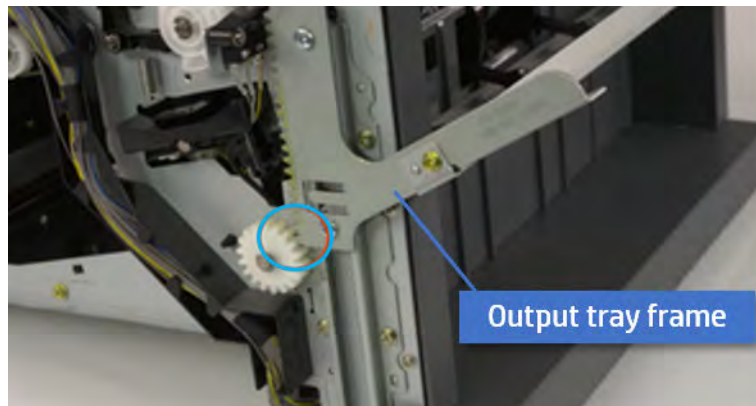

- d. Rotate the pulley until the output tray frame is no longer lifted. It can make to level the output tray frame.

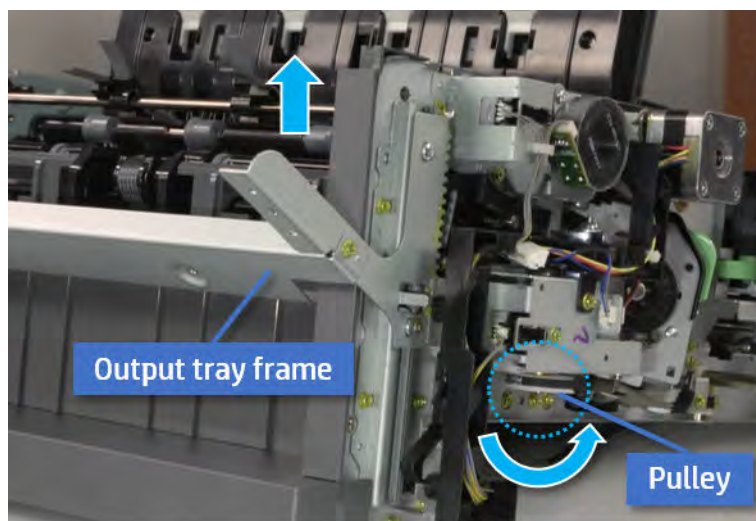

- e. Rotate the pulley in the opposite direction.

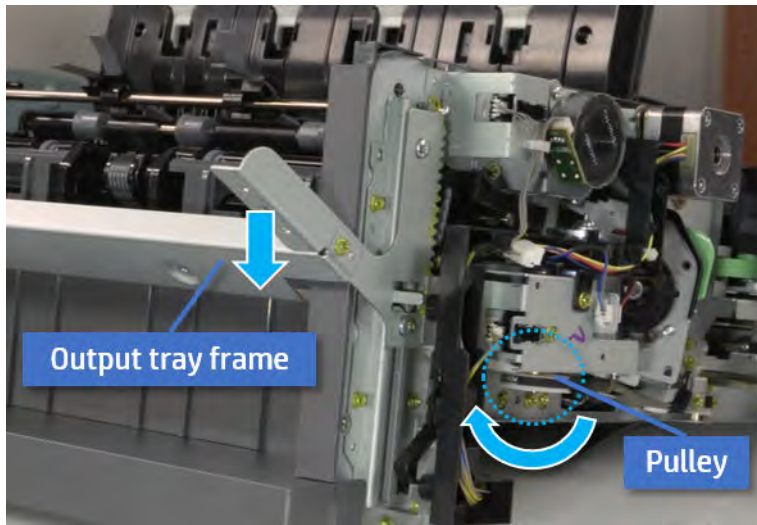

Remove the PCA cover

Follow these steps to remove the PCA cover.

- ▲ Remove two screws, and then remove the PCA cover.

Figure 7-510 Remove the PCA cover

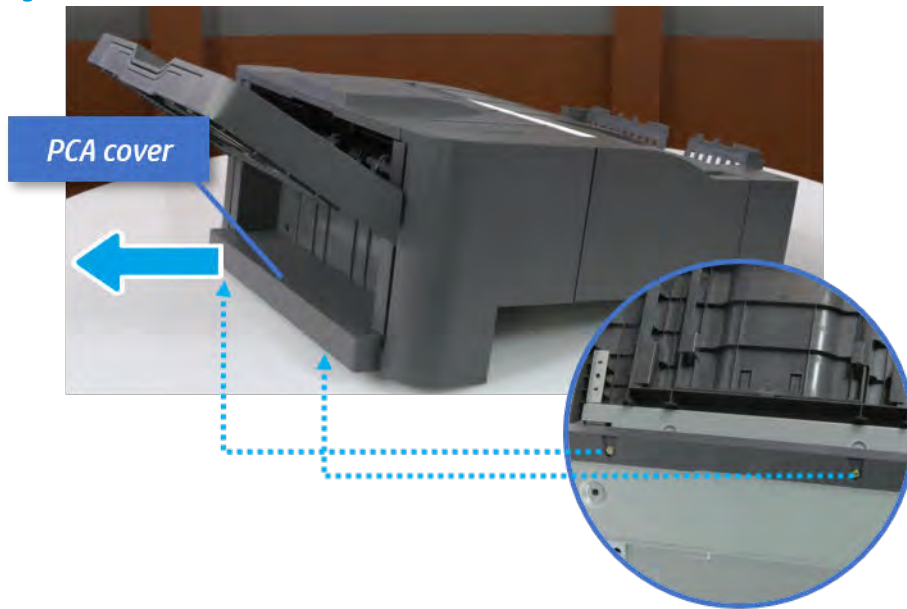

Remove the left cover

Follow these steps to remove the left cover.

1. Remove two screws.

Figure 7-511 Remove two screws

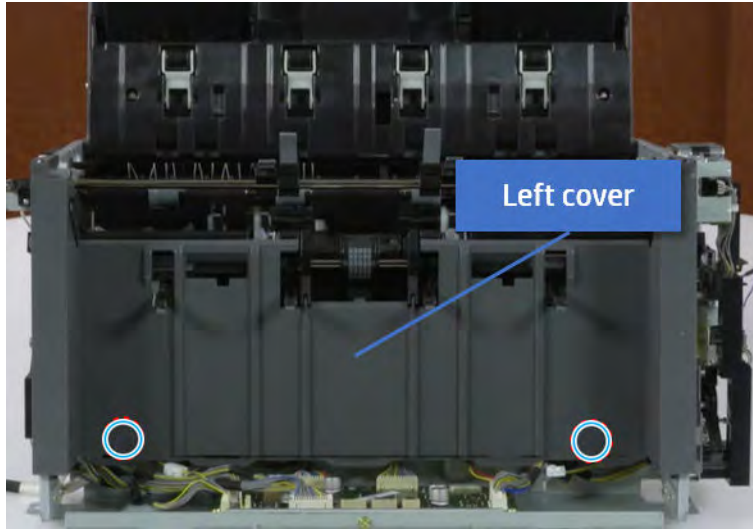

2. Remove four screws from both front and rear sides.

Figure 7-512 Remove four screws

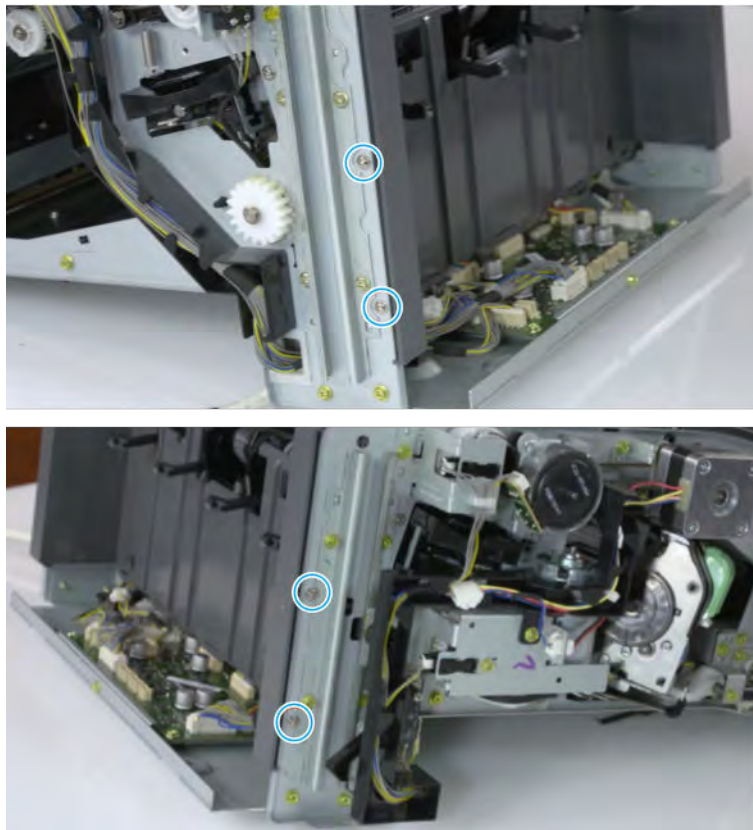

3. Unplug two inline connectors, and then remove the left cover.

Figure 7-513 Unplug two connectors

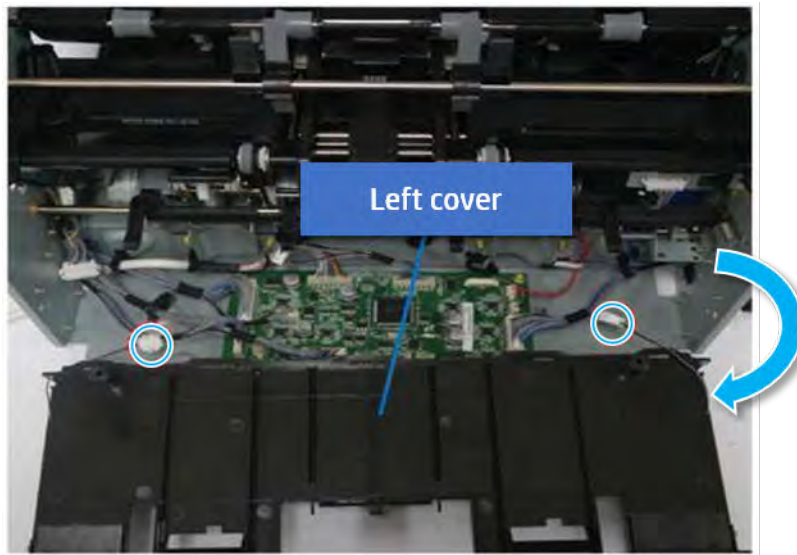

 **TIP:** Be sure to check the hook when reassembling.

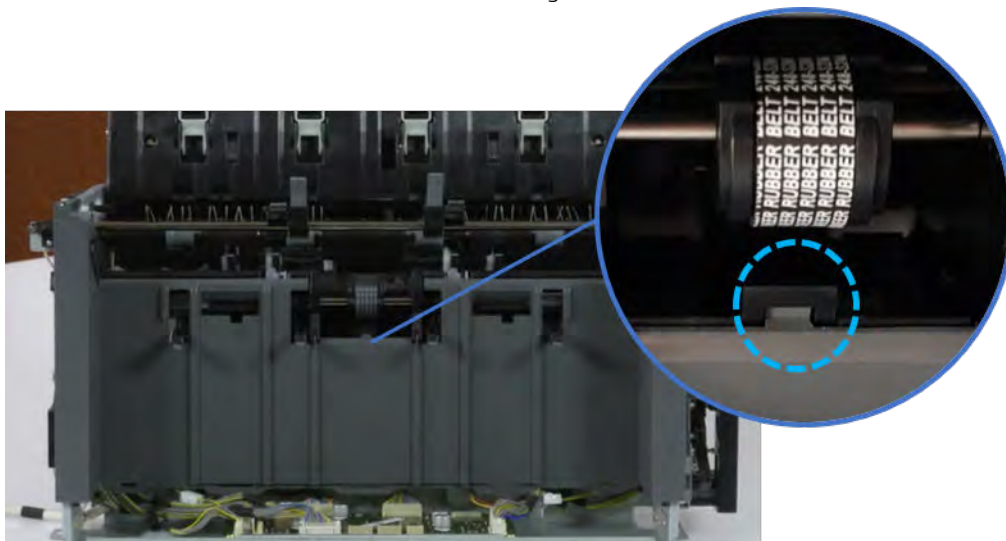

Remove the front harness guide

Follow these steps to remove the front harness guide.

1. Open one clamp and unplug five connectors, and then remove the wire harness from the front harness guide.

2. Remove four screws, and then remove the front harness guide.

Figure 7-514 Remove the front harness guide

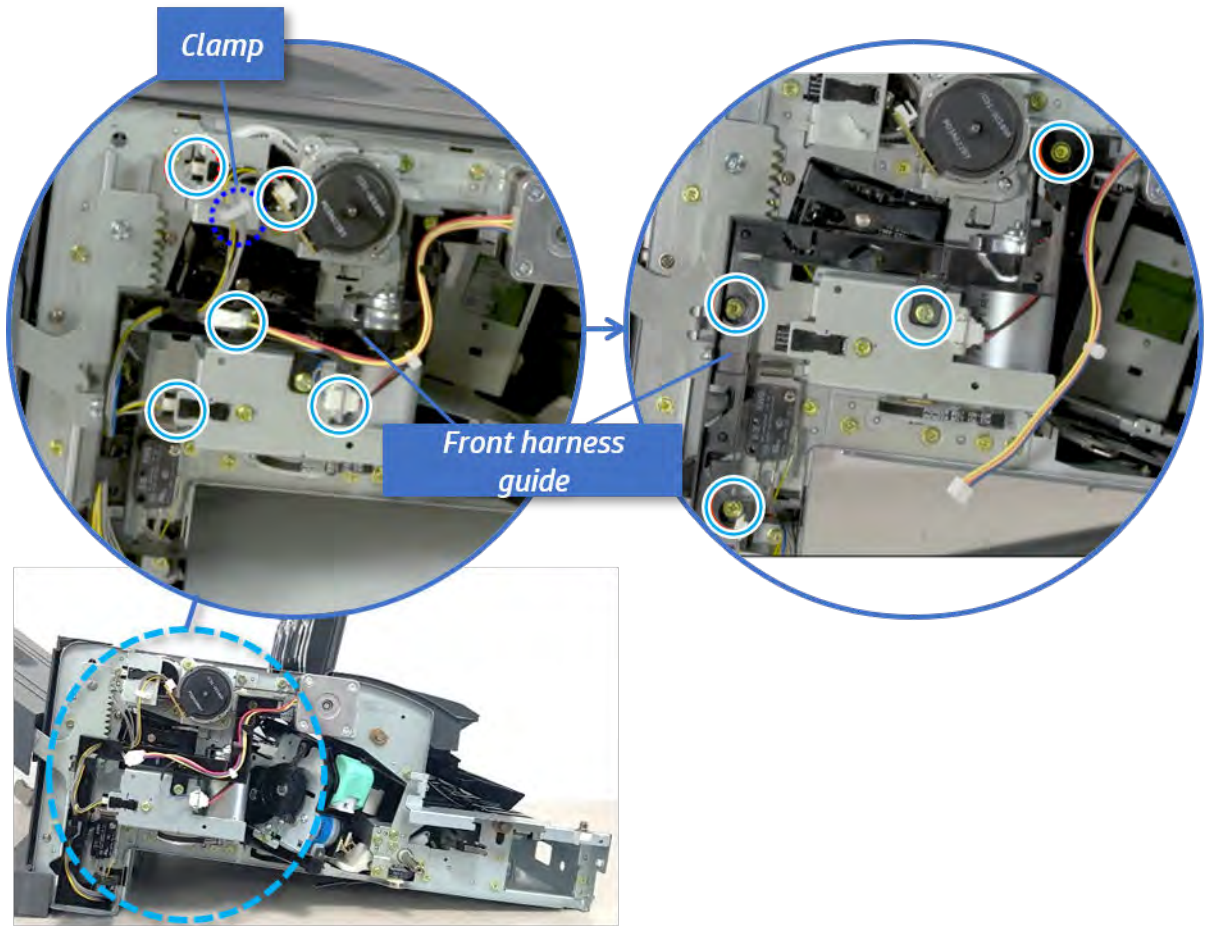

Remove the output tray motor assembly

Follow these steps to remove the output tray motor assembly.

- ▲ Remove three screws, and then remove the output tray motor assembly.

Figure 7-515 Remove the output tray motor assembly

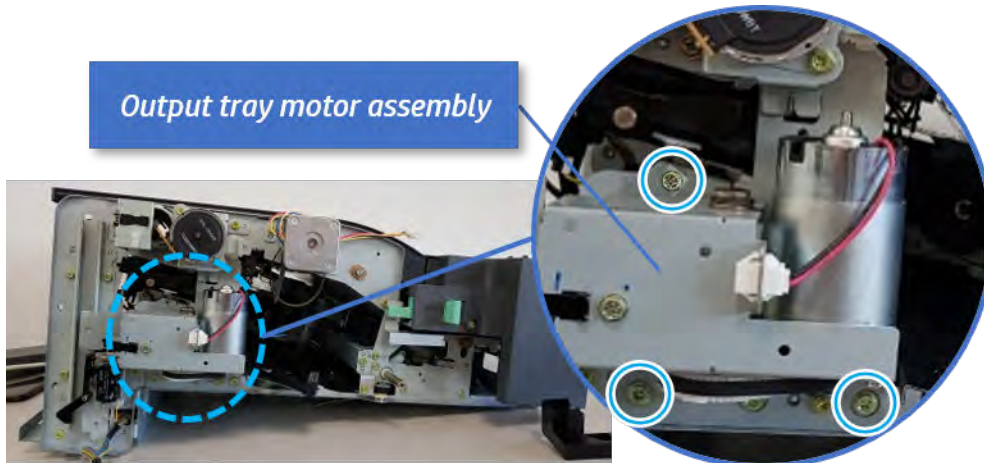

Remove the output tray lower limit switch

Follow these steps to remove the output tray lower limit switch.

- ▲ Remove one screw, and then remove the output tray lower limit switch.

Figure 7-516 Remove the output tray lower limit switch

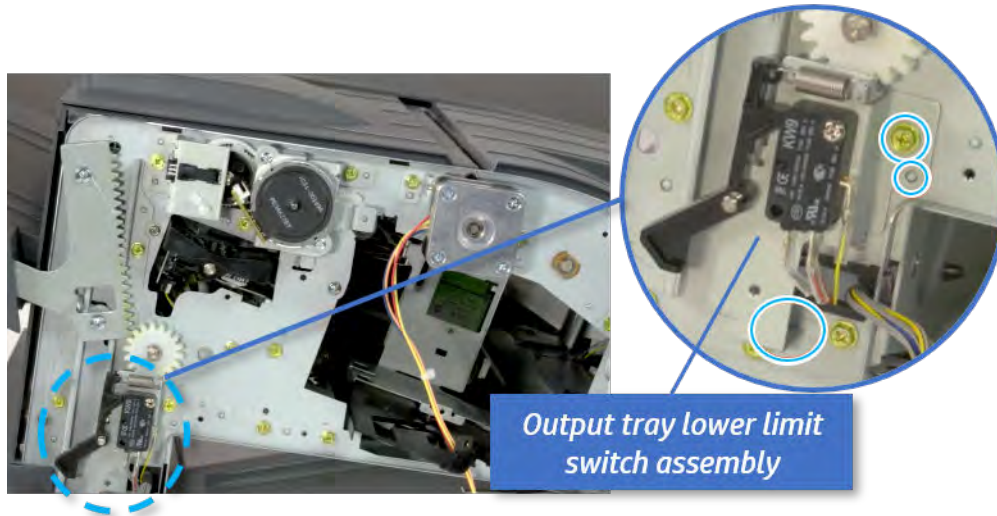

Remove the paper holding

Follow these steps to remove the paper holding.

1. Remove the paper holding actuator spring.

Figure 7-517 Remove the paper holding actuator spring

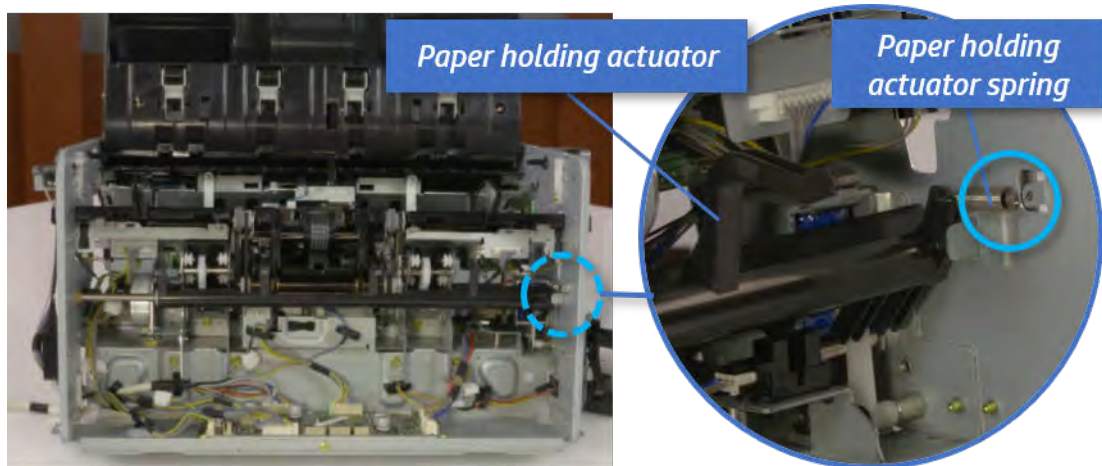

2. Remove the e-ring and the rack pinion gear. And then remove the pin and the e-ring, and then remove the bushing.

Figure 7-518 Remove e-ring, rack pinion gear, pin, and bushing

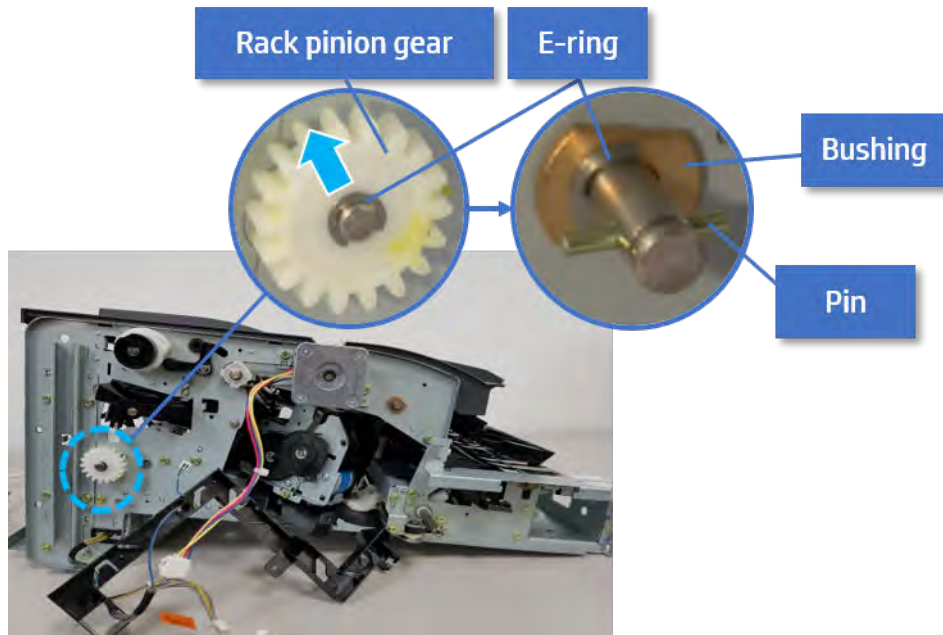

 **NOTE:** Be sure not to lose the pin.

3. Carefully remove the paper holding shaft and the actuator.

Figure 7-519 Remove the paper holding shaft and the actuator

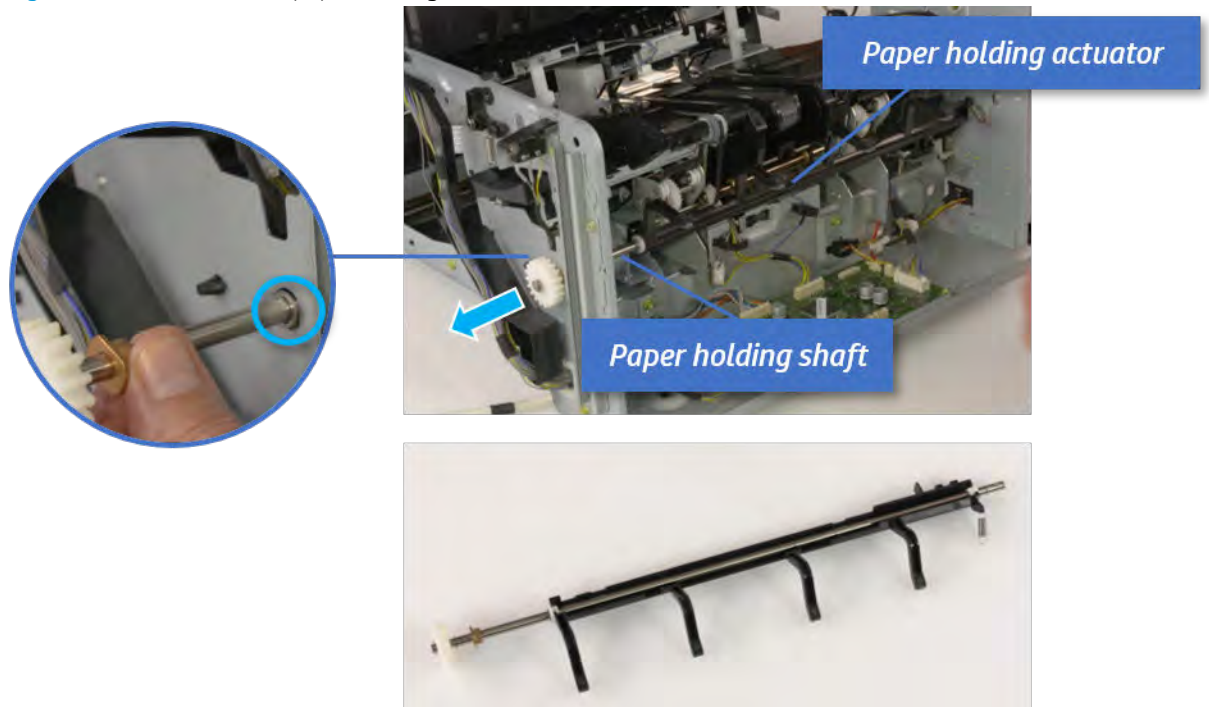

Remove the sub paddle unit

Follow these steps to remove the sub paddle unit.

1. Open the top cover, and then remove one screw securing the sub paddle unit.

Figure 7-520 Remove one screw

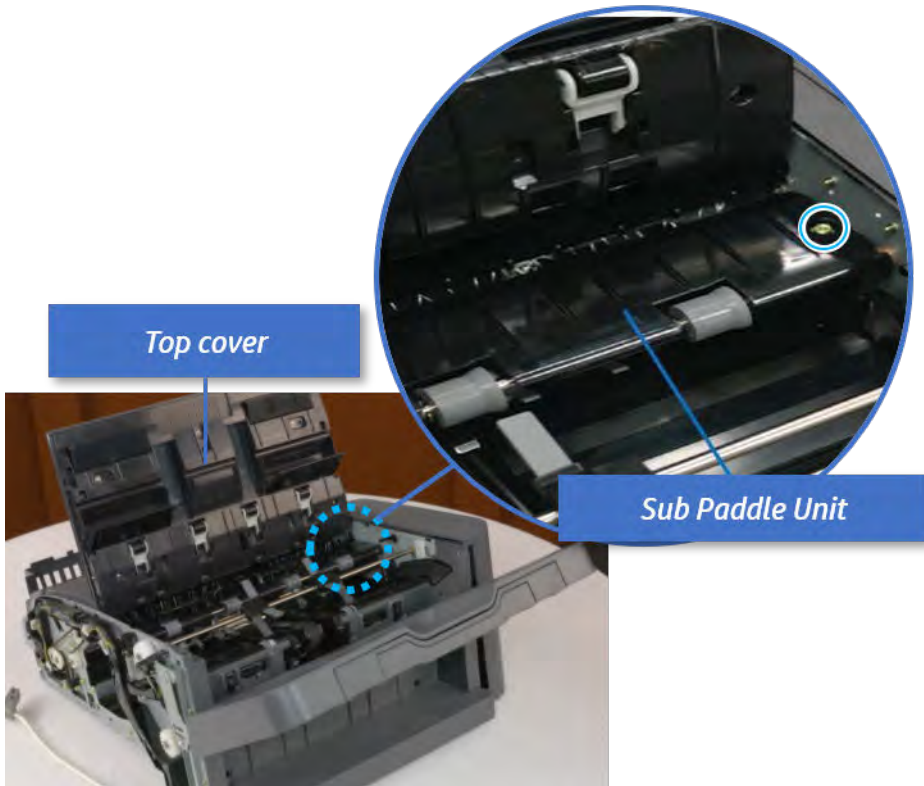

2. Remove the e-ring, and then remove the pulley and timing belt. And then remove the e-ring and the bushing.

Figure 7-521 Remove the e-ring, pulley, timing belt, and bushing

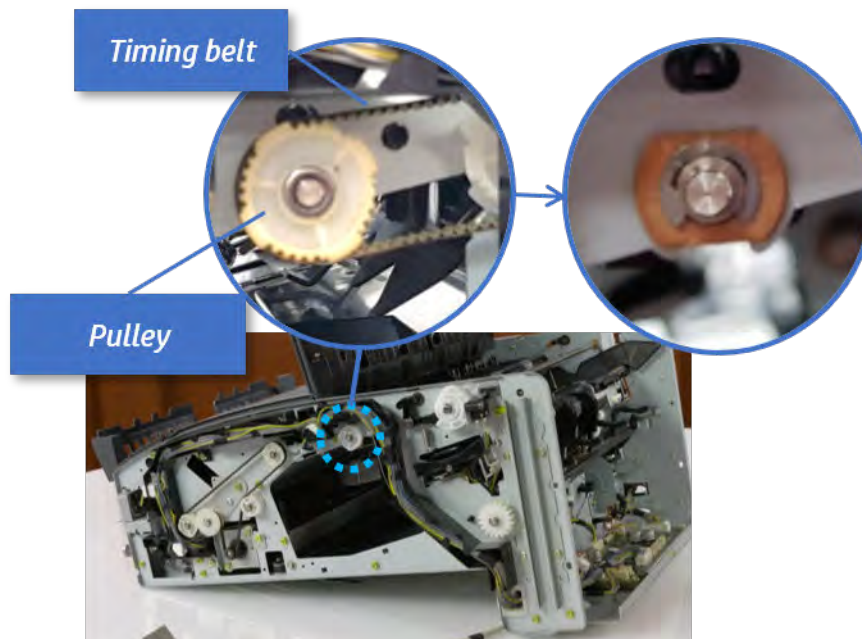

3. Lift up and remove the sub paddle unit.

Figure 7-522 Remove the sub paddle unit

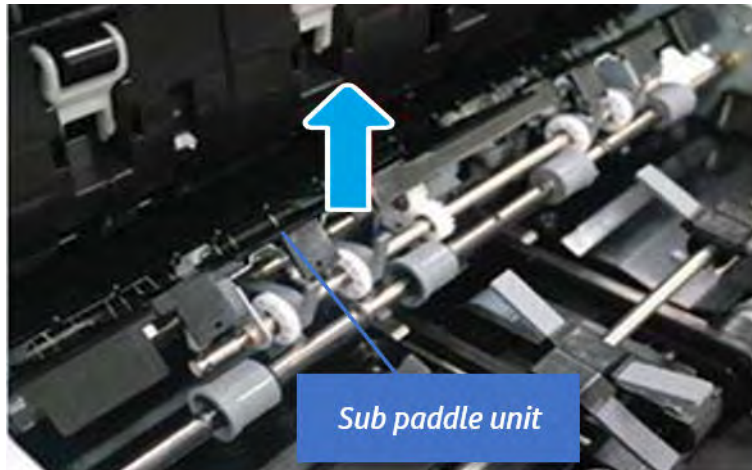

Remove the exit roller

Follow these steps to remove the exit roller.

1. Remove the guide on the center of the exit roller.

Figure 7-523 Remove the guide

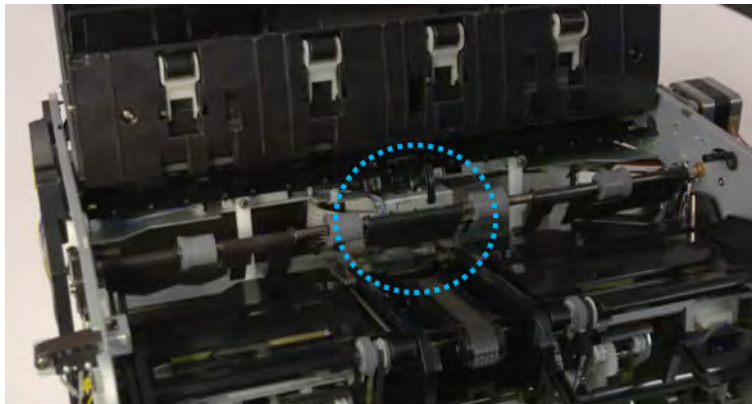

2. On the front of the inner finisher, release the timing belt connected to the exit motor.

Figure 7-524 Release the timing belt

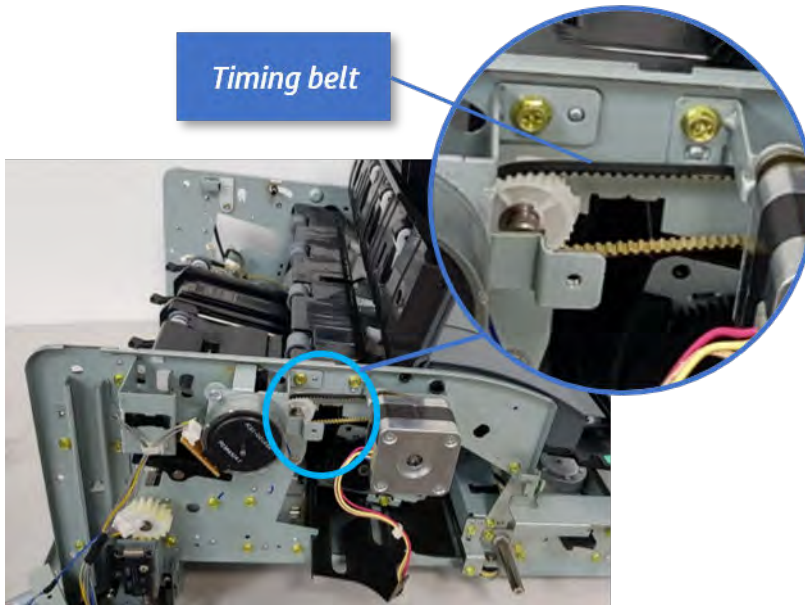

3. Remove five screws securing the rear harness guide.

Figure 7-525 Remove five screws

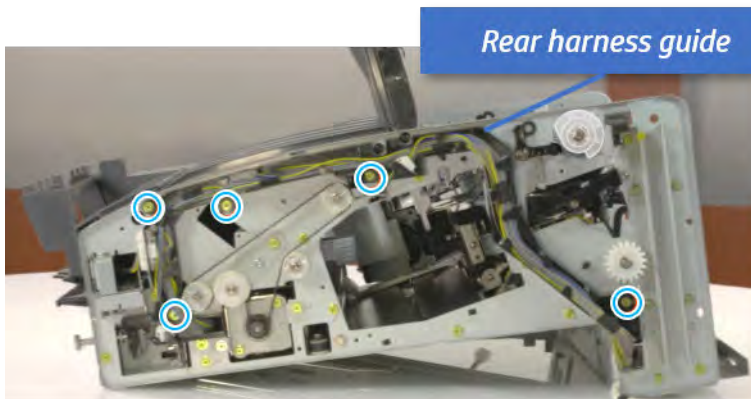

4. On the rear of the inner finisher, remove the e-ring and the pulley and then remove the e-ring and the bushing.

Figure 7-526 Remove e-ring, pulley, and bushing

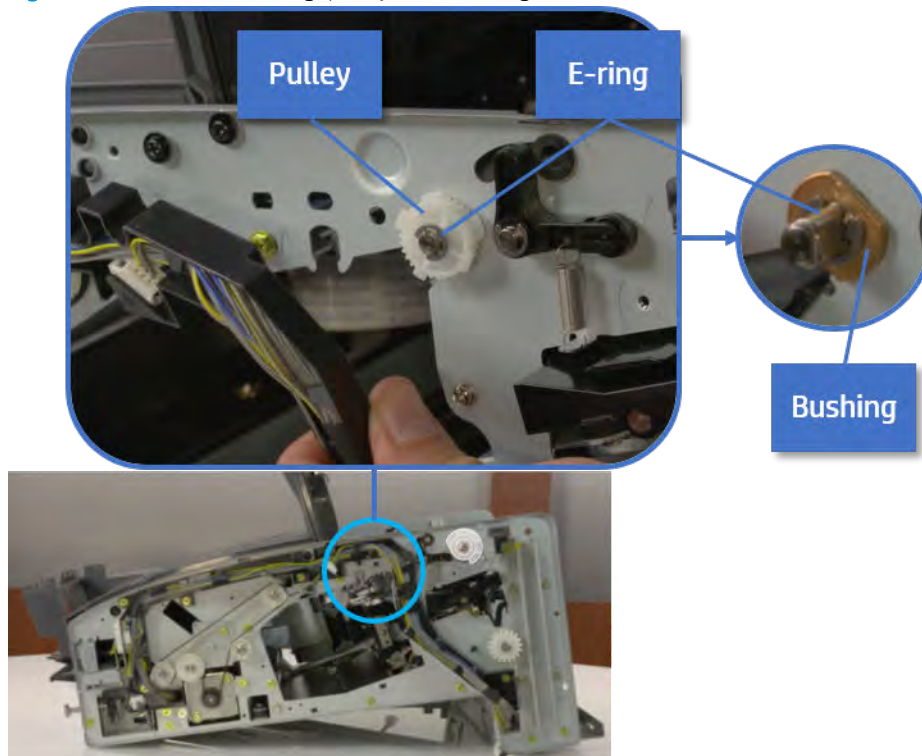

5. Push the bushing to detach it, and then remove the exit roller.

Figure 7-527 Remove the exit roller

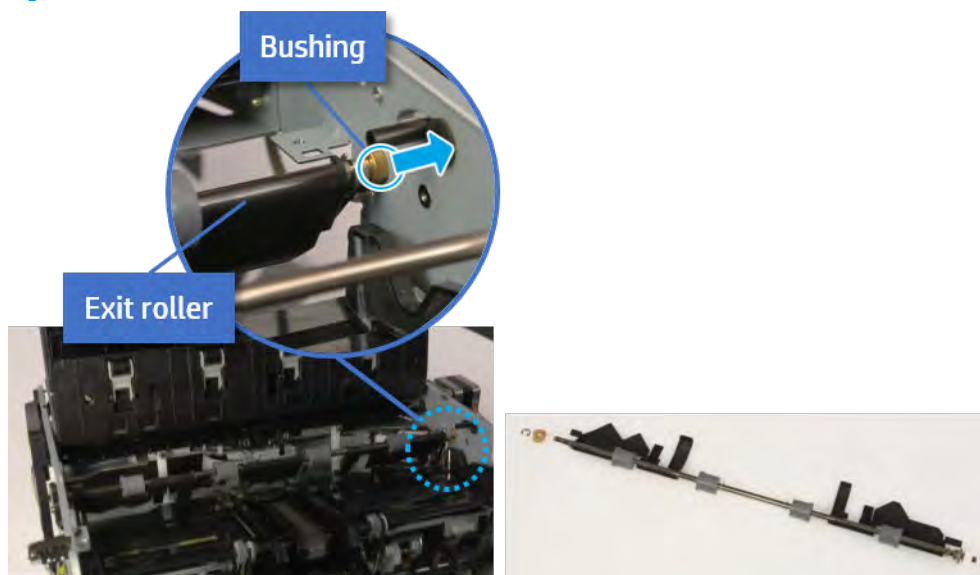

Remove the front tamper

Follow these steps to remove the front tamper.

1. Remove four screws.

Figure 7-528 Remove four screws

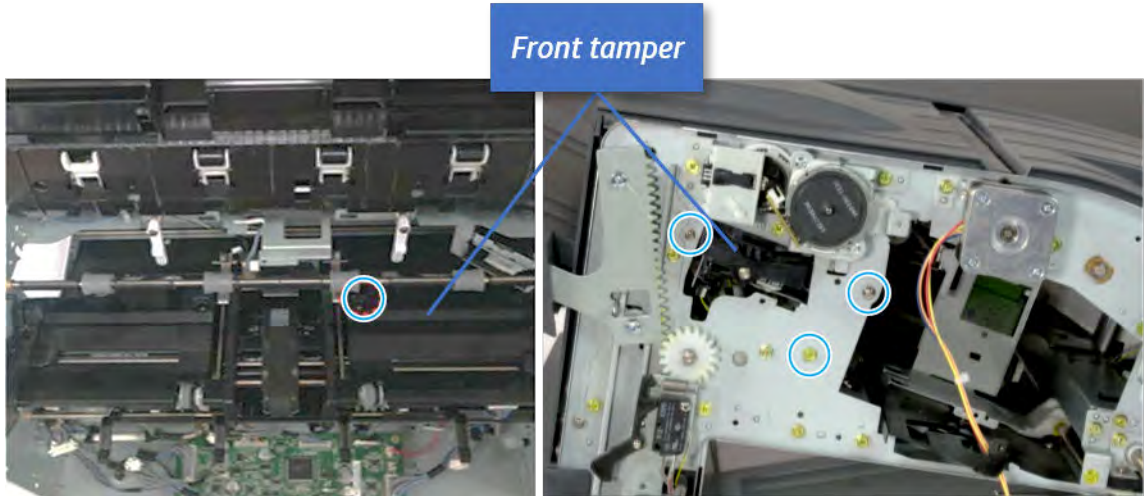

2. Unplug the connector and release the hook, and then pull the front tamper up to remove.

Figure 7-529 Remove the front tamper

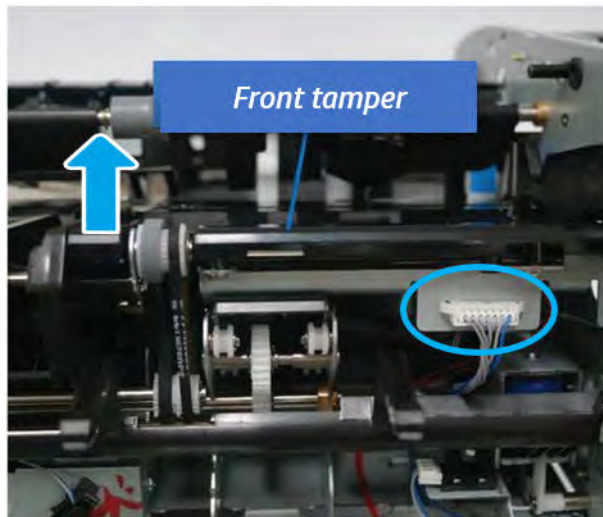

Remove the rear tamper

Follow these steps to remove the rear tamper.

1. Remove four screws.

 **NOTE:** Move cable guide out of position to access the screws.

Figure 7-530 Remove four screws



2. Unplug two connectors and release the hook, and then remove the rear tamper.

Figure 7-531 Remove the rear tamper

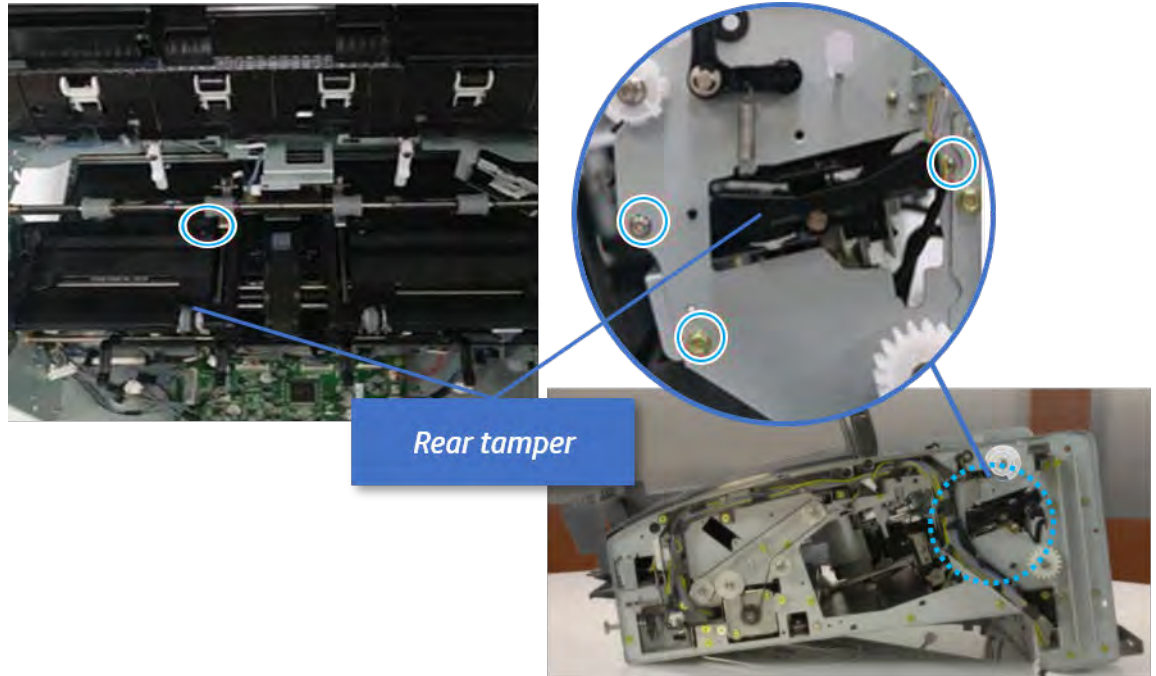
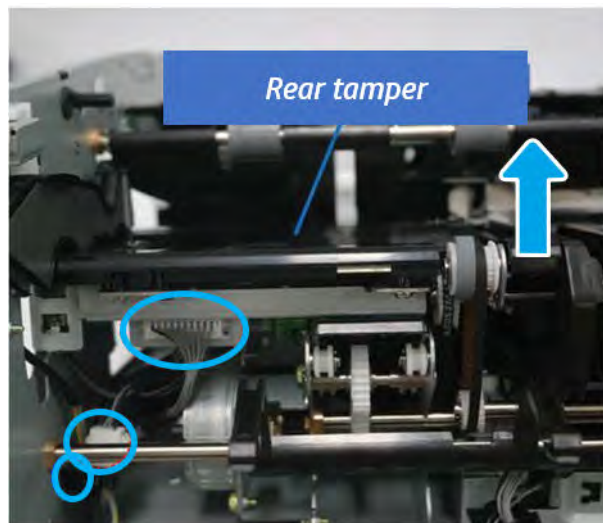

Remove the ejector & paper support assembly

Follow these steps to remove the ejector & paper support assembly.

1. Open one clamp, disconnect one connector.

Figure 7-532 Disconnect one connector

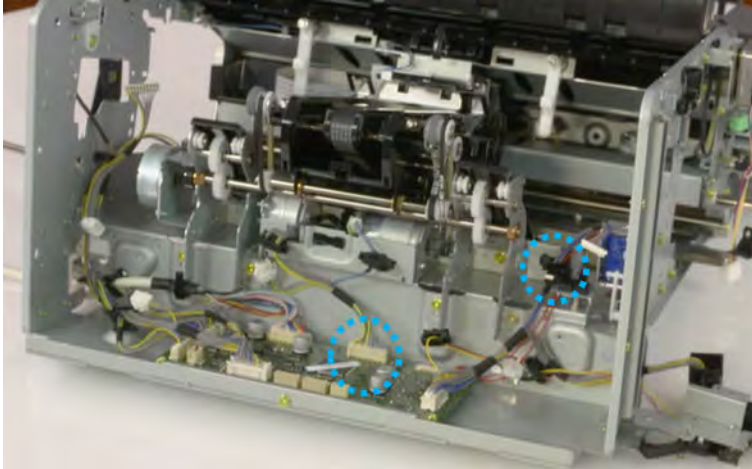

2. Pull the rear paper support up, and then release one clamp and disconnect two connectors.

Figure 7-533 Disconnect two connector

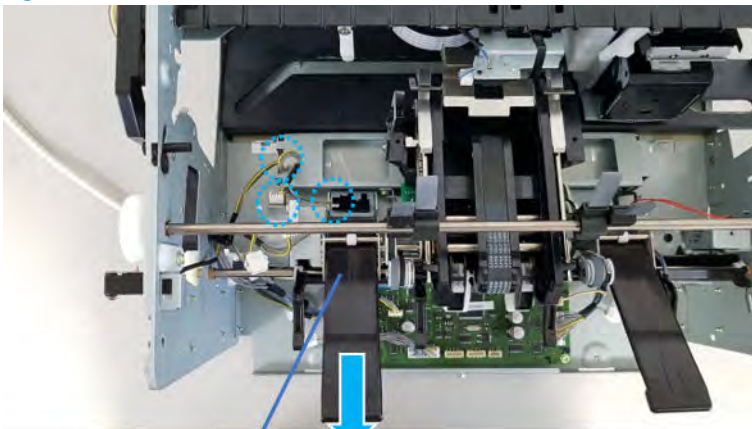

Rear paper support

3. Remove four screws, and then remove the ejector & paper support assembly.

Figure 7-534 Remove the ejector & paper support assembly

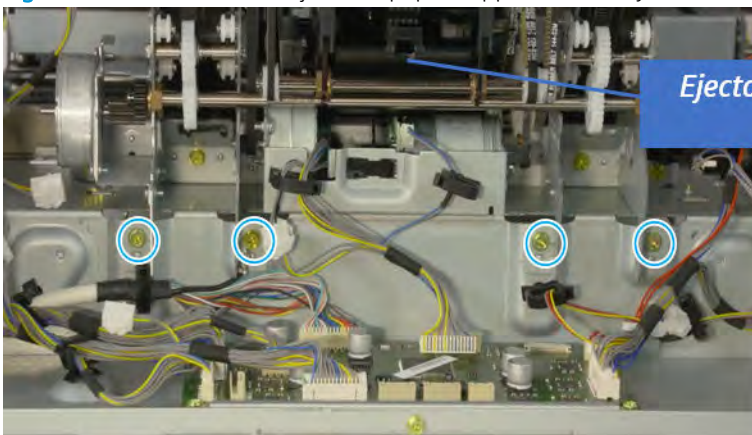

Ejector & paper support assembly

Unpack the replacement assembly

Follow these steps to unpack the replacement assembly.

1. Dispose of the defective part.



NOTE: HP recommends responsible disposal of the defective part.

<http://www8.hp.com/us/en/hp-information/environment/product-recycling.html>

2. Unpack the replacement part from the packaging.



CAUTION:  Some parts are sensitive to electrostatic discharge (ESD). Always perform service work at an ESD-protected workstation or mat. If an ESD workstation or mat is not available, touch the sheet-metal chassis to provide a static ground before touching an ESD-sensitive assembly. Protect the ESD-sensitive assemblies by placing them in ESD pouches when they are out of the printer.



IMPORTANT: Make sure that all of the shipping materials (for example shipping tape) are removed from the replacement part prior to installation.



NOTE: If the replacement part is a roller or pad, avoid touching the spongy part of it. Skin oils on the roller or pad can cause paper pickup and/or print-quality problems. HP recommends using disposable gloves when handling rollers or pads or washing your hands before touching rollers or pads.

3. To install an assembly, reverse the removal steps.



NOTE: When applicable, special installation instructions are provided for an assembly at the end of the removal procedure. Always completely read the removal instructions and follow all special installation instructions.

Removal and replacement: Ejector motor assembly (S11/ M6/ M7)

Learn how to remove and replace the ejector motor assembly.

To view teardown and reassembling video of the inner finisher, click the link below.



[View a teardown video of the inner finisher.](#)



[View a reassembling video of the inner finisher.](#)



IMPORTANT: When applicable, special installation instructions are provided for an assembly at the end of the removal procedure. Always completely read the removal instructions and follow all special installation instructions.

Mean time to repair:

Service level:

Before performing service

Turn the printer power off

- Press the power button on the front of the printer, and then turn off the power switch next to the power cable.
- A shutting-down message appears on the control-panel display.



WARNING! To avoid damage to the printer, turn the power off and wait until the printer shuts down before removing the power cable.

- Disconnect the printer power cable after the printer has completely shut down (the control-panel display is blank).

Use the table below to identify the correct part number for your printer. To order the part, go to www.hp.com/buy/parts.

Table 7-63 Part information

Part number	Part description
JC90-01309A (not orderable)	Ejector motor assembly

Required tools

- #2 JIS screwdriver with a magnetic tip

After performing service

Turn the printer power on

- Connect the power cable.
- Use the power switch to turn the power on.

Post service test

Print any pages necessary to verify that the repair resolved the issue and did not create any new issues.

Remove the front cover

Follow these steps to remove the front cover.

1. Open the front door and open the punch cover.
2. Remove three screws in the front.
3. Remove the lever.
4. Open the top cover.
5. From the right side of the front cover, carefully lift and pry toward the top-left corner to remove the front cover.

Figure 7-535 Remove the front cover

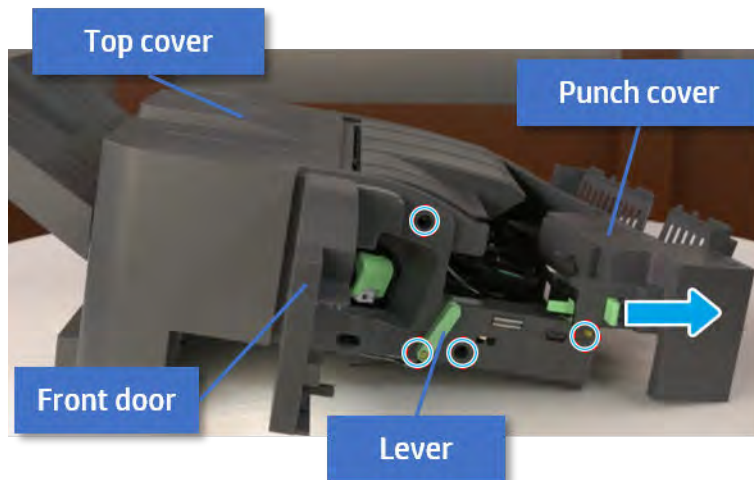

Remove the rear cover

Follow these steps to remove the rear cover.

1. Open the top cover.

Figure 7-536 Open the top cover

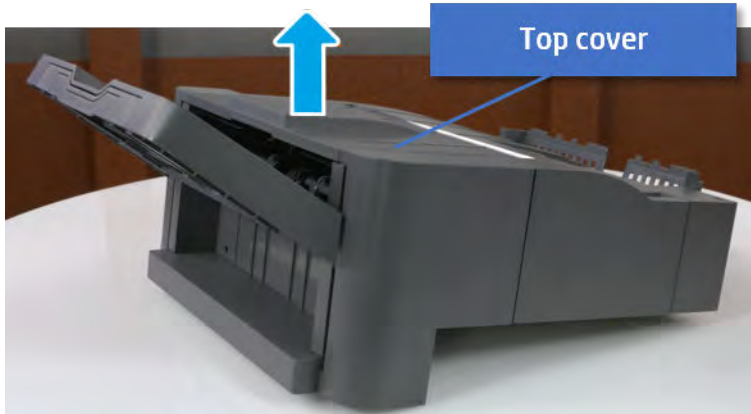

2. Remove three screws.
3. Release hooks carefully and remove the rear cover.

Figure 7-537 Remove the rear cover

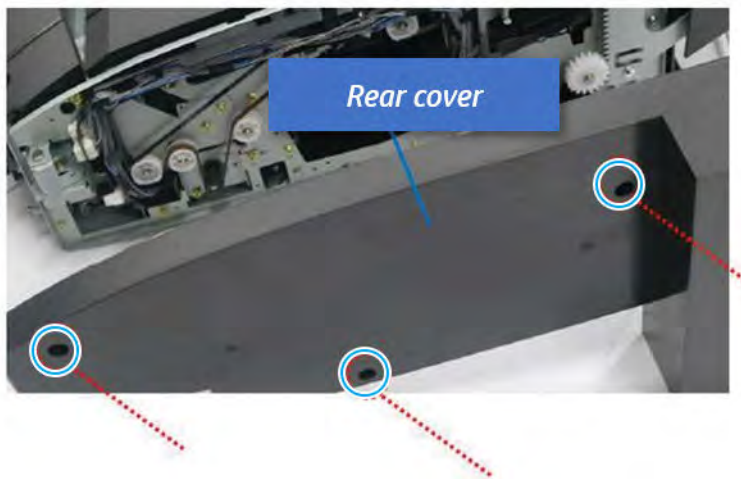

Remove the output tray

Follow these steps to remove the output tray.

1. Remove four screws.

Figure 7-538 Remove four screws

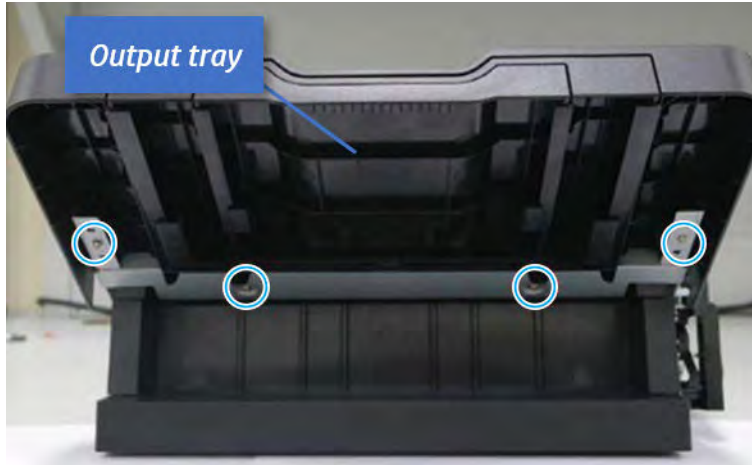

2. Push the paper holding actuator into the inner finisher, and then remove the output tray.

Figure 7-539 Remove the output tray.



Remove the output tray frame

Follow these steps to remove the output tray frame.

1. Rotate the pulley until the output tray frame depart from the gear.

Figure 7-540 Remove the pulley

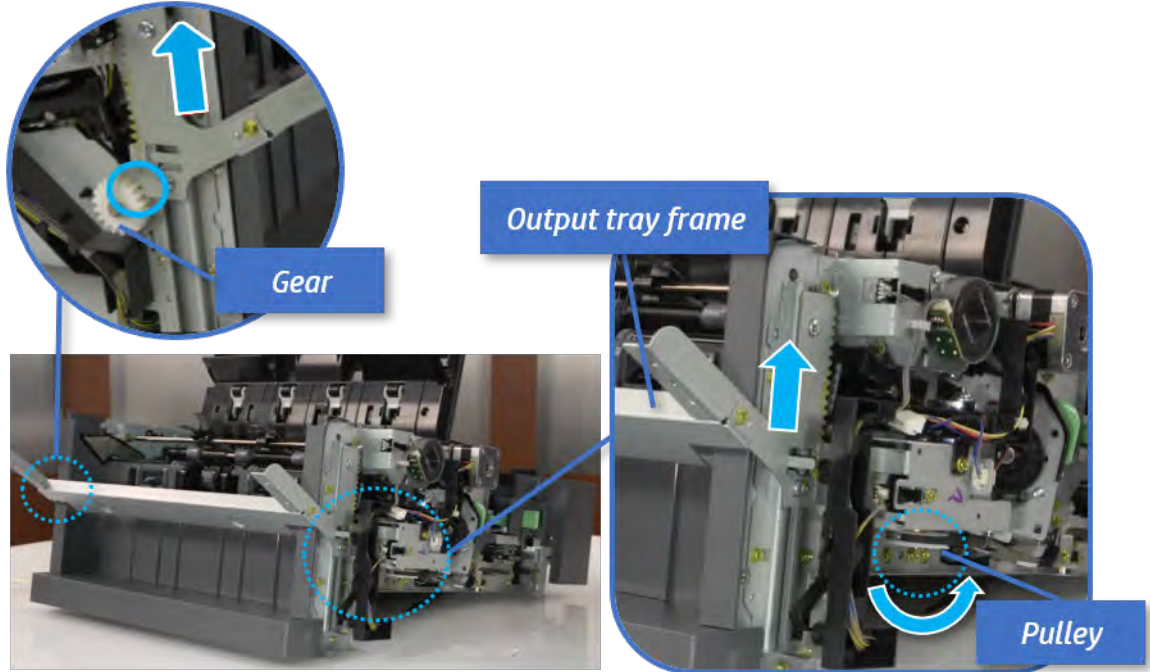

2. Push the paper holding actuator into the inner finisher, and then remove the output tray frame.

Figure 7-541 Remove the output tray frame

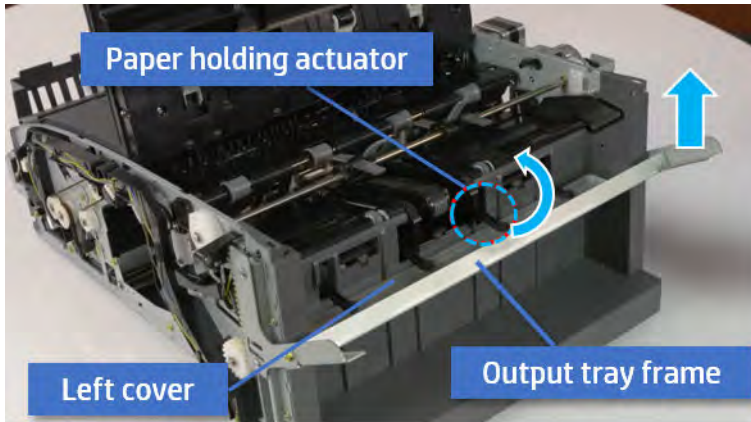

 **TIP:** Push the paper holding actuator into the inner finisher when reassembling. Be sure to level the output tray.

- a. Position the first wheel into the channel on both sides while pushing the paper holding actuator.

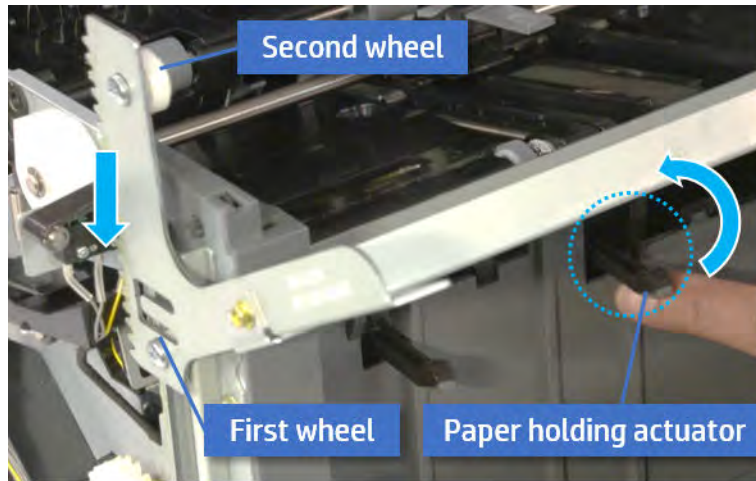

- b. Let the second wheel rest on the channel on both sides simultaneously.
- c. Gently squeeze the wheels into channel until the output tray frame meet the gear.

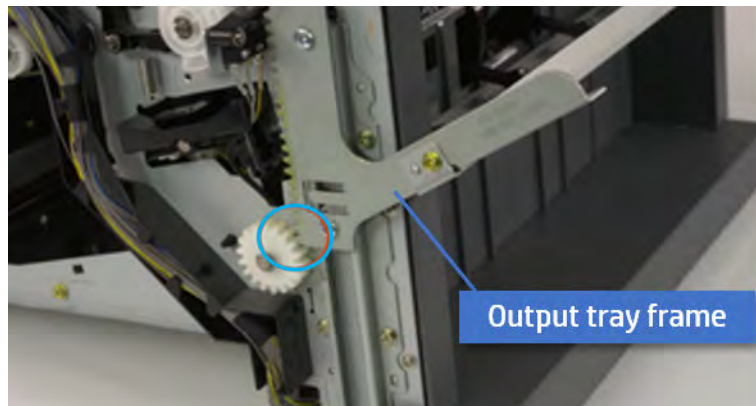

- d. Rotate the pulley until the output tray frame is no longer lifted. It can make to level the output tray frame.

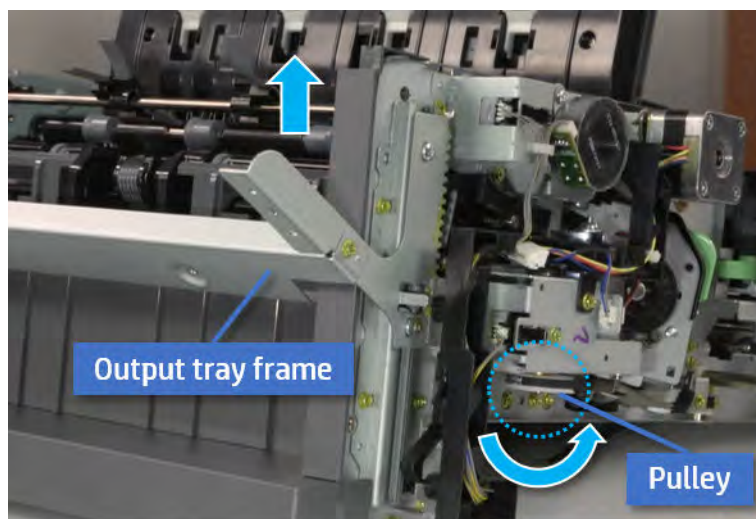

- e. Rotate the pulley in the opposite direction.

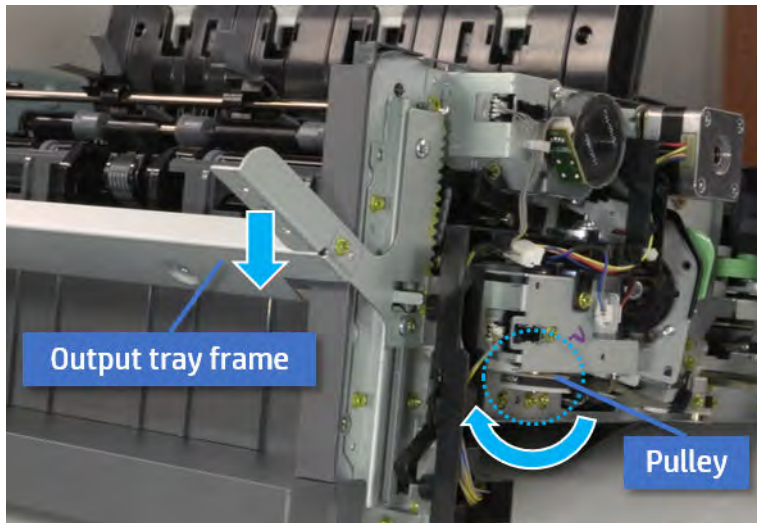

Remove the PCA cover

Follow these steps to remove the PCA cover.

- ▲ Remove two screws, and then remove the PCA cover.

Figure 7-542 Remove the PCA cover

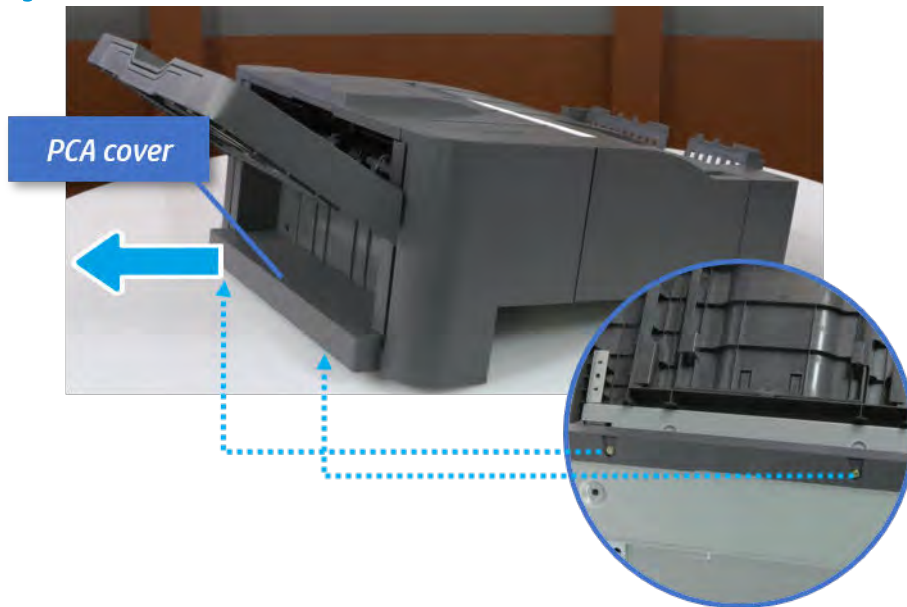

Remove the left cover

Follow these steps to remove the left cover.

1. Remove two screws.

Figure 7-543 Remove two screws

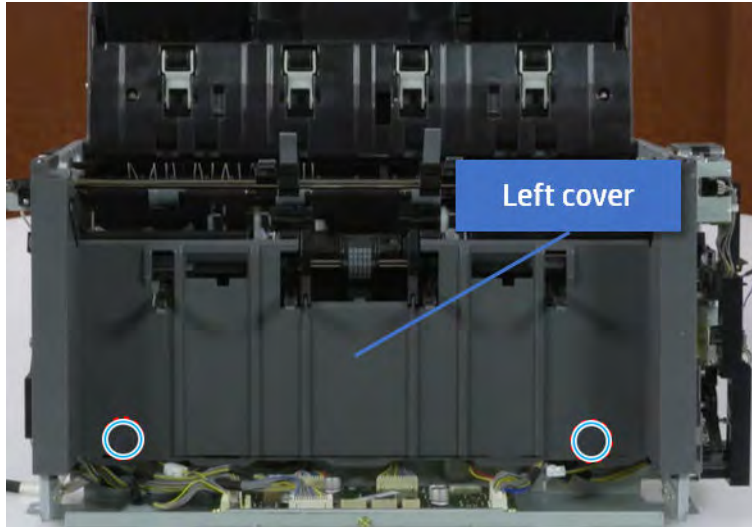

2. Remove four screws from both front and rear sides.

Figure 7-544 Remove four screws

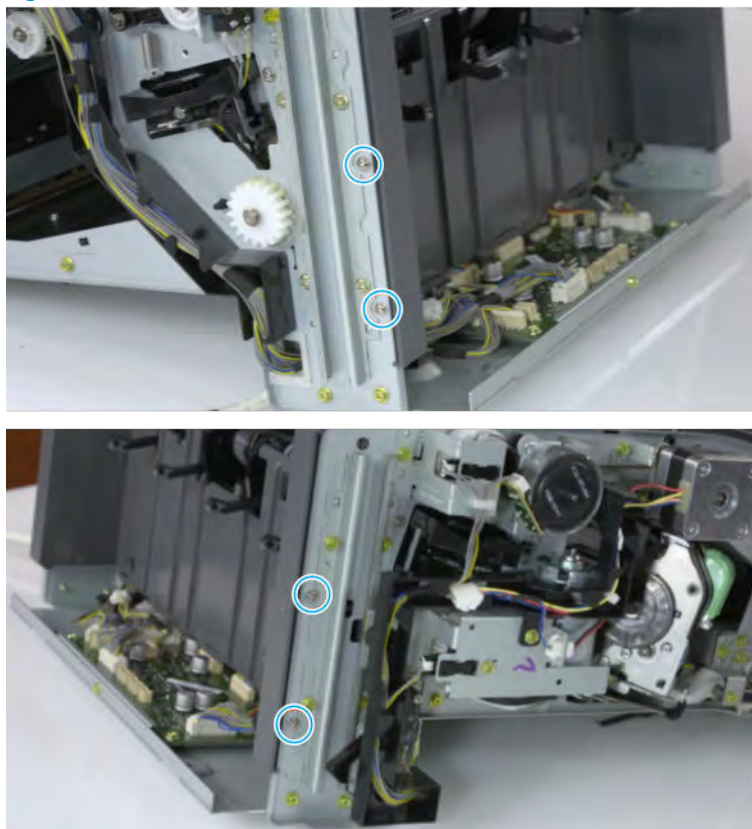

3. Unplug two inline connectors, and then remove the left cover.

Figure 7-545 Unplug two connectors

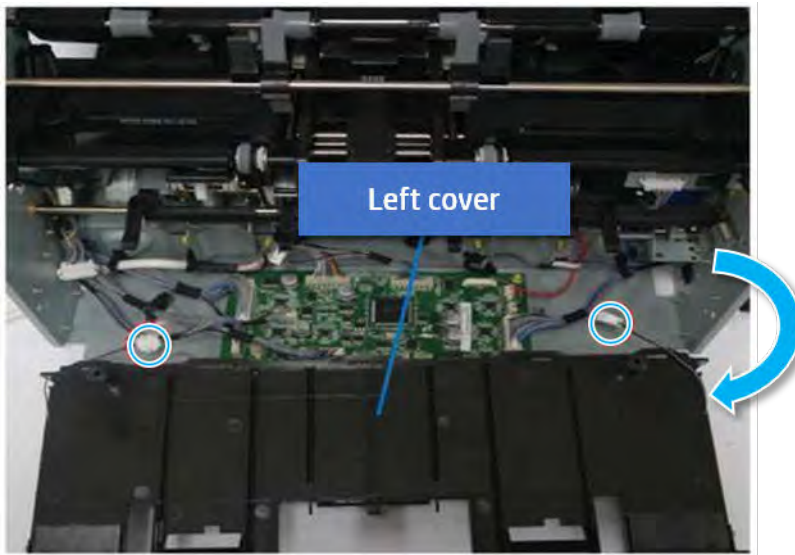

 **TIP:** Be sure to check the hook when reassembling.

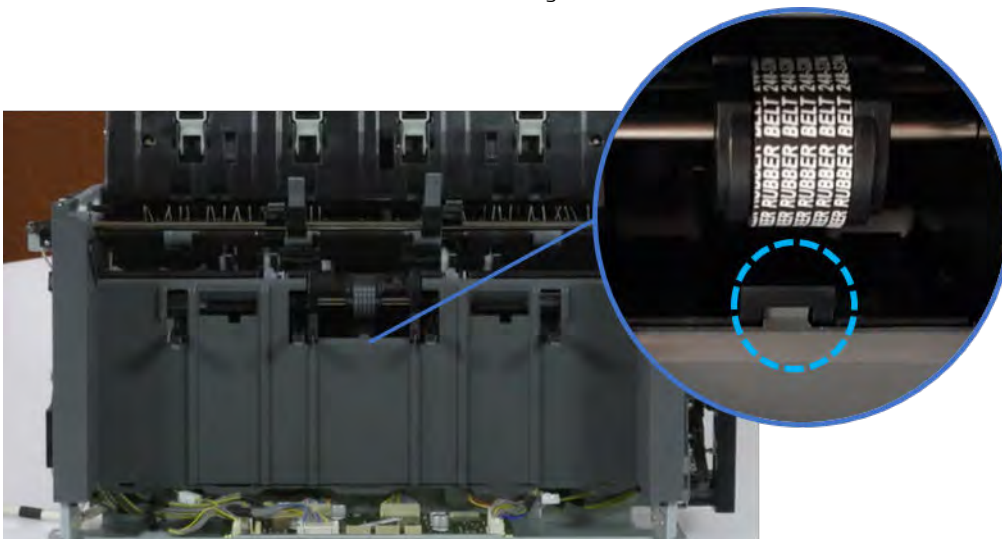

Remove the front harness guide

Follow these steps to remove the front harness guide.

1. Open one clamp and unplug five connectors, and then remove the wire harness from the front harness guide.

2. Remove four screws, and then remove the front harness guide.

Figure 7-546 Remove the front harness guide

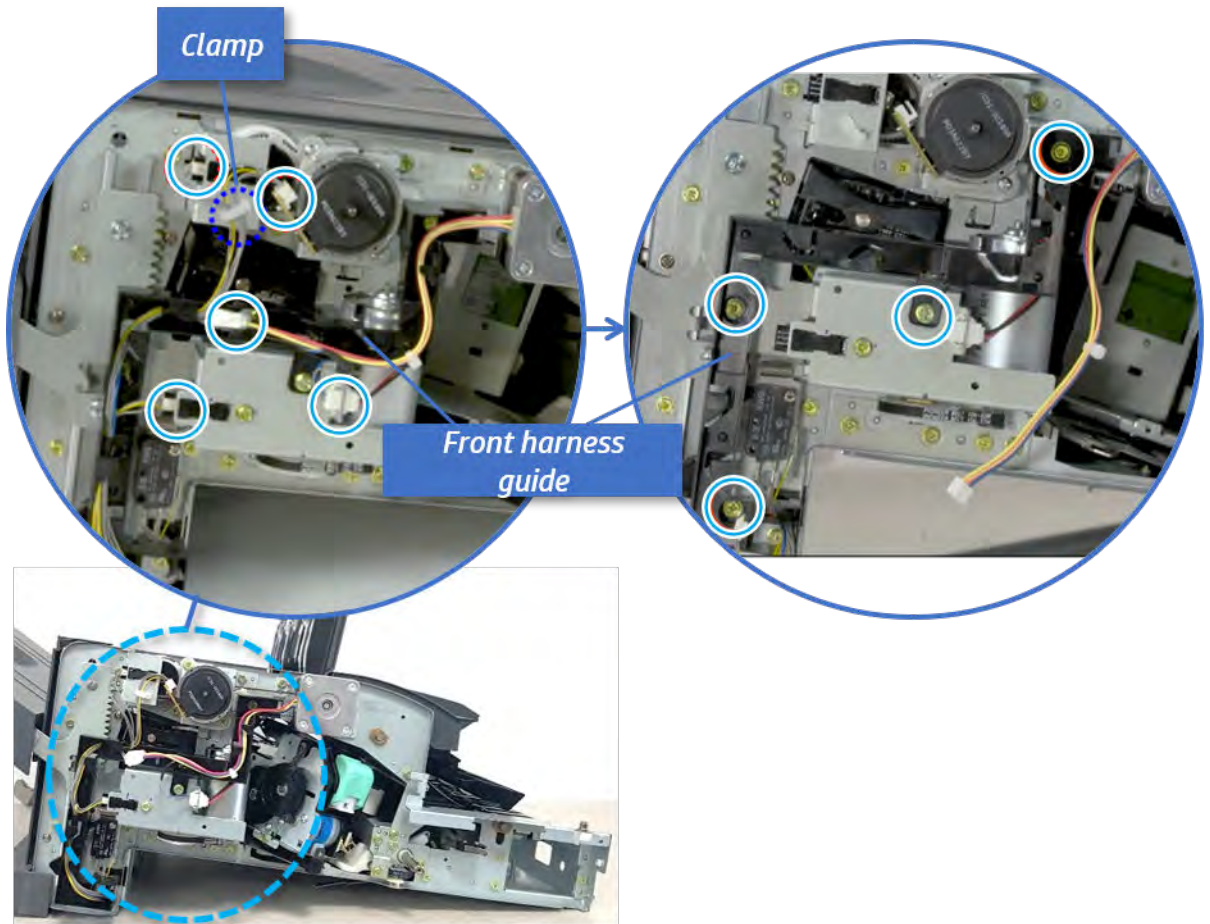

Remove the output tray motor assembly

Follow these steps to remove the output tray motor assembly.

- ▲ Remove three screws, and then remove the output tray motor assembly.

Figure 7-547 Remove the output tray motor assembly

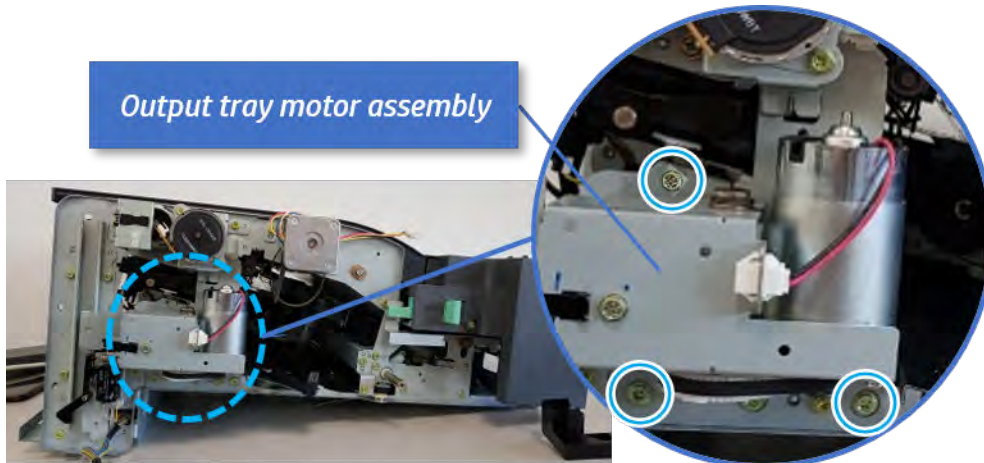

Remove the output tray lower limit switch

Follow these steps to remove the output tray lower limit switch.

- ▲ Remove one screw, and then remove the output tray lower limit switch.

Figure 7-548 Remove the output tray lower limit switch

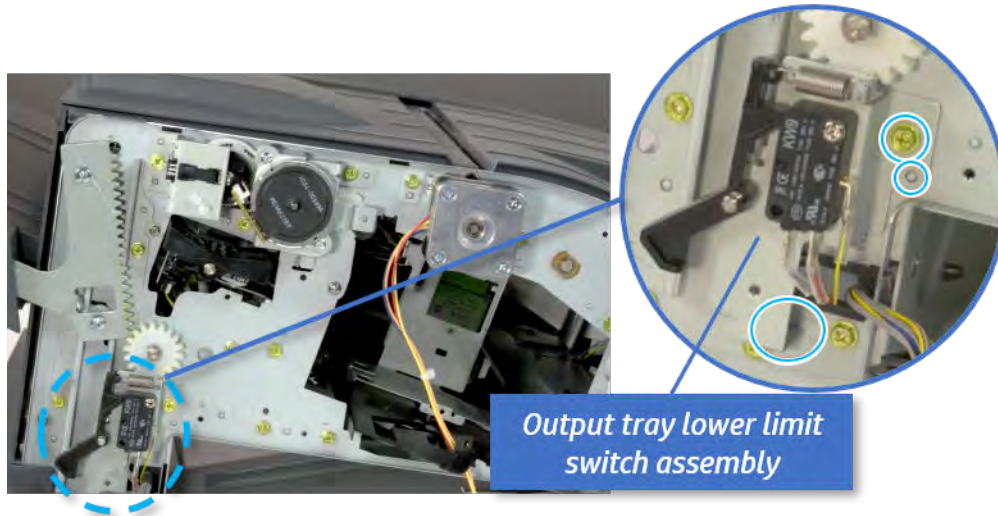

Remove the paper holding

Follow these steps to remove the paper holding.

1. Remove the paper holding actuator spring.

Figure 7-549 Remove the paper holding actuator spring

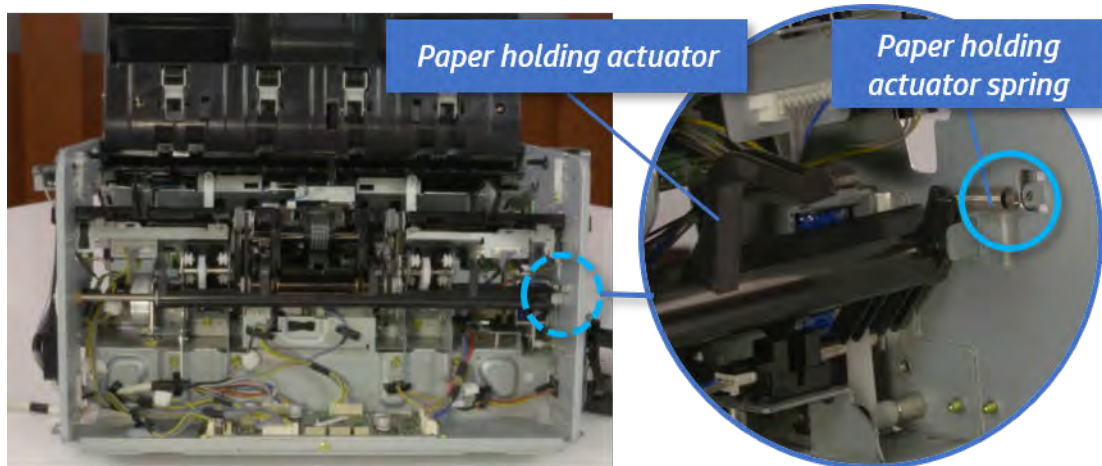

2. Remove the e-ring and the rack pinion gear. And then remove the pin and the e-ring, and then remove the bushing.

Figure 7-550 Remove e-ring, rack pinion gear, pin, and bushing

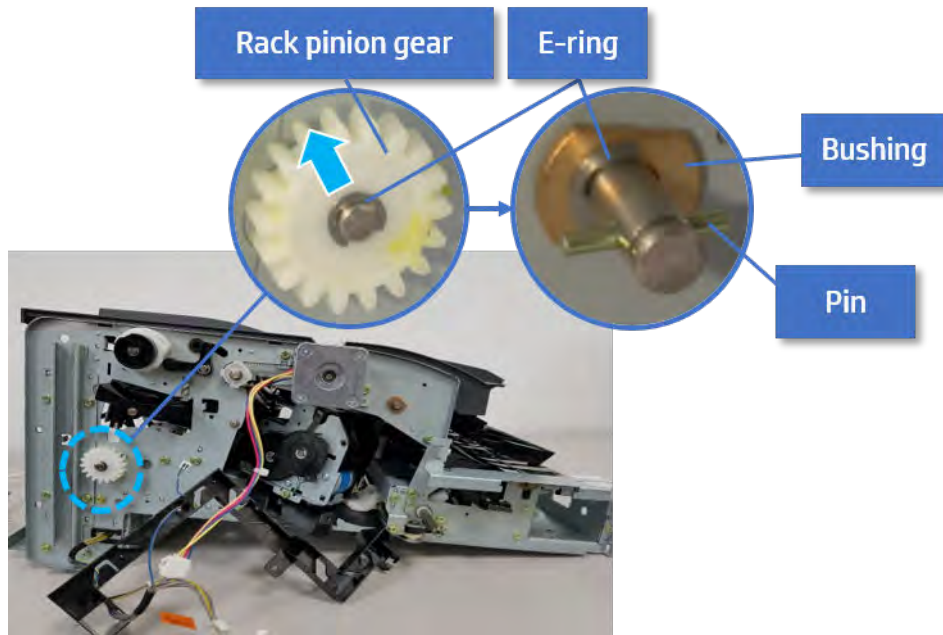

 **NOTE:** Be sure not to lose the pin.

3. Carefully remove the paper holding shaft and the actuator.

Figure 7-551 Remove the paper holding shaft and the actuator

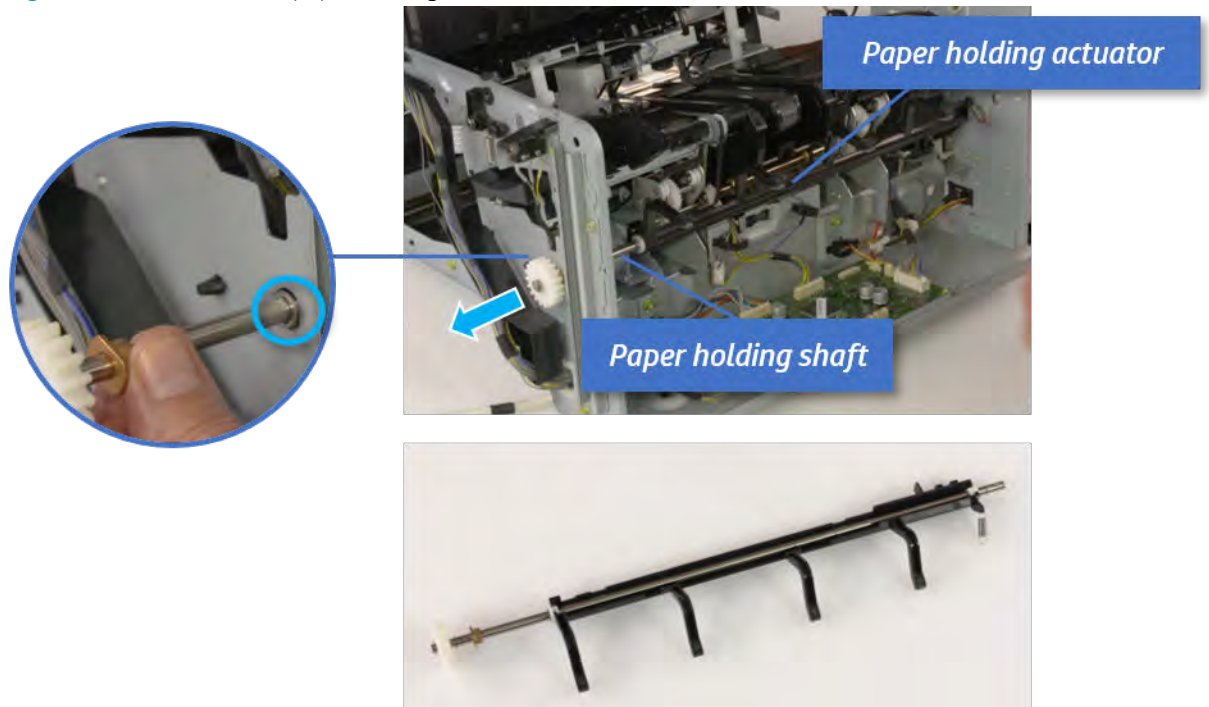

Remove the sub paddle unit

Follow these steps to remove the sub paddle unit.

1. Open the top cover, and then remove one screw securing the sub paddle unit.

Figure 7-552 Remove one screw

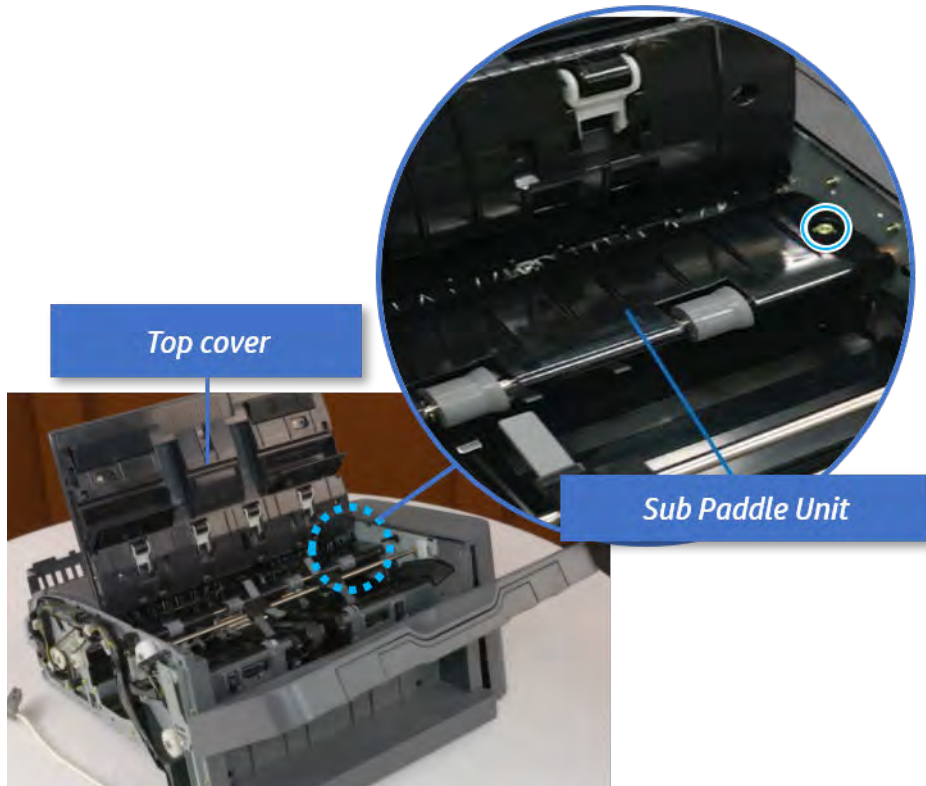

2. Remove the e-ring, and then remove the pulley and timing belt. And then remove the e-ring and the bushing.

Figure 7-553 Remove the e-ring, pulley, timing belt, and bushing

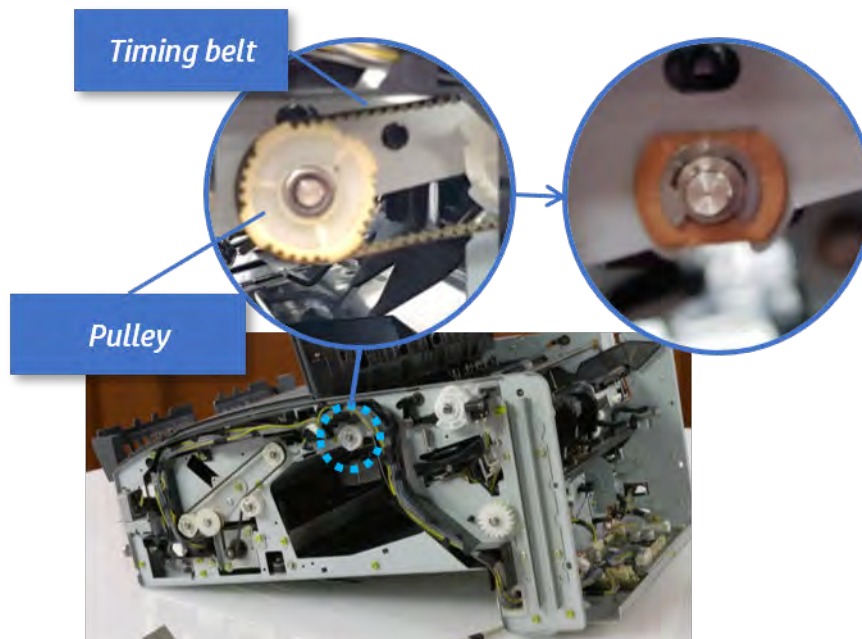

3. Lift up and remove the sub paddle unit.

Figure 7-554 Remove the sub paddle unit

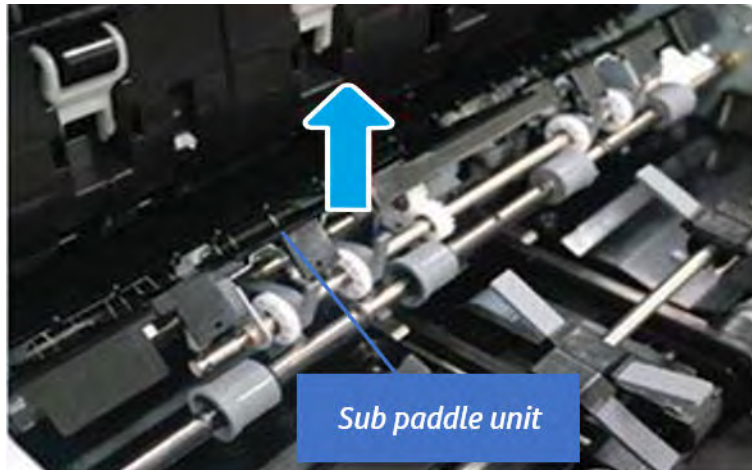

Remove the exit roller

Follow these steps to remove the exit roller.

1. Remove the guide on the center of the exit roller.

Figure 7-555 Remove the guide

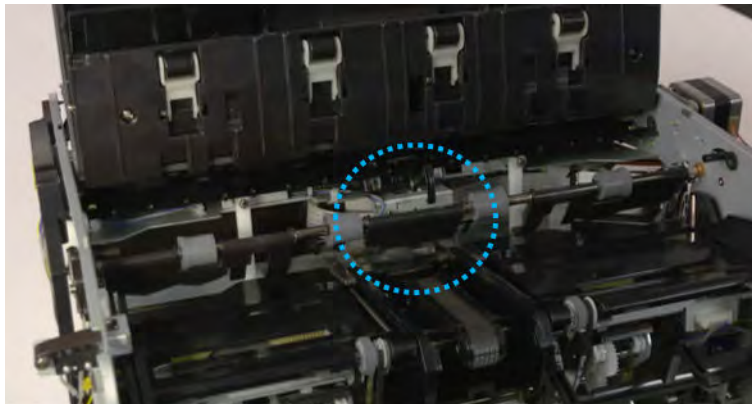

2. On the front of the inner finisher, release the timing belt connected to the exit motor.

Figure 7-556 Release the timing belt

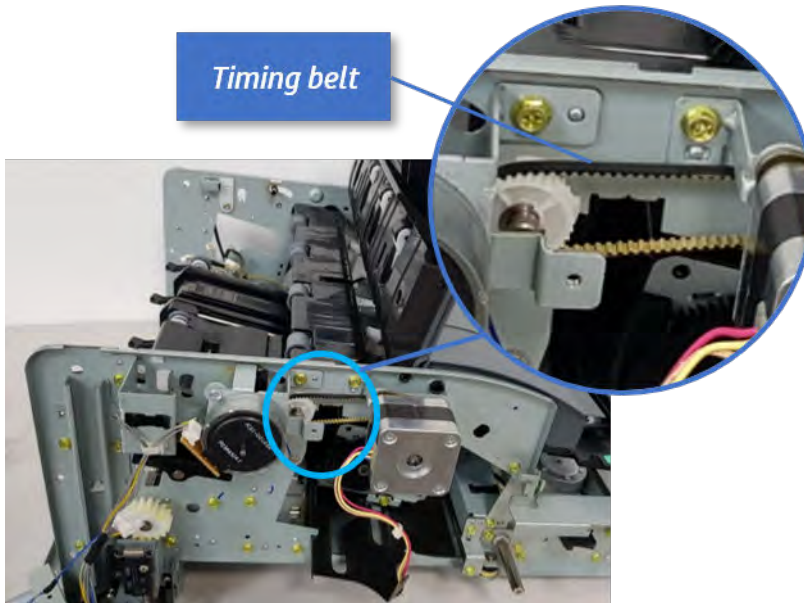

3. Remove five screws securing the rear harness guide.

Figure 7-557 Remove five screws

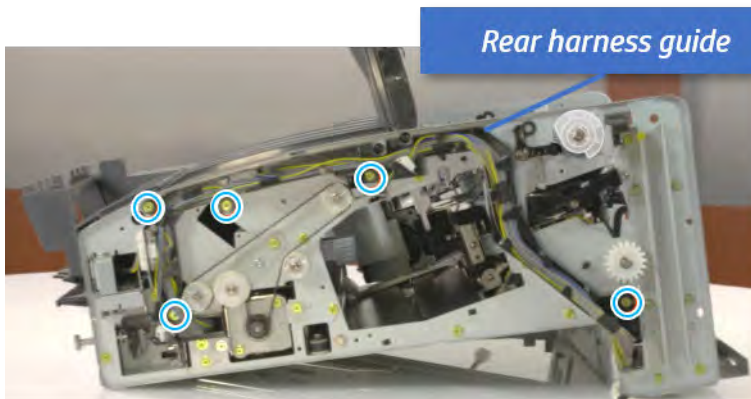

4. On the rear of the inner finisher, remove the e-ring and the pulley and then remove the e-ring and the bushing.

Figure 7-558 Remove e-ring, pulley, and bushing

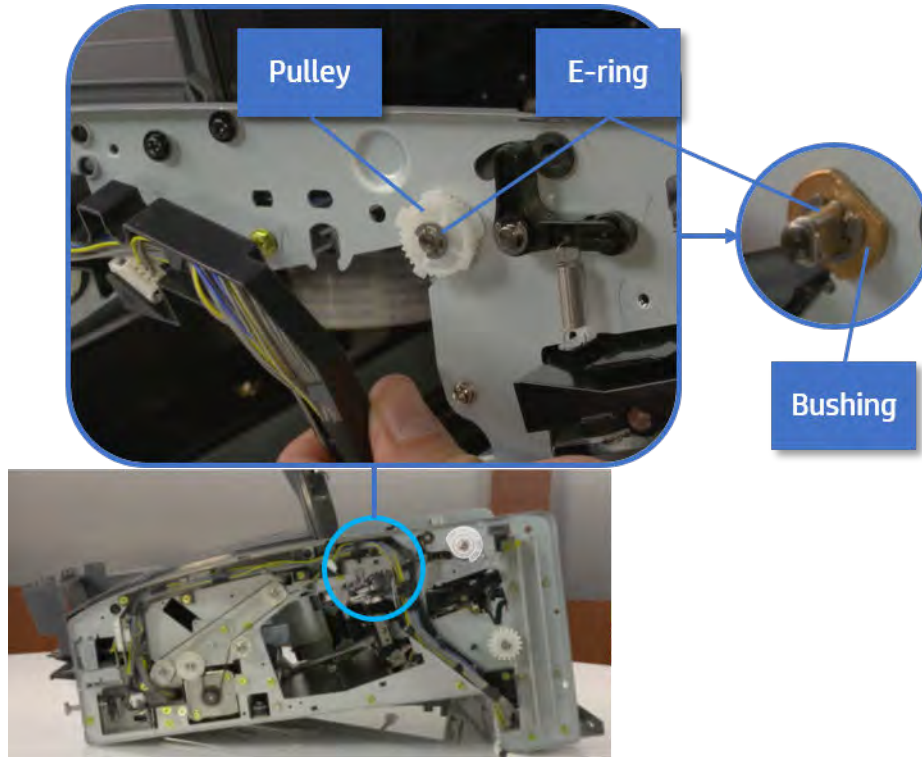

5. Push the bushing to detach it, and then remove the exit roller.

Figure 7-559 Remove the exit roller

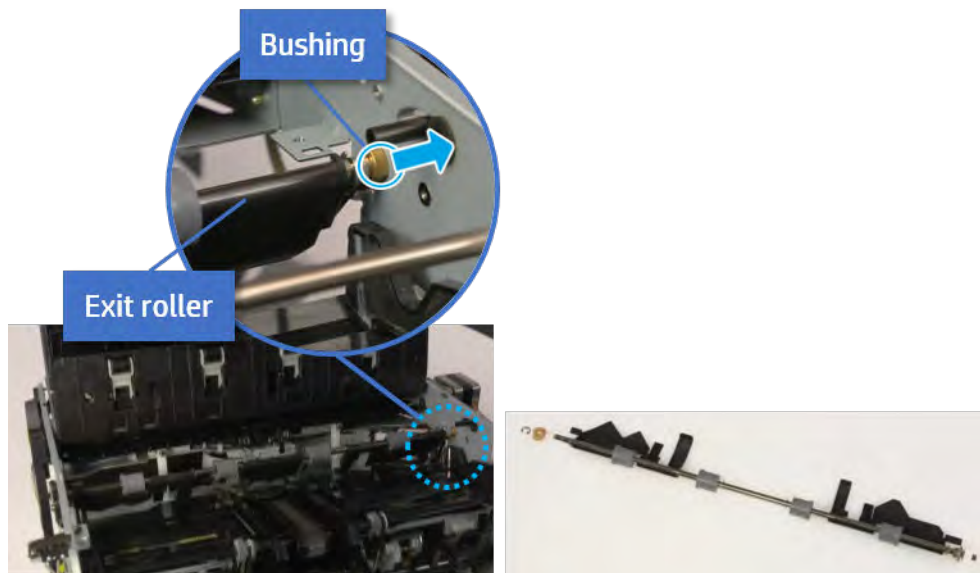

Remove the front tamper

Follow these steps to remove the front tamper.

1. Remove four screws.

Figure 7-560 Remove four screws

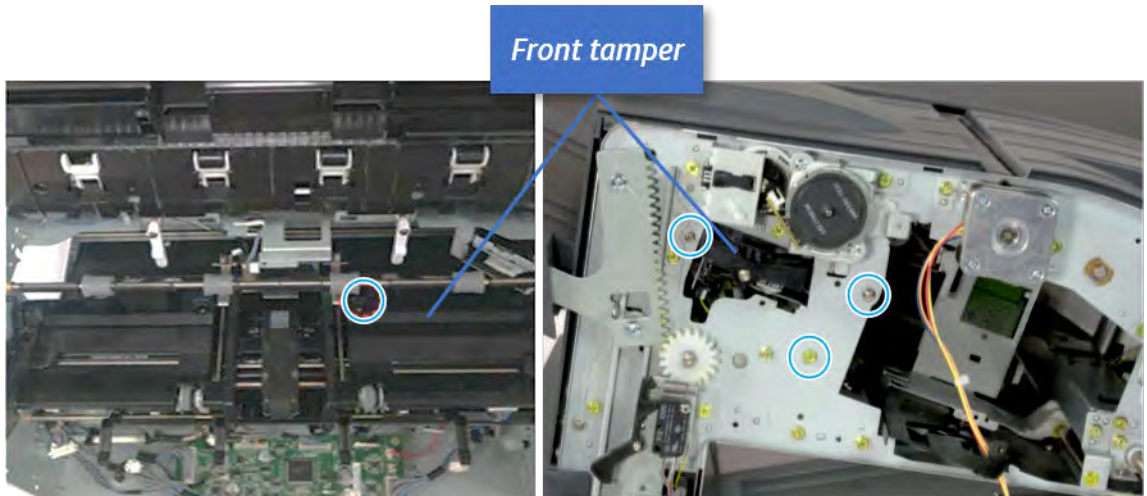

2. Unplug the connector and release the hook, and then pull the front tamper up to remove.

Figure 7-561 Remove the front tamper

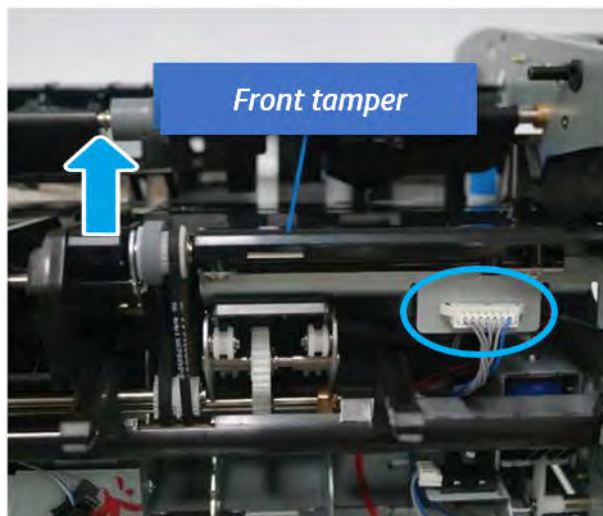

Remove the rear tamper

Follow these steps to remove the rear tamper.

1. Remove four screws.

 **NOTE:** Move cable guide out of position to access the screws.

Figure 7-562 Remove four screws



2. Unplug two connectors and release the hook, and then remove the rear tamper.

Figure 7-563 Remove the rear tamper

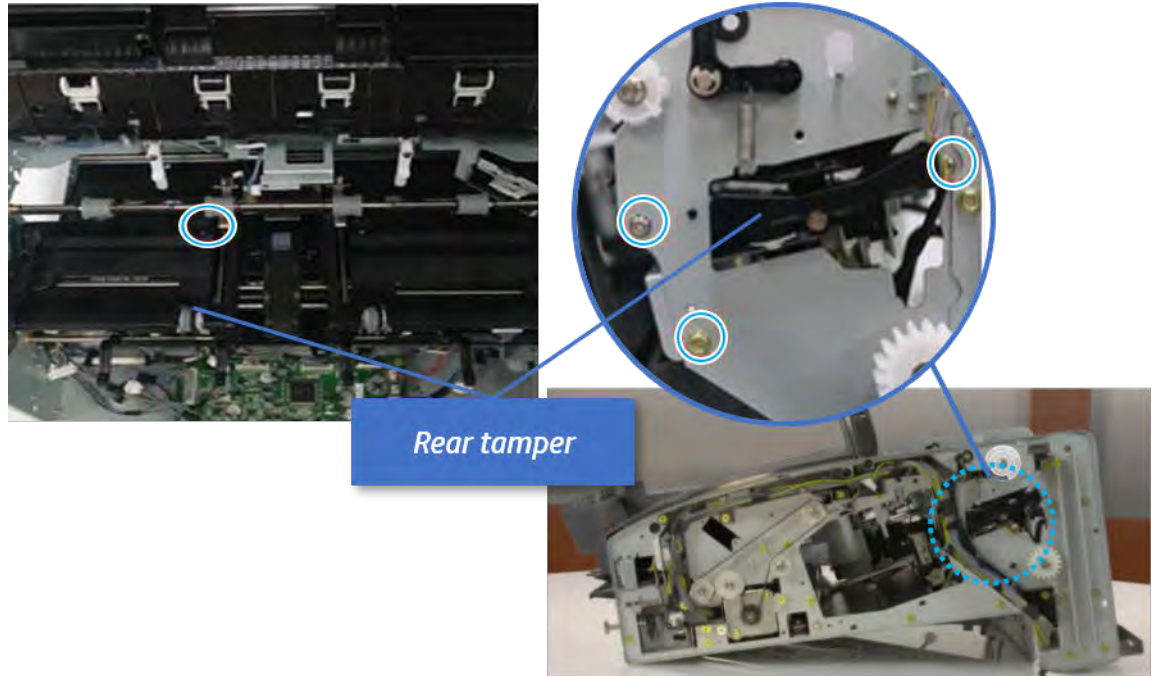
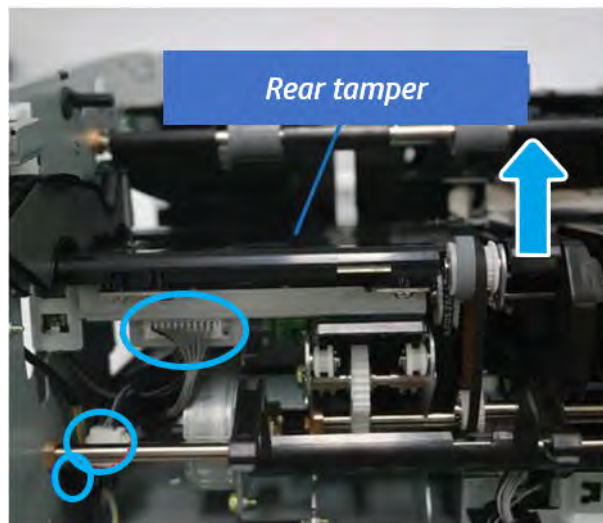

Remove the ejector & paper support assembly

Follow these steps to remove the ejector & paper support assembly.

1. Open one clamp, disconnect one connector.

Figure 7-564 Disconnect one connector

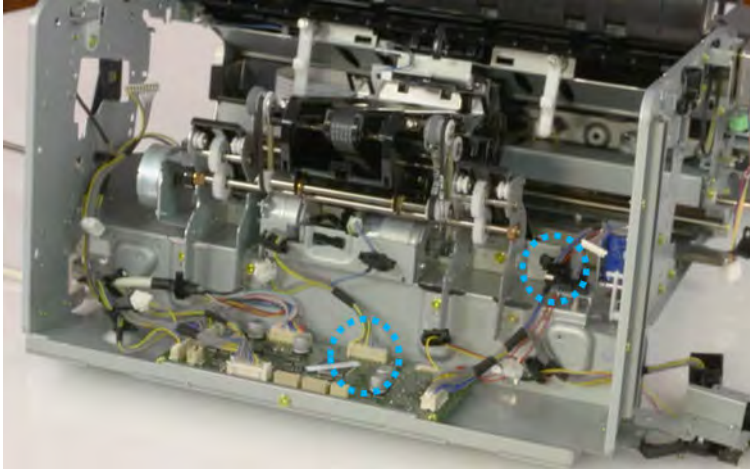

2. Pull the rear paper support up, and then release one clamp and disconnect two connectors.

Figure 7-565 Disconnect two connector

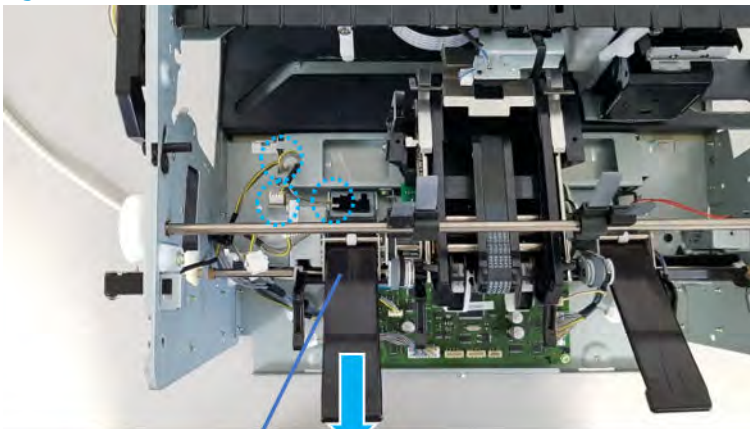

Rear paper support

3. Remove four screws, and then remove the ejector & paper support assembly.

Figure 7-566 Remove the ejector & paper support assembly

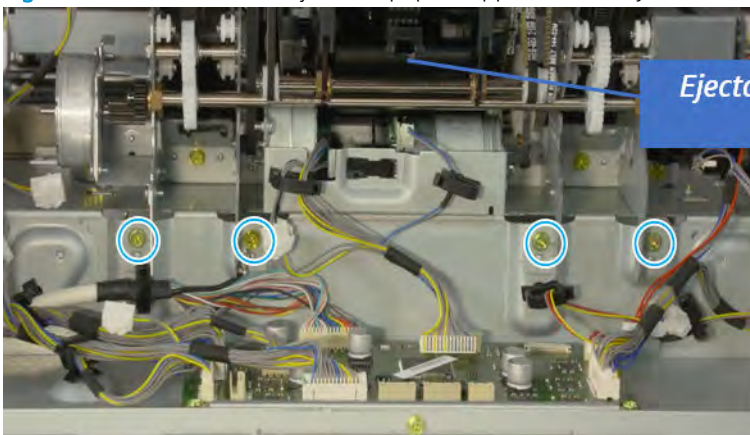

Remove the front paper support and the rear paper support

Follow these steps to remove the front paper support and the rear paper support.

- ▲ Remove two screws, and then pull the paper support assembly out of ejector assembly.

Figure 7-567 Remove paper support assembly

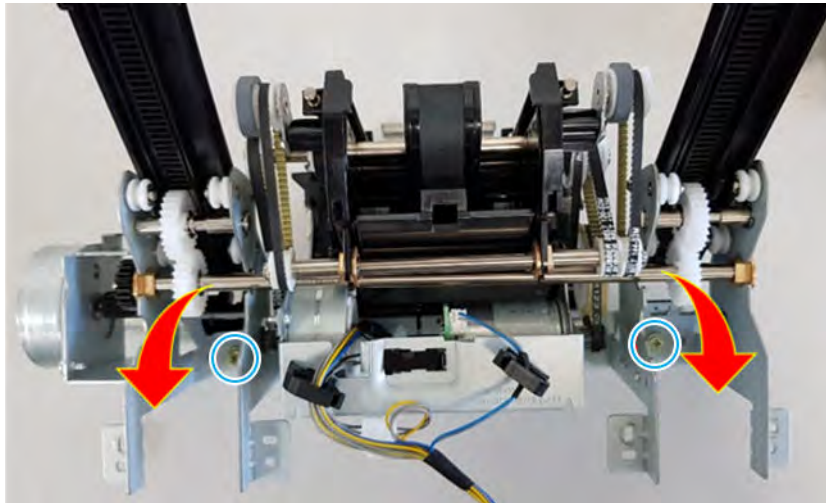

Remove the ejector motor assembly

Follow these steps to remove the ejector motor assembly.

1. Remove the e-ring and washer. Remove two timing belts, and then remove one screw.

Figure 7-568 Remove e-ring, washer, belt, and screw

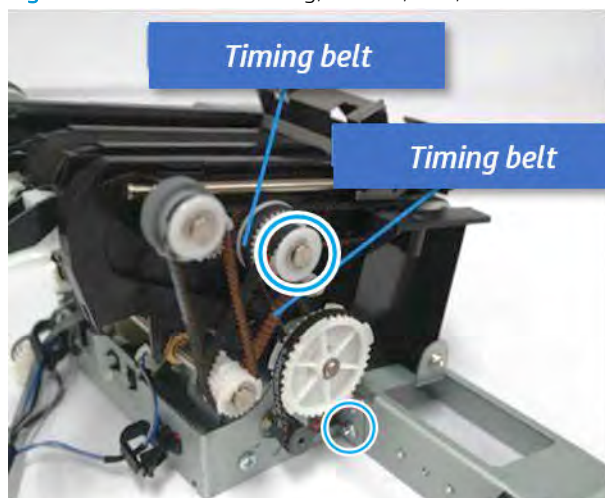

2. Remove the timing belt, and then remove one screw.

Figure 7-569 Remove the belt, screw

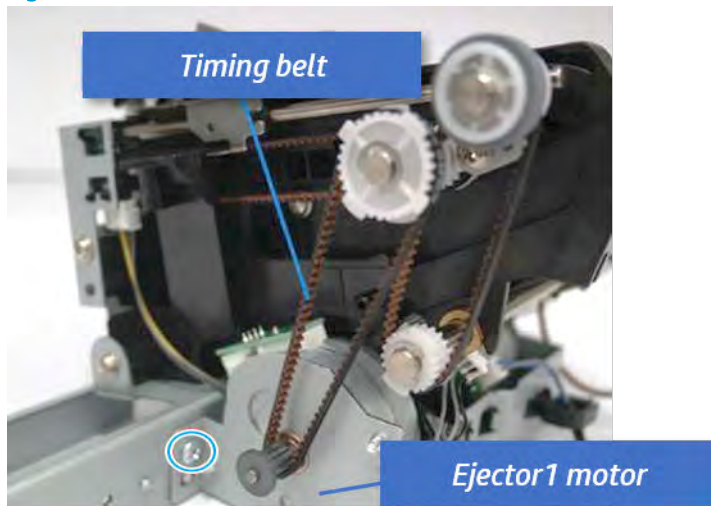

3. Remove the cable from clamp, and then disconnect two motor connectors and the sensor connector.

Figure 7-570 Disconnect the motor and sensor connectors

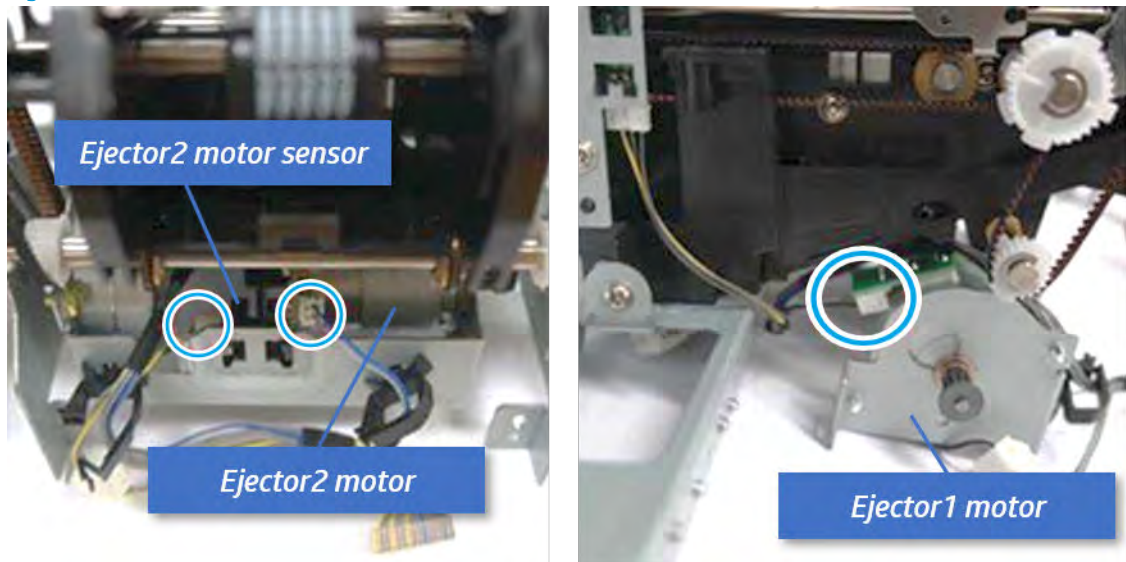

4. Remove the ejector motor assembly.

Figure 7-571 Remove the ejector motor assembly

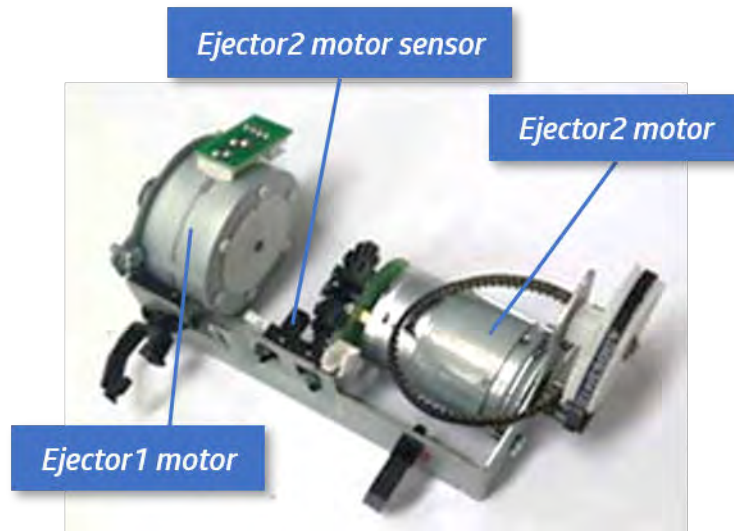

Unpack the replacement assembly



Follow these steps to unpack the replacement assembly.

1. Dispose of the defective part.

 **NOTE:** HP recommends responsible disposal of the defective part.

<http://www8.hp.com/us/en/hp-information/environment/product-recycling.html>

2. Unpack the replacement part from the packaging.

 **CAUTION:**  Some parts are sensitive to electrostatic discharge (ESD). Always perform service work at an ESD-protected workstation or mat. If an ESD workstation or mat is not available, touch the sheet-metal chassis to provide a static ground before touching an ESD-sensitive assembly. Protect the ESD-sensitive assemblies by placing them in ESD pouches when they are out of the printer.

 **IMPORTANT:** Make sure that all of the shipping materials (for example shipping tape) are removed from the replacement part prior to installation.

 **NOTE:** If the replacement part is a roller or pad, avoid touching the spongy part of it. Skin oils on the roller or pad can cause paper pickup and/or print-quality problems. HP recommends using disposable gloves when handling rollers or pads or washing your hands before touching rollers or pads.

3. To install an assembly, reverse the removal steps.

 **NOTE:** When applicable, special installation instructions are provided for an assembly at the end of the removal procedure. Always completely read the removal instructions and follow all special installation instructions.

Removal and replacement: Ejector assembly (include end fence, S10/ S16)

Learn how to remove and replace the ejector assembly.

View videos on how to remove and reassemble the inner finisher below:



[View a teardown video of the inner finisher .](#)



[View a reassembling video of the inner finisher .](#)



IMPORTANT: When applicable, special installation instructions are provided for an assembly at the end of the removal procedure. Always completely read the removal instructions and follow all special installation instructions.

Mean time to repair:

Service level:

Before performing service

Turn the printer power off

- Press the power button on the front of the printer, and then turn off the power switch next to the power cable.
- A shutting-down message appears on the control-panel display.



WARNING! To avoid damage to the printer, turn the power off and wait until the printer shuts down before removing the power cable.

- Disconnect the printer power cable after the printer has completely shut down (the control-panel display is blank).

Use the table below to identify the correct part number for your printer. To order the part, go to www.hp.com/buy/parts.

Table 7-64 Part information

Part number	Part description
SS456-61001	Ejector

Required tools

- #2 JIS screwdriver with a magnetic tip

After performing service

Turn the printer power on

- Connect the power cable.
- Use the power switch to turn the power on.

Post service test

Print any pages necessary to verify that the repair resolved the issue and did not create any new issues.

Remove the front cover

Follow these steps to remove the front cover.

1. Open the front door and open the punch cover.
2. Remove three screws in the front.
3. Remove the lever.
4. Open the top cover.
5. From the right side of the front cover, carefully lift and pry toward the top-left corner to remove the front cover.

Figure 7-572 Remove the front cover

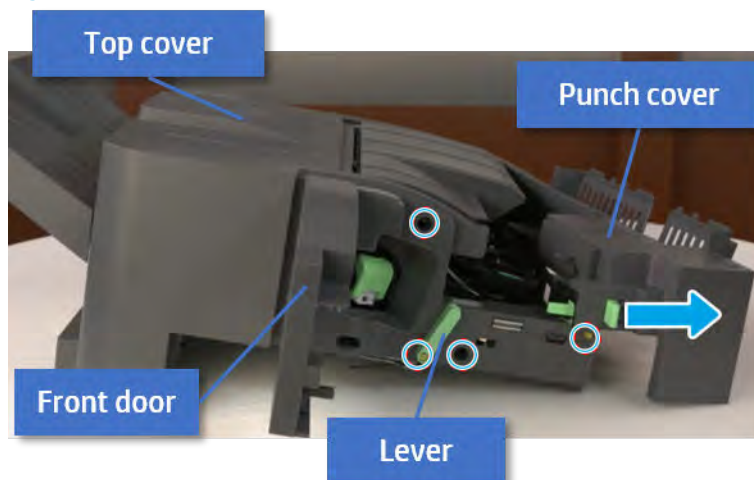

Remove the rear cover

Follow these steps to remove the rear cover.

1. Open the top cover.

Figure 7-573 Open the top cover

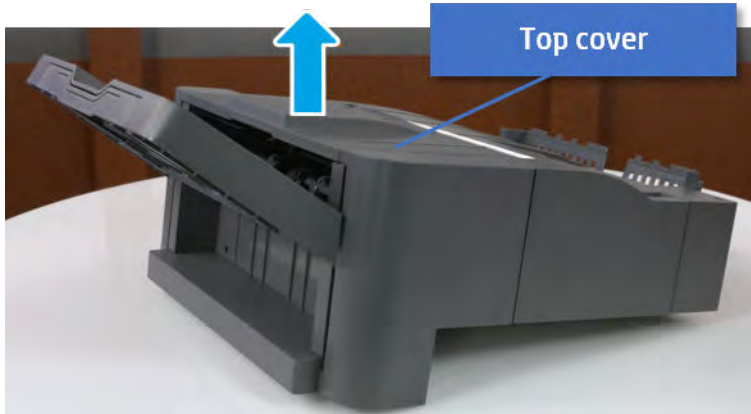

2. Remove three screws.
3. Release hooks carefully and remove the rear cover.

Figure 7-574 Remove the rear cover

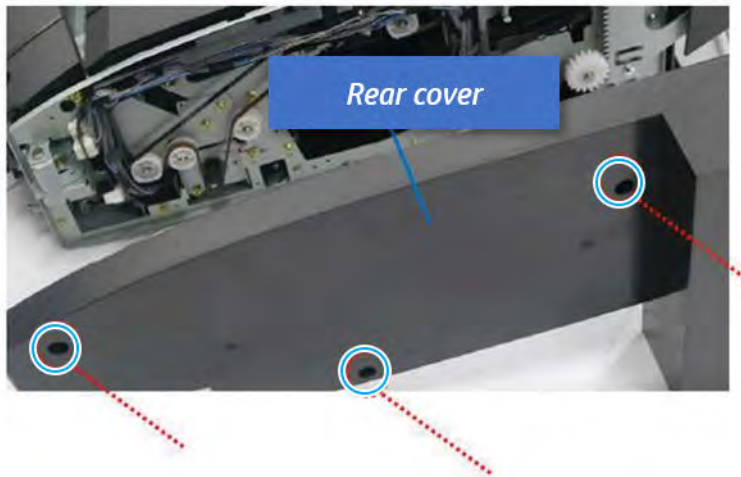

Remove the output tray

Follow these steps to remove the output tray.

1. Remove four screws.

Figure 7-575 Remove four screws

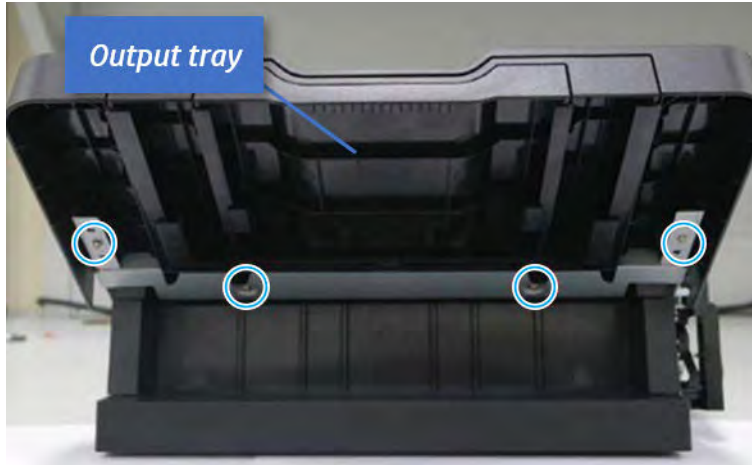

2. Push the paper holding actuator into the inner finisher, and then remove the output tray.

Figure 7-576 Remove the output tray.



Remove the output tray frame

Follow these steps to remove the output tray frame.

1. Rotate the pulley until the output tray frame depart from the gear.

Figure 7-577 Remove the pulley

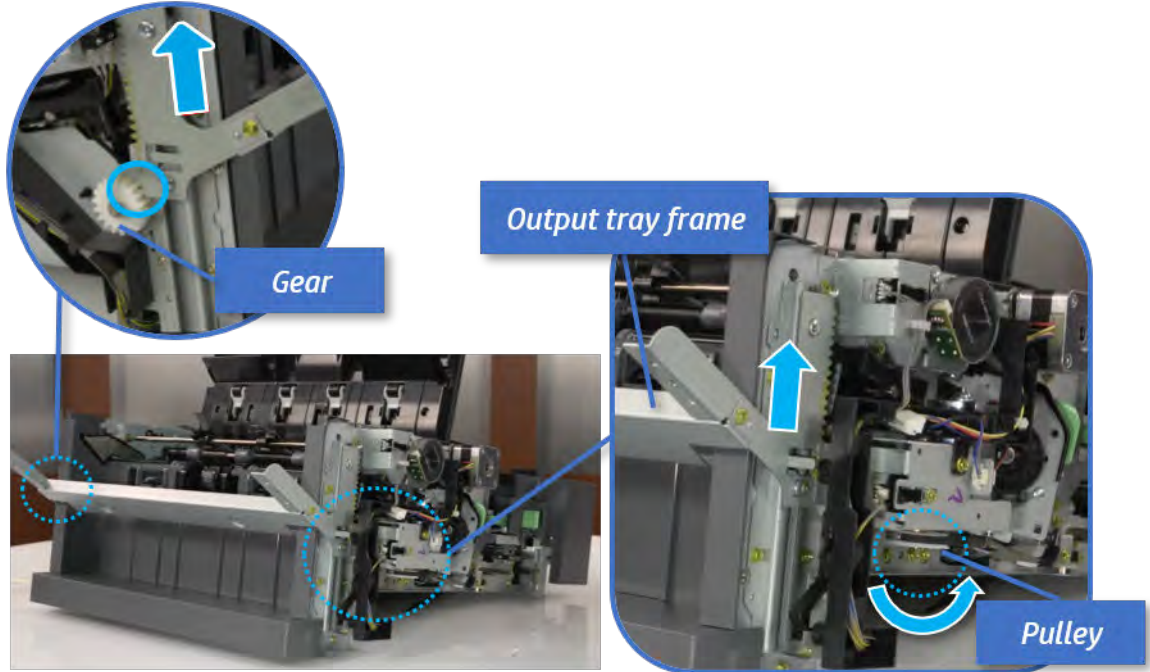

2. Push the paper holding actuator into the inner finisher, and then remove the output tray frame.

Figure 7-578 Remove the output tray frame

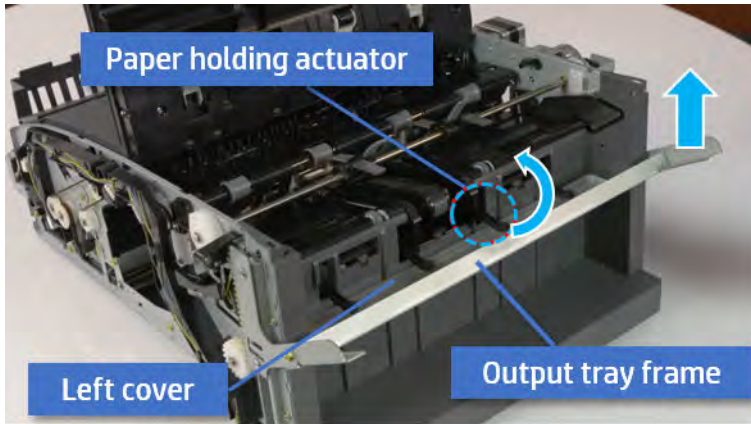

TIP: Push the paper holding actuator into the inner finisher when reassembling. Be sure to level the output tray.

- a. Position the first wheel into the channel on both sides while pushing the paper holding actuator.

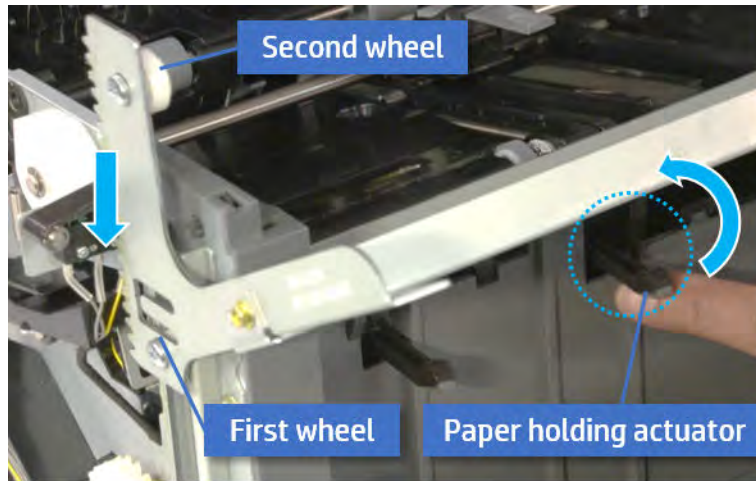

- b. Let the second wheel rest on the channel on both sides simultaneously.
- c. Gently squeeze the wheels into channel until the output tray frame meet the gear.

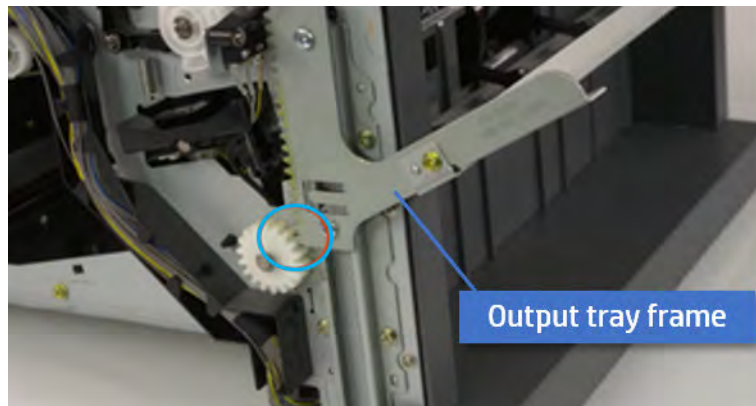

- d. Rotate the pulley until the output tray frame is no longer lifted. It can make to level the output tray frame.

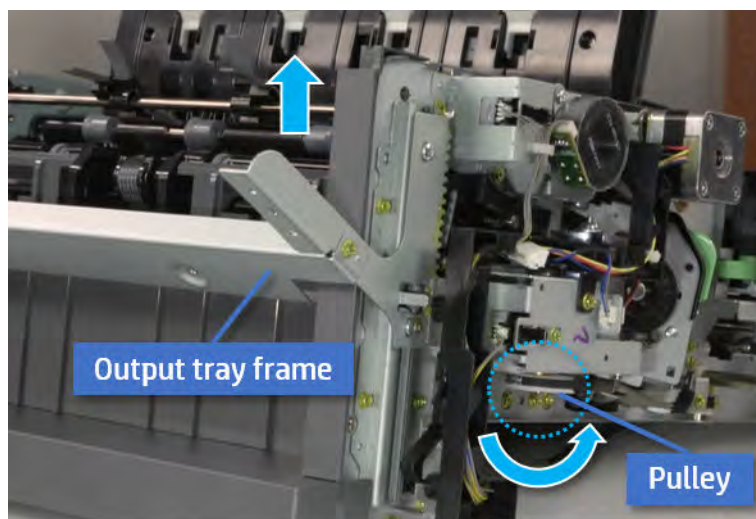

- e. Rotate the pulley in the opposite direction.

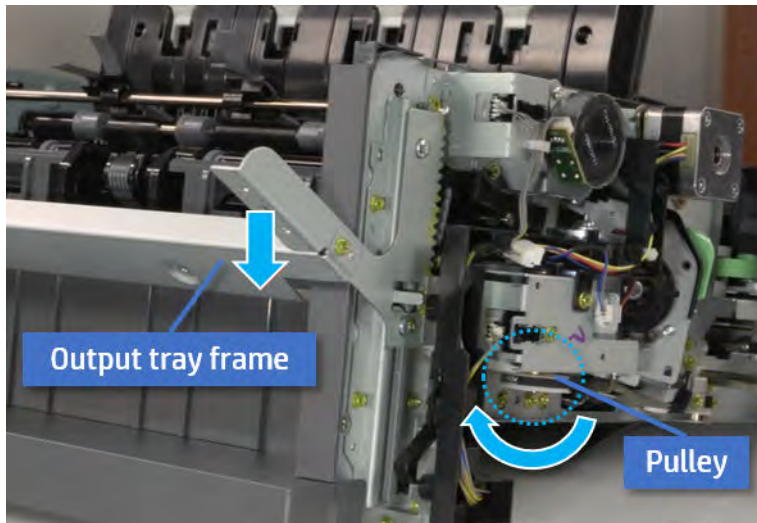

Remove the PCA cover

Follow these steps to remove the PCA cover.

- ▲ Remove two screws, and then remove the PCA cover.

Figure 7-579 Remove the PCA cover

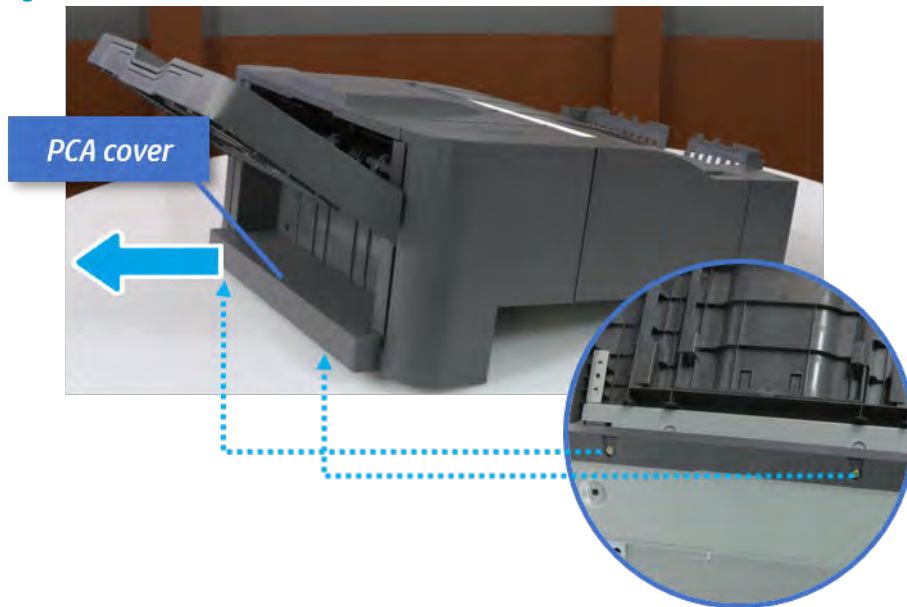

Remove the left cover

Follow these steps to remove the left cover.

1. Remove two screws.

Figure 7-580 Remove two screws

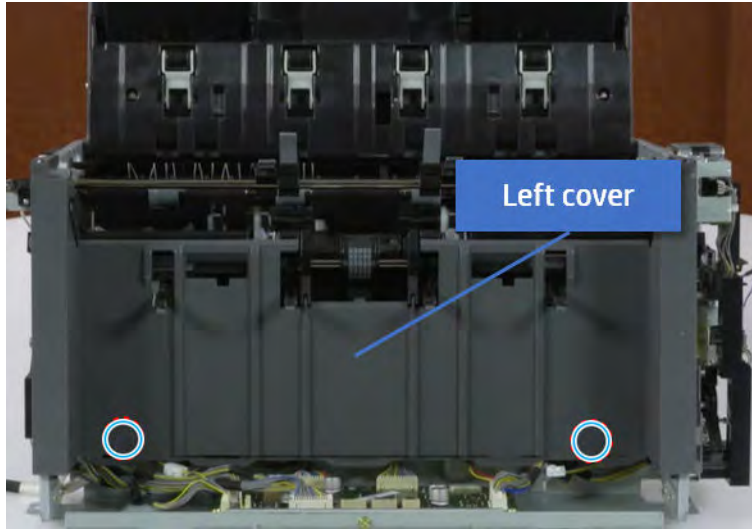

2. Remove four screws from both front and rear sides.

Figure 7-581 Remove four screws

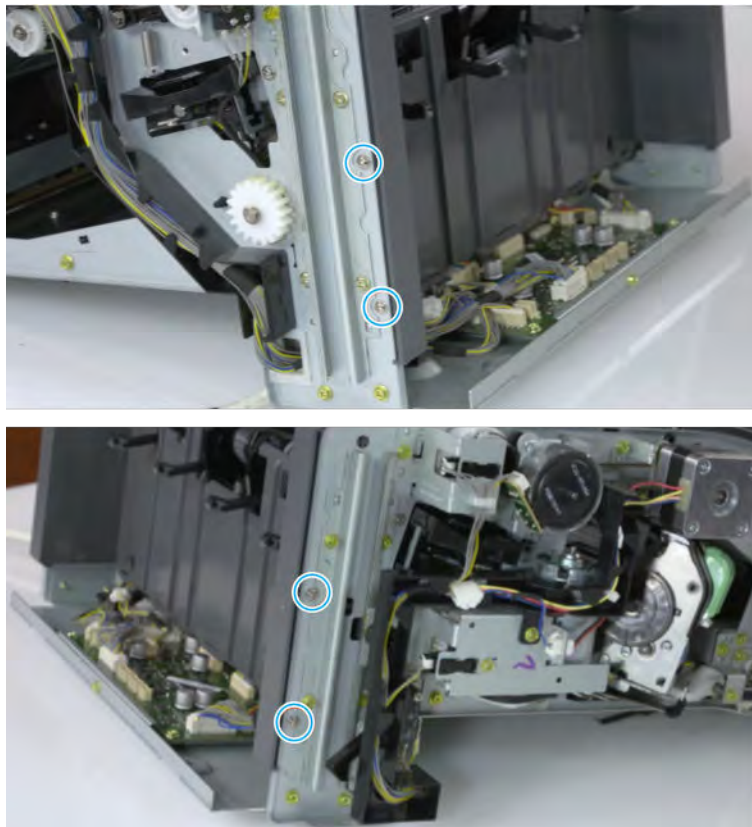

3. Unplug two inline connectors, and then remove the left cover.

Figure 7-582 Unplug two connectors

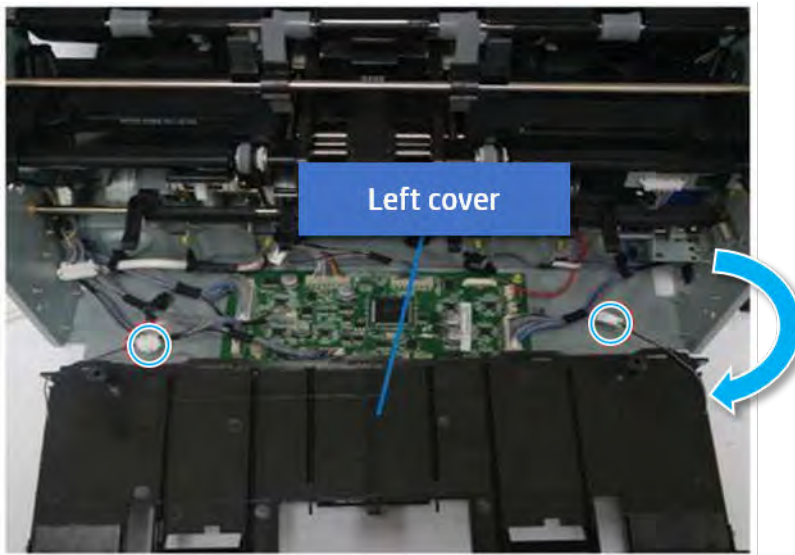

 **TIP:** Be sure to check the hook when reassembling.

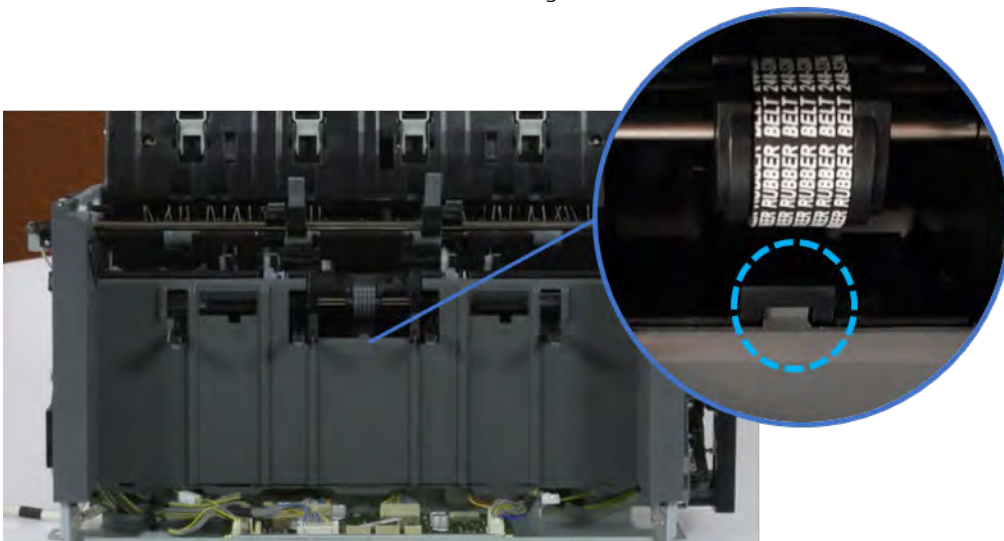

Remove the front harness guide

Follow these steps to remove the front harness guide.

1. Open one clamp and unplug five connectors, and then remove the wire harness from the front harness guide.

2. Remove four screws, and then remove the front harness guide.

Figure 7-583 Remove the front harness guide

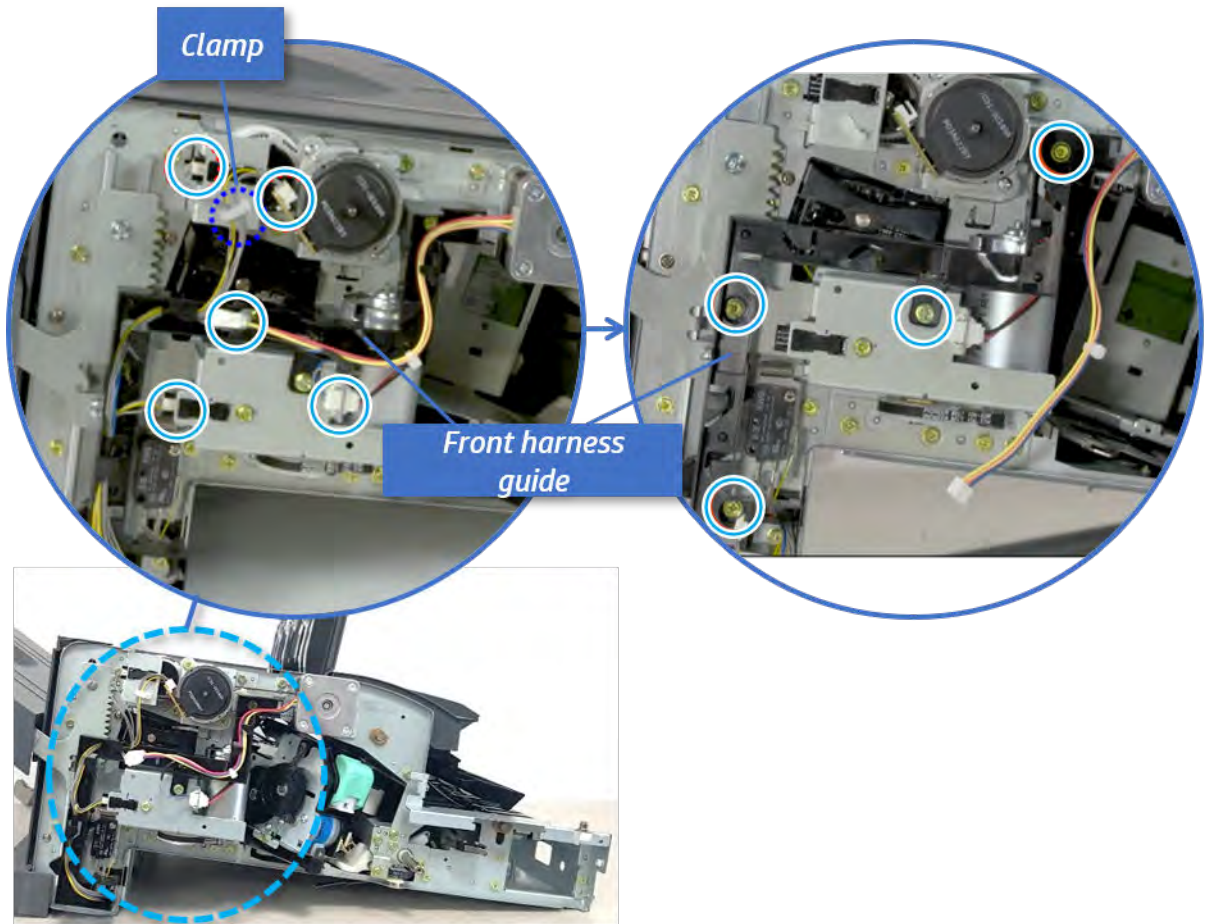

Remove the output tray motor assembly

Follow these steps to remove the output tray motor assembly.

- ▲ Remove three screws, and then remove the output tray motor assembly.

Figure 7-584 Remove the output tray motor assembly

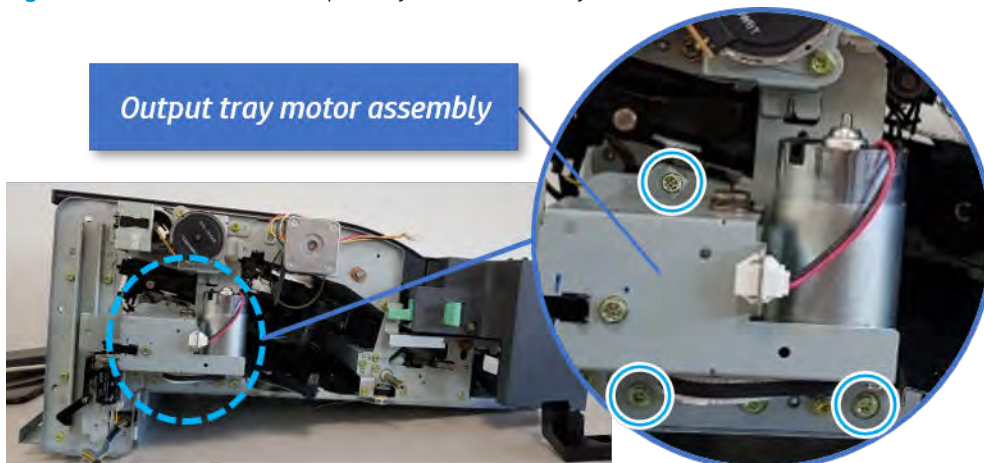

Remove the output tray lower limit switch

Follow these steps to remove the output tray lower limit switch.

- ▲ Remove one screw, and then remove the output tray lower limit switch.

Figure 7-585 Remove the output tray lower limit switch

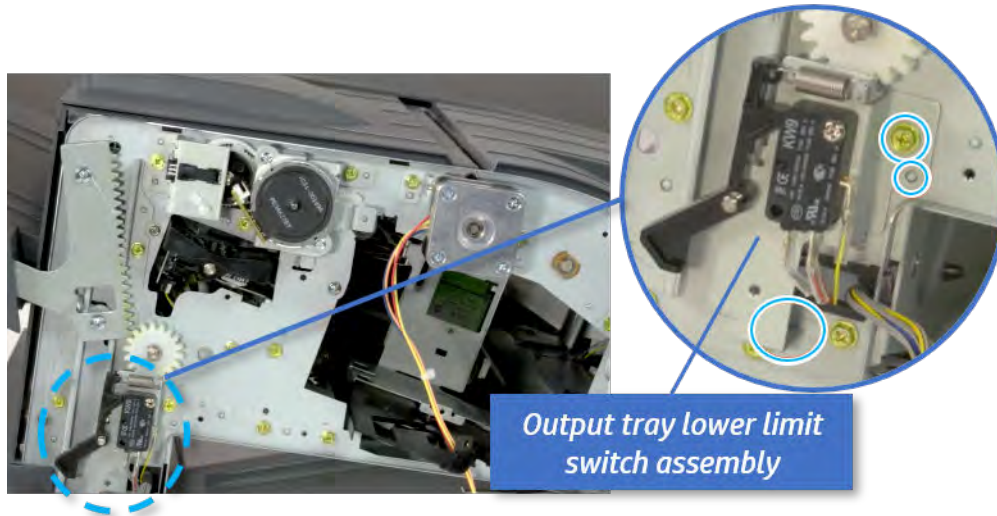

Remove the paper holding

Follow these steps to remove the paper holding.

1. Remove the paper holding actuator spring.

Figure 7-586 Remove the paper holding actuator spring

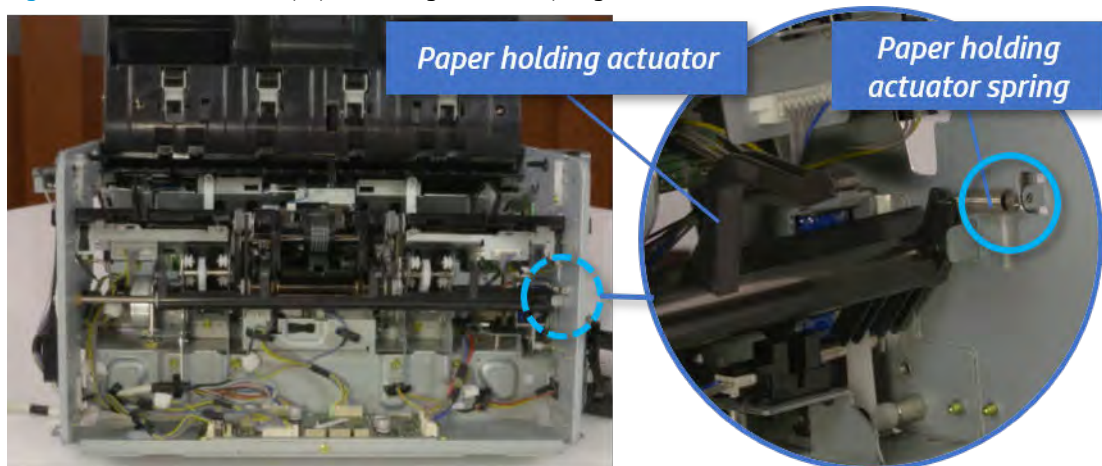

2. Remove the e-ring and the rack pinion gear. And then remove the pin and the e-ring, and then remove the bushing.

Figure 7-587 Remove e-ring, rack pinion gear, pin, and bushing

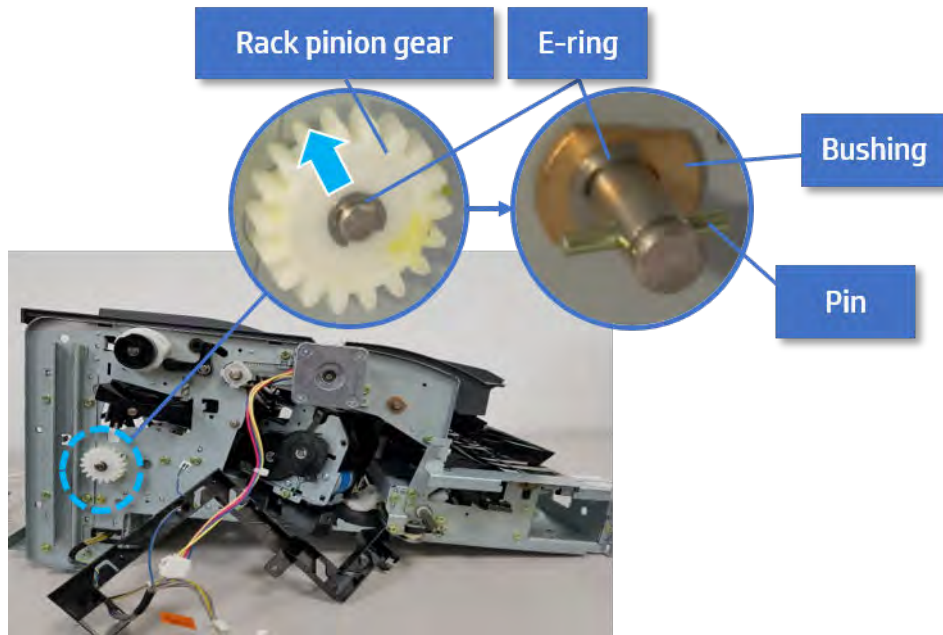

 **NOTE:** Be sure not to lose the pin.

3. Carefully remove the paper holding shaft and the actuator.

Figure 7-588 Remove the paper holding shaft and the actuator

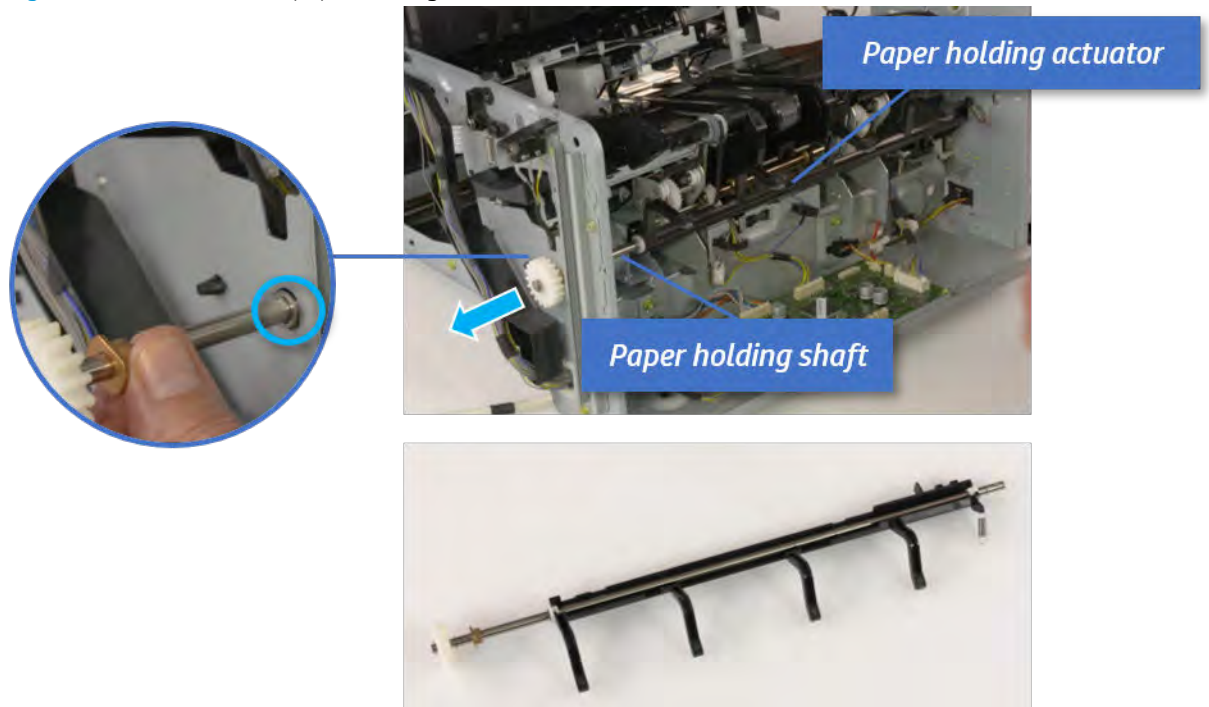

Remove the sub paddle unit

Follow these steps to remove the sub paddle unit.

1. Open the top cover, and then remove one screw securing the sub paddle unit.

Figure 7-589 Remove one screw

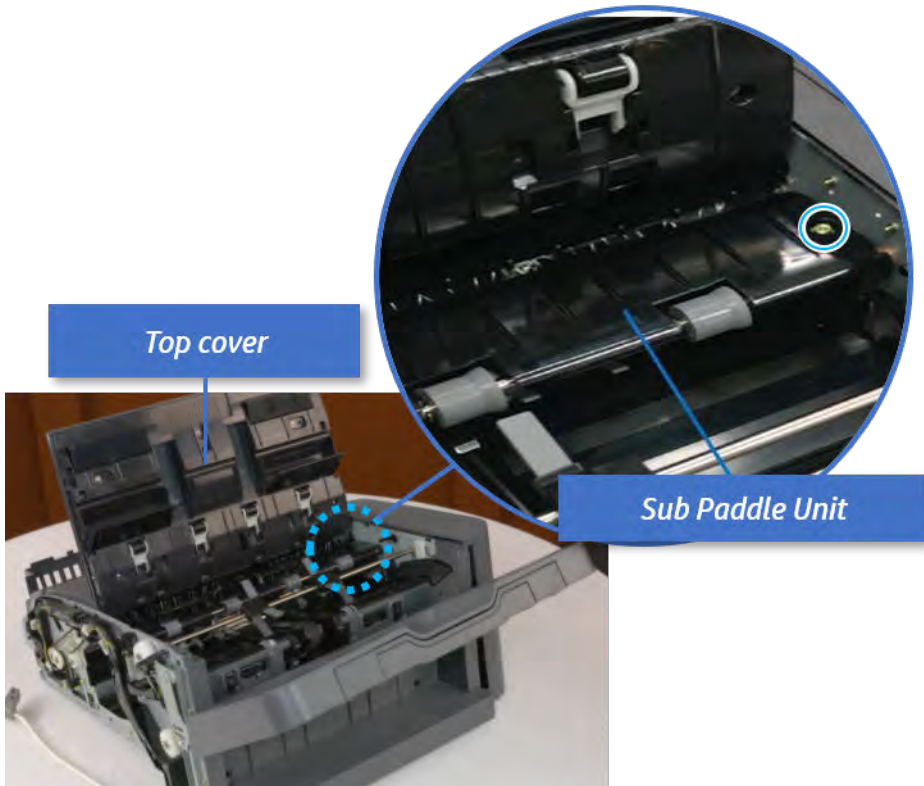

2. Remove the e-ring, and then remove the pulley and timing belt. And then remove the e-ring and the bushing.

Figure 7-590 Remove the e-ring, pulley, timing belt, and bushing

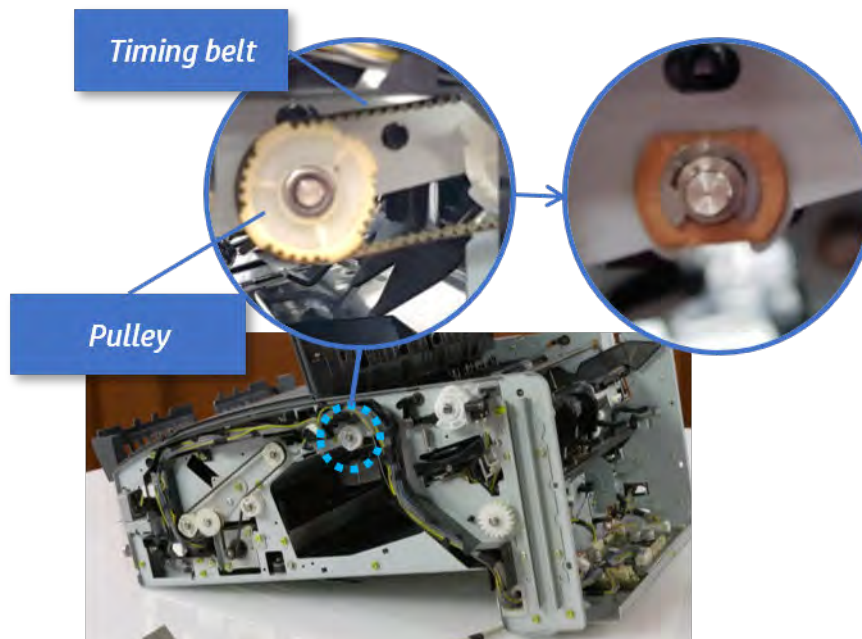

3. Lift up and remove the sub paddle unit.

Figure 7-591 Remove the sub paddle unit

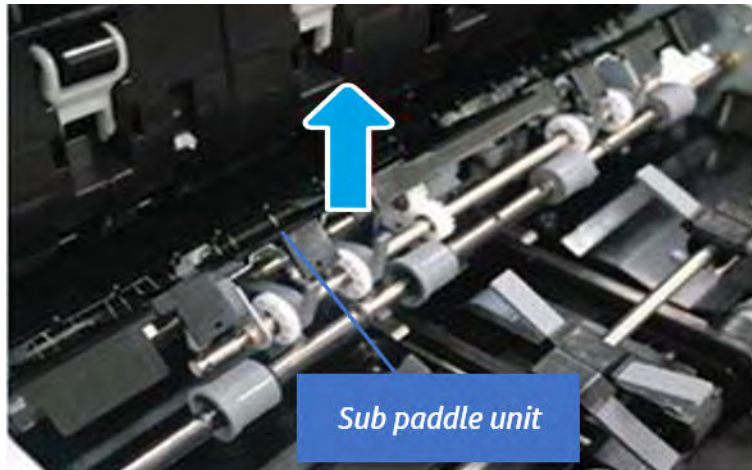

Remove the exit roller

Follow these steps to remove the exit roller.

1. Remove the guide on the center of the exit roller.

Figure 7-592 Remove the guide

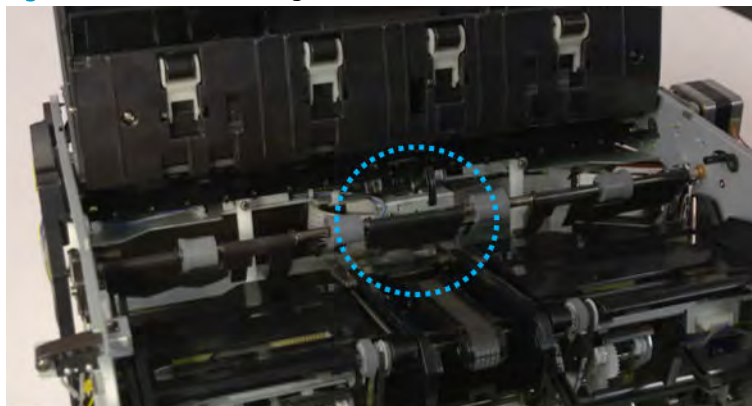

2. On the front of the inner finisher, release the timing belt connected to the exit motor.

Figure 7-593 Release the timing belt

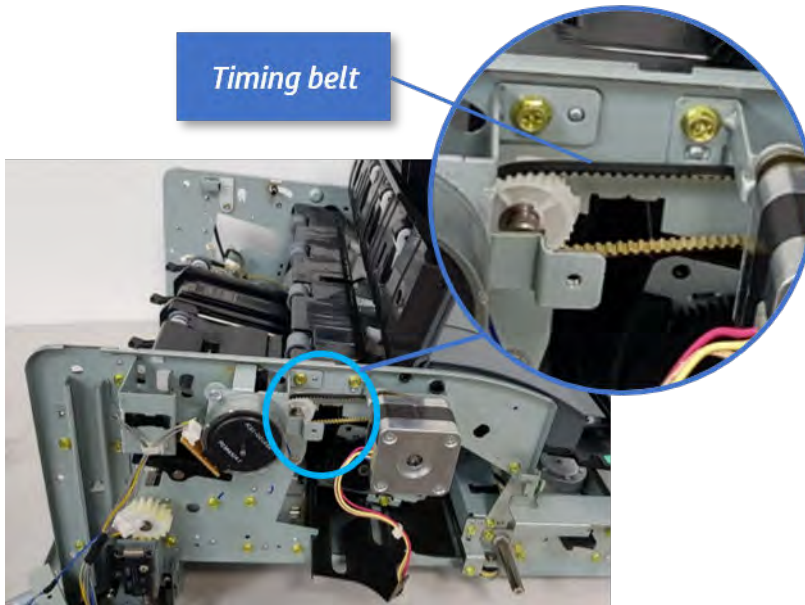

3. Remove five screws securing the rear harness guide.

Figure 7-594 Remove five screws

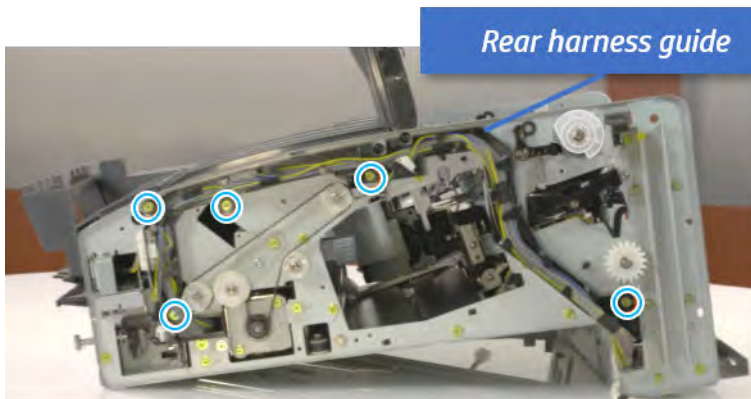

4. On the rear of the inner finisher, remove the e-ring and the pulley and then remove the e-ring and the bushing.

Figure 7-595 Remove e-ring, pulley, and bushing

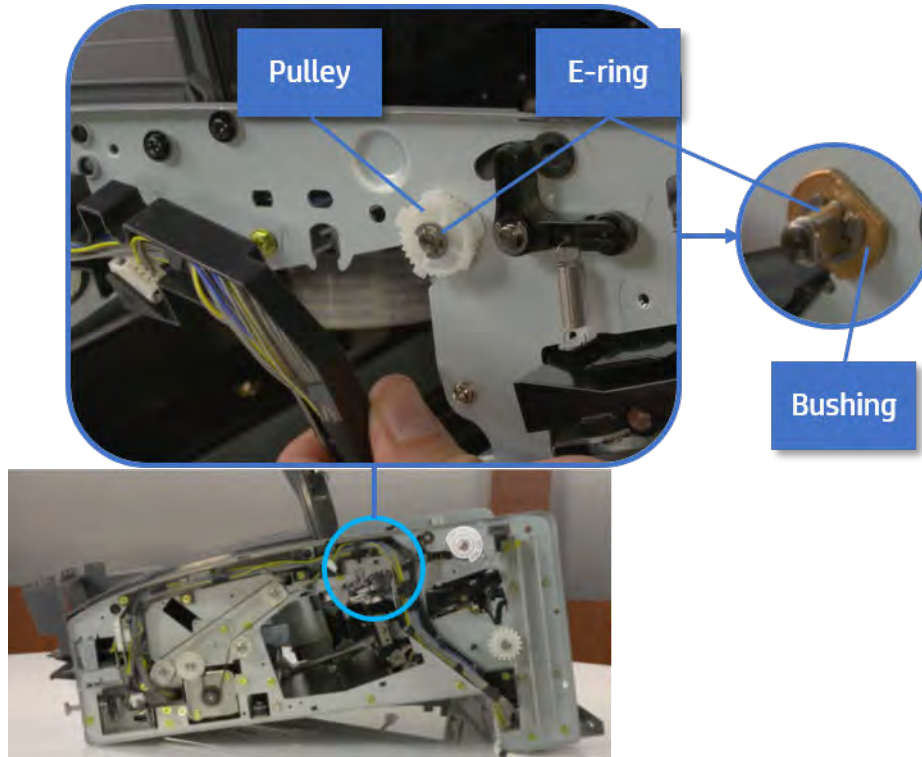

5. Push the bushing to detach it, and then remove the exit roller.

Figure 7-596 Remove the exit roller

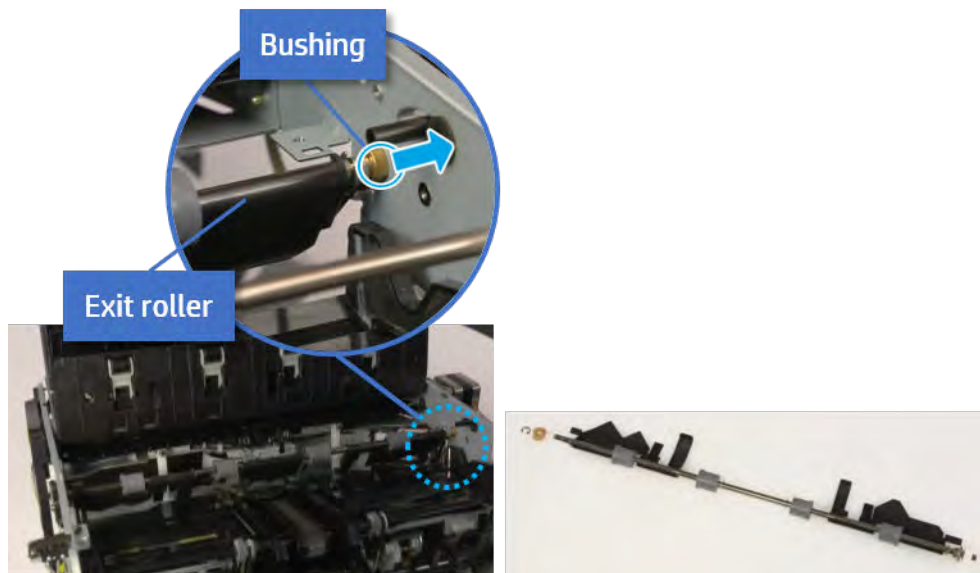

Remove the front tamper

Follow these steps to remove the front tamper.

1. Remove four screws.

Figure 7-597 Remove four screws

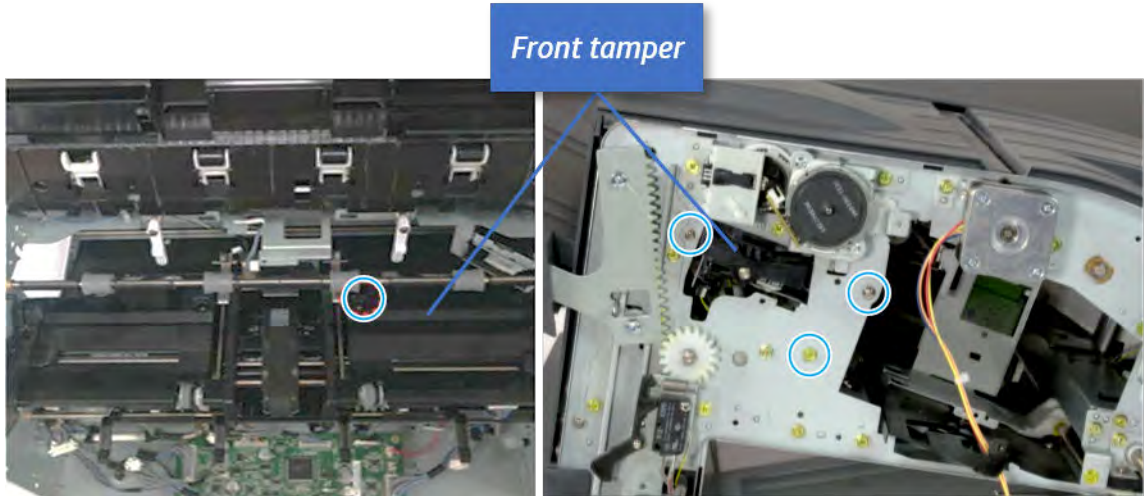

2. Unplug the connector and release the hook, and then pull the front tamper up to remove.

Figure 7-598 Remove the front tamper

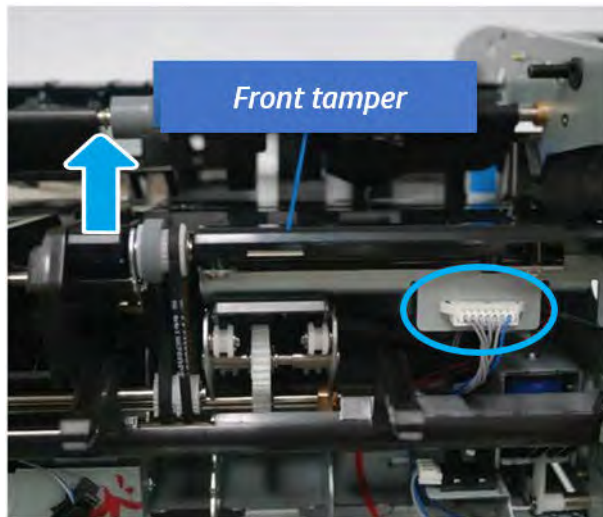

Remove the rear tamper

Follow these steps to remove the rear tamper.

1. Remove four screws.

 **NOTE:** Move cable guide out of position to access the screws.

Figure 7-599 Remove four screws



2. Unplug two connectors and release the hook, and then remove the rear tamper.

Figure 7-600 Remove the rear tamper

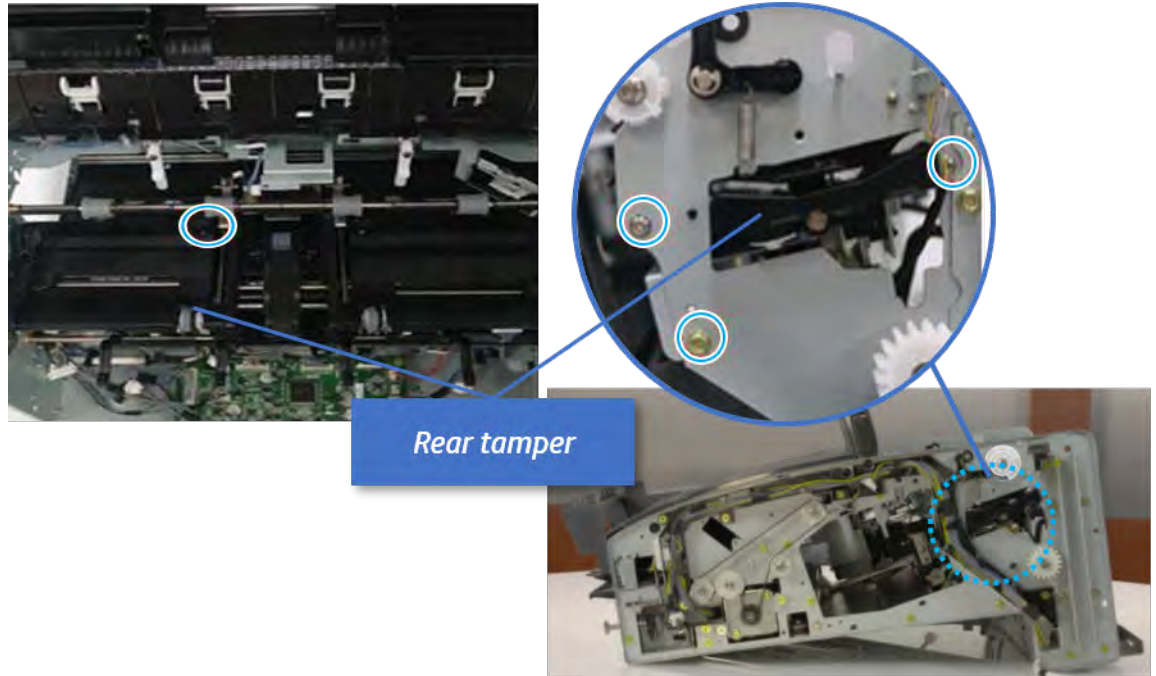
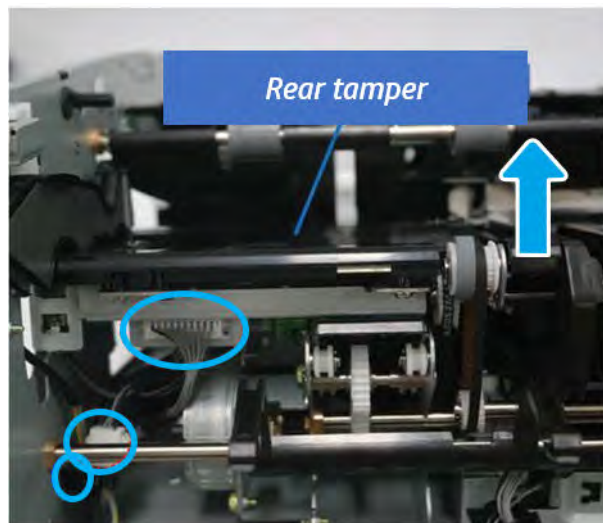

Remove the ejector & paper support assembly

Follow these steps to remove the ejector & paper support assembly.

1. Open one clamp, disconnect one connector.

Figure 7-601 Disconnect one connector

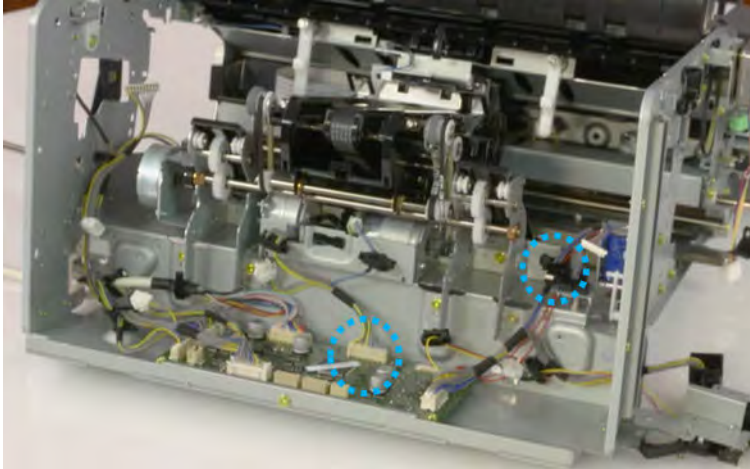

2. Pull the rear paper support up, and then release one clamp and disconnect two connectors.

Figure 7-602 Disconnect two connector

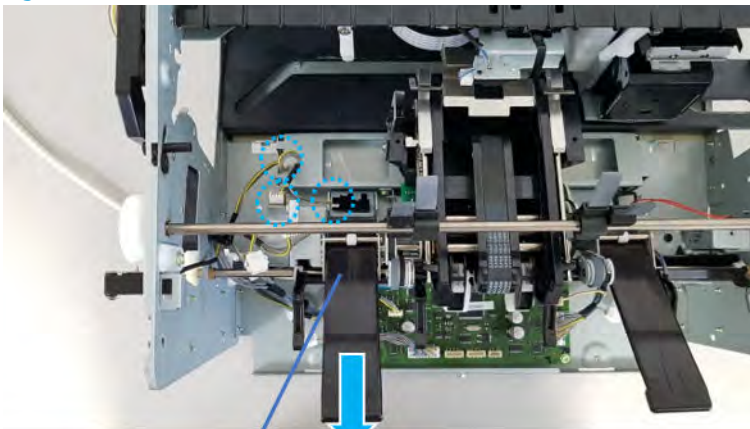

Rear paper support

3. Remove four screws, and then remove the ejector & paper support assembly.

Figure 7-603 Remove the ejector & paper support assembly

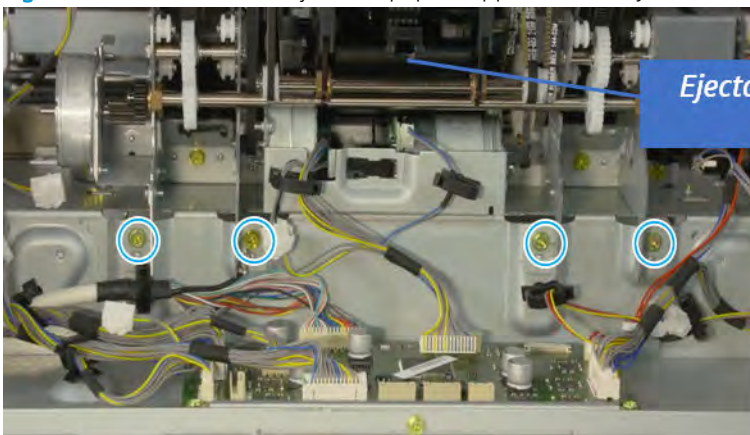

Ejector & paper support assembly

Remove the front paper support and the rear paper support

Follow these steps to remove the front paper support and the rear paper support.

- ▲ Remove two screws, and then pull the paper support assembly out of ejector assembly.

Figure 7-604 Remove paper support assembly

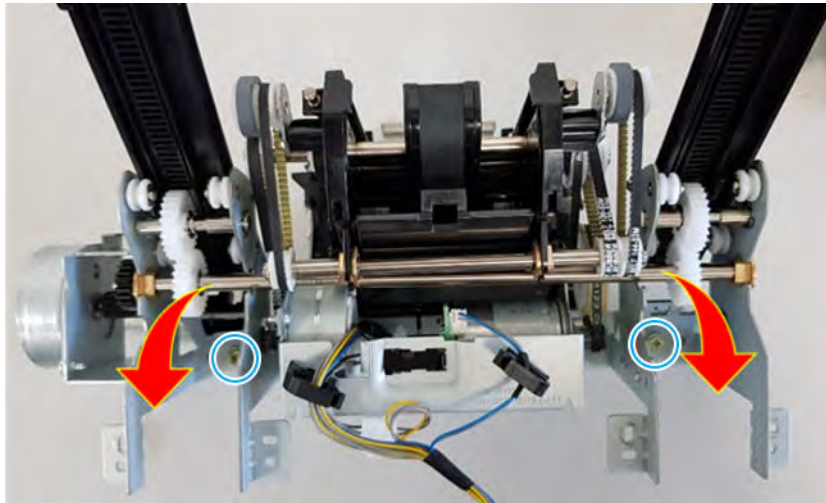

Remove the ejector motor assembly

Follow these steps to remove the ejector motor assembly.

1. Remove the e-ring and washer. Remove two timing belts, and then remove one screw.

Figure 7-605 Remove e-ring, washer, belt, and screw

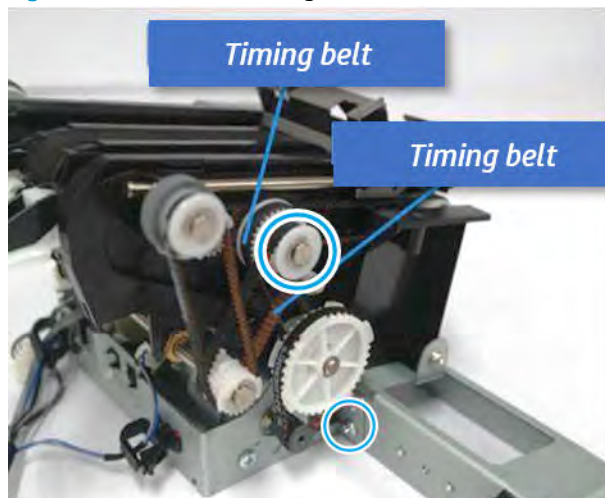

2. Remove the timing belt, and then remove one screw.

Figure 7-606 Remove the belt, screw

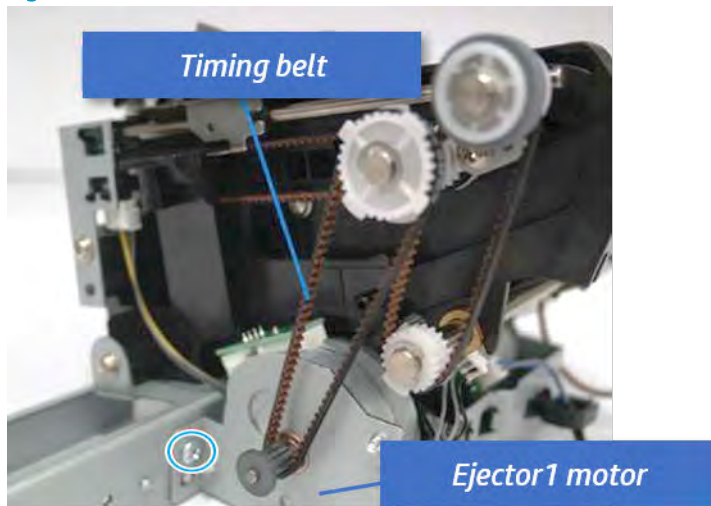

3. Remove the cable from clamp, and then disconnect two motor connectors and the sensor connector.

Figure 7-607 Disconnect the motor and sensor connectors

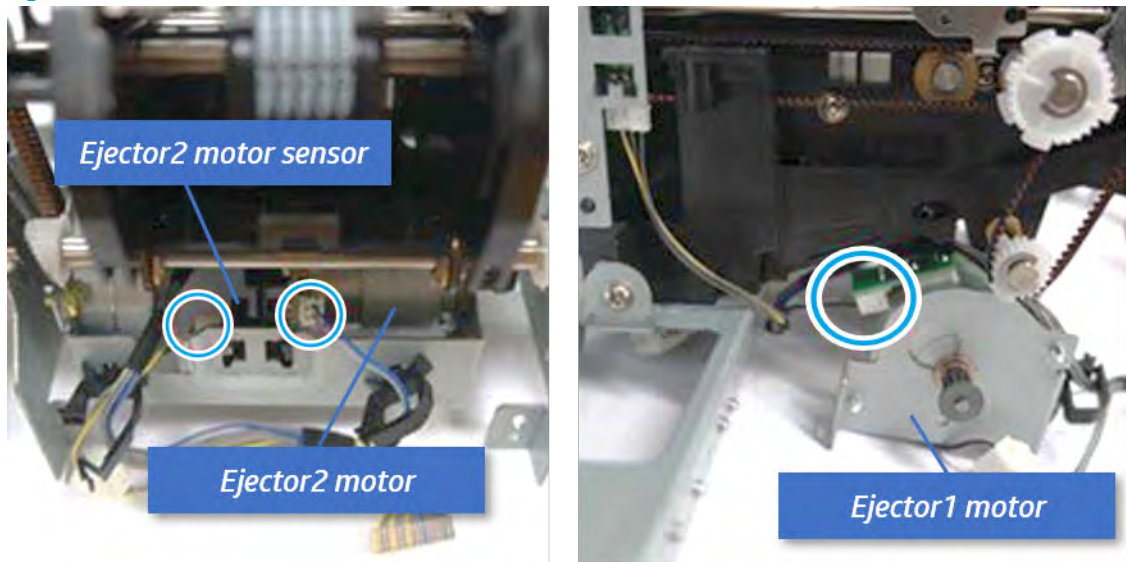

4. Remove the ejector motor assembly.

Figure 7-608 Remove the ejector motor assembly

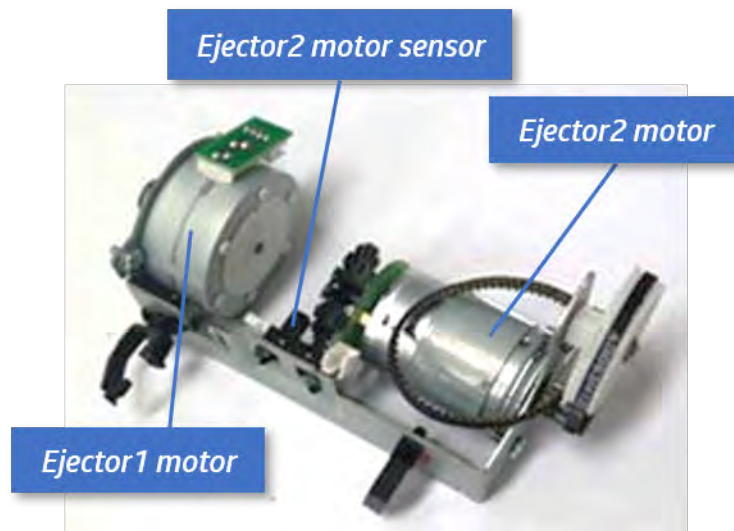

Remove the ejector assembly

Follow these steps to remove the ejector assembly.

1. Remove two screws.

Figure 7-609 Remove two screws

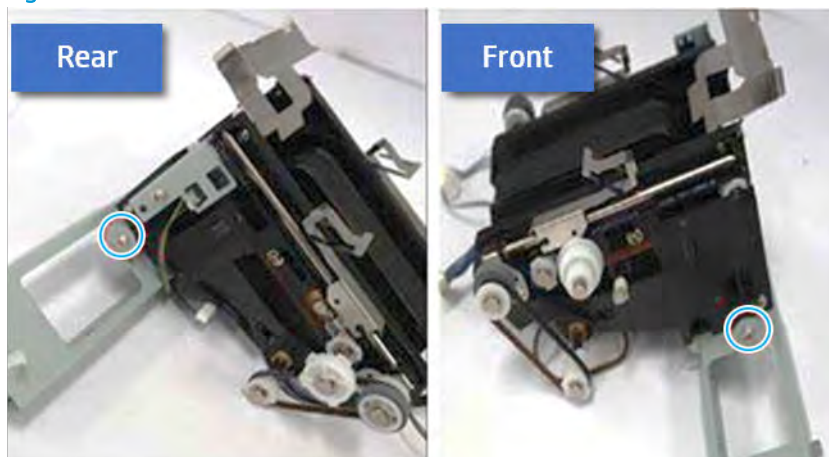

2. Unplug two connectors, and then remove the ejector assembly.

Figure 7-610 Remove the ejector assembly

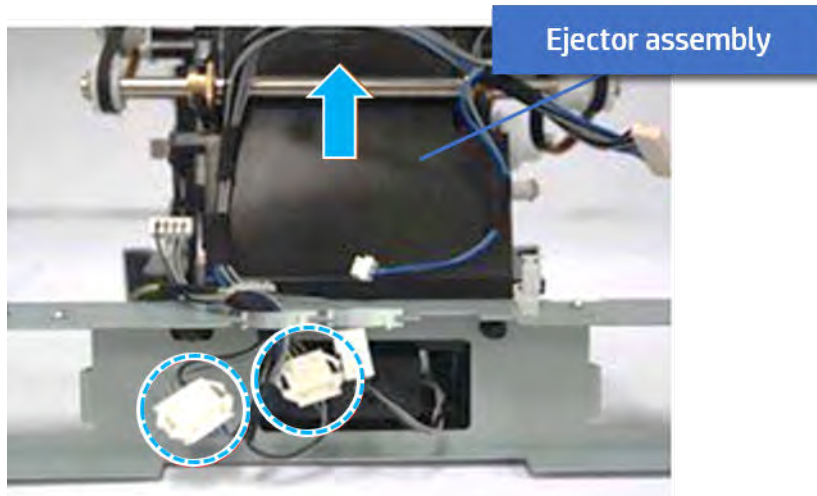

Unpack the replacement assembly



Follow these steps to unpack the replacement assembly.

1. Dispose of the defective part.

 **NOTE:** HP recommends responsible disposal of the defective part.

<http://www8.hp.com/us/en/hp-information/environment/product-recycling.html>

2. Unpack the replacement part from the packaging.

 **CAUTION:**  Some parts are sensitive to electrostatic discharge (ESD). Always perform service work at an ESD-protected workstation or mat. If an ESD workstation or mat is not available, touch the sheet-metal chassis to provide a static ground before touching an ESD-sensitive assembly. Protect the ESD-sensitive assemblies by placing them in ESD pouches when they are out of the printer.

 **IMPORTANT:** Make sure that all of the shipping materials (for example shipping tape) are removed from the replacement part prior to installation.

 **NOTE:** If the replacement part is a roller or pad, avoid touching the spongy part of it. Skin oils on the roller or pad can cause paper pickup and/or print-quality problems. HP recommends using disposable gloves when handling rollers or pads or washing your hands before touching rollers or pads.

3. To install an assembly, reverse the removal steps.

 **NOTE:** When applicable, special installation instructions are provided for an assembly at the end of the removal procedure. Always completely read the removal instructions and follow all special installation instructions.

End fence unit

Removal and replacement: End fence sensor (S17)

Learn how to remove and replace the end fence sensor.

To view teardown and reassembling video of the inner finisher, click the link below.



[View a teardown video of the inner finisher.](#)



[View a reassembling video of the inner finisher.](#)



IMPORTANT: When applicable, special installation instructions are provided for an assembly at the end of the removal procedure. Always completely read the removal instructions and follow all special installation instructions.

Mean time to repair:

Service level:

Before performing service

Turn the printer power off

- Press the power button on the front of the printer, and then turn off the power switch next to the power cable.
- A shutting-down message appears on the control-panel display.



WARNING! To avoid damage to the printer, turn the power off and wait until the printer shuts down before removing the power cable.

- Disconnect the printer power cable after the printer has completely shut down (the control-panel display is blank).

Use the table below to identify the correct part number for your printer. To order the part, go to www.hp.com/buy/parts.

Table 7-65 Part information

Part number	Part description
0604-001381	End fence sensor

Required tools

- #2 JIS screwdriver with a magnetic tip

After performing service

Turn the printer power on

- Connect the power cable.
- Use the power switch to turn the power on.

Post service test

Print any pages necessary to verify that the repair resolved the issue and did not create any new issues.

Remove the front cover

Follow these steps to remove the front cover.

1. Open the front door and open the punch cover.
2. Remove three screws in the front.
3. Remove the lever.
4. Open the top cover.
5. From the right side of the front cover, carefully lift and pry toward the top-left corner to remove the front cover.

Figure 7-611 Remove the front cover

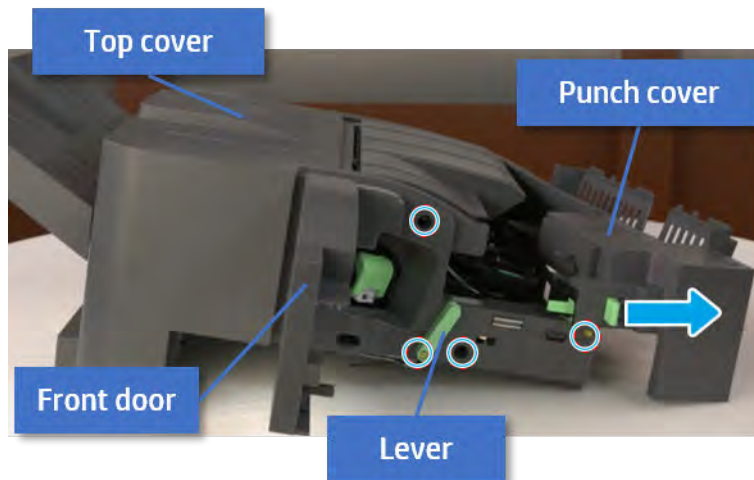

Remove the rear cover

Follow these steps to remove the rear cover.

1. Open the top cover.

Figure 7-612 Open the top cover

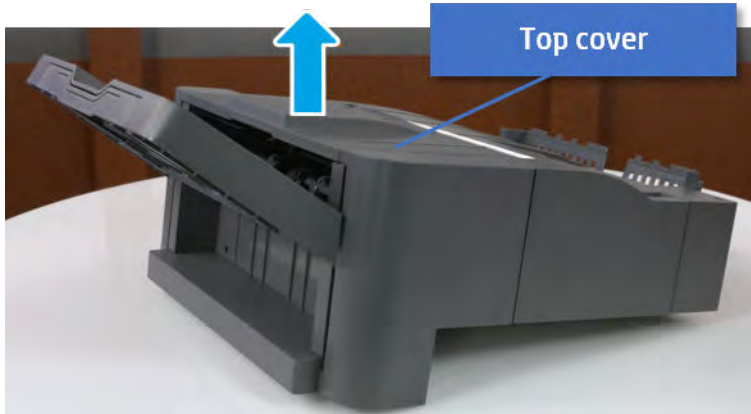

2. Remove three screws.
3. Release hooks carefully and remove the rear cover.

Figure 7-613 Remove the rear cover

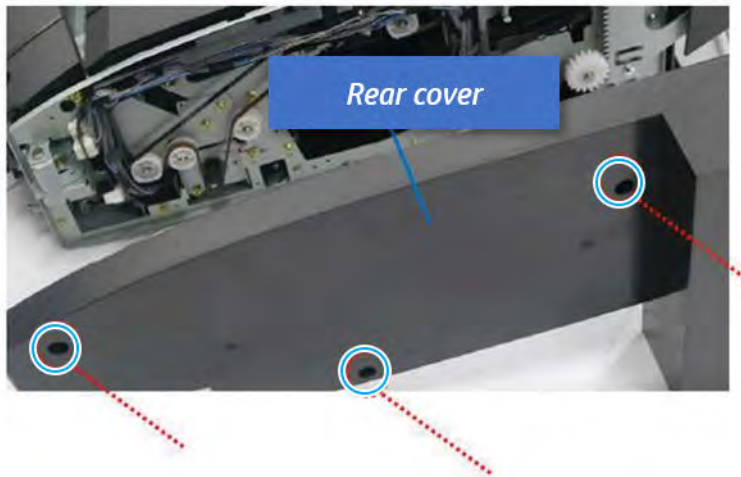

Remove the middle cover

Follow these steps to remove the middle cover.

1. Open the front door and then open the punch cover.

Figure 7-614 Open the front door and punch cover

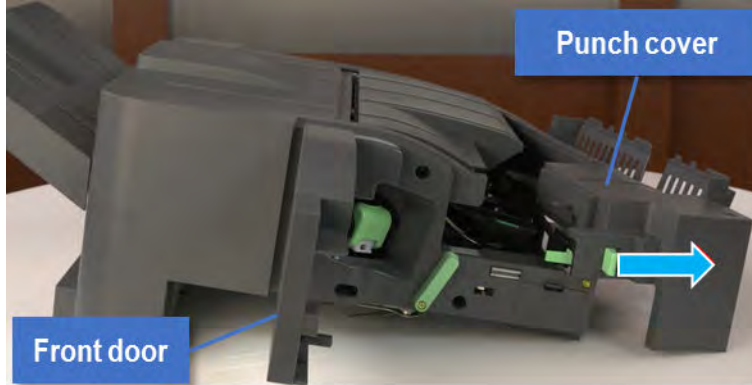

2. Remove left-side one screw at the rear of the inner finisher, and then remove the middle cover by lifting off the hinge pins at the front.

Figure 7-615 Remove the middle cover

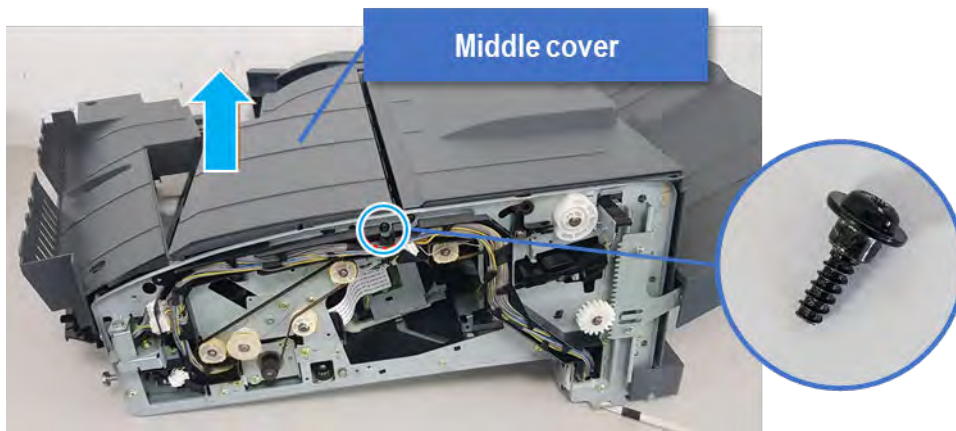

Remove the punch cover

Follow these steps to remove the punch cover.

1. Unplug the connector. Remove the e-ring, and then remove the slide shaft at the rear of the inner finisher.

Figure 7-616 Remove the slide shaft

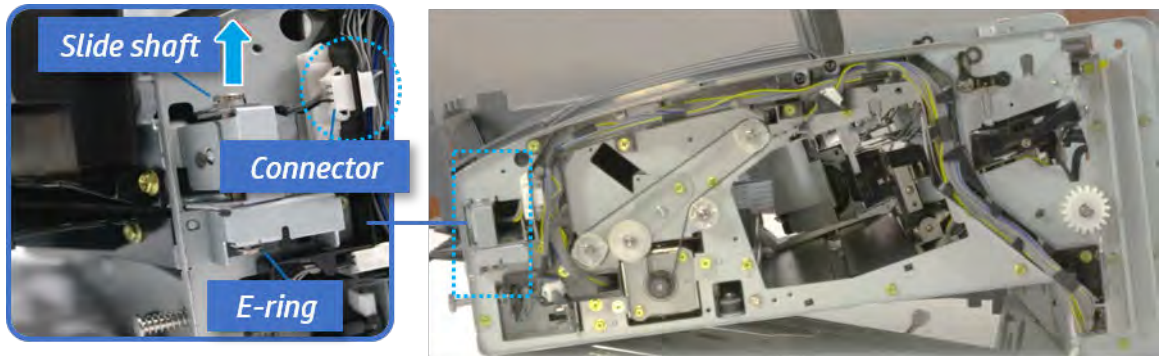

2. Open the punch cover.

Figure 7-617 Open the punch cover

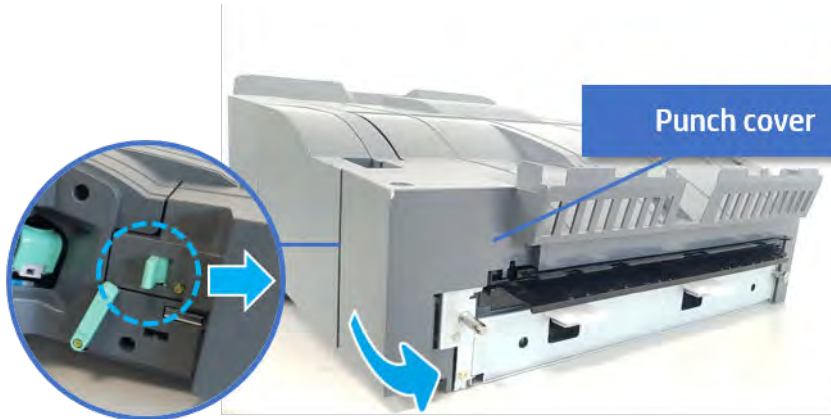

3. Remove the front punch sheet, and then remove the e-ring and the washer. And then remove the punch cover.

Figure 7-618 Remove the punch cover

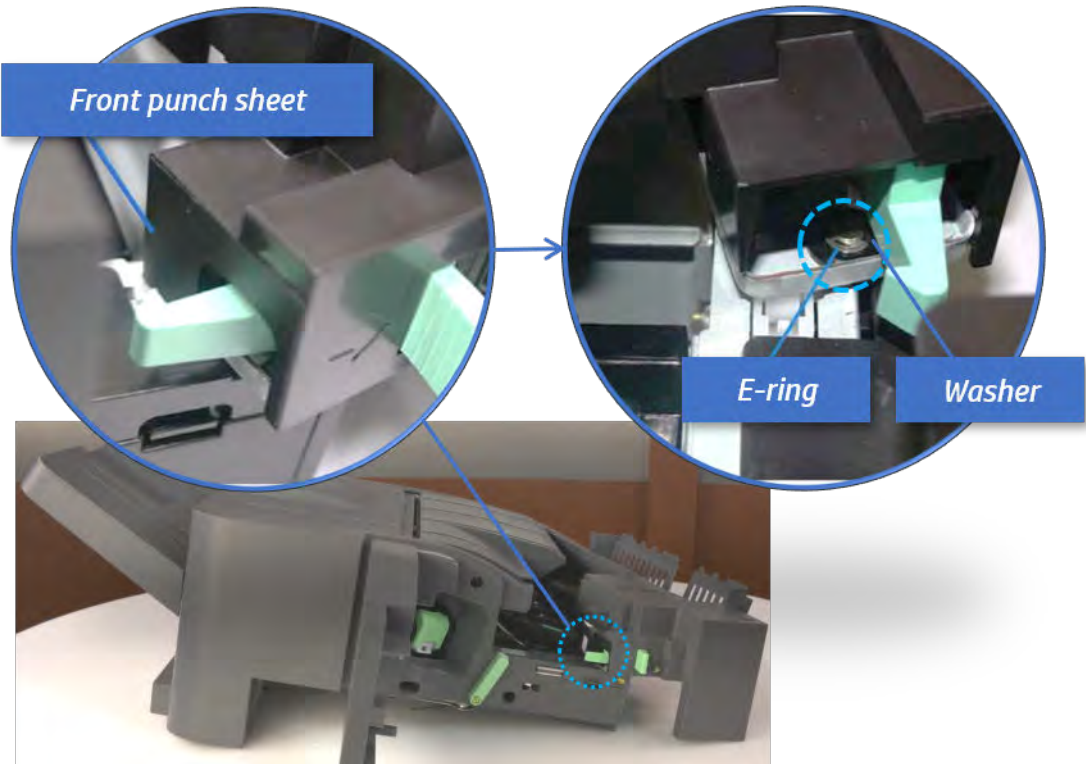

Remove the diverter guide and the middle roller

Follow these steps to remove the diverter guide and the middle roller.

1. On the front of the inner finisher, remove the e-ring and bushing.

Figure 7-619 Remove the e-ring and bushing

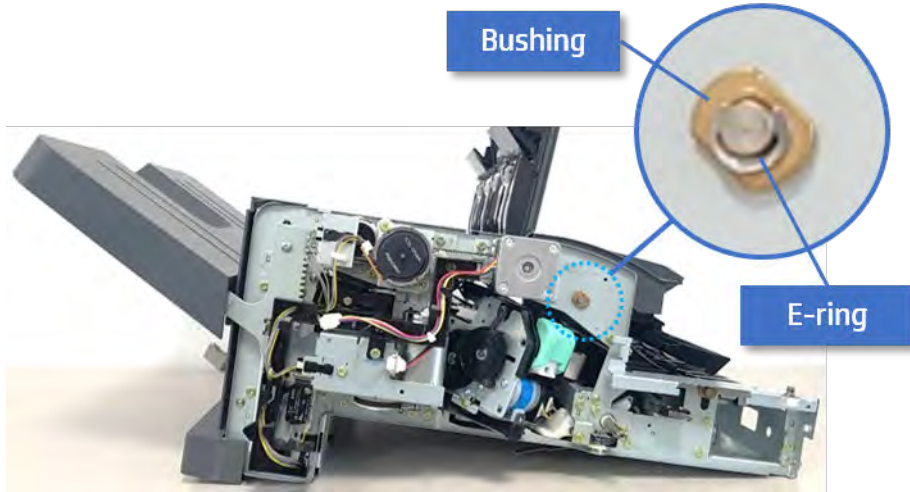

2. On the rear of the inner finisher, remove the e-ring, pulley, bushing, belt, and spring (slightly hidden from view).

Figure 7-620 Remove the e-ring, pulley, bushing, belt, and spring

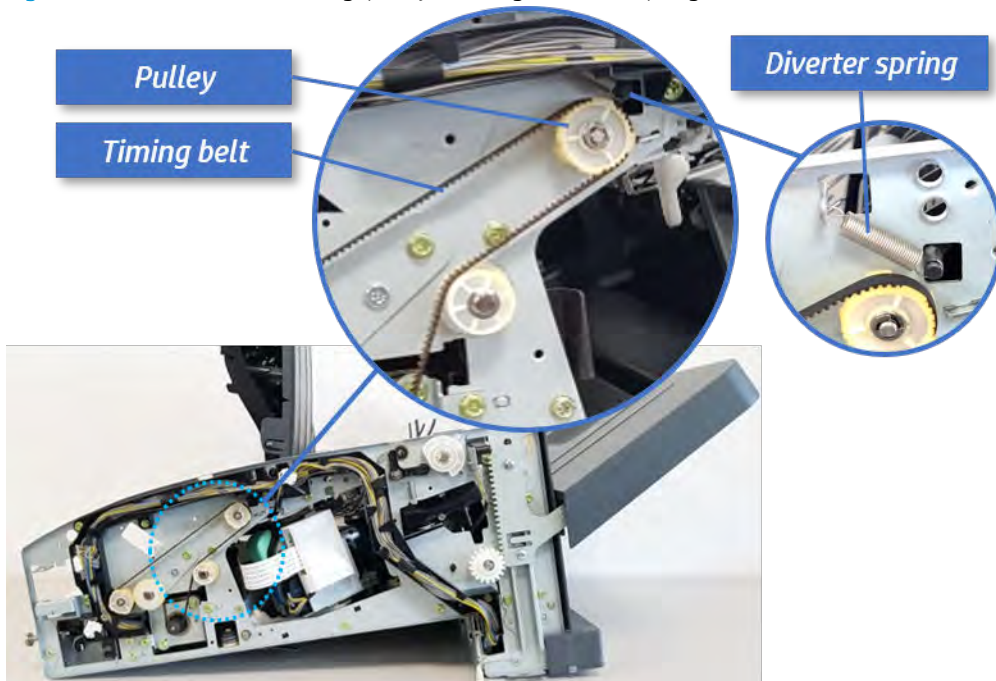

3. Remove the diverter guide and the middle roller.

Figure 7-621 Remove the diverter guide and the middle roller

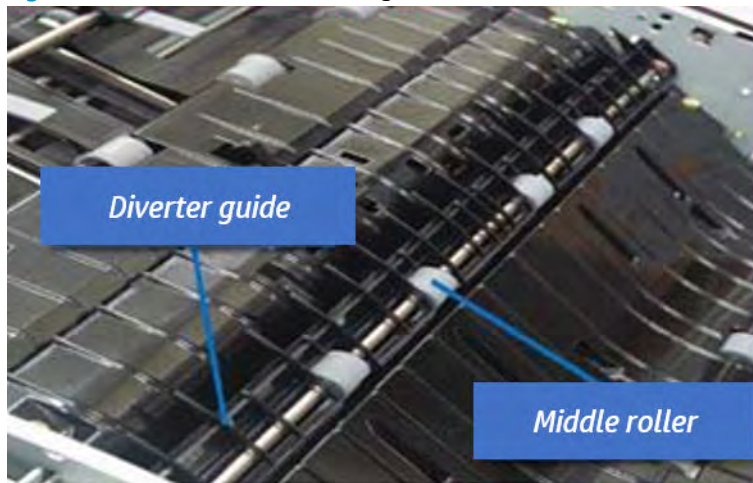

Remove the middle paper guide

Follow these steps to remove the middle paper guide.

1. Remove six screws, and then open the middle paper guide in the direction of the arrow.

Figure 7-622 Open the middle paper guide



 **NOTE:** Be careful not to damage the sensor connector.

2. Unplug the connector under the middle paper guide. And then, remove the middle paper guide.

Figure 7-623 Remove the middle paper guide

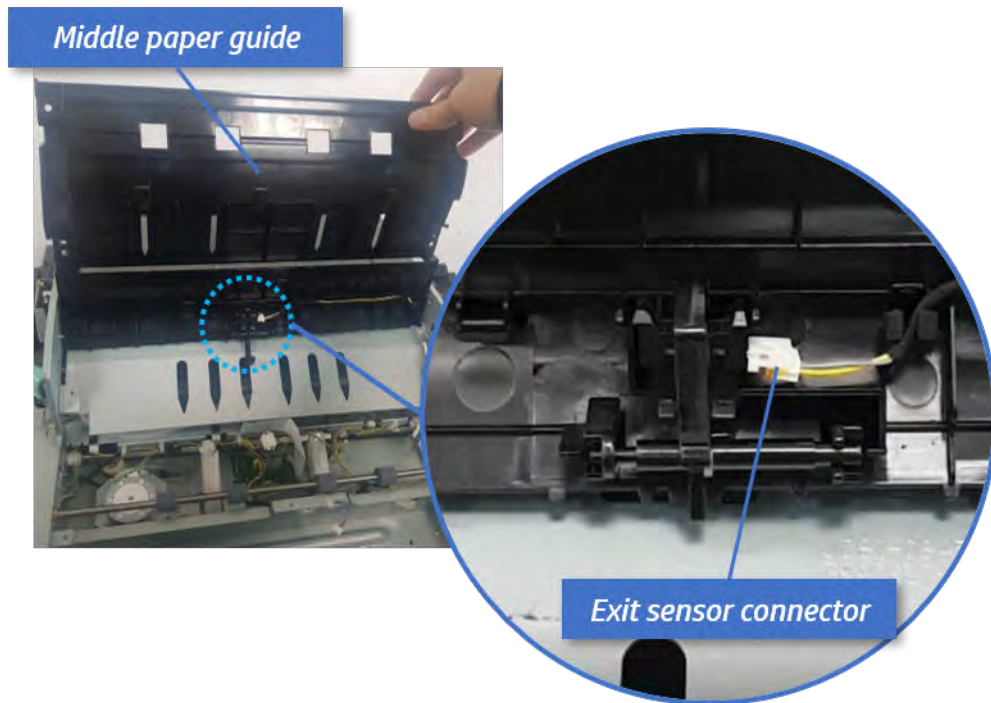

Remove the exit motor bracket

Follow these steps to remove the exit motor bracket.

- ▲ Remove two screws, unplug the motor connector. And then remove exit motor bracket.

Figure 7-624 Remove the exit motor bracket

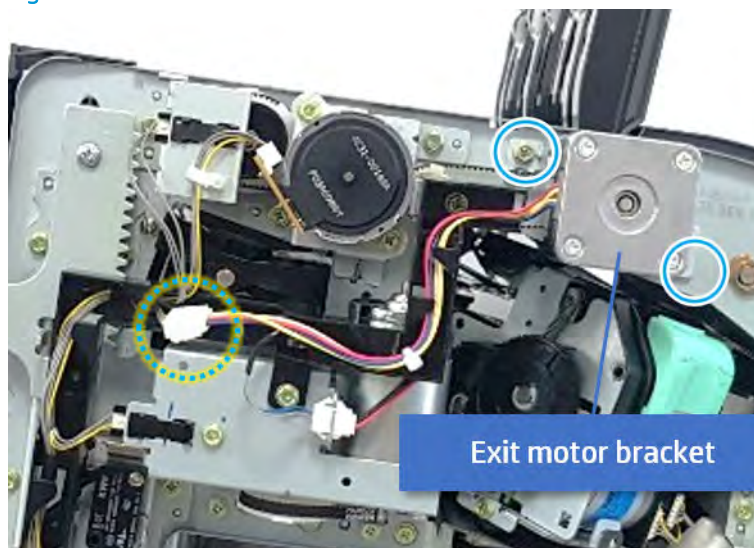

Remove the end fence sensor bracket

Follow these steps to remove the end fence sensor bracket.

1. Remove three screws at the front of the inner finisher, and then remove the bracket.

Figure 7-625 Remove the bracket

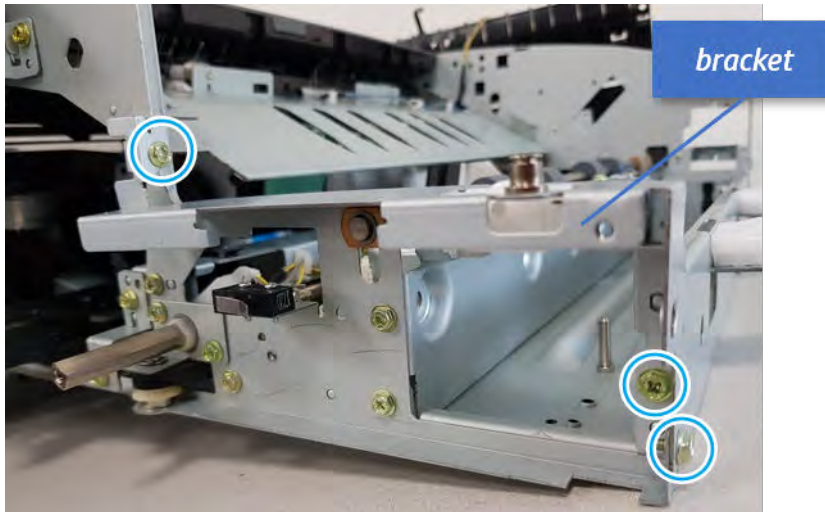

2. Remove two screws at the front of the inner finisher.

Figure 7-626 Remove two screws

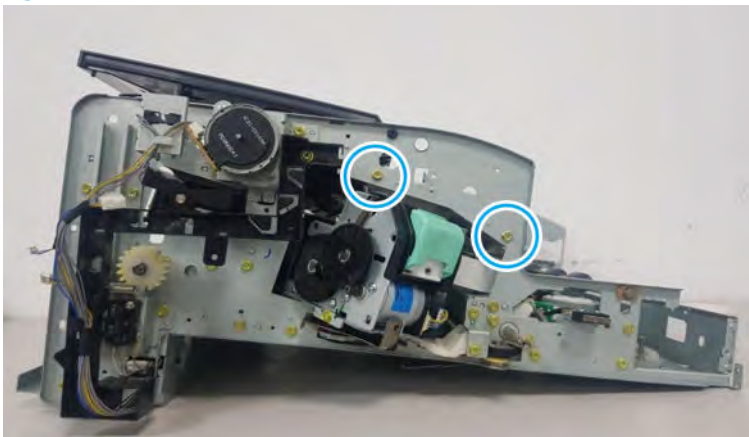

3. Remove two screws at the rear of the inner finisher.

Figure 7-627 Remove two screws

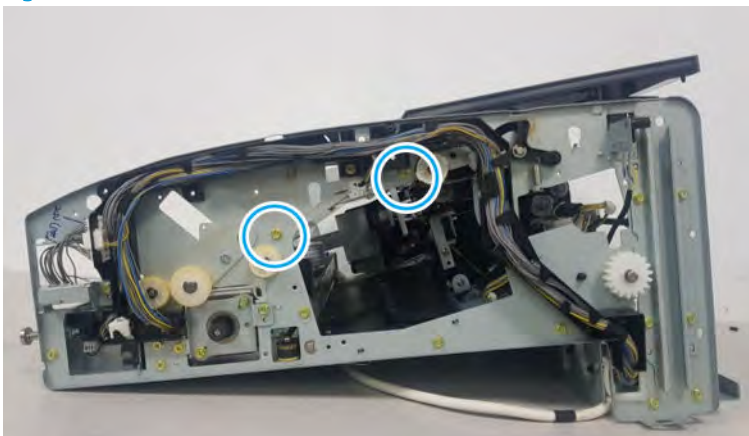

4. Loosen three cable clamps. Unplug the connector at the sensor, and then remove the end fence sensor bracket.

Figure 7-628 Remove the end fence sensor bracket

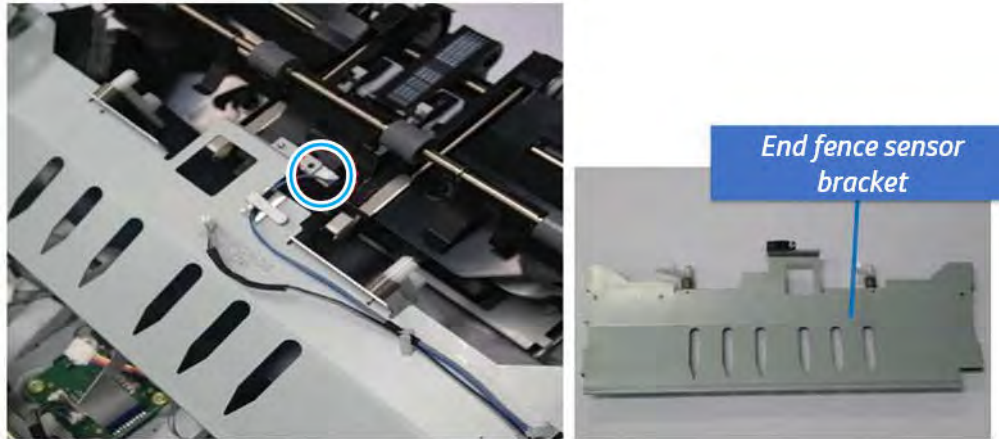

Remove the end fence sensor

Follow these steps to remove the end fence sensor.

- ▲ Remove one screw, and then remove the end fence sensor.

Figure 7-629 Remove the end fence sensor

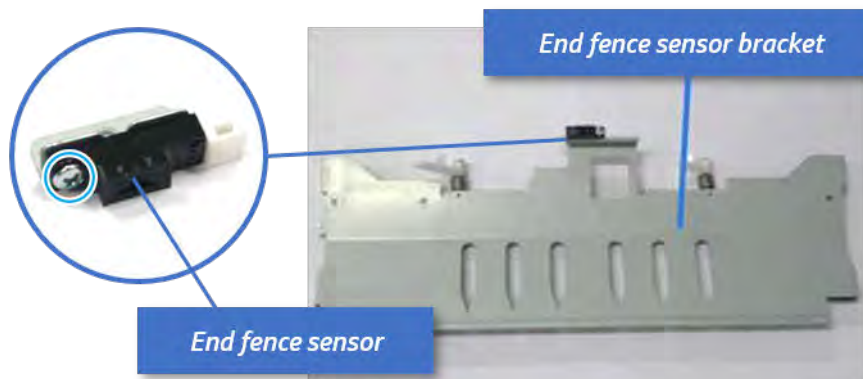

Unpack the replacement assembly

Follow these steps to unpack the replacement assembly.

1. Dispose of the defective part.

 **NOTE:** HP recommends responsible disposal of the defective part.

<http://www8.hp.com/us/en/hp-information/environment/product-recycling.html>

2. Unpack the replacement part from the packaging.



CAUTION:  Some parts are sensitive to electrostatic discharge (ESD). Always perform service work at an ESD-protected workstation or mat. If an ESD workstation or mat is not available, touch the sheet-metal chassis to provide a static ground before touching an ESD-sensitive assembly. Protect the ESD-sensitive assemblies by placing them in ESD pouches when they are out of the printer.

 **IMPORTANT:** Make sure that all of the shipping materials (for example shipping tape) are removed from the replacement part prior to installation.

 **NOTE:** If the replacement part is a roller or pad, avoid touching the spongy part of it. Skin oils on the roller or pad can cause paper pickup and/or print-quality problems. HP recommends using disposable gloves when handling rollers or pads or washing your hands before touching rollers or pads.

3. To install an assembly, reverse the removal steps.

 **NOTE:** When applicable, special installation instructions are provided for an assembly at the end of the removal procedure. Always completely read the removal instructions and follow all special installation instructions.

Output tray unit

Removal and replacement: Output tray

Learn how to remove and replace the output tray.

To view teardown and reassembling video of the inner finisher, click the link below.



[View a teardown video of the inner finisher.](#)



[View a reassembling video of the inner finisher.](#)



IMPORTANT: When applicable, special installation instructions are provided for an assembly at the end of the removal procedure. Always completely read the removal instructions and follow all special installation instructions.

Mean time to repair:

Service level:

Before performing service

Turn the printer power off

- Press the power button on the front of the printer, and then turn off the power switch next to the power cable.
- A shutting-down message appears on the control-panel display.



WARNING! To avoid damage to the printer, turn the power off and wait until the printer shuts down before removing the power cable.

- Disconnect the printer power cable after the printer has completely shut down (the control-panel display is blank).

Use the table below to identify the correct part number for your printer. To order the part, go to <http://www.hp.com/buy/parts>.

Table 7-66 Part information

Part number	Part description
JC90-01337B	Output tray

Required tools

- #2 JIS screwdriver with a magnetic tip

After performing service

Turn the printer power on

- Connect the power cable.
- Use the power switch to turn the power on.

Post service test

Print any pages necessary to verify that the repair resolved the issue and did not create any new issues.

Remove the front cover

Follow these steps to remove the front cover.

1. Open the front door and open the punch cover.
2. Remove three screws in the front.
3. Remove the lever.
4. Open the top cover.
5. From the right side of the front cover, carefully lift and pry toward the top-left corner to remove the front cover.

Figure 7-630 Remove the front cover

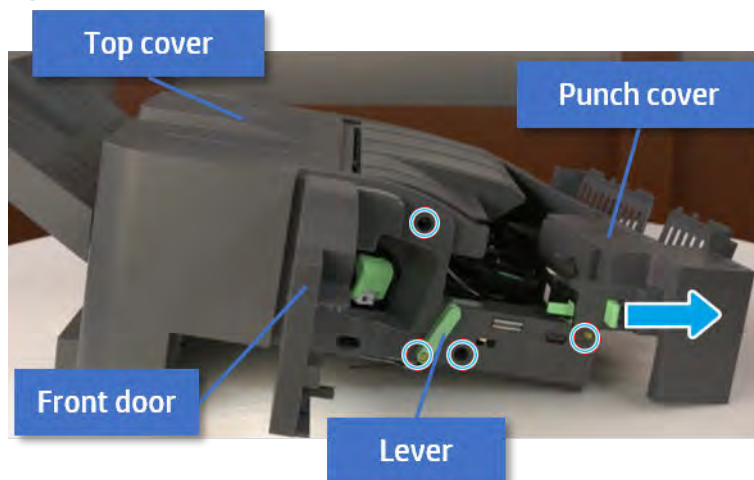

Remove the rear cover

Follow these steps to remove the rear cover.

1. Open the top cover.

Figure 7-631 Open the top cover

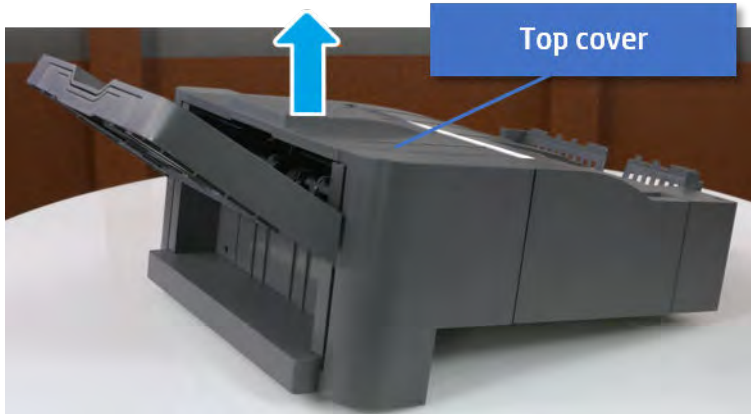

2. Remove three screws.
3. Release hooks carefully and remove the rear cover.

Figure 7-632 Remove the rear cover

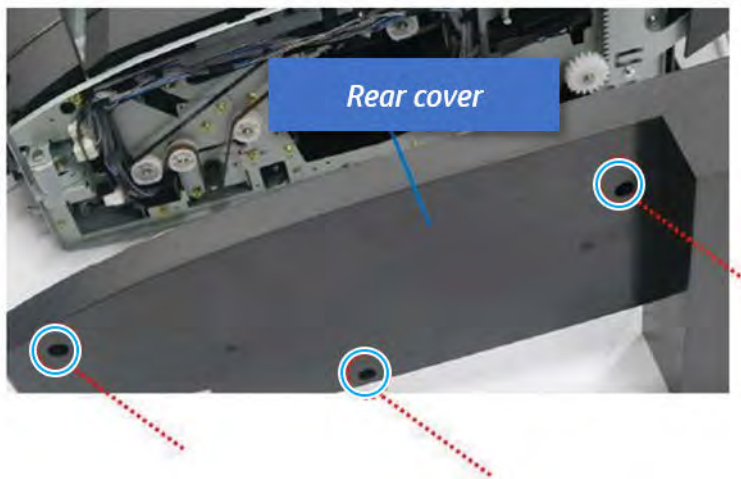

Remove the output tray

Follow these steps to remove the output tray.

1. Remove four screws.

Figure 7-633 Remove four screws

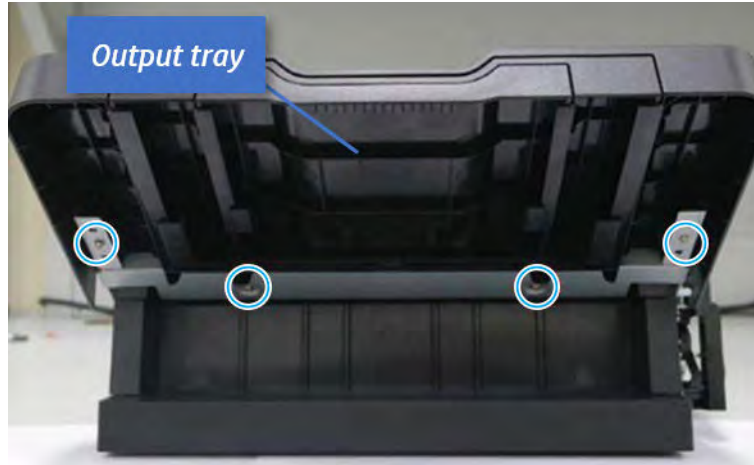

2. Push the paper holding actuator into the inner finisher, and then remove the output tray.

Figure 7-634 Remove the output tray.



Remove the output tray frame

Follow these steps to remove the output tray frame.

1. Rotate the pulley until the output tray frame depart from the gear.

Figure 7-635 Remove the pulley

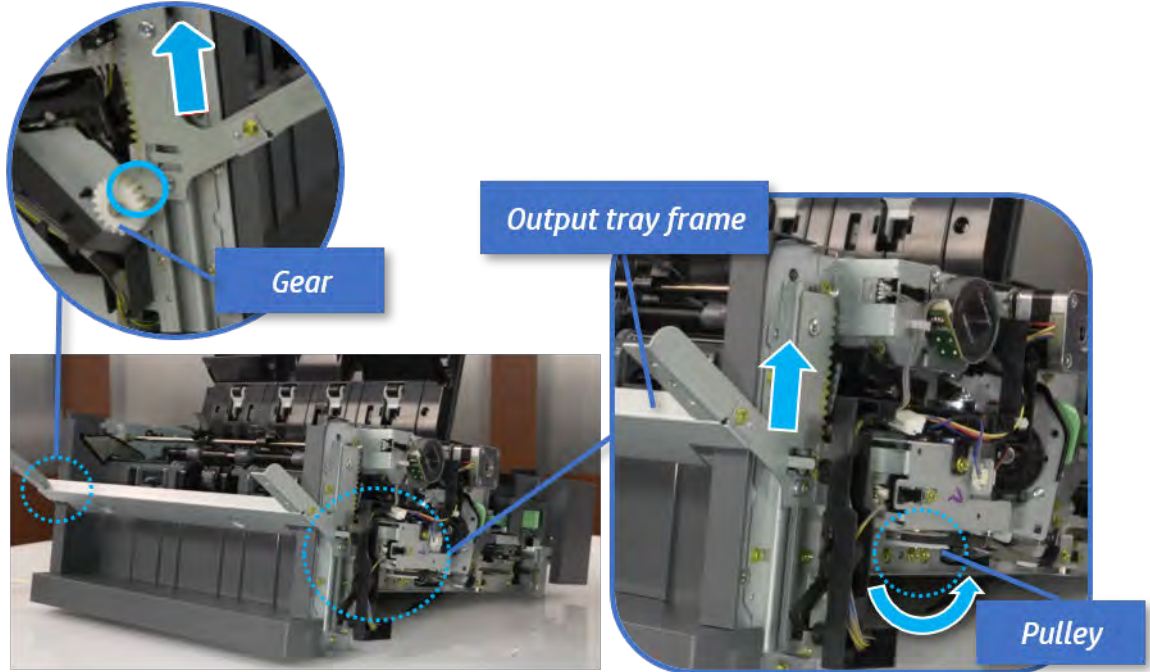

2. Push the paper holding actuator into the inner finisher, and then remove the output tray frame.

Figure 7-636 Remove the output tray frame

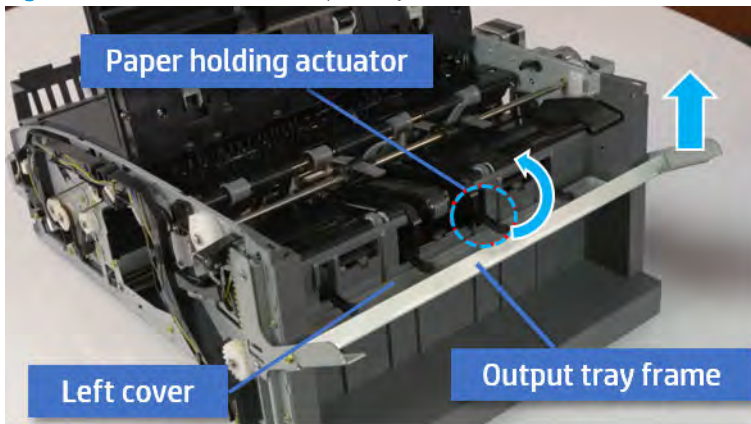

 **TIP:** Push the paper holding actuator into the inner finisher when reassembling. Be sure to level the output tray.

- a. Position the first wheel into the channel on both sides while pushing the paper holding actuator.

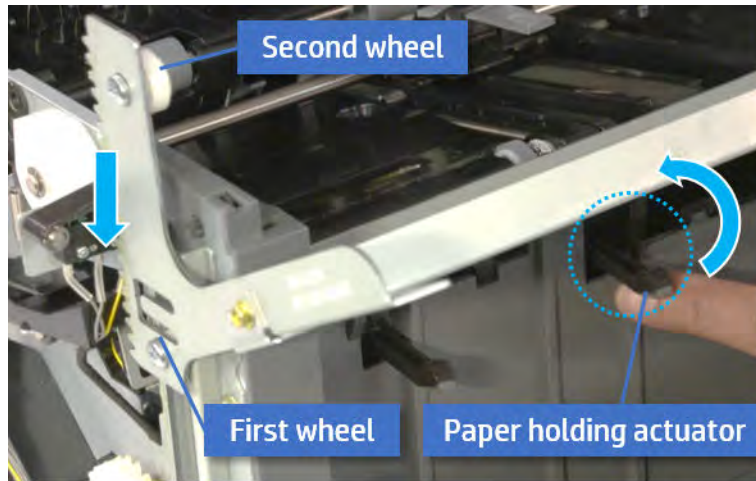

- b. Let the second wheel rest on the channel on both sides simultaneously.
- c. Gently squeeze the wheels into channel until the output tray frame meet the gear.

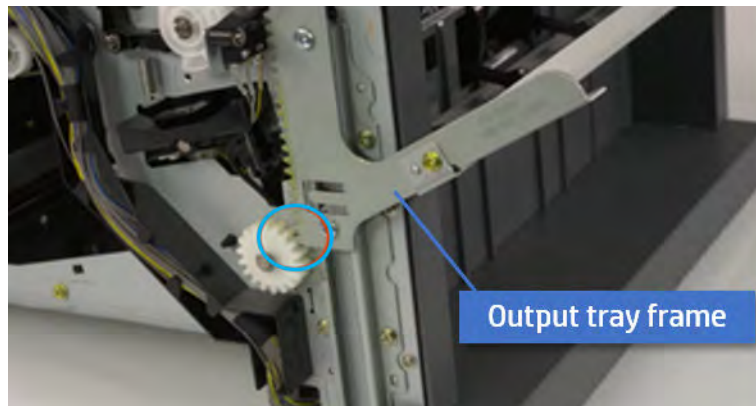

- d. Rotate the pulley until the output tray frame is no longer lifted. It can make to level the output tray frame.

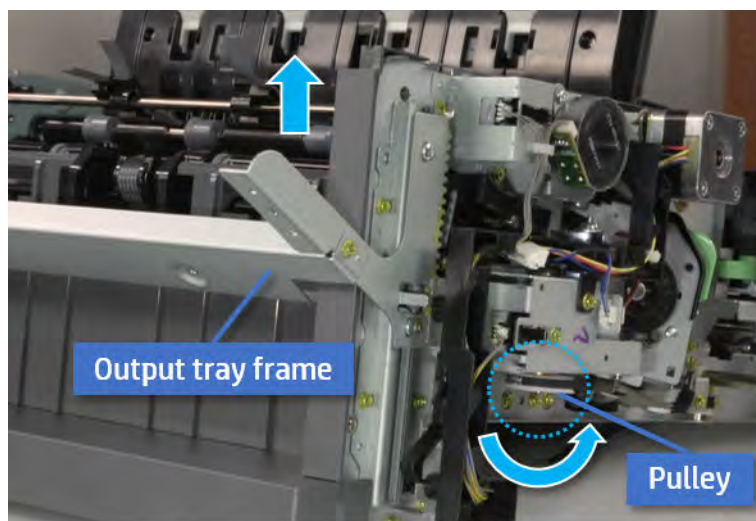

- e. Rotate the pulley in the opposite direction.

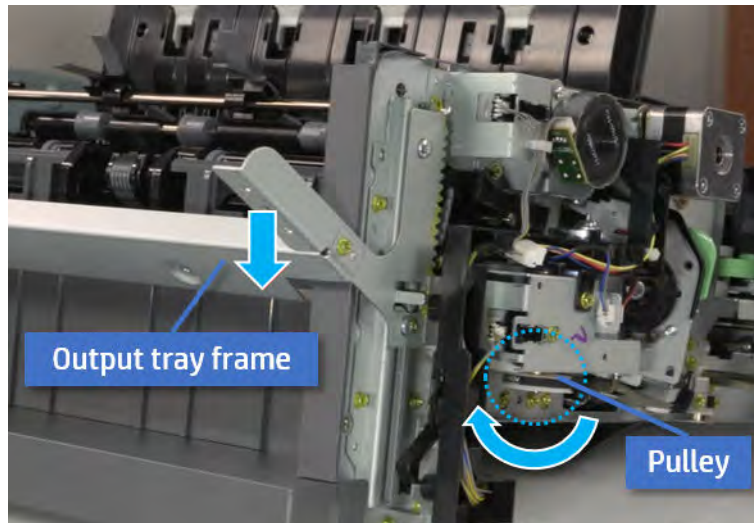

Unpack the replacement assembly



Follow these steps to unpack the replacement assembly.

1. Dispose of the defective part.

 **NOTE:** HP recommends responsible disposal of the defective part.

<http://www8.hp.com/us/en/hp-information/environment/product-recycling.html>

2. Unpack the replacement part from the packaging.

 **CAUTION:**  Some parts are sensitive to electrostatic discharge (ESD). Always perform service work at an ESD-protected workstation or mat. If an ESD workstation or mat is not available, touch the sheet-metal chassis to provide a static ground before touching an ESD-sensitive assembly. Protect the ESD-sensitive assemblies by placing them in ESD pouches when they are out of the printer.

 **IMPORTANT:** Make sure that all of the shipping materials (for example shipping tape) are removed from the replacement part prior to installation.

 **NOTE:** If the replacement part is a roller or pad, avoid touching the spongy part of it. Skin oils on the roller or pad can cause paper pickup and/or print-quality problems. HP recommends using disposable gloves when handling rollers or pads or washing your hands before touching rollers or pads.

3. To install an assembly, reverse the removal steps.

 **NOTE:** When applicable, special installation instructions are provided for an assembly at the end of the removal procedure. Always completely read the removal instructions and follow all special installation instructions.

Removal and replacement: Output tray top of stack sensor (S8)

Learn how to remove and replace the output tray top of stack sensor.

To view teardown and reassembling video of the inner finisher, click the link below.



[View a teardown video of the inner finisher.](#)



[View a reassembling video of the inner finisher.](#)



IMPORTANT: When applicable, special installation instructions are provided for an assembly at the end of the removal procedure. Always completely read the removal instructions and follow all special installation instructions.

Mean time to repair:

Service level:

Before performing service

Turn the printer power off

- Press the power button on the front of the printer, and then turn off the power switch next to the power cable.
- A shutting-down message appears on the control-panel display.



WARNING! To avoid damage to the printer, turn the power off and wait until the printer shuts down before removing the power cable.

- Disconnect the printer power cable after the printer has completely shut down (the control-panel display is blank).

Use the table below to identify the correct part number for your printer. To order the part, go to <http://www.hp.com/buy/parts>.

Table 7-67 Part information

Part number	Part description
JC82-01039A	output tray top of stack sensor

Required tools

- #2 JIS screwdriver with a magnetic tip

After performing service

Turn the printer power on

- Connect the power cable.
- Use the power switch to turn the power on.

Post service test

Print any pages necessary to verify that the repair resolved the issue and did not create any new issues.

Remove the front cover

Follow these steps to remove the front cover.

1. Open the front door and open the punch cover.
2. Remove three screws in the front.
3. Remove the lever.
4. Open the top cover.
5. From the right side of the front cover, carefully lift and pry toward the top-left corner to remove the front cover.

Figure 7-637 Remove the front cover

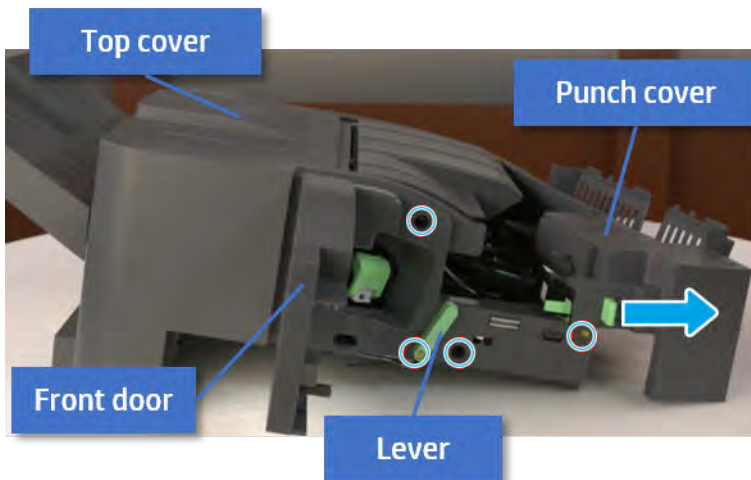

Remove the rear cover

Follow these steps to remove the rear cover.

1. Open the top cover.

Figure 7-638 Open the top cover

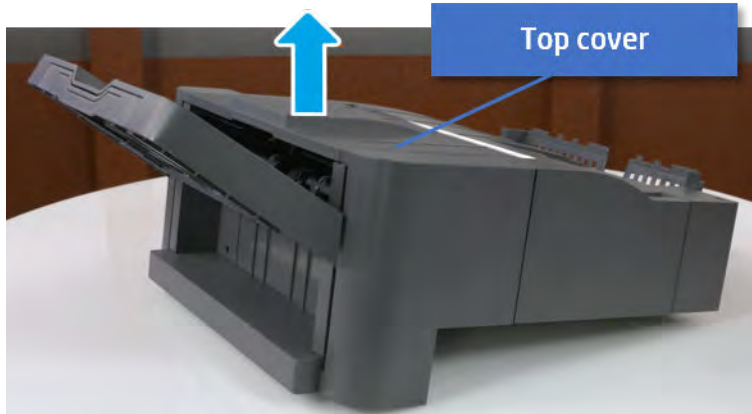

2. Remove three screws.
3. Release hooks carefully and remove the rear cover.

Figure 7-639 Remove the rear cover

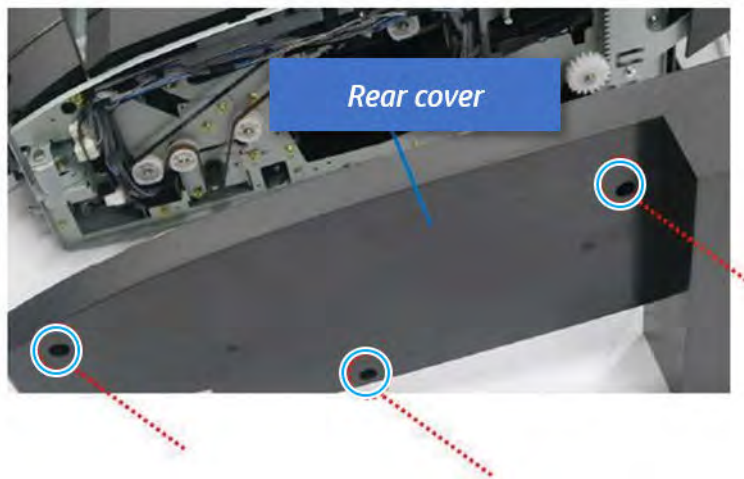

Remove the output tray

Follow these steps to remove the output tray.

1. Remove four screws.

Figure 7-640 Remove four screws

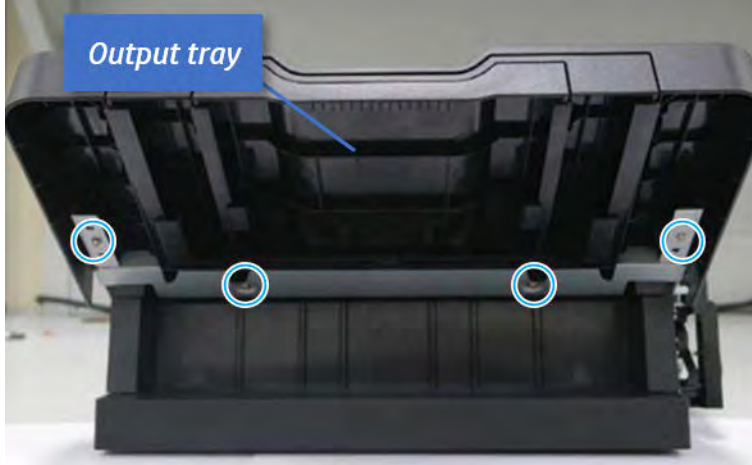

2. Push the paper holding actuator into the inner finisher, and then remove the output tray.

Figure 7-641 Remove the output tray.



Remove the output tray frame

Follow these steps to remove the output tray frame.

1. Rotate the pulley until the output tray frame depart from the gear.

Figure 7-642 Remove the pulley

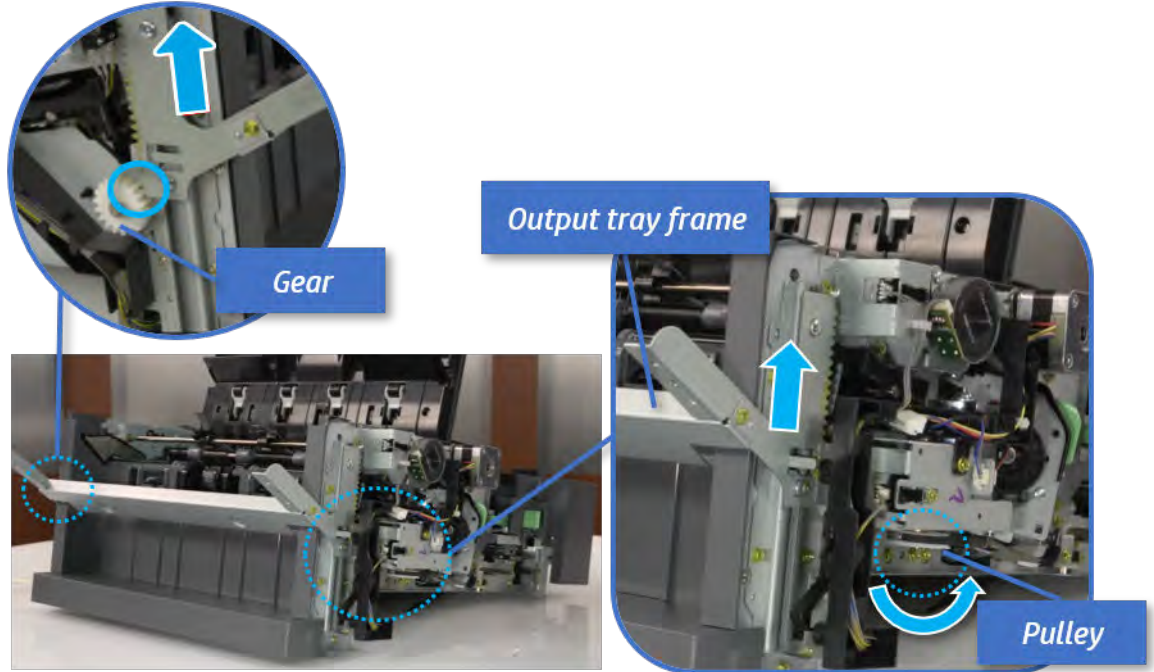

2. Push the paper holding actuator into the inner finisher, and then remove the output tray frame.

Figure 7-643 Remove the output tray frame

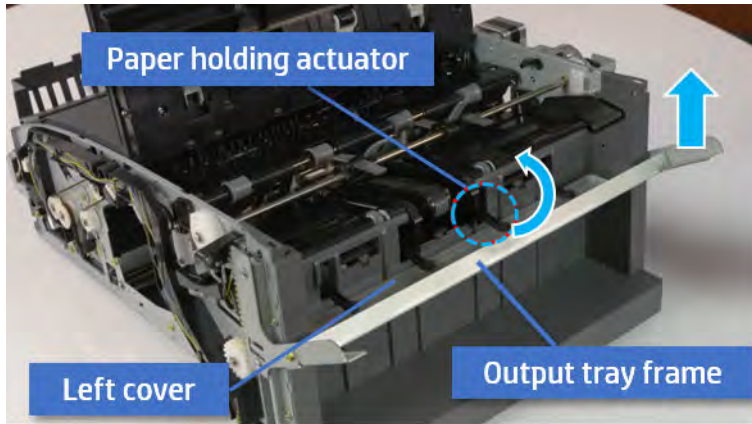

TIP: Push the paper holding actuator into the inner finisher when reassembling. Be sure to level the output tray.

- a. Position the first wheel into the channel on both sides while pushing the paper holding actuator.

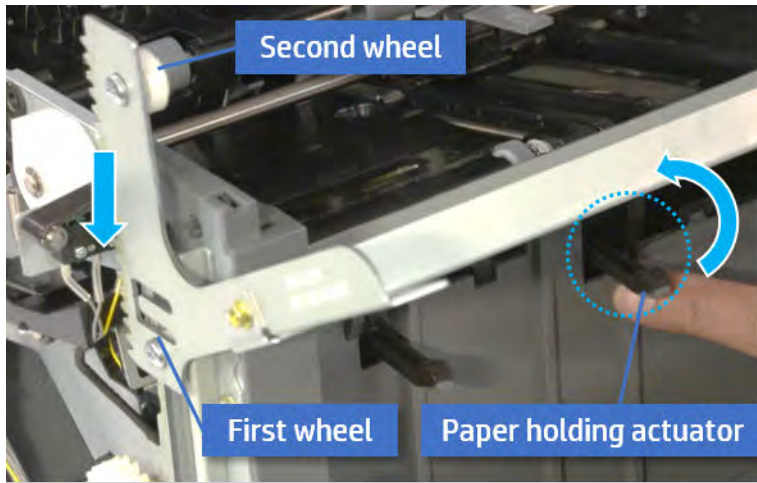

- b. Let the second wheel rest on the channel on both sides simultaneously.
- c. Gently squeeze the wheels into channel until the output tray frame meet the gear.

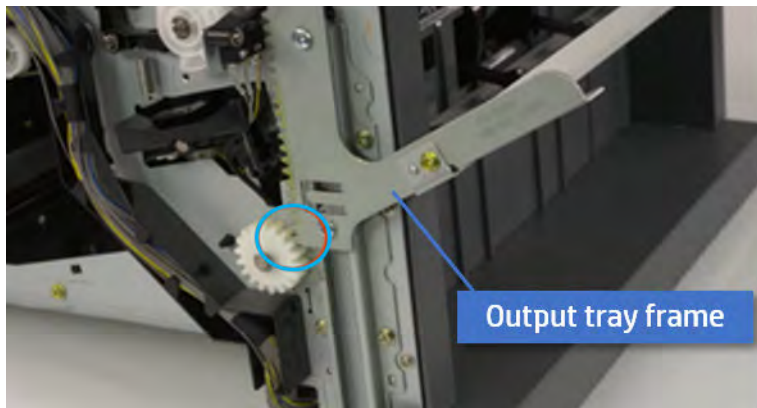

- d. Rotate the pulley until the output tray frame is no longer lifted. It can make to level the output tray frame.

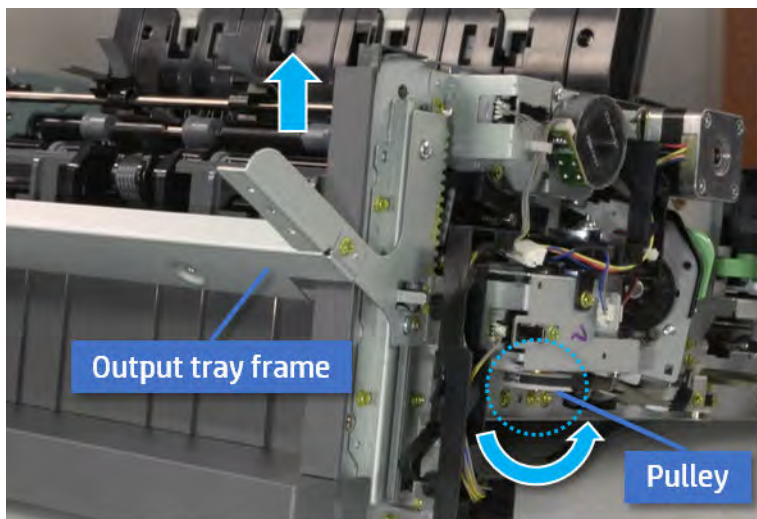

- e. Rotate the pulley in the opposite direction.

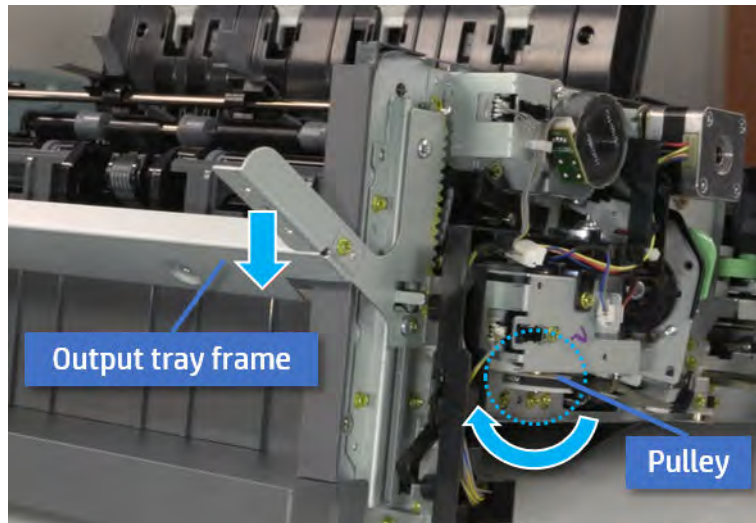

Remove the PCA cover

Follow these steps to remove the PCA cover.

- ▲ Remove two screws, and then remove the PCA cover.

Figure 7-644 Remove the PCA cover

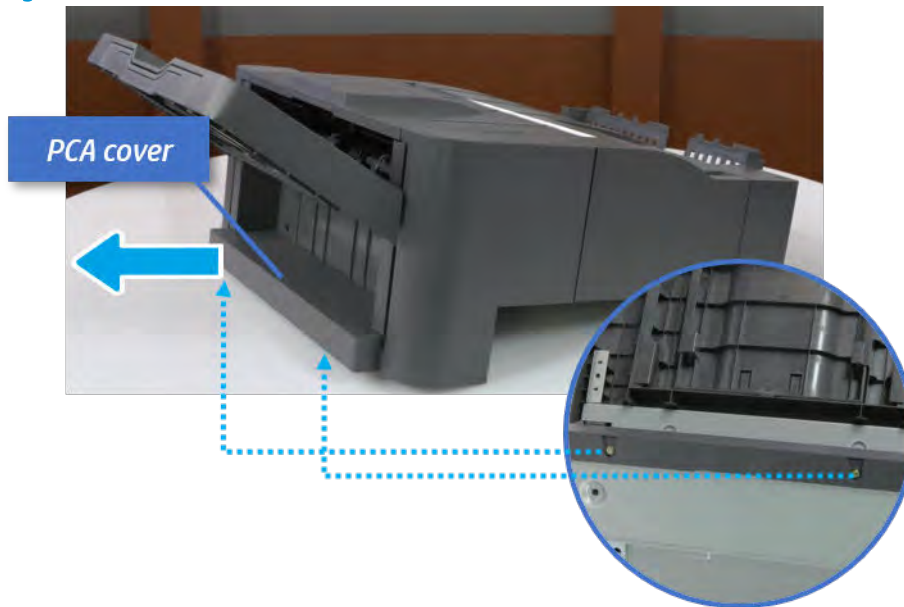

Remove the left cover

Follow these steps to remove the left cover.

1. Remove two screws.

Figure 7-645 Remove two screws

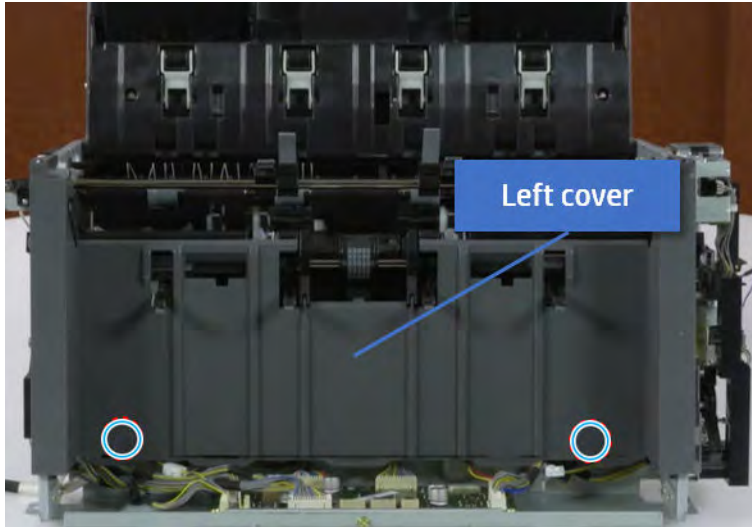

2. Remove four screws from both front and rear sides.

Figure 7-646 Remove four screws

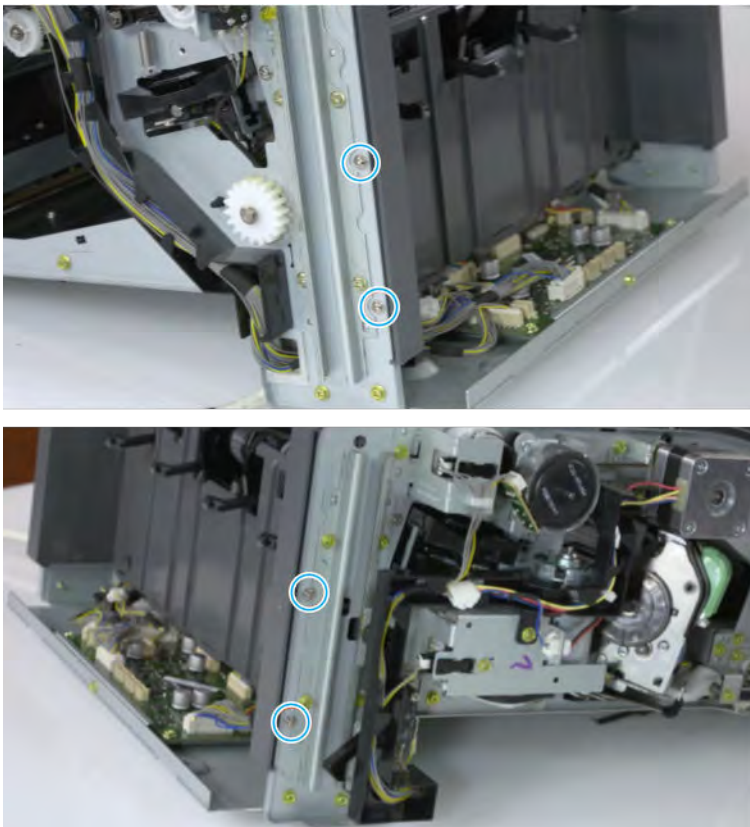

3. Unplug two inline connectors, and then remove the left cover.

Figure 7-647 Unplug two connectors

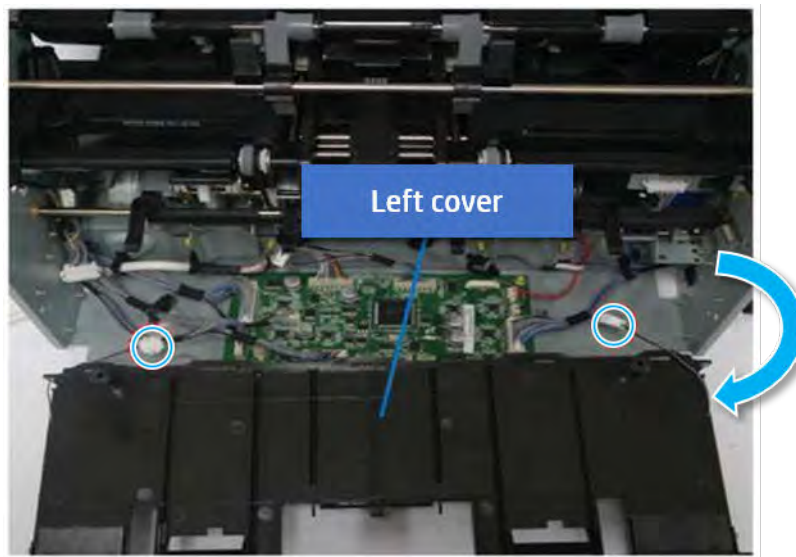

 **TIP:** Be sure to check the hook when reassembling.

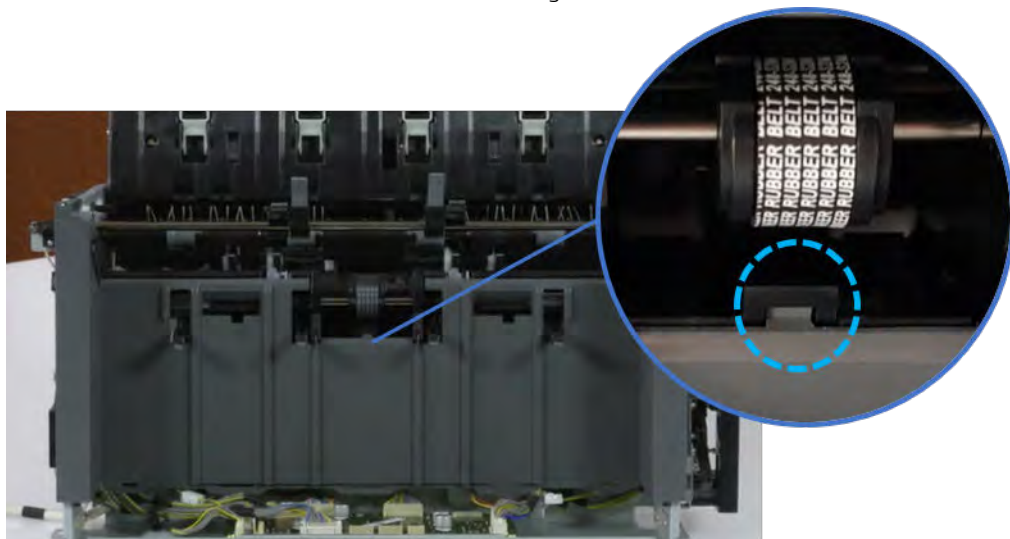

Remove the output tray top of stack sensor

Follow these steps to Remove the output tray top of stack sensor.

- ▲ Remove two screws from both sides of the left cover. Remove the bracket, and then remove the sensor.

Figure 7-648 Remove the output tray top of stack sensor



Unpack the replacement assembly



Follow these steps to unpack the replacement assembly.

1. Dispose of the defective part.

 **NOTE:** HP recommends responsible disposal of the defective part.

<http://www8.hp.com/us/en/hp-information/environment/product-recycling.html>

2. Unpack the replacement part from the packaging.

 **CAUTION:**  Some parts are sensitive to electrostatic discharge (ESD). Always perform service work at an ESD-protected workstation or mat. If an ESD workstation or mat is not available, touch the sheet-metal chassis to provide a static ground before touching an ESD-sensitive assembly. Protect the ESD-sensitive assemblies by placing them in ESD pouches when they are out of the printer.

 **IMPORTANT:** Make sure that all of the shipping materials (for example shipping tape) are removed from the replacement part prior to installation.

 **NOTE:** If the replacement part is a roller or pad, avoid touching the spongy part of it. Skin oils on the roller or pad can cause paper pickup and/or print-quality problems. HP recommends using disposable gloves when handling rollers or pads or washing your hands before touching rollers or pads.

3. To install an assembly, reverse the removal steps.

 **NOTE:** When applicable, special installation instructions are provided for an assembly at the end of the removal procedure. Always completely read the removal instructions and follow all special installation instructions.

Removal and replacement: Output tray lower limit switch (S7)

Learn how to remove and replace the output tray lower limit switch.

To view teardown and reassembling video of the inner finisher, click the link below.



[View a teardown video of the inner finisher.](#)



[View a reassembling video of the inner finisher.](#)



IMPORTANT: When applicable, special installation instructions are provided for an assembly at the end of the removal procedure. Always completely read the removal instructions and follow all special installation instructions.

Mean time to repair:

Service level:

Before performing service

Turn the printer power off

- Press the power button on the front of the printer, and then turn off the power switch next to the power cable.
- A shutting-down message appears on the control-panel display.



WARNING! To avoid damage to the printer, turn the power off and wait until the printer shuts down before removing the power cable.

- Disconnect the printer power cable after the printer has completely shut down (the control-panel display is blank).

Use the table below to identify the correct part number for your printer. To order the part, go to www.hp.com/buy/parts.

Table 7-68 Part information

Part number	Part description
JC90-01320A	Output tray lower limit switch

Required tools

- #2 JIS screwdriver with a magnetic tip

After performing service

Turn the printer power on

- Connect the power cable.
- Use the power switch to turn the power on.

Post service test

Print any pages necessary to verify that the repair resolved the issue and did not create any new issues.

Remove the front cover

Follow these steps to remove the front cover.

1. Open the front door and open the punch cover.
2. Remove three screws in the front.
3. Remove the lever.
4. Open the top cover.
5. From the right side of the front cover, carefully lift and pry toward the top-left corner to remove the front cover.

Figure 7-649 Remove the front cover

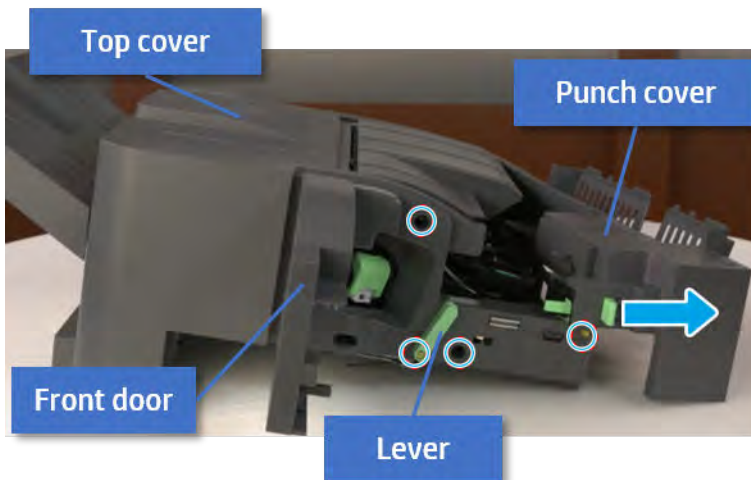

Remove the rear cover

Follow these steps to remove the rear cover.

1. Open the top cover.

Figure 7-650 Open the top cover

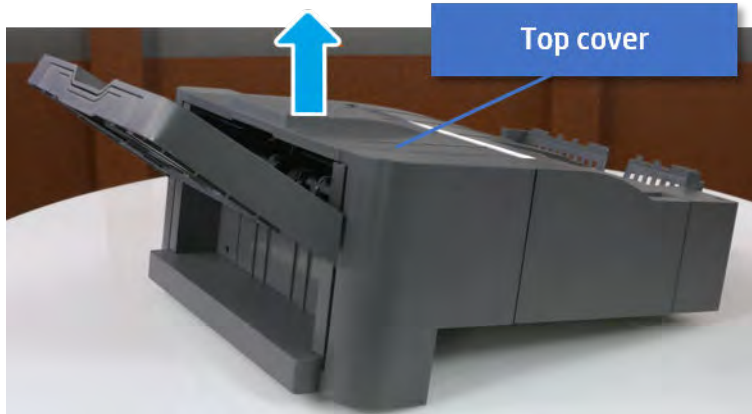

2. Remove three screws.
3. Release hooks carefully and remove the rear cover.

Figure 7-651 Remove the rear cover

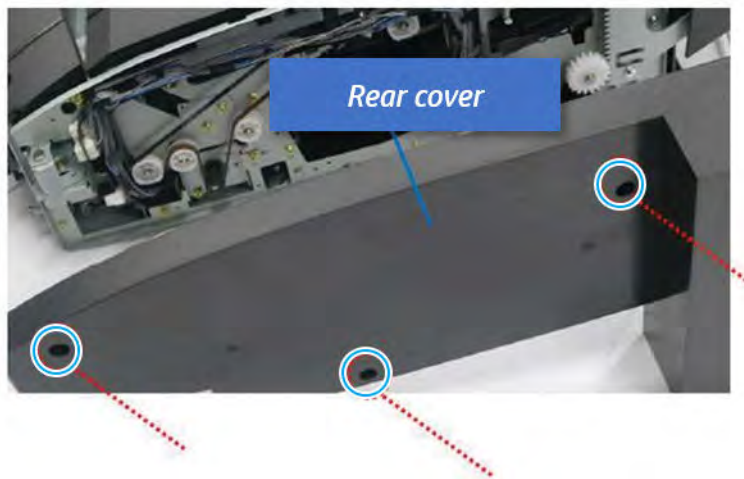

Remove the output tray

Follow these steps to remove the output tray.

1. Remove four screws.

Figure 7-652 Remove four screws

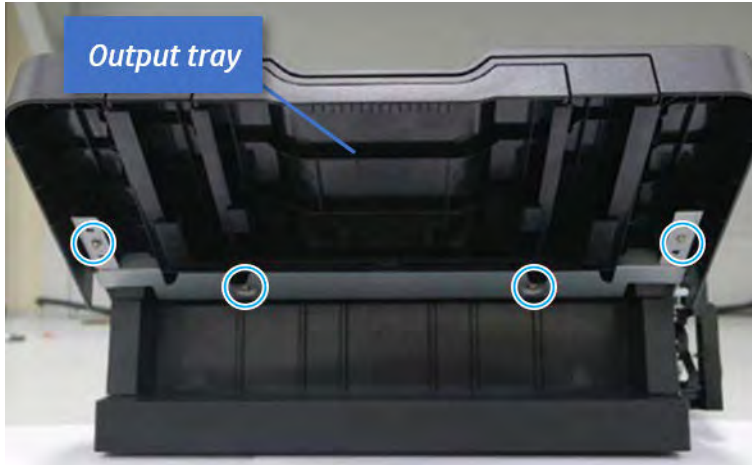

2. Push the paper holding actuator into the inner finisher, and then remove the output tray.

Figure 7-653 Remove the output tray.



Remove the output tray frame

Follow these steps to remove the output tray frame.

1. Rotate the pulley until the output tray frame depart from the gear.

Figure 7-654 Remove the pulley

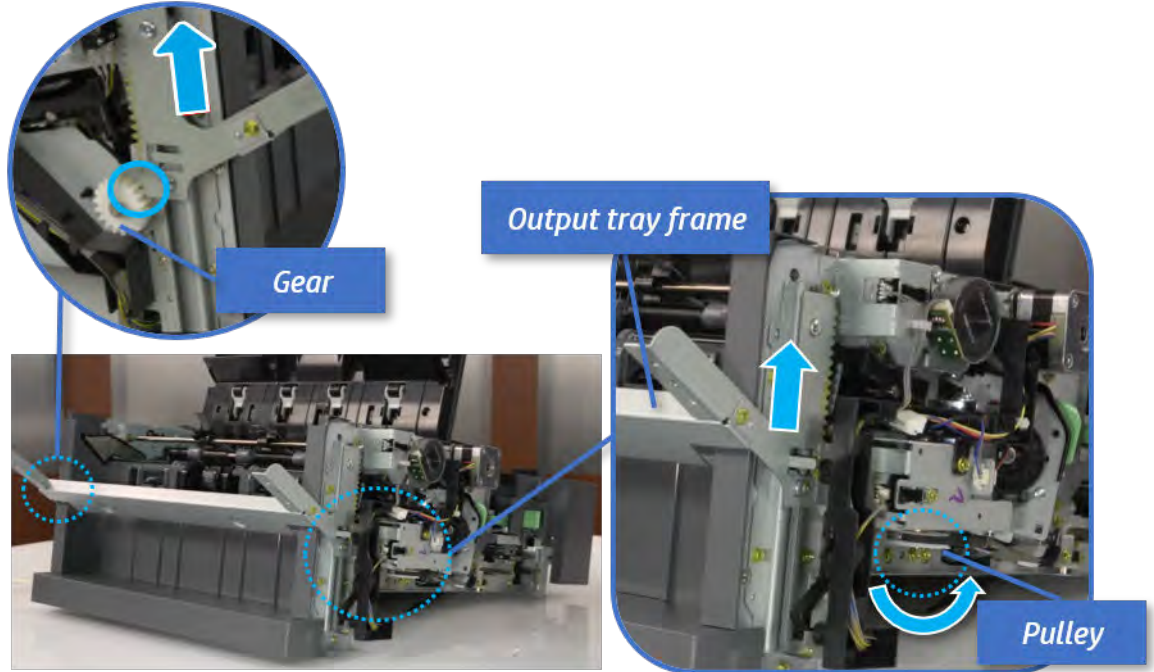

2. Push the paper holding actuator into the inner finisher, and then remove the output tray frame.

Figure 7-655 Remove the output tray frame

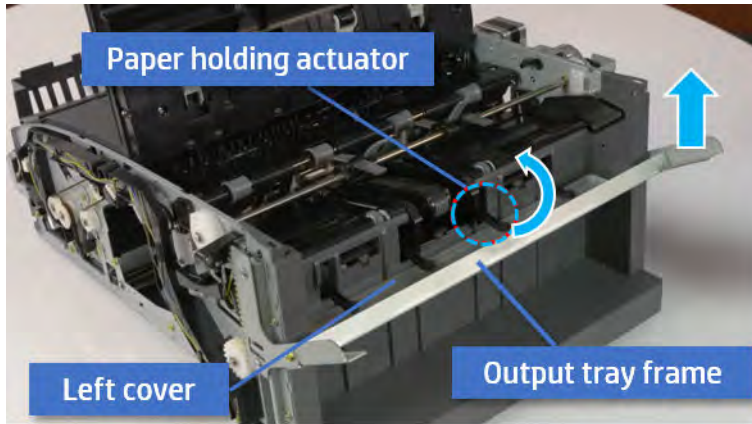

TIP: Push the paper holding actuator into the inner finisher when reassembling. Be sure to level the output tray.

- a. Position the first wheel into the channel on both sides while pushing the paper holding actuator.

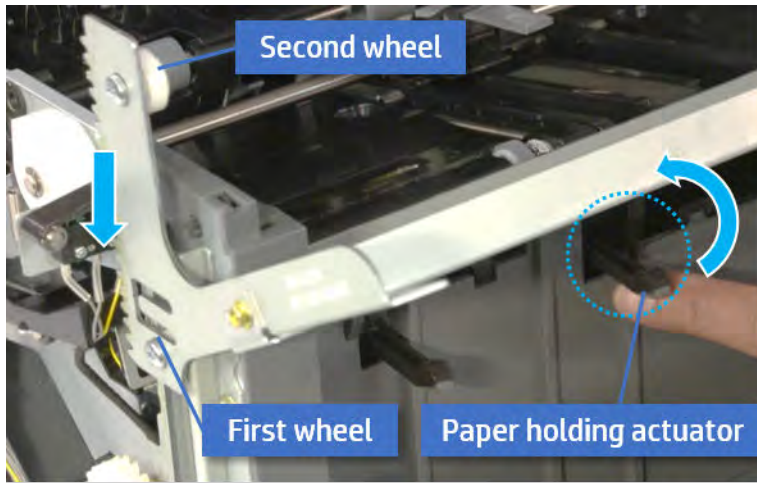

- b. Let the second wheel rest on the channel on both sides simultaneously.
- c. Gently squeeze the wheels into channel until the output tray frame meet the gear.

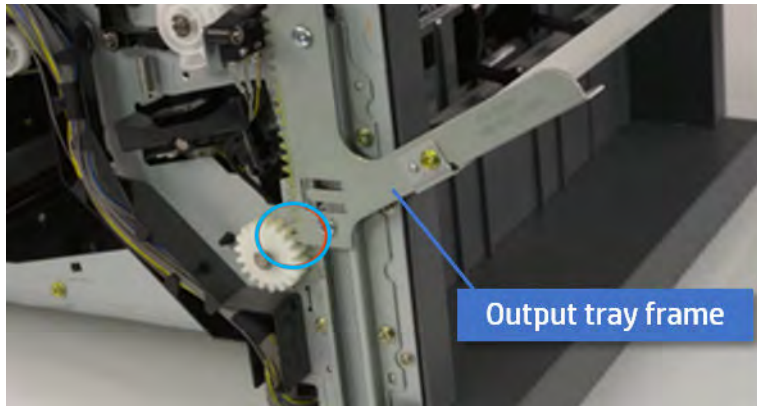

- d. Rotate the pulley until the output tray frame is no longer lifted. It can make to level the output tray frame.

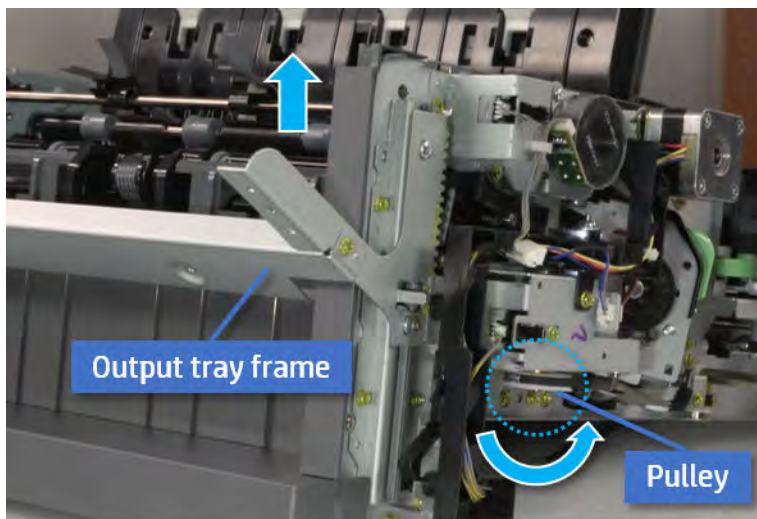

- e. Rotate the pulley in the opposite direction.

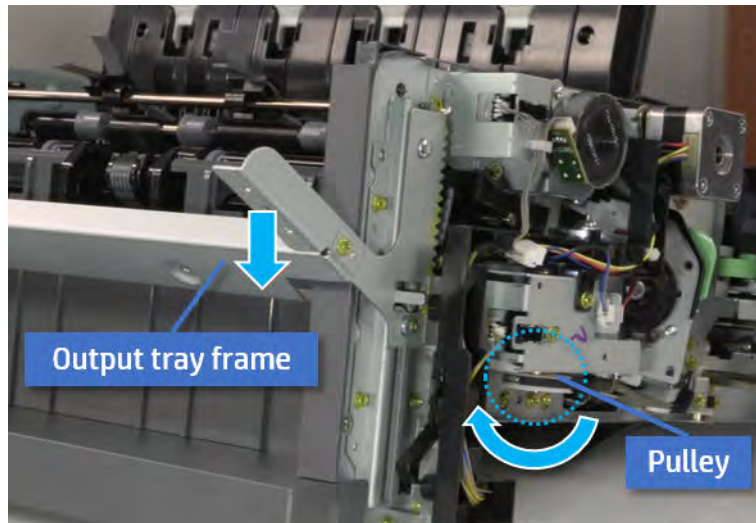

Remove the PCA cover

Follow these steps to remove the PCA cover.

- ▲ Remove two screws, and then remove the PCA cover.

Figure 7-656 Remove the PCA cover

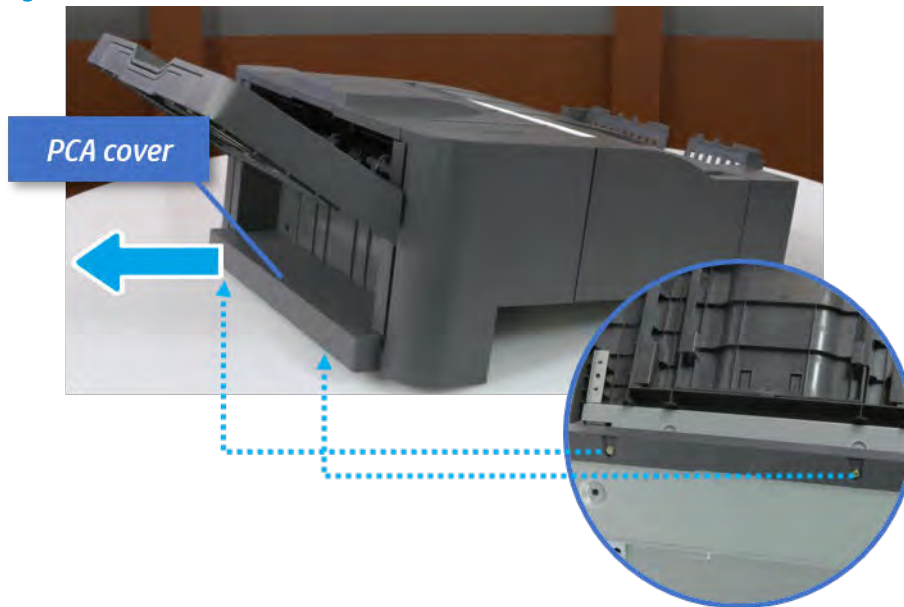

Remove the left cover

Follow these steps to remove the left cover.

1. Remove two screws.

Figure 7-657 Remove two screws

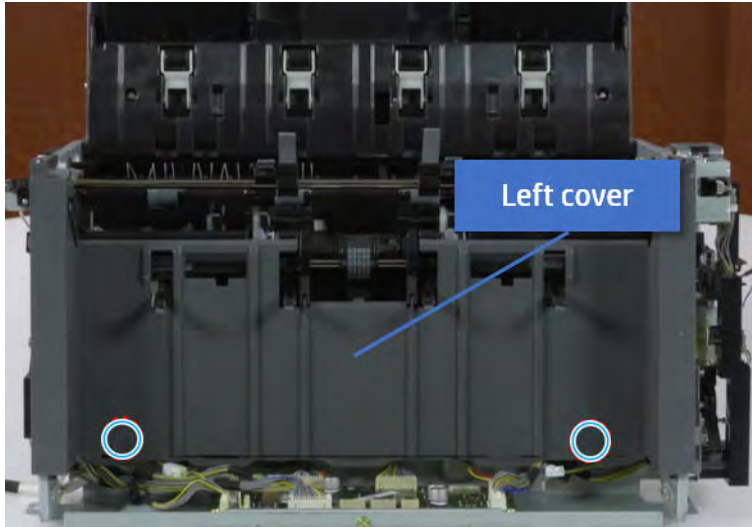

2. Remove four screws from both front and rear sides.

Figure 7-658 Remove four screws

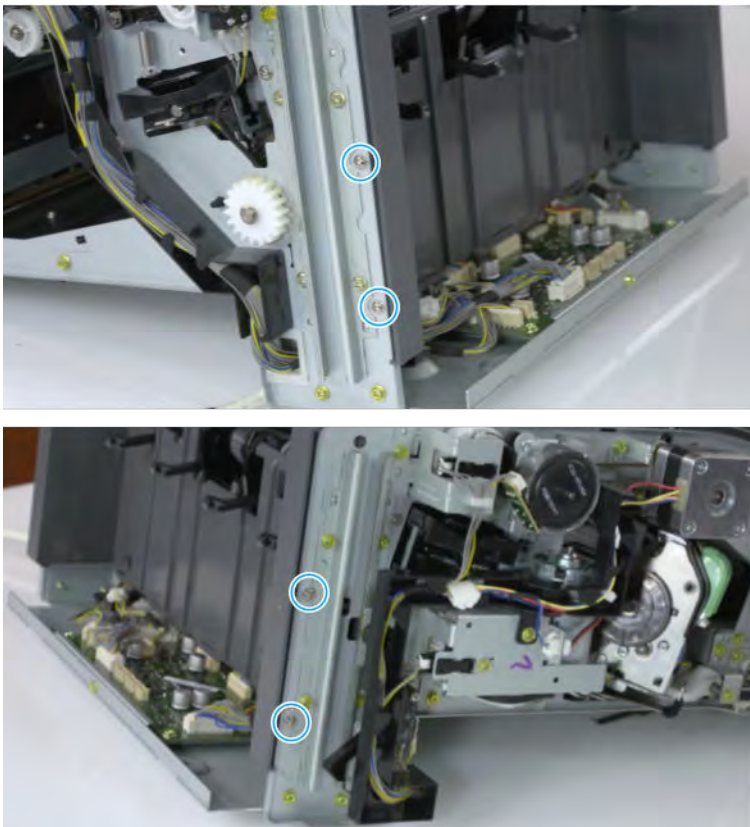

3. Unplug two inline connectors, and then remove the left cover.

Figure 7-659 Unplug two connectors

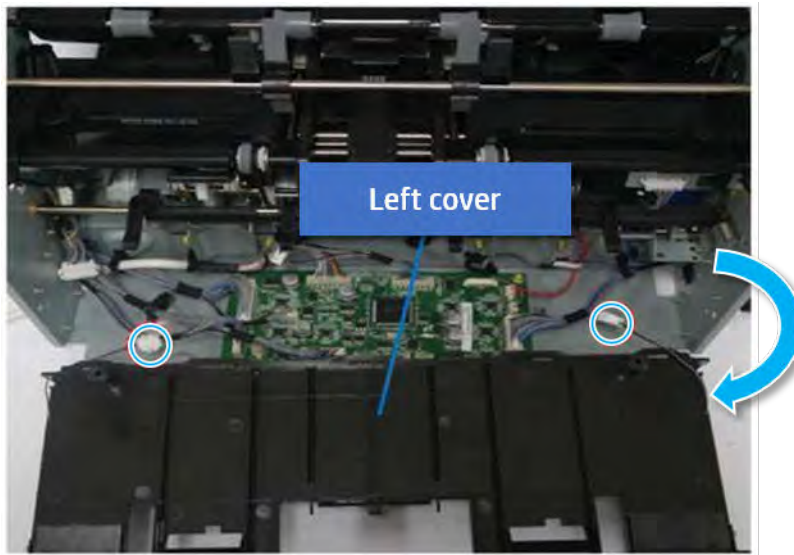

 **TIP:** Be sure to check the hook when reassembling.

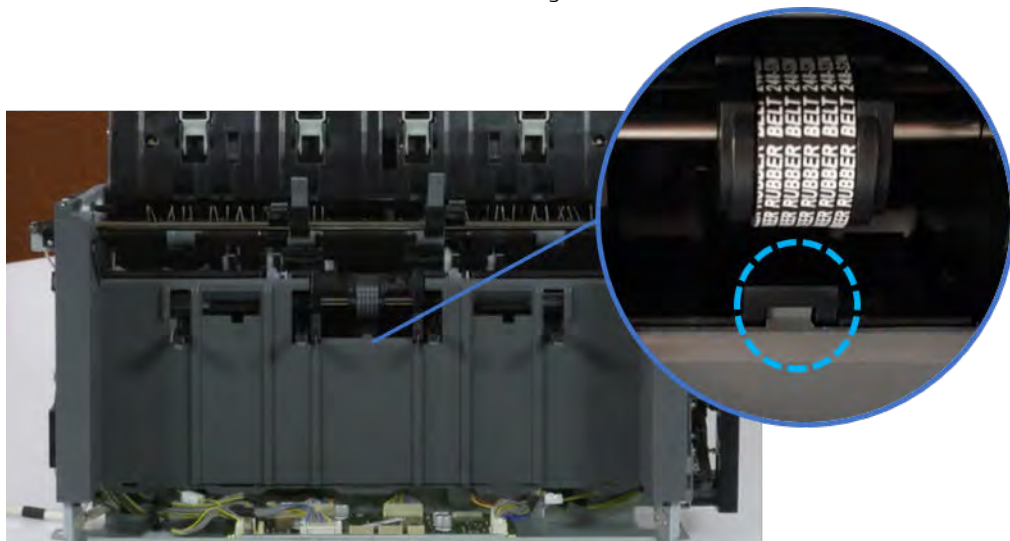

Remove the front harness guide

Follow these steps to remove the front harness guide.

1. Open one clamp and unplug five connectors, and then remove the wire harness from the front harness guide.

2. Remove four screws, and then remove the front harness guide.

Figure 7-660 Remove the front harness guide

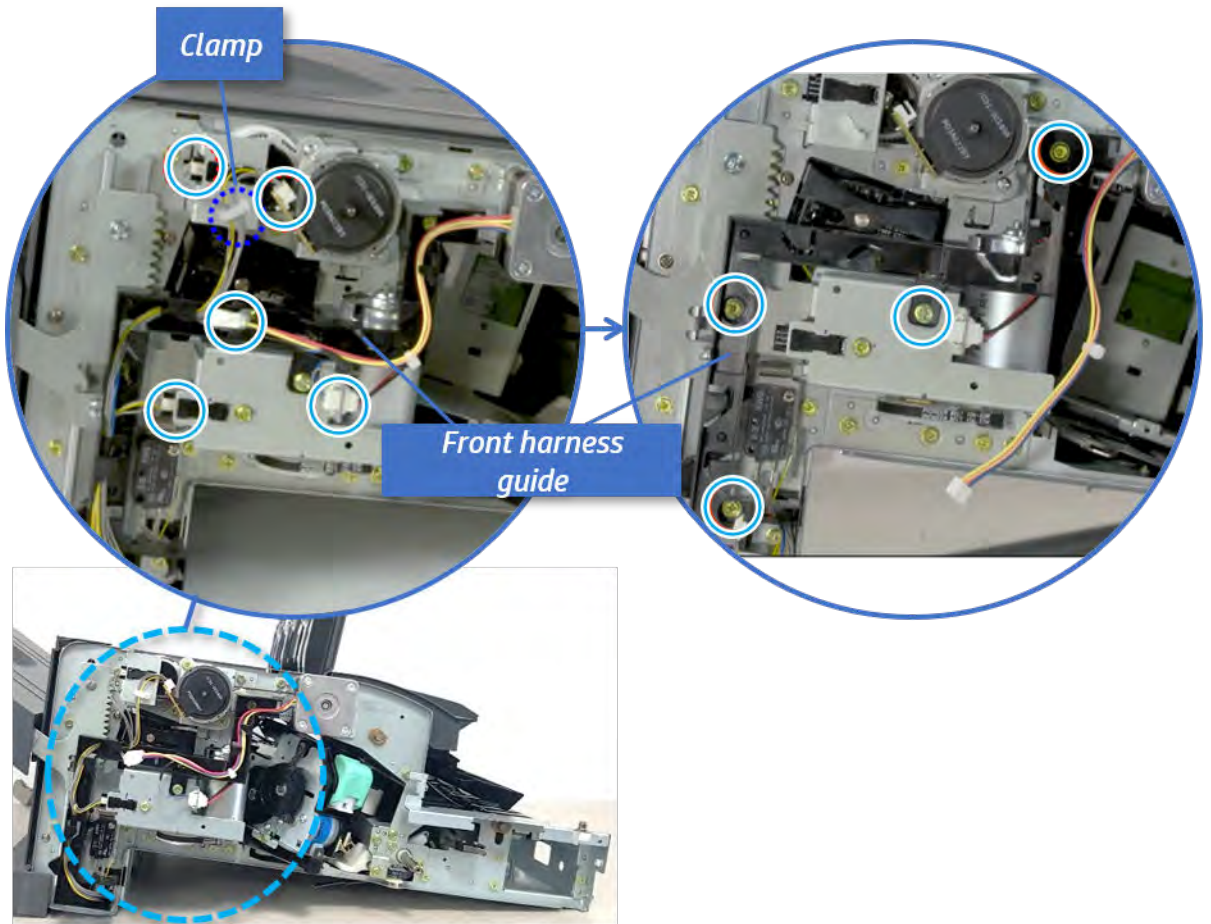

Remove the output tray lower limit switch

Follow these steps to remove the output tray lower limit switch.

- ▲ Remove one screw, and then remove the output tray lower limit switch.

Figure 7-661 Remove the output tray lower limit switch

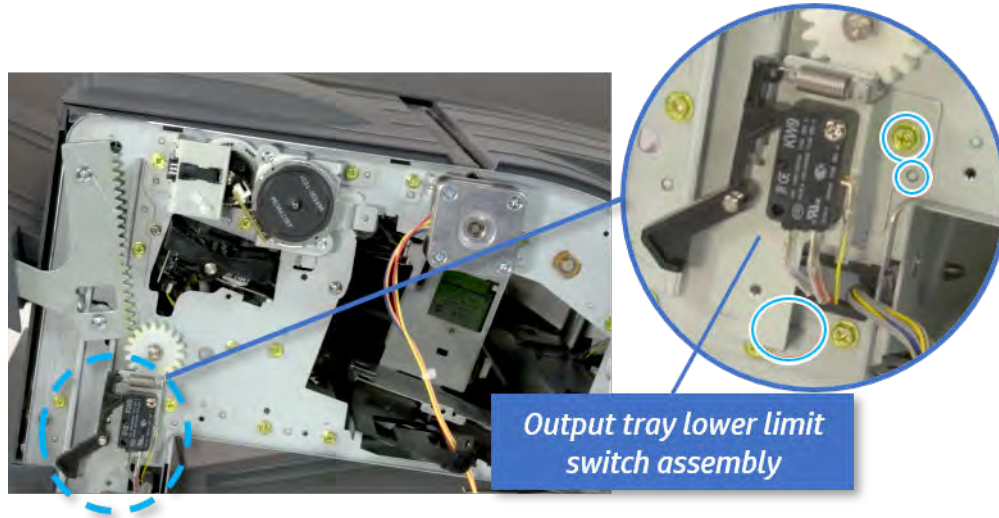

Unpack the replacement assembly



Follow these steps to unpack the replacement assembly.

1. Dispose of the defective part.

 **NOTE:** HP recommends responsible disposal of the defective part.

<http://www8.hp.com/us/en/hp-information/environment/product-recycling.html>

2. Unpack the replacement part from the packaging.

 **CAUTION:**  Some parts are sensitive to electrostatic discharge (ESD). Always perform service work at an ESD-protected workstation or mat. If an ESD workstation or mat is not available, touch the sheet-metal chassis to provide a static ground before touching an ESD-sensitive assembly. Protect the ESD-sensitive assemblies by placing them in ESD pouches when they are out of the printer.

 **IMPORTANT:** Make sure that all of the shipping materials (for example shipping tape) are removed from the replacement part prior to installation.

 **NOTE:** If the replacement part is a roller or pad, avoid touching the spongy part of it. Skin oils on the roller or pad can cause paper pickup and/or print-quality problems. HP recommends using disposable gloves when handling rollers or pads or washing your hands before touching rollers or pads.

3. To install an assembly, reverse the removal steps.

 **NOTE:** When applicable, special installation instructions are provided for an assembly at the end of the removal procedure. Always completely read the removal instructions and follow all special installation instructions.

Output tray motor assembly

Removal and replacement: Output tray motor assembly (M4)

Learn how to remove and replace the output tray motor assembly.

To view teardown and reassembling video of the inner finisher, click the link below.



[View a teardown video of the inner finisher.](#)



[View a reassembling video of the inner finisher.](#)



IMPORTANT: When applicable, special installation instructions are provided for an assembly at the end of the removal procedure. Always completely read the removal instructions and follow all special installation instructions.

Mean time to repair:

Service level:

Before performing service

Turn the printer power off

- Press the power button on the front of the printer, and then turn off the power switch next to the power cable.
- A shutting-down message appears on the control-panel display.



WARNING! To avoid damage to the printer, turn the power off and wait until the printer shuts down before removing the power cable.

- Disconnect the printer power cable after the printer has completely shut down (the control-panel display is blank).

Use the table below to identify the correct part number for your printer. To order the part, go to <http://www.hp.com/buy/parts>.

Table 7-69 Part information

Part number	Part description
JC90-01334B	Output tray motor assembly

Required tools

- #2 JIS screwdriver with a magnetic tip

After performing service

Turn the printer power on

- Connect the power cable.
- Use the power switch to turn the power on.

Post service test

Print any pages necessary to verify that the repair resolved the issue and did not create any new issues.

Remove the front cover

Follow these steps to remove the front cover.

1. Open the front door and open the punch cover.
2. Remove three screws in the front.
3. Remove the lever.
4. Open the top cover.
5. From the right side of the front cover, carefully lift and pry toward the top-left corner to remove the front cover.

Figure 7-662 Remove the front cover

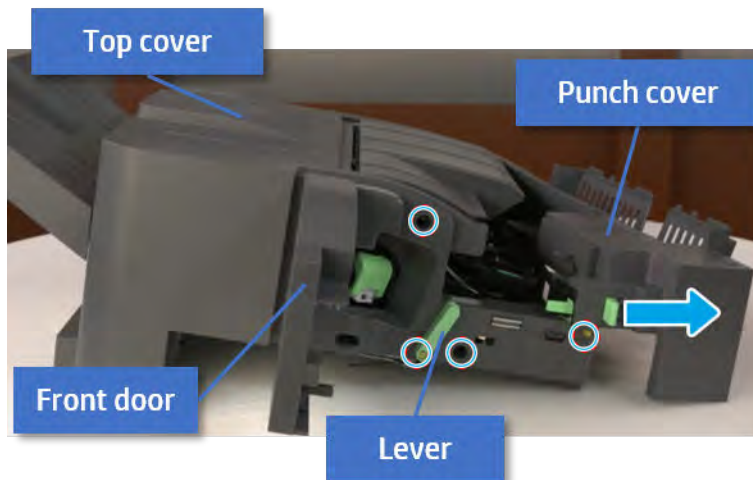

Remove the rear cover

Follow these steps to remove the rear cover.

1. Open the top cover.

Figure 7-663 Open the top cover

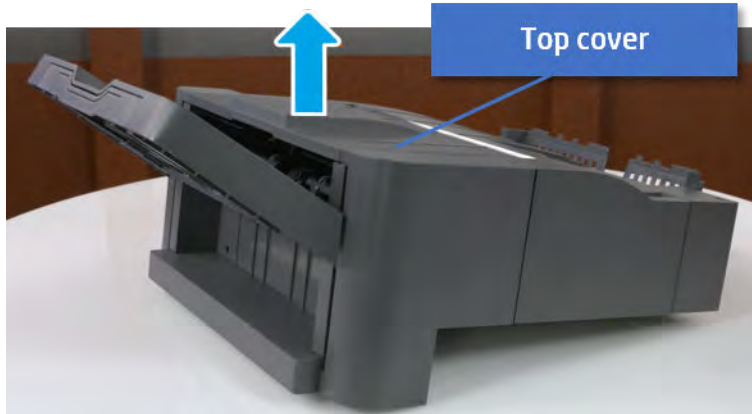

2. Remove three screws.
3. Release hooks carefully and remove the rear cover.

Figure 7-664 Remove the rear cover

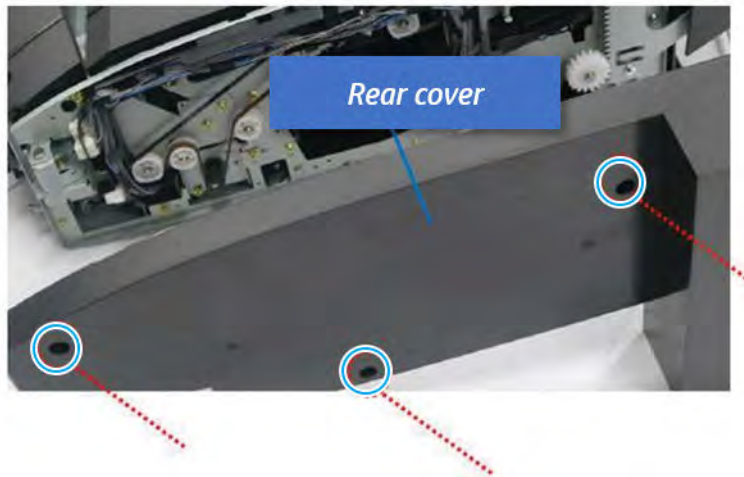

Remove the output tray

Follow these steps to remove the output tray.

1. Remove four screws.

Figure 7-665 Remove four screws

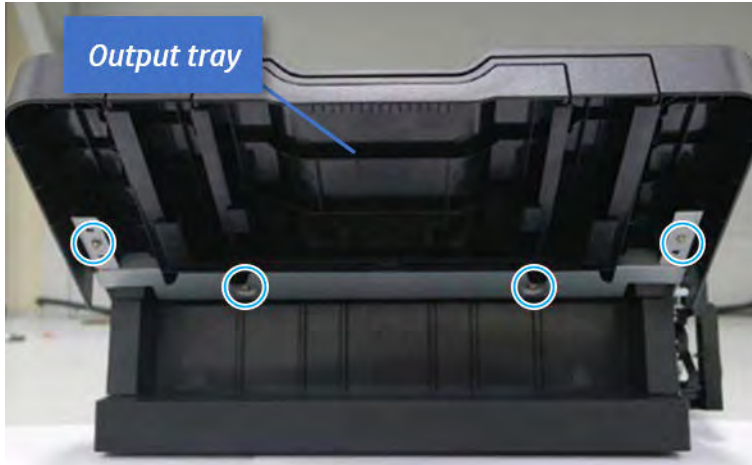

2. Push the paper holding actuator into the inner finisher, and then remove the output tray.

Figure 7-666 Remove the output tray.



Remove the output tray frame

Follow these steps to remove the output tray frame.

1. Rotate the pulley until the output tray frame depart from the gear.

Figure 7-667 Remove the pulley

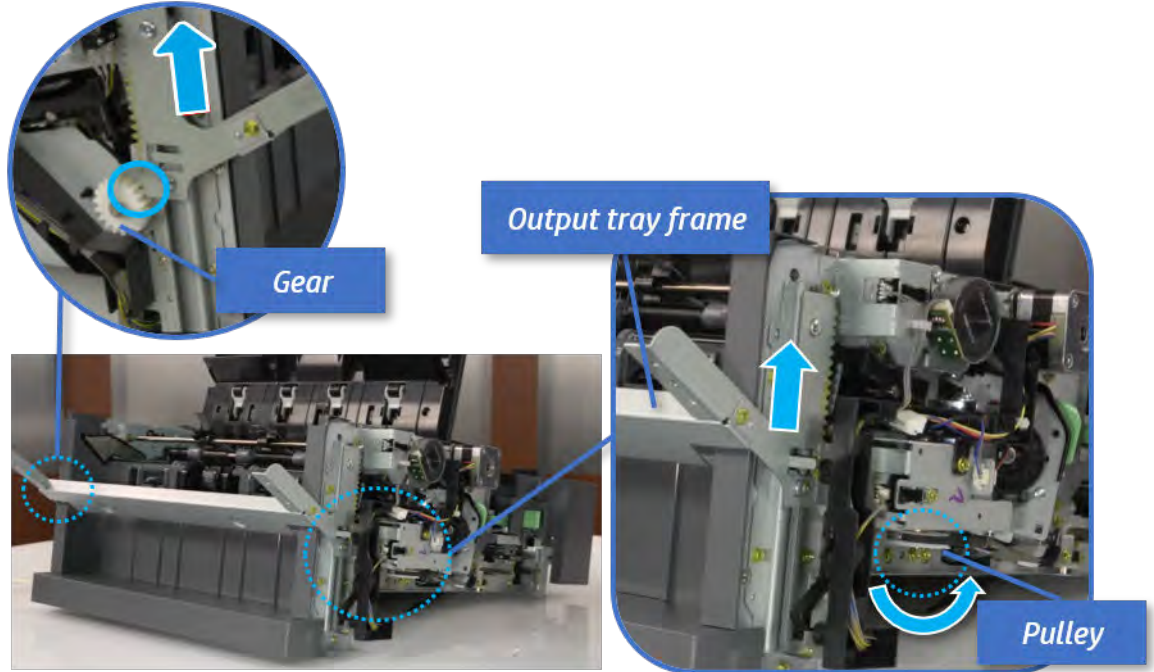

2. Push the paper holding actuator into the inner finisher, and then remove the output tray frame.

Figure 7-668 Remove the output tray frame

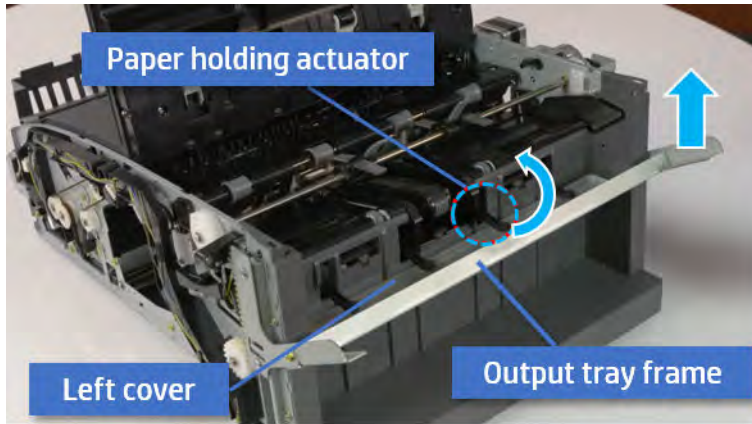

TIP: Push the paper holding actuator into the inner finisher when reassembling. Be sure to level the output tray.

- a. Position the first wheel into the channel on both sides while pushing the paper holding actuator.

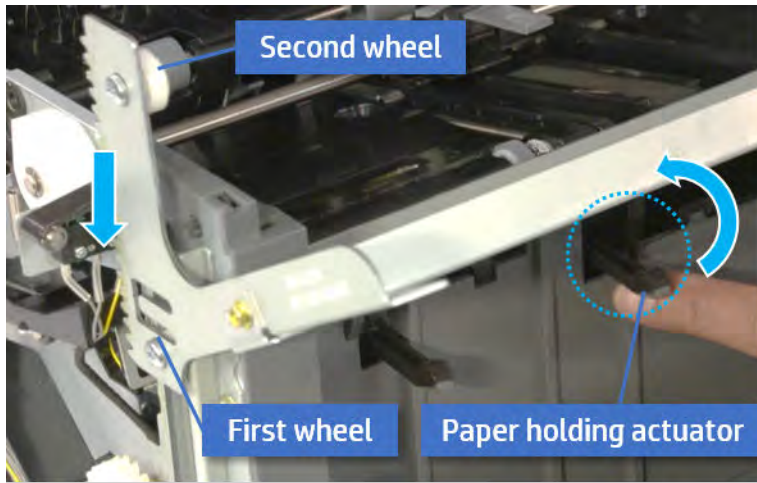

- b. Let the second wheel rest on the channel on both sides simultaneously.
- c. Gently squeeze the wheels into channel until the output tray frame meet the gear.

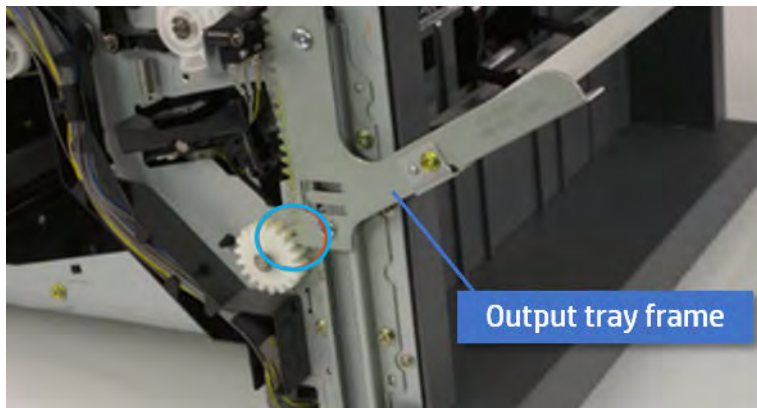

- d. Rotate the pulley until the output tray frame is no longer lifted. It can make to level the output tray frame.

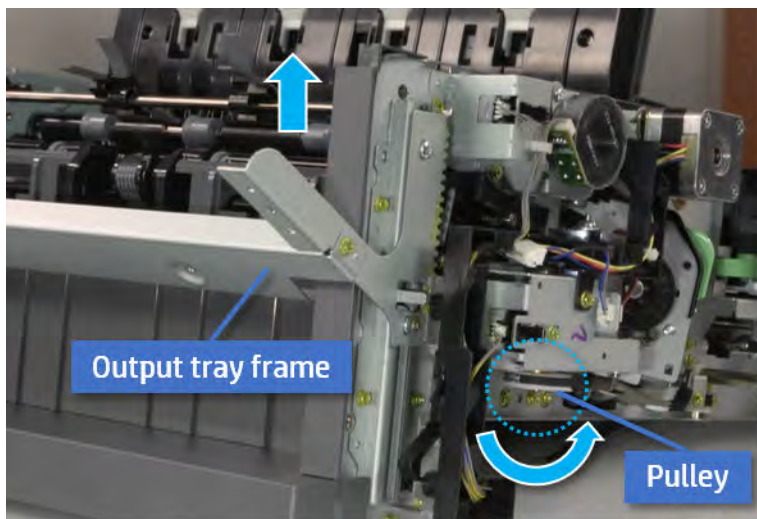

- e. Rotate the pulley in the opposite direction.

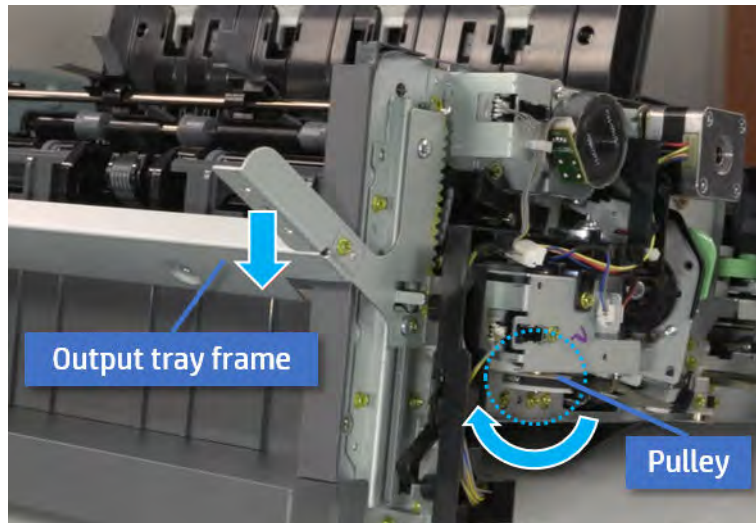

Remove the PCA cover

Follow these steps to remove the PCA cover.

- ▲ Remove two screws, and then remove the PCA cover.

Figure 7-669 Remove the PCA cover

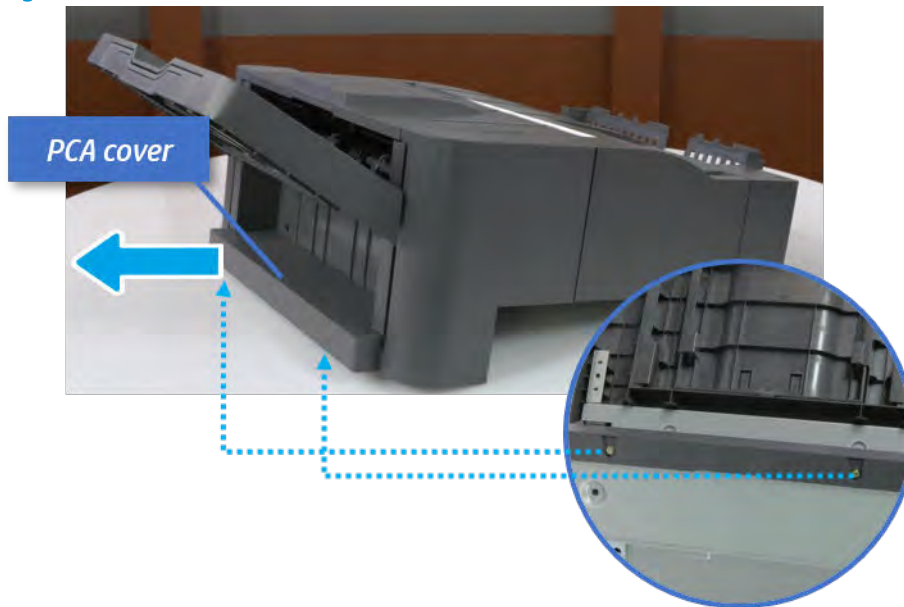

Remove the left cover

Follow these steps to remove the left cover.

1. Remove two screws.

Figure 7-670 Remove two screws

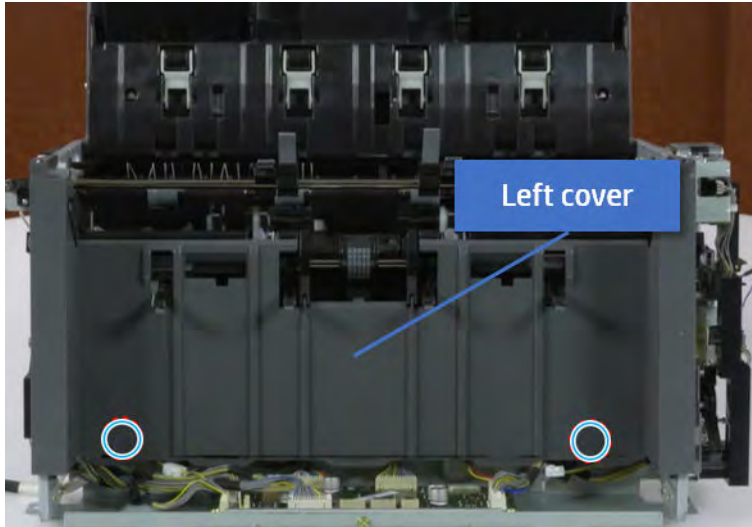

2. Remove four screws from both front and rear sides.

Figure 7-671 Remove four screws

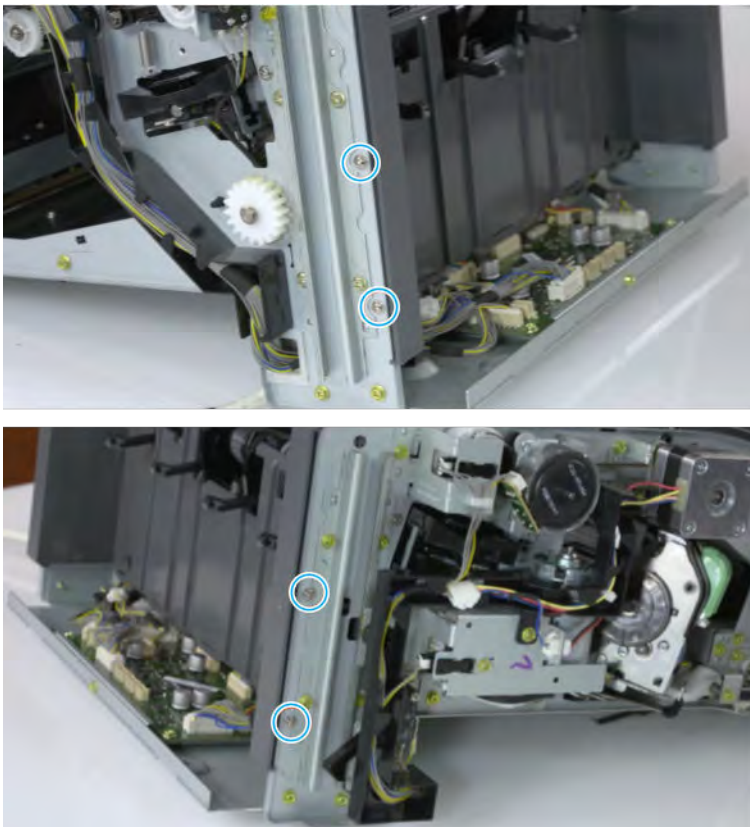

3. Unplug two inline connectors, and then remove the left cover.

Figure 7-672 Unplug two connectors

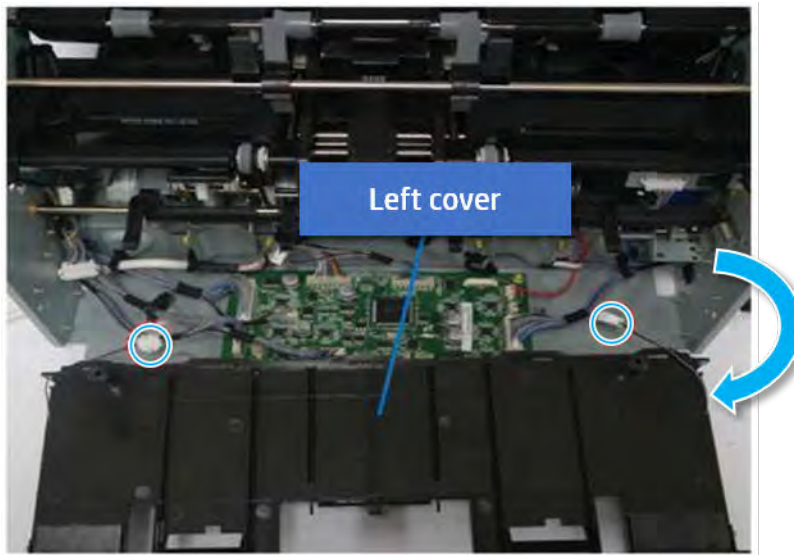

 **TIP:** Be sure to check the hook when reassembling.

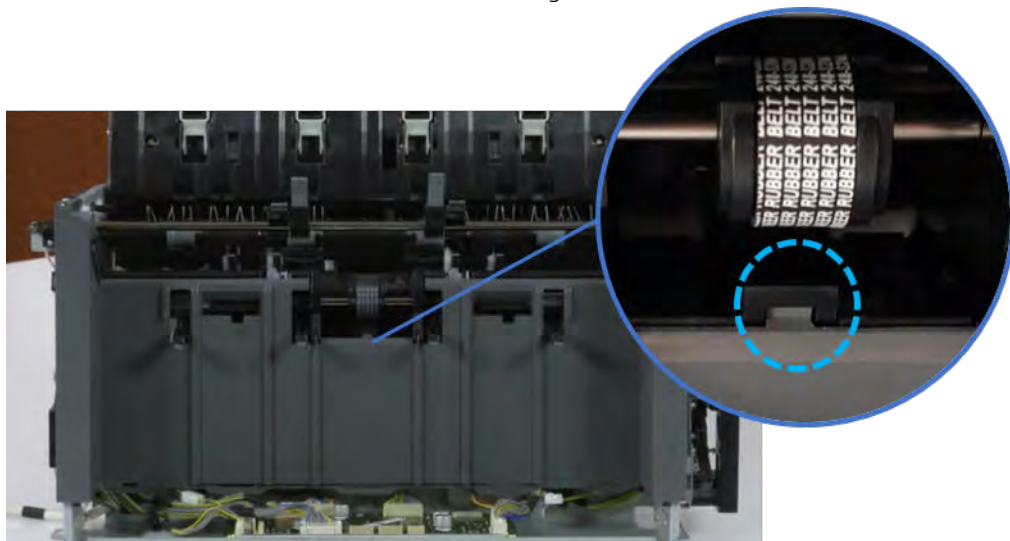

Remove the front harness guide

Follow these steps to remove the front harness guide.

1. Open one clamp and unplug five connectors, and then remove the wire harness from the front harness guide.

2. Remove four screws, and then remove the front harness guide.

Figure 7-673 Remove the front harness guide

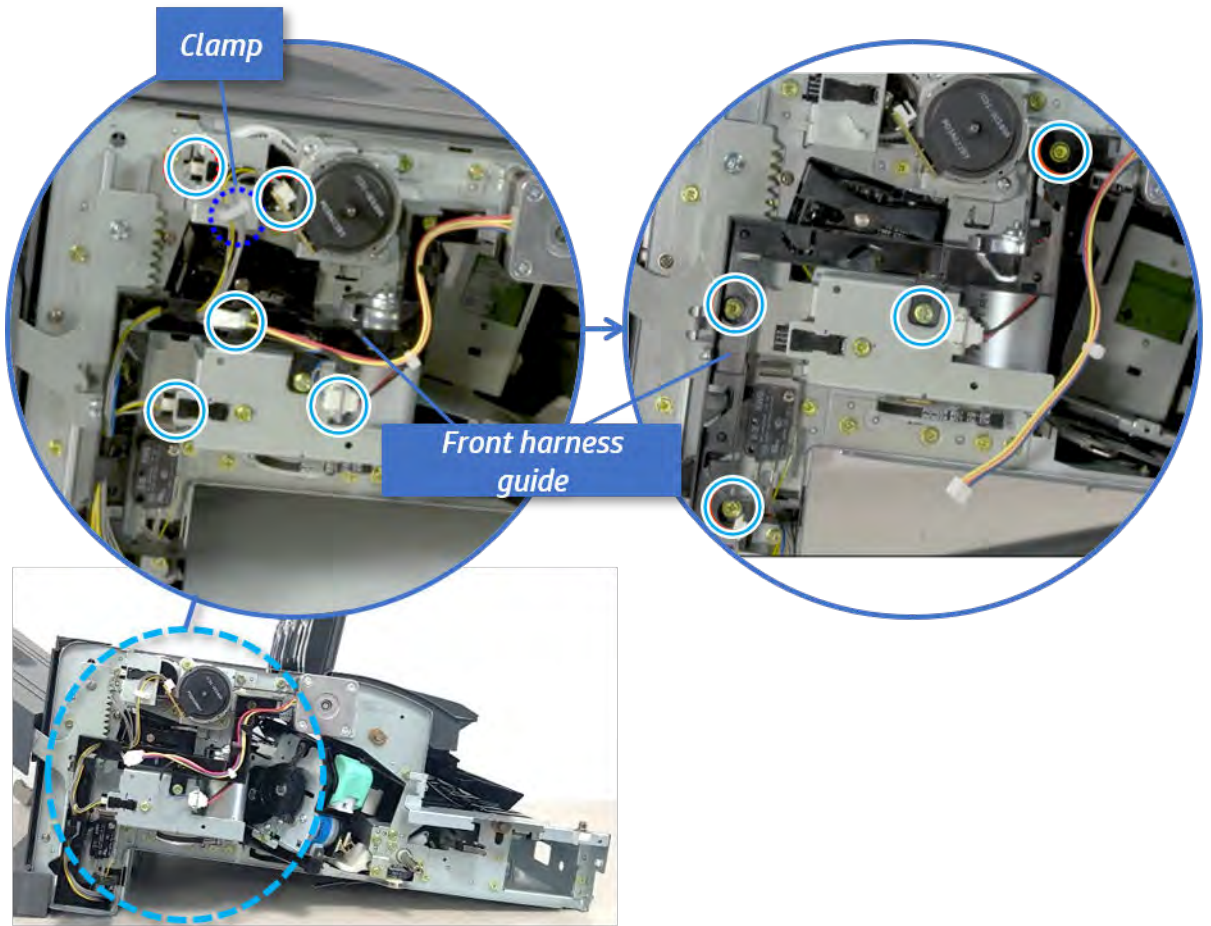

Remove the output tray motor assembly

Follow these steps to remove the output tray motor assembly.

- ▲ Remove three screws, and then remove the output tray motor assembly.

Figure 7-674 Remove the output tray motor assembly

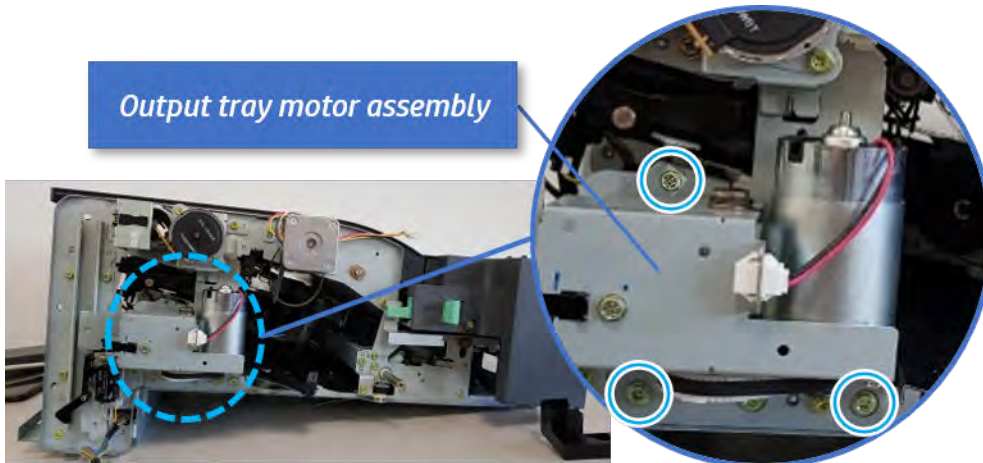

Unpack the replacement assembly

Follow these steps to unpack the replacement assembly.

1. Dispose of the defective part.



NOTE: HP recommends responsible disposal of the defective part.

<http://www8.hp.com/us/en/hp-information/environment/product-recycling.html>

2. Unpack the replacement part from the packaging.



CAUTION:  Some parts are sensitive to electrostatic discharge (ESD). Always perform service work at an ESD-protected workstation or mat. If an ESD workstation or mat is not available, touch the sheet-metal chassis to provide a static ground before touching an ESD-sensitive assembly. Protect the ESD-sensitive assemblies by placing them in ESD pouches when they are out of the printer.



IMPORTANT: Make sure that all of the shipping materials (for example shipping tape) are removed from the replacement part prior to installation.



NOTE: If the replacement part is a roller or pad, avoid touching the spongy part of it. Skin oils on the roller or pad can cause paper pickup and/or print-quality problems. HP recommends using disposable gloves when handling rollers or pads or washing your hands before touching rollers or pads.

3. To install an assembly, reverse the removal steps.



NOTE: When applicable, special installation instructions are provided for an assembly at the end of the removal procedure. Always completely read the removal instructions and follow all special installation instructions.

Removal and replacement: Output tray motor sensor (S6)

Learn how to remove and replace the output tray motor sensor.

To view teardown and reassembling video of the inner finisher, click the link below.



[View a teardown video of the inner finisher.](#)



[View a reassembling video of the inner finisher.](#)



IMPORTANT: When applicable, special installation instructions are provided for an assembly at the end of the removal procedure. Always completely read the removal instructions and follow all special installation instructions.

Mean time to repair:

Service level:

Before performing service

Turn the printer power off

- Press the power button on the front of the printer, and then turn off the power switch next to the power cable.
- A shutting-down message appears on the control-panel display.



WARNING! To avoid damage to the printer, turn the power off and wait until the printer shuts down before removing the power cable.

- Disconnect the printer power cable after the printer has completely shut down (the control-panel display is blank).

Use the table below to identify the correct part number for your printer. To order the part, go to <http://www.hp.com/buy/parts>.

Table 7-70 Part information

Part number	Part description
0604-001393	Output tray motor sensor

Required tools

- #2 JIS screwdriver with a magnetic tip

After performing service

Turn the printer power on

- Connect the power cable.
- Use the power switch to turn the power on.

Post service test

Print any pages necessary to verify that the repair resolved the issue and did not create any new issues.

Remove the front cover

Follow these steps to remove the front cover.

1. Open the front door and open the punch cover.
2. Remove three screws in the front.
3. Remove the lever.
4. Open the top cover.
5. From the right side of the front cover, carefully lift and pry toward the top-left corner to remove the front cover.

Figure 7-675 Remove the front cover

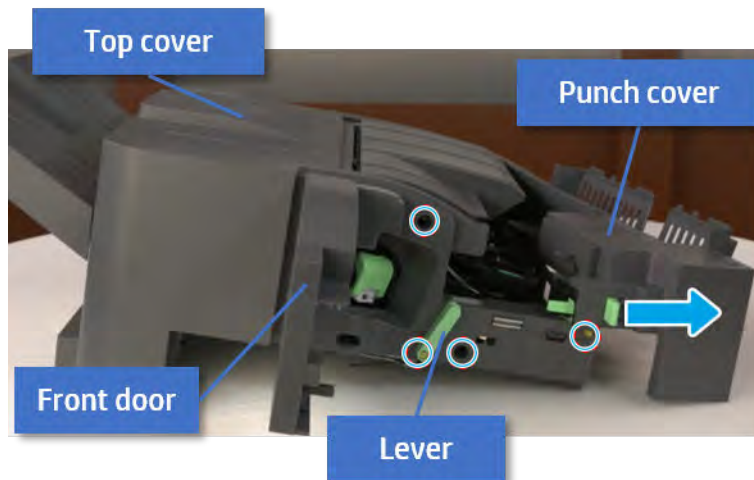

Remove the rear cover

Follow these steps to remove the rear cover.

1. Open the top cover.

Figure 7-676 Open the top cover

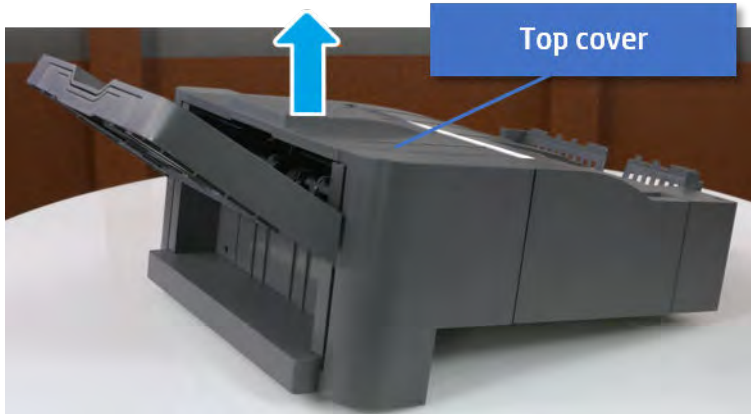

2. Remove three screws.
3. Release hooks carefully and remove the rear cover.

Figure 7-677 Remove the rear cover

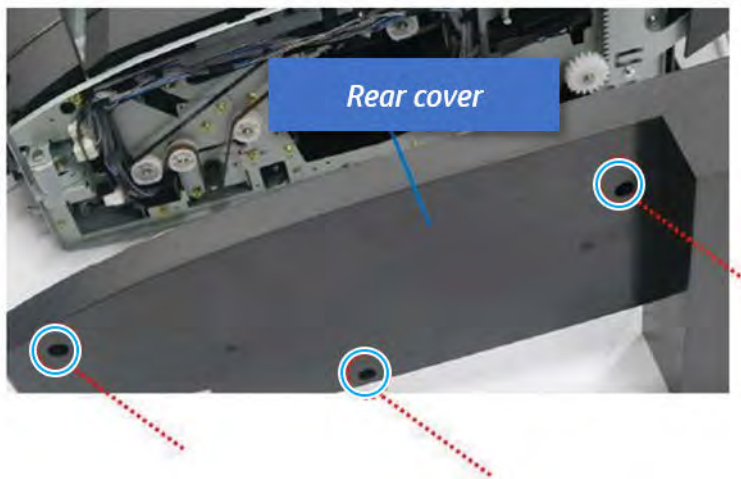

Remove the output tray

Follow these steps to remove the output tray.

1. Remove four screws.

Figure 7-678 Remove four screws

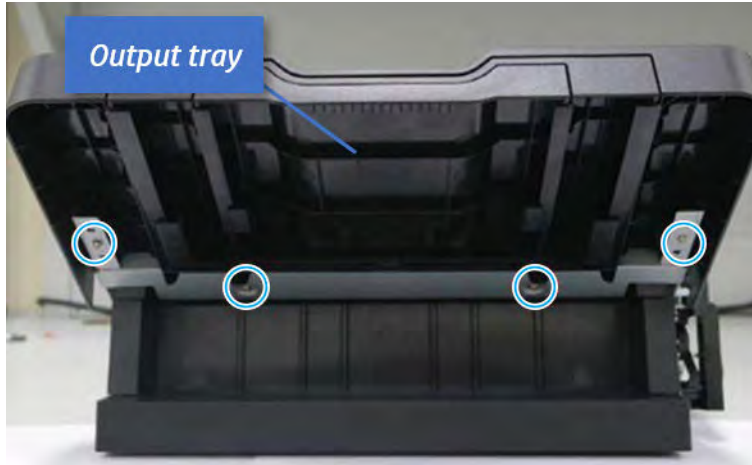

2. Push the paper holding actuator into the inner finisher, and then remove the output tray.

Figure 7-679 Remove the output tray.



Remove the output tray frame

Follow these steps to remove the output tray frame.

1. Rotate the pulley until the output tray frame depart from the gear.

Figure 7-680 Remove the pulley

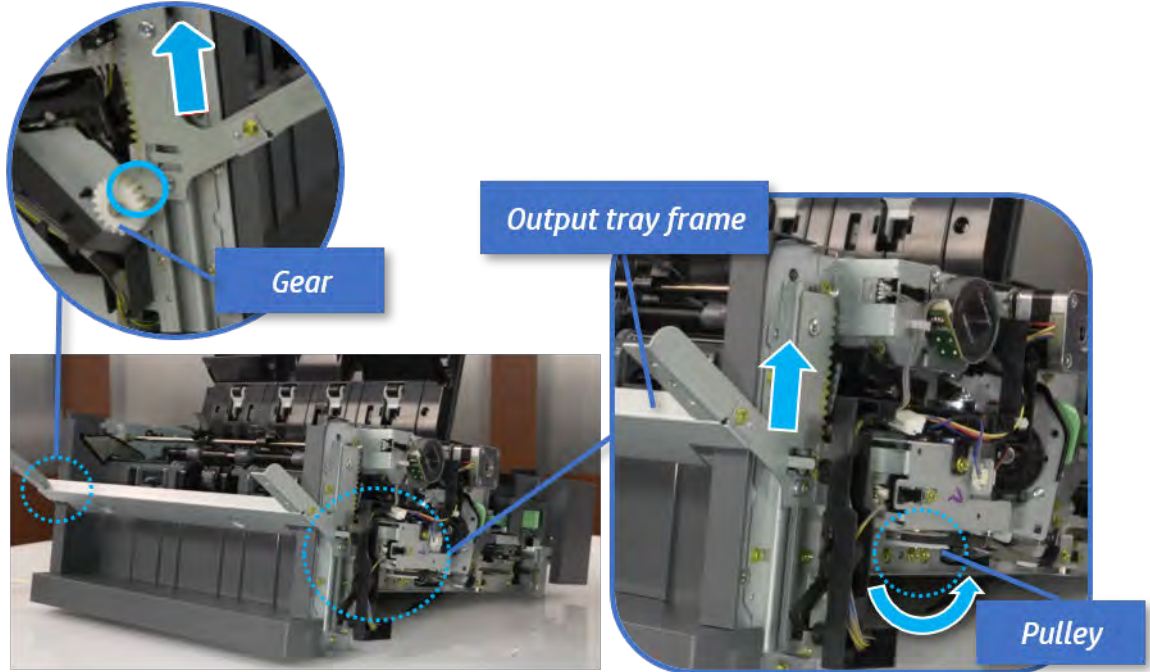

2. Push the paper holding actuator into the inner finisher, and then remove the output tray frame.

Figure 7-681 Remove the output tray frame

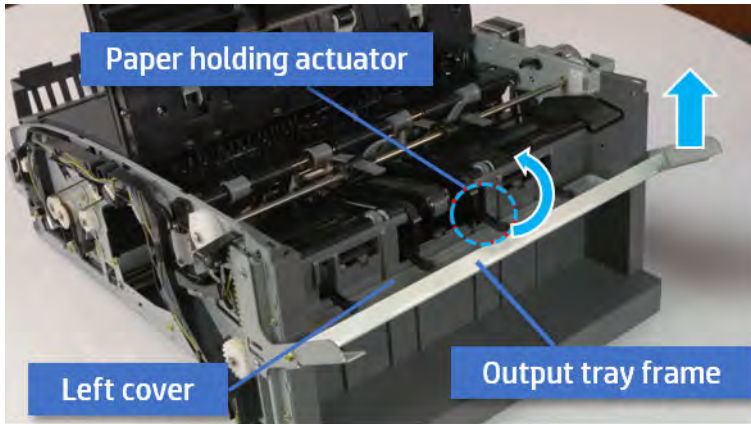

 **TIP:** Push the paper holding actuator into the inner finisher when reassembling. Be sure to level the output tray.

- a. Position the first wheel into the channel on both sides while pushing the paper holding actuator.

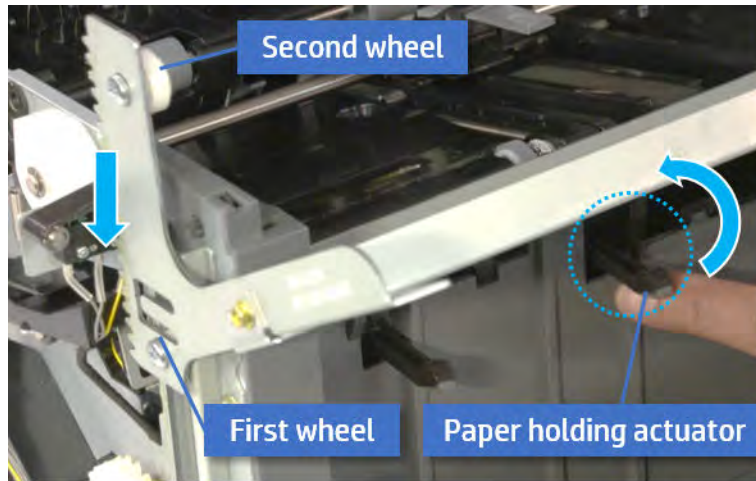

- b. Let the second wheel rest on the channel on both sides simultaneously.
- c. Gently squeeze the wheels into channel until the output tray frame meet the gear.

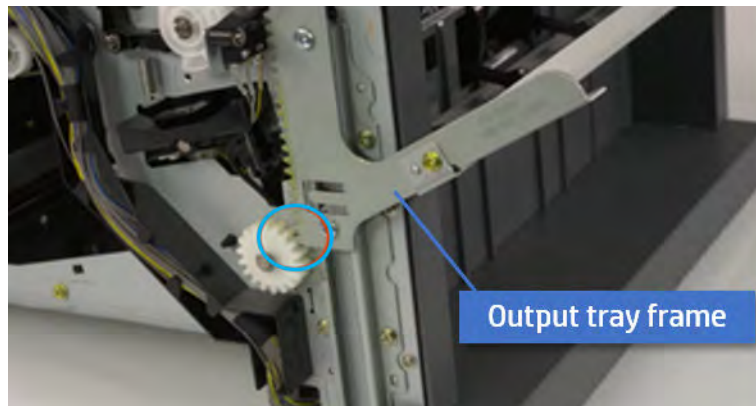

- d. Rotate the pulley until the output tray frame is no longer lifted. It can make to level the output tray frame.

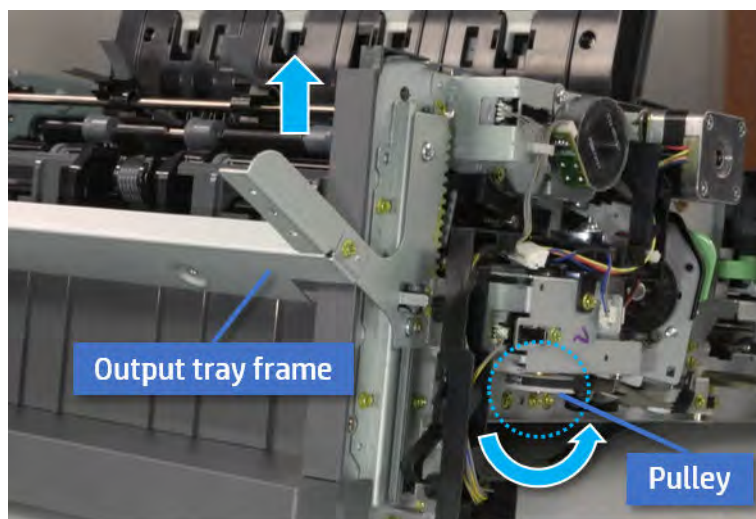

- e. Rotate the pulley in the opposite direction.

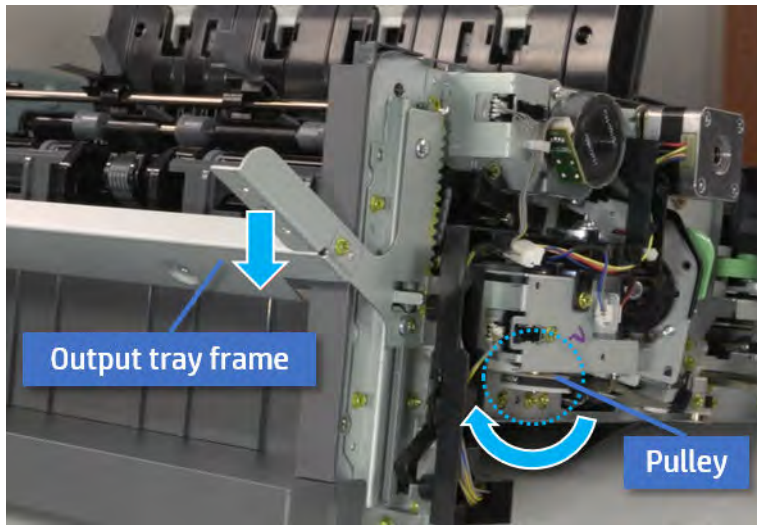

Remove the PCA cover

Follow these steps to remove the PCA cover.

- ▲ Remove two screws, and then remove the PCA cover.

Figure 7-682 Remove the PCA cover

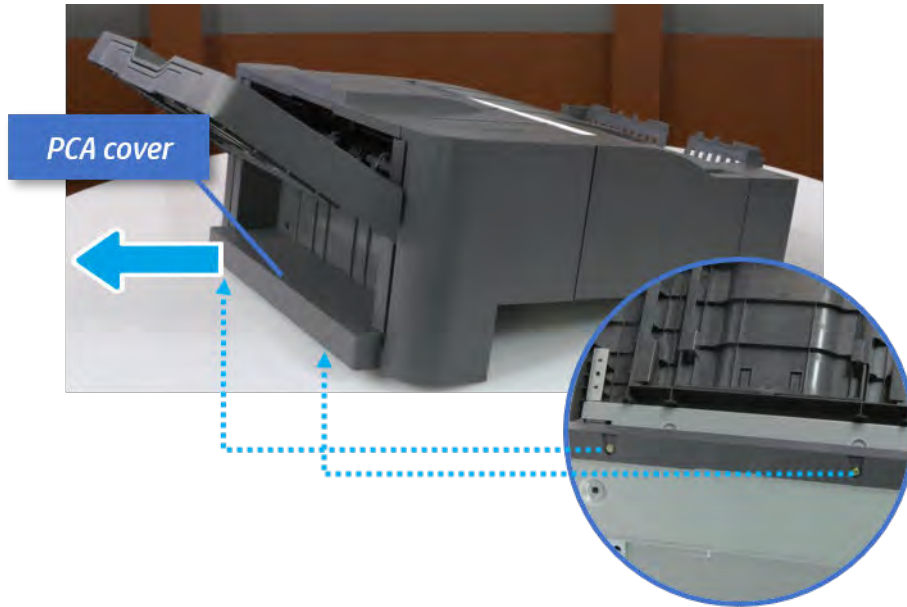

Remove the left cover

Follow these steps to remove the left cover.

1. Remove two screws.

Figure 7-683 Remove two screws

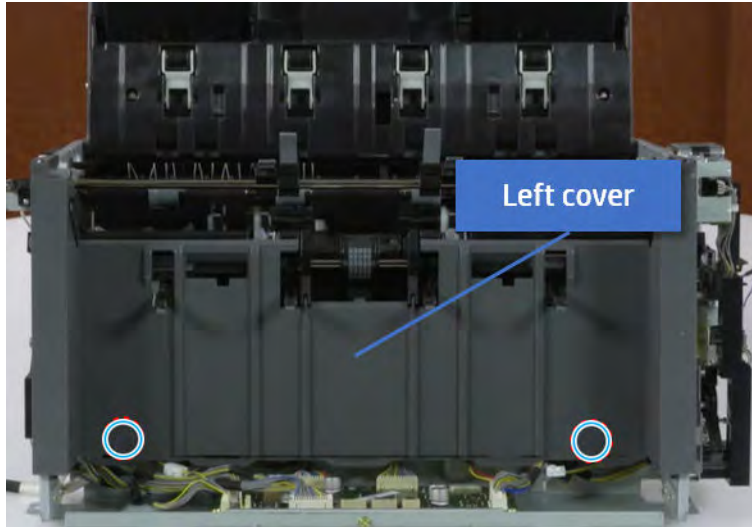

2. Remove four screws from both front and rear sides.

Figure 7-684 Remove four screws

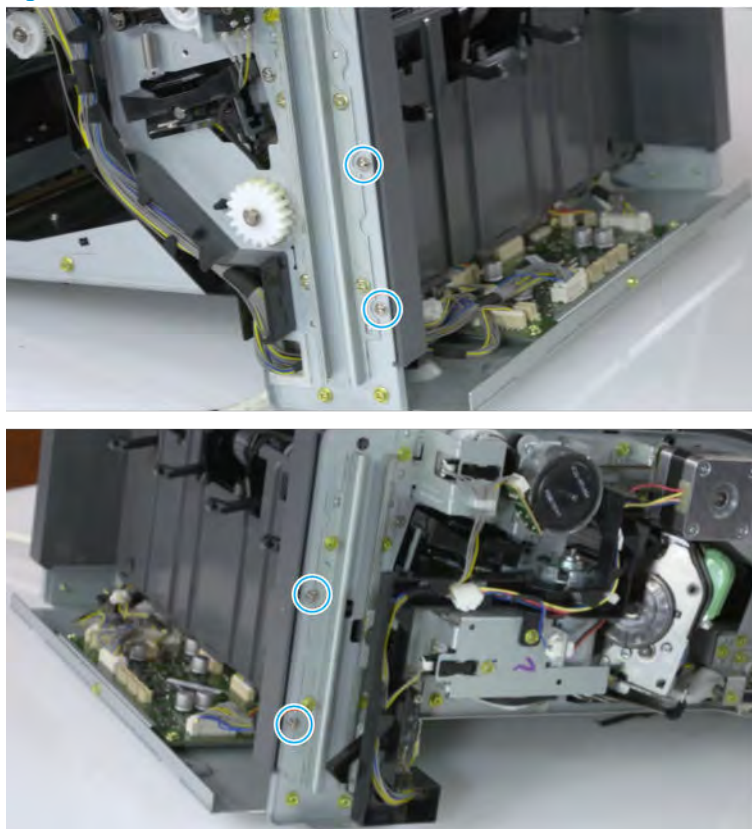

3. Unplug two inline connectors, and then remove the left cover.

Figure 7-685 Unplug two connectors

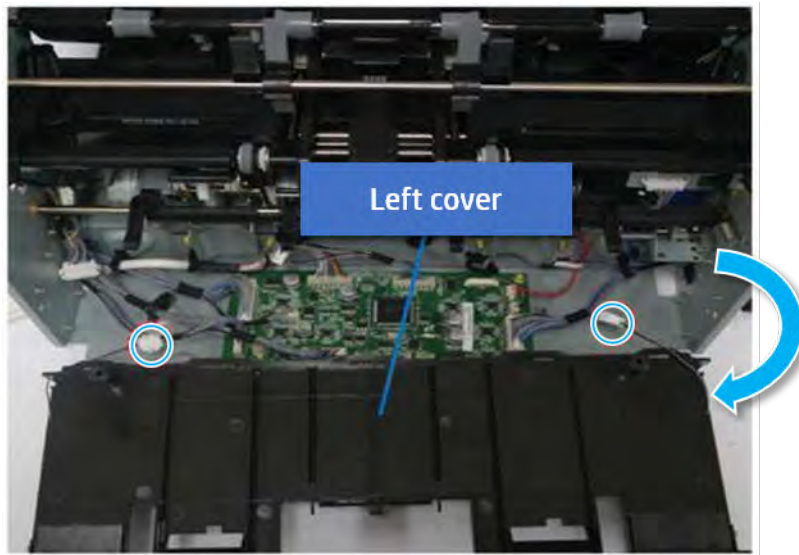

 **TIP:** Be sure to check the hook when reassembling.

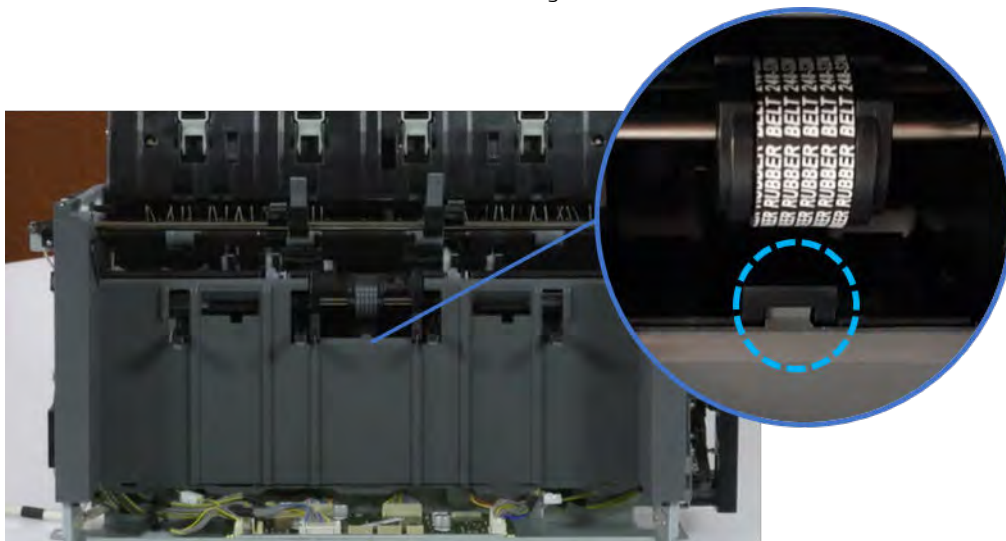

Remove the front harness guide

Follow these steps to remove the front harness guide.

1. Open one clamp and unplug five connectors, and then remove the wire harness from the front harness guide.

2. Remove four screws, and then remove the front harness guide.

Figure 7-686 Remove the front harness guide

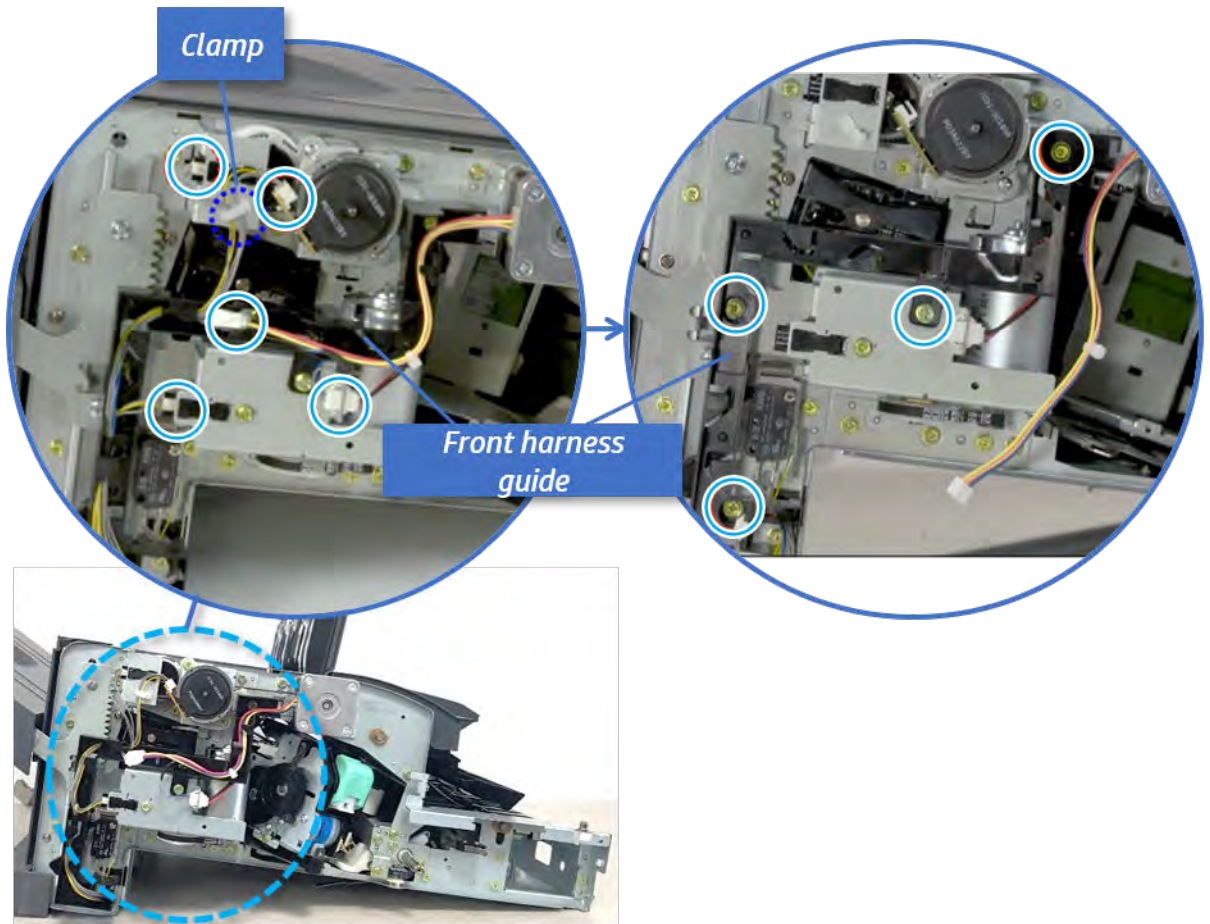

Remove the output tray motor assembly

Follow these steps to remove the output tray motor assembly.

- ▲ Remove three screws, and then remove the output tray motor assembly.

Figure 7-687 Remove the output tray motor assembly

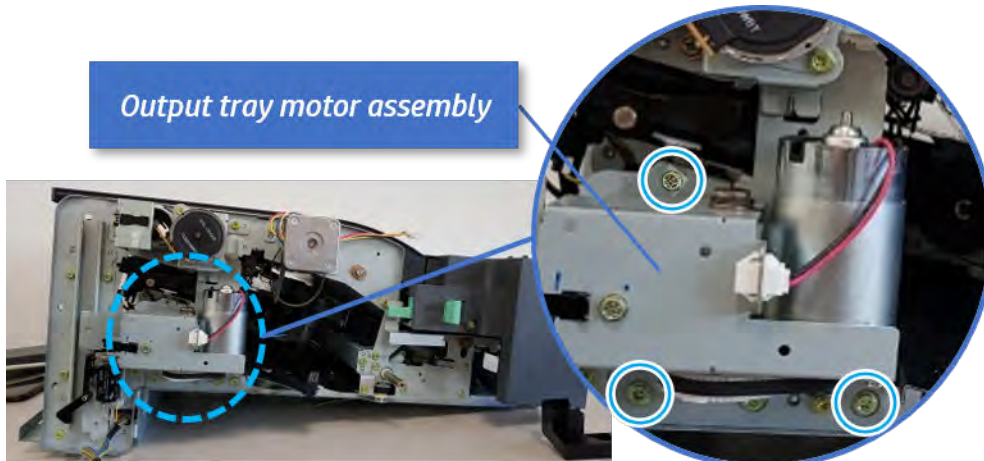

Remove the output tray motor sensor

Follow these steps to remove the output tray motor sensor.

- ▲ Remove one screw, remove the shaft, and then remove the sensor.

Figure 7-688 Remove the output tray motor sensor

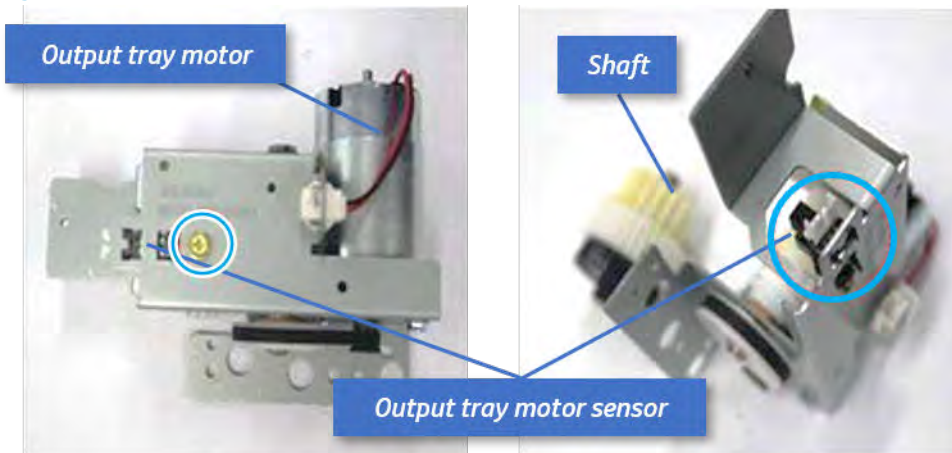

Unpack the replacement assembly



Follow these steps to unpack the replacement assembly.

1. Dispose of the defective part.

 **NOTE:** HP recommends responsible disposal of the defective part.

<http://www8.hp.com/us/en/hp-information/environment/product-recycling.html>

2. Unpack the replacement part from the packaging.

 **CAUTION:**  Some parts are sensitive to electrostatic discharge (ESD). Always perform service work at an ESD-protected workstation or mat. If an ESD workstation or mat is not available, touch the sheet-metal chassis to provide a static ground before touching an ESD-sensitive assembly. Protect the ESD-sensitive assemblies by placing them in ESD pouches when they are out of the printer.

 **IMPORTANT:** Make sure that all of the shipping materials (for example shipping tape) are removed from the replacement part prior to installation.

 **NOTE:** If the replacement part is a roller or pad, avoid touching the spongy part of it. Skin oils on the roller or pad can cause paper pickup and/or print-quality problems. HP recommends using disposable gloves when handling rollers or pads or washing your hands before touching rollers or pads.

3. To install an assembly, reverse the removal steps.

 **NOTE:** When applicable, special installation instructions are provided for an assembly at the end of the removal procedure. Always completely read the removal instructions and follow all special installation instructions.

Removal and replacement: Output tray motor

Learn how to remove and replace the output tray motor.

To view teardown and reassembling video of the inner finisher, click the link below.



[View a teardown video of the inner finisher.](#)



[View a reassembling video of the inner finisher.](#)



IMPORTANT: When applicable, special installation instructions are provided for an assembly at the end of the removal procedure. Always completely read the removal instructions and follow all special installation instructions.

Mean time to repair:

Service level:

Before performing service

Turn the printer power off

- Press the power button on the front of the printer, and then turn off the power switch next to the power cable.
- A shutting-down message appears on the control-panel display.



WARNING! To avoid damage to the printer, turn the power off and wait until the printer shuts down before removing the power cable.

- Disconnect the printer power cable after the printer has completely shut down (the control-panel display is blank).

Use the table below to identify the correct part number for your printer. To order the part, go to <http://www.hp.com/buy/parts>.

Table 7-71 Part information

Part number	Part description
JC31-00178B	Output tray motor

Required tools

- #2 JIS screwdriver with a magnetic tip

After performing service

Turn the printer power on

- Connect the power cable.
- Use the power switch to turn the power on.

Post service test

Print any pages necessary to verify that the repair resolved the issue and did not create any new issues.

Remove the front cover

Follow these steps to remove the front cover.

1. Open the front door and open the punch cover.
2. Remove three screws in the front.
3. Remove the lever.
4. Open the top cover.
5. From the right side of the front cover, carefully lift and pry toward the top-left corner to remove the front cover.

Figure 7-689 Remove the front cover

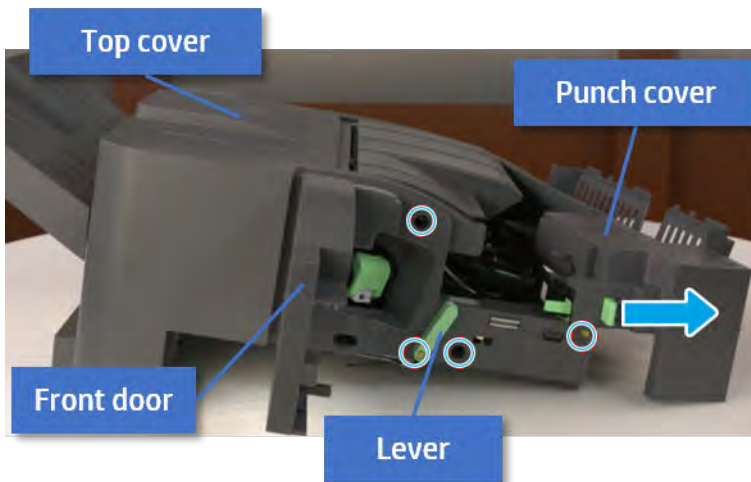

Remove the rear cover

Follow these steps to remove the rear cover.

1. Open the top cover.

Figure 7-690 Open the top cover

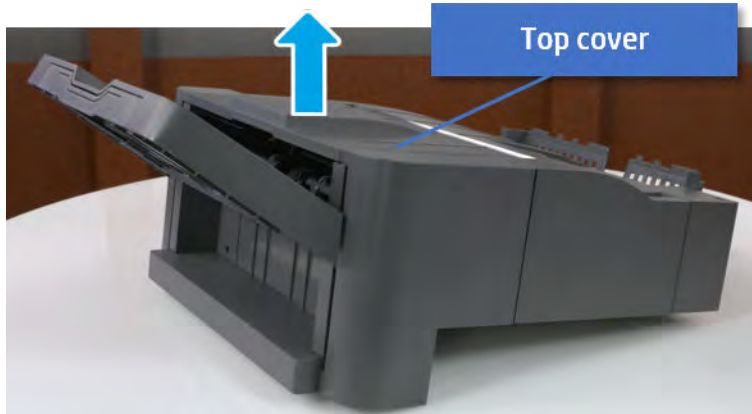

2. Remove three screws.
3. Release hooks carefully and remove the rear cover.

Figure 7-691 Remove the rear cover

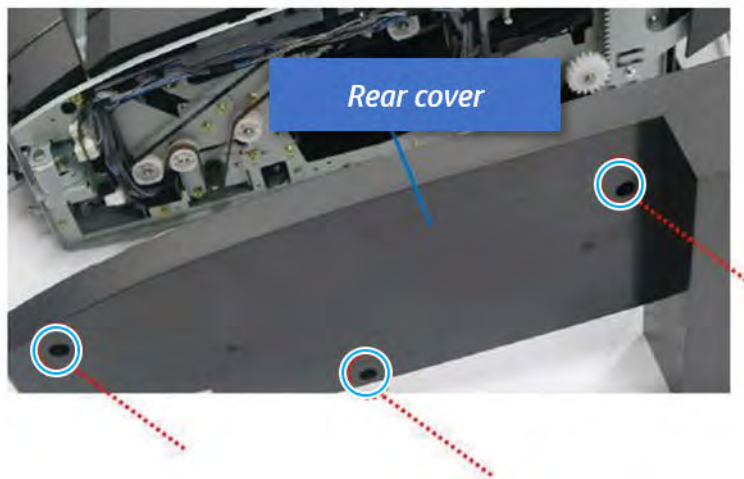

Remove the output tray

Follow these steps to remove the output tray.

1. Remove four screws.

Figure 7-692 Remove four screws

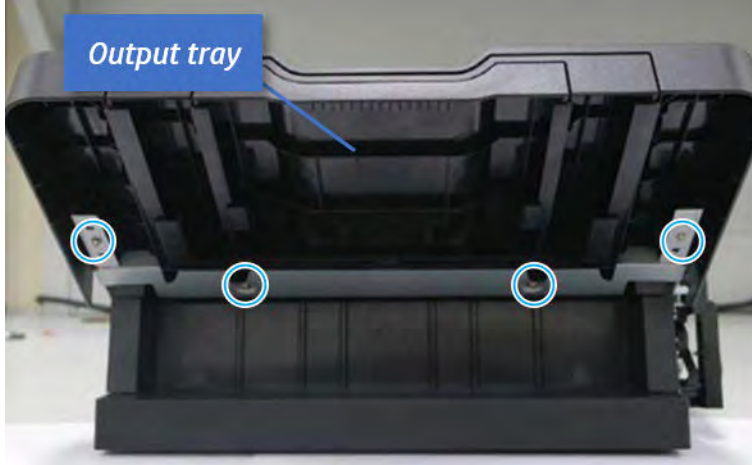

2. Push the paper holding actuator into the inner finisher, and then remove the output tray.

Figure 7-693 Remove the output tray.



Remove the output tray frame

Follow these steps to remove the output tray frame.

1. Rotate the pulley until the output tray frame depart from the gear.

Figure 7-694 Remove the pulley

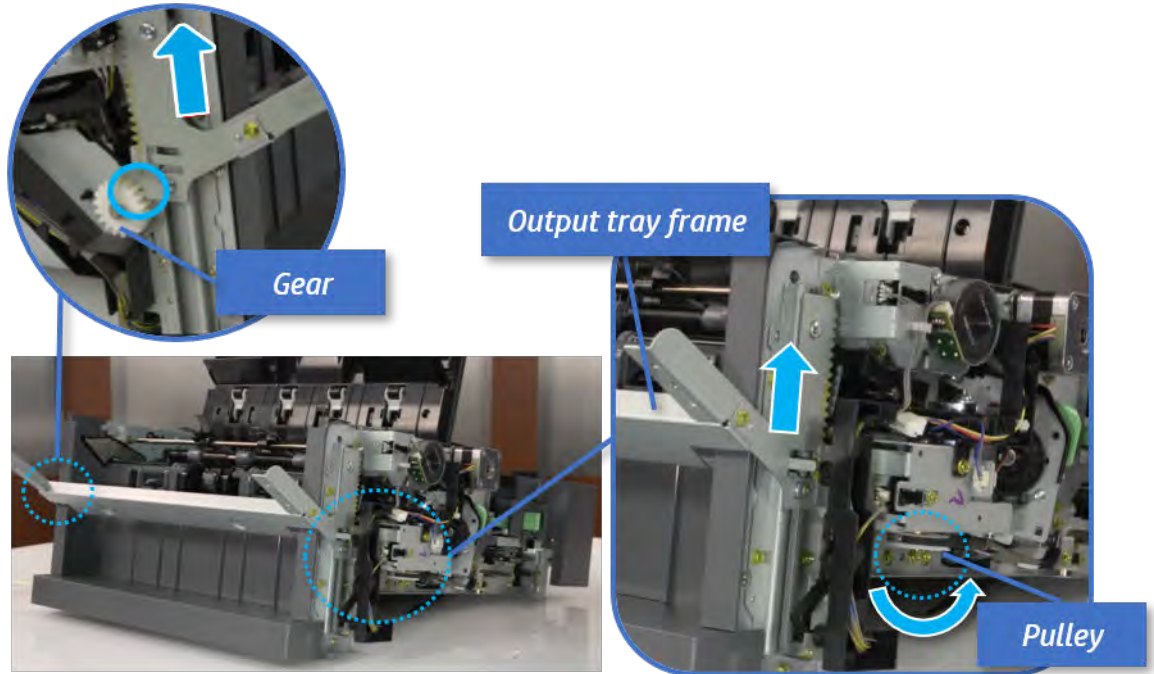

2. Push the paper holding actuator into the inner finisher, and then remove the output tray frame.

Figure 7-695 Remove the output tray frame

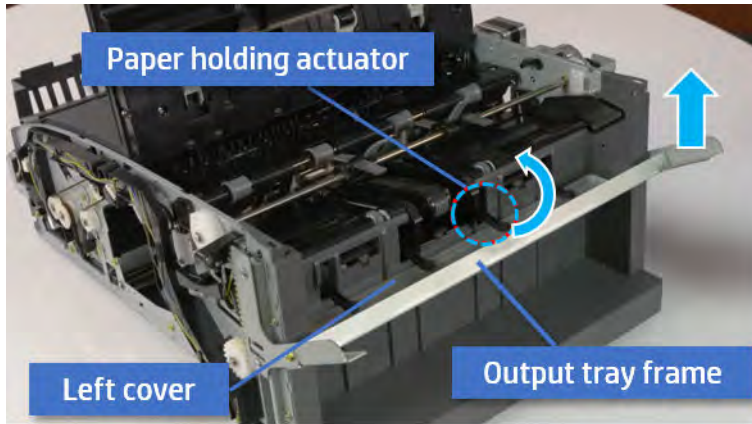

TIP: Push the paper holding actuator into the inner finisher when reassembling. Be sure to level the output tray.

- a. Position the first wheel into the channel on both sides while pushing the paper holding actuator.

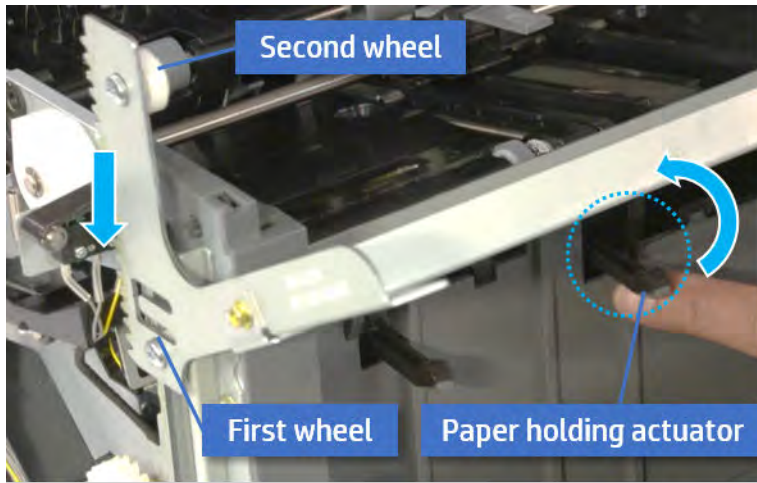

- b. Let the second wheel rest on the channel on both sides simultaneously.
- c. Gently squeeze the wheels into channel until the output tray frame meet the gear.

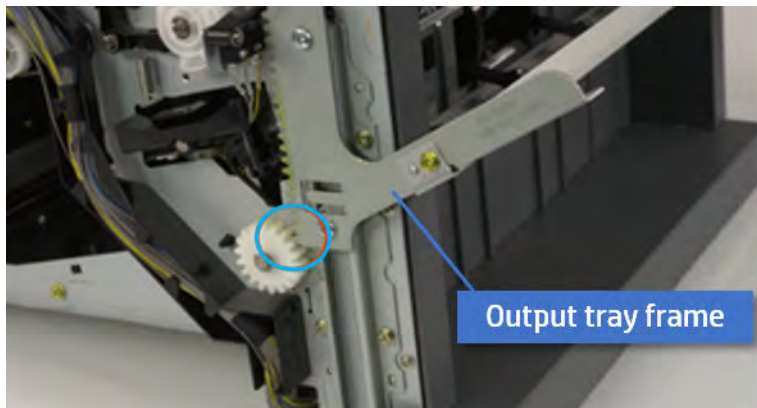

- d. Rotate the pulley until the output tray frame is no longer lifted. It can make to level the output tray frame.

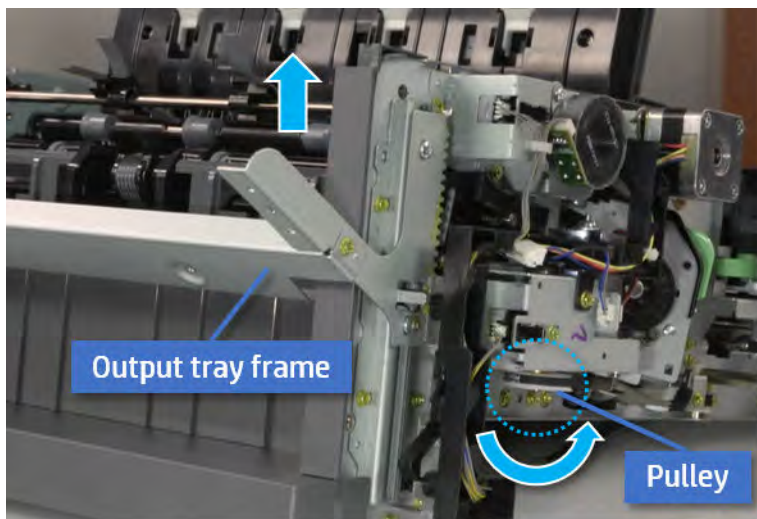

- e. Rotate the pulley in the opposite direction.

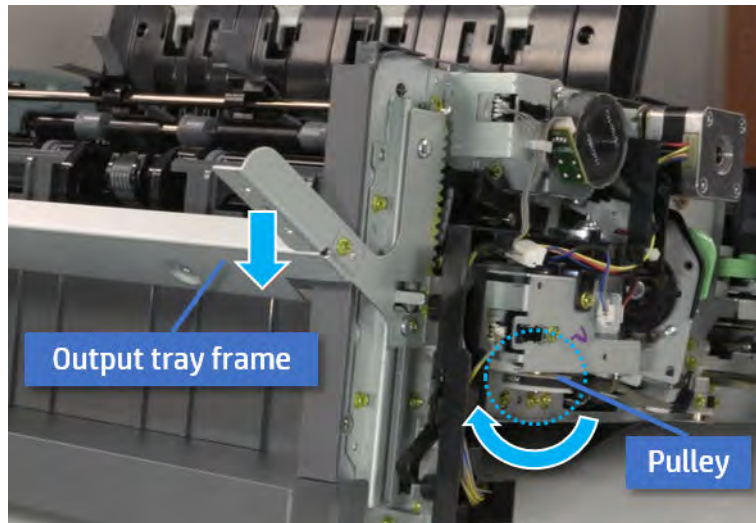

Remove the PCA cover

Follow these steps to remove the PCA cover.

- ▲ Remove two screws, and then remove the PCA cover.

Figure 7-696 Remove the PCA cover

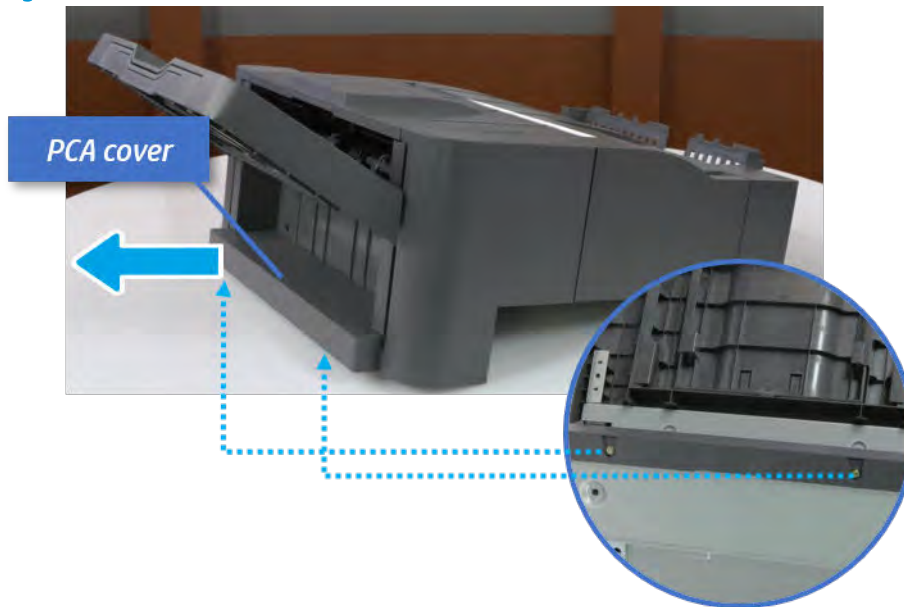

Remove the left cover

Follow these steps to remove the left cover.

1. Remove two screws.

Figure 7-697 Remove two screws

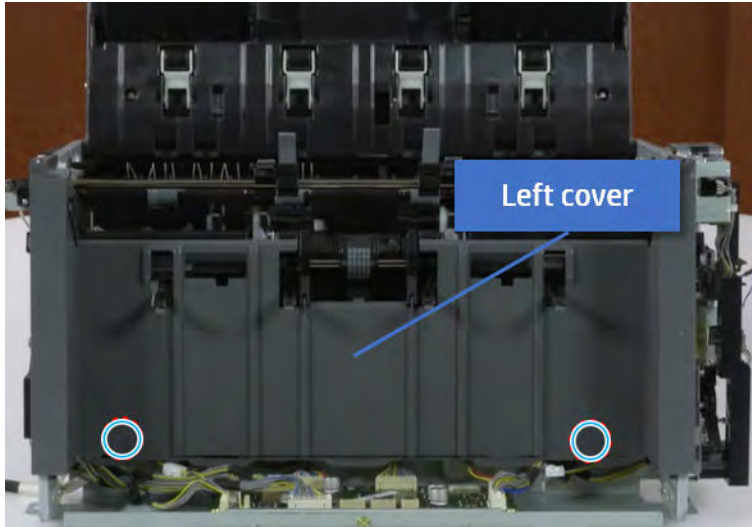

2. Remove four screws from both front and rear sides.

Figure 7-698 Remove four screws

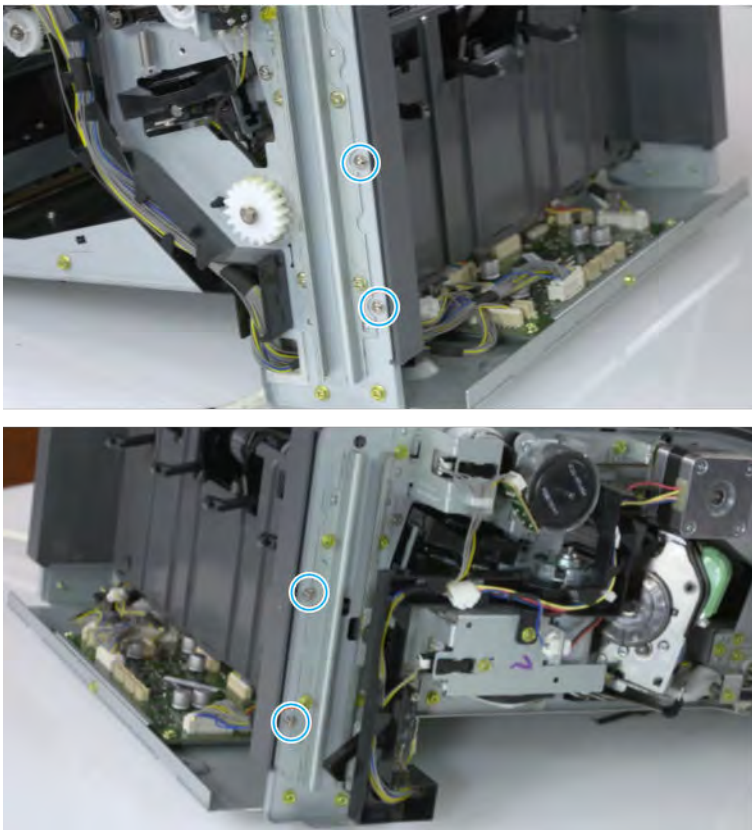

3. Unplug two inline connectors, and then remove the left cover.

Figure 7-699 Unplug two connectors

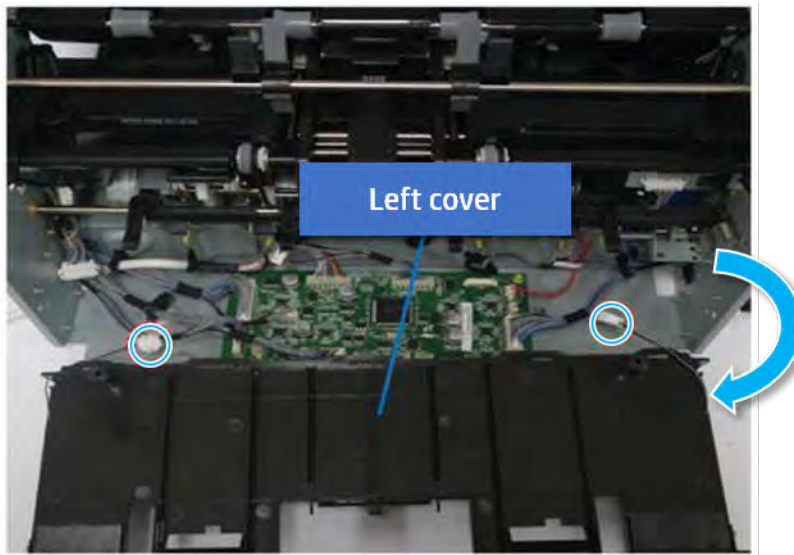

 **TIP:** Be sure to check the hook when reassembling.

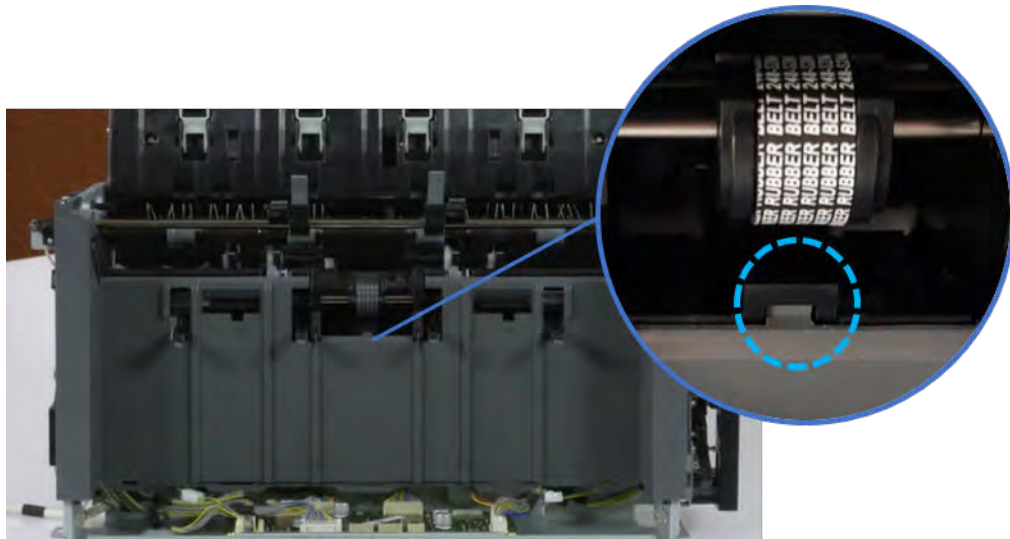

Remove the front harness guide

Follow these steps to remove the front harness guide.

1. Open one clamp and unplug five connectors, and then remove the wire harness from the front harness guide.

2. Remove four screws, and then remove the front harness guide.

Figure 7-700 Remove the front harness guide

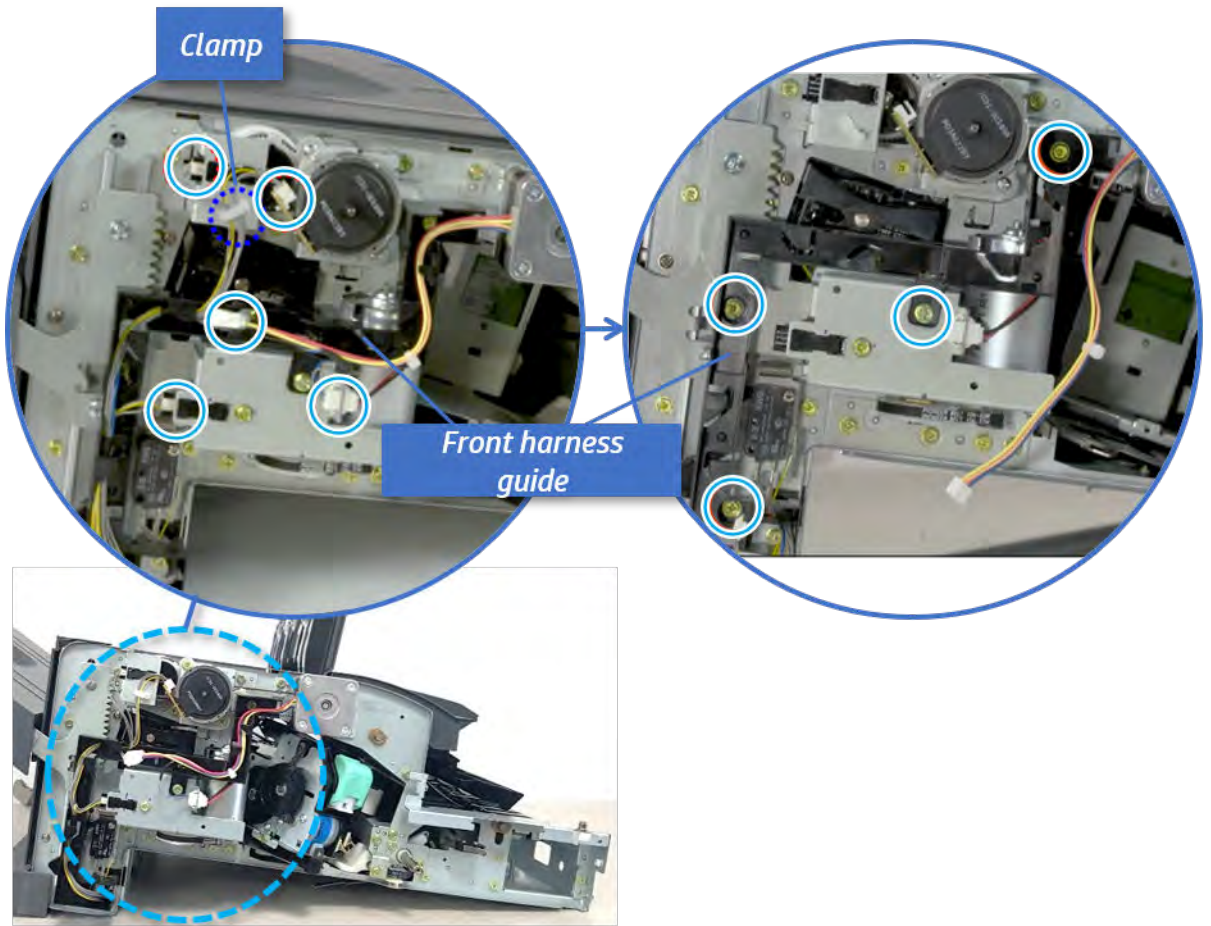

Remove the output tray motor assembly

Follow these steps to remove the output tray motor assembly.

- ▲ Remove three screws, and then remove the output tray motor assembly.

Figure 7-701 Remove the output tray motor assembly

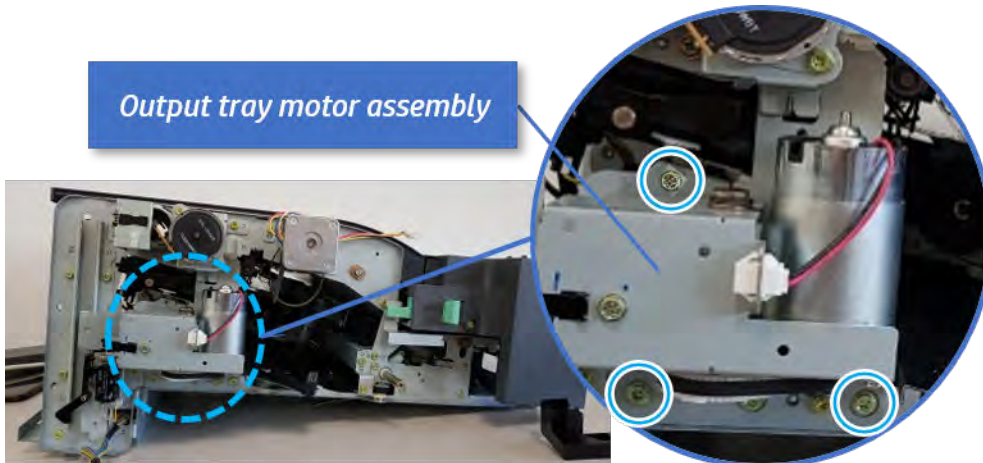

Remove the output tray motor

Follow these steps to remove the output tray motor.

- ▲ Remove two screws, unplug the connector, and then remove the output tray motor.

Figure 7-702 Remove the output tray motor

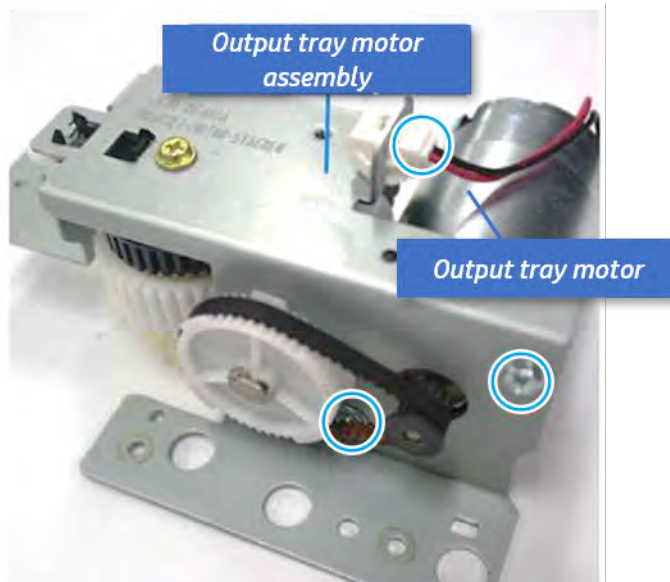

Unpack the replacement assembly



Follow these steps to unpack the replacement assembly.

1. Dispose of the defective part.

 **NOTE:** HP recommends responsible disposal of the defective part.

<http://www8.hp.com/us/en/hp-information/environment/product-recycling.html>

2. Unpack the replacement part from the packaging.

 **CAUTION:**  Some parts are sensitive to electrostatic discharge (ESD). Always perform service work at an ESD-protected workstation or mat. If an ESD workstation or mat is not available, touch the sheet-metal chassis to provide a static ground before touching an ESD-sensitive assembly. Protect the ESD-sensitive assemblies by placing them in ESD pouches when they are out of the printer.

 **IMPORTANT:** Make sure that all of the shipping materials (for example shipping tape) are removed from the replacement part prior to installation.

 **NOTE:** If the replacement part is a roller or pad, avoid touching the spongy part of it. Skin oils on the roller or pad can cause paper pickup and/or print-quality problems. HP recommends using disposable gloves when handling rollers or pads or washing your hands before touching rollers or pads.

3. To install an assembly, reverse the removal steps.

 **NOTE:** When applicable, special installation instructions are provided for an assembly at the end of the removal procedure. Always completely read the removal instructions and follow all special installation instructions.

Paper holding unit

Removal and replacement: Paper holding

Learn how to remove and replace the paper holding.

To view teardown and reassembling video of the inner finisher, click the link below.



[View a teardown video of the inner finisher.](#)



[View a reassembling video of the inner finisher.](#)

IMPORTANT: When applicable, special installation instructions are provided for an assembly at the end of the removal procedure. Always completely read the removal instructions and follow all special installation instructions.

Mean time to repair:

Service level:

Before performing service

Turn the printer power off

- Press the power button on the front of the printer, and then turn off the power switch next to the power cable.
- A shutting-down message appears on the control-panel display.

WARNING! To avoid damage to the printer, turn the power off and wait until the printer shuts down before removing the power cable.

- Disconnect the printer power cable after the printer has completely shut down (the control-panel display is blank).

Use the table below to identify the correct part number for your printer. To order the part, go to <http://www.hp.com/buy/parts>.

Table 7-72 Part information

Part number	Part description
JC90-01313A	Paper holding actuator

Required tools

- #2 JIS screwdriver with a magnetic tip

After performing service

Turn the printer power on

- Connect the power cable.
- Use the power switch to turn the power on.

Post service test

Print any pages necessary to verify that the repair resolved the issue and did not create any new issues.

Remove the front cover

Follow these steps to remove the front cover.

1. Open the front door and open the punch cover.
2. Remove three screws in the front.
3. Remove the lever.
4. Open the top cover.
5. From the right side of the front cover, carefully lift and pry toward the top-left corner to remove the front cover.

Figure 7-703 Remove the front cover

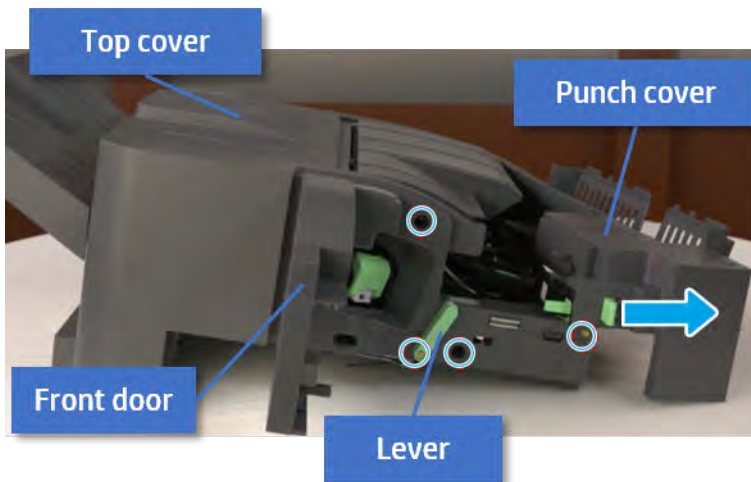

Remove the rear cover

Follow these steps to remove the rear cover.

1. Open the top cover.

Figure 7-704 Open the top cover

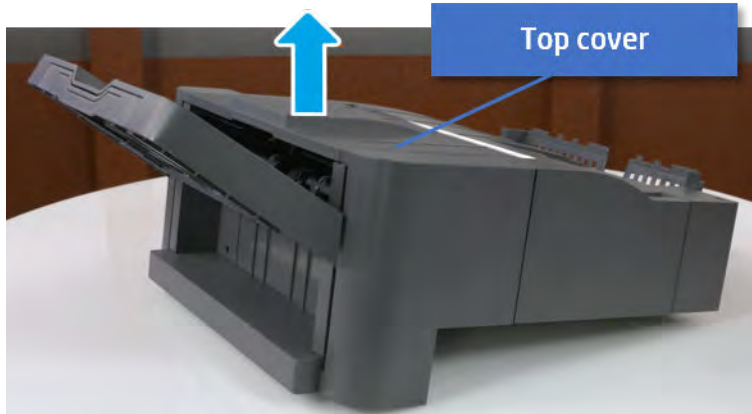

2. Remove three screws.
3. Release hooks carefully and remove the rear cover.

Figure 7-705 Remove the rear cover

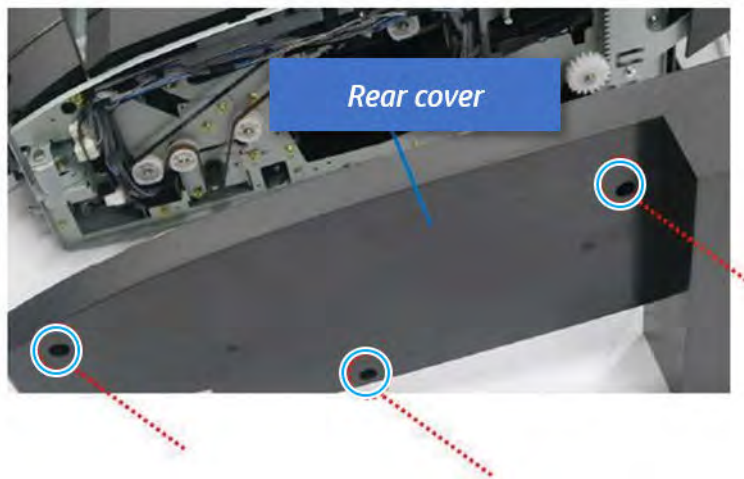

Remove the output tray

Follow these steps to remove the output tray.

1. Remove four screws.

Figure 7-706 Remove four screws

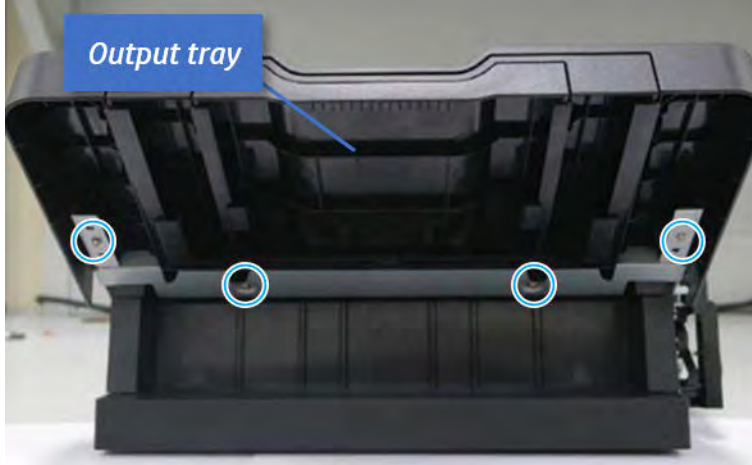

2. Push the paper holding actuator into the inner finisher, and then remove the output tray.

Figure 7-707 Remove the output tray.



Remove the output tray frame

Follow these steps to remove the output tray frame.

1. Rotate the pulley until the output tray frame depart from the gear.

Figure 7-708 Remove the pulley

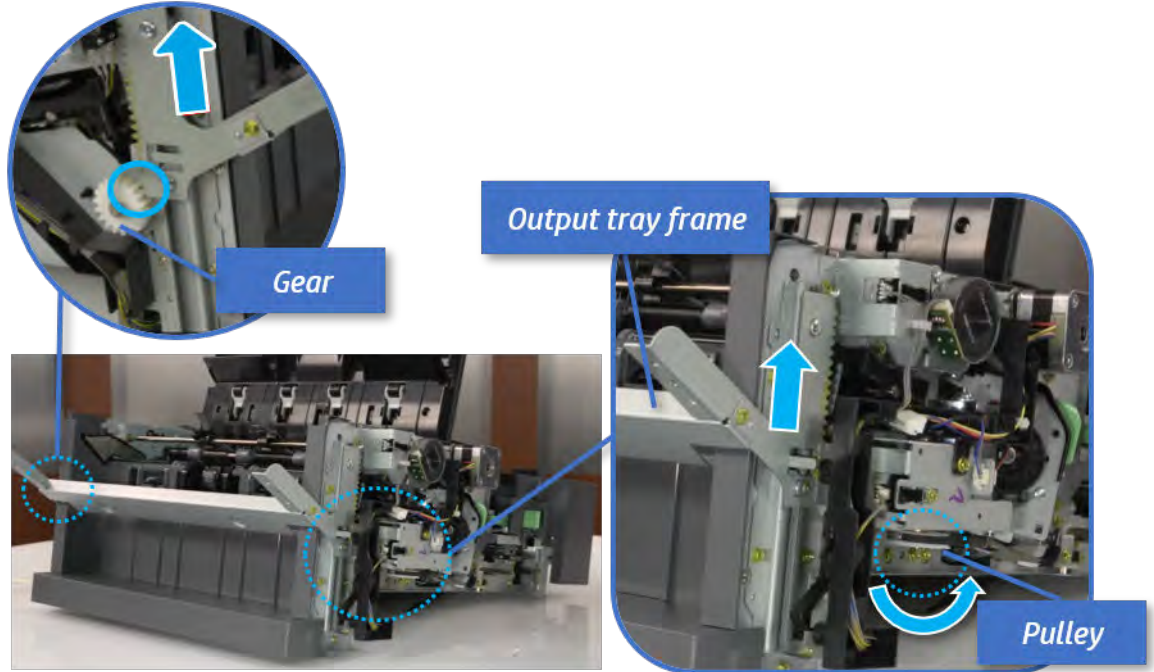

2. Push the paper holding actuator into the inner finisher, and then remove the output tray frame.

Figure 7-709 Remove the output tray frame

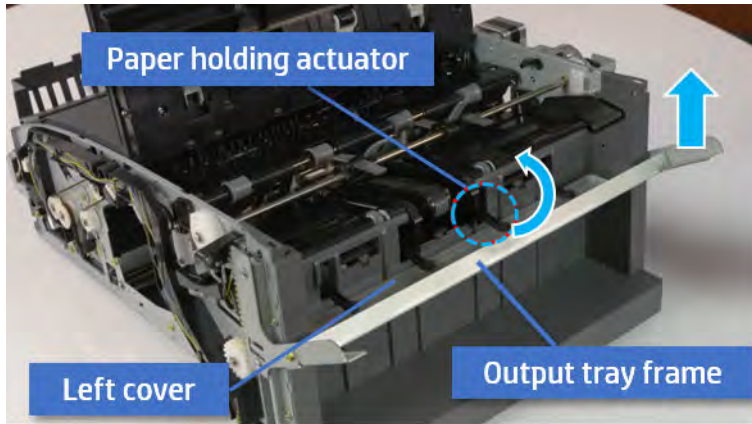

TIP: Push the paper holding actuator into the inner finisher when reassembling. Be sure to level the output tray.

- a. Position the first wheel into the channel on both sides while pushing the paper holding actuator.

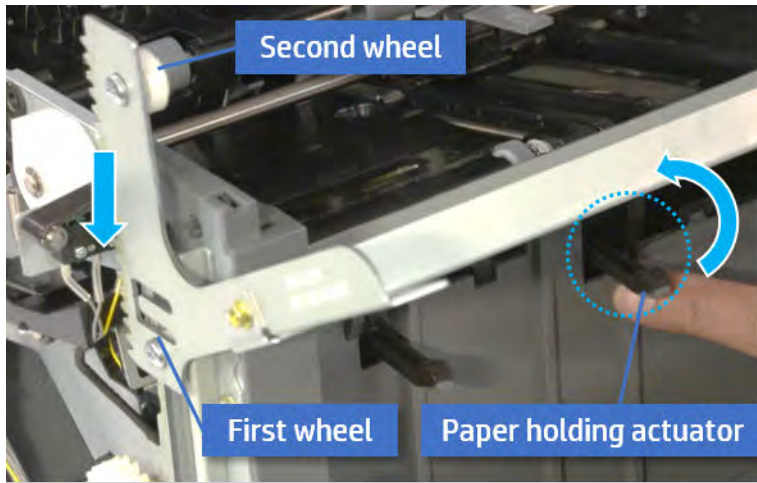

- b. Let the second wheel rest on the channel on both sides simultaneously.
- c. Gently squeeze the wheels into channel until the output tray frame meet the gear.

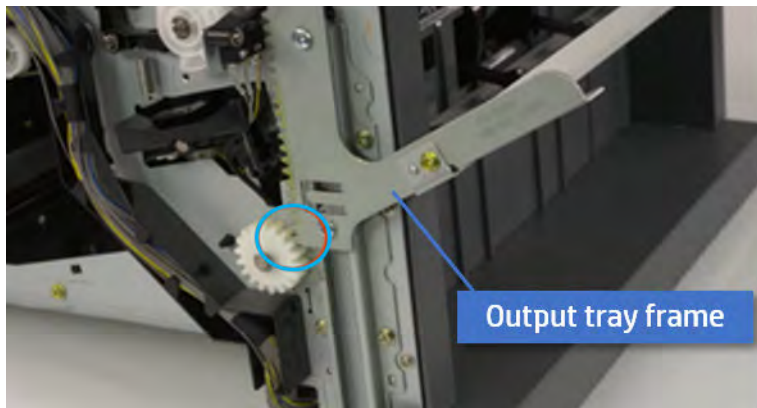

- d. Rotate the pulley until the output tray frame is no longer lifted. It can make to level the output tray frame.

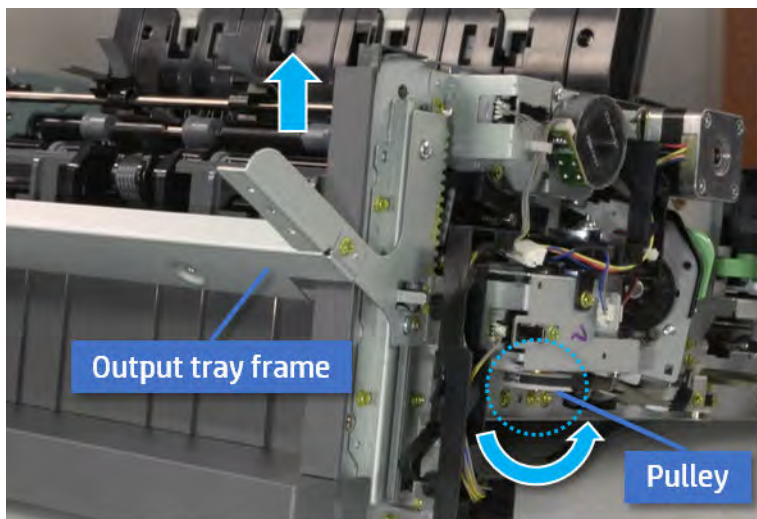

- e. Rotate the pulley in the opposite direction.

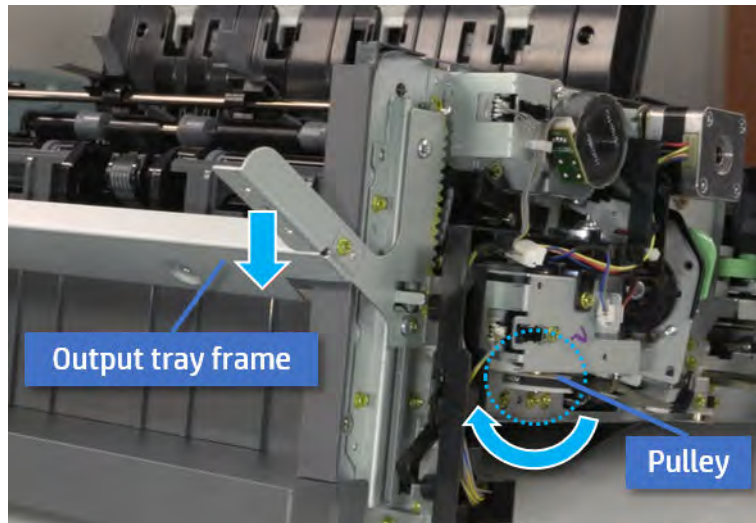

Remove the PCA cover

Follow these steps to remove the PCA cover.

- ▲ Remove two screws, and then remove the PCA cover.

Figure 7-710 Remove the PCA cover

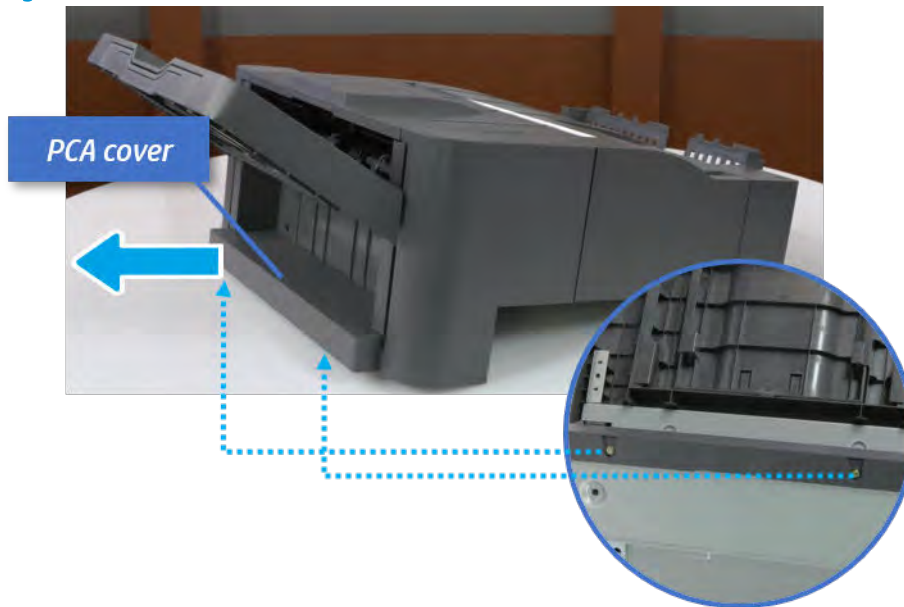

Remove the left cover

Follow these steps to remove the left cover.

1. Remove two screws.

Figure 7-711 Remove two screws

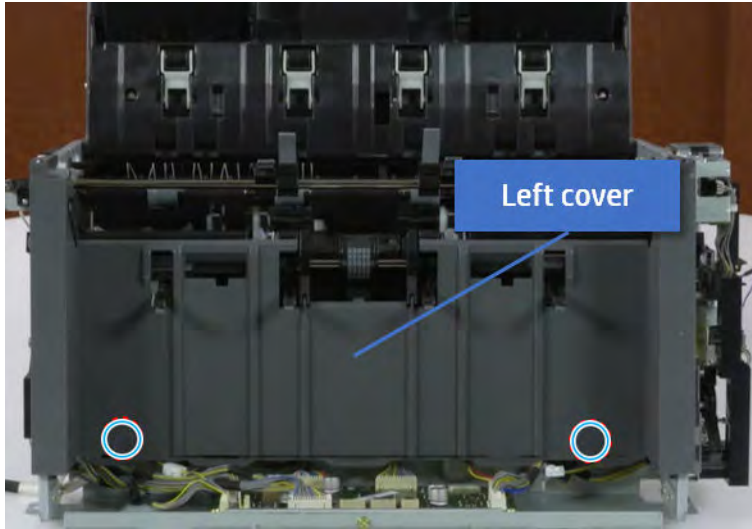

2. Remove four screws from both front and rear sides.

Figure 7-712 Remove four screws

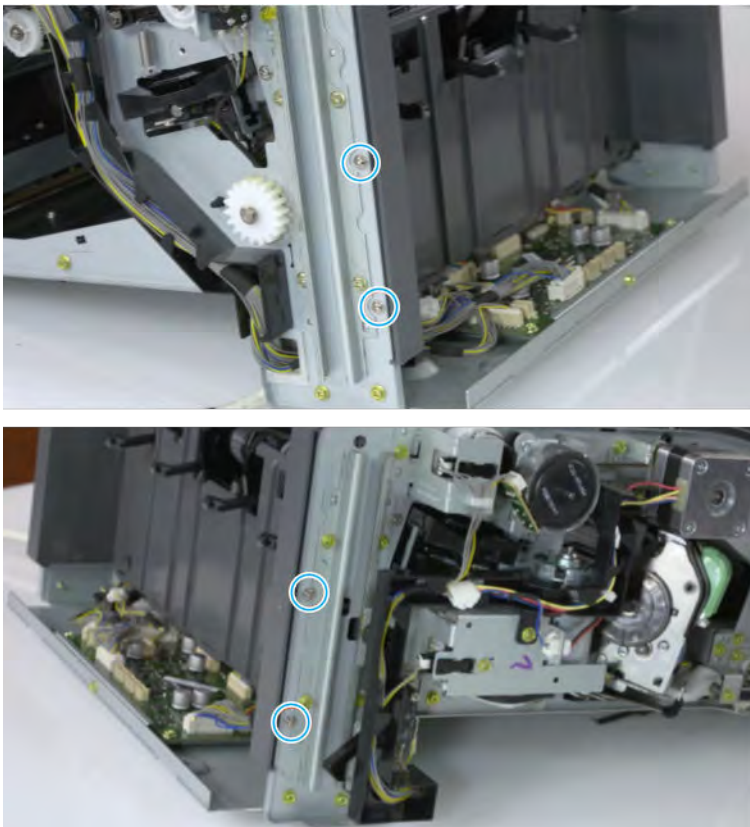

3. Unplug two inline connectors, and then remove the left cover.

Figure 7-713 Unplug two connectors

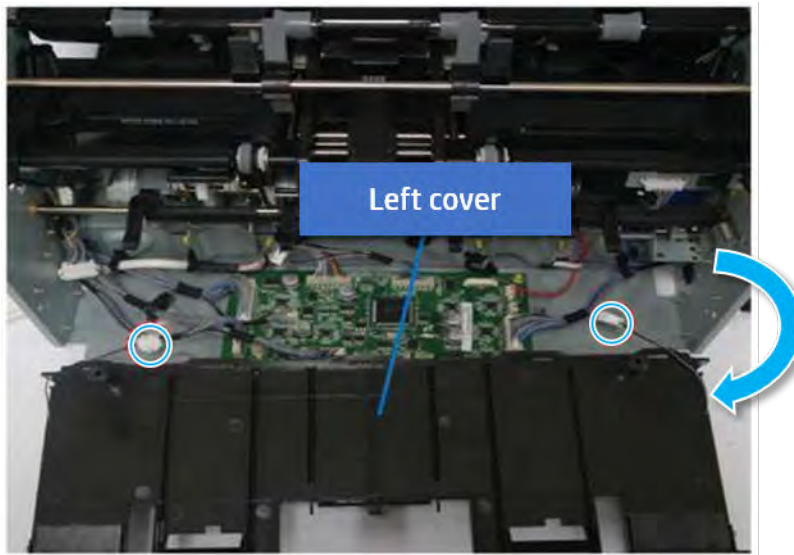

 **TIP:** Be sure to check the hook when reassembling.

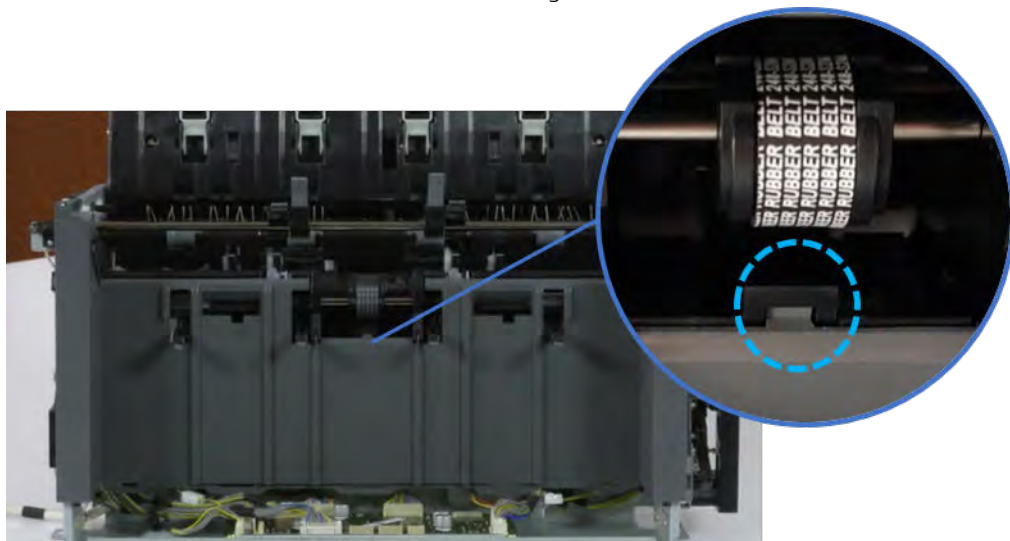

Remove the front harness guide

Follow these steps to remove the front harness guide.

1. Open one clamp and unplug five connectors, and then remove the wire harness from the front harness guide.

2. Remove four screws, and then remove the front harness guide.

Figure 7-714 Remove the front harness guide

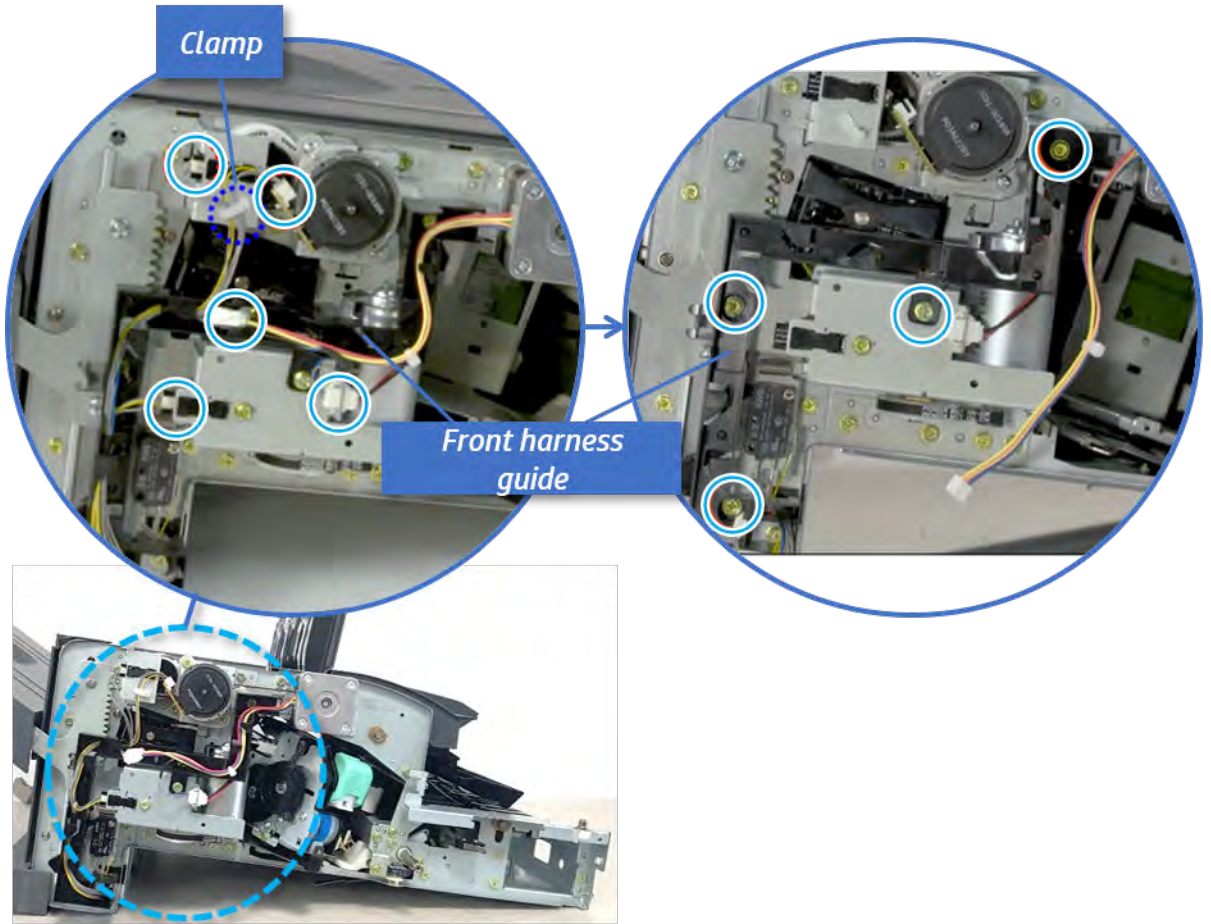

Remove the output tray motor assembly

Follow these steps to remove the output tray motor assembly.

- ▲ Remove three screws, and then remove the output tray motor assembly.

Figure 7-715 Remove the output tray motor assembly

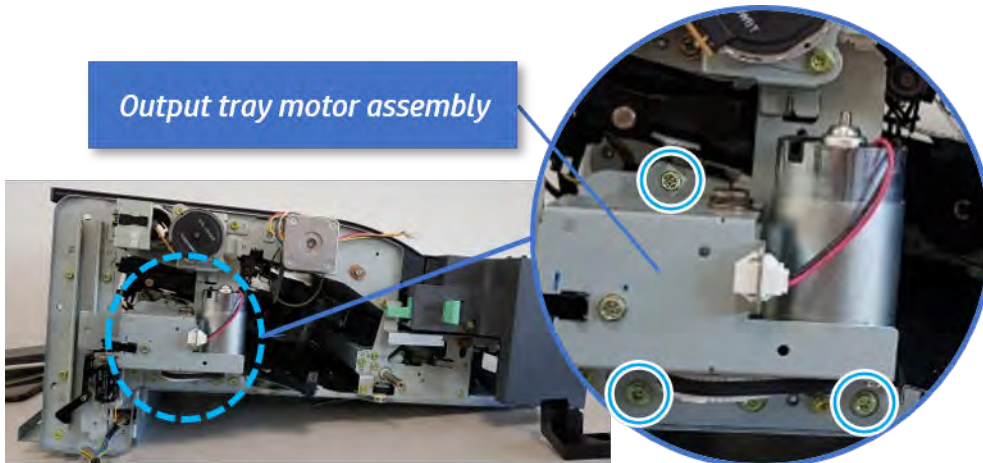

Remove the output tray lower limit switch

Follow these steps to remove the output tray lower limit switch.

- ▲ Remove one screw, and then remove the output tray lower limit switch.

Figure 7-716 Remove the output tray lower limit switch

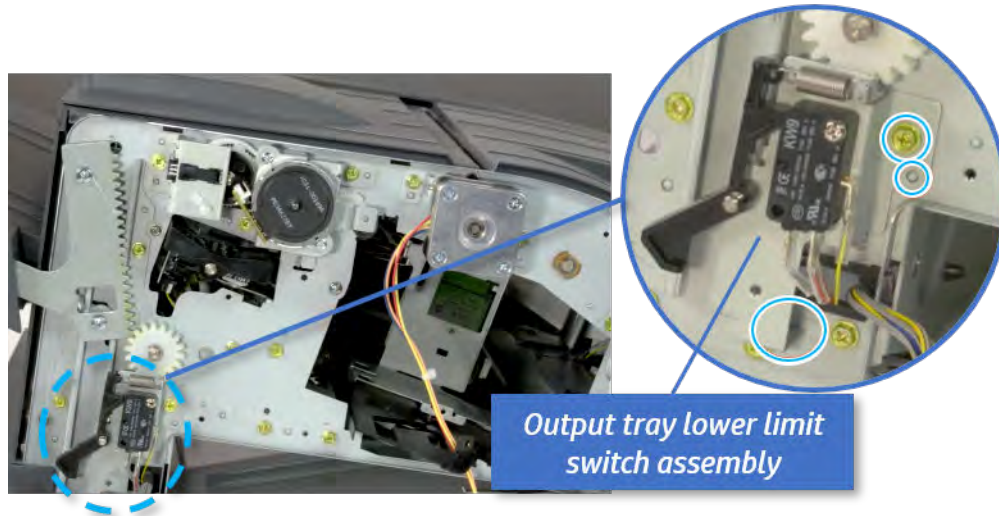

Remove the paper holding

Follow these steps to remove the paper holding.

1. Remove the paper holding actuator spring.

Figure 7-717 Remove the paper holding actuator spring

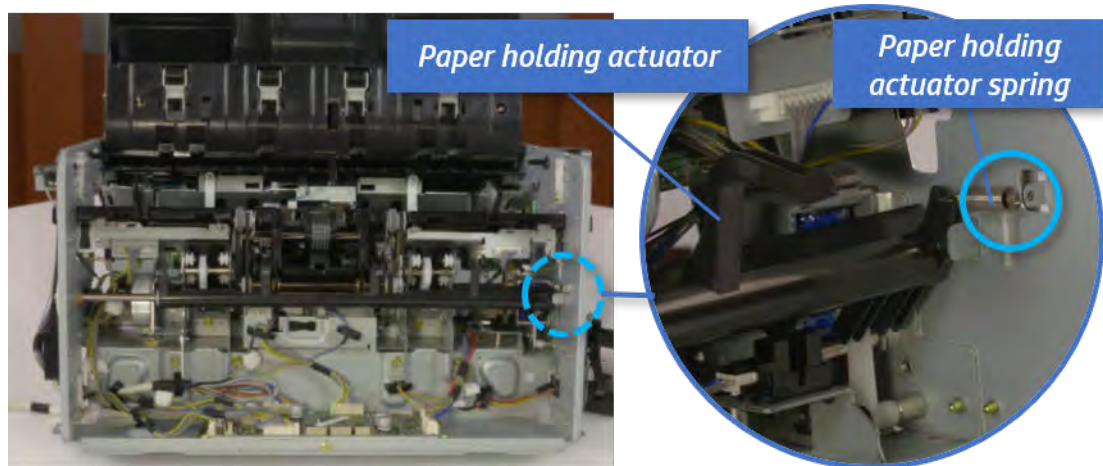

2. Remove the e-ring and the rack pinion gear. And then remove the pin and the e-ring, and then remove the bushing.

Figure 7-718 Remove e-ring, rack pinion gear, pin, and bushing

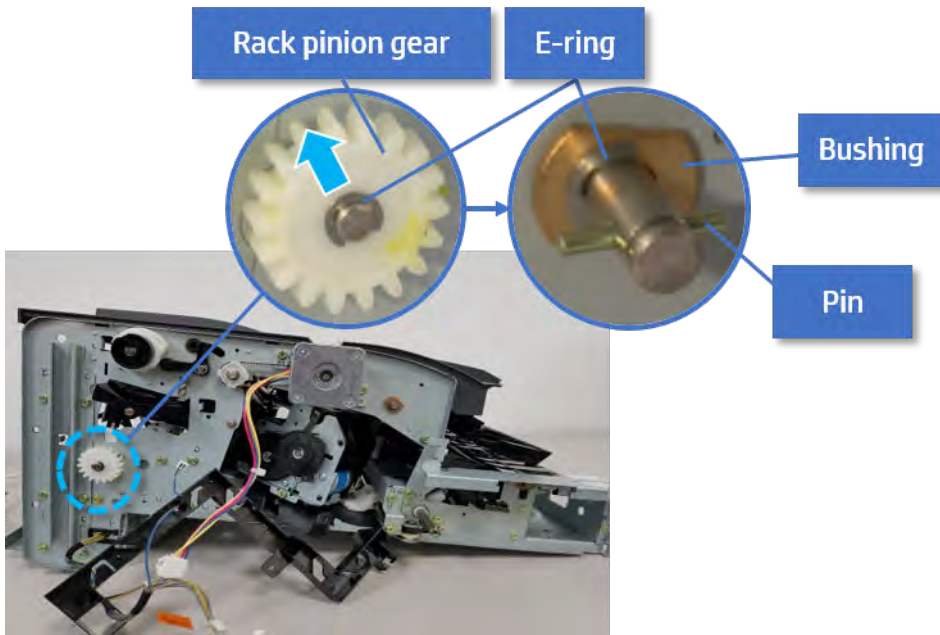

 **NOTE:** Be sure not to lose the pin.

3. Carefully remove the paper holding shaft and the actuator.

Figure 7-719 Remove the paper holding shaft and the actuator

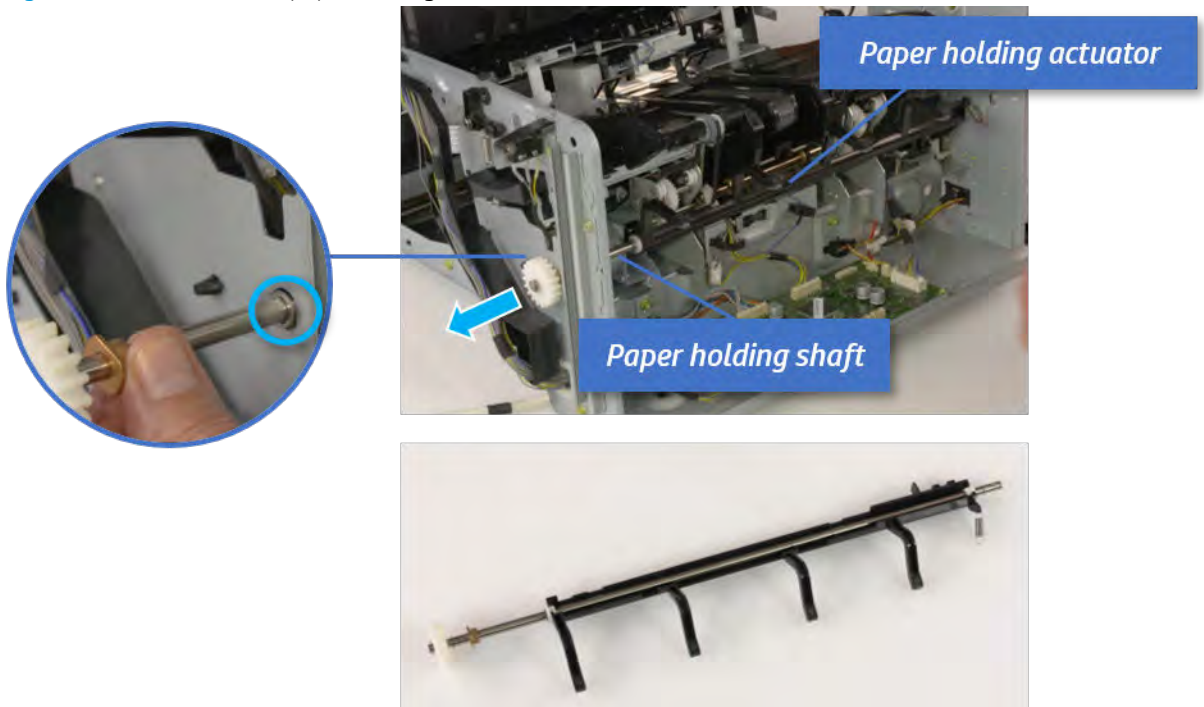

Unpack the replacement assembly

Follow these steps to unpack the replacement assembly.

1. Dispose of the defective part.



NOTE: HP recommends responsible disposal of the defective part.

<http://www8.hp.com/us/en/hp-information/environment/product-recycling.html>

2. Unpack the replacement part from the packaging.



CAUTION:  Some parts are sensitive to electrostatic discharge (ESD). Always perform service work at an ESD-protected workstation or mat. If an ESD workstation or mat is not available, touch the sheet-metal chassis to provide a static ground before touching an ESD-sensitive assembly. Protect the ESD-sensitive assemblies by placing them in ESD pouches when they are out of the printer.



IMPORTANT: Make sure that all of the shipping materials (for example shipping tape) are removed from the replacement part prior to installation.



NOTE: If the replacement part is a roller or pad, avoid touching the spongy part of it. Skin oils on the roller or pad can cause paper pickup and/or print-quality problems. HP recommends using disposable gloves when handling rollers or pads or washing your hands before touching rollers or pads.

3. To install an assembly, reverse the removal steps.



NOTE: When applicable, special installation instructions are provided for an assembly at the end of the removal procedure. Always completely read the removal instructions and follow all special installation instructions.

Removal and replacement: Paper holding sensor (S9)

Learn how to remove and replace the paper holding sensor.

To view teardown and reassembling video of the inner finisher, click the link below.



[View a teardown video of the inner finisher.](#)



[View a reassembling video of the inner finisher.](#)



IMPORTANT: When applicable, special installation instructions are provided for an assembly at the end of the removal procedure. Always completely read the removal instructions and follow all special installation instructions.

Mean time to repair:

Service level:

Before performing service

Turn the printer power off

- Press the power button on the front of the printer, and then turn off the power switch next to the power cable.
- A shutting-down message appears on the control-panel display.



WARNING! To avoid damage to the printer, turn the power off and wait until the printer shuts down before removing the power cable.

- Disconnect the printer power cable after the printer has completely shut down (the control-panel display is blank).

Use the table below to identify the correct part number for your printer. To order the part, go to <http://www.hp.com/buy/parts>.

Table 7-73 Part information

Part number	Part description
0604-001393	Paper holding sensor

Required tools

- #2 JIS screwdriver with a magnetic tip

After performing service

Turn the printer power on

- Connect the power cable.
- Use the power switch to turn the power on.

Post service test

Print any pages necessary to verify that the repair resolved the issue and did not create any new issues.

Remove the front cover

Follow these steps to remove the front cover.

1. Open the front door and open the punch cover.
2. Remove three screws in the front.
3. Remove the lever.
4. Open the top cover.
5. From the right side of the front cover, carefully lift and pry toward the top-left corner to remove the front cover.

Figure 7-720 Remove the front cover

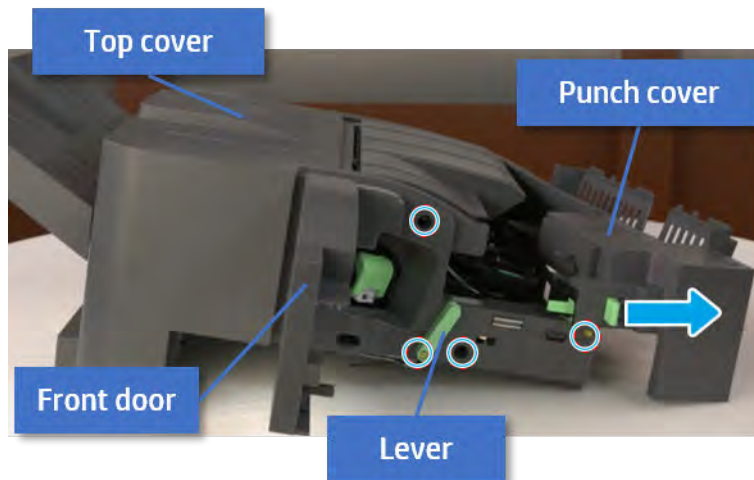

Remove the rear cover

Follow these steps to remove the rear cover.

1. Open the top cover.

Figure 7-721 Open the top cover

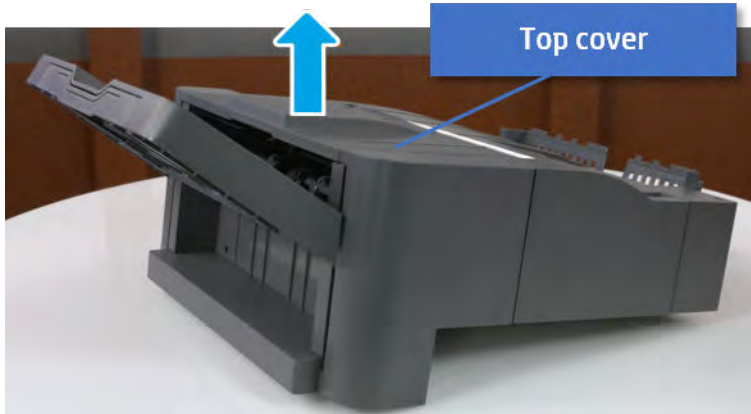

2. Remove three screws.
3. Release hooks carefully and remove the rear cover.

Figure 7-722 Remove the rear cover

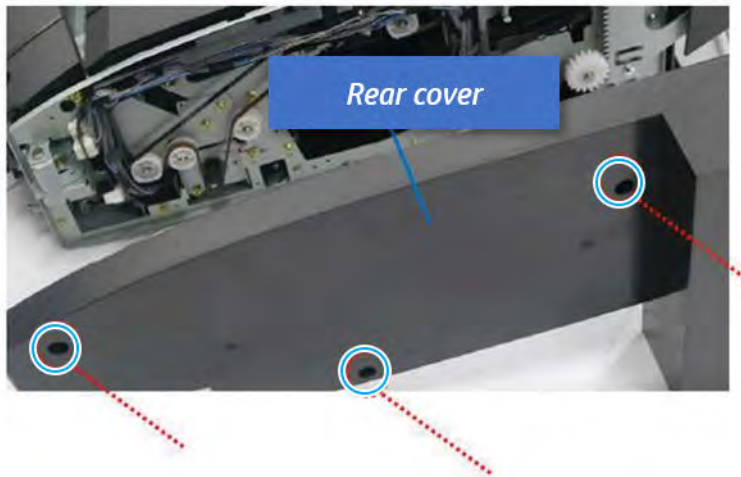

Remove the output tray

Follow these steps to remove the output tray.

1. Remove four screws.

Figure 7-723 Remove four screws

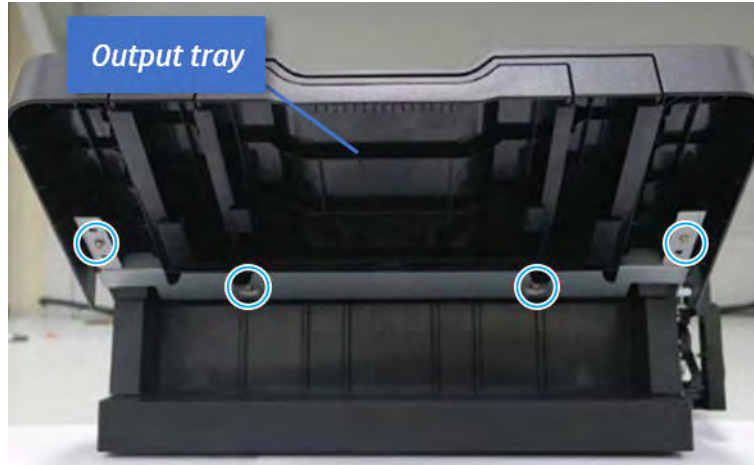

2. Push the paper holding actuator into the inner finisher, and then remove the output tray.

Figure 7-724 Remove the output tray.



Remove the output tray frame

Follow these steps to remove the output tray frame.

1. Rotate the pulley until the output tray frame depart from the gear.

Figure 7-725 Remove the pulley

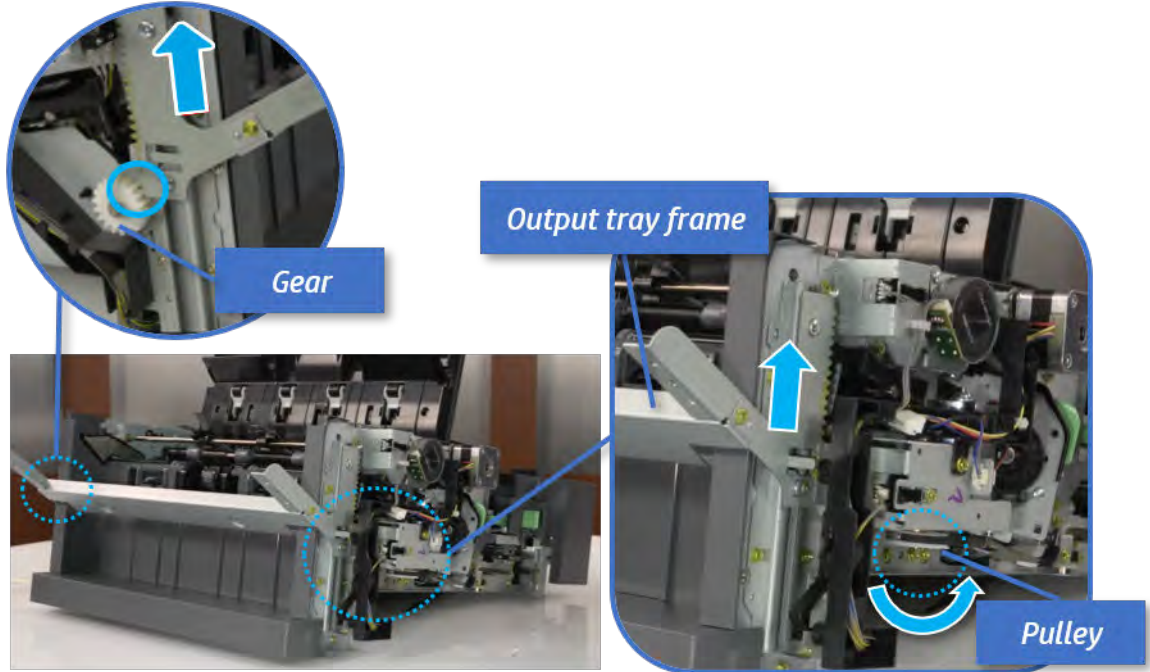

2. Push the paper holding actuator into the inner finisher, and then remove the output tray frame.

Figure 7-726 Remove the output tray frame

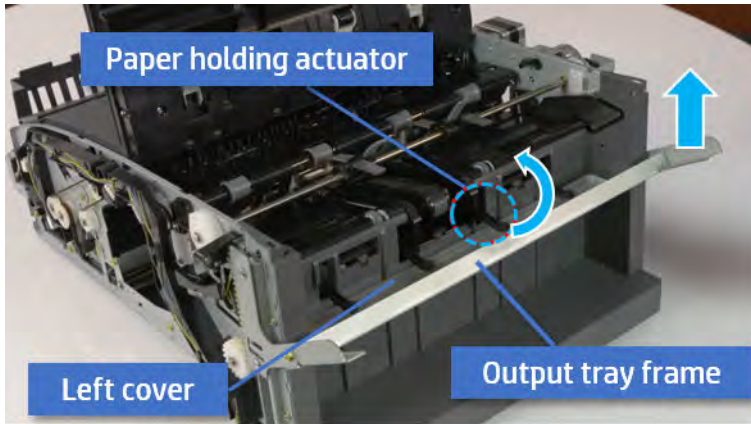

TIP: Push the paper holding actuator into the inner finisher when reassembling. Be sure to level the output tray.

- a. Position the first wheel into the channel on both sides while pushing the paper holding actuator.

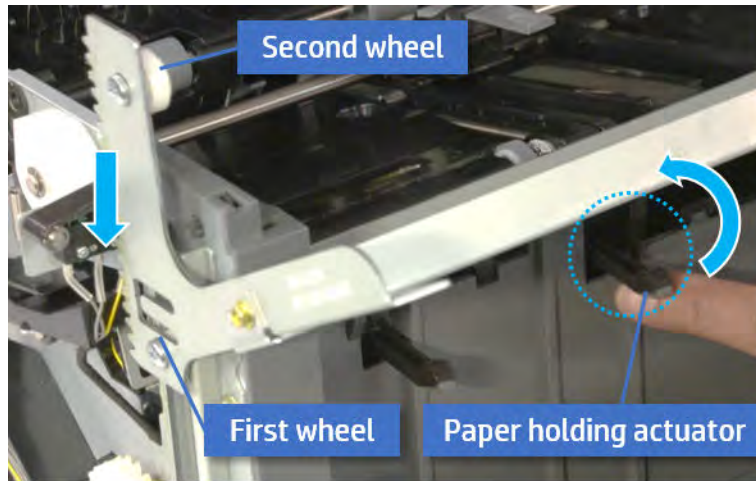

- b. Let the second wheel rest on the channel on both sides simultaneously.
- c. Gently squeeze the wheels into channel until the output tray frame meet the gear.

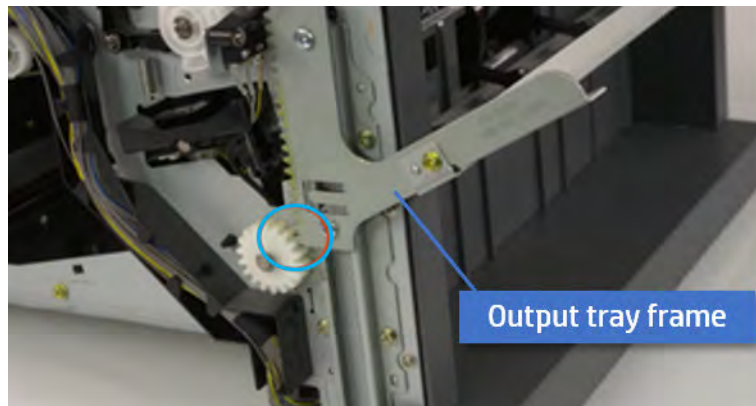

- d. Rotate the pulley until the output tray frame is no longer lifted. It can make to level the output tray frame.

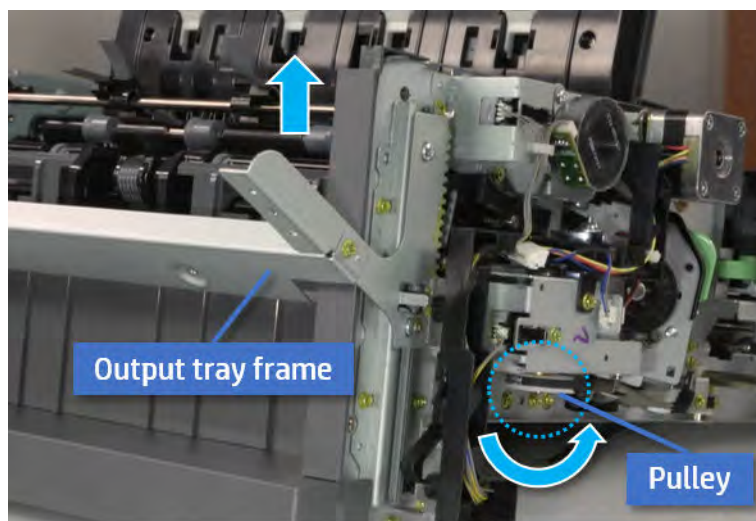

- e. Rotate the pulley in the opposite direction.

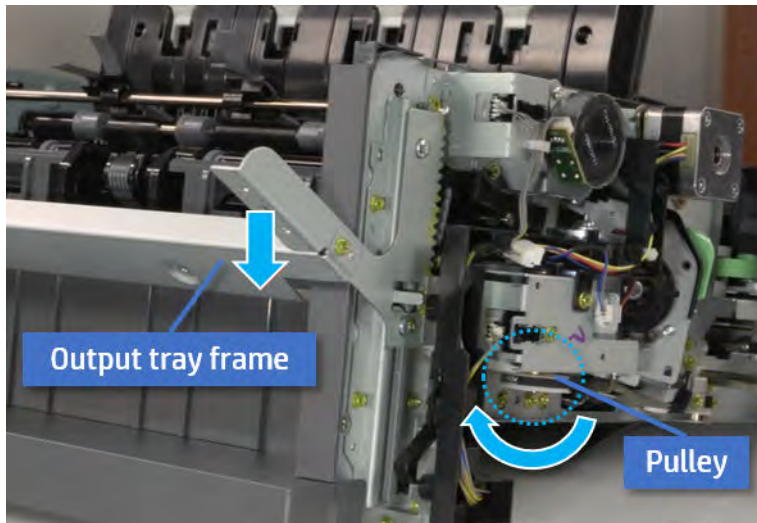

Remove the PCA cover

Follow these steps to remove the PCA cover.

- ▲ Remove two screws, and then remove the PCA cover.

Figure 7-727 Remove the PCA cover

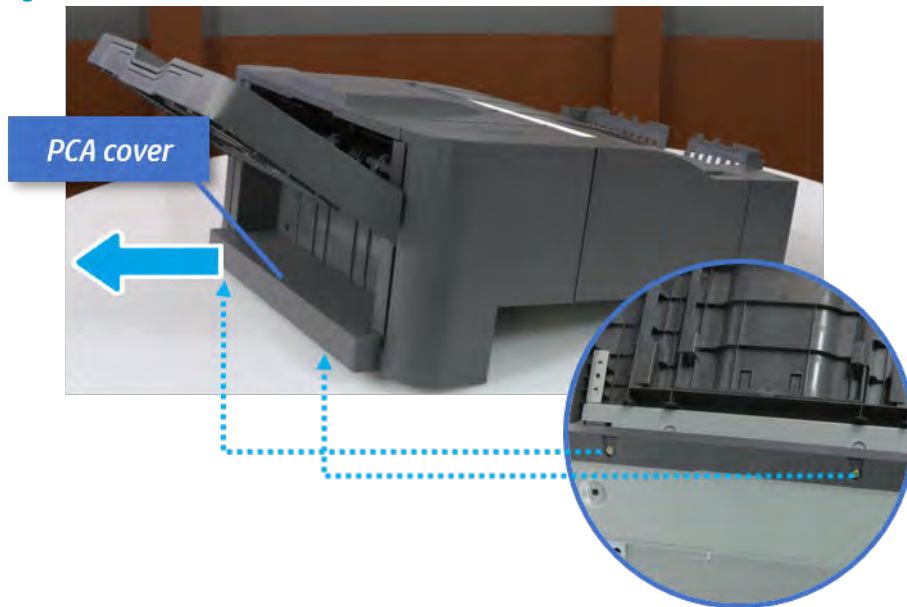

Remove the left cover

Follow these steps to remove the left cover.

1. Remove two screws.

Figure 7-728 Remove two screws

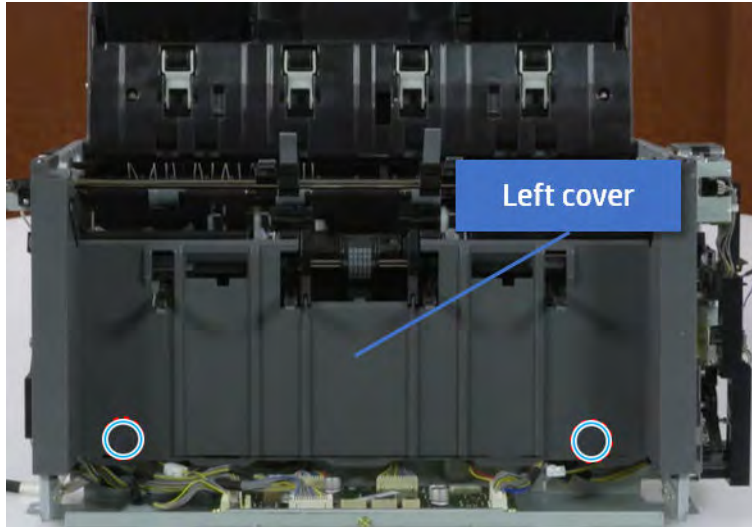

2. Remove four screws from both front and rear sides.

Figure 7-729 Remove four screws

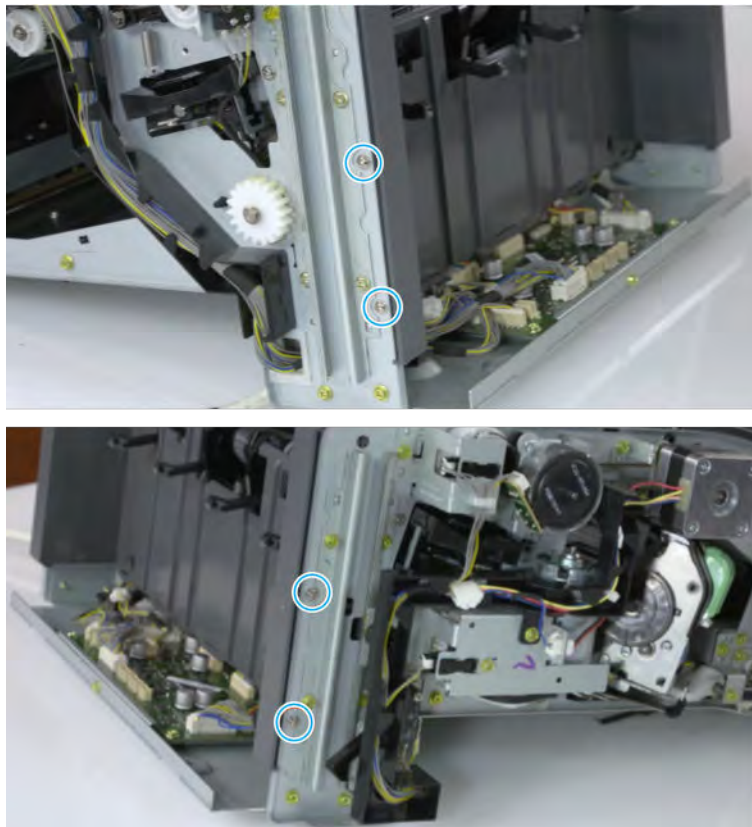

3. Unplug two inline connectors, and then remove the left cover.

Figure 7-730 Unplug two connectors

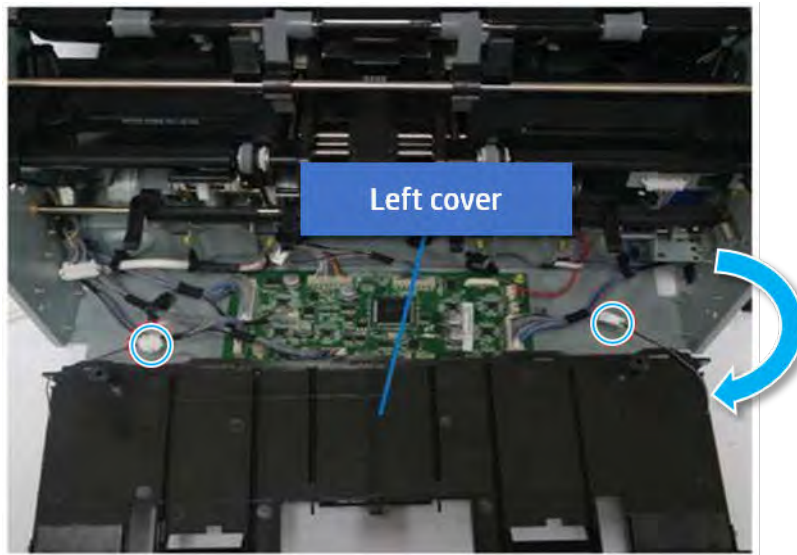

 **TIP:** Be sure to check the hook when reassembling.

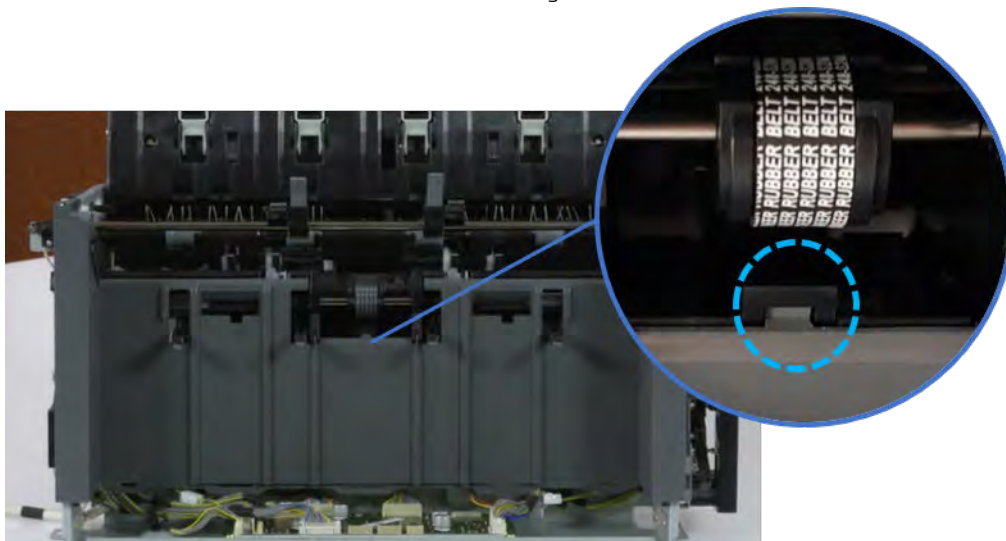

Remove the front harness guide

Follow these steps to remove the front harness guide.

1. Open one clamp and unplug five connectors, and then remove the wire harness from the front harness guide.

2. Remove four screws, and then remove the front harness guide.

Figure 7-731 Remove the front harness guide

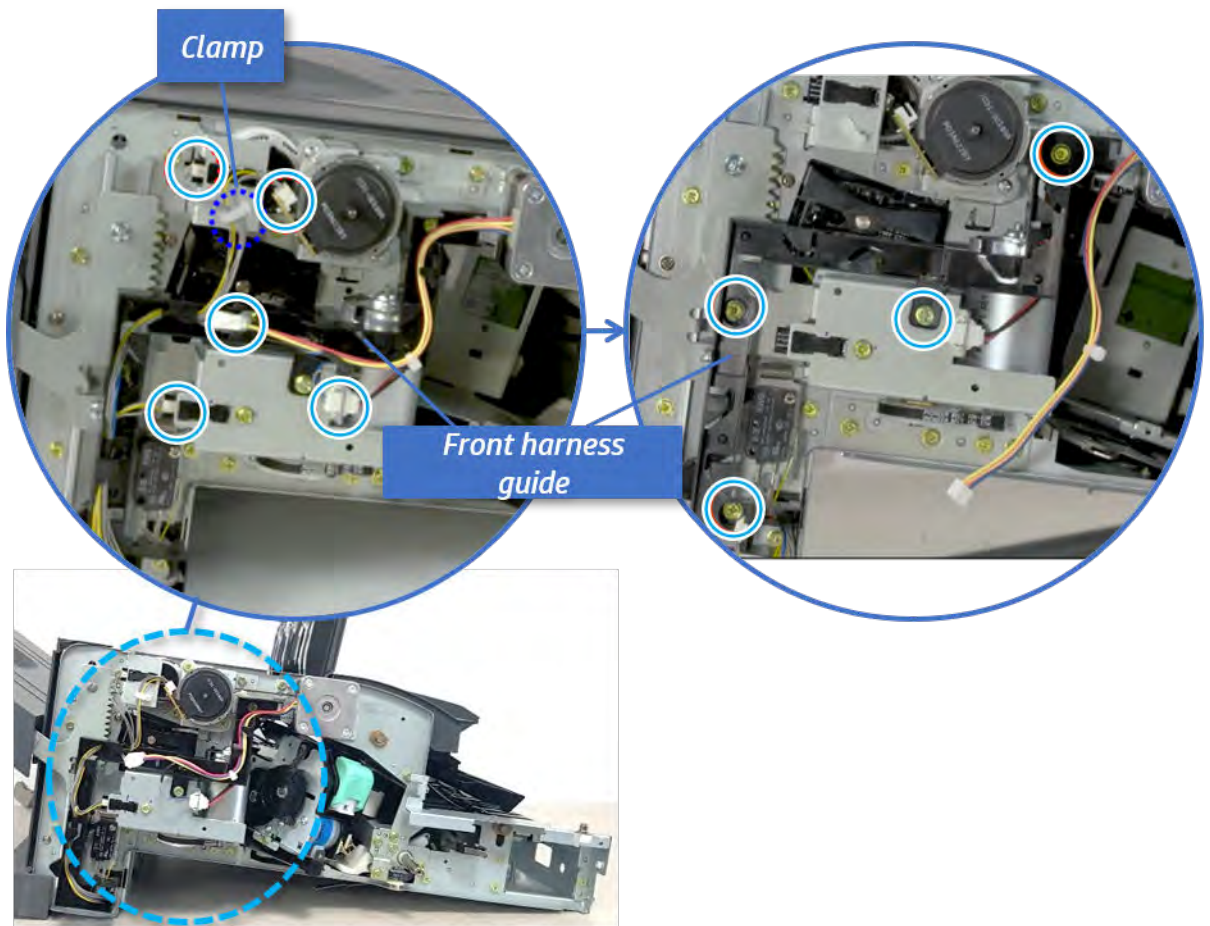

Remove the output tray motor assembly

Follow these steps to remove the output tray motor assembly.

- ▲ Remove three screws, and then remove the output tray motor assembly.

Figure 7-732 Remove the output tray motor assembly

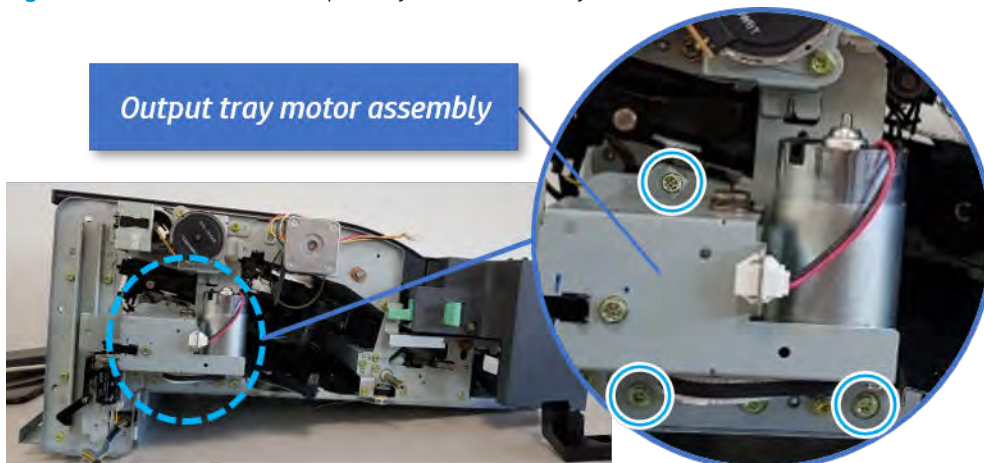

Remove the output tray lower limit switch

Follow these steps to remove the output tray lower limit switch.

- ▲ Remove one screw, and then remove the output tray lower limit switch.

Figure 7-733 Remove the output tray lower limit switch

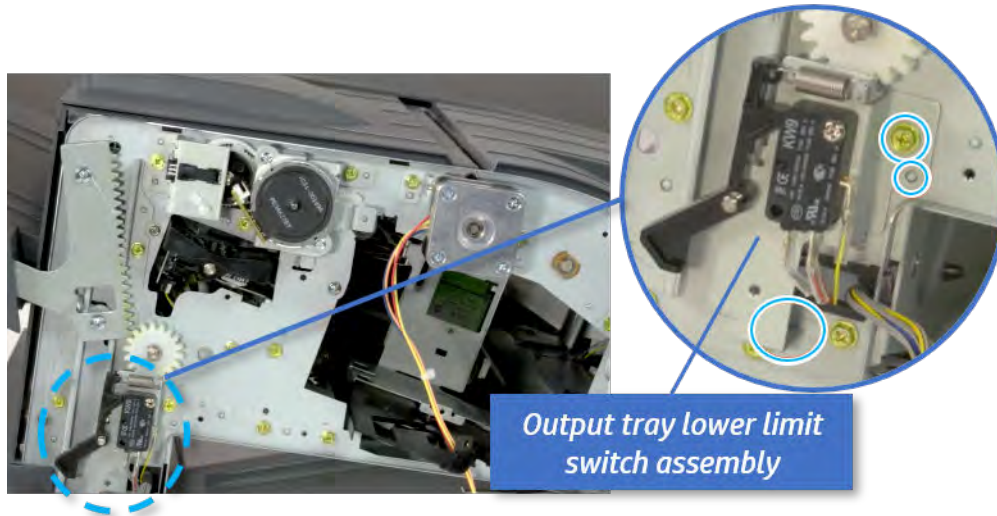

Remove the paper holding

Follow these steps to remove the paper holding.

1. Remove the paper holding actuator spring.

Figure 7-734 Remove the paper holding actuator spring

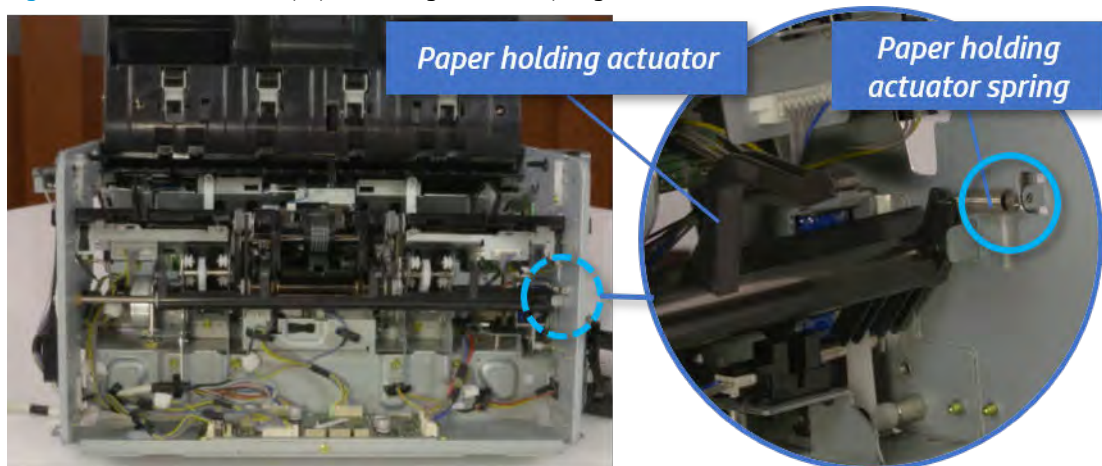

2. Remove the e-ring and the rack pinion gear. And then remove the pin and the e-ring, and then remove the bushing.

Figure 7-735 Remove e-ring, rack pinion gear, pin, and bushing

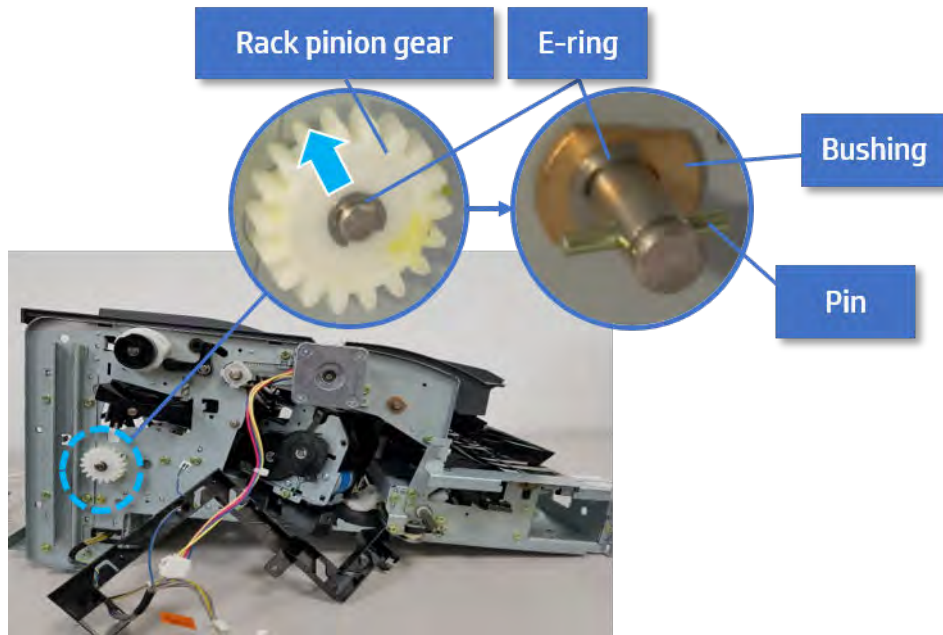

 **NOTE:** Be sure not to lose the pin.

3. Carefully remove the paper holding shaft and the actuator.

Figure 7-736 Remove the paper holding shaft and the actuator

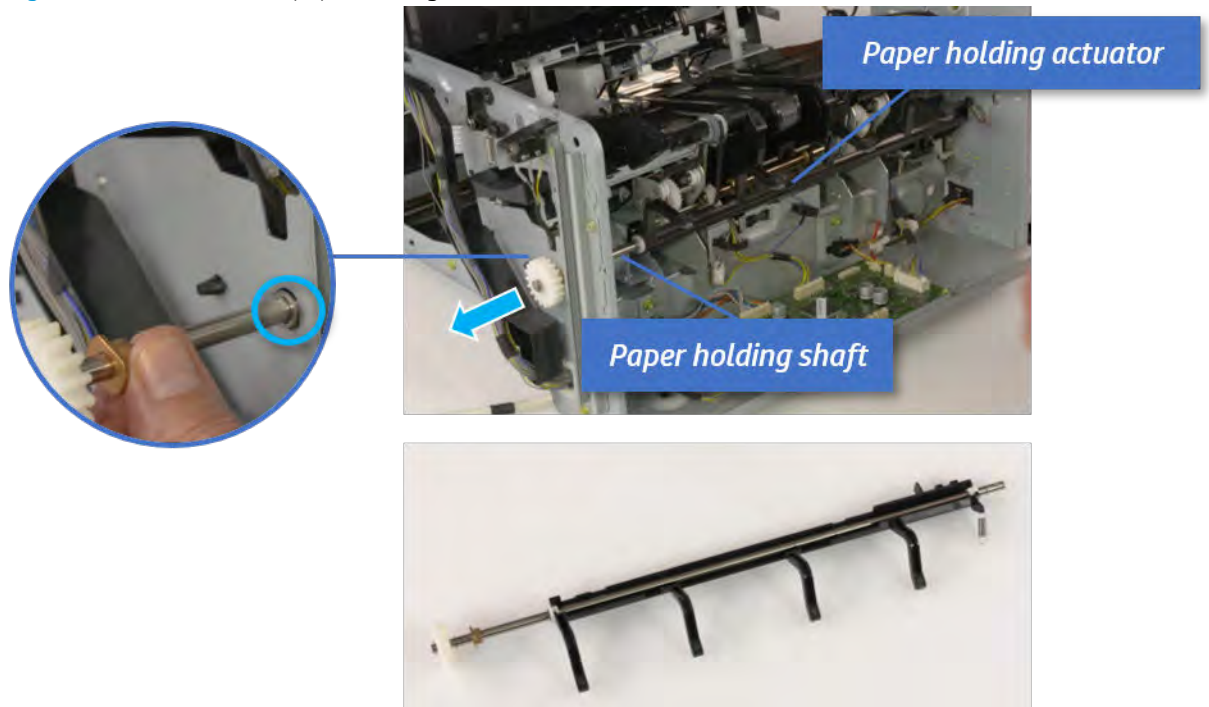

Remove the paper holding sensor

Follow these steps to remove the paper holding sensor.

1. Unplug the connector.
2. Remove the adhesive strip from below the sensor.
3. Remove the paper holding sensor.

Figure 7-737 Remove the paper holding sensor

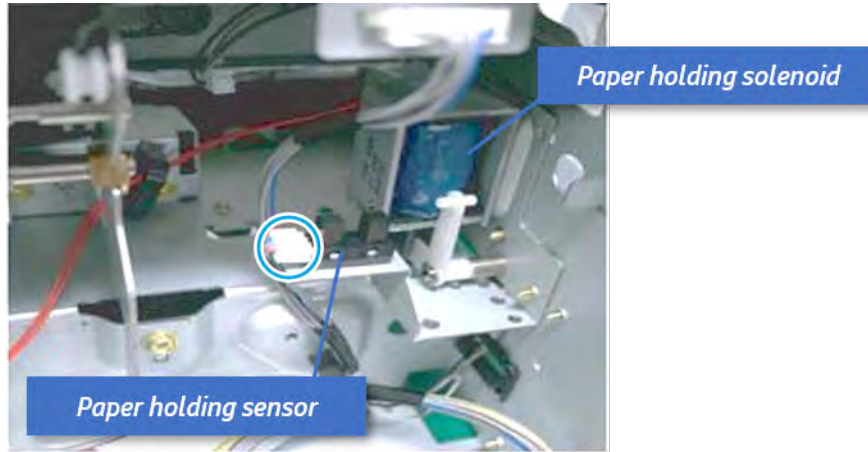

Unpack the replacement assembly



Follow these steps to unpack the replacement assembly.

1. Dispose of the defective part.

 **NOTE:** HP recommends responsible disposal of the defective part.

<http://www8.hp.com/us/en/hp-information/environment/product-recycling.html>

2. Unpack the replacement part from the packaging.

 **CAUTION:**  Some parts are sensitive to electrostatic discharge (ESD). Always perform service work at an ESD-protected workstation or mat. If an ESD workstation or mat is not available, touch the sheet-metal chassis to provide a static ground before touching an ESD-sensitive assembly. Protect the ESD-sensitive assemblies by placing them in ESD pouches when they are out of the printer.

 **IMPORTANT:** Make sure that all of the shipping materials (for example shipping tape) are removed from the replacement part prior to installation.

 **NOTE:** If the replacement part is a roller or pad, avoid touching the spongy part of it. Skin oils on the roller or pad can cause paper pickup and/or print-quality problems. HP recommends using disposable gloves when handling rollers or pads or washing your hands before touching rollers or pads.

3. To install an assembly, reverse the removal steps.

 **NOTE:** When applicable, special installation instructions are provided for an assembly at the end of the removal procedure. Always completely read the removal instructions and follow all special installation instructions.

Removal and replacement: Paper holding solenoid (SL1)

Learn how to remove and replace the paper holding solenoid.

To view teardown and reassembling video of the inner finisher, click the link below.



[View a teardown video of the inner finisher.](#)



[View a reassembling video of the inner finisher.](#)



IMPORTANT: When applicable, special installation instructions are provided for an assembly at the end of the removal procedure. Always completely read the removal instructions and follow all special installation instructions.

Mean time to repair:

Service level:

Before performing service

Turn the printer power off

- Press the power button on the front of the printer, and then turn off the power switch next to the power cable.
- A shutting-down message appears on the control-panel display.



WARNING! To avoid damage to the printer, turn the power off and wait until the printer shuts down before removing the power cable.

- Disconnect the printer power cable after the printer has completely shut down (the control-panel display is blank).

Use the table below to identify the correct part number for your printer. To order the part, go to www.hp.com/buy/parts.

Table 7-74 Part information

Part number	Part description
JC33-00037A	Paper holding solenoid

Required tools

- #2 JIS screwdriver with a magnetic tip

After performing service

Turn the printer power on

- Connect the power cable.
- Use the power switch to turn the power on.

Post service test

Print any pages necessary to verify that the repair resolved the issue and did not create any new issues.

Remove the front cover

Follow these steps to remove the front cover.

1. Open the front door and open the punch cover.
2. Remove three screws in the front.
3. Remove the lever.
4. Open the top cover.
5. From the right side of the front cover, carefully lift and pry toward the top-left corner to remove the front cover.

Figure 7-738 Remove the front cover

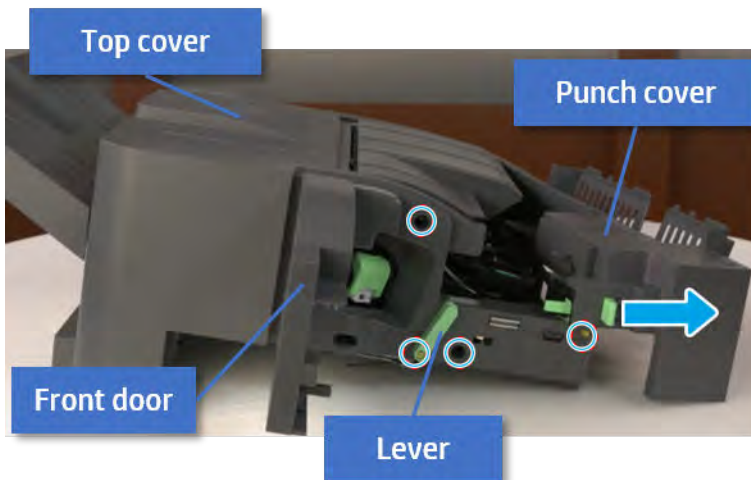

Remove the rear cover

Follow these steps to remove the rear cover.

1. Open the top cover.

Figure 7-739 Open the top cover

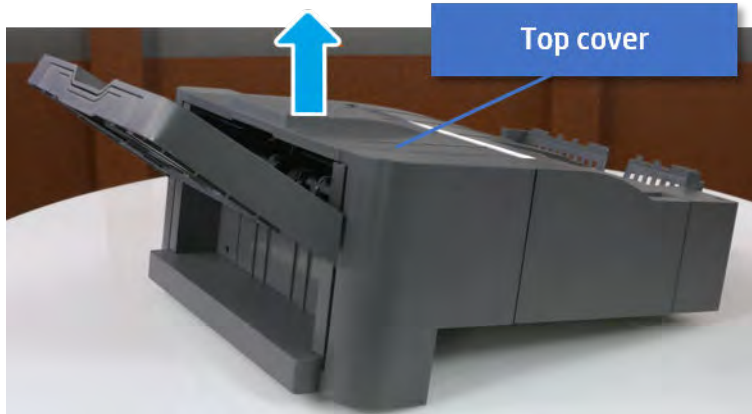

2. Remove three screws.
3. Release hooks carefully and remove the rear cover.

Figure 7-740 Remove the rear cover

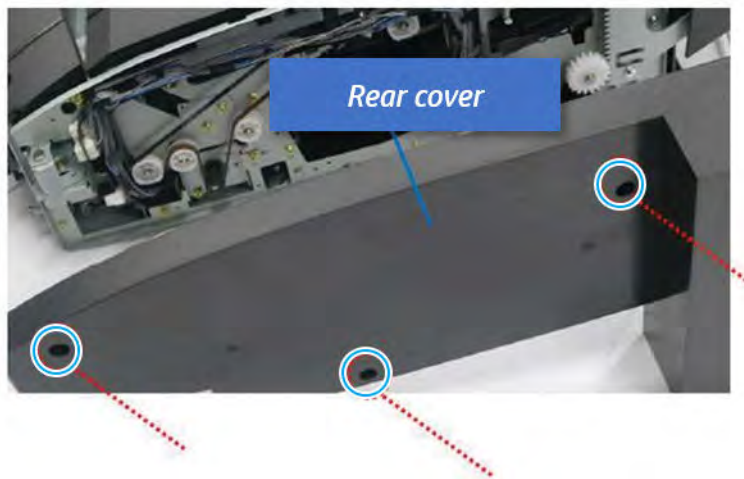

Remove the output tray

Follow these steps to remove the output tray.

1. Remove four screws.

Figure 7-741 Remove four screws

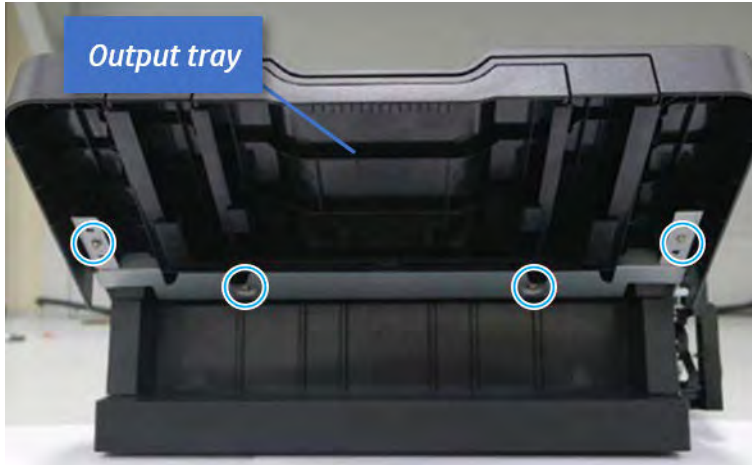

2. Push the paper holding actuator into the inner finisher, and then remove the output tray.

Figure 7-742 Remove the output tray.



Remove the output tray frame

Follow these steps to remove the output tray frame.

1. Rotate the pulley until the output tray frame depart from the gear.

Figure 7-743 Remove the pulley

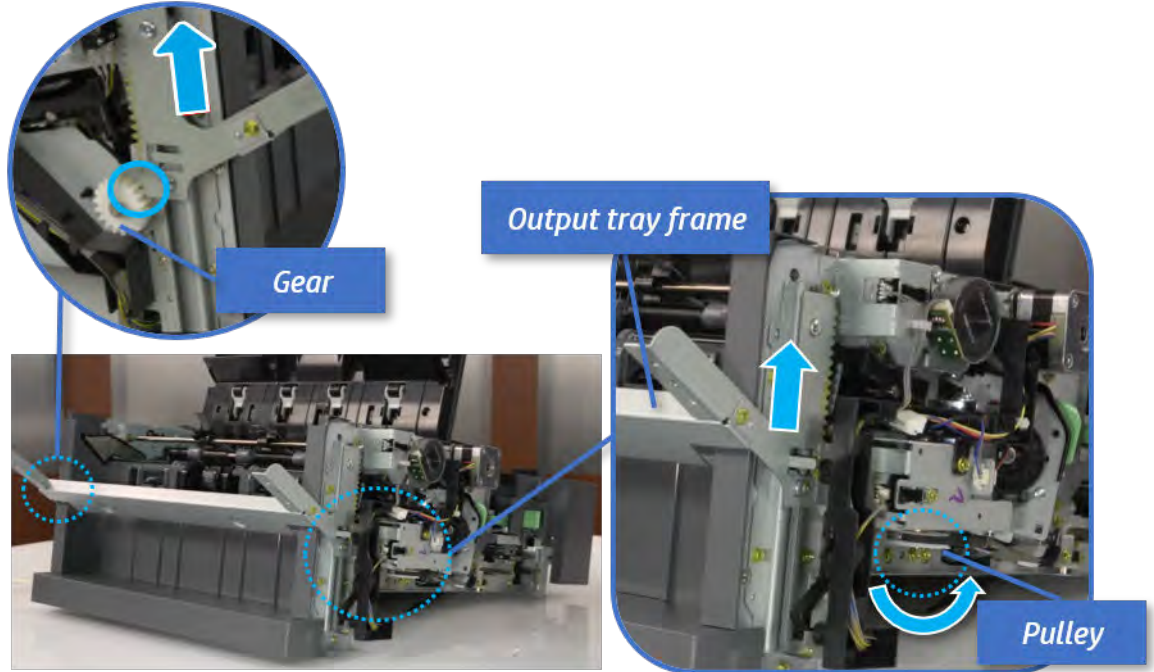

2. Push the paper holding actuator into the inner finisher, and then remove the output tray frame.

Figure 7-744 Remove the output tray frame

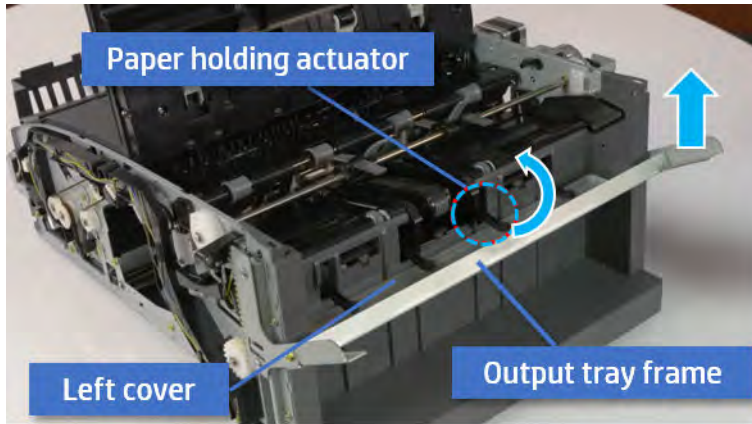

TIP: Push the paper holding actuator into the inner finisher when reassembling. Be sure to level the output tray.

- a. Position the first wheel into the channel on both sides while pushing the paper holding actuator.

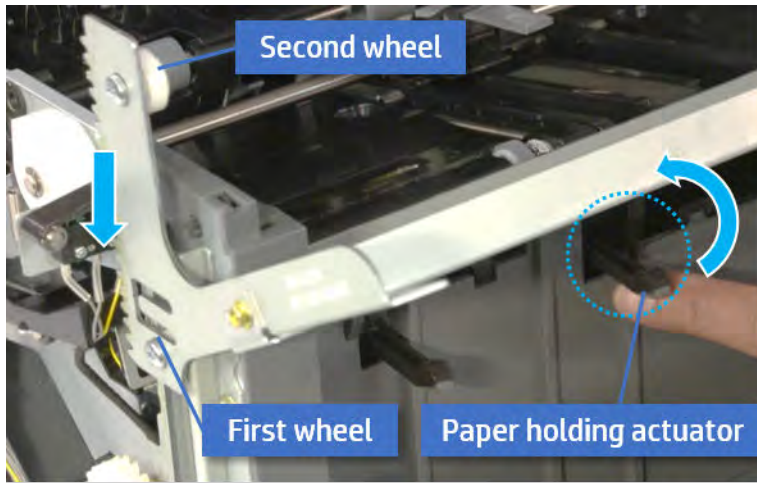

- b. Let the second wheel rest on the channel on both sides simultaneously.
- c. Gently squeeze the wheels into channel until the output tray frame meet the gear.

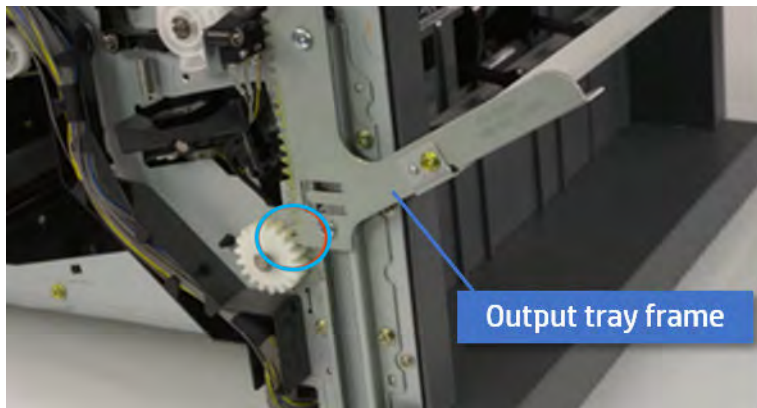

- d. Rotate the pulley until the output tray frame is no longer lifted. It can make to level the output tray frame.

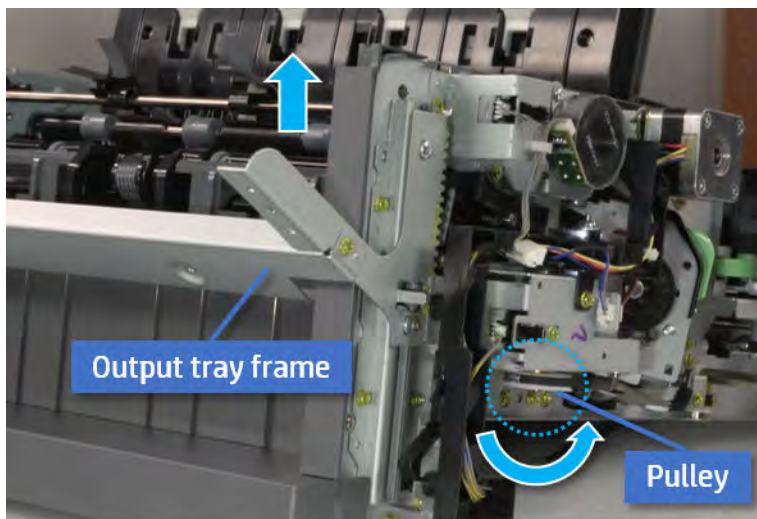

- e. Rotate the pulley in the opposite direction.

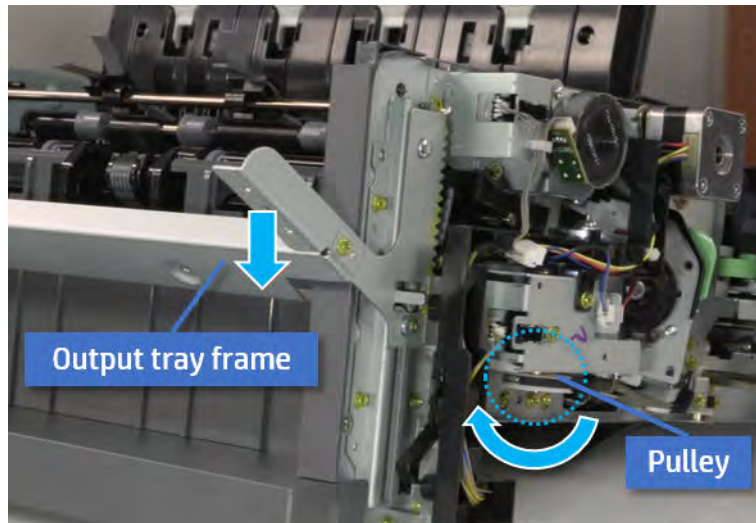

Remove the PCA cover

Follow these steps to remove the PCA cover.

- ▲ Remove two screws, and then remove the PCA cover.

Figure 7-745 Remove the PCA cover

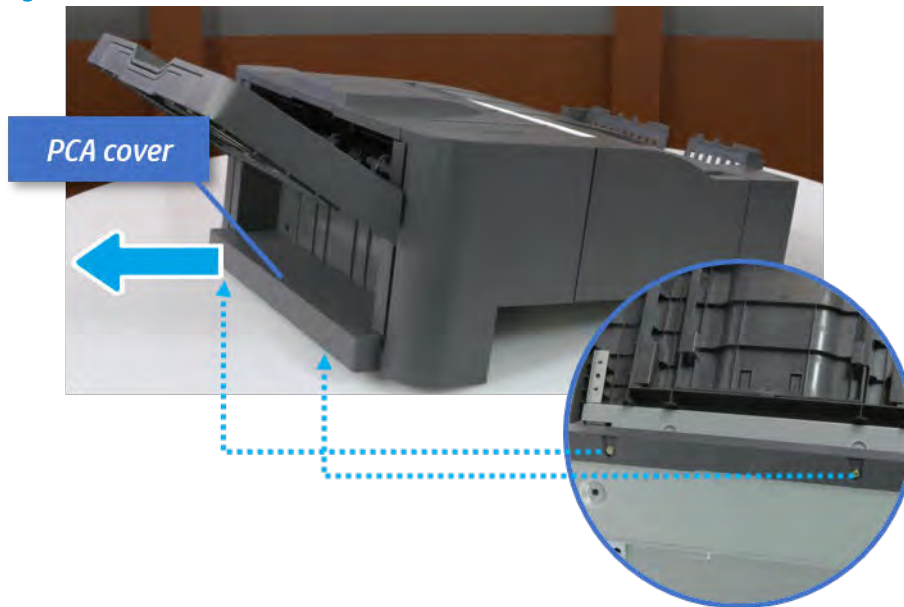

Remove the left cover

Follow these steps to remove the left cover.

1. Remove two screws.

Figure 7-746 Remove two screws

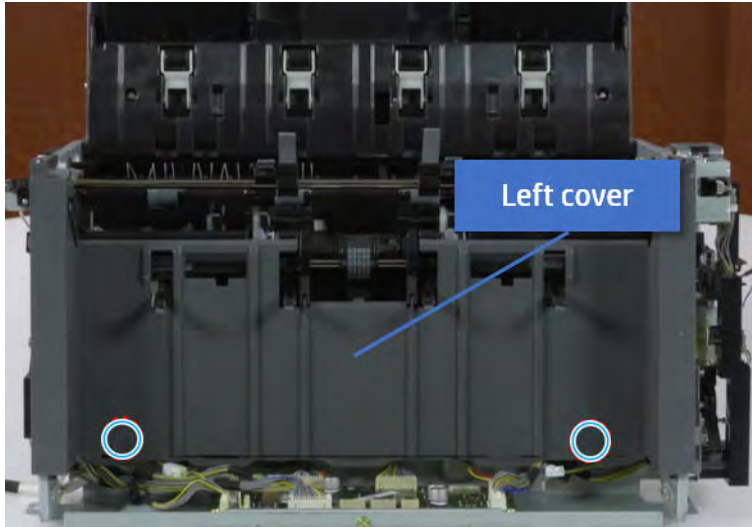

2. Remove four screws from both front and rear sides.

Figure 7-747 Remove four screws

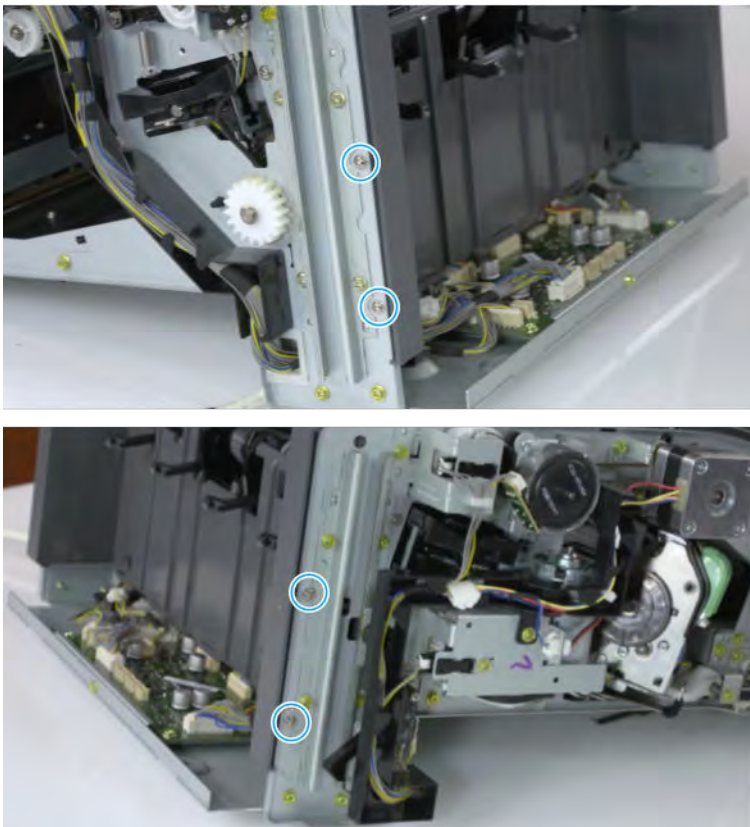

3. Unplug two inline connectors, and then remove the left cover.

Figure 7-748 Unplug two connectors

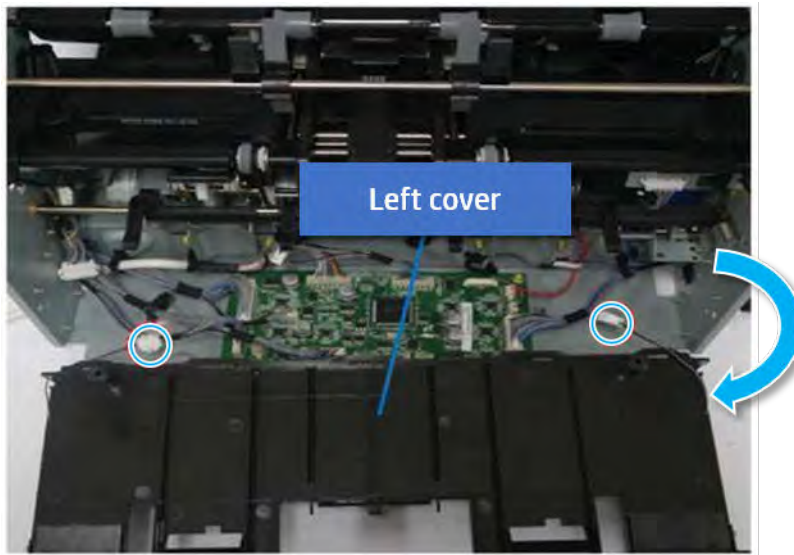

 **TIP:** Be sure to check the hook when reassembling.

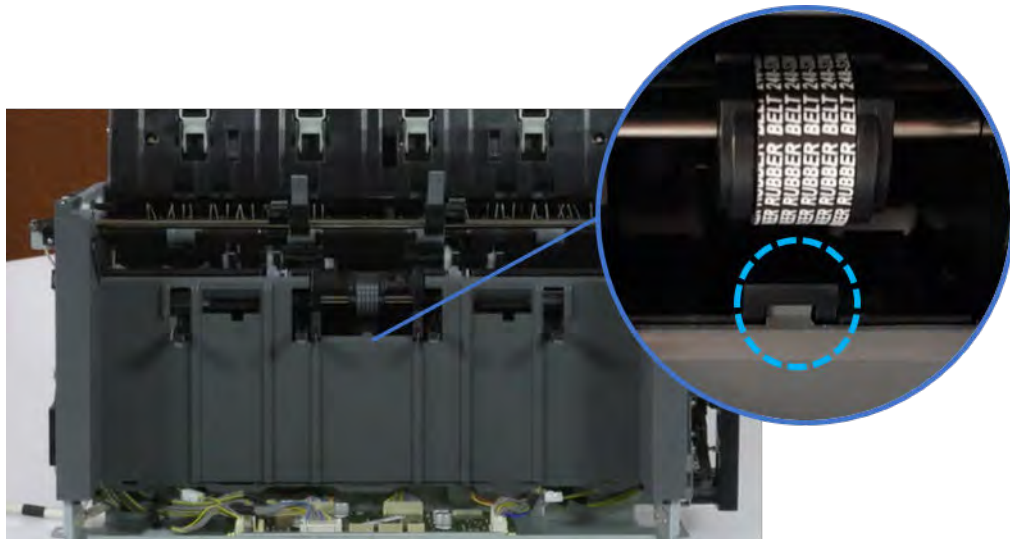

Remove the front harness guide

Follow these steps to remove the front harness guide.

1. Open one clamp and unplug five connectors, and then remove the wire harness from the front harness guide.

2. Remove four screws, and then remove the front harness guide.

Figure 7-749 Remove the front harness guide

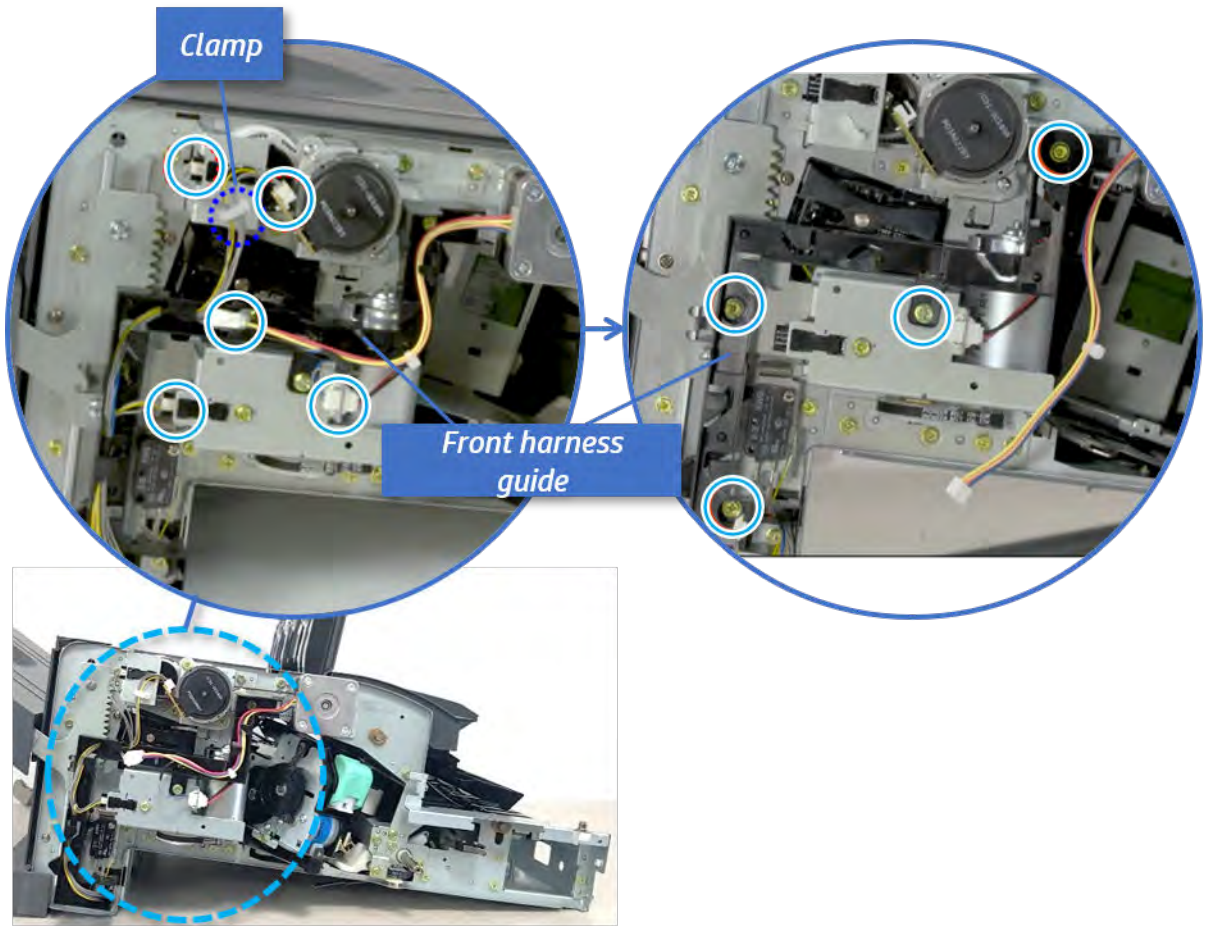

Remove the output tray motor assembly

Follow these steps to remove the output tray motor assembly.

- ▲ Remove three screws, and then remove the output tray motor assembly.

Figure 7-750 Remove the output tray motor assembly

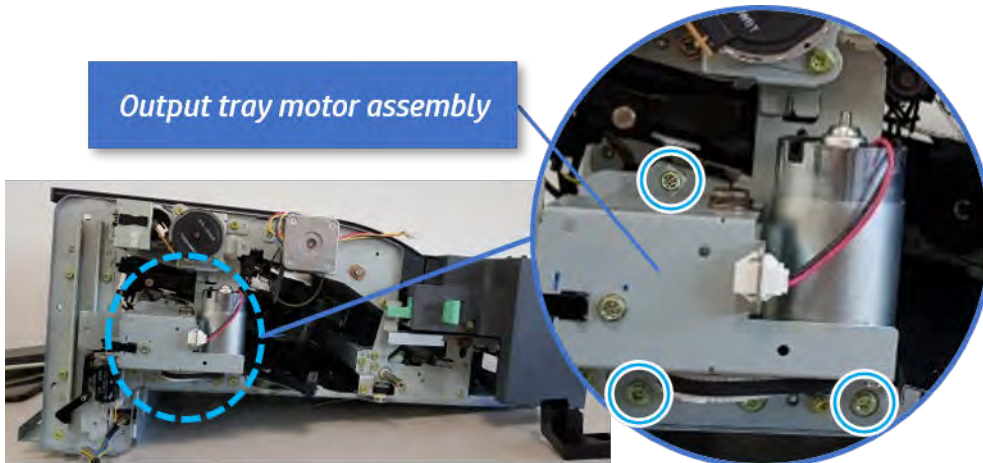

Remove the output tray lower limit switch

Follow these steps to remove the output tray lower limit switch.

- ▲ Remove one screw, and then remove the output tray lower limit switch.

Figure 7-751 Remove the output tray lower limit switch

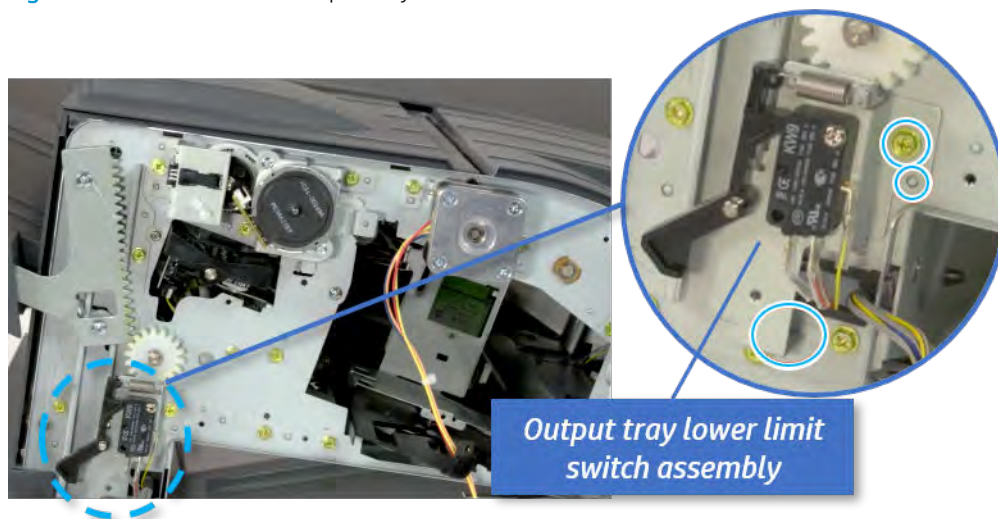

Remove the paper holding

Follow these steps to remove the paper holding.

1. Remove the paper holding actuator spring.

Figure 7-752 Remove the paper holding actuator spring

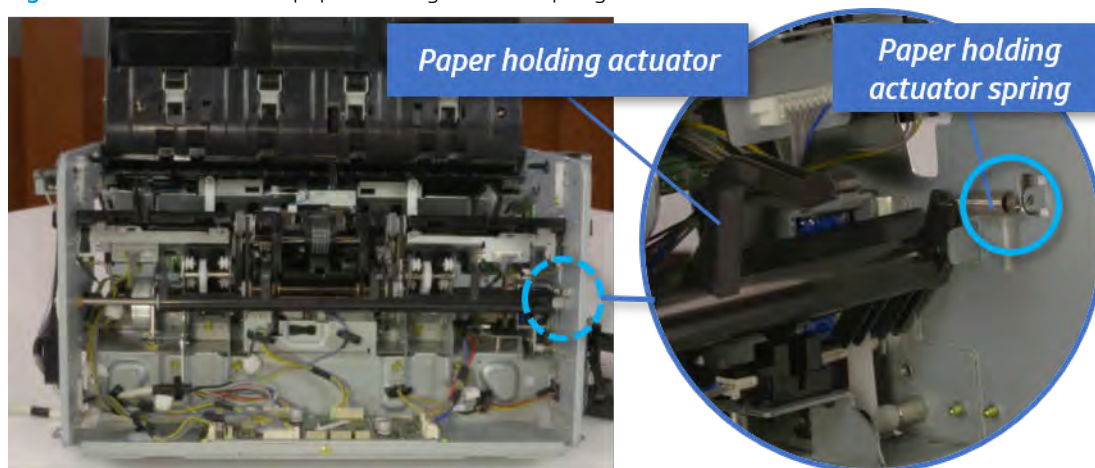

2. Remove the e-ring and the rack pinion gear. And then remove the pin and the e-ring, and then remove the bushing.

Figure 7-753 Remove e-ring, rack pinion gear, pin, and bushing

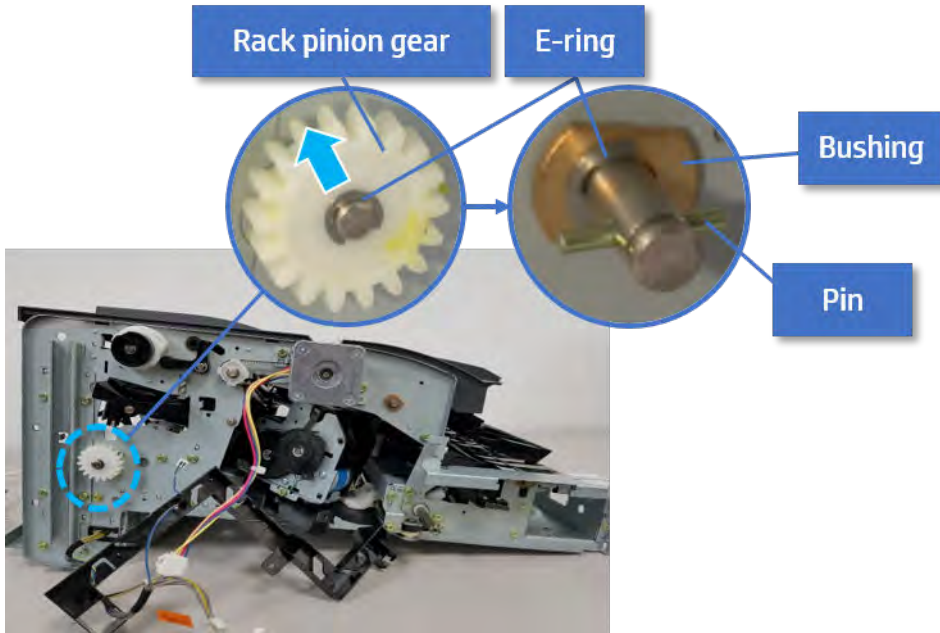

 **NOTE:** Be sure not to lose the pin.

3. Carefully remove the paper holding shaft and the actuator.

Figure 7-754 Remove the paper holding shaft and the actuator

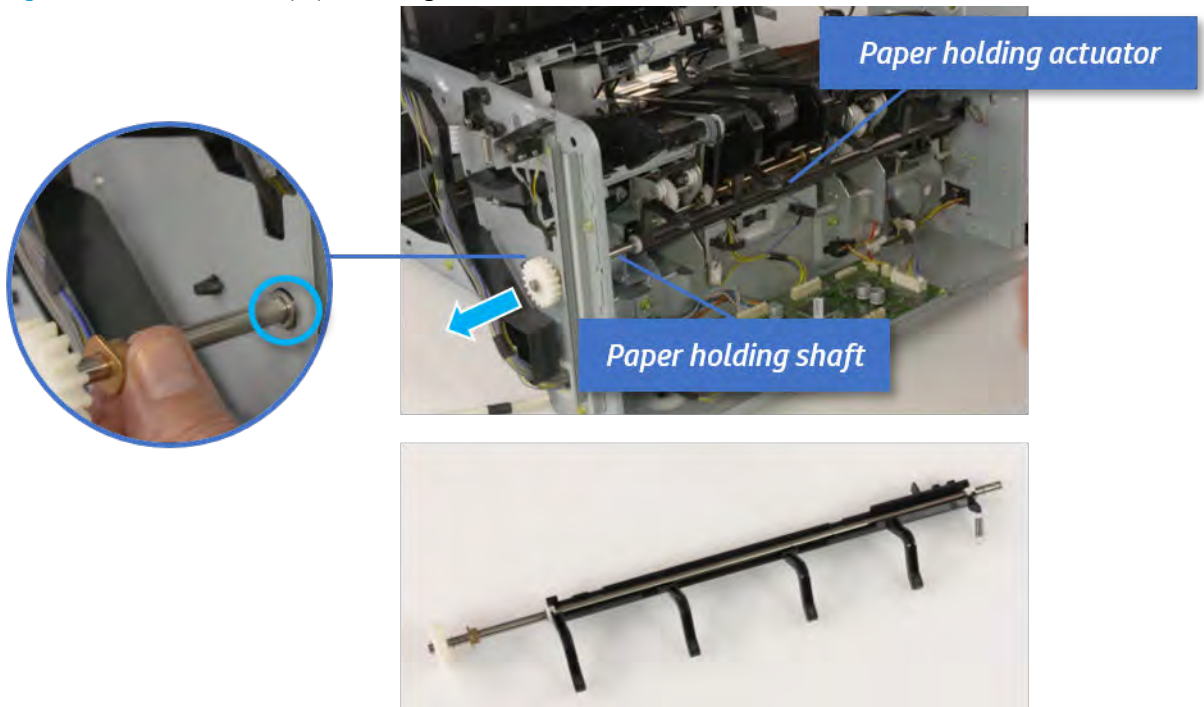

Remove the sub paddle unit

Follow these steps to remove the sub paddle unit.

1. Open the top cover, and then remove one screw securing the sub paddle unit.

Figure 7-755 Remove one screw

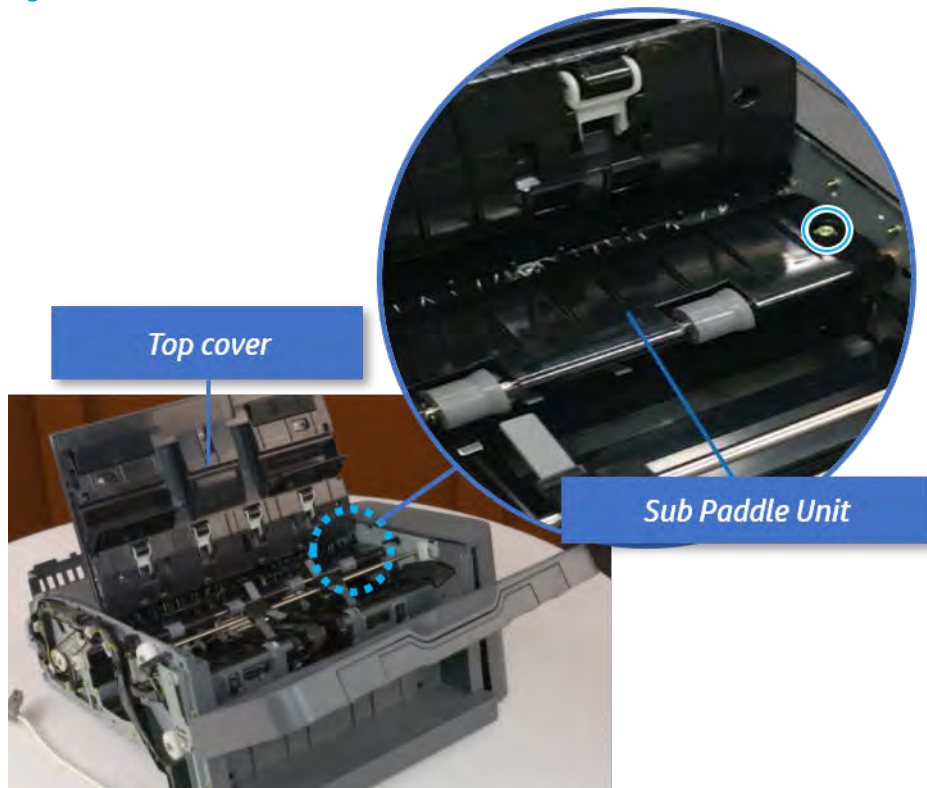

2. Remove the e-ring, and then remove the pulley and timing belt. And then remove the e-ring and the bushing.

Figure 7-756 Remove the e-ring, pulley, timing belt, and bushing

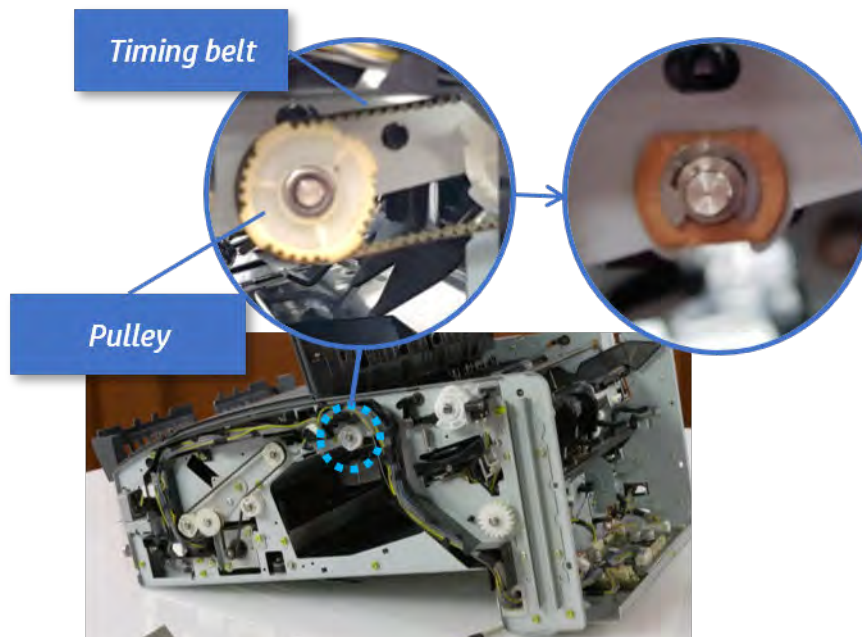

3. Lift up and remove the sub paddle unit.

Figure 7-757 Remove the sub paddle unit

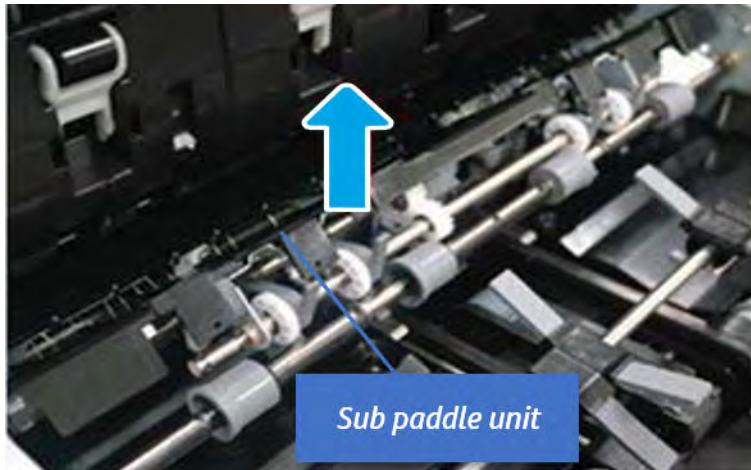

Remove the exit roller

Follow these steps to remove the exit roller.

1. Remove the guide on the center of the exit roller.

Figure 7-758 Remove the guide

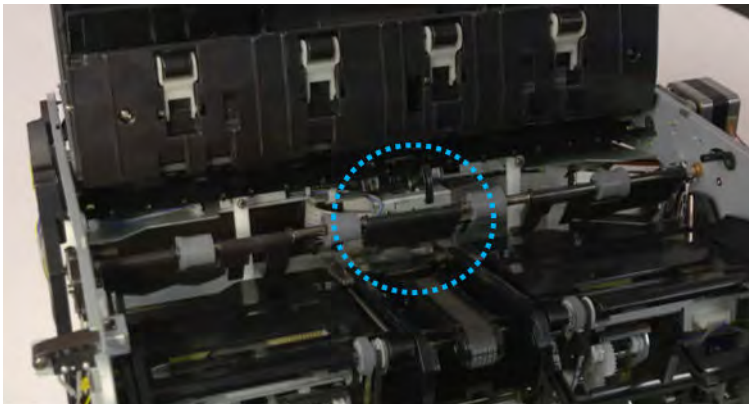

2. On the front of the inner finisher, release the timing belt connected to the exit motor.

Figure 7-759 Release the timing belt

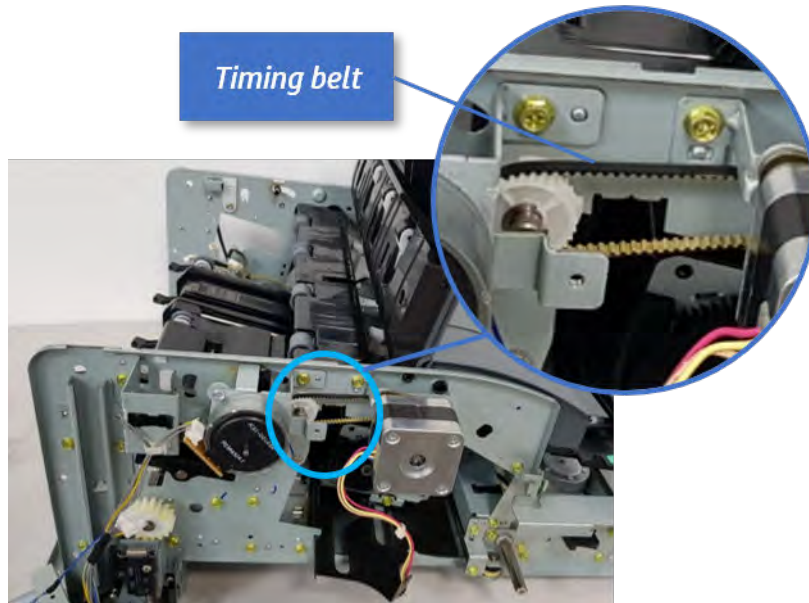

3. Remove five screws securing the rear harness guide.

Figure 7-760 Remove five screws

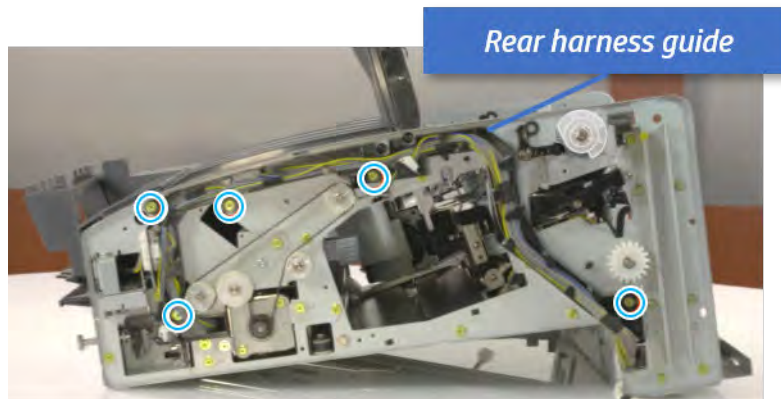

4. On the rear of the inner finisher, remove the e-ring and the pulley and then remove the e-ring and the bushing.

Figure 7-761 Remove e-ring, pulley, and bushing

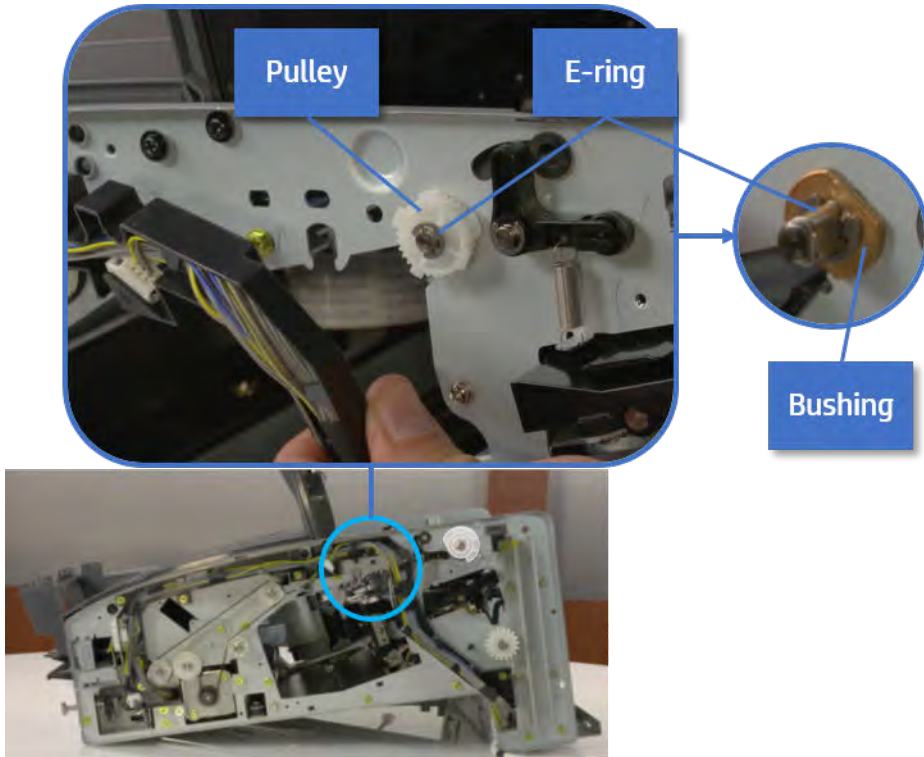

5. Push the bushing to detach it, and then remove the exit roller.

Figure 7-762 Remove the exit roller

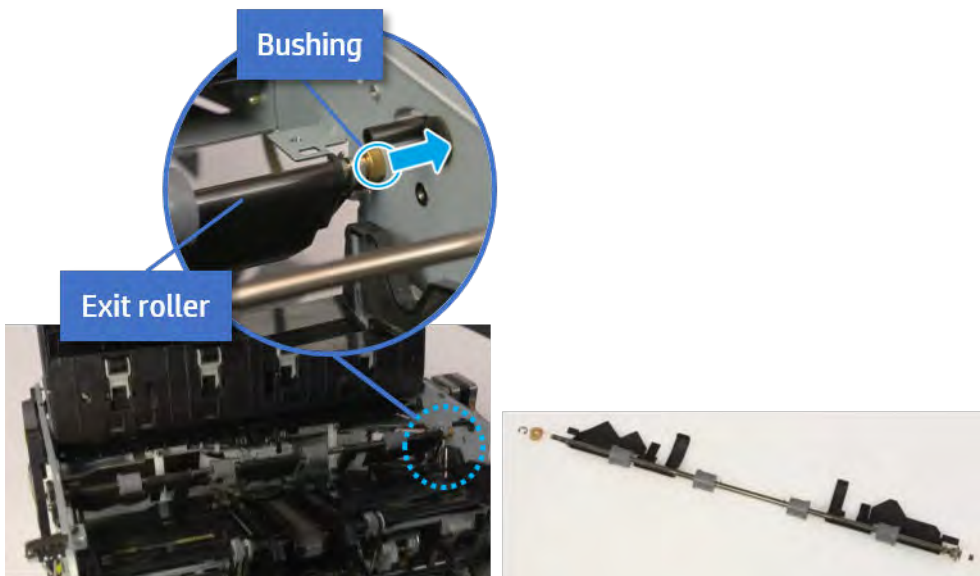

Remove the front tamper

Follow these steps to remove the front tamper.

1. Remove four screws.

Figure 7-763 Remove four screws

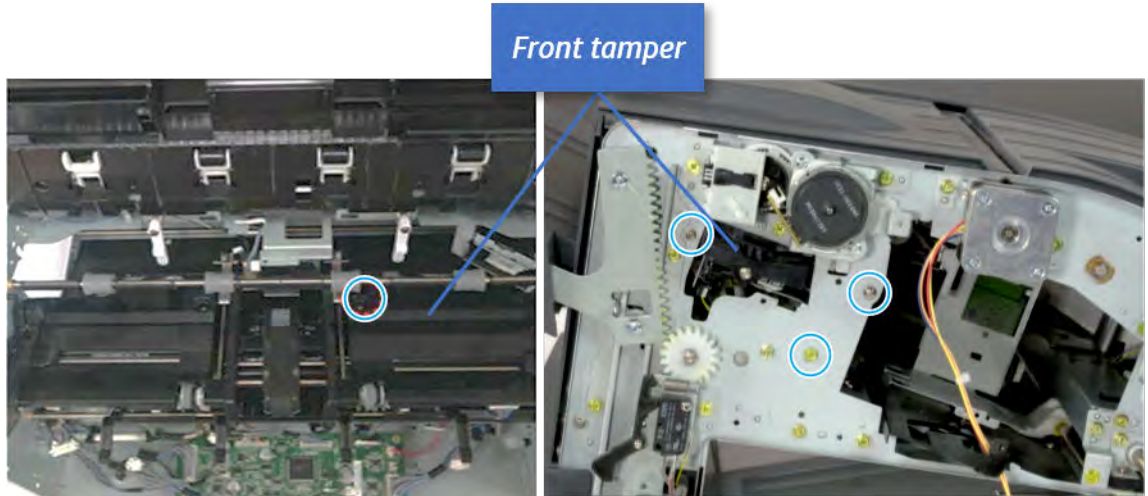

2. Unplug the connector and release the hook, and then pull the front tamper up to remove.

Figure 7-764 Remove the front tamper

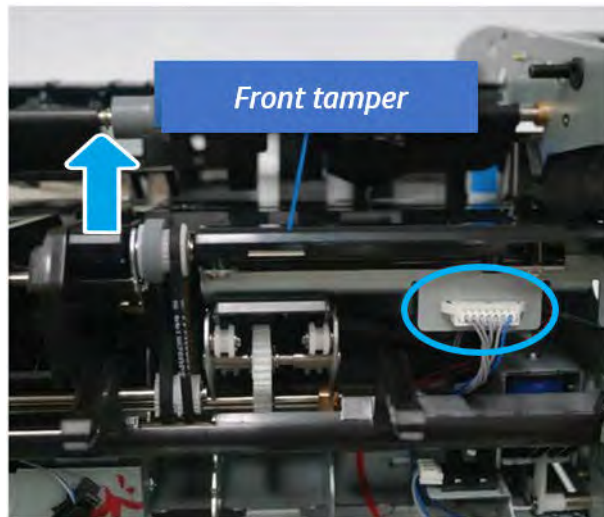

Remove the paper holding solenoid

Follow these steps to remove the paper holding solenoid.

1. Remove two screws at the front of the inner finisher.

Figure 7-765 Remove two screws

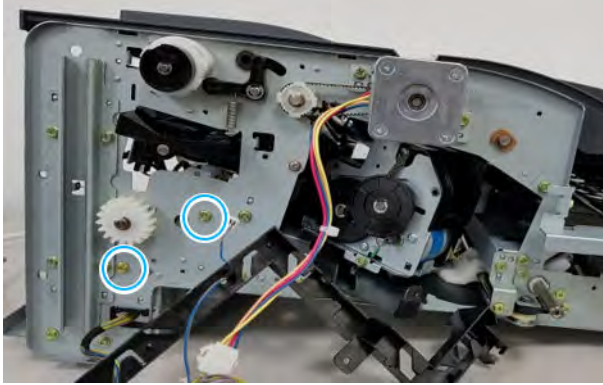

2. Remove one screw.

Figure 7-766 Remove one screw



3. Disconnect two connectors and remove the solenoid assembly.

Figure 7-767 Remove the solenoid assembly

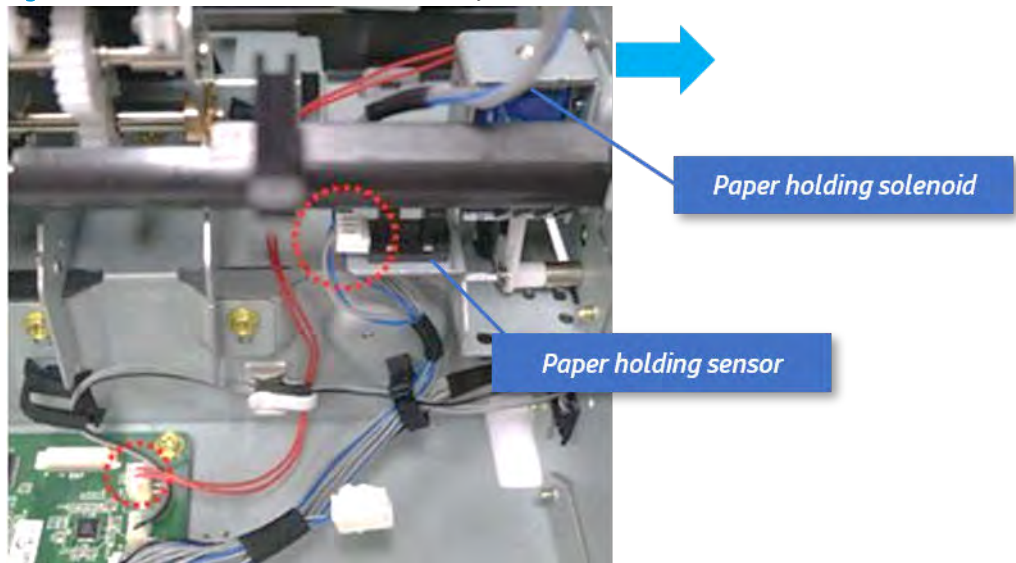

4. Remove two screws, and then release the solenoid from the bracket.

Figure 7-768 Remove the paper holding solenoid

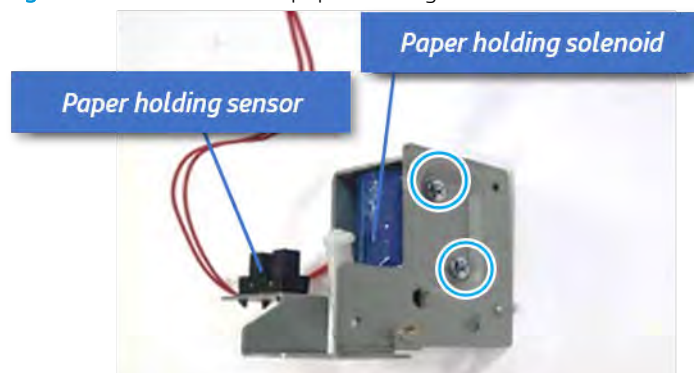

Unpack the replacement assembly



Follow these steps to unpack the replacement assembly.

1. Dispose of the defective part.

 **NOTE:** HP recommends responsible disposal of the defective part.

<http://www8.hp.com/us/en/hp-information/environment/product-recycling.html>

2. Unpack the replacement part from the packaging.

 **CAUTION:**  Some parts are sensitive to electrostatic discharge (ESD). Always perform service work at an ESD-protected workstation or mat. If an ESD workstation or mat is not available, touch the sheet-metal chassis to provide a static ground before touching an ESD-sensitive assembly. Protect the ESD-sensitive assemblies by placing them in ESD pouches when they are out of the printer.

 **IMPORTANT:** Make sure that all of the shipping materials (for example shipping tape) are removed from the replacement part prior to installation.

 **NOTE:** If the replacement part is a roller or pad, avoid touching the spongy part of it. Skin oils on the roller or pad can cause paper pickup and/or print-quality problems. HP recommends using disposable gloves when handling rollers or pads or washing your hands before touching rollers or pads.

3. To install an assembly, reverse the removal steps.

 **NOTE:** When applicable, special installation instructions are provided for an assembly at the end of the removal procedure. Always completely read the removal instructions and follow all special installation instructions.

Punch unit

Removal and replacement: Punch cover

Learn how to remove and replace the punch cover.

To view teardown and reassembling video of the inner finisher, click the link below.



[View a teardown video of the inner finisher.](#)



[View a reassembling video of the inner finisher.](#)



IMPORTANT: When applicable, special installation instructions are provided for an assembly at the end of the removal procedure. Always completely read the removal instructions and follow all special installation instructions.

Mean time to repair:

Service level:

Before performing service

Turn the printer power off

- Press the power button on the front of the printer, and then turn off the power switch next to the power cable.
- A shutting-down message appears on the control-panel display.



WARNING! To avoid damage to the printer, turn the power off and wait until the printer shuts down before removing the power cable.

- Disconnect the printer power cable after the printer has completely shut down (the control-panel display is blank).

Use the table below to identify the correct part number for your printer. To order the part, go to <http://www.hp.com/buy/parts>.

Table 7-75 Part information

Part number	Part description
JC90-01343B	Punch cover

Required tools

- #2 JIS screwdriver with a magnetic tip

After performing service

Turn the printer power on

- Connect the power cable.
- Use the power switch to turn the power on.

Post service test

Print any pages necessary to verify that the repair resolved the issue and did not create any new issues.

Remove the rear cover

Follow these steps to remove the rear cover.

1. Open the top cover.

Figure 7-769 Open the top cover

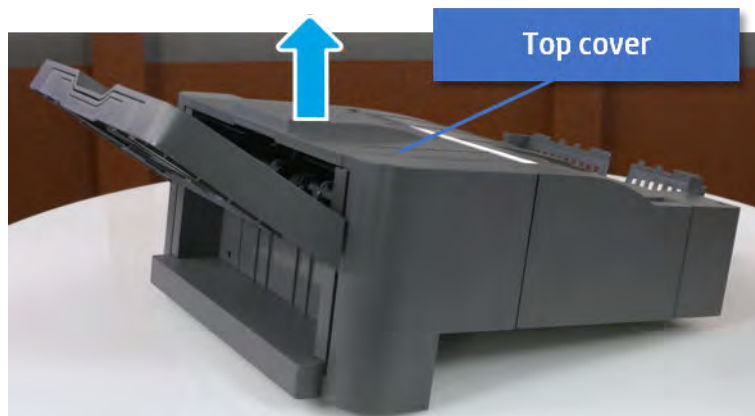

2. Remove three screws.
3. Release hooks carefully and remove the rear cover.

Figure 7-770 Remove the rear cover

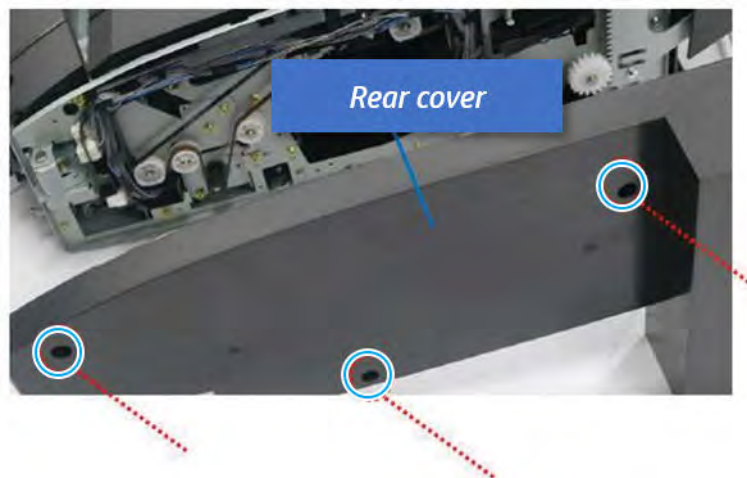

Remove the punch cover

Follow these steps to remove the punch cover.

1. Unplug the connector. Remove the e-ring, and then remove the slide shaft at the rear of the inner finisher.

Figure 7-771 Remove the slide shaft

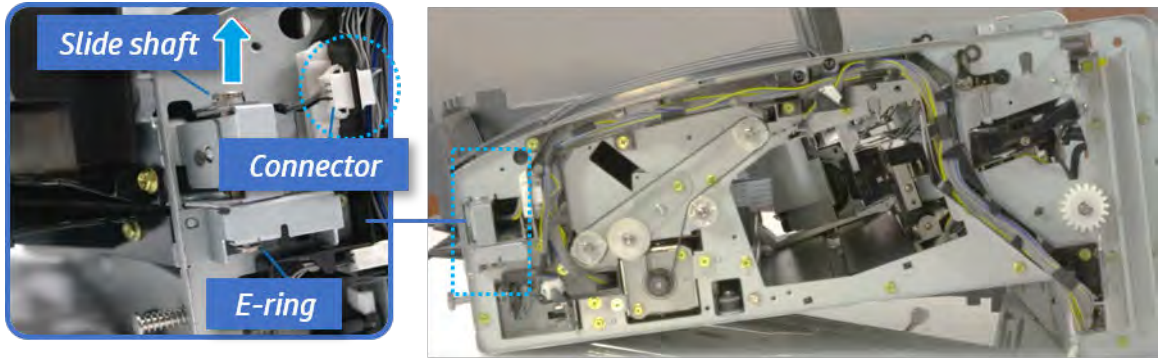

2. Open the punch cover.

Figure 7-772 Open the punch cover

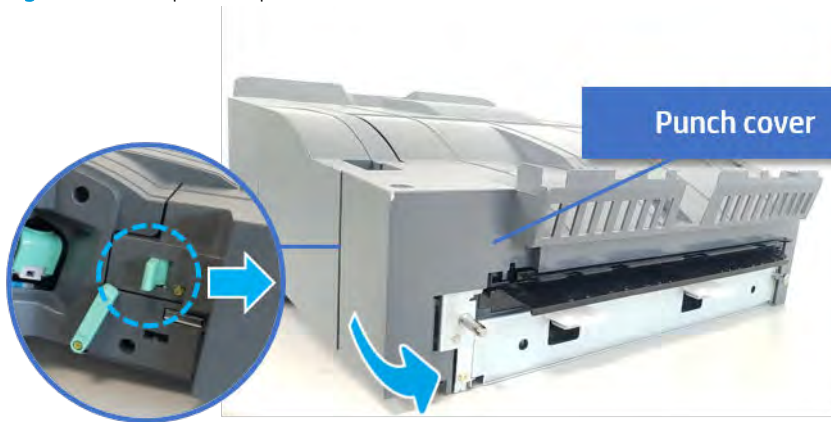

3. Remove the front punch sheet, and then remove the e-ring and the washer. And then remove the punch cover.

Figure 7-773 Remove the punch cover

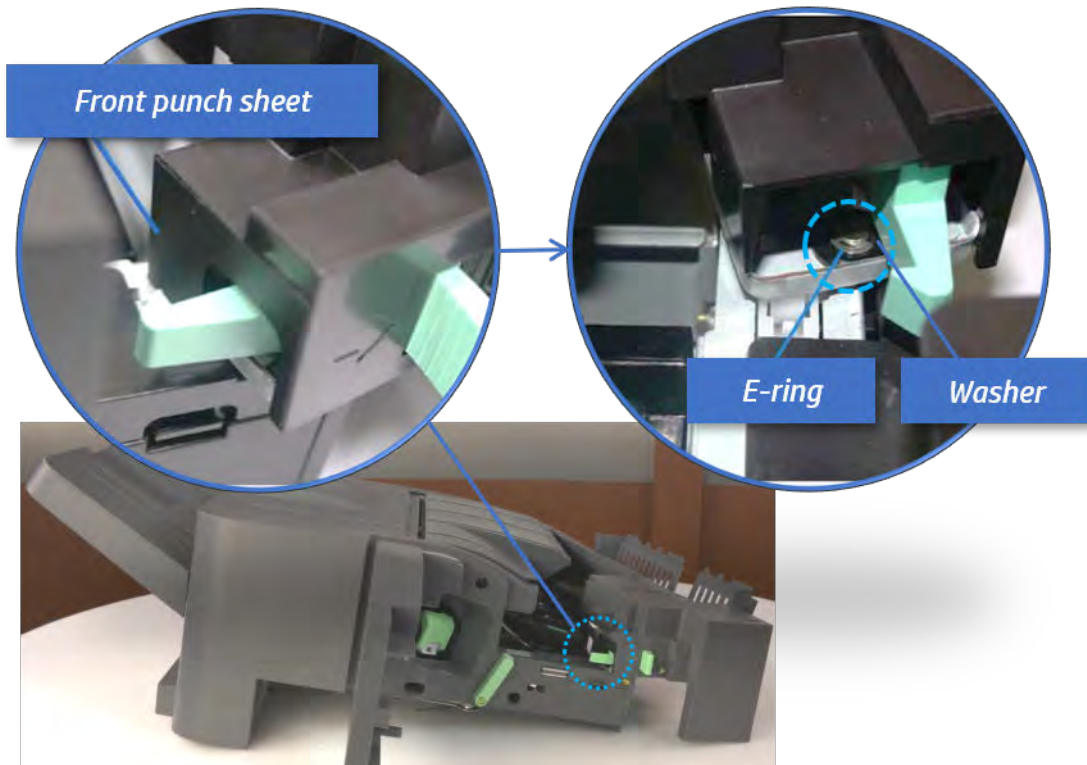

Unpack the replacement assembly



Follow these steps to unpack the replacement assembly.

1. Dispose of the defective part.

 **NOTE:** HP recommends responsible disposal of the defective part.

<http://www8.hp.com/us/en/hp-information/environment/product-recycling.html>

2. Unpack the replacement part from the packaging.

 **CAUTION:**  Some parts are sensitive to electrostatic discharge (ESD). Always perform service work at an ESD-protected workstation or mat. If an ESD workstation or mat is not available, touch the sheet-metal chassis to provide a static ground before touching an ESD-sensitive assembly. Protect the ESD-sensitive assemblies by placing them in ESD pouches when they are out of the printer.

 **IMPORTANT:** Make sure that all of the shipping materials (for example shipping tape) are removed from the replacement part prior to installation.

 **NOTE:** If the replacement part is a roller or pad, avoid touching the spongy part of it. Skin oils on the roller or pad can cause paper pickup and/or print-quality problems. HP recommends using disposable gloves when handling rollers or pads or washing your hands before touching rollers or pads.

3. To install an assembly, reverse the removal steps.



NOTE: When applicable, special installation instructions are provided for an assembly at the end of the removal procedure. Always completely read the removal instructions and follow all special installation instructions.

Removal and replacement: Punch waste full sensor (S19)

Learn how to remove and replace the punch waste full sensor.

To view teardown and reassembling video of the inner finisher, click the link below.



[View a teardown video of the inner finisher.](#)



[View a reassembling video of the inner finisher.](#)

IMPORTANT: When applicable, special installation instructions are provided for an assembly at the end of the removal procedure. Always completely read the removal instructions and follow all special installation instructions.

Mean time to repair:

Service level:

Before performing service

Turn the printer power off

- Press the power button on the front of the printer, and then turn off the power switch next to the power cable.
- A shutting-down message appears on the control-panel display.

WARNING! To avoid damage to the printer, turn the power off and wait until the printer shuts down before removing the power cable.

- Disconnect the printer power cable after the printer has completely shut down (the control-panel display is blank).

Use the table below to identify the correct part number for your printer. To order the part, go to www.hp.com/buy/parts.

Table 7-76 Part information

Part number	Part description
0604-001381	Punch waste full sensor

Required tools

- #2 JIS screwdriver with a magnetic tip

After performing service

Turn the printer power on

- Connect the power cable.
- Use the power switch to turn the power on.

Post service test

Print any pages necessary to verify that the repair resolved the issue and did not create any new issues.

Remove the front cover

Follow these steps to remove the front cover.

1. Open the front door and open the punch cover.
2. Remove three screws in the front.
3. Remove the lever.
4. Open the top cover.
5. From the right side of the front cover, carefully lift and pry toward the top-left corner to remove the front cover.

Figure 7-774 Remove the front cover

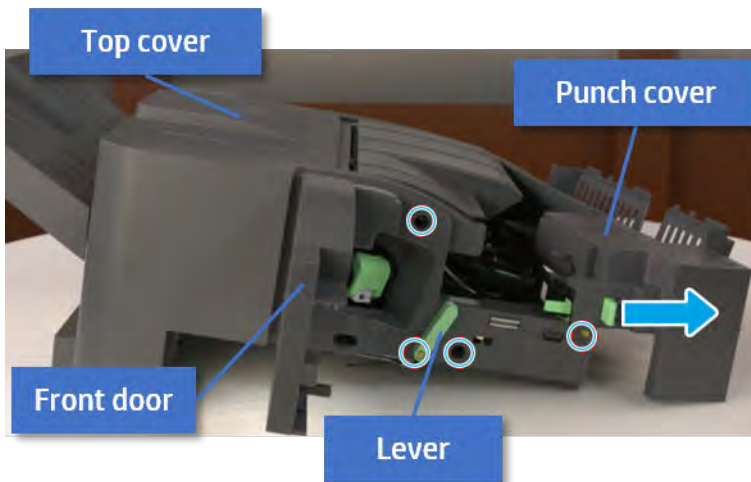

Remove the rear cover

Follow these steps to remove the rear cover.

1. Open the top cover.

Figure 7-775 Open the top cover

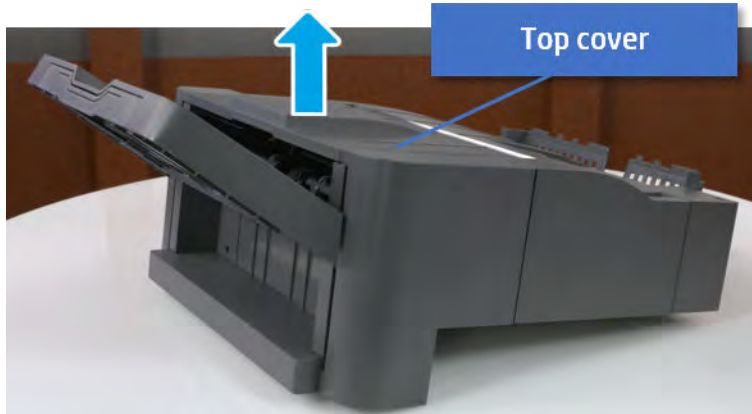

2. Remove three screws.
3. Release hooks carefully and remove the rear cover.

Figure 7-776 Remove the rear cover

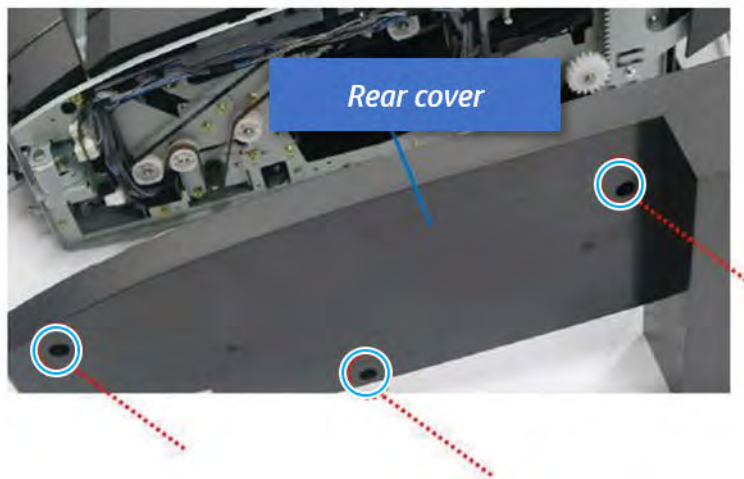

Remove the middle cover

Follow these steps to remove the middle cover.

1. Open the front door and then open the punch cover.

Figure 7-777 Open the front door and punch cover

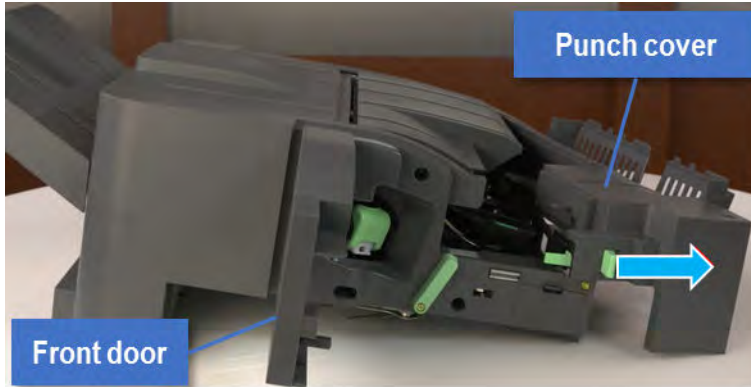

2. Remove left-side one screw at the rear of the inner finisher, and then remove the middle cover by lifting off the hinge pins at the front.

Figure 7-778 Remove the middle cover

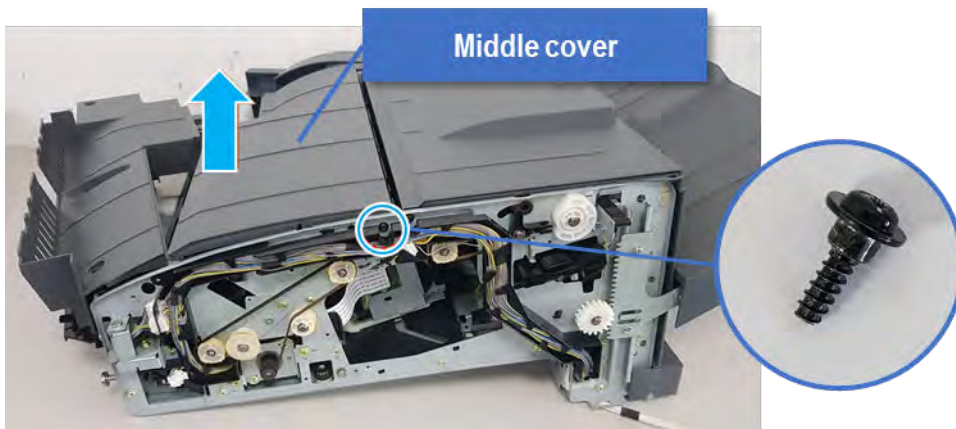

Remove the punch cover

Follow these steps to remove the punch cover.

1. Unplug the connector. Remove the e-ring, and then remove the slide shaft at the rear of the inner finisher.

Figure 7-779 Remove the slide shaft

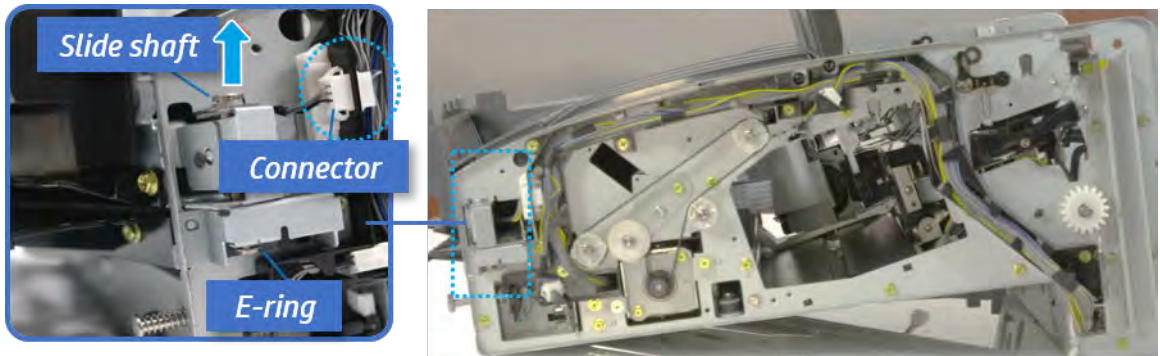

2. Open the punch cover.

Figure 7-780 Open the punch cover

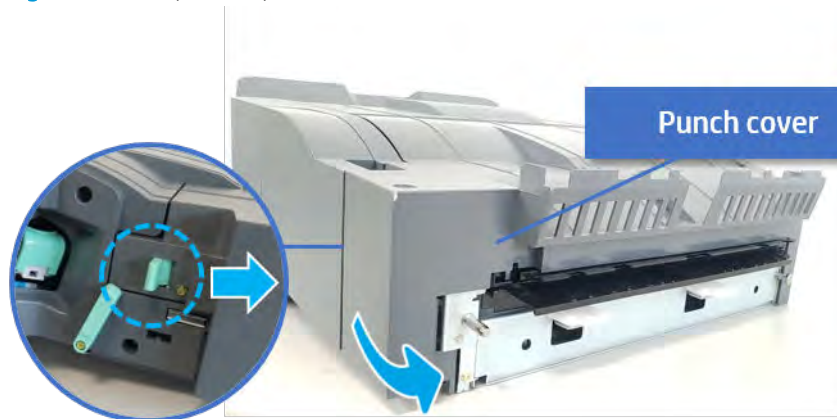

3. Remove the front punch sheet, and then remove the e-ring and the washer. And then remove the punch cover.

Figure 7-781 Remove the punch cover

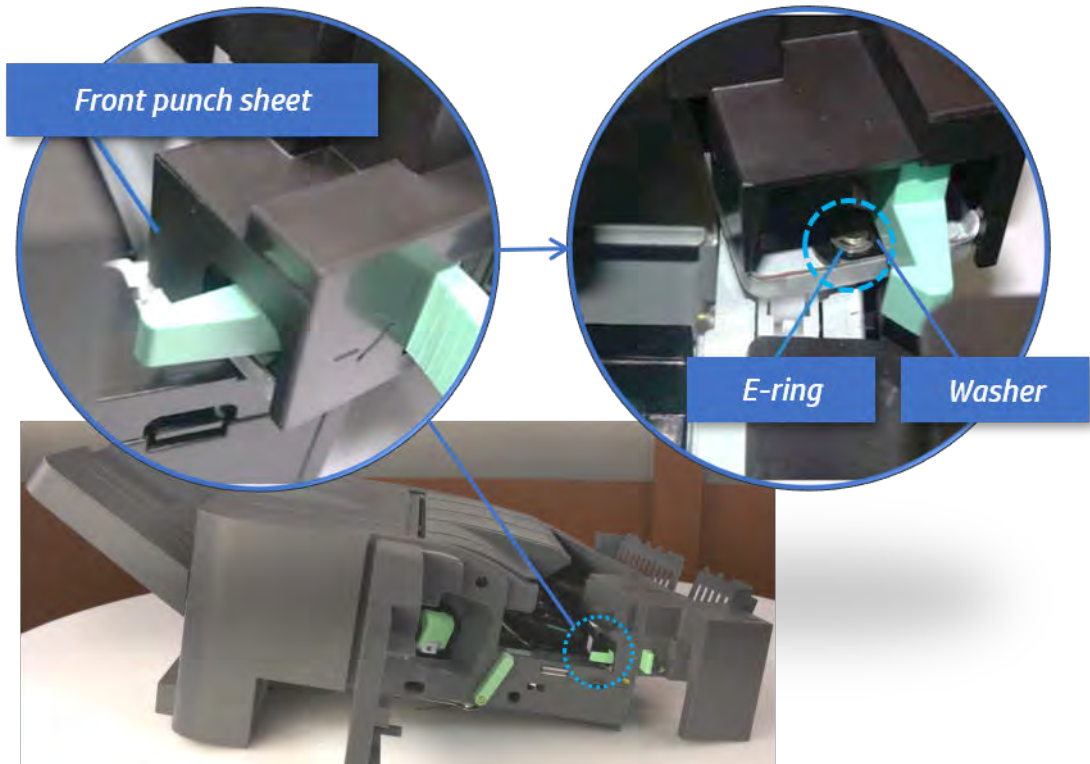

Remove the diverter guide and the middle roller

Follow these steps to remove the diverter guide and the middle roller.

1. On the front of the inner finisher, remove the e-ring and bushing.

Figure 7-782 Remove the e-ring and bushing

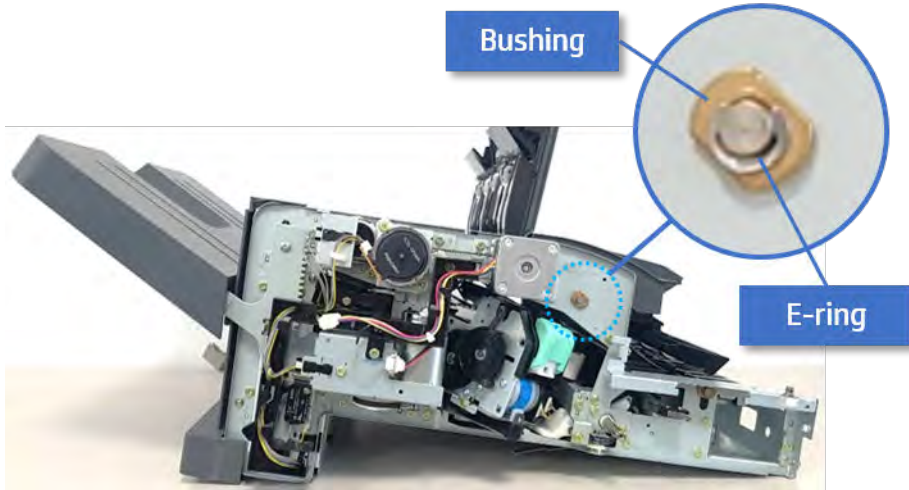

2. On the rear of the inner finisher, remove the e-ring, pulley, bushing, belt, and spring (slightly hidden from view).

Figure 7-783 Remove the e-ring, pulley, bushing, belt, and spring

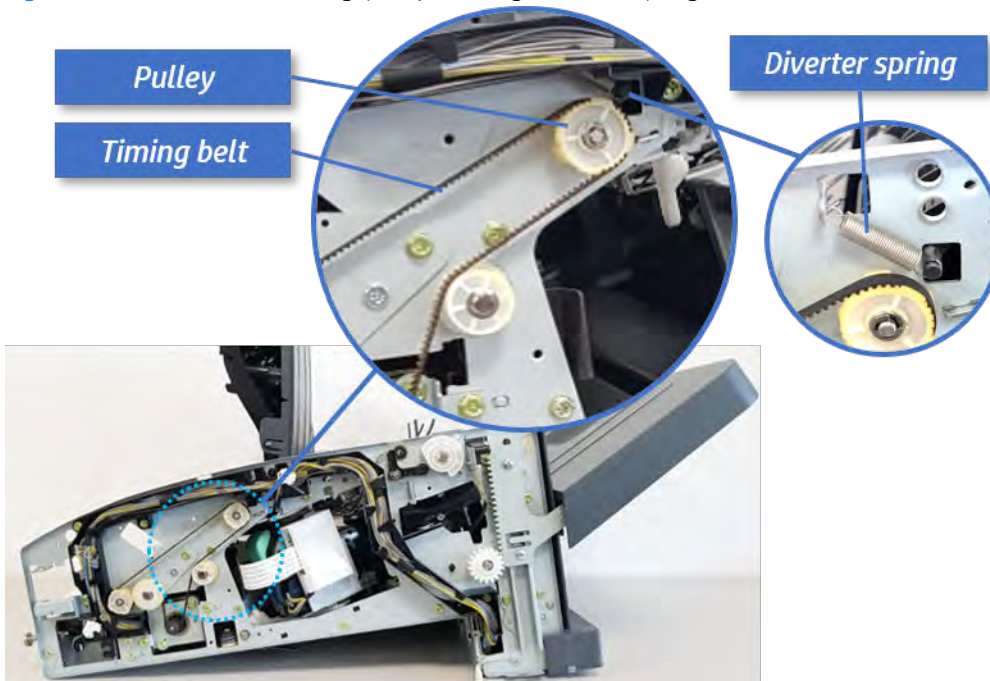

3. Remove the diverter guide and the middle roller.

Figure 7-784 Remove the diverter guide and the middle roller

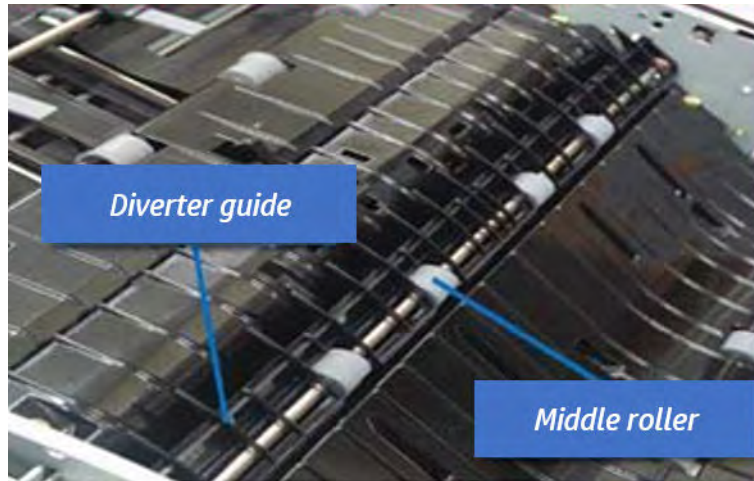

Remove the middle paper guide

Follow these steps to remove the middle paper guide.

1. Remove six screws, and then open the middle paper guide in the direction of the arrow.

Figure 7-785 Open the middle paper guide

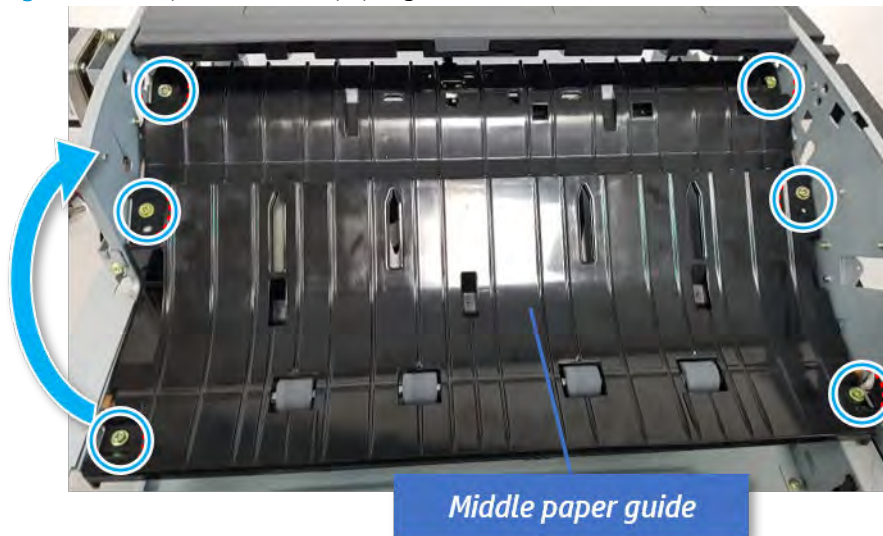

 **NOTE:** Be careful not to damage the sensor connector.

2. Unplug the connector under the middle paper guide. And then, remove the middle paper guide.

Figure 7-786 Remove the middle paper guide

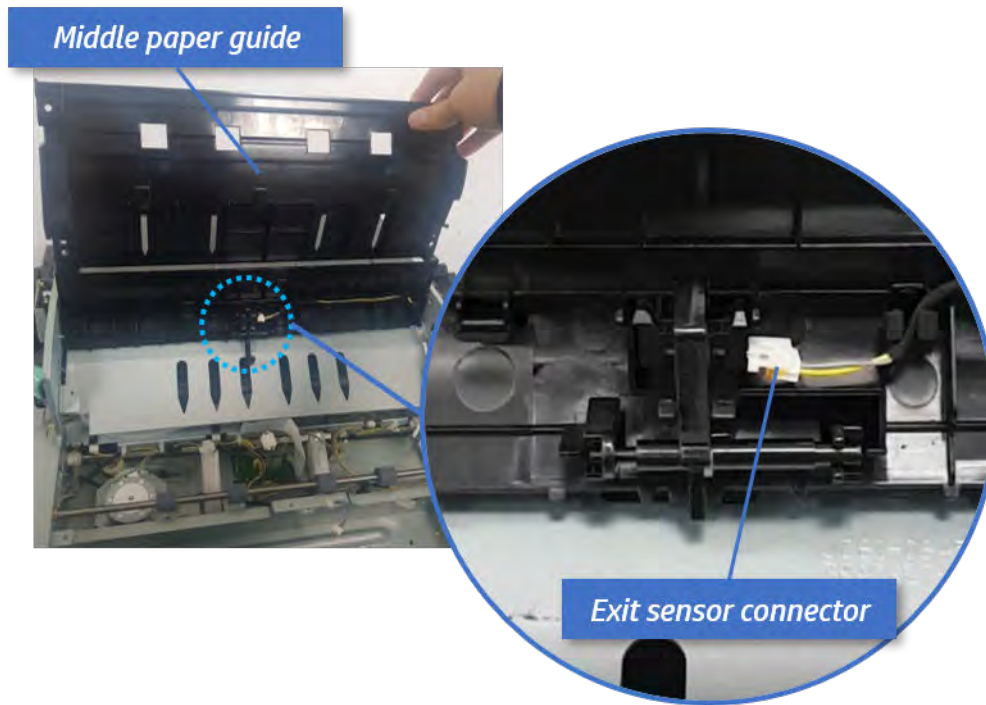

Remove the punch waste full sensor

Follow these steps to remove the punch waste full sensor.

1. Remove one screw, unplug the connector, and then remove the punch waste full sensor bracket.

Figure 7-787 Remove the punch waste full sensor bracket

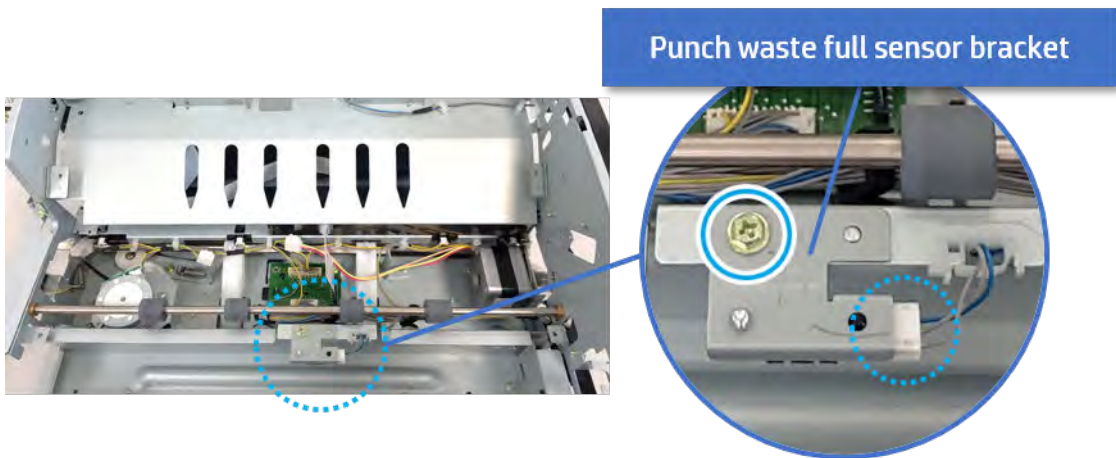

2. Remove one screw, and then remove the punch waste full sensor from the bracket.

Figure 7-788 Remove the punch waste full sensor



Unpack the replacement assembly



Follow these steps to unpack the replacement assembly.

1. Dispose of the defective part.

 **NOTE:** HP recommends responsible disposal of the defective part.

<http://www8.hp.com/us/en/hp-information/environment/product-recycling.html>

2. Unpack the replacement part from the packaging.

 **CAUTION:**  Some parts are sensitive to electrostatic discharge (ESD). Always perform service work at an ESD-protected workstation or mat. If an ESD workstation or mat is not available, touch the sheet-metal chassis to provide a static ground before touching an ESD-sensitive assembly. Protect the ESD-sensitive assemblies by placing them in ESD pouches when they are out of the printer.

 **IMPORTANT:** Make sure that all of the shipping materials (for example shipping tape) are removed from the replacement part prior to installation.

 **NOTE:** If the replacement part is a roller or pad, avoid touching the spongy part of it. Skin oils on the roller or pad can cause paper pickup and/or print-quality problems. HP recommends using disposable gloves when handling rollers or pads or washing your hands before touching rollers or pads.

3. To install an assembly, reverse the removal steps.

 **NOTE:** When applicable, special installation instructions are provided for an assembly at the end of the removal procedure. Always completely read the removal instructions and follow all special installation instructions.

Problem solving

Learn about problem solving.

Control panel message document (CPMD)

Learn about the control panel message document (CPMD).

Refer to [Error codes on page 674](#) for more details.

Electrical Mechanical Diagrams (Inner finisher)

Punch waste full sensor

Figure 7-789 Punch waste full sensor

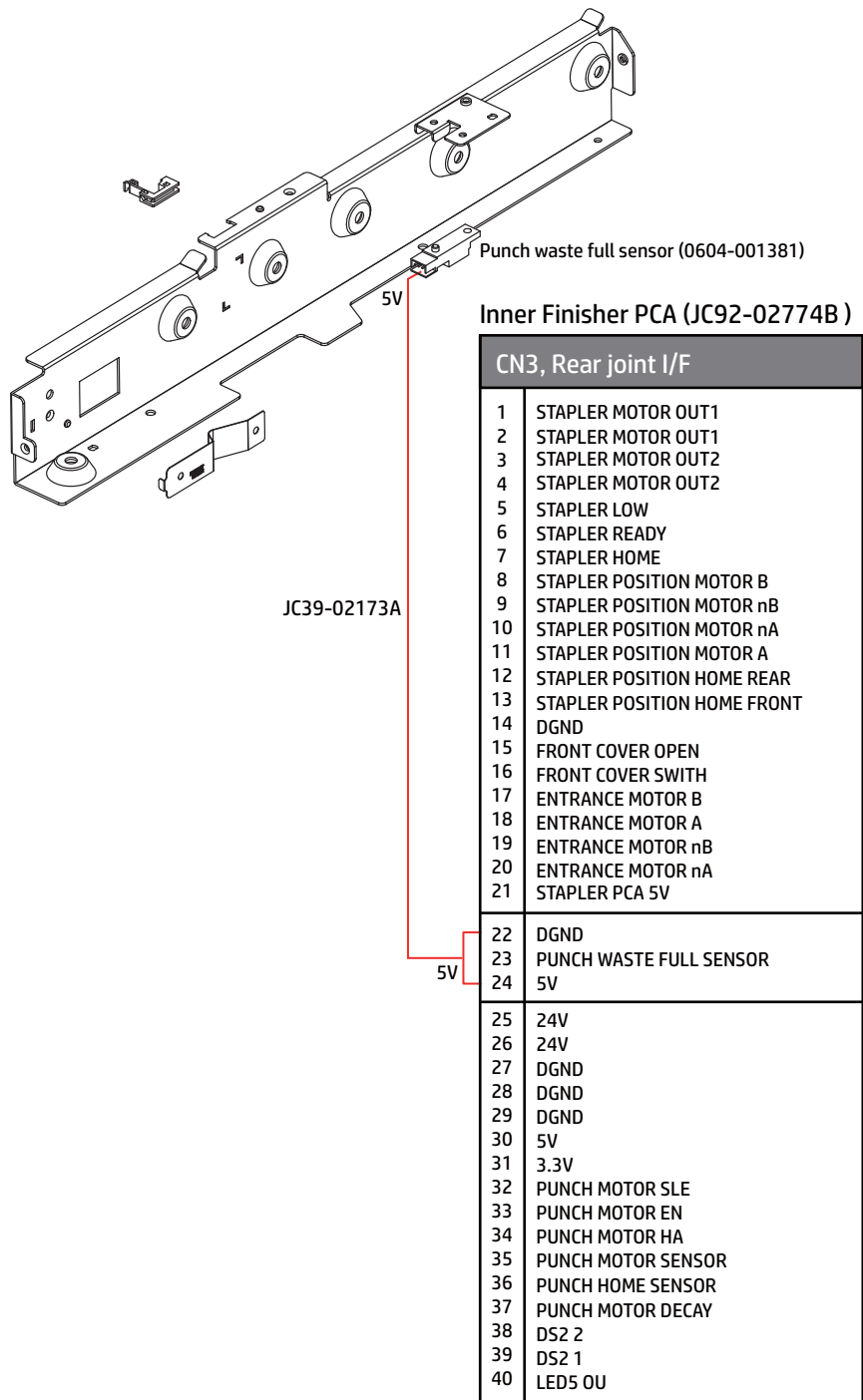

Punch waste box sensor and finisher docking sensor

Figure 7-791 Entrance motor

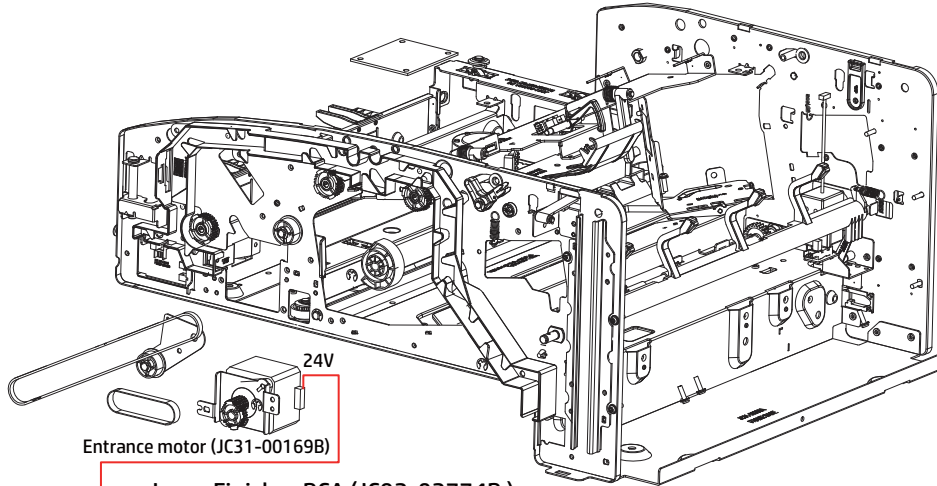

Entrance motor (JC31-00169B)

Inner Finisher PCA (JC92-02774B)

CN3, Rear joint I/F	
1	STAPLER MOTOR OUT1
2	STAPLER MOTOR OUT1
3	STAPLER MOTOR OUT2
4	STAPLER MOTOR OUT2
5	STAPLER LOW
6	STAPLER READY
7	STAPLER HOME
8	STAPLER POSITION MOTOR B
9	STAPLER POSITION MOTOR nB
10	STAPLER POSITION MOTOR nA
11	STAPLER POSITION MOTOR A
12	STAPLER POSITION HOME REAR
13	STAPLER POSITION HOME FRONT
14	DGND
15	FRONT COVER OPEN
16	FRONT COVER SWITH
17	ENTRANCE MOTOR B
18	ENTRANCE MOTOR A
19	ENTRANCE MOTOR nB
20	ENTRANCE MOTOR nA
21	STAPLER PCA 5V
22	DGND
23	PUNCH WASTE FULL SENSOR
24	5V
25	24V
26	24V
27	DGND
28	DGND
29	DGND
30	5V
31	3.3V
32	PUNCH MOTOR SLE
33	PUNCH MOTOR EN
34	PUNCH MOTOR HA
35	PUNCH MOTOR SENSOR
36	PUNCH HOME SENSOR
37	PUNCH MOTOR DECAY
38	DS2 2
39	DS2 1
40	LED5 OU

JC39-02173A

24V

Exit sensor

Figure 7-792 Exit sensor

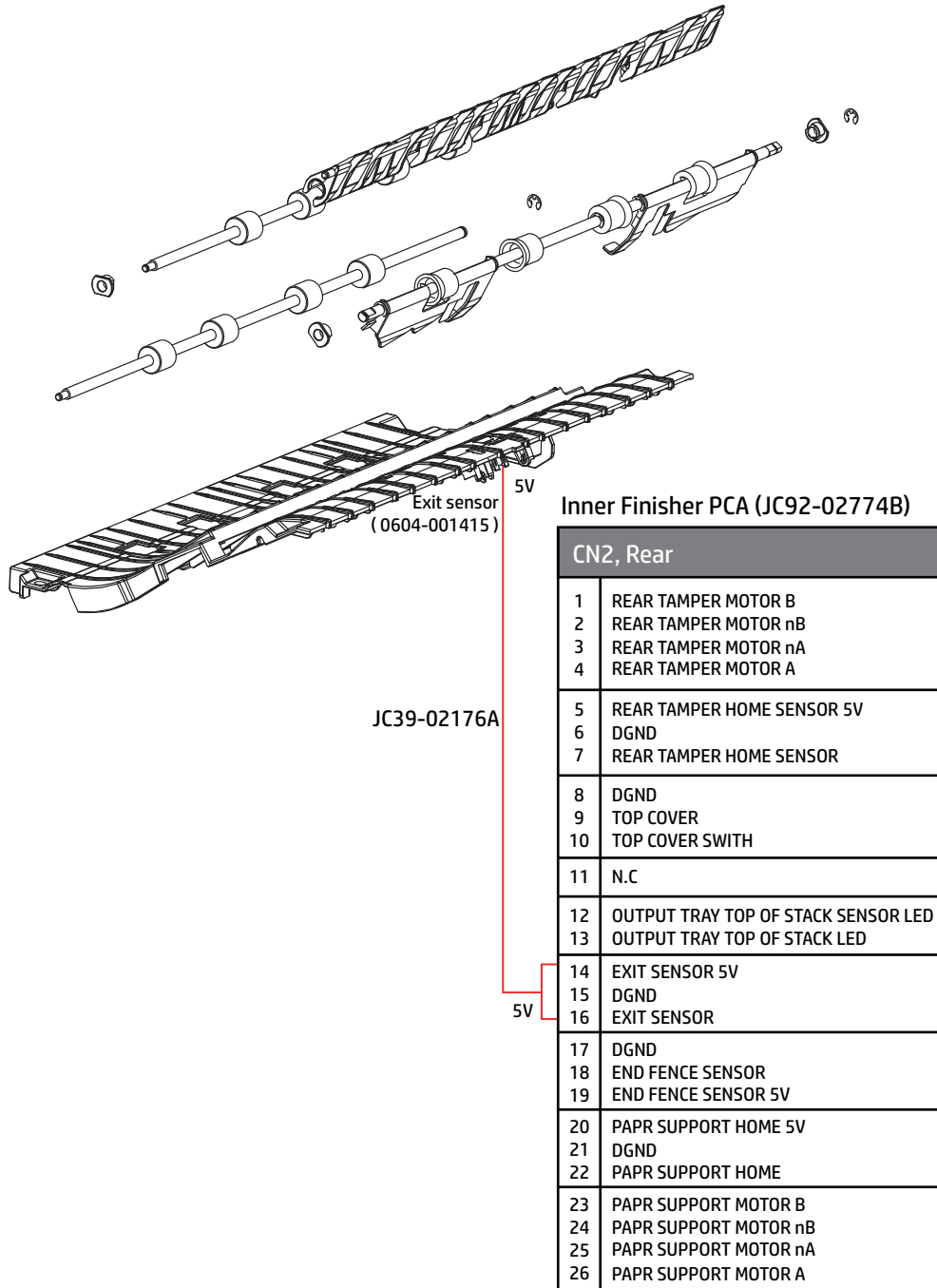

Exit motor, main paddle motor & home sensor, output tray lower limit switch, and paper holding solenoid

Figure 7-793 Exit motor, paddle motor&sensor, output tray lower limit sensor, and paper holding solenoid

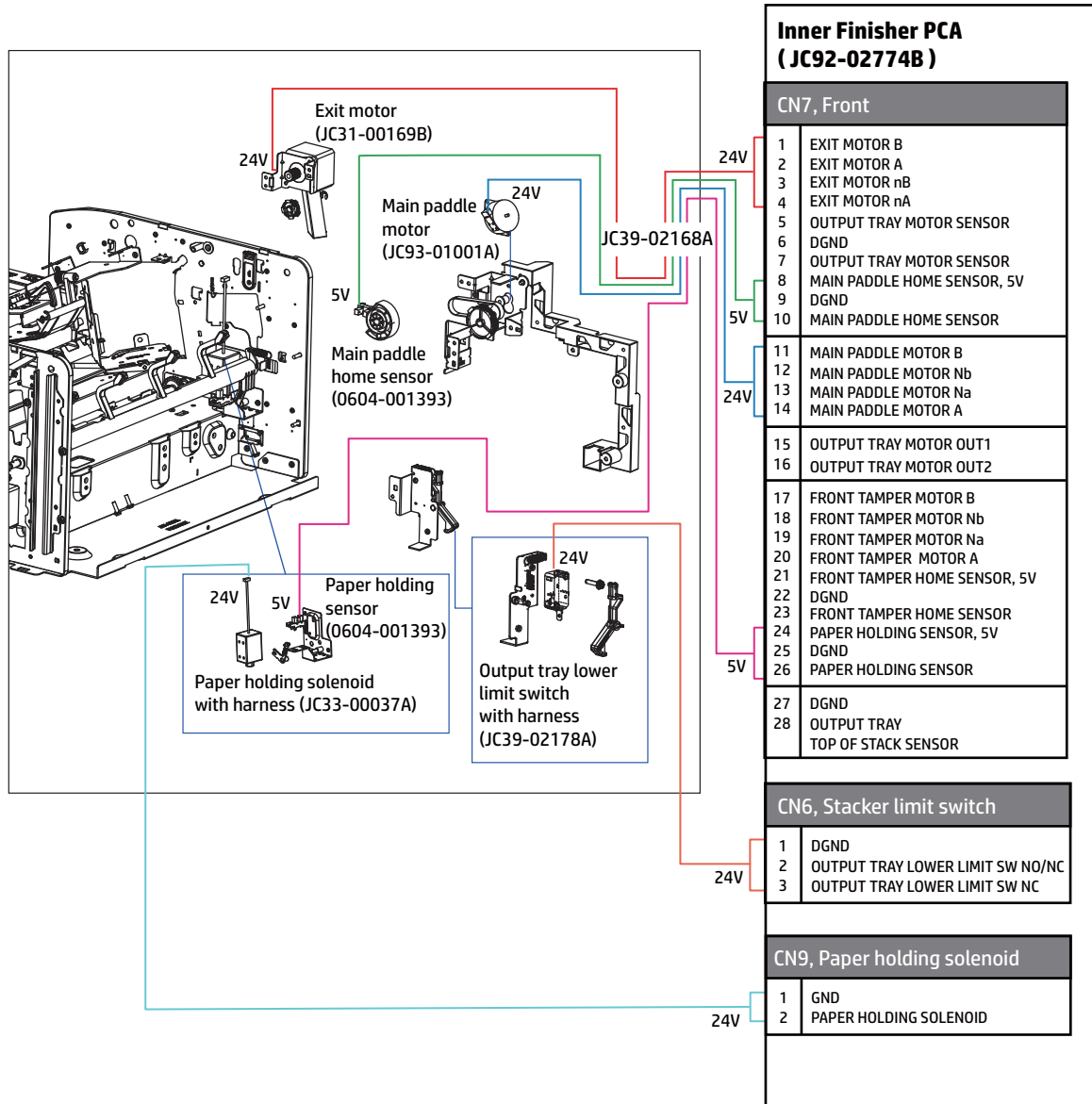

Paper support motor & home sensor

Figure 7-794 Paper support sensor and motor

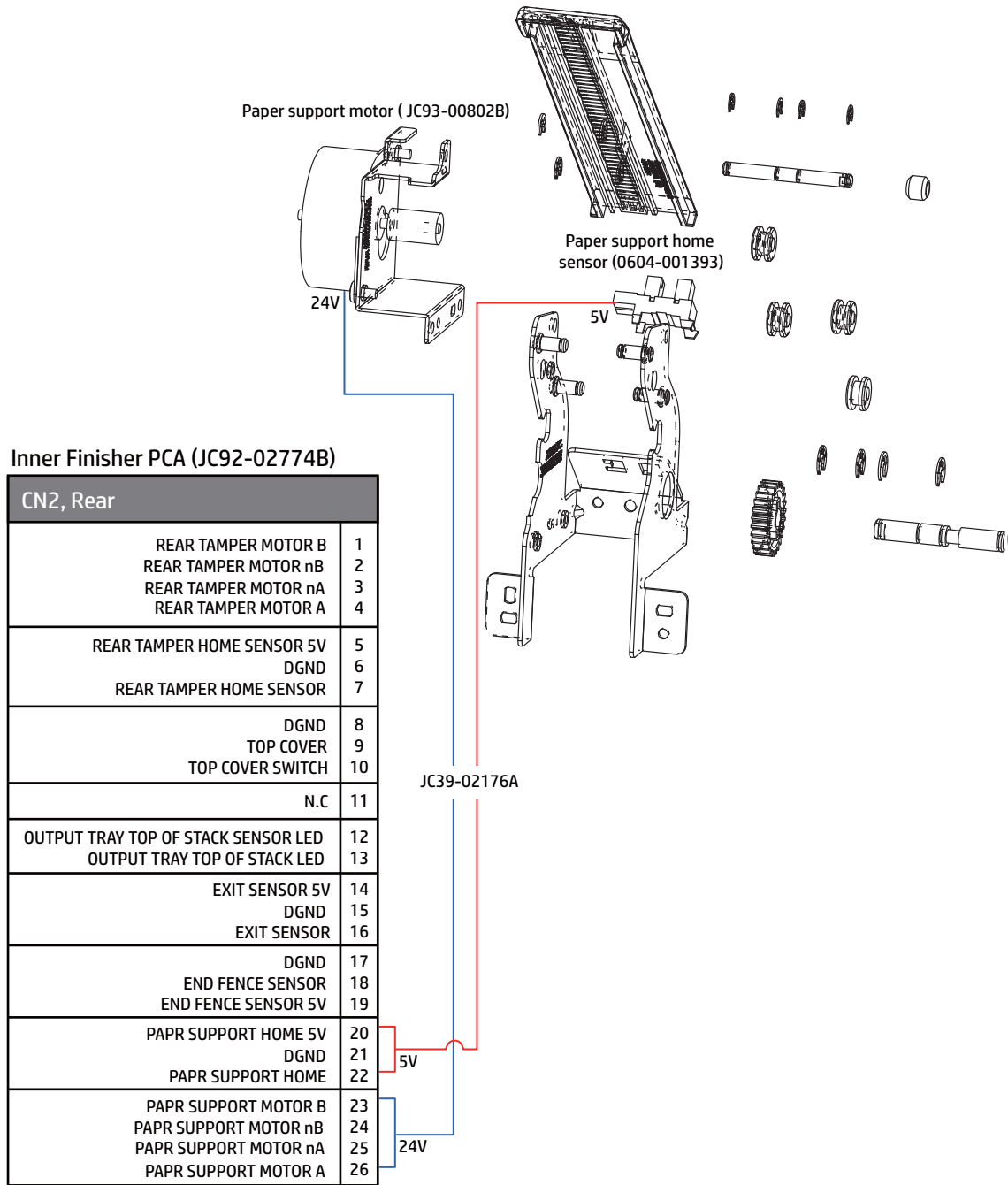

Front tamper motor and home sensor

Figure 7-795 Front tamper sensor and motor

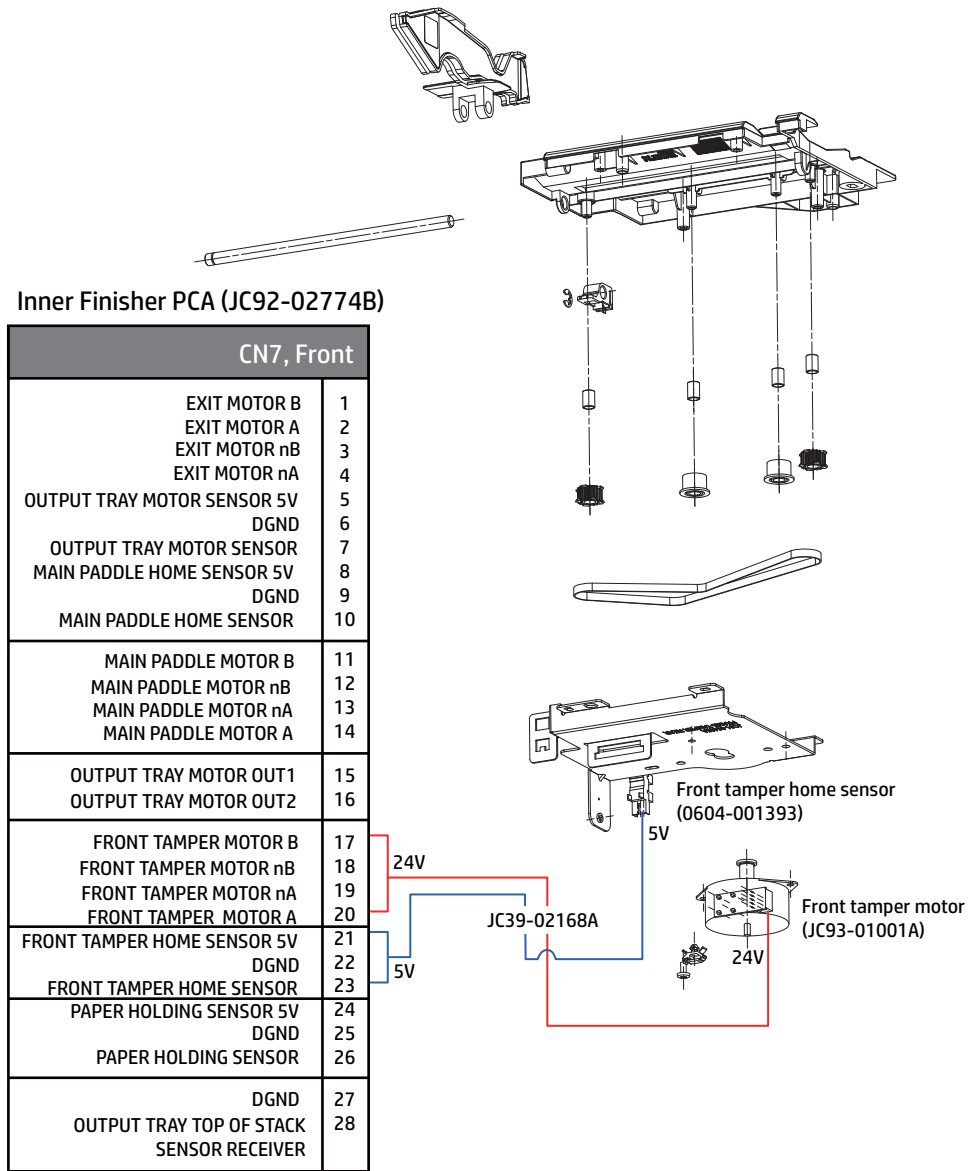

Rear tamper motor and home sensor

Figure 7-796 Rear tamper sensor and motor

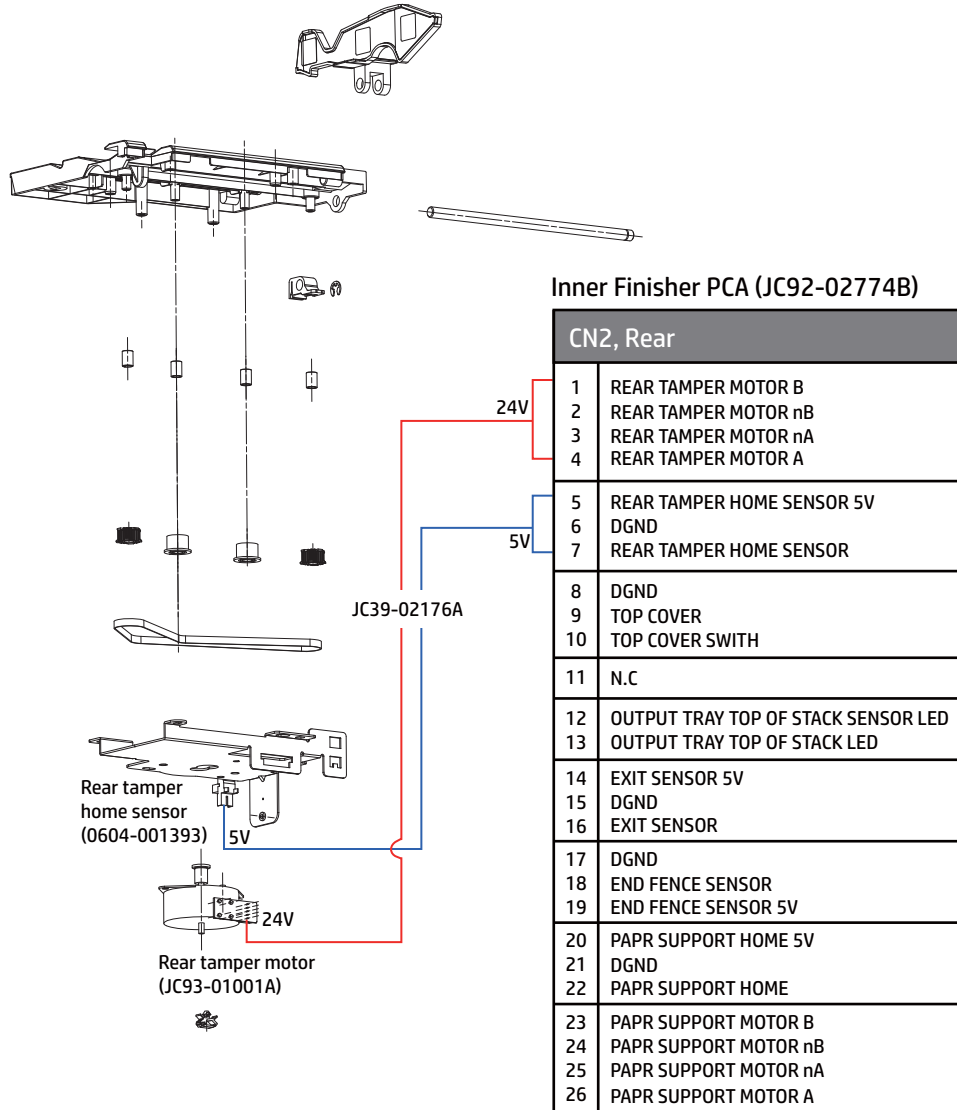

End fence sensor

Figure 7-797 End fence sensor

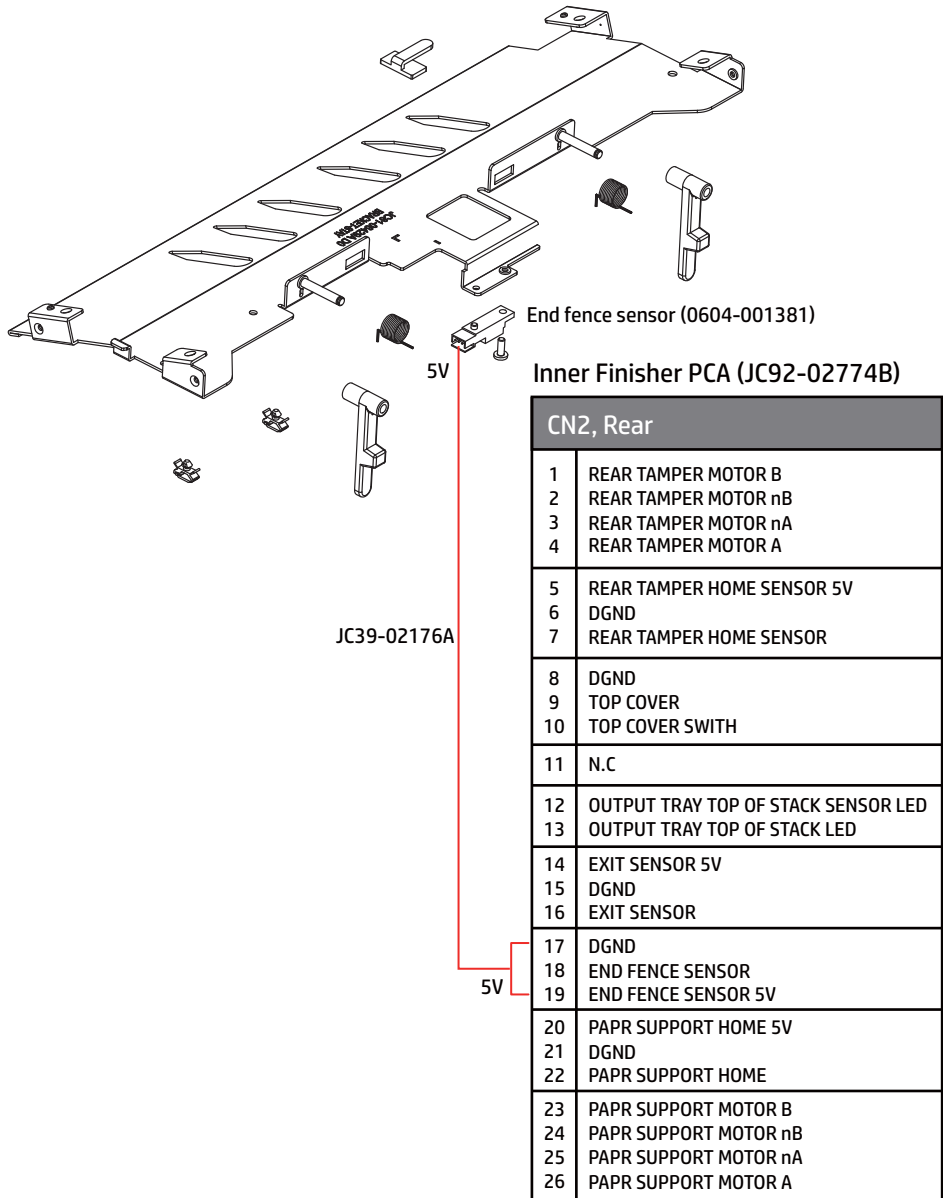

Stapler position motor and sensor

Figure 7-798 Stapler position sensor and motor

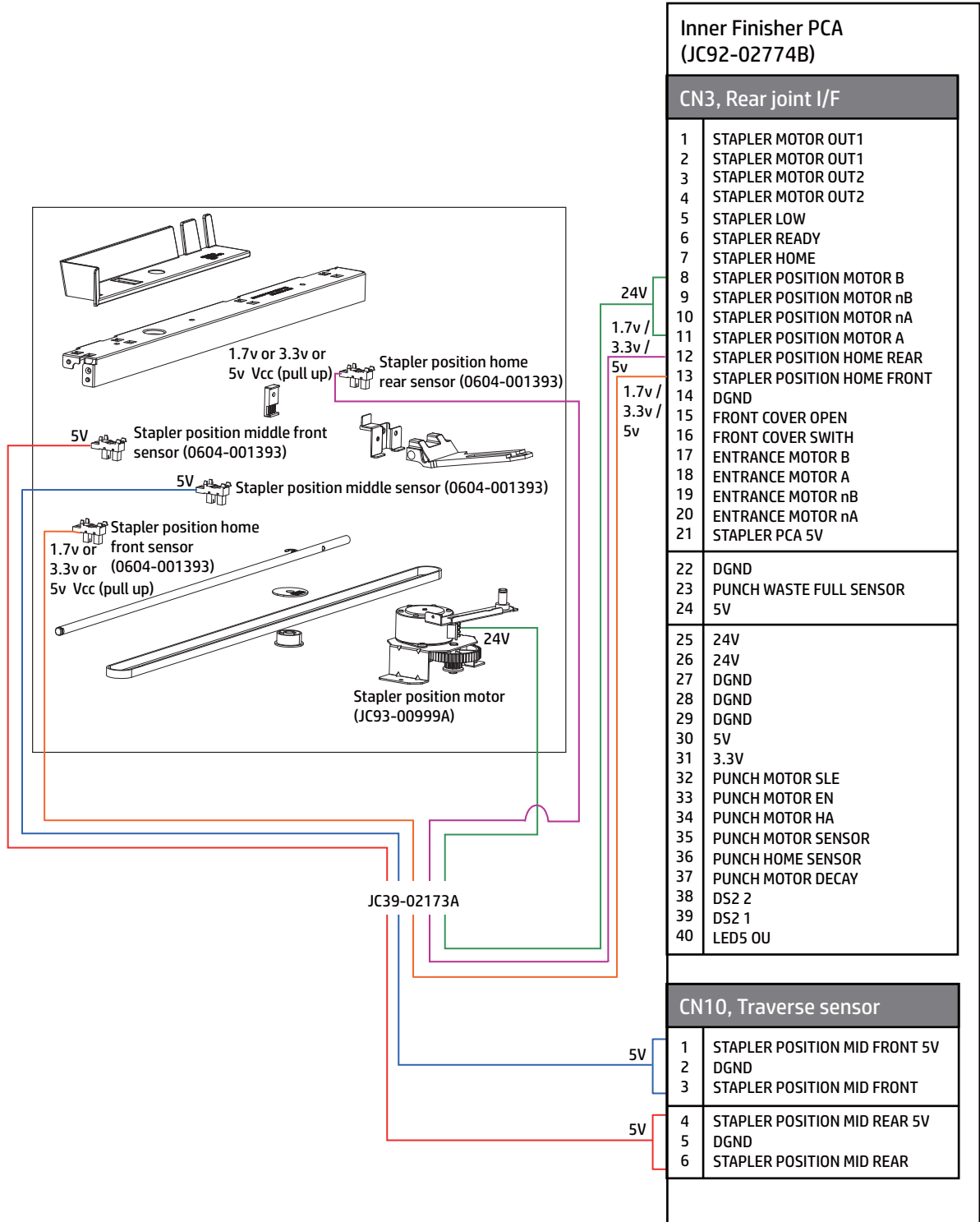

Ejector 1 motor and home sensor, ejector 2 motor, motor sensor, and home sensor

Figure 7-799 Ejector 1 motor and home sensor, ejector 2 motor, motor sensor, and home sensor

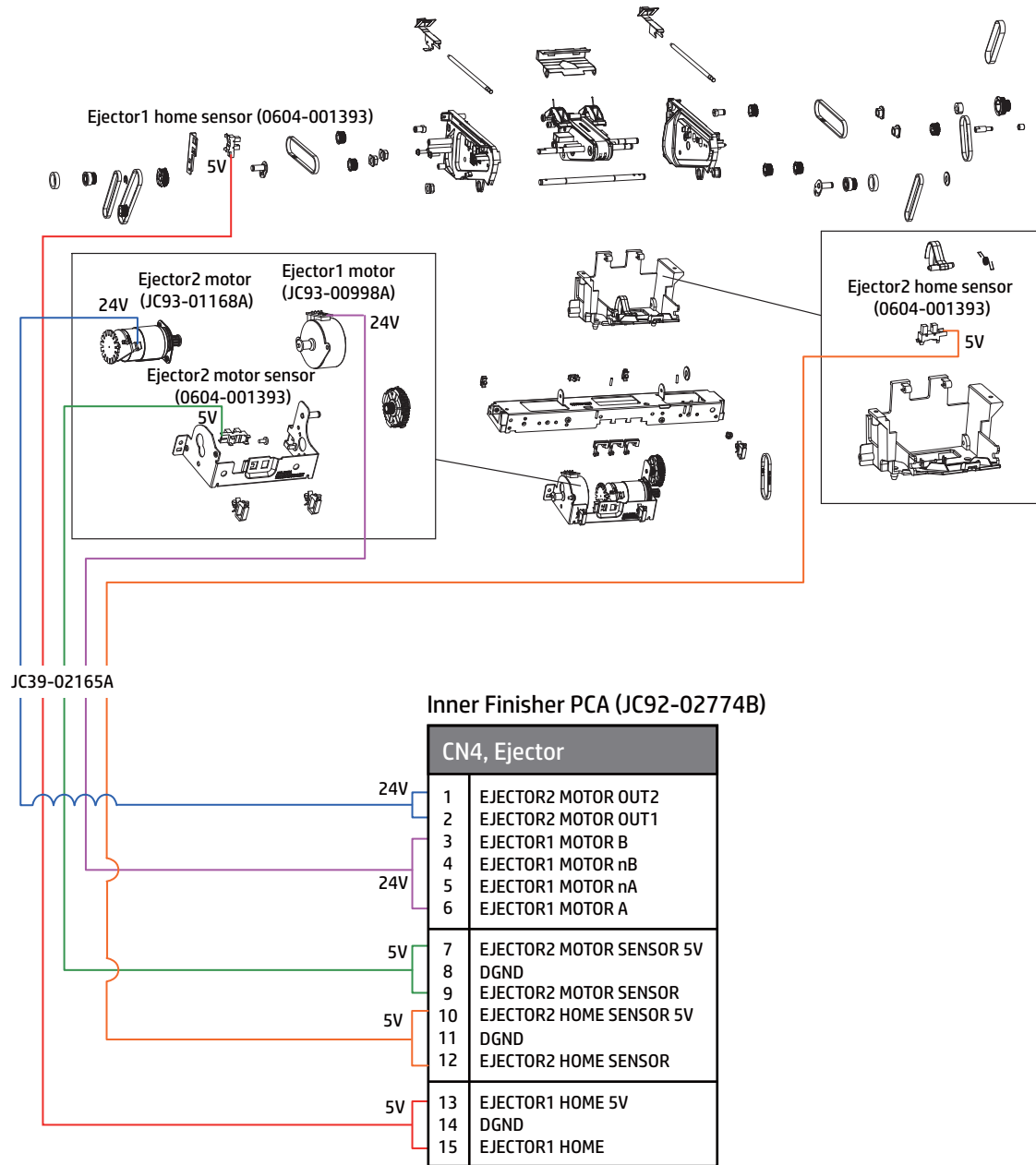

Output tray motor and sensor

Figure 7-800 Output tray motor and sensor

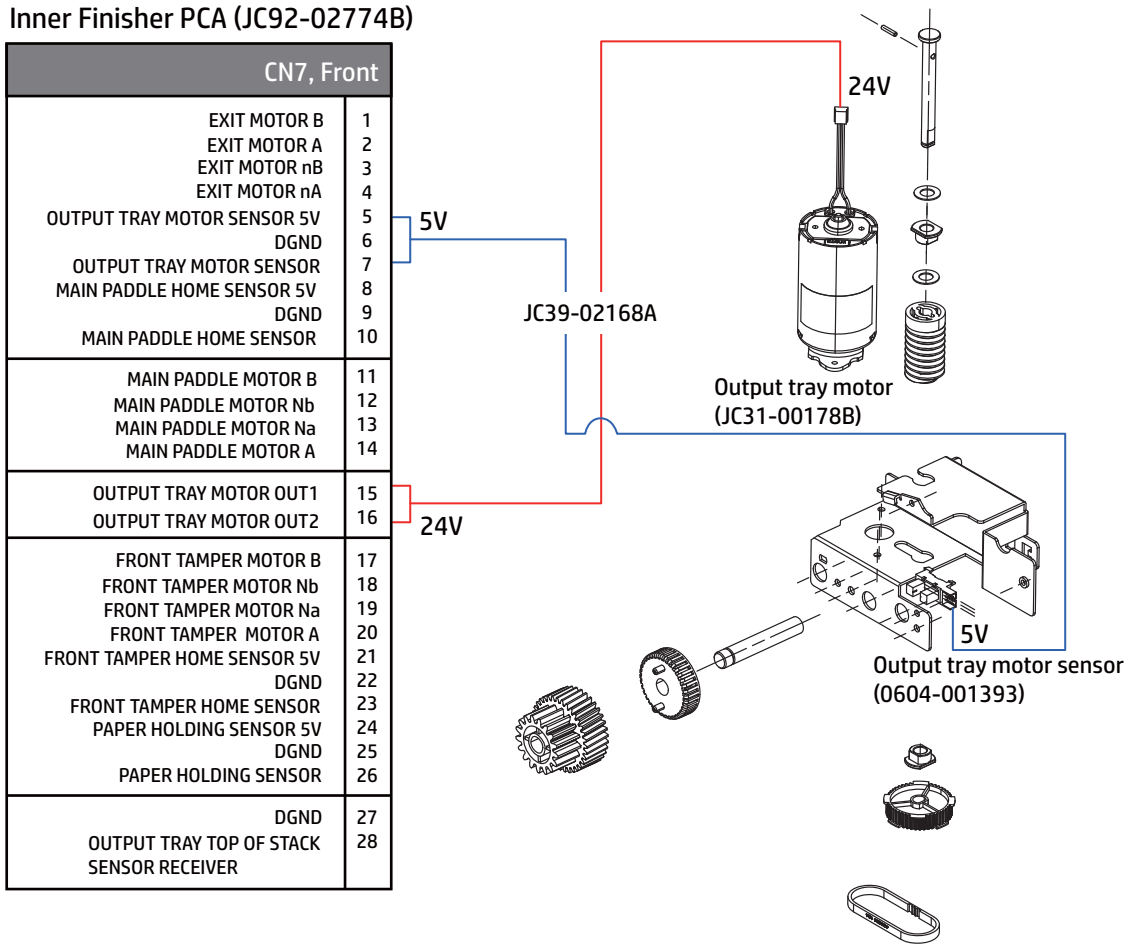

Output tray top of stack sensor

Figure 7-801 Output tray top of stack sensor

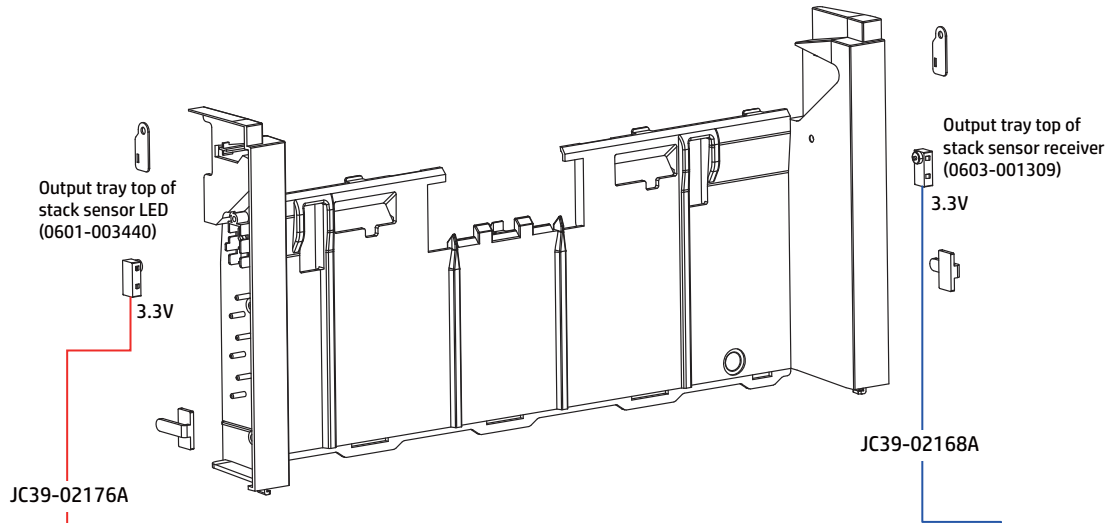

Inner Finisher PCA (JC92-02774B)	
CN2, Rear	
1	REAR TAMPER MOTOR B
2	REAR TAMPER MOTOR nB
3	REAR TAMPER MOTOR nA
4	REAR TAMPER MOTOR A
5	REAR TAMPER HOME SENSOR 5V
6	DGND
7	REAR TAMPER HOME SENSOR
8	DGND
9	TOP COVER 24V
10	TOP COVER SWITCH
11	N.C
12	OUTPUT TRAY TOP OF STACK SENSOR LED 3.3V
13	OUTPUT TRAY TOP OF STACK LED
14	EXIT SENSOR 5V
15	DGND
16	EXIT SENSOR
17	DGND
18	END FENCE SENSOR
19	END FENCE SENSOR 5V
20	PAPR SUPPORT HOME 5V
21	DGND
22	PAPR SUPPORT HOME
23	PAPR SUPPORT MOTOR B
24	PAPR SUPPORT MOTOR nB
25	PAPR SUPPORT MOTOR nA
26	PAPR SUPPORT MOTOR A
CN7, Front	
	EXIT MOTOR B
	EXIT MOTOR A
	EXIT MOTOR nB
	EXIT MOTOR nA
	OUTPUT TRAY MOTOR SENSOR 5V
	DGND
	OUTPUT TRAY MOTOR SENSOR
	MAIN PADDLE HOME SENSOR 5V
	DGND
	MAIN PADDLE HOME SENSOR
	MAIN PADDLE MOTOR B
	MAIN PADDLE MOTOR nB
	MAIN PADDLE MOTOR nA
	MAIN PADDLE MOTOR A
	OUTPUT TRAY MOTOR OUT1
	OUTPUT TRAY MOTOR OUT2
	FRONT TAMPER MOTOR B
	FRONT TAMPER MOTOR nB
	FRONT TAMPER MOTOR nA
	FRONT TAMPER MOTOR A
	FRONT TAMPER HOME SENSOR 5V
	DGND
	FRONT TAMPER HOME SENSOR
	PAPER HOLDING SENSOR 5V
	DGND
	PAPER HOLDING SENSOR
	DGND
	OUTPUT TRAY TOP OF STACK SENSOR RECEIVER 3.3V

Top cover switch

Figure 7-802 Top cover switch

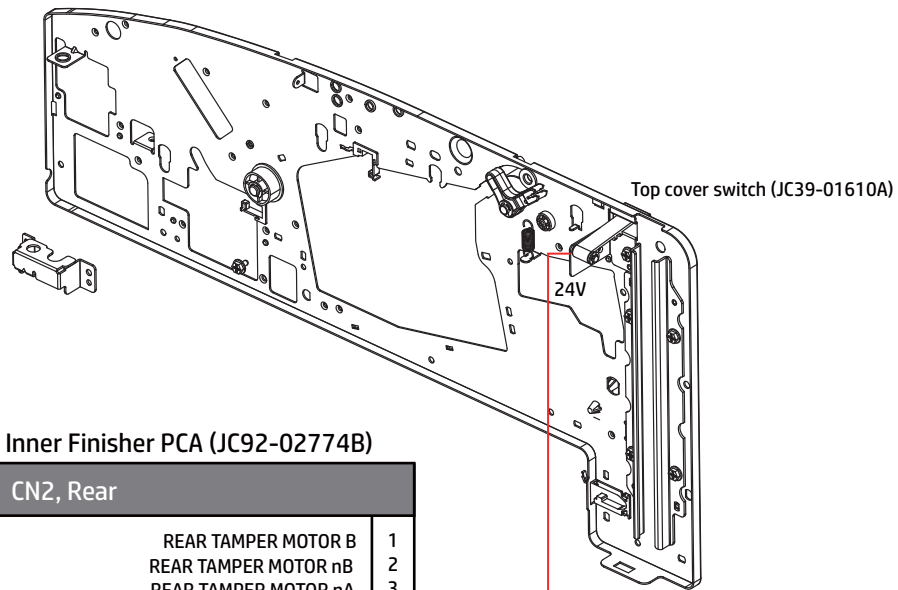

Inner Finisher PCA (JC92-02774B)	
CN2, Rear	
REAR TAMPER MOTOR B	1
REAR TAMPER MOTOR nB	2
REAR TAMPER MOTOR nA	3
REAR TAMPER MOTOR A	4
REAR TAMPER HOME SENSOR 5V	5
DGND	6
REAR TAMPER HOME SENSOR	7
DGND	8
TOP COVER 24V	9
TOP COVER SWITCH	10
N.C	11
OUTPUT TRAY TOP OF STACK SENSOR LED	12
OUTPUT TRAY TOP OF STACK LED	13
EXIT SENSOR 5V	14
DGND	15
EXIT SENSOR	16
DGND	17
END FENCE SENSOR	18
END FENCE SENSOR 5V	19
PAPR SUPPORT HOME 5V	20
DGND	21
PAPR SUPPORT HOME	22
PAPR SUPPORT MOTOR B	23
PAPR SUPPORT MOTOR nB	24
PAPR SUPPORT MOTOR nA	25
PAPR SUPPORT MOTOR A	26

JC39-02176A

24V

Front cover switch

Figure 7-803 Frame front

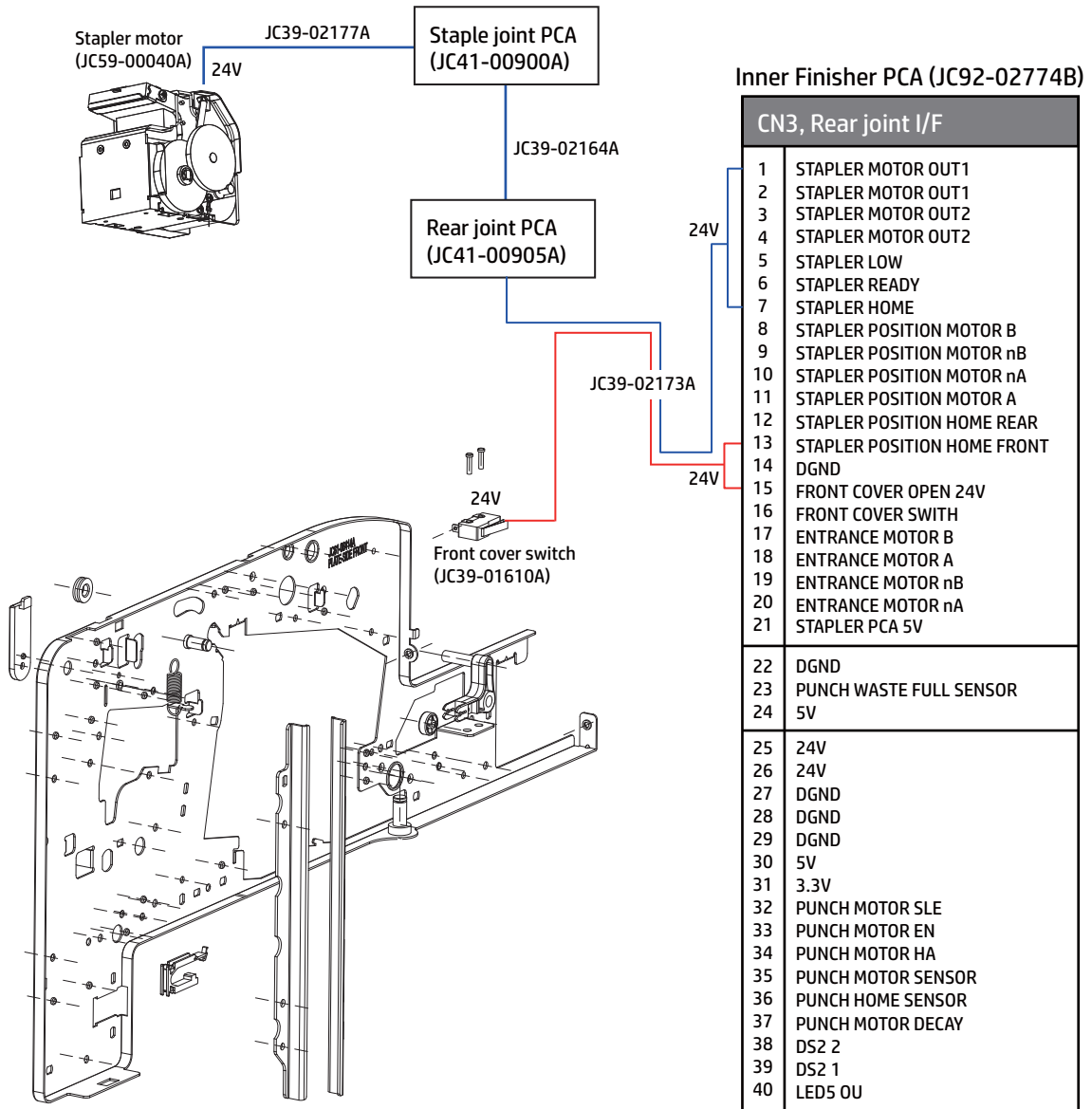

A Certificate of Volatility

[View the product certificates of volatility.](#)

Certificate of Volatility

[Learn about the product certificate of volatility.](#)

Figure A-1 Certificate of Volatility (E725XXdn/z; 1 of 2)

Hewlett-Packard Certificate of Volatility				
Model: HP LaserJet Managed MFP E725XXdn HP LaserJet Managed Flow MFP E725XXz		Part Number: Managed X3A60A= E72525dn X3A63A= E72530dn X3A66A= E72535dn X3A59A= E72525z X3A62A= E72530z X3A65A= E72535z		Address: Hewlett Packard Company 11311 Chinden Blvd Boise, ID 83714
Volatile Memory				
Does the device contain volatile memory (Memory whose contents are lost when power is removed)? <input checked="" type="checkbox"/> Yes <input type="checkbox"/> No If Yes please describe the type, size, function, and steps to clear the memory below				
Type (SRAM, DRAM, etc): Z Bundles DDR3 - DRAM	Size: HP Formatter 3GB- Obsidian 1 GB -Accel board 4 GB - Main Formatter	User Modifiable: <input type="checkbox"/> Yes <input checked="" type="checkbox"/> No	Function: Operation system and print/scan buffer	Steps to clear memory: When the printer is powered off the memory is erased.
Type (SRAM, DRAM, etc): dn Bundles DDR3 - DRAM	Size: HP Formatter 3GB- Obsidian 4 GB - Main Formatter	User Modifiable: <input type="checkbox"/> Yes <input checked="" type="checkbox"/> No	Function:	Steps to clear memory: .
Type (SRAM, DRAM, etc):	Size:	User Modifiable: <input type="checkbox"/> Yes <input type="checkbox"/> No	Function:	Steps to clear memory:
Non-Volatile Memory				
Does the device contain non-volatile memory (Memory whose contents are retained when power is removed)? <input checked="" type="checkbox"/> Yes <input type="checkbox"/> No If Yes please describe the type, size, function, and steps to clear the memory below				
Type (Flash, EEPROM, etc): IOD EEPROM	Size: 32KB	User Modifiable: <input type="checkbox"/> Yes <input checked="" type="checkbox"/> No	Function: Store customer setting data for backup/restore	Steps to clear memory: There are no steps to clear this data.
Type (Flash, EEPROM, etc): HP side: SPI Flash	Size: 4MB	User Modifiable: <input checked="" type="checkbox"/> Yes <input type="checkbox"/> No	Function: Contains the boot code and factory product configuration data required for the device to function. User modifications are limited to downloading digitally signed HP firmware images.	Steps to clear memory: There are no steps to clear this data
Type (Flash, EEPROM, etc): Samsung MSOK : MSOK – TPM MSOK – CRUM MSOK - EEPROM	Size: 2 KB 256 Bytes 1 KB	User Modifiable: <input type="checkbox"/> Yes <input checked="" type="checkbox"/> No	Function: RSA Key Pair is stored on the TPM, HP-signed Immutable ID Certificate is stored on the CRUM, the new Key pair is saved on the EEPROM	Steps to clear memory: There are none. FW reload will handle any issues.

Figure A-2 Certificate of Volatility (E725XXdn/z; 2 of 2)

Mass Storage				
Does the device contain mass storage memory (Hard Disk Drive, Tape Backup)? <input checked="" type="checkbox"/> Yes <input type="checkbox"/> No If Yes please describe the type, size, function, and steps to clear the memory below				
Type (HDD, Tape, etc): dn & z Bundles 1 – HDD Main board	Size: 320GB	User Modifiable: <input checked="" type="checkbox"/> Yes <input type="checkbox"/> No	Function: OS and user data	Steps to clear memory: Firmware update
dn bundles only 1 – EMMC card	16GB	Yes	OS and user data	Firmware update

USB
Does the item accept USB input and if so, for what purpose (i.e Print Jobs, device firmware updates, scan upload)? <input checked="" type="checkbox"/> Yes <input type="checkbox"/> No If Yes please describe below
Print jobs, HP digitally signed firmware upgrades, 3rd party application loading. USB ports can be disabled.
Can any data other than scan upload be sent to the USB device)? <input checked="" type="checkbox"/> Yes <input type="checkbox"/> No If Yes please describe below
Diagnostic service logs can be uploaded. Print files can be printed via a USB thumb drive.

RF/RFID	
Does the item use RF or RFID for receive or transmit of any data including remote diagnostics. (e.g. Cellular phone, Bluetooth) <input type="checkbox"/> Yes <input checked="" type="checkbox"/> No If Yes please describe below	
Purpose:	
Frequency:	Bandwidth:
Modulation:	Effective Radiate Power (ERP):
Specifications:	

Other Transmission Capabilities	
Does the device employ any other methods of non-wired access to transmit or receive any data whatsoever (e.g. anything other than standard hard wired TCP/IP, direct USB, or parallel connections)? <input checked="" type="checkbox"/> Yes <input type="checkbox"/> No If Yes please describe below:	
Purpose: WiFi Direct Print	
Frequency: 2.4 GHz, 5GHz	Bandwidth: 2401 - 2495 MHz; depending on selected channel in 2.4GHz band. 5180 - 5825 MHz; depending on selected channel in 5GHz band.
Modulation:	Effective Radiate Power (ERP):
Specifications: 802.11 b/g/n	

Other Transmission Capabilities	
Does the device employ any other methods of non-wired access to transmit or receive any data whatsoever (e.g. anything other than standard hard wired TCP/IP, direct USB, or parallel connections)? <input checked="" type="checkbox"/> Yes <input type="checkbox"/> No If Yes please describe below:	
Purpose: Device Beaconsing, Secure Print Apps	
Frequency: 2.4 GHz	Bandwidth: 2400-2483.5 MHz; depending on selected channel.
Modulation:	Effective Radiate Power (ERP):
Specifications: BTLE4.0 compliant	

Other Capabilities
Does the device employ any other method of communications such as a Modem to transmit or receive any data whatsoever? <input type="checkbox"/> Yes <input checked="" type="checkbox"/> No If Yes please describe below:
Purpose:
Specifications:

B Service parts changes For Environmental Protection Agency 3.0 Compliant Products

Learn about service part changes for EPA compliance.

HP is introducing A3 Laser Jet MFPs to meet the new Environmental Protection Agency (EPA) 3.0 Compliance standards. A few service parts are changing even though their appearance and ways of replacing them are almost the same as before. These new regulations are primarily concerned with lower power consumption which the parts affected contribute to. All Items listed in this document are service parts being changed for these EPA 3.0 Compliant products.

These EPA 3.0 compliant devices will begin manufacturing in Spring 2020 and will not have new product numbers. Identification of these products will be accomplished by a specific character in their serial numbers.

Printer service parts affected

- Formatter
- FDB (Fuser Drive Board)
- Fuser unit

Printer service parts affected

- HP Color LaserJet Managed MFP **E77822dn / E77825dn** / E77830dn
- HP Color LaserJet Managed Flow MFP **E77822z / E77825z** / E77830z
- HP Color LaserJet Managed MFP **E77422a / E77422dv/ E77422dn** / E77428dn
- HP LaserJet Managed MFP **E72525dn / E72530dn** / E72535dn
- HP LaserJet Managed Flow MFP **E72525z / E72530z** / E72535z
- HP LaserJet Managed MFP **E72425a / E72425dv / E72425dn** / E72430dn

* Parts referenced in this doc are also compatible with the SKU's above. However, installation of these parts in the SKU's in **BOLD** will not make them EPA 3.0 compliant. Only SKU's identified by a specific character in their serial number are EPA 3.0 compliant.

Table B-1 E77822z/E77825z/E77830z (color printers)

Item	Description
1	Formatter Rock

Table B-1 E77822z/E77825z/E77830z (color printers) (continued)

Item	Description
2	FDB V1
3	FDB V2

Table B-2 E77822dn/E77825dn/E77830dn (color printers)

Item	Description
1	Formatter Obisidian1
2	FDB V1
3	FDB V2

Table B-3 E77422a/E77428dv/E77422dn/E77428dn (color printers)

Item	Description
1	Formatter Obisidian2
2	FDB V1
3	FDB V2

Table B-4 E72525z/E72530z/E72535z (mono printers)

Item	Description
1	Formatter Rock
2	FDB V1
3	FDB V2
4	Fuser V1
5	Fuser V2

Table B-5 E72525dn/E72530dn/E72535dn (mono printers)

Item	Description
1	Formatter Obisidian1
2	FDB V1
3	FDB V2
4	Fuser V1
5	Fuser V2

Table B-6 E72425a/E72425dv/E72425dnE72430dn (mono printers)

Item	Description
1	Formatter Obisidian2
2	FDB V1
3	FDB V2
4	Fuser V1
5	Fuser V2

Table B-7 Foramtter type 1/2/3

No	Legacy part number	EPA 3.0 compliant product	Common	Part name	Description	Remark
1	JC92-03070A	Y3K99-60005	New	Formatter	Rock PCA	Formatter_Rock
1	JC92-03005A	X3A92-60006	New	Formatter	Obsidian PCA	Formatter_Obisidian1
1	JC92-03036A	X3A92-60007	New	Formatter	Obsidian PCA	Formatter_Obisidian2

Table B-8 FDB V1/V2

No	Legacy part number	EPA 3.0 compliant product	Common	Part name	Description	Remark
2	JC44-00210E	8GR94-60001	New	FDB	110V(V1)	FDB V1
3	JC44-00211E	8GR94-60002	New	FDB	220V(V2)	FDB V1

Table B-9 Fuser V1/V2

No	Legacy part number	EPA 3.0 compliant product	Common	Part name	Description	Remark
4	JC82-00479A	X3A65-61001	New	Fuser	110V(V1)	Fuser V1
5	JC82-00481A	X3A65-61002	New	Fuser	220V(V2)	Fuser V1

Notes

- Service parts referenced above for legacy products (Gemstone 1.0/1.1) and EPA 3.0 Compliant products are forward and backward compatible. **However, Hp does not recommend installing old service parts which do not meet EPA 3.0 Compliance in EPA 3.0 Compliant products.** This is to ensure these products remain EPA 3.0 compliant after field service.
- If an EPA 3.0 Compliant FUSER is installed in any printer, **that unit needs to have firmware upgraded to the latest level to function properly, especially those with a B or C in 3rd digit of serial number (SN).**

- EPA 3.0 Compliant products will be identified as indicated below : 3rd digit will be shown as "D" from "B" or "C".



Glossary of terms

802.11

802.11 is a set of standards for wireless local area network (WLAN) communication, developed by the IEEE LAN/MAN Standards Committee (IEEE 802).

802.11b/g/n

802.11b/g/n can share the same hardware and use the 2.4 GHz band. 802.11b supports bandwidth up to 11 Mbps, 802.11n supports bandwidth up to 150 Mbps. 802.11b/g/n devices might occasionally suffer interferences from microwave ovens, cordless telephones, and Bluetooth devices.

AC

An electric current that reverses its direction many times a second at regular intervals. For example, the 110V line current found in a typical US electrical wall receptacle.

AC Control Module (PageWide)

The AC Control Module controls the heating elements in the airflow assembly. Function include: voltage monitoring (ensuring correct operation in a low-quality-power environment), isolation (low voltage heater control signals are isolated from the high voltage AC power for safety), AC switching (power is switched on/off to the heater), and heating element configuration (heating element configuration is changed between series and parallel for temperature predictability).

ADF

An Automatic Document Feeder (ADF) is a device that automatically feeds an original sheet (or multiple sheets) of paper into the image scanner. The document feeder is a component of the integrated scanner assembly (ADF and image scanner).

Airflow System (PageWide)

The airflow system conditions the printed pages to avoid page curling due to the ink on the page. The airflow system functionally consists of a fan and heating elements. The pressurized air is blown on the page through the nozzles that are placed on the paper path of the airflow system between print and eject zone.

BOOTP

Bootstrap Protocol. A network protocol used by a network client to obtain its IP address automatically. This is usually done in the bootstrap process of computers or operating systems running on them. The BOOTP servers assigns an IP address from a pool of addresses to each client. BOOTP enables “diskless workstation” computers to obtain an IP address prior to loading any advanced operating system.

CCD

A Charged Coupled Device (CCD) is the scanner module which enables a scan job. A CCD locking mechanism is used to hold the CCD module to prevent any damage when the printer is moved.

CIS

A Contact Image Sensor (CIS) scanner captures an image using the printer's optical path. Red, green, and blue LEDs sequentially illuminate a small strip of the document (often called a raster line), and the optical system captures each color in a single row of Charged Coupled Device (CCD) sensors that cover the entire page width.

Collation

Collation is a process of printing a multiple-copy job in sets. When collation is selected, the device prints an entire set before printing additional copies.

Control Panel

The control panel is a flat, typically vertical panel or screen where the user can control and/or monitor the printer. The control panel is found on the front of the printer.

Coverage

Coverage is the printing term used for a toner usage measurement on printing. For example, 5% coverage means that an A4 sided paper has about 5% image or text on it. If the paper or original has complicated images or a large amount of text, the coverage will be higher and at the same time, a toner usage will be as much as the coverage.

DC

An electric current flowing in one direction only. Typically a low voltage load current supplied to an electrical assembly.

DCC

The DC controller (DCC) controls the operation of the printer sub-systems and electrical components. The DCC sends out various signals to operate motors, solenoids, and other printer components based on the print command and image data that the host computer sends the formatter.

Default

The value or setting that is in effect when a printer is unboxed, reset, or initialized.

DHCP

Dynamic Host Configuration Protocol (DHCP) is a client-server networking protocol. A DHCP server provides configuration parameters specific to the DHCP client host requesting, generally, information required by the client host to participate on an IP network. The DHCP also provides a mechanism for allocation of IP addresses to client hosts.

Digital Send Software

Digital send software allows a multi-function printer (MFP) to scan and send information quickly and securely to email, network folders, other printers, and fax services.

DIMM

A Dual Inline Memory Module (DIMM) is a small circuit board that holds memory. The DIMM stores all data within the printer, such as printing data and received fax data.

DPI

Dots Per Inch (DPI) is a measurement of resolution that is used for scanning and printing. Generally, higher DPI results in a higher resolution (more visible detail in the image and a larger file size).

Duplex

A mechanism that automatically turns over a sheet of paper so that the printer can print (or scan) on both sides of the paper. A printer equipped with a duplex unit can print on both sides of the paper during one print cycle.

Duty Cycle

Duty cycle is the page quantity which does not affect printer performance for a month. Generally, the printer has the lifespan limitation such as pages per year. The lifespan means the average capacity of print-outs, usually within the warranty period. For example, if the duty cycle is 48,000 pages per month the printer limit is 2,400 pages a day (assuming 20 working days/month).

Dynamic Security

Dynamic Security is a toner cartridge design and process for authenticating genuine HP supplies. HP printers use toner cartridges that have security chips or electronic circuitry. Cartridges using a non-HP chip or modified or non-HP circuitry might not work (now or in the future).

e-Duplex

Single-pass electronic duplex (e-Duplex) printer use two separate scan modules to scan the front-side and back-side of an e-duplex copy job page in a single pass through the document feeder.

EMC

EMC is a measure of a device's ability to operate as intended in its shared operating environment while, at the same time, not affecting the ability of other equipment within the same environment to operate as intended.

EMI

EMI is the electromagnetic energy which affects the functioning of an electronic device. Electronic devices (like printers) are a source of EMI. Because it is rare for electronics to operate in isolation, products are generally engineered to function in the presence of some amount of EMI.

eMMC

An embedded Multi-Media Card is a compact memory device consisting of NAND flash memory and a simple storage controller.

Emulation

Emulation is a technique of one machine obtaining the same results as another. An emulator duplicates the functions of one system with a different system, so that the second system behaves like the first system. Emulation focuses on exact reproduction of external behavior. This is different from simulation, which concerns an abstract model of the system being simulated, often considering its internal state.

EPS

Encapsulated PostScript (EPS) is a PostScript (PS) code file which is used for storing font and vector graphic image information.

ESD

An electrostatic discharge (ESD) is a sudden flow of electricity between two electrically charged objects caused by contact, an electrical short, or dielectric breakdown. Discharge of built up static electricity.

Ethernet

Ethernet is a frame-based computer networking technology for local area networks (LANs). It defines wiring and signaling for the physical layer, and frame formats and protocols for the media access control (MAC)/data link layer of the OSI model. Ethernet is mostly standardized as IEEE 802.3. Ethernet has become the most widespread LAN technology in use during the 1990s to present.

Ferrite

A ferrite are used to reduce the amount of radio frequency noise (or interference) in a wire or cable. A ferrite enables proper EMC/EMI performance for regulatory purposes.

FFC

Flat Flexible Cables (FFCs) are designed for Printed Circuit Assembly (PCA) to PCA connections (for example, connecting a fax PCA to the formatter).

FIH

A Foreign Interface Harness (FIH) is a port that enables HP multifunction printers (MFPs) to use third-party devices to extend the capabilities of the MFP.

Firmware

The formatter stores the printer firmware. A remote firmware upgrade process is used to overwrite and upgrade the firmware.

Flash memory

Flash memory is non-volatile, meaning it retains stored data even when the power is turned off.

Flow integrated scanner assembly

A printer scanner assembly that includes a slide-out external physical keyboard.

Formatter (LaserJet)

The formatter controls printer functions like receiving and processes print data, developing and coordinating data placement and timing with the DC controller PCA, storing font and customer configuration information, communicating with the host computer, and monitoring control panel functions and relaying printer status information through the control panel.

FTP

FTP stands for File Transfer Protocol. FTP is a protocol designed for transferring files over the Internet. Files stored on an FTP server can be accessed using an FTP client, such as a web browser, FTP software program, or a command line interface.

Fuser Unit

The fuser unit is part of a laser printer that adheres the toner onto the printed page. It consists of a heat roller and a pressure roller. After toner is transferred onto the paper, the fuser unit applies heat and pressure to make sure that the toner stays on the paper permanently (which is why paper is warm when it comes out of a laser printer).

Gateway

A connection between computer networks, or between a computer network and a telephone line. A gateway is used to connect two different computer networks, especially a connection to the Internet.

Grayscale

Shades of gray that represent light and dark portions of a color image printed in monochrome. Colors are represented by a range of gray shades from white to black.

Halftone

Halftone is a way of reproducing a photograph or other image in which the various tones of gray or color are produced by variously sized dots of ink or toner. Halftone simulates grayscale by varying the number of dots. Highly colored areas consist of a large number of dots, while lighter areas consist of a smaller number of dots.

HDD

A Hard-Disk Drive (HDD) (commonly referred to as a hard drive or hard disk) is a non-volatile storage device which stores digitally-encoded data on rapidly rotating platters with magnetic surfaces.

IEEE

The Institute of Electrical and Electronics Engineers (IEEE) is an international non-profit, professional organization for the advancement of technology related to electricity.

Image scanner

The image scanner (or Sub Scanner Assembly) contains the components to digitally scan an original source document. The image scanner is a component of the integrated scanner assembly (ADF and image scanner).

IP address

An Internet Protocol (IP) address is a unique number that a device uses in order to identify and communicate with other devices on a network utilizing the Internet Protocol standard.

IPM

The Images Per Minute (IPM) is a method of measuring the speed of a printer. An IPM rate indicates the number of single-sided sheets a printer can complete in one minute.

IPP

The Internet Printing Protocol (IPP) defines a standard protocol for printing and managing print jobs, media size, resolution, etc. IPP can be used locally, or over the internet to reach hundreds of printers. IPP also supports access control, authentication, and encryption, making it a capable and secure printing solution.

ISA

The Integrated Scanner Assembly (ISA) includes the document feeder and image scanner.

ISO

The International Organization for Standardization (ISO) is an international standard-setting body composed of representatives from national standards bodies. It produces world-wide industrial and commercial standards.

JBIG

Joint Bi-level Image Experts Group (JBIG) is an image compression standard with no loss of accuracy or quality. It was designed for compression of binary images, particularly for faxes, but can also be used for other images.

JPEG

Joint Photographic Experts Group (JPEG) is a commonly used standard method of loss compression for photographic images. It is the format used for storing and transmitting photographs on the World Wide Web.

LDAP

The Lightweight Directory Access Protocol (LDAP) is a networking protocol for querying and modifying directory services running over TCP/IP.

LED

A Light-Emitting Diode (LED) is a semiconductor device that can indicate the status of a printer (formatter LEDs) or a component in a contact image sensor (CIS) scanner that helps capture an image.

LEDM

Low end data model (LEDM) provides one consistent data representation method and defines the dynamic and capabilities tickets shared between clients and devices, as well as the access protocol, event, security, and discovery methods.

LPDC

Late point differentiation configuration (LPDC) allows the channel partner to configure the speed to the printer depending on the customer's order. LPDC configuration is stored on the Trusted Platform Module (TPM).

LVPS - SMPS

Low Voltage Power Supplies (LVPS) and Switching Mode Power Supplies (SMPS) supply direct current (DC) voltages to various printer components and assemblies.

MAC address

Media Access Control (MAC) address is a unique identifier associated with a network adapter. MAC address is a unique 48-bit identifier usually written as 12 hexadecimal characters grouped in pairs (for example, 00-00-0c-34-11-4e). This address is usually hard-coded into a Network Interface Card (NIC) by the manufacturer, and used as an aid for routers trying to locate machines on a large network.

MEt

HP Memory Enhancement technology (MEt) effectively doubles the standard memory through a variety of font- and data-compression methods. MEt is available only in Printer Command Language (PCL) mode; it is not functional when printing in PostScript (PS) mode.

MFP

A Multi Function Printer (MFP) is a printer that incorporates multiple functionality in a single physical body. For example, an MFP printer can scan, digitally send, fax, copy, and print.

MHV

Miniature High Voltage (MHV) is designed for high voltage applications of BNC connectors (DC voltage between 500 V and 5 kV).

Modem

A device that modulates a carrier signal to encode digital information, and also demodulates such a carrier signal to decode transmitted information.

MPCA (PageWide)

The MPCA integrates both formatter (LaserJet) and engine control electronics (DC controller) into a single assembly. The Main PCA (MPCA) controls printer functions like receiving and processes print data, developing and coordinating data placement, storing font and customer configuration information, communicating with the host computer, and monitoring control panel functions and relaying printer status information through the control panel.

NAND

NAND is not an acronym (the term is short for **NOT AND** a Boolean operator and logic gate). NAND (flash) memory is non-volatile, meaning it retains stored data even when the power is turned off.

NVRAM

Nonvolatile random access memory (NVRAM) is used to store I/O and information about the print environment configuration (stored data even when the power is turned off).

OPC

Organic Photo Conductor (OPC) is a mechanism that makes a virtual image for print using a laser beam emitted from a laser printer. It is usually green or rust colored and has a cylinder shape. An imaging unit containing a drum slowly wears the drum surface during its usage in the printer, and it should be replaced appropriately due to wear from contact with the cartridge development brush, cleaning mechanism, and paper.

Originals

The first example of something, such as a document, photograph, or text which is copied, reproduced, or translated to produce additional copies. The original itself is not copied or derived from something else.

PCA

Printed Circuit Assembly (PCA). Once the printed circuit board (PCB) is complete, electronic components must be assembled to form a functional printed circuit assembly or PCA.

PCL

Printer Command Language (PCL) is a Page Description Language (PDL) developed by HP as a printer protocol. PCL has become an industry standard. Originally developed for early Inkjet printers, PCL has been released in varying levels for thermal, dot matrix printers and laser printers.

PDF

Portable Document Format (PDF) is a proprietary file format developed by Adobe Systems. A PDF represents two dimension documents in a device independent and resolution independent format.

PJL

Printer job language (PJL) is an integral part of printer configuration, in addition to the standard PCL and PostScript (PS). With standard cabling, the printer can use PJL to perform a variety of functions like dynamic I/O switching, context-sensitive switching, and isolation of print environment settings from one print job to the next.

PML

Printer management language (PML) allows remote configuration of the printer and status read-back from the printer through the I/O ports.

PostScript (PS)

PostScript (PS) is a Page Description Language (PDL) and programming language used primarily in electronic and desktop publishing. PostScript is run in an interpreter to generate an image.

PPM

Pages Per Minute (PPM) is a method of measurement for determining how fast a printer works, meaning the number of pages a printer can produce in one minute.

Print Media

Media like paper, envelopes, labels, and transparencies which can be used in a printer, scanner, fax, or copier.

Printer Driver

A program used to send commands and transfer data from the computer to the printer.

Printhead (PageWide)

The printhead converts the digital firing instructions from the printer electronics into properly formed and timed microscopic drops of the four ink colors.

Printhead Wiper (PageWide)

The printhead wiper system keeps the printhead nozzles firing correctly throughout the life of the printer as it performs the wiping and capping functions. The wiping function cleans the nozzles of ink residue and particulates. The capping function keeps the nozzles moist during storage and when the printer is idle.

Protocol

A convention or standard that controls or enables the connection, communication, and data transfer between two computing endpoints.

RAM

Random Access Memory (RAM) is the printer memory device where the data in current use is kept so it can be quickly retrieved by the device's processor. This memory is an important factor in avoiding errors and printing documents properly. Printer memory is used to store and process print jobs as they are sent to the printer from a computer. After printing, the job is cleared from the memory to make room for more print jobs. Printer memory is directly linked to two print characteristics: speed and print quality. More memory allows you to print faster and print larger, high-quality graphics.

Resolution

The sharpness of an image, measured in Dots Per Inch (DPI). The higher the DPI, the greater the resolution.

SCB

The Scanner Control Board (SCB) controls the functions of the image scanner components in the Sub Scanner Assembly (SSA).

Service fluid and aerosol management systems (PageWide)

There are two types of service fluid, shipping fluid and ink. The service fluid management system is contained entirely within the duplex module. Service fluid is discharged as droplets from the printhead, and then collected in a container inside the duplex module. Some of the droplets are called aerosol because they are lighter than air. Aerosol can float inside the printer and collect on the lens of optical sensors, producing false failures. The aerosol management system transports the aerosol and collects it in a safe place. Aerosol management consists of an aerosol fan, mounted on the rear wall of the air flow assembly, which creates air flow that pulls the aerosol through the holes in the platen and into the aerosol filter inside the duplex module.

SFP

A single-function printer only processes print jobs sent from a host computer or from an USB port on the printer.

SMB

Server Message Block (SMB) is a network protocol mainly applied to share files, printers, serial ports, and miscellaneous communications between nodes on a network. SMB also provides an authenticated inter-process communication mechanism.

SMTP

Simple Mail Transfer Protocol (SMTP) is the standard for email transmissions across the internet. SMTP is a relatively simple, text-based protocol, where one or more recipient of a message are specified and the message text is transferred. It is a client server protocol where the client transmits an email message to the server.

SODIMM

Small outline dual in-line memory module (SODIMM) is a thin profile memory storage device (a smaller alternative to a standard DIMM device).

SSA

The Sub-Scanner Assembly is the image scanner component of the Integrated Scanner Assembly (ISA; which includes the document feeder and the image scanner).

Subnet Mask

The subnet mask is used in conjunction with the network address to determine which part of the address is the network address and which part is the host address.

TCP/IP

The Transmission Control Protocol (TCP) and the Internet Protocol (IP) are the set of communications protocols that implement the protocol stack on which the internet and most commercial networks run.

TIFF

Tagged Image File Format (TIFF) is a variable-resolution bit mapped image format. TIFF describes image data that typically come from scanners. TIFF images use tags, keywords defining the characteristics of the image that is included in the file. This flexible and platform-independent format can be used for pictures that have been made by various image processing applications.

Toner Cartridge

A bottle or container that holds toner, which is used in a machine like a printer. Toner is a powder used in laser printers and photocopiers. The toner forms the text and images on printed paper. Toner can be fused by a combination of heat/pressure from the fuser, causing it to bind the fibers in the paper.

TPM

The HP Trusted Platform Module (TPM) is a security accessory for printers. The TPM strengthens protection of encrypted credentials and data stored on your printer. Certificate private keys are both generated by and protected by the TPM. Once installed, the printer and the TPM are sealed and the printer owns the TPM. The TPM may not be moved to another device without losing its ownership from the original printer. Installing a TPM accessory might necessitate a firmware upgrade. The TPM prevents the printer from starting if the TPM is missing. If the TPM is removed from the printer, a control-panel error message appears indicating that the TPM is missing.

TWAIN

An industry standard for scanners and software. By using a TWAIN compliant scanner with TWAIN-compliant software, a scan can be initiated from the program. TWAIN is an image capture API for Microsoft Windows and Apple Macintosh operating systems.

URL

Uniform Resource Locator (URL) is the global address of documents and resources on the internet. The first part of the address indicates what protocol to use. The second part specifies the IP address or the domain name where the resource is located.

USB

Universal Serial Bus (USB) is a standard that was developed by the USB Implementers Forum, Inc., to connect computers and peripherals. Unlike the parallel port, USB is designed to concurrently connect a single computer USB port to multiple peripherals.

Walk-up USB

Some printers support direct printing from a USB flash drive (the walk-up USB port is usually near the control panel).

Watermark

A watermark is a recognizable image or pattern in paper that appears lighter when viewed by transmitted light. Watermarks were first introduced in Bologna, Italy in 1282. Watermarks have been used by paper makers to identify their product, and also on postage stamps, currency, and other government documents to discourage counterfeiting.

XPS

XML Paper Specification (XPS) is a specification for a Page Description Language (PDL) and a new document format developed by Microsoft. This has benefits for portable document and electronic documents. It is an XML-based specification based on a new print path and vector-based, device-independent document format.

ZIF Connector

Zero insertion force (ZIF) connectors use a mechanical locking method to secure Flat Flexible Cables (FFCs) to a Printed Circuit Assembly (PCA).

Index

A

accelerator board
 remove the accelerator board
 218
accelerator board (GX ADF only) 218
accessories
 dimensions 1, 8, 13
 weight 1, 8, 13
acoustic specifications 1, 8, 14
ADF
 parts and diagrams - exterior LX
 420
 parts and diagrams - lower image
 scanner (LX) 544
 parts and diagrams - LX models
 392, 420, 434
 parts and diagrams - main frame
 assembly LX 434
 parts and diagrams - pickup LX
 420
ADF (GX/z)
 parts and diagrams 448
ADF main frame (GX/z)
 parts and diagrams 496
ADF upper pickup (GX/z)
 parts and diagrams 476
after-service checklist 107, 114,
 115, 905, 987, 990, 2203, 2248,
 2251
APS sensor 550
authorized service providers, parts
 112, 992, 2253

B

backup error
 32.WX.YZ error 673, 674
 reset error 673, 674
 restore error 673, 674

belt - timing gear
 HCI 608
booklet blade
 parts and diagrams 1058
booklet blade motor
 parts and diagrams 1058
booklet c-fold blade
 parts and diagrams 1052
booklet c-fold motor
 parts and diagrams 1054
booklet diverter
 parts and diagrams 1052
booklet diverter motor
 parts and diagrams 1054
Booklet diverter unit 976, 2112
booklet diverter unit
 parts and diagrams 1050
Booklet end fence unit 964, 1907
booklet end fence unit
 parts and diagrams 1062
booklet entrance
 parts and diagrams 1044
Booklet entrance unit 961, 1876
booklet entrance unit
 parts and diagrams 1042
booklet entrance-presser motor
 parts and diagrams 1044
booklet exit
 parts and diagrams 1052
Booklet exit unit 978, 2136
booklet exit unit
 parts and diagrams 1050
booklet finisher
 booklet blade 2029
 booklet blade home sensor 2048
 booklet blade motor 2066
 booklet c-fold blade 2075
 booklet c-fold blade home
 sensor 2090

booklet c-fold blade motor 2105
booklet diverter 2113
booklet diverter home sensor
 2130
booklet diverter motor 2133
booklet end fence 1908
booklet end fence home sensor
 1924
booklet end fence motor 1920
booklet entrance motor 1877
booklet entrance sensor 1880
booklet exit sensor 2137
booklet fold motor 2070
booklet front cover 1157
booklet maker 1866
booklet maker PCA 2165
booklet output tray 2156
booklet paddle home sensor
 1898
booklet paddle motor 1895
booklet presser 1930
booklet presser home sensor
 1945
booklet presser motor 1949
booklet stapler unit 2010
booklet tamper home sensor
 1971
booklet tamper motor 1990
booklet tamper unit 1953
bridge door sensor 1085
bridge entrance sensor 1067
bridge exit sensor 1080
bridge motor 1074
buffer motor 1852
buffer solenoid 1858
caster cover 1125
dummy feed guide 1167
ejector assembly 993
ejector motor 993

ejector unit 1577
 ejector1 1628
 ejector1 motor sensor 1602
 ejector2 home sensor 1655
 ejector2 motor 1706
 ejector2 motor sensor 1680
 end fence home 993
 end fence home sensor 1304
 end fence motor 1329
 entrance motor 993
 entrance sensor 993
 exir roller 993
 exit motor 1257
 exit sensor 993
 feed entrance motor 1161
 front cover 1109
 front door 1098
 front lower cover 1117
 front paper holding sensor 1810
 front paper support 993
 front tamper home sensor 1365
 front tamper motor 1391
 front tamper unit 1340
 left lower cover 1129
 left upper cover 1142
 main exit cam motor 1262
 main exit sensor 1244
 main output tray lower limit sensor 1764
 main output tray motor 1784
 main output tray motor sensor 1778
 main output tray top of stack sensor 1733
 main output tray top of stack switch 1749
 main paddle 993
 main PCA 2160
 manual staple sensor 1555
 motor 993
 paddle 1271
 paddle home sensor 1285
 paddle motor 1294
 paper holding home sensor 1794
 paper holding Motor 1836
 paper holding solenoid 993
 paper support 993
 paper support home sensor 993
 punch waste full 993
 rear cover 1104
 rear paper holding sensor 1823
 rear paper support 993
 rear tamper home sensor 1443
 rear tamper motor 1469
 rear tamper unit 1418
 right upper cover 1091
 sensor 993
 stacker lower limit switch 993
 stacker motor 993
 stapler 993
 stapler front sensor 1507
 stapler mid-front sensor 1519
 stapler mid-rear sensor 1531
 stapler position motor 1564
 stapler position sensor 993
 stapler rear sensor 1543
 stapler unit 1496
 switch 993
 top cover 1094
 top exit sensor 1216
 top jam cover assembly 1174
 top lower feed assembly 1203
 top output tray 1230
 top output tray paper full sensor 1232
 tray diverter 1184
 tray diverter home sensor 1192
 booklet finisher diagrams 993, 1040
 booklet finisher parts 993, 1040
 booklet finisher remove and replace 993
 booklet finisher specification 908
 booklet finisher view 906
 booklet fold motor
 parts and diagrams 1054
 booklet fold roller
 parts and diagrams 1056
 Booklet fold unit 972, 2028
 booklet fold unit
 parts and diagrams 1050
 Booklet maker 1865
 booklet maker
 parts and diagrams 1040
 booklet maker baset
 parts and diagrams 1064
 Booklet output tray unit 979, 2155
 Booklet paddle unit 962, 1894
 booklet paddle unit
 parts and diagrams 1060
 Booklet presser unit 966, 1929
 booklet presser unit
 parts and diagrams 1042
 Booklet stapler unit 970
 booklet stapler unit
 parts and diagrams 1046
 Booklet tamper unit 968, 1952
 booklet tamper unit
 parts and diagrams 1048
 bookletr finisher
 exit motor 993
 Bridge unit 1002, 1066
 bridge unit
 parts and diagrams 1002, 1004
 buffer diverter
 parts and diagrams 1038
 Buffer unit 957, 1851
 buffer unit
 parts and diagrams 1036

C

Calibrate/Cleaning menu, control panel 673, 700, 723, 787
 cassette 1, 30, 33
 cassette lift drive 1, 49, 52
 Cassettes Tray 2/3
 parts and diagrams 260
 caster
 HCI 623
 caution v
 caution for moving the scanner 1, 56, 65
 CCDM PCA 1, 83
 certificate of volatility 2809
 CoV E72525/30/35 2809
 Channel partners
 WISE 107
 Channel partners support
 HP Channel Services Network (CSN) 107
 checklists
 after-service 107, 114, 115, 905, 987, 990, 2203, 2248, 2251
 preservice 107, 114, 115, 905, 987, 990, 2203, 2248, 2251
 cleaning page 673, 700, 723, 787
 cleaning the paper dust stick 107, 117
 cleaning the scan glass 107, 117
 clear paper jams 905, 2177, 2178, 2792

component test
 special mode test 673, 680, 681, 693, 699
 components
 diagnostic tests 673, 680, 681, 693, 699
 scanning system 1, 56, 59
 connection
 diagram 2193
 connector error
 65.WX.YZ error 673, 675
 control panel 247
 Backup/Restore menu 673, 700, 723, 787
 Calibrate/Cleaning menu 673, 700, 723, 787
 Copy menu (MFP only) 673, 700, 723, 766
 CPMD 673
 Fax menu (fax models only) 673, 700, 723, 779
 Print menu 673, 700, 723, 782
 Reports menu 673, 700, 723
 Scan menu (MFP only) 673, 700, 723, 770
 Settings menu 673, 700, 723, 724
 Supplies menu 673, 700, 723, 782
 Trays menu 673, 700, 723, 783
 troubleshooting menu 673, 700, 723, 783
 USB Firmware Upgrade menu 673, 700, 723, 787, 788
 control panel diagnostic flowcharts 673, 680, 681, 686, 687
 control panel menus 673, 700, 723
 control panel messages 674
 conventions used v
 Copy menu (MFP only), control panel 673, 700, 723, 766
 copy specifications 1, 8, 20
 CoV
 certificate of volatility 2809
 cover
 parts and diagrams 996
 Covers 1090, 2272
 parts and diagrams 348
 CPMD 674
 CPMP
 WISE 108, 676
 current settings pages 673, 700
D
 DC controller communication error 55.WX.YZ error 673, 675
 DC controller firmware error 70.WX.YZ error 673, 675
 DCF 1, 99
 DCF main frame pickup
 parts and diagrams 580
 DCF main frame pickup 1
 parts and diagrams - drive 578
 DCF main frame pickup upper
 parts and diagrams - drive 586
 decoding
 message 673
 defeating
 interlocks 673, 680, 681, 693, 696, 697
 definitions and terms
 glossary 2817
 determine problem source 673, 680, 681
 developer unit 1, 38, 39, 40
 diagnostics
 adjustment 673, 795, 806, 819
 component 673, 680, 681, 693, 699
 engine 673, 680, 681, 693, 696, 795, 806
 fax 673, 795, 806
 image management 673, 795, 806, 823
 LED 673, 680, 681, 693, 694
 print test patterns 673, 795, 806, 824
 scanner 673, 795, 806, 814
 diagram
 connection 2193
 dual cassette feeder 2201
 FDB/LVPS 2197
 front OPC 2199
 fuser exit 2194
 laser scanner assembly/HVPS 2195
 pickup/ph drive/side 2194
 scanner 2200
 toner 2196
 UI 2198
 diagram, electrical-mechanical relationships
 document feeder section 891
 drive section 872
 dual-cassette feeder (DCF) 896
 exit section 871
 frame section 880
 fuser section 883
 high-capacity input (HCI) 899
 image formation section 893
 MP right door section 885
 paper handling section 878
 PCAs, Boards, and Laser Scanning Unit (LSU) 867
 scanner section 889
 Diagrams
 ADF (GX/z) 448
 ADF (LX models) 392
 ADF exterior and ADF pickup(LX models) 420
 ADF lower image scanner (LX) 544
 ADF main frame (GX/z) 496
 ADF main frame assembly (LX models) 434
 ADF upper pickup (GX/z) 476
 booklet blade 1058
 booklet blade motor 1058
 booklet c-fold blade 1052
 booklet c-fold motor 1054
 booklet diverter 1052
 booklet diverter motor 1054
 booklet diverter unit 1050
 booklet end fence unit 1062
 booklet entrance 1044
 booklet entrance unit 1042
 booklet entrance-presser motor 1044
 booklet exit 1052
 booklet exit unit 1050
 booklet fold motor 1054
 booklet fold roller 1056
 booklet fold unit 1050
 booklet maker 1040
 booklet maker base 1064
 booklet paddle unit 1060
 booklet presser unit 1042
 booklet stapler unit 1046

booklet tamper unit 1048
 bridge unit 1002, 1004
 buffer diverter 1038
 buffer unit 1036
 cassettes tray 2/3 260
 cover 996
 covers 348
 DCF main frame pickup 580
 DCF main frame pickup 1 578
 DCF main frame pickup upper 586
 Dual cassette feeder DCF 560
 ejector unit 1022, 1026
 end fence unit 1018
 entrance motor 1008
 entrance unit 1006, 1008
 exit assemblies 254
 exit motor 1016
 flow ADF image scanner (GX/sGX) 530
 flow ADF open cover (GX/z) 466
 flow ADF stacker (GX/sGX) 492
 front door 1000
 front jam cover 1038
 fuser exit drive 288
 hanress 996
 HCI drive 635
 HCI main 589
 HCI sub - cassette 660
 HCI sub - frame 606
 HCI sub - pickup upper/lower 628
 image scanner assembly 534
 left lower cover 1032
 left upper cover 1030
 lower bridge 1004
 main assembly 122
 main engine frame assembly 264
 main exit CAM motor 1016
 main exit unit 1014, 1018
 main frame 316
 main frame pickup 306
 main frame pickup 1 and 2 302
 main output tray motor 1034
 main output tray unit 1028
 main PCA 1022
 paddle 1020
 paddle motor 1020
 paddle unit 1018
 paper holding motor 1034
 paper holding unit 1028
 registration sub-frame 292
 right door 356
 right door duplex 386
 right door exit 382
 right upper cover 1000
 stapler unit 1022
 tamper unit 1022, 1024
 top cover 1000
 top door 1000
 top exit unit 1014
 top lower cover 1016
 top output tray unit 1014
 Tray 1 374
 Tray diverter CAM 1012
 tray diverter unit 1010
 tray jam cover 1012
 upper bridge 1002
 diagrams
 covers-inner finisher 2258
 ejector unit-inner finisher 2270
 electrical-mechanical 867, 2193
 finisher system 905, 2191
 inner finisher 2255
 paper support unit-inner finisher 2262
 sensor, motor, and roller-inner finisher 2260
 stapler unit-inner finisher 2268
 tamper unit-inner finisher 2264, 2266
 use parts lists and diagrams 112
 digital sending error (firmware)
 44.WX.YZ error 673, 675
 dimensions
 accessories 1, 8, 13
 printer 1, 8, 13
 diverter unit 2220
 document feeder
 document feeder input tray (LX) 398
 document feeder (LX) reverse roller 436
 document feeder error
 31.WX.YZ error 673, 674
 document feeder pick roller (LX) 426
 document feeder section
 electrical-mechanical relationships diagram 891
 document feeder skew (LX du models) 673
 documentation, printer error codes and messages
 WISE 108, 676
 drive assembly - feed
 HCI 637
 drive assembly - feed motor
 HCI 641
 drive assembly - lift drive right and motor - lift drive left motor
 HCI 646
 drive assembly - step motor
 HCI 649
 drive assembly - sub-pulley
 HCI 652
 drive section
 electrical-mechanical relationships diagram 872
 drive system 1, 49
 cassette lift drive 1, 49, 52
 drive motors 1, 49
 duct drive unit 52
 exit drive 1, 49
 feed drive 1, 49
 fuser drive 53
 fuser release drive 1, 49
 main drive unit 50
 main drive unit motor 1, 49
 pickup drive 1, 49, 52
 registration drive 1, 49
 toner reservoir drive 1, 49
 toner supply drive 1, 49, 54
 drivers, supported 1, 8
 dual cassette feeder (DCF) motor 570
 dual cassette feeder (DCF) right door 564
 dual cassette feeder 1, 99
 diagram 2201
 dual cassette feeder (DCF) PCA 567
 dual cassette feeder (DCF) pickup motor 574
 dual cassette feeder (DCF) pickup units 582
 dual cassette feeder (DCF) rear cover 562
 dual cassette feeder (DCF) unit
 dual cassette feeder (DCF) motor 570

- dual cassette feeder (DCF) rear cover 562
- dual cassette feeder (DCF) motor 574
- dual cassette feeder (DCF) PCA 567
- dual cassette feeder (DCF) pickup units 582
- dual cassette feeder (DCF) right door 564
- Dual cassette feeder DCF
 - parts and diagrams - Dual cassette feeder DCF 560
- dual-cassette feeder (DCF)
 - electrical-mechanical relationships diagram 896
- duplexer error
 - 69.WX.YZ error 673, 675

E

- each unit functions
 - finisher system 905, 906, 2204
- ejector home sensor 2803
- ejector motor 2803
- Ejector unit 949, 1576, 2589
- ejector unit 2236
 - parts and diagrams 1022, 1026
- Ejector1 1601
- ejector2 unit 1654
- electrical parts layout
 - finisher system layout 905, 906, 2204
- electrical specifications 1, 8, 14
- electrical-mechanical
 - diagrams 867, 2193
- electrostatic discharge (ESD) 107, 112, 905, 987, 990, 2203, 2248, 2251
- Embedded Jetdirect error
 - 80.WX.YZ error 673, 675
- end fence sensor 2801
- End fence unit 941, 1303, 2655
- end fence unit 2232
 - parts and diagrams 1018
- engine
 - diagnostics 673, 680, 681, 693, 696
- engine error (LaserJet)
 - 46.WX.YZ error 673, 675
 - 63.WX.YZ error 673, 675
- engine error (PageWide)
 - 61.WX.YZ error 673, 675
- entrance motor 2795
 - parts and diagrams 1008
- Entrance unit 1006, 1160, 2299
- entrance unit 2219
 - parts and diagrams 1006, 1008
- eraser PCA 1, 83, 97
- error
 - fault 673
- ESD electrostatic discharge (ESD) 107, 112, 905, 987, 990, 2203, 2248, 2251
- event log 673, 700, 704
 - clear using touchscreen control panel 673, 700, 704
- event log error (firmware)
 - 42.WX.YZ error 673, 675
- Exit assemblies
 - parts and diagrams 254
- exit drive 1, 49, 53
- exit motor
 - parts and diagrams 1016
- exit section
 - electrical-mechanical relationships diagram 871
- exit sensor 2796
- Exit unit 2316
- exit unit 2222
- exploded parts views, use parts lists and diagrams 112

F

- fan error
 - 58.WX.YZ error 673, 675
- Fax menu (fax models only), control panel 673, 700, 723, 779
- FDB/LVPS
 - diagram 2197
- feed drive 1, 49
- feeding system 1, 30
 - cassette 1, 30, 33
 - main components and functions 1, 30, 31
 - MP feeder assembly 1, 30
 - overview 1, 30
 - pickup assembly 34
 - pickup unit 1, 30
 - registration assembly 35
 - registration unit 1, 30
- rollers 1, 30, 31
- sensor, motor, and solenoid 1, 30, 31, 32
 - Tray 1 feeder assembly 36
- feeding system information 1, 30
- finisher docking sensor 2794
- finisher sectional view 905, 906, 2204
- finisher system 905, 906, 915, 2204, 2210
 - diagrams 905, 2191
 - each unit functions 905, 906, 2204
 - electrical parts layout 905, 906, 2204
 - finisher sectional view 905, 906, 2204
 - paper path 905, 906, 2204
 - PCA connection information 905, 906, 2204
- finisher system diagram 915, 2210
- finisher system electrical parts 915, 2210
- finisher system paper path 915, 2210
- finisher system PBA connection 915, 2210
- finisher system sectional view 915, 2210
- firmware communication error
 - 49.WX.YZ error 673, 675
- firmware install error
 - 99.WX.YZ error 673, 676
- hard disk error 673, 676
- remote firmware upgrade error 673, 676
- flatbed scanner system
 - overview 1, 56, 57
- flow (z bundles) document feeder
 - document feeder contact image sensor (CIS) 457
 - document feeder contact image sensor (CIS) fan 515
 - document feeder front motor 499
 - document feeder input tray 450
 - document feeder jam access cover 468
 - document feeder PCA fan 512

- document feeder rear motors
 - 503
 - document feeder ultrasonic sensor
 - with PCA 518
 - Flow ADF image scanner (GX/SGX)
 - parts and diagrams 530
 - Flow ADF open cover (GX/z)
 - parts and diagrams 466
 - flow ADF PCA 1, 83
 - flow ADF skew (LX du models) 673
 - Flow ADF stacker (GX/SGX)
 - parts and diagrams 492
 - formatter
 - locating 1, 2, 3
 - formatter lights 673, 680, 681, 693, 694, 695
 - frame section
 - electrical-mechanical relationships diagram 880
 - front cover switch 2807
 - front door
 - parts and diagrams 1000
 - front jam cover
 - parts and diagrams 1038
 - front OPC
 - diagram 2199
 - Front tamper 1339, 2450
 - front tamper motor 2799
 - front tamper sensor 2799
 - front view 2204
 - fuser drive 53
 - fuser drive assembly 1, 83
 - fuser drive board 94
 - fuser error
 - 41.WX.YZ error 673, 675
 - laser scanner error 673, 675
 - paper path error 673, 675
 - fuser error (LaserJet)
 - 50.WX.YZ error 673, 675
 - fuser exit
 - diagram 2194
 - fuser exit drive
 - parts and diagrams 288
 - fuser PCA 1, 83
 - fuser release drive 1, 49
 - fuser section
 - electrical-mechanical relationships diagram 883
 - fuser unit 1, 42
 - fuser unit drive 1, 42, 43
 - overview 1, 42
 - temperature control 1, 42, 43
 - fuser unit drive 1, 42, 43
 - fuser unit temperature control 1, 42, 43
- G**
- General Settings menu, control panel 673, 700, 723, 724
 - general specifications 1, 8, 15
 - glossary
 - terms and definitions 2817
 - guide post and guide post plate
 - HCI 625
- H**
- hanress
 - parts and diagrams 996
 - hard disk drive 233
 - hard disk partition error
 - 98.WX.YZ error 673, 676
 - hardware configuration 1, 83
 - CCDM PCA 1, 83
 - eraser PCA 1, 83, 97
 - flow ADF PCA 1, 83
 - fuser drive assembly 1, 83
 - fuser drive board 94
 - fuser PCA 1, 83
 - high voltage power supply PCA 1, 83
 - high-voltage power supply (HVPS) PCA 95
 - low voltage power supply (LVPS; Type 5H) / switching mode power supply (SMPS) 91
 - low voltage power supply PCA (Type 3R) 1, 83
 - low voltage power supply PCA (Type 4) 1, 83, 92
 - low voltage power supply PCA (Type 5H) 1, 83
 - LVPS PCA (Type 3R) 1, 83
 - LVPS PCA (Type 4) 1, 83, 92
 - LVPS PCA (Type 5H) 1, 83, 91
 - main controller 1, 83, 87
 - master system operation key 1, 83, 87, 89
 - scan joint PCA 1, 83
 - WLED IF PCA 1, 83
 - WLED PCA 1, 83
 - hardware integration pocket (HIP) is not functioning 673, 680, 681, 686, 687, 691
 - HCI 1
 - HCI belt - timing gear 608
 - HCI caster 623
 - HCI drive
 - parts and diagrams 635
 - HCI drive assembly - feed 637
 - HCI drive assembly - sub-pulley 652
 - HCI guide post and guide post plate 625
 - HCI kit - HP LaserJet E7 tray rollers 630
 - HCI main
 - parts and diagrams 589
 - HCI main electrical connector 620
 - HCI motor - feed drive 641
 - HCI motor - lift drive right and motor - lift drive left 646
 - HCI motor - step drive 649
 - HCI PCA 617
 - HCI photo interrupter and sensor bracket 669
 - HCI right door 601
 - HCI sub - cassette
 - parts and diagrams 660
 - HCI sub - frame
 - parts and diagrams 606
 - HCI sub - pickup upper/lower
 - parts and diagrams 628
 - HCI sub-paper side right 662
 - HCI sup-pickup 591
 - HDD 233
 - high capacity input tray 1
 - high voltage power supply PCA 1, 83
 - high-capacity input (HCI)
 - electrical-mechanical relationships diagram 899
 - high-voltage power supply (HVPS) PCA 95
 - home button is unresponsive 673, 680, 681, 686, 687, 690
 - HP Channel Services Network (CSN)
 - Channel partners support 107
 - HP internal users
 - WISE 107
 - HP Jetdirect print server
 - lights 673, 680, 681, 693, 694, 695

HP LaserJet E7 tray rollers
 HCI 630
 HVPS PCA 1, 83

I

image creation 1, 38
 imaging unit 1, 38, 39
 overview 1, 38
 paper transfer belt unit 1, 38, 39
 toner cartridge 1, 38, 39

image formation section
 electrical-mechanical relationships
 diagram 893

image quality
 black lines, vertical 673, 828,
 829, 832
 blurred image 673, 828, 829,
 838
 drive unit problem 845
 electrical circuit problem 845
 feeding system problems 845
 flow ADF or ADF skew (LX du
 models) 673
 foggy image 673, 828, 829, 839
 fuser problem 845
 image problem 845
 jitter image 673, 828, 829, 840
 laser/scanner problem 845
 light image 673, 828, 829, 839
 light lines, vertical 673, 828, 829,
 834
 periodic black dots, horizontal
 673, 828, 829, 836
 periodic black lines, horizontal
 673, 828, 829, 836
 periodic light/dark dots,
 horizontal 673, 828, 829, 837
 periodic light/dark lines,
 horizontal 673, 828, 829, 837
 poor fusing 673, 828, 829, 842
 scanner and ADF problems 845
 skewed image 673, 828, 829,
 841
 stain on back side 673, 828, 829,
 843
 standard tone, setting 673, 828,
 829
 uneven pitch 673, 828, 829, 840
 white lines, vertical 673, 828,
 829, 834

image scanner assembly
 parts and diagrams 534

imaging unit 1, 38, 39
 developer unit 1, 38, 39, 40
 overview 1, 38, 39

individual component diagnostics
 673, 680, 681, 693

information
 general 673, 795, 802
 print reports 673, 795, 802, 803
 software version 673, 795, 802,
 803
 supply status 673, 795, 802

inner finisher 103
 block diagram 2203
 ejector & paper support
 assembly 2590
 ejector assembly 2254, 2632
 ejector motor 2254
 ejector motor assembly 2610
 end fence home 2254
 end fence sensor 2656
 entrance motor 2254, 2306
 entrance sensor 2254, 2300
 exir roller 2254
 exit motor 2254, 2334
 exit roller 2317
 exit sensor 2254, 2325
 front cover 2273
 front paper support 2254, 2339
 front tamper 2451
 front tamper home sensor 2469
 front tamper motor 2487
 left cover 2289
 main paddle 2254, 2425
 main paddle assembly 2437
 main paddle home sensor 2429
 main paddle motor 2433
 middle cover 2279
 motor 2254
 output tray 2668
 output tray lower limit switch
 2685
 output tray motor 2719
 output tray motor assembly
 2697
 output tray motor sensor 2708
 output tray top of stack sensor
 2675
 paper holding 2731

paper holding sensor 2744
 paper holding solenoid 2254,
 2757
 paper support 2254
 paper support home sensor
 2254, 2382
 paper support motor 2404
 parts and diagrams 2255
 parts and diagrams - covers
 2258
 parts and diagrams - ejector unit
 2270
 parts and diagrams - paper
 support unit 2262
 parts and diagrams - sensor, motor,
 and roller 2260
 parts and diagrams - stapler unit
 2268
 parts and diagrams - tamper
 unit 2264, 2266
 PCA cover 2286
 punch cover 2778
 punch waste full 2254
 punch waste full sensor 2783
 rear cover 2276
 rear paper support 2254, 2361
 rear tamper 2506, 2524
 rear tamper motor 2542
 sensor 2254
 stacker lower limit switch 2254
 stacker motor 2254
 stapler 2254, 2561
 stapler position motor 2579
 stapler position sensor 2254,
 2567
 sub paddle unit 2445
 switch 2254
 top cover 2283

inner finisher diagrams 2254
 inner finisher parts 2254
 inner finisher PCA 2244
 inner finisher remove and replace
 2254
 inner finisher specification 2205

input accessory error
 67.WX.YZ error 673, 675
 input/output error
 40.WX.YZ error 673, 674

interlocks
 defeating 673, 680, 681, 693,
 696, 697
 internal diagnostics error
 90.WX.YZ error 673, 676
 video display error 673, 676
 interpret control-panel messages and
 event log entries 905, 2177, 2203,
 2792

J

jam error (LaserJet)
 13.WX.YZ error 673, 674
 jam error (PageWide)
 13.WX.YZ error 673, 674
 jams
 locations 673, 789
 Jetdirect print server
 lights 673, 680, 681, 693, 694,
 695
 job accounting error (firmware)
 48.WX.YZ error 673, 675
 job management error
 (firmware) 673, 675
 job pipeline error (firmware) 673,
 675
 job parser error (firmware)
 47.WX.YZ error 673, 675
 printer calibration error 673, 675

K

keyboard 250

L

laser scanner assembly 1
 laser scanning optical path 1, 47
 overview 1
 laser scanner assembly/HVPS
 diagram 2195
 laser scanner error (LaserJet)
 51.WX.YZ error 673, 675
 52.WX.YZ error 673, 675
 laser scanner unit 46
 laser scanning optical path 46
 overview 46
 LED lamp module 539
 LEDs. *See* lights
 left lower cover
 parts and diagrams 1032
 left upper cover
 parts and diagrams 1030

lights
 formatter 673, 680, 681, 693,
 694, 695
 troubleshooting with 673, 680,
 681, 693, 694
 low voltage power supply (LVPS; Type
 5H) / switching mode power supply
 (SMPS) 91
 low voltage power supply PCA (Type
 3R) 1, 83
 low voltage power supply PCA (Type
 4) 1, 83, 92
 low voltage power supply PCA (Type
 5H) 1, 83
 lower bridge
 parts and diagrams 1004
 LVPS PCA (Type 3R) 1, 83
 LVPS PCA (Type 4) 1, 83, 92
 LVPS PCA (Type 5H) 1, 83, 91
 switching mode power supply 91

M

machine cleaning for maintenance
 107, 117
 cleaning the flow ADF white bar
 and CIS (GX ADF) 107, 117
 cleaning the flow ADF white bar
 and CIS (LX/du model) 107, 117
 cleaning the paper dust stick
 107, 117
 cleaning the scan glass 107, 117
 main assembly
 parts and diagrams 122
 main controller
 hardware configuration 1, 83, 87
 new model (IR/UI) 1, 83, 87
 previous model 1, 83, 87
 main electrical connector
 HCI 620
 Main engine frame assembly
 parts and diagrams 264
 main exit CAM motor
 parts and diagrams 1016
 Main exit unit 937, 1243
 main exit unit
 parts and diagrams 1014, 1018
 main frame
 parts and diagrams 316
 main frame pickup
 parts and diagrams 306
 main frame pickup 1 and 2
 parts and diagrams 302
 main output tray motor
 parts and diagrams 1034
 Main output tray unit 952, 1732
 main output tray unit
 parts and diagrams 1028
 main parts 121
 main PCA
 parts and diagrams 1022
 maintenance 107, 117
 machine cleaning for
 maintenance 107, 117
 maintenance counts
 part replacement count 673,
 795, 804
 maintenance parts 1, 8, 27
 master system operation key 1, 83,
 87, 89
 memory error
 82.WX.YZ error 673, 676
 EMMC error 673, 676
 hard disk error 673, 676
 menu map 673, 700
 menus, control panel
 Calibrate/Cleaning 673, 700, 723,
 787
 Copy (MFP only) 673, 700, 723,
 766
 Fax (fax models only) 673, 700,
 723, 779
 General Settings 673, 700, 723,
 724
 Manage Trays 673, 700, 723,
 783
 Print 673, 700, 723, 782
 Reports 673, 700, 723
 Scan (MFP only) 673, 700, 723,
 770
 Supplies 673, 700, 723, 782
 motor error (LaserJet)
 59.WX.YZ error 673, 675
 MP right door section
 electrical-mechanical relationships
 diagram 885
 MSOK 1, 83, 87, 89
 multipurpose feeder assembly 1, 30

N

Near Field Communication error
81.WX.YZ error 673, 676
Bluetooth error 673, 676
external I/O card error 673, 676
internal EIO error 673, 676
wireless error 673, 676
network and software specifications
1, 8
network interface 1, 8
no control panel sound 673, 680,
681, 686, 687, 689
note v

O

operating systems, supported 1, 8
operating-environment range
printer 14
option specifications 1, 8
optional configurations 1, 8
optional parts 28
options list 1, 8
orderable parts 112, 992, 2253
ordering 905, 987, 2203, 2248
other errors
drive unit 673, 828
electrical circuit 673, 828
feeding system 673, 828
flow ADF 673, 828
fuser 673, 828
image system 673, 828
laser scanner assembly 673, 828
scanner 673, 828
output accessory error
66.WX.YZ error 673, 675
output tray 2240
output tray motor 2804
Output tray motor assembly 2696
output tray motor sensor 2804
Output tray top of stack sensor 2805
Output tray unit 2667
OXPd/Web kit error
45.WX.YZ error 673, 675

P

paddle
parts and diagrams 1020
paddle motor
parts and diagrams 1020
Paddle unit 940, 1270, 2424

paddle unit 2226
parts and diagrams 1018
page error
21.WX.YZ error 673, 674
paper handling error (LaserJet)
56.WX.YZ error 673, 675
paper handling section
electrical-mechanical relationships
diagram 878
paper handling specifications 1, 8,
23
paper holding motor
parts and diagrams 1034
Paper holding unit 954, 1793, 2730
paper holding unit 2240
parts and diagrams 1028
paper jams
locations 673, 789
paper path
finisher system 905, 906, 2204
paper support motor 2798
paper support sensor 2798
Paper support unit 2338
paper support unit 2225
paper transfer belt unit 1, 38, 39
cleaning blade 1, 38, 39
overview 1, 38, 39
transfer belt drive 1, 38, 39

Parts

ADF (GX/z) 448
ADF (LX models) 392
ADF exterior and ADF pickup(LX
models) 420
ADF lower image scanner (LX)
544
ADF main frame (GX/z) 496
ADF main frame assembly (LX
models) 434
ADF upper pickup (GX/z) 476
booklet blade 1058
booklet blade motor 1058
booklet c-fold blade 1052
booklet c-fold motor 1054
booklet diverter 1052
booklet diverter motor 1054
booklet diverter unit 1050
booklet end fence unit 1062
booklet entrance 1044
booklet entrance unit 1042

booklet entrance-presser motor
1044
booklet exit 1052
booklet exit unit 1050
booklet fold motor 1054
booklet fold roller 1056
booklet fold unit 1050
booklet maker 1040
booklet maker base 1064
booklet paddle unit 1060
booklet presser unit 1042
booklet stapler unit 1046
booklet tamper unit 1048
bridge unit 1002, 1004
buffer diverter 1038
buffer unit 1036
cassettes tray 2/3 260
cover 996
covers 348
covers-inner finisher 2258
DCF main frame pickup 580
DCF main frame pickup 1 578
DCF main frame pickup upper
586
Dual cassette feeder DCF 560
ejector unit 1022, 1026
ejector unit-inner finisher 2270
end fence unit 1018
entrance motor 1008
entrance unit 1006, 1008
exit assemblies 254
exit motor 1016
flow ADF image scanner (GX/
sGX) 530
flow ADF open cover (GX/z) 466
flow ADF stacker (GX/sGX) 492
front door 1000
front jam cover 1038
fuser exit drive 288
hanress 996
HCI drive 635
HCI main 589
HCI sub - cassette 660
HCI sub - frame 606
HCI sub - pickup upper/lower 628
image scanner assembly 534
inner finisher 2255
left lower cover 1032
left upper cover 1030
lower bridge 1004

main assembly 122
 main engine frame assembly 264
 main exit CAM motor 1016
 main exit unit 1014, 1018
 main frame 316
 main frame pickup 306
 main frame pickup 1 and 2 302
 main output tray motor 1034
 main output tray unit 1028
 main PCA 1022
 paddle 1020
 paddle motor 1020
 paddle unit 1018
 paper holding motor 1034
 paper holding unit 1028
 paper support unit-inner finisher 2262
 registration sub-frame 292
 right door 356
 right door duplex 386
 right door exit 382
 right upper cover 1000
 sensor, motor, and roller-inner finisher 2260
 stapler unit 1022
 stapler unit-inner finisher 2268
 tamper unit 1022, 1024
 tamper unit-inner finisher 2264, 2266
 top cover 1000
 top door 1000
 top exit unit 1014
 top lower cover 1016
 top output tray unit 1014
 Tray 1 374
 Tray diverter CAM 1012
 tray diverter unit 1010
 tray jam cover 1012
 upper bridge 1002
 parts 112, 992, 2253
 use parts lists and diagrams 112
 parts and accessories 905, 987, 2203, 2248
 parts and diagrams 107
 parts and diagrams, using 112
 parts list and diagrams, how to use 112
 parts, main 121
 parts, order by authorized service providers 112, 992, 2253
 parts, orderable 112, 992, 2253
 parts, ordering 112, 992, 2253
 PCA 2159
 HCI 617
 PCA connection information 982
 finisher system 905, 906, 2204
 PCA precautions 905, 987, 988, 989, 2248, 2249, 2250
 PCAs, Boards, and Laser Scanning Unit (LSU)
 electrical-mechanical relationships diagram 867
 pick roller
 document feeder (LX) 426
 pickup assembly 34
 pickup drive 1, 49, 52
 pickup unit 1, 30
 pickup/ph drive/side diagram 2194
 plastic latches information 905, 987, 988, 989, 2248, 2249, 2250
 post-service tests 107, 114, 116, 905, 987, 991, 2203, 2248, 2252
 power
 consumption 1, 8, 14
 power subsystem 673, 680, 681, 682
 power supply
 troubleshooting 673, 680, 681, 682, 683
 power-on troubleshooting overview 673, 680, 681, 682, 683
 pre-boot menu options 673, 700, 705
 precautions
 information 905, 987, 988, 2248, 2249
 replacing parts 114, 988, 2249
 preservice checklist 107, 114, 115, 905, 987, 990, 2203, 2248, 2251
 print bar error (PageWide) 62.WX.YZ error 673, 675
 print drivers, supported 1, 8
 Print menu, control panel 673, 700, 723, 782
 print quality
 drive unit problem 855
 electrical circuit problem 860
 feeding system problem 856
 fuser problem 847
 image problem 845
 laser scanner assembly problem 860
 scanner and ADF problem 847
 test 107, 114, 116, 905, 987, 991, 2203, 2248, 2252
 print quality troubleshooting 673, 828
 flow ADF skew adjust 673
 image quality 673, 828, 829
 other errors 673, 828, 845
 print specifications 1, 8, 17
 Print Test Page 673, 700, 723, 724
 printer
 dimensions 1, 8, 13
 operating-environment range 14
 weight 1, 8, 13
 printer memory error 20.WX.YZ error 673, 674
 Process Cleaning Page 673, 700, 723, 787
 product number
 locating 1, 2, 3
 Punch unit 1166, 2777
 punch unit 930, 2216
 punch waste box sensor 2794
 Punch waste full sensor 2793

R
 real-time clock error 11.WX.YZ error 673, 674
 Rear paper support 2360
 Rear tamper 1417, 2505
 rear tamper motor 2800
 rear tamper sensor 2800
 rear view 2204
 registration assembly 35
 registration drive 1, 49
 registration sub-frame
 parts and diagrams 292
 registration unit 1, 30
 removal and replacement 107
 removal and replacement booklet
 finisher 993
 removal and replacement inner
 finisher 2254

- removal and replacement
 - precautions 905, 987, 988, 2248, 2249
- removal order
 - removing order 107, 114, 116, 991, 2252
- removing parts
 - checklists 107, 114, 115, 905, 987, 990, 2203, 2248, 2251
- replacing parts
 - precautions 114, 988, 2249
- replacing the main SVC part
 - right door dampener 338
- Reports menu, control panel 673, 700, 723
- reverse roller
 - document feeder (LX) 436
- revision history iii
- Right door
 - parts and diagrams 356
- right door
 - HCI 601
- right door dampener 338
- Right door duplex
 - parts and diagrams 386
- Right door exit
 - parts and diagrams 382
- right upper cover
 - parts and diagrams 1000

S

- scan glass 536
- scan joint PCA 1, 83
- Scan menu (MFP only), control panel 673, 700, 723, 770
- scan specifications 1, 8, 19
- scanner
 - caution for moving 1, 56, 65
 - CDD and lens 546
 - diagram 2200
 - scanner glass 536
- scanner assembly - CDD and lens 546
- scanner error
 - 30.WX.YZ error 673, 674
- scanner section
 - electrical-mechanical relationships diagram 889
- scanning system
 - components 1, 56, 59
- scanning system components 1, 56, 59
- security error
 - 33.WX.YZ error 673, 674
- sensor and bracket
 - HCI 669
- sensor error
 - 54.WX.YZ error 673, 675
 - 58.WX.YZ error 673, 675
- serial number
 - locating 1, 2, 3
- service and support
 - WISE 107
- service and support information
 - WISE and CSN 107
- service approach 107, 114, 905, 987, 2203, 2248
 - precautions 114, 988, 2249
- service functions
 - capture log 673, 795, 825
 - debug log 673, 795, 825
 - envelope rotate 673, 795, 825, 826
 - main memory clear 673, 795, 825
 - transfer assembly control 673, 795, 825, 826
- service mode 673, 795
 - diagnostics 673, 795, 806
 - entering service mode 673, 795
 - information 673, 795, 802
 - maintenance counts 673, 795, 804
 - mode menu tree 673, 795
 - service functions 673, 795, 825
- sHCI 1
- side high capacity input tray 1
- software and solutions 1, 8
- solve problems
 - control panel messages 674
 - CPMD 674
- specifications 1, 8
 - copy specifications 1, 8, 20
 - electrical and acoustic 1, 8, 14
 - general specifications 1, 8, 15
 - maintenance parts 1, 8, 27
 - network interface 1, 8
 - network specifications 1, 8
 - optional parts 28
 - options 1, 8
 - options list 1, 8
 - paper handling specifications 1, 8, 23
 - print specifications 1, 8, 17
 - scan specifications 1, 8, 19
 - software and solutions 1, 8
 - software specifications 1, 8
 - supplies 1, 8, 27
- Stacker finisher 915
- stacker finisher 906
- standard (dn bundles) document feeder
 - document feeder PCA 526
 - document feeder white backing 129
- standard (du bundles) document feeder
 - document feeder white backing 126
- standard (LX models) document feeder
 - document feeder whole unit 132
- standard (LX) document feeder
 - document feeder (ADF) PCA 422
 - document feeder feed motor 443
- standard (LX) document feeder (ADF)
 - contact image sensor (CIS) 404
 - document feeder (ADF) jam access cover (LX) 394
- standard (LX/du model) document feeder
 - document feeder main motor 414
- standard (z bundles) document feeder
 - document feeder whole unit 137, 143
- Stapler finisher 915
- stapler finisher 906
- stapler position motor 2802
- stapler position sensor 2802
- Stapler unit 1495, 2560
- stapler unit 2234
 - parts and diagrams 1022
- Stapler unit (booklet) 2009
- stapler/stacker diagrams 994
- stapler/stacker parts 994
- static, precautions for 107, 112, 905, 987, 990, 2203, 2248, 2251

- sub-paper side right
 - HCI 662
- sup-pickup
 - HCI 591
- supplies 905, 987, 2203, 2248
- supplies error (LaserJet)
 - 10.WX.YZ error 673, 674
- supplies error (PageWide)
 - 17.WX.YZ error 673, 674
- Supplies menu, control panel 673, 700, 723, 782
- switching mode power supply
 - LVPS PCA (Type 5H) 91
- system error (LaserJet)
 - 62.WX.YZ error 673, 675
- system requirements
 - minimum 1, 8

T

- Tamper unit 943, 946, 1338, 2449
- tamper unit 2229
 - parts and diagrams 1022, 1024
- terms and definitions
 - glossary 2817
- tests
 - post-service 107, 114, 116, 905, 987, 991, 2203, 2248, 2252
 - print-quality 107, 114, 116, 905, 987, 991, 2203, 2248, 2252
- tip v
- toner
 - diagram 2196
- toner cartridge 1, 38, 39
- top cover
 - parts and diagrams 1000
- top cover switch 2806
- top door
 - parts and diagrams 1000
- Top exit unit 935, 1202
- top exit unit
 - parts and diagrams 1014
- top lower cover
 - parts and diagrams 1016
- Top output tray unit 936, 1229
- top output tray unitr
 - parts and diagrams 1014
- touchscreen blank, white, or dim (no image) 673, 680, 681, 686, 687
- touchscreen has an unresponsive zone 673, 680, 681, 686, 687, 688

- Tray 1
 - jams, clearing 673, 789
 - parts and diagrams 374
- Tray 1 feeder assembly 36
- Tray 2
 - jams, clearing 673, 789
- Tray 3
 - jams, clearing 673, 789
- Tray diverter CAM
 - parts and diagrams 1012
- Tray diverter unit 933, 1010, 1173
- tray diverter unit
 - parts and diagrams 1010
- tray jam cover
 - parts and diagrams 1012
- tray motor error (LaserJet)
 - 60.WX.YZ error 673, 675
- tray selection - use requested tray 673, 700, 723, 724
- trays
 - jams, clearing 673, 789
- Trays menu, control panel 673, 700, 723, 783
- troubleshooting
 - checklist 673, 700, 701
 - control panel checks 673, 680, 681, 686
 - lights, using 673, 680, 681, 693, 694
 - power 673, 680, 681, 682, 683
 - process 673, 680
- troubleshooting tools
 - control panel messages 674
 - CPMD 674

U

- UI
 - diagram 2198
- understand lights on the formatter
 - formatter lights 673, 680, 681, 693, 694, 695
- understand the lights on the formatter
 - HP Jetdirect LEDs 673, 680, 681, 693, 694, 695
- upper bridge
 - parts and diagrams 1002
- Use Requested Tray 673, 700, 723, 724

W

- warning v
- Web-based Interactive Search Engine
 - WISE 107
- Web-based Interactive Search Engine (WISE)
 - HP internal users and Channel partners 107
- weight
 - accessories 1, 8, 13
 - printer 1, 8, 13
- WISE
 - CPMD 108, 676
 - HP internal users and Channel partners 107
 - Web-based Interactive Search Engine 107
- WLED IF PCA 1, 83
- WLED PCA 1, 83