



OFFICEJET PRO X451 AND X551 SERIES PRINTERS

Repair Manual



HP OFFICEJET PRO X451



HP OFFICEJET PRO X551



HP Officejet Pro X451 and X551 Printer Series

Repair Manual

Copyright and License

© 2013 Copyright Hewlett-Packard Development Company, L.P.

Reproduction, adaptation, or translation without prior written permission is prohibited, except as allowed under the copyright laws.

The information contained herein is subject to change without notice.

The only warranties for HP products and services are set forth in the express warranty statements accompanying such products and services. Nothing herein should be construed as constituting an additional warranty. HP shall not be liable for technical or editorial errors or omissions contained herein.

CV037-90002

Edition 2, 12/2013

Trademark Credits

Adobe®, Acrobat®, and PostScript® are trademarks of Adobe Systems Incorporated.

Intel® Core™ is a trademark of Intel Corporation in the U.S. and other countries.

Java™ is a US trademark of Sun Microsystems, Inc.

Microsoft®, Windows®, Windows® XP, and Windows Vista® are U.S. registered trademarks of Microsoft Corporation.

UNIX® is a registered trademark of The Open Group.

ENERGY STAR and the ENERGY STAR mark are registered U.S. marks.

Conventions used in this guide

 **TIP:** Tips provide helpful hints or shortcuts.

 **NOTE:** Notes provide important information to explain a concept or to complete a task.

 **CAUTION:** Cautions indicate procedures that you should follow to avoid losing data or damaging the product.

 **WARNING!** Warnings alert you to specific procedures that you should follow to avoid personal injury, catastrophic loss of data, or extensive damage to the product.

Table of contents

| | |
|---|----------|
| 1 Removal and replacement | 1 |
| Removal and replacement strategy | 2 |
| Electrostatic discharge | 2 |
| Required tools | 3 |
| OfficeJet Pro X special tools kit | 3 |
| Advanced Cleaning Kit | 4 |
| Service approach | 5 |
| Before performing service | 5 |
| After performing service | 5 |
| Post-service test | 6 |
| Print-quality test | 6 |
| Removal and replacement procedures | 7 |
| Customer replaceable parts | 7 |
| Tray 2 | 7 |
| Ink cartridges | 8 |
| Duplex module | 12 |
| Output bin | 13 |
| Output bin flap | 13 |
| Menu access | 14 |
| Access the Engineering menu | 14 |
| Access the Support Menu | 15 |
| Place the product into MFG (manufacturing) mode | 15 |
| Place the product into Audit mode | 15 |
| Perform tap tests and interpret results | 17 |
| 10 tap test results (OOBE States) | 17 |
| 12 tap test results (REDI sensor values) | 19 |
| 61 tap results (Align & color calibrations) | 21 |
| 909 tap test results (BDD status) | 22 |
| Covers | 23 |
| Rear cover | 23 |
| Left door | 24 |
| Left rear cover | 27 |

| | |
|--|-----|
| Left front cover | 28 |
| Top cover | 29 |
| Front cover | 34 |
| Right cover | 35 |
| Main assemblies | 36 |
| Aerosol fan assembly | 36 |
| Separator/pick assembly | 43 |
| Duplex drive module | 48 |
| Control panel (X451 models only) | 50 |
| Control panel (X551 models only) | 51 |
| Power supply | 53 |
| Backscatter drop detect (BDD) assembly | 55 |
| Service sled assembly | 57 |
| Right cross brace | 63 |
| Plate console left | 66 |
| Plate console right | 67 |
| Printbar | 68 |
| Printbar calibration procedure | 76 |
| Printbar FFC replacement | 78 |
| Platen | 79 |
| Drying path gear assembly | 83 |
| Printbar lift mechanism assembly | 84 |
| Tray lift transmission assembly | 86 |
| Output drive kit | 88 |
| Output drive gears | 91 |
| Output drive shaft 6 | 91 |
| Output drive shaft 5 | 93 |
| Output drive shaft 4 | 95 |
| Drive shaft 3 | 96 |
| Inner top frame | 99 |
| Top paper guide | 102 |
| Top left paper guide assembly | 105 |
| Center left paper guide assembly | 107 |
| Paper REDI sensors in the center left paper guide assembly | 109 |
| Service sled transmission | 110 |
| Printed circuit-board assemblies (PCAs) | 111 |
| PCA safety shield | 111 |
| Sensor carriage PCA and encoder strip | 112 |
| Power button PCA | 116 |
| Duplex module sensor PCA | 117 |
| Temperature sensor | 118 |

| | |
|---|------------|
| REDI distribution PCA | 119 |
| Feed motor encoder sensor PCA | 120 |
| Eject flap opto PCA | 123 |
| Printzone distribution PCA | 123 |
| Media presence sensor PCA/flag | 126 |
| Main PCA | 127 |
| Main PCA calibration procedure | 132 |
| Tray 3 interconnect PCA | 135 |
| Pick encoder distribution PCA | 136 |
| Wireless PCA | 137 |
| 2 Parts and diagrams | 139 |
| Order parts by authorized service providers | 140 |
| Order replacement parts | 140 |
| Related documentation and software | 140 |
| Supplies part numbers | 140 |
| Customer self-repair parts | 141 |
| Cables and power cords | 142 |
| Service part number and retail SKU cross-references | 142 |
| How to use the parts lists and diagrams | 144 |
| Assembly locations | 145 |
| Front view (X451 Series) | 145 |
| Front view (X551 Series) | 146 |
| Back view | 147 |
| Covers, panels, and doors | 148 |
| Internal assemblies | 150 |
| Alphabetical parts list | 160 |
| Numerical parts list | 165 |
| Index | 171 |

List of figures

| | | |
|-------------|---|----|
| Figure 1-1 | OfficeJet Pro X special tools–ink supply door switch | 3 |
| Figure 1-2 | OfficeJet Pro X special tools–printbar lift knob | 4 |
| Figure 1-3 | OfficeJet Pro X special tools–service sled advance tool | 4 |
| Figure 1-4 | OfficeJet Pro X special tools–printbar dolly | 4 |
| Figure 1-5 | Remove Tray 2 (1 of 2) | 7 |
| Figure 1-6 | Remove Tray 2 (2 of 2) | 8 |
| Figure 1-7 | Replace the ink cartridges (1 of 7) | 8 |
| Figure 1-8 | Replace the ink cartridges (2 of 7) | 9 |
| Figure 1-9 | Replace the ink cartridges (3 of 7) | 9 |
| Figure 1-10 | Replace the ink cartridges (4 of 7) | 10 |
| Figure 1-11 | Replace the ink cartridges (5 of 7) | 10 |
| Figure 1-12 | Replace the ink cartridges (6 of 7) | 11 |
| Figure 1-13 | Replace the ink cartridges (7 of 7) | 11 |
| Figure 1-14 | Remove the duplex module (1 of 2) | 12 |
| Figure 1-15 | Remove the duplex module (2 of 2) | 12 |
| Figure 1-16 | Remove the output bin | 13 |
| Figure 1-17 | Remove the output bin flap | 13 |
| Figure 1-18 | X451 control panel button locations | 14 |
| Figure 1-19 | X551 control panel button locations | 14 |
| Figure 1-20 | 10 tap test results | 18 |
| Figure 1-21 | 12 tap test report | 20 |
| Figure 1-22 | 61 tap test results | 21 |
| Figure 1-23 | 909 tap test results | 22 |
| Figure 1-24 | Remove the rear cover (1 of 2) | 23 |
| Figure 1-25 | Remove the rear cover (2 of 2) | 23 |
| Figure 1-26 | Remove left door (1 of 6) | 24 |
| Figure 1-27 | Remove the left door (2 of 6) | 24 |
| Figure 1-28 | Remove the left door (3 of 6) | 25 |
| Figure 1-29 | Remove the left door (4 of 6) | 26 |
| Figure 1-30 | Remove the left door (5 of 6) | 26 |
| Figure 1-31 | Remove the left door (6 of 6) | 27 |
| Figure 1-32 | Remove the left rear cover (1 of 2) | 27 |

| | | |
|-------------|--|----|
| Figure 1-33 | Remove the left rear cover (2 of 2) | 28 |
| Figure 1-34 | Remove the left front cover (1 of 2) | 28 |
| Figure 1-35 | Remove the left front cover (2 of 2) | 29 |
| Figure 1-36 | Remove the top cover (1 of 8) | 30 |
| Figure 1-37 | Remove the top cover (2 of 8) | 30 |
| Figure 1-38 | Remove the top cover (3 of 8) – X451 models | 31 |
| Figure 1-39 | Remove the top cover (4 of 8) – X551 models | 31 |
| Figure 1-40 | Remove the top cover (5 of 8) | 32 |
| Figure 1-41 | Remove the top cover (6 of 8) | 32 |
| Figure 1-42 | Remove the top cover (7 of 8) | 33 |
| Figure 1-43 | Remove the top cover (8 of 8) | 33 |
| Figure 1-44 | Remove the front cover (1 of 2) | 34 |
| Figure 1-45 | Remove the front cover (2 of 2) | 34 |
| Figure 1-46 | Remove the right cover (1 of 2) | 35 |
| Figure 1-47 | Remove the right cover (2 of 2) | 35 |
| Figure 1-48 | Remove the aerosol fan (1 of 12) | 36 |
| Figure 1-49 | Remove the aerosol fan (2 of 12) | 37 |
| Figure 1-50 | Remove the aerosol fan (3 of 12) | 37 |
| Figure 1-51 | Remove the aerosol fan (4 of 12) | 38 |
| Figure 1-52 | Remove the aerosol fan (5 of 12) | 38 |
| Figure 1-53 | Remove the aerosol fan (6 of 12) | 39 |
| Figure 1-54 | Remove the aerosol fan (7 of 12) | 39 |
| Figure 1-55 | Remove the aerosol fan (8 of 12) | 40 |
| Figure 1-56 | Remove the aerosol fan (9 of 12) | 40 |
| Figure 1-57 | Remove the aerosol fan (10 of 12) | 41 |
| Figure 1-58 | Remove the aerosol fan (11 of 12) | 41 |
| Figure 1-59 | Remove the aerosol fan (12 of 12) | 42 |
| Figure 1-60 | Remove the separator/pick assembly (1 of 4) | 43 |
| Figure 1-61 | Remove the separator/pick assembly (2 of 4) | 44 |
| Figure 1-62 | Remove the separator/pick assembly (3 of 4) | 45 |
| Figure 1-63 | Remove the separator/pick assembly (4 of 4) | 45 |
| Figure 1-64 | Reinstall the separator/pick assembly (1 of 5) | 46 |
| Figure 1-65 | Reinstall the separator/pick assembly (2 of 5) | 46 |
| Figure 1-66 | Reinstall the separator/pick assembly (3 of 5) | 47 |
| Figure 1-67 | Reinstall the separator/pick assembly (4 of 5) | 47 |
| Figure 1-68 | Reinstall the separator/pick assembly (5 of 5) | 48 |
| Figure 1-69 | Remove the duplex drive module (1 of 2) | 49 |
| Figure 1-70 | Remove the duplex drive module (2 of 2) | 49 |
| Figure 1-71 | Remove the control panel (1 of 2) | 50 |
| Figure 1-72 | Remove the control panel (2 of 2) | 50 |
| Figure 1-73 | Remove the touchscreen control panel (1 of 4) | 51 |

| | | |
|--------------|--|----|
| Figure 1-74 | Remove the touchscreen control panel (2 of 4) | 51 |
| Figure 1-75 | Remove the touchscreen control panel (3 of 4) | 52 |
| Figure 1-76 | Remove the touchscreen control panel (4 of 4) | 52 |
| Figure 1-77 | Remove the power supply (1 of 3) | 53 |
| Figure 1-78 | Remove the power supply (2 of 3) | 54 |
| Figure 1-79 | Remove the power supply (3 of 3) | 54 |
| Figure 1-80 | Remove the backscatter drop detect assembly (1 of 2) | 55 |
| Figure 1-81 | Remove the backscatter drop detect assembly (2 of 2) | 56 |
| Figure 1-82 | Remove the service sled assembly (1 of 6) | 57 |
| Figure 1-83 | Remove the service sled assembly (2 of 6) | 58 |
| Figure 1-84 | Remove the service sled assembly (3 of 6) | 59 |
| Figure 1-85 | Remove the service sled assembly (4 of 6) | 59 |
| Figure 1-86 | Remove the service sled assembly (5 of 6) | 60 |
| Figure 1-87 | Remove the service sled assembly (6 of 6) | 60 |
| Figure 1-88 | Remove the web advance rack assembly (1 of 2) | 61 |
| Figure 1-89 | Remove the web advance rack assembly (2 of 2) | 62 |
| Figure 1-90 | Remove the right cross brace (1 of 4) | 63 |
| Figure 1-91 | Remove the right cross brace (2 of 4) | 64 |
| Figure 1-92 | Remove the right cross brace (3 of 4) | 64 |
| Figure 1-93 | Remove the right cross brace (4 of 4) | 65 |
| Figure 1-94 | Remove the plate console left | 66 |
| Figure 1-95 | Remove the plate console right (1 of 2) | 67 |
| Figure 1-96 | Remove the plate console right (2 of 2) | 68 |
| Figure 1-97 | Remove the printbar (1 of 12) | 69 |
| Figure 1-98 | Remove the printbar (2 of 12) | 69 |
| Figure 1-99 | Remove the printbar (3 of 12) | 70 |
| Figure 1-100 | Remove the printbar (4 of 12) | 70 |
| Figure 1-101 | Remove the printbar (5 of 12) | 71 |
| Figure 1-102 | Remove the printbar (6 of 12) | 72 |
| Figure 1-103 | Remove the printbar (7 of 12) | 72 |
| Figure 1-104 | Remove the printbar (8 of 12) | 73 |
| Figure 1-105 | Remove the printbar (9 of 12) | 73 |
| Figure 1-106 | Remove the printbar (10 of 12) | 74 |
| Figure 1-107 | Remove the printbar (11 of 12) | 74 |
| Figure 1-108 | Remove the printbar (12 of 12) | 75 |
| Figure 1-109 | Replace the printbar control FFCs (1 of 2) | 78 |
| Figure 1-110 | Replace the printbar control FFCs (2 of 2) | 78 |
| Figure 1-111 | Remove the platen (1 of 7) | 79 |
| Figure 1-112 | Remove the platen (2 of 7) | 80 |
| Figure 1-113 | Remove the platen (3 of 7) | 80 |
| Figure 1-114 | Remove the platen (4 of 7) | 81 |

| | | |
|--------------|---|-----|
| Figure 1-115 | Remove the platen (5 of 7) | 81 |
| Figure 1-116 | Remove the platen (6 of 7) | 82 |
| Figure 1-117 | Remove the platen (7 of 7) | 83 |
| Figure 1-118 | Remove the drying path gear assembly | 83 |
| Figure 1-119 | Remove the printbar lift motor (1 of 3) | 84 |
| Figure 1-120 | Remove the printbar lift motor (2 of 3) | 84 |
| Figure 1-121 | Remove the printbar lift motor (3 of 3) | 85 |
| Figure 1-122 | Remove the tray lift transmission assembly (1 of 2) | 86 |
| Figure 1-123 | Remove the tray lift transmission assembly (2 of 2) | 87 |
| Figure 1-124 | Remove the flap actuator solenoid | 88 |
| Figure 1-125 | Remove the rack-eject lifter flap (1 of 3) | 89 |
| Figure 1-126 | Remove the rack-eject lifter flap (2 of 3) | 89 |
| Figure 1-127 | Remove the rack-eject lifter flap (3 of 3) | 90 |
| Figure 1-128 | Remove the eject drive gear module | 90 |
| Figure 1-129 | Remove the output drive gears | 91 |
| Figure 1-130 | Remove the output drive shaft 6 (1 of 3) | 92 |
| Figure 1-131 | Remove the output drive shaft 6 (2 of 3) | 92 |
| Figure 1-132 | Remove the output drive shaft 6 (3 of 3) | 93 |
| Figure 1-133 | Remove the output drive shaft 5 (1 of 2) | 94 |
| Figure 1-134 | Remove the output drive shaft 5 (2 of 2) | 94 |
| Figure 1-135 | Remove the output drive shaft 4 (1 of 2) | 95 |
| Figure 1-136 | Remove the output drive shaft 4 (2 of 2) | 96 |
| Figure 1-137 | Remove drive shaft 3 (1 of 4) | 97 |
| Figure 1-138 | Remove drive shaft 3 (2 of 4) | 97 |
| Figure 1-139 | Remove drive shaft 3 (3 of 4) | 98 |
| Figure 1-140 | Remove drive shaft 3 (4 of 4) | 98 |
| Figure 1-141 | Remove the inner top frame (1 of 5) | 99 |
| Figure 1-142 | Remove the inner top frame (2 of 5) | 100 |
| Figure 1-143 | Remove the inner top frame (3 of 5) | 100 |
| Figure 1-144 | Remove the inner top frame (4 of 5) | 101 |
| Figure 1-145 | Remove the inner top frame (5 of 5) | 101 |
| Figure 1-146 | Remove the top paper guide (1 of 6) | 102 |
| Figure 1-147 | Remove the top paper guide (2 of 6) | 102 |
| Figure 1-148 | Remove the top paper guide (3 of 6) | 103 |
| Figure 1-149 | Remove the top paper guide (4 of 6) | 103 |
| Figure 1-150 | Remove the top paper guide (5 of 6) | 104 |
| Figure 1-151 | Remove the top paper guide (6 of 6) | 104 |
| Figure 1-152 | Remove the top left paper guide (1 of 4) | 105 |
| Figure 1-153 | Remove the top left paper guide (2 of 4) | 105 |
| Figure 1-154 | Remove the top left paper guide (3 of 4) | 106 |
| Figure 1-155 | Remove the top left paper guide (4 of 4) | 106 |

| | | |
|--------------|---|-----|
| Figure 1-156 | Remove the center left paper guide (1 of 4) | 107 |
| Figure 1-157 | Remove the center left paper guide (2 of 4) | 107 |
| Figure 1-158 | Remove the center left paper guide (3 of 4) | 108 |
| Figure 1-159 | Remove the center left paper guide (4 of 4) | 108 |
| Figure 1-160 | Remove the paper REDI sensors | 109 |
| Figure 1-161 | Correctly positioned service sled transmission | 110 |
| Figure 1-162 | Incorrectly positioned service sled transmission | 110 |
| Figure 1-163 | Remove the PCA safety shield (1 of 2) | 111 |
| Figure 1-164 | Remove the PCA safety shield (2 of 2) | 111 |
| Figure 1-165 | Remove the sensor carriage PCA and encoder strip (1 of 8) | 112 |
| Figure 1-166 | Remove the sensor carriage PCA and encoder strip (2 of 8) | 112 |
| Figure 1-167 | Remove the sensor carriage PCA and encoder strip (3 of 8) | 113 |
| Figure 1-168 | Remove the sensor carriage PCA and encoder strip (4 of 8) | 113 |
| Figure 1-169 | Remove the sensor carriage PCA and encoder strip (5 of 8) | 114 |
| Figure 1-170 | Remove the sensor carriage PCA and encoder strip (6 of 8) | 114 |
| Figure 1-171 | Remove the sensor carriage PCA and encoder strip (7 of 8) | 115 |
| Figure 1-172 | Remove the sensor carriage PCA and encoder strip (8 of 8) | 115 |
| Figure 1-173 | Remove the power button PCA (1 of 2) | 116 |
| Figure 1-174 | Remove the power button PCA (2 of 2) | 116 |
| Figure 1-175 | Remove the duplex module sensor PCA (1 of 2) | 117 |
| Figure 1-176 | Remove the duplex module sensor PCA (2 of 2) | 117 |
| Figure 1-177 | Remove the temperature sensor (1 of 2) | 118 |
| Figure 1-178 | Remove the temperature sensor (2 of 2) | 118 |
| Figure 1-179 | Remove the REDI distribution PCA (1 of 3) | 119 |
| Figure 1-180 | Remove the REDI distribution PCA (2 of 3) | 119 |
| Figure 1-181 | Remove the REDI distribution PCA (3 of 3) | 120 |
| Figure 1-182 | Remove the feed motor encoder sensor PCA (1 of 4) | 120 |
| Figure 1-183 | Remove the feed motor encoder sensor PCA (2 of 4) | 121 |
| Figure 1-184 | Remove the feed motor encoder sensor PCA (3 of 4) | 121 |
| Figure 1-185 | Remove the feed motor encoder sensor PCA (4 of 4) | 122 |
| Figure 1-186 | Remove the eject flap opto PCA | 123 |
| Figure 1-187 | Remove the printzone distribution PCA (1 of 3) | 124 |
| Figure 1-188 | Remove the printzone distribution PCA (2 of 3) | 124 |
| Figure 1-189 | Remove the printzone distribution PCA (3 of 3) | 125 |
| Figure 1-190 | Remove the media presence sensor PCA/flag (1 of 2) | 126 |
| Figure 1-191 | Remove the media presence sensor PCA/flag (2 of 2) | 126 |
| Figure 1-192 | Remove the main PCA (1 of 8) | 128 |
| Figure 1-193 | Remove the main PCA (2 of 8) | 128 |
| Figure 1-194 | Remove the main PCA (3 of 8) | 129 |
| Figure 1-195 | Remove the main PCA (4 of 8) | 129 |
| Figure 1-196 | Remove the main PCA (5 of 8) | 130 |

| | | |
|--------------|---|-----|
| Figure 1-197 | Remove the main PCA (6 of 8) | 130 |
| Figure 1-198 | Remove the main PCA (7 of 8) | 131 |
| Figure 1-199 | Remove the main PCA (8 of 8) | 131 |
| Figure 1-200 | Remove the Tray 3 interconnect PCA (1 of 2) | 135 |
| Figure 1-201 | Remove the Tray 3 interconnect PCA (2 of 2) | 135 |
| Figure 1-202 | Remove the pick encoder distribution PCA (1 of 2) | 136 |
| Figure 1-203 | Remove the pick encoder distribution PCA (2 of 2) | 136 |
| Figure 1-204 | Remove the wireless PCA. | 137 |
| Figure 2-1 | Front view (X451 Series) | 145 |
| Figure 2-2 | Front view (X551 Series) | 146 |
| Figure 2-3 | Back view | 147 |
| Figure 2-4 | Covers, panels, and doors | 148 |
| Figure 2-5 | Internal assemblies (1 of 3) | 150 |
| Figure 2-6 | Internal assemblies (2 of 3) | 152 |
| Figure 2-7 | Internal assemblies (3 of 3) | 154 |
| Figure 2-8 | PCA locations (1 of 2) | 156 |
| Figure 2-9 | PCA locations (2 of 2) | 158 |

1 Removal and replacement

- [Removal and replacement strategy](#)
- [Service approach](#)
- [Removal and replacement procedures](#)

Removal and replacement strategy

 **WARNING!** Turn the product off, wait 5 seconds, and then remove the power cord before attempting to service the product. If this warning is not followed, severe injury can result, in addition to damage to the product. The power must be on for certain functional checks during problem solving. However, the power supply should be disconnected during parts removal.



The sheet-metal parts can have sharp edges. Be careful when handling sheet-metal parts.

 **CAUTION:** Many repair operations will require you to flatten or straighten flex cables. However, where possible, try to avoid doing so. You *must* make sure that all FFCs are fully seated in their connectors. Failure to fully seat an FFC into a connector can cause a short circuit in a PCA.

 **NOTE:** To install a self-tapping screw, first turn it counterclockwise to align it with the existing thread pattern, and then carefully turn it clockwise to tighten. Do not overtighten. If a self-tapping screw-hole becomes stripped, repair the screw-hole or replace the affected assembly.

Throughout this chapter, the reinstallation process should follow the reverse order of the removal process documented. Where necessary, the tasks include reinstallation tips to aid in the installation of replacement parts.

Electrostatic discharge

 **CAUTION:**  Some parts are sensitive to electrostatic discharge (ESD). Look for the ESD reminder when removing product parts. Always perform service work at an ESD-protected workstation or mat. If an ESD workstation or mat is not available, ground yourself by touching the sheet-metal chassis *before* touching an ESD-sensitive part.

Protect the ESD-sensitive parts by placing them in ESD pouches when they are out of the product.

Required tools

- #T10 TORX driver with a magnetic tip and a 152 mm (6 in) shaft length
- #T10 TORX driver with a magnetic tip and a 25 mm (1 in) shaft length
- Small flat-blade screwdriver
- Needle-nose pliers
- Tweezers
- ESD mat (if one is available) or ESD strap
- Penlight
- One-quarter inch nut driver (for use with the OfficeJet Pro X special tools kit)

⚠ CAUTION: While the use of a motorized screwdriver is recommended, the screwdriver must have a torque limiter, and it must be set to a low torque.

OfficeJet Pro X special tools kit

The OfficeJet Pro X special tools kit (part number CN598-67056) is required for replacing the service sled and printbar assemblies.

The OfficeJet Pro X special tools kit contains the following parts:

- Ink supply door switch—used to tell the printer that the supply door is closed when the front cover is removed.

Figure 1-1 OfficeJet Pro X special tools—ink supply door switch

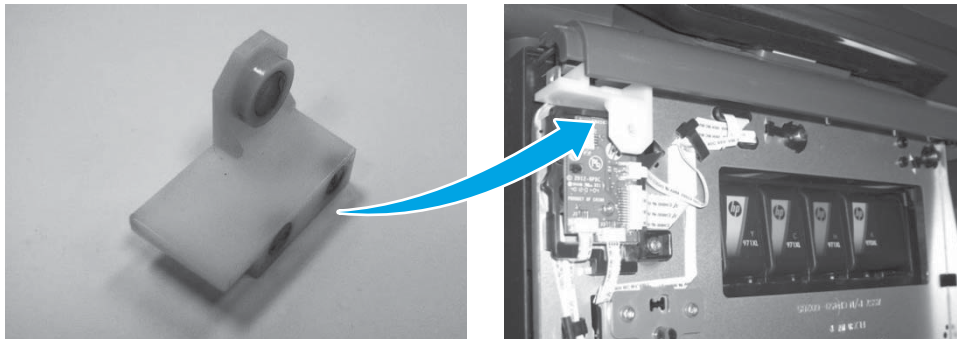

- Printbar lift knob—used for lifting and holding the printbar.

 **NOTE:** Use a one-quarter inch nut driver to raise the printbar.

Figure 1-2 OfficeJet Pro X special tools—printbar lift knob



- Service sled advance tool—used to remove and reinstall the service sled.

 **NOTE:** Use a one-quarter inch nut driver to remove or install the service sled

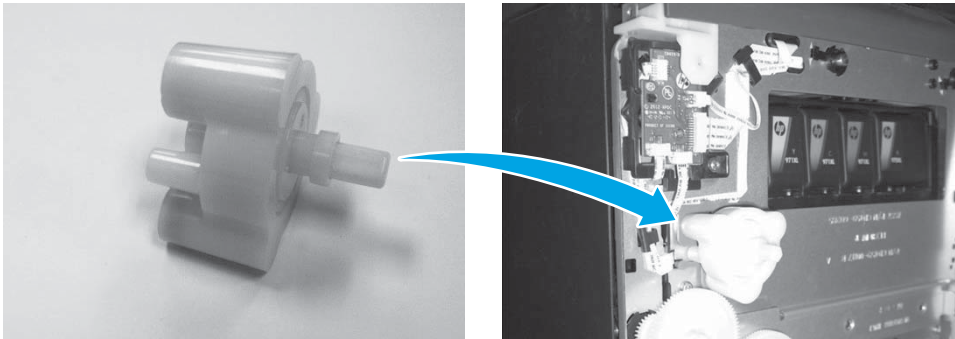
Figure 1-3 OfficeJet Pro X special tools—service sled advance tool



- Printbar dolly—used to support the printbar during removal and installation.

Figure 1-4 OfficeJet Pro X special tools—printbar dolly

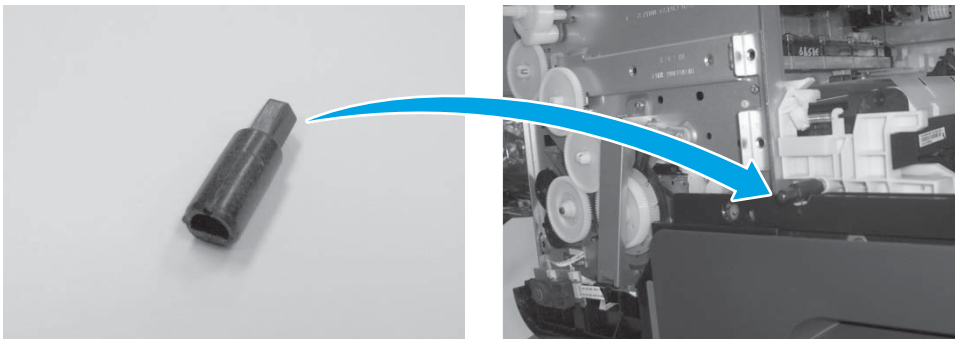
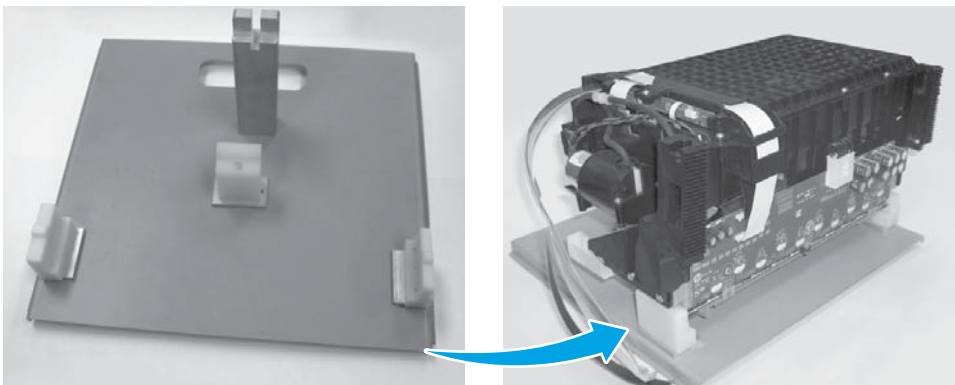

Advanced Cleaning Kit

The Advanced Cleaning Kit (part number CN459-67006) is used for resolving shim whiskers print quality issues.

The Advanced Cleaning Kit contains the following items:

- Sheet cleaner - full mid
- Shim whisker kit Instructions
- Corrugated box
- Corrugated insert

Service approach

 **IMPORTANT:** Ensure the product has the latest firmware installed for the initial installation of the product. Certain repairs to this product also require updated firmware, as noted in this document. Download firmware for this product at www.hp.com.

 **CAUTION:** When working on the product, do not pick up the unit by the output tray, which will likely detach under the weight of the product.

Before performing service

- Remove all paper from the product.
- Turn off the power using the power button.
- Unplug the power cable and interface cable or cables.
- Remove the output bin.
- Place the product on an ESD workstation or mat, or use an ESD strap (if one is available). If an ESD workstation, mat, or strap is not available, ground yourself by touching the sheet-metal chassis *before* touching an ESD-sensitive part.
- Remove the Tray 2 cassette.
- Remove the duplex module, which is located inside the left door.

 **NOTE:** When removing the duplex module, avoid making direct contact with the black cylinder to prevent ink smear on skin or clothes. Keep the duplex module level to avoid spilling any maintenance ink.

After performing service

- Plug in the power cable.
- Reinstall the output bin.
- Reinstall the ink cartridges (if they were removed prior to performing service).
- Reinstall the Tray 2 cassette.
- Reinstall the duplex module.
- Load paper in the product.

Post-service test

Perform the following test to verify that the repair or replacement was successful.

Print-quality test

1. Verify that the necessary reassembly steps have been completed.
2. Make sure that the tray contains clean, unmarked paper.
3. Attach the power cord and interface cable or interface cables, and then turn on the product.
4. Verify that the expected startup sounds occur.
5. Print a configuration page, and verify that the expected printing sounds occur.
6. Print a print-quality page, and then verify that there are no lines, streaks, banding, or other print quality defects.
7. Send a print job from the host computer, and then verify that the output meets expectations.
8. Clean the outside of the product with a damp cloth.

Removal and replacement procedures

 **NOTE:** Due to time constraints in producing this manual, the product might look slightly different than what is depicted in the photographs in this section. Most changes will be cosmetic in nature and should not affect the repair procedures.

Customer replaceable parts

Tray 2

1. Pull out the tray.

Figure 1-5 Remove Tray 2 (1 of 2)

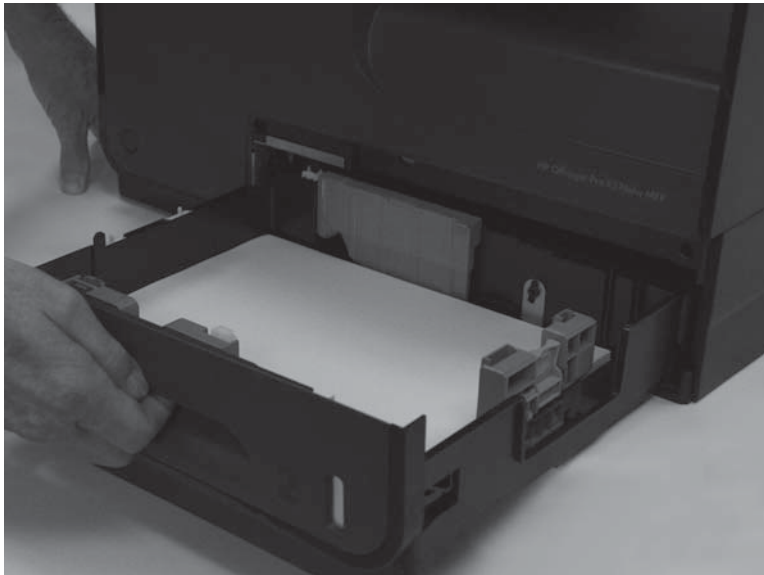

2. Press the latch in left-rear corner of the tray.

Figure 1-6 Remove Tray 2 (2 of 2)

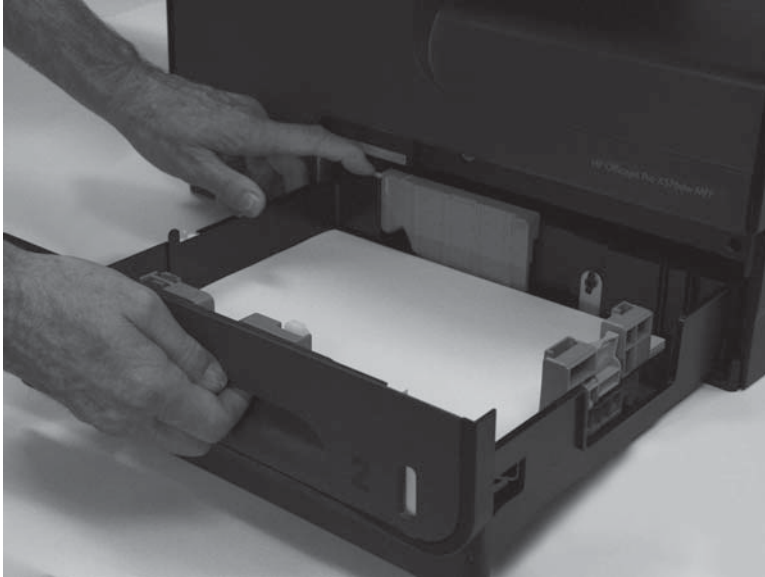

3. Remove the tray from the product.

Ink cartridges

The product uses four colors and has a different ink cartridge for each color: yellow (Y), cyan (C), magenta (M), and black (K).

1. Open the ink cartridge access door.

Figure 1-7 Replace the ink cartridges (1 of 7)



2. Push the old ink cartridge inward to unlock it.

Figure 1-8 Replace the ink cartridges (2 of 7)

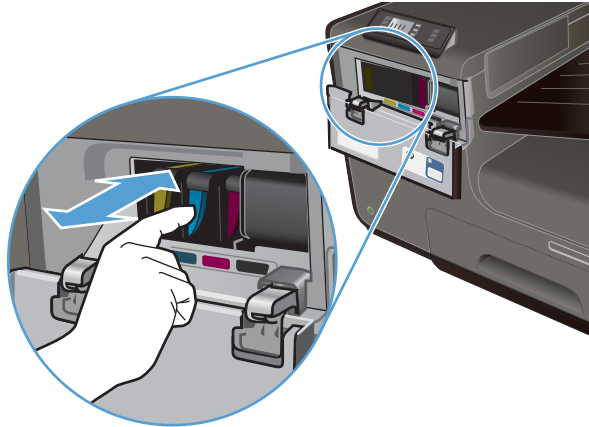

3. Grasp the edge of the old ink cartridge, and then pull the cartridge straight out to remove it.

Figure 1-9 Replace the ink cartridges (3 of 7)

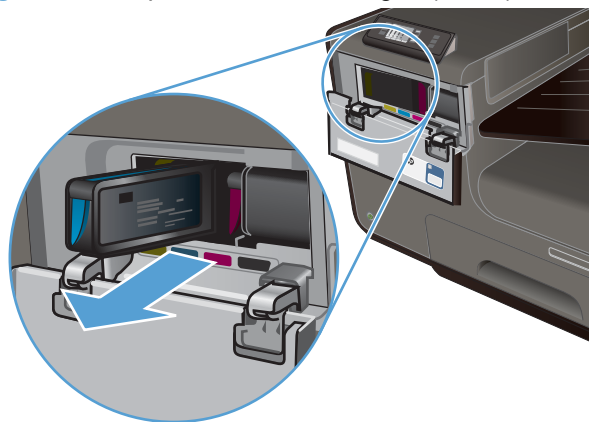

4. Remove the new ink cartridge from the packaging.

Figure 1-10 Replace the ink cartridges (4 of 7)

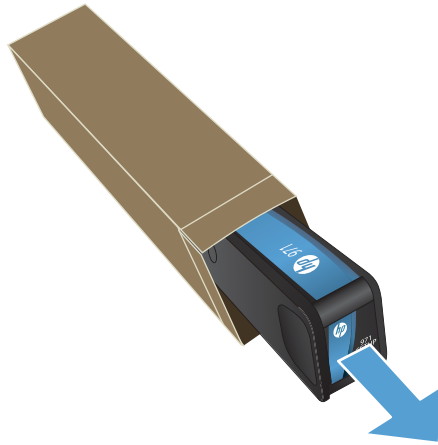

 **NOTE:** Do not touch the metal connector of the ink cartridge. Fingerprints on the connector can cause product operation problems.

Figure 1-11 Replace the ink cartridges (5 of 7)



5. Insert the new ink cartridge into the product.

Figure 1-12 Replace the ink cartridges (6 of 7)

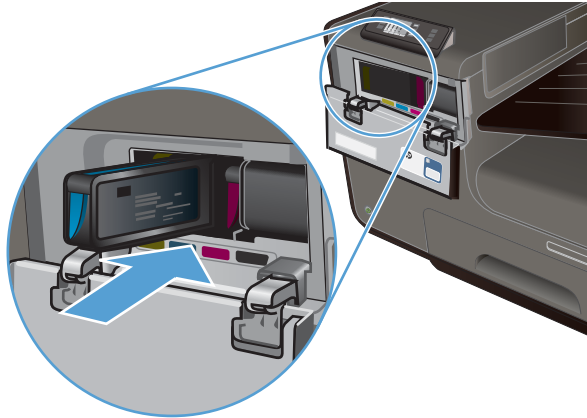

6. Close the ink cartridge door.

Figure 1-13 Replace the ink cartridges (7 of 7)



7. Place the old ink cartridge in the box, and refer to the HP recycling instructions at www.hp.com/recycle.

Duplex module

1. Open the left door.

Figure 1-14 Remove the duplex module (1 of 2)

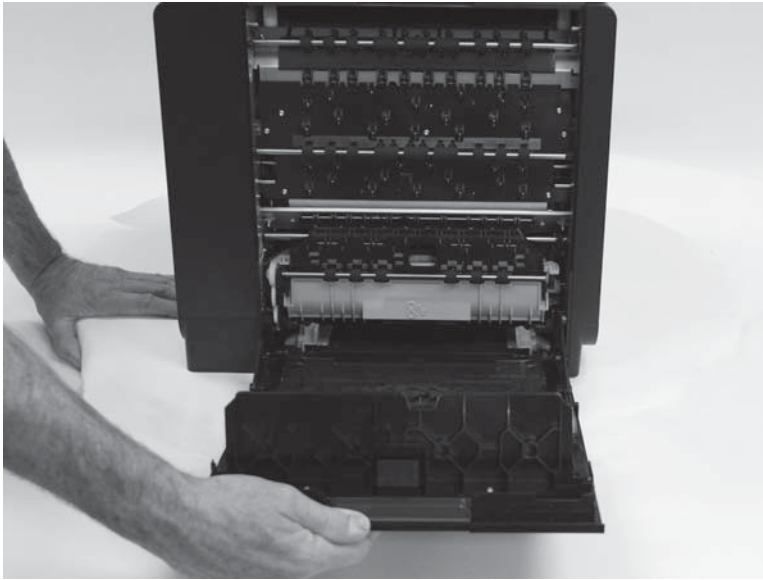

2. Pull the duplex module out of the product.

Figure 1-15 Remove the duplex module (2 of 2)



 **NOTE:** When removing the duplex module, avoid making direct contact with the black cylinder to prevent ink smear on skin or clothes. Keep the duplex module level to avoid spilling any maintenance ink.

When removing the duplex module, do not let the bottom of the duplex module touch or rest on the ribs on the left door, which will damage them and might lead to paper damage and jams.

Output bin

- ▲ Lift and remove the output bin.

Figure 1-16 Remove the output bin



Output bin flap

1. Remove the output bin. See [Output bin on page 13](#).
2. Flex the middle of the output bin flap, and then remove the flap by pulling the rear pin (callout 1) away from the product first.

Figure 1-17 Remove the output bin flap



 **Reinstallation tip** With the flap in the open position, insert the front pin into the product first, and then flex or bend the flap to install the rear pin.

Menu access

These hidden engineering menus are used for testing and calibration. Some or all of them are referenced in remove and replace sections as required.

WARNING! Misuse of these menus could damage the product or make it unusable.

NOTE: These buttons are not illuminated until they are touched with sufficient pressure. Locate these buttons by sweeping your finger over the general areas indicated in [Figure 1-18 X451 control panel button locations on page 14](#).

Figure 1-18 X451 control panel button locations



Figure 1-19 X551 control panel button locations

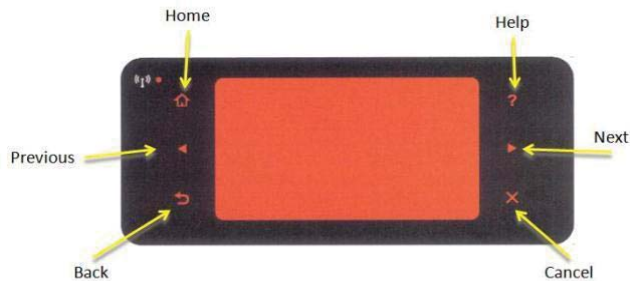

Access the Engineering menu

X451

1. Press the Cancel **X** button.
2. Press the Back **↶** button.
3. Press the Cancel **X** button twice.

X551

1. Touch the Home **🏠** button.
2. Touch the Back **↶** button.
3. Touch the Home **🏠** button twice to enter the [Engineering menu](#).

NOTE: The [Service menu](#) is accessed from the [Engineering menu](#).

Access the Support Menu

X451

1. Press the Back ↩ button.
2. Press the Cancel ✕ button.
3. Press the Back ↩ button twice.

X551

- ▲ Touch the Back ↩ button four times consecutively to open the [Support Menu](#).



NOTE: The [Support Menu](#) is usually used by HP call center agents for assisting customers.

Place the product into MFG (manufacturing) mode



NOTE: These two modes are ONLY to be used by authorized service providers. They should NEVER be accessed by the end user.

X451

1. Press and hold the [ATM1](#) and [ATM2](#) buttons while plugging in the product.
2. Press the power button to enter MFG (on) mode.

X551

1. Press and hold the power button while plugging in the product. The HP logo appears on the product control panel, and then disappears. Continue to hold the power button for five seconds after the logo disappears.
2. Release the power button.
3. Touch the Home 🏠 button.
4. Touch the Back ↩ button.
5. Touch the Home 🏠 button twice.
6. After a new screen appears, touch the Home 🏠 button again to enter MFG (off) mode.
7. Press the power button to enter MFG (on) mode.

Place the product into Audit mode









NOTE: These two modes are ONLY to be used by authorized service providers. They should NEVER be accessed by the end user.

X451

- ▲ Press and hold the [ATM1](#) and [ATM3](#) buttons while plugging in the product.

 **WARNING!** Audit mode is used only when the main PCA is replaced.

1. Press and hold the power button while plugging in the product. The HP logo appears on the control panel, and then disappears. Continue to hold the power button for five seconds after the logo disappears.
2. Release the power button.
3. Touch the Home  button.
4. Touch the Back  button
5. Touch the Home  button twice.
6. Touch the  button.
7. Press the power button.

 **NOTE:** The product touchscreen is not active in this menu access mode. Use the  and  buttons on the control panel frame.

Perform tap tests and interpret results

Perform a tap test

1. Open the Engineering Menu. See [Access the Engineering menu on page 14](#).
2. Touch [Manufacturing Menu](#).
3. Use the arrow key to find the [Reports Menu](#), and then touch the [OK](#) button.
4. Use the arrow key to find the [Print-mech tap tests](#), and then touch the [OK](#) button.
5. Use the arrow key to find the tap test to run.

10 tap test results (OOBE States)

The printed tap test results contain a sequence of numbers at line number 68, "Startup Complete," of the printed report.

Use the following table to interpret these numbers.

Table 1-1 10 tap test results, row 68

| Column | Code | Acceptable values |
|----------|-------------------------------|--|
| Column 1 | DSID_PEN_PRINTER_STARTUP_BITS | A value of 1 indicates that the printbar has been started up. This means that shipping fluid has been removed from the printbar and replaced with ink. This is the expected state for a printer after initialization. |
| Column 2 | DSID_OOBE_STATE | 255—OOBE messaging complete. |
| Column 3 | DSID_INK_SUPPLY_OOBE_COMPELTE | 1—SHF purge is complete and service wipes have been enabled. |
| Column 4 | DSID_CAL_OOBE_STATE | A value of 2 means that the OOBE printed calibrations are complete. A value of 1 means the OOBE printed calibrations are in progress. A value of 0 means the OOBE printed calibration does not exist so no printing/calibration for OOBE is attempted. |
| Column 5 | DSID_IQ_LIST_INDEX | A value of 3 means that pen height and beam center have been completed, and that BDD is scheduled (or pending) to perform normally. NOTE: For 1315FR firmware and above. |
| Column 6 | DSID_BDD_FAIL_MASK | 0—internal use only. |

Table 1-1 10 tap test results, row 68 (continued)

| Column | Code | Acceptable values |
|----------|--------------------------------|---|
| Column 7 | DSID_IDS_FIRST_CHARGE_REQUIRED | 0—internal use only. |
| Column 8 | DSID_PRINTHEAD_CAL_NEEDED | A value of 0 indicates that OOB calibrations (not IQ calibrations) are complete. This is so the messaging is complete for the calibrations. For example, if this value is 0, but the CAL_OOB_STATE=1, you will get the printed OOB calibrations, but the control panel may display Preparing instead of Calibrating . |

Figure 1-20 10 tap test results

Printer Hardware Information

Extended Self Test Diagnostic Page - 1 of 2





Product Information

11. Product Name: HP Officejet Pro 8540 MFP series
 12. Product Number: CN598A
 13. Serial Number: CN2M09J0DS
 14. Service ID: 22334
 15. Date/Time: 11/5/2013 13:46:58
 16. Printer ID: 0
 17. Default Symbol Set: 341
 18. Total Page Count: 611
 19. Duplex Page Count: 42

Revision Information

24. Main PCA Revision: ID: 20616 MFG: 5 FAN: 4 NUM: 8
 25. Digital ASIC: SHEMP Rev A.3 Mfg: Marvell
 26. Analog ASIC: 1- REV: 0 MFG: 0, 2- REV: 0 MFG: 0
 27. Firmware Version: L2PICNL336MR
 28. Flows Revision: OFFICIAL
 29. Patch Revision: 0
 33. Duplexer Installed: Yes

Ink Delivery System Information

| | | | | |
|----------------------------|---|---|---|---|
| 43. Ink Supply: | Yellow | Cyan | Magenta | Black |
| 44. Ink Level: |  F |  F |  F |  F |
| 45. Ink Status: | Ready | Ready | Ready | Ready |
| 47. Ink Status Slider: | 200 | 200 | 200 | 200 |
| 48. Selectability Number: | 971XL | 971XL | 971XL | 970XL |
| 49. SHAID Status: | 0 | 0 | 0 | 0 |
| 50. SHAID Function: | 0 | 0 | 0 | 0 |
| 51. Host/Trade Acumen Bit: | 0 | 0 | 0 | 0 |
| 52. Start Up Complete: | 0 | 0 | 0 | 0 |
| 53. Supply Serial Number: | 178009178 | 182981570 | 178533525 | 183277097 |
| 54. Mfg. Date: | 10/14/2012 | 11/18/2012 | 10/21/2012 | 11/18/2012 |
| 55. Ink Install: | 01/01/2013 | 01/01/2013 | 01/01/2013 | 01/01/2013 |
| 56. Warranty Ends: | 10/15/2014 | 11/19/2014 | 10/22/2014 | 11/19/2014 |
| 57. Warranty Status: | OK | OK | OK | OK |
| 58. RHID: 0 | | | | |
| 59. IRO: 00 | | | | |

Print Head Assembly Information

60. TVAL: 190
 61. Total Dot Count (Kilo dots):
 a. Magenta: 1979745
 b. Cyan: 1662998
 c. Yellow: 1869496
 d. Black: 1000000

68. Startup complete: 1 255 1 2 0 0 0 0

| | | | | | | |
|-----------------------------|-------------|-------------|-------------|-------------|-------------|-------------|
| 69. NUMBER OF CALIBRATIONS: | PEN_ALIGN_0 | PEN_ALIGN_1 | PEN_ALIGN_2 | COLOR_CAL_0 | COLOR_CAL_1 | COLOR_CAL_2 |
| Success: | 1 | 1 | 1 | 1 | 1 | 1 |
| Failed: | 0 | 0 | 0 | 0 | 0 | 0 |

12 tap test results (REDI sensor values)

Table 1-2 12 tap test report

| Callout | Report area | Item | Acceptable values |
|----------------|--|---|--|
| 1 | Print Humidity Sensor Data | Stable Relative Humidity | 0–100 RH |
| 2 | Pen TSR Ambient Temperature Estimate | Pen TSR Ambient Temperature x10 °C | ± 10 °C of current ambient temperature |
| 3 | Digital Temperature Sensor Ambient Temperature | Digital Temperature Sensor Ambient Temperature x10 °C | ± 10 °C of current ambient temperature |
| 4 | Print REDI Sensor Calibration Data | TOF sensor, p value ¹ | Between 10 and 100 |
| 5 | Print REDI Sensor Calibration Data | TOF sensor, m value ¹ | Between 25 and 380 |

¹ "M" is mirror result, "P" is blocked with paper.

Figure 1-21 12 tap test report

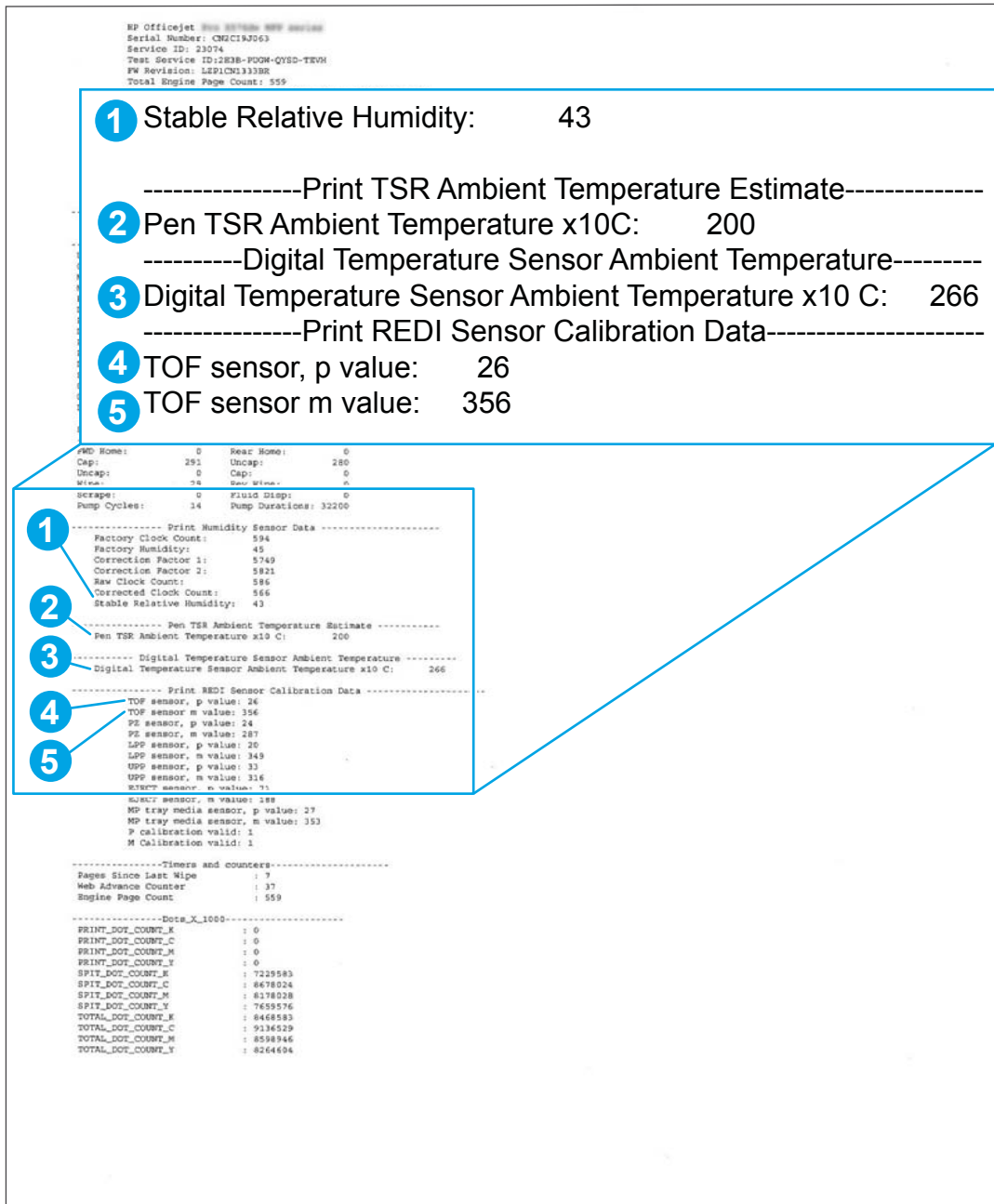

61 tap results (Align & color calibrations)

 **NOTE:** If you press and hold the up or down arrows, the tap count will start incrementing by 10, or 100

An acceptable 61 tap test has identical values for the parameters in the “Color scale (factory)” (callout 1) and “Color scale (current)” (callout 2) on the printed report areas. “Color scale (factory)” (callout 1) and “Color scale (current)” will be identical after a main PCA replacement, but may not be the same under other conditions. The values should also be identical after a printbar replacement

Figure 1-22 61 tap test results

```

*****
WRITING SYSTEM CALIBRATION REPORT
*****

* ledb : 14
* ledb so saturation : 14

* pen_to_sim_X(isero column) #7200: -45
* pen_to_sim_Y(tof) #7200: 0
* Measured zero column and tof #7200:
* Tray: Main      MP      Accessory
* side: Front    Back    Front    Back    Front    Back
* Z-Col: 0        0        0        0        0        0
* TOF: 0         0        0        0        0        0

error type:      sensor_n_target centroid lphase ledb vernier l_sigma analysis
* Last pen align 0 status = 0x0 : 0 0 0 0 0 0 0 0 0 0
* Last pen align 1 status = 0x0 : 0 0 0 0 0 0 0 0 0 0
* Last pen align 2 status = 0x0 : 0 0 0 0 0 0 0 0 0 0

* Last pen align analysis die status(hex) for page 0: 0 0 0 0 0 0 0 0 0 0
* Last pen align analysis die status(hex) for page 1: 0 0 0 0 0 0 0 0 0 0
* Last pen align analysis die status(hex) for page 2: 0 0 0 0 0 0 0 0 0 0

* Last successful pen alignment values in NVM:
* Pen die X alignment(factory) #7200:
* die: 0 1 2 3 4 5 6 7 8 9
* K: -24 -6 -6 0 6 6 6 18 18 24
* C: -24 -6 -6 0 6 6 6 18 18 24

= Color scale (factory) :
= dia: 0 1 2 3 4 5 6 7 8 9
1 = K: 0x7eec 0x7f3c 0x8265 0x8280 0x8215 0x8070 0x7fcf 0x804b 0x7cea 0x7d65
  = C: 0x7d51 0x7fbo 0x8063 0x81b5 0x80c5 0x81a1 0x7fc5 0x80ed 0x7dea 0x7fe6
  = M: 0x7d51 0x7fbo 0x8063 0x81b5 0x80c5 0x81a1 0x7fc5 0x80ed 0x7dea 0x7fe6
  = Y: 0x7d51 0x7fbo 0x8063 0x81b5 0x80c5 0x81a1 0x7fc5 0x80ed 0x7dea 0x7fe6

= Color scale (factory) :
= dia: 0 1 2 3 4 5 6 7 8 9
2 = K: 0x7eec 0x7f3c 0x8265 0x8280 0x8215 0x8070 0x7fcf 0x804b 0x7cea 0x7d65
  = C: 0x7d51 0x7fbo 0x8063 0x81b5 0x80c5 0x81a1 0x7fc5 0x80ed 0x7dea 0x7fe6
  = M: 0x7d51 0x7fbo 0x8063 0x81b5 0x80c5 0x81a1 0x7fc5 0x80ed 0x7dea 0x7fe6
  = Y: 0x7d51 0x7fbo 0x8063 0x81b5 0x80c5 0x81a1 0x7fc5 0x80ed 0x7dea 0x7fe6

* Last density cal analysis die status(hex) for page 1: 0 0 0 0 0 0 0 0 0 0
* Last density cal analysis die status(hex) for page 2: 0 0 0 0 0 0 0 0 0 0

* Last successful density cal values in NVM:

1 = Color scale (factory):
= dia: 0 1 2 3 4 5 6 7 8 9
  = K: 0x7eec 0x7f3c 0x8265 0x8280 0x8215 0x8070 0x7fcf 0x804b 0x7cea 0x7d65
  = C: 0x7d51 0x7fbo 0x8063 0x81b5 0x80c5 0x81a1 0x7fc5 0x80ed 0x7dea 0x7fe6
  = M: 0x7d51 0x7fbo 0x8063 0x81b5 0x80c5 0x81a1 0x7fc5 0x80ed 0x7dea 0x7fe6
  = Y: 0x7d51 0x7fbo 0x8063 0x81b5 0x80c5 0x81a1 0x7fc5 0x80ed 0x7dea 0x7fe6

2 = Color scale (factory):
= dia: 0 1 2 3 4 5 6 7 8 9
  = K: 0x7eec 0x7f3c 0x8265 0x8280 0x8215 0x8070 0x7fcf 0x804b 0x7cea 0x7d65
  = C: 0x7d51 0x7fbo 0x8063 0x81b5 0x80c5 0x81a1 0x7fc5 0x80ed 0x7dea 0x7fe6
  = M: 0x7d51 0x7fbo 0x8063 0x81b5 0x80c5 0x81a1 0x7fc5 0x80ed 0x7dea 0x7fe6
  = Y: 0x7d51 0x7fbo 0x8063 0x81b5 0x80c5 0x81a1 0x7fc5 0x80ed 0x7dea 0x7fe6

* Last successful calibration at page count: 552
* Last failed calibration at page count: 0
* Last Calibration at page count: 552

Number of Calibrations: PEN_ALIGN_0  PEN_ALIGN_1  PEN_ALIGN_2  COLOR_CAL_0  COLOR_CAL_1  COLOR_CAL_2
Success: 3 3 3 2 2 2
Failed: 0 0 0 0 0 0
    
```

909 tap test results (BDD status)

NOTE: If you press hold the up or down arrows, the tap count will start incrementing by 10, or 100

An acceptable 909 tap test has the following values:

- BDD is operating (callout 1)
- Cal OOB is complete state=2 (callout 2)
- Cal IQ is in pending, index=1 (callout 3)

Figure 1-23 909 tap test results

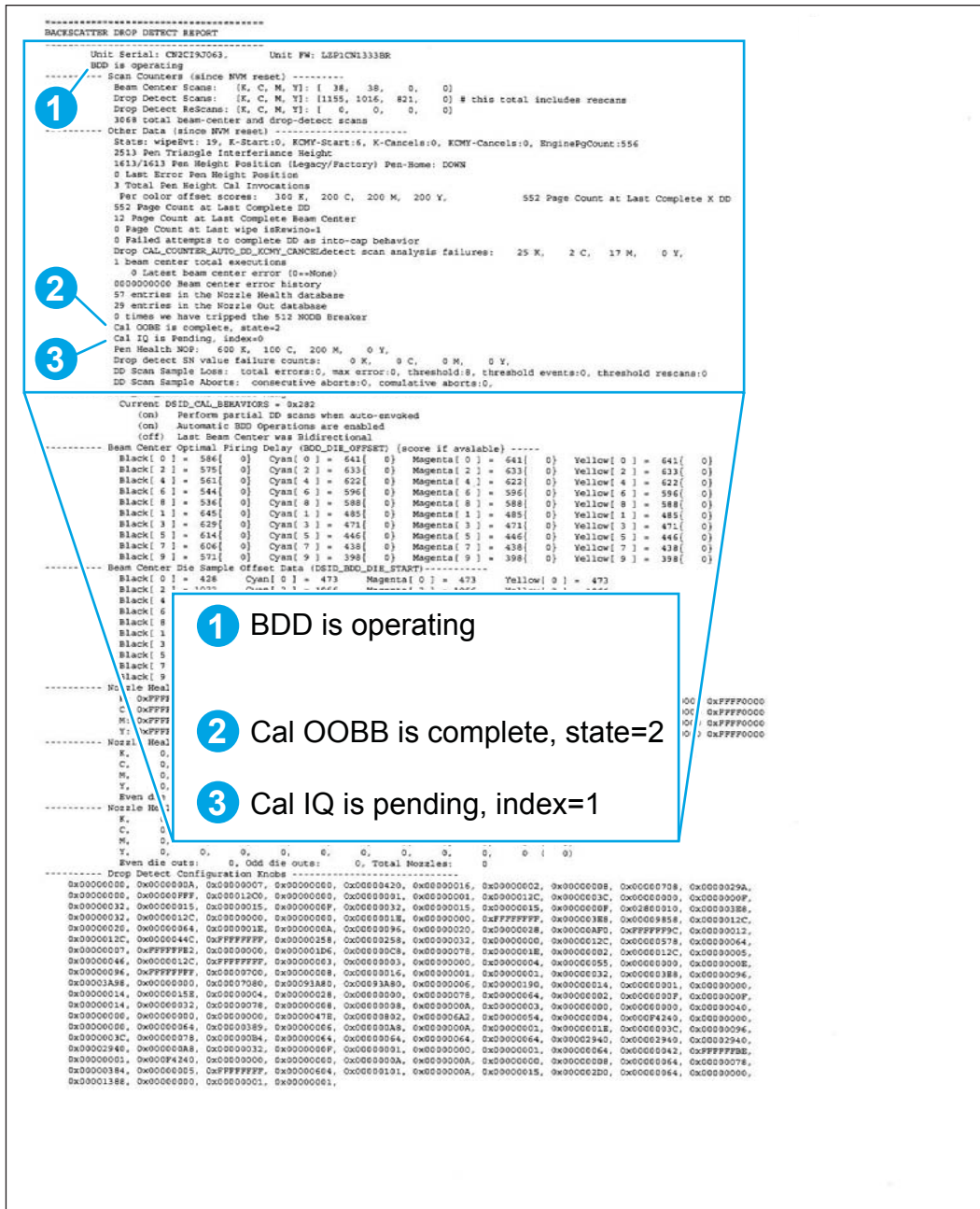

Covers

Rear cover

1. Remove the left rear cover. See [Left rear cover on page 27](#).
2. Remove one screw (callout 1).

Figure 1-24 Remove the rear cover (1 of 2)

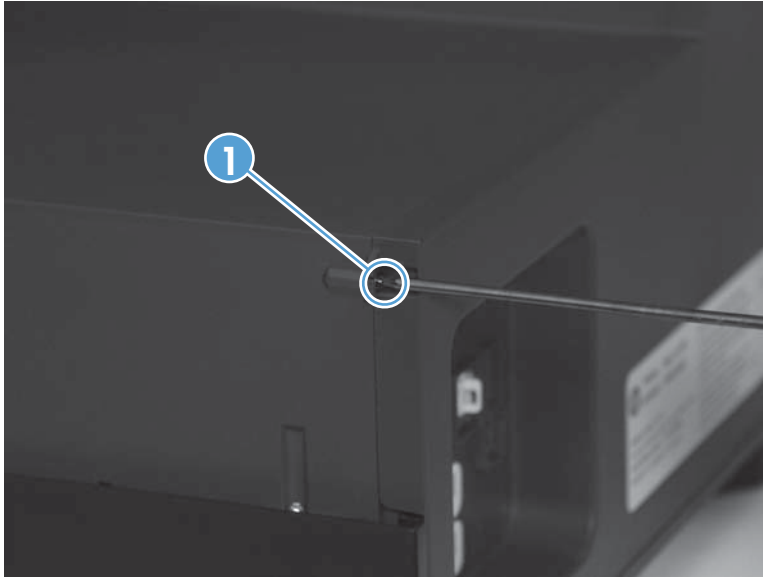

3. Pull the cover to the right, and then remove it.

Figure 1-25 Remove the rear cover (2 of 2)

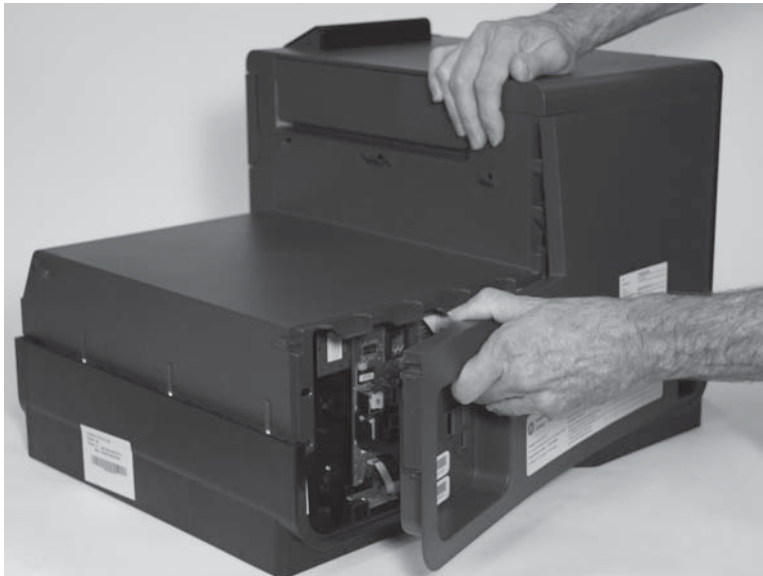

Left door

1. Open the left door.

Figure 1-26 Remove left door (1 of 6)

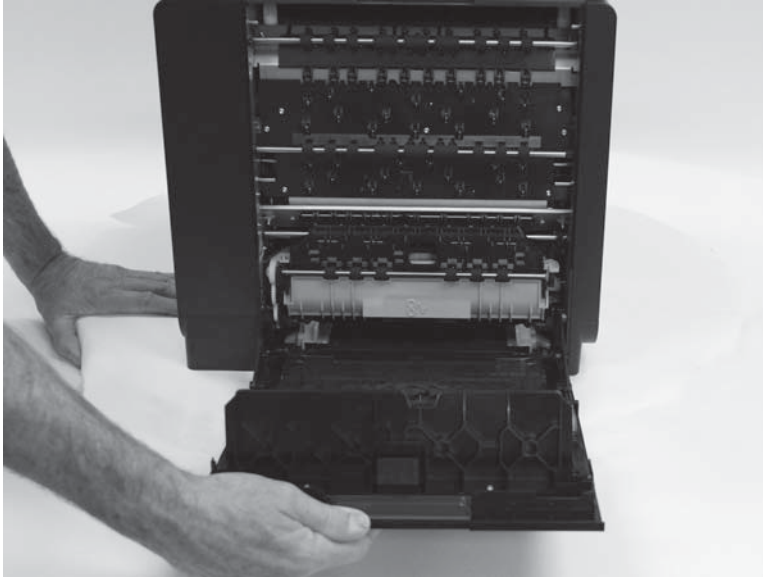

2. Remove the duplex module.

Figure 1-27 Remove the left door (2 of 6)



3. Unhook each restraining strap by twisting the bottom end of the strap away from the door.

Figure 1-28 Remove the left door (3 of 6)



4. Underneath the rear door hinge, locate the catch lever.

Figure 1-29 Remove the left door (4 of 6)



The following figure shows the tab on the underside of the product.

Figure 1-30 Remove the left door (5 of 6)

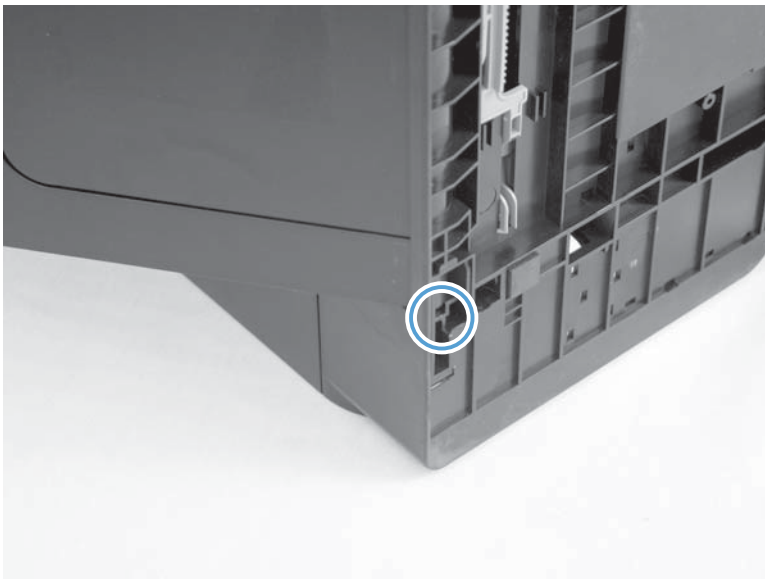

5. While pushing the catch lever to the rear of the product, rotate the door to the right, and then remove the door.

Figure 1-31 Remove the left door (6 of 6)



Left rear cover

1. Remove the left door. See [Left door on page 24](#).
2. Remove two screws (callout 1).

Figure 1-32 Remove the left rear cover (1 of 2)

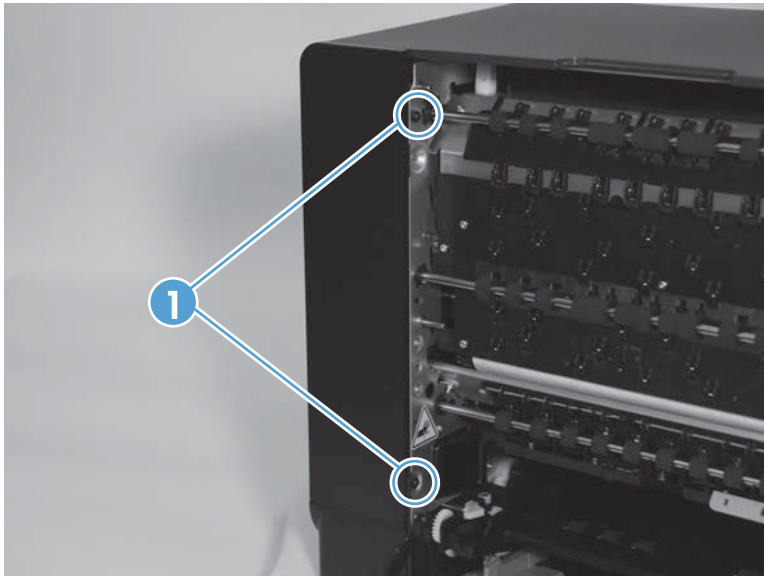

3. Remove the cover by sliding the cover up 10 mm (0.4 in), and then rotating the cover away from the product.

Figure 1-33 Remove the left rear cover (2 of 2)



Left front cover

1. Remove the left door. See [Left door on page 24](#).
2. Remove one screw (callout 1).

Figure 1-34 Remove the left front cover (1 of 2)

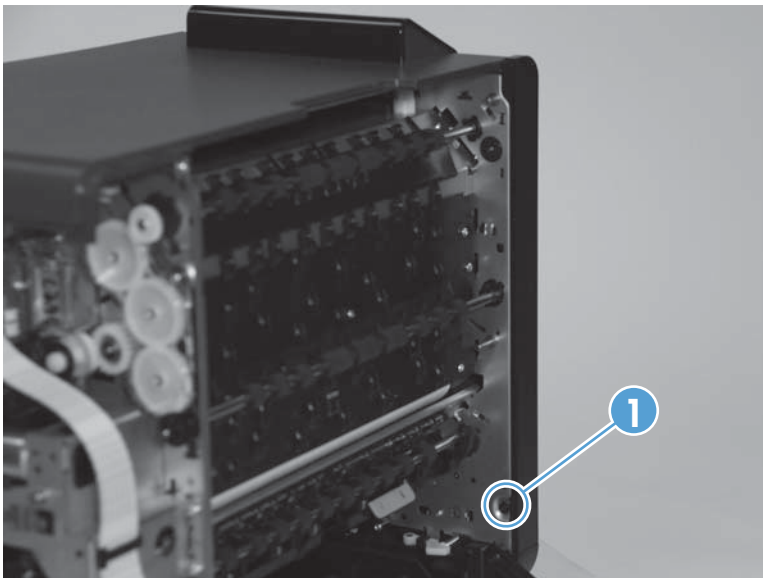

3. Use a screwdriver to depress the tab (callout 1), and then remove the cover (callout 2) by sliding the cover up 10 mm (0.4 in), and then rotating the cover away from the product.

Figure 1-35 Remove the left front cover (2 of 2)

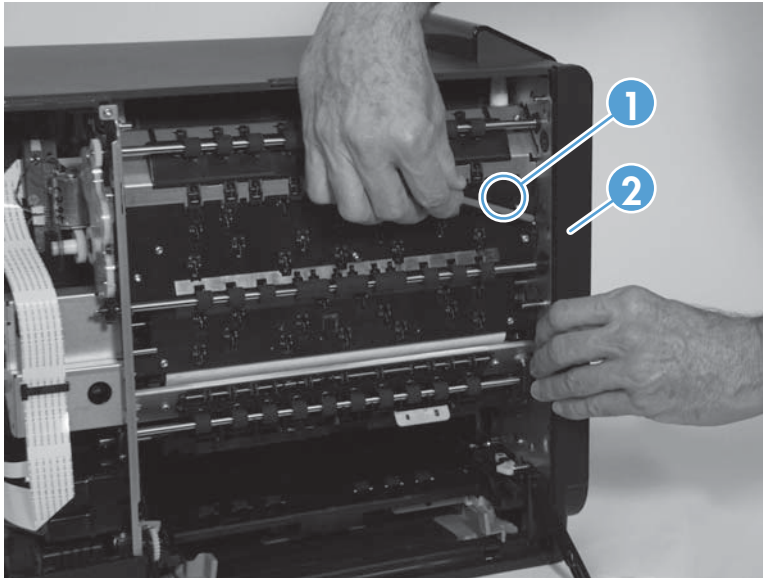

Top cover

1. Remove the following components:
 - Rear cover. See [Rear cover on page 23](#).
 - Left door. See [Left door on page 24](#).
 - Left rear cover. See [Left rear cover on page 27](#).
 - Left front cover. See [Left front cover on page 28](#).
 - Output bin flap. See [Output bin flap on page 13](#).

2. **X551 models:** On the top cover, remove three screws (callout 1) from behind the control panel, and then pull the control panel away from the top cover.

Figure 1-36 Remove the top cover (1 of 8)

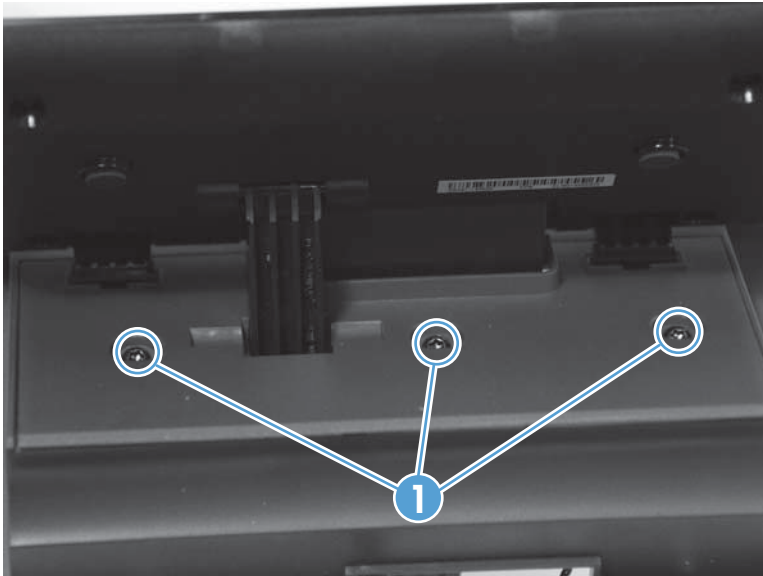

3. **X551 models:** In the control panel cavity, remove one screw (callout 1).

Figure 1-37 Remove the top cover (2 of 8)

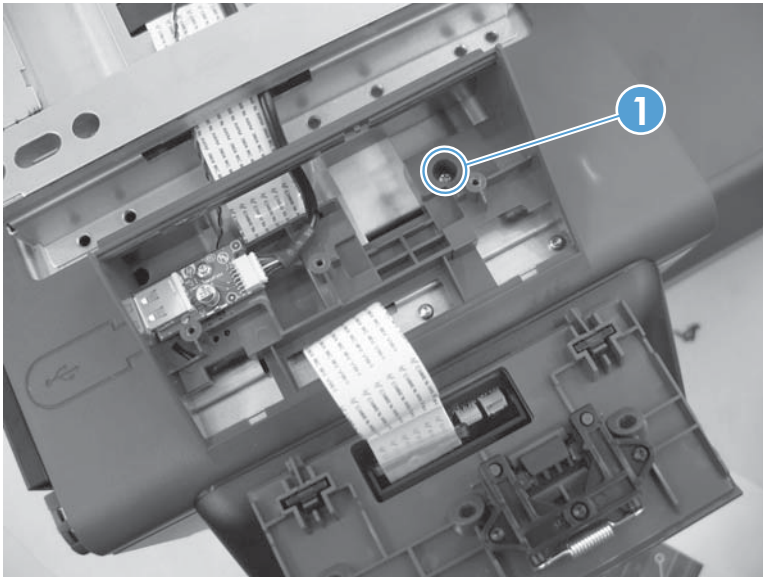

4. Remove two screws (callout 1).

Figure 1-38 Remove the top cover (3 of 8) – X451 models

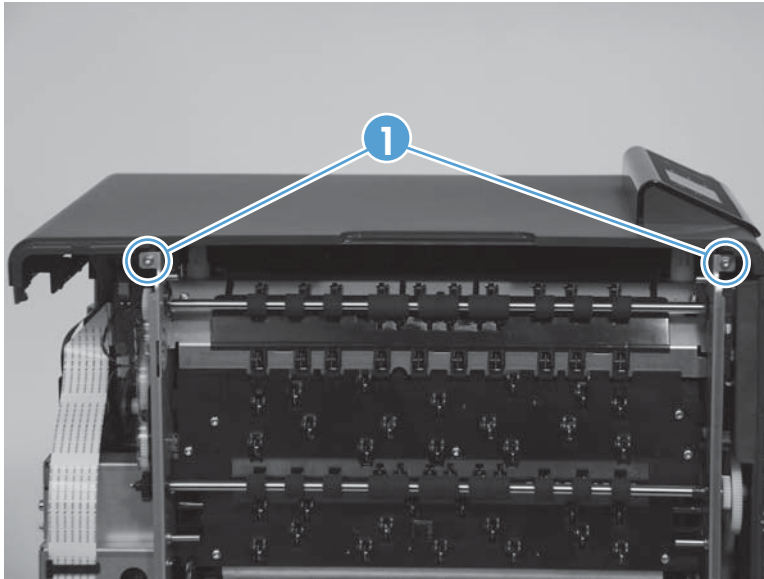
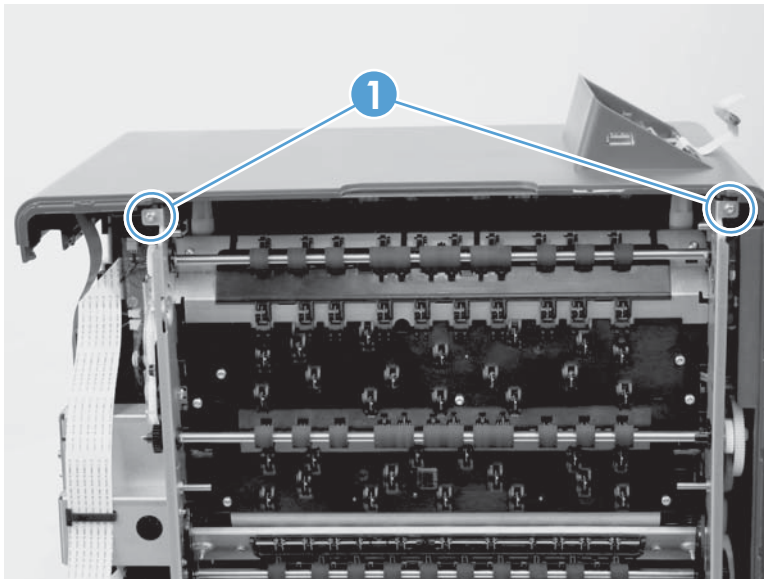
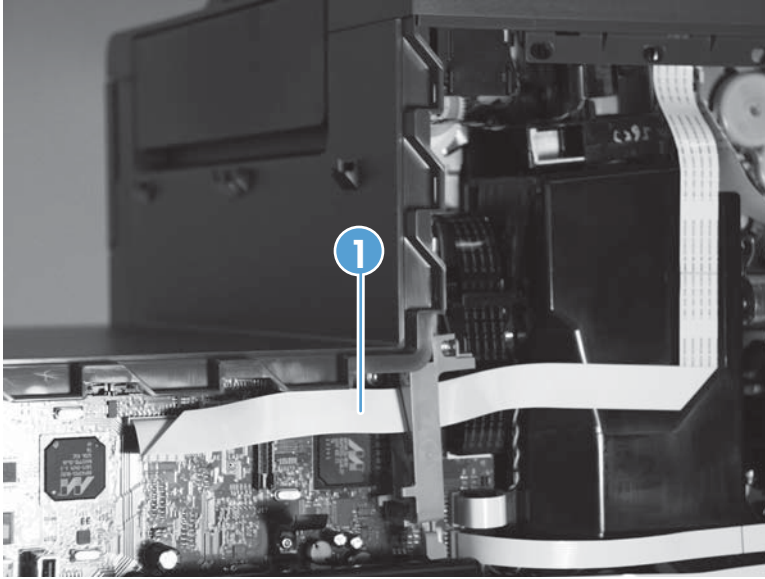

Figure 1-39 Remove the top cover (4 of 8) – X551 models



5. Disconnect the control panel flex cable (callout 1) from the formatter PCA.

Figure 1-40 Remove the top cover (5 of 8)



X551 models: Also disconnect the speaker cable (callout 1) and the USB cable (callout 2) from the main PCA.

Figure 1-41 Remove the top cover (6 of 8)

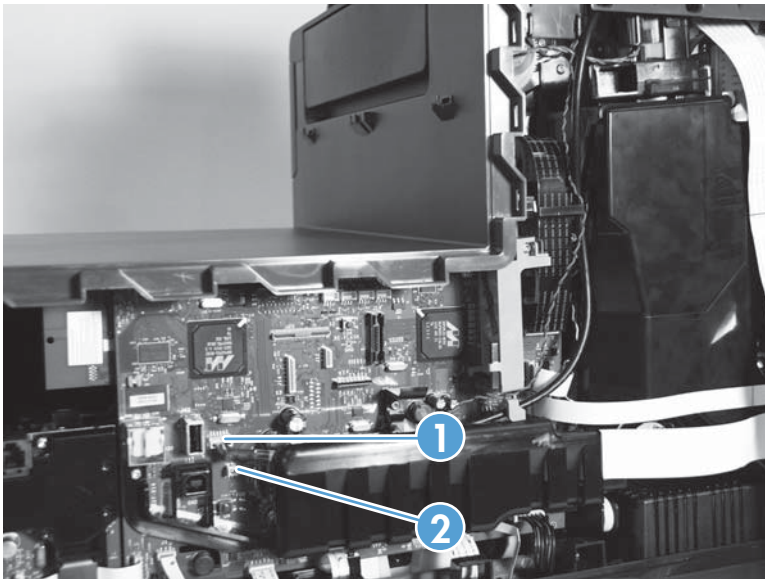

6. Unthread the flex cable through the bracket ferrites and the aerosol fan housing.

Figure 1-42 Remove the top cover (7 of 8)

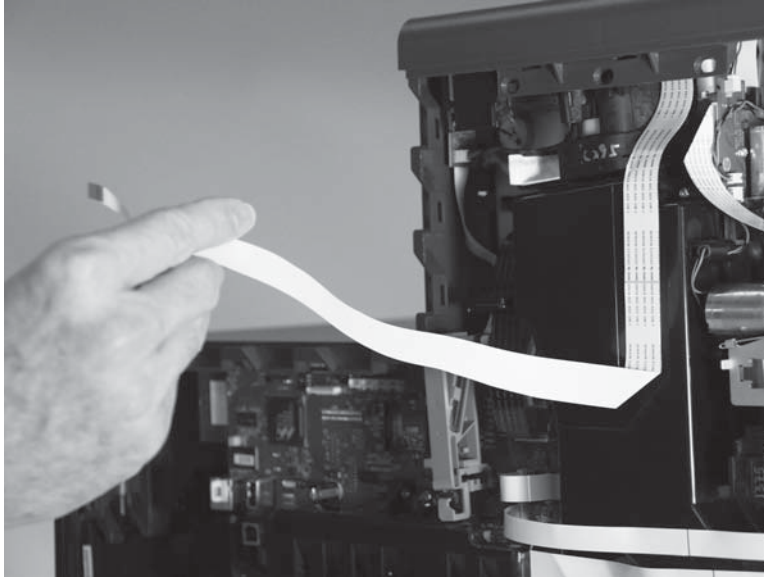

 **Reinstallation tip** When reinstalling, remember to thread the flex cable through the bracket ferrite correctly. Doing so ensures that the product meets regulatory standards.

7. Remove the top cover from the product by sliding it to the right, and then lifting it away.

Figure 1-43 Remove the top cover (8 of 8)



Front cover

1. Remove the top cover. See [Top cover on page 29](#).
2. Remove one screw (callout 1).

Figure 1-44 Remove the front cover (1 of 2)

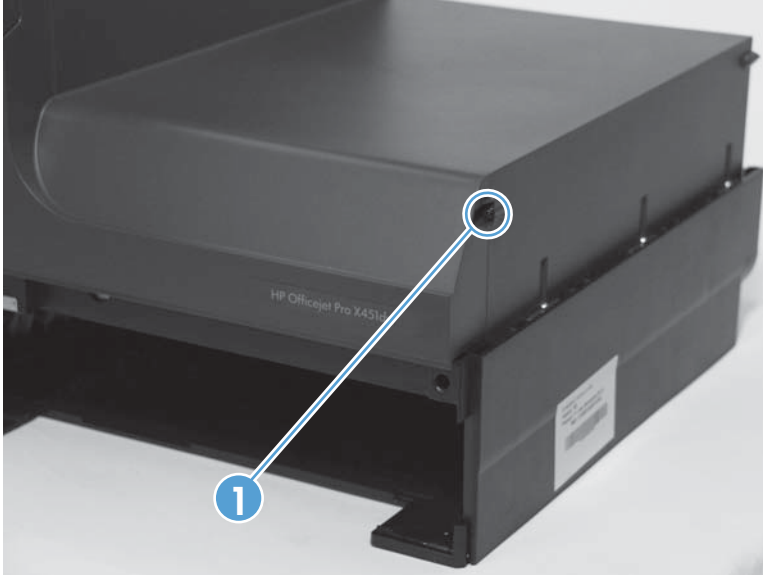

3. Remove the front cover.

Figure 1-45 Remove the front cover (2 of 2)

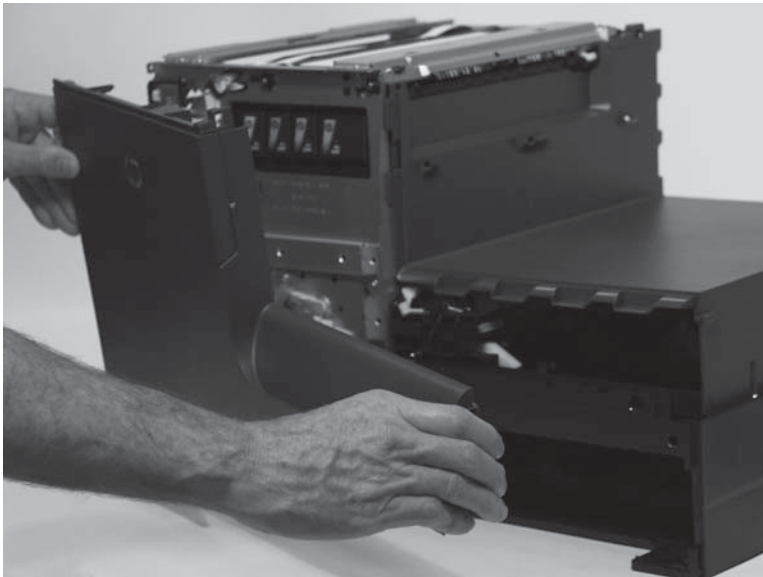

Right cover

1. Remove the front cover. See [Front cover on page 34](#).
2. Remove three screws (callout 1).

Figure 1-46 Remove the right cover (1 of 2)

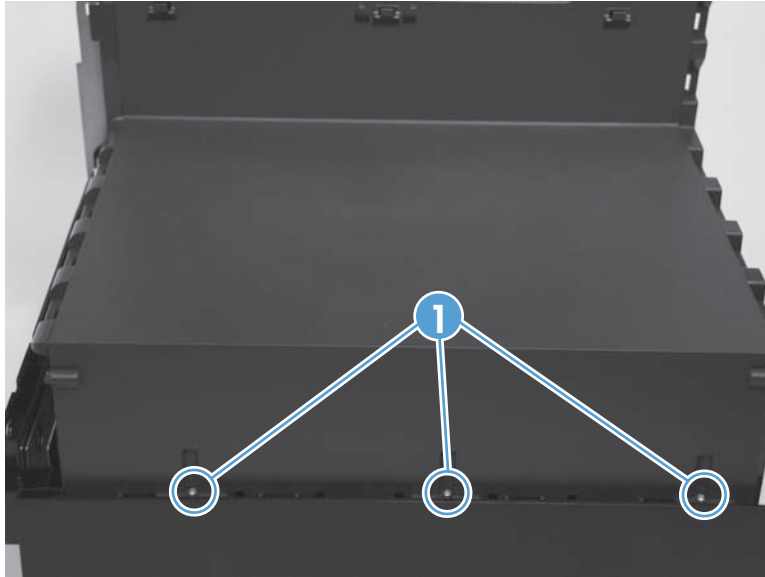

3. Remove the right cover from the product.

Figure 1-47 Remove the right cover (2 of 2)





Main assemblies

Aerosol fan assembly

1. Remove the following components:
 - Rear cover. See [Rear cover on page 23](#).
 - PCA safety shield. See [PCA safety shield on page 111](#).
2. Disconnect the control panel flex cable (callout 1). Rotate the ZIF (zero-insertion force) connector to unclasp the connector first, and then disconnect the cable.

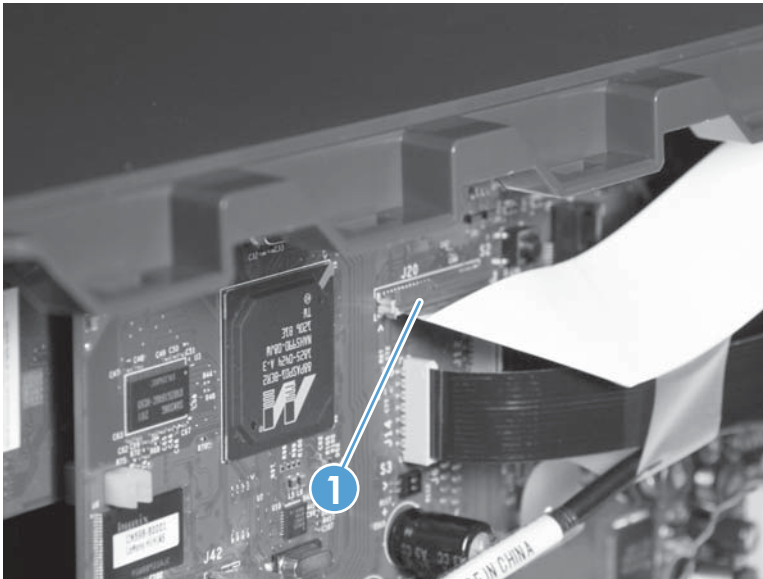
Figure 1-48 Remove the aerosol fan (1 of 12)



 **NOTE:** **X451 models:** The cable should pull straight out.

X551 models: Unclasp the connector first, and then pull the cable.

3. Disconnect the printbar lift distribution cable (callout 1) and the sensor carriage cable (callout 2).

Figure 1-49 Remove the aerosol fan (2 of 12)

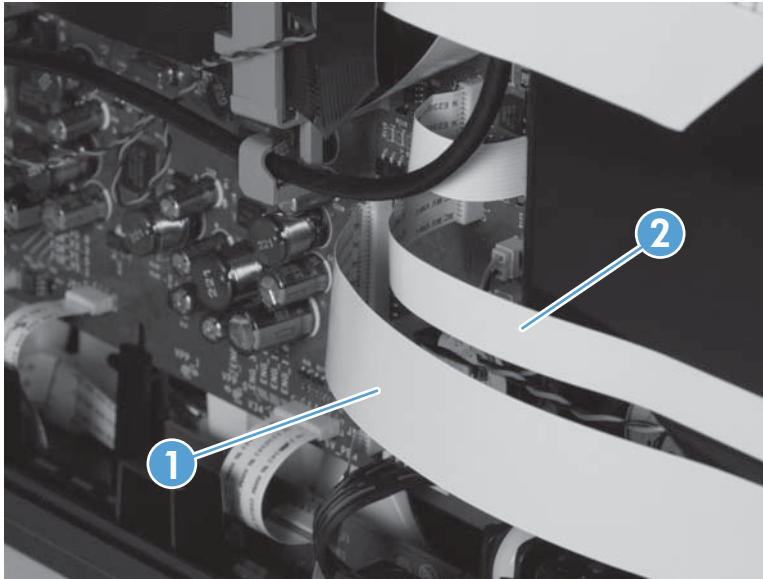

4. Unthread the printbar lift distribution cable (callout 1).

Figure 1-50 Remove the aerosol fan (3 of 12)

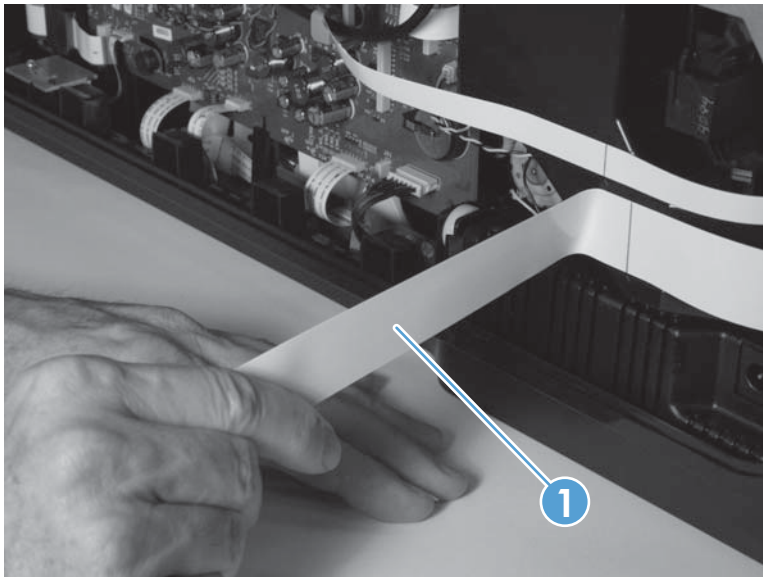

5. Unthread the sensor carriage cable (callout 1).

Figure 1-51 Remove the aerosol fan (4 of 12)

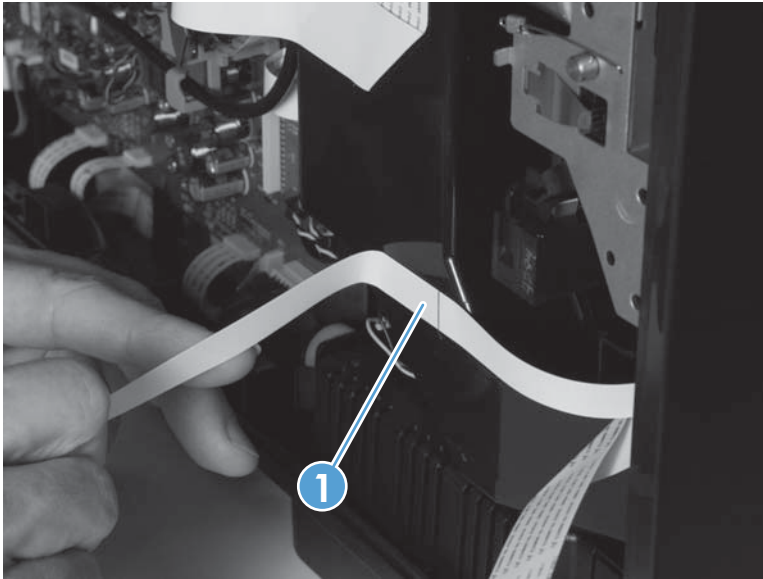

6. Unthread the control panel cable (callout 1) through the ferrite.

Figure 1-52 Remove the aerosol fan (5 of 12)

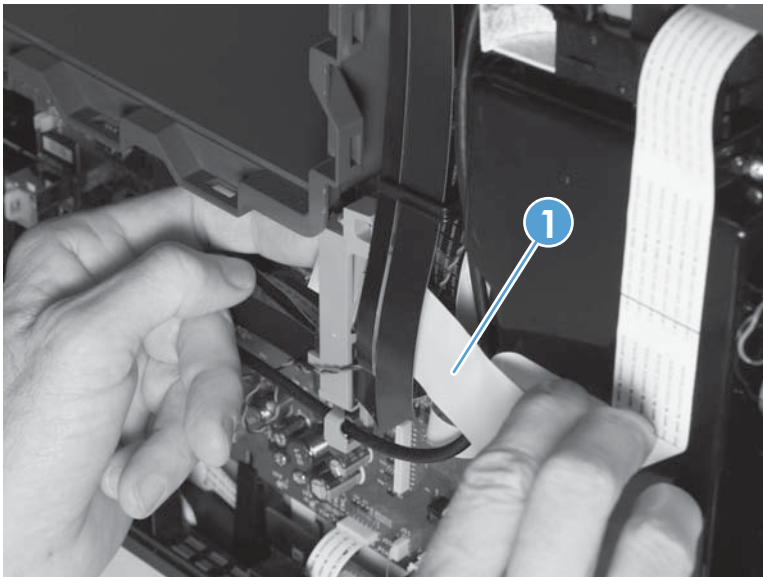

7. Use needle-nose pliers to disconnect the fan motor power cable (callout 1).

Figure 1-53 Remove the aerosol fan (6 of 12)

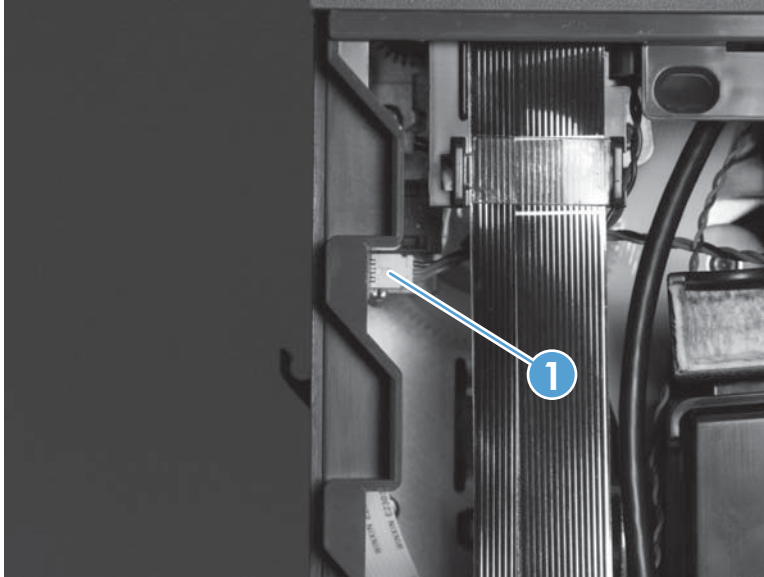

8. Disconnect the feed drive motor cable (callout 1).

Figure 1-54 Remove the aerosol fan (7 of 12)

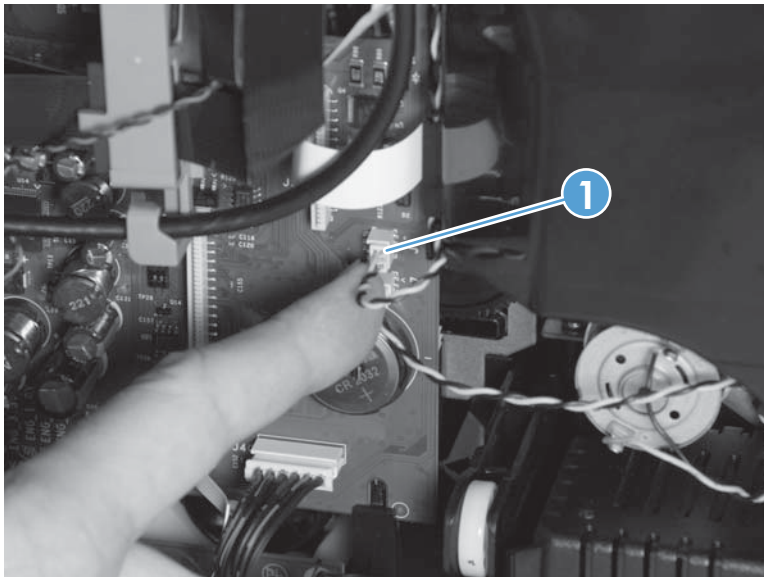

9. Unthread the feed drive motor cable from the fan assembly housing.

Figure 1-55 Remove the aerosol fan (8 of 12)

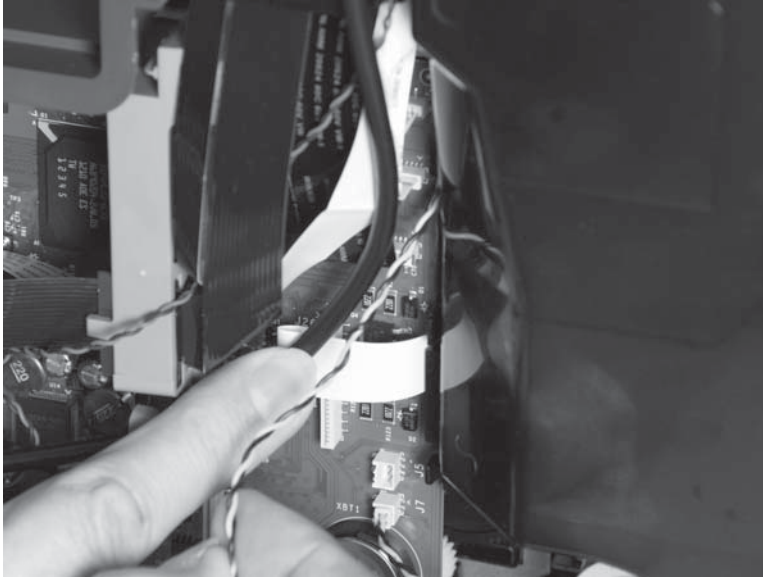

10. Push the sensor carriage ferrite (callout 1) out through the side of the snap using a small screwdriver. Leave the sensor carriage motor plugged in. During re-assembly, the sensor carriage ferrite can be pushed to the left back through the snaps as shown in [Figure 1-56 Remove the aerosol fan \(9 of 12\) on page 40](#).

Figure 1-56 Remove the aerosol fan (9 of 12)

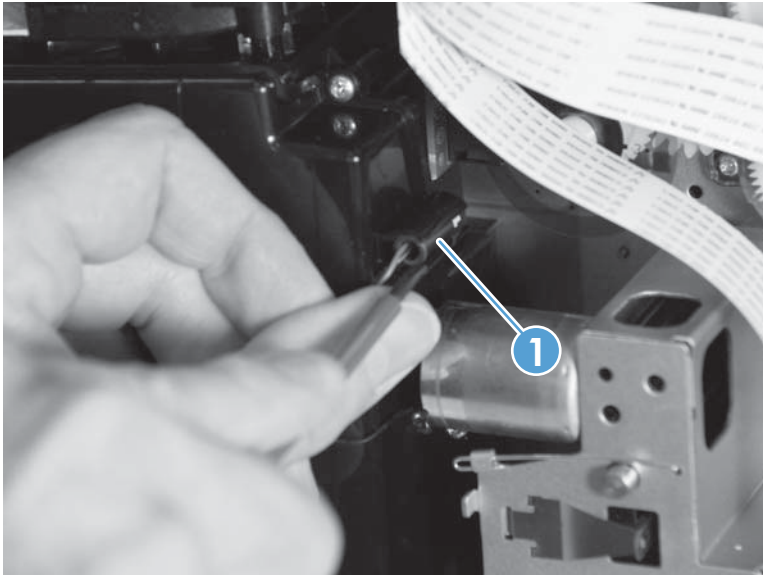

11. Remove three screws (callout 1) mounting the housing to the sheet metal.

Figure 1-57 Remove the aerosol fan (10 of 12)

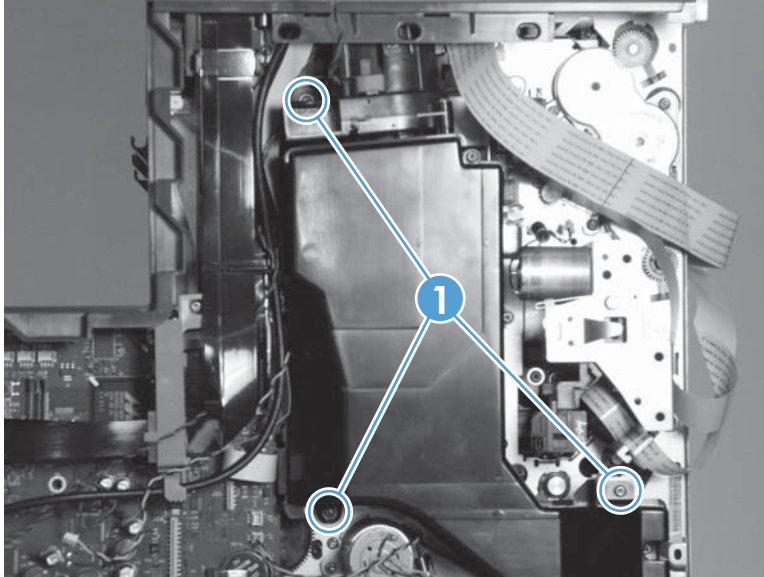

12. Pull out the fan assembly.

Figure 1-58 Remove the aerosol fan (11 of 12)

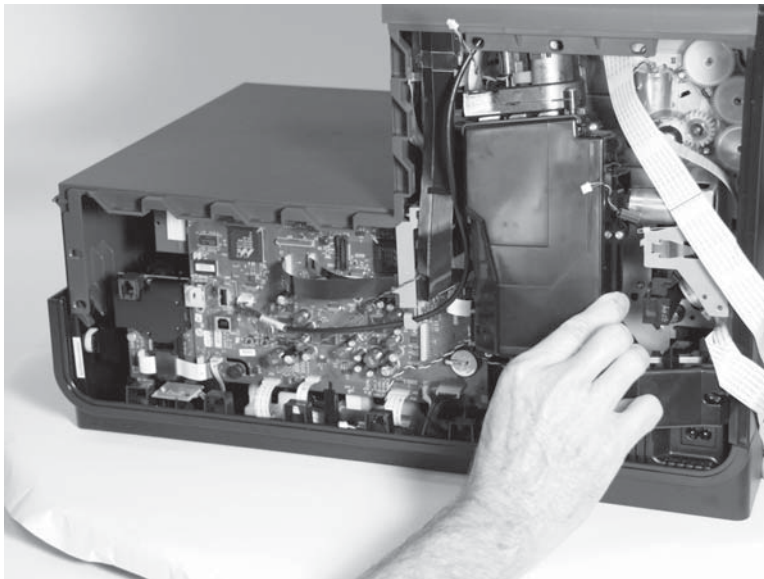

CAUTION: Avoid placing the assembly on any surface with the duct opening and gasket ring in contact with the surface. Doing so will leave an ink ring on the surface. Additionally, avoid touching the duct opening and gasket ring.

Reinstallation tip Align the black lines (callout 1) on the flex cables with the indicators on the fan assembly housing.

Figure 1-59 Remove the aerosol fan (12 of 12)

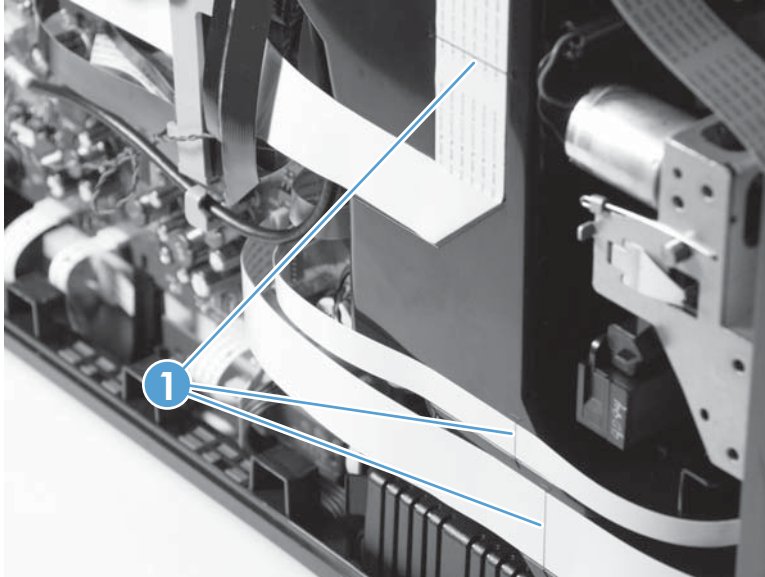

Separator/pick assembly

1. Remove the service sled assembly. See [Service sled assembly on page 57](#).
2. Remove one screw, and then remove the separation pad assembly.

Figure 1-60 Remove the separator/pick assembly (1 of 4)

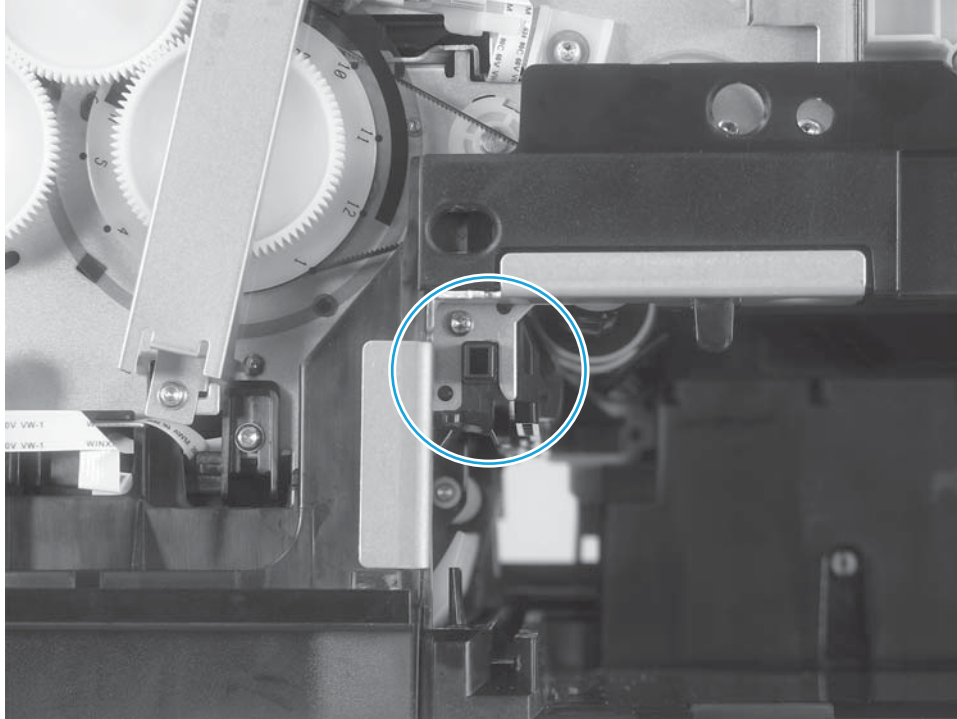

3. Rotate the pick assembly to position the white tabs (callout 1) as shown below.

 **NOTE:** If you have a new pick assembly removal tool, use that tool and follow the instructions provided with the tool to remove the assembly.

Figure 1-61 Remove the separator/pick assembly (2 of 4)



4. Use a small flat blade screwdriver (or hook screwdriver) to depress the black locking tab on the left side of the pick assembly, and then push down on the pick assembly to partially release it. Repeat for the locking tab on the right.

Figure 1-62 Remove the separator/pick assembly (3 of 4)

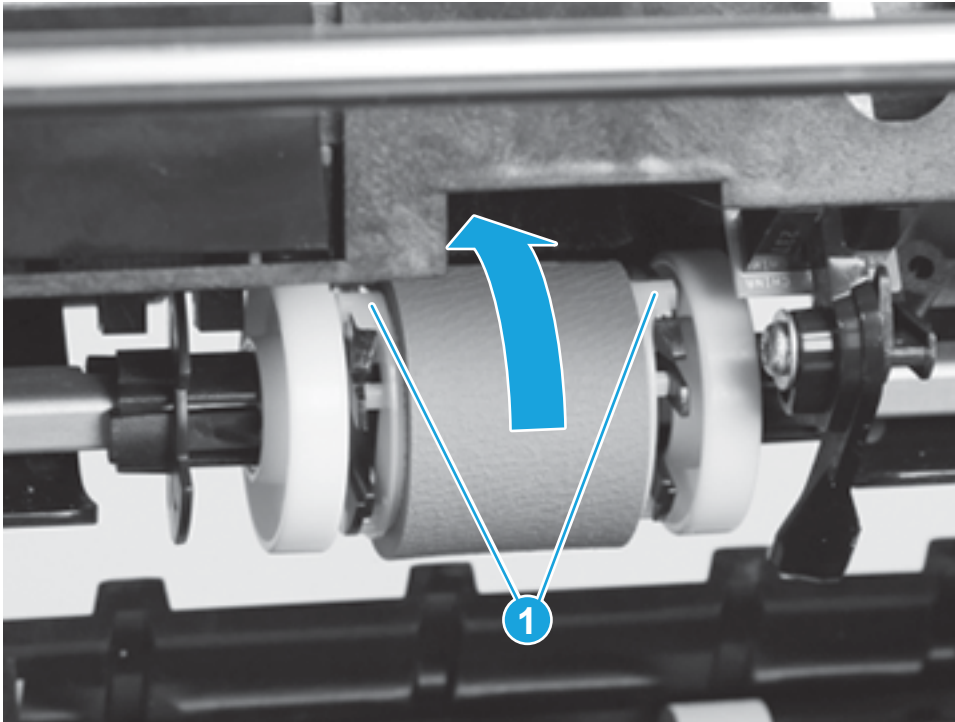
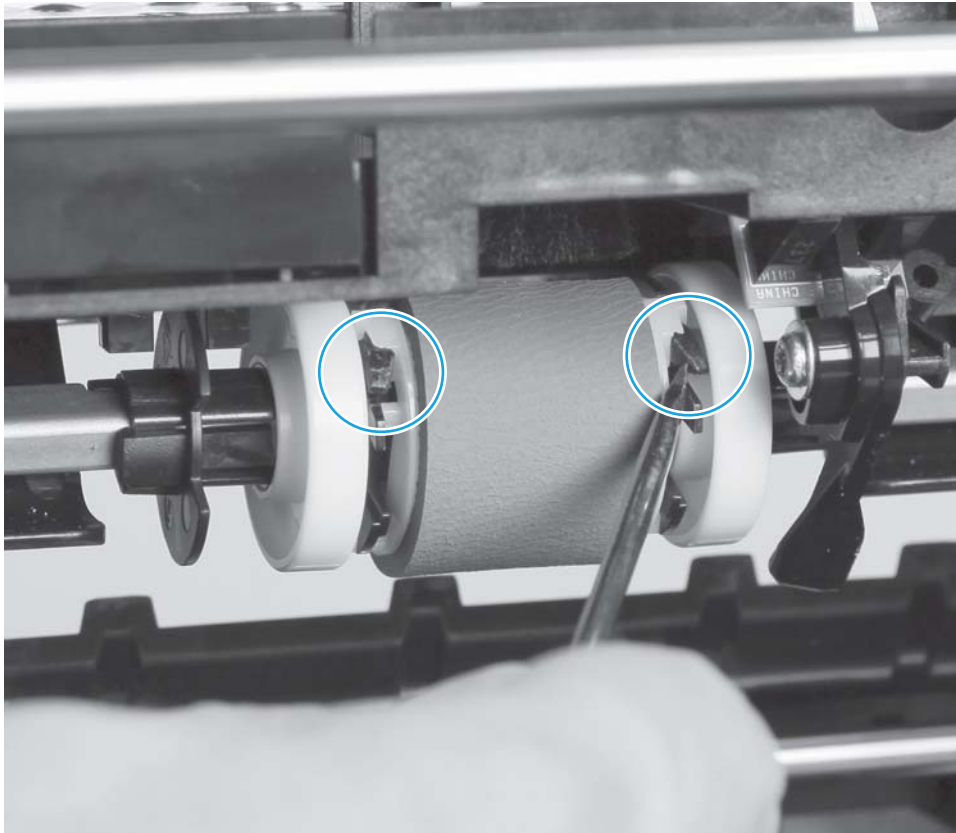

5. Push down on the pick assembly to remove it.

Figure 1-63 Remove the separator/pick assembly (4 of 4)

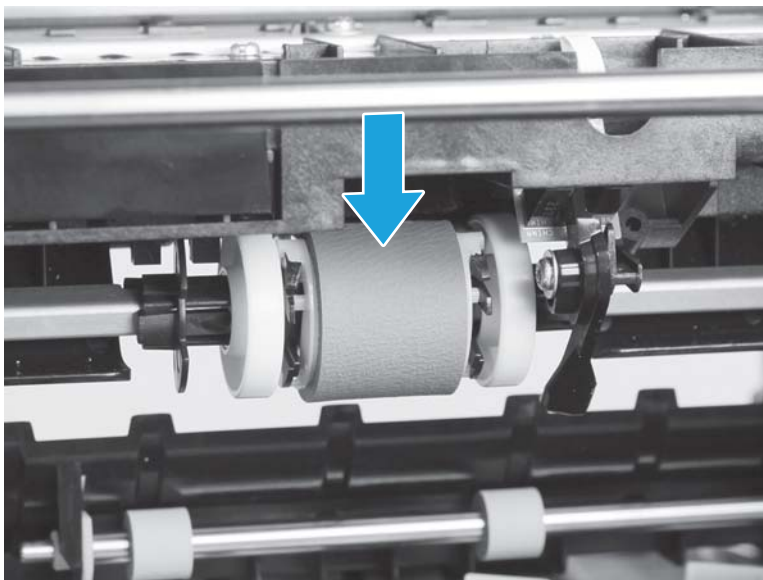

Reinstall the pick assembly/separator

Wear a vinyl glove while handling the new pick assembly to prevent skin oils from contaminating the roller.

1. Rotate the pick assembly shaft and mounting bracket so that the narrow tabs (callout 1) on the bracket are positioned near the bottom of the bracket, and the wide tabs (callout 2) are near the top of the bracket as shown below.

Figure 1-64 Reinstall the separator/pick assembly (1 of 5)

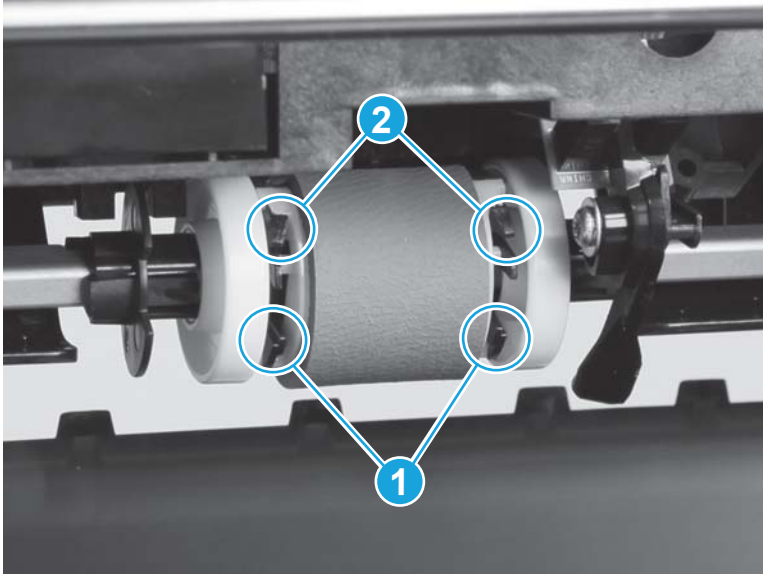

2. Position the flat side of the pick assembly against the flat side of the pick assembly shaft as shown below.

Figure 1-65 Reinstall the separator/pick assembly (2 of 5)



3. Attach the narrower pick assembly tabs.

Figure 1-66 Reinstall the separator/pick assembly (3 of 5)

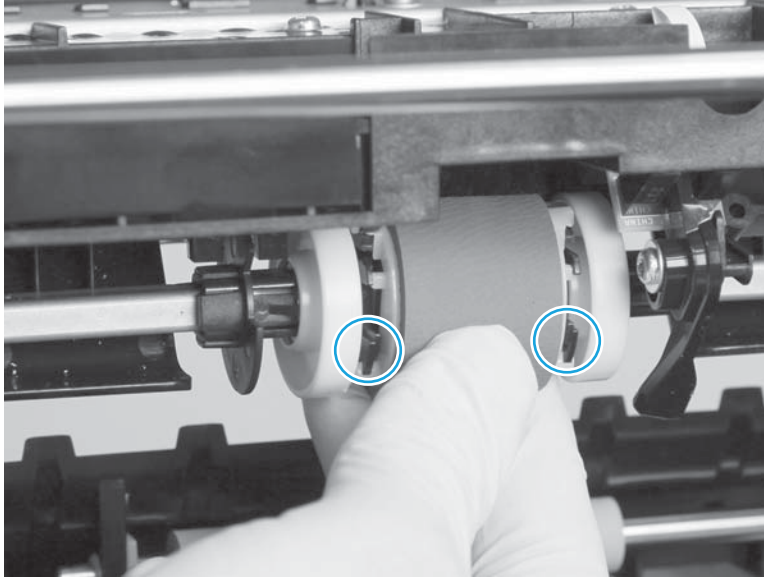

4. Press down on the top of the pick assembly until the wide tabs snap into place.

 **NOTE:** Reposition the roller shaft if it rotates while snapping the wider tabs into place.

Figure 1-67 Reinstall the separator/pick assembly (4 of 5)



5. Verify that the tabs are correctly snapped into place and the pick assembly is seated squarely in the mounting bracket.

Figure 1-68 Reinstall the separator/pick assembly (5 of 5)

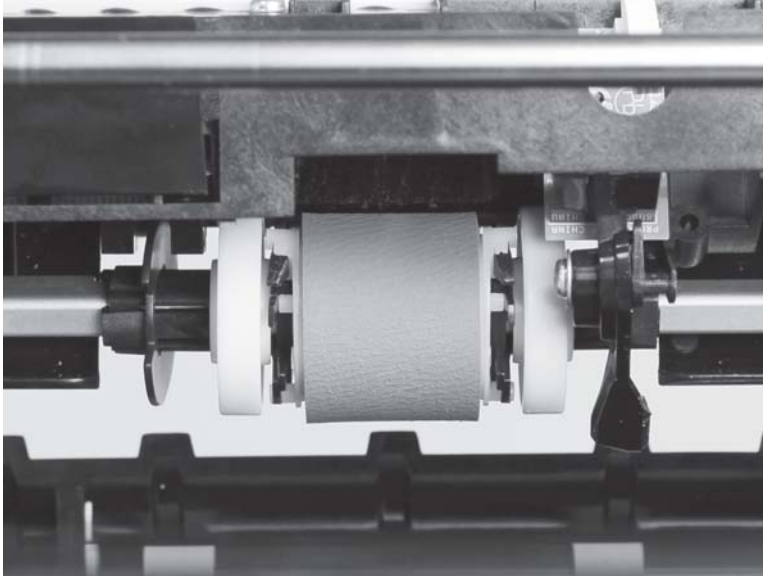

6. Reinstall the separator assembly.

Duplex drive module

1. Remove the following components:
 - Rear cover. See [Rear cover on page 23](#).
 - Aerosol fan assembly. See [Aerosol fan assembly on page 36](#).
 - Power supply. See [Power supply on page 53](#).

2. Disconnect one wire connector (callout 1).

Figure 1-69 Remove the duplex drive module (1 of 2)

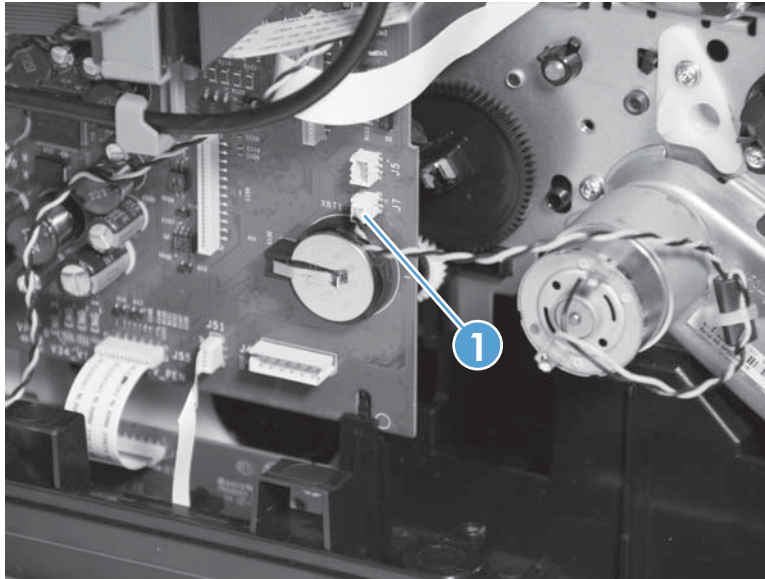

3. Remove two screws (callout 1), and then remove the module.

Figure 1-70 Remove the duplex drive module (2 of 2)

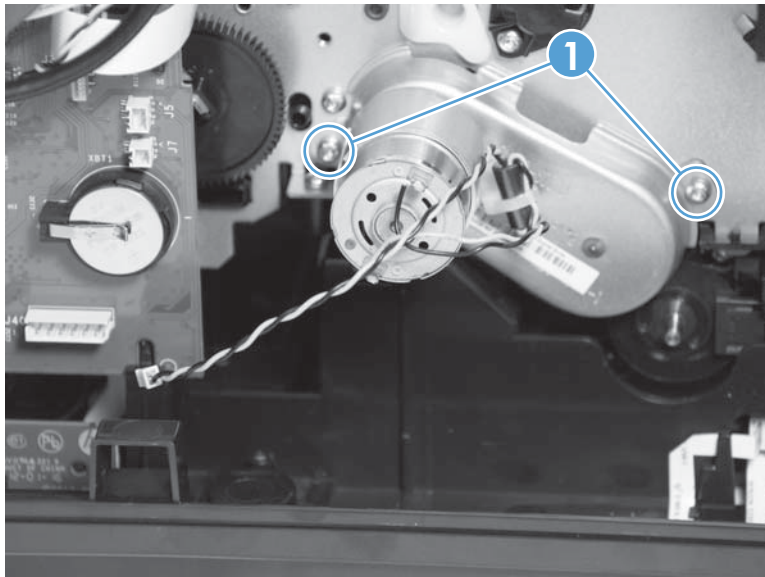

Control panel (X451 models only)

1. Remove the top cover. See [Top cover on page 29](#).
2. From the inside of the top cover, remove four T8 screws (callout 1).

Figure 1-71 Remove the control panel (1 of 2)

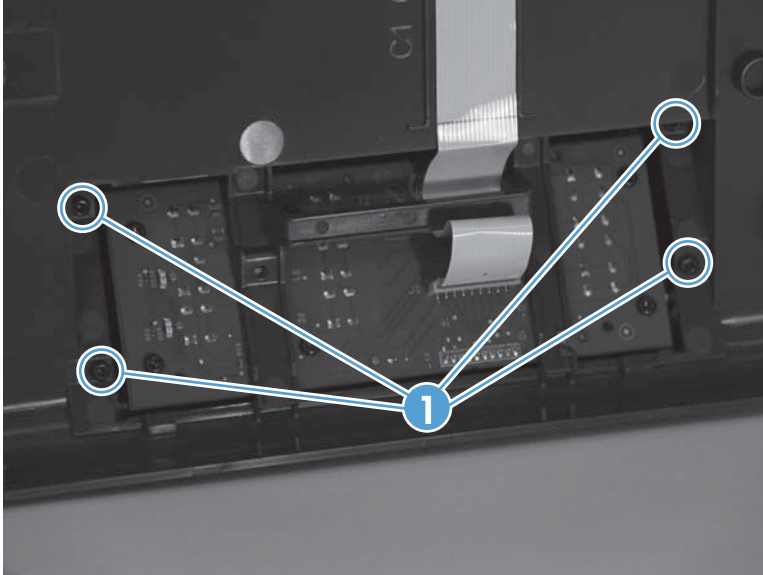

3. Remove the control panel, and then disconnect one flex cable (callout 1).

Figure 1-72 Remove the control panel (2 of 2)

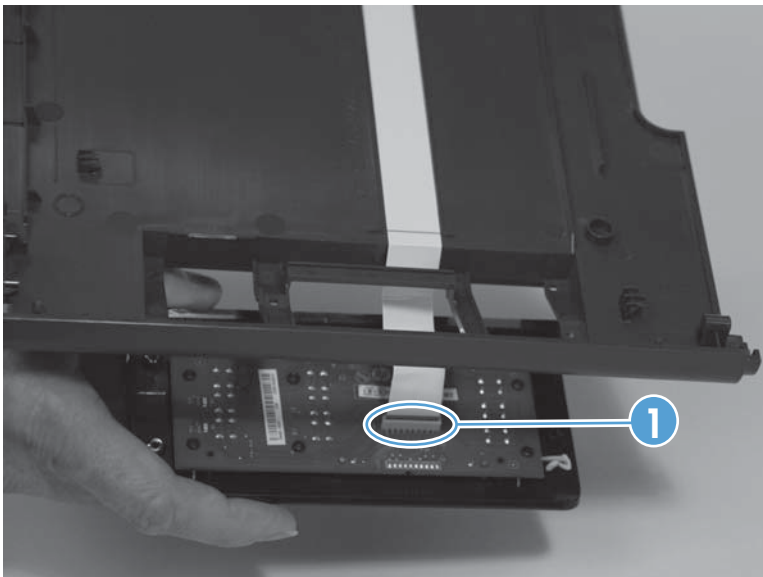

Control panel (X551 models only)

1. Remove the following components.
 - Rear cover. See [Rear cover on page 23](#).
 - Left door. See [Left door on page 24](#).
2. Rotate the ZIF latch, and then disconnect the control panel flex cable (callout 1) from the main PCA.

Figure 1-73 Remove the touchscreen control panel (1 of 4)

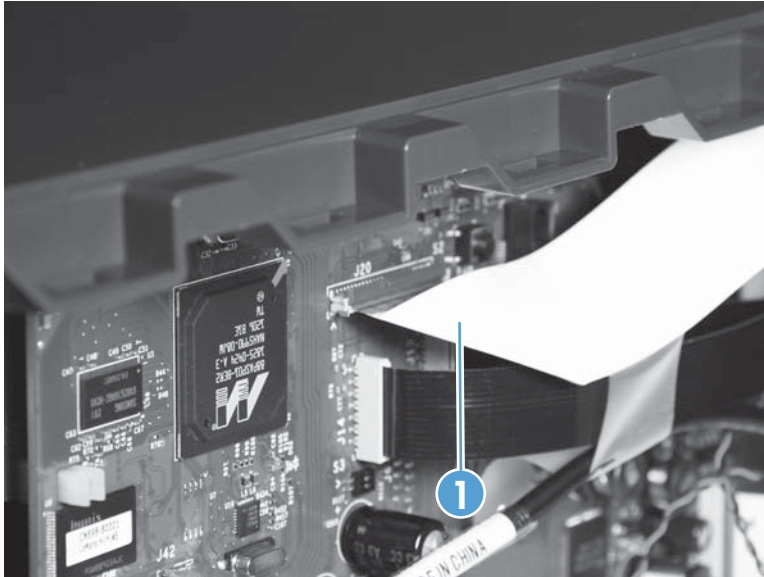

3. Disconnect the USB cable (callout 1) and speaker cable (callout 2).

Figure 1-74 Remove the touchscreen control panel (2 of 4)

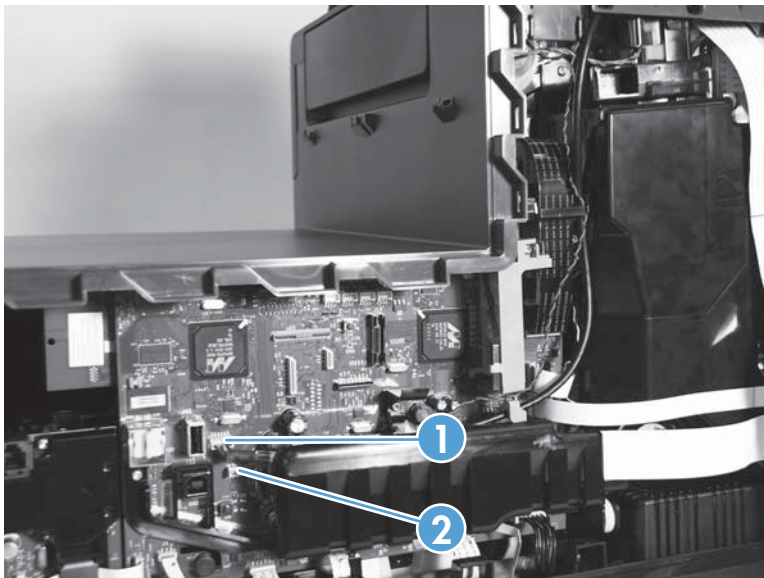

4. Unthread the cables (callout 1) through the back of the product.

Figure 1-75 Remove the touchscreen control panel (3 of 4)

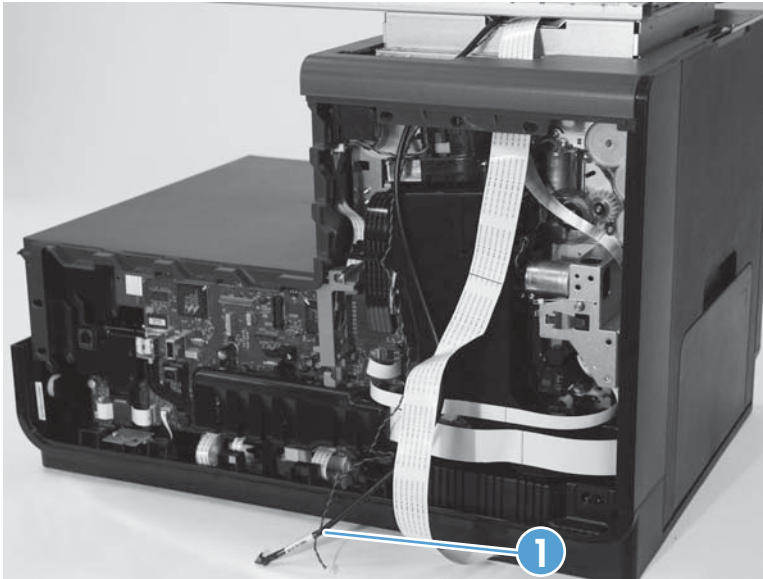

5. On the back of the top panel, remove three screws (callout 1) from behind the control panel, and then remove the control panel.

Figure 1-76 Remove the touchscreen control panel (4 of 4)

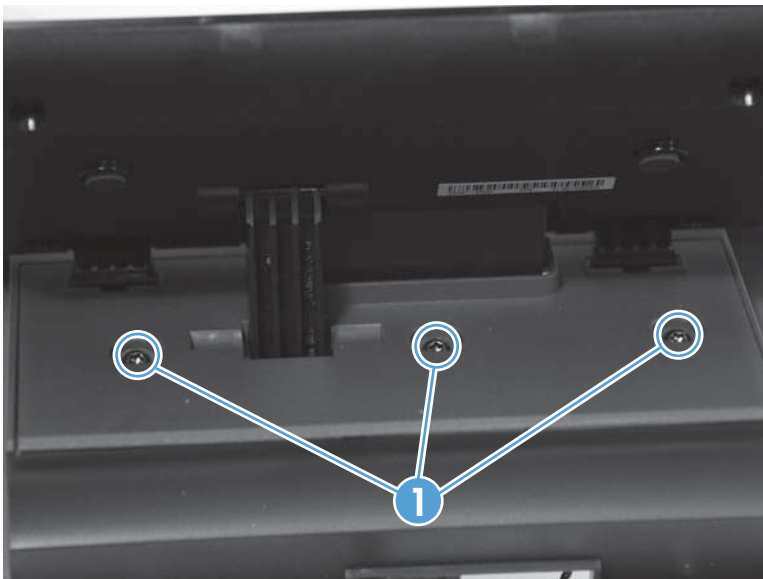

Power supply

⚠ CAUTION: Make sure that the power cable is disconnected from the product.

1. Remove the following components:
 - Rear cover. See [Rear cover on page 23](#).
 - Left door. See [Left door on page 24](#).
 - Left rear cover. See [Left rear cover on page 27](#).
 - Aerosol fan assembly. See [Aerosol fan assembly on page 36](#).
2. Disconnect the cable that connects the power supply to the main PCA.

Figure 1-77 Remove the power supply (1 of 3)

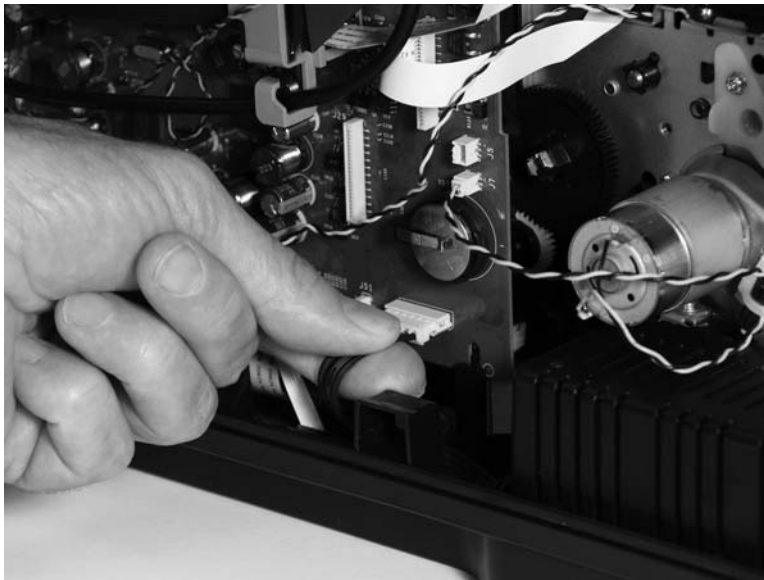

3. Remove two screws (callout 1) from the base of the power supply.

Figure 1-78 Remove the power supply (2 of 3)

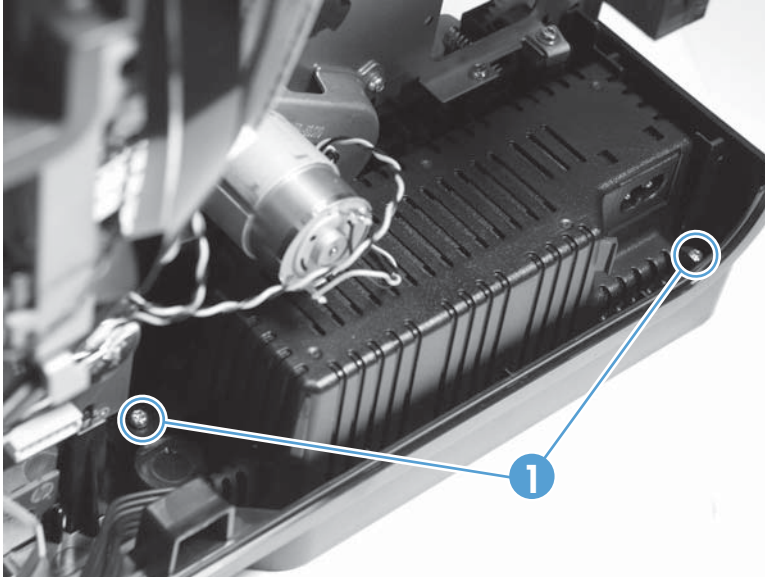

4. Remove the power supply.

Figure 1-79 Remove the power supply (3 of 3)

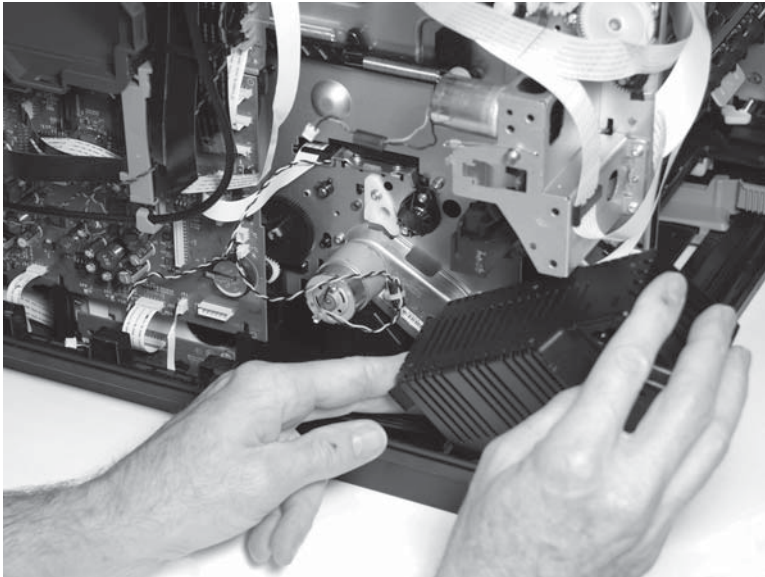

 **NOTE:** You might have to loosen the fasteners on the duplex drive module in order to remove the power supply. If that is the case, see [Duplex drive module on page 48](#).

Backscatter drop detect (BDD) assembly

 **IMPORTANT:** Ensure the product firmware is upgraded to at least version 1336MR before performing this repair procedure. If the firmware upgrade cannot be completed, contact HP support.

1. Remove the following components:
 - Rear cover. See [Rear cover on page 23](#).
 - Aerosol fan assembly. See [Aerosol fan assembly on page 36](#).
2. Verify that the sensor carriage is in the home position.
3. Remove one screw (callout 1).

Figure 1-80 Remove the backscatter drop detect assembly (1 of 2)

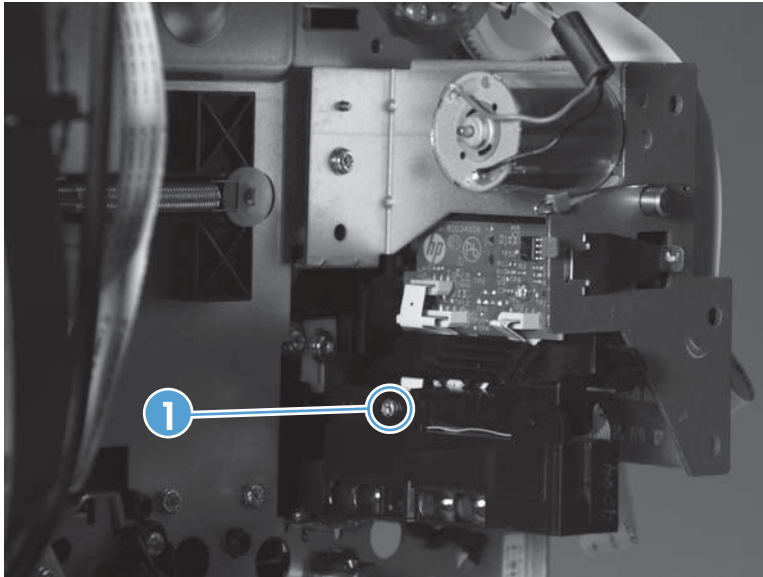

4. Detach the BDD assembly, and then disconnect the flex cable (callout 1).

Figure 1-81 Remove the backscatter drop detect assembly (2 of 2)

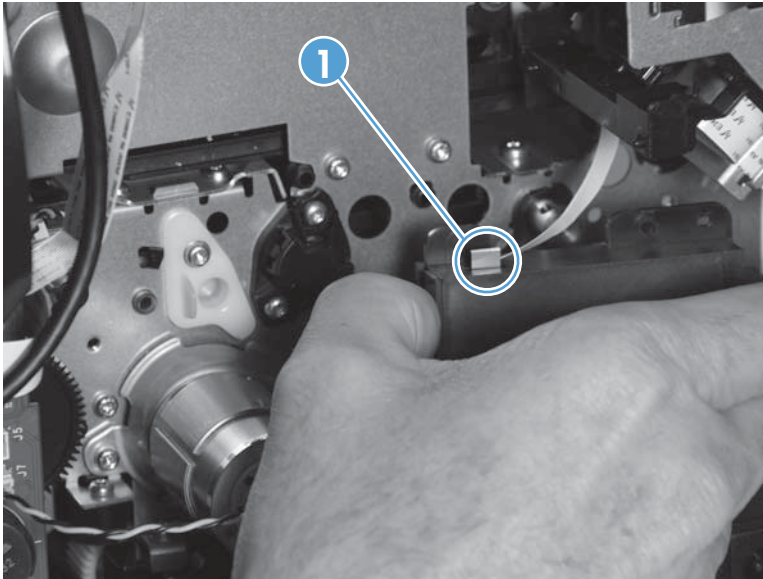

5. After installing a new BDD assembly, perform the following calibrations:
 - a. From the control panel, open the [Service menu](#). See [Access the Engineering menu on page 14](#) for information on how to access the [Service menu](#).
 - b. Select [System Configuration](#), and then select [Enable Drop Detect Calibration](#).
 - c. Touch the [OK](#) button.
 - d. After resetting the drop detect calibrations, run Clean Printhead, level 1. This will take approximately 17 minutes.

Service sled assembly

Remove the following components:

- Rear cover. See [Rear cover on page 23](#).
- Left door. See [Left door on page 24](#).
- Left rear cover. See [Left rear cover on page 27](#).
- Left front cover. See [Left front cover on page 28](#).
- Top cover. See [Top cover on page 29](#).
- Front cover. See [Front cover on page 34](#).
- Right cover. See [Right cover on page 35](#).
- Right cross brace. See [Right cross brace on page 63](#).

Service sled assembly

 **IMPORTANT:** The OfficeJet Pro X special tools kit (part CN598-67056) is required when replacing the service sled assembly.

1. On the front of the product, locate the printbar lock mount.

Figure 1-82 Remove the service sled assembly (1 of 6)

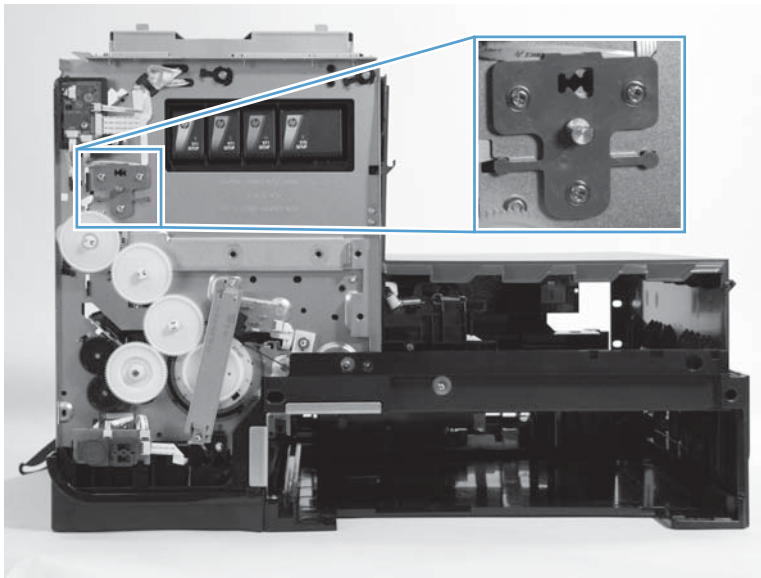

2. Insert the printbar lift lock tool into the printbar lock mount. When mounted correctly and with the printbar already in the up position, the printbar lift lock tool needs only to be held in place while the service sled is removed. It locks the printbar in the up position. If you need to raise the printbar, use a one-quarter inch nut driver to turn the printbar lift lock tool counter-clockwise. **Use extreme caution when driving the printbar lift lock tool to raise the printbar. Over-driving might break the lock tool.**

 **NOTE:** The printbar lift lock tool may look different than what is shown here.

 **NOTE:** Do not use excessive force when installing the printbar lift lock tool.

 **CAUTION:** The printbar lift lock tool must remain in place until either the printbar is removed, or the service sled assembly is reinstalled in the product. If the printbar drops to the bottom of the product, the printbar might be damaged, and likely will need to be replaced.

Figure 1-83 Remove the service sled assembly (2 of 6)



3. Locate the service sled cartridge drive shaft (callout 1).

Figure 1-84 Remove the service sled assembly (3 of 6)

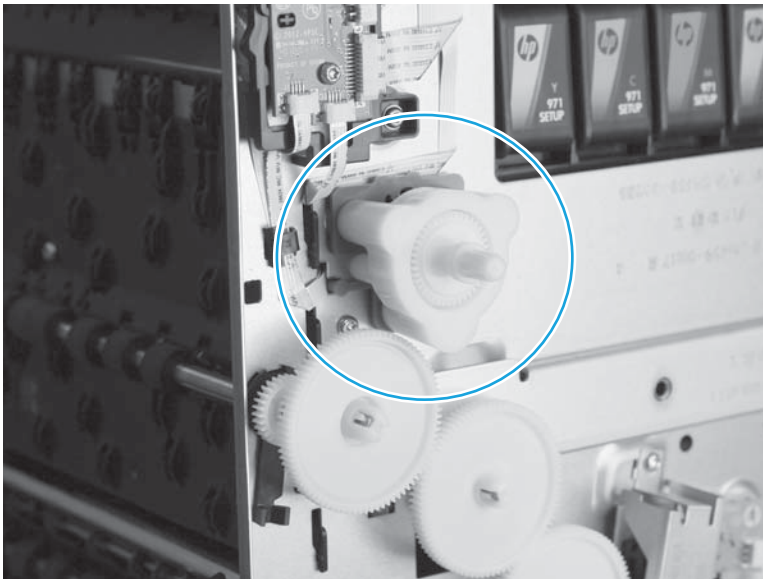
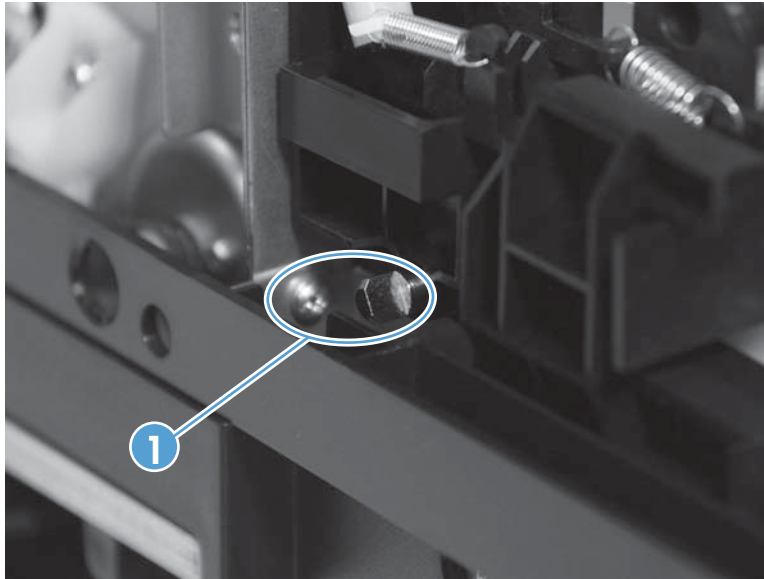

4. Mount the service sled advance tool on the drive shaft.

 **NOTE:** On older products, part of the base material may need to be removed to mount the service sled advance tool on the drive shaft.

Figure 1-85 Remove the service sled assembly (4 of 6)



5. Turn the tool clockwise to fully advance the service sled forward.

Figure 1-86 Remove the service sled assembly (5 of 6)

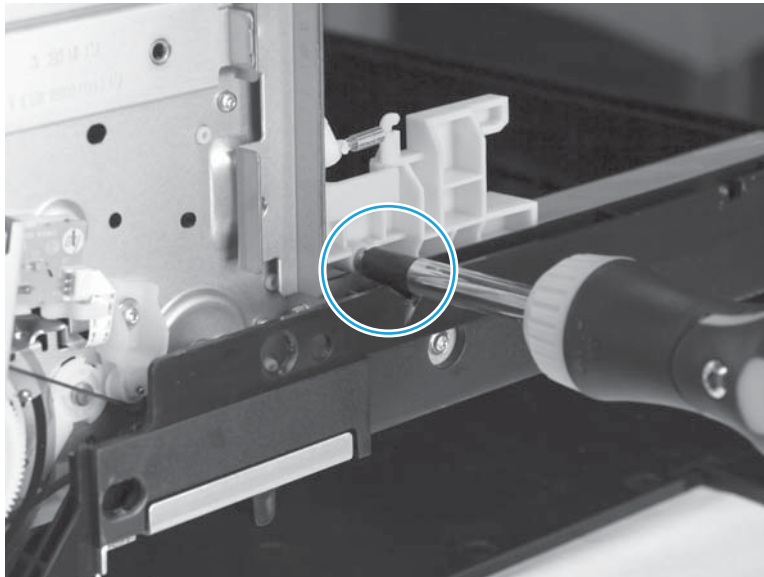
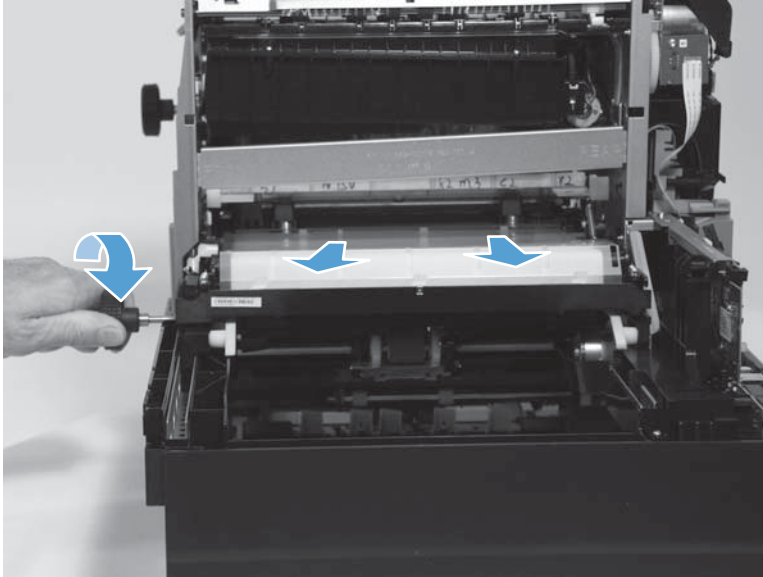

6. Lift the service sled cartridge from the product.

Figure 1-87 Remove the service sled assembly (6 of 6)

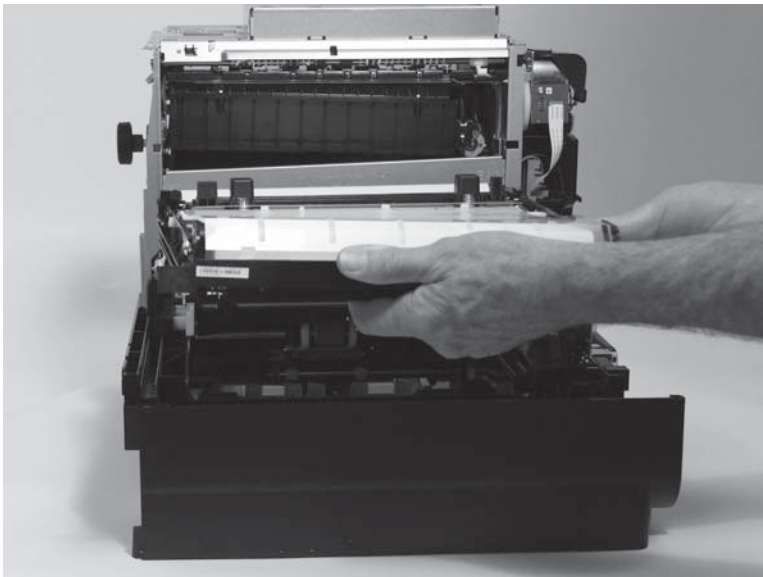

 **NOTE:** Do not touch the web contact roller during the removal process. The roller is saturated with ink. Also, any contaminants from your hands that transfer to the roller could affect print quality.

7. After reinstalling the service sled assembly, test for correct operation using the following steps:
 - a. Open the [Engineering menu](#). See [Access the Engineering menu on page 14](#) for information on accessing the [Engineering menu](#).
 - b. Select [Service](#), select [Service Tests](#), select [Test Service Station](#), and then touch the [OK](#) button.

- c. Select two service cycles, and then touch the **OK** button.
- d. The service sled module should move out of, and back into cap smoothly. If the operation isn't smooth, check for correct installation, including whether the service sled is aligned correctly. Also check that the service sled transmission is in the correct position. See Service sled transmission on page 97.

 **Reinstallation tip** During the reinstallation process, you must ensure that the service sled is aligned with the case part.

 **NOTE:** If you are working on the product at a repair center, use the special alignment tool (PN T-285463) to make sure the sled is aligned correctly. In the field, you will have to align it by sight. See Service sled transmission on page 97.

Web advance rack assembly

1. Remove one screw (callout 1) from behind the flag.

Figure 1-88 Remove the web advance rack assembly (1 of 2)

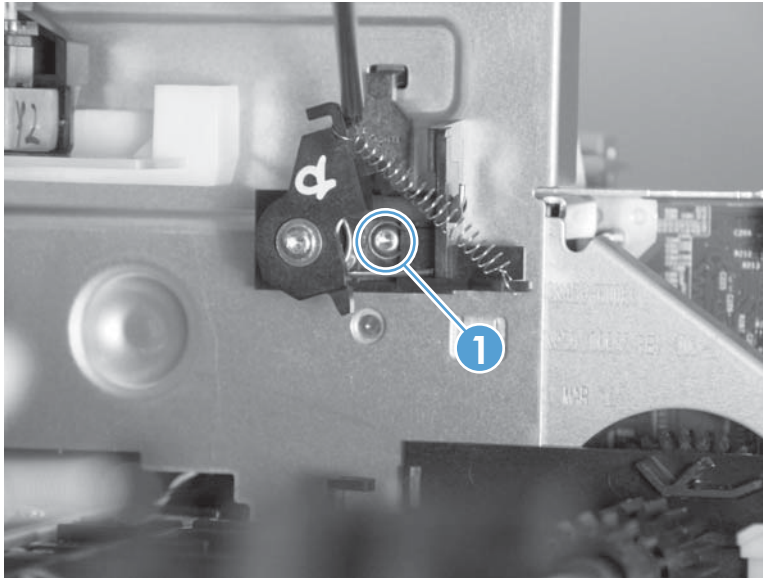

2. Rotate the assembly upward to clear the tab from the right wall, and then remove the assembly.

Figure 1-89 Remove the web advance rack assembly (2 of 2)

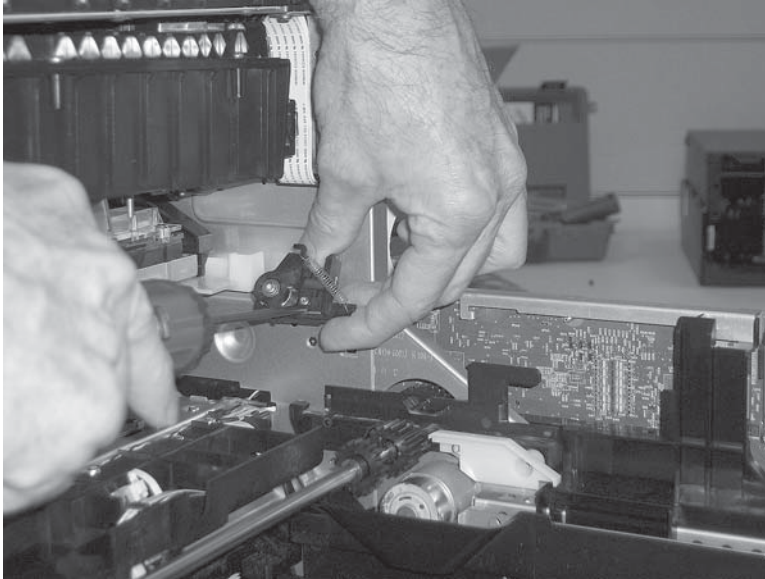

 **NOTE:** If you are working on the product at a repair center, use a special alignment tool (PN T-285463) to make sure the sled is aligned correctly. In the field, you will have to align it by sight.

Right cross brace

1. Remove the following components:
 - Rear cover. See [Rear cover on page 23](#).
 - Left door. See [Left door on page 24](#).
 - Left rear cover. See [Left rear cover on page 27](#).
 - Left front cover. See [Left front cover on page 28](#).
 - Top cover. See [Top cover on page 29](#).
 - Front cover. See [Front cover on page 34](#).
 - Right cover. See [Right cover on page 35](#).
2. Remove two screws (callout 1) from the front of the product.

Figure 1-90 Remove the right cross brace (1 of 4)

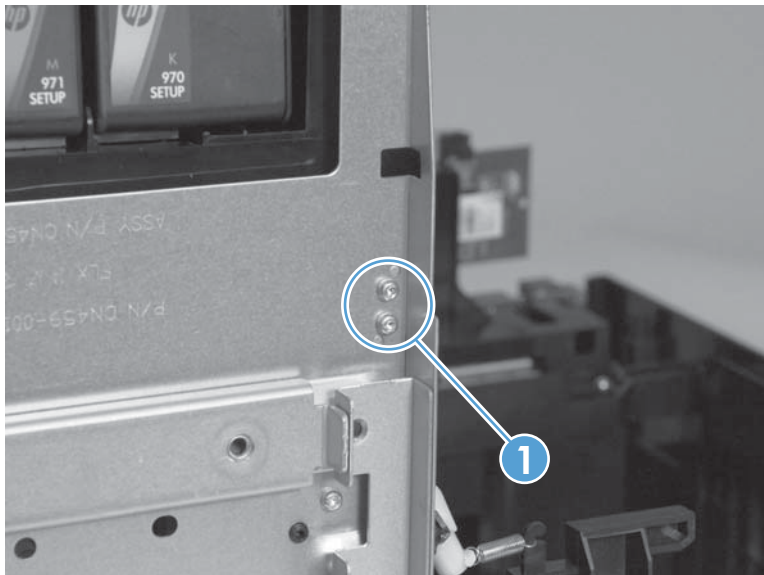

3. Remove two screws (callout 1) from the rear of the product.

Figure 1-91 Remove the right cross brace (2 of 4)

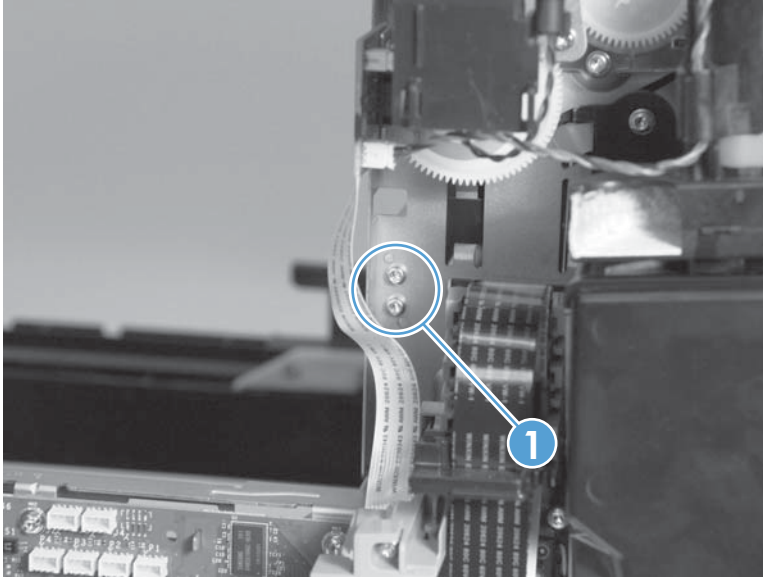

4. Remove the brace.

Figure 1-92 Remove the right cross brace (3 of 4)

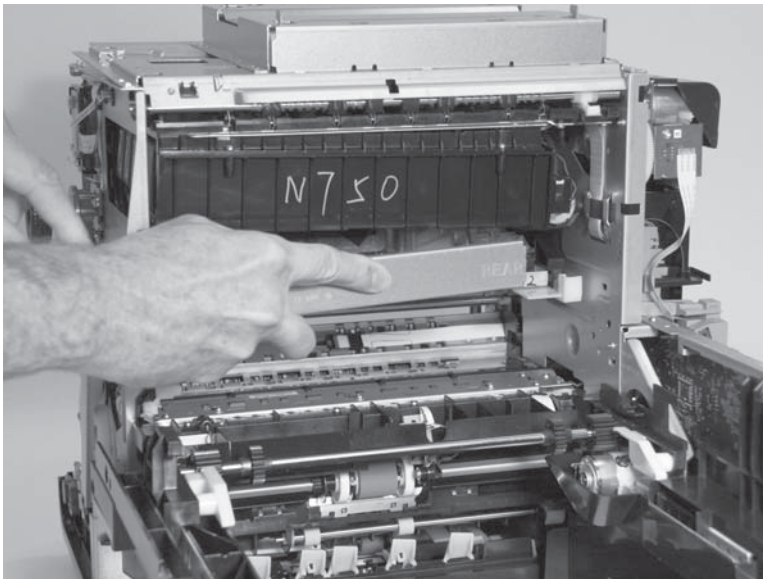

 **Reinstallation tip** The front and rear ends are labeled. Set the locator bumps on the bar in the locator holes on the product.

Figure 1-93 Remove the right cross brace (4 of 4)



Plate console left

1. Remove the following components:
 - Rear cover. See [Rear cover on page 23](#).
 - Left door. See [Left door on page 24](#).
 - Left rear cover. See [Left rear cover on page 27](#).
 - Left front cover. See [Left front cover on page 28](#).
 - Top cover. See [Top cover on page 29](#).
2. Remove five screws (callout 1), and then remove the brace (callout 2).

Figure 1-94 Remove the plate console left

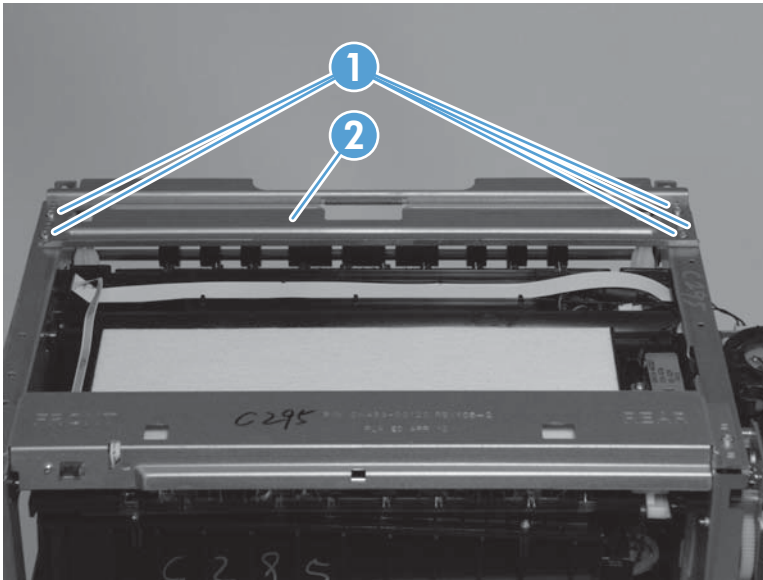
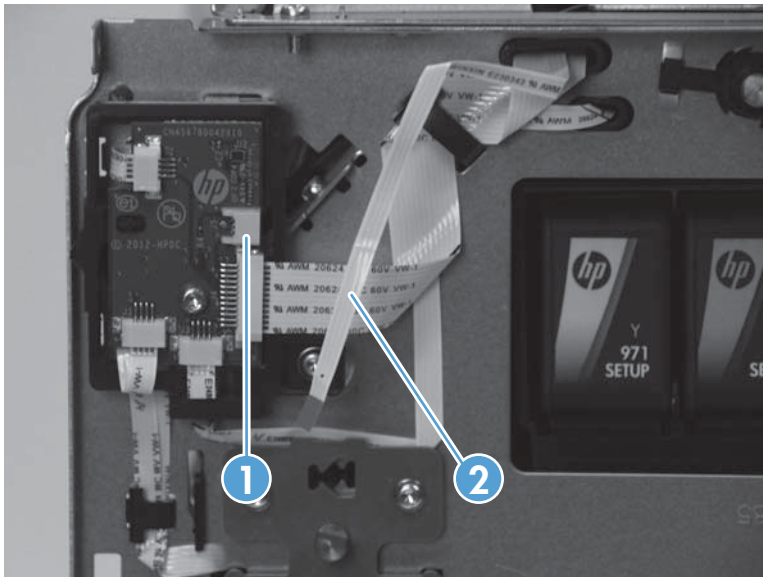

Plate console right

1. Remove the following components:
 - Rear cover. See [Rear cover on page 23](#).
 - Left door. See [Left door on page 24](#).
 - Left rear cover. See [Left rear cover on page 27](#).
 - Left front cover. See [Left front cover on page 28](#).
 - Top cover. See [Top cover on page 29](#).
 - Right cover. See [Right cover on page 35](#).
2. Disconnect the eject flap opto PCA flex cable connection (callout 1), and then unthread the cable (callout 2) from the product frame.

Figure 1-95 Remove the plate console right (1 of 2)



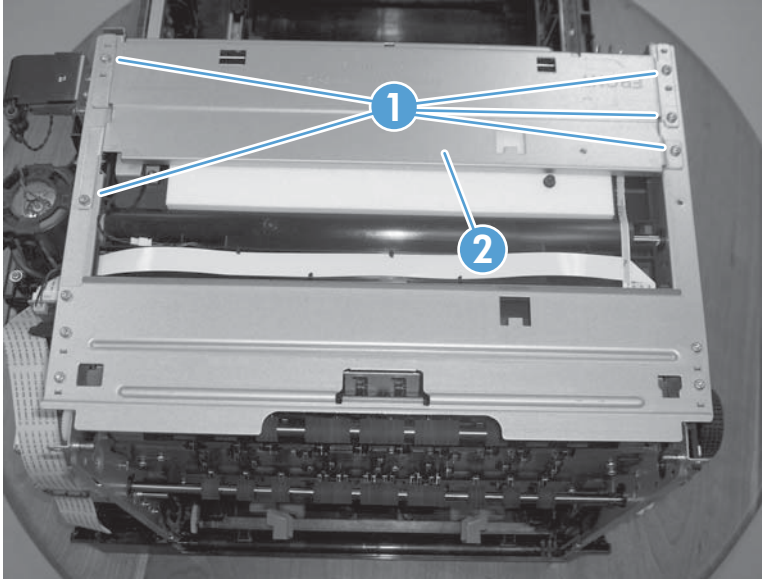

3. Remove five screws (callout 1), and then remove the brace (callout 2).

Figure 1-96 Remove the plate console right (2 of 2)



Printbar

 **IMPORTANT:** Ensure the product firmware is upgraded to at least version 1336MR before performing this repair procedure. If the firmware upgrade cannot be completed, contact HP support.

 **NOTE:** Refer to document number CN598-67045.

 **NOTE:** If the product has printed more than 30,000 pages, replacing the service sled assembly is recommended.

 **WARNING!** The printbar testing and calibration instructions must be followed exactly. Failure to follow these instructions exactly may result in a printer problem that is not recoverable in the field.

1. Before replacing the printbar:

- Replace the duplex module. The duplex module must be replaced any time the printbar is replaced.
- A set of trade supplies will be required to test that the printbar has been installed correctly. The existing customer supplies will be sufficient as long as they have ink left.

2. Remove the following components:

- Service sled cartridge. See [Service sled assembly on page 57](#).
- Aerosol duct, remove for easier access (optional).
- Right cross brace. See [Right cross brace on page 63](#).
- Web advance rack assembly. See [Web advance rack assembly on page 61](#).
- Plate console, left. See [Plate console left on page 66](#).

IMPORTANT: The HP OfficeJet Pro X special tools kit (part CN598-67056) is required when replacing a printbar. If you are working on the product at a repair center, use the special alignment tool (PN T-285463) to make sure the sled is aligned correctly. In the field, you will have to align it by sight. See [Service sled transmission on page 110](#).

CAUTION: The printbar lift lock tool must remain in place until the printbar is lowered onto the dolly. If the printbar drops to the bottom of the product, the printbar might be damaged.

3. Install the nozzle “helmet” on the printbar to protect the ink nozzles. Install the two front rubber bumpers (callout 1) into the matching notches in the printbar, then rotate the printbar safety cap back and up to engage the catches on the back of the printbar (callout 2).

Figure 1-97 Remove the printbar (1 of 12)

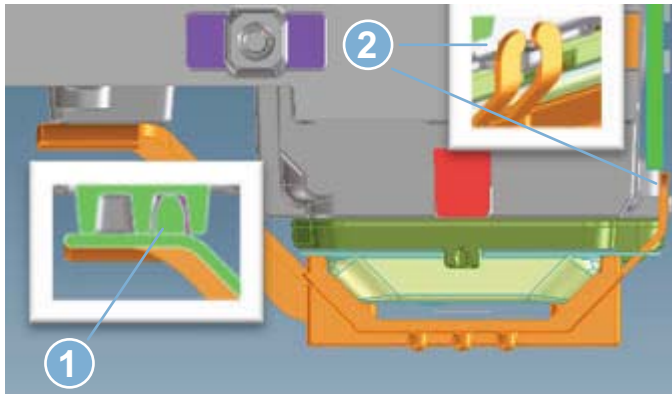

4. Install the printbar dolly.
 - a. Locate the service sled guides (callout 1).

Figure 1-98 Remove the printbar (2 of 12)

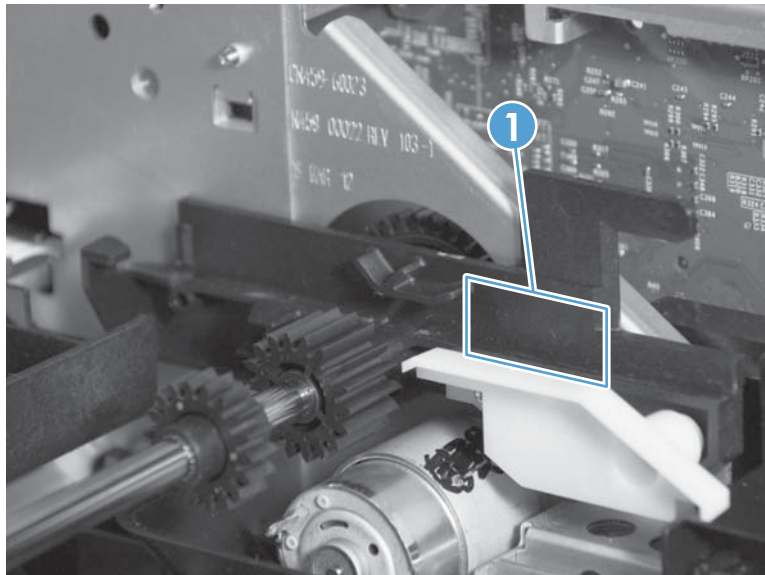

- b. Place the dolly (callout 1) on the guides.

Figure 1-99 Remove the printbar (3 of 12)

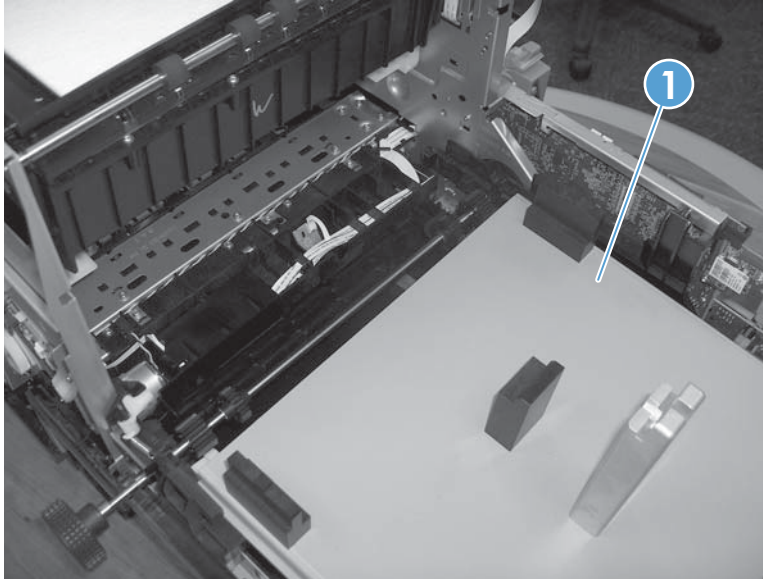

- c. Push the dolly into the product until it reaches the left side, and then lower the printbar by hand onto to the seated dolly. This will prevent the printbar from inadvertently dropping onto the dolly.

Figure 1-100 Remove the printbar (4 of 12)

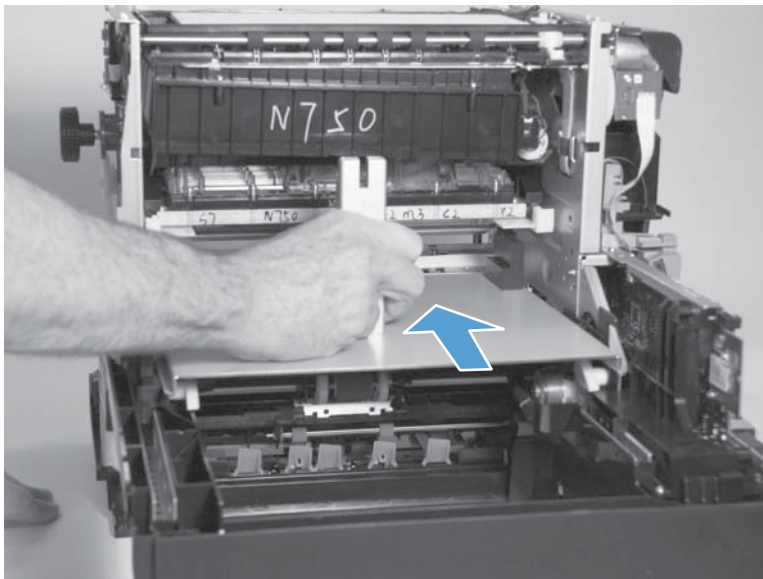

5. Disconnect three printbar flex cables (callout 1).

⚠ CAUTION: Two of these cables are installed in zero insertion force (ZIF) sockets that have a black holder on top. The black holder must be pulled up *carefully* to release the cables. It is very easy to break these connectors.

Figure 1-101 Remove the printbar (5 of 12)

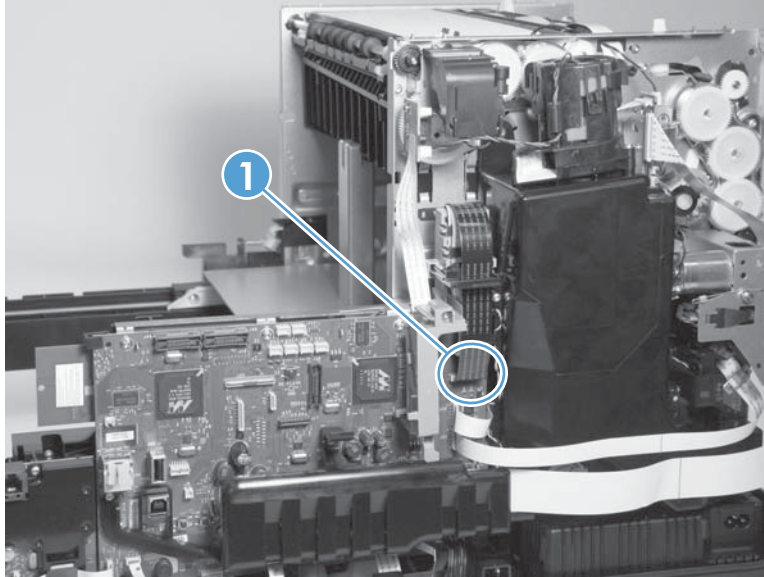

6. Unthread the three flex cables through the ferrite holder (callout 1).

Figure 1-102 Remove the printbar (6 of 12)

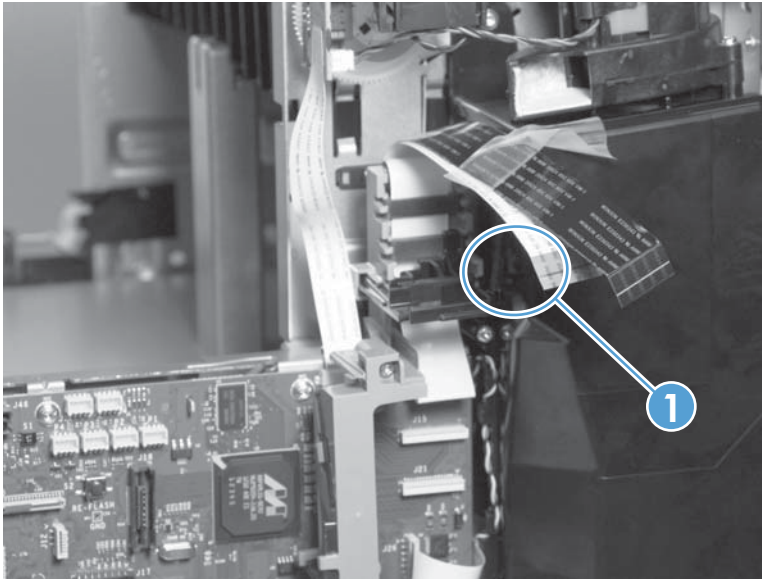

 **Reinstallation tip** When reinstalling, remember to thread the two white flex cables through the ferrites correctly. (The black flex cable goes through a slot in the plastic holder.) Doing so ensures that the product meets regulatory standards.

Reinstallation tip When reinstalling, inspect the printbar flex cables for damage. If any damage exists, replace the damaged cable.

Reinstallation tip Manually clasp the cables to make sure that the ZIF sockets are closed on the cables correctly.

7. Carefully use a screwdriver to remove the flex cable retainer (callout 1) from the product. Take care to avoid damaging the cable.

Figure 1-103 Remove the printbar (7 of 12)

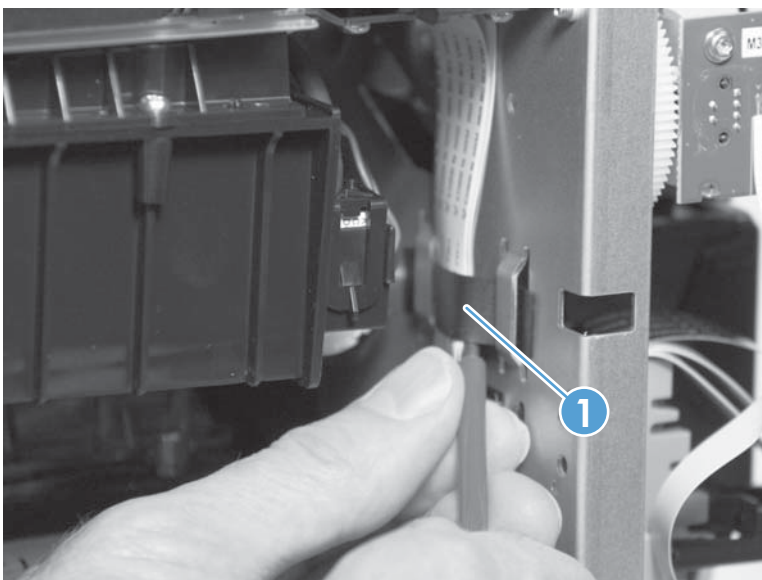

8. Unthread all three of the printbar cables through the front frame of the product.

Figure 1-104 Remove the printbar (8 of 12)

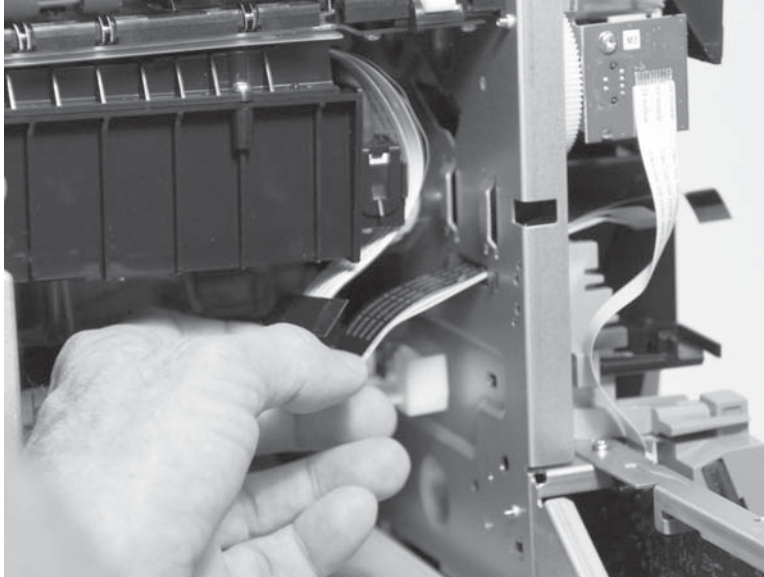

9. Gently remove the printbar lift lock tool to lower the printbar onto the dolly.
10. Locate both lift guides (callout 1) on the top left of the product.

Figure 1-105 Remove the printbar (9 of 12)

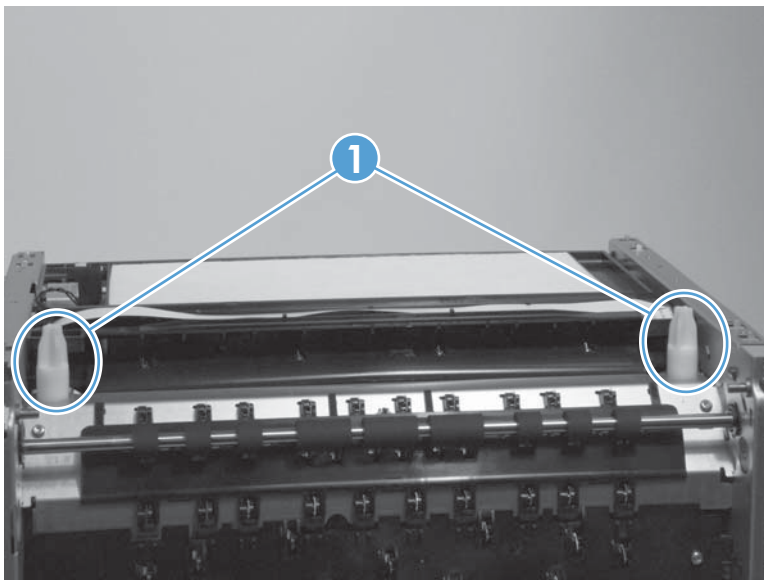

11. Pull each lift guide up to remove.

⚠ CAUTION: The lift guides are greasy.

Figure 1-106 Remove the printbar (10 of 12)

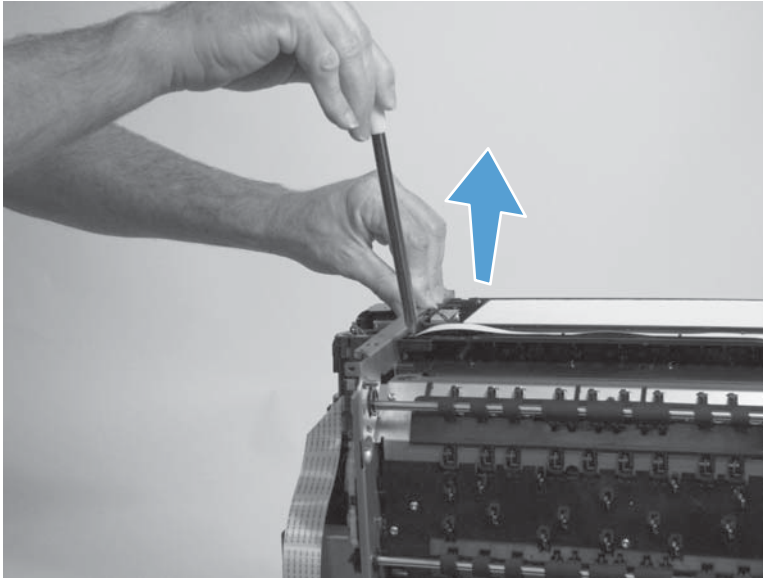

12. Slide the dolly (callout 1) forward, away from the product, to remove the printbar assembly (callout 2).

Figure 1-107 Remove the printbar (11 of 12)

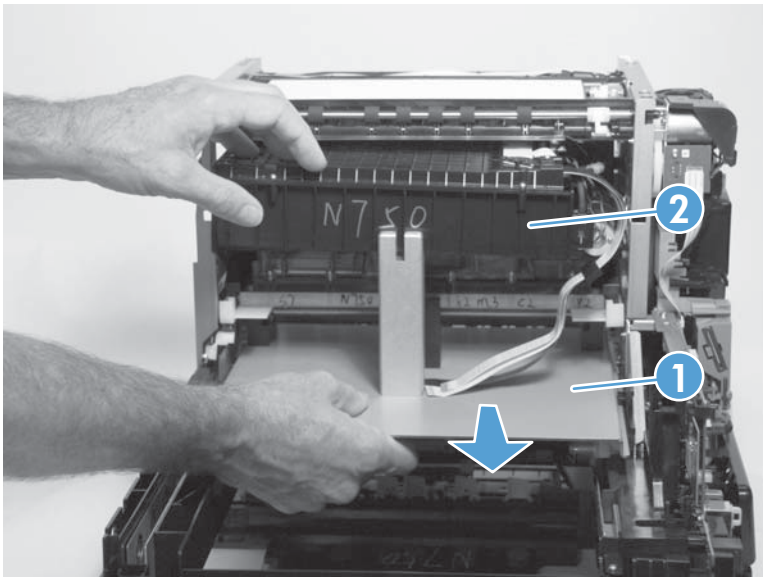

⚠ CAUTION: Use extreme care when handling the printbar while it is out of the product. It can be easily damaged.

13. Before reinstalling the printbar, check the shims for a significant buildup of ink/dust. If there is a significant build up, the shims can be cleaned very carefully with a **lint free** wipe.

Figure 1-108 Remove the printbar (12 of 12)

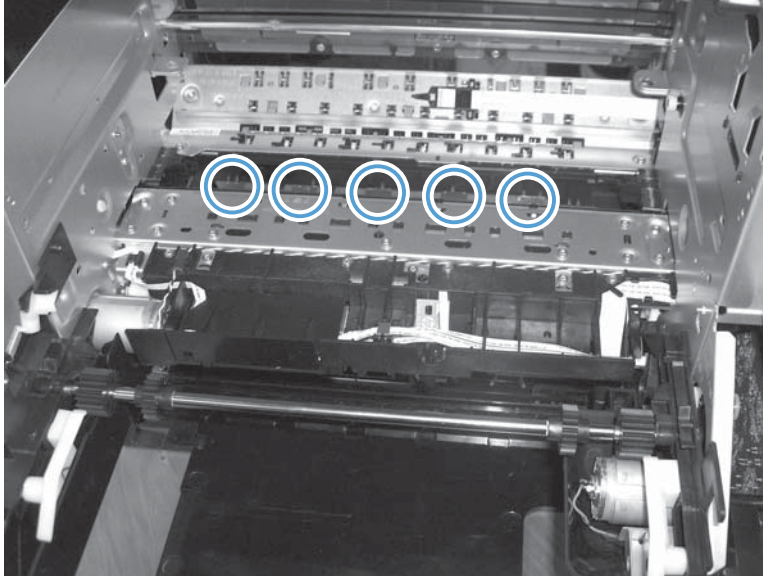

Reinstall the printbar

1. Slide the printbar dolly with new printbar gently into position and ensure it is fully seated. Insert the front and rear lift guide rods and ensure they are fully seated in their pockets.

 **Reinstallation tip** Ensure that the lift guide pockets have adequate grease in them during reinstallation. Failure to apply enough lubricant to the lift pocket guides can cause a noticeable increase in product operation noise.

Reinstallation tip Lift guide rods must be replaced in the same position. For example, front guide back into the front of the product.

If the printbar lift rod Z stop is broken, it must be replaced (part CN598-67048). If you are installing a new Z-stop, the top of the lift guide rods will stand above the top of the case. Installing the plate console left will cause the Z stop to crush down to the correct height.

2. Reinstall the plate console left.
3. Reinstall the printbar lock. Turn the lock to lift the printbar to it's top-most position. There should not be more than a 1.5 mm gap between where the printbar guide meets the lift rod Z stop on the front and rear guide rods. If a larger gap is evident, the printbar guide might be misaligned by a tooth. Lower the printbar back onto the dolly and see step 10 of Remove the printbar to remove and reinstall the lift guide rods.
4. Remove the printbar dolly and verify that the service sled drive is *not* easy to turn. If the service sled is not easy to turn, this indicates that the service sled transmission is in the correct position. See [Service sled transmission on page 110](#) for details.

 **Reinstallation tip** Remove the printbar safety cap before reinstalling the service sled.

Printbar calibration procedure

Test the printbar installation

Test the printbar installation after installing a printbar.

1. Temporarily connect the front panel into the main PCA. Temporarily install the right case part.
2. Place the printer into MFG (on) mode. See [Place the product into MFG \(manufacturing\) mode on page 15](#) for information on putting the product into MFG mode.

 **WARNING!** Follow the instructions for placing the product into MFG (manufacturing) mode **exactly** as listed in [Place the product into MFG \(manufacturing\) mode on page 15](#). Failure to follow these instructions while placing the product into MFG (manufacturing) mode can render the product inoperable.

- Temporarily install a set of trade supplies or use the existing customer supplies. Host supplies will be rejected in MFG (on) mode.
3. Verify that the new printbar is functional:
 - a. Temporarily install the left door.
 - b. Cover the ink supply door sensor with a magnet.
 - c. Print a Printer Status Report page.
 - d. Ensure that the service sled is aligned with the arrows. Perform a 21 tap test. Observe that the service sled moves smoothly, and that once it caps the printbar, that the cap is level and aligned correctly.
 - e. Turn the product off using the power button, and then unplug the product.
 4. Reinstall the product covers.

Calibrate the printbar



IMPORTANT: All the product covers must be installed before calibrating the printbar.

A new duplex module must be installed before calibration/initialization.

1. Place the product into MFG (off) mode, and then place the product into MFG (on) mode. See [Place the product into MFG \(manufacturing\) mode on page 15](#) for information on placing the product into these MFG modes.



NOTE: Use trade ink supplies while in MFG (on) mode. Host supplies will be rejected in MFG (on) mode.

2. Open the [Engineering menu](#). See [Access the Engineering menu on page 14](#) for information accessing the [Engineering menu](#).

 **WARNING!** Follow the instructions for accessing the [Engineering menu](#) **exactly** as listed in [Access the Engineering menu on page 14](#). Failure to follow these instructions when accessing the [Engineering menu](#) can render the product inoperable.

3. Select the [Service Menu](#), scroll to [System Configuration](#), select [Service ink container Or Duplex module](#), select [Replace Duplex Module](#), and then touch the [OK](#) button.

 **WARNING!** Replacing the duplex module is critical. Failure to replace the duplex module and to inform the firmware that the duplex module has been replaced will likely force the system into an unrecoverable error.

4. From the [Service Menu](#), scroll to [System Configuration](#), select [Replace Printbar](#) and follow the onscreen prompts, and then touch the [OK](#) button.
5. After the product restarts, remove the trade supplies, and then install the HP Setup supplies that came with the printbar replacement kit.

 **NOTE:** An initialization screen will be displayed on the product control panel while the printbar purges the shipping fluid.

 **NOTE:** After the printbar purges the shipping fluid, the product begins calibrating. The calibrations will take approximately 20 to 25 minutes and a total of nine pages will print. When the calibrations are complete, the control panel will return to the [Home](#) screen.

6. Turn off the product, and then turn the product on. The product will boot in user (standard) mode.

 **NOTE:** Use the power button to turn the product off and on. If the power button does not work, see the Troubleshooting guide.

7. Print a Print Quality Report. If there are problems, then follow the Print Quality Checklist in the Troubleshooting Guide.
8. Open the [Engineering](#) menu. See [Access the Engineering menu on page 14](#) for information accessing the [Engineering](#) menu.
9. Run the following tap tests:
 - 10 tap
 - 12 tap
 - 61 tap
 - 909 tap

For more information on running and verifying tap test results, see [Perform tap tests and interpret results on page 17](#).

10. Return to the [Ready](#) screen, and then complete the customer configurations, including network settings, preferred paper size and trays, and so forth.

Printbar FFC replacement

 **IMPORTANT:** The printbar safety cap must remain securely fastened to the printbar during this procedure. If the printbar safety cap is unfastened, then the printbar might be damaged and require replacement.

1. Remove the printbar. See [Printbar on page 68](#)
2. Remove two screws, and then remove the two FFC retainers.

Figure 1-109 Replace the printbar control FFCs (1 of 2)

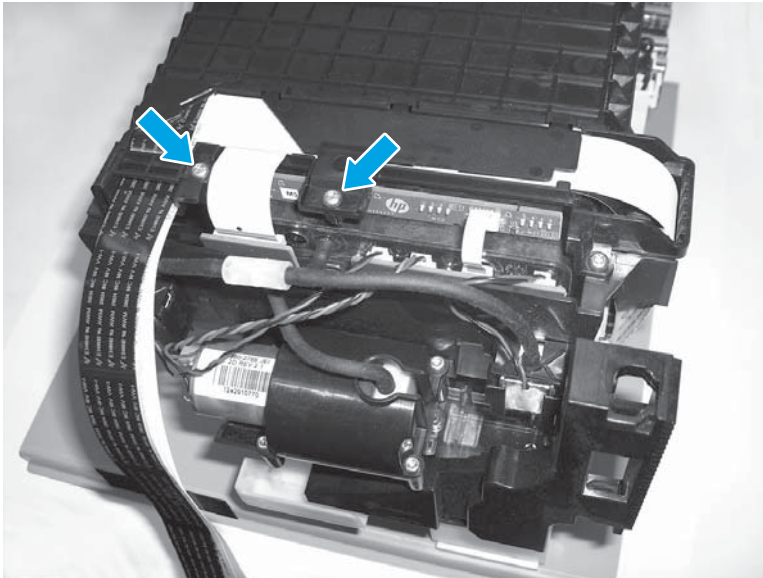

3. Remove two printbar FFCs installed in ZIF sockets, and then remove the prime pump FFC.

Figure 1-110 Replace the printbar control FFCs (2 of 2)

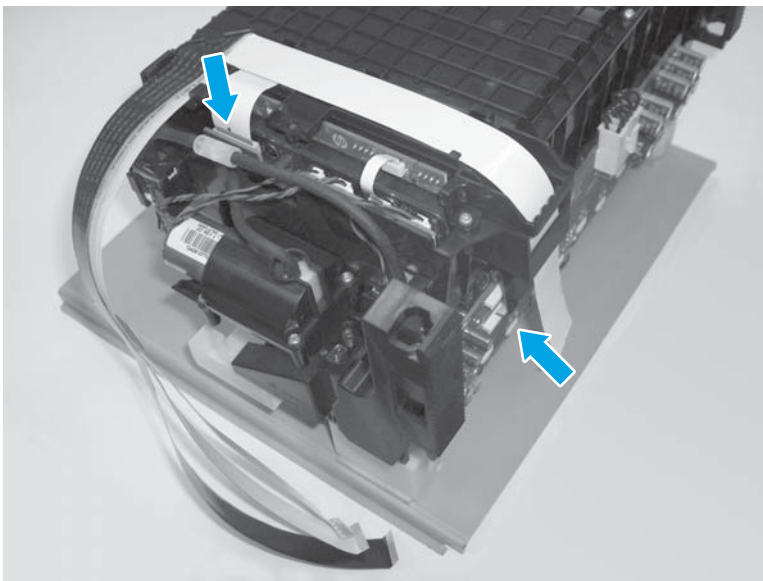

4. Install the new FFCs.

Platen

 **NOTE:** Ensure the product firmware is upgraded to at least version 1336MR before performing this repair procedure. If the firmware upgrade cannot be completed, contact HP support.

1. Remove the following components:
 - Aerosol fan assembly. See [Aerosol fan assembly on page 36](#).
 - Right cross brace. See [Right cross brace on page 63](#).
 - Service sled assembly. See [Service sled assembly on page 57](#).
2. Remove the printzone distribution PCA cover (callout 1).

Figure 1-111 Remove the platen (1 of 7)

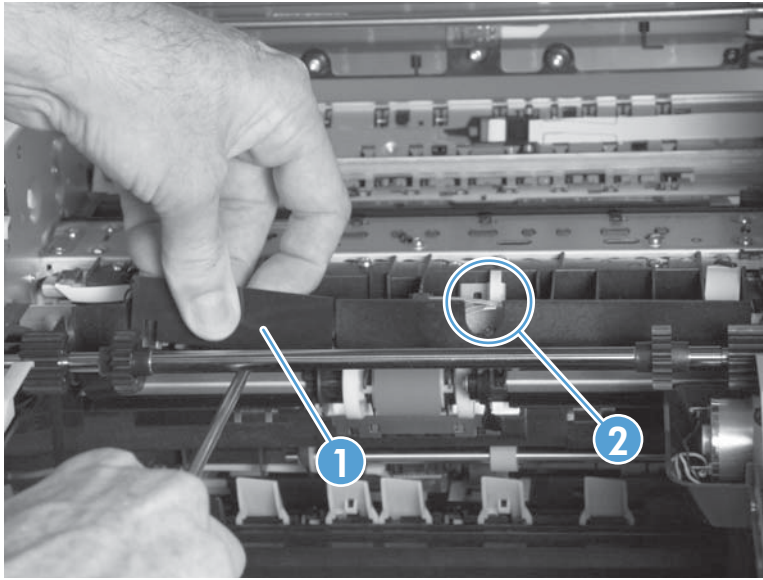

 **NOTE:** The printzone distribution PCA is indicated by callout 2.

3. Disconnect two flat flexible cables (callout 1). Note that the white cable is on the left and the black cable is on the right, and then unthread the cables through the chassis wall.

Figure 1-112 Remove the platen (2 of 7)

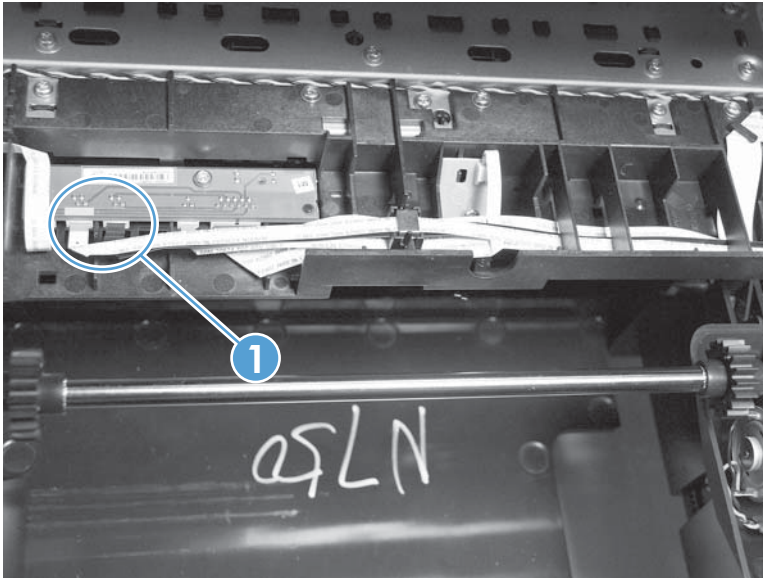

 **Reinstallation tip** Remember the cable orientation and order. Take care to avoid crimping the flex cables when removing or reinstalling them.

4. Lower the platen (callout 1).

Figure 1-113 Remove the platen (3 of 7)

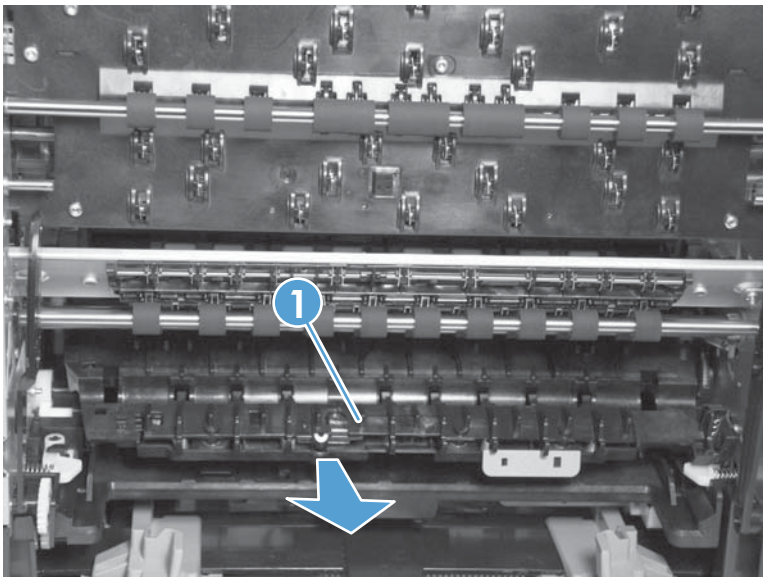

5. Remove one screw (callout 1) from the rear wall.

Figure 1-114 Remove the platen (4 of 7)

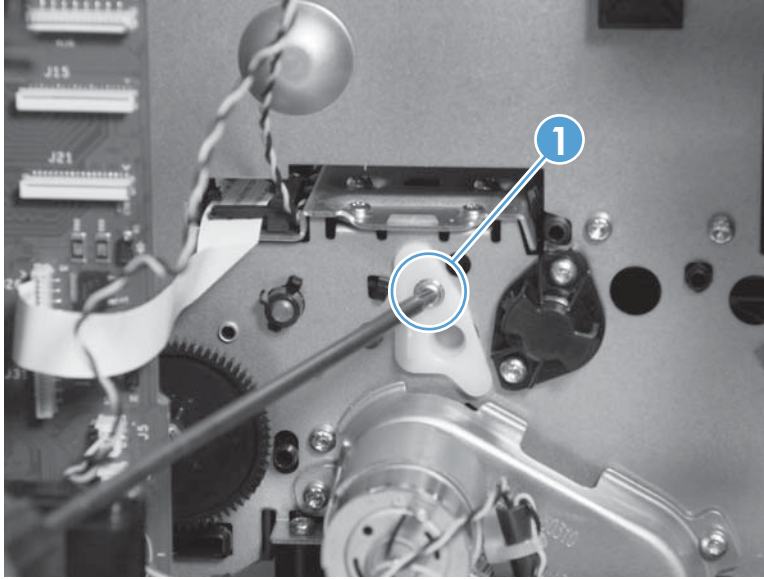

6. Remove the bracket (callout 1).

Figure 1-115 Remove the platen (5 of 7)

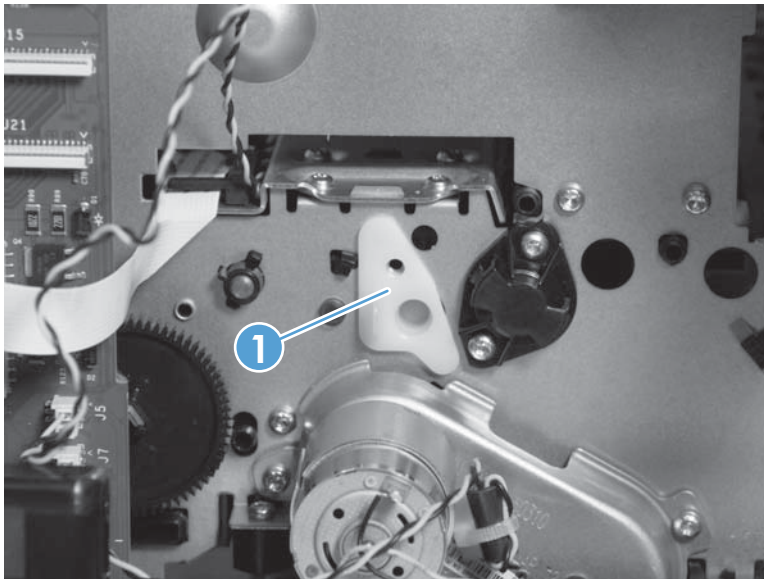

7. Push the platen towards the rear of the product to clear the retention spring on the front pivot, and then remove the platen.

Figure 1-116 Remove the platen (6 of 7)

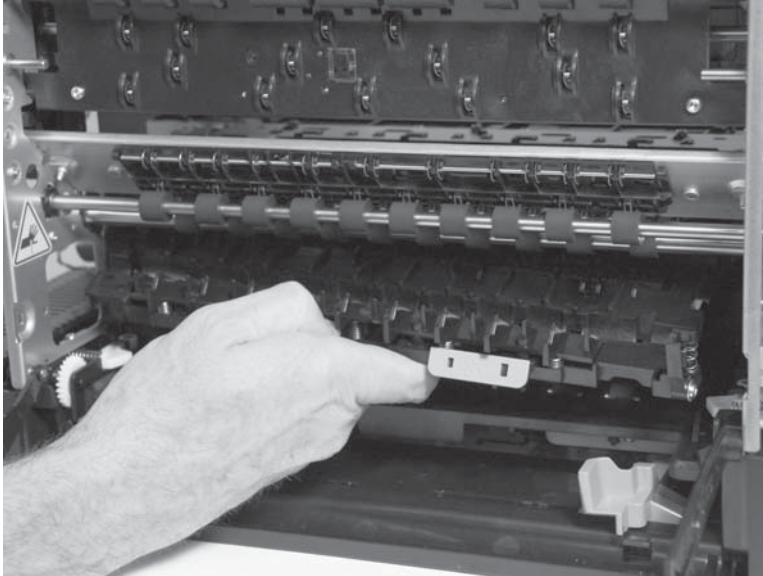

 **TIP:** Temporarily tape the two REDI FFCs together to make them easier to thread through the wall. Remove the tape after the FFCs are threaded through the wall.

8. New REDI sensors were installed with the new platen and require calibration. Use the following steps to calibrate the REDI sensors.

Calibrate the REDI sensors

- a. Open the [Engineering menu](#).
- b. From the [Engineering Menu](#), select the [Service Menu](#), and then select [System Configuration](#).
- c. Select [Paper Sensor Calibration](#).

 **NOTE:** The paper sensor calibrations require one sheet of blank HP Colorlok paper. HP Colorlok paper **must** be used for the Paper Sensor Calibration. The same sheet of paper can be reused if it is undamaged.

- d. Select [Calibrate Main tray](#). The tray will eject one blank page.
- e. Select [Calibrate MP tray](#). The product will eject one blank page into the tray.

 **Reinstallation tip** Place the black cable (callout 1) under the white cable and thread the cables through the hole in the product interior.

Reinstallation tip While reinstalling the right end of the platen, depress the spring in the front of the unit.

Figure 1-117 Remove the platen (7 of 7)

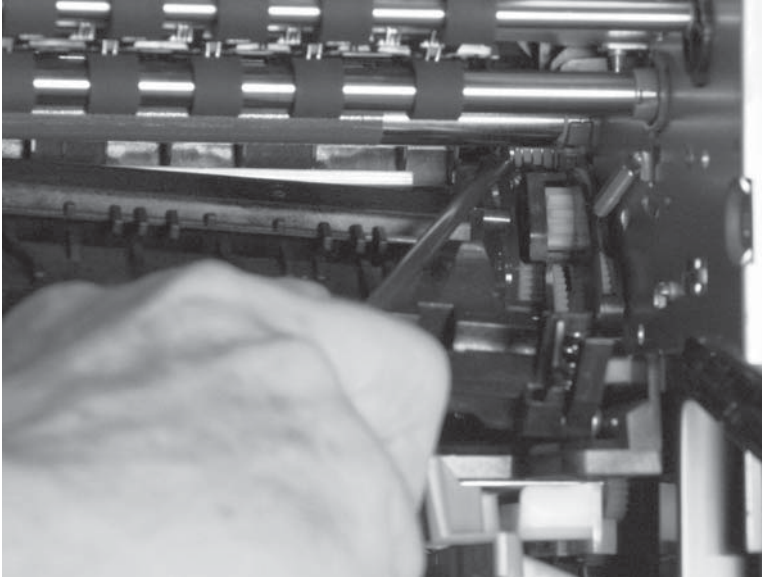

Drying path gear assembly

1. Remove the following components:
 - Rear cover. See [Rear cover on page 23](#).
 - Left rear cover. See [Left rear cover on page 27](#).
 - PCA safety shield. See [PCA safety shield on page 111](#).
2. Remove three screws (callout 1), and then remove the assembly (callout 2).

Figure 1-118 Remove the drying path gear assembly

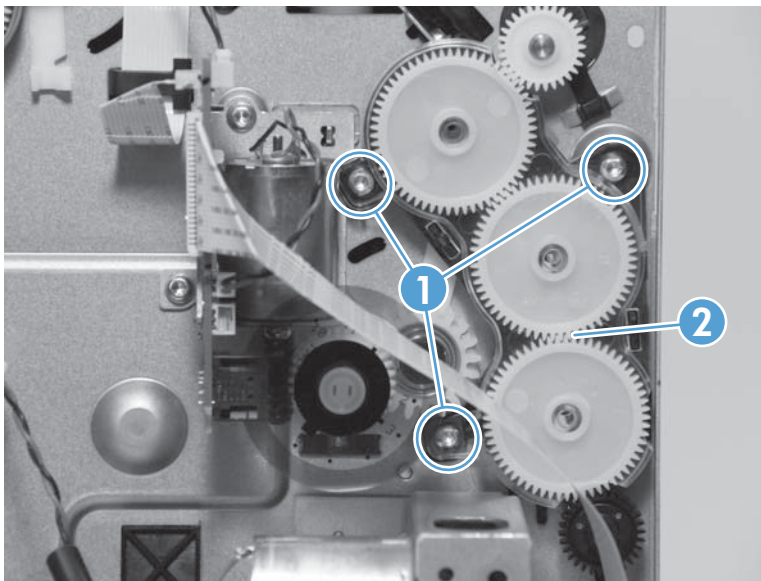

Printbar lift mechanism assembly

Remove the following components:

- Aerosol fan assembly. See [Aerosol fan assembly on page 36](#).
- Drying path gear assembly. See [Drying path gear assembly on page 83](#).

Printbar lift bracket worm drive

1. Disconnect three wire connectors (callout 1).

Figure 1-119 Remove the printbar lift motor (1 of 3)

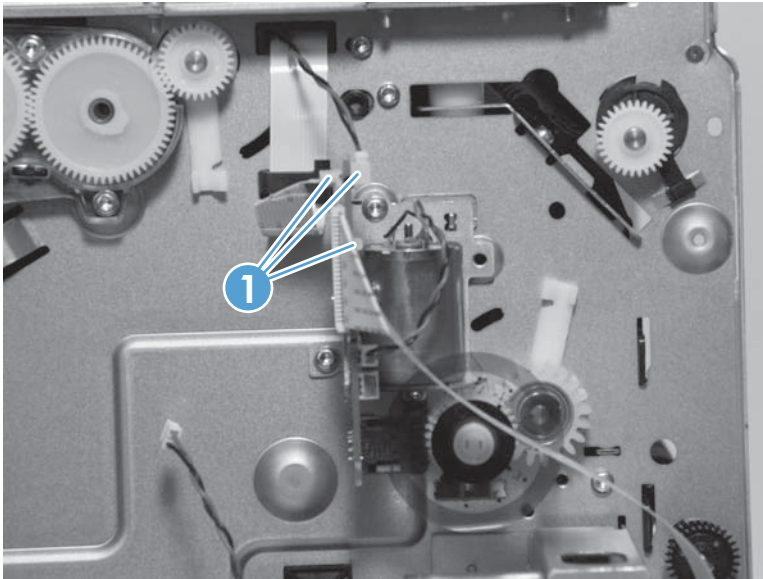

2. Remove two screws (callout 1), and then remove the assembly.

Figure 1-120 Remove the printbar lift motor (2 of 3)

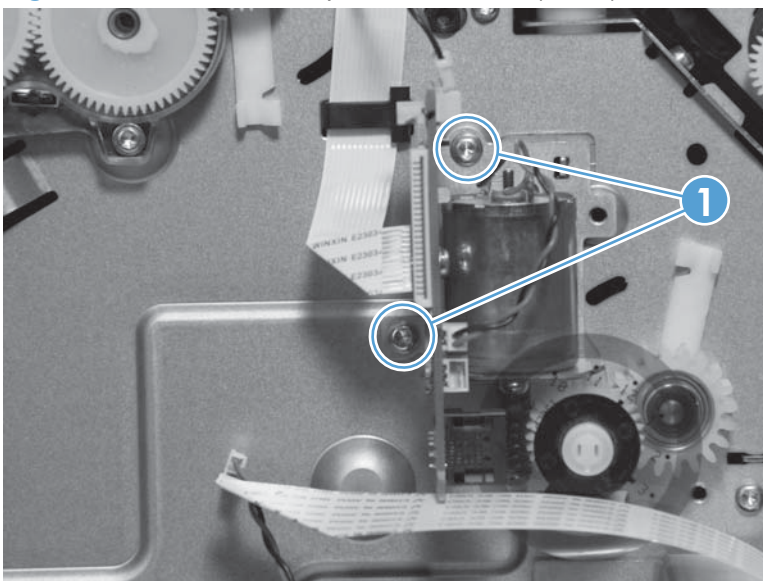

3. Remove the plastic clip (callout 1) from the printbar lift encoder shaft. Remove the lift encoder/ gear assembly.

Figure 1-121 Remove the printbar lift motor (3 of 3)

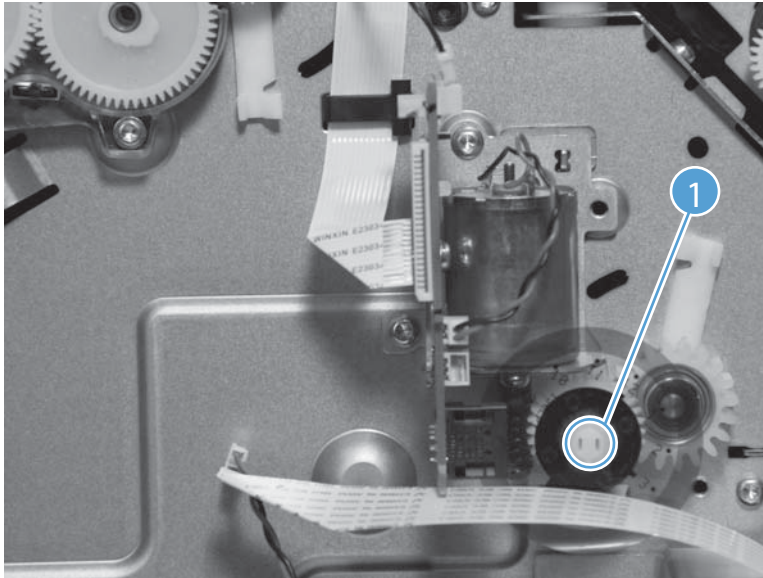

 **Reinstallation tip** Fit the encoder wheel through the sensor on the back of the PCA assembly.

Reinstallation tip Use the clip supplied with the printbar lift mechanism kit. Do **not** reuse the existing clip.

Tray lift transmission assembly

1. Remove the following components:
 - Main PCA. See [Main PCA on page 127](#).
 - Pick encoder distribution PCA. See [Pick encoder distribution PCA on page 136](#).
 - Tray 3 interconnect PCA. See [Tray 3 interconnect PCA on page 135](#).
2. Remove two screws (callout 1).

Figure 1-122 Remove the tray lift transmission assembly (1 of 2)

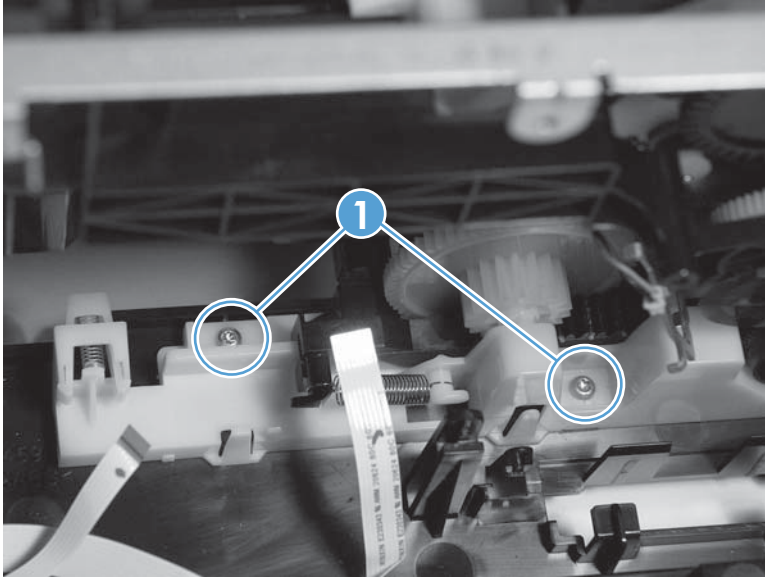

- Carefully remove the assembly (callout 1). The main gear drive axle must clear a post on the product chassis before the assembly can be removed.

Figure 1-123 Remove the tray lift transmission assembly (2 of 2)

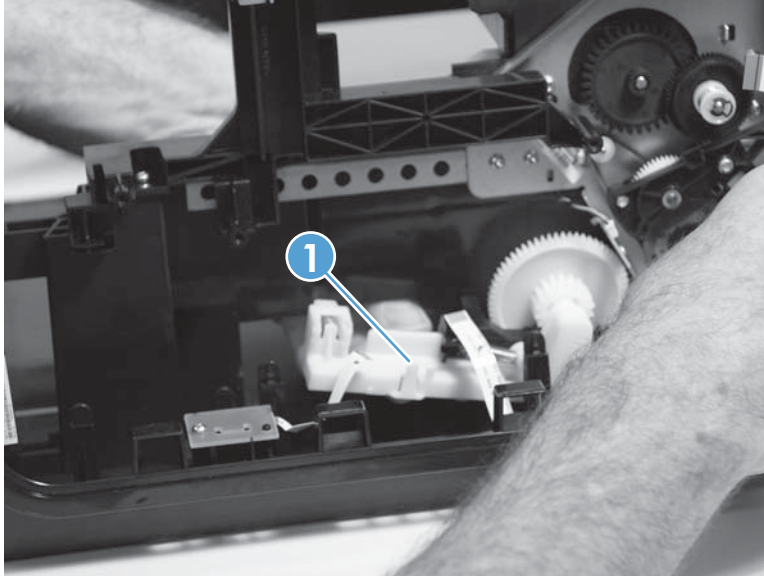

 **Reinstallation tip** When reinstalling the tray lift transmission assembly, ensure the service sled is installed correctly. See [Service sled transmission on page 110](#).

Output drive kit

Remove the following components:

- Rear cover. See [Rear cover on page 23](#).
- Left door. See [Left door on page 24](#).
- Left rear cover. See [Left rear cover on page 27](#).
- Left front cover. See [Left front cover on page 28](#).
- Top cover. See [Top cover on page 29](#).
- Plate console right. See [Plate console right on page 67](#).

Flap actuator solenoid

1. Remove two screws (callout 1).

Figure 1-124 Remove the flap actuator solenoid

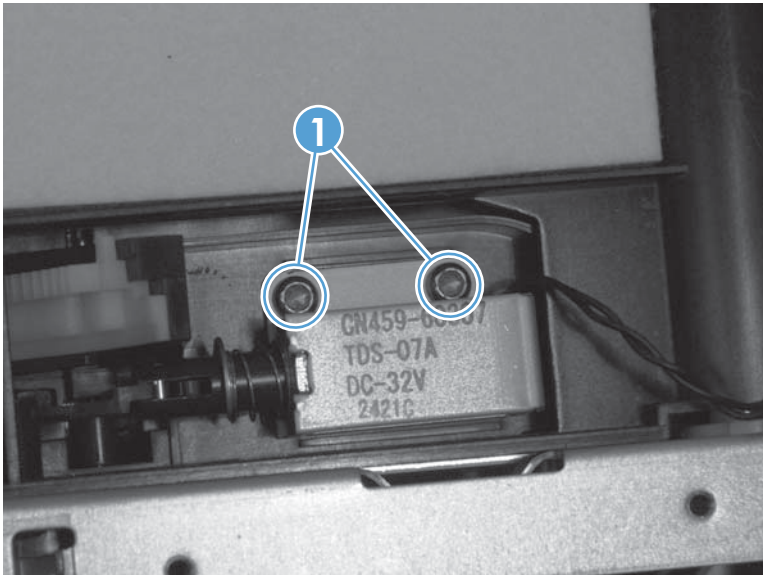

2. Remove the solenoid and disconnect the solenoid activation cable.

Rack-eject lifter flap

1. Pull the actuator forward.

Figure 1-125 Remove the rack-eject lifter flap (1 of 3)

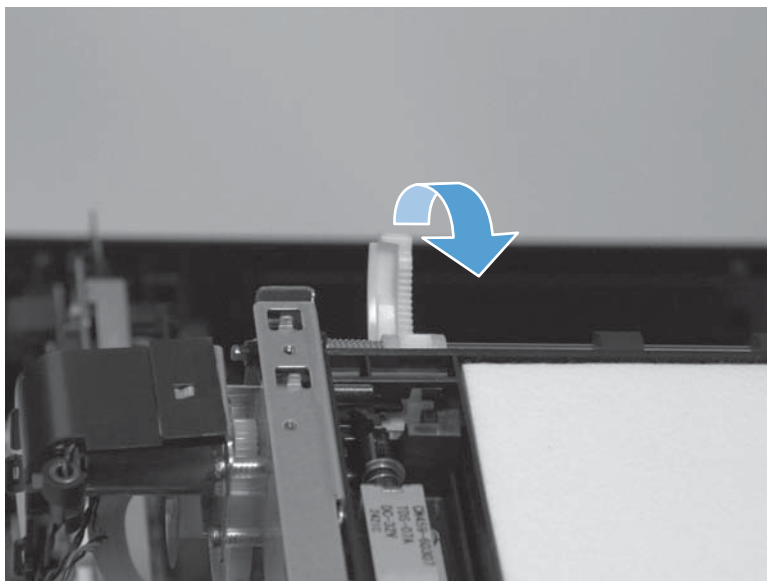

2. Locate the tab (callout 1) on the right of the actuator.

Figure 1-126 Remove the rack-eject lifter flap (2 of 3)

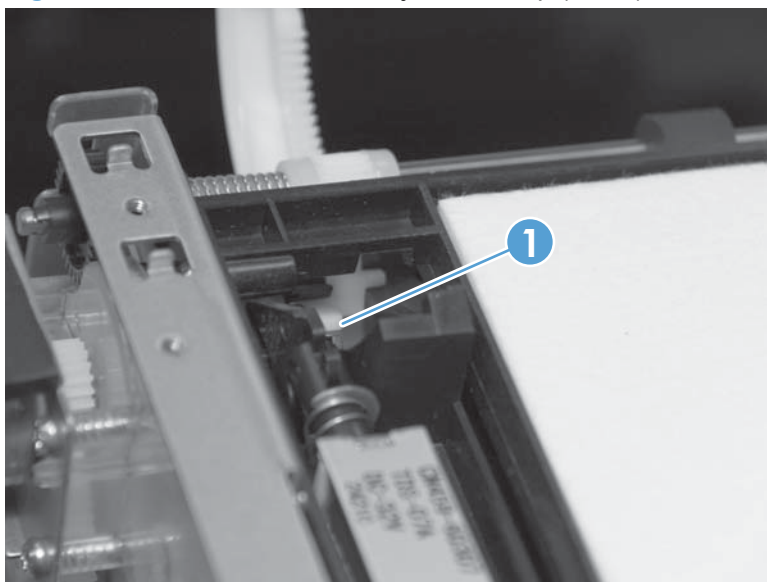

3. Use a screwdriver to lift the tab, and then rotate the actuator to remove it.

Figure 1-127 Remove the rack-eject lifter flap (3 of 3)

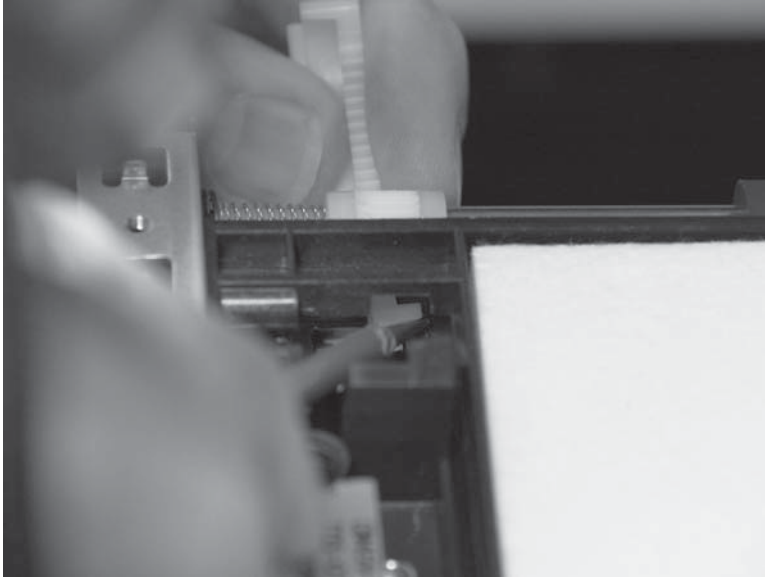

 **Reinstallation tip** Ensure that the actuator is correctly aligned during reinstallation. If the actuator is aligned incorrectly, the actuator flap will not open. The actuator must pass through the guide anchored on both sides of the guide.

Eject drive gear module

- ▲ Remove four screws (callout 1), and then remove the assembly.

Figure 1-128 Remove the eject drive gear module

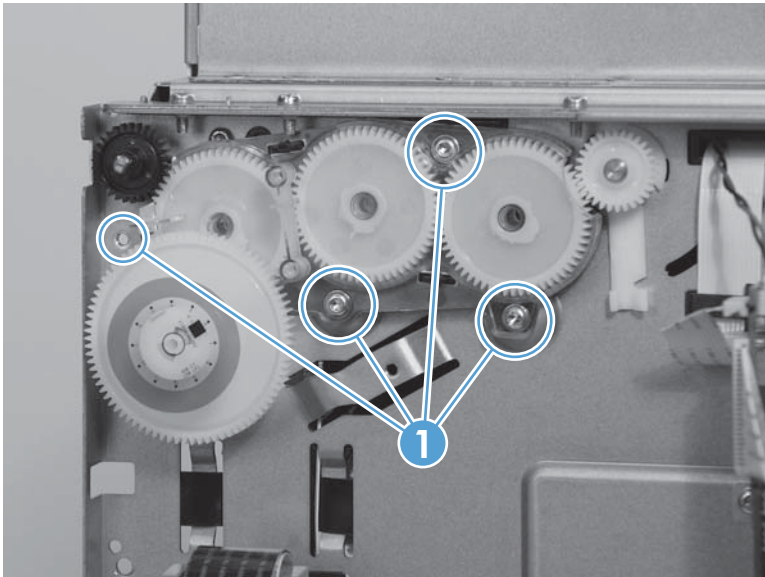

Output drive gears

1. Spread the retainers (using a pair of tweezers) holding the gear onto the shaft, and then slide the gear off the shaft. Repeat this step for each gear.

Figure 1-129 Remove the output drive gears

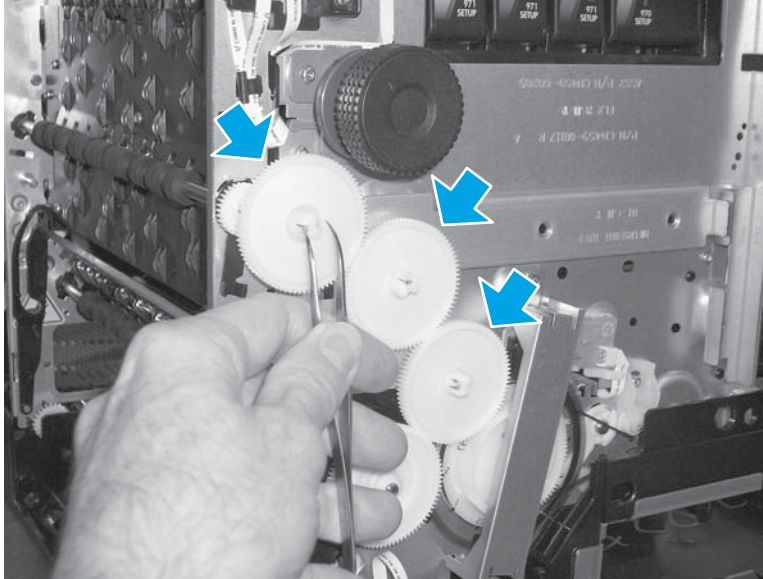

2. Snap the new output drive gears onto the shafts.

Output drive shaft 6

1. Remove the following components:
 - Rear cover. See [Rear cover on page 23](#).
 - Left door. See [Left door on page 24](#).
 - Left rear cover. See [Left rear cover on page 27](#).
 - Left front cover. See [Left front cover on page 28](#).
 - Top cover. See [Top cover on page 29](#).
 - Front cover. See [Front cover on page 34](#).
 - Right cover. See [Right cover on page 35](#).
 - Plate console right. See [Plate console right on page 67](#).
 - Output flap actuator. See [Rack-eject lifter flap on page 89](#).

2. Pry apart the clip (callout 1) from the pulley on the rear of the shaft.

Figure 1-130 Remove the output drive shaft 6 (1 of 3)

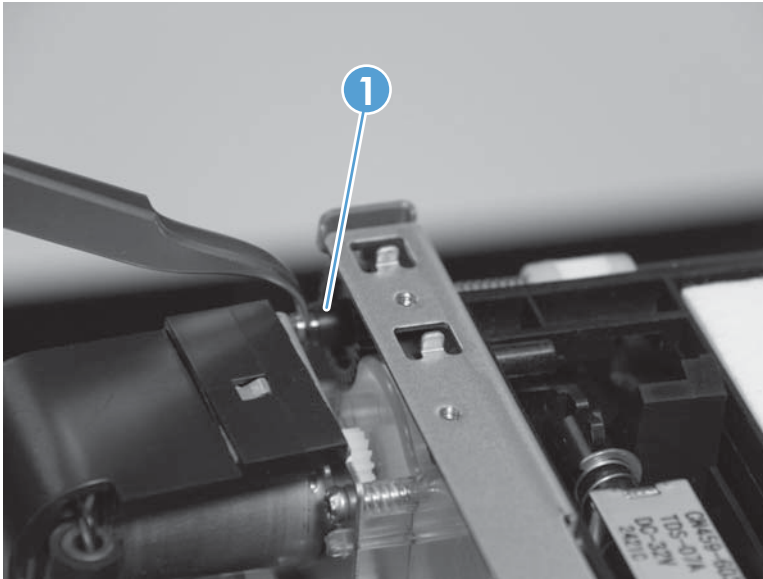

3. Rotate the front output drive shaft bearing counterclockwise.

Figure 1-131 Remove the output drive shaft 6 (2 of 3)



4. Grip the rear pulley, pull the shaft (callout 1) to the front of the product, and then remove the shaft.

Figure 1-132 Remove the output drive shaft 6 (3 of 3)

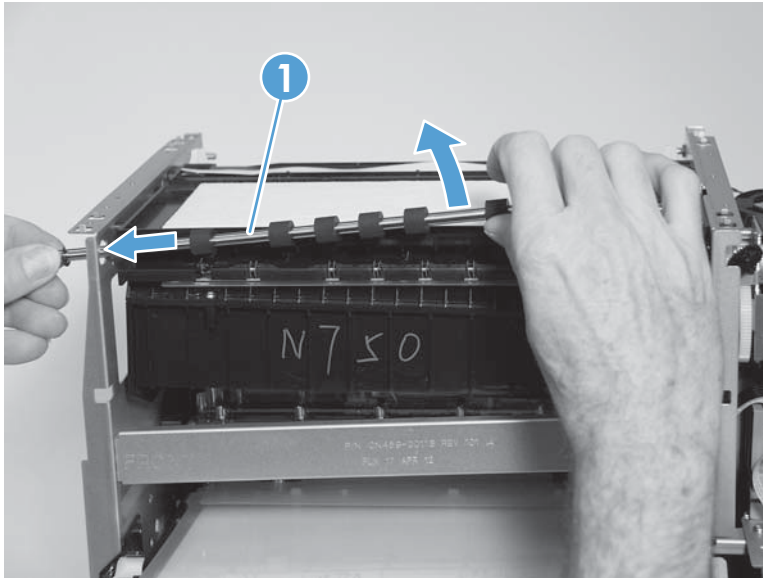

Output drive shaft 5

1. Remove the following components:
 - Rear cover. See [Rear cover on page 23](#).
 - Left door. See [Left door on page 24](#).
 - Left rear cover. See [Left rear cover on page 27](#).
 - Left front cover. See [Left front cover on page 28](#).
 - Top cover. See [Top cover on page 29](#).
 - Front cover. See [Front cover on page 34](#).
 - Right cover. See [Right cover on page 35](#).
 - Inner top frame. See [Inner top frame on page 99](#).
 - Plate console right. See [Plate console right on page 67](#).
 - Plate console left. See [Plate console left on page 66](#).

2. Rotate the rear output drive shaft bearing counterclockwise.

Figure 1-133 Remove the output drive shaft 5 (1 of 2)

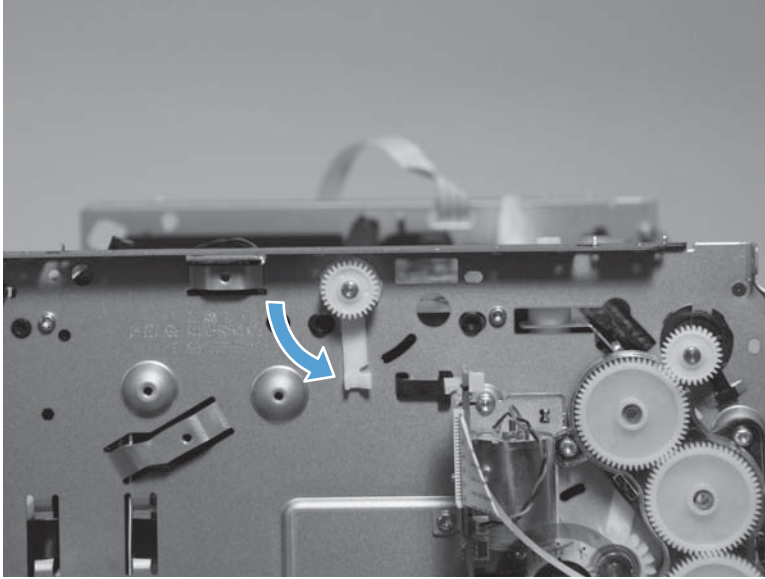

3. Pull the shaft (callout 1) to the rear of the product, and then remove the shaft.

Figure 1-134 Remove the output drive shaft 5 (2 of 2)

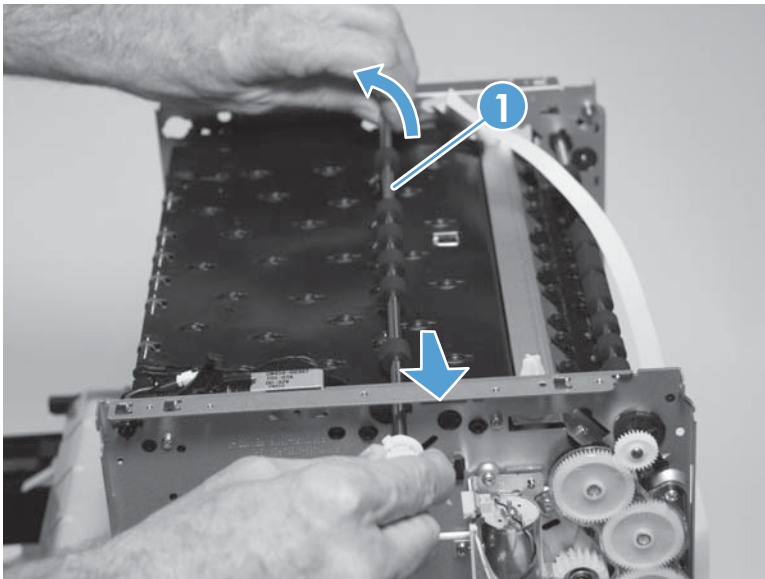

Output drive shaft 4

1. Remove the following components:
 - Rear cover. See [Rear cover on page 23](#).
 - Left door. See [Left door on page 24](#).
 - Left rear cover. See [Left rear cover on page 27](#).
 - Left front cover. See [Left front cover on page 28](#).
 - Drying path gear assembly. See [Drying path gear assembly on page 83](#).
2. Rotate the rear output drive shaft bearing counterclockwise.

Figure 1-135 Remove the output drive shaft 4 (1 of 2)

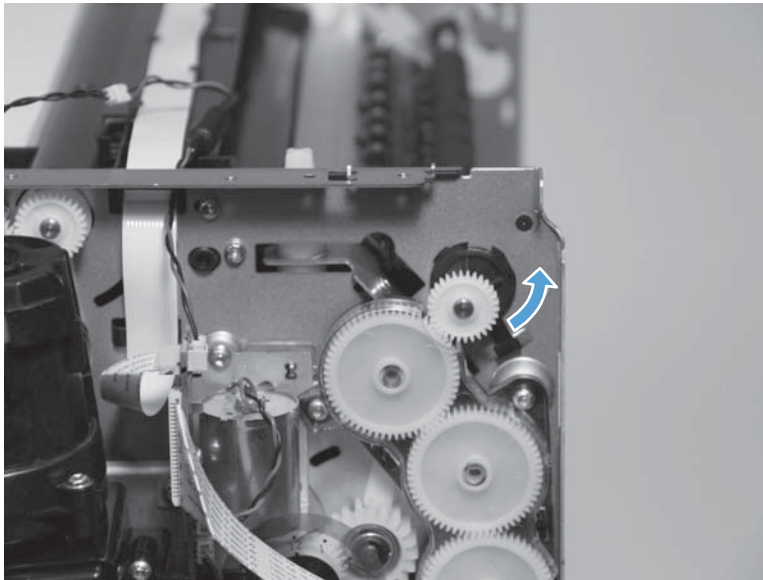

3. Remove the shaft (callout 1).

Figure 1-136 Remove the output drive shaft 4 (2 of 2)

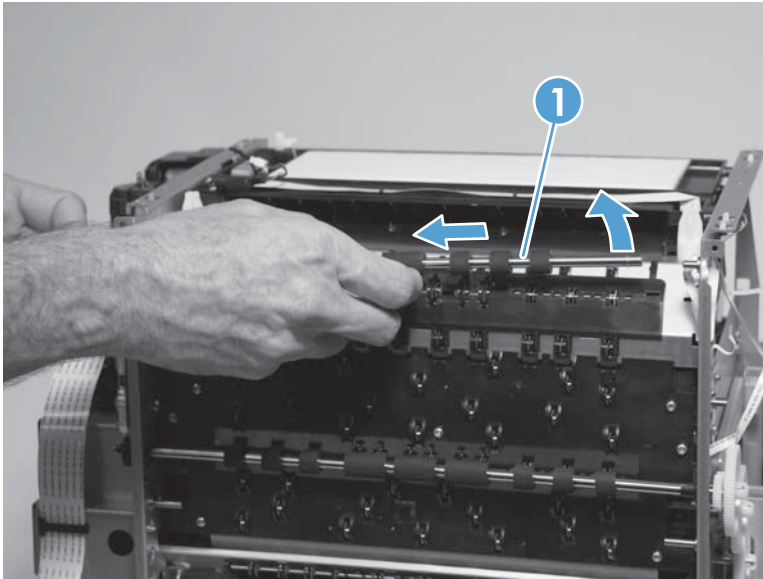

Drive shaft 3

1. Remove the following components:
 - Rear cover. See [Rear cover on page 23](#).
 - Left door. See [Left door on page 24](#).
 - Left rear cover. See [Left rear cover on page 27](#).
 - Left front cover. See [Left front cover on page 28](#).
 - Top cover. See [Top cover on page 29](#).
 - Front cover. See [Front cover on page 34](#).

2. Remove one gear (callout 1).

Figure 1-137 Remove drive shaft 3 (1 of 4)

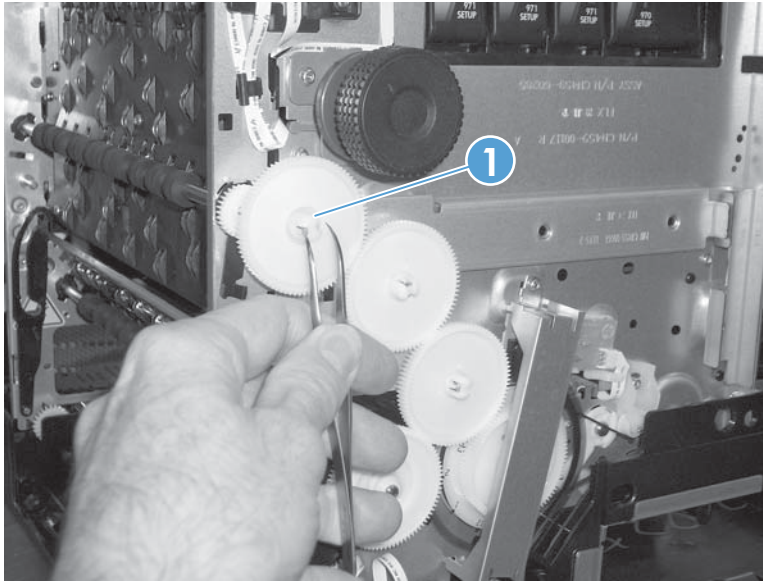

3. Use tweezers to release the hooks on the rear gear so it can slide off the shaft.

Figure 1-138 Remove drive shaft 3 (2 of 4)

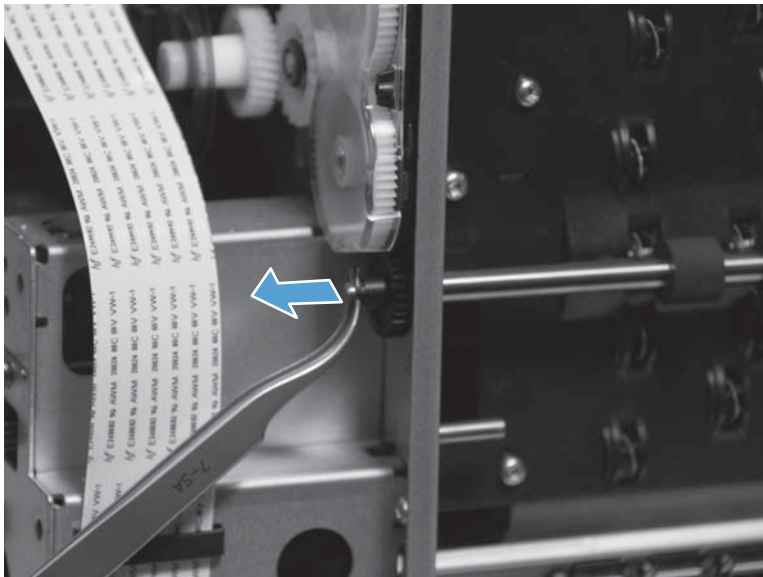

4. Rotate the front output drive shaft bearing counterclockwise.

Figure 1-139 Remove drive shaft 3 (3 of 4)

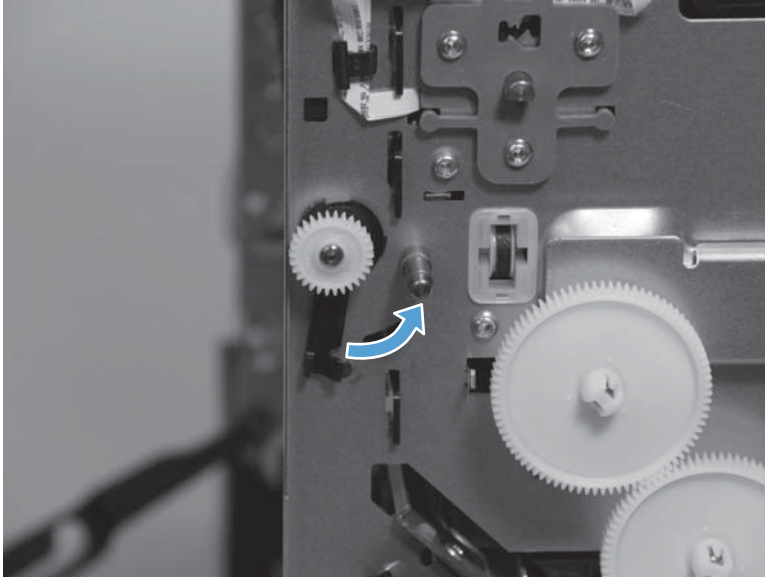

5. Remove the shaft (callout 1).

Figure 1-140 Remove drive shaft 3 (4 of 4)

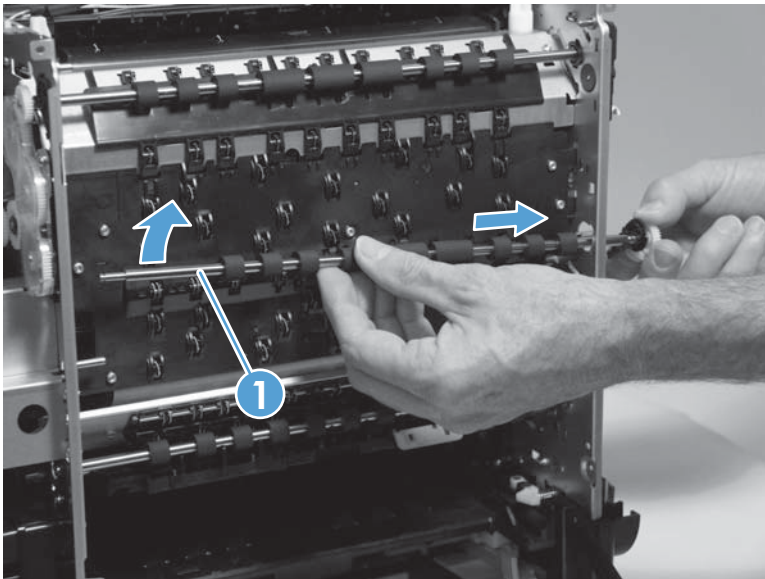

Inner top frame

1. Remove the following components:
 - Top cover. See [Top cover on page 29](#).
 - Aerosol fan assembly. See [Aerosol fan assembly on page 36](#).
 - Eject drive gear module. See [Eject drive gear module on page 90](#).
 - Plate console right. See [Plate console right on page 67](#).
 - Plate console left. See [Plate console left on page 66](#).
2. Disconnect the printzone distribution PCA flex cable (callout 1).

Figure 1-141 Remove the inner top frame (1 of 5)

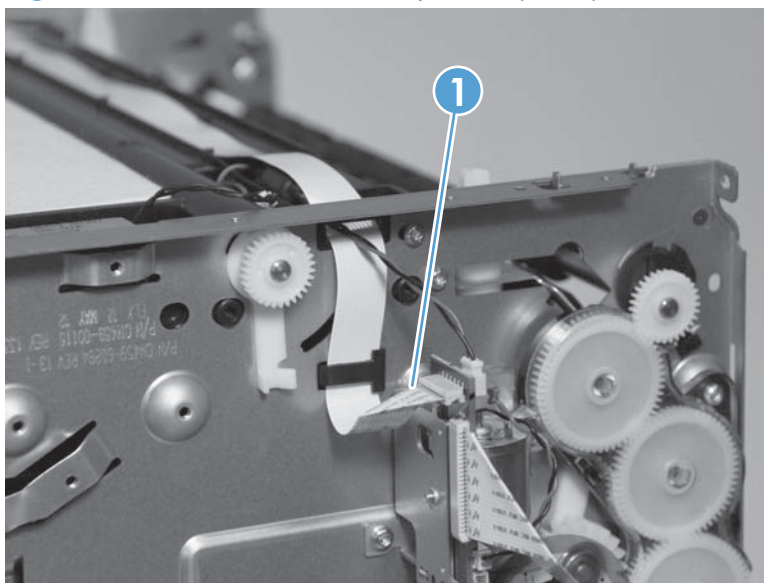

3. Unthread the flex cable (callout 1).

Figure 1-142 Remove the inner top frame (2 of 5)

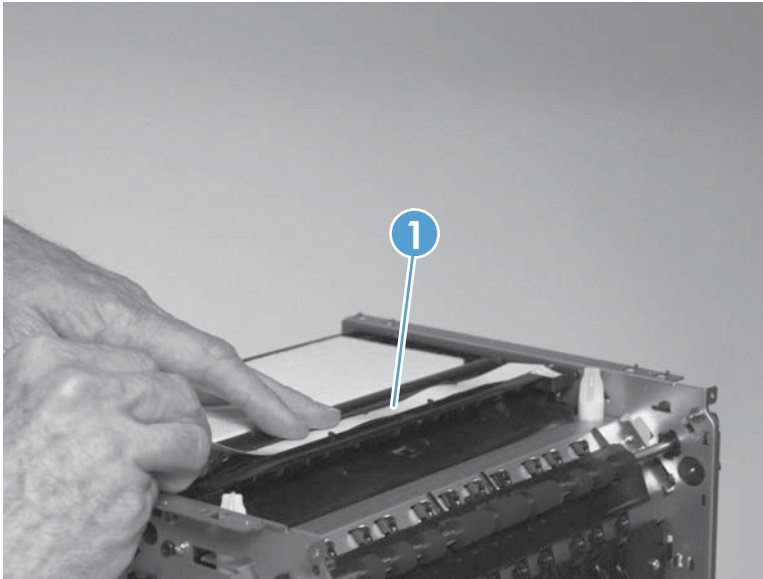

4. Disconnect the flap actuator solenoid cable (callout 1) from the printzone distribution PCA.

Figure 1-143 Remove the inner top frame (3 of 5)

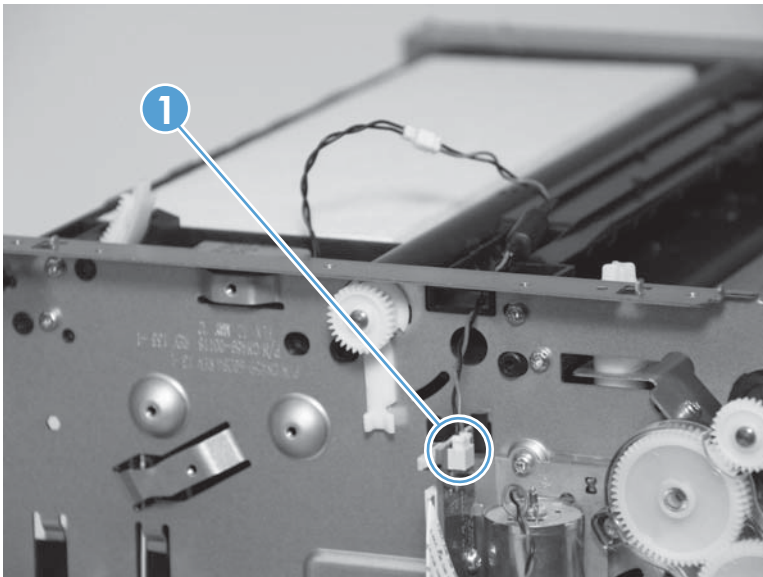

5. Remove two screws (callout 1) from the rear of the product.

Figure 1-144 Remove the inner top frame (4 of 5)

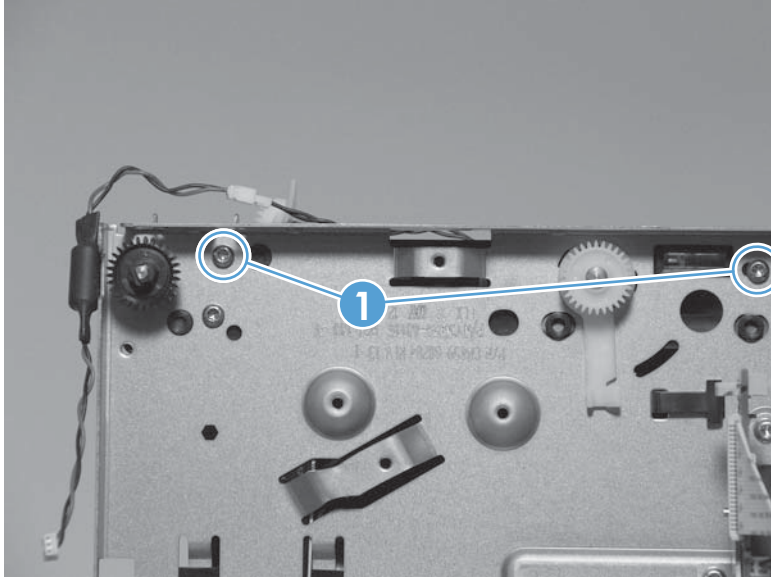

6. Remove the inner top frame.

Figure 1-145 Remove the inner top frame (5 of 5)

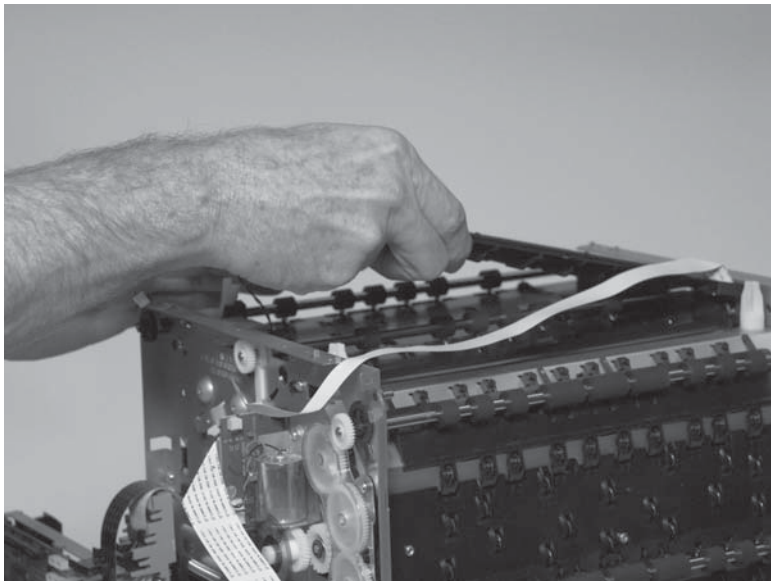

 **NOTE:** It can be quite difficult getting the inner top frame out from the slots in the metal cube. Bias the assembly toward the front, and it should lift out from the rear.

Top paper guide

1. Remove the following components:
 - Printbar. See [Printbar on page 68](#).
 - Output drive shaft 6. See [Output drive shaft 6 on page 91](#).
 - Output drive shaft 5. See [Output drive shaft 5 on page 93](#).
2. Disconnect two cables (callout 1) from the printzone distribution PCA.

Figure 1-146 Remove the top paper guide (1 of 6)

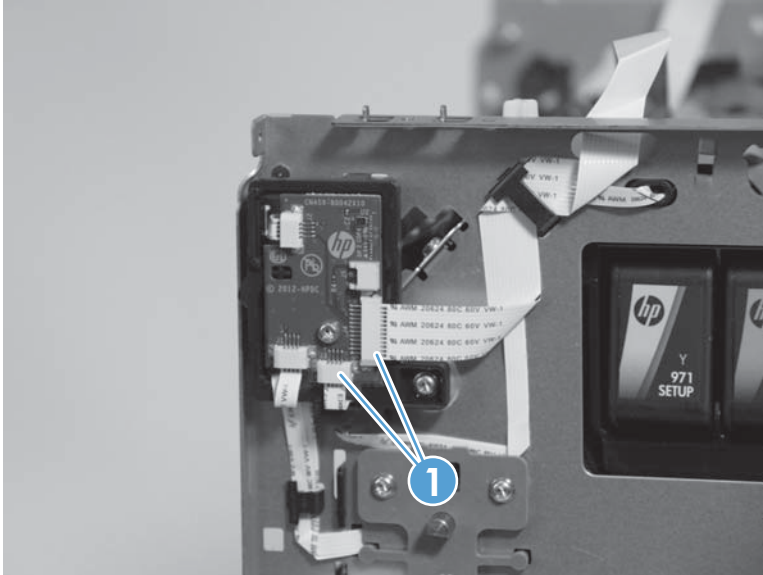

3. Remove the flex cable (callout 1) and the wire retainer (callout 2).

Figure 1-147 Remove the top paper guide (2 of 6)

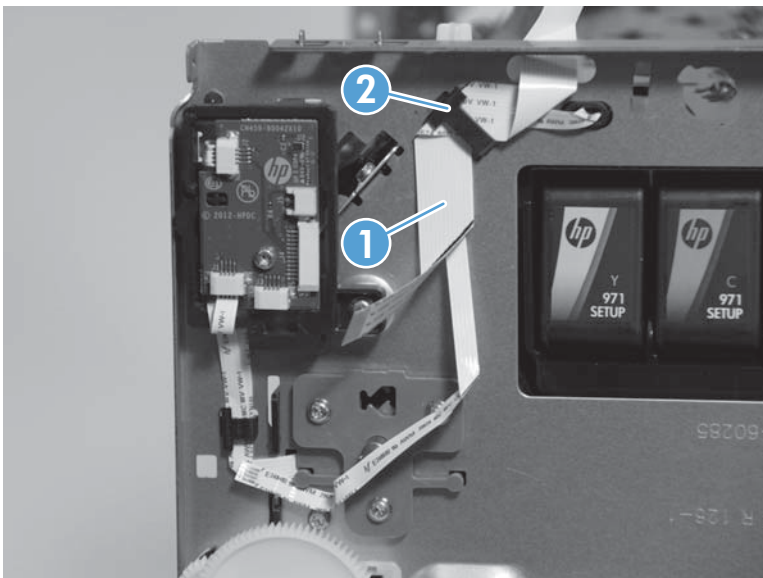

4. Remove two screws (callout 1) from the rear of the product.

Figure 1-148 Remove the top paper guide (3 of 6)

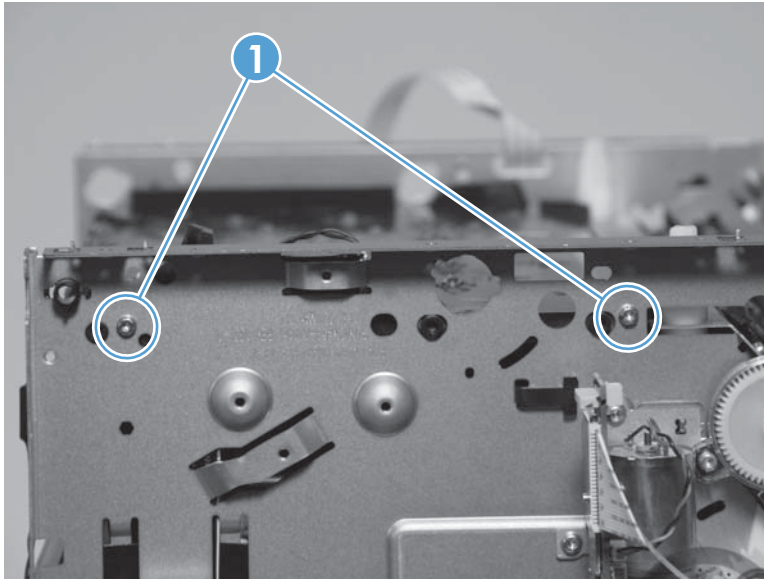

5. Raise the top paper guide (callout 1).

Figure 1-149 Remove the top paper guide (4 of 6)

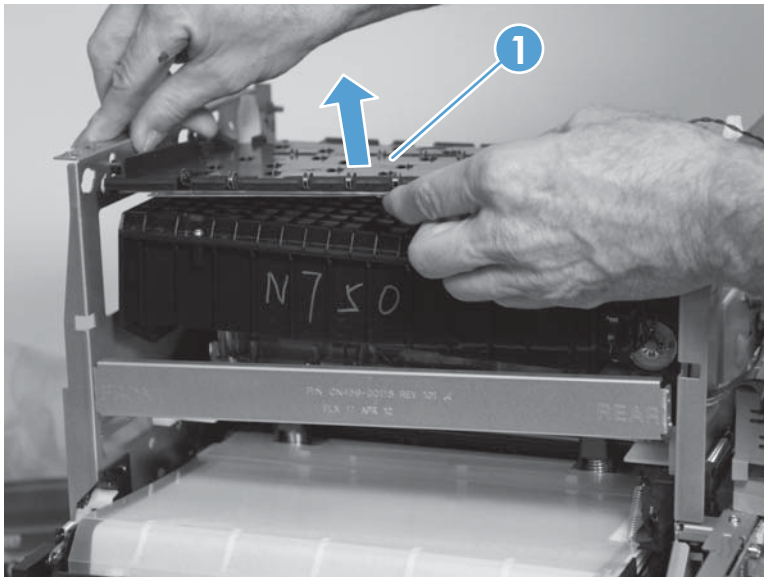

6. Use a screwdriver to unclip the plastic shield (callout 1) from underneath the top paper guide.

 **NOTE:** Use caution to avoid breaking the plastic tabs on the shield. Take care to correctly plug the shield back into the top paper guide.

Figure 1-150 Remove the top paper guide (5 of 6)



7. Remove the guide.

Figure 1-151 Remove the top paper guide (6 of 6)

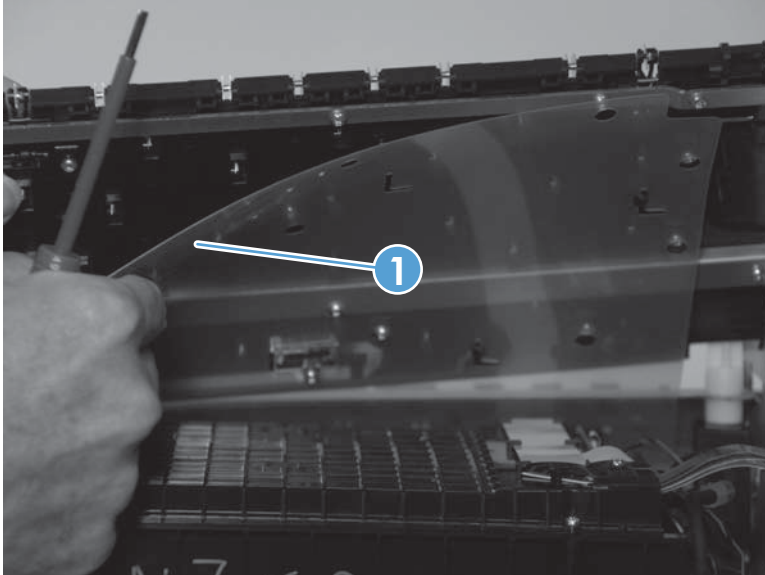
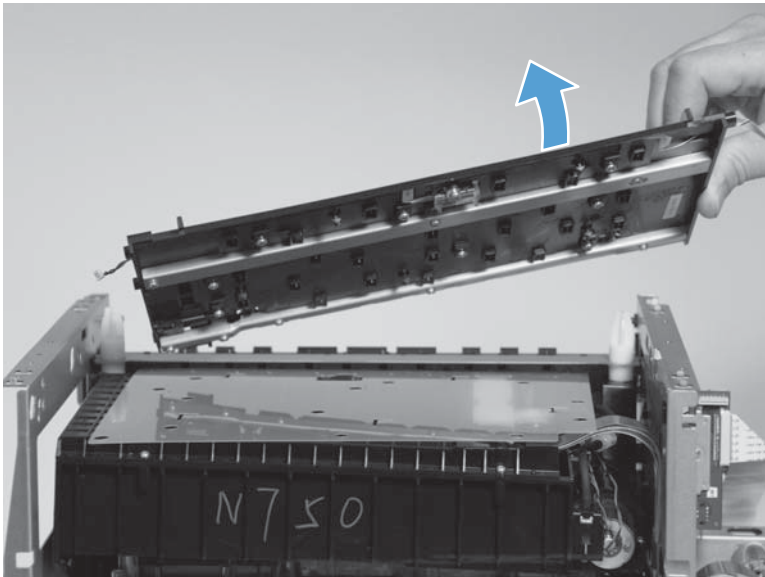

Top left paper guide assembly

1. Remove the following components:
 - Printbar. See [Printbar on page 68](#).
 - Plate console right. See [Plate console right on page 67](#).
 - Output drive shaft 4. See [Output drive shaft 4 on page 95](#).
 - Drying path gear assembly. See [Drying path gear assembly on page 83](#).
2. Remove the output drive shaft 4 front bearing (callout 1).

Figure 1-152 Remove the top left paper guide (1 of 4)

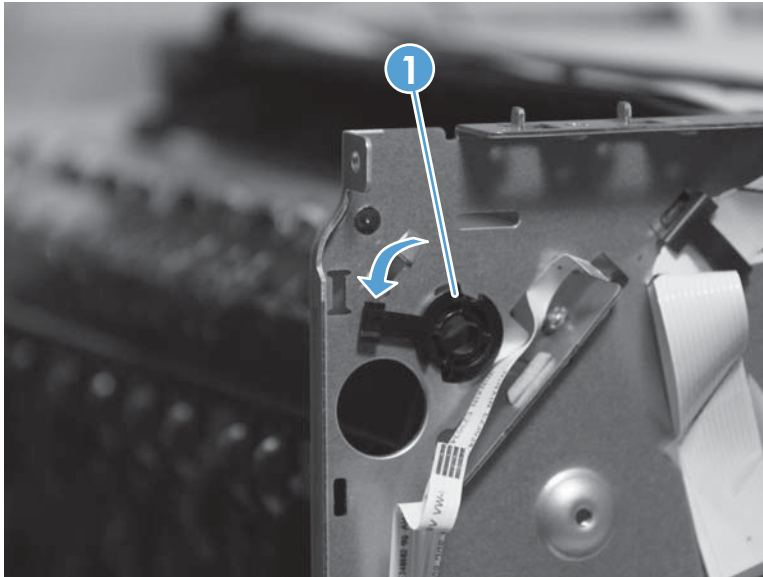

3. Remove two screws (callout 1).

Figure 1-153 Remove the top left paper guide (2 of 4)

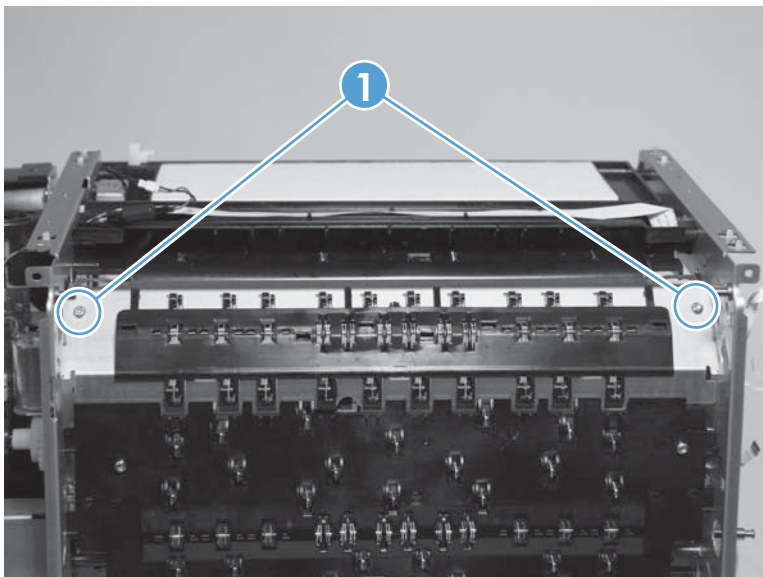

4. Remove the paper guide assembly (callout 1).

Figure 1-154 Remove the top left paper guide (3 of 4)

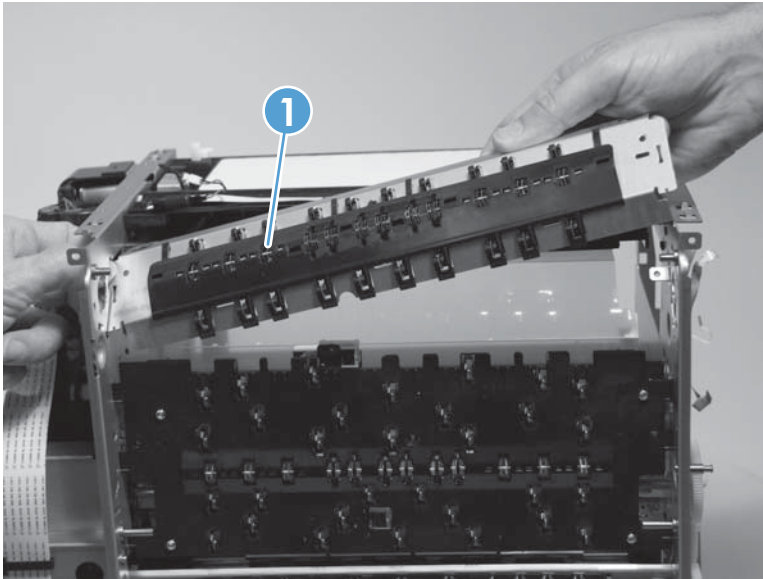

 **Reinstallation tip** During the reinstallation process, the bottom metal edge of the assembly inserts into the grooves in the plastic center left paper guide.

Figure 1-155 Remove the top left paper guide (4 of 4)



Center left paper guide assembly

1. Remove the following components:
 - Top left paper guide assembly. See [Top left paper guide assembly on page 105](#).
 - Drive shaft 3. See [Drive shaft 3 on page 96](#).
2. Remove three screws (callout 1).

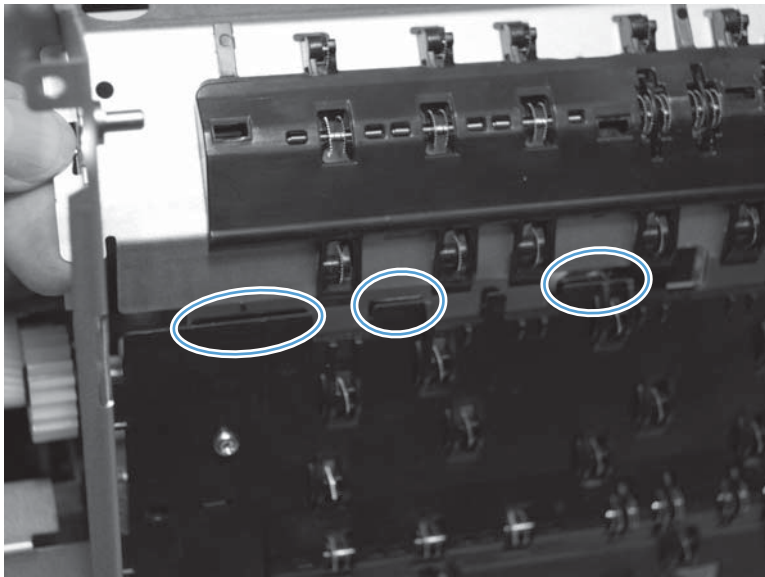
Figure 1-156 Remove the center left paper guide (1 of 4)

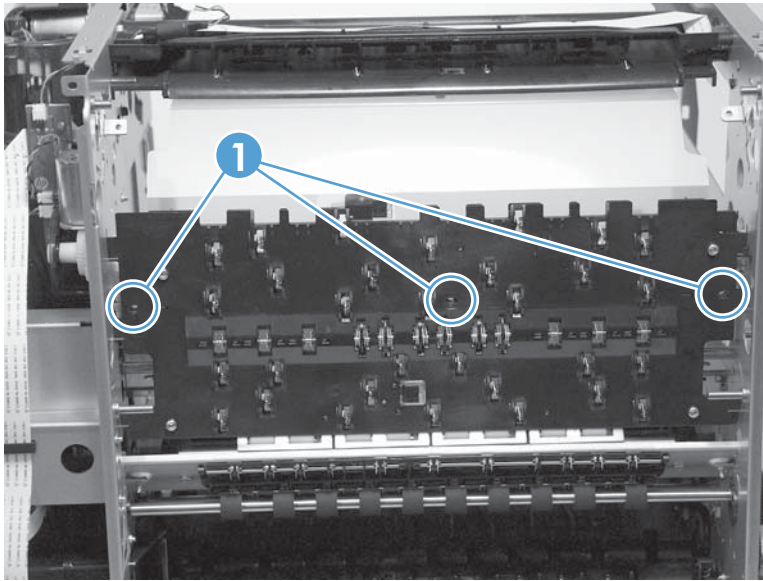

3. Locate two dust shield tabs (callout 1) inside the product.

Figure 1-157 Remove the center left paper guide (2 of 4)

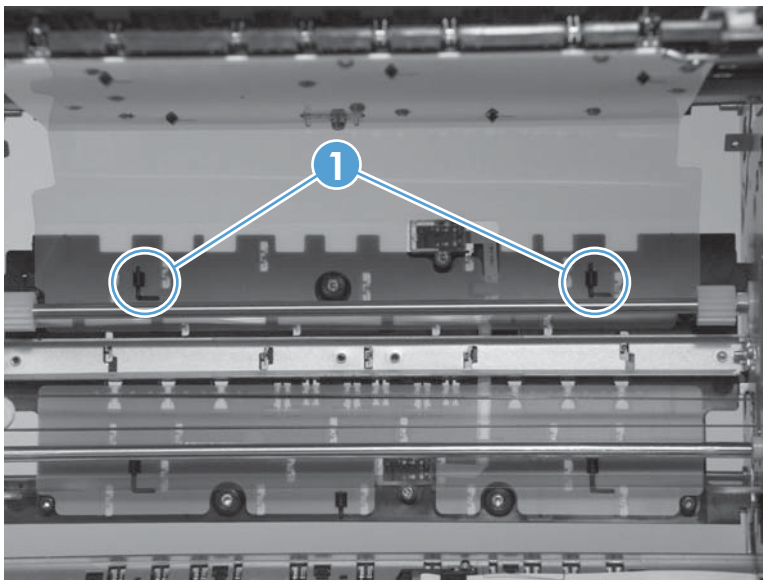

4. Lift and flex the assembly to remove it.

Figure 1-158 Remove the center left paper guide (3 of 4)

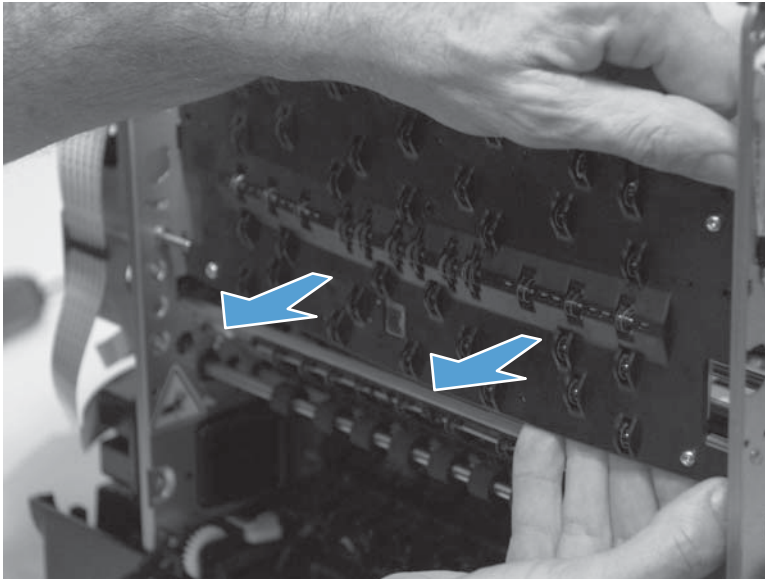

5. Remove one cable retainer (callout 1).

Figure 1-159 Remove the center left paper guide (4 of 4)

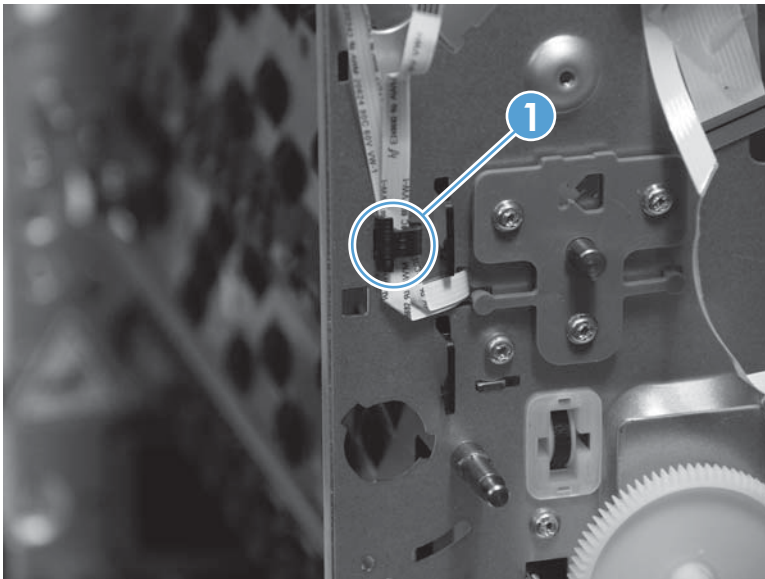

Paper REDI sensors in the center left paper guide assembly

 **IMPORTANT:** Ensure the product firmware is upgraded to at least version 1336MR before performing this repair procedure. If the firmware upgrade cannot be completed, contact HP support.

There are two paper REDI sensors; the lower paper path REDI sensor and the upper paper path REDI sensor. This procedure works for both.

1. Remove the printbar. See [Printbar on page 68](#).
2. Remove two screws (callout 1) and disconnect two flex cables (callout 2), and then remove the sensors (callout 3).

Figure 1-160 Remove the paper REDI sensors

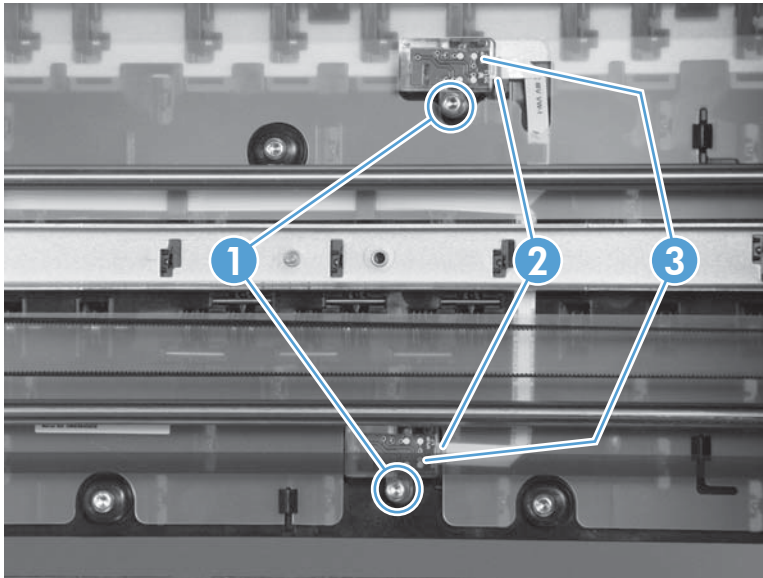

3. After replacing the sensors, use the following steps to calibrate the REDI sensors.

Calibrate the REDI sensors

- a. Open the [Engineering menu](#). See [Access the Engineering menu on page 14](#) for information accessing the [Engineering menu](#).
- b. From the [Engineering menu](#), select the [Service Menu](#), and then select [System Configuration](#).
- c. Select [Paper Sensor Calibration](#).

 **NOTE:** The paper sensor calibrations require one sheet of blank HP Colorlok paper. HP Colorlok paper **must** be used for the Paper Sensor Calibration. The same sheet of paper can be reused if it is undamaged.

- d. Select [Calibrate Main tray](#). The tray will eject one blank page.
- e. Select [Calibrate MP tray](#). The product will eject one blank page into the tray.

Service sled transmission

Before reassembling the product, ensure that the service sled transmission is installed in the correct position. If the service sled transmission is not installed correctly, the product will not operate correctly.

The service sled transmission is located behind the main PCA. Remove the aerosol fan assembly to check or adjust the positioning of the service sled transmission.

- Service sled transmission in the correct position.

Figure 1-161 Correctly positioned service sled transmission

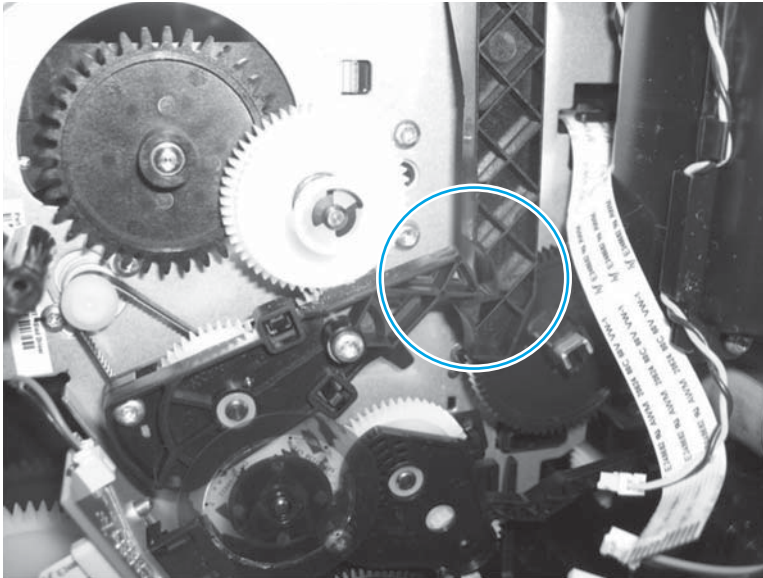

- Service sled transmission in the incorrect position.

Figure 1-162 Incorrectly positioned service sled transmission

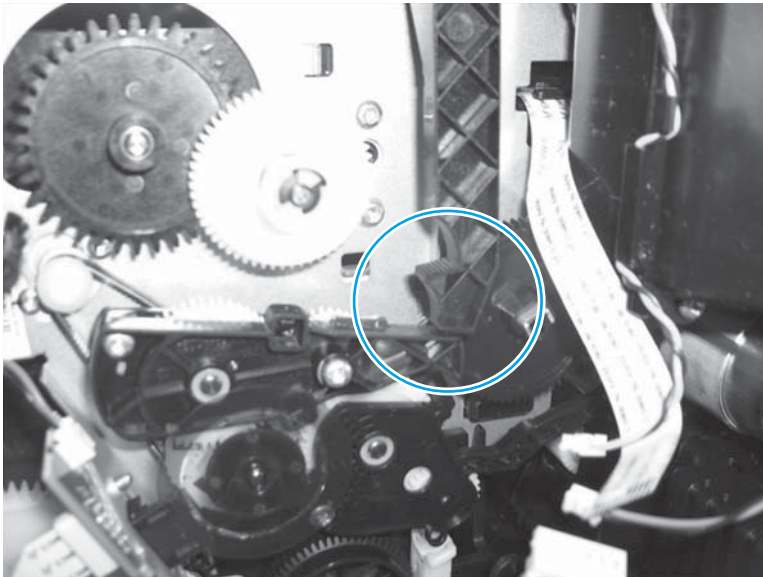

Printed circuit-board assemblies (PCAs)

PCA safety shield

1. Remove the rear cover. See [Rear cover on page 23](#).
2. Remove two screws (callout 1).

Figure 1-163 Remove the PCA safety shield (1 of 2)

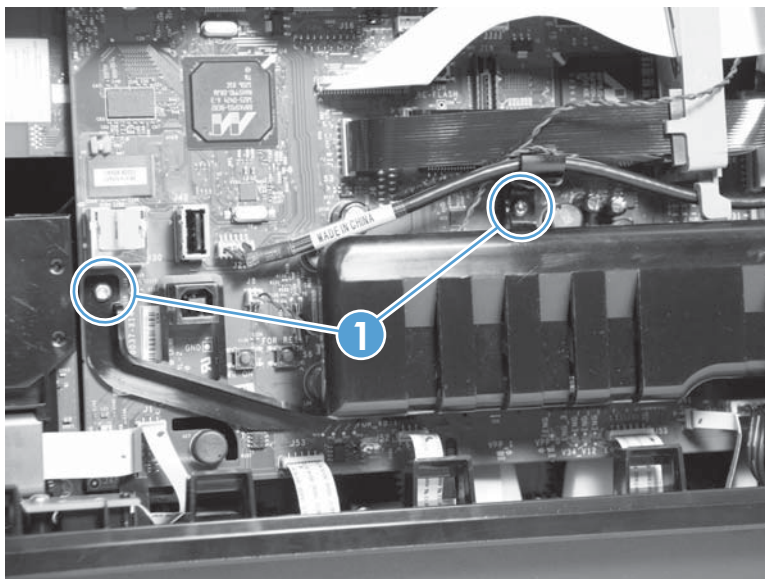

3. Remove the shield (callout 1) by pushing the shield toward the aerosol fan assembly.

Figure 1-164 Remove the PCA safety shield (2 of 2)

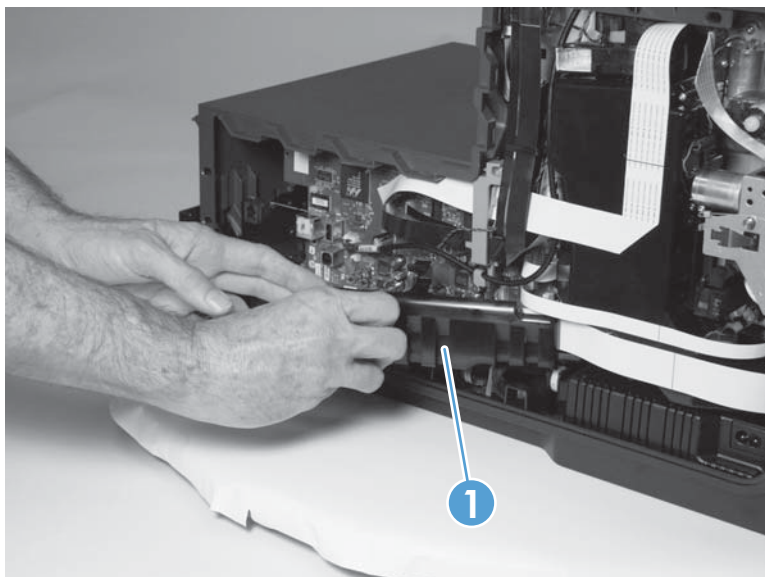

Sensor carriage PCA and encoder strip

1. Remove the following components:
 - Rear cover. See [Rear cover on page 23](#).
 - Aerosol fan assembly. See [Aerosol fan assembly on page 36](#).
2. Disconnect three wire connectors (callout 1).

Figure 1-165 Remove the sensor carriage PCA and encoder strip (1 of 8)

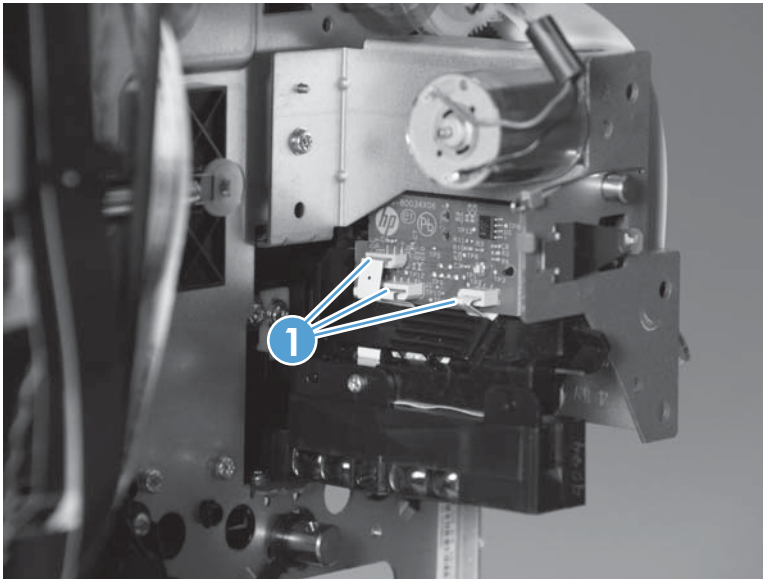

3. Remove one screw (callout 1).

Figure 1-166 Remove the sensor carriage PCA and encoder strip (2 of 8)

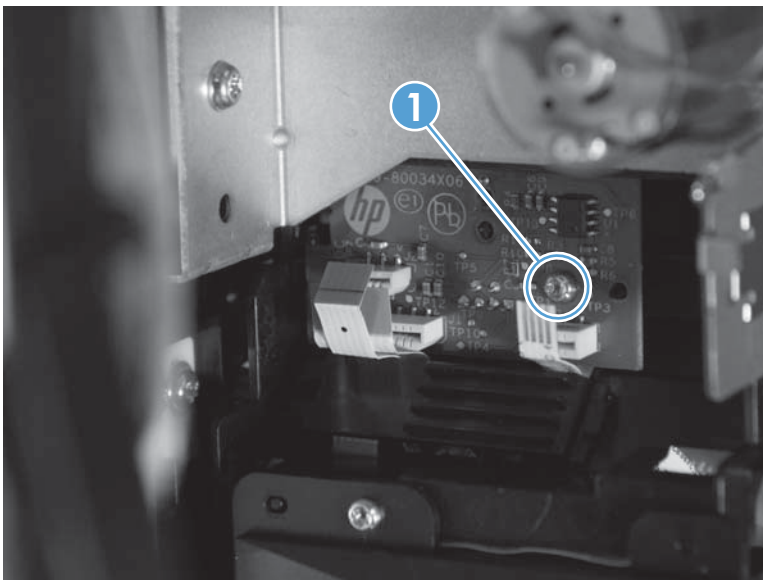

4. Remove the PCA (callout 1).

Figure 1-167 Remove the sensor carriage PCA and encoder strip (3 of 8)

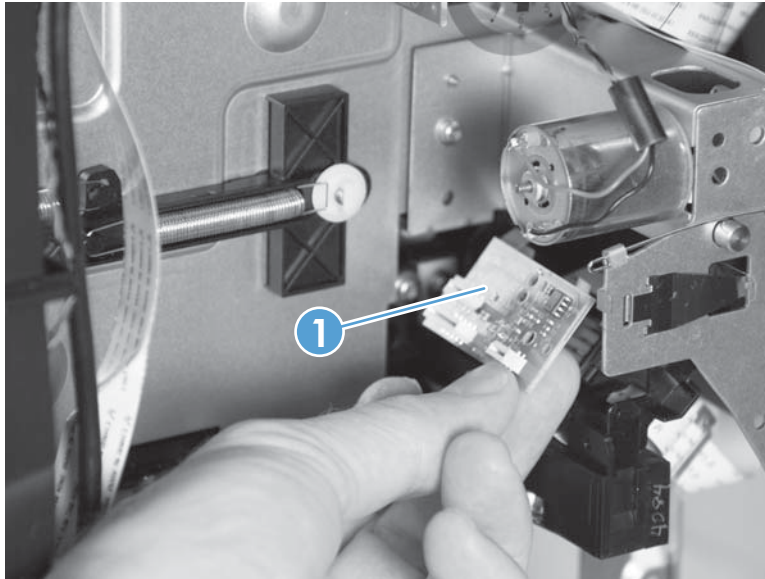

5. Locate the sensor carriage encoder strip (callout 1). The sensor carriage encoder strip feeds through the product, passes through the encoder strip sensor on the back of the sensor carriage PCA (callout 2), and then attaches to the bracket (callout 3) at the back of the product.

Figure 1-168 Remove the sensor carriage PCA and encoder strip (4 of 8)

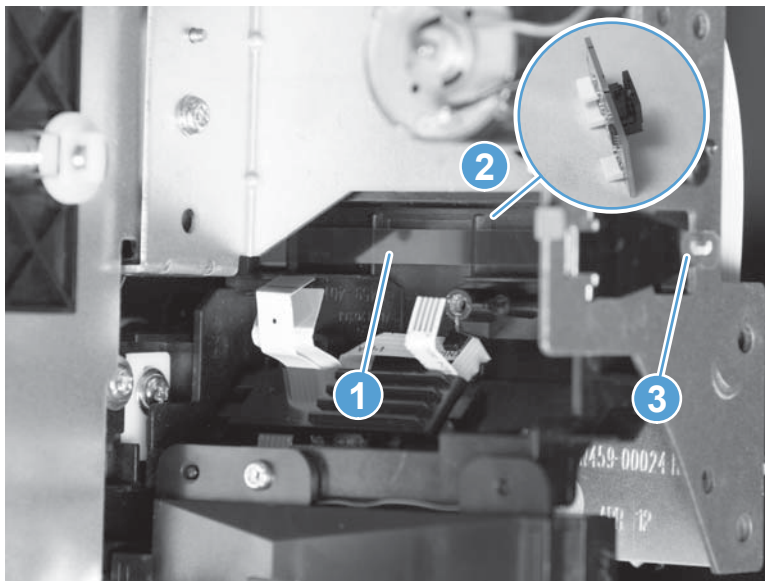

6. Thread a piece of floss or thread through the opening on the end of the sensor carriage encoder strip (callout 1), and then depress the bracket (callout 2) while lifting up on the sensor carriage encoder strip to remove the encoder strip from the bracket.

Figure 1-169 Remove the sensor carriage PCA and encoder strip (5 of 8)

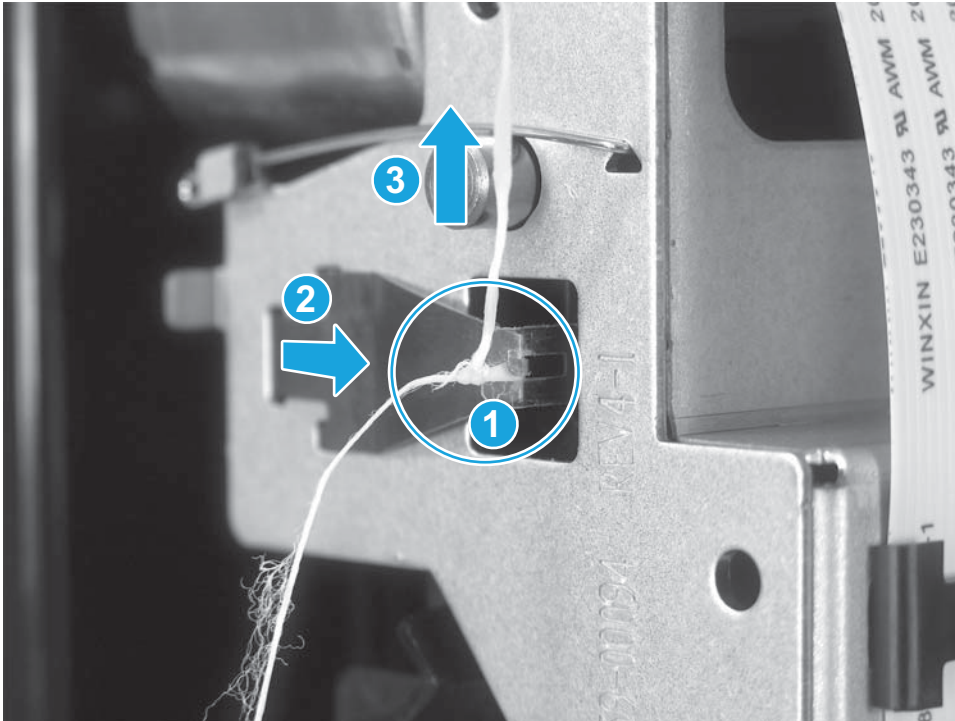

7. At the front of product, use a pair of needle nose pliers to grasp the encoder strip, and then lift it off the bracket.

Figure 1-170 Remove the sensor carriage PCA and encoder strip (6 of 8)

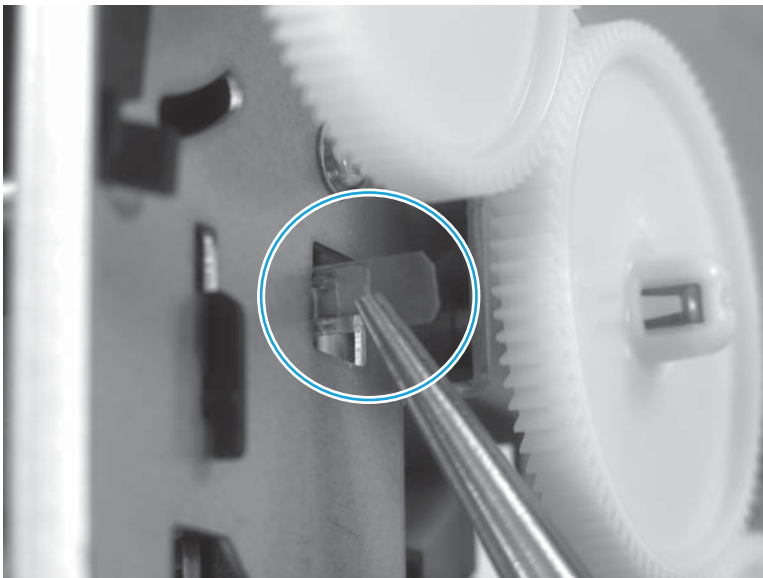

8. At the front of the product, carefully pull the encoder strip through the product and remove it. Ensure that you can still grasp the thread at the back of the product.

9. At the front of the product, tie the thread or floss passed through the product to the new encoder strip. The encoder strip must be positioned with the smiley face as shown in [Figure 1-171](#) [Remove the sensor carriage PCA and encoder strip \(7 of 8\) on page 115](#).

Figure 1-171 Remove the sensor carriage PCA and encoder strip (7 of 8)

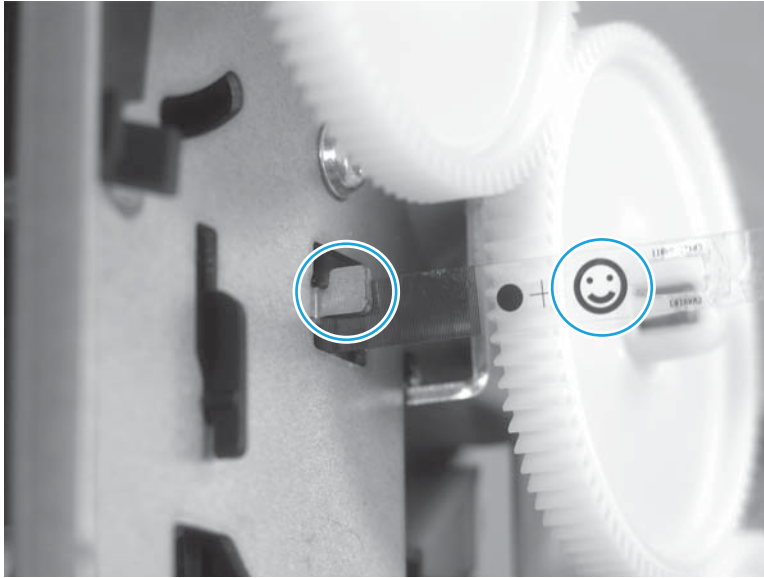

10. Carefully pull the encoder strip through the product, and then reattach the encoder strip on the bracket at the rear of the product.
11. Install the new sensor carriage PCA. Ensure that the encoder strip threads through encoder strip sensor on the back of the sensor carriage PCA.

Figure 1-172 Remove the sensor carriage PCA and encoder strip (8 of 8)

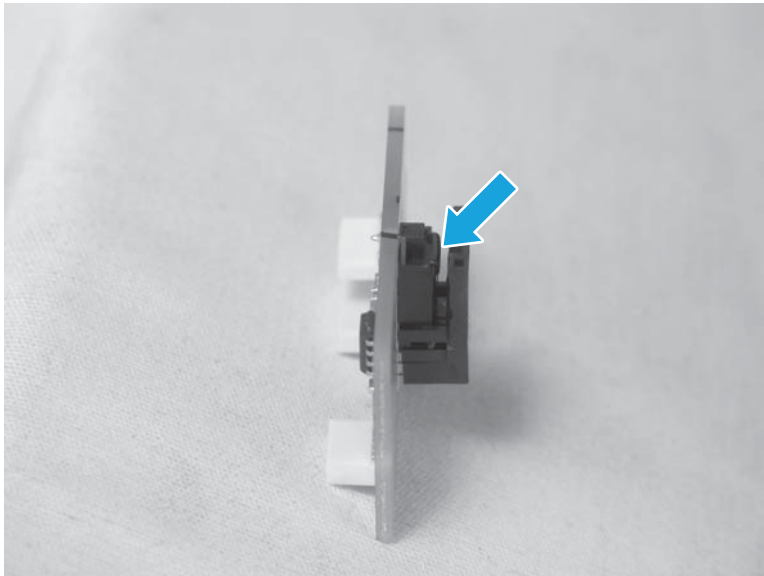

 **IMPORTANT:** Threading the sensor carriage encoder strip through the product and through the encoder strip sensor on the back of the sensor carriage PCA can be a difficult procedure. If the sensor carriage encoder strip is not correctly positioned, then the front panel will display a 61000012 error when the product is turned on.

Power button PCA

The power button PCA is located in the product front cover.

1. Remove the front cover. See [Front cover on page 34](#).
2. Disconnect three wire connectors (callout 1).

Figure 1-173 Remove the power button PCA (1 of 2)

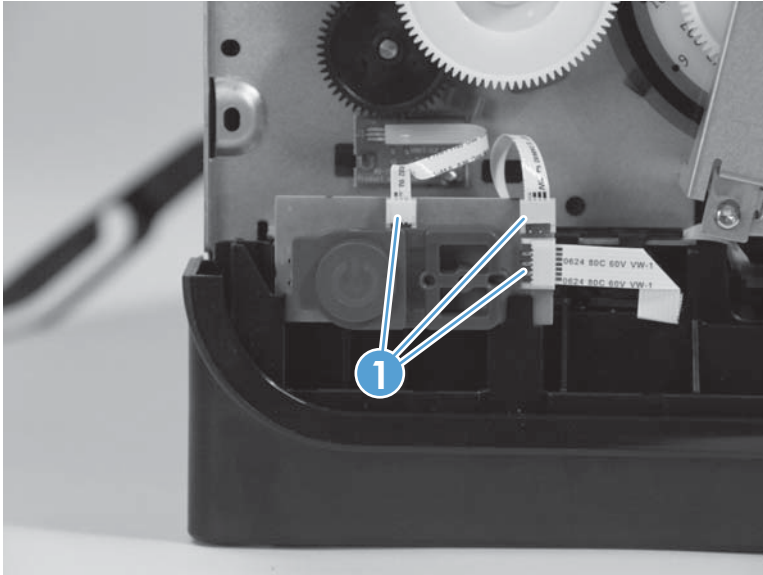

3. Remove the assembly (callout 1).

Figure 1-174 Remove the power button PCA (2 of 2)

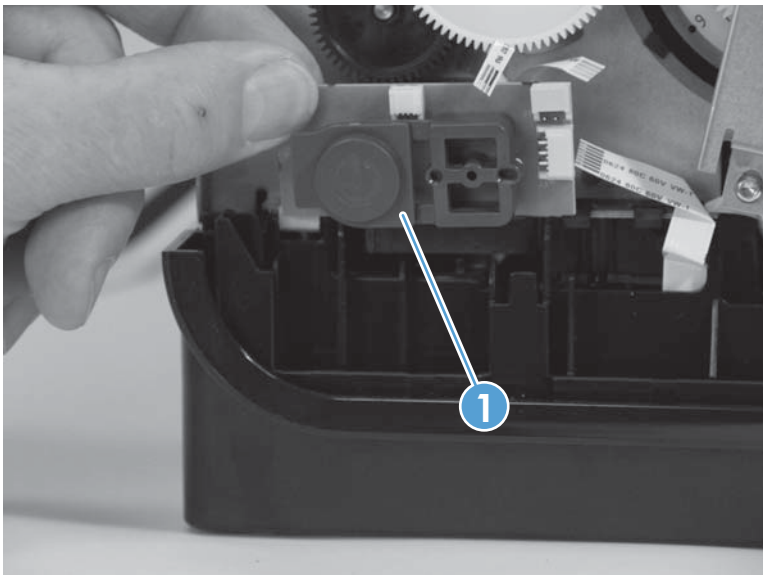

Duplex module sensor PCA

1. Remove the front cover. See [Front cover on page 34](#).
2. Remove one screw (callout 1).

Figure 1-175 Remove the duplex module sensor PCA (1 of 2)

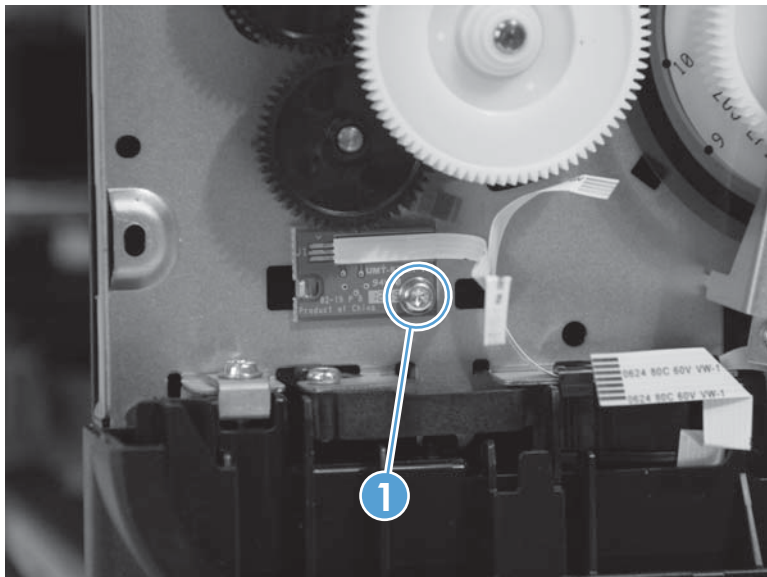

3. Remove the sensor PCA (callout 1).

Figure 1-176 Remove the duplex module sensor PCA (2 of 2)

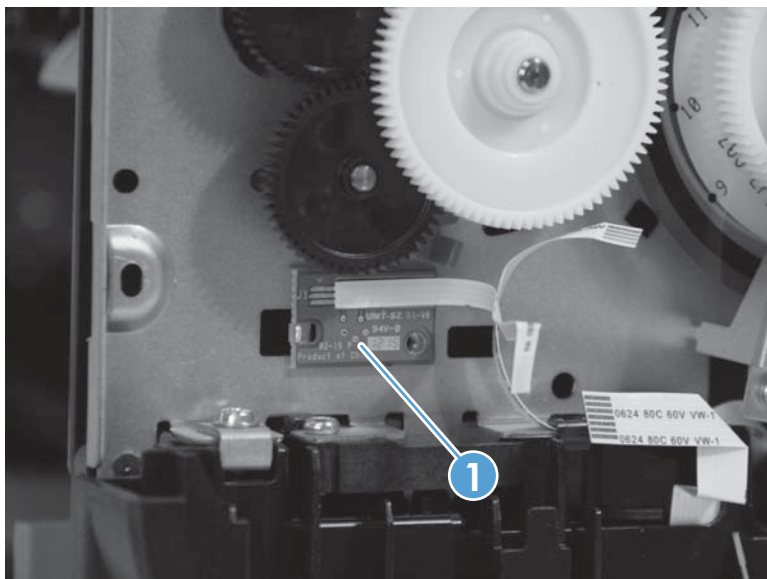

Temperature sensor

1. Remove the rear cover. See [Rear cover on page 23](#).
2. Disconnect one cable (callout 1).

Figure 1-177 Remove the temperature sensor (1 of 2)

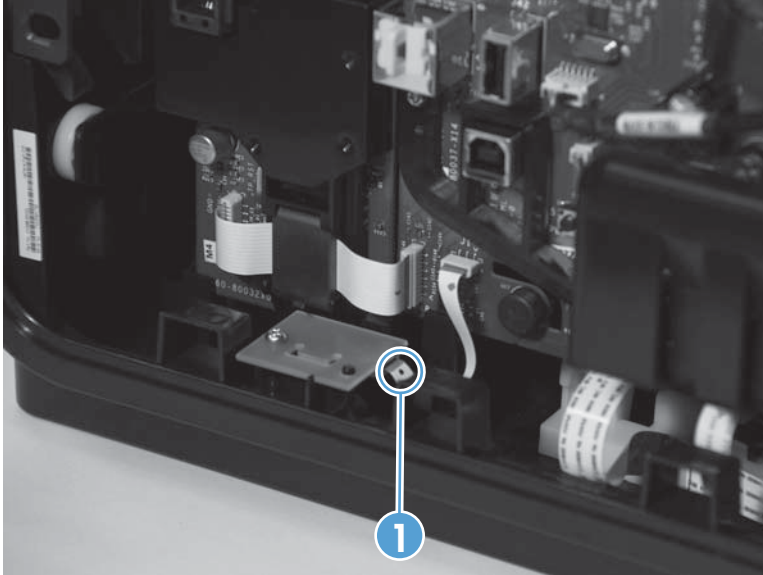

3. Remove one screw (callout 1), and then remove the sensor.

Figure 1-178 Remove the temperature sensor (2 of 2)

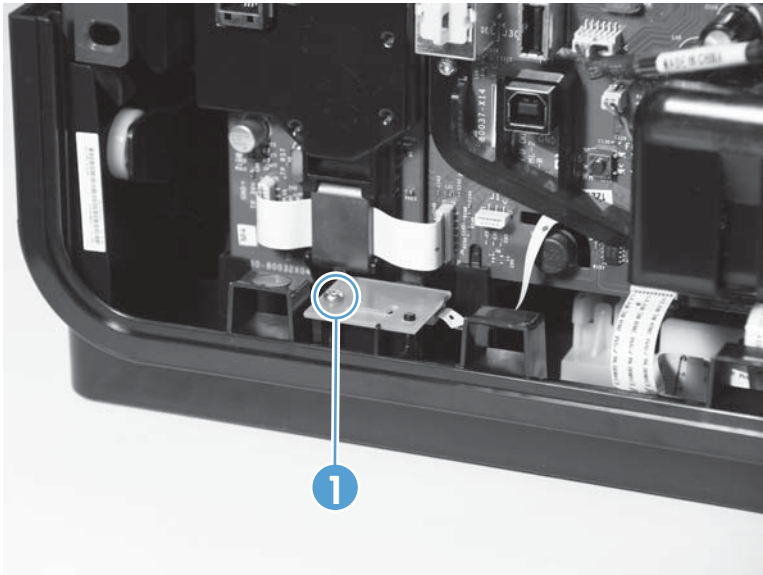

4. After reinstalling the temperature sensor, test for the correct operation: A correctly operating temperature sensor is indicated by the results of a 12 tap test. Print a 12 tap test, and check for the correct temperature. See [12 tap test results \(REDI sensor values\) on page 19](#).

REDI distribution PCA

1. Remove the front cover. See [Front cover on page 34](#).
2. Disconnect five wire connectors (callout 1).

Figure 1-179 Remove the REDI distribution PCA (1 of 3)

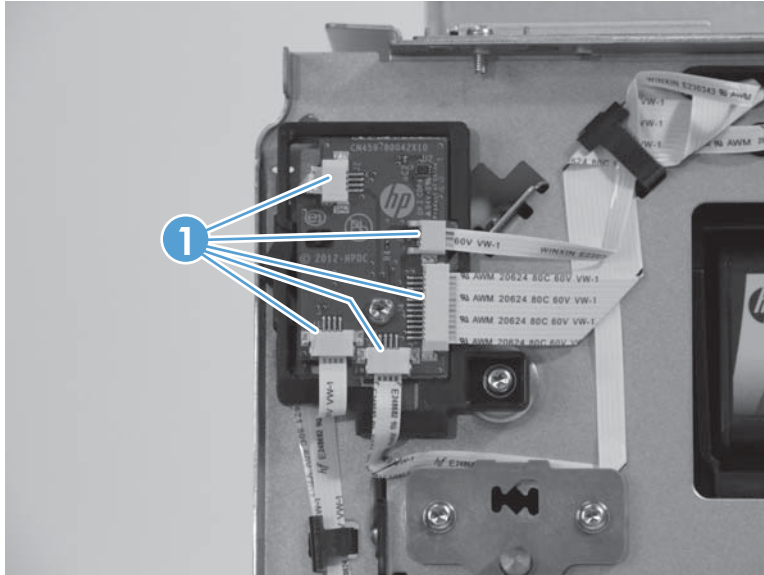

3. Remove one screw (callout 1).

Figure 1-180 Remove the REDI distribution PCA (2 of 3)

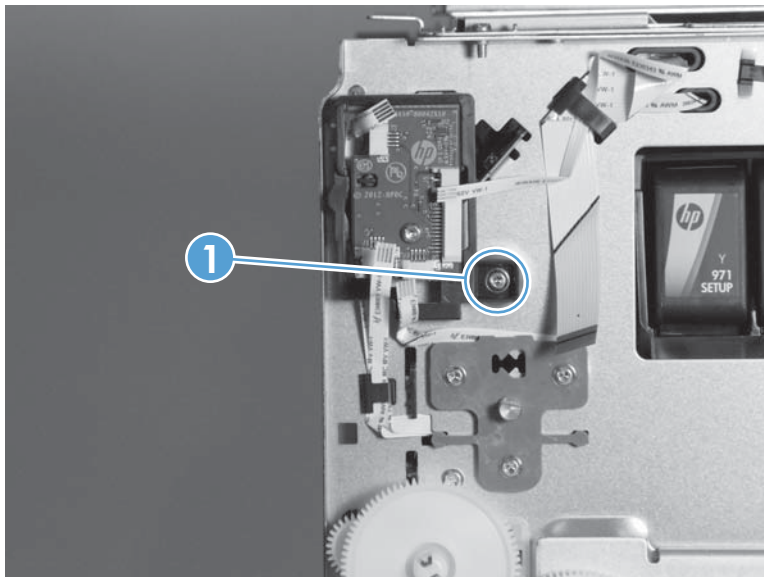

4. Remove the sensor PCA.

Figure 1-181 Remove the REDI distribution PCA (3 of 3)

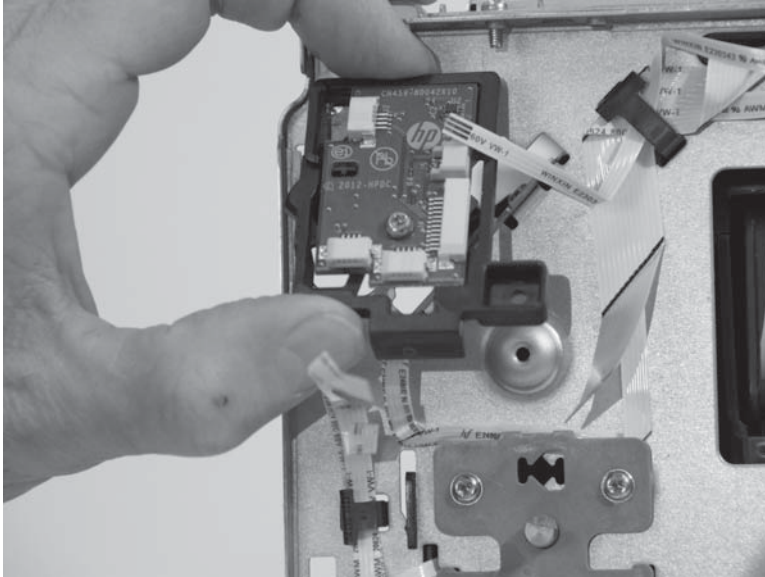

 **Reinstallation tip** Ensure that the upper left flex cable does not poke through the front wall. It should not be visible when looking at the wall from the left door.

Feed motor encoder sensor PCA

1. Remove the front cover. See [Front cover on page 34](#).
2. Remove two screws (callout 1) from the guard bracket, and then remove the bracket.

Figure 1-182 Remove the feed motor encoder sensor PCA (1 of 4)

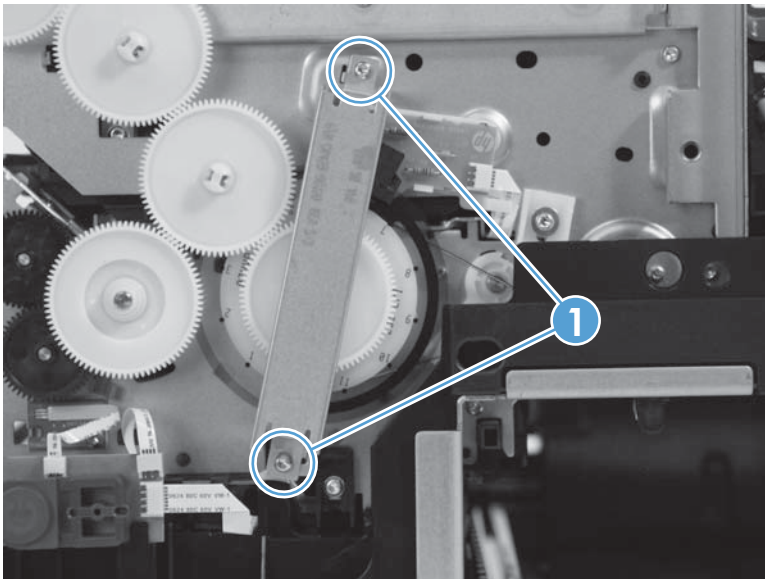

3. Disconnect the flex cable (callout 1).

Figure 1-183 Remove the feed motor encoder sensor PCA (2 of 4)

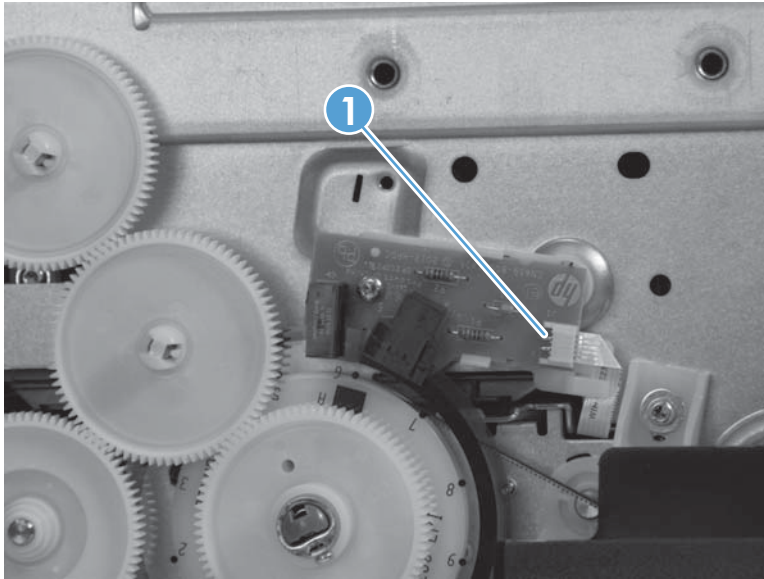

4. Remove one screw (callout 1).

Figure 1-184 Remove the feed motor encoder sensor PCA (3 of 4)

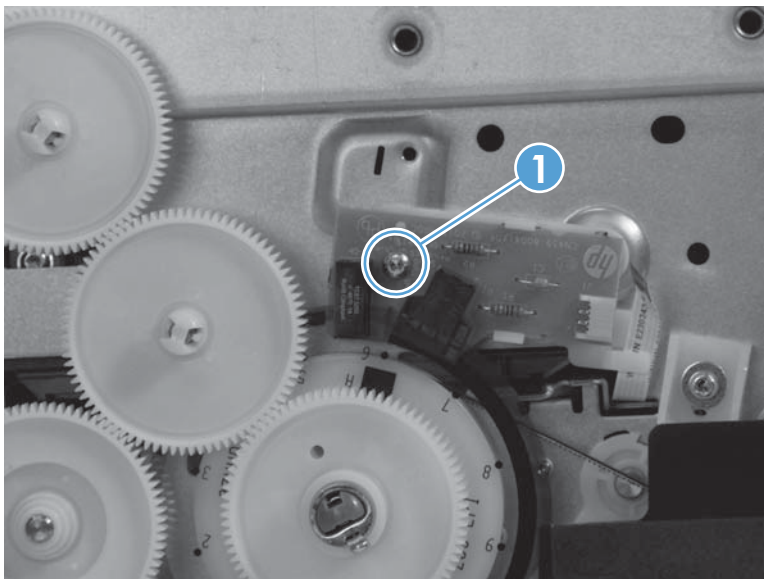

5. Unclip and remove the sensor PCA (callout 1).

Figure 1-185 Remove the feed motor encoder sensor PCA (4 of 4)

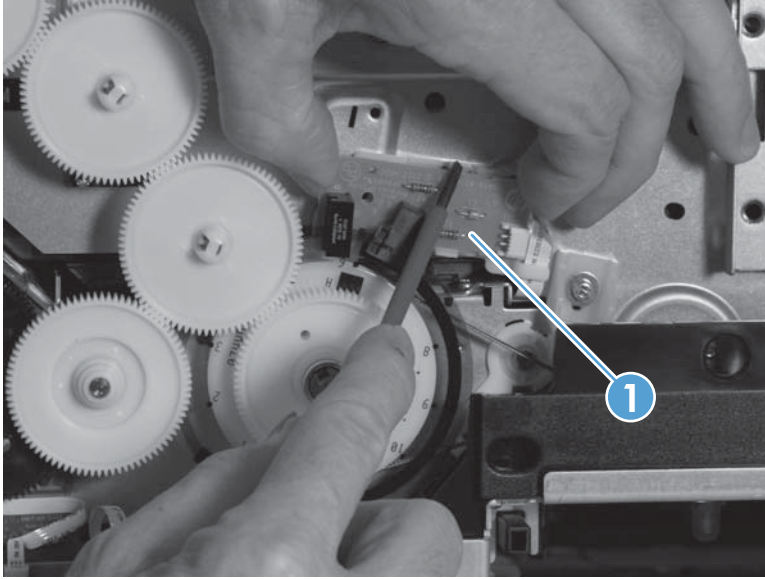

 **Reinstallation tip** Make sure that the encoder disk is inserted into both sensors on the sensor PCA.

Eject flap opto PCA

1. Remove the following components:
 - Rear cover. See [Rear cover on page 23](#).
 - Left door. See [Left door on page 24](#).
 - Left rear cover. See [Left rear cover on page 27](#).
 - Left front cover. See [Left front cover on page 28](#).
 - Top cover. See [Top cover on page 29](#).
 - Front cover. See [Front cover on page 34](#).
2. Remove one screw (callout 1) from the underneath of the plate console left, and then remove the sensor PCA (callout 2).

Figure 1-186 Remove the eject flap opto PCA

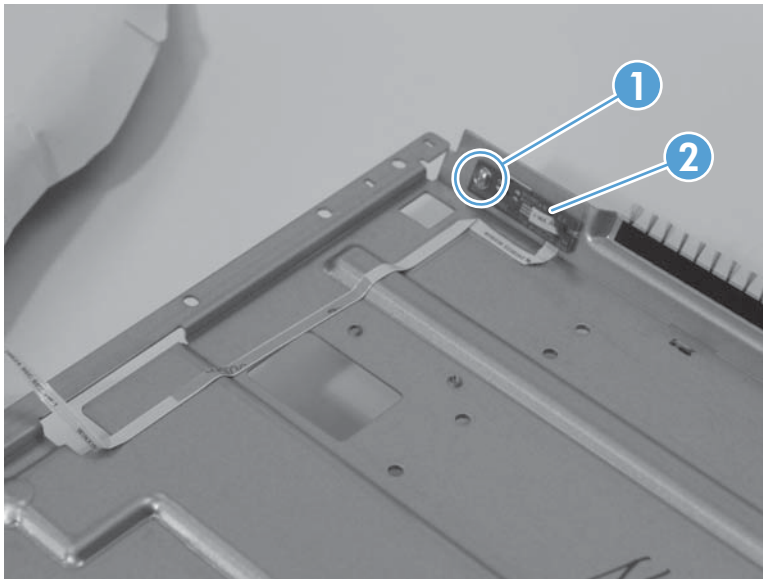

Printzone distribution PCA

1. Remove the service sled assembly. See [Service sled assembly on page 57](#).

2. Use a screwdriver to remove the PCA cover (callout 1).

Figure 1-187 Remove the printzone distribution PCA (1 of 3)

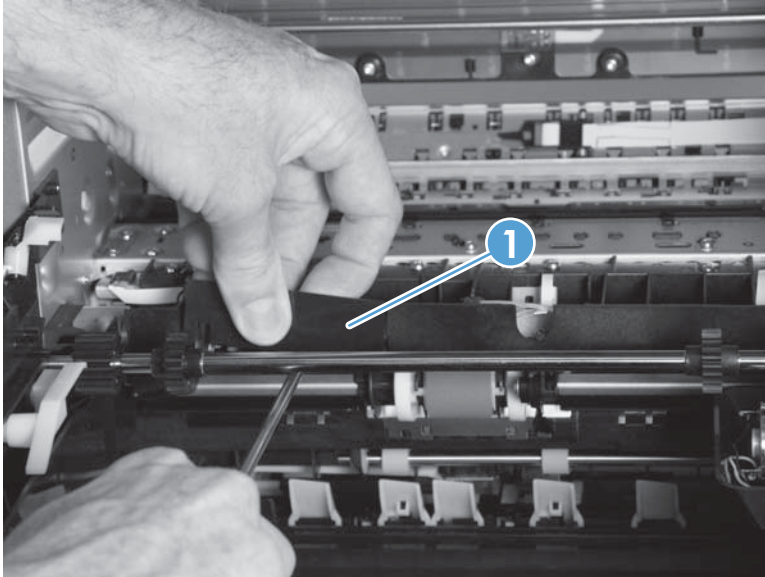

3. Remove one screw (callout 1).

Figure 1-188 Remove the printzone distribution PCA (2 of 3)

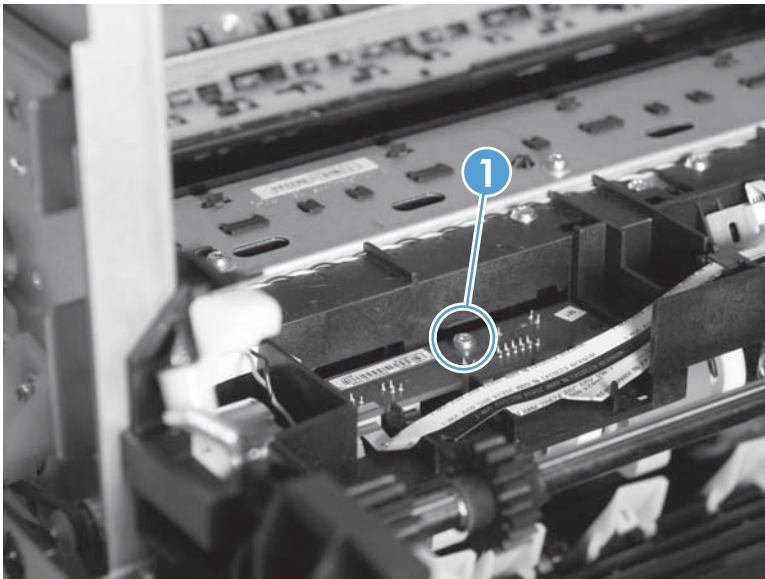

4. Disconnect five flex cables (callout 1), and then remove the PCA (callout 2).

Figure 1-189 Remove the printzone distribution PCA (3 of 3)

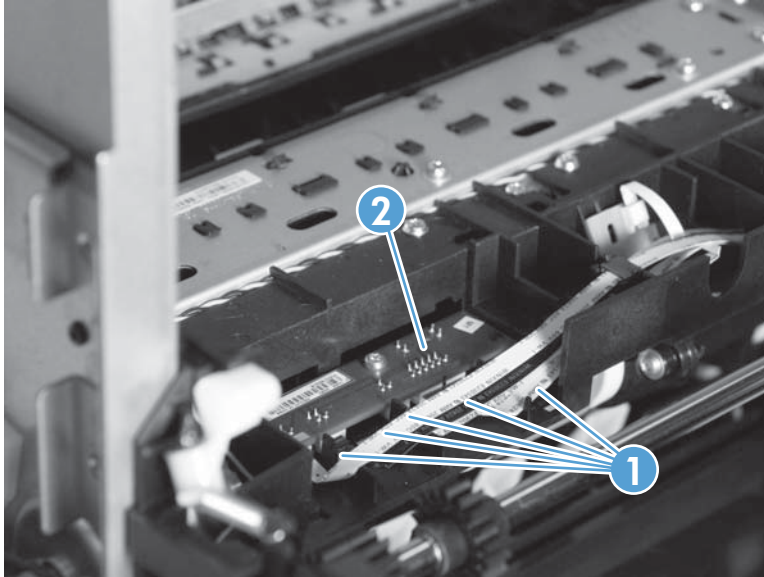

Media presence sensor PCA/flag

1. Remove the printbar. See [Printbar on page 68](#).
2. Remove one screw (callout 1) from the sensor flag (callout 2), and then remove the flag.

Figure 1-190 Remove the media presence sensor PCA/flag (1 of 2)

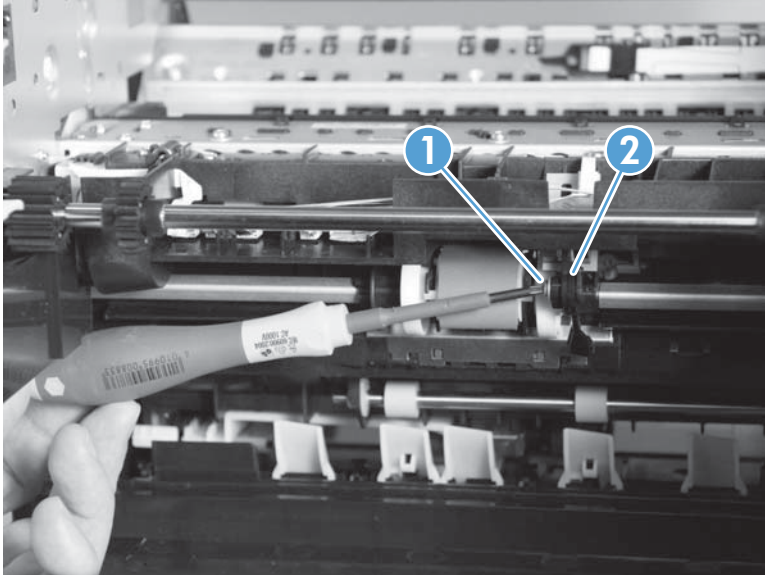

3. Disconnect the flex cable connector (callout 1), remove one screw (callout 2), and then remove the sensor PCA.

Figure 1-191 Remove the media presence sensor PCA/flag (2 of 2)

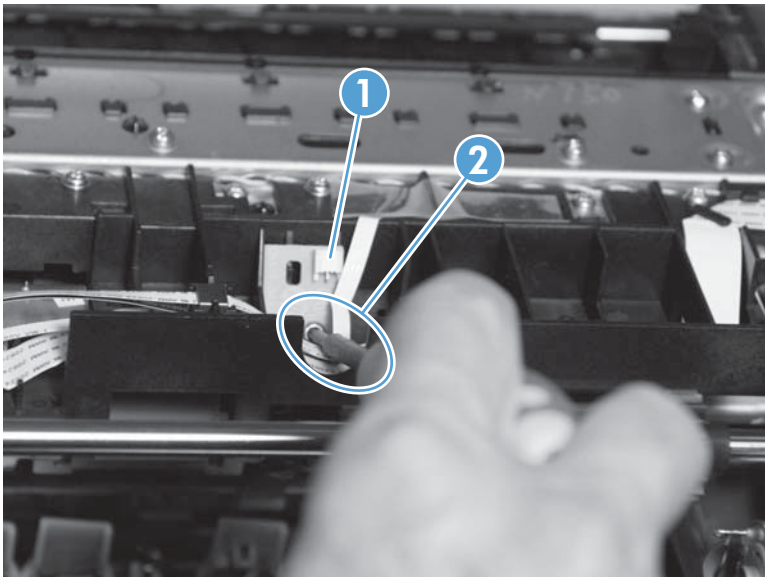

Main PCA

 **NOTE:** If the product has printed more than 5,000 pages, replacement of the duplex module assembly is recommended.

If the product has printed more than 30,000 pages, replacement of the service sled assembly is recommended. This only applies if the main PCA is being replaced.

 **NOTE:** The replacement main PCA should already have the required revision of firmware – 1336MR or later. Earlier versions of firmware do not support the required calibrations. If the replacement main PCA has older firmware, contact HP support.

1. Remove the following components:
 - Rear cover. See [Rear cover on page 23](#).
 - PCA safety shield. See [PCA safety shield on page 111](#).

2. Disconnect all cables from the PCA.

Figure 1-192 Remove the main PCA (1 of 8)

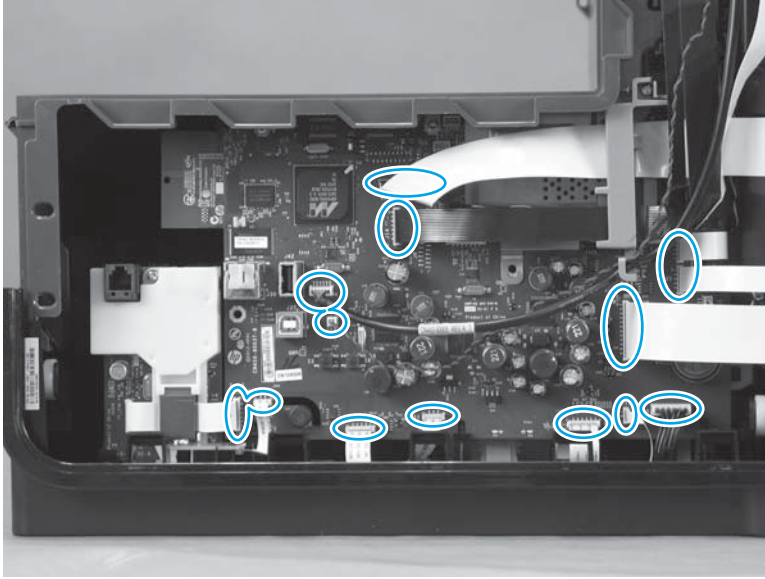

 **NOTE:** Additional clearance can be obtained by removing the aerosol fan assembly.

 **IMPORTANT:** The main PCA sockets highlighted in [Figure 1-193 Remove the main PCA \(2 of 8\)](#) on [page 128](#) are ZIF sockets. Take care to not break the latches on these ZIF sockets when removing or installing the FFCs in these sockets.

Figure 1-193 Remove the main PCA (2 of 8)



3. Remove one screw (callout 1) from behind the three print bar cables.

Figure 1-194 Remove the main PCA (3 of 8)

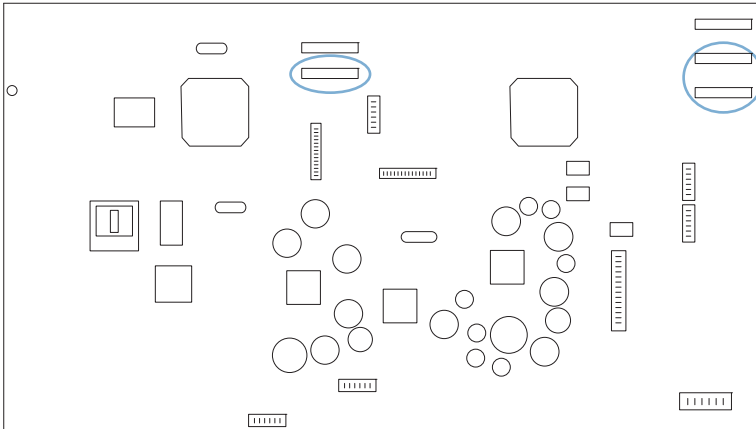
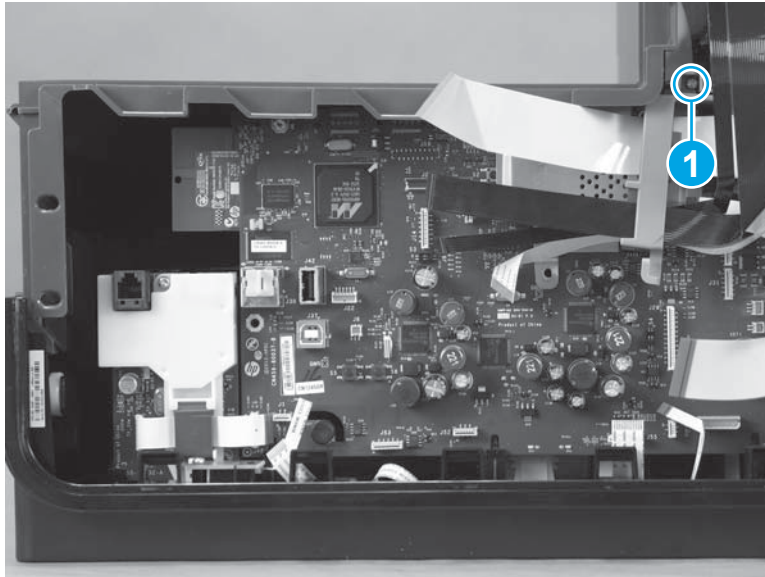

4. Lift the wire harness (callout 1) away from the PCA. The printbar flex cables can remain in the wire harness.

Figure 1-195 Remove the main PCA (4 of 8)

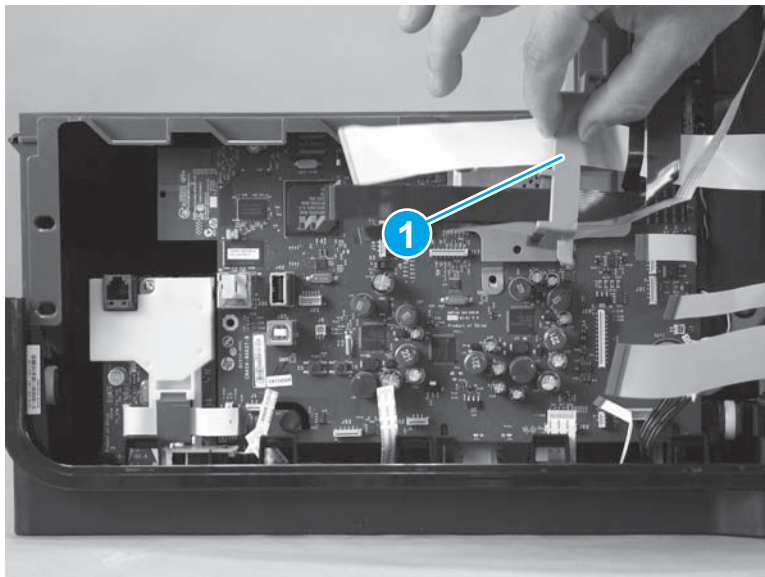

5. Remove three screws (callout 1) from the PCA.

Figure 1-196 Remove the main PCA (5 of 8)

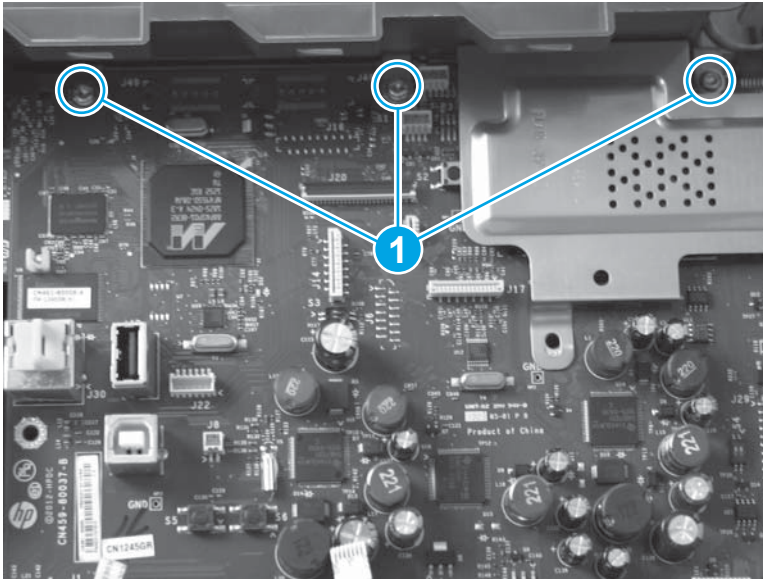

6. Remove the EMI shield.

Figure 1-197 Remove the main PCA (6 of 8)

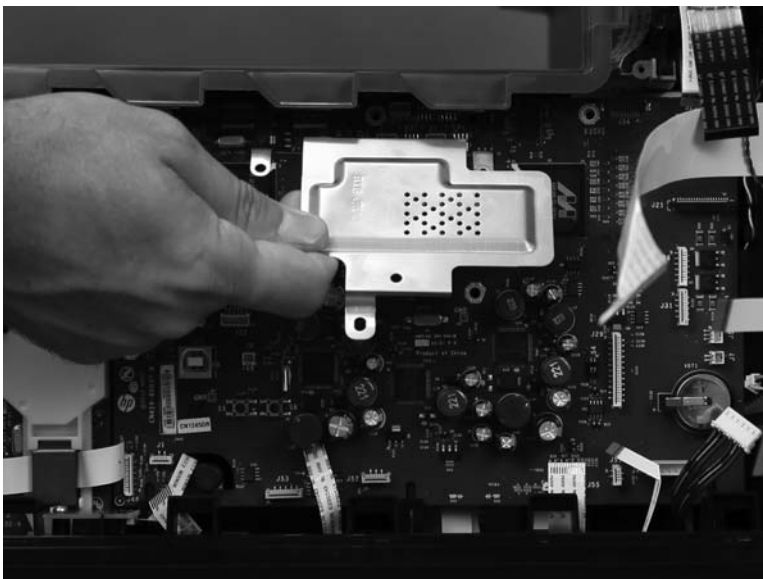

7. Lift the PCA up slightly to remove it from the mounting posts, and then lower it into the product.

Figure 1-198 Remove the main PCA (7 of 8)

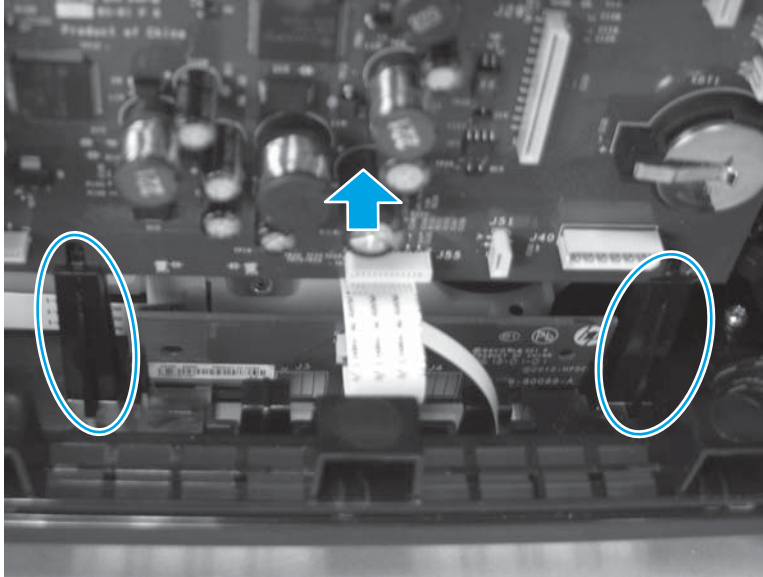

8. Rotate the top of the PCA (callout 1) outward, and then lift the PCA up (callout 2) to remove.

Figure 1-199 Remove the main PCA (8 of 8)

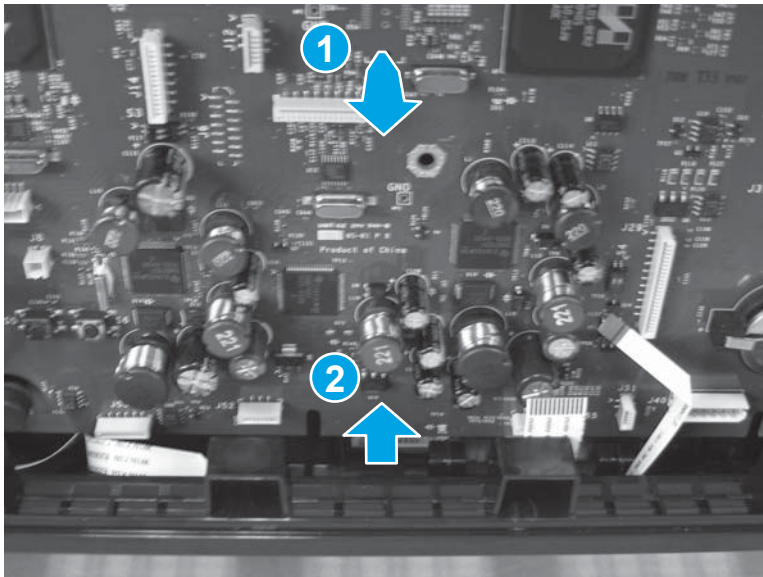

 **Reinstallation tip** Fit the bottom of the PCA in the slot in the product frame.

 **NOTE:** After replacing the main PCA, you must perform all calibration processes.

Main PCA calibration procedure

Test the main PCA installation

1. Place the product into Audit mode. See [Place the product into Audit mode on page 15](#) for information on placing the product into Audit mode.
2. Press the power button to enter Audit (on) mode.
 - Temporarily install a set of trade supplies or use the existing customer supplies. Host supplies will be rejected in MFG (on) mode.
3. Select the **Country** and the **Language**, and then enter the localization information.
4. Verify the main PCA functionality:
 - a. Cover the IDS door sensor with a magnet.
 - b. Print a verification page.
 - c. Press the power button to turn the product off.

Calibrate the main PCA

1. Turn the product on and enter the **Engineering** menu. See [Access the Engineering menu on page 14](#) for information on accessing the **Engineering** menu.
2. Scroll to **Service**, select **System Configuration**, and then touch the **OK** button.
3. Scroll to **Enter Serial Number**. Use the up and down arrows on the control panel to enter the serial number



NOTE: The serial number only contains 10 digits. Any digits entered after the tenth are ignored.

4. Scroll to **Enter Ethernet MAC** address, and then touch the **OK** button. Enter the Ethernet MAC address using the up and down arrows on the control panel, and then touch the **OK** button.



NOTE: The Ethernet MAC address is located on the back panel.

5. For DW models only: Scroll to **Enter wireless MAC** address and then touch the **OK** button.
6. Enter the wireless MAC address using the up and down arrows on the control panel, and then touch the **OK** button.



NOTE: The wireless MAC address is located on the back panel.

7. Scroll to **Paper Sensor Calibration**, and then touch the **OK** button.





NOTE: HP Colorlok paper must be used for the Paper Sensor Calibration.

The paper sensor calibrations require one sheet of blank paper for each calibration. The same sheet of paper can be reused if it is undamaged.

8. Select **Calibrate Main tray**. The tray will eject one blank page.

9. Select **Calibrate MP tray**. The tray will eject one blank page.
10. MFP models only: Scroll to **Enter scanner barcode** and then touch the **OK** button.
11. Enter the scanner calibration bar code, and then touch the **OK** button.

 **NOTE:** The scanner calibration bar code is located underneath the main scan glass on the left side of the glass.

12. Touch the **Cancel**  button to return to the **Engineering menu**.
13. Select the **Manufacturing menu**.
14. Scroll to the **Special Tests** menu, and then touch the **OK** button.
15. Scroll to **TouchScreen Calibration**, and then touch the **OK** button.
16. Calibrate the touch screen.

 **IMPORTANT:** Use a stylus or other rounded object to complete the interactive screen calibration in order to prevent scratching or damaging the screen.

17. Touch the **Cancel** button to return to the **Engineering** menu.
18. Select the **Underware** menu.
19. Scroll to the **System** menu, and then touch the **OK** button.
20. Scroll to **Set Derivative**, and then touch the **OK** button.
21. Set the derivative for the country/region. Select from the following choices:

Table 1-3 Country/region derivatives

| Code name | Product Number | Country/region |
|----------------|------------------------|----------------|
| BAJA_AMERICAS | X451dn, X451dw, X551dw | North America |
| BAJA_AP | X451dn, X451dw, X551dw | Asia Pacific |
| BAJA_AP_TAIWAN | X451dn, X451dw, X551dw | Taiwan |
| BAJA_EMEA | X451dn, X451dw, X551dw | Europe |
| BAJA_LA | X451dn, X451dw, X551dw | Latin America |
| BAJA_JAPAN | X451dn, X451dw, X551dw | Japan |

22. Enter the language and country/region information.

 **NOTE:** The localization information is similar to the information entered after turning the product on in Audit Mode. However, the derivative has additional country/region specific settings. This will be the last time you will be prompted to enter language and country/region information in this process.

23. Turn the product off, and then unplug it.
24. Finish assembling the case parts.

25. Turn the product on to User Mode.
26. Open the [Engineering](#) menu. See [Access the Engineering menu on page 14](#) for information on accessing the [Engineering](#) menu.
27. Select the [Service](#) menu. See [Access the Support Menu on page 15](#) for information on accessing the [Service](#) menu.
28. Scroll to [System Configuration](#), and then touch the [OK](#) button.
29. Scroll to [Trigger All Calibrations](#), and then touch the [OK](#) button.



NOTE: The product automatically restarts and begins the calibrations. The calibrations will take approximately 20 to 25 minutes and a total of 9 pages will print. When the calibrations are complete, the control panel will return to the [Home](#) screen.

30. From the [Ready](#) screen, touch the left arrow, and then select [Setup](#).
31. Scroll to and touch [Print Reports](#), and then select [Print Quality Report](#).



NOTE: If there are any discrepancies in the Print Quality Report, consult the *Troubleshooting Manual* for recovery methods.

32. Touch the [Back](#) button  twice to return to the [Ready](#) screen.
33. Open the [Engineering](#) menu. See [Menu access on page 14](#) for information on accessing the [Engineering](#) menu.
34. Select the [Manufacturing](#) menu.
35. Scroll to the [Reports](#) menu, and then touch the [OK](#) button.
36. Run the following tap tests:
 - 10 tap
 - 12 tap
 - 61 tap
 - 909 tap

For more information on running and verifying tap test results, see [Perform tap tests and interpret results on page 17](#).

37. Return to the [Ready](#) screen, and then complete the customer configurations, including network settings, preferred paper size and trays, and so forth.

Tray 3 interconnect PCA

1. Remove the rear cover. See [Rear cover on page 23](#).
2. Remove the FFC (callout 1) from the tray 3 interconnect PCA.

Figure 1-200 Remove the Tray 3 interconnect PCA (1 of 2)

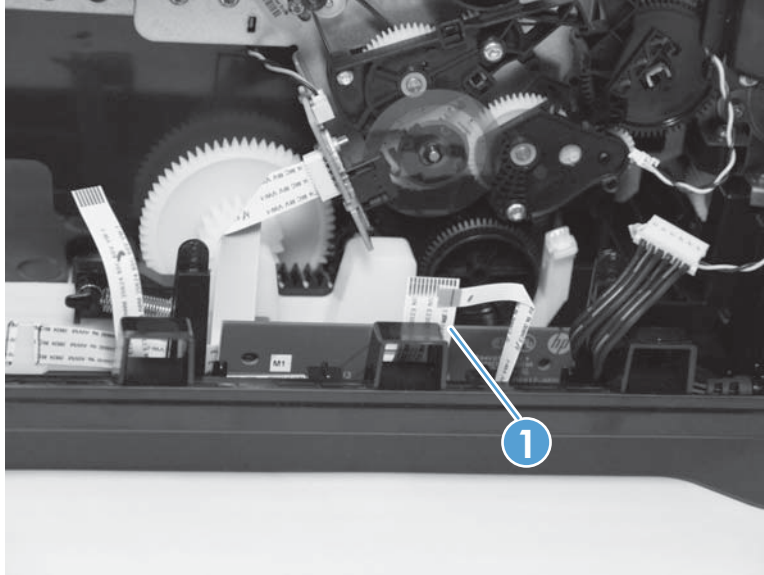

3. Use a small screwdriver to release the tab on the right side of the PCA (callout 1), and lift the PCA slightly. Release the tab on the left side of the PCA (callout 2), and then remove the PCA.

Figure 1-201 Remove the Tray 3 interconnect PCA (2 of 2)

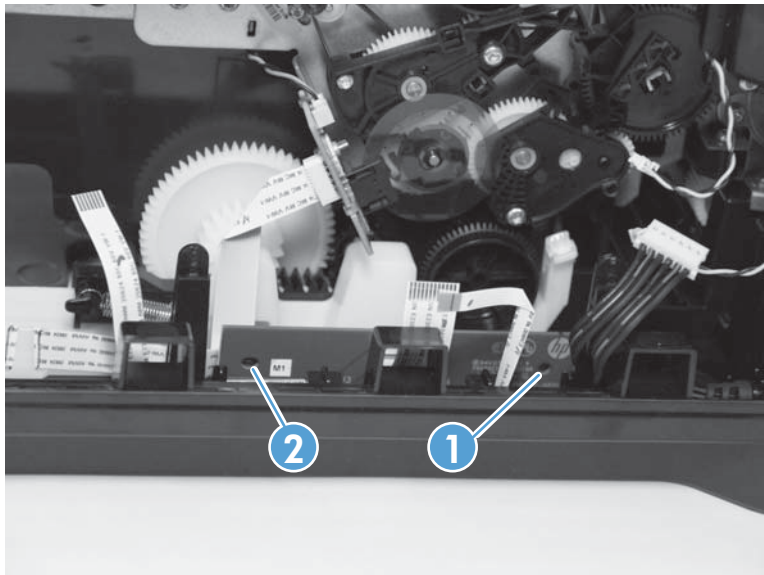

Pick encoder distribution PCA

1. Remove the main PCA. See [Main PCA on page 127](#).
2. Disconnect two cables (callout 1).

Figure 1-202 Remove the pick encoder distribution PCA (1 of 2)

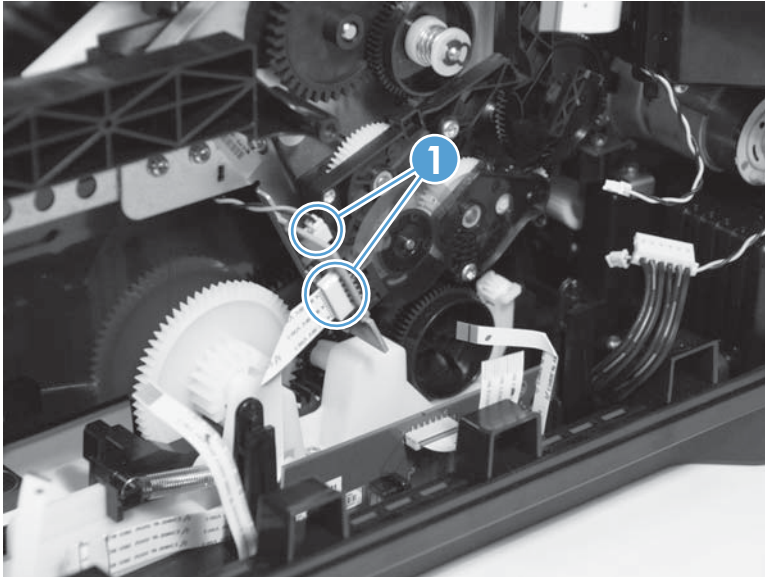

3. Remove one screw (callout 1), which requires the T10 Torx driver with the 25 mm (1 in) shaft.

Figure 1-203 Remove the pick encoder distribution PCA (2 of 2)

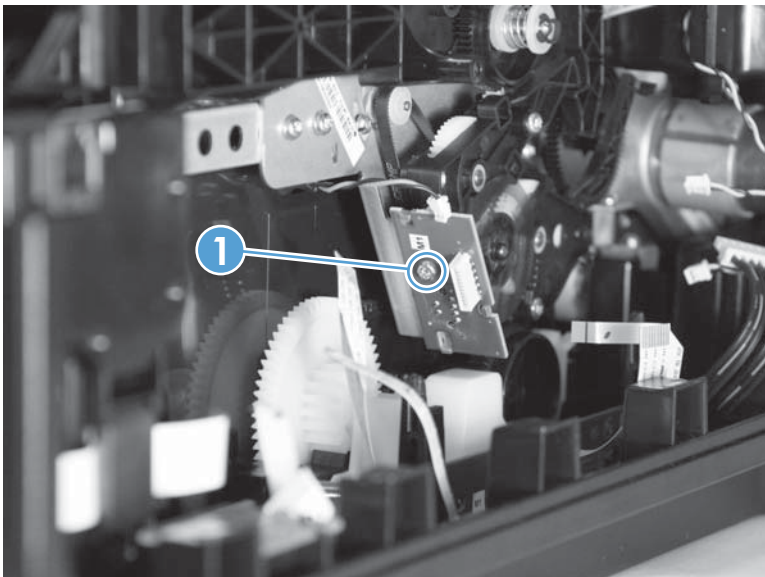

4. Remove the PCA.

 **Reinstallation tip** Make sure that the encoder disk is seated correctly in the sensor when reinstalling the PCA.

Wireless PCA

1. Remove the main PCA. See [Main PCA on page 127](#).
2. Remove the screw and retention holder that fastens the wireless PCA to the main PCA
3. Remove the wireless PCA connector by lifting the wireless PCA vertically from the main PCA.

Figure 1-204 Remove the wireless PCA.

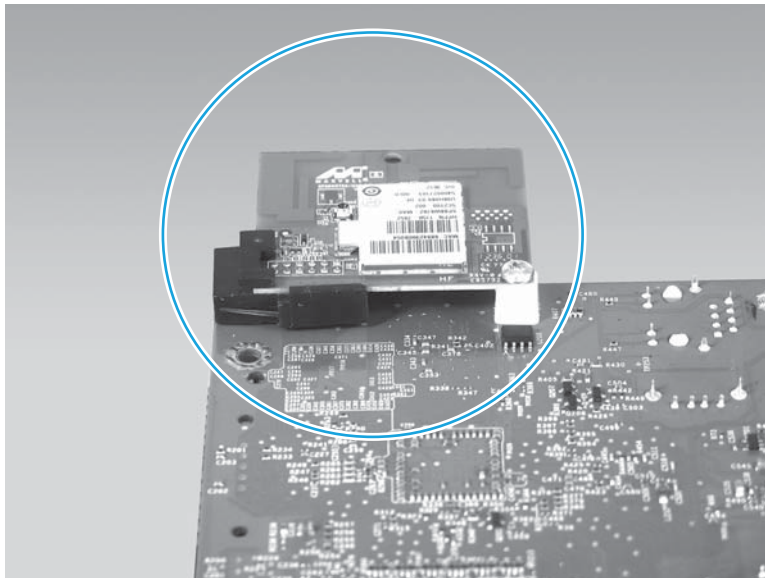

2 Parts and diagrams



NOTE: In this chapter, part numbers are listed only for available replaceable parts.

- [Order parts by authorized service providers](#)
- [How to use the parts lists and diagrams](#)
- [Assembly locations](#)
- [Covers, panels, and doors](#)
- [Internal assemblies](#)
- [Alphabetical parts list](#)
- [Numerical parts list](#)

Order parts by authorized service providers

Order replacement parts

Table 2-1 Order parts, accessories, and supplies

| | |
|--|--|
| Order supplies and paper | www.hp.com/go/suresupply . |
| Order genuine HP parts or accessories | www.hp.com/buy/parts |
| Order through service or support providers | Contact an HP-authorized service or support provider. |

Related documentation and software

Table 2-2 Related documentation and software

| Item | Description | Part number |
|---|-------------------------------------|-------------|
| HP Officejet Pro X451 and X551 Series Printers User Guide | Product user guide | CE863-90907 |
| HP Officejet Pro X451 and X551 Series Printers Repair Manual | English repair manual (this manual) | CV037-90002 |
| HP Officejet Pro X451 and X551 Series Printers Troubleshooting Manual | English troubleshooting manual | CV037-90001 |

Supplies part numbers

Table 2-3 Ink cartridge supplies

| Selectability | Size | Color | Type | Part Number |
|---------------|-------|---------|-------|-------------|
| 970 | 32 mm | Black | Host | D8J18-30001 |
| 971 | A | Cyan | Host | CN622-30002 |
| 971 | A | Magenta | Host | CN623-30002 |
| 971 | A | Yellow | Host | CN624-30002 |
| 970 | A | Black | Trade | CN621-30001 |
| 971 | A | Cyan | Trade | CN622-30001 |
| 971 | A | Magenta | Trade | CN623-30001 |
| 971 | A | Yellow | Trade | CN624-30001 |
| 970XL | XL | Black | Trade | CN625-30001 |
| 971XL | XL | Cyan | Trade | CN626-30001 |
| 971XL | XL | Magenta | Trade | CN627-30001 |
| 971XL | XL | Yellow | Trade | CN628-30001 |



NOTE: For information about the yield for the cartridges, see www.hp.com/go/pageyield. Actual yield depends on specific use.

Some ink cartridges may not be available in all countries/regions.

Customer self-repair parts

The following customer self-repair parts are available for the product.

Each kit includes parts and installation instructions. The customer self repair (CSR) level indicates the expected difficulty the customer will experience when replacing this part:

- A: Easy
- B: Difficult

Table 2-4 Customer self-repair parts

| Item | Description | CSR level | Part number |
|-------------------------------|--|-----------|-------------|
| Document feeder assembly | <ul style="list-style-type: none"> • Document feeder assembly • Document feeder foam pad • Document feeder replacement instructions | B | CN598-67008 |
| Duplex assembly | Duplex module | A | CN598-67004 |
| Output bin assembly | Output bin | A | CN598-67007 |
| Main tray assembly | Main tray | A | CN598-67005 |
| Accessory paper tray (Tray 3) | 500-sheet paper feeder (optional Tray 3) | A | CN595-65001 |
| Left door assembly | Left door | B | CN598-67001 |
| Left door strap | Left door strap | B | CN598-67002 |
| Left door rear strap | Left door rear strap | B | CN598-67003 |
| Eject flap assembly | Eject flap | B | CN598-67006 |

Cables and power cords

The following cables and power cords are available for the product.

Table 2-5 Cables and power cords

| Part number | Description |
|-------------|---|
| 8121-0868 | USB cable, A-to-B, 1.8 m (6.0 ft) long |
| 8121-1186 | USB cable, 1.8 m (6.0 ft) long, unbagged |
| 8120-8905 | Ethernet cable assembly (black), Cat-5e, 3 m (9.8 ft) long |
| 8120-6313 | Power cord (black), 2-wire, 1.8 m (6.0 ft) long—U.S., Canada, Mexico |
| 8121-0514 | Power cord (black), 2-wire, 1.8 m (6.0 ft) long—Chile |
| 8120-8373 | Power cord (black), 2-wire, 1.8 m (6.0 ft) long—China |
| 8121-0870 | Power cord (black), 2-wire, 1.8 m (6.0 ft) long—Australia, NZ |
| 8120-8699 | Power cord (black), 2-wire, 1.8 m (6.0 ft) long—UK, HK, Singapore, Middle East |
| 8121-0664 | Power cord (black), 2-wire, 1.8 m (6.0 ft) long—Thailand |
| 8120-6314 | Power cord (black), 2-wire, 1.8 m (6.0 ft) long—Europe, Indonesia, Vietnam, Middle East |
| 8120-8441 | Power cord (black), 2-wire, 1.8 m (6.0 ft) long—Korea |
| 8120-8367 | Power cord (black), 2-wire, 1.8 m (6.0 ft) long—Argentina |
| 8121-0963 | Power cord (black), 2-wire, 1.8 m (6.0 ft) long—Taiwan |
| 8121-1081 | Power cord (black), 2-wire, 1.8 m (6.0 ft) long—Brazil |
| 8121-1168 | Power cord (black), 2-wire, 1.8 m (6.0 ft) long— India (6A-2wire) |

Service part number and retail SKU cross-references

The following table lists the service part numbers and corresponding retail SKU numbers for X451 and X551 series products.

Table 2-6 Service part number and retail SKU cross-references

| Product | Service part number | Retail SKU number | Country/region |
|---------|---------------------|-------------------|----------------------|
| X451dn | CN459-69001 | CN459A#B1H | North America only |
| | CN459-69003 | CN459A#201 | U.S. government only |

Table 2-6 Service part number and retail SKU cross-references (continued)

| Product | Service part number | Retail SKU number | Country/region |
|------------|---------------------|-------------------|-------------------------------------|
| X451dw | CN463-69003 | CN463A#A81 | Europe, the Middle East, and Africa |
| | | CN463A#BHG | |
| | CN463-69009 | CN463A#ABT | Israel |
| | CN463-69010 | CN463A#A81 | Turkey |
| | CN463-69001 | CN463A#B1H | North America only |
| | CN463-69004 | CN463A#AB0 | Taiwan only |
| | CN463-69005 | CN463A#AB2 | India and China |
| | | CN463A#ACJ | |
| | CN463-69006 | CN463A#AB1 | Rest of Asia Pacific |
| | | CN463A#BBU | |
| | | CN463A#BGM | |
| | CN463-69002 | CN463A#AC4 | Latin America |
| | | CN463A#AC8 | |
| | | CN463A#AKH | |
| CN463A#AKY | | | |
| X551dw | CV037-69002 | CV037A#A81 | Europe, the Middle East, and Africa |
| | | CV037A#BHG | |
| | CV037-69008 | CV037A#ABT | Israel |
| | CV037-69009 | CV037A#A81 | Turkey |
| | CV037-69001 | CV037A#B1H | North America only |
| | CV037-69003 | CV037A#AB0 | Taiwan only |
| | CV037-69004 | CV037A#AB2 | India and China |
| | | CV037A#ACJ | |
| | CV037-69005 | CV037A#AB1 | Rest of Asia Pacific |
| | | CV037A#BBU | |
| CV037A#BGM | | | |

How to use the parts lists and diagrams

The figures in this chapter show the major subassemblies in the product and their component parts. A parts list table follows each exploded view assembly diagram. Each table lists the item number, the associated part number, and the description of each part. If a part is not listed in the table, then it is not a field replacement unit (FRU).

 **CAUTION:** Be sure to order the correct part. When looking for part numbers for electrical components, pay careful attention to the voltage that is listed in the description column. Doing so will ensure that the part number selected is for the correct product model.

 **NOTE:** In this manual, the abbreviation “PCA” stands for “printed circuit-board assembly.” Components described as a PCA might consist of a single circuit board or a circuit board plus other parts, such as cables and sensors.

Assembly locations

Front view (X451 Series)

Figure 2-1 Front view (X451 Series)

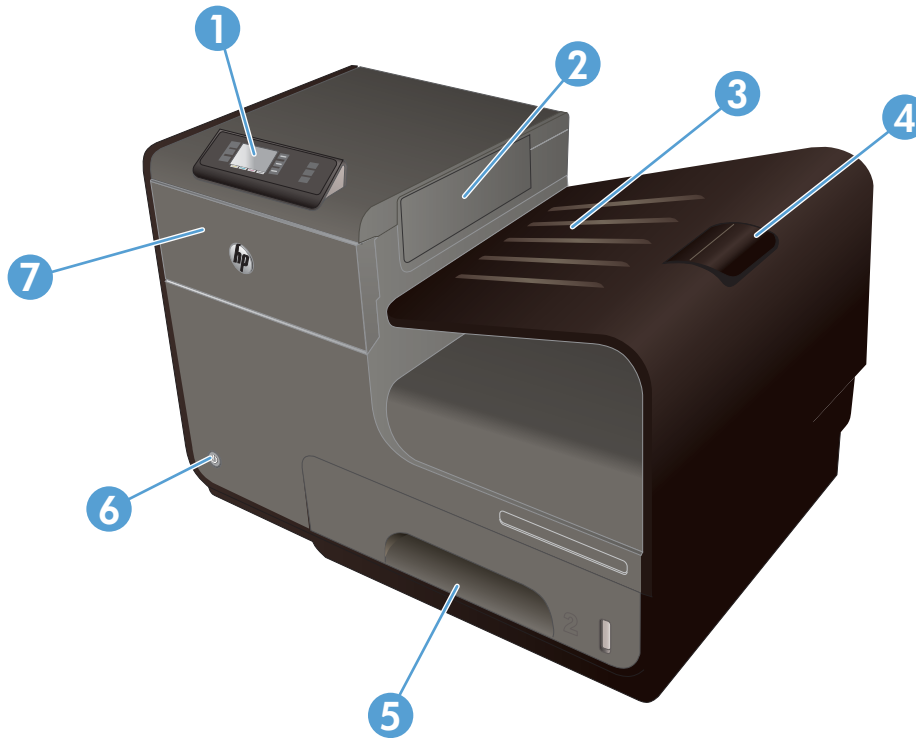

| | |
|---|--------------------------|
| 1 | Control panel |
| 2 | Output eject flap. |
| 3 | Output bin |
| 4 | Output bin extension |
| 5 | Tray 2 (Main paper tray) |
| 6 | On/Off button |
| 7 | Ink cartridge door |

Front view (X551 Series)

Figure 2-2 Front view (X551 Series)

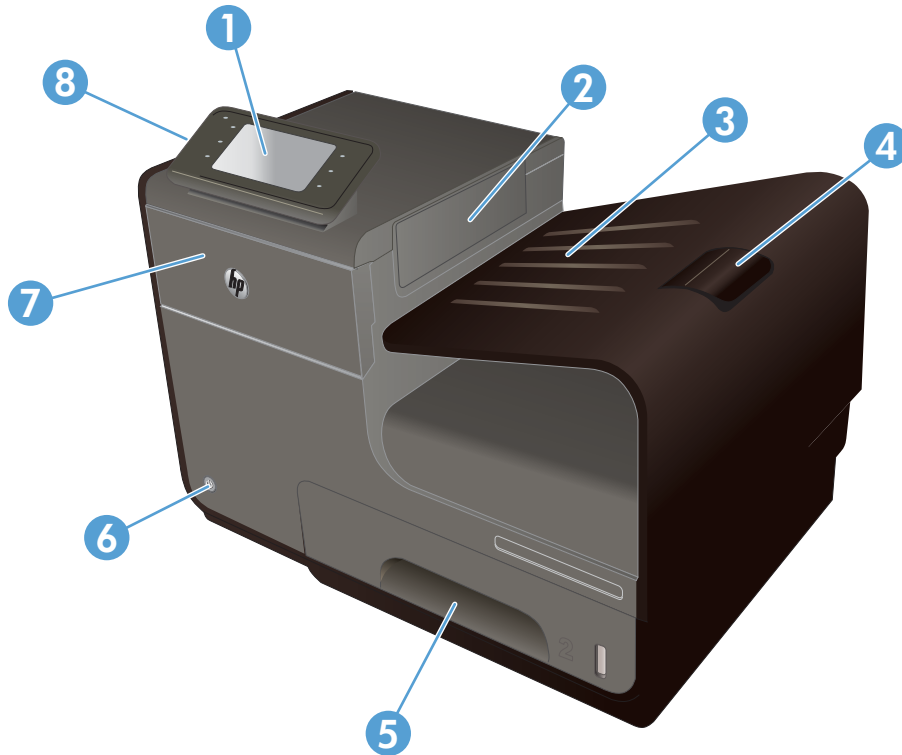

| | |
|---|---|
| 1 | Control panel |
| 2 | Output bin door |
| 3 | Output bin |
| 4 | Output bin extension |
| 5 | Tray 2 (Main paper tray) |
| 6 | On/Off button |
| 7 | Ink cartridge door |
| 8 | USB 2.0 Host port that accepts USB storage devices for Plug and Print USB Drive printing. |

Back view

Figure 2-3 Back view

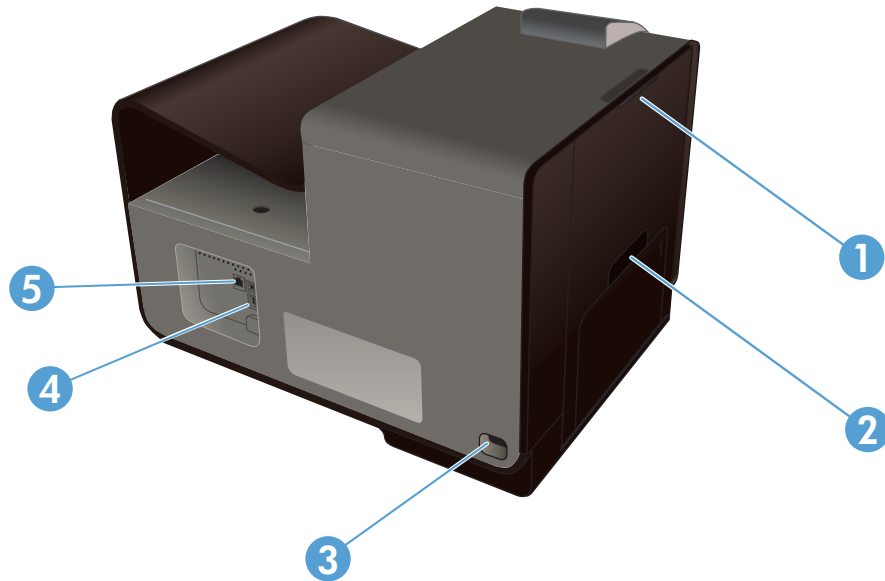

| | |
|---|--------------------------------------|
| 1 | Left door (access for clearing jams) |
| 2 | Tray 1 (Multi-purpose tray) |
| 3 | Power connection |
| 4 | Hi-Speed USB 2.0 ports |
| 5 | Ethernet port |

Covers, panels, and doors

Figure 2-4 Covers, panels, and doors

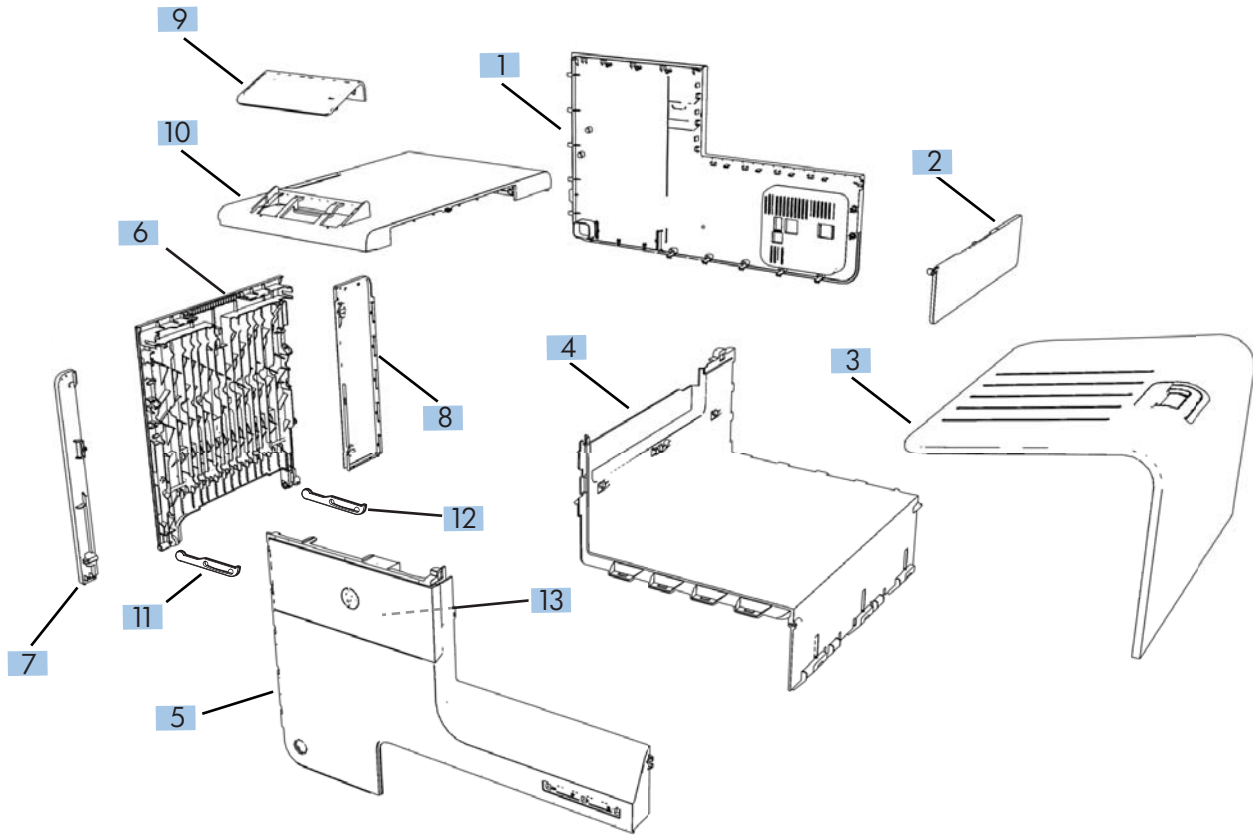

Table 2-7 Covers, panels, and doors

| Ref | Description | Part number | Qty |
|------------|-------------------------------|--------------------|------------|
| 1 | Rear cover | CN598-67047 | 1 |
| 2 | Eject flap assembly | CN598-67023 | 1 |
| 3 | Output bin | CN598-67007 | 1 |
| 4 | Right cover | CN598-67051 | 1 |
| 5 | Front cover | CN598-67052 | 1 |
| 6 | Left door | CN598-67001 | 1 |
| 7 | Left front cover | CN598-67050 | 1 |
| 8 | Left rear cover | CN598-67049 | 1 |
| 9 | Control-panel assembly—X551 | CN461-67003 | 1 |
| 9 | Control-panel assembly—X451dn | CN459-67008 | 1 |
| 9 | Control-panel assembly—X451dw | CN463-67001 | 1 |
| 10 | Top cover (X551) | CV037-67003 | 1 |
| 10 | Top cover (X451) | CN459-67007 | 1 |
| 11 | Strap, left door | CN598-67002 | 1 |
| 12 | Strap, left door, rear | CN598-67003 | 1 |
| 13 | Hinge, ISS door | CN598-67053 | 2 |
| Not shown | Control panel FFC—X551 | CV037-67002 | 1 |
| Not shown | Control panel FFC—X451 | CN463-67003 | 1 |

Internal assemblies

Figure 2-5 Internal assemblies (1 of 3)

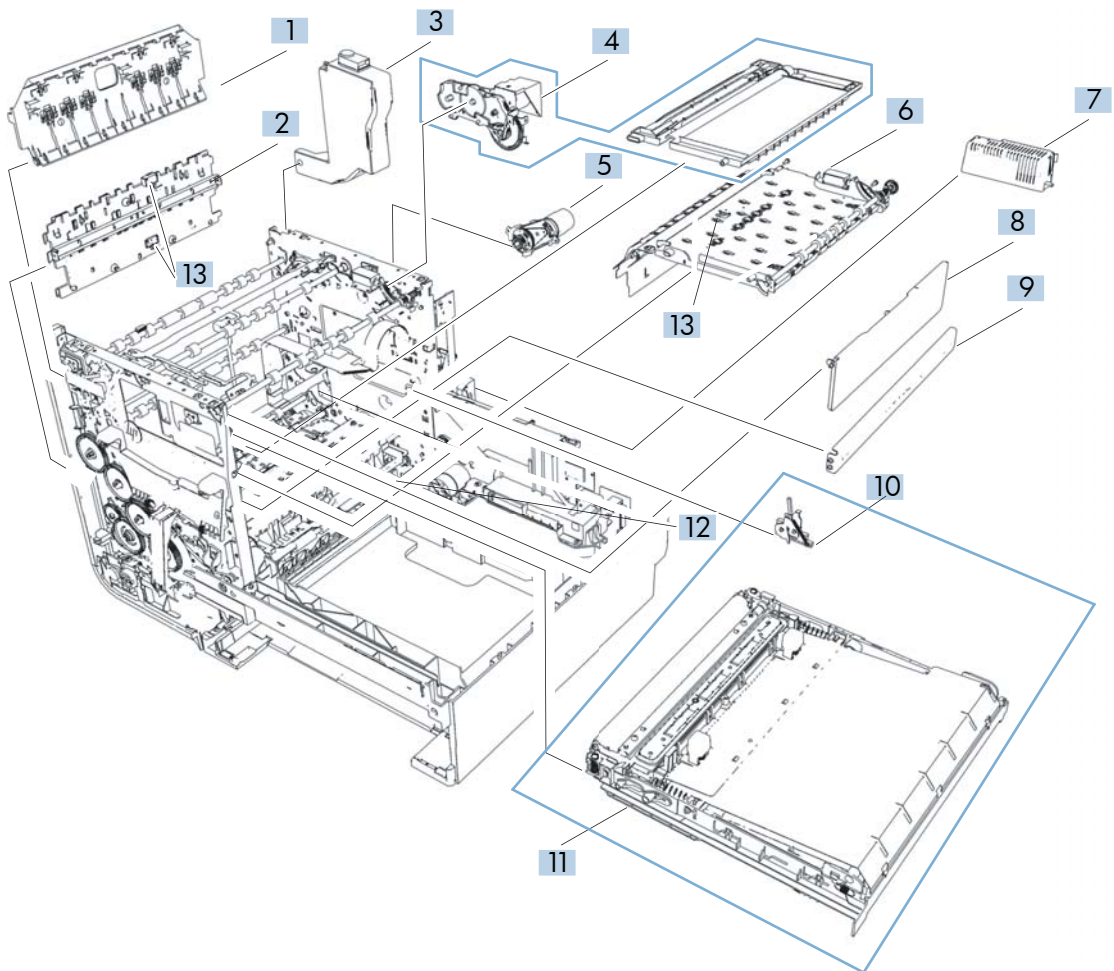

Table 2-8 Internal assemblies (1 of 3)

| Ref | Description | Part number | Qty |
|------------|--|--------------------|------------|
| 1 | Upper hanger assembly | Not supported | 1 |
| 2 | Vertical star wheel wall | Not supported | 1 |
| 3 | Aerosol fan assembly | CN598-67046 | 1 |
| 4 | Output drive kit | CN598-67022 | 1 |
| Not shown | Eject drive gear module (part of output drive kit) | CN459-60292 | 1 |
| Not shown | Flap actuator solenoid (part of output drive kit) | CN459-60307 | 1 |
| Not shown | Rack-eject lifter flap (part of output drive kit) | CN459-40410 | 1 |
| 5 | Duplex drive module | CN598-67036 | 1 |
| 6 | Floor eject assembly | Not supported | 1 |
| 7 | Power supply | CN598-67016 | 1 |
| 7 | Power supply — India and China only | CN598-67017 | 1 |
| 8 | Eject flap assembly | CN598-67023 | 1 |
| 9 | Cross brace, right | Not supported | 1 |
| 10 | Web advance rack assembly | CN598-67021 | 1 |
| 11 | Service sled assembly | CN598-67021 | 1 |
| 12 | Media presence sensor PCA/flag | CN598-67034 | 1 |
| 13 | REDI sensors | CN598-67038 | 3 |
| Not shown | BDD sensor | CN598-67035 | 1 |
| Not shown | FFC, 11 pin printzone | CN598-67039 | 1 |
| Not shown | FFC, 24 pin printbar lift | CN598-67040 | 1 |
| Not shown | FFC, 10 pin pick drive enc | CN598-67041 | 1 |
| Not shown | FFC, 12 pin REDI distribution | CN598-67042 | 1 |
| Not shown | FFC, 5 pin sensor carriage BDD | CN598-67043 | 1 |

Figure 2-6 Internal assemblies (2 of 3)

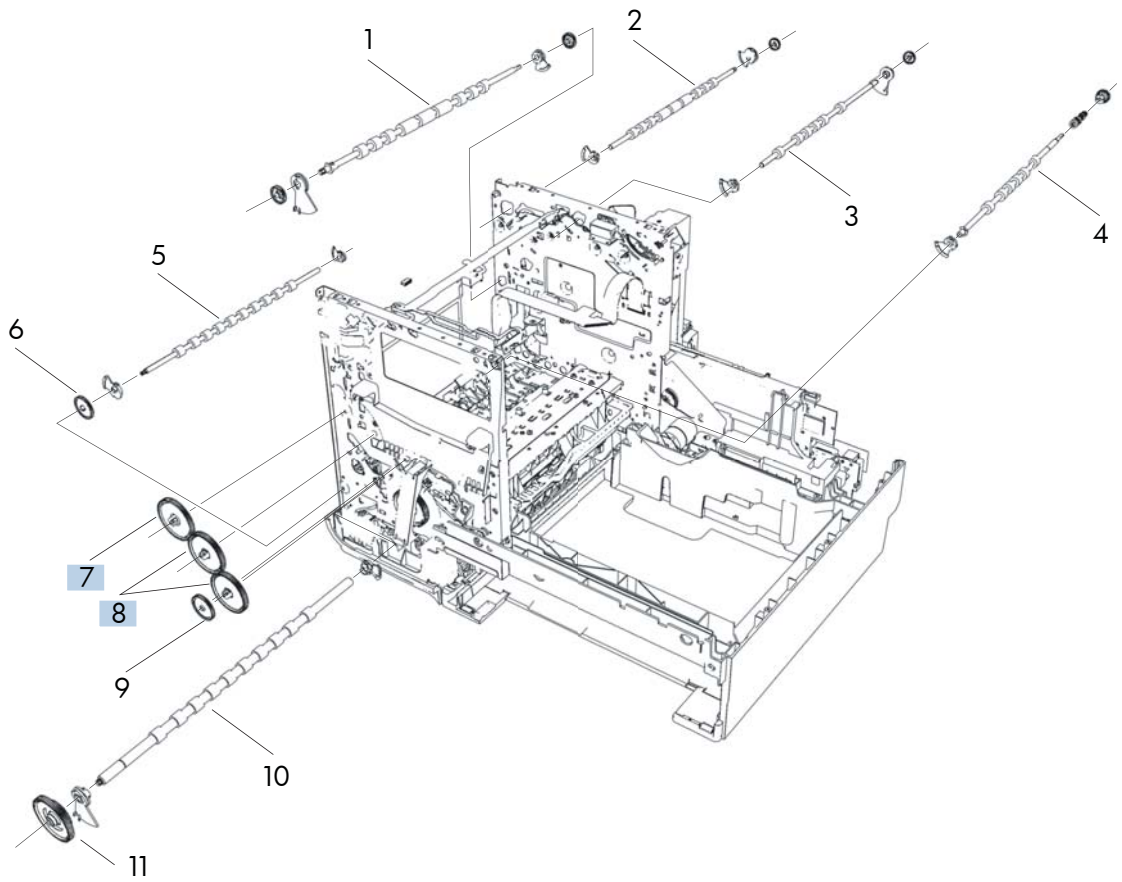

Table 2-9 Internal assemblies (2 of 3)

| Ref | Description | Part number | Qty |
|------------|----------------------------------|--------------------|------------|
| 1 | Transfer 3 shaft | Not supported | 1 |
| 2 | Output upper 4 shaft | Not supported | 1 |
| 3 | Output eject 5 shaft | Not supported | 1 |
| 4 | Output eject 6 shaft | Not supported | 1 |
| 5 | Output lower 2 shaft | Not supported | 1 |
| 6 | Gear, shaft output lower | Not supported | 1 |
| 7 | Gear, output idler gear, 83t/30t | CN598-67031 | 1 |
| 8 | Gear, idler gear train, 78t/48t | CN598-67031 | 2 |
| 9 | Spurgear, idler gear train, 52t | Not supported | 1 |
| 10 | Platen output 1 shaft | Not supported | 1 |
| 11 | Gear, shaft output platen 1 | Not supported | 1 |

Figure 2-7 Internal assemblies (3 of 3)

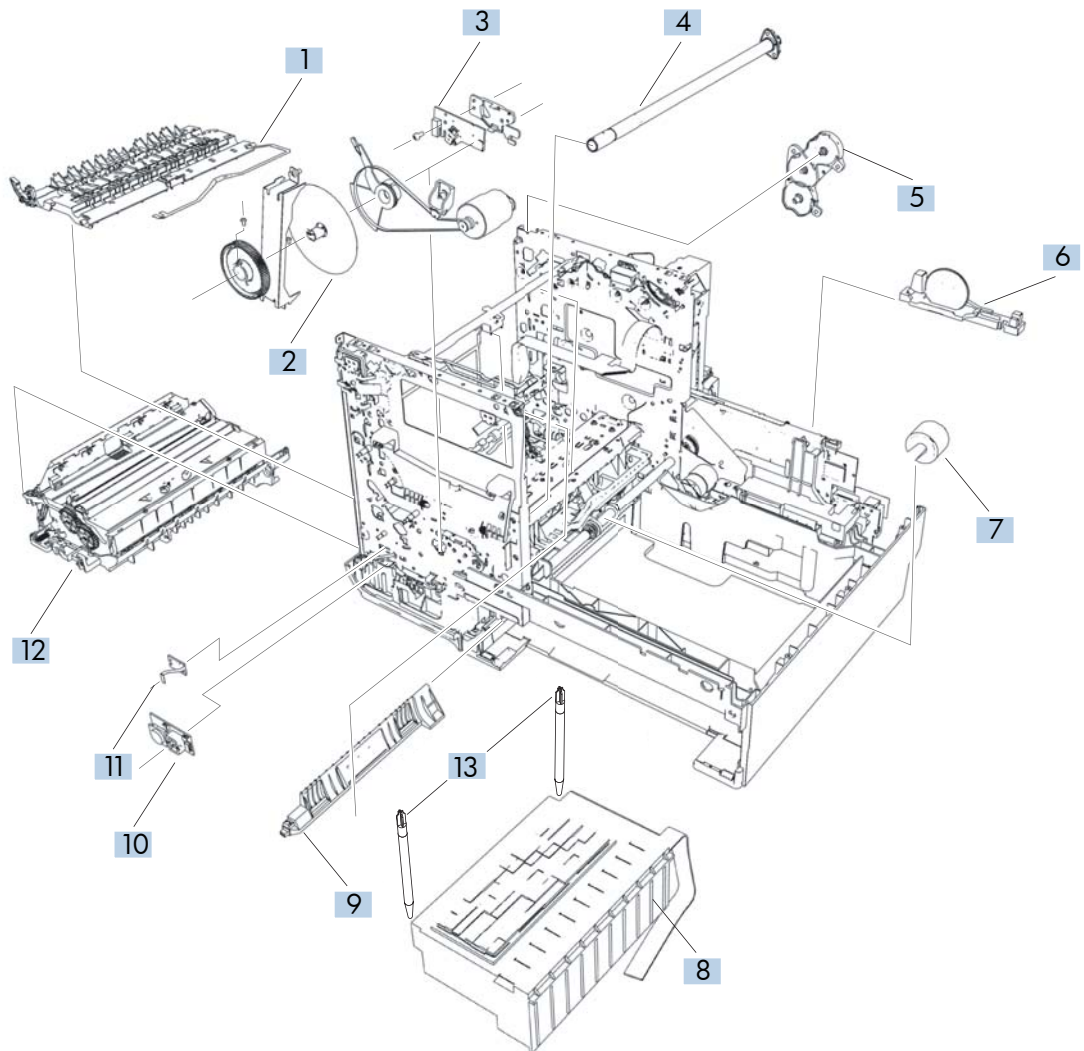

Table 2-10 Internal assemblies (3 of 3)

| Ref | Description | Part number | Qty |
|-----------|--|-----------------|-----|
| 1 | Platen NOTE: The platen kit contains a TOF REDI sensor and a print zone REDI sensor. | CN598-67025 | 1 |
| 2 | Encoder disk | (Not supported) | 1 |
| 3 | Feedshaft Encoder PCA | CN598-67030 | 1 |
| 4 | Feedshaft | (Not supported) | 1 |
| 5 | Drying path gear assembly | CN598-67060 | 1 |
| 6 | Tray lift transmission assembly | CN598-67020 | 1 |
| 7 | Separator/pick assembly kit | CN598-67018 | 1 |
| 8 | Printbar | CN598-67045 | 1 |
| Not shown | Printbar lift mechanism assembly | CN598-67027 | 1 |
| 9 | Separation assembly | CN598-67018 | 1 |
| 10 | Power button assembly | CN598-67019 | 1 |
| 11 | Duplex presence sensor PCA | CN598-67057 | 1 |
| 12 | Duplex module | CN598-67004 | 1 |
| 13 | Z stop, printbar lift rod | CN598-67048 | 2 |
| Not shown | Shaft, printbar lift, clutched | CN598-67028 | 1 |

Figure 2-8 PCA locations (1 of 2)

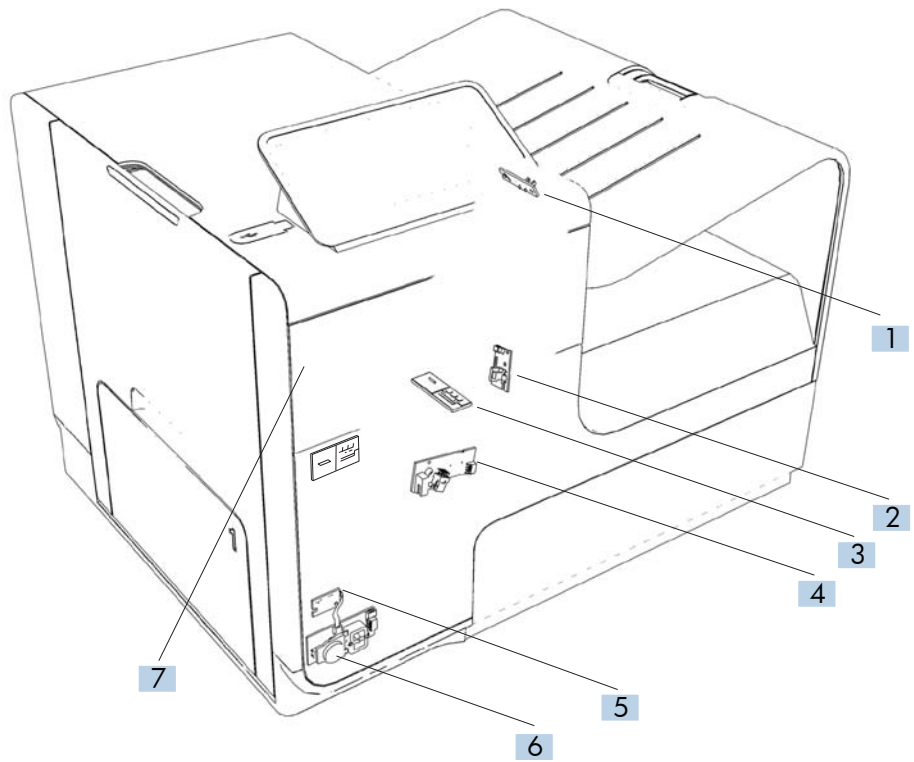

Table 2-11 PCA locations (1 of 2)

| Ref | Description | Part number | Qty |
|------------|-------------------------------|--------------------|------------|
| 1 | Eject flap opto PCA | CN598-67023 | 1 |
| 2 | Pick encoder distribution PCA | CN598-67029 | 1 |
| 3 | Print zone distribution PCA | CN598-67033 | 1 |
| 4 | Feedshaft encoder PCA | CN598-67030 | 1 |
| 5 | Duplex presence sensor PCA | CN598-67057 | 1 |
| 6 | Power button assembly | CN598-67019 | 1 |
| 7 | REDI distribution PCA, | CN598-67037 | 1 |

Figure 2-9 PCA locations (2 of 2)

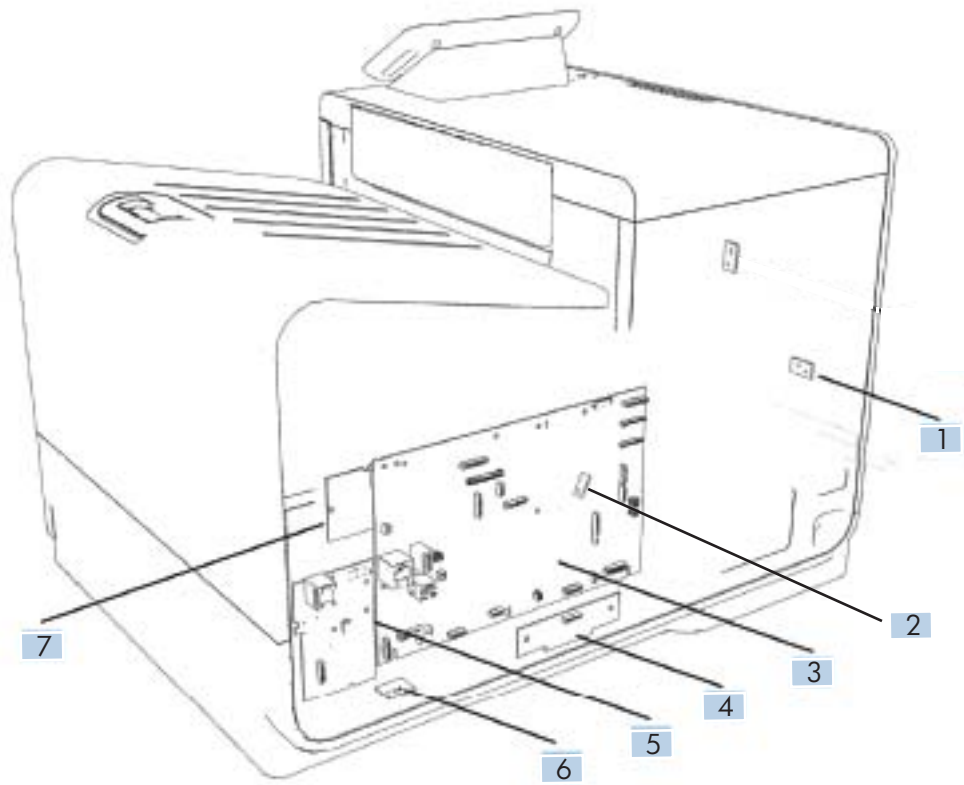

Table 2-12 PCA locations (2 of 2)

| Ref | Description | Part number | Qty |
|------------|-----------------------------------|--------------------|------------|
| 1 | Sensor carriage PCA/encoder strip | CN598-67061 | 1 |
| 2 | Media presence flag/opto PCA kit | CN598-67034 | 1 |
| 3 | Main PCA (X451dn models) | CN463-67002 | 1 |
| 3 | Main PCA (X451dw models) | CN463-67004 | 1 |
| 3 | Main PCA (X551dw models) | CV037-67001 | 1 |
| 4 | Tray 3 interconnect PCA | CN598-67059 | 1 |
| 5 | Fax PCA | CN460-67007 | 1 |
| 6 | Temperature sensor | CN598-67024 | 1 |
| 7 | Wireless PCA | CN598-67055 | 1 |

Alphabetical parts list

Table 2-13 Alphabetical parts list

| Description | Part number | Table and page |
|--|-----------------|--|
| Aerosol fan assembly | CN598-67046 | Internal assemblies (1 of 3) on page 151 |
| BDD sensor | CN598-67035 | Internal assemblies (1 of 3) on page 151 |
| Control panel FFC—X451 | CN463-67003 | Covers, panels, and doors on page 149 |
| Control panel FFC—X551 | CV037-67002 | Covers, panels, and doors on page 149 |
| Control-panel assembly—X451dn | CN459-67008 | Covers, panels, and doors on page 149 |
| Control-panel assembly—X451dw | CN463-67001 | Covers, panels, and doors on page 149 |
| Control-panel assembly—X551 | CN461-67003 | Covers, panels, and doors on page 149 |
| Cross brace, right | Not supported | Internal assemblies (1 of 3) on page 151 |
| Drying path gear assembly | CN598-67060 | Internal assemblies (3 of 3) on page 155 |
| Duplex drive module | CN598-67036 | Internal assemblies (1 of 3) on page 151 |
| Duplex module | CN598-67004 | Internal assemblies (3 of 3) on page 155 |
| Duplex presence sensor PCA | CN598-67057 | Internal assemblies (3 of 3) on page 155 |
| Duplex presence sensor PCA | CN598-67057 | PCA locations (1 of 2) on page 157 |
| Eject drive gear module (part of output drive kit) | CN459-60292 | Internal assemblies (1 of 3) on page 151 |
| Eject flap assembly | CN598-67023 | Covers, panels, and doors on page 149 |
| Eject flap assembly | CN598-67023 | Internal assemblies (1 of 3) on page 151 |
| Eject flap opto PCA | CN598-67023 | PCA locations (1 of 2) on page 157 |
| Encoder disk | (Not supported) | Internal assemblies (3 of 3) on page 155 |
| Fax PCA | CN460-67007 | PCA locations (2 of 2) on page 159 |

Table 2-13 Alphabetical parts list (continued)

| Description | Part number | Table and page |
|---|--------------------|--|
| Feedshaft | (Not supported) | Internal assemblies (3 of 3) on page 155 |
| Feedshaft Encoder PCA | CN598-67030 | Internal assemblies (3 of 3) on page 155 |
| Feedshaft encoder PCA | CN598-67030 | PCA locations (1 of 2) on page 157 |
| FFC, 10 pin pick drive enc | CN598-67041 | Internal assemblies (1 of 3) on page 151 |
| FFC, 11 pin printzone | CN598-67039 | Internal assemblies (1 of 3) on page 151 |
| FFC, 12 pin REDI distribution | CN598-67042 | Internal assemblies (1 of 3) on page 151 |
| FFC, 24 pin printbar lift | CN598-67040 | Internal assemblies (1 of 3) on page 151 |
| FFC, 5 pin sensor carriage BDD | CN598-67043 | Internal assemblies (1 of 3) on page 151 |
| Flap actuator solenoid (part of output drive kit) | CN459-60307 | Internal assemblies (1 of 3) on page 151 |
| Floor eject assembly | Not supported | Internal assemblies (1 of 3) on page 151 |
| Front cover | CN598-67052 | Covers, panels, and doors on page 149 |
| Gear, idler gear train, 78t/48t | CN598-67031 | Internal assemblies (2 of 3) on page 153 |
| Gear, output idler gear, 83t/30t | CN598-67031 | Internal assemblies (2 of 3) on page 153 |
| Gear, shaft output lower | Not supported | Internal assemblies (2 of 3) on page 153 |
| Gear, shaft output platen 1 | Not supported | Internal assemblies (2 of 3) on page 153 |
| Hinge, ISS door | CN598-67053 | Covers, panels, and doors on page 149 |
| Left door | CN598-67001 | Covers, panels, and doors on page 149 |
| Left front cover | CN598-67050 | Covers, panels, and doors on page 149 |
| Left rear cover | CN598-67049 | Covers, panels, and doors on page 149 |
| Main PCA (X451dn models) | CN463-67002 | PCA locations (2 of 2) on page 159 |

Table 2-13 Alphabetical parts list (continued)

| Description | Part number | Table and page |
|--|---------------|--|
| Main PCA (X451dw models) | CN463-67004 | PCA locations (2 of 2) on page 159 |
| Main PCA (X551dw models) | CV037-67001 | PCA locations (2 of 2) on page 159 |
| Media presence flag/opto PCA kit | CN598-67034 | PCA locations (2 of 2) on page 159 |
| Media presence sensor PCA/flag | CN598-67034 | Internal assemblies (1 of 3) on page 151 |
| Output bin | CN598-67007 | Covers, panels, and doors on page 149 |
| Output drive kit | CN598-67022 | Internal assemblies (1 of 3) on page 151 |
| Output eject 5 shaft | Not supported | Internal assemblies (2 of 3) on page 153 |
| Output eject 6 shaft | Not supported | Internal assemblies (2 of 3) on page 153 |
| Output lower 2 shaft | Not supported | Internal assemblies (2 of 3) on page 153 |
| Output upper 4 shaft | Not supported | Internal assemblies (2 of 3) on page 153 |
| Pick encoder distribution PCA | CN598-67029 | PCA locations (1 of 2) on page 157 |
| Platen output 1 shaft | Not supported | Internal assemblies (2 of 3) on page 153 |
| Platen | CN598-67025 | Internal assemblies (3 of 3) on page 155 |
| NOTE: The platen kit contains a TOF REDI sensor and a print zone REDI sensor. | | |
| Power button assembly | CN598-67019 | Internal assemblies (3 of 3) on page 155 |
| Power button assembly | CN598-67019 | PCA locations (1 of 2) on page 157 |
| Power supply | CN598-67016 | Internal assemblies (1 of 3) on page 151 |
| Power supply — India and China only | CN598-67017 | Internal assemblies (1 of 3) on page 151 |
| Print zone distribution PCA | CN598-67033 | PCA locations (1 of 2) on page 157 |
| Printbar | CN598-67045 | Internal assemblies (3 of 3) on page 155 |

Table 2-13 Alphabetical parts list (continued)

| Description | Part number | Table and page |
|---|--------------------|--|
| Printbar lift mechanism assembly | CN598-67027 | Internal assemblies (3 of 3) on page 155 |
| Rack-eject lifter flap (part of output drive kit) | CN459-40410 | Internal assemblies (1 of 3) on page 151 |
| Rear cover | CN598-67047 | Covers, panels, and doors on page 149 |
| REDI distribution PCA, | CN598-67037 | PCA locations (1 of 2) on page 157 |
| REDI sensors | CN598-67038 | Internal assemblies (1 of 3) on page 151 |
| Right cover | CN598-67051 | Covers, panels, and doors on page 149 |
| Sensor carriage PCA/encoder strip | CN598-67061 | PCA locations (2 of 2) on page 159 |
| Separation assembly | CN598-67018 | Internal assemblies (3 of 3) on page 155 |
| Separator/pick assembly kit | CN598-67018 | Internal assemblies (3 of 3) on page 155 |
| Service sled assembly | CN598-67021 | Internal assemblies (1 of 3) on page 151 |
| Shaft, printbar lift, clutched | CN598-67028 | Internal assemblies (3 of 3) on page 155 |
| Spurgear, idler gear train, 52t | Not supported | Internal assemblies (2 of 3) on page 153 |
| Strap, left door | CN598-67002 | Covers, panels, and doors on page 149 |
| Strap, left door, rear | CN598-67003 | Covers, panels, and doors on page 149 |
| Temperature sensor | CN598-67024 | PCA locations (2 of 2) on page 159 |
| Top cover (X451) | CN459-67007 | Covers, panels, and doors on page 149 |
| Top cover (X551) | CV037-67003 | Covers, panels, and doors on page 149 |
| Transfer 3 shaft | Not supported | Internal assemblies (2 of 3) on page 153 |
| Tray 3 interconnect PCA | CN598-67059 | PCA locations (2 of 2) on page 159 |
| Tray lift transmission assembly | CN598-67020 | Internal assemblies (3 of 3) on page 155 |

Table 2-13 Alphabetical parts list (continued)

| Description | Part number | Table and page |
|---------------------------|--------------------|--|
| Upper hanger assembly | Not supported | Internal assemblies (1 of 3) on page 151 |
| Vertical star wheel wall | Not supported | Internal assemblies (1 of 3) on page 151 |
| Web advance rack assembly | CN598-67021 | Internal assemblies (1 of 3) on page 151 |
| Wireless PCA | CN598-67055 | PCA locations (2 of 2) on page 159 |
| Z stop, printbar lift rod | CN598-67048 | Internal assemblies (3 of 3) on page 155 |

Numerical parts list

Table 2-14 Numerical parts list

| Part number | Description | Table and page |
|-----------------|--|--|
| (Not supported) | Encoder disk | Internal assemblies (3 of 3) on page 155 |
| (Not supported) | Feedshaft | Internal assemblies (3 of 3) on page 155 |
| CN459-40410 | Rack-eject lifter flap (part of output drive kit) | Internal assemblies (1 of 3) on page 151 |
| CN459-60292 | Eject drive gear module (part of output drive kit) | Internal assemblies (1 of 3) on page 151 |
| CN459-60307 | Flap actuator solenoid (part of output drive kit) | Internal assemblies (1 of 3) on page 151 |
| CN459-67007 | Top cover (X451) | Covers, panels, and doors on page 149 |
| CN459-67008 | Control-panel assembly—X451dn | Covers, panels, and doors on page 149 |
| CN460-67007 | Fax PCA | PCA locations (2 of 2) on page 159 |
| CN461-67003 | Control-panel assembly—X551 | Covers, panels, and doors on page 149 |
| CN463-67001 | Control-panel assembly—X451dw | Covers, panels, and doors on page 149 |
| CN463-67002 | Main PCA (X451dn models) | PCA locations (2 of 2) on page 159 |
| CN463-67003 | Control panel FFC—X451 | Covers, panels, and doors on page 149 |
| CN463-67004 | Main PCA (X451dw models) | PCA locations (2 of 2) on page 159 |
| CN598-67001 | Left door | Covers, panels, and doors on page 149 |
| CN598-67002 | Strap, left door | Covers, panels, and doors on page 149 |
| CN598-67003 | Strap, left door, rear | Covers, panels, and doors on page 149 |
| CN598-67004 | Duplex module | Internal assemblies (3 of 3) on page 155 |
| CN598-67007 | Output bin | Covers, panels, and doors on page 149 |
| CN598-67016 | Power supply | Internal assemblies (1 of 3) on page 151 |

Table 2-14 Numerical parts list (continued)

| Part number | Description | Table and page |
|-------------|--|--|
| CN598-67017 | Power supply — India and China only | Internal assemblies (1 of 3) on page 151 |
| CN598-67018 | Separator/pick assembly kit | Internal assemblies (3 of 3) on page 155 |
| CN598-67018 | Separation assembly | Internal assemblies (3 of 3) on page 155 |
| CN598-67019 | Power button assembly | Internal assemblies (3 of 3) on page 155 |
| CN598-67019 | Power button assembly | PCA locations (1 of 2) on page 157 |
| CN598-67020 | Tray lift transmission assembly | Internal assemblies (3 of 3) on page 155 |
| CN598-67021 | Web advance rack assembly | Internal assemblies (1 of 3) on page 151 |
| CN598-67021 | Service sled assembly | Internal assemblies (1 of 3) on page 151 |
| CN598-67022 | Output drive kit | Internal assemblies (1 of 3) on page 151 |
| CN598-67023 | Eject flap assembly | Covers, panels, and doors on page 149 |
| CN598-67023 | Eject flap assembly | Internal assemblies (1 of 3) on page 151 |
| CN598-67023 | Eject flap opto PCA | PCA locations (1 of 2) on page 157 |
| CN598-67024 | Temperature sensor | PCA locations (2 of 2) on page 159 |
| CN598-67025 | Platen NOTE: The platen kit contains a TOF REDI sensor and a print zone REDI sensor. | Internal assemblies (3 of 3) on page 155 |
| CN598-67027 | Printbar lift mechanism assembly | Internal assemblies (3 of 3) on page 155 |
| CN598-67028 | Shaft, printbar lift, clutched | Internal assemblies (3 of 3) on page 155 |
| CN598-67029 | Pick encoder distribution PCA | PCA locations (1 of 2) on page 157 |
| CN598-67030 | Feedshaft Encoder PCA | Internal assemblies (3 of 3) on page 155 |
| CN598-67030 | Feedshaft encoder PCA | PCA locations (1 of 2) on page 157 |

Table 2-14 Numerical parts list (continued)

| Part number | Description | Table and page |
|--------------------|----------------------------------|--|
| CN598-67031 | Gear, output idler gear, 83t/30t | Internal assemblies (2 of 3) on page 153 |
| CN598-67031 | Gear, idler gear train, 78t/48t | Internal assemblies (2 of 3) on page 153 |
| CN598-67033 | Print zone distribution PCA | PCA locations (1 of 2) on page 157 |
| CN598-67034 | Media presence sensor PCA/flag | Internal assemblies (1 of 3) on page 151 |
| CN598-67034 | Media presence flag/opto PCA kit | PCA locations (2 of 2) on page 159 |
| CN598-67035 | BDD sensor | Internal assemblies (1 of 3) on page 151 |
| CN598-67036 | Duplex drive module | Internal assemblies (1 of 3) on page 151 |
| CN598-67037 | REDI distribution PCA, | PCA locations (1 of 2) on page 157 |
| CN598-67038 | REDI sensors | Internal assemblies (1 of 3) on page 151 |
| CN598-67039 | FFC, 11 pin printzone | Internal assemblies (1 of 3) on page 151 |
| CN598-67040 | FFC, 24 pin printbar lift | Internal assemblies (1 of 3) on page 151 |
| CN598-67041 | FFC, 10 pin pick drive enc | Internal assemblies (1 of 3) on page 151 |
| CN598-67042 | FFC, 12 pin REDI distribution | Internal assemblies (1 of 3) on page 151 |
| CN598-67043 | FFC, 5 pin sensor carriage BDD | Internal assemblies (1 of 3) on page 151 |
| CN598-67045 | Printbar | Internal assemblies (3 of 3) on page 155 |
| CN598-67046 | Aerosol fan assembly | Internal assemblies (1 of 3) on page 151 |
| CN598-67047 | Rear cover | Covers, panels, and doors on page 149 |
| CN598-67048 | Z stop, printbar lift rod | Internal assemblies (3 of 3) on page 155 |
| CN598-67049 | Left rear cover | Covers, panels, and doors on page 149 |
| CN598-67050 | Left front cover | Covers, panels, and doors on page 149 |

Table 2-14 Numerical parts list (continued)

| Part number | Description | Table and page |
|--------------------|-----------------------------------|--|
| CN598-67051 | Right cover | Covers, panels, and doors on page 149 |
| CN598-67052 | Front cover | Covers, panels, and doors on page 149 |
| CN598-67053 | Hinge, ISS door | Covers, panels, and doors on page 149 |
| CN598-67055 | Wireless PCA | PCA locations (2 of 2) on page 159 |
| CN598-67057 | Duplex presence sensor PCA | Internal assemblies (3 of 3) on page 155 |
| CN598-67057 | Duplex presence sensor PCA | PCA locations (1 of 2) on page 157 |
| CN598-67059 | Tray 3 interconnect PCA | PCA locations (2 of 2) on page 159 |
| CN598-67060 | Drying path gear assembly | Internal assemblies (3 of 3) on page 155 |
| CN598-67061 | Sensor carriage PCA/encoder strip | PCA locations (2 of 2) on page 159 |
| CV037-67001 | Main PCA (X551dw models) | PCA locations (2 of 2) on page 159 |
| CV037-67002 | Control panel FFC—X551 | Covers, panels, and doors on page 149 |
| CV037-67003 | Top cover (X551) | Covers, panels, and doors on page 149 |
| Not supported | Upper hanger assembly | Internal assemblies (1 of 3) on page 151 |
| Not supported | Vertical star wheel wall | Internal assemblies (1 of 3) on page 151 |
| Not supported | Floor eject assembly | Internal assemblies (1 of 3) on page 151 |
| Not supported | Cross brace, right | Internal assemblies (1 of 3) on page 151 |
| Not supported | Transfer 3 shaft | Internal assemblies (2 of 3) on page 153 |
| Not supported | Output upper 4 shaft | Internal assemblies (2 of 3) on page 153 |
| Not supported | Output eject 5 shaft | Internal assemblies (2 of 3) on page 153 |
| Not supported | Output eject 6 shaft | Internal assemblies (2 of 3) on page 153 |

Table 2-14 Numerical parts list (continued)

| Part number | Description | Table and page |
|--------------------|---------------------------------|--|
| Not supported | Output lower 2 shaft | Internal assemblies (2 of 3) on page 153 |
| Not supported | Gear, shaft output lower | Internal assemblies (2 of 3) on page 153 |
| Not supported | Spurgear, idler gear train, 52t | Internal assemblies (2 of 3) on page 153 |
| Not supported | Platen output 1 shaft | Internal assemblies (2 of 3) on page 153 |
| Not supported | Gear, shaft output platen 1 | Internal assemblies (2 of 3) on page 153 |

Index

A

- accessories
 - ordering 140
- after-service checklist 5

B

- bin, output
 - locating 145, 146

C

- cautions iii
- checklists
 - after-service 5
 - preservice 5
- control panel, removing 50, 51
- conventions, document iii
- covers
 - front, removing 34
 - left door, removing 24
 - left front, removing 28
 - left rear, removing 27
 - locations 148
 - parts list 148
 - right, removing 35
 - top, removing 29
- covers, removing
 - rear 23

D

- diagrams 139
 - covers, panels, and doors 148
 - internal assemblies 150
- document conventions iii
- document feeder
 - locating 145, 146
- door release, locating 145, 146
- doors
 - parts list 148

E

- eject flap sensor PCA, removing 123
- electrostatic discharge (ESD) 2
- ESD (electrostatic discharge)
 - precaution during parts removal 2
- ethernet port
 - locating 147

F

- front cover, removing 34

I

- input tray
 - locating 145, 146
- interface ports
 - locating 147
- internal assembly
 - locations 150
 - parts list 150

L

- left door, removing 24
- left front cover, removing 28
- left rear cover, removing 27

M

- main PCA, removing 127

N

- notes iii

O

- ordering
 - product documents 140
 - supplies and accessories 140
- output bin
 - locating 145, 146

P

- panels
 - parts list 148
- parts 139
 - cover locations 148
 - door locations 148
 - internal assembly locations 150
 - panel locations 148
- pliers, required 3
- ports
 - locating 147
- post-service tests 6
- preservice checklist 5
- print cartridges
 - door release, locating 145, 146
- print quality
 - test 6

R

- rear cover, removing 23
- removing parts
 - cautions for 2
 - checklists 5
 - control panel 50, 51
 - Eject flap opto PCA 123
 - front cover 34
 - left door 24
 - left front cover 28
 - left rear cover 27
 - main PCA 127
 - rear cover 23
 - right cover 35
 - tools, required 3
 - top cover 29
- replacing
 - parts 2
- right cover, removing 35

S

- screwdrivers, required 3
- screws
 - replacing 2
- service
 - tools, required 3
- static precautions 2
- supplies
 - ordering 140

T

- tests
 - post-service 6
 - print-quality 6
- tips iii
- tools, required 3
- top cover, removing 29
- trays
 - locating 145, 146

U

- USB port
 - locating 147

W

- warnings iii



CV037-90002

