



OFFICEJET PRO X451 AND X551 SERIES PRINTERS

Troubleshooting Manual



HP OFFICEJET PRO X451



HP OFFICEJET PRO X551



HP Officejet Pro X451 and X551 Printer Series

Troubleshooting Manual

Copyright and License

© 2013 Copyright Hewlett-Packard Development Company, L.P.

Reproduction, adaptation, or translation without prior written permission is prohibited, except as allowed under the copyright laws.

The information contained herein is subject to change without notice.

The only warranties for HP products and services are set forth in the express warranty statements accompanying such products and services. Nothing herein should be construed as constituting an additional warranty. HP shall not be liable for technical or editorial errors or omissions contained herein.

CV037-90001

Edition 2, 12/2013

Trademark Credits

Adobe®, Acrobat®, and PostScript® are trademarks of Adobe Systems Incorporated.

Intel® Core™ is a trademark of Intel Corporation in the U.S. and other countries.

Java™ is a US trademark of Sun Microsystems, Inc.

Microsoft®, Windows®, Windows® XP, and Windows Vista® are U.S. registered trademarks of Microsoft Corporation.

UNIX® is a registered trademark of The Open Group.

ENERGY STAR and the ENERGY STAR mark are registered U.S. marks.

Conventions used in this guide

 **TIP:** Tips provide helpful hints or shortcuts.

 **NOTE:** Notes provide important information to explain a concept or to complete a task.

 **CAUTION:** Cautions indicate procedures that you should follow to avoid losing data or damaging the product.

 **WARNING!** Warnings alert you to specific procedures that you should follow to avoid personal injury, catastrophic loss of data, or extensive damage to the product.

Table of contents

1 Theory of operation	1
Basic operation	2
Function structure	2
Operation sequence	3
System control	6
Formatter and data path	6
Engine control	7
Pen interface (I/F)	9
Power supply	10
Print subsystem	11
Printbar	11
Printbar lift	13
Ink cartridges	13
Optical scan carriage	13
Print system operational states	13
Paper-handling system	15
Input trays	19
Paper path zones	19
Servicing system	22
Service sled	23
Transmission system	24
Components	25
States	25
Aerosol management system	27
2 Solve problems	29
Restore the factory-set defaults	30
Menu access	30
Access the Engineering menu	31
Access the Support Menu	31
Place the product into MFG (manufacturing) mode	31

Place the product into Audit mode	32
Perform tap tests and interpret results	33
10 tap test results (OOBE states)	33
12 tap test results (REDI sensor values)	35
61 tap results (Align & color calibrations)	36
909 tap test results (BDD status)	37
Troubleshooting flowchart	39
Front-panel error codes	41
Control-panel messages	47
Error-related symptoms	54
Check symptoms	55
Power and electronics	55
Solve print quality problems	57
Solve paper handling problems	79
Solve product connectivity problems	98
Solve memory device problems	105
Index	107

List of figures

Figure 1-1	Main components	2
Figure 1-2	System control	6
Figure 1-3	Print subsystem components	11
Figure 1-4	Printbar components	12
Figure 1-5	Paper-handling system paper path	15
Figure 1-6	Product sensors	16
Figure 1-7	Paper-handling-system motors	18
Figure 1-8	Paper path zones	20
Figure 1-9	Servicing system components	22
Figure 1-10	Service sled components	23
Figure 1-11	Transmission components, rear view	24
Figure 1-12	Transmission main components	25
Figure 1-13	Aerosol management process	27
Figure 1-14	Aerosol management system components	28
Figure 2-1	X451 control panel button locations	30
Figure 2-2	X551 control panel button locations	30
Figure 2-3	10 tap test results	34
Figure 2-4	12 tap test report	36
Figure 2-5	61 tap test results	37
Figure 2-6	909 tap test results	38
Figure 2-7	Printer status report—determining genuine HP ink usage	60
Figure 2-8	Mark the Web wipe	73
Figure 2-9	Tray lift mechanism	81

1 Theory of operation

- [Basic operation](#)
- [System control](#)
- [Print subsystem](#)
- [Paper-handling system](#)
- [Servicing system](#)
- [Transmission system](#)
- [Aerosol management system](#)

Basic operation

Function structure

The product consists of the following components.

Figure 1-1 Main components

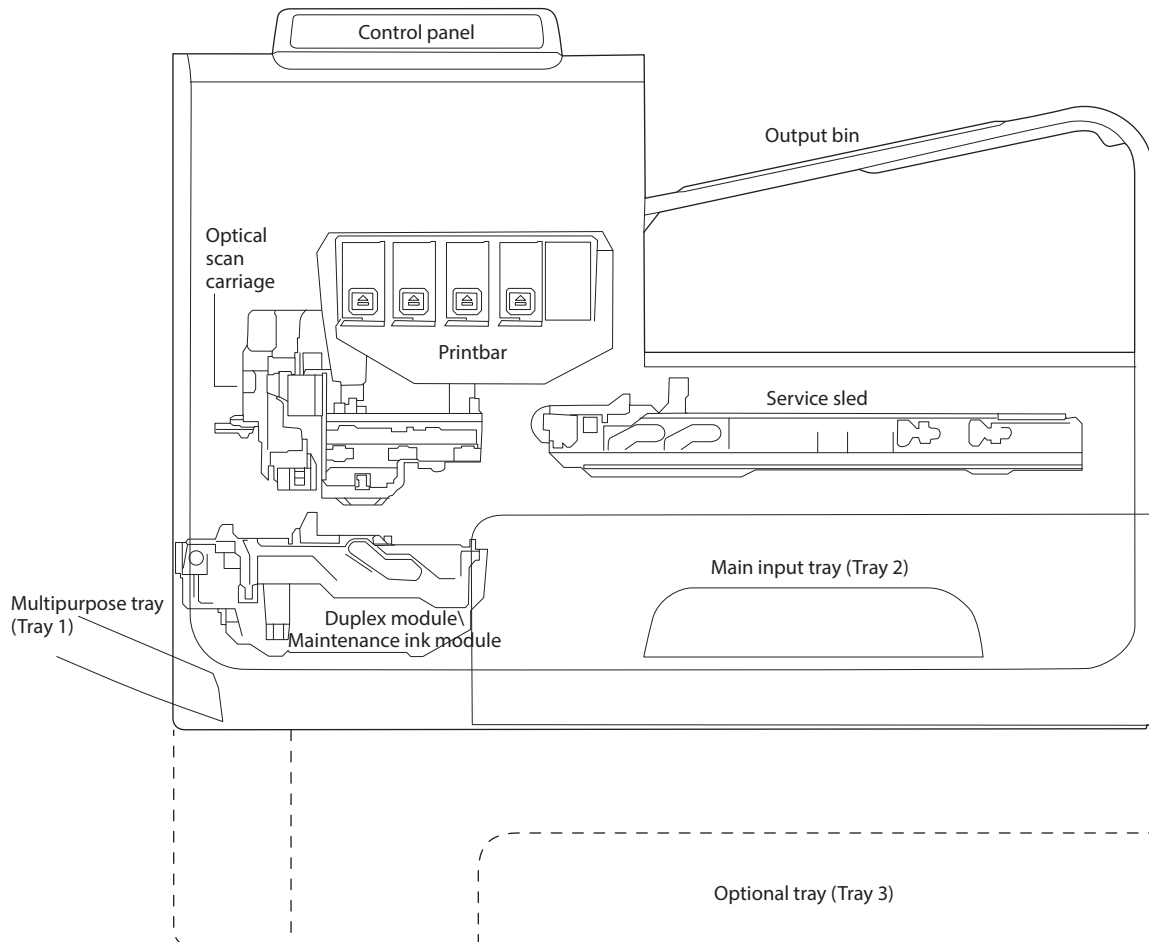

The product contains the following systems.

- Engine control system
- Print subsystem
- Paper-handling system
- Servicing system
- Aerosol management system

Two elements influence the product architecture.

- The first is the need to orient the printbar with its active face downwards and statically located above the print media. This requires the printbar to move vertically to access its active face.
- The second is producing face-down output. Rather than ejecting the page face-up immediately after the ink is applied, as do many inkjet s, the printed page is routed up and back over the printbar to eject face-down.

Operation sequence

The engine-control system on the formatter PCA controls the operational sequences. The following table describes durations and operations for each period of a print operation from when the product is turned on until the motor stops rotating.

Table 1-1 Operation sequence

Period	Duration	Purpose
Initial startup and calibrations	When the product is set up for the first time from the factory.	This period gets the product ready to print for the first time. <ul style="list-style-type: none">• The product flushes the shipping and handling fluid out of the printbar and replaces it with ink.• Die alignment — The product aligns the 10 die on the printbar active face.• Die density leveling — The product measures and compensates for the drop variation.
Servicing operations	Performed when the printbar is entering the capping state after printing, when leaving capping state after a print job is initiated, or during extended print jobs.	Servicing maintains the print quality by ensuring debris and excess ink are removed and missing nozzles are replaced. <ul style="list-style-type: none">• Nozzle presence detection — The optical scan carriage detects and disables inoperable nozzles, and replaces them with operable nozzles.• Printbar servicing — The Web wipe on the service sled moves under the printbar to clean the active face and fire the nozzles into the maintenance ink module to clear clogs.

Table 1-1 Operation sequence (continued)

Period	Duration	Purpose
Print preparation	From the time the product receives a command until paper enters the print zone.	<p>Prepares the product for a print job.</p> <ul style="list-style-type: none">• The printbar leaves the capping state as the service sled moves away from the printbar.• If needed, some servicing occurs.• The printbar lowers to the printing position. The media type and printing mode determine the print zone height.• The product picks media from one of the input trays.• Every page from Tray 1 is scanned. For Tray 2 and optional Tray 3, the product performs media edge detection after printing the first sheet after the main or optional tray is loaded. The last sheet of each job is also scanned if at least five sheets have been printed.• The product monitors environmental conditions. The product can slow the print speed if conditions are significantly different than a normal office environment (23 degrees C, 50% relative humidity).• The formatter PCA processes print data and transmits the data to the printbar.
Printing	From the end of the preparation period until the last sheet is delivered.	<p>Processes the print job.</p> <ul style="list-style-type: none">• As the page travels through the print zone, the printbar applies ink to the page.• Simplex print job: the page moves up, over the printbar, and out to the output bin (face-down).• Duplex print job: the page moves up until the trailing edge is 40 mm past the star-wheel jam reflective sensor, then it reverses direction down through the duplex path underneath the maintenance ink module, and then it reenters the print zone where the printbar applies ink to the second side.• The process continues until all the pages of the print job are completed. The process can be interrupted by occasional nozzle presence detection and servicing events if the job includes many pages.

Table 1-1 Operation sequence (continued)

Period	Duration	Purpose
End of print job	Performed after the print job is completed, and continues until the next job is initiated.	<p>This period puts the product in a state where it's ready for the next print job.</p> <ul style="list-style-type: none">• If needed, some servicing occurs.• The printbar moves to the capping position after a short dwell interval.• The service sled moves to cap the printbar.
Standby	The product is sitting idle, waiting for the next print job to be initiated.	<p>This period is intended to conserve energy when the product is sitting idle. Certain functions might be disabled to save power, then are re-started only when needed. The product has three sleep modes:</p> <ul style="list-style-type: none">• Idle mode — The printbar is capped and the product is ready to immediately start a new job• Sleep1 mode — After the product is inactive for about 10 minutes (a setting that can be adjusted from the control panel), the control panel dims and the power LED blinks to indicate the unit is in Sleep1. All product functions are available.• Sleep2 mode — After the product is inactive for a longer period of time (typically 2 hours, a setting that can be adjusted from the control panel), the engine controller powers down to minimize power consumption.

System control

The system control coordinates all the other systems, according to commands from the formatter.

Figure 1-2 System control

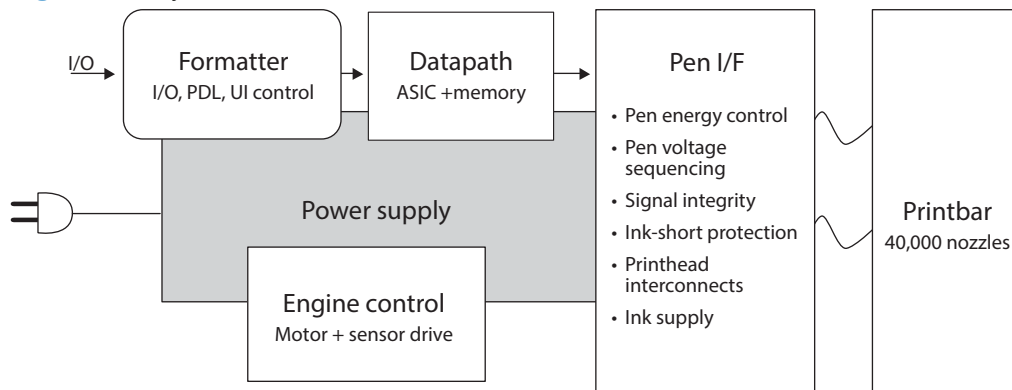

The system consists of the following major sections:

- Formatter
- Data path
- Engine control
- Pen interface
- Power supply
- Print bar

The engine PCA integrates both formatter and engine control electronics onto a single assembly. The wireless radio unit (wireless models only) plugs into the back of the engine PCA.

Formatter and data path

The formatter controller ASIC controls the input/output (I/O) control, the user interface, and the rendering of page description language files into -specific commands.

Input/output (I/O) control

The product supports 10/100 Ethernet, 802.11 wireless (wireless models), a rear USB host port, and a control panel USB host port (HP OfficeJet Pro X551 models only). For Ethernet networks, the formatter ASIC uses a separate integrated circuit (Broadcom 5241) to provide the physical network layer.

The formatter ASIC controls the USB device and USB host as well.

Wireless I/O is provided via a separate radio module.

User interface

HP OfficeJet Pro X451 models: The product contains a 2-in LCD control panel with tactile buttons surrounding the display.

HP OfficeJet Pro X551 models: The product contains a 4.3-in color graphics display. For wireless models, there is an additional LED to denote that the wireless feature is enabled. The control panel includes a USB host port for connection to thumb drives.

Formatter digital ASIC

The formatter digital ASIC has dual ARM CPUs (792 MHz and 528 MHz) that execute firmware code that provides high-level device control. The digital ASIC uses a standard PCIe interface to pass data to the engine control ASIC.

Formatter analog ASIC

The formatter analog ASIC generates the system voltage for the formatter and manages the real-time clock. Also, the engine uses this ASIC to drive the ISS pumps, solenoids, and aerosol fan.

Real-time clock

The real-time clock (RTC) determines the elapsed time between printhead and ISS calibration events. The RTC uses a special block inside the engine analog ASIC, along with a crystal and a battery.

Engine control

The engine controller digital ASIC receives high-level commands from the formatter, and it then provides low-level control to the print mechanism. In particular, the engine controller digital ASIC and its firmware control motors, system sensors, and the printbar. The engine controller analog ASIC integrates motor drivers, voltage regulators, sensor interfaces, and supervisory circuits.

Engine controller digital ASIC

The engine controller digital ASIC has a high-performance 480 MHz ARM CPU and DSP co-processors that execute firmware code to provide low-level engine control. It also drives the printbar via 15 high-speed LVDS transmission lines, which are routed from the engine PCA to the printbar via two large FFC cables. The engine controller digital ASIC receives pre-rendered data from the formatter digital ASIC over a standard PCIe interface.

In some product sleep modes, the digital ASIC powers down. If a print job is received while the product is in this mode, power resumes to the digital ASIC, which then must “boot up”. This can take approximately 15 seconds, which will delay the first page out (FPO) time accordingly. This sleep mode typically begins after two hours of product inactivity, although the user can change this setting.

Engine controller analog ASIC

The engine uses two analog ASICs to generate the system voltages for the engine, drive the engine motors, control various engine sensors, and monitor printbar power delivery for correct operation.

The engine has seven motors, some of which are shared with other subsystems:

- Pick motor
- Feed motor
- Duplex motor
- Lift motor
- Eject motor
- Sensor carriage motor
- Aerosol fan motor

Each one is a DC motor with encoder feedback, to provide precision servo control. These motors are driven directly by one of the engine analog ASICs. Small DC motors also are used to drive the ISS pump and the aerosol fan. There are solenoids that actuate the ejection flap and the ISS priming system.

The product uses many sensors to track the media as it travels through the paper path. Most of these are optical REDI sensors, which are used in conjunction with mirrors to sense the presence or absence of paper in a particular location. These are carefully aligned and calibrated at the factory, so care must be taken when servicing these sensors. See the Remove and Replace chapter in the repair manual for more details.

Other printed circuit-board assemblies (PCAs)

In addition to hosting the system ASICs, the engine PCA is home to many circuits needed to interface to sensors and other sub-system components. In some cases, this circuitry is located on a smaller remote PCA (SLB) to optimize cable interconnects.

- Humidity sensor — The humidity sensor causes the product to adjust printing speed if ambient conditions are outside the optimal humidity range. This sensor is calibrated at the factory to ensure maximum accuracy.
- Temperature sensor — The temperature sensor causes the product to adjust printing speed if ambient conditions are outside the optimal temperature range. In some products, this sensor resides on a separate, remote PCA.
- Main tray presence sensor — The hall-effect sensor that detects if the main tray is properly engaged resides on the back of the engine PCA. A small magnet on the back of the main tray actuates the sensor. If the tray is fully engaged, the magnetic field strength is sufficient to trigger the sensor.

Additionally, the product includes the following PCAs:

- Front USB PCA — This PCA governs the control panel USB port (HP Officejet Pro X551dw model only).
- Duplex module presence sensor — A hall-effect sensor that detects that the duplex module is properly seated.

- Power button PCA — This PCA includes the power button and power LED, as well as interface cables to the duplex module presence sensor and the MP tray empty REDI sensor.
- Accessory tray interconnect PCA — This PCA provides communication to optional Tray 3.
- Pick encoder distribution PCA — This PCA includes the pick motor encoder and the pick motor interconnect cable.
- Eject encoder distribution PCA — This PCA includes the eject motor encoder, plus the interconnect cables to the eject motor and the aerosol fan.
- Print zone distribution PCA—This PCA joins interconnect cables to the following sensors: separator REDI, feed motion encoder, main tray empty sensor, Top of Form (TOF) REDI sensor, and the Print zone REDI sensor.
- REDI distribution PCA—This PCA includes hall-effect sensors that detect ink cartridge door and left door positions. It also combines the interconnect cables for the Eject REDI sensor, the Upper paper path REDI sensor, the Lower paper path REDI sensor, and the eject flap opto flag sensor.
- Sensor carriage PCA — This PCA includes a carriage motion encoder, a ZIM sensor, and the BDD sensor.
- Printbar lift encoder distribution PCA — This PCA includes the printbar lift motion encoder, and combines interconnect cables to the printbar lift motor, carriage motor, and eject flap solenoid.
- Duplex encoder PCA — This PCA contains the motion encoder for the duplex motor.
- SHAID PCA — This PCA contains interfaces to the out-of-ink sensors for the ink cartridges, and combines the interface cables to the acumen PCA, the ISS pump, and the ISS solenoids.
- Acumen PCA — This PCA contains interfaces to the acumen memory devices for the ink cartridges.

Pen interface (I/F)

The printbar is the key component that differentiates this product from other inkjet s. The conventional approach is to print a page in horizontal swaths by moving a “scanning” printhead horizontally over a fixed sheet of paper, advancing the paper a fixed amount, and then printing the next swath. With this product, the paper moves underneath a fixed page-wide printhead in a single smooth motion.

Single pass page-wide printing requires that data and power be delivered to the printbar at a very high rate, while also maintaining good control of paper position as it moves past the printhead nozzles.

The engine PCA sends power and data to the printbar via two large flat flexible cables (36 and 38 pins). The printbar PCA routes power and data to 10 printhead die, which are attached to the PCA using a flexible tab circuit and wire-bonding process.

There are also electronics to control the ink supply station (ISS). The SHAID PCA detects low-ink conditions. It gauges ink levels by means of electrically sensing the presence of ink and/or ink foam in the X-chamber. The SHAID PCA also collects and distributes electrical signals that drive the push-prime pump(s), engage the solenoids, and read the ink supply acumen data. All are routed through a single 17-pin FFC from the SHAID PCA to the engine PCA.

Each ink supply has a memory tag that stores information about its type of ink, the amount of ink remaining, and other critical data. It uses a special authentication scheme to ensure that only genuine HP supplies are used and the product is not damaged by using invalid supplies. Acumen uses a two-line serial bus, which, along with 3.3 V and ground, is cabled via the SHAID PCA to the engine PCA and the engine control digital ASIC.

Power supply

The power supply module converts 100-240 VAC to 33 VDC to power the system. The power supply module has a sleep mode that reduces power consumption in system low-power modes. When in its sleep mode, the power supply generates approximately 12 V.

The power supply module supplies 33 V to the engine PCA. The power supply module has two operating modes, depending upon the state of its nSLEEP input pin:

- Normal mode: $V_o = 33\text{ V}$ (nSLEEP = high logic level)
- Sleep mode: $V_o = 12\text{ V}$ (nSLEEP = low logic level)

The power supply is a self-contained module that can be replaced if it is determined to be defective (see the Remove and Replace chapter of the Repair Manual).

To ensure safe operation, the power supply will “latch off” if a persistent over-current fault condition exists. This would typically be caused by a short-circuit from 33 V to ground in the product. In addition, less severe faults can cause the power supply to latch off, if present for an extended period of time, or if the product is operated above the recommended operating range.



NOTE: In some countries/regions, the product is equipped with a high-voltage power supply in order to prevent power supply unit failures due to over-voltage conditions.

Print subsystem

The print subsystem includes the following components.

- Printbar
- Printbar lift
- Ink cartridges
- Optical scan carriage

Figure 1-3 Print subsystem components

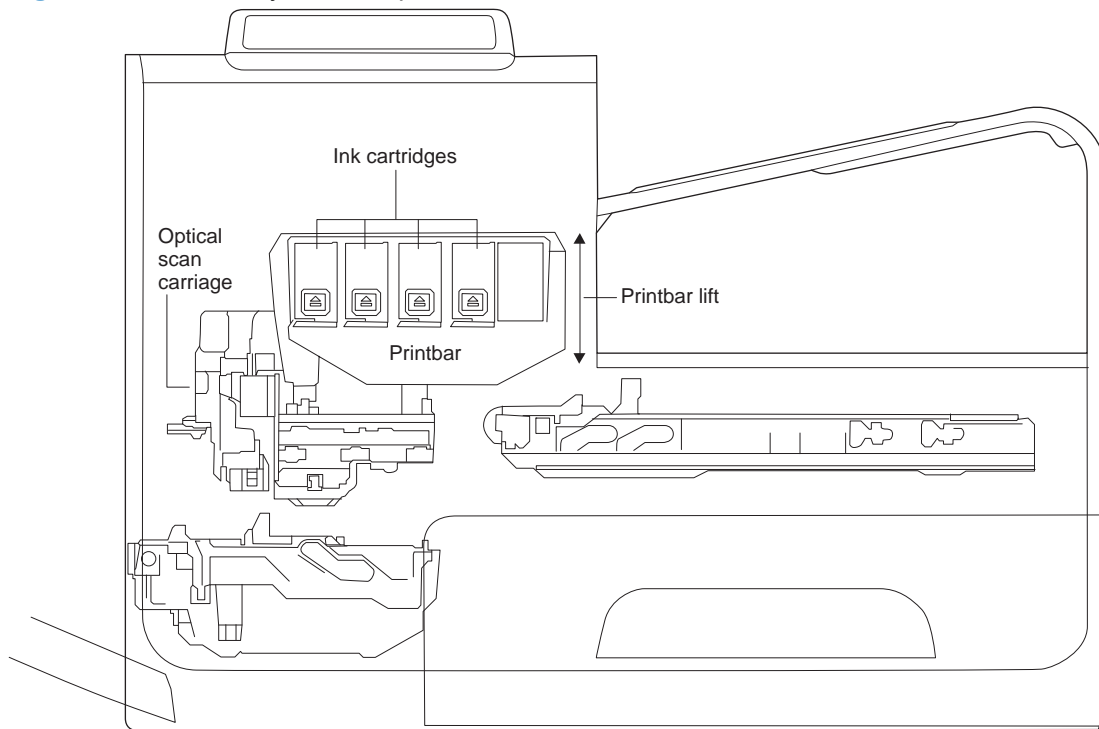

Printbar

The printbar's fundamental purpose is to convert the digital firing instructions from the product electronics into properly formed and timed microscopic drops of the four ink colors. The printbar spans the full width of a letter/A4-size sheet (216 mm (8.5 in)), which allows the printbar to be

statically positioned within the product and have the media move underneath it, printing the entire page in a single motion.

Figure 1-4 Printbar components

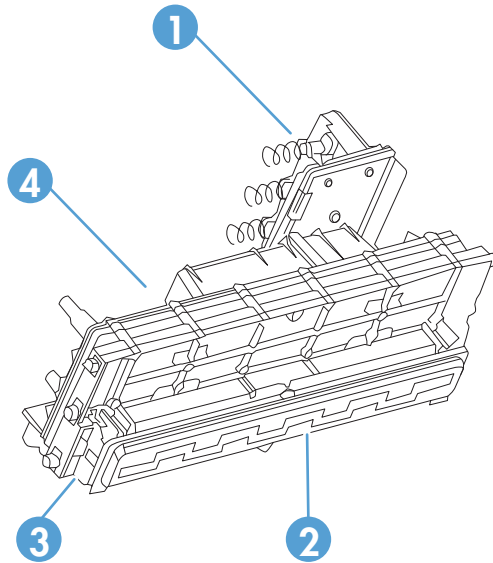

Item	Description
1	Ink cartridge connections
2	Thermal inkjet (TIJ) die array
3	Data/power flow and regulation
4	Inkflow channels and pressure regulation

The printbar has a fixed array of 10 thermal inkjet (TIJ) die oriented in two staggered rows. Each individual die contains over one thousand nozzles for each of the four ink colors (black (K), cyan (C), magenta (M) and yellow (Y)). Behind the die array are the ink flow channels and pressure regulation mechanisms that supply the die array with ink at the proper pressure and flow. The die must also be fed power and data at the appropriate levels and rates, which is the function of the onboard electronic circuitry. Finally, situated at the top of the printbar, there are four ink cartridge receptacles, one for each color. These cartridges are linked by flow connections to the rest of the printbar and supply the ink necessary for its operation.

A sensor technology called back-scatter drop detect (BDD) monitors printbar health and calibrations. This system looks at the reflection of the miniscule drops in flight, and then passes these signals through high-speed, high-gain, bandpass filters. A complex artificial intelligence (AI) system decides which drop ejectors are currently out of specifications, and which are not.

After the AI system determines which drop ejectors are out of specification, the product compensates for them. Some ejectors use neighboring nozzles and at times even tiny amounts of other inks – whichever combination of methods necessary to deliver the best print quality possible at that moment. In some cases, fully half of the nozzles can be “out” without a noticeable degradation in quality. The compensation is done in real time with a dedicated high-speed DSP. The system can scan portions of the system after print jobs, but it is fully interruptible by new incoming print jobs.

Printbar lift

The printbar lift is responsible for positioning the printbar it within the product and moving it up and down as required. This vertical motion is both to establish proper spacing to the paper during printing, and to raise it to either access the active face or perform necessary calibrations.

During printing, the lift mechanism sets the printbar height and paper height depending on the type of paper.

Ink cartridges

This product has new, state of the art pigmented inks. These inks are filtered using proprietary processes to prevent printhead contamination. These inks are designed to produce optimal print quality on ColorLok office papers, but also produce very good print quality on regular office papers and specialty media.

Optical scan carriage

The optical scan carriage has optical sensors used for calibration. Its motion is along the long axis of the printbar. These sensors are used by a number of in- calibration features that are important for proper subsystem function. The BDD sensor is located on the optical scan carriage.

Print system operational states

The print subsystem has a number of distinct operational states besides active printing.

Startup

As it comes from the factory, the printbar is initially filled with an inert ink-substitute called Shipping and Handling Fluid (SHF). This fluid, essential for the manufacture and transportation of the printbar, must be flushed and replaced with actual ink. This is accomplished during the startup phase. The flushing process automatically commences when ink supplies are inserted and the unit powered up for the first time. The SHF is removed by sustained printbar operation and replaced by ink from the supplies. The process terminates once all the SHF has been flushed from the printbar.

Special host supplies are supplied with the product prior to its first use. These supplies contain additional ink so that the SHF can be replaced with ink, and there will still be a 100 percent of ink level. These supplies can be used only to initialize the product. You cannot use them in another product that has been initialized.



NOTE: The initial startup time is noticeably longer than the following regular startup times.

Die alignment

Since there are 10 die comprising the printbar active face, each with associated positional tolerances, an active calibration must be performed to prevent errors and allow a uniform ink application to the media (without any gaps or overlaps between adjacent die). This die alignment is done by printing a special diagnostic image on a sheet of paper and then scanning it with the optical scan carriage. Die alignment is performed as part of initial unit startup, and can be performed manually as part of the print quality recovery tool.

Die density leveling

There are also tolerances associated with the drops fired by the individual printbar die. Another active calibration measures and compensates for these variations to produce a visually uniform ink application to the media. Another set of diagnostic images is printed and scanned by the optical scan carriage to achieve this die density leveling. Die alignment and die density leveling are usually paired together.

Nozzle presence detection

In printing, since all the ink is applied in a single smooth motion of the media past the printbar, any inoperable nozzle can show up as a noticeable streak. The operational state of each of the thousands of nozzles comprising the printbar is periodically measured after a certain amount of printing. The printbar is raised by the printbar lift, and the BDD assembly on the optical scan carriage watches for drop presence as each nozzle is fired. Inoperable nozzles are turned off and other operable nozzles employed on subsequent printed pages to apply the missing ink. Nozzle presence detection can be interrupted by new incoming print jobs.

Media edge position detection

The product employs a learning algorithm to define media center as a function of input source—multipurpose tray, main tray, or accessory tray. The edge scan is located downstream of the print zone. As media is scanned, the media center database is updated. The image is registered to the page using the media center database.

Servicing and capping

When not in use, the printbar is normally in the capped state – the printbar is fully raised, the service sled is positioned underneath, and the printbar cap engaged against the printbar active face. Servicing – the cleaning of the active face and the firing of the nozzles – can occur either during Sleep2 mode or after extended time in storage. It can also occur during extended print jobs.

Printing

The printing state begins by the printbar leaving the capping state, and being lowered to the printing position after the service sled moves out of the way. Concurrently, a sheet of media is picked from one of the trays and the leading edge staged at the entrance to the print zone. Once the print data has been processed and is available for transmission to the printbar, the sheet is fed at a constant velocity through the print zone and the ink applied by the printbar.

In the case of one-sided printing the inked sheet is moved up, over and out to the output tray. For two-sided printing the sheet is moved until its trailing edge is past the merge to the vertical path and then it is reversed, through the duplex path underneath the maintenance ink module, and reintroduced into the print zone for inking of the second side.

This process continues until all the pages of the print job are completed. If the print job is large enough, it can be interrupted by servicing processes.

Paper-handling system

The paper-handling system moves paper through the product according to commands from the formatter.

The following figure shows the product paper path.

Figure 1-5 Paper-handling system paper path

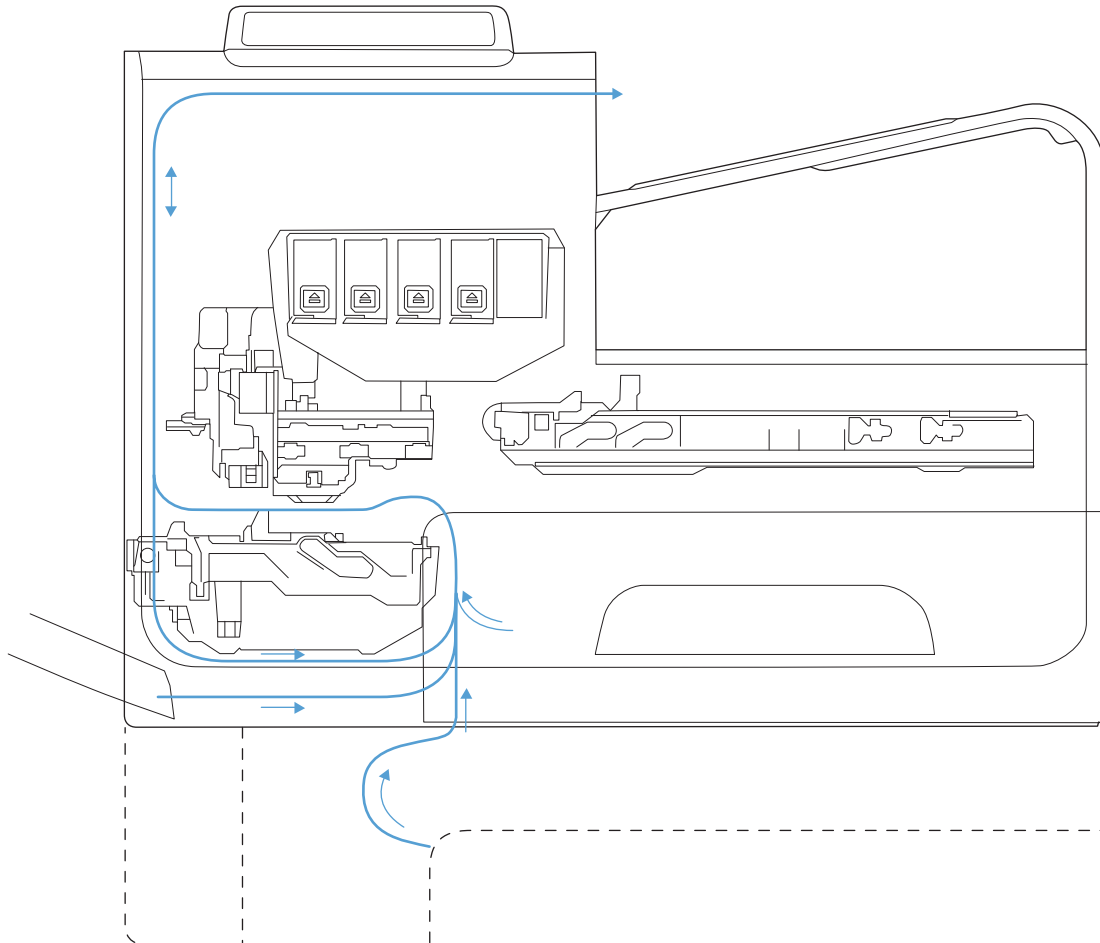

The paper path consists of the following major components:

- Two integrated input trays plus one optional accessory tray
- Four motors and a solenoid plus two more motors in the accessory tray
- Duplex module
- Sensors placed throughout the device, including the paper trays
- Multiple feed rollers, pinch rollers, star wheels, and media guides
- Transmission components (gears, shafts, levers, swingarms) that interface with other subsystems such as the printbar and service sled.

Components of the paper path move the paper from the desired input tray to a position underneath the printbar, and then deliver the printed result to the output tray. It is the combined orientations and actions of the printbar, the printbar lift, and the paper path that establish the print zone, which is the precisely controlled region in which the ink drops move from the active face of the printbar to the paper situated 1 to 2 mm beneath it.

The following figure shows the product sensors.

Figure 1-6 Product sensors

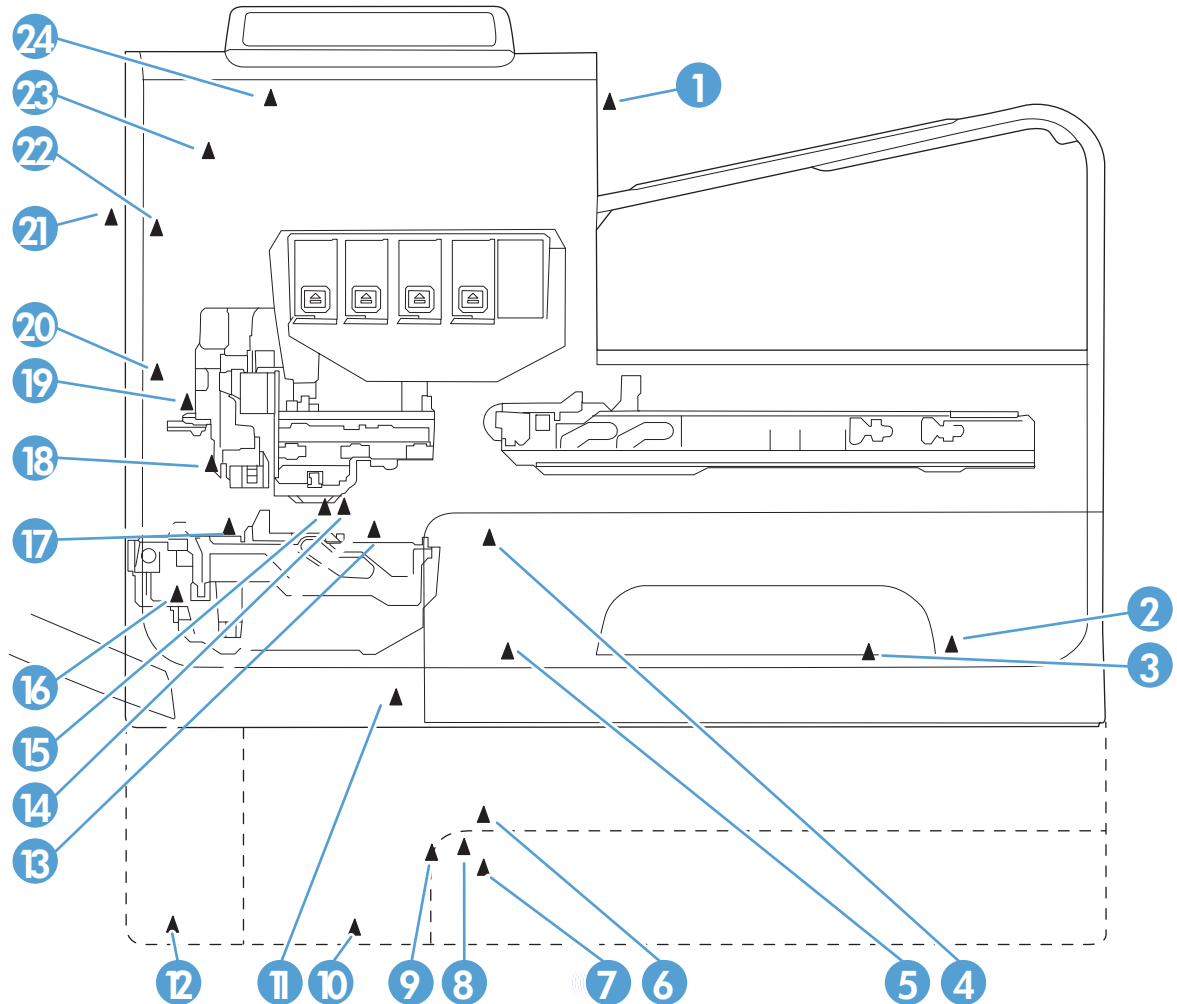

Table 1-2 Product sensors

Item	Description	Item	Description
1	Output flap jam sensor	13	Top of Form (TOF) REDI sensor (located on platen)
2	Ambient temperature sensor	14	Feed roller encoder
3	Ambient humidity sensor	15	Feed roller home sensor
4	Tray 2 pickup tire home sensor	16	Duplex module presence sensor
5	Tray 2 tray presence sensor	17	Print zone REDI sensor (located on platen)
6	Tray 3 pickup tire home sensor	18	Back-scatter drop detect sensor

Table 1-2 Product sensors (continued)

Item	Description	Item	Description
7	Tray 3 paper presence sensor	19	Print calibration/Media edge detect sensor
8	Tray 3 separation sensor	20	Lower paper path REDI sensor
9	Turn roller sensor	21	Left door open sensor
10	Tray 3 tray presence sensor	22	Upper paper path REDI sensor
11	Tray 1 paper presence sensor	23	Ink supply door open sensor
12	Tray 3 cleanout presence sensor	24	Eject REDI sensor

There are several motors in the product for pick, feed, duplexing, printbar lift, delivery, and the scanning sensor carriage.

Figure 1-7 Paper-handling-system motors

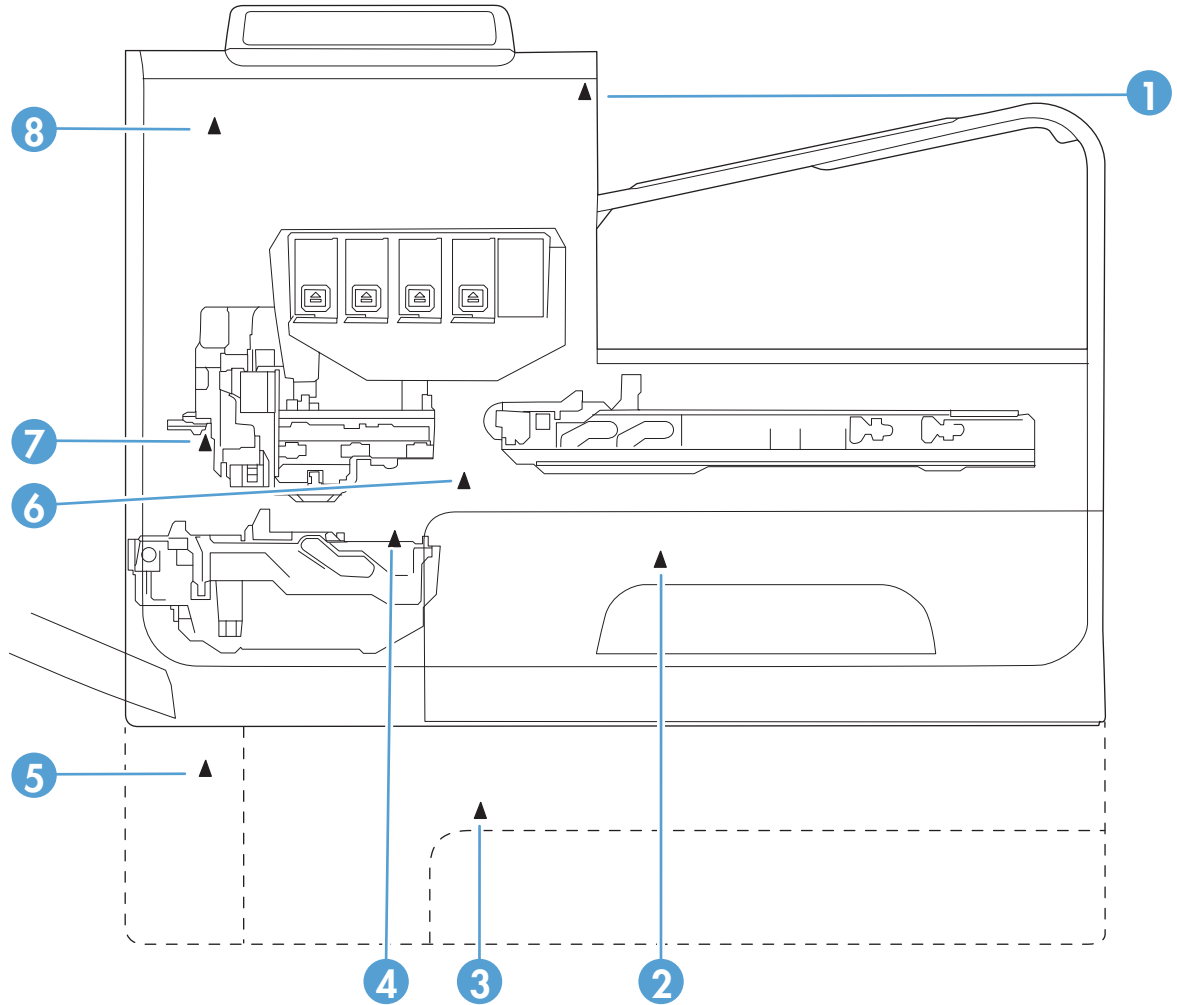

Table 1-3 Paper-handling system motors

Item	Description
1	Eject (or output drive) motor
2	Tray 2 pickup motor
3	Tray 3 pickup motor
4	Duplex Tray 1 motor
5	Tray 3 feed motor
6	Feed motor
7	Optical carriage motor
8	Printbar lift motor

Input trays

The product comes standard with two input trays, and also accepts an accessory tray.

- 50-page multipurpose (MP) tray — Tray 1: The tray shares a motor with the duplex module and has only one sensor. It is a reflective (REDI) sensor that determines if media is present in the tray. The feed roller reflective REDI sensor determines if a sheet of media is successfully picked from the tray.
- 500-sheet letter/A4 size main tray — Tray 2: The tray has a pick motor, which is also moves the service sled. Similar to the accessory tray, both the main tray motor and the duplex MP tray motor will operate at the same time when picking paper from the main tray. The main tray has three sensors:
 - A hall effect sensor determines if the tray is closed.
 - A flag/opto sensor determines if there is media in the tray.
 - A flag/opto sensor determines if the pick roller is in home position.

The feed roller jam sensor is used to determine if a sheet of media is successfully picked from the main tray.

- Optional 500-sheet legal size accessory tray — Tray 3: This optional tray has two motors, one for picking paper and one for the turn roller. This roller receives paper from the pickup roller and transfers it to the multipurpose tray ITR that is driven by the duplex module/MP tray motor. Both the accessory tray motor and the duplex module/MP tray motor will operate at the same time when picking paper out of the accessory tray.

The accessory tray has the following sensors:

- A hall effect sensor determines if the tray is closed.
- A flag/opto sensor determines if there is media in the tray.
- A flag/opto sensor determines if the pickup roller is in the home position.
- A hall effect sensor determines if the left door is closed.
- A separation sensor determines if the product successfully picked media.

Paper path zones

The product paper path includes the following elements:

- Deskew buckle
- Print zone
- Duplex

- Output
- Eject

Figure 1-8 Paper path zones

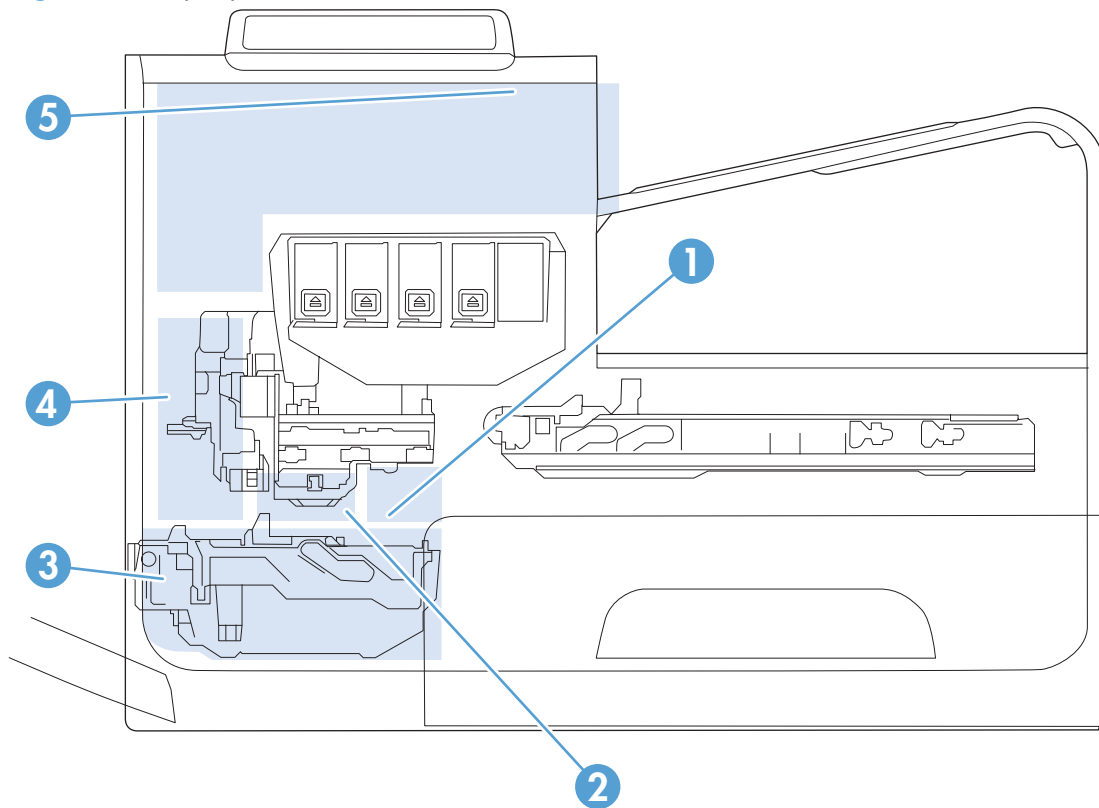

Item	Zone	Description
1	Deskew buckle	This is the area between the turn roller and feed roller, and all print job paper passes through this zone. During the deskew operation, the duplex module/MP tray motor rotates forward, driving the paper into the feed roller nip while the feed roller is not moving. The Top of Form (TOF) REDI sensor determines the leading edge for accurate deskew buckle size, jam detection, and if the tray successfully picked media.
2	Print zone	<p>This is the path between the feed roller and output pinch 1 roller. The feed roller, which has an analog quadrature encoder, precisely controls the paper in the paper feed direction. In the vertical direction, a combination of the platen, feed roller, and output pinch roller 1 controls the paper. The user can rotate the platen down for jam access after removing the duplex module.</p> <p>There are no paper path sensors in the print zone. Therefore, if a jam occurs in the print zone, it is not detected until the leading edge of the paper is determined to be “late” in reaching the jam sensor in the output path.</p> <p>When a user pulls on jammed media in the print zone that is still partially in the feed roller nip, the servo control will detect a slight movement of the feed roller and assist the user by applying a forward torque to the roller. Also, the motion control system will disengage the duplex module rectifier (swing arm) so that the turn roller can spin freely. This feature reduces the pulling force needed by the user and therefore reduces the chance of leaving torn pieces of paper in the path – especially in the deskew buckle zone.</p>

Item	Zone	Description
3	Duplex	<p>By opening the left door, the duplex module can be removed to clear jams. The duplex module also serves as a maintenance ink collection unit for the print bar and will expose the user to maintenance ink when it is removed; therefore there are warnings on the module not to touch certain areas.</p> <p>When a user pulls on jammed media from the duplex module (or any of the trays) that is partially in the feed roller nip, the servo control will detect a slight movement of the feed roller and assist the user by applying a reverse torque to the feed roller and disengage. Also, the motion control system will disengage the duplex module rectifier so the turn roller can spin freely. This feature reduces the pulling force needed by the user and therefore reduces the chance of leaving torn pieces of paper in the path—especially in the deskew buckle zone.</p> <p>To determine its presence, the duplex module has a magnet that triggers a hall effect sensor mounted to the product chassis.</p>
4	Output	<p>The output path begins at output pinch roller 1 and continues to output pinch roller 5. There are four REDI sensors in this path that detect leading and trailing edges and jams.</p> <p>The feed motor drives the rollers in the output path, except output pinch roller 5. All the pinch rollers in the output and exit path are star wheels to prevent roller tracking on wet/damp ink. However, the turn roller pinch is solid and has a high amount of force for deskew buckle formation. Also, the feed motor drives all output shafts except shafts 5 and 6.</p> <p>The Lower paper path REDI, Upper paper path REDI, and Eject REDI sensor in the output path all track the leading and trailing edges of paper.</p> <p>The outer and top portions of the vertical path are formed by paper guides molded in and attached to the left door. The left door can be opened for jam clearance and has a hall effect sensor to determine if it is closed. Also when the left door is opened, drive rollers that form pinches 3 and 4 disengage from the feed motor for safety purposes.</p>
5	Eject	<p>The eject portion of the paper path includes the zone from output pinch roller 5 to the eject flap.</p> <p>The eject motor powers output pinch roller 5 and eject pinch roller 6.</p> <p>The eject flap has three positions:</p> <ul style="list-style-type: none"> • It is closed when not printing. • It is partially open for heavy ink printing in dry environments, to limit severe curl. • It is fully open for all other printing. This position controls moderately curled media. <p>The flap is opened and closed by a torque clutch on the eject roller shaft. The flap also has a locking feature that is controlled by a solenoid. In order for the door to open all the way, or move between positions, the solenoid must be actuated.</p>

Servicing system

The servicing system comprises the service sled, which maintains print quality by wiping debris and ink off the print nozzles, and the service ink module, where maintenance ink is deposited.

Figure 1-9 Servicing system components

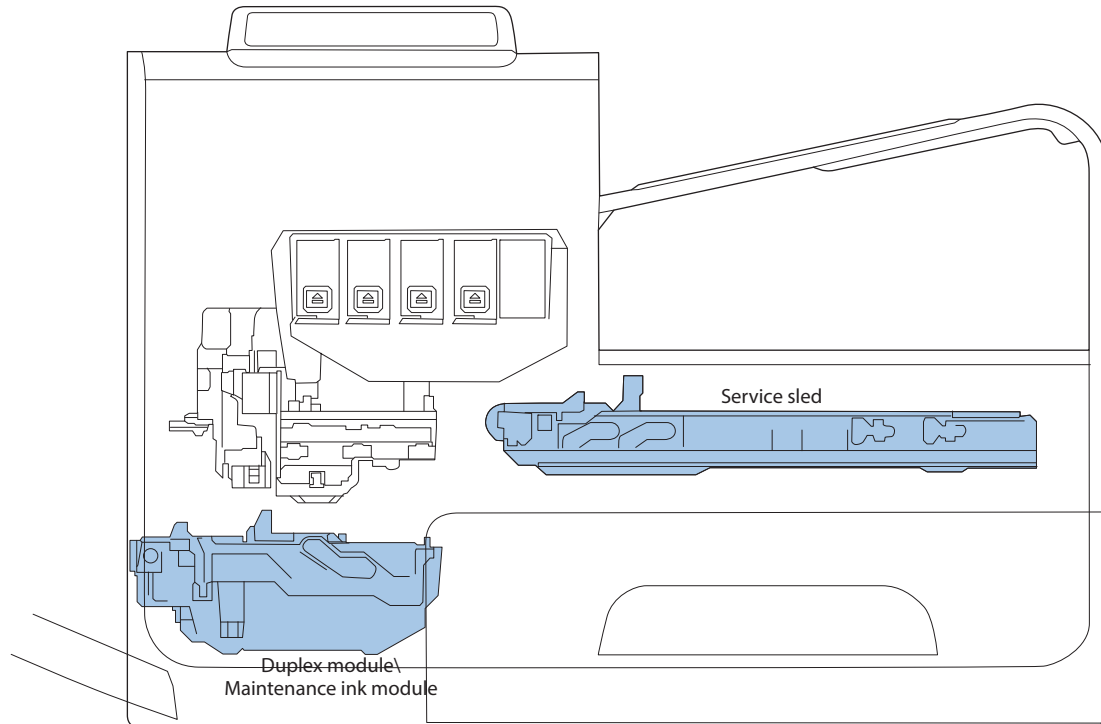

Service sled

Figure 1-10 Service sled components

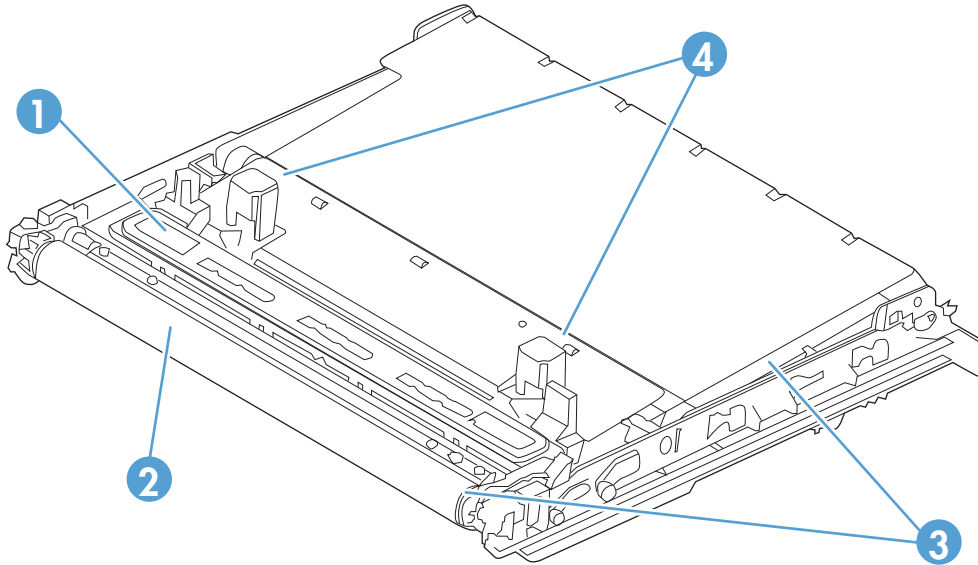

Table 1-4 Service sled components

Item	Description
1	Service sled cap
2	Service sled wiping surface
3	Service sled Web fabric loop
4	Printbar support posts

The service sled system keeps the printbar nozzles firing correctly throughout the life of the product as it performs the wiping and capping functions.

- The wiping function cleans the nozzles of ink residue and particulates.
- The capping function keeps the nozzles moist during storage when the product is idle.

The service sled system uses the pick drive system (a component of the paper path) for horizontal motion to perform its functions.

To perform the wiping function, the product moves the service sled underneath the printbar (which is elevated from the print position) so that the Web fabric makes contact with the ink nozzles. The Web fabric works in the form of a belt loop that advances after every wipe. Since the belt is a finite loop, it will eventually reuse previously used material. The Web advances when the Web wipe module moves to the right out of the print zone. The advance mechanism is triggered by a mechanism located on the rear wall of the unit.

To perform the capping function, the service sled moves underneath the printbar (which is elevated from the print position), which allows the rubber cap to seal the print nozzles from the environment.

Transmission system

The pick/service motor uses a multi-state transmission to power the following three functions:

- Move the service sled
- Pick paper from the main tray
- Lift the main tray paper stack

The transmission has the following states:

- Service sled (forward/reverse)
- Pick (forward direction)/Tray lift (reverse direction)

Printbar movement to a specific location releases the transmission lock, and enables the pick/service motor to select the transmission state. The general location of the transmission parts is in [Figure 1-11 Transmission components, rear view on page 24](#).



NOTE: The transmission components are behind the main PCA electronics and are difficult to access.

Figure 1-11 Transmission components, rear view

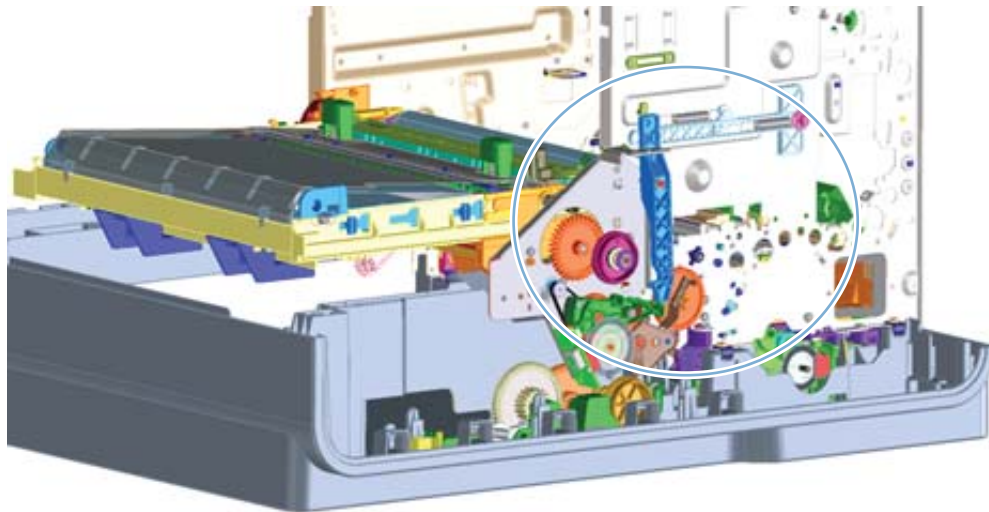

The product will not function with the transmission in the main tray pick/main tray lift state if the service station has been manually capped.

Reusing caps or pushing the caps too far onto the printbar lift guide rods while servicing the product can result in the transmission not shifting reliably.

Components

Figure 1-12 Transmission main components

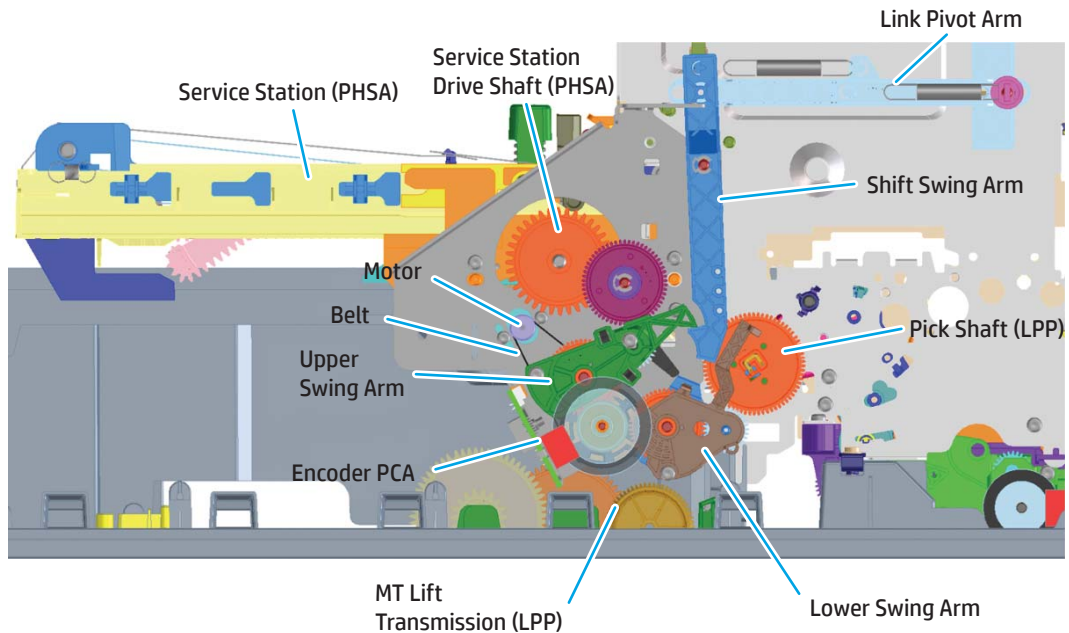

States

1. State 1—Main tray lift

- Link pivot arm and shift swing arm in locked position
- Upper swing arm down, engaged with lower swing arm
- Lower swing arm down, engaged with main tray lift transmission
- Printbar either up or down



2. State 1—Main tray pick

- Link pivot arm and shift swing arm in locked position
- Upper swing arm down, engaged with lower swing arm
- Lower swing arm up, engaged with pick shaft
- Printbar either up or down



3. State 1–Mid - Switch

- Link pivot arm and shift swing arm in un-locked position
- Upper swing arm in mid switch position
- Printbar in middle position



4. State 2–Service Station

- Link pivot arm and shift swing arm in locked position
- Upper swing arm up, engaged with service sled drive shaft
- Printbar either up or down

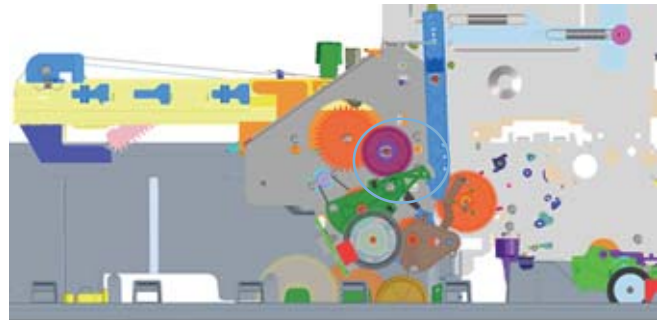

Aerosol management system

The aerosol management system consists of a fan module and filter box to keep ink aerosol from building up inside the product. The following figure shows the service ink and aerosol capture system components.

Figure 1-13 Aerosol management process

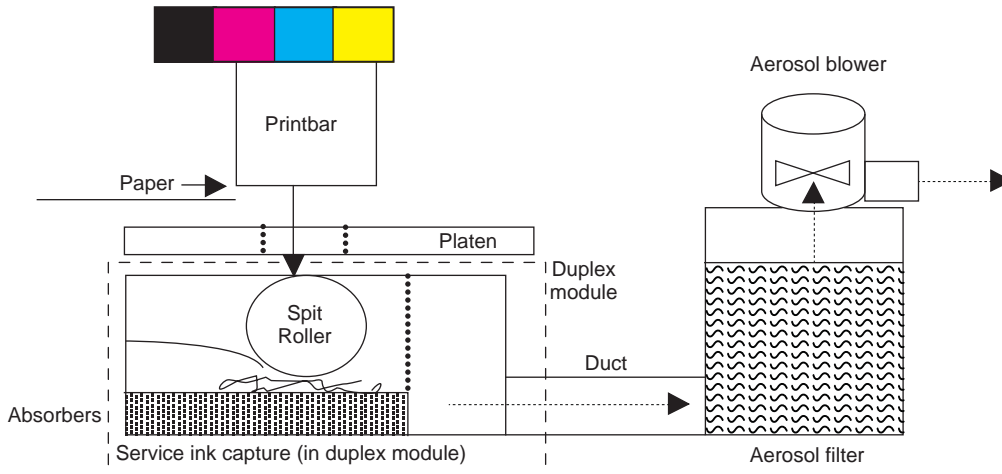

In between pages, printed aerosol is drawn through the platen openings. Service ink travels directly through the platen, impacting and collecting on the spit roller. Aerosol from the service spitting is also collected via the same system. Service ink collects in the duplex module, and a porous filter element captures the aerosol as aerosol-laden air passes through it. The aerosol blower mounted to the filter housing creates the air motion (suction — lower pressure — in the print zone).

Most of printbar servicing ink (maintenance ink) is captured by the spit roller and scraped into the bottom of the bucket on the duplex module. The service ink spit roller is indexed slowly by the motion of paper through the product, specifically driven by the swingarm and turn-roller gear train, with power provided by the duplex motor.

The product purges the printbar of its shipping fluid at initial startup, and then absorbers in the base of the duplex module collect the fluid. These absorbers allow much of the initial water to evaporate from the shipping fluid over time. Also, they allow service ink coming into contact with the absorbers to leach some of their fluids into them, assisting with drying and thickening of the sludge.

The blower remains active as long as the printbar is uncapped, and it continues to operate for a few seconds after capping is complete.

Figure 1-14 Aerosol management system components

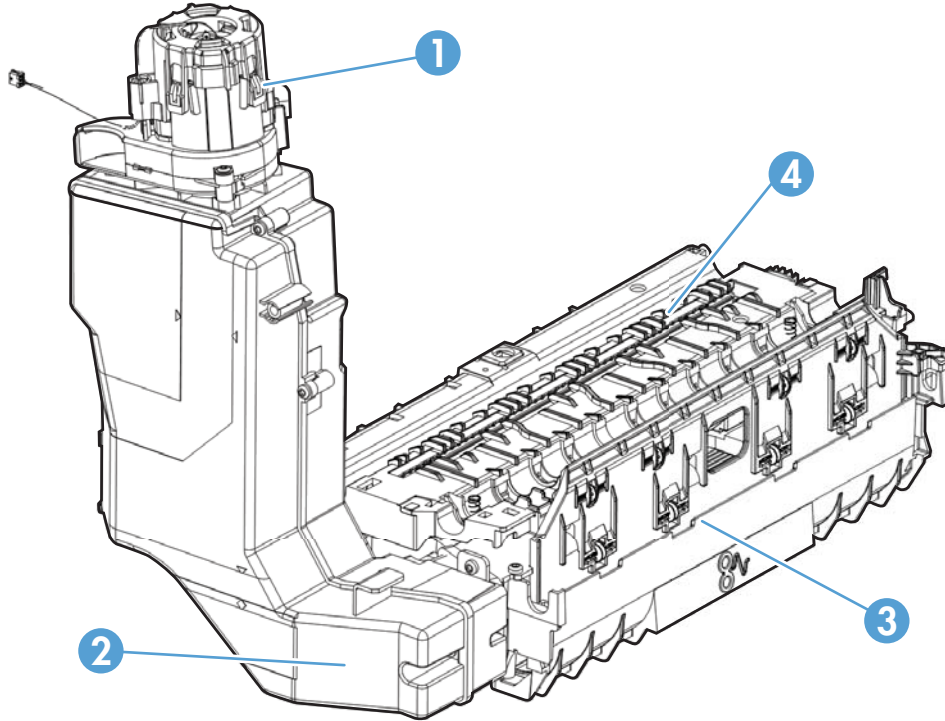

Table 1-5 Aerosol management system components

Item	Description
1	Blower
2	Aerosol filter housing
3	Duplex module/maintenance ink module
4	Platen

2 Solve problems

- [Restore the factory-set defaults](#)
- [Menu access](#)
- [Perform tap tests and interpret results](#)
- [Troubleshooting flowchart](#)
- [Front-panel error codes](#)
- [Control-panel messages](#)
- [Error-related symptoms](#)
- [Check symptoms](#)

Restore the factory-set defaults

CAUTION: Restoring the factory-set defaults returns all of the product and network settings to the factory defaults, and it also clears the fax header name, phone number, and any stored faxes in the product memory. This procedure also clears the fax phone book, and deletes any pages that are stored in the memory. The procedure then automatically restarts the product.

1. On the product control panel, scroll to the **Setup** menu.
2. Select **Tools**, and then touch **Restore Factory Defaults**.
3. Select **Yes**.

The product automatically restarts.

Menu access

These hidden engineering menus are used for testing and calibration. Some or all of them are referenced in remove and replace sections as required.

WARNING! Misuse of these menus could damage the product or make it unusable.

NOTE: These buttons on touch screen-equipped products are not illuminated until they are touched with sufficient pressure. Locate these buttons by sweeping your finger over the general areas indicated in [Figure 2-2 X551 control panel button locations on page 30](#).

Figure 2-1 X451 control panel button locations

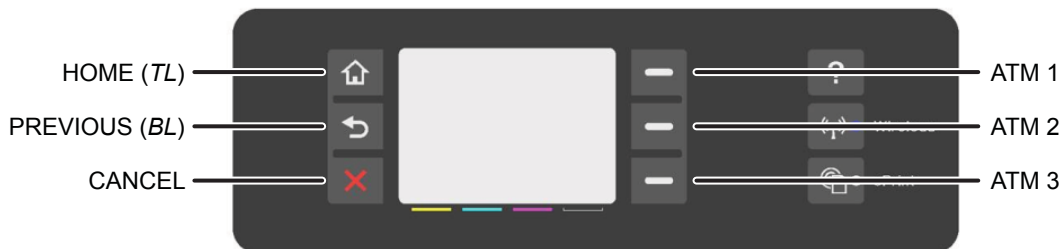
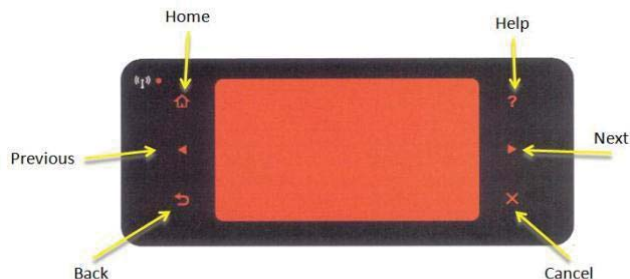





Figure 2-2 X551 control panel button locations







Access the Engineering menu

X451

1. Press the Cancel  button.
2. Press the Back  button.
3. Press the Cancel  button twice.



X551

1. Touch the Home  button.
2. Touch the Back  button.
3. Touch the Home  button twice to enter the [Engineering menu](#).

 **NOTE:** The [Service menu](#) is accessed from the [Engineering menu](#).

Access the Support Menu

X451

1. Press the Back  button.
2. Press the Cancel  button.
3. Press the Back  button twice.

X551

- ▲ Touch the Back  button four times consecutively to open the [Support Menu](#).

 **NOTE:** The [Support Menu](#) is usually used by HP call center agents for assisting customers.





Place the product into MFG (manufacturing) mode

 **NOTE:** These two modes are ONLY to be used by authorized service providers. They should NEVER be accessed by the end user.

X451

1. Press and hold the [ATM1](#) and [ATM2](#) buttons while plugging in the product.
2. Press the power button to enter MFG (on) mode.

X551

1. Press and hold the power button while plugging in the product. The HP logo appears on the product control panel, and then disappears. Continue to hold the power button for five seconds after the logo disappears.
2. Release the power button.
3. Touch the Home  button.
4. Touch the Back  button.
5. Touch the Home  button twice.
6. After a new screen appears, touch the Home  button again to enter MFG (off) mode.
7. Press the power button to enter MFG (on) mode.

Place the product into Audit mode





 **NOTE:** These two modes are ONLY to be used by authorized service providers. They should NEVER be accessed by the end user.



 **WARNING!** Audit mode is used only when the main PCA is replaced.

X451

- ▲ Press and hold the **ATM1** and **ATM3** buttons while plugging in the product.

X551

1. Press and hold the power button while plugging in the product. The HP logo appears on the control panel, and then disappears. Continue to hold the power button for five seconds after the logo disappears.
2. Release the power button.
3. Touch the Home  button.
4. Touch the Back  button
5. Touch the Home  button twice.
6. Touch the  button.
7. Press the power button.

 **NOTE:** The product touchscreen is not active in this mode. Use the  and  buttons on the control panel frame.

Perform tap tests and interpret results

Perform a tap test

1. Open the [Engineering Menu](#). See [Access the Engineering menu on page 31](#).
2. Touch [Manufacturing Menu](#).
3. Use the arrow key to find the [Reports Menu](#), and then touch the [OK](#) button.
4. Use the arrow key to find the [Print-mech tap tests](#), and then touch the [OK](#) button.
5. Use the arrow key to find the tap test to run.

10 tap test results (OOBE states)

The printed tap test results contain a sequence of numbers at line number 68, "Startup Complete," of the printed report.

Use the following table to interpret these numbers.

Table 2-1 10 tap test results

Column	Code	Acceptable values
Column 1	DSID_PEN_PRINTER_STARTUP_BITS	A value of 1 indicates that the printbar has been started up. This means that shipping fluid has been removed from the printbar and replaced with ink. This is the expected state for a printer after initialization.
Column 2	DSID_OOBE_STATE	255—OOBE messaging complete.
Column 3	DSID_INK_SUPPLY_OOBE_COMPELTE	1—SHF purge is complete and service wipes have been enabled.
Column 4	DSID_CAL_OOBE_STATE	A value of 2 means that the OOBE printed calibrations are complete. A value of 1 means the OOBE printed calibrations are in progress A value of 0 means the OOBE printed calibration does not exist so no printing/calibration for OOBE is attempted.
Column 5	DSID_IQ_LIST_INDEX	A value of 3 means that pen height and beam center have been completed, and that BDD is scheduled (or pending) to perform normally. NOTE: For 1315FR firmware and above.
Column 6	DSID_BDD_FAIL_MASK	0—internal use only.

Table 2-1 10 tap test results (continued)

Column	Code	Acceptable values
Column 7	DSID_IDS_FIRST_CHARGE_REQUIRED	0—internal use only.
Column 8	DSID_PRINTHEAD_CAL_NEEDED	A value of 0 indicates that OOB calibrations (not IQ calibrations) are complete. This is so the messaging is complete for the calibrations. For example, if this value is 0, but the CAL_OOB_STATE=1, you will get the printed OOB calibrations, but the control panel may display Preparing instead of Calibrating .

Figure 2-3 10 tap test results

Printer Hardware Information

Extended Self Test Diagnostic Page - 1 of 2

Product Information

11. Product Name: HP OfficeJet Pro 8540 MFP series
 12. Product Number: CN598A
 13. Serial Number: CN2M09J0DS
 14. Service ID: 22334
 15. Date/Time: 11/5/2013 13:46:58
 16. Printer ID: 0
 17. Default Symbol Set: 341
 18. Total Page Count: 611
 19. Duplex Page Count: 42

Revision Information

24. Main PCA Revision: ID: 20616 MFG: 5 FAN: 4 NUM: 8
 25. Digital ASIC: SHEMP Rev A.3 Mfg: Marvell
 26. Analog ASIC: 1- REV: 0 MFG: 0, 2- REV: 0 MFG: 0
 27. Firmware Version: L2PICNL336MR
 28. Flows Revision: OFFICIAL
 29. Patch Revision: 0
 33. Duplexer Installed: Yes

Ink Delivery System Information

	Yellow	Cyan	Magenta	Black
43. Ink Supply:	Yellow	Cyan	Magenta	Black
44. Ink Level:	E F	E F	E F	E F
45. Ink Status:	Ready	Ready	Ready	Ready
47. Ink Status Slider:	200	200	200	200
48. Selectability Number:	971XL	971XL	971XL	970XL
49. SHAID Status:	0	0	0	0
50. SHAID Function:	0	0	0	0
51. Host/Trade Acumen Bit:	0	0	0	0
52. Start Up Complete:	0	0	0	0
53. Supply Serial Number:	178009178	182981570	178533525	183277097
54. Mfg. Date:	10/14/2012	11/18/2012	10/21/2012	11/18/2012
55. Ink Install:	01/01/2013	01/01/2013	01/01/2013	01/01/2013
56. Warranty Ends:	10/15/2014	11/19/2014	10/22/2014	11/19/2014
57. Warranty Status:	OK	OK	OK	OK
58. RHID: 0				
59. IRO: 00				

Print Head Assembly Information

60. TVAL: 190
 61. Total Dot Count (Kilo dots):
 a. Magenta: 1979745
 b. Cyan: 1668988
 c. Yellow: 1868496
 d. Black: 183277097
 75. TIOE done: 1

68. Startup complete: 1 255 1 2 0 0 0 0

DD-SYS:	1200				
DD-HIS:	0	200	100		1200
DD-CURR:	0	200	100		1200

A. Last successful calibration at page count: 81
 65. Last failed calibration at page count: 0
 66. Last calibration at page count: 81
 67. Donee printed since last manual jam: 407

68. Startup complete: 1 255 1 2 0 0 0 0

NUMBER OF CALIBRATIONS:	PEN_ALIGN_0	PEN_ALIGN_1	PEN_ALIGN_2	COLOR_CAL_0	COLOR_CAL_1	COLOR_CAL_2
Success:	1	1	1	1	1	1
Failed:	0	0	0	0	0	0

12 tap test results (REDI sensor values)

Table 2-2 12 tap test report

Callout	Report area	Item	Acceptable values
1	Print Humidity Sensor Data	Stable Relative Humidity	0–100 RH
2	Pen TSR Ambient Temperature Estimate	Pen TSR Ambient Temperature x10 °C	± 10 °C of current ambient temperature.
3	Digital Temperature Sensor Ambient Temperature	Digital Temperature Sensor Ambient Temperature x10 °C	± 10 °C of current ambient temperature.
4	Print REDI Sensor Calibration Data	TOF sensor, p value ¹	Between 10 and 100.
5	Print REDI Sensor Calibration Data	TOF sensor, m value ¹	Between 25 and 380

¹ "M" is mirror result, "P" is blocked with paper.

Figure 2-4 12 tap test report

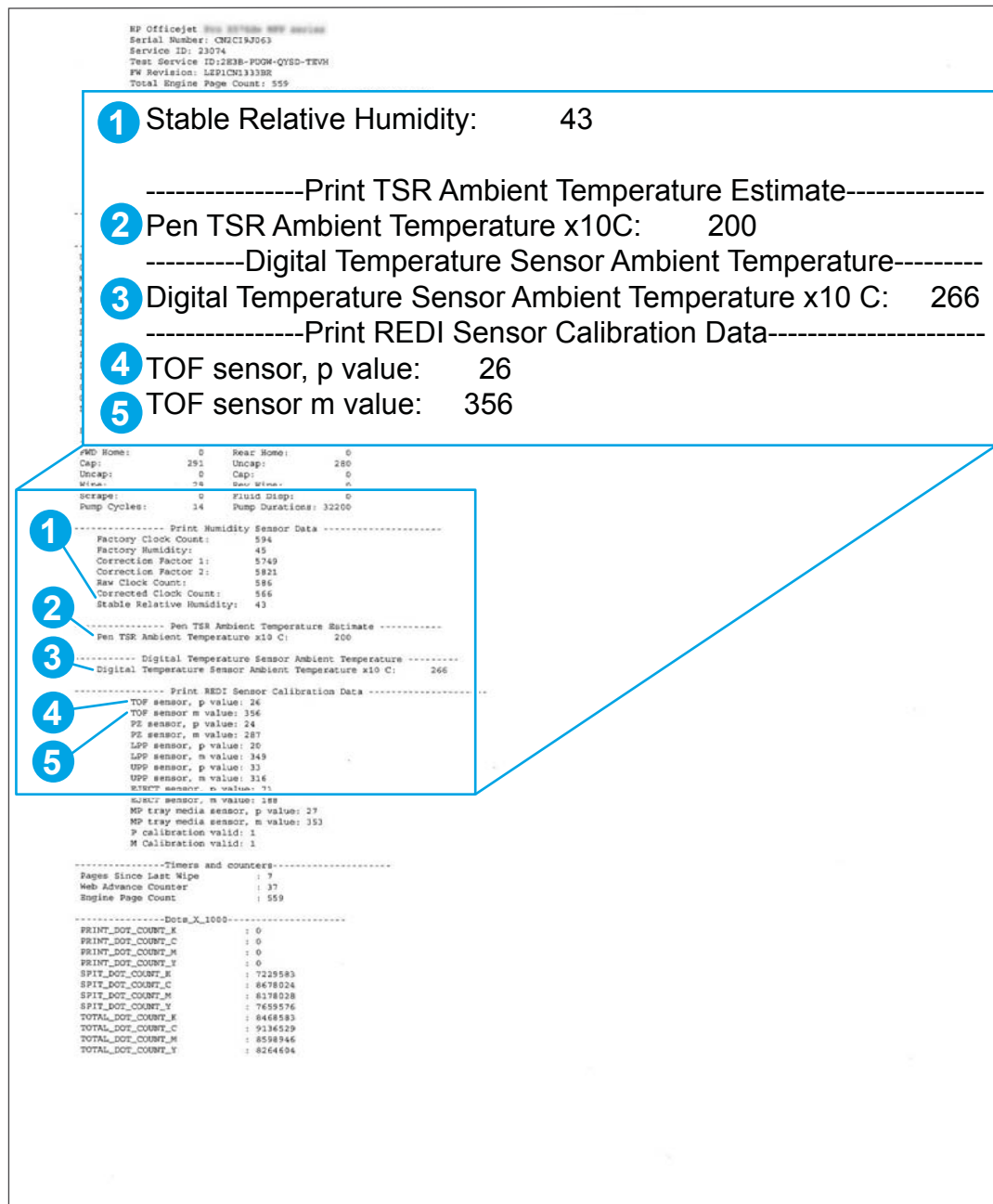

61 tap results (Align & color calibrations)



NOTE: If you hold the up or down arrows down, the tap count will start incrementing by 10, or 100

An acceptable 61 tap test has identical values for the parameters in the “Color scale (factory)” (callout 1) and “Color scale (current)” (callout 2) on the printed report areas. “Color scale (factory)” (callout 1) and “Color scale (current)” will be identical after a main PCA replacement, but may not be the same under other conditions. The values should also be identical after a printbar replacement.

Figure 2-5 61 tap test results

```

*****
WRITING SYSTEM CALIBRATION REPORT
*****

= ledb : 14
= ledb no saturation : 14

= pen_to_align_X(zero column) #7200: -45
= pen_to_align_Y(tof) #7200: 0
= Measured zero column and tof #7200:
= Tray: Main MP Accessory
= side: Front Back Front Back Front Back
= Z-Col.: 0 0 0 0 0 0 0
= TOP: 0 0 0 0 0 0 0

error type: sensor_n_target centroid hphase ledb vernier 3_sigma analysis
= Last pen align 0 status = 0x0 : 0 0 0 0 0 0 0 0 0
= Last pen align 1 status = 0x0 : 0 0 0 0 0 0 0 0 0
= Last pen align 2 status = 0x0 : 0 0 0 0 0 0 0 0 0

= Last pen align analysis die status(hex) for page 0: 0 0 0 0 0 0 0 0 0
= Last pen align analysis die status(hex) for page 1: 0 0 0 0 0 0 0 0 0
= Last pen align analysis die status(hex) for page 2: 0 0 0 0 0 0 0 0 0

= Last successful pen alignment values in NVM:

= Pen die X alignment (factory) #7200:
= die: 0 1 2 3 4 5 6 7 8 9
= K: -24 -6 -6 0 6 6 6 18 18 24
= C: -24 -6 -6 0 6 6 6 18 18 24

= Color scale (factory) :
= dia: 0 1 2 3 4 5 6 7 8 9
1 = K: 0x7eec 0x7f3c 0x8265 0x8280 0x8215 0x8070 0x7fcf 0x804b 0x7cea 0x7d65
= C: 0x7d51 0x7fbo 0x8063 0x81b5 0x80c5 0x81a1 0x7fc5 0x80ed 0x7dea 0x7fe6
= M: 0x7d51 0x7fbo 0x8063 0x81b5 0x80c5 0x81a1 0x7fc5 0x80ed 0x7dea 0x7fe6
= Y: 0x7d51 0x7fbo 0x8063 0x81b5 0x80c5 0x81a1 0x7fc5 0x80ed 0x7dea 0x7fe6

= Color scale (factory) :
= dia: 0 1 2 3 4 5 6 7 8 9
2 = K: 0x7eec 0x7f3c 0x8265 0x8280 0x8215 0x8070 0x7fcf 0x804b 0x7cea 0x7d65
= C: 0x7d51 0x7fbo 0x8063 0x81b5 0x80c5 0x81a1 0x7fc5 0x80ed 0x7dea 0x7fe6
= M: 0x7d51 0x7fbo 0x8063 0x81b5 0x80c5 0x81a1 0x7fc5 0x80ed 0x7dea 0x7fe6
= Y: 0x7d51 0x7fbo 0x8063 0x81b5 0x80c5 0x81a1 0x7fc5 0x80ed 0x7dea 0x7fe6

= Last density cal analysis die status(hex) for page 1: 0 0 0 0 0 0 0 0 0
= Last density cal analysis die status(hex) for page 2: 0 0 0 0 0 0 0 0 0

= Last successful density cal values in NVM:

1 = Color scale (factory):
= dia: 0 1 2 3 4 5 6 7 8 9
= K: 0x7eec 0x7f3c 0x8265 0x8280 0x8215 0x8070 0x7fcf 0x804b 0x7cea 0x7d65
= C: 0x7d51 0x7fbo 0x8063 0x81b5 0x80c5 0x81a1 0x7fc5 0x80ed 0x7dea 0x7fe6
= M: 0x7d51 0x7fbo 0x8063 0x81b5 0x80c5 0x81a1 0x7fc5 0x80ed 0x7dea 0x7fe6
= Y: 0x7d51 0x7fbo 0x8063 0x81b5 0x80c5 0x81a1 0x7fc5 0x80ed 0x7dea 0x7fe6

2 = Color scale (factory):
= dia: 0 1 2 3 4 5 6 7 8 9
= K: 0x7eec 0x7f3c 0x8265 0x8280 0x8215 0x8070 0x7fcf 0x804b 0x7cea 0x7d65
= C: 0x7d51 0x7fbo 0x8063 0x81b5 0x80c5 0x81a1 0x7fc5 0x80ed 0x7dea 0x7fe6
= M: 0x7d51 0x7fbo 0x8063 0x81b5 0x80c5 0x81a1 0x7fc5 0x80ed 0x7dea 0x7fe6
= Y: 0x7d51 0x7fbo 0x8063 0x81b5 0x80c5 0x81a1 0x7fc5 0x80ed 0x7dea 0x7fe6

= Last successful calibration at page count: 552
= Last failed calibration at page count: 0
= Last Calibration at page count: 552

Number of Calibrations: PEN_ALIGN_0 PEN_ALIGN_1 PEN_ALIGN_2 COLOR_CAL_0 COLOR_CAL_1 COLOR_CAL_2
Success: 3 3 3 2 2 2
Failed: 0 0 0 0 0 0

```

909 tap test results (BDD status)

 **NOTE:** If you hold the up or down arrows down, the tap count will start incrementing by 10, or 100

An acceptable 909 tap test has the following values:

- BDD is operating (callout 1)
- Cal OOB is complete state=2 (callout 2)
- Cal IQ is in progress, index=1 (callout 3)

Figure 2-6 909 tap test results

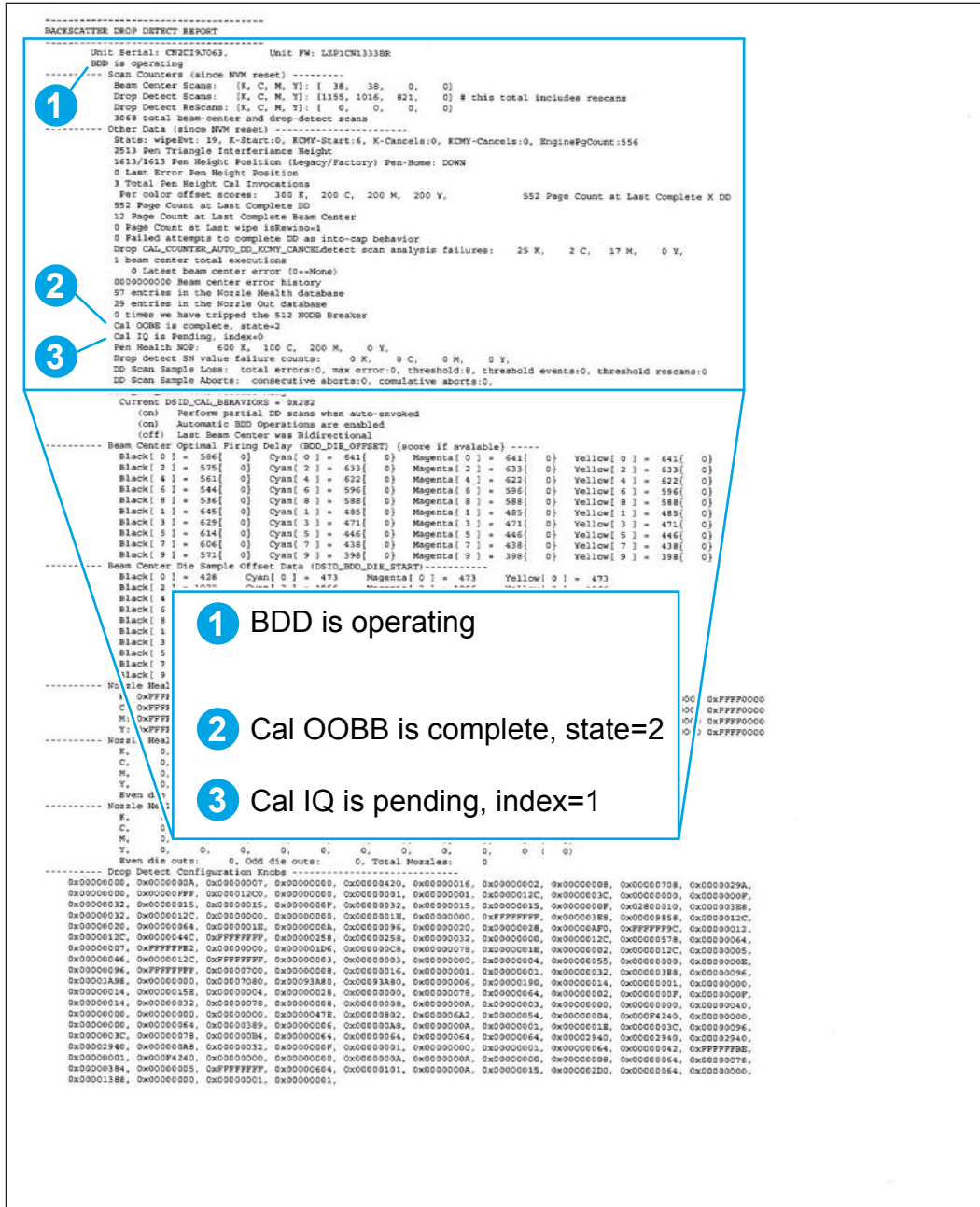

Troubleshooting flowchart

Use the troubleshooting flowchart to pinpoint the root cause of hardware malfunctions. The flowchart guides you to the section of this chapter that contains steps for correcting the malfunction.

Before beginning any troubleshooting procedure, check the following issues:

- Are supply items within their rated life?
- Does the configuration page reveal any configuration errors?

 **NOTE:** The customer is responsible for checking supplies and for using supplies that are in good condition.

This flowchart highlights the general processes that you can follow to quickly isolate and solve product hardware problems.

Each row depicts a major troubleshooting step. A “yes” answer to a question allows you to proceed to the next major step. A “no” answer indicates that more testing is needed. Go to the appropriate section in this chapter, and follow the instructions there. After completing the instructions, go to the next major step in this troubleshooting flowchart.

Table 2-3 Troubleshooting flowchart

1 Power and electronics	Is the product on and does a readable message display?		Follow the power-on troubleshooting checks. After the control panel display is functional, see step 2.
	Yes ↓	No →	
2 Control panel messages	Does the normal operational messaging display on the control panel?		After the errors have been corrected, go to step 3.
	Yes ↓	No →	
3 Information pages	Open the menu and print the configuration pages to verify that all the accessories are installed. Are all the accessories installed?		If accessories that are installed are not listed on the configuration page, remove the accessory and reinstall it. After evaluating the configuration pages, see step 4.
	Yes ↓	No →	
4 Image quality	Does the print quality meet the customer's requirements?		Compare the images with the sample defects in Table 2-6 Print quality defect examples on page 67 . After the print-quality is acceptable, see step 5.
	Yes ↓	No →	
5 Paper handling	Is the customer experiencing paper-handling problems?		See Solve paper handling problems on page 79 . When the paper handling issues have been resolved, see step 6.
	Yes ↓	No →	

Table 2-3 Troubleshooting flowchart (continued)

6 Interface	Can the customer print successfully from the host computer?		Verify that all I/O cables are connected correctly and that a valid IP address is listed on the Jetdirect configuration page.
	Yes. This is the end of the troubleshooting process.	No →	If error messages display on the control panel when you try to print an event log, see Control-panel messages on page 47 . When the customer can print from the host computer, this is the end of the troubleshooting process.

Front-panel error codes

The following front-panel error codes indicate the current product status or situations that might require action.



NOTE: If you encounter an error code that isn't in this list, then you will likely have to return the product for service.

Front-panel error code	Description	Remote	Onsite
0xC6FDxx02	No pen IO	Turn the product off, then on.	Ensure that the three printbar flex cables are inserted correctly in the main PCA.
0xC6FDxx03	Incorrect pen IO		
0xC6FDxx04	Pen WDOG fault		If any of the printbar flex cables are damaged, replace them. Order part number CN459-60407.
0xC6FDxx05			
0xC6FDxx06	Unrecognized pen type		Replace the printbar.
0xC6FDxx07	Pen LVDS error		
0xC6FDxx08	Pen ID invalid		
0xC6FDxx09	Pen ID bit flipped		
0xC6FDxx10	Pen bad DSTR		
0xC6FDxx11			
0xC6FDxx12	Pen TSR fault		
0xC6FDxx13	Pen stuck, cold		
0xC6FDxx14	Pen not heating		
0xC6FDxx15	Pen too cold		
0xC714xx20	Pen VDD short low		
0xC714xx21	Pen VDD short high		
0xC714xx22	Pen VDD expected on		
0xC714xx23	Pen VPP init short low		
0xC714xx24	Pen VPP short low		
0xC714xx25	Pen VPP short init high		
0xC714xx26	Pen VPP short high		
0xC714xx27	Pen VPP short test out of range low		
0xC714xx28	Pen VPP short test out of range high		
0xC6FDxx15	Pen too cold	Wait for the printhead to warm up. This can take up to four hours.	Replace the printbar.

Front-panel error code	Description	Remote	Onsite
610000B	Service station pen too cold	If the room temperature is below 5C or the product was stored in an environment below 5C, allow the product to warm up. This can take up to four hours.	Replace the printbar.
610000C	Service Station Home Failure	Turn the product off, then on.	<p>Verify that the service sled transmission is in the correct position.</p> <p>Verify that the Web wipe assembly is installed correctly and not racked.</p>
610000D	Service station cap home long	Turn the product off, then on.	<p>Check the transmission springs. Verify that the cam follower is installed.</p> <p>Replace the dwell gear (usually will also have 610000C8 asserts to go with ...0D)</p> <p>Ensure that the swingarms are engaged correctly.</p> <p>Ensure that the printbar is installed correctly. That it is not racked</p>
610000E	Service station cap home short	Turn the product off, then on.	<p>Inspect the service sled for debris (screws, plastic tabs, etc.) blocking its path.</p> <p>If the carriage is blocking the service sled, inspect the path between the carriage and carriage garage for debris blocking the path.</p> <p>Use the test Carriage function in the support test menu to confirm correct operation of the sensor carriage.</p> <p>NOTE: The service motor assembly is not field replaceable.</p>
61000010	Service station stall on interlock engage	Turn the product off, then on.	Ensure that the service sled can move fully from cap to Web advance position.
61000011	Service sled restricted movement service error		Ensure that the service sled transmission is in the correct position. If the swingarm is in the wrong position for pick/service, that cannot be repaired during DPU.

Front-panel error code	Description	Remote	Onsite
61000012	Lift restricted movement service error	Turn the product off, then on.	<p>Ensure that the printbar lift is not obstructed.</p> <p>Ensure that the printbar lift guide assembly and guide rods are not obstructed.</p> <p>Verify that the service sled transmission is in the correct position.</p> <p>Check that the printbar is not racked. If it is, remove and reinstall the printbar.</p> <p>The printbar lift assembly may be defective. Replace the assembly.</p> <p>The sensor carriage encoder strip may be dirty or damaged.</p>
61000013	Carriage restricted movement service error	Turn the product off, then on.	<p>Check that the sensor carriage flex cable (J31) is connected correctly and not damaged. Check that the sensor carriage motor is connected.</p> <p>Ensure that the transmission is in the correct position.</p> <p>Verify that there is no debris blocking carriage movement.</p> <p>NOTE: The carriage movement mechanisms are not field replaceable.</p>
61000017	Printbar transmission state error	Turn the product off, then on.	<p>Ensure that the service sled transmission is in the correct position.</p>
6100001E	Paper motor thermal error	Turn the product off, then on.	<p>Check that there is no debris in the paper path or print zone that could be causing drag on the motor.</p> <p>The paper motor is not field replaceable.</p>
6100001F	Duplex motor thermal error	Turn the product off, then on.	<p>Check that there is no debris in the lower paper path (below the duplex module) that could be causing drag on the motor.</p> <p>Replace the duplex motor.</p>

Front-panel error code	Description	Remote	Onsite
61000020	Output motor thermal error	Turn the product off, then on.	<p>Check that there is no debris in the upper paper path that could be causing drag on the motor.</p> <p>Check that all portions of the output drive rotate freely.</p> <p>Replace the output drive assembly.</p>
6100002D	Paper load tray 1 pick motor	Turn the product off, then on.	Verify that the pick tire moved. If it moved, the top of the page in the tray will move about an inch.
6100002E	Paper load pick tire index sensor		<p>Verify that the service/pick transmission is in the correct position.</p> <p>Check for a missing wavy spring in lower swing arm.</p> <p>NOTE: The Tray 1 pick tire/index sensor is not field replaceable.</p>
61000035	Printbar clutch slippage	Turn the product off, then on.	<ul style="list-style-type: none"> • Check for any objects obstructing printbar motion. Check that there is no debris on the printbar lift guide rods. • Replace a stripped gear or clutch plate.
6100004E	Pen startup spits already done	Turn the product off, then on.	Replace the printbar.
610000C7	Service wipe pens toward cap motor	Turn the product off, then on.	Verify that the service sled transmission is in the correct position. Check for missing gears, retainers, and so forth.
610000C8	Service move to transmission state		
610000D2	DPU service station unlimited move		
610000D3	DPU printbar crash into service station		Ensure that the service sled transmission is in the correct position.
610000C9	Service carriage home invalid	Turn the product off, then on.	<p>Verify that the encoder stalled against the garage wall. Check the carriage encoder for a faulty encoder strip or sensor.</p> <p>Use the Test Carriage function in the support test menu to confirm correct operation of the sensor carriage.</p>

Front-panel error code	Description	Remote	Onsite
61000D4	DPU printbar under service station	Turn the product off, then on.	<p>Check for any objects obstructing printbar motion.</p> <p>Replace a stripped gear or clutch plate.</p>
83C00024	Invalid firmware upgrade	Use the correct firmware	Use the correct firmware File. Usually caused by using firmware for a different product.
C18A000A	The spittoon level is too full during OOBE. The product may be attempting a second OOBE.	This is a very rare error condition. If this error occurs, replace the product.	If this error occurs during a printbar replacement, then replace the product.
C4E81xxx C4E0Dxxx	Internal bus error	Turn the product off, then on.	<p>The printer firmware may be corrupted. Use the FSErase utility to reload the firmware. Call HP support for the location of the utility and instructions for use.</p> <p>Check the cable connection to the Tray 3 interface board.</p> <p>Replace Tray 3.</p> <p>Replace the main PCA.</p>
All other C4Exxxxx errors			<p>The printer firmware may be corrupted. Use the FSErase utility to reload the firmware. Call HP support for the location of the utility and instructions for use.</p> <p>Replace the main PCA.</p>
C7140024	VPP power short detected	Turn the product off, then on.	<p>Ensure that the three printbar FFCs are inserted correctly in the main PCA.</p> <p>If any of the printbar flex cables are damaged, replace them. Order part number CN459-60407.</p> <p>Replace the printbar.</p> <p>The main PCA could be defective (rare).</p>
C8190012 C8190014		Turn the product off, then on.	<p>Check the printbar cable and replace if it is damaged.</p> <p>Replace the printbar.</p> <p>Replace main PCA.</p>

Front-panel error code	Description	Remote	Onsite
E8190Cxx		Turn the product off, then on.	<p>If the duplex motor, eject motor, or eject solenoid are defective, replace them.</p> <p>If the sensor carriage motor is defective, return the product.</p>
E8191Cxx		Turn the product off, then on.	<p>If the printbar is defective, replace it.</p> <p>If the printbar is not defective and no other problem can be found, return the product.</p>

Control-panel messages

Message	Description	Remote	Onsite
Non-HP ink cartridges installed	The product has detected a non-HP cartridge or cartridges.	Replace the cartridges with HP cartridges to ensure that the best print quality.	
Used or Counterfeit Cartridge Detected	The product has detected a refilled or counterfeit cartridge.	At the computer, click Yes or No to clear the message.	
Counterfeit Cartridge Advisory	The product has detected a possibly counterfeit cartridge.	At the computer, click the hypertext link to report fraud, or click the Continue button to clear the message.	
Used, Refilled or Counterfeit Cartridge Detected	The product has detected a possibly counterfeit cartridge.	At the computer, click the Buy Now button to purchase a genuine HP cartridge, or click the OK button to clear the message.	
Use SETUP cartridges	The product needs the setup ink cartridges that came with the product to perform the initial setup process.	Replace the cartridges with the setup ink cartridges that came with the product.	
Do not use SETUP cartridges	The setup cartridges that came with the product cannot be used after the product has been initialized.	Remove those cartridges, and then install non-setup cartridges.	
Service Motor Stall		Turn the product off, then on.	<ul style="list-style-type: none"> • Ensure that the service sled is properly inserted. Check for rub points. • Check the PB shims. They should not be stuck. • Check to make sure that the lead in ramps on the edge of the printbar head are present and, if not, find them. <p>NOTE: The service station motor is not field replaceable. Return the product to an authorized HP service center.</p>
Ink cartridge problem	The product has detected that a cartridge is missing or damaged.	Replace the cartridge indicated in the error message.	

Message	Description	Remote	Onsite
Empty Ink Cartridge		<p>If the Empty Ink Cartridge message occurs with a new, genuine HP ink cartridge, follow these steps:</p> <ol style="list-style-type: none"> 1. Turn the product off, then on. 2. Open the supply door and remove the cartridge indicated in the error message, and then close the supply door. 3. Turn the product off by pressing the power button. If the product does not power off in 60 seconds, unplug the product. 4. Turn the product back on and wait until is in the Ready state. This takes about 60 seconds. 5. Open the supply door and replace the supply that generated the error message. 6. Close the supply door. 	
Startup Routine Ink Alert	The cartridge indicated might not have enough ink to complete the product startup process.	Replace the cartridge indicated in the error message.	
HP Protected Cartridge Installed	The product has detected cartridges that were locked in another product using the HP Cartridge Protection feature. Cartridges locked in another product will not work in this product.	Replace the cartridge indicated in the error message.	
Ink Sensor Failure	The product ink sensor has failed and the product no longer prints.	Turn the product off, then on.	Replace the BDD sensor.
Ink Sensor Warning	This message can occur when using a refilled ink cartridge or when the ink sensor has failed.	If this message occurs with a refilled ink cartridge and print quality is still acceptable, acknowledge the error message and continue printing.	If this message is accompanied by massive print quality issues, the ink sensor might have failed and must be replaced. Failed ink sensors cannot determine ink cartridge ink levels.

Message	Description	Remote	Onsite
Low on ink	The ink level in the indicated cartridge has reached a low level.	It is not necessary to replace the cartridge at this point. HP recommends having a replacement cartridge ready for when the cartridge is empty.	
Very low on ink	The ink level in the indicated cartridge has reached a very low level.	It is not necessary to replace the cartridge at this point. HP recommends having a replacement cartridge ready for when the cartridge is empty.	
Ink Cartridges Depleted		<p>If the Ink Cartridges Depleted message occurs, follow these steps:</p> <ol style="list-style-type: none"> 1. Ensure that the product is in a level operating position. 2. Perform a 24–tap test. 3. If a high-volume print job has just completed, and the ink cartridge is near end of life, wait 8 hours to see if the error goes away. 4. Replace the ink cartridge. 	
Problem with SETUP cartridges	The product has detected a problem with the setup cartridges, which prevents the product from completing the initialization process during initial installation.	Replace the cartridges.	
Problem with Printer Preparation	<p>The Problem with Printer Preparation message can occur due to the following conditions:</p> <ul style="list-style-type: none"> • The product clock has failed and ink preparation might not be complete. • The Estimated Ink Level gauge might be inaccurate. 	<ol style="list-style-type: none"> 1. Open and close the ink cartridge door. 2. Turn the product off, then on. 	

Message	Description	Remote	Onsite
Preparing printer...	The Preparing printer... message can occur frequently, for example with every other printed page.	<p>If this message occurs with a nearly empty ink cartridge, either replace the ink cartridge or let the ink cartridge rest for eight hours before resuming printing.</p> <p>If this message occurs with a full ink cartridge, or an ink cartridge more than 80% full, try replacing the ink cartridge.</p>	
Paper Jam <Location>	The product has experienced a paper jam. Printing cannot continue until the jam has been cleared.	Follow the instructions on the product control panel to clear the jam, or see Resolve paper jam issues on page 86	See Clear jams on page 86 .
Paper too short	The product cannot print on paper smaller than 12.5 cm (4.9 in) in length.	Load paper that exceeds the product minimum supported size and re-send the print job.	
Main Tray 2 Missing or Open	The product cannot detect the tray.	<p>If customer experiences this error, even though Tray 2 is fully inserted, perform the following:</p> <ol style="list-style-type: none"> 1. Remove Tray 2. 2. Inspect the rear-left guide arm. There should be a magnet (silver piece) at the end. If this is missing, replace the tray. 	Replace the main PCA.

Message	Description	Remote	Onsite
Service Ink Capacity Warning	<p>The maintenance ink container on the duplex module is full or almost full. This can cause print quality issues (smearing).</p> <p>Replace the duplex module, and then reset the service ink detection mechanism.</p>	<p>Replace the duplex module.</p> <ol style="list-style-type: none"> 1. Open the Support Menu by pressing the Back button four times. 2. Scroll to System Configuration Menu, and then touch the OK button. 3. Scroll to Service ink container Or Duplex module, and then touch the OK button. 4. Scroll to Replace duplex module, and then touch the OK button. 5. Follow the onscreen instructions to complete the process. 	<p>Replace the service ink container, part number CN598-67004.</p>
Accessory Tray 3 Missing or Open	<p>The product cannot detect the tray.</p>	<p>Install and close Tray 3.</p>	<p>Replace Tray 3</p> <p>Check the Tray 3 interconnect (J55).</p>
Add Paper to Multi-Purpose Tray	<p>The product cannot detect paper in Tray 1.</p>	<p>Load more paper into the tray, and then touch the OK button.</p>	
Ink cartridge failure	<p>The product has detected damage to one or more ink cartridges.</p>	<p>Replace the ink cartridge or cartridges indicated in the error message.</p>	
Printer Supply Upgrade	<p>The product has detected an upgrade cartridge.</p>	<p>Press the OK button or touch the Upgrade button to install the upgrade cartridge, or replace the cartridge.</p>	
Printer Supply Upgrade Problem	<p>A supply upgrade failed.</p>	<p>Replace the ink cartridges.</p>	
Previously used genuine HP cartridges installed	<p>The product has detected a used cartridge or cartridges.</p>	<p>Press or touch the OK button to clear the message.</p>	

Message	Description	Remote	Onsite
Duplex Module Missing	The product cannot detect the duplex module.	<p>Install the duplex module. If this does not solve the problem, install a new duplex module.</p> <p>NOTE: If you replace the duplex module, you will need to reset the counters.</p> <ol style="list-style-type: none"> 1. Open the Support Menu by pressing the Back button four times. 2. Scroll to System Configuration Menu, and then touch the OK button. 3. Scroll to Service ink container Or Duplex module, and then touch the OK button. 4. Scroll to Replace duplex module, and then touch the OK button. 5. Follow the onscreen instructions to complete the process. 	If replacing the duplex module does not solve the problem, then the duplex sensor PCA may be defective. In rare cases, the power button assembly may be defective.
Close Left Door	The product has detected that the left door is open.	Close the left door.	<p>Replace the left door.</p> <p>Replace the front distribution board PCA.</p>
Close Ink Access Door	The product has detected that the ink cartridge door is open.	<p>Close the ink access door.</p> <p>If the ink access door is broken, replace the front cover.</p>	Replace the front distribution PCA.
Clear Output Area	The product has detected a jam in the output area.	<p>Remove any paper from the output flap area.</p> <p>Make sure that the flap can open and close. If it cannot, replace the output flap.</p> <p>See Clear jams in the output bin on page 94.</p>	If the output flap is operating correctly, then the output flap sensor may be defective.
Tray 2 Out of Paper	The product cannot detect paper in the tray.	Load more paper into the tray, and then touch the OK button.	See Solve paper handling problems on page 79

Message	Description	Remote	Onsite
Tray 3 Out of Paper	The product cannot detect paper in the tray.	Load more paper into the tray, and then touch the OK button. Replace Tray 3	
Tray 3 Door Open	The product has detected that the jam access door on the right side of accessory Tray 3 is open or shut incorrectly.	Close the door. Replace Tray 3	
Paper type mismatch	The paper type detected by the product does not match the type selected in the software.	Select the correct type in the software, load the type dictated by the software, or touch the OK button to continue the job with the size mismatch. See Use the correct print settings on page 62 .	
Paper type mismatch	The paper size detected by the product does not match the size selected in the software.	Select the correct size in the software, load the size dictated by the software, or touch the OK button to continue the job with the size mismatch. See Use the correct print settings on page 62 .	
Paper too short to auto-duplex	The paper in the product does not meet the minimum size requirements for automatic two-sided printing (duplexing).	Load paper that meets specifications for automatic duplexing. See Use HP ColorLok Paper on page 61	

Error-related symptoms

Symptom	Remote solution	Onsite solution
The product does not pick up paper	The product does not pick up paper from the input tray. See The product does not pick up paper on page 80.	See The product does not pick up paper on page 80.
The product picks up multiple sheets of paper at once	See The product picks up multiple sheets of paper on page 80.	See The product picks up multiple sheets of paper on page 80.
Product states that the tray is empty, even though it has paper	See The product states that a paper tray is empty, even though it has paper on page 81.	See The product states that a paper tray is empty, even though it has paper on page 81.
Paper jam in Tray 2	See Clear jams in Tray 2 on page 89.	See Clear jams in Tray 2 on page 89.
Print zone jam	See Print zone jams on page 83.	See Print zone jams on page 83.
Generic paper jam error	See Resolve paper jam issues on page 86.	See General paper jams issues (onsite solutions) on page 82.
Clear output tray error	See Clear jams in the output bin on page 94.	See Output tray jam errors (onsite solutions) on page 82.
Output motor stall	See Output motor stall on page 84.	See Output motor stall on page 84.
Output flap won't retract (no obstacle to prevent it)	See Output flap won't retract - no obstacle to prevent it on page 84.	See Output flap won't retract - no obstacle to prevent it on page 84.
Paper jams continuously	Paper continues to jam after jam is cleared. See Frequent jams in the paper path on page 83.	See Frequent jams in the paper path on page 83.

Check symptoms

Power and electronics

If a printer status page can be printed, see [Solve product connectivity problems on page 98](#). If the product's power does not come on, or a printer status page cannot be printed, use the following steps to troubleshoot:

Verify that the product power is on

1. Make sure that the product is plugged in and turned on and the cables are all connected correctly. The power button should be lit with a green light. If it is not, press the power button. It should first glow with an amber color, and then change to green once it is ready. If the power button does not light up, check the following conditions:
 - Make sure that the power cable is connected to the product and the outlet.
 - Check the power source by connecting the power cable to a different outlet.
 - If the power button is still not lit with an amber light when the power button is pressed, then the power supply is likely faulty. Replace the power supply.



NOTE: In rare cases, this symptom can also be caused by a faulty main PCA.

2. If the amber light does come on, then the power supply is operating correctly. After pushing the power button, if the green power light does not glow, check the following:
 - There are two green LEDs on the main PCA that flash slowly when the processors are operating correctly. If these LEDs are not flashing slowly, then the main PCA is probably faulty.
 - In rare cases, the power button assembly might be defective.
3. If the product motors do not rotate, make sure that the ink cartridges are installed and that the doors are all closed. The control panel displays messages to indicate these problems.
4. If the product powers up, but the front panel does not work, check the following:
 - Try printing a document. If the product can print, then the control panel or control-panel FFC might be defective.
 - If the product doesn't print, then the main PCA might be defective.

Test the control panel

1. Open the [Engineering menu](#). See [Access the Engineering menu on page 31](#) for information accessing the [Engineering menu](#).
2. Select the [Service menu](#).
3. Select [Service tests](#).

4. Run the following tests:
 - [Test Keys](#)
 - [Test LEDs](#)
 - [Test Display](#)
5. If any of these tests fail, or if the control-panel FFC is damaged, replace the control panel.

Check the network connections

1. Check the light next to the network connection on the product. If the network is active, the light is green.
2. Make sure that you are using a network cable and not a phone cord to connect to the network.
3. Make sure that the network router, hub, or switch is turned on and that it is working correctly.
4. Verify that the port settings:
 - a. From the list of products on your computer, right-click the name of this product, click **Properties**, and click the **Ports** tab.
 - b. If you are using a network cable to connect to the network, make sure that the product name listed on the **Ports** tab matches the product name on the product configuration page.
 - c. If you are using a USB cable and are connecting to a wireless network, make sure that the box is checked next to **Virtual printer port for USB**.
5. If you are using a personal firewall system on the computer, it might be blocking communication with the product. Try temporarily disabling the firewall to see if it is the source of the problem.
6. If your computer or the product is connected to a wireless network, low signal quality or interference might be delaying print jobs.

The product prints slowly

If the product prints but it seems slow, try the following solutions:

1. Make sure that the computer meets the minimum specifications for this product. For a list of specifications, go to this Web site: www.hp.com/go/support.
2. If the paper type setting is not correct for the type of paper you are using, change the setting to the correct paper type.
3. If your computer or the product is connected to a wireless network, low signal quality or interference might be delaying print jobs.
4. If the product is in an environment that experiences high humidity, low temperatures, or both conditions, the print speed might be affected.

Solve print quality problems

You can prevent most print-quality problems by following these guidelines.

- [Print quality troubleshooting flowchart](#)
- [Use genuine HP cartridges](#)
- [Use HP ColorLok Paper](#)
- [Use the correct print settings](#)
- [Diagnose print quality problems using the Print Quality Page](#)
- [Solve print quality issues](#)
- [Inspect the ink cartridge for damage](#)
- [Service technician notes](#)

Print quality troubleshooting flowchart

Table 2-4 Print quality troubleshooting flowchart

1	Genuine HP cartridges must be used for best results.	Replace any non-HP cartridges. See Use genuine HP cartridges on page 58 for more information.
Are genuine HP cartridges being used?	Yes ↓	No →
2	HP ColorLok paper must be used for best results	Replace non-HP ColorLok paper. See Use HP ColorLok Paper on page 61 .
Is HP ColorLok paper being used?	Yes ↓	No →
3	The print settings must be set correctly for the paper type being used.	Correct the print settings. See Use the correct print settings on page 62 .
Are the print settings correct?	Yes ↓	No →
4	The print quality page can help identify causes of print quality problems.	See Diagnose print quality problems using the Print Quality Page on page 66 .
Print a Print Quality Page		

Use genuine HP cartridges

 **CAUTION:** The use of non-HP ink cartridges might damage the product printhead.

HP recommends that you use genuine HP cartridges. HP cannot guarantee the quality or reliability of non-HP cartridges or refilled HP cartridges. If you are not using genuine HP cartridges, the following solutions might not resolve your print quality issue.

Determine if you are using genuine HP cartridges

Use the HP embedded Web server (EWS) to view the ink cartridge information

1. Open the product's EWS, click on the **Tools** tab, and then select **Ink Gauge**.
2. In the **Installed Cartridges** area, genuine HP ink usage is indicated by the following:
 - In the **Part Number** row, the ink cartridge part numbers begin with the letters "HP".
 - The **Type** row contains an HP logo.
 - The **HP** row has the value "0" or "00".

 **NOTE:** A value of "1" in the **Use** row indicates non-HP ink usage.

Use the printer status report to view the ink cartridge information

1. Print a printer status report.

2. Genuine HP ink usage is indicated by the following:

- Line 27 Use: the value for this line should be 0. A value of 1 indicates that a non HP supply is installed. This field is reset with each supply change.
- Line 28 HP: the value for this line should be 1. A value of 1 indicates that an HP supply is installed. A value of 0 indicates that a non-HP supply is installed. This field is reset with each supply change.

- Line 31 NHIO: the value for this field should be 0 or 00. If the value for this item is not 0 or 00, then a non-HP ink cartridge has been installed in the product but not necessarily used. This field is persistent, and not reset.
- Line 32 IRO: the value for this field should be 0 or 00. If the value for this item is not 0 or 00, then a, non-HP ink cartridge has been installed in the product and the user confirmed the message to use the non-HP ink. This field is persistent, and not reset.

Figure 2-7 Printer status report—determining genuine HP ink usage

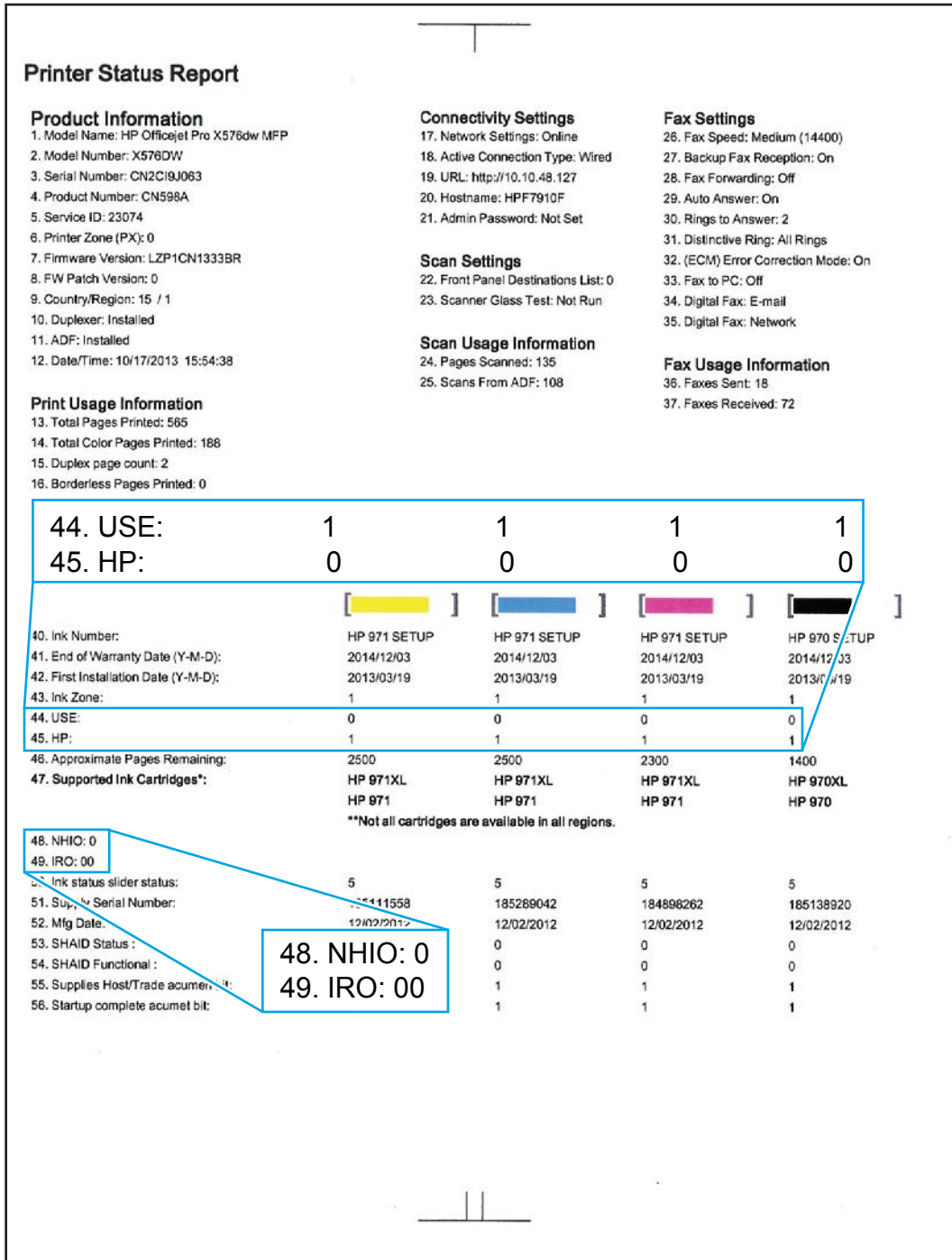

Use HP ColorLok Paper

Based on HP internal testing using a range of plain papers, HP highly recommends using papers with the ColorLok® logo for this product. For details, go to www.hp.com/go/printpermanence.



If HP ColorLok paper is unavailable, see [Use paper that meets HP specifications on page 62](#)

Use paper that meets HP specifications

Use different paper if you are having any of the following problems:

- The printing is too light or seems faded in areas.
- Specks of ink are on the printed pages.
- Ink is smearing on the printed pages.
- Printed characters seem misformed.
- Printed pages are curled.

Always use a paper type and weight that this product supports. In addition, follow these guidelines when selecting paper:

- Use paper that is of good quality and free of cuts, nicks, tears, spots, loose particles, dust, wrinkles, voids, staples, and curled or bent edges.
- Use paper that has not been previously printed on.
- Use paper that is designed for use in inkjet products.
- Use paper that is not too rough. Using smoother paper generally results in better print quality.

Use the correct print settings

Use the correct paper type setting in the print driver

Check the paper type setting if you are having any of the following problems:

- Ink is smearing on the printed pages.
- Repeated marks occur on the printed pages.
- Printed pages are curled.
- Printed pages have small unprinted areas.

Change the paper type and size setting for Windows

1. From a software program that has the **Print** feature available, click on the **File** menu, and then click **Print**.
2. Select the product, and then click the **Properties** or **Preferences** button.
3. Click the **Paper/Quality** tab.
4. From the **Paper type** drop-down list, click the **More...** option.
5. Expand the list of **Type is:** options.
6. Expand each category of paper types until you find the paper type that you are using.
7. Select the option for the type of paper you are using, and click the **OK** button.

Change the paper type and size setting for Mac

1. On the menu in the software program, click the **File** option.
2. Select a size from the **Paper Size** drop-down list.
3. Open the **Paper/Quality** menu.
4. Select a type from the **Media Type** drop-down list.
5. Click the **Print** button.

Adjust color

Manage color by changing the settings on the **Color** tab (Windows) and **Color Options** tab (Mac) in the print driver.

If the customer is using the correct print settings, and good quality paper, check the environmental conditions. If the product is in a location that is very cold, or humid, there might be a failure in the temperature/humidity sensor. If the customer is not happy with the following solution, then check the sensors, and replace if necessary. The sensors status is displayed on the 12 tap test page. See [12 tap test results \(REDI sensor values\) on page 35](#).



NOTE: The **HP EasyColor** check box appears only in the PCL6 print driver. It is not available in the universal print drivers.

Change the color theme for a print job

1. On the **File** menu in the software program, click **Print**.
2. Click **Properties** or **Preferences** (Windows).
3. Click the **Color** tab (Windows) or **Color Options** tab (Mac) and uncheck HP EasyColor.
4. Select a color theme from the **Color Themes** (Windows) or **RGB Color** (Mac) drop-down list.

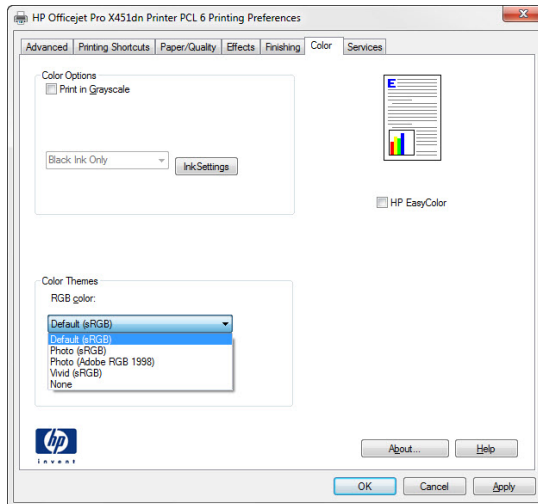

- **Default (sRGB):** This theme sets the product to print RGB data in raw device mode. When using this theme, manage color in the software program or in the operating system for correct rendering.
- **Vivid:** The product increases the color saturation in the midtones. Use this theme when printing business graphics.
- **Photo:** The product interprets RGB color as if it were printed as a photograph using a digital mini lab. The product renders deeper, more saturated colors differently than with the Default (sRGB) theme. Use this theme when printing photos.
- **Photo (Adobe RGB 1998):** Use this theme with printing digital photos that use the AdobeRGB color space rather than sRGB. Turn off color management in the software program when using this theme.
- **None:** No color theme is used.

Change print settings for wet, over-saturated, or ragged edge print output

The method can only be used in the PCL6 print driver.



NOTE: The need to use this functionality should be rare. Be sure to check the following first:

That the customer is using good quality paper with the correct settings. This is by far the largest cause of this symptom.

Determine if the printer operating in a cold or humid environment.

If the printer is operating in extreme environmental conditions, check the temperature and humidity sensors. The current values can be found in the 12 tap report. If the values don't match the conditions, then the faulty sensor should be replaced. The humidity sensor is mounted on the main PCA, so in that case, the main PCA will need to be replaced.

1. On the **Printing Preferences** tab click the **Color** tab, and then unselect the **HP EasyColor** option.
2. Click the **Ink Settings** button.
 - Increase the **Dry Time** setting to help resolve the following issues:
 - Roller tracking
 - Ink smearing
 - Starwheel tracking



NOTE: Increasing the **Dry Time** setting will slow down the overall printing process. Changing the **Dry Time** setting is most effective when using plain paper.

- Decrease the **Saturation** setting to help resolve the following issues:
 - Roller tracking
 - Ink smearing
 - Starwheel tracking



NOTE: Decreasing the **Saturation** setting might cause fading in the printed output. Changing the **Saturation** setting is most effective when using brochure or photo paper.

- The **Saturation** setting determines how much ink is used to achieve the print job. This setting is a value in the range of -2 to 2. The default setting is 0. Increasing **Saturation** setting might make images look more vibrant.
- The **Black Ink Spread** setting can help control ink spread or wicking on different types of media. This setting can be changed to one of the following values:
 - **Default:** This value is the default black ink spread setting.
 - **Less:** This value sets the ink spread at about halfway between **Default** and **Least**.
 - **Least:** This value imposes the most control on black ink spread.

Decreasing the **Black Ink Spread** will improve areas where black and color are adjacent if the black is spreading into the adjacent color.

Diagnose print quality problems using the Print Quality Page

Print and interpret the print quality page

1. Load the product with regular, unused white paper.
2. On the control panel, touch the [Setup](#) button.
3. Open the [Print Reports](#) menu.
4. Select the [print quality report](#) item to print it.

This page contains four bands of color, which are divided into the groups as indicated in the following illustration. By examining each group, you can isolate the problem to a particular ink cartridge.

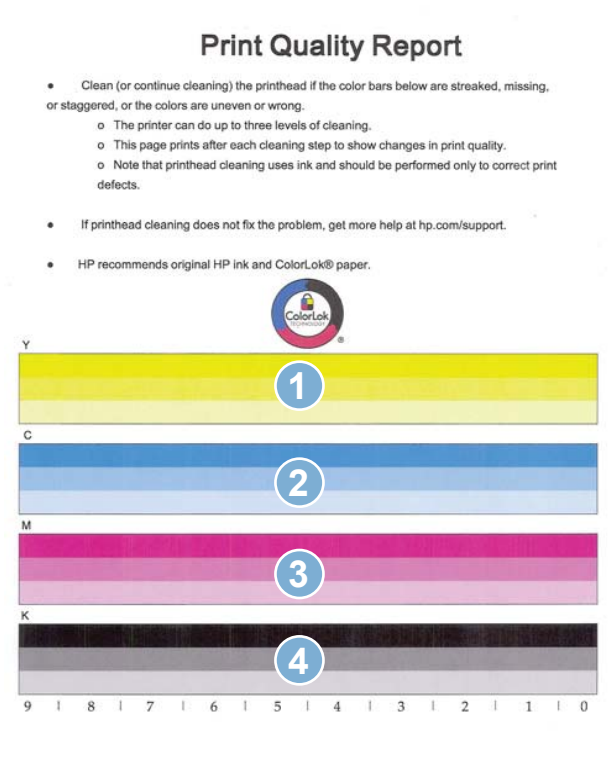



Table 2-5 Print Quality Page ink cartridge identification

Section	Ink cartridge
1	Yellow
2	Magenta
3	Cyan
4	Black

 **TIP:** Mark this page with a “1” in a corner. If you clean the printhead later, you will want to keep track of which page was printed first, in order to note any progress.

In general, if the ink system is working correctly, all the color bars are present and not streaked. Each bar has three distinct shades, but otherwise the color should not vary across the bar. The bars should also be evenly lined up. The black text on the page should not show ink streaks.

The following table shows some representative examples of defects on the print quality report.

Table 2-6 Print quality defect examples

Defect/action to take	Example
Color variation/ink mix across bar Clean the printhead on page 72	<div style="display: flex; flex-direction: column; gap: 5px;"> <div> <p>Black</p>  </div> <div> <p>Cyan</p>  </div> <div> <p>Magenta</p>  </div> <div> <p>Yellow</p>  </div> </div>
Color intensity/ink mix variation across bars Clean the printhead on page 72	<div style="display: flex; flex-direction: column; gap: 5px;"> <div> <p>Black</p>  </div> <div> <p>Cyan</p>  </div> <div> <p>Magenta</p>  </div> <div> <p>Yellow</p>  </div> </div>

Table 2-6 Print quality defect examples (continued)

Defect/action to take	Example
Uneven bars/die misalignment Clean the printhead on page 72	 <p>The example shows four color bars: Black, Cyan, Magenta, and Yellow. Each bar consists of multiple horizontal lines of varying shades. The edges of these lines are irregular and jagged, and the ink density is uneven across the width of each bar, with some areas appearing darker than others. This indicates a misalignment or a dirty printhead.</p>
Vertical dark lines Clean the printhead on page 72	 <p>The example shows four color bars: Black, Cyan, Magenta, and Yellow. Each bar consists of multiple horizontal lines of varying shades. There are distinct vertical dark lines running through each bar, indicating a dirty printhead.</p>

Table 2-6 Print quality defect examples (continued)





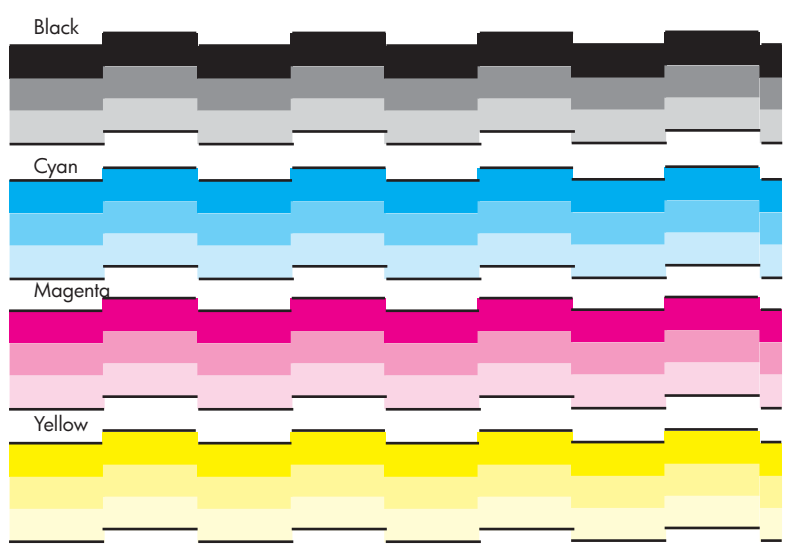
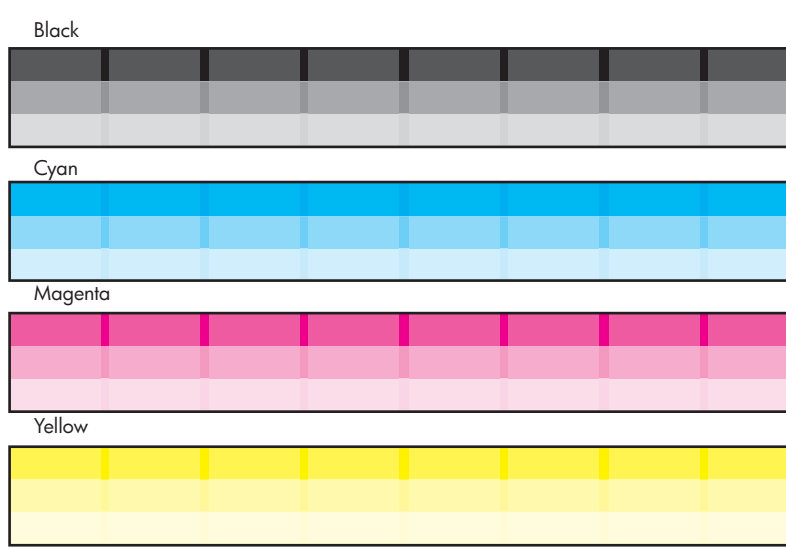

Defect/action to take	Example
Vertical white lines on all bars Clean the printhead on page 72	<div style="text-align: center;"> <p>Black</p>  </div> <div style="text-align: center;"> <p>Cyan</p>  </div> <div style="text-align: center;"> <p>Magenta</p>  </div> <div style="text-align: center;"> <p>Yellow</p>  </div>
Vertical white lines on select bars Clean the printhead on page 72	<div style="text-align: center;"> <p>Black</p>  </div> <div style="text-align: center;"> <p>Cyan</p>  </div> <div style="text-align: center;"> <p>Magenta</p>  </div> <div style="text-align: center;"> <p>Yellow</p>  </div>

Table 2-6 Print quality defect examples (continued)

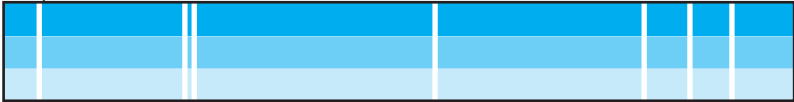

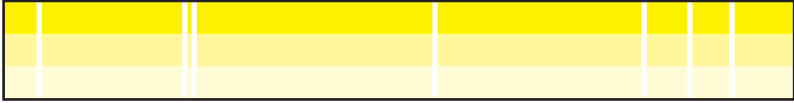



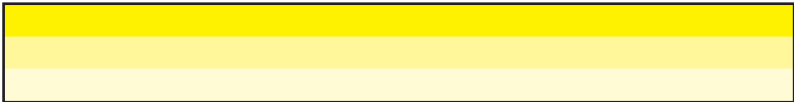

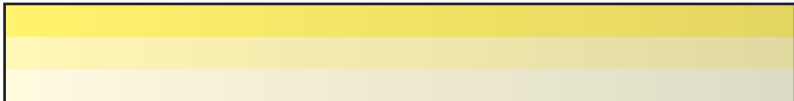

Defect/action to take	Example
Shade gradations not sharp Clean the printhead on page 72	<div style="display: flex; flex-direction: column; align-items: center;"> <div style="text-align: center; margin-bottom: 5px;">Black</div>  <div style="text-align: center; margin-bottom: 5px;">Cyan</div>  <div style="text-align: center; margin-bottom: 5px;">Magenta</div>  <div style="text-align: center; margin-bottom: 5px;">Yellow</div>  </div>
Nozzles out Clean the printhead on page 72	   
Deprime or starvation <ol style="list-style-type: none"> 1. Ensure that the ink cartridge has ink and is installed correctly. 2. Clean the printhead on page 72. If print quality improves after the first phase of printhead cleaning, continue to the second phase. If print quality does not improve after the first phase of printhead cleaning, service the product. 	<div style="display: flex; flex-direction: column; align-items: center;"> <div style="text-align: center; margin-bottom: 5px;">Black</div>  <div style="text-align: center; margin-bottom: 5px;">Cyan</div>  <div style="text-align: center; margin-bottom: 5px;">Magenta</div>  <div style="text-align: center; margin-bottom: 5px;">Yellow</div>  </div>

Table 2-6 Print quality defect examples (continued)

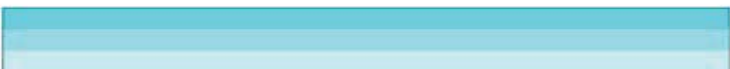
Defect/action to take	Example
<p>Page is blank or only partially printed</p> <p>Clean the printhead on page 72</p>	<p style="text-align: center;">Print Quality Printhead Cleaning Diagnostic</p> <p style="text-align: center;">XXXXXXXXXXXXXXXXXXXXXXXXXXXX</p> <p style="text-align: center;">XXXXXXXXXXXXXXXXXXXXXXXXXXXX</p> <p style="text-align: center;">XXXXXXXXXXXXXXXXXXXXXXXXXXXX XXXXXXXXXXXXXXXXXXXXXXXXXXXX</p> <p style="text-align: center;">XXXXXXXXXXXXXXXXXXXXXXXXXXXX</p> <p style="text-align: center;">XXXXXXXXXXXXXXXXXXXXXXXXXXXX</p> <p style="text-align: center;">XXXXXXXXXXXXXXXXXXXXXXXXXXXX</p> <p style="text-align: center;">1 2 3 4 5 6 7 8 9 10</p> <p style="text-align: center;">Black</p>  <p style="text-align: center;">1 2 3 4 5 6 7 8 9 10</p>

Scratches on the paper, especially thicker paper.

It will be very difficult to determine whether the white line is caused by printing issues or a scratch caused by a mechanical issue. For remote support, unless the customer is very sure they have a scratch (evidenced by physical damage to the media), then you should have them run through the pen cleaning procedure. If you are certain that is a mechanical issue, see [Service technician notes on page 78](#).

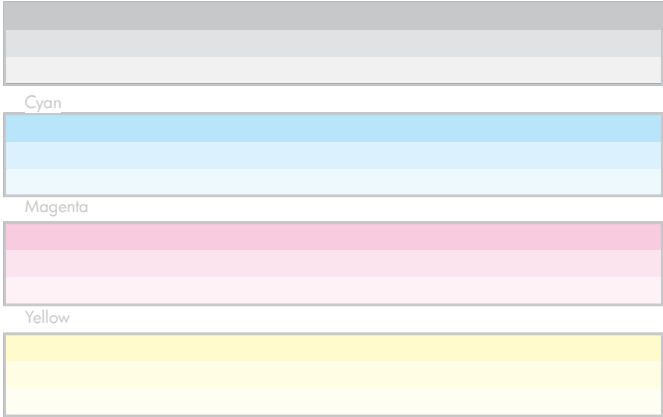
[Clean the printhead on page 72](#)

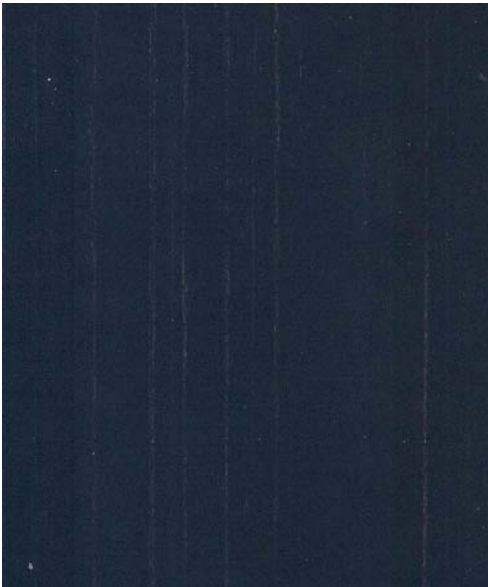

Solve print quality issues

Clean the printhead

If the print quality report shows defects like the ones listed in [Print and interpret the print quality page on page 66](#), clean the printhead.

The printhead cleaning process consists of three phases. After each phase completes, a Print Quality Diagnostics page is printed. The user is prompted to check the page, and continue onto the next section if the problem is not solved. The printhead cleaning process takes approximately 30 minutes to complete.

Printhead cleaning phases

Phase 1: Spit, BDD 1 calibration

Phase 2: Prime, Service, Wipe, BDD 2 calibration

Phase 3: Align and density calibration

If the printhead cleaning process is interrupted, for example by a power outage or an error condition, when the process is started again it will attempt to start where it was interrupted.

1. Load the product with regular, unused white paper.
2. On the control panel, touch the **Setup**  button.
3. Open the **Tools** menu.
4. Select the **Clean Printhead** item.

 **TIP:** Number each of the print quality pages so you don't lose track of the prints later.

5. If you finish the cleaning process and still see defects on the print quality report, retry cleaning, especially if you have seen improvement in the print quality reports.
6. If the print quality report still shows defects after a second cleaning, go to the next section to service the product.

If the defect on the print quality report is color variation across the bars (see [Print and interpret the print quality page on page 66](#)), and if the problem seems to go away after a cleaning, but then reoccurs in the same location on the color bar the next day, complete the following procedure:

1. Check to see if any of the following conditions are true:
 - Prior to the print quality problem, the product was unused for more than three weeks.
 - The product was recently moved or experienced a large temperature shift.
 - There was a recent paper jam.
 - The print quality problem seems to be getting better as the product is used (especially if print jobs with dense backgrounds are printed).

If any of these conditions exist, instruct and assist the customer in performing a printhead recovery. See [Printhead recovery on page 74](#).

2. If none of the conditions above are true, the color problem is likely to reoccur, even if a cleaning fixes it temporarily.

If the print quality report has no defects, then the ink system is working correctly. There is no reason to clean the printhead, which unnecessarily wastes ink and paper. Complete the following steps:

1. Retry the original print job. Just printing the print quality report can solve some problems. If the print job meets print quality standards, stop troubleshooting here.
2. If problems still exist on print jobs, review the earlier steps in this document: make sure that the ink and paper are appropriate, and that the print settings are correct. In addition, these suggestions might help with some problems:
 - If you are printing an image, make sure it has sufficient resolution. Images that have been enlarged too much might appear fuzzy or blurry.
 - If the problem is confined to a band near the edge of a printout, use the software you installed with the product or another software program to rotate the image 180°. The problem might not appear on the other end of the printout.
 - Always use the power button to turn the product off. This protects the printhead from exposure to air.
 - If all colors are experiencing poor print quality, there might be an issue with the Web wipe not advancing. Open the left door, and then mark the edge of the Web wipe above the duplex module.

Figure 2-8 Mark the Web wipe

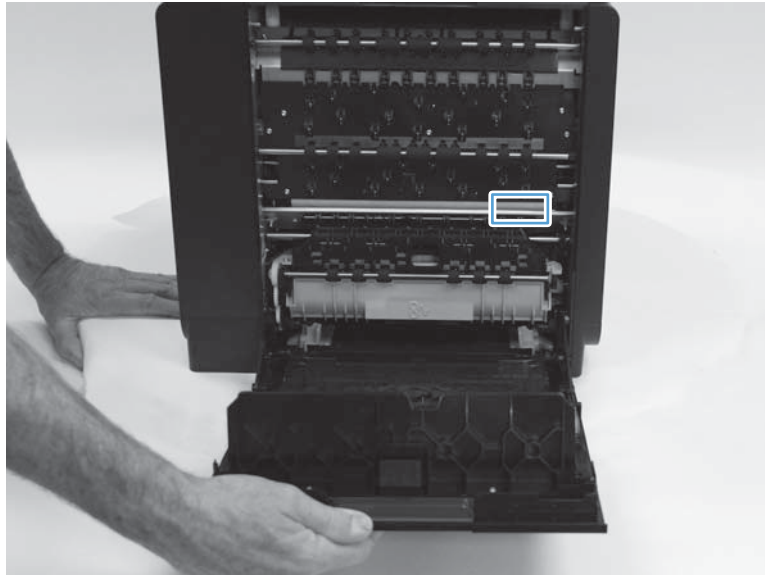

Run the product so that it performs a wipe, and then see if the Web has advanced. If it has not, replace the Web wipe/service sled assembly using the service sled kit (part number CN598-67021).

3. If the problem persists, contact HP to service the product.

Clean ink smears

Print a cleaning page to remove dust and excess ink from the printhead and paper path if you are having any of the following problems:

- Specks of ink are on the printed pages.
- Ink is smearing on the printed pages.
- Repeated marks occur on the printed pages.

Use the following procedure to clean ink smears.

1. Load the product with regular, unused white paper.
2. From the control panel, touch the **Setup**  button.
3. Open the **Tools** menu.
4. Select the **Clean Ink Smear** item.
5. Touch the **OK** button to begin the cleaning process.

A page feeds through the product slowly. Retain this page for further print quality evaluation.

If the print jobs are showing ink smears on the back of the page, try the following solutions:

- Remove the duplex module and then reinstall it. Black ink can build up on the duplex module on products that have been used heavily (over 100,000 pages of printed output).
- The platen might have an ink buildup. Run a few sheets of blank (no text/graphics) thick paper through the product to clean the platen.
- Check the ink service station level:
 1. Open the **Support Menu** by pressing the **Back**  button four consecutive times.
 2. Scroll to the **System Configuration Menu**.
 3. Select **Service ink container** or **Duplex module**.
 4. Select **View current status**.
- If the error persists, service the product.

Printhead recovery

Use the printhead recovery procedure if a color mix issue reappears after printhead cleaning, but one of the following is true:

- Prior to the print quality problem, the product was unused for more than three weeks.
- The product was recently moved or experienced a large temperature shift.
- There was a recent paper jam.
- The print quality problem seems to be getting better as the product is used (especially if prints with dense backgrounds are printed).

 **IMPORTANT:** Never perform the printhead recovery procedure more than two times in one day. Excessive printhead recovery wastes ink and can result in ink leaks.

1. From the Home menu, touch the Back ↵ button four times consecutively.
2. Select [Support Menu](#).
3. Open the [Printhead Diagnostic Menu](#), and then select [Printhead Recover](#).

-or-

Open the [Reports](#) menu, select [Print Mech Button Tap](#), and then select **23** to perform a 23 Tap test. A printhead recovery is performed as part of the 23 Tap test.

4. Touch the [OK](#) button.

Advanced cleaning

If white lines still appear in printed output after the printhead and ink smears have been cleaned, the cause of the white lines could be a shim whisker. This issue typically appears with products with high page counts that operate in dirty environments.

A shim whisker is a piece of fiber (such as carpet fiber or hair) adhering to either the printhead or to the shims underneath the printhead. On denser images, it can also result in ink drips/smearing on the page.

If shim whiskers are suspected, ship the customer an Advanced Cleaning Kit (part number CN459-67006).

Use the Advanced Cleaning Kit

1. From the [Setup](#) menu, select [Tools](#), and then select [Advanced Cleaning](#).
2. Load the foam-backed sheet included in the Advanced Cleaning Kit into the product, and then touch [OK](#). The foam-backed sheet feeds through the product slowly, about two inches per second.

 **NOTE:** The cleaning sheet must be run through the product with the correct orientation. The foam pad should be closer to the left side of the paper tray. If the cleaning sheet is run through with the wrong orientation, it will still work, but there is the possibility of the user experiencing an output paper jam.

 **NOTE:** The foam-backed sheet might need to be run through the product more than once to remove the fiber.

 **NOTE:** Vertical lines in the printed output can have other causes besides shim whiskers. Use of the Advanced Cleaning Kit is normally the last step before servicing the product to solve this issue.

Other Support Menu print quality procedures

 **NOTE:** These procedures are normally used by service technicians.

Solve “ghosting” print quality issues

1. From the Home menu, touch the Back ↵ button four times consecutively.
2. Select [Support Menu](#).
3. Open the [Reports Menu](#).
4. Select [Print-mech button test](#).
5. Select [22](#), and then touch the [OK](#) button.

Solve incomplete alignment issues

Print a printer status page. The results of these calibrations is listed in row 69 of the printer status page. If the number of successful calibrations is zero, or if you think that the last calibration effort failed, then run the pen alignment calibration and/or the printhead die density calibration using the following steps.



NOTE: These calibrations are also implicitly called in the clean printhead tool, and this would be the way a customer would invoke calibrations. This method would typically only be used for service tech test/troubleshooting.

1. From the Home menu, touch the Back ↵ button four times consecutively.
2. Select [Support Menu](#).
3. Open the [Printhead Diagnostic Menu](#), and then select [Printhead Calibration](#).
4. Select either [Pen Alignment Calibration](#) or [Printhead die density calibration](#).

Inspect the ink cartridge for damage

Ink cartridges should be cleaned and inspected for damage if any of the following control-panel messages appear:

- **Ink Cartridge failure**
- **Problem with SETUP cartridges**
- **Ink Cartridge problem**

If cleaning the ink cartridges does not clear the error message, use the following steps to inspect the ink cartridge for damage:

1. Remove the ink cartridge from the product, and verify that there is no debris in the cartridge path.

2. Examine the metal connector of the ink cartridge.

CAUTION: Do not touch the metal connector on the edge of the cartridge. Fingerprints on the metal connector can cause print-quality problems.



3. If you see any scratches or other damage on the metal connector, replace the ink cartridge.
4. If the metal connector does not appear to be damaged, push the cartridge gently back into its slot until it locks in place. Print a few pages to see if the problem has resolved.

NOTE: If any of these control-panel messages appear while the product is being installed, and the product initialization hasn't completed, then the setup cartridge must be replaced with another setup cartridge. If the customer cannot wait for a new setup cartridge to be delivered, it is possible to override the use of setup cartridges, and use trade cartridges. In this case, you must use full XL cartridges. Use the following steps to override the use of setup cartridges.

Override the use of setup cartridges

1. Open the [Support](#) menu.
2. Select [System Config](#), and then select [Trade at OOB](#).
3. Ensure that all doors and trays are closed.
4. Unplug the product, wait 30 seconds, and then plug the product back in.
5. If trade supplies are being used with an override to initialize, replace any cartridges that feel light or might be empty.

-or-

Touch [OK](#) when the **Startup Routine Ink Alert** message appears.

-or-

If a **Depleted** or **Printer Failure** message appears, replace with new setup cartridges, or override to startup with (different) trade cartridges.

6. If message reappears, service the product.



NOTE: If the message clears and the product successfully initializes, the cartridge might show low on ink.

Service technician notes

If the customer cannot solve the print-quality issue through any of the tools and procedures available to them, then the product must be serviced.

- In some cases, maintenance ink can persist through cleaning efforts. Check that the problems aren't being caused by ink somewhere in the system.
- It's also possible that some print-quality issues can be caused by a jammed starwheel. This will typically look like a narrow white line down the page. If the customer continues to experience a white vertical line, then the problem could be caused either by a stuck starwheel, or a piece of debris stuck somewhere along the paper path. The horizontal location of the issue can be determined by the location of the line on the page. In any case, inspect the whole paper path. Note that if this line only appears on one page of a duplexed output, then the stuck starwheel/debris is likely on the duplex module.
- If all troubleshooting tools and procedures fail, replace the printbar.
- When replacing the printbar, check the condition of the service sled. HP recommends that the service sled be replaced on products that have printed more than 30,000 pages.

Solve paper handling problems

- [Paper handling troubleshooting flowchart](#)
- [Paper pickup issues](#)
- [Clear jams](#)

Paper handling troubleshooting flowchart

1	<p>Is the paper installed correctly?</p>	<p>Paper tray guides must be set correctly, supported paper sizes must be used, must using good quality paper—HP ColorLok is recommended.</p>	<p>See the <i>HP OFFICEJET PRO X451 AND X551 MFP SERIES</i> user guide for more information.</p>
	Yes ↓	No →	
2	<p>Does product fail to pick up paper, or pick multiple sheets?</p>	<p>No ↓</p>	<p>Yes →</p> <p>See or The product picks up multiple sheets of paper on page 80.</p>
3	<p>Is the product experiencing paper jams?</p>	<p>Is paper jammed in any of the input or output areas, print zone, or other location in the print path?</p>	<p>See Clear jams on page 86.</p> <p>NOTE: For information on preventing paper jams, see Prevent paper jams on page 86.</p>
	No ↓	Yes →	
4	<p>Other paper handling problems</p>	<ul style="list-style-type: none"> • Trays 2 or 3 report being empty when they have paper loaded—see The product states that a paper tray is empty, even though it has paper on page 81. • Frequent paper jams—see Frequent jams in the paper path on page 83. • Abnormal noises when feeding paper—see The product makes grinding noises when feeding paper on page 81. • The output motor stalls—see Output motor stall on page 84. • The output flap doesn't retract and nothing is blocking it—see Output flap won't retract - no obstacle to prevent it on page 84. 	

Paper pickup issues

Resolve paper pickup issues

The product does not pick up paper

If the product does not pick up paper from the tray, try these solutions.

1. Open the product and remove any jammed sheets of paper.
2. Load the tray with the correct size of paper for your job.
3. Make sure that the paper guides in the tray are adjusted correctly for the size of paper. Align the guides with the paper-size markings in the bottom of the tray.
4. Remove the stack of paper from the tray and **flex it**, rotate it 180 degrees, and flip it over. *Do not fan the paper.* Return the stack of paper to the tray.
5. Check the product control panel to see if the product is waiting for you to acknowledge a prompt to feed the paper manually through Tray 1, the multi-purpose tray on the left side of the product. Load paper, and continue.

Onsite solutions

On products that have seen a lot of use, the pick tire/separator pad might be worn. Replace the pick tire/separator pad if they are worn.

Verify that the pick shaft rotates. If the pick shaft does not rotate, check the pick motor connectors to verify they are connected securely and undamaged. Verify that the transmission operates correctly.

The product picks up multiple sheets of paper

If the product picks up multiple sheets of paper from the tray, try these solutions.

1. Remove the stack of paper from the tray and **flex it**, rotate it 180 degrees, and flip it over. *Do not fan the paper.* Return the stack of paper to the tray.
2. Use only paper that meets HP specifications for this product.
3. Use paper that is not wrinkled, folded, or damaged. If necessary, use paper from a different package. Make sure all paper in the tray is the same type and size.
4. Make sure that the tray is not overfilled. If it is, remove the entire stack of paper from the tray, straighten the stack, and then return less paper to the tray.
5. Make sure that the paper guides in the tray are adjusted correctly for the size of paper. Align the guides with the paper-size markings in the bottom of the tray.

Onsite solution

Replace the pick tire/separator pad.

The product states that a paper tray is empty, even though it has paper

1. Ensure that there is paper in the tray, and that the tray is adjusted correctly.
2. Verify that the correct tray is being selected.

Onsite solutions

Ensure that the tray lift mechanism on the tray is working. Remove the tray from the product. Remove the paper from the tray. Push the ratchet mechanism on the back of the tray. If the metal base of the tray lifts up, check the following:

- Check the media presence sensor flag. If the media presence sensor flag is broken or does not move freely, replace it.
- Determine if the tray lift mechanism is functioning by removing the rear cover and observing the tray while it operates. Verify that the return spring is in place, and then push the ratchet mechanism to the left. The ratchet mechanism should operate smoothly and the metal floor in the tray should rise when the ratchet is pushed. Replace the tray lift mechanism if it is defective.

Figure 2-9 Tray lift mechanism

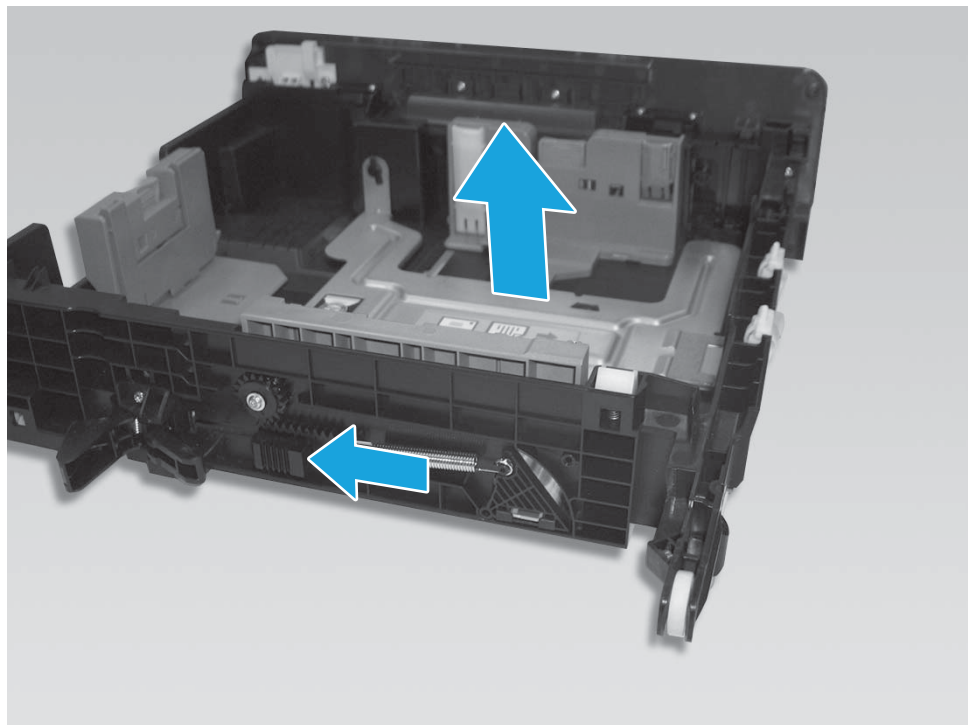

- If metal base of the tray does not lift up, then replace the tray.

The product makes grinding noises when feeding paper

If the product makes grinding noises when trying to feed paper, there might be an obstruction in the paper path or a REDI sensor might be defective. Have the customer feed a sheet of stiff paper into

the product to try to dislodge the paper path obstruction. A paper scrap might be lodged in the paper path.

Onsite solutions

If the product makes grinding noises when feeding paper, and there are no obstructions in the paper path, verify that the service sled transmission is in the correct position.

If the service sled transmission is in the correct position, check the REDI sensors. Use an IR sensitive camera (most cell phone cameras work) to determine if all the REDI sensors are operational. You can also determine where a failed REDI sensor might be by how far the paper gets through the paper path before a jam is signaled. The TOF REDI and Print zone REDI are contained on the platen. The platen is field replaceable. The Lower paper path, upper paper path and Eject REDIs are all field replaceable.

If there is a sheet of paper at feed roller and the product sounds like it keeps trying to repick the sheet, then lifts the tray, then tries to pick the paper again several times:

- There might be a calibration issue with the TOF REDI (TOF sensor). Recalibrate the REDI sensor through the [Support](#) menu. See [Access the Support Menu on page 31](#) for information on accessing the [Support Menu](#).
- Verify that the print zone distribution cable (cable 17) is plugged in correctly to J26 on main PCA and is not shorting.
- Verify that there is no damage to the cables.

General paper jams issues (onsite solutions)

Onsite solutions

Ensure that the FFCs for the Lower paper path, upper paper path, and eject REDI sensors are undamaged and securely connected. If any of these REDI sensors are defective, replace them.

If the product states that there is a paper jam, but the paper is undamaged, then it is most likely a REDI sensor, motor, or feed encoder issue. The location of the suspect REDI can be determined approximately by how far the paper moved through the paper path. See [Figure 1-6 Product sensors on page 16](#) for REDI locations and naming.

Recalibrate the REDI sensors.

Verify that the feed motor/encoder is not defective.

Verify that the FFCs at the feedshaft encoder PCA/print zone distribution PCA are undamaged and securely connected.

Verify that the motor connections on the main PCA (J5) are undamaged and securely connected. Replace the feedshaft encoder PCA. The feed motor is not replaceable.

Output tray jam errors (onsite solutions)

Onsite solutions

Ensure that the output flap sensor tab is not broken. If the output flap sensor tab is broken, install a new output flap.

Ensure that the output flap sensor FFC is undamaged and securely connected.

Verify that the output flap sensor is not damaged. Replace the sensor/flap if the output flap sensor is damaged.

Frequent jams in the paper path



Onsite solutions

Make sure that there are no star-wheels missing or damaged. Check components such as the duplex module to verify that the star-wheels are intact and working properly. If a star-wheel is seized, free it. Otherwise, replace the assembly on which the star-wheels are located.

Print zone jams

If paper was torn while clearing a print zone jam but the product still reports a jam in the print zone, there might be scraps of paper obstructing the print zone. Verify that the TOF void area is clear of any scraps of paper by running a heavy sheet of paper through it (sometimes referred to as the “snowplow” method):

Clear the TOF area of paper scraps

1. Touch the Home  button.
2. Touch the Back  button four times.
3. Select [Support Menu](#).
4. Scroll to [Print Diagnostics Menu](#), and then touch the **OK** button.
5. Select [Clear paper jams](#).
6. Load a sheet of paper into tray 1 when the control-panel message prompts you, and then touch the **OK** button.
7. After the paper feeds through the product the jam recovery process is complete. Press the **Cancel**  button until you return to the Home screen.

Onsite solutions

Clear the TOF area of paper scraps using the steps in [Clear the TOF area of paper scraps on page 83](#) and then follow these steps:

- a. Recalibrate the TOF sensor emitter from the [Service Menu](#).
- b. Inspect the contacts for damage on J26 on main PCA where FFC, 11 pin print zone cable plugs in. Ensure that the FFC is securely attached. Damaged contacts on the connector or improper insertion of the FFC could cause shorting.
- c. Replace the TOF sensor if it is defective.
- d. Replace any damaged cables that might be shorting to metal.

- e. Inspect the print zone distribution PCA solder ball for signs of shorting. Replace the print zone distribution PCA (CN459-60083) if it is defective.
- f. If the main PCA connector is defective, or the main PCA has a defective component, replace the main PCA.



NOTE: Problems with the main PCA connector or components are unlikely.

If paper will not feed into the product, the TOF REDI sensor might be defective or disconnected.

If paper feeds into the print zone and a jam message is displayed, but there is no damage to the paper or signs of an actual jam, then the either TOF REDI or Print Zone REDI sensor might be faulty.

If the problem only occurs during duplex printing, then the Lower paper path REDI and the Upper paper path REDI sensors might be defective.

The output drive train could be worn or broken if the product has been in use for a long time.

Ensure that the TOF and Print zone REDI sensor FFCs on the print zone distribution PCA are undamaged and securely connected. These FFCs are located second from the front – one FFC is white, the other is black.

If either the TOF or Print zone REDIs are faulty, we recommend that you replace the platen, rather than the individual REDI sensors.

Check the output drive train (gear train in front of the cube) gear(s). If the gears are worn, replace them using the output drive kit.

Output motor stall

Clear any paper that might be blocking the output area.

Onsite solutions

Verify that there is no debris blocking the eject gear module/eject flap actuator.

If the output flap opens, then the encoder disc could be faulty. Replace the output drive system.

If the flap doesn't open, then the motor could be faulty. Replace the output drive system.

In very rare cases, the main PCA could be defective.

Output flap won't retract - no obstacle to prevent it

Turn the product off, then on.

Onsite solutions

Verify that the output solenoid is not defective and the solenoid cable is undamaged and securely connected.

Verify that the output flap actuator is not defective.

Verify that the output assembly is not defective. Replace the output assembly if it is defective.

Clear jams

Resolve paper jam issues

Prevent paper jams

To reduce the number of paper jams, try these solutions.

1. Use only paper that meets HP specifications for this product. Light-weight, short grain paper is not recommended for use in this product.
2. Use paper that is not wrinkled, folded, or damaged. If necessary, use paper from a different package.
3. Use paper that has not previously been printed or copied on.
4. Make sure the tray is not overfilled. If it is, remove the entire stack of paper from the tray, straighten the stack, and then return some of the paper to the tray.
5. Make sure the paper guides in the tray are adjusted correctly for the size of paper. Adjust the guides so they are touching the paper stack without bending it.
6. Make sure that the tray is fully inserted in the product.
7. If you are printing on heavy, embossed, or perforated paper, use Tray 1, the multi-purpose tray on the left side of the printer, and then feed sheets manually one at a time.

Jam locations

Jams can occur in these locations:

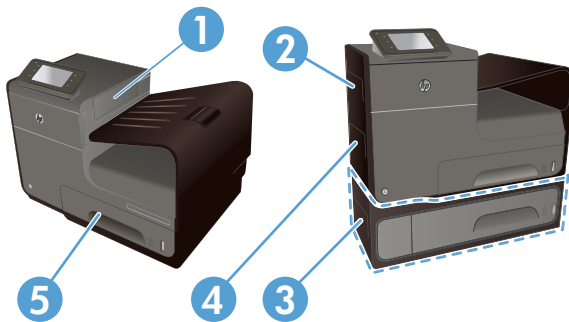

1	Output bin
2	Left door
3	Optional Tray 3 and left jam-access door
4	Tray 1
5	Tray 2

Traces of ink might remain in the product after a jam. This problem typically resolves itself after a few sheets have been printed.

Clear jams in Tray 1 (multi-purpose tray)

1. If the jammed sheet is visible and easily accessible in Tray 1, pull it from Tray 1.

NOTE: If the sheet tears, make sure that all of the fragments are removed before you resume printing.

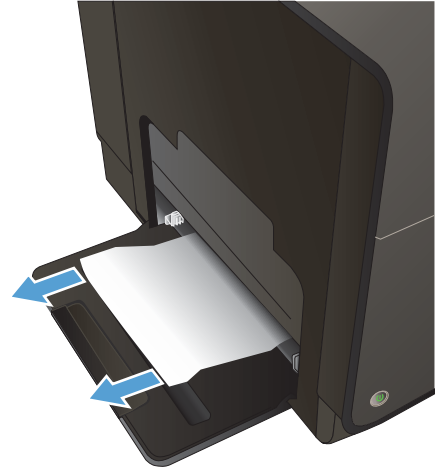

2. If the jammed sheet is not visible or easily accessible in Tray 1, open the left door to access the jammed sheet.

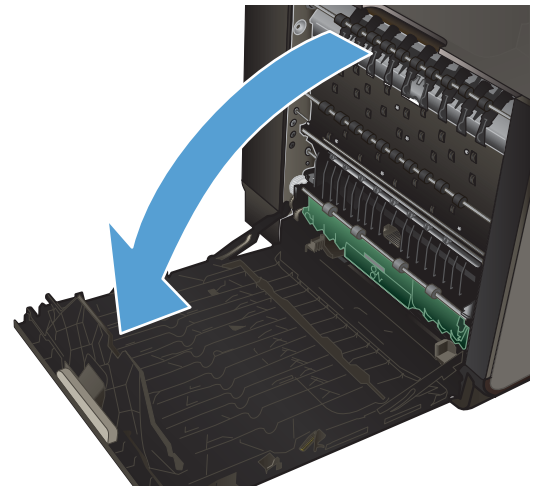

3. If the paper is still not visible or accessible, remove the duplexer by pulling it out with both hands. Set the duplexer aside, upright, on a piece of paper to prevent ink spills.

CAUTION: When pulling out the duplexer, avoid making direct contact with the black cylinder to prevent ink smear on skin or clothes.

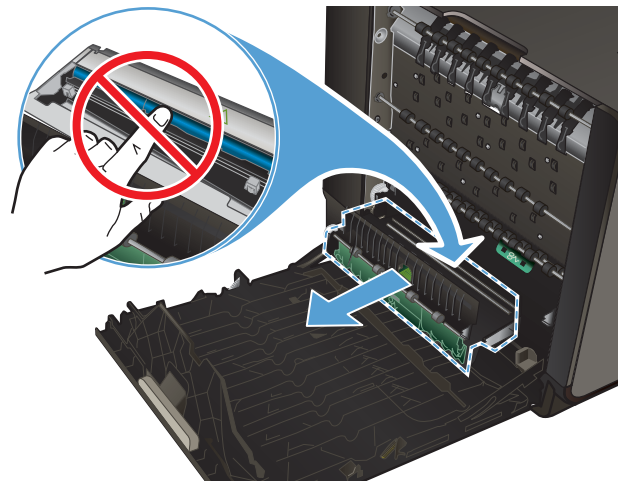

4. Lower the platen by pressing down on the green tab. This will cause the product to try to feed the sheet through the print zone. You might need to gently pull on the sheet if it does not feed. Remove the sheet.

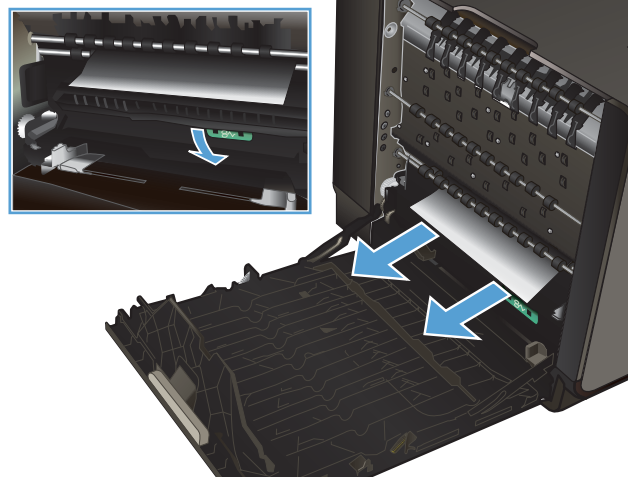

5. Lift the green tab to place the platen back into its operating position.

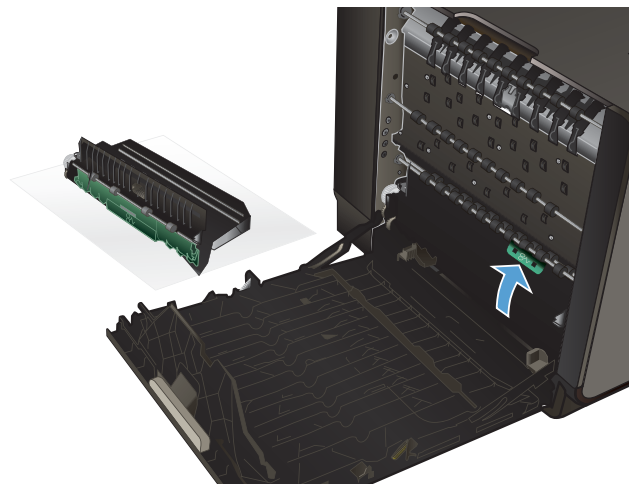

6. Reinstall the duplexer.

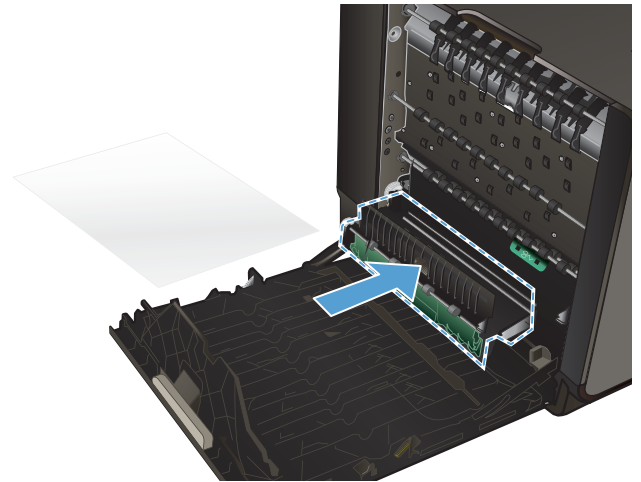

7. Close the left door.

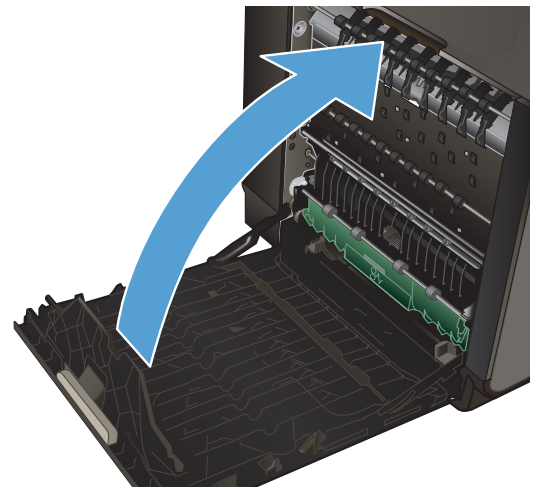

Clear jams in Tray 2

1. Open Tray 2 by pulling it out and releasing the latch at the rear left of the tray.

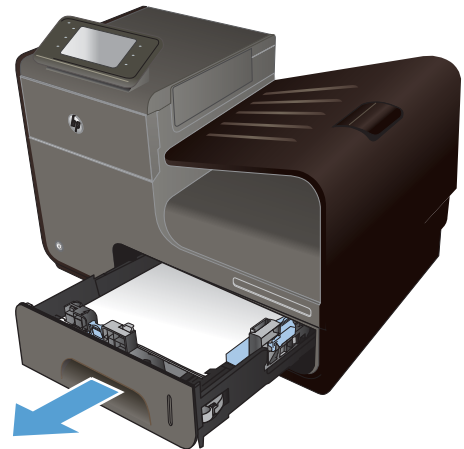

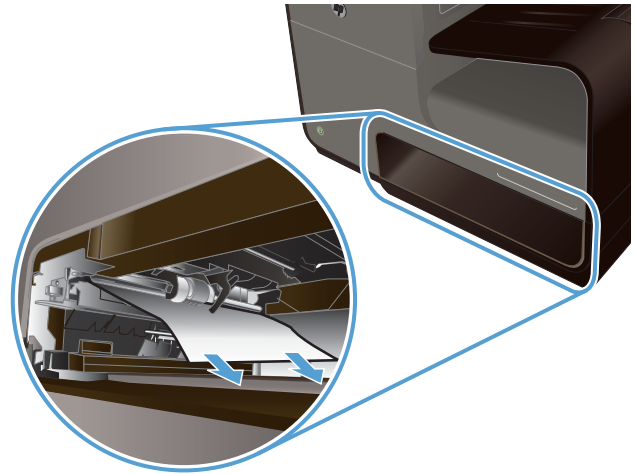

2. Remove the jammed sheet by pulling it to the right and then out of the product.

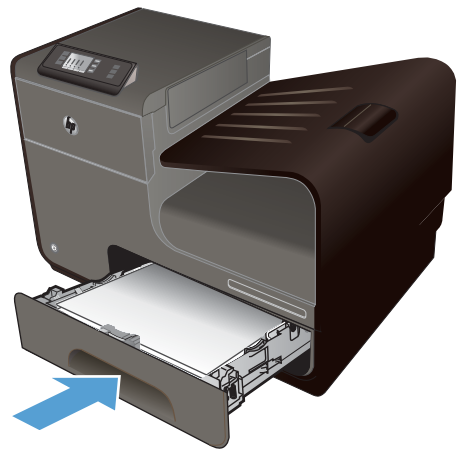

3. Close Tray 2.

NOTE: To close the tray, push in the middle or with even pressure on both sides. Avoid pushing on one side only.



 **NOTE:** If there is no paper in Tray 2, but the product continues to attempt to pick paper, then eventually gives a paper jam in Tray 2 error, check the media presence flag opto sensor. The sensor could be faulty, or the FFC disconnected or defective. If the FFC is not disconnected or defective, replace the media presence flag opto sensor.

Clear jams in optional Tray 3

1. Open Tray 3.

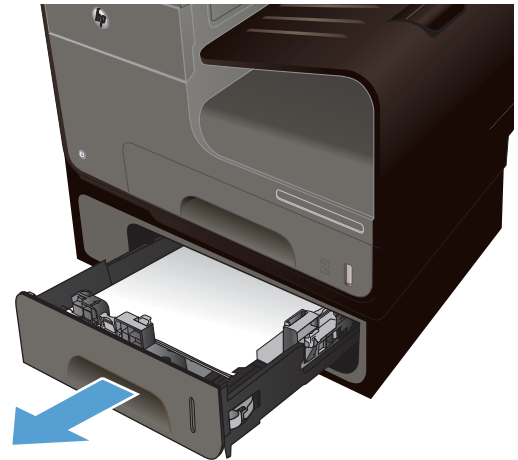

2. Remove the jammed sheet by pulling it to the right and then out of the product.

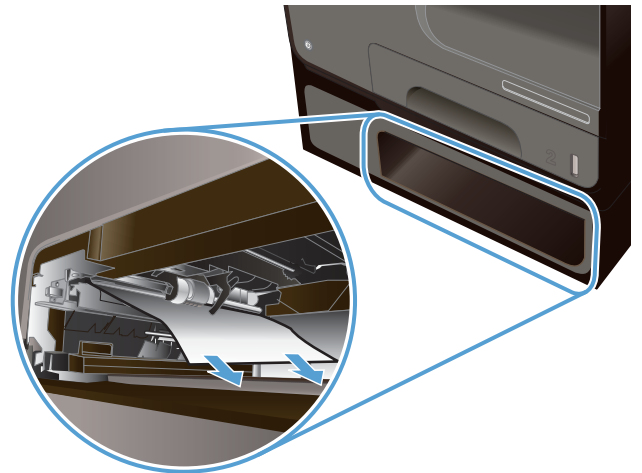

3. If the jam cannot be cleared at the tray, try clearing the jam from the Tray 3 left door.

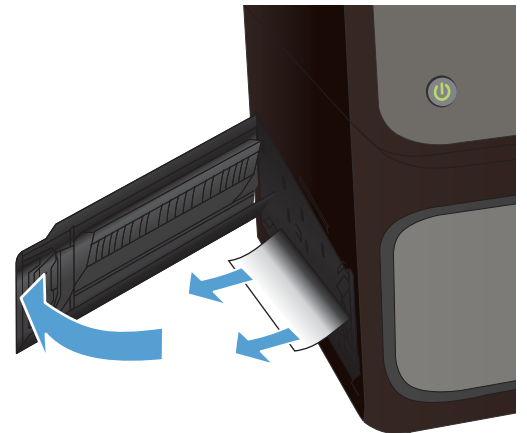

4. Close Tray 3.

NOTE: To close the tray, push in the middle or with even pressure on both sides. Avoid pushing on one side only.

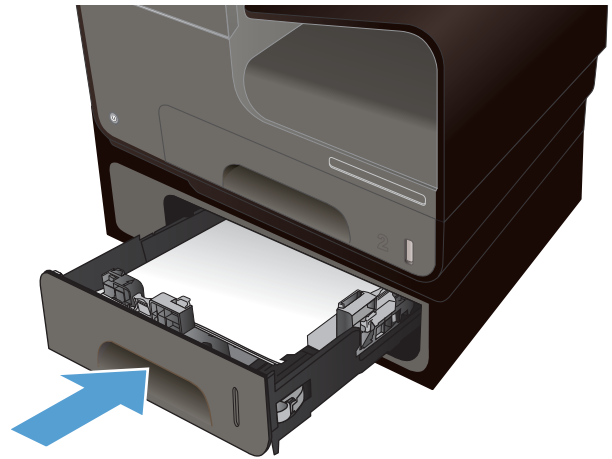

5. If the paper jams issue cannot be solved, replace Tray 3. This is a CSR part, CN598-65003.

Clear jams in the left door

1. Open the left door.

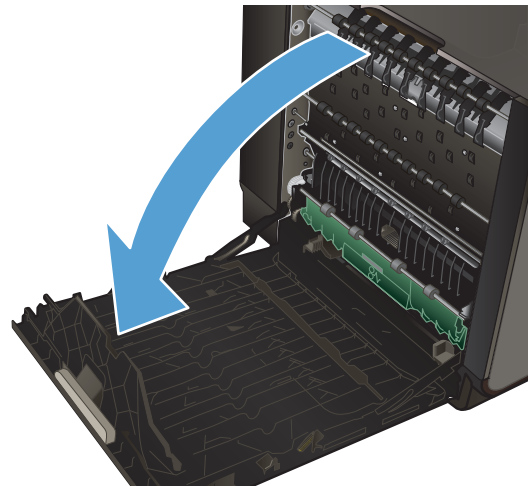

2. Gently remove any visible paper from the rollers and delivery area.

NOTE: If the sheet tears, make sure that all fragments are removed before you resume printing. Do not use sharp objects to remove fragments.

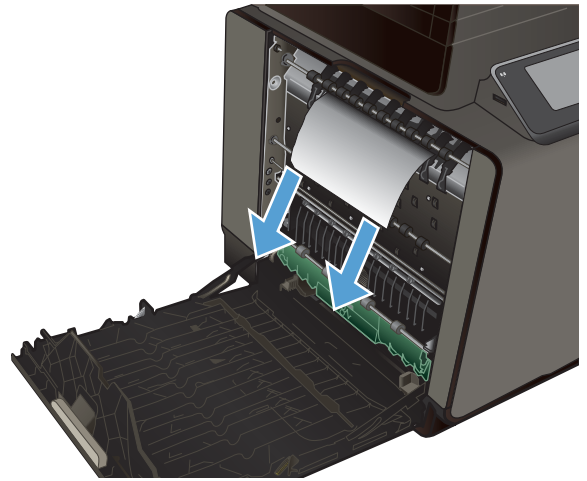

3. Close the left door.

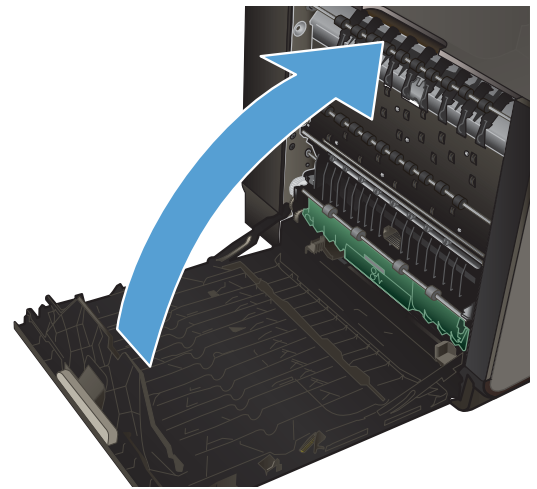

Clear jams in the output bin

 **NOTE:** Make sure that the output eject flap is installed and working correctly. If it is missing or broken, replace the flap.

1. Look for jammed paper in the output bin area.
2. Remove any visible media.

NOTE: If the sheet tears, make sure that all fragments are removed before resuming printing.



3. Open and then close the left door to clear the message.

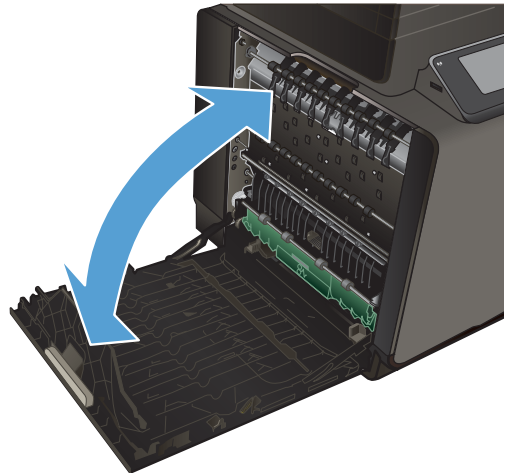

Clear jams in the duplexer

1. Open the left door.

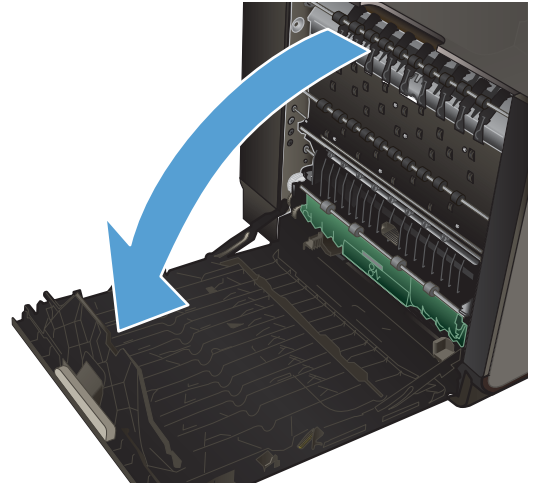

2. If you can see the trailing edge of the sheet, remove the sheet from the product.

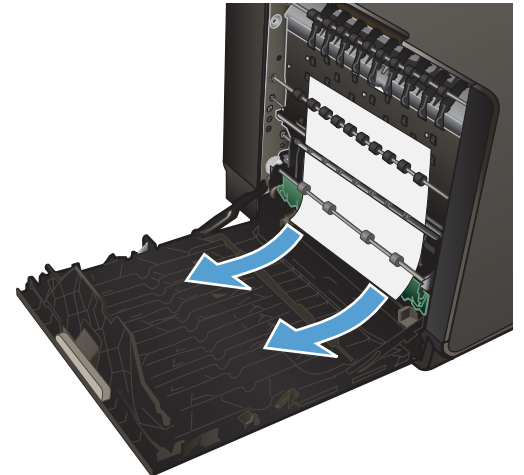

3. If the paper is not visible or accessible, remove the duplexer by pulling it out with both hands. Set the duplexer aside, upright, on a piece of paper to prevent ink spills.

CAUTION: When pulling out the duplexer, avoid making direct contact with the black cylinder to prevent ink smear on skin or clothes.

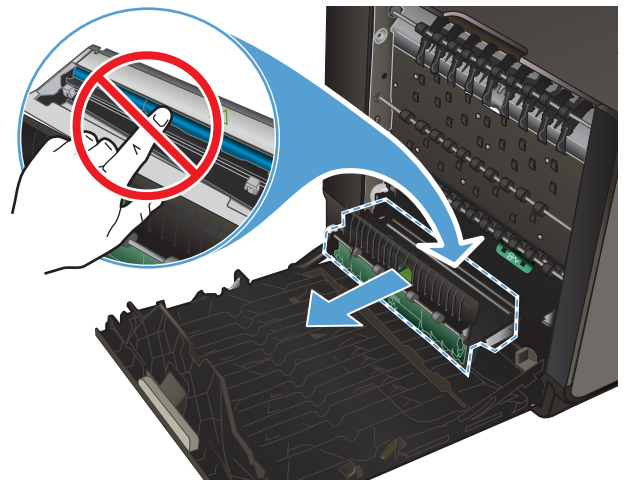

4. Lower the platen by pressing down on the green tab. This will cause the product to try to feed the sheet through the print zone. You might need to gently pull on the sheet if it does not feed. Remove the sheet.

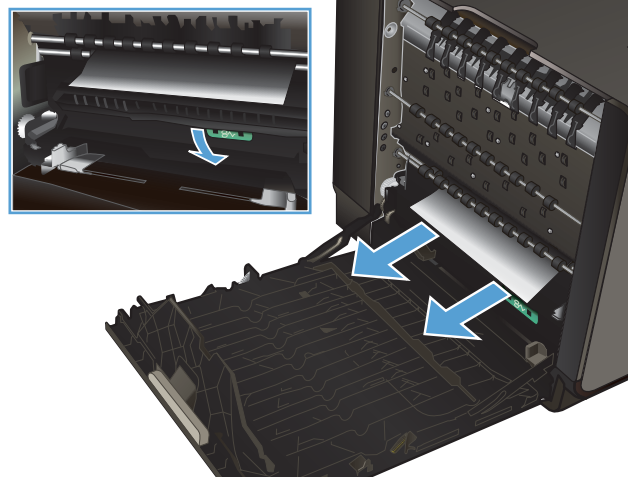

5. Lift the green tab to place the platen back into its operating position.

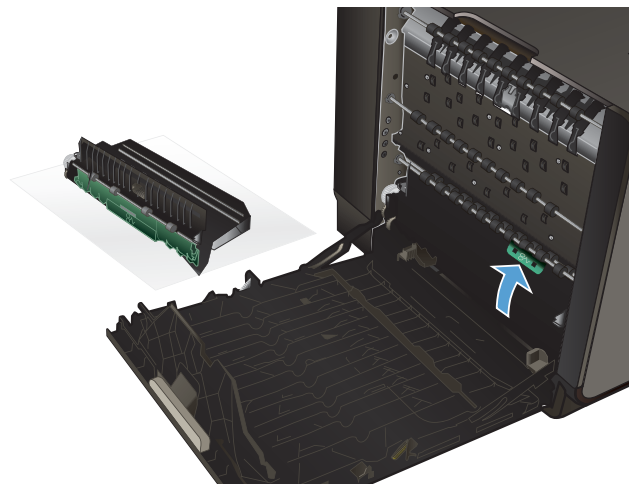

6. Reinstall the duplexer.

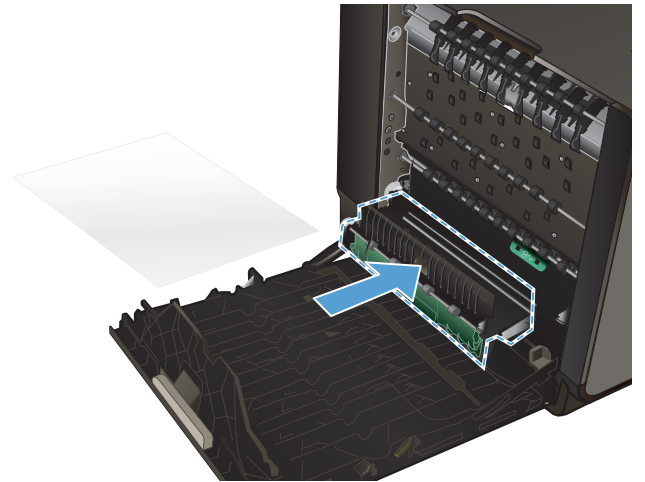

7. Close the left door.

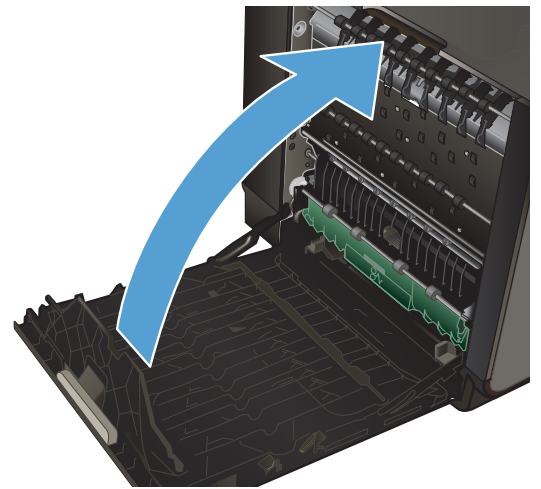

Solve product connectivity problems

Solve USB direct-connect problems

If you have connected the product directly to a computer, check the USB cable.

- Verify that the cable is connected to the computer and to the product.
- Verify that the cable is not longer than 5 m (16.4 ft). Try using a shorter cable.
- Verify that the cable is working correctly by connecting it with another product. Replace the cable if necessary.

Solve network problems

Check the following items to verify that the product is communicating with the network. Before beginning, print a configuration page from the product control panel and locate the product IP address that is listed on this page.

- [Poor physical connection](#)
- [The computer is using the incorrect IP address for the product](#)
- [The computer is unable to communicate with the product](#)
- [The product is using incorrect link and duplex settings for the network](#)
- [New software programs might be causing compatibility problems](#)
- [The computer or workstation might be set up incorrectly](#)
- [The product is disabled, or other network settings are incorrect](#)

Poor physical connection

1. Verify that the product is attached to the correct ethernet port using the proper cable.
2. Verify that cable connections are securely attached.
3. Look at the ethernet port on the back of the product, and verify that the amber activity light and the green link-status light are active.
4. If the problem continues, try a different cable or port on the network router, switch, or hub.

The computer is using the incorrect IP address for the product

1. On the computer, open the product properties and click the **Ports** tab. Verify that the current IP address for the product is selected. The product IP address is listed on the product configuration page or through the control panel.
2. If you installed the product using an HP standard TCP/IP port, select the box labeled **Always print to this printer, even if its IP address changes**.

3. If you installed the product using a Microsoft standard TCP/IP port, use the hostname instead of the IP address.

If you installed the product using the CD installer, or downloaded the fully-featured installer from the HP Web site, you can view or change the product IP address using the following steps:

- a. Click **Start**.
 - b. Click **All Programs**.
 - c. Click **HP**.
 - d. Click your product.
 - e. Click **Update IP Address** to open a utility that reports the known (“previous”) IP address for the product and allows you to change the IP address, if necessary.
4. If the IP address is correct, delete the product entry from the list of installed s, and then add it again.

The computer is unable to communicate with the product

1. Test network communication by pinging the product.
 - a. Open a command-line prompt on your computer. For Windows, click **Start**, click **Run**, and then type `cmd`.
 - b. Type `ping` followed by the IP address for your product.
 - c. If the window displays round-trip times, both the network and device are working.
2. If the ping command failed, verify that the network router, hubs, or switches are on, and then verify that the network settings, the product, and the computer are all configured for the same network.

The product is using incorrect link and duplex settings for the network

Hewlett-Packard recommends leaving this setting in automatic mode (the default setting). If you change these settings, you must also change them for your network.

New software programs might be causing compatibility problems

Verify that any new software programs are correctly installed and that they use the correct print driver.

The computer or workstation might be set up incorrectly

1. Check the network drivers, print drivers, and the network redirection.
2. Verify that the operating system is configured correctly.

The product is disabled, or other network settings are incorrect

1. Review the configuration page to check the status of the network protocol. Enable it if necessary.
2. Reconfigure the network settings if necessary.

Solve wireless network problems

- [Wireless connectivity checklist](#)
- [The control panel displays the message: The wireless feature on this product has been turned off](#)
- [The product does not print after the wireless configuration completes](#)
- [The product does not print, and the computer has a third-party firewall installed](#)
- [The wireless connection does not work after moving the wireless router or product](#)
- [Cannot connect more computers to the wireless product](#)
- [The wireless product loses communication when connected to a VPN](#)
- [The network does not appear in the wireless networks list](#)
- [The wireless network is not functioning](#)

Wireless connectivity checklist

- Verify that the product and the wireless router are turned on and have power. Also make sure that the wireless radio in the product is turned on.
- Verify that the service set identifier (SSID) is correct. Print a configuration page to determine the SSID. If you are not sure that the SSID is correct, run the wireless setup again.
- With secured networks, make sure that the security information is correct. If the security information is incorrect, run the wireless setup again.
- If the wireless network is working correctly, try accessing other computers on the wireless network. If the network has Internet access, try connecting to the Internet over another wireless connection.
- Verify that the encryption method (AES or TKIP) is the same for the product as it is for the wireless access point, such as a wireless router (on networks using WPA security).
- Verify that the product is within the range of the wireless network. For most networks, the product must be within 30 m (100 ft) of the wireless access point (wireless router).
- Verify that obstacles do not block the wireless signal. Remove any large metal objects between the access point and the product. Make sure poles, walls, or support columns containing metal or concrete do not separate the product and wireless access point.
- Verify that the product is located away from electronic devices that might interfere with the wireless signal. Many devices can interfere with the wireless signal including motors, cordless phones, security system cameras, other wireless networks, and some Bluetooth devices.

- Verify that the print driver is installed on the computer.
- Verify that you have selected the correct printer port.
- Verify that the computer and product connect to the same wireless network.

The control panel displays the message: The wireless feature on this product has been turned off

1. Touch the [Setup](#)  button, and then touch the [Wireless Setup](#) menu.
2. Touch the [Turn Wireless On/Off](#) button, and then touch the [On](#) button.

The product does not print after the wireless configuration completes

1. Make sure that the product is turned on and in the ready state.
2. Make sure you are connecting to the correct wireless network.
3. Make sure that the wireless network is working correctly.
 - a. On the control panel, touch the [Setup](#)  button, and then touch the [Network Setup](#) menu item.
 - b. Select the [Print Wireless Network Test](#) item to test the wireless network. The product prints a report with the results.
4. Make sure that the correct port or product is selected.
 - a. For products installed *without* the fully-featured installer:
 1. From the list of products on your computer, right-click the name of this product, click **Properties**, and then open the **Ports** tab.
 2. Make sure that the box is checked next to **Virtual printer port for USB**.
 - b. If you installed the product using the CD installer, or downloaded the fully-featured installer from the HP Web site, you can view or change the product IP address using the following steps:
 - i. Click **Start**.
 - ii. Click **All Programs**.
 - iii. Click **HP**.
 - iv. Click your product.
 - v. Click **Update IP Address** to open a utility that reports the known (“previous”) IP address for the product and allows you to change the IP address, if necessary.
5. Make sure that your computer is working correctly. If necessary, restart your computer.

The product does not print, and the computer has a third-party firewall installed

1. Update the firewall with the most recent update available from the manufacturer.
2. If programs request firewall access when you install the product or try to print, make sure that you allow the programs to run.
3. Temporarily turn off the firewall, and then install the wireless product on the computer. Enable the firewall when you have completed the wireless installation.

The wireless connection does not work after moving the wireless router or product

Make sure that the router or product connects to the same network that your computer connects to.

1. From the control panel, touch the **Setup**  button, and then touch the **Print Reports** menu.
2. Select the **Network Configuration Page** item to print the report.
3. Compare the service set identifier (SSID) on the configuration report to the SSID in the configuration for your computer.
4. If the SSIDs are not the same, the devices are not connecting to the same network. Reconfigure the wireless setup for your product.

Cannot connect more computers to the wireless product

1. Make sure that the other computers are within the wireless range and that no obstacles block the signal. For most networks, the wireless range is within 30 m (100 ft) of the wireless access point.
2. Make sure that the product is turned on and in the ready state.
3. Turn off any third-party firewalls on your computer.
4. Make sure that the wireless network is working correctly.
 - a. On the product control panel, touch the **Setup**  button, and then touch the **Network Setup** menu.
 - b. Touch the **Print Wireless Test Report** item to test the wireless network. The product prints a report with the results.

5. Make sure that the correct port or product is selected.
 - a. For products installed *without* the fully-featured installer:
 1. From the list of products on your computer, right-click the name of this product, click **Properties**, and then open the **Ports** tab.
 2. Make sure that the box is checked next to **Virtual printer port for USB**.
 - b. If you installed the product using the CD installer, or downloaded the fully-featured installer from the HP Web site, you can view or change the product IP address using the following steps:
 - i. Click **Start**.
 - ii. Click **All Programs**.
 - iii. Click **HP**.
 - iv. Click your product.
 - v. Click **Update IP Address** to open a utility that reports the known (“previous”) IP address for the product and allows you to change the IP address, if necessary.
6. Make sure that your computer is working correctly. If necessary, restart your computer.

The wireless product loses communication when connected to a VPN

- Typically, you cannot connect to a VPN and other networks at the same time.

The network does not appear in the wireless networks list

- Make sure that the wireless router is turned on and has power.
- The network might be hidden. However, you can still connect to a hidden network.

The wireless network is not functioning

1. To verify if the network has lost communication, try connecting other devices to the network.
2. Test network communication by pinging the network.
 - a. Open a command-line prompt on your computer. For Windows, click **Start**, click **Run**, and then type `cmd`.
 - b. Type `ping` followed by the IP address for the wireless router.
 - c. If the window displays round-trip times, the network is working.
3. Make sure that the router or product connects to the same network that your computer connects to.
 - a. From the product control panel, touch the **Setup**  button, and then touch the **Print Reports** menu.
 - b. Touch the **Network Configuration Page** item to print the report.

- c.** Compare the service set identifier (SSID) on the configuration report to the SSID in the configuration for your computer.
- d.** If the SSIDs are not the same, the devices are not connecting to the same network. Reconfigure the wireless setup for your product.

Solve memory device problems

Table 2-8 Solve memory device problems

Issue	Solution
The product cannot read the memory device.	<p>Check the memory device.</p> <ul style="list-style-type: none">• Ensure that the memory device is one of the supported types.• Some memory devices have a switch that controls how they can be used. Ensure that the switch is set so that the memory device can be read.• Inspect the ends of the memory device for dirt or material that closes a hole or spoils a metal contact. Clean the contacts with a lint-free cloth and small amounts of isopropyl alcohol.• Ensure that the memory device is working correctly by testing it with other devices. <p>Check the memory device slot.</p> <ul style="list-style-type: none">• Ensure that the memory device is fully inserted into the correct slot.• Remove the memory card (when the light is not blinking) and shine a flashlight into the empty slot. See if any of the small pins inside are bent. When the product is off, you can straighten slightly bent pins by using the tip of a thin, retracted ballpoint pen. If a pin has bent in such a way that it touches another pin, replace the memory card reader or have the product serviced.• Ensure that only one memory device has been inserted at a time in the slots. An error message should appear on the control-panel display if more than one memory device is inserted.
The product cannot read photos on the memory device.	<p>Check the memory device. The memory device might be corrupt.</p>

Index

B

bin, output
 jams, clearing 94

C

calibration period 3
cautions iii
cleaning
 paper path 74
color
 adjusting 63
connectivity
 solving problems 98
conventions, document iii

D

defaults, restoring 30
document conventions iii

E

end of print job period 5
engine control system
 operations 6

F

factory-set defaults, restoring 30
fax
 factory-set defaults, restoring 30
flowcharts
 troubleshooting 39

I

ink cartridges
 checking for damage 76

J

jams
 causes of 86

locating 86
output bin, clearing 94
paper path, clearing 92

L

left door
 jams, clearing 92

N

notes iii

O

operation sequence 3
operations
 engine control system 6
 paper-handling system 15
output bin
 jams, clearing 94

P

paper
 jams 86
 paper-handling system
 operations 15
 selecting 62
paper path
 jams, clearing 92
paper pickup problems
 solving 80
paper type
 changing 62
paper-handling system
 sensors 15
print preparation period 4
print quality
 improving 57, 62
print quality page
 interpreting 66
 printing 66

printing period 4

R

restoring factory-set defaults 30

S

sensors
 paper-handling operations 15
servicing operations 3
settings
 factory-set defaults, restoring 30
solving
 network problems 98
 USB direct-connect problems 98
startup period 3

T

theory of operations
 engine control system 6
 paper-handling system 15
tips iii
Tray 1
 jams, clearing 87
tray 1
 pickup-and-feed system
 operations 15
Tray 2
 jams, clearing 89, 91
 paper-handling operations 15
trays
 jams, clearing 89, 91
 paper-handling system
 operations 15
troubleshooting
 flowchart 39
 jams 86
 network problems 98

paper feed problems 79
USB direct-connect problems
98

W

warnings iii



CV037-90001

