



PageWide Pro 352/377, 452/477, and 552/577

Repair Manual



352
452
552

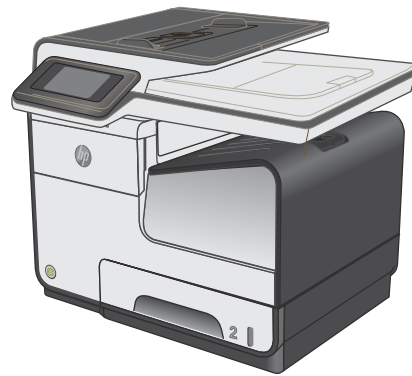

377
477
577



www.hp.com/support



HP PageWide Pro 352/377, 452/477, and 552/577

Repair Manual

Copyright and License

© Copyright 2016 HP Development Company, L.P.

Reproduction, adaptation, or translation without prior written permission is prohibited, except as allowed under the copyright laws.

The information contained herein is subject to change without notice.

The only warranties for HP products and services are set forth in the express warranty statements accompanying such products and services. Nothing herein should be construed as constituting an additional warranty. HP shall not be liable for technical or editorial errors or omissions contained herein.

Edition 1, 3/2016

Trademark Credits

ENERGY STAR® and the ENERGY STAR® mark are registered U.S. marks.

Conventions used in this guide

 **TIP:** Tips provide helpful hints or shortcuts.

 **NOTE:** Notes provide important information to explain a concept or to complete a task.

 **CAUTION:** Cautions indicate procedures that you should follow to avoid losing data or damaging the product.

 **WARNING!** Warnings alert you to specific procedures that you should follow to avoid personal injury, catastrophic loss of data, or extensive damage to the product.

Table of contents

1 Removal and replacement	1
Removal and replacement strategy	2
Electrostatic discharge	2
Required tools	3
OfficeJet Pro X special tools kit	3
Advanced Cleaning Kit	5
Types of screws	6
Service approach	6
Before performing service	6
After performing service	7
Post-service test	7
Print-quality test	7
Removal and replacement procedures	8
Customer replaceable parts	8
Tray 2	8
Ink cartridges	8
Duplex module	11
Output bin (352, 452, 377, and 477 models)	11
Menu access on monochrome control panels	12
Access the Engineering menu	12
Access the Support menu	12
Place the printer into MFG (manufacturing) mode	13
Menu access on color control panels	14
Access the Engineering menu	14
Access the Support Menu	14
Place the printer into MFG (manufacturing) mode	15
Perform tap tests and interpret results	16
10 tap test results (OOBE states)	16
12 tap test results (REDI sensor values)	18
61 tap results (Align and color calibrations)	20
909 tap test results (BDD status)	20
Verify that the pig tails have an adequate seal	21

Covers	23
Output bin flap	23
Control panel (color displays)	24
Control panel (monochrome displays—352, 452 models)	25
Left door	26
Left rear cover	28
Rear cover (552, 577, P55250, and P57750 models)	29
Rear cover (352, 452, 377, 477 models)	30
Left front cover	31
Top cover (377, 477, 577 models)	33
Top cover (352, 452, 552 models)	35
Front cover (352, 452, 377, 477 models)	37
Front cover (552, 577 models)	39
Supply door hinge (352, 452, 377, 477 models)	41
Supply door hinge (552, 557 models)	44
Right cover	47
Assemblies accessed through the rear cover	49
Drying path gear assembly	49
Temperature sensor	50
PCA safety shield	51
Fax PCA (MFP models)	52
Main PCA	54
Main PCA calibration procedure	57
Tray 3 interconnect PCA	58
Aerosol fan assembly	59
Printbar lift mechanism assembly	64
Pick encoder distribution PCA	66
Service sled transmission	67
Backscatter drop detect (BDD) assembly	69
Power supply	71
Duplex drive module	73
Sensor carriage PCA and encoder strip	75
Assemblies accessed through the top and front covers	78
Scanner assembly and scanner support bracket (MFP models only)	78
Document feeder assembly (MFP models—377, 477, 577 models)	84
Top cap assembly	86
Output eject drive kit	88
Feed motor encoder sensor PCA	91
Duplex module sensor PCA	93
Power button PCA	95
REDI distribution PCA	96

Output drive gears	97
Output drive shaft 6	98
Inner top frame	101
Eject flap opto PCA	104
Output drive shaft 3	105
Output drive shaft 5	107
Top paper guide	109
Output drive shaft 4	112
Top left paper guide assembly	114
Center left paper guide assembly	117
Assemblies accessed through the right cover	119
Tray lift transmission assembly	119
IDS bracket (552, 577 models)	122
Service sled assembly	128
Separator/pick assembly	132
Media presence sensor PCA/flag	136
Printzone distribution PCA	138
Platen	140
Cross brace (352, 452, 377, 477 models)	144
Web advance rack assembly	146
Printbar	147
Test installation and calibrate the printbar	155
Paper REDI sensors in the center left paper guide assembly	158

2 Parts and diagrams 161

For additional service and support	162
Assembly locations	163
Printer front view (352/452 models)	164
Printer front view (552 models)	165
Printer back view (352/452/552 models)	166
Printer front view (377/477 models)	167
Printer front view (577 models)	168
Printer back view (377/477/577 models)	169
Order parts, accessories, and supplies	170
Ordering	170
Supplies and accessories	170
Customer self-repair parts	173
Related documentation and software	173
Parts and diagrams: Document feeder and scanner (477/577 models)	176
Document feeder and scanner ((477/577 models))	176
Parts and diagrams: Covers	178

Covers (352/452 models)	178
Covers (377/477 models)	180
Covers (552 models)	182
Covers (577 models)	184
Parts and diagrams: Internal assemblies	186
Internal assemblies (352/452/377/477 models)	186
Internal assemblies (552/577 models)	188
Internal assemblies—not shown (300/400/500 series)	190
Alphabetical parts list	193
Numerical parts list	201
Index	209

1 Removal and replacement

- [Removal and replacement strategy](#)
- [Service approach](#)
- [Removal and replacement procedures](#)

Removal and replacement strategy

 **WARNING!** Turn the printer off, wait 5 seconds, and then remove the power cord before attempting to service the printer. If this warning is not followed, severe injury can result, in addition to damage to the printer. The power must be on for certain functional checks during problem solving. However, the power supply should be disconnected during parts removal.



The sheet-metal parts can have sharp edges. Be careful when handling sheet-metal parts.

 **CAUTION:** Many repair operations will require you to flatten or straighten flex cables. However, where possible, try to avoid doing so. Before inserting the FFC, examine the foil connectors for damage. You *must* make sure that all FFCs are fully seated in their connectors. Failure to fully seat an FFC into a connector can cause a short circuit in a PCA or errors when restarting the printer.

 **NOTE:** To install a self-tapping screw, first turn it counterclockwise to align it with the existing thread pattern, and then carefully turn it clockwise to tighten. Do not overtighten. If a self-tapping screw-hole becomes stripped, repair the screw-hole or replace the affected assembly.

Throughout this chapter, the reinstallation process should follow the reverse order of the removal process documented. Where necessary, the tasks include reinstallation tips to aid in the installation of replacement parts.

Electrostatic discharge

 **CAUTION:**  Some parts are sensitive to electrostatic discharge (ESD). Look for the ESD reminder when removing printer parts. Always perform service work at an ESD-protected workstation or mat. If an ESD workstation or mat is not available, ground yourself by touching the sheet-metal chassis *before* touching an ESD-sensitive part.

Protect the ESD-sensitive parts by placing them in ESD pouches when they are out of the printer.

Required tools

- T10 Torx driver with a magnetic tip and a 152 mm (6 in) shaft length
- T10 Torx driver with a magnetic tip and a 25 mm (1 in) shaft length
- T8 Torx driver with a magnetic tip and a 25 mm (1 in) shaft length
- Small flat-blade screwdriver
- Needle-nose pliers
- Curved tweezers
- ESD mat (if one is available) or ESD strap
- Penlight, preferably a headlight
- 1/4 in (6.4 mm) nut driver (for use with the OfficeJet Pro X special tools kit)

⚠ CAUTION: While the use of a motorized screwdriver is recommended, the screwdriver must have a torque limiter, and it must be set to a low torque.

OfficeJet Pro X special tools kit

The OfficeJet Pro X special tools kit (part number CN598-67056) is required for replacing the service sled and printbar assemblies.

The OfficeJet Pro X special tools kit contains the following parts:

- Ink supply door switch—used to tell the printer that the supply door is closed when the front cover is removed.

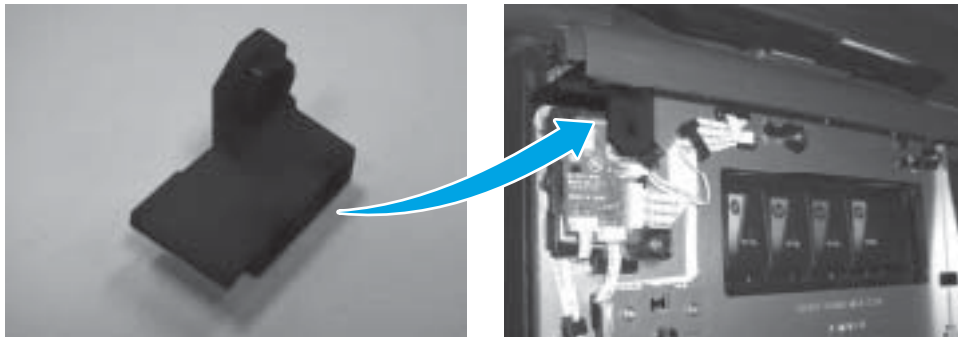

- Printbar lock tool—used for holding the printbar in place.

 **NOTE:** Rotate the tool to line up the shaft opening with the printbar shaft, and then place the tool over the shaft to lock the printbar in place. Do not use this tool to raise or lower the printbar.

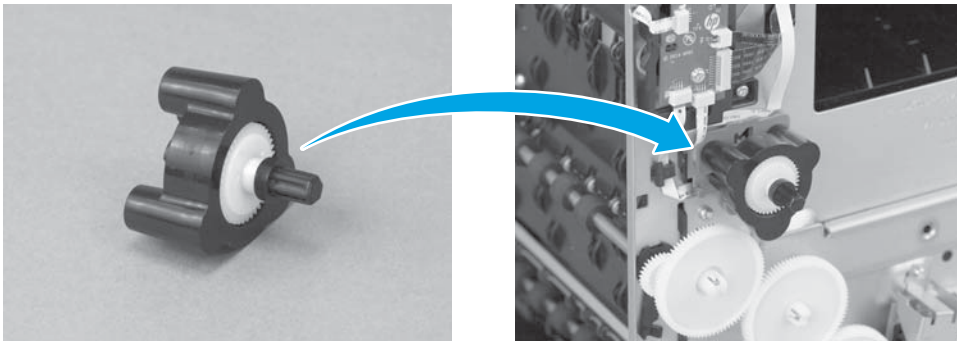

- Service sled advance tool—used to remove and reinstall the service sled. Also raises the printbar.

 **NOTE:** Use a one-quarter inch nut driver to remove or install the service sled.

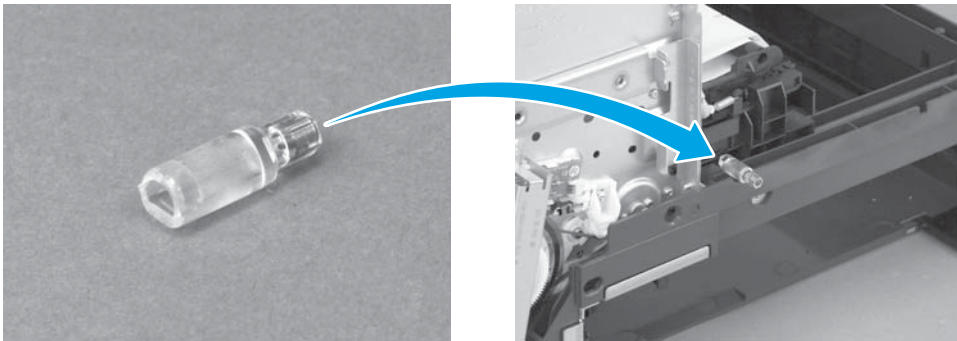

- Printbar dolly—used to support the printbar during removal and installation.

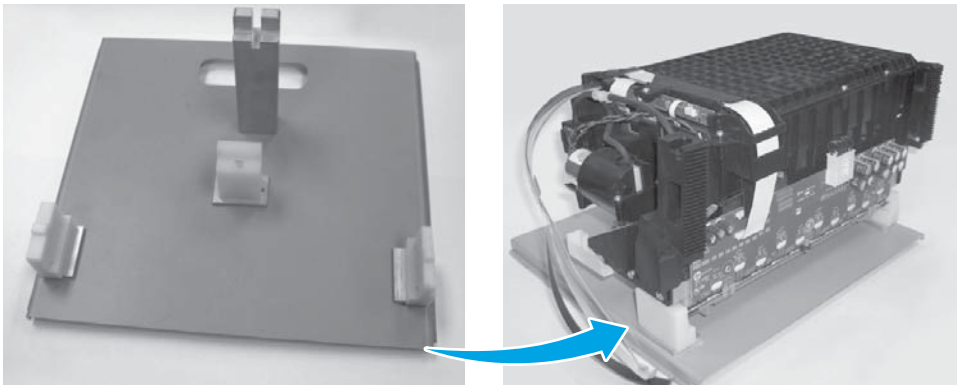

- Pick tire replacement tool—used to remove the Tray 2 pickup roller assembly.

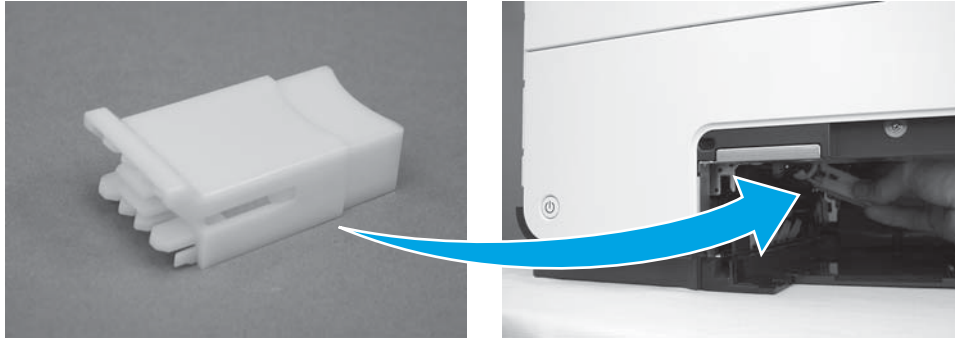

Use this tool to release the tabs that hold the tray 2 pick-up roller in place.

Advanced Cleaning Kit

The Advanced Cleaning Kit (part number CN459-67006) is used for resolving shim whiskers print quality issues.

The Advanced Cleaning Kit contains the following items:

- Sheet cleaner - full mid

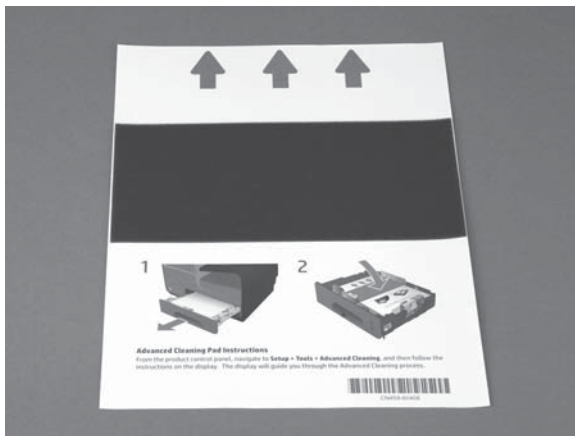

- Shim whisker kit Instructions

To use the cleaning kit, complete the following steps.

1. On the printer control panel, open the [Setup](#) menu, and then open the following menus:

352 and 452 models

- [Tools](#)
- [Perform Advanced Cleaning](#)

All other models

- [Printer Maintenance](#)
- [Perform Advanced Cleaning](#)

2. Open Tray 2, and then load the cleaning page face up in the tray, with the arrows pointing to the left side of the tray.

NOTE: The correct page orientation is shown on the cleaning page itself.

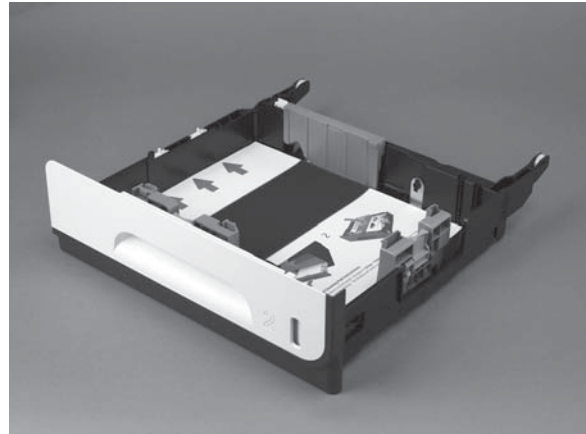

3. Reinsert Tray 2, and then follow the instructions on the control panel to complete the process.

Types of screws

WARNING! Make sure that assemblies are replaced with the correct screw type. Using the incorrect screw (for example, substituting a long screw for the correct shorter screw) can cause damage to the printer or interfere with printer operation. Do not intermix screws that are removed from one assembly with the screws that are removed from another assembly.

Service approach

IMPORTANT: Ensure the printer has the latest firmware installed for the initial installation of the printer. Certain repairs to this printer also require updated firmware, as noted in this document. Download firmware for this printer at www.hp.com.

CAUTION: When working on the printer, do not pick up the unit by the scanner assembly or output tray. If you need to move the printer while performing any service procedures, remove the scanner assembly/output tray to reduce the weight of the printer and decrease the chances of damaging the printer.

Before performing service

- Remove all paper from the printer.
- Verify that the printbar is up and in the capped position.
- Turn off the power using the power button.
- Unplug the power cable and interface cable or cables.
- Remove the output bin.
- Place the printer on an ESD workstation or mat, or use an ESD strap (if one is available). If an ESD workstation, mat, or strap is not available, ground yourself by touching the sheet-metal chassis *before* touching an ESD-sensitive part.
- Remove the Tray 2 cassette.
- Remove the duplex module, which is located inside the left door.



NOTE: When removing the duplex module, avoid making direct contact with the black cylinder to prevent ink smear on skin or clothes. Keep the duplex module level to avoid spilling any maintenance ink.

After performing service

- Plug in the power cable.
- Reinstall the output bin.
- Reinstall the ink cartridges (if they were removed prior to performing service).
- Reinstall the Tray 2 cassette.
- Reinstall the duplex module.
- Load paper in the printer.

Post-service test

Perform the following test to verify that the repair or replacement was successful.

Print-quality test

1. Verify that the necessary reassembly steps have been completed.
2. Make sure that the tray contains clean, unmarked paper.
3. Attach the power cord and interface cable or interface cables, and then turn on the printer.
4. Print a printer status page, network configuration page, or other test pages as specified in the part-replacement procedures in this manual.
5. Print a print-quality page, and then verify that there are no lines, streaks, banding, or other print quality defects.
6. Send a print job from the host computer, and then verify that the output meets expectations.
7. Clean the outside of the printer with a damp cloth.

Removal and replacement procedures

Customer replaceable parts

Tray 2

1. Pull out the tray.



2. Press the latch in the left-rear corner of the tray, lift the front of the tray up, and then pull the tray out completely.

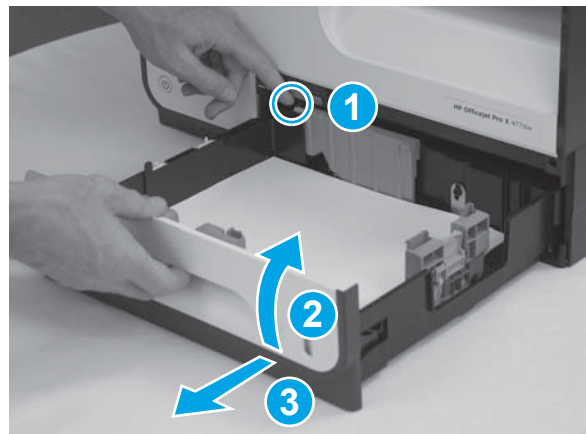

Ink cartridges

The printer uses four colors and has a different ink cartridge for each color: yellow (Y), cyan (C), magenta (M), and black (K).

1. Open the ink cartridge access door.



2. Push the old ink cartridge inward to unlock it.

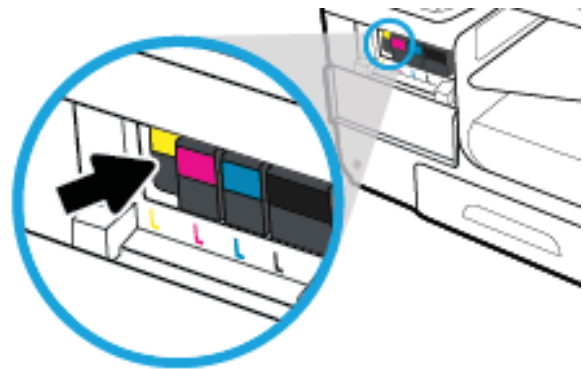

3. Grasp the edge of the old ink cartridge, and then pull the cartridge straight out to remove it.

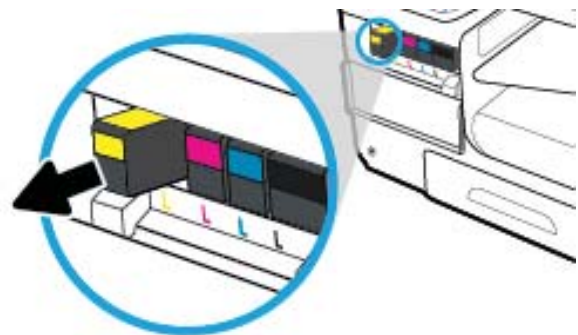

4. Remove the new ink cartridge from the packaging. Do not touch the metal connector of the ink cartridge. Fingerprints on the connector can cause printer operation problems.



5. Insert the new ink cartridge into the printer. Make sure that the metal connector on the cartridge is facing up. If it is not installed correctly, the cartridge will not lock in place.

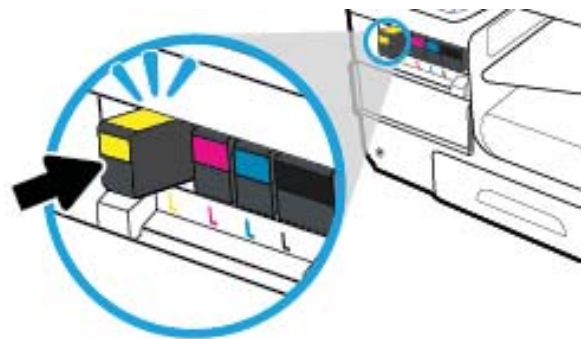

6. Close the ink cartridge door.

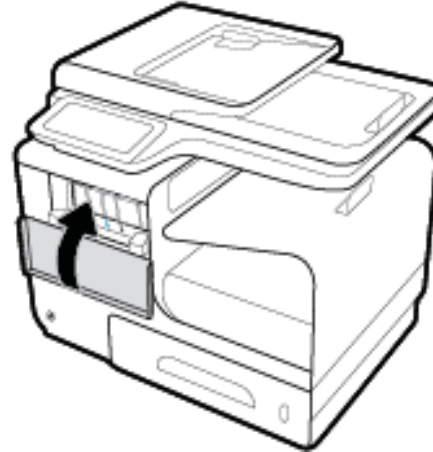

7. Place the old ink cartridge in the box, and refer to the HP recycling instructions at www.hp.com/recycle.

Duplex module

1. Press the latch to open the left door.

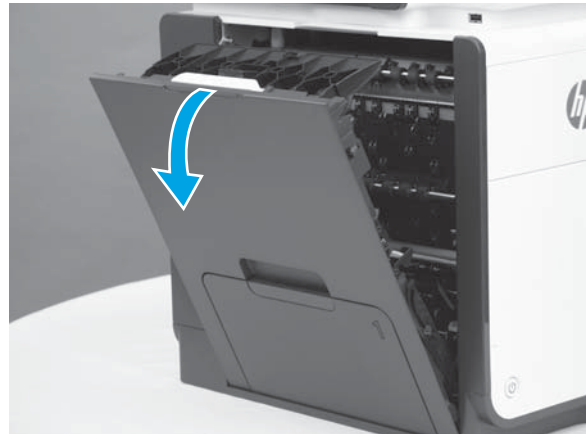

2. Grab the duplex module as shown, and then pull it out of the printer.

NOTE: When removing the duplex module, avoid making direct contact with the black cylinder to prevent ink smear on skin or clothes. Keep the duplex module level to avoid spilling any maintenance ink.

When removing the duplex module, do not let the bottom of the duplex module touch or rest on the ribs on the left door, which will damage them and might lead to paper damage and jams.

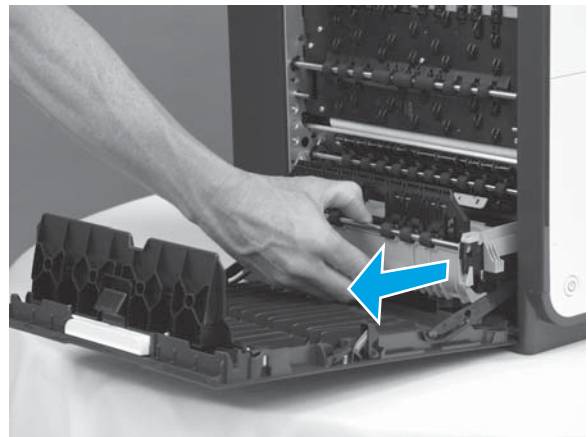

Output bin (352, 452, 377, and 477 models)

1. Detach the top of the output bin from the printer, and then pull the bin up to remove it.



Menu access on monochrome control panels

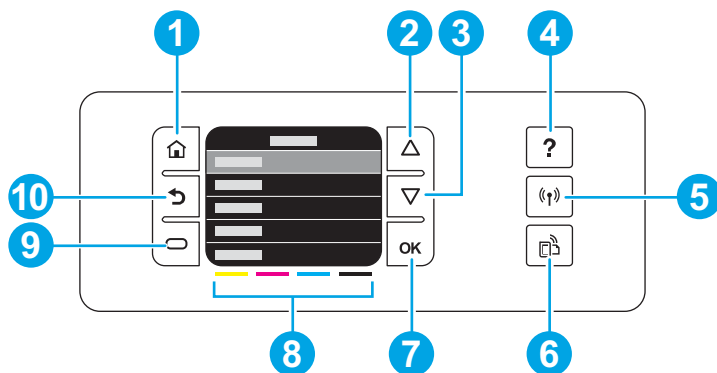

These hidden engineering menus are used for testing and calibration. Some or all of them are referenced in remove and replace sections as required.

⚠ WARNING! Misuse of these menus could damage the printer or make it unusable.



Item	Description
1	Home button: Return to the power-on Home screen.
2	Up arrow button: Navigate the menus.
3	Down arrow button: Navigate the menus.
4	Help button: Open the printer help system.
5	Wireless button: Open the Wireless Setup menu.
6	HP ePrint button: Activate or deactivate the HP ePrint features.
7	OK button: Confirm the selected item.
8	Ink cartridge fuel gauges: View the estimated cartridge ink levels.
9	ATM button: Function defined by the firmware. Usually used to cancel a request.
10	Back button: Return to the previous screen.

Access the Engineering menu

1. Press the Home  button.
2. Press the Back  button.
3. Press the Home  button twice to enter the **Engineering** menu.

NOTE: The [Service menu](#) is accessed from the **Engineering** menu.

Access the Support menu

- ▲ Press the Back  button four times to enter the **Support** menu.

NOTE: The **Support** menu is usually used by HP call center agents for assisting customers.

Place the printer into MFG (manufacturing) mode



NOTE: This mode is to be used **only** by authorized service providers. It should **never** be accessed by the end user.

1. Press and hold the Up ▲ and Down ▼ buttons together while plugging in the printer until the control-panel displays MFG mode.
2. Press the power button to enter MFG (on) mode.

Menu access on color control panels

These hidden engineering menus are used for testing and calibration. Some or all of them are referenced in remove and replace sections as required.

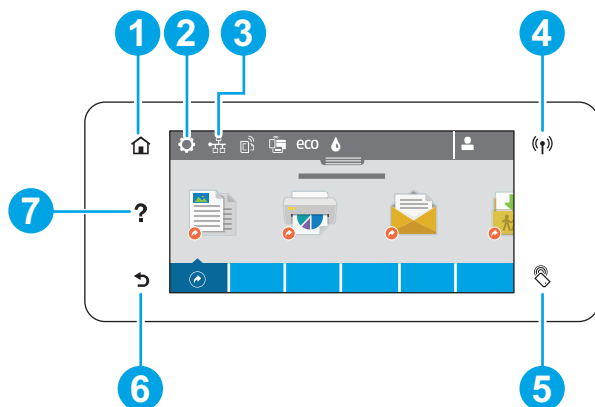

WARNING! Misuse of these menus could damage the printer or make it unusable.

NOTE: These buttons are not illuminated until they are touched with sufficient pressure. Locate these buttons by sweeping your finger over the general areas.



Item	Description
1	Home button: Return to the power-on Home screen.
2	Setup button: Open the Setup menu.
3	Network button: Open the Network Setup menu.
4	Wireless button: Open the Wireless Setup menu.
5	NFC button: Connect to the printer via the near field communication (NFC) protocol.
6	Back button: Return to the previous screen.
7	Help button: Open the printer help system.

Access the Engineering menu

1. Touch the Home  button.
2. Touch the Back  button.
3. Touch the Home  button twice to enter the [Engineering menu](#).

NOTE: The [Service menu](#) is accessed from the [Engineering menu](#).

Access the Support Menu





Touch the Back  button four times consecutively to open the [Support Menu](#).

NOTE: The [Support Menu](#) is usually used by HP call center agents for assisting customers.

Place the printer into MFG (manufacturing) mode



NOTE: These two modes are ONLY to be used by authorized service providers. They should NEVER be accessed by the end user.

1. Press and hold the power button while plugging in the printer. The HP logo appears on the printer control panel, and then disappears. Continue to hold the power button for five seconds after the logo disappears.
2. Release the power button.
3. Touch the Home  button.
4. Touch the Back  button.
5. Touch the Home  button twice.
6. After a new screen appears, touch the Home  button again to enter MFG (off) mode.
7. Press the power button to enter MFG (on) mode.

Perform tap tests and interpret results

Perform a tap test

1. Open the Engineering Menu. See [Menu access on monochrome control panels on page 12](#) or [Menu access on color control panels on page 14](#).
2. Open the [Manufacturing Menu](#).
3. Open the [Reports Menu](#).
4. Open the [Print-mech tap tests](#) menu.
5. Select the tap test to run.

10 tap test results (OOBE states)

The printed tap test results contain a sequence of numbers at line number 68, "Startup Complete," of the printed report.

Use the following table to interpret these numbers.

Table 1-1 10 tap test results, row 69

Column	Code	Acceptable values
Column 1	DSID_PEN_PRINTER_STARTUP_BITS	A value of 1 indicates that the printbar has been started up. This means that shipping fluid has been removed from the printbar and replaced with ink. This is the expected state for a printer after initialization.
Column 2	DSID_OOBE_STATE	255—OOBE messaging complete.
Column 3	DSID_INK_SUPPLY_OOBE_COMPELTE	1—SHF purge is complete and service wipes have been enabled.
Column 4	DSID_CAL_OOBE_STATE	A value of 2 means that the OOBE printed calibrations are complete. A value of 1 means the OOBE printed calibrations are in progress A value of 0 means the OOBE printed calibration does not exist so no printing/calibration for OOBE is attempted.
Column 5	DSID_IQ_LIST_INDEX	A value of 3 means that pen height and beam center have been completed, and that BDD is scheduled (or pending) to perform normally.

Printer Hardware Information

Extended Self Test Diagnostic Page - 1 of 2

Product Information

11. Product Name: HP PageWide Pro 577 MFP series
 12. Product Number: D3Q21A
 13. Serial Number: CN56MSX549
 14. Service ID: 25215
 15. Date/Time: 9/14/2015 15:12:33
 16. Printer ID: 1
 18. Total Page Count: 1159
 19. Duplex Page Count: 462

Revision Information

24. Main PCA Revision: ID: 22246 MFG: 5 PAM: 55 NUM: 6
 25. Digital ASIC: NEURON Rev A.3 Mfg: ST
 26. Analog ASIC: 1- REV: 0 MFG: 0, 2- REV: 0 MFG: 0
 27. FW PNG Rev and Patch Rev: MAHDWOMP2A001.1536H.00
 28. Flows Revision: OFFICIAL
 17. Default Symbol Set: 341
 31. Number of Trays Present: 4
 32. Duplexer Installed: Yes
 19. Duplex Speed Limit = 0

Print System Information

	Yellow	Magenta	Cyan	Black
43. Cartridge:	Yellow	Magenta	Cyan	Black
44. Estimated Cartridge Level:				
45. Cartridge Status:	Ready	Ready	Ready	Ready
46. Cartridge Status Slider:	-1	-1	-1	-1
47. Selectability Number:	HP 972 SETUP	HP 972 SETUP	HP 972 SETUP	HP 972 SETUP
48. Sensor Status One:	0	0	0	0
49. Sensor Status Two:	0	0	0	0
50. Host/Trade Acumen Bit:	1	1	1	1
51. Start Up Complete:	1	1	1	1
52. Serial Number:	357077068	355941158	355871950	356277534
53. Mfg. Date:	05/21/2015	05/14/2015	05/14/2015	05/14/2015
54. Cartridge Install:	07/30/2015	07/30/2015	07/30/2015	07/30/2015
55. Warranty Ends:	05/21/2018	05/14/2018	05/14/2018	05/14/2018
56. CM:	1	1	1	1
57. NHIO:	0	0	0	0
58. IRO:	0	0	0	0
59. EX: 03,050,0000 RC: 31102				
60. HPSuppliesOnly-State:	Disabled			

Print Head Assembly Information

61. TVAL: 34884500, TVAL:210, AMB:226, AMB:221
 62. Total Dot Count (In ml):
 a. Yellow: 59
 b. Magenta: 70
 75. TT08 done: 1

69. Startup complete: 1 255 1 2 0

63. Page Count: 1159
 64. Nozzle Health
 DD-SYS: 100
 DD-HIS: 0 100 100 0
 DD-CURR: 0 100 100 0
 f. Last successful calibration at page count: 6
 g. Last failed calibration at page count: 0
 7. Last calibration at page count: 5
 68. Pages printed since last nozzle clean: 0
 69. Startup complete: 1 255 1 2 0 0
 70. NUMBER OF CALIBRATIONS: PEN_ALIGN_0 PEN_ALIGN_1 PEN_ALIGN_2 COLOR_CAL_0 COLOR_CAL_1 COLOR_CAL_2
 Success: 0 1 1 1 1 1
 Failed: 0 0 0 0 0 0

12 tap test results (REDI sensor values)

Table 1-2 12 tap test report

Callout	Report area	Item	Acceptable values
1	Print Humidity Sensor Data	Stable Relative Humidity	0–100 RH
2	Pen TSR Ambient Temperature Estimate	Pen TSR Ambient Temperature x10 °C	± 10 °C of current ambient temperature
3	Digital Temperature Sensor Ambient Temperature	Digital Temperature Sensor Ambient Temperature x10 °C	± 10 °C of current ambient temperature
4	Print REDI Sensor Calibration Data	TOF sensor, p value ¹	Between 10 and 100
5	Print REDI Sensor Calibration Data	TOF sensor, m value ¹	Between 25 and 380

¹ “M” is mirror result, “P” is blocked with paper.

```

HP PageWide Pro 5770e MFP series
Serial Number: CH5AN6V01E
Service ID: 26011
Test Service ID:LQXL-TK3D-ACSZ-X9AW
FW PKG Rev: MANDWOPF1A001.1548D.00
Total Engine Page Count: 773
Page Count Thermally-Limited: Not Currently Available
RTC date time: 1/29/2016 20:36:35
System date time: 1/29/2016 12:35:25
Rear Accessory: Duplexer installed.
Digital ASIC: NEURON Rev A.3 Mfg: ST

Power state: 2

```

Assert details

- 1 Stable Relative Humidity: 22
-----Print TSR Ambient Temperature Estimate-----
- 2 Pen TSR Ambient Temperature x10C: 170
-----Digital Temperature Sensor Ambient Temperature-----
- 3 Digital Temperature Sensor Ambient Temperature x10 C: 278
-----Print REDI Sensor Calibration Data-----
- 4 TOF sensor, p value: 57
- 5 TOF sensor m value: 308

Service Station Primitive Operations:

```

-----
FWD Home: 0 Rear Home: 0
Cap: 27 Uncap: 27
Uncap: 0 Cap: 0
Wipe: 8 Rev Wipe: 0
Scrape: 0
Pump Cycles: 12 Pump Durations: 25400

```

- 1 ----- Print Humidity Sensor Data -----
- 2 Stable Relative Humidity: 22
- 3 ----- Pen TSR Ambient Temperature Estimate -----
- 4 Pen TSR Ambient Temperature x10 C: 170
- 5 ----- Digital Temperature Sensor Ambient Temperature -----
- 6 Digital Temperature Sensor Stable Ambient Temperature x10 C: 278
- 7 ----- Print REDI Sensor Calibration Data -----
- 8 TOF sensor, p value: 57
- 9 TOF sensor, m value: 308
- 10 PZ sensor, p value: 76
- 11 PZ sensor, m value: 154
- 12 LPP sensor, p value: 80
- 13 LPP sensor, m value: 82
- 14 UPF sensor, p value: 58
- 15 UPF sensor, m value: 308
- 16 EJECT sensor, p value: 86
- 17 EJECT sensor, m value: 151
- 18 MP tray media sensor, p value: 72
- 19 MP tray media sensor, m value: 208
- 20 P calibration valid: 1
- 21 W Calibration valid: 1

-----Timers and counters-----

```

Pages Since Last Wipe : 1
Web Advance Counter : 8
Engine Page Count : 773

```

```

-----Dots_X_1000-----
SPIT_DOT_COUNT_K : 6723970
SPIT_DOT_COUNT_C : 6583975
SPIT_DOT_COUNT_M : 7244854
SPIT_DOT_COUNT_Y : 6236273
TOTAL_DOT_COUNT_K(in ml): 77
TOTAL_DOT_COUNT_C(in ml): 61
TOTAL_DOT_COUNT_M(in ml): 65
TOTAL_DOT_COUNT_Y(in ml): 57

```

61 tap results (Align and color calibrations)



NOTE: If you hold the up or down arrows down, the tap count will start incrementing by 10, or 100

An acceptable 61 tap test has identical values for the parameters in the “Color scale (factory)” (1) and “Color scale (current)” (2) on the printed report areas. “Color scale (factory)” and “Color scale (current)” will be identical after a main PCA replacement, but may not be the same under other conditions. The values should also be identical after a printbar replacement.

```

*****
WRITING SYSTEM CALIBRATION REPORT
*****

= ledb : 14
= ledb no saturation : 14

= pen_tc_sis_X(zero column) #7200: -45
= pen_tc_sis_Y(tof) #7200: 0
= Measured zero column and tof #7200:
= Tray: Main      MP      Accessory
= side: Front  Back  Front  Back  Front  Back
= E-Col:      0    0    0    0    0    0
= Tof:        0    0    0    0    0    0

error type:  sensor_n_target centroid hphase ledb vernier 3_sigma analysis
= Last pen align 0 status = 0x0 : 0 0 0 0 0 0 0 0 0 0
= Last pen align 1 status = 0x0 : 0 0 0 0 0 0 0 0 0 0
= Last pen align 2 status = 0x0 : 0 0 0 0 0 0 0 0 0 0

= Last pen align analysis die status(hex) for page 0: 0 0 0 0 0 0 0 0 0 0
= Last pen align analysis die status(hex) for page 1: 0 0 0 0 0 0 0 0 0 0
= Last pen align analysis die status(hex) for page 2: 0 0 0 0 0 0 0 0 0 0

= Last successful pen alignment values in NVM:

= Pen die X alignment (factory) #7200:
= dia: 0 1 2 3 4 5 6 7 8 9
= K: -24 -6 -6 0 6 6 6 18 18 24
= C: -24 -6 -6 0 6 6 6 18 18 24

= Color scale (factory) :
= dia: 0 1 2 3 4 5 6 7 8 9
1 = K: 0x7eec 0x7f3c 0x8265 0x8280 0x8215 0x8070 0x7fcf 0x804b 0x7cea 0x7d65
= C: 0x7d51 0x7fbo 0x8063 0x81b5 0x80c5 0x81a1 0x7fc5 0x80ed 0x7dea 0x7fe6
= M: 0x7d51 0x7fbo 0x8063 0x81b5 0x80c5 0x81a1 0x7fc5 0x80ed 0x7dea 0x7fe6
= Y: 0x7d51 0x7fbo 0x8063 0x81b5 0x80c5 0x81a1 0x7fc5 0x80ed 0x7dea 0x7fe6

= Color scale (current) :
= dia: 0 1 2 3 4 5 6 7 8 9
2 = K: 0x7eec 0x7f3c 0x8265 0x8280 0x8215 0x8070 0x7fcf 0x804b 0x7cea 0x7d65
= C: 0x7d51 0x7fbo 0x8063 0x81b5 0x80c5 0x81a1 0x7fc5 0x80ed 0x7dea 0x7fe6
= M: 0x7d51 0x7fbo 0x8063 0x81b5 0x80c5 0x81a1 0x7fc5 0x80ed 0x7dea 0x7fe6
= Y: 0x7d51 0x7fbo 0x8063 0x81b5 0x80c5 0x81a1 0x7fc5 0x80ed 0x7dea 0x7fe6

= Last density cal analysis die status(hex) for page 1: 0 0 0 0 0 0 0 0 0 0
= Last density cal analysis die status(hex) for page 2: 0 0 0 0 0 0 0 0 0 0

= Last successful density cal values in NVM:

1 = Color scale (factory):
= dia: 0 1 2 3 4 5 6 7 8 9
= K: 0x7eec 0x7f3c 0x8265 0x8280 0x8215 0x8070 0x7fcf 0x804b 0x7cea 0x7d65
= C: 0x7d51 0x7fbo 0x8063 0x81b5 0x80c5 0x81a1 0x7fc5 0x80ed 0x7dea 0x7fe6
= M: 0x7d51 0x7fbo 0x8063 0x81b5 0x80c5 0x81a1 0x7fc5 0x80ed 0x7dea 0x7fe6
= Y: 0x7d51 0x7fbo 0x8063 0x81b5 0x80c5 0x81a1 0x7fc5 0x80ed 0x7dea 0x7fe6

2 = Color scale (current):
= dia: 0 1 2 3 4 5 6 7 8 9
= K: 0x7eec 0x7f3c 0x8265 0x8280 0x8215 0x8070 0x7fcf 0x804b 0x7cea 0x7d65
= C: 0x7d51 0x7fbo 0x8063 0x81b5 0x80c5 0x81a1 0x7fc5 0x80ed 0x7dea 0x7fe6
= M: 0x7d51 0x7fbo 0x8063 0x81b5 0x80c5 0x81a1 0x7fc5 0x80ed 0x7dea 0x7fe6
= Y: 0x7d51 0x7fbo 0x8063 0x81b5 0x80c5 0x81a1 0x7fc5 0x80ed 0x7dea 0x7fe6

= Last successful calibration at page count: 552
= Last failed calibration at page count: 0
= Last Calibration at page count: 552

Number of Calibrations: PEN_ALIGN_0 PEN_ALIGN_1 PEN_ALIGN_2 COLOR_CAL_0 COLOR_CAL_1 COLOR_CAL_2
Success: 3 3 3 2 2 2
Failed : 0 0 0 0 0 0
    
```

909 tap test results (BDD status)



NOTE: If you hold the up or down arrows down, the tap count will start incrementing by 10, or 100

- [Service Menu](#)
 - [Special Reports](#)
 - [Print Mech Button Tap](#)
3. Test for low-pressure leaks by running the 378 tap test and verifying that there are no leaks.
 4. Test for medium-pressure leaks by running the 379 tap test and verifying that there are no leaks.
 5. Test for normal-pressure leaks by running the 380 tap test and verifying that there are no leaks.
 6. Print a Printer Status Report.
 7. Ensure that the service sled is aligned with the arrows, and then perform a 21 tap test. Verify that the service sled moves smoothly, and that once it caps the printbar, that the cap is level and aligned correctly.
 8. Turn the printer off using the power button, and then unplug the printer.



IMPORTANT: You must install a new duplex module before calibration/initialization.

Covers

Output bin flap

1. Remove the output bin. See [Output bin \(352, 452, 377, and 477 models\) on page 11](#).
2. Flex the middle of the output bin flap, and then remove the flap by pulling the rear pin away from the printer first.

Reinstallation tip: With the flap in the open position, insert the front pin into the printer first, and then flex or bend the flap to install the rear pin.



Control panel (color displays)

Table 1-3 Control panel location (color displays)

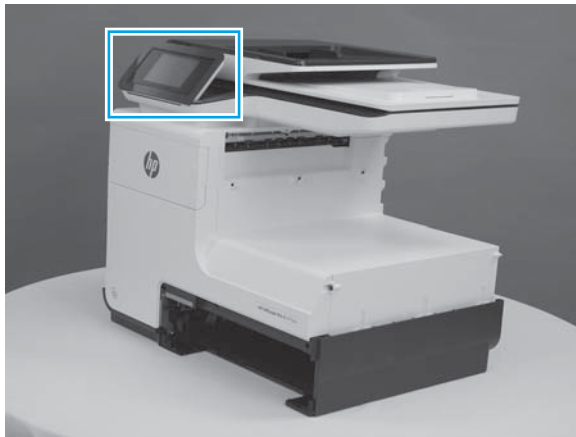

1. Extend the control panel away from the printer, and then, behind the control panel, remove two screws.



2. Disconnect the control panel FFC, and then remove the control panel.



Control panel (monochrome displays—352, 452 models)



1. Extend the control panel away from the printer, and then, behind the control panel, remove three screws.

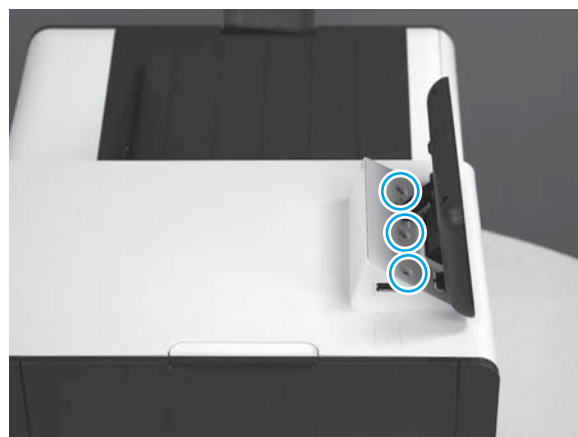

2. Disconnect the control panel FFC, and then remove the control panel.



Left door

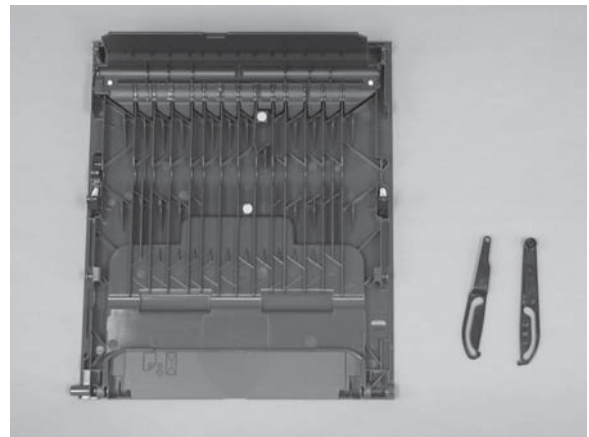

1. Press the latch to open the left door.

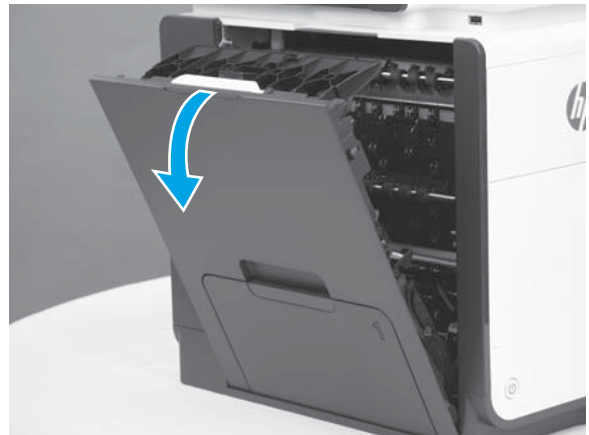

2. Unhook each restraining strap by twisting the bottom end of the strap away from the door.

Reinstallation tip: To replace the straps, pull them off their pivot shafts, and then install the new strap.

Reinstallation tip: Straps are position-sensitive. Replace the front and rear straps with the matching part.

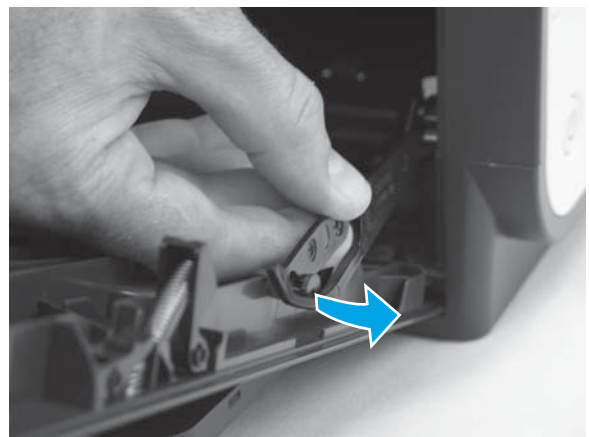

3. Underneath the rear door hinge, locate the catch lever.

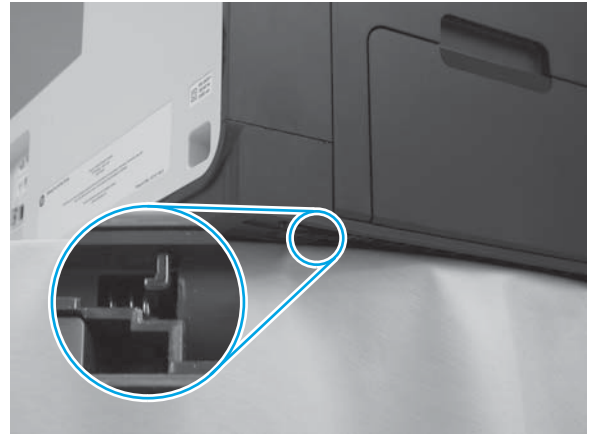

4. Push the catch lever to the rear of the printer and hold it.

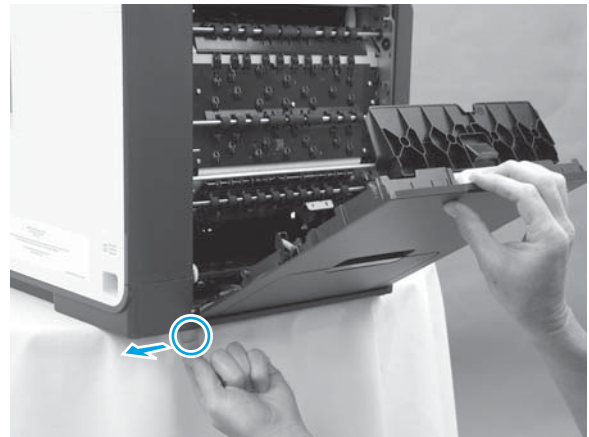

5. While pushing the catch lever to the rear of the printer and holding the door at a 45 degree angle, rotate the rear side of the door to the front of the printer, and then remove the door.

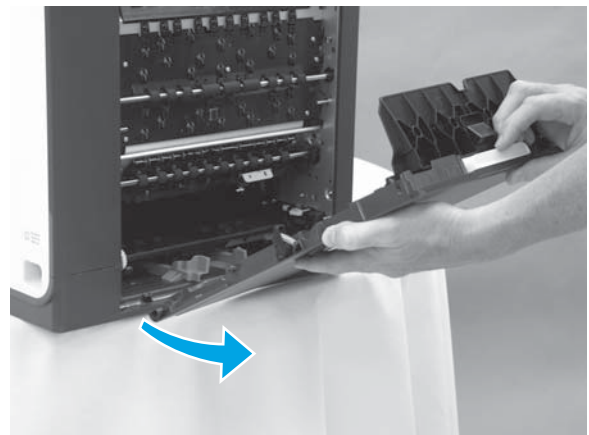

Left rear cover



1. Optional: remove the left door. See [Left door](#) on page 26.
2. Remove two screws.

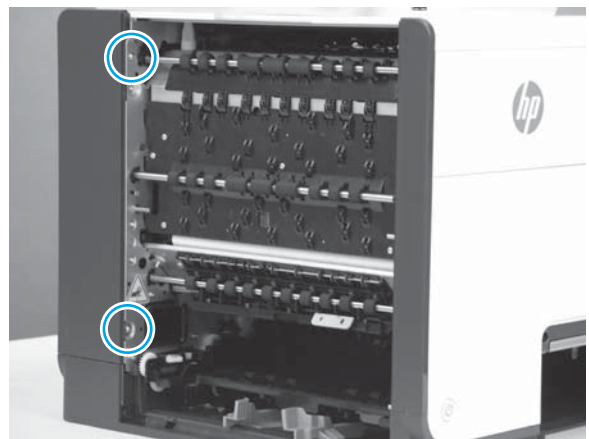

3. Remove the cover by sliding the cover up and rotating it out.

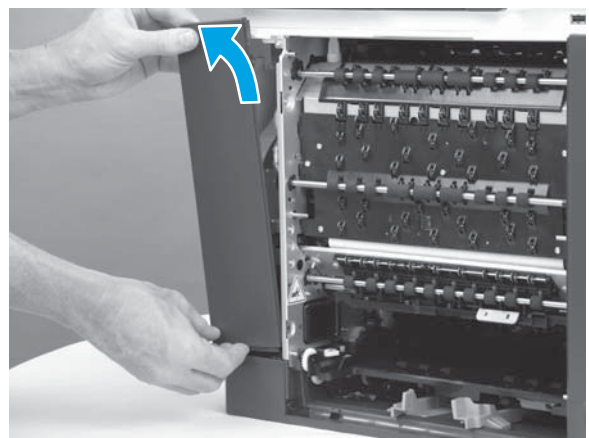

Rear cover (552, 577, P55250, and P57750 models)



Remove these parts in this order:

1. Optional: left door. See [Left door on page 26](#).
2. Duplex module. See [Duplex module on page 11](#).
3. Left rear cover. See [Left rear cover on page 28](#).

1. Locate four rubber plugs at the top of the rear cover and at the left of the cover. Use tweezers to remove the plugs, and then remove the screws behind the plugs.



2. Pull the cover to the right, and then remove it.
The tabs at the top connecting the cover to the printer will make loud noises when being released. This is normal.



Rear cover (352, 452, 377, 477 models)



Remove these parts in this order:

1. Output bin. See [Output bin \(352, 452, 377, and 477 models\) on page 11](#).
2. Optional: left door. See [Left door on page 26](#).
3. Duplex module. See [Duplex module on page 11](#).
4. Left rear cover. See [Left rear cover on page 28](#).

1. Remove one screw.



2. Locate two rubber plugs at the top of the rear cover. Use tweezers to remove the plugs, and then remove the two screws behind the plugs.

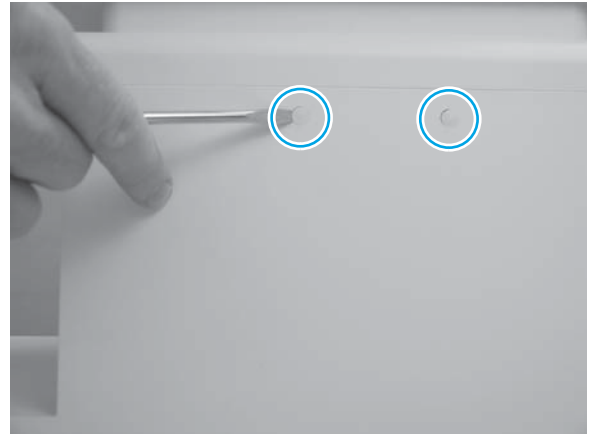

3. Pull the cover to the right, and then remove it.
The tabs at the top connecting the cover to the printer will make loud noises when being released. This is normal.



Left front cover



Remove these parts in this order:

1. Output bin. See [Output bin \(352, 452, 377, and 477 models\) on page 11](#).
2. Optional: left door. See [Left door on page 26](#).

3. Duplex module. See [Duplex module on page 11](#).
4. Left rear cover. See [Left rear cover on page 28](#).

1. Remove one screw.

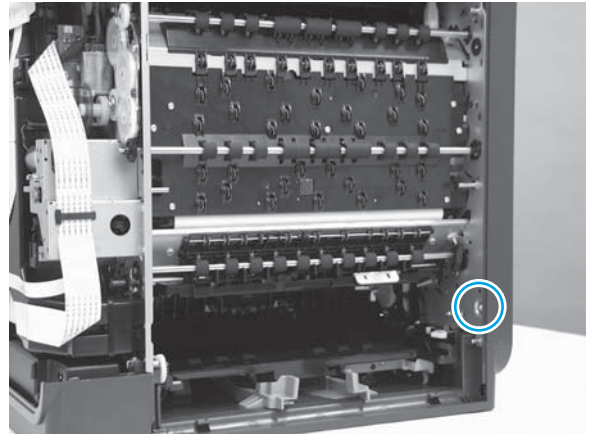

2. Use a screwdriver to depress the tab (1), and then remove the cover (2) by sliding the cover up, and then rotating the cover away from the printer.

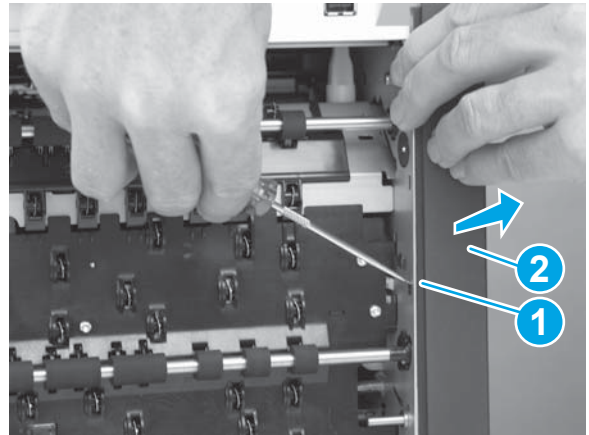

Top cover (377, 477, 577 models)

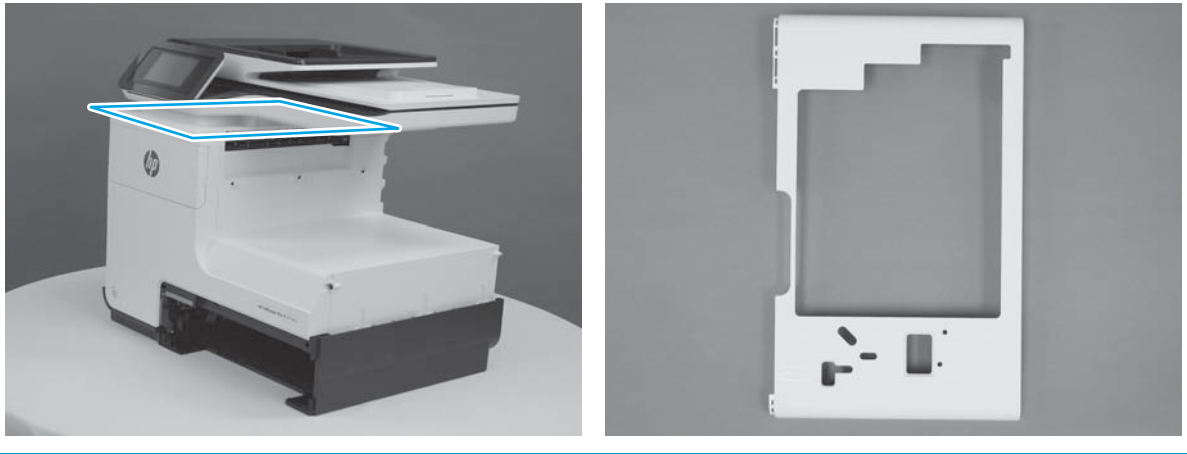

Remove these parts in this order:

1. Output bin. See [Output bin \(352, 452, 377, and 477 models\) on page 11](#).
2. Optional: left door. See [Left door on page 26](#).
3. Duplex module. See [Duplex module on page 11](#).
4. Left rear cover. See [Left rear cover on page 28](#).
5. Rear cover. See [Rear cover \(552, 577, P55250, and P57750 models\) on page 29](#) or [Rear cover \(352, 452, 377, 477 models\) on page 30](#).
6. Control panel. See [Control panel \(color displays\) on page 24](#) or [Control panel \(monochrome displays—352, 452 models\) on page 25](#).
7. MFP models: scanner assembly. See [Scanner assembly and scanner support bracket \(MFP models only\) on page 78](#).
8. MFP models: scanner support bracket. See [Scanner assembly and scanner support bracket \(MFP models only\) on page 78](#).
9. Left front cover. See [Left front cover on page 31](#).

1. On the left side of the printer, remove the two screws.

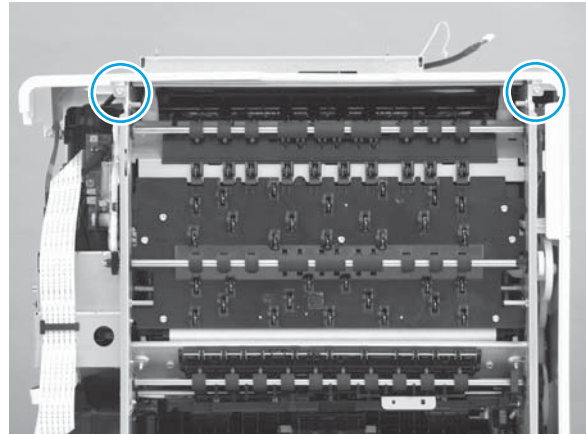

2. Remove the top cover from the printer by sliding it to the right side, and then lifting it away.

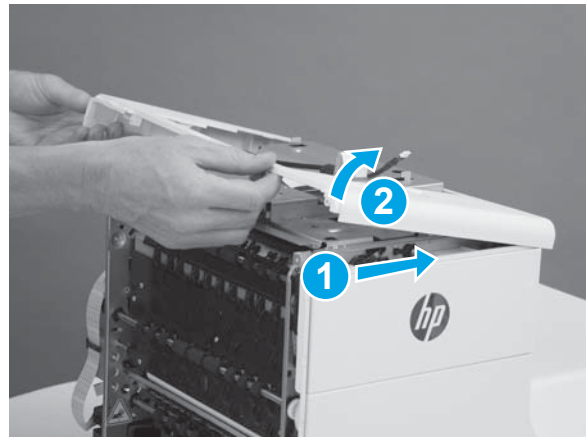

Top cover (352, 452, 552 models)

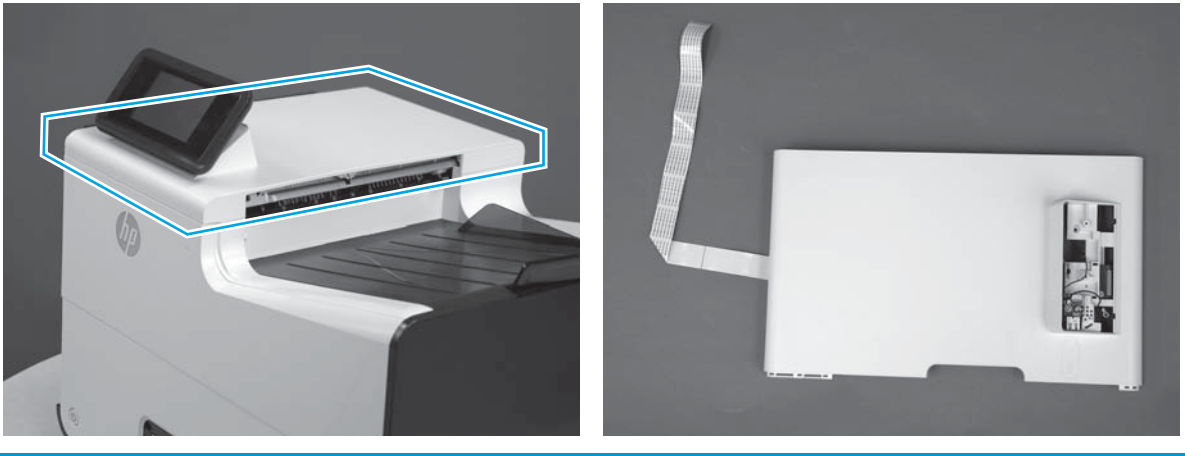

Remove these parts in this order:

1. Output bin. See [Output bin \(352, 452, 377, and 477 models\) on page 11](#).
2. Optional: left door. See [Left door on page 26](#).
3. Duplex module. See [Duplex module on page 11](#).
4. Left rear cover. See [Left rear cover on page 28](#).
5. Rear cover. See [Rear cover \(552, 577, P55250, and P57750 models\) on page 29](#) or [Rear cover \(352, 452, 377, 477 models\) on page 30](#).
6. Control panel. See [Control panel \(color displays\) on page 24](#) or [Control panel \(monochrome displays—352, 452 models\) on page 25](#).
7. Left front cover. See [Left front cover on page 31](#).

1. On the left side of the printer, remove two screws.

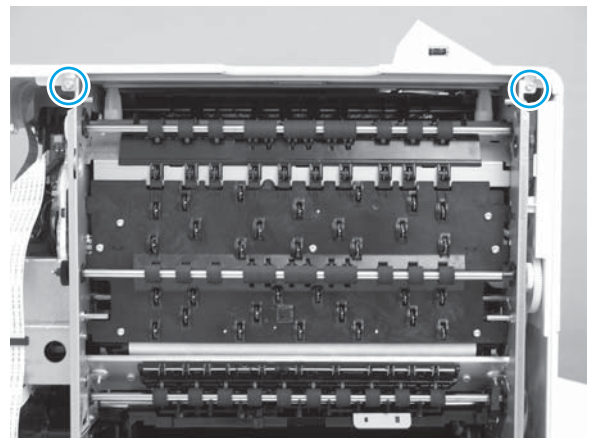

2. In the control-panel cavity, disconnect one cable connector (1) and two screws (2).

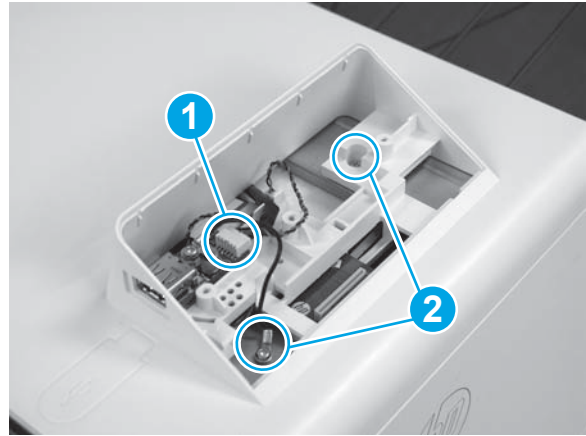

3. At the rear of the printer, on the main PCA, disconnect the FFC (1), and then unthread the cable from the guide (2).

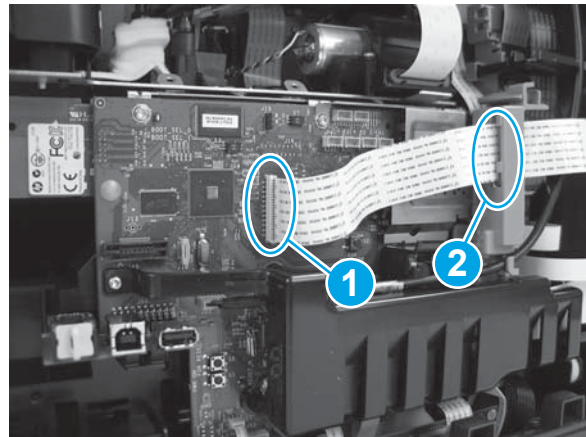

4. Remove the top cover from the printer by sliding it to the right side, and then lifting the left edge of the cover away from the printer chassis.

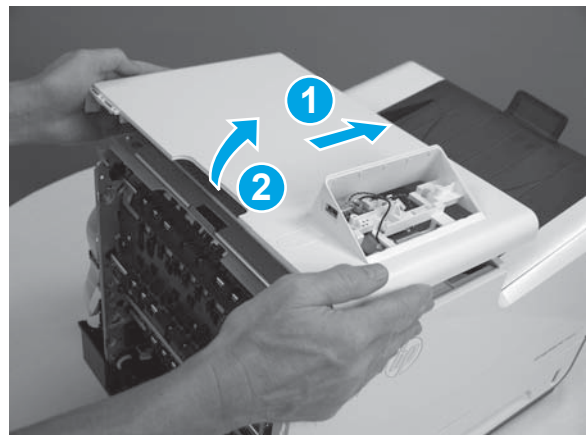

Front cover (352, 452, 377, 477 models)

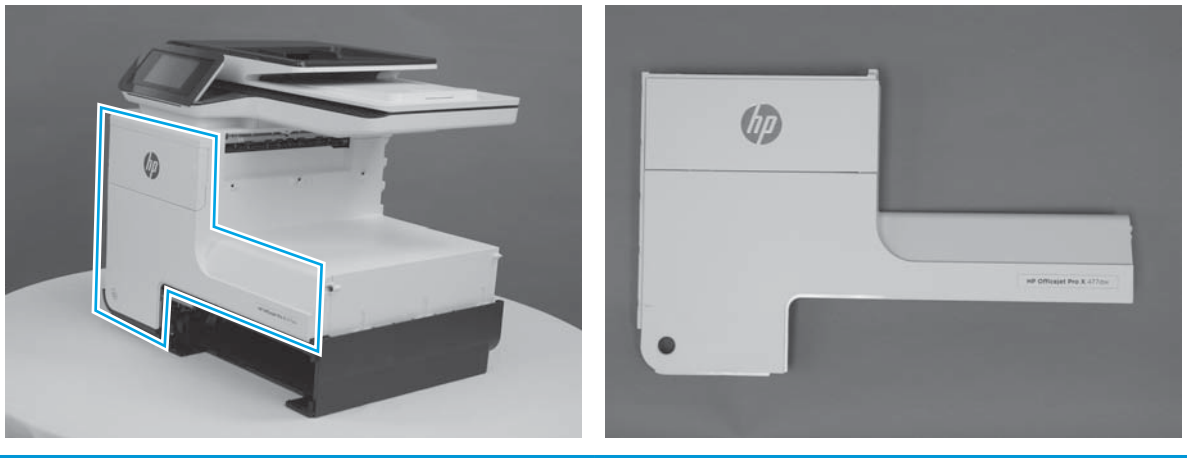

Remove these parts in this order:

1. Output bin. See [Output bin \(352, 452, 377, and 477 models\) on page 11](#).
2. Optional: left door. See [Left door on page 26](#).
3. Duplex module. See [Duplex module on page 11](#).
4. Left rear cover. See [Left rear cover on page 28](#).
5. Rear cover. See [Rear cover \(552, 577, P55250, and P57750 models\) on page 29](#) or [Rear cover \(352, 452, 377, 477 models\) on page 30](#).
6. MFP models: scanner assembly. See [Scanner assembly and scanner support bracket \(MFP models only\) on page 78](#).
7. MFP models: scanner support bracket. See [Scanner assembly and scanner support bracket \(MFP models only\) on page 78](#).
8. Left front cover. See [Left front cover on page 31](#).
9. Top cover. See [Top cover \(377, 477, 577 models\) on page 33](#) or [Top cover \(352, 452, 552 models\) on page 35](#).

1. Remove one screw.



2. Remove the front cover.



Front cover (552, 577 models)



Remove these parts in this order:

1. Output bin. See [Output bin \(352, 452, 377, and 477 models\) on page 11](#).
2. Optional: left door. See [Left door on page 26](#).
3. Duplex module. See [Duplex module on page 11](#).
4. Left rear cover. See [Left rear cover on page 28](#).
5. Rear cover. See [Rear cover \(552, 577, P55250, and P57750 models\) on page 29](#) or [Rear cover \(352, 452, 377, 477 models\) on page 30](#).
6. MFP models: scanner assembly. See [Scanner assembly and scanner support bracket \(MFP models only\) on page 78](#).
7. MFP models: scanner support bracket. See [Scanner assembly and scanner support bracket \(MFP models only\) on page 78](#).
8. Left front cover. See [Left front cover on page 31](#).
9. Top cover. See [Top cover \(377, 477, 577 models\) on page 33](#) or [Top cover \(352, 452, 552 models\) on page 35](#).

1. Remove one screw.



2. Remove the front cover.

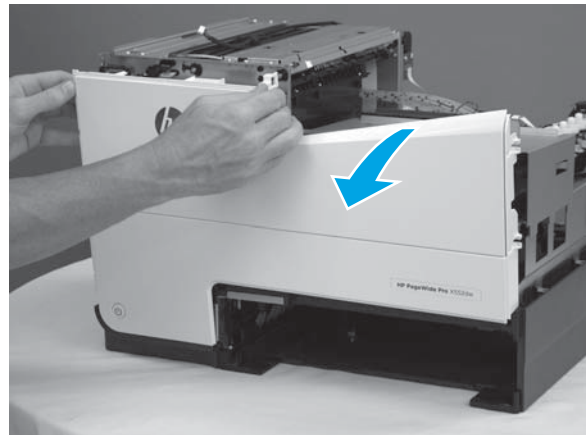

Supply door hinge (352, 452, 377, 477 models)



Remove these parts in this order:

1. Output bin. See [Output bin \(352, 452, 377, and 477 models\) on page 11](#).
2. Optional: left door. See [Left door on page 26](#).
3. Duplex module. See [Duplex module on page 11](#).
4. Left rear cover. See [Left rear cover on page 28](#).
5. Rear cover. See [Rear cover \(552, 577, P55250, and P57750 models\) on page 29](#) or [Rear cover \(352, 452, 377, 477 models\) on page 30](#).
6. Control panel. See [Control panel \(color displays\) on page 24](#) or [Control panel \(monochrome displays—352, 452 models\) on page 25](#).
7. MFP models: scanner assembly. See [Scanner assembly and scanner support bracket \(MFP models only\) on page 78](#).
8. MFP models: scanner support bracket. See [Scanner assembly and scanner support bracket \(MFP models only\) on page 78](#).
9. Left front cover. See [Left front cover on page 31](#).
10. Top cover. See [Top cover \(377, 477, 577 models\) on page 33](#) or [Top cover \(352, 452, 552 models\) on page 35](#).
11. Front cover. See [Front cover \(352, 452, 377, 477 models\) on page 37](#) or [Front cover \(552, 577 models\) on page 39](#).

1. Using a flat head screwdriver, gently pry the right hinge post until it clears the plastic retention extrusion.



2. Flex the supply door slightly to disengage the right hinge inner stub.



3. Slide the supply door to the right to remove the door from the front cover.

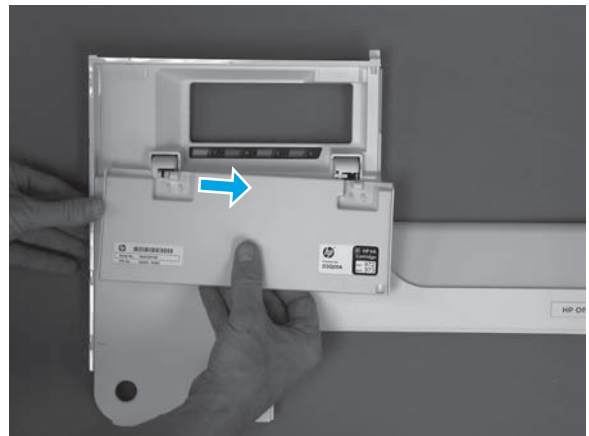

4. Remove two spring clips using needle nose pliers.

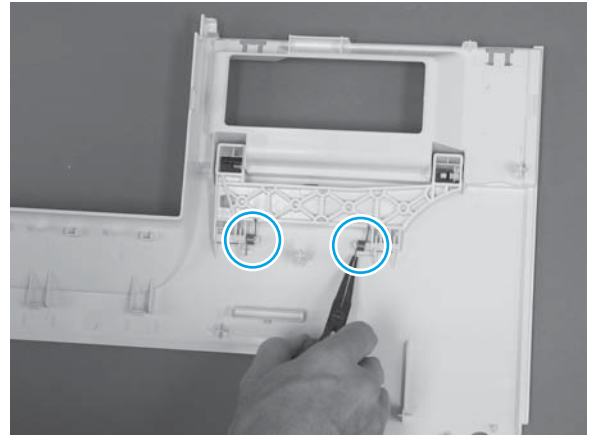

5. Rotate the hinge away from the front door and pull out.

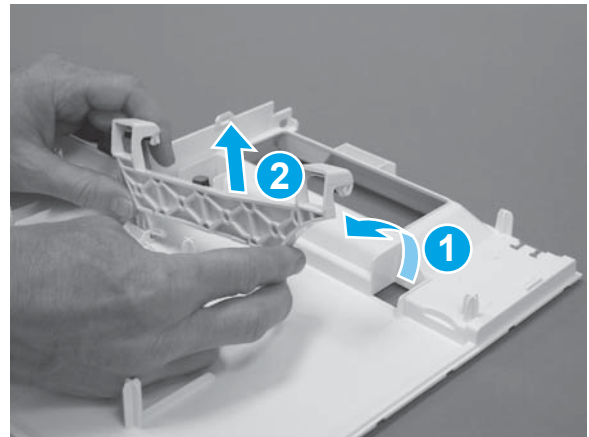

 **Reinstallation tip:** Position the straight portion of the spring clip into the V-notch using needle nose pliers while sliding the spring onto its post.

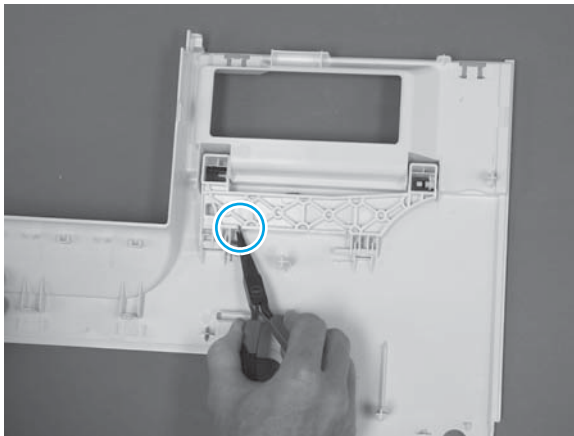

Supply door hinge (552, 557 models)

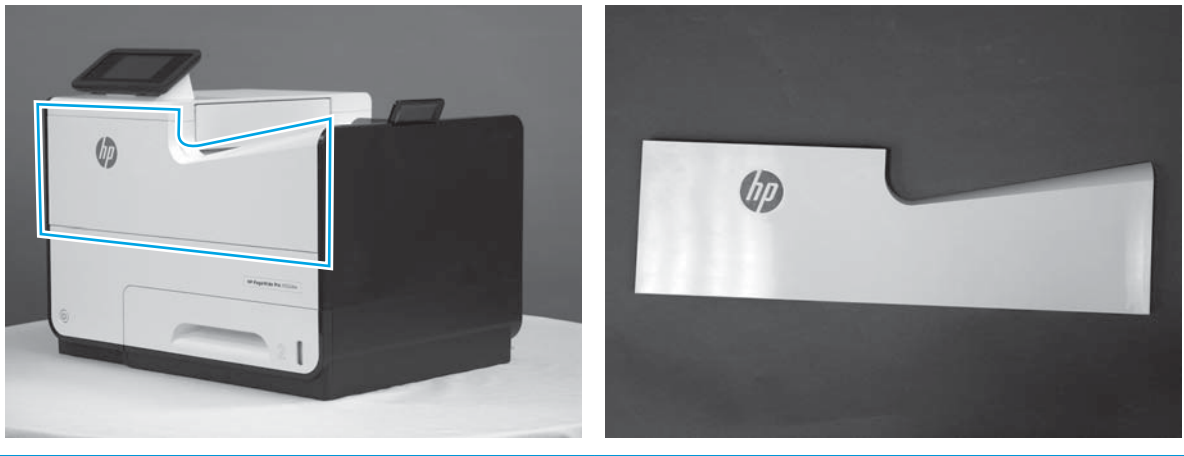

Remove these parts in this order:

1. Output bin. See [Output bin \(352, 452, 377, and 477 models\) on page 11](#).
2. Optional: left door. See [Left door on page 26](#).
3. Duplex module. See [Duplex module on page 11](#).
4. Left rear cover. See [Left rear cover on page 28](#).
5. Rear cover. See [Rear cover \(552, 577, P55250, and P57750 models\) on page 29](#) or [Rear cover \(352, 452, 377, 477 models\) on page 30](#).
6. Control panel. See [Control panel \(color displays\) on page 24](#) or [Control panel \(monochrome displays—352, 452 models\) on page 25](#).
7. MFP models: scanner assembly. See [Scanner assembly and scanner support bracket \(MFP models only\) on page 78](#).
8. MFP models: scanner support bracket. See [Scanner assembly and scanner support bracket \(MFP models only\) on page 78](#).
9. Left front cover. See [Left front cover on page 31](#).
10. Top cover. See [Top cover \(377, 477, 577 models\) on page 33](#) or [Top cover \(352, 452, 552 models\) on page 35](#).
11. Front cover. See [Front cover \(352, 452, 377, 477 models\) on page 37](#) or [Front cover \(552, 577 models\) on page 39](#).

1. Using a flat head screwdriver, gently pry the right hinge post until it clears the plastic retention extrusion.



2. Flex the supply door slightly to disengage the right hinge inner stub.



3. Remove three screws.

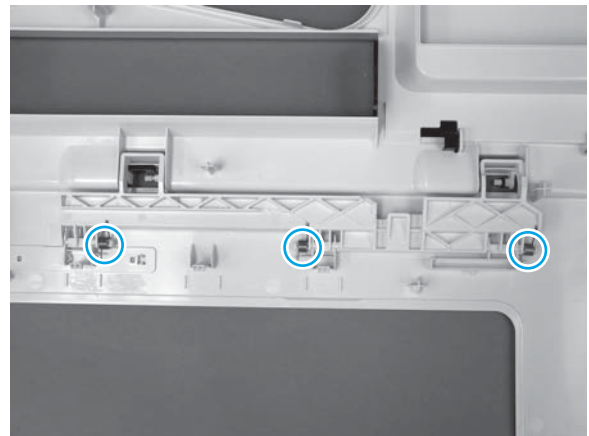

4. Remove two spring clips using needle nose pliers.

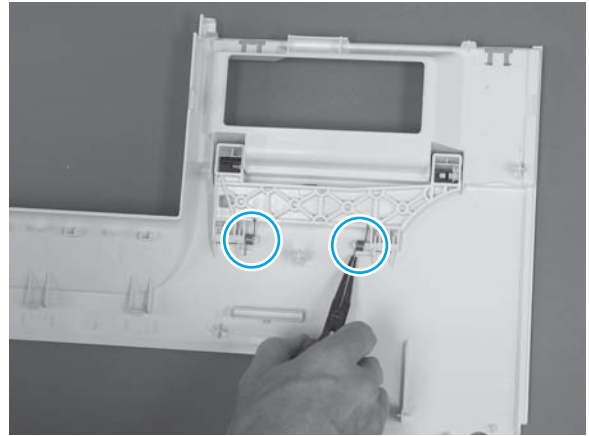

5. Rotate the hinge away from the front door and pull out.

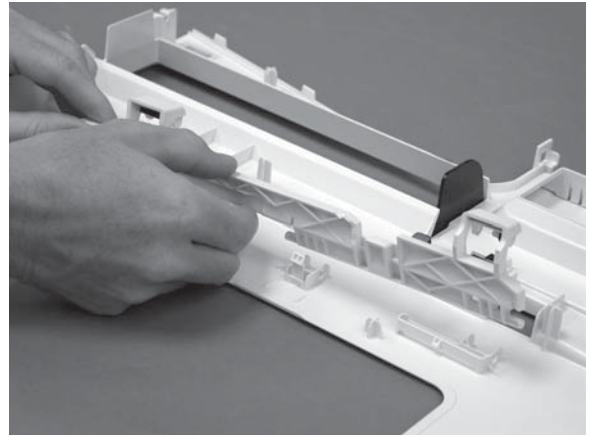

 **Reinstallation tip:** Position the straight portion of the spring clip into the V-notch using needle nose pliers while sliding the spring onto its post.

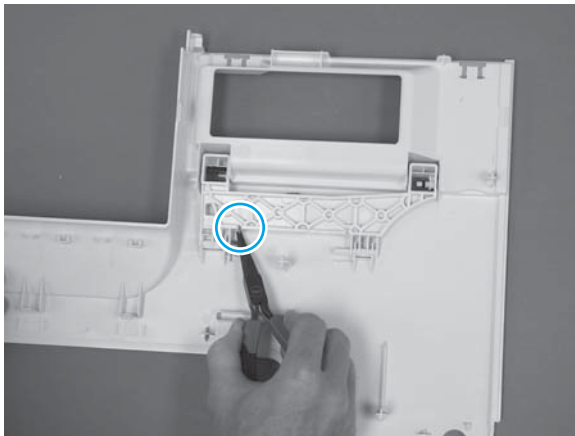

Right cover

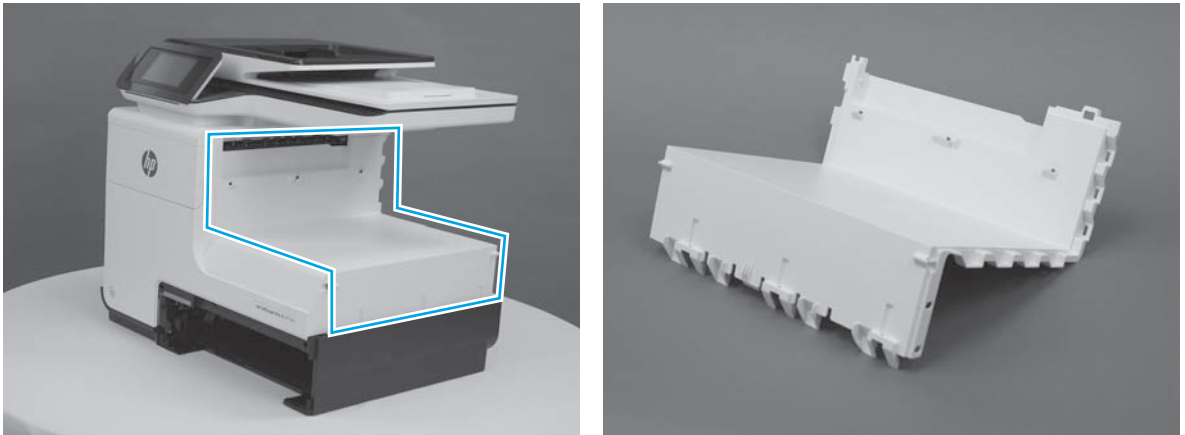

Remove these parts in this order:

1. Output bin. See [Output bin \(352, 452, 377, and 477 models\) on page 11](#).
2. Optional: left door. See [Left door on page 26](#).
3. Duplex module. See [Duplex module on page 11](#).
4. Left rear cover. See [Left rear cover on page 28](#).
5. Rear cover. See [Rear cover \(552, 577, P55250, and P57750 models\) on page 29](#) or [Rear cover \(352, 452, 377, 477 models\) on page 30](#).
6. Control panel. See [Control panel \(color displays\) on page 24](#) or [Control panel \(monochrome displays—352, 452 models\) on page 25](#).
7. MFP models: scanner assembly. See [Scanner assembly and scanner support bracket \(MFP models only\) on page 78](#).
8. MFP models: scanner support bracket. See [Scanner assembly and scanner support bracket \(MFP models only\) on page 78](#).
9. Left front cover. See [Left front cover on page 31](#).
10. Top cover. See [Top cover \(377, 477, 577 models\) on page 33](#) or [Top cover \(352, 452, 552 models\) on page 35](#).
11. Front cover. See [Front cover \(352, 452, 377, 477 models\) on page 37](#) or [Front cover \(552, 577 models\) on page 39](#).

1. 552, 577 models: Remove the right trim cover by pulling the top part loose and then lifting the cover up off of the printer.

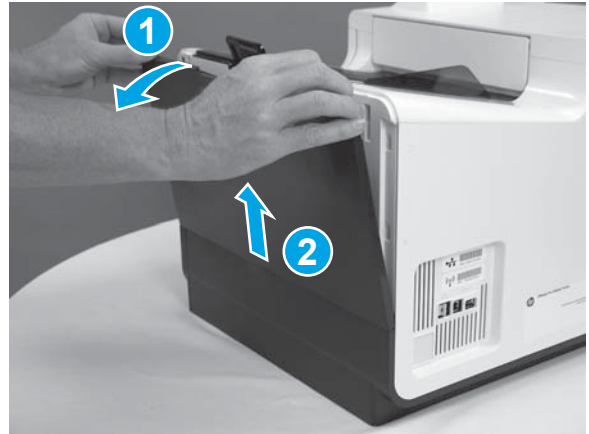

2. Remove three screws.

NOTE: 552, 577 models: Remove only the two outside screws. The middle screw should stay in place.

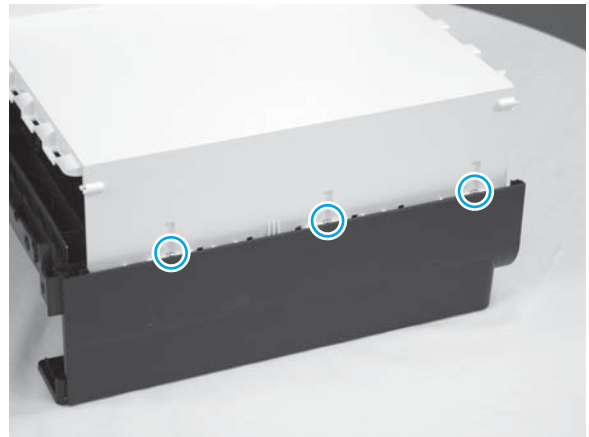

3. Remove the right cover from the printer.

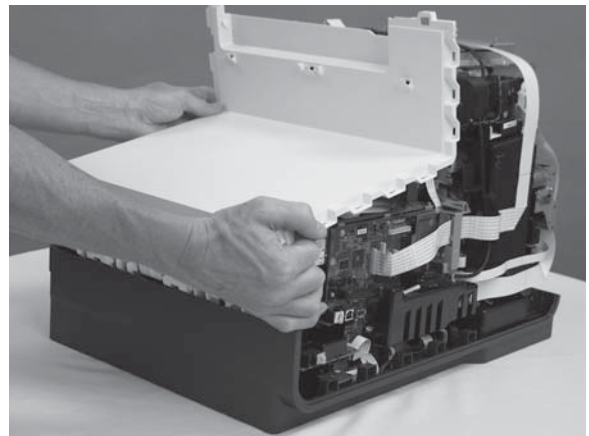

Assemblies accessed through the rear cover

Drying path gear assembly

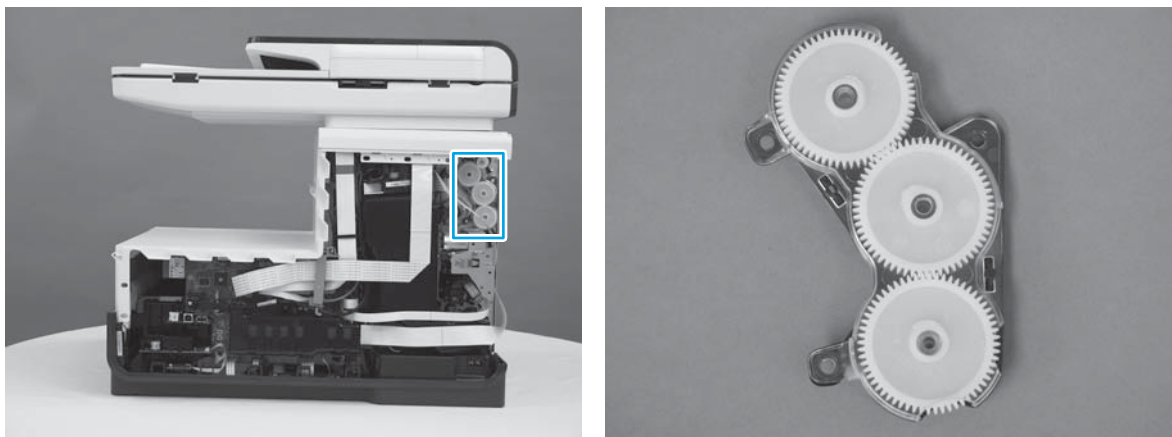

Remove these parts in this order:

1. Output bin. See [Output bin \(352, 452, 377, and 477 models\) on page 11](#).
2. Rear cover. See [Rear cover \(552, 577, P55250, and P57750 models\) on page 29](#) or [Rear cover \(352, 452, 377, 477 models\) on page 30](#).

1. Remove three screws (1), and then remove the assembly (2).

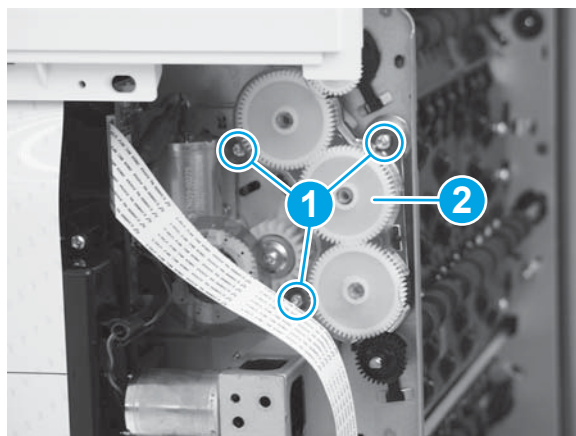

Temperature sensor

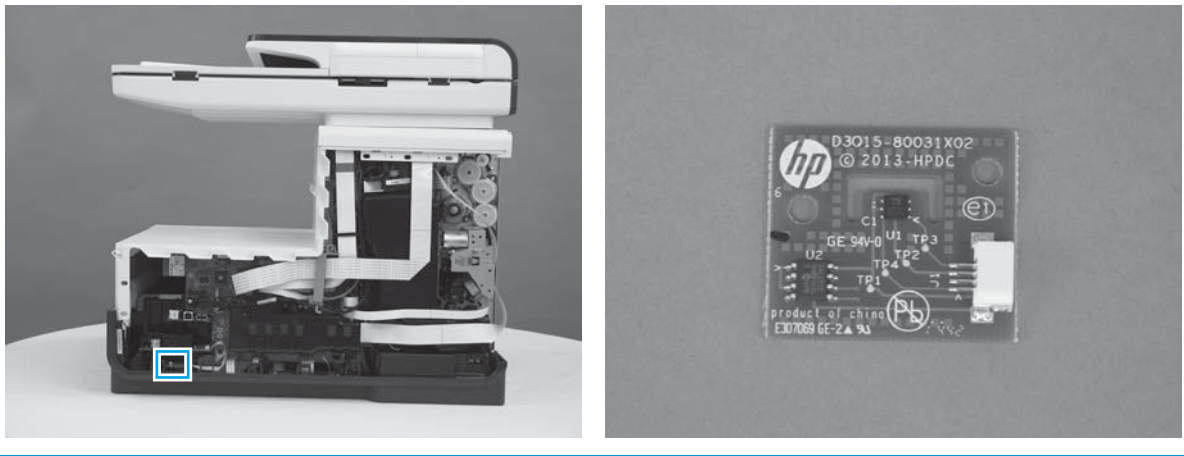

Remove these parts in this order:

1. Output bin. See [Output bin \(352, 452, 377, and 477 models\) on page 11](#).
 2. Optional: left door. See [Left door on page 26](#).
 3. Duplex module. See [Duplex module on page 11](#).
 4. Optional: left rear cover. See [Left rear cover on page 28](#).
 5. Rear cover. See [Rear cover \(552, 577, P55250, and P57750 models\) on page 29](#) or [Rear cover \(352, 452, 377, 477 models\) on page 30](#).
1. Disconnect one FFC.

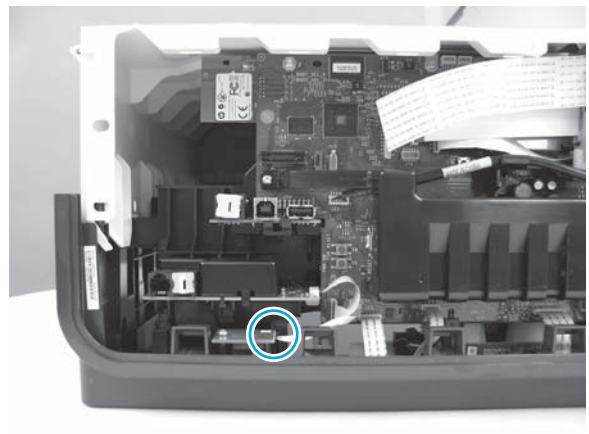

2. Remove one screw (1), and then remove the sensor.

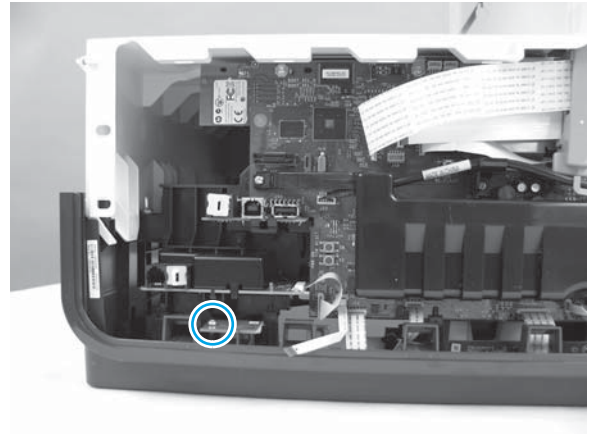

3. After reinstalling the temperature sensor, test for the correct operation. A correctly operating temperature sensor is indicated by the results of a 12 tap test. Print a 12 tap test, and check for the correct temperature. See [12 tap test results \(REDI sensor values\) on page 18](#).

PCA safety shield

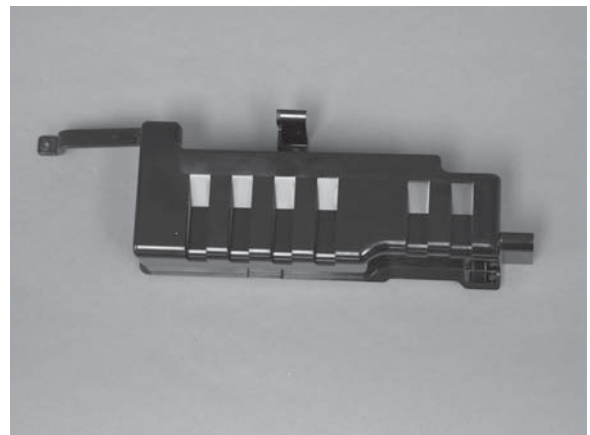
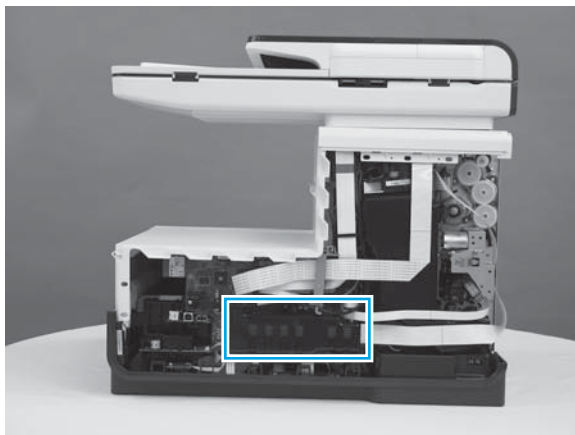

Remove these parts in this order:

1. Output bin. See [Output bin \(352, 452, 377, and 477 models\) on page 11](#).
2. Optional: left door. See [Left door on page 26](#).
3. Duplex module. See [Duplex module on page 11](#).
4. Left rear cover. See [Left rear cover on page 28](#).
5. Rear cover. See [Rear cover \(552, 577, P55250, and P57750 models\) on page 29](#) or [Rear cover \(352, 452, 377, 477 models\) on page 30](#).

1. Remove two screws (1).

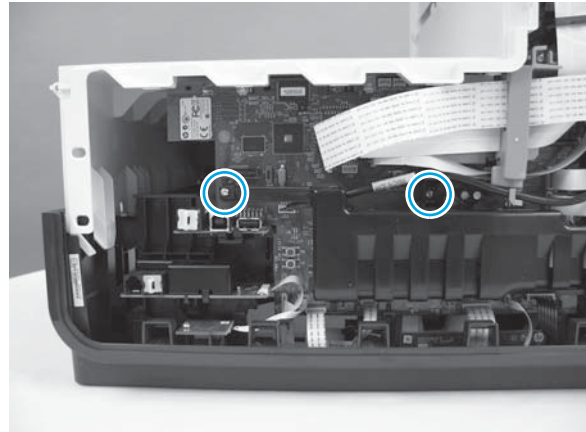

2. Remove the shield (1) by pushing the shield toward the aerosol fan assembly.

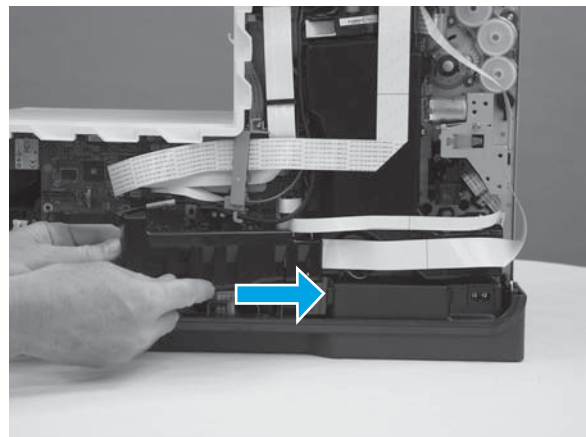

Fax PCA (MFP models)

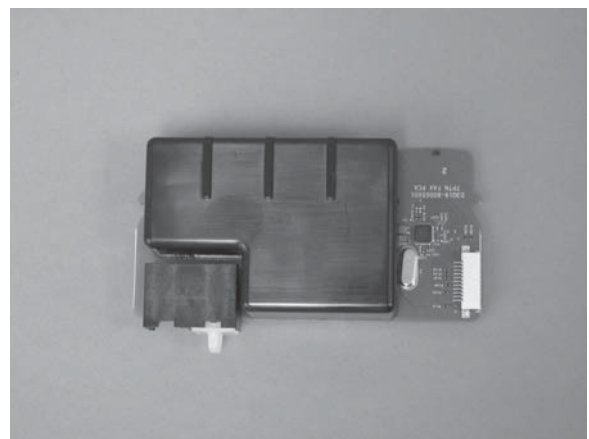
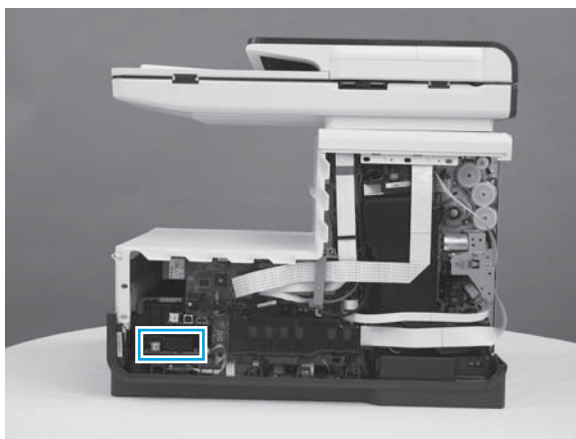

 **NOTE:** If the fax PCA is removed permanently, cover the fax line port opening in the rear cover with a piece of electrical tape.

Remove these parts in this order:

1. Output bin. See [Output bin \(352, 452, 377, and 477 models\) on page 11](#).
2. Optional: left door. See [Left door on page 26](#).
3. Duplex module. See [Duplex module on page 11](#).
4. Optional: left rear cover. See [Left rear cover on page 28](#).
5. Rear cover. See [Rear cover \(552, 577, P55250, and P57750 models\) on page 29](#) or [Rear cover \(352, 452, 377, 477 models\) on page 30](#).

1. Disconnect one FFC.

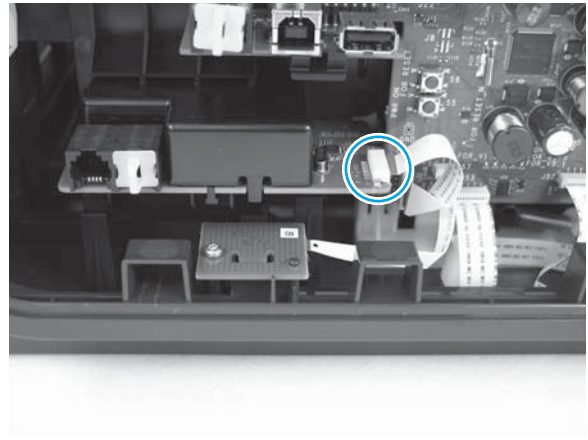

2. Release the plastic retention clips by pushing them left and right while pulling the PCA out.

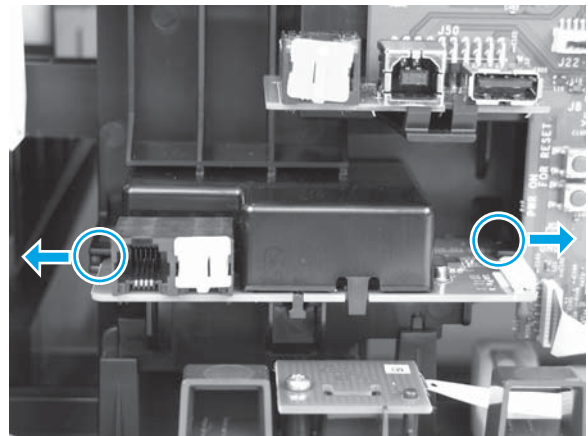

Main PCA

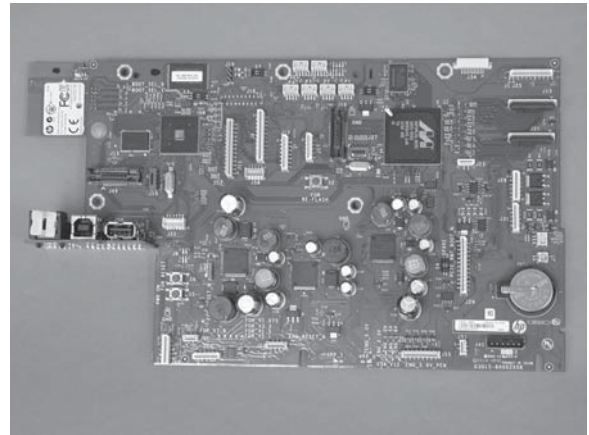
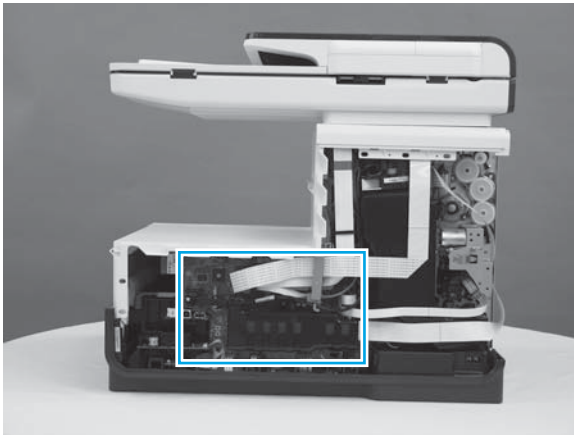

NOTE: If the printer has printed more than 5,000 pages, HP recommends replacing the duplex module assembly.

If the printer has printed more than 30,000 pages, HP recommends replacing the service sled assembly. This only applies if the main PCA is being replaced.

Verify that the printer is turned off, and that the power cable and all interface cables are disconnected. Remove these parts in this order:

1. Output bin. See [Output bin \(352, 452, 377, and 477 models\) on page 11](#).
 2. Optional: left door. See [Left door on page 26](#).
 3. Duplex module. See [Duplex module on page 11](#).
 4. Left rear cover. See [Left rear cover on page 28](#).
 5. Rear cover. See [Rear cover \(552, 577, P55250, and P57750 models\) on page 29](#) or [Rear cover \(352, 452, 377, 477 models\) on page 30](#).
 6. PCA safety shield. See [PCA safety shield on page 51](#).
1. Disconnect all cables from the PCA.

NOTE: Additional clearance can be obtained by removing the aerosol fan assembly.

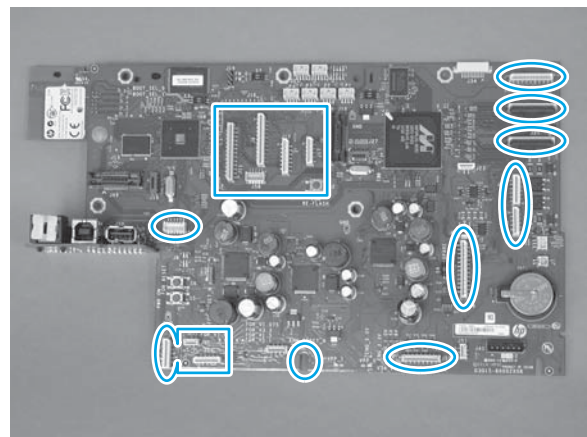

2. The main PCA sockets highlighted are ZIF sockets. Take care to not break the latches on these ZIF sockets when removing or installing the FCCs in these sockets.

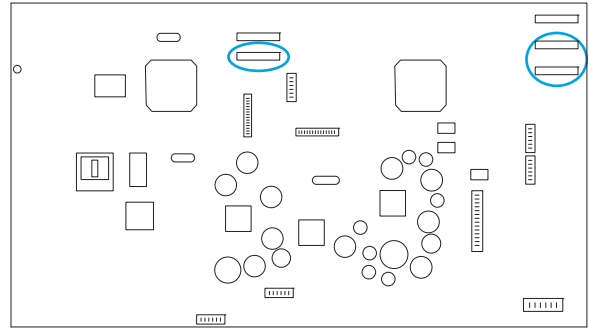

3. Remove one screw on the wire harness, and the lift the wire harness away from the PCA.

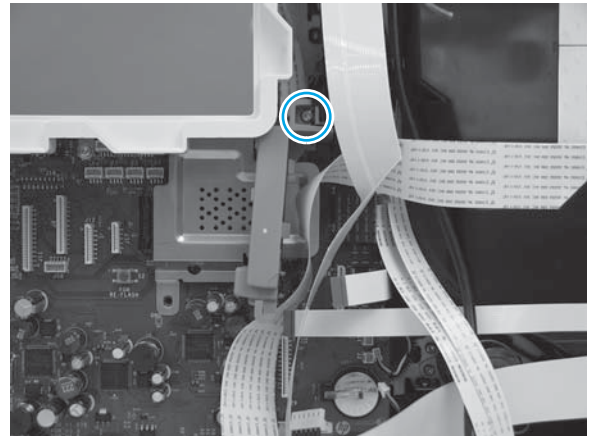

4. Remove three screws from the PCA.

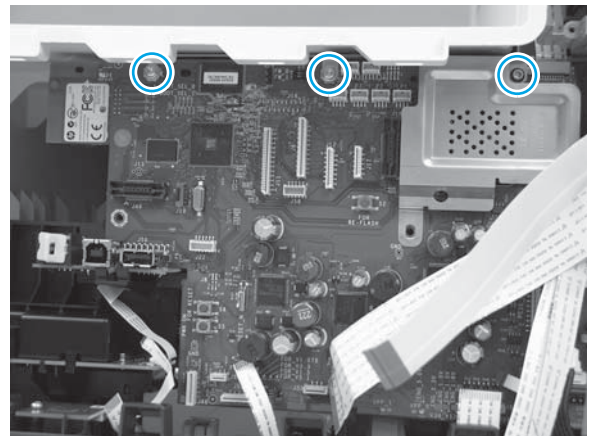

5. Remove the EMI shield.

Reinstallation tip: The EMI shield has a clip on it that must attach to the main PCA during the reinstallation process.

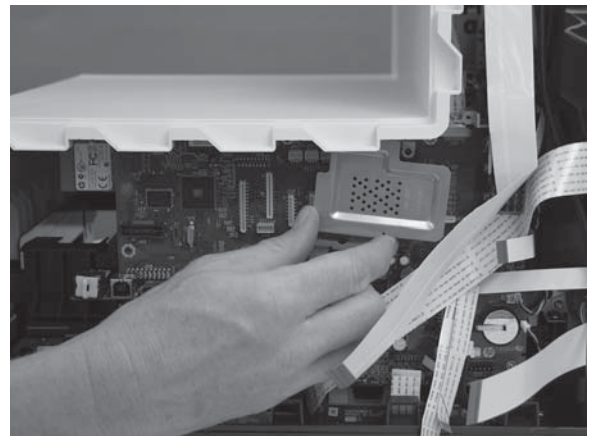

6. Press the plastic retention clip down.

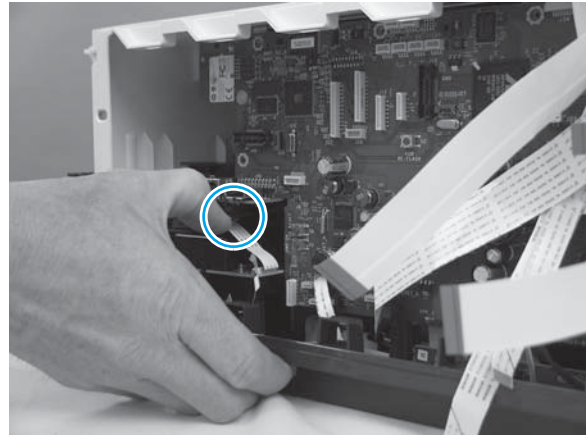

7. Slide the PCA up to remove it from the mounting posts.

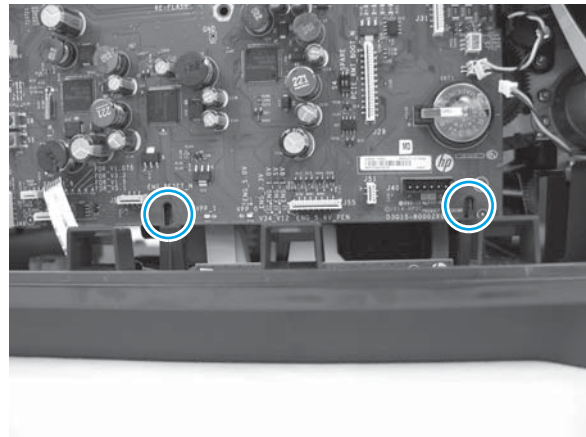

8. Rotate the bottom of the PCA outward then pull the PCA to remove.

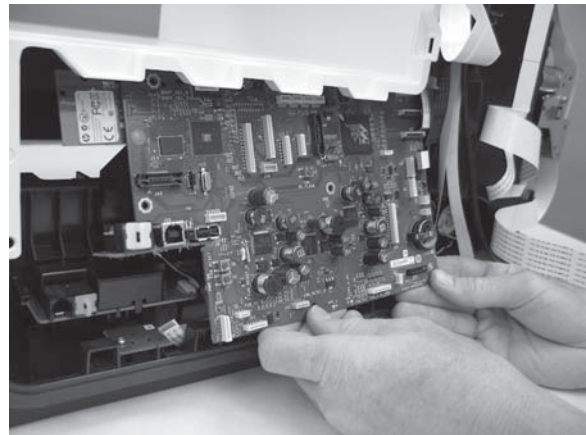

 **Reinstallation tip:** Fit the bottom of the PCA onto the mounting posts in the printer frame.

When reinstalling the main PCA, verify that the service sled is installed correctly. See [Service sled transmission on page 67](#).

 **NOTE:** After replacing the main PCA, you must perform all calibration processes.

Main PCA calibration procedure

1. Reconnect the cable routing, shielding, and the cables.
 2. Turn on the printer.
 3. Print a printer status report and verify that there are no errors in printing, and that the serial number and printer model are listed correctly.
 4. Print a configuration page.
 5. Turn off the printer.
 6. Replace the rear cover.
 7. Turn on the printer, and then set the time and date settings, plus any customer settings as appropriate.
 8. Again run a copy (MFP models) or print (SFP models) job.
 9. Open the [Engineering](#) menu. See [Menu access on monochrome control panels on page 12](#) or [Menu access on color control panels on page 14](#).
 10. Select the [Service](#) menu.
 11. Select the [Special Reports](#) menu.
 12. Select the [Print Mech Tap Tests](#) menu.
 13. Run the following tap tests:
 - 10 tap
 - 12 tap
 - 61 tap
 - 909 tap
- For more information on running and verifying tap test results, see [Perform tap tests and interpret results on page 16](#).
14. Return to the [Ready](#) screen, and then complete the customer configurations, including network settings, preferred paper size and trays, and so forth.

Tray 3 interconnect PCA

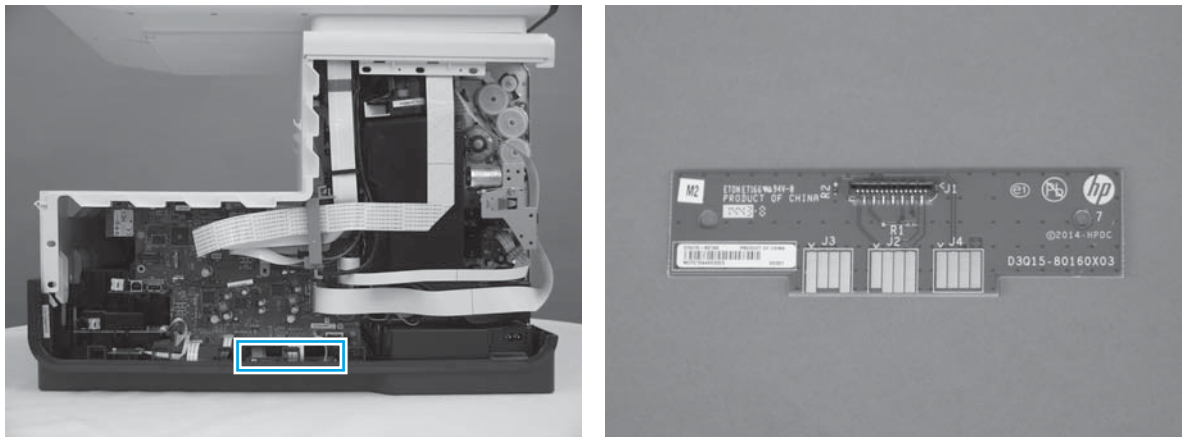

Remove these parts in this order:

1. Output bin. See [Output bin \(352, 452, 377, and 477 models\) on page 11](#).
2. Optional: left door. See [Left door on page 26](#).
3. Duplex module. See [Duplex module on page 11](#).
4. Left rear cover. See [Left rear cover on page 28](#).
5. Rear cover. See [Rear cover \(552, 577, P55250, and P57750 models\) on page 29](#) or [Rear cover \(352, 452, 377, 477 models\) on page 30](#).
6. PCA safety shield. See [PCA safety shield on page 51](#).

1. Remove the FFC from the tray 3 interconnect PCA.

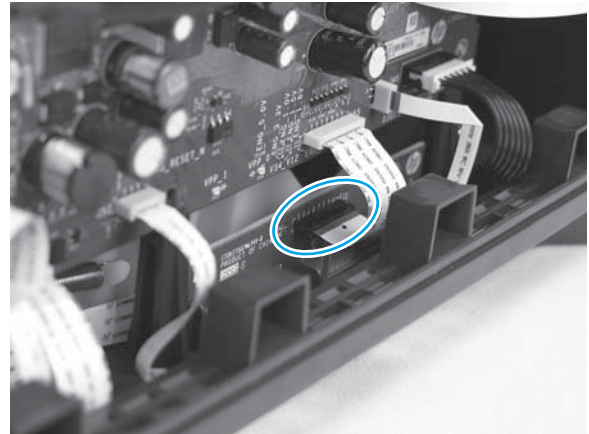

2. Use a small screwdriver to release the tab on the right side of the PCA (1) and lift slightly. Repeat on the left side (2), and then remove the PCA.

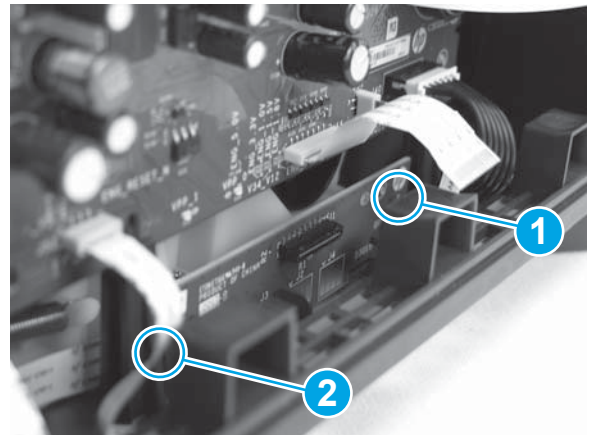

Aerosol fan assembly

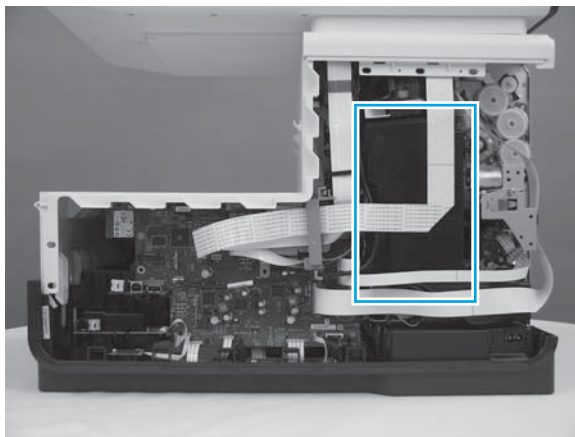

Remove these parts in this order:

1. Output bin. See [Output bin \(352, 452, 377, and 477 models\) on page 11](#).
2. Optional: left door. See [Left door on page 26](#).

3. Duplex module. See [Duplex module on page 11](#).
4. Left rear cover. See [Left rear cover on page 28](#).
5. Rear cover. See [Rear cover \(552, 577, P55250, and P57750 models\) on page 29](#) or [Rear cover \(352, 452, 377, 477 models\) on page 30](#).
6. PCA safety shield. See [PCA safety shield on page 51](#).

1. Disconnect the control panel flex cable.

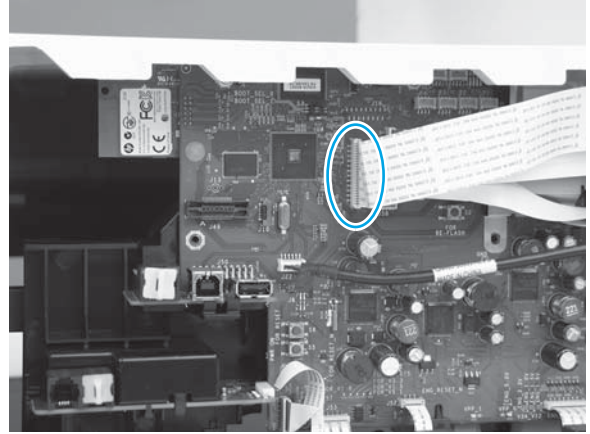

2. Disconnect the printbar lift distribution FFC (1) and the sensor carriage FFC (2).

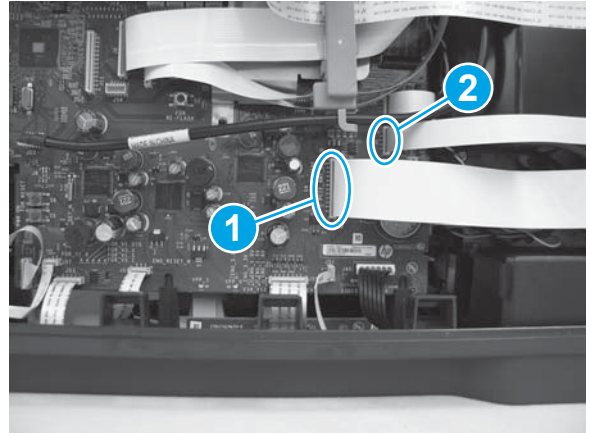

3. Unthread the printbar lift distribution FFC (1) and the sensor carriage FFC (2).

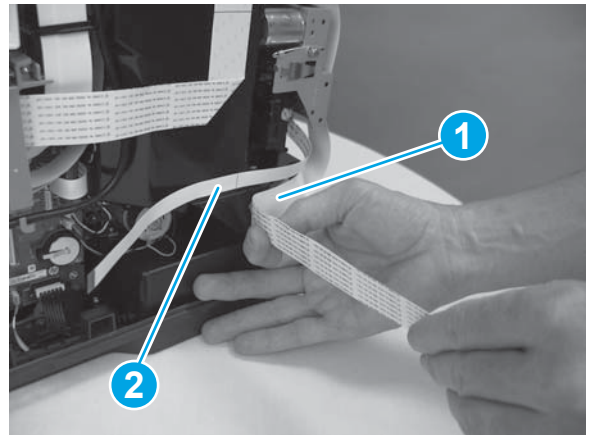

4. Unthread the control panel cable (1) through the ferrite (2).

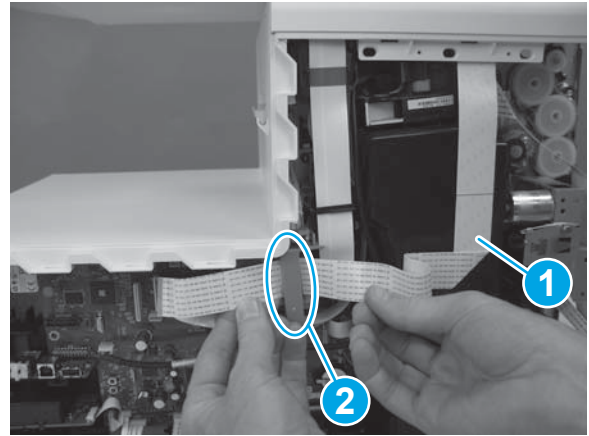

5. Use needle-nose pliers to disconnect the fan motor power cable.

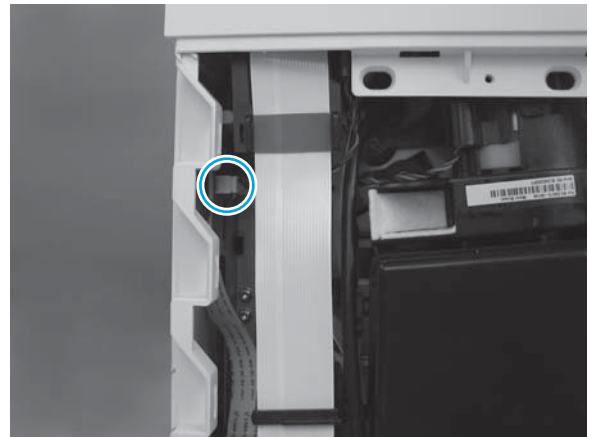

6. Disconnect the feed drive motor cable.

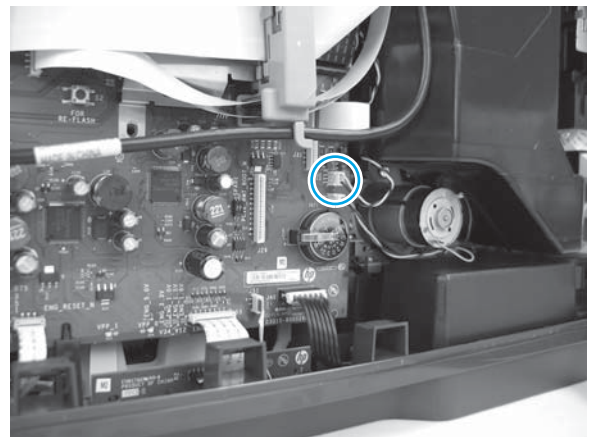

7. Unthread the feed drive motor cable from the fan assembly housing.

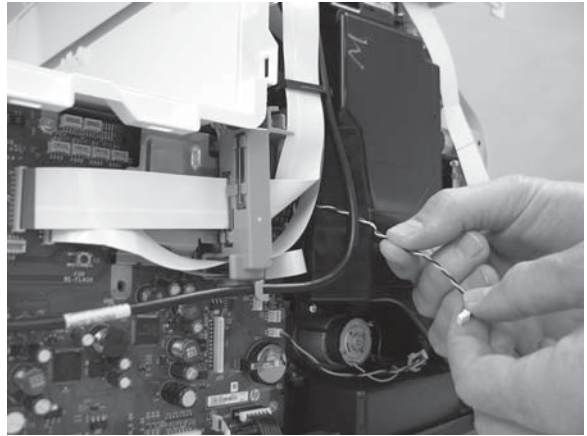

8. Slide the sensor carriage ferrite out while widening the retention clip using a small screwdriver. Leave the sensor carriage motor plugged in.

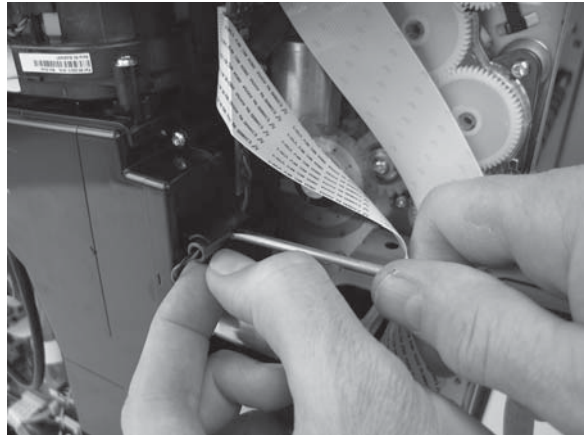

9. Remove three screws mounting the housing to the chassis.

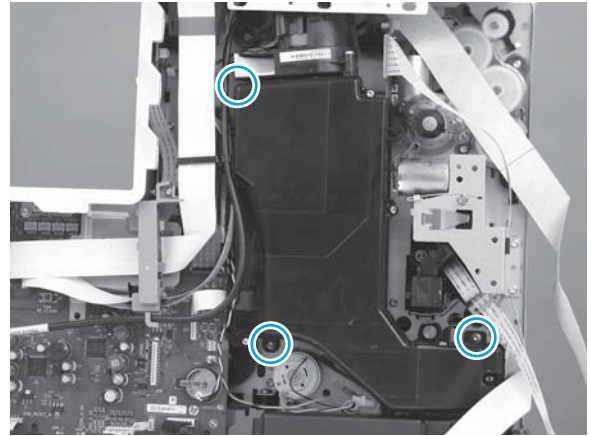

10. Pull out the fan assembly.

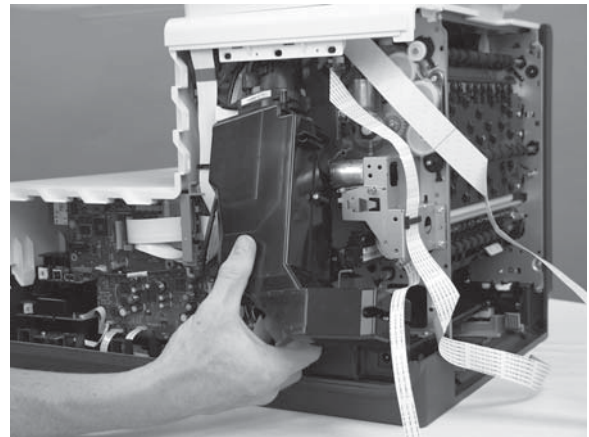

CAUTION: Avoid placing the assembly on any surface with the duct opening and gasket ring in contact with the surface. Doing so will leave an ink ring on the surface. Additionally, avoid touching the duct opening and gasket ring.

Reinstallation tip: Align the black lines on the flex cables with the indicators on the fan assembly housing.

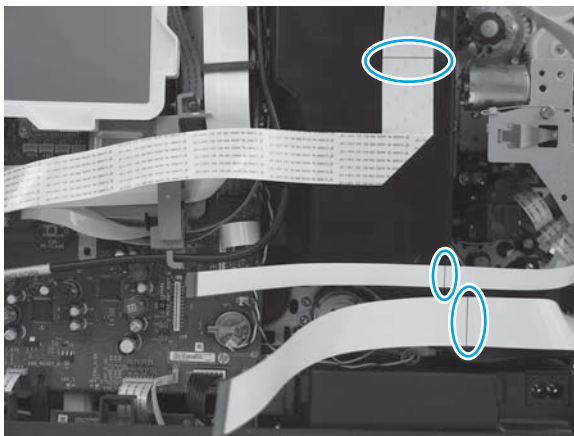

Printbar lift mechanism assembly

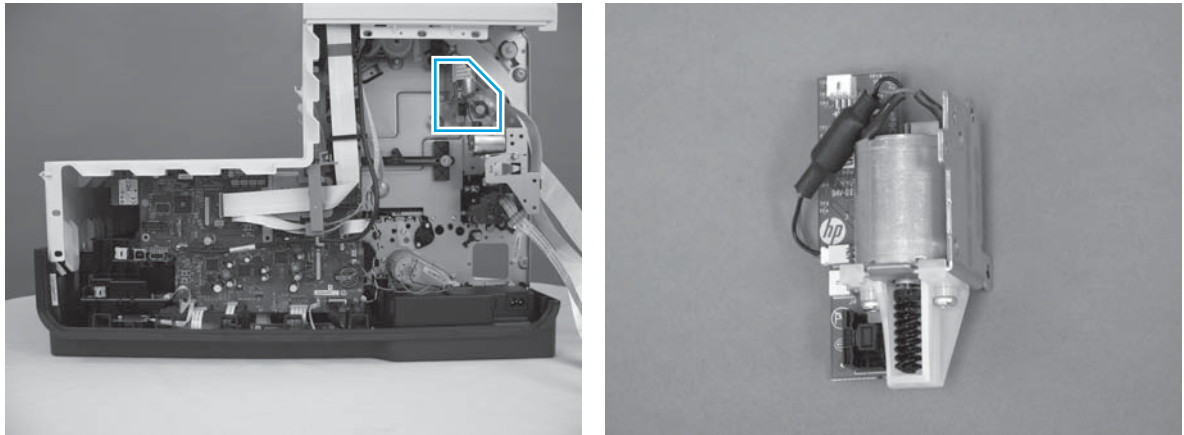

Remove these parts in this order:

1. Output bin. See [Output bin \(352, 452, 377, and 477 models\) on page 11](#).
2. Optional: left door. See [Left door on page 26](#).
3. Duplex module. See [Duplex module on page 11](#).
4. Left rear cover. See [Left rear cover on page 28](#).
5. Rear cover. See [Rear cover \(552, 577, P55250, and P57750 models\) on page 29](#) or [Rear cover \(352, 452, 377, 477 models\) on page 30](#).
6. PCA safety shield. See [PCA safety shield on page 51](#).
7. Aerosol fan assembly. See [Aerosol fan assembly on page 59](#).
8. Drying path gear assembly. See [Drying path gear assembly on page 49](#).

1. Disconnect three connectors.

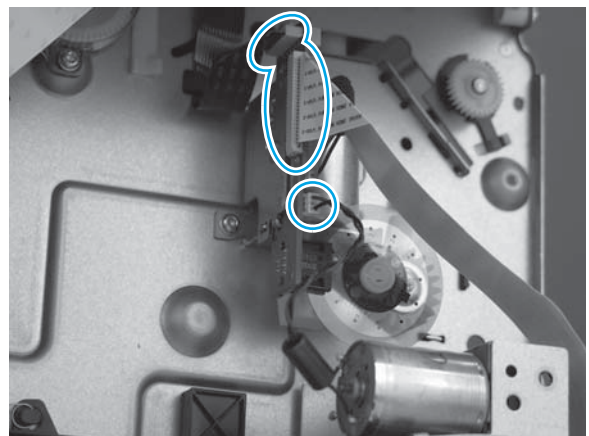

2. Remove two screws, and then remove the assembly.

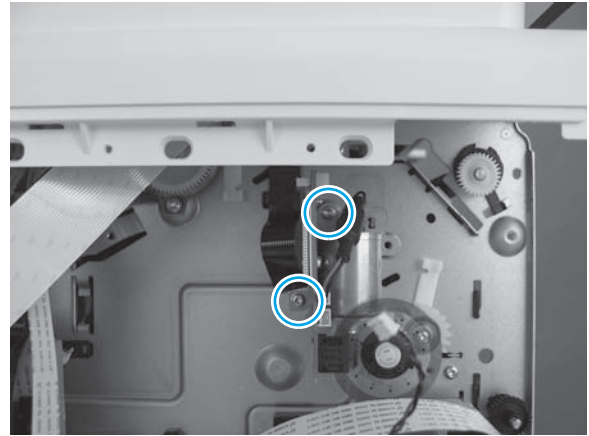

3. Remove the plastic clip from the printbar lift encoder shaft. Remove the lift encoder/gear assembly. Lift up the shaft when removing it to avoid damage to the disc.

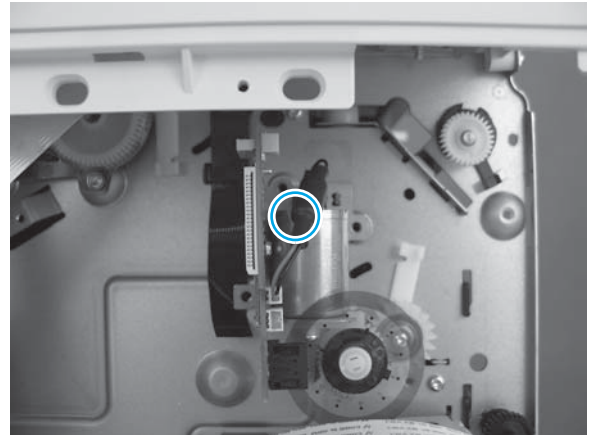

 **Reinstallation tip:** Fit the encoder wheel through the sensor on the back of the PCA assembly.

Reinstallation tip: Use the clip supplied with the printbar lift mechanism kit. Do **not** reuse the existing clip.

Pick encoder distribution PCA

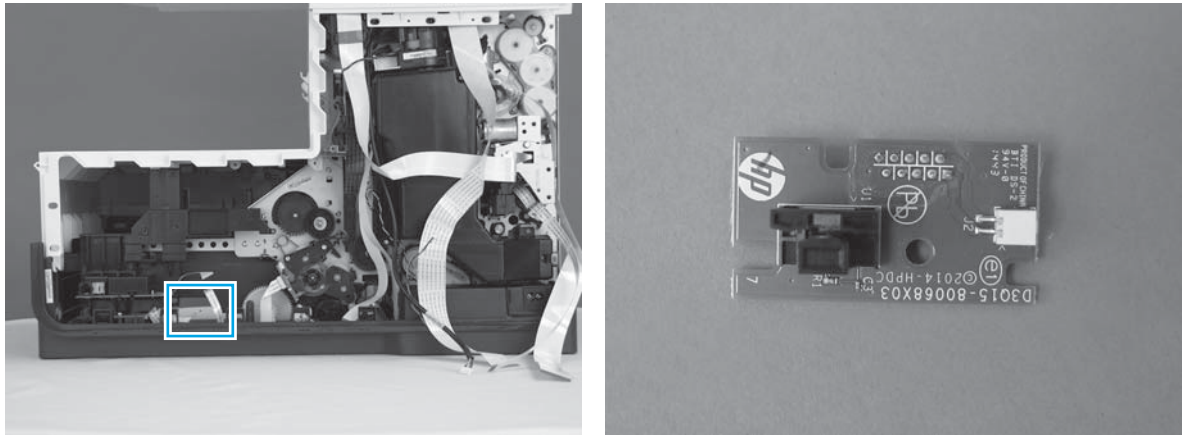

Remove these parts in this order:

1. Output bin. See [Output bin \(352, 452, 377, and 477 models\) on page 11](#).
2. Optional: left door. See [Left door on page 26](#).
3. Duplex module. See [Duplex module on page 11](#).
4. Left rear cover. See [Left rear cover on page 28](#).
5. Rear cover. See [Rear cover \(552, 577, P55250, and P57750 models\) on page 29](#) or [Rear cover \(352, 452, 377, 477 models\) on page 30](#).
6. PCA safety shield. See [PCA safety shield on page 51](#).
7. Main PCA. See [Main PCA on page 54](#).

1. Disconnect two cables (1).

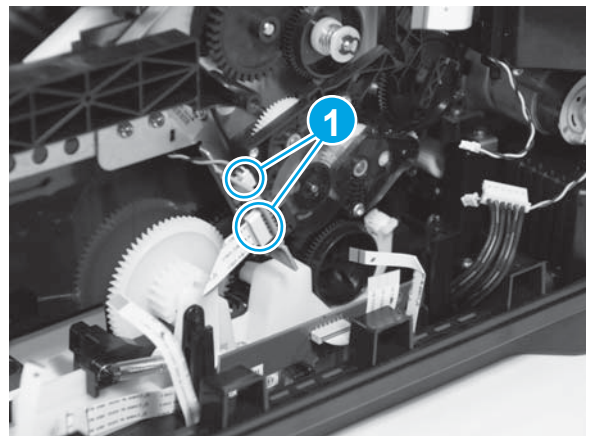

2. Remove one screw (1), which requires the T10 Torx driver with the 25 mm (1 in) shaft.

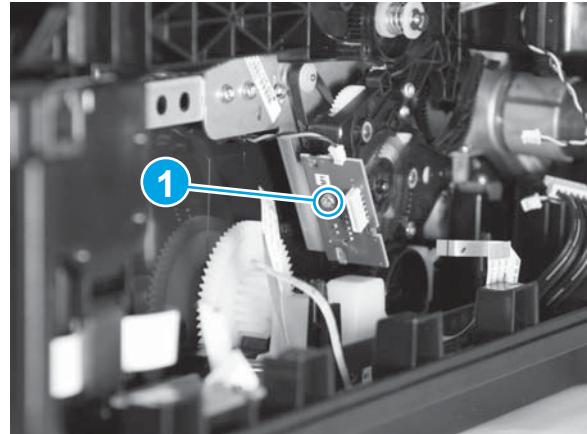

3. Remove the PCA.

 **Reinstallation tip:** Make sure that the encoder disk is seated correctly in the sensor when reinstalling the PCA.

Service sled transmission

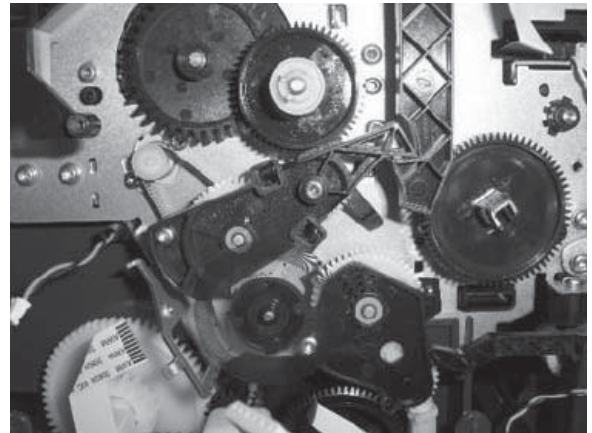
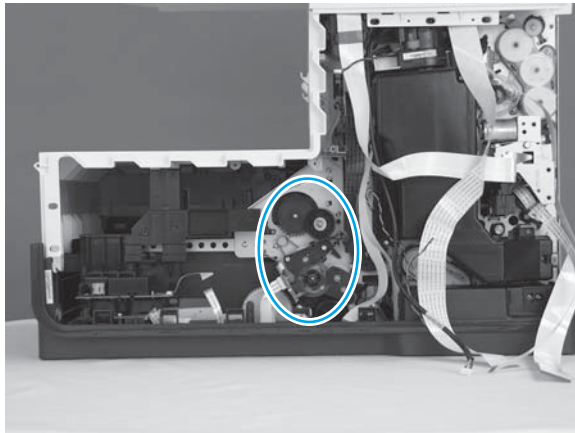

▲ Remove these parts in this order:

1. Output bin. See [Output bin \(352, 452, 377, and 477 models\) on page 11](#).
2. Optional: left door. See [Left door on page 26](#).
3. Duplex module. See [Duplex module on page 11](#).
4. Left rear cover. See [Left rear cover on page 28](#).
5. Rear cover. See [Rear cover \(552, 577, P55250, and P57750 models\) on page 29](#) or [Rear cover \(352, 452, 377, 477 models\) on page 30](#).
6. PCA safety shield. See [PCA safety shield on page 51](#).
7. Main PCA. See [Main PCA on page 54](#).

Before reassembling the printer, ensure that the service sled transmission is installed in the correct position. If the service sled transmission is not installed correctly, the printer will not operate correctly.

The service sled transmission is located behind the main PCA. Remove the aerosol fan assembly to check or adjust the positioning of the service sled transmission.

- Service sled transmission in the correct position.

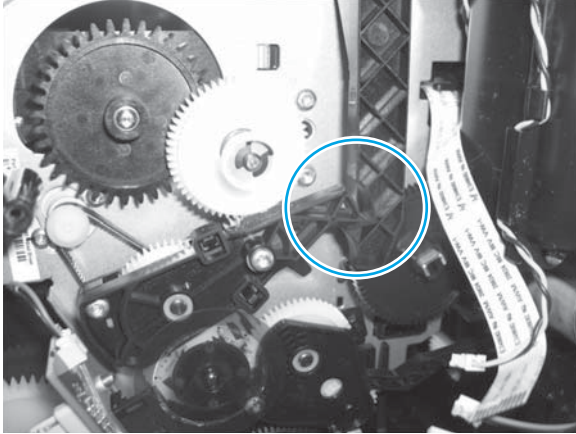

- Service sled transmission in the incorrect position.

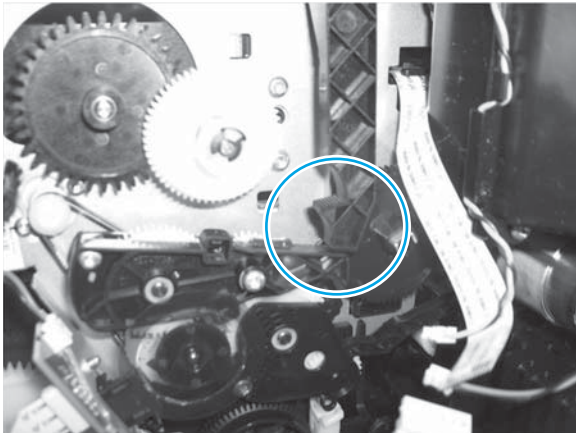

Backscatter drop detect (BDD) assembly

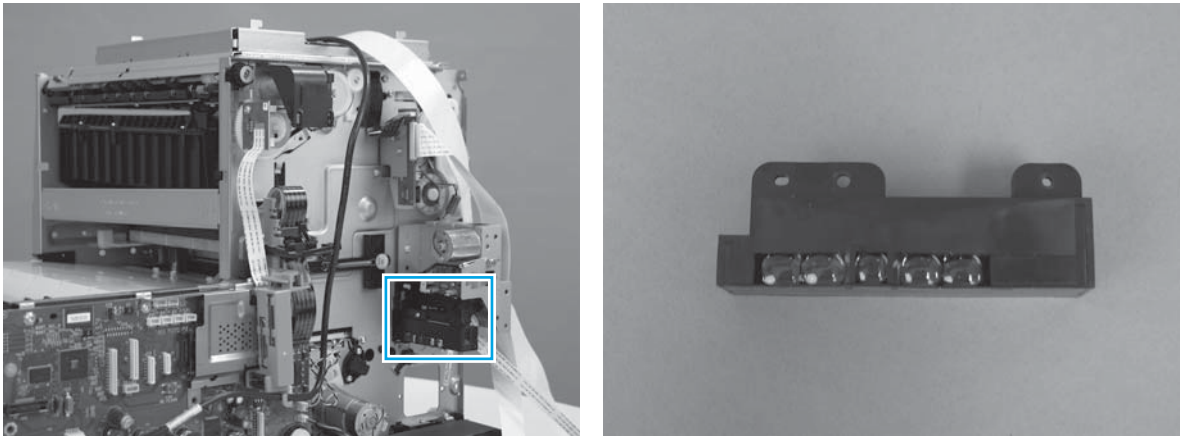

Remove these parts in this order:

1. Output bin. See [Output bin \(352, 452, 377, and 477 models\) on page 11](#).
 2. Optional: left door. See [Left door on page 26](#).
 3. Duplex module. See [Duplex module on page 11](#).
 4. Left rear cover. See [Left rear cover on page 28](#).
 5. Rear cover. See [Rear cover \(552, 577, P55250, and P57750 models\) on page 29](#) or [Rear cover \(352, 452, 377, 477 models\) on page 30](#).
 6. PCA safety shield. See [PCA safety shield on page 51](#).
 7. Aerosol fan assembly. See [Aerosol fan assembly on page 59](#).
-
1. Verify that the sensor carriage is in the home position.

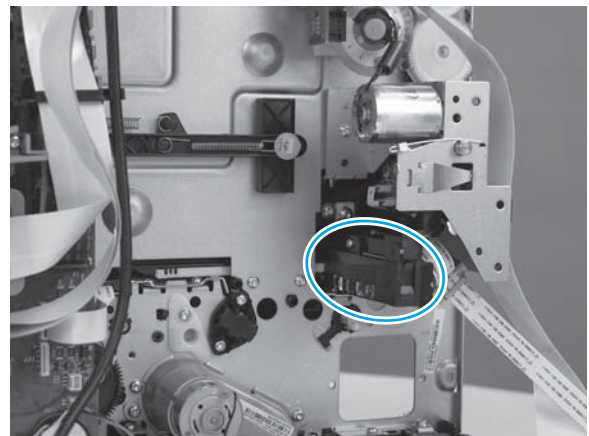

2. Remove one T8 Torx screw.

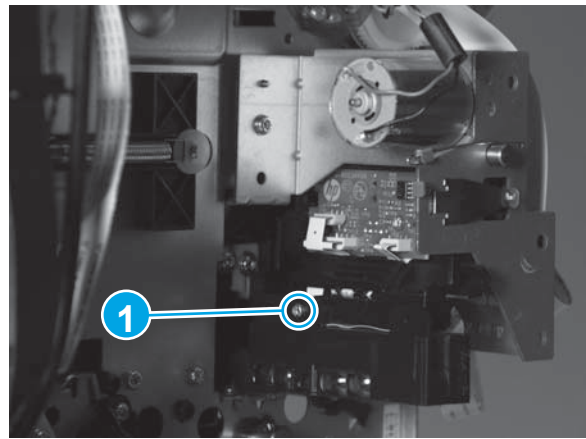

3. Detach the BDD assembly, and then disconnect the FFC.



4. After installing a new BDD assembly, perform the following calibrations:
 - a. From the control panel, open the [Service](#) menu. See [Access the Engineering menu on page 14](#) for information on how to access the [Service](#) menu.
 - b. Select [System Configuration](#), and then select [Enable Drop Detect Calibration](#).
 - c. Touch the [OK](#) button.
 - d. After resetting the drop detect calibrations, run Clean Printhead, level 1. This will take approximately 17 minutes.

Power supply

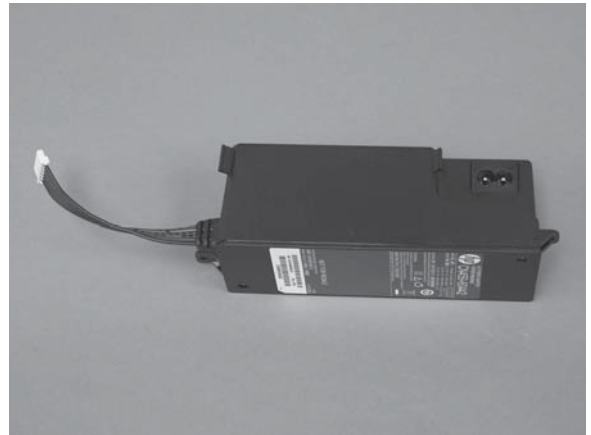
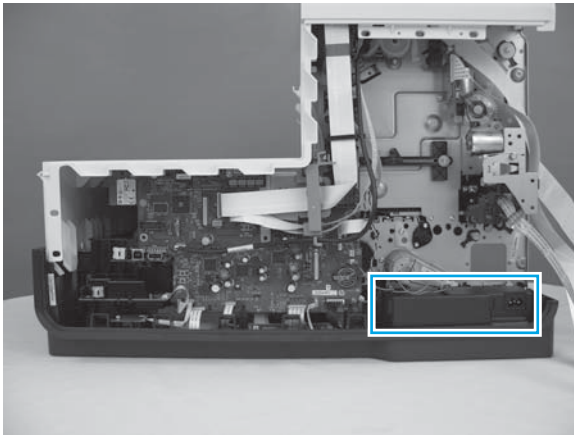

⚠ CAUTION: Make sure that the power cable is disconnected from the printer.

Remove these parts in this order:

1. Output bin. See [Output bin \(352, 452, 377, and 477 models\) on page 11](#).
 2. Optional: left door. See [Left door on page 26](#).
 3. Duplex module. See [Duplex module on page 11](#).
 4. Left rear cover. See [Left rear cover on page 28](#).
 5. Rear cover. See [Rear cover \(552, 577, P55250, and P57750 models\) on page 29](#) or [Rear cover \(352, 452, 377, 477 models\) on page 30](#).
 6. PCA safety shield. See [PCA safety shield on page 51](#).
 7. Aerosol fan assembly. See [Aerosol fan assembly on page 59](#).
-
1. Disconnect the cable that connects the power supply to the main PCA.

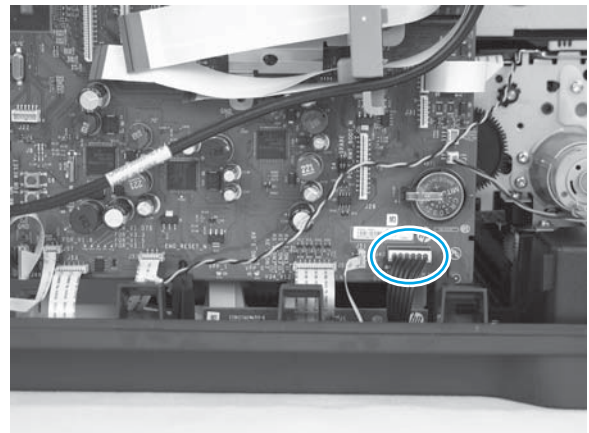

2. Remove two screws from the base of the power supply.

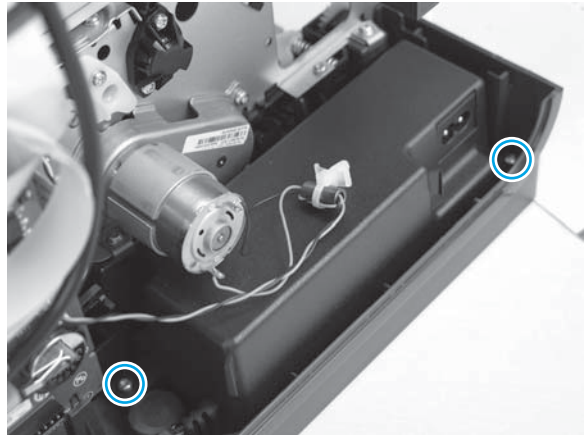

3. Remove the power supply.

NOTE: It might be necessary to loosen the fasteners on the duplex drive module in order to remove the power supply. If that is the case, see [Duplex drive module on page 73](#).



Duplex drive module

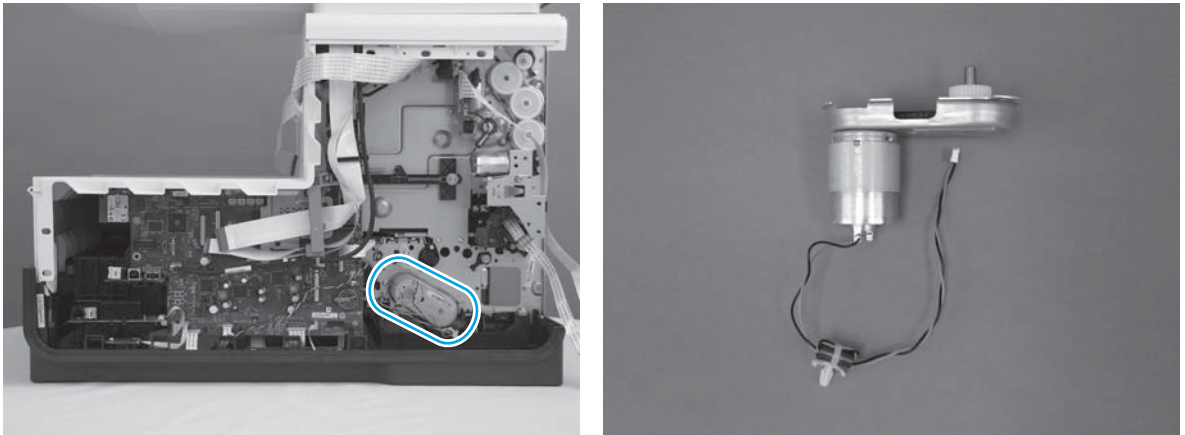

Remove these parts in this order:

1. Output bin. See [Output bin \(352, 452, 377, and 477 models\) on page 11](#).
2. Optional: left door. See [Left door on page 26](#).
3. Duplex module. See [Duplex module on page 11](#).
4. Left rear cover. See [Left rear cover on page 28](#).
5. Rear cover. See [Rear cover \(552, 577, P55250, and P57750 models\) on page 29](#) or [Rear cover \(352, 452, 377, 477 models\) on page 30](#).
6. PCA safety shield. See [PCA safety shield on page 51](#).
7. Aerosol fan assembly. See [Aerosol fan assembly on page 59](#).
8. Power supply. See [Power supply on page 71](#).

1. Disconnect one wire.

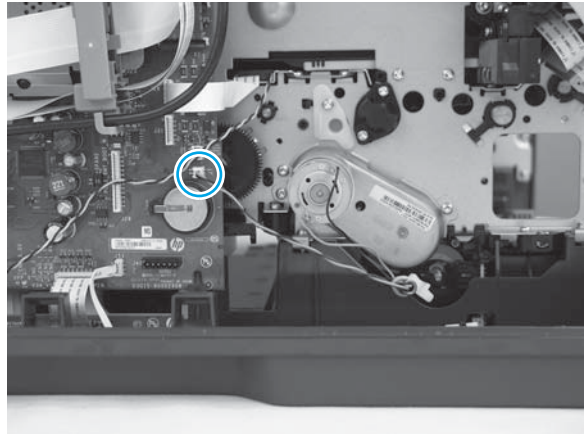

2. Remove two screws, and then remove the module.

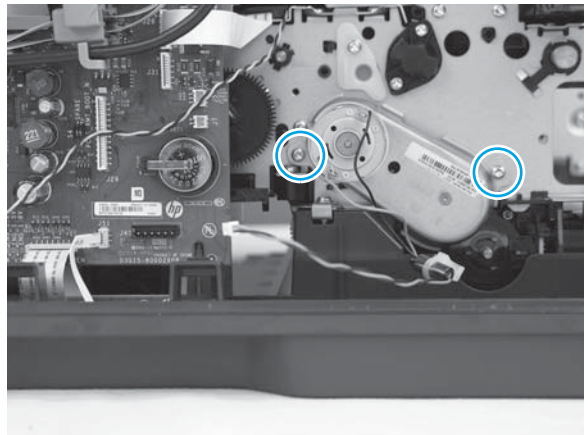

Sensor carriage PCA and encoder strip

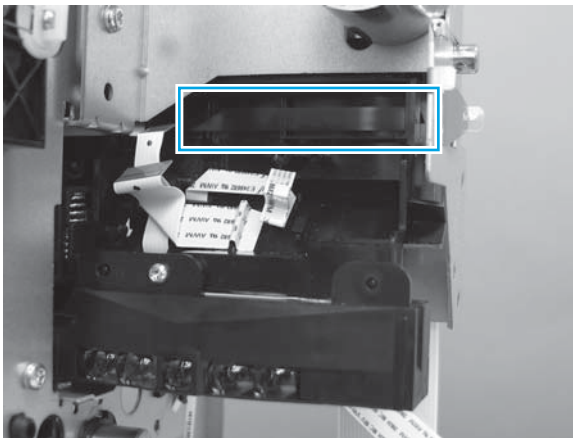
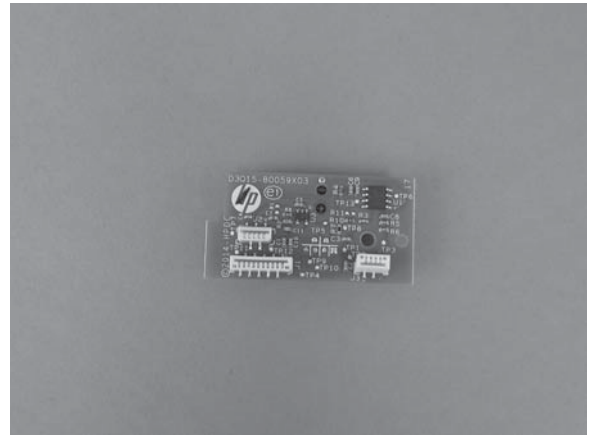
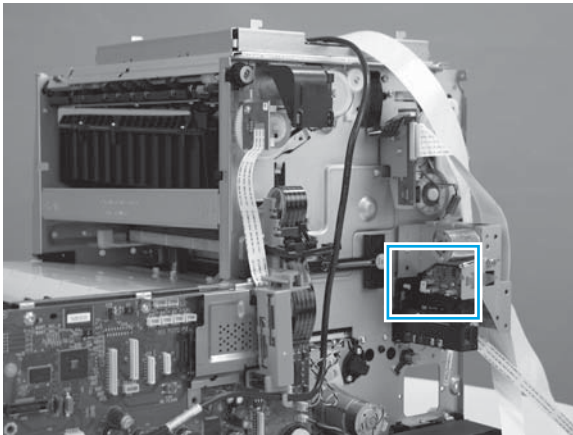

Remove these parts in this order:

1. Output bin. See [Output bin \(352, 452, 377, and 477 models\) on page 11](#).
2. Optional: left door. See [Left door on page 26](#).
3. Duplex module. See [Duplex module on page 11](#).
4. Left rear cover. See [Left rear cover on page 28](#).
5. Rear cover. See [Rear cover \(552, 577, P55250, and P57750 models\) on page 29](#) or [Rear cover \(352, 452, 377, 477 models\) on page 30](#).
6. PCA safety shield. See [PCA safety shield on page 51](#).
7. Aerosol fan assembly. See [Aerosol fan assembly on page 59](#).
8. Sensor carriage PCA.
9. MFP models: scanner assembly. See [Scanner assembly and scanner support bracket \(MFP models only\) on page 78](#).
10. MFP models: scanner support bracket. See [Scanner assembly and scanner support bracket \(MFP models only\) on page 78](#).

11. Left front cover. See [Left front cover on page 31](#).
12. Top cover. See [Top cover \(377, 477, 577 models\) on page 33](#) or [Top cover \(352, 452, 552 models\) on page 35](#).
13. Front cover. See [Front cover \(352, 452, 377, 477 models\) on page 37](#) or [Front cover \(552, 577 models\) on page 39](#).
14. Encoder strip.

1. Use tweezers to disconnect three FFCs (1), and then use a T8 Torx driver to remove one screw (2) to remove the PCA.

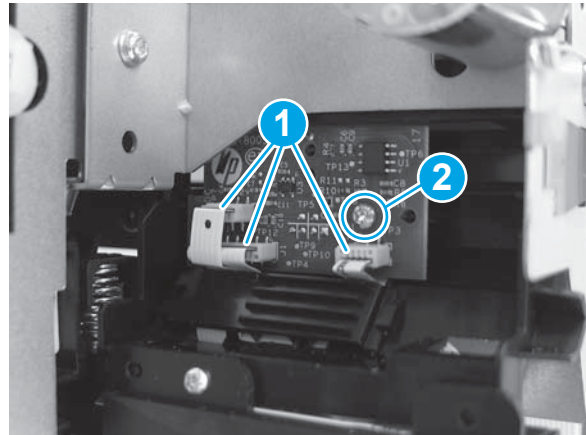

2. Locate the sensor carriage encoder strip. The sensor carriage encoder strip feeds through the printer, passes through the encoder strip sensor on the back of the sensor carriage PCA, and then attaches to the bracket at the back of the printer.

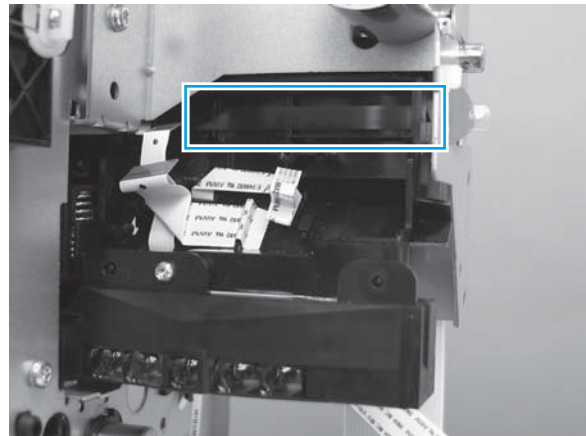

3. Thread a piece of floss or thread through the opening on the end of the sensor carriage encoder strip (1), and then depress the bracket (2) while lifting up on the sensor carriage encoder strip to remove the encoder strip from the bracket.

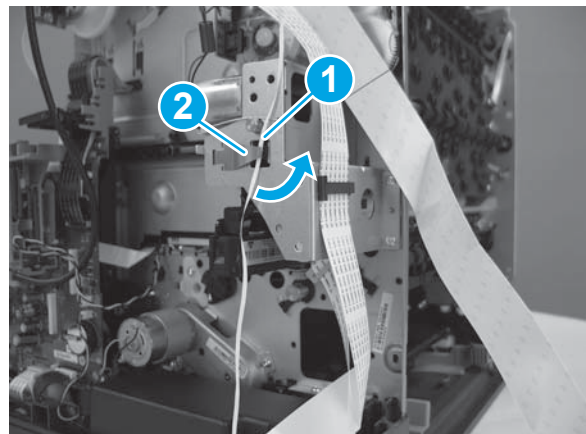

4. At the front of printer, use a pair of needle nose pliers to grasp the encoder strip, and then lift it off the bracket.

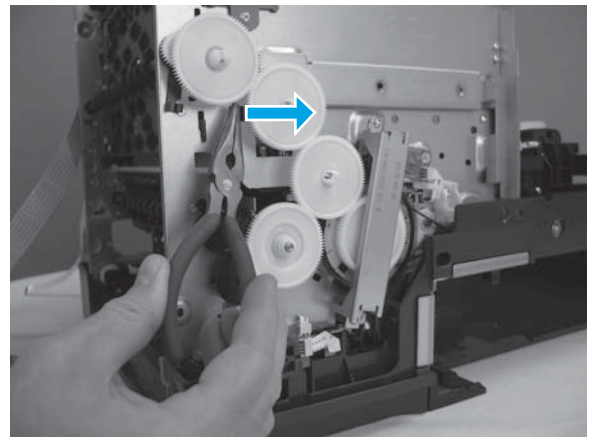

5. At the front of the printer, carefully pull the encoder strip through the printer and remove it. Ensure that you can still grasp the thread at the back of the printer.
6. At the front of the printer, tie the thread or floss passed through the printer to the new encoder strip. The encoder strip must be positioned with the smiley face as shown.

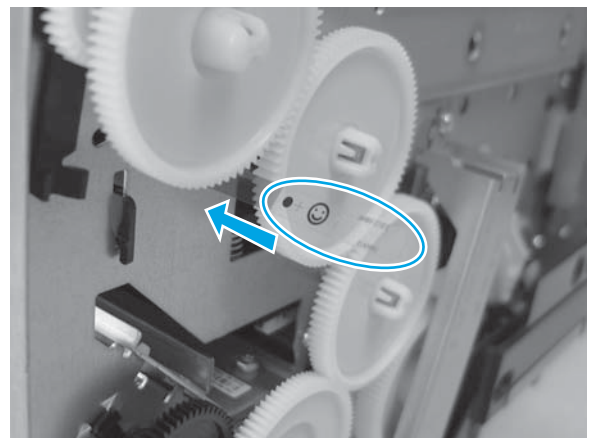

7. Carefully pull the encoder strip through the printer, and then reattach the encoder strip on the bracket at the rear of the printer.
8. Install the new sensor carriage PCA. Ensure that the encoder strip threads through encoder strip sensor on the back of the sensor carriage PCA.

IMPORTANT: Threading the sensor carriage encoder strip through the printer and through the encoder strip sensor on the back of the sensor carriage PCA can be a difficult procedure. If the sensor carriage encoder strip is not correctly positioned, then the front panel will display an error when the printer is turned on.

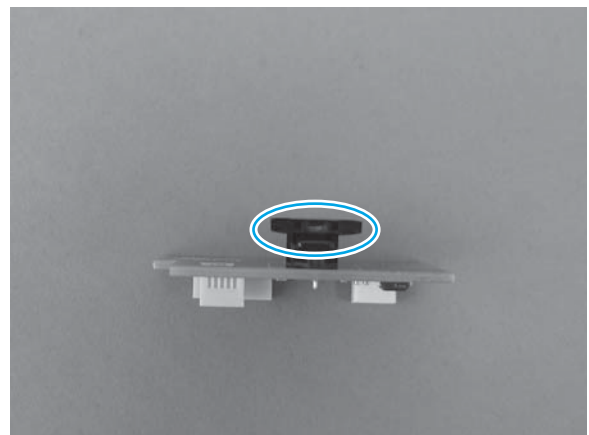

Assemblies accessed through the top and front covers

Scanner assembly and scanner support bracket (MFP models only)

The scanner assembly includes the document feeder assembly. The scanner can be removed with or without the document feeder attached

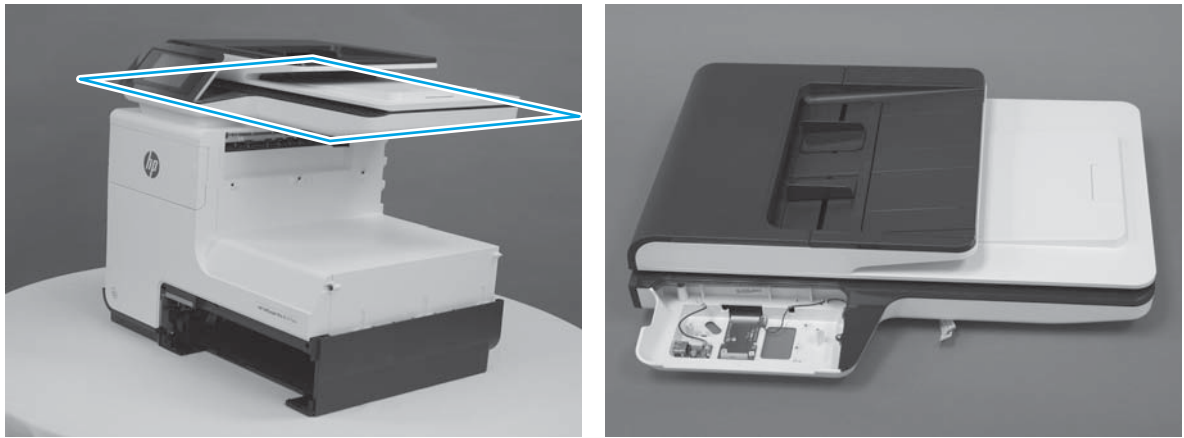

Remove these parts in this order:

1. Output bin. See [Output bin \(352, 452, 377, and 477 models\) on page 11](#).
 2. Optional: left door. See [Left door on page 26](#).
 3. Duplex module. See [Duplex module on page 11](#).
 4. Left rear cover. See [Left rear cover on page 28](#).
 5. Rear cover. See [Rear cover \(552, 577, P55250, and P57750 models\) on page 29](#) or [Rear cover \(352, 452, 377, 477 models\) on page 30](#).
1. Remove the scanner base cover.



2. On the main PCA, disconnect 3 FFCs. The black cable has two connections.

TIP: Unscrew the gray FFC retainer to make unthreading the FFCs easier. This will also make it easier to remove the control panel FFC.

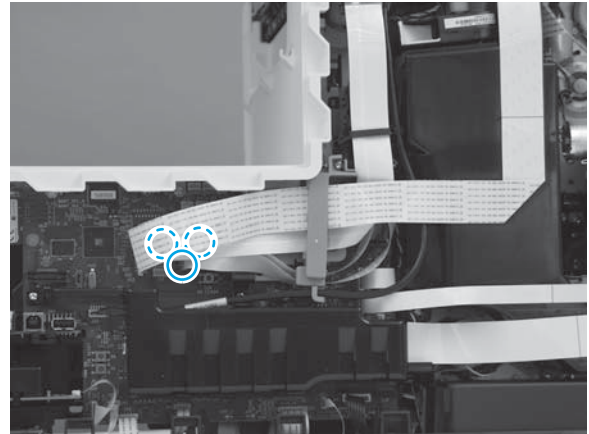

3. Unthread the scanner FFCs.

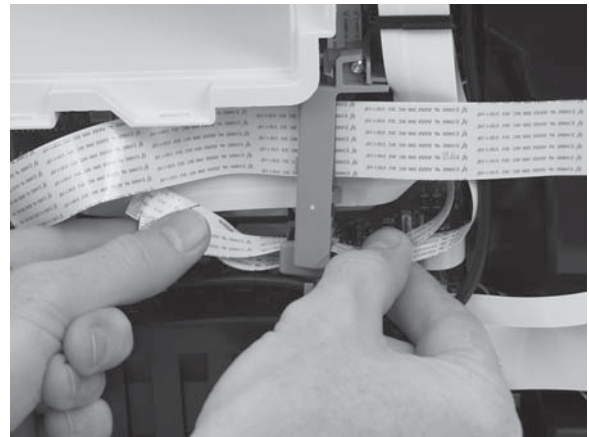

4. Unthread the document feeder FFC.

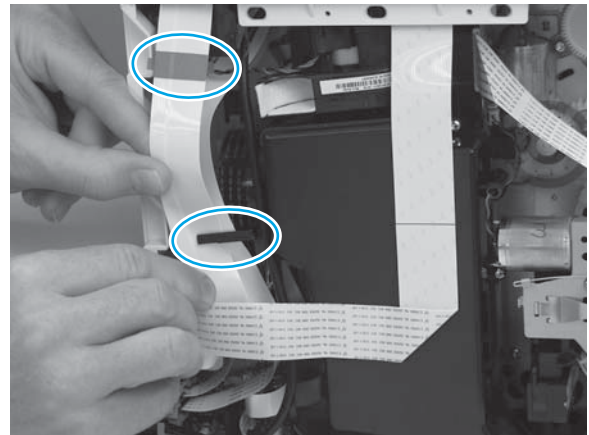

- 5. Behind the control panel, remove two screws, and then pull out the control panel.



- 6. Unplug the USB cable and the FFC.



- 7. Remove 2 screws (1) and 1 grounding screw (2).

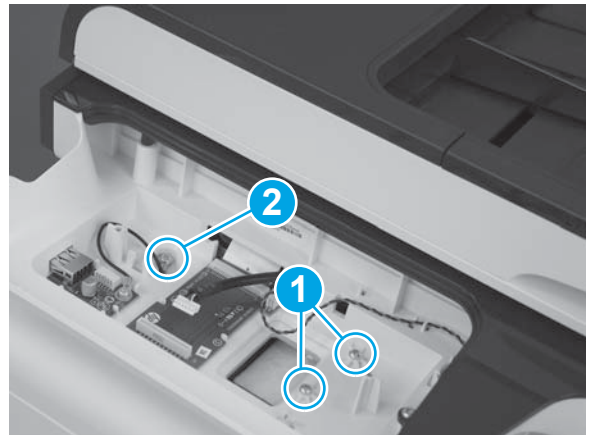

8. Move the scanner assembly toward the left side of the printer.



9. Partially lift the front of the assembly and disconnect one FFC.



10. Partially lift the rear of the assembly and disconnect one ground wire.



11. Lift the assembly to remove it.

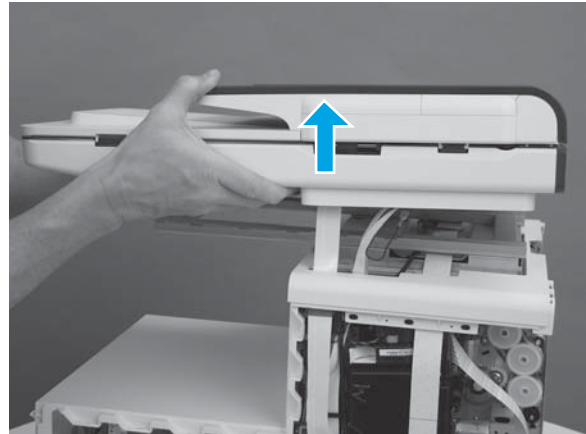

12. Remove eight screws, and then remove the scanner support bracket.

NOTE: Removing the scanner support bracket is not necessary if only the scanner is being replaced.

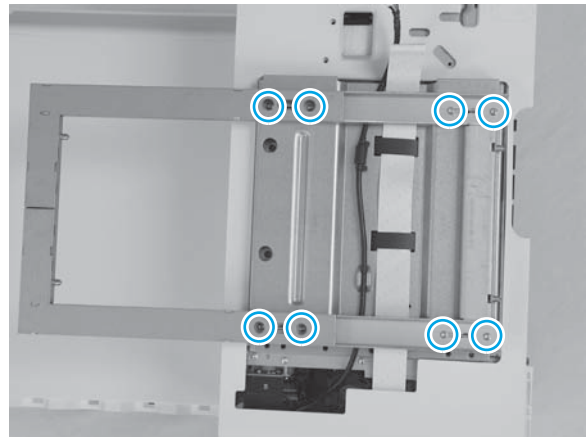

Calibrate the scanner

1. Open the **Engineering** menu. See [Access the Engineering menu on page 14](#) for information on accessing the **Engineering** menu.
2. Select **Service**, select **System Configuration**, and then touch the **OK** button.
3. Scroll to **Enter scanner barcode**, and then touch the **OK** button.

4. Enter the scanner calibration bar code, and then touch the **OK** button.



NOTE: The scanner calibration bar code is located underneath the main scan glass on the left side of the glass. See below.



5. Touch the **Cancel** button to return to the **Engineering menu** when the calibration is complete.

Document feeder assembly (MFP models—377, 477, 577 models)

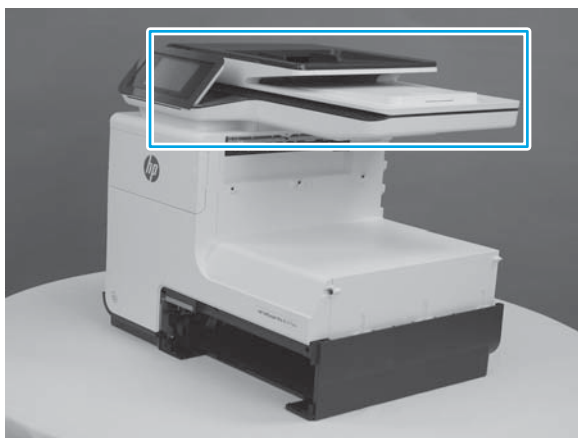

Remove these parts in this order:

1. Output bin. See [Output bin \(352, 452, 377, and 477 models\) on page 11](#).
 2. Optional: left door. See [Left door on page 26](#).
 3. Duplex module. See [Duplex module on page 11](#).
 4. Left rear cover. See [Left rear cover on page 28](#).
 5. Rear cover. See [Rear cover \(552, 577, P55250, and P57750 models\) on page 29](#) or [Rear cover \(352, 452, 377, 477 models\) on page 30](#).
 6. MFP models: scanner assembly. See [Scanner assembly and scanner support bracket \(MFP models only\) on page 78](#).
1. Lift the document feeder assembly (which also functions as the flatbed scanner lid).



2. Remove one screw.

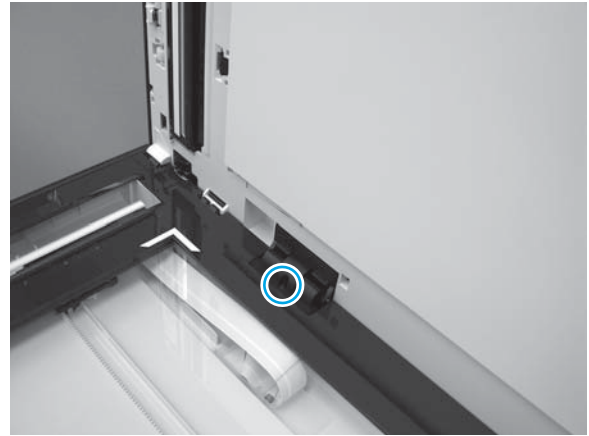

3. Lift the assembly to remove it. Make sure the FFCs clear the pass-throughs in the scanner housing.



Top cap assembly



Remove these parts in this order:

1. Output bin. See [Output bin \(352, 452, 377, and 477 models\) on page 11](#).
2. Optional: left door. See [Left door on page 26](#).
3. Duplex module. See [Duplex module on page 11](#).
4. Left rear cover. See [Left rear cover on page 28](#).
5. Rear cover. See [Rear cover \(552, 577, P55250, and P57750 models\) on page 29](#) or [Rear cover \(352, 452, 377, 477 models\) on page 30](#).
6. MFP models: scanner assembly. See [Scanner assembly and scanner support bracket \(MFP models only\) on page 78](#).
7. MFP models: scanner support bracket. See [Scanner assembly and scanner support bracket \(MFP models only\) on page 78](#).
8. Left front cover. See [Left front cover on page 31](#).
9. Top cover. See [Top cover \(377, 477, 577 models\) on page 33](#) or [Top cover \(352, 452, 552 models\) on page 35](#).
10. Front cover. See [Front cover \(352, 452, 377, 477 models\) on page 37](#) or [Front cover \(552, 577 models\) on page 39](#).

1. Disconnect the eject flap opto PCA flex cable connection, and then unthread the cable from the printer frame.

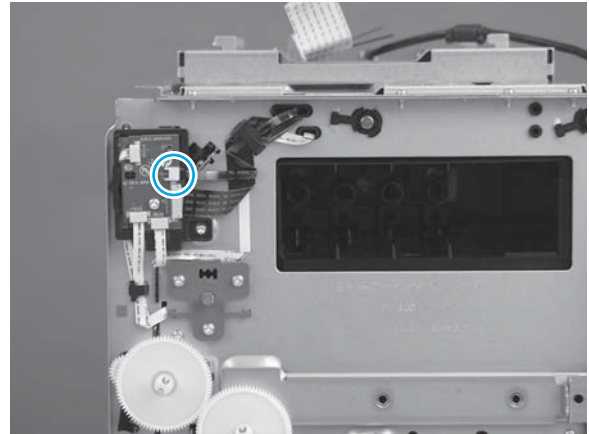

2. Unthread the control panel cables from the top cap.

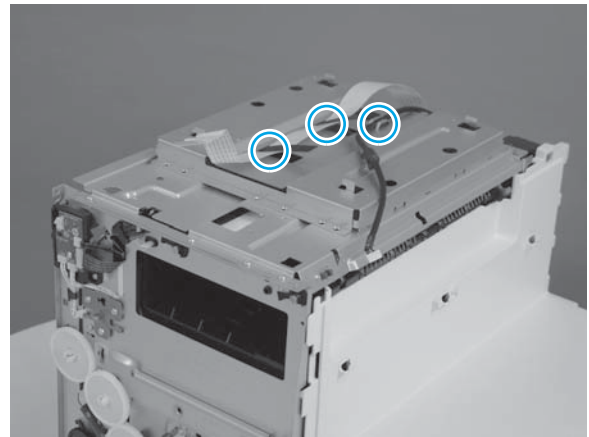

3. Remove 10 screws, and then lift the assembly to remove it from the printer.

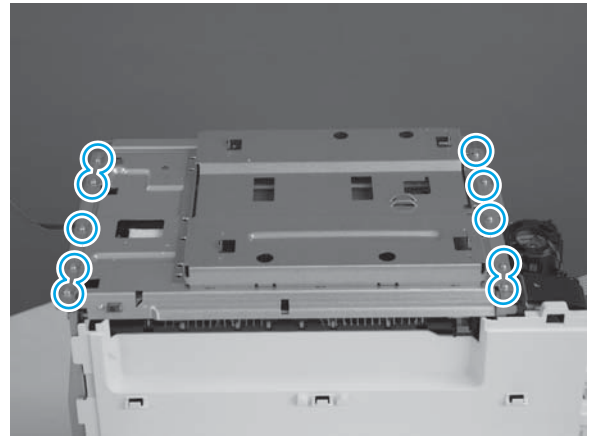

Output eject drive kit

Eject flap lifter

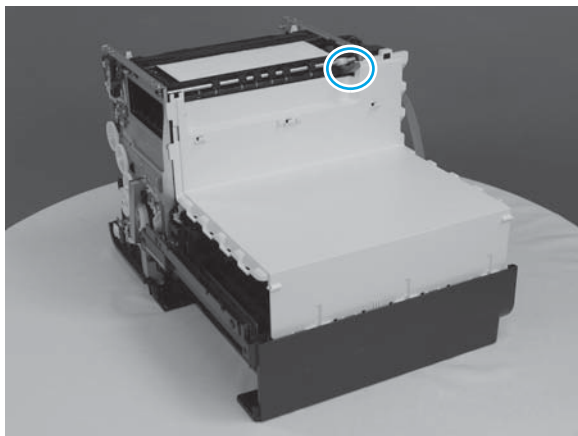

Remove these parts in this order:

1. Output bin. See [Output bin \(352, 452, 377, and 477 models\) on page 11](#).
2. Optional: left door. See [Left door on page 26](#).
3. Duplex module. See [Duplex module on page 11](#).
4. Left rear cover. See [Left rear cover on page 28](#).
5. Rear cover. See [Rear cover \(552, 577, P55250, and P57750 models\) on page 29](#) or [Rear cover \(352, 452, 377, 477 models\) on page 30](#).
6. MFP models: scanner assembly. See [Scanner assembly and scanner support bracket \(MFP models only\) on page 78](#).
7. MFP models: scanner support bracket. See [Scanner assembly and scanner support bracket \(MFP models only\) on page 78](#).
8. Left front cover. See [Left front cover on page 31](#).
9. Top cover. See [Top cover \(377, 477, 577 models\) on page 33](#) or [Top cover \(352, 452, 552 models\) on page 35](#).
10. Front cover. See [Front cover \(352, 452, 377, 477 models\) on page 37](#) or [Front cover \(552, 577 models\) on page 39](#).
11. Top cap assembly. See [Top cap assembly on page 86](#).

1. Pull the lifter forward.

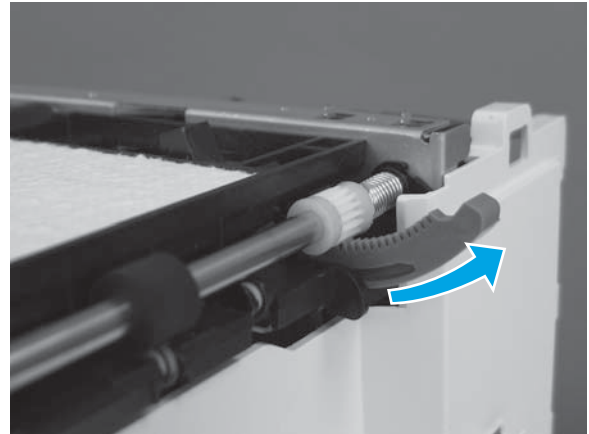

2. Locate the tab (1) on the right of the lifter.

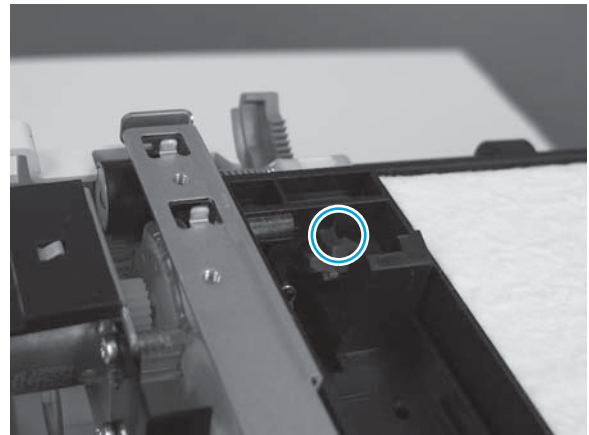

3. Use a screwdriver to lift the tab, and then rotate the lifter to remove it.

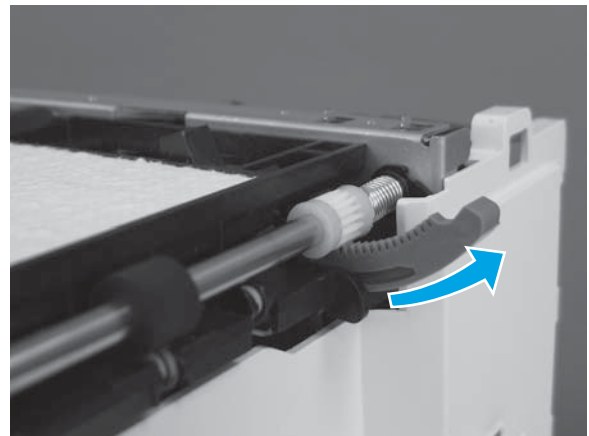

 **Reinstallation tip:** Ensure that the lifter is correctly aligned during reinstallation. If the lifter is aligned incorrectly, the actuator flap will not open. The lifter must pass through the guide anchored on both sides of the guide.

Eject drive gear module

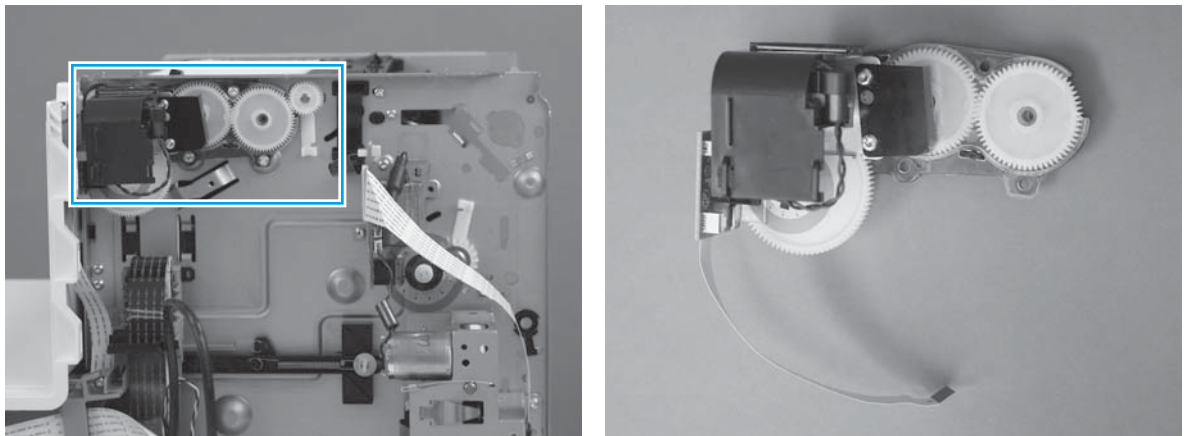

Remove these parts in this order:

1. Output bin. See [Output bin \(352, 452, 377, and 477 models\) on page 11](#).
2. Optional: left door. See [Left door on page 26](#).
3. Duplex module. See [Duplex module on page 11](#).
4. Left rear cover. See [Left rear cover on page 28](#).
5. Rear cover. See [Rear cover \(552, 577, P55250, and P57750 models\) on page 29](#) or [Rear cover \(352, 452, 377, 477 models\) on page 30](#).
6. PCA safety shield. See [PCA safety shield on page 51](#)
7. Aerosol fan assembly. See [Aerosol fan assembly on page 59](#).
8. MFP models: scanner assembly. See [Scanner assembly and scanner support bracket \(MFP models only\) on page 78](#).
9. MFP models: scanner support bracket. See [Scanner assembly and scanner support bracket \(MFP models only\) on page 78](#).
10. Left front cover. See [Left front cover on page 31](#).
11. Top cover. See [Top cover \(377, 477, 577 models\) on page 33](#) or [Top cover \(352, 452, 552 models\) on page 35](#).

1. Remove four screws, and then remove the assembly.

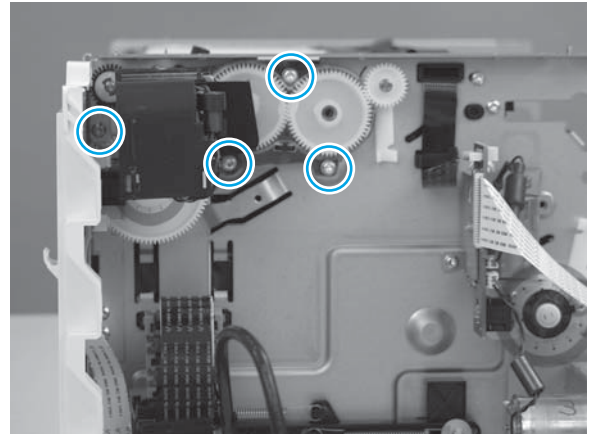

Feed motor encoder sensor PCA

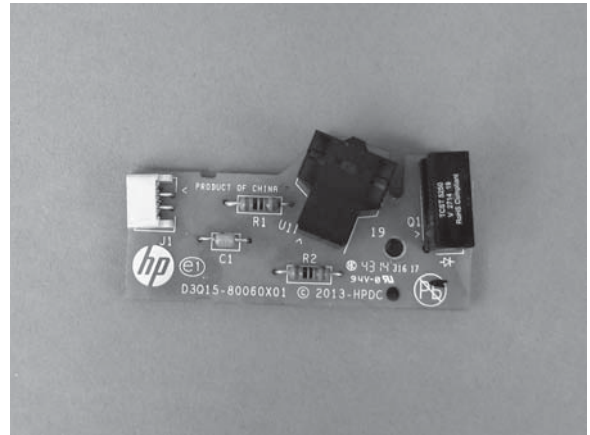
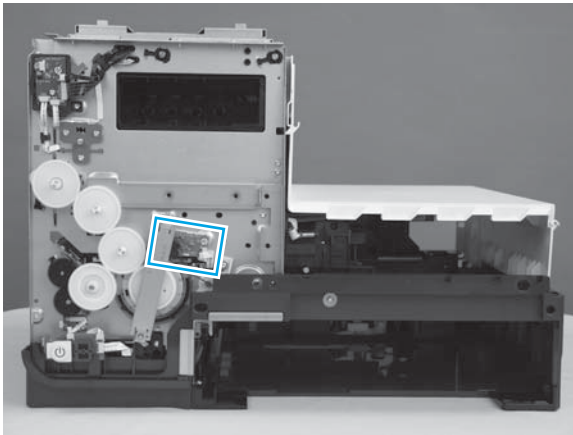

Remove these parts in this order:

1. Output bin. See [Output bin \(352, 452, 377, and 477 models\) on page 11](#).
2. Optional: left door. See [Left door on page 26](#).
3. Duplex module. See [Duplex module on page 11](#).
4. Left rear cover. See [Left rear cover on page 28](#).
5. Rear cover. See [Rear cover \(552, 577, P55250, and P57750 models\) on page 29](#) or [Rear cover \(352, 452, 377, 477 models\) on page 30](#).
6. MFP models: scanner assembly. See [Scanner assembly and scanner support bracket \(MFP models only\) on page 78](#).
7. MFP models: scanner support bracket. See [Scanner assembly and scanner support bracket \(MFP models only\) on page 78](#).
8. Left front cover. See [Left front cover on page 31](#).

9. Top cover. See [Top cover \(377, 477, 577 models\) on page 33](#) or [Top cover \(352, 452, 552 models\) on page 35](#).
10. Front cover. See [Front cover \(352, 452, 377, 477 models\) on page 37](#) or [Front cover \(552, 577 models\) on page 39](#).

1. Remove two screws (1) from the guard bracket (2), remove the bracket, and then disconnect the FFC (3).

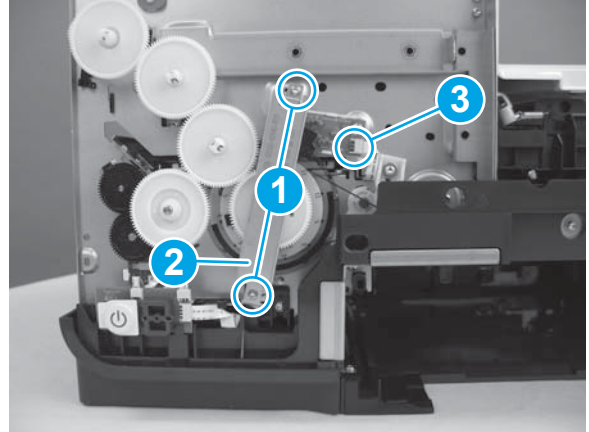

2. Remove one screw (1), and then unclip and remove the sensor PCA (2).

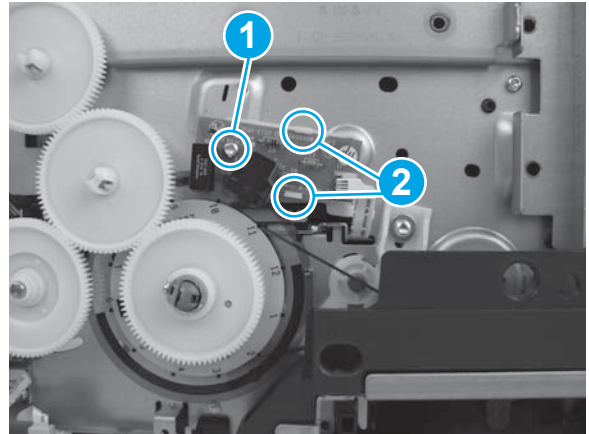

Duplex module sensor PCA

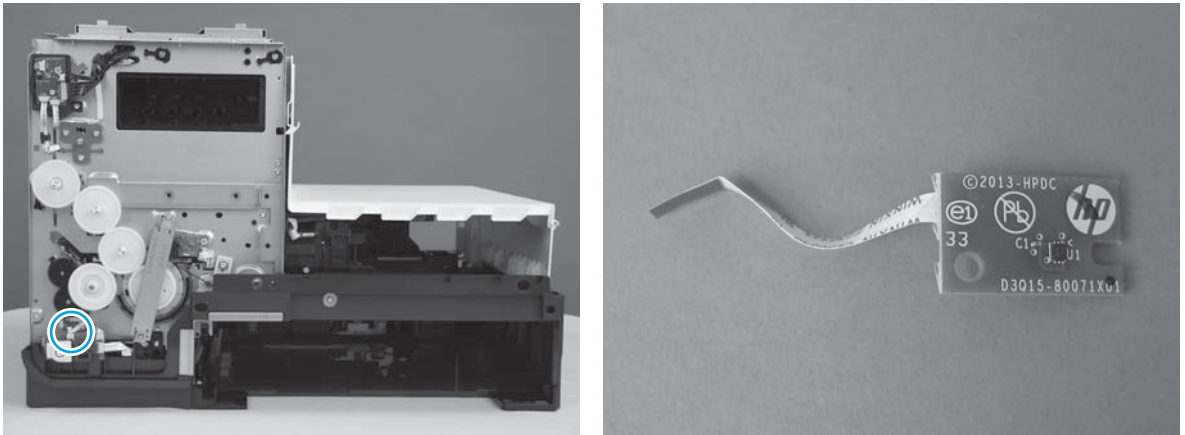

Remove these parts in this order:

1. Output bin. See [Output bin \(352, 452, 377, and 477 models\) on page 11](#).
2. Optional: left door. See [Left door on page 26](#).
3. Duplex module. See [Duplex module on page 11](#).
4. Left rear cover. See [Left rear cover on page 28](#).
5. Rear cover. See [Rear cover \(552, 577, P55250, and P57750 models\) on page 29](#) or [Rear cover \(352, 452, 377, 477 models\) on page 30](#).
6. MFP models: scanner assembly. See [Scanner assembly and scanner support bracket \(MFP models only\) on page 78](#).
7. MFP models: scanner support bracket. See [Scanner assembly and scanner support bracket \(MFP models only\) on page 78](#).
8. Left front cover. See [Left front cover on page 31](#).
9. Top cover. See [Top cover \(377, 477, 577 models\) on page 33](#) or [Top cover \(352, 452, 552 models\) on page 35](#).
10. Front cover. See [Front cover \(352, 452, 377, 477 models\) on page 37](#) or [Front cover \(552, 577 models\) on page 39](#).

1. Disconnect one FFC (1), remove one screw (2), and then remove the sensor PCA.

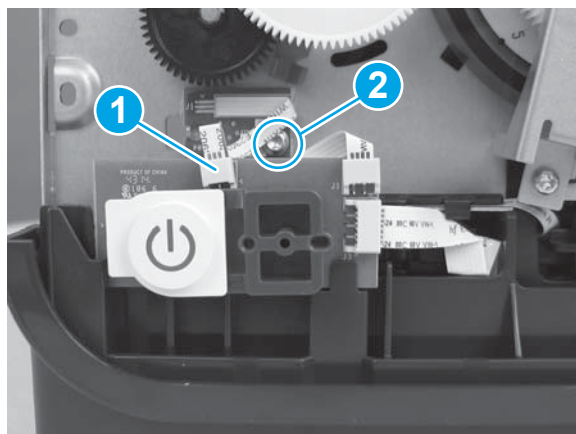

Power button PCA

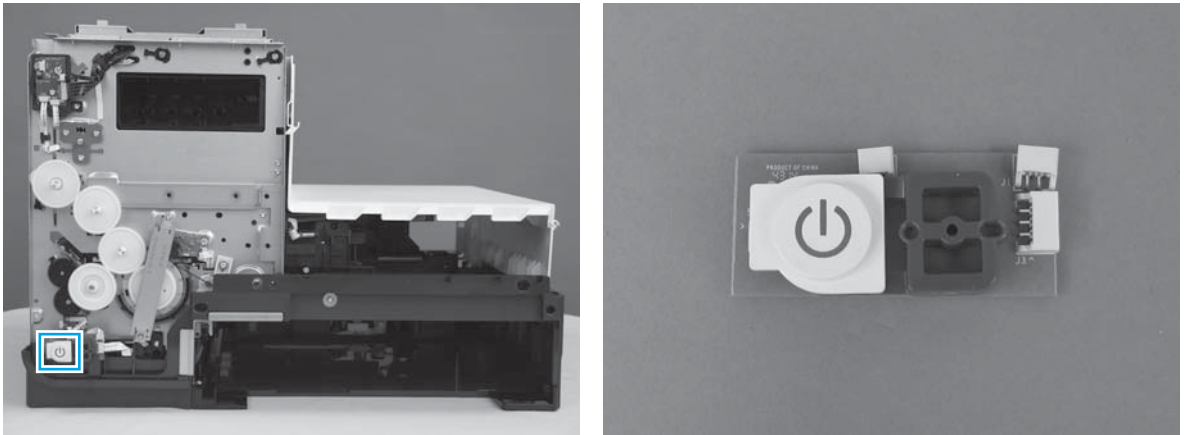

Remove these parts in this order:

1. Output bin. See [Output bin \(352, 452, 377, and 477 models\) on page 11](#).
2. Optional: left door. See [Left door on page 26](#).
3. Duplex module. See [Duplex module on page 11](#).
4. Left rear cover. See [Left rear cover on page 28](#).
5. Rear cover. See [Rear cover \(552, 577, P55250, and P57750 models\) on page 29](#) or [Rear cover \(352, 452, 377, 477 models\) on page 30](#).
6. MFP models: scanner assembly. See [Scanner assembly and scanner support bracket \(MFP models only\) on page 78](#).
7. MFP models: scanner support bracket. See [Scanner assembly and scanner support bracket \(MFP models only\) on page 78](#).
8. Left front cover. See [Left front cover on page 31](#).
9. Top cover. See [Top cover \(377, 477, 577 models\) on page 33](#) or [Top cover \(352, 452, 552 models\) on page 35](#).
10. Front cover. See [Front cover \(352, 452, 377, 477 models\) on page 37](#) or [Front cover \(552, 577 models\) on page 39](#).

1. Disconnect three FFCs (1), and then remove the PCA (2).

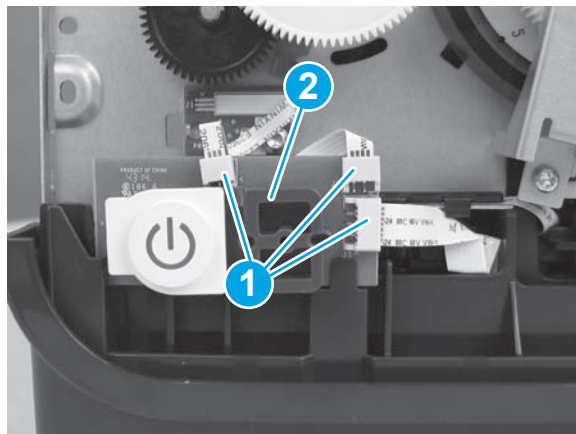

REDI distribution PCA

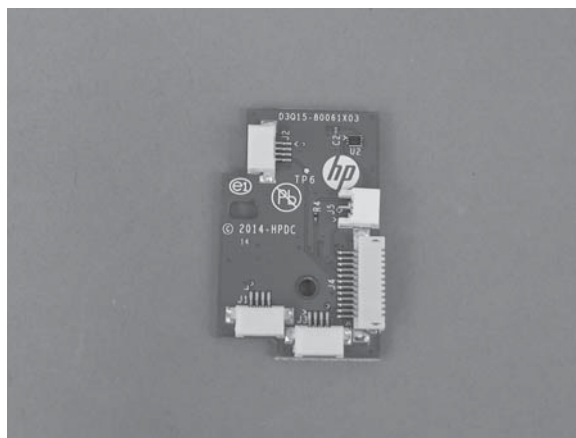
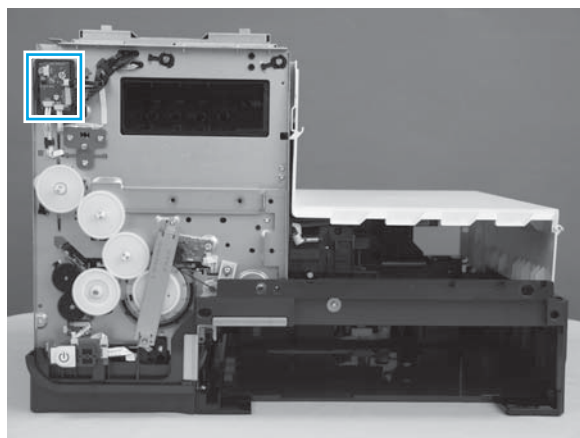



Remove these parts in this order:

1. Output bin. See [Output bin \(352, 452, 377, and 477 models\) on page 11](#).
2. Optional: left door. See [Left door on page 26](#).
3. Duplex module. See [Duplex module on page 11](#).
4. Left rear cover. See [Left rear cover on page 28](#).
5. Rear cover. See [Rear cover \(552, 577, P55250, and P57750 models\) on page 29](#) or [Rear cover \(352, 452, 377, 477 models\) on page 30](#).
6. MFP models: scanner assembly. See [Scanner assembly and scanner support bracket \(MFP models only\) on page 78](#).
7. MFP models: scanner support bracket. See [Scanner assembly and scanner support bracket \(MFP models only\) on page 78](#).
8. Left front cover. See [Left front cover on page 31](#).

9. Top cover. See [Top cover \(377, 477, 577 models\) on page 33](#) or [Top cover \(352, 452, 552 models\) on page 35](#).
10. Front cover. See [Front cover \(352, 452, 377, 477 models\) on page 37](#) or [Front cover \(552, 577 models\) on page 39](#).

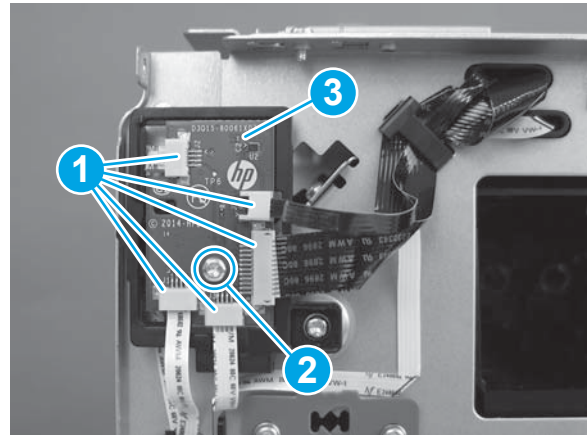
1. Disconnect FFCs (1), remove one screw (2), and then remove the PCA (3).



 **Reinstallation tip:** Ensure that the upper left FFC does not poke through the front wall. It should not be visible when looking at the wall from the left door.

Output drive gears

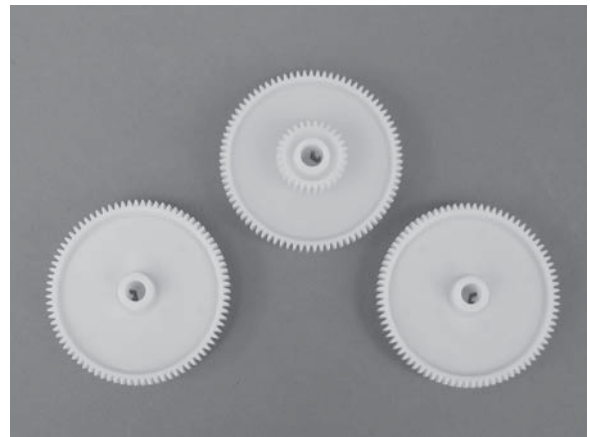
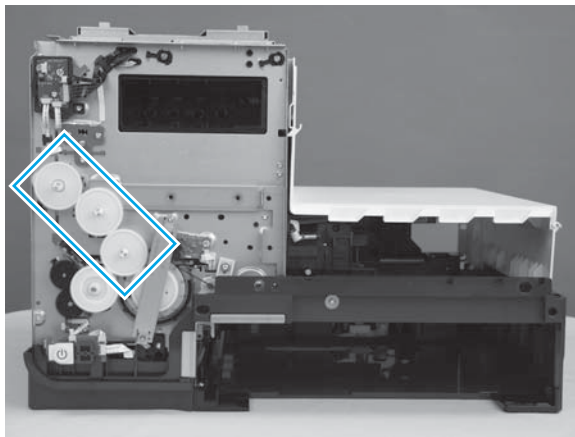

Remove these parts in this order:

1. Output bin. See [Output bin \(352, 452, 377, and 477 models\) on page 11](#).
2. Optional: left door. See [Left door on page 26](#).
3. Duplex module. See [Duplex module on page 11](#).
4. Left rear cover. See [Left rear cover on page 28](#).
5. Rear cover. See [Rear cover \(552, 577, P55250, and P57750 models\) on page 29](#) or [Rear cover \(352, 452, 377, 477 models\) on page 30](#).

6. MFP models: scanner assembly. See [Scanner assembly and scanner support bracket \(MFP models only\) on page 78](#).
7. MFP models: scanner support bracket. See [Scanner assembly and scanner support bracket \(MFP models only\) on page 78](#).
8. Left front cover. See [Left front cover on page 31](#).
9. Top cover. See [Top cover \(377, 477, 577 models\) on page 33](#) or [Top cover \(352, 452, 552 models\) on page 35](#).
10. Front cover. See [Front cover \(352, 452, 377, 477 models\) on page 37](#) or [Front cover \(552, 577 models\) on page 39](#).

1. Spread the retainers (using a pair of tweezers) holding the gear onto the shaft then slide the gear off the shaft. Repeat this step for each gear.

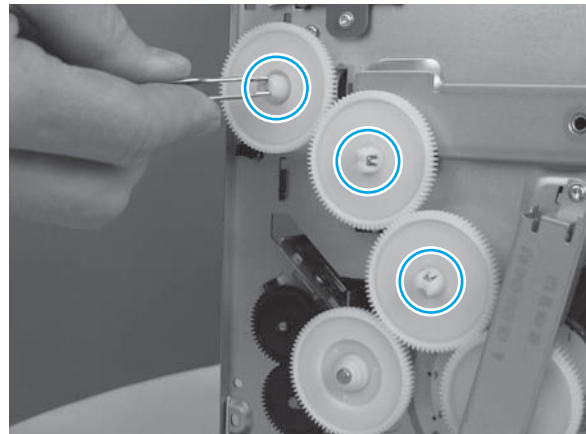

2. Snap the new output drive gears onto the shafts.

Output drive shaft 6

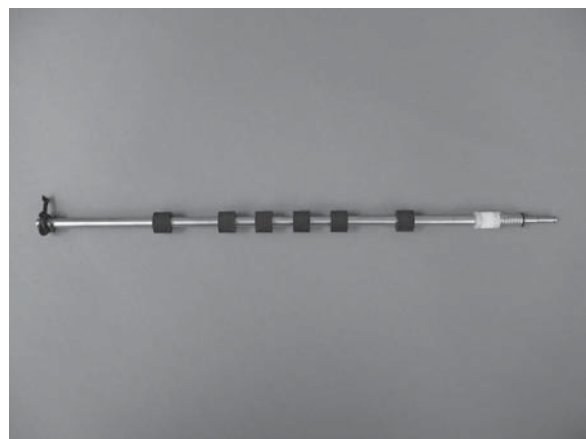
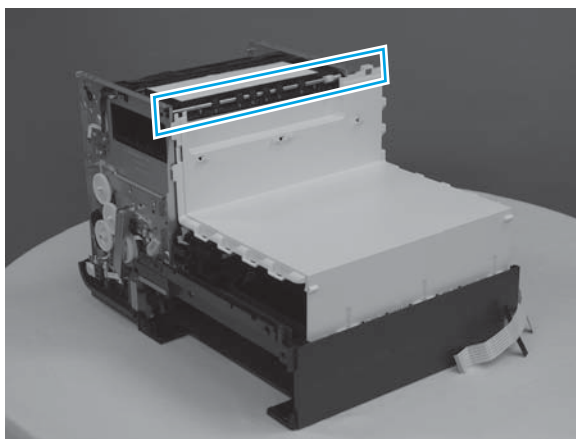

Remove these parts in this order:

1. Output bin. See [Output bin \(352, 452, 377, and 477 models\) on page 11](#).
2. Optional: left door. See [Left door on page 26](#).

3. Duplex module. See [Duplex module on page 11](#).
 4. Left rear cover. See [Left rear cover on page 28](#).
 5. Rear cover. See [Rear cover \(552, 577, P55250, and P57750 models\) on page 29](#) or [Rear cover \(352, 452, 377, 477 models\) on page 30](#).
 6. MFP models: scanner assembly. See [Scanner assembly and scanner support bracket \(MFP models only\) on page 78](#).
 7. MFP models: scanner support bracket. See [Scanner assembly and scanner support bracket \(MFP models only\) on page 78](#).
 8. Left front cover. See [Left front cover on page 31](#).
 9. Top cover. See [Top cover \(377, 477, 577 models\) on page 33](#) or [Top cover \(352, 452, 552 models\) on page 35](#).
 10. Front cover. See [Front cover \(352, 452, 377, 477 models\) on page 37](#) or [Front cover \(552, 577 models\) on page 39](#).
 11. Top cap assembly. See [Top cap assembly on page 86](#).
 12. Eject flap lifter. See [Eject flap lifter on page 88](#).
1. Remove the shaft rear gear assembly by pulling it off toward the rear.

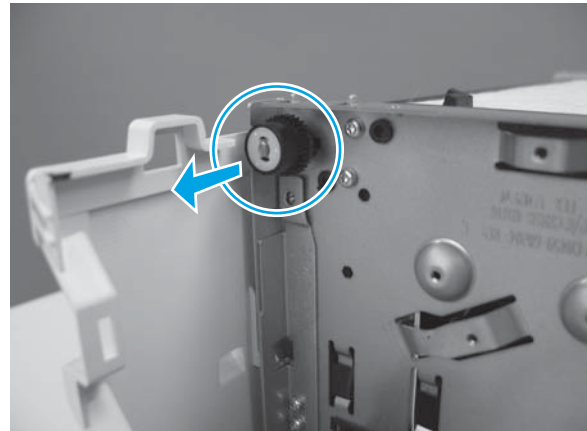

2. Rotate the front output drive shaft bearing counterclockwise.

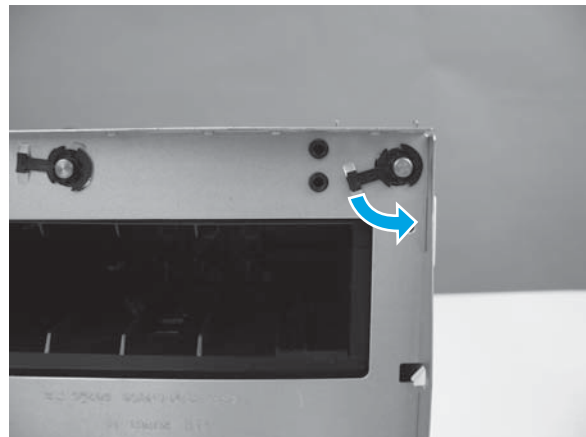

3. Slide the shaft to the front of the printer, and then remove it.

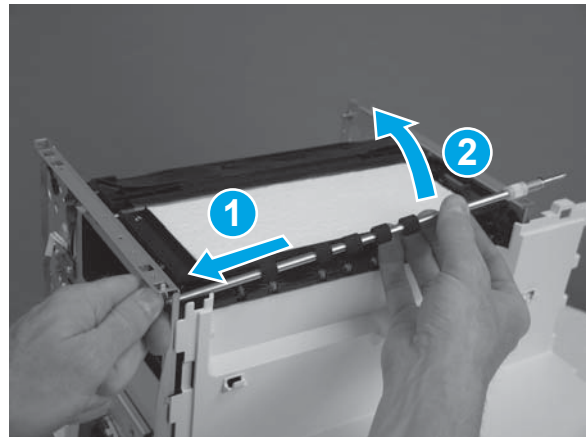

Inner top frame

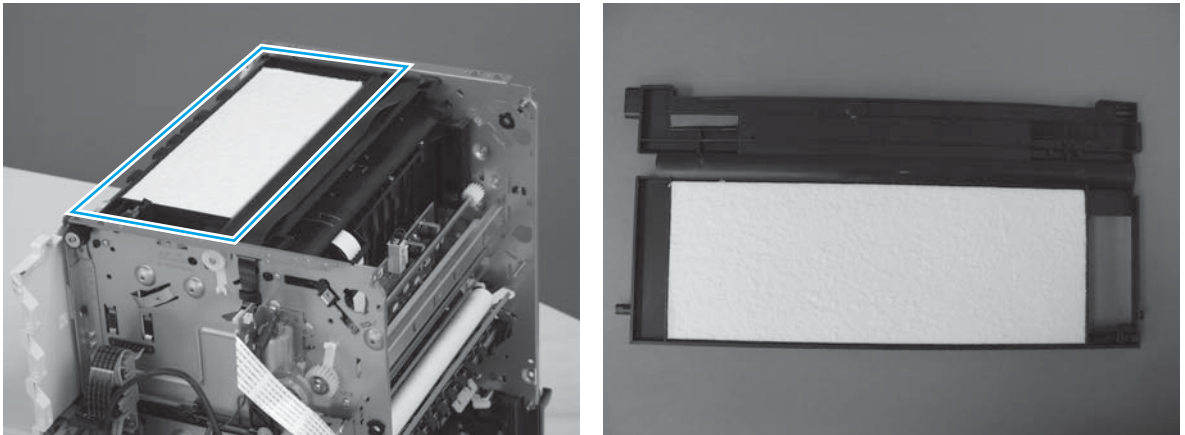

Remove these parts in this order:

1. Output bin. See [Output bin \(352, 452, 377, and 477 models\) on page 11](#).
2. Optional: left door. See [Left door on page 26](#).
3. Duplex module. See [Duplex module on page 11](#).
4. Left rear cover. See [Left rear cover on page 28](#).
5. Rear cover. See [Rear cover \(552, 577, P55250, and P57750 models\) on page 29](#) or [Rear cover \(352, 452, 377, 477 models\) on page 30](#).
6. PCA safety shield. See [PCA safety shield on page 51](#).
7. Aerosol fan assembly. See [Aerosol fan assembly on page 59](#).
8. MFP models: scanner assembly. See [Scanner assembly and scanner support bracket \(MFP models only\) on page 78](#).
9. MFP models: scanner support bracket. See [Scanner assembly and scanner support bracket \(MFP models only\) on page 78](#).
10. Left front cover. See [Left front cover on page 31](#).
11. Top cover. See [Top cover \(377, 477, 577 models\) on page 33](#) or [Top cover \(352, 452, 552 models\) on page 35](#).
12. Eject drive gear module. See [Eject drive gear module on page 90](#).
13. Front cover. See [Front cover \(352, 452, 377, 477 models\) on page 37](#) or [Front cover \(552, 577 models\) on page 39](#).
14. Top cap assembly. See [Top cap assembly on page 86](#).

1. Disconnect the printzone distribution PCA FFC.

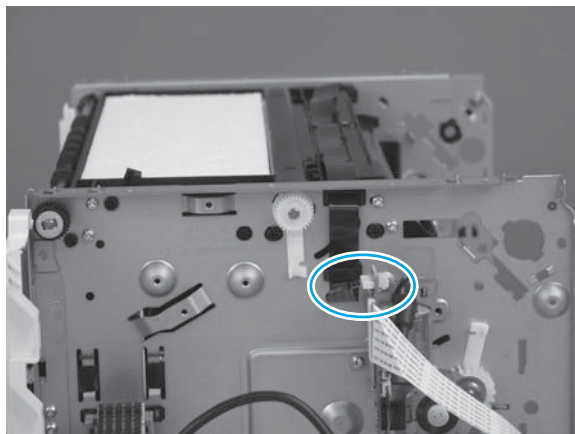

2. Unthread the FFC through the chassis.

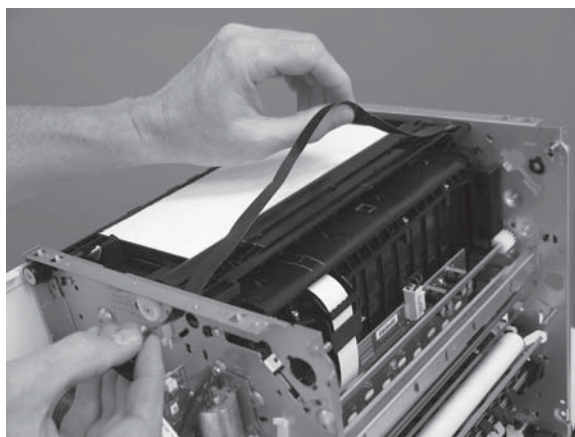

3. Remove two screws from the rear of the printer.

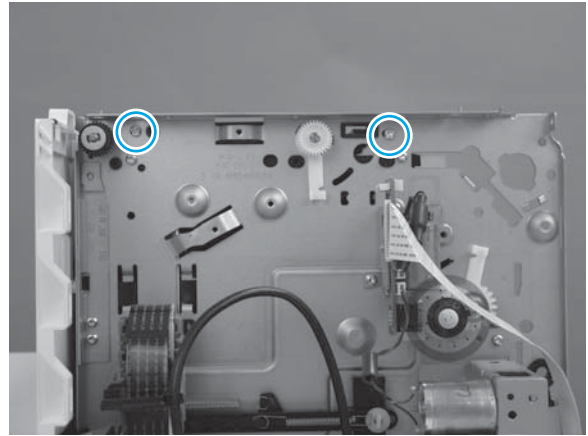

4. Remove the inner top frame.

NOTE: It can be difficult getting the inner top frame out of the metal chassis. Slide the assembly toward the front, and then lift it out from the rear.

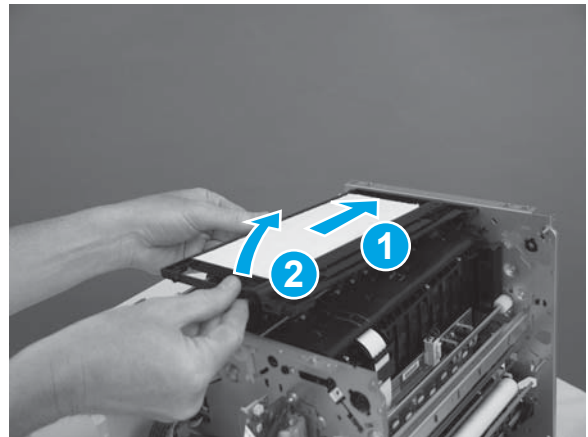

Eject flap opto PCA

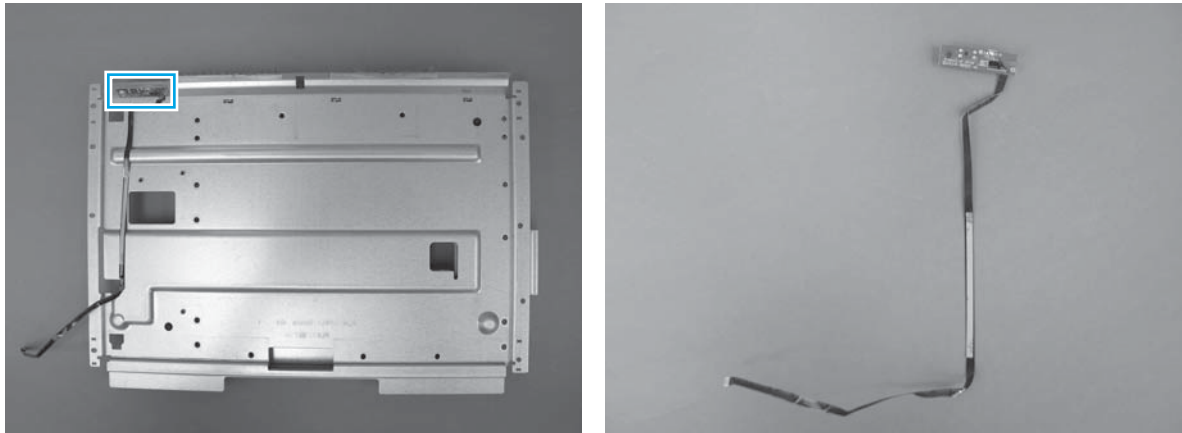

NOTE: MFP models: The assembly is mounted on the top cap assembly.

Remove these parts in this order:

1. Output bin. See [Output bin \(352, 452, 377, and 477 models\) on page 11](#).
2. Optional: left door. See [Left door on page 26](#).
3. Duplex module. See [Duplex module on page 11](#).
4. Left rear cover. See [Left rear cover on page 28](#).
5. Rear cover. See [Rear cover \(552, 577, P55250, and P57750 models\) on page 29](#) or [Rear cover \(352, 452, 377, 477 models\) on page 30](#).
6. MFP models: scanner assembly. See [Scanner assembly and scanner support bracket \(MFP models only\) on page 78](#).
7. MFP models: scanner support bracket. See [Scanner assembly and scanner support bracket \(MFP models only\) on page 78](#).
8. Left front cover. See [Left front cover on page 31](#).
9. Top cover. See [Top cover \(377, 477, 577 models\) on page 33](#) or [Top cover \(352, 452, 552 models\) on page 35](#).
10. Front cover. See [Front cover \(352, 452, 377, 477 models\) on page 37](#) or [Front cover \(552, 577 models\) on page 39](#).
11. Top cap assembly. See [Top cap assembly on page 86](#).

1. Remove one screw from the underneath of the top cap assembly, and then remove the sensor PCA.

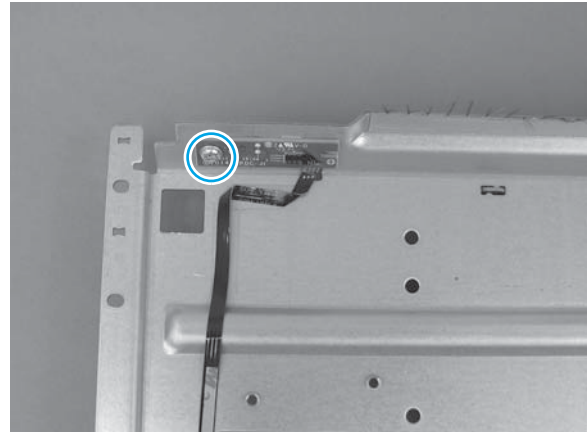

Output drive shaft 3

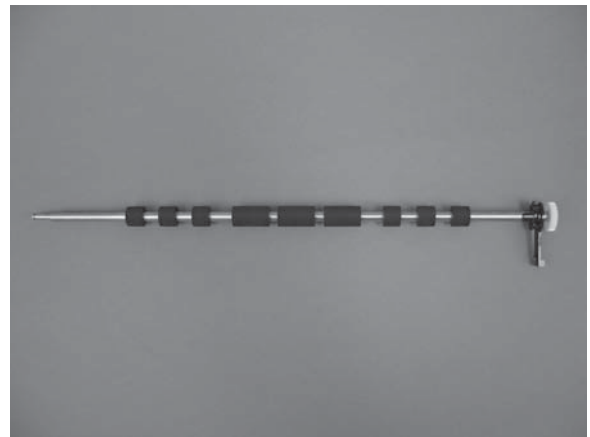
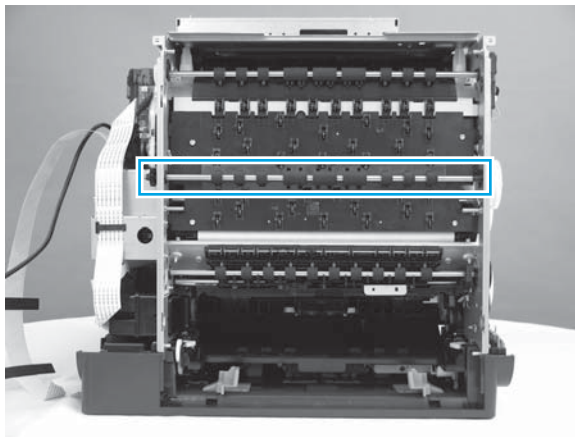

Remove these parts in this order:

1. Output bin. See [Output bin \(352, 452, 377, and 477 models\) on page 11](#).
2. Optional: left door. See [Left door on page 26](#).
3. Duplex module. See [Duplex module on page 11](#).
4. Left rear cover. See [Left rear cover on page 28](#).
5. Rear cover. See [Rear cover \(552, 577, P55250, and P57750 models\) on page 29](#) or [Rear cover \(352, 452, 377, 477 models\) on page 30](#).
6. MFP models: scanner assembly. See [Scanner assembly and scanner support bracket \(MFP models only\) on page 78](#).
7. MFP models: scanner support bracket. See [Scanner assembly and scanner support bracket \(MFP models only\) on page 78](#).
8. Left front cover. See [Left front cover on page 31](#).

9. Top cover. See [Top cover \(377, 477, 577 models\) on page 33](#) or [Top cover \(352, 452, 552 models\) on page 35](#).
10. Front cover. See [Front cover \(352, 452, 377, 477 models\) on page 37](#) or [Front cover \(552, 577 models\) on page 39](#).

1. On the front side of the printer, remove one gear.

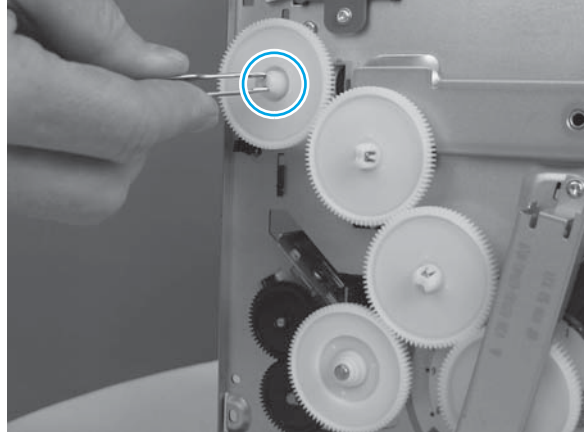

2. Use tweezers to release the hooks on the rear gear so it can slide off the shaft.

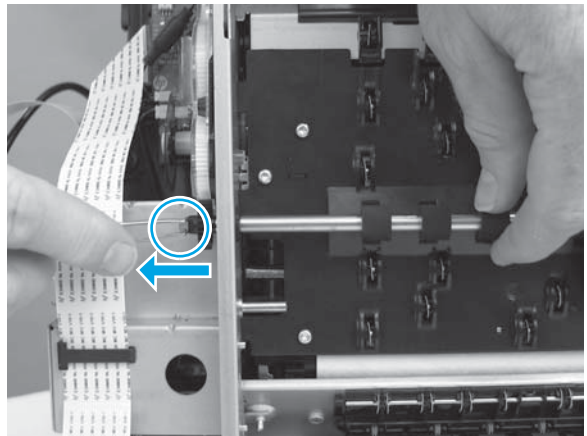

3. Rotate the front output drive shaft bearing counterclockwise, and then remove the shaft from the chassis.

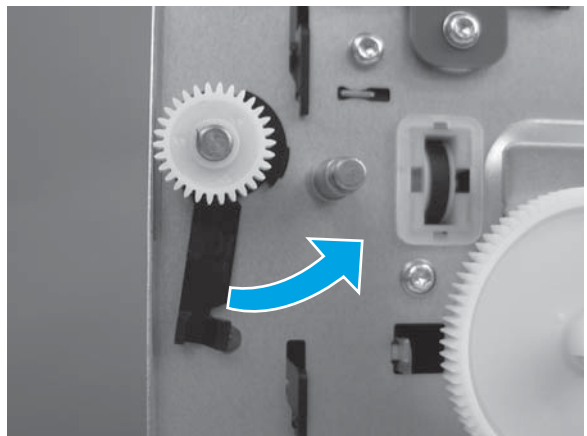

Output drive shaft 5

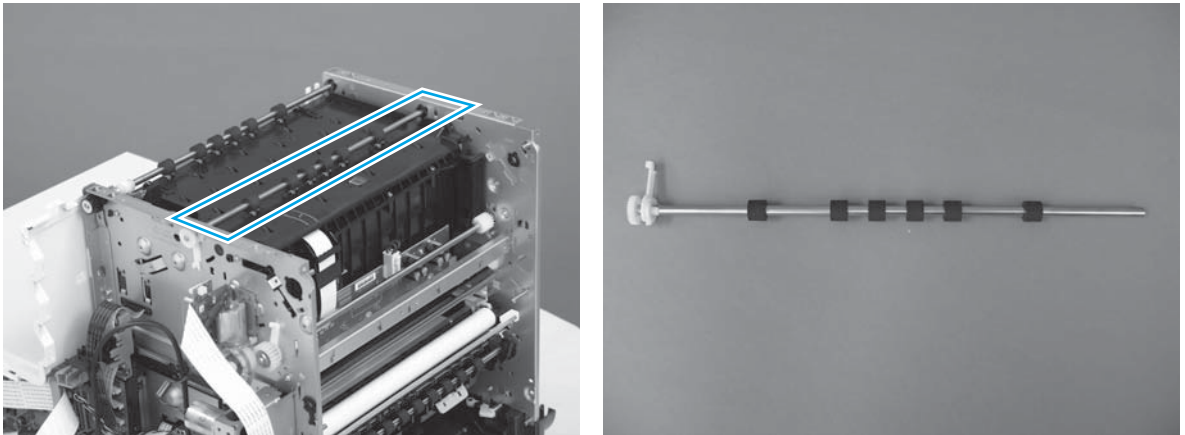

Remove these parts in this order:

1. Output bin. See [Output bin \(352, 452, 377, and 477 models\) on page 11](#).
2. Optional: left door. See [Left door on page 26](#).
3. Duplex module. See [Duplex module on page 11](#).
4. Left rear cover. See [Left rear cover on page 28](#).
5. Rear cover. See [Rear cover \(552, 577, P55250, and P57750 models\) on page 29](#) or [Rear cover \(352, 452, 377, 477 models\) on page 30](#).
6. PCA safety shield. See [PCA safety shield on page 51](#).
7. Aerosol fan assembly. See [Aerosol fan assembly on page 59](#).
8. MFP models: scanner assembly. See [Scanner assembly and scanner support bracket \(MFP models only\) on page 78](#).
9. MFP models: scanner support bracket. See [Scanner assembly and scanner support bracket \(MFP models only\) on page 78](#).
10. Left front cover. See [Left front cover on page 31](#).
11. Top cover. See [Top cover \(377, 477, 577 models\) on page 33](#) or [Top cover \(352, 452, 552 models\) on page 35](#).
12. Front cover. See [Front cover \(352, 452, 377, 477 models\) on page 37](#) or [Front cover \(552, 577 models\) on page 39](#).
13. Eject drive gear module. See [Eject drive gear module on page 90](#).
14. Top cap assembly. See [Top cap assembly on page 86](#).
15. Inner top frame. See [Inner top frame on page 101](#).

1. Rotate the rear output drive shaft bearing counterclockwise.

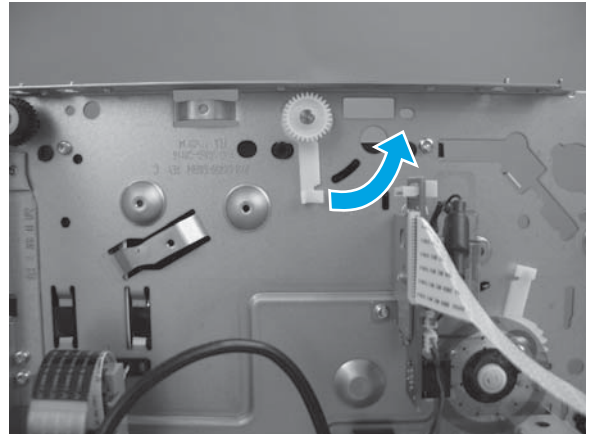

2. Pull the shaft to the rear of the printer, and then remove the shaft.

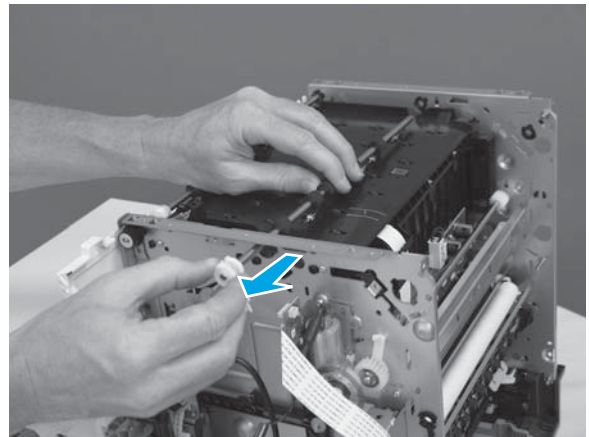

Top paper guide

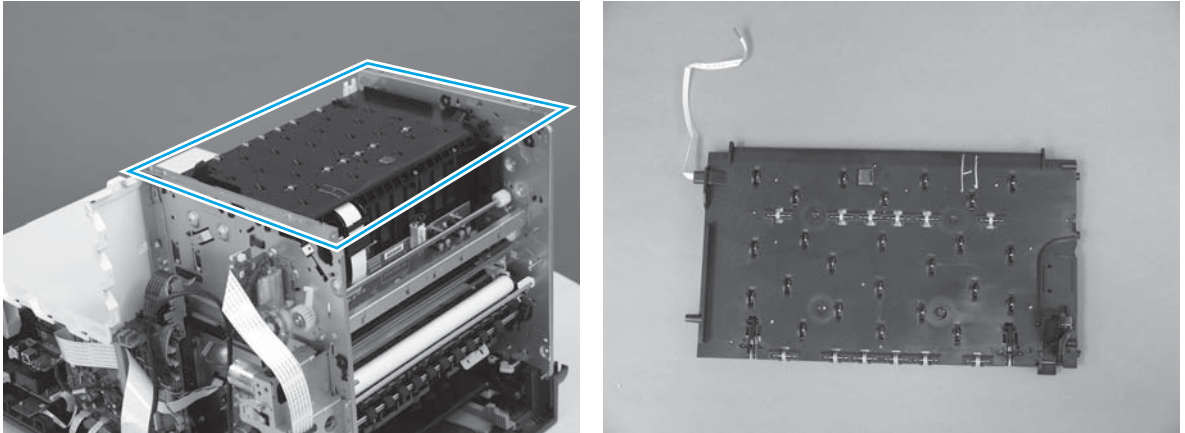

Remove these parts in this order:

1. Output bin. See [Output bin \(352, 452, 377, and 477 models\) on page 11](#).
2. Optional: left door. See [Left door on page 26](#).
3. Duplex module. See [Duplex module on page 11](#).
4. Left rear cover. See [Left rear cover on page 28](#).
5. Rear cover. See [Rear cover \(552, 577, P55250, and P57750 models\) on page 29](#) or [Rear cover \(352, 452, 377, 477 models\) on page 30](#).
6. MFP models: scanner assembly. See [Scanner assembly and scanner support bracket \(MFP models only\) on page 78](#).
7. MFP models: scanner support bracket. See [Scanner assembly and scanner support bracket \(MFP models only\) on page 78](#).
8. Left front cover. See [Left front cover on page 31](#).
9. Top cover. See [Top cover \(377, 477, 577 models\) on page 33](#) or [Top cover \(352, 452, 552 models\) on page 35](#).
10. Front cover. See [Front cover \(352, 452, 377, 477 models\) on page 37](#) or [Front cover \(552, 577 models\) on page 39](#).
11. PCA safety shield. See [PCA safety shield on page 51](#).
12. Aerosol fan assembly. See [Aerosol fan assembly on page 59](#).
13. Drying path gear assembly. See [Drying path gear assembly on page 49](#).
14. Top cap assembly. See [Top cap assembly on page 86](#).
15. Inner top frame. See [Inner top frame on page 101](#).
16. Output drive shaft 5. See [Output drive shaft 5 on page 107](#).

1. Disconnect two cables from the REDI sensor distribution PCA.

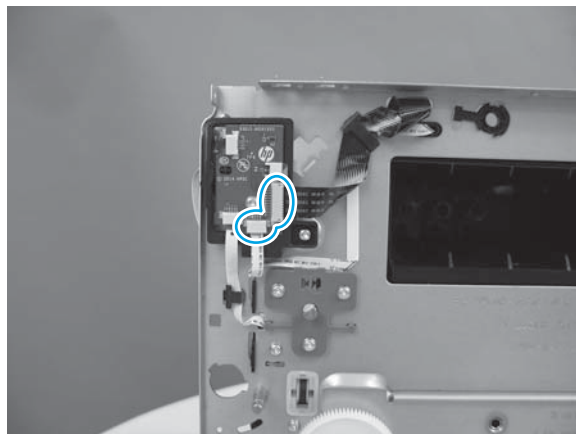

2. Remove the cable retainer (1), and then unthread the FFC (2).

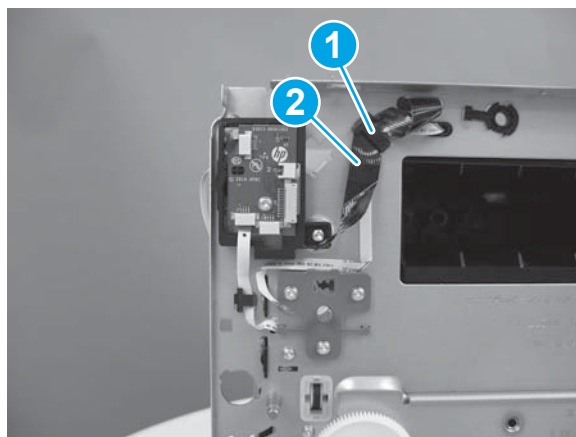

3. Remove two screws from the rear of the printer.

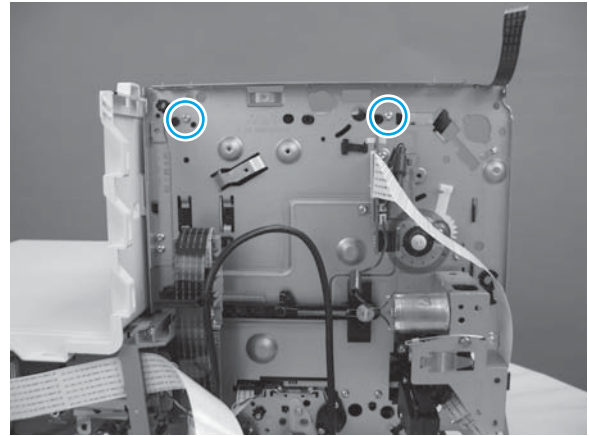

4. Lift the top paper guide to remove it.

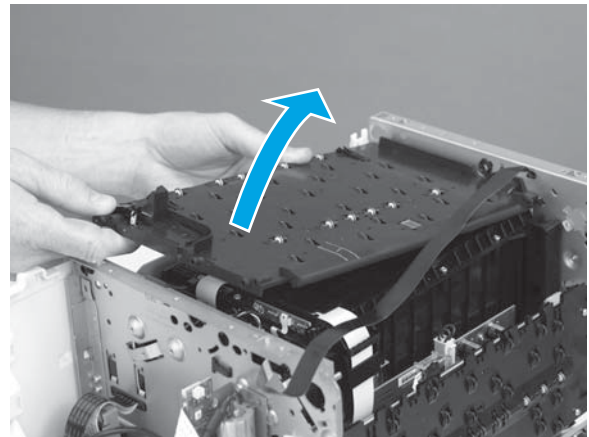

Output drive shaft 4

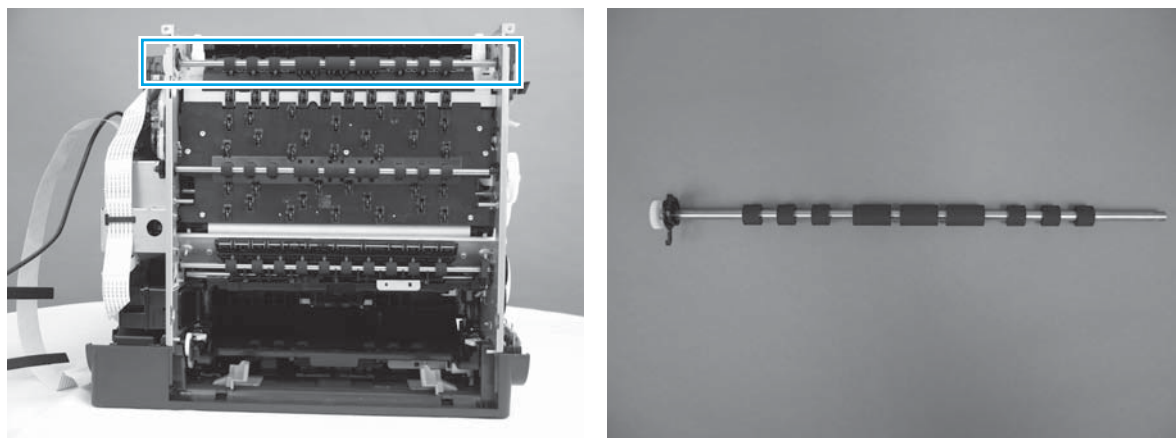

Remove these parts in this order:

1. Output bin. See [Output bin \(352, 452, 377, and 477 models\) on page 11](#).
2. Optional: left door. See [Left door on page 26](#).
3. Duplex module. See [Duplex module on page 11](#).
4. Left rear cover. See [Left rear cover on page 28](#).
5. Rear cover. See [Rear cover \(552, 577, P55250, and P57750 models\) on page 29](#) or [Rear cover \(352, 452, 377, 477 models\) on page 30](#).
6. MFP models: scanner assembly. See [Scanner assembly and scanner support bracket \(MFP models only\) on page 78](#).
7. MFP models: scanner support bracket. See [Scanner assembly and scanner support bracket \(MFP models only\) on page 78](#).
8. Left front cover. See [Left front cover on page 31](#).
9. Top cover. See [Top cover \(377, 477, 577 models\) on page 33](#) or [Top cover \(352, 452, 552 models\) on page 35](#).
10. Front cover. See [Front cover \(352, 452, 377, 477 models\) on page 37](#) or [Front cover \(552, 577 models\) on page 39](#).
11. Top cap assembly. See [Top cap assembly on page 86](#).
12. REDI distribution PCA. See [REDI distribution PCA on page 96](#).

1. Rotate the rear output drive shaft bearing counterclockwise.

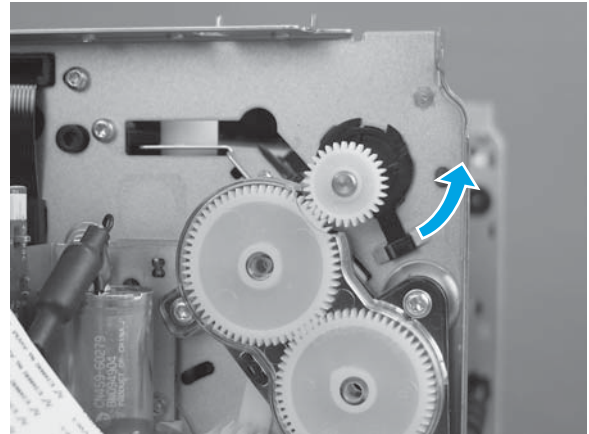

2. Slide the shaft to the rear side to remove the shaft.

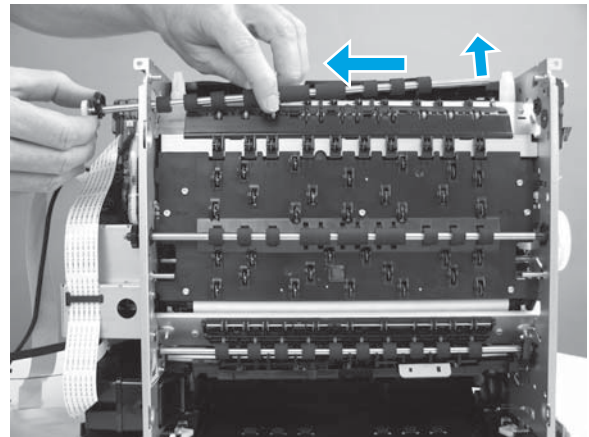

Top left paper guide assembly

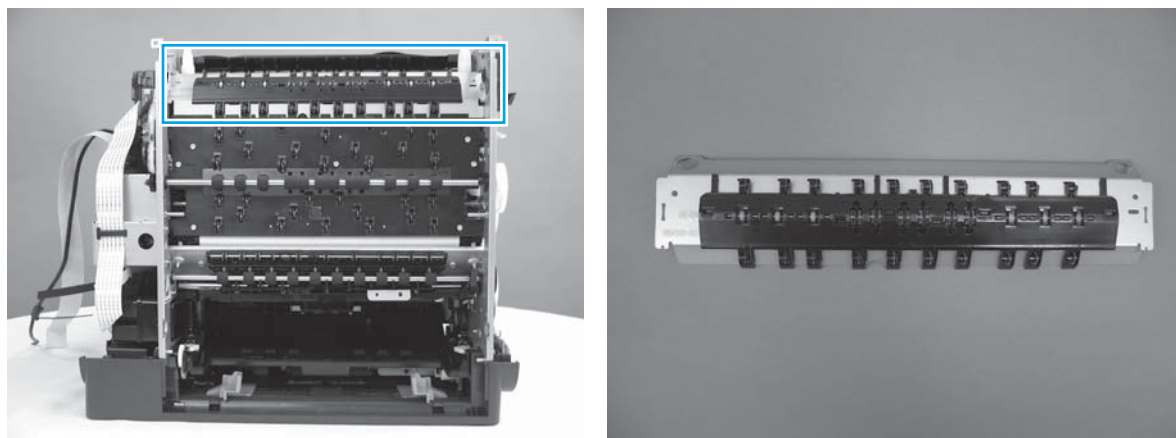

Remove these parts in this order:

1. Output bin. See [Output bin \(352, 452, 377, and 477 models\) on page 11](#).
2. Optional: left door. See [Left door on page 26](#).
3. Duplex module. See [Duplex module on page 11](#).
4. Left rear cover. See [Left rear cover on page 28](#).
5. Rear cover. See [Rear cover \(552, 577, P55250, and P57750 models\) on page 29](#) or [Rear cover \(352, 452, 377, 477 models\) on page 30](#).
6. MFP models: scanner assembly. See [Scanner assembly and scanner support bracket \(MFP models only\) on page 78](#).
7. MFP models: scanner support bracket. See [Scanner assembly and scanner support bracket \(MFP models only\) on page 78](#).
8. Left front cover. See [Left front cover on page 31](#).
9. Top cover. See [Top cover \(377, 477, 577 models\) on page 33](#) or [Top cover \(352, 452, 552 models\) on page 35](#).
10. Front cover. See [Front cover \(352, 452, 377, 477 models\) on page 37](#) or [Front cover \(552, 577 models\) on page 39](#).
11. Top cap assembly. See [Top cap assembly on page 86](#).
12. Drying path gear assembly. See [Drying path gear assembly on page 49](#).
13. REDI distribution PCA. See [REDI distribution PCA on page 96](#).
14. Output drive shaft 4. See [Output drive shaft 4 on page 112](#).

1. Remove the paper path shaft 4 front bearing.

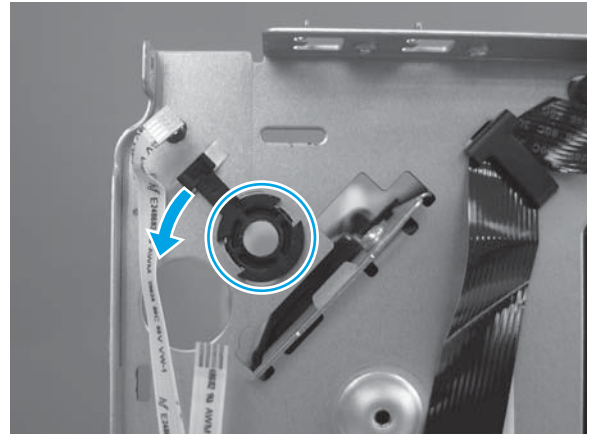

2. Locate the printbar lift guide Z stops.

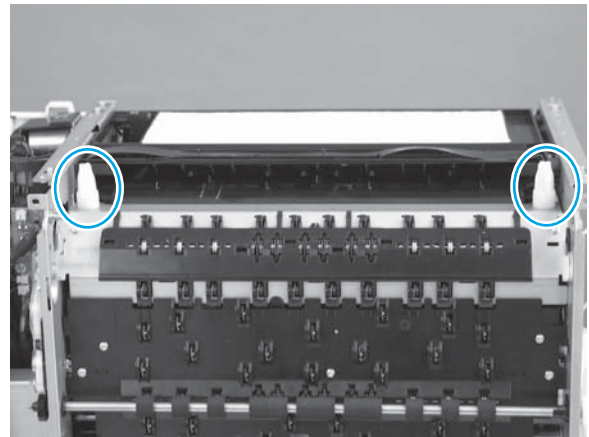

3. Lift up to remove the printbar lift guides.

Reinstallation tip: Before re-inserting the lift guides, make sure to replace the caps on top of the lift guides (otherwise they can interfere with proper operation of the printer). The replacement caps are part of the printbar replacement kit—CN598-67048.

CAUTION: The lift guides are greasy.

CAUTION: Replace the lift guides in their original front and rear locations.

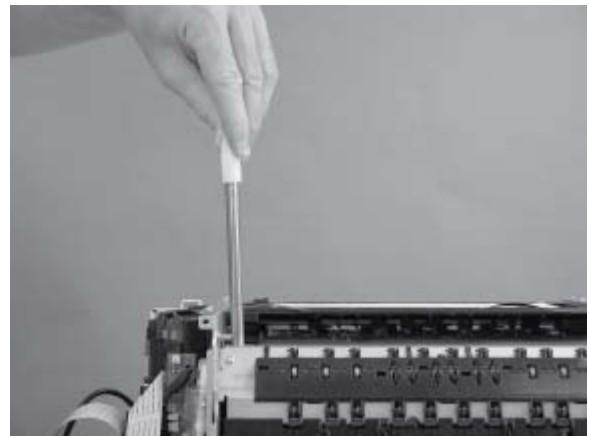

4. Remove two screws.

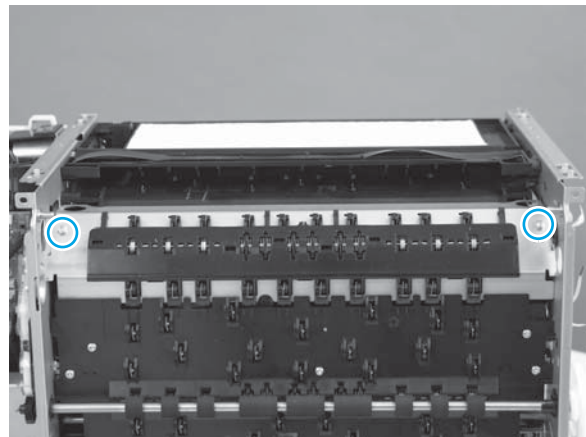

5. Remove the paper guide assembly.

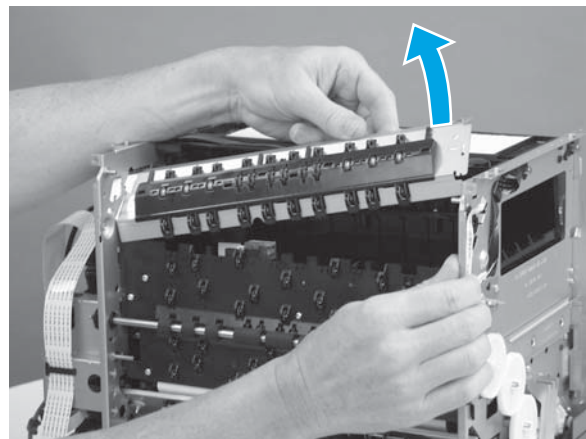

 **Reinstallation tip:** During the reinstallation process, the bottom metal edge of the assembly inserts into the grooves in the plastic center left paper guide.

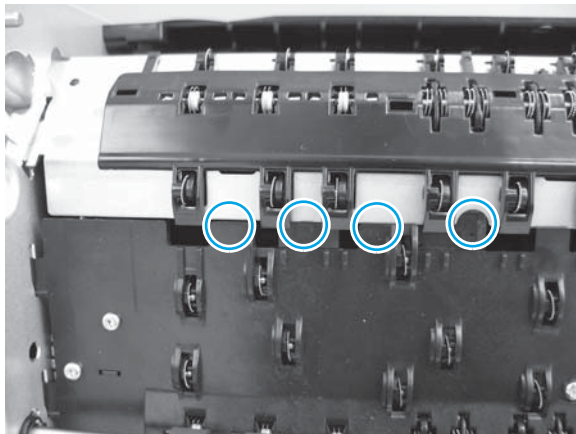

Center left paper guide assembly

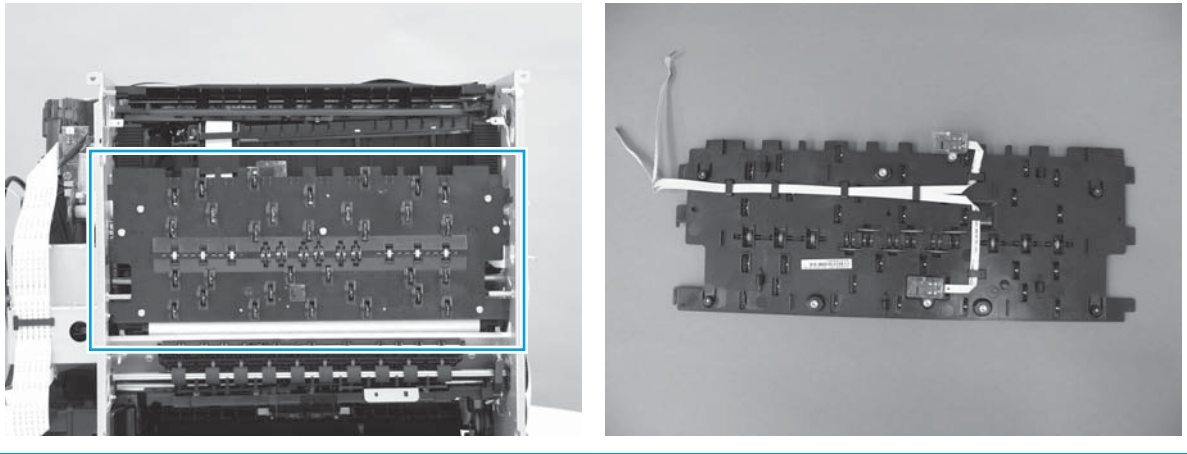

Remove these parts in this order:

1. Output bin. See [Output bin \(352, 452, 377, and 477 models\) on page 11](#).
2. Optional: left door. See [Left door on page 26](#).
3. Duplex module. See [Duplex module on page 11](#).
4. Left rear cover. See [Left rear cover on page 28](#).
5. Rear cover. See [Rear cover \(552, 577, P55250, and P57750 models\) on page 29](#) or [Rear cover \(352, 452, 377, 477 models\) on page 30](#).
6. MFP models: scanner assembly. See [Scanner assembly and scanner support bracket \(MFP models only\) on page 78](#).
7. MFP models: scanner support bracket. See [Scanner assembly and scanner support bracket \(MFP models only\) on page 78](#).
8. Left front cover. See [Left front cover on page 31](#).
9. Top cover. See [Top cover \(377, 477, 577 models\) on page 33](#) or [Top cover \(352, 452, 552 models\) on page 35](#).
10. Front cover. See [Front cover \(352, 452, 377, 477 models\) on page 37](#) or [Front cover \(552, 577 models\) on page 39](#).
11. Output drive shaft 3. See [Output drive shaft 3 on page 105](#).
12. Top cap assembly. See [Top cap assembly on page 86](#).
13. Drying path gear assembly. See [Drying path gear assembly on page 49](#).
14. REDI distribution PCA. See [REDI distribution PCA on page 96](#).
15. Output drive shaft 4. See [Output drive shaft 4 on page 112](#).
16. Top left paper guide assembly. See [Top left paper guide assembly on page 114](#).

1. On the left side of the printer, remove three screws.

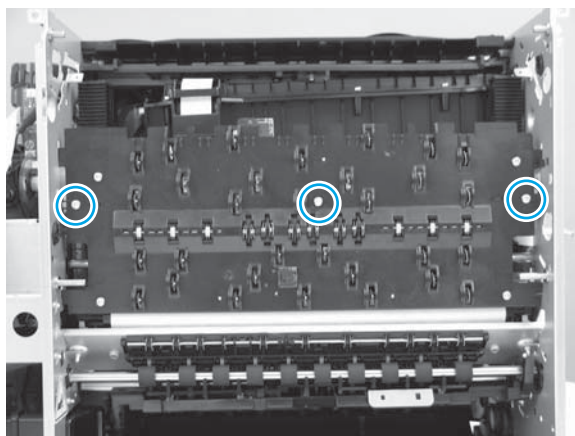

2. Locate two dust shield tabs inside the printer.

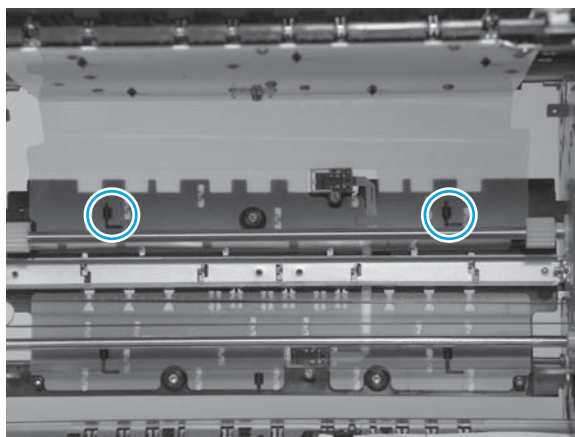

3. Lift and flex the assembly to remove it.

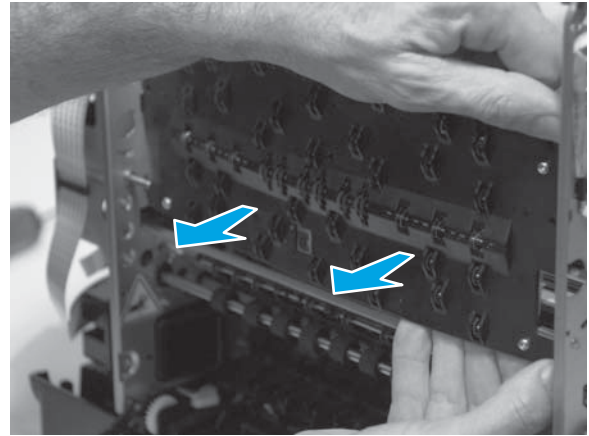

4. Remove one cable retainer.

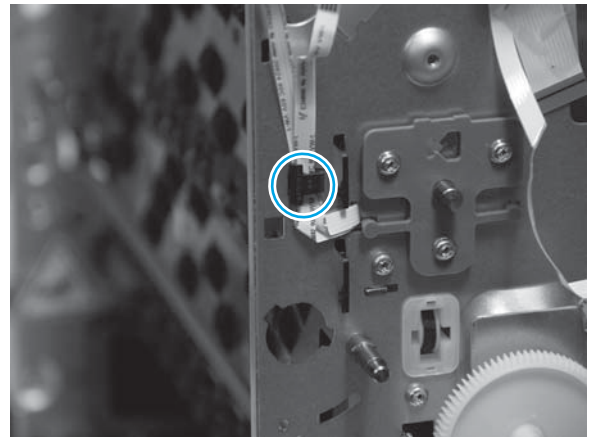

Assemblies accessed through the right cover

Tray lift transmission assembly

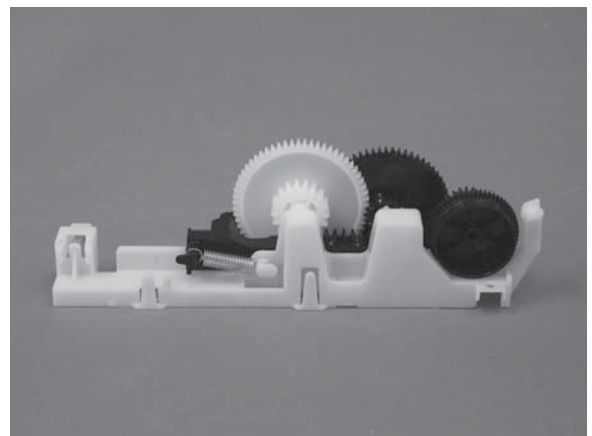
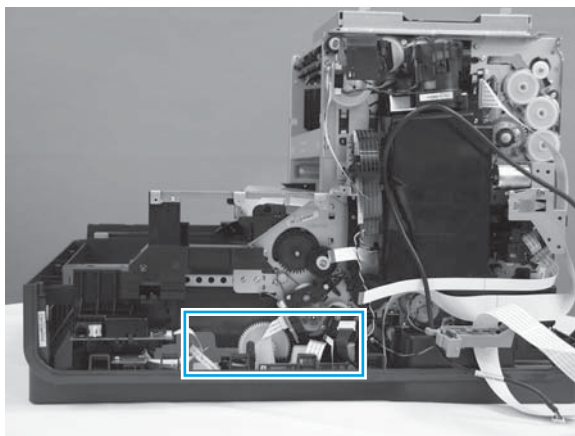

Remove these parts in this order:

1. Output bin. See [Output bin \(352, 452, 377, and 477 models\) on page 11](#).
2. Optional: left door. See [Left door on page 26](#).
3. Duplex module. See [Duplex module on page 11](#).
4. Left rear cover. See [Left rear cover on page 28](#).
5. Rear cover. See [Rear cover \(552, 577, P55250, and P57750 models\) on page 29](#) or [Rear cover \(352, 452, 377, 477 models\) on page 30](#).
6. PCA safety shield. See [PCA safety shield on page 51](#).
7. Main PCA. See [Main PCA on page 54](#).
8. Pick encoder distribution PCA. See [Pick encoder distribution PCA on page 66](#).
9. MFP models: scanner assembly. See [Scanner assembly and scanner support bracket \(MFP models only\) on page 78](#).
10. MFP models: scanner support bracket. See [Scanner assembly and scanner support bracket \(MFP models only\) on page 78](#).
11. Left front cover. See [Left front cover on page 31](#).
12. Top cover. See [Top cover \(377, 477, 577 models\) on page 33](#) or [Top cover \(352, 452, 552 models\) on page 35](#).
13. Front cover. See [Front cover \(352, 452, 377, 477 models\) on page 37](#) or [Front cover \(552, 577 models\) on page 39](#).
14. Right cover. See [Right cover on page 47](#).
15. 552, 577 models: IDS bracket. See [IDS bracket \(552, 577 models\) on page 122](#).

1. Remove two screws.



2. Remove 3 screws, then swing the plastic fixture up to create space to remove the tray lift transmission assembly.

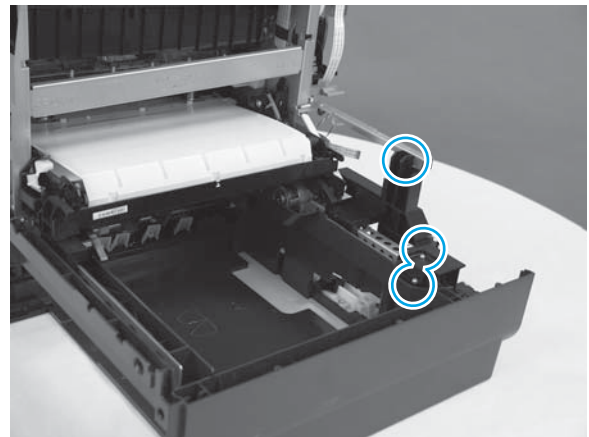

3. Carefully remove the assembly. The main gear drive axle must clear a post on the printer chassis before the assembly can be removed.

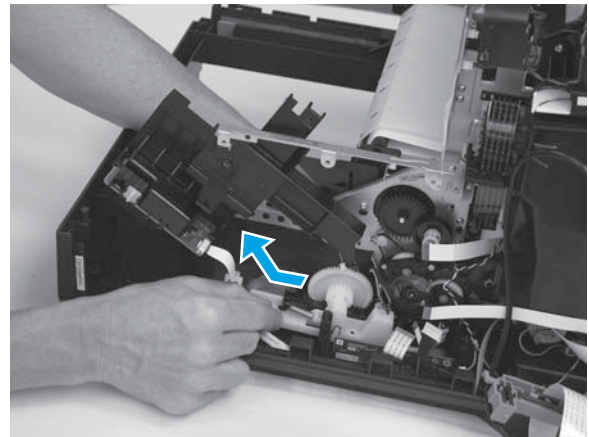

IDS bracket (552, 577 models)

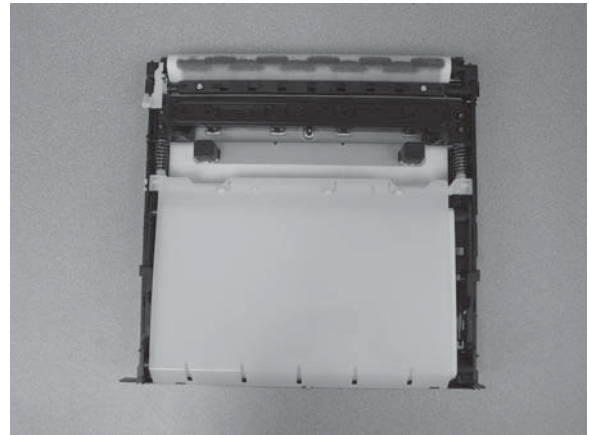
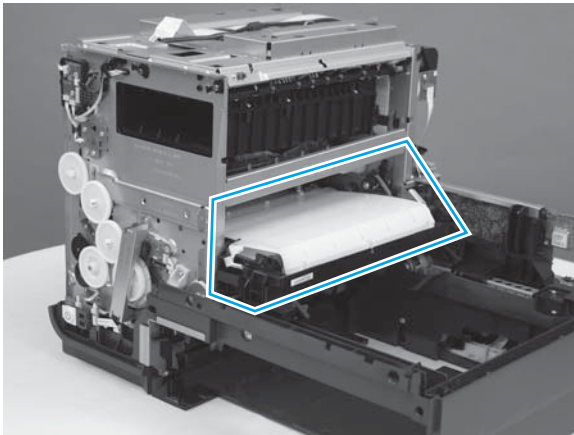

Remove these parts in this order:

1. Output bin. See [Output bin \(352, 452, 377, and 477 models\) on page 11](#).
2. Optional: left door. See [Left door on page 26](#).
3. Duplex module. See [Duplex module on page 11](#).
4. Left rear cover. See [Left rear cover on page 28](#).
5. Rear cover. See [Rear cover \(552, 577, P55250, and P57750 models\) on page 29](#) or [Rear cover \(352, 452, 377, 477 models\) on page 30](#).
6. MFP models: scanner assembly. See [Scanner assembly and scanner support bracket \(MFP models only\) on page 78](#).
7. MFP models: scanner support bracket. See [Scanner assembly and scanner support bracket \(MFP models only\) on page 78](#).
8. Left front cover. See [Left front cover on page 31](#).
9. Top cover. See [Top cover \(377, 477, 577 models\) on page 33](#) or [Top cover \(352, 452, 552 models\) on page 35](#).
10. Front cover. See [Front cover \(352, 452, 377, 477 models\) on page 37](#) or [Front cover \(552, 577 models\) on page 39](#).
11. Right cover. See [Right cover on page 47](#).

1. On the right side of the printer, remove one screw..

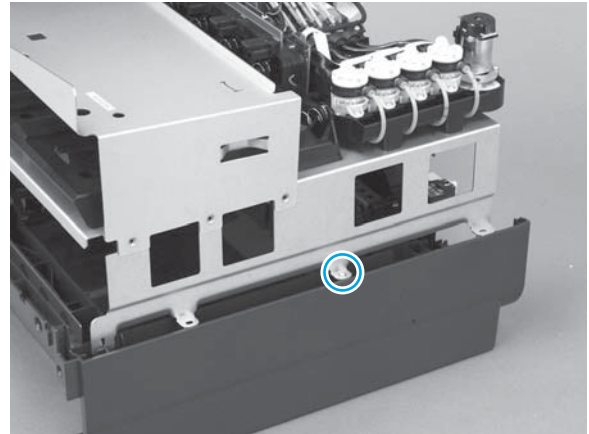

2. At the rear of the printer, remove two screws.

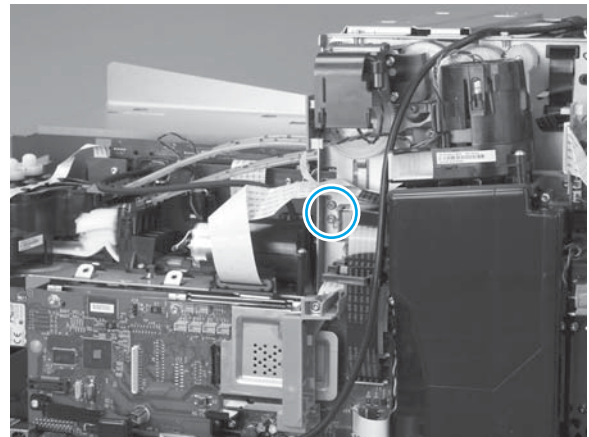

3. At the front of the printer, remove two screws.

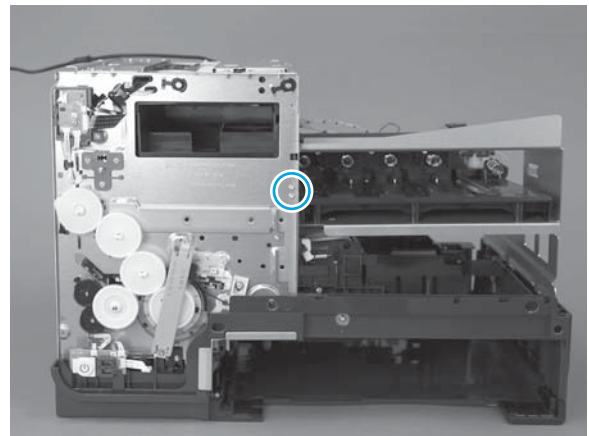

4. At the rear of the printer, disconnect three FFCs.

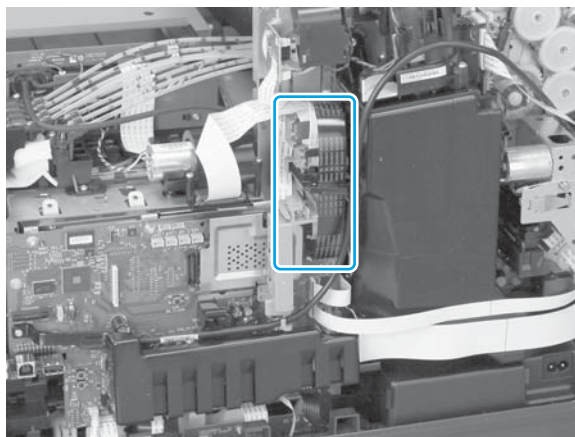

5. On top of the IDS bracket, remove the two screws for the upper pigtail connections.

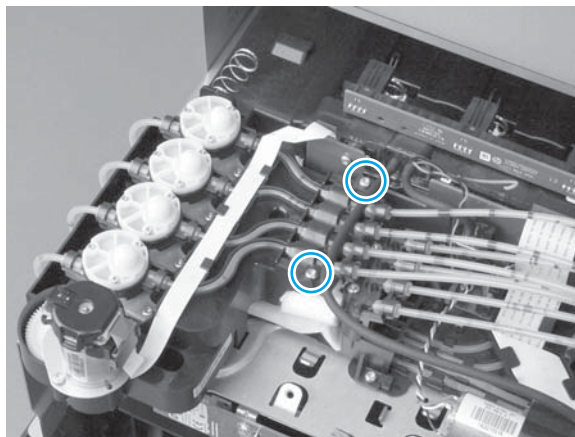

6. Pull the pigtail connector assembly toward the left side of the printer to disconnect the connectors.

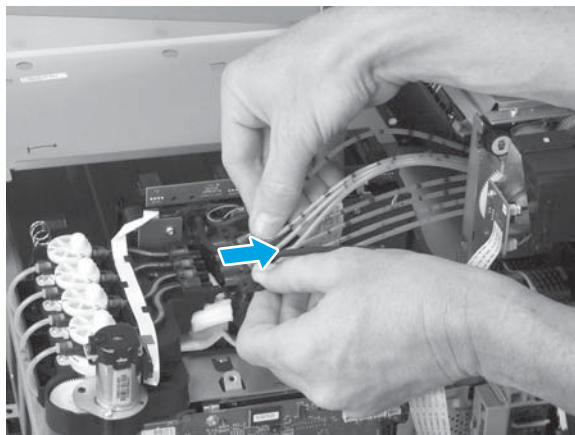

7. Remove the two screws on the lower pigtail connector assembly.

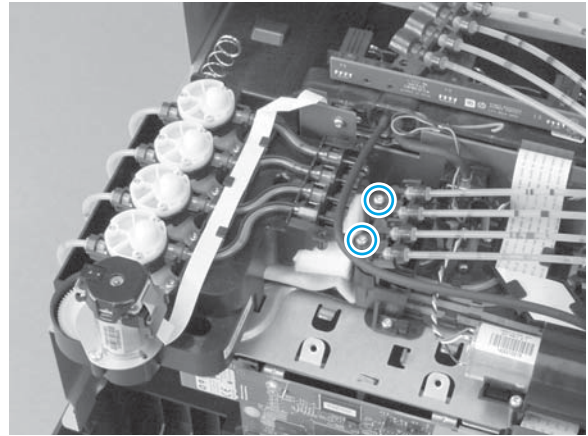

8. Pull up on the lower pigtail connector to disconnect it.

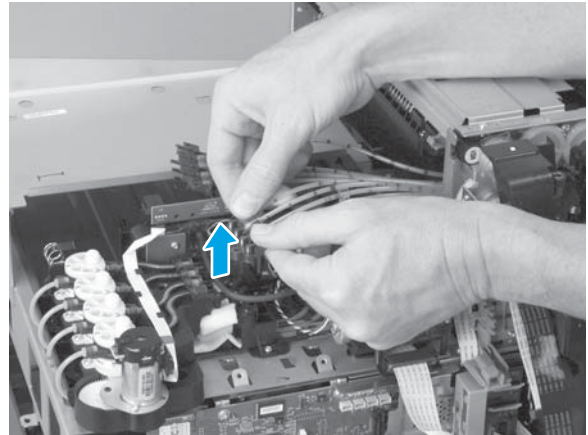

9. Lift the right side of the bracket up and then pull it away from the printer to remove it.

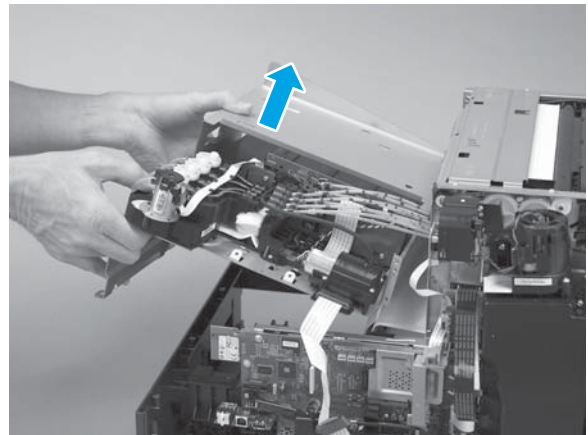

 **NOTE:** At the front of the printer, you might need to depress the bracket pin to release the left side of the IDS bracket from the printer chassis.

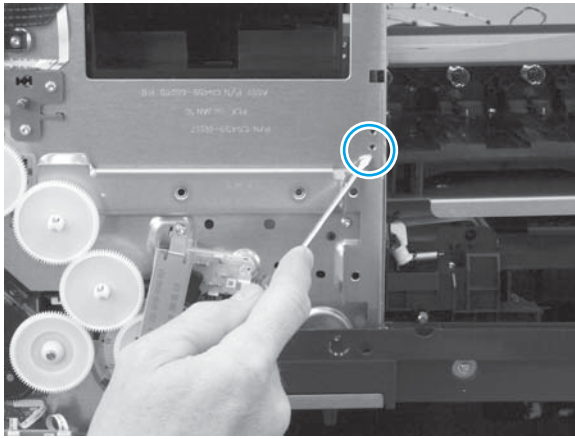

Reinstallation tip: When reinstalling the pigtails, ensure that the black vent hose rests on top of the pigtails.

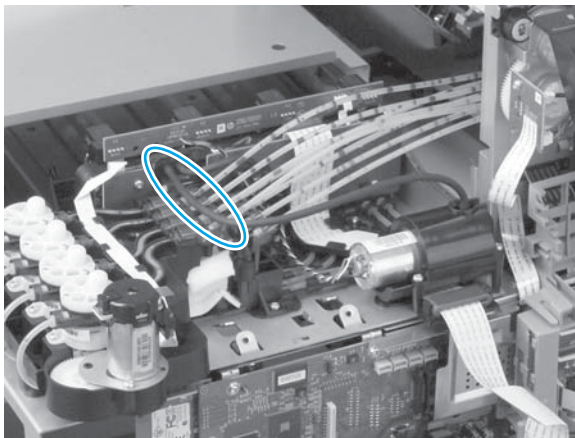

Reinstallation tip: When disconnecting the pigtail connectors, a connector seal can loosen and detach from the connector. Use tweezers or a small flat-blade screwdriver to reinstall any seals that detached from the connectors.

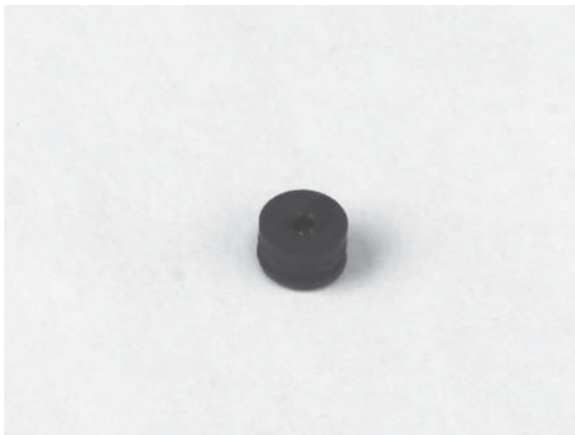

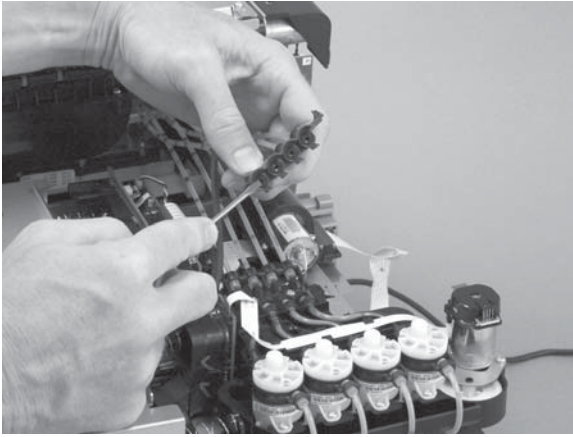

Reinstallation tip: Check the areas around the pigtails for leakage during and after the 378, 379, and 380 tap tests (see [Verify that the pig tails have an adequate seal on page 21](#)). The tests are very quick and quiet. You can verify that it is running as the gear shown below briefly spins when you touch **OK** to run a tap test. Touch **OK** again to continue after completing the tests.

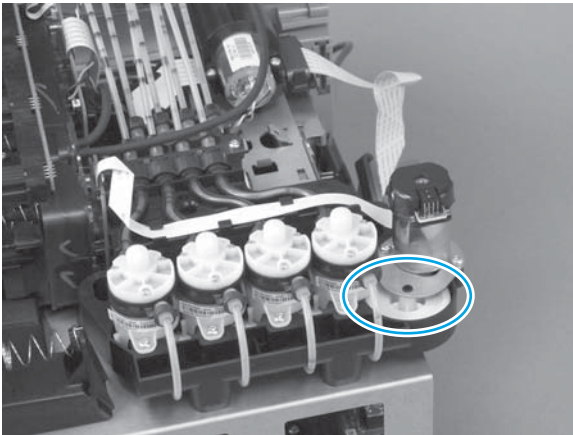

Service sled assembly

Service sled assembly

 **IMPORTANT:** The Pagewide Pro special tools kit (part CN598-67056) is required when replacing the service sled assembly.

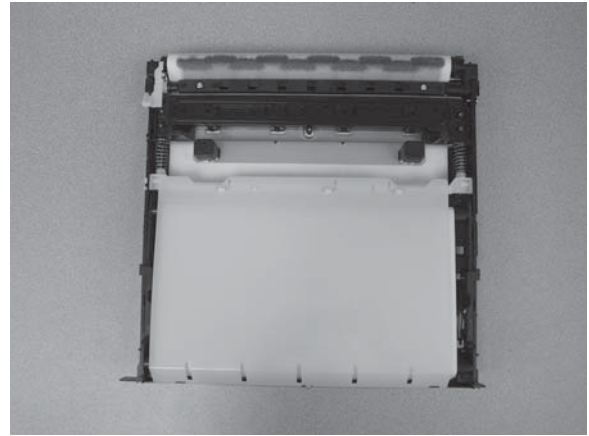
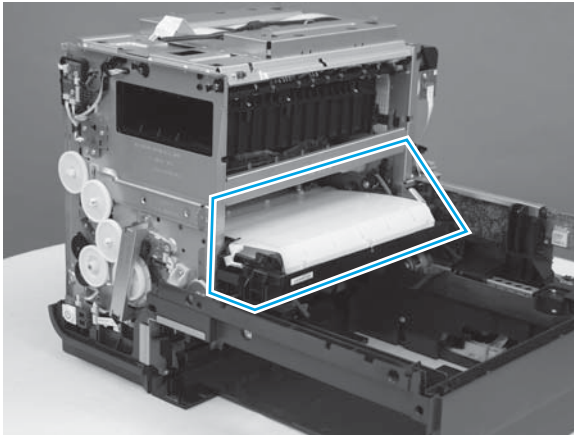

Remove these parts in this order:

1. Output bin. See [Output bin \(352, 452, 377, and 477 models\) on page 11](#).
2. Optional: left door. See [Left door on page 26](#).
3. Duplex module. See [Duplex module on page 11](#).
4. Left rear cover. See [Left rear cover on page 28](#).
5. Rear cover. See [Rear cover \(552, 577, P55250, and P57750 models\) on page 29](#) or [Rear cover \(352, 452, 377, 477 models\) on page 30](#).
6. MFP models: scanner assembly. See [Scanner assembly and scanner support bracket \(MFP models only\) on page 78](#).
7. MFP models: scanner support bracket. See [Scanner assembly and scanner support bracket \(MFP models only\) on page 78](#).
8. Left front cover. See [Left front cover on page 31](#).
9. Top cover. See [Top cover \(377, 477, 577 models\) on page 33](#) or [Top cover \(352, 452, 552 models\) on page 35](#).
10. Front cover. See [Front cover \(352, 452, 377, 477 models\) on page 37](#) or [Front cover \(552, 577 models\) on page 39](#).
11. Right cover. See [Right cover on page 47](#).

1. On the front of the printer, locate the printbar lock mount.

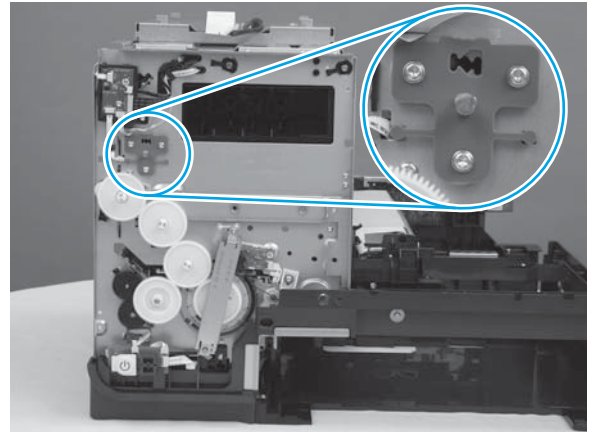

2. Use the service sled advance tool — see [OfficeJet Pro X special tools kit on page 3](#) — to raise the printbar. Hold the printbar in place with one hand while inserting the printbar lock tool into the printbar lock mount. When mounted correctly and with the printbar already in the up position, the printbar lock tool needs only to be held in place while the service sled is removed. It locks the printbar in the up position.

NOTE: The printbar lock tool may look different than what is shown here.

NOTE: Do not use excessive force when installing the printbar lock tool.

CAUTION: The printbar lock tool must remain in place until either the printbar is removed, or the service sled assembly is reinstalled in the printer. If the printbar drops to the bottom of the printer, the printbar might be damaged, and likely will need to be replaced.

3. Locate the service sled cartridge drive shaft.

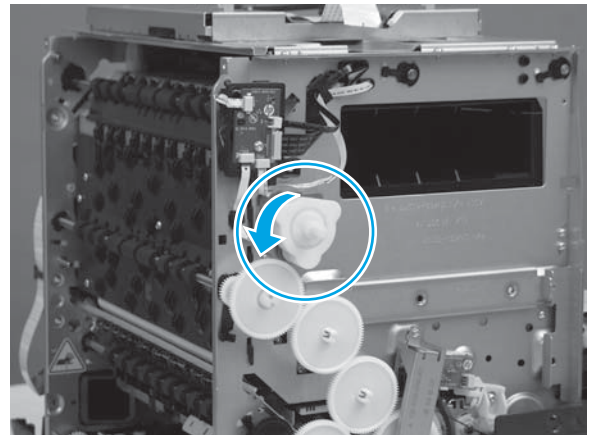

4. Mount the service sled advance tool on the drive shaft.

NOTE: On older printers, part of the base material may need to be removed to mount the service sled advance tool on the drive shaft.

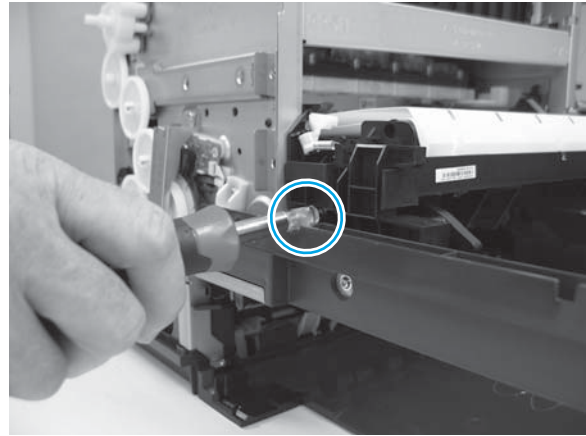

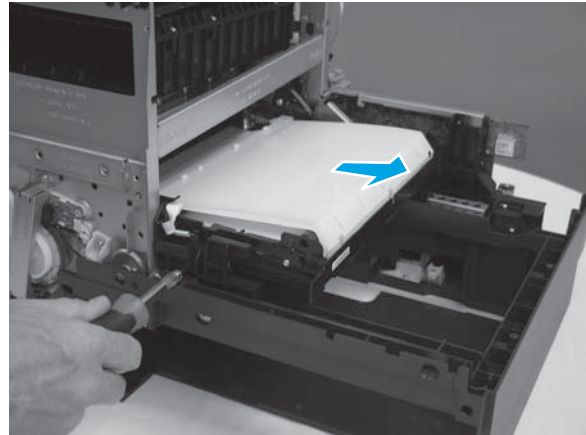

5. Turn the tool clockwise to fully advance the service sled forward.

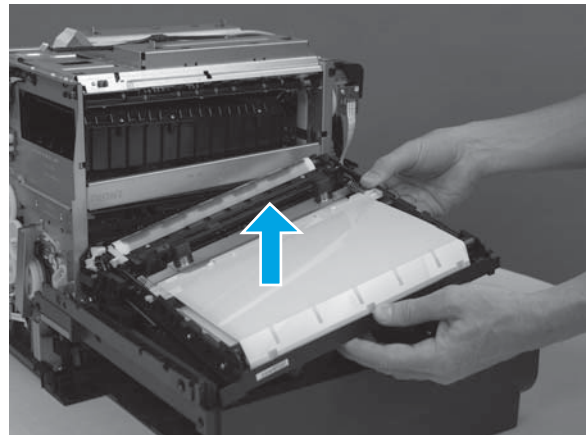

6. Lift the service sled cartridge from the printer.

NOTE: Do not touch the web contact roller during the removal process. The roller is saturated with ink. Also, any contaminants from your hands that transfer to the roller could affect print quality.



 **Reinstallation tip:** When you reinstall the service sled assembly, ensure that the service sled is aligned with the arrows. The service sled module should move out of and back into the cap smoothly. If the operation is not smooth, check for correct installation, including whether the service sled is aligned correctly. Also, check that the service sled transmission is in the correct position.

 **NOTE:** If you are working on the printer at a repair center, use the special alignment tool (PN T-285463) to make sure the sled is aligned correctly. In the field, you will have to align it by sight.

Test the service sled

1. Open the [Engineering menu](#). See [Menu access on monochrome control panels on page 12](#) or [Menu access on color control panels on page 14](#).
2. Open the following menus:
 - [Service menu](#)
 - [Service Tests](#)
 - [Test Service Station](#)
3. Select two service cycles, and then touch the [OK](#) button.

The service sled module should move out of, and back into cap smoothly. If the operation isn't smooth, check for correct installation, including whether the service sled is aligned correctly. Also check that the service sled transmission is in the correct position. See [Service sled transmission on page 67](#).

Separator/pick assembly

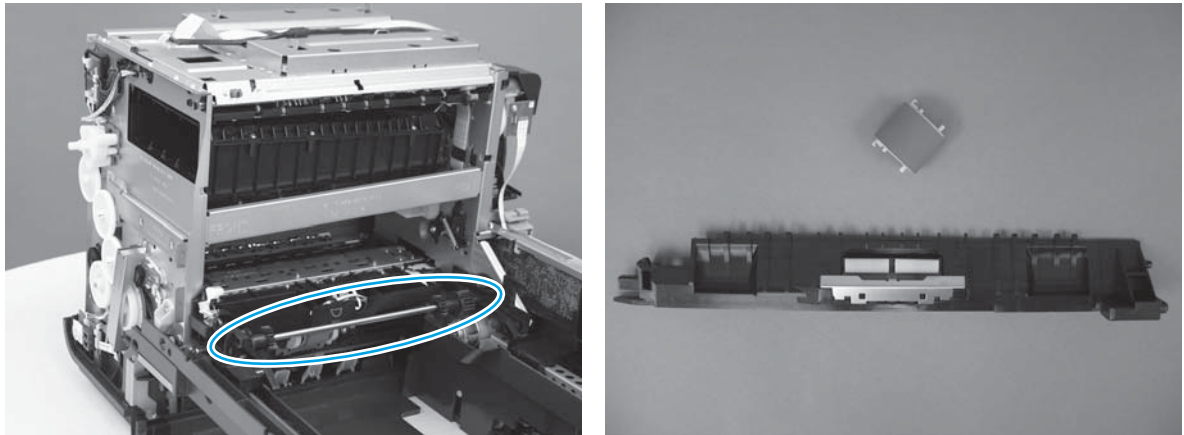

Remove these parts in this order:

1. Output bin. See [Output bin \(352, 452, 377, and 477 models\) on page 11](#).
2. Optional: left door. See [Left door on page 26](#).
3. Duplex module. See [Duplex module on page 11](#).
4. Left rear cover. See [Left rear cover on page 28](#).
5. Rear cover. See [Rear cover \(552, 577, P55250, and P57750 models\) on page 29](#) or [Rear cover \(352, 452, 377, 477 models\) on page 30](#).
6. MFP models: scanner assembly. See [Scanner assembly and scanner support bracket \(MFP models only\) on page 78](#).
7. MFP models: scanner support bracket. See [Scanner assembly and scanner support bracket \(MFP models only\) on page 78](#).
8. Left front cover. See [Left front cover on page 31](#).
9. Top cover. See [Top cover \(377, 477, 577 models\) on page 33](#) or [Top cover \(352, 452, 552 models\) on page 35](#).
10. Front cover. See [Front cover \(352, 452, 377, 477 models\) on page 37](#) or [Front cover \(552, 577 models\) on page 39](#).
11. Right cover. See [Right cover on page 47](#).
12. Service sled assembly. See [Service sled assembly on page 128](#).

1. Remove one screw, and then remove the separator assembly.

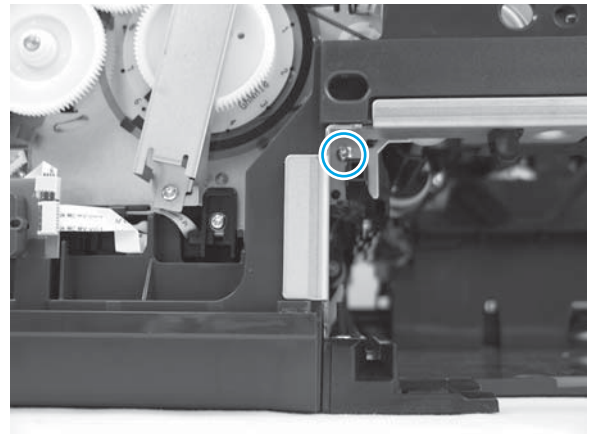

2. Rotate the pick assembly to position the white tabs as shown below.

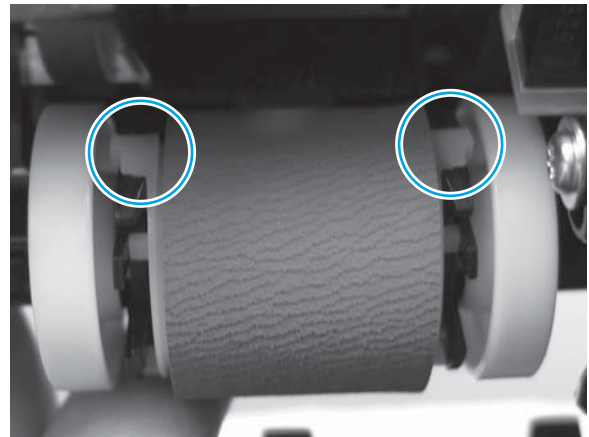

3. Use the pick tire replacement tool to depress the black locking tab on the left side of the pick assembly, and then push down on the pick assembly to partially release it. Repeat for the locking tab on the right.



4. Push down on the pick assembly to remove it.

Reinstallation tip: Wear a vinyl glove while handling the new pick assembly to prevent skin oils from contaminating the roller.

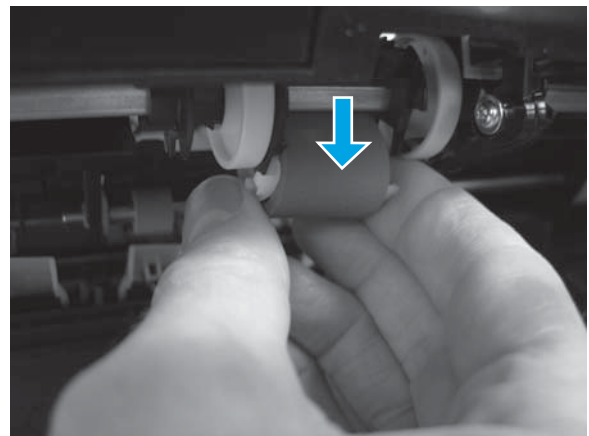

1. Rotate the pick assembly shaft and mounting bracket so that the narrow tabs (1) on the bracket are positioned near the bottom of the bracket and the wide tabs (2) are near the top of the bracket as shown.

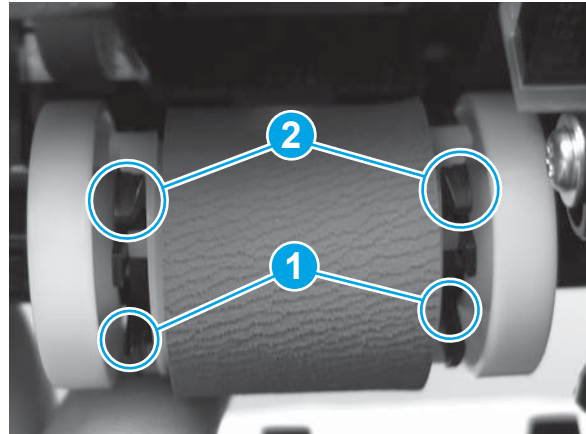

2. Position the flat side of the pick assembly against the flat side of the pick assembly shaft as shown below.

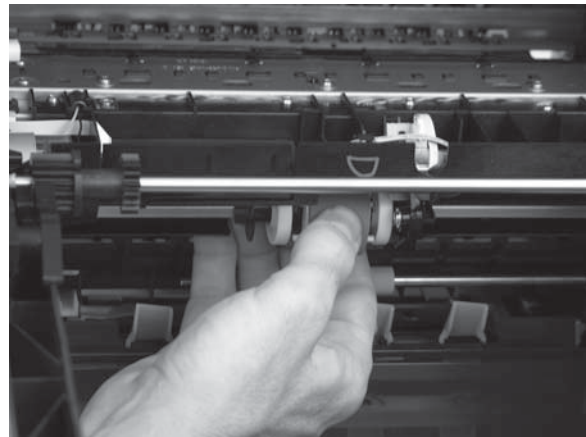

3. Attach the narrower pick assembly tabs.

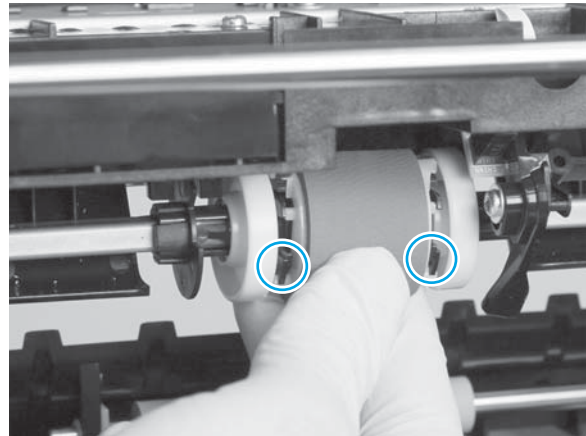

4. Press down on the top of the pick assembly until the wide tabs snap into place.

NOTE: Reposition the roller shaft if it rotates while snapping the wider tabs into place.

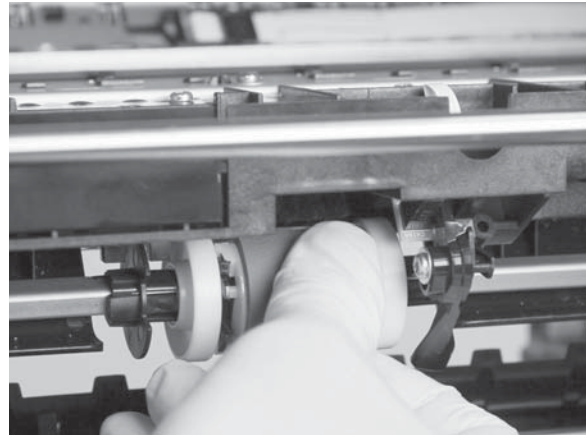

5. Verify that the tabs are correctly snapped into place and the pick assembly is seated squarely in the mounting bracket.

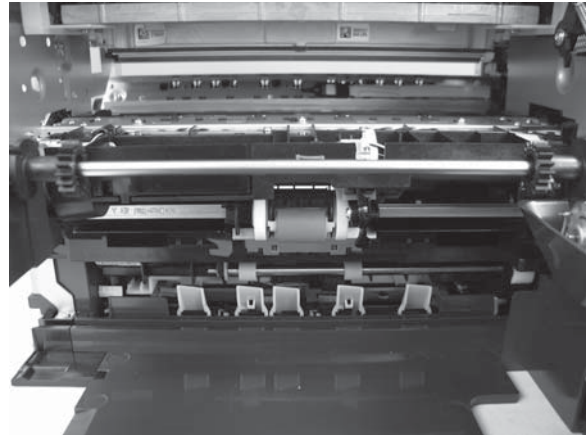

6. Reinstall the separator assembly.

Media presence sensor PCA/flag

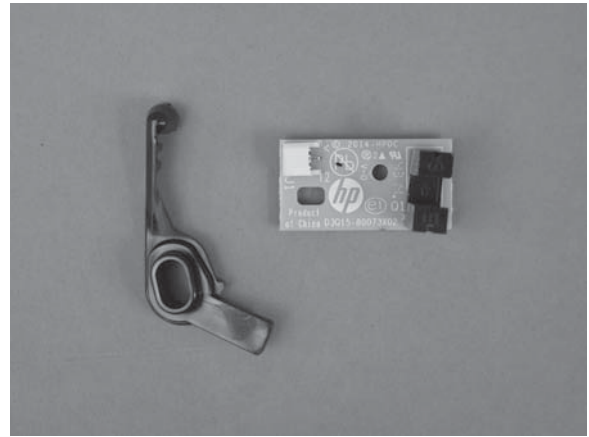
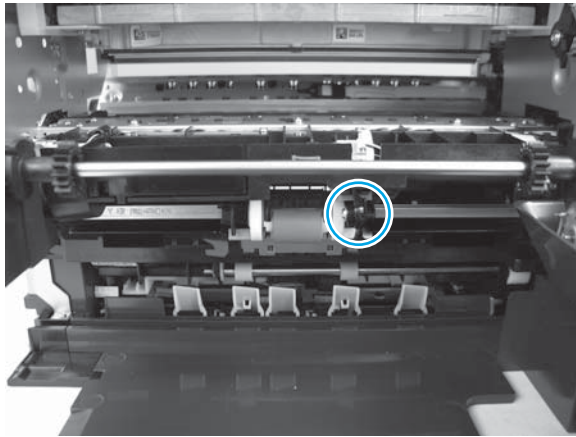

Remove these parts in this order:

1. Output bin. See [Output bin \(352, 452, 377, and 477 models\) on page 11](#).
2. Optional: left door. See [Left door on page 26](#).
3. Duplex module. See [Duplex module on page 11](#).
4. Left rear cover. See [Left rear cover on page 28](#).
5. Rear cover. See [Rear cover \(552, 577, P55250, and P57750 models\) on page 29](#) or [Rear cover \(352, 452, 377, 477 models\) on page 30](#).
6. MFP models: scanner assembly. See [Scanner assembly and scanner support bracket \(MFP models only\) on page 78](#).
7. MFP models: scanner support bracket. See [Scanner assembly and scanner support bracket \(MFP models only\) on page 78](#).
8. Left front cover. See [Left front cover on page 31](#).
9. Top cover. See [Top cover \(377, 477, 577 models\) on page 33](#) or [Top cover \(352, 452, 552 models\) on page 35](#).
10. Front cover. See [Front cover \(352, 452, 377, 477 models\) on page 37](#) or [Front cover \(552, 577 models\) on page 39](#).
11. Right cover. See [Right cover on page 47](#).
12. Service sled assembly. See [Service sled assembly on page 128](#).

1. Remove one screw (1) from the sensor flag (2), and then remove the flag.

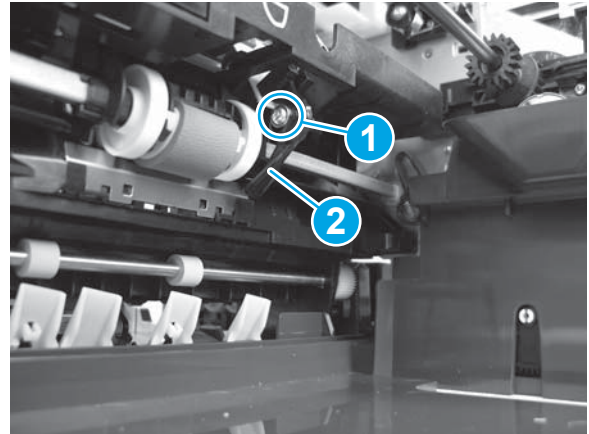

2. Disconnect the flex cable connector (1), remove one screw (2), and then remove the sensor PCA.

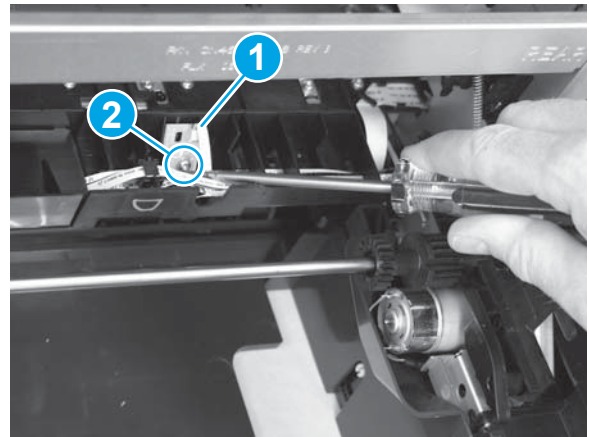

Printzone distribution PCA

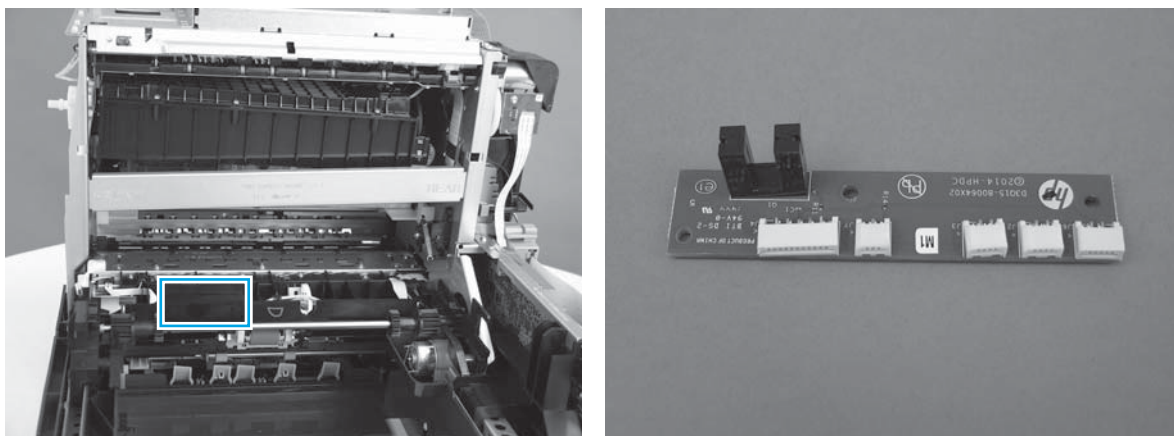

Remove these parts in this order:

1. Output bin. See [Output bin \(352, 452, 377, and 477 models\) on page 11](#).
2. Optional: left door. See [Left door on page 26](#).
3. Duplex module. See [Duplex module on page 11](#).
4. Left rear cover. See [Left rear cover on page 28](#).
5. Rear cover. See [Rear cover \(552, 577, P55250, and P57750 models\) on page 29](#) or [Rear cover \(352, 452, 377, 477 models\) on page 30](#).
6. MFP models: scanner assembly. See [Scanner assembly and scanner support bracket \(MFP models only\) on page 78](#).
7. MFP models: scanner support bracket. See [Scanner assembly and scanner support bracket \(MFP models only\) on page 78](#).
8. Left front cover. See [Left front cover on page 31](#).
9. Top cover. See [Top cover \(377, 477, 577 models\) on page 33](#) or [Top cover \(352, 452, 552 models\) on page 35](#).
10. Front cover. See [Front cover \(352, 452, 377, 477 models\) on page 37](#) or [Front cover \(552, 577 models\) on page 39](#).
11. Right cover. See [Right cover on page 47](#).
12. Service sled assembly. See [Service sled assembly on page 128](#).

1. Use a screwdriver to remove the PCA cover.

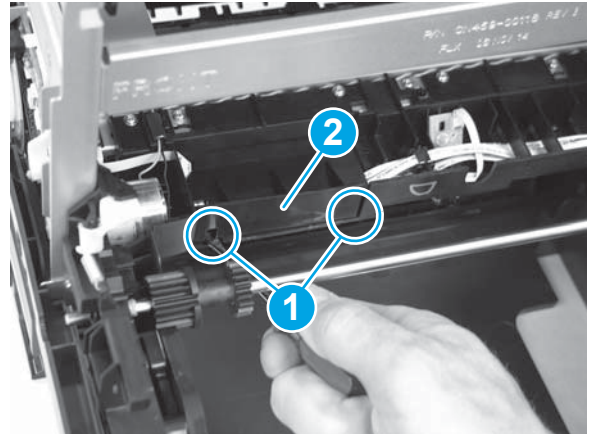

2. Remove one screw.

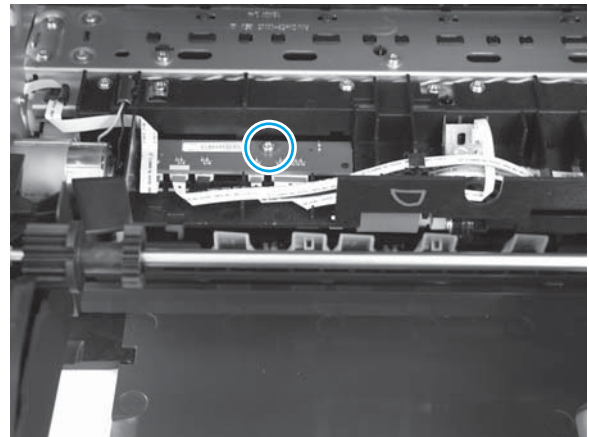

3. Disconnect five flex cables, and then remove the PCA.

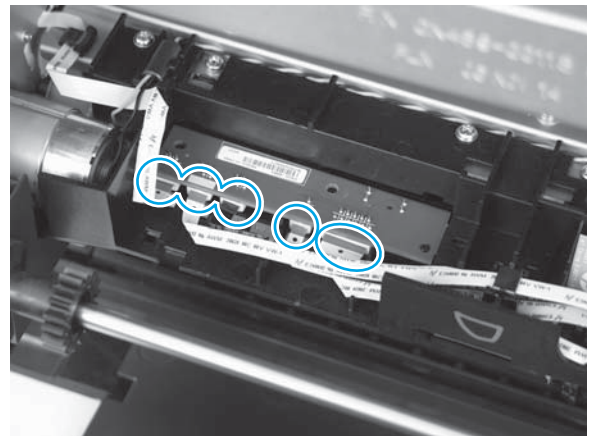

Platen

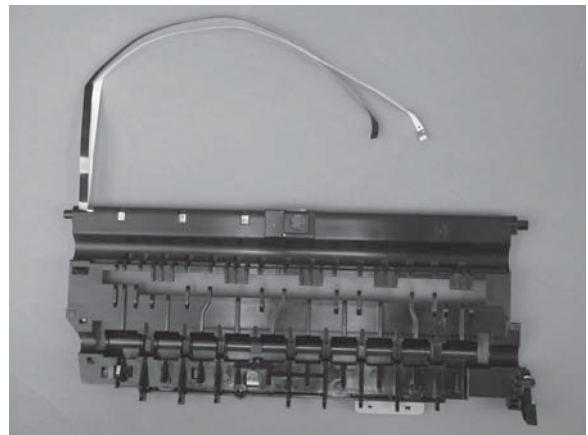
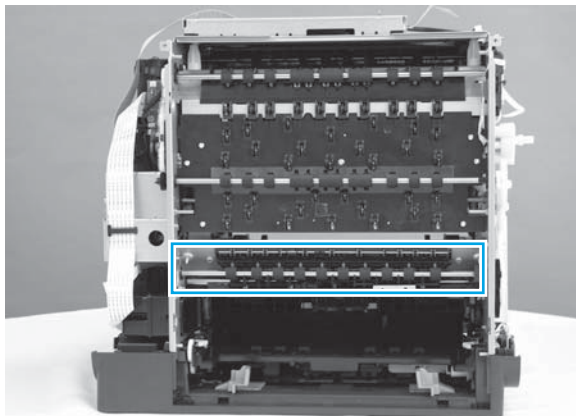

Remove these parts in this order:

1. Output bin. See [Output bin \(352, 452, 377, and 477 models\) on page 11](#).
2. Optional: left door. See [Left door on page 26](#).
3. Duplex module. See [Duplex module on page 11](#).
4. Left rear cover. See [Left rear cover on page 28](#).
5. Rear cover. See [Rear cover \(552, 577, P55250, and P57750 models\) on page 29](#) or [Rear cover \(352, 452, 377, 477 models\) on page 30](#).
6. PCA safety shield. See [PCA safety shield on page 51](#).
7. Aerosol fan assembly. See [Aerosol fan assembly on page 59](#).
8. MFP models: scanner assembly. See [Scanner assembly and scanner support bracket \(MFP models only\) on page 78](#).
9. MFP models: scanner support bracket. See [Scanner assembly and scanner support bracket \(MFP models only\) on page 78](#).
10. Left front cover. See [Left front cover on page 31](#).
11. Top cover. See [Top cover \(377, 477, 577 models\) on page 33](#) or [Top cover \(352, 452, 552 models\) on page 35](#).
12. Front cover. See [Front cover \(352, 452, 377, 477 models\) on page 37](#) or [Front cover \(552, 577 models\) on page 39](#).
13. Right cover. See [Right cover on page 47](#).
14. Service sled assembly. See [Service sled assembly on page 128](#).

1. Remove the printzone distribution PCA cover (1).

NOTE: The printzone distribution PCA is indicated by callout 2.

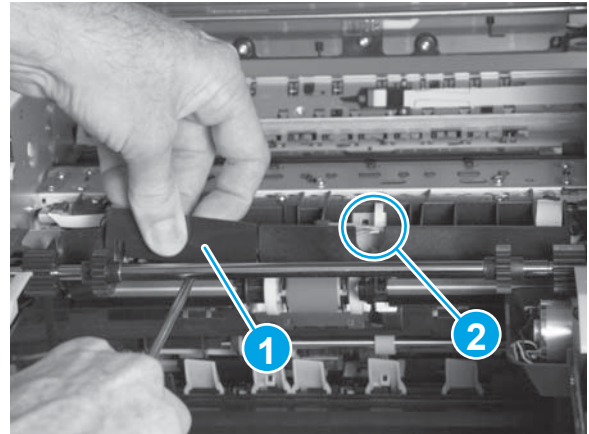

2. Disconnect two flat flexible cables. Note that the white cable is on the left and the black cable is on the right, and then unthread the cables through the chassis wall.

Reinstallation tip: Remember the cable orientation and order. Take care to avoid crimping the FFCs when removing or reinstalling them.

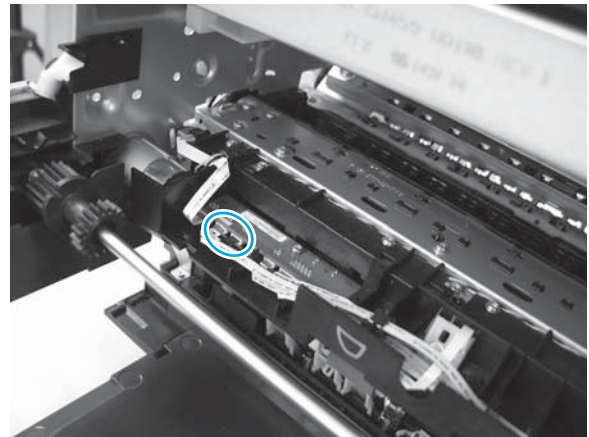

3. Lower the platen (1).

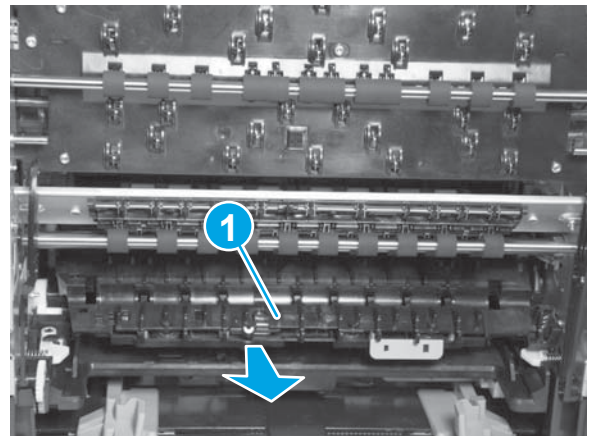

4. Remove one screw from the rear wall.

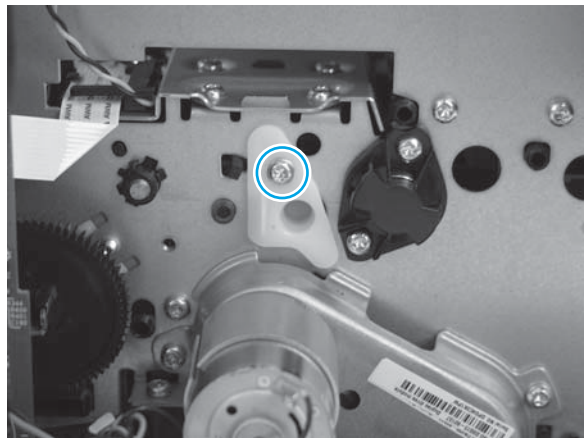

5. Remove the bracket.

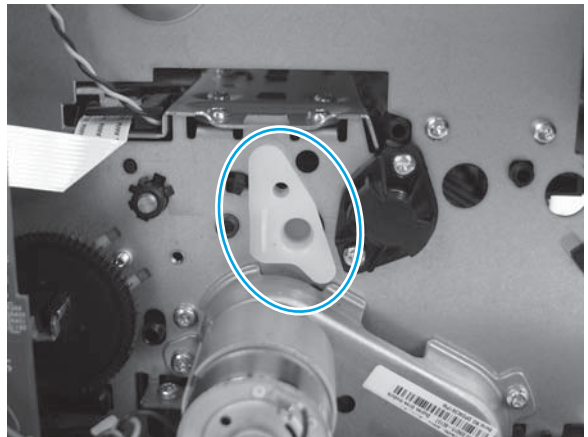

6. Push the platen towards the rear of the printer to clear the retention spring on the front pivot, and then remove the platen.

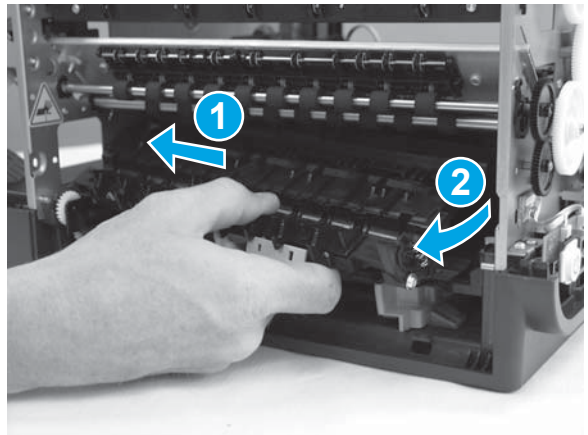

7. Temporarily tape the two REDI FFCs together to make them easier to thread through the wall. Remove the tape after the FFCs are threaded through the wall.

Reinstallation tip: Place the black cable under the white cable and thread the cables through the hole in the printer interior.

Reinstallation tip: While reinstalling the right end of the platen, depress the spring in the front of the unit.

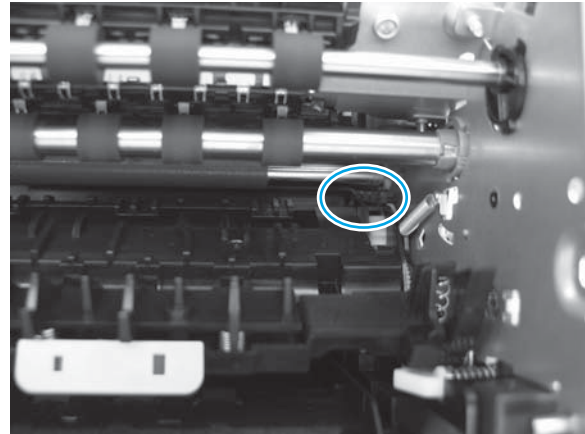

8. New REDI sensors were installed with the new platen and require calibration. Use the following steps to calibrate the REDI sensors.

- a. Open the [Engineering menu](#).
- b. From the [Engineering Menu](#), select the [Service Menu](#), and then select [System Configuration](#).
- c. Select [Paper Sensor Calibration](#).

NOTE: The paper sensor calibrations require one sheet of blank HP Colorlok paper. HP Colorlok paper **must** be used for the Paper Sensor Calibration. The same sheet of paper can be reused if it is undamaged.

- d. Select [Calibrate Main tray](#). Insert a blank HP Colorlok page into Tray 2. The tray will eject one blank page.
- e. Select [Calibrate MP tray](#). Insert a blank HP Colorlok page into Tray 1. The printer will eject one blank page.

Cross brace (352, 452, 377, 477 models)

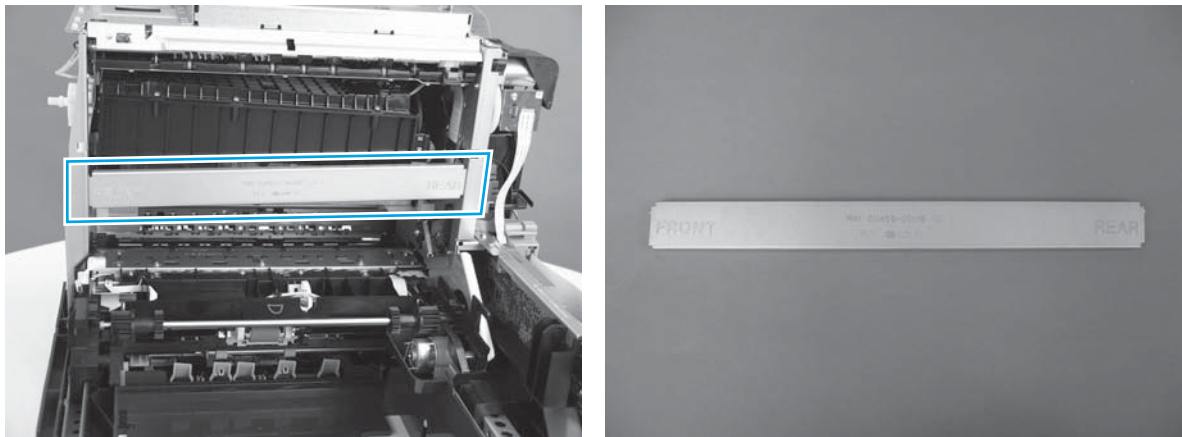

Remove these parts in this order:

1. Output bin. See [Output bin \(352, 452, 377, and 477 models\) on page 11](#).
2. Optional: left door. See [Left door on page 26](#).
3. Duplex module. See [Duplex module on page 11](#).
4. Left rear cover. See [Left rear cover on page 28](#).
5. Rear cover. See [Rear cover \(552, 577, P55250, and P57750 models\) on page 29](#) or [Rear cover \(352, 452, 377, 477 models\) on page 30](#).
6. MFP models: scanner assembly. See [Scanner assembly and scanner support bracket \(MFP models only\) on page 78](#).
7. MFP models: scanner support bracket. See [Scanner assembly and scanner support bracket \(MFP models only\) on page 78](#).
8. Left front cover. See [Left front cover on page 31](#).
9. Top cover. See [Top cover \(377, 477, 577 models\) on page 33](#) or [Top cover \(352, 452, 552 models\) on page 35](#).
10. Front cover. See [Front cover \(352, 452, 377, 477 models\) on page 37](#) or [Front cover \(552, 577 models\) on page 39](#).
11. Right cover. See [Right cover on page 47](#).
12. Service sled assembly. See [Service sled assembly on page 128](#).

1. Remove two screws from the front of the printer.

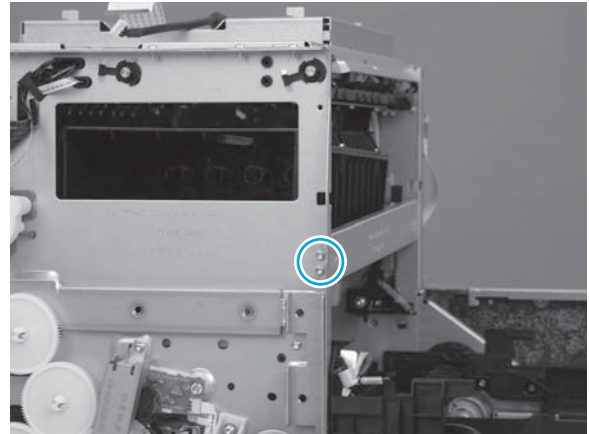

2. Remove two screws from the rear of the printer, and then remove the brace.

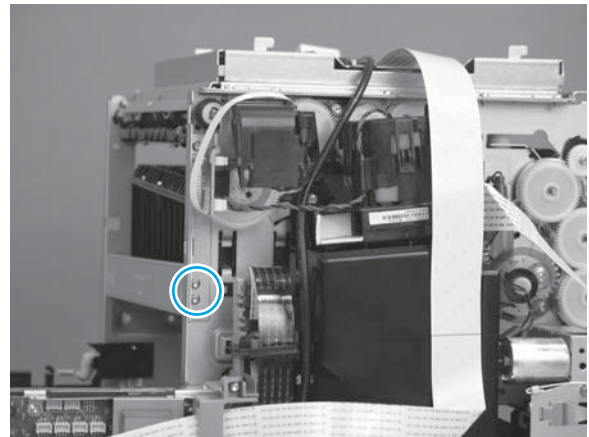

 **Reinstallation tip:** The front and rear ends are labeled. Set the locator bumps on the bar in the locator holes on the printer.

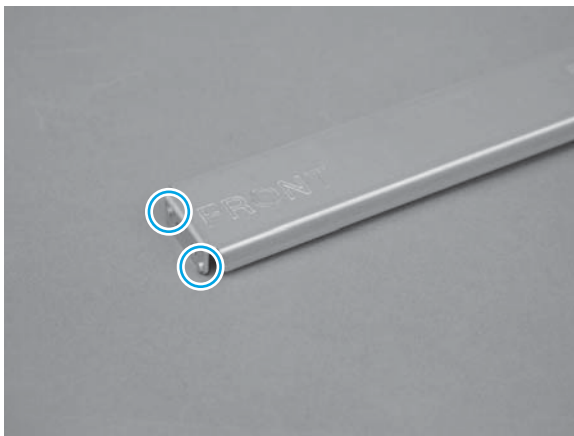

Web advance rack assembly

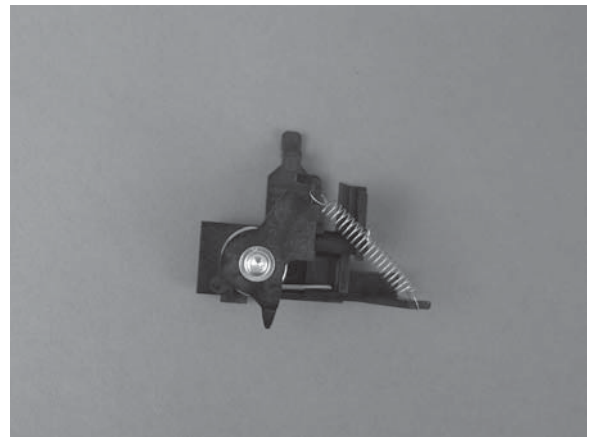
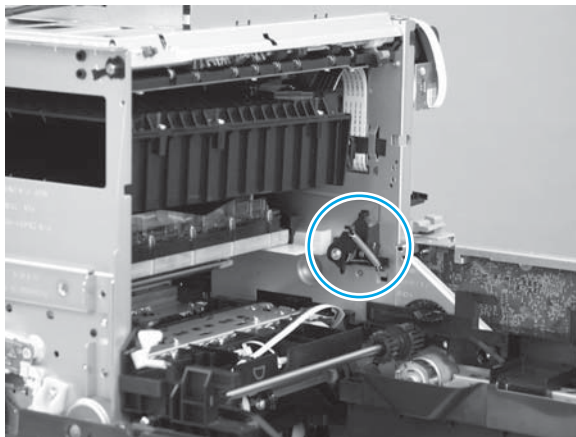

Remove these parts in this order:

1. Output bin. See [Output bin \(352, 452, 377, and 477 models\) on page 11](#).
2. Optional: left door. See [Left door on page 26](#).
3. Duplex module. See [Duplex module on page 11](#).
4. Left rear cover. See [Left rear cover on page 28](#).
5. Rear cover. See [Rear cover \(552, 577, P55250, and P57750 models\) on page 29](#) or [Rear cover \(352, 452, 377, 477 models\) on page 30](#).
6. MFP models: scanner assembly. See [Scanner assembly and scanner support bracket \(MFP models only\) on page 78](#).
7. MFP models: scanner support bracket. See [Scanner assembly and scanner support bracket \(MFP models only\) on page 78](#).
8. Left front cover. See [Left front cover on page 31](#).
9. Top cover. See [Top cover \(377, 477, 577 models\) on page 33](#) or [Top cover \(352, 452, 552 models\) on page 35](#).
10. Front cover. See [Front cover \(352, 452, 377, 477 models\) on page 37](#) or [Front cover \(552, 577 models\) on page 39](#).
11. Right cover. See [Right cover on page 47](#).
12. Service sled assembly. See [Service sled assembly on page 128](#).
13. 352, 452, 377, 477 models: Cross brace. See [Cross brace \(352, 452, 377, 477 models\) on page 144](#).
14. 552, 577 models: IDS bracket. See [IDS bracket \(552, 577 models\) on page 122](#).

1. Remove one screw.

NOTE: Do **not** remove the large screw on the left of the assembly.

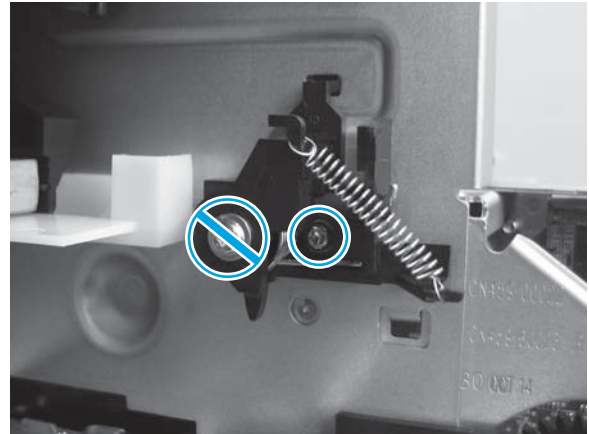

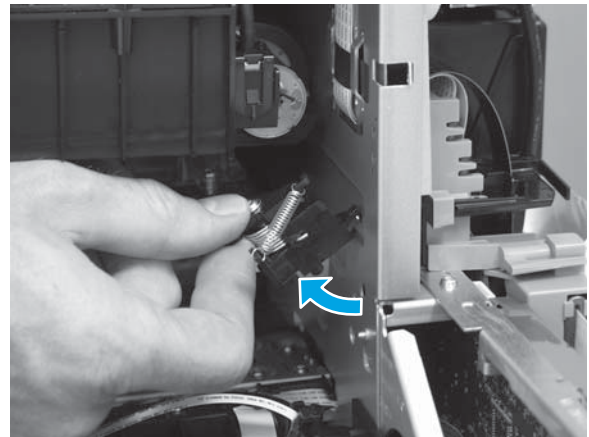

2. Rotate the assembly upward to clear the tab from the right wall, and then remove the assembly.



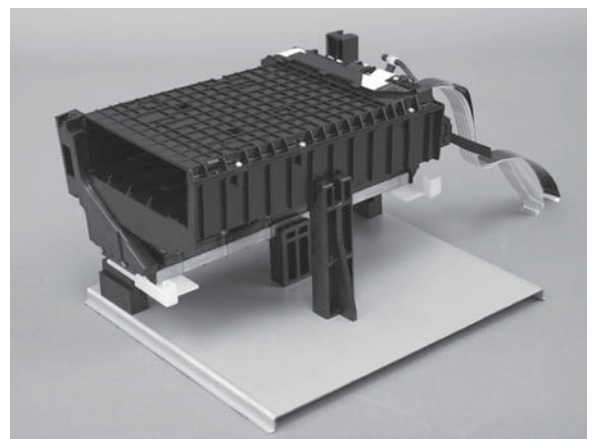
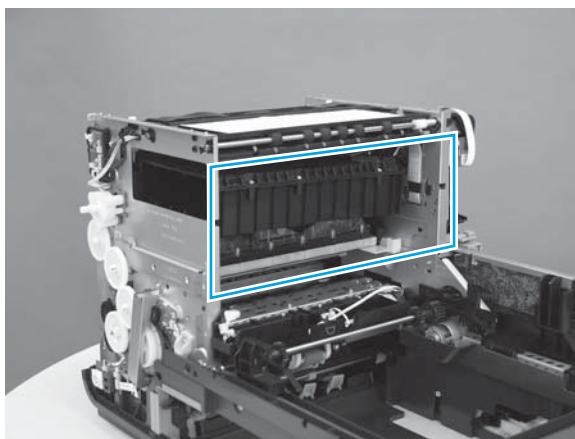

 **NOTE:** If you are working on the printer at a repair center, use a special alignment tool (PN T-285463) to make sure the sled is aligned correctly. In the field, you will have to align it by sight.

Printbar



 **NOTE:** Refer to document number CN598-67045.

 **NOTE:** If the printer has printed more than 30,000 pages, HP recommends replacing the service sled assembly.

 **NOTE:** HP recommends that the printer firmware be upgraded to the latest version prior to printbar replacement.

 **IMPORTANT:** The HP Officejet Pro X special Tools kit (part CN598-67056) is required when replacing a printbar. If you are working on the printer at a repair center, use the special alignment tool (PN T-285463) to make sure that the sled is aligned correctly. In the field you will have to align it by sight.

 **WARNING!** The printbar testing and calibration instructions must be followed exactly. Failure to follow these instructions exactly can result in a printer problem that is not recoverable in the field.

Replace the duplex module. The duplex module must be replaced any time the printbar is replaced.

Before replacing the printbar:

- Verify that the printer is turned off and that the power cable and input/output cables are disconnected.
- Replace the duplex module. The duplex module must be replaced any time the printbar is replaced.
- A set of trade supplies will be required to test that the printbar has been installed correctly. The existing customer supplies will be sufficient as long as they have ink left.

Remove these parts in this order:

1. Output bin. See [Output bin \(352, 452, 377, and 477 models\) on page 11](#).
2. Optional: left door. See [Left door on page 26](#).
3. Duplex module. See [Duplex module on page 11](#).
4. Left rear cover. See [Left rear cover on page 28](#).
5. Rear cover. See [Rear cover \(552, 577, P55250, and P57750 models\) on page 29](#) or [Rear cover \(352, 452, 377, 477 models\) on page 30](#).
6. MFP models: scanner assembly. See [Scanner assembly and scanner support bracket \(MFP models only\) on page 78](#).
7. MFP models: scanner support bracket. See [Scanner assembly and scanner support bracket \(MFP models only\) on page 78](#).
8. Left front cover. See [Left front cover on page 31](#).
9. Top cover. See [Top cover \(377, 477, 577 models\) on page 33](#) or [Top cover \(352, 452, 552 models\) on page 35](#).
10. Front cover. See [Front cover \(352, 452, 377, 477 models\) on page 37](#) or [Front cover \(552, 577 models\) on page 39](#).
11. Right cover. See [Right cover on page 47](#).
12. 552, 577 models: IDS bracket. See [IDS bracket \(552, 577 models\) on page 122](#).
13. Service sled assembly. See [Service sled assembly on page 128](#).
14. 352, 452, 377, 477 models: Cross brace. See [Cross brace \(352, 452, 377, 477 models\) on page 144](#).

15. Web advance rack assembly. See [Web advance rack assembly on page 146](#).

16. Top cap assembly. See [Top cap assembly on page 86](#).

 **IMPORTANT:** The HP Pagemwide Pro special tools kit (part CN598-67056) is required when replacing a printbar. If you are working on the printer at a repair center, use the special alignment tool (PN T-285463) to make sure the sled is aligned correctly. In the field, you will have to align it by sight. See [Service sled assembly on page 128](#).

 **CAUTION:** The printbar lock must remain in place until the printbar is lowered onto the dolly. If the printbar drops to the bottom of the printer, the printbar might be damaged.

1. Locate the printbar nozzle “helmet” in the tools kit.



2. Install the nozzle helmet on the printbar to protect the ink nozzles. Install the two front rubber bumpers into the matching notches in the printbar, then rotate the printbar safety cap back and up to engage the catches on the back of the printbar.

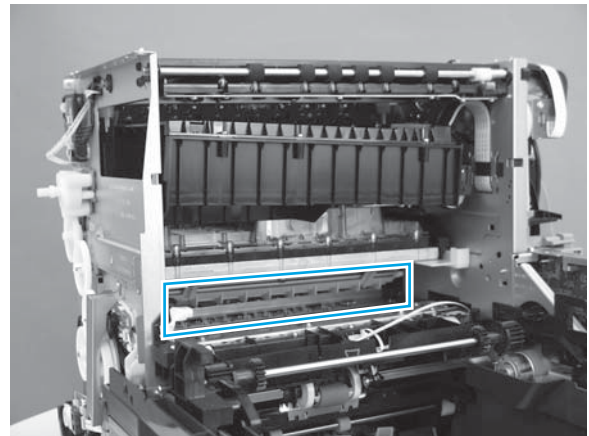

3. Install the printbar dolly.

a. Locate the service sled guides.

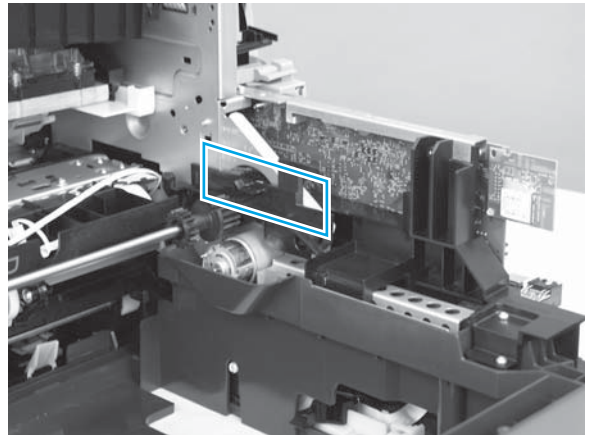

b. Place the dolly on the guides, and then push the dolly into the printer until it reaches the left side.

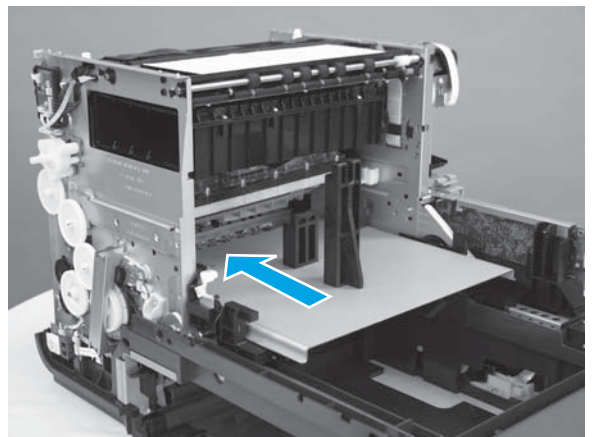

c. Lower the printbar by hand onto the seated dolly. This prevents the printbar from inadvertently dropping onto the dolly.

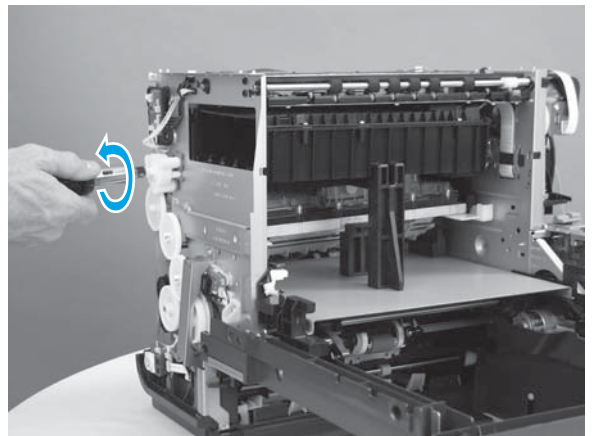

4. Disconnect three printbar flex cables.

CAUTION: Two of these cables are installed in zero insertion force (ZIF) sockets that have a black holder on top. The black holder must be pulled up *carefully* to release the cables. It is very easy to break these connectors.

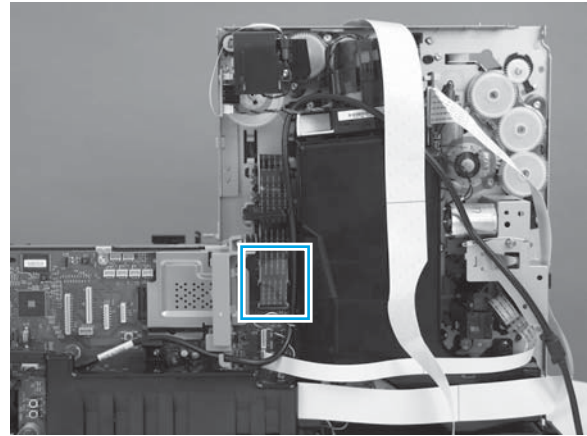

5. Unthread the FFCs through the ferrite holder.

Reinstallation tip: When reinstalling, remember to thread the two white flex cables through the ferrites correctly. (The black flex cable goes through a slot in the plastic holder.) Doing so ensures that the printer meets regulatory standards.

Reinstallation tip: When reinstalling, inspect the printbar flex cables for damage. If any damage exists, replace the damaged cable.

Reinstallation tip: Manually clasp the cables to make sure that the ZIF sockets are closed on the cables correctly. The ZIF clasps are fragile and easily broken. If one breaks, the lock must be replaced in order for the unit to function correctly.

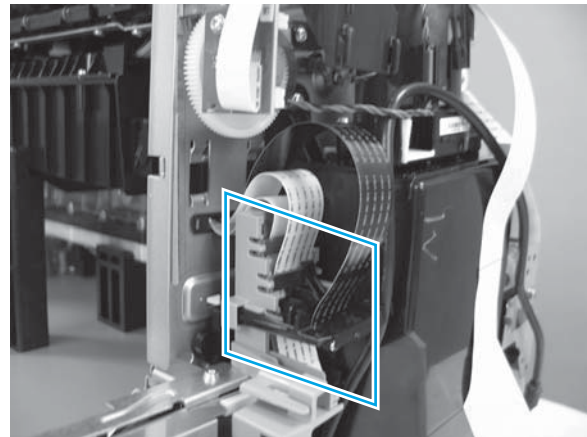

6. Carefully use a screwdriver to remove the flex cable retainer (1) from the printer. Unthread all three of the printbar FFCs (2) through the front frame of the printer.

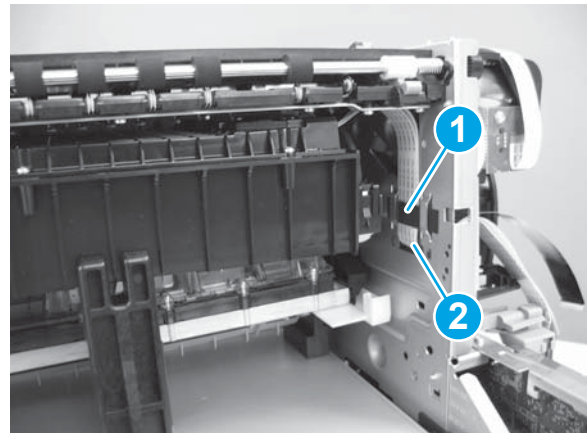

7. Gently remove the printbar lock tool to fully lower the printbar onto the dolly.

8. Locate the printbar lift guide Z stops.

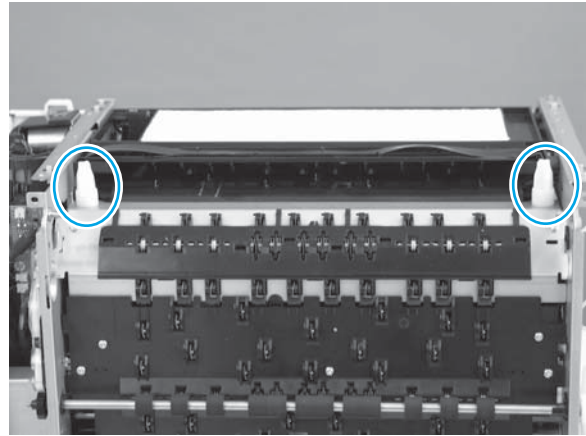

9. Lift up to remove the printbar lift guides.

CAUTION: The lift guides are greasy.

CAUTION: Replace the lift guides in their original front and rear locations.

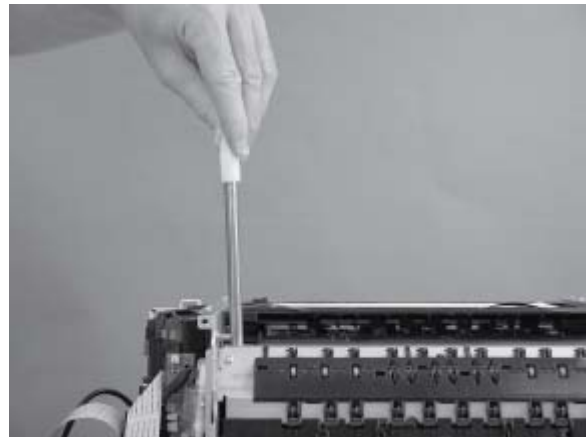

10. Slide the dolly toward the right side, away from the printer, to remove the printbar assembly.

CAUTION: Use extreme care when handling the printbar while it is out of the printer. It can be easily damaged.

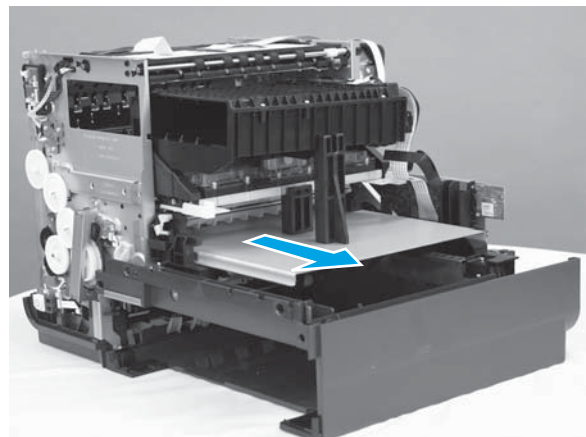

11. 552, 577 models only: Remove four screws on the upper pigtail connector assembly, and then lift the connector assembly straight up to disconnect the connectors.

IMPORTANT: There are no replacement pigtails as part of the printbar replacement kit. You must reuse the existing pigtails.

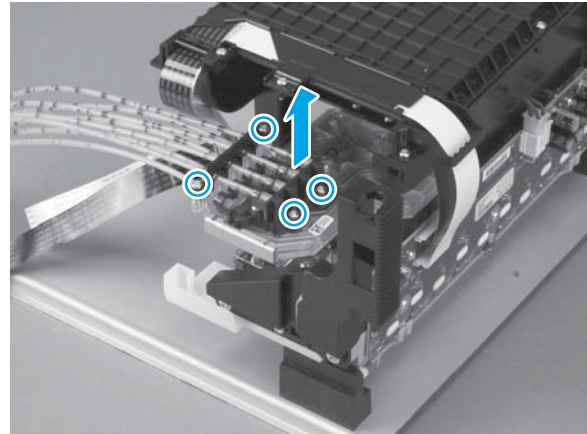

12. 552, 577 models only: Remove two screws on the lower pigtail connector assembly, and then pull the connector assembly horizontally to disconnect the connectors.

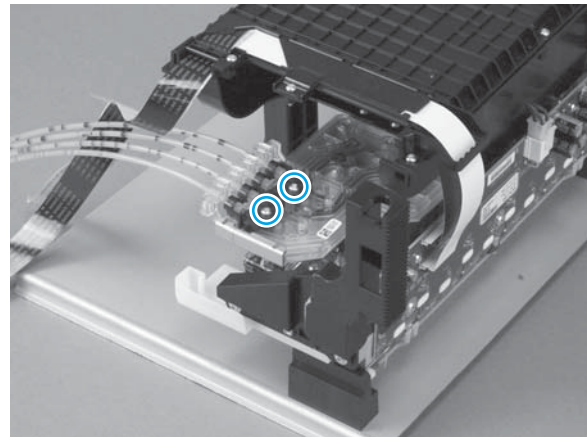

13. Before reinstalling the printbar, check the shims for a significant buildup of ink/dust. If there is a significant buildup, the shims can be cleaned very carefully with a **lint free** wipe.

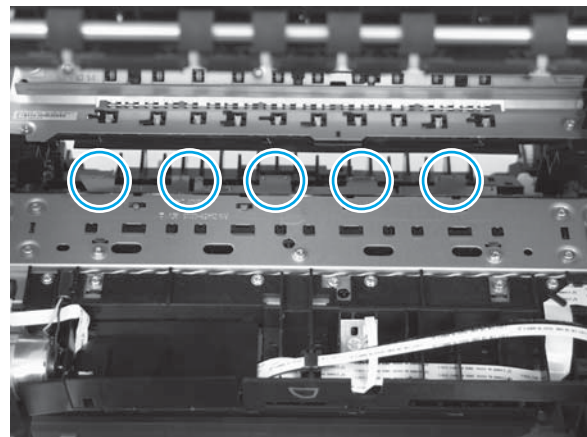

Reinstall the printbar

1. Place the printbar nozzle helmet on the new printbar.

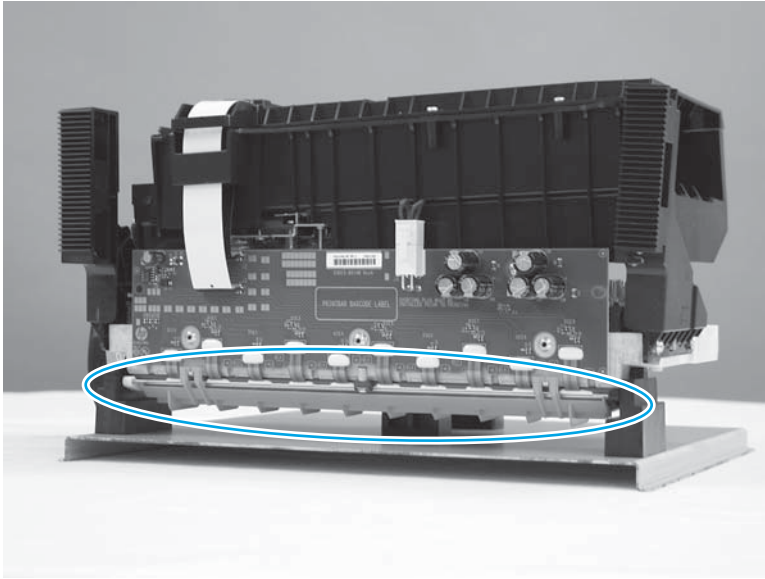

2. Slide the printbar dolly with new printbar gently into position and ensure it is fully seated. Insert the front and rear lift guide rods and ensure they are fully seated in their pockets.

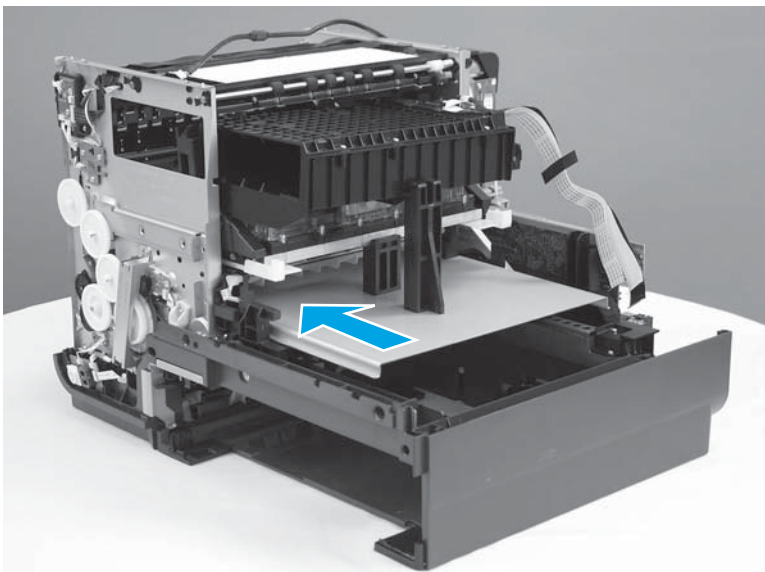

If the printbar lift rod Z stop is broken, it must be replaced (part CN598-67048). If you are installing a new Z-stop, the top of the lift guide rods will stand above the top of the case. Installing the plate console left will cause the Z stop to crush down to the correct height.

 **Reinstallation tip:** Ensure that the lift guide pockets have adequate grease in them during reinstallation. Failure to apply enough lubricant to the lift pocket guides can cause a noticeable increase in printer operation noise.

Reinstallation tip: Lift guide rods must be replaced in the same position. For example, front guide back into the front of the product.

3. Reinstall the top cap assembly.

4. Verify that the printbar is at its top-most position. There should not be more than a 1.5 mm gap between where the printbar guide meets the lift rod Z stop on the front and rear guide rods. If a larger gap is evident, the printbar guide might be misaligned by a tooth. Lower the printbar back onto the dolly and reinstall the lift guide rods.

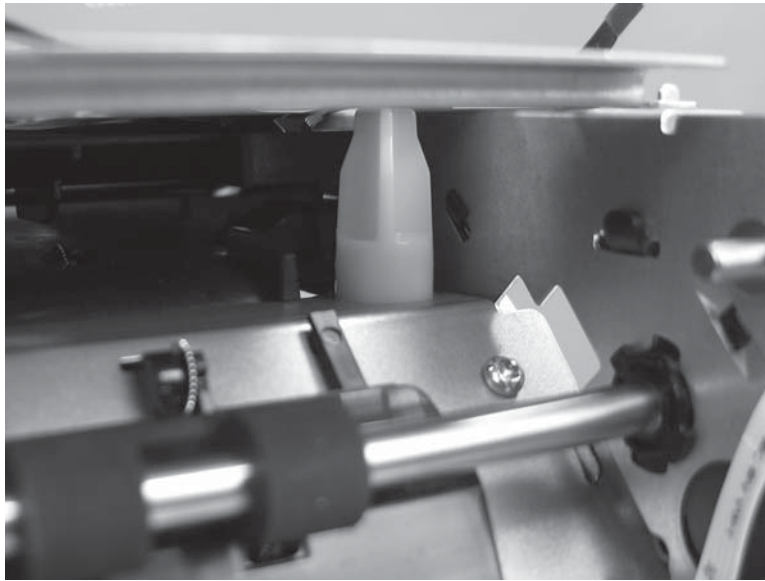

5. Remove the printbar dolly and verify that the service sled drive is *not* easy to turn. If the service sled drive is not easy to turn, this indicates that the service sled transmission is in the correct position. See [Service sled assembly on page 128](#) for details.
6. Remove the printbar helmet, and then reinstall the service sled.
7. 552, 577 models only: Reinstall the IDS bracket.

Test installation and calibrate the printbar

 **IMPORTANT:** A new duplex module must be installed before calibration/initialization.

1. Temporarily connect the control panel to the main PCA.
2. Temporarily install the right case part.
3. Temporarily install the left door.
4. Cover the ink supply door sensor with the magnet tool.
5. Turn on the printer.
6. Open the [Engineering menu](#). See [Menu access on monochrome control panels on page 12](#) or [Menu access on color control panels on page 14](#).
7. Open the following menus:
 - [Service menu](#)
 - [Special Reports](#)
 - [Print Mech Tap Tests](#)

8. 552 and 577 models only: Run tap tests 378, 379, 380 and check for pigtail leaks after each test. After starting each tap test, check that the pump gear is moving. The first two leak test taps run very quickly.
 9. Run tap test 10 to verify that the printbar is printing (ignore the test results).
 10. Run tap test 20 to verify that the service sled is moving properly. No page will print, but the service sled will move out and then return to the capping position.
 11. Turn off the printer, and then disconnect the power cable.
 12. Finish reinstalling all the covers.
 13. Install new host supplies.
 14. Turn on the printer.
 15. Open the **Engineering menu**. See [Menu access on monochrome control panels on page 12](#) or [Menu access on color control panels on page 14](#).
 16. Open the following menus:
 - **Service Menu**
 - **System Configuration**
 - **Service ink container or Duplex module**
 17. Select **Replace Duplex Module**.
 18. Open the **Engineering menu**. See [Menu access on monochrome control panels on page 12](#) or [Menu access on color control panels on page 14](#).
 19. Open the following menus:
 - **Service Menu**
 - **System Configuration**
 - **Trigger All Calibrations**
- After the product restarts, an initialization screen displays on the product control panel while the printbar purges the shipping fluid.



NOTE: After the printbar purges the shipping fluid, the product begins calibrating. The purging and calibrations will take approximately 20 to 25 minutes and a total of seven pages will print. When the calibrations are complete, the control panel will return to the **Home** screen.

20. Print a Print Quality Report. If there are problems, then follow the Print Quality Checklist in the Troubleshooting Guide.
21. Open the **Engineering menu**. See [Menu access on monochrome control panels on page 12](#) or [Menu access on color control panels on page 14](#).
22. Open the following menus:
 - **Service Menu**
 - **Special Reports**
 - **Print Mech Tap Tests**

23. Run the following tap tests:

- 10 tap
- 12 tap
- 61 tap
- 909 tap

For more information on running and verifying tap test results, see [Perform tap tests and interpret results on page 16](#).

24. Return to the **Ready** screen, and then complete the customer configurations, including network settings, preferred paper size and trays, and so forth.

 **Reinstallation tip:** If the duplex module is replaced and the menu for the duplex module is reset **before** the printbar is physically changed, a blocking message will appear when selecting [Trigger All Calibrations](#). If this occurs, return to the [Service ink container or Duplex module](#) menu and select [Replace Duplex Module](#) again.

Reinstallation tip: If the printbar is replaced and [Trigger All Calibrations](#) is run **before** the duplex module is replaced **and** the [Replace Duplex Module](#) item is selected, a blocking message will indicate that the duplex module must be replaced and the spittoon reset before being able to continue. If this occurs, replace the duplex module, return to the [Service ink container or Duplex module](#) menu, and then select [Replace Duplex Module](#) again. Return to the [System Configuration](#) menu, and select [Trigger All Calibrations](#) again.

Paper REDI sensors in the center left paper guide assembly

There are two paper REDI sensors; the lower paper path REDI sensor and the upper paper path REDI sensor. This procedure works for both.

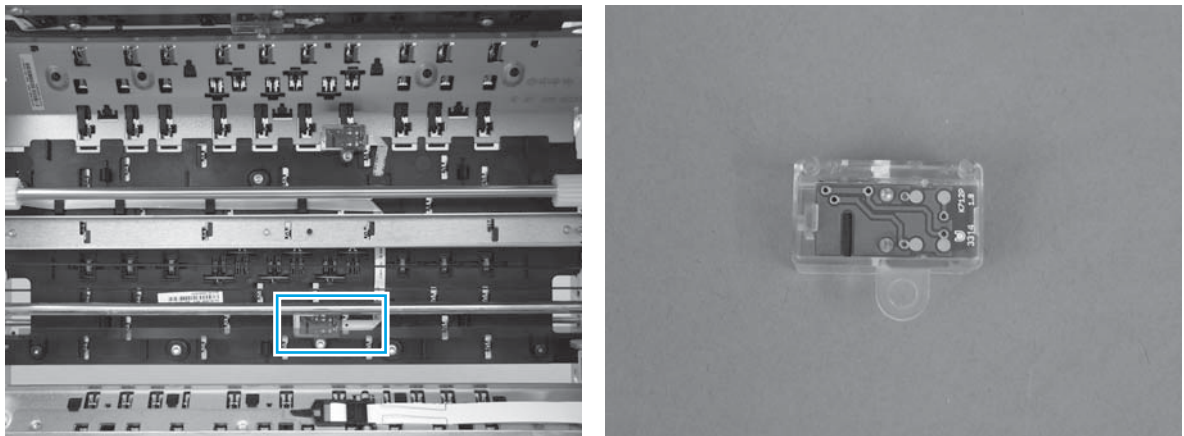

Remove these parts in this order:

1. Output bin. See [Output bin \(352, 452, 377, and 477 models\) on page 11](#).
2. Optional: left door. See [Left door on page 26](#).
3. Duplex module. See [Duplex module on page 11](#).
4. Left rear cover. See [Left rear cover on page 28](#).
5. Rear cover. See [Rear cover \(552, 577, P55250, and P57750 models\) on page 29](#) or [Rear cover \(352, 452, 377, 477 models\) on page 30](#).
6. MFP models: scanner assembly. See [Scanner assembly and scanner support bracket \(MFP models only\) on page 78](#).
7. MFP models: scanner support bracket. See [Scanner assembly and scanner support bracket \(MFP models only\) on page 78](#).
8. Left front cover. See [Left front cover on page 31](#).
9. Top cover. See [Top cover \(377, 477, 577 models\) on page 33](#) or [Top cover \(352, 452, 552 models\) on page 35](#).
10. Front cover. See [Front cover \(352, 452, 377, 477 models\) on page 37](#) or [Front cover \(552, 577 models\) on page 39](#).
11. Right cover. See [Right cover on page 47](#).
12. 552, 577 models: IDS bracket. See [IDS bracket \(552, 577 models\) on page 122](#).
13. Service sled assembly. See [Service sled assembly on page 128](#).
14. 352, 452, 377, 477 models: Cross brace. See [Cross brace \(352, 452, 377, 477 models\) on page 144](#).
15. Web advance rack assembly. See [Web advance rack assembly on page 146](#).

16. Top cap assembly. See [Top cap assembly on page 86](#).

17. Printbar. See [Printbar on page 147](#).

1. Remove two screws (1) and disconnect two flex cables (2), and then remove the sensors (3).

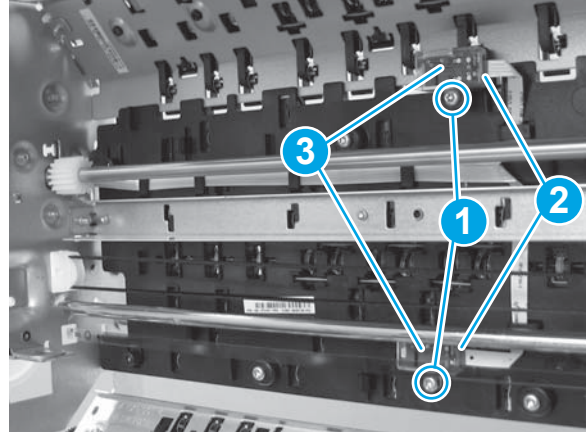

2. Calibrate the REDI sensors.

- a. Open the [Engineering menu](#). See [Access the Engineering menu on page 14](#) for information accessing the [Engineering menu](#).
- b. From the [Engineering menu](#), select the [Service Menu](#), and then select [System Configuration](#).
- c. Select [Paper Sensor Calibration](#).
NOTE: The paper sensor calibrations require one sheet of blank HP Colorlok paper. HP Colorlok paper **must** be used for the Paper Sensor Calibration. The same sheet of paper can be reused if it is undamaged.
- d. Select [Calibrate Main tray](#). Insert a blank HP Colorlok page into the tray. The printer will eject one blank page.
- e. Select [Calibrate MP tray](#). Insert a blank HP Colorlok page into Tray 1. The printer will eject one blank page.

2 Parts and diagrams

- [For additional service and support](#)
- [Assembly locations](#)
- [Order parts, accessories, and supplies](#)
- [Parts and diagrams: Document feeder and scanner \(477/577 models\)](#)
- [Parts and diagrams: Covers](#)
- [Parts and diagrams: Internal assemblies](#)
- [Alphabetical parts list](#)
- [Numerical parts list](#)

For additional service and support

HP service personnel, go to the Service Access Work Bench (SAW) at <http://h41302.www4.hp.com/km/saw/home.do>.

Channel partners, go to HP Channel Services Network (CSN) at <https://h30125.www3.hp.com/hpcsn>.

At these locations, find information on the following topics:

- Install and configure
- Printer specifications
- Up-to-date control panel message (CPMD) troubleshooting
- Solutions for printer issues and emerging issues
- Remove and replace part instructions and videos
- Service advisories
- Warranty and regulatory information

To access HP PartSurfer information from any mobile device, go to <http://partsurfermobile.hp.com/> or scan the Quick Response (QR) code below.



Assembly locations

- [Printer front view \(352/452 models\)](#)
- [Printer front view \(552 models\)](#)
- [Printer back view \(352/452/552 models\)](#)
- [Printer front view \(377/477 models\)](#)
- [Printer front view \(577 models\)](#)
- [Printer back view \(377/477/577 models\)](#)

Printer front view (352/452 models)

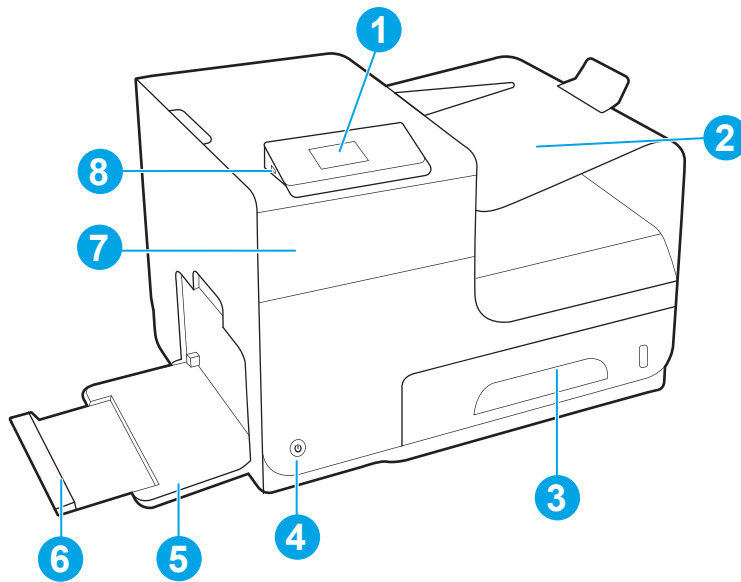

1	Control panel
2	Output bin
3	Tray 2 (main paper tray)
4	On/Off button
5	Tray 1 (multi-purpose tray)
6	Tray 1 (multi-purpose tray) extension
7	Cartridge door
8	USB 2.0 port

Printer front view (552 models)

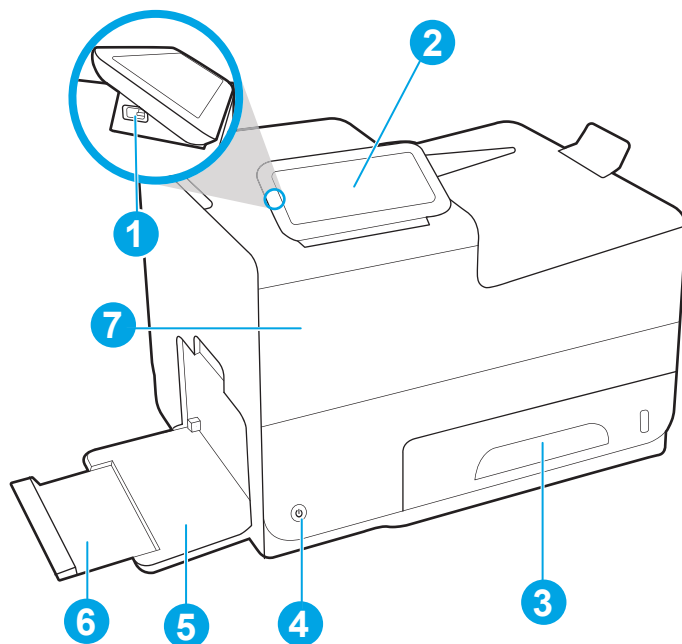

1	USB 2.0 port
2	Control panel
3	Tray 2 (main paper tray)
4	On/Off button
5	Tray 1 (multi-purpose tray)
6	Tray 1 (multi-purpose tray) extension
7	Cartridge door

Printer back view (352/452/552 models)

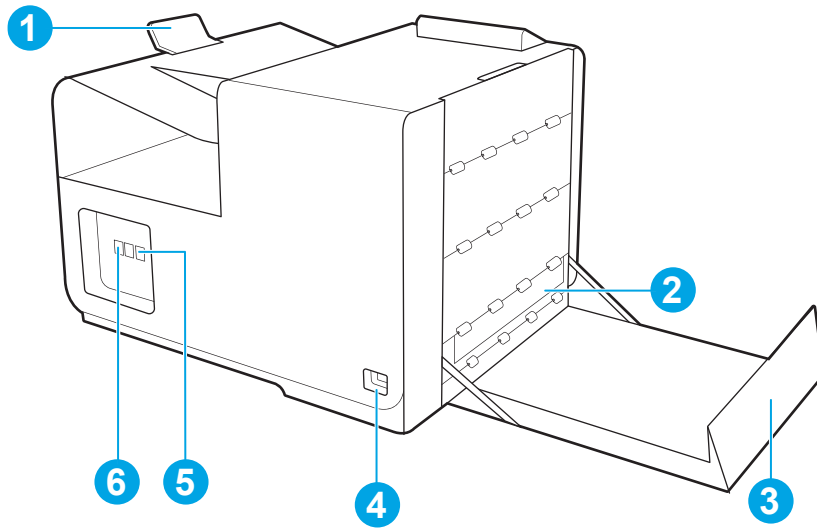

1	Output bin extension
2	Ink collection unit
3	Left door (access for clearing jams)
4	Power connection
5	Hi-speed USB 2.0 ports
6	Ethernet port

Printer front view (377/477 models)

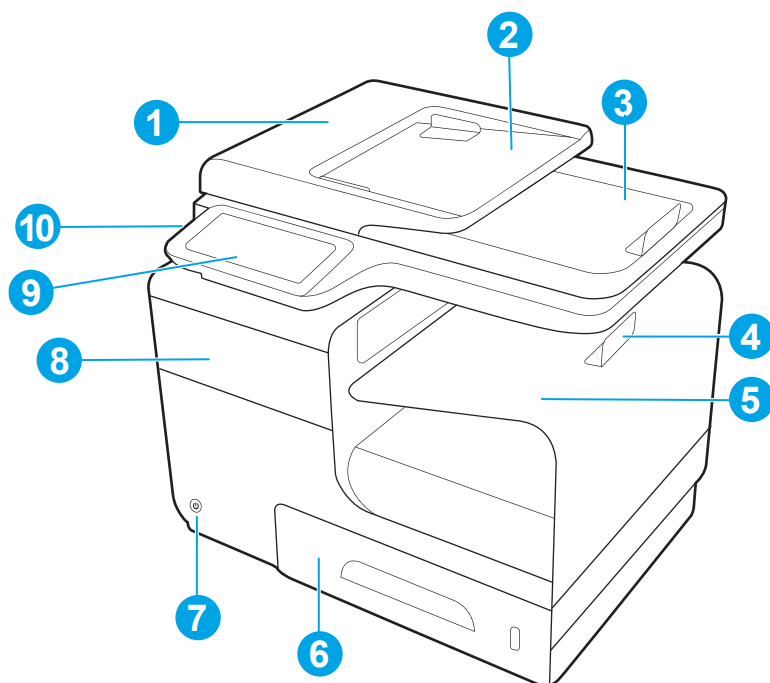

1	Document-feeder cover (access for clearing jams)
2	Document-feeder input tray
3	Document-feeder output bin
4	Output-bin extension
5	Output bin
6	Tray 2 (main paper tray)
7	On/Off button
8	Cartridge door
9	Color touchscreen control panel
10	USB 2.0 port

Printer front view (577 models)

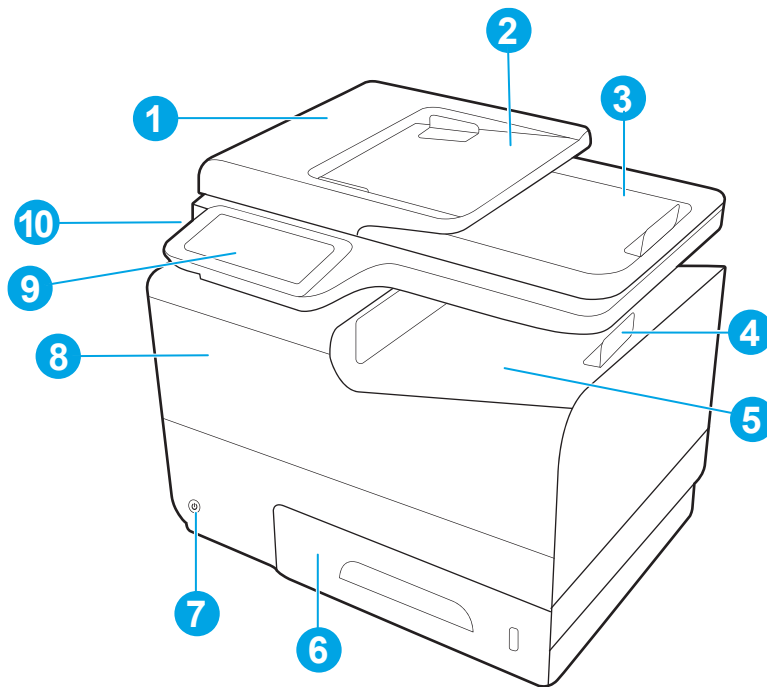

1	Document-feeder cover (access for clearing jams)
2	Document-feeder input tray
3	Document-feeder output bin
4	Output-bin extension
5	Output bin
6	Tray 2 (main paper tray)
7	On/off button
8	Cartridge door
9	Color touchscreen control panel
10	USB 2.0 port

Printer back view (377/477/577 models)

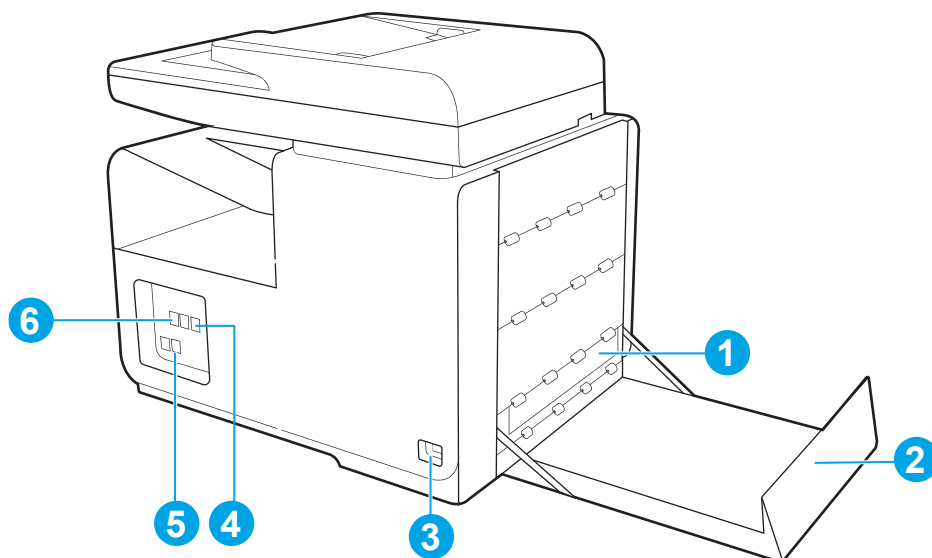

1	Ink collection unit
2	Left door (access for clearing jams)
3	Power connection
4	Hi-Speed USB 2.0 ports
5	Fax line port
6	Ethernet port

Order parts, accessories, and supplies

Ordering

Order supplies and paper	www.hp.com/go/suresupply
Order genuine HP parts or accessories	www.hp.com/buy/parts
	or
	partsurfer.hp.com
Order through service or support providers	Contact an HP-authorized service or support provider.
Order using the HP Embedded Web Server (EWS)	To access, in a supported Web browser on your computer, enter the printer IP address or host name in the address/URL field. The EWS contains a link to the HP SureSupply Web site, which provides options for purchasing Original HP supplies.

Supplies and accessories

Following are the part numbers for the supplies and accessories available for the printers.



NOTE: See training materials and support documentation for further information on replacement supplies to use in different circumstances.

Table 2-1 Supplies and accessories

Item	Description	Part number	Selectability number
Supplies			
Black host cartridge	Replacement black host cartridge	F6T76A (NA)	972 (NA)
		N9J66A (EMEA 300 series)	913 (EMEA; 300 series)
		LOR59A (EMEA)	973 (EMEA)
		LOR60A (LAR)	974 (LAR)
		LOR61A (APJ)	975 (APJ)
Cyan host cartridge	Replacement cyan host cartridge	LOR50A(NA)	972 (NA)
		N9J63A (EMEA 300 series)	913 (EMEA; 300 series)
		F6T73A (EMEA)	973 (EMEA)
		LOR51A (LAR)	974 (LAR)
		LOR52A (APJ)	975 (APJ)
Yellow host cartridge	Replacement yellow host cartridge	LOR56A (NA)	972 (NA)
		N9J65A (EMEA 300 series)	913 (EMEA; 300 series)
		F6T75A (EMEA)	973 (EMEA)
		LOR57A (LAR)	974 (LAR)
		LOR58A (APJ)	975 (APJ)

Table 2-1 Supplies and accessories (continued)

Item	Description	Part number	Selectability number
Magenta host cartridge	Replacement magenta host cartridge	LOR53A (NA)	972 (NA)
		N9J64A (EMEA 300 series)	913 (EMEA; 300 series)
		F6T74A (EMEA)	973 (EMEA)
		LOR54A (LAR)	974 (LAR)
		LOR55A (APJ)	975 (APJ)
Black host cartridge (500 series)	Replacement black host cartridge for 500 series models	LOR74A(NA)	972 (NA)
		LOR75A (EMEA)	973 (EMEA)
		LOR76A (LAR)	974 (LAR)
		LOR77A (APJ)	975 (APJ)
Cyan host cartridge (500 series)	Replacement cyan host cartridge for 500 series models	LOR62A(NA)	972 (NA)
		LOR63A (EMEA)	973 (EMEA)
		LOR64A (LAR)	974 (LAR)
		LOR65A (APJ)	975 (APJ)
Yellow host cartridge (500 series)	Replacement yellow host cartridge for 500 series models	LOR70A (NA)	972 (NA)
		LOR71A (EMEA)	973 (EMEA)
		LOR72A (LAR)	974 (LAR)
		LOR73A (APJ)	975 (APJ)
Magenta host cartridge (500 series)	Replacement magenta host cartridge for 500 series models	LOR66A (NA)	972 (NA)
		LOR67A (EMEA)	973 (EMEA)
		LOR68A (LAR)	974 (LAR)
		LOR69A (APJ)	975 (APJ)
Black standard-capacity cartridge	Replacement standard-capacity black cartridge	F6T80A (NA)	972A (NA)
		LOR95A (EMEA)	913A (EMEA)
		LOR96A (LAR)	974A (LAR)
		LOR97A (APJ)	975A (APJ)
Cyan standard-capacity cartridge	Replacement standard-capacity cyan cartridge	LOR86A(NA)	972A (NA)
		F6T77A (EMEA)	913A (EMEA)
		LOR87A (LAR)	974A (LAR)
		LOR88A (APJ)	975A (APJ)
Yellow standard-capacity cartridge	Replacement standard-capacity yellow cartridge	LOR92A (NA)	972A (NA)
		F6T79A (EMEA)	913A (EMEA)
		LOR93A (LAR)	974A (LAR)
		LOR94A (APJ)	975A (APJ)

Table 2-1 Supplies and accessories (continued)

Item	Description	Part number	Selectability number
Magenta standard-capacity cartridge	Replacement standard-capacity magenta cartridge	LOR89A (NA)	972A (NA)
		F6T78A (EMEA)	913A (EMEA)
		LOR90A (LAR)	974A (LAR)
		LOR91A (APJ)	975A (APJ)
Black high-yield cartridge	Replacement high-capacity black cartridge	F6T84A (NA)	972X (NA)
		L0S07A (EMEA)	973X (EMEA)
		L0S08A (LAR)	974X (LAR)
		L0S09A (APJ)	975X (APJ)
Cyan high-yield cartridge	Replacement high-capacity cyan cartridge	LOR98A(NA)	972X (NA)
		F6T81A (EMEA)	973X (EMEA)
		LOR99A (LAR)	974X (LAR)
		L0S00A (APJ)	975X (APJ)
Yellow high-yield cartridge	Replacement high-capacity yellow cartridge	L0S04A (NA)	972X (NA)
		F6T83A (EMEA)	973X (EMEA)
		L0S05A (LAR)	974X (LAR)
		L0S06A (APJ)	975X (APJ)
Magenta high-yield cartridge	Replacement high-capacity magenta cartridge	L0S01A (NA)	972X (NA)
		F6T82A (EMEA)	973X (EMEA)
		L0S02A (LAR)	974X (LAR)
		L0S03A (APJ)	975X (APJ)
Black extra high-yield cartridge	Replacement extra high-capacity black cartridge	LOR08A (NA/LAR/APJ) Not supported in EMEA	976Y
Cyan extra high-yield cartridge	Replacement extra high-capacity cyan cartridge	LOR05A (NA/LAR/APJ) Not supported in EMEA	976Y
Yellow extra high-yield cartridge	Replacement extra high-capacity yellow cartridge	LOR07A (NA/LAR/APJ) Not supported in EMEA	976Y
Magenta extra high-yield cartridge	Replacement extra high-capacity magenta cartridge	LOR06A (NA/LAR/APJ) Not supported in EMEA	976Y
Black extra high-yield contract cartridge	Replacement extra high-capacity contract black cartridge	L0S20YC	976YC
Cyan extra high-yield contract cartridge	Replacement extra high-capacity contract cyan cartridge	L0S29YC	976YC
Yellow extra high-yield contract cartridge	Replacement extra high-capacity contract yellow cartridge	L0S31YC	976YC

Table 2-1 Supplies and accessories (continued)

Item	Description	Part number	Selectability number
Magenta extra high-yield contract cartridge	Replacement extra high-capacity contract magenta cartridge	LOS30YC	976YC
Accessories			
Tray 3	Optional Tray 3 (1 x 500-sheet paper feeder)	D3Q24-67066	Not applicable
Tray 4	Optional Tray 4 (1 x 500-sheet paper feeder)	D3Q24-67067	Not applicable
Cart	Optional cart	POV03-65001	Not applicable
Tray 3, Tray 4, and cart	Optional Tray 3, Tray 4, and cart	POV04A	Not applicable

Customer self-repair parts

Customer Self-Repair (CSR) parts are available for HP PageWide printers to reduce repair time. More information about the CSR program and benefits can be found at www.hp.com/go/csr-support and www.hp.com/go/csr-faq.

Genuine HP replacement parts can be ordered at www.hp.com/buy/parts or by contacting an HP-authorized service or support provider. When ordering, one of the following will be needed: part number, serial number (found on back of printer), product number, or printer name.

- Parts listed as **A**: Easy
- Parts listed as **B**: Difficult and/or requires tools

Item	Description	CSR level	Part number
Ink collection unit	Ink collection and duplex module assembly	A	CN598-67004
Output bin	Output bin assembly	A	D3Q24-67038 (300 and 400 series) D3Q24-67043 (500 series)
Tray 2	Main paper tray	A	D3Q24-67036
Tray 3	500-sheet paper feeder (optional Tray 3)	A	D3Q24-67066
Tray 4	500-sheet paper feeder (optional Tray 4)	A	D3Q24-67067
Left door	Left door assembly	B	D3Q24-67039
Left door front strap	Strap for the front hinge of the left door	B	CN598-67002
Left door rear strap	Strap for the rear hinge of the left door	B	CN598-67003
Eject flap assembly	Flap covering paper output opening	B	D3Q24-67004

Related documentation and software

HP service personnel, go to the Service Access Work Bench (SAW) at <http://h41302.www4.hp.com/km/saw/home.do>.

Channel partners, go to HP Channel Services Network (CSN) at <https://h30125.www3.hp.com/hpcsn>.

Parts and diagrams: Document feeder and scanner (477/577 models)

The figure below shows the component parts of the printer. A parts list table follows each exploded view assembly diagram. Each table lists the item number, the associated part number, and the description of each part. If a part is not listed in the table, then it is not a field replacement unit (FRU).

Document feeder and scanner ((477/577 models))

Figure 2-1 Document feeder and scanner

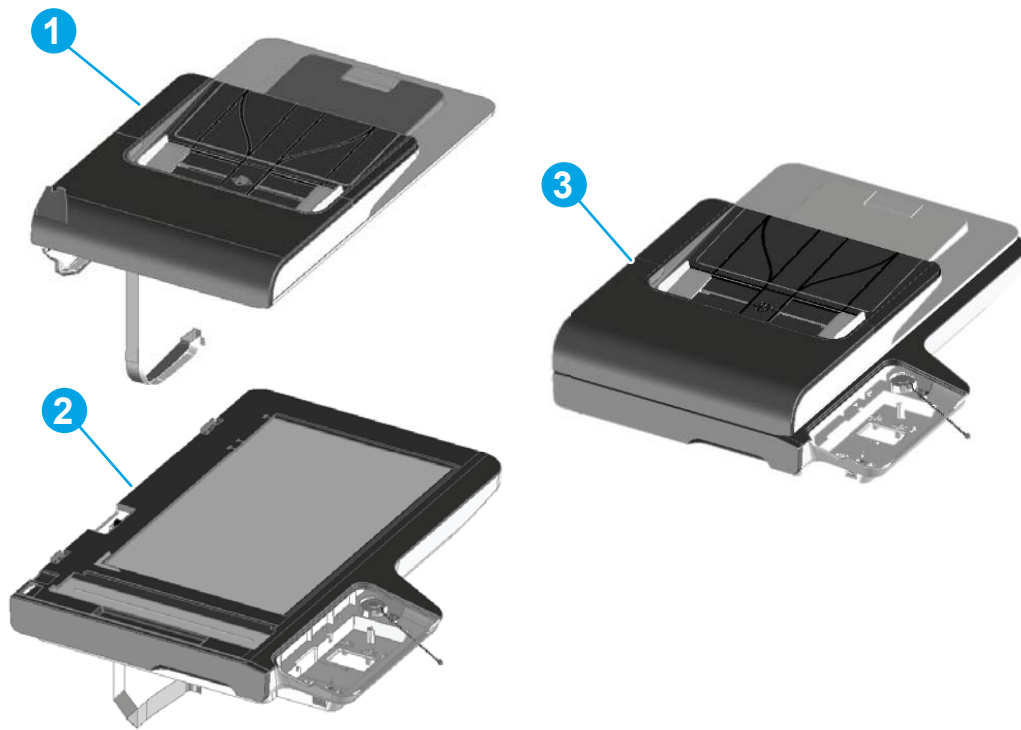

Table 2-2 Document feeder and scanner

Ref	Description	Part number	Qty
1	Document feeder	Not supported	1
2	Scanner assembly	D3Q24-67059	1
3	Document feeder and scanner assembly	D3Q24-67058	1

¹ To access HP PartSurfer information, go to <http://partsurfermobile.hp.com/>.

Parts and diagrams: Covers

The figures below show component parts of the printer. A parts list table follows the figure, listing the item number, the associated part number, and the description of each part. If a part is not listed in the table, then it is not a field replacement unit (FRU).

Covers (352/452 models)

Figure 2-2 Covers (352/452 models)

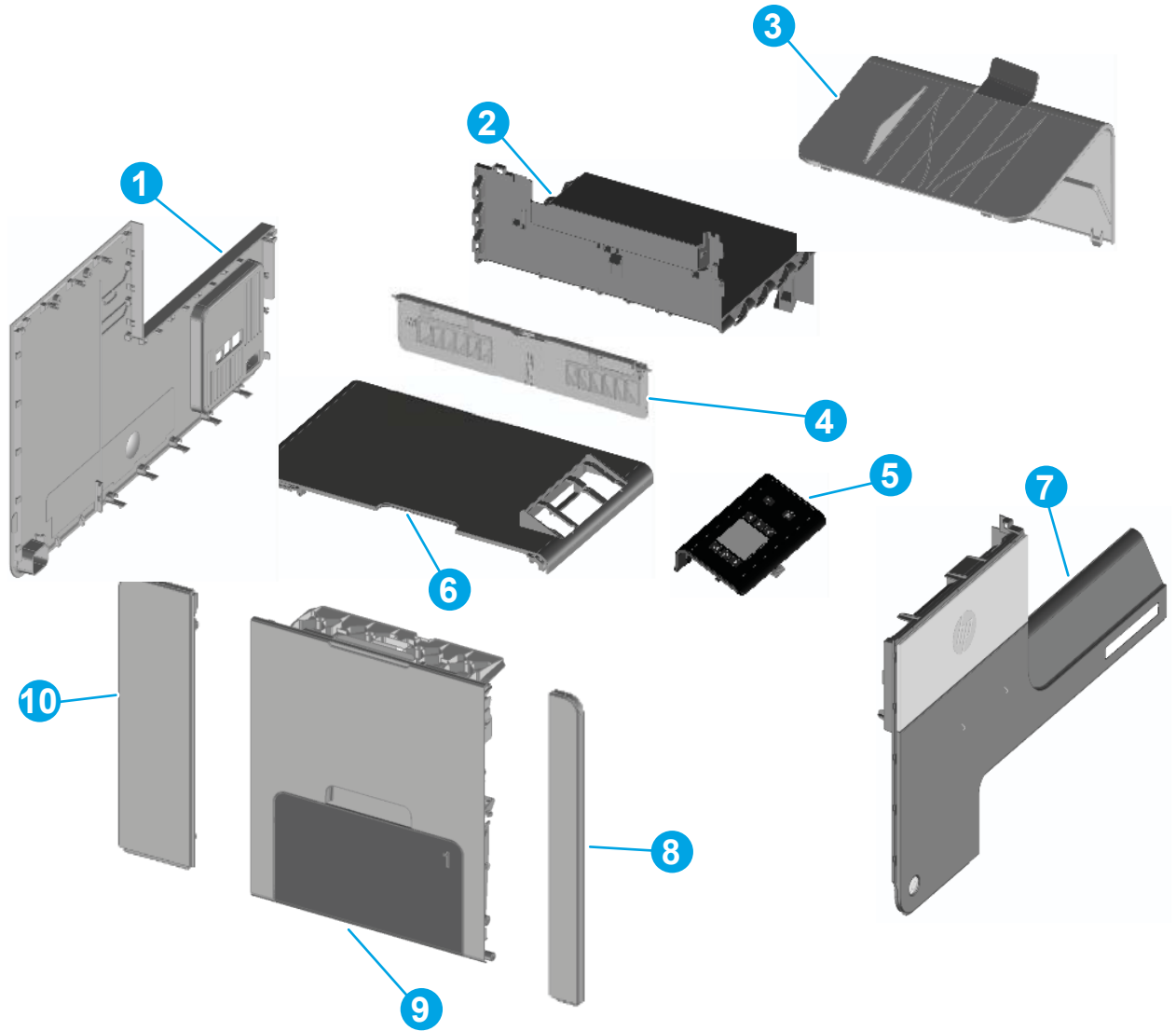

Table 2-3 Covers (352/452 models)

Ref	Description	Part number	Qty
1	Cover, rear (300/400 series)	D3Q24-67022	1
2	Cover, right (300/400 series)	D3Q24-67026	1
3	Output bin (300/400 series)	D3Q24-67038	1
4	Eject flap assembly	D3Q24-67004	1
5	Control panel (x45xdn model)	D3Q21-67001	1
5	Control panel (x45xdw model)	D3Q17-67001	1
6	Cover, top (352/452 models)	D3Q15-67002	
7	Cover, front (300/400 series)	D3Q24-67027	1
8	Cover, left front	D3Q24-67025	1
9	Door, left	D3Q24-67039	1
10	Cover, left rear	D3Q24-67024	1
Not shown	FFC, control panel (452 models)	CN459-50051	1
Not shown	Strap, left door front	CN598-67002	1
Not shown	Strap, left door rear	CN598-67003	1

¹ To access HP PartSurfer information, go to <http://partsurfermobile.hp.com/>.

Covers (377/477 models)

Figure 2-3 Covers (377/477 models)

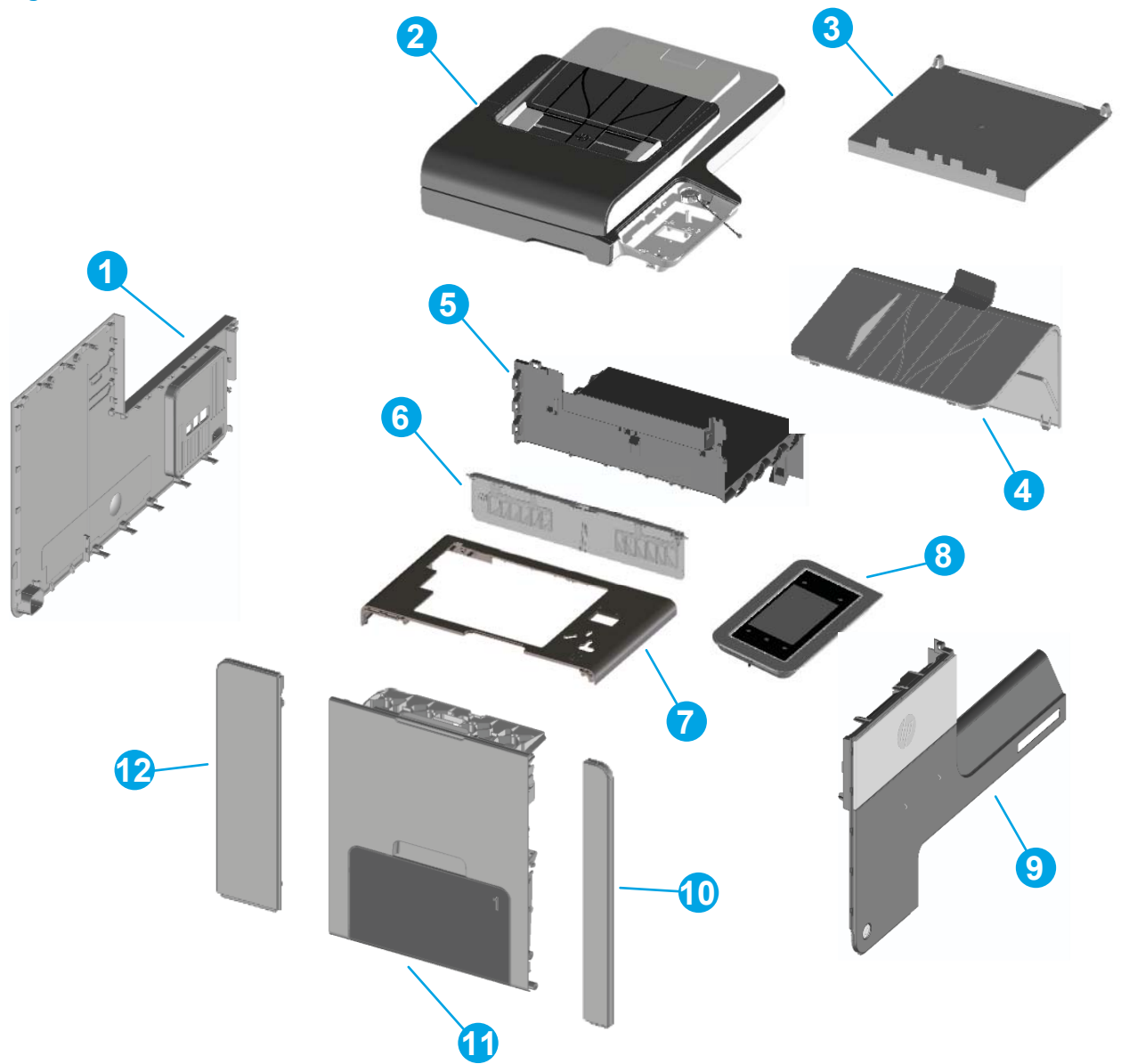

Table 2-4 Covers (377/477 models)

Ref	Description	Part number	Qty
1	Cover, rear (300/400 series)	D3Q24-67022	1
2	Scanner/ADF assembly	D3Q24-67058	1
3	Cover, image scanner base	Not supported	1
4	Output bin (300/400 series)	D3Q24-67038	1
5	Cover, front (300/400 series)	D3Q24-67027	1
6	Cover, left front	D3Q24-67025	1
7	Door, left	D3Q24-67039	1
8	Cover, left rear	D3Q24-67024	1
9	Cover, top (377/477/577 models)	D3Q24-67060	1
10	Eject flap assembly	D3Q24-67004	1
11	Cover, right (300/400 series)	D3Q24-67026	1
12	Control panel (x47xdn model)	D3Q24-67044	1
12	Control panel, service assembly (X47xdn model)	D3Q19-60013	1
12	Control panel, service assembly (47x-57xdw models)	D3Q20-60007	1
Not shown	Strap, left door front	CN598-67002	1
Not shown	Strap, left door rear	CN598-67003	1

¹ To access HP PartSurfer information, go to <http://partsurfermobile.hp.com/>.

Covers (552 models)

Figure 2-4 Covers (552 models)

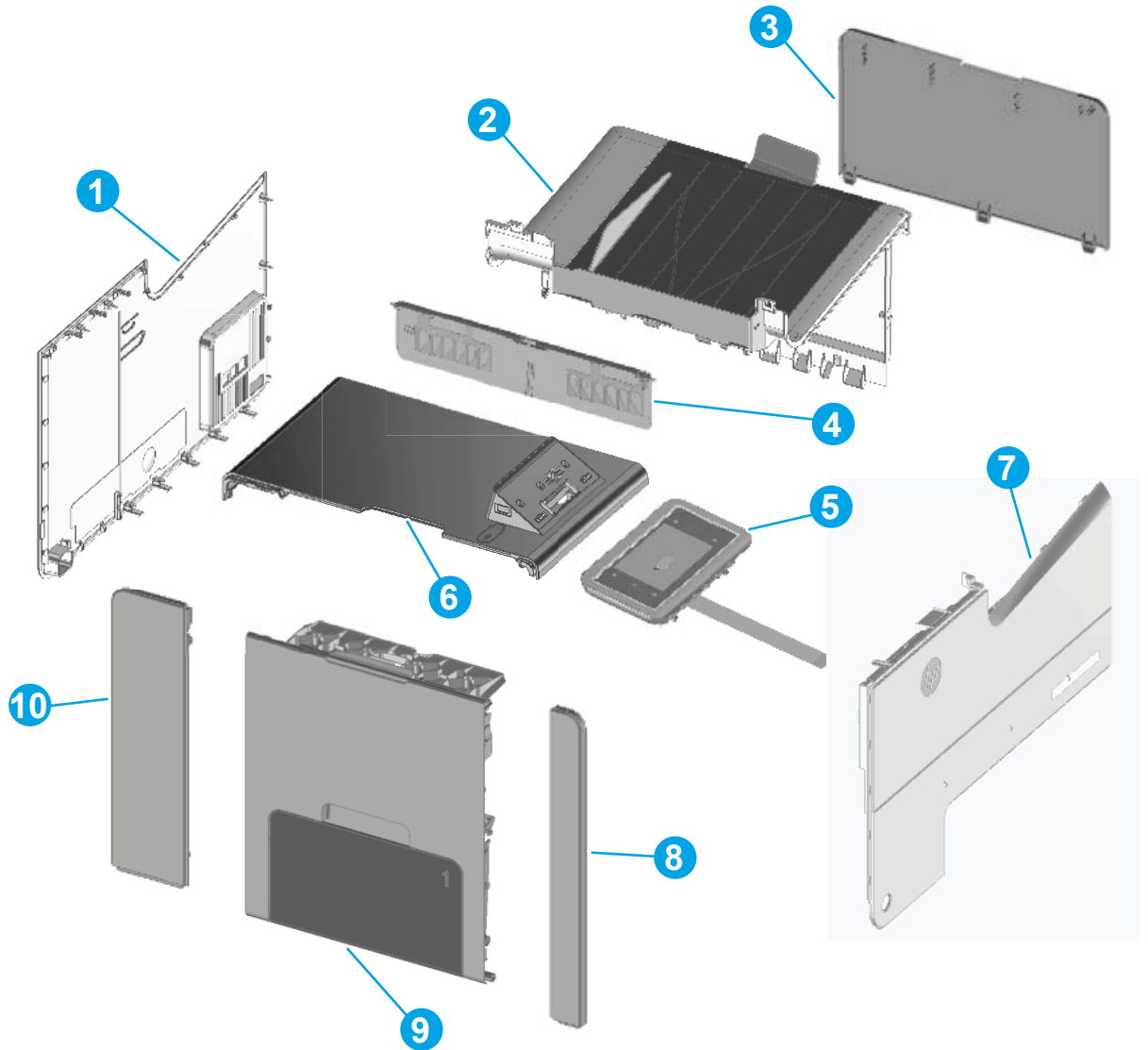

Table 2-5 Covers (552 models)

Ref	Description	Part number	Qty
1	Cover, rear (500 series)	D3Q24-67023	1
2	Output bin (500 series)	D3Q24-67043	1
3	Cover, right (500 series)	D3Q24-67029	1
4	Eject flap assembly	D3Q24-67004	1
5	Control panel (x55xdw model)	D3Q17-67002	1
6	Cover, top (552 models)	D3Q17-67005	
7	Cover, front (500 series)	D3Q24-67042	1
8	Cover, left front	D3Q24-67025	1
9	Door, left	D3Q24-67039	1
10	Cover, left rear	D3Q24-67024	1
Not shown	FFC, control panel (552 models)	D3Q15-50005	1
Not shown	Strap, left door front	CN598-67002	1
Not shown	Strap, left door rear	CN598-67003	1

¹ To access HP PartSurfer information, go to <http://partsurfermobile.hp.com/>.

Covers (577 models)

Figure 2-5 Covers (577 models)

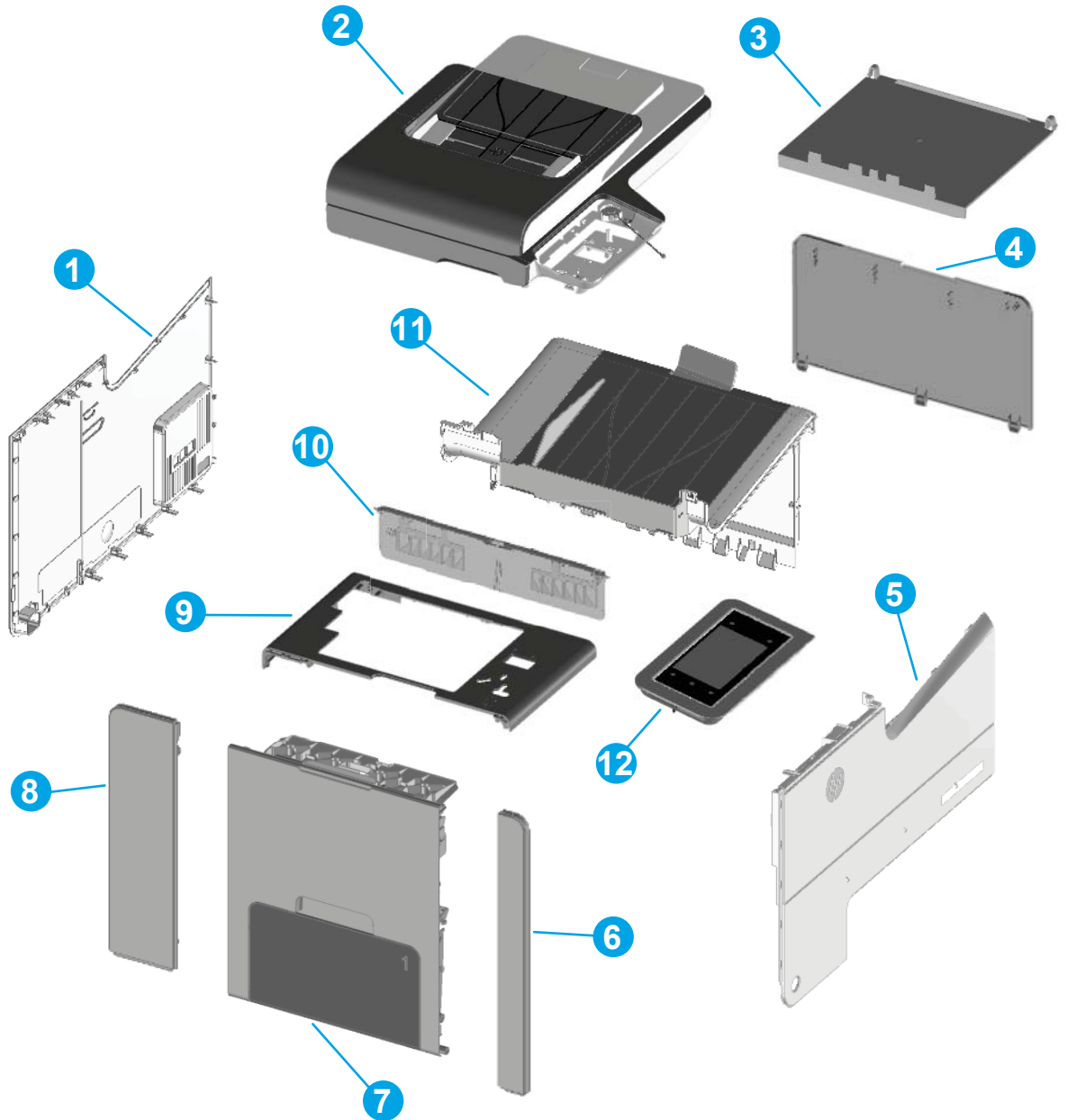

Table 2-6 Covers (577 models)

Ref	Description	Part number	Qty
1	Cover, rear (500 series)	D3Q24-67023	1
2	Scanner/ADF assembly	D3Q24-67058	1
3	Cover, image scanner base	Not supported	1
4	Cover, right (500 series)	D3Q24-67029	1
5	Cover, front (500 series)	D3Q24-67042	1
6	Cover, left front	D3Q24-67025	1
7	Door, left	D3Q24-67039	1
8	Cover, left rear	D3Q24-67024	1
9	Cover, top (377/477/577 models)	D3Q24-67060	
10	Eject flap assembly	D3Q24-67004	1
11	Output bin (500 series)	D3Q24-67043	1
12	Control panel, service assembly (47x-57xdw models)	D3Q20-60007	1
Not shown	Strap, left door front	CN598-67002	1
Not shown	Strap, left door rear	CN598-67003	1

¹ To access HP PartSurfer information, go to <http://partsurfermobile.hp.com/>.

Parts and diagrams: Internal assemblies

The figures below show component parts of the printer. A parts list table follows each figure, listing the item number, the associated part number, and the description of each part. If a part is not listed in the tables, then it is not a field replacement unit (FRU).

NOTE: The abbreviation “PCA” stands for “printed circuit-board assembly.” Components described as a PCA might consist of a single circuit board or a circuit board plus other parts, such as cables and sensors.

Internal assemblies (352/452/377/477 models)

Figure 2-6 Internal assemblies (352/452/377/477 models)

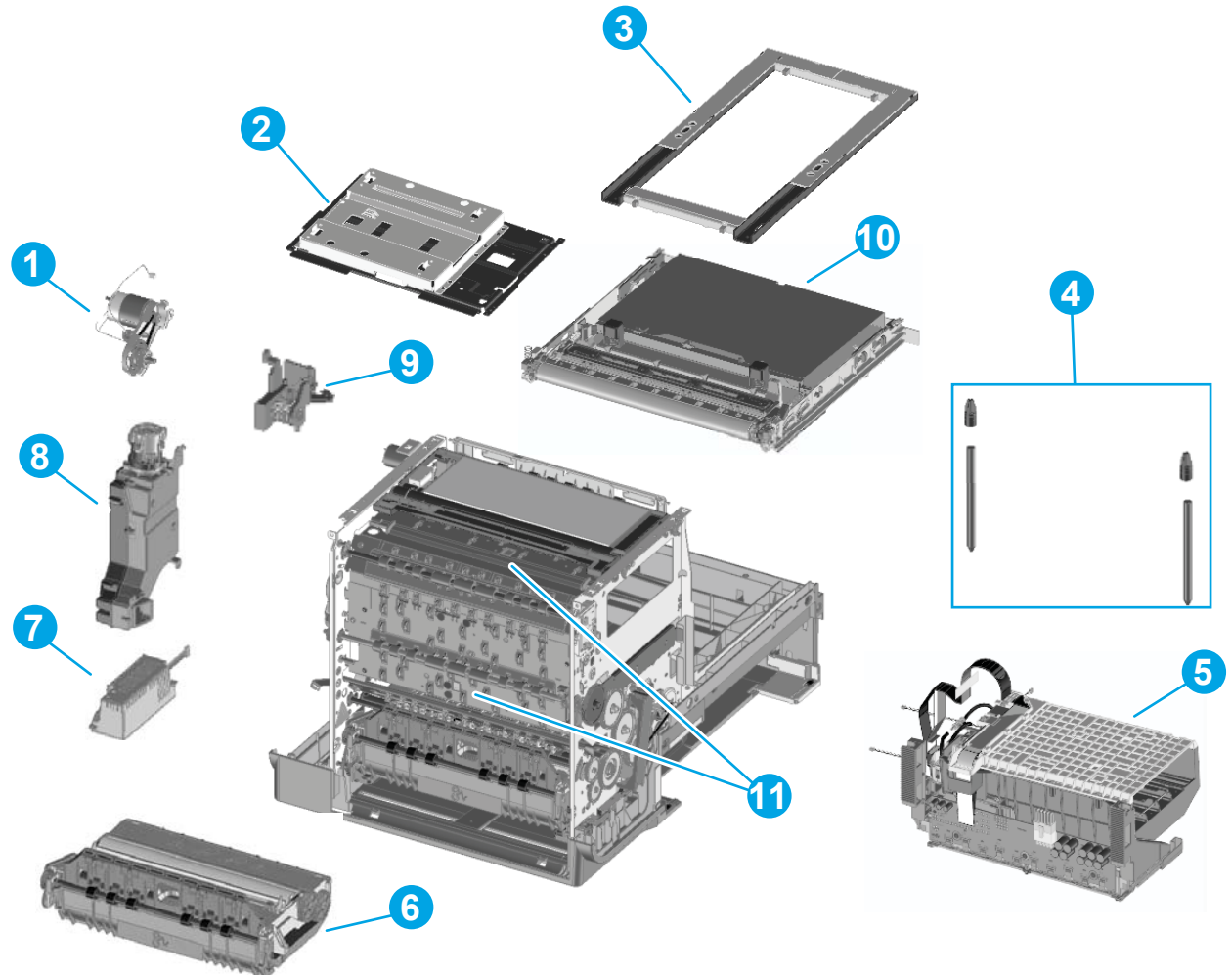

Table 2-7 Internal assemblies (352/452/377/477 models)

Ref	Description	Part number	Qty
1	Eject drive-gear module	D3Q24-67003	1
2	Console Plate Assembly	Not supported	1
3	Scanner support (377/477 models)	Not supported	1
4	Printbar lift rod assembly	CN598-67048	1
5	Printbar assembly (352/452/377/477 models)	CN598-67044	1
6	Ink collection unit	CN598-67004	1
7	Power supply	CN598-67016	1
7	Power supply (India and China only)	CN598-67017	1
8	Aerosol fan assembly	D3Q24-67021	1
9	Web advance rack assembly	D3Q24-67002	1
10	Service Sled Assembly (352/452/377/477 models)	D3Q24-67001	1
11	REDI sensors	CN598-67038	1

¹ To access HP PartSurfer information, go to <http://partsurfermobile.hp.com/>.

Internal assemblies (552/577 models)

Figure 2-7 Internal assemblies (552/577 models)

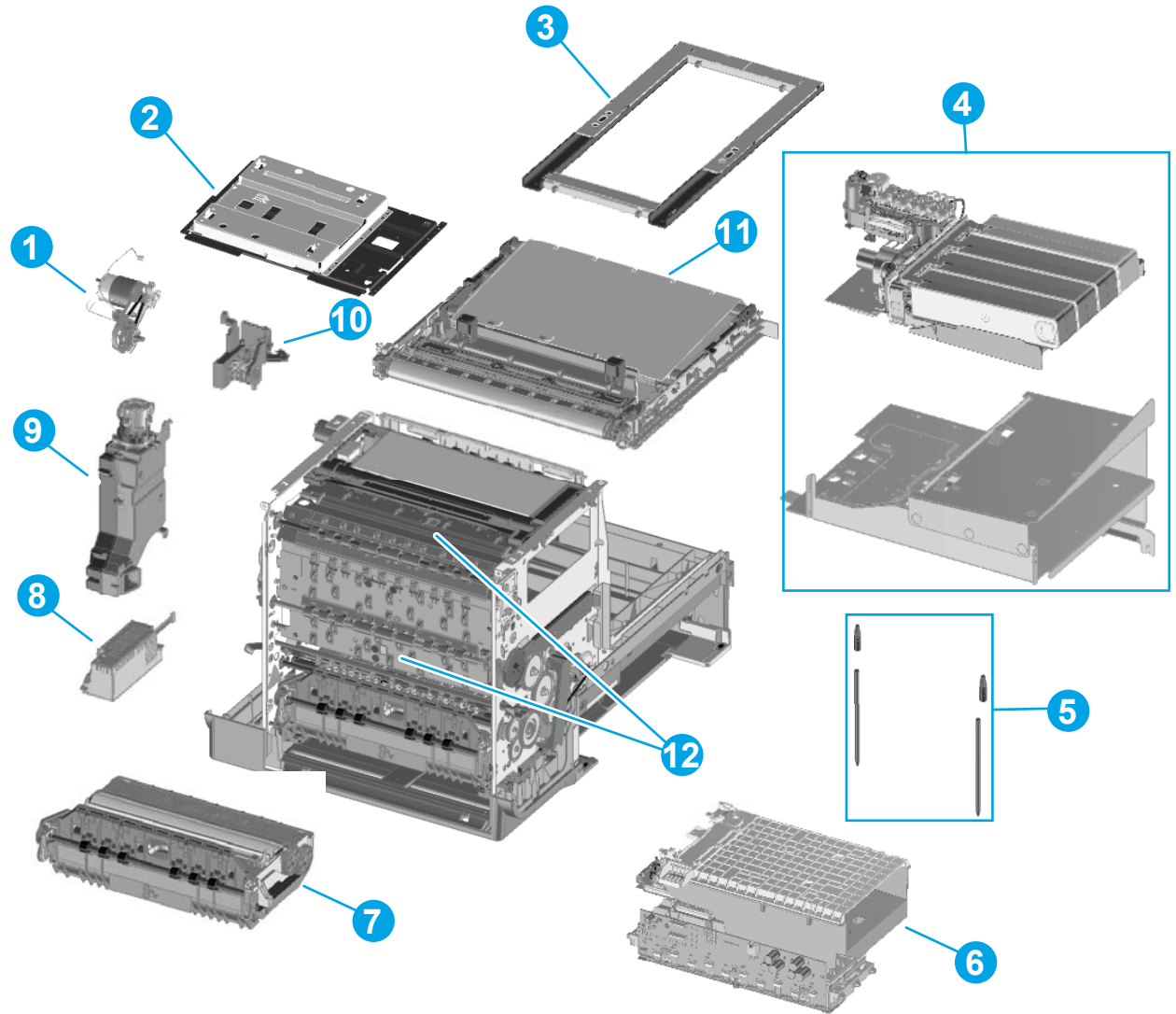

Table 2-8 Internal assemblies (552/577 models)

Ref	Description	Part number	Qty
1	Eject drive-gear module	D3Q24-67003	1
2	Console Plate Assembly	Not supported	1
3	Scanner support (577 models)	Not supported	1
4	Off-axis IDS (500 series)	D3Q24-67063	1
5	Printbar lift rod assembly	CN598-67048	1
6	Printbar assembly (552/577 models)	D3Q24-67020	1
7	Ink collection unit	CN598-67004	1
8	Power supply	CN598-67016	1
8	Power supply (India and China only)	CN598-67017	1
9	Aerosol fan assembly	D3Q24-67021	1
10	Web advance rack assembly	D3Q24-67002	1
11	Service Sled Assembly (552/577 models)	D3Q24-67002	1
12	REDI sensors	CN598-67038	1

¹ To access HP PartSurfer information, go to <http://partsurfermobile.hp.com/>.

Internal assemblies—not shown (300/400/500 series)

Figure 2-8 Internal assemblies—not shown (300/400/500 series)

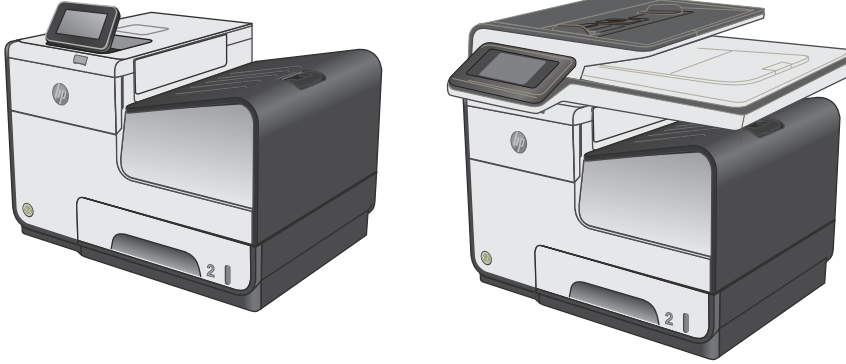

Table 2-9 Internal assemblies—not shown (300/400/500 series)

Ref	Description	Part number	Qty
Not shown	BDD sensor	D3Q15-60168	1
Not shown	Cross brace, right	CN459-00118	1
Not shown	Drying path gear assembly	CN598-67060	1
Not shown	Duplex drive module	D3Q24-67016	1
Not shown	Duplex presence sensor PCA	D3Q24-67010	1
Not shown	Eject flap opto PCA	D3Q24-67037	1
Not shown	Fax PCA	D3Q24-67056	1
Not shown	Feedshaft	CN459-20151	1
Not shown	Feedshaft encoder PCA	D3Q24-67012	1
Not shown	FFC, 10-pin pick drive enc	CN598-67041	1
Not shown	FFC, 11-pin printzone	CN598-67039	1
Not shown	FFC, 12-pin REDI distribution	CN598-67042	1
Not shown	FFC, 24-pin printbar lift	CN598-67040	1
Not shown	FFC, 5-pin sensor carriage BDD	CN598-67043	1
Not shown	Flap actuator solenoid	D3Q24-67004	1
Not shown	Floor eject assembly	CN459-60075	1
Not shown	Gear, output idler gear, 83t/30t	CN598-67031	1
Not shown	Gear, shaft output lower	CN598-67031	1
Not shown	Gear, shaft output platen 1	CN459-60104	1
Not shown	Hinge, ISS door	D3Q24-67028	1
Not shown	IDS bracket assembly (500 series)	D3Q17-60009	1
Not shown	Main PCA—D3Q15	D3Q24-67048	1
Not shown	Main PCA—D3Q16	D3Q24-67049	1
Not shown	Main PCA—D3Q19	D3Q24-67050	1
Not shown	Main PCA—D3Q20	D3Q24-67051	1
Not shown	Main PCA—D3Q17	D3Q24-67052	1
Not shown	Main PCA—D3Q21 / K9Z76	D3Q24-67053	1
Not shown	Main PCA—J6U55A	D3Q24-67054	1
Not shown	Main PCA—J9V82, service assembly	D3Q24-67055	1
Not shown	Media presence flag/opto PCA kit	D3Q24-67014	1
Not shown	Media presence sensor PCA/flag	E3E01-60106	1
Not shown	Output eject 5 shaft	CN459-60108	1
Not shown	Output eject 6 shaft	CN459-60109	1
Not shown	Output lower 2 shaft	CN459-60105	1

Table 2-9 Internal assemblies—not shown (300/400/500 series) (continued)

Ref	Description	Part number	Qty
Not shown	Output upper 4 shaft	CN459-60107	1
Not shown	Pick encoder distribution PCA	D3Q24-67011	1
Not shown	Pigtail PB assembly, short	K5H62-60021	1
Not shown	Pigtail PB assembly, tall	K5H62-60022	1
Not shown	Platen	CN598-67025	1
Not shown	Platen output 1 shaft	CN459-60104	1
Not shown	Power button assembly	D3Q24-67061	1
Not shown	Printbar lift mechanism assembly	D3Q24-67008	1
Not shown	REDI distribution PCA	D3Q24-67017	1
Not shown	Sensor carriage PCA/encoder strip	D3Q24-67007	1
Not shown	Separator/pick assembly kit	CN598-67018	1
Not shown	Spurgear, idler gear train, 52t	CN459-40300	1
Not shown	Temperature sensor	D3Q24-67005	1
Not shown	Transfer 3 shaft	CN459-60106	1
Not shown	Tray lift transmission assembly	CN598-67020	1
Not shown	Upper hanger assembly	CN459-60317	1
Not shown	Vertical star wheel wall	CN459-00119	1

¹ To access HP PartSurfer information, go to <http://partsurfermobile.hp.com/>.

Alphabetical parts list

Table 2-10 Alphabetical parts list

Description	Part number	Table and page
Aerosol fan assembly	D3Q24-67021	Internal assemblies (352/452/377/477 models) on page 187
Aerosol fan assembly	D3Q24-67021	Internal assemblies (552/577 models) on page 189
BDD sensor	D3Q15-60168	Internal assemblies—not shown (300/400/500 series) on page 191
Console Plate Assembly	Not supported	Internal assemblies (352/452/377/477 models) on page 187
Console Plate Assembly	Not supported	Internal assemblies (552/577 models) on page 189
Control panel (x45xdn model)	D3Q21-67001	Covers (352/452 models) on page 179
Control panel (x45xdw model)	D3Q17-67001	Covers (352/452 models) on page 179
Control panel (x47xdn model)	D3Q24-67044	Covers (377/477 models) on page 181
Control panel (x55xdw model)	D3Q17-67002	Covers (552 models) on page 183
Control panel, service assembly (47x-57xdw models)	D3Q20-60007	Covers (377/477 models) on page 181
Control panel, service assembly (47x-57xdw models)	D3Q20-60007	Covers (577 models) on page 185
Control panel, service assembly (X47xdn model)	D3Q19-60013	Covers (377/477 models) on page 181
Cover, front (300/400 series)	D3Q24-67027	Covers (352/452 models) on page 179
Cover, front (300/400 series)	D3Q24-67027	Covers (377/477 models) on page 181
Cover, front (500 series)	D3Q24-67042	Covers (552 models) on page 183
Cover, front (500 series)	D3Q24-67042	Covers (577 models) on page 185
Cover, image scanner base	Not supported	Covers (377/477 models) on page 181
Cover, image scanner base	Not supported	Covers (577 models) on page 185
Cover, left front	D3Q24-67025	Covers (352/452 models) on page 179

Table 2-10 Alphabetical parts list (continued)

Description	Part number	Table and page
Cover, left front	D3Q24-67025	Covers (377/477 models) on page 181
Cover, left front	D3Q24-67025	Covers (552 models) on page 183
Cover, left front	D3Q24-67025	Covers (577 models) on page 185
Cover, left rear	D3Q24-67024	Covers (352/452 models) on page 179
Cover, left rear	D3Q24-67024	Covers (377/477 models) on page 181
Cover, left rear	D3Q24-67024	Covers (552 models) on page 183
Cover, left rear	D3Q24-67024	Covers (577 models) on page 185
Cover, rear (300/400 series)	D3Q24-67022	Covers (352/452 models) on page 179
Cover, rear (300/400 series)	D3Q24-67022	Covers (377/477 models) on page 181
Cover, rear (500 series)	D3Q24-67023	Covers (552 models) on page 183
Cover, rear (500 series)	D3Q24-67023	Covers (577 models) on page 185
Cover, right (300/400 series)	D3Q24-67026	Covers (352/452 models) on page 179
Cover, right (300/400 series)	D3Q24-67026	Covers (377/477 models) on page 181
Cover, right (500 series)	D3Q24-67029	Covers (552 models) on page 183
Cover, right (500 series)	D3Q24-67029	Covers (577 models) on page 185
Cover, top (352/452 models)	D3Q15-67002	Covers (352/452 models) on page 179
Cover, top (377/477/577 models)	D3Q24-67060	Covers (377/477 models) on page 181
Cover, top (377/477/577 models)	D3Q24-67060	Covers (577 models) on page 185
Cover, top (552 models)	D3Q17-67005	Covers (552 models) on page 183
Cross brace, right	CN459-00118	Internal assemblies—not shown (300/400/500 series) on page 191
Document feeder	Not supported	Document feeder and scanner on page 177

Table 2-10 Alphabetical parts list (continued)

Description	Part number	Table and page
Document feeder and scanner assembly	D3Q24-67058	Document feeder and scanner on page 177
Door, left	D3Q24-67039	Covers (352/452 models) on page 179
Door, left	D3Q24-67039	Covers (377/477 models) on page 181
Door, left	D3Q24-67039	Covers (552 models) on page 183
Door, left	D3Q24-67039	Covers (577 models) on page 185
Drying path gear assembly	CN598-67060	Internal assemblies—not shown (300/400/500 series) on page 191
Duplex drive module	D3Q24-67016	Internal assemblies—not shown (300/400/500 series) on page 191
Duplex presence sensor PCA	D3Q24-67010	Internal assemblies—not shown (300/400/500 series) on page 191
Eject drive-gear module	D3Q24-67003	Internal assemblies (352/452/377/477 models) on page 187
Eject drive-gear module	D3Q24-67003	Internal assemblies (552/577 models) on page 189
Eject flap assembly	D3Q24-67004	Covers (352/452 models) on page 179
Eject flap assembly	D3Q24-67004	Covers (377/477 models) on page 181
Eject flap assembly	D3Q24-67004	Covers (552 models) on page 183
Eject flap assembly	D3Q24-67004	Covers (577 models) on page 185
Eject flap opto PCA	D3Q24-67037	Internal assemblies—not shown (300/400/500 series) on page 191
Fax PCA	D3Q24-67056	Internal assemblies—not shown (300/400/500 series) on page 191
Feedshaft	CN459-20151	Internal assemblies—not shown (300/400/500 series) on page 191
Feedshaft encoder PCA	D3Q24-67012	Internal assemblies—not shown (300/400/500 series) on page 191

Table 2-10 Alphabetical parts list (continued)

Description	Part number	Table and page
FFC, 10-pin pick drive enc	CN598-67041	Internal assemblies—not shown (300/400/500 series) on page 191
FFC, 11-pin printzone	CN598-67039	Internal assemblies—not shown (300/400/500 series) on page 191
FFC, 12-pin REDI distribution	CN598-67042	Internal assemblies—not shown (300/400/500 series) on page 191
FFC, 24-pin printbar lift	CN598-67040	Internal assemblies—not shown (300/400/500 series) on page 191
FFC, 5-pin sensor carriage BDD	CN598-67043	Internal assemblies—not shown (300/400/500 series) on page 191
FFC, control panel (452 models)	CN459-50051	Covers (352/452 models) on page 179
FFC, control panel (552 models)	D3Q15-50005	Covers (552 models) on page 183
Flap actuator solenoid	D3Q24-67004	Internal assemblies—not shown (300/400/500 series) on page 191
Floor eject assembly	CN459-60075	Internal assemblies—not shown (300/400/500 series) on page 191
Gear, output idler gear, 83t/30t	CN598-67031	Internal assemblies—not shown (300/400/500 series) on page 191
Gear, shaft output lower	CN598-67031	Internal assemblies—not shown (300/400/500 series) on page 191
Gear, shaft output platen 1	CN459-60104	Internal assemblies—not shown (300/400/500 series) on page 191
Hinge, ISS door	D3Q24-67028	Internal assemblies—not shown (300/400/500 series) on page 191
IDS bracket assembly (500 series)	D3Q17-60009	Internal assemblies—not shown (300/400/500 series) on page 191
Ink collection unit	CN598-67004	Internal assemblies (352/452/377/477 models) on page 187
Ink collection unit	CN598-67004	Internal assemblies (552/577 models) on page 189
Main PCA—D3Q15	D3Q24-67048	Internal assemblies—not shown (300/400/500 series) on page 191

Table 2-10 Alphabetical parts list (continued)

Description	Part number	Table and page
Main PCA—D3Q16	D3Q24-67049	Internal assemblies—not shown (300/400/500 series) on page 191
Main PCA—D3Q17	D3Q24-67052	Internal assemblies—not shown (300/400/500 series) on page 191
Main PCA—D3Q19	D3Q24-67050	Internal assemblies—not shown (300/400/500 series) on page 191
Main PCA—D3Q20	D3Q24-67051	Internal assemblies—not shown (300/400/500 series) on page 191
Main PCA—D3Q21 / K9Z76	D3Q24-67053	Internal assemblies—not shown (300/400/500 series) on page 191
Main PCA—J6U55A	D3Q24-67054	Internal assemblies—not shown (300/400/500 series) on page 191
Main PCA—J9V82, service assembly	D3Q24-67055	Internal assemblies—not shown (300/400/500 series) on page 191
Media presence flag/opto PCA kit	D3Q24-67014	Internal assemblies—not shown (300/400/500 series) on page 191
Media presence sensor PCA/flag	E3E01-60106	Internal assemblies—not shown (300/400/500 series) on page 191
Off-axis IDS (500 series)	D3Q24-67063	Internal assemblies (552/577 models) on page 189
Output bin (300/400 series)	D3Q24-67038	Covers (352/452 models) on page 179
Output bin (300/400 series)	D3Q24-67038	Covers (377/477 models) on page 181
Output bin (500 series)	D3Q24-67043	Covers (552 models) on page 183
Output bin (500 series)	D3Q24-67043	Covers (577 models) on page 185
Output eject 5 shaft	CN459-60108	Internal assemblies—not shown (300/400/500 series) on page 191
Output eject 6 shaft	CN459-60109	Internal assemblies—not shown (300/400/500 series) on page 191
Output lower 2 shaft	CN459-60105	Internal assemblies—not shown (300/400/500 series) on page 191

Table 2-10 Alphabetical parts list (continued)

Description	Part number	Table and page
Output upper 4 shaft	CN459-60107	Internal assemblies—not shown (300/400/500 series) on page 191
Pick encoder distribution PCA	D3Q24-67011	Internal assemblies—not shown (300/400/500 series) on page 191
Pigtail PB assembly, short	K5H62-60021	Internal assemblies—not shown (300/400/500 series) on page 191
Pigtail PB assembly, tall	K5H62-60022	Internal assemblies—not shown (300/400/500 series) on page 191
Platen	CN598-67025	Internal assemblies—not shown (300/400/500 series) on page 191
Platen output 1 shaft	CN459-60104	Internal assemblies—not shown (300/400/500 series) on page 191
Power button assembly	D3Q24-67061	Internal assemblies—not shown (300/400/500 series) on page 191
Power supply	CN598-67016	Internal assemblies (352/452/377/477 models) on page 187
Power supply	CN598-67016	Internal assemblies (552/577 models) on page 189
Power supply (India and China only)	CN598-67017	Internal assemblies (352/452/377/477 models) on page 187
Power supply (India and China only)	CN598-67017	Internal assemblies (552/577 models) on page 189
Printbar assembly (352/452/377/477 models)	CN598-67044	Internal assemblies (352/452/377/477 models) on page 187
Printbar assembly (552/577 models)	D3Q24-67020	Internal assemblies (552/577 models) on page 189
Printbar lift mechanism assembly	D3Q24-67008	Internal assemblies—not shown (300/400/500 series) on page 191
Printbar lift rod assembly	CN598-67048	Internal assemblies (352/452/377/477 models) on page 187
Printbar lift rod assembly	CN598-67048	Internal assemblies (552/577 models) on page 189
REDI distribution PCA	D3Q24-67017	Internal assemblies—not shown (300/400/500 series) on page 191

Table 2-10 Alphabetical parts list (continued)

Description	Part number	Table and page
REDI sensors	CN598-67038	Internal assemblies (352/452/377/477 models) on page 187
REDI sensors	CN598-67038	Internal assemblies (552/577 models) on page 189
Scanner assembly	D3Q24-67059	Document feeder and scanner on page 177
Scanner support (377/477 models)	Not supported	Internal assemblies (352/452/377/477 models) on page 187
Scanner support (577 models)	Not supported	Internal assemblies (552/577 models) on page 189
Scanner/ADF assembly	D3Q24-67058	Covers (377/477 models) on page 181
Scanner/ADF assembly	D3Q24-67058	Covers (577 models) on page 185
Sensor carriage PCA/encoder strip	D3Q24-67007	Internal assemblies—not shown (300/400/500 series) on page 191
Separator/pick assembly kit	CN598-67018	Internal assemblies—not shown (300/400/500 series) on page 191
Service Sled Assembly (352/452/377/477 models)	D3Q24-67001	Internal assemblies (352/452/377/477 models) on page 187
Service Sled Assembly (552/577 models)	D3Q24-67002	Internal assemblies (552/577 models) on page 189
Spurgear, idler gear train, 52t	CN459-40300	Internal assemblies—not shown (300/400/500 series) on page 191
Strap, left door front	CN598-67002	Covers (352/452 models) on page 179
Strap, left door front	CN598-67002	Covers (377/477 models) on page 181
Strap, left door front	CN598-67002	Covers (552 models) on page 183
Strap, left door front	CN598-67002	Covers (577 models) on page 185
Strap, left door rear	CN598-67003	Covers (352/452 models) on page 179
Strap, left door rear	CN598-67003	Covers (377/477 models) on page 181
Strap, left door rear	CN598-67003	Covers (552 models) on page 183

Table 2-10 Alphabetical parts list (continued)

Description	Part number	Table and page
Strap, left door rear	CN598-67003	Covers (577 models) on page 185
Temperature sensor	D3Q24-67005	Internal assemblies—not shown (300/400/500 series) on page 191
Transfer 3 shaft	CN459-60106	Internal assemblies—not shown (300/400/500 series) on page 191
Tray lift transmission assembly	CN598-67020	Internal assemblies—not shown (300/400/500 series) on page 191
Upper hanger assembly	CN459-60317	Internal assemblies—not shown (300/400/500 series) on page 191
Vertical star wheel wall	CN459-00119	Internal assemblies—not shown (300/400/500 series) on page 191
Web advance rack assembly	D3Q24-67002	Internal assemblies (352/452/377/477 models) on page 187
Web advance rack assembly	D3Q24-67002	Internal assemblies (552/577 models) on page 189

Numerical parts list

Table 2-11 Numerical parts list

Part number	Description	Table and page
CN459-00118	Cross brace, right	Internal assemblies—not shown (300/400/500 series) on page 191
CN459-00119	Vertical star wheel wall	Internal assemblies—not shown (300/400/500 series) on page 191
CN459-20151	Feedshaft	Internal assemblies—not shown (300/400/500 series) on page 191
CN459-40300	Spurgear, idler gear train, 52t	Internal assemblies—not shown (300/400/500 series) on page 191
CN459-50051	FFC, control panel (452 models)	Covers (352/452 models) on page 179
CN459-60075	Floor eject assembly	Internal assemblies—not shown (300/400/500 series) on page 191
CN459-60104	Gear, shaft output platen 1	Internal assemblies—not shown (300/400/500 series) on page 191
CN459-60104	Platen output 1 shaft	Internal assemblies—not shown (300/400/500 series) on page 191
CN459-60105	Output lower 2 shaft	Internal assemblies—not shown (300/400/500 series) on page 191
CN459-60106	Transfer 3 shaft	Internal assemblies—not shown (300/400/500 series) on page 191
CN459-60107	Output upper 4 shaft	Internal assemblies—not shown (300/400/500 series) on page 191
CN459-60108	Output eject 5 shaft	Internal assemblies—not shown (300/400/500 series) on page 191
CN459-60109	Output eject 6 shaft	Internal assemblies—not shown (300/400/500 series) on page 191
CN459-60317	Upper hanger assembly	Internal assemblies—not shown (300/400/500 series) on page 191
CN598-67002	Strap, left door front	Covers (352/452 models) on page 179
CN598-67002	Strap, left door front	Covers (377/477 models) on page 181

Table 2-11 Numerical parts list (continued)

Part number	Description	Table and page
CN598-67002	Strap, left door front	Covers (552 models) on page 183
CN598-67002	Strap, left door front	Covers (577 models) on page 185
CN598-67003	Strap, left door rear	Covers (352/452 models) on page 179
CN598-67003	Strap, left door rear	Covers (377/477 models) on page 181
CN598-67003	Strap, left door rear	Covers (552 models) on page 183
CN598-67003	Strap, left door rear	Covers (577 models) on page 185
CN598-67016	Power supply	Internal assemblies (352/452/377/477 models) on page 187
CN598-67016	Power supply	Internal assemblies (552/577 models) on page 189
CN598-67017	Power supply (India and China only)	Internal assemblies (352/452/377/477 models) on page 187
CN598-67017	Power supply (India and China only)	Internal assemblies (552/577 models) on page 189
CN598-67018	Separator/pick assembly kit	Internal assemblies—not shown (300/400/500 series) on page 191
CN598-67020	Tray lift transmission assembly	Internal assemblies—not shown (300/400/500 series) on page 191
CN598-67025	Platen	Internal assemblies—not shown (300/400/500 series) on page 191
CN598-67031	Gear, output idler gear, 83t/30t	Internal assemblies—not shown (300/400/500 series) on page 191
CN598-67031	Gear, shaft output lower	Internal assemblies—not shown (300/400/500 series) on page 191
CN598-67038	REDI sensors	Internal assemblies (352/452/377/477 models) on page 187
CN598-67038	REDI sensors	Internal assemblies (552/577 models) on page 189
CN598-67039	FFC, 11-pin printzone	Internal assemblies—not shown (300/400/500 series) on page 191

Table 2-11 Numerical parts list (continued)

Part number	Description	Table and page
CN598-67040	FFC, 24-pin printbar lift	Internal assemblies—not shown (300/400/500 series) on page 191
CN598-67041	FFC, 10-pin pick drive enc	Internal assemblies—not shown (300/400/500 series) on page 191
CN598-67042	FFC, 12-pin REDI distribution	Internal assemblies—not shown (300/400/500 series) on page 191
CN598-67043	FFC, 5-pin sensor carriage BDD	Internal assemblies—not shown (300/400/500 series) on page 191
CN598-67044	Printbar assembly (352/452/377/477 models)	Internal assemblies (352/452/377/477 models) on page 187
CN598-67048	Printbar lift rod assembly	Internal assemblies (352/452/377/477 models) on page 187
CN598-67048	Printbar lift rod assembly	Internal assemblies (552/577 models) on page 189
CN598-67060	Drying path gear assembly	Internal assemblies—not shown (300/400/500 series) on page 191
D3Q15-50005	FFC, control panel (552 models)	Covers (552 models) on page 183
D3Q24-67021	Aerosol fan assembly	Internal assemblies (352/452/377/477 models) on page 187
D3Q24-67021	Aerosol fan assembly	Internal assemblies (552/577 models) on page 189
D3Q15-60168	BDD sensor	Internal assemblies—not shown (300/400/500 series) on page 191
D3Q15-67002	Cover, top (352/452 models)	Covers (352/452 models) on page 179
D3Q17-60009	IDS bracket assembly (500 series)	Internal assemblies—not shown (300/400/500 series) on page 191
D3Q17-67001	Control panel (x45xdw model)	Covers (352/452 models) on page 179
D3Q17-67002	Control panel (x55xdw model)	Covers (552 models) on page 183
D3Q17-67005	Cover, top (552 models)	Covers (552 models) on page 183
D3Q19-60013	Control panel, service assembly (X47xdn model)	Covers (377/477 models) on page 181

Table 2-11 Numerical parts list (continued)

Part number	Description	Table and page
D3Q20-60007	Control panel, service assembly (47x-57xdw models)	Covers (377/477 models) on page 181
D3Q20-60007	Control panel, service assembly (47x-57xdw models)	Covers (577 models) on page 185
D3Q21-67001	Control panel (x45xdn model)	Covers (352/452 models) on page 179
D3Q24-67001	Service Sled Assembly (352/452/377/477 models)	Internal assemblies (352/452/377/477 models) on page 187
D3Q24-67002	Web advance rack assembly	Internal assemblies (352/452/377/477 models) on page 187
D3Q24-67002	Web advance rack assembly	Internal assemblies (552/577 models) on page 189
D3Q24-67002	Service Sled Assembly (552/577 models)	Internal assemblies (552/577 models) on page 189
D3Q24-67003	Eject drive-gear module	Internal assemblies (352/452/377/477 models) on page 187
D3Q24-67003	Eject drive-gear module	Internal assemblies (552/577 models) on page 189
D3Q24-67004	Eject flap assembly	Covers (352/452 models) on page 179
D3Q24-67004	Eject flap assembly	Covers (377/477 models) on page 181
D3Q24-67004	Eject flap assembly	Covers (552 models) on page 183
D3Q24-67004	Eject flap assembly	Covers (577 models) on page 185
D3Q24-67004	Flap actuator solenoid	Internal assemblies—not shown (300/400/500 series) on page 191
D3Q24-67005	Temperature sensor	Internal assemblies—not shown (300/400/500 series) on page 191
D3Q24-67007	Sensor carriage PCA/encoder strip	Internal assemblies—not shown (300/400/500 series) on page 191
D3Q24-67008	Printbar lift mechanism assembly	Internal assemblies—not shown (300/400/500 series) on page 191
D3Q24-67010	Duplex presence sensor PCA	Internal assemblies—not shown (300/400/500 series) on page 191

Table 2-11 Numerical parts list (continued)

Part number	Description	Table and page
D3Q24-67011	Pick encoder distribution PCA	Internal assemblies—not shown (300/400/500 series) on page 191
D3Q24-67012	Feedshaft encoder PCA	Internal assemblies—not shown (300/400/500 series) on page 191
D3Q24-67014	Media presence flag/opto PCA kit	Internal assemblies—not shown (300/400/500 series) on page 191
CN598-67004	Ink collection unit	Internal assemblies (352/452/377/477 models) on page 187
CN598-67004	Ink collection unit	Internal assemblies (552/577 models) on page 189
D3Q24-67016	Duplex drive module	Internal assemblies—not shown (300/400/500 series) on page 191
D3Q24-67017	REDI distribution PCA	Internal assemblies—not shown (300/400/500 series) on page 191
D3Q24-67020	Printbar assembly (552/577 models)	Internal assemblies (552/577 models) on page 189
D3Q24-67022	Cover, rear (300/400 series)	Covers (352/452 models) on page 179
D3Q24-67022	Cover, rear (300/400 series)	Covers (377/477 models) on page 181
D3Q24-67023	Cover, rear (500 series)	Covers (552 models) on page 183
D3Q24-67023	Cover, rear (500 series)	Covers (577 models) on page 185
D3Q24-67024	Cover, left rear	Covers (352/452 models) on page 179
D3Q24-67024	Cover, left rear	Covers (377/477 models) on page 181
D3Q24-67024	Cover, left rear	Covers (552 models) on page 183
D3Q24-67024	Cover, left rear	Covers (577 models) on page 185
D3Q24-67025	Cover, left front	Covers (352/452 models) on page 179
D3Q24-67025	Cover, left front	Covers (377/477 models) on page 181
D3Q24-67025	Cover, left front	Covers (552 models) on page 183

Table 2-11 Numerical parts list (continued)

Part number	Description	Table and page
D3Q24-67025	Cover, left front	Covers (577 models) on page 185
D3Q24-67026	Cover, right (300/400 series)	Covers (352/452 models) on page 179
D3Q24-67026	Cover, right (300/400 series)	Covers (377/477 models) on page 181
D3Q24-67027	Cover, front (300/400 series)	Covers (352/452 models) on page 179
D3Q24-67027	Cover, front (300/400 series)	Covers (377/477 models) on page 181
D3Q24-67028	Hinge, ISS door	Internal assemblies—not shown (300/400/500 series) on page 191
D3Q24-67029	Cover, right (500 series)	Covers (552 models) on page 183
D3Q24-67029	Cover, right (500 series)	Covers (577 models) on page 185
D3Q24-67037	Eject flap opto PCA	Internal assemblies—not shown (300/400/500 series) on page 191
D3Q24-67038	Output bin (300/400 series)	Covers (352/452 models) on page 179
D3Q24-67038	Output bin (300/400 series)	Covers (377/477 models) on page 181
D3Q24-67039	Door, left	Covers (352/452 models) on page 179
D3Q24-67039	Door, left	Covers (377/477 models) on page 181
D3Q24-67039	Door, left	Covers (552 models) on page 183
D3Q24-67039	Door, left	Covers (577 models) on page 185
D3Q24-67042	Cover, front (500 series)	Covers (552 models) on page 183
D3Q24-67042	Cover, front (500 series)	Covers (577 models) on page 185
D3Q24-67043	Output bin (500 series)	Covers (552 models) on page 183
D3Q24-67043	Output bin (500 series)	Covers (577 models) on page 185
D3Q24-67044	Control panel (x47xdn model)	Covers (377/477 models) on page 181

Table 2-11 Numerical parts list (continued)

Part number	Description	Table and page
D3Q24-67048	Main PCA—D3Q15	Internal assemblies—not shown (300/400/500 series) on page 191
D3Q24-67049	Main PCA—D3Q16	Internal assemblies—not shown (300/400/500 series) on page 191
D3Q24-67050	Main PCA—D3Q19	Internal assemblies—not shown (300/400/500 series) on page 191
D3Q24-67051	Main PCA—D3Q20	Internal assemblies—not shown (300/400/500 series) on page 191
D3Q24-67052	Main PCA—D3Q17	Internal assemblies—not shown (300/400/500 series) on page 191
D3Q24-67053	Main PCA—D3Q21 / K9Z76	Internal assemblies—not shown (300/400/500 series) on page 191
D3Q24-67054	Main PCA—J6U55A	Internal assemblies—not shown (300/400/500 series) on page 191
D3Q24-67055	Main PCA—J9V82, service assembly	Internal assemblies—not shown (300/400/500 series) on page 191
D3Q24-67056	Fax PCA	Internal assemblies—not shown (300/400/500 series) on page 191
D3Q24-67058	Document feeder and scanner assembly	Document feeder and scanner on page 177
D3Q24-67058	Scanner/ADF assembly	Covers (377/477 models) on page 181
D3Q24-67058	Scanner/ADF assembly	Covers (577 models) on page 185
D3Q24-67059	Scanner assembly	Document feeder and scanner on page 177
D3Q24-67060	Cover, top (377/477/577 models)	Covers (377/477 models) on page 181
D3Q24-67060	Cover, top (377/477/577 models)	Covers (577 models) on page 185
D3Q24-67061	Power button assembly	Internal assemblies—not shown (300/400/500 series) on page 191
D3Q24-67063	Off-axis IDS (500 series)	Internal assemblies (552/577 models) on page 189
E3E01-60106	Media presence sensor PCA/flag	Internal assemblies—not shown (300/400/500 series) on page 191

Table 2-11 Numerical parts list (continued)

Part number	Description	Table and page
K5H62-60021	Pigtail PB assembly, short	Internal assemblies—not shown (300/400/500 series) on page 191
K5H62-60022	Pigtail PB assembly, tall	Internal assemblies—not shown (300/400/500 series) on page 191
Not supported	Document feeder	Document feeder and scanner on page 177
Not supported	Cover, image scanner base	Covers (377/477 models) on page 181
Not supported	Cover, image scanner base	Covers (577 models) on page 185
Not supported	Console Plate Assembly	Internal assemblies (352/452/377/477 models) on page 187
Not supported	Scanner support (377/477 models)	Internal assemblies (352/452/377/477 models) on page 187
Not supported	Console Plate Assembly	Internal assemblies (552/577 models) on page 189
Not supported	Scanner support (577 models)	Internal assemblies (552/577 models) on page 189

Index

A

- aerosol fan assembly
 - removing 59
- after-service checklist 7

B

- backscatter drop detect (BDD) assembly
 - removing 69

C

- calibration
 - main PCA 57
 - printbar 155
- cartridges
 - part numbers 173
 - removing 8
- cautions iii
- center left paper guide
 - removing 117
- checklists
 - after-service 7
 - preservice 6
- control panel, color
 - removing 24
- control panel, monochrome
 - removing 25
- conventions, document iii
- covers
 - locations 178
 - parts list 178
- cross brace
 - location 0
 - reinstallation 145
 - removing 144

D

- diagrams 161
 - covers 178
 - internal assemblies 186
- document conventions iii
- document feeder
 - removing 84
- document feeder and scanner whole units
 - parts lists and diagrams 176
- drying path gear assembly
 - removing 49
- duplex drive module
 - removing 73
- duplex module
 - removing 11
- duplex module sensor PCA
 - removing 93

E

- eject flap sensor PCA
 - removing 104
- electrostatic discharge (ESD) 2
- ESD (electrostatic discharge)
 - precaution during parts removal 2

F

- fax PCA
 - removing 52
- feed motor encoder sensor PCA
 - removing 91
- front cover, 352, 452, 377, 477 models
 - removing 37
- front cover, 552, 577 models
 - removing 39

I

- IDS bracket
 - removing 122
- inner top frame
 - removing 101
- internal assembly
 - locations 186
 - parts list 186

L

- left door
 - removing 26
- left door restraining strap
 - removing 26
- left front cover
 - removing, 31
- left rear cover
 - removing 28

M

- main PCA
 - calibration 57
 - removing 54
- media presence sensor PCA/flag
 - removing 136

N

- notes iii

O

- output bin
 - removing 11
- output bin flap
 - removing 23
- output drive gears
 - removing 97
- output drive shaft 3
 - removing 105

- output drive shaft 4
 - removing 112
- output drive shaft 5
 - removing 107
- output drive shaft 6
 - removing 98
- output eject drive kit
 - removing 88

P

- paper REDI sensors
 - removing 158
- part numbers
 - cartridges 173
 - replacement parts 173
 - supplies 173
- parts 161
 - cover locations 178
 - internal assembly locations 186
- parts lists and diagrams
 - document feeder and scanner whole units 176
- PCA safety shield
 - removing 51
- pick encoder distribution PCA
 - removing 66
- platen
 - removing 140
- pliers, required 3
- post-service tests 7
- power button PCA
 - removing 95
- power supply
 - removing 71
- preservice checklist 6
- print quality
 - test 7
- printbar
 - calibration 155
 - removing 147
- printbar lift mechanism assembly
 - removing 64
- printzone distribution PCA
 - removing 138

R

- rear cover, 352, 452, 377, 477 models
 - removing 30
- rear cover, 552, 577 models
 - removing 29

- REDI distribution PCA
 - removing 96
- removing
 - aerosol fan assembly 59
 - backscatter drop detect (BDD) assembly 69
 - cartridges 8
 - center left paper guide 117
 - control panel, color 24
 - control panel, monochrome 25
 - cross brace 144
 - document feeder 84
 - drying path gear assembly 49
 - duplex drive module 73
 - duplex module 11
 - duplex module sensor PCA 93
 - eject flap opto PCA 104
 - fax PCA 52
 - feed motor encoder sensor PCA 91
 - front cover, 352, 452, 377, 477 models 37
 - front cover, 552, 577 models 39
 - IDS bracket 122
 - inner top frame 101
 - left door 26
 - left door restraining strap 26
 - left front cover 31
 - left rear cover 28
 - main PCA 54
 - media presence sensor PCA/flag 136
 - output bin 11
 - output bin flap 23
 - output drive gears 97
 - output drive shaft 3 105
 - output drive shaft 4 112
 - output drive shaft 5 107
 - output drive shaft 6 98
 - output eject drive kit 88
 - paper REDI sensors 158
 - PCA safety shield 51
 - pick encoder distribution PCA 66
 - platen 140
 - power button PCA 95
 - power supply 71
 - printbar 147
 - printbar lift mechanism assembly 64
 - printzone distribution PCA 138

- rear cover, 352, 452, 377, 477 models 30
- rear cover, 552, 577 models 29
- REDI distribution PCA 96
- right cover 47
- scanner assembly 78
- sensor carriage PCA and encoder strip 75
- separator/pick assembly 132
- service sled 128
- service sled transmission 67
- supply door hinge, 352, 452, 377, 477 models 41
- supply door hinge, 552, 557 models 44
- temperature sensor 50
- top cap 86
- top cover, MFP 33
- top cover, SFP 35
- top left paper guide 114
- top paper guide 109
- Tray 2 8
- tray 3 interconnect PCA 58
- tray lift transmission assembly 119
- web advance rack assembly 146
- removing parts
 - cautions for 2
 - checklists 6
 - tools, required 3
- replacement parts
 - part numbers 173
- replacing
 - parts 2
- right cover
 - removing 47

S

- scanner assembly
 - location 0
 - removing 78
- screwdrivers, required 3
- screws
 - replacing 2
- sensor carriage PCA and encoder strip
 - removing 75
- separator/pick assembly
 - removing 132
- service
 - tools, required 3

- service and support information
 - 162, 173
- service sled
 - removing 128
- service sled transmission
 - removing 67
- static precautions 2
- supplies
 - part numbers 173
- supply door hinge, 352, 452, 377, 477 models
 - removing 41
- supply door hinge, 552, 557 models
 - removing 44

T

- temperature sensor
 - removing 50
- tests
 - post-service 7
 - print-quality 7
- tips iii
- tools, required 3
- top cap
 - removing 86
- top cap, removing 86
- top cover, MFP
 - removing 33
- top cover, SFP
 - removing 35
- top left paper guide
 - removing 114
- top paper guide
 - removing 109
- Tray 2
 - removing 8
- Tray 3 interconnect PCA
 - removing 58
- tray lift transmission assembly
 - removing 119

W

- warnings iii
- web advance rack assembly
 - removing 146

