



Lexmark™

CS720, CS725, and C4150

5028-135, -630, -639

Service Manual

- [Start diagnostics](#)
- [Maintenance](#)
- [Safety and notices](#)
- [Trademarks](#)
- [Index](#)

January 25, 2016

www.lexmark.com

Product information

Product name:

Lexmark(TM) CS720de, CS720dte, CS725de, CS725dte

Machine type:

5028

Model(s):

135, 630

Edition notice

January 25, 2016

The following paragraph does not apply to any country where such provisions are inconsistent with local law: LEXMARK INTERNATIONAL, INC., PROVIDES THIS PUBLICATION “AS IS” WITHOUT WARRANTY OF ANY KIND, EITHER EXPRESS OR IMPLIED, INCLUDING, BUT NOT LIMITED TO, THE IMPLIED WARRANTIES OF MERCHANTABILITY OR FITNESS FOR A PARTICULAR PURPOSE. Some states do not allow disclaimer of express or implied warranties in certain transactions; therefore, this statement may not apply to you.

This publication could include technical inaccuracies or typographical errors. Changes are periodically made to the information herein; these changes will be incorporated in later editions. Improvements or changes in the products or the programs described may be made at any time.

References in this publication to products, programs, or services do not imply that the manufacturer intends to make these available in all countries in which it operates. Any reference to a product, program, or service is not intended to state or imply that only that product, program, or service may be used. Any functionally equivalent product, program, or service that does not infringe any existing intellectual property right may be used instead. Evaluation and verification of operation in conjunction with other products, programs, or services, except those expressly designated by the manufacturer, are the user's responsibility.

Trademarks

Lexmark and the Lexmark logo are trademarks of Lexmark International, Inc., registered in the United States and/or other countries. PCL® is a registered trademark of the Hewlett-Packard Company. PCL is Hewlett-Packard Company's designation of a set of printer commands (language) and functions included in its printer products. This printer is intended to be compatible with the PCL language. This means the printer recognizes PCL commands used in various application programs, and that the printer emulates the functions corresponding to the commands.

PostScript is a registered trademark of Adobe Systems Incorporated in the United States and/or other countries.

All other trademarks are the property of their respective owners.

© 2016 Lexmark International, Inc.

All rights reserved.

P/N 12G3399

Table of contents

Product information.....	2
Edition notice.....	2
Notices and safety information.....	13
Laser notice.....	13
Avis relatif à l'utilisation du laser.....	13
Notificació del làser.....	13
Aviso de láser.....	13
Aviso sobre laser.....	14
Avvertenze sui prodotti laser.....	14
Laserinformatie.....	14
Lasererklæring.....	14
Laser-Hinweis.....	15
Laserilmoitus.....	15
Lasermerknad.....	15
Meddelande om laser.....	15
レーザーについて.....	16
레이저 고지사항.....	16
激光注意事项.....	16
雷射聲明.....	16
Safety information.....	16
Consignes de sécurité.....	17
Informació de seguretat.....	17
Información de seguridad.....	18
Informações sobre segurança.....	18
Informatie over veiligheid.....	18
Informazioni sulla sicurezza.....	19
Säkerhetsinformation.....	19
Sicherheitshinweise.....	20
Sikkerhedsoplysninger.....	20
Sikkerhetsinformasjon.....	20
Turvallisuusohjeet.....	21
안전 정보.....	21

安全信息.....	21
安全情報.....	22
安全資訊.....	22
Preface.....	23
Conventions.....	23
General caution statements.....	23
General information.....	25
Finding the serial number.....	25
Paper and specialty media guide.....	26
Paper guidelines.....	26
Using specialty media.....	27
Supported paper sizes, types, and weights.....	29
Data security notice.....	31
Tools required for service.....	31
Diagnostic information.....	33
Troubleshooting overview.....	33
Performing the initial troubleshooting check.....	33
Power-on reset (POR) sequence.....	33
Fixing print quality issues.....	34
Initial print quality check.....	34
Toner easily rubs off check.....	34
Background or gray background check.....	36
Blank or white pages check.....	37
Gapping or half color page check.....	39
Blurred print or color misalignment check.....	40
Horizontal colored lines or banding check.....	41
Text or images cut off check.....	43
Mottled print and dots check.....	43
Vertical white lines check.....	44
Ghost images check.....	46
Solid color or black image check.....	47
Vertical colored lines or banding check.....	48
Image void scan direction check.....	49
Image void process direction check.....	51
Dark print check.....	52
Missing color check.....	53
Uneven print density check.....	54
Repeating defects check.....	55
Random marks check.....	57

Light print check	57
Skewed print service check	60
Paper jams.....	61
Avoiding jams	61
Identifying jam locations.....	63
Paper jam in trays	64
Paper jam in the multipurpose feeder	65
Paper jam in the standard bin	65
Paper jam in door A	66
200 paper jams.....	69
201 paper jams.....	75
202 paper jams.....	76
203 paper jams.....	84
211 paper jams	85
221 paper jams	86
230 paper jams	87
231 paper jams	93
232 paper jams	99
240 paper jams.....	104
241 paper jams	116
242–244 paper jams	124
User attendance messages.....	149
31 user attendance error messages	149
32 user attendance error messages.....	149
33 user attendance error messages	150
42 user attendance error messages.....	151
43 user attendance error messages.....	151
80 user attendance error messages.....	152
82 user attendance error messages.....	152
83 user attendance error messages	152
84 user attendance error messages.....	153
85 user attendance error messages.....	154
88 user attendance error messages.....	155
Non-supply user attendance error messages.....	155
Missing toner, developer, or photoconductor service check.....	156
Waste toner bottle service check.....	158
Region mismatch service check.....	158
Maintenance kit service check	159
Cartridge or photoconductor error service check.....	159
Mismatched paper size service check	160
Insufficient memory service check	161
Complex page service check.....	161
Flash memory failure service check.....	162
Insufficient flash memory service check	162

Unsupported internal option service check.....	163
Disabled port service check.....	163
Excess options service check.....	164
Incompatible hardware option service check.....	165
Hard disk failure service check.....	165
Printer hardware errors.....	166
1yy errors.....	166
6yy errors.....	201
9yy errors.....	207
Symptoms.....	223
Base printer symptoms.....	223
Control panel service check.....	223
Interlock switch service check.....	224
Sensor (narrow media) and sensor (fuser buckle) service check.....	226
Dead machine service check.....	226
Mobile solutions module NFC service check.....	228
Network service check.....	229
Toner meter cycle (TMC) card service check.....	232
USB service check.....	233
Control panel USB cable service check.....	233
Toner patch sensing service check.....	234
Auto alignment service check.....	236

Service menus..... 241

Understanding the printer control panel.....	241
Using the control panel.....	241
Understanding the status of the power button and indicator light.....	242
Using the home screen.....	242
Menu list.....	243
Diagnostics menu.....	244
Entering the Diagnostics menu.....	244
Event Log.....	244
Reports.....	245
Advanced Print Quality Samples.....	245
Input tray quick print.....	245
Printer Setup.....	246
Printer diagnostics and adjustments.....	248
Additional input tray diagnostics.....	250
Service Engineer menu.....	250
Entering Invalid engine mode.....	250
Entering the Service Engineer (SE) menu.....	250
General SE.....	251
Network SE.....	251

Repair information.....	253
Removal precautions.....	253
Data security notice	253
Handling ESD-sensitive parts.....	254
Controller board/control panel replacement	254
Restoring the printer configuration after replacing the controller board	255
Restoring solutions, licenses, and configuration settings	258
Updating the printer firmware	259
Backing up eSF solutions and settings	260
Disconnecting ribbon cables.....	260
Adjustments.....	261
Printhead alignment adjustment	261
Registration adjustment.....	263
Removal procedures.....	265
Cover removals.....	265
Front cover removal.....	265
Top cover removal.....	268
Left cover removal	271
Right cover removal.....	272
Motor cover removal	273
Toner door removal.....	276
Toner door mount bracket removal.....	278
Toner door mount removal	279
External air filter removal.....	280
Control panel removals.....	280
Upper control panel removal	280
Badge cover removal	283
Number pad cover removal.....	284
Control panel arms removal	284
Speaker removal	286
Control panel base cover removal	287
Duplex removals.....	289
Duplex outer guide removal.....	289
Duplex inner guide removal	291
Pivot shaft removal.....	291
Tensioner belt removal	292
Sensor (duplex) removal.....	293
Sensors (fuser buckle and narrow media) removal.....	294
Left removals.....	296
Motor (EP drive) removal	296
Power cable removal.....	297
Motor (output) removal.....	297

Motor (deskew) removal	299
Fuser fan removal.....	299
Main fan removal	301
EP gear box removal	302
LVPS removal.....	305
LVPS cage removal	308
Motor (black only retract) removal	309
Right removals.....	311
Sensor (weather station) removal	311
Sensor (paper size) removal.....	312
Sensor (waste toner contact) removal	314
TMC card removal.....	315
Motor (duplex/MPF) removal	315
Motor (fuser) removal	318
HVPS removal	319
Sensor (MPF paper present) removal	322
Waste toner bottle idler gear removal	324
Imaging unit cover removal	324
Sensor (TPS) removal.....	325
TPS sled removal.....	327
Toner cartridge contacts removal	328
TPS wiper mechanism removal	330
TPS wiper removal.....	332
Front removals.....	333
Fuser removal.....	333
Transfer module removal.....	334
Transfer module guide rail removal.....	336
Sensor (media type) removal.....	340
Sensor (input) removal	341
Deskew rollers removal	342
Diverter removal	350
Redrive guide removal.....	354
Sensor (redrive) removal	354
Rear removals.....	356
Controller board shield removal.....	356
Inner controller board shield removal.....	357
Controller board removal	357
TPS cables removal	359
Secure element SIM card removal.....	360
Top removals.....	361
Printhead removal	361
Developer hold down removal	363
Output roll removal	364
Output bin exit cover removal	367

Output bin flag removal	367
Bottom removals.....	368
Front cover hinges removal.....	368
Tray rail removal.....	369
Aligner idler gears removal	370
Isolation unit removal	371
Media feeder removal	373
550-sheet tray removals.....	375
550-sheet tray right cover removal.....	375
Motor (550-sheet tray pass-through) removal.....	376
550-sheet tray paper feeder removal	378
Sensor (550-sheet tray pass-through) removal.....	379
Sensor (550-sheet tray trailing edge) removal.....	380
Sensor (550-sheet tray paper size) removal.....	380
550-sheet tray controller board assembly removal.....	382
550-sheet tray interface cable removal	383
550-sheet tray empty sensor actuator removal.....	384
Sensor (550-sheet tray empty) removal.....	385
Sensor (550-sheet tray index) removal	386
Component locations.....	389
Printer configurations.....	389
Controller board connectors.....	390
LVPS controller board connectors.....	402
Motor locations.....	404
Sensor locations.....	405
Maintenance.....	407
Inspection guide.....	407
Scheduled maintenance.....	408
Maintenance kits.....	408
Identifying the type of fuser used in the printer	409
Cleaning the printer.....	410
Cleaning the printer	410
Cleaning the printhead lenses.....	410
Cleaning the main tray duplex turnaround.....	411
Parts catalog.....	412
Legend.....	412
Assembly 1: Covers 1.....	413
Assembly 2: Covers 2.....	415

Assembly 3: Control panel.....	417
Assembly 4: Fuser.....	419
Assembly 5: Transfer module.....	421
Assembly 6: Paper feed.....	423
Assembly 7: Paper path 1.....	425
Assembly 8: Paper path 2.....	427
Assembly 9: Duplex.....	429
Assembly 10: Electrical.....	431
Assembly 11: 550-sheet tray option 1.....	435
Assembly 12: 550-sheet tray option 2.....	437
Assembly 13: Adjustable stand.....	439
Assembly 14: Miscellaneous parts.....	441
Assembly 15: Power cords.....	443

Appendix A: Printer specifications.....445

Power consumption.....	445
Product power consumption	445
Sleep Mode.....	445
Hibernate Mode.....	445
Off mode	446
Total energy usage	446
Selecting a location for the printer.....	446
Noise emission levels.....	447
Temperature information.....	447

Appendix B: Options and features.....449

Available internal options.....	449
Installing optional trays.....	449
Adding available options in the print driver.....	450

Appendix C: Theory of operation.....453

Paper path and transport components.....	453
Tray section	453
MPF section	454
Isolation unit section.....	455
Aligner section	456
Fuser section	458
Duplex section	459
Print engine theory.....	461

Electrophotographic process	461
EP process basics	461
Color theory.....	469
Color theory	469
Appendix D: Acronyms.....	473
Acronyms.....	473
Index.....	475
Part number index.....	481
Part name index.....	487

Notices and safety information

Laser notice

The printer is certified in the U.S. to conform to the requirements of DHHS 21 CFR, Chapter I, Subchapter J for Class I (1) laser products, and elsewhere is certified as a Class I laser product conforming to the requirements of IEC 60825-1.

Class I laser products are not considered to be hazardous. The printer contains internally a Class IIIb (3b) AlGaInP laser that is nominally 15-milliwatts operating in the wavelength region of 650–670 nanometers and enclosed in a non-serviceable printhead assembly. The laser system and printer are designed so there is never any human access to laser radiation above a Class I level during normal operation, user maintenance, or prescribed service conditions.

Avis relatif à l'utilisation du laser

Cette imprimante est certifiée conforme aux exigences de la réglementation des Etats-Unis relative aux produits laser de classe I (1) (DHHS 21 CFR, Chapitre I, Sous-chapitre J). Pour les autres pays, elle est certifiée conforme aux exigences des normes CEI 60825-1 relatives aux produits laser de classe I.

Les produits laser de Classe I ne sont pas considérés comme dangereux. L'imprimante contient un dispositif laser AlGaInP (aluminium, gallium, indium et phosphore) de classe IIIb (3b) d'une puissance nominale de 15 milliwatts fonctionnant dans la plage de longueurs d'onde allant de 650 à 670 nanomètres et scellé dans un compartiment de têtes d'impression non réparable. Le système laser ainsi que l'imprimante ont été conçus de manière à ce que personne ne soit jamais exposé à des radiations laser dépassant le niveau de classe I dans le cadre d'un fonctionnement normal, de l'entretien par l'utilisateur ou de la maintenance.

Notificació del làser

La impressora està certificada als EUA per complir els requeriments de DHHS 21 CFR, capítol I, subcapítol J per a productes de làser Classe I (1), i a la resta del món s'ha certificat com productes de làser Classe I segons els requeriments de la norma IEC 60825-1.

Els productes de làser Classe I no es consideren perillosos. La impressora conté un làser intern Classe IIIb (3b) AlGaInP que normalment és de 15 miliwatts, que funciona a la regió de longitud d'ona de 650 a 670 nanòmetres i es troba dins d'una unitat de capçals d'impressió no substituïble. El sistema làser i la impressora estan dissenyats de manera que les persones no estiguin exposades a una radiació del làser superior al nivell de Classe I durant el funcionament normal, el manteniment de l'usuari o les condicions de servei prescrites.

Aviso de láser

Esta impresora se ha certificado en EE.UU. cumpliendo con los requisitos de DHHS 21 CFR, capítulo I, subcapítulo J para los productos láser de Clase I (1) y en otros países está certificada como un producto láser de Clase I de acuerdo con los requisitos de IEC 60825-1.

Los productos láser de Clase I no se consideran peligrosos. Este producto contiene un láser interno de Clase IIIb (3b) AlGaInP que opera nominalmente a 20 milivatios en una longitud de onda de 650–670 nanómetros cerrado en un conjunto de cabezal de impresión que no se puede reparar. El sistema láser y la impresora se

han diseñado para que el ser humano no acceda nunca a las radiaciones láser por encima del nivel de Clase I durante su uso normal, ni en tareas de mantenimiento o intervenciones de servicio técnico prescritas.

Aviso sobre laser

Esta impressora foi certificada nos EUA por estar em conformidade com os requisitos do DHHS 21 CFR capítulo I, subcapítulo J, para produtos a laser de Classe I (1) e, nos demais países, foi certificada como um produto a laser de Classe I em conformidade com os requisitos da IEC 60825-1.

Os produtos a laser de Classe I não são considerados prejudiciais. A impressora contém, internamente, um laser de Classe IIIb (3b) AlGaInP que funciona nominalmente a 15 miliwatts no comprimento de onda de 650-670 nanômetros, incluso em um conjunto do cabeçote de impressão sem possibilidade de manutenção. O sistema do laser e a impressora foram projetados para que jamais haja acesso humano à radiação do laser acima do nível da Classe I durante a operação normal ou a manutenção pelo usuário ou sob as condições de manutenção prescritas.

Avvertenze sui prodotti laser

La stampante è certificata negli Stati Uniti come prodotto conforme ai requisiti DHHS 21 CFR Capitolo I, Sottocapitolo J per i prodotti laser di Classe I (1), mentre in altri paesi è certificata come prodotto laser di Classe I conforme ai requisiti IEC 60825-1.

I prodotti laser di Classe I non sono considerati pericolosi. La stampante contiene internamente un laser AlGaInP di Classe IIIb (3b) con valore nominale di 15 milliwatt, funzionante nella regione della lunghezza d'onda dei 650-670 nanometri e contenuto in un gruppo testina di stampa non riparabile. Il sistema laser e la stampante sono stati progettati in modo da impedire l'esposizione a radiazioni laser superiori al livello previsto dalla Classe I durante le normali operazioni di stampa, manutenzione o assistenza.

Laserinformatie

De printer is in de Verenigde Staten gecertificeerd als een product dat voldoet aan de vereisten van DHHS 21 CFR hoofdstuk 1, paragraaf J voor laserproducten van klasse I (1). Elders is de printer gecertificeerd als een laserproduct van klasse I dat voldoet aan de vereisten van IEC 60825-1.

Laserproducten van klasse I worden geacht geen gevaar op te leveren. De printer bevat intern een laser van klasse IIIb (3b) AlGaInP met een nominaal vermogen van 15 milliwatt in een golflengtebereik van 650-670 nanometer in een niet-bruikbare printkopenheid. Het lasersysteem en de printer zijn zodanig ontworpen dat gebruikers nooit blootstaan aan laserstraling die hoger is dan het toegestane niveau voor klasse I-apparaten, tijdens normaal gebruik, onderhoudswerkzaamheden door de gebruiker of voorgeschreven servicewerkzaamheden.

Lasererklæring

Printeren er certificeret i USA i henhold til kravene i DHHS 21 CFR kapitel I, underafsnit J for klasse I (1) laserprodukter og er andre steder certificeret som et klasse I-laserprodukt i henhold til kravene i IEC 60825-1.

Klasse I-laserprodukter er ikke anset som farlige. Printeren indeholder internt en Klasse IIIb (3b) AlGaAs-laser, der nominelt er en 15 milliwatt laser, som fungerer i bølglængdeområdet 650–670 nanometer og indbygget i en printhovedenhed, der ikke er servicierbar. Lasersystemet og printeren er designet på en sådan måde, at

der ikke er en direkte laserstråling, der overskrider Klasse I-niveauet under normal brug, brugers vedligeholdelse eller de foreskrevne servicebetingelser.

Laser-Hinweis

Der Drucker wurde in den USA zertifiziert und entspricht den Anforderungen der Vorschriften DHHS 21 CFR Kapitel I für Laserprodukte der Klasse I (1), andernorts ist er als Laserprodukt der Klasse I zertifiziert, das den Anforderungen von IEC 60825-1 entspricht.

Laserprodukte der Klasse I werden nicht als gefährlich betrachtet. Der Drucker enthält im Inneren einen Laser der Klasse IIIb (3b) AlGaInP mit 15 Milliwatt, im Wellenlängenbereich von 650 bis 670 Nanometern arbeitet. Dieser befindet sich in einer Druckkopfeinheit, die nicht gewartet werden kann. Das Lasersystem und der Drucker sind so konstruiert, dass unter normalen Betriebsbedingungen, bei der Wartung durch den Benutzer oder bei den vorgeschriebenen Wartungsbedingungen Menschen keiner Laserstrahlung ausgesetzt sind, die die Werte für Klasse I überschreitet.

Laserilmoitus

Tämä tulostin on sertifioitu Yhdysvalloissa DHHS 21 CFR, Chapter I, Subchapter J -standardin mukaiseksi luokan I (1) -lasertuotteeksi ja muualla IEC 60825-1 -standardin mukaiseksi luokan I lasertuotteeksi.

Luokan I lasertuotteita ei pidetä haitallisina. Tulostimen sisällä on luokan IIIb (3b) AlGaInP -laser, jonka nimellisteho on 15 mW milliwatts, joka toimii 650–670 nanometrillä aallonpituuksilla ja joka on suljettu tulostuspäähän, jota käyttäjä ei voi huoltaa. Laserjärjestelmä ja tulostin ovat rakenteeltaan sellaisia, että käyttäjä ei joudu alttiiksi luokkaa 1 suuremmalle säteilylle normaalin käytön, ylläpidon tai huollon aikana.

Lasermerknad

Skrivaren er sertifisert i USA for samsvar med kravene i DHHS 21 CFR, kapittel I, underkapittel J for laserprodukter av klasse I (1) og er andre steder sertifisert som et laserprodukt av klasse I som samsvarer med kravene i IEC 60825-1.

Laserprodukter av klasse I anses ikke som helseskadelige. Skrivaren inneholder en intern AlGaInP-laser av klasse IIIb (3b) på nominelt 15 milliwatt, som opererer i bølgelengder på 650–670 nanometer, inne i en skrivhodeenhet som ikke kan vedlikeholdes. Lasersystemet og skrivaren er utformet slik at mennesker ikke utsettes for laserstråling utover nivået i klasse I under normal drift, vedlikehold eller foreskrevet service.

Meddelande om laser

Skrivaren är certifierad i USA i enlighet med kraven i DHHS 21 CFR kapitel I, underkapitel J för klass I (1)-laserprodukter, och på andra platser certifierad som en klass I-laserprodukt i enlighet med kraven i IEC 60825-1.

Laserprodukter av klass I anses inte vara skadliga. Skrivaren innehåller en klass IIIb (3b) AlGaInP-laser på nominellt 15 mW som arbetar inom en våglängd på 650–670 nm och är innesluten i en icke-servicebar skrivhuvudenhet. Lasersystemet och skrivaren är utformade så att människor aldrig utsätts för laserstrålning över klass I-nivå under normala förhållanden vid användning, underhåll eller service.

レーザーについて

本機は、米国においてクラス I(1)レーザー製品に対する DHHS 21 CFR、Chapter I、Subchapter J の要件に準拠し、その他の国では IEC 60825-1 の要件に準拠するクラス Iレーザー製品として認可されています。

クラス Iレーザー製品は、危険性がないとみなされています。本機には、クラス IIIb(3b) AlGaInP レーザーが内蔵されています。これは、650 ~ 670 ナノメートルの波長で、定格 15 ミリワットで動作するレーザーであり、整備不可のプリントヘッドアセンブリに収容されています。レーザーシステムとプリンタは、通常の操作、ユーザーによるメンテナンス、または所定のサービス条件の下で、ユーザーがクラス Iレベルを超えるレーザー放射に絶対にさらされないように設計されています。

레이저 고지사항

프린터는 미국에서 레이저 제품용 DHHS 21 CFR Chapter I, Subchapter J의 요구 사항을 준수하며 이외 지역에서 IEC 60825-1의 요구 사항을 준수하는 클래스 I(1) 레이저 제품으로 승인되었습니다.

Class I 레이저 제품은 위험한 제품으로 간주되지 않습니다. 프린터에는 650~670 나노미터 범위의 파장 영역에서 공칭 작동하는 15밀리와트 AlGaInP 레이저인 클래스 IIIb(3b) 레이저가 내부에 포함되어 있으며 서비스 불가 프린트 헤드 어셈블리가 포함되어 있습니다. 레이저 시스템과 프린터는 정상적인 작동, 사용자 유지 관리 또는 사전 설명된 서비스 조건에는 사람에게 클래스 I 수준 이상의 레이저 방사가 노출되지 않도록 설계되었습니다.

激光注意事项

本打印机在美国认证合乎 DHHS 21 CFR Chapter I, Subchapter J 对分类 I (1) 激光产品的标准，而在其他地区则被认证是合乎 IEC 60825-1 的分类 I 激光产品。

一般认为分类 I 激光产品不具有危险性。本打印机内部含有分类 IIIb (3b) 的磷化铝镓铟激光，标称值为 15 毫瓦，其工作波长范围在 650 - 670nm 之间，并被封闭在不可维修的打印头配件中。本激光系统及打印机的设计，在一般操作、使用者维护或规定内的维修情况下，不会使人体接触分类 I 以上等级的辐射。



雷射聲明

本印表機係經過美國核可，符合 DHHS 21 CFR, Chapter I, Subchapter J 規定的 I (1) 級雷射產品；在美國以外的地區，為符合 IEC 60825-1 規定的 I 級雷射產品。



根據 I 級雷射產品的規定，這類產品不會對人體造成傷害。本印表機所採用之 IIIb (3b) 級 AlGaInP 雷射在 650 至 670 奈米 (nanometer) 波長範圍內運作時通常為 15 毫瓦特 (milliwatt)，且含括在不可修復列印頭組件中。使用者只要以正確的方法操作及維護保養，並依照先前所述之維修方式進行修護，此印表機與其雷射系統絕不會產生 I 級以上的放射線，而對人體造成傷害。

Safety information



- The safety of this product is based on testing and approvals of the original design and specific components. The manufacturer is not responsible for safety in the event of use of unauthorized replacement parts.
- The maintenance information for this product has been prepared for use by a professional service person and is not intended to be used by others.
- There may be an increased risk of electrical shock and personal injury during disassembly and servicing of this product. Professional service personnel should understand this risk and take necessary precautions.

-  **CAUTION—SHOCK HAZARD:** When you see this symbol, there is a danger from hazardous voltage in the area of the product where you are working. Unplug the product before you begin, or use caution if the product must receive power in order to perform the task.
-  **CAUTION—POTENTIAL INJURY:** The lithium battery in this product is not intended to be replaced. There is a danger of explosion if a lithium battery is incorrectly replaced. Do not recharge, disassemble, or incinerate a lithium battery. Discard used lithium batteries according to the manufacturer's instructions and local regulations.

Consignes de sécurité

- La sécurité de ce produit est basée sur des tests et certifications de sa conception d'origine et de ses composants spécifiques. Le fabricant décline toute responsabilité en cas d'utilisation de pièces de rechange non autorisées.
 - Les informations de maintenance de ce produit sont destinées à des professionnels qualifiés et ne sont pas conçues pour être utilisées par d'autres personnes.
 - Il existe un risque potentiel de choc électrique et de blessures lors du démontage et de la maintenance de ce produit. Le personnel professionnel de maintenance doit comprendre les risques et prendre les précautions nécessaires.
-  **ATTENTION—RISQUE D'ELECTROCUTION :** Ce symbole indique un danger lié à des niveaux de tension dangereux dans la zone du produit à manipuler. Débranchez le produit avant de commencer, ou agissez avec prudence si le produit doit être alimenté pour effectuer l'opération.
-  **ATTENTION—RISQUE DE BLESSURE :** La batterie lithium de ce produit n'est pas destinée à être remplacée. Si vous ne respectez pas les instructions de remplacement de la batterie, vous risquez de provoquer une explosion. Ne rechargez pas, ne désassemblez pas et ne brûlez pas la batterie au lithium. Mettez les batteries lithium usagées au rebut selon les instructions du fabricant et les réglementations locales.

Informació de seguretat

- La seguretat d'aquest producte es basa en les proves i les homologacions del disseny original i dels components específics. El fabricant no és responsable de la seguretat en el cas d'ús de peces de recanvi no autoritzades.
 - La informació de manteniment d'aquest producte s'ha preparat per a l'ús d'un professional tècnic i no per a l'ús d'altres persones.
 - És possible que el risc de descàrrega elèctrica i lesions personals augmenti durant el desmuntatge i les tasques de manteniment d'aquest producte. El professional tècnic ha de comprendre aquest risc i prendre les precaucions necessàries.
-  **ATENCIÓ: PERILL DE DESCÀRREGA:** Quan vegeu aquest símbol, indica que hi ha un perill de voltatge elevat en l'àrea del producte on esteu treballant. Desconnecteu el producte abans de començar o tingueu precaució si el producte ha de rebre alimentació per realitzar la tasca.
-  **ATENCIÓ: POSSIBLES DANYS:** La bateria de liti d'aquest producte no ha estat dissenyada perquè se substitueixi. Hi ha perill d'explosió si no es substitueix correctament la bateria de liti. No recarregueu, desmunteu o incinereu una bateria de liti. Desfeu-vos de les bateries de liti usades d'acord amb les instruccions del fabricant i les regulacions locals.

Información de seguridad

- La seguridad de este producto se basa en las pruebas y comprobaciones del diseño original y los componentes específicos. El fabricante no se hace responsable de la seguridad en caso de uso de piezas de repuesto no autorizadas.
- La información de mantenimiento de este producto se ha preparado para su uso por parte de un profesional de asistencia técnica y no está diseñada para su uso por parte de otros usuarios.
- Es posible que haya un mayor riesgo de descarga eléctrica y daños personales durante el desmontaje y el mantenimiento de este producto. El personal de asistencia profesional debe conocer este riesgo y tomar las precauciones necesarias.

 **PRECAUCIÓN: PELIGRO DE DESCARGAS ELÉCTRICAS** Cuando vea este símbolo, existe peligro de tensiones peligrosas en el área del producto en la que está trabajando. Desconecte el producto antes de empezar o tenga cuidado si el producto debe recibir alimentación a fin de realizar la tarea.

 **PRECAUCIÓN: POSIBLES DAÑOS PERSONALES:** La batería de litio de este producto no debe reemplazarse. Existe riesgo de explosión si se sustituye incorrectamente una batería de litio. No recargue, desmonte ni incinere una batería de litio. Deseche las baterías de litio usadas según las instrucciones del fabricante y las normativas locales.

Informações sobre segurança

- A segurança deste produto é baseada em testes e aprovações do design original e de componentes específicos. O fabricante não é responsável por segurança em caso de uso não autorizado de peças de substituição.
- As informações sobre manutenção deste produto foram preparadas para utilização por um técnico profissional experiente e não se destinam ao uso por outros.
- Pode haver maior risco de choque elétrico e danos pessoais durante a desmontagem e manutenção deste produto. Os técnicos profissionais experientes devem entender esses riscos e tomar as precauções necessárias.

 **ATENÇÃO—PERIGO DE CHOQUE:** Se você vir este símbolo, existe perigo de tensão elétrica na área do produto onde está trabalhando. Desligue o produto antes de começar ou tenha cuidado se o produto precisar receber energia para executar a tarefa.

 **ATENÇÃO — RISCO DE FERIMENTO:** A bateria de lítio neste produto não deve ser substituída. Existe o risco de explosão se uma bateria de lítio for substituída incorretamente. Não recarregue, desmonte nem incinere uma bateria de lítio. Descarte as baterias de lítio usadas de acordo com as instruções do fabricante e regulamentos locais.

Informatie over veiligheid

- De veiligheid van dit product is gebaseerd op testen en goedkeuringen van het oorspronkelijke ontwerp en specifieke onderdelen. De fabrikant is niet verantwoordelijk voor de veiligheid bij gebruik van ongeautoriseerde vervangende onderdelen.
- De informatie over het onderhoud van dit product is opgesteld voor gebruik door een professionele onderhoudsmonteur en is niet bedoeld voor gebruik door anderen.
- Tijdens demontage en onderhoud van dit product bestaat mogelijk een hoger risico op elektrische schokken en lichamelijk letsel. Professionele onderhoudsmonteurs dienen op de hoogte te zijn van dit risico en de noodzakelijke voorzorgsmaatregelen te nemen.

 **LET OP—KANS OP ELEKTRISCHE SCHOK:** Wanneer u dit symbool ziet, bestaat er een gevaar voor gevaarlijke spanning in het gebied van het product waaraan u werkt. Haal de stekker van het product uit het stopcontact voordat u begint, of let extra goed op als het product stroom nodig heeft om een taak te kunnen uitvoeren.

 **LET OP—KANS OP LETSEL:** De lithiumbatterij in dit product moet niet worden vervangen. Wanneer de lithiumbatterij niet juist wordt vervangen, bestaat er explosiegevaar. Probeer nooit lithiumbatterijen op te laden, open te maken of te verbranden. Gooi gebruikte lithiumbatterijen weg volgens de aanwijzingen van de fabrikant en houd hierbij de plaatselijke regelgeving in acht.

Informazioni sulla sicurezza

- La sicurezza di questo prodotto è basata sui test e sulle approvazioni del design originale e dei componenti specifici. Il produttore non è responsabile della sicurezza in caso di utilizzo di parti di ricambio non autorizzate.
- Le informazioni di manutenzione per questo prodotto sono state predisposte per essere utilizzate da un tecnico dell'assistenza professionale e non sono state previste per l'uso da parte di altre persone.
- È possibile che vi sia un maggior rischio di scosse elettriche e lesioni personali durante lo smontaggio e la manutenzione di questo prodotto. Il personale dell'assistenza deve comprendere questo rischio e prendere le precauzioni necessarie.

 **ATTENZIONE — PERICOLO DI SCOSSA:** Questo simbolo indica la presenza di un rischio per tensioni pericolose nell'area del prodotto in cui si lavora. Scollegare l'alimentazione prima di iniziare, o prestare la massima attenzione se per effettuare l'operazione il prodotto deve ricevere l'alimentazione.

 **ATTENZIONE — PERICOLO DI LESIONI:** La batteria al litio contenuto nel prodotto non deve essere sostituita: in caso di sostituzione errata della batteria al litio, potrebbe verificarsi un'esplosione. Non ricaricare, smontare o bruciare batterie al litio. Smaltire le batterie al litio usate seguendo le istruzioni del produttore e le norme locali.

Säkerhetsinformation

- Säkerheten för denna produkt baseras på tester och godkännanden av ursprungsdesignen och av specifika komponenter. Tillverkaren har inget ansvar vid användning av oauktoriserade reservdelar.
- Underhållsinformationen för produkten är avsedd att användas av utbildade servicetekniker och inte avsedd att användas av andra.
- Risken för elektriska stötar och personskador kan vara förhöjd vid isärtagning och service av produkten. Professionell servicepersonal bör vara medvetna om denna risk och vidta nödvändiga försiktighetsåtgärder.

 **VARNING – RISK FÖR ELCHOCK:** När du ser denna symbol är det risk att det finns farlig spänning i den del av produkten du arbetar med. Koppla från strömmen innan du börjar, eller var försiktig om produkten måste vara strömförsörjd för att uppgiften ska kunna utföras.

 **VARNING – RISK FÖR SKADOR:** Litiumbatteriet i produkten är inte utbytbart. Om ett litiumbatteri byts ut på fel sätt finns det risk att det exploderar. Du får inte ladda om, ta isär eller elda upp ett litiumbatteri. Gör dig av med använda litiumbatterier enligt tillverkarens instruktioner och lokala föreskrifter.

Sicherheitshinweise

- Die Sicherheit dieses Produkts basiert auf Tests und Zulassungen des Originaldesigns und der spezifischen Komponenten. Sofern nicht autorisierte Ersatzteile eingesetzt werden, übernimmt der Hersteller keinerlei Verantwortung in Bezug auf die Sicherheit dieses Produkts.
- Die Wartungsinformationen für dieses Produkt wurden für ausgebildete Servicemitarbeiter zusammengestellt und dürfen nicht von anderen verwendet werden.
- Möglicherweise besteht bei der Demontage und Wartung dieses Produkts eine erhöhte Stromschlag- und Verletzungsgefahr. Ausgebildete Servicemitarbeiter sollten sich dieser Gefahr bewusst sein und die notwendigen Vorsichtsmaßnahmen ergreifen.

 **VORSICHT - STROMSCHLAGGEFAHR:** Wenn Sie dieses Symbol sehen, besteht eine Gefahr durch gefährliche Spannungen in dem Produktbereich, in dem Sie arbeiten. Trennen Sie das Produkt von seiner Stromverbindung, bevor Sie beginnen, oder gehen Sie vorsichtig vor, wenn das Produkt für die Durchführung der Aufgabe mit Strom versorgt werden muss.

 **VORSICHT - VERLETZUNGSGEFAHR:** Die Lithiumbatterie in diesem Produkt darf nicht ausgetauscht werden. Wird eine Lithiumbatterie nicht ordnungsgemäß ausgetauscht, besteht Explosionsgefahr. Lithiumbatterien dürfen auf keinen Fall wieder aufgeladen, auseinander genommen oder verbrannt werden. Befolgen Sie zum Entsorgen verbrauchter Lithiumbatterien die Anweisungen des Herstellers und die örtlichen Bestimmungen.

Sikkerhedsoplysninger



- Sikkerheden for dette produkt er baseret på afprøvning og godkendelser af det oprindelige design og specifikke komponenter. Producenten er ikke ansvarlig for sikkerhed i tilfælde af brug af uautoriserede dele til udskiftning.
- Vedligeholdelsesoplysninger om dette produkt er udarbejdet til brug af en kvalificeret servicetekniker og er ikke beregnet til at blive brugt af andre.
- Der kan være en forøget risiko for elektrisk stød eller personskade ved afmontering og service af dette produkt. Professionelt servicepersonale bør forstå denne risiko og tage nødvendige forholdsregler.

 **FORSIGTIG! RISIKO FOR ELEKTRISK STØD:** Når du ser dette symbol, er der risiko for elektrisk spænding i nærheden af produktet, hvor du arbejder. Tag strømtikket ud inden du begynder, eller udvis forsigtighed, hvis produktet skal modtage strøm for at udføre opgaven.



 **FORSIGTIG! RISIKO FOR SKADE:** Litium-batteriet i dette produkt er ikke beregnet til at blive udskiftet. Der er fare for eksplosion, hvis et litium-batteri udskiftes forkert. Du må ikke genoplade, demontere eller afbrænde et litium-batteri. Brugte litium-batterier skal bortskaffes i overensstemmelse med producentens instruktioner og lokale retningslinjer.

Sikkerhetsinformasjon



- Sikkerheten til dette produktet er basert på testing og godkjenning av originaldesignet og bestemte komponenter. Produsenten er ikke ansvarlig for sikkerheten ved bruk av uautoriserte reservedeler.
- Vedlikeholdsinformasjonen for dette produktet er tilrettelagt for bruk av profesjonelt servicepersonale, og er ikke ment for bruk av andre.
- Det kan være en økt risiko for elektrisk stød og personskade under demontering og vedlikehold av produktet. Profesjonelt servicepersonell må være innforstått med denne risikoen og ta nødvendige forholdsregler.

-  **FORSIKTIG – FARE FOR ELEKTRISK STØT:** Dette symbolet betyr at det er fare for farlig spenning i det området av produktet der du arbeider. Koble fra produktet før du begynner, eller vær forsiktig hvis produktet må ha strøm for å kunne utføre oppgaven.
-  **FORSIKTIG – FARE FOR PERSONSKADE:** Litiumbatteriet i dette produktet er ikke beregnet for å byttes. Det er fare for eksplosjon hvis litiumbatteriet skiftes ut på feil måte. Ikke lad opp, demonter eller destruer et litiumbatteri. Kast brukte litiumbatterier i henhold til produsentens instruksjoner og lokale regelverk.

Turvallisuusohjeet

- Tämän laitteen turvallisuus perustuu alkuperäisen rakenteen ja tiettyjen osien testaukseen ja hyväksymiseen. Valmistaja ei vastaa turvallisuudessa, jos laitteessa on käytetty luvattomia vaihto-osia.
 - Tämän tuotteen huoltoa koskevat tiedot on tarkoitettu vain ammattitaitoisen huoltohenkilön käyttöön.
 - Tämän tuotteen purkamiseen ja huoltoon voi liittyä kasvanut sähköiskun tai henkilövahingon vaara. Ammattitaitoisen huoltohenkilön on ymmärrettävä tämä vaara ja toimittava sen edellyttämällä tavalla.
-  **VAARA—SÄHKÖISKUN VAARA:** Tämä symboli ilmaisee, että tuotteen työskentelyalueella on olemassa vaarallinen jännite. Irrota laite verkkovirrasta ennen kuin aloitat tai toimi erittäin varovasti, jos laitteessa on oltava virta työn aikana.
-  **VAARA—LOUKKAANTUMISVAARA:** Tuotteessa olevaa litiumakkua ei ole tarkoitettu vaihdettavaksi. Litiumakun poistaminen väärin aiheuttaa räjähdysvaaran. Älä lataa, pura tai polta litiumakkua. Hävitä käytetyt litiumakut valmistajan ohjeiden ja paikallisten säädösten mukaisesti.

안전 정보

- 이 제품의 안전은 기본 디자인 및 특정 구성품의 승인 및 테스트를 기반으로 합니다. 제조업체는 권한 없는 교체 부품 사용 시 안전에 대해 책임을 지지 않습니다.
 - 이 제품의 유지관리 정보는 전문 서비스 요원을 대상으로 하며 다른 사람은 사용할 수 없습니다.
 - 제품 분해 및 서비스 중에는 감전 및 상해 위험이 증가할 수 있습니다. 전문 서비스 요원은 이와 같은 위험을 이해하고 필요한 예방 조치를 취해야 합니다.
-  **주의—감전 위험:** 이 기호가 표시된 경우 작업 중인 제품 주변에서 위험 전압 위험이 있습니다. 사용 전/후에 전원 코드를 뽑아 두시고 제품에서 작업을 수행하는 데 반드시 전원이 필요한 경우에는 주의하여 사용하십시오.
-  **주의—부상 위험:** 이 제품에 들어 있는 리튬 배터리는 교체할 수 없습니다. 리튬 배터리를 잘못 교체하면 폭발할 위험이 있습니다. 리튬 배터리를 충전, 분해하거나 불에 태우지 마십시오. 제조업체의 지침과 지역 규정에 따라 다 쓴 리튬 배터리를 폐기하십시오.

安全信息

- 本产品的安全性以原始设计和特定组件的测试和审批为基础。如果使用未经授权的替换部件，制造商不对安全性负责。
 - 本产品的维护信息仅供专业服务人员使用，并不打算由其他人使用。
 - 本产品在拆卸和维修时，遭受电击和人员受伤的危险性会增高。专业服务人员对这点必须有所了解，并采取必要的预防措施。
-  **当心—电击危险:** 当您看到此符号时，在您工作的产品区域内存在危险电压的威胁。在您开始操作之前请拔掉产品电源，如果产品必须接收功率才能执行任务，请务必谨慎操作。

 **当心—可能的伤害：**本产品中的锂电池不可更换。如果不正确更换锂电池，可能会有爆炸危险。不要再充电、拆解或焚烧锂电池。丢弃旧的锂电池时应按照制造商的指导及当地法规进行处理。

安全情報

- 本製品の安全性は、本来の設計、特定コンポーネントの試験、承認に基づいています。承認されていない交換部品をお客様が使用した場合、メーカーは安全性に対して責任を負いません。
- 本製品のメンテナンス情報は、専門のサービス担当者による利用を目的としており、その他の人を対象としていません。
- 本製品の分解や保守サービスを行う場合は、感電や傷害の危険性があります。専門のサービス担当者はこの危険性を理解し、十分な対策を講じる必要があります。

 **危険！感電の恐れあり：**この表記がある場合、対象製品の作業領域には、高電圧による危険性が生じています。作業を始める前に、製品から電源コードを取り外してください。また作業時に、製品に給電する必要がある場合は、十分に注意するようにしてください。

 **危険！ケガの恐れあり：**この製品に使用されているリチウム電池は、交換を前提としていません。リチウム電池の交換を誤ると破裂する危険性があります。リチウム電池の充電、解体、焼却はしないでください。使用済みのリチウム電池を廃棄する際は、製造元の指示およびお使いの地域の法律に従ってください。

安全資訊

- 本產品安全性係以原始設計及特定元件之測試與核准為依據。如有使用未獲授權替換組件之情形者，製造商對安全性概不負責。
- 本產品之維護資訊僅供專業維修人員使用，而非預定由他人使用。
- 拆裝及維修本產品時，有可能造成電擊與人員損傷之危險。專業維修人員應瞭解前項危險並採取必要措施。

 **請當心—有觸電的危險：**當您看到此符號時，表示您所在產品工作區有危險電壓。開始工作之前，請先拔掉產品電源線，若產品必須接上電源方能執行作業，用電時請務必小心。

 **請當心—有潛在傷害的危險：**本產品中的鋰電池原本並不需要予以更換。若未正確更換鋰電池，可能會有的爆炸的危險。請勿將鋰電池充電、拆裝或焚燒。請遵照製造商的指示及當地法規，丟棄用過的電池。

Preface

This manual contains maintenance procedures for service personnel.

It is divided into the following chapters:

- **General information** provides a general description of the printer, tools, and equipment needed to service the printer.
- **Diagnostic information** contains diagnostic aids such as error code tables, symptoms, and service checks that you can use to isolate failing field replaceable units (FRUs).
- **Service menus** describes the printer interface, user, and service menus.
- **Repair information** provides instructions for making printer adjustments and for removing and installing FRUs.
- **Component locations** illustrates the basic and fully configured models and identifies the locations of the basic printer parts.
- **Maintenance** contains the specifications for lubricating the printer and recommendations to prevent printer problems.
- **Parts catalog** shows illustrations and part numbers for the FRUs.
- **Appendix A: Printer specifications** contains detailed specifications of the product.
- **Appendix B: Options and features** contains the available options and other features of the product.
- **Appendix C: Theory of operation** contains the theory on how the printer operates.
- **Appendix D: Acronyms** contains a list of acronyms in the manual and their meanings.

Conventions

Note: A *note* identifies information that could help you.

Warning—Potential Damage: A *warning* identifies something that could damage the product hardware or software.

A *caution* indicates a potentially hazardous situation that could injure you. Different types of caution statements include:



CAUTION—POTENTIAL INJURY: Indicates a risk of injury.



CAUTION—SHOCK HAZARD: Indicates a risk of electrical shock.



CAUTION—HOT SURFACE: Indicates a risk of burn if touched.





CAUTION—TIPPING HAZARD: Indicates a crush hazard.

General caution statements



CAUTION—POTENTIAL INJURY: To avoid the risk of fire or electrical shock, connect the power cord to an appropriately rated and properly grounded electrical outlet that is near the product and easily accessible.

-  **CAUTION—POTENTIAL INJURY:** To avoid the risk of fire or electrical shock, use only the power cord provided with this product or the manufacturer's authorized replacement.
-  **CAUTION—POTENTIAL INJURY:** Do not use this product with extension cords, multioutlet power strips, multioutlet extenders, or UPS devices. The power capacity of these types of accessories can be easily overloaded by a laser printer and may result in a risk of fire, property damage, or poor printer performance.
-  **CAUTION—POTENTIAL INJURY:** Only a Lexmark Inline Surge Protector that is properly connected between the printer and the power cord provided with the printer may be used with this product. The use of non-Lexmark surge protection devices may result in a risk of fire, property damage, or poor printer performance.

General information

The Lexmark™ CS720 and CS725 are network-capable, A4 laser printers that print both color and monochrome print jobs. All information in this service manual pertains to all models unless explicitly noted.

The printers are available in the following models:

Model	Configurations	Machine type / model
CS720dte	4.3-in. color touch screen display, duplex print, networking, additional 550-sheet tray	5028-135
CS720de	4.3-in. color touch screen display, duplex print, networking	
CS725dte	4.3-in. color touch screen display, duplex print, networking, additional 550-sheet tray	5028-630
CS725de	4.3-in. color touch screen display, duplex print, networking	
C4150	4.3-in. color touch screen display, duplex print, networking	5028-639

For information on diagnosing a problem, see [“Diagnostic information” on page 33](#). For information on removing and reinstalling parts, see [“Repair information” on page 253](#) for information about removing and reinstalling parts. For information on identifying the parts, see [“Parts catalog” on page 412](#).

Finding the serial number

Open the front cover, and then find the serial number at the lower left side of the printer.



Paper and specialty media guide

Paper guidelines

Paper characteristics

The following paper characteristics affect print quality and reliability. Consider these factors before printing on them:

Weight

See [“Supported paper types and weights” on page 30](#).

Curl

Curl is the tendency for paper to curl at its edges. Excessive curl can cause paper feeding problems. Curl can occur after the paper passes through the printer, where it is exposed to high temperatures. Storing paper unwrapped in hot, humid, cold, or dry conditions can contribute to paper curling before printing and can cause feeding problems.

Smoothness

Paper smoothness directly affects print quality. If paper is too rough, toner cannot fuse to it properly. If paper is too smooth, it can cause paper feeding or print quality issues. Always use paper between 100 and 200 Sheffield points.

Moisture content

The amount of moisture in paper affects both print quality and the printer ability to feed the paper correctly. Leave paper in its original wrapper until you use it. Exposure of paper to moisture changes can degrade its performance.

Store paper in its original wrapper in the same environment as the printer for 24 to 48 hours before printing. Extend the time several days if the storage or transportation environment is very different from the printer environment. Thick paper may also require a longer conditioning period.

Grain direction

Grain refers to the alignment of the paper fibers in a sheet of paper. Grain is either *grain long*, running the length of the paper, or *grain short*, running the width of the paper.

For 60–176 g/m² (16–65-lb) paper, grain long paper is recommended.

Fiber content

Most high-quality xerographic paper is made from 100% chemically treated pulped wood. This content provides the paper with a high degree of stability, resulting in fewer paper feeding problems and better print quality. Paper containing fibers such as cotton can negatively affect paper handling.

Selecting paper

Using the appropriate paper prevents jams and helps ensure trouble-free printing.

To help avoid paper jams and poor print quality:

- *Always* use new, undamaged paper.
- Before loading paper, know the recommended printable side of the paper. This information is usually indicated on the paper package.
- *Do not* use paper that has been cut or trimmed by hand.
- *Do not* mix paper sizes, types, or weights in the same tray; mixing results in jams.
- *Do not* use coated papers unless they are specifically designed for electrophotographic printing.

Storing paper

Use these paper storage guidelines to help avoid jams and uneven print quality:

- For best results, store paper where the temperature is 21°C (70°F) and the relative humidity is 40 percent. Most label manufacturers recommend printing in a temperature range of 18–24°C (65–75°F) with relative humidity between 40 and 60 percent.
- Store paper in cartons, on a pallet or shelf, rather than on the floor.
- Store individual packages on a flat surface.
- Do not store anything on top of individual paper packages.
- Take paper out of the carton or wrapper only when you are ready to load it in the printer. The carton and wrapper help keep the paper clean, dry, and flat.

Using specialty media

Tips on using envelopes

- From the printer control panel, set the paper size, type, texture, and weight in the Paper menu to match the envelopes loaded in the tray.
- Print samples on the envelopes being considered for use before buying large quantities.
- Use envelopes designed specifically for laser printers.
- For best performance, use envelopes made from 90-g/m² (24-lb) paper or 25% cotton.
- Use only new envelopes from undamaged packages.
- To optimize performance and minimize jams, do not use envelopes that:
 - Have excessive curl or twist.
 - Are stuck together or damaged in any way.
 - Have windows, holes, perforations, cutouts, or embossing.
 - Have metal clasps, string ties, or folding bars.
 - Have an interlocking design.
 - Have postage stamps attached.
 - Have any exposed adhesive when the flap is in the sealed or closed position.
 - Have bent corners.
 - Have rough, cockle, or laid finishes.
- Adjust the width guides to fit the width of the envelopes.
- Before loading the envelopes on the tray, flex the stack of envelopes back and forth to loosen them, and then fan them. Straighten the edges on a level surface.

Note: A combination of high humidity (over 60%) and high printing temperature may wrinkle or seal envelopes.

Tips on using labels

- From the printer control panel, set the paper size, type, texture, and weight in the Paper menu to match the labels loaded in the tray.
- Print samples on labels being considered for use before buying large quantities.
- For more information on label printing, characteristics, and design, see the *Card Stock & Label Guide* on the Lexmark Web site at <http://support.lexmark.com>.
- Use labels designed specifically for laser printers.
- Do not use labels with slick backing material.
- Do not use labels with exposed adhesive.
- Use full label sheets. Partial sheets may cause labels to peel off during printing, resulting in a jam. Partial sheets also contaminate the printer and the cartridge with adhesive, and could void the printer and toner cartridge warranties.
- Before loading labels on the tray, flex and fan labels to loosen them. Straighten the edges on a level surface.

Tips on using card stock

Card stock is heavy, single-ply specialty media. Many of its variable characteristics, such as moisture content, thickness, and texture, can significantly affect print quality.

- From the printer control panel, set the paper size, type, texture, and weight in the Paper menu to match the card stock loaded in the tray.
- Print samples on the card stock being considered for use before buying large quantities.
- Specify the paper texture and weight from the tray settings to match the paper loaded in the tray.
- Preprinting, perforation, and creasing may significantly affect the print quality and cause jams or other paper feed problems.
- Before loading the card stock on the tray, flex and fan the card stock to loosen them. Straighten the edges on a level surface.

Supported paper sizes, types, and weights

The following tables provide information on standard and optional paper sources and the sizes, types, and weights of paper they support.

Note: For an unlisted paper size, select the closest *larger* listed size.

Supported paper sizes

Paper sizes supported by the trays and multipurpose feeder

Paper size	Dimensions	550-sheet tray	Multipurpose feeder	Two-sided printing
A6	105 x 148 mm (4.1 x 5.8 in.)	✓	✓	✓
A5	148 x 210 mm (5.8 x 8.3 in.)	✓ ¹	✓	✓
ISO B5²	176 x 250 mm (6.9 x 9.8 in.)	✓	✓	✓
JIS B5	182 x 257 mm (7.2 x 10.1 in.)	✓	✓	✓
A4	210 x 297 mm (8.3 x 11.7 in.)	✓	✓	✓
Oficio	216 x 340 mm (8.5 x 13.4 in.)	✓	✓	✓
3 x 5²	76.2 x 127 mm (3 x 5 in.)	X	✓	X
4 x 5²	101.6 x 127 mm (4 x 5 in.)	X	✓	X
Statement	140 x 216 mm (5.5 x 8.5 in.)	✓	✓	✓
Executive	184 x 267 mm (7.3 x 10.5 in.)	✓	✓	✓
Letter	216 x 279 mm (8.5 x 11 in.)	✓	✓	✓
Folio	216 x 330 mm (8.5 x 13 in.)	✓	✓	✓
Legal	216 x 356 mm (8.5 x 14 in.)	✓	✓	✓
DL Envelope	110 x 220 mm (4.3 x 8.7 in.)	✓	✓	X
C5 Envelope	162 x 229 mm (6.4 x 9 in.)	✓	✓	X
B5 Envelope	176 x 250 mm (6.9 x 9.8 in.)	✓	✓	X
7 3/4 Envelope	98 x 191 mm (3.9 x 7.5 in.)	X	✓	X
9 Envelope	98 x 225 mm (3.9 x 8.9 in.)	X	✓	X

¹ Supported only in long-edge orientation.

² Supported only using Universal paper size setting.

³ Supported only if Size Sensing is set to Off.

Note: Banner is supported in the multipurpose feeder only if width up to 215.9 mm (8.5 in.) and length to 1320.8 mm (52 in.). Make sure the paper size setting is set Universal.

Paper size	Dimensions	550-sheet tray	Multipurpose feeder	Two-sided printing
10 Envelope	105 x 241 mm (4.1 x 9.5 in.)	✓	✓	X
Monarch Envelope	98.4 x 190.5 mm (3.9 x 7.5 in.)	X	✓	X
Other Envelope³	98 x 162 mm (3.9 x 6.4 in.) to 176 x 250 mm (6.9 x 9.8 in.)	X	✓	X
Universal	104.8 x 148 mm (4.13 x 5.83 in.) to 215.9 x 360 mm (8.5 x 14.17 in.)	✓	✓	✓
	76.2 x 123.8 mm (3 x 4.9 in.) to 215.9 x 1321 mm (8.5 x 52 in.)	X	✓	X

¹ Supported only in long-edge orientation.

² Supported only using Universal paper size setting.

³ Supported only if Size Sensing is set to Off.

Note: Banner is supported in the multipurpose feeder only if width up to 215.9 mm (8.5 in.) and length to 1320.8 mm (52 in.). Make sure the paper size setting is set Universal.

Supported paper types and weights

Note: Labels, envelopes, and card stock always print at reduced speed.

Paper type	Standard 550-sheet tray	Optional 550-sheet tray	Multipurpose feeder
Plain Paper¹	✓	✓	✓
Card Stock²	✓	✓	✓
Glossy¹	✓	✓	✓
Labels • Paper ¹ • Vinyl	✓	✓	✓
Envelopes	✓	✓	✓
Light Paper¹	✓	✓	✓
Heavy Paper¹	✓	✓	✓

¹ Supported for two-sided printing.

² Supported for two-sided printing only up to 162-g/m² (90-lb) index.

Data security notice

Identifying printer memory

- **Volatile memory**—The printer uses standard random access memory (RAM) to buffer user data temporarily during simple print and copy jobs.
- **Non-volatile memory**—The printer may use two forms of non-volatile memory: EEPROM and NAND (flash memory). Both types are used to store the operating system, printer settings, network information, scanner and bookmark settings, and embedded solutions.
- **Hard disk memory**—Some printers have a hard disk drive installed. The printer hard disk is designed for printer-specific functionality and cannot be used for the long-term storage of data that is not print-related. The hard disk does not provide the capability for users to extract information, create folders, create disk or network file shares, or transfer FTP information directly from a client device. The hard disk can retain buffered user data from complex print jobs, form data, and font data.

The following parts can store memory:

- Printer control panel
- User interface controller card (UICC)
- Controller board
- Optional hard disks

Note: The printer control panel and controller board contain NVRAM.

Erasing printer memory

To erase volatile memory, turn off the printer.

To erase non-volatile memory:

- 1 From the home screen, touch **Settings > Device > Maintenance > Out of Service Erase**.
- 2 Select the **Sanitize all information on nonvolatile memory** check box, and then touch **ERASE**.
- 3 Follow the instructions on the display.

To erase the hard disk memory:

- 1 From the home screen, touch **Settings > Device > Maintenance > Out of Service Erase**.
- 2 Select the **Sanitize all information on hard disk** check box, and then touch **ERASE**.
- 3 Follow the instructions on the display.

Notes:



- This process can take from several minutes to more than an hour, making the printer unavailable for other tasks.
- After removing the hard disk, return it to the next level of support.

Tools required for service

- Flat-blade screwdrivers, magnetic, various sizes

- #1 Phillips screwdriver, magnetic
- #2 Phillips screwdriver, magnetic
- #2 Phillips screwdriver, magnetic short-blade
- 7/32 inch (5.5 mm) open-end wrench
- 7.0 mm nut driver
- Needle-nose pliers
- Diagonal side cutters
- Spring hook
- Feeler gauges
- Analog or digital multimeter
- Parallel wrap plug 1319128
- Twinax/serial debug cable 1381963
- Coax/serial debug cable 1381964
- Flash light (optional)
- 3 mm hex wrench

Diagnostic information

-  **CAUTION—SHOCK HAZARD:** To avoid the risk of electrical shock and to prevent damage to the printer, remove the power cord from the electrical outlet before you connect or disconnect any cable or electronic card or assembly for personal safety and to prevent damage to the printer. Disconnect any connections between the printer and computers or peripherals.
-  **CAUTION—POTENTIAL INJURY:** The printer weight is greater than 18 kg (40 lb) and requires two or more trained personnel to lift it safely. Always use the hand holds on the sides of the printer. Make sure that your fingers are not under the printer when you lift or set the printer down.
-  **CAUTION—HOT SURFACE:** The inside of the printer might be hot. To reduce the risk of injury from a hot component, allow the surface to cool before touching.

Troubleshooting overview

Performing the initial troubleshooting check

- With the power cord unplugged from the electrical outlet, check if the cord is free from breakage, short circuits, disconnected wires, or incorrect connections.
- Make sure that the printer is properly grounded.
- Make sure that the power supply line voltage is within 10% of the rated line voltage.
- Make sure that the printer is securely installed on a level surface in a well-ventilated area.
- Make sure that the temperature and relative humidity are within the specifications. See [“Temperature information” on page 447](#).
- Avoid locations that:
 - Generate ammonia gas
 - Are exposed to direct sunlight
 - Are near open flames
 - Are dusty
- Make sure that the recommended paper for this printer is used.
- Do a test print with paper from a newly opened package, and then check the result.

Power-on reset (POR) sequence

When you turn on the printer, it performs a POR sequence.

Check for the correct POR function of the printer by observing the following:

- 1 The initial boot screen appears.
- 2 The splash screen appears.

- 3 The progress bar appears on the splash screen.
- 4 The printer begins to POST, and the motors and sensors are polled and tested.
- 5 The home screen displays.
- 6 Printer calibration may begin.

Note: If any of the tests fail, the printer displays an error code.

Fixing print quality issues

Initial print quality check

Before troubleshooting print problems, perform the following:

- Make sure that the printer is located in an area that follows the recommended operating environment and power requirement specifications.
- Check the status of supplies. Replace supplies that are low or empty.
- Load 20-lb plain letter or A4 paper. Make sure that the paper guides are properly set and locked. From the control panel, set the paper size and type to match the paper loaded in the tray.
- Print and keep the menu settings page. The original menu settings page will be used to restore the custom settings if necessary.
- Make sure that the Print resolution and Toner darkness on the menu settings page are set to their default values.
- Check the toner cartridge for damage, and replace if necessary.
- Print the advanced print quality samples to see if the problem remains. Use tray 1 to test print quality problems. Look for variations in the print from what is expected.
- Make sure that the correct print driver is used to prevent print problems. If the wrong print driver is installed, incorrect characters could print and the copy may not fit the page correctly.

Toner easily rubs off check

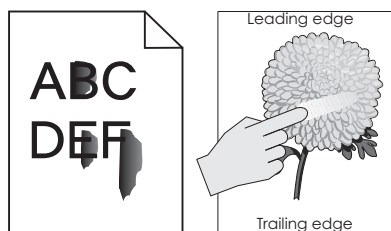

Actions	Yes	No
<p>Step 1</p> <p>a From the home screen, touch Settings > Device > Preferences.</p> <p>b Check if the paper type and size settings match the paper type and size set on the tray.</p> <p>Do the settings match?</p>	Go to step 3.	Go to step 2.
<p>Step 2</p> <p>Change the paper size and type, or adjust the size settings in the tray.</p> <p>Does the problem remain?</p>	Go to step 3.	The problem is solved.
<p>Step 3</p> <p>Check the paper for texture or rough finish.</p> <p>Is the paper textured or rough?</p>	Go to step 4.	Go to step 5.
<p>Step 4</p> <p>Replace the textured or rough paper with plain paper.</p> <p>Does the problem remain?</p>	Go to step 5.	The problem is solved.
<p>Step 5</p> <p>Remove, and then reinstall the fuser. See “Fuser removal” on page 333.</p> <p>Does the problem remain?</p>	Go to step 6.	The problem is solved.
<p>Step 6</p> <p>Replace the fuser. See “Fuser removal” on page 333.</p> <p>Does the problem remain?</p>	Go to step 7.	The problem is solved.
<p>Step 7</p> <p>a From the home screen, touch Settings > Device > Maintenance > Configuration Menu > Reports > Event Log.</p> <p>b Check the log history for fuser error codes.</p> <p>Are there fuser error codes on the event log?</p>	Go to step 8.	Go to step 9.
<p>Step 8</p> <p>Perform the service check for the error code found.</p> <p>Does the problem remain?</p>	Go to step 9.	The problem is solved.
<p>Step 9</p> <p>Replace the LVPS. See “LVPS removal” on page 305.</p> <p>Does the problem remain?</p>	Contact the next level of support.	The problem is solved.

Background or gray background check

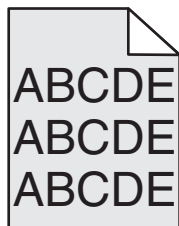

Action	Yes	No
<p>Step 1</p> <p>a From the home screen, touch Settings > Reports > Device > Device Statistics.</p> <p>b Check the status of the imaging unit if it was recently replaced.</p> <p>Does the status show that the imaging unit was recently replaced?</p>	Go to step 2.	Go to step 3.
<p>Step 2</p> <p>Check if only one color is producing the background of the print job.</p> <p>Is only one color producing the background?</p>	Go to step 3.	Go to step 4.
<p>Step 3</p> <ul style="list-style-type: none"> If the affected color is cyan, magenta, or yellow, then replace the developer unit of the affected color. If the affected color is black, then replace the imaging unit. <p>Does the problem remain?</p>	Go to step 4.	The problem is solved.
<p>Step 4</p> <p>Replace the imaging kit.</p> <p>Does the problem remain?</p>	Go to step 5.	The problem is solved.
<p>Step 5</p> <p>Reseat the HVPS cable on the HVPS and on the JHVPS1 connector on the controller board.</p> <p>Does the problem remain?</p>	Go to step 6.	The problem is solved.
<p>Step 6</p> <p>Check the contact pins connecting the HVPS to the transfer module for damage.</p> <p>Are the contact pins damaged?</p>	Go to step 7.	Go to step 8.
<p>Step 7</p> <p>Replace the HVPS. See “HVPS removal” on page 319.</p> <p>Does the problem remain?</p>	Go to step 8.	The problem is solved.

Action	Yes	No
<p>Step 8 Remove the printhead, and then clean the printhead lenses. See “Printhead removal” on page 361.</p> <p>Does the problem remain?</p>	Go to step 9.	The problem is solved.
<p>Step 9 Replace the printhead. See “Printhead removal” on page 361.</p> <p>Does the problem remain?</p>	Contact the next level of support.	The problem is solved.

Blank or white pages check

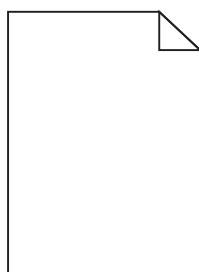

Action	Yes	No
<p>Step 1 Make sure all the packing materials on the imaging unit are removed.</p> <p>Does the problem remain?</p>	Go to step 2.	The problem is solved.
<p>Step 2 a Enter the Diagnostics menu, and then navigate to: Advanced Print Quality Samples > Advanced Print Quality Samples b Check the test page.</p> <p>Is only one color missing?</p>	Go to step 3.	Go to step 5.
<p>Step 3 Check the contacts between the imaging unit and developer unit of the affected color.</p> <p>Are the contacts clean?</p>	Go to step 5.	Go to step 4.
<p>Step 4 Clean the contacts.</p> <p>Does the problem remain?</p>	Go to step 5.	The problem is solved.

Action	Yes	No
<p>Step 5</p> <ul style="list-style-type: none"> • If the affected color is cyan, magenta, or yellow, then replace the developer unit of the affected color. • If the affected color is black, then replace the imaging unit. <p>Does the problem remain?</p>	Go to step 6.	The problem is solved.
<p>Step 6</p> <p>a Remove the imaging kit.</p> <p>b Enter the Diagnostics menu, and then navigate to: Printer diagnostics & adjustments > Motor tests</p> <p>c Select the developer unit motor of the affected color, and then touch Start.</p> <p>Does the motor run?</p>	Go to step 8.	Go to step 7.
<p>Step 7</p> <p>Replace the motor. See “Motor (EP drive) removal” on page 296.</p> <p>Does the problem remain?</p>	Go to step 8.	The problem is solved.
<p>Step 8</p> <p>a Manually turn the motor.</p> <p>b While turning the motor, check if the couplers that drive the imaging kit move.</p> <p>Do the couplers move?</p>	Go to step 10.	Go to step 9.
<p>Step 9</p> <p>Replace the EP gear box. See “EP gear box removal” on page 302.</p> <p>Does the problem remain?</p>	Go to step 10.	The problem is solved.
<p>Step 10</p> <p>Check if the pins on the HVPS freely move.</p> <p>Do the pins freely move?</p>	Go to step 12.	Go to step 11.
<p>Step 11</p> <p>Replace the HVPS. See “HVPS removal” on page 319.</p> <p>Does the problem remain?</p>	Go to step 12.	The problem is solved.
<p>Step 12</p> <p>Check the continuity of the cable on the JSC1 connector on the controller board.</p> <p>Does the cable have continuity?</p>	Go to step 14.	Go to step 13.

Action	Yes	No
<p>Step 13 Replace the cable.</p> <p>Does the problem remain?</p>	Go to step 14.	The problem is solved.
<p>Step 14 Replace the printhead. See “Printhead removal” on page 361.</p> <p>Does the problem remain?</p>	Go to step 15.	The problem is solved.
<p>Step 15 Replace the controller board. See “Controller board removal” on page 357.</p> <p>Does the problem remain?</p>	Contact the next level of support.	The problem is solved.

Gapping or half color page check

Action	Yes	No
<p>Step 1 Make sure all the packing materials on the imaging unit are removed.</p> <p>Does the problem remain?</p>	Go to step 2.	The problem is solved.
<p>Step 2</p> <ul style="list-style-type: none"> a Reseat the cyan, magenta, and yellow developer units in the imaging kit. b Reseat the imaging kit. c Enter the Diagnostics menu, and then navigate to: Advanced Print Quality Samples > Advanced Print Quality Samples d Check the test page. <p>Does the problem remain?</p>	Go to step 3.	The problem is solved.
<p>Step 3 Check the developer hold down arms and springs for damage, and replace if necessary. See “Developer hold down removal” on page 363.</p> <p>Does the problem remain?</p>	Go to step 4.	The problem is solved.

Action	Yes	No
<p>Step 4</p> <ul style="list-style-type: none"> • If the affected color is cyan, magenta, or yellow, then replace the developer unit of the affected color. • If the affected color is black, then replace the imaging unit. <p>Does the problem remain?</p>	Go to step 5.	The problem is solved.
<p>Step 5</p> <p>Replace the imaging kit.</p> <p>Does the problem remain?</p>	Contact the next level of support.	The problem is solved.

Blurred print or color misalignment check

Action	Yes	No
<p>Step 1</p> <p>Remove, and then reinstall the transfer belt.</p> <p>Does the problem remain?</p>	Go to step 2.	The problem is solved.
<p>Step 2</p> <p>a Enter the Diagnostics menu, and then navigate to: Advanced Print Quality Samples > Advanced Print Quality Samples</p> <p>b Check the test page.</p> <p>Is only one color blurred or misaligned?</p>	Go to step 3.	Go to step 6.
<p>Step 3</p> <ul style="list-style-type: none"> • If the affected color is cyan, magenta, or yellow, then replace the developer unit of the affected color. • If the affected color is black, then reseal the imaging unit. <p>Does the problem remain?</p>	Go to step 4.	The problem is solved.
<p>Step 4</p> <p>Perform the color alignment service check for the affected color.</p> <p>Does the problem remain?</p>	Go to step 5.	The problem is solved.
<p>Step 5</p> <ul style="list-style-type: none"> • If the affected color is cyan, magenta, or yellow, then replace the developer unit of the affected color. • If the affected color is black, then replace the imaging unit. <p>Does the problem remain?</p>	Go to step 6.	The problem is solved.

Action	Yes	No
<p>Step 6 Perform the color alignment service check for all the colors.</p> <p>Does the problem remain?</p>	Go to step 7.	The problem is solved.
<p>Step 7 Perform the auto alignment sensors service check.</p> <p>Does the problem remain?</p>	Go to step 8.	The problem is solved.
<p>Step 8 Remove the printhead, and then check the printhead lenses for contamination. See “Printhead removal” on page 361.</p> <p>Are the lenses contaminated?</p>	Go to step 9.	Go to step 10.
<p>Step 9 Clean the lenses, and then reinstall the printhead.</p> <p>Does the problem remain?</p>	Go to step 10.	The problem is solved.
<p>Step 10 Replace the EP gear box. See “EP gear box removal” on page 302.</p> <p>Does the problem remain?</p>	Go to step 11.	The problem is solved.
<p>Step 11 Replace the printhead. See “Printhead removal” on page 361.</p> <p>Does the problem remain?</p>	Go to step 12.	The problem is solved.
<p>Step 12 Replace the controller board. See “Controller board removal” on page 357.</p> <p>Does the problem remain?</p>	Contact the next level of support.	The problem is solved.

Horizontal colored lines or banding check

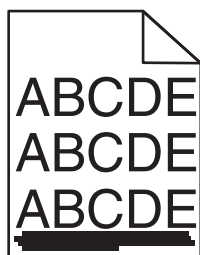

Actions	Yes	No
<p>Step 1</p> <p>a Enter the Diagnostics menu, and then navigate to: Advanced Print Quality Samples > Advanced Print Quality Samples</p> <p>b Check the test page for lines.</p> <p>Are the lines white?</p>	Go to step 2.	Go to step 3.
<p>Step 2</p> <p>Perform the repeating defects check. See “Repeating defects check” on page 55.</p> <p>Does the problem remain?</p>	Go to step 3.	The problem is solved.
<p>Step 3</p> <p>a Enter the Diagnostics menu, and then navigate to: Advanced Print Quality Samples > Advanced Print Quality Samples</p> <p>b Check if the lines appear on the same area of the page.</p> <p>Do the lines appear on the same area?</p>	Go to step 4.	Go to step 5.
<p>Step 4</p> <p>Perform the repeating defects check. See “Repeating defects check” on page 55.</p> <p>Does the problem remain?</p>	Go to step 5.	The problem is solved.
<p>Step 5</p> <p>Check the pages right after the defective page.</p> <p>Do the lines appear after two consecutive normal pages were printed?</p>	Go to step 6.	The problem is solved.
<p>Step 6</p> <p>Check the transfer module for contamination.</p> <p>Is the transfer module free of contamination?</p>	Contact the next level of support.	Go to step 7.
<p>Step 7</p> <p>Clean the transfer module.</p> <p>Does the problem remain?</p>	Contact the next level of support.	The problem is solved.

Text or images cut off check

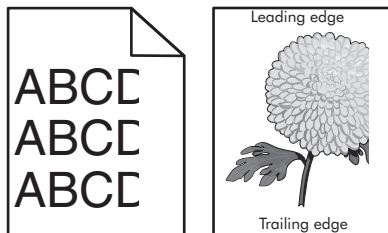

Actions	Yes	No
<p>Step 1</p> <p>a From the home screen, touch Settings > Device > Preferences.</p> <p>b Check if the paper type and size settings match the paper type and size set on the tray.</p> <p>Do the settings match?</p>	Contact the next level of support.	Go to step 2.
<p>Step 2</p> <p>Change the paper size and type, or adjust the size settings in the tray.</p> <p>Does the problem remain?</p>	Contact the next level of support.	The problem is solved.

Mottled print and dots check

Action	Yes	No
<p>Step 1</p> <p>a From the home screen, touch Settings > Device > Preferences.</p> <p>b Check if the paper type and size settings match the paper type and size set on the tray.</p> <p>Do the settings match?</p>	Go to step 3.	Go to step 2.
<p>Step 2</p> <p>Change the paper size and type, or adjust the size settings in the tray.</p> <p>Does the problem remain?</p>	Go to step 3.	The problem is solved.
<p>Step 3</p> <p>Check the paper for texture or rough finish.</p> <p>Is the paper textured or rough?</p>	Go to step 4.	Go to step 5.
<p>Step 4</p> <p>Replace the textured or rough paper with plain paper.</p> <p>Does the problem remain?</p>	Go to step 5.	The problem is solved.

Action	Yes	No
<p>Step 5 Check the printer for toner leaks.</p> <p>Are there toner leaks?</p>	Go to step 6.	Go to step 7.
<p>Step 6 a Clean the printer thoroughly using a toner vacuum. b Perform a print job to clear the remaining toner from the imaging components.</p> <p>Does the problem remain?</p>	Go to step 7.	The problem is solved.
<p>Step 7</p> <ul style="list-style-type: none"> • If the affected color is cyan, magenta, or yellow, then replace the developer unit of the affected color. • If the affected color is black, then replace the imaging unit. <p>Does the problem remain?</p>	Go to step 8.	The problem is solved.
<p>Step 8 Check if the affected color is black.</p> <p>Is the affected color black?</p>	Go to step 10.	Go to step 9.
<p>Step 9 Replace the photoconductor unit.</p> <p>Does the problem remain?</p>	Go to step 10.	The problem is solved.
<p>Step 10 Check the transfer module for proper installation and damage, and replace if necessary. See “Transfer module removal” on page 334.</p> <p>Does the problem remain?</p>	Contact the next level of support.	The problem is solved.

Vertical white lines check



Action	Yes	No
<p>Step 1</p> <p>a Enter the Diagnostics menu, and then navigate to: Advanced Print Quality Samples > Advanced Print Quality Samples</p> <p>b Check the test page.</p> <p>Did the print defect appear on all the pages?</p>	Go to step 5.	Go to step 2.
<p>Step 2</p> <ul style="list-style-type: none"> • If the affected color is cyan, magenta, or yellow, then replace the developer unit of the affected color. • If the affected color is black, then replace the imaging unit. <p>Does the problem remain?</p>	Go to step 3.	The problem is solved.
<p>Step 3</p> <p>Check if the affected color is black.</p> <p>Is the affected color black?</p>	Contact the next level of support.	Go to step 4.
<p>Step 4</p> <p>Replace the photoconductor unit.</p> <p>Does the problem remain?</p>	Contact the next level of support.	The problem is solved.
<p>Step 5</p> <p>Check the transfer module for proper installation and damage, and replace if necessary. See “Transfer module removal” on page 334.</p> <p>Does the problem remain?</p>	Go to step 6.	The problem is solved.
<p>Step 6</p> <p>Clean the printhead. See “Cleaning the printhead lenses” on page 410.</p> <p>Are the lenses contaminated?</p>	Go to step 7.	Go to step 8.
<p>Step 7</p> <p>Clean the lenses, and then reinstall the printhead.</p> <p>Does the problem remain?</p>	Go to step 8.	The problem is solved.
<p>Step 8</p> <p>Replace the printhead. See “Printhead removal” on page 361.</p> <p>Does the problem remain?</p>	Contact the next level of support.	The problem is solved.

Ghost images check

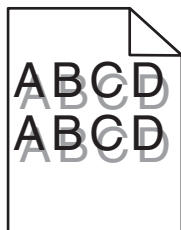

Action	Yes	No
<p>Step 1</p> <p>a From the home screen, touch Status/supplies > Hardware.</p> <p>b Check the status of the black and color imaging components.</p> <p>Does the status indicate OK?</p>	Go to step 2.	Go to step 4.
<p>Step 2</p> <p>Measure the distance from one point of the original image to the same point on the ghost image.</p> <p>Is the distance 43.9 mm?</p>	Go to step 3.	Go to step 4.
<p>Step 3</p> <ul style="list-style-type: none"> • If the affected color is cyan, magenta, or yellow, then replace the developer unit of the affected color. • If the affected color is black, then replace the imaging unit. <p>Does the problem remain?</p>	Go to step 4.	The problem is solved.
<p>Step 4</p> <p>a Check if the ghost image is colored or black.</p> <p>b Measure the distance from one point of the original image to the same point on the ghost image.</p> <p>Is the distance 94.2 mm?</p>	Go to step 5.	Go to step 6.
<p>Step 5</p> <ul style="list-style-type: none"> • If the ghost image is colored, then replace the color photoconductor unit. • If the ghost image is black, then replace the black imaging kit. <p>Does the problem remain?</p>	Go to step 6.	The problem is solved.
<p>Step 6</p> <p>a From the home screen, touch Settings > Reports > Menu Settings Page.</p> <p>Note: Perform this step twice to clear any debris.</p> <p>b Check the fuser assembly for toner contamination.</p> <p>Is there toner contamination?</p>	Go to step 7.	Contact the next level of support.

Action	Yes	No
<p>Step 7 Replace the fuser. See “Fuser removal” on page 333.</p> <p>Does the problem remain?</p>	Contact the next level of support.	The problem is solved.

Solid color or black image check



Action	Yes	No
<p>Step 1 a Enter the Diagnostics menu, and then navigate to: Advanced Print Quality Samples > Advanced Print Quality Samples b Check the test page.</p> <p>Is the solid color page black only?</p>	Go to step 2.	Go to step 3.
<p>Step 2 Replace the imaging unit.</p> <p>Does the problem remain?</p>	Go to step 4.	The problem is solved.
<p>Step 3 Replace the photocopier unit.</p> <p>Does the problem remain?</p>	Go to step 4.	The problem is solved.
<p>Step 4 a Place a narrow strip of paper over the gap between the developers. Note: Make sure that the paper stays in place when reinstalling the imaging unit to prevent the laser from discharging the photoconductors. b From the home screen, touch Settings > Reports > Print Quality Pages. c Check the test page.</p> <p>Is there vertical banding?</p>	Go to step 5.	Go to step 6.

Action	Yes	No
<p>Step 5 Replace the printhead. See “Printhead removal” on page 361.</p> <p>Does the problem remain?</p>	Go to step 6.	The problem is solved.
<p>Step 6 Check the toner cartridge contacts for damage, and replace if necessary. See “Toner cartridge contacts removal” on page 328.</p> <p>Does the problem remain?</p>	Go to step 7.	The problem is solved.
<p>Step 7 Turn off the printer, and then check the continuity of the HVPS cable.</p> <p>Does the cable have continuity?</p>	Go to step 9.	Go to step 8.
<p>Step 8 Replace the HVPS cable.</p> <p>Does the problem remain?</p>	Go to step 9.	The problem is solved.
<p>Step 9 Replace the HVPS. See “HVPS removal” on page 319.</p> <p>Does the problem remain?</p>	Go to step 10.	The problem is solved.
<p>Step 10 Replace the printhead. See “Printhead removal” on page 361.</p> <p>Does the problem remain?</p>	Contact the next level of support.	The problem is solved.

Vertical colored lines or banding check

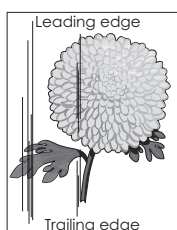
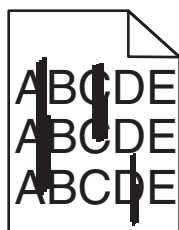

Action	Yes	No
<p>Step 1</p> <p>a Enter the Diagnostics menu, and then navigate to: Advanced Print Quality Samples > Advanced Print Quality Samples</p> <p>b Check the test page.</p> <p>Is only one color producing the defect?</p>	Go to step 2.	Go to step 4.
<p>Step 2</p> <ul style="list-style-type: none"> If the affected color is cyan, magenta, or yellow, then replace the developer unit of the affected color. If the affected color is black, then replace the imaging unit. <p>Does the problem remain?</p>	Go to step 3.	The problem is solved.
<p>Step 3</p> <p>Replace the photoconductor unit.</p> <p>Does the problem remain?</p>	Go to step 4.	The problem is solved.
<p>Step 4</p> <p>Replace the transfer module. See “Transfer module removal” on page 334.</p> <p>Does the problem remain?</p>	Go to step 5.	The problem is solved.
<p>Step 5</p> <p>Replace the fuser. See “Fuser removal” on page 333.</p> <p>Does the problem remain?</p>	Contact the next level of support.	The problem is solved.

Image void scan direction check

Action	Yes	No
<p>Step 1</p> <p>Load paper from a fresh package.</p> <p>Note: Paper may absorb moisture due to high humidity. Store paper in its original wrapper until it is ready to be used.</p> <p>Does the problem remain?</p>	Go to step 2.	The problem is solved.
<p>Step 2</p> <p>Reseat the imaging kit, and then perform a print job.</p> <p>Does the problem remain?</p>	Go to step 3.	The problem is solved.

Action	Yes	No
<p>Step 3 Check if the problem affects only one color.</p> <p>Does the problem affect only one color?</p>	Go to step 4.	Go to step 5.
<p>Step 4</p> <ul style="list-style-type: none"> • If the affected color is cyan, magenta, or yellow, then reseal the developer unit of the affected color. • If the affected color is black, then reseal the imaging unit. <p>Does the problem remain?</p>	Go to step 6.	The problem is solved.
<p>Step 5 Reseat all the developer units in the imaging kit.</p> <p>Does the problem remain?</p>	Go to step 6.	The problem is solved.
<p>Step 6 Measure the interval between every defect.</p> <p>Does the defect occur in 55-mm intervals?</p>	Contact the next level of support.	Go to step 7.
<p>Step 7 Check the HVPS cable for proper connection and damage, and replace if necessary.</p> <p>Does the problem remain?</p>	Go to step 8.	The problem is solved.
<p>Step 8 Replace the HVPS. See “HVPS removal” on page 319.</p> <p>Does the problem remain?</p>	Go to step 9.	The problem is solved.
<p>Step 9 Replace the controller board. See “Controller board removal” on page 357.</p> <p>Does the problem remain?</p>	Go to step 10.	The problem is solved.
<p>Step 10 Replace the printhead. See “Printhead removal” on page 361.</p> <p>Does the problem remain?</p>	Contact the next level of support.	The problem is solved.

Image void process direction check

Action	Yes	No
<p>Step 1 Load paper from a fresh package.</p> <p>Note: Paper may absorb moisture due to high humidity. Store paper in its original wrapper until it is ready to be used.</p> <p>Does the problem remain?</p>	Go to step 2.	The problem is solved.
<p>Step 2 Reseat all the developer units in the imaging kit, and then perform a print job.</p> <p>Does the problem remain?</p>	Go to step 3.	The problem is solved.
<p>Step 3 Check if the problem appears only on one side of the page.</p> <p>Does the problem appear only on one side?</p>	Go to step 4.	Go to step 6.
<p>Step 4 Check the developer hold downs for damage or loose springs, and replace if necessary. See “Developer hold down removal” on page 363.</p> <p>Does the problem remain?</p>	Go to step 5.	The problem is solved.
<p>Step 5 Check for missing colors.</p> <p>Is only one color missing?</p>	Go to step 8.	Go to step 6.
<p>Step 6 Check the printhead for dust or debris.</p> <p>Is the printhead free of dust or debris?</p>	Go to step 8.	Go to step 7.
<p>Step 7 Remove the dust or debris.</p> <p>Does the problem remain?</p>	Go to step 8.	The problem is solved.
<p>Step 8</p> <ul style="list-style-type: none"> • If the affected color is cyan, magenta, or yellow, then replace the developer unit of the affected color. • If the affected color is black, then replace the imaging unit. <p>Does the problem remain?</p>	Go to step 9.	The problem is solved.

Action	Yes	No
<p>Step 9 Replace the printhead. See “Printhead removal” on page 361.</p> <p>Does the problem remain?</p>	Go to step 10.	The problem is solved.
<p>Step 10 Replace the controller board. See “Controller board removal” on page 357.</p> <p>Does the problem remain?</p>	Contact the next level of support.	The problem is solved.

Dark print check

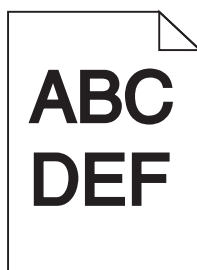

Action	Yes	No
<p>Step 1 a From the home screen, touch Settings > Print > Quality. b Check the Toner darkness setting value.</p> <p>Is the darkness setting too high?</p>	Go to step 2.	Go to step 3.
<p>Step 2 Adjust the darkness setting to the proper value.</p> <p>Does the problem remain?</p>	Go to step 3.	The problem is solved.
<p>Step 3 Reseat the imaging kit, and then perform a print job.</p> <p>Does the problem remain?</p>	Go to step 4.	The problem is solved.
<p>Step 4 a Enter the Diagnostics menu, and then navigate to: Advanced Print Quality Samples > Advanced Print Quality Samples b Check the test page.</p> <p>Is only one page showing the dark prints?</p>	Go to step 5.	Go to step 6.

Action	Yes	No
<p>Step 5 Remove the imaging kit, and then reseal the developer unit of the affected color.</p> <p>Does the problem remain?</p>	Go to step 6.	The problem is solved.
<p>Step 6 Check the HVPS cable for proper connection and damage, and replace if necessary.</p> <p>Does the problem remain?</p>	Go to step 7.	The problem is solved.
<p>Step 7</p> <ul style="list-style-type: none"> • If the affected color is cyan, magenta, or yellow, then replace the developer unit of the affected color. • If the affected color is black, then replace the imaging unit. <p>Does the problem remain?</p>	Go to step 8.	The problem is solved.
<p>Step 8 Replace the imaging kit.</p> <p>Does the problem remain?</p>	Go to step 9.	The problem is solved.
<p>Step 9 Replace the HVPS. See “HVPS removal” on page 319.</p> <p>Does the problem remain?</p>	Go to step 10.	The problem is solved.
<p>Step 10 Replace the controller board. See “Controller board removal” on page 357.</p> <p>Does the problem remain?</p>	Contact the next level of support.	The problem is solved.

Missing color check

Action	Yes	No
<p>Step 1</p> <ol style="list-style-type: none"> Reseat the imaging kit. Enter the Diagnostics menu, and then navigate to: Advanced Print Quality Samples > Advanced Print Quality Samples Check the test page. <p>Does the problem remain?</p>	Go to step 2.	The problem is solved.

Action	Yes	No
<p>Step 2</p> <p>a Reseat all the developer units in the imaging kit.</p> <p>b Enter the Diagnostics menu, and then navigate to: Advanced Print Quality Samples > Advanced Print Quality Samples</p> <p>c Check the test page.</p> <p>Does the problem remain?</p>	Go to step 3.	The problem is solved.
<p>Step 3</p> <p>Check the HVPS cable for proper connection and damage, and replace if necessary.</p> <p>Does the problem remain?</p>	Go to step 4.	The problem is solved.
<p>Step 4</p> <p>Replace the imaging kit.</p> <p>Does the problem remain?</p>	Go to step 5.	The problem is solved.
<p>Step 5</p> <p>Check the toner cartridge contacts for damage, and replace if necessary. See “Toner cartridge contacts removal” on page 328.</p> <p>Does the problem remain?</p>	Go to step 6.	The problem is solved.
<p>Step 6</p> <p>Replace the HVPS. See “HVPS removal” on page 319.</p> <p>Does the problem remain?</p>	Go to step 7.	The problem is solved.
<p>Step 7</p> <p>Replace the controller board. See “Controller board removal” on page 357.</p> <p>Does the problem remain?</p>	Contact the next level of support.	The problem is solved.

Uneven print density check

Action	Yes	No
<p>Step 1</p> <p>a From the home screen, touch Settings > Device > Preferences.</p> <p>b Check if the paper type and size settings match the paper type and size set on the tray.</p> <p>Do the settings match?</p>	Go to step 3.	Go to step 2.

Action	Yes	No
<p>Step 2 Change the paper size and type, or adjust the size settings in the tray.</p> <p>Does the problem remain?</p>	Go to step 3.	The problem is solved.
<p>Step 3 Check the paper for texture or rough finish.</p> <p>Is the paper textured or rough?</p>	Go to step 4.	Go to step 5.
<p>Step 4 Replace the textured or rough paper with plain paper.</p> <p>Does the problem remain?</p>	Go to step 5.	The problem is solved.
<p>Step 5 Remove, and then reinstall the fuser. See “Fuser removal” on page 333.</p> <p>Does the problem remain?</p>	Go to step 6.	The problem is solved.
<p>Step 6 Replace the fuser. See “Fuser removal” on page 333.</p> <p>Does the problem remain?</p>	Go to step 7.	The problem is solved.
<p>Step 7 Replace the LVPS. See “LVPS removal” on page 305.</p> <p>Does the problem remain?</p>	Contact the next level of support.	The problem is solved.

Repeating defects check

Action	Yes	No
<p>Step 1 Check the printer rollers for dust or debris.</p> <p>Are the rollers free of dust or debris?</p>	Go to step 3.	Go to step 2.
<p>Step 2 Remove the dust or debris.</p> <p>Does the problem remain?</p>	Go to step 3.	The problem is solved.
<p>Step 3 Measure the distance between the repeating marks.</p> <p>Is the distance between the marks either 43.9 mm or 45.5 mm?</p>	Go to step 4.	Go to step 5.

Action	Yes	No
<p>Step 4</p> <ul style="list-style-type: none"> • If the affected color is cyan, magenta, or yellow, then replace the developer unit of the affected color. • If the affected color is black, then replace the imaging unit. <p>Does the problem remain?</p>	Contact the next level of support.	The problem is solved.
<p>Step 5</p> <p>Measure the distance between the repeating marks.</p> <p>Is the distance between the marks either 29.8 mm, 25.1 mm, or 94.2 mm?</p>	Go to step 6.	Go to step 7.
<p>Step 6</p> <ul style="list-style-type: none"> • If the affected color is cyan, magenta, or yellow, then replace the CMY imaging kit. • If the affected color is black, then replace the black imaging kit. <p>Does the problem remain?</p>	Contact the next level of support.	The problem is solved.
<p>Step 7</p> <p>Measure the distance between the repeating marks.</p> <p>Is the distance between the marks either 34.6 mm, 95 mm, or 110 mm?</p>	Go to step 8.	Go to step 9.
<p>Step 8</p> <p>Replace the fuser. See “Fuser removal” on page 333.</p> <p>Does the problem remain?</p>	Contact the next level of support.	The problem is solved.
<p>Step 9</p> <p>Measure the distance between the repeating marks.</p> <p>Is the distance between the marks either 37.7 mm, 55 mm, or 78.5 mm?</p>	Go to step 11.	Go to step 10.
<p>Step 10</p> <p>Check the marks that appear on a multi-page print job.</p> <p>Do the marks appear on every other page?</p>	Go to step 11.	Contact the next level of support.
<p>Step 11</p> <p>Replace the transfer module. See “Transfer module removal” on page 334.</p> <p>Does the problem remain?</p>	Contact the next level of support.	The problem is solved.

Random marks check

Action	Yes	No
<p>Step 1 Check the printer for toner leaks.</p> <p>Are there toner leaks?</p>	Go to step 2.	Go to step 3.
<p>Step 2 a Clean the printer thoroughly using a toner vacuum. b Perform a print job to clear the remaining toner from the imaging components.</p> <p>Does the problem remain?</p>	Go to step 3.	The problem is solved.
<p>Step 3 Check the imaging kit for debris and fragments.</p> <p>Is the imaging kit free of debris and fragments?</p>	Go to step 5.	Go to step 4.
<p>Step 4 Remove the debris and fragments.</p> <p>Does the problem remain?</p>	Go to step 5.	The problem is solved.
<p>Step 5 Check the transfer module for debris and fragments.</p> <p>Is the transfer module free of debris and fragments?</p>	Contact the next level of support.	Go to step 6.
<p>Step 6 Remove the debris and fragments.</p> <p>Does the problem remain?</p>	Contact the next level of support.	The problem is solved.

Light print check

Action	Yes	No
<p>Step 1 a From the home screen, touch Settings > Print > Quality. b Check the Toner darkness setting value.</p> <p>Is the darkness setting too low?</p>	Go to step 2.	Go to step 3.
<p>Step 2 Adjust the darkness setting to the proper value.</p> <p>Does the problem remain?</p>	Go to step 3.	The problem is solved.

Action	Yes	No
<p>Step 3</p> <p>a Enter the Diagnostics menu, and then navigate to: Advanced Print Quality Samples > Advanced Print Quality Samples</p> <p>b Check the test page.</p> <p>Is only one color affected?</p>	Go to step 4.	Go to step 12.
<p>Step 4</p> <p>Check the toner cartridge of the affected color for proper installation.</p> <ul style="list-style-type: none"> • Make sure that there are no packing materials still on it. • Check for misalignment. <p>Is the toner cartridge properly installed?</p>	Go to step 6.	Go to step 5.
<p>Step 5</p> <p>Reinstall the toner cartridge.</p> <p>Does the problem remain?</p>	Go to step 6.	The problem is solved.
<p>Step 6</p> <p>Check the cartridge toner level.</p> <p>Is the cartridge empty?</p>	Go to step 7.	Go to step 8.
<p>Step 7</p> <p>Replace the toner cartridge.</p> <p>Does the problem remain?</p>	Go to step 8.	The problem is solved.
<p>Step 8</p> <p>Remove, and then reinstall the developer unit of the affected color.</p> <p>Does the problem remain?</p>	Go to step 9.	The problem is solved.
<p>Step 9</p> <p>a Enter the Diagnostics menu, and then navigate to: Printer diagnostics & adjustments > Motor tests</p> <p>b Select the developer unit of the affected color, and then touch Start.</p> <p>Does the motor run?</p>	Go to step 12.	Go to step 10.
<p>Step 10</p> <p>Check the motor cable for proper installation, and reseal if necessary.</p> <p>Does the problem remain?</p>	Go to step 11.	The problem is solved.

Action	Yes	No
<p>Step 11 Replace the motor. See “Motor (EP drive) removal” on page 296.</p> <p>Does the problem remain?</p>	Go to step 12.	The problem is solved.
<p>Step 12 Remove the printhead, and then check the printhead lenses for dust or debris. See “Printhead removal” on page 361.</p> <p>Are the lenses free of dust or debris?</p>	Go to step 14.	Go to step 13.
<p>Step 13 Clean the printhead lenses.</p> <p>Does the problem remain?</p>	Go to step 14.	The problem is solved.
<p>Step 14 Check the HVPS cable on the HVPS and on the JHVPS1 connector on the controller board for proper connection.</p> <p>Is the cable properly connected at both ends?</p>	Go to step 16.	Go to step 15.
<p>Step 15 Reconnect the cable.</p> <p>Does the problem remain?</p>	Go to step 16.	The problem is solved.
<p>Step 16 Check the cable for continuity.</p> <p>Does the cable have continuity?</p>	Go to step 18.	Go to step 17.
<p>Step 17 Replace the HVPS cable.</p> <p>Does the problem remain?</p>	Go to step 18.	The problem is solved.
<p>Step 18 Check the toner cartridge contacts for damage, and replace if necessary. See “Toner cartridge contacts removal” on page 328.</p> <p>Does the problem remain?</p>	Go to step 19.	The problem is solved.
<p>Step 19 Remove the transfer module, and then check the three HVPS contacts. See “Transfer module removal” on page 334.</p> <p>Do the contacts freely move?</p>	Go to step 21.	Go to step 20.

Action	Yes	No
<p>Step 20 Reseat the HVPS and make sure that the contacts freely move.</p> <p>Does the problem remain?</p>	Go to step 21.	The problem is solved.
<p>Step 21 Replace the transfer module. See “Transfer module removal” on page 334.</p> <p>Does the problem remain?</p>	Go to step 22.	The problem is solved.
<p>Step 22 Replace the HVPS. See “HVPS removal” on page 319.</p> <p>Does the problem remain?</p>	Contact the next level of support.	The problem is solved.

Skewed print service check

Action	Yes	No
<p>Step 1 Check the paper for improper loading and damage, and replace if necessary.</p> <p>Does the problem remain?</p>	Go to step 2.	The problem is solved.
<p>Step 2 a From the home screen, touch Settings > Device > Preferences. b Check if the paper type and size settings match the paper type and size set on the tray.</p> <p>Do the settings match?</p>	Go to step 4.	Go to step 3.
<p>Step 3 Change the paper size and type, or adjust the size settings in the tray.</p> <p>Does the problem remain?</p>	Go to step 4.	The problem is solved.
<p>Step 4 Check the ITM for proper installation and damage, and reinstall if necessary.</p> <p>Does the problem remain?</p>	Go to step 5.	The problem is solved.
<p>Step 5 Perform the printhead alignment adjustment. See “Printhead alignment adjustment” on page 261.</p> <p>Does the problem remain?</p>	Go to step 6.	The problem is solved.

Action	Yes	No
<p>Step 6 Check the isolation unit for dust or debris.</p> <p>Is the isolation unit free of dust or debris?</p>	Go to step 8.	Go to step 7.
<p>Step 7 Remove the dust or debris.</p> <p>Does the problem remain?</p>	Go to step 8.	The problem is solved.
<p>Step 8 a Enter the Diagnostics menu, and then navigate to: Printer diagnostics & adjustments > Motor tests > Deskew b Touch Start.</p> <p>Does the motor run?</p>	Go to step 11.	Go to step 9.
<p>Step 9 Check the cable on the JMTR1 connector on the controller board for proper connection and damage, and replace if necessary.</p> <p>Does the problem remain?</p>	Go to step 10.	The problem is solved.
<p>Step 10 Replace the motor (deskew). See “Motor (deskew) removal” on page 299.</p> <p>Does the problem remain?</p>	Go to step 11.	The problem is solved.
<p>Step 11 Check the condition of the deskew rollers.</p> <p>Are the rollers free from excess wear, contamination, and damage?</p>	Contact the next level of support.	Go to step 12.
<p>Step 12 Clean or replace the rollers.</p> <p>Does the problem remain?</p>	Contact the next level of support.	The problem is solved.

Paper jams

Avoiding jams

Load paper properly

- Make sure that the paper lies flat in the tray.

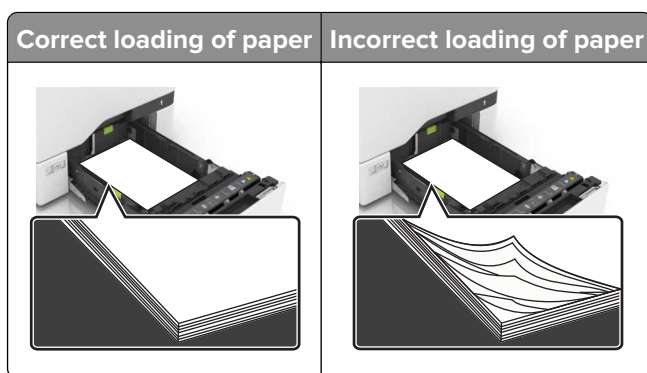

- Do not load or remove a tray while the printer is printing.
- Do not load too much paper. Make sure that the stack height is below the maximum paper fill indicator.
- Do not slide paper into the tray. Load paper as shown in the illustration.



- Make sure that the paper guides are positioned correctly and are not pressing tightly against the paper or envelopes.
- Push the tray firmly into the printer after loading paper.

Use recommended paper

- Use only recommended paper or specialty media.
- Do not load paper that is wrinkled, creased, damp, bent, or curled.
- Flex, fan, and align the paper edges before loading.

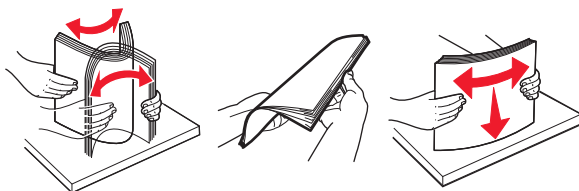

- Do not use paper that has been cut or trimmed by hand.
- Do not mix paper sizes, weights, or types in the same tray.

- Make sure that the paper size and type are set correctly on the computer or printer control panel.
- Store paper according to manufacturer recommendations.

Identifying jam locations

Notes:

- When Jam Assist is set to On, the printer flushes blank pages or pages with partial prints after a jammed page has been cleared. Check your printed output for blank pages.
- When Jam Recovery is set to On or Auto, the printer reprints jammed pages.

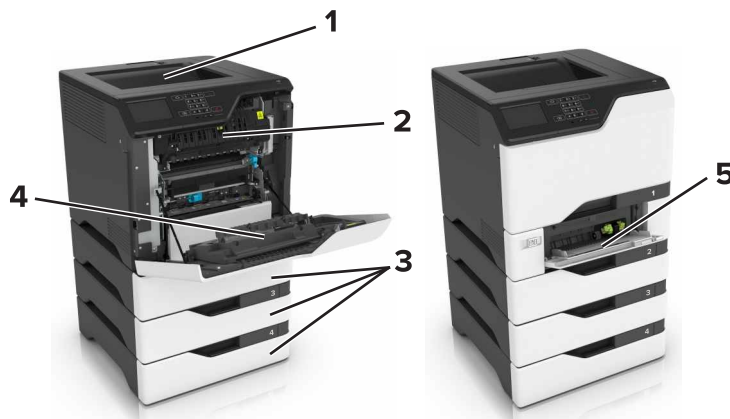

	Jam locations
1	Standard bin
2	Fuser
3	Trays
4	Duplex unit
5	Multipurpose feeder

Paper jam in trays

- 1 Pull out the tray.



Warning—Potential Damage: A sensor inside the optional tray is easily damaged by static electricity. Touch a metal surface before removing the jammed paper in the tray.

- 2 Remove the jammed paper.

Note: Make sure that all paper fragments are removed.

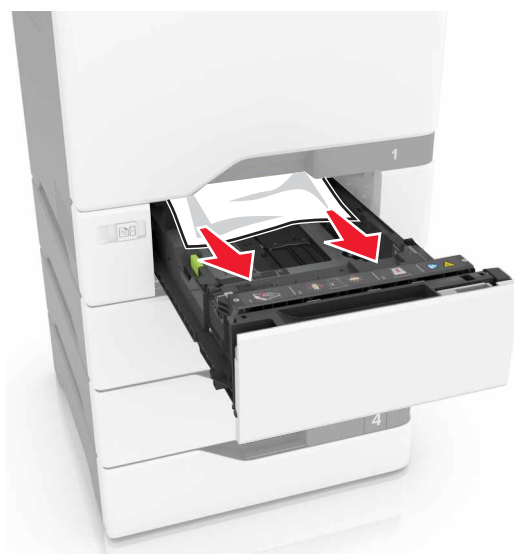

- 3 Insert the tray.

Paper jam in the multipurpose feeder

- 1 Remove paper from the multipurpose feeder.
- 2 Pull out the tray.
- 3 Remove the jammed paper.

Note: Make sure that all paper fragments are removed.

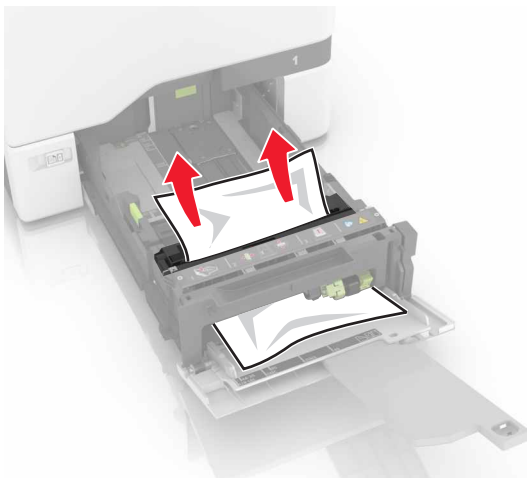

- 4 Insert the tray.

Paper jam in the standard bin

- 1 Remove the jammed paper.

Note: Make sure that all paper fragments are removed.



- Open doors A and D, and then remove any paper fragments.

 **CAUTION—HOT SURFACE:** The inside of the printer might be hot. To reduce the risk of injury from a hot component, allow the surface to cool before touching it.

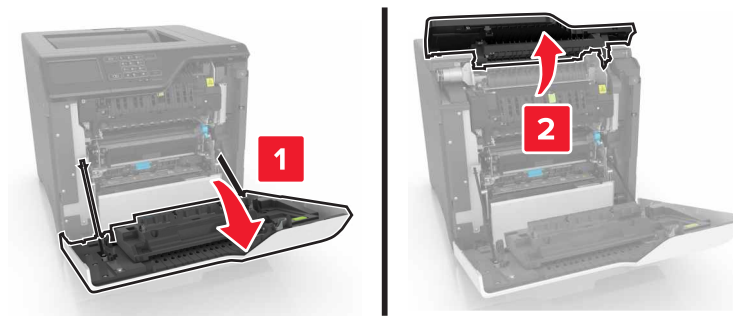

- Close doors D and A.

Paper jam in door A

Paper jam in the fuser

- Open door A.

 **CAUTION—HOT SURFACE:** The inside of the printer might be hot. To reduce the risk of injury from a hot component, allow the surface to cool before touching it.



- Remove the jammed paper.

Note: Make sure that all paper fragments are removed.

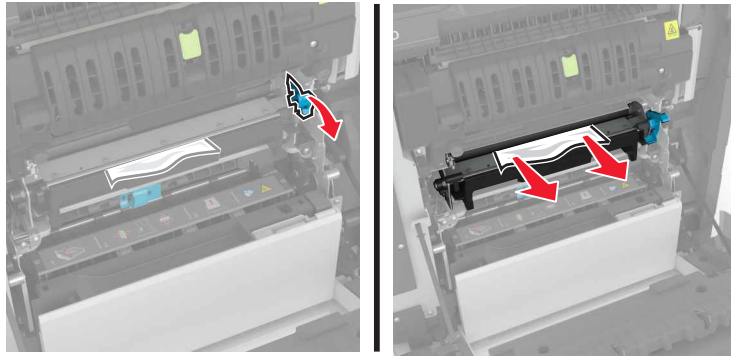

3 Open the fuser access door.

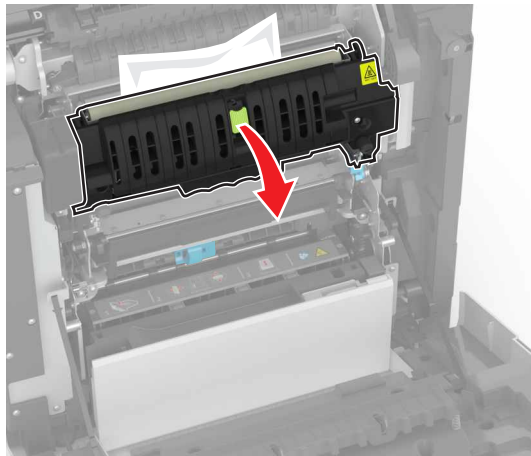

4 Remove the jammed paper.

Note: Make sure that all paper fragments are removed.

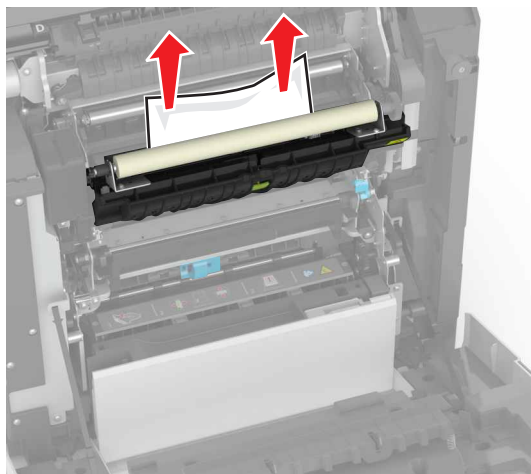

5 Close door A.

Paper jam in the duplex unit

- 1 Open door A.

 **CAUTION—HOT SURFACE:** The inside of the printer might be hot. To reduce the risk of injury from a hot component, allow the surface to cool before touching it.



- 2 Open the duplex cover.

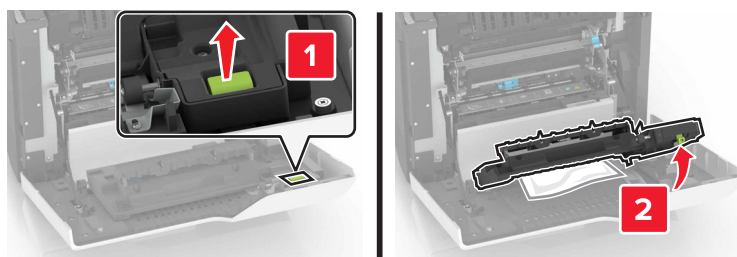

- 3 Remove the jammed paper.

Note: Make sure that all paper fragments are removed.

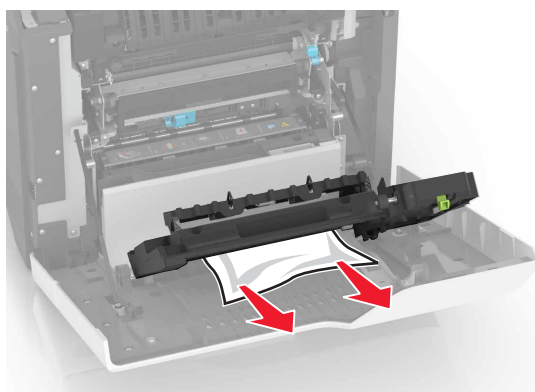

- 4 Close the duplex cover and door A.

200 paper jams

200 paper jam messages

Error code	Description	Action
200.05	Paper fed from the MPF never cleared the sensor (input).	See “Sensor (input): Paper failed to clear service check” on page 72.
200.12	Paper fed from tray 1 was detected earlier than expected at the sensor (input).	See “Sensor (input): Paper arrived too early service check” on page 70.
200.13	Paper fed from tray 1 never arrived at the sensor (input).	See “Sensor (input): Paper failed to arrive service check” on page 70.
200.14	Paper fed from tray 1 cleared the sensor (input) earlier than expected.	See “Sensor (input): Paper cleared too early service check” on page 73.
200.15	Paper fed from tray 1 never cleared the sensor (input).	See “Sensor (input): Paper failed to clear service check” on page 72.
200.22	Paper fed from tray 2 was detected earlier than expected at the sensor (input).	See “Sensor (input): Paper arrived too early service check” on page 70.
200.23	Paper fed from tray 2 did not reach the sensor (input).	See “Sensor (input): Paper failed to arrive service check” on page 70.
200.24	Paper fed from tray 2 cleared the sensor (input) earlier than expected.	See “Sensor (input): Paper cleared too early service check” on page 73.
200.25	Paper fed from tray 2 never cleared the sensor (input).	See “Sensor (input): Paper failed to clear service check” on page 72.
200.32	Paper fed from tray 3 was detected earlier than expected at the sensor (input).	See “Sensor (input): Paper arrived too early service check” on page 70.
200.33	Paper fed from tray 3 did not reach the sensor (input).	See “Sensor (input): Paper failed to arrive service check” on page 70.
200.34	Paper fed from tray 3 cleared the sensor (input) earlier than expected.	See “Sensor (input): Paper cleared too early service check” on page 73.
200.35	Paper fed from tray 3 never cleared the sensor (input).	See “Sensor (input): Paper failed to clear service check” on page 72.
200.42	Paper fed from tray 4 was detected earlier than expected at the sensor (input).	See “Sensor (input): Paper arrived too early service check” on page 70.
200.43	Paper fed from tray 4 did not reach the sensor (input).	See “Sensor (input): Paper failed to arrive service check” on page 70.
200.44	Paper fed from tray 4 cleared the sensor (input) earlier than expected.	See “Sensor (input): Paper cleared too early service check” on page 73.
200.45	Paper fed from tray 4 never cleared the sensor (input).	See “Sensor (input): Paper failed to clear service check” on page 72.
200.91	Paper remains detected at the sensor (input) after the printer is turned on.	See “Sensor (input) static jam service check” on page 74.

Sensor (input): Paper arrived too early service check

Action	Yes	No
<p>Step 1</p> <p>a From the home screen, touch Settings > Device > Preferences.</p> <p>b Check if the paper size matches the size set on the tray guides.</p> <p>Does the paper size match the size set on the tray?</p>	Go to step 3.	Go to step 2.
<p>Step 2</p> <p>Change the paper size or adjust the size setting in the tray.</p> <p>Does the problem remain?</p>	Go to step 3.	The problem is solved.
<p>Step 3</p> <p>Check the tray for overfilling.</p> <p>Is the tray overfilled?</p>	Go to step 4.	Go to step 5.
<p>Step 4</p> <p>Remove the excess paper from the tray.</p> <p>Does the problem remain?</p>	Go to step 5.	The problem is solved.
<p>Step 5</p> <p>Check the paper path along the tray exit.</p> <p>Is the paper path free of fragments and contamination?</p>	Go to step 7.	Go to step 6.
<p>Step 6</p> <p>Clean the paper path.</p> <p>Does the problem remain?</p>	Go to step 7.	The problem is solved.
<p>Step 7</p> <p>Perform a print job.</p> <p>Does the problem remain?</p>	Contact the next level of support.	The problem is solved.

Sensor (input): Paper failed to arrive service check

Action	Yes	No
<p>Step 1</p> <p>a From the home screen, touch Settings > Device > Preferences.</p> <p>b Check if the paper type and size settings match the paper type and size set on the tray.</p> <p>Does the paper size match the size set on the tray?</p>	Go to step 3.	Go to step 2.

Action	Yes	No
<p>Step 2 Change the paper size or adjust the size setting in the tray.</p> <p>Does the problem remain?</p>	Go to step 3.	The problem is solved.
<p>Step 3 Check the paper path for paper jams and fragments.</p> <p>Is the paper path free of jams and fragments?</p>	Go to step 5.	Go to step 4.
<p>Step 4 Remove the jams and fragments.</p> <p>Does the problem remain?</p>	Go to step 5.	The problem is solved.
<p>Step 5 a Enter the Diagnostics menu, and then navigate to: Printer diagnostics & adjustments > Sensor tests b Find the sensor (Input).</p> <p>Does the sensor status change while toggling the sensor?</p>	Go to step 8.	Go to step 6.
<p>Step 6 Check the sensor cable for proper connection and damage, and replace if necessary.</p> <p>Does the problem remain?</p>	Go to step 7.	The problem is solved.
<p>Step 7 Check the sensor for damage, and replace if necessary.</p> <p>Does the problem remain?</p>	Go to step 8.	The problem is solved.
<p>Step 8 a Enter the Diagnostics menu, and then navigate to: Printer diagnostics & adjustments > Motor tests > Deskew b Touch Start.</p> <p>Does the motor run?</p>	Contact the next level of support.	Go to step 9.
<p>Step 9 Check the motor cable for proper connection and damage, and replace if necessary.</p> <p>Does the problem remain?</p>	Go to step 10.	The problem is solved.
<p>Step 10 Replace the motor (registration).</p> <p>Does the problem remain?</p>	Contact the next level of support.	The problem is solved.

Sensor (input): Paper failed to clear service check

Action	Yes	No
<p>Step 1</p> <p>a From the home screen, touch Settings > Device > Preferences.</p> <p>b Check if the paper size matches the size set on the tray guides.</p> <p>Does the paper size match the size set on the tray?</p>	Go to step 3.	Go to step 2.
<p>Step 2</p> <p>Change the paper size or adjust the size setting in the tray.</p> <p>Does the problem remain?</p>	Go to step 3.	The problem is solved.
<p>Step 3</p> <p>Check the paper path for paper jams and obstructions.</p> <p>Is the paper path free of jams and obstructions?</p>	Go to step 5.	Go to step 4.
<p>Step 4</p> <p>Remove the jams and obstructions.</p> <p>Does the problem remain?</p>	Go to step 5.	The problem is solved.
<p>Step 5</p> <p>a Enter the Diagnostics menu, and then navigate to: Printer diagnostics & adjustments > Sensor tests</p> <p>b Find the sensor (Input).</p> <p>Does the sensor status change while toggling the sensor?</p>	Go to step 8.	Go to step 6.
<p>Step 6</p> <p>Check the sensor cable for proper connection and damage, and replace if necessary.</p> <p>Does the problem remain?</p>	Go to step 7.	The problem is solved.
<p>Step 7</p> <p>Check the sensor for damage, and replace if necessary.</p> <p>Does the problem remain?</p>	Go to step 8.	The problem is solved.
<p>Step 8</p> <p>a Enter the Diagnostics menu, and then navigate to: Printer diagnostics & adjustments > Motor tests > Deskew</p> <p>b Touch Start.</p> <p>Does the motor run?</p>	Contact the next level of support.	Go to step 9.

Action	Yes	No
<p>Step 9 Check the motor cable for proper connection and damage, and replace if necessary.</p> <p>Does the problem remain?</p>	Go to step 10.	The problem is solved.
<p>Step 10 a Replace the motor (registration). b Perform a print job.</p> <p>Does the problem remain?</p>	Contact the next level of support.	The problem is solved.

Sensor (input): Paper cleared too early service check

Action	Yes	No
<p>Step 1 a From the home screen, touch Settings > Device > Preferences. b Check if the paper size matches the size set on the tray guides.</p> <p>Does the paper size match the size set on the tray?</p>	Go to step 3.	Go to step 2.
<p>Step 2 Change the paper size or adjust the size setting in the tray.</p> <p>Does the problem remain?</p>	Go to step 3.	The problem is solved.
<p>Step 3 Check the tray for overfilling.</p> <p>Is the tray overfilled?</p>	Go to step 4.	Go to step 5.
<p>Step 4 Remove the excess paper from the tray.</p> <p>Does the problem remain?</p>	Go to step 5.	The problem is solved.
<p>Step 5 Check the paper condition in the tray.</p> <p>Is the paper crumpled or damaged?</p>	Go to step 6.	Go to step 7.
<p>Step 6 Replace the crumpled or damaged paper.</p> <p>Does the problem remain?</p>	Go to step 7.	The problem is solved.

Action	Yes	No
<p>Step 7</p> <p>a Enter the Diagnostics menu, and then navigate to: Printer diagnostics & adjustments > Sensor tests</p> <p>b Find the sensor (Input).</p> <p>Does the sensor status change while toggling the sensor?</p>	Go to step 9.	The problem is solved.
<p>Step 8</p> <p>Check the sensor cable for proper connection, and then reseal if necessary.</p> <p>Does the problem remain?</p>	Go to step 9.	The problem is solved.
<p>Step 9</p> <p>Replace the sensor. See “Sensor (input) removal” on page 341.</p> <p>Does the problem remain?</p>	Go to step 10.	The problem is solved.
<p>Step 10</p> <p>Perform a print job.</p> <p>Does the problem remain?</p>	Contact the next level of support.	The problem is solved.

Sensor (input) static jam service check

Action	Yes	No
<p>Step 1</p> <p>a From the home screen, touch Settings > Device > Preferences.</p> <p>b Check if the paper size matches the size set on the tray guides.</p> <p>Does the paper size match the size set on the tray?</p>	Go to step 3.	Go to step 2.
<p>Step 2</p> <p>Change the paper size or adjust the size setting in the tray.</p> <p>Does the problem remain?</p>	Go to step 3.	The problem is solved.
<p>Step 3</p> <p>Check the paper path for partially fed or jammed paper.</p> <p>Is the paper path free of partially fed or jammed paper?</p>	Go to step 5.	Go to step 4.
<p>Step 4</p> <p>Remove the partially fed or jammed paper.</p> <p>Does the problem remain?</p>	Go to step 5.	The problem is solved.

Action	Yes	No
<p>Step 5</p> <p>a Enter the Diagnostics menu, and then navigate to: Printer diagnostics & adjustments > Sensor tests</p> <p>b Find the sensor (Input).</p> <p>Does the sensor status change while toggling the sensor?</p>	Go to step 8.	Go to step 6.
<p>Step 6</p> <p>Check the sensor cable for proper connection and damage, and replace if necessary.</p> <p>Does the problem remain?</p>	Go to step 7.	The problem is solved.
<p>Step 7</p> <p>Check the sensor for damage, and replace if necessary.</p> <p>Does the problem remain?</p>	Contact the next level of support.	The problem is solved.
<p>Step 8</p> <p>Perform a print job.</p> <p>Does the problem remain?</p>	Contact the next level of support.	The problem is solved.

201 paper jams

201 paper jam messages

Error code	Description	Action
201.91	Paper remains detected at the sensor (fuser buckle).	See “Sensor (fuser buckle) jam service check” on page 75.

Sensor (fuser buckle) jam service check

Action	Yes	No
<p>Step 1</p> <p>a From the home screen, touch Settings > Device > Preferences.</p> <p>b Check if the paper size matches the size set on the tray guides.</p> <p>Does the paper size match the size set on the tray?</p>	Go to step 3.	Go to step 2.
<p>Step 2</p> <p>Change the paper size or adjust the size setting in the tray.</p> <p>Does the problem remain?</p>	Go to step 3.	The problem is solved.

Action	Yes	No
<p>Step 3</p> <p>Check the paper path for partially fed or jammed paper.</p> <p>Is the paper path free of partially fed or jammed paper?</p>	Go to step 5.	Go to step 4.
<p>Step 4</p> <p>Remove the partially fed or jammed paper.</p> <p>Does the problem remain?</p>	Go to step 5.	The problem is solved.
<p>Step 5</p> <p>a Enter the Diagnostics menu, and then navigate to: Printer diagnostics & adjustments > Sensor tests</p> <p>b Find the sensor (Fuser buckle).</p> <p>Does the sensor status change while toggling the sensor?</p>	Contact the next level of support.	Go to step 6.
<p>Step 6</p> <p>Check the sensor cable for proper connection and damage, and replace if necessary.</p> <p>Does the problem remain?</p>	Go to step 7.	The problem is solved.
<p>Step 7</p> <p>a Check the sensor for damage, and replace if necessary.</p> <p>b Perform a print job.</p> <p>Does the problem remain?</p>	Contact the next level of support.	The problem is solved.

202 paper jams

202 paper jam messages

Error code	Description	Action
202.12	Paper fed from tray 1 was detected earlier than expected at the sensor (fuser exit).	See “Sensor (fuser exit): Paper arrived too early service check” on page 77.
202.13	Paper fed from tray 1 never arrived at the sensor (fuser exit).	See “Sensor (fuser exit): Paper failed to arrive service check” on page 78.
202.14	Paper fed from tray 1 cleared the sensor (fuser exit) earlier than expected.	See “Sensor (fuser exit): Paper cleared too early service check” on page 82.
202.15	Paper fed from tray 1 never cleared the sensor (fuser exit).	See “Sensor (fuser exit): Paper failed to clear service check” on page 80.
202.22	Paper fed from tray 2 was detected earlier than expected at the sensor (fuser exit).	See “Sensor (fuser exit): Paper arrived too early service check” on page 77.
202.23	Paper fed from tray 2 never arrived at the sensor (fuser exit).	See “Sensor (fuser exit): Paper failed to arrive service check” on page 78.

Error code	Description	Action
202.24	Paper fed from tray 2 cleared the sensor (fuser exit) earlier than expected.	See “Sensor (fuser exit): Paper cleared too early service check” on page 82.
202.25	Paper fed from tray 2 never cleared the sensor (fuser exit).	See “Sensor (fuser exit): Paper failed to clear service check” on page 80.
202.32	Paper fed from tray 3 was detected earlier than expected at the sensor (fuser exit).	See “Sensor (fuser exit): Paper arrived too early service check” on page 77.
202.33	Paper fed from tray 3 never arrived at the sensor (fuser exit).	See “Sensor (fuser exit): Paper failed to arrive service check” on page 78.
202.34	Paper fed from tray 3 cleared the sensor (fuser exit) earlier than expected.	See “Sensor (fuser exit): Paper cleared too early service check” on page 82.
202.35	Paper fed from tray 3 never cleared the sensor (fuser exit).	See “Sensor (fuser exit): Paper failed to clear service check” on page 80.
202.42	Paper fed from tray 4 was detected earlier than expected at the sensor (fuser exit).	See “Sensor (fuser exit): Paper arrived too early service check” on page 77.
202.43	Paper fed from tray 4 never arrived at the sensor (fuser exit).	See “Sensor (fuser exit): Paper failed to arrive service check” on page 78.
202.44	Paper fed from tray 4 cleared the sensor (fuser exit) earlier than expected.	See “Sensor (fuser exit): Paper cleared too early service check” on page 82.
202.45	Paper fed from tray 4 never cleared the sensor (fuser exit).	See “Sensor (fuser exit): Paper failed to clear service check” on page 80.
202.91	Paper remains detected at the sensor (fuser exit) after the printer is turned on.	See “Sensor (fuser exit) static jam service check” on page 83.

Sensor (fuser exit): Paper arrived too early service check

Action	Yes	No
<p>Step 1</p> <p>a From the home screen, touch Settings > Device > Preferences.</p> <p>b Check if the paper size matches the size set on the tray guides.</p> <p>Does the paper size match the size set on the tray?</p>	Go to step 3.	Go to step 2.
<p>Step 2</p> <p>Change the paper size or adjust the size setting in the tray.</p> <p>Does the problem remain?</p>	Go to step 3.	The problem is solved.
<p>Step 3</p> <p>Check the paper path just before the fuser for paper jams and fragments.</p> <p>Is the paper path free of fragments and contamination?</p>	Go to step 5.	Go to step 4.

Action	Yes	No
Step 4 Remove the paper jams and fragments. Does the problem remain?	Go to step 5.	The problem is solved.
Step 5 Check the fuser rollers for damage. Are the rollers free of damage?	Go to step 7.	Go to step 6.
Step 6 Replace the fuser. See “Fuser removal” on page 333 . Does the problem remain?	Go to step 7.	The problem is solved.
Step 7 Perform a print job. Does the problem remain?	Contact the next level of support.	The problem is solved.

Sensor (fuser exit): Paper failed to arrive service check

Action	Yes	No
Step 1 a From the home screen, touch Settings > Device > Preferences . b Check if the paper size matches the size set on the tray guides. Does the paper size match the size set on the tray?	Go to step 3.	Go to step 2.
Step 2 Change the paper size or adjust the size setting in the tray. Does the problem remain?	Go to step 3.	The problem is solved.
Step 3 Check the paper path for paper jams and fragments. Is the paper path free of jams and fragments?	Go to step 5.	Go to step 4.
Step 4 Remove the jams and fragments. Does the problem remain?	Go to step 5.	The problem is solved.
Step 5 Check the fuser for obstructions. Is the fuser free from obstructions?	Go to step 7.	Go to step 6.

Action	Yes	No
<p>Step 6 Remove the obstructions in the fuser area.</p> <p>Does the problem remain?</p>	Go to step 7.	The problem is solved.
<p>Step 7 Check the fuser for damage or life expiration, and replace if necessary. See “Fuser removal” on page 333.</p> <p>Does the problem remain?</p>	Go to step 8.	The problem is solved.
<p>Step 8 a Enter the Diagnostics menu, and then navigate to: Printer diagnostics & adjustments > Sensor tests b Find the sensor (Fuser exit).</p> <p>Does the sensor status change while toggling the sensor?</p>	Go to step 11.	Go to step 9.
<p>Step 9 a Make sure that the fuser is properly seated. b Check the cable on the JFSNS connector on the controller board for proper connection, and reseal if necessary.</p> <p>Does the problem remain?</p>	Go to step 10.	The problem is solved.
<p>Step 10 Check the sensor for damage, and replace if necessary.</p> <p>Does the problem remain?</p>	Go to step 11.	The problem is solved.
<p>Step 11 Check the transfer belt for damage and replace if necessary. See “Transfer module removal” on page 334.</p> <p>Does the problem remain?</p>	Go to step 12.	The problem is solved.
<p>Step 12 a Enter the Diagnostics menu, and then navigate to: Printer diagnostics & adjustments > Motor tests > Fuser b Select a setting, and then touch Start.</p> <p>Does the motor run?</p>	Go to step 15.	Go to step 13.
<p>Step 13 Check the cable on the JFUSED1 connector on the controller board for proper connection and damage, and replace if necessary.</p> <p>Does the problem remain?</p>	Go to step 14.	The problem is solved.

Action	Yes	No
<p>Step 14</p> <p>a Replace the motor. See “Motor (fuser) removal” on page 318.</p> <p>b Perform a print job.</p> <p>Does the problem remain?</p>	Go to step 15.	The problem is solved.
<p>Step 15</p> <p>a Enter the Diagnostics menu, and then navigate to: Printer diagnostics & adjustments > Motor tests > K developer-transfer</p> <p>b Touch Start.</p> <p>Does the motor run?</p>	Contact the next level of support.	Go to step 16.
<p>Step 16</p> <p>Check the cable on the JCARTK connector on the controller board for proper connection and damage, and replace if necessary.</p> <p>Does the problem remain?</p>	Go to step 17.	The problem is solved.
<p>Step 17</p> <p>a Replace the motor (K cartridge). See “Motor (EP drive) removal” on page 296.</p> <p>b Perform a print job.</p> <p>Does the problem remain?</p>	Contact the next level of support.	The problem is solved.

Sensor (fuser exit): Paper failed to clear service check

Action	Yes	No
<p>Step 1</p> <p>a From the home screen, touch Settings > Device > Preferences.</p> <p>b Check if the paper size matches the size set on the tray guides.</p> <p>Does the paper size match the size set on the tray?</p>	Go to step 3.	Go to step 2.
<p>Step 2</p> <p>Change the paper size or adjust the size setting in the tray.</p> <p>Does the problem remain?</p>	Go to step 3.	The problem is solved.
<p>Step 3</p> <p>Check the redrive paper path for paper jams and fragments.</p> <p>Is the paper path free of jams and fragments?</p>	Go to step 5.	Go to step 4.

Action	Yes	No
<p>Step 4 Remove the jams and fragments.</p> <p>Does the problem remain?</p>	Go to step 5.	The problem is solved.
<p>Step 5 Check the fuser for obstructions.</p> <p>Is the fuser free from obstructions?</p>	Go to step 7.	Go to step 6.
<p>Step 6 Remove the obstructions in the fuser area.</p> <p>Does the problem remain?</p>	Go to step 7.	The problem is solved.
<p>Step 7 Check the fuser for damage or life expiration, and replace if necessary. See “Fuser removal” on page 333.</p> <p>Does the problem remain?</p>	Go to step 8.	The problem is solved.
<p>Step 8</p> <p>a Enter the Diagnostics menu, and then navigate to: Printer diagnostics & adjustments > Sensor tests</p> <p>b Find the sensor (Fuser exit).</p> <p>Does the sensor status change while toggling the sensor?</p>	Go to step 11.	Go to step 9.
<p>Step 9</p> <p>a Make sure that the fuser is seated properly.</p> <p>b Check the cable on the JFSNS connector on the controller board for proper connection, and reseal if necessary.</p> <p>Does the problem remain?</p>	Go to step 10.	The problem is solved.
<p>Step 10 Check the sensor for damage, and replace if necessary.</p> <p>Does the problem remain?</p>	Go to step 11.	The problem is solved.
<p>Step 11</p> <p>a Enter the Diagnostics menu, and then navigate to: Printer diagnostics & adjustments > Motor tests > Fuser</p> <p>b Select a setting, and then touch Start.</p> <p>Does the motor run?</p>	Contact the next level of support.	Go to step 12.

Action	Yes	No
<p>Step 12</p> <p>Check the motor cable for proper connection and damage, and replace if necessary.</p> <p>Does the problem remain?</p>	Go to step 13.	The problem is solved.
<p>Step 13</p> <p>a Replace the motor. See “Motor (fuser) removal” on page 318.</p> <p>b Perform a print job.</p> <p>Does the problem remain?</p>	Contact the next level of support.	The problem is solved.

Sensor (fuser exit): Paper cleared too early service check

Action	Yes	No
<p>Step 1</p> <p>a From the home screen, touch Settings > Device > Preferences.</p> <p>b Check if the paper size matches the size set on the tray guides.</p> <p>Does the paper size match the size set on the tray?</p>	Go to step 3.	Go to step 2.
<p>Step 2</p> <p>Change the paper size or adjust the size setting in the tray.</p> <p>Does the problem remain?</p>	Go to step 3.	The problem is solved.
<p>Step 3</p> <p>Check the fuser rollers for damage.</p> <p>Are the rollers free of damage?</p>	Go to step 5.	Go to step 4.
<p>Step 4</p> <p>Replace the fuser. See “Fuser removal” on page 333.</p> <p>Does the problem remain?</p>	Go to step 5.	The problem is solved.
<p>Step 5</p> <p>a Enter the Diagnostics menu, and then navigate to: Printer diagnostics & adjustments > Sensor tests</p> <p>b Find the sensor (Fuser exit).</p> <p>Does the sensor status change while toggling the sensor?</p>	Go to step 8.	Go to step 6.
<p>Step 6</p> <p>Check the sensor cable for proper connection, and then reseal if necessary.</p> <p>Does the problem remain?</p>	Go to step 7.	The problem is solved.

Action	Yes	No
<p>Step 7 Replace the fuser. See “Fuser removal” on page 333.</p> <p>Does the problem remain?</p>	Go to step 8.	The problem is solved.
<p>Step 8 Perform a print job.</p> <p>Does the problem remain?</p>	Contact the next level of support.	The problem is solved.

Sensor (fuser exit) static jam service check

Action	Yes	No
<p>Step 1 a From the home screen, touch Settings > Device > Preferences. b Check if the paper size matches the size set on the tray guides.</p> <p>Does the paper size match the size set on the tray?</p>	Go to step 3.	Go to step 2.
<p>Step 2 Change the paper size or adjust the size setting in the tray.</p> <p>Does the problem remain?</p>	Go to step 3.	The problem is solved.
<p>Step 3 Check the paper path for partially fed or jammed paper.</p> <p>Is the paper path free of partially fed or jammed paper?</p>	Go to step 5.	Go to step 4.
<p>Step 4 Remove the partially fed or jammed paper.</p> <p>Does the problem remain?</p>	Go to step 5.	The problem is solved.
<p>Step 5 a Enter the Diagnostics menu, and then navigate to: Printer diagnostics & adjustments > Sensor tests b Find the sensor (Fuser exit).</p> <p>Does the sensor status change while toggling the sensor?</p>	Contact the next level of support.	Go to step 6.
<p>Step 6 a Make sure that the fuser is properly seated. b Check the cable on the JFSNS connector on the controller board for proper connection, and reseal if necessary.</p> <p>Does the problem remain?</p>	Go to step 7.	The problem is solved.

Action	Yes	No
<p>Step 7</p> <p>a Check the sensor for damage, and replace if necessary.</p> <p>b Perform a print job.</p> <p>Does the problem remain?</p>	Contact the next level of support.	The problem is solved.

203 paper jams

203 paper jam messages

Error code	Description	Action
203.91	Paper remains detected at the sensor (bin full) after the printer is turned on.	See “Sensor (output bin full) static jam service check” on page 84.

Sensor (output bin full) static jam service check

Action	Yes	No
<p>Step 1</p> <p>a From the home screen, touch Settings > Device > Preferences.</p> <p>b Check if the paper size matches the size set on the tray guides.</p> <p>Does the paper size match the size set on the tray?</p>	Go to step 3.	Go to step 2.
<p>Step 2</p> <p>Change the paper size or adjust the size setting in the tray.</p> <p>Does the problem remain?</p>	Go to step 3.	The problem is solved.
<p>Step 3</p> <p>Check the paper path for partially fed or jammed paper.</p> <p>Is the paper path free of partially fed or jammed paper?</p>	Go to step 5.	Go to step 4.
<p>Step 4</p> <p>Remove the partially fed or jammed paper.</p> <p>Does the problem remain?</p>	Go to step 5.	The problem is solved.
<p>Step 5</p> <p>a Enter the Diagnostics menu, and then navigate to: Printer diagnostics & adjustments > Sensor tests</p> <p>b Find the sensor (Output bin full).</p> <p>Does the sensor status change while toggling the sensor?</p>	Contact the next level of support.	Go to step 6.

Action	Yes	No
<p>Step 6</p> <p>Check the cable on the JDSNS connector on the controller board for proper connection and damage, and replace if necessary.</p> <p>Does the problem remain?</p>	Go to step 7.	The problem is solved.
<p>Step 7</p> <p>a Check the sensor for damage, and replace if necessary.</p> <p>b Perform a print job.</p> <p>Does the problem remain?</p>	Contact the next level of support.	The problem is solved.

211 paper jams

211 paper jam messages

Error code	Description	Action
211.91	Paper remains detected at the sensor (narrow media) after the printer is turned on.	See “Sensor (narrow media) static jam service check” on page 85.

Sensor (narrow media) static jam service check

Action	Yes	No
<p>Step 1</p> <p>a From the home screen, touch Settings > Device > Preferences.</p> <p>b Check if the paper size matches the size set on the tray guides.</p> <p>Does the paper size match the size set on the tray?</p>	Go to step 3.	Go to step 2.
<p>Step 2</p> <p>Change the paper size or adjust the size setting in the tray.</p> <p>Does the problem remain?</p>	Go to step 3.	The problem is solved.
<p>Step 3</p> <p>Check the paper path for partially fed or jammed paper.</p> <p>Is the paper path free of partially fed or jammed paper?</p>	Go to step 5.	Go to step 4.
<p>Step 4</p> <p>Remove the partially fed or jammed paper.</p> <p>Does the problem remain?</p>	Go to step 5.	The problem is solved.

Action	Yes	No
<p>Step 5</p> <p>a Enter the Diagnostics menu, and then navigate to: Printer diagnostics & adjustments > Sensor tests</p> <p>b Find the sensor (Narrow media).</p> <p>Does the sensor status change while toggling the sensor?</p>	Contact the next level of support.	Go to step 6.
<p>Step 6</p> <p>Check the cable on the JMSNS connector on the controller board for proper connection and damage, and replace if necessary.</p> <p>Does the problem remain?</p>	Go to step 7.	The problem is solved.
<p>Step 7</p> <p>a Check the sensor for damage, and replace if necessary.</p> <p>b Perform a print job.</p> <p>Does the problem remain?</p>	Contact the next level of support.	The problem is solved.

221 paper jams

221 paper jam messages

Error code	Description	Action
221.xx	Paper in the paper path of the redrive area remains detected at the sensor (duplex path 1) when the printer is turned on.	See “Sensor (duplex path 1) static jam service check” on page 86.

Sensor (duplex path 1) static jam service check

Action	Yes	No
<p>Step 1</p> <p>a From the home screen, touch Settings > Device > Preferences.</p> <p>b Check if the paper size matches the size set on the tray guides.</p> <p>Does the paper size match the size set on the tray?</p>	Go to step 3.	Go to step 2.
<p>Step 2</p> <p>Change the paper size or adjust the size setting in the tray.</p> <p>Does the problem remain?</p>	Go to step 3.	The problem is solved.
<p>Step 3</p> <p>Check the paper path for partially fed or jammed paper.</p> <p>Is the paper path free of partially fed or jammed paper?</p>	Go to step 5.	Go to step 4.

Action	Yes	No
<p>Step 4</p> <p>Remove the partially fed or jammed paper.</p> <p>Does the problem remain?</p>	Go to step 5.	The problem is solved.
<p>Step 5</p> <p>a Enter the Diagnostics menu, and then navigate to: Printer diagnostics & adjustments > Sensor tests</p> <p>b Find the sensor (Duplex path 1).</p> <p>Does the sensor status change while toggling the sensor?</p>	Contact the next level of support.	Go to step 6.
<p>Step 6</p> <p>Check the cable on the JDSNS connector on the controller board for proper connection and damage, and replace if necessary.</p> <p>Does the problem remain?</p>	Go to step 7.	The problem is solved.
<p>Step 7</p> <p>a Check the sensor for damage, and replace if necessary. See “Sensor (redrive) removal” on page 354.</p> <p>b Perform a print job.</p> <p>Does the problem remain?</p>	Contact the next level of support.	The problem is solved.

230 paper jams

230 paper jam messages

Error code	Description	Action
230.12	Paper fed from tray 1 was detected earlier than expected at the sensor (duplex path 1).	See “Sensor (duplex path 1): Paper arrived too early service check” on page 88.
230.13	Paper fed from tray 1 never arrived at the sensor (duplex path 1).	See “Sensor (duplex path 1): Paper failed to arrive service check” on page 89.
230.14	Paper fed from tray 1 cleared the sensor (duplex path 1) earlier than expected.	See “Sensor (duplex path 1): Paper cleared too early service check” on page 92.
230.15	Paper fed from tray 1 never cleared the sensor (duplex path 1).	See “Sensor (duplex path 1): Paper failed to clear service check” on page 90.
230.22	Paper fed from tray 2 was detected earlier than expected at the sensor (duplex path 1).	See “Sensor (duplex path 1): Paper arrived too early service check” on page 88.
230.22	All motor errors are reported as paper jam.	
230.23	Paper fed from tray 2 never arrived at the sensor (duplex path 1).	See “Sensor (duplex path 1): Paper failed to arrive service check” on page 89.
230.24	Paper fed from tray 2 cleared the sensor (duplex path 1) earlier than expected.	See “Sensor (duplex path 1): Paper cleared too early service check” on page 92.

Error code	Description	Action
230.25	Paper fed from tray 2 never cleared the sensor (duplex path 1).	See “Sensor (duplex path 1): Paper failed to clear service check” on page 90.
230.32	Paper fed from tray 3 was detected earlier than expected at the sensor (duplex path 1).	See “Sensor (duplex path 1): Paper arrived too early service check” on page 88.
230.33	Paper fed from tray 3 never arrived at the sensor (duplex path 1).	See “Sensor (duplex path 1): Paper failed to arrive service check” on page 89.
230.34	Paper fed from tray 3 cleared the sensor (duplex path 1) earlier than expected.	See “Sensor (duplex path 1): Paper cleared too early service check” on page 92.
230.35	Paper fed from tray 3 never cleared the sensor (duplex path 1).	See “Sensor (duplex path 1): Paper failed to clear service check” on page 90.
230.42	Paper fed from tray 4 was detected earlier than expected at the sensor (duplex path 1).	See “Sensor (duplex path 1): Paper arrived too early service check” on page 88.
230.43	Paper fed from tray 4 never arrived at the sensor (duplex path 1).	See “Sensor (duplex path 1): Paper failed to arrive service check” on page 89.
230.44	Paper fed from tray 4 cleared the sensor (duplex path 1) earlier than expected.	See “Sensor (duplex path 1): Paper cleared too early service check” on page 92.
230.45	Paper fed from tray 4 never cleared the sensor (duplex path 1).	See “Sensor (duplex path 1): Paper failed to clear service check” on page 90.
230.91	Paper remains detected at the sensor (duplex path 1) after the printer is turned on.	See “Sensor (duplex path 1) static jam service check” on page 86.

Sensor (duplex path 1): Paper arrived too early service check

Action	Yes	No
<p>Step 1</p> <p>a From the home screen, touch Settings > Device > Preferences.</p> <p>b Check if the paper size matches the size set on the tray guides.</p> <p>Does the paper size match the size set on the tray?</p>	Go to step 3.	Go to step 2.
<p>Step 2</p> <p>Change the paper size or adjust the size setting in the tray.</p> <p>Does the problem remain?</p>	Go to step 3.	The problem is solved.
<p>Step 3</p> <p>Check the paper path entering the duplex path for paper jams and fragments.</p> <p>Is the paper path free of fragments and contamination?</p>	Go to step 5.	Go to step 4.
<p>Step 4</p> <p>Remove the paper jams and fragments.</p> <p>Does the problem remain?</p>	Go to step 5.	The problem is solved.

Action	Yes	No
<p>Step 5 Perform a print job.</p> <p>Does the problem remain?</p>	Contact the next level of support.	The problem is solved.

Sensor (duplex path 1): Paper failed to arrive service check

Action	Yes	No
<p>Step 1 a From the home screen, touch Settings > Device > Preferences. b Check if the paper size matches the size set on the tray guides.</p> <p>Does the paper size match the size set on the tray?</p>	Go to step 3.	Go to step 2.
<p>Step 2 Change the paper size or adjust the size setting in the tray.</p> <p>Does the problem remain?</p>	Go to step 3.	The problem is solved.
<p>Step 3 Check the redrive paper path for paper jams and obstructions.</p> <p>Is the paper path free of jams and obstructions?</p>	Go to step 5.	Go to step 4.
<p>Step 4 Remove the jams and obstructions.</p> <p>Does the problem remain?</p>	Go to step 5.	The problem is solved.
<p>Step 5 Check the duplex paper path for paper jams and obstructions.</p> <p>Is the paper path free of jams and obstructions?</p>	Go to step 7.	Go to step 6.
<p>Step 6 Remove the jams and obstructions.</p> <p>Does the problem remain?</p>	Go to step 7.	The problem is solved.
<p>Step 7 Check the diverter for smooth movement.</p> <p>Does the diverter freely move without interference?</p>	Go to step 9.	Go to step 8.
<p>Step 8 Replace the diverter. See “Diverter removal” on page 350.</p> <p>Does the problem remain?</p>	Go to step 9.	The problem is solved.

Action	Yes	No
<p>Step 9</p> <p>a Enter the Diagnostics menu, and then navigate to: Printer diagnostics & adjustments > Sensor tests</p> <p>b Find the sensor (Duplex path 1).</p> <p>Does the sensor status change while toggling the sensor?</p>	Go to step 11.	Go to step 10.
<p>Step 10</p> <p>Replace the sensor.</p> <p>Does the problem remain?</p>	Go to step 11.	The problem is solved.
<p>Step 11</p> <p>a Enter the Diagnostics menu, and then navigate to: Printer diagnostics & adjustments > Motor tests > Redrive</p> <p>b Select a setting, and then touch Start.</p> <p>Does the motor run?</p>	Go to step 13.	Go to step 12.
<p>Step 12</p> <p>Check the cable on the JOUTDC connector on the controller board for proper connection and damage, and replace if necessary.</p> <p>Does the problem remain?</p>	Go to step 13.	The problem is solved.
<p>Step 13</p> <p>Replace the motor (output). See “Motor (output) removal” on page 297.</p> <p>Does the problem remain?</p>	Contact the next level of support.	The problem is solved.

Sensor (duplex path 1): Paper failed to clear service check

Action	Yes	No
<p>Step 1</p> <p>a From the home screen, touch Settings > Device > Preferences.</p> <p>b Check if the paper size matches the size set on the tray guides.</p> <p>Does the paper size match the size set on the tray?</p>	Go to step 3.	Go to step 2.
<p>Step 2</p> <p>Change the paper size or adjust the size setting in the tray.</p> <p>Does the problem remain?</p>	Go to step 3.	The problem is solved.
<p>Step 3</p> <p>Check if the paper size matches the size set on the tray guides.</p> <p>Does the paper size match the size set on the tray?</p>	Go to step 5.	Go to step 4.

Action	Yes	No
<p>Step 4 Change the paper size or adjust the size setting in the tray.</p> <p>Does the problem remain?</p>	Go to step 5.	The problem is solved.
<p>Step 5 Check the paper path for paper jams and obstructions.</p> <p>Is the paper path free of jams and obstructions?</p>	Go to step 7.	Go to step 6.
<p>Step 6 Remove the jams and obstructions.</p> <p>Does the problem remain?</p>	Go to step 7.	The problem is solved.
<p>Step 7</p> <p>a Enter the Diagnostics menu, and then navigate to: Printer diagnostics & adjustments > Sensor tests</p> <p>b Find the sensor (Duplex path 1).</p> <p>Does the sensor status change while toggling the sensor?</p>	Go to step 10.	Go to step 8.
<p>Step 8 Check the sensor cable for proper connection and damage, and replace if necessary.</p> <p>Does the problem remain?</p>	Go to step 9.	The problem is solved.
<p>Step 9 Check the sensor for damage, and replace if necessary.</p> <p>Does the problem remain?</p>	Go to step 10.	The problem is solved.
<p>Step 10</p> <p>a Enter the Diagnostics menu, and then navigate to: Printer diagnostics & adjustments > Motor tests > Duplex/MPF</p> <p>b Select a setting, and then touch Start.</p> <p>Does the motor run?</p>	Contact the next level of support.	Go to step 11.
<p>Step 11 Check the motor cable for proper connection and damage, and replace if necessary.</p> <p>Does the problem remain?</p>	Go to step 12.	The problem is solved.

Action	Yes	No
<p>Step 12</p> <p>a Replace the motor. See “Motor (duplex/MPF) removal” on page 315.</p> <p>b Perform a print job.</p> <p>Does the problem remain?</p>	Contact the next level of support.	The problem is solved.

Sensor (duplex path 1): Paper cleared too early service check

Action	Yes	No
<p>Step 1</p> <p>a From the home screen, touch Settings > Device > Preferences.</p> <p>b Check if the paper size matches the size set on the tray guides.</p> <p>Does the paper size match the size set on the tray?</p>	Go to step 3.	Go to step 2.
<p>Step 2</p> <p>Change the paper size or adjust the size setting in the tray.</p> <p>Does the problem remain?</p>	Go to step 3.	The problem is solved.
<p>Step 3</p> <p>Check the duplex rollers for damage.</p> <p>Are the rollers free of damage?</p>	Go to step 5.	Go to step 4.
<p>Step 4</p> <p>Replace the duplex assembly.</p> <p>Does the problem remain?</p>	Go to step 5.	The problem is solved.
<p>Step 5</p> <p>a Enter the Diagnostics menu, and then navigate to: Printer diagnostics & adjustments > Sensor tests</p> <p>b Find the sensor (Duplex path 1).</p> <p>Does the sensor status change while toggling the sensor?</p>	Go to step 8.	Go to step 6.
<p>Step 6</p> <p>Check the sensor cable for proper connection, and then reseal if necessary.</p> <p>Does the problem remain?</p>	Go to step 7.	The problem is solved.
<p>Step 7</p> <p>Replace the sensor.</p> <p>Does the problem remain?</p>	Go to step 8.	The problem is solved.

Action	Yes	No
<p>Step 8</p> <p>Perform a print job.</p> <p>Does the problem remain?</p>	Contact the next level of support.	The problem is solved.

231 paper jams

231 paper jam messages

Error code	Description	Action
231.12	Paper fed from tray 1 was detected earlier than expected at the sensor (duplex path 2).	See “Sensor (duplex path 2): Paper arrived too early service check” on page 94.
231.13	Paper fed from tray 1 never arrived at the sensor (duplex path 2).	See “Sensor (duplex path 2): Paper failed to arrive service check” on page 94.
231.14	Paper fed from tray 1 cleared the sensor (duplex path 2) earlier than expected.	See “Sensor (duplex path 2): Paper (duplex job) cleared too early service check” on page 97.
231.15	Paper fed from tray 1 never cleared the sensor (duplex path 2).	See “Sensor (duplex path 2): Paper failed to clear service check” on page 96.
231.22	Paper fed from tray 2 was detected earlier than expected at the sensor (duplex path 2).	See “Sensor (duplex path 2): Paper arrived too early service check” on page 94.
231.23	Paper fed from tray 2 never arrived at the sensor (duplex path 2).	See “Sensor (duplex path 2): Paper failed to arrive service check” on page 94.
231.24	Paper fed from tray 2 cleared the sensor (duplex path 2) earlier than expected.	See “Sensor (duplex path 2): Paper (duplex job) cleared too early service check” on page 97.
231.32	Paper fed from tray 3 was detected earlier than expected at the sensor (duplex path 2).	See “Sensor (duplex path 2): Paper arrived too early service check” on page 94.
231.33	Paper fed from tray 3 never arrived at the sensor (duplex path 2).	See “Sensor (duplex path 2): Paper failed to arrive service check” on page 94.
231.34	Paper fed from tray 3 cleared the sensor (duplex path 2) earlier than expected.	See “Sensor (duplex path 2): Paper (duplex job) cleared too early service check” on page 97.
231.42	Paper fed from tray 4 was detected earlier than expected at the sensor (duplex path 2).	See “Sensor (duplex path 2): Paper arrived too early service check” on page 94.
231.43	Paper fed from tray 4 never arrived at the sensor (duplex path 2).	See “Sensor (duplex path 2): Paper failed to arrive service check” on page 94.
231.44	Paper fed from tray 4 cleared the sensor (duplex path 2) earlier than expected.	See “Sensor (duplex path 2): Paper (duplex job) cleared too early service check” on page 97.
231.91	Paper remains detected at the sensor (duplex path 2) after the printer is turned on.	See “Sensor (duplex path 2) static jam service check” on page 98.

Sensor (duplex path 2): Paper arrived too early service check

Action	Yes	No
<p>Step 1</p> <p>a From the home screen, touch Settings > Device > Preferences.</p> <p>b Check if the paper size matches the size set on the tray guides.</p> <p>Does the paper size match the size set on the tray?</p>	Go to step 3.	Go to step 2.
<p>Step 2</p> <p>Change the paper size or adjust the size settings in the tray.</p> <p>Does the problem remain?</p>	Go to step 3.	The problem is solved.
<p>Step 3</p> <p>a From the home screen, touch Settings > Device > Preferences.</p> <p>b Check if the paper settings matches the paper in the tray guides.</p> <p>Do the paper settings match the paper in the tray?</p>	Go to step 5.	Go to step 4.
<p>Step 4</p> <p>Change the paper settings to match the paper in the tray.</p> <p>Does the problem remain?</p>	Go to step 5.	The problem is solved.
<p>Step 5</p> <p>Check the duplex paper path for paper jams and obstructions.</p> <p>Is the paper path free of jams and obstructions?</p>	Go to step 6.	Go to step 6.
<p>Step 6</p> <p>Remove the jams and obstructions.</p> <p>Does the problem remain?</p>	Contact the next level of support.	The problem is solved.

Sensor (duplex path 2): Paper failed to arrive service check

Action	Yes	No
<p>Step 1</p> <p>a From the home screen, touch Settings > Device > Preferences.</p> <p>b Check if the paper size matches the size set on the tray guides.</p> <p>Does the paper size match the size set on the tray?</p>	Go to step 3.	Go to step 2.
<p>Step 2</p> <p>Change the paper size or adjust the size setting in the tray.</p> <p>Does the problem remain?</p>	Go to step 3.	The problem is solved.

Action	Yes	No
<p>Step 3 Check the duplex paper path for paper jams and obstructions.</p> <p>Is the paper path free of jams and obstructions?</p>	Go to step 5.	Go to step 4.
<p>Step 4 Remove the jams and obstructions.</p> <p>Does the problem remain?</p>	Go to step 5.	The problem is solved.
<p>Step 5 a Enter the Diagnostics menu, and then navigate to: Printer diagnostics & adjustments > Sensor tests b Find the sensor (Duplex path 2).</p> <p>Does the sensor status change while toggling the sensor?</p>	Go to step 8.	Go to step 6.
<p>Step 6 Check the sensor cable for proper connection and damage, and replace if necessary.</p> <p>Does the problem remain?</p>	Go to step 7.	The problem is solved.
<p>Step 7 Check the sensor for damage, and replace if necessary.</p> <p>Does the problem remain?</p>	Go to step 8.	The problem is solved.
<p>Step 8 a Enter the Diagnostics menu, and then navigate to: Printer diagnostics & adjustments > Motor tests > Duplex/MPF b Select a setting, and then touch Start.</p> <p>Does the motor run?</p>	Go to step 11.	Go to step 9.
<p>Step 9 Check the motor cable for proper connection and damage, and replace if necessary.</p> <p>Does the problem remain?</p>	Go to step 10.	The problem is solved.
<p>Step 10 a Replace the motor. See “Motor (duplex/MPF) removal” on page 315. b Perform a print job.</p> <p>Does the problem remain?</p>	Go to step 11.	The problem is solved.

Action	Yes	No
<p>Step 11 Check the duplex drive gears in the printer for damage, and replace if necessary.</p> <p>Does the problem remain?</p>	Go to step 12.	The problem is solved.
<p>Step 12</p> <p>a In the duplex inner guide, check the drive gears, belts, and pinch rollers for damage. Replace the duplex inner guide if necessary. See “Duplex inner guide removal” on page 291.</p> <p>b Perform a print job.</p> <p>Does the problem remain?</p>	Contact the next level of support.	The problem is solved.

Sensor (duplex path 2): Paper failed to clear service check

Action	Yes	No
<p>Step 1</p> <p>a From the home screen, touch Settings > Device > Preferences.</p> <p>b Check if the paper size matches the size set on the tray guides.</p> <p>Does the paper size match the size set on the tray?</p>	Go to step 3.	Go to step 2.
<p>Step 2 Change the paper size or adjust the size setting in the tray.</p> <p>Does the problem remain?</p>	Go to step 3.	The problem is solved.
<p>Step 3 Check if the paper size matches the size set on the tray guides.</p> <p>Does the paper size match the size set on the tray?</p>	Go to step 5.	Go to step 4.
<p>Step 4 Change the paper size or adjust the size setting in the tray.</p> <p>Does the problem remain?</p>	Go to step 5.	The problem is solved.
<p>Step 5 Check the paper path for paper jams and obstructions.</p> <p>Is the paper path free of jams and obstructions?</p>	Go to step 7.	Go to step 6.
<p>Step 6 Remove the jams and obstructions.</p> <p>Does the problem remain?</p>	Go to step 7.	The problem is solved.

Action	Yes	No
<p>Step 7</p> <p>a Enter the Diagnostics menu, and then navigate to: Printer diagnostics & adjustments > Sensor tests</p> <p>b Find the sensor (Duplex path 2).</p> <p>Does the sensor status change while toggling the sensor?</p>	Go to step 10.	Go to step 8.
<p>Step 8</p> <p>Check the sensor cable for proper connection and damage, and replace if necessary.</p> <p>Does the problem remain?</p>	Go to step 9.	The problem is solved.
<p>Step 9</p> <p>Check the sensor for damage, and replace if necessary.</p> <p>Does the problem remain?</p>	Go to step 10.	The problem is solved.
<p>Step 10</p> <p>a Enter the Diagnostics menu, and then navigate to: Printer diagnostics & adjustments > Motor tests > Isolation</p> <p>b Touch Start.</p> <p>Does the motor run?</p>	Contact the next level of support.	Go to step 11.
<p>Step 11</p> <p>Check the motor cable for proper connection and damage, and replace if necessary.</p> <p>Does the problem remain?</p>	Go to step 12.	The problem is solved.
<p>Step 12</p> <p>a Replace the isolation unit. See “Isolation unit removal” on page 371.</p> <p>b Perform a print job.</p> <p>Does the problem remain?</p>	Contact the next level of support.	The problem is solved.

Sensor (duplex path 2): Paper (duplex job) cleared too early service check

Action	Yes	No
<p>Step 1</p> <p>a From the home screen, touch Settings > Device > Preferences.</p> <p>b Check if the paper size matches the size set on the tray guides.</p> <p>Does the paper size match the size set on the tray?</p>	Go to step 3.	Go to step 2.

Action	Yes	No
<p>Step 2 Change the paper size or adjust the size setting in the tray.</p> <p>Does the problem remain?</p>	Go to step 3.	The problem is solved.
<p>Step 3 Check the duplex rollers for damage.</p> <p>Are the rollers free of damage?</p>	Go to step 5.	Go to step 4.
<p>Step 4 Replace the duplex.</p> <p>Does the problem remain?</p>	Go to step 5.	The problem is solved.
<p>Step 5 a Enter the Diagnostics menu, and then navigate to: Printer diagnostics & adjustments > Sensor tests b Find the sensor (Duplex path 2).</p> <p>Does the sensor status change while toggling the sensor?</p>	Go to step 8.	Go to step 6.
<p>Step 6 Check the sensor cable for proper connection, and then reseal if necessary.</p> <p>Does the problem remain?</p>	Go to step 7.	The problem is solved.
<p>Step 7 Check the sensor for damage, and replace if necessary.</p> <p>Does the problem remain?</p>	Go to step 8.	The problem is solved.
<p>Step 8 Perform a print job.</p> <p>Does the problem remain?</p>	Contact the next level of support.	The problem is solved.

Sensor (duplex path 2) static jam service check

Action	Yes	No
<p>Step 1 a From the home screen, touch Settings > Device > Preferences. b Check if the paper size matches the size set on the tray guides.</p> <p>Does the paper size match the size set on the tray?</p>	Go to step 3.	Go to step 2.

Action	Yes	No
<p>Step 2 Change the paper size or adjust the size setting in the tray.</p> <p>Does the problem remain?</p>	Go to step 3.	The problem is solved.
<p>Step 3 Check the paper path for partially fed or jammed paper.</p> <p>Is the paper path free of partially fed or jammed paper?</p>	Go to step 5.	Go to step 4.
<p>Step 4 Remove the partially fed or jammed paper.</p> <p>Does the problem remain?</p>	Go to step 5.	The problem is solved.
<p>Step 5 a Enter the Diagnostics menu, and then navigate to: Printer diagnostics & adjustments > Sensor tests b Find the sensor (Duplex path 2).</p> <p>Does the sensor status change while toggling the sensor?</p>	Contact the next level of support.	Go to step 6.
<p>Step 6 Check the sensor cable for proper connection and damage, and replace if necessary.</p> <p>Does the problem remain?</p>	Go to step 7.	The problem is solved.
<p>Step 7 a Check the sensor for damage, and replace if necessary. b Perform a print job.</p> <p>Does the problem remain?</p>	Contact the next level of support.	The problem is solved.

232 paper jams

232 paper jam messages

Error code	Description	Action
232.x3	Paper fed from the duplex never arrived at the sensor (MPF/pass-through) during a duplex print job.	See “Sensor (MPF/pass-through): Paper (duplex job) failed to arrive service check” on page 100.
232.x4	Paper fed from the duplex cleared the sensor (MPF/pass-through) earlier than expected during a duplex print job.	See “Sensor (MPF/pass-through): Paper (MPF/pass-through) cleared too early service check” on page 103.
232.x5	Paper fed from the duplex never cleared the sensor (MPF/pass-through) during a duplex print job.	See “Sensor (MPF/pass-through): Paper (duplex job) failed to clear service check” on page 102.

Error code	Description	Action
232.91	Paper remains detected at the sensor (duplex path 2) after the printer is turned on.	See “Sensor (duplex path 2) static jam service check” on page 98.

Sensor (MPF/pass-through): Paper (duplex job) failed to arrive service check

Action	Yes	No
<p>Step 1</p> <p>a From the home screen, touch Settings > Device > Preferences.</p> <p>b Check if the paper size matches the size set on the tray guides.</p> <p>Does the paper size match the size set on the tray?</p>	Go to step 3.	Go to step 2.
<p>Step 2</p> <p>Change the paper size or adjust the size setting in the tray.</p> <p>Does the problem remain?</p>	Go to step 3.	The problem is solved.
<p>Step 3</p> <p>Check the duplex paper path for paper jams and obstructions.</p> <p>Is the paper path free of jams and obstructions?</p>	Go to step 5.	Go to step 4.
<p>Step 4</p> <p>Remove the jams and obstructions.</p> <p>Does the problem remain?</p>	Go to step 5.	The problem is solved.
<p>Step 5</p> <p>Check the tray for damage, and replace if necessary.</p> <p>Does the problem remain?</p>	Go to step 6.	The problem is solved.
<p>Step 6</p> <p>Check the sensor (MPF/pass-through) area for paper jams and obstructions.</p> <p>Is the paper path free of jams and obstructions?</p>	Go to step 8.	Go to step 7.
<p>Step 7</p> <p>Remove the jams and obstructions.</p> <p>Does the problem remain?</p>	Go to step 8.	The problem is solved.
<p>Step 8</p> <p>a Enter the Diagnostics menu, and then navigate to: Printer diagnostics & adjustments > Sensor tests</p> <p>b Find the sensor (MPF/pass-through).</p> <p>Does the sensor status change while toggling the sensor?</p>	Go to step 11.	Go to step 9.

Action	Yes	No
<p>Step 9</p> <p>Check the sensor cable for proper connection and damage, and replace if necessary.</p> <p>Does the problem remain?</p>	Go to step 10.	The problem is solved.
<p>Step 10</p> <p>Replace the isolation unit. See “Isolation unit removal” on page 371.</p> <p>Does the problem remain?</p>	Go to step 11.	The problem is solved.
<p>Step 11</p> <p>a Enter the Diagnostics menu, and then navigate to: Printer diagnostics & adjustments > Motor tests > Duplex/MPF</p> <p>b Select a setting, and then touch Start.</p> <p>Does the motor run?</p>	Go to step 14.	Go to step 12.
<p>Step 12</p> <p>Check the motor cable for proper connection and damage, and replace if necessary.</p> <p>Does the problem remain?</p>	Go to step 13.	The problem is solved.
<p>Step 13</p> <p>a Replace the motor. See “Motor (duplex/MPF) removal” on page 315.</p> <p>b Perform a print job.</p> <p>Does the problem remain?</p>	Go to step 14.	The problem is solved.
<p>Step 14</p> <p>Check the duplex drive gears in the printer for damage, and replace if necessary.</p> <p>Does the problem remain?</p>	Go to step 15.	The problem is solved.
<p>Step 15</p> <p>a In the duplex inner guide, check the drive gears, belts, and pinch rollers for damage. Replace the duplex inner guide if necessary. See “Duplex inner guide removal” on page 291.</p> <p>b Perform a print job.</p> <p>Does the problem remain?</p>	Contact the next level of support.	The problem is solved.

Sensor (MPF/pass-through): Paper (duplex job) failed to clear service check

Action	Yes	No
<p>Step 1</p> <p>a From the home screen, touch Settings > Device > Preferences.</p> <p>b Check if the paper size matches the size set on the tray guides.</p> <p>Does the paper size match the size set on the tray?</p>	Go to step 3.	Go to step 2.
<p>Step 2</p> <p>Change the paper size or adjust the size setting in the tray.</p> <p>Does the problem remain?</p>	Go to step 3.	The problem is solved.
<p>Step 3</p> <p>Check if the paper size matches the size set on the tray guides.</p> <p>Does the paper size match the size set on the tray?</p>	Go to step 5.	Go to step 4.
<p>Step 4</p> <p>Change the paper size or adjust the size setting in the tray.</p> <p>Does the problem remain?</p>	Go to step 5.	The problem is solved.
<p>Step 5</p> <p>Check the paper path for paper jams and obstructions.</p> <p>Is the paper path free of jams and obstructions?</p>	Go to step 7.	Go to step 6.
<p>Step 6</p> <p>Remove the jams and obstructions.</p> <p>Does the problem remain?</p>	Go to step 7.	The problem is solved.
<p>Step 7</p> <p>a Enter the Diagnostics menu, and then navigate to: Printer diagnostics & adjustments > Sensor tests</p> <p>b Find the sensor (MPF/pass-through).</p> <p>Does the sensor status change while toggling the sensor?</p>	Go to step 10.	Go to step 8.
<p>Step 8</p> <p>Check the sensor cable for proper connection and damage, and replace if necessary.</p> <p>Does the problem remain?</p>	Go to step 9.	The problem is solved.
<p>Step 9</p> <p>Check the isolation unit for damage, and replace if necessary. See “Isolation unit removal” on page 371.</p> <p>Does the problem remain?</p>	Go to step 10.	The problem is solved.

Action	Yes	No
<p>Step 10</p> <p>a Enter the Diagnostics menu, and then navigate to: Printer diagnostics & adjustments > Motor tests > Deskew</p> <p>b Touch Start.</p> <p>Does the motor run?</p>	Contact the next level of support.	Go to step 11.
<p>Step 11</p> <p>Check the motor cable for proper connection and damage, and replace if necessary.</p> <p>Does the problem remain?</p>	Go to step 12.	The problem is solved.
<p>Step 12</p> <p>a Replace the motor (registration).</p> <p>b Perform a print job.</p> <p>Does the problem remain?</p>	Contact the next level of support.	The problem is solved.

Sensor (MPF/pass-through): Paper (MPF/pass-through) cleared too early service check

Action	Yes	No
<p>Step 1</p> <p>a From the home screen, touch Settings > Device > Preferences.</p> <p>b Check if the paper size matches the size set on the tray guides.</p> <p>Does the paper size match the size set on the tray?</p>	Go to step 3.	Go to step 2.
<p>Step 2</p> <p>Change the paper size or adjust the size setting in the tray.</p> <p>Does the problem remain?</p>	Go to step 3.	The problem is solved.
<p>Step 3</p> <p>Check the duplex rollers for damage.</p> <p>Are the rollers free of damage?</p>	Go to step 5.	Go to step 4.
<p>Step 4</p> <p>Replace the duplex.</p> <p>Does the problem remain?</p>	Go to step 5.	The problem is solved.

Action	Yes	No
<p>Step 5</p> <p>a Enter the Diagnostics menu, and then navigate to: Printer diagnostics & adjustments > Sensor tests</p> <p>b Find the sensor (Input).</p> <p>Does the sensor status change while toggling the sensor?</p>	Go to step 8.	Go to step 6.
<p>Step 6</p> <p>Check the sensor cable for proper connection, and then reseal if necessary.</p> <p>Does the problem remain?</p>	Go to step 7.	The problem is solved.
<p>Step 7</p> <p>Replace the isolation unit. See “Isolation unit removal” on page 371.</p> <p>Does the problem remain?</p>	Go to step 8.	The problem is solved.
<p>Step 8</p> <p>Perform a print job.</p> <p>Does the problem remain?</p>	Contact the next level of support.	The problem is solved.

240 paper jams

240 paper jam messages

Error code	Description	Action
240.06	Paper never arrived at the sensor (MPF/pass-through).	See “Sensor (MPF/pass-through): Paper (MPF tray) failed to arrive service check” on page 106 .
240.23	Paper fed from tray 2 was picked but it never arrived at the sensor (MPF/pass-through).	See “Sensor (MPF/pass-through): Paper (tray 2) failed to arrive service check” on page 108 .
240.33	Paper fed from tray 3 was picked but it never arrived at the sensor (MPF/pass-through).	See “Sensor (MPF/pass-through): Paper (tray 3) failed to arrive service check” on page 110 .
240.43	Paper fed from tray 4 was picked but it never arrived at the sensor (MPF/pass-through).	See “Sensor (MPF/pass-through): Paper (tray 4) failed to arrive service check” on page 112 .
240.15	Paper fed from tray [x] never cleared the sensor (MPF/pass-through).	See “Sensor (MPF/pass-through): Paper failed to clear service check” on page 105 .
240.25		
240.35		
240.45		

Error code	Description	Action
240.82	The motor (duplex/MPF) has stalled.	See “Motor (duplex/MPF) jam service check” on page 115.
240.84	The motor (duplex/MPF) failed to achieve expected speed or has stalled.	
240.91	Paper remains detected at the sensor (MPF/pass-through) after the printer is turned on.	See “Sensor (MPF/pass-through) static jam service check” on page 114.

Sensor (MPF/pass-through): Paper failed to clear service check

Action	Yes	No
<p>Step 1</p> <p>a From the home screen, touch Settings > Device > Preferences.</p> <p>b Check if the paper size matches the size set on the tray guides.</p> <p>Does the paper size match the size set on the tray?</p>	Go to step 3.	Go to step 2.
<p>Step 2</p> <p>Change the paper size or adjust the size setting in the tray.</p> <p>Does the problem remain?</p>	Go to step 3.	The problem is solved.
<p>Step 3</p> <p>Check the duplex and MPF paper paths for paper jams and obstructions.</p> <p>Are the paper paths free of jams and obstructions?</p>	Go to step 5.	Go to step 4.
<p>Step 4</p> <p>Remove the paper jams and obstructions.</p> <p>Does the problem remain?</p>	Go to step 5.	The problem is solved.
<p>Step 5</p> <p>Check the tray paper path and drive gears for damage, and replace the tray if necessary.</p> <p>Does the problem remain?</p>	Go to step 6.	The problem is solved.
<p>Step 6</p> <p>a Enter the Diagnostics menu, and then navigate to: Printer diagnostics & adjustments > Sensor tests</p> <p>b Find the sensor (MPF/pass-through).</p> <p>Does the sensor status change while toggling the sensor?</p>	Go to step 8.	Go to step 7.
<p>Step 7</p> <p>Check the sensor cable for proper connection and damage, and replace if necessary.</p> <p>Does the problem remain?</p>	Go to step 8.	The problem is solved.

Action	Yes	No
<p>Step 8 Check the sensor and sensor flag for damage.</p> <p>Is the sensor or sensor flag damaged?</p>	Go to step 9.	Contact the next level of support.
<p>Step 9 Replace the isolation unit. See “Isolation unit removal” on page 371.</p> <p>Does the problem remain?</p>	Contact the next level of support.	The problem is solved.

Sensor (MPF/pass-through): Paper (MPF tray) failed to arrive service check

Action	Yes	No
<p>Step 1 a From the home screen, touch Settings > Device > Preferences. b Check if the paper size matches the size set on the tray guides.</p> <p>Does the paper size match the size set on the tray?</p>	Go to step 3.	Go to step 2.
<p>Step 2 Change the paper size or adjust the size setting in the tray.</p> <p>Does the problem remain?</p>	Go to step 3.	The problem is solved.
<p>Step 3 Check the tray for overfilling.</p> <p>Is the paper tray overfilled?</p>	Go to step 4.	Go to step 5.
<p>Step 4 Remove the excess paper from the MPF tray.</p> <p>Does the problem remain?</p>	Go to step 5.	The problem is solved.
<p>Step 5 Check the paper condition in the MPF tray.</p> <p>Is the paper crumpled or damaged?</p>	Go to step 6.	Go to step 7.
<p>Step 6 Replace the crumpled or damaged paper.</p> <p>Does the problem remain?</p>	Go to step 7.	The problem is solved.
<p>Step 7 Check the condition of the MPF pick rollers.</p> <p>Are the pick rollers free from excess wear, contamination, and damage?</p>	Go to step 9.	Go to step 8.

Action	Yes	No
<p>Step 8 Replace the pick rollers.</p> <p>Does the problem remain?</p>	Go to step 9.	The problem is solved.
<p>Step 9 a Check the pick rollers for proper installation. b Firmly press the pick roller assembly upward to make sure that it is properly engaged to the shaft.</p> <p>Is the pick roller assembly properly installed?</p>	Go to step 11.	Go to step 10.
<p>Step 10 Reinstall the pick roller assembly.</p> <p>Does the problem remain?</p>	Go to step 11.	The problem is solved.
<p>Step 11 Check the paper path exiting the tray.</p> <p>Is the paper path free of fragments and contamination?</p>	Go to step 13.	Go to step 12.
<p>Step 12 Clean the paper path.</p> <p>Does the problem remain?</p>	Go to step 13.	The problem is solved.
<p>Step 13 Check the tray paper path and drive gears for damage, and replace the tray if necessary.</p> <p>Does the problem remain?</p>	Go to step 14.	The problem is solved.
<p>Step 14 a Enter the Diagnostics menu, and then navigate to: Printer diagnostics & adjustments > Sensor tests b Find the sensor (MPF/pass-through).</p> <p>Does the sensor status change while toggling the sensor?</p>	Go to step 17.	Go to step 15.
<p>Step 15 Check the sensor cable for proper connection and damage, and replace if necessary.</p> <p>Does the problem remain?</p>	Go to step 16.	The problem is solved.
<p>Step 16 Check the sensor for damage, and replace if necessary.</p> <p>Does the problem remain?</p>	Go to step 17.	The problem is solved.

Action	Yes	No
<p>Step 17</p> <p>a Enter the Diagnostics menu, and then navigate to: Printer diagnostics & adjustments > Motor tests > Duplex/MPF</p> <p>b Select a setting, and then touch Start.</p> <p>Does the motor run?</p>	Contact the next level of support.	Go to step 18.
<p>Step 18</p> <p>Check the motor cable for proper connection and damage, and replace if necessary.</p> <p>Does the problem remain?</p>	Go to step 19.	The problem is solved.
<p>Step 19</p> <p>a Replace the motor. See “Motor (duplex/MPF) removal” on page 315.</p> <p>b Perform a print job.</p> <p>Does the problem remain?</p>	Contact the next level of support.	The problem is solved.

Sensor (MPF/pass-through): Paper (tray 2) failed to arrive service check

Action	Yes	No
<p>Step 1</p> <p>a From the home screen, touch Settings > Device > Preferences.</p> <p>b Check if the paper size matches the size set on the tray guides.</p> <p>Does the paper size match the size set on the tray?</p>	Go to step 3.	Go to step 2.
<p>Step 2</p> <p>Change the paper size or adjust the size setting in the tray.</p> <p>Does the problem remain?</p>	Go to step 3.	The problem is solved.
<p>Step 3</p> <p>Check the tray for overfilling.</p> <p>Is the tray overfilled?</p>	Go to step 4.	Go to step 5.
<p>Step 4</p> <p>Remove the excess paper from the tray.</p> <p>Does the problem remain?</p>	Go to step 5.	The problem is solved.
<p>Step 5</p> <p>Check the paper condition in the tray.</p> <p>Is the paper crumpled or damaged?</p>	Go to step 6.	Go to step 7.

Action	Yes	No
<p>Step 6 Replace the crumpled or damaged paper.</p> <p>Does the problem remain?</p>	Go to step 7.	The problem is solved.
<p>Step 7 Check the condition of the tray 2 pick rollers.</p> <p>Are the pick rollers free from excess wear, contamination, and damage?</p>	Go to step 9.	Go to step 8.
<p>Step 8 Replace the pick rollers.</p> <p>Does the problem remain?</p>	Go to step 9.	The problem is solved.
<p>Step 9</p> <p>a Check the pick rollers for proper installation.</p> <p>b Firmly press the pick roller assembly upward to make sure that it is properly engaged to the shaft.</p> <p>Is the pick roller assembly properly installed?</p>	Go to step 11.	Go to step 10.
<p>Step 10 Reinstall the pick roller assembly.</p> <p>Does the problem remain?</p>	Go to step 11.	The problem is solved.
<p>Step 11 Check the paper path exiting the tray.</p> <p>Is the paper path free of fragments and contamination?</p>	Go to step 13.	Go to step 12.
<p>Step 12 Clean the paper path.</p> <p>Does the problem remain?</p>	Go to step 13.	The problem is solved.
<p>Step 13</p> <p>a Enter the Diagnostics menu, and then navigate to: Printer diagnostics & adjustments > Sensor tests</p> <p>b Find the sensor (MPF/pass-through).</p> <p>Does the sensor status change while toggling the sensor?</p>	Go to step 16.	Go to step 14.
<p>Step 14 Check the sensor cable for proper connection and damage, and replace if necessary.</p> <p>Does the problem remain?</p>	Go to step 15.	The problem is solved.

Action	Yes	No
<p>Step 15 Check the sensor for damage, and replace if necessary.</p> <p>Does the problem remain?</p>	Go to step 16.	The problem is solved.
<p>Step 16 a Enter the Diagnostics menu, and then navigate to: Printer diagnostics & adjustments > Motor tests > Pick (tray 2) b Select a setting, and then touch Start.</p> <p>Does the motor run?</p>	Go to step 19.	Go to step 17.
<p>Step 17 Check the motor cable for proper connection and damage, and replace if necessary.</p> <p>Does the problem remain?</p>	Go to step 18.	The problem is solved.
<p>Step 18 a Replace the motor (550-sheet tray pass-through). See “Motor (550-sheet tray pass-through) removal” on page 376. b Perform a print job.</p> <p>Does the problem remain?</p>	Go to step 19.	The problem is solved.
<p>Step 19 a Replace the media feeder. See “Media feeder removal” on page 373. b Perform a print job.</p> <p>Does the problem remain?</p>	Contact the next level of support.	The problem is solved.

Sensor (MPF/pass-through): Paper (tray 3) failed to arrive service check

Action	Yes	No
<p>Step 1 a From the home screen, touch Settings > Device > Preferences. b Check if the paper size matches the size set on the tray guides.</p> <p>Does the paper size match the size set on the tray?</p>	Go to step 3.	Go to step 2.
<p>Step 2 Change the paper size or adjust the size setting in the tray.</p> <p>Does the problem remain?</p>	Go to step 3.	The problem is solved.

Action	Yes	No
<p>Step 3</p> <p>a Enter the Diagnostics menu, and then navigate to: Printer diagnostics & adjustments > Sensor tests</p> <p>b Find the sensor (MPF/pass-through).</p> <p>Does the sensor status change while toggling the sensor?</p>	Go to step 6.	Go to step 4.
<p>Step 4</p> <p>Check the sensor cable for proper connection and damage, and replace if necessary.</p> <p>Does the problem remain?</p>	Go to step 5.	The problem is solved.
<p>Step 5</p> <p>Check the sensor for damage and replace if necessary.</p> <p>Does the problem remain?</p>	Go to step 6.	The problem is solved.
<p>Step 6</p> <p>a Enter the Diagnostics menu, and then navigate to: Printer diagnostics & adjustments > Sensor tests</p> <p>b Find the sensor (Pass-through (tray 2)).</p> <p>Does the sensor status change while toggling the sensor?</p>	Go to step 9.	Go to step 7.
<p>Step 7</p> <p>Check the sensor cable for proper connection and damage, and replace if necessary.</p> <p>Does the problem remain?</p>	Go to step 8.	The problem is solved.
<p>Step 8</p> <p>Check the sensor for damage and replace if necessary. See “Sensor (550-sheet tray pass-through) removal” on page 379.</p> <p>Does the problem remain?</p>	Go to step 9.	The problem is solved.
<p>Step 9</p> <p>a Enter the Diagnostics menu, and then navigate to: Printer diagnostics & adjustments > Motor tests > Pass-through (tray 2)</p> <p>b Select a setting, and then touch Start.</p> <p>Does the motor run?</p>	Contact the next level of support.	Go to step 10.
<p>Step 10</p> <p>Check the motor cable for proper connection and damage, and replace if necessary.</p> <p>Does the problem remain?</p>	Go to step 11.	The problem is solved.

Action	Yes	No
<p>Step 11</p> <p>a Replace the motor (550-sheet tray pass-through). See “Motor (550-sheet tray pass-through) removal” on page 376.</p> <p>b Perform a print job.</p> <p>Does the problem remain?</p>	Contact the next level of support.	The problem is solved.

Sensor (MPF/pass-through): Paper (tray 4) failed to arrive service check

Action	Yes	No
<p>Step 1</p> <p>a From the home screen, touch Settings > Device > Preferences.</p> <p>b Check if the paper size matches the size set on the tray guides.</p> <p>Does the paper size match the size set on the tray?</p>	Go to step 3.	Go to step 2.
<p>Step 2</p> <p>Change the paper size or adjust the size setting in the tray.</p> <p>Does the problem remain?</p>	Go to step 3.	The problem is solved.
<p>Step 3</p> <p>Check the paper path in tray 3 for paper jams and fragments.</p> <p>Is the paper path free of jams and fragments?</p>	Go to step 5.	Go to step 4.
<p>Step 4</p> <p>Remove the paper jams and fragments.</p> <p>Does the problem remain?</p>	Go to step 5.	The problem is solved.
<p>Step 5</p> <p>a Enter the Diagnostics menu, and then navigate to: Printer diagnostics & adjustments > Sensor tests</p> <p>b Find the sensor (MPF/pass-through).</p> <p>Does the sensor status change while toggling the sensor?</p>	Go to step 8.	Go to step 6.
<p>Step 6</p> <p>Check the sensor cable for proper connection and damage, and replace if necessary.</p> <p>Does the problem remain?</p>	Go to step 7.	The problem is solved.
<p>Step 7</p> <p>Check the sensor for damage and replace if necessary.</p> <p>Does the problem remain?</p>	Go to step 8.	The problem is solved.

Action	Yes	No
<p>Step 8</p> <p>a Enter the Diagnostics menu, and then navigate to: Printer diagnostics & adjustments > Sensor tests</p> <p>b Find the sensor (Pass-through (tray 2)).</p> <p>Does the sensor status change while toggling the sensor?</p>	Go to step 11.	Go to step 9.
<p>Step 9</p> <p>Check the sensor cable for proper connection and damage, and replace if necessary.</p> <p>Does the problem remain?</p>	Go to step 10.	The problem is solved.
<p>Step 10</p> <p>Check the sensor for damage and replace if necessary. See “Sensor (550-sheet tray pass-through) removal” on page 379.</p> <p>Does the problem remain?</p>	Go to step 11.	The problem is solved.
<p>Step 11</p> <p>a Enter the Diagnostics menu, and then navigate to: Printer diagnostics & adjustments > Sensor tests</p> <p>b Find the sensor (Pass-through (tray 3)).</p> <p>Does the sensor status change while toggling the sensor?</p>	Go to step 14.	Go to step 12.
<p>Step 12</p> <p>Check the sensor cable for proper connection and damage, and replace if necessary.</p> <p>Does the problem remain?</p>	Go to step 13.	The problem is solved.
<p>Step 13</p> <p>Check the sensor for damage and replace if necessary. See “Sensor (550-sheet tray pass-through) removal” on page 379.</p> <p>Does the problem remain?</p>	Go to step 14.	The problem is solved.
<p>Step 14</p> <p>a Enter the Diagnostics menu, and then navigate to: Printer diagnostics & adjustments > Motor tests > Pass-through (tray 2)</p> <p>b Touch Start.</p> <p>Does the motor run?</p>	Go to step 17.	Go to step 15.

Action	Yes	No
<p>Step 15</p> <p>Check the motor cable for proper connection and damage, and replace if necessary.</p> <p>Does the problem remain?</p>	Go to step 16.	The problem is solved.
<p>Step 16</p> <p>a Replace the motor (550-sheet tray pass-through). See “Motor (550-sheet tray pass-through) removal” on page 376.</p> <p>b Perform a print job.</p> <p>Does the problem remain?</p>	Go to step 17.	The problem is solved.
<p>Step 17</p> <p>a Enter the Diagnostics menu, and then navigate to: Printer diagnostics & adjustments > Motor tests > Pass-through (tray 3)</p> <p>b Touch Start.</p> <p>Does the motor run?</p>	Contact the next level of support.	Go to step 18.
<p>Step 18</p> <p>Check the motor cable for proper connection and damage, and replace if necessary.</p> <p>Does the problem remain?</p>	Go to step 19.	The problem is solved.
<p>Step 19</p> <p>a Replace the motor (550-sheet tray pass-through). See “Motor (550-sheet tray pass-through) removal” on page 376.</p> <p>b Perform a print job.</p> <p>Does the problem remain?</p>	Contact the next level of support.	The problem is solved.

Sensor (MPF/pass-through) static jam service check

Action	Yes	No
<p>Step 1</p> <p>a From the home screen, touch Settings > Device > Preferences.</p> <p>b Check if the paper size matches the size set on the tray guides.</p> <p>Does the paper size match the size set on the tray?</p>	Go to step 3.	Go to step 2.
<p>Step 2</p> <p>Change the paper size or adjust the size setting in the tray.</p> <p>Does the problem remain?</p>	Go to step 3.	The problem is solved.

Action	Yes	No
<p>Step 3</p> <p>a Enter the Diagnostics menu, and then navigate to: Printer diagnostics & adjustments > Sensor tests</p> <p>b Find the sensor (MPF/pass-through).</p> <p>Does the sensor status change while toggling the sensor?</p>	Contact the next level of support.	Go to step 4.
<p>Step 4</p> <p>Check the sensor cable for proper connection and damage, and replace if necessary.</p> <p>Does the problem remain?</p>	Go to step 5.	The problem is solved.
<p>Step 5</p> <p>a Check the isolation unit for damage, and replace if necessary. See “Isolation unit removal” on page 371.</p> <p>b Perform a print job.</p> <p>Does the problem remain?</p>	Contact the next level of support.	The problem is solved.

Motor (duplex/MPF) jam service check

Action	Yes	No
<p>Step 1</p> <p>Check if this is a duplex issue.</p> <p>Is this a duplex issue?</p>	Go to step 6.	Go to step 2.
<p>Step 2</p> <p>Check the MPF tray for overfilling.</p> <p>Is the tray overfilled?</p>	Go to step 3.	Go to step 4.
<p>Step 3</p> <p>Remove the excess paper from the tray.</p> <p>Does the problem remain?</p>	Go to step 4.	The problem is solved.
<p>Step 4</p> <p>Check the paper condition in the MPF tray.</p> <p>Is the paper crumpled or damaged?</p>	Go to step 5.	Go to step 6.
<p>Step 5</p> <p>Replace the crumpled or damaged paper.</p> <p>Does the problem remain?</p>	Go to step 6.	The problem is solved.

Action	Yes	No
<p>Step 6 Check the duplex and MPF paper path exiting tray 1.</p> <p>Is the paper path free of fragments and contamination?</p>	Go to step 7.	Go to step 8.
<p>Step 7 Clean the paper path.</p> <p>Does the problem remain?</p>	Go to step 8.	The problem is solved.
<p>Step 8</p> <p>a Enter the Diagnostics menu, and then navigate to: Printer diagnostics & adjustments > Motor tests > Duplex/MPF</p> <p>b Select a setting, and then touch Start.</p> <p>Does the motor run?</p>	Contact the next level of support.	Go to step 9.
<p>Step 9 Check the cable on the JMTR1 connector on the controller board for proper connection and damage, and replace if necessary.</p> <p>Does the problem remain?</p>	Go to step 10.	The problem is solved.
<p>Step 10</p> <p>a Replace the motor (duplex/MPF). See “Motor (duplex/MPF) removal” on page 315.</p> <p>b Perform a duplex or MPF feed test.</p> <p>Does the problem remain?</p>	Contact the next level of support.	The problem is solved.

241 paper jams

241 paper jam messages

Error code	Description	Action
241.12	Paper fed from tray 1 covered the sensor (tray 1 pick) earlier than expected.	See “Sensor (tray 1 pick): Paper arrived too early service check” on page 120 .
241.14	Paper fed from tray 1 cleared the sensor (tray 1 pick) earlier than expected.	See “Sensor (tray 1 pick): Paper arrived too early service check” on page 120 .
241.15	Paper fed from tray 1 never cleared the sensor (tray 1 pick).	See “Sensor (tray 1 pick): Paper failed to clear service check” on page 117 .
241.16	Paper fed from tray 1 was never detected by the sensor (tray 1 pick).	See “Sensor (tray 1 pick): Paper failed to arrive service check” on page 118 .

Error code	Description	Action
241.82	The motor (tray 1 pick) failed to achieve expected speed or has stalled.	See “Motor (tray 1 pick) jam service check” on page 123.
241.83		
241.84		
241.91	Paper remains detected at the sensor (tray 1 pick) after the printer is turned on.	See “Sensor (tray 1 pick) static jam service check” on page 122.

Sensor (tray 1 pick): Paper failed to clear service check

Action	Yes	No
<p>Step 1</p> <p>a From the home screen, touch Settings > Device > Preferences.</p> <p>b Check if the paper size matches the size set on the tray guides.</p> <p>Does the paper size match the size set on the tray?</p>	Go to step 3.	Go to step 2.
<p>Step 2</p> <p>Change the paper size or adjust the size setting in the tray.</p> <p>Does the problem remain?</p>	Go to step 3.	The problem is solved.
<p>Step 3</p> <p>Check the paper path for paper jams and fragments.</p> <p>Is the paper path free of jams and fragments?</p>	Go to step 5.	Go to step 4.
<p>Step 4</p> <p>Remove the paper jams and fragments.</p> <p>Does the problem remain?</p>	Go to step 5.	The problem is solved.
<p>Step 5</p> <p>Check the tray paper path and drive gears for damage, and replace the tray if necessary.</p> <p>Does the problem remain?</p>	Go to step 6.	The problem is solved.
<p>Step 6</p> <p>a Enter the Diagnostics menu, and then navigate to: Printer diagnostics & adjustments > Sensor tests</p> <p>b Find the sensor (Input).</p> <p>Does the sensor status change while toggling the sensor?</p>	Go to step 9.	Go to step 7.
<p>Step 7</p> <p>Check the sensor cable for proper connection and damage, and replace if necessary.</p> <p>Does the problem remain?</p>	Go to step 8.	The problem is solved.

Action	Yes	No
<p>Step 8 Check the sensor for damage and replace if necessary. See “Sensor (input) removal” on page 341.</p> <p>Does the problem remain?</p>	Go to step 9.	The problem is solved.
<p>Step 9 a Enter the Diagnostics menu, and then navigate to: Printer diagnostics & adjustments > Motor tests > Isolation b Touch Start.</p> <p>Does the motor run?</p>	Contact the next level of support.	Go to step 10.
<p>Step 10 Check the motor cable for proper connection and damage, and replace if necessary.</p> <p>Does the problem remain?</p>	Go to step 11.	The problem is solved.
<p>Step 11 a Replace the isolation unit. See “Isolation unit removal” on page 371. b Perform a print job.</p> <p>Does the problem remain?</p>	Contact the next level of support.	The problem is solved.

Sensor (tray 1 pick): Paper failed to arrive service check

Action	Yes	No
<p>Step 1 a From the home screen, touch Settings > Device > Preferences. b Check if the paper size matches the size set on the tray guides.</p> <p>Does the paper size match the size set on the tray?</p>	Go to step 3.	Go to step 2.
<p>Step 2 Change the paper size or adjust the size setting in the tray.</p> <p>Does the problem remain?</p>	Go to step 3.	The problem is solved.
<p>Step 3 Check the tray for overfilling.</p> <p>Is the tray overfilled?</p>	Go to step 4.	Go to step 5.
<p>Step 4 Remove the excess paper from the tray.</p> <p>Does the problem remain?</p>	Go to step 5.	The problem is solved.

Action	Yes	No
<p>Step 5 Check the paper condition in tray 1.</p> <p>Is the paper crumpled or damaged?</p>	Go to step 6.	Go to step 7.
<p>Step 6 Replace the crumpled or damaged paper.</p> <p>Does the problem remain?</p>	Go to step 7.	The problem is solved.
<p>Step 7 Check the condition of the pick rollers.</p> <p>Are the pick rollers free from excess wear, contamination, and damage?</p>	Go to step 9.	Go to step 8.
<p>Step 8 Replace the pick rollers.</p> <p>Does the problem remain?</p>	Go to step 9.	The problem is solved.
<p>Step 9</p> <p>a Check the pick rollers for proper installation.</p> <p>b Firmly press the pick roller assembly upward to make sure that it is properly engaged to the shaft.</p> <p>Is the pick roller assembly properly installed?</p>	Go to step 11.	Go to step 10.
<p>Step 10 Reinstall the pick roller assembly.</p> <p>Does the problem remain?</p>	Go to step 11.	The problem is solved.
<p>Step 11 Check the paper path exiting the paper tray.</p> <p>Is the paper path free of fragments and contamination?</p>	Go to step 13.	Go to step 12.
<p>Step 12 Clean the paper path.</p> <p>Does the problem remain?</p>	Go to step 13.	The problem is solved.
<p>Step 13</p> <p>a Enter the Diagnostics menu, and then navigate to: Printer diagnostics & adjustments > Sensor tests</p> <p>b Find the sensor (Input).</p> <p>Does the sensor status change while toggling the sensor?</p>	Go to step 16.	Go to step 14.

Action	Yes	No
<p>Step 14 Check the sensor cable for proper connection and damage, and replace if necessary.</p> <p>Does the problem remain?</p>	Go to step 15.	The problem is solved.
<p>Step 15 Check the sensor for damage, and replace if necessary. See “Sensor (input) removal” on page 341.</p> <p>Does the problem remain?</p>	Go to step 16.	The problem is solved.
<p>Step 16 a Enter the Diagnostics menu, and then navigate to: Printer diagnostics & adjustments > Motor tests > Pick (tray 1) b Select a setting, and then touch Start.</p> <p>Does the motor run?</p>	Go to step 19.	Go to step 17.
<p>Step 17 Check the motor cable for proper connection and damage, and replace if necessary.</p> <p>Does the problem remain?</p>	Go to step 18.	The problem is solved.
<p>Step 18 a Replace the motor (tray 1 pick). b Perform a print job.</p> <p>Does the problem remain?</p>	Go to step 19.	The problem is solved.
<p>Step 19 a Replace the media feeder. See “Media feeder removal” on page 373. b Perform a print job.</p> <p>Does the problem remain?</p>	Contact the next level of support.	The problem is solved.

Sensor (tray 1 pick): Paper arrived too early service check

Action	Yes	No
<p>Step 1 a From the home screen, touch Settings > Device > Preferences. b Check if the paper size matches the size set on the tray guides.</p> <p>Does the paper size match the size set on the tray?</p>	Go to step 3.	Go to step 2.

Action	Yes	No
<p>Step 2 Change the paper size or adjust the size setting in the tray.</p> <p>Does the problem remain?</p>	Go to step 3.	The problem is solved.
<p>Step 3 Check the tray for overfilling.</p> <p>Is the tray overfilled?</p>	Go to step 4.	Go to step 5.
<p>Step 4 Remove the excess paper from the tray.</p> <p>Does the problem remain?</p>	Go to step 5.	The problem is solved.
<p>Step 5 Check the paper path along the tray exit.</p> <p>Is the paper path free of fragments and contamination?</p>	Go to step 7.	Go to step 6.
<p>Step 6 Clean the paper path.</p> <p>Does the problem remain?</p>	Go to step 7.	The problem is solved.
<p>Step 7 Perform a print job.</p> <p>Does the problem remain?</p>	Contact the next level of support.	The problem is solved.

Sensor (tray 1 pick): Paper cleared too early service check

Action	Yes	No
<p>Step 1 a From the home screen, touch Settings > Device > Preferences. b Check if the paper size matches the size set on the tray guides.</p> <p>Does the paper size match the size set on the tray?</p>	Go to step 3.	Go to step 2.
<p>Step 2 Change the paper size or adjust the size setting in the tray.</p> <p>Does the problem remain?</p>	Go to step 3.	The problem is solved.
<p>Step 3 Check the tray for overfilling.</p> <p>Is the tray overfilled?</p>	Go to step 4.	Go to step 5.

Action	Yes	No
<p>Step 4 Remove the excess paper from the tray.</p> <p>Does the problem remain?</p>	Go to step 5.	The problem is solved.
<p>Step 5 Check the paper condition in the tray.</p> <p>Is the paper crumpled or damaged?</p>	Go to step 6.	Go to step 7.
<p>Step 6 Replace the crumpled or damaged paper.</p> <p>Does the problem remain?</p>	Go to step 7.	The problem is solved.
<p>Step 7 a Enter the Diagnostics menu, and then navigate to: Printer diagnostics & adjustments > Sensor tests b Find the sensor (Input).</p> <p>Does the sensor status change while toggling the sensor?</p>	Go to step 9.	The problem is solved.
<p>Step 8 Check the sensor cable for proper connection, and then reseal if necessary.</p> <p>Does the problem remain?</p>	Go to step 9.	The problem is solved.
<p>Step 9 Replace the sensor. See “Sensor (input) removal” on page 341.</p> <p>Does the problem remain?</p>	Go to step 10.	The problem is solved.
<p>Step 10 Perform a print job.</p> <p>Does the problem remain?</p>	Contact the next level of support.	The problem is solved.

Sensor (tray 1 pick) static jam service check

Action	Yes	No
<p>Step 1 a From the home screen, touch Settings > Device > Preferences. b Check if the paper size matches the size set on the tray guides.</p> <p>Does the paper size match the size set on the tray?</p>	Go to step 3.	Go to step 2.

Action	Yes	No
<p>Step 2 Change the paper size or adjust the size setting in the tray.</p> <p>Does the problem remain?</p>	Go to step 3.	The problem is solved.
<p>Step 3 a Enter the Diagnostics menu, and then navigate to: Printer diagnostics & adjustments > Sensor tests b Find the sensor (Input).</p> <p>Does the sensor status change while toggling the sensor?</p>	Contact the next level of support.	Go to step 4.
<p>Step 4 Check the sensor cable for proper connection and damage, and replace if necessary.</p> <p>Does the problem remain?</p>	Go to step 5.	The problem is solved.
<p>Step 5 a Check the sensor for damage and replace if necessary. See “Sensor (input) removal” on page 341. b Perform a print job.</p> <p>Does the problem remain?</p>	Contact the next level of support.	The problem is solved.

Motor (tray 1 pick) jam service check

Action	Yes	No
<p>Step 1 Check the tray for overfilling.</p> <p>Is the tray overfilled?</p>	Go to step 2.	Go to step 3.
<p>Step 2 Remove the excess paper from the tray.</p> <p>Does the problem remain?</p>	Go to step 3.	The problem is solved.
<p>Step 3 Check the paper condition in the tray.</p> <p>Is the paper crumpled or damaged?</p>	Go to step 4.	Go to step 5.
<p>Step 4 Replace the crumpled or damaged paper.</p> <p>Does the problem remain?</p>	Go to step 5.	The problem is solved.

Action	Yes	No
<p>Step 5 Check the paper path exiting the tray.</p> <p>Is the paper path free of fragments and contamination?</p>	Go to step 7.	Go to step 6.
<p>Step 6 Clean the paper path.</p> <p>Does the problem remain?</p>	Go to step 7.	The problem is solved.
<p>Step 7 a Enter the Diagnostics menu, and then navigate to: Printer diagnostics and adjustments > Motor tests > Pick (tray 1) b Select a setting, and then touch Start.</p> <p>Does the motor run?</p>	Contact the next level of support.	Go to step 8.
<p>Step 8 Check the motor cable for proper connection and damage, and replace if necessary.</p> <p>Does the problem remain?</p>	Go to step 9.	The problem is solved.
<p>Step 9 a Replace the motor (tray 1 pick). b Perform a print job.</p> <p>Does the problem remain?</p>	Contact the next level of support.	The problem is solved.

242–244 paper jams

242 paper jam messages

Error code	Description	Action
242.21	Paper fed from tray 2 remains detected at the sensor (tray 2 pass-through) or at the sensor (tray 2 trailing edge) after the printer is turned on.	See “Sensors (tray [x] trailing edge and pass-through) static jam service check” on page 129.
242.22	Paper fed from tray 2 was detected earlier than expected at the sensor (tray 2 pass-through) or at the sensor (tray 2 trailing edge).	See “Sensors (tray [x] trailing edge and pass-through): Paper arrived too early service check” on page 130.
242.24	Paper fed from tray 2 cleared the sensor (tray 2 pass-through) or the sensor (tray 2 trailing edge) earlier than expected.	See “Sensors (tray [x] trailing edge and pass-through): Paper cleared too early service check” on page 137.
242.25	Paper fed from tray 2 cleared the sensor (tray 2 pass-through) or the sensor (tray 2 trailing edge) later than expected.	See “Sensors (tray [x] trailing edge and pass-through): Paper cleared too late service check” on page 138.

Error code	Description	Action
242.26	Paper fed from tray 2 was picked but it never arrived at the sensor (tray 2 trailing edge).	See “Sensor (tray [x] pass-through): Tray [x] failed to pick service check” on page 141.
242.27	Paper fed from tray 2 never cleared the sensor (tray 2 trailing edge).	See “Sensors (tray [x] trailing edge and pass-through): Paper failed to clear service check” on page 143.
242.28	Paper fed from tray 2 was detected later than expected at the sensor (tray 2 pass-through) or at the sensor (tray 2 trailing edge).	See “Sensors (tray [x] trailing edge and pass-through): Paper arrived too late service check” on page 145.
242.31	Paper fed from tray 3 remains detected at the sensor (tray 2 pass-through) or at the sensor (tray 2 trailing edge) after the printer is turned on.	See “Sensors (tray [x] trailing edge and pass-through) static jam service check” on page 129.
242.32	Paper fed from tray 3 was detected earlier than expected at the sensor (tray 2 pass-through) or at the sensor (tray 2 trailing edge).	See “Sensors (tray [x] trailing edge and pass-through): Paper arrived too early service check” on page 130.
242.33	Paper fed from tray 3 never arrived at the sensor (tray 2 pass-through).	See “Sensor (tray 2 pass-through): Paper failed to arrive service check” on page 132.
242.34	Paper fed from tray 3 cleared the sensor (tray 2 pass-through) or the sensor (tray 2 trailing edge) earlier than expected.	See “Sensors (tray [x] trailing edge and pass-through): Paper cleared too early service check” on page 137.
242.35	Paper fed from tray 3 cleared the sensor (tray 2 pass-through) or the sensor (tray 2 trailing edge) later than expected.	See “Sensors (tray [x] trailing edge and pass-through): Paper cleared too late service check” on page 138.
242.37	Paper fed from tray 3 never cleared the sensor (tray 2 trailing edge).	See “Sensors (tray [x] trailing edge and pass-through): Paper failed to clear service check” on page 143.
242.38	Paper fed from tray 3 was detected later than expected at the sensor (tray 2 pass-through) or at the sensor (tray 2 trailing edge).	See “Sensors (tray [x] trailing edge and pass-through): Paper arrived too late service check” on page 145.
242.41	Paper fed from tray 4 remains detected at the sensor (tray 2 pass-through) or at the sensor (tray 2 trailing edge) after the printer is turned on.	See “Sensors (tray [x] trailing edge and pass-through) static jam service check” on page 129.
242.42	Paper fed from tray 4 was detected earlier than expected at the sensor (tray 2 pass-through) or at the sensor (tray 2 trailing edge).	See “Sensors (tray [x] trailing edge and pass-through): Paper arrived too early service check” on page 130.
242.43	Paper fed from tray 4 never arrived at the sensor (tray 2 pass-through).	See “Sensor (tray 2 pass-through): Paper failed to arrive service check” on page 132.
242.44	Paper fed from tray 4 cleared the sensor (tray 2 pass-through) or the sensor (tray 2 trailing edge) earlier than expected.	See “Sensors (tray [x] trailing edge and pass-through): Paper cleared too early service check” on page 137.
242.45	Paper fed from tray 4 cleared the sensor (tray 2 pass-through) or the sensor (tray 2 trailing edge) later than expected.	See “Sensors (tray [x] trailing edge and pass-through): Paper cleared too late service check” on page 138.

Error code	Description	Action
242.47	Paper fed from tray 4 never cleared the sensor (tray 2 trailing edge).	See “Sensors (tray [x] trailing edge and pass-through): Paper failed to clear service check” on page 143.
242.48	Paper fed from tray 4 was detected later than expected at the sensor (tray 2 pass-through) or at the sensor (tray 2 trailing edge).	See “Sensors (tray [x] trailing edge and pass-through): Paper arrived too late service check” on page 145.
242.91	Paper remains detected at the sensor (tray 2 pass-through) or at the sensor (tray 2 trailing edge) after the printer is turned on. Paper source is undetermined.	See “Sensors (tray [x] trailing edge and pass-through) static jam service check” on page 129.
242.92	Paper was detected earlier than expected at the sensor (tray 2 pass-through) or at the sensor (tray 2 trailing edge). Paper source is undetermined.	See “Sensors (tray [x] trailing edge and pass-through): Paper arrived too early service check” on page 130.
242.93	Paper never arrived at the sensor (tray 2 pass-through). Paper source is undetermined.	See “Sensor (tray 2 pass-through): Paper failed to arrive service check” on page 132.
242.94	Paper cleared the sensor (tray 2 pass-through) or the sensor (tray 2 trailing edge) earlier than expected. Paper source is undetermined.	See “Sensors (tray [x] trailing edge and pass-through): Paper cleared too early service check” on page 137.
242.95	Paper cleared the sensor (tray 2 pass-through) or the sensor (tray 2 trailing edge) later than expected. Paper source is undetermined.	See “Sensors (tray [x] trailing edge and pass-through): Paper cleared too late service check” on page 138.
242.96	Paper was picked but it never arrived at the sensor (tray 2 trailing edge). Paper source is undetermined.	See “Sensor (tray [x] pass-through): Tray [x] failed to pick service check” on page 141.
242.97	Paper never cleared the sensor (tray 2 trailing edge). Paper source is undetermined.	See “Sensors (tray [x] trailing edge and pass-through): Paper failed to clear service check” on page 143.
242.98	Paper was detected later than expected at the sensor (tray 2 pass-through) or at the sensor (tray 2 trailing edge). Paper source is undetermined.	See “Sensors (tray [x] trailing edge and pass-through): Paper arrived too late service check” on page 145.

243 paper jam messages

Error code	Description	Action
243.31	Paper fed from tray 3 remains detected at the sensor (tray 3 pass-through) or at the sensor (tray 3 trailing edge) after the printer is turned on.	See “Sensors (tray [x] trailing edge and pass-through) static jam service check” on page 129 .
243.32	Paper fed from tray 3 was detected earlier than expected at the sensor (tray 3 pass-through) or at the sensor (tray 3 trailing edge).	See “Sensors (tray [x] trailing edge and pass-through): Paper arrived too early service check” on page 130.
243.34	Paper fed from tray 3 cleared the sensor (tray 3 pass-through) or the sensor (tray 3 trailing edge) earlier than expected.	See “Sensors (tray [x] trailing edge and pass-through): Paper cleared too early service check” on page 137.

Error code	Description	Action
243.35	Paper fed from tray 3 cleared the sensor (tray 3 pass-through) or the sensor (tray 3 trailing edge) later than expected.	See “Sensors (tray [x] trailing edge and pass-through): Paper cleared too late service check” on page 138.
243.36	Paper fed from tray 3 was picked but it never arrived at the sensor (tray 3 trailing edge).	See “Sensor (tray [x] pass-through): Tray [x] failed to pick service check” on page 141.
243.37	Paper fed from tray 3 never cleared the sensor (tray 3 trailing edge).	See “Sensors (tray [x] trailing edge and pass-through): Paper failed to clear service check” on page 143.
243.38	Paper fed from tray 3 was detected later than expected at the sensor (tray 3 pass-through) or at the sensor (tray 3 trailing edge).	See “Sensors (tray [x] trailing edge and pass-through): Paper arrived too late service check” on page 145.
243.41	Paper fed from tray 4 remains detected at the sensor (tray 3 pass-through) or at the sensor (tray 3 trailing edge) after the printer is turned on.	See “Sensors (tray [x] trailing edge and pass-through) static jam service check” on page 129 .
243.42	Paper fed from tray 4 was detected earlier than expected at the sensor (tray 3 pass-through) or at the sensor (tray 3 trailing edge).	See “Sensors (tray [x] trailing edge and pass-through): Paper arrived too early service check” on page 130.
243.43	Paper fed from tray 4 never arrived at the sensor (tray 3 pass-through).	See “Sensor (tray 3 pass-through): Paper failed to arrive service check” on page 134.
243.44	Paper fed from tray 4 cleared the sensor (tray 3 pass-through) or the sensor (tray 3 trailing edge) earlier than expected.	See “Sensors (tray [x] trailing edge and pass-through): Paper cleared too early service check” on page 137.
243.45	Paper fed from tray 4 cleared the sensor (tray 3 pass-through) or the sensor (tray 3 trailing edge) later than expected.	See “Sensors (tray [x] trailing edge and pass-through): Paper cleared too late service check” on page 138.
243.47	Paper fed from tray 4 never cleared the sensor (tray 3 trailing edge).	See “Sensors (tray [x] trailing edge and pass-through): Paper failed to clear service check” on page 143.
243.48	Paper fed from tray 4 was detected later than expected at the sensor (tray 3 pass-through) or at the sensor (tray 3 trailing edge).	See “Sensors (tray [x] trailing edge and pass-through): Paper arrived too late service check” on page 145.
243.91	Paper remains detected at the sensor (tray 3 pass-through) or at the sensor (tray 3 trailing edge) after the printer is turned on. Paper source is undetermined.	See “Sensors (tray [x] trailing edge and pass-through) static jam service check” on page 129 .
243.92	Paper was detected earlier than expected at the sensor (tray 3 pass-through) or at the sensor (tray 3 trailing edge). Paper source is undetermined.	See “Sensors (tray [x] trailing edge and pass-through): Paper arrived too early service check” on page 130.
243.93	Paper never arrived at the sensor (tray 3 pass-through). Paper source is undetermined.	See “Sensor (tray 3 pass-through): Paper failed to arrive service check” on page 134.
243.94	Paper cleared the sensor (tray 3 pass-through) or the sensor (tray 3 trailing edge) earlier than expected. Paper source is undetermined.	See “Sensors (tray [x] trailing edge and pass-through): Paper cleared too early service check” on page 137.

Error code	Description	Action
243.95	Paper cleared the sensor (tray 3 pass-through) or the sensor (tray 3 trailing edge) later than expected. Paper source is undetermined.	See “Sensors (tray [x] trailing edge and pass-through): Paper cleared too late service check” on page 138.
243.96	Paper was picked but it never arrived at the sensor (tray 3 trailing edge). Paper source is undetermined.	See “Sensor (tray [x] pass-through): Tray [x] failed to pick service check” on page 141.
243.97	Paper never cleared the sensor (tray 3 trailing edge). Paper source is undetermined.	See “Sensors (tray [x] trailing edge and pass-through): Paper failed to clear service check” on page 143.
243.98	Paper was detected later than expected at the sensor (tray 3 pass-through) or at the sensor (tray 3 trailing edge). Paper source is undetermined.	See “Sensors (tray [x] trailing edge and pass-through): Paper arrived too late service check” on page 145.

244 paper jam messages

Error code	Description	Action
244.41	Paper fed from tray 4 remains detected at the sensor (tray 4 pass-through) or at the sensor (tray 4 trailing edge) after the printer is turned on.	See “Sensors (tray [x] trailing edge and pass-through) static jam service check” on page 129 .
244.42	Paper fed from tray 4 was detected earlier than expected at the sensor (tray 4 pass-through) or at the sensor (tray 4 trailing edge).	See “Sensors (tray [x] trailing edge and pass-through): Paper arrived too early service check” on page 130.
244.44	Paper fed from tray 4 cleared the sensor (tray 4 pass-through) or the sensor (tray 4 trailing edge) earlier than expected.	See “Sensors (tray [x] trailing edge and pass-through): Paper cleared too early service check” on page 137.
244.45	Paper fed from tray 4 cleared the sensor (tray 4 pass-through) or the sensor (tray 4 trailing edge) later than expected.	See “Sensors (tray [x] trailing edge and pass-through): Paper cleared too late service check” on page 138.
244.46	Paper fed from tray 4 was picked but it never arrived at the sensor (tray 4 trailing edge).	See “Sensor (tray [x] pass-through): Tray [x] failed to pick service check” on page 141.
244.47	Paper fed from tray 4 never cleared the sensor (tray 4 trailing edge).	See “Sensors (tray [x] trailing edge and pass-through): Paper failed to clear service check” on page 143.
244.48	Paper fed from tray 4 was detected later than expected at the sensor (tray 4 pass-through) or at the sensor (tray 4 trailing edge).	See “Sensors (tray [x] trailing edge and pass-through): Paper arrived too late service check” on page 145.
244.91	Paper remains detected at the sensor (tray 4 pass-through) or at the sensor (tray 4 trailing edge) after the printer is turned on. Paper source is undetermined.	See “Sensors (tray [x] trailing edge and pass-through) static jam service check” on page 129 .
244.92	Paper was detected earlier than expected at the sensor (tray 4 pass-through) or at the sensor (tray 4 trailing edge). Paper source is undetermined.	See “Sensors (tray [x] trailing edge and pass-through): Paper arrived too early service check” on page 130.

Error code	Description	Action
244.94	Paper cleared the sensor (tray 4 pass-through) or the sensor (tray 4 trailing edge) earlier than expected. Paper source is undetermined.	See “Sensors (tray [x] trailing edge and pass-through): Paper cleared too early service check” on page 137.
244.95	Paper cleared the sensor (tray 4 pass-through) or the sensor (tray 4 trailing edge) later than expected. Paper source is undetermined.	See “Sensors (tray [x] trailing edge and pass-through): Paper cleared too late service check” on page 138.
244.96	Paper was picked but it never arrived at the sensor (tray 4 trailing edge). Paper source is undetermined.	See “Sensor (tray [x] pass-through): Tray [x] failed to pick service check” on page 141.
244.97	Paper never cleared the sensor (tray 4 trailing edge). Paper source is undetermined.	See “Sensors (tray [x] trailing edge and pass-through): Paper failed to clear service check” on page 143.
244.98	Paper was detected later than expected at the sensor (tray 4 pass-through) or at the sensor (tray 4 trailing edge). Paper source is undetermined.	See “Sensors (tray [x] trailing edge and pass-through): Paper arrived too late service check” on page 145.

Sensors (tray [x] trailing edge and pass-through) static jam service check

Action	Yes	No
<p>Step 1</p> <p>a From the home screen, touch Settings > Device > Preferences.</p> <p>b Check if the paper size matches the size set on the tray guides.</p> <p>Does the paper size match the size set on the tray?</p>	Go to step 3.	Go to step 2.
<p>Step 2</p> <p>Change the paper size or adjust the size setting in the tray.</p> <p>Does the problem remain?</p>	Go to step 3.	The problem is solved.
<p>Step 3</p> <p>Check the paper path for partially fed or jammed paper.</p> <p>Is the paper path free of partially fed or jammed paper?</p>	Go to step 5.	Go to step 4.
<p>Step 4</p> <p>Remove the partially fed or jammed paper.</p> <p>Does the problem remain?</p>	Go to step 5.	The problem is solved.
<p>Step 5</p> <p>a Enter the Diagnostics menu, and then navigate to: Additional input tray diagnostics > Sensor tests</p> <p>b Find the sensor (Trailing edge (tray [x])).</p> <p>Does the sensor status change while toggling the sensor?</p>	Go to step 8.	Go to step 6.

Action	Yes	No
<p>Step 6</p> <p>Reseat the sensor cable, and then check the sensor for misalignment and damage.</p> <p>Is the sensor properly installed and free of damage?</p>	Go to step 8.	Go to step 7.
<p>Step 7</p> <p>Reinstall or replace the sensor. See “Sensor (550-sheet tray trailing edge) removal” on page 380.</p> <p>Does the problem remain?</p>	Go to step 8.	The problem is solved.
<p>Step 8</p> <p>a Enter the Diagnostics menu, and then navigate to: Additional input tray diagnostics > Sensor tests</p> <p>b Find the sensor (Pass-through (tray [x])).</p> <p>Does the sensor status change while toggling the sensor?</p>	Go to step 11.	Go to step 9.
<p>Step 9</p> <p>Reseat the sensor cable, and then check the sensor for misalignment and damage.</p> <p>Is the sensor properly installed and free of damage?</p>	Go to step 11.	Go to step 10.
<p>Step 10</p> <p>Reinstall or replace the sensor. See “Sensor (550-sheet tray pass-through) removal” on page 379.</p> <p>Does the problem remain?</p>	Go to step 11.	The problem is solved.
<p>Step 11</p> <p>Perform a print test.</p> <p>Does the problem remain?</p>	Contact the next level of support.	The problem is solved.

Sensors (tray [x] trailing edge and pass-through): Paper arrived too early service check

Action	Yes	No
<p>Step 1</p> <p>a From the home screen, touch Settings > Device > Preferences.</p> <p>b Check if the paper size matches the size set on the tray guides.</p> <p>Does the paper size match the size set on the tray?</p>	Go to step 3.	Go to step 2.
<p>Step 2</p> <p>Change the paper size or adjust the size setting in the tray.</p> <p>Does the problem remain?</p>	Go to step 3.	The problem is solved.

Action	Yes	No
<p>Step 3</p> <p>Check the paper path for partially fed or jammed paper.</p> <p>Is the paper path free of partially fed or jammed paper?</p>	Go to step 5.	Go to step 4.
<p>Step 4</p> <p>Remove the partially fed or jammed paper.</p> <p>Does the problem remain?</p>	Go to step 5.	The problem is solved.
<p>Step 5</p> <p>a Enter the Diagnostics menu, and then navigate to: Additional input tray diagnostics > Sensor tests</p> <p>b Find the sensor (Trailing edge (tray [x])).</p> <p>Does the sensor status change while toggling the sensor?</p>	Go to step 8.	Go to step 6.
<p>Step 6</p> <p>Reseat the sensor cable, and then check the sensor for misalignment and damage.</p> <p>Is the sensor properly installed and free of damage?</p>	Go to step 8.	Go to step 7.
<p>Step 7</p> <p>Reinstall or replace the sensor. See “Sensor (550-sheet tray trailing edge) removal” on page 380.</p> <p>Does the problem remain?</p>	Go to step 8.	The problem is solved.
<p>Step 8</p> <p>a Enter the Diagnostics menu, and then navigate to: Additional input tray diagnostics > Sensor tests</p> <p>b Find the sensor (Pass-through (tray [x])).</p> <p>Does the sensor status change while toggling the sensor?</p>	Go to step 11.	Go to step 9.
<p>Step 9</p> <p>Reseat the sensor cable, and then check the sensor for misalignment and damage.</p> <p>Is the sensor properly installed and free of damage?</p>	Go to step 11.	Go to step 10.
<p>Step 10</p> <p>Reinstall or replace the sensor. See “Sensor (550-sheet tray pass-through) removal” on page 379.</p> <p>Does the problem remain?</p>	Go to step 11.	The problem is solved.

Action	Yes	No
<p>Step 11 Perform a print test.</p> <p>Does the problem remain?</p>	Contact the next level of support.	The problem is solved.

Sensor (tray 2 pass-through): Paper failed to arrive service check

Action	Yes	No
<p>Step 1 a From the home screen, touch Settings > Device > Preferences. b Check if the paper size matches the size set on the tray guides.</p> <p>Does the paper size match the size set on the tray?</p>	Go to step 3.	Go to step 2.
<p>Step 2 Change the paper size or adjust the size setting in the tray.</p> <p>Does the problem remain?</p>	Go to step 3.	The problem is solved.
<p>Step 3 Check if the paper size matches the size set on the tray guides.</p> <p>Does the paper size match the size set on the tray?</p>	Go to step 5.	Go to step 4.
<p>Step 4 Replace the paper or change the paper size setting in the tray.</p> <p>Does the problem remain?</p>	Go to step 5.	The problem is solved.
<p>Step 5 Check the paper tray for overfilling.</p> <p>Is the paper tray overfilled?</p>	Go to step 6.	Go to step 7.
<p>Step 6 Remove the excess paper from the tray.</p> <p>Does the problem remain?</p>	Go to step 7.	The problem is solved.
<p>Step 7 Check the paper condition in the tray.</p> <p>Is the paper crumpled or damaged?</p>	Go to step 8.	Go to step 9.
<p>Step 8 Replace the crumpled or damaged paper.</p> <p>Does the problem remain?</p>	Go to step 9.	The problem is solved.

Action	Yes	No
<p>Step 9 Check the paper path for partially fed or jammed paper.</p> <p>Is the paper path free of partially fed or jammed paper?</p>	Go to step 11.	Go to step 10.
<p>Step 10 Remove the partially fed or jammed paper.</p> <p>Does the problem remain?</p>	Go to step 11.	The problem is solved.
<p>Step 11 a Enter the Diagnostics menu, and then navigate to: Additional input tray diagnostics > Sensor tests b Find the sensor (Pass-through (tray 2)).</p> <p>Does the sensor status change while toggling the sensor?</p>	Go to step 14.	Go to step 12.
<p>Step 12 Reseat the sensor cable, and then check the sensor for misalignment and damage.</p> <p>Is the sensor properly installed and free of damage?</p>	Go to step 14.	Go to step 13.
<p>Step 13 Reinstall or replace the sensor. See “Sensor (550-sheet tray pass-through) removal” on page 379.</p> <p>Does the problem remain?</p>	Go to step 14.	The problem is solved.
<p>Step 14 a Enter the Diagnostics menu, and then navigate to: Additional input tray diagnostics > Motor tests b Find the motor (Pass-through (tray 2)), and then touch Start.</p> <p>Does the motor run?</p>	Go to step 17.	Go to step 15.
<p>Step 15 Reseat the motor cable, and then check the motor for misalignment and damage.</p> <p>Is the motor properly installed and free of damage?</p>	Go to step 17.	Go to step 16.
<p>Step 16 Reinstall or replace the motor. See “Motor (550-sheet tray pass-through) removal” on page 376.</p> <p>Does the problem remain?</p>	Go to step 17.	The problem is solved.

Action	Yes	No
<p>Step 17</p> <p>a Enter the Diagnostics menu, and then navigate to: Additional input tray diagnostics > Motor tests</p> <p>b Find the motor (Pass-through (tray 3)), and then touch Start.</p> <p>Does the motor run?</p>	Go to step 20.	Go to step 18.
<p>Step 18</p> <p>Reseat the motor cable, and then check the motor for misalignment and damage.</p> <p>Is the motor properly installed and free of damage?</p>	Go to step 20.	Go to step 19.
<p>Step 19</p> <p>Reinstall or replace the motor. See “Motor (550-sheet tray pass-through) removal” on page 376.</p> <p>Does the problem remain?</p>	Go to step 20.	The problem is solved.
<p>Step 20</p> <p>Perform a print test.</p> <p>Does the problem remain?</p>	Contact the next level of support.	The problem is solved.

Sensor (tray 3 pass-through): Paper failed to arrive service check

Action	Yes	No
<p>Step 1</p> <p>a From the home screen, touch Settings > Device > Preferences.</p> <p>b Check if the paper size matches the size set on the tray guides.</p> <p>Does the paper size match the size set on the tray?</p>	Go to step 3.	Go to step 2.
<p>Step 2</p> <p>Change the paper size or adjust the size setting in the tray.</p> <p>Does the problem remain?</p>	Go to step 3.	The problem is solved.
<p>Step 3</p> <p>Check if the paper size matches the size set on the tray guides.</p> <p>Does the paper size match the size set on the tray?</p>	Go to step 5.	Go to step 4.
<p>Step 4</p> <p>Replace the paper or change the paper size setting in the tray.</p> <p>Does the problem remain?</p>	Go to step 5.	The problem is solved.

Action	Yes	No
<p>Step 5 Check the paper tray for overfilling.</p> <p>Is the paper tray overfilled?</p>	Go to step 6.	Go to step 7.
<p>Step 6 Remove the excess paper from the tray.</p> <p>Does the problem remain?</p>	Go to step 7.	The problem is solved.
<p>Step 7 Check the paper condition in the tray.</p> <p>Is the paper crumpled or damaged?</p>	Go to step 8.	Go to step 9.
<p>Step 8 Replace the crumpled or damaged paper.</p> <p>Does the problem remain?</p>	Go to step 9.	The problem is solved.
<p>Step 9 Check the paper path for partially fed or jammed paper.</p> <p>Is the paper path free of partially fed or jammed paper?</p>	Go to step 11.	Go to step 10.
<p>Step 10 Remove the partially fed or jammed paper.</p> <p>Does the problem remain?</p>	Go to step 11.	The problem is solved.
<p>Step 11 a Enter the Diagnostics menu, and then navigate to: Additional input tray diagnostics > Sensor tests b Find the sensor (Pass-through (tray 3)).</p> <p>Does the sensor status change while toggling the sensor?</p>	Go to step 14.	Go to step 12.
<p>Step 12 Reseat the sensor cable, and then check the sensor for misalignment and damage.</p> <p>Is the sensor properly installed and free of damage?</p>	Go to step 14.	Go to step 13.
<p>Step 13 Reinstall or replace the sensor. See “Sensor (550-sheet tray pass-through) removal” on page 379.</p> <p>Does the problem remain?</p>	Go to step 14.	The problem is solved.

Action	Yes	No
<p>Step 14</p> <p>a Enter the Diagnostics menu, and then navigate to: Additional input tray diagnostics > Motor tests</p> <p>b Find the motor (Pass-through (tray 3)), and then touch Start.</p> <p>Does the motor run?</p>	Go to step 17.	Go to step 15.
<p>Step 15</p> <p>Reseat the motor cable, and then check the motor for misalignment and damage.</p> <p>Is the motor properly installed and free of damage?</p>	Go to step 17.	Go to step 16.
<p>Step 16</p> <p>Reinstall or replace the motor. See “Motor (550-sheet tray pass-through) removal” on page 376.</p> <p>Does the problem remain?</p>	Go to step 17.	The problem is solved.
<p>Step 17</p> <p>a Enter the Diagnostics menu, and then navigate to: Additional input tray diagnostics > Motor tests</p> <p>b Find the motor (Pass-through (tray 4)), and then touch Start.</p> <p>Does the motor run?</p>	Go to step 20.	Go to step 18.
<p>Step 18</p> <p>Reseat the motor cable, and then check the motor for misalignment and damage.</p> <p>Is the motor properly installed and free of damage?</p>	Go to step 20.	Go to step 19.
<p>Step 19</p> <p>Reinstall or replace the motor. See “Motor (550-sheet tray pass-through) removal” on page 376.</p> <p>Does the problem remain?</p>	Go to step 20.	The problem is solved.
<p>Step 20</p> <p>Perform a print test.</p> <p>Does the problem remain?</p>	Contact the next level of support.	The problem is solved.

Sensors (tray [x] trailing edge and pass-through): Paper cleared too early service check

Action	Yes	No
<p>Step 1</p> <p>a From the home screen, touch Settings > Device > Preferences.</p> <p>b Check if the paper size matches the size set on the tray guides.</p> <p>Does the paper size match the size set on the tray?</p>	Go to step 3.	Go to step 2.
<p>Step 2</p> <p>Change the paper size or adjust the size setting in the tray.</p> <p>Does the problem remain?</p>	Go to step 3.	The problem is solved.
<p>Step 3</p> <p>Check if the paper size matches the size set on the tray guides.</p> <p>Does the paper size match the size set on the tray?</p>	Go to step 5.	Go to step 4.
<p>Step 4</p> <p>Replace the paper or change the paper size setting in the tray.</p> <p>Does the problem remain?</p>	Go to step 5.	The problem is solved.
<p>Step 5</p> <p>Check the paper tray for overfilling.</p> <p>Is the paper tray overfilled?</p>	Go to step 6.	Go to step 7.
<p>Step 6</p> <p>Remove the excess paper from the tray.</p> <p>Does the problem remain?</p>	Go to step 7.	The problem is solved.
<p>Step 7</p> <p>Check the paper condition in the tray.</p> <p>Is the paper crumpled or damaged?</p>	Go to step 8.	Go to step 9.
<p>Step 8</p> <p>Replace the crumpled or damaged paper.</p> <p>Does the problem remain?</p>	Go to step 9.	The problem is solved.
<p>Step 9</p> <p>a Enter the Diagnostics menu, and then navigate to: Additional input tray diagnostics > Sensor tests</p> <p>b Find the sensor (Trailing edge (tray [x])).</p> <p>Does the sensor status change while toggling the sensor?</p>	Go to step 12.	Go to step 10.

Action	Yes	No
<p>Step 10</p> <p>Reseat the sensor cable, and then check the sensor for misalignment and damage.</p> <p>Is the sensor properly installed and free of damage?</p>	Go to step 12.	Go to step 11.
<p>Step 11</p> <p>Reinstall or replace the sensor. See “Sensor (550-sheet tray trailing edge) removal” on page 380.</p> <p>Does the problem remain?</p>	Go to step 12.	The problem is solved.
<p>Step 12</p> <p>a Enter the Diagnostics menu, and then navigate to: Additional input tray diagnostics > Sensor tests</p> <p>b Find the sensor (Pass-through (tray [x])).</p> <p>Does the sensor status change while toggling the sensor?</p>	Go to step 15.	Go to step 13.
<p>Step 13</p> <p>Reseat the sensor cable, and then check the sensor for misalignment and damage.</p> <p>Is the sensor properly installed and free of damage?</p>	Go to step 15.	Go to step 14.
<p>Step 14</p> <p>Reinstall or replace the sensor. See “Sensor (550-sheet tray pass-through) removal” on page 379.</p> <p>Does the problem remain?</p>	Go to step 15.	The problem is solved.
<p>Step 15</p> <p>Perform a print test.</p> <p>Does the problem remain?</p>	Contact the next level of support.	The problem is solved.

Sensors (tray [x] trailing edge and pass-through): Paper cleared too late service check

Action	Yes	No
<p>Step 1</p> <p>a From the home screen, touch Settings > Device > Preferences.</p> <p>b Check if the paper size matches the size set on the tray guides.</p> <p>Does the paper size match the size set on the tray?</p>	Go to step 3.	Go to step 2.
<p>Step 2</p> <p>Change the paper size or adjust the size setting in the tray.</p> <p>Does the problem remain?</p>	Go to step 3.	The problem is solved.

Action	Yes	No
<p>Step 3 Check if the paper size matches the size set on the tray guides.</p> <p>Does the paper size match the size set on the tray?</p>	Go to step 5.	Go to step 4.
<p>Step 4 Replace the paper or change the paper size setting in the tray.</p> <p>Does the problem remain?</p>	Go to step 5.	The problem is solved.
<p>Step 5 Check the primary paper path for paper jams and obstructions.</p> <p>Is the paper path free of jams and obstructions?</p>	Go to step 7.	Go to step 6.
<p>Step 6 Remove the paper jams and obstructions.</p> <p>Does the problem remain?</p>	Go to step 7.	The problem is solved.
<p>Step 7</p> <p>a Enter the Diagnostics menu, and then navigate to: Additional input tray diagnostics > Sensor tests</p> <p>b Find the sensor (Trailing edge (tray [x])).</p> <p>Does the sensor status change while toggling the sensor?</p>	Go to step 10.	Go to step 8.
<p>Step 8 Reseat the sensor cable, and then check the sensor for misalignment and damage.</p> <p>Is the sensor properly installed and free of damage?</p>	Go to step 10.	Go to step 9.
<p>Step 9 Reinstall or replace the sensor. See “Sensor (550-sheet tray trailing edge) removal” on page 380.</p> <p>Does the problem remain?</p>	Go to step 10.	The problem is solved.
<p>Step 10</p> <p>a Enter the Diagnostics menu, and then navigate to: Printer diagnostics & adjustments > Motor tests</p> <p>b Find the motor (Duplex/MPF), and then touch Start.</p> <p>Does the motor run?</p>	Go to step 13.	Go to step 11.
<p>Step 11 Reseat the motor cable, and then check the motor for misalignment and damage.</p> <p>Is the motor properly installed and free of damage?</p>	Go to step 13.	Go to step 12.

Action	Yes	No
<p>Step 12 Reinstall or replace the motor. See “Motor (duplex/MPF) removal” on page 315.</p> <p>Does the problem remain?</p>	Go to step 13.	The problem is solved.
<p>Step 13 a Enter the Diagnostics menu, and then navigate to: Additional input tray diagnostics > Sensor tests b Find the sensor (Pass-through (tray [x])).</p> <p>Does the sensor status change while toggling the sensor?</p>	Go to step 16.	Go to step 14.
<p>Step 14 Reseat the sensor cable, and then check the sensor for misalignment and damage.</p> <p>Is the sensor properly installed and free of damage?</p>	Go to step 16.	Go to step 15.
<p>Step 15 Reinstall or replace the sensor. See “Sensor (550-sheet tray pass-through) removal” on page 379.</p> <p>Does the problem remain?</p>	Go to step 16.	The problem is solved.
<p>Step 16 a Enter the Diagnostics menu, and then navigate to: Additional input tray diagnostics > Motor tests b Find the motor (Pass-through (tray [x])), and then touch Start.</p> <p>Does the motor run?</p>	Go to step 19.	Go to step 17.
<p>Step 17 Reseat the motor cable, and then check the motor for misalignment and damage.</p> <p>Is the motor properly installed and free of damage?</p>	Go to step 19.	Go to step 18.
<p>Step 18 Reinstall or replace the motor. See “Motor (550-sheet tray pass-through) removal” on page 376.</p> <p>Does the problem remain?</p>	Go to step 19.	The problem is solved.
<p>Step 19 Perform a print test.</p> <p>Does the problem remain?</p>	Contact the next level of support.	The problem is solved.

Sensor (tray [x] pass-through): Tray [x] failed to pick service check

Action	Yes	No
<p>Step 1</p> <p>a From the home screen, touch Settings > Device > Preferences.</p> <p>b Check if the paper size matches the size set on the tray guides.</p> <p>Does the paper size match the size set on the tray?</p>	Go to step 3.	Go to step 2.
<p>Step 2</p> <p>Change the paper size or adjust the size setting in the tray.</p> <p>Does the problem remain?</p>	Go to step 3.	The problem is solved.
<p>Step 3</p> <p>Check if the paper size matches the size set on the tray guides.</p> <p>Does the paper size match the size set on the tray?</p>	Go to step 5.	Go to step 4.
<p>Step 4</p> <p>Replace the paper or change the paper size setting in the tray.</p> <p>Does the problem remain?</p>	Go to step 5.	The problem is solved.
<p>Step 5</p> <p>Check the paper tray for overfilling.</p> <p>Is the paper tray overfilled?</p>	Go to step 6.	Go to step 7.
<p>Step 6</p> <p>Remove the excess paper from the tray.</p> <p>Does the problem remain?</p>	Go to step 7.	The problem is solved.
<p>Step 7</p> <p>Check the paper condition in the tray.</p> <p>Is the paper crumpled or damaged?</p>	Go to step 8.	Go to step 9.
<p>Step 8</p> <p>Replace the crumpled or damaged paper.</p> <p>Does the problem remain?</p>	Go to step 9.	The problem is solved.
<p>Step 9</p> <p>a Check the pick rollers for proper installation.</p> <p>b Fully press the pick roller assembly upward to make sure that the mounting latches are properly engaging the slot on the shaft.</p> <p>Is the pick roller assembly properly installed?</p>	Go to step 11.	Go to step 10.

Action	Yes	No
<p>Step 10 Reinstall the pick roller assembly.</p> <p>Does the problem remain?</p>	Go to step 11.	The problem is solved.
<p>Step 11 Check the condition of the pick rollers.</p> <p>Are the pick rollers free from excess wear, contamination, and damage?</p>	Go to step 13.	Go to step 12.
<p>Step 12 Replace the pick rollers.</p> <p>Does the problem remain?</p>	Go to step 13.	The problem is solved.
<p>Step 13 Check the paper path exiting the paper tray.</p> <p>Is the paper path free of fragments and contamination?</p>	Go to step 15.	Go to step 14.
<p>Step 14 Clean the paper path.</p> <p>Does the problem remain?</p>	Go to step 15.	The problem is solved.
<p>Step 15 a Enter the Diagnostics menu, and then navigate to: Additional input tray diagnostics > Sensor tests b Find the sensor (Trailing edge (tray [x])).</p> <p>Does the sensor status change while toggling the sensor?</p>	Go to step 18.	Go to step 16.
<p>Step 16 Reseat the sensor cable, and then check the sensor for misalignment and damage.</p> <p>Is the sensor properly installed and free of damage?</p>	Go to step 18.	Go to step 17.
<p>Step 17 Reinstall or replace the sensor. See “Sensor (550-sheet tray trailing edge) removal” on page 380.</p> <p>Does the problem remain?</p>	Go to step 18.	The problem is solved.

Action	Yes	No
<p>Step 18</p> <p>a Enter the Diagnostics menu, and then navigate to: Additional input tray diagnostics > Motor tests > Motor tests > Pick (tray [x])</p> <p>b Select a setting, and then touch Start.</p> <p>Does the motor run?</p>	Go to step 21.	Go to step 19.
<p>Step 19</p> <p>Reseat the motor cable, and then check the motor for misalignment and damage.</p> <p>Is the motor properly installed and free of damage?</p>	Go to step 21.	Go to step 20.
<p>Step 20</p> <p>Reinstall or replace the motor. See “550-sheet tray paper feeder removal” on page 378.</p> <p>Does the problem remain?</p>	Go to step 21.	The problem is solved.
<p>Step 21</p> <p>Replace the media feeder. See “Media feeder removal” on page 373.</p> <p>Does the problem remain?</p>	Go to step 22.	The problem is solved.
<p>Step 22</p> <p>Perform a print test.</p> <p>Does the problem remain?</p>	Contact the next level of support.	The problem is solved.

Sensors (tray [x] trailing edge and pass-through): Paper failed to clear service check

Action	Yes	No
<p>Step 1</p> <p>a From the home screen, touch Settings > Device > Preferences.</p> <p>b Check if the paper size matches the size set on the tray guides.</p> <p>Does the paper size match the size set on the tray?</p>	Go to step 3.	Go to step 2.
<p>Step 2</p> <p>Change the paper size or adjust the size setting in the tray.</p> <p>Does the problem remain?</p>	Go to step 3.	The problem is solved.
<p>Step 3</p> <p>Check the paper path for partially fed or jammed paper.</p> <p>Is the paper path free of partially fed or jammed paper?</p>	Go to step 5.	Go to step 4.

Action	Yes	No
<p>Step 4 Remove the partially fed or jammed paper.</p> <p>Does the problem remain?</p>	Go to step 5.	The problem is solved.
<p>Step 5 a Enter the Diagnostics menu, and then navigate to: Additional input tray diagnostics > Sensor tests b Find the sensor (Trailing edge (tray [x])).</p> <p>Does the sensor status change while toggling the sensor?</p>	Go to step 8.	Go to step 6.
<p>Step 6 Reseat the sensor cable, and then check the sensor for misalignment and damage.</p> <p>Is the sensor properly installed and free of damage?</p>	Go to step 8.	Go to step 7.
<p>Step 7 Reinstall or replace the sensor. See “Sensor (550-sheet tray trailing edge) removal” on page 380.</p> <p>Does the problem remain?</p>	Go to step 8.	The problem is solved.
<p>Step 8 a Enter the Diagnostics menu, and then navigate to: Printer diagnostics & adjustments > Motor tests b Find the motor (Duplex/MPF), and then touch Start.</p> <p>Does the motor run?</p>	Go to step 11.	Go to step 9.
<p>Step 9 Reseat the motor cable, and then check the motor for misalignment and damage.</p> <p>Is the motor properly installed and free of damage?</p>	Go to step 11.	Go to step 10.
<p>Step 10 Reinstall or replace the motor. See “Motor (duplex/MPF) removal” on page 315.</p> <p>Does the problem remain?</p>	Go to step 11.	The problem is solved.
<p>Step 11 a Enter the Diagnostics menu, and then navigate to: Additional input tray diagnostics > Sensor tests b Find the sensor (Pass-through (tray [x])).</p> <p>Does the sensor status change while toggling the sensor?</p>	Go to step 14.	Go to step 12.

Action	Yes	No
<p>Step 12</p> <p>Reseat the sensor cable, and then check the sensor for misalignment and damage.</p> <p>Is the sensor properly installed and free of damage?</p>	Go to step 14.	Go to step 13.
<p>Step 13</p> <p>Reinstall or replace the sensor. See “Sensor (550-sheet tray pass-through) removal” on page 379.</p> <p>Does the problem remain?</p>	Go to step 14.	The problem is solved.
<p>Step 14</p> <p>a Enter the Diagnostics menu, and then navigate to: Printer diagnostics & adjustments > Motor tests</p> <p>b Find the motor (Pass-through (tray [x])), and then touch Start.</p> <p>Does the motor run?</p>	Go to step 17.	Go to step 15.
<p>Step 15</p> <p>Reseat the motor cable, and then check the motor for misalignment and damage.</p> <p>Is the motor properly installed and free of damage?</p>	Go to step 17.	Go to step 16.
<p>Step 16</p> <p>Reinstall or replace the motor. See “Motor (550-sheet tray pass-through) removal” on page 376.</p> <p>Does the problem remain?</p>	Go to step 17.	The problem is solved.
<p>Step 17</p> <p>Perform a print test.</p> <p>Does the problem remain?</p>	Contact the next level of support.	The problem is solved.

Sensors (tray [x] trailing edge and pass-through): Paper arrived too late service check

Action	Yes	No
<p>Step 1</p> <p>a From the home screen, touch Settings > Device > Preferences.</p> <p>b Check if the paper size matches the size set on the tray guides.</p> <p>Does the paper size match the size set on the tray?</p>	Go to step 3.	Go to step 2.
<p>Step 2</p> <p>Change the paper size or adjust the size setting in the tray.</p> <p>Does the problem remain?</p>	Go to step 3.	The problem is solved.

Action	Yes	No
<p>Step 3 Check if the paper size matches the size set on the tray guides.</p> <p>Does the paper size match the size set on the tray?</p>	Go to step 5.	Go to step 4.
<p>Step 4 Replace the paper or change the paper size setting in the tray.</p> <p>Does the problem remain?</p>	Go to step 5.	The problem is solved.
<p>Step 5 Check the paper tray for overfilling.</p> <p>Is the paper tray overfilled?</p>	Go to step 6.	Go to step 7.
<p>Step 6 Remove the excess paper from the tray.</p> <p>Does the problem remain?</p>	Go to step 7.	The problem is solved.
<p>Step 7 Check the paper condition in the tray.</p> <p>Is the paper crumpled or damaged?</p>	Go to step 8.	Go to step 9.
<p>Step 8 Replace the crumpled or damaged paper.</p> <p>Does the problem remain?</p>	Go to step 9.	The problem is solved.
<p>Step 9 Check the tray separator pad for proper installation and damage.</p> <p>Is the separator pad properly installed and free of damage?</p>	Go to step 11.	Go to step 10.
<p>Step 10 Reinstall or replace the separator pad.</p> <p>Does the problem remain?</p>	Go to step 11.	The problem is solved.
<p>Step 11 Check the condition of the tray pick rollers.</p> <p>Are the pick rollers free from excess wear, contamination, and damage?</p>	Go to step 13.	Go to step 12.
<p>Step 12 Replace the pick rollers.</p> <p>Does the problem remain?</p>	Go to step 13.	The problem is solved.

Action	Yes	No
<p>Step 13</p> <p>Check the paper path exiting the paper tray.</p> <p>Is the paper path free of fragments and contamination?</p>	Go to step 15.	Go to step 14.
<p>Step 14</p> <p>Clean the paper path.</p> <p>Does the problem remain?</p>	Go to step 15.	The problem is solved.
<p>Step 15</p> <p>a Enter the Diagnostics menu, and then navigate to: Additional input tray diagnostics > Sensor tests</p> <p>b Find the sensor (Trailing edge (tray [x])).</p> <p>Does the sensor status change while toggling the sensor?</p>	Go to step 18.	Go to step 16.
<p>Step 16</p> <p>Reseat the sensor cable, and then check the sensor for misalignment and damage.</p> <p>Is the sensor properly installed and free of damage?</p>	Go to step 18.	Go to step 17.
<p>Step 17</p> <p>Reinstall or replace the sensor. See “Sensor (550-sheet tray trailing edge) removal” on page 380.</p> <p>Does the problem remain?</p>	Go to step 18.	The problem is solved.
<p>Step 18</p> <p>a Enter the Diagnostics menu, and then navigate to: Additional input tray diagnostics > Motor tests > Pick (tray [x])</p> <p>b Select a setting, and then touch Start.</p> <p>Does the motor run?</p>	Go to step 21.	Go to step 19.
<p>Step 19</p> <p>Reseat the motor cable, and then check the motor for misalignment and damage.</p> <p>Is the motor properly installed and free of damage?</p>	Go to step 21.	Go to step 20.
<p>Step 20</p> <p>Reinstall or replace the motor. See “550-sheet tray paper feeder removal” on page 378.</p> <p>Does the problem remain?</p>	Go to step 21.	The problem is solved.

Action	Yes	No
<p>Step 21 Replace the media feeder. See “Media feeder removal” on page 373.</p> <p>Does the problem remain?</p>	Go to step 22.	The problem is solved.
<p>Step 22 a Enter the Diagnostics menu, and then navigate to: Additional input tray diagnostics > Sensor tests b Find the sensor (Pass-through (tray [x])).</p> <p>Does the sensor status change while toggling the sensor?</p>	Go to step 25.	Go to step 23.
<p>Step 23 Reseat the sensor cable, and then check the sensor for misalignment and damage.</p> <p>Is the sensor properly installed and free of damage?</p>	Go to step 25.	Go to step 24.
<p>Step 24 Reinstall or replace the sensor. See “Sensor (550-sheet tray pass-through) removal” on page 379.</p> <p>Does the problem remain?</p>	Go to step 25.	The problem is solved.
<p>Step 25 a Enter the Diagnostics menu, and then navigate to: Additional input tray diagnostics > Motor tests b Find the motor (Pass-through (tray [x])), and then touch Start.</p> <p>Does the motor run?</p>	Go to step 28.	Go to step 26.
<p>Step 26 Reseat the motor cable, and then check the motor for misalignment and damage.</p> <p>Is the motor properly installed and free of damage?</p>	Go to step 28.	Go to step 27.
<p>Step 27 Reinstall or replace the motor. See “Motor (550-sheet tray pass-through) removal” on page 376.</p> <p>Does the problem remain?</p>	Go to step 28.	The problem is solved.
<p>Step 28 Perform a print test.</p> <p>Does the problem remain?</p>	Contact the next level of support.	The problem is solved.

User attendance messages

31 user attendance error messages

Error code	Description	Action
31.40z	Smart chip communications problem. Reinstall the missing or unresponsive black cartridge.	See “Missing toner, developer, or photoconductor service check” on page 156.
31.41z	Smart chip communications problem. Reinstall the missing or unresponsive cyan cartridge.	
31.42z	Smart chip communications problem. Reinstall the missing or unresponsive magenta cartridge.	
31.43z	Smart chip communications problem. Reinstall the missing or unresponsive yellow cartridge.	
31.30'	Motor (black only retract) failed to stall. Reinstall the missing transfer module.	
31.35	Analog sensor out of range. Reinstall the missing waste toner bottle.	See “Waste toner bottle service check” on page 158.
31.50z	Smart chip communications problem. Reinstall the missing or unresponsive black developer.	See “Missing toner, developer, or photoconductor service check” on page 156.
31.64z	Smart chip communications problem. Reinstall the missing or unresponsive color imaging unit.	
31.80'	All fuser sensors are out of range. Reinstall the fuser.	See “Fuser service check” on page 184.

Z code:

- 31.xxN— Non-genuine Lexmark supply

32 user attendance error messages

Error code	Description	Action
32.40z	Cartridge compatibility problem. Replace the unsupported black cartridge.	See “Missing toner, developer, or photoconductor service check” on page 156.
32.41z	Cartridge compatibility problem. Replace the unsupported cyan cartridge.	
32.42z	Cartridge compatibility problem. Replace the unsupported magenta cartridge.	
32.43z	Cartridge compatibility problem. Replace the unsupported yellow cartridge.	
32.50z	Developer compatibility problem. Replace the unsupported black developer.	
32.64z	Color imaging unit compatibility problem. Replace the unsupported color imaging unit.	

Error code	Description	Action
32.80'	Printer and fuser ID mismatch. Replace the unsupported fuser.	

Z codes:

- 32.xxA— Cartridge fails the OEM_ID test
- 32.xxB— Cartridge is not compatible with the printer
- 32.xxC— Printer is not compatible with the cartridge
- 32.xxD— SWE supply reject ID mismatch
- 32.xxE— SWE reject cartridge married
- 32.xxF— Black developer fails the OEM_ID test
- 32.xxG— Color imaging unit fails the OEM_ID test
- 32.xxH— Black developer is not compatible with the printer
- 32.xxJ— Color imaging unit is not compatible with the printer
- 32.xxK— Printer is not compatible with the black imaging unit (developer and PCU)
- 32.xxL— Printer is not compatible with the color imaging kit (color developers, PCU, basket)
- 32.xxN— Non-genuine Lexmark supply

33 user attendance error messages

Error code	Description	Action
33.40z	Non-Lexmark black cartridge. The smart chip contents have been manipulated by a third party manufacturer.	See “Missing toner, developer, or photoconductor service check” on page 156.
33.41z	Non-Lexmark cyan cartridge. The smart chip contents have been manipulated by a third party manufacturer.	
33.42z	Non-Lexmark magenta cartridge. The smart chip contents have been manipulated by a third party manufacturer.	
33.43z	Non-Lexmark yellow cartridge. The smart chip contents have been manipulated by a third party manufacturer.	
33.50z	Non-Lexmark black developer. The smart chip contents have been manipulated by a third party manufacturer.	
33.64z	Non-Lexmark color imaging unit. The smart chip contents have been manipulated by a third party manufacturer.	

Z codes:

- 33.xxA— Non-genuine Lexmark supply
- 33.xxB— Supply exposed

42 user attendance error messages

Error code	Description	Action
42.xyK	Printer and cartridge region mismatch. Replace the black cartridge.	See “Region mismatch service check” on page 158.
42.xyC	Printer and cartridge region mismatch. Replace the cyan cartridge.	
42. xyM	Printer and cartridge region mismatch. Replace the magenta cartridge.	
42. xyY	Printer and cartridge region mismatch. Replace the yellow cartridge.	

xyz codes:

- x— Printer region
- y— Cartridge region
- z— Color (CMYK)

Region codes:

- 0— World Wide (WW)
- 1— North America (NA)
- 2— Europe Economic Area + extras (EEA+)
- 5— Rest of Europe, Middle East, Africa (RoEMEA)
- 7— Latin America, Asia Pacific (LAD / AP) (+Aus/ NZ)

43 user attendance error messages

Error code	Description	Action
43.41z	Cyan bottle TMC error.	See “Toner meter cycle (TMC) card service check” on page 232.
43.42z	Magenta bottle TMC error.	
43.43z	Yellow bottle TMC error.	

z codes:

- Y— First error, recoverable
- Z— Second error, non-recoverable

80 user attendance error messages

Error code	Description	Action
80.01	The maintenance kit is nearly low. The backup roll or fuser page count threshold has been reached.	See “Maintenance kit service check” on page 159.
80.09	The maintenance kit is nearly low. The user-selected EWS set point has been reached.	
80.11	The maintenance kit is low. The backup roll or fuser page count threshold has been reached.	
80.19	The maintenance kit is low. The user-selected EWS set point has been reached.	
80.21	The maintenance kit is very low. The backup roll or fuser page count threshold has been reached.	
80.29	The maintenance kit is very low. The user-selected EWS set point has been reached.	
80.31	Replace the maintenance kit. The backup roll or fuser page count threshold has been reached. The fuser may continue to function beyond end of life.	
80.39	Replace the maintenance kit. The user-selected EWS set point has been reached. The fuser may continue to function beyond end of life.	

82 user attendance error messages

Error code	Description	Action
82.11	The waste toner bottle is nearly full. The sensor threshold has been reached.	See “Waste toner bottle service check” on page 158.
82.19	The waste toner bottle is nearly full. The user-selected EWS set point has been reached.	
82.31	Replace the waste toner bottle. The sensor end of life threshold has been reached.	

83 user attendance error messages

Error code	Description	Action
83.01	The transfer module is nearly low. The transfer module page count threshold has been reached.	
83.09	The transfer module is nearly low. The user-selected EWS set point has been reached.	
83.11	The transfer module is low. The transfer module page count threshold has been reached.	

Error code	Description	Action
83.19	The transfer module is low. The user-selected EWS set point has been reached.	
83.21	The transfer module is very low. The transfer module page count threshold has been reached.	
83.29	The transfer module is very low. The user-selected EWS set point has been reached.	
83.31	Replace the transfer module. The transfer module page count threshold has been reached. The transfer module may continue to function beyond end of life.	
83.39	Replace the transfer module. The user-selected EWS set point has been reached. The transfer module may continue to function beyond end of life.	

84 user attendance error messages

Error code	Description	Action
84.01	The imaging kit is nearly low. The photoconductor threshold has been reached.	See “Cartridge or photoconductor error service check” on page 159.
84.09	The imaging kit is nearly low. The user-selected EWS set point has been reached.	
84.11	The imaging kit is low. The photoconductor threshold has been reached.	
84.19	The imaging kit is low. The user-selected EWS set point has been reached.	
84.21	The imaging kit is very low. The photoconductor threshold has been reached.	
84.29	The imaging kit is very low. The user-selected EWS set point has been reached.	
84.31	Replace the imaging kit. The imaging kit has exceeded its recommended life span. The imaging kit may continue to function beyond end of life.	
84.39	Replace the imaging kit. The imaging kit has exceeded its recommended life span. The user-selected EWS set point has been reached. The imaging kit may continue to function beyond end of life.	
84.41	Replace the imaging kit to resume printing. The photoconductor threshold for “Absolute End of Life” has been reached.	

85 user attendance error messages

Error code	Description	Action
85.01	The black imaging unit is nearly low. The photoconductor threshold has been reached.	See “Cartridge or photoconductor error service check” on page 159 .
85.09	The black imaging unit is nearly low. The user-selected EWS set point has been reached.	
85.11	The black imaging unit is low. The photoconductor threshold has been reached.	
85.19	The black imaging unit is low. The user-selected EWS set point has been reached.	
85.21	The black imaging unit is very low. The photoconductor threshold has been reached.	
85.29	The black imaging unit is very low. The user-selected EWS set point has been reached.	
85.31	Replace the black imaging unit. The black imaging unit has exceeded its recommended life span. The photoconductor threshold for “End of Life” has been reached. The black developer may continue to function beyond end of life.	
85.39	Replace black imaging unit. The black imaging unit has exceeded its recommended life span. The user-selected EWS set point has been reached. The black developer may continue to function beyond end of life.	
85.41	Replace black imaging unit to resume printing. The photoconductor threshold for “Absolute End of Life” has been reached.	

88 user attendance error messages

Error code	Description	Action
88.01z	The cartridge is nearly low. The TMC threshold has been reached.	See “Cartridge or photoconductor error service check” on page 159.
88.09z	The cartridge is nearly low. The user-selected EWS set point has been reached.	
88.11z	The cartridge is low, and [x] estimated pages remain. The TMC threshold has been reached.	
88.19z	The cartridge is low, and [x] estimated pages remain. The user-selected EWS set point has been reached.	
88.21z	The cartridge is very low, and [x] estimated pages remain. The TMC threshold has been reached.	
88.29z	The cartridge is very low, and [x] estimated pages remain. The user-selected EWS set point has been reached.	
88.31z	The cartridge is empty. Replace the cartridge to continue printing. The TMC threshold has been reached.	
88.38z	The cartridge is empty. Replace the cartridge to continue printing. “Secure quanta expired” was declared.	
88.39z	The cartridge is empty. Replace the cartridge to continue printing. The user-selected EWS set point has been reached.	

Z codes:

- z— Color (CMYK)

Non-supply user attendance error messages

Error code	Description	Action
34	Short paper.	See “Mismatched paper size service check” on page 160.
35	Insufficient memory.	See “Insufficient memory service check” on page 161.
36	The resolution is reduced.	
37	No memory for collation, defrag, or held jobs.	See “Insufficient memory service check” on page 161.
38	Memory is full.	See “Insufficient memory service check” on page 161.
39	Complex page.	See “Complex page service check” on page 161.

Error code	Description	Action
51	Defective flash memory.	See “Flash memory failure service check” on page 162.
52	Flash memory is full.	See “Insufficient flash memory service check” on page 162.
53	Unformatted flash memory.	See “Flash memory failure service check” on page 162.
54	Serial port or network error.	See “Flash memory failure service check” on page 162.
55	Unsupported option.	See “Unsupported internal option service check” on page 163
56	Parallel, serial, or USB port disabled.	See “Disabled port service check” on page 163.
57	Configuration changed – held jobs lost.	
58	Too many flash options or trays.	See “Excess options service check” on page 164.
59	Incompatible option or tray.	See “Incompatible hardware option service check” on page 165.
61	Defective hard disk.	See “Hard disk failure service check” on page 165.
62	Hard disk is full.	See “Hard disk failure service check” on page 165.
63	Unformatted hard disk.	Format the hard disk.
64	Unsupported hard disk format.	Format the hard disk.

Missing toner, developer, or photoconductor service check

Action	Yes	No
<p>Step 1</p> <p>a Make sure that the cartridge or photoconductor is properly installed.</p> <p>b Check the error code on the display, and then verify if the cartridge, developer, or photoconductor is supported.</p> <p>c Replace the unsupported supply.</p> <p>Does the problem remain?</p>	Go to step 2.	The problem is solved.
<p>Step 2</p> <p>Check the HVPS and pogo pin cables for proper connection, and reseal if necessary.</p> <p>Does the problem remain?</p>	Go to step 3.	The problem is solved.

Action	Yes	No
<p>Step 3 Check the pogo pin contacts for damage, and replace if necessary.</p> <p>Does the problem remain?</p>	Go to step 4.	The problem is solved.
<p>Step 4 Check the pogo pin contacts for dust or debris.</p> <p>Are the contacts free of dust or debris?</p>	Go to step 6.	Go to step 5.
<p>Step 5 Remove the dust or debris.</p> <p>Does the problem remain?</p>	Go to step 6.	The problem is solved.
<p>Step 6 Replace the imaging kit.</p> <p>Does the problem remain?</p>	Go to step 7.	The problem is solved.
<p>Step 7</p> <p>a Enter the Diagnostics menu, and then navigate to: Printer diagnostics & adjustments > Sensor tests</p> <p>b Find the sensor (Toner meter).</p> <p>Does the sensor status change while toggling the sensor?</p>	Go to step 9.	Go to step 8.
<p>Step 8 Replace the TMC card. See “TMC card removal” on page 315.</p> <p>Does the problem remain?</p>	Go to step 9.	The problem is solved.
<p>Step 9 Replace the controller board. See “Controller board removal” on page 357.</p> <p>Does the problem remain?</p>	Contact the next level of support.	The problem is solved.

Waste toner bottle service check

Action	Yes	No
<p>Step 1 Reseat the waste toner bottle.</p> <p>Does the problem remain?</p>	Go to step 2.	The problem is solved.
<p>Step 2 Check if the printer is placed on a flat surface.</p> <p>Is the printer placed on a flat surface?</p>	Go to step 4.	Go to step 3.
<p>Step 3 Place the printer on a flat surface.</p> <p>Does the problem remain?</p>	Go to step 4.	The problem is solved.
<p>Step 4 Check the waste toner bottle contacts and waste toner contact block contacts for dust or debris.</p> <p>Are the contacts free of dust or debris?</p>	Go to step 6.	Go to step 5.
<p>Step 5 Remove the dust or debris.</p> <p>Does the problem remain?</p>	Go to step 6.	The problem is solved.
<p>Step 6 Check the waste toner contact block for proper connection and damage, and replace if necessary.</p> <p>Does the problem remain?</p>	Contact the next level of support.	The problem is solved.

Region mismatch service check

Action	Yes	No
<p>Step 1 Check the region number of the cartridge and the printer.</p> <p>Do the numbers match?</p>	Contact the next level of support.	Go to step 2.
<p>Step 2 Install the appropriate cartridge.</p> <p>Does the problem remain?</p>	Contact the next level of support.	The problem is solved.

Maintenance kit service check

Action	Yes	No
<p>Warning—Potential Damage: Do not perform this step if the printer is on.</p> <p>a Replace the required maintenance kit.</p> <p>b Reset the maintenance counter:</p> <ul style="list-style-type: none"> For 300K, enter the Configuration menu, and then navigate to Reset Maintenance counter > Reset 300K Maintenance Kit. For 600K, enter the Diagnostics menu, and then navigate to Reset Maintenance counter > Reset 600K Maintenance Kit. <p>Does the problem remain?</p>	Contact the next level of support.	The problem is solved.

Cartridge or photoconductor error service check

Action	Yes	No
<p>Step 1</p> <p>a Make sure that the cartridge or photoconductor is installed.</p> <p>b Check if the cartridge or photoconductor is supported, and replace if necessary.</p> <p>Does the problem remain?</p>	Go to step 2.	The problem is solved.
<p>Step 2</p> <p>a Make sure that the cartridge or photoconductor is properly installed.</p> <p>b Make sure that the cartridge or photoconductor cables are properly connected.</p> <p>Does the problem remain?</p>	Go to step 3.	The problem is solved.
<p>Step 3</p> <p>Check the cartridge or photoconductor contacts for damage, and replace if necessary.</p> <p>Does the problem remain?</p>	Go to step 4.	The problem is solved.
<p>Step 4</p> <p>Check the controller board pins for damage, and replace if necessary. See “Controller board removal” on page 357.</p> <p>Does the problem remain?</p>	Contact the next level of support.	The problem is solved.

Mismatched paper size service check

Action	Yes	No
<p>Step 1</p> <p>a From the home screen, touch Settings > Device > Preferences.</p> <p>b Check if the paper size matches the size set on the tray guides.</p> <p>Does the paper size match the size set on the tray?</p>	Go to step 3.	Go to step 2.
<p>Step 2</p> <p>Change the paper size or adjust the size setting in the tray.</p> <p>Does the problem remain?</p>	Go to step 3.	The problem is solved.
<p>Step 3</p> <p>a Make sure that the tray paper length and tray paper width guides are properly installed.</p> <p>b Check the guides for wear or damage, and replace if necessary.</p> <p>Does the problem remain?</p>	Go to step 4.	The problem is solved.
<p>Step 4</p> <p>Check the paper width and paper length sensor actuators for damage, and replace if necessary.</p> <p>Does the problem remain?</p>	Go to step 5.	The problem is solved.
<p>Step 5</p> <p>a Reseat the paper width and paper length sensor cables.</p> <p>b Check the cables for damage, and replace if necessary.</p> <p>Does the problem remain?</p>	Go to step 6.	The problem is solved.
<p>Step 6</p> <p>Check the paper width and paper length sensors for damage, and replace if necessary.</p> <p>Does the problem remain?</p>	Go to step 7.	The problem is solved.
<p>Step 7</p> <p>Check the controller board pins for damage, and replace if necessary. See “Controller board removal” on page 357.</p> <p>Does the problem remain?</p>	Contact the next level of support.	The problem is solved.

Insufficient memory service check

Action	Yes	No
<p>Step 1 Reset the printer, and then navigate to: Paper Menu > Print Settings > Download Target > Disk</p> <p>Does the problem remain?</p>	Go to step 2.	The problem is solved.
<p>Step 2 If applicable, install extra memory card. If applicable, make sure that the additional memory card is properly installed.</p> <p>Does the problem remain?</p>	Go to step 3.	The problem is solved.
<p>Step 3 Check the controller board pins for damage, and replace if necessary. See “Controller board removal” on page 357.</p> <p>Does the problem remain?</p>	Contact the next level of support.	The problem is solved.

Complex page service check

Action	Yes	No
<p>Step 1 Reset the printer, and then navigate to: Paper Menu > Print Settings > Download Target > Disk</p> <p>Does the problem remain?</p>	Go to step 2.	The problem is solved.
<p>Step 2 Enter the Diagnostics menu, and then navigate to: PRINTER TESTS > Tray 1 > Single</p> <p>Does the problem remain?</p>	Go to step 4.	Go to step 3.
<p>Step 3 If applicable, install extra memory card. If applicable, make sure that the additional memory card is properly installed.</p> <p>Does the problem remain?</p>	Go to step 4.	The problem is solved.
<p>Step 4 Check the controller board pins for damage, and replace if necessary. See “Controller board removal” on page 357.</p> <p>Does the problem remain?</p>	Contact the next level of support.	The problem is solved.

Flash memory failure service check

Action	Yes	No
<p>Step 1 Navigate to Settings > Print settings > Job Accounting Menu Settings > Log Near Full Level. Make sure that the value is set to maximum.</p> <p>Does the problem remain?</p>	Go to step 2.	The problem is solved.
<p>Step 2 If applicable, make sure that the optional memory card is supported.</p> <p>Does the problem remain?</p>	Go to step 3.	The problem is solved.
<p>Step 3 Check the controller board pins for damage, and replace if necessary. See “Controller board removal” on page 357.</p> <p>Does the problem remain?</p>	Go to step 4.	The problem is solved.
<p>Step 4 Make sure that the firmware version is the latest, and update if necessary.</p> <p>Does the problem remain?</p>	Contact the next level of support.	The problem is solved.

Insufficient flash memory service check

Action	Yes	No
<p>Step 1 Navigate to Settings > Print settings > Utilities Menu > Format Flash > Yes.</p> <p>Does the problem remain?</p>	Go to step 3.	Go to step 2.
<p>Step 2 Navigate to Settings > Print > Job Accounting > Log Near Full Level. Make sure that the value is set to maximum.</p> <p>Does the problem remain?</p>	Go to step 3.	The problem is solved.
<p>Step 3 If applicable, make sure that the optional memory card is supported.</p> <p>Does the problem remain?</p>	Go to step 4.	The problem is solved.

Action	Yes	No
<p>Step 4</p> <p>Check the controller board pins for damage, and replace if necessary. See “Controller board removal” on page 357.</p> <p>Does the problem remain?</p>	Go to step 5.	The problem is solved.
<p>Step 5</p> <p>Make sure that the firmware version is the latest, and update if necessary.</p> <p>Does the problem remain?</p>	Contact the next level of support.	The problem is solved.

Unsupported internal option service check

Action	Yes	No
<p>Step 1</p> <p>If applicable, make sure that the option cards are supported.</p> <p>Does the problem remain?</p>	Go to step 2.	The problem is solved.
<p>Step 2</p> <p>Check the controller board pins for damage, and replace if necessary. See “Controller board removal” on page 357.</p> <p>Does the problem remain?</p>	Go to step 3.	The problem is solved.
<p>Step 3</p> <p>Make sure that the firmware version installed is the latest, and update if necessary.</p> <p>Does the problem remain?</p>	Contact the next level of support.	The problem is solved.

Disabled port service check

Action	Yes	No
<p>Step 1</p> <p>a Make sure that the cables connected to ports are properly installed.</p> <p>b Check the cables for damage, and replace if necessary.</p> <p>Does the problem remain?</p>	Go to step 2.	The problem is solved.
<p>Step 2</p> <p>Enter the Network/Ports menu and make sure that the applicable port settings are enabled.</p> <p>Does the problem remain?</p>	Go to step 3.	The problem is solved.

Action	Yes	No
<p>Step 3 If applicable, make sure that the option card is supported.</p> <p>Does the problem remain?</p>	Go to step 4.	The problem is solved.
<p>Step 4 Check the controller board pins for damage, and replace if necessary. See “Controller board removal” on page 357.</p> <p>Does the problem remain?</p>	Go to step 5.	The problem is solved.
<p>Step 5 Make sure that the firmware version installed is the latest, and update if necessary.</p> <p>Does the problem remain?</p>	Contact the next level of support.	The problem is solved.

Excess options service check

Action	Yes	No
<p>Step 1 Reset the printer, and then resend the print job.</p> <p>Does the problem remain?</p>	Go to step 2.	The problem is solved.
<p>Step 2 If applicable, make sure that the internal option is supported.</p> <p>Does the problem remain?</p>	Go to step 3.	The problem is solved.
<p>Step 3 a If applicable, remove all internal options. b Reset the printer, and then resend the print job.</p> <p>Does the problem remain?</p>	Go to step 6.	Go to step 4.
<p>Step 4 Check if the number of internal options installed is allowed, and remove the excess option.</p> <p>Does the problem remain?</p>	Go to step 5.	The problem is solved.
<p>Step 5 Check if the number of input options installed is allowed, and remove the excess option.</p> <p>Does the problem remain?</p>	Go to step 6.	The problem is solved.

Action	Yes	No
<p>Step 6 Check the controller board pins for damage, and replace if necessary. See “Controller board removal” on page 357.</p> <p>Does the problem remain?</p>	Contact the next level of support.	The problem is solved.

Incompatible hardware option service check

Action	Yes	No
<p>Step 1 Warning—Potential Damage: Do not perform this step if the printer is on.</p> <ul style="list-style-type: none"> a Reseat the hardware option cables. b Check the cables for damage, and replace if necessary. <p>Does the problem remain?</p>	Go to step 2.	The problem is solved.
<p>Step 2 Check the firmware version of the hardware option if it is supported by the engine firmware. Update the firmware if necessary. Note: Contact the next level of support for the correct firmware version.</p> <p>Does the problem remain?</p>	Go to step 3.	The problem is solved.
<p>Step 3 Check the hardware option controller board pins for damage, and replace if necessary.</p> <p>Does the problem remain?</p>	Contact the next level of support.	The problem is solved.

Hard disk failure service check

Action	Yes	No
<p>Step 1 Delete unnecessary files:</p> <ul style="list-style-type: none"> • Navigate to Settings > Print Settings > Utilities Menu > Delete Downloads on Disk > Yes. • Enter the Configuration menu, and then navigate to Settings > Jobs on Disk > Delete. <p>Does the problem remain?</p>	Go to step 2.	The problem is solved.

Action	Yes	No
<p>Step 2</p> <p>Make sure that the firmware version installed is the latest.</p> <p>Note: The latest firmware versions are available on the Technical service bulletins at support.lexmark.com.</p> <p>Does the problem remain?</p>	Go to step 3.	The problem is solved.
<p>Step 3</p> <p>a Make sure that the hard disk cable is properly installed.</p> <p>b Check the cable for damage, and replace if necessary.</p> <p>Does the problem remain?</p>	Go to step 4.	The problem is solved.
<p>Step 4</p> <p>a Make sure that the hard disk is properly installed.</p> <p>b Check the hard disk for damage, and replace if necessary.</p> <p>Does the problem remain?</p>	Go to step 5.	The problem is solved.
<p>Step 5</p> <p>Check the controller board pins for damage, and replace if necessary. See “Controller board removal” on page 357.</p> <p>Does the problem remain?</p>	Contact the next level of support.	The problem is solved.

Printer hardware errors

1yy errors

100 error messages

Error code	Description	Action
100.01	The weather station data is not valid.	See “Sensor (weather station) service check” on page 181 .
100.4D	The printhead thermistor reading is out of range.	See “Printhead service check” on page 182 .
100.05A	The fuser exit sensor cable is unplugged.	See “Fuser sensors service check” on page 179 .
100.05B	The fuser nip sensor cable is unplugged.	
100.25	The transfer module thermistor reading is out of range.	See “Transfer module thermistor service check” on page 195 .
100.27	The tray 1 paper exit sensor cable is unplugged.	See “Tray 1 sensor (media out) cable is unplugged service check” on page 196 .
100.32	The duplex path 1 sensor cable is unplugged.	See “Upper paper path sensors service check” on page 178 .
100.33	The output bin full sensor cable is unplugged.	

Error code	Description	Action
100.35	The following sensors appear to be disconnected: <ol style="list-style-type: none"> 1 Sensor (MPF paper present) 2 Sensor (duplex path 2) 3 Sensor (fuser buckle) 4 Sensor (narrow media) 	See “Sensor (duplex/MPF input) service check” on page 180.
100.36	The MPF paper present sensor is unplugged.	
100.37	The duplex path 2 sensor is unplugged.	
100.38	The fuser buckle sensor is unplugged.	
100.39	The narrow media sensor cable is unplugged.	
100.41	The following sensors are unplugged: <ol style="list-style-type: none"> 1 Sensor (MPF-pass through) 2 Sensor (input) 3 Sensor (tray 1 pick) 	See “Lower paper path sensors service check” on page 177.
100.42	The tray 1 pick sensor is unplugged.	
100.43	The MPF pass-through sensor is unplugged.	
100.44	The input sensor cable is unplugged.	

102 error messages

Error code	Description	Action
102.20	Tray 2 product ID is invalid.	See “Invalid input option type or ID is detected service check” on page 181.
102.21	Tray 2 board ID is invalid.	
102.22	Tray 2 type is invalid.	
102.30	Tray 3 product ID is invalid.	
102.31	Tray 3 board ID is invalid.	
102.32	Tray 3 type is invalid.	
102.40	Tray 4 product ID is invalid.	
102.41	Tray 4 board ID is invalid.	
102.42	Tray 4 type is invalid.	

110 error messages

Error code	Description	Action
110.20	Printhead error was detected before the motor was turned on.	See “Printhead service check” on page 182.
110.21	No printhead power when the laser servo started.	
110.31	Printhead error (no first Hysnc) was detected.	
110.32	Printhead error (lost first Hysnc) was detected.	
110.33	Printhead error (lost first Hysnc) was detected during servo.	
11.34	Printhead error (mirror motor lost lock) was detected.	
110.35	Printhead error (mirror motor no first lock) was detected.	
110.36	Printhead error (mirror motor never stabilized) was detected.	
110.41	Printhead NVRAM read failure occurred.	
110.70	Printhead NVRAM values were incorrect.	
110.71	Printhead timing measurement error was detected.	
110.90	Video cable unplugged.	
110.91	Printhead timing reading error was detected.	
110.92	Printhead NVRAM checksum mismatch occurred.	

120 error messages

Error code	Description	Action
120.80	The motor (fuser) did not turn on.	See “Motor (fuser) service check” on page 183.
120.81	The motor (fuser) did not turn off.	
120.82	The motor (fuser) speed did not ramp up to the required level.	
120.83	The motor (fuser) stalled.	
120.84	The motor (fuser) ran too slow.	
120.85	The motor (fuser) ran too fast.	
120.86	The motor (fuser) did not run at the correct timing.	

121 error messages

Error code	Description	Action
121.02	Fuser went over the required temperature during EWC/line voltage detection.	See “Fuser service check” on page 184.
121.03	Fuser hardware and driver mismatch.	
121.06	Fuser power is at 100% but did not reach the required temperature.	
121.08	Fuser did not reach the required temperature while the page is in the fuser.	
121.09	Fuser did not reach the required temperature for motors. Note: Not applicable to standby mode.	
121.10	Fuser did not reach the required temperature during start of EWC/line voltage detection.	
121.11	Fuser reached the required temperature during final EWC/line voltage detection too late.	
121.12	Fuser did not reach the required temperature during final EWC/line voltage detection.	
121.13	Fuser reached the required temperature during final EWC/line voltage detection too fast.	
121.20	Fuser did not reach the required temperature during steady state control.	
121.21	Fuser low power trace heating rate exceeded error threshold.	
121.22	Open fuser relay was detected.	
121.23	Fuser reached the required temperature during final EWC/line voltage detection too late.	
121.24	Fuser did not reach the required temperature during final EWC/line voltage detection.	
121.25	Control did not roll over to steady state control after line voltage detection.	
121.26	Fuser did not reach the required temperature during warm up.	
121.28	Fuser did not reach the required temperature during EP warm up.	
121.30	Fuser is on for more than the allowed time after a gap blowout, and did not reach the required temperature.	
121.31	Fuser too hot.	
121.32	Fuser did not reach the required temperature at 100% power.	

Error code	Description	Action
121.33	Fuser did not reach the required temperature while the page is in the fuser.	See “Fuser service check” on page 184.
121.34	Fuser did not reach the required temperature during steady state control.	
121.35	Fuser too warm to power up and execute EWC/line voltage detection after a wrong fuser was installed.	
121.36	Open fuser relay was detected in very cold or unknown ambient temperature.	
121.37	Fuser heated too fast during final EWC/line voltage detection.	
121.41	Fuser mechanism did not detect the expected cam sensor signal.	
121.42	Fuser gate time increasing out of control.	
121.48	Fuser type does not match the fuser driver.	
121.50	Fuser went over the required temperature during global over temperature check.	
121.51	Fuser secondary heater is too hot.	
121.70	Heater resistance is too high.	
121.71	Open fuser main heater thermistor was detected.	
121.72	Open fuser secondary heater thermistor was detected.	
121.73	Open fuser middle heater thermistor was detected.	
121.74	Open fuser edge thermistor was detected.	
121.76	Open contact belt thermistor was detected.	
121.81	Open fuser backup roll thermistor was detected.	
121.82	Open fuser second backup roll thermistor was detected.	
121.83	Open fuser narrow media backup roll thermistor was detected.	
121.84	Non-contact sensor (BUR) is missing.	

126 and 127 error messages

Error code	Description	Action
126.01	LVPS line voltage error was detected.	See “LVPS service check” on page 185.
126.02	LVPS line voltage error was detected.	
126.06	LVPS 25V line error was detected.	
126.07	LVPS 5V rail was down during POR.	
126.10	No line frequency was detected.	
126.11	Line frequency has gone outside the operating range.	
127.01	HVPS primary power supply was not detected.	See “HVPS service check” on page 185.
127.02	HVPS secondary power supply was not detected.	

128 error message

Error code	Description	Action
128.00	TPS communications error	See “TPS communications service check” on page 197.

142 error messages

Error code	Description	Action
142.80	The motor (CM developer) did not turn on.	See “Motor (CM developer) service check” on page 186.
142.81	The motor (CM developer) did not turn off.	
142.82	The motor (CM developer) speed did not ramp up to the required level.	
142.83	The motor (CM developer) stalled.	
142.84	The motor (CM developer) ran too slow.	
142.85	The motor (CM developer) ran too fast.	
142.86	The motor (CM developer) did not run at the correct timing.	

144 error messages

Error code	Description	Action
144.80	The motor (Y developer) did not turn on.	See “Motor (Y developer) service check” on page 188.
144.81	The motor (Y developer) did not turn off.	
144.82	The motor (Y developer) speed did not ramp up to the required level.	
144.83	The motor (Y developer) stalled.	
144.84	The motor (Y developer) ran too slow.	
144.85	The motor (Y developer) ran too fast.	
144.86	The motor (Y developer) did not run at the correct timing.	

145 error messages

Error code	Description	Action
145.80	The motor (BOR) did not turn on.	See “Motor (BOR) service check” on page 189.
145.81	The motor (BOR) did not turn off.	
145.82	The motor (BOR) speed did not ramp up to the required level.	
145.83	The motor (BOR) stalled.	
145.84	The motor (BOR) ran too slow.	
145.85	The motor (BOR) ran too fast.	
145.86	The motor (BOR) did not run at the correct timing.	

147 error messages

Error code	Description	Action
147.80	The motor (deskew) did not turn on.	See “Motor (deskew) service check” on page 190.
147.81	The motor (deskew) did not turn off.	
147.82	The motor (deskew) speed did not ramp up to the required level.	
147.83	The motor (deskew) stalled.	
147.84	The motor (deskew) ran too slow.	
147.85	The motor (deskew) ran too fast.	
147.86	The motor (deskew) did not run at the correct timing.	

149 error messages

Error code	Description	Action
149.80	The motor (output) did not turn on.	See “Motor (output) service check” on page 191.
149.81	The motor (output) did not turn off.	
149.82	The motor (output) speed did not ramp up to the required level.	
149.83	The motor (output) stalled.	
149.84	The motor (output) ran too slow.	
149.85	The motor (output) ran too fast.	
149.86	The motor (output) did not run at the correct timing.	

150 and 160 error messages

Error code	Description	Action
150.80	The motor (duplex/MPF) did not turn on.	See “Motor (duplex/MPF) service check” on page 192.
160.80	The motor (duplex/MPF) did not turn on.	
150.81	The motor (duplex/MPF) did not turn off.	
160.81	The motor (duplex/MPF) did not turn off.	
150.82	The motor (duplex/MPF) speed did not ramp up to the required level.	
160.82	The motor (duplex/MPF) speed did not ramp up to the required level.	
150.83	The motor (duplex/MPF) stalled.	
160.83	The motor (duplex/MPF) stalled.	
150.84	The motor (duplex/MPF) ran too slow.	
160.84	The motor (duplex/MPF) ran too slow.	
150.85	The motor (duplex/MPF) ran too fast.	
150.86	The motor (duplex/MPF) did not run at the correct timing.	
160.86	The motor (duplex/MPF) did not run at the correct timing.	

161 and 162 error messages

Error code	Description	Action
161.80	The motor (tray 1 pick) did not turn on.	See “Tray pick roller assembly and lift motor service check” on page 196.
161.81	The motor (tray 1 pick) did not turn off.	
161.82	The motor (tray 1 pick) speed did not ramp up to the required level.	
161.83	The motor (tray 1 pick) stalled.	
161.84	The motor (tray 1 pick) ran too slow.	
161.85	The motor (tray 1 pick) ran too fast.	
161.86	The motor (tray 1 pick) did not run at the correct timing.	
162.80	The motor (tray 2 pick) did not turn on.	
162.81	The motor (tray 2 pick) did not turn off.	
162.82	The motor (tray 2 pick) speed did not ramp up to the required level.	
162.83	The motor (tray 2 pick) stalled.	
162.84	The motor (tray 2 pick) ran too slow.	
162.85	The motor (tray 2 pick) ran too fast.	
162.86	The motor (tray 2 pick) did not run at the correct timing.	

151 error messages

Error code	Description	Action
151.80	The motor (K developer) did not turn on.	See “Motor (K developer) service check” on page 193.
151.81	The motor (K developer) did not turn off.	
151.82	The motor (K developer) speed did not ramp up to the required level.	
151.83	The motor (K developer) stalled.	
151.84	The motor (K developer) ran too slow.	
150.85	The motor (K developer) ran too fast.	
150.86	The motor (K developer) did not run at the correct timing.	

153 error messages

Error code	Description	Action
153.80	The isolation unit did not turn on.	See “Isolation unit service check” on page 194.
153.81	The isolation unit did not turn off.	
153.82	The isolation unit speed did not ramp up to the required level.	
153.83	The isolation unit stalled.	
153.84	The isolation unit ran too slow.	
153.85	The isolation unit ran too fast.	
153.86	The isolation unit did not run at the correct timing.	

163 and 164 error messages

Error code	Description	Action
163.80	The motor (tray 3 pick) did not turn on.	See “Tray pick roller assembly and lift motor service check” on page 196.
163.81	The motor (tray 3 pick) did not turn off.	
163.82	The motor (tray 3 pick) speed did not ramp up to the required level.	
163.83	The motor (tray 3 pick) stalled.	
163.84	The motor (tray 3 pick) ran too slow.	
163.85	The motor (tray 3 pick) ran too fast.	
163.86	The motor (tray 3 pick) did not run at the correct timing.	
164.80	The motor (tray 4 pick) did not turn on.	
164.81	The motor (tray 4 pick) did not turn off.	
164.82	The motor (tray 4 pick) speed did not ramp up to the required level.	
164.83	The motor (tray 4 pick) stalled.	
164.84	The motor (tray 4 pick) ran too slow.	
164.85	The motor (tray 4 pick) ran too fast.	
164.86	The motor (tray 4 pick) did not run at the correct timing.	

166–168 error messages

166.80	The motor (tray 2 pass-through) did not turn on.	See “Motor (tray [x] transport) failure service check” on page 198.
166.81	The motor (tray 2 pass-through) did not turn off.	
166.82	The motor (tray 2 pass-through) speed did not ramp up to the required level.	
166.83	The motor (tray 2 pass-through) stalled.	
166.84	The motor (tray 2 pass-through) ran too slow.	
166.85	The motor (tray 2 pass-through) ran too fast.	
166.86	The motor (tray 2 pass-through) did not run at the correct timing.	
167.80	The motor (tray 3 pass-through) did not turn on.	
167.81	The motor (tray 3 pass-through) did not turn off.	
167.82	The motor (tray 3 pass-through) speed did not ramp up to the required level.	
167.83	The motor (tray 3 pass-through) stalled.	
167.84	The motor (tray 3 pass-through) ran too slow.	
167.85	The motor (tray 3 pass-through) ran too fast.	
167.86	The motor (tray 3 pass-through) did not run at the correct timing.	
168.80	The motor (tray 4 pass-through) did not turn on.	
168.81	The motor (tray 4 pass-through) did not turn off.	
168.82	The motor (tray 4 pass-through) speed did not ramp up to the required level.	
168.83	The motor (tray 4 pass-through) stalled.	
168.84	The motor (tray 4 pass-through) ran too slow.	
168.85	The motor (tray 4 pass-through) ran too fast.	
168.86	The motor (tray 4 pass-through) did not run at the correct timing.	

17y error messages

Error code	Description	Action
171.82	The main fan speed did not ramp up to the required level.	See “Main fan service check” on page 200.
171.83	The main fan stalled.	
171.84	The main fan ran too slow.	
171.85	The main fan ran too fast.	

Error code	Description	Action
172.82	The LVPS fuser fan speed did not ramp up to the required level.	See “LVPS fuser fan service check” on page 199.
172.83	The LVPS fuser fan stalled.	
172.84	The LVPS fuser fan ran too slow.	
172.85	The LVPS fuser fan ran too fast.	

Lower paper path sensors service check

Action	Yes	No
<p>Step 1 Check the error that appeared.</p> <p>Is the error 100.41?</p>	Go to step 3.	Go to step 2.
<p>Step 2 Check the error that appeared.</p> <p>Is the error 100.44?</p>	Go to step 10.	Go to step 3.
<p>Step 3 Check the cable on the JPKSNS1 connector on the controller board for proper connection.</p> <p>Is the cable properly connected?</p>	Go to step 5.	Go to step 4.
<p>Step 4 Reconnect the cable.</p> <p>Does the problem remain?</p>	Go to step 5.	The problem is solved.
<p>Step 5 Check the error that appeared.</p> <p>Is the error 100.42 or 100.43?</p>	Go to step 6.	Go to step 10.
<p>Step 6 Check the sensor cables in the isolation unit for proper connection.</p> <p>Are the cables properly connected?</p>	Go to step 8.	Go to step 7.
<p>Step 7 Reconnect the cables.</p> <p>Does the problem remain?</p>	Go to step 8.	The problem is solved.

Action	Yes	No
<p>Step 8</p> <p>Check the green, yellow, and blue cables connecting the JPKSNS1 connector to the blue and green cables on the isolation unit for proper connection and damage. Replace the cables if necessary.</p> <p>Does the problem remain?</p>	Go to step 9.	The problem is solved.
<p>Step 9</p> <p>Replace the isolation unit. See “Isolation unit removal” on page 371.</p> <p>Does the problem remain?</p>	Contact the next level of support.	The problem is solved.
<p>Step 10</p> <p>Check the red cables connecting the JPKSNS1 connector to the sensor (input) for proper connection and damage, and replace if necessary.</p> <p>Does the problem remain?</p>	Go to step 11.	The problem is solved.
<p>Step 11</p> <p>Replace the sensor (input). See “Sensor (input) removal” on page 341.</p> <p>Does the problem remain?</p>	Contact the next level of support.	The problem is solved.

Upper paper path sensors service check

Action	Yes	No
<p>Step 1</p> <p>Check the following sensors for proper connection, and reseal if necessary:</p> <ul style="list-style-type: none"> • Sensor (output) • Sensor (bin full) <p>Does the problem remain?</p>	Go to step 2.	The problem is solved.
<p>Step 2</p> <p>Check the sensor cables for proper connection on the sensors and on the JDSNS1 connector on the controller board.</p> <p>Are the cables properly connected at both ends?</p>	Go to step 4.	Go to step 3.
<p>Step 3</p> <p>Reconnect the cables.</p> <p>Does the problem remain?</p>	Go to step 4.	The problem is solved.

Action	Yes	No
<p>Step 4 Check the sensors for damage, and replace if necessary.</p> <p>Does the problem remain?</p>	Contact the next level of support.	The problem is solved.

Fuser sensors service check

Action	Yes	No
<p>Step 1 Check the error that appeared.</p> <p>Is the error 100.4?</p>	Go to step 2.	Go to step 3.
<p>Step 2 Check the sensor (fuser nip) for proper connection, and reseal if necessary.</p> <p>Does the problem remain?</p>	Go to step 3.	The problem is solved.
<p>Step 3 Check the sensor (fuser exit) for proper connection, and reseal if necessary.</p> <p>Does the problem remain?</p>	Go to step 4.	The problem is solved.
<p>Step 4 Check the cable on the JFSNS1 connector on the controller board for proper connection and damage, and replace if necessary.</p> <p>Does the problem remain?</p>	Go to step 5.	The problem is solved.
<p>Step 5 Replace the fuser. See “Fuser removal” on page 333.</p> <p>Does the problem remain?</p>	Contact the next level of support.	The problem is solved.

Sensor (duplex/MPF input) service check

Action	Yes	No
<p>Step 1 Check the error that appeared.</p> <p>Is the error 100.35?</p>	Go to step 2.	Go to step 5.
<p>Step 2 a Remove the cable cover from the front door. b Check if the cable is properly connected to the door and to the JMSNS1 connector on the controller board.</p> <p>Is the cable properly connected at both ends?</p>	Go to step 4.	Go to step 3.
<p>Step 3 Reconnect the cable.</p> <p>Does the problem remain?</p>	Go to step 4.	The problem is solved.
<p>Step 4 Replace the cable.</p> <p>Does the problem remain?</p>	Contact the next level of support.	The problem is solved.
<p>Step 5 Check the following sensors for proper connection, and reseal if necessary:</p> <ul style="list-style-type: none"> • Sensor (MPF empty) • Sensor (duplex path 1) • Sensor (fuser buckle) • Sensor (narrow media) <p>Does the problem remain?</p>	Go to step 6.	The problem is solved.
<p>Step 6 Check the sensors for damage, and replace if necessary.</p> <p>Does the problem remain?</p>	Contact the next level of support.	The problem is solved.

Sensor (weather station) service check

Action	Yes	No
<p>Step 1 Check the sensor cable for proper connection and damage, and replace if necessary.</p> <p>Does the problem remain?</p>	Go to step 2.	The problem is solved.
<p>Step 2 Replace the sensor. See “Sensor (weather station) removal ” on page 311.</p> <p>Does the problem remain?</p>	Contact the next level of support.	The problem is solved.

Invalid input option type or ID is detected service check

Action	Yes	No
<p>Step 1</p> <ul style="list-style-type: none"> a Make sure that the latest firmware is installed. b Make sure that the options configuration is supported. See the <i>Printer, Option, and Stand Compatibility Guide</i>. c Reset the printer. <p>Does the problem remain?</p>	Go to step 2.	The problem is solved.
<p>Step 2 Reseat the interface cable, and then check the cable for damage.</p> <p>Is the cable free of damage?</p>	Go to step 4.	Go to step 3.
<p>Step 3 Replace the cable. See “550-sheet tray interface cable removal” on page 383.</p> <p>Does the problem remain?</p>	Go to step 4.	The problem is solved.
<p>Step 4 Check the printer interface cable and adjacent options for damage.</p> <p>Are the cable and options free of damage?</p>	Go to step 6.	Go to step 5.
<p>Step 5 Replace the cable and options.</p> <p>Does the problem remain?</p>	Go to step 6.	The problem is solved.

Action	Yes	No
<p>Step 6 Replace the input option controller board. See “550-sheet tray controller board assembly removal” on page 382.</p> <p>Does the problem remain?</p>	Go to step 7.	The problem is solved.
<p>Step 7 Reset the printer.</p> <p>Does the problem remain?</p>	Contact the next level of support.	The problem is solved.

Printhead service check

Action	Yes	No
<p>Step 1 Reset the printer.</p> <p>Does the problem remain?</p>	Go to step 2.	The problem is solved.
<p>Step 2 Check the cables on the printhead and on the JMIRR1 and JPH1 connectors on the controller board for proper connection.</p> <p>Are the cables properly connected at both ends?</p>	Go to step 4.	Go to step 3.
<p>Step 3 Reconnect the cables.</p> <p>Does the problem remain?</p>	Go to step 4.	The problem is solved.
<p>Step 4 Check the printhead cable for damage, and replace if necessary.</p> <p>Does the problem remain?</p>	Go to step 5.	The problem is solved.
<p>Step 5 Replace the printhead. See “Printhead removal” on page 361.</p> <p>Does the problem remain?</p>	Go to step 6.	The problem is solved.
<p>Step 6 Replace the controller board. See “Controller board removal” on page 357.</p> <p>Does the problem remain?</p>	Contact the next level of support.	The problem is solved.

Motor (fuser) service check

Action	Yes	No
<p>Step 1 Reset the printer.</p> <p>Does the problem remain?</p>	Go to step 2.	The problem is solved.
<p>Step 2 Check the fuser for damage or life expiration, and replace if necessary. See “Fuser removal” on page 333.</p> <p>Does the problem remain?</p>	Go to step 3.	Go to step 4.
<p>Step 3 Check the motor cable on the JFUSED1 connector on the controller board for proper connection.</p> <p>Is the cable properly connected at both ends?</p>	Go to step 5.	Go to step 4.
<p>Step 4 Reconnect the cable.</p> <p>Does the problem remain?</p>	Go to step 5.	The problem is solved.
<p>Step 5 Check the cable for damage, and replace if necessary.</p> <p>Does the problem remain?</p>	Go to step 6.	The problem is solved.
<p>Step 6 Remove the fuser, and then manually turn the fuser drive gear.</p> <p>Does the gear freely turn?</p>	Go to step 8.	Go to step 7.
<p>Step 7 Replace the fuser drive gear.</p> <p>Does the problem remain?</p>	Go to step 8.	The problem is solved.
<p>Step 8 Replace the motor (fuser). See “Motor (fuser) removal” on page 318.</p> <p>Does the problem remain?</p>	Go to step 9.	The problem is solved.
<p>Step 9 Replace the controller board. See “Controller board removal” on page 357.</p> <p>Does the problem remain?</p>	Contact the next level of support.	The problem is solved.

Fuser service check

Action	Yes	No
<p>Step 1 Check the fuser for proper installation.</p> <p>Is the fuser properly installed?</p>	Go to step 3.	Go to step 2.
<p>Step 2 Reinstall the fuser.</p> <p>Does the problem remain?</p>	Go to step 3.	The problem is solved.
<p>Step 3 Check the LVPS cable on the LVPS and on the JFSNS connector on the controller for proper connection.</p> <p>Is the cable properly connected at both ends?</p>	Go to step 5.	Go to step 4.
<p>Step 4 Reconnect the cable.</p> <p>Does the problem remain?</p>	Go to step 5.	The problem is solved.
<p>Step 5 Check the cable for damage, and replace if necessary.</p> <p>Does the problem remain?</p>	Go to step 6.	The problem is solved.
<p>Step 6 Check the fuser cable for proper connection and damage, and replace if necessary.</p> <p>Does the problem remain?</p>	Go to step 7.	The problem is solved.
<p>Step 7 Replace the fuser. See “Fuser removal” on page 333.</p> <p>Does the problem remain?</p>	Go to step 8.	The problem is solved.
<p>Step 8 Replace the LVPS. See “LVPS removal” on page 305.</p> <p>Does the problem remain?</p>	Go to step 9.	The problem is solved.
<p>Step 9 Replace the controller board. See “Controller board removal” on page 357.</p> <p>Does the problem remain?</p>	Contact the next level of support.	The problem is solved.

LVPS service check

Action	Yes	No
<p>Step 1 Reset the printer.</p> <p>Does the problem remain?</p>	Go to step 2.	The problem is solved.
<p>Step 2 Check the LVPS cable on the JLVPS connector on the controller board for proper connection.</p> <p>Is the cable properly connected at both ends?</p>	Go to step 4.	Go to step 3.
<p>Step 3 Reconnect the cable.</p> <p>Does the problem remain?</p>	Go to step 4.	The problem is solved.
<p>Step 4 Check the cable for damage, and replace if necessary.</p> <p>Does the problem remain?</p>	Go to step 5.	The problem is solved.
<p>Step 5 Replace the LVPS. See “LVPS removal” on page 305.</p> <p>Does the problem remain?</p>	Go to step 6.	The problem is solved.
<p>Step 6 Replace the controller board. See “Controller board removal” on page 357.</p> <p>Does the problem remain?</p>	Contact the next level of support.	The problem is solved.

HVPS service check

Action	Yes	No
<p>Step 1 Reset the printer.</p> <p>Does the problem remain?</p>	Go to step 2.	The problem is solved.
<p>Step 2 Check the HVPS cable on the JHVPS connector on the controller board for proper connection.</p> <p>Is the cable properly connected at both ends?</p>	Go to step 4.	Go to step 3.

Action	Yes	No
<p>Step 3 Reconnect the cable.</p> <p>Does the problem remain?</p>	Go to step 4.	The problem is solved.
<p>Step 4 Check the cable for damage, and replace if necessary.</p> <p>Does the problem remain?</p>	Go to step 5.	The problem is solved.
<p>Step 5 Replace the HVPS. See “HVPS removal” on page 319.</p> <p>Does the problem remain?</p>	Go to step 6.	The problem is solved.
<p>Step 6 Replace the controller board. See “Controller board removal” on page 357.</p> <p>Does the problem remain?</p>	Contact the next level of support.	The problem is solved.

Motor (CM developer) service check

Action	Yes	No
<p>Step 1 Reset the printer.</p> <p>Does the problem remain?</p>	Go to step 2.	The problem is solved.
<p>Step 2</p> <p>a Remove the imaging kit, and then remove the transfer module. See “Transfer module removal” on page 334.</p> <p>b Enter the Diagnostics menu, and then navigate to: Printer diagnostics & adjustments > Motor tests > CM developer</p> <p>c Touch Start.</p> <p>Does the motor run?</p>	Go to step 3.	Go to step 6.
<p>Step 3 Manually turn the drive gears.</p> <p>Do the black developer and transfer module drive gears freely turn?</p>	Go to step 5.	Go to step 4.

Action	Yes	No
<p>Step 4 Replace the motor (EP drive). See “Motor (EP drive) removal” on page 296.</p> <p>Does the problem remain?</p>	Go to step 5.	The problem is solved.
<p>Step 5 Check the imaging kit components and transfer module for damage or life expiration, and replace if necessary.</p> <p>Does the problem remain?</p>	Contact the next level of support.	The problem is solved.
<p>Step 6 Check the cables on the motor and on the JCARTP and JCARTS connectors on the controller board for proper connection.</p> <p>Are the cables properly connected at both ends?</p>	Go to step 8.	Go to step 7.
<p>Step 7 Reconnect the cables.</p> <p>Does the problem remain?</p>	Go to step 8.	The problem is solved.
<p>Step 8 Check the cables for damage, and replace if necessary.</p> <p>Does the problem remain?</p>	Go to step 9.	The problem is solved.
<p>Step 9 Replace the motor (CM developer). See “Motor (EP drive) removal” on page 296.</p> <p>Does the problem remain?</p>	Go to step 10.	The problem is solved.
<p>Step 10 Replace the controller board. See “Controller board removal” on page 357.</p> <p>Does the problem remain?</p>	Contact the next level of support.	The problem is solved.

Motor (Y developer) service check

Action	Yes	No
<p>Step 1 Reset the printer.</p> <p>Does the problem remain?</p>	Go to step 2.	The problem is solved.
<p>Step 2 a Remove the imaging kit, and then remove the transfer module. See “Transfer module removal” on page 334. b Enter the Diagnostics menu, and then navigate to: Printer diagnostics & adjustments > Motor tests > Y developer c Touch Start.</p> <p>Does the motor run?</p>	Go to step 3.	Go to step 6.
<p>Step 3 Manually turn the drive gears.</p> <p>Do the black developer and transfer module drive gears freely turn?</p>	Go to step 5.	Go to step 4.
<p>Step 4 Replace the motor (EP drive). See “Motor (EP drive) removal” on page 296.</p> <p>Does the problem remain?</p>	Go to step 5.	The problem is solved.
<p>Step 5 Check the imaging kit components and transfer module for damage or life expiration, and replace if necessary.</p> <p>Does the problem remain?</p>	Contact the next level of support.	The problem is solved.
<p>Step 6 Check the cables on the motor and on the JCARTP and JCARTS connectors on the controller board for proper connection.</p> <p>Are the cables properly connected at both ends?</p>	Go to step 8.	Go to step 7.
<p>Step 7 Reconnect the cables.</p> <p>Does the problem remain?</p>	Go to step 8.	The problem is solved.
<p>Step 8 Check the cables for damage, and replace if necessary.</p> <p>Does the problem remain?</p>	Go to step 9.	The problem is solved.

Action	Yes	No
<p>Step 9 Replace the motor (Y developer). See “Motor (EP drive) removal” on page 296.</p> <p>Does the problem remain?</p>	Go to step 10.	The problem is solved.
<p>Step 10 Replace the controller board. See “Controller board removal” on page 357.</p> <p>Does the problem remain?</p>	Contact the next level of support.	The problem is solved.

Motor (BOR) service check

Action	Yes	No
<p>Step 1 Reset the printer.</p> <p>Does the problem remain?</p>	Go to step 2.	The problem is solved.
<p>Step 2</p> <p>a Remove the transfer module. See “Transfer module removal” on page 334.</p> <p>b Enter the Diagnostics menu, and then navigate to: Printer diagnostics & adjustments > Motor tests > Black only retract</p> <p>c Touch Start.</p> <p>Does the motor run?</p>	Go to step 3.	Go to step 5.
<p>Step 3 Manually turn the BOR gear on the transfer module.</p> <p>Does the gear freely turn?</p>	Contact the next level of support.	Go to step 4.
<p>Step 4 Replace the transfer module. See “Transfer module removal” on page 334.</p> <p>Does the problem remain?</p>	Go to step 9.	The problem is solved.
<p>Step 5 Check the cable on the motor and on the JBOR1 connector on the controller board for proper connection.</p> <p>Is the cable properly connected at both ends?</p>	Go to step 7.	Go to step 6.

Action	Yes	No
Step 6 Reconnect the cable. Does the problem remain?	Go to step 7.	The problem is solved.
Step 7 Check the cable for damage, and replace if necessary. Does the problem remain?	Go to step 8.	The problem is solved.
Step 8 Replace the motor. See “Motor (black only retract) removal” on page 309. Does the problem remain?	Go to step 9.	The problem is solved.
Step 9 Replace the controller board. See “Controller board removal” on page 357. Does the problem remain?	Contact the next level of support.	The problem is solved.

Motor (deskew) service check

Action	Yes	No
Step 1 Reset the printer. Does the problem remain?	Go to step 2.	The problem is solved.
Step 2 a Enter the Diagnostics menu, and then navigate to: Printer diagnostics & adjustments > Motor tests > Deskew b Touch Start . Does the motor run?	Go to step 3.	Go to step 5.
Step 3 Turn the aligner and registration rollers. Is there binding or uneven movement when turning the rollers?	Go to step 4.	Go to step 5.
Step 4 Check the aligner roller gears for damage, and replace if necessary. Does the problem remain?	Go to step 5.	The problem is solved.

Action	Yes	No
<p>Step 5 Check the cable on the motor and on the JMTR1 connector on the controller board for proper connection.</p> <p>Is the cable properly connected at both ends?</p>	Go to step 7.	Go to step 6.
<p>Step 6 Reconnect the cable.</p> <p>Does the problem remain?</p>	Go to step 7.	The problem is solved.
<p>Step 7 Check the cable for damage, and replace if necessary.</p> <p>Does the problem remain?</p>	Go to step 8.	The problem is solved.
<p>Step 8 Replace the motor. See “Motor (deskew) removal” on page 299.</p> <p>Does the problem remain?</p>	Go to step 9.	The problem is solved.
<p>Step 9 Replace the controller board. See “Controller board removal” on page 357.</p> <p>Does the problem remain?</p>	Contact the next level of support.	The problem is solved.

Motor (output) service check

Action	Yes	No
<p>Step 1 Reset the printer.</p> <p>Does the problem remain?</p>	Go to step 2.	The problem is solved.
<p>Step 2 Check the cable on the motor (output) and on the JOUTDC connector on the controller board for proper connection and damage, and replace if necessary.</p> <p>Does the problem remain?</p>	Go to step 3.	The problem is solved.
<p>Step 3 Reset the printer.</p> <p>Does the problem remain?</p>	Go to step 4.	The problem is solved.

Action	Yes	No
<p>Step 4 Replace the motor. See “Motor (output) removal” on page 297.</p> <p>Does the problem remain?</p>	Go to step 5.	The problem is solved.
<p>Step 5 Reset the printer.</p> <p>Does the problem remain?</p>	Go to step 6.	The problem is solved.
<p>Step 6 Replace the controller board. See “Controller board removal” on page 357.</p> <p>Does the problem remain?</p>	Contact the next level of support.	The problem is solved.

Motor (duplex/MPF) service check

Action	Yes	No
<p>Step 1 Reset the printer.</p> <p>Does the problem remain?</p>	Go to step 2.	The problem is solved.
<p>Step 2 a Enter the Diagnostics menu, and then navigate to: Printer diagnostics & adjustments > Motor tests > Duplex/MPF b Touch Start.</p> <p>Does the motor run?</p>	Go to step 3.	Go to step 5.
<p>Step 3 Open the front door, and then manually turn the duplex/MPF drive gears.</p> <p>Is there binding in the gears?</p>	Go to step 4.	Go to step 5.
<p>Step 4 Replace the motor. See “Motor (duplex/MPF) removal” on page 315.</p> <p>Does the problem remain?</p>	Go to step 5.	The problem is solved.
<p>Step 5 Check the motor cable for proper connection and damage, and replace if necessary.</p> <p>Does the problem remain?</p>	Go to step 6.	The problem is solved.

Action	Yes	No
<p>Step 6 Replace the controller board. See “Controller board removal” on page 357.</p> <p>Does the problem remain?</p>	Contact the next level of support.	The problem is solved.

Motor (K developer) service check

Action	Yes	No
<p>Step 1 Reset the printer.</p> <p>Does the problem remain?</p>	Go to step 2.	The problem is solved.
<p>Step 2</p> <p>a Remove the imaging kit, and then remove the transfer module. See “Transfer module removal” on page 334.</p> <p>b Enter the Diagnostics menu, and then navigate to: Printer diagnostics & adjustments > Motor tests > K developer</p> <p>c Touch Start.</p> <p>Does the motor run?</p>	Go to step 3.	Go to step 6.
<p>Step 3 Manually turn the drive gears.</p> <p>Do the black developer and transfer module drive gears freely turn?</p>	Go to step 5.	Go to step 4.
<p>Step 4 Replace the motor (EP drive). See “Motor (EP drive) removal” on page 296.</p> <p>Does the problem remain?</p>	Go to step 5.	The problem is solved.
<p>Step 5 Check the imaging kit components and transfer module for damage or life expiration, and replace if necessary.</p> <p>Does the problem remain?</p>	Contact the next level of support.	The problem is solved.
<p>Step 6 Check the cable on the motor and on the JCARTK connector on the controller board for proper connection.</p> <p>Is the cable properly connected at both ends?</p>	Go to step 8.	Go to step 7.

Action	Yes	No
Step 7 Reconnect the cable. Does the problem remain?	Go to step 8.	The problem is solved.
Step 8 Check the cable for damage, and replace if necessary. Does the problem remain?	Go to step 9.	The problem is solved.
Step 9 Replace the motor (K developer). See “Motor (EP drive) removal” on page 296 . Does the problem remain?	Go to step 10.	The problem is solved.
Step 10 Replace the controller board. See “Controller board removal” on page 357 . Does the problem remain?	Contact the next level of support.	The problem is solved.

Isolation unit service check

Action	Yes	No
Step 1 Reset the printer. Does the problem remain?	Go to step 2.	The problem is solved.
Step 2 a Enter the Diagnostics menu, and then navigate to: Printer diagnostics & adjustments > Motor tests > Isolation b Touch Start . Does the motor run?	Go to step 3.	Go to step 5.
Step 3 Manually turn the isolation unit input rollers. Is there binding or uneven movement when turning the rollers?	Go to step 4.	Go to step 5.
Step 4 Replace the isolation unit. See “Isolation unit removal” on page 371 . Does the problem remain?	Go to step 5.	The problem is solved.

Action	Yes	No
<p>Step 5 Check the cable on the motor and on the JMTR1 connector on the controller board for proper connection.</p> <p>Is the cable properly connected at both ends?</p>	Go to step 7.	Go to step 6.
<p>Step 6 Reconnect the cable.</p> <p>Does the problem remain?</p>	Go to step 7.	The problem is solved.
<p>Step 7 Check the cable for damage, and replace if necessary.</p> <p>Does the problem remain?</p>	Go to step 8.	The problem is solved.
<p>Step 8 Replace the controller board. See “Controller board removal” on page 357.</p> <p>Does the problem remain?</p>	Contact the next level of support.	The problem is solved.

Transfer module thermistor service check

Action	Yes	No
<p>Step 1 Check the cable on the JTHM1 connector on the controller board for proper connection, and reseal if necessary.</p> <p>Does the problem remain?</p>	Go to step 2.	The problem is solved.
<p>Step 2 Replace the sensor (TPS). See “Sensor (TPS) removal” on page 325.</p> <p>Does the problem remain?</p>	Contact the next level of support.	The problem is solved.

Tray 1 sensor (media out) cable is unplugged service check

Action	Yes	No
<p>Step 1 Check the cable on the JMTR1 connector on the controller board for proper connection, and reseal if necessary.</p> <p>Does the problem remain?</p>	Go to step 2.	The problem is solved.
<p>Step 2 a Remove the media feeder. See “Media feeder removal” on page 373. b Check the cable on the sensor (media out), and reseal if necessary.</p> <p>Does the problem remain?</p>	Go to step 3.	The problem is solved.
<p>Step 3 Replace the media feeder. See “Media feeder removal” on page 373.</p> <p>Does the problem remain?</p>	Contact the next level of support.	The problem is solved.

Tray pick roller assembly and lift motor service check

Action	Yes	No
<p>Step 1 Check the pick roller for misalignment and damage.</p> <p>Is the pick roller properly installed and free of damage?</p>	Go to step 3.	Go to step 2.
<p>Step 2 Reinstall or replace the pick roller.</p> <p>Does the problem remain?</p>	Go to step 3.	The problem is solved.
<p>Step 3 Check the cable for socket "INDEX/PAP OUT/PICK MTR" on the controller board for misalignment and damage.</p> <p>Is the cable properly seated and free of damage?</p>	Go to step 5.	Go to step 4.
<p>Step 4 Reseat or replace the cable.</p> <p>Does the problem remain?</p>	Go to step 5.	The problem is solved.
<p>Step 5 Reset the printer.</p> <p>Does the problem remain?</p>	Go to step 6.	The problem is solved.

Action	Yes	No
<p>Step 6 Replace the media feeder. See “Media feeder removal” on page 373.</p> <p>Does the problem remain?</p>	Go to step 7.	The problem is solved.
<p>Step 7 Replace the controller board. See “Controller board removal” on page 357.</p> <p>Does the problem remain?</p>	Contact the next level of support.	The problem is solved.

TPS communications service check

Action	Yes	No
<p>Step 1 Check the TPS cable for proper connection and damage, and replace if necessary.</p> <p>Does the problem remain?</p>	Go to step 2.	The problem is solved.
<p>Step 2 Check the cable on the JTPSAA1 connector on the controller board and sensor for proper connection.</p> <p>Is the cable properly connected at both ends?</p>	Go to step 4.	Go to step 3.
<p>Step 3 Reconnect the cable.</p> <p>Does the problem remain?</p>	Go to step 4.	The problem is solved.
<p>Step 4 Replace the sensor (TPS). See “Sensor (TPS) removal” on page 325.</p> <p>Does the problem remain?</p>	Go to step 5.	The problem is solved.
<p>Step 5 Replace the controller board. See “Controller board removal” on page 357.</p> <p>Does the problem remain?</p>	Contact the next level of support.	The problem is solved.

Motor (tray [x] transport) failure service check

Action	Yes	No
<p>Step 1 Reset the printer</p> <p>Does the problem remain?</p>	Go to step 2.	The problem is solved.
<p>Step 2 Check the connections between the motor (tray [x] transport) and controller board.</p> <p>Is the motor properly connected?</p>	Go to step 4.	Go to step 3.
<p>Step 3 Reseat the cable.</p> <p>Does the problem remain?</p>	Go to step 4.	The problem is solved.
<p>Step 4 Check the motor (tray [x] transport) cable for damage.</p> <p>Is the cable free of damage?</p>	Go to step 6.	Go to step 5.
<p>Step 5 Replace the cable.</p> <p>Does the problem remain?</p>	Go to step 6.	The problem is solved.
<p>Step 6 Reset the printer.</p> <p>Does the problem remain?</p>	Go to step 7.	The problem is solved.
<p>Step 7 Replace the motor (tray [x] transport).</p> <p>Does the problem remain?</p>	Go to step 8.	The problem is solved.
<p>Step 8 Reset the printer.</p> <p>Does the problem remain?</p>	Go to step 9.	The problem is solved.
<p>Step 9 Replace the controller board.</p> <p>Does the problem remain?</p>	Contact the next level of support.	The problem is solved.

Motor (pick and lift) service check

Action	Yes	No
<p>Step 1 Check the pick roller for damage and proper installation, and replace if necessary.</p> <p>Does the problem remain?</p>	Go to step 2.	The problem is solved.
<p>Step 2 Check the cable on the JMTR1 connector on the controller board for proper connection and damage, and replace if necessary.</p> <p>Does the problem remain?</p>	Go to step 3.	The problem is solved.
<p>Step 3 Reset the printer.</p> <p>Does the problem remain?</p>	Go to step 4.	The problem is solved.
<p>Step 4 Replace the media feeder. See “Media feeder removal” on page 373.</p> <p>Does the problem remain?</p>	Go to step 5.	The problem is solved.
<p>Step 5 Replace the controller board. See “Controller board removal” on page 357.</p> <p>Does the problem remain?</p>	Contact the next level of support.	The problem is solved.

LVPS fuser fan service check

Action	Yes	No
<p>Step 1 Check the fuser fan area for obstructions.</p> <p>Is the fan area free from obstructions?</p>	Go to step 3.	Go to step 2.
<p>Step 2 Remove the obstructions.</p> <p>Does the problem remain?</p>	Go to step 3.	The problem is solved.
<p>Step 3 Check the cable on the JFAN1 connector on the controller board for proper connection.</p> <p>Is the cable properly connected?</p>	Go to step 5.	Go to step 4.

Action	Yes	No
Step 4 Reconnect the cable. Does the problem remain?	Go to step 5.	The problem is solved.
Step 5 Replace the fuser fan. See “Fuser fan removal” on page 299. Does the problem remain?	Go to step 6.	The problem is solved.
Step 6 Replace the controller board. See “Controller board removal” on page 357. Does the problem remain?	Contact the next level of support.	The problem is solved.

Main fan service check

Action	Yes	No
Step 1 Check the main fan area for obstructions. Is the fan area free from obstructions?	Go to step 3.	Go to step 2.
Step 2 Remove the obstructions. Does the problem remain?	Go to step 3.	The problem is solved.
Step 3 Check the cable on the JFAN2 connector on the controller board for proper connection. Is the cable properly connected?	Go to step 5.	Go to step 4.
Step 4 Reconnect the cable. Does the problem remain?	Go to step 5.	The problem is solved.
Step 5 Replace the main fan. See “Main fan removal” on page 301. Does the problem remain?	Go to step 6.	The problem is solved.
Step 6 Replace the controller board. See “Controller board removal” on page 357. Does the problem remain?	Contact the next level of support.	The problem is solved.

6yy errors

647 error messages

Error code	Description	Action
647.80	The motor (deskew) did not turn on.	See “Motor (deskew) service check” on page 190.
647.81	The motor (deskew) did not turn off.	
647.82	The motor (deskew) speed did not ramp up to the required level.	
647.83	The motor (deskew) stalled.	
647.84	The motor (deskew) ran too slow.	
647.85	The motor (deskew) ran too fast.	
647.86	The motor (deskew) did not run at the correct timing.	

649 error messages

Error code	Description	Action
649.80	The motor (redrive) did not turn on.	See .
649.81	The motor (redrive) did not turn off.	
649.82	The motor (redrive) speed did not ramp up to the required level.	
649.83	The motor (redrive) stalled.	
649.84	The motor (redrive) ran too slow.	
649.85	The motor (redrive) ran too fast.	
649.86	The motor (redrive) did not run at the correct timing.	

650 error messages

Error code	Description	Action
650.80	The motor (duplex/MPF) did not turn on.	See “Motor (duplex/MPF) service check” on page 192.
650.81	The motor (duplex/MPF) did not turn off.	
650.82	The motor (duplex/MPF) speed did not ramp up to the required level.	
650.83	The motor (duplex/MPF) stalled.	
650.84	The motor (duplex/MPF) ran too slow.	
650.85	The motor (duplex/MPF) ran too fast.	
650.86	The motor (duplex/MPF) did not run at the correct timing.	

653 error messages

Error code	Description	Action
653.80	The motor (ISO) did not turn on.	See “Isolation unit service check” on page 194.
653.81	The motor (ISO) did not turn off.	
653.82	The motor (ISO) speed did not ramp up to the required level.	
653.83	The motor (ISO) stalled.	
653.84	The motor (ISO) ran too slow.	
653.85	The motor (ISO) ran too fast.	
653.86	The motor (ISO) did not run at the correct timing.	

660 error messages

Error code	Description	Action
660.80	The motor (MPF) did not turn on.	See .
660.81	The motor (MPF) did not turn off.	
660.82	The motor (MPF) speed did not ramp up to the required level.	
660.83	The motor (MPF) stalled.	
660.84	The motor (MPF) ran too slow.	
660.85	The motor (MPF) ran too fast.	
660.86	The motor (MPF) did not run at the correct timing.	

661–668 error messages

Error code	Description	Action
661.13	The tray 1 lift plate failed to lift.	See “Motor (tray 1 pick) lifting error service check” on page 203.
662.23	The tray 2 lift plate failed to lift.	
663.33	The tray 3 lift plate failed to lift.	
664.43	The tray 4 lift plate failed to lift.	
666.83	The motor (tray 2 pass-through) stalled.	See “Motor (tray [x] pass-through) stalled service check” on page 206.
667.83	The motor (tray 3 pass-through) stalled.	
668.83	The motor (tray 4 pass-through) stalled.	

Motor (tray 1 pick) lifting error service check

Action	Yes	No
<p>Step 1 Reset the printer.</p> <p>Does the problem remain?</p>	Go to step 2.	The problem is solved.
<p>Step 2 Make sure that the tray insert is properly seated or fully inserted.</p> <p>Does the problem remain?</p>	Go to step 3.	The problem is solved.
<p>Step 3 a Enter the Diagnostics menu, and then navigate to: Printer diagnostics & adjustments > Sensor tests b Find the sensor (Pick roller index (tray 1)).</p> <p>Does the sensor status change while toggling the sensor?</p>	Go to step 8.	Go to step 4.
<p>Step 4 Check the cable that connects the sensor (tray 1 pick roller index) to the controller board.</p> <p>Are both ends of the cable properly seated?</p>	Go to step 6.	Go to step 5.
<p>Step 5 Reseat the cable.</p> <p>Does the problem remain?</p>	Go to step 6.	The problem is solved.
<p>Step 6 Check the sensor cable for damage.</p> <p>Is the cable free of damage?</p>	Go to step 7.	Go to step 12.
<p>Step 7 Replace the sensor. See “Sensor (550-sheet tray index) removal” on page 386.</p> <p>Does the problem remain?</p>	Go to step 8.	The problem is solved.
<p>Step 8 Check the cable that connects the motor (tray 1 pick) to the controller board.</p> <p>Are both ends of the cable properly seated?</p>	Go to step 10.	Go to step 9.
<p>Step 9 Reseat the cable.</p> <p>Does the problem remain?</p>	Go to step 10.	The problem is solved.

Action	Yes	No
<p>Step 10 Check the motor (tray 1 pick) for proper operation and noise.</p> <p>a Remove the tray insert.</p> <p>b Enter the Diagnostics menu, and then navigate to: Printer diagnostics & adjustments > Motor tests > Pick (tray 1)</p> <p>c Select Pick (tray 1) lifting, and then touch Start.</p> <p>Does the motor run or does it sound normal?</p>	Go to step 13.	Go to step 11.
<p>Step 11 Check the motor cable for damage.</p> <p>Is the cable free of damage?</p>	Go to step 13.	Go to step 12.
<p>Step 12 Replace the paper feeder. See “Media feeder removal” on page 373.</p> <p>Does the problem remain?</p>	Go to step 13.	The problem is solved.
<p>Step 13 Reset the printer.</p> <p>Does the problem remain?</p>	Contact the next level of support.	The problem is solved.

Motor (option tray pick) lifting error service check

Action	Yes	No
<p>Step 1 Reset the printer.</p> <p>Does the problem remain?</p>	Go to step 2.	The problem is solved.
<p>Step 2 Make sure that the tray insert is properly seated or fully inserted.</p> <p>Does the problem remain?</p>	Go to step 3.	The problem is solved.
<p>Step 3</p> <p>a Enter the Diagnostics menu, and then navigate to: Additional input tray diagnostics > Sensor tests</p> <p>b Find the sensor (Pick roller index (tray [x])).</p> <p>Does the sensor status change while toggling the sensor?</p>	Go to step 8.	Go to step 4.

Action	Yes	No
<p>Step 4</p> <p>Check the cable that connects the sensor (tray [x] pick roller index) to the controller board.</p> <p>Are both ends of the cable properly seated?</p>	Go to step 6.	Go to step 5.
<p>Step 5</p> <p>Reseat the cable.</p> <p>Does the problem remain?</p>	Go to step 6.	The problem is solved.
<p>Step 6</p> <p>Check the sensor cable for damage.</p> <p>Is the cable free of damage?</p>	Go to step 7.	Go to step 12.
<p>Step 7</p> <p>Replace the sensor. See “Sensor (550-sheet tray index) removal” on page 386.</p> <p>Does the problem remain?</p>	Go to step 8.	The problem is solved.
<p>Step 8</p> <p>Check the cable that connects the motor (tray [x] pick) to the controller board.</p> <p>Are both ends of the cable properly seated?</p>	Go to step 10.	Go to step 9.
<p>Step 9</p> <p>Reseat the cable.</p> <p>Does the problem remain?</p>	Go to step 10.	The problem is solved.
<p>Step 10</p> <p>Check the motor (tray [x] pick) for proper operation and noise.</p> <p>a Remove the tray insert.</p> <p>b Enter the Diagnostics menu, and then navigate to: Additional input tray diagnostics > Motor tests > Pick (tray [x])</p> <p>c Select Pick (tray [x]) lifting, and then touch Start.</p> <p>Does the motor run or does it sound normal?</p>	Go to step 13.	Go to step 11.
<p>Step 11</p> <p>Check the motor cable for damage.</p> <p>Is the cable free of damage?</p>	Go to step 13.	Go to step 12.

Action	Yes	No
<p>Step 12 Replace the paper feeder. See “Media feeder removal” on page 373.</p> <p>Does the problem remain?</p>	Go to step 13.	The problem is solved.
<p>Step 13 Reset the printer.</p> <p>Does the problem remain?</p>	Contact the next level of support.	The problem is solved.

Motor (tray [x] pass-through) stalled service check

Action	Yes	No
<p>Step 1 a Enter the Diagnostics menu, and then navigate to: Additional input tray diagnostics > Motor tests > Pass-through (tray [x]) b Touch Start.</p> <p>Does the motor run?</p>	Go to step 4.	Go to step 2.
<p>Step 2 Check the motor cable for proper connection, and reseal if necessary.</p> <p>Does the problem remain?</p>	Go to step 3.	The problem is solved.
<p>Step 3 Replace the motor. See “Motor (550-sheet tray pass-through) removal” on page 376.</p> <p>Does the problem remain?</p>	Go to step 4.	The problem is solved.
<p>Step 4 Check the motor for noise.</p> <p>Does the motor sound abnormal or do the gears make a grinding sound?</p>	Contact the next level of support.	Go to step 5.
<p>Step 5 Perform a print job.</p> <p>Does the problem remain?</p>	Go to step 6.	The problem is solved.

Action	Yes	No
<p>Step 6 Replace the controller board. See “550-sheet tray controller board assembly removal” on page 382.</p> <p>Does the problem remain?</p>	Contact the next level of support.	The problem is solved.

9yy errors

Procedure before starting the 9yy service checks

You will need to retrieve certain information. This information will aid your next level of support in diagnosing the problem before replacing the controller board.

Warning—Potential Damage: Do not replace the controller board unless directed by your next level of support.

- 1 Collect the history information and firmware logs (Fwdebug and logs.tar.gz) from the SE menu.
- 2 Collect the settings from the menu settings page.
- 3 Collect information from the user.

Note: Not all of the items are retrievable from the printer you are working on.

A. Collecting the history information from the SE menu

Note: Make sure that your printer is connected to a network or to a print server.

- 1 Open a Web browser, type **http://printer_IP_address/se**, and then press **Enter**.

Notes:

- **printer_IP_address** is the TCP/IP address of the printer
- **se** is required to access the printer diagnostic information

- 2 Click **History Information**, copy all information, and then save it as a text file.
- 3 E-mail the text file to your next level of support.

B. Collecting the firmware logs (Fwdebug and logs.tar.gz) from the SE menu

Notes:

- Make sure that your printer is connected to a network or to a print server.
- Some printers are designed to restart automatically after a 9yy error. On these printers, you can retrieve the secondary crash code information using the SE menu.

- Fwedebugs can also be referred to as LBtrace. If FWEdebugs does not appear in the list, then look for LBtrace. Multiple LBtrace logs can appear in the list of links referred to in step 2.

1 Open a Web browser, type **http://printer_IP_address/se**, and then press **Enter**.

2 Click **List Fwedebugs captured during reboots**.

Note: A list of the secondary crash codes retrieved from previous reboots will be generated. If there are Fwedebugs listed, then click **Dump Fwedebug log0**, **Dump Fwedebug log1**, and **Dump Fwedebug log2**. Clicking these links will dump the debug logs to the computer. Take note of the destination folder where the logs are saved.

3 E-mail the logs to your next level of support.

Note: Some printer SE menus give you the option of clicking **Logs Gzip Compressed**. If this option is shown in the menu, then click it and retrieve the compressed log file. Take note of the destination folder where the log file is saved.

C. Collecting the settings from the menu settings page

Note: The menu settings page is different for each printer. For more information see the *User's Guide*. Your next level of support will tell you which page they want to see.

Copying the menu settings page from the Embedded Web Server (EWS)

Note: Make sure that your printer is connected to a network or to a print server.

1 Open a Web browser, type **http://printer_IP_address**, and then press **Enter**.

2 Click Settings, and then select one of the settings pages from the links shown on the page.

3 Copy all the information, and then save it as a text file.

4 E-mail the text file to your next level of support.

Printing the menu settings page

1 From the home screen, navigate to:

Reports > Menu Settings Page

2 Print the menu settings page, and then use Scan to E-mail to send it to your next level of support.

D. Collecting information from the user

Ask the user for information about the following:

- Print job being run
- Operating system being used
- Print driver being used
- Other information on what was happening when the 9yy error occurred

900 error messages

Error code	Description	Action
900.xx	Unrecoverable RIP software error/illegal trap.	See “System software error service check” on page 213 .

91y error messages

Error code	Description	Action
910.xx	A general engine software error.	See “91x.xx (910.xx-919.xx) Engine software service check” on page 218.
911.xx	A general engine software error.	
912.xx	A general engine software error.	
913.xx	A general engine software error.	
914.xx	A general engine software error.	
915.xx	A general engine software error.	
916.xx	A general engine software error.	
917.xx	A general engine software error.	
918.xx	A general engine software error.	
919.xx	A general engine software error.	

938 error messages

Error code	Description	Action
938.01	Board level was not obtained.	See “Controller board removal” on page 357.
938.02	Time out waiting for bullet serial data to be updated.	
938.03	NVM_OK was not received from NV2 server for successfully submitted request.	
938.04	Over temperature condition detected.	

95y error messages

Error code	Description	Action
950.xx	There is a mismatch between controller EEPROM and mirror. <ul style="list-style-type: none"> 950.00 through 950.29 codes: mismatch between controller and mirror 950.30 through 950.60 codes: mismatch between secure and controller 	Go to “950.xx NVRAM failure service check” on page 218.
951.xx	Error NV part on system board.	Go to “Controller board removal” on page 357.
952.xx	A recoverable MVRAM Cyclic Redundancy Check (CRC) error occurred. <i>n</i> is the offset at which the error occurred.	Performing a POR will clear this error.
953.xx	NVRAM chip failure with mirror. <ol style="list-style-type: none"> POR the printer. If the problem persists, replace the UICC card. 	Go to “Upper control panel removal” on page 280.

Error code	Description	Action
954.xx	The NVRAM chip failure with controller part.	Go to “950.xx NVRAM failure service check” on page 218.
955.xx	The Code ROM or NAND flash failed the Cyclic Redundancy Check (CRC) check or the NAND experienced an uncorrectable multi-bit failure. <loc> indicates the source of the failure and has one of the following values: <ul style="list-style-type: none"> • CRC Failure: The source is a failing package indicated by Pn where n is the package number. This error could occur on a controller with ROM or NAND flash and could occur as a result of the CRC check done when the machine is powered on. The range of package numbers is from 0 to 15. • Error Correction Code (ECC) Failure: The source is a failing page indicated by Bn where “n” is the page number. This error occurs only if a multi-bit failure is detected during the ECC execution. Single bit failures will be corrected automatically and will not result in a service error. The range of page numbers is from 0 to 1023. 	
956.xx	Controller board failure. Processor failure. Check on .02 for fan error.	
957.xx	Controller board failure. ASIC failure.	
958.xx	Printer has performed more than 100 “shift and reflash” operations as a result of ECC bit corrections.	
959.xx	Controller verification failure of system boot code.	
959.0x	System hardware failure.	Go to “Controller board removal” on page 357.

96y error messages

Error code	Description	Action
960.xx	RAM memory error: RAM soldered on the board is bad.	See “Controller board removal” on page 357.
961.xx	RAM memory error: slot 1 RAM is bad.	See “Memory failure service check” on page 220.
964.xx	Download emulation cyclic redundancy check (CRC) failure has occurred. A checksum failure detected in the emulation header or emulation file.	See “Download emulation cyclic redundancy service check” on page 220.

97y error messages

Error code	Description	Action
975.xx 975.xx	Network error: unrecognizable network port.	Replace the standard network card or the card in the specified slot.
976.xx	Unrecoverable software or error in network or network card x.	See “Standard network/network card error service check” on page 221.
978.xx	Bad checksum while programming Standard Network or Network Card x port.	See “Standard network/network card programming error service check” on page 221.
979.xx	Flash parts failed while programming the Standard Network or Network Card x port.	See “Standard network/network card error service check” on page 221.

980–984 error messages

Error code	Description	Action
980.xx	Engine experiencing unreliable communication with the specified device. Note: <device> can be one of the following: <ul style="list-style-type: none"> • Tray 2 • Tray 3 • Tray 4 	See “Options communication error service check” on page 222.
981.xx	Engine protocol violation detected by the specified device. Note: <device> can be one of the following: <ul style="list-style-type: none"> • Tray 2 • Tray 3 • Tray 4 	
982.xx	Communications error detected by the specified device. Note: <device> can be one of the following: <ul style="list-style-type: none"> • Tray 2 • Tray 3 • Tray 4 	
983.xx	Invalid command received by the specified device. Note: <device> can be one of the following: <ul style="list-style-type: none"> • Tray 2 • Tray 3 • Tray 4 	
984.xx	Invalid command parameter received by the specified device. Note: <device> can be one of the following: <ul style="list-style-type: none"> • Tray 2 • Tray 3 • Tray 4 	

99y error messages

Error code	Description	Action
990.xx	An equipment check condition occurred but unable to determine the exact component failure.	See “Options communication error service check” on page 222.
991.xx	An equipment check condition occurred in the controller card.	
992.xx	General software error.	

System software error service check

There are different types of 900.xx errors that can occur. There may be a communication problem (bad cable, network connection, and so on) software issue, or a hardware problem with the controller board, or ISP (internal solutions port). The communication and software aspects should be checked first. Determine if the problem is constant or intermittent. Use the following troubleshooting procedure to isolate the issue. Take notes as instructed. You will need that information in the event that you need to contact your next level of support.

Before troubleshooting:

- 1 Perform the [“Procedure before starting the 9yy service checks” on page 207](#).
- 2 Determine the operating system used when the error occurred. If possible, determine whether a PostScript or PCL file was sent to the printer when the error occurred. Ask the customer which Lexmark Solutions applications are installed on the printer.

Action	Yes	No
<p>Step 1 Reset the printer.</p> <p>Does the error remain?</p>	Go to step 2.	The problem is solved.
<p>Step 2</p> <ul style="list-style-type: none"> a Write down the exact 900.xx error code that appears on the display. b Turn off the printer. c Clear the print queues. d Disconnect all communication cables, and then remove all memory options. e Remove any installed ISP. f Reset the printer into the Diagnostics menu. <p>Does the problem remain?</p>	Go to step 3.	Go to step 6.
<p>Step 3 Check all the cables on the controller board for proper connection.</p> <p>Are the cables properly connected?</p>	Go to step 5.	Go to step 4.
<p>Step 4</p> <ul style="list-style-type: none"> a Reconnect the cables. b Reset the printer into the Diagnostics menu. <p>Does the problem remain?</p>	Go to step 5.	Go to step 6.

Action	Yes	No
<p>Step 5</p> <p>a Replace the controller board. See “Controller board removal” on page 357.</p> <p>b Reset the printer.</p> <p>Note: If a different error code displays, then go to the service check for that error code.</p> <p>Does the problem remain?</p>	Go to step 31.	The problem is solved.
<p>Step 6</p> <p>Print the following:</p> <ul style="list-style-type: none"> • Error log • Menu settings page • Network settings page <p>Does the problem remain while printing these pages?</p>	Go to step 31.	Go to step 7.
<p>Step 7</p> <p>Note: Before performing this step, write down the following information about the file being sent to the printer:</p> <ul style="list-style-type: none"> • Application used • Operating system • Driver type • File type (PCL, PostScript, XPS, etc.) <p>a Reattach the communications cable.</p> <p>b Reset the printer.</p> <p>c Perform a print job.</p> <p>Does the problem remain?</p>	Go to step 8.	Go to step 10.
<p>Step 8</p> <p>a Reset the printer.</p> <p>b Perform a different print job.</p> <p>Does the problem remain?</p>	Go to step 9.	Go to step 10.
<p>Step 9</p> <p>a Upgrade the firmware.</p> <p>Note: Contact your next level of support for the correct firmware level to use.</p> <p>b Reset the printer.</p> <p>c Perform a print job.</p> <p>Does the problem remain?</p>	Go to step 31.	Go to step 10.

Action	Yes	No
<p>Step 10 Verify if the printer is an MFP? Is the printer an MFP?</p>	Go to step 11.	Go to step 13.
<p>Step 11 Perform a copy job. Does the problem remain?</p>	Go to step 31.	Go to step 12.
<p>Step 12 Perform a scan to PC job. Does the problem remain?</p>	Go to step 31.	Go to step 13.
<p>Step 13 Verify if an optional memory is installed. Is there an optional memory installed?</p>	Go to step 14.	Go to step 16.
<p>Step 14 a Reinstall the memory. b Perform a print job. Does the problem remain?</p>	Go to step 15.	Go to step 16.
<p>Step 15 a Install a Lexmark-recommended memory option. b Perform a print job. Does the problem remain?</p>	Go to step 31.	The problem is solved.
<p>Step 16 Verify if a modem is installed. Is a modem installed?</p>	Go to step 17.	Go to step 21.
<p>Step 17 a Reinstall the modem. b Reset the printer. Does the problem remain?</p>	Go to step 18.	Go to step 20.

Action	Yes	No
<p>Step 18</p> <p>a Upgrade the firmware if it was not upgraded in a previous step. Note: Contact your next level of support for the correct firmware level to use.</p> <p>b Reset the printer.</p> <p>c Perform a print job.</p> <p>Does the problem remain?</p>	Go to step 19.	The problem is solved.
<p>Step 19</p> <p>a Replace the modem.</p> <p>b Reset the printer.</p> <p>Does the problem remain?</p>	Go to step 31.	The problem is solved.
<p>Step 20</p> <p>Perform a fax job.</p> <p>Does the problem remain?</p>	Go to step 31.	Go to step 21.
<p>Step 21</p> <p>Verify if an ISP option is installed.</p> <p>Is an ISP option installed?</p>	Go to step 22.	The problem is solved.
<p>Step 22</p> <p>a Reinstall the first ISP option.</p> <p>b Reset the printer.</p> <p>Does the problem remain?</p>	Go to step 24.	Go to step 23.
<p>Step 23</p> <p>Perform a job to test the option.</p> <p>Does the problem remain?</p>	Go to step 24.	Go to step 26.
<p>Step 24</p> <p>a Upgrade the firmware if it was not upgraded in a previous step. Note: Contact your next level of support for the correct firmware level to use.</p> <p>b Reset the printer.</p> <p>c Perform a print job.</p> <p>Does the problem remain?</p>	Go to step 25.	The problem is solved.

Action	Yes	No
<p>Step 25</p> <p>a Replace the faulty ISP option.</p> <p>b Reset the printer.</p> <p>Does the problem remain?</p>	Go to step 31.	Go to step 26.
<p>Step 26</p> <p>Verify if there are more ISP options to install?</p> <p>Are there more ISP options to install?</p>	Go to step 27.	The problem is solved.
<p>Step 27</p> <p>a Install the next ISP option.</p> <p>b Reset the printer.</p> <p>Does the problem remain?</p>	Go to step 29.	Go to step 28.
<p>Step 28</p> <p>Perform a job to test the option.</p> <p>Does the problem remain?</p>	Go to step 29.	Go to step 26.
<p>Step 29</p> <p>a Upgrade the firmware if it was not upgraded in a previous step. Note: Contact your next level of support for the correct firmware level to use.</p> <p>b Reset the printer.</p> <p>c Send a print job.</p> <p>Does the problem remain?</p>	Go to step 30.	Go to step 26.
<p>Step 30</p> <p>a Replace the faulty ISP option.</p> <p>b Reset the printer.</p> <p>Does the problem remain?</p>	Go to step 31.	Go to step 26.
<p>Step 31</p> <p>Contact your next level of support. You will need the following information:</p> <ul style="list-style-type: none"> • Exact 900.xx error digits and complete error message • Printed menu settings page • Printed network settings page • Device error log • A sample print file if the error appears to be isolated to a single file • File/Application used if the error is related to specific print file • Device operating system • Driver used (PCL/PS) • Frequency of the occurrence of the error 		

91x.xx (910.xx-919.xx) Engine software service check

Actions	Yes	No
<p>Step 1</p> <p>a Remove the controller board shield. See “Controller board shield removal” on page 356.</p> <p>b Check the cables on the controller board for proper connection.</p> <p>Are the cables properly connected?</p>	Go to step 2.	Go to step 3.
<p>Step 2</p> <p>Replace the controller board. See “Controller board removal” on page 357.</p> <p>Does the problem remain?</p>	Contact the next level of support.	The problem is solved.
<p>Step 3</p> <p>Reconnect the cables, and then reset the printer.</p> <p>Does the problem remain?</p>	Contact the next level of support.	The problem is solved.

950.xx NVRAM failure service check

Warning—Potential Damage: When replacing any of the following components, replace only one component at a time or the printer will be rendered inoperable:

Replace the required component, bring the printer up in Diagnostics mode, and then verify that the problem is fixed before performing a POR.

This error indicates a mismatch between the operator panel assembly and the system board.

Actions	Yes	No
<p>Step 1</p> <p>Verify if the control panel has been replaced.</p> <p>Has the control panel been replaced?</p>	Go to step 2.	Go to step 3.
<p>Step 2</p> <p>Replace the control panel with a new, and not previously installed, UICC card. See “Upper control panel removal” on page 280.</p> <p>Does the problem remain?</p>	Go to step 3.	The problem is solved.
<p>Step 3</p> <p>Verify if the controller board has been replaced.</p> <p>Has the controller board been replaced?</p>	Go to step 4.	Go to step 5.

Actions	Yes	No
<p>Step 4 Replace the controller board with a new, and not previously installed, controller board. See “Controller board removal” on page 357.</p> <p>Does the problem remain?</p>	Go to step 5.	The problem is solved.
<p>Step 5 a Turn the printer off for ten or more seconds. b Turn the printer back on.</p> <p>Does the problem remain?</p>	Go to step 6.	The problem is solved.
<p>Step 6 Clear the NVRAM of the printer: a Turn the printer off. b With the printer off, press and hold buttons 6, 7, and 8 on the keypad. c Turn the printer on. d When Restoring Factory Defaults appears, release the buttons.</p> <p>Note: If the printer looks up on the Restoring Factory Defaults, then wait two minutes, and then turn the printer off. After ten seconds or more, turn the printer back on without holding down any buttons.</p> <p>Does the problem remain?</p>	Go to step 7.	The problem is solved.
<p>Step 7 Replace the control panel. See “Upper control panel removal” on page 280.</p> <p>Does the problem remain?</p>	Go to step 8.	The problem is solved.
<p>Step 8 Replace the controller board. See “Controller board removal” on page 357.</p> <p>Does the problem remain?</p>	Contact the next level of support.	The problem is solved.

Invalid firmware/controller board service check

Action	Yes	No
<p>Step 1 Update the printer firmware.</p> <p>Note: Contact the next level of support for the correct firmware level.</p> <p>Does the problem remain?</p>	Go to step 2.	The problem is solved.
<p>Step 2 Replace the controller board. See “Controller board removal” on page 357.</p> <p>Does the problem remain?</p>	Contact the next level of support.	The problem is solved.

Memory failure service check

Action	Yes	No
<p>Step 1 Check the memory module on the controller board for proper installation and damage, and reseal if necessary.</p> <p>Is the memory module properly installed and free of damage?</p>	Go to step 2.	Go to step 3.
<p>Step 2 Reset the printer.</p> <p>Does the problem remain?</p>	Go to step 3.	The problem is solved.
<p>Step 3 Replace the memory module.</p> <p>Does the problem remain?</p>	Contact the next level of support.	The problem is solved.

Download emulation cyclic redundancy service check

Action	Yes	No
<p>Step 1 Disable the download emulation, and then program the download emulation into the firmware card again.</p> <p>Does the error remain?</p>	Go to step 2.	The problem is solved.
<p>Step 2 Replace the firmware card and download the emulation to the new card.</p> <p>Does the error remain?</p>	Contact the next level of support.	The problem is solved.

Standard network/network card error service check

Action	Yes	No
<p>Step 1 Check if the network card is installed.</p> <p>Is the network card installed?</p>	Go to step 2.	Go to step 3.
<p>Step 2 Make sure that the network card is properly installed, and reseal if necessary.</p> <p>Does the problem remain?</p>	Contact the next level of support.	The problem is solved.
<p>Step 3 Replace the controller board. See “Controller board removal” on page 357.</p> <p>Does the problem remain?</p>	Contact the next level of support.	The problem is solved.

Standard network/network card programming error service check

Action	Yes	No
<p>Step 1 Make sure that you have downloaded the code in binary mode and not in ASCII, and then reprogram the network card.</p> <p>Does the problem remain?</p>	Go to step 2.	The problem is solved.
<p>Step 2 Check if the network card is installed.</p> <p>Is the network card installed?</p>	Go to step 3.	Go to step 4.
<p>Step 3 Make sure that the network card is properly installed, and reseal if necessary.</p> <p>Does the problem remain?</p>	Contact the next level of support.	The problem is solved.
<p>Step 4 Replace the controller board. See “Controller board removal” on page 357.</p> <p>Does the problem remain?</p>	Contact the next level of support.	The problem is solved.

Options communication error service check

Action	Yes	No
<p>Step 1</p> <p>a Check if the firmware is updated, and then update the firmware if necessary.</p> <p>b Make sure that the printer supports the option. See the <i>Printer, Option, and Stand Compatibility Guide</i>.</p> <p>c Make sure that the option is properly attached to the printer or adjacent option.</p> <p>d Reset the printer.</p> <p>Does the problem remain?</p>	Go to step 2.	The problem is solved.
<p>Step 2</p> <p>Reseat the printer interface cable on the printer controller board.</p> <p>Does the problem remain?</p>	Go to step 3.	The problem is solved.
<p>Step 3</p> <p>Do the following to each option:</p> <p>a Reinstall the option.</p> <p>b Print a test page, and then check if the option is defective.</p> <p>Are all options properly working?</p>	Go to step 4.	Contact the next level of support
<p>Step 4</p> <p>Reseat the option interface cable.</p> <p>Does the problem remain?</p>	Go to step 5.	The problem is solved.
<p>Step 5</p> <p>Check the option interface cable for damage.</p> <p>Is the cable free of damage?</p>	Go to step 6.	Go to step 7.
<p>Step 6</p> <p>Replace the option interface cable. See “550-sheet tray interface cable removal” on page 383.</p> <p>Does the problem remain?</p>	Go to step 7.	The problem is solved.
<p>Step 7</p> <p>Replace the option controller board. See “550-sheet tray controller board assembly removal” on page 382.</p> <p>Does the problem remain?</p>	Contact the next level of support	The problem is solved.

Symptoms

Base printer symptoms

Symptom	Action
Printer has no power.	See “Dead machine service check” on page 226.
Control panel not functioning.	See “Control panel service check” on page 223.
False values for the front door appear on the display.	See “Interlock switch service check” on page 224.
NFC communications failure.	See “Mobile solutions module NFC service check” on page 228.
Toner out displays.	See “Toner meter cycle (TMC) card service check” on page 232.
Printer not communicating with host (USB).	See “USB service check” on page 233.
Printer not communicating with host (network).	See “Network service check” on page 229.
Paper jam in the output bin.	See “Sensor (output bin full) static jam service check” on page 84.

Control panel service check

Action	Yes	No
<p>Step 1 Reset the printer.</p> <p>Does the problem remain?</p>	Go to step 2.	The problem is solved.
<p>Step 2 Check the blue LED on the control panel.</p> <p>Is the LED on?</p>	Go to step 3.	Go to step 4.
<p>Step 3 Check the Ethernet and controller board LEDs on the control panel.</p> <p>Are the LEDs on?</p>	Go to step 4.	Go to step 9.
<p>Step 4 Check the ribbon cable connection on the control panel and controller board.</p> <p>Is the cable properly connected at both ends?</p>	Go to step 6.	Go to step 5.
<p>Step 5 Reconnect the cable.</p> <p>Does the problem remain?</p>	Go to step 6.	The problem is solved.

Action	Yes	No
<p>Step 6 Check the cable for damage, and replace if necessary.</p> <p>Does the problem remain?</p>	Go to step 7.	The problem is solved.
<p>Step 7 Replace the control panel cable.</p> <p>Does the problem remain?</p>	Go to step 8.	The problem is solved.
<p>Step 8 Replace the control panel. See “Upper control panel removal” on page 280.</p> <p>Does the problem remain?</p>	Go to step 12.	The problem is solved.
<p>Step 9 Disconnect the LVPS cable from the controller board, and then measure the voltages of the red and orange wires.</p> <p>Is the reading on the red wire +6.5 V, and the orange wire +25 V?</p>	Go to step 12.	Go to step 10.
<p>Step 10 Replace the LVPS cable.</p> <p>Does the problem remain?</p>	Go to step 11.	The problem is solved.
<p>Step 11 Replace the LVPS. See “LVPS removal” on page 305.</p> <p>Does the problem remain?</p>	Go to step 12.	The problem is solved.
<p>Step 12 Replace the controller board. See “Controller board removal” on page 357.</p> <p>Does the problem remain?</p>	Contact the next level of support.	The problem is solved.

Interlock switch service check

Action	Yes	No
<p>Step 1</p> <p>a Enter the Diagnostics menu, and then navigate to: Printer diagnostics & adjustments > Sensor tests</p> <p>b Find the sensor (Door interlock).</p> <p>Does the sensor status change while toggling the sensor?</p>	The problem is solved.	Go to step 2.

Action	Yes	No
<p>Step 2 Check the sensor cable for proper connection.</p> <p>Is the cable properly connected?</p>	Go to step 4.	Go to step 3.
<p>Step 3 Reconnect the cable.</p> <p>Does the problem remain?</p>	Go to step 4.	The problem is solved.
<p>Step 4 Remove the motor cover, and then check the interlock cable relay for proper connection.</p> <p>Is the cable properly connected?</p>	Go to step 6.	Go to step 5.
<p>Step 5 Reconnect the cable.</p> <p>Does the problem remain?</p>	Go to step 6.	The problem is solved.
<p>Step 6 Check the front door interlock switch actuator for damage.</p> <p>Is the actuator free of damage?</p>	Go to step 8.	Go to step 7.
<p>Step 7 Replace the duplex outer guide. See “Duplex outer guide removal” on page 289.</p> <p>Does the problem remain?</p>	Go to step 8.	The problem is solved.
<p>Step 8 Check the toner door interlock switch actuator for damage.</p> <p>Is the actuator free of damage?</p>	Go to step 10.	Go to step 9.
<p>Step 9 Replace the toner door. See “Toner door removal” on page 276.</p> <p>Does the problem remain?</p>	Go to step 10.	The problem is solved.
<p>Step 10 Replace the motor cover. See “Motor cover removal” on page 273.</p> <p>Does the problem remain?</p>	Go to step 11.	The problem is solved.

Action	Yes	No
<p>Step 11 Replace the controller board. See “Controller board removal” on page 357.</p> <p>Does the problem remain?</p>	Contact the next level of support.	The problem is solved.

Sensor (narrow media) and sensor (fuser buckle) service check

Actions	Yes	No
<p>Step 1 Check the sensor (narrow media) and sensor (fuser buckle) for proper connection and damage, and replace if necessary.</p> <p>Does the problem remain?</p>	Go to step 2.	The problem is solved.
<p>Step 2 a Enter the Diagnostics menu, and then navigate to: Printer diagnostics & adjustments > Sensor tests b Find the sensor (Fuser buckle) and sensor (Narrow media).</p> <p>Does the sensor status change while toggling the sensor?</p>	Go to step 4.	Go to step 3.
<p>Step 3 Check the sensor cables for proper connection and damage, and replace if necessary.</p> <p>Does the problem remain?</p>	Go to step 4.	The problem is solved.
<p>Step 4 Replace the sensors.</p> <p>Does the problem remain?</p>	Contact the next level of support.	The problem is solved.

Dead machine service check

Action	Yes	No
<p>Step 1 Check the AC line for proper voltage.</p> <p>Does the AC line have proper voltage?</p>	Go to step 3.	Go to step 2.
<p>Step 2 Use an electrical outlet that has proper voltage.</p> <p>Does the problem remain?</p>	Go to step 3.	The problem is solved.

Action	Yes	No
<p>Step 3 Check the power cord for damage, and replace if necessary.</p> <p>Does the problem remain?</p>	Go to step 4.	The problem is solved.
<p>Step 4 Check the cable on the LVPS and on the JLVPS connector on the controller board for proper connection.</p> <p>Is the cable properly connected at both ends?</p>	Go to step 6.	Go to step 5.
<p>Step 5 Reconnect the cable.</p> <p>Does the problem remain?</p>	Go to step 6.	The problem is solved.
<p>Step 6 Check the cable for continuity.</p> <p>Does the cable have continuity?</p>	Go to step 8.	Go to step 7.
<p>Step 7 Replace the cable.</p> <p>Does the problem remain?</p>	Go to step 8.	The problem is solved.
<p>Step 8 Measure the values of pin 4, 6, 8, and 11 to 26 of the JLVPS connector on the controller board. See “Controller board connectors” on page 390.</p> <p>Are the values approximately correct?</p>	Go to step 10.	Go to step 9.
<p>Step 9 Replace the LVPS. See “LVPS removal” on page 305.</p> <p>Does the problem remain?</p>	Go to step 10.	The problem is solved.
<p>Step 10 Replace the controller board. See “Controller board removal” on page 357.</p> <p>Does the problem remain?</p>	Contact the next level of support.	The problem is solved.

Mobile solutions module NFC service check

Action	Yes	No
<p>Step 1 Check if the control panel is functioning properly.</p> <p>Is the control panel functioning properly?</p>	Go to step 3.	Go to step 2.
<p>Step 2 Replace the control panel.</p> <p>Does the problem remain?</p>	Go to step 3.	The problem is solved.
<p>Step 3 Verify if the mobile device is an Android device that supports NFC and can read passive NFC tags.</p> <p>Does the device support NFC and can it read passive NFC tags?</p>	Go to step 5.	Go to step 4.
<p>Step 4 Use a mobile device that supports NFC.</p> <p>Does the problem remain?</p>	Go to step 5.	The problem is solved.
<p>Step 5 Make sure that the latest version of the Lexmark Mobile Printing application is installed on the Android device.</p> <p>Is the latest version of the application installed?</p>	Go to step 7.	Go to step 6.
<p>Step 6 Install the latest version of the Lexmark Mobile Printing application on the mobile device.</p> <p>Does the problem remain?</p>	Go to step 7.	The problem is solved.
<p>Step 7 Check if the printer has a wireless ISP installed and if it is functioning properly.</p> <p>Is the wireless ISP installed and functioning properly?</p>	Go to step 9.	Go to step 8.
<p>Step 8 Install or reinstall the wireless ISP in the printer.</p> <p>Does the problem remain?</p>	Go to step 9.	The problem is solved.
<p>Step 9 Verify if WiFi Direct is enabled in the printer.</p> <p>Is WiFi Direct enabled?</p>	Go to step 11.	Go to step 10.

Action	Yes	No
<p>Step 10 Enable WiFi direct in the printer.</p> <p>Does the problem remain?</p>	Go to step 11.	The problem is solved.
<p>Step 11 Verify that the NFC tap sticker is in the proper place on the control panel.</p> <p>Is the NFC tap sticker properly located on the control panel?</p>	Go to step 13.	Go to step 12.
<p>Step 12 Using a template, reposition the tap sticker.</p> <p>Note: The sticker should be placed over the NFC antenna on the mobile solutions module.</p> <p>Does the problem remain?</p>	Go to step 13.	The problem is solved.
<p>Step 13 Check if the mobile solutions module is properly installed on the control panel assembly.</p> <p>Is the mobile solutions module properly installed?</p>	Go to step 15.	Go to step 14.
<p>Step 14 Reinstall the mobile solutions module on the control panel assembly.</p> <p>Does the problem remain?</p>	Go to step 15.	The problem is solved.
<p>Step 15 Install a new NFC card.</p> <p>Does the problem remain?</p>	Contact the next level of support.	The problem is solved.

Network service check

Notes:

- Before starting this service check, print out the network setup page. From the home screen, touch **Settings > Reports > Network > Network Setup Page**.
- Consult the network administrator to verify that the physical and wireless network settings displayed on the network settings page for the device are properly configured.
- If a wireless network is used, then verify that the printer is in range of the host computer or wireless access point, and there is no electronic interference.
- Have the network administrator verify that the device is using the correct SSID, and wireless security protocols.
- For more network troubleshooting information, consult the Lexmark Network Setup Guide.

Actions	Yes	No
<p>Step 1 If the printer is physically connected to the network, make sure that the Ethernet cable is properly connected on both ends.</p> <p>Does the problem remain?</p>	Go to step 2.	The problem is solved.
<p>Step 2 If the network is wireless, check the online status of the printer under Printers and Faxes on the host computer. Delete all print jobs in the print queue.</p> <p>Is the printer online and in Ready state?</p>	Go to step 4.	Go to step 3.
<p>Step 3 Change the printer status to online.</p> <p>Does the problem remain?</p>	Go to step 4.	The problem is solved.
<p>Step 4 Check the IP address displayed on the network settings page.</p> <p>Does it match the IP address in the port of the drivers using the printer?</p>	Go to step 9.	Go to step 5.
<p>Step 5 Note: A printer should use a static IP address on a network.</p> <p>Does the LAN use DHCP?</p>	Go to step 6.	Go to step 8.
<p>Step 6 Check the first two segments of the IP address.</p> <p>Does the IP address start with 169.254?</p>	Go to step 7.	Go to step 8.
<p>Step 7 Reset the printer.</p> <p>Does the problem remain?</p>	Go to step 9.	The problem is solved.
<p>Step 8 Reset the address on the printer to match the IP address on the driver.</p> <p>Does the problem remain?</p>	Go to step 9.	The problem is solved.
<p>Step 9 Have the network administrator check if the printer and computer IP address have identical subnet addresses.</p> <p>Are the subnet addresses the same?</p>	Go to step 11.	Go to step 10.

Actions	Yes	No
<p>Step 10 Using the subnet address supplied by the network administrator, assign a unique IP address to the printer.</p> <p>Note: The printer IP address should match the IP address on the print driver.</p> <p>Does the problem remain?</p>	Go to step 11.	The problem is solved.
<p>Step 11</p> <p>Is the printer physically connected (Ethernet cable) to the network?</p>	Go to step 12.	Go to step 15.
<p>Step 12</p> <p>Try using a different Ethernet cable.</p> <p>Does the problem remain?</p>	Go to step 13.	The problem is solved.
<p>Step 13</p> <p>Have the network administrator check the network drop for activity.</p> <p>Is the network drop functioning properly?</p>	Go to step 14.	Contact the network administrator.
<p>Step 14</p> <p>Replace the controller board. See “Controller board removal” on page 357.</p> <p>Does the problem remain?</p>	Go to step 15.	The problem is solved.
<p>Step 15</p> <p>Is the printer on the same wireless network as the other devices?</p>	Go to step 17.	Go to step 16.
<p>Step 16</p> <p>Assign the correct wireless network to the printer.</p> <p>Does the problem remain?</p>	Go to step 17.	The problem is solved.
<p>Step 17</p> <p>Are the other devices on the wireless network communicating properly?</p>	Go to step 18.	Contact the network administrator.
<p>Step 18</p> <p>Make sure that the wireless card on the controller board is properly installed.</p> <p>Does the problem remain?</p>	Go to step 19.	The problem is solved.

Actions	Yes	No
<p>Step 19 If there is an attached antenna, check it for damage, and replace if necessary.</p> <p>Does the problem remain?</p>	Go to step 20.	The problem is solved.
<p>Step 20 Make sure that the antenna is properly connected to the wireless card.</p> <p>Does the problem remain?</p>	Go to step 21.	The problem is solved.
<p>Step 21 Replace the wireless card.</p> <p>Does the problem remain?</p>	Go to step 22.	The problem is solved.
<p>Step 22 Replace the controller board. See “Controller board removal” on page 357.</p> <p>Does the problem remain?</p>	Contact the next level of support.	The problem is solved.

Toner meter cycle (TMC) card service check

Actions	Yes	No
<p>Step 1</p> <p>a Enter the Diagnostics menu, and then navigate to: Printer diagnostics & adjustments > Sensor tests</p> <p>b Find the sensor (Toner meter).</p> <p>Does the sensor status change while toggling the sensor?</p>	Go to step 2.	Go to step 3.
<p>Step 2 Replace the toner cartridge.</p> <p>Does the problem remain?</p>	Go to step 3.	The problem is solved.
<p>Step 3 Replace the TMC card. See “TMC card removal” on page 315.</p> <p>Does the problem remain?</p>	Contact the next level of support.	The problem is solved.

USB service check

Actions	Yes	No
Step 1 Is the USB cable properly connected to the printer and host PC?	Go to step 2.	Properly connect the cable at both ends.
Step 2 Try a different USB cable. Does this fix the issue?	Issue fixed.	Go to step 3.
Step 3 Connect a different device to the USB cable. Did the host PC see the device?	Replace the controller board. See “Controller board removal” on page 357.	There is an issue with the host machine.

Control panel USB cable service check

Actions	Yes	No
Step 1 a Remove the controller board shield. See “Controller board shield removal” on page 356. b Check the USB cable on the JPFUSB1 connector on the controller board for proper connection. Is the cable properly connected?	Go to step 3.	Go to step 2.
Step 2 Reconnect the cable. Does the problem remain?	Go to step 3.	The problem is solved.
Step 3 Replace the cable. Does the problem remain?	Go to step 4.	The problem is solved.
Step 4 Replace the controller board. See “Controller board removal” on page 357. Does the problem remain?	Contact the next level of support.	The problem is solved.

Toner patch sensing service check

Pre-check procedure

- 1 Enter the Diagnostics menu, and then navigate to:
Printer setup > EP setup > Toner patch sensor adjust > Clean sensing and laser optics
- 2 Allow the cleaning operation to run for three minutes.
- 3 Enter the Diagnostics menu, and then navigate to:
Printer diagnostics & adjustments > Color alignment adjust
- 4 On the AA adjustment row, touch **Start**.

Note: This triggers the auto align routine which performs the color alignment error corrections.

The following lists the different auto align routine results:

- AA Result 1—Failed to complete
- AA Result 2—Normal data deficient
- AA Result 3—All OK, normal data within limits
- AA Result 4—Normal exceeds sense limits
- AA Result 5—Normal exceeds margin limits
- AA Result 6—All OK, normal corrections applied
- AA Result 7—Coarse data within limits
- AA Result 8—Coarse data deficient
- AA Result 9—Coarse failed to converse
- AA Result 10—Coarse exceeds sense limits
- AA Result 11—Coarse exceeds margin limits
- AA Result 12—Coarse corrections applied
- AA Result 13—Normal exceeds skew limits
- AA Result 14—Coarse exceeds skew limits
- AA Result 15—Coarse new ITU speed
- AA Result 16—AA characterization successfully completed
- AA Result 17—AA characterization deficient, using defaults
- AA Result 18—AA manufacturing mode successfully completed
- AA Result 19—AA manufacturing mode deficient, not updating the results

- 5 Enter the Diagnostics menu, and then navigate to:
Printer setup > EP setup > Toner patch sensor adjust > Full calibration

Note: This triggers the auto align routine (0.42mm—Normal range only).

Action	Yes	No
<p>Step 1</p> <p>a From the home screen, touch Settings > Reports > Print Quality Pages.</p> <p>b On the Device information section of the print quality test page, check the CalSet values of the following:</p> <ul style="list-style-type: none"> • C Developer operating point • C Laser operating point • C Linearization stat • M Developer operating point • M Laser operating point • M Linearization stat • Y Developer operating point • Y Laser operating point • Y Linearization stat • K Developer operating point • K Laser operating point • K Linearization stat <p>Are the values 0?</p>	Go to step 2.	The problem is solved.
<p>Step 2</p> <p>Perform the blank or white pages service check. See “Blank or white pages check” on page 37.</p> <p>Was an issue found and resolved?</p>	Go to step 3.	Go to step 4.
<p>Step 3</p> <p>Perform the auto alignment service check. See “Auto alignment service check” on page 236.</p> <p>Does the problem remain?</p>	Go to step 4.	The problem is solved.
<p>Step 4</p> <p>a Enter the Diagnostics menu, and then navigate to: Printer setup > EP setup > Toner patch sensor adjust</p> <p>b On the sensor gain characterization row, touch Start.</p> <p>c On the sensor gain verification row, touch Start.</p> <p>d On the sensor gain verification section of the test page, check the average signal values of the patch number.</p> <p>Are the values within the requirement?</p>	The problem is solved.	Go to step 5.
<p>Step 5</p> <p>a Remove the imaging kit.</p> <p>b Move the TPS wiper mechanism lever up and down.</p> <p>Does the wiper mechanism properly move?</p>	Go to step 8.	Go to step 6.

Action	Yes	No
<p>Step 6</p> <p>a Reinstall, repair, or replace the TPS sled and wiper mechanism.</p> <p>b Perform the auto alignment service check. See “Auto alignment service check” on page 236.</p> <p>Does the problem remain?</p>	Go to step 7.	The problem is solved.
<p>Step 7</p> <p>Check the cable on the sensor (TPS) and on the JTPSAA1 connector on the controller board for proper connection, and reseal if necessary.</p> <p>Does the problem remain?</p>	Go to step 8.	The problem is solved.
<p>Step 8</p> <p>a Replace the sensor (TPS). See “Sensor (TPS) removal” on page 325.</p> <p>b Enter the Diagnostics menu, and then navigate to: Printer setup > EP setup > Toner patch sensor adjust</p> <p>c On the sensor gain characterization row, touch Start.</p> <p>d On the sensor gain verification row, touch Start.</p> <p>e On the sensor gain verification section of the test page, check the average signal values of the patch number.</p> <p>Are the values within the requirement?</p>	The problem is solved.	Contact the next level of support.

Auto alignment service check

Pre-check procedure

- 1 Enter the Diagnostics menu, and then navigate to:
Printer setup > EP setup > Toner patch sensor adjust > Clean sensing and laser optics
- 2 Allow the cleaning operation to run for three minutes.
- 3 Enter the Diagnostics menu, and then navigate to:
Printer diagnostics & adjustments > Color alignment adjust
- 4 On the AA adjustment row, touch **Start**.

Note: This triggers the auto align routine which performs the color alignment error corrections.

The following lists the different auto align routine results:

- AA Result 1—Failed to complete
- AA Result 2—Normal data deficient
- AA Result 3—All OK, normal data within limits
- AA Result 4—Normal exceeds sense limits
- AA Result 5—Normal exceeds margin limits
- AA Result 6—All OK, normal corrections applied

- AA Result 7—Coarse data within limits
- AA Result 8—Coarse data deficient
- AA Result 9—Coarse failed to converse
- AA Result 10—Coarse exceeds sense limits
- AA Result 11—Coarse exceeds margin limits
- AA Result 12—Coarse corrections applied
- AA Result 13—Normal exceeds skew limits
- AA Result 14—Coarse exceeds skew limits
- AA Result 15—Coarse new ITU speed
- AA Result 16—AA characterization successfully completed
- AA Result 17—AA characterization deficient, using defaults
- AA Result 18—AA manufacturing mode successfully completed
- AA Result 19—AA manufacturing mode deficient, not updating the results

5 Enter the Diagnostics menu, and then navigate to:

Printer setup > EP setup > Toner patch sensor adjust > Full calibration

Note: This triggers the auto align routine (0.42mm—Normal range only).

Action	Yes	No
<p>Step 1</p> <p>a From the home screen, touch Settings > Reports > Print Quality Pages.</p> <p>b On the CalSet section of the test page, check the color alignment stat value.</p> <p>Is the value 0?</p>	Go to step 2.	The problem is solved.

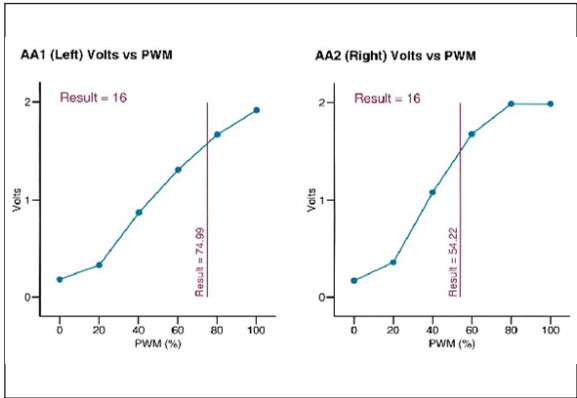
Action	Yes	No
<p>Step 2</p> <p>a Perform the blank or white pages service check or missing color service check. See “Blank or white pages check” on page 37 or “Missing color check” on page 53.</p> <p>b Enter the Diagnostics menu, and then navigate to: Printer setup > EP setup > Toner patch sensor adjust</p> <p>c On the sensor gain characterization row, touch Start.</p> <p>d On the sensor gain verification row, touch Start.</p> <p>e Check the graph in the printout. This sample graph shows good values:</p>  <p>Note: The normal range of the sensor voltage is 1.5–2.0 volts.</p> <p>Does the graph show good values?</p>	<p>The problem is solved.</p>	<p>Go to step 3.</p>
<p>Step 3</p> <p>a Remove the imaging kit.</p> <p>b Move the TPS wiper mechanism lever up and down.</p> <p>Does the wiper mechanism properly move?</p>	<p>Go to step 5.</p>	<p>Go to step 4.</p>
<p>Step 4</p> <p>Check the TPS sled and TPS wiper mechanism for proper installation.</p> <p>Are the TPS sled and TPS wiper mechanism properly installed?</p>	<p>Go to step 6.</p>	<p>Go to step 5.</p>
<p>Step 5</p> <p>Reinstall, repair, or replace the TPS sled and TPS wiper mechanism. See “TPS sled removal” on page 327 and “TPS wiper mechanism removal” on page 330.</p> <p>Does the problem remain?</p>	<p>Go to step 6.</p>	<p>The problem is solved.</p>

Action	Yes	No
<p>Step 6</p> <p>Check the cables on the sensor (auto alignment) and on the JTPSAA1 connector on the controller board for proper connection, and reseat if necessary.</p> <p>Does the problem remain?</p>	Go to step 7.	The problem is solved.
<p>Step 7</p> <p>a Replace the sensor (TPS). See “Sensor (TPS) removal” on page 325.</p> <p>b Enter the Diagnostics menu, and then navigate to: Printer setup > EP setup > Toner patch sensor adjust</p> <p>c On the sensor gain characterization row, touch Start.</p> <p>d On the sensor gain verification row, touch Start.</p> <p>e Check the graph in the printout.</p> <p>This sample graph shows good values:</p> <div data-bbox="305 800 878 1192" data-label="Figure"> <p>The figure contains two side-by-side line graphs. The left graph is titled 'AA1 (Left) Volts vs PWM' and the right graph is titled 'AA2 (Right) Volts vs PWM'. Both graphs have 'Volts' on the y-axis (ranging from 0 to 2) and 'PWM (%)' on the x-axis (ranging from 0 to 100). Each graph shows a blue line with data points that starts at (0,0) and rises to approximately (100, 2.0). A vertical red line is drawn at approximately 75% PWM in the AA1 graph, with a label 'Result = 16' and 'Slope = 74.99'. Similarly, a vertical red line is drawn at approximately 51% PWM in the AA2 graph, with a label 'Result = 16' and 'Slope = 51.22'.</p> </div> <p>Note: The normal range of the sensor voltage is 1.5–2.0 volts.</p> <p>Does the graph show good values?</p>	The problem is solved.	Contact the next level of support.

Service menus

Understanding the printer control panel

Using the control panel

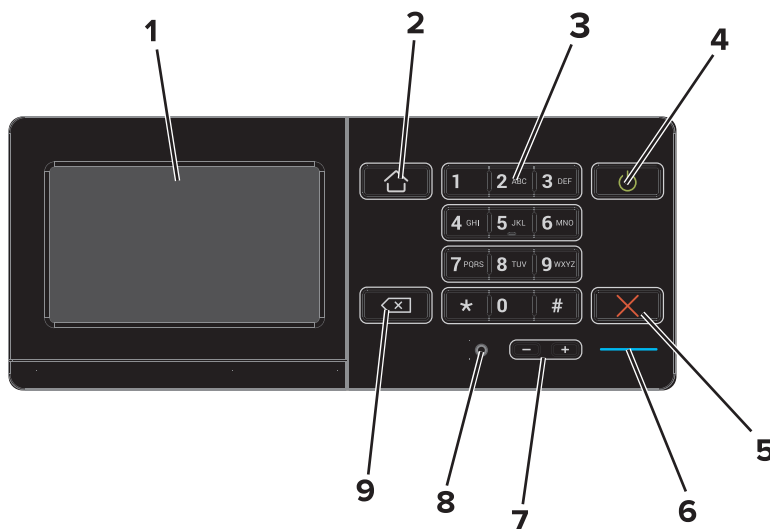

#	Use the	To
1	Display	<ul style="list-style-type: none"> View the printer messages and supply status. Set up and operate the printer.
2	Home button	Go to the home screen.
3	Keypad	Enter numbers or symbols in an input field.
4	Power button	<ul style="list-style-type: none"> Turn on or turn off the printer. <p>Note: To turn off the printer, press and hold the power button for five seconds.</p> <ul style="list-style-type: none"> Set the printer to Sleep or Hibernate mode. Wake the printer from Sleep or Hibernate mode.
5	Stop or Cancel button	Stop the current job.
6	Indicator light	Check the status of the printer.
7	Volume buttons	Adjust the volume of the headset or speaker.
8	Headset or speaker port	Attach a headset or speaker.
9	Backspace button	Move the cursor backward and delete a character in an input field.

Understanding the status of the power button and indicator light

Indicator light	Printer status
Off	The printer is off or in Hibernate mode.
Blue	The printer is ready or processing data.
Red	The printer requires user intervention.

Power button light	Printer status
Off	The printer is off, ready, or processing data.
Solid amber	The printer is in sleep mode.
Blinking amber	The printer is in hibernate mode.

Using the home screen

When the printer is turned on, the display shows the home screen. Use the home screen buttons and icons to initiate an action.

Note: Your home screen may vary depending on your home screen customization settings, administrative setup, and active embedded solutions.

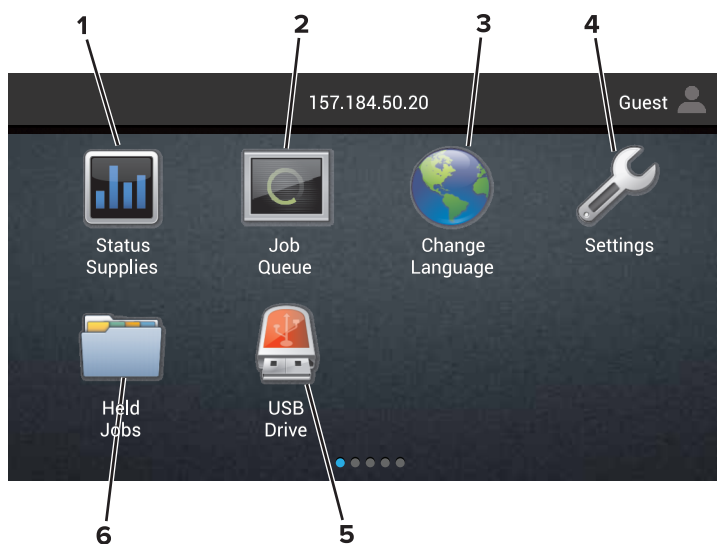

#	Touch	To
1	Status/Supplies	<ul style="list-style-type: none"> Show a printer warning or error message whenever the printer requires intervention to continue processing. View more information on the printer warning or message, and on how to clear it. <p>Note: You can also access this setting by touching the top section of the home screen.</p>
2	Job Queue	<p>Show all the current print jobs.</p> <p>Note: You can also access this setting by touching the top section of the home screen.</p>

#	Touch	To
3	Change Language	Change the language on the printer display.
4	Settings	Access the printer menus.
5	USB Drive	View, select, or print photos and documents from a flash drive.
6	Held Jobs	Show all the current held print jobs.

These settings may also appear on the home screen

Touch	To
Bookmarks	Access bookmarks.
App Profiles	Access application profiles.
Lock Device	Prevent users from accessing any printer functions from the home screen.

Menus list

Device	Print	Paper	Network/Ports	USB Drive
Preferences	Layout	Tray Configuration	Network Overview	Flash
Notifications	Setup	Media Configuration	Wireless	Drive
Group Lists	Quality	Bin Configuration	AirPrint	Print
Alert Types	Job Accounting		Ethernet	
Anti-Spam Logic Description	Image		TCP/IP	
Suppressing Duplicate Alerts	XPS		IPv6	
Power Management	PDF		SNMP	
Information Sent to Lexmark	HTML		802.1x	
Accessibility	PostScript		IPSec	
Restore Factory Defaults	PCL		LPD Configuration	
Maintenance	PPDS		HTTP/FTP Settings	
Remote Operator Panel			ThinPrint	
Visible Home Screen Icons			USB	
Site Map			Parallel [x]	
Update Firmware			Serial	
About This Printer			Wi-Fi Direct	

Security

Login Methods
 Certificate Management
 Schedule USB Devices
 Security Audit Log
 Login Restrictions
 Confidential Print Setup
 Disk Encryption
 Erase Temporary Data Files
 Solutions LDAP Settings
 Miscellaneous

Option Card Menu

Note: This setting appears only when an optional card is installed.

Reports

Menu Settings Page
 Print Quality Pages
 Device
 Print
 Shortcuts
 Network

Help

Print All Guides
 Color Quality Guide
 Connection Guide
 Information Guide
 Media Guide
 Moving Guide
 Print Quality Guide
 Supplies Guide

Diagnostics menu

Entering the Diagnostics menu

The Diagnostics menu contains tests that are used to help isolate issues with the printer. To access some of these tests, avoid POST tests that run at POR. Some POST tests can generate errors that prevent a diagnostic test from running.

- To access the Diagnostics menu without running the POST tests:
 - 1 Press and hold the **3** and **6** buttons while turning on the printer.
 - 2 Release the buttons when the splash screen appears.
- To access the Diagnostics menu from the home screen, press **** 3 6** on the control panel.

Event Log

Display Log

This setting displays the panel text that appears when the event occurs.

Enter the Diagnostics menu, and then navigate to:

Event Log > Display Log

Print Log

This setting lists an extended version of the various printer events.

- 1 Enter the Diagnostics menu, and then navigate to:

Event Log > Print Log

- 2 Touch **Start**.

Note: The events that appear in the report vary depending on the operational history of the printer.

Print Log Summary

This setting lists a brief summary of the various printer events.

- 1 Enter the Diagnostics menu, and then navigate to:

Event Log > Print Log Summary

- 2 Touch **Start**.

Note: The events that appear in the report vary depending on the operational history of the printer.

Mark Log

This setting allows you to create a service, maintenance, or custom log entry. Each log entry is added in the printer event log.

- 1 Enter the Diagnostics menu, and then navigate to:

Event Log > Mark Log

- 2 Select a log that you want to create, and then touch **Start**.

Reports

Device Settings

This report lists all the current printer settings.

Enter the Diagnostics menu, and then navigate to:

Reports > Device Settings

Installed Licenses

This setting lists all the installed licenses and their feature data.

Enter the Diagnostics menu, and then navigate to:

Reports > Installed Licenses

Advanced Print Quality Samples

This setting prints a list of the printer settings and sample pages to check print quality.

Enter the Diagnostics menu, and then navigate to:

Advanced Print Quality Samples > Advanced Print Quality Samples

Input tray quick print

This setting allows you to print a single or continuous Quick Test page in either duplex or simplex mode.

- 1 Enter the Diagnostics menu, and then touch **Input tray quick print**.

- 2 Select where you want to print the pages from.

- 3 Select whether to print a single or continuous test page, and then touch **Start**.

Printer Setup

Printed page count (mono)

This setting displays the amount of pages printed in mono.

- 1 Enter the Diagnostics menu, and then touch **Printer Setup**.
- 2 View the printed page count for mono.

Printed page count (color)

This setting displays the amount of pages printed in color.

- 1 Enter the Diagnostics menu, and then touch **Printer Setup**.
- 2 View the printed page count for color.

Permanent page count

This setting displays the total number of pages printed in mono and color. After all the print tests are completed, this value resets to zero.

- 1 Enter the Diagnostics menu, and then touch **Printer Setup**.
- 2 View the permanent page count.

Enable edge-to-edge (printing)

This setting shifts all four margins to the physical edges of the page.

- 1 Enter the Diagnostics menu, and then navigate to:
Printer Setup > Enable edge-to-edge (printing)
- 2 Select a setting.

Note: This feature does not work in PPDS emulation.

Enable edge-to-edge (copy)

This setting determines whether the printer accepts the ADF or flatbed edge erase value when performing an ADF or flatbed copy.

- 1 Enter the Diagnostics menu, and then navigate to:
Printer Setup > Enable edge-to-edge (copy)
- 2 Select a setting.

Processor ID

This setting indicates the ID of the processor on the controller board.

- 1 Enter the Diagnostics menu, and then touch **Printer Setup**.
- 2 View the processor ID.

Serial number

This setting displays a read-only value of the serial number.

- 1 Enter the Diagnostics menu, and then touch **Printer Setup**.
- 2 View the serial number.

Model name

This setting displays the model name of the printer.

- 1 Enter the Diagnostics menu, and then touch **Printer Setup**.
- 2 View the model name.

Engine setting [x]

Warning—Potential Damage: Do not change this setting without specific instructions from the next level of support.

This setting allows you to select a printer engine setting. Possible values are 0–255. 0 is the default.

- 1 Enter the Diagnostics menu, and then navigate to:
Printer Setup > Engine setting [x]
- 2 Select a setting, enter a value, and then touch **OK**.

EP setup

Warning—Potential Damage: Do not change this setting without specific instructions from the next level of support.

This setting allows you to adjust the EP setup of the printer.

- 1 Enter the Diagnostics menu, and then navigate to:
Printer Setup > EP setup
- 2 Select a setting.

Printer diagnostics and adjustments

Sensor tests

- 1 Enter the Diagnostics menu, and then touch **Printer diagnostics & adjustments**.
- 2 From the Sensor tests section, touch **Start**.
A dialog listing the sensor tests appears.
- 3 Find, and then manually toggle the sensor.

Notes:

- The sensor status on the screen toggles between **1** and **0** when the sensor is properly working.
- If a sensor test fails, the test failure may not indicate a failed sensor. Further troubleshooting may be required. Check the boards and cables for possible issues.

Motor tests

- 1 Enter the Diagnostics menu, and then navigate to:
Printer diagnostics & adjustments > Motor tests
- 2 Select a motor, and then touch **Start**.

Notes:

- If the motor is activated, then it is properly working.
- Some motors require automatic deactivation in order to avoid secondary issues such as possible damage and contamination.
- Some tests require a special action to activate a motor such as removing a major component.
- If the motor fails, the test failure may not indicate a failed motor. Further troubleshooting may be required. Check the boards and cables for possible issues.

Registration adjust

This setting allows you to adjust the skew, margins, or perform a Quick Test.

- 1 Enter the Diagnostics menu, and then navigate to:
Printer diagnostics & adjustments > Registration adjust
- 2 Select a setting.

Memory tests

This setting allows you to test or flash the printer memory or test or format the printer hard disk.

- 1 Enter the Diagnostics menu, and then navigate to:
Printer diagnostics & adjustments > Memory tests
- 2 Select a setting.

Color alignment adjust

This setting allows you to adjust the color alignments and to print or reset the default settings.

- 1 Enter the Diagnostics menu, and then navigate to:
Printer diagnostics & adjustments > Color alignment adjust
- 2 Select a setting.

Supply reset

The setting resets the fuser and ITM counter values to zero.

- 1 Enter the Diagnostics menu, and then navigate to:
Printer diagnostics & adjustments > Supply reset
- 2 Select a setting, and then touch **Start**.

Add-on cards tests

This setting allows you to test the add-on cards installed on the printer.

- 1 Enter the Diagnostics menu, and then navigate to:
Printer diagnostics & adjustments > Add-on cards tests
- 2 Select a card.

Printhead diagnostics

This setting allows you to test the printhead.

- 1 Enter the Diagnostics menu, and then navigate to:
Printer diagnostics & adjustments > Printhead diagnostics
- 2 Select a test, and then touch **Start**.

Weather station

This setting lets you view the temperature of the weather station sensor.

- 1 Enter the Diagnostics menu, and then touch **Printer diagnostics & adjustments**.
- 2 From the Weather station section, touch **Start**.

Fuser temperature

This setting lets you view the fuser temperature.

- 1 Enter the Diagnostics menu, and then touch **Printer diagnostics & adjustments**.
- 2 From the Fuser temperature section, touch **Start**.

Additional input tray diagnostics

Sensor tests

- 1 Enter the Diagnostics menu, and then touch **Additional input tray diagnostics**.
- 2 From the Sensor tests section, touch **Start**.
A dialog listing the sensor tests appears.
- 3 Find, and then manually toggle the sensor.

Notes:

- The sensor status on the screen toggles between **1** and **0** when the sensor is properly working.
- If a sensor test fails, the test failure may not indicate a failed sensor. Further troubleshooting may be required. Check the boards and cables for possible issues.

Motor tests

- 1 Enter the Diagnostics menu, and then navigate to:
Additional input tray diagnostics > Motor tests
- 2 Select a motor, and then touch **Start**.

Notes:

- If the motor is activated, then it is properly working.
- Some motors require automatic deactivation in order to avoid secondary issues such as possible damage and contamination.
- Some tests require a special action to activate a motor such as removing a major component.
- If the motor fails, the test failure may not indicate a failed motor. Further troubleshooting may be required. Check the boards and cables for possible issues.

Service Engineer menu

Entering Invalid engine mode

This mode allows the printer to load the correct firmware code.

- 1 Turn off the printer.
- 2 Press and hold **3**, **4**, and **6** while turning on the printer.
- 3 Release the buttons after 10 seconds.

Entering the Service Engineer (SE) menu

To access the Service Engineer (SE) menu:

- 1 Turn on the printer.
- 2 When the home screen appears, press **** 4 1** on the control panel.

General SE

This setting allows you to save a log file to a USB drive.

Enter the Service Engineer (SE) menu, and then navigate to:

General SE > Capture Logs to USB Drive

Network SE



Enter the Service Engineer (SE) menu, and then touch **Network SE**.

Note: Use these settings as directed by the next level of support.

Top level menu	Intermediate menu
Print SE Menus	Print SE Menus
History	<ul style="list-style-type: none"> • Print History • Mark History
MAC	<ul style="list-style-type: none"> • Set Card Speed • LAA • Keep Alive
NPAP	Print Alerts
TCP/IP	<ul style="list-style-type: none"> • netstat • arp • Allow SNMP Set • MTU • Meditech Mode • RAW LPR Mode
Wireless	Enable Wi-Fi Direct Sigma Control Agent
Ping Test	<ul style="list-style-type: none"> • Ping • Ping6
Other Actions	<ul style="list-style-type: none"> • ifconfig • IPtables [Firewall Dump] • IP6tables [Firewall Dump] • IPsec Dump

Repair information

Removal precautions

-  **CAUTION—SHOCK HAZARD:** To avoid the risk of electrical shock and to prevent damage to the printer, remove the power cord from the electrical outlet before you connect or disconnect any cable or electronic card or assembly for personal safety and to prevent damage to the printer. Disconnect any connections between the printer and computers or peripherals.
-  **CAUTION—POTENTIAL INJURY:** The printer weight is greater than 18 kg (40 lb) and requires two or more trained personnel to lift it safely. Always use the hand holds on the sides of the printer. Make sure that your fingers are not under the printer when you lift or set the printer down.
-  **CAUTION—HOT SURFACE:** The inside of the printer might be hot. To reduce the risk of injury from a hot component, allow the surface to cool before touching.

Data security notice

Identifying printer memory

- **Volatile memory**—The printer uses standard random access memory (RAM) to buffer user data temporarily during simple print and copy jobs.
- **Non-volatile memory**—The printer may use two forms of non-volatile memory: EEPROM and NAND (flash memory). Both types are used to store the operating system, printer settings, network information, scanner and bookmark settings, and embedded solutions.
- **Hard disk memory**—Some printers have a hard disk drive installed. The printer hard disk is designed for printer-specific functionality and cannot be used for the long-term storage of data that is not print-related. The hard disk does not provide the capability for users to extract information, create folders, create disk or network file shares, or transfer FTP information directly from a client device. The hard disk can retain buffered user data from complex print jobs, form data, and font data.

The following parts can store memory:

- Printer control panel
- User interface controller card (UICC)
- Controller board
- Optional hard disks

Note: The printer control panel and controller board contain NVRAM.

Erasing printer memory

To erase volatile memory, turn off the printer.

To erase non-volatile memory:

- 1 From the home screen, touch **Settings** > **Device** > **Maintenance** > **Out of Service Erase**.
- 2 Select the **Sanitize all information on nonvolatile memory** check box, and then touch **ERASE**.
- 3 Follow the instructions on the display.

To erase the hard disk memory:

- 1 From the home screen, touch **Settings > Device > Maintenance > Out of Service Erase**.
- 2 Select the **Sanitize all information on hard disk** check box, and then touch **ERASE**.
- 3 Follow the instructions on the display.

Notes:

- This process can take from several minutes to more than an hour, making the printer unavailable for other tasks.
- After removing the hard disk, return it to the next level of support.

Handling ESD-sensitive parts

To prevent damage to the electrostatic discharge (ESD)-sensitive parts in the printer, do the following:

- Turn off the printer before removing logic boards.
- Keep the parts in their original packing material until you are ready to install them into the printer.
- Make the least-possible movements with your body to prevent an increase of static electricity from clothing fibers, carpets, and furniture.
- Use the ESD wrist strap. Connect the wrist band to the system ground point. This action discharges any static electricity in your body to the printer.
- Hold the parts by their edge connector shroud. Do not touch its pins. If you are removing a pluggable module, then use the correct tool.
- If possible, keep all parts in a grounded metal cabinet.
- Do not place the parts on the printer cover or on a metal table. If you need to put down the parts, then put them in their packing material.
- Prevent parts from being accidentally touched by other personnel. Cover the printer when you are not working on it.
- Be careful while working with the parts when cold-weather heating is used. Low humidity increases static electricity.

Controller board/control panel replacement

Note: Perform this procedure only if both the controller board and the control panel fail.

 **CAUTION—POTENTIAL INJURY:** The lithium battery in this product is not intended to be replaced. There is a danger of explosion if a lithium battery is incorrectly replaced. Do not recharge, disassemble, or incinerate a lithium battery. Discard used lithium batteries according to the manufacturer's instructions and local regulations.

Warning—Potential Damage: When replacing both the controller board and control panel, replace the parts in the following order to avoid damaging the printer.

- 1 Replace the controller board first, and then start the printer into diagnostics mode.

Note: Do not replace the control panel and controller board at the same time.
- 2 Turn off the printer, replace the control panel, and then start the printer into diagnostics mode. Allow the printer to go through a complete startup cycle.
- 3 If the problem persists, then leave the new control panel and reinstall the old controller board.

- 4 Restart the printer and allow it to go through a complete startup cycle.
- 5 After the startup, turn off the printer, and then install the new controller board.
- 6 Restart the printer and allow it to go through a complete startup cycle.

If the procedure is successful, then there is no need to adjust any settings.

If the procedure fails, then contact technical support for assistance.

Restoring the printer configuration after replacing the controller board

Restore the printer to its correct configuration to complete the replacement service. Use the Service Restore Tool to download the software bundle, and then flash the printer settings and embedded solutions.

Note: The software bundle contains the latest version of the firmware, applications, and software licenses from the Lexmark Virtual Solutions Center (VSC). The printer firmware may be at a different level from what was used before replacing the controller board.

Using the Service Restore Tool

- 1 Go to <https://cdp.lexmark.com/service-restore-tool/> to access the tool.
- 2 Log in using your Lexmark or partner login.
If your login fails, then contact your next level of support.
- 3 Enter the printer serial number, and then submit the information.

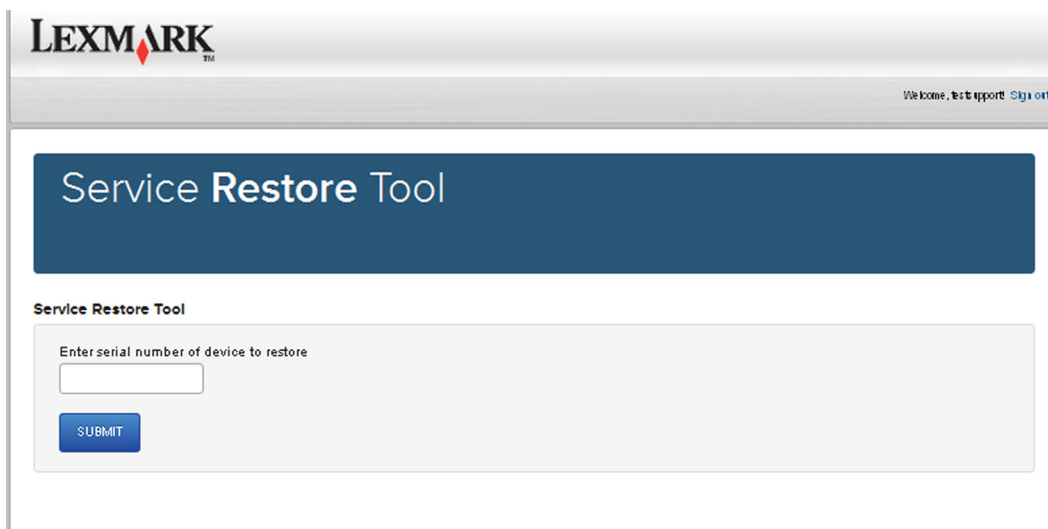

The screenshot shows the Lexmark Service Restore Tool web interface. At the top left is the Lexmark logo. At the top right, there is a navigation bar with the text "Welcome, test support! Sign out". Below this is a large blue header with the text "Service Restore Tool". Underneath the header, there is a section titled "Service Restore Tool" containing a form. The form has a label "Enter serial number of device to restore" above a text input field. Below the input field is a blue "SUBMIT" button.

Note: Make sure that the serial number that appears on the verification screen is correct.

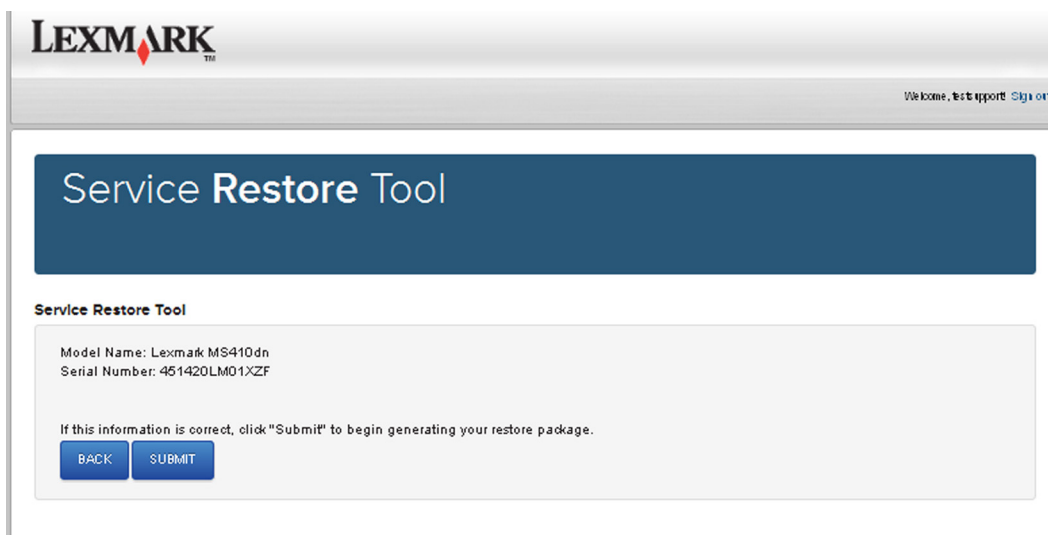

4 Save the zip file.

Note: Make sure that the serial number in the zip file matches the serial number of the printer being restored.

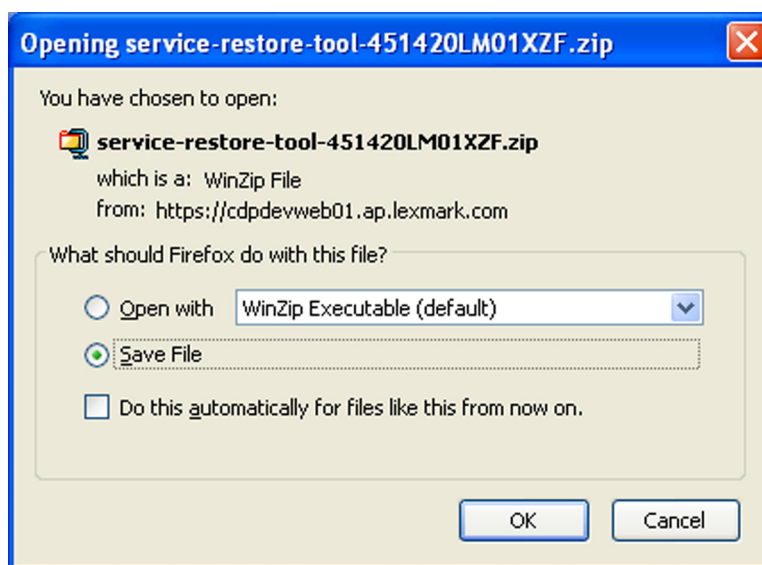

5 Extract the contents of the zip file, open the *Readme* file, and then follow the instructions in the file.

Notes:

- Perform the install instructions on the *Readme* file in the exact order shown. Only restart the printer when instructed to in the file.
- For more information on how to flash the downloaded files, see [“Updating the printer firmware” on page 259](#).
- To load the zip files that are extracted from the Service Restore Tool, see [“Restoring solutions, licenses, and configuration settings” on page 258](#).

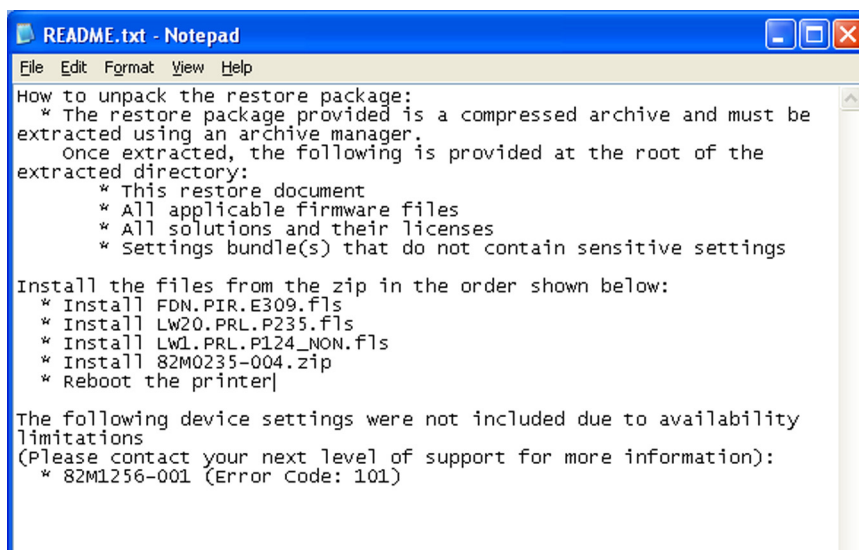

```
README.txt - Notepad
File Edit Format View Help
How to unpack the restore package:
* The restore package provided is a compressed archive and must be
extracted using an archive manager.
  once extracted, the following is provided at the root of the
extracted directory:
  * This restore document
  * All applicable firmware files
  * All solutions and their licenses
  * Settings bundle(s) that do not contain sensitive settings

Install the files from the zip in the order shown below:
* Install FDN.PIR.E309.fls
* Install Lw20.PRL.P235.fls
* Install Lw1.PRL.P124_NON.fls
* Install 82M0235-004.zip
* Reboot the printer

The following device settings were not included due to availability
limitations
(Please contact your next level of support for more information):
* 82M1256-001 (Error Code: 101)
```

- 6 After performing the installation instructions in the *Readme* file, confirm from the customer if all the eSF apps have been installed.

Notes:

- If you are unable to access the administrative menus to verify that the printer is restored, then ask the customer for access rights.
- If a 10.00 error is displayed after you restart the printer, then contact the next level of support.

Restoring solutions, licenses, and configuration settings

To load the zip files that are extracted from the Service Restore Tool, do the following:

- 1 Open a Web browser, and then type the printer IP address.
- 2 Click **Apps**.

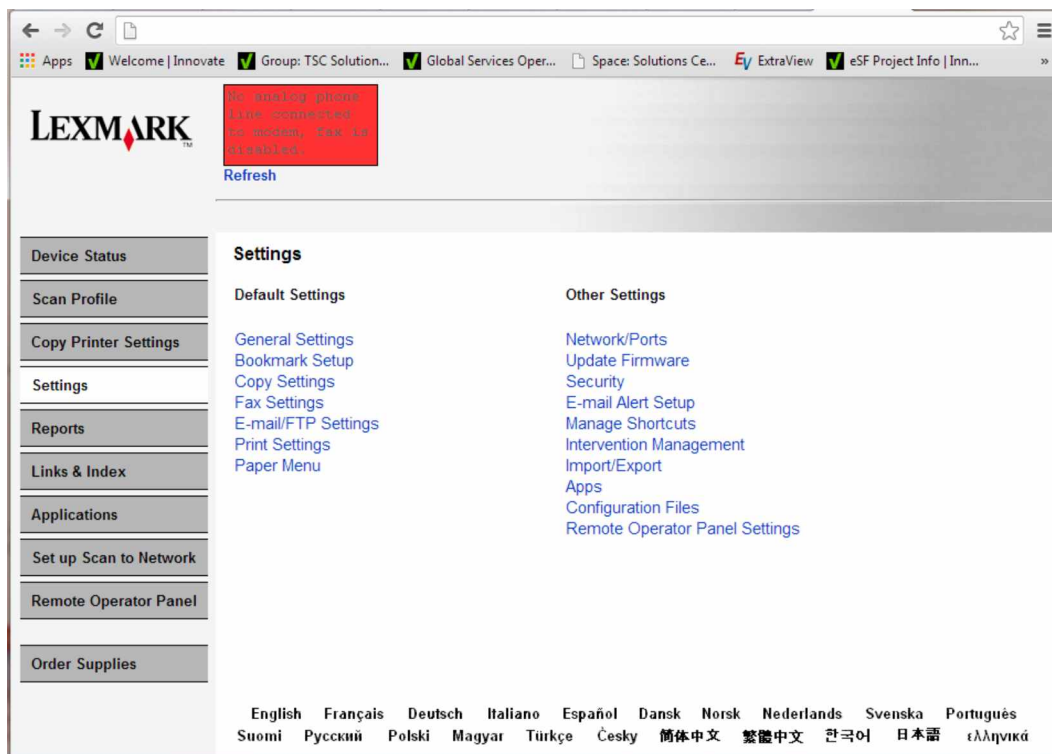

- 3 Click **Import Configuration**.
- 4 Select the zip file from the expanded Service Restore Tool package.

5 Click **Import**.

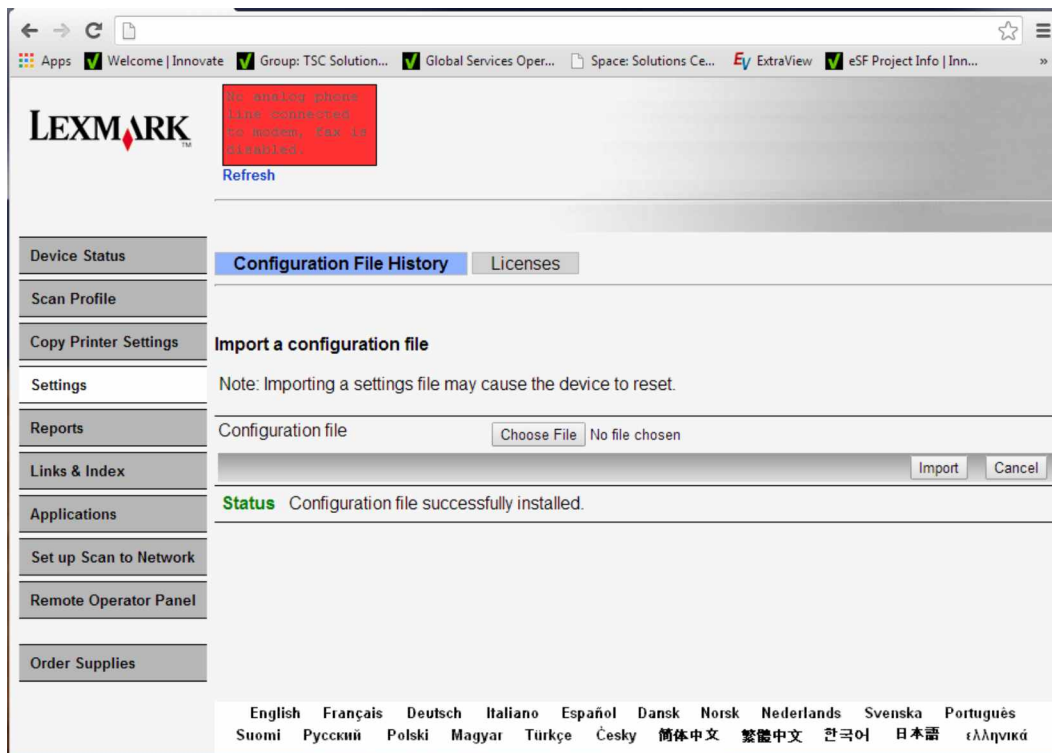

6 Repeat steps 3 through 5 for the other zip files that are included in the expanded zip file.

Updating the printer firmware

Warning—Potential Damage: Before updating the printer firmware, ask the next level of support for the correct code. Using an incorrect code level may damage the printer.

The printer must be in ready state in order to update the firmware.

Using a flash drive

This option is available only in printer models with front USB port.

Make sure to enable the Enable Drive and Update Code settings. You can find the settings in the Flash drive menu under the Settings menu.

- 1 Insert the flash drive.

The display lists the files on the thumbdrive.

- 2 Select the file that you need to flash.

Note: Do not turn off the printer while the update is going on.

Using a network computer

Using the File Transfer Protocol (FTP)

Make sure that the printer is in ready state before flashing.

- 1 Turn on the printer.
- 2 Obtain the IP address:
 - From the home screen
 - From the TCP/IP section of the Network/Ports menu
- 3 From the command prompt of a network computer, open an FTP session to the printer IP address.
- 4 Use a PUT command to place the firmware file on the printer.
The printer performs a POR sequence and terminates the FTP session.
- 5 Repeat steps 2 through 4 for the other files.

Using the Embedded Web Server

Make sure that the printer is in ready state before flashing.

- 1 Open a Web browser, and then type the printer IP address.
- 2 From the home page, navigate to **Configuration > Update Firmware**.
- 3 Select the file to use.
The printer performs a POR sequence and terminates the FTP session.
- 4 Repeat steps 2 through 3 for the other files.

Backing up eSF solutions and settings

Note: Export the eSF solutions and settings from the printer before replacing the controller board.

Exporting eSF solutions and settings file

- 1 Reset the printer into Invalid engine mode. See [“Entering Invalid engine mode” on page 250](#).
- 2 Open a Web browser, and then type the printer IP address.
Note: If the Web page cannot be accessed or an error occurs when starting the printer into Invalid engine mode, then data backup is not an option. Inform the customer that the data cannot be saved.
- 3 Click **Apps**, click **Export Configuration**, and then select one of the options in the dropdown menu.
- 4 Click **Export**.
Note: There is a size limit of 128 KB on the export file.

Disconnecting ribbon cables

Warning—Potential Damage: The ribbon cable and its socket may get damaged if it is not properly disconnected. When disconnecting the cable, hold its connector and press its tab before unplugging it.

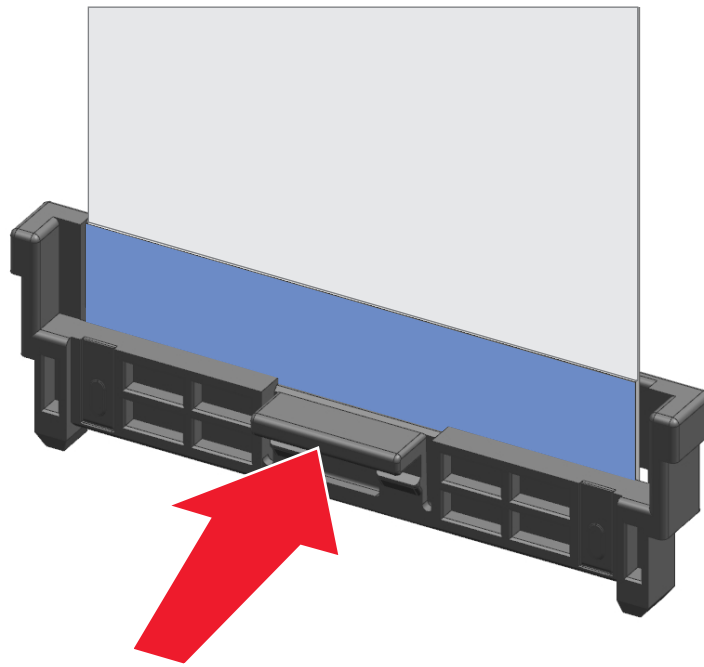

Adjustments

Printhead alignment adjustment

Printhead misalignment may cause crooked or skewed print. Perform this procedure after replacing the printhead or if there are skewed print issues.

Checking the test page for alignment

- 1 Enter the Diagnostics menu, and then navigate to:
Printer diagnostics & adjustments > Registration adjust > Quick test
- 2 Check the test page.

The following test page result shows a properly aligned printhead:

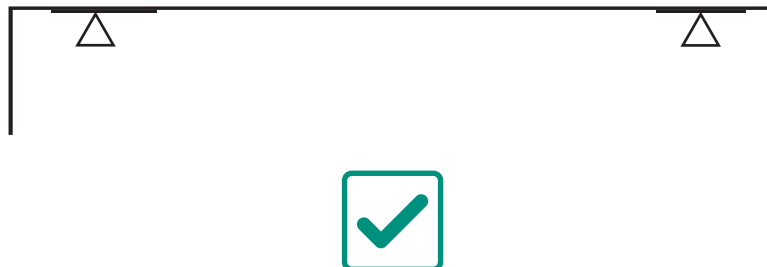

Aligning a printhead skewed in the counterclockwise direction

In most cases, the printhead is skewed counterclockwise, as shown in the following test page result.



- 1 Remove the top cover. See [“Top cover removal” on page 268](#).
- 2 Loosen the three screws.

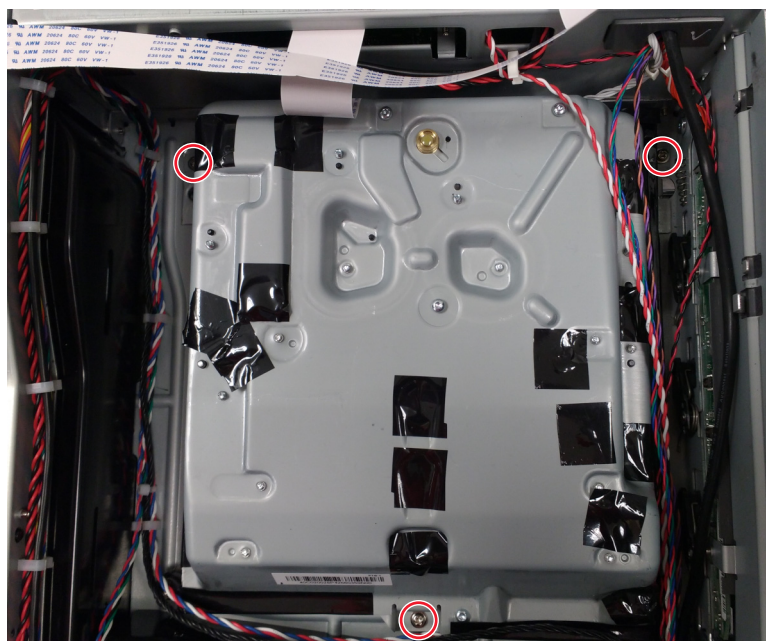

- 3 Adjust the printhead until the bottom left corner of the printhead touches the alignment pin (A).

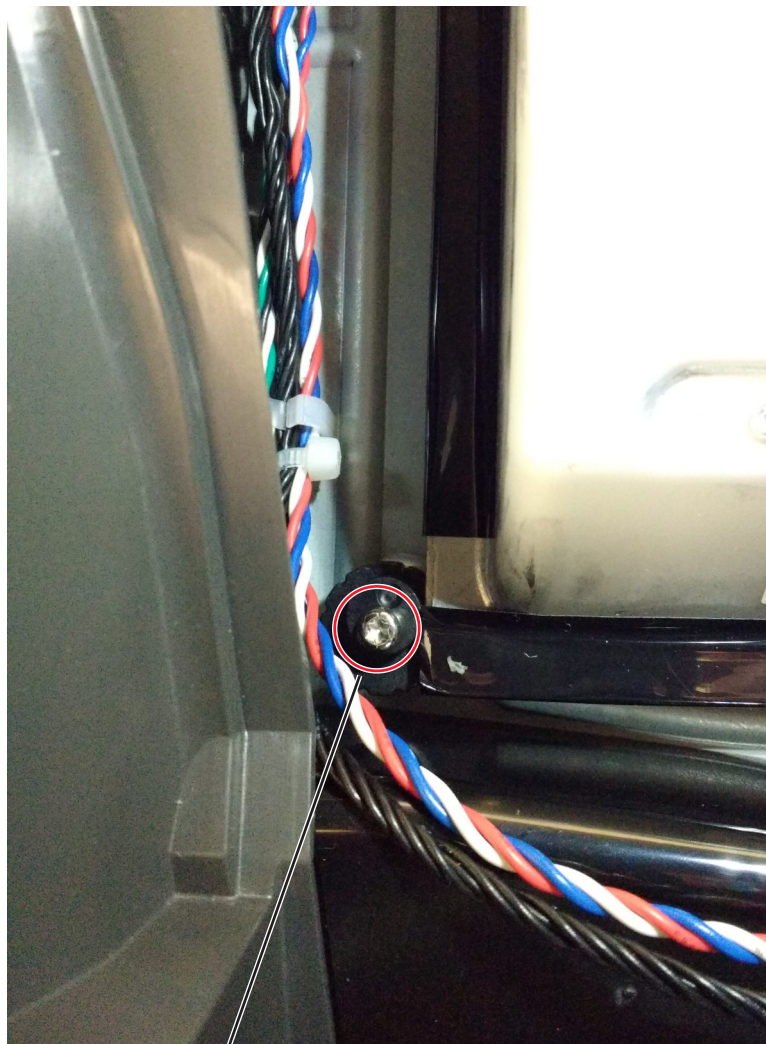
**A**

- 4 Print another test page, and then check if the printhead is aligned.
- 5 Repeat steps 4 and 5 until the printhead is aligned.
- 6 Tighten the three screws.

Registration adjustment

Image misalignments may occur after printhead replacement. Perform this procedure to correct the position of the image relative to the paper edges.

Generating a test page for margin alignment

Enter the Diagnostics menu, and then navigate to:

Printer diagnostics & adjustments > Registration adjust > Quick test

A test page showing the margins is generated.

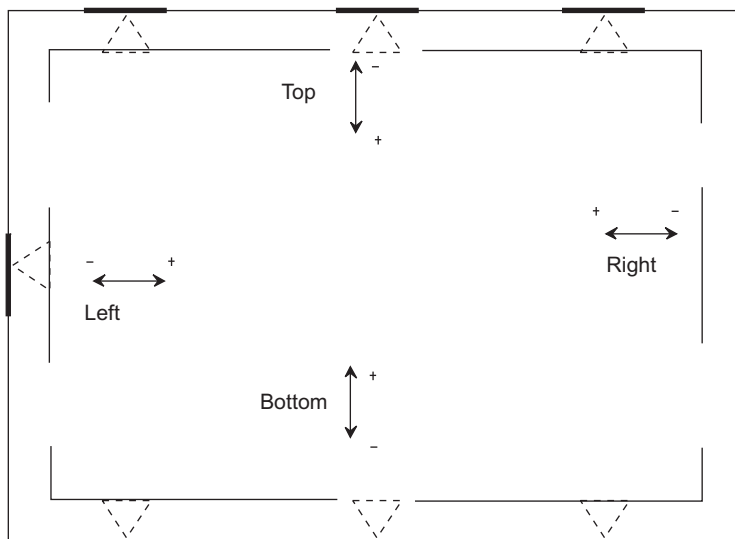

Adjusting the margins

Note: The procedure may not work for old firmware versions. Make sure that the latest firmware version is installed.

- 1 Refer to the test page generated for margin alignment.

Check the arrows along the margin.

- The arrows should be completely visible along the edge.
- The tip of the arrows should point to the edge.

If the arrows are misaligned, then adjust the Top margin setting:

Enter the Diagnostics menu, and then navigate to **Printer diagnostics & adjustments > Registration adjust > Top Margin**.

- 2 If necessary, perform printhead alignment until the test page arrows are squarely aligned. See [“Printhead alignment adjustment” on page 261](#).

Note: After printhead alignment, make sure that the three printhead screws are tightened.

- 3 Generate a new test page for margin alignment, check the arrows, and if necessary, adjust the following settings:

- Top margin
- Bottom margin
- Left margin
- Right margin

Note: Correcting the printhead and margin settings is necessary before proceeding with the Color alignment procedure.

4 Enter the Diagnostics menu, and then navigate to:

Printer diagnostics & adjustments > Color alignment adjust

On the AA Adjustment row, touch **Start**.

The Color alignment procedure is performed on the cyan, magenta, and yellow colors.

Note: The procedure may not work for old firmware versions. Make sure that the latest firmware version is installed.

5 Enter the Diagnostics menu, and then navigate to:

Printer diagnostics & adjustments > Color alignment adjust > Cyan > Quick test

Check the alignment markings on the test page generated. Follow the instructions on the test page to correct the color misalignment.

6 Enter the Diagnostics menu, and then navigate to:

Printer diagnostics & adjustments > Color alignment adjust > Yellow > Quick test

Check the alignment markings on the test page generated. Follow the instructions on the test page to correct the color misalignment.

7 Enter the Diagnostics menu, and then navigate to:

Printer diagnostics & adjustments > Color alignment adjust > Magenta > Quick test

Check the alignment markings on the test page generated. Follow the instructions on the test page to correct the color misalignment.

8 If color misalignment still occurs, then repeat steps 4 to 7.

Removal procedures

Keep the following tips in mind as you replace parts:

- Some removal procedures require removing cable ties. You must replace cable ties during reassembly to avoid pinching wires, obstructing the paper path, or restricting mechanical movement.
- Remove the toner cartridges, imaging unit, and media tray before removing other printer parts. The imaging unit should be carefully set on a clean, smooth, and flat surface. It should also be protected from light while out of the device.
- Disconnect all external cables from the printer to prevent possible damage during service.
- Unless otherwise stated, reinstall the parts in reverse order of removal.
- When reinstalling a part held with several screws, start all screws before the final tightening.

Cover removals

Front cover removal

1 Open the front door, and then disconnect the two straps (A).



CAUTION—POTENTIAL INJURY: Make sure that the front door has support after the straps are removed to avoid damage.

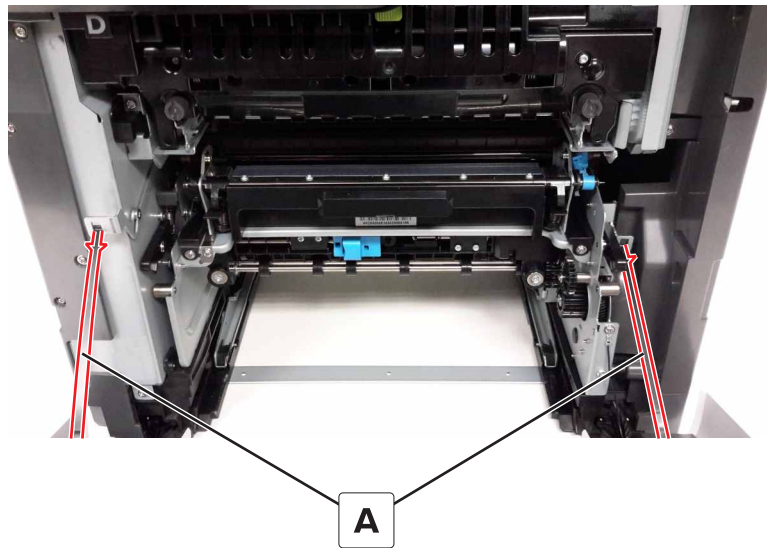

2 Remove the screw (B) securing the ground cables.



3 Remove the two screws (C).

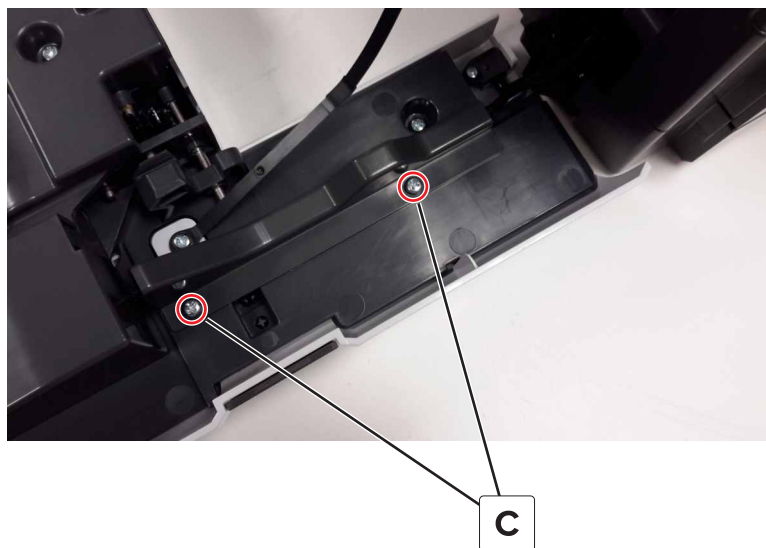

4 Disconnect the cable (D), and then remove the screw (E).

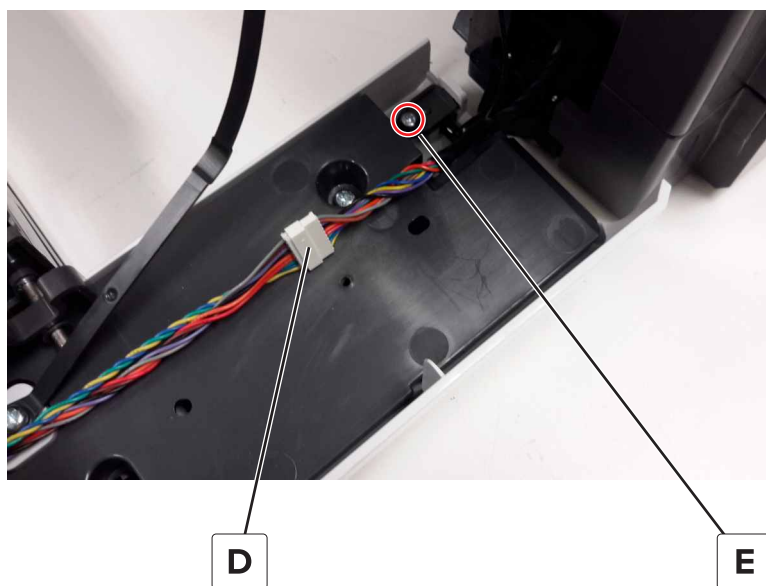

5 Remove the straps from the duplex outer guide.

6 Remove the front cover from the duplex outer guide. See [“Duplex outer guide removal” on page 289](#).

Top cover removal

- 1 Open the toner door cover.
- 2 Remove the two screws (A) on the upper-left corner of the printer.

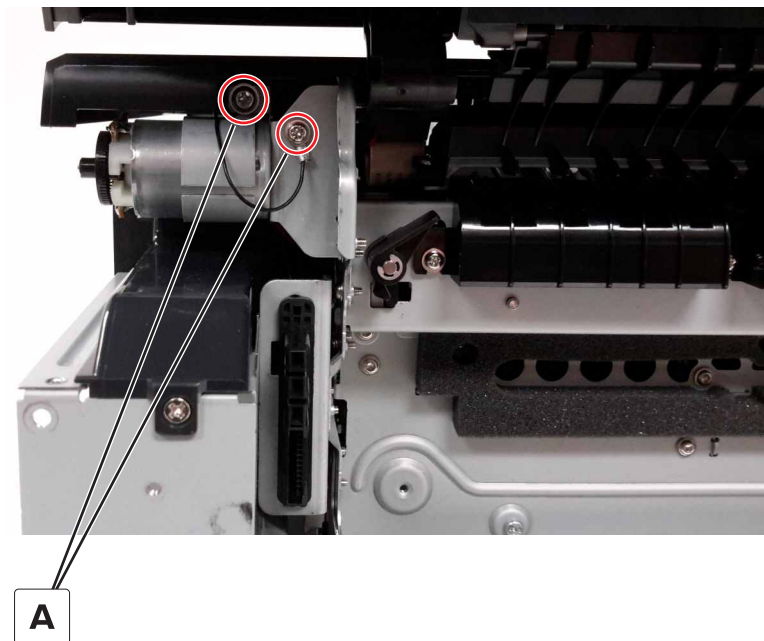

3 Remove the two screws (B) on the top of the printer.

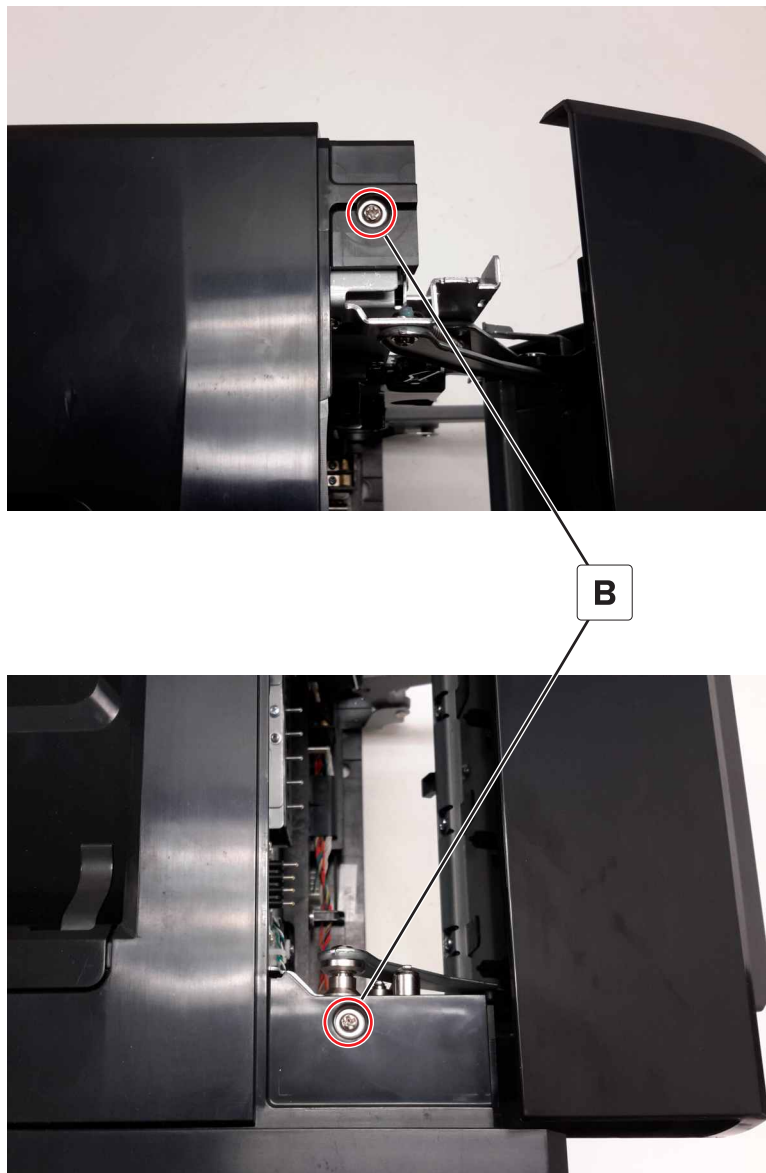

Repair information

269

- 4 Remove the screw (C) on the output bin.

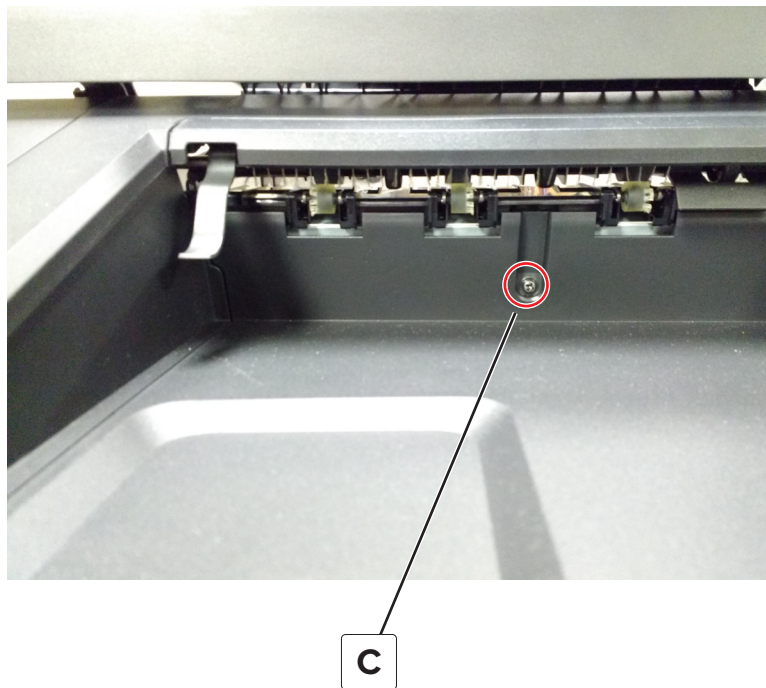

- 5 Disconnect the sensor cable (D), and then remove the cover.

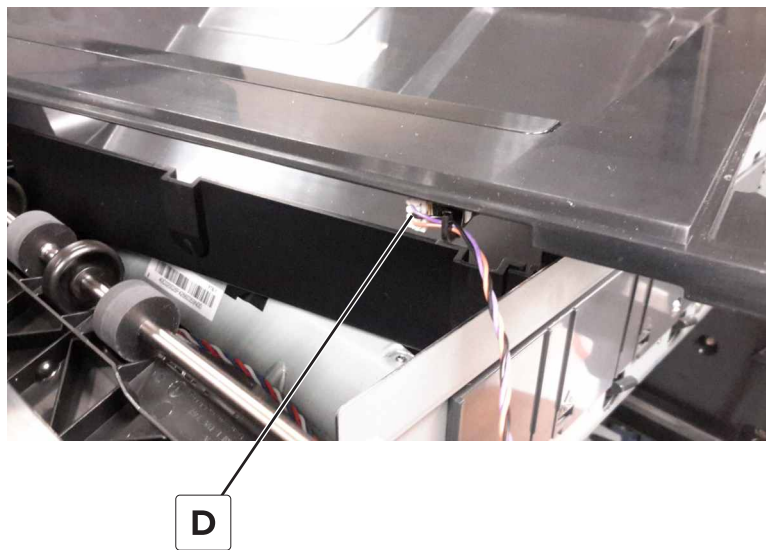

Left cover removal

- 1 Open the front door.
- 2 Remove the two screws (A) on the front of the cover.

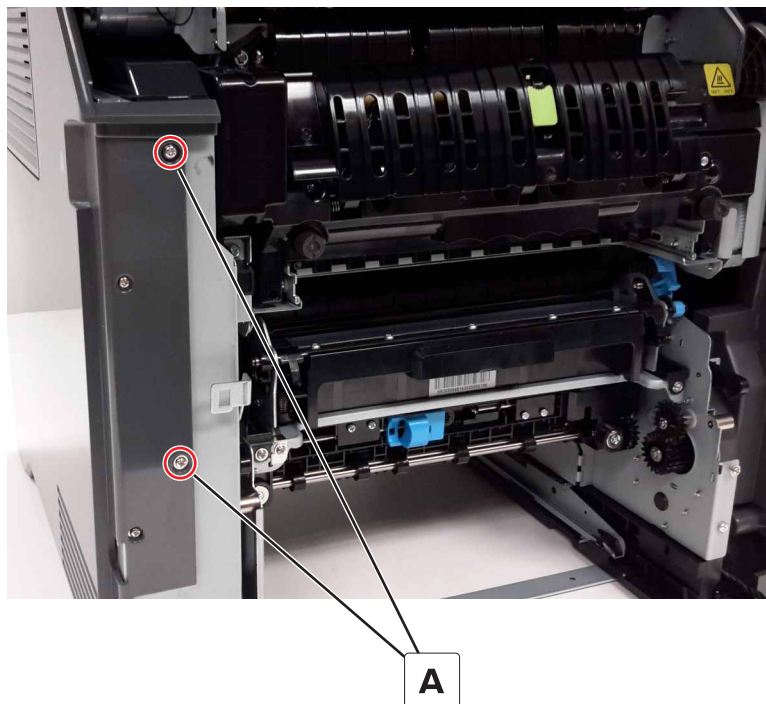

- 3 Remove the three screws (B) on the left side of the cover.

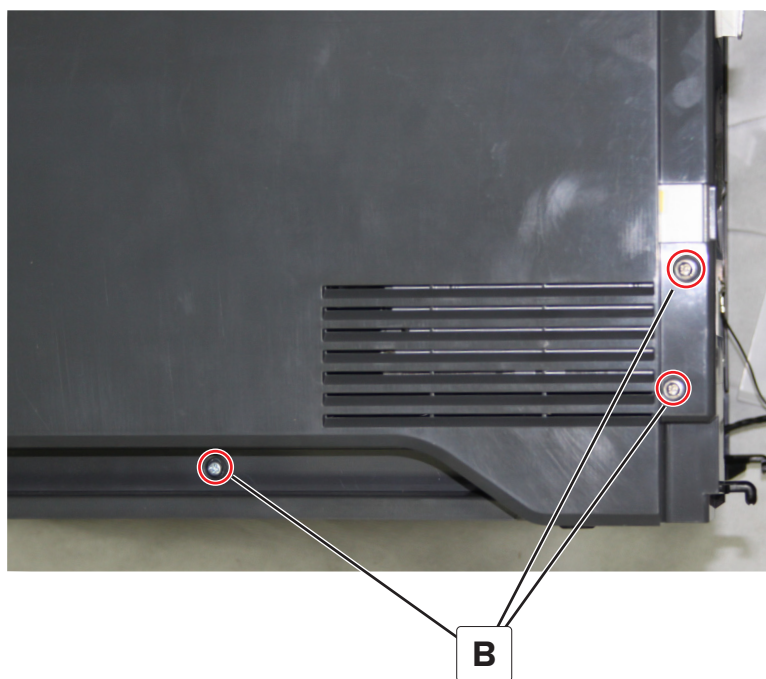

- 4 Remove the three screws (C) on the rear of the cover, and then remove the cover.



Right cover removal

- 1 Remove the motor cover. See [“Motor cover removal” on page 273](#).
- 2 Remove the waste toner bottle.

- 3 Remove the five screws (A).

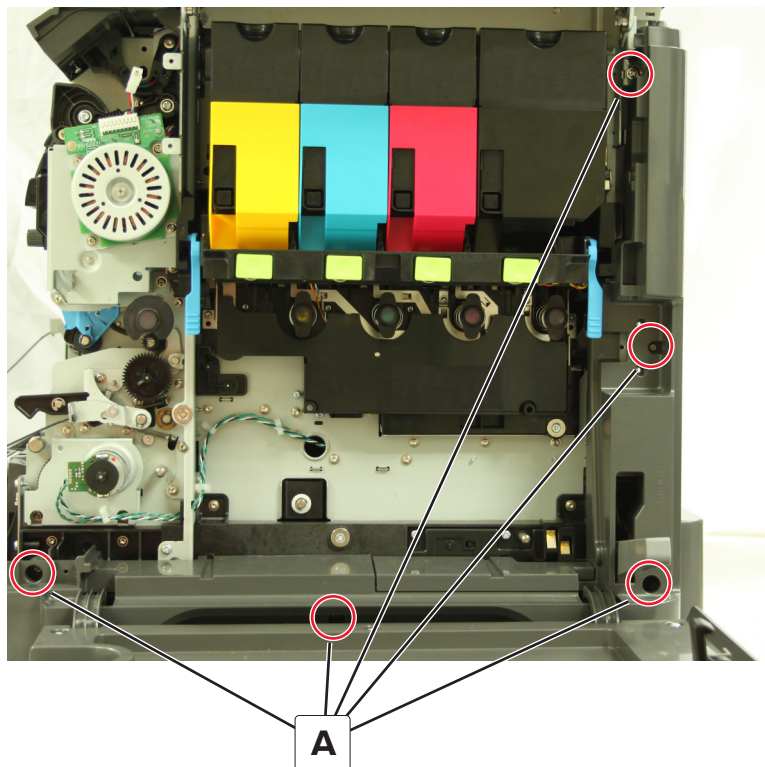

- 4 Remove the right cover from the printer.
- 5 Remove the right cover from the imaging unit cover. See [“Imaging unit cover removal” on page 324.](#)

Motor cover removal

- 1 Open the toner door.
- 2 Open the imaging unit cover.

3 Remove the three screws (A).

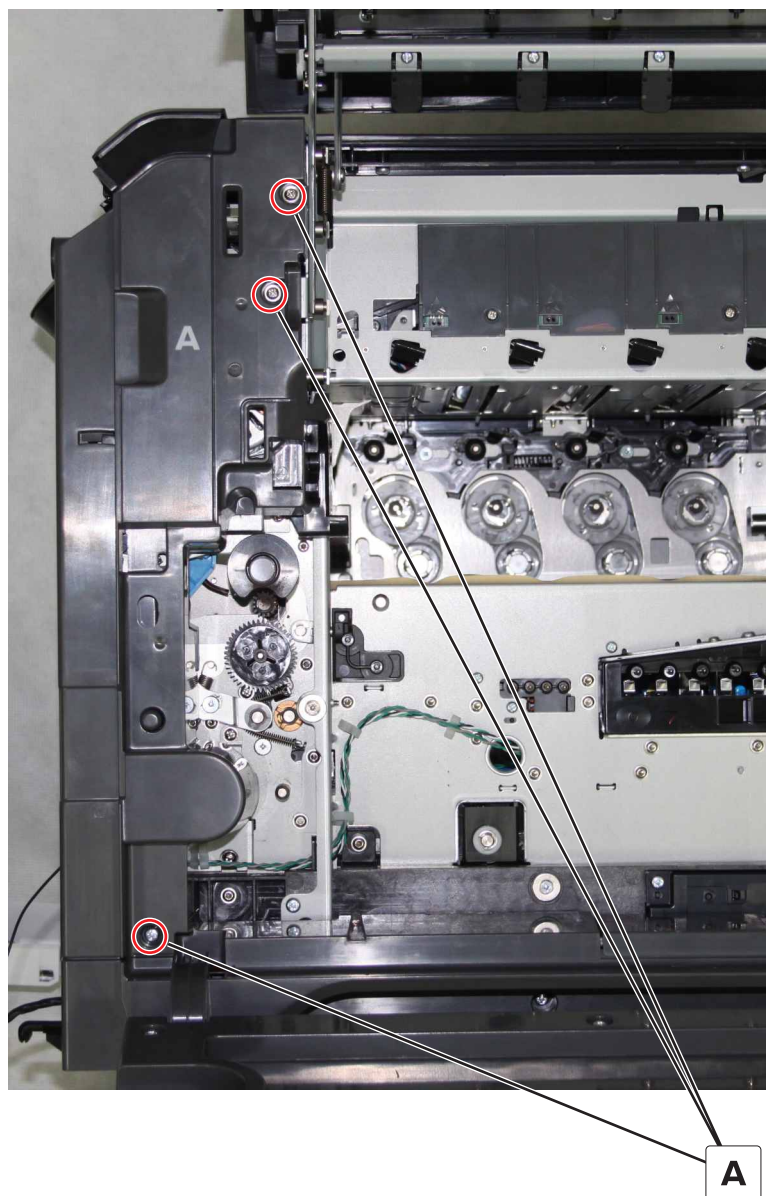

- 4 Open the front cover, and then remove the screw (B) from the front of the cover.

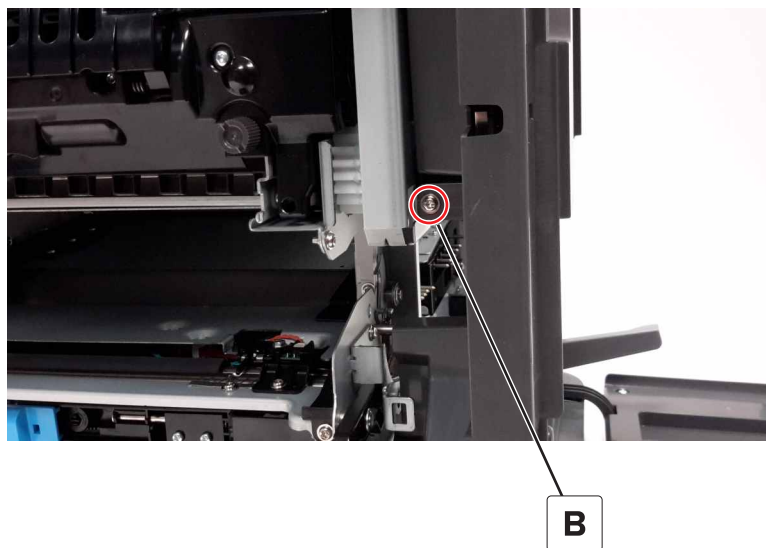

- 5 Disconnect the cable (C), and then remove the cover.

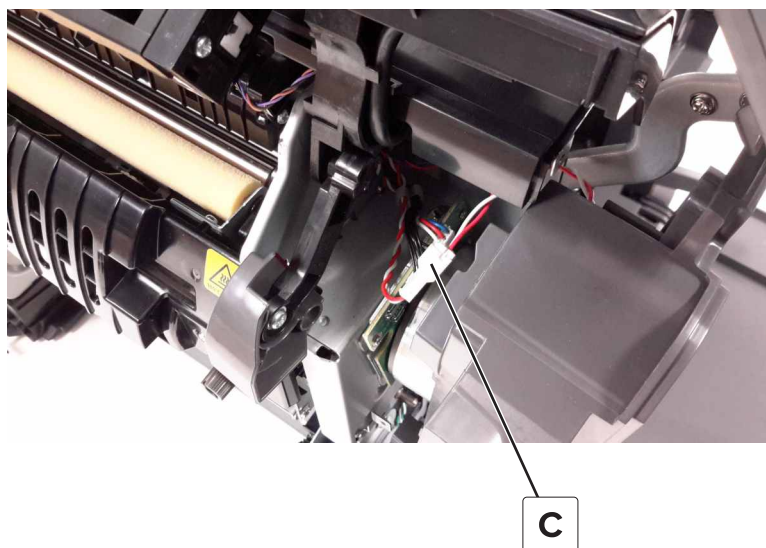

Toner door removal

- 1 Open the toner door, and then remove the two outer screws (A) from the door bracket.

**A**

2 Remove the two inner screws (B) from the door bracket.



B



3 Gently pull the toner door away from the bracket to remove.

Toner door mount bracket removal

- 1 Remove the toner door. See [“Toner door removal” on page 276](#).
- 2 Remove the six screws (A), and then remove the bracket.

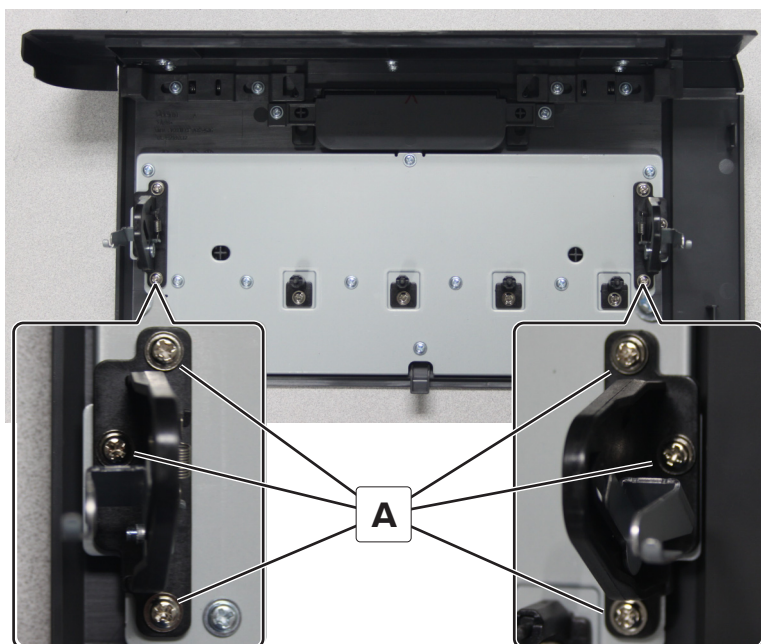

Toner door mount removal

- 1 Remove the toner door. See [“Toner door removal” on page 276](#).
- 2 Unhook the spring (A), and then remove the two screws (B) on the rear side.

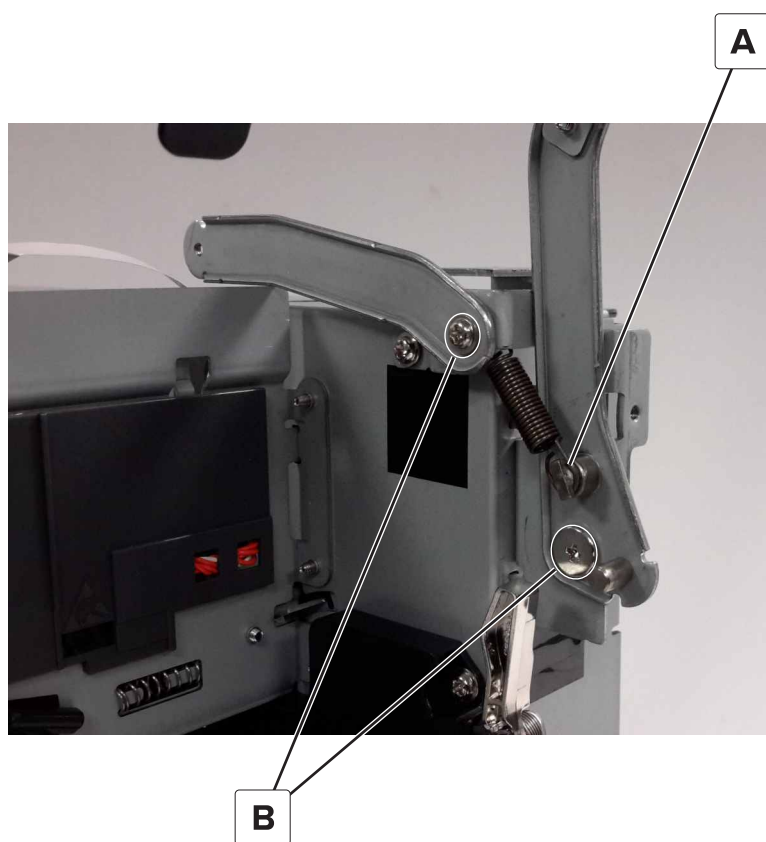

- 3 Unhook the spring (C), and then remove the two screws (D) on the front.

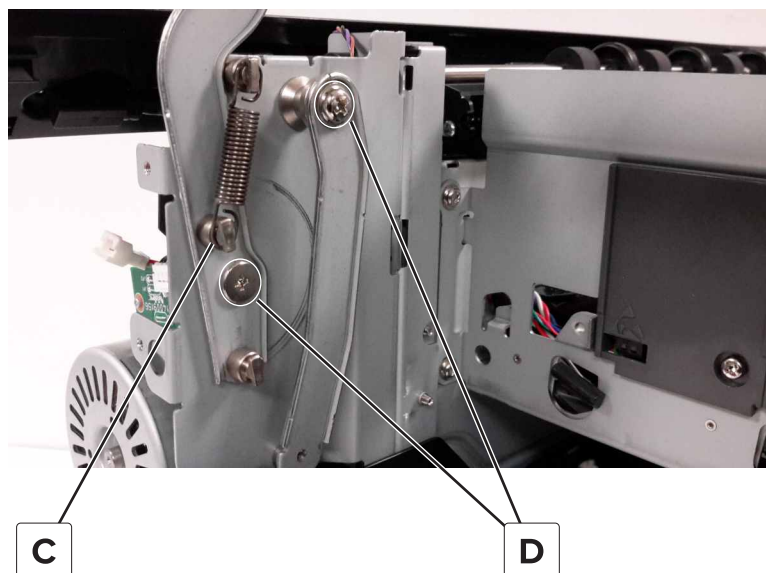

- 4 Remove the toner door mount from the printer.

External air filter removal

- 1 Firmly hold the air filter.
- 2 Pull the air filter to remove.

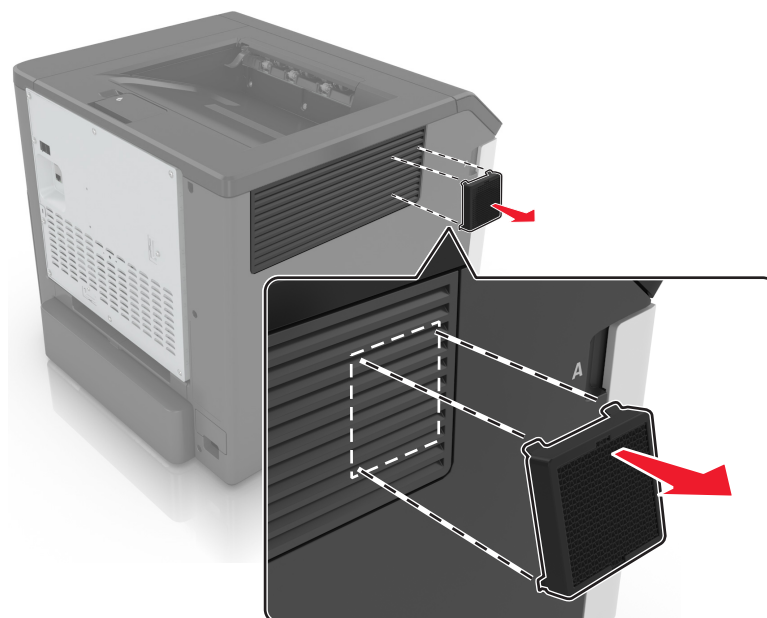

Control panel removals

Upper control panel removal

- 1 Remove the badge cover. See [“Badge cover removal” on page 283](#).
- 2 Remove the number pad cover. See [“Number pad cover removal” on page 284](#).

3 Remove the five screws (A).

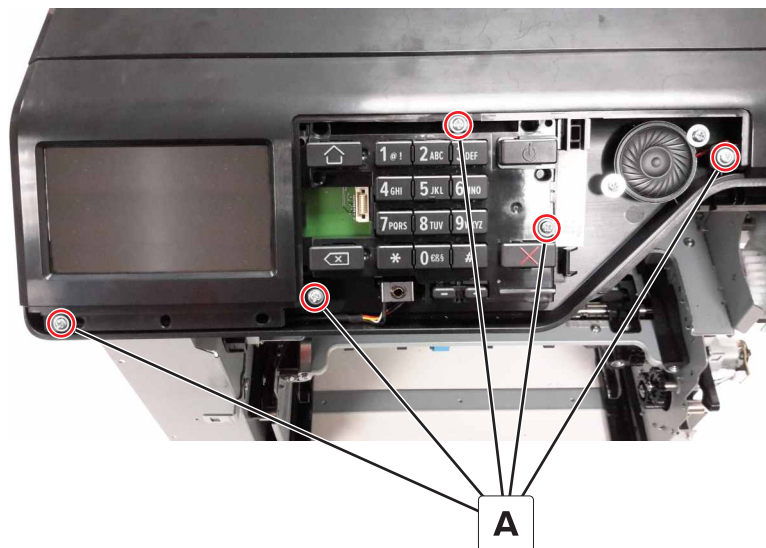

4 Release the three tabs (B) securing the upper control panel.

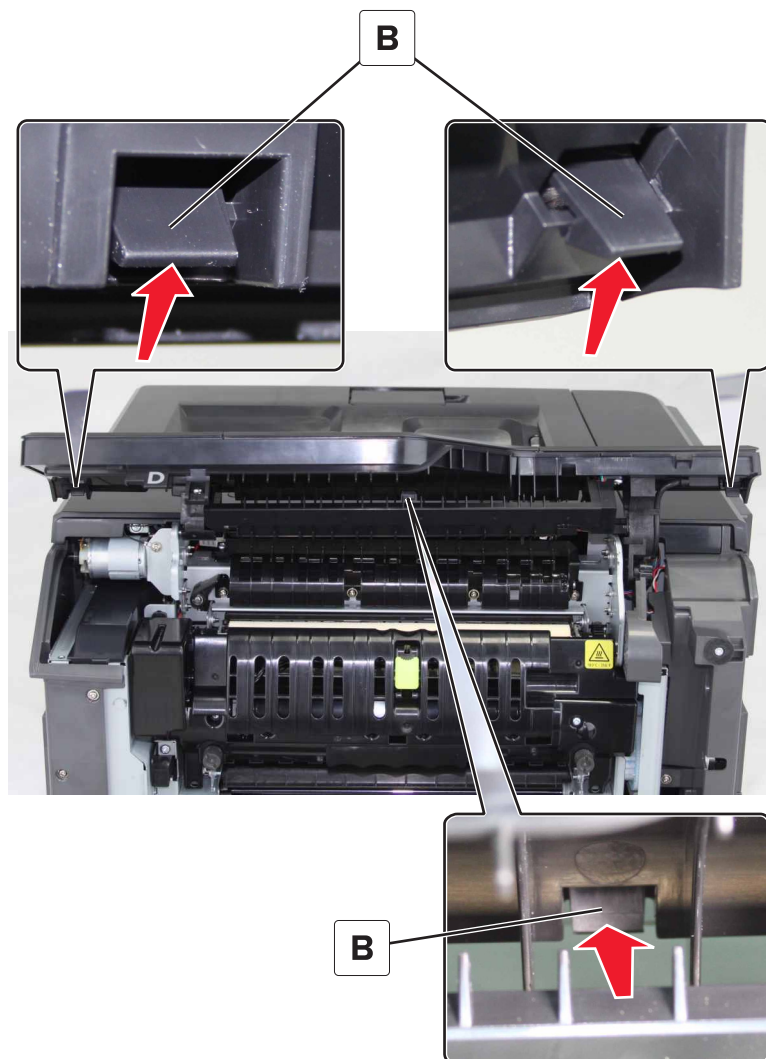

- 5 Disconnect the two cables (C).

Warning—Potential Damage: Do not yank the ribbon cable. See [“Disconnecting ribbon cables” on page 260.](#)

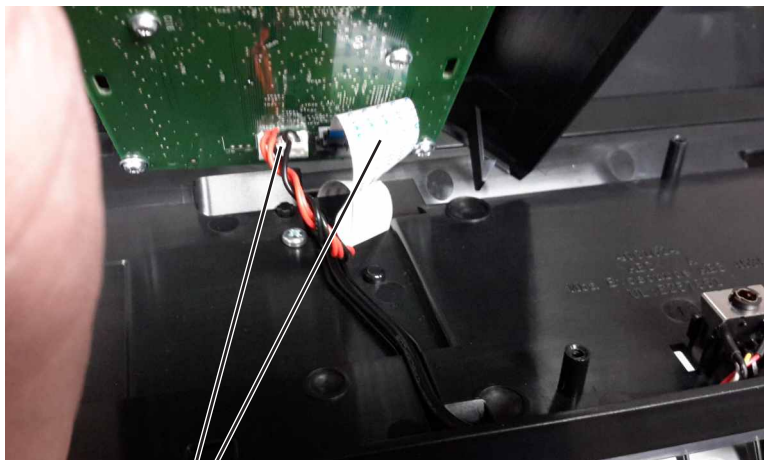

C

- 6 Remove the four screws (D), and then remove the control panel.

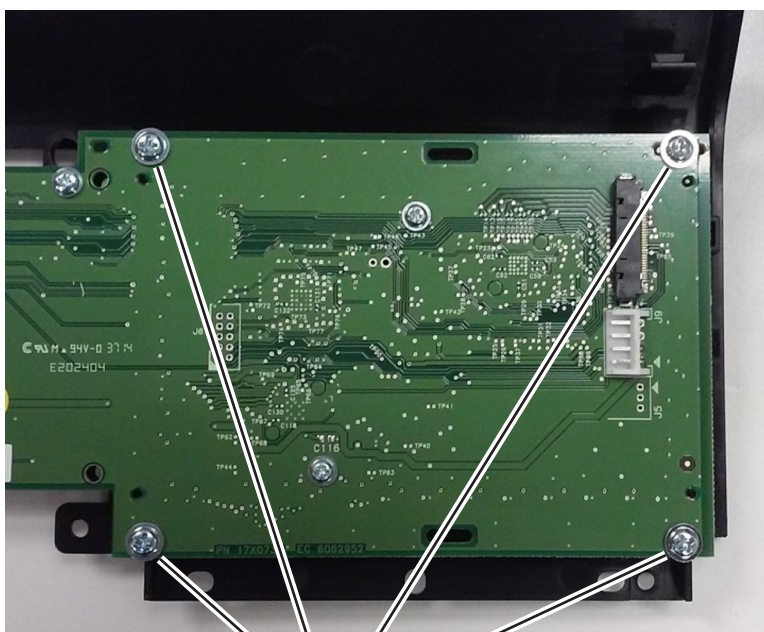

D

Badge cover removal

- 1 Carefully pull to detach the badge cover.



- 2 Remove the cover

Number pad cover removal

- 1 Remove the badge cover. See [“Badge cover removal” on page 283](#).
- 2 Remove the number pad cover.



Control panel arms removal

Note: The control panel arms are two separate FRUs. This procedure shows how to remove both arms.

- 1 Remove the fuser. See [“Fuser removal” on page 333](#).
- 2 Remove the redrive guide. See [“Redrive guide removal” on page 354](#).
- 3 Remove the control panel base cover. See [“Control panel base cover removal” on page 287](#).

4 Disconnect the cable (A), and then remove the two screws (B).

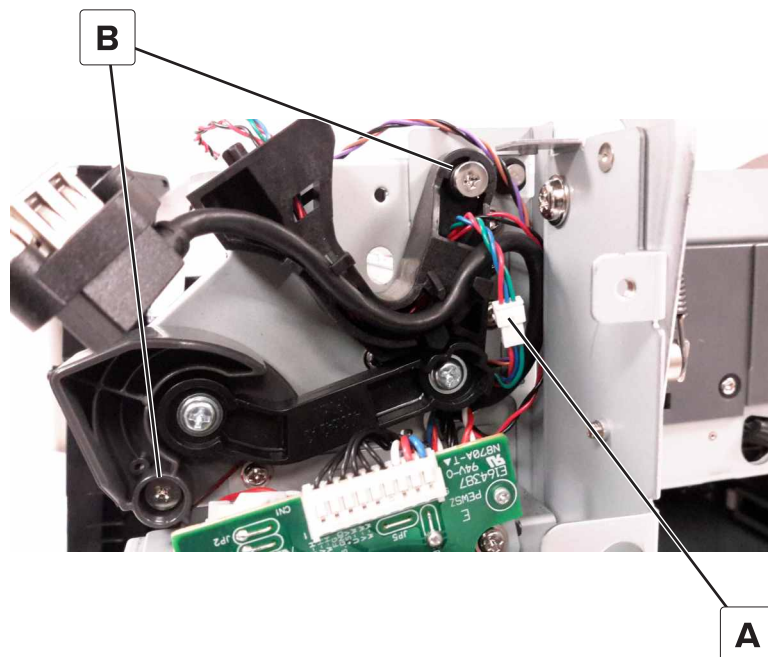

5 Remove the arm, and then route the cables (C) out of the right arm.

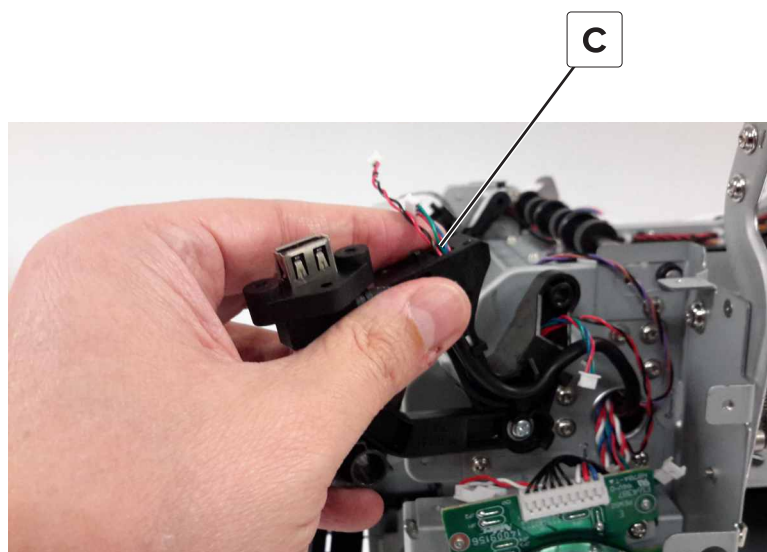

- 6 Remove the left arm (D) from the mounting pin.

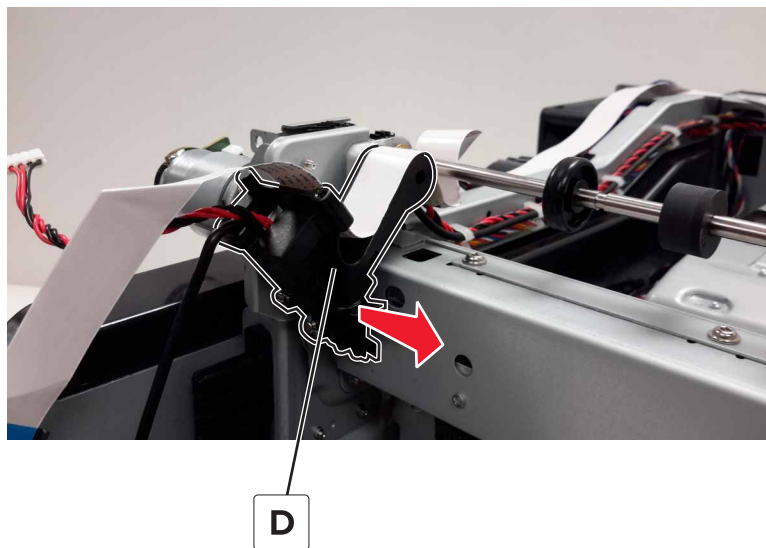

- 7 Carefully remove the ribbon cable (E), and then route the control panel cable (F) and headphone cable (G) out of the arm.

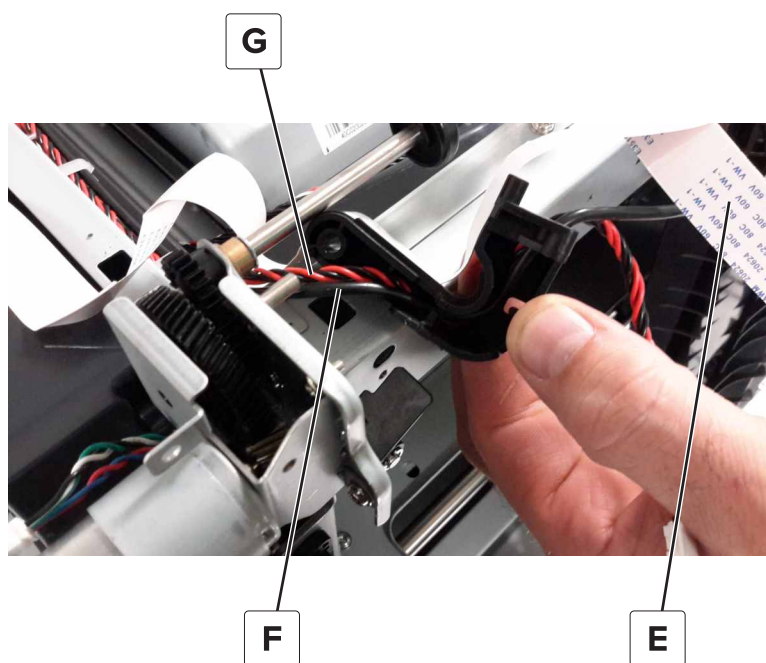

Speaker removal

- 1 Remove the badge cover. See [“Badge cover removal” on page 283](#).
- 2 Remove the number pad cover. See [“Number pad cover removal” on page 284](#).

- 3** Disconnect the speaker cable (A), remove the two screws (B), and then remove the speaker.

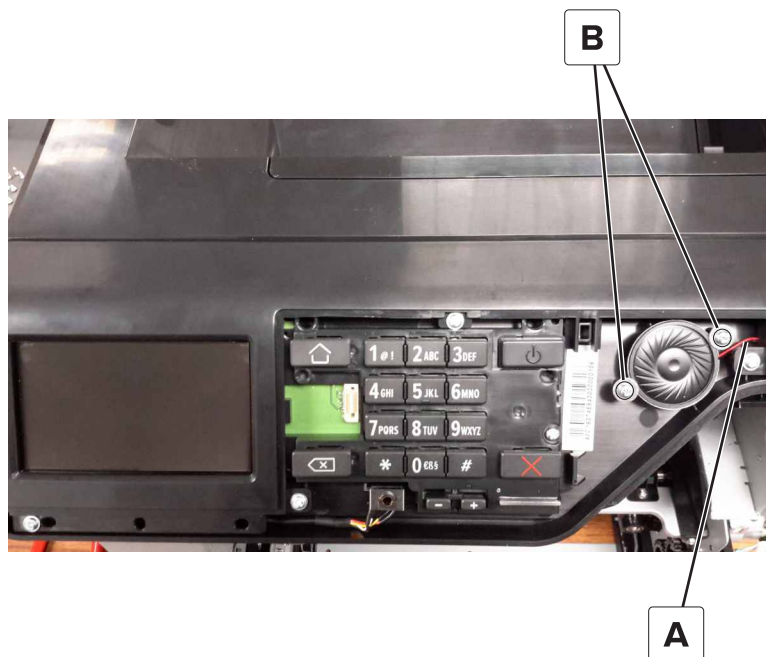

Control panel base cover removal

- 1** Remove the badge cover. See [“Badge cover removal” on page 283](#).
- 2** Remove the number pad cover. See [“Number pad cover removal” on page 284](#).
- 3** Remove the upper control panel. See [“Upper control panel removal” on page 280](#).
- 4** Disconnect the speaker cable (A) and sensor cable (B), and then remove the two screws (C).

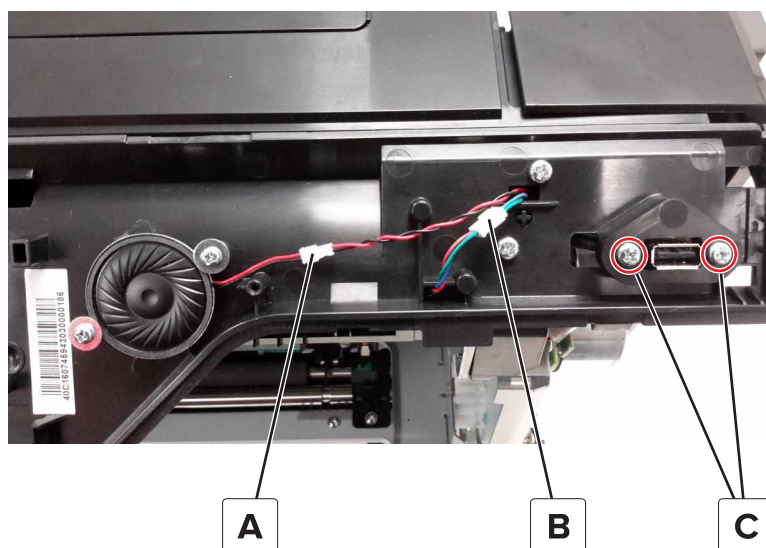

5 Remove the headphone port (D).

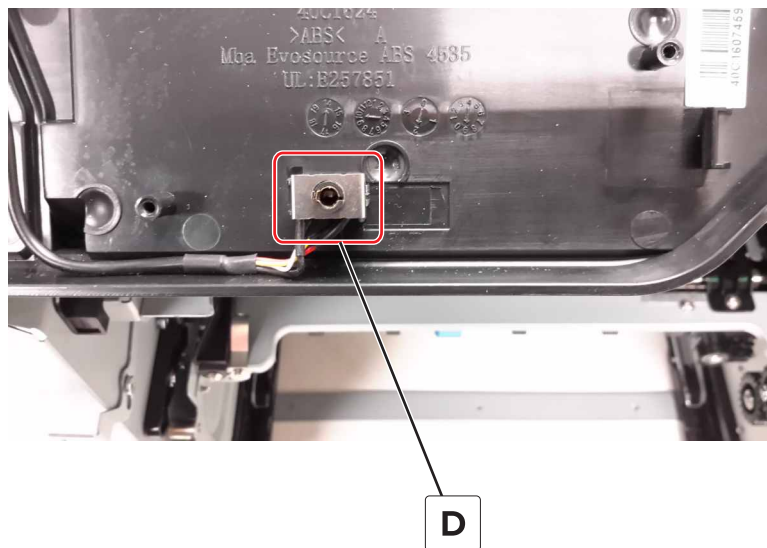

- 6 Remove the four screws (E), and then remove the cover.

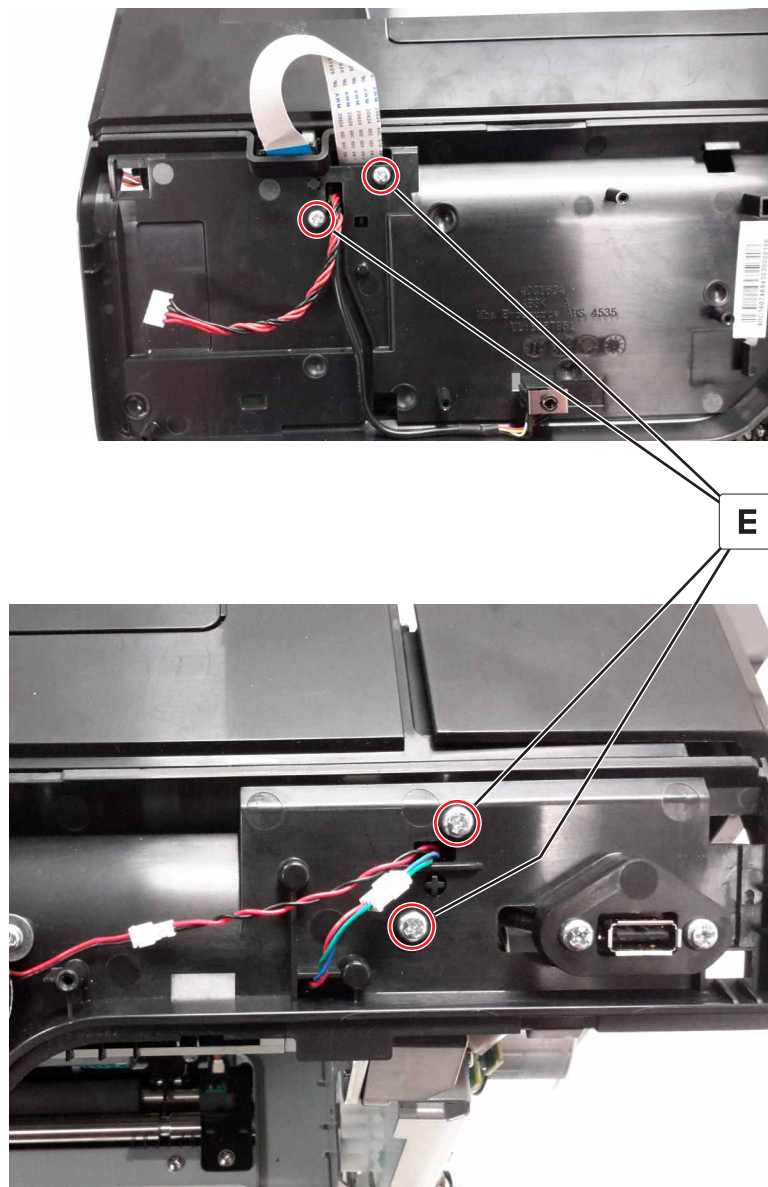

Duplex removals

Duplex outer guide removal

- 1 Remove the front cover. See [“Front cover removal” on page 265.](#)
- 2 Remove the pivot shaft. See [“Pivot shaft removal” on page 291.](#)
- 3 Remove the duplex inner guide. See [“Duplex inner guide removal” on page 291.](#)

4 Remove the ten screws (A).

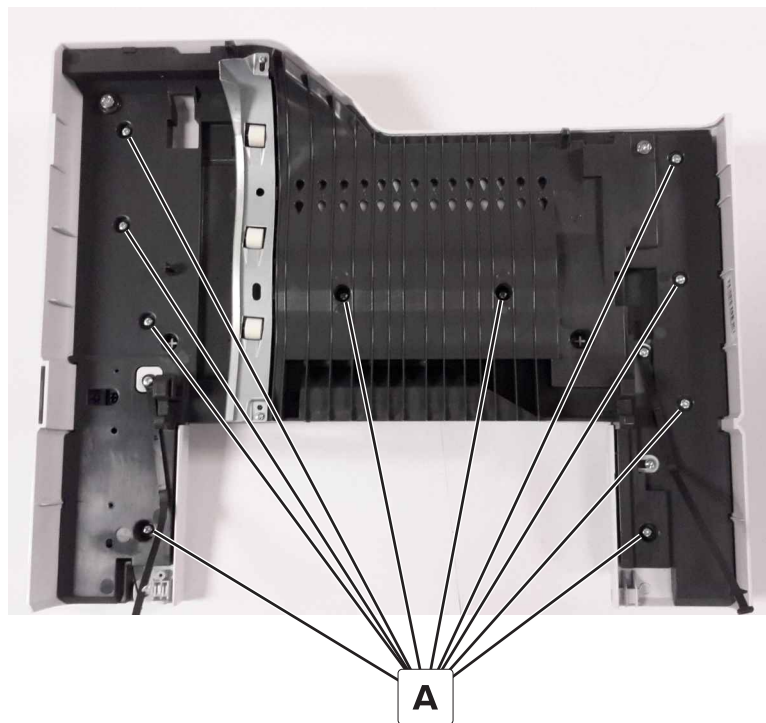

5 Remove the tray indicator (B), and then remove the duplex outer guide.



Duplex inner guide removal

- 1 Remove the front cover. See [“Front cover removal” on page 265.](#)
- 2 Remove the pivot shaft. See [“Pivot shaft removal” on page 291.](#)
- 3 Release the latch (A), and then slide the guide to remove.

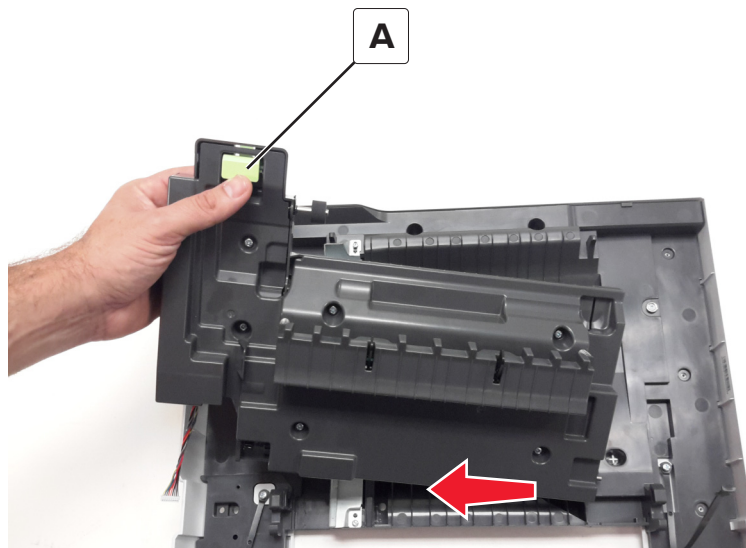

Pivot shaft removal

- 1 Remove the front cover. See [“Front cover removal” on page 265.](#)
- 2 Remove the two E-clips (A), and then remove the shaft (B).

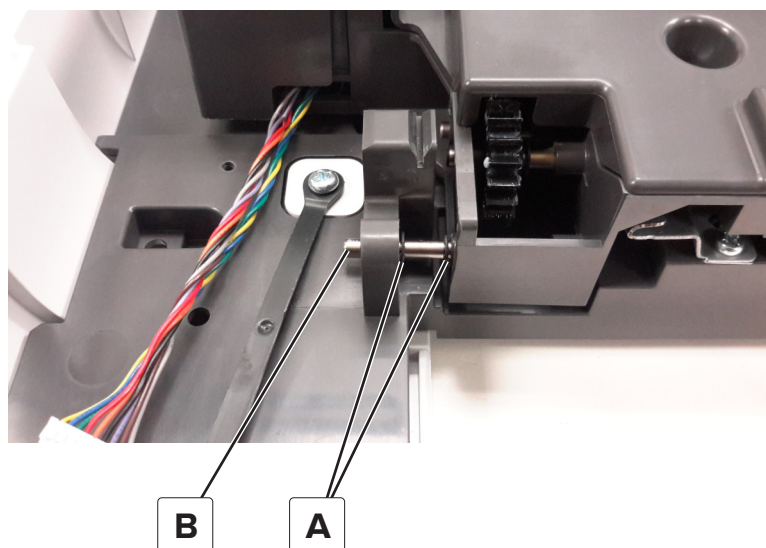

Tensioner belt removal

- 1 Remove the front cover. See [“Front cover removal” on page 265.](#)
- 2 Remove the duplex inner guide. See [“Duplex inner guide removal” on page 291.](#)
- 3 Remove the pivot shaft. See [“Pivot shaft removal” on page 291.](#)
- 4 Remove the six screws (A), and then remove the cover.

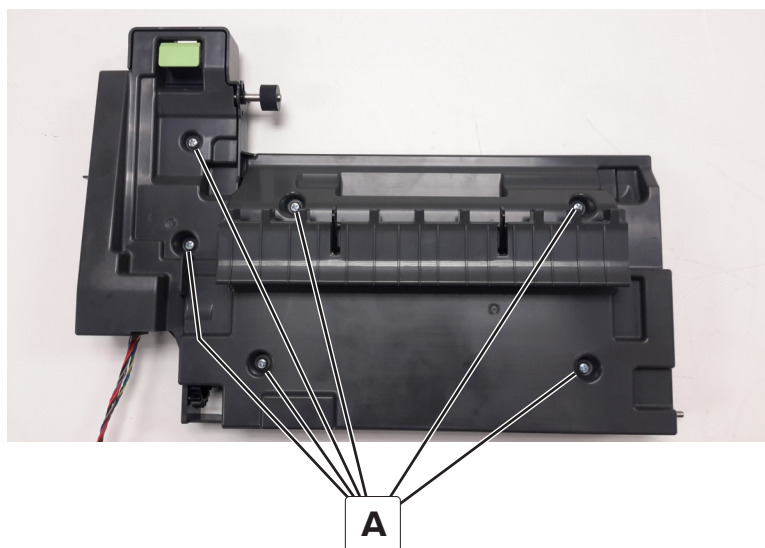

- 5 Remove the belt.

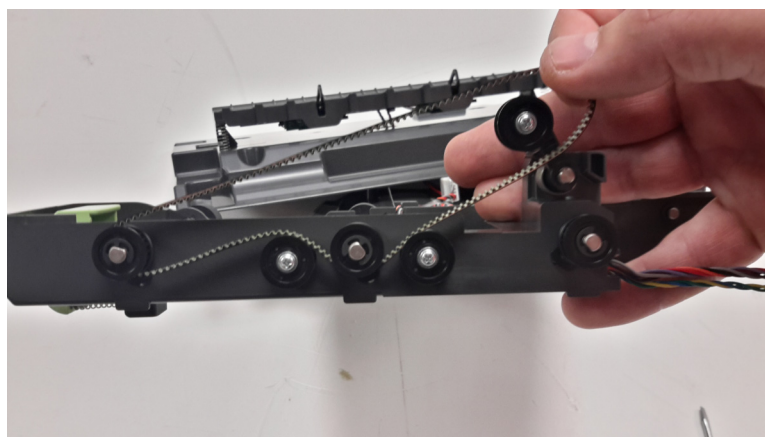

Note: Pay attention to the belt path before removing the belt.

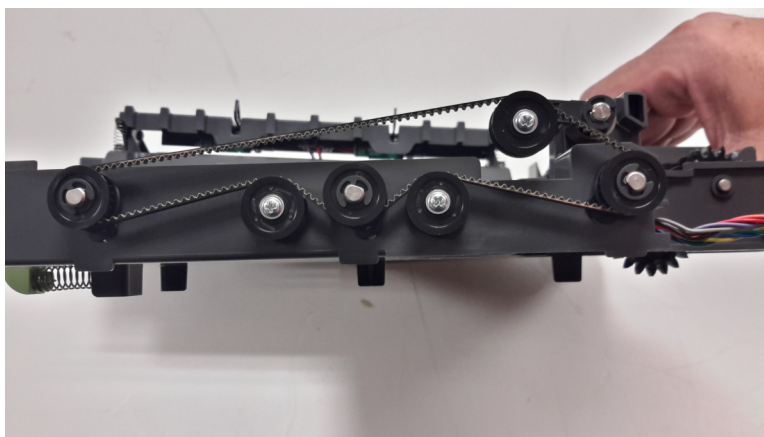

Sensor (duplex) removal

- 1 Remove the front cover. See [“Front cover removal” on page 265.](#)
- 2 Remove the duplex inner guide. See [“Duplex inner guide removal” on page 291.](#)
- 3 Remove the pivot shaft. See [“Pivot shaft removal” on page 291.](#)
- 4 Remove the six screws (A).

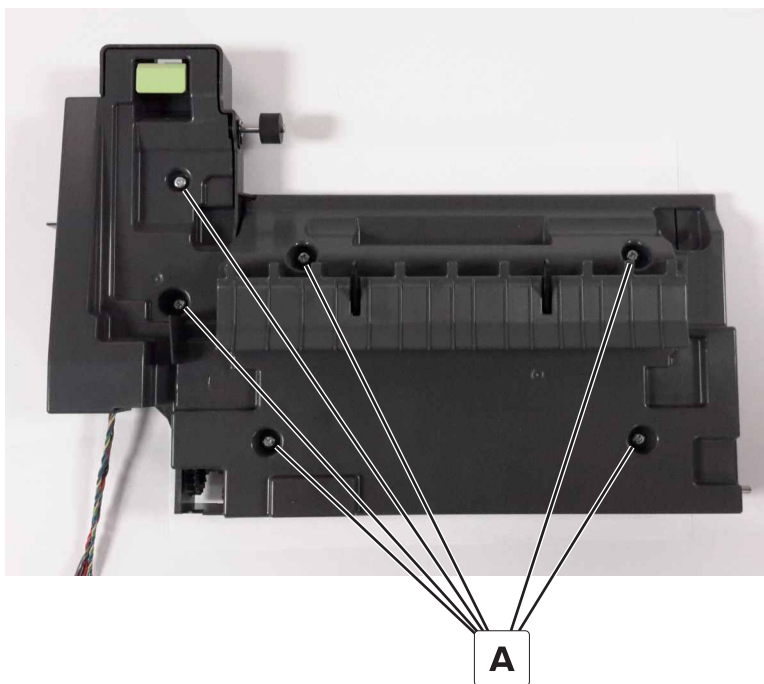

- 5** Disconnect the sensor cable (B), and then remove the sensor (C).

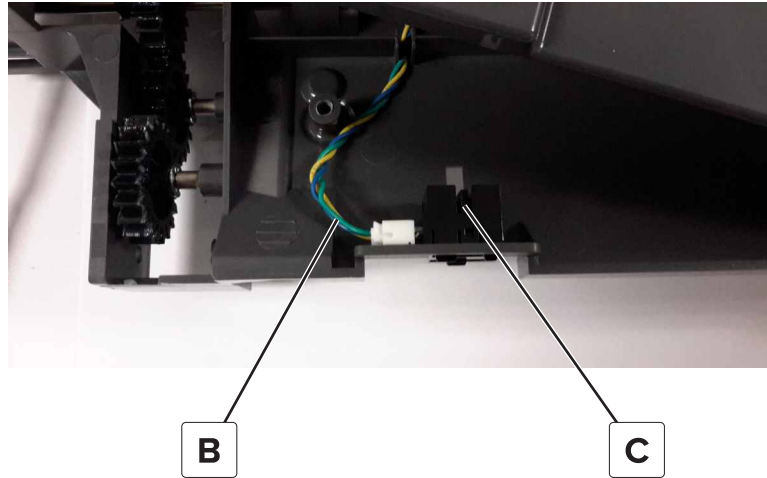

Sensors (fuser buckle and narrow media) removal

- 1** Open the front cover.
- 2** Remove the screw (A).

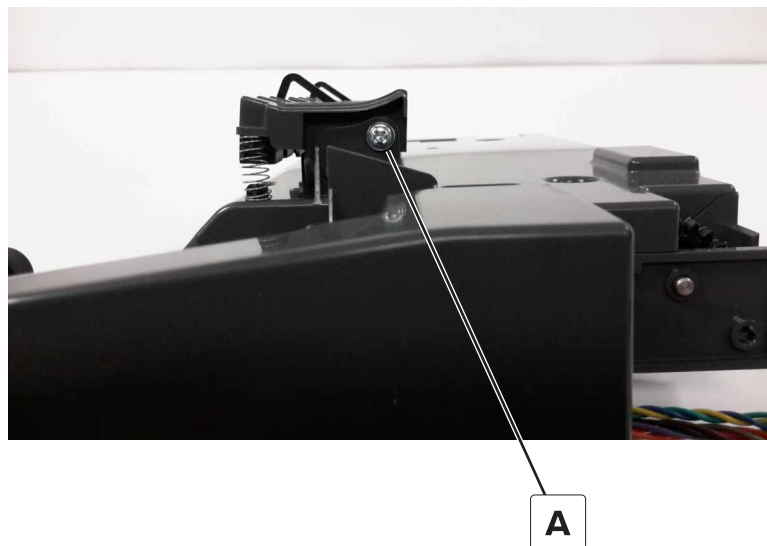

- 3 Slide the paper guide to the right to remove.



- 4 Disconnect the sensor cable (B), remove the screw (C), and then remove the sensors.

Note: The left sensor is the sensor (fuser buckle). The right sensor is the sensor (narrow media).

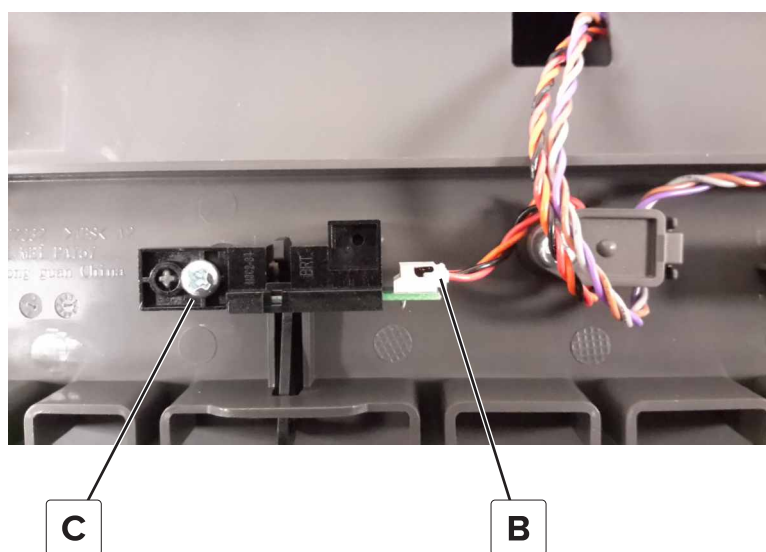

Left removals

Motor (EP drive) removal

This removal shows how to remove all three motors. The motors can be replaced individually.

- 1 Remove the left cover. See [“Left cover removal” on page 271](#).
- 2 On each of the motor, disconnect the motor cable (A), remove the four screws (B), and then remove the motor.

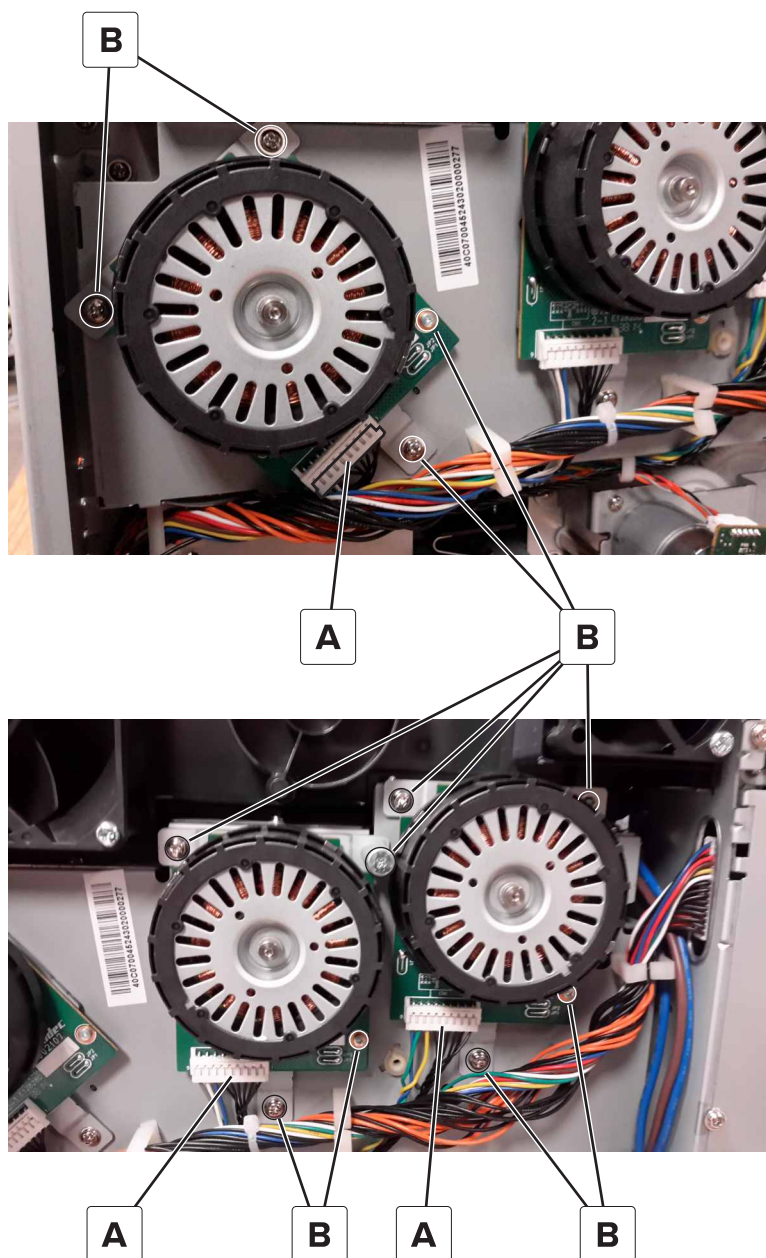

Power cable removal

- 1 Remove the left cover. See [“Left cover removal” on page 271.](#)
- 2 Disconnect the power cable from the LVPS.
- 3 Remove the two screws (A).

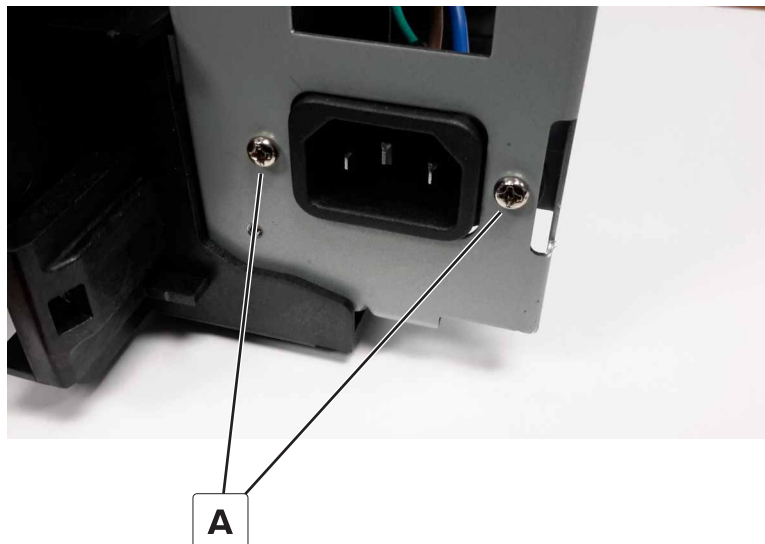

- 4 Remove the cable from the cable ties (B).

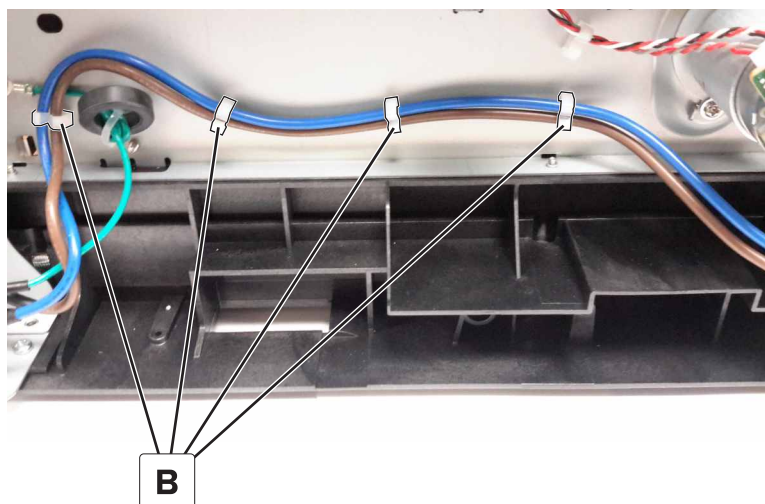

- 5 Disconnect the cable from the LVPS.

Motor (output) removal

- 1 Remove the left cover. See [“Left cover removal” on page 271.](#)
- 2 Remove the top cover. See [“Top cover removal” on page 268.](#)

3 Disconnect the motor cable (A).

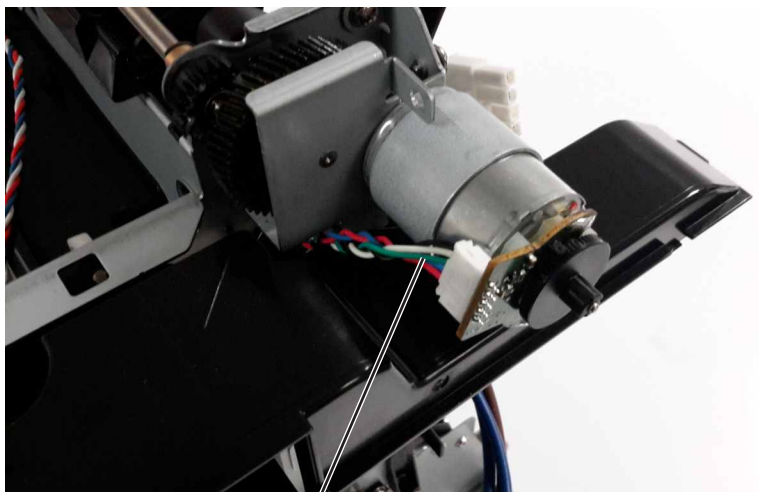

A

4 Remove the three screws (B), and then remove the motor.

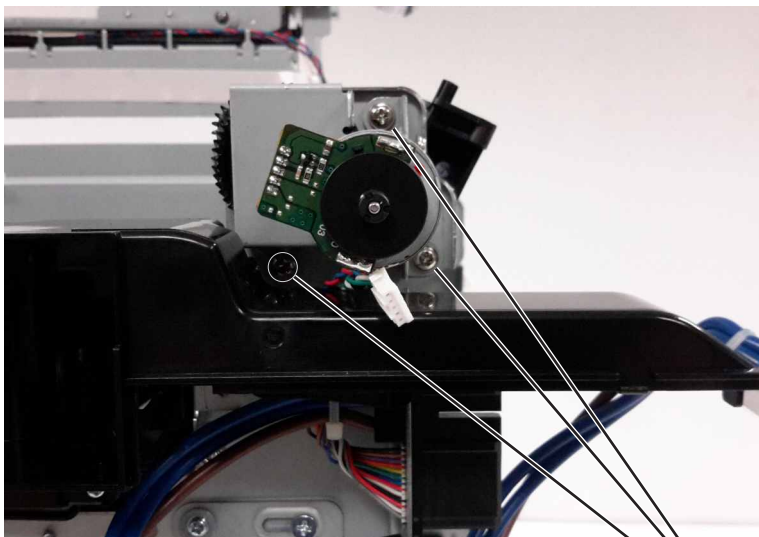

B

Motor (deskew) removal

- 1 Remove the left cover. See [“Left cover removal” on page 271.](#)
- 2 Disconnect the motor cable (A).

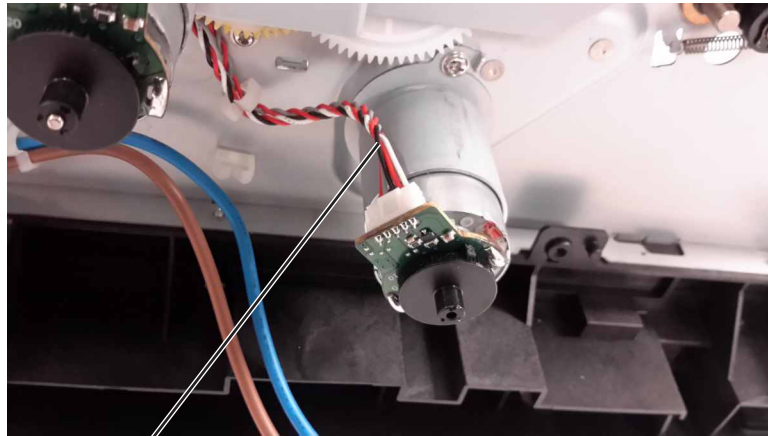

A

- 3 Remove the two screws (B), and then remove the motor.

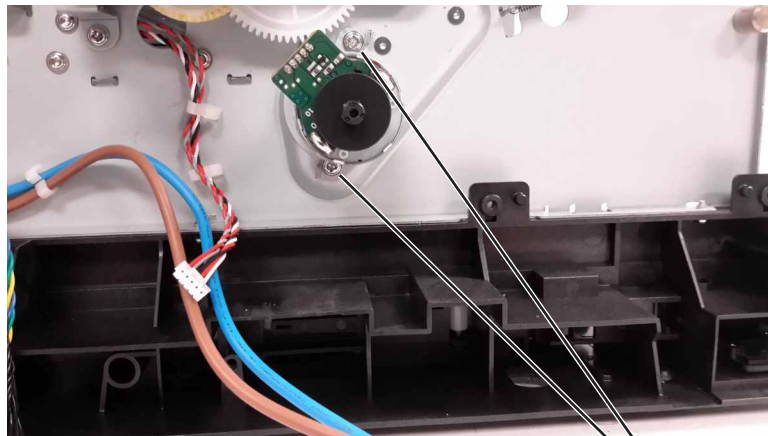

B

Fuser fan removal

- 1 Remove the left cover. See [“Left cover removal” on page 271.](#)
- 2 Remove the controller board shield. See [“Controller board shield removal” on page 356.](#)
- 3 Remove the inner controller board shield. See [“Inner controller board shield removal” on page 357.](#)

4 Disconnect the fuser fan cable (A) from the controller board.

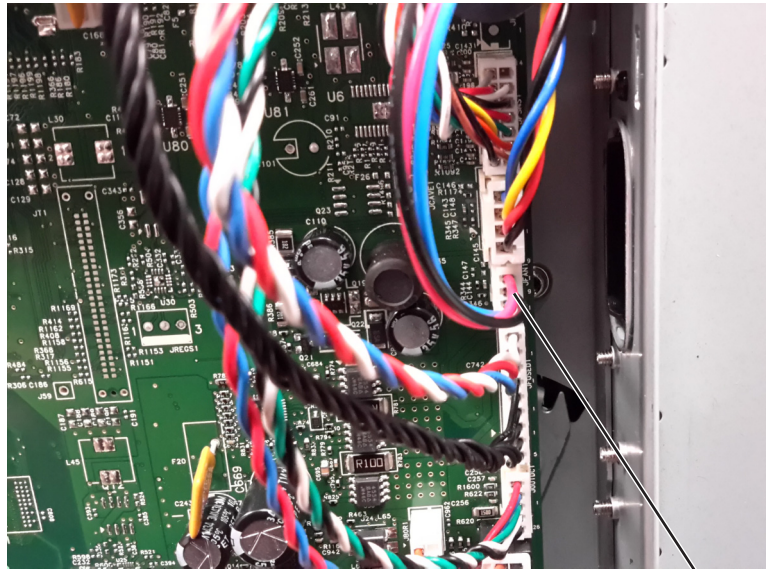

A

5 Remove the two screws (B).

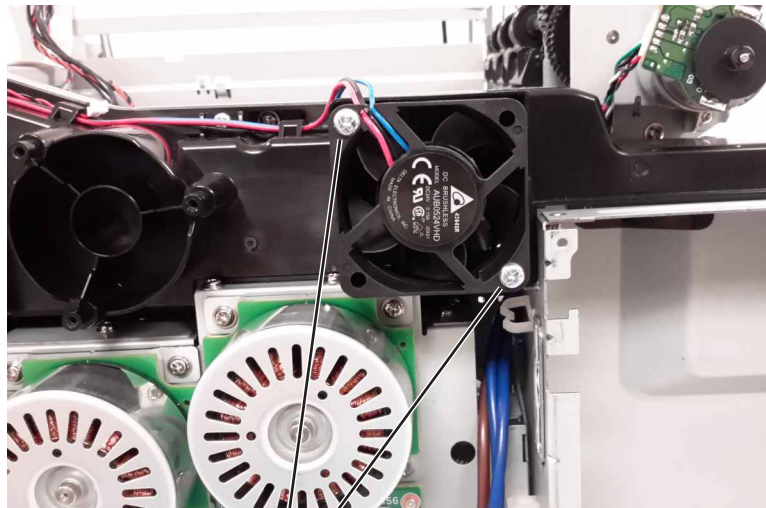

B

- 6 Route the fuser fan cable out of the retainers (C), and then remove the fan.

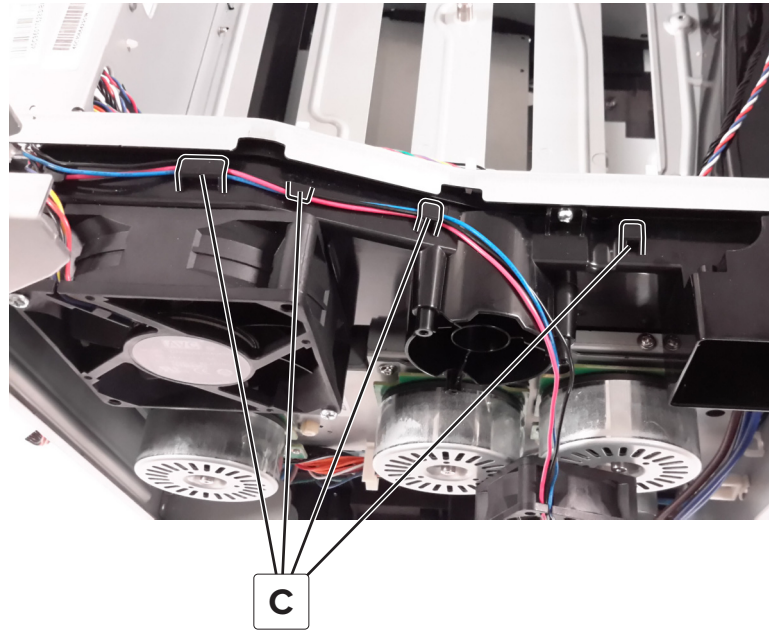

Main fan removal

- 1 Remove the left cover. See [“Left cover removal” on page 271.](#)
- 2 Remove the controller board shield. See [“Controller board shield removal” on page 356.](#)
- 3 Remove the inner controller board shield. See [“Inner controller board shield removal” on page 357.](#)
- 4 Disconnect the main fan cable (A) from the controller board.

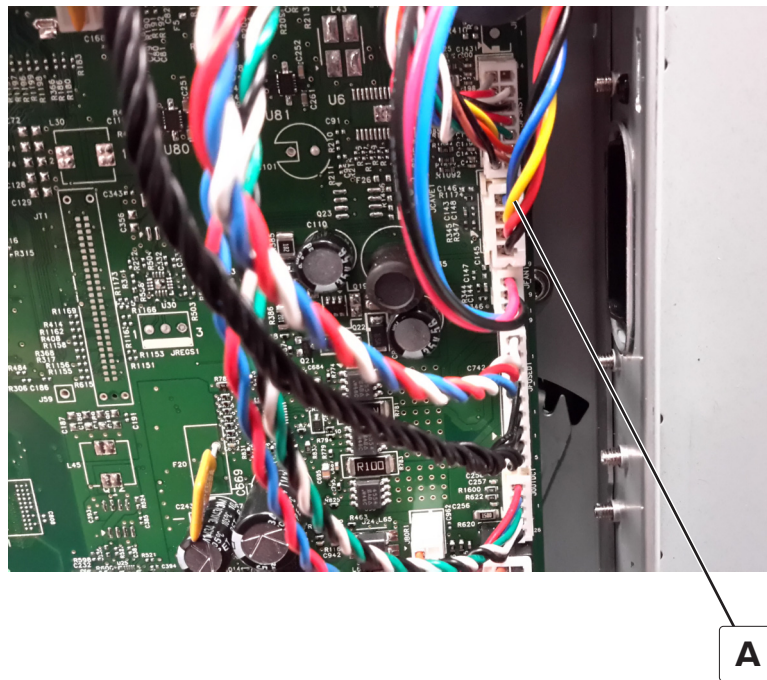

- 5 Remove the two screws (B), and then route the fan cable through the hole in the frame to remove the fan.

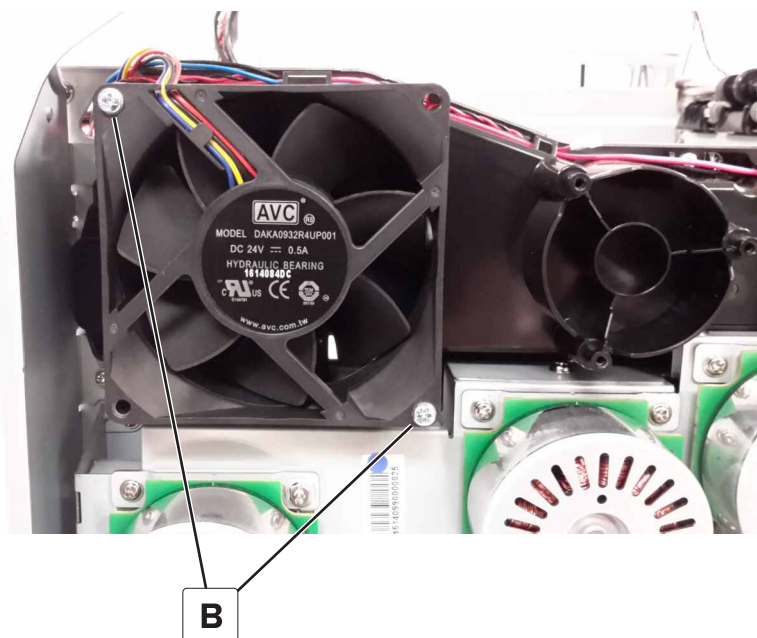

EP gear box removal

- 1 Remove the left cover. See [“Left cover removal” on page 271](#).
- 2 Route the cable out of the guides (A).

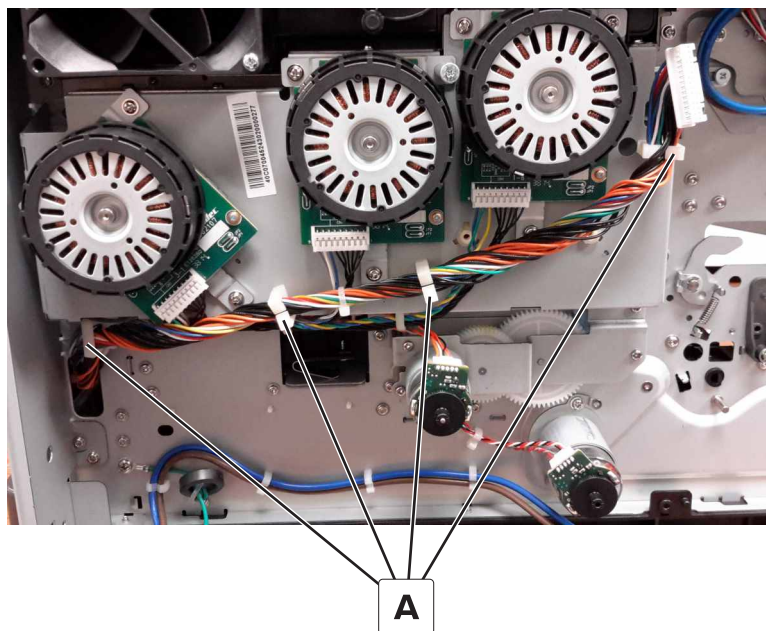

3 Disconnect the three motor cables (B).

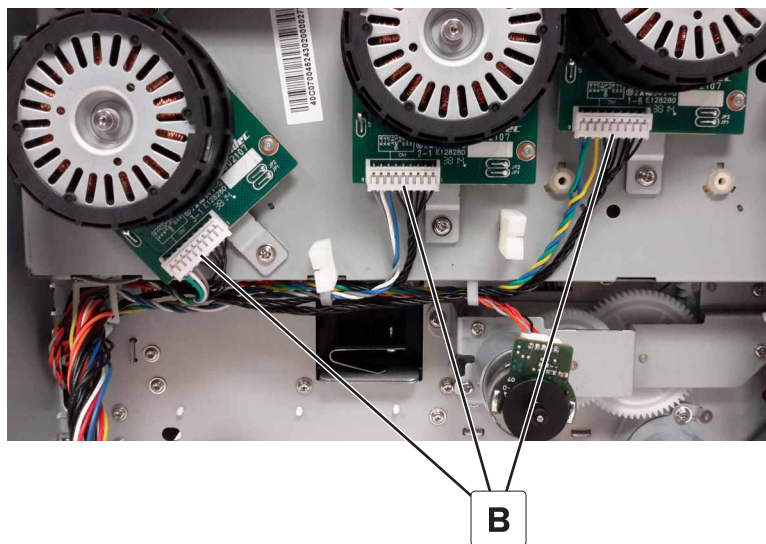

4 Route the motor cables out of the guides (C) from under the gear box.

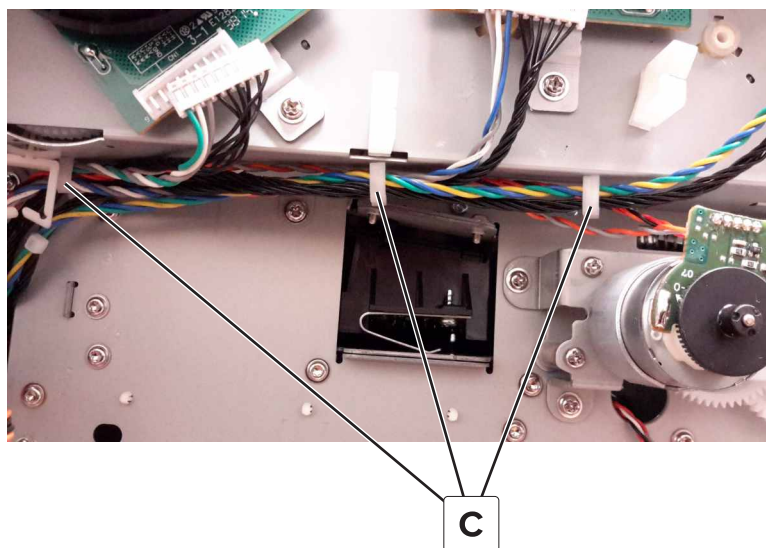

5 Remove the two screws (D) from under the gear box.

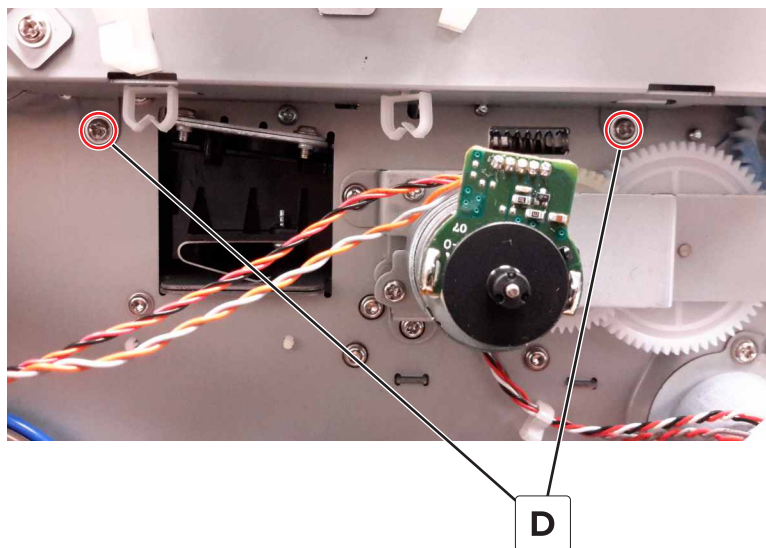

- 6 Remove the two screws (E) from the top-left and top-right corners of the EP drive, and then remove the gear box.

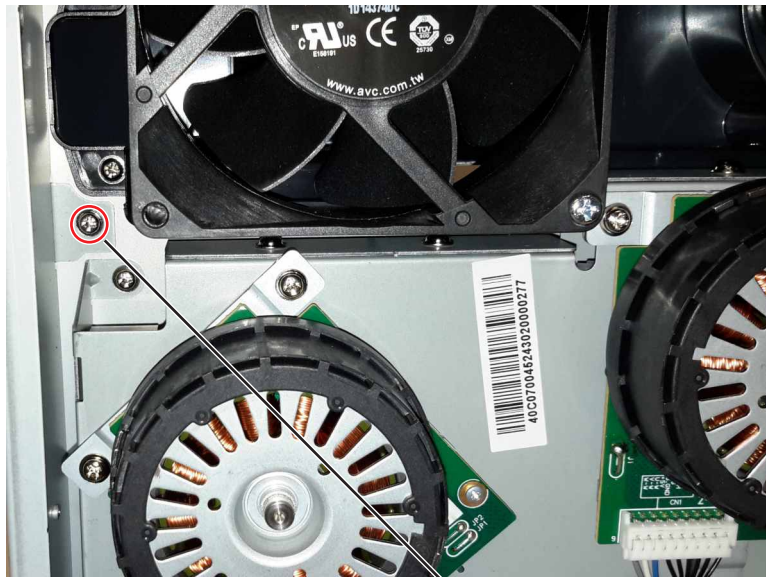

E

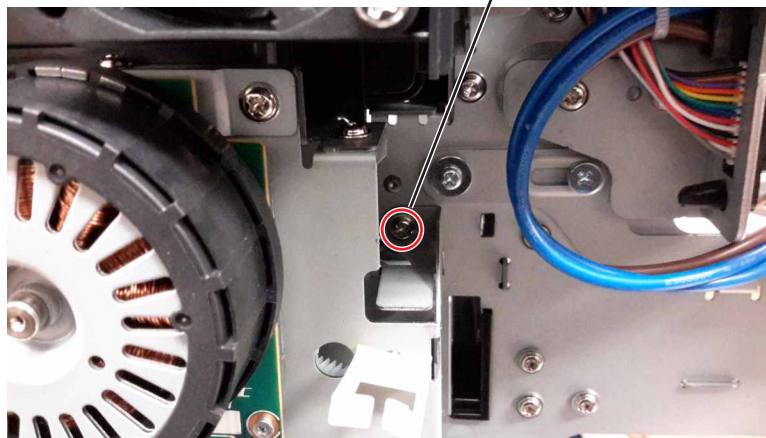

LVPS removal

⚠ CAUTION—SHOCK HAZARD: The LVPS may have residual voltage present. To avoid the risk of electrical shock, do not touch its circuit components. Only handle it by its outer edges.

- 1 Open the front door.
- 2 Remove the left cover. See [“Left cover removal” on page 271](#).

3 Disconnect the cable (A) from the LVPS.

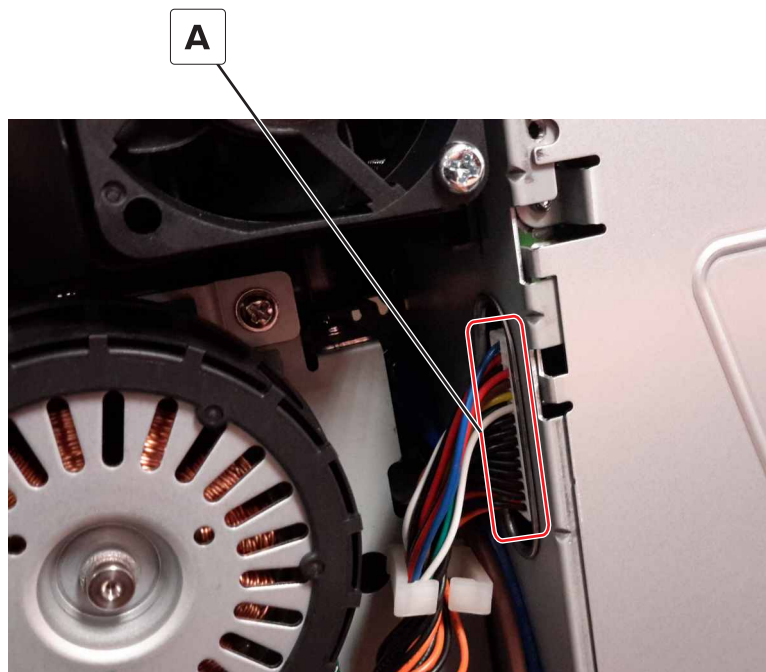

4 Remove the seven screws (B).

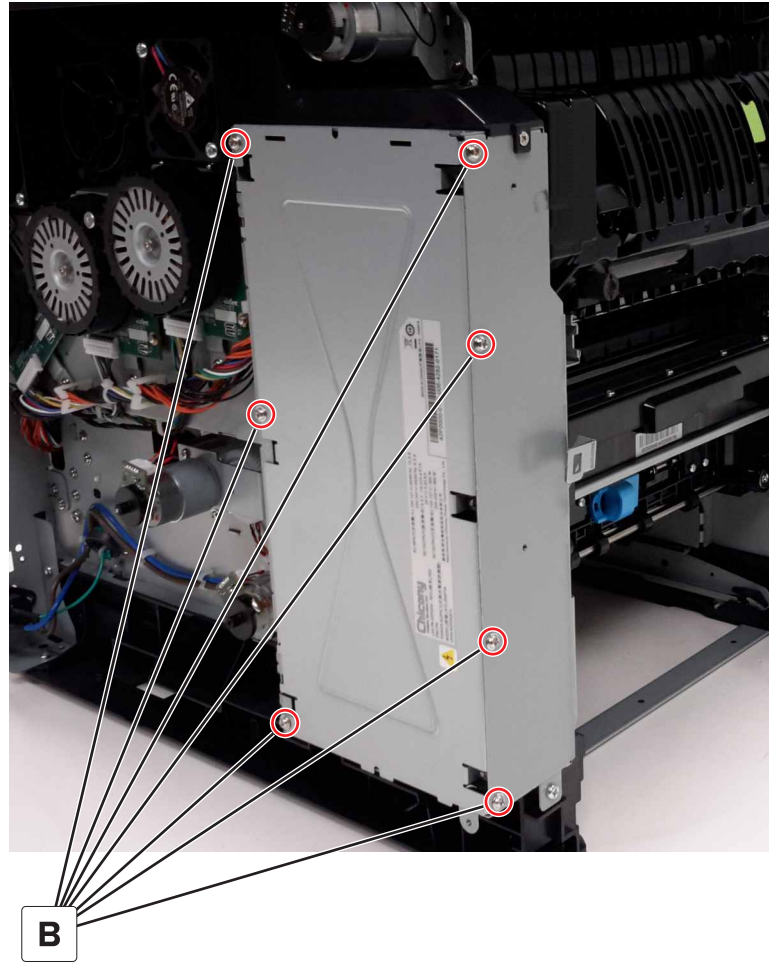

5 Disconnect the two cables (C), and then remove the LVPS.

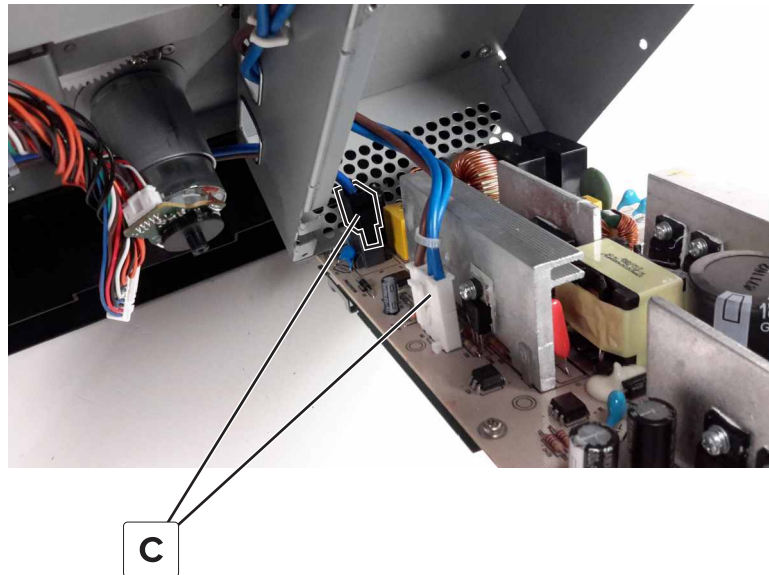

Repair information

307

LVPS cage removal

Note: This is not a FRU.

- 1 Remove the left cover. See [“Left cover removal” on page 271.](#)
- 2 Remove the LVPS. See [“LVPS removal” on page 305.](#)
- 3 Remove the two screws (A) from the right side of the cage.

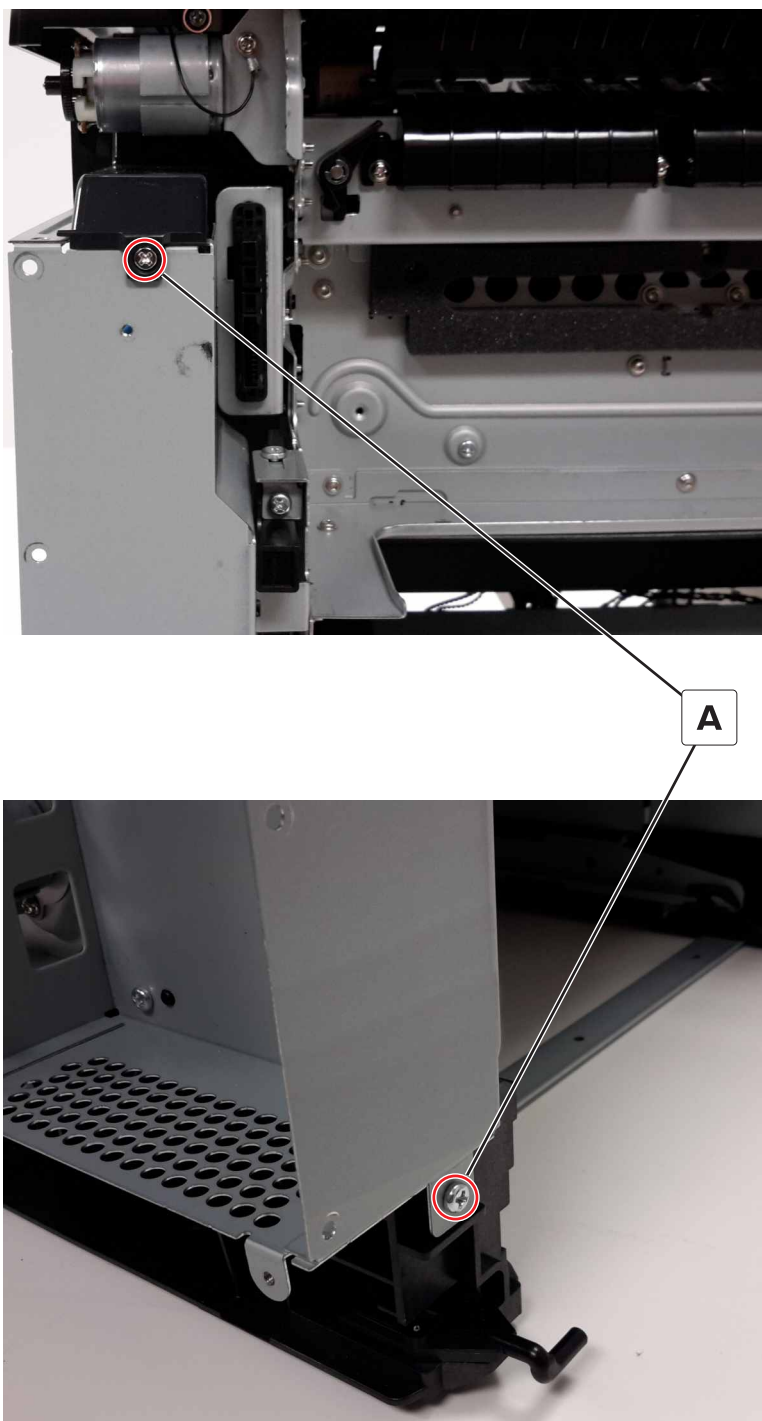

- 4 Remove the five screws (B) from the inside of the cage, and then remove the cage.

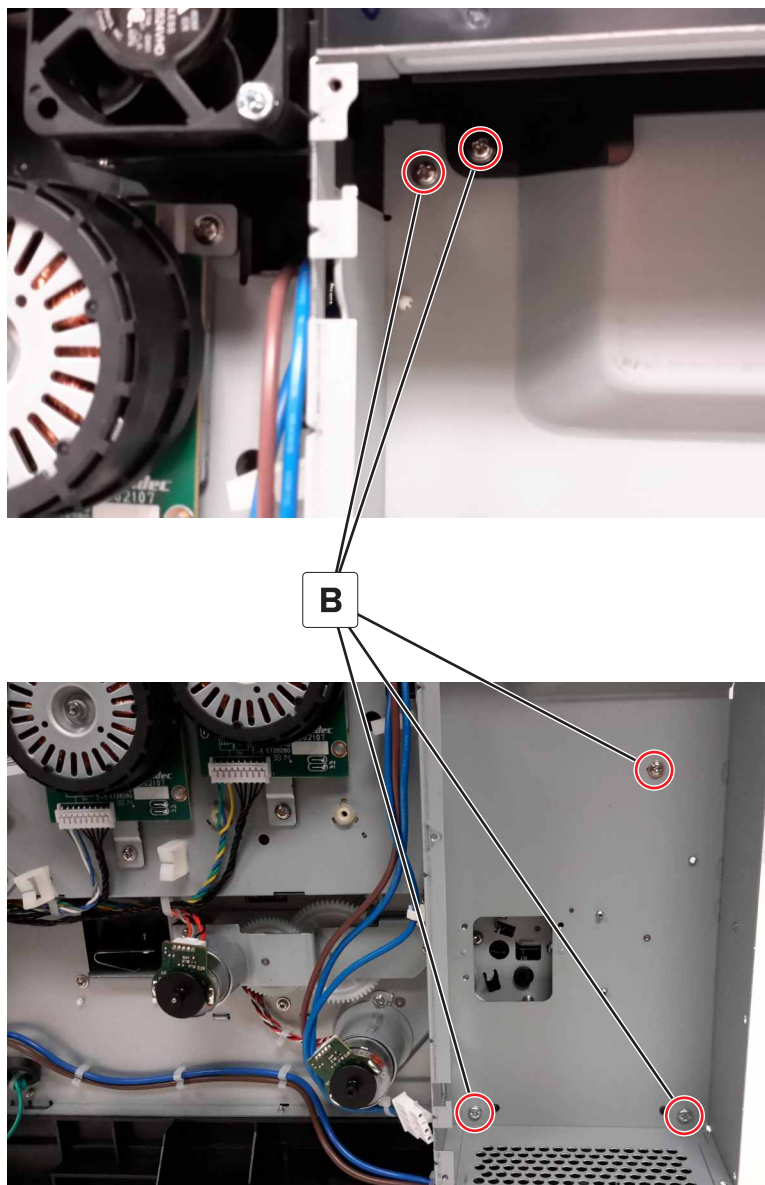

Motor (black only retract) removal

- 1 Remove the front cover. See [“Front cover removal” on page 265.](#)
- 2 Remove the left cover. See [“Left cover removal” on page 271.](#)
- 3 Remove the LVPS. See [“LVPS removal” on page 305.](#)
- 4 Remove the LVPS cage. See [“LVPS cage removal” on page 308.](#)
- 5 Remove the EP gear box. See [“EP gear box removal” on page 302.](#)

6 Disconnect the black only retract motor cable (A).

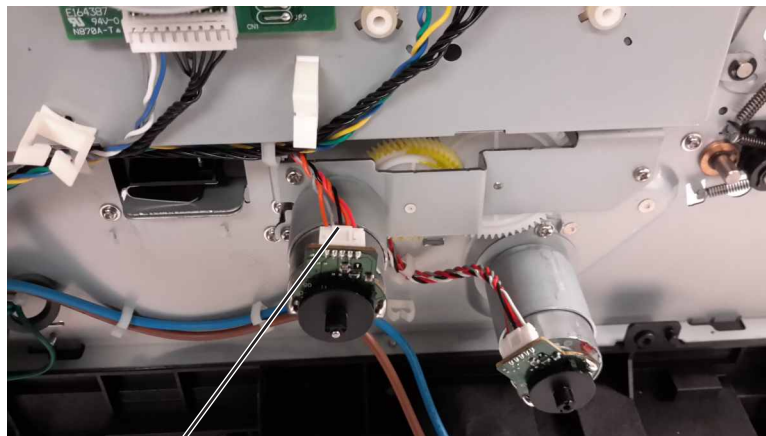

A

7 Remove the two screws (B).

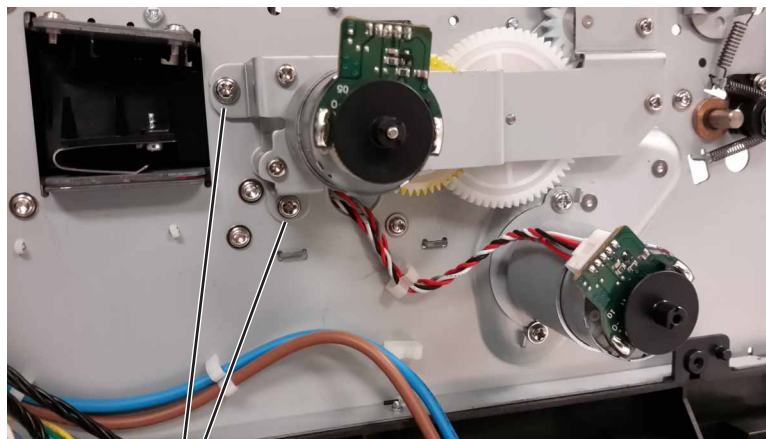

B

- 8 Remove the two screws (C), and then remove the motor.

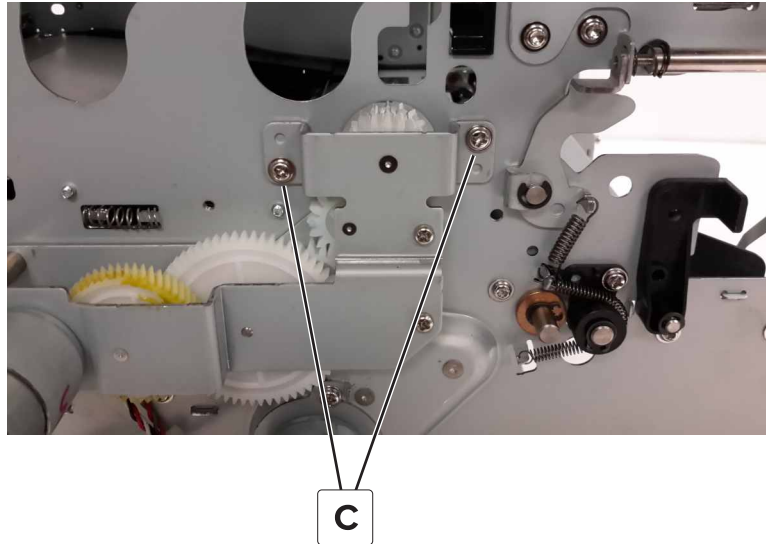

Right removals

Sensor (weather station) removal

- 1 Remove the waste toner bottle.
- 2 Remove the motor cover. See [“Motor cover removal” on page 273](#).
- 3 Remove the right cover. See [“Right cover removal” on page 272](#).

- 4 Remove the screw (A), disconnect the cable (B), and then remove the sensor.

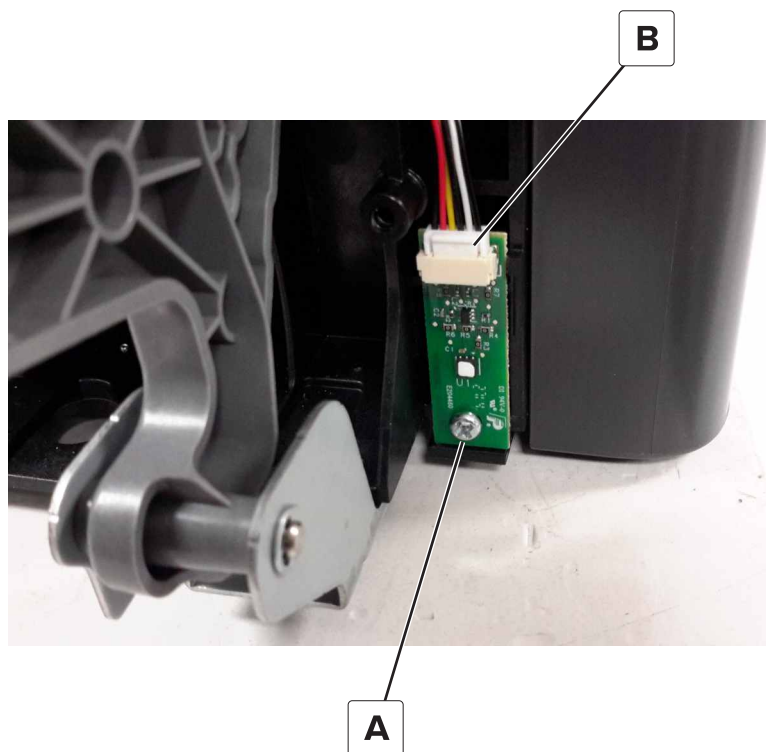

Sensor (paper size) removal

- 1 Remove the waste toner bottle.
- 2 Remove the motor cover. See [“Motor cover removal” on page 273](#).
- 3 Remove the right cover. See [“Right cover removal” on page 272](#).
- 4 Remove the three screws (A).

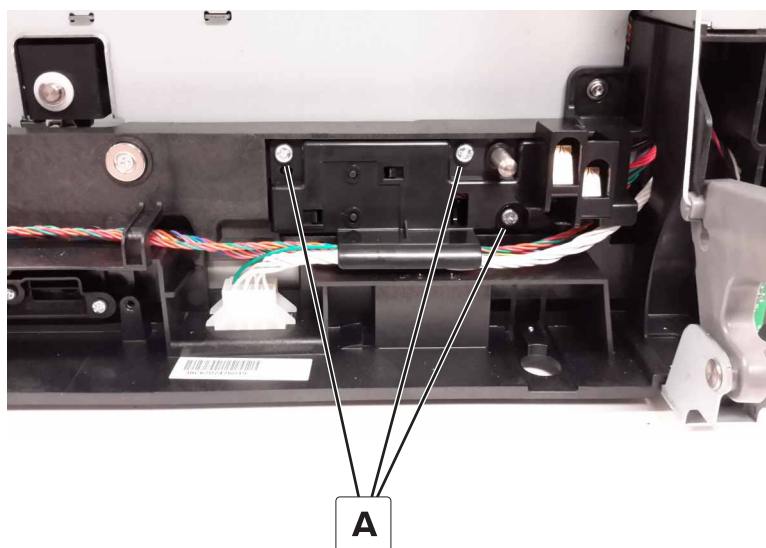

5 Pull the mounting assembly away from the printer.

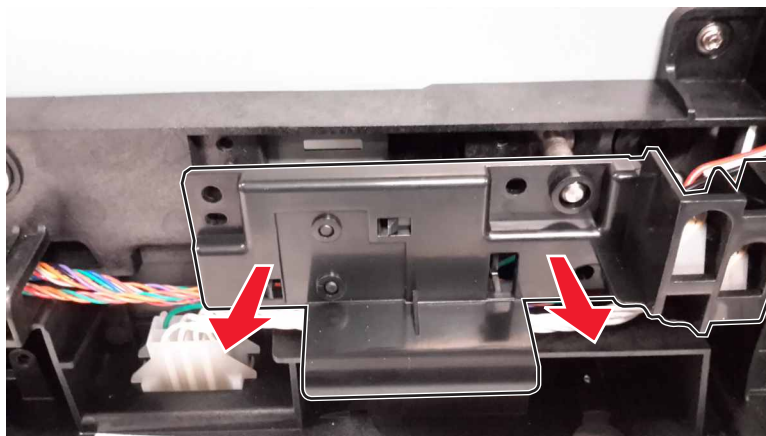

6 Disconnect the sensor cable (B).

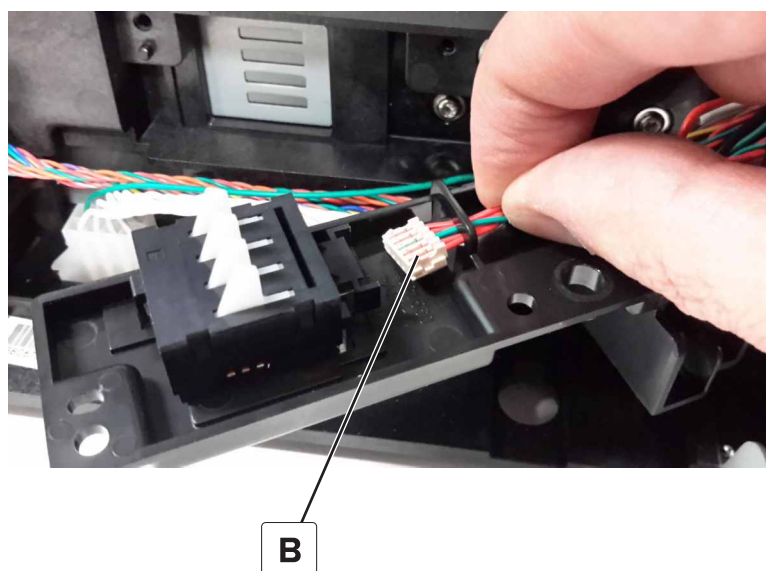

- 7 Release the two tabs (C) from the mounting assembly, and then remove the sensor.

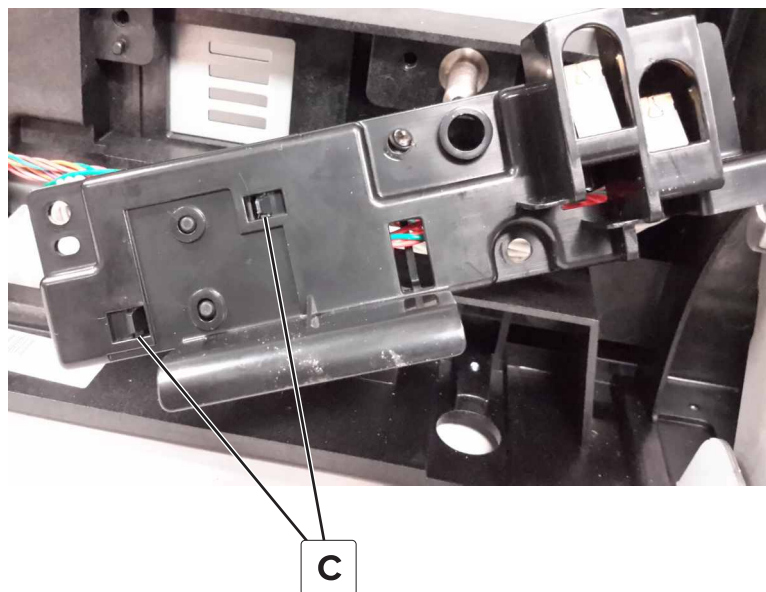

Sensor (waste toner contact) removal

- 1 Remove the waste toner bottle.
- 2 Remove the motor cover. See [“Motor cover removal” on page 273.](#)
- 3 Remove the sensor (paper size). See [“Sensor \(paper size\) removal” on page 312.](#)
- 4 Disconnect the waste toner bottle contact cable (A) from the controller board.



- 5 Route the cable through the printer, and then remove the sensor contact assembly.

TMC card removal

- 1 Remove the imaging unit.
- 2 Remove the two screws (A) securing the TMC cover.



A

- 3 Disconnect the cable (B), and then remove the TMC card from the cover.

B

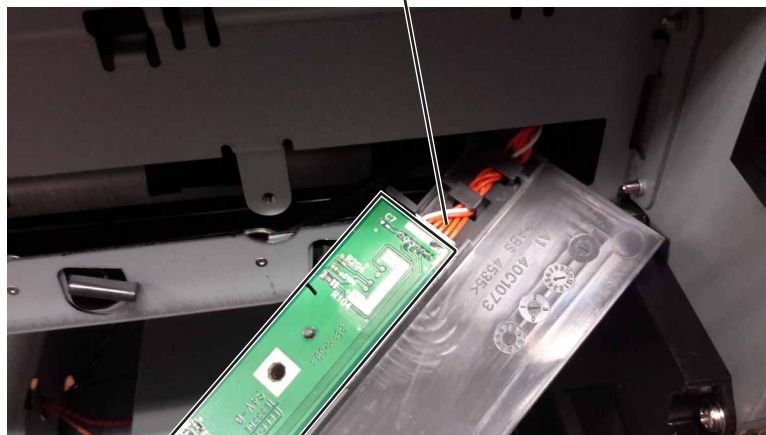

Motor (duplex/MPF) removal

- 1 Remove the right cover. See [“Right cover removal” on page 272.](#)
- 2 Remove the motor cover. See [“Motor cover removal” on page 273.](#)

3 Disconnect the motor cable (A).

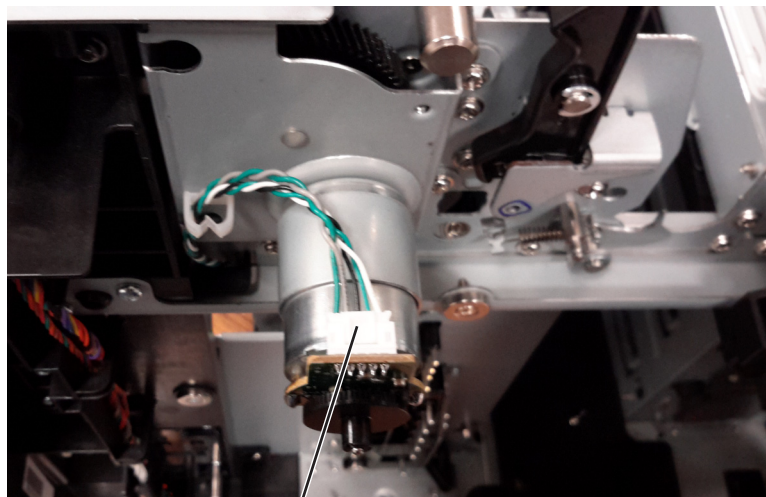

A

4 Remove the four screws (B), and then remove the motor.

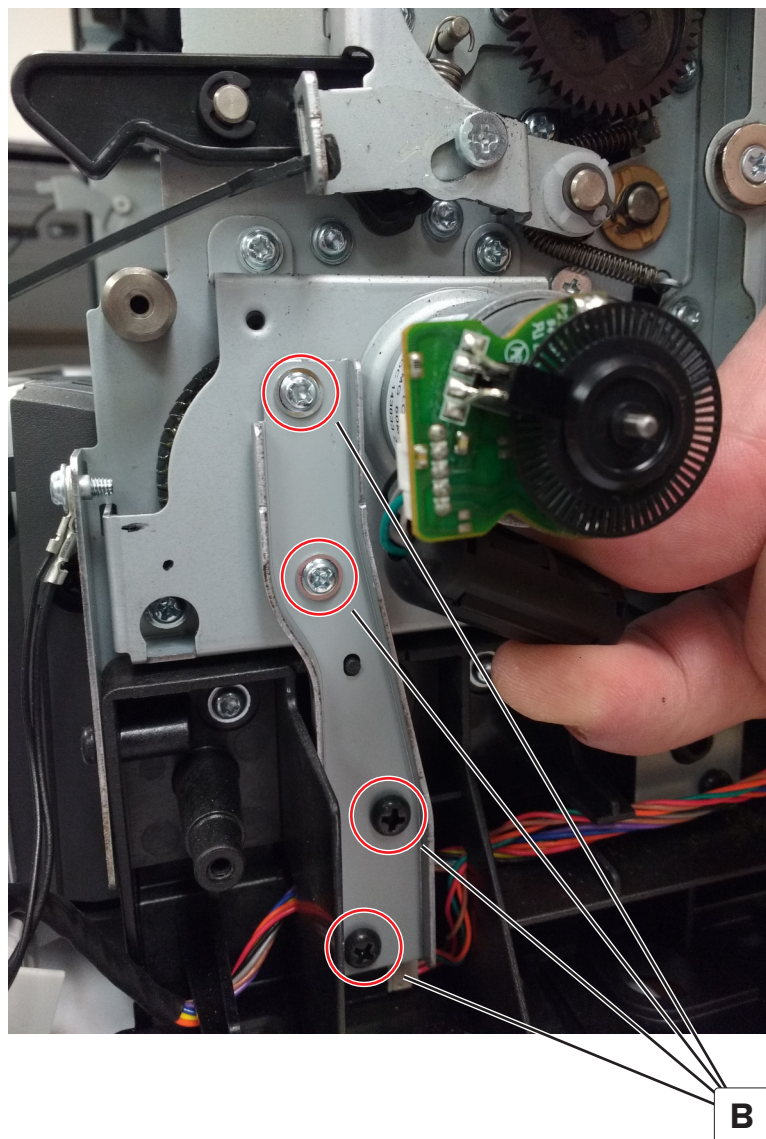

Repair information

317

Motor (fuser) removal

- 1 Remove the motor cover. See [“Motor cover removal” on page 273.](#)
- 2 Disconnect the motor cable (A).

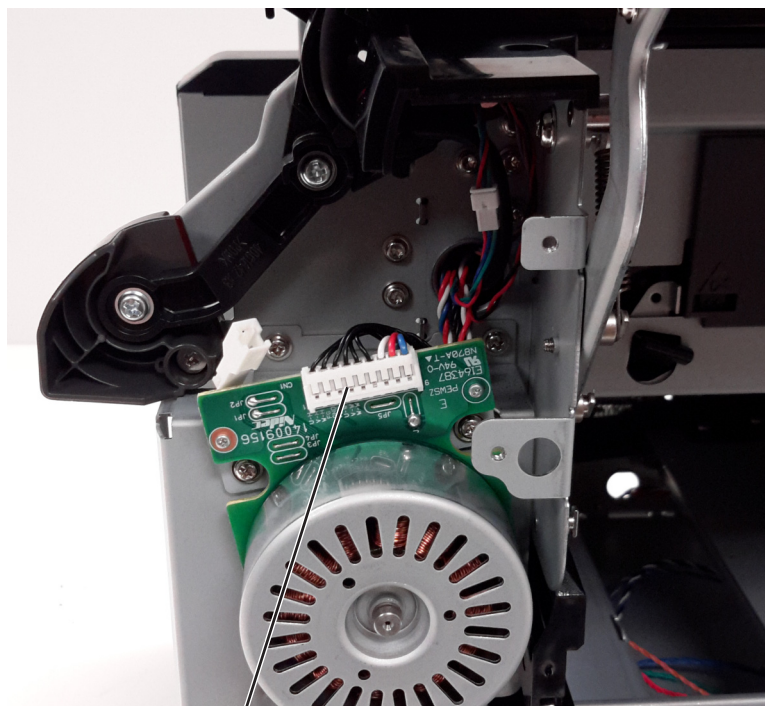

A

- 3 Remove the four screws (B), and then remove the motor.

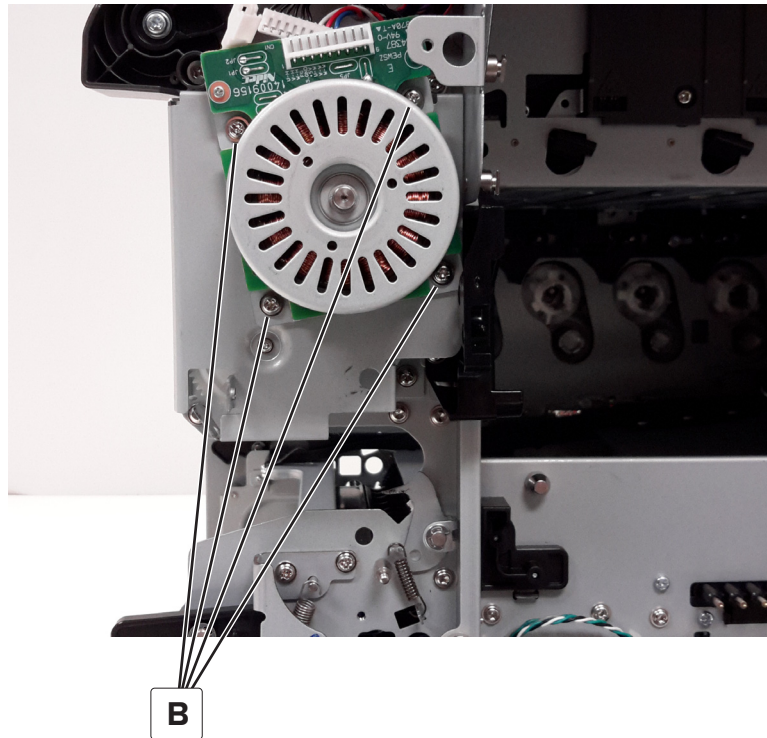

HVPS removal

- 1 Remove the transfer module. See [“Transfer module removal” on page 334.](#)
- 2 Remove the controller board. See [“Controller board removal” on page 357.](#)
- 3 Remove the retainer (A).



4 Disconnect the cable (B).



B

5 Remove the screw (C) securing the HVPS.

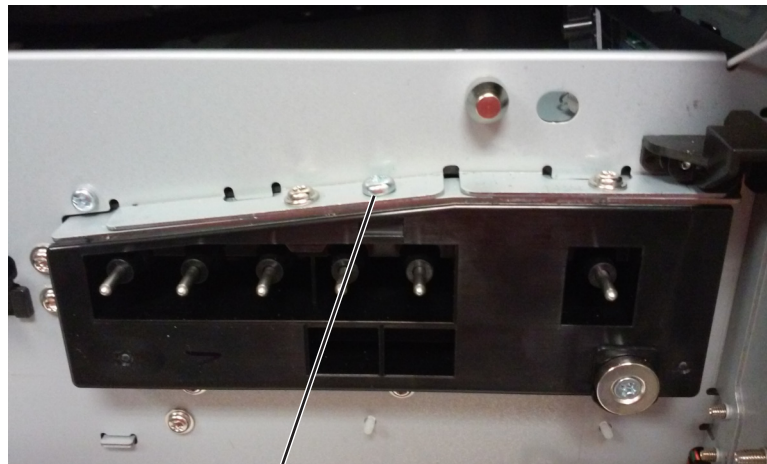

C

6 Press the three toner contacts (D) from inside the printer, and then remove the power supply.

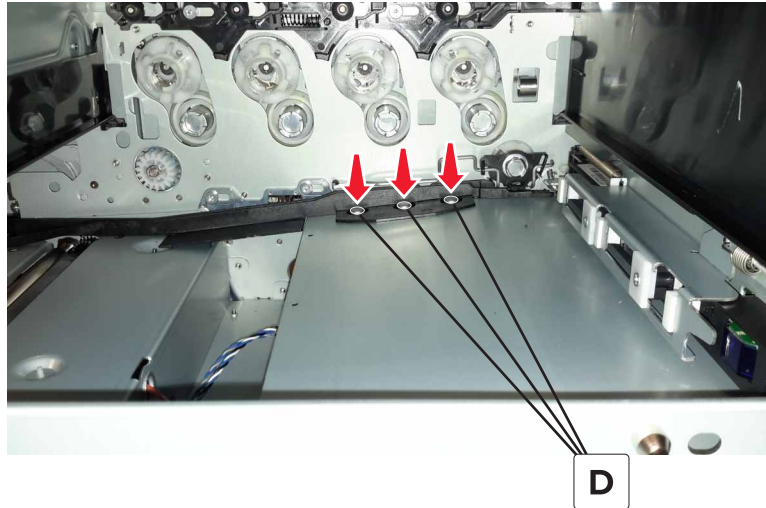

Installation notes:

- Make sure that the transfer module guide rail does not block the three toner contacts.
- Make sure that the three toner contacts freely move and are fully extended.

- Make sure that the index pin (A) behind the transfer module retract arm is properly aligned.

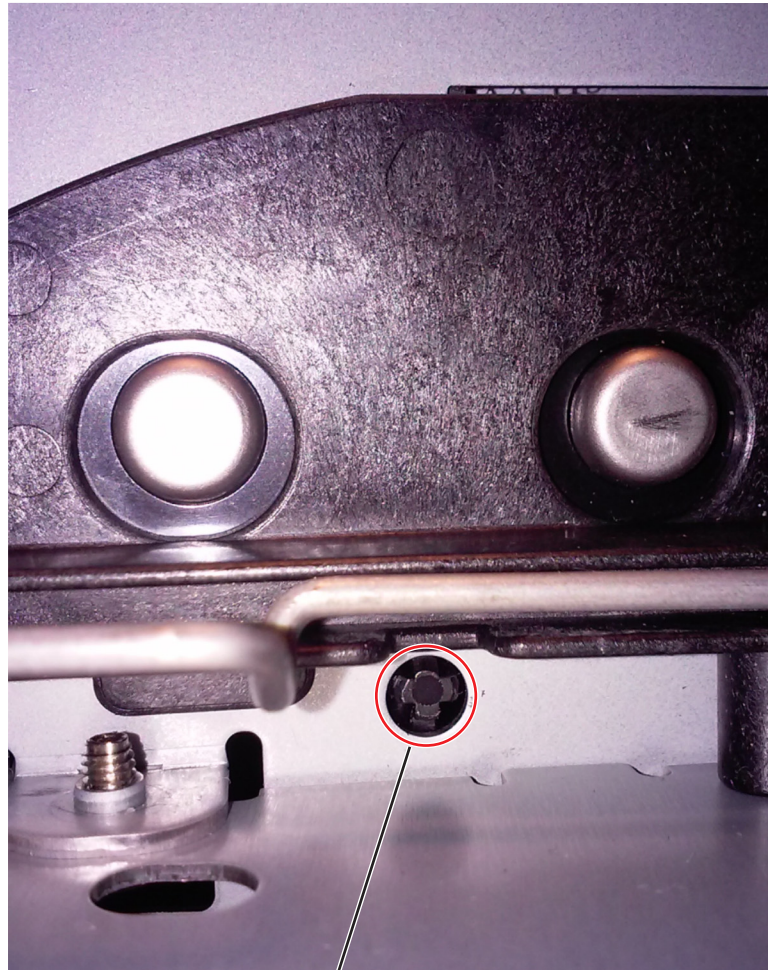

D

Sensor (MPF paper present) removal

- 1 Remove the waste toner bottle.
- 2 Remove the motor cover. See [“Motor cover removal” on page 273.](#)
- 3 Remove the right cover. See [“Right cover removal” on page 272.](#)

- 4 Pull the sensor (MPF paper present) and cable out of the printer.

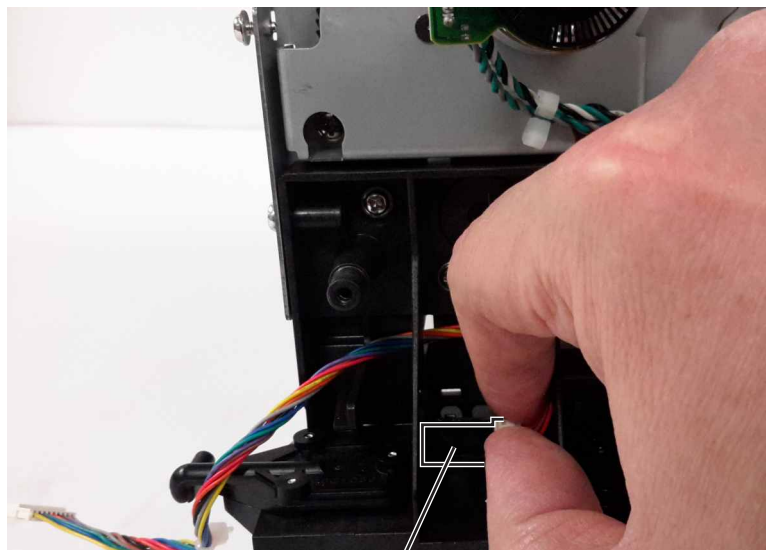

A

- 5 Disconnect the sensor cable (A), and then remove the sensor.

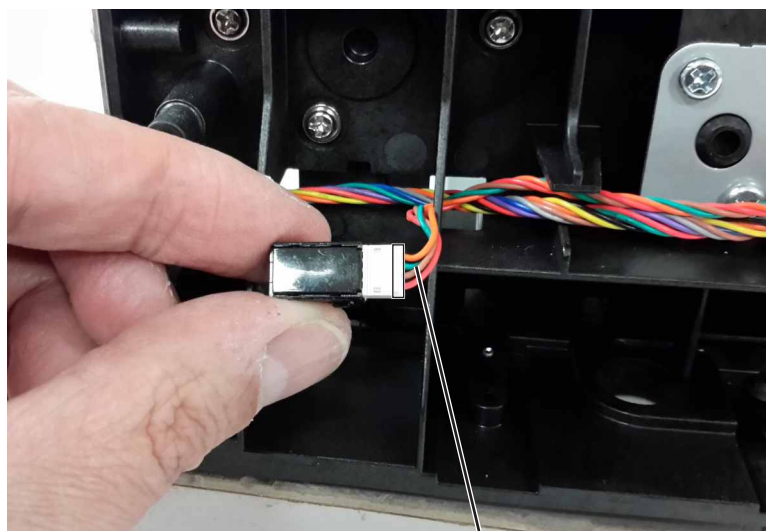

B

Waste toner bottle idler gear removal

- 1 Remove the waste toner bottle.
- 2 Remove the gear.

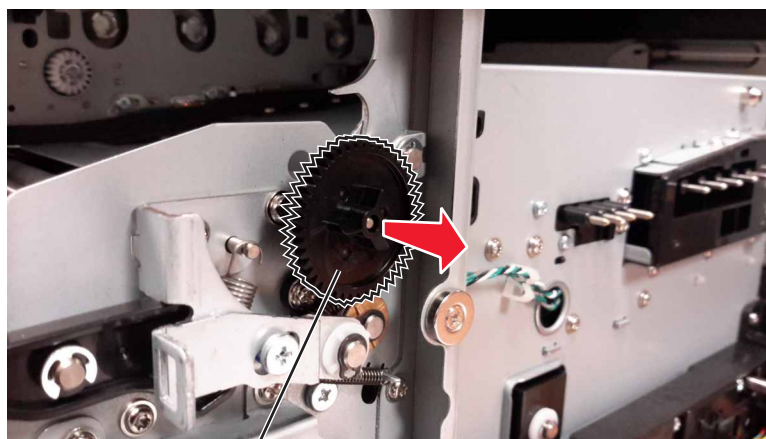

A

Imaging unit cover removal

- 1 Remove the waste toner bottle.
- 2 Remove the motor cover. See [“Motor cover removal” on page 273](#).
- 3 Remove the right cover. See [“Right cover removal” on page 272](#).
- 4 Remove the four screws (A).

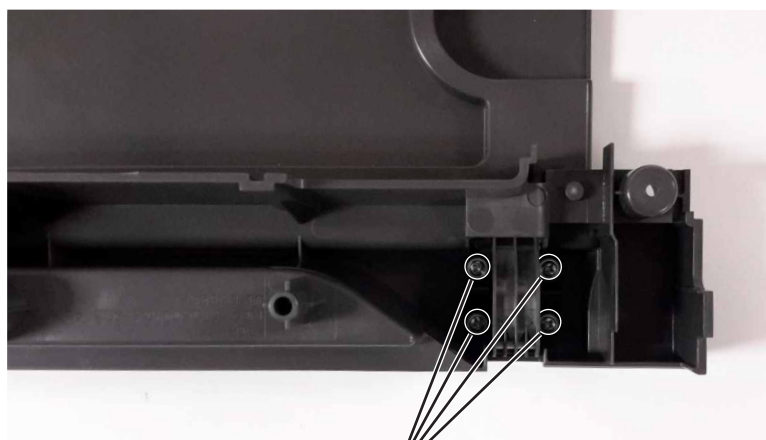

A

- 5 Remove the two waste toner bottle stops (B), and then remove the toner door from the right cover assembly.

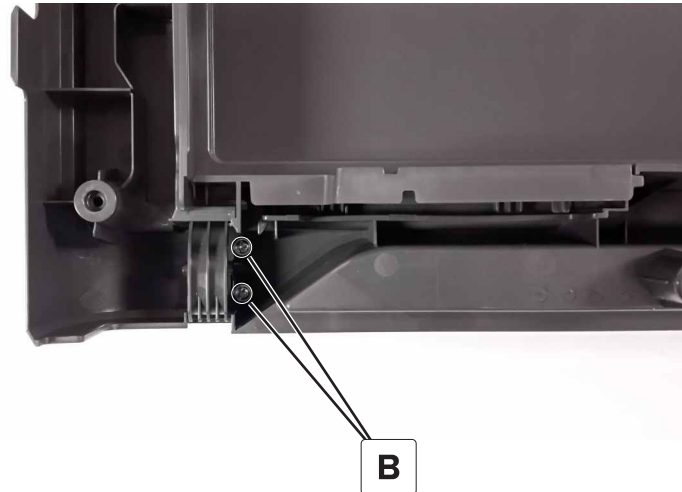

Sensor (TPS) removal

- 1 Remove the controller board shield. See [“Controller board shield removal” on page 356.](#)
- 2 Remove the inner controller board shield. See [“Inner controller board shield removal” on page 357.](#)
- 3 Remove the TPS sled. See [“TPS sled removal” on page 327.](#)
- 4 Disconnect the thermistor cable (A) from the controller board.

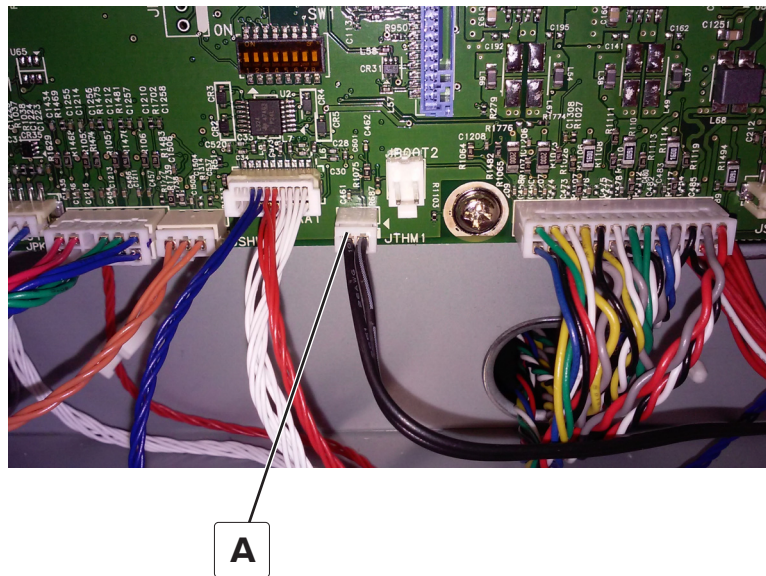

- 5 Remove the two screws (B).

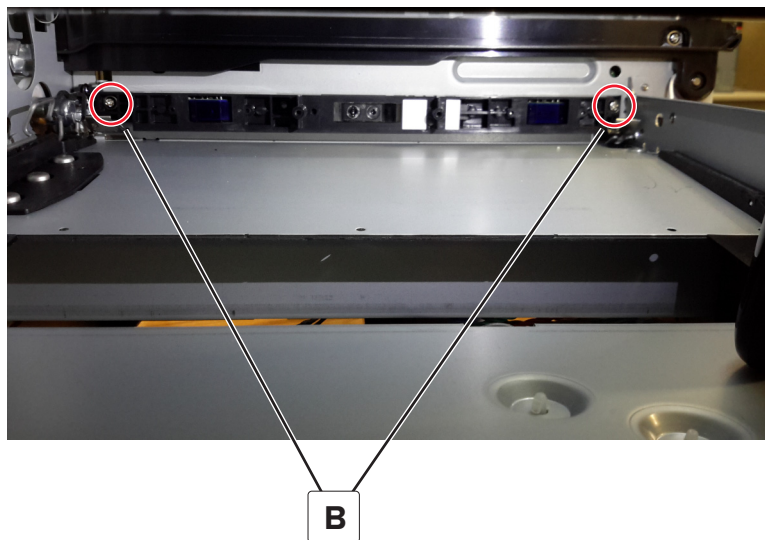

- 6 Carefully pull the sensor while guiding the black thermistor cable through the hole at the rear of the printer.

- 7 Disconnect the three cables (C) from the sensor.

Warning—Potential Damage: Press the tab on the white cable while disconnecting it to avoid damage.

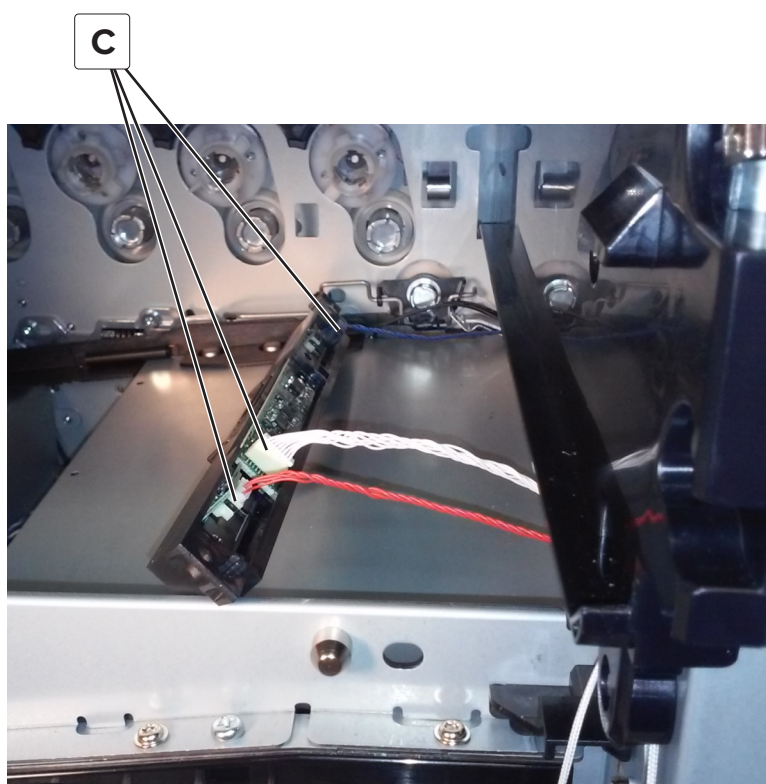

Installation notes:

- a** After routing the thermistor cable through the hole at the rear of the printer, make sure that the sensor is placed behind the transfer module retract mechanism to avoid interference with the transfer module retract.

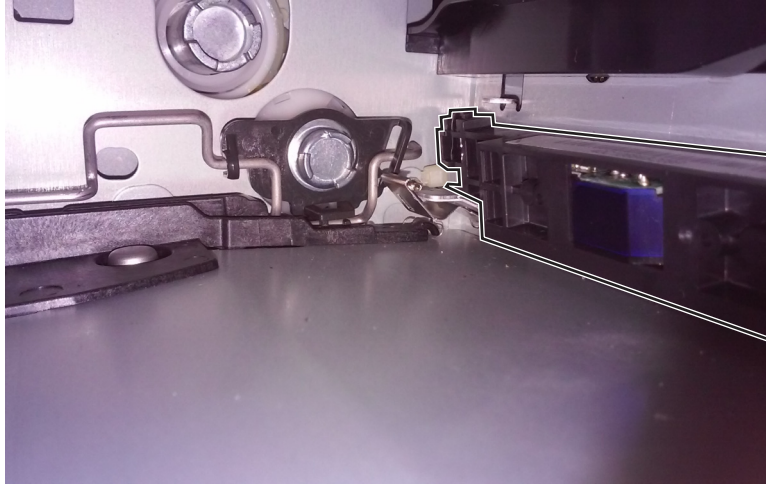

- b** After installing the sensor to the printer, restart the printer to test the cable connections to the sensor. A **128.xx** error indicates a bad connection at the sensor.
- c** Perform the TPS sensor characterization.
Enter the Diagnostics menu, and then navigate to:
Printer Diagnostics > Printer Setup > EP setup > Toner patch sensor adjust > Sensor Gain Characterization
- d** Perform the TPS sensor calibration.
Enter the Diagnostics menu, and then navigate to:
Printer Diagnostics > Printer Setup > EP setup > Toner patch sensor adjust > Full Calibration

TPS sled removal

Note: This is not a FRU.

- 1** Remove the interlocks (A).

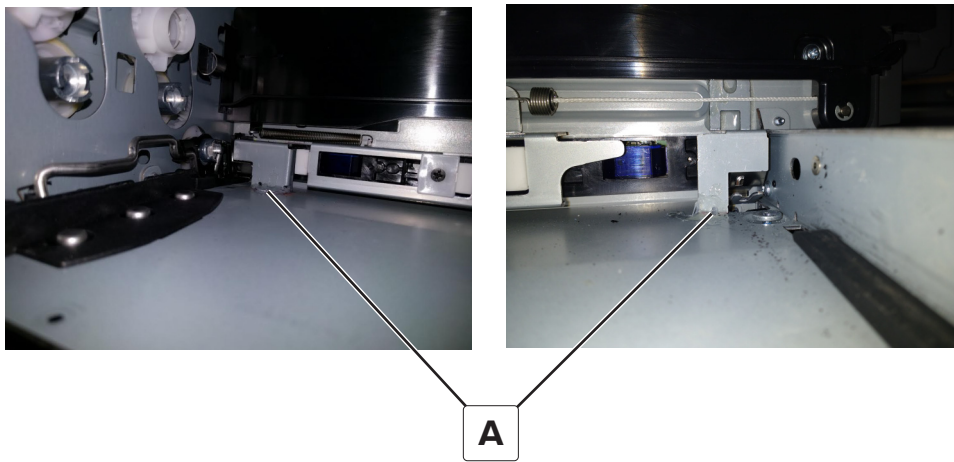

- 2** Disconnect the two springs (B) from the TPS sled.

- 3 Remove the two screws (C), and then remove the sled.

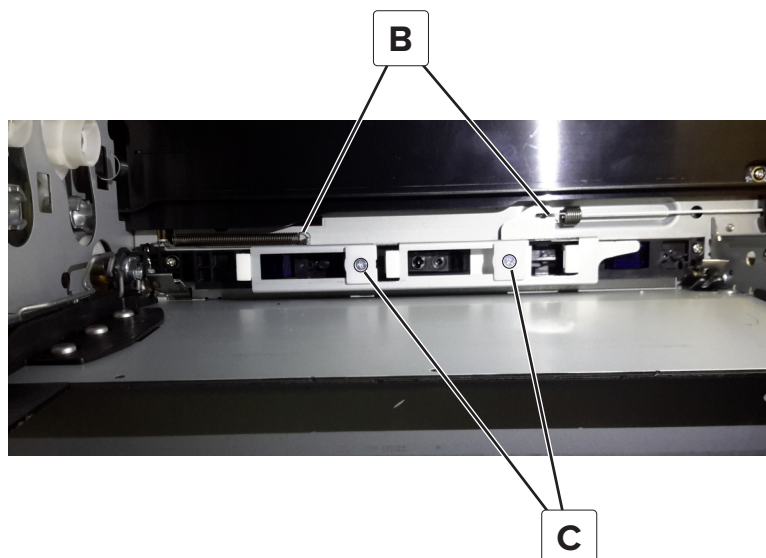

Toner cartridge contacts removal

- 1 Remove the imaging unit.
- 2 Remove the controller board shield. See [“Controller board shield removal” on page 356.](#)
- 3 Disconnect the toner cartridge contacts cable (A) from the controller board.

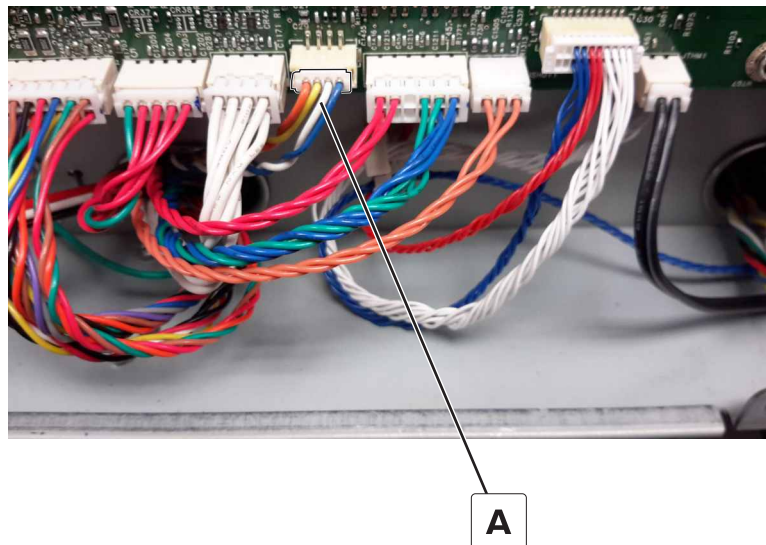

- 4 Remove the screw (B), and then push the tab (C) to the right.

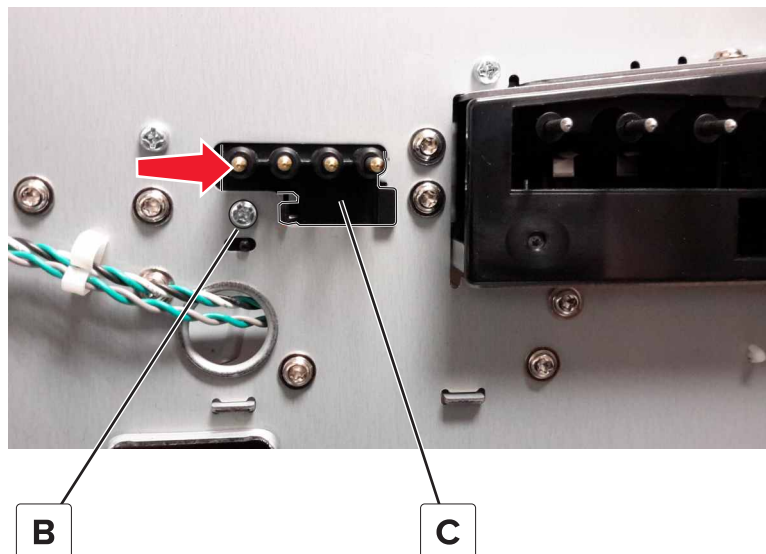

- 5 Push the cartridge contacts assembly into the printer.



- 6 Remove the cable from the retainer clips, and then remove the cartridge contacts.



TPS wiper mechanism removal

- 1 Remove the waste toner bottle.
- 2 Remove the motor cover. See [“Motor cover removal” on page 273](#).
- 3 Remove the right cover. See [“Right cover removal” on page 272](#).
- 4 Remove the three screws (A).

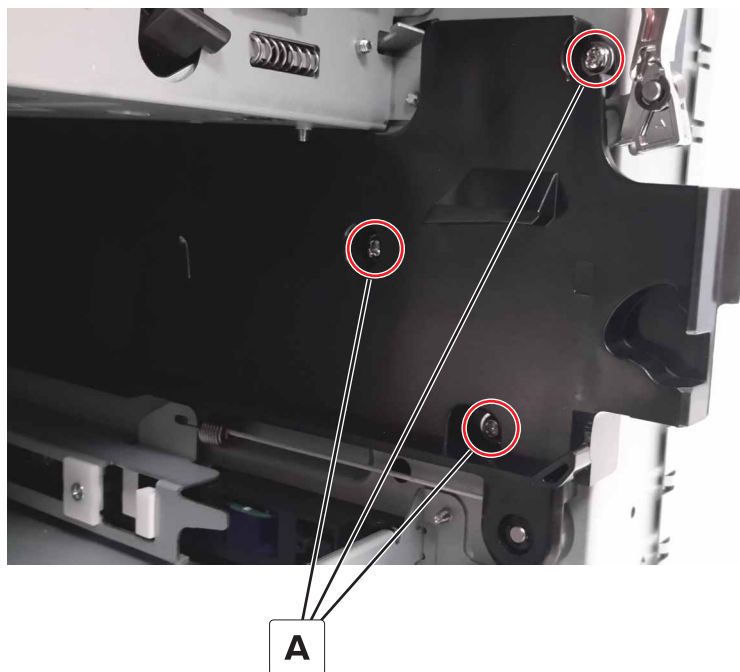

5 Unhook the spring (B) from the sled, and then remove the cord (C) from the pulley.

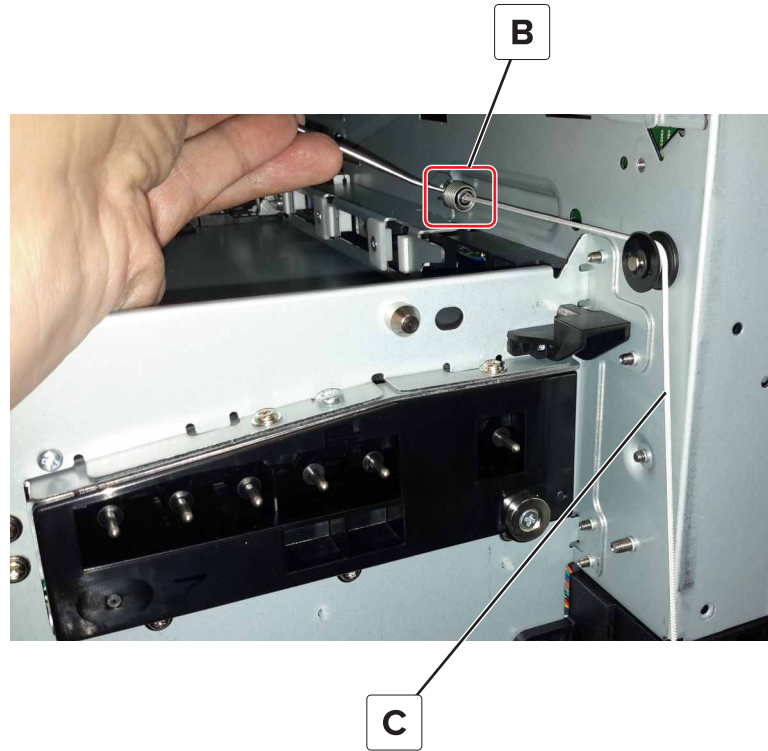

6 Remove the clip (D).

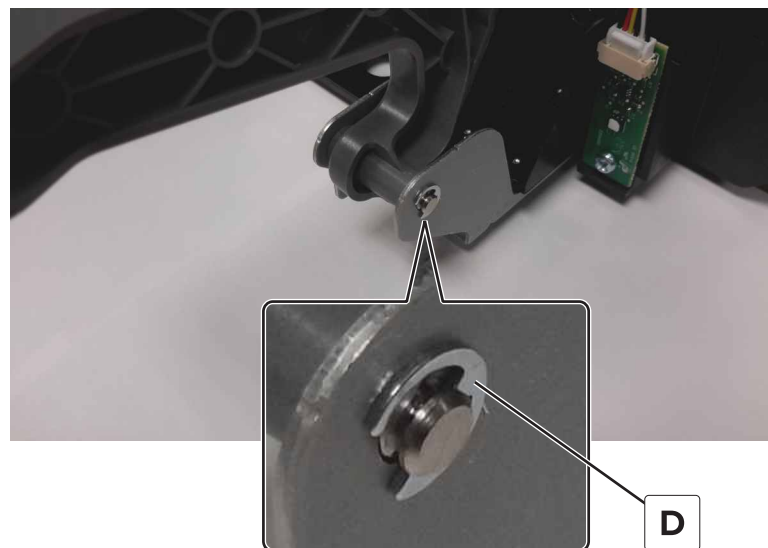

- 7 Slide the shaft out, and then remove the TPS wiper.

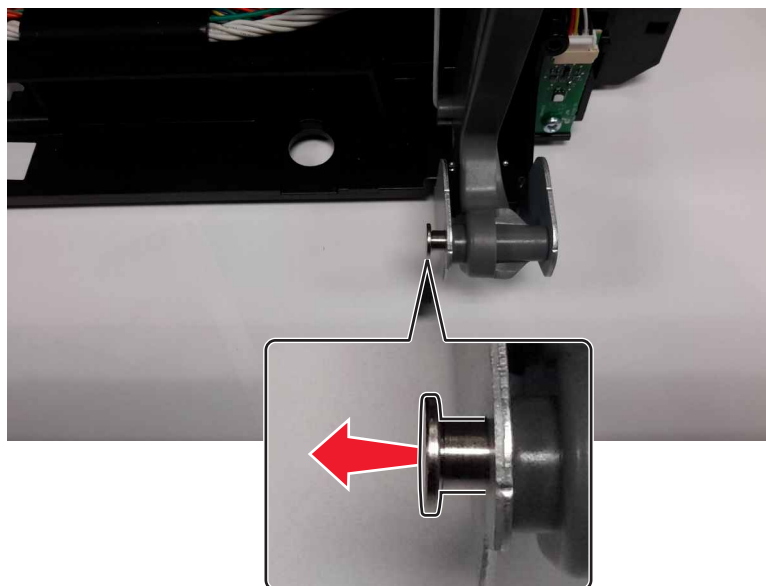

TPS wiper removal

- 1 Remove the TPS sled. See [“TPS sled removal” on page 327](#).
- 2 Remove the three wipers (A) from the sled.

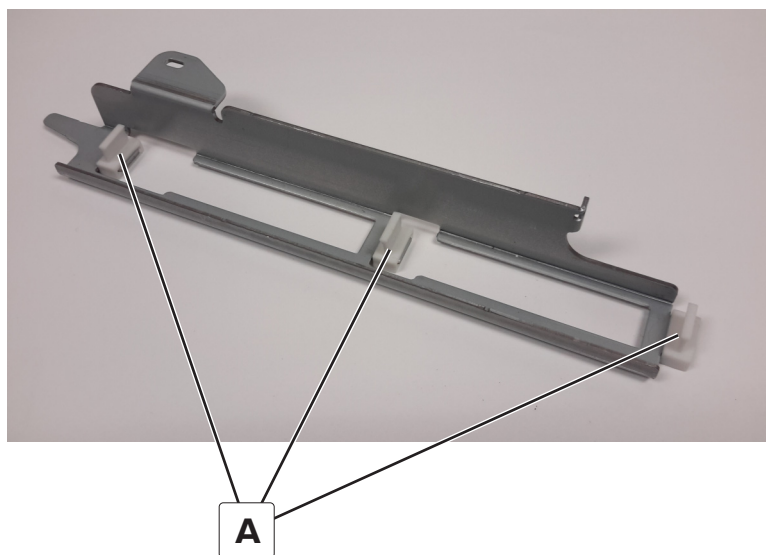

Front removals

Fuser removal

- 1 Open the front cover.
- 2 Raise the redrive guide.

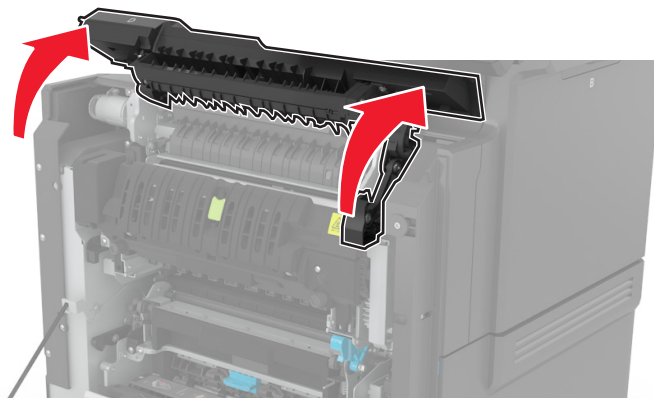

- 3 Turn the fuser lock counterclockwise.

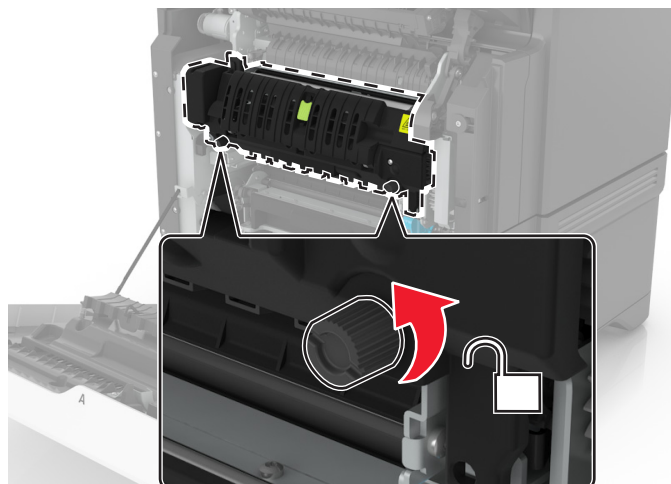

- 4 Remove the fuser.

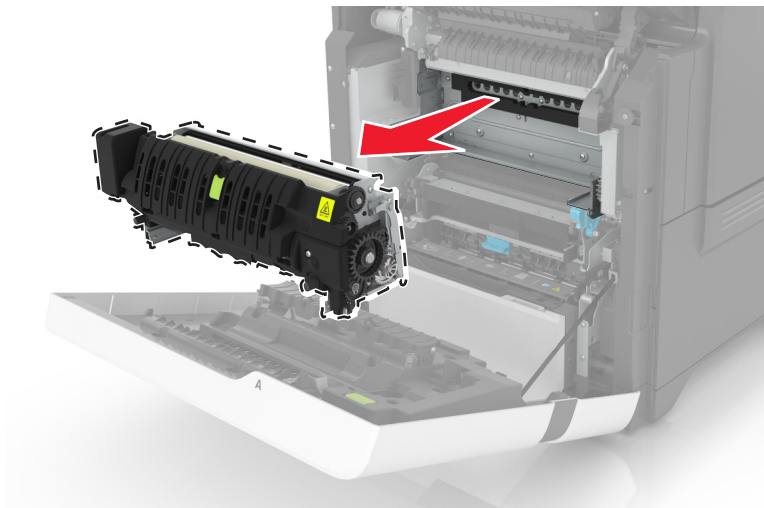

Transfer module removal

- 1 Open the toner door.
- 2 Open the imaging unit cover.
- 3 Remove the waste toner bottle.
- 4 Unlock the transfer module.

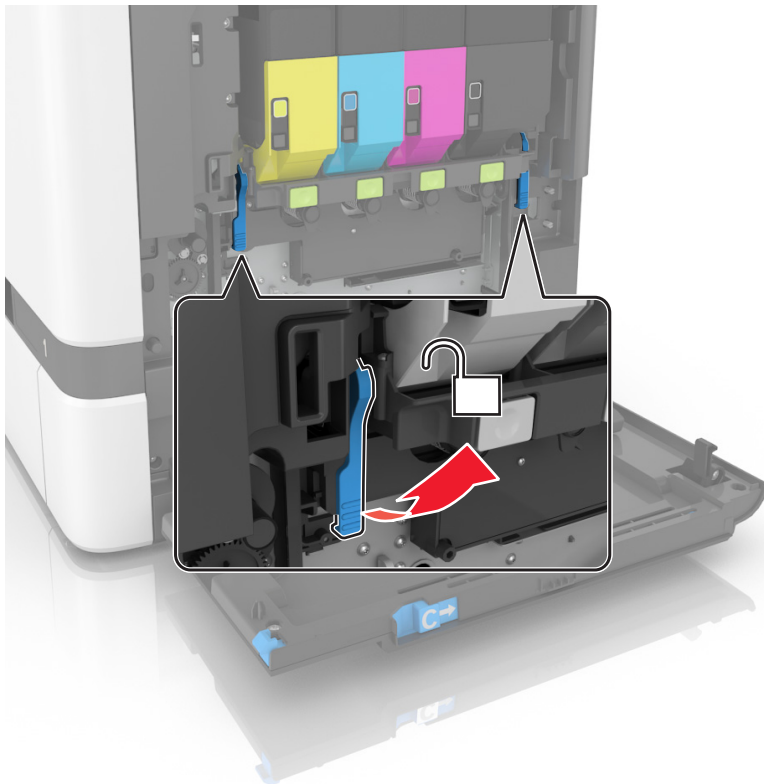

5 Remove the imaging kit.

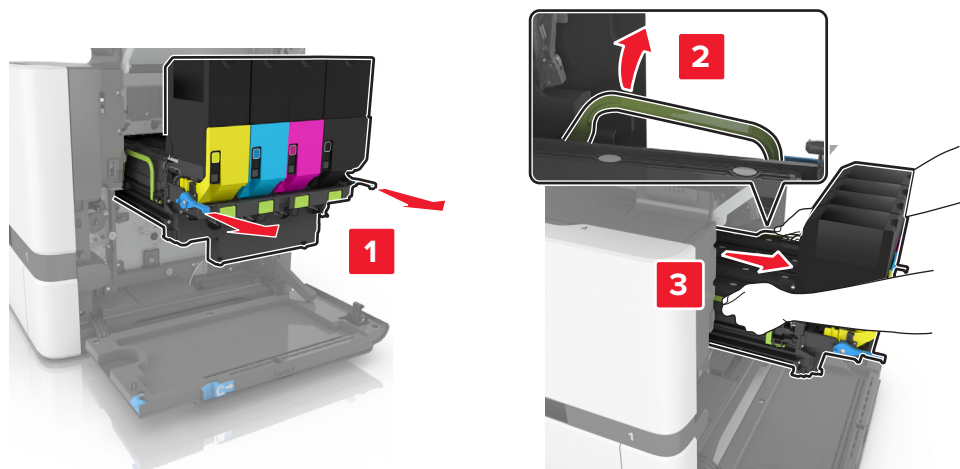

6 Open the front cover.

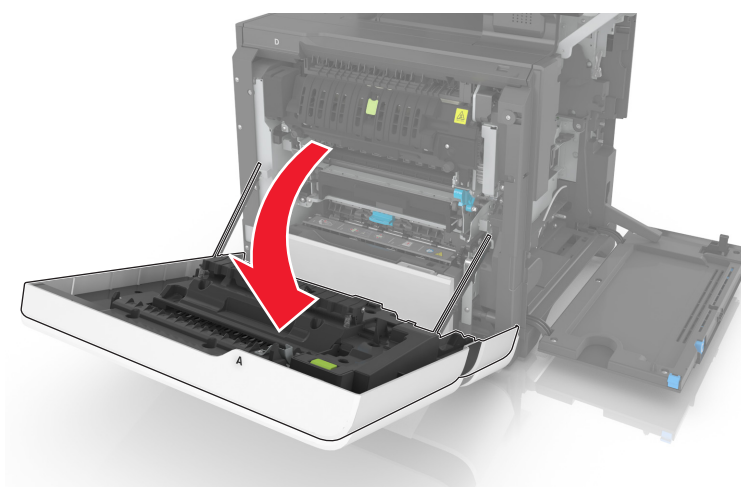

7 Remove the transfer module.

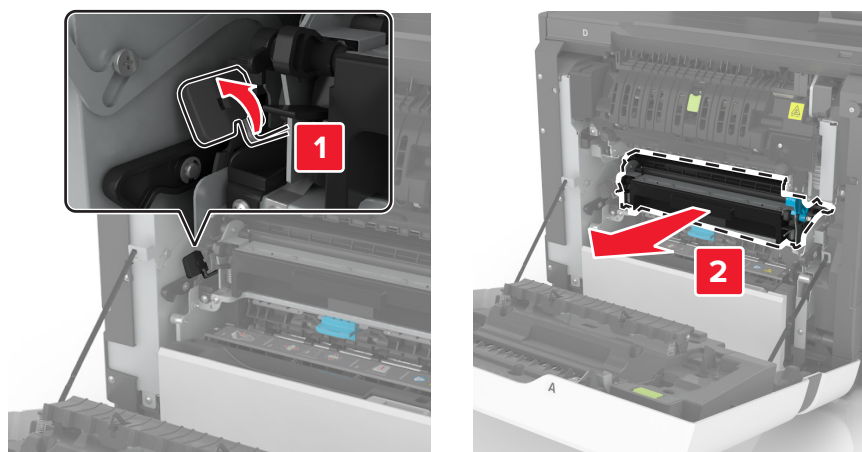

Transfer module guide rail removal

- 1 Remove the left cover. See [“Left cover removal” on page 271.](#)
- 2 Remove the LVPS. See [“LVPS removal” on page 305.](#)
- 3 Remove the screw (A).

**A**

- 4 Remove the LVPS cage. See [“LVPS cage removal” on page 308.](#)
- 5 Remove the EP gear box. See [“EP gear box removal” on page 302.](#)
- 6 Remove the two screws (B).

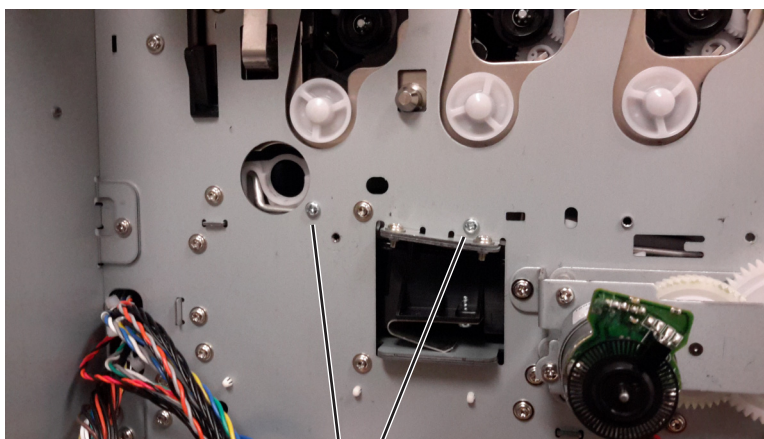
**B**

7 Remove the two screws (C), to release the ITU ground spring.

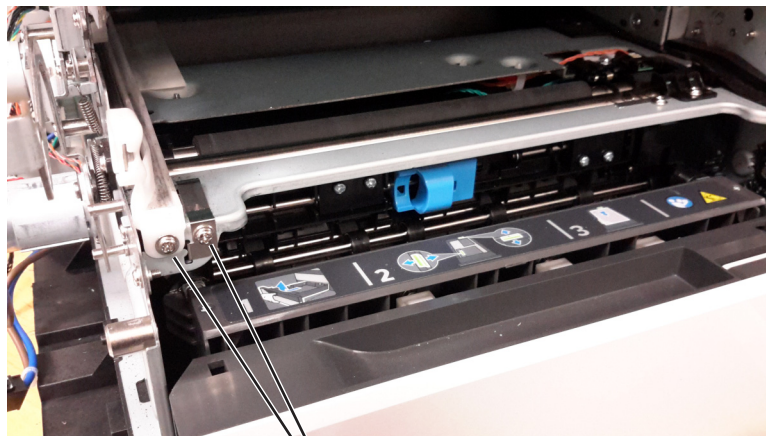

C

8 Lift the rail, and then move it slightly to the right.

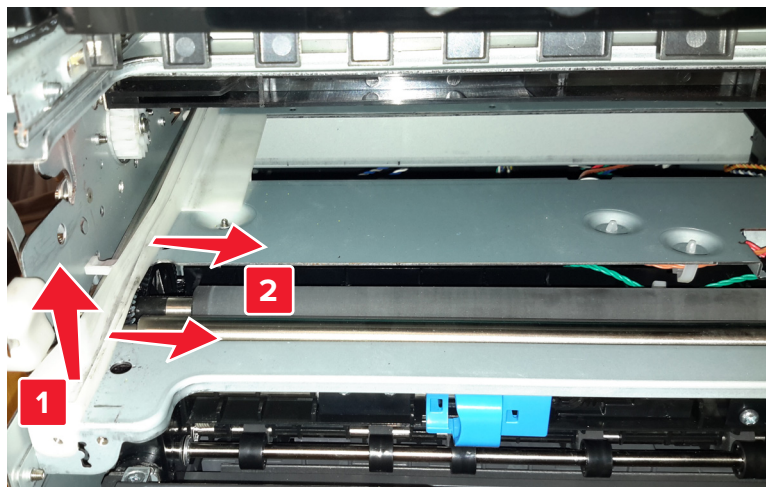

- 9 Gently twist the rail to release the two tabs (D) from the frame, and then remove it.

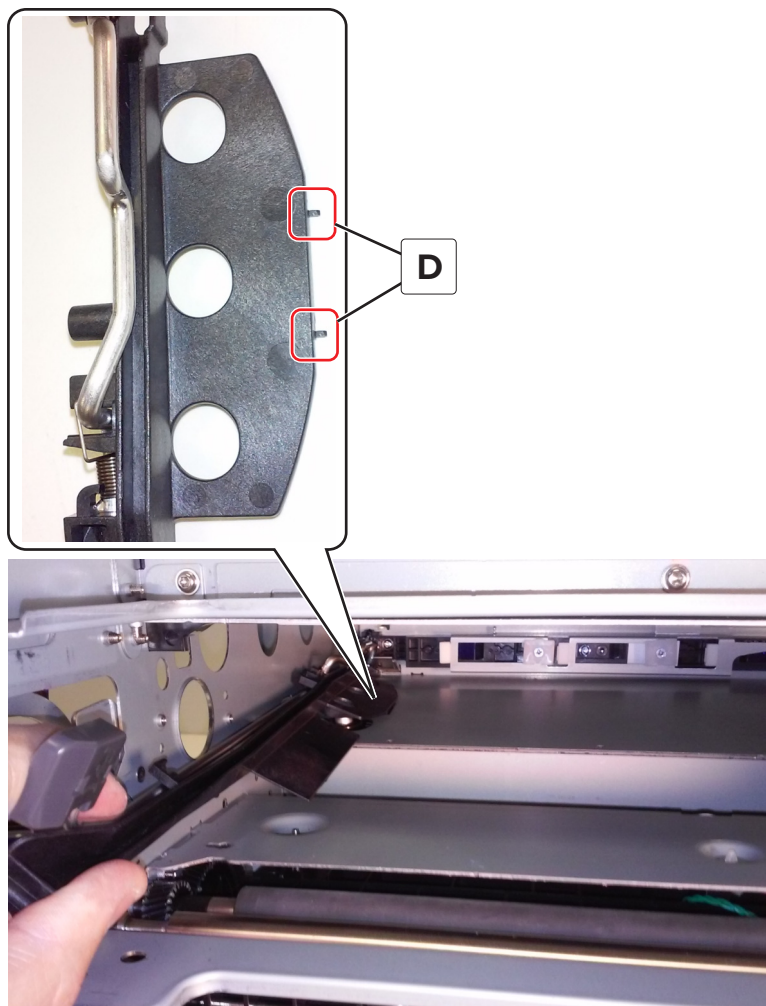

Installation notes:

- a Make sure that ITM dog bone retract (A) and the spring (B) on the new rail are securely attached.



A

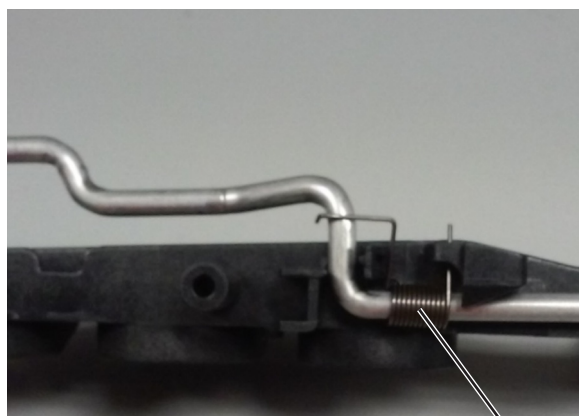

B

- b** When reinstalling the EP gear box, carefully insert the ITM drive shaft through the left side of the frame and rail to avoid damaging the ITM dog bone retract.
- c** Make sure that the tabs (C) are properly inserted into the frame.

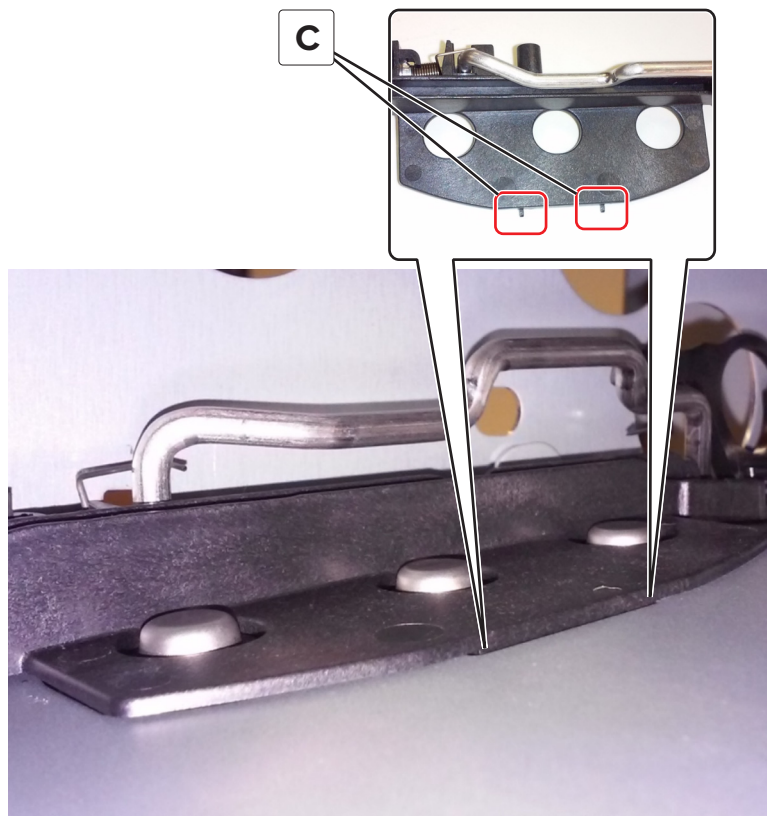

- d** Make sure to place the rail below the thermistor wire tie (D).

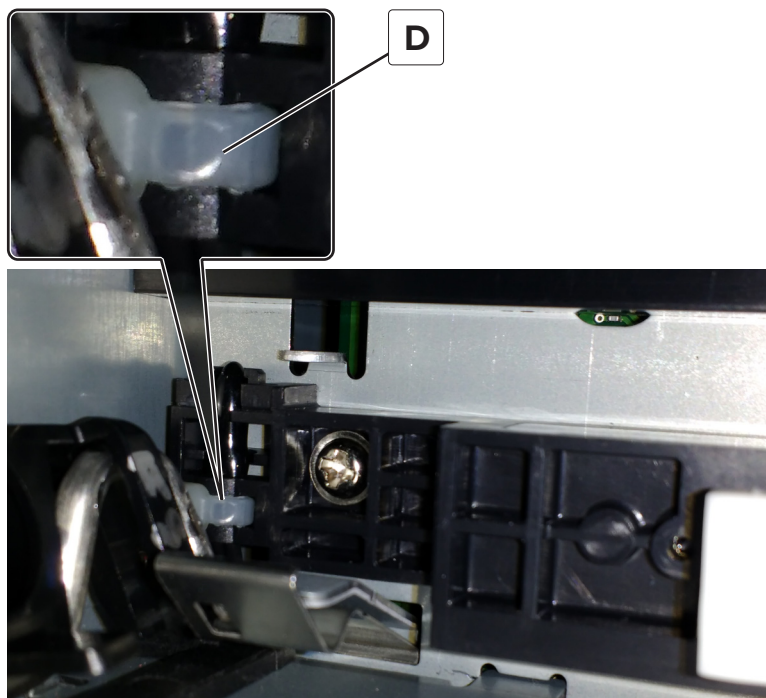

- e Make sure that the three HVPS contacts (E) move freely and are fully extended.

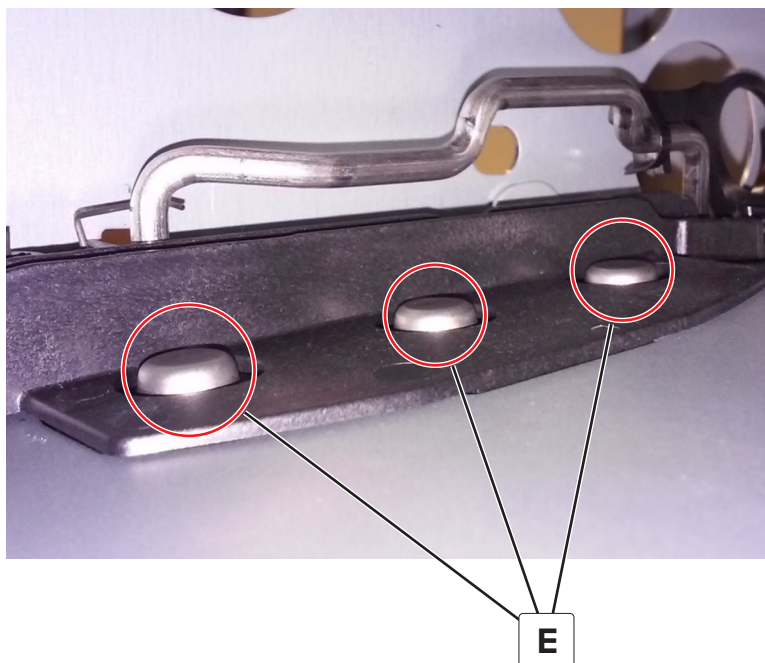

Sensor (media type) removal

- 1 Remove the transfer module. See [“Transfer module removal” on page 334](#).
- 2 Open the front door.
- 3 Remove the screw (A).

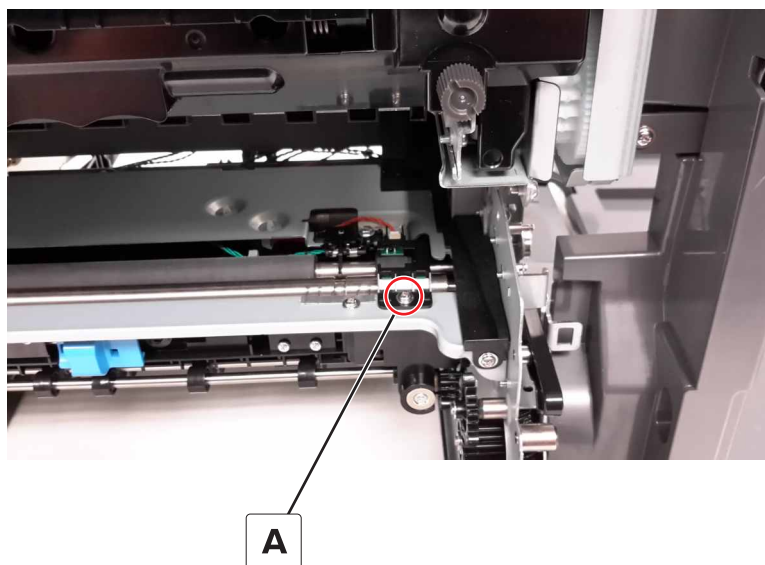

- 4 Disconnect the sensor cable (B), and then remove the sensor.

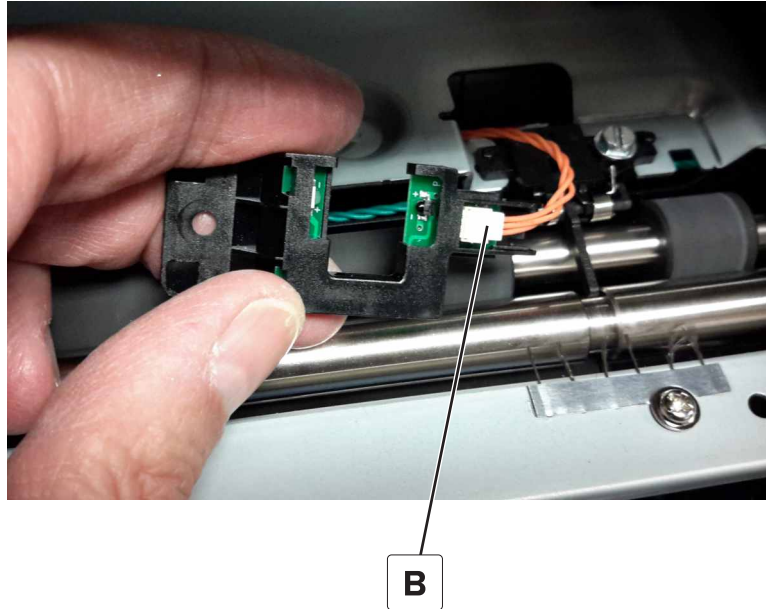

Sensor (input) removal

- 1 Remove the transfer module. See [“Transfer module removal” on page 334.](#)
- 2 Open the front door.
- 3 Remove the sensor (media type). See [“Sensor \(media type\) removal” on page 340.](#)
- 4 Remove the screw (A).

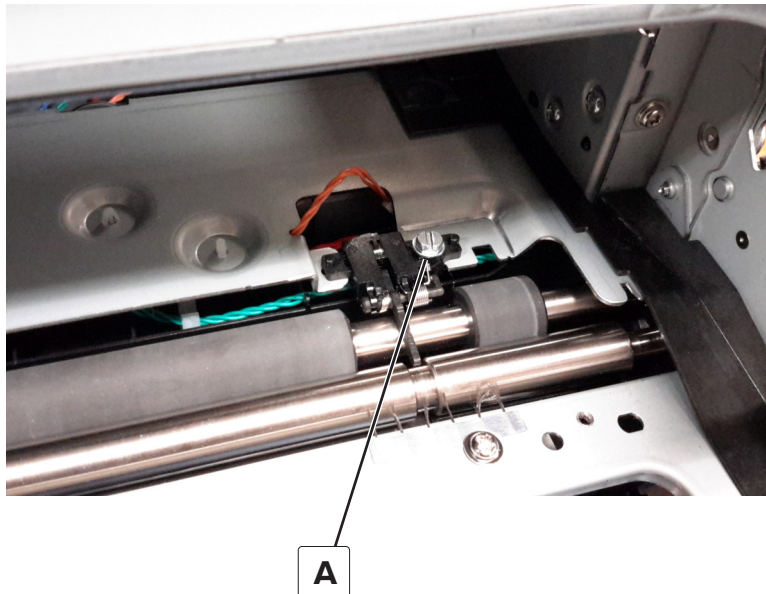

- 5 Disconnect the sensor cable (B), and then remove the sensor.

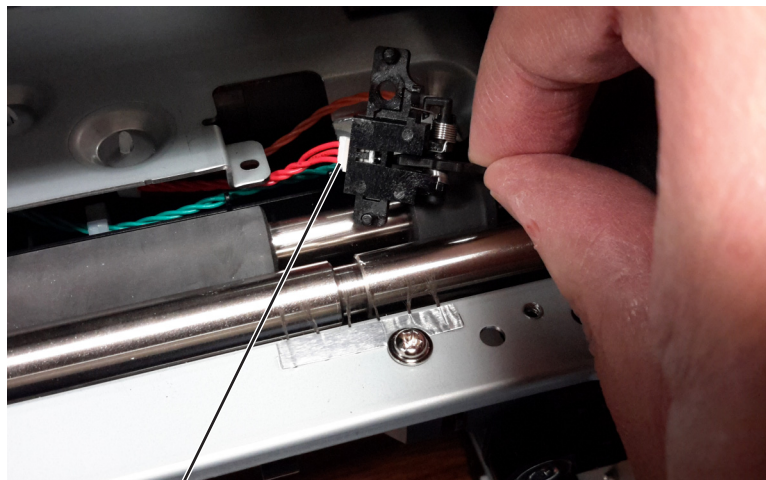
**B**

Deskew rollers removal

- 1 Open the front door.
- 2 Remove the right cover. See [“Right cover removal” on page 272.](#)
- 3 Remove the left cover. See [“Left cover removal” on page 271.](#)
- 4 Remove the LVPS. See [“LVPS removal” on page 305.](#)
- 5 Remove the sensor (media type). See [“Sensor \(media type\) removal” on page 340.](#)
- 6 Remove the sensor (input). See [“Sensor \(input\) removal” on page 341.](#)

7 On the right side of the printer, remove the gear (A), and then remove the screw (B).

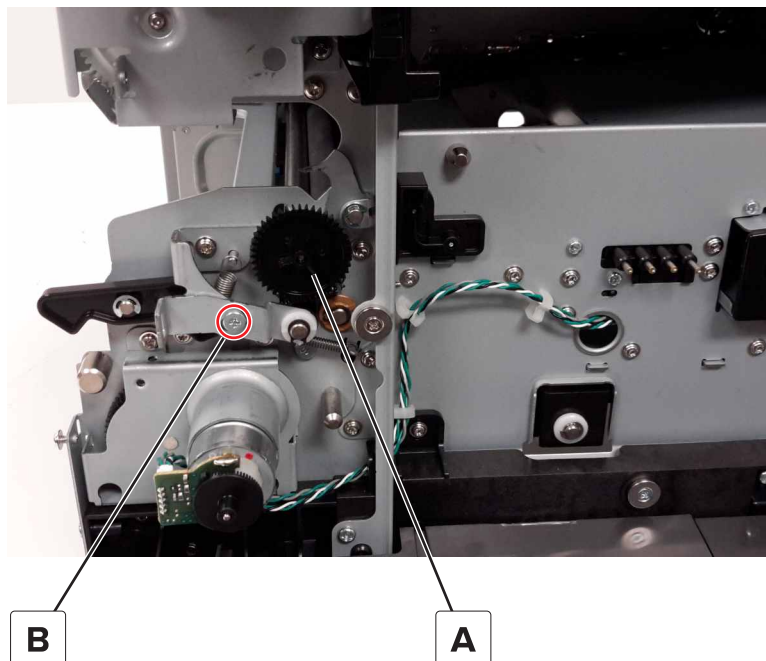

8 Remove the clip (C), and then remove the spacer.

Warning—Potential Damage: Be careful not to over extend the clip when removing or installing to avoid damage.

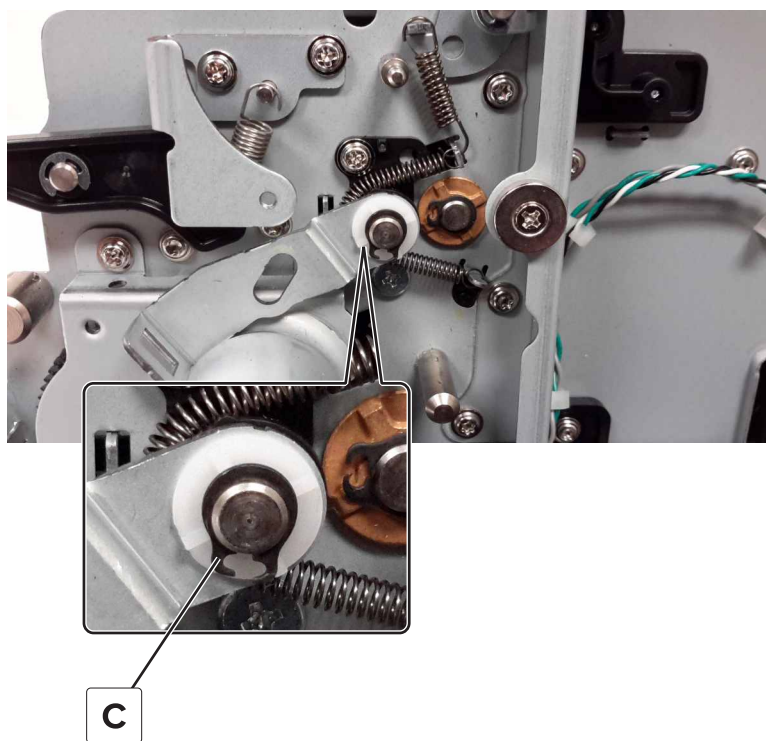

9 Remove the bracket (D), and then unhook the spring (E).

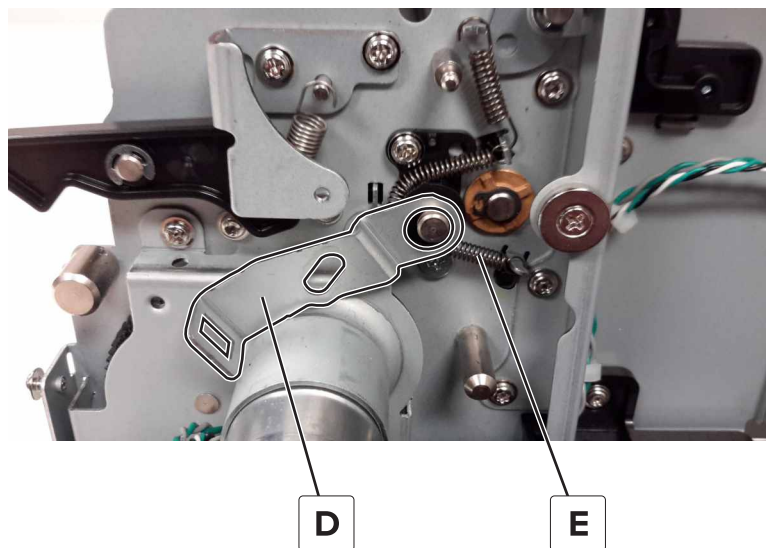

10 Remove the spacer (F).

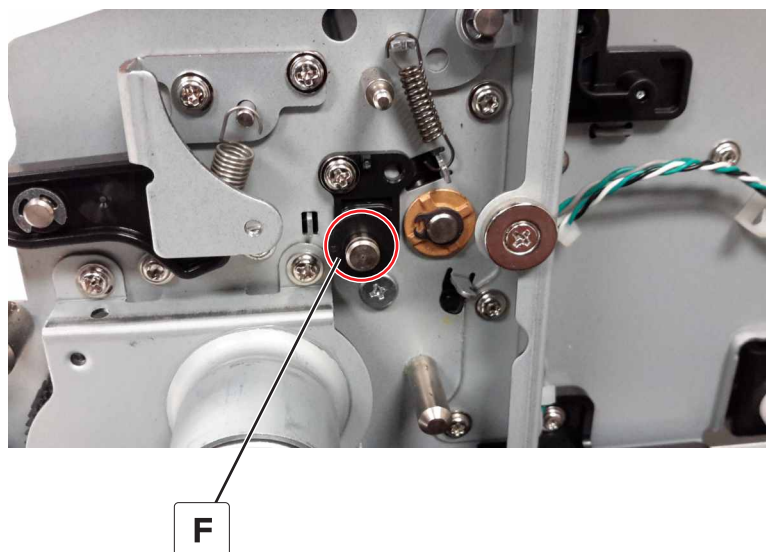

- 11 Remove the screw (G), and then remove the guide (H).

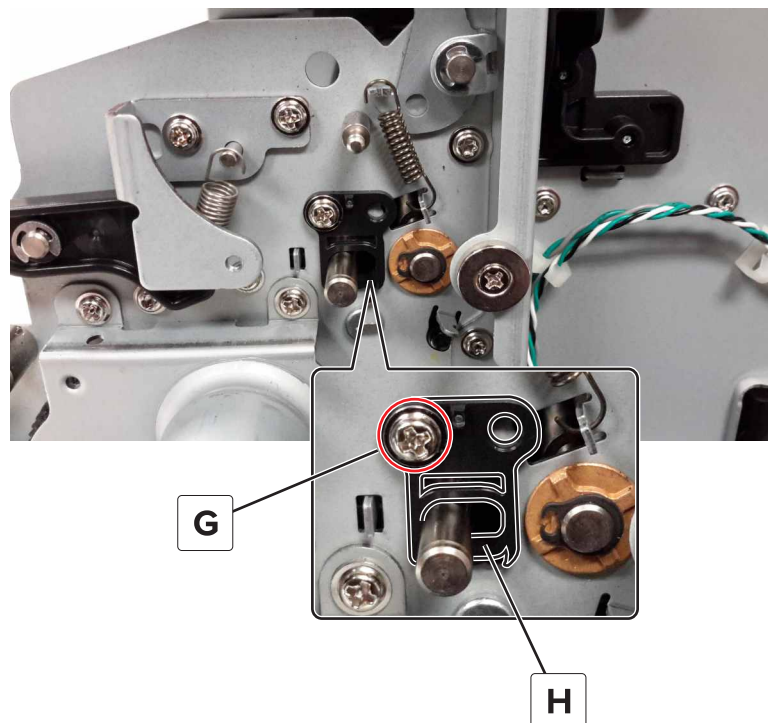

- 12 Remove the clip (J), and then remove the bushing.

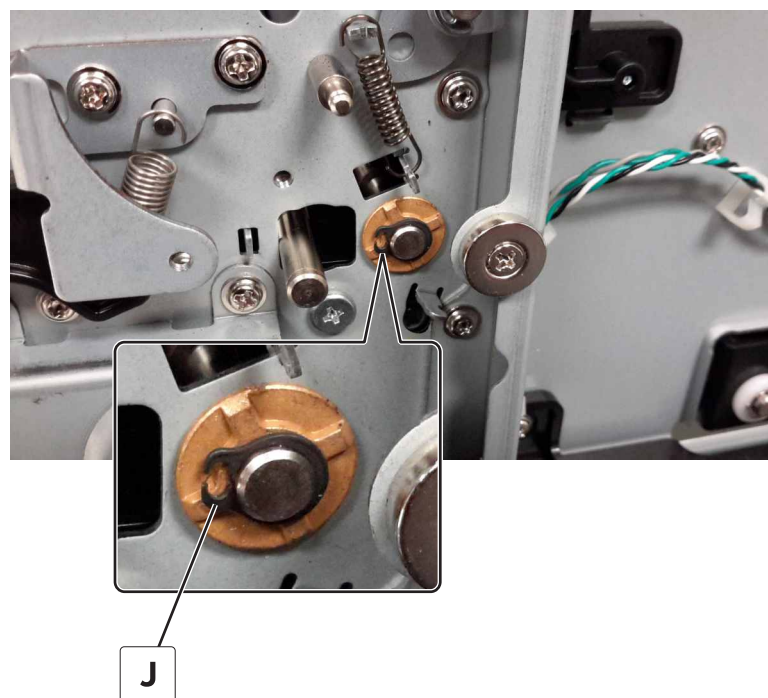

- 13 On the left side of the printer, remove the three screws (K), and then remove the plate (L) from inside the LVPS cage.

 **CAUTION—SHOCK HAZARD:** To avoid the risk of electrical shock, make sure to replace the plate.

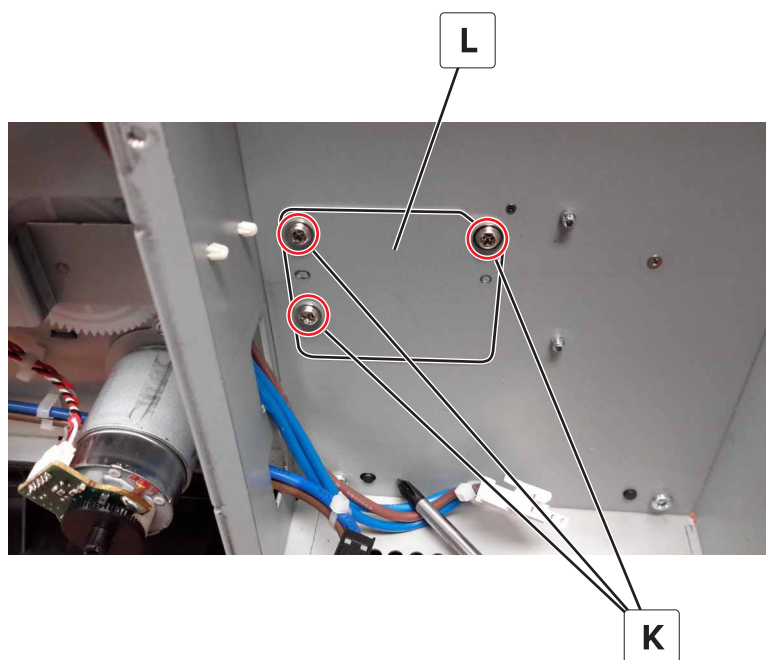

14 Remove the clip (M), and then remove the spacer.

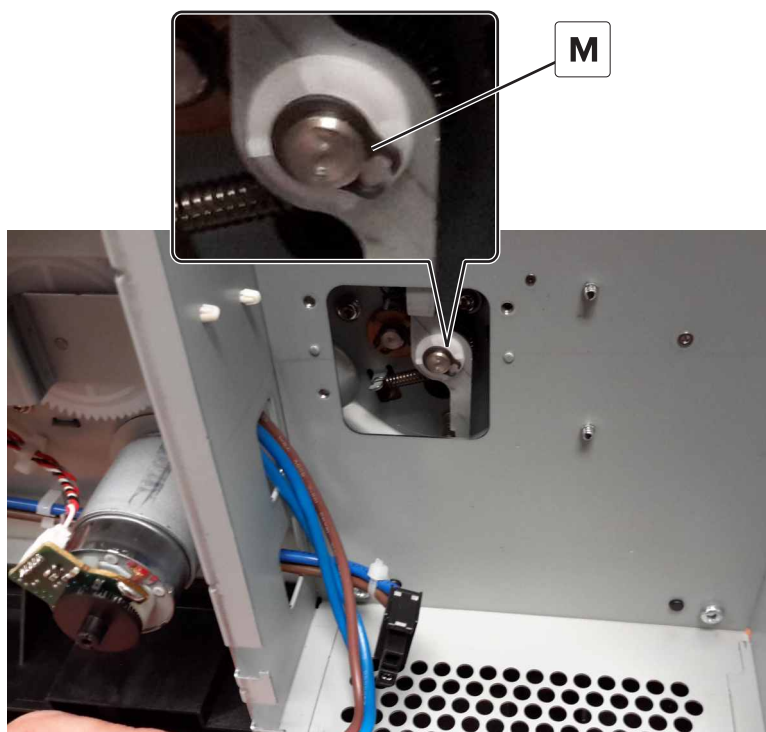

15 Remove the screw (N) securing the nip release arm.



N

16 Remove the spring (P), and then remove the spacer (Q).

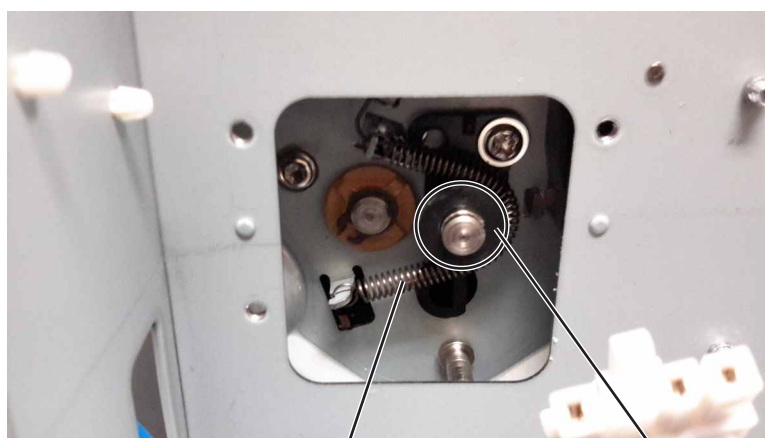

P

Q

17 Remove the screw (R), and then remove the guide (S).

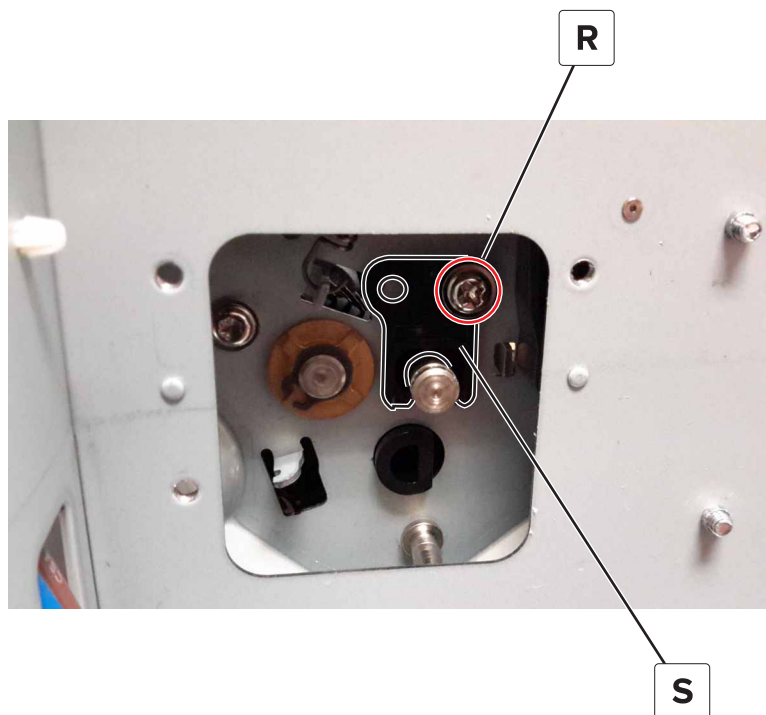

18 Remove the clip (T), and then remove the bushing.

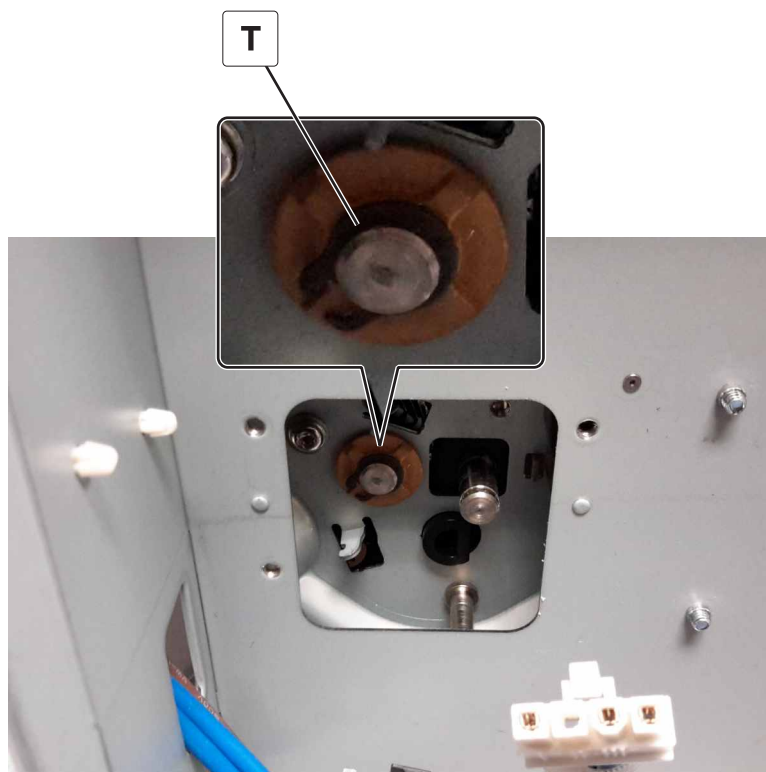

19 Slide the front deskew roller to the right to remove.

Note: Be careful not to drop or lose the washer on the left side of the shaft.

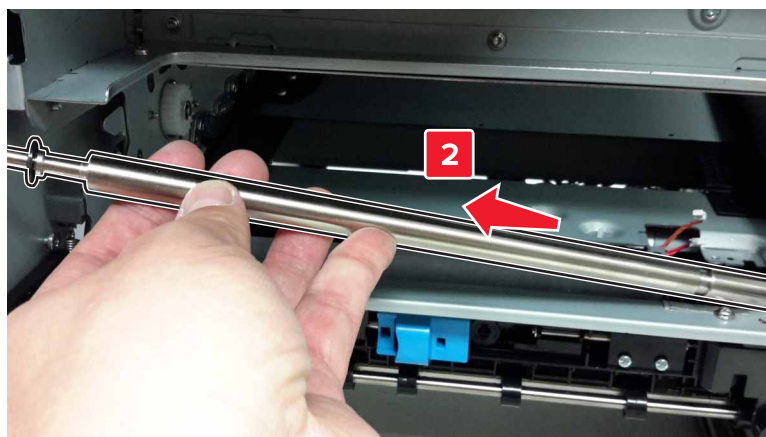
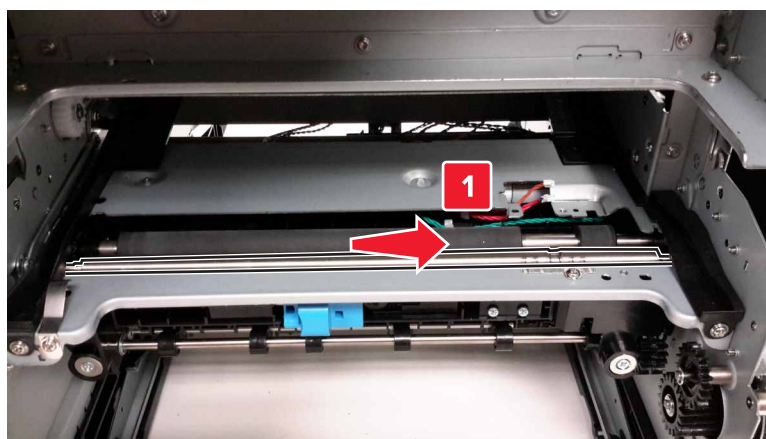

20 Slide the rear deskew roller to the right to remove.

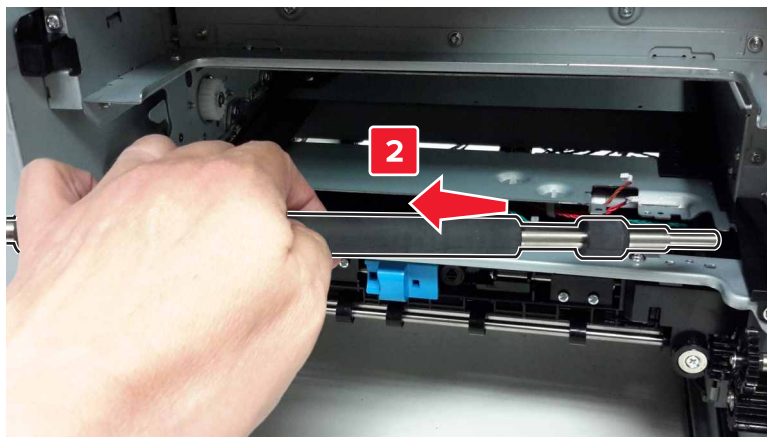
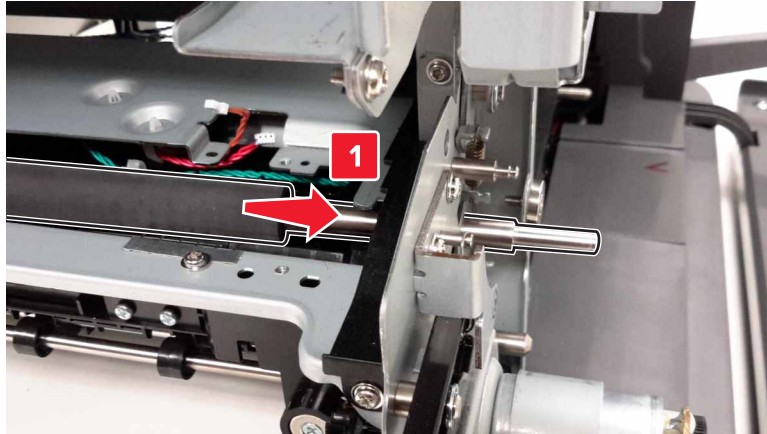

Diverter removal

- 1** Remove the badge cover. See [“Badge cover removal” on page 283.](#)
- 2** Remove the number pad cover. See [“Number pad cover removal” on page 284.](#)
- 3** Remove the upper control panel. See [“Upper control panel removal” on page 280.](#)

- 4 Disconnect the speaker cable (A) and sensor cable (B), and then remove the two screws (C).

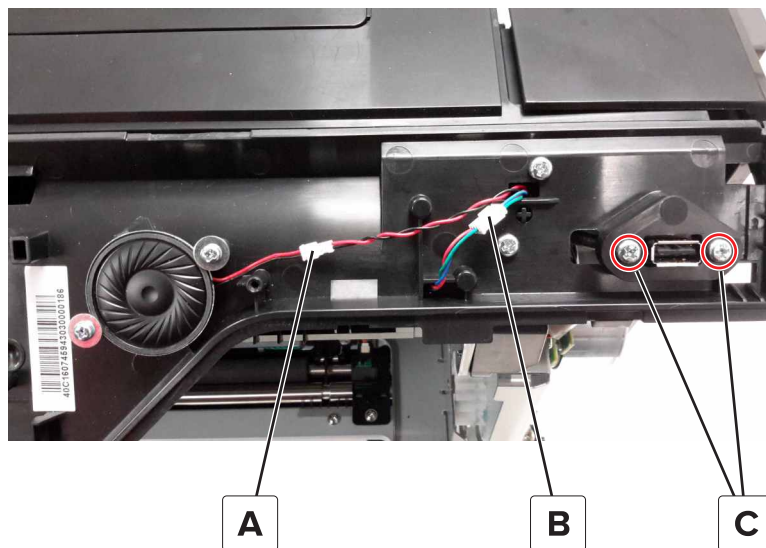

- 5 Remove the headphone port (D).

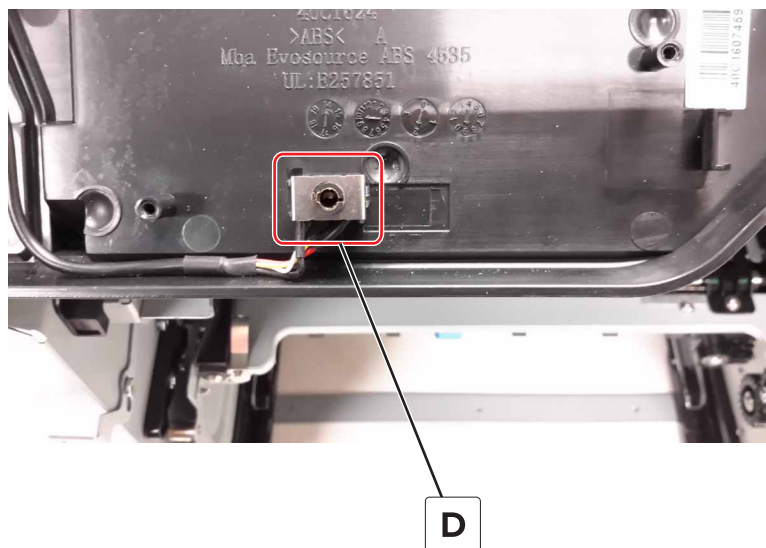

6 Remove the four screws (E).

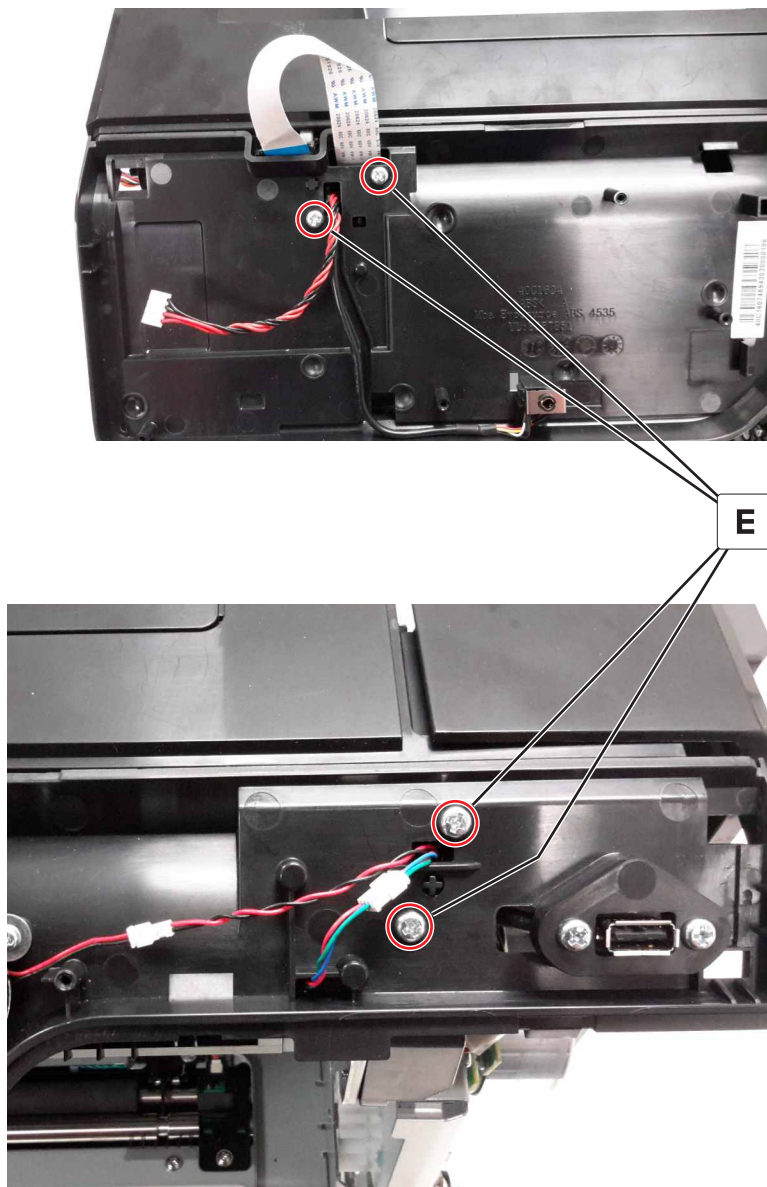

7 Route the control panel cables, speaker cable, and redrive sensor cable through the tub.

8 Remove the three screws (F), and then remove the diverter.

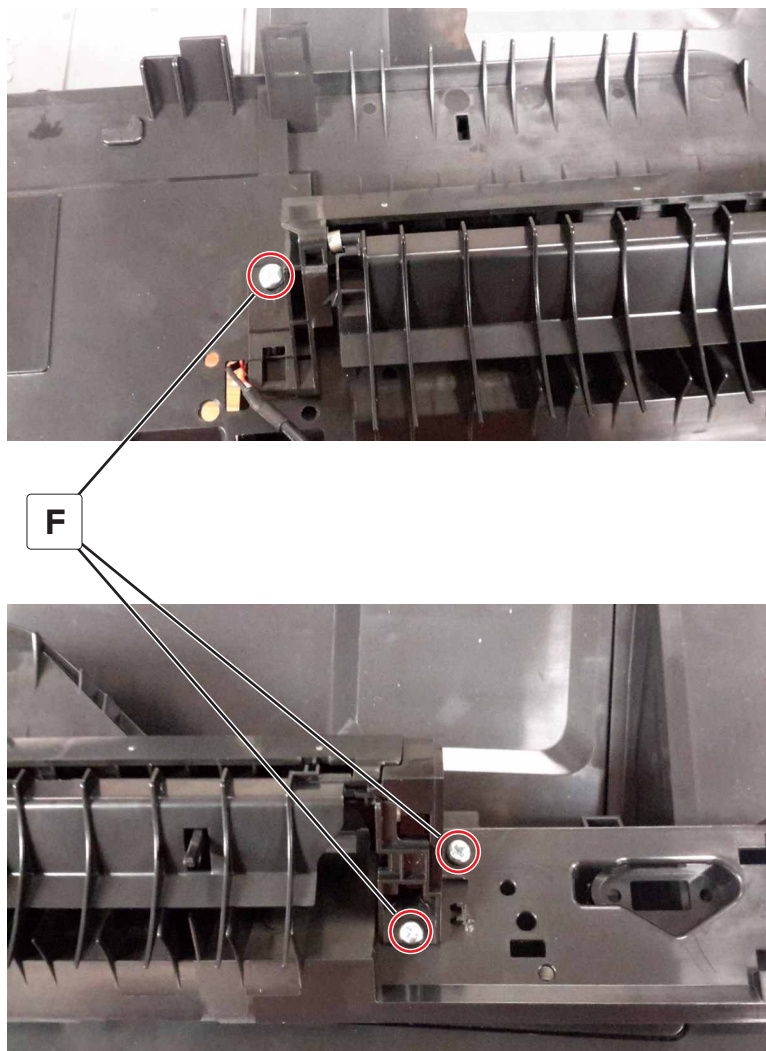

Installation note: Make sure that the headphone cable is routed properly through its cable guide.



Redrive guide removal

- 1 Remove the fuser. See [“Fuser removal” on page 333](#).
- 2 Remove the four screws (A).

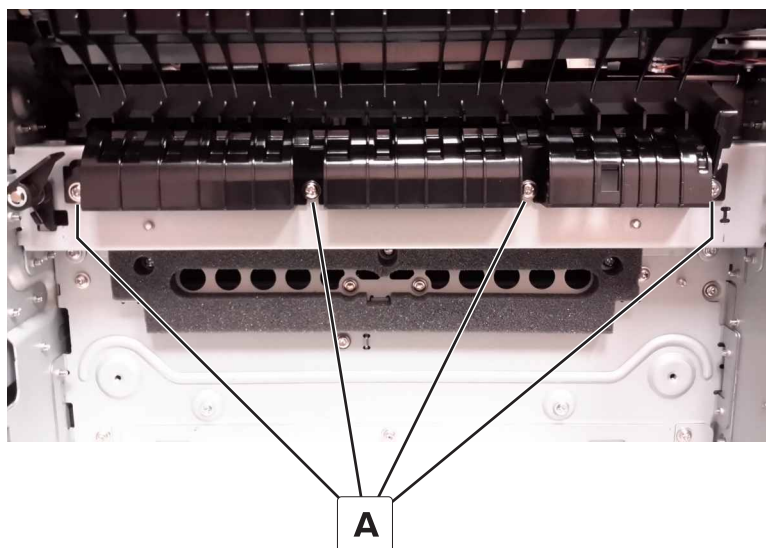

- 3 Hold the redrive deflector up, and then remove the redrive guide.

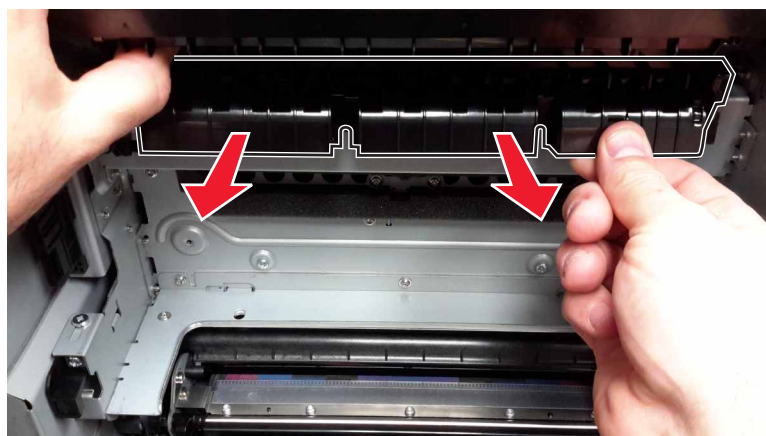

Sensor (redrive) removal

- 1 Remove the badge cover. See [“Badge cover removal” on page 283](#).
- 2 Remove the number pad cover. See [“Number pad cover removal” on page 284](#).
- 3 Remove the upper controller cover. See [“Upper control panel removal” on page 280](#).

4 Remove the screw (A).

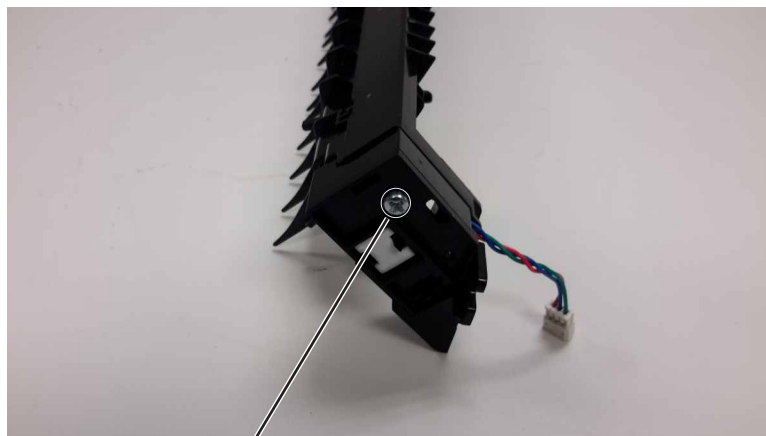

A

5 Remove the retainer (B), and then remove the sensor from the bracket.

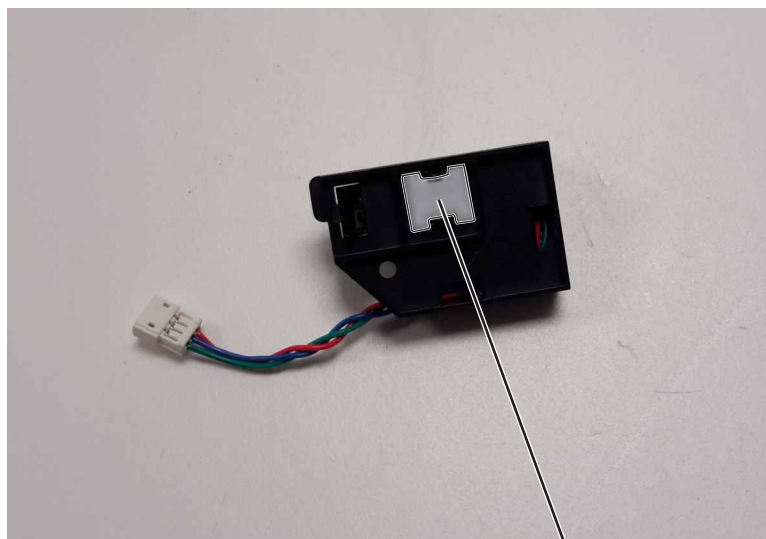

B

Installation note: Use the retainer of the old sensor when installing the new sensor.

Rear removals

Controller board shield removal

Note: This is not a FRU.

- 1 Remove the eight screws (A).

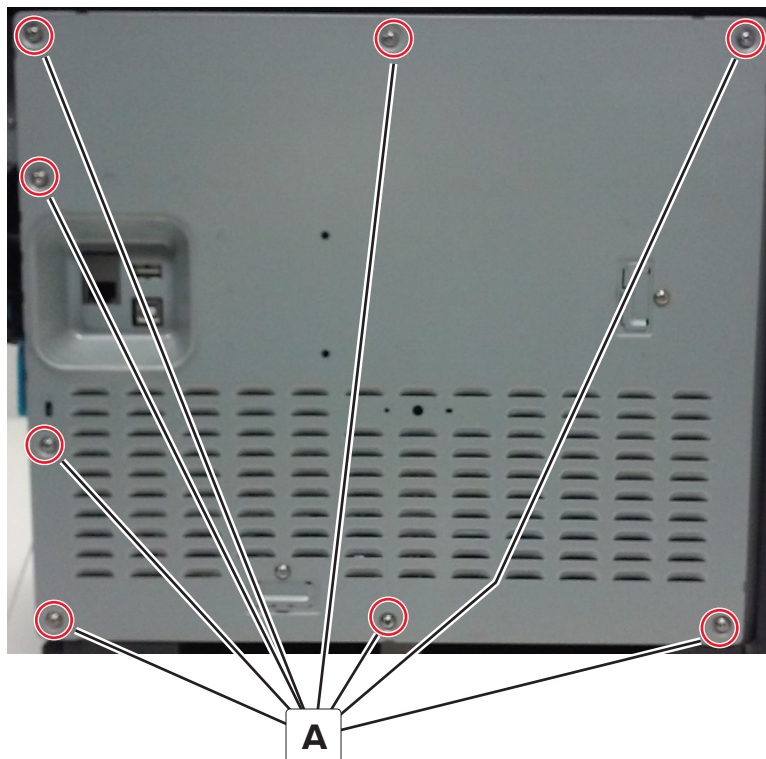

- 2 Remove the controller board shield.

Inner controller board shield removal

Note: This is not a FRU.

- 1 Remove the controller board shield. See [“Controller board shield removal” on page 356](#).
- 2 Remove the four screws (A), and then remove the inner controller board shield.

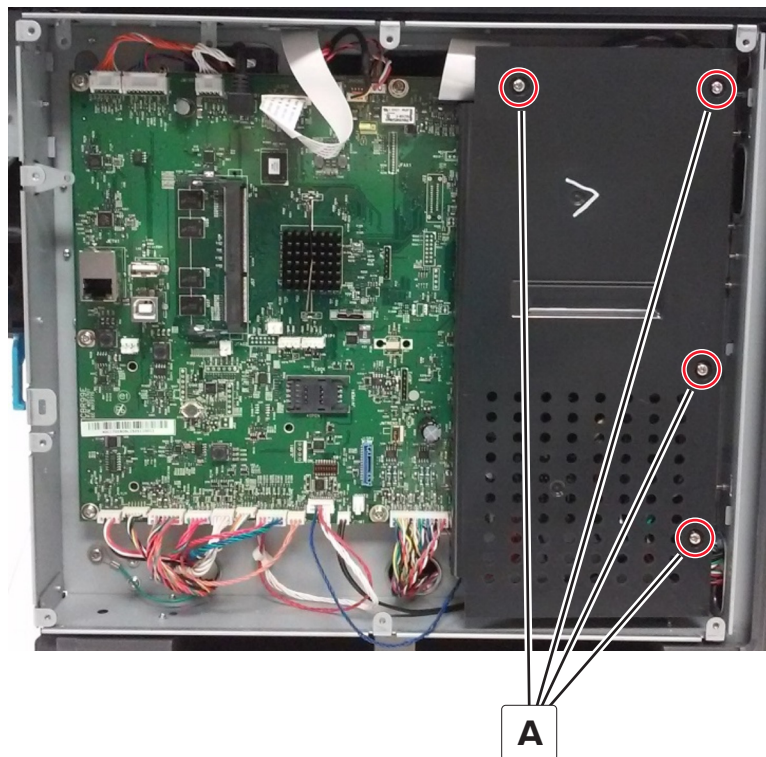

Controller board removal

Warning—Potential Damage: The controller board may contain a secure element SIM card that must be transferred from the old controller board to the new controller board. This SIM card contains software and security settings that are unique to the printer. See [“Secure element SIM card removal” on page 360](#).

- 1 Remove the controller board shield. See [“Controller board shield removal” on page 356](#).
- 2 Remove the inner controller board shield. See [“Inner controller board shield removal” on page 357](#).
- 3 Remove all option cards from the controller board.
- 4 Disconnect all the cables from the controller board.

Warning—Potential Damage: When removing the TPS cable from JTPSAA1 connector, gently pry the cable connector from the controller board connector. Do not pull the cable by the wires.

Warning—Potential Damage: Do not yank the ribbon cables. See [“Disconnecting ribbon cables” on page 260](#).

5 Using a hex wrench or pliers, remove the four hex standoffs (A).

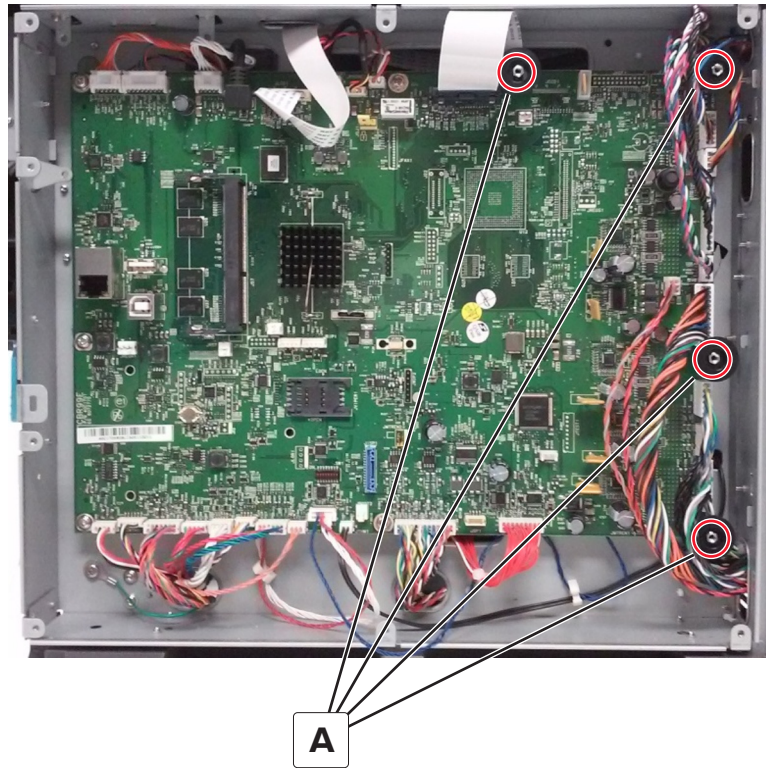

6 Remove the five screws (A), and then remove the controller board.

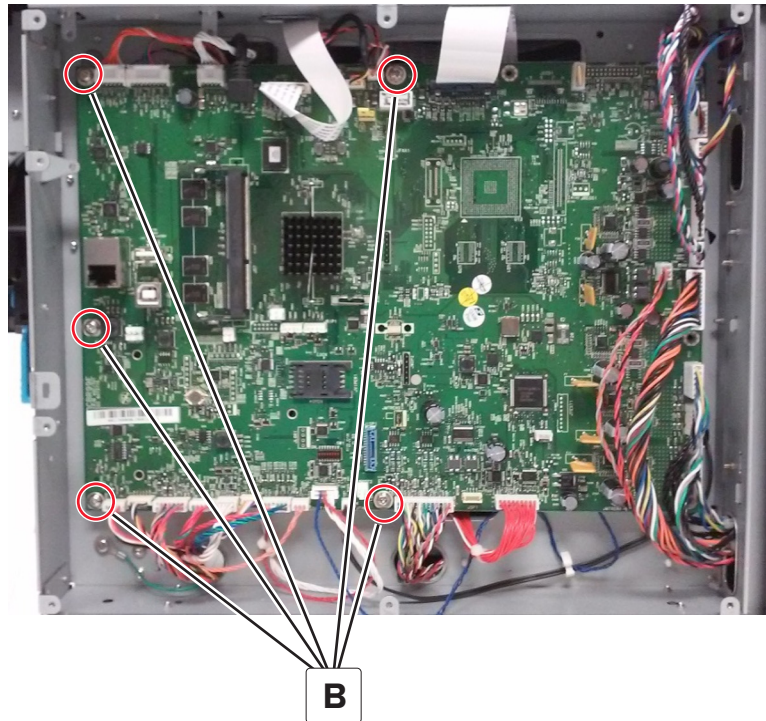

TPS cables removal

- 1 Remove the controller board shield. See [“Controller board shield removal” on page 356](#).
- 2 Remove the inner controller board shield. See [“Inner controller board shield removal” on page 357](#).
- 3 Remove the controller board. See [“Controller board removal” on page 357](#).
- 4 Disconnect the three cables (A) from the sensor.

Warning—Potential Damage: Be careful when disconnecting the cables. Press the tab on the white cable while disconnecting to avoid damage.

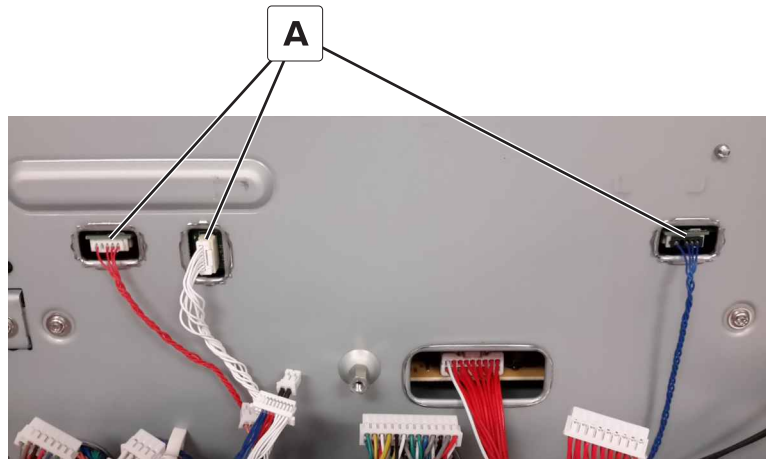

- 5 Remove the cables.

Secure element SIM card removal

Warning—Potential Damage: The controller board may contain a secure element SIM card that must be transferred from the old controller board to the new controller board. This SIM card contains software and security settings that are unique to the printer.

- 1 Remove the controller board shield. See [“Controller board shield removal” on page 356](#).
- 2 Slide the SIM card cover to unlock the SIM card holder.

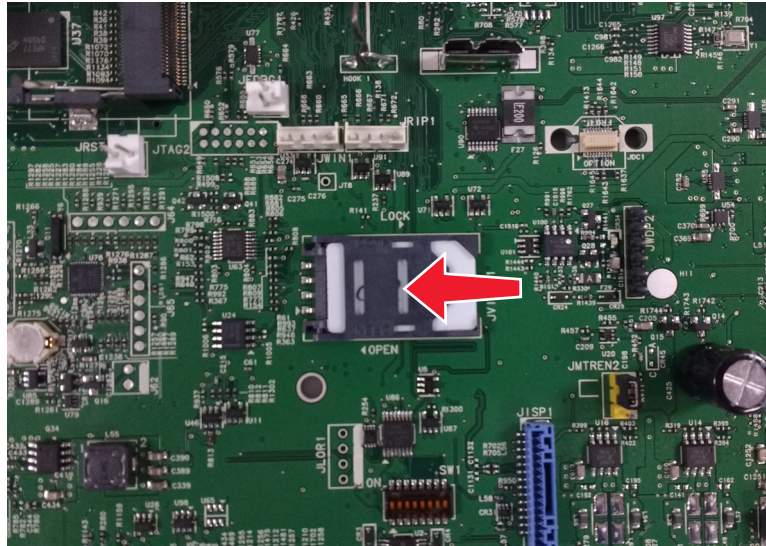

- 3 Open the SIM card holder.

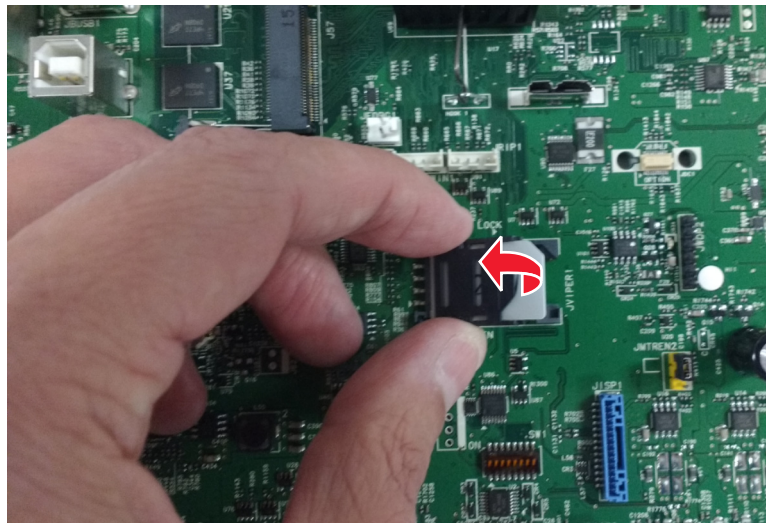

- 4 Remove the SIM card.

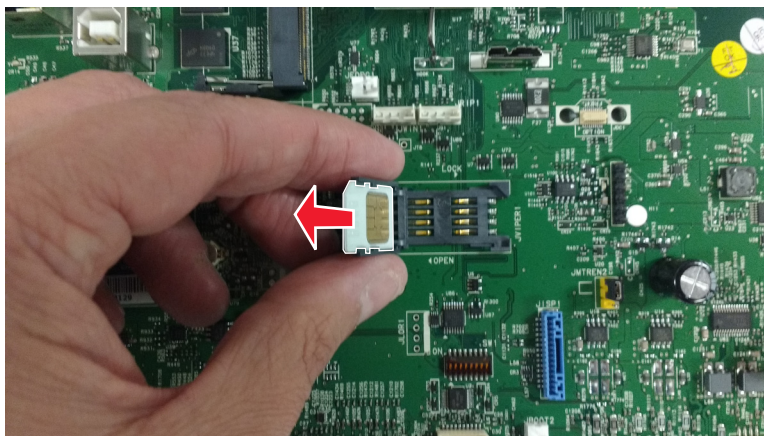

Top removals

Printhead removal

- 1 Remove the top cover. See [“Top cover removal” on page 268](#).
- 2 Remove the control board shield. See [“Controller board shield removal” on page 356](#).
- 3 Disconnect the ribbon cable (A) and printhead cable (B).

Warning—Potential Damage: Do not yank the ribbon cable. See [“Disconnecting ribbon cables” on page 260](#).

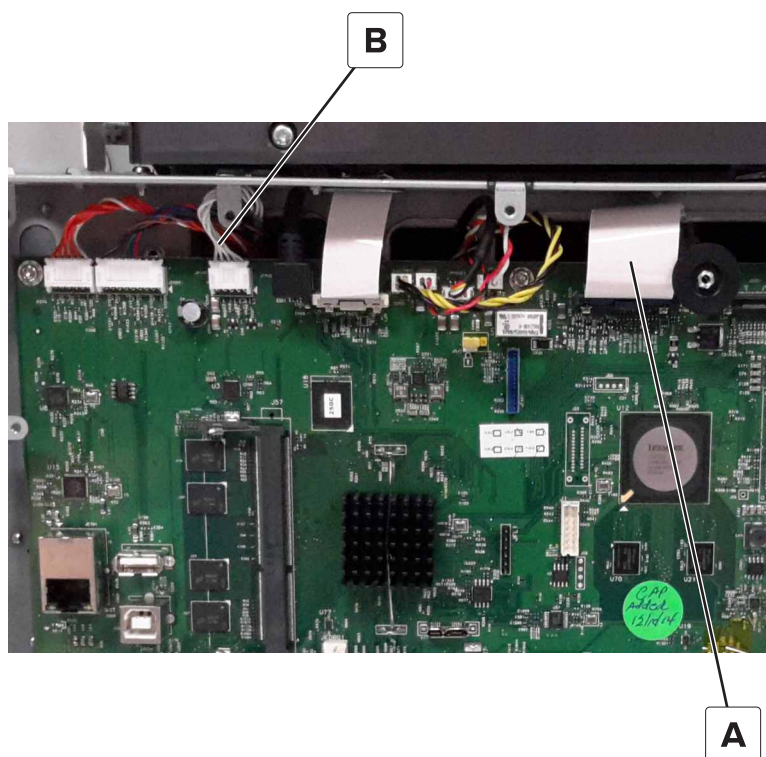

- 4 Remove the screw (C) from the printhead.

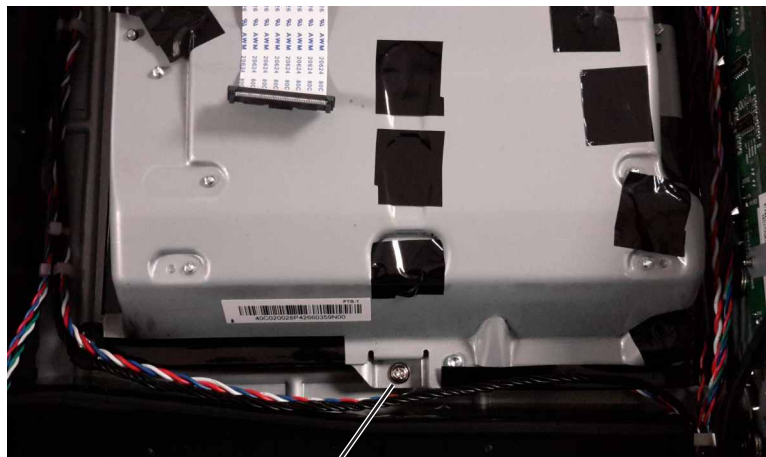

C

- 5 Remove the rear right screw (D) from the printhead.

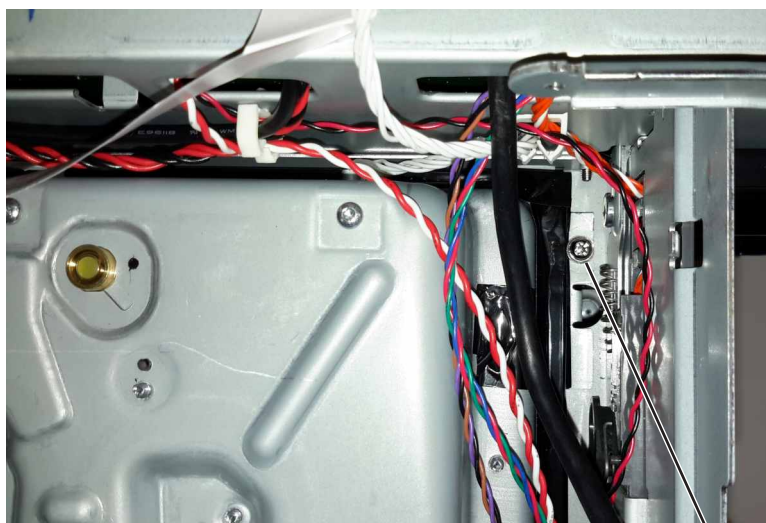

D

- 6 Remove the rear left screw (E) from the printhead.

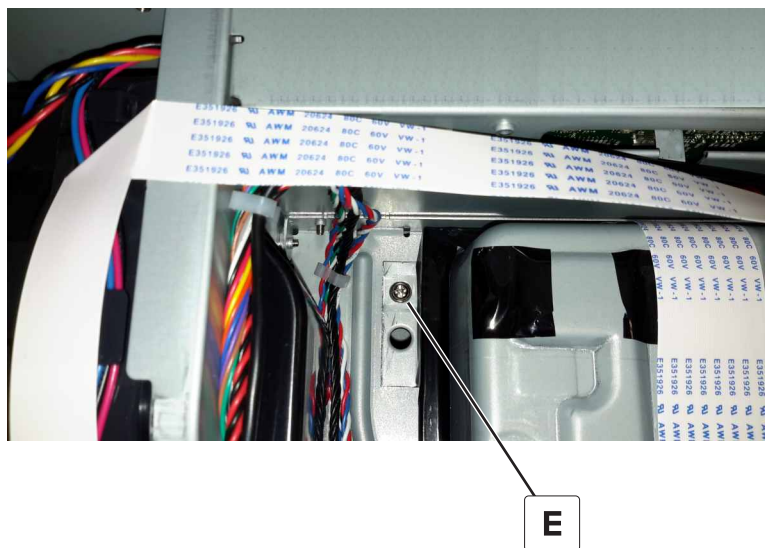

Installation note: When installing the printhead, replace the screws but do not tighten them right away. After installing the screws, turn the printhead clockwise until it stops before tightening the screws fully. After performing these steps, you may need to align the printhead if there is skew. You will also need to perform (TBD).

Developer hold down removal

- 1 Remove the top cover. See [“Top cover removal” on page 268](#).
- 2 Remove the controller board shield. See [“Controller board shield removal” on page 356](#).
- 3 Remove the printhead. See [“Printhead removal” on page 361](#).
- 4 Pull the bell crank and spring off the mounting pin.

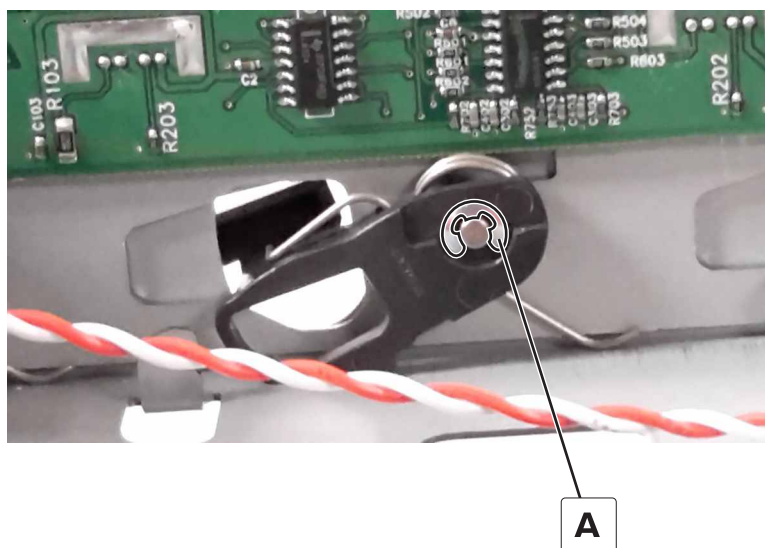

- 5 Pull the bell crank (B) and spring (C) off the mounting pin.

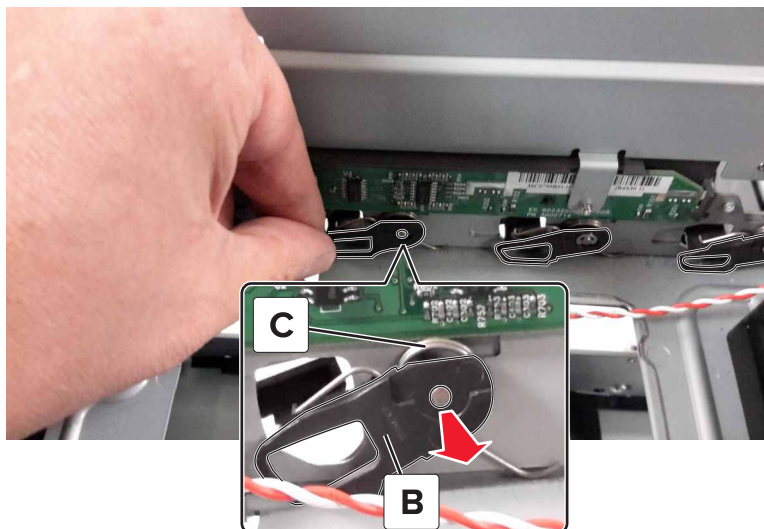

Output roll removal

- 1 Remove the left cover. See [“Left cover removal” on page 271.](#)
- 2 Remove the fuser. See [“Fuser removal” on page 333.](#)
- 3 Remove the redrive guide. See [“Redrive guide removal” on page 354.](#)
- 4 Remove the motor (output). See [“Motor \(output\) removal” on page 297.](#)
- 5 Remove the screw (A), and then remove the cable guide (B).

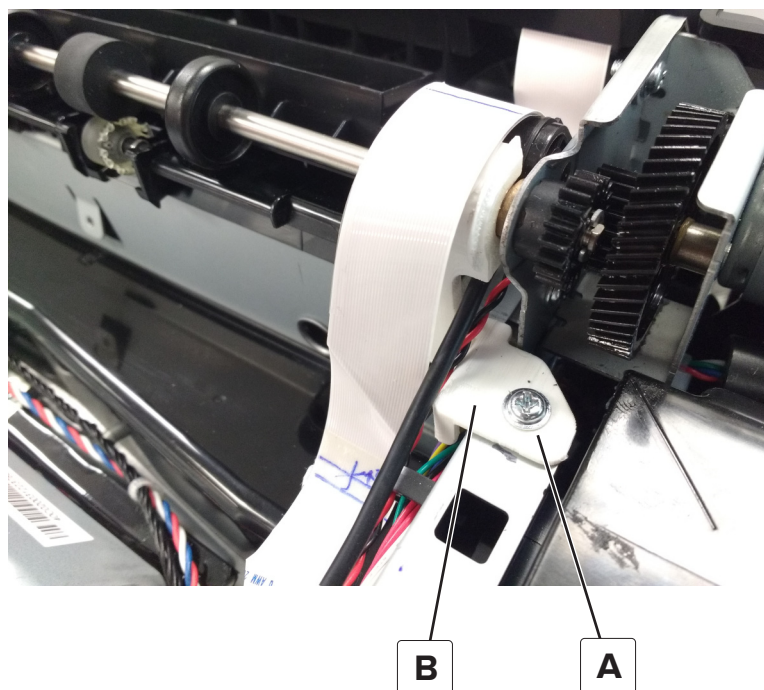

6 Remove the e-clip (C), and then remove the gear.

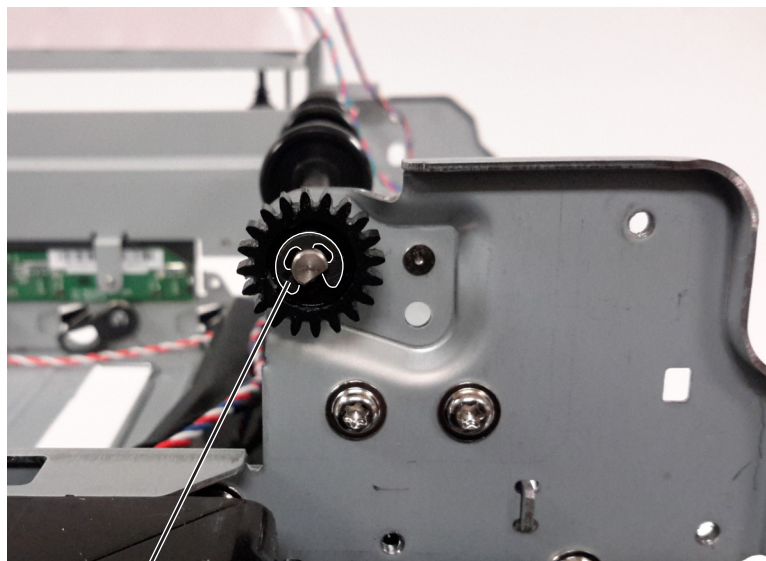

C

7 Remove the e-clip (D) from inside the frame.

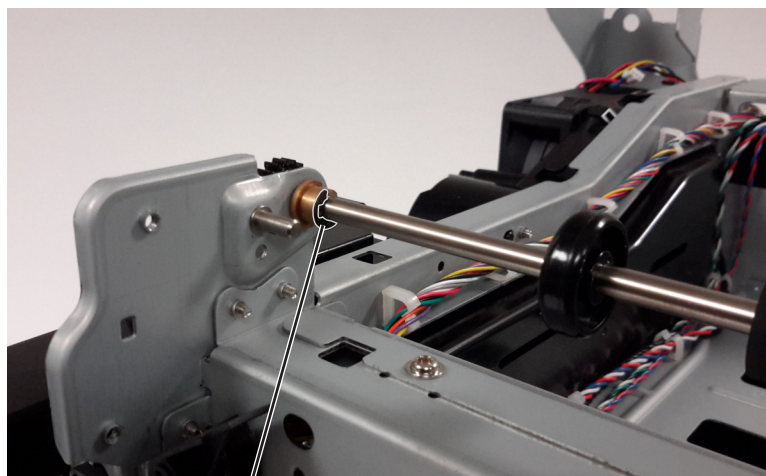

D

- 8 Slide the output shaft to the left, and then remove from the printer.

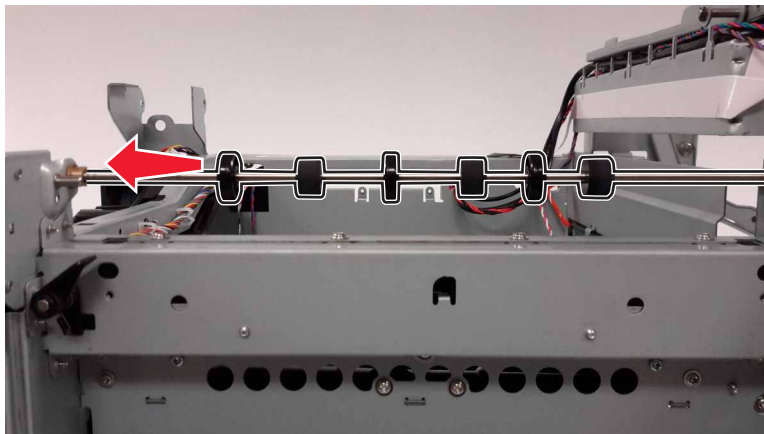

- 9 Remove the e-clip (E).

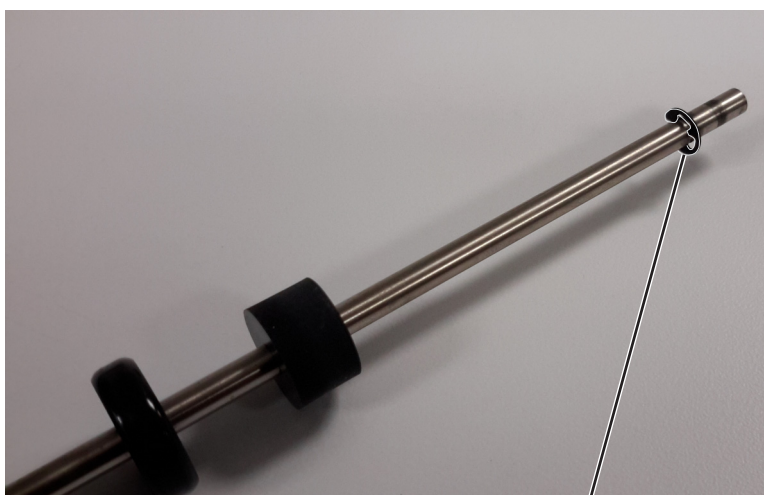

E

Note: Use the e-clips and bushings on the new shaft.

Output bin exit cover removal

- 1 Remove the top cover. See [“Top cover removal” on page 268.](#)
- 2 Disengage the tab (A), and then remove the cable from the tabs.

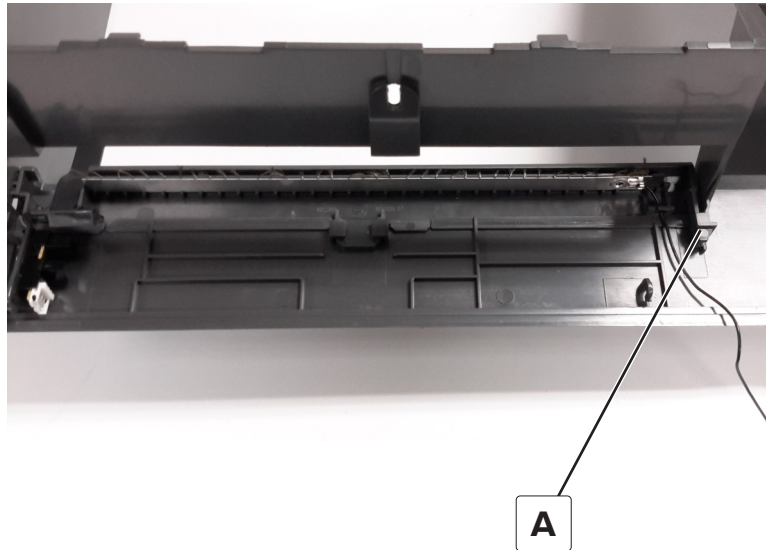

- 3 Remove the cover.

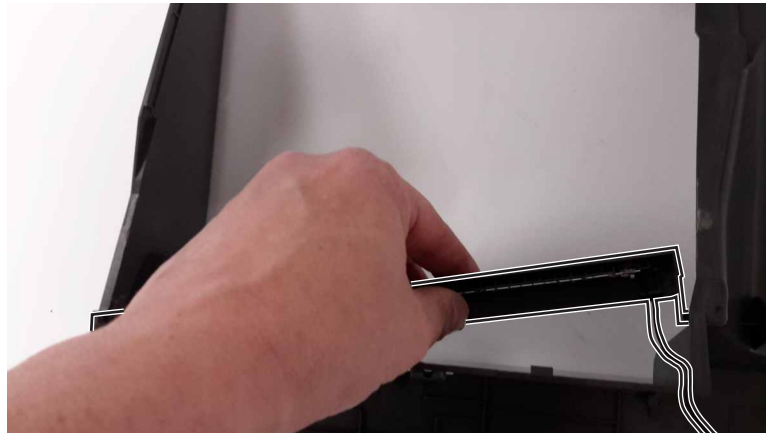

Output bin flag removal

- 1 Remove the top cover. See [“Top cover removal” on page 268.](#)
- 2 Remove the output bin exit cover. See [“Output bin exit cover removal” on page 367.](#)

- 3 Slide the flag to the left to remove.

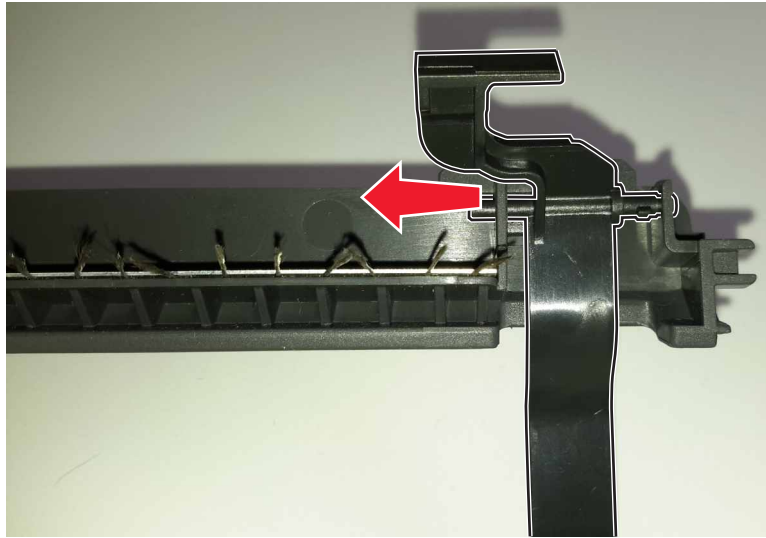

Bottom removals

Front cover hinges removal

Warning—Potential Damage: Remove the waste toner bottle and imaging kit first before removing the hinges. Failure to do this can lead to toner spillage and damage to the printer.

Note: This procedure is applicable to the left and right front cover hinges.

- 1 Remove the front cover. See [“Front cover removal” on page 265](#).
- 2 Place the printer on its side.

- 3 Remove the three screws (A) securing the hinge, and then remove the hinge.

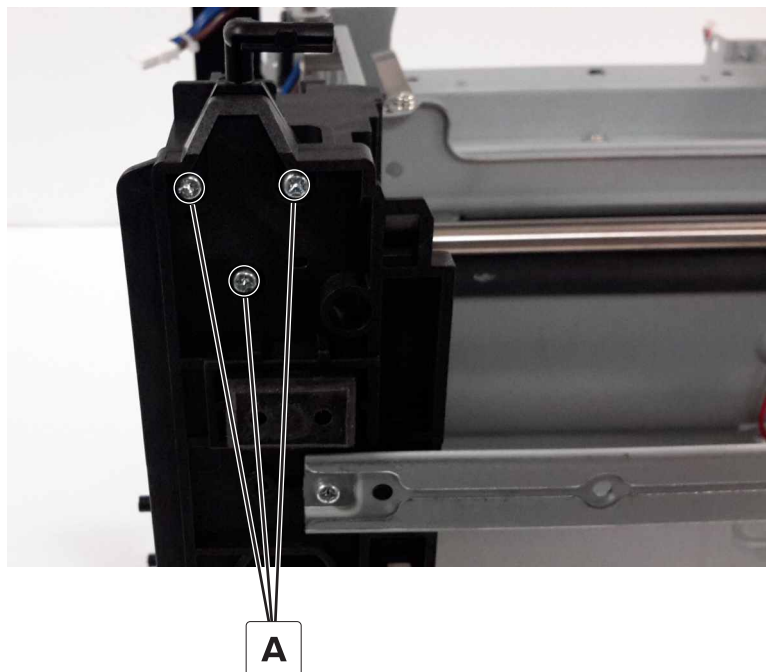

Tray rail removal

- 1 Remove the motor cover. See [“Motor cover removal” on page 273.](#)
- 2 Remove the waste toner bottle.
- 3 Remove the right cover. See [“Right cover removal” on page 272.](#)
- 4 Remove the left cover. See [“Left cover removal” on page 271.](#)
- 5 Pull the tab (A) on the rail.

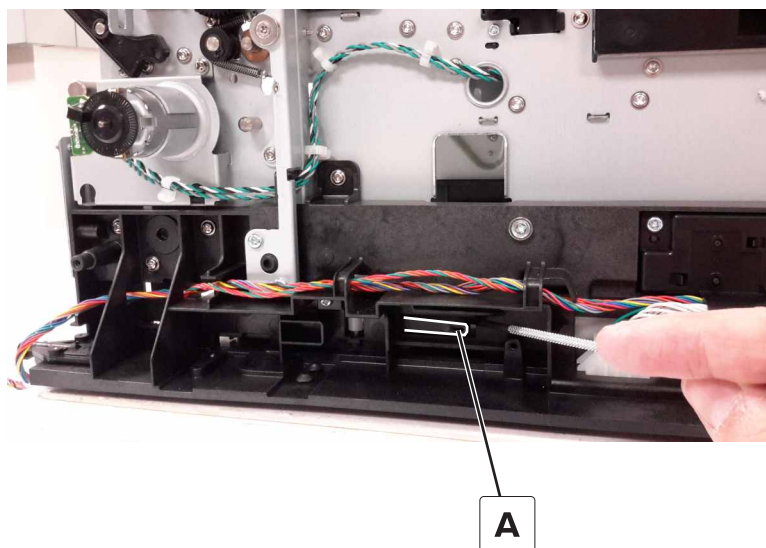

- 6 Hold the tab in place, and then slide the rail toward the front of the printer to remove.

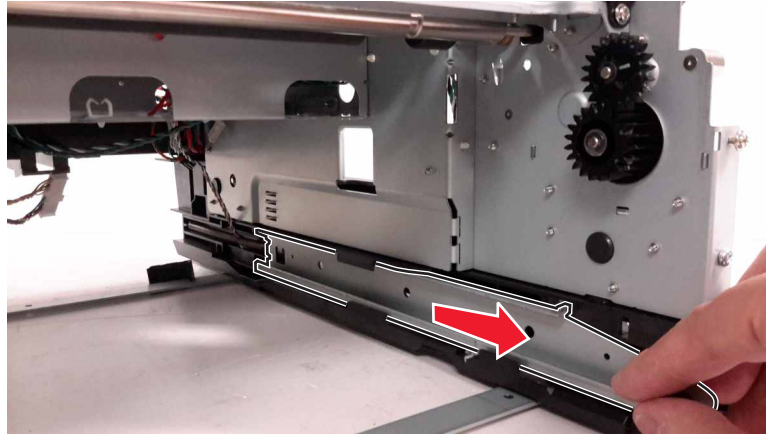

- 7 Disconnect the spring (B) from the rail.

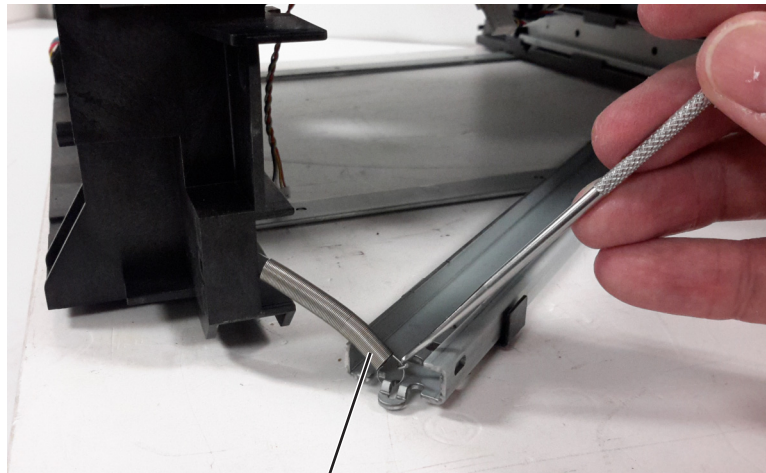

B

Aligner idler gears removal

- 1 Remove the imaging kit.
- 2 Remove the media feeder. See [“Media feeder removal” on page 373.](#)
- 3 Remove the isolation unit. See [“Isolation unit removal” on page 371.](#)

- 4 Remove the E-clip (A), and then remove the outer gear (B).

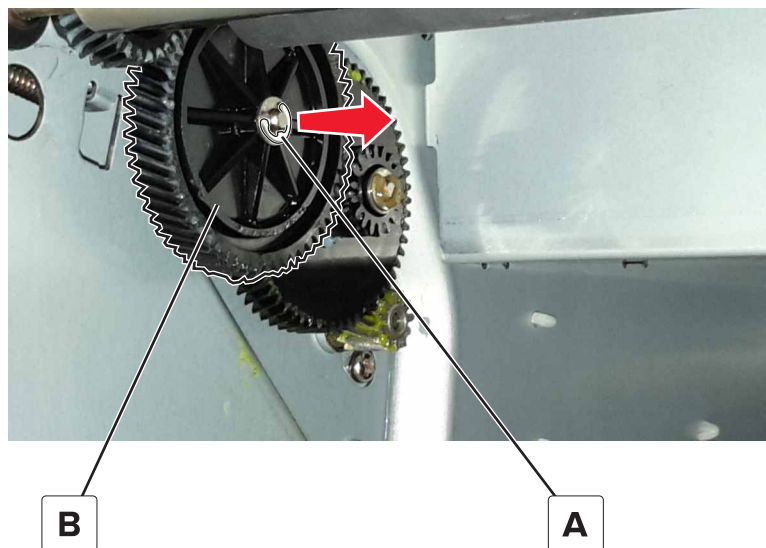

Installation note: Use the washer in the new gear.

- 5 Remove the E-clip (C), and then remove the inner gear (D).

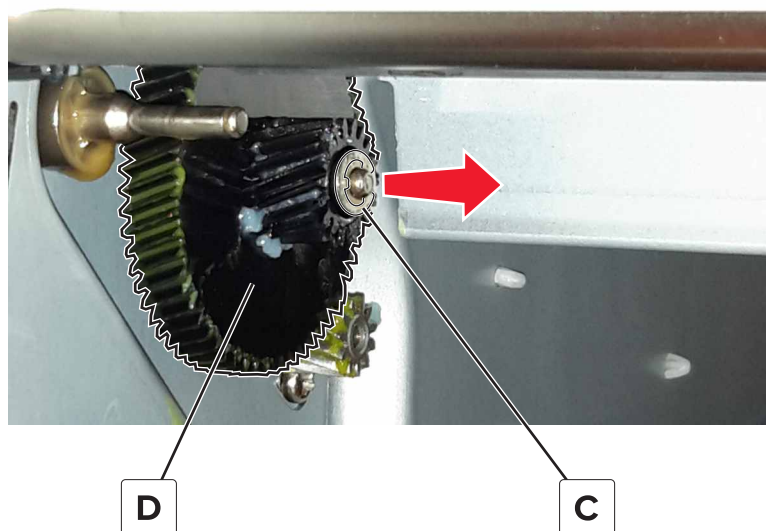

Installation note: Use the washer in the new gear.

Isolation unit removal

Warning—Potential Damage: Remove the waste toner bottle and imaging kit first before removing the isolation unit. Failure to do this can lead to toner spillage and damage to the printer.

- 1 Remove the imaging unit.
- 2 Remove the media feeder. See [“Media feeder removal” on page 373](#).

3 Remove the three screws (A) securing the isolation unit.

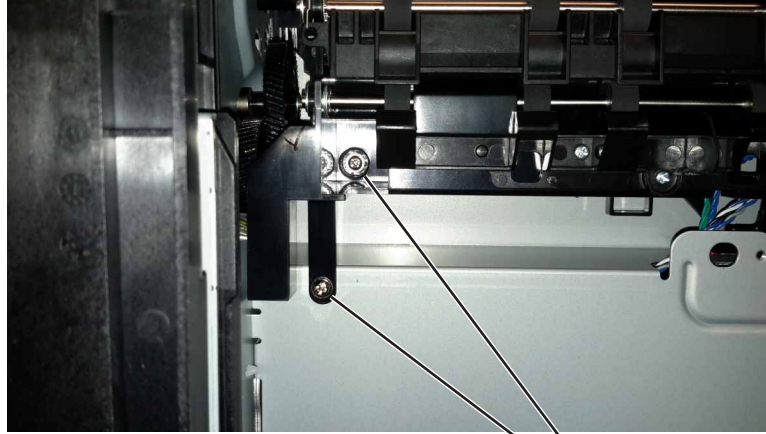

A

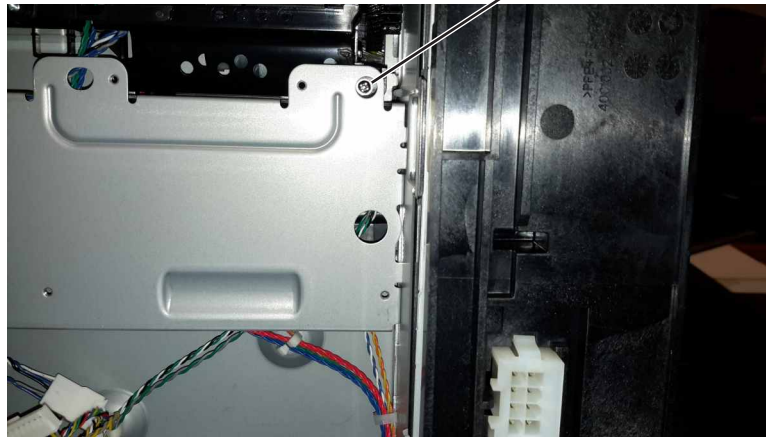

4 Remove the biasing screw (B).



B

Installation note: Make sure to replace this screw first before replacing the three screws to secure the unit.

- 5 Disconnect the motor cable (C) and sensor cable (D).

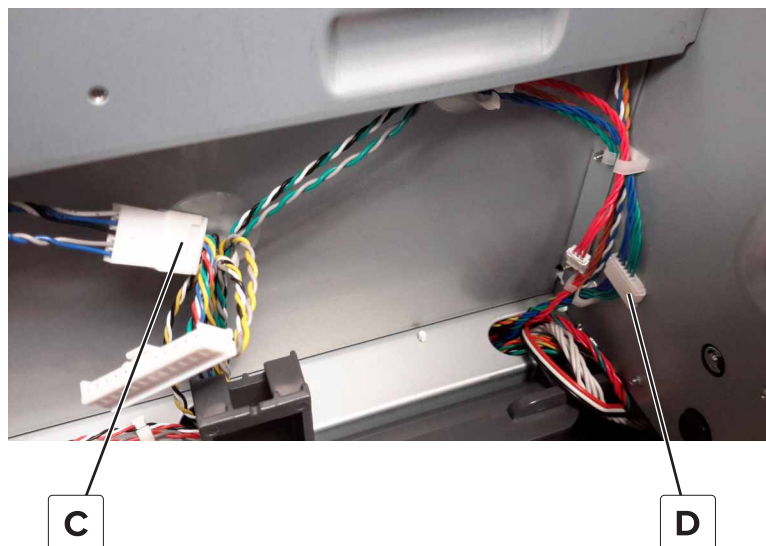

- 6 Tilt the right portion of the isolation unit to the front, and then remove the unit.

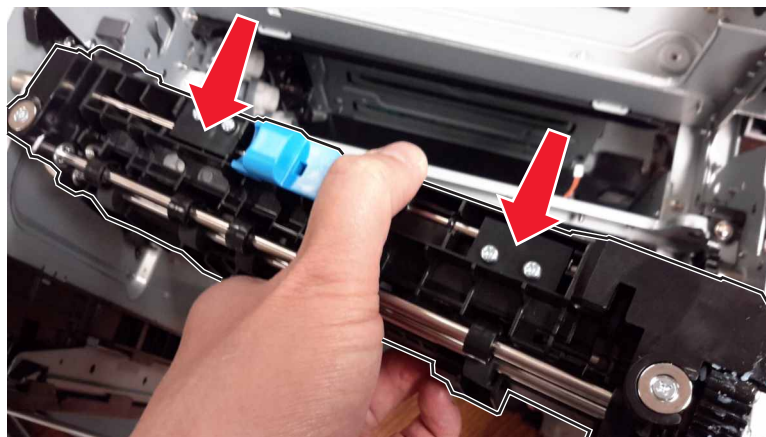

- 7 Route the isolation unit cables out of the printer.

Media feeder removal

Warning—Potential Damage: Remove the waste toner bottle and imaging kit first before removing the media feeder. Failure to do this can lead to toner spillage and damage to the printer.

- 1 Remove the imaging unit.
- 2 Place printer on its back, and then disconnect the cables.
- 3 Remove the pick roller assembly.

4 Remove the four screws (A), and then remove the media feeder.

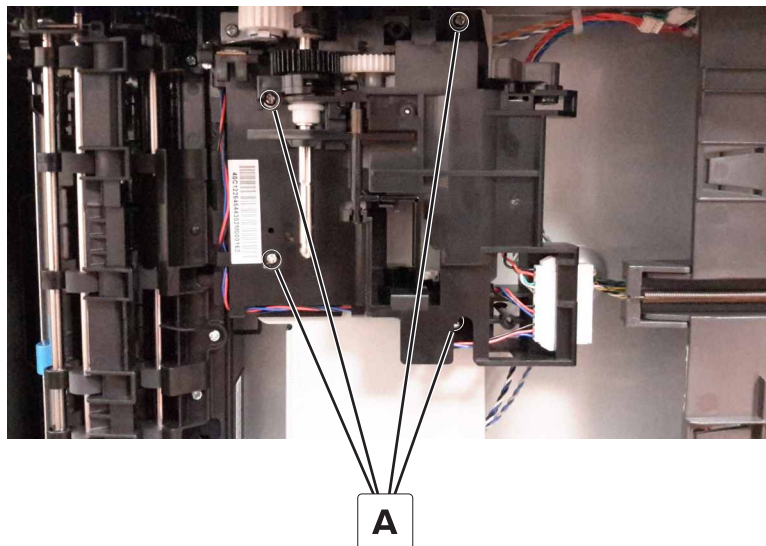

550-sheet tray removals

550-sheet tray right cover removal

- 1 Remove the tray insert.
- 2 Remove the three screws (A).

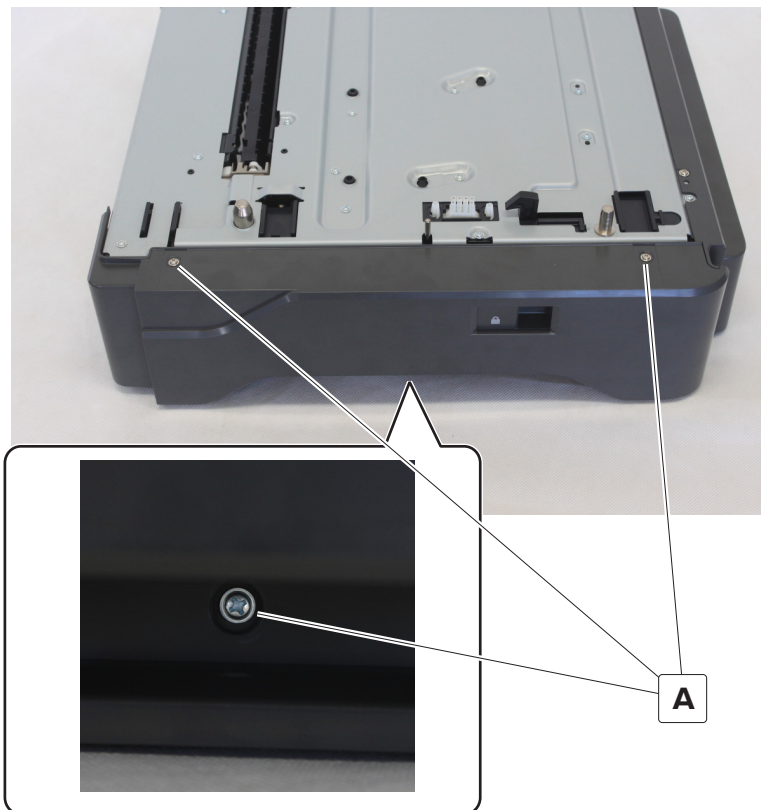

- 3 Remove the right cover.

Motor (550-sheet tray pass-through) removal

- 1 Remove the tray insert.
- 2 Remove the three screws (A).

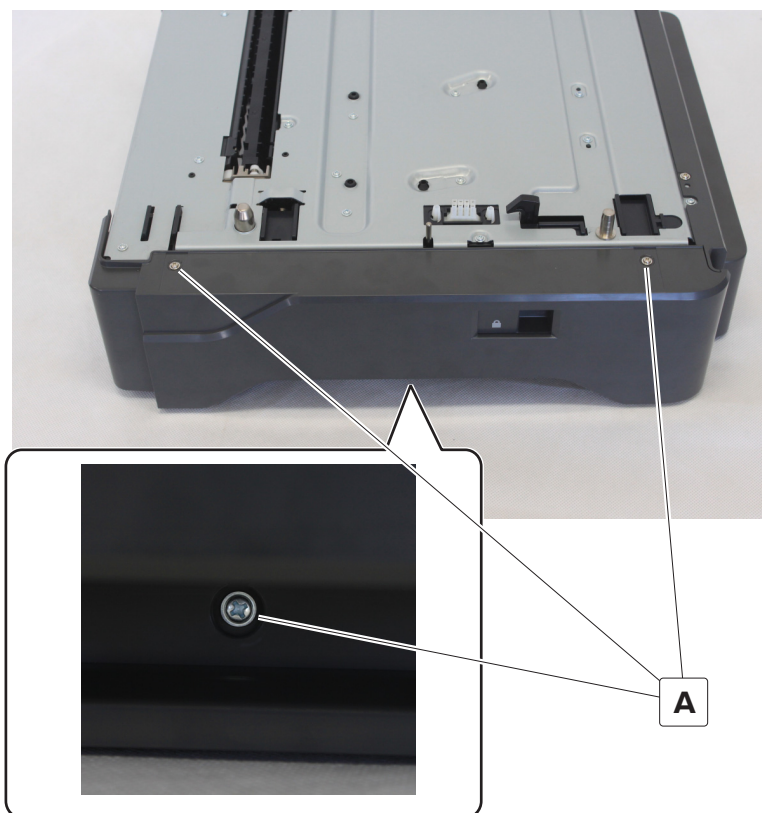

- 3 Remove the right cover.
- 4 Remove the motor cover.

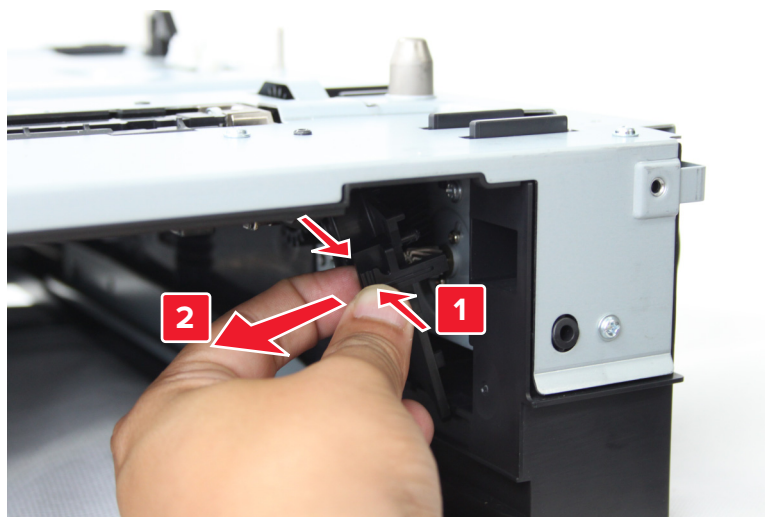

5 Remove the two screws (B).

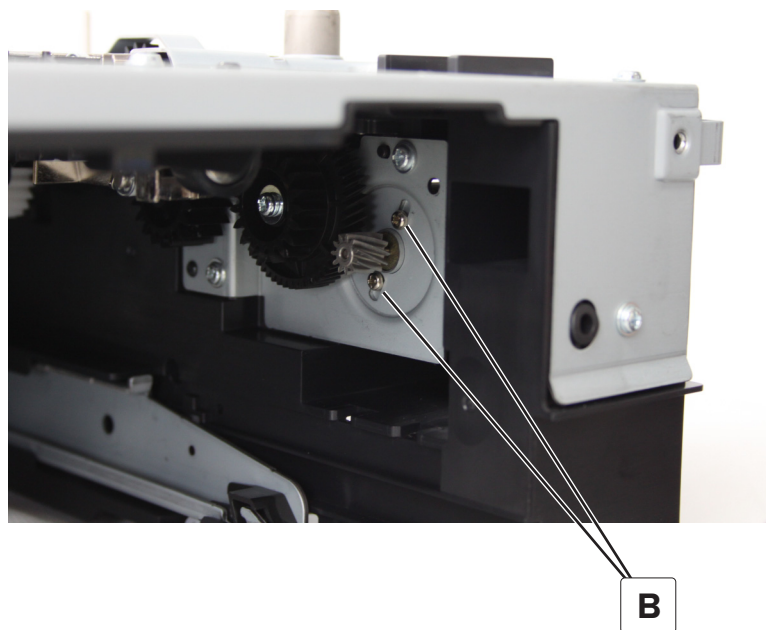

6 Disconnect the cable (C).

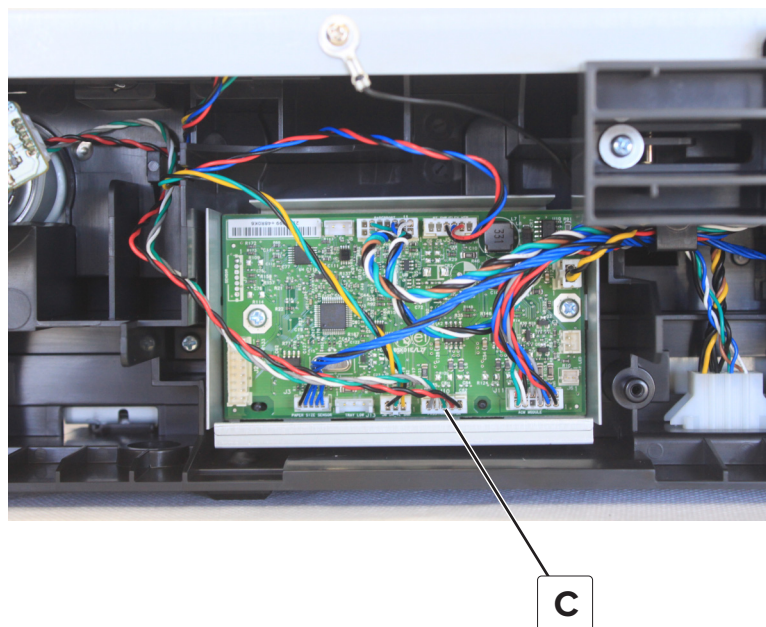

7 Remove the motor.

550-sheet tray paper feeder removal

- 1 Remove the tray insert.
- 2 Remove the four screws (A), and then release the two latches (B).

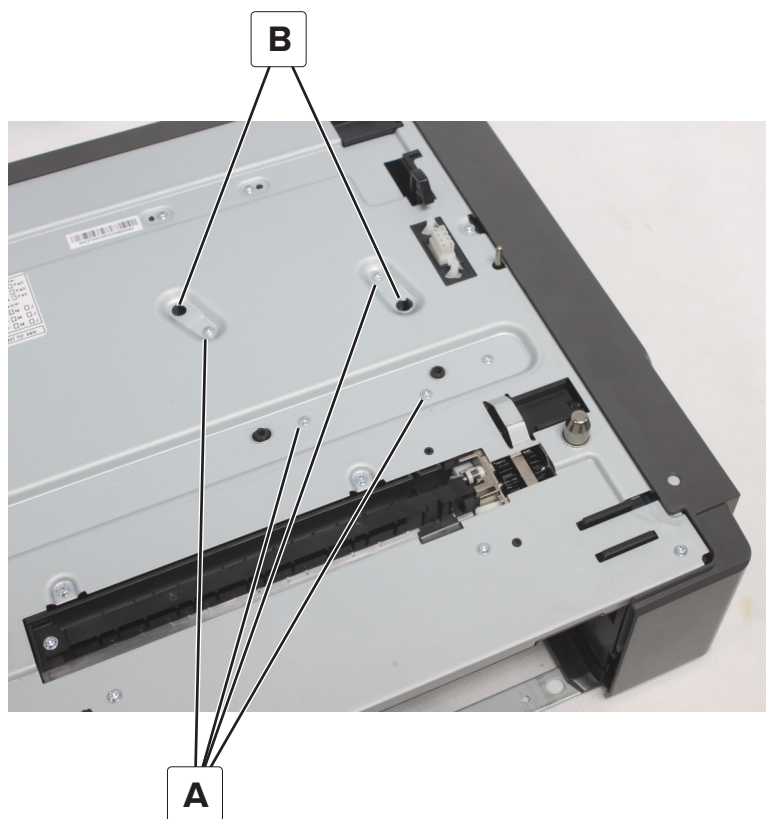

- 3 Disconnect the cable (C).

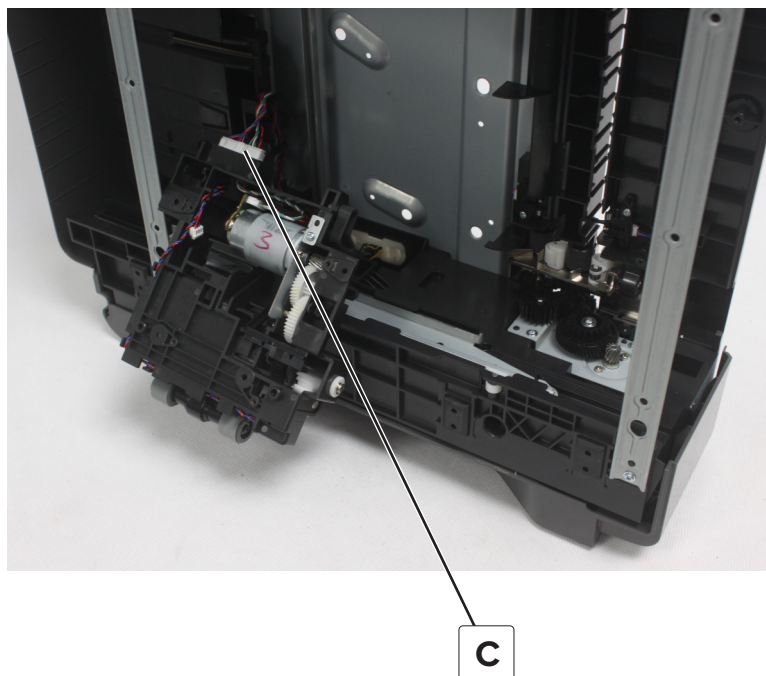

- 4 Remove the paper feeder.

Sensor (550-sheet tray pass-through) removal

- 1 Remove the tray insert.
- 2 Remove the screw (A), and then disconnect the cable (B).

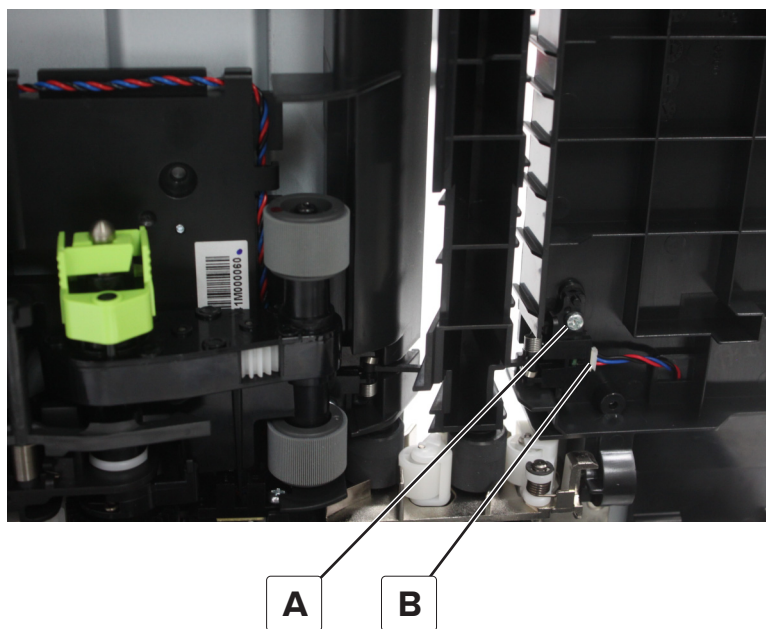

- 3 Remove the sensor.

Sensor (550-sheet tray trailing edge) removal

- 1 Remove the tray insert.
- 2 Remove the pick roller.
- 3 Remove the screw (A), and then disconnect the cable (B).

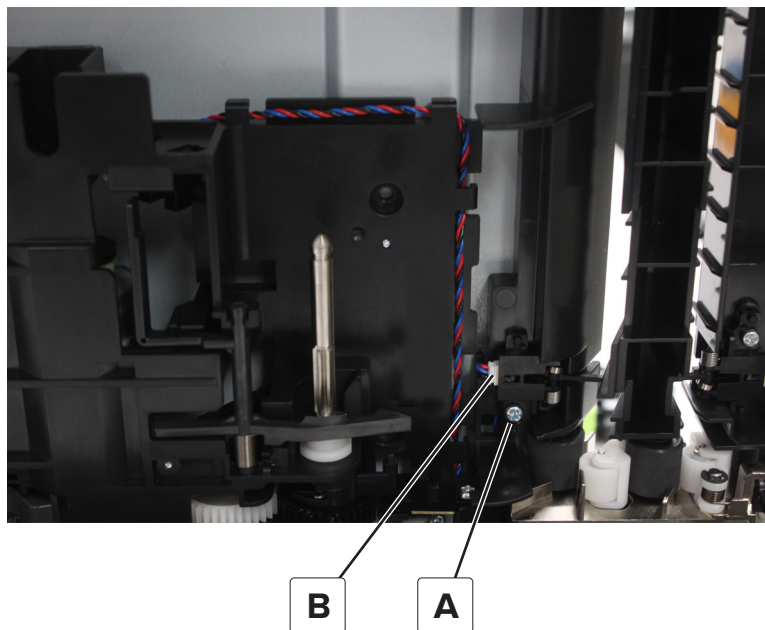

- 4 Remove the sensor.

Sensor (550-sheet tray paper size) removal

- 1 Remove the tray insert.
- 2 Remove the right cover. See [“550-sheet tray right cover removal” on page 375.](#)

3 Release the latch (A), and then remove the sensor cover.

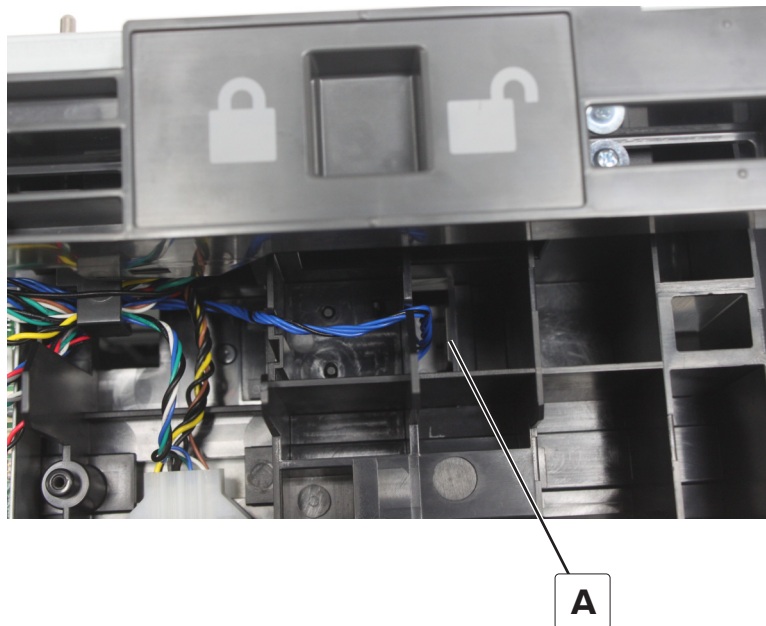

4 Release the two latches (B).

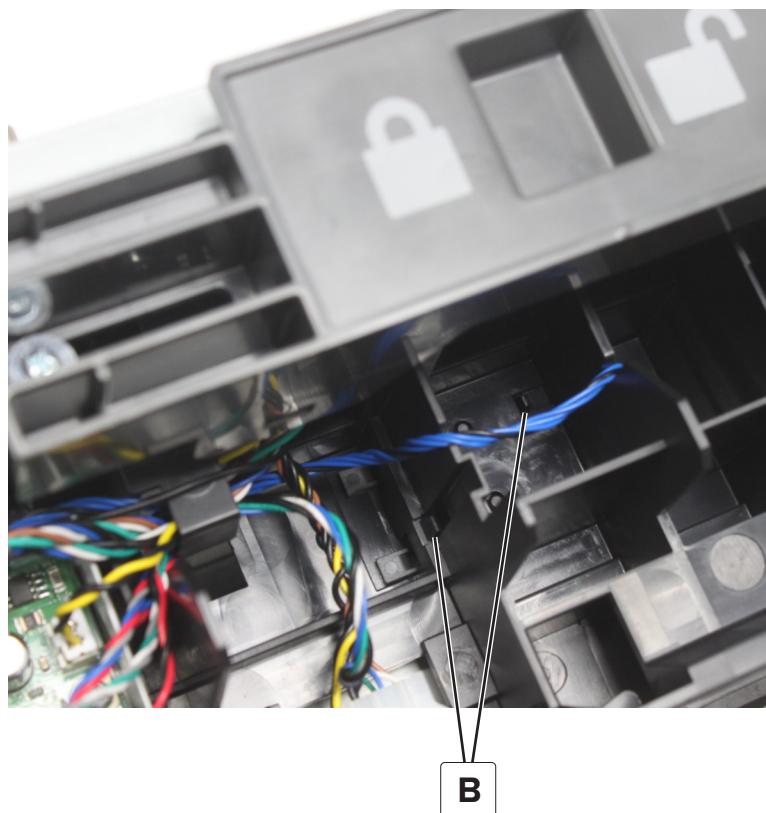

- 5 Disconnect the cable (C), and then remove the sensor.

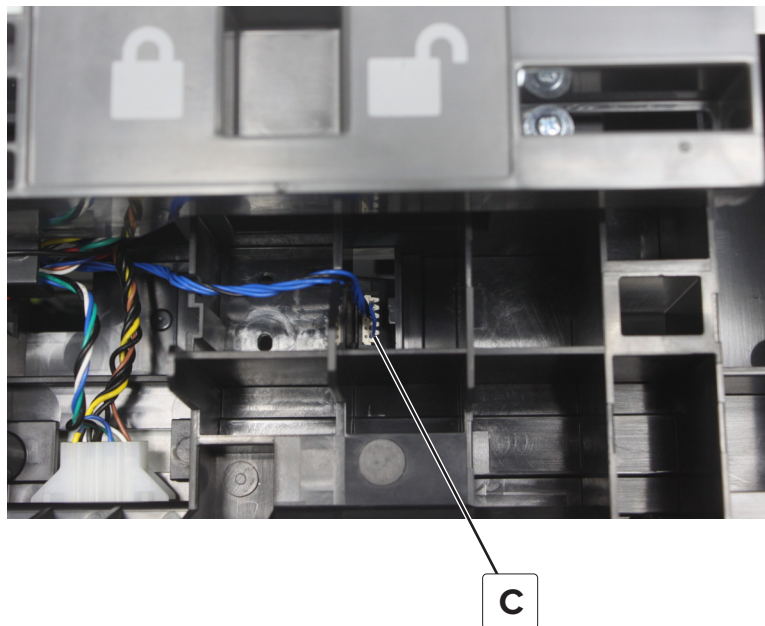

550-sheet tray controller board assembly removal

- 1 Remove the tray insert.
- 2 Remove the right cover. See [“550-sheet tray right cover removal” on page 375.](#)
- 3 Disconnect all cables from the assembly, and then remove the two screws (A).

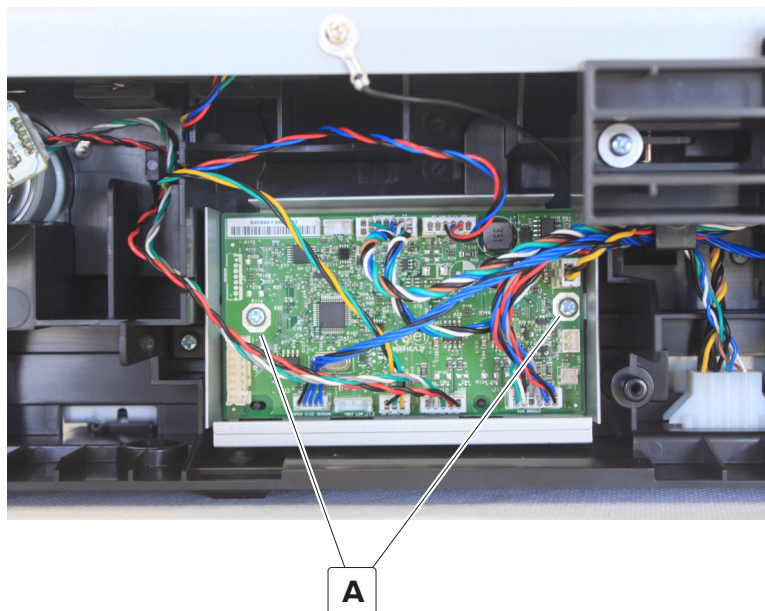

- 4 Remove the controller board assembly.

550-sheet tray interface cable removal

- 1 Remove the tray insert.
- 2 Remove the right cover. See [“550-sheet tray right cover removal” on page 375.](#)
- 3 Disconnect the two cables (A), and then remove the screws (B).

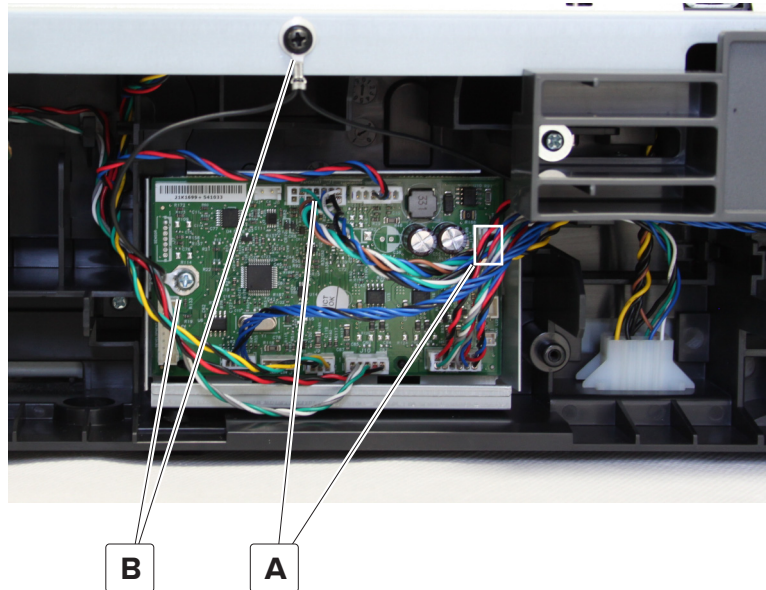

- 4 Squeeze, and then push the latches into the tray base to release the cable.

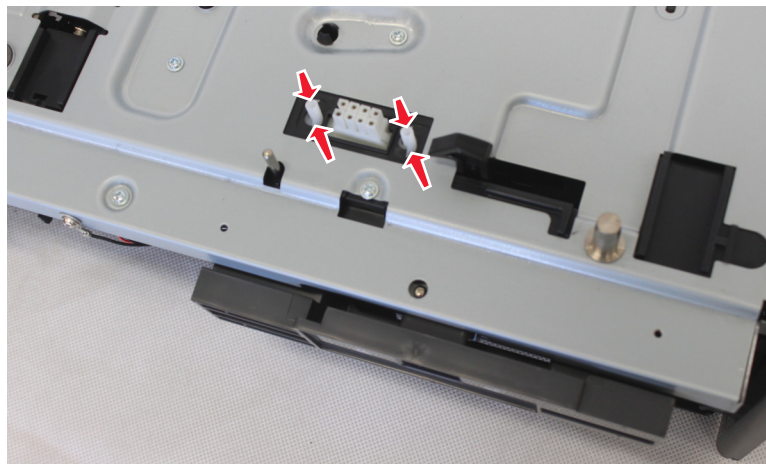

- 5 Squeeze, and then push the latches into the tray base to release the cable.

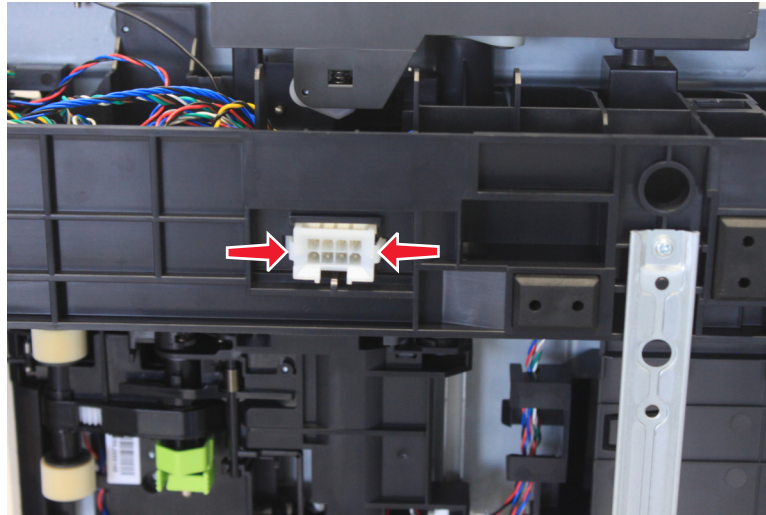

550-sheet tray empty sensor actuator removal

- 1 Remove the tray insert.
- 2 Turn over the tray base.
- 3 Remove the pick roller.
- 4 Pull out the actuator to release, and then remove the actuator.

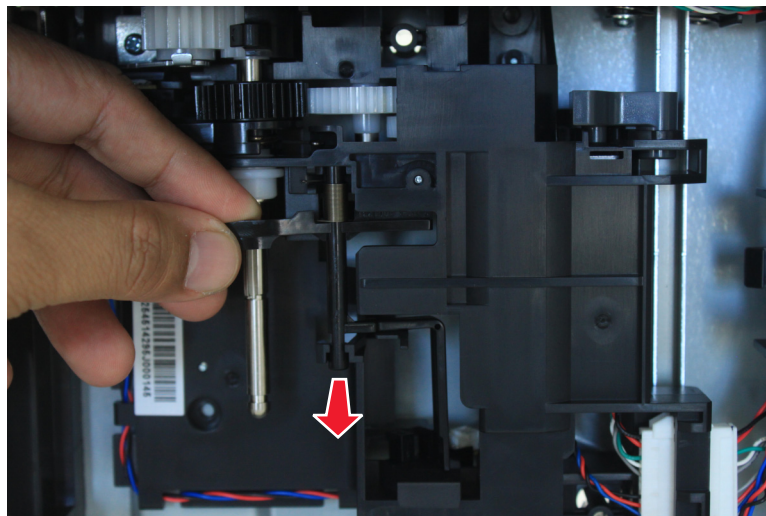

Installation note: Make sure that the actuator is properly installed as shown.

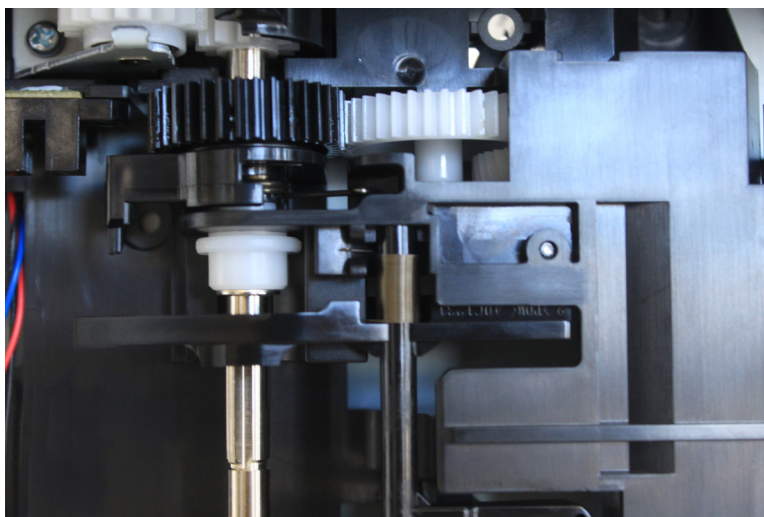

Sensor (550-sheet tray empty) removal

- 1 Remove the tray insert.
- 2 Remove the paper feeder. See [“550-sheet tray right cover removal” on page 375](#).
- 3 Disconnect the cable (A), and then remove the sensor.

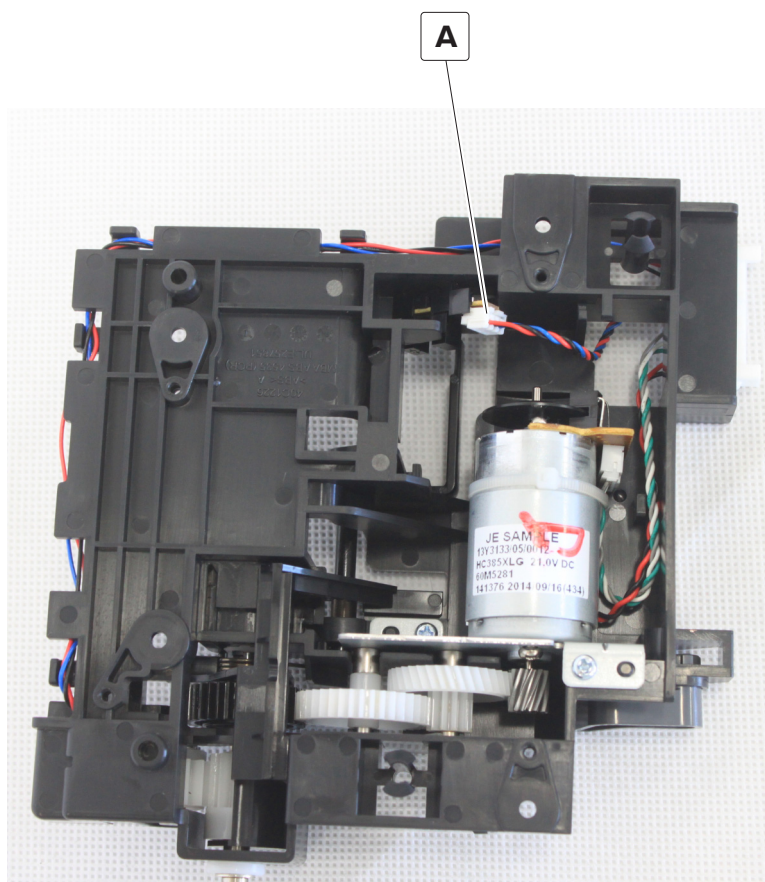

Sensor (550-sheet tray index) removal

- 1 Remove the tray insert.
- 2 Remove the paper feeder. See [“550-sheet tray right cover removal” on page 375.](#)
- 3 Remove the screw (A).

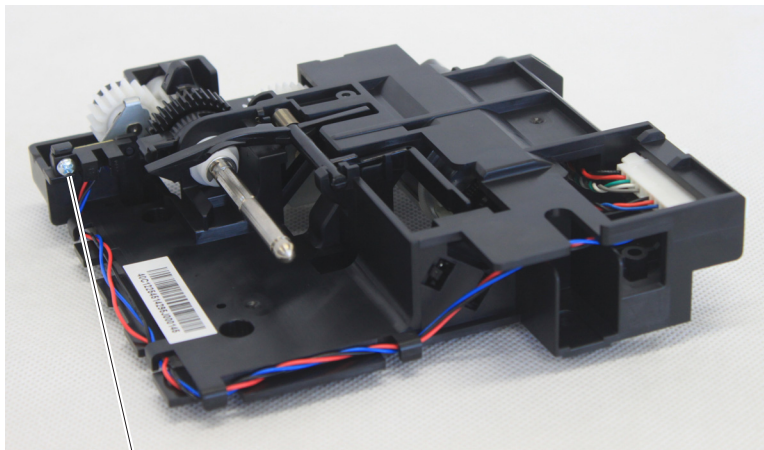

A

- 4 Disconnect the two cables (B), and then cut the zip tie (C).

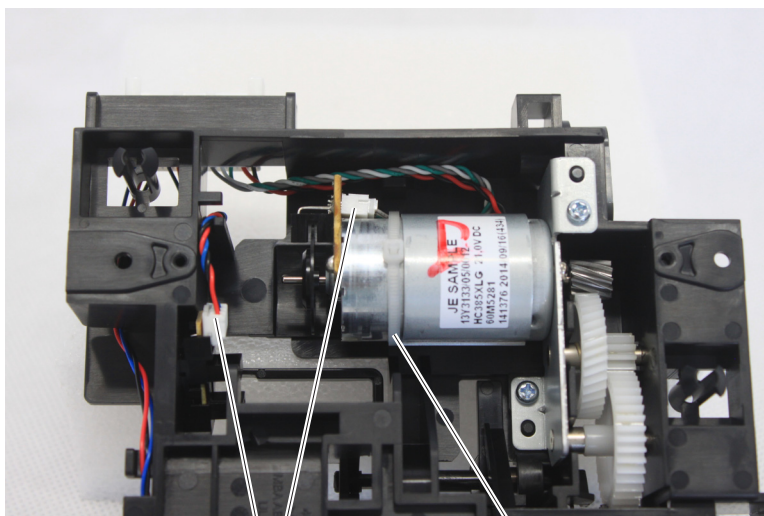

B

C

5 Squeeze, and then push the latches into the tray base to release the cable.

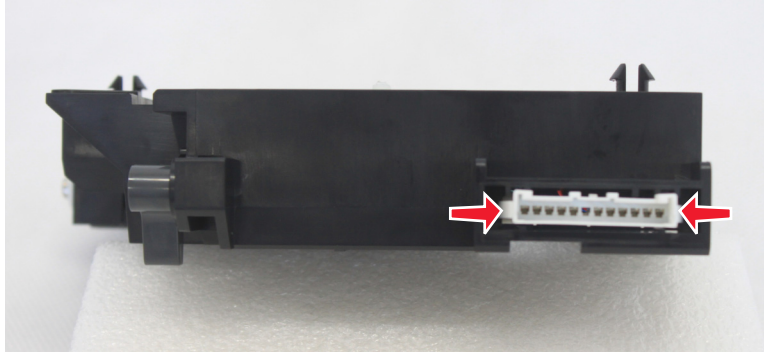

6 Remove the sensor.

Component locations

Printer configurations

CAUTION—TIPPING HAZARD: Installing one or more options on your printer or MFP may require a caster base, furniture, or other feature to prevent instability causing possible injury. For more information on supported configurations, see www.lexmark.com/multifunctionprinters.

CAUTION—TIPPING HAZARD: To reduce the risk of equipment instability, load each tray separately. Keep all other trays closed until needed.

You can configure your printer by adding three optional 550-sheet trays.



1	Standard bin
2	650-sheet duo tray
3	Optional 550-sheet trays
4	Control panel

Controller board connectors

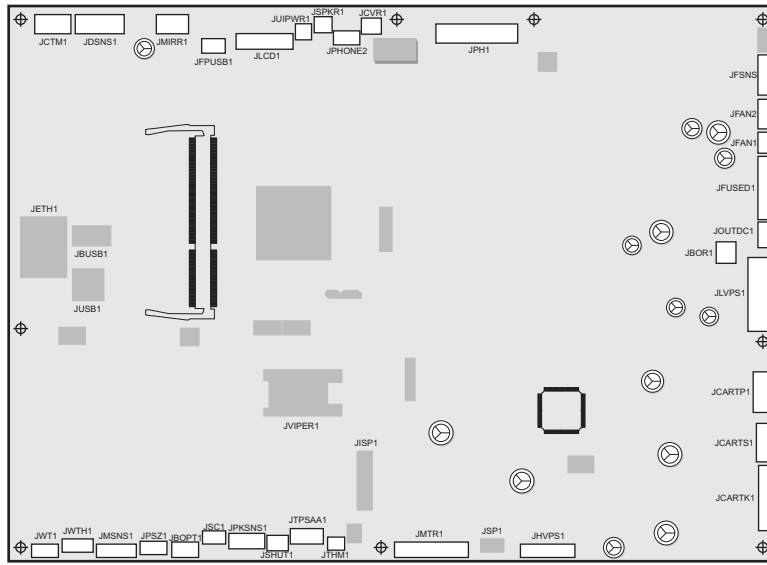

Connector	Connects to	Pin no.	Signal
JFSNS1	Fuser / LVPS	1	GND
		2	S_FBR1_IN
		3	S_FBR2_IN
		4	S_FBLT_SNS
		5	S_FHE1_IN
		6	S_FHE2_IN
		7	S_FHE3_IN
		8	VS10_FNP
		9	S_FNP_IN
		10	GND
		11	VS10_FXP
		12	S_FX_IN
		13	GD_FUSER_ID
		14	GND
JFAN1	Fuser / LVPS	1	FAN1_FG_IN
		2	GND
		3	V25_FAN_OUT
JFAN2	Fuser / LVPS	1	GND
		2	+25V_FAN
		3	FAN2_FG_IN
		4	GR_FAN2_PWM

Component locations

Connector	Connects to	Pin no.	Signal
JFUSED	Fuser motor	1	HALLF_A_IN
		2	HALLF_B_IN
		3	HALLF_C_IN
		4	FG_F_IN
		5	GND
		6	+5V_SW
		7	V45_FUSER_W
		8	V45_FUSER_V
		9	V45_FUSER_U
JOUTDC1	Output motor	1	VS10_OUT_LED
		2	S_OUT_ENC
		3	GND
		4	V30_OUT_MT-
		5	V30_OUT_MT+
JBOR	Black only retract	1	VS10_BOR_LED
		2	S_BOR_ENC
		3	GND
		4	V30_BOR_MT-
		5	V30_BOR_MT+
		6	GND

Connector	Connects to	Pin no.	Signal
JLVPS1	LVPS	1	PS_ZERO_X
		2	PS_HEAT2_ON
		3	PS_HEAT1_ON
		4	GND
		5	V15_RELAY_DRIVE
		6	GND
		7	PS_25V_ON
		8	GND
		9	PS_PM_TX
		10	PS_PM_RX
		11	+6.5V
		12	GND
		13	+6.5V
		14	GND
		15	+25V_RAW
		16	GND
		17	+25V_RAW
		18	GND
		19	+25V_RAW
		20	GND
		21	+25V_RAW
		22	GND
		23	+25V_RAW
		24	GND
		25	+25V_RAW
		26	GND
JCARTP1	CM cartridge motor	1	V45_CM_CART_W
		2	V45_CM_CART_V
		3	V45_CM_CART_U
		4	V45_Y_CART_W
		5	V45_Y_CART_V
		6	V45_Y_CART_U

Connector	Connects to	Pin no.	Signal
JCARTS1	Y cartridge motor	1	CM_FG
		2	CM_HALL_U
		3	+5V_SW
		4	CM_HALL_V
		5	GND
		6	CM_HALL_W
		7	GND
		8	Y_HALL_U
		9	+5V_SW
		10	Y_HALL_V
		11	Y_FG
		12	Y_HALL_W
JCARTK1	K cartridge motor	1	K_HALL_U
		2	K_HALL_V
		3	K_HALL_W
		4	K_FG
		5	GND
		6	+5V_SW
		7	V45_K_CART_W
		8	V45_K_CART_V
		9	V45_K_CART_U

Connector	Connects to	Pin no.	Signal
JHVPS1	HVPS	1	+5V_HVPS_REF
		2	GND
		3	M_DEV_PWM_OUT
		4	K_DEV_PWM_OUT
		5	C_DEV_PWM_OUT
		6	CMY_CHG_PWM_OUT
		7	Y_DEV_PWM_OUT
		8	K_CHG_PWM_OUT
		9	K_TX_PWM_OUT
		10	CMY_TX_PWM_OUT
		11	ITM_TX_PWM_OUT
		12	GND
		13	CMY_SRVO_OUT
		14	K_SRVO_OUT
		15	ITM_SRVO_OUT
		16	GD_HVPS_ID
		17	V_25V_HVPS
		18	GND

Connector	Connects to	Pin no.	Signal
JMTR1	Isolation unit motor and pick motor and sensors	1	VS10_BA_LED
		2	V30_BA+
		3	S_BA_ENC
		4	V30_BA-
		5	GND
		6	GND
		7	VS10_ISO_LED
		8	V30_ISO-
		9	S_ISO_ENC
		10	V30_ISO+
		11	VS10_MPF_LED
		12	S_MPF_ENC
		13	GND
		14	V40_MPF+D
		15	V40_MPF-M
		16	VS10_PE_LED
		17	S_PE_ENC
		18	GND
		19	V40_PE-M
		20	V40_PE+D
		21	VS10_ELEV
		22	S_ELEV_IN
		23	GND
		24	VS10_EMP
		25	S_T1_EMP
		26	GND
JTHM1	Thermistor	1	S_TT_IN
		2	GND

Connector	Connects to	Pin no.	Signal
JTPSAA1	TPS and auto align sensors	1	VS10_TPS1_VDD
		2	TPS1_DIFF
		3	TPS1_SPEC
		4	GND
		5	TPS1_SPEC_G
		6	TPS1_LED_G
		7	I2C_DATA_TPS
		8	I2C_CLK_TPS
		9	VS10_TPS1_VDD
		10	GND
		11	AA1_ADC
		12	AA1_PWM
		13	VS10_TPS1_VDD
		14	GND
		15	AA2_ADC
		16	AA2_PWM
JSHUT1	Media sensor	1	VS10_SHTR
		2	S_SHTR
		3	GND
JPKSNS1	Isolation unit sensors	1	VS10_S1
		2	S_S1_IN
		3	GND
		4	VS10_S1_ALT
		5	S_S1_ALT_IN
		6	GND
		7	VS10_BAN
		8	S_BAN_IN
		9	GND
		10	VS10_S2
		11	S_S2_IN
		12	GND

Connector	Connects to	Pin no.	Signal
JSC1	Imaging	1	V_FUSE_5V
		2	I2CDATA_AR_R
		3	I2CCLK_AR_R
		4	GND
JBOPT1	Option trays	1	VS45_INOPT_PWR
		2	GND
		3	GND
		4	S1_OPTION
		5	RXD_PTR_IN
		6	BUMPA_ENC_OPT
		7	GND
		8	TXD_PTR_BTM_OUT
JPSZ1	Paper size sensor	1	PSIZE0
		2	PSIZE1
		3	PSIZE2
		4	PSIZE3
		5	GND
JMSNS1	MFP paper present sensor, bubble / narrow media sensors, and duplex staging sensor	1	VS10_MPP
		2	VS10_MPM
		3	S_MPP_IN
		4	GND
		5	VS10_DSS
		6	S_DSS_IN
		7	GND
		8	VS10_BBS
		9	S_BBS_IN
		10	GND
		11	VS10_TRAY_NMS
		12	S_TRAY_NMS
		13	GND
		14	GND
JWTH1	Weather station	--	--

Connector	Connects to	Pin no.	Signal
JWT1	Waste toner	1	SENSE
		2	WT_VREF
		3	VAC
		4	GND
JISP1	ISP connector	1	GND
		2	USBOUT+
		3	USBOUT-
		4	GND
		5	USB_HD1_D+
		6	USB_HD1_D-
		7	GND
		8	+3.3V
		9	ISP_RST_R
		10	+5V_RIP
		11	I2C_DAT_ISP_L
		12	+5V_RIP
		13	I2C_CLK_ISP_L
		14	+5V_RIP
J61	Hard drive		
JCTM1	TMC	1	+5V_SW
		2	-CART_METER_C_IN
		3	-CART_METER_M_IN
		4	-CART_METER_Y_IN
		5	-CART_METER_K_IN
		6	GND
JSNS1	Bin full / duplex entry sensor		
JMIRR1	Mirror motor	1	MM_REF_CLKC
		2	MM_LOCK_IN
		3	MM_START_OUT
		4	GND
		5	V25_MM_25V
JPFUSB1	USB port		

Connector	Connects to	Pin no.	Signal
JLCD1	LCD display	1	LED_DRV_YLW2
		2	+5VL
		3	GSPI_TXD
		4	MIR_SPI_CS
		5	PWR_BUTTON_R2
		6	NC_SPICS_EXPAN1
		7	NC_SPICS_EXPAN2
		8	GSPI_RXD
		9	V15_UI
		10	GSPI_CLK_UIC
		11	GND
		12	I2CDATA_PANEL
		13	I2CCLK_PANEL
		14	V15_UI
		15	UIPIN24
		16	OP_IRQ_R2-
		17	GND
		18	LVDS_UI_D3R+
		19	LVDS_UI_D3R-
		20	V15_UI
		21	LVDS_UI_CLK_L+
		22	LVDS_UI_CLK_L-
		23	GND
		24	LVDS_UI_D2R+
		25	LVDS_UI_D2R-
		26	V15_UI
		27	LVDS_UI_D1R+
		28	LVDS_UI_D1R-
		29	GND
		30	LVDS_UI_D0R+
		31	LVDS_UI_D0R-
		32	V15_UI
MTG1	GND		
MTG2	GND		

Connector	Connects to	Pin no.	Signal
JUIPWR1	NFC	1	V15_UI
		2	V15_UI
		3	GND
		4	GND
JSPKR1	Speaker	1	SPEAKER1
		2	SPEAKER2
JPHONE2	Headphone jack	1	HEADPHONE_DET
		2	HPL_C
		3	HPR_C
		4	GND
JCVR1	Interlock switches	1	+25V_RAW
		2	+25V_HVPS

Connector	Connects to	Pin no.	Signal
JPH1	Printhead	1	LADJ_D4_OUT
		2	I2CDATA_PH
		3	GND
		4	I2CCLK_PH
		5	GND
		6	SHADE_Y_R2
		7	LADJ_D2_OUT
		8	SHADE_C_R2
		9	LENA_CMY-_OUT
		10	LPOW_Y_OUT
		11	GND
		12	LPOW_C_OUT
		13	BOOST_OUT
		14	SHADE_M_R2
		15	LADJ_D1_OUT
		16	SHADE_K_R2
		17	GND
		18	LPOW_M_OUT
		19	GND
		20	LPOW_K_OUT
		21	LENA_K-_OUT
		22	PH_THERM_ADC
		23	GND
		24	HSYNC_IN
		25	GND
		26	YDATA2-
		27	YDATA2+
		28	GND
		29	YDATA1-
		30	YDATA1+

Connector	Connects to	Pin no.	Signal
JPH1	Printhead	31	GND
		32	MDATA2-
		33	MDATA2+
		34	GND
		35	MDATA1-
		36	MDATA1+
		37	GND
		38	CDATA2-
		39	CDATA2+
		40	GND
		41	CDATA1-
		42	CDATA1+
		43	GND
		44	KDATA2-
		45	KDATA2+
		46	GND
		47	KDATA1-
		48	KDATA1+
		49	GND
		50	LADJ_D3_OUT
MTG1	GND		
MTG2	GND		

LVPS controller board connectors

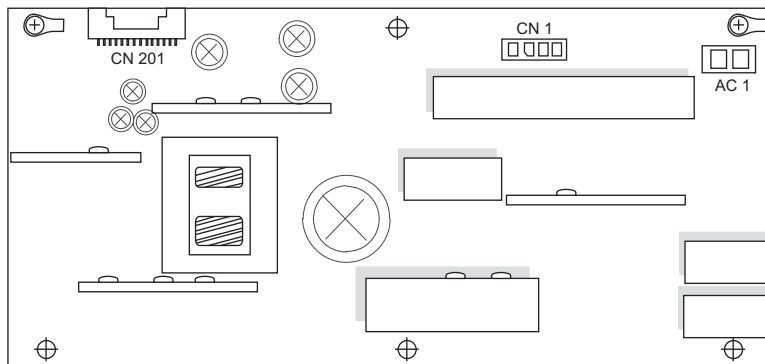

Component locations

Connector	Connects to	Pin no.	Signal
CN201	Controller board	1	+25V
		2	GND
		3	+25V
		4	GND
		5	+25V
		6	GND
		7	+25V
		8	GND
		9	+25V
		10	GND
		11	+25V
		12	GND
		13	+25V
		14	GND
		15	+25V
		16	GND
		17	GND
		18	GND
		19	Zero_Cross
		20	Heat_On2
		21	Heat_On1
		22	Main_On_Off
		23	Tx_PwrMtr
		24	Relay_Drive
		25	Ground
		26	+6.5V
		27	+6.5V
		28	+6.5V
		29	Rx_PwrMtr
		30	Heat_On3
CN1	Fuser	1	AC Common
		2	AC Out 3
		3	AC Out 2
		4	AC Out 1

Connector	Connects to	Pin no.	Signal
AC1	AC line in	1	Phase
		2	Neutral

Motor locations

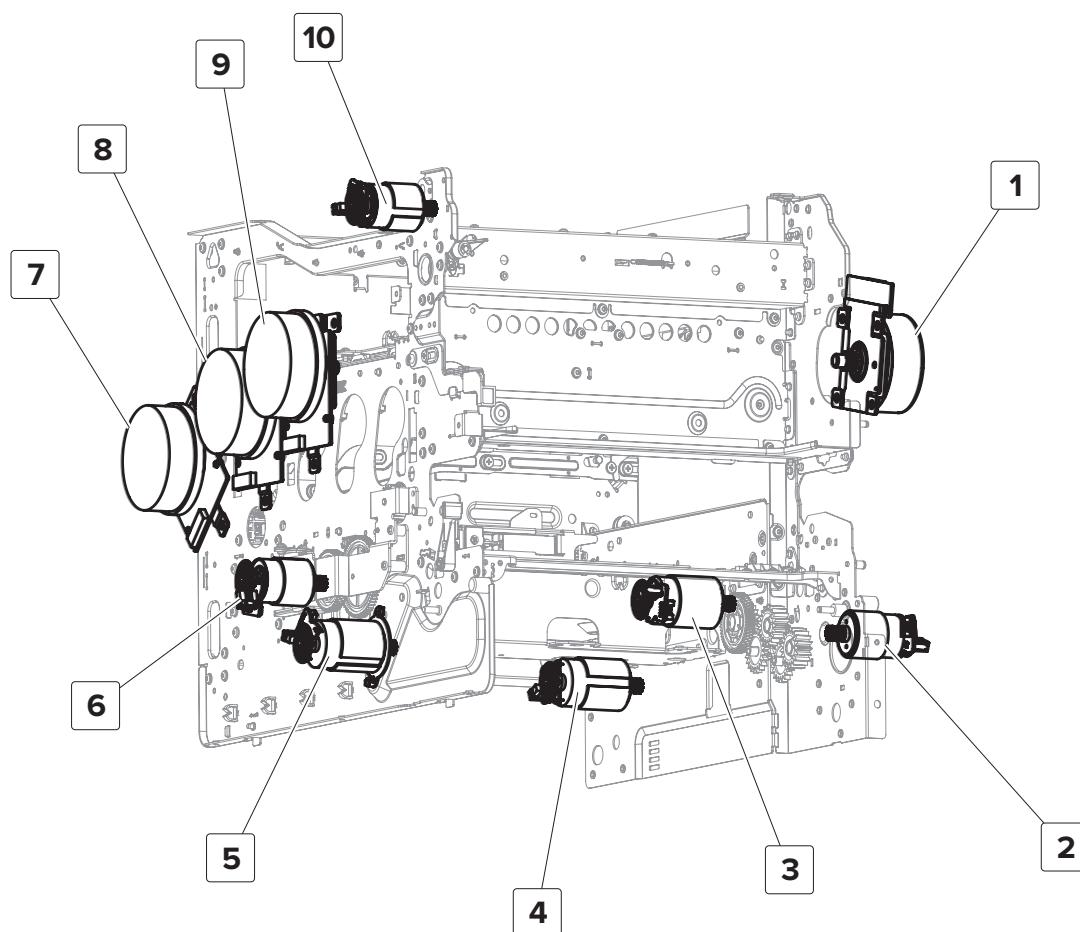

Part	Description
1	Motor (fuser)
2	Motor (duplex/MPF)
3	Motor (isolation)
4	Motor (pick/elevator)
5	Motor (deskew)
6	Motor (BOR)
7	Motor (K developer) Motor (ITM)

Part	Description
8	Motor (CM developer)
9	Motor (Y developer)
10	Motor (output)

Sensor locations

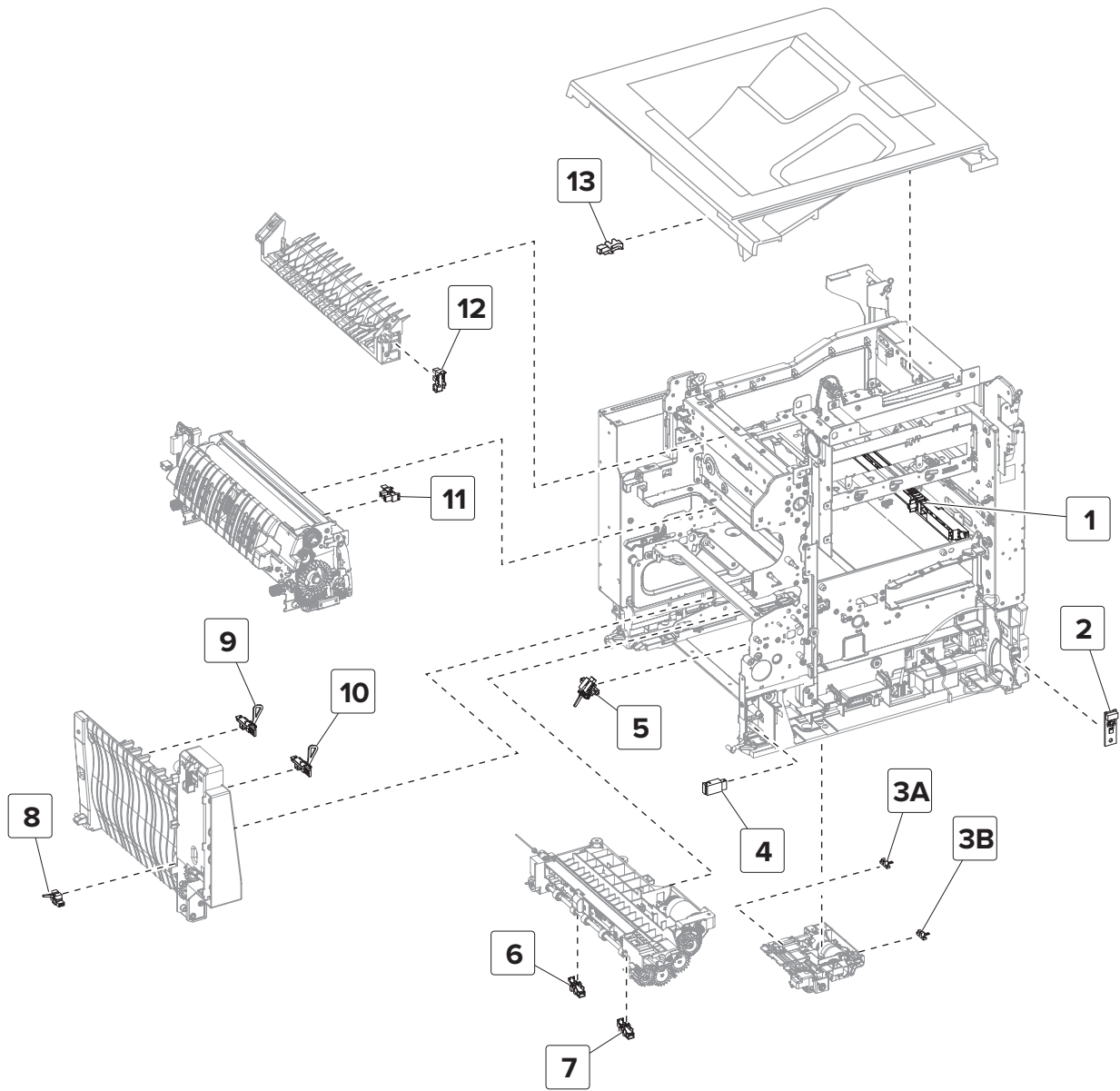

Component locations

Part	Description
1	Sensor (TPS)
2	Sensor (weather station)
3A	Sensor (media out)
3B	Sensor (pick roller index)
4	Sensor (MPF paper present)
5	Sensor (input)
6	Sensor (tray 1 pick)
7	Sensor (MPF pass-through)
8	Sensor (duplex path 2)
9	Sensor (narrow media)
10	Sensor (fuser buckle)
11	sensor (fuser exit)
12	sensor (duplex path 1)
13	sensor (bin full)

Maintenance

Inspection guide

The purpose of this Inspection guide is to aid you in identifying the intervals, based on page count, at which parts must be Inspected (for visible physical damage), cleaned, or replaced.

If any unsafe conditions exist, find out how serious the hazard could be and if you can continue before you correct the hazard.

As you service the machine, check for the following:

- Damaged, missing, or altered parts, especially in the area of the On/Off switch and the power supply
- Damaged, missing, or altered covers, especially in the area of the top cover and the power supply cover
- Possible safety exposure from any non-Lexmark attachments

Use the following tables to determine when specified parts should be Inspected:

Lexmark CS720, CS725, and C4150	Every service call	Every 150K	Notes
Media tray - All			
Media tray side guides	Inspect		Check for correct positioning
Media tray length guides	Inspect		Check for correct positioning
Transfer module (ITM)	Inspect	Replace	Ensure correct installation
Fuser	Inspect	Replace	Ensure correct installation
Media feeders - All			
Media tray pick tires	Inspect and clean if needed		Clean with a damp cloth
MPF pick tires	Inspect and clean if needed		Clean with a damp cloth
Paper path			
Duplex path rollers	Inspect		<ul style="list-style-type: none"> • Check for media fragments and tears • Check for excessive toner build-up on white rollers • Clean with damp cloth if needed
Miscellaneous			
Toner spillage	Clean		Use a toner vacuum and cloth to remove all toner spillage from the printer

Scheduled maintenance

The control panel displays an **80 .xx** error when it reaches certain page counts. It is necessary to replace the appropriate maintenance kit to maintain print quality and printer reliability. Reset the maintenance counter after replacing the maintenance kit.

Maintenance kits

The printer may stop printing when the fuser rated life is reached. After 150K printed pages (sides) a maintenance kit may be required. The correct fuser maintenance kit must be installed for the type of fuser that is installed in the printer. See [“Identifying the type of fuser used in the printer” on page 409](#).

The following table shows the error codes that indicate that the fuser is nearing its end of life, and that a maintenance kit is required:

Error code	Description
80.0x	The maintenance kit is nearly low.
80.1x	The maintenance kit is low.
80.2x	The maintenance kit is very low. Only 2000 estimated pages remain.
80.3x	The maintenance kit is low. 0 estimated pages remain.
80.4x	The maintenance kit is very low. 0 estimated pages remain.

The parts are available as a maintenance kit with the following part numbers:

Description	Part number	Maintenance interval
CS72x fuser maintenance kit, type 02, 100V	41X0552	150K
CS72x fuser maintenance kit, type 07, 100V, narrow media	41X0553	150K
CS72x fuser maintenance kit, type 00, 110–120V	41X0554	150K
CS72x fuser maintenance kit, type 05, 110–120V, narrow media	41X0555	150K
CS72x fuser maintenance kit, type 01, 220–240V	41X0556	150K
CS72x fuser maintenance kit, type 06, 220–240V, narrow media	41X0557	150K

When performing the scheduled maintenance procedure, the following areas should be cleaned of media dust and toner contamination:

- Trays
- PC cartridge area
- Developer housings area
- Transfer roll area
- Duplex area
- Standard bin
- Bridge unit area (if equipped)
- Finisher media bins (if equipped)

Identifying the type of fuser used in the printer

- 1 Open the front cover.
- 2 Locate the identification number on the fuser.

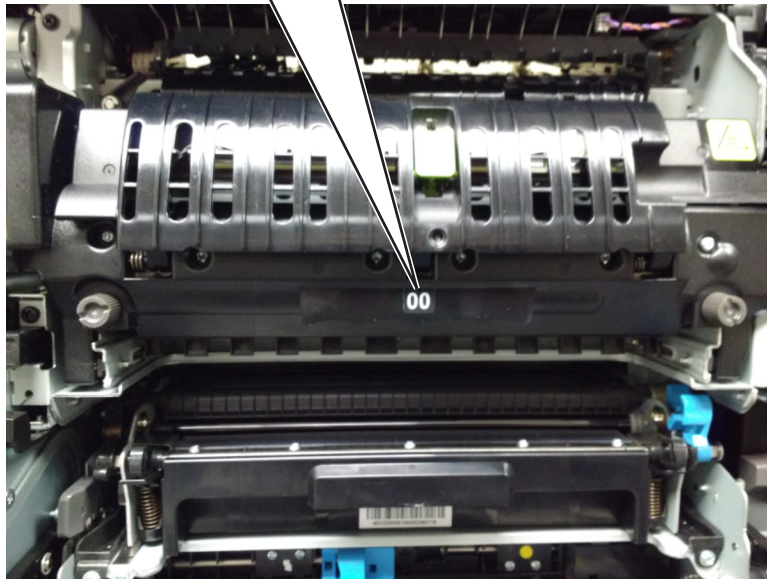

Cleaning the printer

Cleaning the printer

CAUTION—SHOCK HAZARD: To avoid the risk of electrical shock when cleaning the exterior of the printer, unplug the power cord from the electrical outlet and disconnect all cables from the printer before proceeding.

Notes:

- Perform this task after every few months.
- Damage to the printer caused by improper handling is not covered by the printer warranty.

- 1 Turn off the printer, and then unplug the power cord from the electrical outlet.
- 2 Remove paper from the standard bin and multipurpose feeder.
- 3 Remove any dust, lint, and pieces of paper around the printer using a soft brush or vacuum.
- 4 Wipe the outside of the printer with a damp, soft, lint-free cloth.

Notes:

- Do not use household cleaners or detergents, as they may damage the finish of the printer.
- Make sure that all areas of the printer are dry after cleaning.

- 5 Connect the power cord, and then turn on the printer.

Cleaning the printhead lenses

- 1 Remove the waste toner bottle.
- 2 Remove the imaging kit.
- 3 Using a lint-free cloth, wipe the printhead lenses (A).

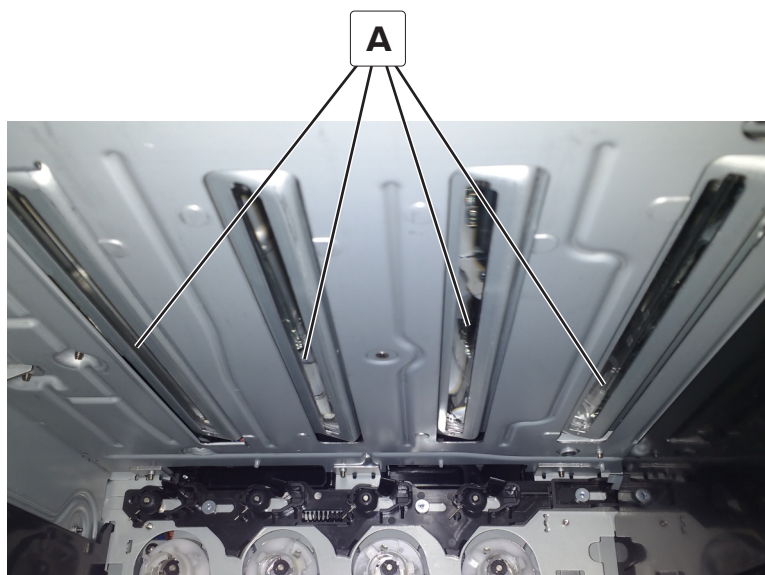

Cleaning the main tray duplex turnaround

- 1 Remove the two screws (A).

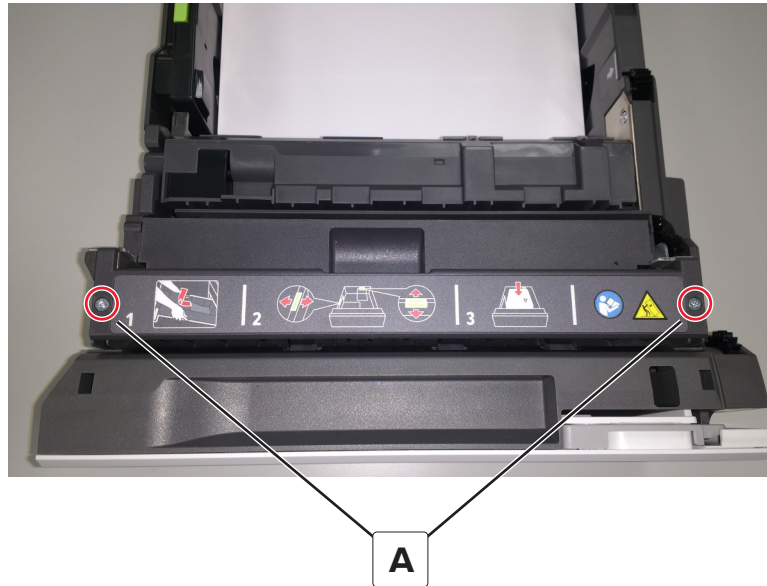

- 2 Open the turnaround cover.

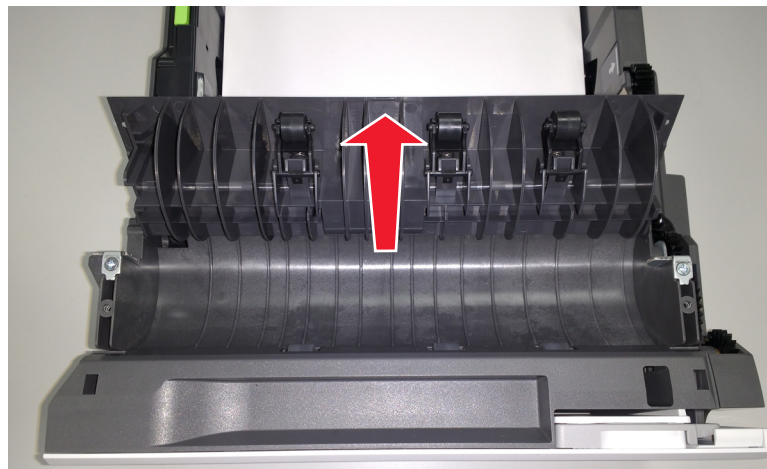

- 3 Remove the debris in the duplex turnaround area.
- 4 Close the cover, and then replace the screws.

Parts catalog

Legend

The following column headings are used in the parts catalog:

- **Asm-index**—Identifies the item in the illustration
- **P/N**—Identifies the part number of a FRU
- **Units/mach**—Refers to the number of units in a printer
- **Units/opt**—Refers to the number of units in an option
- **Units/FRU**—Refers to the number of units in a FRU
- **Description**—A brief description of the part

The following abbreviations are used in the parts catalog:

- **NS** (not shown) in the Asm-index column indicates that the part is procurable but is not shown in the illustration.
- **PP** (parts packet) in the Description column indicates that the part is contained in a parts packet.

Assembly 1: Covers 1

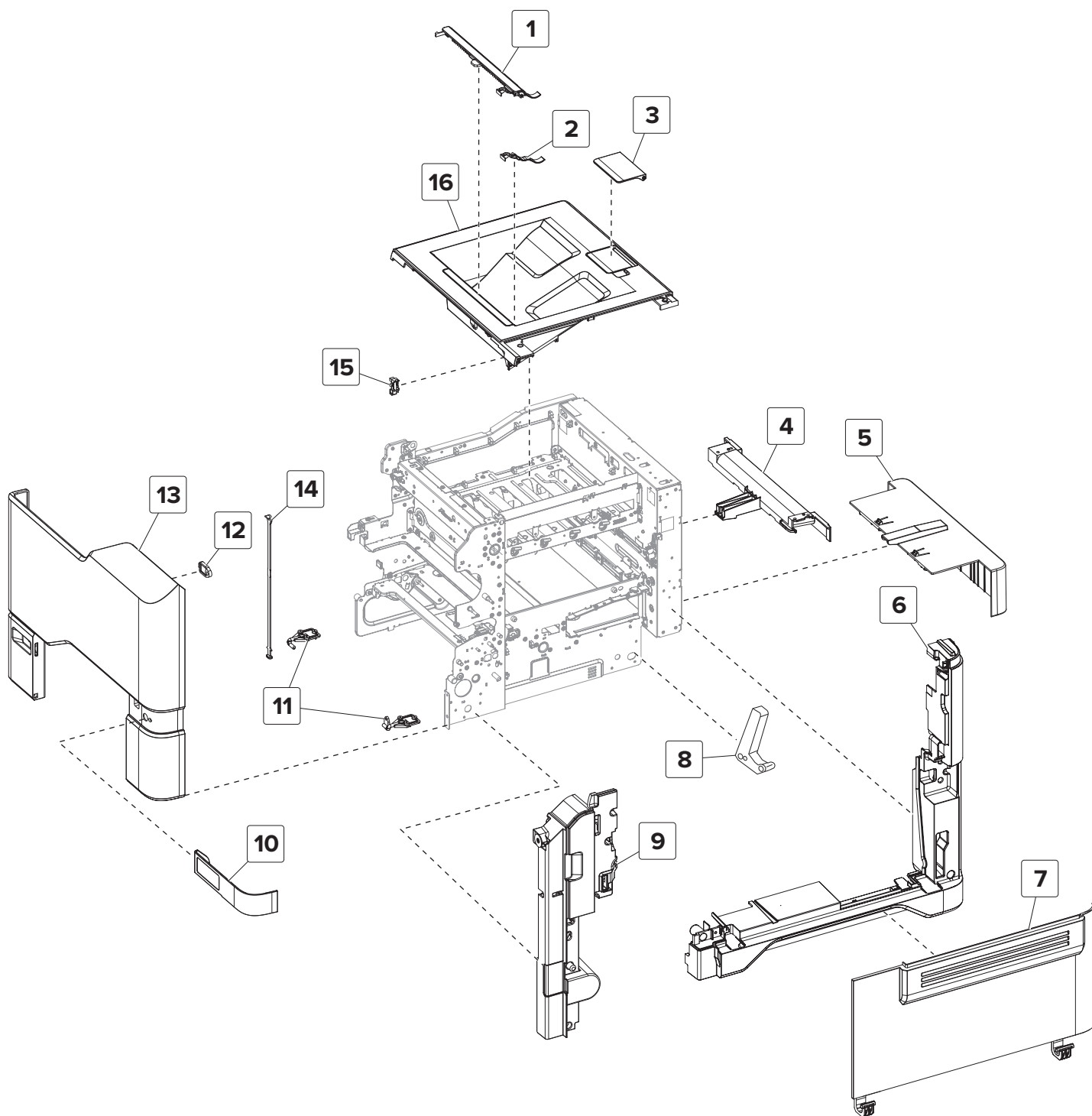

Assembly 1: Covers 1

Asm-index	P/N	Units/opt	Units/FRU	Description	Removal procedure
1	41X0773	1	1	Output bin exit cover	“Output bin exit cover removal” on page 367
2	41X0772	1	1	Output bin flag	“Output bin flag removal” on page 367
3	41X0410	1	1	Bin extender	--
4	41X0424	1	1	Rear handle cover	--
5	41X0408	1	1	Rear tray cover	--
6	41X0419	1	1	Right cover	“Right cover removal” on page 272
7	41X0403	1	1	Imaging unit cover	“Imaging unit cover removal” on page 324
8	41X0686	1	1	TPS wiper mechanism	“TPS wiper mechanism removal” on page 330
9	41X0421	1	1	Motor cover	“Motor cover removal” on page 273
10	41X0401	1	1	Tray indicator cover	--
11	41X0567	2	1	Front cover hinges	“Front cover hinges removal” on page 368
12	41X0560	1	1	Front door bracket	--
13	41X0411	1	1	Front cover	“Front cover removal” on page 265
14	41X0380	2	1	Front door strap	--
15	41X0570	1	1	Sensor (bin full)	--
16	41X0409	1	1	Top cover	“Top cover removal” on page 268
NS	41X0448	1	1	Sensor (interlock assembly)	--

Assembly 2: Covers 2

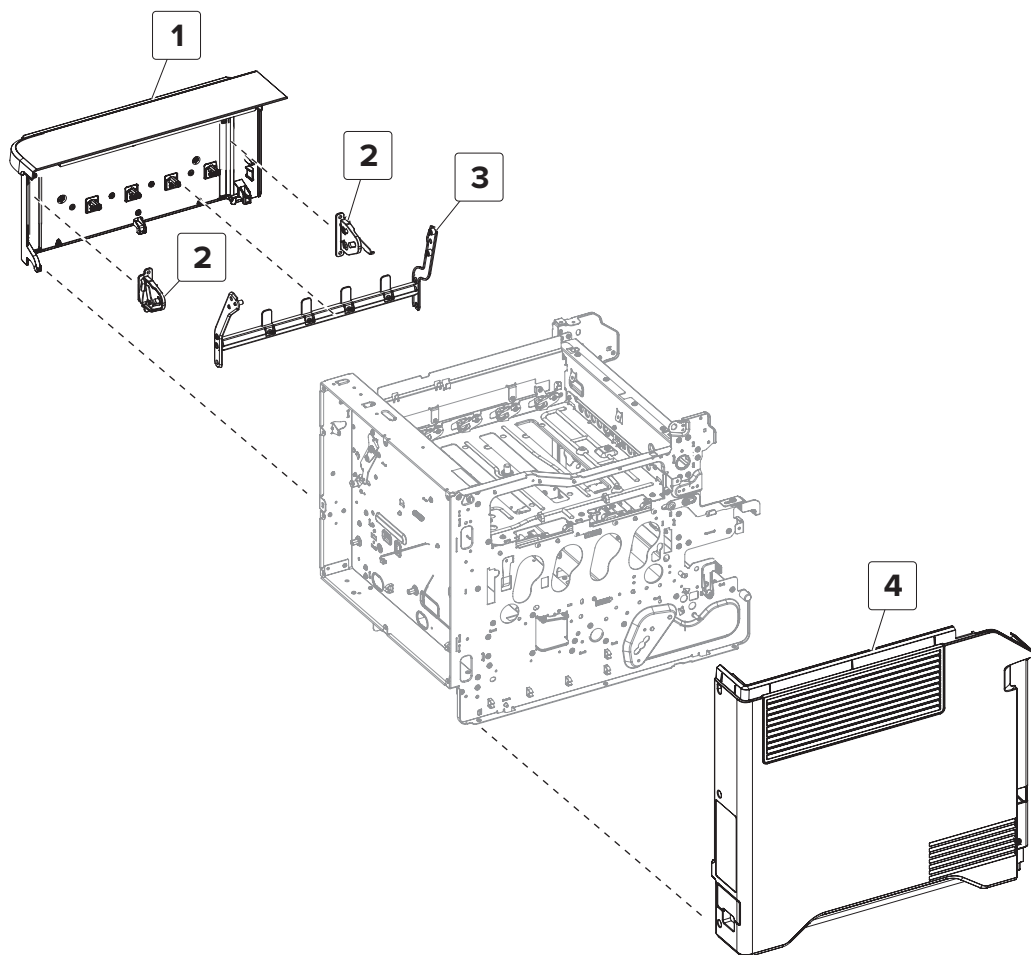

Assembly 2: Covers 2

Asm-index	P/N	Units/mach	Units/FRU	Description	Removal procedure
1	41X0414	1	1	Toner door	“Toner door removal” on page 276
2	41X0558	1	2	Toner door mount bracket	“Toner door mount bracket removal” on page 278
3	41X0415	1	1	Toner door mount	“Toner door mount removal” on page 279
4	41X0412	1	1	Left cover	“Left cover removal” on page 271
NS	41X1009	1	1	External air filter	“External air filter removal” on page 280

Assembly 3: Control panel

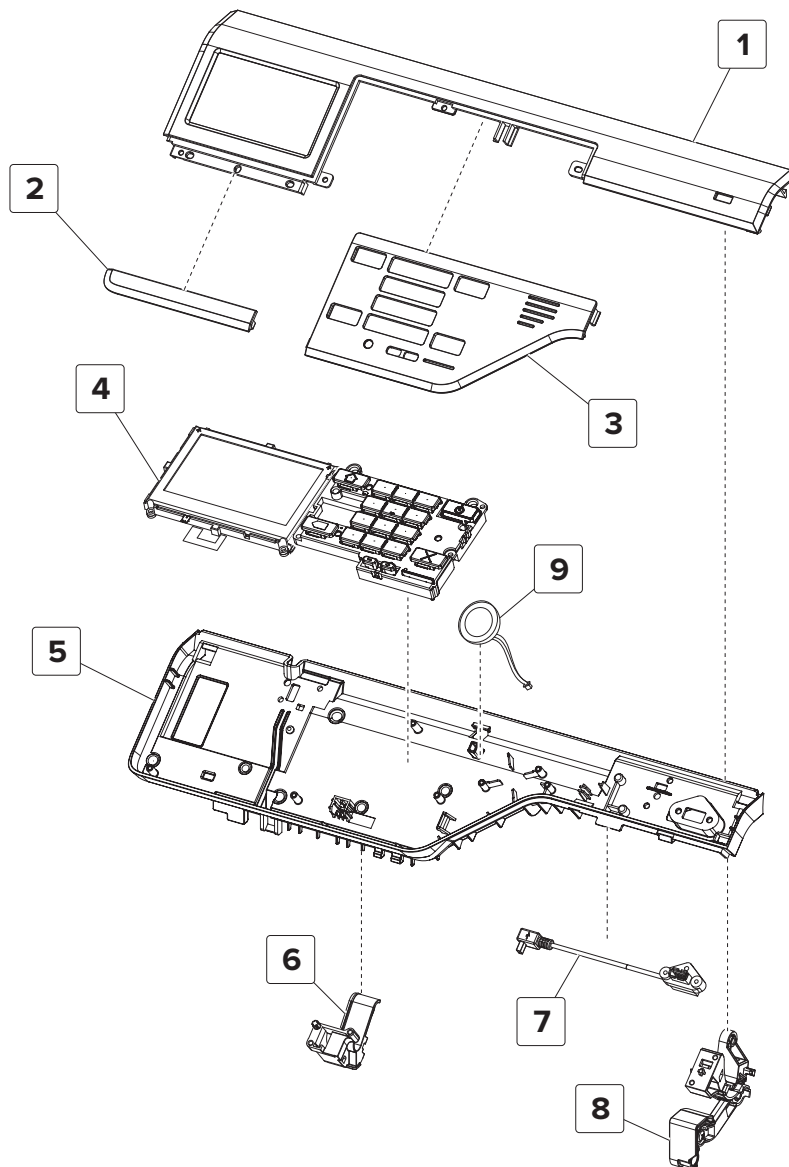

Assembly 3: Control panel

Asm-index	P/N	Units/mach	Units/FRU	Description	Removal procedure
1	41X0416	1	1	Upper control panel cover	“Upper control panel removal” on page 280
2	41X0871	1	1	C620 badge cover	“Badge cover removal” on page 283
2	41X0872	1	1	C720 badge cover	“Badge cover removal” on page 283
2	41X0873	1	1	C4150 badge cover	“Badge cover removal” on page 283
3	41X0422	1	1	Number pad cover	“Number pad cover removal” on page 284
4	41X0050	1	1	4.3-in. control panel	“Upper control panel removal” on page 280
5	41X0423	1	1	Control panel base cover	“Control panel base cover removal” on page 287
6	41X0561	1	1	Left control panel arm	“Control panel arms removal” on page 284
7	41X0441	1	1	Control panel USB cable	--
8	41X0562	1	1	Right control panel arm	“Control panel arms removal” on page 284
9	41X0399	1	1	Speaker	“Speaker removal” on page 286

Assembly 4: Fuser

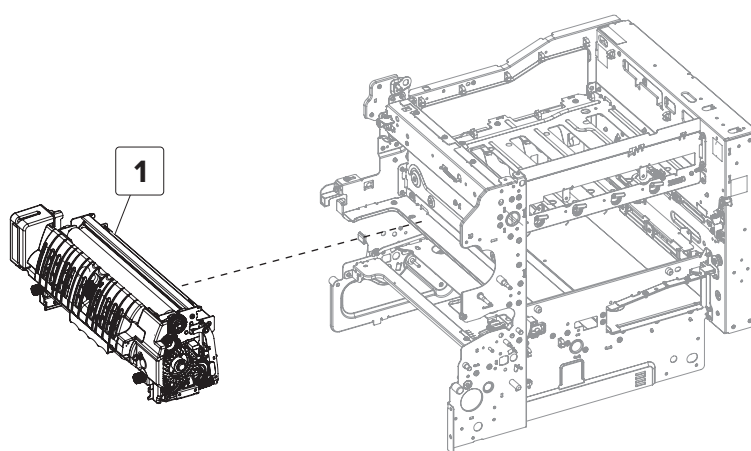

Assembly 4: Fuser

Asm-index	P/N	Units/mach	Units/FRU	Description	Removal procedure
1	41X0251	1	1	CS72x fuser type 02, 100V	“Fuser removal” on page 333
1	41X0252	1	1	CS72x fuser type 00, 110-120V	“Fuser removal” on page 333
1	41X0253	1	1	CS72x fuser type 01, 220-240V	“Fuser removal” on page 333
1	41X0254	1	1	CS72x fuser type 07, 100V (narrow media)	“Fuser removal” on page 333
1	41X0255	1	1	CS72x fuser type 05, 110-120V (narrow media)	“Fuser removal” on page 333
1	41X0256	1	1	CS72x fuser type 06, 220-240V (narrow media)	“Fuser removal” on page 333

Assembly 5: Transfer module

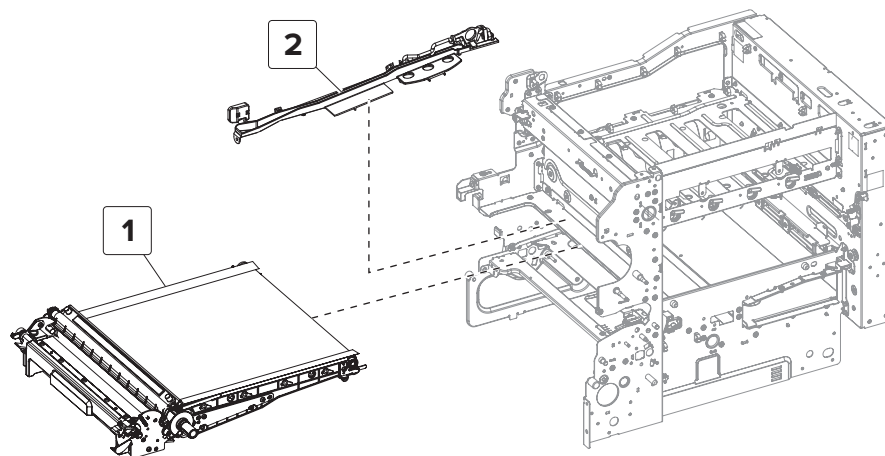

Assembly 5: Transfer module

Asm-index	P/N	Units/mach	Units/FRU	Description	Removal procedure
1	40X9929	1	1	Transfer module	“Transfer module removal” on page 334
2	41X0683	1	1	Transfer module guide rail	“Transfer module guide rail removal” on page 336

Assembly 6: Paper feed

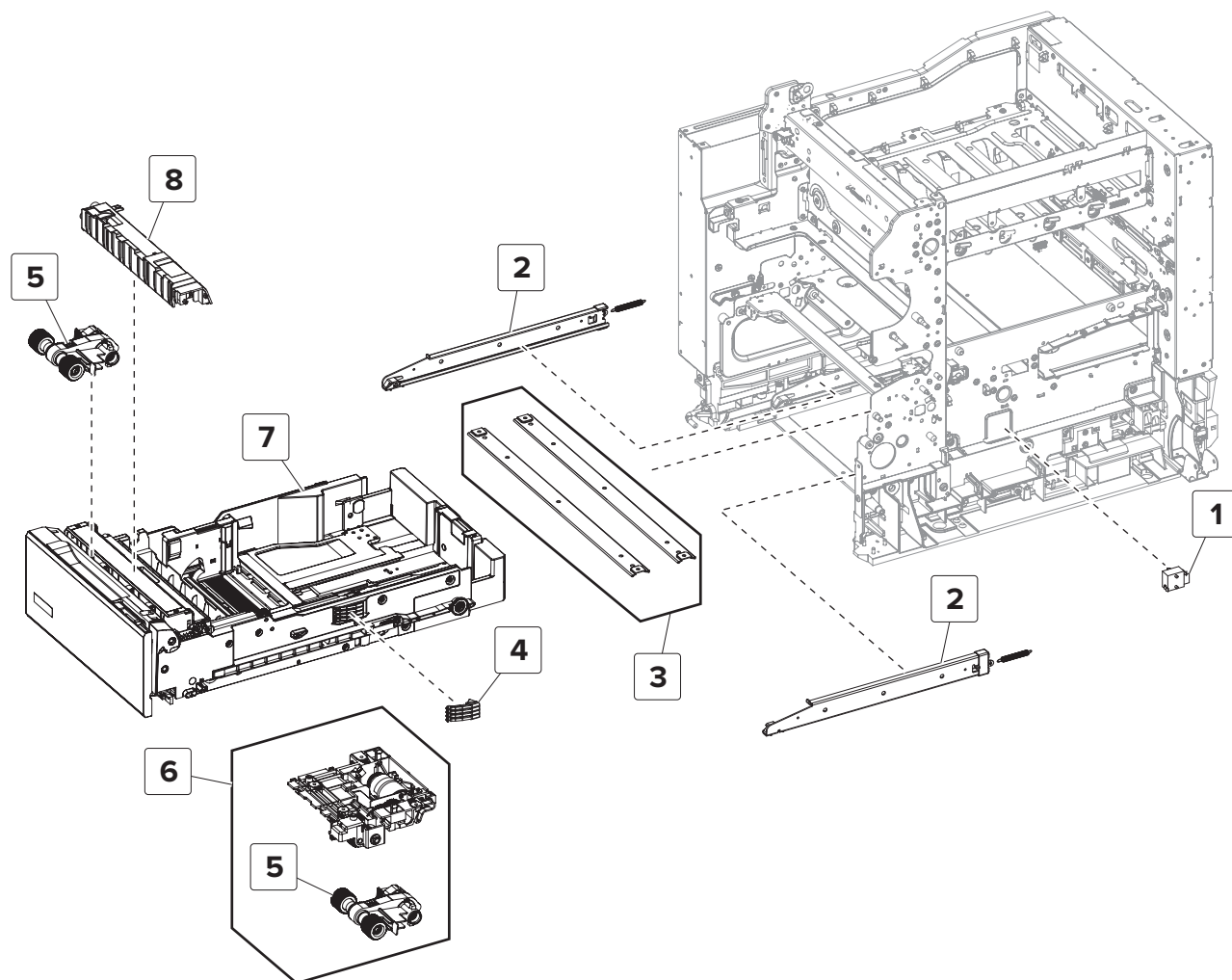

Assembly 6: Paper feed

Asm-index	P/N	Units/mach	Units/FRU	Description	Removal procedure
1	40X7911	1	1	Sensor (paper size)	“Sensor (paper size) removal” on page 312
2	41X0372	1	1	Tray rails	“Tray rail removal” on page 369
3	41X0825	2	1	Support strap	--
4	41X0373	1	1	Paper size sensor actuators	--
5	41X0956	2	1	Pick roller (tray 1 and MPF)	--
6	41X0396	1	1	Media feeder	“Media feeder removal” on page 373
7	41X0268	1	1	550-sheet tray	--
8	41X0374	1	1	Separation block	--

Assembly 7: Paper path 1

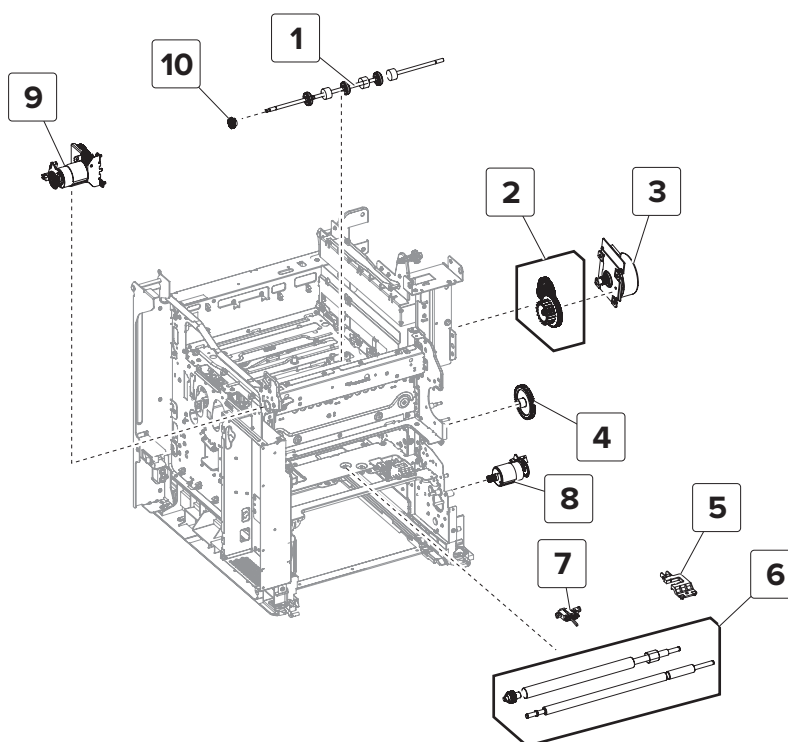

Assembly 7: Paper path 1

Asm-index	P/N	Units/mach	Units/FRU	Description	Removal procedure
1	41X0390	1	1	Output roll	“Output roll removal” on page 364
2	41X0395	1	1	Fuser drive gear	--
3	41X0001	1	1	Motor (fuser)	“Motor (fuser) removal” on page 318
4	41X0757	1	1	Waste toner bottle idler gear	“Waste toner bottle idler gear removal” on page 324
5	41X0450	1	1	Sensor (media type)	“Sensor (media type) removal” on page 340
6	41X0386	1	1	Deskew rollers	“Deskew rollers removal” on page 342
7	41X0385	1	1	Sensor (input)	“Sensor (input) removal” on page 341
8	41X0381	1	1	Motor (duplex/MPF)	“Motor (duplex/MPF) removal” on page 315
9	41X0451	1	1	Motor (output)	“Motor (output) removal” on page 297
10	41X0391	1	1	Output gear	--
NA	41X0392	1	1	Output drive	--

Assembly 8: Paper path 2

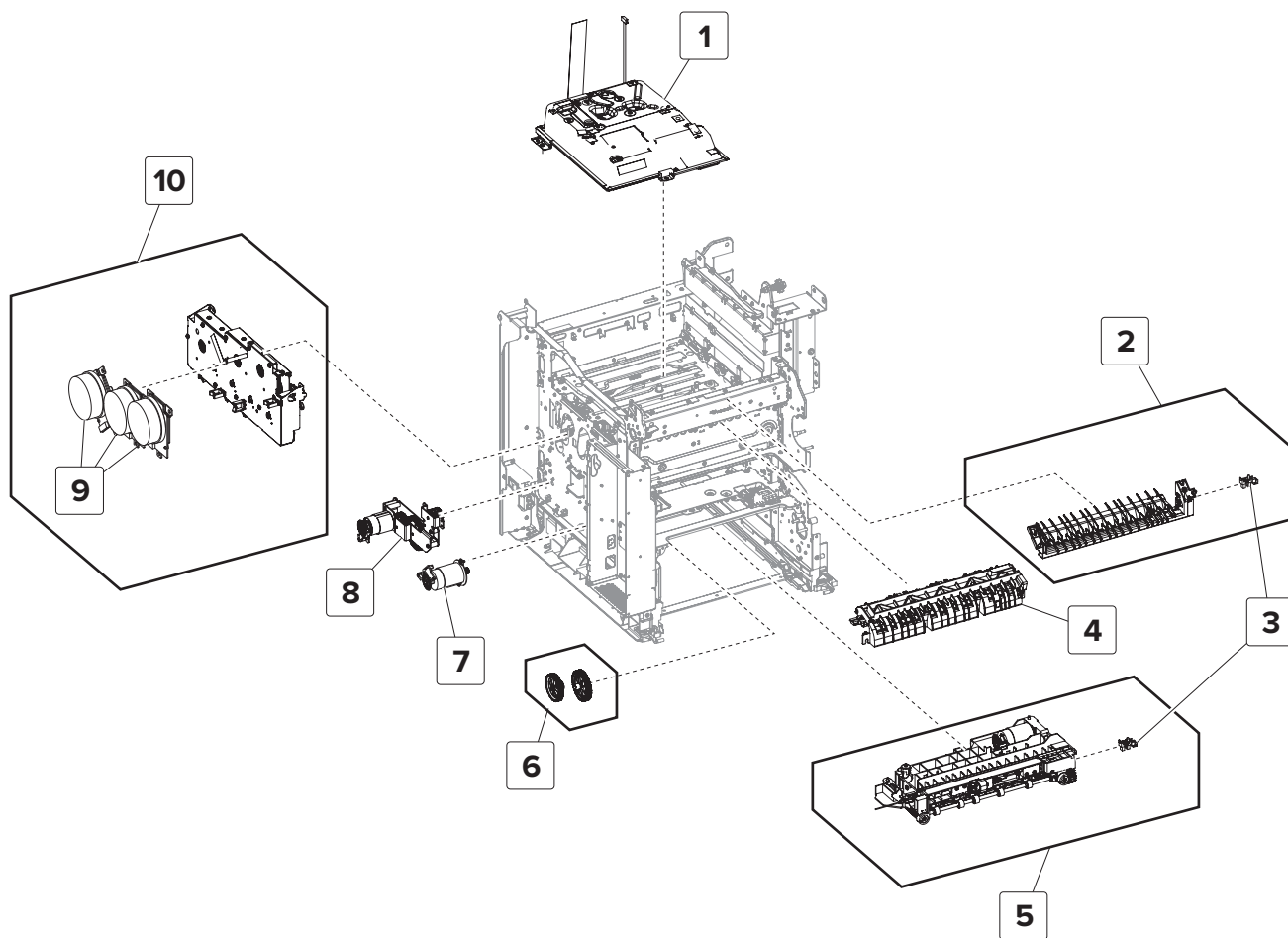

Assembly 8: Paper path 2

Asm-index	P/N	Units/mach	Units/FRU	Description	Removal procedure
1	41X0265	1	1	Printhead	“Printhead removal” on page 361
2	41X0389	1	1	Diverter	“Diverter removal” on page 350
3	41X0570	2	1	Sensor (duplex path 1 / MPF pass-through)	--
4	41X0388	1	1	Redrive guide	“Redrive guide removal” on page 354
5	41X0384	1	1	Isolation unit	“Isolation unit removal” on page 371
6	41X0758	1	1	Aligner drivetrain kit	--
7	41X0387	1	1	Motor (deskew)	“Motor (deskew) removal” on page 299
8	41X0393	1	1	Motor (black only retract)	“Motor (black only retract) removal” on page 309
9	41X0564	1	1	Motor (EP drive)	“Motor (EP drive) removal” on page 296
10	41X0264	1	1	EP gear box	“EP gear box removal” on page 302
NS	41X0897	4	1	Developer hold down arm	“Developer hold down removal” on page 363

Assembly 9: Duplex

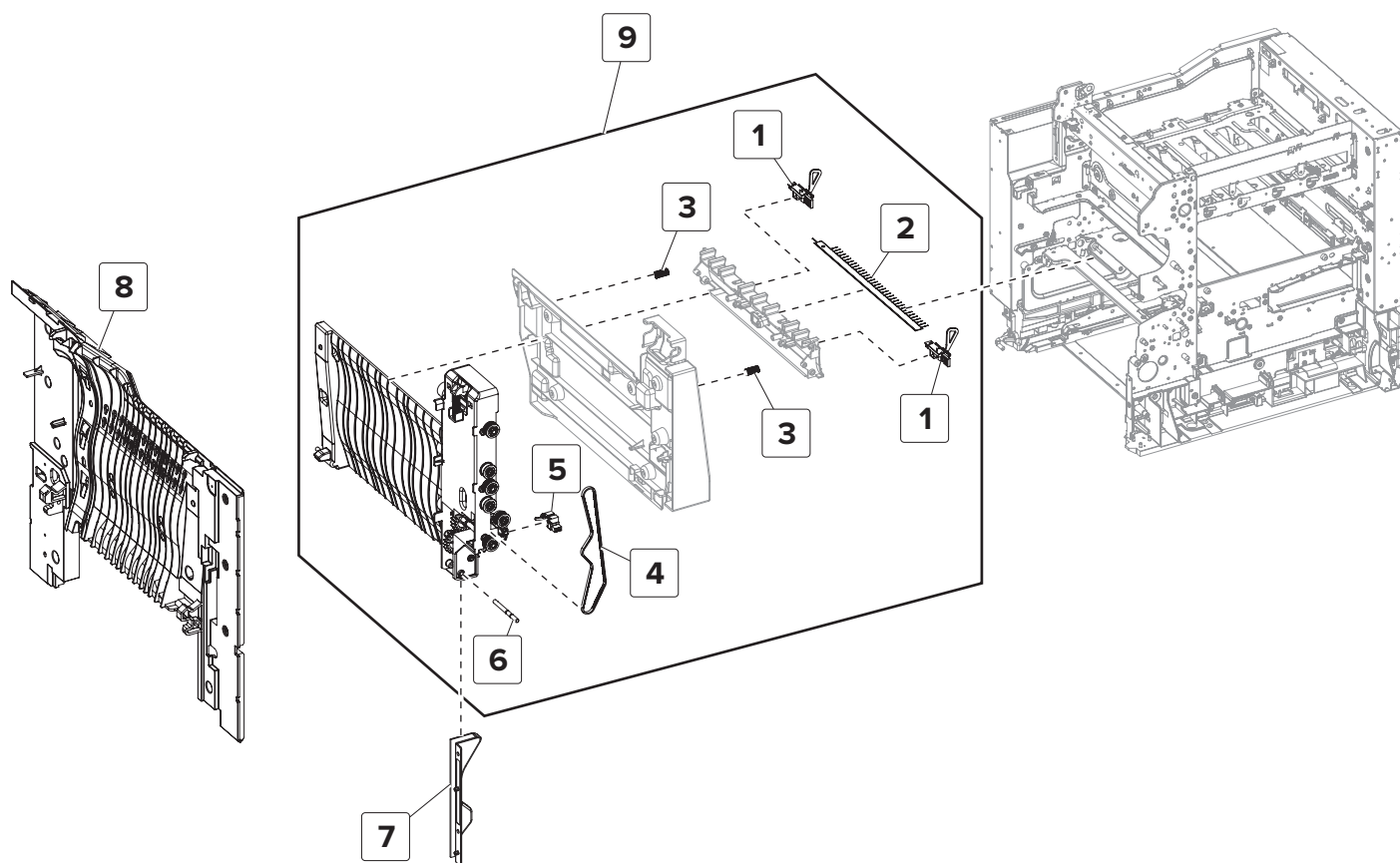

Assembly 9: Duplex

Asm-index	P/N	Units/mach	Units/FRU	Description	Removal procedure
1	41X0447	2	1	Sensor (fuser buckle / narrow media)	“Sensors (fuser buckle and narrow media) removal” on page 294
2	41X0824	1	1	Static brush	--
3	41X0379	2	1	Guide spring	--
4	41X0378	1	1	Tensioner belt	“Tensioner belt removal” on page 292
5	41X0446	1	1	Sensor (duplex staging)	--
6	41X0377	1	1	Pivot shaft	“Pivot shaft removal” on page 291
7	41X0400	1	1	Cable cover	--
8	41X0407	1	1	Duplex outer guide	“Duplex outer guide removal” on page 289
9	41X0376	1	1	Duplex inner guide	“Duplex inner guide removal” on page 291

Assembly 10: Electrical

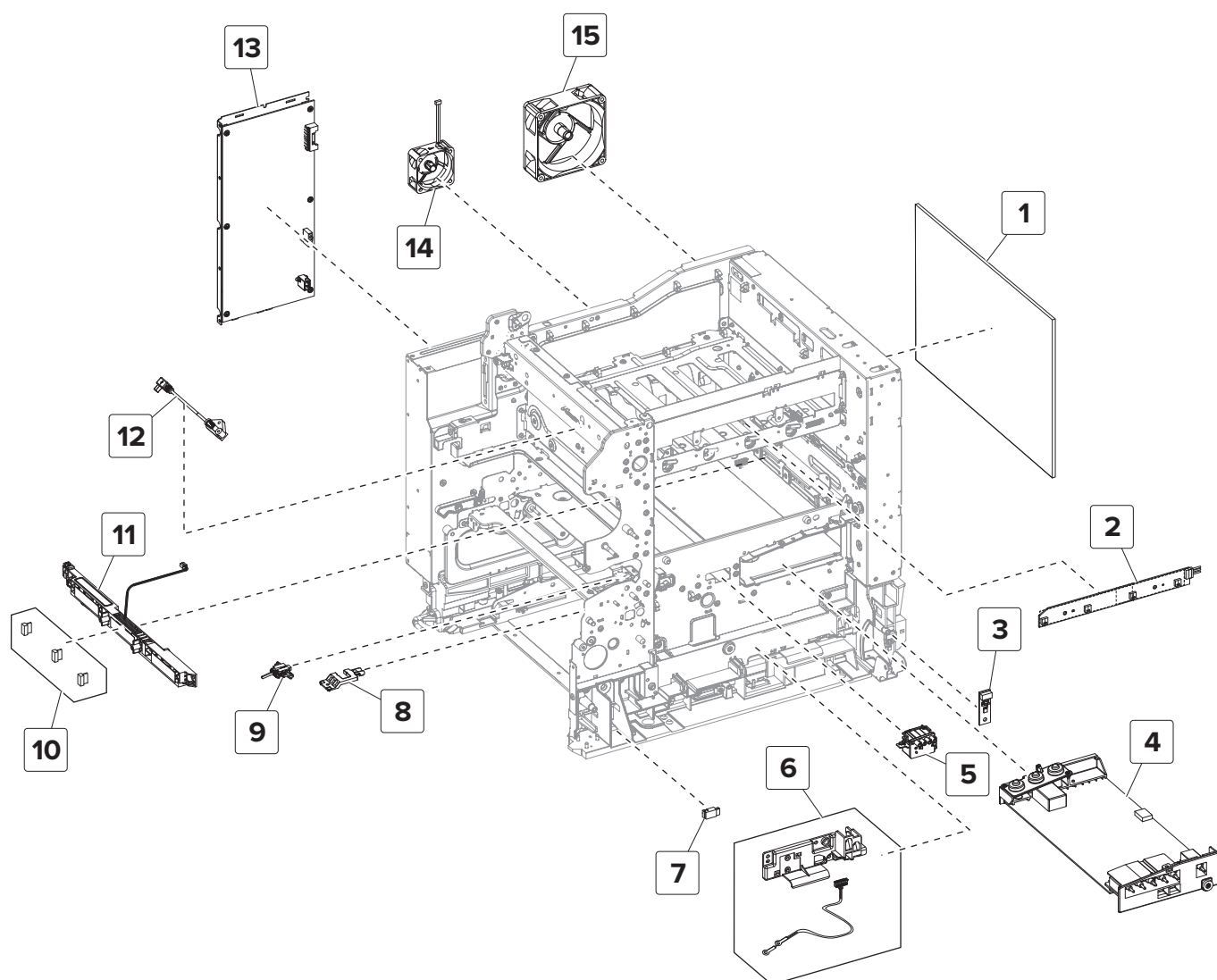

Assembly 10: Electrical

Asm-index	P/N	Units/mach	Units/FRU	Description	Removal procedure
1	41X0267	1	1	Controller board	“Controller board removal” on page 357
2	41X0394	1	1	TMC card	“TMC card removal” on page 315
3	41X0785	1	1	Sensor (weather station)	“Sensor (weather station) removal ” on page 311
4	41X0270	1	1	High voltage power supply	“HVPS removal” on page 319
5	41X0382	1	1	Toner cartridge contact	“Toner cartridge contacts removal” on page 328
6	41X0486	1	1	Sensor (waste toner contact)	“Sensor (waste toner contact) removal ” on page 314
7	41X0566	1	1	Sensor (MPF paper present)	“Sensor (MPF paper present) removal” on page 322
8	41X0450	1	1	Sensor (media type)	“Sensor (media type) removal” on page 340
9	41X0385	1	1	Sensor (input)	“Sensor (input) removal” on page 341
10	41X0578	1	3	TPS wipers	“TPS wiper removal” on page 332
11	41X0383	1	1	Sensor (TPS)	“Sensor (TPS) removal” on page 325
12	41X0441	1	1	Control panel USB cable	--
13	41X0425	1	1	Low voltage power supply	“LVPS removal” on page 305
14	41X0398	1	1	Fuser fan	“Fuser fan removal” on page 299
15	41X0397	1	1	Main fan	“Main fan removal” on page 301
NS	41X0719	1	1	Control panel cable kit	--
NS	41X0575	1	1	TPS cable	--

Asm-index	P/N	Units/mach	Units/FRU	Description	Removal procedure
NS	41X0413	1	1	Cable replacement pack: <ul style="list-style-type: none"> • Output roll motor cable • Paper path motors cable • CMY cartridge motors cable • Fuser motor cable • K cartridge ITM motor cable • Lower path sensors cable • Upper path sensors cable • Fuser DC cable • Input option cables • HVPS cable • LVPS DC cable • Fuser AC cable • AC line in cable • BOR motor cable 	--
NS	41X0418	1	1	Control panel FFC cable	--
NS	41X0420	1	1	Speaker cable	--

Assembly 11: 550-sheet tray option 1

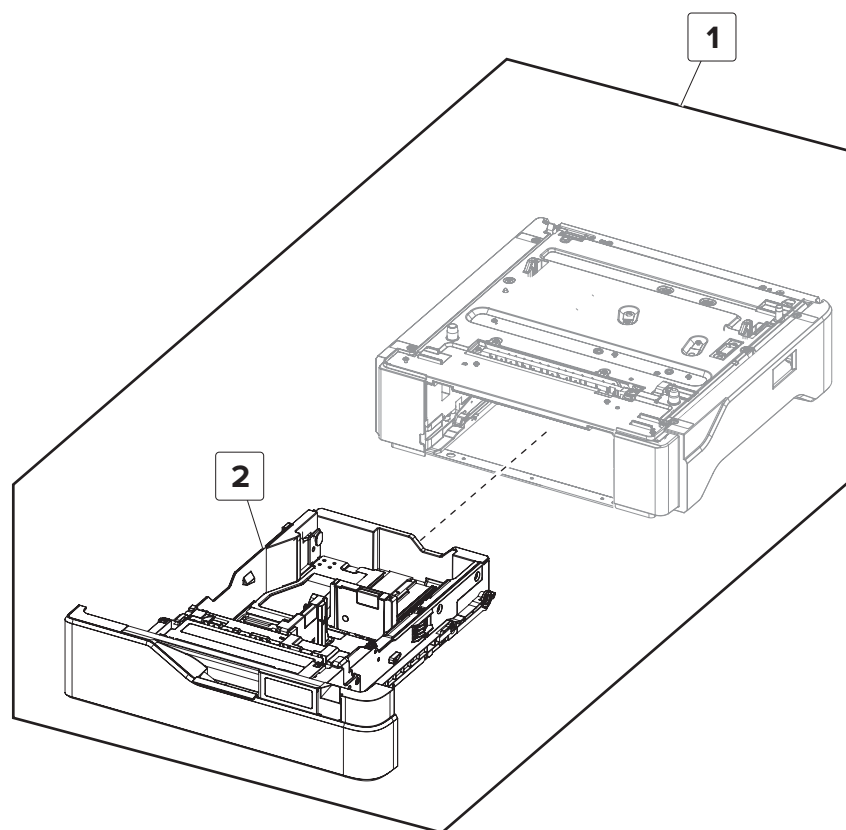

Assembly 11: 550-sheet tray option 1

Asm-index	P/N	Units/opt	Units/FRU	Description	Removal procedure
1	41X0271	1	1	550-sheet tray	--
2	41X0361	1	1	550-sheet tray insert	--

Assembly 12: 550-sheet tray option 2

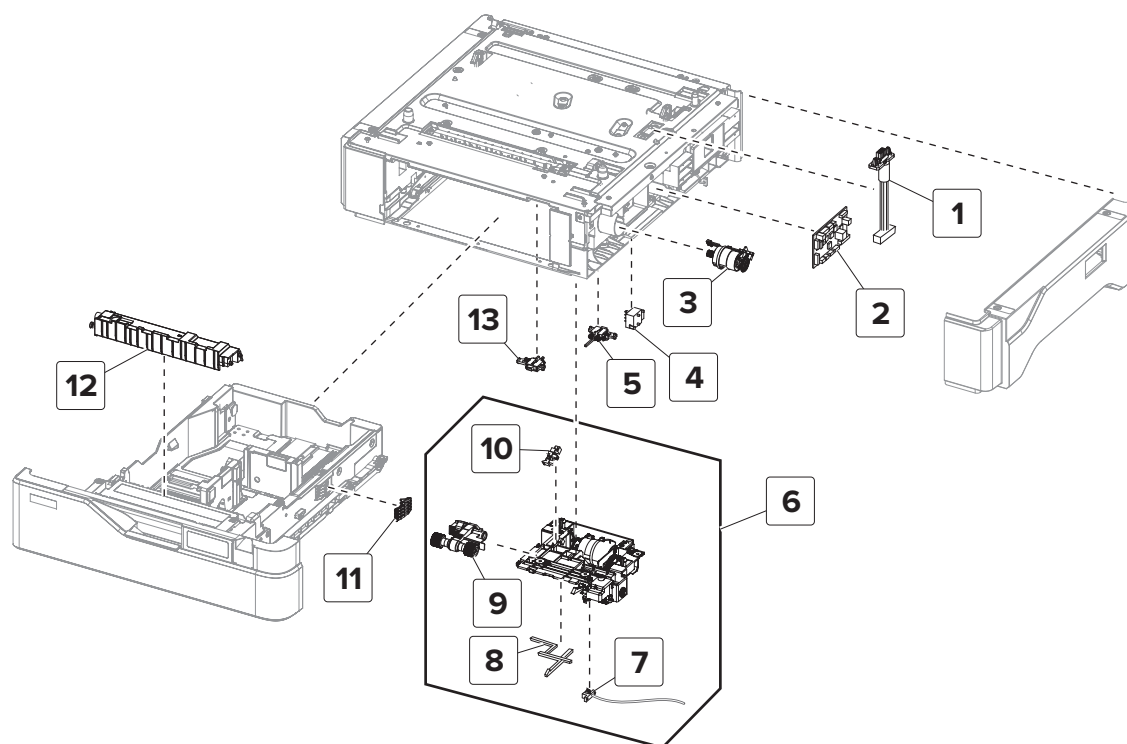

Assembly 12: 550-sheet tray option 2

Asm-index	P/N	Units/opt	Units/FRU	Description	Removal procedure
1	41X0471	1	1	550-sheet tray interface cable	“550-sheet tray interface cable removal” on page 383
2	41X0331	1	1	550-sheet tray controller board	“550-sheet tray controller board assembly removal” on page 382
3	41X0466	1	1	Motor (550-sheet tray pass-through)	“Motor (550-sheet tray pass-through) removal” on page 376
4	40X7911	1	1	Sensor (550-sheet tray paper size)	“Sensor (550-sheet tray paper size) removal” on page 380
5	41X0468	1	1	Sensor (550-sheet tray trailing edge)	“Sensor (550-sheet tray trailing edge) removal” on page 380
6	41X0396	1	1	550-sheet tray paper feeder	“550-sheet tray paper feeder removal” on page 378
7	41X0469	1	1	Sensor (550-sheet tray index)	“Sensor (550-sheet tray index) removal” on page 386
8	41X0472	1	1	550-sheet tray empty sensor actuator	“550-sheet tray empty sensor actuator removal” on page 384
9	41X0956	1	1	550-sheet tray pick roller	--
10	41X0470	1	1	Sensor (550-sheet tray empty)	“Sensor (550-sheet tray empty) removal” on page 385
11	41X0373	1	1	550-sheet tray paper size sensor actuator	--
12	41X0374	1	1	550-sheet tray separator pad	--
13	41X0334	1	1	Sensor (550-sheet tray pass-through)	“Sensor (550-sheet tray pass-through) removal” on page 379

Assembly 13: Adjustable stand

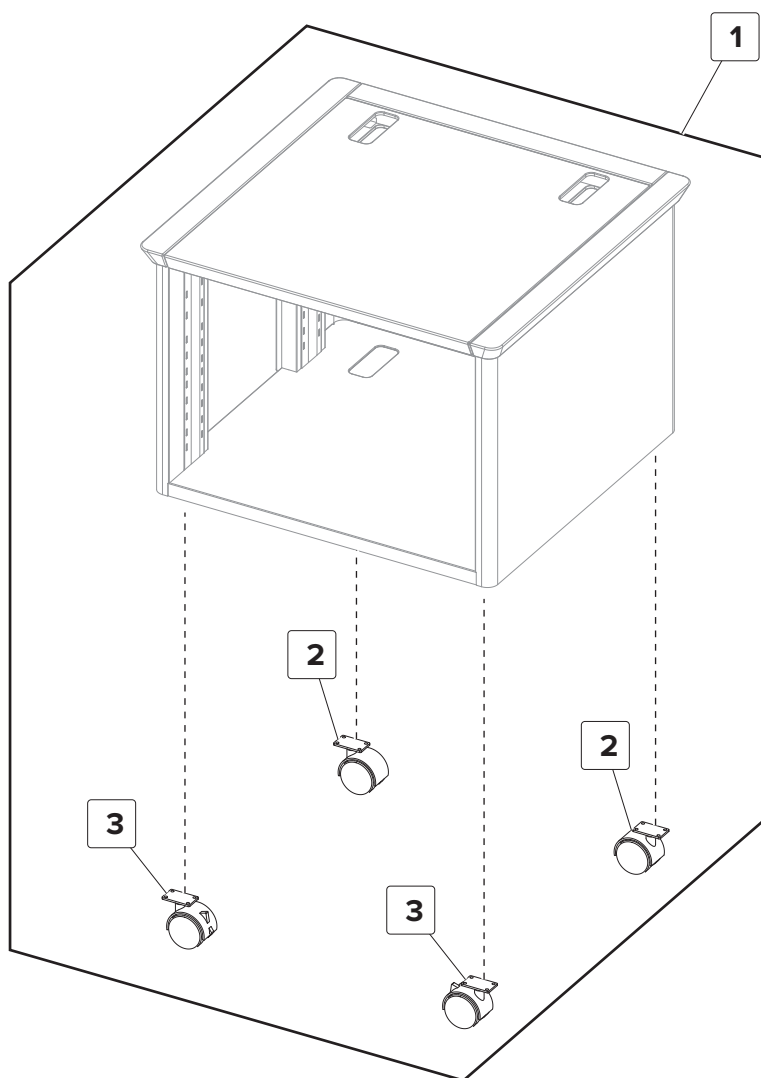

Assembly 13: Adjustable stand

Asm-index	P/N	Units/opt	Units/FRU	Description	Removal procedure
1	41X0764	1	1	Locking caster	--
2	41X0775	2	1	Nonlocking caster	--
3	41X0774	2	1	Locking caster	--

Assembly 14: Miscellaneous parts

Asm-index	P/N	Units/mach	Units/FRU	Description	Removal procedure
NS	41X0015	1	1	Adapter–N8360 ISP + NFC/BLE dual band	--
NS	40X9652	1	1	Adapter–Fiber gigabit ISP	--
NS	41X0028	1	1	DDR3 RAM, (G2) 2GB, 512Mx32, 204 SODIMM, Unbuffered Non-ECC	--
NS	41X1011	1	1	Font card, Hebrew	--
NS	41X1012	1	1	Font card, Arabic	--
NS	41X1013	1	1	Font card, Simplified Chinese	--
NS	41X1014	1	1	Font card, Traditional Chinese	--
NS	41X1015	1	1	Font card, Korean	--
NS	41X1016	1	1	Font card, Japanese	--
NS	41X1002	1	1	Forms bar code card	--
NS	41X1006	1	1	Prescribe card	--
NS	41X1004	1	1	IPDS SCS TNE card	--
NS	41X1010	1	1	Flash card	--

Assembly 15: Power cords

Asm-index	P/N	Units/mach	Units/FRU	Description	Removal procedure
NS	40X7104	1	1	US, Canada, Latin America LV	--
NS	40X0288	1	1	Argentina	--
NS	40X0259	1	1	Brazil LV	--
NS	40X0273	1	1	Chile, Uruguay	--
NS	40X0297	1	1	Bolivia, Peru, Paraguay	--
NS	40X0301	1	1	Australia, New Zealand	--
NS	40X3609	1	1	Japan	--
NS	40X1792	1	1	Korea	--
NS	40X0303	1	1	PRC	--
NS	40X1791	1	1	Taiwan	--
NS	40X0271	1	1	Hong Kong	--
NS	40X0279	1	1	Philippines, Thailand	--
NS	40X1767	1	1	Indonesia, Vietnam, Cambodia, Laos	--
NS	40X1773	1	1	Bangladesh, Nepal, Bhutan	--
NS	40X0271	1	1	Singapore, Malaysia, Pakistan, Sri Lanka, Myanmar, Brunei, India	--
NS	40X1767	1	1	Algeria, Austria, Benelux (Belgium, Luxembourg, Netherlands), Bosnia, Bulgaria, Croatia, Czech Republic, Egypt, Estonia, France, Germany, Greece, Hungary, Iceland, Italy, Latvia, Lithuania, Morocco, Poland, Portugal, Romania, Russia (CIS), Serbia, Slovakia, Spain, Turkey	--
NS	40X1774	1	1	Nordics	--
NS	40X0275	1	1	Israel	--
NS	40X1773	1	1	South Africa	--
NS	40X1772	1	1	Switzerland	--
NS	40X0271	1	1	UK, Saudi Arabia	--

Appendix A: Printer specifications

Power consumption

Product power consumption

The following table documents the power consumption characteristics of the product.

Note: Some modes may not apply to your product.

Mode	Description	Power consumption (Watts)
Printing	The product is generating hard-copy output from electronic inputs.	560 (CS720); 680 (CS725); 700 (CX725)
Copy	The product is generating hard-copy output from hard-copy original documents.	N/A
Scan	The product is scanning hard-copy documents.	N/A
Ready	The product is waiting for a print job.	Ready 1: 80 (CS720, CS725); 100 (CX725)
Sleep Mode	The product is in a high-level energy-saving mode.	4 (CS720de, CS720dte, CS725de, CS725dte)
Hibernate	The product is in a low-level energy-saving mode.	1 (CS720de, CS720dte, CS725de, CS725dte)
Off	The product is plugged into an electrical outlet, but the power switch is turned off.	0.2 (CS720de, CS720dte, CS725de, CS725dte)

The power consumption levels listed in the previous table represent time-averaged measurements. Instantaneous power draws may be substantially higher than the average.

Values are subject to change. See www.lexmark.com for current values.

Sleep Mode

This product is designed with an energy-saving mode called *Sleep Mode*. The Sleep Mode saves energy by lowering power consumption during extended periods of inactivity. The Sleep Mode is automatically engaged after this product is not used for a specified period of time, called the *Sleep Mode Timeout*.

Factory default Sleep Mode Timeout for this product (in minutes):	1
---	---

By using the configuration menus, the Sleep Mode Timeout can be modified between 1 minute and 120 minutes. Setting the Sleep Mode Timeout to a low value reduces energy consumption, but may increase the response time of the product. Setting the Sleep Mode Timeout to a high value maintains a fast response, but uses more energy.

Hibernate Mode

This product is designed with an ultra-low power operating mode called *Hibernate mode*. When operating in Hibernate Mode, all other systems and devices are powered down safely.

The Hibernate mode can be entered in any of the following methods:

- Using the Hibernate Timeout
- Using the Schedule Power modes
- Using the Sleep/Hibernate button

Factory default Hibernate Timeout for this product in all countries or regions
--

3 days

The amount of time the printer waits after a job is printed before it enters Hibernate mode can be modified between one hour and one month.

Off mode

If this product has an off mode which still consumes a small amount of power, then to completely stop product power consumption, disconnect the power supply cord from the electrical outlet.

Total energy usage

It is sometimes helpful to calculate the total product energy usage. Since power consumption claims are provided in power units of Watts, the power consumption should be multiplied by the time the product spends in each mode in order to calculate energy usage. The total product energy usage is the sum of each mode's energy usage.

Selecting a location for the printer

When selecting a location for the printer, leave enough room to open trays, covers, and doors and to install hardware options.

- Set up the printer near an electrical outlet.

 **CAUTION—POTENTIAL INJURY:** To avoid the risk of fire or electrical shock, connect the power cord to an appropriately rated and properly grounded electrical outlet that is near the product and easily accessible.

 **CAUTION—SHOCK HAZARD:** To avoid the risk of electrical shock, do not place or use this product near water or wet locations.

- Make sure that airflow in the room meets the latest revision of the ASHRAE 62 standard or the CEN Technical Committee 156 standard.
- Provide a flat, sturdy, and stable surface.
- Keep the printer:
 - Clean, dry, and free of dust.
 - Away from stray staples and paper clips.
 - Away from the direct airflow of air conditioners, heaters, or ventilators.
 - Free from direct sunlight and humidity extremes.
- Observe the recommended temperatures and avoid fluctuations:

Ambient temperature	10 to 32.2°C (50 to 90°F)
Storage temperature	-40 to 43°C (-40 to 110°F)

- Allow the following recommended amount of space around the printer for proper ventilation:

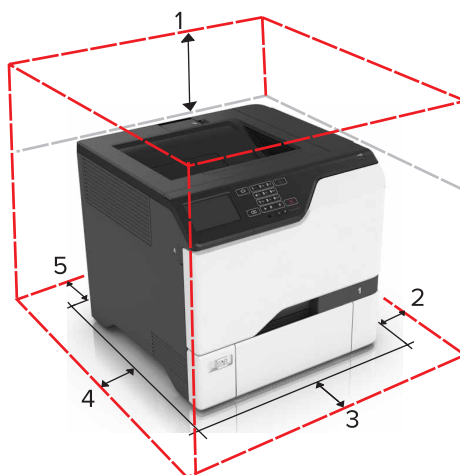

1	Top	178 mm (7 in.)
2	Right side	127 mm (5 in.)
3	Front	508 mm (20 in.)
4	Left side	127 mm (5 in.)
5	Rear	76 mm (3 in.)

Noise emission levels

The following measurements were made in accordance with ISO 7779 and reported in conformance with ISO 9296.

Note: Some modes may not apply to your product.

1-meter average sound pressure, dBA	
Printing	54 (one-sided); 55 (two-sided)
Scanning	N/A
Copying	N/A
Ready	16

Values are subject to change. See www.lexmark.com for current values.

Temperature information

Ambient operating temperature	10 to 32.2°C (50 to 90°F)
Shipping temperature	-40 to 43.3°C (-40 to 110°F)
Storage temperature and relative humidity	1 to 35°C (34 to 95°F) 8 to 80% RH

Appendix B: Options and features

Some of the options may not be available in every country or region.

Available internal options

- Memory card
 - DDR3 DIMM
 - Flash memory
 - Fonts
 - Application cards
 - Forms and Bar Code
 - PRESCRIBE
 - IPDS
- Lexmark Internal Solutions Port (ISP)
 - MarkNet™ N8360 (802.11 b/g/n/a wireless print server bundled with LEX-M06-001 Mobile Solutions Module)
 - IEEE 1284-B Parallel Card
 - RS-232C Serial Card

Installing optional trays

 **CAUTION—TIPPING HAZARD:** Installing one or more options on your printer may require a caster base, furniture, or other feature to prevent instability causing possible injury. For more information on supported configurations, see www.lexmark.com/multifunctionprinters.

 **CAUTION—SHOCK HAZARD:** To avoid the risk of electrical shock, if you are accessing the controller board or installing optional hardware or memory devices sometime after setting up the printer, then turn the printer off, and unplug the power cord from the electrical outlet before continuing. If you have any other devices attached to the printer, then turn them off as well, and unplug any cables going into the printer.

- 1 Turn off the printer.
- 2 Unplug the power cord from the electrical outlet, and then from the printer.
- 3 Unpack the optional tray, and then remove all packing material.

 **CAUTION—POTENTIAL INJURY:** The printer weight is greater than 18 kg (40 lb) and requires two or more trained personnel to lift it safely. Always use the hand holds on the sides and rear of the printer. Make sure that your fingers are not under the printer when you lift or set the printer down.

Note: If optional trays are already installed, then unlock them from the printer before lifting the printer. Do not try to lift the printer and trays at the same time.

- 4 Align the printer with the optional tray, and then lower the printer until it *clicks* into place.

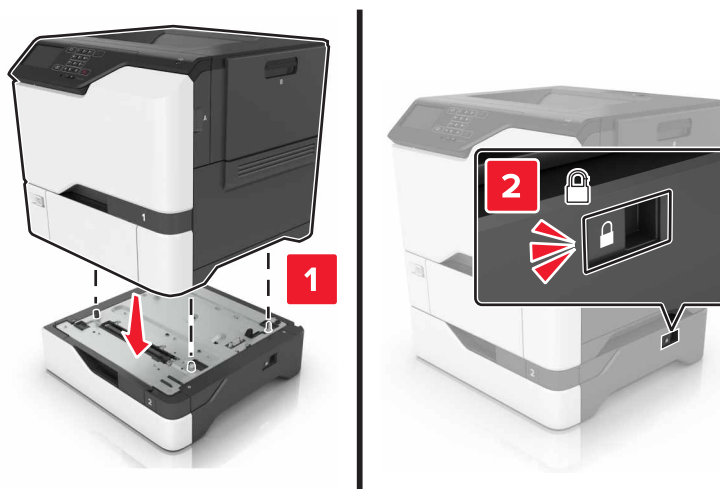

- 5 Connect the power cord to the printer, and then to the electrical outlet.

⚠ CAUTION—POTENTIAL INJURY: To avoid the risk of fire or electrical shock, connect the power cord to an appropriately rated and properly grounded electrical outlet that is near the product and easily accessible.

- 6 Turn on the printer.

If necessary, manually add the tray in the print driver to make it available for print jobs. For more information, see [“Adding available options in the print driver” on page 450](#).

Install the printer and hardware options in the following order:

- Optional 550-sheet tray
- Printer

Adding available options in the print driver

For Windows users

- 1 Open the printers folder.
- 2 Select the printer you want to update, and then do either of the following:
 - For Windows 7 or later, select **Printer properties**.
 - For earlier versions, select **Properties**.
- 3 Navigate to the Configuration tab, and then select **Update Now - Ask Printer**.
- 4 Apply the changes.

For Macintosh users

- 1 From System Preferences in the Apple menu, navigate to your printer, and then select **Options & Supplies**.
- 2 Navigate to the list of hardware options, and then add any installed options.

3 Apply the changes.

Appendix C: Theory of operation

Paper path and transport components

For an image to be printed, the paper or specialty media has to be moved from an input source (such as a tray) into the printer and eventually exit into an output source.

The most important component in this process is this paper itself. Old, damaged, or out-of-specification paper can and will cause feed and transport problems. If you encounter problems, you should always check the paper first. See [“Paper and specialty media guide” on page 26](#). In addition, it is always good practice to check the printer and driver settings to see if the paper being used matches the user’s settings. It is not uncommon to find a user printing on cardstock with the printer programmed to print on a plain paper setting.

The printer’s feed and transport components can fail and cause paper jams or other feed and transport problems. These components should be examined for damage or wear and replaced if necessary.

Tray section

Paper size and detection

The paper size is only detected based on the setting of the length guide. The width guides do not provide paper size information to the printer. The length guide can be adjusted to accommodate different paper sizes by moving it to the front or rear of the tray. The length guide should come into contact with the paper and hold it in position. The width guide is designed so that it can adjust to the paper width by moving the guide to the left or right. Both paper guides can be locked to position.

The sensor (550-sheet tray empty) detects paper and the sensor (550-sheet tray paper size) detects the size of paper supplied from each tray assembly. A system of four switches is used to decode the paper size, which is then sent to the controller board.

Paper lift

The sensor (pick roller position) determines if the lift plate in the paper tray is at the optimum position for paper to be properly picked. As paper is fed out, clearance occurs between the paper and the pick rollers. When the sensor determines the specified amount of clearance, the lift plate is raised to position the paper in the optimum position to be picked properly.

Paper pick

The pick roller assembly is a mechanical unit supplying paper from the tray to the paper path. Three motors move the paper from the tray to the transfer module at the second transfer station. The motor (isolation) feeds the paper from the pick system to the alignment rollers. The leading edge of the paper is aligned to the alignment rollers and then fed into the transfer nip.

The system is timed so that the image is formed and the page is picked to allow the image to be correctly placed on the paper. The sensor (550-sheet tray empty) detects if there is paper present in the tray. If paper is present, the media feeder drives the pick roller which moves the paper from the tray to the isolation unit.

MPF section

The MPF has a sensor (MPF empty) which detects if paper is present. The motor (duplex/MPF) drives the MPF pick assembly. The pick assembly feeds the paper from the MPF tray into the printer through the sensor (MPF/pass-through) and isolation nip at tray 1. The paper is then transported to the aligner roller.

Note: A clutch in the MPF keeps the motor (duplex/MPF) from picking paper when the duplex path is active.

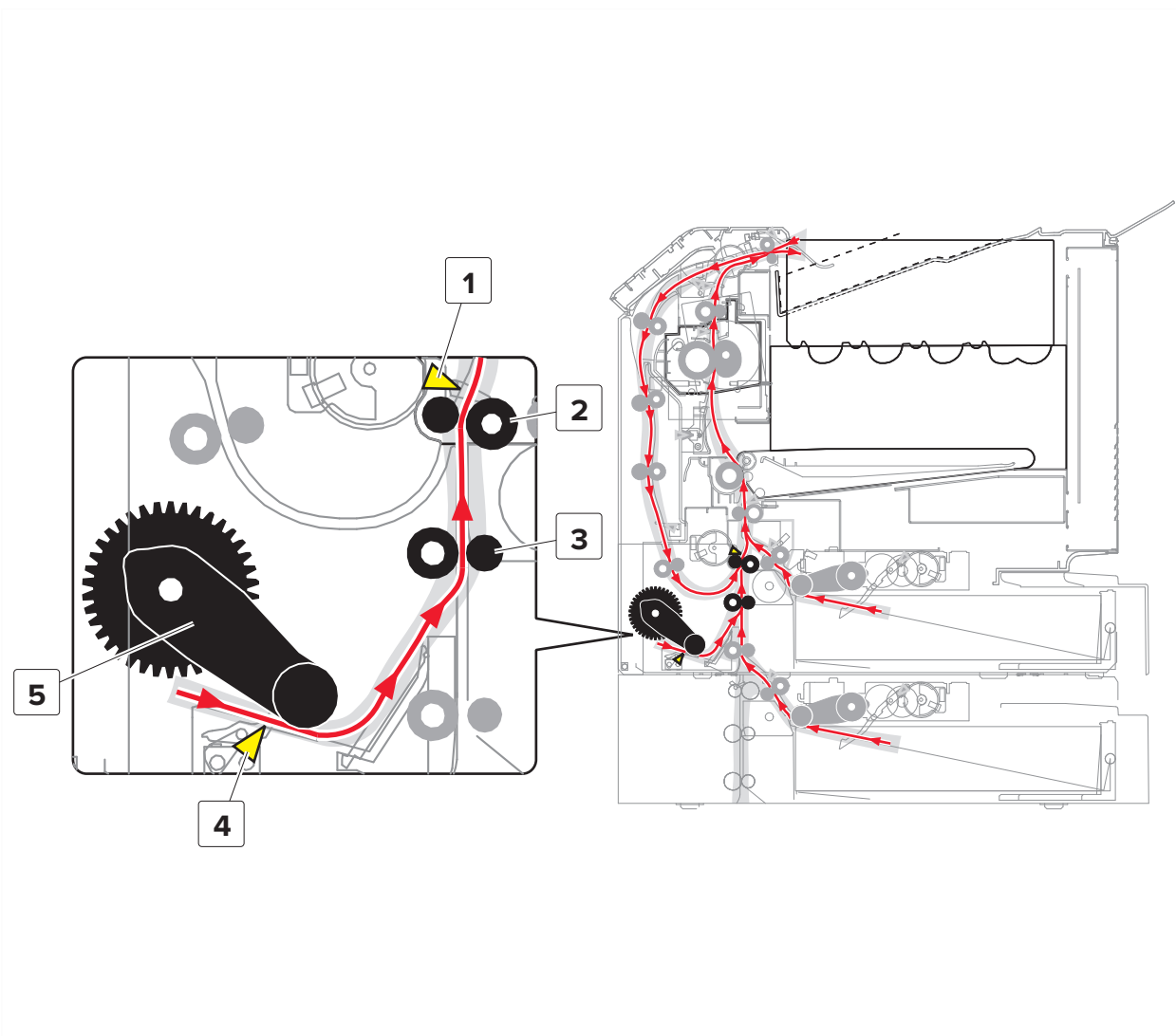

#	Description
1	Sensor (MPF/pass-through)
2	MPF/pass-through roller
3	isolation roller
4	Sensor (MPF empty)
5	MPF pick assembly

Isolation unit section

The paper enters the isolation unit through one of two paths, each path having its own isolation roller. If the paper is fed from tray 1, the tray 1 isolation nip moves the paper through the isolation housing and into the aligner roller. If the paper is fed from MPF, option tray, or duplex, the alternate isolation roller moves the paper through the isolation housing and into the aligner roller.

The following occurs if the paper does not reach the sensor (tray 1 pick):

- If the paper is fed from the tray and does not reach the sensor, a 241.16 error is generated.
- If the paper is fed from the MPF and does not reach the sensor, a 240.06 error is generated.
- If the paper is fed from an option tray and does not reach the sensor, a 240.x3 error is generated.
- If the paper is fed from the duplex and does not reach the sensor, a 232.x3 error is generated.

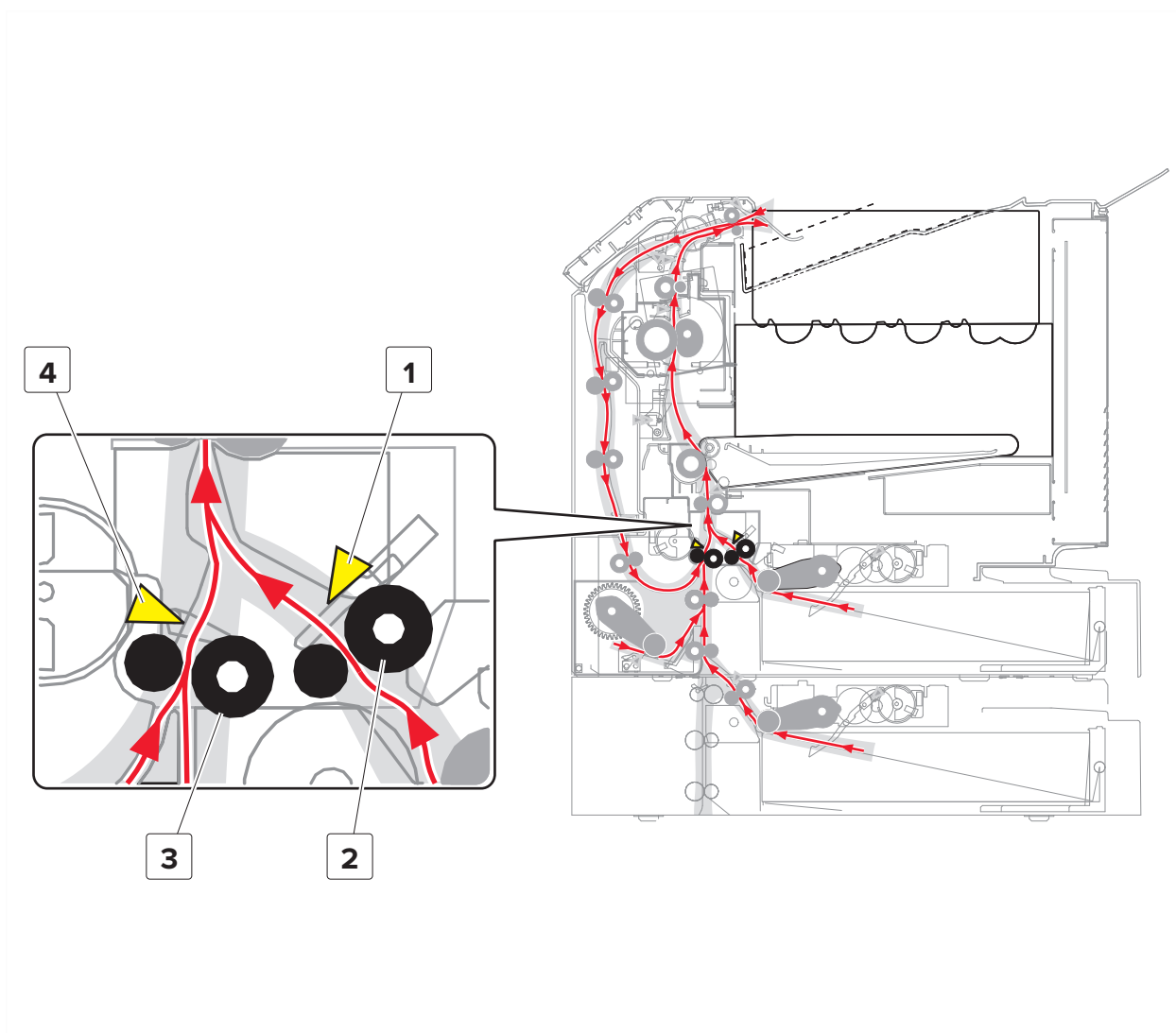

#	Description
1	Sensor (input)
2	Tray 1 isolation roller
3	Alternate isolation roller

#	Description
4	Sensor (MPF/pass-through)

Aligner section

After the paper reaches the sensor (input), or the sensor (MPF/pass-through), a count is started. The paper is pushed up against the aligner rollers to align the leading edge of the paper and form a bubble. After a predetermined count from the sensor (input) is reached, the motor (aligner) turns and moves the paper through the aligner rollers and the sensor (input). The sensor (input) detects the leading edge of the paper and determines the timing from the aligner rollers to the second transfer area, ensuring the proper placement of the image on the paper. Depending on the position of the paper in the paper path, it is fed faster or slower to ensure that the paper and image are properly aligned. The image is then transferred from the belt to the right position on the paper in the second transfer area.

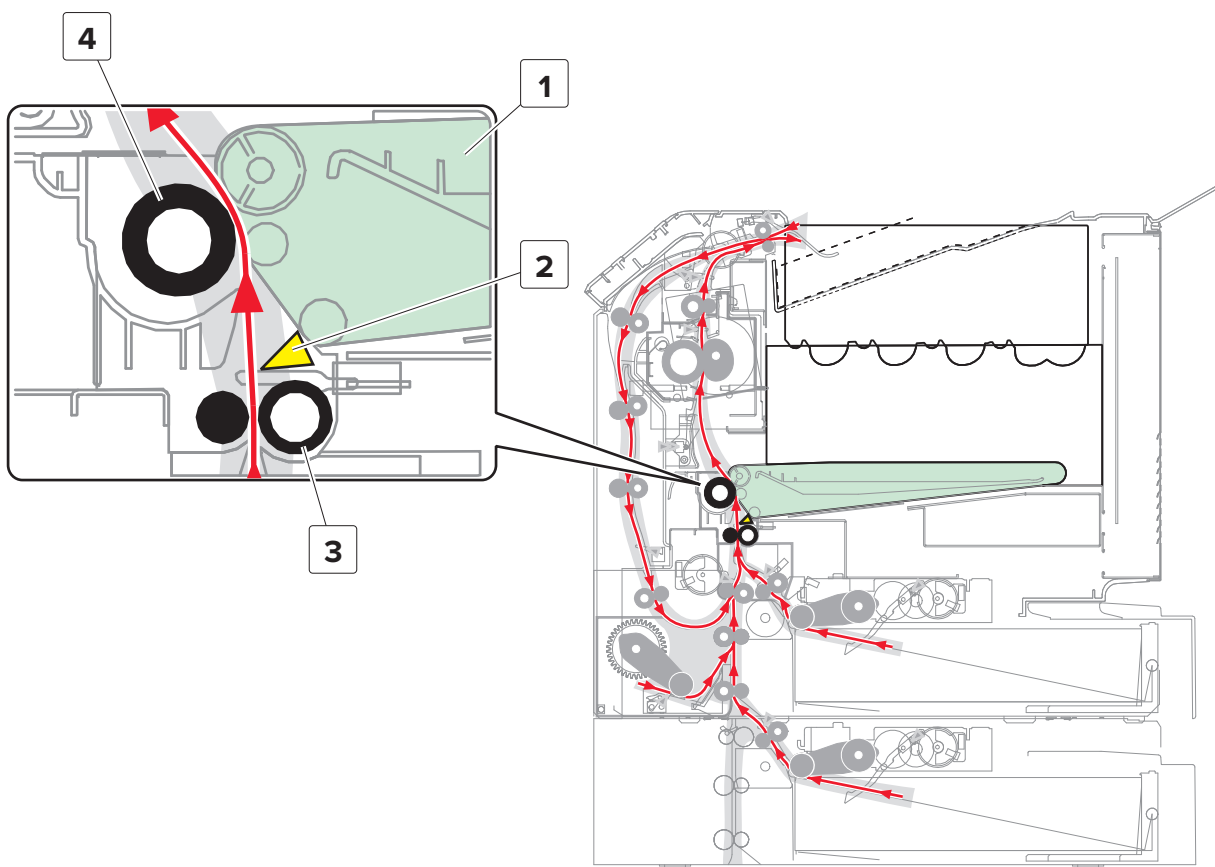

#	Description
1	Transfer belt
2	Sensor (input)
3	Aligner roller
4	Transfer roller

Fuser section

After the second transfer, the paper is fed to the fuser. The paper passes through the sensor (fuser buckle) located before the fuser. The sensor detects the buckle in the paper when it hits the fuser rollers. If the buckle is too great, the motor (fuser) speeds up to avoid causing a paper jam. If the buckle is too small, the motor slows to avoid smearing the image. At the same location, the sensor (narrow media) is also present. The sensor (narrow media) detects whether narrow paper is being passed through. Depending on the width of the paper detected, a process speed change, fuser temperature change, and print speed change occurs to avoid damaging the fuser. The paper then passes through the fuser where heat and pressure are applied to melt the toner particles and bond them permanently to the paper. As the paper leaves the fuser, the paper passes through the sensor (fuser exit). The sensor (fuser exit) detects fuser wraps and helps prevent wraps to go completely around the belt. The paper then moves through the decurl rollers and passes through the sensor (paper exit). If the print job is one-sided, the paper is passed through the exit rollers and into the output bin. If the print job is duplex, the paper is retracted into the duplex path after the trailing edge passes through the sensor (paper exit) actuator.

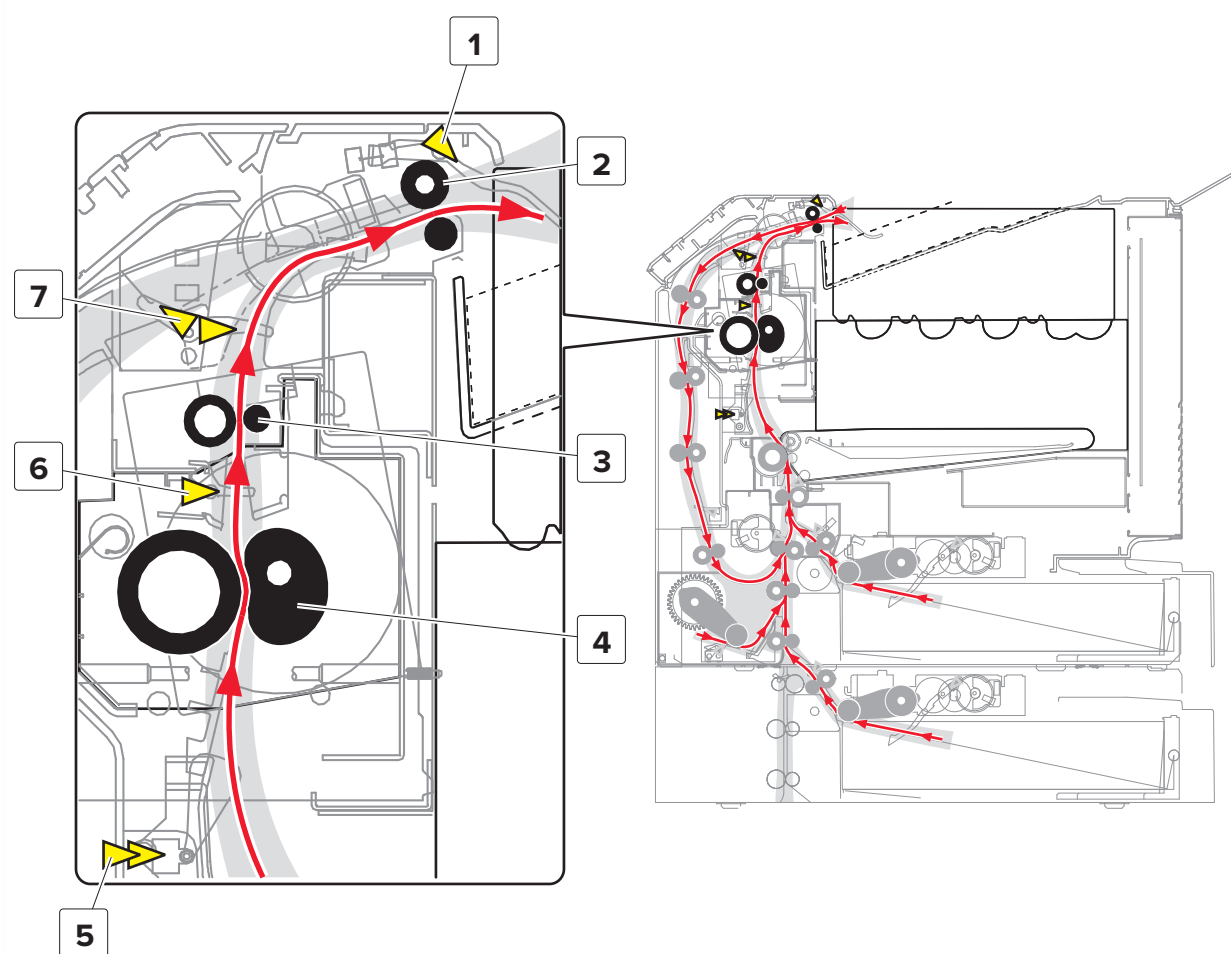

#	Description
1	Sensor (bin full)
2	Exit roller

#	Description
3	Decurl roller
4	Fuser
5	Sensor (fuser buckle) / Sensor (narrow media)
6	Sensor (fuser exit)
7	Sensor (paper exit) / Sensor (duplex entry)

Duplex section

After the first side of the paper is printed and the trailing edge of the paper clears the diverter, the diverter drops and the motor (output) engages in reverse. The output roller turns in reverse to retract and feed the paper into the duplex path. The paper goes through the sensor (duplex entry) where the new leading-edge position of the paper is determined. The paper is then moved to the first duplex paper path nip (duplex bottom turn nip) through the three duplex aligner rollers. The duplex aligner rollers are driven by the motor (duplex/MPF) which continuously adjusts its speed as the paper passes through the duplex path to achieve the desired belt image offset at the aligner. After the paper passes through the three aligner rollers, the paper reaches the sensor (duplex staging) where the leading edge of the paper is updated.

After passing the sensor (duplex staging), the duplex aligner roller drives the paper to the isolation nip and to the sensor (MPF/pass-through) where the leading-edge position of the paper is again updated. When the paper reaches the sensor (MPF/pass-through) in the isolation unit, the paper is pushed to the deskew rollers. As the paper reaches the sensor (input) after the registration process, the motor (aligner) adjusts its speed to line up the leading edge exactly with the belt image at the second transfer. After the paper passes through the deskew rollers, it goes through the transfer and fusing process again. The paper is then passed through the exit roller and moved to the output bin.

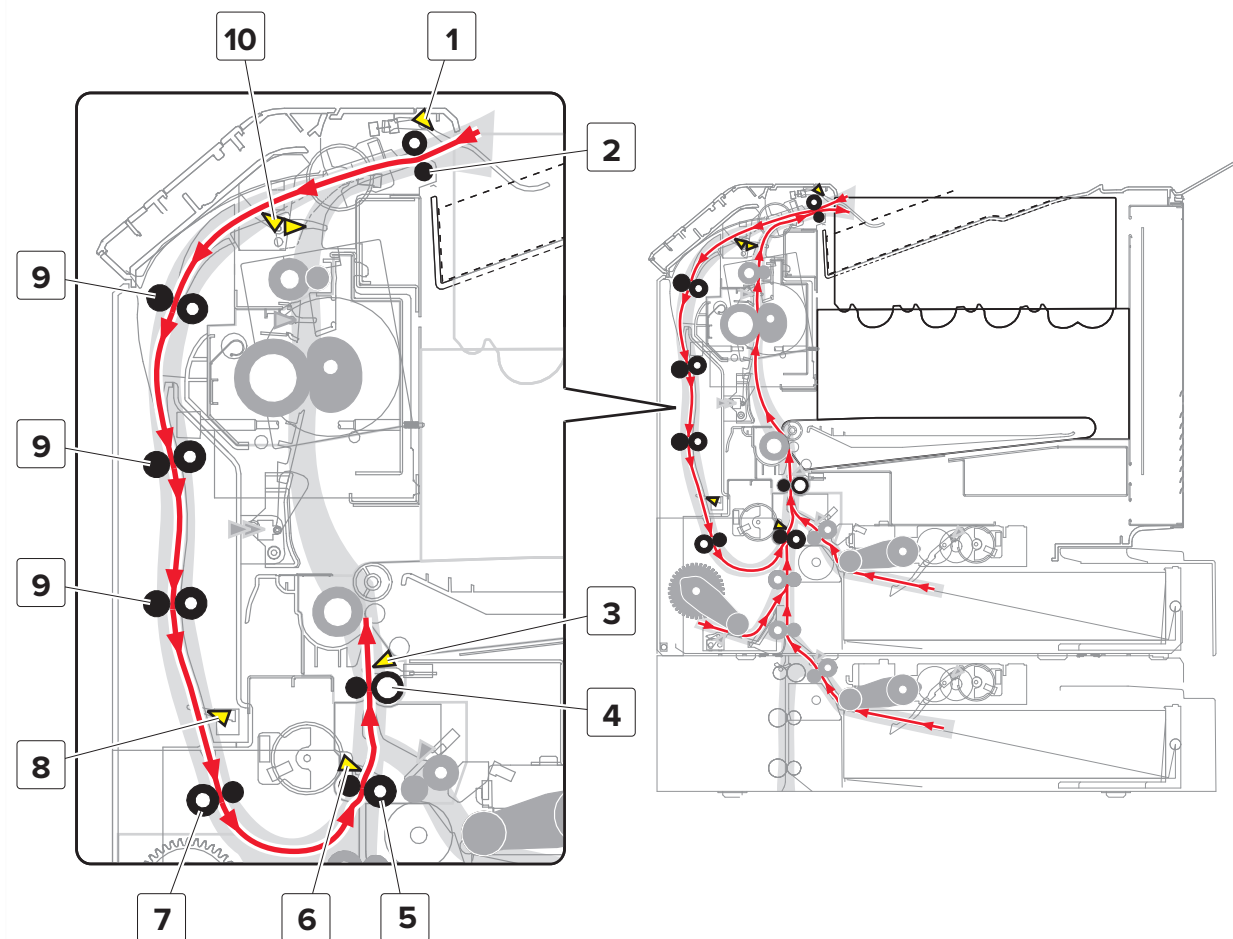

#	Description
1	Sensor (bin full)
2	Output roller
3	Sensor (input)
4	Deskew roller
5	Alternate isolation roller
6	Sensor (MPF/pass-through)

#	Description
7	Duplex feed roller
8	Sensor (duplex staging)
9	Duplex aligner roller
10	Sensor (duplex entry)

Print engine theory

Electrophotographic process

The method that all laser and LED printers use to print is called the electrophotographic (EP) process. These machines use differences in charge to manipulate and move toner from the print cartridge to the printed page.

Even though the basic EP process is the same for every laser and LED printer, the specifics for each printer are different.

EP process basics

This printer is a four-laser tandem color laser printer that uses four print cartridges (cyan, yellow, magenta, and black) to create text and images on paper.

The printer has a black imaging unit including a developer unit and a photoconductor drum. It also has a color imaging kit including three separate color developers and a combined photoconductor unit with three photoconductor drums.

During the printing process, the printer follows the six basic EP process steps to create its output to the page.

- 1 Charge the photoconductor.
- 2 Expose the photoconductor with the laser.
- 3 Develop toner on the photoconductor.
- 4 First transfer to the transfer module , and second transfer to the paper.
- 5 Fuse the toner to the paper.
- 6 Clean/Erase the photoconductor and the transfer module.

In summary, the printer controller board receives print data and print command. The controller board then initiates the print process. The controller board is the command center for the EP process and coordinates the various motors and signals.

The high-voltage power supply (HVPS) sends charge to various components in the EP process. The laser fires on the photoconductors and alters the surface charge relative to the planed image for each photoconductor. Each photoconductor rotates past its respective developer roll, and toner is developed on the surface of each photoconductor. The four separate color images are then transferred to the transfer belt on the transfer module as it passes under the photoconductors. After the image is transferred to the transfer belt, the photoconductors are cleaned and recharged.

The transfer belt carries the four-colored image towards the transfer rolls. Paper is picked up from the tray and carried to the transfer roll where the image is transferred from the transfer belt to the paper. The timing of the paper pick is determined by the speed of the transfer belt.

The paper is carried to the fuser rollers where heat and pressure are applied to the page to permanently bond the toner to the page. The fuser rollers push the paper into the output bin. The transfer unit is cleaned and the process begins again for the next page.

Step 1: Charge

During the charge step, voltage is sent from the HVPS to the charge roller beside each of the four photoconductors. In this printer, the charge roll is part of the photoconductor unit in the print cartridges.

The charge roller puts a uniform negative charge over the entire surface of the photoconductor to prepare it for the laser beam.

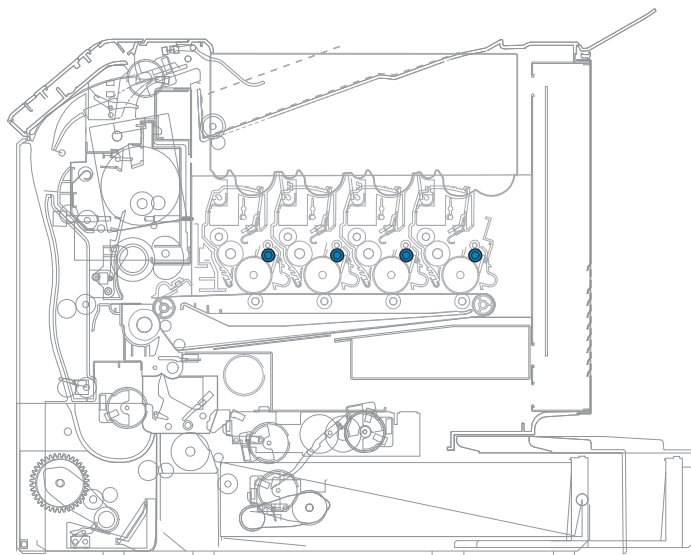

Service tips

- If the surface of the charge roller is damaged (such as a nick or pit), it will cause the charge on the photoconductor to be uneven. This causes a repeating mark on the printed page. Check the service manual for the repeating marks table.
- If the charge roller is severely damaged, the surface of the photoconductor will not be properly charged and heavy amounts of toner will be deposited on the photoconductor. This causes the printed page to be saturated with 100% of each color. The imaging kit will need to be replaced sooner.

Step 2: Expose

During the expose step, the laser fires a focused beam of light at the surface of each photoconductor and writes an invisible image, called a latent image or electrostatic image, for each color.

The laser beam only discharges the surface where the beam hits the photoconductor. This creates a difference in charge potential between the exposed area and the rest of the photoconductor surface.

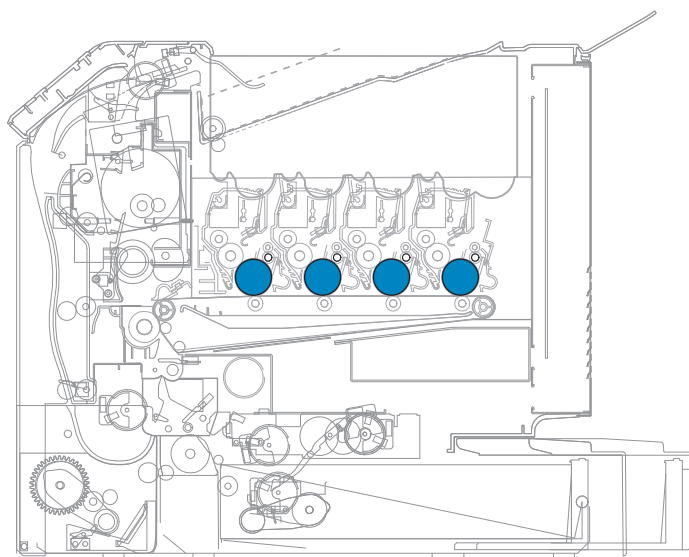

Service tips

- The laser beam passes through a glass lens as it exits the laser unit. If this lens gets contaminated with toner or other debris, vertical streaking of white/lightness on the page occurs. Cleaning the lens will solve the problem.
- Never touch the surface of the photoconductor with your bare hand. The oil from your skin may cause a charge differential on the surface, and the toner will not properly stick. The result would be repeating blotches of voids/light print on a page, and the photoconductor will have to be replaced.
- The surface of the photoconductor is coated with an organic substance that makes it sensitive to light. Make sure to cover the photoconductor to avoid damage. If it is exposed to light for too long, light/dark print quality problems may occur, and it will have to be replaced.

Step 3: Develop

When the laser exposes the photoconductor, the HVPS sends a charge to the developer roll. For each color, the print cartridge engages the photoconductor so that it is in contact with the surface. Because of the charge difference between the toner on the developer roller and the electrostatic image created by the laser, the toner is attracted to areas of the photoconductor surface exposed by the laser.

This process is similar to using glue to write on a can and then rolling it over glitter. The glitter sticks to the glue but will not stick to the rest of the can.

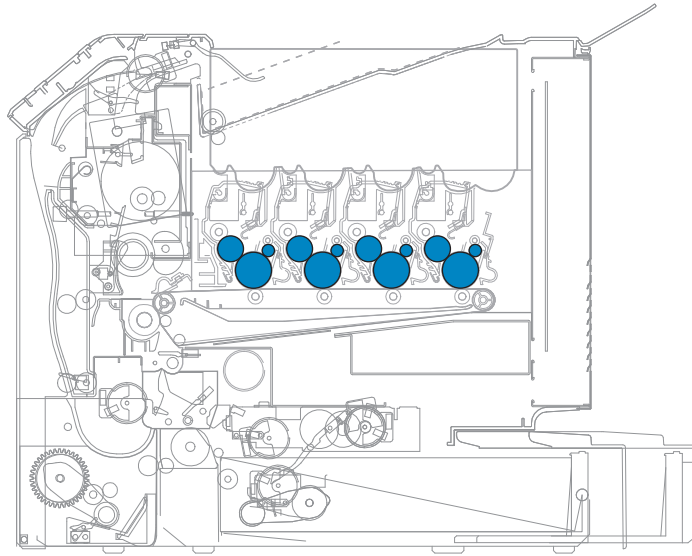

Service tips

- Never touch the surface of the developer roller with your bare hand. The oil from your skin may cause a charge differential on the surface, and the toner will not stick properly. The result would be repeating blotches of voids/light print on a page, and the affected cartridge will have to be replaced.
- If the developer roller is damaged, it will not contact the surface of the photoconductor properly. The result could be repeating marks, thin vertical voids, or thin vertical lines of color on the printed page. Check the surface of the developer for damage.

Step 4a: First transfer

When the latent images are developed on each photoconductor, the HVPS sends voltage to the first transfer rollers inside the transfer module.

The charge difference between the developed toner image on the photoconductor surface and the first transfer roller causes the images to transfer to the surface of the transfer module belt for each color. This takes place by a direct surface-to-surface contact between the photoconductors and the transfer module belt.

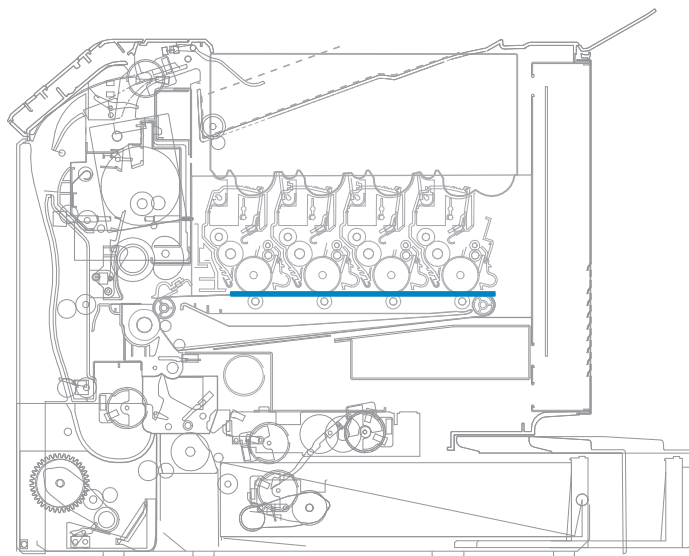

Service tips

- Never touch the surface of the transfer module belt with your bare hand. The oil from your skin will cause a charge differential on the surface, and the toner will not stick properly. The result would be repeating blotches of voids/light print on a page, and the transfer module belt will have to be replaced.
- Do not use solvents or other cleaners to clean the transfer module belt surface. No matter how careful you are, the surface will be compromised, causing scratches or a charge differential that will produce voids or light blotches on the printed page.

Step 4b: Second transfer

When the four planes of color are transferred to the transfer belt from the photoconductors, the image is carried towards the transfer roll, which is also part of the transfer module. Based on the speed of the transfer belt, the proper time to send the signal to pick the paper from an input source is determined. The pick is timed so that the paper passes between the transfer belt and transfer roll when the image on the belt reaches the second transfer area.

The HVPS sends voltage to the transfer roll to create a positive charge. When the image on the transfer belt reaches the transfer roll, the negatively charged toner clings to the paper and the entire image is transferred from the transfer belt to the paper.

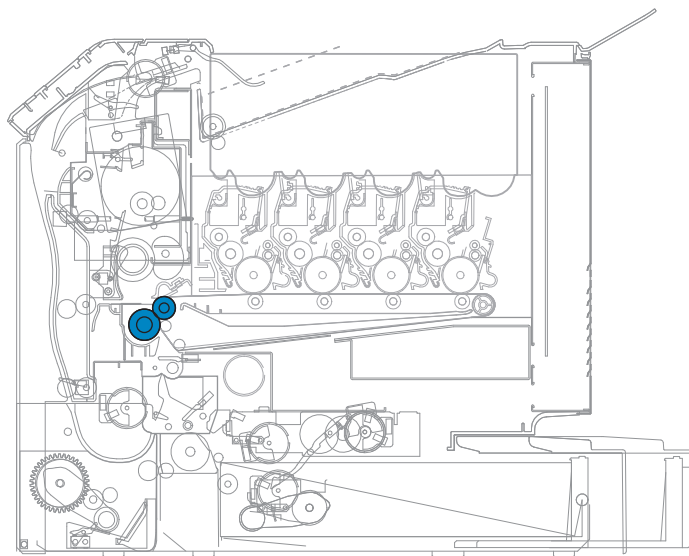

Service tips

- If the transfer roller has nicks, pits, or flat spots on it, the surface does not come into contact with the paper and transfer unit. This causes voids or light spots on the page or repeating voids/light areas.
- If the transfer roller does not engage the transfer unit, or does not have voltage coming from the HVPS, the toner will not fully transfer from the transfer unit; the entire page will be very light or blank. Any toner that does transfer will be due to a contact transfer instead of a charge transfer. Check the HVPS contacts to the transfer roller.

Step 5: Fuse

When the image has been fully transferred to the paper, the transfer roll helps move the paper into the fuser area.

The fuser applies heat and pressure to the page to melt the toner particles and bond them permanently to the paper. The fuser moves the paper to the redrive rolls which move the paper to the output bin.

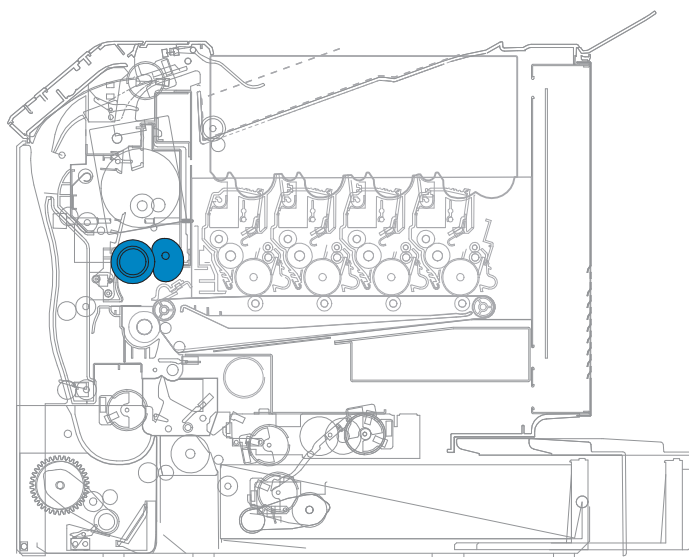

Service tips

- If the fuser rollers are damaged, they can cause toner to be pulled off the page or cause paper jams.
- Toner that rubs off a printed page can be a sign of a malfunctioning fuser or an improper paper setting. Always check the paper type setting before replacing the fuser. A common mistake is to print on heavier media (such as cardstock) with the paper type set to plain paper.
- Never pull unfused toner through the fuser. Try to back the jammed page out of the fuser in the opposite direction it was travelling.

Step 6: Clean/Erase

There are two main cleaning processes that take place during the EP Process. One process cleans the transfer belt, and the other cleans the photoconductors.

Transfer unit clean

When the toner image on the transfer belt has been transferred to the page, the transfer belt rotates around and is cleaned by the cleaning blade. This occurs for every page that is printed.

After the toner is moved to the cleaning blade, the toner is moved to the waste toner area using an auger system.

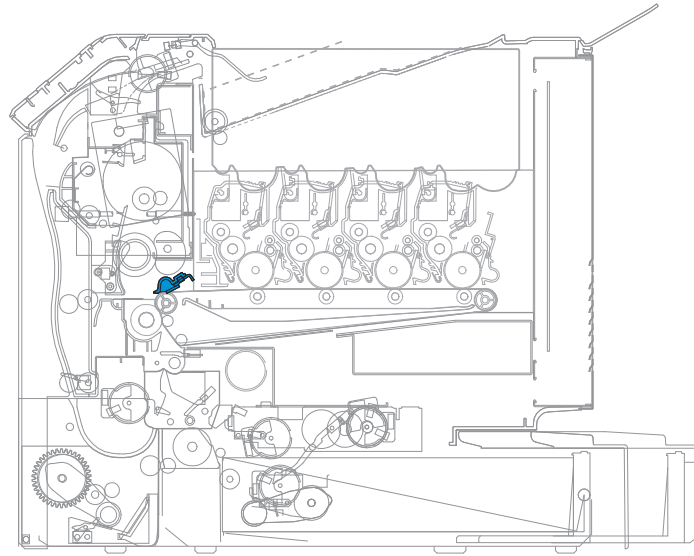

Photoconductor clean/erase

After each plane of color has been transferred to the transfer belt from the photoconductors, a cleaning blade scrapes the remaining toner from the surface of each photoconductor.

Now the photoconductor surface is prepared to restart the EP Process. This cleaning/erasing cycle happens after each plane of color is transferred to the transfer belt.

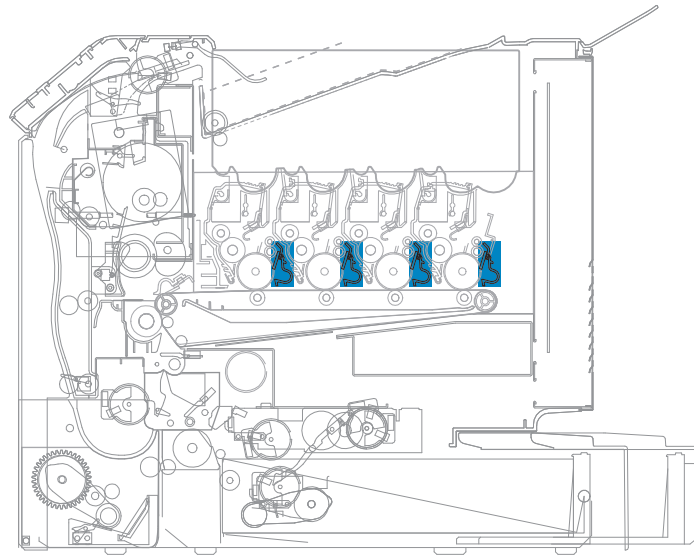

Color theory

Color theory

What is RGB color?

Red, green, and blue light can be added together in various amounts to produce a large range of colors observed in nature. For example, red and green can be combined to create yellow. Televisions and computer monitors create colors in this manner. RGB color is a method of describing colors by indicating the amount of red, green, or blue needed to produce a certain color.

What is CMYK color?

Cyan, magenta, yellow, and black inks or toners can be printed in various amounts to produce a large range of colors observed in nature. For example, cyan and yellow can be combined to create green. Printing presses, inkjet printers, and color laser printers create colors in this manner. CMYK color is a method of describing colors by indicating the amount of cyan, magenta, yellow, and black needed to reproduce a particular color.

How is color specified in a document to be printed?

Software programs typically specify document color using RGB or CMYK color combinations. Additionally, they allow users to modify the color of each object in a document. For more information, see the software program Help topics.

How does the printer know what color to print?

When a user prints a document, information describing the type and color of each object is sent to the printer. The color information is passed through color conversion tables that translate the color into the appropriate amounts of cyan, magenta, yellow, and black toner needed to produce the desired color. The object information determines the application of color conversion tables. For example, it is possible to apply one type of color conversion table to text while applying a different color conversion table to photographic images.

Should I use PostScript or PCL emulation? What settings produce the best color?

The PostScript driver is strongly recommended for best color quality. The default settings in the PostScript driver provide the preferred color quality for the majority of printouts.

Why doesn't the printed color match the color I see on the computer screen?

The color conversion tables used in Auto Color Correction mode generally approximate the colors of a standard computer monitor. However, because of technology differences that exist between printers and monitors, there are many colors that can also be affected by monitor variations and lighting conditions.

The printed page appears tinted. Can I adjust the color?

Sometimes a printed page may appear tinted (for example, everything printed seems to be too red). This can be caused by environmental conditions, paper type, lighting conditions, or user preference. In these instances, adjust the Color Balance setting to create a more preferable color. Color Balance provides the user with the ability to make subtle adjustments to the amount of toner being used in each color plane. Selecting positive or negative values for cyan, magenta, yellow, and black (from the Color Balance menu) will slightly increase or decrease the amount of toner used for the chosen color. For example, if a printed page has a red tint, then decreasing both magenta and yellow could potentially improve the color balance.

What is manual color correction?

When manual color correction is enabled, the printer employs user-selected color conversion tables to process objects. However, Color Correction must be set to Manual, or no user-defined color conversion will be implemented. Manual color correction settings are specific to the type of object being printed (text, graphics, or images), and how the color of the object is specified in the software program (RGB or CMYK combinations).

Notes:

- Manual color correction is not useful if the software program does not specify colors with RGB or CMYK combinations. It is also not effective in situations in which the software program or the computer operating system controls the adjustment of colors.
- The color conversion tables—applied to each object when Color Correction is set to Auto—generate preferred colors for the majority of documents.

To manually apply a different color conversion table:

- 1 From the home screen, touch **Settings > Print > Quality > Advanced Imaging > Color Correction**.
- 2 Select **Manual**, and then touch **Color Correction Content**.
- 3 Select the appropriate color conversion table for the affected object type.

Object type	Color conversion tables
RGB Image RGB Text RGB Graphics	<ul style="list-style-type: none"> • Vivid—Produces brighter, more saturated colors and may be applied to all incoming color formats. • sRGB Display—Produces an output that approximates the colors displayed on a computer monitor. Black toner usage is optimized for printing photographs. • Display—True Black—Produces an output that approximates the colors displayed on a computer monitor. Uses only black toner to create all levels of neutral gray. • sRGB Vivid—Provides an increased color saturation for the sRGB Display color correction. Black usage is optimized for printing business graphics. • Off—No color correction is implemented.
CMYK Image CMYK Text CMYK Graphics	<ul style="list-style-type: none"> • US CMYK—Applies color correction to approximate the SWOP (Specifications for Web Offset Publishing) color output. • Euro CMYK—Applies color correction to approximate EuroScale color output. • Vivid CMYK—Increases the color saturation of the US CMYK color correction setting. • Off—No color correction is implemented.

How can I match a particular color (such as a corporate logo)?

From the printer Quality menu, nine types of Color Samples sets are available. These are also available from the Color Samples page of the Embedded Web Server. Selecting any sample set generates a multiple-page printout consisting of hundreds of colored boxes. Either a CMYK or RGB combination is located on each box, depending on the table selected. The observed color of each box is obtained by passing the CMYK or RGB combination labelled on the box through the selected color conversion table.

To print Color samples from the printer:

- 1 From the home screen, touch **Settings > Print > Quality > Advanced Imaging > Color Samples > Print Color Samples**.
- 2 Select the appropriate color conversion table to print.

By examining Color Samples sets, a user can identify the box whose color is the closest to the desired color. The color combination labelled on the box can then be used for modifying the color of the object in a software program. For more information, see the software program Help topics. Manual color correction may be necessary to utilize the selected color conversion table for the particular object.

Selecting which Color Samples set to use for a particular color-matching problem depends on the Color Correction setting being used (Auto, Off, or Manual), the type of object being printed (text, graphics, or images), and how the color of the object is specified in the software program (RGB or CMYK combinations). When the printer Color Correction setting is set to Off, the color is based on the print job information; and no color conversion is implemented.

Note: The Color Samples pages are not useful if the software program does not specify colors with RGB or CMYK combinations. Additionally, certain situations exist in which the software program or the computer operating system adjusts the RGB or CMYK combinations specified in the program through color management. The resulting printed color may not be an exact match of the Color Samples pages.

What are detailed Color Samples and how do I access them?

Detailed Color Samples sets are available only through the Embedded Web Server of a network printer. A detailed Color Samples set contains a range of shades (displayed as colored boxes) that are similar to a user-defined RGB or CMYK value. The likeness of the colors in the set are dependent on the value entered in the RGB or CMYK Increment box.

To access a detailed Color Samples set from the Embedded Web Server:

- 1** From the home screen, touch **Settings > Print > Quality > Advanced Imaging > Color Samples > Print Color Samples**.
- 2** Touch **Detailed Options** to narrow the set to one color range.
- 3** Select the appropriate color conversion table to print.
- 4** Enter the RGB or CMYK color number.
- 5** Enter an Increment value from 1–255.

Note: The closer the value is to 1, the narrower the color sample range will appear.

- 6** Touch **Print** to print the detailed Color Samples set.

Appendix D: Acronyms

Acronyms

ASIC	Application-specific integrated circuit
BLDC	Brushless DC motor
BOR	Black only retract
C	Cyan
CCD	Charge coupled device
CCP	Carbonless copy paper
CRC	Cyclic redundancy check
CSU	Customer setup
CTLS	Capacitance toner level sensing
DIMM	Dual inline memory module
DRAM	Dynamic random access memory
EDO	Enhanced data out
EP	Electrophotography
EPROM	Erasable programmable read-only memory
ESD	Electrostatic discharge
FFC	Flat flexible cable
FRU	Field replaceable unit
GB	Gigabyte
HCF	High-capacity feeder
HCIT	High-capacity input tray
HCOF	High-capacity output finisher
HVPS	High voltage power supply
ITU	Image transfer unit
K	Black
LAA	Locally Administered Access
LCD	Liquid crystal display
LDAP	Lightweight directory access protocol
LED	Light-emitting diode
LVPS	Low voltage power supply
M	Magenta
MB	Megabyte
MFP	Multi-function product

MPF	Multipurpose feeder
MROM	Masked read only memory
MS	Microswitch
NVM	Nonvolatile memory
NVRAM	Nonvolatile random access memory
OEM	Original equipment manufacturer
OPT	Optical sensor
PC	Photoconductor
pel, pixel	Picture element
POR	Power-on reset
POST	Power-on self test
PSD	Position sensing device
PWM	Pulse width modulation
RIP	Raster imaging processor
ROM	Read only memory
SDRAM	Synchronous dual random access memory
SIMM	Single inline memory module
SRAM	Static random access memory
TMC	Toner meter cycle
TPS	Toner patch sensing
UPR	Used parts return
V ac	Volts alternating current
V dc	Volts direct current
Y	Yellow

Index

A

- acronyms 473
- adding hardware options
 - print driver 450
- adding internal options
 - print driver 450
- additional input tray diagnostics
 - motor tests 250
 - sensor tests 250
- adjustment
 - printhead 261
 - registration alignment 263
- advanced print quality samples 245
- available internal options 449
- avoiding jams 27
- avoiding paper jams 61

C

- card stock
 - tips 28
- cleaning
 - exterior of the printer 410
 - interior of the printer 410
 - main tray duplex turnaround 411
 - printhead lenses 410
- cleaning the machine 407
- cleaning the printer 410
- color theory 469
- connectors
 - controller board 390
 - LVPS controller board 402
- control panel
 - controller board, removing with 254
 - using 241
- controller board
 - control panel, removing with 254
- controller board, restoring configuration 255

D

- data security notice 31, 253
- diagnostics menu
 - accessing 244

E

- electrophotographic process 461
- electrostatic-sensitive parts 254
- embedded solutions 260

- emission notices 447
- envelopes
 - tips on using 27
- EP process 461
- error codes
 - 100 error messages 166
 - 102 error messages 167
 - 110 error messages 168
 - 120 error messages 168
 - 121 error messages 169
 - 126 and 127 error messages 171
 - 128 error message 171
 - 142 error messages 171
 - 144 error messages 172
 - 145 error messages 172
 - 147 error messages 172
 - 149 error messages 173
 - 150 and 160 error messages 173
 - 151 error messages 174
 - 153 error messages 175
 - 161 and 162 error messages 174
 - 163 and 164 error messages 175
 - 166–168 error messages 176
 - 17y error messages 176
 - 200 paper jam messages 69
 - 201 paper jam messages 75
 - 202 paper jam messages 76
 - 203 paper jam messages 84
 - 211 paper jam messages 85
 - 221 paper jam messages 86
 - 230 paper jam messages 87
 - 231 paper jam messages 93
 - 232 paper jam messages 99
 - 240 paper jam messages 104
 - 241 paper jam messages 116
 - 242 paper jam messages 124
 - 243 paper jam messages 126
 - 244 paper jam messages 128
 - 647 error messages 201
 - 649 error messages 201
 - 650 error messages 201
 - 653 error messages 202
 - 660 error messages 202
 - 661–665 error messages 202
- ESD-sensitive parts 254
- eSF solutions 260
- event log
 - display log 244

- mark log 245
- print log 244
- print log summary 245
- exterior of the printer
 - cleaning 410

F

- finding
 - serial number 25
- firmware card 449
- fuser
 - identifying the fuser type 409

G

- general caution statements 23

H

- hardware options
 - trays 449
- hardware options, adding
 - print driver 450
- home screen buttons
 - using 242

I

- indicator light
 - printer status 242
- Inspection guide 407
- interior of the printer
 - cleaning 410
- internal options 449
- internal options, adding
 - print driver 450
- invalid code, fixing 250
- invalid engine mode
 - accessing 250

J

- jam, clearing
 - multipurpose feeder 65
 - trays 64
- jams
 - avoiding 61
 - locating jam areas 63
 - locations 63
- jams, clearing
 - in the duplex unit 66
 - in the fuser 66

L

- labels, paper
 - tips 28
- locations
 - motor 404
 - sensor 405

M

- maintenance kits 408
- memory card 449
- menus
 - diagram of 243
- menus diagram 243
- moving the printer 446

N

- noise emission levels 447
- notices 445, 446, 447

O

- options
 - firmware cards 449
 - memory card 449

P

- paper
 - characteristics 26
 - selecting 26
 - storing 26, 27
- paper characteristics 26
- paper jam clearing
 - standard bin 65
- paper jam in door A 66
- paper jam in the multipurpose feeder 65
- paper jam in the standard bin 65
- paper jam in trays 64
- paper jam, clearing
 - multipurpose feeder 65
 - trays 64
- paper jams
 - avoiding 61
- paper jams, clearing
 - in the duplex unit 66
 - in the fuser 66
- paper path
 - aligner section 456
 - duplex section 459
 - fuser section 458
 - isolation unit section 455
 - MPF section 454

- tray section 453
 - paper sizes
 - supported 29
 - paper types
 - supported 30
 - paper weights
 - supported 30
 - parts catalog legend 412
 - POR sequence 33
 - power button light
 - printer status 242
 - power-on reset sequence 33
 - print driver
 - hardware options, adding 450
 - print quality
 - initial check 34
 - print quality troubleshooting
 - background or gray background 36
 - blank or white pages 37
 - blurred print or color misalignment 40
 - dark print 52
 - gapping or half color page 39
 - ghost images 46
 - horizontal colored lines or banding 41
 - image void process direction 51
 - image void scan direction 49
 - light print 57
 - mottled print and dots 43
 - random marks 57
 - solid color or black image 47
 - text or images cut off 43
 - toner easily rubs off 34
 - uneven print density 54
 - vertical colored lines or banding 48
 - vertical white lines 44
 - printer
 - basic model 389
 - fully configured 389
 - minimum clearances 446
 - moving 446
 - selecting a location 446
 - printer configurations 389
 - printer diagnostics
 - input tray quick print 245
 - printer diagnostics & adjustments
 - motor tests 248
 - sensor tests 248
 - printer diagnostics and adjustments
 - add-on cards tests 249
 - color alignment adjust 249
 - fuser temperature 249
 - memory tests 248
 - printhead diagnostics 249
 - registration adjust 248
 - supply reset 249
 - weather station 249
 - printer setup
 - enable edge-to-edge (copy) 246
 - enable edge-to-edge (printing) 246
 - engine setting [x] 247
 - EP setup 247
 - model name 247
 - permanent page count 246
 - printed page count (color) 246
 - printed page count (mono) 246
 - process ID 247
 - serial number 247
 - printhead lenses
 - cleaning 410
- ## R
- removal
 - duplex inner guide 291
 - tensioner belt 292
 - removal procedures
 - tips 265
 - removals
 - 550-sheet tray controller board assembly 382
 - 550-sheet tray empty sensor actuator 384
 - 550-sheet tray interface cable 383
 - 550-sheet tray right cover 375
 - 550-sheet tray paper feeder 378
 - aligner idler gears 370
 - badge cover 283
 - control panel arms 284
 - control panel base cover 287
 - controller board 357
 - controller board shield 356
 - deskew roller 342
 - developer hold down 363
 - diverter 350
 - duplex outer guide 289
 - EP gear box 302
 - external air filter 280
 - front cover 265
 - front cover hinges 368
 - fuser 333
 - fuser fan 299
 - high voltage power supply (HVPS) 319
 - imaging unit cover 324
 - inner controller board shield 357
 - isolation unit 371
 - left cover 271
 - LVPS 305

- LVPS cage 308
- main fan 301
- media feeder 373
- Motor (550-sheet tray pass-through) 376
- motor (black only retract) 309
- motor (deskew) 299
- motor (duplex/MPF) 315
- motor (EP drive) 296
- motor (fuser) 318
- motor (output) 297
- motor cover 273
- number pad cover 284
- output bin exit cover 367
- output bin flag 367
- output roll 364
- pivot shaft 291
- power cable 297
- printhead 361
- redrive guide 354
- right cover 272
- secure element SIM card 360
- sensor (550-sheet tray empty) 385
- sensor (550-sheet tray index) 386
- sensor (550-sheet tray paper size) 380
- sensor (550-sheet tray pass-through) 379
- sensor (550-sheet tray trailing edge) 380
- sensor (duplex) 293
- sensor (fuser buckle and narrow media) 294
- sensor (input) 341
- sensor (media type) 340
- sensor (MPF paper present) 322
- sensor (paper size) 312
- sensor (redrive) 354
- sensor (TPS) 325
- sensor (waste toner contact) 314
- sensor (weather station) 311
- speaker 286
- TMC card 315
- toner cartridge contacts 328
- toner door 276
- toner door mount 279
- toner door mount bracket 278
- top cover 268
- TPS cable 359
- TPS sled 327
- TPS wiper 332
- TPS wiper mechanism 330
- transfer module 334
- transfer module guide rail 336
- tray rail 369
- upper control panel 280
- waste toner bottle idler gear 324

- reports
 - device settings 245
 - installed licenses 245
- restoring
 - configuration file 258
 - license file 258
- ribbon cables 260

S

- schedule for Inspection 407
- scheduled maintenance 408
- selecting a location for the printer 446
- selecting paper 26
- service checks troubleshooting
 - 900 service error messages 208
 - 91y service error messages 209
 - 938 service error messages 209
 - 95y service error messages 209
 - 96y service error messages 210
 - 97y service error messages 211
 - 980–984 service error messages 212
 - 99y service error messages 212
 - network service check 229
 - usb service check 233
- service engineer (SE) menu
 - accessing 250
 - general SE 251
 - network SE 251
- service manual conventions 23
- storing
 - paper 27
- supply reset
 - fuser reset 249
 - ITM reset 249
- supported paper sizes 29
- supported paper types 30
- supported paper weights 30
- symptoms
 - printer 223

T

- tips
 - card stock 28
 - labels, paper 28
 - on using envelopes 27
- tips on using envelopes 27
- tools, required 31
- trays
 - installing 449
- troubleshooting
 - initial check 33

- troubleshooting, print quality
 - background or gray background 36
 - blank or white pages 37
 - blurred print or color misalignment 40
 - dark print 52
 - gapping or half color page 39
 - ghost images 46
 - horizontal colored lines or banding 41
 - image void process direction 51
 - image void scan direction 49
 - light print 57
 - mottled print and dots 43
 - random marks 57
 - solid color or black image 47
 - text or images cut off 43
 - toner easily rubs off 34
 - uneven print density 54
 - vertical colored lines or banding 48
 - vertical white lines 44
- troubleshooting, service checks
 - 900 service error messages 208
 - 91y service error messages 209
 - 938 service error messages 209
 - 95y service error messages 209
 - 96y service error messages 210
 - 97y service error messages 211
 - 980–984 service error messages 212
 - 99y service error messages 212
 - network service check 229
 - usb service check 233

U

- understanding the status of the power button and indicator light 242
- updating the printer firmware
 - using a flash drive 259
 - using a network computer 259
- user attendance messages
 - 31 user attendance error messages 149
 - 32 user attendance error messages 149
 - 33 user attendance error messages 150
 - 42 user attendance error messages 151
 - 43 user attendance error messages 151
 - 80 user attendance error messages 152
 - 82 user attendance error messages 152
 - 83 user attendance error messages 152
 - 84 user attendance error messages 153
 - 85 user attendance error messages 154
 - 88 user attendance error messages 155
 - non-supply user attendance error messages 155
- using the control panel 241
- using the home screen 242

Part number index

P/N	Part name	Page
40X0259	Brazil LV.....	443
40X0271	Hong Kong.....	443
40X0271	Singapore, Malaysia, Pakistan, Sri Lanka, Myanmar, Brunei, India.....	443
40X0271	UK, Saudi Arabia.....	443
40X0273	Chile, Uruguay.....	443
40X0275	Israel.....	443
40X0279	Philippines, Thailand.....	443
40X0288	Argentina.....	443
40X0297	Bolivia, Peru, Paraguay.....	443
40X0301	Australia, New Zealand	443
40X0303	PRC.....	443
40X1767	Algeria, Austria, Benelux (Belgium, Luxembourg, Netherlands), Bosnia, Bulgaria, Croatia, Czech Republic, Egypt, Estonia, France, Germany, Greece, Hungary, Iceland, Italy, Latvia, Lithuania, Morocco, Poland, Portugal, Romania, Russia (CIS), Serbia, Slovakia, Spain, Turkey.....	443
40X1767	Indonesia, Vietnam, Cambodia, Laos.....	443
40X1772	Switzerland.....	443
40X1773	Bangladesh, Nepal, Bhutan.....	443
40X1773	South Africa.....	443
40X1774	Nordics.....	443
40X1791	Taiwan.....	443
40X1792	Korea.....	443
40X3609	Japan.....	443
40X7104	US, Canada, Latin America LV	443
40X7911	Sensor (550-sheet tray paper size).....	438
40X7911	Sensor (paper size).....	424
40X9652	Adapter–Fiber gigabit ISP.....	441
40X9929	Transfer module.....	422
41X0001	Motor (fuser).....	426
41X0015	Adapter–N8360 ISP + NFC/BLE dual band.....	441
41X0028	DDR3 RAM, (G2) 2GB, 512Mx32, 204 SODIMM, Unbuffered Non-ECC.....	441
41X0050	4.3-in. control panel.....	418
41X0251	CS72x fuser type 02, 100V.....	420

P/N	Part name	Page
41X0252	CS72x fuser type 00, 110-120V.....	420
41X0253	CS72x fuser type 01, 220-240V.....	420
41X0254	CS72x fuser type 07, 100V (narrow media).....	420
41X0255	CS72x fuser type 05, 110-120V (narrow media).....	420
41X0256	CS72x fuser type 06, 220-240V (narrow media).....	420
41X0264	EP gear box.....	428
41X0265	Printhead.....	428
41X0267	Controller board.....	432
41X0268	550-sheet tray.....	424
41X0270	High voltage power supply.....	432
41X0271	550-sheet tray.....	436
41X0331	550-sheet tray controller board.....	438
41X0334	Sensor (550-sheet tray pass-through).....	438
41X0361	550-sheet tray insert.....	436
41X0372	Tray rails.....	424
41X0373	550-sheet tray paper size sensor actuator.....	438
41X0373	Paper size sensor actuators.....	424
41X0374	550-sheet tray separator pad.....	438
41X0374	Separation block.....	424
41X0376	Duplex inner guide.....	430
41X0377	Pivot shaft.....	430
41X0378	Tensioner belt.....	430
41X0379	Guide spring.....	430
41X0380	Front door strap.....	414
41X0381	Motor (duplex/MPF).....	426
41X0382	Toner cartridge contact.....	432
41X0383	Sensor (TPS).....	432
41X0384	Isolation unit.....	428
41X0385	Sensor (input).....	426, 432
41X0386	Deskew rollers.....	426
41X0387	Motor (deskew).....	428
41X0388	Redrive guide.....	428
41X0389	Diverter.....	428
41X0390	Output roll.....	426

P/N	Part name	Page
41X0391	Output gear.....	426
41X0392	Output drive.....	426
41X0393	Motor (black only retract).....	428
41X0394	TMC card.....	432
41X0395	Fuser drive gear.....	426
41X0396	550-sheet tray paper feeder.....	438
41X0396	Media feeder.....	424
41X0397	Main fan.....	432
41X0398	Fuser fan.....	432
41X0399	Speaker.....	418
41X0400	Cable cover.....	430
41X0401	Tray indicator cover.....	414
41X0403	Imaging unit cover.....	414
41X0407	Duplex outer guide.....	430
41X0408	Rear tray cover.....	414
41X0409	Top cover.....	414
41X0410	Bin extender.....	414
41X0411	Front cover.....	414
41X0412	Left cover.....	416
41X0413	Cable replacement pack.....	433
41X0414	Toner door.....	416
41X0415	Toner door mount.....	416
41X0416	Upper control panel cover.....	418
41X0418	Control panel FFC cable.....	433
41X0419	Right cover.....	414
41X0420	Speaker cable.....	433
41X0421	Motor cover.....	414
41X0422	Number pad cover.....	418
41X0423	Control panel base cover.....	418
41X0424	Rear handle cover.....	414
41X0425	Low voltage power supply.....	432
41X0441	Control panel USB cable.....	418, 432
41X0446	Sensor (duplex staging).....	430
41X0447	Sensor (fuser buckle / narrow media).....	430

P/N	Part name	Page
41X0448	Sensor (interlock assembly).....	414
41X0450	Sensor (media type).....	426, 432
41X0451	Motor (output).....	426
41X0466	Motor (550-sheet tray pass-through).....	438
41X0468	Sensor (550-sheet tray trailing edge).....	438
41X0469	Sensor (550-sheet tray index).....	438
41X0470	Sensor (550-sheet tray empty).....	438
41X0471	550-sheet tray interface cable.....	438
41X0472	550-sheet tray empty sensor actuator.....	438
41X0486	Sensor (waste toner contact).....	432
41X0558	Toner door mount bracket.....	416
41X0560	Front door bracket.....	414
41X0561	Left control panel arm.....	418
41X0562	Right control panel arm.....	418
41X0564	Motor (EP drive).....	428
41X0566	Sensor (MPF paper present).....	432
41X0567	Front cover hinges.....	414
41X0570	Sensor (bin full).....	414
41X0570	Sensor (duplex path 1 / MPF pass-through).....	428
41X0575	TPS cable.....	432
41X0578	TPS wipers.....	432
41X0683	Transfer module guide rail.....	422
41X0686	TPS wiper mechanism.....	414
41X0719	Control panel cable kit.....	432
41X0757	Waste toner bottle idler gear.....	426
41X0758	Aligner drivetrain kit.....	428
41X0764	Locking caster.....	440
41X0772	Output bin flag.....	414
41X0773	Output bin exit cover.....	414
41X0774	Locking caster.....	440
41X0775	Nonlocking caster.....	440
41X0785	Sensor (weather station).....	432
41X0824	Static brush.....	430
41X0825	Support strap.....	424

P/N	Part name	Page
41X0871	C620 badge cover.....	418
41X0872	C720 badge cover.....	418
41X0873	C4150 badge cover.....	418
41X0897	Developer hold down arm.....	428
41X0956	550-sheet tray pick roller.....	438
41X0956	Pick roller (tray 1 and MPF).....	424
41X1002	Forms bar code card.....	441
41X1004	IPDS SCS TNE card.....	441
41X1006	Prescribe card.....	441
41X1009	External air filter.....	416
41X1010	Flash card.....	441
41X1011	Font card, Hebrew.....	441
41X1012	Font card, Arabic.....	441
41X1013	Font card, Simplified Chinese.....	441
41X1014	Font card, Traditional Chinese.....	441
41X1015	Font card, Korean.....	441
41X1016	Font card, Japanese.....	441

Part name index

P/N	Part name	Page
41X0050	4.3-in. control panel.....	418
41X0268	550-sheet tray.....	424
41X0271	550-sheet tray.....	436
41X0331	550-sheet tray controller board.....	438
41X0472	550-sheet tray empty sensor actuator.....	438
41X0361	550-sheet tray insert.....	436
41X0471	550-sheet tray interface cable.....	438
41X0396	550-sheet tray paper feeder.....	438
41X0373	550-sheet tray paper size sensor actuator.....	438
41X0956	550-sheet tray pick roller.....	438
41X0374	550-sheet tray separator pad.....	438
40X9652	Adapter–Fiber gigabit ISP.....	441
41X0015	Adapter–N8360 ISP + NFC/BLE dual band.....	441
40X1767	Algeria, Austria, Benelux (Belgium, Luxembourg, Netherlands), Bosnia, Bulgaria, Croatia, Czech Republic, Egypt, Estonia, France, Germany, Greece, Hungary, Iceland, Italy, Latvia, Lithuania, Morocco, Poland, Portugal, Romania, Russia (CIS), Serbia, Slovakia, Spain, Turkey.....	443
41X0758	Aligner drivetrain kit.....	428
40X0288	Argentina.....	443
40X0301	Australia, New Zealand	443
40X1773	Bangladesh, Nepal, Bhutan.....	443
41X0410	Bin extender.....	414
40X0297	Bolivia, Peru, Paraguay.....	443
40X0259	Brazil LV.....	443
41X0873	C4150 badge cover.....	418
41X0871	C620 badge cover.....	418
41X0872	C720 badge cover.....	418
41X0400	Cable cover.....	430
41X0413	Cable replacement pack.....	433
40X0273	Chile, Uruguay.....	443
41X0423	Control panel base cover.....	418
41X0719	Control panel cable kit.....	432
41X0418	Control panel FFC cable.....	433

P/N	Part name	Page
41X0441	Control panel USB cable.....	418, 432
41X0267	Controller board.....	432
41X0252	CS72x fuser type 00, 110-120V.....	420
41X0253	CS72x fuser type 01, 220-240V.....	420
41X0251	CS72x fuser type 02, 100V.....	420
41X0255	CS72x fuser type 05, 110-120V (narrow media).....	420
41X0256	CS72x fuser type 06, 220-240V (narrow media).....	420
41X0254	CS72x fuser type 07, 100V (narrow media).....	420
41X0028	DDR3 RAM, (G2) 2GB, 512Mx32, 204 SODIMM, Unbuffered Non-ECC.....	441
41X0386	Deskew rollers.....	426
41X0897	Developer hold down arm.....	428
41X0389	Diverter.....	428
41X0376	Duplex inner guide.....	430
41X0407	Duplex outer guide.....	430
41X0264	EP gear box.....	428
41X1009	External air filter.....	416
41X1010	Flash card.....	441
41X1012	Font card, Arabic.....	441
41X1011	Font card, Hebrew.....	441
41X1016	Font card, Japanese.....	441
41X1015	Font card, Korean.....	441
41X1013	Font card, Simplified Chinese.....	441
41X1014	Font card, Traditional Chinese.....	441
41X1002	Forms bar code card.....	441
41X0411	Front cover.....	414
41X0567	Front cover hinges.....	414
41X0560	Front door bracket.....	414
41X0380	Front door strap.....	414
41X0395	Fuser drive gear.....	426
41X0398	Fuser fan.....	432
41X0379	Guide spring.....	430
41X0270	High voltage power supply.....	432
40X0271	Hong Kong.....	443
41X0403	Imaging unit cover.....	414

P/N	Part name	Page
40X1767	Indonesia, Vietnam, Cambodia, Laos.....	443
41X1004	IPDS SCS TNE card.....	441
41X0384	Isolation unit.....	428
40X0275	Israel.....	443
40X3609	Japan.....	443
40X1792	Korea.....	443
41X0561	Left control panel arm.....	418
41X0412	Left cover.....	416
41X0764	Locking caster.....	440
41X0774	Locking caster.....	440
41X0425	Low voltage power supply.....	432
41X0397	Main fan.....	432
41X0396	Media feeder.....	424
41X0466	Motor (550-sheet tray pass-through).....	438
41X0393	Motor (black only retract).....	428
41X0387	Motor (deskew).....	428
41X0381	Motor (duplex/MPF).....	426
41X0564	Motor (EP drive).....	428
41X0001	Motor (fuser).....	426
41X0451	Motor (output).....	426
41X0421	Motor cover.....	414
41X0775	Nonlocking caster.....	440
40X1774	Nordics.....	443
41X0422	Number pad cover.....	418
41X0773	Output bin exit cover.....	414
41X0772	Output bin flag.....	414
41X0392	Output drive.....	426
41X0391	Output gear.....	426
41X0390	Output roll.....	426
41X0373	Paper size sensor actuators.....	424
40X0279	Philippines, Thailand.....	443
41X0956	Pick roller (tray 1 and MPF).....	424
41X0377	Pivot shaft.....	430
40X0303	PRC.....	443

P/N	Part name	Page
41X1006	Prescribe card.....	441
41X0265	Printhead.....	428
41X0424	Rear handle cover.....	414
41X0408	Rear tray cover.....	414
41X0388	Redrive guide.....	428
41X0562	Right control panel arm.....	418
41X0419	Right cover.....	414
41X0470	Sensor (550-sheet tray empty).....	438
41X0469	Sensor (550-sheet tray index).....	438
40X7911	Sensor (550-sheet tray paper size).....	438
41X0334	Sensor (550-sheet tray pass-through).....	438
41X0468	Sensor (550-sheet tray trailing edge).....	438
41X0570	Sensor (bin full).....	414
41X0570	Sensor (duplex path 1 / MPF pass-through).....	428
41X0446	Sensor (duplex staging).....	430
41X0447	Sensor (fuser buckle / narrow media).....	430
41X0385	Sensor (input).....	426, 432
41X0448	Sensor (interlock assembly).....	414
41X0450	Sensor (media type).....	426, 432
41X0566	Sensor (MPF paper present).....	432
40X7911	Sensor (paper size).....	424
41X0383	Sensor (TPS).....	432
41X0486	Sensor (waste toner contact).....	432
41X0785	Sensor (weather station).....	432
41X0374	Separation block.....	424
40X0271	Singapore, Malaysia, Pakistan, Sri Lanka, Myanmar, Brunei, India.....	443
40X1773	South Africa.....	443
41X0399	Speaker.....	418
41X0420	Speaker cable.....	433
41X0824	Static brush.....	430
41X0825	Support strap.....	424
40X1772	Switzerland.....	443
40X1791	Taiwan.....	443
41X0378	Tensioner belt.....	430

P/N	Part name	Page
41X0394	TMC card.....	432
41X0382	Toner cartridge contact.....	432
41X0414	Toner door.....	416
41X0415	Toner door mount.....	416
41X0558	Toner door mount bracket.....	416
41X0409	Top cover.....	414
41X0575	TPS cable.....	432
41X0686	TPS wiper mechanism.....	414
41X0578	TPS wipers.....	432
40X9929	Transfer module.....	422
41X0683	Transfer module guide rail.....	422
41X0401	Tray indicator cover.....	414
41X0372	Tray rails.....	424
40X0271	UK, Saudi Arabia.....	443
41X0416	Upper control panel cover.....	418
40X7104	US, Canada, Latin America LV	443
41X0757	Waste toner bottle idler gear.....	426



CAUTION—SHOCK HAZARD: This type of caution indicates a danger from hazardous voltage in the area of the product where you are working. Unplug the product before you start working, or use caution if the product must receive power to perform the task.



CAUTION—POTENTIAL INJURY: The lithium battery in this product is not intended to be replaced. There is a danger of explosion if a lithium battery is incorrectly replaced. Do not recharge, disassemble, or incinerate a lithium battery. Discard used lithium batteries according to the manufacturer's instructions and local regulations.

CS 720
CS 725
C4 150

WIRING DIAGRAM

