



Lexmark™

CX310, CX317, CX410, CX417, CX510, CX517de, XC2130, and XC2132 MFPs

7527-2xx, -4xx, -63x, 697

Service Manual

- [Start diagnostics](#)
- [Maintenance](#)
- [Safety and notices](#)
- [Trademarks](#)
- [Index](#)

January 12, 2021

www.lexmark.com

Product information

Product name:

Lexmark CX310, CX317, CX410, CX417, CX510, CX517de, XC2130, and XC2132 MFPs

Machine type:

7527

Model(s):

2xx, 4xx, 63x, 697

Edition notice

January 12, 2021

The following paragraph does not apply to any country where such provisions are inconsistent with local law: LEXMARK INTERNATIONAL, INC., PROVIDES THIS PUBLICATION “AS IS” WITHOUT WARRANTY OF ANY KIND, EITHER EXPRESS OR IMPLIED, INCLUDING, BUT NOT LIMITED TO, THE IMPLIED WARRANTIES OF MERCHANTABILITY OR FITNESS FOR A PARTICULAR PURPOSE. Some states do not allow disclaimer of express or implied warranties in certain transactions; therefore, this statement may not apply to you.

References in this publication to products, programs, or services do not imply that the manufacturer intends to make these available in all countries in which it operates. Any reference to a product, program, or service is not intended to state or imply that only that product, program, or service may be used. Any functionally equivalent product, program, or service that does not infringe any existing intellectual property right may be used instead. Evaluation and verification of operation in conjunction with other products, programs, or services, except those expressly designated by the manufacturer, are the user's responsibility.

Trademarks

Lexmark, Lexmark with diamond design, and MarkNet are trademarks of Lexmark International, Inc., registered in the United States and/or other countries.

PrintCryption is a trademark of Lexmark International, Inc.

PCL® is a registered trademark of the Hewlett-Packard Company. PCL is Hewlett-Packard Company's designation of a set of printer commands (language) and functions included in its printer products. This printer is intended to be compatible with the PCL language. This means the printer recognizes PCL commands used in various application programs, and that the printer emulates the functions corresponding to the commands.

All other trademarks are the property of their respective owners.

© 2017 Lexmark International, Inc.

All rights reserved.

P/N 12G3313

Table of contents

Product information.....	2
Edition notice.....	2
Notices, conventions, and safety information.....	13
Laser notice.....	13
Conventions.....	16
Safety information.....	16
General caution statements.....	22
Change history.....	23
Change history.....	23
General information.....	31
Printer model configurations.....	31
Media guidelines.....	31
Paper guidelines.....	32
Using recycled paper and other office papers.....	34
Using specialty media.....	34
Supported paper sizes, types, and weights.....	37
Data security notice.....	40
Tools required for service.....	41
Diagnostics and troubleshooting.....	43
Troubleshooting overview.....	43
Performing the initial troubleshooting check.....	43
Power-on Reset (POR) sequence.....	44
Using Safe Mode.....	44
Fixing print quality issues.....	45
Initial print quality check.....	46
Toner smear check.....	47
Background or toner fog check.....	48
Blank pages check.....	49
Blurred or fuzzy print check.....	50
Half-color page check.....	51
Horizontal banding check.....	51
Horizontal line check.....	51
Missing image at edge check.....	52

Toner specks check.....	52
Narrow vertical line check.....	52
Random marks check.....	52
Residual image check.....	53
Solid color pages check.....	53
Vertical banding check.....	54
Light print on solids check.....	54
Color problems check.....	54
Missing color check.....	55
Paper jams.....	58
Avoiding jams.....	58
Understanding jam messages and locations.....	60
200 paper jams.....	60
202 paper jams.....	65
203 paper jams.....	72
23y paper jams.....	75
24y paper jams.....	79
25y paper jams.....	80
28y paper jams.....	83
29y paper jams.....	87
Understanding the printer messages.....	89
Printer hardware errors.....	101
110 errors.....	101
121 errors.....	103
126 errors.....	109
133 errors.....	109
141 errors.....	112
147 errors.....	114
171 errors.....	116
Procedure before starting the 9yy service checks.....	117
900 errors.....	119
91y errors.....	124
938 errors.....	126
95y errors.....	126
96y errors.....	129
97y errors.....	130
982 errors.....	131
990 errors.....	132
ADF/Scanner hardware errors.....	134
8yy service error messages.....	134
Scanner disabled error service check.....	135
ADF service check.....	137
CCD service check.....	138
Scanner configuration error service check.....	139

Scan/fax/copy symptoms	139
Black or blank page copy service check	140
Flatbed motor service check.....	141
Flatbed home position service check.....	141
ADF rattling noise service check	142
Flatbed legal scan service check.....	142
ADF streak service check	143
ADF feed errors service check.....	143
ADF duplex service check	144
Modem/fax card service check.....	145
Blank spaces on incoming fax service check	146
Stretched words on incoming fax service check.....	147
Fax reception service check	147
Fax transmission service check.....	149
Fax error log codes.....	151
Escalating a fax issue to second-level support	155
Other symptoms.....	156
Base printer symptoms	156
Input option symptoms	178

Service menus..... 201

Understanding the printer control panel.....	201
Using the printer control panel.....	201
Understanding the colors of the indicator light and Sleep button lights.....	203
Understanding the home screen for CX410 and CX510 models.....	203
Menu list.....	206
Diagnostics menu.....	208
Entering the Diagnostics menu	209
REGISTRATION	209
Skew	210
Quick Test.....	211
Alignment Menu.....	212
Scanner calibration	212
MISC TESTS	213
PRINT TESTS	214
Feed Tests	214
Print quality test pages	215
HARDWARE TESTS	215
DUPLEX TESTS	217
INPUT TRAY TESTS	219
BASE SENSOR TEST	219
DEVICE TESTS	221
PRINTER SETUP.....	221
EP SETUP	224

TPS Setup: Right or Left.....	225
TPS Setup: Reset Color Cal	225
TPS Setup: Cal Ref Adj.....	226
REPORTS	226
EVENT LOG.....	226
Scanner tests.....	228
Exit Diagnostics.....	232
Configuration menu.....	233
Entering the Configuration menu.....	234
USB scan to local.....	234
Black Only Mode	234
Print Quality Pages.....	234
Fuser Cleaning Process.....	234
Reports	235
Color Trapping.....	235
Tray Insert Msg.....	235
Panel Menus	236
PPDS Emulation	236
Download emuls.....	236
Safe Mode	236
Energy Conserve.....	236
Fax low power support	237
Min copy memory.....	237
Num pad job assist.....	237
Format fax storage	237
Auto Color Adjustment	238
Auto Align Adj	238
Color Alignment.....	238
ADF Edge Erase.....	238
Flatbed edge erase.....	239
Scanner manual registration	239
Disable scanner	240
Paper Prompts.....	240
Envelope Prompts	241
Action for prompts	241
Jobs on Disk	242
Disk Encryption	242
Font Sharpening	242
Require Standby	242
UI Automation.....	243
LES Applications.....	243
Key Repeat Initial Delay	243
Key Repeat Rate	243
Clear Supply Usage History.....	244
Clear Custom Status	244

PEL Blurring.....	244
USB Speed.....	244
Automatically Display Error Screens	244
USB PnP.....	245
Size sensing.....	245
Demo Mode	245
Factory Defaults.....	245
Restore Factory Defaults.....	246
Exit Config	247
Entering Invalid engine mode.....	247
Entering Recovery mode.....	247
Accessing restore point.....	247
Accessing the Network SE menu.....	249
Service Engineer menu.....	249
Accessing the service engineer (SE) menu.....	249
Service engineer (SE) menu	249
Fax service engineer (SE) menu.....	250

Parts removal.....251

Removal precautions.....	251
Data security notice	251
Handling ESD-sensitive parts.....	252
Controller board/control panel replacement	252
Restoring the printer configuration after replacing the controller board	253
Restoring solutions, licenses, and configuration settings	256
Updating the printer firmware	257
Backing up eSF solutions and settings	258
Ribbon cable connectors	259
Zero Insertion Force (ZIF) connectors.....	259
Horizontal top contact connector	260
Horizontal bottom contact connector	263
Vertical mount contact connector.....	266
Horizontal sliding contact connector	269
Low Insertion Force (LIF) connector	272
Removal procedures.....	273
Left side removals.....	274
Left cover assembly removal	274
Drive unit motor removal.....	275
EP drive assembly removal.....	275
Developer drive coupling removal	281
Low-voltage power supply (LVPS) removal	285
Fuser exit sensor removal.....	286
Speaker removal	288

Right side removals.....	288
Right cover assembly removal.....	288
Fuser drive motor assembly removal.....	289
Toner meter cycle (TMC) card removal.....	290
Thermistor removal.....	292
Toner density sensor (TDS) (left or right sensor) removal.....	293
Developer unit removal	295
High-voltage power supply (HVPS) removal.....	296
Image transfer unit (ITU) removal.....	300
Imaging unit (IU) removal.....	303
Toner cartridge contacts removal	305
Waste toner bottle removal	307
Waste toner bottle contact block removal.....	308
Front removals.....	309
Front cover assembly removal.....	309
Front cover inner deflector removal.....	311
Front middle cover removal.....	312
Front logo cover removal.....	312
Operator panel bezel removal.....	312
Operator panel logo plate removal	313
Operator panel removal (for CX310 and CX410 models only).....	313
Operator panel removal (for CX510 models only)	320
UICC to controller board cable removal	321
USB port connector removal.....	321
Duplex reference edge removal	322
Fuser assembly removal.....	324
Bottom removals.....	328
Lower left frame removal.....	328
Lower right frame removal.....	334
Duplex sensor removal.....	338
ITU guide removal.....	339
Tray present sensor removal.....	342
Paper pick motor drive assembly (standard tray) removal.....	343
Rear side removals.....	346
Rear cover removal.....	346
Controller board removal	348
System fan removal	351
Top side removals.....	352
Top cover assembly removal.....	352
Output bin tray and exit bail removal.....	357
AIO toner cover removal	359
AIO link removal	360
AIO release lever removal	361
Bin-full flag removal.....	362

MFP fuser deflector flag removal	362
Narrow media sensor removal.....	363
Narrow media sensor flag removal.....	364
Printhead removal	365
Redrive unit removal.....	365
ADF/scanner removals.....	367
ADF assembly removal	367
ADF input tray removal	369
ADF separator roll removal.....	370
ADF separator pad removal	370
Top cover ADF sheet feed removal.....	371
Right scanner cover removal	372
Rear scanner cover removal.....	374
Flatbed scanner assembly removal.....	374
Flatbed pivot link (rear right) removal	379
Flatbed pivot link (front left) removal.....	381
Options removals.....	383
650-sheet duo drawer tray assembly removal	384
650-sheet duo drawer assembly removal.....	385
Dust cover removal.....	386
Pick tire removal	387
Component locations.....	389
Controller board.....	389
Maintenance.....	397
Inspection guide.....	397
Scheduled maintenance.....	398
Maintenance kits.....	398
Preventive maintenance.....	398
Device-specific preventive maintenance.....	398
Lubrication specification.....	399
Cleaning the printer.....	399
Cleaning the printer	399
Cleaning the scanner glass	400
Cleaning the printhead lenses.....	401
Parts catalog.....	402
Legend.....	402
Assembly 1: Covers.....	403
Assembly 2: Scanner.....	405
Assembly 3: Paper path.....	409

Assembly 4: Operator panels.....	413
Assembly 5: Electronics.....	417
Assembly 6: Cables and sensors.....	421
Assembly 7: Media drawers and trays.....	423
Assembly 8: Options and miscellaneous.....	425
Printer specifications.....	427
Power specifications.....	427
Electrical specifications.....	427
Operating clearances.....	428
Acoustics.....	429
Environment.....	430
Processor.....	430
Enabling the security reset jumper.....	430
Options and features.....	433
Available internal options.....	433
Media handling options.....	433
Option configurations.....	434
Theory of operation.....	437
Paper path and transport components.....	437
Paper path information	437
Transport components.....	438
Duplexing	438
Print engine theory.....	439
Electrophotographic process (EP process)	440
Electrophotographic process basics.....	440
ADF theory.....	443
ADF theory of operation.....	443
Color theory.....	445
Color theory	445
Acronyms.....	449
Acronyms.....	449
Screw and retainer identification table.....	451
Screw and retainer identification table.....	451

Index.....454

Part number index.....463

Part name index..... 469

Notices, conventions, and safety information

Laser notice

The printer is certified in the U.S. to conform to the requirements of DHHS 21 CFR, Chapter I, Subchapter J for Class I (1) laser products, and elsewhere is certified as a Class I laser product conforming to the requirements of IEC 60825-1: 2014.

Class I laser products are not considered to be hazardous. The printer contains a Class IIIb (3b) laser that is nominally a 12-milliwatt gallium arsenide laser operating in the wavelength of 655–675 nanometers. The laser system and printer are designed so there is never any human access to laser radiation above a Class I level during normal operation, user maintenance, or prescribed service condition.

Avis relatif à l'utilisation du laser

Cette imprimante est certifiée conforme aux exigences de la réglementation des Etats-Unis relative aux produits laser de classe I (1) (DHHS 21 CFR, Chapitre I, Sous-chapitre J). Pour les autres pays, elle est certifiée conforme aux exigences des normes CEI 60825-1:2014 relatives aux produits laser de classe I.

Les produits laser de classe I ne sont pas considérés comme dangereux. L'imprimante contient un laser de classe IIIb (3b), laser arséniure de gallium 12 milliwatts opérant sur une longueur d'onde de l'ordre de 655 à 675 nanomètres. Le système laser ainsi que l'imprimante ont été conçus de manière à ce que personne ne soit exposé à des rayonnements laser dépassant le niveau de classe I dans le cadre d'un fonctionnement normal, de l'entretien par l'utilisateur ou de la maintenance.

Notificació del làser

La impressora està certificada als EUA per complir els requeriments de DHHS 21 CFR, capítol I, subcapítol J per a productes de làser Classe I (1), i a la resta del món s'ha certificat com productes de làser Classe I segons els requeriments de la norma IEC 60825-1: 2014.

Els productes de làser Classe I no es consideren perillosos. La impressora conté un làser intern Classe IIIb (3b) que normalment és un arsenur de galió de 12 miliwatts, que funciona a la regió de longitud d'ona de 655 a 675 nanòmetres i es troba dins d'una unitat de capçals d'impressió no substituïbles. El sistema làser i la impressora estan dissenyats de manera que les persones no estiguin exposades a una radiació del làser superior al nivell de Classe I durant el funcionament normal, el manteniment de l'usuari o les condicions de servei prescrites.

Aviso de láser

Esta impresora se ha certificado en EE.UU. cumpliendo con los requisitos de DHHS 21 CFR, capítulo I, subcapítulo J para los productos láser de Clase I (1) y en otros países está certificada como un producto láser de Clase I de acuerdo con los requisitos de IEC 60825-1: 2014.

Los productos láser de Clase I no se consideran peligrosos. La impresora contiene un láser interno de Clase IIIb (3b) que nominalmente es un láser de arsenide galio de 12 milivatios que funciona en una longitud de onda de 655-675 nanómetros. El sistema láser y la impresora se han diseñado para que el ser humano no acceda nunca a las radiaciones láser por encima del nivel de Clase I durante su uso normal, ni en tareas de mantenimiento o intervenciones de servicio técnico prescritas.

Aviso sobre laser

Esta impressora foi certificada nos EUA por estar em conformidade com os requisitos do DHHS 21 CFR capítulo I, subcapítulo J, para produtos a laser de Classe I (1) e, nos demais países, foi certificada como um produto a laser de Classe I em conformidade com os requisitos da IEC 60825-1: 2014.

Os produtos a laser de Classe I não são considerados prejudiciais. A impressora contém, internamente, um laser de Classe IIIb (3b) que é, nominalmente, um laser de arsenieto de gálio de 12 miliwatts operando no comprimento de onda de 655-675 nanômetros. O sistema do laser e a impressora foram projetados para que jamais haja acesso humano à radiação do laser acima do nível da Classe I durante a operação normal ou a manutenção pelo usuário ou sob as condições de manutenção prescritas.

Avvertenze sui prodotti laser

La stampante è certificata negli Stati Uniti come prodotto conforme ai requisiti DHHS 21 CFR Capitolo I, Sottocapitolo J per i prodotti laser di Classe I (1), mentre in altri paesi è certificata come prodotto laser di Classe I conforme ai requisiti IEC 60825-1: 2014.

I prodotti laser di Classe I non sono considerati pericolosi. La stampante contiene un laser di Classe IIIb (3b), che è nominalmente un laser ad arseniuro di gallio a 12 milliwatt funzionante a una lunghezza d'onda di 655-675 nanometri. Il sistema laser e la stampante sono stati progettati in modo da impedire l'esposizione a radiazioni laser superiori al livello previsto dalla Classe I durante le normali operazioni di stampa, manutenzione o assistenza.

Laserinformatie

De printer is in de Verenigde Staten gecertificeerd als een product dat voldoet aan de vereisten van DHHS 21 CFR hoofdstuk 1, paragraaf J voor laserproducten van klasse I (1). Elders is de printer gecertificeerd als een laserproduct van klasse I dat voldoet aan de vereisten van IEC 60825-1: 2014.

Laserproducten van klasse I worden geacht geen gevaar op te leveren. De printer bevat een interne laser van klasse IIIb (3b); een galliumarsenide laser met een nominaal vermogen van 12 milliwatt en een golflengtebereik van 655-675 nanometer. Het lasersysteem en de printer zijn zodanig ontworpen dat gebruikers nooit blootstaan aan laserstraling die hoger is dan het toegestane niveau voor klasse I-apparaten, tijdens normaal gebruik, onderhoudswerkzaamheden door de gebruiker of voorgeschreven servicewerkzaamheden.

Lasererklæring

Printeren er certificeret i USA i henhold til kravene i DHHS 21 CFR kapitel I, underafsnit J for klasse I (1)-laserprodukter og er andre steder certificeret som et klasse I laserprodukt i henhold til kravene i IEC 60825-1: 2014.

Klasse I-laserprodukter anses ikke som farlige. Printeren indeholder internt en klasse IIIb (3b)-laser, der nominelt er en 12 milliwatt galliumarsenid-laser, som fungerer i bølglængdeområdet 655-675 nanometer. Lasersystemet og printeren er udviklet på en sådan måde, at der ikke er en direkte laserstråling, der overskrider Klasse I-niveauet under normal brug, brugers vedligeholdelse eller de foreskrevne servicebetingelser.

Laser-Hinweis

Der Drucker wurde in den USA zertifiziert und entspricht den Anforderungen der Vorschriften DHHS 21 CFR Kapitel I für Laserprodukte der Klasse I (1), andernorts ist er als Laserprodukt der Klasse I zertifiziert, das den Anforderungen von IEC 60825-1 entspricht: 2014.

Laserprodukte der Klasse I werden nicht als gefährlich betrachtet. Der Drucker enthält im Inneren einen Laser der Klasse IIIb (3b), und zwar einen 12-Milliwatt-Gallium-Arsenid-Laser, der im Wellenlängenbereich von 655 bis 675 Nanometern arbeitet. Das Lasersystem und der Drucker sind so konstruiert, dass unter normalen Betriebsbedingungen, bei der Wartung durch den Benutzer oder bei den vorgeschriebenen Wartungsbedingungen Menschen keiner Laserstrahlung ausgesetzt sind, die die Werte für Klasse I überschreitet.

Laserilmoitus

Tämä tulostin on sertifioitu Yhdysvalloissa DHHS 21 CFR Chapter I, Subchapter J -standardin mukaiseksi luokan I (1) -lasertuotteeksi ja muualla IEC 60825-1:2014 -standardin mukaiseksi luokan I lasertuotteeksi.

Luokan I lasertuotteita ei pidetä haitallisina. Tulostimen sisällä on luokan IIIb (3b) laser, joka on nimellisteholtaan 12 mW:n galliumarsenidilaser ja toimii 655–675 nanometrin aallonpituuksilla. Laserjärjestelmä ja tulostin ovat rakenteeltaan sellaisia, että käyttäjä ei joudu alttiiksi luokkaa 1 suuremmalle säteilylle normaalin käytön, ylläpidon tai huollon aikana.

Lasermerknad

Skriveren er sertifisert i USA for samsvar med kravene i DHHS 21 CFR kapittel I, underkapittel J for laserprodukter av klasse I (1) og er andre steder sertifisert som et laserprodukt av klasse I som samsvarer med kravene i IEC 60825-1: 2014.

Laserprodukter av klasse I anses ikke som helseskadelige. Skriveren inneholder en intern laser av klasse IIIb (3b) som nominelt er en 12 milliwatt galliumarsenid-laser som opererer i bølgelengder på 655–675 nanometer. Lasersystemet og skriveren er utformet slik at mennesker ikke utsettes for laserstråling utover nivået i klasse I under normal drift, vedlikehold eller foreskrevet service.

Meddelande om laser

Skrivaren är certifierad i USA i enlighet med kraven i DHHS 21 CFR kapitel I, underkapitel J för klass I (1)-laserprodukter, och på andra platser certifierad som en klass I-laserprodukt i enlighet med kraven i IEC 60825-1: 2014.

Laserprodukter av klass I anses inte vara skadliga. Skrivaren innehåller en klass IIIb (3b)-laser, vilket är en 12 mW galliumarseniklaser som arbetar inom en våglängd på 655–675 nm. Lasersystemet och skrivaren är utformade så att människor aldrig utsätts för laserstrålning över klass I-nivå under normala förhållanden vid användning, underhåll eller service.

レーザーについて

本機は、米国においてクラス I (1) レーザー製品に対する DHHS 21 CFR Chapter I、Subchapter J の要件に準拠し、その他の国では IEC 60825-1: 2014 の要件に準拠するクラス I レーザー製品として認可されています。

クラス I レーザー製品は、危険性がないとみなされています。本機には、クラス IIIb (3b) レーザーが内蔵されています。これは、655 ~ 675 ナノメートルの波長で動作する定格 12 ミリワットのガリウムヒ素レーザーです。レーザーシステムとプリンタは、通常の操作、ユーザによるメンテナンス、または所定のサービス条件の下で、ユーザがクラス I レベルを超えるレーザー放射に絶対にさらされないように設計されています。

레이저 고지사항

프린터는 미국에서 레이저 제품용 DHHS 21 CFR Chapter I, Subchapter J의 요구 사항을 준수하며 이외 지역에서 IEC 60825-1:2014의 요구 사항을 준수하는 클래스 I(1) 레이저 제품으로 승인되었습니다.

클래스 I 레이저 제품은 위험한 제품으로 간주되지 않습니다. 프린터에는 655-675 나노미터의 파장 영역에서 작동하는 공칭 12밀리와트 갈륨 비소 레이저인 클래스 IIIb(3b) 레이저가 내부에 포함되어 있습니다. 레이저 시스템과 프린터는 정상적인 작동, 사용자 유지 관리 또는 사전 설명된 서비스 조건에는 사람에게 클래스 I 수준 이상의 레이저 방사가 노출되지 않도록 설계되었습니다.

激光注意事项

本打印机在美国认证合乎 DHHS 21 CFR Chapter I, Subchapter J 对分类 I (1) 激光产品的标准, 而在其他地区则被认证是合乎 IEC 60825-1: 2014 的分类 I 激光产品。

一般认为分类 I 激光产品不具有危险性。本打印机内部含有分类 IIIb (3b) 的激光, 是标称值为 12 毫瓦的砷化镓激光, 其工作波长范围在 655–675nm 之间。本激光系统及打印机的设计, 在一般操作、使用者维护或规定内的维修情况下, 不会使人体接触分类 I 以上等级的辐射。

雷射聲明

本印表機係經過美國核可, 符合 DHHS 21 CFR, Chapter I, Subchapter J 規定的 I (1) 級雷射產品; 在美國以外的地區, 為符合 IEC 60825-1 2014 規定的 I 級雷射產品。

根據 I 級雷射產品的規定, 這類產品不會對人體造成傷害。本印表機內部所採用之 IIIb (3b) 級雷射只會產生 12 毫瓦特 (milliwatt)、波長 655 至 675 奈米 (nanometer) 的鎵砷放射線 (gallium arsenide laser)。使用者只要以正確的方法操作及維護保養, 並依照先前所述之維修方式進行修護, 此印表機與其雷射系統絕不會產生 I 級以上的放射線, 而對人體造成傷害。

Conventions

Note: A *note* identifies information that could help you.

Warning: A *warning* identifies something that could damage the product hardware or software.

CAUTION: A *caution* indicates a potentially hazardous situation that could injure you.

Different types of caution statements include:



CAUTION—POTENTIAL INJURY: Indicates a risk of injury.



CAUTION—SHOCK HAZARD: Indicates a risk of electrical shock.



CAUTION—HOT SURFACE: Indicates a risk of burn if touched.



CAUTION—TIPPING HAZARD: Indicates a crush hazard.





CAUTION—PINCH HAZARD: Indicates a risk of being caught between moving parts.

Safety information

- The safety of this product is based on testing and approvals of the original design and specific components. The manufacturer is not responsible for safety in the event of use of unauthorized replacement parts.
- The maintenance information for this product has been prepared for use by a professional service person and is not intended to be used by others.

- There may be an increased risk of electrical shock and personal injury during disassembly and servicing of this product. Professional service personnel should understand this risk and take necessary precautions.

 **CAUTION—SHOCK HAZARD:** When you see this symbol, there is a danger from hazardous voltage in the area of the product where you are working. Unplug the product before you begin, or use caution if the product must receive power in order to perform the task.

 **CAUTION—POTENTIAL INJURY:** The lithium battery in this product is not intended to be replaced. There is a danger of explosion if a lithium battery is incorrectly replaced. Do not recharge, disassemble, or incinerate a lithium battery. Discard used lithium batteries according to the manufacturer's instructions and local regulations.

Consignes de sécurité

- La sécurité de ce produit est basée sur des tests et certifications de sa conception d'origine et de ses composants spécifiques. Le fabricant décline toute responsabilité en cas d'utilisation de pièces de rechange non autorisées.
- Les informations de maintenance de ce produit sont destinées à des professionnels qualifiés et ne sont pas conçues pour être utilisées par d'autres personnes.
- Il existe un risque potentiel de choc électrique et de blessures lors du démontage et de la maintenance de ce produit. Le personnel professionnel de maintenance doit comprendre les risques et prendre les précautions nécessaires.

 **ATTENTION—RISQUE D'ELECTROCUTION :** Ce symbole indique un danger lié à des niveaux de tension dangereux dans la zone du produit à manipuler. Débranchez le produit avant de commencer, ou agissez avec prudence si le produit doit être alimenté pour effectuer l'opération.

 **ATTENTION—RISQUE DE BLESSURE :** La batterie lithium de ce produit n'est pas destinée à être remplacée. Si vous ne respectez pas les instructions de remplacement de la batterie, vous risquez de provoquer une explosion. Ne rechargez pas, ne désassemblez pas et ne brûlez pas la batterie au lithium. Mettez les batteries lithium usagées au rebut selon les instructions du fabricant et les réglementations locales.

Informació de seguretat

- La seguretat d'aquest producte es basa en les proves i les homologacions del disseny original i dels components específics. El fabricant no és responsable de la seguretat en el cas d'ús de peces de recanvi no autoritzades.
- La informació de manteniment d'aquest producte s'ha preparat per a l'ús d'un professional tècnic i no per a l'ús d'altres persones.
- És possible que el risc de descàrrega elèctrica i lesions personals augmenti durant el desmuntatge i les tasques de manteniment d'aquest producte. El professional tècnic ha de comprendre aquest risc i prendre les precaucions necessàries.

 **PRECAUCIÓ. PERILL DE DESCÀRREGA ELÈCTRICA:** Quan vegeu aquest símbol, indica que hi ha un perill de voltatge elevat en l'àrea del producte on esteu treballant. Desconnecteu el producte abans de començar o tingueu precaució si el producte ha de rebre alimentació per realitzar la tasca.

 **PRECAUCIÓ. POSSIBLES DANYS:** La bateria de liti d'aquest producte no ha estat dissenyada perquè se substitueixi. Hi ha perill d'explosió si no es substitueix correctament la bateria de liti. No recarregueu, desmunteu o incinereu una bateria de liti. Desfeu-vos de les bateries de liti usades d'acord amb les instruccions del fabricant i les regulacions locals.

Información de seguridad

- La seguridad de este producto se basa en las pruebas y comprobaciones del diseño original y los componentes específicos. El fabricante no se hace responsable de la seguridad en caso de uso de piezas de repuesto no autorizadas.
- La información de mantenimiento de este producto se ha preparado para su uso por parte de un profesional de asistencia técnica y no está diseñada para su uso por parte de otros usuarios.
- Es posible que haya un mayor riesgo de descarga eléctrica y daños personales durante el desmontaje y el mantenimiento de este producto. El personal de asistencia profesional debe conocer este riesgo y tomar las precauciones necesarias.

 **PRECAUCIÓN: PELIGRO DE DESCARGAS ELÉCTRICAS:** Cuando vea este símbolo, existe peligro de tensiones peligrosas en el área del producto en la que está trabajando. Desconecte el producto antes de empezar o tenga cuidado si el producto debe recibir alimentación a fin de realizar la tarea.

 **PRECAUCIÓN: POSIBLES DAÑOS PERSONALES:** La batería de litio de este producto no debe reemplazarse. Existe riesgo de explosión si se sustituye incorrectamente una batería de litio. No recargue, desmonte ni incinere una batería de litio. Deseche las baterías de litio usadas según las instrucciones del fabricante y las normativas locales.

Informações sobre segurança

- A segurança deste produto é baseada em testes e aprovações do design original e de componentes específicos. O fabricante não é responsável por segurança em caso de uso não autorizado de peças de substituição.
- As informações sobre manutenção deste produto foram preparadas para utilização por um técnico profissional experiente e não se destinam ao uso por outros.
- Pode haver maior risco de choque elétrico e danos pessoais durante a desmontagem e manutenção deste produto. Os técnicos profissionais experientes devem entender esses riscos e tomar as precauções necessárias.

 **ATENÇÃO—RISCO DE CHOQUE:** Se você vir este símbolo, existe perigo de tensão elétrica na área do produto onde está trabalhando. Desligue o produto antes de começar ou tenha cuidado se o produto precisar receber energia para executar a tarefa.

 **ATENÇÃO—RISCO DE FERIMENTO:** A bateria de lítio neste produto não deve ser substituída. Existe o risco de explosão se uma bateria de lítio for substituída incorretamente. Não recarregue, desmonte nem incinere uma bateria de lítio. Descarte as baterias de lítio usadas de acordo com as instruções do fabricante e regulamentos locais.

Informazioni sulla sicurezza

- La sicurezza di questo prodotto è basata sui test e sulle approvazioni del design originale e dei componenti specifici. Il produttore non è responsabile della sicurezza in caso di utilizzo di parti di ricambio non autorizzate.
- Le informazioni di manutenzione per questo prodotto sono state predisposte per essere utilizzate da un tecnico dell'assistenza professionale e non sono state previste per l'uso da parte di altre persone.
- È possibile che vi sia un maggior rischio di scosse elettriche e lesioni personali durante lo smontaggio e la manutenzione di questo prodotto. Il personale dell'assistenza deve comprendere questo rischio e prendere le precauzioni necessarie.

 **ATTENZIONE - PERICOLO DI SCOSSE ELETTRICHE:** Questo simbolo indica la presenza di un rischio per tensioni pericolose nell'area del prodotto in cui si lavora. Scollegare l'alimentazione prima di iniziare, o prestare la massima attenzione se per effettuare l'operazione il prodotto deve ricevere l'alimentazione.

 **ATTENZIONE - PERICOLO DI LESIONI:** La batteria al litio contenuto nel prodotto non deve essere sostituita: in caso di sostituzione errata della batteria al litio, potrebbe verificarsi un'esplosione. Non ricaricare, smontare o bruciare batterie al litio. Smaltire le batterie al litio usate seguendo le istruzioni del produttore e le norme locali.

Informatie over veiligheid

- De veiligheid van dit product is gebaseerd op testen en goedkeuringen van het oorspronkelijke ontwerp en specifieke onderdelen. De fabrikant is niet verantwoordelijk voor de veiligheid bij gebruik van ongeautoriseerde vervangende onderdelen.
- De informatie over het onderhoud van dit product is opgesteld voor gebruik door een professionele onderhoudsmonteur en is niet bedoeld voor gebruik door anderen.
- Tijdens demontage en onderhoud van dit product bestaat mogelijk een hoger risico op elektrische schokken en lichamelijk letsel. Professionele onderhoudsmonteurs dienen op de hoogte te zijn van dit risico en de noodzakelijke voorzorgsmaatregelen te nemen.

 **LET OP: GEVAAR VOOR ELEKTRISCHE SCHOKKEN:** Wanneer u dit symbool ziet, bestaat er een gevaar voor gevaarlijke spanning in het gebied van het product waaraan u werkt. Haal de stekker van het product uit het stopcontact voordat u begint, of let extra goed op als het product stroom nodig heeft om een taak te kunnen uitvoeren.

 **LET OP: RISICO OP LETSEL:** De lithiumbatterij in dit product moet niet worden vervangen. Wanneer de lithiumbatterij niet juist wordt vervangen, bestaat er explosiegevaar. Probeer nooit lithiumbatterijen op te laden, open te maken of te verbranden. Gooi gebruikte lithiumbatterijen weg volgens de aanwijzingen van de fabrikant en houd hierbij de plaatselijke regelgeving in acht.

Sikkerhedsoplysninger

- Sikkerheden for dette produkt er baseret på afprøvning og godkendelser af det oprindelige design og specifikke komponenter. Producenten er ikke ansvarlig for sikkerhed i tilfælde af brug af uautoriserede dele til udskiftning.
- Vedligeholdelsesoplysninger om dette produkt er udarbejdet til brug af en kvalificeret servicetekniker og er ikke beregnet til at blive brugt af andre.
- Der kan være en forøget risiko for elektrisk stød eller personskade ved afmontering og service af dette produkt. Professionelt servicepersonale bør forstå denne risiko og tage nødvendige forholdsregler.

 **FORSIGTIG - ELEKTRISK STØD:** Når du ser dette symbol, er der risiko for elektrisk spænding i nærheden af produktet, hvor du arbejder. Tag strømskiftet ud inden du begynder, eller udvis forsigtighed, hvis produktet skal modtage strøm for at udføre opgaven.

 **FORSIGTIG - RISIKO FOR SKADE:** Litium-batteriet i dette produkt er ikke beregnet til at blive udskiftet. Der er fare for eksplosion, hvis et litium-batteri udskiftes forkert. Du må ikke genoplade, demontere eller afbrænde et litium-batteri. Brugte litium-batterier skal bortskaffes i overensstemmelse med producentens instruktioner og lokale retningslinjer.

Sicherheitshinweise

- Die Sicherheit dieses Produkts basiert auf Tests und Zulassungen des Originaldesigns und der spezifischen Komponenten. Sofern nicht autorisierte Ersatzteile eingesetzt werden, übernimmt der Hersteller keinerlei Verantwortung in Bezug auf die Sicherheit dieses Produkts.
- Die Wartungsinformationen für dieses Produkt wurden für ausgebildete Servicemitarbeiter zusammengestellt und dürfen nicht von anderen verwendet werden.
- Möglicherweise besteht bei der Demontage und Wartung dieses Produkts eine erhöhte Stromschlag- und Verletzungsgefahr. Ausgebildete Servicemitarbeiter sollten sich dieser Gefahr bewusst sein und die notwendigen Vorsichtsmaßnahmen ergreifen.

 **VORSICHT – STROMSCHLAGGEFAHR:** Wenn Sie dieses Symbol sehen, besteht eine Gefahr durch gefährliche Spannungen in dem Produktbereich, in dem Sie arbeiten. Trennen Sie das Produkt von seiner Stromverbindung, bevor Sie beginnen, oder gehen Sie vorsichtig vor, wenn das Produkt für die Durchführung der Aufgabe mit Strom versorgt werden muss.

 **VORSICHT – MÖGLICHE VERLETZUNGSGEFAHR** Die Lithiumbatterie in diesem Produkt darf nicht ausgetauscht werden. Wird eine Lithiumbatterie nicht ordnungsgemäß ausgetauscht, besteht Explosionsgefahr. Lithiumbatterien dürfen auf keinen Fall wieder aufgeladen, auseinander genommen oder verbrannt werden. Befolgen Sie zum Entsorgen verbrauchter Lithiumbatterien die Anweisungen des Herstellers und die örtlichen Bestimmungen.

Turvallisuusohjeet

- Tämän laitteen turvallisuus perustuu alkuperäisen rakenteen ja tiettyjen osien testaukseen ja hyväksymiseen. Valmistaja ei vastaa turvallisuudessa, jos laitteessa on käytetty luvattomia vaihto-osia.
- Tämän tuotteen huoltoa koskevat tiedot on tarkoitettu vain ammattitaitoisen huoltohenkilön käyttöön.
- Tämän tuotteen purkamiseen ja huoltoon voi liittyä kasvanut sähköiskun tai henkilövahingon vaara. Ammattitaitoisen huoltohenkilön on ymmärrettävä tämä vaara ja toimittava sen edellyttämällä tavalla.

 **HUOMIO – SÄHKÖISKUN VAARA:** Tämä symboli ilmaisee, että tuotteen työskentelyalueella on olemassa vaarallinen jännite. Irrota laite verkkovirrasta ennen kuin aloitat tai toimi erittäin varovasti, jos laitteessa on oltava virta työn aikana.

 **HUOMIO – TAPATURMAN MAHDOLLISUUS:** Tuotteessa olevaa litiumakkua ei ole tarkoitettu vaihdettavaksi. Litiumakun poistaminen väärin aiheuttaa räjähdysvaaran. Älä lataa, pura tai polta litiumakkua. Hävitä käytetyt litiumakut valmistajan ohjeiden ja paikallisten säädösten mukaisesti.

Sikkerhetsinformasjon

- Sikkerheten til dette produktet er basert på testing og godkjenning av originaldesignet og bestemte komponenter. Produsenten er ikke ansvarlig for sikkerheten ved bruk av uautoriserte reservedeler.
- Vedlikeholdsinformasjonen for dette produktet er tilrettelagt for bruk av profesjonelt servicepersonale, og er ikke ment for bruk av andre.
- Det kan være en økt risiko for elektrisk støt og personskade under demontering og vedlikehold av produktet. Profesjonelt servicepersonell må være innforstått med denne risikoen og ta nødvendige forholdsregler.

 **FORSIKTIG – FARE FOR STØT:** Dette symbolet betyr at det er fare for farlig spenning i det området av produktet der du arbeider. Koble fra produktet før du begynner, eller vær forsiktig hvis produktet må ha strøm for å kunne utføre oppgaven.

-  **FORSIKTIG – POTENSIELLE SKADER:** Litiumbatteriet i dette produktet er ikke beregnet for å byttes. Det er fare for eksplosjon hvis litiumbatteriet skiftes ut på feil måte. Ikke lad opp, demonter eller destruer et litiumbatteri. Kast brukte litiumbatterier i henhold til produsentens instruksjoner og lokale regelverk.

Säkerhetsinformation

- Säkerheten för denna produkt baseras på tester och godkännanden av ursprungsdesignen och av specifika komponenter. Tillverkaren har inget ansvar vid användning av oauktorerade reservdelar.
- Underhållsinformationen för produkten är avsedd att användas av utbildade servicetekniker och inte avsedd att användas av andra.
- Risken för elektriska stötar och personskador kan vara förhöjd vid isärtagning och service av produkten. Professionell servicepersonal bör vara medvetna om denna risk och vidta nödvändiga försiktighetsåtgärder.

-  **VAR FÖRSIKTIG– RISK FÖR ELEKTRISK STÖT:** När du ser denna symbol är det risk att det finns farlig spänning i den del av produkten du arbetar med. Koppla från strömmen innan du börjar, eller var försiktig om produkten måste vara strömförsörjd för att uppgiften ska kunna utföras.

-  **VAR FÖRSIKTIG – RISK FÖR SKADA:** Litiumbatteriet i produkten är inte utbytbart. Om ett litiumbatteri byts ut på fel sätt finns det risk att det exploderar. Du får inte ladda om, ta isär eller elda upp ett litiumbatteri. Gör dig av med använda litiumbatterier enligt tillverkarens instruktioner och lokala föreskrifter.

安全情報

- 本製品の安全性は、本来の設計、特定コンポーネントの試験、承認に基づいています。承認されていない交換部品をお客様が使用した場合、メーカーは安全性に対して責任を負いません。
- 本製品のメンテナンス情報は、専門のサービス担当者による利用を目的としており、その他の人を対象としていません。
- 本製品の分解や保守サービスを行う場合は、感電や傷害の危険性があります。専門のサービス担当者はこの危険性を理解し、十分な対策を講じる必要があります。

-  **注意—感電危険:** この表記がある場合、対象製品の作業領域には、高電圧による危険性が生じています。作業を始める前に、製品から電源コードを取り外してください。また作業時に、製品に給電する必要がある場合は、十分に注意するようにしてください。

-  **注意—傷害の恐れあり:** この製品に使用されているリチウム電池は、交換を前提としていません。リチウム電池の交換を誤ると破裂する危険性があります。リチウム電池の充電、解体、焼却はしないでください。使用済みのリチウム電池を廃棄する際は、製造元の指示およびお使いの地域の法律に従ってください。

안전 정보

- 이 제품의 안전은 기본 디자인 및 특정 구성품의 승인 및 테스트를 기반으로 합니다. 제조업체는 권한 없는 교체 부품 사용 시 안전에 대해 책임을 지지 않습니다.
- 이 제품의 유지관리 정보는 전문 서비스 요원을 대상으로 하며 다른 사람은 사용할 수 없습니다.
- 제품 분해 및 서비스 중에는 감전 및 상해 위험이 증가할 수 있습니다. 전문 서비스 요원은 이와 같은 위험을 이해하고 필요한 예방 조치를 취해야 합니다.

-  **주의—감전 위험:** 이 기호가 표시된 경우 작업 중인 제품 주변에서 위험 전압 위험이 있습니다. 사용 전/후에 전원 코드를 뽑아 두시고 제품에서 작업을 수행하는 데 반드시 전원이 필요한 경우에는 주의하여 사용하십시오.

-  **주의—상해 위험:** 이 제품에 들어 있는 리튬 배터리는 교체할 수 없습니다. 리튬 배터리를 잘못 교체하면 폭발할 위험이 있습니다. 리튬 배터리를 충전, 분해하거나 불에 태우지 마십시오. 제조업체의 지침과 지역 규정에 따라 다 쓴 리튬 배터리를 폐기하십시오.

安全信息

- 本产品的安全性以原始设计和特定组件的测试和审批为基础。如果使用未经授权的替换部件，制造商不对安全性负责。
- 本产品的维护信息仅供专业服务人员使用，并不打算由其他人使用。
- 本产品在拆卸和维修时，遭受电击和人员受伤的危险性会增高。专业服务人员对这点必须有所了解，并采取必要的预防措施。

 **小心—电击危险:** 当您看到此符号时，在您工作的产品区域内存在危险电压的威胁。在您开始操作之前请拔掉产品电源，如果产品必须接收功率才能执行任务，请务必谨慎操作。

 **小心—可能的伤害:** 本产品中的锂电池不可更换。如果不正确更换锂电池，可能会有爆炸危险。不要再充电、拆解或焚烧锂电池。丢弃旧的锂电池时应按照制造商的指导及当地法规进行处理。





安全資訊

- 本產品安全性係以原始設計及特定元件之測試與核准為依據。如有使用未獲授權替換組件之情形者，製造商對安全性概不負責。
- 本產品之維護資訊僅供專業維修人員使用，而非預定由他人使用。
- 拆裝及維修本產品時，有可能造成電擊與人員損傷之危險。專業維修人員應瞭解前項危險並採取必要措施。

 **請當心—觸電危險:** 當您看到此符號時，表示您所在產品工作區有危險電壓。開始工作之前，請先拔掉產品電源線，若產品必須接上電源方能執行作業，用電時請務必小心。

 **請當心—潛在受傷危險性:** 本產品中的鋰電池原本並不需要予以更換。若未正確更換鋰電池，可能會有爆炸的危險。請勿將鋰電池充電、拆裝或焚燒。請遵照製造商的指示及當地法規，丟棄用過的電池。

General caution statements

-  **CAUTION—POTENTIAL INJURY:** To avoid the risk of fire or electrical shock, connect the power cord to an appropriately rated and properly grounded electrical outlet that is near the product and easily accessible.
-  **CAUTION—POTENTIAL INJURY:** To avoid the risk of fire or electrical shock, use only the power cord provided with this product or the manufacturer's authorized replacement.
-  **CAUTION—POTENTIAL INJURY:** Do not use this product with extension cords, multioutlet power strips, multioutlet extenders, or UPS devices. The power capacity of these types of accessories can be easily overloaded by a laser printer and may result in a risk of fire, property damage, or poor printer performance.
-  **CAUTION—POTENTIAL INJURY:** Only a Lexmark Inline Surge Protector that is properly connected between the printer and the power cord provided with the printer may be used with this product. The use of non-Lexmark surge protection devices may result in a risk of fire, property damage, or poor printer performance.

Change history

Change history

January 7, 2021

- Added Printer model configurations topic in the General information chapter.

July 14, 2020

- A note for obsolescence was added to the following parts in the Parts catalog chapter:
 - Forms and Bar Code Card (CX310 and CX317dn) (41X0880)
 - Forms and Bar Code Card (CX410, CX417de and XC2130) (41X0882)
 - Forms and Bar Code Card (CX510, CX517de and XC2132) (41X0884)
 - Card for PRESCRIBE (CX410, CX417de and XC2130) (41X0883)
 - Card for PRESCRIBE (CX510, CX517de and XC2132) (41X0886)

June 2, 2020

- Updated the Entering Recovery mode topic in the Service menus chapter.
- Removed the following parts from the Parts catalog chapter:
 - 40X8659
 - 40X8666
 - 40X8664
 - 40X8668

Note: These parts are obsolete.

July 2, 2019

- Updated the description of the affected part numbers regarding the missing Bolt models.
 - Added CX317dn to the following parts:
 - Rear cover (40X7845)
 - Simplex ADF assembly (40X7831)
 - Simplex ADF separator pad assembly (40X6247)
 - Simplex top cover assembly (40X7842)
 - Operator panel cable (40X7835)
 - UICC to controller board cable(40X7835)
 - Operator panel and display assembly (41X0910)
 - Upper front cover (40X7839)
 - Front logo cover (40X7808)
 - User interface support bracket (40X7840)
 - Controller board (40X7804)
 - Forms and Bar Code Card (41X0880)
 - Card for PRESCRIBE (41X0881)

- Added CX417de to the following parts:
 - Rear cover (40X7846)
 - Duplex ADF assembly (40X7830)
 - Duplex ADF separator roller assembly (41X0917)
 - Duplex ADF top cover assembly (40X7843)
 - Operator panel cable (40X7835)
 - USB thumbdrive cable (40X7836)
 - UICC to controller board cable (40X7835)
 - Operator panel and display assembly (41X0911)
 - Upper front cover (40X7839)
 - Front logo cover (40X7808)
 - User interface support bracket (40X7840)
 - Controller board (40X7805)
 - Optional 550-sheet drawer (complete) (40X8090)
 - Forms and Bar Code Card (41X0882)
 - Card for PRESCRIBE (41X0883)
- Added CX517de to the following parts:
 - Rear cover (40X7814)
 - Duplex ADF assembly (40X7830)
 - Duplex ADF separator roller assembly (41X0917)
 - Duplex ADF top cover assembly (40X7843)
 - Operator panel cable (40X7837)
 - USB thumbdrive cable (40X5480)
 - UICC to controller board cable (40X7837)
 - Operator panel and display assembly (41X0912)
 - Upper front cover (40X7838)
 - Front logo cover (40X7816)
 - User interface support bracket (40X7841)
 - Controller board (40X7806)
 - Optional 550-sheet drawer (complete) (40X8090)
 - Forms and Bar Code Card (41X0884)
 - Card for PRESCRIBE (41X0886)

May 15, 2019

- Added the PN 41X2663 in the Parts catalog chapter.
- Added the Front cover inner deflector removal topic in the Parts removal chapter.

January 14, 2019

- Updated the description of PN 40X7809 in the Parts catalog chapter.

June 29, 2018

- Replaced PN 40X8709 (XC2132 bezel) with PN 40X9151 (CX510, CX517de, and XC2132 blank bezel) in Assembly 4: Operator panels in the parts catalog chapter.
- Updated the installation note for the fuser assembly removal in the parts removal chapter.

February 8, 2018

- Updated the ADF service check topic in the Diagnostics and troubleshooting chapter.

September 4, 2017

- Created [“913.xx error code check” on page 125](#).

August 30, 2017

- Updated [“Options and miscellaneous” on page 425](#) to correct the part numbers of the Forms and Bar Code cards.

August 2, 2017

- Updated the description for 41X0917 in the topic “Scanner” in the “Parts catalog” chapter.

May 31, 2017

- Updated 40X4827 to 40X9652 in the topic “Miscellaneous” in the “Parts catalog” chapter.

May 23, 2017

- Updated [“Options and miscellaneous” on page 425](#) to replace PN 40X7060 with PN 40X9939.

April 24, 2017

- Added "CX517de" in the cover.
- Added "CX517de" in the introduction to the “General information” chapter.
- Added 41X2016 to the revised topic "Operator panels" in the "Parts catalog" chapter.

March 1, 2017

- Updated [“Thermistor removal” on page 292](#).

February 17, 2017

- Updated the 33.xy entry in the “Understanding the printer messages” topic in the “Diagnostic information” chapter.
- Added "CX317" and “CX417” in the cover.
- Added "CX317dn" and “CX417de” in the introduction to the “General information” chapter.
- Added "CX317" and “CX417” to rows 8 of the table of the topic “Covers” in the “Parts catalog” chapter.
- Called out the pick tires in the topic “Paper path,” instead of in the topic “Covers,” in the “Parts catalog” chapter.
- Added the restraint pad and called out the ADF pick roll in the topic “Scanner” in the “Parts catalog” chapter.
- Added 40X7835 and 40X7837 to rows 13 of the table of the topic “Scanner” in the “Parts catalog” chapter.

February 3, 2017

- Created [“Thermistor removal” on page 292](#).
- Updated [“Cables and sensors” on page 421](#) to add a cross-reference to the thermistor removal.
- Updated [“Toner density sensor \(TDS\) \(left or right sensor\) removal” on page 293](#) to add a cross-reference to the thermistor removal.

November 8, 2016

- Removed the Reset Separator Roll and Pick Assembly Counter topic in the Service menus chapter.

October 7, 2016

- Updated the fuser assembly removal topic in the Repair information chapter.
- Changed PN 40X8667 to 41X0883 in the Parts catalog chapter.

September 19, 2016

- Added PN 41X0923 in the Media drawers and trays topic of the Parts catalog chapter.
- Changed PN 40X9108 to 41X0917 in the Parts catalog chapter.

August 4, 2016

- Updated [“ADF paper jam service check” on page 85](#).

July 28, 2016

- Updated the Missing color check topic in the Diagnostic information chapter.

July 20, 2016

- Added the Missing color check topic in the Diagnostic information chapter.
- Moved all of the symptoms topics into the Other symptoms group in the Diagnostic information chapter.
- Updated the descriptions of the following part numbers in the Parts catalog chapter:
 - 40X6247
 - 40X9108
 - 40X7842
 - 40X7843
 - 40X7830
 - 40X7831

June 28, 2016

- Updated the “LES Applications” topic in the “Service menus” chapter.

May 24, 2016

- Added the Missing color check topic in the Diagnostics information chapter.

March 17, 2016

- Added the Replace unsupported cartridge error service check topic in the Diagnostics chapter.

February 22, 2016

- Added the Enabling the security reset jumper topic in Appendix A.

February 10, 2016

- Updated the Top cover assembly removal topic in the Repair information chapter.

December 15, 2015

- Added note at the end of the “Fuser removal” topic of the ”Front removals” group of the “Repair information” chapter.
- Added note at the end of the “Image transfer unit (ITU) removal” topic of the ”Right side removals” group of the “Repair information” chapter.

November 20, 2015

- Updated the Scanner assembly and Operator panel assembly topics in the Parts catalog chapter.
- Updated the Cleaning the printhead lenses topic in the Maintenance chapter.

October 5, 2015

- Added PN 41X0826 in the Parts catalog chapter.
- Added the Developer drive coupling removal topic in the Repair chapter.

April 29, 2015

- Removed the Bubble sensors topic from the Theory of operation section.

April 14, 2015

- Removed PN 40X7832 from the Parts catalog.
- Updated the Sensor Test topic in the Service menus chapter.

March 30, 2015

- Updated the Image transfer unit (ITU) removal topic in the Repair information chapter.
- Updated the Controller board/control panel replacement topic in the Repair chapter.

February 11, 2015

- Added PN 40X7618 in the covers assembly section of the Parts catalog chapter.

November 26, 2014

- Updated the image transfer unit (ITU) removal topic in the Repair information chapter.

November 06, 2014

- Added the ITU guide removal topic in the Repair information chapter.
- Added the ITU guide FRU (PN 41X0580) in the Parts catalog chapter.

September 18, 2014

- Updated the assembly 2 parts catalog art in the Parts catalog chapter.
- Added the Flatbed pivot link (front left) removal topic in the Repair information chapter.

- Updated the Flatbed pivot link (rear right) removal topic in the Repair information chapter.

July 4, 2014

- Added the UICC to controller board cable removal topic in the Repair information chapter.

June 10, 2014

- Updated the Inspection guide topic in the Maintenance chapter.

May 28, 2014

- Added PN 40X8736 in the Parts catalog chapter.
- Updated the removal reference for PN 40X7842 and PN 40X7843 in the Parts catalog chapter.
- Updated the Input option hardware errors section in the Diagnostic information chapter.

April 1, 2014

- Added PN 41X0001 in the Parts catalog chapter.
- Updated the Operator panels and Paper path section in the Parts catalog chapter.
- Added the Drive unit motor removal in the Repair information chapter.
- Removed the Transfer module removal topic from the Repair information chapter.
- Added a note at the beginning of the ADF paper jam service check topic.

March 6, 2014

- Added the MFP fuser deflector flag removal topic.
- Updated the Paper path section in the Parts catalog chapter.
- Updated the General information chapter.

February 28, 2014

- Added the Restoring solutions, licenses, and configuration settings topic under Removal precautions.
- Updated the Restoring the printer configuration after replacing the controller board topic.
- Changed the title from eSF backup to Backing up eSF solutions and settings, and updated the topic.
- Updated the Controller board removal topic.
- Updated the Image transfer unit (ITU) removal topic.
- Editorial changes

February 13, 2014

- Editorial changes.

February 5, 2014

- Editorial changes.

January 16, 2014

- Added BSD model name XC2130.
- Updated the Diagnostics menu and Configurations menu sections.
- Updated the Assembly 3: paper path art in the Parts catalog chapter.

- Revised the Updating the printer firmware topic.
- Added the Image transfer unit (ITU) removal topic in the Repair information chapter.

December 16, 2013

- Updated the Dead printer service check topic in the Diagnostic information chapter.

November 28, 2013

- Updated the controller board removal topic in the Repair chapter.

November 15, 2013

- Updated description for PN 40X8555 in the Parts catalog chapter.

October 17, 2013

- Replaced PN 40X7634 with PN 40X7579 in the Parts catalog chapter.

October 2, 2013

- Added the front toner door pivot bracket (40X8674) in the Parts catalog chapter.

September 16, 2013

- Updated the printhead removal topic in the Repair information chapter.

August 19, 2013

- Updated the installation note in the controller board removal topic.

August 8, 2013

- Added the topic “Steps before starting the 9yy service checks” in the Diagnostic information chapter.
- Updated the 550-sheet and 650-sheet trays input options symptoms.
- Added the 550 and 650 input option service check group and topics.
- Updated the “Tray (x) sensor service check” topic.
- Added the “Restoring the printer configuration after replacing the controller board” topic under the Removal precautions.

July 22, 2013

- Updated the description for **Left Margin** under **Registration**.

July 5, 2013

- Updated the ADF paper jam service check.
- Added the following service checks:
 - Invalid firmware/controller board service check
 - Memory failure service check
 - Download emulation cyclic redundancy check
 - Standard network/network card service check
 - ADF rattling noise

June 4, 2013

- Added BSD model name (XC2132) in the Parts catalog chapter.

April 1, 2013

- Updated the Safety information topic.
- Added an installation note to the “Printhead removal” topic in the Repair information chapter.

March 18, 2013

- Updated the topic “Fuser assembly removal” in the Repair information chapter.

February 4, 2013

- Updated the cover to reflect model XC2132.
- Added machine type 697 for XC2132.
- Added CX510dhe and XC2132 and deleted Cx510e for the model numbers in the General information chapter.
- Added the topic “Updating the printer firmware” in the Service menus chapter.

January 17, 2013

- Updated the description for PN 40X3141 in Assembly 5 of the Parts catalog chapter.
- Deleted PN 40X1455 in Assembly 8 of the Parts catalog chapter.
- Added the following PNs in Assembly 8 of the Parts catalog chapter: 40X8570, 40X8571, 40X8659, 40X5660, 40X8664, 40X8666, 40X8667, 40X8668, 40X7445, 40X7567, and 40X7857.
- Added an installation in the controller board removal in the Repair Information chapter.

January 08, 2013

- Added the list of items under the screw parts packet (PN 40X7832) in Assembly 3 of the Parts catalog chapter.
- Updated the description for PN 40X7652 to “Spring parts packet” from “Screw parts packet” in Assembly 3 of the Parts catalog chapter.
- Replaced PN 40X0259 to PN 40X4596 for the Brazil power cord in Assembly 5 of the Parts catalog chapter.
- Updated the description for PN 40X1766 to Bolivia and Peru only in Assembly 5 of the Parts catalog chapter.
- Added PN 40X0269 for the power cord for USA, Canada, APG, and LAD in Assembly 5 of the Parts catalog chapter.
- Updated the description for PN 40X7852 to fax card, and changed index to NS in Assembly 5 of the Parts catalog chapter.
- Updated the description for PN 40X7835 to “UICC to controller board (CX310, CX410)” in Assembly 6 of the pParts catalog chapter.
- Added PN 40X7837 in Assembly 6 of the Parts catalog chapter.
- Added PN 40X7836 for the operator panel USB cable in Assembly 6 of the Parts catalog chapter.
- Updated the art in Assembly 6 to update the call-outs, and rearranged the items in the table to match the art.

General information

Printer model configurations

The Lexmark™ CX310, CX410, and CX510 (7527-2xx, 7527-4xx, 7527-6xx) are network-capable, multi-function laser printers that print both four-color and monochrome print jobs. All information in this service manual pertains to all models unless explicitly noted.

The printers are available in the following models:

Model	Configurations	Machine type / model
CX310n	Duplex network printer, simplex ADF/scanner, 2.4 inch color display	7527-211
CX310dn and CX317dn	Duplex network printer, simplex ADF/scanner, 2.4 inch color display	7527-231
CX410e	Simplex network printer, 4.3 inch touchscreen, FAX	7527-415
CX410de and CX417de	Duplex network printer, duplex ADF/scanner, FAX	7527-436
CX510de	Duplex Network, Duplex ADF/scanner, 7 inch touchscreen, FAX	7527-636
CX517de		
CX510dhe	Duplex Network, Duplex ADF/scanner, 7 inch touchscreen, FAX, Hard drive	7527-637
XC2132	Duplex Network, Duplex ADF/scanner, 7 inch touchscreen, FAX, Hard drive	7527-697
XC2130	Duplex network printer, duplex ADF/scanner, FAX	7527-496

The diagnostic information in this manual leads you to the correct field replaceable unit (FRU) or part. Use the error code charts, symptom index, and service checks to determine the symptom and then repair the failure. After you complete the repair, perform tests as needed to verify the repair.

To begin diagnosing a problem, go to [“Diagnostics and troubleshooting” on page 43](#). See [“Parts removal” on page 251](#) for information about removing and reinstalling parts. See [“Parts catalog” on page 402](#) to help identify parts.

Media guidelines

- [“Paper guidelines” on page 32](#)
- [“Using recycled paper and other office papers” on page 34](#)
- [“Using specialty media” on page 34](#)
- [“Supported paper sizes, types, and weights” on page 37](#)

Paper guidelines

Select the correct paper or specialty media to reduce printing problems. For the best print quality, try a sample of the paper or specialty media before buying large quantities.

Paper characteristics

The following paper characteristics affect print quality and reliability. Consider these characteristics when evaluating new paper stock.

Weight

The printer trays can automatically feed paper weights up to 176-g/m² (47-lb) bond grain long paper. The multipurpose feeder can automatically feed paper weights up to 176-g/m² (47-lb) bond grain long paper. Paper lighter than 60 g/m² (16 lb) might not be stiff enough to feed properly, causing jams. For best performance, use 75-g/m² (20-lb) bond grain long paper. For paper smaller than 182 x 257 mm (7.2 x 10.1 inches), we recommend 90 g/m² (24 lb) or heavier paper.

Note: Duplex printing is supported from 60–105-g/m² (16–28-lb) bond grain long paper.

Curl

Curl is the tendency for paper to curl at its edges. Excessive curl can cause paper feeding problems. Curl can occur after the paper passes through the printer, where it is exposed to high temperatures. Storing paper unwrapped in hot, humid, cold, or dry conditions, even in the trays, can contribute to paper curling prior to printing and can cause feeding problems.

Smoothness

Paper smoothness directly affects print quality. If paper is too rough, then toner cannot fuse to it properly. If paper is too smooth, then it can cause paper feeding or print quality issues. Always use paper between 100 and 300 Sheffield points; smoothness between 150 and 250 Sheffield points produces the best print quality.

Moisture content

The amount of moisture in paper affects both print quality and the ability of the printer to feed the paper correctly. Leave paper in its original wrapper until it is time to use it. This limits the exposure of paper to moisture changes that can degrade its performance.

Store paper in its original wrapper in the same environment as the printer for 24 to 48 hours before printing. Extend the time to several days if the storage or transportation environment is very different from the printer environment. Thick paper may also require a longer conditioning period.

Grain direction

Grain refers to the alignment of the paper fibers in a sheet of paper. Grain is either *grain long*, running the length of the paper, or *grain short*, running the width of the paper.

For 60–90-g/m² (16–24-lb) bond paper, grain long paper is recommended.

Fiber content

Most high-quality xerographic paper is made from 100% chemically treated pulped wood. This content provides the paper with a high degree of stability resulting in fewer paper feeding problems and better print quality. Paper containing fibers such as cotton can negatively affect paper handling.

Unacceptable paper

The following paper types are not recommended for use with the printer:

- Chemically treated papers used to make copies without carbon paper, also known as carbonless papers, carbonless copy paper (CCP), or no carbon required (NCR) paper
- Preprinted papers with chemicals that may contaminate the printer
- Preprinted papers that can be affected by the temperature in the printer fuser
- Preprinted papers that require a registration (the precise print location on the page) greater than ± 2.3 mm (± 0.9 in.), such as optical character recognition (OCR) forms

In some cases, registration can be adjusted with a software application to successfully print on these forms.

- Coated papers (erasable bond), synthetic papers, thermal papers
- Rough-edged, rough or heavily textured surface papers, or curled papers
- Recycled papers that fail EN12281:2002 (European)
- Paper weighing less than 60 g/m² (16 lb)
- Multiple-part forms or documents

Selecting paper

Using the appropriate paper prevents jams and helps ensure trouble-free printing.

To help avoid paper jams and poor print quality:

- *Always* use new, undamaged paper.
- Before loading paper, know the recommended printable side of the paper. This information is usually indicated on the paper package.
- *Do not* use paper that has been cut or trimmed by hand.
- *Do not* mix paper sizes, types, or weights in the same tray; mixing results in jams.
- *Do not* use coated papers unless they are specifically designed for electrophotographic printing.

Selecting preprinted forms and letterhead

Use these guidelines when selecting preprinted forms and letterhead:

- Use grain long for 60–90-g/m² (16–24-lb) paper.
- Use only forms and letterhead printed using an offset lithographic or engraved printing process.
- Avoid paper with rough or heavily textured surfaces.

Use inks that are not affected by the resin in toner. Inks that are oxidation-set or oil-based generally meet these requirements; latex inks might not.

When in doubt, contact your paper supplier.

Storing paper

Use these paper storage guidelines to help avoid jams and uneven print quality:

- For best results, store paper where the temperature is 21°C (70°F) and the relative humidity is 40 percent. Most label manufacturers recommend printing in a temperature range of 18–24°C (65–75°F) with relative humidity between 40 and 60 percent.
- Store paper in cartons, on a pallet or shelf, rather than on the floor.

- Store individual packages on a flat surface.
- Do not store anything on top of individual paper packages.
- Take paper out of the carton or wrapper only when you are ready to load it in the printer. The carton and wrapper help keep the paper clean, dry, and flat.

Using recycled paper and other office papers

As an environmentally conscious company, Lexmark supports the use of recycled office paper produced specifically for use in laser (electrophotographic) printers. In 1998, Lexmark presented to the US government a study demonstrating that recycled paper produced by major mills in the US fed as well as non-recycled paper. However, no blanket statement can be made that *all* recycled paper will feed well.

Lexmark consistently tests its printers with recycled paper (20–100% post-consumer waste) and a variety of test paper from around the world, using chamber tests for different temperature and humidity conditions. Lexmark has found no reason to discourage the use of today's recycled office papers, but generally the following property guidelines apply to recycled paper.

- Low moisture content (4–5%)
- Suitable smoothness (100–200 Sheffield units, or 140–350 Bendtsen units, European)

Note: Some much smoother papers (such as premium 24 lb laser papers, 50–90 Sheffield units) and much rougher papers (such as premium cotton papers, 200–300 Sheffield units) have been engineered to work very well in laser printers, despite surface texture. Before using these types of paper, consult your paper supplier.





- Suitable sheet-to-sheet coefficient of friction (0.4–0.6)
- Sufficient bending resistance in the direction of feed

Recycled paper, paper of lower weight (<60 g/m² [16 lb bond]) and/or lower caliper (<3.8 mils [0.1 mm]), and paper that is cut grain-short for portrait (or short-edge) fed printers may have lower bending resistance than is required for reliable paper feeding. Before using these types of paper for laser (electrophotographic) printing, consult your paper supplier. Remember that these are general guidelines only and that paper meeting these guidelines may still cause paper feeding problems in any laser printer (for example, if the paper curls excessively under normal printing conditions).

Using specialty media

Tips on using letterhead

- Use letterhead designed specifically for laser printers.
- Print a test page on the letterhead being considered for use before buying large quantities.
- Before loading letterhead, flex, fan, and straighten the stacks to prevent sheets from sticking together.
- Page orientation is important when printing on letterhead.

Source	Printing	Printable side	Paper orientation
Trays 	One-sided	Faceup	Load the sheet with the top edge entering the printer first.
Trays 	Two-sided	Facedown	Load the sheet with the bottom edge entering the printer first.
Manual feeder 	One-sided	Facedown	Load the sheet with the top edge entering the printer first.
Manual feeder 	Two-sided	Faceup	Load the sheet with the bottom edge entering the printer first.
Multipurpose feeder 	One-sided	Facedown	Load the sheet with the top edge entering the printer first.
Note: Check with the manufacturer or vendor to determine whether or not the preprinted letterhead is acceptable for laser printers.			

Source	Printing	Printable side	Paper orientation
Multipurpose feeder 	Two-sided	Faceup	Load the sheet with the bottom edge entering the printer first.
Note: Check with the manufacturer or vendor to determine whether or not the preprinted letterhead is acceptable for laser printers.			

Tips on using transparencies

Print a test page on the transparencies being considered for use before buying large quantities.

- From the printer control panel, set the paper size, type, texture, and weight in the Paper menu to match the transparencies loaded in the tray.
- Print a test page on the transparencies being considered for use before buying large quantities.
- Feed transparencies from the 250-sheet tray, manual feeder, or multipurpose feeder.
- Use transparencies designed specifically for laser printers.
- Avoid getting fingerprints on the transparencies to prevent print quality problems.
- Before loading transparencies, flex, fan, and straighten the stacks to prevent sheets from sticking together.

Tips on using envelopes

- From the printer control panel, set the paper size, type, texture, and weight in the Paper menu to match the envelopes loaded in the tray.
- Print samples on the envelopes being considered for use before buying large quantities.
- Use envelopes designed specifically for laser printers.
- For best performance, use envelopes made from 90-g/m² (24-lb) paper or 25% cotton.
- Use only new envelopes from undamaged packages.
- To optimize performance and minimize jams, do not use envelopes that:
 - Have excessive curl or twist.
 - Are stuck together or damaged in any way.
 - Have windows, holes, perforations, cutouts, or embossing.
 - Have metal clasps, string ties, or folding bars.
 - Have an interlocking design.
 - Have postage stamps attached.
 - Have any exposed adhesive when the flap is in the sealed or closed position.
 - Have bent corners.
 - Have rough, cockle, or laid finishes.

- Adjust the width guides to fit the width of the envelopes.
- Before loading the envelopes on the tray, flex and fan the envelopes to loosen them. Straighten the edges on a level surface.

Note: A combination of high humidity (over 60%) and high printing temperature may wrinkle or seal envelopes.

Tips on using labels

- From the printer control panel, set the paper size, type, texture, and weight in the Paper menu to match the labels loaded in the tray.
- Print samples on labels being considered for use before buying large quantities.
- For more information on label printing, characteristics, and design, see the *Card Stock & Label Guide* at <http://support.lexmark.com>.
- Use labels designed specifically for laser printers.
- Do not use labels with slick backing material.
- Use full label sheets. Partial sheets may cause labels to peel off during printing, resulting in a jam. Partial sheets also contaminate the printer and the cartridge with adhesive, and could void the printer and toner cartridge warranties.
- Do not use labels with exposed adhesive.
- Before loading labels on the tray, flex and fan labels to loosen them. Straighten the edges on a level surface.

Tips on using card stock

Card stock is heavy, single-ply specialty media. Many of its variable characteristics, such as moisture content, thickness, and texture, can significantly affect print quality.

- From the printer control panel, set the paper size, type, texture, and weight in the Paper menu to match the card stock loaded in the tray.
- Print samples on the card stock being considered for use before buying large quantities.
- Specify the paper texture and weight from the tray settings to match the paper loaded in the tray.
- Preprinting, perforation, and creasing may significantly affect the print quality and cause jams or other paper feed problems.
- Before loading the card stock on the tray, flex and fan the card stock to loosen them. Straighten the edges on a level surface.

Supported paper sizes, types, and weights

The following tables provide information on standard and optional paper sources and the sizes, types, and weights of paper they support.

Note: For an unlisted paper size, select the closest *larger* listed size.

Supported paper sizes

Note: Your printer model may have a 650-sheet duo tray, which consists of a 550-sheet tray and an integrated 100-sheet multipurpose feeder. The 550-sheet tray of the 650-sheet duo tray supports the same paper sizes as the optional 550-sheet tray. The integrated multipurpose feeder supports different paper sizes, types, and weights.

Paper size and dimension	Standard 250-sheet tray	Manual feeder	650-sheet duo tray		550-sheet tray	ADF	Scanner glass	Duplex mode
			550-sheet tray	Multipurpose feeder				
A4 210 x 297 mm (8.3 x 11.7 in.)	√ ¹	√	√ ¹	√ ¹	√ ¹	√	√	√
A5 148 x 210 mm (5.83 x 8.3 in.)	√ ¹	√	√ ²	√ ¹	√ ²	√	√	X
A6 105 x 148 mm (4.1 x 5.8 in.)	X	√	X	√ ¹	X	X	√	X
JIS B5 182 x 257 mm (7.2 x 10.1 in.)	√ ¹	√	√ ¹	√ ¹	√ ¹	√	√	X
Letter 216 x 279 mm (8.5 x 11 in.)	√ ¹	√	√ ¹	√ ¹	√ ¹	√	√	√
Legal 216 x 356 mm (8.5 x 14 in.)	√ ¹	√	√ ¹	√ ¹	√ ¹	√	X	√
Executive 184 x 267 mm (7.3 x 10.5 in.)	√ ¹	√	√ ¹	√ ¹	√ ¹	√	√	X
Oficio (Mexico) 216 x 340 mm (8.5 x 13.4 in.)	√ ¹	√	√ ¹	√ ¹	√ ¹	√	X	√
Folio 216 x 330 mm (8.5 x 13 in.)	√ ¹	√	√ ¹	√ ¹	√ ¹	√	X	√
Statement 140 x 216 mm (5.5 x 8.5 in.)	X	√	X	√ ¹	X	√	√	X

¹ The paper source supports paper size without *size sensing*.

² Universal is supported in the standard 250- and optional 550-sheet trays only if the paper size is from 148 x 215.9 mm (5.83 x 8.5 in.) to 215.9 x 355.6 mm (8.5 x 14 in.).

³ Universal is supported in the multipurpose feeder and manual feeder only if the paper size is from 76.2 x 127 mm (3 x 5 in.) to 215.9 x 359.9 mm (8.5 x 14.17 in.).

⁴ Universal is supported in duplex mode only if the width is from 210 mm (8.27 in.) to 215.9 mm (8.5 in.), and the length is from 279.4 mm (11 in.) to 355.6 mm (14 in.).

Paper size and dimension	Standard 250-sheet tray	Manual feeder	650-sheet duo tray		550-sheet tray	ADF	Scanner glass	Duplex mode
			550-sheet tray	Multipurpose feeder				
Universal 76 x 127 mm (3 x 5 in.) to 216 x 356 mm (8.5 x 14 in.)	X	√ ^{1,3}	X	√ ^{1,3}	X	√	√	X
Universal 148 x 210 mm (5.8 x 8.3 in) to 216 x 356 mm (8.5 x 14 in).	√ ^{1,2}	√	√ ^{1,2}	√	√ ^{1,2}	X	X	√ ⁴
7 3/4 Envelope (Monarch) 98 x 191 mm (3.9 x 7.5 in.)	X	√	X	√ ¹	X	X	X	X
9 Envelope 98 x 225 mm (3.9 x 8.9 in.)	X	√	X	√ ¹	X	X	X	X
10 Envelope 105 x 241 mm (4.1 x 9.5 in.)	X	√	X	√ ¹	X	X	X	X
DL Envelope 110 x 220 mm (4.3 x 8.7 in.)	X	√	X	√ ¹	X	X	X	X
C5 Envelope 162 x 229 mm (6.4 x 9 in.)	X	√	X	√ ¹	X	X	X	X
B5 Envelope 176 x 250 mm (6.9 x 9.8 in.)	X	√	X	√ ¹	X	X	X	X
Other Envelope 98 x 162 mm (3.9 x 6.3 in.) up to 176 x 250 mm (6.9 x 9.8 in.)	X	√	X	√ ¹	X	X	X	X

¹ The paper source supports paper size without *size sensing*.

² Universal is supported in the standard 250- and optional 550-sheet trays only if the paper size is from 148 x 215.9 mm (5.83 x 8.5 in.) to 215.9 x 355.6 mm (8.5 x 14 in.).

³ Universal is supported in the multipurpose feeder and manual feeder only if the paper size is from 76.2 x 127 mm (3 x 5 in.) to 215.9 x 359.9 mm (8.5 x 14.17 in.).

⁴ Universal is supported in duplex mode only if the width is from 210 mm (8.27 in.) to 215.9 mm (8.5 in.), and the length is from 279.4 mm (11 in.) to 355.6 mm (14 in.).

Supported paper types and weights

Notes:

- Your printer model may have a 650-sheet duo tray, which consists of a 550-sheet tray and an integrated 100-sheet multipurpose feeder. The 550-sheet tray of the 650-sheet duo tray supports the same paper as the 550-sheet tray. The integrated multipurpose feeder supports different paper sizes, types, and weights.
- Labels, transparencies, envelopes, and card stock always print at reduced speed.

Paper type	250-sheet tray	Manual feeder	650-sheet duo tray		550-sheet tray	ADF	Scanner glass	Duplex mode
			550-sheet tray	Multipurpose feeder				
Paper <ul style="list-style-type: none"> Plain Recycled Glossy Bond Letterhead Preprinted Colored Light Heavy Rough/Cotton Custom Type [X] 	✓	✓	✓	✓	✓	✓	✓	✓
Card stock	✓	✓	✓	✓	✓	✓	✓	X
Transparencies	✓	✓	X	✓	X	✓	✓	X
Labels <ul style="list-style-type: none"> Paper 	✓	✓	✓	✓	✓	✓	✓	X
Envelope	X	✓	X	✓	X	✓	✓	X

Data security notice

- The printer contains various types of memory that store printer and network settings, information from embedded solutions, and user data.

The following are the types of memory and data that they store.

- Volatile memory**—The printer uses standard random access memory (RAM) to buffer user data temporarily during simple print and copy jobs.
- Non-volatile memory**—The printer may use two forms of non-volatile memory: EEPROM and NAND (flash memory). Both types are used to store the operating system, printer settings, network information, scanner and bookmark settings, and embedded solutions.

- **Hard disk memory**—The printer hard disk is designed for printer-specific functionality and cannot be used for the long-term storage of data that is not print-related. The hard disk can retain buffered user data from complex print jobs, form data, and font data.

To erase volatile memory, turn off the printer.

To erase the non-volatile and printer hard disk memory, see [“Configuration menu” on page 233](#).

The following parts are capable of storing memory:

- Printer control panel
- User interface controller card (UICC)
- Controller board
- Optional hard disk

Note: The control panel and controller board contain NVRAM.

2 After removing the old part, return it to your next level of support.

Tools required for service

- Flat-blade screwdrivers, magnetic, various sizes
- #1 Phillips screwdriver, magnetic
- #2 Phillips screwdriver, magnetic
- #2 Phillips screwdriver, magnetic short-blade
- 7/32 inch (5.5 mm) open-end wrench
- 7.0 mm nut driver
- Needle-nose pliers
- Diagonal side cutters
- Spring hook
- Feeler gauges
- Analog or digital multimeter
- Parallel wrap plug 1319128
- Twinax/serial debug cable 1381963
- Coax/serial debug cable 1381964
- Flash light (optional)
- 3 mm hex wrench

Diagnostics and troubleshooting

- “[Troubleshooting overview](#)” on page 43
- “[Fixing print quality issues](#)” on page 45
- “[Paper jams](#)” on page 58
- “[Understanding the printer messages](#)” on page 89
- “[Printer hardware errors](#)” on page 101
- “[ADF/Scanner hardware errors](#)” on page 134
- “[Other symptoms](#)” on page 156

 **CAUTION—SHOCK HAZARD:** Remove the power cord from the electrical outlet before you connect or disconnect any cable or electronic card or assembly for personal safety and to prevent damage to the printer. Disconnect any connections between the printer and PCs/peripherals.

 **CAUTION—POTENTIAL INJURY:** The printer weight is greater than 18kg (40 lb) and requires two or more trained personnel to lift it safely. Use the hand holds on the side of the printer. Make sure your fingers are not under the printer when you lift or set the printer on the floor or another stable surface.

 **CAUTION—HOT SURFACE:** The inside of the printer might be hot. To reduce the risk of injury from a hot component, allow the surface to cool before touching.

Troubleshooting overview

- “[Performing the initial troubleshooting check](#)” on page 43
- “[Power-on Reset \(POR\) sequence](#)” on page 44
- “[Using Safe Mode](#)” on page 44

Performing the initial troubleshooting check

Before you start the troubleshooting procedures, perform the following checks:

- With the power cord unplugged from the electrical outlet, check that the cord is free from the breakage, short circuits, disconnected wires, or incorrect connections.
- Make sure the printer is properly grounded. Check the power cord ground terminal.
- Make sure the power supply line voltage is within 10% of the rated line voltage.
- Make sure the machine is securely installed on a level surface in a well-ventilated area.
- Make sure the room temperature is between 16 and 32°C (60 and 90°F) and that the relative humidity is between 20 and 80%.
- Avoid sites generating ammonia gas, high temperature, high humidity (near water faucets, kettles, humidifiers), cold spaces, near open flames, and dusty areas.
- Avoid sites exposed to direct sunlight.
- Make sure the paper is the recommended paper for this printer.

- Make a trial print with paper from a newly opened package, and check the result.

Power-on Reset (POR) sequence

When you turn on the printer, it performs a POR sequence.

Check for correct POR functioning of the base printer by observing the following:

- 1 The LED turns on.
- 2 The main fan turns on.
- 3 The control panel turns on.
- 4 The fuser heater turns on.
 - Note:** The fuser takes longer to warm up from a cold start than a warm start.
- 5 The control panel LED starts blinking.
- 6 A splash screen appears on the display. The following errors or messages may appear:
 - **Close Door** or **Insert Cartridge** appears if the front access door is open or the print cartridge is missing
 - Cartridge errors, such as **Defective Cartridge** or **Missing Cartridge**
- 7 **Ready** appears on the display.
- 8 The main drive motor turns on.
- 9 The EP drive assembly drives the developer shaft located in the print cartridge.
- 10 The exit rollers turn.
- 11 The printer may begin calibration.

Using Safe Mode

Safe Mode lets the printer continue to operate in a special limited mode in which it attempts to continue offering as much functionality as possible despite known issues.

Warning—Potential Damage: Safe Mode is intended as a short-term workaround and should be used only in the case of a non-critical error when a print job must be completed before service can be arranged to repair the printer. The printer must be returned to standard operating mode before diagnostics can be run or full-function printing can continue.

You can enter Safe Mode in one of the following ways:

- Enable Safe Mode from the Configuration menu, and then POR the printer.
- For 2.4" display models, press the **Stop** and **Back** keys, and then POR the printer.
- For 4.3" and 7" display touchscreen models, press the **6** and **7** keys, and then POR the printer.

Return the printer to standard operating mode to service the printer and return to full-function printing.

Safe mode print behavior

The following table outlines the behavior for this printer model while in Safe Mode:

Safe Mode engine features	Engine behavior	Control panel behavior
Simplex printing only	Reports that duplex printing is disabled.	Duplex print option is not selectable.
Ignore duplex sensor		
Ignore standard bin full sensor	Standard bin full messages are not reported.	Standard bin full messages will not occur.
Print at narrow media operating point	Pages are printed slower.	N/A
Ignore all input options	Reports that only Tray 1 is installed.	Only Tray 1 and the MPF are selectable.
Ignore all output options	Does not any report installed finishing options.	No finishing options are selectable.
Ignore rear door sensor	Rear door open messages are not reported.	Rear door open messages do not occur.
Reduce print speed	Pages are printed slower.	N/A
Reduce time to first print	Slower time to first print.	N/A

Fixing print quality issues

- [“Initial print quality check” on page 46](#)
- [“Toner smear check” on page 47](#)
- [“Background or toner fog check” on page 48](#)
- [“Blank pages check” on page 49](#)
- [“Blurred or fuzzy print check” on page 50](#)
- [“Half-color page check” on page 51](#)
- [“Horizontal banding check” on page 51](#)
- [“Horizontal line check” on page 51](#)
- [“Missing image at edge check” on page 52](#)
- [“Toner specks check” on page 52](#)
- [“Narrow vertical line check” on page 52](#)
- [“Random marks check” on page 52](#)
- [“Residual image check” on page 53](#)
- [“Solid color pages check” on page 53](#)
- [“Vertical banding check” on page 54](#)
- [“Light print on solids check” on page 54](#)
- [“Color problems check” on page 54](#)
- [“Missing color check” on page 55](#)

The symptoms described in this chapter might require replacement of one or more CRUs (Customer Replaceable Units) designated as supplies or maintenance items, which are the responsibility of the customer. With the customer's permission, you might need to install a developer (toner) cartridge.

Initial print quality check

Before troubleshooting specific print problems, complete the following initial print quality check:

- The printer must be in a location that follows the recommended operating environment specifications. See [“Environment” on page 430](#).
- Check the life status of all supplies. Any supply that is low should be replaced.
- Load 20-lb plain letter or A4 paper. Make sure the paper guides are properly set and locked. From the control panel, set the paper size and type to match the paper loaded in the tray.
- Print a menu settings page. Be sure to keep the original menu settings page to restore the customer's custom settings if needed.
- Verify on the menu settings page if the following are set to their default values:
 - Color Correction: Set to Auto.
 - Print Resolution: Set to 4800 dpi (print quality problems should be checked at different resolution settings).
 - Toner Darkness: Set to 4 (default).
 - Color Saver: Set to OFF.
 - RGB Brightness, RGB Contrast, RGB Saturation: Set to 0.
 - Color Balance: Select **Reset Defaults** to zero out all colors.
 - Check the paper type, texture and weight settings against the paper that is loaded in the printer.
- Check the image transfer unit for damage. Replace if damaged.
- Check the print cartridges and imaging unit for damage. Replace if damaged.
- Print the print quality pages to see if the problem remains. Use Tray 1 to test print quality problems.
- Print a print quality test page, and then look for variations in the print from what is expected. Verify if the settings under EP Setup are set to their default values. See [“EP Defaults” on page 224](#).
- Check to ensure the correct printer driver for the installed software is being used. An incorrect printer driver for the installed software can cause problems. Incorrect characters could print, and the copy may not fit the page correctly.

Toner smear check

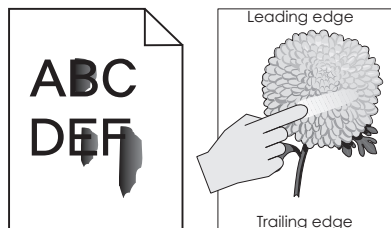

Actions	Yes	No
<p>Step 1 From the Paper Menu on the printer control panel, check the paper type and paper weight settings.</p> <p>Is the paper tray set to the type and weight of paper in the tray?</p>	Go to step 2.	Change the paper type and weight settings to match the paper in the tray.
<p>Step 2 Check for paper with texture or rough finishes.</p> <p>Are you printing on textured or rough paper?</p>	Change the textured or rough paper to plain paper and print again.	Go to step 3.
<p>Step 3 Is the fuser properly installed?</p>	Go to step 4.	Install the fuser properly.
<p>Step 4 Replace the fuser. See “Fuser assembly removal” on page 324.</p> <p>Does this solve the problem?</p>	The problem is solved.	Go to step 5.
<p>Step 5 Replace the LVPS. See “Low-voltage power supply (LVPS) removal” on page 285.</p> <p>Does this fix the problem?</p>	The problem is solved.	Contact your next level of support.

Background or toner fog check

Actions	Yes	No
<p>Step 1 Read the current status of the imaging unit from the customer menus. To view the status of the photoconductor units:</p> <ul style="list-style-type: none"> a In Ready mode, press Menus b Select Reports, and press Select. c Select Device Statistics, and press Select <p>It is possible a new imaging unit was installed, but the counter was not reset.</p> <p>Has the imaging unit been recently replaced?</p>	<p>Reset the value. To reset this value:</p> <ol style="list-style-type: none"> 1 In Ready mode, press Menus 2 Select Supplies Menu, and press Select 3 Select Replace Supply, and press Select 4 Select the imaging unit you want to change, and press Select 5 Select Yes, and press Select <p>If this does not fix the problem, then go to step 2.</p>	<p>Go to step 2.</p>
<p>Step 2 Is the background only one of the primary colors; yellow, cyan, magenta, or black?</p>	<p>Go to step 3.</p>	<p>Go to step 4.</p>
<p>Step 3 Replace the developer unit.</p> <p>Did replacing the developer unit correct the problem?</p>	<p>Problem is solved.</p>	<p>Go to step 4.</p>
<p>Step 4 Replace the photoconductor unit.</p> <p>Did this fix the problem?</p>	<p>Problem is solved.</p>	<p>Go to step 5.</p>
<p>Step 5 Check the high-voltage contact from the HVPS to the image transfer unit (ITU).</p> <p>Is a problem found?</p>	<p>Replace the failing part:</p> <ul style="list-style-type: none"> • Image transfer unit. See “Image transfer unit (ITU) removal” on page 300. • High-voltage power supply (HVPS). See “High-voltage power supply (HVPS) removal” on page 296. 	<p>Go to step 6.</p>

Actions	Yes	No
<p>Step 6 With the printer off, reset the cable in the JHVPS1 connector.</p> <p>Does this fix the problem?</p>	Problem is solved.	Go to step 7.
<p>Step 7 Replace the HVPS. See “High-voltage power supply (HVPS) removal” on page 296.</p> <p>Does this fix the problem?</p>	Problem is solved.	Go to step 8.
<p>Step 8 Clean the printhead.</p> <p>Does this fix the problem?</p>	Problem is solved.	Replace the printhead. See “Printhead removal” on page 365.

Blank pages check

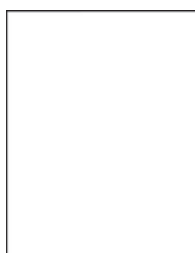

Actions	Yes	No
<p>Step 1</p> <p>Is all the packing material for the imaging unit in question removed?</p>	Go to step 2.	Remove the packing material.
<p>Step 2 Print a document that requires all four colors with just a few characters to verify if one specific color is a problem. For example, print the Print Quality Test Pages: Diagnostics Menu > PRINT TESTS > Prt Qual pgs</p> <p>Is only one color missing?</p>	Replace the developer unit for the missing color. See “Developer unit removal” on page 295.	Go to step 3.
<p>Step 3 Replace the imaging unit. See “Imaging unit (IU) removal” on page 303.</p> <p>Does this fix the problem?</p>	Problem is solved.	Go to step 4.

Actions	Yes	No
<p>Step 4</p> <p>POR into the Diagnostics menu, and then perform a cartridge drive motor test for the missing color:</p> <p>Diagnostics Menu > MISC TESTS > Motor Detect</p> <p>Does the motor run?</p>	Go to step 5.	Replace the main drive gear assembly. See Main drive gear assembly with motor removal.
<p>Step 5</p> <p>Remove the developer unit. See “Developer unit removal” on page 295. Check the developer cartridge contacts from the HVPS to the IU.</p> <p>Are all the toner cartridge contacts clean on both the Pin and IU?</p>	Go to step 6..	Clean the developer cartridge contacts. See “Developer unit removal” on page 295 .
<p>Step 6</p> <p>Are all the spring-loaded pins in the HVPS free to move in and out with an equal amount of spring force?</p>	Go to step 7.	Replace the HVPS. See “High-voltage power supply (HVPS) removal” on page 296 .
<p>Step 7</p> <p>Turn the printer off, and remove the rear cover. See “Rear cover removal” on page 346. Check the continuity between the spring-loaded pin and the JSC1 connector on the lower left side of the controller board.</p> <p>Are all conductors continuous?</p>	Go to step 8.	Replace the cable.
<p>Step 8</p> <p>Replace the printhead. See “Printhead removal” on page 365.</p> <p>Does this solve the problem?</p>	Problem is solved.	Replace the controller board. See “Controller board removal” on page 348 .

Blurred or fuzzy print check

Run the automatic alignment. The TPS sensor may be damaged. To run Reset Color Cal:

- 1** Enter the Diagnostics Menu.
Turn the printer off, and press and hold **3** and **6**.
- 2** Select **Reset Color Cal**, and press **Select**.
- 3** Select **TPS Setup**.
- 4** Select **Reset Color Cal**, and press **Select**. **Resetting** appears. When the reset is complete, the screen is automatically returned to TPS Setup.

Blurred or fuzzy print is usually caused by a problem in the main gear drive assembly or in the image transfer unit (ITU). Check the main drive gear assembly and ITU for correct operation.

Blurred print can also be caused by incorrect feeding from one of the input paper sources, media trays, or duplex paper path.

Check the high-voltage spring contacts to ensure they are not bent, corroded, or damaged. Replace the high-voltage power supply as necessary. See High voltage power supply (HVPS) assembly removal.

Half-color page check

A photoconductor unit is not properly seated. Reset the specific photoconductor unit.

Horizontal banding check

Actions	Yes	No
<p>Step 1</p> <p>Measure the distance between repeating bands.</p> <p>Is the distance between bands either 34.6 or 94.2 mm?</p>	<p>Replace the photoconductor unit. Remove the imaging unit and remove the original developer units, and then put them back into the new photoconductor unit, and reinstall the imaging unit. See “Imaging unit (IU) removal” on page 303.</p>	<p>Go to step 2.</p>
<p>Step 2</p> <p>Does the distance measure 95 mm or 108 mm?</p>	<p>Replace the fuser. See “Fuser assembly removal” on page 324.</p>	<p>Go to step 3.</p>
<p>Step 3</p> <p>Does the distance measure 37.7, 55, or 78.5 mm?</p>	<p>Replace the ITU. See “Image transfer unit (ITU) removal” on page 300.</p>	<p>Go to step 4.</p>
<p>Step 4</p> <p>Does the distance measure 43.9 mm or 45.5?</p>	<p>Replace the developers that match the missing color (black, cyan, magenta, or yellow.) See Developer unit removal.</p>	<p>Check the various rollers in the printer for debris.</p>

Horizontal line check

Either the photoconductor unit or one of the developer units that make up the imaging unit is defective. Remove and inspect the imaging unit. Replace the damaged part of the imaging unit. See Imaging unit (IU) removal.

Missing image at edge check

Remove and reset the following:

- Toner cartridge
- Imaging unit
- Developer units

Toner specks check

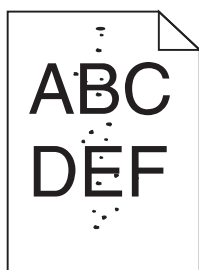

Keep running prints through, and the problem normally clears up. If the problem persists, then replace the developer cartridge.

Narrow vertical line check

Actions	Yes	No
Replace the photoconductor unit. Does this solve the problem?	The problem is solved.	Replace the developer unit.

Random marks check

Service tip: The primary cause of random marks is due to loose material moving around inside the printer and attaching to the photoconductor unit, developer roll, or transfer belt.

Actions	Yes	No
Step 1 Is there any loose or foreign material on the imaging unit?	Inspect the imaging unit by looking at the individual developers and photoconductors. Clean or replace the faulty unit. See “Imaging unit (IU) removal” on page 303.	Go to step 2.
Step 2 Is there any loose or foreign material on the developer roll?	Replace the developer unit.	Go to step 3.

Actions	Yes	No
<p>Step 3</p> <p>Is there any loose or foreign material on the transfer belt?</p>	<p>Replace the ITU. See “Image transfer unit (ITU) removal” on page 300.</p>	<p>Contact your next level of support.</p>

Residual image check

Service tip: The primary cause of random marks is due to loose material moving around inside the printer and attaching to the photoconductor unit, developer roll, or transfer belt.

Actions	Yes	No
<p>Step 1</p> <p>Check the condition of the imaging unit using the customer menus (administration menus):</p> <ul style="list-style-type: none"> a At the Ready prompt, press Menu. b Select Supplies Menu, and press Select. c Select Imaging Kit, and press Select. <p>Does the display indicate OK?</p>	<p>Go to step 2.</p>	<p>Replace the imaging unit or the photoconductor unit. See “Imaging unit (IU) removal” on page 303.</p>
<p>Step 2</p> <p>Measure the distance from the original image to the same point on the residual image.</p> <p>Is the distance 43.9 mm?</p>	<p>Replace the developer corresponding to the color of the image. See “Developer unit removal” on page 295.</p>	<p>Replace the imaging unit or the photoconductor unit. See “Imaging unit (IU) removal” on page 303.</p>
<p>Step 3</p> <p>Is the distance between the original image and the residual image 94.2 mm?</p>	<p>Replace the photoconductor.l.</p>	<p>Go to step 4.</p>
<p>Step 4</p> <p>Run the Menu Setting Page twice to clear any debris.</p> <ul style="list-style-type: none"> a Press Menu on the control panel. b Select Reports from the Admin Menu, and press Select. c Select Imaging Kit, and press Select. <p>Is there still any toner contamination on the fuser assembly?</p>	<p>Replace the fuser. See “Fuser assembly removal” on page 324.</p>	<p>Contact your next level of support.</p>

Solid color pages check

Service tip: A solid color page is generally caused by a problem in the high-voltage power supply or an incorrect high voltage in the printing process resulting in toner development on the entire photoconductor.

Actions	Yes	No
<p>Step 1 Replace the photoconductor unit (part of the imaging unit). Remove the imaging unit and remove the developers. Place the original developers in the new photoconductor, and then replace the imaging unit. See “Imaging unit (IU) removal” on page 303.</p> <p>Does this solve the problem?</p>	Problem is solved.	Go to step 2.
<p>Step 2 A faulty printhead can cause the problem. To test the printhead for solid colors, place a narrow strip of paper over the gap between the developers. Make sure the paper stays in place when you replace the imaging unit. This will block the laser from discharging the photoconductors. Select the Print Quality Page.</p> <p>Does the uniform color page have a white vertical band?</p>	Replace the printhead. See “Printhead removal” on page 365.	Go to step 3.
<p>Step 3 Check the high-voltage contact from the HVPS to the photoconductor charge roll. Ensure the contact springs are properly mounted and that the charge roll contact spring is making good contact with the HVPS spring that runs through the left printer frame. See “Toner cartridge contacts removal” on page 305 to view the proper mounting and for removal procedures.</p> <p>Are the springs defective?</p>	Replace the transfer contact assembly. See “Toner cartridge contacts removal” on page 305.	Go to step 4.
<p>Step 4 Turn the printer off, and check the continuity of the HVPS cable.</p> <p>Is there continuity?</p>	Go to step 5.	Replace the cable assembly.
<p>Step 5 Replace the HVPS. See “High-voltage power supply (HVPS) removal” on page 296.</p> <p>Does this solve the problem?</p>	Problem is solved.	Replace the controller board. See “Controller board removal” on page 348.

Vertical banding check

Replace the developer cartridge.

Light print on solids check

Light print can be caused by incorrect media. For more information, see [“Media guidelines” on page 31.](#)

Color problems check

For more information on non-mechanical color issues, see [“Color theory” on page 445.](#)

Missing color check

Action	Yes	No
<p>Step 1</p> <p>a Enter the Diagnostics menu, and then navigate to: Print Quality Pages > Print Quality Pages</p> <p>b Check the test page.</p> <p>Are there missing colors?</p>	Go to step 2.	The problem is solved.
<p>Step 2</p> <p>Make sure that all packing materials of the imaging unit are removed.</p> <p>Does the problem remain?</p>	Go to step 3.	The problem is solved.
<p>Step 3</p> <p>Make sure that the toner bottles and developer units are properly installed.</p> <p>Does the problem remain?</p>	Go to step 4.	The problem is solved.
<p>Step 4</p> <p>Reinstall the imaging unit and waste toner bottle.</p> <p>Does the problem remain?</p>	Go to step 5.	The problem is solved.
<p>Step 5</p> <p>Remove the imaging unit, and then check if any of the couplers are damaged or detached from the EP drive unit.</p> <p>Are any of the couplers damaged or detached from the EP drive unit?</p>	Go to step 6.	Go to step 7.
<p>Step 6</p> <p>Replace the damaged coupler. See “Developer drive coupling removal” on page 281</p> <p>Does the problem remain?</p>	Go to step 7.	The problem is solved.
<p>Step 7</p> <p>Check if the missing color is yellow.</p> <p>Is the missing color yellow?</p>	Go to step 8.	Go to step 10.

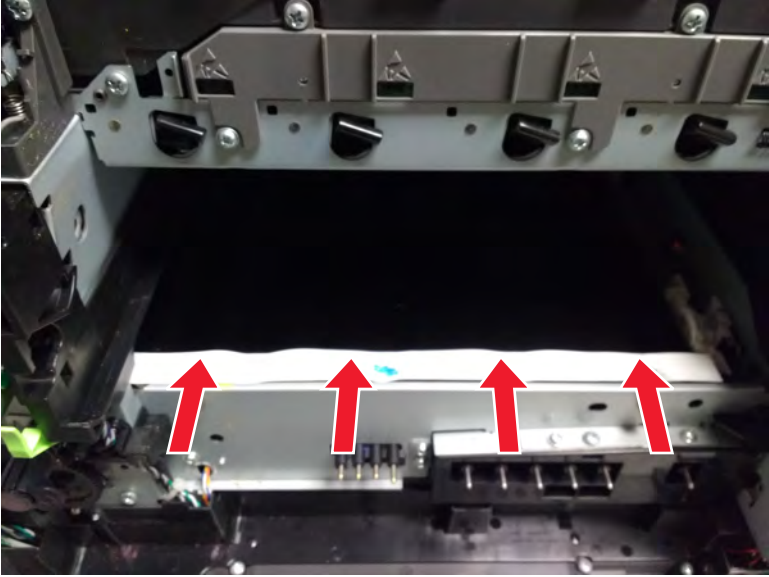
Action	Yes	No
<p>Step 8 Remove the imaging unit, and then check if the cleaning blade is in the correct position. See “Imaging unit (IU) removal” on page 303.</p>  <p>Does the cleaning blade appear like the picture above?</p>	<p>Go to step 9.</p>	<p>Go to step 10.</p>
<p>Step 9 Replace the ITU. See “Image transfer unit (ITU) removal” on page 300.</p> <p>Does the problem remain?</p>	<p>Go to step 10.</p>	<p>The problem is solved.</p>
<p>Step 10 Remove the ITU, and then check the amount of pressure on the transfer rolls by pressing down on the roll of the affected color.</p>  <p>Is there resistance?</p>	<p>Go to step 12.</p>	<p>Go to step 11.</p>

Action	Yes	No
<p>Step 11 Replace the ITU. See “Image transfer unit (ITU) removal” on page 300.</p> <p>Does the problem remain?</p>	Go to step 12.	The problem is solved.
<p>Step 12 Check the contacts on the imaging unit and the developer of the missing color for dust or debris.</p> <p>Are the contacts free of dust or debris?</p>	Go to step 15.	Go to step 13.
<p>Step 13 Clean the contacts between the developer and the imaging unit.</p> <p>Does the problem remain?</p>	Go to step 14.	The problem is solved.
<p>Step 14 Replace the developer unit. See “Developer unit removal” on page 295.</p> <p>Does the problem remain?</p>	Go to step 15.	The problem is solved.
<p>Step 15</p> <p>a Remove the left cover. See “Left cover assembly removal” on page 274.</p> <p>b Enter the Diagnostics menu, and then navigate to: Print Quality Pages > Print Quality Pages</p> <p>c Check the EP motors on the EP drive assembly for proper operation.</p> <p>Does the motor run?</p>	Go to step 17.	Go to step 16.
<p>Step 16 Replace the defective EP drive motor. See “Drive unit motor removal” on page 275.</p> <p>Does the problem remain?</p>	Go to step 17.	The problem is solved.
<p>Step 17 While manually turning the motors, check if the couplers that drive the imaging kit move.</p> <p>Do the couplers move?</p>	Go to step 19.	Go to step 18.
<p>Step 18 Replace the EP drive assembly. See “EP drive assembly removal” on page 275.</p> <p>Does the problem remain?</p>	Go to step 19.	The problem is solved.

Action	Yes	No
<p>Step 19</p> <p>Check if the three contacts on the rear of the HVPS freely move with an equal amount of spring force.</p> <p>Do the contacts freely move?</p>	Go to step 21.	Go to step 20.
<p>Step 20</p> <p>Replace the HVPS. See “High-voltage power supply (HVPS) removal” on page 296.</p> <p>Does the problem remain?</p>	Go to step 21.	The problem is solved.
<p>Step 21</p> <p>Replace the printhead. See “Printhead removal” on page 365.</p> <p>Does the problem remain?</p>	Go to step 22.	The problem is solved.
<p>Step 22</p> <p>Replace the controller board. See “Controller board removal” on page 348.</p> <p>Does the problem remain?</p>	Contact the next level of support.	The problem is solved.

Paper jams

- [“Avoiding jams” on page 58](#)
- [“Understanding jam messages and locations” on page 60](#)
- [“200 paper jams” on page 60](#)
- [“202 paper jams” on page 65](#)
- [“203 paper jams” on page 72](#)
- [“23y paper jams” on page 75](#)
- [“24y paper jams” on page 79](#)
- [“25y paper jams” on page 80](#)
- [“28y paper jams” on page 83](#)
- [“29y paper jams” on page 87](#)

Avoiding jams

Load paper properly

- Make sure that the paper lies flat in the tray.
- Do not remove a tray while the printer is printing.
- Do not load a tray while the printer is printing. Load it before printing, or wait for a prompt to load it.
- Do not load too much paper. Make sure that the stack height is below the maximum paper fill indicator.

- Do not slide paper into the tray. Load paper as shown in the illustration.

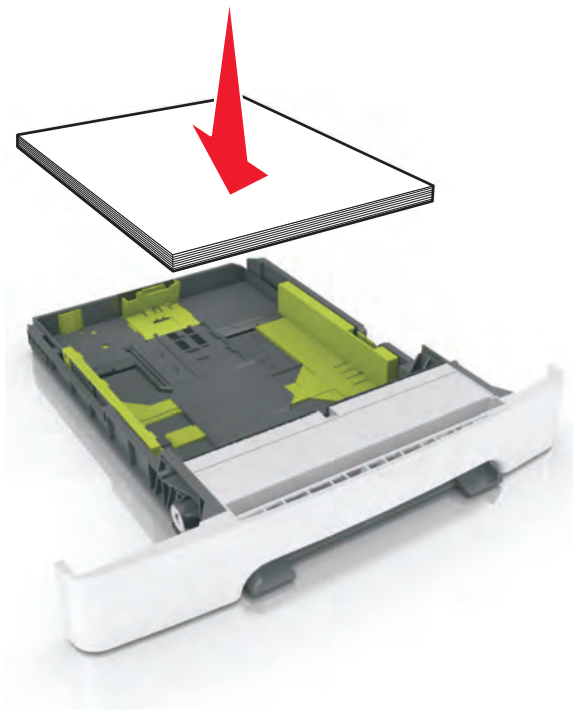

- Make sure that the paper guides are properly positioned.
- Push the tray firmly into the printer after loading paper.

Use recommended paper

- Use only recommended paper or specialty media.
- Do not load wrinkled, creased, damp, bent, or curled paper.
- Flex, fan, and straighten paper before loading it.

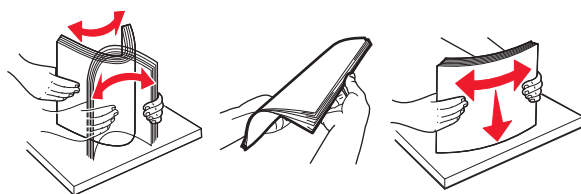

- Do not use paper that has been cut or trimmed by hand.
- Do not mix paper sizes, weights, or types in the same tray.
- Make sure that the paper size and type are set correctly on the Embedded Web Server or the computer.

Note: Depending on your operating system, access the Paper menu using Local Printer Settings Utility or Printer Settings.

- Store paper according to manufacturer recommendations.

Understanding jam messages and locations

When a jam occurs, a message indicating the jam location and information to clear the jam appears on the printer display. Open the doors, covers, and trays indicated on the display to remove the jam.

Note: When Jam Recovery is set to On or Auto, the printer reprints jammed pages. However, Auto does not guarantee that the page will print.

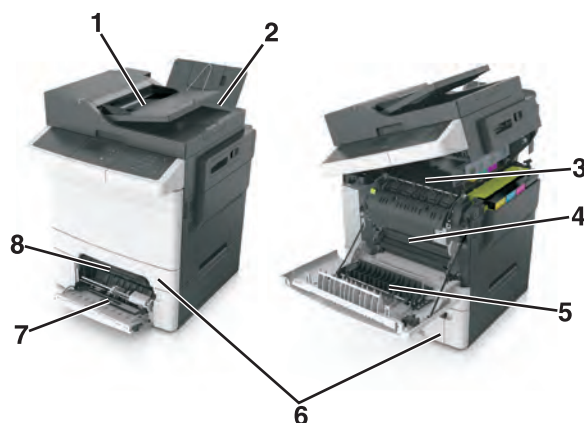

#	Jam location	Message on the display	What to do
1	Automatic document feeder (ADF)	[x]-page jam, open automatic feeder top cover [28y.xx]	Remove all paper from the ADF tray, and then remove the jammed paper.
2	Standard bin	[x]-page jam, clear standard bin [203.xx]	Remove the jammed paper.
3	Fuser	[x]-page jam, open front door to clear fuser [202.xx]	Open the front door, then pull the tab and hold the fuser cover down, and then remove the jammed paper.
4	Front door	[x]-page jam, open front door [20y.xx]	Open the front door, and then remove the jammed paper.
5	Duplex area	[x]-page jam, open front door to clear duplex [23y.xx]	Open the front door, and then remove the jammed paper.
6	Tray [x]	[x]-page jam, open tray [x] [24y.xx]	Pull out the indicated tray, and then remove the jammed paper.
7	Multipurpose feeder	[x]-page jam, clear multipurpose feeder [250.xx]	Push the paper release lever to lift the paper rollers, and then remove the jammed paper.
8	Manual feeder	[x]-page jam, clear manual feeder [251.xx]	Remove the jammed paper.

200 paper jams

[x]-page jam, open front door [20y.xx]

- 1 Open the front door.



CAUTION—HOT SURFACE: The inside of the printer might be hot. To reduce the risk of injury from a hot component, allow the surface to cool before touching.

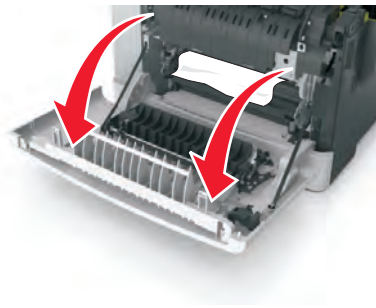

2 Firmly grasp the jammed paper on each side, and then gently pull it out.

Note: Make sure all paper fragments are removed.

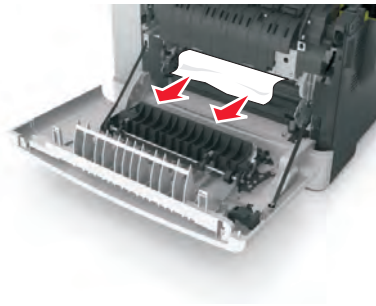

3 Close the front door.



4 From the printer control panel, touch **Done** to clear the message and continue printing.

200 paper jam messages

Error code	Description	Action
200.xx	A single page of media jam at the input (S2) sensor. Multiple pages of media are jammed at the input sensor.	Go to “200.xx Input (S2) sensor service check” on page 62.
200.01	The input (S2) sensor is obstructed.	Go to “200.xx Input (S2) sensor service check” on page 62.

Error code	Description	Action
200.02	The input (S2) sensor was made early.	Go to “200.xx Input (S2) sensor service check” on page 62.
200.03	The input (S2) sensor did not make.	Go to “200.xx Input (S2) sensor service check” on page 62.
200.05	The input (S2) sensor did not break.	Go to “200.xx Input (S2) sensor service check” on page 62.
200.20	The staging motor has an error.	Go to “Paper pick motor drive assembly service check” on page 115.
200.21	The staging motor has an error.	Go to “Paper pick motor drive assembly service check” on page 115.
200.22	The staging motor has an error.	Go to “Paper pick motor drive assembly service check” on page 115.
201.xx	A software induced stoppage has occurred. This should not happen in the field.	POR the printer.

200.xx Input (S2) sensor service check

The input (S2) sensor is part of the paper pick motor drive assembly FRU, and is not available otherwise.

Actions	Yes	No
<p>Step 1 Open the front door to access the jam area, and then remove the jammed page or pages.</p> <p>Does this solve the problem?</p>	The problem is solved.	Go to step 2.
<p>Step 2 Check the pick tires for dirt or debris.</p> <p>Is there dirt or debris?</p>	Go to step 3.	Go to step 4.
<p>Step 3 Clean the pick tires.</p> <p>Does the problem remain?</p>	Go to step 4.	The problem is solved.
<p>Step 4 Replace the pick tires.</p> <p>Does the problem remain?</p>	Go to step 5.	The problem is solved.

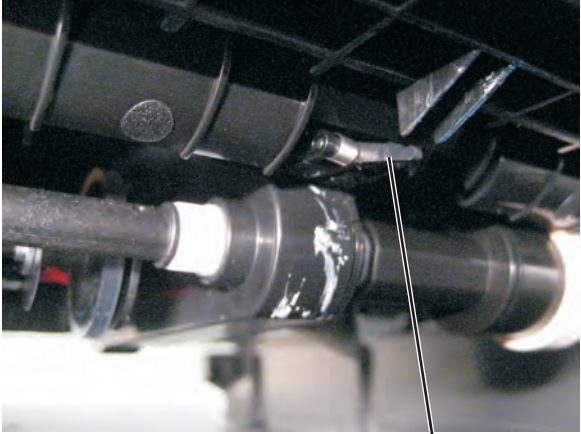
Actions	Yes	No
<p>Step 5 Remove tray 1.</p> <p>Is the input S2 sensor flag (A) damaged?</p>  <p>A</p>	<p>Replace the paper pick motor drive assembly. See “Paper pick motor drive assembly (standard tray) removal” on page 343.</p>	<p>Go to step 6.</p>

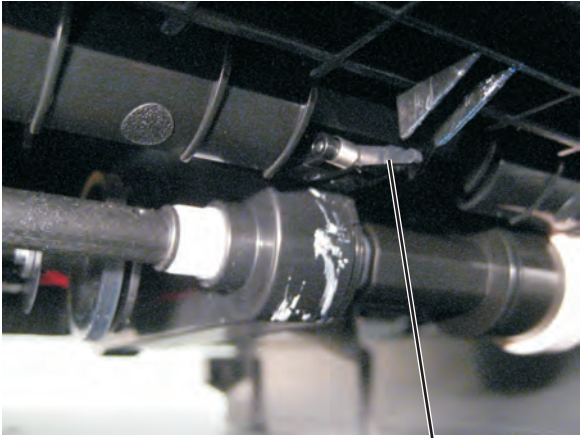
Actions	Yes	No
<p>Step 6 Enter Diagnostics Menu.</p> <p>Turn the printer on, press and hold 3 and 6, and release the buttons with the installed memory and processor speed displays.</p> <p>Perform the Base Sensor Test. See “BASE SENSOR TEST” on page 219.</p> <ul style="list-style-type: none"> a Select Base Sensor Test, and press Select. b Select S2 Sensor, and press Select. c Pull tray 1 out, and rotate the S2 sensor flag (A). (The S2 sensor is located in the front of the center paper pick motor drive assembly housing.) It should rotate freely and return to its original position.  <p style="text-align: center;">A</p> <p>Watch the display while pushing up on the flag.</p> <p>Does the display indicate Media Clean and Media Present?</p>	<p>The problem is solved.</p>	<p>Go to step 7.</p>

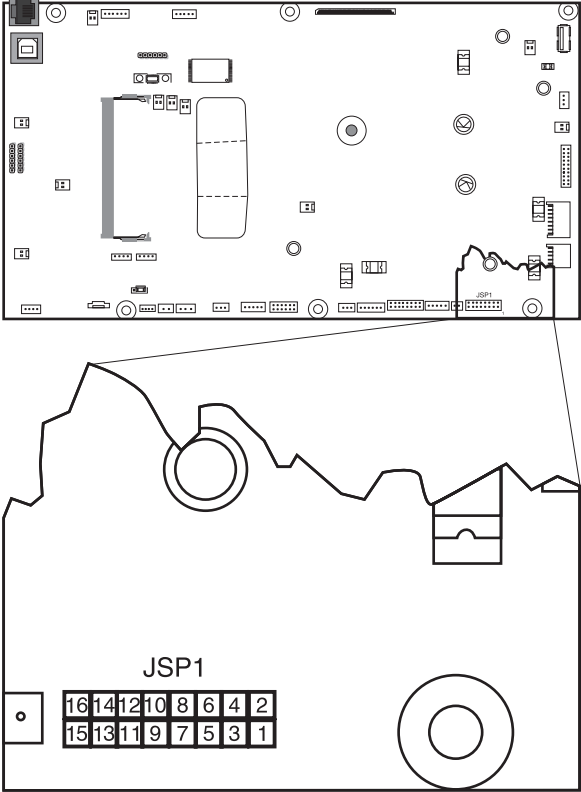
Actions	Yes	No
<p>Step 7</p> <p>Turn the printer off, and remove the rear cover. See “Rear cover removal” on page 346.</p> <p>Is the JSP1 cable connector properly connected to the controller board?</p>  <p>Turn the printer on, and check the voltage at JSP1 pin 15.</p>	<p>Go to step 8.</p>	<p>Reset the connector.</p>
<p>Step 8</p> <p>Is the voltage approximately +5 V dc?</p>	<p>Replace the paper pick motor drive assembly. See “Paper pick motor drive assembly (standard tray) removal” on page 343.</p>	<p>Replace the controller board. See “Controller board removal” on page 348.</p>

202 paper jams

[x]-page jam, open front door to clear fuser [20y.xx]

- 1 Open the front door.

 **CAUTION—HOT SURFACE:** The inside of the printer might be hot. To reduce the risk of injury from a hot component, allow the surface to cool before touching.



2 Open the top door.



- 3 Pull the green lever to open the fuser cover.

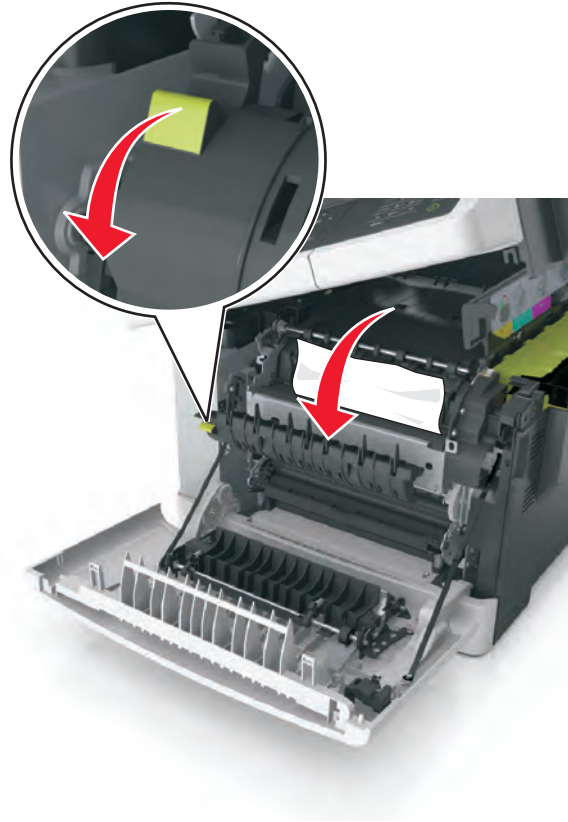

- 4 Hold down the fuser cover, and then remove the jammed paper.

Note: Make sure all paper fragments are removed.

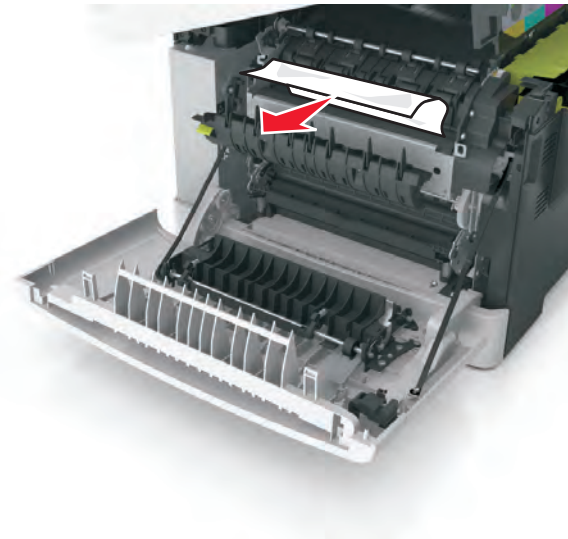

5 Slide and hold the release latch on the right side of the printer, and then slowly close the top door.

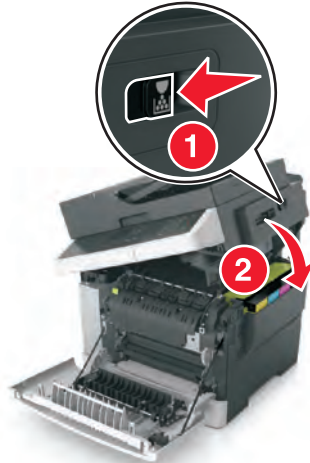

6 Close the front door.



7 From the printer control panel, touch **Done** to clear the message and continue printing.

202 paper jam messages

Error code	Description	Action
202.xx	A single page of media is jammed at the exit sensor. Multiple pages of media are jammed at the exit sensor.	Go to “202.xx fuser exit sensor service check” on page 70.
202.01	The exit sensor is obstructed.	Go to “202.xx fuser exit sensor service check” on page 70.
202.02	The exit sensor was made early.	Go to “202.xx fuser exit sensor service check” on page 70.
202.03	The exit sensor did not make.	Go to “202.xx fuser exit sensor service check” on page 70.
202.04	The exit sensor broke early.	Go to “202.xx fuser exit sensor service check” on page 70.

Error code	Description	Action
202.05	The exit sensor did not break.	Go to “202.xx fuser exit sensor service check” on page 70.
202.51	The exit sensor is obstructed. The fuser is past end of life.	Go to “202.xx fuser exit sensor service check” on page 70.
202.52	The exit sensor was made early. The fuser is past end of life.	Go to “202.xx fuser exit sensor service check” on page 70.
202.53	The exit sensor did not make. The fuser is past end of life.	Go to “202.xx fuser exit sensor service check” on page 70.
202.54	The exit sensor broke early. The fuser is past end of life.	Go to “202.xx fuser exit sensor service check” on page 70.
202.55	The exit sensor did not break. The fuser is past end of life.	Go to “202.xx fuser exit sensor service check” on page 70.

202.xx fuser exit sensor service check

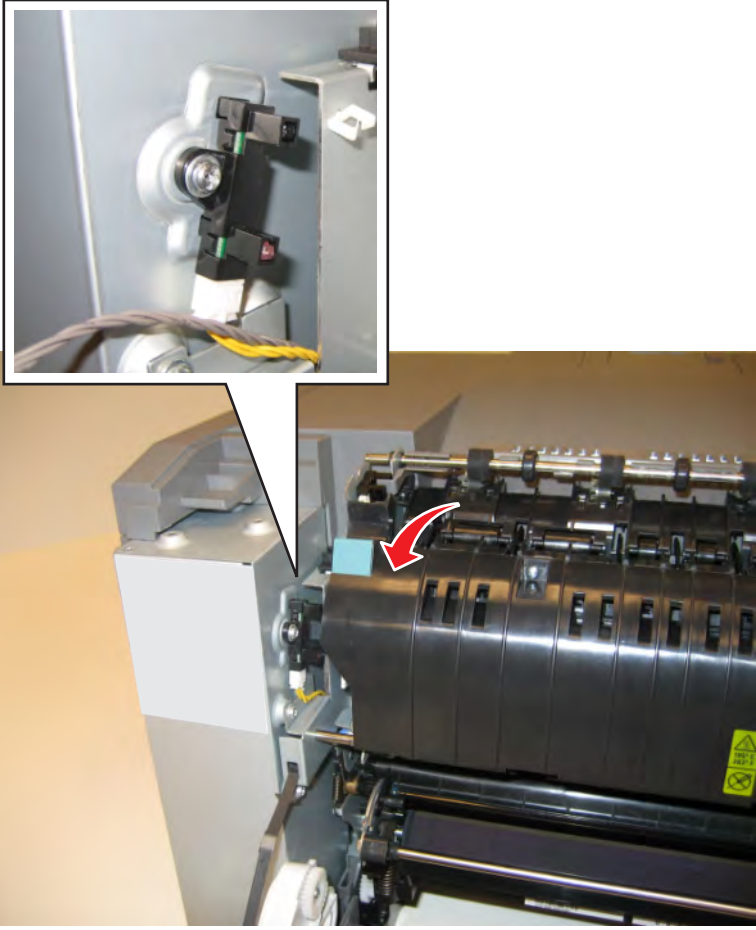
Actions	Yes	No
<p>Step 1 Open the front door to access the jam area, and then remove the jammed page or pages.</p> <p>Does this solve the problem?</p>	<p>The problem is solved.</p>	<p>Go to step 2.</p>
<p>Step 2 Open the front cover.</p>  <p>Is the sensor dislodged or damaged?</p>	<p>Replace the fuser exit sensor. See “Fuser exit sensor removal” on page 286.</p>	<p>Go to step 3.</p>

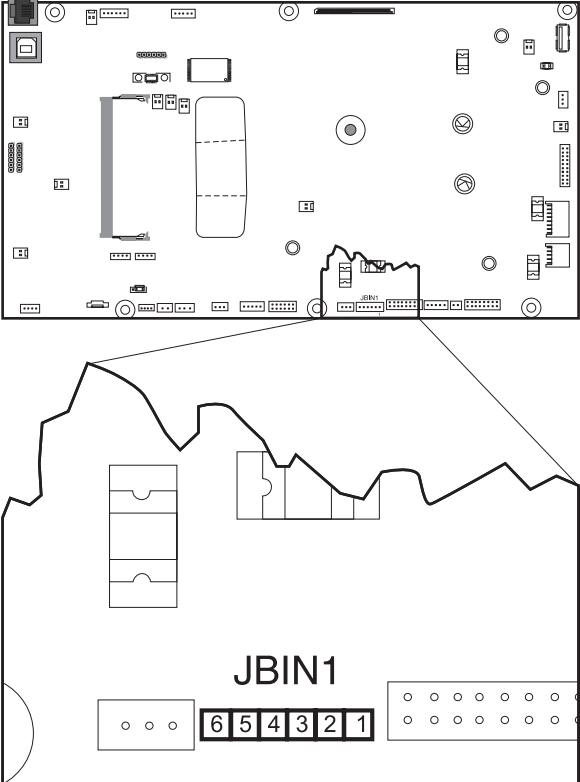
Actions	Yes	No
<p>Step 3 Enter Diagnostics Menu. Turn the printer off, press and hold 3 and 6, turn the printer on, and then release the buttons when the installed memory and processor speed displays) Perform the Base Sensor Test. See “BASE SENSOR TEST” on page 219.</p> <ul style="list-style-type: none"> a Select Base Sensor Test, and press Select. b Select Fuser Exit Sensor, and press Select. c Watch the display while rotating the flag in and out of the sensor. <p>Did the sensor go from closed to open?</p>	<p>The problem is solved.</p>	<p>Go to step 4.</p>
<p>Step 4 Turn the printer off, and then remove the rear shield. See “Rear cover removal” on page 346.</p> <p>Is the cable correctly connected to JBIN1 on the controller board and to the sensor?</p> 	<p>Go to step 5.</p>	<p>Reconnect the cable.</p>

Actions	Yes	No
<p>Step 5</p> <p>Turn the printer on, and check the values at JBIN1:</p> <ul style="list-style-type: none"> Pin 4: 0 V dc (+5 V dc during cycle) Pin 5: +0 V dc (unblocked), +3.3 V dc (blocked) Pin 6: Ground <p>Are the values correct?</p>	<p>Replace the fuser exit sensor. See “Fuser exit sensor removal” on page 286.</p>	<p>Replace the controller board. See “Controller board removal” on page 348.</p>

203 paper jams

[x]-page jam, clear standard bin [203.xx]

- 1 Open the top door.



- 2 Firmly grasp the jammed paper on each side, and then gently pull it out.

Note: Make sure all paper fragments are removed.



3 Open the front door.

 **CAUTION—HOT SURFACE:** The inside of the printer might be hot. To reduce the risk of injury from a hot component, allow the surface to cool before touching.

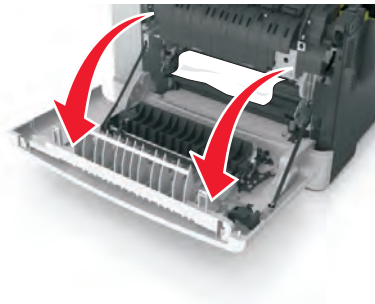

- a** If there is a jammed paper under the fuser, then firmly grasp the paper on each side, and then gently pull it out.

Note: Make sure all paper fragments are removed.

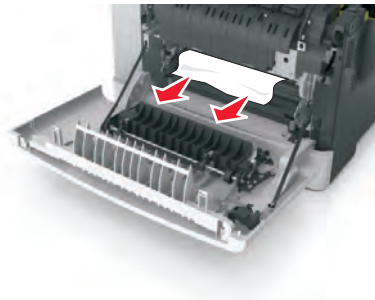

- b** Pull the green lever to open the fuser cover.

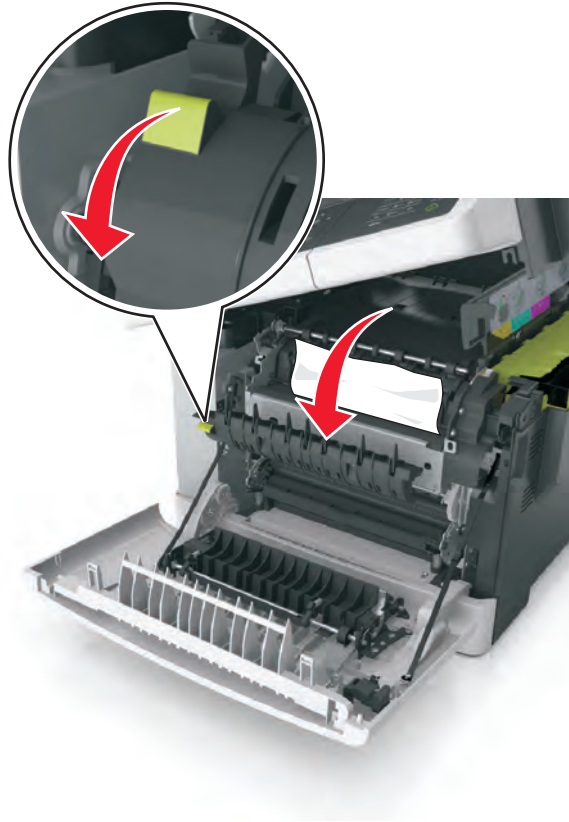

- c** If there is a jammed paper in the fuser, then hold down the fuser cover, and then remove the paper.

Note: Make sure all paper fragments are removed.



- 4 Slide and hold the release latch on the right side of the printer, and then slowly close the top door.



- 5 Close the front door.



- 6 From the printer control panel, touch **Done** to clear the message and continue printing.

23y paper jams

[x]-page jam, open front door to clear duplex [23y.xx]

- 1 Open the front door.

 **CAUTION—HOT SURFACE:** The inside of the printer might be hot. To reduce the risk of injury from a hot component, allow the surface to cool before touching.

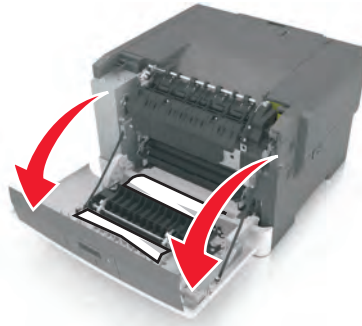

2 Firmly grasp the jammed paper on each side, and then gently pull it out.

Note: Make sure all paper fragments are removed.

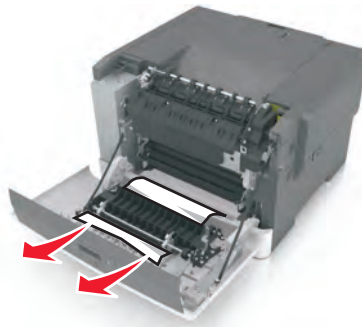

3 Close the front door.

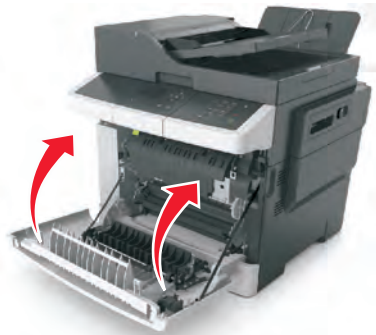

4 From the printer control panel, touch **Done** to clear the message and continue printing.

23y paper jam messages

Error code	Description	Action
230.xx	A single page of media is jammed at the inner door. Multiple pages of media are jammed at the inner door.	Go to “230.xx Duplex/manual feed sensor (S1) service check” on page 77.
230.01	The duplex (S1) sensor is obstructed.	Go to “230.xx Duplex/manual feed sensor (S1) service check” on page 77.
230.02	The duplex (S1) sensor was made early.	Go to “230.xx Duplex/manual feed sensor (S1) service check” on page 77.
230.03	The duplex (S1) sensor did not make.	Go to “230.xx Duplex/manual feed sensor (S1) service check” on page 77.
230.06	No media in duplexer.	Go to “200.xx Input (S2) sensor service check” on page 62.
232.02	The input (S2) sensor was made early while duplexing.	Go to “200.xx Input (S2) sensor service check” on page 62.
232.03	The input (S2) sensor did not make while duplexing.	Go to “200.xx Input (S2) sensor service check” on page 62.
232.05	The input (S2) sensor did not break while duplexing.	Go to “200.xx Input (S2) sensor service check” on page 62.

230.xx Duplex/manual feed sensor (S1) service check

Actions	Yes	No
<p>Step 1</p> <p>Open the front door to access the jam area, and then remove the jammed page or pages.</p> <p>Does this solve the problem?</p>	The problem is solved.	Go to step 2.
<p>Step 2</p> <p>Is the printer setting on a hard, flat surface?</p>	Go to step 3.	Make sure the printer is setting on a level, flat surface
<p>Step 3</p> <p>Enter Diagnostics Menu.</p> <p>Turn the printer off, press and hold 3 and 6, turn the printer on, and then release the buttons when the installed memory and processor speed displays).</p> <p>Perform the Base Sensor Test. See “BASE SENSOR TEST” on page 219.</p> <p>a Select Base Sensor Test, and press Select.</p> <p>b Select S1, and press Select.</p> <p>c Install tray 1.</p> <p>Does the display indicate InputS1-Media Clear...?</p>	Go to step 4.	Go to step 5.

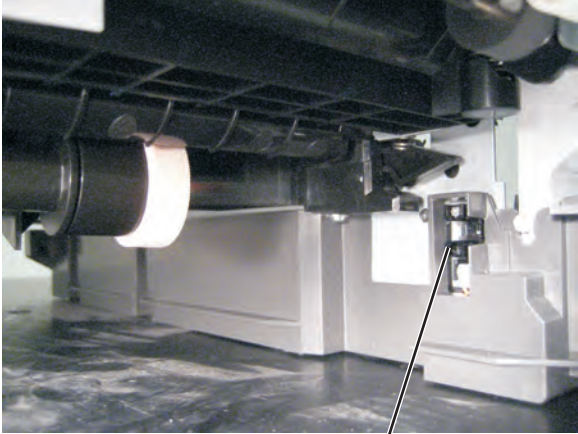
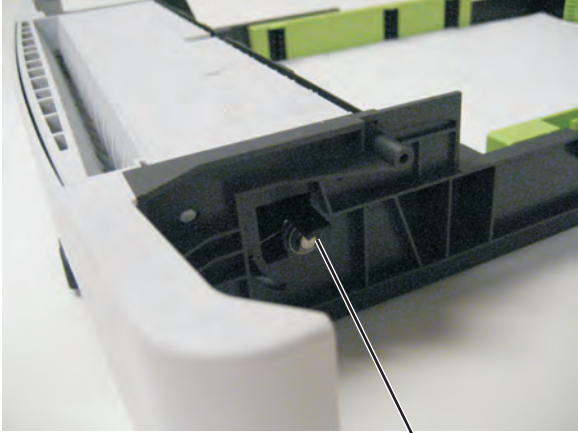
Actions	Yes	No
<p>Step 4 Pull tray 1 out.</p> <p>Does the display indicate InputS1-Media Present...?</p>	<p>The sensor is functioning correctly.</p>	<p>Go to step 5.</p>
<p>Step 5 Remove the tray, and inspect the sensor (A).</p>  <p style="text-align: center;">A</p> <p>Is there something obstructing the sensor?</p>	<p>Remove the obstruction, and restart the test.</p>	<p>Go to step 6.</p>
<p>Step 6 Inspect the spring-loaded shaft/flag (B) in the tray.</p>  <p style="text-align: center;">B</p> <p>The flag portion of the shaft intercepts the sensor, except when a sheet is being staged for duplexing.</p> <p>Does the shaft rotate freely and return to home position (flag at top of rotation?)</p>	<p>Go to step 7.</p>	<p>Replace the tray with a new one.</p>
<p>Step 7 is the flag on the shaft broken?</p>	<p>Replace the tray.</p>	<p>Go to step 8.</p>

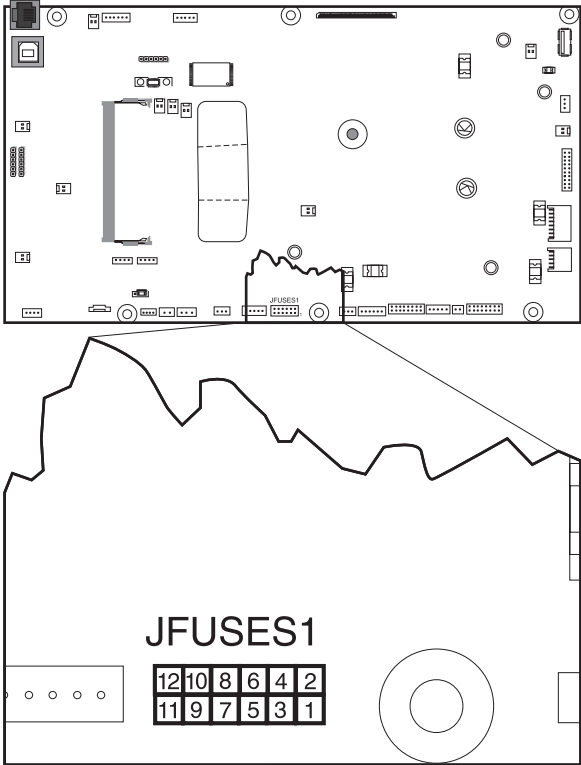
Actions	Yes	No
<p>Step 8</p> <p>Turn the printer off, and remove the rear shield. See “Rear cover removal” on page 346.</p> <p>Verify the cable is correctly connected to JFUSES1 on the controller board and to the sensor.</p>  <p>Is the sensor cable properly connected?</p>	<p>Go to step 9.</p>	<p>Reconnect the cable. If the problem persists, then go to step 8.</p>
<p>Step 9</p> <p>Turn the printer on, and check the values at JFUSES1:</p> <ul style="list-style-type: none"> Pin 8: Ground Pin 9: +3.3 V dc <p>Are the values approximately correct?</p>	<p>Replace the duplex sensor. See “Duplex sensor removal” on page 338.</p>	<p>Replace the controller board. See “Controller board removal” on page 348.</p>

24y paper jams

[x]-page jam, open tray [x] [24y.xx]

- 1 Pull out the tray completely.

Note: The message on the printer display determines in which tray the paper jam is located.



2 Firmly grasp the jammed paper on each side, and then gently pull it out.

Note: Make sure all paper fragments are removed.



3 Insert the tray.

4 From the printer control panel, touch **Done** to clear the message and continue printing.

24y paper jam messages

Error code	Description	Action
242.xx	A single or multiple page media jam in the 650-sheet Duo Drawer (tray 2). Multiple pages of media are jammed in the 650-sheet Duo Drawer (tray 2).	Go to “200.xx Input (S2) sensor service check” on page 62.
243.xx	A single or multiple page media jam in the 650-sheet Duo Drawer (tray 2). Multiple pages of media are jammed in the 650-sheet Duo Drawer (tray 2).	Go to “200.xx Input (S2) sensor service check” on page 62.
244.xx	A single or multiple page media jam in the 650-sheet Duo Drawer (tray 2). Multiple pages of media are jammed in the 650-sheet Duo Drawer (tray 2).	Go to “200.xx Input (S2) sensor service check” on page 62.

25y paper jams

[x]-page jam, clear multipurpose feeder [250.xx]

1 Push the paper release lever in the multipurpose feeder to access the jammed paper, and then gently pull out the paper.

Note: Make sure all paper fragments are removed.

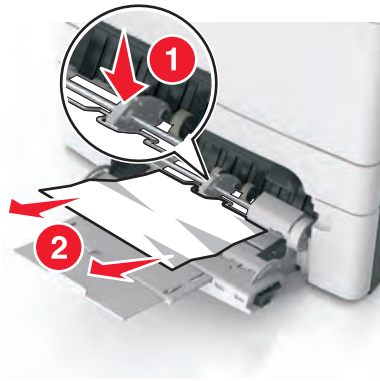

- 2** Flex the sheets of paper back and forth to loosen them, and then fan them. Do not fold or crease the paper. Straighten the edges on a level surface.

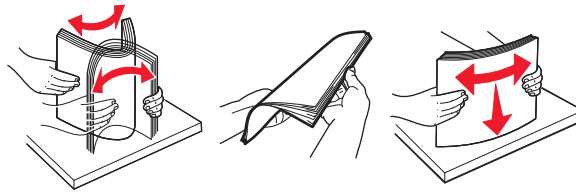

- 3** Reload paper into the multipurpose feeder.



- 4 Slide the paper guide until it lightly rests against the edge of the paper stack.

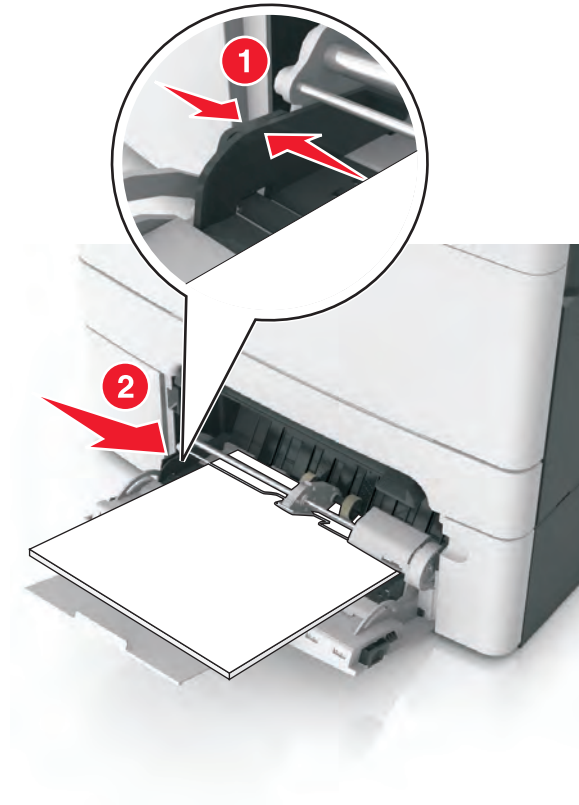

- 5 From the printer control panel, touch **Done** to clear the message and continue printing.

[x]-page jam, clear manual feeder [251.xx]

- 1 Pull out the standard 250-sheet tray (Tray 1) and manual feeder.

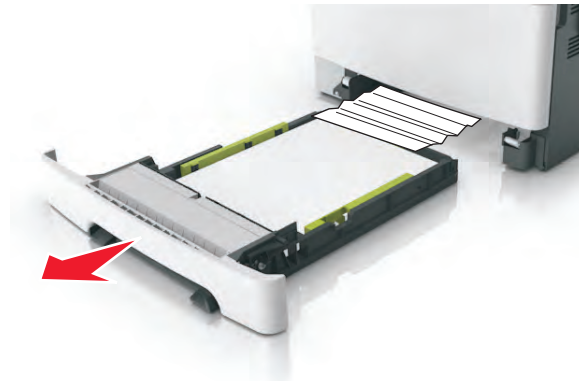

- 2 Firmly grasp the jammed paper on each side, and then gently pull it out.

Note: Make sure all paper fragments are removed.

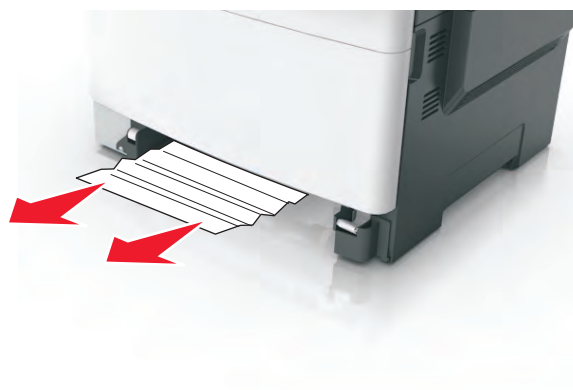

3 Insert the tray.

4 From the printer control panel, touch **Done** to clear the message and continue printing.

25y paper jam messages

Error code	Description	Action
250.xx	A single page of media is jammed in the multipurpose feeder.	Go to “200.xx Input (S2) sensor service check” on page 62.

28y paper jams

[x]-page jam, open automatic feeder top cover [28y.xx]

1 Remove all original documents from the ADF tray.

Note: The message is cleared when the pages are removed from the ADF tray.

2 Open the ADF cover.

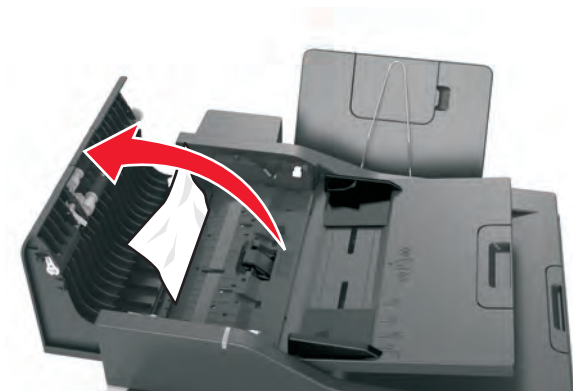

3 Firmly grasp the jammed paper on each side, and then gently pull it out.

Note: Make sure all paper fragments are removed.

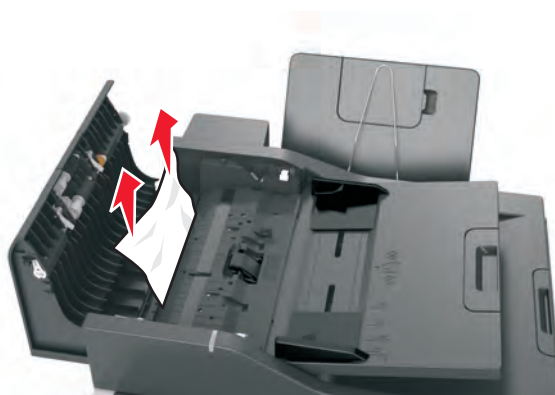

- 4 Close the ADF cover.
- 5 Straighten the edges of the original documents, then load the documents into the ADF, and then adjust the paper guide.
- 6 From the printer control panel, touch **Done** to clear the message and continue printing.

28y paper jam messages

Error code	Description	Action
280.06	Paper Missing—Posted when paper is removed from input tray after job is initiated.	Go to “ADF paper jam service check” on page 85.
282.01	ADF Static Jam—Interval Sensor active at POR time.	Go to “ADF paper jam service check” on page 85.
282.03	ADF Pickup Jam—LE of paper does not reach Interval Sensor in time.	Go to “ADF paper jam service check” on page 85.
282.05	ADF Long Page—TE never clears interval sensor (but 1st Scan Sensor and Exit Sensor are both active).	Go to “ADF paper jam service check” on page 85.
283.01	ADF Static Jam—1st Scan Sensor active at POR time.	Go to “ADF paper jam service check” on page 85.
283.03	ADF Feed Jam—LE of paper does not reach 1st Scan Sensor in time.	Go to “ADF paper jam service check” on page 85.
283.05	1st Scan Sensor Jam—TE never clears 1st Scan Sensor.	Go to “ADF paper jam service check” on page 85.
286.02	ADF Backfeed—Page(s) in the exit area accidentally gets pulled into the reverse path.	Too many sheets of paper in the ADF exit bin. Remove the sheets from the ADF exit bin.
286.03	ADF Backside Feed Jam—LE does not reach the multipurpose Interval Sensor in time when page routed through reverse area.	Go to “ADF paper jam service check” on page 85.

Error code	Description	Action
286.05	ADF Backside Jam—TE does not reach the multipurpose Interval Sensor in time when page routed through reverse area.	Go to “ADF paper jam service check” on page 85.

ADF paper jam service check

Notes:

- Before performing this check, update the scanner firmware. For more information on the correct firmware version, contact the next level of support.
- This service check should be used if the paper feeds and jams in the ADF. If the paper is not feeding into the ADF, then see [“ADF feed errors service check” on page 143.](#)

Actions	Yes	No
Step 1 Check the paper for damage such as wrinkles, moisture or tears. Is the paper damaged?	Go to step 2.	Go to step 3.
Step 2 Send a scan job using an undamaged paper. Does the problem remain?	Go to step 3.	The problem is solved.
Step 3 Run another scan job. Is the paper skewing when it is fed into the ADF?	Go to step 4.	Go to step 5.
Step 4 a Check the ADF guides for proper adjustment. b Check if the ADF top cover is properly closed. c Run a scan job. Does the problem remain?	Go to step 5.	The problem is solved.
Step 5 Check the ADF rollers for dirt, debris, contamination or wear. Are the rollers contaminated or worn?	Go to step 6.	Go to step 7.
Step 6 Replace the separator roller and ADF top cover. Does the problem remain?	Go to step 7.	The problem is solved.

Actions	Yes	No
<p>Step 7 Check the paper path for paper fragments and debris.</p> <p>Is the paper path free from obstructions?</p>	Go to step 9.	Go to step 8.
<p>Step 8 Clear the paper path of debris or obstructions.</p> <p>Does the problem remain?</p>	Go to step 9.	The problem is solved.
<p>Step 9 Perform the motor (ADF pick and ADF feed) tests. See “Motor tests” on page 228.</p> <p>Are the motors working properly?</p>	Go to step 10.	Go to step 16.
<p>Step 10 Perform the sensor (ADF paper present and ADF scan) tests. See “Sensor tests” on page 229.</p> <p>Are the sensors properly functioning?</p>	Go to step 11.	Go to step 12.
<p>Step 11 Perform the sensor (ADF interval) tests. See “Sensor tests” on page 229.</p> <p>Are the sensors properly functioning?</p>	Go to step 14.	Go to step 12.
<p>Step 12 Inspect all the sensors for debris or dust.</p> <p>Is there dirt or debris in the sensors?</p>	Go to step 13.	Go to step 14.
<p>Step 13 Clean the sensors.</p> <p>Does the problem remain?</p>	Go to step 14.	The problem is solved.
<p>Step 14 Check the ADF mechanism sensor actuators for damage.</p> <p>Are the actuators jammed or damaged?</p>	Go to step 15.	Go to step 16.
<p>Step 15 Replace the ADF assembly. See “ADF assembly removal” on page 367.</p> <p>Does the problem remain?</p>	Contact your next level of support.	The problem is solved.

Actions	Yes	No
<p>Step 16</p> <p>a Reconnect the ADF cable to the controller board.</p> <p>b If applicable, reconnect the ADF cable to the ADF relay card.</p> <p>Does the problem remain?</p>	Go to step 17.	The problem is solved.
<p>Step 17</p> <p>If there is a separate ADF cable, then check it for continuity. Replace the cable if there is no continuity.</p> <p>Does the problem remain?</p>	Go to step 18.	The problem is solved.
<p>Step 18</p> <p>Check for signals or voltages from JADF1 on the controller board. Pins 14 and 16 should measure +24VDC. Pins 15 and 22 should measure +3.3VDC.</p> <p>Are the signals or voltages present?</p>	Replace the ADF assembly. See “ADF assembly removal” on page 367.	Replace the controller board. See “Controller board removal” on page 348.

29y paper jams

29y paper jam messages

Error code	Description	Action
290.11	ADF Cover Open Jam—Posted when ADF top cover is opened during ADF job.	Go to “ADF cover open service check” on page 87.

ADF cover open service check

Actions	Yes	No
<p>Step 1</p> <p>Is the ADF cover properly closed?</p>	Go to step 3.	Go to step 2.
<p>Step 2</p> <p>Close the ADF cover.</p> <p>Does the problem go away?</p>	Issue resolved.	Go to step 3.
<p>Step 3</p> <p>Perform the ADF cover open sensor test. See “Scanner tests” on page 228.</p> <p>Does the sensor work properly?</p>	Go to step 4	Go to step 8.

Actions	Yes	No
<p>Step 4 On the bottom of the ADF cover, inspect the ADF cover closed sensor actuator.</p> <p>Does it move freely?</p>	Go to step 6.	Go to step 5.
<p>Step 5 Fix the actuator so it moves freely.</p> <p>Does this fix the problem?</p>	Issue resolved.	Go to step 6.
<p>Step 6 Remove the ADF rear cover and inspect the ADF cover closed sensor for dirt and debris.</p> <p>Is there dirt and debris present?</p>	Go to step 7.	Go to step 8.
<p>Step 7 Clean the dirt and debris from the sensor.</p> <p>Does this fix the issue?</p>	Issue resolved.	Go to step 8.
<p>Step 8 Inspect the connections on the ADF relay card in the ADF.</p> <p>Are all the connections properly connected?</p>	Go to step 9.	Secure all the connections.
<p>Step 9 Check the ADF cable for continuity.</p> <p>Is there continuity?</p>	Go to step 10.	Replace the ADF cable.
<p>Step 10 Check for signals or voltages from JADF1 on the controller board. Pin 11 and 12 should measure +24VDC. Pin 5 should measure +14VDC.</p> <p>Are there signals or voltages present?</p>	Replace the ADF. See “ADF assembly removal” on page 367.	Replace the controller board. See “Controller board removal” on page 348.

Understanding the printer messages

Message	Action
Adjusting color	Wait for the process to complete.
Change [paper source] to [custom type name]	Try one or more of the following: <ul style="list-style-type: none"> Load the correct size and type of paper in the tray, and then select Finished changing paper on the printer control panel to clear the message and continue printing. For non-touch-screen models, press OK to confirm. Note: Make sure the paper size and type are specified in the Paper menu on the printer control panel. Cancel the job.
Change [paper source] to [custom string]	
Change [paper source] to [paper type] [paper size]	
Close door	Make sure the right side cover is installed, and then close the front and top doors to clear the message.
Close flatbed cover and load originals if restarting job [2yy.xx]	Try one or more of the following: <ul style="list-style-type: none"> Touch Scan from automatic feeder to continue scanning from the ADF immediately after the last successful scan job. Touch Scan from flatbed to continue scanning from the scanner glass immediately after the last successful scan job. Touch Finish job without further scanning to end the last successful scan job. Note: This does not cancel the scan job. All successfully scanned pages will be processed further for copying, faxing, or e-mailing. Touch Cancel job to clear the message and cancel the scan job.
[Color] cartridge low [88.xy]	You may need to order a toner cartridge. If necessary, select Continue to clear the message and continue printing. For non-touch-screen models, press OK to confirm.
[Color] cartridge nearly low [88.xy]	If necessary, select Continue to clear the message and continue printing. For non-touch-screen models, press OK to confirm.
[Color] cartridge very low [88.xy]	You may need to replace the toner cartridge very soon. If necessary, select Continue to clear the message and continue printing. For non-touch-screen models, press OK to confirm.
Black and color imaging kit low [84.xy]	You may need to order an imaging kit. If necessary, select Continue to clear the message and continue printing. For non-touch-screen models, press OK to confirm.
Black and color imaging kit nearly low [84.xy]	If necessary, select Continue to clear the message and continue printing. For non-touch-screen models, press OK to confirm.

Message	Action
Black and color imaging kit very low [84.xy]	You may need to replace the imaging kit very soon. If necessary, select Continue to clear the message and continue printing. For non-touch-screen models, press OK to confirm.
Complex page, some data may not have printed [39]	Try one or more of the following: <ul style="list-style-type: none"> • From the printer control panel, select Continue to ignore the message and continue printing. For non-touch-screen models, press OK to confirm. • Cancel the current job. For non-touch-screen models, press OK to confirm. • Install additional printer memory.
Configuration change, some held jobs were not restored [57]	Held jobs are invalidated because of any of the following possible changes in the printer: <ul style="list-style-type: none"> • The printer firmware has been updated. • The tray for the print job is removed. • The print job is sent from a flash drive that is no longer attached to the USB port. • The printer hard disk contains print jobs that were stored when the hard disk was installed in a different printer model. From the printer control panel, select Continue to clear the message. For non-touch-screen models, press OK to confirm.
Defective flash detected [51]	Try one or more of the following: <ul style="list-style-type: none"> • Replace the defective flash memory card. • From the printer control panel, select Continue to ignore the message and continue printing. For non-touch-screen models, press OK to confirm. • Cancel the current print job.
Disk full [62]	Try one or more of the following: <ul style="list-style-type: none"> • From the printer control panel, touch Continue to clear the message and continue processing. • Delete fonts, macros, and other data stored in the printer hard disk. • Install a printer hard disk with larger capacity.
Disk must be formatted for use in this device	From the printer control panel, touch Format disk to format the printer hard disk and clear the message. Note: Formatting deletes all the files stored in the printer hard disk.
Error reading USB drive. Remove USB.	An unsupported USB device is inserted. Remove the USB device, and then insert a supported one.
Error reading USB hub. Remove hub.	An unsupported USB hub has been inserted. Remove the USB hub, and then install a supported one.

Message	Action
Fax partition inoperative. Contact system administrator.	Try one or more of the following: <ul style="list-style-type: none"> • From the printer control panel, touch Continue to clear the message. • Turn off the printer, and then turn it back on. If the message appears again, then contact your system support person.
Fax server 'To Format' not set up. Contact system administrator.	Try one or more of the following: <ul style="list-style-type: none"> • From the printer control panel, touch Continue to clear the message. • Complete the Fax Server setup. If the message appears again, then contact your system support person.
Fax Station Name not set up. Contact system administrator.	Try either of the following: <ul style="list-style-type: none"> • From the printer control panel, touch Continue to clear the message. • Complete the Analog Fax setup. If the message appears again after completing the setup, then contact your system support person.
Fax Station Number not set up. Contact system administrator.	Try one or more of the following: <ul style="list-style-type: none"> • From the printer control panel, touch Continue to clear the message. • Complete the Analog Fax setup. If the message appears again after completing the setup, then contact your system support person.
Incompatible tray [x] [59]	Remove, and then reinstall the indicated tray to clear the message.
Incorrect paper size, open [paper source] [34]	Try one or more of the following: <ul style="list-style-type: none"> • Load the correct size of paper in the tray. • From the printer control panel, select Continue to clear the message and print using a different tray. For non-touch-screen models, press OK to confirm. • Check the tray length and width guides and make sure the paper is loaded properly in the tray. • Make sure the correct paper size and type are specified in the Printing Preferences or in the Print dialog. • Make sure the paper size and type are specified in the Paper menu on the printer control panel. • Make sure that the paper size is correctly set. For example, if MP Feeder Size is set to Universal, then make sure the paper is large enough for the data being printed. • Cancel the print job.
Insert Tray [x]	Insert the indicated tray into the printer.

Message	Action
Insufficient memory for Flash Memory Defragment operation [37]	Try one or more of the following: <ul style="list-style-type: none"> From the printer control panel, select Continue to stop the defragmentation and continue printing. For non-touch-screen models, press OK to confirm.
Insufficient memory, some Held Jobs were deleted [37]	The printer deleted some held job to process current job. Select Continue to clear the message. For non-touch-screen models, press OK to confirm.
Insufficient memory to collate job [37]	Try one or more of the following: <ul style="list-style-type: none"> From the printer control panel, select Continue to print the part of the job already stored and begin collating the rest of the print job. For non-touch-screen models, press OK to confirm. Cancel the current print job.
Insufficient memory to support Resource Save feature [35]	Install additional printer memory or select Continue on the printer control panel to disable Resource Save, clear the message, and continue printing. For non-touch-screen printer models, press OK to confirm.
Insufficient memory, some held jobs will not be restored [37]	Try one or more of the following: <ul style="list-style-type: none"> From the printer control panel, select Continue to clear the message. For non-touch-screen printer models, press OK to confirm. Delete other held jobs to free up additional printer memory.
Load [paper source] with [custom type name]	Try one or more of the following: <ul style="list-style-type: none"> Load the tray or feeder with the correct size and type of paper. To use the tray with the correct paper size or type, select Finished loading paper on the printer control panel. For non-touch-screen printer models, press OK to confirm. <p>Note: If the printer detects a tray that has the correct paper type and size, then it feeds from that tray. If the printer cannot detect a tray that has the correct paper type and size, then it prints from the default paper source.</p> <ul style="list-style-type: none"> Cancel the current job.
Load [paper source] with [custom string]	
Load [paper source] with [paper size]	
Load [paper source] with [paper type] [paper size]	
Load Manual Feeder with [custom string]	Try one or more of the following: <ul style="list-style-type: none"> Load the feeder with the correct size and type of paper. Depending on your printer model, touch Prompt each page, paper loaded or press OK on the printer control panel to clear the message and continue printing. Cancel the current job.
Load Manual Feeder with [custom type name]	
Load Manual Feeder with [paper size]	
Load Manual Feeder with [paper type] [paper size]	

Message	Action
Maintenance kit low [80.xy]	You may need to order a maintenance kit. For more information, contact customer support at http://support.lexmark.com or your service representative. If necessary, select Continue to clear the message and continue printing. For non-touch-screen printer models, press OK to confirm.
Maintenance kit nearly low [80.xy]	For more information, contact customer support at http://support.lexmark.com or your service representative. If necessary, select Continue to clear the message and continue printing. For non-touch-screen printer models, press OK to confirm.
Maintenance kit very low [80.xy]	You may need to replace the maintenance kit very soon. For more information, contact customer support at http://support.lexmark.com or your service representative. If necessary, select Continue to clear the message and continue printing. For non-touch-screen printer models, press OK to confirm.
Memory full [38]	Try one or more of the following: <ul style="list-style-type: none"> • From the printer control panel, select Cancel job to clear the message. For non-touch-screen printer models, press OK to confirm. • Turn off the printer, wait for about 10 seconds, and then turn the printer back on. • Update the network firmware in the printer or print server. For more information, contact customer support.
Memory full, cannot print faxes	From the printer control panel, touch Continue to clear the message without printing. Held faxes attempt to print after the printer is restarted.
Memory full, cannot send faxes	<ol style="list-style-type: none"> 1 From the printer control panel, touch Continue to clear the message and cancel the fax job. 2 Try one or more of the following: <ul style="list-style-type: none"> • Reduce the fax resolution, and then resend the fax job. • Reduce the number of pages in the fax, and then resend the fax job.
Network [x] software error [54]	Try one or more of the following: <ul style="list-style-type: none"> • From the printer control panel, touch Continue to continue printing. • Turn off the printer, wait for about 10 seconds, and then turn the printer back on. • Update the network firmware in the printer or print server. For more information, visit the Lexmark support Web site at http://support.lexmark.com.
No analog phone line connected to modem, fax is disabled.	Connect the printer to an analog phone line.

Message	Action
<p>Not enough free space in flash memory for resources [52]</p>	<p>Try one or more of the following:</p> <ul style="list-style-type: none"> • From the printer control panel, select Cancel job to clear the message. For non-touch-screen printer models, press OK to confirm. • Delete fonts, macros, and other data stored in the flash memory. • Upgrade to a larger capacity flash memory card. <p>Note: Downloaded fonts and macros that are not previously stored in the flash memory are deleted.</p>
<p>Non-Lexmark [color] [supply type], see User's Guide [33.xy]</p> <p>33.01 Non-Lexmark black cartridge</p> <p>33.02 Non-Lexmark black and color imaging kit</p> <p>33.11 Non-Lexmark cyan cartridge</p> <p>33.21 Non-Lexmark magenta cartridge</p> <p>33.31 Non-Lexmark yellow cartridge</p>	<p>Note: The supply type can be toner cartridge or the imaging kit.</p> <p>The printer has detected a non-Lexmark supply or part installed in the printer.</p> <p>Your Lexmark printer is designed to function best with genuine Lexmark supplies and parts. Use of third-party supplies or parts may affect the performance, reliability, or life of the printer and its imaging components.</p> <p>All life indicators are designed to function with Lexmark supplies and parts, and may deliver unpredictable results if third-party supplies or parts are used. Imaging component usage beyond the intended life may damage your Lexmark printer or its associated components.</p> <p>Warning—Potential Damage: Use of third-party supplies or parts can affect warranty coverage. Damage caused by the use of third-party supplies or parts may not be covered by warranty. To accept any and all of these risks, and to proceed with the use of non-genuine supplies or parts in your printer, press and hold Cancel and # on the printer control panel simultaneously for 15 seconds. For non-touch-screen printer models, press OK and Cancel simultaneously for 15 seconds to clear the message and continue printing. If you do not wish to accept these risks, then remove the third-party supply or part from your printer, and then install a genuine Lexmark supply or part.</p> <p>Note: For the list of supported supplies, see the "Ordering supplies" section of the User's Guide or go to http://support.lexmark.com.</p>

Message	Action
PPDS font error [50]	<p>Try one or more of the following:</p> <ul style="list-style-type: none"> From the printer control panel, select Continue to clear the message and continue printing. For non-touch-screen printer models, press OK to confirm. If the printer cannot find the requested font, then from the printer control panel, navigate to: PPDS menu > Best Fit > On The printer will find a similar font and reformat the affected text. Cancel the job.
Printer had to restart. Last job may be incomplete.	<p>From the printer control panel, touch Continue to clear the message and continue printing.</p> <p>For more information, go to http://support.lexmark.com or contact customer support.</p>
Reinstall missing or unresponsive [color] cartridge [31.xy]	<p>Try one or more of the following:</p> <ul style="list-style-type: none"> Install the missing toner cartridge. For more information, see the "Replacing supplies" section of the <i>User's Guide</i>. Remove the unresponsive cartridge, and then reinstall it. <p>Note: If the message appears after reinstalling the supply, then the cartridge may be defective. Replace the cartridge.</p>
Reinstall missing or unresponsive black and color imaging kit [31.xy]	<p>Try one or more of the following:</p> <ul style="list-style-type: none"> Install the missing imaging kit. For more information, see the "Replacing supplies" section of the <i>User's Guide</i>. Remove the unresponsive imaging kit, and then reinstall it. <p>Note: If the message appears after reinstalling the supply, then the imaging kit may be defective. Replace the imaging kit.</p>
Reload printed pages in Tray [x]	<p>Try one or more of the following:</p> <ul style="list-style-type: none"> From the printer control panel, select Continue to clear the message and continue printing the second side of the sheet. For non-touch-screen printer models, press OK to confirm.
Remove defective disk [61]	<p>Remove and replace the defective printer hard disk.</p> <p>Note: To replace the printer hard disk, contact customer support at http://support.lexmark.com or your service representative.</p>

Message	Action
Remove packaging material, [area name]	<ol style="list-style-type: none"> 1 Remove any remaining packing material from the indicated location. 2 From the printer control panel, touch Continue to clear the message. For non-touch-screen printer models, press OK to confirm.
Remove paper from standard output bin	Remove the paper stack from the standard bin.
Replace all originals if restarting job.	<p>Try one or more of the following:</p> <ul style="list-style-type: none"> • Touch Cancel job to clear the message and cancel the scan job. • Touch Scan from automatic feeder to continue scanning from the ADF immediately after the last successful scan job. • Touch Scan from flatbed to continue scanning from the scanner immediately after the last successful scan job. • Touch Finish job without further scanning to end the last successful scan job. • Touch Restart job to restart the scan job with the same settings from the previous scan job.
Replace [color] cartridge, 0 estimated pages remain [88.xy]	<p>Replace the indicated toner cartridge to clear the message and continue printing. For more information, see the instruction sheet that came with the supply.</p> <p>Note: If you do not have a replacement cartridge, then see the “Ordering supplies” section of the <i>User’s Guide</i> or visit http://support.lexmark.com.</p>
Replace [color] cartridge, printer region mismatch [42.xy]	<p>Install a toner cartridge that matches the region number of the printer. <i>x</i> indicates the value of the printer region. <i>y</i> indicates the value of the cartridge region. <i>x</i> and <i>y</i> can have the following values:</p> <ul style="list-style-type: none"> • 0: Global • 1: United States, Canada • 2: European Union (EU), European Economic Area (EEA), Switzerland • 8: Rest of the world • 9: Invalid <p>Notes:</p> <ul style="list-style-type: none"> • The <i>x</i> and <i>y</i> values are the .xy of the error code shown on the printer control panel. • The <i>x</i> and <i>y</i> values must match for printing to continue.

Message	Action
Replace [type] imaging kit, 0 estimated pages remain [84.xy]	<p>Replace the indicated imaging kit to clear the message and continue printing. For more information, see the instruction sheet that came with the supply.</p> <p>Note: If you do not have a replacement imaging kit, then see the "Ordering supplies" section of the <i>User's Guide</i> or go to http://support.lexmark.com.</p>
Replace defective [color] cartridge [31.xy]	<p>Replace the defective toner cartridge to clear the message. For more information, see the instruction sheet that came with the supply.</p> <p>Note: If you do not have a replacement toner cartridge, then see the "Ordering supplies" section of the <i>User's Guide</i> or go to http://support.lexmark.com.</p>
Replace defective black and color imaging kit [31.xy]	<p>Replace the defective imaging kit to clear the message and continue printing. For more information, see the instruction sheet that came with the supply.</p> <p>Note: If you do not have a replacement imaging kit, then see the "Ordering supplies" section of the <i>User's Guide</i> or go to http://support.lexmark.com.</p>
Replace jammed originals if restarting job.	<p>Try one or more of the following:</p> <ul style="list-style-type: none"> • Touch Cancel job to clear the message and cancel the scan job. • Touch Scan from automatic feeder to continue scanning from the ADF immediately after the last successful scan job. • Touch Scan from flatbed to continue scanning from the scanner immediately after the last successful scan job. • Touch Finish job without further scanning to end the last successful scan job. • Touch Restart job to restart the scan job with the same settings from the previous scan job.
Replace maintenance kit, 0 estimated pages remain [80.xy]	<p>Contact customer support at http://support.lexmark.com or your service representative, and then report the message. The printer is scheduled for maintenance.</p>
Replace missing [color] cartridge [31.xy]	<p>Install the indicated toner cartridge to clear the message. For more information, see the "Replacing supplies" section of the <i>User's Guide</i>.</p>
Replace missing black and color imaging kit [31.xy]	<p>Install the indicated imaging kit to clear the message. For more information, see the "Replacing supplies" section of the <i>User's Guide</i>.</p>
Replace waste toner bottle [82.xy]	<p>Replace the waste toner bottle to clear the message.</p>
Replace unsupported [color] cartridge [32.xy]	<p>Remove the toner cartridge, and then install a supported one to clear the message.</p> <p>Note: If you do not have a replacement cartridge, then see the "Ordering supplies" section of the <i>User's Guide</i> or go to http://support.lexmark.com.</p>

Message	Action
Replace unsupported black and color imaging kit [32.xy]	Remove the indicated imaging kit, and then install a supported one to clear the message. Note: If you do not have a replacement imaging kit, then see the "Ordering supplies" section of the <i>User's Guide</i> or go to http://support.lexmark.com .
Replace missing waste toner bottle [82.xy]	Install the missing waste toner bottle to clear the message. For more information, see the instruction sheet that came with the supply.
Restore held jobs?	Try one or more of the following: <ul style="list-style-type: none"> • Select Restore on the printer control panel to restore all held jobs stored in the printer hard disk. For non-touch-screen printer models, press OK to confirm. • Select Do not restore if you do not want any print jobs to be restored. For non-touch-screen printer models, press OK to confirm.
Scanner automatic feeder cover open	Close the ADF cover.
Scanner disabled by admin [840.01]	Print without the scanner, or contact your system support person.
Scanner disabled. Contact system administrator if problem persists. [840.02]	Try one or more of the following: <ul style="list-style-type: none"> • Touch Continue with scanner disabled to return to the home screen, and then contact your system support person. • Touch Reboot and automatically enable scanner to cancel the job. Note: This attempts to enable the scanner.
Scanner jam, remove all originals from the scanner [2yy.xx]	Remove the jammed paper from the scanner.
Scanner jam, remove jammed originals from the scanner [2yy.xx]	Remove the jammed paper from the scanner.
SMTP server not set up. Contact system administrator.	From the printer control panel, touch Continue to clear the message. Note: If the message appears again, then contact your system support person
Some held jobs were not restored	From the printer control panel, select Continue to clear the message. For non-touch-screen printer models, press OK to confirm. Note: Held jobs that are not restored remain in the printer hard disk and are inaccessible.

Message	Action
Standard network software error [54]	<p>Try one or more of the following:</p> <ul style="list-style-type: none"> • From the printer control panel, select Continue to continue printing. For non-touch-screen printer models, press OK to confirm. • Turn off the printer and then turn it back on. • Update the network firmware in the printer or print server. For more information, contact customer support.
Standard USB port disabled [56]	<p>From the printer control panel, select Continue to clear the message. For non-touch-screen printer models, press OK to confirm.</p> <p>Notes:</p> <ul style="list-style-type: none"> • The printer discards any data received through the USB port. • Make sure the USB Buffer menu is not set to Disabled.
Supply needed to complete job	<p>Try one or more of the following:</p> <ul style="list-style-type: none"> • From the printer control panel, touch Prompt for supplies to view all error messages that indicate what supplies are needed to continue processing the current job. For non-touch-screen printer models, press OK to clear the message and continue printing. <ol style="list-style-type: none"> 1 Order the missing supply immediately. 2 Install the supply. For more information, see the instruction sheet that came with the supply. • Cancel the print job, then install the missing supply, and then resent the print job.
Too many flash options installed [58]	<ol style="list-style-type: none"> 1 Turn off the printer. 2 Unplug the power cord from the electrical outlet. 3 Remove the extra trays. 4 Connect the power cord to properly grounded electrical outlet. 5 Turn the printer back on.
Too many trays attached [58]	<ol style="list-style-type: none"> 1 Turn off the printer. 2 Unplug the power cord from the electrical outlet. 3 Remove the extra trays. 4 Connect the power cord to a properly grounded electrical outlet. 5 Turn the printer back on.
[Type] imaging kit low [84.xy]	<p>Note: The type can be a black imaging kit, or a black and color imaging kit.</p> <p>You may need to replace the imaging kit. If necessary, touch Continue on the printer control panel to clear the message and continue printing.</p>

Message	Action
[Type] imaging kit nearly low [84.xy]	<p>Note: The type can be a black imaging kit, or a black and color imaging kit.</p> <p>If necessary, touch Continue on the printer control panel to clear the message and continue printing.</p>
[Type] imaging kit very low, [x] estimated pages remain [84.xy]	<p>Note: The type can be a black imaging kit, or a black and color imaging kit.</p> <p>You may need to replace the imaging kit very soon. For more information, see the “Replacing supplies” section of the <i>User’s Guide</i>.</p> <p>If necessary, touch Continue on the printer control panel to clear the message and continue printing.</p>
Unformatted flash detected [53]	<p>Try one or more of the following:</p> <ul style="list-style-type: none"> • From the printer control panel, select Continue to continue printing. For non-touch-screen printer models, press OK to confirm. • Format the flash memory. <p>Note: If the error message remains, then the flash memory may be defective and need to be replaced.</p>
Waste toner bottle nearly full [82.xy]	<p>You may need to order a waste toner bottle. If necessary, select Continue on the printer control panel to clear the message and continue printing. For non-touch-screen printer models, press OK to confirm.</p>
Weblink server not set up. Contact system administrator.	<p>An error occurred on the SMTP server, or the SMTP server is not configured properly.</p> <p>From the printer control panel, touch Continue to clear the message.</p> <p>Note: If the message appears again, then contact your system support person.</p>

Printer hardware errors

110 errors

110 error messages

Error code	Description	Action
110.xx	The printhead <color> error.	Go to “Printhead service check” on page 102.
110.01	The printhead <color> lost HSYNC	
110.02	The printhead <color> failed to complete servo.	
110.03	The printhead <color> mirror motors lost motor lock.	
110.04	The printhead <color> mirror motors lost motor lock.	
110.05	Failure reading NVRAM from printhead	
110.06	The printhead <color> thermistor is open.	
110.07	The printhead <color> thermistor is shorted.	
110.08	The printhead <color> laser showed bad in testing.	
110.09	The printhead <color> SOS EOS measurement did not complete.	
110.10	The printhead <color> has bad SOS EOS measurement.	
110.11	Failure writing data to the printhead.	
110.12	Failure reading data from the printhead.	
110.13	Printhead declared error.	

Printhead service check

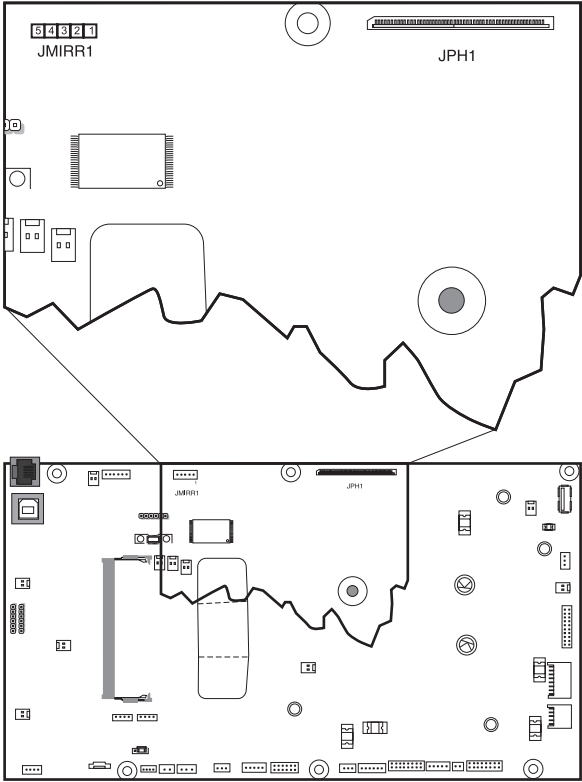
Actions	Yes	No
<p>Step 1 POR the printer.</p> <p>Does this solve the problem?</p>	<p>The problem is solved.</p>	<p>Go to step 2.</p>
<p>Step 2 Turn the printer off, and then remove the rear cover. See “Rear cover removal” on page 346.</p> <p>Check the cables at JMIRR1 and JPH1 on the controller board for proper connection, the printhead cable for pinch points, and the cable or connector for any other damage.</p> <p>Is the cable damaged?</p> 	<p>Replace the printhead. See “Printhead removal” on page 365.</p>	<p>Go to step 3.</p>
<p>Step 3 Turn the printer on, and then wait until the printer posts an error. Using a voltmeter, check the following values at JMIRR1:</p> <ul style="list-style-type: none"> Pin 1: +5 V dc Pin 2: +3.3 V dc Pin 3: +5 V dc Pin 4: Ground Pin 5: +24 V dc <p>Are the values approximately correct?</p>	<p>Replace the controller board. See “Controller board removal” on page 348.</p>	<p>Replace the printhead. See “Printhead removal” on page 365.</p>

121 errors

121 error messages

Error code	Description	Action
121.xx	Fuser error	Go to “Fuser service check” on page 105.
121.01	Attempting to print with estimated power at or below minimum power.	
121.02	Fuser is over temperature.	
121.03	Fuser open thermistor check failed.	
121.04	Attempting to print with estimated power at or above minimum power.	
121.05	Fuser failed to reach final temperature in time.	
121.06	Attempting to print when the estimated power is too low.	
121.07	Timed out waiting for home sensor event	
121.08	Wrong lamp bit is set in NVRAM.	
121.10	Fuser failed to warm up.	
121.11	Fuser under temperature error while in standby.	
121.12	Fuser under temperature error while printing.	
121.13	Fuser open thermistor check failed for second thermistor.	
121.14	Fuser shorted thermistor check failed for hot roll thermistor.	
121.15	Fuser shorted thermistor check failed for second thermistor.	
121.16	Estimated power is at or above the maximum power.	
121.17	Total failure to close fuser nip.	
121.26	Attempting to print with estimated power at or below minimum power.	
121.27	Fuser over temperature.	
121.28	Fuser open thermistor check failed.	

Error code	Description	Action
121.29	Attempting to print with estimated power at or above minimum power.	Go to “Fuser service check” on page 105.
121.30	Fuser failed to reach final temperature in time.	
121.31	Fuser power is below minimum.	
121.36	Fuser under temperature in standby.	
121.37	Fuser under temperature while printing.	
121.38	Fuser open thermistor.	
121.39	Fuser shorted thermistor.	
121.40	Fuser shorted thermistor.	
121.42	Fuser power above maximum.	
121.5x	Fuser is past life and has an error.	
121.6x	Fuser is past life and has an error.	
121.7x	Fuser is past life and has an error.	
121.8x	Fuser is past life and has an error.	
121.9x	Fuser is past life and has an error.	

Fuser service check

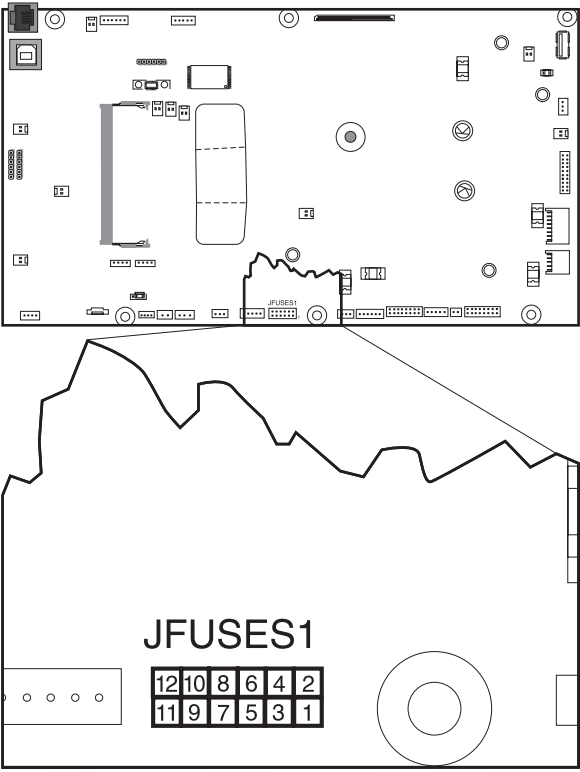
Actions	Yes	No
<p>Step 1</p> <p>Some of these errors are caused by a faulty component on the LVPS. Check the history file in the printer to verify other occurrences. If there are others, then replace the LVPS. See “Low-voltage power supply (LVPS) removal” on page 285.</p> <p>Does this solve the problem?</p>	<p>The problem is solved.</p>	<p>Go to step 2.</p>
<p>Step 2</p> <p>Turn the printer off, and remove the rear cover. See “Rear cover removal” on page 346.</p> <p>Check the cable at JFUSES1 for proper connection to the controller board, the cable for pinch points, and the cable or connector for any other damage.</p>  <p>Is the cable damaged?</p>	<p>Replace the fuser cable.</p>	<p>Go to step 3.</p>

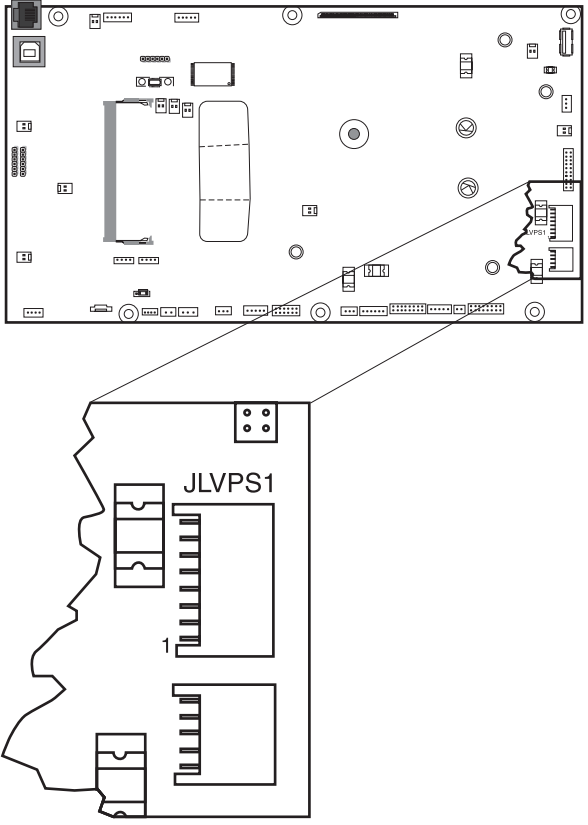
Actions	Yes	No
<p>Step 3 Check the connector JLVPS1 for proper connection to the controller board, the cable for pinch points, and the cable or connector for any other damage.</p>  <p>Is the cable damaged?</p>	<p>Repair or replace the LVPS cable.</p>	<p>Go to step 4.</p>

Actions	Yes	No
<p>Step 4</p> <p>Open the front cover, and check the power cable (A) on the left side of the fuser.</p> <p>Remove the right cover assembly. See “Right cover assembly removal” on page 288.</p> <p>Check the thermistor cables and connections (B) on the right side of the fuser.</p> <div data-bbox="285 478 857 1199"> </div> <p>Are the cables or connectors damaged?</p>	<p>Repair the cables. If the cables cannot be repaired, then replace the fuser. See “Fuser assembly removal” on page 324.</p>	<p>Go to step 5.</p>

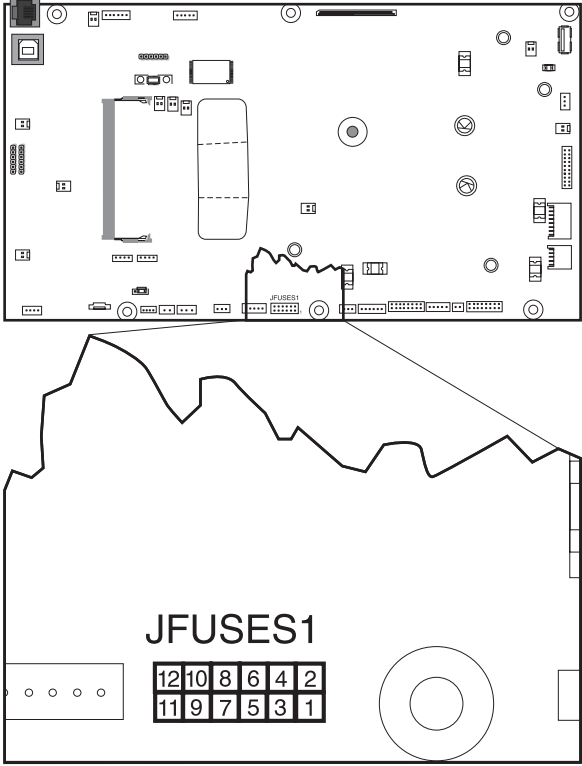
Actions	Yes	No
<p>Step 5</p> <p>Check the following values at JFUSES1:</p> <ul style="list-style-type: none"> Pin 1: +24 V dc (door closed) Pin 2: +24 V dc (doors closed) Pin 3: +24 V dc (doors closed) Pin 4: +24 V dc (doors closed) Pin 5: Between 0.6 and 3.28 V dc Pin 6: Ground Pin 8: Ground Pin 10: Between -3 and +3.3 V dc Pin 11: Ground (no wire)  <p>Are the values correct?</p>	<p>Go to step 6.</p>	<p>Replace the controller board. See “Controller board removal” on page 348.</p>
<p>Step 6</p> <p>Replace the fuser. See “Fuser assembly removal” on page 324.</p> <p>Does the error clear?</p>	<p>The problem is solved.</p>	<p>Replace the controller board. See “Controller board removal” on page 348.</p>

126 errors

126 error messages

Error code	Description	Action
126.xx	Low voltage power supply did not detect zero crossing.	Go to “Low-voltage power supply (LVPS) removal” on page 285.
126.01	Low voltage power supply did not detect zero crossing.	Go to “Low-voltage power supply (LVPS) removal” on page 285.

133 errors

133 error messages

Error code	Description	Action
133.1x	The black cartridge toner meter cycle (TMC) switch error: <ul style="list-style-type: none"> • .11 recoverable • .12 nonrecoverable 	Go to “Toner meter sensors (Y, C, M, K) on TMC card service check” on page 110.
133.2x	The cyan cartridge toner meter cycle (TMC) switch error: <ul style="list-style-type: none"> • .21 recoverable • .22 nonrecoverable 	
133.3x	The magenta cartridge toner meter cycle (TMC) switch error: <ul style="list-style-type: none"> • .31 recoverable • .32 nonrecoverable 	
133.4x	The yellow cartridge toner meter cycle (TMC) switch error: <ul style="list-style-type: none"> • .41 recoverable • .52 nonrecoverable 	

Toner meter sensors (Y, C, M, K) on TMC card service check

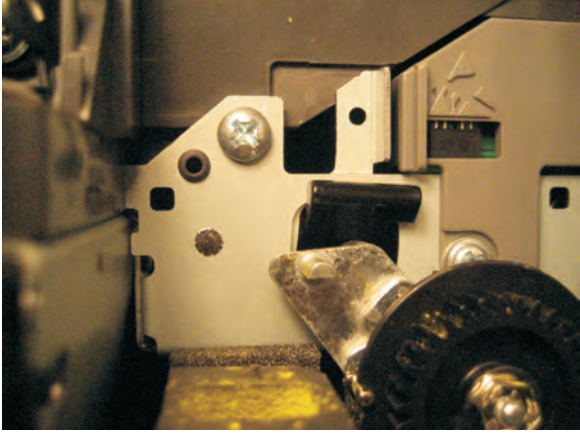
Actions	Yes	No
<p>Step 1 Remove the toner cartridge, and inspect the lenses on the toner meter cycle (TMC) card.</p>  <p>Are the lenses blocked, damaged, or dirty?</p>	<p>Repair or replace the TMC card. See “Toner meter cycle (TMC) card removal” on page 290.</p>	<p>Go to step 2.</p>

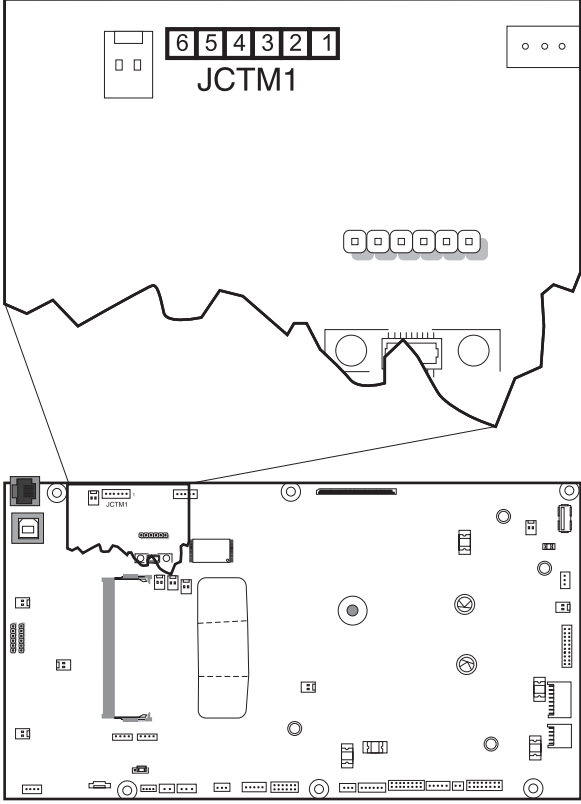
Actions	Yes	No
<p>Step 2</p> <p>Turn the printer off, and remove the rear cover. See “Rear cover removal” on page 346.</p> <p>Turn the printer on, and measure the values below at JCTM1 during POR:</p> <ul style="list-style-type: none"> Pin 1: +5 V dc Pin 2: +3.3 V dc Pin 3: +3.3 V dc Pin 4: +3.3 V dc Pin 5: +3.3 V dc Pin 6: Ground  <p>Are any of the values incorrect?</p>	<p>Replace the controller board. “Controller board removal” on page 348.</p>	<p>Replace the TMC card. See “Toner meter cycle (TMC) card removal” on page 290.</p>

141 errors

141 error messages

Error code	Description	Action
141.0x	Cartridge motor error	Go to “Cartridge motor error service check” on page 113.
141.01	Failed to achieve lock for motor within allotted time.	
141.02	Time out waiting for SAP BLDC motor to reach valid FG speed.	
141.03	Time out waiting for MP_NUM_INITIAL_SAP_HALLS.	
141.05	Lost lock for motor.	
141.06	Excessive SAP BLDC PWM.	
141.07	Motor stalled in timebased communication.	
141.2x	Cyan/magenta/yellow cartridge motor error.	
141.21	Failed to achieve lock for motor within allotted time.	
141.22	Time out waiting for SAP BLDC motor to reach valid FG speed.	
141.23	Time out waiting for MP_NUM_INITIAL_SAP_HALLS.	
141.24	Time out waiting for SAP BLDC motor.	
141.25	Lost lock for motor.	
141.26	Excessive SAP BLDC PWM.	
141.27	Motor stalled in timebased communication.	

Cartridge motor error service check

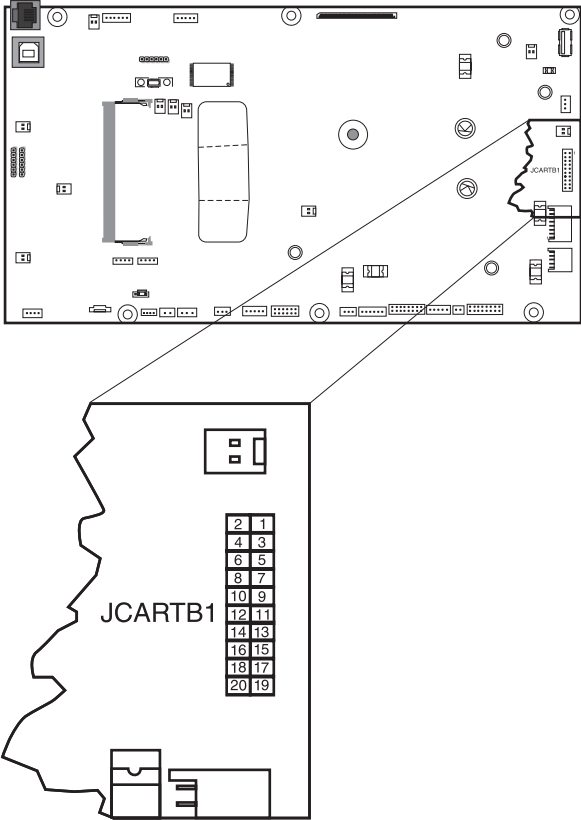
Action	Yes	No
<p>Step 1</p> <p>Turn the printer off, and remove the rear cover. See “Rear cover removal” on page 346.</p> <p>Check the cable JCARTB1 for proper connection to the system board.</p>  <p>The diagram shows a top-down view of the system board with a callout to a specific connector. The callout shows a 20-pin connector labeled JCARTB1. The pins are numbered in a grid: 2-1, 4-3, 6-5, 8-7, 10-9, 12-11, 14-13, 16-15, 18-17, and 20-19.</p> <p>Is the cable properly connected?</p>	<p>Go to step 2.</p>	<p>Reseat the cable.</p>
<p>Step 2</p> <p>Check the cable for damage.</p> <p>Is the cable damaged?</p>	<p>Replace the BLDC K image transfer unit cable. See “Image transfer unit (ITU) removal” on page 300.</p>	<p>Go to step 3.</p>

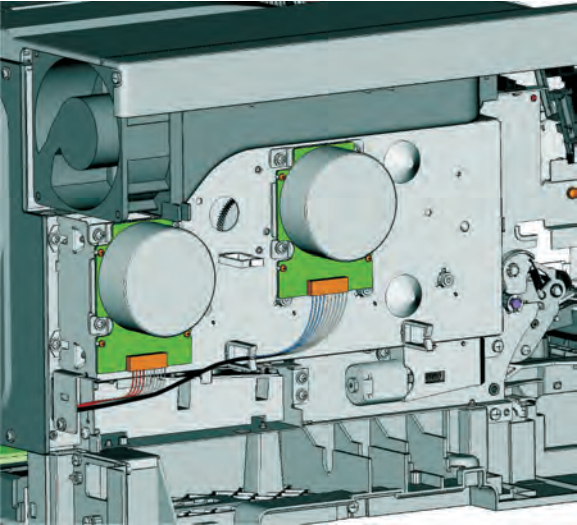
Action	Yes	No
<p>Step 3</p> <p>Remove the left cover assembly. See “Left cover assembly removal” on page 274.</p> <p>Check the cables connected to the cartridge motor assembly.</p>  <p>Is the cable connected properly?</p>	Go to step 4.	Reseat the cable.
<p>Step 4</p> <p>Replace the EP drive assembly. See “EP drive assembly removal” on page 275.</p> <p>Does the problem remain?</p>	Replace the controller board. See “Controller board removal” on page 348.	The problem is solved.

147 errors

147 error messages

Error code	Description	Action
147.xx	Staging motor error	Go to “Paper pick motor drive assembly service check” on page 115.
147.01	Staging motor has exceeded the ramp up table.	
147.02	Staging motor has exceeded number of encoders at minimum PWM.	
147.03	Staging motor has exceeded number of encoders at maximum PWM.	
147.04	Motor encoder count did not change between interrupts.	
147.05	Staging motor has encountered a stall time out.	

Paper pick motor drive assembly service check

The input (S2) sensor is part of the paper pick motor drive assembly, and is not available separately.

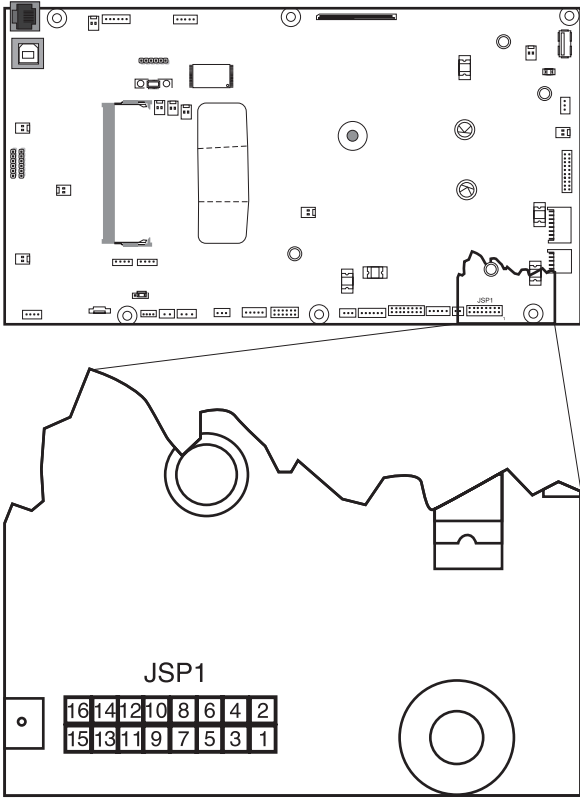
Actions	Yes	No
<p>Step 1 Check the condition of the pick tires, and replace if necessary. See “Pick tire removal” on page 387.</p> <p>Does this solve the problem?</p>	<p>The problem is solved.</p>	<p>Go to step 2.</p>
<p>Step 2 Turn the printer off, and then remove the rear cover. See “Rear cover removal” on page 346. Check the table at JSP1 on the controller board for proper connection.</p>  <p>The diagram shows a top-down view of the controller board with various components. A callout box provides a detailed view of the JSP1 connector, which is a 15-pin connector. The pins are arranged in two rows: the top row contains pins 16, 14, 12, 10, 8, 6, 4, 2 and the bottom row contains pins 15, 13, 11, 9, 7, 5, 3, 1.</p> <p>Is the cable properly connected?</p>	<p>Go to step 4.</p>	<p>Properly connect the cables, and POR the printer. Go to step 3.</p>
<p>Step 3 Did the printer function correctly after reconnecting the cables?</p>	<p>The problem is solved.</p>	<p>Go to step 4.</p>

Actions	Yes	No
<p>Step 4</p> <p>Turn the printer on, and then verify the following approximate values at JSP1:</p> <ul style="list-style-type: none"> Pin 2: +24 V dc Pin 4: +24 V dc Pin 5: +5 V (when paper is picked) Pin 7: Ground Pin 8: Ground Pin 10: +5 V dc Pin 12: _5 V dc (when paper is picked) Pin 15: +5 V dc Pin 16: Ground <p>Are the values approximately correct?</p>	<p>Replace the paper pick motor drive assembly. See “Paper pick motor drive assembly (standard tray) removal” on page 343.</p>	<p>Replace the controller board. See “Controller board removal” on page 348.</p>

171 errors

171 error messages

Error code	Description	Action
171.01	The printer fan has stalled.	Go to “Fan error service check” on page 117.

Fan error service check

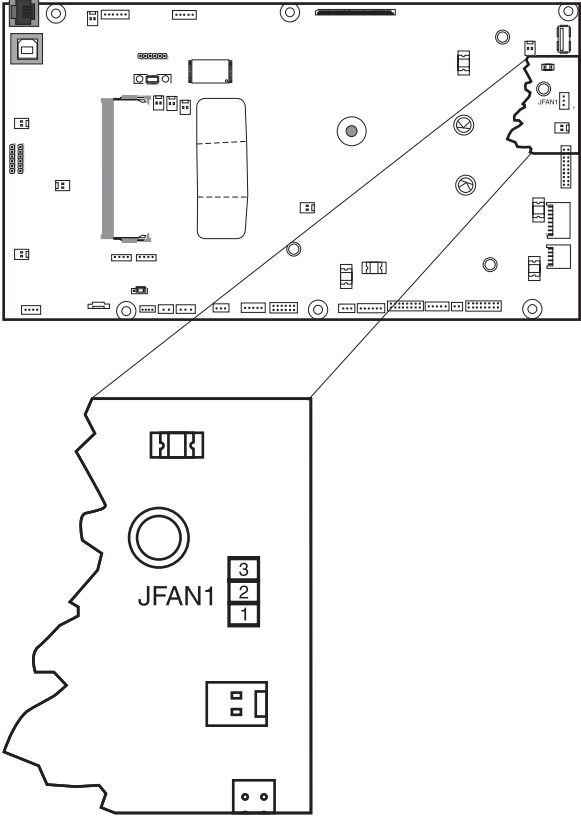
Actions	Yes	No
<p>Turn the printer off, and remove the rear cover. See “Rear cover removal” on page 346.</p> <p>Turn the printer on, and check the fan cable at JFAN1 for the following values:</p> <ul style="list-style-type: none"> Pin 1: +3.3 V dc Pin 2: Ground Pin 3 0 (fan off)  <p>Are the measured values correct?</p>	<p>Replace the fan.</p>	<p>Replace the controller board. See “Controller board removal” on page 348.</p>

Procedure before starting the 9yy service checks

You will need to retrieve certain information. This information will aid your next level of support in diagnosing the problem before replacing the controller board.

Warning—Potential Damage: Do not replace the controller board unless directed by your next level of support.

- 1 Collect the history information and firmware logs (Fwdebug and logs.tar.gz) from the SE menu.
- 2 Collect the settings from the menu settings page.
- 3 Collect information from the user.

Note: Not all of the items are retrievable from the printer you are working on.

A. Collecting the history information from the SE menu

Note: Make sure that your printer is connected to a network or to a print server.

- 1 Open a Web browser, type **http://printer_IP_address/se**, and then press **Enter**.

Notes:

- **printer_IP_address** is the TCP/IP address of the printer
- **se** is required to access the printer diagnostic information

- 2 Click **History Information**, copy all information, and then save it as a text file.

- 3 E-mail the text file to your next level of support.

B. Collecting the firmware logs (Fwdebug and logs.tar.gz) from the SE menu

Notes:

- Make sure that your printer is connected to a network or to a print server.
- Some printers are designed to restart automatically after a 9yy error. On these printers, you can retrieve the secondary crash code information using the SE menu.
- Fwdebugs can also be referred to as LBtrace. If FWEdebugs does not appear in the list, then look for LBtrace. Multiple LBtrace logs can appear in the list of links referred to in step 2.

- 1 Open a Web browser, type **http://printer_IP_address/se**, and then press **Enter**.

- 2 Click **List Fwdebugs captured during reboots**.

Note: A list of the secondary crash codes retrieved from previous reboots will be generated. If there are Fwdebugs listed, then click **Dump Fwdebug log0**, **Dump Fwdebug log1**, and **Dump Fwdebug log2**. Clicking these links will dump the debug logs to the computer. Take note of the destination folder where the logs are saved.

- 3 E-mail the logs to your next level of support.

Note: Some printer SE menus give you the option of clicking **Logs Gzip Compressed**. If this option is shown in the menu, then click it and retrieve the compressed log file. Take note of the destination folder where the log file is saved.

C. Collecting the settings from the menu settings page

Note: The menu settings page is different for each printer. For more information see the *User's Guide*. Your next level of support will tell you which page they want to see.

Copying the menu settings page from the Embedded Web Server (EWS)

Note: Make sure that your printer is connected to a network or to a print server.

- 1 Open a Web browser, type **http://printer_IP_address**, and then press **Enter**.
- 2 Click Settings, and then select one of the settings pages from the links shown on the page.
- 3 Copy all the information, and then save it as a text file.
- 4 E-mail the text file to your next level of support.

Printing the menu settings page

- 1 From the home screen, navigate to:
Reports > Menu Settings Page
- 2 Print the menu settings page, and then use Scan to E-mail to send it to your next level of support.

D. Collecting information from the user

Ask the user for information about the following:

- Print job being run
- Operating system being used
- Print driver being used
- Other information on what was happening when the 9yy error occurred

900 errors

900 error messages

Error code	Description	Action
900.xx	Unrecoverable RIP software error/illegal trap.	See “900.xx System software error service check” on page 120.

900.xx System software error service check

Note: Make sure to perform the [“Procedure before starting the 9yy service checks” on page 117](#) before proceeding.

There are different types of 900.xx errors that can occur. There may be a communication problem (bad cable, network connection, and so on) software issue, or a hardware problem with the controller board of ISP (Internal Solutions Port). The communication and software aspects should be checked first. Determine if the problem is constant or intermittent. Use the troubleshooting procedure below to isolate the issue. Take any notes as instructed. You will need that information in the event you need to contact your next level support.

Note: Before troubleshooting, determine the operating system used when the error occurred. If possible, determine whether or PostScript or PCL files were sent to the device when the error occurred. Ask the customer which Lexmark Solutions applications are installed on the device.

Actions	Yes	No
<p>Step 1 POR the printer.</p> <p>Does the error occur?</p>	Go to step 2.	Problem resolved.
<p>Step 2</p> <ul style="list-style-type: none"> a Write down the exact 900.xx error code displayed on the device. b Turn the device off. c Clear the print queues. d Disconnect all communication cables, and remove all memory options. e Remove all ISP and modem cards. f Restart the device into diagnostic mode. Turn the printer on, press and hold 3 and 6, and release the buttons with the installed memory and processor speed displays. <p>Does the 900.xx error occur during startup?</p>	Go to step 3.	Go to step 6.
<p>Step 3 Check all the cables connected to the RIP board for proper connectivity.</p> <p>Are the cables properly connected?</p>	Go to step 5.	Go to step 4.

Actions	Yes	No
<p>Step 4 Properly connect the cables to the RIP board. Restart the device into diagnostic mode.</p>  <p>Does the 900.xx error reoccur during startup?</p>	Go to step 5.	Go to step 6.
<p>Step 5 Replace the RIP board, and restart the device.</p> <p>Does this fix the problem?</p> <p>Note: If an error, different from the original 900.xx, is displayed, then consult the service check for that error.</p>	Problem resolved.	Go to step 31.
<p>Step 6 Print the following:</p> <ul style="list-style-type: none"> • Error log • Menu settings page • Network settings page <p>Does the 900.xx error reoccur while these pages are printing?</p>	Go to step 31.	Go to step 7.
<p>Step 7 Reattach the communications cable. Restart the printer to operating mode. Send the printer a print job.</p> <p>Does the 900.xx error reoccur?</p> <p>Note: Before performing this step, write down this information about the file being sent to the printer:</p> <ul style="list-style-type: none"> • Application used • Operating system • Driver type • File type (PCL, PostScript, XPS, etc.) 	Go to step 8.	Go to step 10.

Actions	Yes	No
<p>Step 8 Restart the printer to operating mode. Send a different print job to the device.</p> <p>Does the 900.xx error reoccur?</p>	Go to step 9.	Go to step 10.
<p>Step 9 Upgrade the firmware. Contact your next level of support for the correct firmware level to use. Restart the printer to operating mode. Send the printer a print job.</p> <p>Does the 900.xx error reoccur?</p>	Go to step 31.	Go to step 10.
<p>Step 10 Is the device a Multi Function Printer?</p>	Go to step 11.	Go to step 13.
<p>Step 11 Run a copy job.</p> <p>Does the 900.xx error reoccur?</p>	Go to step 31.	Go to step 12.
<p>Step 12 Run a scan to PC job.</p> <p>Does the 900.xx error reoccur?</p>	Go to step 31.	Go to step 13.
<p>Step 13 Is there optional memory installed?</p>	Go to step 14.	Go to step 16.
<p>Step 14 Reinstall the memory, and send the print job to the device.</p> <p>Does the 900.xx error reoccur?</p>	Go to step 15.	Go to step 16.
<p>Step 15 Install a Lexmark recommended memory option, and send a print job to the device.</p> <p>Does the 900.xx error reoccur?</p>	Go to step 31.	Problem resolved.
<p>Step 16 Is there a modem installed on the device?</p>	Go to step 17.	Go to step 21.
<p>Step 17 Reinstall the modem, and restart the device.</p> <p>Does the 900.xx error reoccur?</p>	Go to step 18.	Go to step 20.

Actions	Yes	No
<p>Step 18</p> <p>Upgrade the firmware if it has not been upgraded in any previous step. Contact your next level of support for the correct firmware level to use.</p> <p>Restart the printer to operating mode. Send the printer a print job.</p> <p>Does the 900.00 error reoccur?</p>	Go to step 19.	Problem resolved.
<p>Step 19</p> <p>Replace the modem. Restart the device.</p> <p>Does the 900.xx error reoccur?</p>	Go to step 31.	Problem resolved.
<p>Step 20</p> <p>Replace the modem, and restart the device.</p> <p>Does the 900.xx error reoccur?</p>	Go to step 31.	Problem resolved.
<p>Step 21</p> <p>Run a fax job.</p> <p>Does the 900.xx error reoccur?</p>	Go to step 31.	Go to step 21.
<p>Step 22</p> <p>Are there any ISP (internal solutions port) options installed?</p>	Go to step 22.	Problem resolved.
<p>Step 23</p> <p>Upgrade the firmware if it has not been upgraded in any previous step.</p> <p>Reinstall the first ISP option, and restart the device.</p> <p>Does the 900.xx error reoccur?</p>	Go to step 24.	Go to step 26.
<p>Step 24</p> <p>Upgrade the firmware if it has not been upgraded in any previous step. Contact your next level of support for the correct firmware level to use.</p> <p>Restart the printer to operating mode.</p> <p>Does the 900.xx error reoccur?</p>	Go to step 25.	Problem resolved.
<p>Step 25</p> <p>Replace the faulty ISP option, and restart the device.</p> <p>Does the 900.xx error reoccur?</p>	Go to step 31.	Go to step 26.
<p>Step 26</p> <p>Are there anymore ISP options to install?</p>	Go to step 27.	Problem resolved.

Actions	Yes	No
<p>Step 27 Install the next ISP option, and restart the device.</p> <p>Does the 900.xx error occur?</p>	Go to step 29.	Go to step 28.
<p>Step 28 Run a job to test the option.</p> <p>Does the 900.xx error reoccur?</p>	Go to step 29.	Go to step 26.
<p>Step 29 Upgrade the firmware. Contact your next level of support for the correct firmware level to use. Restart the printer to operating mode.</p> <p>Does the 900.xx error occur?</p>	Go to step 30.	Go to step 26.
<p>Step 30 Replace the faulty ISP option, and restart the device.</p> <p>Does the 900.xx error reoccur?</p>	Go to step 31.	Go to step 26.
<p>Step 31 Contact your next level of support. You will need the following information for them:</p> <ul style="list-style-type: none"> • Exact 900.xx error digits and complete error message • Printed menu settings page • Printed network settings page • Device error log • A sample print file if error appears to be isolated to a single file • File/Application used if error is related to specific print file • Device Operating System • Driver used (PCL/PS) • Frequency of the occurrence of the error 		

91y errors

91y error messages

Error code	Description	Action
910.xx	General engine software error.	See “91x.xx (910.xx-919.xx) Engine software service check” on page 125.
911.xx		
912.xx		
913.xx	General engine software error.	See “913.xx error code check” on page 125.

Error code	Description	Action
914.xx	General engine software error.	See “91x.xx (910.xx-919.xx) Engine software service check” on page 125.
915.xx		
916.xx		
917.xx		
918.xx		
919.xx		

91x.xx (910.xx-919.xx) Engine software service check

Actions	Yes	No
<p>Turn the printer off, and remove the rear cover See “Rear cover removal” on page 346.</p> <p>Check the cable connections. See “Controller board removal” on page 348 for proper disconnecting and connecting of cables from controller board.</p> <p>Are all cable connections secure?</p>	<p>Replace the controller board. See “Controller board removal” on page 348.</p>	<p>Secure all connections. POR the printer.</p>

913.xx error code check

Actions	Yes	No
<p>Step 1</p> <p>a Turn the printer off, and remove the rear cover. See “Rear cover removal” on page 346.</p> <p>b Check the cable connections. See “Controller board removal” on page 348 for proper disconnecting and connecting of cables from controller board.</p> <p>Are all cable connections secure?</p>	<p>Go to step 3.</p>	<p>Go to step 2.</p>
<p>Step 2</p> <p>a Reconnect any loose connections.</p> <p>b Print multiple print tests.</p> <p>Does the problem remain?</p>	<p>Go to step 3.</p>	<p>The problem is solved.</p>
<p>Step 3</p> <p>Replace the fuser drive motor.</p> <p>Does the problem remain?</p>	<p>Go to step 4.</p>	<p>The problem is solved.</p>

Actions	Yes	No
<p>Step 4</p> <p>Replace the controller board. See “Controller board removal” on page 348.</p> <p>Does the problem remain?</p>	Contact the next level of support.	The problem is solved.

938 errors

938 error messages

Error code	Description	Action
938.01	The board level was not obtained.	See “Controller board removal” on page 348 .
938.02	Timed out while waiting for the bullet serial data to be updated.	
938.03	The NVM_OK was not received from the NV2 server for a successfully submitted request.	
938.04	An over temperature condition is detected.	

95y errors

95y error messages

Error code	Description	Action
950.xx	<p>There is a mismatch between controller EEPROM and mirror.</p> <ul style="list-style-type: none"> 950.00 through 950.29 codes: mismatch between controller and mirror 950.30 through 950.60 codes: mismatch between secure and controller 	Go to “950.xx NVRAM failure service check” on page 127 .
951.xx	Error NV part on system board.	Go to “Controller board removal” on page 348 .
952.xx	A recoverable MVRAM Cyclic Redundancy Check (CRC) error occurred. <i>n</i> is the offset at which the error occurred.	Performing a POR will clear this error.
953.xx	<p>(CX310 - CX410)</p> <p>NVRAM chip failure with mirror.</p> <ol style="list-style-type: none"> POR the printer. If the problem persists, replace the UICC card. 	Go to “Operator panel removal (for CX310 and CX410 models only)” on page 313 .

Error code	Description	Action
953.xx	(CX510) NVRAM chip failure with mirror. 1 POR the printer. 2 If the problem persists, replace the UICC card.	Go to “Operator panel removal (for CX510 models only)” on page 320.
954.xx	The NVRAM chip failure with controller part.	Go to “950.xx NVRAM failure service check” on page 127.
955.xx	The Code ROM or NAND flash failed the Cyclic Redundancy Check (CRC) check or the NAND experienced an uncorrectable multi-bit failure. </oc> indicates the source of the failure and has one of the following values: <ul style="list-style-type: none"> • CRC Failure: The source is a failing package indicated by Pn where n is the package number. This error could occur on a controller with ROM or NAND flash and could occur as a result of the CRC check done when the machine is powered on. The range of package numbers is from 0 to 15. • Error Correction Code (ECC) Failure: The source is a failing page indicated by Bn where “n” is the page number. This error occurs only if a multi-bit failure is detected during the ECC execution. Single bit failures will be corrected automatically and will not result in a service error. The range of page numbers is from 0 to 1023. 	
956.xx	Controller board failure. Processor failure. Check on .02 for fan error.	
957.xx	Controller board failure. ASIC failure.	
958.xx	Printer has performed more than 100 “shift and reflash” operations as a result of ECC bit corrections.	
959.xx	Controller verification failure of system boot code.	Go to “Invalid firmware/controller board service check” on page 129.
959.0x	System hardware failure.	Go to “Controller board removal” on page 348.

950.xx NVRAM failure service check

Warning—Potential Damage: When replacing any of the following components, replace only one component at a time or the printer will be rendered inoperable:

For CX310 models:

- Controller board
- Operator panel with UICC card

For CX410 and CX510 models:

- Controller board
- UICC card

Replace the required component, bring the printer up in Diagnostics mode (See [“Entering the Diagnostics menu” on page 209](#)), and verify that the problem is fixed before performing a POR.

This error indicates a mismatch between the operator panel assembly and the system board.

Actions	Yes	No
<p>Step 1</p> <p>For CX310 models, has the operator panel with UICC card been replaced recently?</p> <p>For CX410 and CX510 models, has the UICC card been replaced recently?</p>	Replace the operator panel assembly with a new, and not previously installed, UICC card.	Go to step 2.
<p>Step 2</p> <p>Has the controller board been replaced recently?</p>	Replace the controller board with a new, and not previously installed, controller board. See “Controller board removal” on page 348 .	Go to step 3.
<p>Step 3</p> <p>Turn the printer power off for ten or more seconds. Then, turn the printer back on (POR the printer).</p> <p>Is the error gone, and can the printer print?</p>	Problem solved.	Go to step 4.
<p>Step 4</p> <p>Clear the NVRAM of the printer:</p> <p>a Turn the printer power off.</p> <p>b With the printer off, press and hold 6,7, and 8 on the keypad.</p> <p>c Turn the printer on.</p> <p>d When Restoring Factory Defaults appears, release the buttons.</p> <p>Note: If the printer looks up on the Restoring Factory Defaults, then wait two minutes, and then turn the printer power off. After ten seconds or more, turn the printer power back on without holding down any buttons.</p> <p>Does the error message still appear?</p>	Go to step 5.	Problem solved.
<p>Step 5</p> <p>For CX310 models replace the operator panel with UICC card.</p> <p>For CX410 and CX510 models, replace the UICC card.</p> <p>Does the error message still appear?</p>	Replace the controller board. See “Controller board removal” on page 348 .	Problem solved.

Invalid firmware/controller board service check

Action	Yes	No
Update the firmware. Note: Contact the next level of support for the correct firmware level. Does the error remain?	Replace the controller board. See “Controller board removal” on page 348.	The problem is solved.

96y errors

96y error messages

Error code	Description	Action
960.xx	RAM memory error: RAM soldered on the board is bad.	Go to “Controller board removal” on page 348.
961.xx	RAM memory error: slot 1 RAM is bad.	Go to “Memory failure service check” on page 129.
962.xx	RAM memory error: slot 2 RAM is bad.	
964.xx	Download emulation cyclic redundancy check (CRC) failure has occurred. A checksum failure detected in the emulation header or emulation file.	Go to “Download emulation cyclic redundancy service check” on page 130.

Memory failure service check

Action	Yes	No
Step 1 Check the RAM in slot 2. Is the RAM ok?	POR the printer.	Go to step 2.
Step 2 Replace the bad memory card. Does this solve the problem?	The problem is solved.	Contact the next level of support.

Download emulation cyclic redundancy service check

Action	Yes	No
<p>Step 1</p> <p>Disable the download emulation, and then program the download emulation into the firmware card again.</p> <p>Does the error remain?</p>	Go to step 2.	The problem is solved.
<p>Step 2</p> <p>Replace the firmware card and download the emulation to the new card.</p> <p>Does the error remain?</p>	Contact the next level of support.	The problem is solved.

97y errors

97y error messages

Error code	Description	Action
975.xx 975.xx	Network error—Unrecognizable network port.	Replace the standard network card, or the card in the specified slot.
976.xx	Unrecoverable software or error in the network or network card [x].	See “Standard network/network card error service check” on page 130.
978.xx	Bad checksum while programming the standard network or network card [x] port.	See “Standard network/network card programming error service check” on page 131.
979.xx	Flash parts failed while programming the standard network or network card [x] port.	See “Standard network/network card error service check” on page 130.

Standard network/network card error service check

Action	Yes	No
<p>Step 1</p> <p>Is the network card installed?</p>	Go to step 2.	Go to step 3.
<p>Step 2</p> <p>Make sure that the network card is installed correctly. If not, then reinstall the card.</p> <p>Does this solve the problem?</p>	The problem is solved.	Contact the next level of support.
<p>Step 3</p> <p>Replace the controller board.</p> <p>Does this solve the problem?</p>	The problem is solved.	Contact the next level of support.

Standard network/network card programming error service check

Action	Yes	No
<p>Step 1 Make sure that you have downloaded the code in binary mode and not in ASCII, and then reprogram the network card.</p> <p>Does this solve the problem?</p>	The problem is solved.	Go to step 2.
<p>Step 2 Is the network card installed?</p>	Go to step 3.	Go to step 4.
<p>Step 3 Make sure that the network card is installed correctly. If not, then reinstall the card.</p> <p>Does this solve the problem?</p>	The problem is solved.	Contact the next level of support.
<p>Step 4 Replace the controller board. See “Controller board removal” on page 348.</p> <p>Does this solve the problem?</p>	The problem is solved.	Contact the next level of support.

982 errors

982 error messages

Error code	Description	Action
982.xx	<p>Communications error detected by the specified device.</p> <p>Note: <device> can be one of the following:</p> <ul style="list-style-type: none"> • Tray 2 • Tray 3 	Call the next level of support.

990 errors

990 error messages

Error code	Description	Action
990.xx	<p>This error message indicates that an equipment check condition has occurred in the specified device.</p> <p>Go to the service check for the device indicated</p> <p>Note: <device> can be one of the following:</p> <ul style="list-style-type: none"> • Tray 2 • Tray 3 	Go to “Trays 2 and 3 (optional) service check” on page 132.

Trays 2 and 3 (optional) service check

Actions	Yes	No
<p>Step 1</p> <p>Are two option trays being used?</p>	Go to step 2.	Go to step 4.
<p>Step 2</p> <p>If two option trays are being used, then is the 550-sheet tray on the bottom?</p>	Go to step 4.	Go to step 3.
<p>Step 3</p> <p>Switch the order of the trays so that the 55-sheet tray is on the bottom, and then print a page from both trays.</p> <p>Did the pages print from both trays?</p>	Problem resolved.	Go to step 4.
<p>Step 4</p> <p>Inspect the paperfeed pick tires on the tray that fails to pick.</p> <p>Do they appear worn or damaged?</p>	Go to step 5.	Go to step 6.
<p>Step 5</p> <p>Replace the pick tires on the faulty tray, and then print a page with media from the affected tray. See “Pick tire removal” on page 387.</p> <p>Did the page print?</p>	Problem resolved.	Go to step 6.
<p>Step 6</p> <p>Remove the rear cover. See “Rear cover removal” on page 346.</p> <p>Check the option cable connected to JOPT1 for continuity.</p> <p>Is the cable properly seated? Is there continuity?</p>	Go to step 8.	Go to step 7.

Actions	Yes	No
<p>Step 7 Replace the cable, and print from both option trays.</p> <p>Did the pages print from both trays?</p>	Problem resolved.	Go to step 8.
<p>Step 8 Print a menu settings page. If two option trays are used, then the 650-sheet tray will appear as tray 2, and the 550-sheet tray will appear as tray 3.</p> <p>Are all of the attached option trays listed on the first page of the menu settings pages?</p>	Go to step 9.	<p>If the 550-sheet option failed to appear, then go to step 9.</p> <p>If the 650-sheet tray failed to appear, then go to step 10.</p>
<p>Step 9 Remove the 650-sheet tray from the printer. Attach the 550-sheet tray directly to the printer. Print a page from the 550-sheet tray.</p> <p>Did the page print?</p>	Go to step 11.	Replace the 550-sheet tray.
<p>Step 10 With only the 650-sheet tray attached to the printer, print a page from the 650 sheet tray.</p> <p>Did the page print?</p>	Go to step 11.	Replace the 650-sheet tray.
<p>Step 11</p> <ul style="list-style-type: none"> a Turn off the printer. b Remove the rear cover. See “Rear cover removal” on page 346. c Disconnect the cable at JOPT1 on the controller board. d Turn the printer on. e Measure to voltages below: <p>JOPT1:</p> <ul style="list-style-type: none"> Pin 2: Ground Pin 3: Ground Pin 5: +24 V dc Pin 6: Ground Pin 7: +5 V dc Pin 9: Ground Pin 10: Ground <p>Are the voltages correct?</p>	Contact your next level of support.	Replace the controller board. See “Controller board removal” on page 348.

ADF/Scanner hardware errors

8yy service error messages

Error code	Description	Action
840.01	The scanner is disabled and can't be used.	Go to "Scanner disabled error service check" on page 135.
840.02	The scanner is disabled and can't be used. This message is posted when the MFP PORs. Enter the configuration menu, and reenale the scanner module.	Go to "Scanner disabled error service check" on page 135.
840.03	The scanner is disabled and can't be used. This message is posted when the MFP PORs. Enter the configuration menu, and reenale the scanner module.	Go to "Scanner disabled error service check" on page 135.
841.xx	Scanner failure—front side image processing ASIC. Invalid configuration or ASIC not found Image pipeline ASIC.	Go to "CCD service check" on page 138. Also, go to "Flatbed home position service check" on page 141.
842.xx	Scanner failure—communications	Go to "CCD service check" on page 138.
843.00	Scanner failure—carriage failed to Home or move to desired position	Go to "ADF service check" on page 137.
843.01	ADF mechanical failure	Go to "ADF service check" on page 137.
843.02	Generic Mechanical failure detected	Go to "ADF service check" on page 137.
843.03	Pick Roller Engage Failure	Go to "ADF service check" on page 137.
843.04	Pick Roller Disengage Failure	Go to "ADF service check" on page 137.
843.05	Carriage overrun	Go to "ADF service check" on page 137.
843.06	ADF nudger	Go to "ADF service check" on page 137.
843.99	Scanner complete timeout error	Go to "ADF service check" on page 137.
846.00	Scanner failure: Calibration strip	Go to "CCD service check" on page 138.
846.01	Rear Calibration Strip Unusable	Go to "CCD service check" on page 138.
846.02	Front calibration strip too far left	Go to "CCD service check" on page 138.

Error code	Description	Action
846.03	Front calibration strip too far right The front calibrations strip is placed too high or too low.	Go to “CCD service check” on page 138.
846.04	Front calibration strip has excessive skew	Go to “CCD service check” on page 138.
846.05	Front calibration strip has excessive bow	Go to “CCD service check” on page 138.
846.06	Front calibration strip has excessive dark area Front excessive variability for Mono, Red, Green, or Blue.	Go to “CCD service check” on page 138.
846.07	Front magnification exceeds limits Rear excessive variability for Mono, Red, Green, or Blue.	Go to “CCD service check” on page 138.
849.01	Configuration error—the device had modem installed, but configID indicates it should not.	Go to “Scanner configuration error service check” on page 139.
849.10	Configuration error—the device had HD installed, but configID indicates it should not.	Go to “Scanner configuration error service check” on page 139.

Scanner disabled error service check

Actions	Yes	No
<p>Step 1</p> <p>POR the machine into Configuration menu > Disable scanner. From there, select Enabled to change the settings to reenble the scanner module and then save the setting.</p> <p>POR the MPF to operating mode. Try running a copy from the ADF and flatbed.</p> <p>Did the 840.xx error reoccur?</p>	Go to step 2.	The problem is solved.
<p>Step 2</p> <p>Reenter the Configuration mode, and scroll to and select the Disable Scanner menu item.</p> <p>Does the screen display “ADF disabled” or “Auto Disabled”?</p>	Go to step 3.	Go to step 8.
<p>Step 3</p> <p>Check the ADF cable connections on the ADF relay card and connector J17 on the controller board. Also inspect the cable connections J28, J12, J13, and J30 on the controller board.</p> <p>Are the connections properly connected?</p>	Go to step 5.	Go to step 4.

Actions	Yes	No
<p>Step 4 Properly connect the connections on the ADF relay card and controller board.</p> <p>POR the machine into Configuration menu > Disable scanner. From there, select Enabled to change the settings to re-enable the scanner module and then save the setting.</p> <p>POR the MPF to operating mode. Try running a copy from the ADF and flatbed.</p> <p>Did the 840.xx error reoccur?</p>	Go to step 5.	The problem is solved.
<p>Step 5 Check the continuity on the ADF cable.</p> <p>Is there continuity?</p>	Go to step 7.	Go to step 6.
<p>Step 6 Replace the ADF cable.</p> <p>POR the machine into Configuration menu > Disable scanner. From there, select Enabled to change the settings to re-enable the scanner module and then save the setting.</p> <p>POR the MPF to operating mode. Try running a copy from the ADF and flatbed.</p> <p>Did the 840.xx error reoccur?</p>	Go to step 7.	The problem is solved.
<p>Step 7 Replace the ADF assembly. See “ADF assembly removal” on page 367.</p> <p>POR the machine into configuration mode. Go to the disable scanner menu item. See “Disable scanner” on page 240.</p> <p>POR the machine into Configuration menu > Disable scanner. From there, select Enabled to change the settings to re-enable the scanner module and then save the setting.</p> <p>POR the MFP to operating mode. Run a copy from the flatbed.</p> <p>Did the 840.xx error reoccur?</p>	Go to step 8.	The problem is solved.
<p>Step 8 Inspect JFBM1, JHS1 and JCCD1 on the controller board.</p> <p>Are they properly connected?</p>	Go to step 10.	Go to step 9.
<p>Step 9 Properly connect all the connections.</p> <p>Did the 840.xx error reoccur?</p>	Go to step 10.	The problem is solved.

Actions	Yes	No
<p>Step 10 Replace the flatbed unit. See “Flatbed scanner assembly removal” on page 374.</p> <p>POR the machine into Configuration menu > Disable scanner. From there, select Enabled to change the settings to re-enable the scanner module and then save the setting.</p> <p>POR the MPF to operating mode. Try running a copy from the ADF and flatbed.</p> <p>Did the 840.xx error reoccur?</p>	Go to step 11.	The problem is solved.
<p>Step 11 Replace the controller board. See “Controller board removal” on page 348.</p> <p>Does this solve the problem?</p>	The problem is solved.	Contact the next level of support.

ADF service check

Action	Yes	No
<p>Step 1 Check all cables connecting the ADF and flatbed to the controller board.</p> <p>Are they properly connected?</p>	Go to step 3.	Go to step 2.
<p>Step 2 Re-connect the cables to the controller board.</p> <p>Did this fix the problem?</p>	The problem is solved.	Go to step 3.
<p>Step 3 a Enter diagnostics mode and navigate to: SCANNER TESTS > Sensor Test Perform the scanner sensor tests.</p> <p>b Navigate to: SCANNER TESTS > Motor Tests Perform the scanner sensor and motor tests.</p> <p>Did any test fail?</p>	Go to step 4.	Go to step 8.
<p>Step 4 Did the Flatbed Home Sensor test, or Flatbed motor test fail?</p>	Go step 5.	Go to step 6.

Action	Yes	No
<p>Step 5 Replace the flatbed. See “Flatbed scanner assembly removal” on page 374.</p> <p>Did this solve the problem?</p>	The problem is solved.	Go to step 6.
<p>Step 6 Did the ADF pick motor, or feed motor tests fail?</p>	Go to step 7.	Go to step 8.
<p>Step 7 Replace the ADF. See “ADF assembly removal” on page 367.</p> <p>Did this fix the problem?</p>	The problem is solved.	Go to step 8.
<p>Step 8 Replace the LVPS. See “Low-voltage power supply (LVPS) removal” on page 285.</p> <p>Did this fix the problem?</p>	The problem is solved.	Go to step 9.
<p>Step 9 Replace the controller board. See “Controller board removal” on page 348.</p> <p>Did this fix the problem?</p>	The problem is solved.	Contact the next level of support.

CCD service check

Actions	Yes	No
<p>Step 1 Restart the device, and retry the scan / copy job. Repeat this step with a few copy jobs.</p> <p>Does the error return?</p>	Go to step 2.	No issue.
<p>Step 2 Is the CCD ribbon cable properly connected to JCCD1 on the controller board?</p>	Go to step 3.	Properly connect the ribbon cable to JCCD1.
<p>Step 3 Replace the flatbed unit. See “Flatbed scanner assembly removal” on page 374.</p> <p>Did this resolve the issue?</p>	Problem resolved.	Replace the controller board. See “Controller board removal” on page 348.

Scanner configuration error service check

Action	Yes	No
Contact the next level of support. They will give the instructions on how to resolve the error.	N/A	N/A

Scan/fax/copy symptoms

Symptom	Action
ADF won't duplex (Duplex ADF only)	Go to “ADF duplex service check” on page 144.
ADF skew	Go to “ADF feed errors service check” on page 143.
Multiple pages feed into ADF	Go to “ADF feed errors service check” on page 143.
Documents wont feed into ADF	Go to “ADF feed errors service check” on page 143.
Scanner makes buzzing noise on startup or during a scan.	Go to “Flatbed home position service check” on page 141.
Document feeds, but jams in ADF.	Go to “ADF paper jam service check” on page 85.
Blank page	Go to “Black or blank page copy service check” on page 140.
Black page	
No dial tone	Go to “Modem/fax card service check” on page 145.
Machine dials a number but fails to make a connection with another fax machine.	The other fax machine may be turned off. Ask the fax recipient to check their machine.
Incoming fax has blank spaces or poor quality.	Go to “Blank spaces on incoming fax service check” on page 146.
Invalid fax partition, or fax partition too small.	Go to “Format fax storage” on page 237.
Some words on an incoming fax are stretched.	Go to “Stretched words on incoming fax service check” on page 147.
Faxes fail to transmit.	Go to “Fax transmission service check” on page 149.
Fax reception fails.	Go to “Fax reception service check” on page 147.
Rattling noise coming from the ADF unit.	Go to “ADF rattling noise service check” on page 142.
Scanner fails to scan legal size paper	Go to “Flatbed legal scan service check” on page 142.

Black or blank page copy service check

Actions	Yes	No
<p>Step 1 Print a menu page, or a page from the host.</p> <p>Is the page black?</p>	See “Solid color pages check” on page 53.	Go to step 2.
<p>Step 2 Is the copy an ADF scan?</p>	Go to step 3.	Go to step 4.
<p>Step 3 Run a flatbed copy.</p> <p>Is it blank or black?</p>	Go to step 5.	Go to step 4.
<p>Step 4 Did the sheet feed into the ADF?</p>	Go to step 6.	Go to step 5.
<p>Step 5 Is the CCD ribbon cable properly connected to JCCD1 on the controller board?</p>	Go to step 6.	Properly connect the ribbon cable to JCCD1.
<p>Step 6 Check for +14VDC on Pin 33 and 34 on connector JCCD1. Pin 31 and 32 are +5VDC. Are the voltages present?</p>	Go to step 7.	Properly connect the ribbon cable to JCCD1.
<p>Step 7 Replace the flatbed. See “Flatbed scanner assembly removal” on page 374.</p> <p>Does the problem remain?</p>	Go to step 8.	The problem is solved.
<p>Step 8 Replace the controller board. See “Controller board removal” on page 348.</p> <p>Does the problem remain?</p>	Contact the next level of support.	The problem is solved.

Flatbed motor service check

Actions	Yes	No
<p>Step 1 Ensure that the flatbed motor cable (JFB1) is connected.</p> <p>Is the cable connected?</p>	Go to step 2.	Properly connect the cable.
<p>Step 2 Check pin 1 in JFBM1 for voltage. The voltage is only present when a flatbed copy job is running. The voltage should measure +24V AC.</p> <p>Is voltage present?</p>	Replace the flatbed unit. See “Flatbed scanner assembly removal” on page 374.	Replace the controller board. See “Controller board removal” on page 348.

Flatbed home position service check

Actions	Yes	No
<p>Step 1 POR the MFP.</p> <p>Does the CCD move and return to the home position?</p>	Problem solved.	Go to step 2.
<p>Step 2 Perform the home position sensor test. See “Scanner tests” on page 228.</p> <p>Is the sensor working properly?</p>	Go to step 3.	Go to step 5.
<p>Step 3 Check JFB1 on the controller for proper connection.</p> <p>Is it connected properly?</p>	Go to step 4.	Properly connect the cable.
<p>Step 4 Check pin 1 in JFB1 for voltage. The voltage is only present when a flatbed copy job is running. The voltage should measure +24V AC.</p> <p>Is voltage present?</p>	Go to step 5.	Replace the controller board. See “Controller board removal” on page 348.
<p>Step 5 Ensure that the home position cable (JHS1) is connected.</p> <p>Is the cable connected?</p>	Go to step 6.	Properly connect the cable.
<p>Step 6 Check pin 1 in JHS1 for voltage. The voltage should measure +5V DC. Pin 2 should be GND.</p> <p>Is voltage present and is it correct?</p>	Replace the flatbed. See “Flatbed scanner assembly removal” on page 374.	Replace the controller board. See “Controller board removal” on page 348.

ADF rattling noise service check

Actions	Yes	No
<p>Step 1</p> <p>Is the ADF separator roller properly installed?</p>	If the error persists, then go to step 2.	Replace the ADF separator roll. Go to “ADF separator roll removal” on page 370.
<p>Step 2</p> <p>Is the ADF top cover assembly properly installed?</p>	If the error persists, then contact the next level of support.	Replace the ADF top cover assembly. Go to “Top cover ADF sheet feed removal” on page 371.

Flatbed legal scan service check

Action	Yes	No
<p>Step 1</p> <p>Check the JPLEN1 connector on the controller board for proper connection.</p> <p>Is it properly connected?</p>	Go to step 3.	Go to step 2.
<p>Step 2</p> <p>Re-connect the cable to the controller board.</p> <p>Did this fix the problem?</p>	The problem is solved.	Go to step 3.
<p>Step 3</p> <p>Enter diagnostics mode and navigate to: SCANNER TESTS > Sensor Test</p> <p>Select Paper FB Long to perform the sensor test.</p> <p>Did it pass?</p>	Go to step 5.	Go to step 4.
<p>Step 4</p> <p>Replace the flatbed. See “Flatbed scanner assembly removal” on page 374.</p> <p>Did this fix the problem?</p>	The problem is solved.	Go to step 5.
<p>Step 5</p> <p>Replace the controller. See “Controller board removal” on page 348.</p> <p>Did this fix the problem?</p>	The problem is solved.	Contact the next level of support.

ADF streak service check

Actions	Yes	No
Do streaks appear on the middle of scans when using the ADF?	Clean the ADF glass on the flatbed using a lint-free cloth. Also, clean the separator roll and pad with a damp cloth.	No issue to fix.

ADF feed errors service check

Note: This service check should be used if the paper feeds and jams in the ADF. If the paper is not feeding into the ADF see [“ADF feed errors service check” on page 143](#).

Actions	Yes	No
<p>Step 1</p> <p>If the ADF is multi-feeding, check for dirt on the ADF separator pad and ADF separator rollers.</p> <p>Are they dirty?</p>	Clean themf with a lint free cloth and isopropyl alcohol.	Replace the separator pad and ADF pick roll.
<p>Step 2</p> <p>If the paper is skewing when it is fed into the ADF, check the paper guide width.</p> <p>Is it set correctly?</p>	Go to step 3.	Set the paper guides so they contact the edges of the paper.
<p>Step 3</p> <p>If paper is skewing when fed or jamming check to see if the top cover is open or ajar.</p> <p>Is the ADF top cover open or ajar?</p>	Properly close the top cover.	Go to step 4. If the paper is jamming in the ADF, see “ADF paper jam service check” on page 85 .
<p>Step 4</p> <p>Is the leading edge of the paper wrinkled or torn?</p>	Use different media.	Go to step 5.
<p>Step 5</p> <p>Perform the ADF pick motor and ADF feed motor tests.</p> <p>Are the motors working properly?</p>	Go to step 6.	Go to step 8.
<p>Step 6</p> <p>Perform the ADF paper present sensor test. See “Scanner tests” on page 228.</p> <p>Is the sensor working properly?</p>	Go to step 7.	Go to step 8.

Actions	Yes	No
<p>Step 7 Check the ADF sensor actuators to see if they are dirty or jammed.</p> <p>Are the actuators ok?</p>	If any actuators on the ADF are broken, then replace the ADF unit. See “ADF assembly removal” on page 367.	Go to step 8.
<p>Step 8 Properly connect all the connections in the ADF relay card and controller board.</p> <p>Did this fix the situation?</p>	Problem resolved	Go to step 9.
<p>Step 9 Check the ADF cable for continuity.</p> <p>Is there continuity?</p>	Go to step 11.	Go to step 10.
<p>Step 10 Replace the ADF cable.</p> <p>Does this fix the situation?</p>	Problem resolved	Go to step 11.
<p>Step 11 Replace the ADF. See “ADF assembly removal” on page 367.</p> <p>Does this fix the situation?</p>	Problem solved.	Replace the controller board. See “Controller board removal” on page 348.

ADF duplex service check

Note: This service check should be used if the paper feeds and jams in the ADF. If the paper is not feeding into the ADF see [“ADF feed errors service check” on page 143.](#)

Actions	Yes	No
<p>Step 1 Perform the ADF motor tests to verify that the motors are working properly. See “Motor tests” on page 228.</p> <p>Are the motors operating properly?</p>	Go to step 2.	Go to step 4.
<p>Step 2 Perform the scanner sensor tests. See “Scanner tests” on page 228.</p> <p>Are the sensors working properly?</p>	Go to step 3.	Go to step 4.

Actions	Yes	No
<p>Step 3</p> <p>Check the ADF sensor actuators to see if they are dirty or jammed.</p> <p>Are the actuators ok?</p>	Go to step 4.	Clean the actuators. If any actuators on the ADF are broken, then replace the ADF unit. See “ADF assembly removal” on page 367.
<p>Step 4</p> <p>Check all of the connections on the ADF relay</p> <p>Are the properly connected?</p>	Go to step 5.	Properly connect all of the connections.
<p>Step 5</p> <p>Check the ADF cable to ensure that is it properly connected to the ADF relay card, and the main controller board at JADF1.</p> <p>Is the ADF cable properly connected?</p>	Go to step 6.	Properly connect the ADF cable to its connections.
<p>Step 6</p> <p>Check the ADF cable for continuity. Make sure pin 22 has continuity.</p> <p>Does pin 22 have continuity?</p>	Go to step 7.	Replace the ADF cable.
<p>Step 7</p> <p>Replace the ADF. See “ADF assembly removal” on page 367.</p> <p>Does this fix the situation?</p>	Problem solved.	Replace the controller board. See “Controller board removal” on page 348.

Modem/fax card service check

Actions	Yes	No
<p>Step 1</p> <p>Is the phone line properly connected to the modem card and the wall jack?</p>	Go to step 2.	Go to step 3.
<p>Step 2</p> <p>Properly connect the phone line to the modem card and wall jack.</p> <p>Did this fix the problem?</p>	Problem resolved.	Go to step 3.
<p>Step 3</p> <p>Test the phone line’s ability to send and receive calls.</p> <p>Did the phone line work properly?</p>	Go to step 5.	Go to step 4.

Actions	Yes	No
<p>Step 4 Use the MFP on a properly functioning phone jack.</p> <p>Did this fix the problem?</p>	Problem resolved.	Go to step 5.
<p>Step 5 Is the modem card ribbon cable properly connected to the system board at JMOD2 and the modem card?</p>	Go to step 7.	Go to step 6.
<p>Step 6 Properly connect the modem card cable to the modem card and system board.</p> <p>Did this fix the problem?</p>	Problem resolved.	Go to step 7.
<p>Step 7 Check the modem card ribbon cable for continuity.</p> <p>Is there continuity?</p>	Go to step 8.	Replace the modem card cable.
<p>Step 8 Check the voltages from connector JMOD2 on the controller board. Check Pin 4 and 5 for +3.3VDC. Pin 7 for +5VDC. 9, 11, 13, 15, 17, and 19 are grounds.</p> <p>Are the signals or voltages present?</p>	Replace the fax card.	Replace the controller board. See “Controller board removal” on page 348.

Blank spaces on incoming fax service check

Actions	Yes	No
<p>Step 1 Have a fax sent from another machine.</p> <p>Does the problem remain?</p>	Go to step 2.	The problem is solved.
<p>Step 2 Attach the MFP to a different phone line.</p> <p>Does the problem remain?</p>	Go to step 3.	The problem is solved.
<p>Step 3 Print a test page.</p> <p>Does the image quality issue remain?</p>	Go to step 4.	The problem is solved.
<p>Step 4 Install a new toner cartridge.</p> <p>Does the problem remain?</p>	Contact the next level of support.	The problem is solved.

Stretched words on incoming fax service check

Actions	Yes	No
Have a fax sent from another machine. Does the problem remain?	Contact the next level of support.	The problem is solved.

Fax reception service check

Note: Before performing this service check, verify that the correct country code for the MFP is selected. This setting must match the country in which the MFP is used to transmit and receive faxes. If the setting is wrong, the modem settings can be changed in the Fax/SE menu. See step 14. These settings should only be performed with guidance from your second-level support. See [“ADF feed errors service check” on page 143](#).

Actions	Yes	No
Step 1 Is the phone line properly connected to the modem card and the wall jack?	Go to step 2.	Go to step 3.
Step 2 Properly connect the phone line to the modem card and wall jack. Did this fix the problem?	Problem resolved	Go to step 3.
Step 3 Test the phone line’s ability to send and receive calls. Did the phone line work properly?	Go to step 5.	Go to step 4.
Step 4 Use the MFP on a properly functioning phone jack. Did this fix the problem?	Problem resolved.	Go to step 5.
Step 5 Is the phone line being used by the MFP an analog line?	Go to step 8.	Go to step 6.
Step 6 Is the line being used a VOIP line?	Go to step 7.	Go to step 8.
Step 7 Have the system administrator verify that the VOIP server is configured to receive faxes. Is the server properly configured?	Go to step 8.	Stop here. The issue is VOIP related. The VOIP provider needs to change the server configuration.
Step 8 Is the MFP on a PABX?	Go to step 9.	Go to step 10.

Actions	Yes	No
<p>Step 9 Enable Behind a PABX under fax settings in the Administration menu.</p> <p>Did this fix the issue?</p>	Problem fixed.	Disable Behind a PABX , and go to step 10.
<p>Step 10 Is a dial prefix needed to get an outside line?</p>	Go to step 11.	Go to step 12.
<p>Step 11 Try sending a fax using a dial prefix.</p> <p>Did the fax transmit?</p>	Problem fixed.	Go to step 12.
<p>Step 12 Is the fax failing to send to one specific destination?</p>	Go to step 13.	Go to step 14.
<p>Step 13 Check the device that cannot receive a fax.</p> <p>Can it send a fax?</p>	Go to step 14.	Stop here. The issue is with the other device.
<p>Step 14 Press **411 to enter the Fax/SE Menu. Select "Print Logs". Print the T30 transmission log. Check the error being reported with the fax error code table. See "Fax error log codes" on page 151. Perform the suggested resolution for the error.</p> <p>Did this fix the problem?</p>	Problem resolved.	Go to step 15.
<p>Step 15 Adjust the "Transmit Level" setting in the SE menu. press **411 to enter the SE menu, enter Modem settings, and select "Transmit Level". Test by adjusting the transmitted signal strength by decreasing/increasing the 'Transmit Level' setting in steps of 1db. For example, if default value is -11 db, changing it to -12db will decrease the signal strength by 1db, and changing it to -10db will increase the signal strength by 1db. Recommended adjustment range is ± 5 db (in 1db steps) from the default value.</p> <p>Did this fix the problem?</p>	Stop. Problem resolved.	Go to your second-level of support. See "Escalating a fax issue to second-level support" on page 155 .

Fax transmission service check

Actions	Yes	No
Step 1 Is the phone line properly connected to the modem card and the wall jack?	Go to step 2.	Go to step 3.
Step 2 Properly connect the phone line to the modem card and wall jack. Did this fix the problem?	Problem resolved	Go to step 3.
Step 3 Check for a dial tone. Is there a dial tone?	Go to step 4.	Go to step 6.
Step 4 Use a telephone to test the phone line's ability to send and receive calls. Did the phone line work properly?	Go to step 7.	Go to step 5.
Step 5 Use a telephone handset to verify the phone line is free of static or external noise. Is the phone line noise-free?	Go to step 7.	Go to step 6.
Step 6 Use the MFP on a properly functioning phone jack. Did this fix the problem?	Problem resolved.	Go to step 7.
Step 7 In <diags / config menu>, verify that the Enable Fax Receive setting is on. Is the setting set to on?	Go to step 9.	Go to step 8.
Step 8 Set "Enable Fax Receive" to On. Did this fix the problem?	Problem resolved.	Go to step 9.
Step 9 Is Distinctive Ring enabled?	Go to step 11.	Go to step 10.
Step 10 Turn on Distinctive ring. Did this fix the problem?	Problem resolved.	Go to step 11.

Actions	Yes	No
Step 11 Is the phone line analog?	Go to step 13.	Go to step 12.
Step 12 Is the VOIP server configured to support fax?	Go to step 13.	Stop here. This is an issue with the VOIP provider.
Step 13 Does the MFP have reception issues with only a certain remote device?	Go to step 14.	Go to step 15.
Step 14 Verify communications with a different remote device. Can the other device receive faxes?	The issue is with the other device.	Go to step 15.
Step 15 Go to the Administrator menu. Enter the Fax settings - Analog Fax Settings submenu. Verify the Block No Name Fax user setting. Is it enabled?	Go to step 16.	Go to step 17.
Step 16 Disable Block No Name Fax user setting. Did this fix the issue?	Problem resolved.	Go to step 17.
Step 17 Go to the Administrator menu. Enter the Fax settings - Analog Fax Settings submenu. Verify the remote device number is not in the Banned Fax List user setting. Is the remote device number in the banned fax list?	Go to step 18	Go to step 19.
Step 18 Remove the remote number from the banned fax list. Did this fix the problem?	Problem resolved.	Go to step 19.
Step 19 Adjust the "Receive Threshold" setting in the SE menu. press **411 to enter the SE menu, enter Modem settings, and select "Receive Threshold". Test by adjusting the received signal level by decreasing/increasing the "Receive Threshold" setting in steps of 2db. For example, if default value is -43 db, changing it to -45db will decrease the received signal level by 2db, and changing it to -41db will increase the received signal level by 2db. Recommended adjustment range is between -33db and -48db (in 2db steps). Did this fix the problem?	Problem resolved	Go to step 20.

Actions	Yes	No
<p>Step 20</p> <p>press **411 to enter the SE Menu. Select “Print Logs”.</p> <p>Print the T30 transmission/ job log. Check the error code being reported. See “Fax error log codes” on page 151.</p> <p>Perform the suggested resolution for the error.</p> <p>Did this fix the problem?</p>	Problem resolved.	Contact your second-level of support. See “Escalating a fax issue to second-level support” on page 2-79 .

Fax error log codes

Error code	Description	Action
000	No error occurred during fax transmission.	No action is needed.
200	Error occurred when transmitting training.	<ul style="list-style-type: none"> • Check line quality. • Select a lower Max Speed value under Fax Send settings. • Adjust the transmit level.
3XX	Error occurred when receiving image data.	<ul style="list-style-type: none"> • Check line quality. • Adjust Receive Threshold. • Select a lower Max Speed value under Fax Receive settings.
4XX	Error occurred when sending image data.	<ul style="list-style-type: none"> • Check line quality. • Adjust ‘Transmit Level’. • Select a lower ‘Max Speed’ value under Fax Receive settings.
5XX	Received unknown response from remote fax device.	No action needed. Issue is with the other device.
6XX	Error occurred when receiving a frame.	<ul style="list-style-type: none"> • Check line quality. • Adjust ‘Receive Threshold’.
7XX	Error occurred when sending a frame.	<ul style="list-style-type: none"> • Check line quality. • Adjust ‘Transmit Level’. • Select a lower ‘Max Speed’ value under Fax Send settings.
800	Received EOT unexpectedly from the modem in V34 mode.	If error persists, then disable V34 modulation scheme.
802	Too many timeouts occurred during ECM reception.	If error persists, then disable ECM mode.
803	Fax cancelled by user	No action needed.

Error code	Description	Action
804	Unexpectedly received a disconnect command from the remote end.	<ul style="list-style-type: none"> • Check line quality. • Adjust Transmit Level/Receive Threshold values. • Remote device could be requesting an unsupported feature.
805	Remote fax device failed to respond to the DCS command.	<ul style="list-style-type: none"> • Adjust Transmit Level/Receive Threshold values. • Remote device could be malfunctioning.
808	T1 timeout occurred when trying to establish a connection with a remote fax device.	Adjust Transmit Level/Receive Threshold values.
809	T2 Timeout occurred due to loss of command/response synchronization.	Adjust Transmit Level/Receive Threshold values.
80A	T5 Timeout occurred when transmitting image data to remote fax device.	<ul style="list-style-type: none"> • Check line quality. • Adjust 'Transmit Level'. • Select a lower 'Max Speed' value under Fax Send settings.
80B	Too many errors when transmitting in ECM mode.	<ul style="list-style-type: none"> • Check line quality. • Adjust 'Transmit Level'. • Select a lower 'Max Speed' value under Fax Send settings.
80C	Remote device failed to respond to the CTC command.	<ul style="list-style-type: none"> • Select a lower 'Max Speed' value under Fax Send settings. • Adjust 'Transmit Level'.
80D	Received too many requests from remote end to repeat the previous command sent.	<ul style="list-style-type: none"> • Check line quality. • Adjust 'Transmit Level'. • Check if line conditions on remote end will facilitate a good connection.
80E	Functional limitation-Remote fax device does not support G3 receive capability.	No action needed. Issue with the remote device.
811	Failed to detect a fax device at the remote end.	<ul style="list-style-type: none"> • Verify MFD is answering to fax call and not a voice call. • Decrease value of 'Rings To Answer' setting.
812	No more data rates available in V34 modulation scheme.	Adjust to a lower modulation scheme.
813	Timeout occurred after waiting too long to receive a good frame.	Adjust "Receive Threshold".
814	Tried too many times at selected speed using V34 modulation scheme.	<ul style="list-style-type: none"> • Adjust 'Transmit Level'. • Adjust to a lower modulation scheme.

Error code	Description	Action
815	Fax transmission was interrupted due to power failure.	Troubleshoot MFP if error persists. See “Modem/fax card service check” on page 145 .
818	Fax transmission failed due to insufficient memory to store scanned image.	Adjust ‘Memory Use’ setting to allocate more memory for send jobs.
819	Fax transmission failed due to insufficient memory to store received image.	Adjust ‘Memory Use’ setting to allocate more memory for receive jobs.
81A	A timeout occurred during transmission of a page in ECM mode.	Select a lower ‘Max Speed’ value under Fax Send settings.
880	Failure to transmit training successfully in V17, V29, V27 terminal modulation schemes.	<ul style="list-style-type: none"> • Select a lower “Max Speed” under Fax Send settings. • Adjust the “Transmit Level”. • Check line quality.
881	Failure to transmit training successfully in V33, V29, V27 terminal modulation schemes.	<ul style="list-style-type: none"> • Select a lower “Max Speed” under Fax Send settings. • Adjust the “Transmit Level”. • Check line quality.
882	Failure to transmit training successfully in V17, V29 terminal modulation schemes.	<ul style="list-style-type: none"> • Select a lower “Max Speed” under Fax Send settings. • Adjust the “Transmit Level”. • Check line quality.
883	Failure to transmit training successfully in V17, V27 terminal modulation schemes.	<ul style="list-style-type: none"> • Select a lower “Max Speed” under Fax Send settings. • Adjust the “Transmit Level”. • Check line quality.
884	Failure to transmit training successfully in V29, V27 terminal modulation schemes.	<ul style="list-style-type: none"> • Select a lower “Max Speed” under Fax Send settings. • Adjust the “Transmit Level”. • Check line quality.
885	Failure to transmit training successfully in V17 terminal modulation scheme.	<ul style="list-style-type: none"> • Select a lower “Max Speed” under Fax Send settings. • Adjust the “Transmit Level”. • Check line quality.
886	Failure to transmit training successfully in V29 terminal modulation scheme.	<ul style="list-style-type: none"> • Select a lower “Max Speed” under Fax Send settings. • Adjust the “Transmit Level”. • Check line quality.
887	Failure to transmit training successfully in V27 terminal modulation scheme.	<ul style="list-style-type: none"> • Select a lower “Max Speed” under Fax Send settings. • Adjust the “Transmit Level”. • Check line quality.

Error code	Description	Action
888	Failure to transmit training successfully at 2400 bps in V27 terminal modulation scheme.	<ul style="list-style-type: none"> • Adjust “Transmit Level”. • Check line quality.
889	Failed to connect at the minimum speed supported by the MFP.	<ul style="list-style-type: none"> • Adjust “Transmit Level”. • Incompatible connection.
88A	Failed to connect using V.34 modulation scheme.	<ul style="list-style-type: none"> • Check line quality. • Adjust to a lower modulation scheme. • Adjust Transmit Level Receive Threshold values.
901	No fax tones detected from remote end.	<ul style="list-style-type: none"> • Verify destination phone number. • Verify that the remote fax is authorized to receive faxes.
902	No dial tone detected.	<ul style="list-style-type: none"> • Check by enabling ‘Behind a PABX’ setting. • Check phone line. • Check MFD modem hardware.
903	Busy tone detected.	Check with remote end if successive attempts fail.
904	Hardware error detected.	See “Modem/fax card service check” on page 145.
905	A timeout occurred after dialing the number and waiting for a response.	Check with remote end if successive attempts fail.
906	Fax cancelled by user.	No action needed.
907	Modem detected a digital line connection.	Verify the MFP is connected to an analog line. See “Fax transmission service check” on page 149.
908	Phone line was disconnected	Restore phone line connection.
A00	Received request for unsupported function from remote fax device.	No action needed.
A01	Received request for unsupported image width from remote fax device.	No action needed.
A02	Received request for unsupported image resolution from remote fax device.	No action needed.
A03	Received request for unsupported compression type from remote fax device.	No action needed.
A04	Received request for unsupported image length from remote fax device.	No action needed.
F00	Unknown error occurred.	No action needed.

Escalating a fax issue to second-level support

Before contacting the second-level support, go to the SE menu on the MFP, and then generate a Fax error file. This file contains machine settings information and debug information that will help second-level support determine the cause of a failure.

To generate the fax error file, perform the following steps:

- 1 In a Web browser, type **http://MFP/<IP address>/se**.
- 2 The MFP's SE menu page will display. Click the "Dump Job History" link. The following displays:

Fax Job Log							
Wednesday, 2006-02-08 11:25							
Action	Date	Time	Job #	Length	Station Name/Number	Pages	Status
SCAN	1969-12-31	19:00				9	OK
SEND	2006-02-01	13:55	73	17:53	4039	2	CANCELED
SEND	2006-02-01	13:56	74	17:53	4039	0	CANCELED

- 3 Write down the type of connection, the type of error, and the job in which the error occurred.
- 4 In the Web browser address bar, type **http://MFP/<IP address>/se**.
- 5 Click **Report a Fax Problem**. The fax check list displays.
- 6 Fill in the requested information. This is where you will type in the information you retrieved in step 3. Second-level support can assist you if you have questions about the information requested on the page.

Title/Name of Tester: <input type="text" value="Your Name"/>	Date of Event: <input type="text" value="Date of Event"/> mm/dd/yyyy
Customer: <input type="text" value="Customer Name"/>	Time of Event: <input type="text" value="Time of Event"/> hh:mm [A,P]M
Job ID: <input type="text" value="Job ID"/> #####	
Describe the Physical Connection:	
Type: <ul style="list-style-type: none"> <input checked="" type="radio"/> Analog <input type="radio"/> Digital 	Description: <ul style="list-style-type: none"> <input type="checkbox"/> VoIP/FoIP <input type="checkbox"/> PAB <input type="checkbox"/> ISD
Channel Quality: <ul style="list-style-type: none"> <input checked="" type="radio"/> Clear <input type="radio"/> OK <input type="radio"/> Some Noise <input type="radio"/> Very Noisy 	

Note: The fields requesting the code levels, model number, type of problem are auto-filled. If the information is not in the fields, it can be retrieved from the SE menu. The SE menu can be accessed by pressing ****411** or typing **http://MFP/<IP address>/se** in a Web browser.

- 7 After all the requested information is entered into the Fax Checklist Web page, press the **Submit** button on the bottom of the page. A dialogue asking you to save the file appears.

Note: The file generated by the MFP is not automatically transmitted to second-level support. It is placed on the computer desktop.

- 8 Enter a name for the file, and indicated where you want to save the file.
- 9 Press **OK**. The file appears on the desktop.
- 10 E-mail the file to second-level support.

Other symptoms

Base printer symptoms

Base printer symptoms

Symptom	Action
Printer not have power.	Go to “Dead printer service check” on page 157.
False values appear on the display for front door.	Go to “Front door sensor or switches service check” on page 159.
Sensor (narrow media) and sensor (fuser buckle) service check.	Go to “Narrow media sensor service check” on page 163.
Control panel display is dim and unchanging) service check	Go to “Operator panel (display is dim and unchanging) service check” on page 165.
Operator panel (displays all diamonds, no beeps, or five beeps) service check	Go to “Operator panel (displays all diamonds, no beeps, or five beeps) service check” on page 167.
Operator panel (display blank) service check	Go to “Operator panel (display blank) service check” on page 169.
Operator panel (one or more operator buttons fail) service check	Go to “Operator panel (one or more operator panel buttons fail) service check” on page 171.
Operator panel USB cable service check	Go to “Operator panel (one or more operator panel buttons fail) service check” on page 171.
Toner meter cycle (TMC) card service check	Go to “Toner meter cycle (TMC) card service check” on page 174.
Printer not communicating with host (USB)	Go to “USB service check” on page 174.
Printer not communicating with host (Network)	Go to “Network service check” on page 174.
32.52 'Replace Unsupported Cartridge' error displays when a new cartridge is installed	Go to “Replace unsupported cartridge error service check” on page 177.

Dead printer service check

A dead printer is one which, when powered on from a known good electrical outlet, displays no indication of power to the printer by changes to the LCD, LED, or any movement of the fan or motors. If the printer appears dead but makes a *beeping* sound, check the operator panel. See [“Operator panel \(displays all diamonds, no beeps, or five beeps\) service check” on page 167](#).

If a 650-sheet Duo Drawer is installed, then remove the option and check the base printer for correct operation. If the base printer operates correctly, replace the 650-sheet Duo Drawer.

Warning—Potential Damage: Observe all necessary ESD precautions when removing and handling the controller board or any installed option cards or assemblies.

 **CAUTION—SHOCK HAZARD:** When you see this symbol, there is a danger from hazardous voltage in the area of the product where you are working. Unplug the product before you begin, or use caution if the product must receive power to perform the task.

Note: Remove any input paper-handling options from the printer.

Actions	Yes	No
<p>Step 1 Check the AC power voltage.</p> <p>Is the line voltage correct?</p>	Go to step 2.	There may be issues with the line voltage. Inform the customer.
<p>Step 2 Is the AC power cord damaged?</p>	Replace the power cord.	Go to step 3.
<p>Step 3 Are the USB ground contacts attached to the USB connections on the controller board and controller board cage?</p>	Go to step 5.	Go to step 4.
<p>Step 4 Install the USB ground contacts in the controller board.</p> <p>Did this fix the problem?</p>	Problem solved.	Go to step 5.

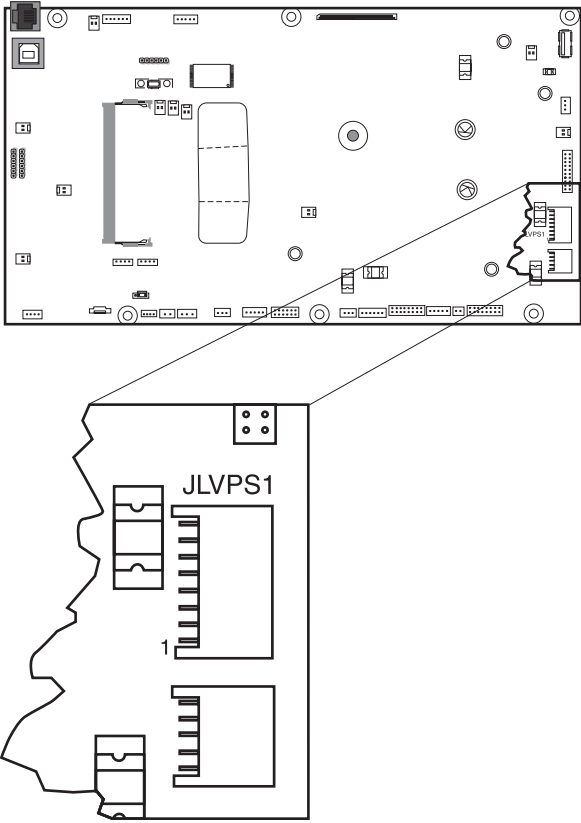
Actions	Yes	No
<p>Step 5 Turn the printer off, and remove the rear cover. See “Rear cover removal” on page 346.</p>  <p>The diagram shows the back of the printer with the rear cover removed. A callout provides a detailed view of the controller board, highlighting the JLVP1 connector. A small '1' is placed next to the JLVP1 connector to indicate the correct connection point for the LVPS cable.</p> <p>Is the LVPS cable correctly connected at JLVP1 on the controller board?</p>	<p>Go to step 6.</p>	<p>Reconnect the cable at JLVP1, and then go to step 6.</p>
<p>Step 6 Turn the printer off, and then on.</p> <p>Does the problem persist?</p>	<p>Go to step 7.</p>	<p>Problem solved.</p>

Actions	Yes	No
<p>Step 7</p> <p>Damage to the printer is possible. Be careful to touch only one conductor at a time. Rest the probe against the connector to steady it.</p> <p>With the printer on, verify the following values at JLVPS1:</p> <ul style="list-style-type: none"> Pin 1: +5 V dc Pin 2: Ground Pin 3: +5 V dc Pin 4: Ground Pin 5: +5 V dc Pin 6: Ground Pin 7: +24 V dc Pin 8: Ground Pin 9: +24 V dc Pin 10: Ground Pin 11: +24 V dc Pin 12: Ground Pin 16: Ground <p>Are the values approximately correct?</p>	<p>Replace the controller board. See “Controller board removal” on page 348.</p>	<p>Replace the LVPS. See “Low-voltage power supply (LVPS) removal” on page 285.</p>

Front door sensor or switches service check

Actions	Yes	No
<p>Step 1</p> <p>Enter Diagnostics Menu.</p> <p>Turn the printer on, press and hold 3 and 6, and release the buttons with the installed memory and processor speed displays.</p> <p>Perform the Base Sensor Test. See “BASE SENSOR TEST” on page 219.</p> <ul style="list-style-type: none"> a Select Base Sensor Test, and press Select. b Select Front Door, and press Select. c Open and close the front door, and observe the display. <p>Does the display indicate Value Closed with the door closed, and Value Opened with the door open?</p>	<p>Sensor, toner door, and right doors are okay.</p>	<p>Go to step 2.</p>

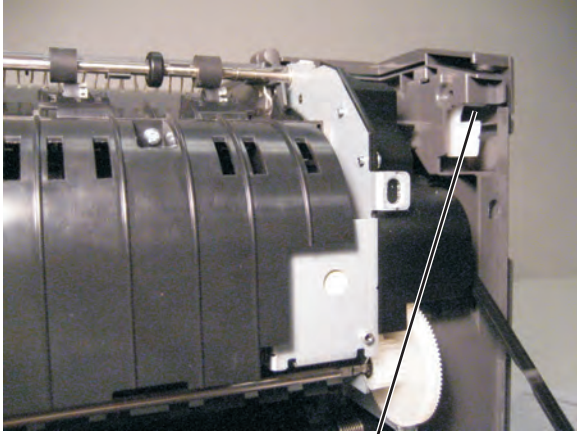
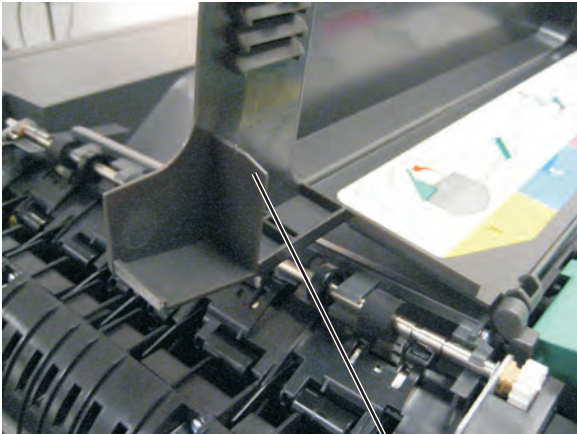
Actions	Yes	No
<p>Step 2</p> <p>Open the front door, and check the thin, tall, plastic web (pivot plate) (A) at the top right of the printer. With the other covers in place and closed, the web interacts with switches in the door.</p>  <p style="text-align: center;">A</p> <p>Open the toner cover, and check the motion of the wed. Is the web loose, damaged, or missing?</p>	<p>Replace the right cover assembly. See “Right cover assembly removal” on page 288.</p>	<p>Go to step 3.</p>
<p>Step 3</p> <p>Open the toner door, and inspect the vertical web that pushes and rotates the pivot plate.</p>  <p style="text-align: center;">B</p> <p>Is it damaged?</p>	<p>Replace the top cover assembly. See “Top cover assembly removal” on page 352.</p>	<p>Go to step 4.</p>

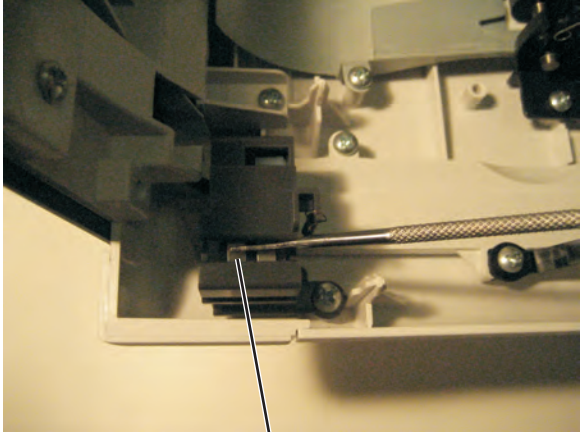
Actions	Yes	No
<p>Step 4</p> <p>With the front cover open, inspect the two switches. Using a tool, such as a spring hook, push the metal arms (C) to check the movement.</p>  <p style="text-align: center;">C</p> <p>Is there any damage to the switches or the surrounding area?</p>	<p>Replace the right cover assembly. See “Right cover assembly removal” on page 288.</p>	<p>Go to step 5.</p>

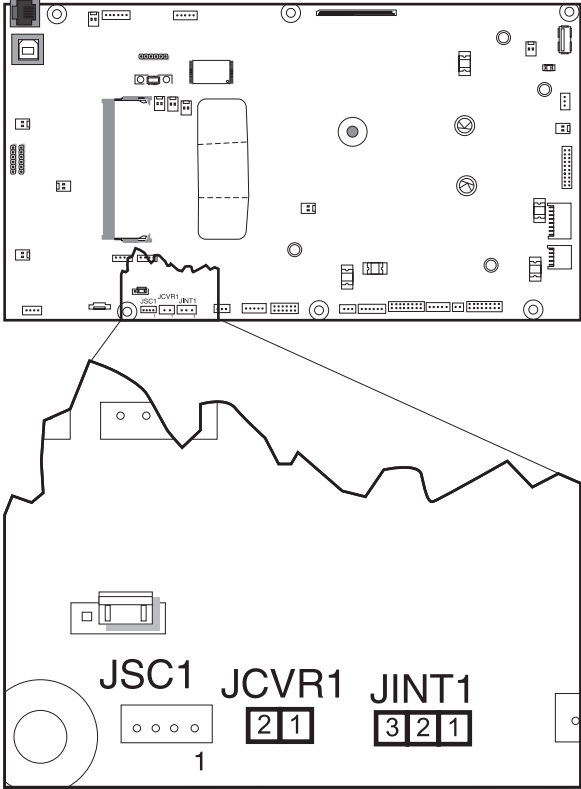
Actions	Yes	No
<p>Step 5</p> <p>Turn the printer off, and remove the rear cover. See “Rear cover removal” on page 346. Turn the printer on, and verify the following values at JINT1 and JCVR1.</p> <p>JINT1</p> <p>Pin 1: +5 V dc Pin 2: Ground</p> <p>JCVR1</p> <p>Pin 1: +24 V dc</p>  <p>Are the values approximately correct?</p>	<p>Go to step 6.</p>	<p>Replace the controller board. See “Controller board removal” on page 348.</p>
<p>Step 6</p> <p>Close the front cover and the toner door. Be sure that the right cover is in place. Turn the printer off, and then disconnect the cables at JINT1 and JCVR1.</p> <p>Test continually at the connector under the following conditions:</p> <ul style="list-style-type: none"> • With the front cover and toner door closed: Test pin 1 and pin 3 at JINT1 cable end, and pin 1 and pin 2 at JCVR1 cable end. • With one or both doors open: Pin 2 and 3 at JINT1 cable end should indicate continuity, but pins 1 and 2 at JCVR1 should have no continuity. <p>Are the tests verified?</p>	<p>Contact your next level or support.</p>	<p>Replace the front cover assembly. See “Front door sensor or switches service check” on page 159.</p>

Narrow media sensor service check

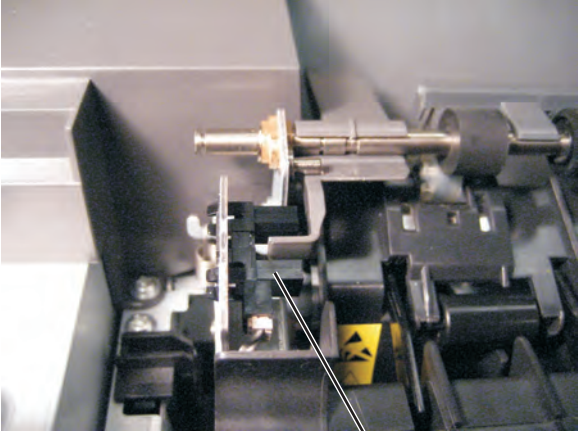
Actions	Yes	No
<p>Step 1 Open the front cover, and inspect the narrow media sensor (A) located towards the front of the top cover assembly.</p>  <p style="text-align: center;">A</p> <p>Is the narrow media sensor dislodged or damaged?</p>	<p>Repair or replace the narrow media sensor. See “Narrow media sensor removal” on page 363.</p>	<p>Go to step 2.</p>
<p>Step 2 Does the flag rotate freely?</p>	<p>Go to step 3.</p>	<p>Reposition or replace the flag. See “Narrow media sensor removal” on page 363.</p>

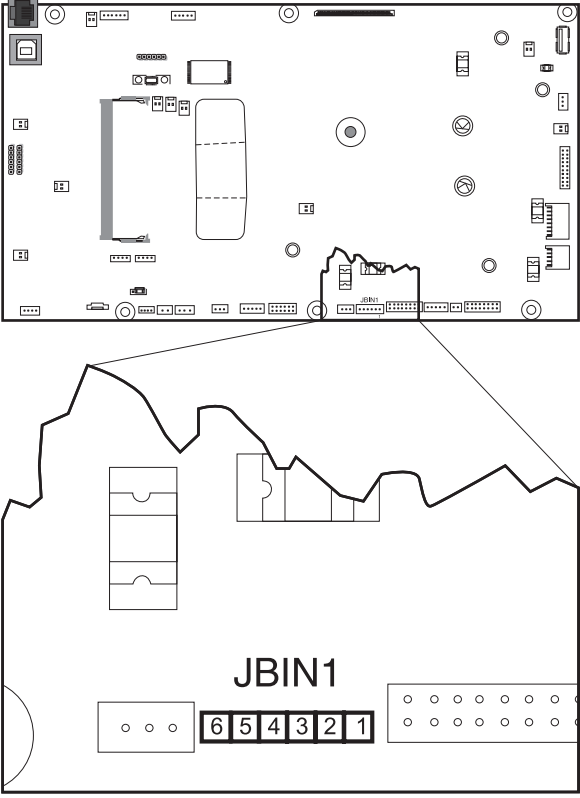
Actions	Yes	No
<p>Step 3</p> <p>Enter Diagnostics Menu.</p> <p>Turn the printer on, press and hold 3 and 6, and release the buttons with the installed memory and processor speed displays.</p> <p>Perform the Base Sensor Test. See “BASE SENSOR TEST” on page 219.</p> <ol style="list-style-type: none"> Select Base Sensor Test, and press Select. Select Fuser Exit Sensor, and press Select. Open the close the front door, and inspect the fuser exit sensor located on the LVPS shield. <p>Turn the printer off, and remove the rear cover. See “Rear cover removal” on page 346.</p> <p>Turn the printer on, and then click the values below at JBIN1:</p> <p>Pin 1: 0 V dc (+5 V dc during cycle)</p> <p>Pin 2: +3.3 V dc beam blocked 0 V dc unblocked</p> <p>Pin 3: Ground</p>  <p>Are the values correct?</p>	<p>Problem resolved.</p>	<p>Replace the controller board. See “Controller board removal” on page 348.</p>

Operator panel (display is dim and unchanging) service check

Replace one of the following components, and perform a POR before replacing a second component. Never replace both of the components without performing a POR after installing each one, or the printer will be rendered inoperable.

For CX310 models:



- Controller board
- Operator panel with UICC card

For CX410 and CX510 models:

- Controller board
- UICC card

Warning—Potential Damage: Never install and remove components listed above as a method of troubleshooting components. Once a component has been installed in a printer, and the printer is powered on, it cannot be used in another printer. It must be returned to the manufacturer.

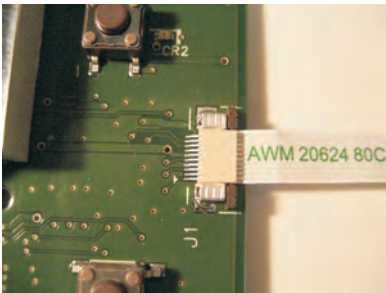
For CX310 and CX410 models:

Actions	Yes	No
<p>Step 1</p> <p>Enter the Diagnostics Menu (turn the printer off, press and hold 3 and 6, turn the printer on, and then release the buttons when the installed memory and processor speed displays).</p> <p>Perform the Panel Test. See “Panel Test” on page 215.</p> <p>Did all the pixels come on?</p>	<p>Go to step 2.</p>	<p>Replace the operator panel. See “Operator panel removal (for CX310 and CX410 models only)” on page 313.</p>
<p>Step 2</p> <p>Turn the printer off.</p> <p>Remove the rear cover. See “Rear cover removal” on page 346.</p> <p>Remove the operator panel. See “Operator panel removal (for CX310 and CX410 models only)” on page 313.</p> <p>Is the operator panel cable properly installed at JLCD1 on the controller board and the operator panel assembly?</p> <p>Note: JLCD1 is the ribbon cable connector on the right side facing the controller board.</p>	<p>Go to step 3.</p> <p>CX310</p>  <p>CX410</p> 	<p>Reinstall the cable.</p>
<p>Step 3</p> <p>Replace the operator panel. See “Operator panel removal (for CX310 and CX410 models only)” on page 313.</p> <p>Is the operator panel still dim and unchanging?</p>	<p>Replace the controller board. See “Controller board removal” on page 348.</p>	<p>Problem resolved.</p>

For CX510 models:

Actions	Yes	No
<p>Step 1</p> <p>Enter the Diagnostics Menu (turn the printer off, press and hold 3 and 6, turn the printer on, and then release the buttons when the installed memory and processor speed displays).</p> <p>Perform the Panel Test. See “Panel Test” on page 215.</p> <p>Did all the pixels come on?</p>	Go to step 2.	Go to step 4.
<p>Step 2</p> <p>Turn the printer off.</p> <p>Remove the rear cover. See “Rear cover removal” on page 346.</p> <p>Remove the operator panel. See “Operator panel removal (for CX510 models only)” on page 320.</p> <p>Is the operator panel cable properly installed at JLCD1 on the controller board and the operator panel assembly?</p> <p>Note: JLCD1 is the ribbon cable connector on the right side facing the controller board.</p>	Go to step 3.	Reinstall the cable.
<p>Step 3</p> <p>Check the UICC card to display cable.</p> <p>Is the display cable installed at the UICC card correctly?</p>	Go to step 4.	Reinstall the cable.
<p>Step 4</p> <p>Replace the display. See “Operator panel removal (for CX510 models only)” on page 320.</p> <p>Is the operator panel still dim and unchanging?</p>	Go to step 5.	Problem resolved.
<p>Step 5</p> <p>Replace the UICC card. See “Operator panel removal (for CX510 models only)” on page 320.</p> <p>Is the operator panel still dim and unchanging?</p>	Replace the controller board. See “Controller board removal” on page 348 .	Problem resolved.

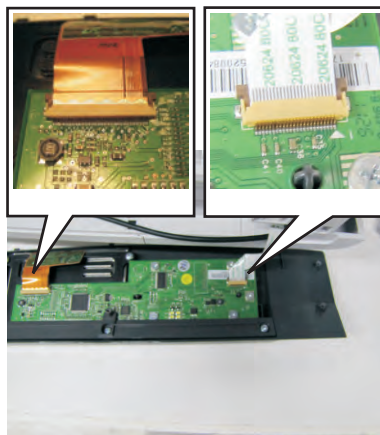

Operator panel (displays all diamonds, no beeps, or five beeps) service check

Replace one of the following components, and perform a POR before replacing a second component. Never replace both of the components without performing a POR after installing each one, or the printer will be rendered inoperable.

For CX310 models:

- Controller board
- Operator panel with UICC card

For CX410 and CX510 models:

- Controller board
- UICC card

Warning—Potential Damage: Never install and remove components listed above as a method of troubleshooting components. Once a component has been installed in a printer, and the printer is powered on, it cannot be used in another printer. It must be returned to the manufacturer.

For CX310 models:

Actions	Yes	No
<p>Step 1</p> <p>Turn the printer off.</p> <p>Remove the rear cover. See “Rear cover removal” on page 346.</p> <p>Remove the operator panel. See “Operator panel removal (for CX310 and CX410 models only)” on page 313.</p> <p>Is the operator panel cable properly installed at JLCD1 on the controller board and the operator panel assembly?</p> <p>Note: JLCD1 is the ribbon cable connector on the right side facing the controller board.</p>	Go to step 2.	Reinstall the cable.
<p>Step 2</p> <p>Replace the operator panel assembly. See “Operator panel removal (for CX310 and CX410 models only)” on page 313.</p> <p>Does the operator panel display all diamonds?</p>	Problem solved.	Replace the controller board. See “Controller board removal” on page 348 .

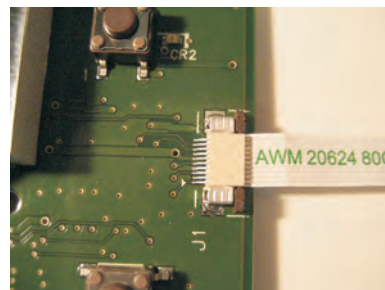

For CX410 models:

Actions	Yes	No
<p>Step 1</p> <p>Turn the printer off.</p> <p>Remove the rear shield. See “Rear cover removal” on page 346.</p> <p>Remove the operator panel. See “Operator panel removal (for CX310 and CX410 models only)” on page 313.</p> <p>Is the operator panel cable properly installed at JLCD1 on the controller board and the operator panel assembly?</p> <p>Note: JLCD1 is the ribbon cable connector on the right side facing the controller board.</p>	Go to step 2.	Reinstall the cable.
<p>Step 2</p> <p>Replace the UICC card with display. See “Operator panel removal (for CX310 and CX410 models only)” on page 313.</p> <p>Does the operator panel display all diamonds?</p>	Replace the controller board. See “Controller board removal” on page 348 .	Problem resolved.



For CX510 models:

Actions	Yes	No
<p>Step 1</p> <p>Turn the printer off.</p> <p>Remove the rear cover. See “Rear cover removal” on page 346.</p> <p>Remove the operator panel. See “Operator panel removal (for CX510 models only)” on page 320.</p> <p>Is the operator panel cable properly installed at JLCD1 on the controller board and the operator panel assembly?</p> <p>Note: JLCD1 is the ribbon cable connector on the right side facing the controller board.</p>	Go to step 2.	Reinstall the cable.
<p>Step 2</p> <p>Check UICC card to display cable.</p> <p>Is the display cable installed at the UICC card correctly?</p>	Go to step 3.	Reinstall the cable.
<p>Step 3</p> <p>Replace the UICC card with display. See “Operator panel removal (for CX510 models only)” on page 320.</p> <p>Does the operator panel display all diamonds?</p>	Replace the controller board. See “Controller board removal” on page 348.	Problem resolved.

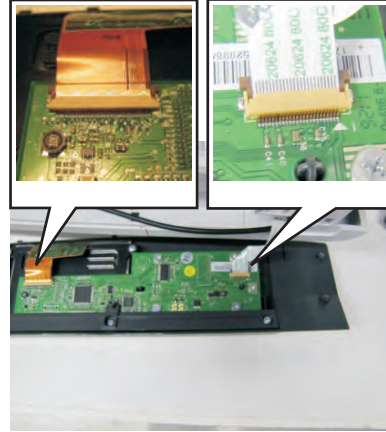

Operator panel (display blank) service check

Replace one of the following components, and perform a POR before replacing a second component. Never replace both of the components without performing a POR after installing each one, or the printer will be rendered inoperable.

For CX310 models:

- Controller board
- Operator panel with UICC card



For CX410 and CX510 models:

- Controller board
- UICC card

Warning—Potential Damage: Never install and remove components listed above as a method of troubleshooting components. Once a component has been installed in a printer, and the printer is powered on, it cannot be used in another printer. It must be returned to the manufacturer.

Note: The printer has detected a problem with the controller board, the operator panel assembly cable (part of the front cover assembly), or the operator panel assembly if POST does not complete. The printer emits five *beeps*, and sticks in a continuous pattern until the printer is turned off.

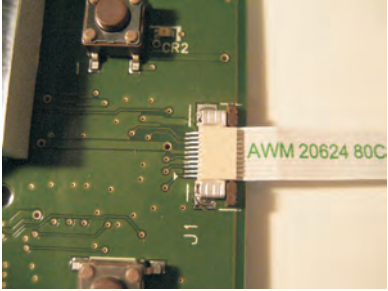
For CX310 and CX410 models:

Actions	Yes	No
<p>Step 1</p> <p>Turn the printer off.</p> <p>Remove the rear cover. See “Rear cover removal” on page 346.</p> <p>Remove the operator panel. See “Operator panel removal (for CX310 and CX410 models only)” on page 313.</p> <p>Is the operator panel assembly cable properly installed at JLCD1 on the controller board and the operator panel assembly?</p> <p>Note: JCDL1 is the ribbon cable connector on the right side facing the controller board.</p>	<p>Go to step 2.</p> <p>CX310</p>  <p>CX410</p> 	<p>Reinstall the cable.</p>
<p>Step 2</p> <p>Replace the operator panel assembly. See “Operator panel removal (for CX310 and CX410 models only)” on page 313.</p> <p>Is the operator panel still blank?</p>	<p>Replace the controller board. See “Controller board removal” on page 348.</p>	<p>Problem resolved.</p>

For CX510 models:

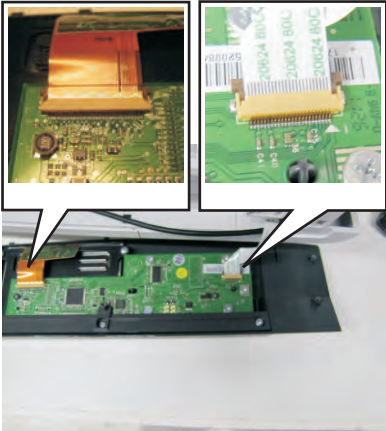
Actions	Yes	No
<p>Step 1</p> <p>Turn the printer off.</p> <p>Remove the rear cover. See “Rear cover removal” on page 346.</p> <p>Remove the operator panel. See “Operator panel removal (for CX310 and CX410 models only)” on page 313.</p> <p>Is the operator panel assembly cable properly installed at JLCD1 on the controller board and the operator panel assembly?</p> <p>Note: JCDL1 is the ribbon cable connector on the right side facing the controller board.</p>	<p>Go to step 2.</p> 	<p>Reinstall the cable.</p>
<p>Step 2</p> <p>Replace the UICC card to display cable.</p> <p>Is the display cable installed at the UICC card correctly?</p>	<p>Go to step 3.</p>	<p>Reinstall the cable.</p>
<p>Step 3</p> <p>Replace the display. See “Operator panel removal (for CX510 models only)” on page 320.</p> <p>Is the operator panel still blank?</p>	<p>Go to step 4.</p>	<p>Problem resolved.</p>
<p>Step 4</p> <p>Replace the UICC card. See “Operator panel removal (for CX510 models only)” on page 320.</p> <p>Is the operator panel still blank?</p>	<p>Replace the controller board. See “Controller board removal” on page 348.</p>	<p>Problem resolved.</p>

Operator panel (one or more operator panel buttons fail) service check

Replace one of the following components, and perform a POR before replacing a second component. Never replace both of the components without performing a POR after installing each one, or the printer will be rendered inoperable.

For CX310 models:

- Controller board
- Operator panel with UICC card

For CX410 models and CX510 models:

- Controller board
- UICC card

Warning—Potential Damage: Never install and remove components listed above as a method of troubleshooting components. Once a component has been installed in a printer, and the printer is powered on, it cannot be used in another printer. It must be returned to the manufacturer.

For CX310 models:

Actions	Yes	No
<p>Enter Diagnostics Menu (turn the printer off, press and hold 3 and 6, turn the printer on, and then release the buttons when the installed memory and processor speed displays). Perform the Panel Test. See “Panel Test” on page 215. The Panel Test should show alternating display of all pixels on, and all pixels off. Press Stop to end the test.</p> <p>Did the test show errors on the display?</p>	<p>Replace the operator panel assembly. See “Operator panel removal (for CX310 and CX410 models only)” on page 313.</p>	<p>Problem resolved.</p>

For CX410 models:

Actions	Yes	No
<p>Enter Diagnostics Menu (turn the printer off, press and hold 3 and 6, turn the printer on, and then release the buttons when the installed memory and processor speed displays).</p> <p>Perform the Button Test. See “Button Test” on page 215 in the Diagnostics menu.</p> <p>Did any of the buttons fail the test?</p>	<p>Replace the UICC card with display. See “Operator panel removal (for CX310 and CX410 models only)” on page 313.</p>	<p>Problem resolved.</p>

For CX510 models:

Actions	Yes	No
<p>Enter Diagnostics Menu (turn the printer off, press and hold 3 and 6, turn the printer on, and then release the buttons when the installed memory and processor speed displays).</p> <p>Perform the Button Test. See “Button Test” on page 215 in the Diagnostics menu.</p> <p>Did any of the buttons fail the test?</p>	<p>Replace the UICC card.</p>	<p>Problem resolved.</p>

Operator panel USB cable service check

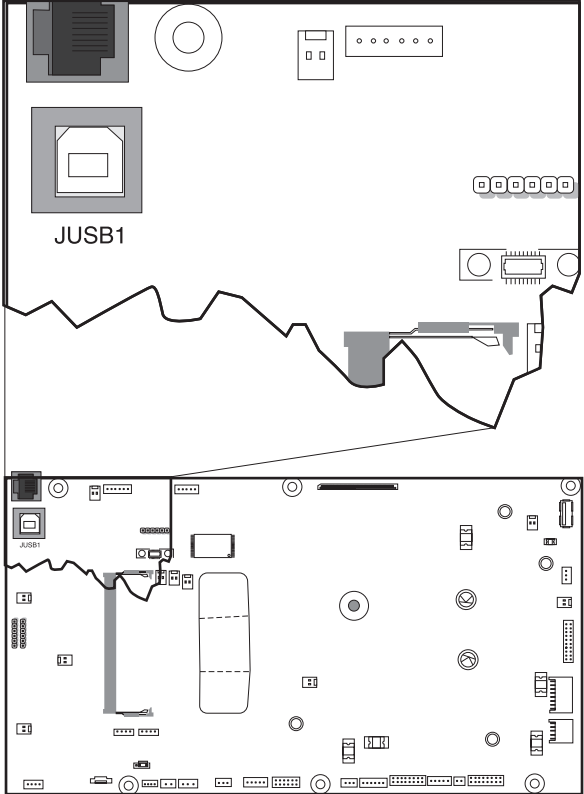
Actions	Yes	No
<p>Step 1 Remove the rear cover. See “Rear cover removal” on page 346.</p> <p>Is the cable properly seated in the controller board?</p>  <p>The diagram consists of two parts. The top part is a close-up of the controller board, showing a USB port labeled 'JUSB1' and other components like a circular hole and a multi-pin connector. The bottom part is a larger view of the main board, with a dashed line indicating the location of the controller board and a callout line pointing to the JUSB1 port.</p>	Go to step 2.	Reseat the USB cable.
<p>Step 2 Replace the USB cable. See “USB port connector removal” on page 321.</p> <p>Is the problem fixed?</p>	Problem resolved.	Replace the controller board. See “Controller board removal” on page 348.

Toner meter cycle (TMC) card service check

Actions	Yes	No
<p>Perform the Base Sensor Test:</p> <ul style="list-style-type: none"> a Enter Diagnostics menu. <ul style="list-style-type: none"> Turn the printer on, press and hold 3 and 6, and release the buttons with the installed memory and processor speed displays. b Select Base Sensor Test, and press Select. c Select the sensor you want to test, open the toner door, remove the corresponding toner cartridge, and press Select. d Note whether the operator panel shows a change in state. <p>Note: If the reflective disk is not showing on the cartridge, then rotate the gear clockwise to expose the reflective surface.</p> <p>For additional information about the Base Sensor Test, see “BASE SENSOR TEST” on page 219.</p> <p>Does the operator panel display a change of state?</p>	Replace the toner cartridge.	Replace the toner meter cycle (TMC) card. See “Toner meter cycle (TMC) card removal” on page 290 .

USB service check

Actions	Yes	No
<p>Step 1</p> <p>Is the USB cable properly connected to the printer and host PC?</p>	Go to step 2.	Properly connect the cable at both ends.
<p>Step 2</p> <p>Try a different USB cable.</p> <p>Does this fix the issue?</p>	Issue fixed.	Go to step 3.
<p>Step 3</p> <p>Connect a different device to the USB cable.</p> <p>Did the host PC see the device?</p>	Replace the controller board. See “Controller board removal” on page 348 .	There is an issue with the host machine.

Network service check

Note: Before starting this service check, print out the network setup page. This page is found under **Menu>Reports>Network Settings**. Consult the network administrator to verify that the physical and wireless network settings displayed on the network settings page for the device are properly configured. If a wireless network is used, then verify that the printer is in range of the host computer or wireless access point, and there is no electronic interference. Have the network administrator verify that the device is using the correct SSID, and wireless security protocols. For more network troubleshooting information, consult the Lexmark Network Setup Guide.

Actions	Yes	No
<p>Step 1 If the device is physically connected to the network, verify that the ethernet cable is properly connected on both ends.</p> <p>Is the cable properly connected?</p>	Go to step 3. If the network is wireless, then go to step 3.	Go to step 2.
<p>Step 2 Connect the ethernet cable.</p> <p>Does this fix the problem?</p>	Problem solved.	Go to step 3.
<p>Step 3 Check the printer's online status under Printers and Faxes on the host computer. Delete all print jobs in the print queue. Is the printer online and in a Ready state.</p>	Go to step 5.	Go to step 4.
<p>Step 4 Change the printer status to online.</p> <p>Did this fix the issue?</p>	Problem resolved.	Go to step 5.
<p>Step 5 Does the IP address displayed on the network settings page match the IP address in the port of the drivers using the printer?</p>	Go to step 10.	Go to step 6.
<p>Step 6 Does the LAN use DHCP? Note: A printer should use a static IP address on a network.</p>	Go to step 7.	Go to step 9.
<p>Step 7 Are the first two segments of the IP address 169.254</p>	Go to step 8.	Go to step 9.
<p>Step 8 POR the printer.</p> <p>Did this resolve the issue?</p>	Problem resolved.	Go to step 10.
<p>Step 9 Reset the address on the printer to match the IP address on the driver.</p> <p>Did this resolve the issue?</p>	Problem fixed.	Go to step 10.
<p>Step 10 Have the network admin verify that the printer and PC's IP address have identical subnet addresses.</p> <p>Are the subnet addresses the same?</p>	Go to step 12.	Go to step 11.

Actions	Yes	No
<p>Step 11 Using the subnet address supplied by the network administrator, assign a unique IP address to the printer.</p> <p>Note: The printer IP address should match the IP address on the printer driver.</p> <p>Did this fix the problem?</p>	Problem resolved.	Go to step 12.
<p>Step 12 Is the device physically connected (ethernet cable) to the network?</p>	Go to step 13.	Go to step 15.
<p>Step 13 Try using a different ethernet cable.</p> <p>Did this fix the problem?</p>	Problem solved.	Go to step 14.
<p>Step 14 Have the network administrator check the network drop for activity.</p> <p>Is the network drop functioning properly?</p>	Replace the controller board. See “Controller board removal” on page 348.	Contact the network administrator.
<p>Step 15 Is the printer on the same wireless network as the other devices?</p>	Go to step 17.	Go to step 16.
<p>Step 16 Assign the correct wireless network to the printer.</p> <p>Did this fix the problem?</p>	Problem resolved.	Go to step 17.
<p>Step 17 Are the other devices on the wireless network communicating properly?</p>	Go to step 18.	Contact the network administrator.
<p>Step 18 Properly reseal the wireless cable.</p> <p>Did this fix the problem?</p>	Problem resolved.	Go to step 20.
<p>Step 19 If there is an attached antenna, is the antenna damaged?</p> <p>Note: The optional wireless unit does not have an external antenna.</p>	Go to step 22.	Go to step 21.
<p>Step 20 Replace the antenna.</p> <p>Did this fix the problem?</p>	Problem resolved.	Go to step 22.

Actions	Yes	No
<p>Step 21 Verify that the antenna is properly connected to the wireless option.</p> <p>Is it connected correctly?</p>	Problem resolved.	Go to step 23.
<p>Step 22 Properly connect the antenna.</p> <p>Did this fix the problem?</p>	Problem resolved.	Go to step 24.
<p>Step 23 Replace the wireless card.</p> <p>Did this fix the problem?</p>	Problem resolved.	Go to step 25.
<p>Step 24 Replace the controller board. See “Controller board removal” on page 348.</p> <p>Did this fix the problem?</p>	Problem resolved.	Contact your next level of support.

Replace unsupported cartridge error service check

Actions	Yes	No
<p>Step 1 Check the cartridge for any damage.</p> <p>Is the cartridge damaged?</p>	Go to step 3.	Go to step 2.
<p>Step 2 Replace the cartridge.</p> <p>Does the problem remain?</p>	Go to step 3.	Problem solved.
<p>Step 3 Check if the cartridge used is a new genuine Lexmark cartridge.</p> <p>Is a new genuine Lexmark cartridge being used?</p>	Go to step 5.	Go to step 4.
<p>Step 4 Replace the cartridge with a genuine Lexmark cartridge.</p> <p>Does the problem remain?</p>	Go to step 5.	Problem solved.

Actions	Yes	No
<p>Step 5 Update the printer firmware to E402 or the latest level.</p> <p>Note: If the printer is in a 32.52 Replace Unsupported Cartridge error state, boot the printer into Invalid Engine mode to allow the firmware update.</p> <p>a Power off the printer.</p> <p>b Press and hold the 3, 4, and 6 buttons while turning on the printer.</p> <p>An Invalid Engine Code message should display on the control panel.</p> <p>Does the problem remain?</p>	Contact your next level or support.	Problem solved.

Input option symptoms

550-sheet and 650-sheet trays input option symptoms

Symptom	Action
Printer fails to recognize the option is installed.	Go to “Option and media size not recognized service check” on page 180.
Tray X does not recognize the media size loaded.	Go to “Option and media size not recognized service check” on page 180.
Tray missing message appears even if media tray is installed. Media tray does not fit in the drawer.	Go to “Tray (x) sensor service check” on page 179.
Double feed	Go to “Double feed and printout skewed service check” on page 182.
Printout is skewed.	Go to “Double feed and printout skewed service check” on page 182.
Failed to feed from input option tray.	Go to “Failed to feed from option tray and leading edge damaged service check” on page 187.
Leading edge damaged.	Go to “Failed to feed from option tray and leading edge damaged service check” on page 187.
Failed to feed from multipurpose feeder.	Go to “Failed to load/feed from multipurpose feeder service check” on page 185.
Load multipurpose feeder with plain paper letter.	Go to “Failed to load/feed from multipurpose feeder service check” on page 185.
Paper input tray missing (tray 2 or tray 3).	Go to “Tray 2 or tray 3 missing service check” on page 192.
Tray 2 or tray 3 not detected.	Go to “Tray 2 or tray 3 not detected service check” on page 190.
Input option tray 2 or 3 empty.	Go to “Tray 2 or tray 3 empty service check” on page 195.
Incompatible tray 3.	Go to “Incompatible tray 3 service check” on page 197.

Tray (x) sensor service check

Actions	Yes	No
<p>Step 1</p> <p>a POR the printer.</p> <p>b Reseat the printer from the input option. Make sure it is installed correctly.</p> <p>c Make sure the input option configuration is supported for that printer. Refer to the <i>Input Option Configuration Guide</i>.</p> <p>Does the error remain?</p>	Go to step 2.	Problem resolved.
<p>Step 2</p> <p>When the printer is in Ready state, pull the standard tray out. The display should indicate Tray (x) Missing. Reinsert the tray.</p> <p>Does the message remain on the display?</p>	Go to step 3.	Go to step 5.
<p>Step 3</p> <p>Check the vertical wall at the right rear of the tray for damage.</p> <p>Is the tray damaged?</p>	Replace the tray.	Go to step 4.
<p>Step 4</p> <p>Check for a dislodged tray present sensor.</p> <p>Is the sensor dislodged?</p>	<p>Replace the option tray present sensor.</p> <ul style="list-style-type: none"> • If the 650-sheet tray is affected, then replace the 650-sheet drawer assembly. • If the 550-sheet drawer assembly is affected, then replace the entire 550-sheet drawer assembly. 	Contact the next level of support.
<p>Step 5</p> <p>Does the message Tray (x) Missing fail to appear when the tray is pulled out?</p>	Go to step 6.	Problem resolved.

Actions	Yes	No
<p>Step 6</p> <p>a Turn off the printer.</p> <p>b Remove the rear cover. See “Rear cover removal” on page 346.</p> <p>c Disconnect the cable at JTRAY1 connector for tray 1 or JOPT1 for tray 2 and 3 on the controller board.</p> <p>d Turn the printer on, and measure the following voltages: For tray 1, check JTRAY1 on the controller board for +5 Vdc on pin 1, +5 Vdc on pin 2, and GND on pin 3. For tray 2 or 3, check JOPT1 on the controller board for GND on pin 2, GND on pin 3, and +24 Vdc on pin 5.</p> <p>Are the voltage values approximately correct?</p>	Problem resolved.	Replace the controller board. See “Controller board removal” on page 348 .

Option and media size not recognized service check

Action	Yes	No
<p>Step 1</p> <p>a POR the printer.</p> <p>b Reseat the printer from the input option and make sure it is installed correctly.</p> <p>c Make sure the input option configuration is supported for that printer. Refer to the <i>Input Option Configuration Guide</i>.</p> <p>Does the error remain?</p>	Go to step 2.	Problem resolved.
<p>Step 2</p> <p>Is the machine using both 650 and 550 input option tray?</p>	Go to step 3.	Go to step 4.
<p>Step 3</p> <p>a Make sure the sequence of the input option trays is correct. The 650 option tray should be in tray 2, and the 550 option tray should be in tray 3.</p> <p>b Bring the printer into the Diagnostics Menu.</p> <p>c Navigate to Feed Test > Tray # > Single Feed Test.</p> <p>d Run a continuous feed test (feed at least 5 pages).</p> <p>Does the feed test run successfully on each option?</p>	Go to step 8.	Go to step 4.
<p>Step 4</p> <p>Isolate the problem. Verify the problem by installing only one input option to the printer at a time.</p> <p>a Bring the printer into the Diagnostics Menu.</p> <p>b Navigate to Feed Test > Tray # > Single Feed Test.</p> <p>Does the feed test run successfully on each option?</p>	Go to step 8.	Go to step 5.

Action	Yes	No
<p>Step 5</p> <p>Check the following for any damage:</p> <p>For 550 input option:</p> <ul style="list-style-type: none"> • Input tray • Paper restrains • Paper dams • Pick pads <p>For 650 input option:</p> <ul style="list-style-type: none"> • Input tray • Paper restrains • Paper dams • Pick pads • MPF gear • MPF pick assembly • MPF tray <p>Is the input option tray assembly free of damage?</p>	Go to step 6.	<ul style="list-style-type: none"> • For 550 input option, replace the optional 550-sheet drawer. • For 650 input option, replace the optional 650-sheet duo drawer.
<p>Step 6</p> <p>Check the pick tires for wear, damage, contamination, and if they are installed correctly.</p> <p>Is the pick tire free of wear and damaged?</p>	Go to step 7.	Replace the pick tire assembly. See “Pick tire removal” on page 387.
<p>Step 7</p> <p>Check the input option drawer and the following for any damage or contamination:</p> <ul style="list-style-type: none"> • Top and bottom autoconnector • Pass-through sensors • Feed rollers • Input option pick assembly (if it can go down every time the paper input tray is inserted) <p>Is the option drawer assembly free of damage or contamination?</p>	Go to step 8.	<ul style="list-style-type: none"> • For 550 input option, replace the optional 550-sheet drawer. • For 650 input option, replace the optional 650-sheet duo drawer.
<p>Step 8</p> <p>a Turn off the printer.</p> <p>b Remove the printer from the input option trays.</p> <p>c Remove the rear shield.</p> <p>d Reseat the JOPT1 cable on the system board.</p> <p>e Check the JOPT1 cable for any damage.</p> <p>f Position the printer to partially hang on the side of a table, and check the autoconnect/option tray cable for damage.</p> <p>Is the tray 2 to controller board cable damaged?</p>	<ul style="list-style-type: none"> • If the printer autoconnector is damaged, then replace the tray 2 to controller board cable. • If the option tray autoconnector is damaged, then go to step 8. 	Go to step 9.

Action	Yes	No
<p>Step 9</p> <ul style="list-style-type: none"> • For 550 input option, replace the optional 550-sheet drawer. • For 650 input option, replace the optional 650-sheet duo drawer. <p>Does this fix the problem?</p>	Problem resolved.	Go to step 10.
<p>Step 10</p> <p>a Turn off the printer.</p> <p>b Remove the rear cover. See</p> <p>c Disconnect the cable at JOPT1 on the controller board.</p> <p>d Turn the printer on.</p> <p>e Measure the voltages below:</p> <p>JOPT1:</p> <ul style="list-style-type: none"> • Pin 2: Ground • Pin 3: Ground • Pin 5: +24 V dc • Pin 6: Ground • Pin 7: +5 V dc • Pin 9: Ground • Pin 10: Ground <p>Are the voltages correct?</p>	Contact your next level of support.	Replace the controller board. See “Controller board removal” on page 348.

Double feed and printout skewed service check

Action	Yes	No
<p>Step 1</p> <p>a Fan the media.</p> <p>b Verify the proper tray settings for the media.</p> <p>c Check the condition of the multipurpose feeder pick tires.</p> <p>d Make sure the tray is fully inserted.</p> <p>e Make sure the paper tray guides are set correctly.</p> <p>Does the error remain?</p>	Go to step 2.	Problem resolved.
<p>Step 2</p> <p>Is the machine using both 650 and 550 input option tray?</p>	Go to step 3.	Go to step 4.

Action	Yes	No
<p>Step 3</p> <p>a Make sure the sequence of the input option trays is correct. The 650 option tray should be in tray 2, and the 550 option tray should be in tray 3.</p> <p>b Bring the printer into the Diagnostics Menu.</p> <p>c Navigate to Feed Test > Tray # > Single Feed Test.</p> <p>d Run a continuous feed test (feed at least 5 pages).</p> <p>Does the feed test run successfully on each option?</p>	Go to step 8.	Go to step 4.
<p>Step 4</p> <p>Isolate the problem. Verify the problem by installing only one input option to the printer at a time.</p> <p>a Bring the printer into the Diagnostics Menu.</p> <p>b Navigate to Feed Test > Tray # > Single Feed Test.</p> <p>Does the feed test run successfully on each option?</p>	Go to step 8.	Go to step 5.
<p>Step 5</p> <p>Check the following for any damage:</p> <p>For 550 input option:</p> <ul style="list-style-type: none"> • Input tray • Paper restrains • Paper dams • Pick pads <p>For 650 input option:</p> <ul style="list-style-type: none"> • Input tray • Paper restrains • Paper dams • Pick pads • MPF gear • MPF pick assembly • MPF tray <p>Is the input option tray assembly free of damage?</p>	Go to step 6.	<ul style="list-style-type: none"> • For 550 input option, replace the optional 550-sheet drawer. • For 650 input option, replace the optional 650-sheet duo drawer.
<p>Step 6</p> <p>Check the pick tires for wear, damage, contamination, and if they are installed correctly.</p> <p>Is the pick tire free of wear and damaged?</p>	Go to step 7.	Replace the pick tire assembly. See “Pick tire removal” on page 387 .

Action	Yes	No
<p>Step 7</p> <p>Check the input option drawer and the following for any damage or contamination:</p> <ul style="list-style-type: none"> • Top and bottom autoconnector • Pass-through sensors • Feed rollers • Input option pick assembly (if it can go down every time the paper input tray is inserted) <p>Is the option drawer assembly free of damage or contamination?</p>	<p>Go to step 8.</p>	<ul style="list-style-type: none"> • For 550 input option, replace the optional 550-sheet drawer. • For 650 input option, replace the optional 650-sheet duo drawer.
<p>Step 8</p> <p>a Turn off the printer.</p> <p>b Remove the printer from the input option trays.</p> <p>c Remove the rear shield.</p> <p>d Reseat the JOPT1 cable on the system board.</p> <p>e Check the JOPT1 cable for any damage.</p> <p>f Position the printer to partially hang on the side of a table, and check the autoconnect/option tray cable for damage.</p> <p>Is the tray 2 to controller board cable damaged?</p>	<ul style="list-style-type: none"> • If the printer autoconnector is damaged, then replace the tray 2 to controller board cable. • If the option tray autoconnector is damaged, then go to step 8. 	<p>Go to step 9.</p>
<p>Step 9</p> <ul style="list-style-type: none"> • For 550 input option, replace the optional 550-sheet drawer. • For 650 input option, replace the optional 650-sheet duo drawer. <p>Does this fix the problem?</p>	<p>Problem resolved.</p>	<p>Go to step 10.</p>
<p>Step 10</p> <p>a Turn off the printer.</p> <p>b Remove the rear cover. See</p> <p>c Disconnect the cable at JOPT1 on the controller board.</p> <p>d Turn the printer on.</p> <p>e Measure the voltages below:</p> <p>JOPT1:</p> <ul style="list-style-type: none"> • Pin 2: Ground • Pin 3: Ground • Pin 5: +24 V dc • Pin 6: Ground • Pin 7: +5 V dc • Pin 9: Ground • Pin 10: Ground <p>Are the voltages correct?</p>	<p>Contact your next level of support.</p>	<p>Replace the controller board. See “Controller board removal” on page 348.</p>

Failed to load/feed from multipurpose feeder service check

Action	Yes	No
<p>Step 1</p> <ul style="list-style-type: none"> a Make sure the 650 input option tray is at tray 2. b Make sure the correct 650 tray is inserted on the options drawer. c Fan the media. d Verify the proper tray settings for the media. e Verify the input source. f Check the condition of the multipurpose feeder pick tires. g Make sure the tray is fully inserted. h Refer to media specifications and check the condition of the media. i Make sure the media is free from damage and defects. <p>Does the error remain?</p>	Go to step 2.	Problem resolved.
<p>Step 2</p> <p>Is the machine using both 650 and 550 input option tray?</p>	Go to step 3.	Go to step 4.
<p>Step 3</p> <ul style="list-style-type: none"> a Make sure the sequence of the input option trays is correct. The 650 option tray should be in tray 2, and the 550 option tray should be in tray 3. b Bring the printer into the Diagnostics Menu. c Navigate to Feed Test > Tray # > Single Feed Test. d Run a continuous feed test (feed at least 5 pages). <p>Does the feed test run successfully on each option?</p>	Go to step 8.	Go to step 4.
<p>Step 4</p> <p>Isolate the problem. Verify the problem by installing only one input option to the printer at a time.</p> <ul style="list-style-type: none"> a Bring the printer into the Diagnostics Menu. b Navigate to Feed Test > Tray # > Single Feed Test. <p>Does the feed test run successfully on each option?</p>	Go to step 8.	Go to step 5.

Action	Yes	No
<p>Step 5</p> <p>Check the following for any damage:</p> <p>For 550 input option:</p> <ul style="list-style-type: none"> • Input tray • Paper restrains • Paper dams • Pick pads <p>For 650 input option:</p> <ul style="list-style-type: none"> • Input tray • Paper restrains • Paper dams • Pick pads • MPF gear • MPF pick assembly • MPF tray <p>Is the input option tray assembly free of damage?</p>	Go to step 6.	<ul style="list-style-type: none"> • For 550 input option, replace the optional 550-sheet drawer. • For 650 input option, replace the optional 650-sheet duo drawer.
<p>Step 6</p> <p>Check the pick tires for wear, damage, contamination, and if they are installed correctly.</p> <p>Is the pick tire free of wear and damaged?</p>	Go to step 7.	Replace the pick tire assembly. See “Pick tire removal” on page 387 .
<p>Step 7</p> <p>Check the input option drawer and the following for any damage or contamination:</p> <ul style="list-style-type: none"> • Top and bottom autoconnector • Pass-through sensors • Feed rollers • Input option pick assembly (if it can go down every time the paper input tray is inserted) <p>Is the option drawer assembly free of damage or contamination?</p>	Go to step 8.	<ul style="list-style-type: none"> • For 550 input option, replace the optional 550-sheet drawer. • For 650 input option, replace the optional 650-sheet duo drawer.
<p>Step 8</p> <p>a Turn off the printer.</p> <p>b Remove the printer from the input option trays.</p> <p>c Remove the rear shield.</p> <p>d Reseat the JOPT1 cable on the system board.</p> <p>e Check the JOPT1 cable for any damage.</p> <p>f Position the printer to partially hang on the side of a table, and check the autoconnect/option tray cable for damage.</p> <p>Is the tray 2 to controller board cable damaged?</p>	<ul style="list-style-type: none"> • If the printer autoconnector is damaged, then replace the tray 2 to controller board cable. • If the option tray autoconnector is damaged, then go to step 8. 	Go to step 9.

Action	Yes	No
<p>Step 9</p> <ul style="list-style-type: none"> For 550 input option, replace the optional 550-sheet drawer. For 650 input option, replace the optional 650-sheet duo drawer. <p>Does this fix the problem?</p>	Problem resolved.	Go to step 10.
<p>Step 10</p> <p>a Turn off the printer.</p> <p>b Remove the rear cover. See</p> <p>c Disconnect the cable at JOPT1 on the controller board.</p> <p>d Turn the printer on.</p> <p>e Measure the voltages below:</p> <p>JOPT1:</p> <ul style="list-style-type: none"> Pin 2: Ground Pin 3: Ground Pin 5: +24 V dc Pin 6: Ground Pin 7: +5 V dc Pin 9: Ground Pin 10: Ground <p>Are the voltages correct?</p>	Contact your next level of support.	Replace the controller board. See “Controller board removal” on page 348.

Failed to feed from option tray and leading edge damaged service check

Action	Yes	No
<p>Step 1</p> <p>a Fan the media.</p> <p>b Verify the proper tray settings for the media.</p> <p>c Verify the input source.</p> <p>d Check the condition of the multipurpose feeder pick tires.</p> <p>e Make sure the tray is fully inserted.</p> <p>f Refer to media specifications and check the condition of the media.</p> <p>g Make sure the media is free from damage and defects.</p> <p>Does the error remain?</p>	Go to step 2.	Problem resolved.
<p>Step 2</p> <p>Is the machine using both 650 and 550 input option tray?</p>	Go to step 3.	Go to step 4.

Action	Yes	No
<p>Step 3</p> <p>a Make sure the sequence of the input option trays is correct. The 650 option tray should be in tray 2, and the 550 option tray should be in tray 3.</p> <p>b Bring the printer into the Diagnostics Menu.</p> <p>c Navigate to Feed Test > Tray # > Single Feed Test.</p> <p>d Run a continuous feed test (feed at least 5 pages).</p> <p>Does the feed test run successfully on each option?</p>	Go to step 8.	Go to step 4.
<p>Step 4</p> <p>Isolate the problem. Verify the problem by installing only one input option to the printer at a time.</p> <p>a Bring the printer into the Diagnostics Menu.</p> <p>b Navigate to Feed Test > Tray # > Single Feed Test.</p> <p>Does the feed test run successfully on each option?</p>	Go to step 8.	Go to step 5.
<p>Step 5</p> <p>Check the following for any damage:</p> <p>For 550 input option:</p> <ul style="list-style-type: none"> • Input tray • Paper restrains • Paper dams • Pick pads <p>For 650 input option:</p> <ul style="list-style-type: none"> • Input tray • Paper restrains • Paper dams • Pick pads • MPF gear • MPF pick assembly • MPF tray <p>Is the input option tray assembly free of damage?</p>	Go to step 6.	<ul style="list-style-type: none"> • For 550 input option, replace the optional 550-sheet drawer. • For 650 input option, replace the optional 650-sheet duo drawer.
<p>Step 6</p> <p>Check the pick tires for wear, damage, contamination, and if they are installed correctly.</p> <p>Is the pick tire free of wear and damaged?</p>	Go to step 7.	Replace the pick tire assembly. See “Pick tire removal” on page 387 .

Action	Yes	No
<p>Step 7</p> <p>Check the input option drawer and the following for any damage or contamination:</p> <ul style="list-style-type: none"> • Top and bottom autoconnector • Pass-through sensors • Feed rollers • Input option pick assembly (if it can go down every time the paper input tray is inserted) <p>Is the option drawer assembly free of damage or contamination?</p>	Go to step 8.	<ul style="list-style-type: none"> • For 550 input option, replace the optional 550-sheet drawer. • For 650 input option, replace the optional 650-sheet duo drawer.
<p>Step 8</p> <p>a Turn off the printer.</p> <p>b Remove the printer from the input option trays.</p> <p>c Remove the rear shield.</p> <p>d Reseat the JOPT1 cable on the system board.</p> <p>e Check the JOPT1 cable for any damage.</p> <p>f Position the printer to partially hang on the side of a table, and check the autoconnect/option tray cable for damage.</p> <p>Is the tray 2 to controller board cable damaged?</p>	<ul style="list-style-type: none"> • If the printer autoconnector is damaged, then replace the tray 2 to controller board cable. • If the option tray autoconnector is damaged, then go to step 8. 	Go to step 9.
<p>Step 9</p> <ul style="list-style-type: none"> • For 550 input option, replace the optional 550-sheet drawer. • For 650 input option, replace the optional 650-sheet duo drawer. <p>Does this fix the problem?</p>	Problem resolved.	Go to step 10.
<p>Step 10</p> <p>a Turn off the printer.</p> <p>b Remove the rear cover. See</p> <p>c Disconnect the cable at JOPT1 on the controller board.</p> <p>d Turn the printer on.</p> <p>e Measure the voltages below:</p> <p>JOPT1:</p> <ul style="list-style-type: none"> • Pin 2: Ground • Pin 3: Ground • Pin 5: +24 V dc • Pin 6: Ground • Pin 7: +5 V dc • Pin 9: Ground • Pin 10: Ground <p>Are the voltages correct?</p>	Contact your next level of support.	Replace the controller board. See “Controller board removal” on page 348.

Tray 2 or tray 3 not detected service check

Action	Yes	No
<p>Step 1</p> <p>a POR the printer.</p> <p>b Reseat the input options.</p> <p>Does the error remain?</p>	Go to step 2.	Problem resolved.
<p>Step 2</p> <p>Is the machine using both 650 and 550 input option tray?</p>	Go to step 3.	Go to step 4.
<p>Step 3</p> <p>a Make sure the sequence of the input option trays is correct. The 650 option tray should be in tray 2, and the 550 option tray should be in tray 3.</p> <p>b Bring the printer into the Diagnostics Menu.</p> <p>c Navigate to Feed Test > Tray # > Single Feed Test.</p> <p>d Run a continuous feed test (feed at least 5 pages).</p> <p>Does the feed test run successfully on each option?</p>	Go to step 8.	Go to step 4.
<p>Step 4</p> <p>Isolate the problem. Verify the problem by installing only one input option to the printer at a time.</p> <p>a Bring the printer into the Diagnostics Menu.</p> <p>b Navigate to Feed Test > Tray # > Single Feed Test.</p> <p>Does the feed test run successfully on each option?</p>	Go to step 8.	Go to step 5.
<p>Step 5</p> <p>Check the following for any damage:</p> <p>For 550 input option:</p> <ul style="list-style-type: none"> • Input tray • Paper restrains • Paper dams • Pick pads <p>For 650 input option:</p> <ul style="list-style-type: none"> • Input tray • Paper restrains • Paper dams • Pick pads • MPF gear • MPF pick assembly • MPF tray <p>Is the input option tray assembly free of damage?</p>	Go to step 6.	<ul style="list-style-type: none"> • For 550 input option, replace the optional 550-sheet drawer. • For 650 input option, replace the optional 650-sheet duo drawer.

Action	Yes	No
<p>Step 6</p> <p>Check the pick tires for wear, damage, contamination, and if they are installed correctly.</p> <p>Is the pick tire free of wear and damaged?</p>	Go to step 7.	Replace the pick tire assembly. See “Pick tire removal” on page 387.
<p>Step 7</p> <p>Check the input option drawer and the following for any damage or contamination:</p> <ul style="list-style-type: none"> • Top and bottom autoconnector • Pass-through sensors • Feed rollers • Input option pick assembly (if it can go down every time the paper input tray is inserted) <p>Is the option drawer assembly free of damage or contamination?</p>	Go to step 8.	<ul style="list-style-type: none"> • For 550 input option, replace the optional 550-sheet drawer. • For 650 input option, replace the optional 650-sheet duo drawer.
<p>Step 8</p> <p>a Turn off the printer.</p> <p>b Remove the printer from the input option trays.</p> <p>c Remove the rear shield.</p> <p>d Reseat the JOPT1 cable on the system board.</p> <p>e Check the JOPT1 cable for any damage.</p> <p>f Position the printer to partially hang on the side of a table, and check the autoconnect/option tray cable for damage.</p> <p>Is the tray 2 to controller board cable damaged?</p>	<ul style="list-style-type: none"> • If the printer autoconnector is damaged, then replace the tray 2 to controller board cable. • If the option tray autoconnector is damaged, then go to step 8. 	Go to step 9.
<p>Step 9</p> <ul style="list-style-type: none"> • For 550 input option, replace the optional 550-sheet drawer. • For 650 input option, replace the optional 650-sheet duo drawer. <p>Does this fix the problem?</p>	Problem resolved.	Go to step 10.

Action	Yes	No
<p>Step 10</p> <p>a Turn off the printer.</p> <p>b Remove the rear cover. See</p> <p>c Disconnect the cable at JOPT1 on the controller board.</p> <p>d Turn the printer on.</p> <p>e Measure the voltages below:</p> <p>JOPT1:</p> <ul style="list-style-type: none"> • Pin 2: Ground • Pin 3: Ground • Pin 5: +24 V dc • Pin 6: Ground • Pin 7: +5 V dc • Pin 9: Ground • Pin 10: Ground <p>Are the voltages correct?</p>	Contact your next level of support.	Replace the controller board. See “Controller board removal” on page 348.

Tray 2 or tray 3 missing service check

Action	Yes	No
<p>Step 1</p> <p>a POR the printer.</p> <p>b Reseat the input options.</p> <p>c Reinsert the paper input tray.</p> <p>d Check if the option paper pick assembly can go down and trigger manually.</p> <p>Does the error remain?</p>	Go to step 2.	Problem resolved.
<p>Step 2</p> <p>Is the machine using both 650 and 550 input option tray?</p>	Go to step 3.	Go to step 4.
<p>Step 3</p> <p>a Make sure the sequence of the input option trays is correct. The 650 option tray should be in tray 2, and the 550 option tray should be in tray 3.</p> <p>b Bring the printer into the Diagnostics Menu.</p> <p>c Navigate to Feed Test > Tray # > Single Feed Test.</p> <p>d Run a continuous feed test (feed at least 5 pages).</p> <p>Does the feed test run successfully on each option?</p>	Go to step 8.	Go to step 4.

Action	Yes	No
<p>Step 4</p> <p>Isolate the problem. Verify the problem by installing only one input option to the printer at a time.</p> <p>a Bring the printer into the Diagnostics Menu.</p> <p>b Navigate to Feed Test > Tray # > Single Feed Test.</p> <p>Does the feed test run successfully on each option?</p>	Go to step 8.	Go to step 5.
<p>Step 5</p> <p>Check the following for any damage:</p> <p>For 550 input option:</p> <ul style="list-style-type: none"> • Input tray • Paper restrains • Paper dams • Pick pads <p>For 650 input option:</p> <ul style="list-style-type: none"> • Input tray • Paper restrains • Paper dams • Pick pads • MPF gear • MPF pick assembly • MPF tray <p>Is the input option tray assembly free of damage?</p>	Go to step 6.	<ul style="list-style-type: none"> • For 550 input option, replace the optional 550-sheet drawer. • For 650 input option, replace the optional 650-sheet duo drawer.
<p>Step 6</p> <p>Check the pick tires for wear, damage, contamination, and if they are installed correctly.</p> <p>Is the pick tire free of wear and damaged?</p>	Go to step 7.	Replace the pick tire assembly. See “Pick tire removal” on page 387 .
<p>Step 7</p> <p>Check the input option drawer and the following for any damage or contamination:</p> <ul style="list-style-type: none"> • Top and bottom autoconnector • Pass-through sensors • Feed rollers • Input option pick assembly (if it can go down every time the paper input tray is inserted) <p>Is the option drawer assembly free of damage or contamination?</p>	Go to step 8.	<ul style="list-style-type: none"> • For 550 input option, replace the optional 550-sheet drawer. • For 650 input option, replace the optional 650-sheet duo drawer.

Action	Yes	No
<p>Step 8</p> <ul style="list-style-type: none"> a Turn off the printer. b Remove the printer from the input option trays. c Remove the rear shield. d Reseat the JOPT1 cable on the system board. e Check the JOPT1 cable for any damage. f Position the printer to partially hang on the side of a table, and check the autoconnect/option tray cable for damage. <p>Is the tray 2 to controller board cable damaged?</p>	<ul style="list-style-type: none"> • If the printer autoconnector is damaged, then replace the tray 2 to controller board cable. • If the option tray autoconnector is damaged, then go to step 8. 	<p>Go to step 9.</p>
<p>Step 9</p> <ul style="list-style-type: none"> • For 550 input option, replace the optional 550-sheet drawer. • For 650 input option, replace the optional 650-sheet duo drawer. <p>Does this fix the problem?</p>	<p>Problem resolved.</p>	<p>Go to step 10.</p>
<p>Step 10</p> <ul style="list-style-type: none"> a Turn off the printer. b Remove the rear cover. See c Disconnect the cable at JOPT1 on the controller board. d Turn the printer on. e Measure the voltages below: JOPT1: <ul style="list-style-type: none"> • Pin 2: Ground • Pin 3: Ground • Pin 5: +24 V dc • Pin 6: Ground • Pin 7: +5 V dc • Pin 9: Ground • Pin 10: Ground <p>Are the voltages correct?</p>	<p>Contact your next level of support.</p>	<p>Replace the controller board. See “Controller board removal” on page 348.</p>

Tray 2 or tray 3 empty service check

Action	Yes	No
<p>Step 1</p> <ul style="list-style-type: none"> a Add media on the paper tray. b Properly set the paper restraints on the paper tray. c POR the printer. d Reseat the input option tray from the printer. e Refer to the media specifications and check the condition of the media. f Make sure the media is free from damage and defects. <p>Does the error remain?</p>	Go to step 2.	Problem resolved.
<p>Step 2</p> <p>Is the machine using both 650 and 550 input option tray?</p>	Go to step 3.	Go to step 4.
<p>Step 3</p> <ul style="list-style-type: none"> a Make sure the sequence of the input option trays is correct. The 650 option tray should be in tray 2, and the 550 option tray should be in tray 3. b Bring the printer into the Diagnostics Menu. c Navigate to Feed Test > Tray # > Single Feed Test. d Run a continuous feed test (feed at least 5 pages). <p>Does the feed test run successfully on each option?</p>	Go to step 8.	Go to step 4.
<p>Step 4</p> <p>Isolate the problem. Verify the problem by installing only one input option to the printer at a time.</p> <ul style="list-style-type: none"> a Bring the printer into the Diagnostics Menu. b Navigate to Feed Test > Tray # > Single Feed Test. <p>Does the feed test run successfully on each option?</p>	Go to step 8.	Go to step 5.

Action	Yes	No
<p>Step 5</p> <p>Check the following for any damage:</p> <p>For 550 input option:</p> <ul style="list-style-type: none"> • Input tray • Paper restrains • Paper dams • Pick pads <p>For 650 input option:</p> <ul style="list-style-type: none"> • Input tray • Paper restrains • Paper dams • Pick pads • MPF gear • MPF pick assembly • MPF tray <p>Is the input option tray assembly free of damage?</p>	Go to step 6.	<ul style="list-style-type: none"> • For 550 input option, replace the optional 550-sheet drawer. • For 650 input option, replace the optional 650-sheet duo drawer.
<p>Step 6</p> <p>Check the pick tires for wear, damage, contamination, and if they are installed correctly.</p> <p>Is the pick tire free of wear and damaged?</p>	Go to step 7.	Replace the pick tire assembly. See “Pick tire removal” on page 387.
<p>Step 7</p> <p>Check the input option drawer and the following for any damage or contamination:</p> <ul style="list-style-type: none"> • Top and bottom autoconnector • Pass-through sensors • Feed rollers • Input option pick assembly (if it can go down every time the paper input tray is inserted) <p>Is the option drawer assembly free of damage or contamination?</p>	Go to step 8.	<ul style="list-style-type: none"> • For 550 input option, replace the optional 550-sheet drawer. • For 650 input option, replace the optional 650-sheet duo drawer.
<p>Step 8</p> <p>a Turn off the printer.</p> <p>b Remove the printer from the input option trays.</p> <p>c Remove the rear shield.</p> <p>d Reseat the JOPT1 cable on the system board.</p> <p>e Check the JOPT1 cable for any damage.</p> <p>f Position the printer to partially hang on the side of a table, and check the autoconnect/option tray cable for damage.</p> <p>Is the tray 2 to controller board cable damaged?</p>	<ul style="list-style-type: none"> • If the printer autoconnector is damaged, then replace the tray 2 to controller board cable. • If the option tray autoconnector is damaged, then go to step 8. 	Go to step 9.

Action	Yes	No
<p>Step 9</p> <ul style="list-style-type: none"> • For 550 input option, replace the optional 550-sheet drawer. • For 650 input option, replace the optional 650-sheet duo drawer. <p>Does this fix the problem?</p>	Problem resolved.	Go to step 10.
<p>Step 10</p> <p>a Turn off the printer.</p> <p>b Remove the rear cover. See</p> <p>c Disconnect the cable at JOPT1 on the controller board.</p> <p>d Turn the printer on.</p> <p>e Measure the voltages below:</p> <p>JOPT1:</p> <ul style="list-style-type: none"> • Pin 2: Ground • Pin 3: Ground • Pin 5: +24 V dc • Pin 6: Ground • Pin 7: +5 V dc • Pin 9: Ground • Pin 10: Ground <p>Are the voltages correct?</p>	Contact your next level of support.	Replace the controller board. See “Controller board removal” on page 348.

Incompatible tray 3 service check

Action	Yes	No
<p>Step 1</p> <p>a Make sure the correct input option tray is installed in its proper tray slot. The 650 input option tray should be in tray 2, and the 550 input option tray should be in tray 3.</p> <p>b Reseat the input options from the printer.</p> <p>Does the error remain?</p>	Go to step 2.	Problem resolved.
<p>Step 2</p> <p>Is the machine using both 650 and 550 input option tray?</p>	Go to step 3.	Go to step 4.

Action	Yes	No
<p>Step 3</p> <p>a Make sure the sequence of the input option trays is correct. The 650 option tray should be in tray 2, and the 550 option tray should be in tray 3.</p> <p>b Bring the printer into the Diagnostics Menu.</p> <p>c Navigate to Feed Test > Tray # > Single Feed Test.</p> <p>d Run a continuous feed test (feed at least 5 pages).</p> <p>Does the feed test run successfully on each option?</p>	Go to step 8.	Go to step 4.
<p>Step 4</p> <p>Isolate the problem. Verify the problem by installing only one input option to the printer at a time.</p> <p>a Bring the printer into the Diagnostics Menu.</p> <p>b Navigate to Feed Test > Tray # > Single Feed Test.</p> <p>Does the feed test run successfully on each option?</p>	Go to step 8.	Go to step 5.
<p>Step 5</p> <p>Check the following for any damage:</p> <p>For 550 input option:</p> <ul style="list-style-type: none"> • Input tray • Paper restrains • Paper dams • Pick pads <p>For 650 input option:</p> <ul style="list-style-type: none"> • Input tray • Paper restrains • Paper dams • Pick pads • MPF gear • MPF pick assembly • MPF tray <p>Is the input option tray assembly free of damage?</p>	Go to step 6.	<ul style="list-style-type: none"> • For 550 input option, replace the optional 550-sheet drawer. • For 650 input option, replace the optional 650-sheet duo drawer.
<p>Step 6</p> <p>Check the pick tires for wear, damage, contamination, and if they are installed correctly.</p> <p>Is the pick tire free of wear and damaged?</p>	Go to step 7.	Replace the pick tire assembly. See “Pick tire removal” on page 387 .

Action	Yes	No
<p>Step 7</p> <p>Check the input option drawer and the following for any damage or contamination:</p> <ul style="list-style-type: none"> • Top and bottom autoconnector • Pass-through sensors • Feed rollers • Input option pick assembly (if it can go down every time the paper input tray is inserted) <p>Is the option drawer assembly free of damage or contamination?</p>	<p>Go to step 8.</p>	<ul style="list-style-type: none"> • For 550 input option, replace the optional 550-sheet drawer. • For 650 input option, replace the optional 650-sheet duo drawer.
<p>Step 8</p> <p>a Turn off the printer.</p> <p>b Remove the printer from the input option trays.</p> <p>c Remove the rear shield.</p> <p>d Reseat the JOPT1 cable on the system board.</p> <p>e Check the JOPT1 cable for any damage.</p> <p>f Position the printer to partially hang on the side of a table, and check the autoconnect/option tray cable for damage.</p> <p>Is the tray 2 to controller board cable damaged?</p>	<ul style="list-style-type: none"> • If the printer autoconnector is damaged, then replace the tray 2 to controller board cable. • If the option tray autoconnector is damaged, then go to step 8. 	<p>Go to step 9.</p>
<p>Step 9</p> <ul style="list-style-type: none"> • For 550 input option, replace the optional 550-sheet drawer. • For 650 input option, replace the optional 650-sheet duo drawer. <p>Does this fix the problem?</p>	<p>Problem resolved.</p>	<p>Go to step 10.</p>
<p>Step 10</p> <p>a Turn off the printer.</p> <p>b Remove the rear cover. See</p> <p>c Disconnect the cable at JOPT1 on the controller board.</p> <p>d Turn the printer on.</p> <p>e Measure the voltages below:</p> <p>JOPT1:</p> <ul style="list-style-type: none"> • Pin 2: Ground • Pin 3: Ground • Pin 5: +24 V dc • Pin 6: Ground • Pin 7: +5 V dc • Pin 9: Ground • Pin 10: Ground <p>Are the voltages correct?</p>	<p>Contact your next level of support.</p>	<p>Replace the controller board. See “Controller board removal” on page 348.</p>

Service menus

- “Understanding the printer control panel” on page 201
- “Menu list” on page 206
- “Diagnostics menu” on page 208
- “Configuration menu” on page 233
- “Entering Invalid engine mode” on page 247
- “Entering Recovery mode” on page 247
- “Accessing restore point” on page 247
- “Accessing the Network SE menu” on page 249
- “Service Engineer menu” on page 249

Understanding the printer control panel

The printer control panel is used to navigate through printer menus and to control printer settings.

Using the printer control panel

CX310

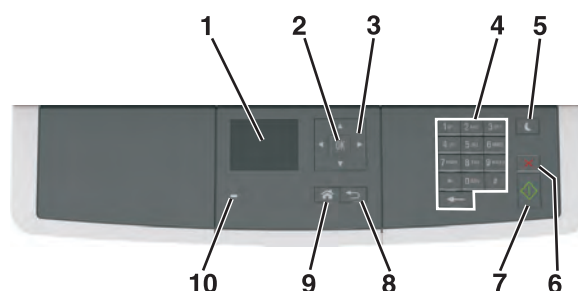

#	Use the	To
1	Display	<ul style="list-style-type: none"> • Views printing, copying, e-mailing, and scanning options • Views printer status and error messages
2	Select button	Selects menu options and saves settings
3	Arrow buttons	Scrolls through menus or settings on the display
4	Keypad	Enters numbers, letters, or symbols
5	Sleep button	Enables sleep mode or hibernate mode
6	Cancel button	Stops all printer activity
7	Start button	Starts a job, depending on which mode is selected
8	Back button	Returns to the previous screen.
9	Home button	Goes to the home screen
10	Indicator light	Checks the status of the printer

#	Use the	To
13	Indicator light	Check the status of the printer.

CX410

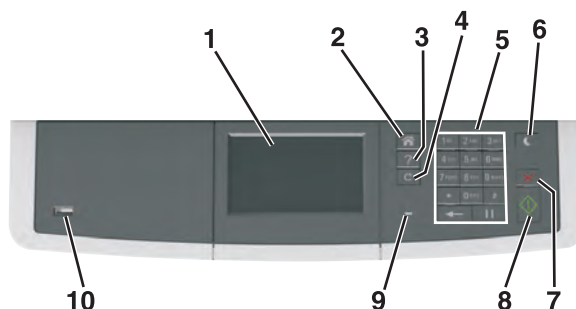

#	Use the	To
1	Display	<ul style="list-style-type: none"> Views the printer status and messages Sets up and operates the printer
2	Home button	Goes to the home screen
3	Help button	Goes to the Help menus
4	Clear all/Reset button	Resets the default settings of a function, such as printing, copying, or e-mailing
5	Keypad	Enters numbers, letters, or symbols
6	Sleep button	Enables sleep mode or hibernate mode
7	Cancel button	Cancels all printer activity
8	Start button	Starts a job, depending on which mode is selected
9	Indicator light	Checks the status of the printer
10	USB port	Connects a flash drive to the printer Note: Only the front USB port supports flash drives

CX510

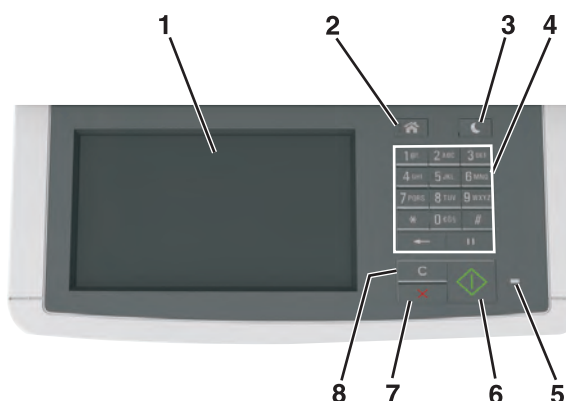

#	Use the	To
1	Display	<ul style="list-style-type: none"> Views printing, copying, e-mailing, faxing, and scanning options Views the printer status and error messages
2	Home button	Goes to the home screen
3	Sleep button	Enables Sleep mode or Hibernate mode
4	Keypad	Enters numbers, letters, or symbols
5	Indicator light	Checks the status of the printer
6	Start button	Starts a job, depending on which mode is selected
7	Stop or cancel button	Cancels all printer activity
8	Clear all/Reset button	Resets the default settings of a function, such as printing, copying, or e-mailing

Understanding the colors of the indicator light and Sleep button lights

The colors of the indicator light and Sleep button lights on the printer operator panel signify a certain printer status or condition.

Indicator light	Printer status
Off	The printer is off or in hibernation mode.
Blinking green	The printer is warming up, processing data, or printing.
Solid green	The printer is on, but idle.
Blinking red	The printer requires user intervention.

Sleep button light	Printer status
Off	The printer is idle or in Ready state.
Solid amber	The printer is in Sleep mode.
Blinking amber	The printer is waking from entering hibernation mode.
Blinking amber for 0.1 second, then goes completely off for 1.9 seconds in pulsing pattern.	The printer is in hibernation mode.

Understanding the home screen for CX410 and CX510 models

When the printer is turned on, the display shows a basic screen, referred to as the home screen. Use the home screen buttons and icons to initiate an action such as copying, faxing, or scanning; to open the menu screen; or to respond to messages.

Note: Your home screen may vary depending on your home screen customization settings, administrative setup, and active embedded solutions.

For CX410 models



#	Touch	To
1	Copy	Accesses the Copy menus and makes copies
2	Fax	Accesses the Fax menus and sends faxes
3	E-mail	Accesses the E-mail menus and sends e-mails.
4	FTP	Accesses the File Transfer Protocol (FTP) menus and scan documents directly to an FTP server
5	Menu icon	Accesses the printer menus Note: The menus are available only when the printer is in ready state
6	Status message bar	<ul style="list-style-type: none"> Shows the current printer status such as Ready or Busy Shows printer supply conditions such as Imaging unit low or Cartridge low Shows intervention messages and the instructions on how to clear them
7	Status/Supplies	<ul style="list-style-type: none"> Shows a printer warning or error message whenever the printer requires intervention to continue processing View more information on the printer warning or message, and on how to clear it

For CX510 models

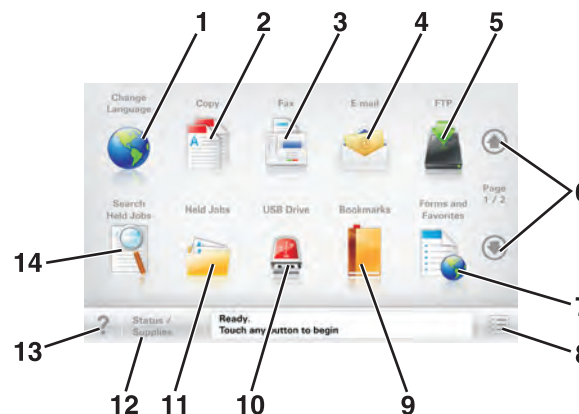

Service menus

#	Touch	To
1	Change language	Launches the Change Language pop-up window that lets you change the primary language of the printer
2	Copy	Accesses the Copy menus and makes copies
3	Fax	Accesses the Fax menus and sends faxes
4	E-mail	Accesses the E-mail menus and sends e-mails
5	FTP	Accesses the File Transfer Protocol (FTP) menus and scan documents directly to an FTP server
6	Arrows	Scrolls up or down
7	Forms and Favorites	Quickly finds and prints frequently used online forms
8	Menu Icon	Accesses the printer menus Note: The menus are available only when the printer is in Ready state
9	Bookmarks	Creates, organizes, and saves a set of bookmarks (URL) into a tree view of folders and file links Note: The tree view supports only bookmarks created from this function, and not from any other application
10	USB Drive	Views, selects, prints, scans, or e-mails photos and documents from a flash drive Note: This icon appears only when you return to the home screen while a memory card or flash drive is connected to the printer
11	Held Jobs	Displays all current held jobs
12	Status/Supplies	<ul style="list-style-type: none"> Shows a warning or error message whenever the printer requires intervention to continue processing Accesses the messages screen for more information on the message, and how to clear it
13	Tips	Opens a context-sensitive Help dialog
14	Search Held Jobs	Searches for one or more of the following items: <ul style="list-style-type: none"> Use name for held or confidential print jobs Job names for held jobs, excluding confidential print jobs Profile names Bookmark container or print job names USB container or print job names for supported file types

Menus list

CX510

Supplies Menu	Paper Menu	Reports	Network/Ports	
Cyan Cartridge	Default Source	Menu Settings Page	Active NIC	
Magenta Cartridge	Paper Size/Type	Device Statistics	Standard Network ¹	
Yellow Cartridge	Substitute Size	Network Setup Page	Standard USB	
Black Cartridge	Paper Texture	Network [x] Setup Page	SMTP Setup	
Waste Toner Bottle	Paper Weight	Shortcut List		
Black and Color Imaging Kit	Paper Loading	Fax Job Log		
Maintenance Kit	Custom Types	Fax Call Log		
	Custom Names	Copy Shortcuts		
	Custom Scan Sizes	E-mail Shortcuts		
	Universal Setup	Fax Shortcuts		
		FTP Shortcuts		
		Profiles List		
		Print Fonts		
		Print Directory		
		Print Demo		
		Asset Report		
Security	Settings	Help	Manage Shortcuts	Option Card Menu²
Edit Security Setups	General Settings	Print All Guides	Fax Shortcuts	[index of each installed DLE]
Miscellaneous Security Settings	Copy Settings	Copy Guide	E-mail Shortcuts	
Confidential Print	Fax Settings	E-mail Guide	FTP Shortcuts	
Erase Temporary Data Files	E-mail Settings	Fax Guide	Copy Shortcuts	
Security Audit Log	FTP Settings	FTP Guide	Profile Shortcuts	
Set Date and Time	Flash Drive Menu	Color Quality		
	Print Settings	Print Defects Guide		
		Information Guide		
		Supplies Guide		

¹ Depending on the printer setup, this menu item appears as Standard Network or Network [x].

² This menu appears only when one or more DLEs are installed.

CX410**Supplies Menu**

Cyan Cartridge
 Magenta Cartridge
 Yellow Cartridge
 Black Cartridge
 Waste Toner Bottle
 Maintenance Kit

Paper Menu

Default Source
 Paper Size/Type
 Substitute Size
 Paper Texture
 Paper Weight
 Paper Loading
 Custom Types
 Custom Names
 Custom Scan Sizes
 Universal Setup

Reports

Menu Settings Page
 Device Statistics
 Network Setup Page
 Network [x] Setup Page
 Shortcut List
 Fax Job Log
 Fax Call Log
 Copy Shortcuts
 E-mail Shortcuts
 Fax Shortcuts
 FTP Shortcuts
 Profiles List
 Print Fonts
 Print Directory
 Print Demo
 Asset Report

Network/Ports

Active NIC
 Standard Network or
 Network [x]
 Standard USB
 SMTP Setup

Security

Miscellaneous
 Security
 Settings
 Confidential Print
 Erase Temporary
 Data Files
 Security Audit Log
 Set Date and Time

Settings

General Settings
 Copy Settings
 Fax Settings
 E-mail Settings
 FTP Settings
 Flash Drive Menu
 Print Settings

Help

Print All Guides
 Copy Guide
 E-mail Guide
 Fax Guide
 FTP Guide
 Color Quality
 Print Defects Guide
 Information Guide
 Supplies Guide

Manage Shortcuts

Fax Shortcuts
 E-mail Shortcuts
 FTP Shortcuts
 Copy Shortcuts
 Profile Shortcuts

Option Card Menu

[index of each
 installed DLE]

CX310

Supplies Menu

Cyan Cartridge
Magenta Cartridge
Yellow Cartridge
Black Cartridge
Waste Toner Bottle
Maintenance Kit

Paper Menu

Default Source
Paper Size/Type
Substitute Size
Paper Texture
Paper Weight
Paper Loading
Custom Types
Custom Scan Sizes
Universal Setup

Reports

Menu Settings Page
Device Statistics
Network Setup Page
Network [x] Setup Page
Shortcut List
Copy Shortcuts
E-mail Shortcuts
FTP Shortcuts
Profiles List
Print Fonts
Print Directory
Print Demo
Asset Report

Network/Ports

Active NIC
Standard Network or
Network [x]
Standard USB
SMTP Setup

Security

Confidential Print
Security Audit Log
Set Date and Time

Settings

General Settings
Copy Settings
E-mail Settings
FTP Settings
Print Settings

Help

Print All Guides
Copy Guide
E-mail Guide
FTP Guide
Color Quality
Print Defects Guide
Information Guide
Supplies Guide

Option Card Menu

[index of each installed
DLE]

Diagnostics menu

- [“Entering the Diagnostics menu” on page 209](#)
- [“REGISTRATION” on page 209](#)
- [“Skew” on page 210](#)
- [“Quick Test” on page 211](#)
- [“Alignment Menu” on page 212](#)
- [“Scanner calibration” on page 212](#)
- [“MISC TESTS” on page 213](#)
- [“PRINT TESTS” on page 214](#)
- [“Feed Tests” on page 214](#)
- [“Print quality test pages” on page 215](#)
- [“HARDWARE TESTS” on page 215](#)
- [“DUPLEX TESTS” on page 217](#)
- [“INPUT TRAY TESTS” on page 219](#)
- [“BASE SENSOR TEST” on page 219](#)
- [“DEVICE TESTS” on page 221](#)

- “**PRINTER SETUP**” on page 221
- “**EP SETUP**” on page 224
- “**TPS Setup: Right or Left**” on page 225
- “**TPS Setup: Reset Color Cal**” on page 225
- “**TPS Setup: Cal Ref Adj**” on page 226
- “**REPORTS**” on page 226
- “**EVENT LOG**” on page 226
- “**Scanner tests**” on page 228
- “**Exit Diagnostics**” on page 232

Entering the Diagnostics menu

- 1 Turn off the printer.
- 2 Press and hold **3** and **6** while turning on the printer.
Release the buttons when the splash screen appears.

REGISTRATION

Print registration makes sure the black printing plane is properly aligned on the page. This is one of the steps in aligning a new printhead. It is also the first step in aligning the duplex registration. See [“Quick Test” on page 211](#).

To set Registration:

- 1 Select **Registration** from the Diag Menu, and press **Select**.
- 2 Use **Left** or **Right** to select **Print Quick Test**, and press **Select**.
See [“Quick Test” on page 211](#) for addition information.
The message **Printing...** appears on the display, and the page prints.
Retain this page to determine the changes you need to make to the margin settings.
- 3 Press **Select** to enter the **Registration**.
- 4 Use **Left** or **Right** to select the margin setting you need to change, and press **Select**.
- 5 Use **Left** to decrease or **Right** to increase the offset values, and press **Select** to confirm the value. The message **Submitting** changes displays, and the original margin setting screen appears.

The print registration ranges are:

Description	Value	Direction of change
Top margin	-50 to +50 Each increment corresponds to 8 scans at a 600 dpi scan rate (0.0133 inches or 0.339 mm). The default is 0.	A positive change moves the image down the page and increases the top margin. A negative change moves the image up and decreases the top margin. No compression or expansion occurs.

Bottom margin	-25 to +25 Each increment causes approximately 0.55 mm shift in the bottom margin. The default is 0.	A positive offset moves text down the page and narrows the bottom margin, while a negative offset moves text up the page and narrows the bottom margin. The image is compressed or expanded.
Left margin	-25 to +25 Each increment corresponds to 4 pixels at 600 dpi (0.00666 in. or 0.1693 mm). The default is 0.	A positive change moves the image to the left, and a negative change moves the image to the right.
Right margin	-50 to +50 Each increment corresponds to an approximate shift of 4 pixels at 600 dpi. The default is 0.	A positive change moves the image to the left, and a negative change moves the image to the right.
Skew	-100 to +100 Each increment corresponds to 1/1200 of an inch. The default is 0.	A positive value causes the left end of the scan line to move down the page. A negative value causes the left end of the scan line to move up the page. The right end stays fixed. There is no compression or expansion of the image.

6 Print another copy of the Quick Test to verify your changes.

7 Continue changing the settings by repeating steps 3 through 5.

To exit Registration, press **Back** or **Stop**.

Skew

One printhead houses the four color planes. The black plane is aligned to the printer, and the other color planes are internally aligned to black. Electronic alignment fine tunes the alignment of the color planes to the black plane once the printhead is installed. See [“Setting alignment for color” on page 212](#) for instructions on setting printhead alignment. This must be performed before color skew adjustment is attempted. The following illustration shows proper alignment versus skewed alignment.

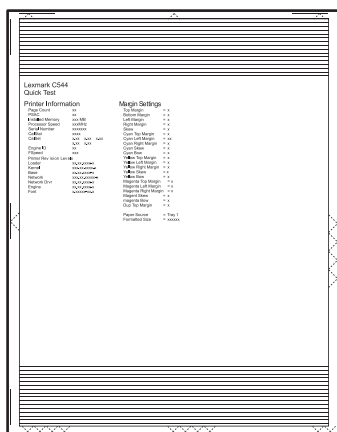

Straight

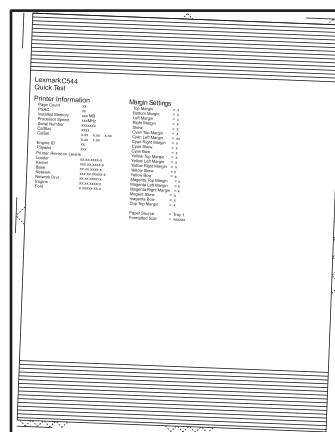

Skewed

Quick Test

The Quick Test contains the following information:

- Print registration settings
- Alignment diamonds at the left, right, top, and bottom
- Horizontal lines to check for skew
- General printer information, including current page count, installed memory, serial number, and code level

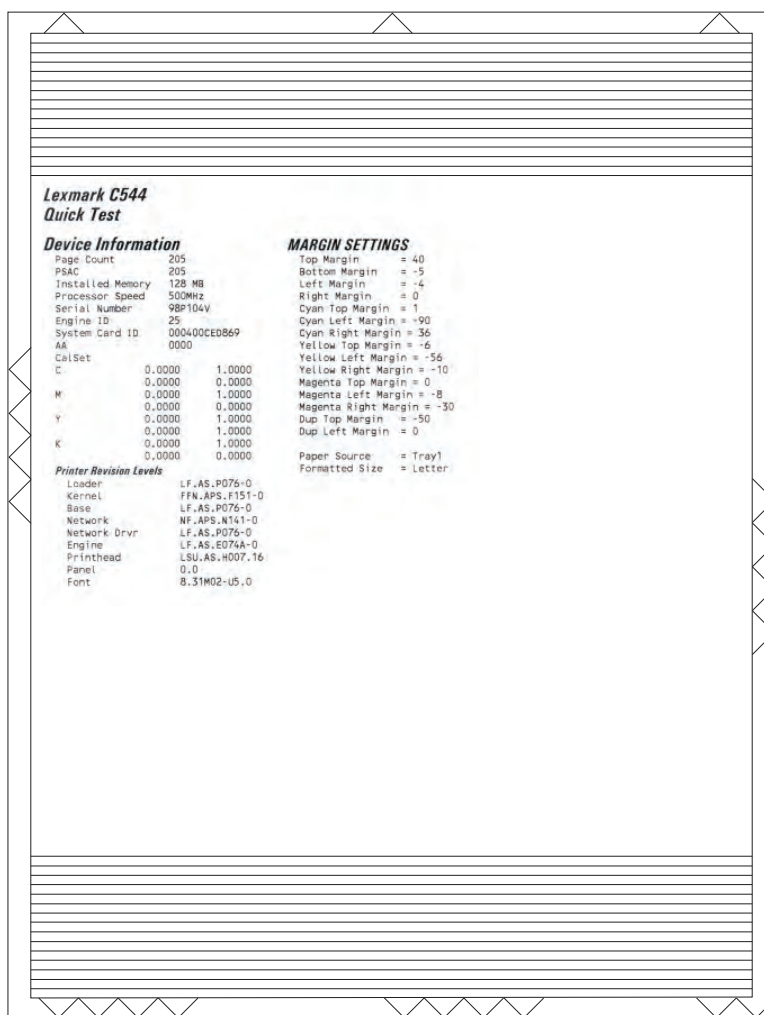

To print the Quick Test page:

Note: Print the Quick Test Page on letter or A4 paper.

1 Select **Registration** from Diag Menu, and press **Select**.

2 Select **Quick Test Page**, and press **Select**.

The message **Printing...** appears on the display.

Once the Quick Test Page completes printing, the Registration screen displays again.

Alignment Menu

Use the alignment menu to align the image on the page for cyan, yellow, and magenta. The black image should be aligned using REGISTRATION before the individual colors are aligned.

Warning—Potential Damage: Read the instructions for the alignment carefully.

Setting alignment for color

- 1 From the Diagnostics menu, touch **Alignment Menu**.
- 2 Select **CYAN**, **YELLOW**, or **MAGENTA**.
- 3 Touch **Quick Test**. You may need to scroll to the next page.

A two-page instruction sheet prints.

The printer prints the test page from the default paper source, however if the default source only supports envelopes, then the page prints from Tray 1. Print on A4 or letter paper for the best results.

- 4 Determine which settings to change and follow the instructions on the printed sheets to determine the adjustment.

Description	Range
Top Margin	-128 to +127
Left Margin	-1200 to +1200
Right Margin	-1200 to +1200
Skew	-50 to +50
Bow	-50 to +50
Linearity	Linearity has a separate Quick Test sheet and adjustment instructions.

- 5 Touch (-) to decrease the value or (+) to increase the value. After the value appears, touch to save the value or **Back** to cancel.
- 6 Reprint the Quick Test to evaluate the changes. Continue until each adjustment is correct.
- 7 Repeat steps 4 through 6 as needed.
- 8 Continue until all three colors are aligned. A separate Quick Test prints for each color.
- 9 Touch **Back** to exit the Alignment Menu

Scanner calibration

This test calibrates the black and white values for the ADF and flatbed. Use the following values to manually adjust a replacement scanner.

Menu items	Values
Flatbed Black	-10 to 10*
ADF Front Black	-10 to 10*
ADF Back Black	-10 to 10*
* The default value is 0.	

Menu items	Values
Flatbed White	-10 to 10*
ADF Front White	-10 to 10*
ADF Back White	-10 to 10*
* The default value is 0.	

To adjust a calibration value, do the following steps:

- 1** Navigate to **Diagnostics Menu > Scanner Calibration**.
- 2** Select a calibration value to adjust.
- 3** To view the result for an ADF front adjustment, place a test page image side up and touch **Copy Quick Test**. Compare the results to the original. Adjust if necessary.
- 4** To view the result for an ADF back adjustment, place a test page image side down and touch **Copy Quick Test**. Compare the results to the original. Adjust if necessary.
- 5** To view the result for a flatbed adjustment, do the following:
 - a** Remove any paper from the ADF. Compare the results to the original. Adjust as needed.
 - b** Place a test page on the flatbed and touch **Copy Quick Test**.
 - c** Compare the results to the original. Adjust if necessary.

Reset flatbed, ADF front, and ADF back calibration values

These settings revert the selected scan source IQT black and white values back to the Nominal Black and Nominal White settings.

Perform this test only on a replacement scanner.

To reset a scanner calibration value, do the following:

- 1** Navigate to **Diagnostics Menu > Scanner Calibration**.
- 2** Select a calibration value to adjust.
- 3** Apply the changes.

MISC TESTS

Motor Detect

This test initiates an automatic motor detection process that should be performed whenever the controller board is replaced.

To run Motor Detect:

- 1** Remove the imaging unit and the waste toner bottle. See [“Imaging unit \(IU\) removal” on page 303](#).
- 2** Reinstall the right cover assembly.
- 3** Close the front door.
- 4** Enter Diagnostics menu.

5 Select **MISC TESTS** in the Diag Menu, and press **Select**.

6 Select **Motor Detect**, and press **Select**.

If you press **Select** before closing the front cover, then a message appears: **Close Cover. Press Select.**

Motor Detection In Progress... appears.

The motor detection process takes about 10 seconds, and stops automatically.

Detect Complete. Rebooting... appears, and the printer performs a POR (Power On Reset).

If the motor ran, the test was passed. If the motor did not run, the test failed.

PRINT TESTS

The Print Test determines if the printer can print on media from any of the paper input sources. Each of the installed sources is available within the Print Tests menu.

The content of the test page varies depending on the media installed in the selected input source.

- If a source is selected that contains paper, then a page similar to the Quick Test Page is printed and does not contain the Print Registration diamonds.
- If a source is selected which contains envelopes, then an Envelope Print Test pattern is printed. This pattern contains only text, which consists of continuous prints of each character in the selected symbol set.
- If **Continuous** is selected, then the same page prints continuously from the selected source until you press **Stop (X)**. If Continuous is selected from a source which contains envelopes, then the envelope print test pattern is printed on the first envelope, and the rest are blank.

The Print Test page always prints single-sided, regardless of the Duplex setting or the presence of the Duplex option.

To run the Print Test:

- 1** From the Diagnostics menu, touch **PRINT TESTS**.
- 2** Select the paper source.
- 3** Select either **Single** or **Continuous**.
- 4** If **Single** is selected, no buttons are active while the Print Test Page is printing. If **Continuous** is selected, **Stop (X)** can be pressed to cancel the test.
- 5** At the end of the test, the printer returns to the PRINT TESTS menu.

Print Quality Pages

The print quality test consists of five pages. Pages one and two contain a mixture of graphics and text. The remainder of the pages only contain graphics.

This test may be printed from either Configuration menu or the Diagnostics menu. To run the print quality pages from the Diagnostics menu, touch **PRINT TESTS > Print Quality Pages**. This test cannot be canceled or terminated after the test has begun. After the test pages print, the printer returns to the **PRINT TESTS** menu.

Feed Tests

Any installed input tray can be tested. The pages fed through the printer are blank.

To run the Feed Test:

- 1 Select **INPUT TRAY TESTS** from Diag Menu, and press **Select**.
- 2 Select **Feed Tests**, and press **Select**.
- 3 Select the tray to be tested. Choices are installed trays, including **Tray 1, Tray 2, MP Feeder**.
- 4 Select **Single** or **Continuous**, and press **Select**.
 - Single—a single sheet of blank paper is fed, and the test stops.
 - Continuous—sheets are fed continuously, until **Stop** is pressed.

Print quality test pages

The print quality test consists of five pages. Pages one and two contain a mixture of graphics and text. The remainder of the pages contain only graphics. The test prints on the media in tray 1.

To run the print quality pages from the Diagnostics Menu:

- 1 Select **PRINT TESTS**, and press **Select**.
- 2 Select **Prt Qual Pgs**, and press **Select**.
The message **Printing Quality Test Pages** is displayed.

Note: Once the test is started, it cannot be canceled.

When the test pages print, the printer returns to the original screen.

HARDWARE TESTS

- [“Panel Test” on page 215](#)
- [“Button Test” on page 215](#)
- [“DRAM Test” on page 216](#)
- [“USB HS Test Mode” on page 216](#)

If the hardware test fails, replace the failing part.

Panel Test

This test verifies the operator panel display function.

To run the Panel Test:

- 1 From the Diagnostics menu, navigate to **HARDWARE TESTS > LCD Test**.
The Panel test continually executes.
- 2 Press **Stop (X)** to cancel the test.

Button Test

This test verifies the operator panel button function.

To run the Button Test:

- 1 From the Diagnostics menu, navigate to:
HARDWARE TESTS > Button Test
- 2 With no buttons pressed, a pattern matching the operator panel buttons is displayed. Press each operator panel button one at a time, and an “X” displays in the box that represents the button.
- 3 Press **Stop** (X) or touch **Back** to exit the test.

DRAM Test

This test checks the validity of DRAM, both standard and optional. The test repeatedly writes patterns of data to DRAM to verify that each bit in memory can be set and read correctly.

To run the DRAM Test:

From the Diagnostics menu, navigate to **HARDWARE TESTS > DRAM Test**.

DRAM Test **Testing...** appears on the screen, followed by **Resetting the Printer**.

After the printer resets, the results of the test appear: DRAM Test (x)MB P:##### F:#####.

- (x) represents the size of the installed DRAM.
- P:##### represents the number of times the memory test has passed and finished successfully, with the maximum pass count being 999,999.
- F:##### represents the number of times the memory test has failed and finished with errors, with the maximum fail count being 999,999.

After the maximum pass count or fail count is reached, or when all the DRAM has been tested, the test stops and the final results appear.

USB HS Test Mode

- 1 From the Diagnostics menu, navigate to:
Hardware Tests > USB HS Test Mode
- 2 Choose the desired port, and then choose the desired test.

Ports	Tests
Port 0	Test J
Port 1	Test K
Port 2	Test SEO NAK
Port 3	Test Packet
	Test Force Enable
Single Step Get Device	
Single Step Set Feature	

- 3 To exit the test, POR the printer.
- 4 If the test fails, replace the failing USB cable.

DUPLEX TESTS

- “Duplex Quick Test” on page 217
- “Duplex Top Margin” on page 218
- “Duplex Left Margin” on page 218

Duplex Quick Test

The duplex quick test determines if the Duplex Option Top Margin is set correctly. This test prints a duplexed version of the Quick Test Page that can be used to adjust the Top Margin for the back of the duplexed page. You can run one duplexed page (**Single**) or continue printing duplexed pages (**Continuous**) until **Stop (X)** is pressed.

You must use either Letter or A4 paper.

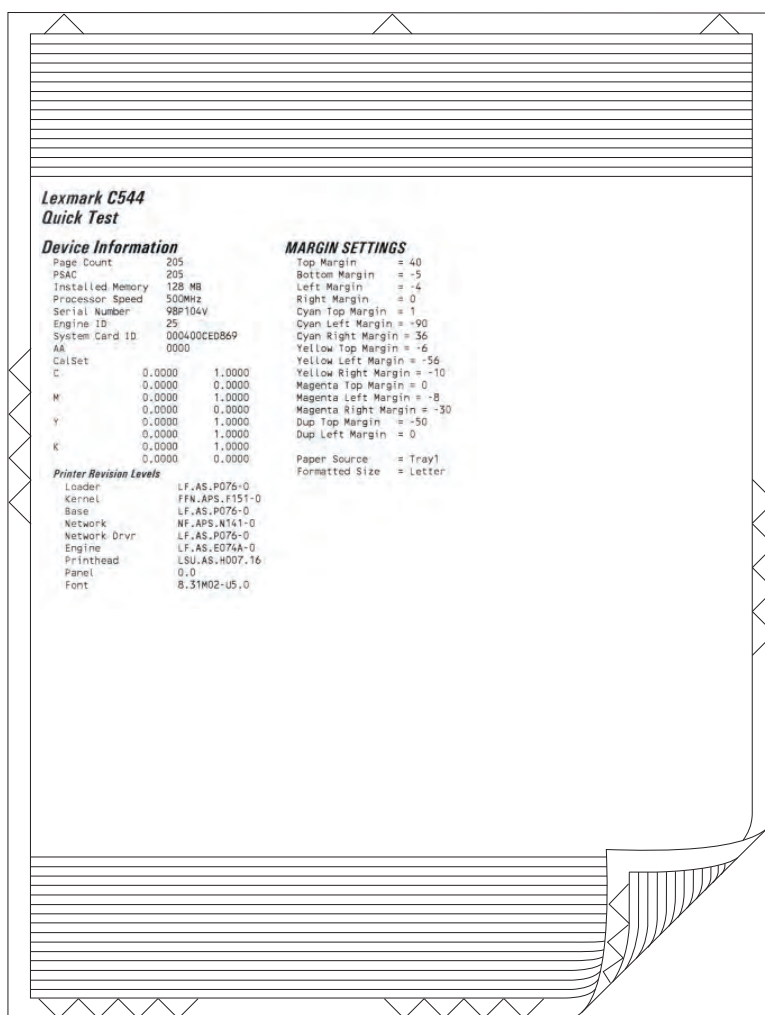

To run the duplex quick test:

- 1 From the Diagnostics menu, touch **DUPLEX TESTS > Duplex Quick Test**.
- 2 Select **Single** or **Continuous**. The single test cannot be canceled.

The printer attempts to print the Quick Test Page from the default paper source. If the default paper source supports only envelopes, then the page is printed from Tray 1.

- 3 Check the Quick Test Page for the correct offset between the placement of the first scan line on the front and back side of a duplexed sheet.
- 4 If adjustment is necessary, the Top Margin in the Registration menu must be adjusted first. The Duplex Top Margin Offset may be adjusted next. A positive offset moves the text down the page and widens the top margin, while a negative offset moves the text up the page and narrows the top margin.
- 5 Press **Stop** (X) to cancel the test.

Duplex Top Margin

This setting controls the offset between the first scan line on the front of the duplex page and the first scan line on the back of the page. Therefore, be sure to set the top margin in REGISTRATION before setting the duplex top margin. See [“REGISTRATION” on page 209](#).

To set the Duplex Top Margin

- 1 Select **DUPLEX TESTS** from Diag Menu, and press **Select**.
- 2 Select **Quick Test**, and press **Select**.
- 3 Select **Single**, and press **Select**.
- 4 Hold the page to the light to see whether the top margin of the back aligns with the top margin of the front.
- 5 Select **Top Margin** from DUPLEX TESTS.
- 6 Use **Left** or **Right** to select the margin setting you need to change.
 - Each increment shifts the duplex top margin by 1/100 of an inch.
 - The Top Margin (duplex) range is -50 to +50, and the default value is 0.
 - An increase in the value moves the backside top margin down and widens the top margin. A decrease moves the top margin upward and narrows the top margin.
- 7 Press **Select** to save the new value.
- 8 Print the Quick Test (duplex) again (steps 1–4) to verify the adjustment. Repeat if necessary.

Duplex Left Margin

This setting shifts the image on the back of the duplex sheet to the left or right to correctly position it on the page. Therefore, be sure to set the top margin in REGISTRATION before setting the duplex top margin. See [“REGISTRATION” on page 209](#).

To set the Duplex Left Margin

- 1 Select **DUPLEX TESTS** from Diag Menu, and press **Select**.
- 2 Select **Quick Test**, and press **Select**.
- 3 Select **Single**, and press **Select**.
- 4 Hold the page to the light to see whether the top margin of the back aligns with the top margin of the front.
- 5 Select **Left Margin** from DUPLEX TESTS.
- 6 Use **Left** or **Right** to select the margin setting you need to change.
 - Each increment shifts the duplex left margin by 4 pixels at 500 dpi (0.0067 inches or 0.1693 mm).
 - The Left Margin (duplex) range is -25 to +25, and the default value is 0.

- An increase in the value moves the backside left margin to the right, and widens the left margin. A decrease moves the backside left margin to the left, and narrows the left margin.

7 Press **Select** to save the new value.

8 Print the Quick Test (duplex) again (steps 1–4) to verify the adjustment. Repeat if necessary.

INPUT TRAY TESTS

- “**Feed Tests**” on page 219
- “**Sensor Test**” on page 219

Feed Tests

Any installed input tray can be tested. The pages fed through the printer are blank.

To run the Feed Test:

- 1** Select **INPUT TRAY TESTS** from Diag Menu, and press **Select**.
- 2** Select **Feed Tests**, and press **Select**.
- 3** Select the tray to be tested. Choices are installed trays, including **Tray 1, Tray 2, MP Feeder**.
- 4** Select **Single** or **Continuous**, and press **Select**.
 - Single—a single sheet of blank paper is fed, and the test stops.
 - Continuous—sheets are fed continuously, until **Stop** is pressed.

Sensor Test

Note: This test is not available on all models.

This test is used to verify that the sensors are working correctly for an individual input tray.

- 1** Select **INPUT TRAY TESTS** from Diag Menu, and press **Select**.
- 2** Select **Sensor Test**, and press **Select**.
- 3** Select the tray where you want to test the sensors. .
- 4** Depending on the tray selected, you may have **Empty Sensor**, **Low Sensor**, or **Passthru Sensor**.

Sensors will be displayed with either **Open** or **Closed**. Toggle the sensor you want to test and note the change of state of that sensor.

Input Tray	Empty Sensor	Low Sensor	Passthru Sensor
Tray 2 (650-sheet duo tray)	Open	Open	Open
Tray 3 (550-sheet tray, C546tdn)	Open	Open	Open

- 5** To Exit the test, press **Back** or **Stop**.

BASE SENSOR TEST

These tests allow you to verify the correct functioning of the front door, input, and output sensors.

 **CAUTION—SHOCK HAZARD:** Do not use your hand to toggle these switches. Use a nonconducting item.

To run the Base Sensor Test.

1 Select **Base Sensor Test** from Diag Menu, and press **Select**

2 Select the sensor you want to test, and press **Select**

The following tests are available:

Sensor	Value	How to test
Front Door	Opened/Closed	Open and close the front door. The sensor should change state.
Input - S1	Media clear... or Media present...	Activate the sensor by removing and reinserting the paper tray. The sensor should change state.
Input - S2	Media clear... or Media present...	Remove the media tray. Activate the input (S2) sensor flag. The sensor should change state.
Fuser exit sensor	Media clear... or Media present...	Open the front cover. Activate the fuser exit flag. The sensor should change state.
Standard Bin	Bin full or Bin empty	Lift up on the bin-full/narrow media flag, and then release. The sensor should change state.
C-TMC	Not Closed/Closed	Remove the cyan toner cartridge while noticing the operator panel for a change in state. If none is noticed, pass a flat reflective object or bright light in front of the TMC sensor. The sensor should momentarily change state.
M-TMC	Not Closed/Closed	Remove the magenta toner cartridge while noticing the operator panel for a change in state. If none is noticed, pass a flat reflective object or bright light in front of the TMC sensor. The sensor should momentarily change state.
Y-TMC	Not Closed/Closed	Remove the yellow toner cartridge while noticing the operator panel for a change in state. If none is noticed, pass a flat reflective object or bright light in front of the TMC sensor. The sensor should momentarily change state.
K-TMC	Not Closed/Closed	Remove the black toner cartridge while noticing the operator panel for a change in state. If none is noticed, pass a flat reflective object or bright light in front of the TMC sensor. The sensor should momentarily change state.

3 To exit the test, press **Back** or **Stop**.

DEVICE TESTS

Quick Disk Test

This test will perform a non-destructive read/write on one block per track on the disk. Once executed, this test cannot be canceled.

Note: This test only appears when a non-defective disk is installed.

Disk Test/Clean

This test will perform a low-level format of the hard disk which will destroy all data on the disk and which should never be performed on a good disk. This test should only be used when the disk contains bad data.

Note: This test only appears when a non-defective disk is installed.

Note: This process does not erase any information stored on the device's NAND.

Note: When this test is completed, the disk automatically is initialized with a new file system.

Flash test

This menu item appears only if the flash card is installed. Data is written to the flash card and read back to check the accuracy.

Warning—Potential Damage: This test deletes all data stored on the flash device. After the test is over, reformat the flash using **Format Flash** in the customer Utilities Menu.

To run the Flash Test:

- 1 Select **DEVICE TESTS** from Diag Menu, and press **Select**.
- 2 Select **Flash Test**, and press **Select**.
Contents will be lost. Continue? appears.
- 3 To continue, select **Yes**, and press **Select**. To end the test, select **No**, and press **Select**.

If you continue, **Flash Test Testing...** appears.

- If the test is successful, then **Flash Test Test Passed** appears. Use Format Flash in the Utilities Menu to reformat the flash card
- If the test is unsuccessful, then **Flash Test Test Failed** appears. Replace the flash card.

- 4 Press **Back** to remove the message and return to the Device Tests menu.

PRINTER SETUP

- [“Defaults” on page 222](#)
- [“PAGE COUNTS” on page 222](#)
- [“Serial Number” on page 222](#)
- [“Engine Setting 1 through 4” on page 222](#)
- [“Model Name” on page 223](#)
- [“Configuration ID” on page 223](#)
- [“ITU Barcode” on page 223](#)

- “**Processor ID**” on page 224
- “**Reset Fuser Count**” on page 224

Defaults

This setting is used by the printer to determine whether US or non-US factory default values should be used. The following printer settings have different US and non-US values:

Printer default values	US value	Non-US value
Paper Sizes setting in the General Settings menu	U.S.	Metric
Default Paper Size (paper feeding sources which do not have hardware size sensing capabilities)	Letter	A4
Default Envelope Size (envelope feeding sources which do not have hardware size sensing capability)	10 Envelope	DL Envelope
Fax media size	Letter	A4
PCL Symbol Set	PC-8	PC-850
PPDS Code Page	437	850
Universal Units of Measure	Inches	Millimeters

Warning—Potential Damage: Modification of the printer setting Defaults causes the NVRAM space to be restored to the printer’s factory settings.

PAGE COUNTS

This menu lets you view the total page counts of the printer or the page counts broken down into color and mono pages printed. Unlike in previous printers, none of these values can be changed.

Touch **Back** to return to the Diagnostics menu.

Serial Number

This menu lets you view the total page counts of the printer or the page counts broken down into color and mono pages printed. Unlike in previous printers, none of these values can be changed.

To view the serial number:

- 1 Select **Printer Setup** from Diag Menu, and press **Select** .
- 2 Select **Serial number**, and press **Select**.
The Serial Number is displayed.
- 3 Press **Back** to return to Printer Setup.

Engine Setting 1 through 4

Warning—Potential Damage: Do not change these settings unless requested to do so by your next level of support.

Model Name

The model name can only be viewed and cannot be changed.

Configuration ID

The two configuration IDs are used to communicate information about certain areas of the printer that cannot be determined using hardware sensors. The configuration IDs are originally set at the factory when the printer is manufactured. However, the servicer may need to reset Configuration ID 1 or Configuration ID 2 whenever the system board is replaced. The IDs consist of eight digits. The first seven digits in each ID are hexadecimal numbers, while the last digit is a checksum of the preceding seven digits. Each ID can contain a combination of the digits 0 through 9, and A through F.

Note: When the printer detects a Configuration ID that is not defined or invalid, the following occurs:

- The default standard model Configuration ID is used instead.
- Configuration ID is the only function available in the Diagnostics Menu.
- Unless the menu is in the Diagnostics Menu, Check Config ID displays.

To set the configuration ID:

1 Select **Printer Setup** from Diag Menu, and press **Select** .

2 Select **Configuration ID**, and press **Select** .

The current value for Configuration ID 1 is displayed.

3 Enter the Configuration ID 1.

- Change the left character or digit first.
- To change the value of a character or digit, press **Left** to decrease or **Right** to increase the underlined value, and press **Select** to move to the next character or digit.
- To move to the next character or digit without changing the current value, press **Select**.
- When you press **Select** on the last digit, the value will be submitted.

If **Invalid ID** appears, then the entry is discarded, and the previous Configuration ID 1 is displayed on the screen.

If the process is successful, then **Submitting Selection** appears on the display, followed by the current value for Configuration ID 2.

4 Repeat the steps for entering the Configuration ID 2, and press **Select**.

If the Configuration ID 2 is validated, **Submitting Selection** appears, and a check mark appears next to **Printer Setup**.

5 Restart the printer. A POR is not automatically performed.

ITU Barcode

The 16-digit numeric value matches the image transfer unit installed in the printer. If you replace the image transfer unit, reenter this value. **Stop** exits the menu.

To enter the ITU barcode:

1 Select **Printer Setup** from Diag Menu, and press **Select** .

2 Select **ITU Barcode**, and press **Select**.

3 To enter the 16-digit numeric value:

- Use **Left** to decrease the left most digit value or **Right** to increase the value.
- Press **Select** to advance to the next digit.
- If a digit is already correct, then press **Select** to accept the number and to continue.
- When the last number is entered and you press **Select**, **Submitting changes...** should appear.
- If the entered number is incorrect, then **Check Sum Does Not Match** displays. Check and reenter the number.

Processor ID

This is a 16-digit hexadecimal value representing the ID of the processor on the controller card.

Reset Fuser Count

Resets the fuser count value to zero. The Event Log records each time that a user executes the Reset Fuser Count operation. See [“EVENT LOG” on page 226](#) for more information. This setting appears only if the Maintenance Warning and Intervention function is enabled in the printer Configuration ID.

To reset the fuser count:

- 1** Select **Printer Setup** from Diag Menu, and press **Select**.
- 2** Select **Reset Fuser Cnt**, and press **Select**.
- 3** Select **Reset**, and press **Select**.
Reset Resetting... appears.
- 4** To cancel a reset, press **Back**.

EP SETUP

EP Defaults

This setting is used to restore each printer setting listed in EP Setup to its factory default value. Sometimes this is used to help correct print quality problems.

To restore EP Defaults:

- 1** Select **EP Setup** from Diag Menu, and press **Select**.
- 2** Select **EP Defaults**, and press **Select**.
- 3** Select **Restore** to reset the values to the factory settings, and select **Do Not Restore**.
- 4** To cancel a reset, press **Back**.

Fuser temperature

This adjustment can be used to help solve some customer problems with paper curl on low-grade papers and problems with letterheads on some types of media.

To adjust the fuser temperature:

- 1 Select **EP Setup** from Diag Menu, and press **Select**.
- 2 Select **Fuser Temp**, and press **Select**.
- 3 Select Normal, High, or Low. The default is Normal.
- 4 To return to the menus, press **Back**.

DC Charge Adjust, Bias Adjust, Transfer Adjust

Each of these three settings enables you to adjust the high voltage levels controlling the electrophotographic process. You will use these settings to compensate for unusual operating circumstances such as high humidity. The printer uses the value of these settings together with other settings to calculate printing speed and media selection.

TPS Setup: Right or Left

The value of the toner density sensor (also called toner patch sensor or TPS) is set at manufacturing. If a sensor is replaced, enter the 32-digit hexadecimal toner density value (TPS) value from the bar code next to the sensor.

To enter the value:

- 1 Select **TPS Setup** from Diag Menu, and press **Select**.
- 2 Select **Right** or **Left**, and press **Select**.
TPS Right 1-16 or **TPS Left 1-16** appears above a blinking 0 in the left position.
- 3 To enter a character or digit:
 - a Press **Left** to decrease or **Right** to increase the blinking value.
 - b Pause for several seconds without pressing any buttons. The blinking value becomes solid.
 If the value is incorrect, then use **Back** to go back and reenter the number.
 - c Continue until the last value is reached.
 - d When the last of the 16 values is entered and becomes solid, **TPS Right 17-32** or **TPS Left 17-32** appears.
 - e Continue entering and pausing
- 4 After the 32nd number is entered and becomes solid, the number is automatically entered.
 - If the number is incorrect, then **Checksum does not match** appears, and the original screen appears to reenter the value.
 If the number is correct, then **Saving changes to NVRAM** appears.

TPS Setup: Reset Color Cal

This setting allows the device to adjust the alignment of the color planes using pre-programmed default values.

To reset the programmed value:

- 1 Select **TPS Setup** from Diag Menu, and press **Select**.
- 2 Select **Reset Color Cal**, and press **Select**.
Resetting appears. When the reset is complete, the screen is automatically returned to TPS Setup.

TPS Setup: Cal Ref Adj

The Cal Ref Adj is used with Reset Color Cal, which resets to a default value, Cal Ref Adj allows you to fine tune the TPS function.

To set the Cal Ref Adj:

- 1 Select **TPS Setup** from Diag Menu, and press **Select**.
- 2 Select **Cal Ref Adj**, and press **Select**.
- 3 Select **CMY** or **Black**, and press **Select**.
- 4 Press **Left** to decrease or **Right** to increase the value.
The values can be -8 to +8, and the default value is 0.
- 5 To cancel and return to the menus, press **Back**.

REPORTS

Menu Settings Page

To print the Menu Settings Page:

- 1 Select **Reports** from Diag Menu, and press **Select**.
- 2 Select **Menu Settings Page**, and press **Select**.

Installed Licenses

This setting lists all the installed licenses and their feature data.

Enter the Diagnostics menu, and then navigate to:

Reports > Installed Licenses

EVENT LOG

Display Log

The event log provides a history of printer errors. It contains the most recent errors that have occurred on the printer. The most recent error displays in position 1. If an error occurs after the log is full, the oldest error is discarded. Identical errors in consecutive positions in the log are entered, so there may be repetitions. All 2xx and 9xx error messages are stored in the Event Log.

To view the event log:

- 1 Select **Event Log** from Diag Menu, and press **Select**.
- 2 Select **Display Log**, and press **Select**.
Error codes display on the screen. Press **Left** or **Right** to view additional error codes. Press **Right** to view additional details.
- 3 Press **Back** to return to the Event Log menu.

Print Log

Additional diagnostic information is available when you print the event log from the Diagnostics Menu rather than the Configuration Menu.

The Event Log printed from Diag Menu includes:

- Detailed printer information, including code versions
- Time and date stamps
- Page counts for most errors
- Additional debug information in some cases

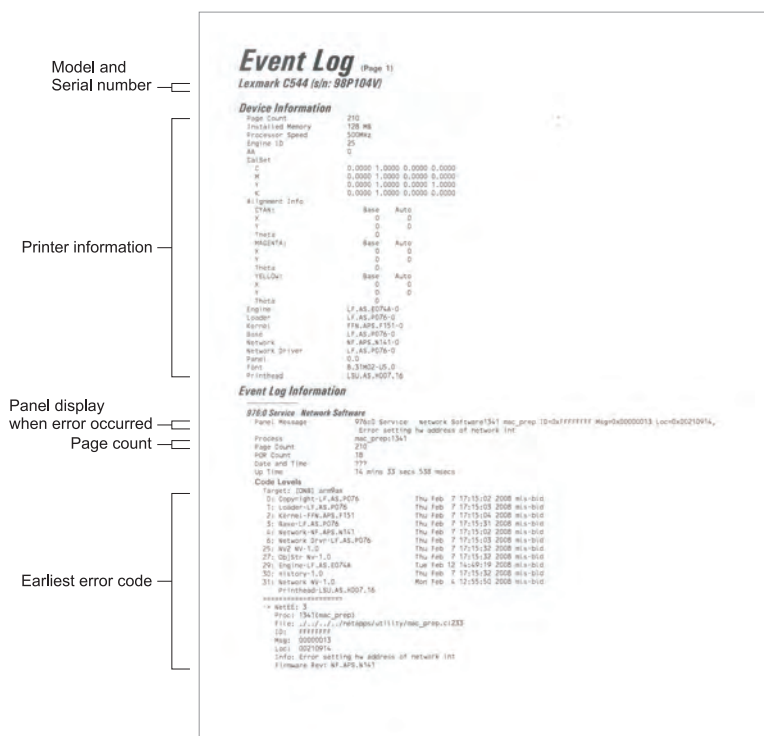

The printed event log can be faxed to your next level of support for verification or diagnosis.

To print the event log:

- 1 Select **Event Log** from Diag Menu, and press **Select**.
- 2 Select **Print Log**, and press **Select**.
- 3 Press **Back** to return to Event Log.

Clear Log

Use Clear Log to remove the current information in the Event Log. This affects both the viewed log and the printed log information.

To clear the event log:

- 1 Select **Event Log** from Diag Menu, and press **Select**.
- 2 Select **Clear Log**, and press **Select**.

- 3 Select **YES** to clear the Event Log or **NO** to exit the Clear Log menu. If **YES** is selected, the **Deleting EVENT LOG** displays on the screen.
- 4 Press **Back** to return to Event Log.

Scanner tests

- [“ASIC Test” on page 228](#)
- [“Motor tests” on page 228](#)
- [“Feed test” on page 229](#)
- [“Sensor tests” on page 229](#)
- [“Scanner calibration reset” on page 232](#)
- [“ADF magnification” on page 232](#)
- [“Flatbed magnification” on page 232](#)

ASIC Test

This setting initiates a scan of the scanner ASIC’s memory.

To perform this test, do the following:

- 1 Navigate to **Scanner Tests > ASIC Test**.
- 2 The test executes. While this test executes, the screen displays **ASIC Test Running...** If the scanner ASIC passed the test, then the panel posts **ASIC Test Passed. Rebooting...** If the scanner ASIC failed the test, then the panel posts **ASIC Test Failed. Rebooting...**

Motor tests

ADF pick

When **Motor On** is selected, the device runs the pick motor continuously for five seconds and then automatically stops the motor.

To perform this test, do the following:

- 1 Navigate to **Scanner Tests > Motor Tests**.
- 2 Select **ADF pick**.
The test will run if it is working properly.

Flatbed scanner motor

When **Motor On** is selected, the device moves the flatbed scanner along the entire flatbed scanner path (that is, to the far wall and back to the Home position) and then automatically stops at the Home position.

To perform this test, do the following:

- 1 Navigate to **Scanner Tests > Motor Tests**.
- 2 Select **Flatbed Scanner Motor**.
The test will run.

ADF feed motor forward

When **Motor On** is selected, the device runs the motor forward continuously until **Motor Off** is selected.

To perform this test, do the following:

1 Navigate to **Scanner Tests > Motor Tests**.

2 Select **ADF Feed Motor Forward**.

The test will run.

ADF feed motor backward

When **Motor On** is selected, the device runs the motor forward continuously until **Motor Off** is selected.

To perform this test, do the following:

1 Navigate to **Scanner Tests > Motor Tests**.

2 Select **ADF Feed Motor Backward**.

The test will run.

Feed test

This test enables a servicer to execute a continuous feed test from either the ADF or the flatbed. The default is to perform the ADF test if paper is loaded into the ADF. To perform the Feed Test, do the following:

1 Navigate to **Diagnostic Menu > Scanner Tests > Feed Test**.

2 Press **Select a paper size**.

3 Select your paper size: A4 or Legal.

4 Select the check button on the screen. The screen displays **Feed Test passed** or **Feed Test failed**.

5 Press **X** on the keypad to exit the test.

Sensor tests

Sensor tests are available to test the sensors on the flatbed and ADF units.

The following sensors can be tested:

- ADF document set – Paper Present
- FB cover open (flatbed top cover)
- Home sensor (carriage home position)
- ADF interval sensor
- ADF stage skew (paper skew) - available on duplex scanners only
- ADF cover open (ADF top cover)
- Scan 1st sensor (paper feed sensor)
- Paper FB long

To test a flatbed or ADF sensor, perform the following steps:

- 1 Navigate to **Scanner Tests > Sensor Tests > <sensor to test>**. The following is displayed:

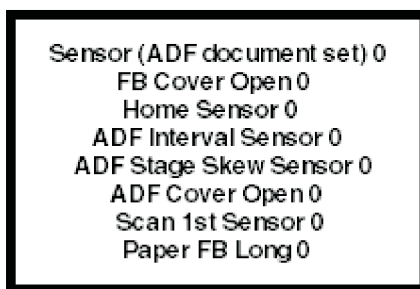

- 2 Select the sensor to be tested.

- 3 Actuate the sensor you selected.

The screen will toggle between 0 and 1 if the sensor is properly functioning.



- 4 Select **Exit** to leave the test.

To test the Paper FB long test, place a sheet of legal paper on the flatbed and close the cover. If the sensor is working properly, the indicator will change from 0 to 1.

To test the Home sensor, perform the following steps:

- 1 Exit the sensor test.
- 2 Open the flatbed cover.
- 3 Use the carriage motor test to move the carriage out of the home position.
- 4 Close the flatbed cover.
- 5 Enter the sensor test. If the home sensor is working properly, then a 1 will display instead of a 0.

A	Stage skew sensor (paper skew)	
B	Paper present	
C	Interval sensor	

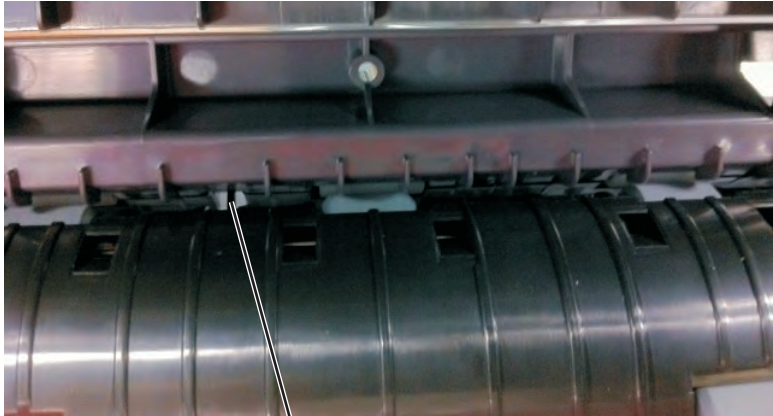
<p>D</p>	<p>ADF cover open</p>	 <p>A photograph showing the top of a scanner with the ADF cover open. A white callout line with the letter 'D' at the end points to the hinge mechanism of the cover.</p>
<p>E</p>	<p>Flatbed cover open</p>	 <p>A close-up photograph of the flatbed cover hinge. A white callout line with the letter 'E' at the end points to the hinge mechanism.</p>
<p>F</p>	<p>paper feed sensor</p>	 <p>A photograph of the paper feed sensor assembly. A white callout line with the letter 'F' at the end points to the sensor component.</p>

Scanner calibration reset

This test is run to reset the scanner calibration. This test should only be run after a flatbed or ADF unit has been replaced.

To perform this operation, do the following:

- 1 Navigate to **Scanner Tests**.
- 2 Select **Scanner Calibration Reset. This procedure should only be run after the scanner or ADF has been replaced** displays.
- 3 Ensure that the scanner glass and white flatbed cushion on the ADF are clean.
- 4 Select **Continue**. If the test is successful, then **Operation completed successfully** displays for three seconds, and then returns to the main Scanner Calibration Reset menu. If an error occurs during the test, then **Test Failed, Please Retry** displays, and a Continue button appears that takes you back to the main Scanner Calibration Rest Menu screen.
- 5 Select **Exit** to leave the test.

After successfully executing this test, verify the results.

- 1 Load the ADF with a document containing both light and dark content.
- 2 Perform a duplex copy. If the back side of the resulting copy contains vertical streaks, then the SE should clean the scanner glass and backing sheet, execute the back side scan uniformity procedure, and then perform another copy. If streaks still appear on the resulting copy, then the SE can repeat the cleaning and verification procedure a second time or can replace the ADF entirely.

ADF magnification

This test allows the service technician to adjust the ADF magnification level. To adjust the ADF magnification level, perform the following steps:

- 1 Navigate to **Diagnostic menu > Scanner Tests > ADF magnification**.
- 2 Use the plus or minus buttons to scroll through the magnification values. The values are 1.000, 1.005, 1.007, .980, .985, .990 and .995.
- 3 Press the check button to accept the value. Press **X** on the screen to exit the test.

Flatbed magnification

This test allows the service technician to adjust the flatbed magnification level. To adjust the flatbed magnification level, perform the following steps:

- 1 Navigate to **Diagnostic menu > Scanner Tests > Flatbed magnification**.
- 2 Use the plus or minus buttons to scroll through the magnification values. The values are from 0.98 to 1.007.
- 3 Press the check button to accept the value. Press **X** on the screen to exit the test.

Exit Diagnostics

Press **Select** to exit Diag Menu. The printer performs a power-on reset and returns to normal mode.

Configuration menu

- “Entering the Configuration menu” on page 234
- “USB scan to local” on page 234
- “Black Only Mode” on page 234
- “Print Quality Pages” on page 234
- “Fuser Cleaning Process” on page 234
- “Reports” on page 235
- “Color Trapping” on page 235
- “Tray Insert Msg” on page 235
- “Panel Menus” on page 236
- “PPDS Emulation” on page 236
- “Download emuls” on page 236
- “Safe Mode” on page 236
- “Energy Conserve” on page 236
- “Fax low power support” on page 237
- “Min copy memory” on page 237
- “Num pad job assist” on page 237
- “Format fax storage” on page 237
- “Auto Color Adjustment” on page 238
- “Auto Align Adj” on page 238
- “Color Alignment” on page 238
- “ADF Edge Erase” on page 238
- “Flatbed edge erase” on page 239
- “Scanner manual registration” on page 239
- “Disable scanner” on page 240
- “Paper Prompts” on page 240
- “Envelope Prompts” on page 241
- “Action for prompts” on page 241
- “Jobs on Disk” on page 242
- “Disk Encryption” on page 242
- “Font Sharpening” on page 242
- “Require Standby” on page 242
- “UI Automation” on page 243
- “LES Applications” on page 243
- “Key Repeat Initial Delay” on page 243
- “Key Repeat Rate” on page 243
- “Clear Supply Usage History” on page 244
- “Clear Custom Status” on page 244
- “PEL Blurring” on page 244
- “USB Speed” on page 244

- “Automatically Display Error Screens” on page 244
- “USB PnP” on page 245
- “Size sensing” on page 245
- “Demo Mode” on page 245
- “Factory Defaults” on page 245
- “Restore Factory Defaults” on page 246
- “Exit Config” on page 247

The Configuration menu group consists of menus, settings, and operations that are used to configure a printer for operation.

Entering the Configuration menu

- 1 Turn off the printer.
- 2 Press and hold **2** and **6** while turning on the printer.
Release the buttons when the splash screen appears.

USB scan to local

Value	Description
Off	The USB device driver enumerates as a USB simple device (single interface).
On (default)	The USB device driver enumerates as a USB composite device (multiple interfaces).

Black Only Mode

This setting enables the user to force the printer to always print color content in grayscale. The printer will ignore any PJI or data stream commands that attempt to change the print mode setting. If this setting is set to off, then the printer will print color content as normal.

Print Quality Pages

The Print Quality Pages can be printed from both the Configuration Menu and the Diagnostics Menu. The Configuration Menu is limited in information compared to the pages printed from the Diagnostics Menu.

To help isolate print quality problems, print the Print Quality Test Pages. The pages are formatted. The **Printing Quality Test Pages** message appears, and then the pages print. The message remains on the operator panel until all the pages print.

Press **Select** to print the pages. The Print Quality Test Pages contain several pages. The first page, which is printed in English text only, contains a mixture of text and graphics. The information includes values of the Quality Menu settings in Settings and printer and toner cartridge configuration information. The remaining pages contain only graphics.

Fuser Cleaning Process

Over the lifetime of the device, flecks that adhere to the fuser may transfer to printed pages. The three step fuser cleaning process removes these flecks.

Values	Description
Print Cleaning Pages	The printer prints three very high-coverage, one-sided pages. Each of these pages contain instructions and information that the process heats the fuser to a very high temperature in order to loosen the flecks and make them sticky.
Start Cleaning Process	Several high-coverage sheets are fed through the fuser in order to pick up and remove the flecks.

Reports

The Reports setting contains the Menu Settings Page and Event Log.

Menu Settings Page

Print the menu settings pages to list the customer settings and to verify printer options are installed correctly. It is helpful to print the customer settings before you restore the factory defaults or make major changes.

To print the menu settings:

- 1 Select **Reports** from the Config Menu, and press **Select**.
- 2 Select **Menu Settings Page**, and press **Select**.

Event Log

The Event Log lets the system support person print a limited set of the information contained in the Diagnostic Menu version of the printed Event Log. The limited Configuration log and the full Diagnostics log printed versions show the same operator panel messages when the print and follow the same layout guidelines.

To print the Event Log:

- 1 Select **Reports** from the Config Menu, and press **Select**.
- 2 Select **Print Log**, and press **Select** to begin printing the log.

Color Trapping

Color Trapping uses an algorithm to compensate for mechanical incorrect registration in the printer. When small black text or fine black lines are being printed, the printer checks to see if they are being printed on top of a colored background. If so, then rather than remove the color from beneath the black content, the printer leaves the color around the edge of the text or line. The hole in the colored region is reduced in size, which prevents the characteristic white gap that is caused by incorrect registration.

Values include Off and number 1-5 (the default is 2). Values 1 through 5 indicate the amount of color remaining beneath the black content. Each setting increments by 1/600 of an inch. The more inaccurate the registration setting, the higher the setting needs to be adjusted. Selecting **Off** disables color trapping.

Tray Insert Msg

This setting determines how many seconds the panel will display the **Tray Insert** message after a user has inserted a tray into the printer.

The user can choose to disable this setting, or to set the value between 1 to 90 seconds. The default value is 5 seconds.

Panel Menus

The Panel Menus lets the system support person enable or disable the control panel menus. Selecting **On** (the default) allows users to change values for the printer. **Off** disables the users' access to menus. If a user presses **Menu**, then they receive a message that the panel menus are locked. When set to **Off**, this setting restricts all menu access, even to menus or items set for PIN access. However, when set to **On**, all PIN restrictions are restored.

This menu item appears only when the PJI PASSWORD Environment variable is set to 0.

PPDS Emulation

PPDS Emulation activates or deactivates (default) the Personal Printer Data Stream (PPDS) emulation language. This menu item appears only if the PPDS interpreter is available.

Download emuls

This appears only if at least one download emulator (DLE) is installed. The default setting is Disable. All download emulators (DLEs) are re-enabled automatically after two PORs.

Safe Mode

The settings for this menu item are On and Off (default). When enabled, Safe Mode lets the printer operate in a special limited mode in which it attempts to continue offering as much functionality as possible despite known issues. For more information about Safe Mode and the Safe Mode print behavior for this model, see [“Using Safe Mode” on page 44](#).

To change the setting:

- 1 From the Configuration menu, navigate to **Safe Mode**.
- 2 Select **On** or **Off** to change the setting.
- 3 Select **Submit**.
- 4 POR the printer.

Energy Conserve

Energy Conserve affects the values that appear in the Power Saver menu in the customer Setup Menu. This menu item appears only when the printer model does not support Automatic Power Saver or has deactivated Automatic Power Saver. Energy Conserve affects only the values that are displayed in the Power Saver menu.

Select **Off** in Energy Conserve to allow Power Saver in the customer menu to display Disable as an option. If **Disable** is selected in the customer Power Saver, the printer deactivates the Power Saver feature. Select **On** (the default) in Energy Conserve to prevent **Disable** from appearing as an option in the Power Saver setting, and preventing the customer from turning off Power Saver.

Fax low power support

Fax Low Power support allows you to select one of three power settings for the fax. The Auto value relies on the firmware's logic to determine if the device supports the fax portion of the low power architecture. Permit Sleep allows the fax chip to enter low power mode whenever the device determines that it should. Disable Sleep prohibits the fax chip from ever entering low power mode.

To change the fax low power support setting:

- 1 Select **Fax low-power support** in the configuration menu to open the item
- 2 Select one of the three settings: disable, sleep permit, or sleep auto.
- 3 Select  to accept the setting, or press the **X** on the screen to exit the item.

Min copy memory

Values will only be displayed if the amount of installed DRAM is at least twice the amount of the value, that is, at least 200 MB of installed DRAM is required to display the 100 MB selection.

To change this setting:

- 1 Select **Min Copy Memory** from the Configuration Menu. [**setting's current value**] displays.
- 2 Select one of the three settings: disable, sleep permit or sleep auto
- 3 Select the minus to decrease the setting's value or the plus to increase the setting's value.
- 4 Select **Submit** to save the change.

Num pad job assist

This setting determines if a user can configure and initiate a job using the control panel's hard buttons.

To change this setting:

- 1 Select **Num Pad Job Assist** from the Configuration Menu. [**setting's current value**] displays.
- 2 Select the minus to decrease the setting's value or the plus to increase the setting's value.
- 3 Select **Submit** to save the change.

Format fax storage

This setting enables you to format the non-volatile storage used for storing faxes.

To change this setting:

- 1 Select **Format Fax Storage** from the Configuration Menu.

Note: If an advanced password has been established, then you must enter this password to change the setting. If no advanced password exists, then you can establish one by using the keyboard that appears on the LCD.
- 2 Select **Submit** to save the change.
- 3 Select **Back** to cancel and return to the Configuration Menu. **Formatting Fax Flash DO NOT POWER OFF** appears on the display while the format operation is active.

Auto Color Adjustment

Auto Color Adjustment sets the suggested number of pages which the printer should print between consecutive calibrations.

Selections are **Off** and the values between **100** and **1000** in increments of 50. The default is 700 pages.

If the printer exceeds the set value while printing a job, it completes the current job and any other jobs received while printing the current job before it initiates a calibration. The printer does not cancel or suspend an active job to perform a calibration. If a user is using the menus, including the Configuration Menu and the Diagnostics Menu, an automatic color adjust calibration does not occur.

When an event other than page count triggers this calibration, the count that monitors the maximum number of pages printed will be reset. For example, if the user replaces an empty toner cartridge, the next time the printer is started, it will sense the new cartridge and perform the automatic color adjustment, even though the page counter for Auto Color Adj is fewer than required. The Auto Color Adj page counter is then reset.

Auto Align Adj

Note: This setting should never be set to off during normal printer usage.

Toner Patch Sensing (TPS) is a diagnostic mechanism that automatically adjusts the printer's toner density. When TPS executes, the printer generates toner patches on the belt and then uses these to calculate the appropriate amount of necessary adjustment. When an event initiates a TPS operation, the device performs a toner density calibration.

Regardless of this setting's value, the device always performs an automatic alignment calibration after any initiating event occurs. If this setting's value is set to off, then the device does not use the results of this test to automatically adjust its alignment, and may eventually require the user to have to manually align the device.

Color Alignment

A user will need to run the color alignment process after any event that might cause the printhead to misalign. When this setting is selected, the device generates several alignment pages. The user can then manually adjust the value of any of the settings **A** through **L** as necessary in order to improve the device's alignment. Regardless of this setting's value, the device always performs an automatic alignment calibration after any initiating event occurs. If this setting's value is set to off, the device does not use the results of this test to automatically adjust its alignment, and may eventually require the user to have to manually align the device.

Note: The user will not be allowed to access the **Cancel Job** or **Reset Printer** functions while printing the color alignment pages.

ADF Edge Erase

The value of this setting determines the size in millimeters of the "no-print" zone around an ADF scan job.

To change this setting:

- 1** From the Configuration Menu, navigate to **ADF Edge Erase**.
- 2** Touch **Left** or **Right** to change the setting.
- 3** Touch **Submit** to save the setting, or touch **Back** to return to the Configuration Menu without saving any changes.

Flatbed edge erase

This menu item sets the size, in millimeters, of the no print area around a flatbed scan job. Copy jobs will use the setting or two millimeters, whichever is larger.

To adjust the flatbed edge erase setting, perform the following steps:

- 1 Select **FB Edge Erase** from the Configuration Menu. [**setting's current value**] displays.
- 2 Select minus to decrease the setting's value or plus to increase the setting's value.
- 3 Select **Submit** to save the change.
- 4 Select **Back** to cancel and return to the Configuration Menu.

Scanner manual registration

This item is used to manually register the flatbed and ADF on the MFP scanner unit. Registration should be performed whenever the ADF unit, flatbed unit, or controller card are replaced.

To manually register a Duplex ADF, perform the following steps:

- 1 In the Configuration Menu, scroll to the Scanner Manual Registration menu item.
- 2 Select **Scanner Manual Registration**.
- 3 Select **Print Quick Test Page**.
- 4 To view and adjust the duplex ADF front side registration, place the quick test page faceup into the ADF.
- 5 Select **Copy Quick Test**.
- 6 After the quick test page copies, select **ADF Front**.
- 7 Use the plus to increase or the minus to decrease the settings value for horizontal adjust and top margin.
Note: Each button press moves the margin values one pixel in the respective direction.
- 8 Select **Submit** to accept the value.
- 9 Save changes by placing the print quick test page face up and selecting **Copy Quick Test**.
- 10 Repeat steps 6, 7, and 8 as needed.
- 11 To view and adjust the duplex ADF backside registration, place the quick test page face down up into the ADF, and select **Copy Quick Test**.
- 12 After the quick test page copies, select **ADF Back**.
- 13 Use the plus or minus to increase or decrease the settings value for horizontal adjust and top margin.
Note: Each button press moves the margin values one pixel in the respective direction.
- 14 Select **Submit** to accept the value.
- 15 Verify the changes by placing the print quick test page face down and selecting **Copy Quick Test**.
- 16 Repeat steps 13, 14, and 15 as needed.

To manually register the flatbed, perform the following steps:

- 1 In the Configuration Menu, select the Scanner Manual Registration menu item.
- 2 Select the Print Quick Test Page menu item.

- 3 To view and adjust the flatbed registration, place the quick test page into the flatbed.
- 4 Select the Copy Quick Test Page item.
- 5 After the quick test page copies, select **Flatbed**.
- 6 Use the plus or minus to increase or decrease the settings value for the left or top margin.
Note: Each button press moves the margin values one pixel in the respective direction.
- 7 Select **Submit** to accept the value.
- 8 Place the print quick test page on the flatbed and select **Copy Quick Test**.
- 9 Repeat steps 5 and 6 as needed.
- 10 To exit REGISTRATION, select **Back** or **Stop**.

Disable scanner

This menu item is used to disable the MFP scanner if it is malfunctioning. The MFP must be powered off and on for the new settings to take effect.

To change this setting:

- 1 Select **Disable Scanner** from the Configuration menu.
- 2 Scroll through the setting's other possible values. The values are Enable, Disable, ADF disable.
- 3 To save the setting's new value, select **Submit**.

Paper Prompts

This controls which tray a change prompt is directed to when paper is sensed to be the wrong size.

Note: The value of [“Action for prompts” on page 241](#) may override the value of this setting.

To change this setting:

- 1 From the Configuration menu, navigate to **Paper Prompts**.
- 2 Select from the available options:
 - Auto (default)
 - Multi-purpose Feeder
 - Manual Paper
- 3 Depending on the printer model, press **OK** or touch  to save the setting, or press **X** to return to the Configuration menu without saving any changes.

When it is set to **Auto**, the emulator selected to print the job determines which of the installed input sources will receive the change prompt. When set to a value other than Auto, the selected source always receives this type of prompt.

Envelope Prompts

This controls which tray a change prompt is directed to when the envelopes are sensed to be the wrong size.

Note: The value of [“Action for prompts” on page 241](#) may override the value of this setting.

To change this setting:

- 1 From the Configuration menu, navigate to **Envelope Prompts**.
- 2 Select from the available options:
 - Auto (default)
 - Multi-purpose Feeder
 - Manual Envelope
- 3 Depending on the printer model, press **OK** or touch  to save the setting, or press **X** to return to the Configuration menu without saving any changes.

When it is set to **Auto**, the emulator selected to print the job determines which of the installed input sources will receive the change prompt. When set to a value other than Auto, the selected source always receives this type of prompt.

Action for prompts

This setting enables users to determine which input source would receive paper-related or envelope-related change prompts when they occur. Regardless of the target source, the device always requires some type of user assistance to resolve the change prompt (examples: pushing a button to ignore the prompt and changing the source's installed media). However, this setting gives a user the option of having the device resolve change prompt situations without requiring any user assistance.

To change this setting:

- 1 From the Configuration Menu, navigate to **Action for prompts**.
- 2 Touch **Left** or **Right** to change the setting.
- 3 Touch **Submit** to save the setting, or touch **Back** to return to the Configuration Menu without saving any changes.

When set to **Prompt user**, the device behaves like the past implementation. When a change prompt occurs, the device stops printing, posts the change prompt to the target source, and waits for the user to select an action before continuing.

When set to **Continue**, the device automatically assumes that the user selects **Continue** every time a change prompt is encountered. Likewise, when the device is set to **Use Current**, all change prompts will perform as if **Use Current** was selected by the user.

Jobs on Disk

This setting appears only if a hard disk is installed. It allows buffered jobs to be deleted from the disk. This does not affect Print and Hold or parked jobs.

To change the setting:

- 1 From the Configuration menu, navigate to **Jobs on Disk**.
- 2 Select from the available options to change the setting:
 - Delete
 - Do Not Delete (default)
- 3 Press **X** to return to the Configuration menu.

Disk Encryption

Warning—Potential Damage: If the settings are changed, then the printer completely formats the hard disk. All information on the disk will be unrecoverable.

This setting appears only if a hard disk is installed. It controls whether the printer encrypts the information that it writes to the hard disk.

To change the setting:

- 1 From the Configuration menu, navigate to **Disk Encryption**.
- 2 Select from the available options to change the setting.
 - Enable—enables encryption of hard disk.
 - Disable (default)—enables formatting of hard disk.
- 3 **Contents will be lost. Continue?** appears. Select **Yes** to proceed with the encryption or formatting of the disk, or **No** to cancel the operation. If Yes is selected, then a progress bar appears on the display that indicates the overall completion of the selected operation. After completion, the display returns to Disk Encryption.

Font Sharpening

Font Sharpening allows a user to set a text point-size value below the setting of the high-frequency screens used when printing font data. This menu item affects only the PostScript, PCL 5, PCL XL, and PDF emulators.

Settings are in the range of 0–150 (24 is the default). For example, if the value is set to 24, then all fonts sized 24 points or less use the high-frequency screens. To increase the value by 1, press the right arrow; to decrease the value by 1, press the left arrow.

Require Standby

This turns On or Off the standby mode in the General Settings Menu. The default setting is On.

UI Automation

Once enabled, this setting creates an **ENABLE_UI_AUTOMATION** file in the `/var/fs/shared/` directory. As long as this file exists, the printer permits external developers to test the stability of their applications against the printer to make sure that their applications have an appropriate level of stability. Disabling this setting deletes the file and prohibits automated testing.

To change the setting:

- 1 From the Configuration menu, navigate to **UI Automation**.
- 2 Select from the available options to change the setting.
 - Enable
 - Disable (default)
- 3 Depending on the printer model, press **OK** or touch  to save the setting, or press **X** to return to the Configuration menu without saving any changes.

LES Applications

This setting enables or disables the Lexmark Embedded Solutions (LES) applications. This setting does not affect built-in applications. The default setting is Enable.

Key Repeat Initial Delay

Note: This setting is available only on the MS610de model.

This setting determines the length of delay before a repeating key starts repeating. The range is 0.25–5 seconds, with increments of 0.25. The default setting is one second.

To adjust this setting:

- 1 From the Configuration menu, navigate to **Key Repeat Initial Delay**.
- 2 Touch the arrow keys to adjust the setting.
- 3 Touch  to save the setting, or press **X** to return to the Configuration menu without saving any changes.

Key Repeat Rate

Note: This setting is available only on the MS610de model.

This setting indicates the number of presses per second for repeating keys. The range is 0.5–100, with increments of 0.5. The default setting is 15 presses per second.

To adjust this setting:

- 1 From the Configuration menu, navigate to **Key Repeat Rate**.
- 2 Touch the arrow keys to adjust the setting.
- 3 Touch  to save the setting, or press **X** to return to the Configuration menu without saving any changes.

Clear Supply Usage History

This setting reverts the supply usage history (number of pages and days remaining) to the factory shipped level.

To clear the supply usage history:

- 1 From the Configuration menu, navigate to **Clear Supply Usage History**.
- 2 Depending on the printer model, press **OK** or touch **Clear Supply Usage History** to proceed.

Clear Custom Status

Executing this operation erases any strings that have been defined by the user for the default or alternate custom messages.

To clear the custom status:

- 1 From the Configuration menu, navigate to **Clear Custom Status**.
- 2 Depending on the printer model, press **OK** or touch **Clear Custom Status** to proceed.

PEL Blurring

This setting enables customers who notice step artifacts in their error diffused copies to activate the pel synthesis function. The default setting is Off.

USB Speed

This setting is used to set the throughput of the USB port on the printer.

Available options:

- Auto
- Full—Forces the USB port to run at full speed and also disables its high-speed capabilities.

Automatically Display Error Screens

If On, the panel automatically displays any existing printer-related IR after the printer remains inactive on the home screen for a length of time equal to the Screen timeout setting in the Timeouts section of the General settings menu. Any IR that appears on the display will give the user the option of returning to the home screen without clearing it. From the home screen, any other workflow or feature can be initiated as usual. Once the printer returns to the home screen, any existing IR will again appear after the printer remains inactive for a length of time equal to the Screen timeout setting.

To change this setting:

- 1 From the Configuration menu, navigate to **Automatically Display Error Screens**.
- 2 Select from the available options:
 - On (default)
 - Off
- 3 Depending on the printer model, press **OK** or touch  to save the setting, or press **X** to return to the Configuration menu without saving any changes.

USB PnP

In some cases, the USB port at the back of the printer may be incompatible with the chipset in a user's PC. This setting lets the user change the USB driver mode to improve its compatibility with these PCs.

Available options:

- 1
- 2

Size sensing

B5/Executive

Due to engine limitations, Trays 1 through 4 cannot simultaneously sense executive and JIS-B5-size paper. The value of this setting determines which of the two paper sizes these trays will sense automatically. This setting will apply to all automatic trays, but not to the MP Feeder. The MP Feeder can support these paper sizes regardless of the value of this setting.

Tray [x] sensing

By turning the tray [x] sensing setting to **Auto**, every input option equipped with size sensing hardware automatically registers what size of paper it contains. When this setting is turned Off, the printer ignores the size detected by the hardware and treats the input source as a non-sensing source. The media size can be set by the operator panel or the data stream.

To change this setting:

- 1** From the Configuration menu, navigate to **SIZE SENSING**. The screen displays each size sensing equipped input source and its current Size Sensing setting.
- 2** Select the appropriate input source.
- 3** Touch **Left** or **Right** to change the setting.
- 4** Touch **Submit** to save the setting, or touch **Back** to return to the Configuration menu without saving any changes.

Demo Mode

The Demo Mode lets marketing personnel or merchandisers demonstrate the printer to potential customers by printing the demo page.

Selections include Deactivate (default) and Activate. Select **Deactivate** to turn Demo Mode off; or select **Activate** to turn Demo Mode on.

Factory Defaults

Warning—Potential Damage: This operation cannot be undone.

This setting enables a user to restore all of the device settings to either the network settings (on network models only) or to the base device settings.

To print current menu settings:

Note: It is recommended that you first print the customer's current settings by printing a copy of the Menu Settings pages. Customer settings are available from the Ready prompt Diagnostics Menu settings are available in the Diagnostics Menu, and Config Menu settings are available in the Config Menu.

- 1 Turn the printer off, or select **Exit Config Menu**.
- 2 At the Ready prompt, select **Menus** and press **Select**.
- 3 Select **Reports**, and press **Select**.
- 4 Select **Menu Settings Page**, and press **Select**.
- 5 Enter the Diagnostic Menu, select **Reports, Menu Settings Page**, and press **Select**.
- 6 Turn the printer off, or select **Exit Diags**.
- 7 Enter Configuration Menu, select **Reports, Menu Settings Page**, and press **Select**.

To reset factory defaults:

- 1 Select **Reports** from the Config Menu, and press **Select**.
- 2 Select **Factory Defaults**, and press **Select**
- 3 Select **Restore Base** (for locally attached printers) or **Restore STD NET** (if you have integrated network support).

Submitting Changes... appears on the operator panel, and then the printer PORs (restarts in Ready mode).

Restore Factory Defaults

Restore Settings

This setting enables a user to restore all of the printer settings to either the network settings (on network models only) or to the base printer settings.

To restore the settings:

- 1 From the Configuration menu, navigate to **Restore Factory Defaults > Restore Settings**.
- 2 Select from the available options:
 - Restore Printer Settings—restores all non-critical base printer NVRAM settings.
 - Restore Network Settings—restores all network NVRAM settings.
 - Restore Apps—restores the factory default eSF configuration.

Erase Printer Memory

This makes any sensitive information that may exist on the volatile or non-volatile storage of the device completely indecipherable. When selected, the printer performs a non-critical NVRAM reset and then reboots.

Erase Hard Disk

This setting performs a wipe of the printer hard disk, erasing all data.

Warning—Potential Damage: This deletes all data on the printer hard disk, including downloaded fonts, macros, and held jobs. Do not initiate a disk wipe if you have information on the printer that you want to save.

Available options:

- Single Pass Erase—overwrites all data and the file system. This wipe is faster but less secure since it is possible to retrieve the deleted data with forensic data-retrieval techniques.
- Multi Pass Erase—overwrites all data without rewriting the file system. This wipe is DoD 5220.22-M compliant since the deleted data is irretrievable.

Note: If the printer is reset while a disk wipe operation is executing, then **Corrupt Disk** appears upon regaining power.

Exit Config

Press **Select** to exit the Configuration Menu. The printer performs a power-on reset and returns to normal mode.

Entering Invalid engine mode

This mode allows the printer to load the correct firmware code.

- 1 Turn off the printer.
- 2 From the control panel, press and hold the **3**, **4**, and **6** while turning on the printer.
- 3 Release the buttons after 10 seconds.

Entering Recovery mode

This mode allows the printer to boot from a secondary set of instructions and flash firmware code. While in this mode, you can only flash firmware code through a USB cable directly connected to a PC.

Depending on your printer model, do any of the following:

For LED display

- 1 Turn off the printer.
- 2 Open the front door.
- 3 Press and hold the **Stop** button.
- 4 Turn on the printer.
- 5 When all the icons flash, release the button.

For 2-line display

- 1 Turn off the printer.
- 2 Press and hold the **OK** and **Back** buttons.
- 3 Turn on the printer.

- 4 When the display shows the following icon, release the buttons.



For 2.4-, 4.3-, 7-, and 10-inch displays

- 1 Turn off the printer.
- 2 Press and hold the **2**, **7**, and **8** buttons.
- 3 Turn on the printer.
- 4 When the display shows the following icon, release the buttons.



For 2.8-inch display

- 1 Turn off the printer.
- 2 Open tray 1.
- 3 Make sure that paper is loaded in tray 1.
- 4 Turn on the printer.
- 5 When the display shows the following icon, close tray 1.



Note: If tray 1 is not closed, then the printer will boot normally.

6 A screen with red selection items appears.

Touch -> to navigate to Recovery mode.

7 Touch **Boot** or **RECOVERY**.

Accessing restore point

Note: This functionality is available for 4.3", 7" and 10" display printers only.

This functionality allows the printer firmware to roll back to a previous state whenever a firmware update causes problems in the printer.

Notes:

- A restore point is generated when a new firmware code is flashed. Only one restore point is saved.
- If the printer is new, then there are no existing restore points and the key sequence is ignored.

1 Turn off the printer.

2 Press and hold the **7** and **8** buttons simultaneously.

3 Turn on the printer.

4 Release the buttons when a splash screen appears.

Accessing the Network SE menu

This menu contains settings for fine tuning the communication settings for the network interfaces and protocols.

1 Touch **Select** and **Right**.

2 Navigate to **Networks/Ports** > **Standard Network** > **Std Network Setup**.

3 Press and hold **6**, **7**, and **9** simultaneously.

Service Engineer menu

Accessing the service engineer (SE) menu

From a Web browser on a host PC, add `/se` to the printer IP address.

Service engineer (SE) menu

This menu should be used as directed by the next level of support.

Top level menu	Intermediate menu
Print SE Menus	
General	Copyright — Displays copyright information

Top level menu	Intermediate menu
Code Revision Info	<ul style="list-style-type: none"> • Network code level — Displays network code level • Network Compile Info — Displays network compile information • Printer Code Level — Displays printer code information • Printer Compile Info — Displays compile information
History	<ul style="list-style-type: none"> • Print History • Mark History • History Mode
MAC	<ul style="list-style-type: none"> • Set Card Speed • LAA • Keep Alive
NVRAM	<ul style="list-style-type: none"> • Dump NVRAM • Reinit NVRAM
TCP/IP	<ul style="list-style-type: none"> • netstat-r • arp-a • Allow SNMP Set • MTU • Meditech Mode • RAW LPR Mode • Gather Debug • Enable Debug

Fax service engineer (SE) menu

The Fax SE menu is used for the Fax transmission service check and the Fax reception service check. It should only be used as directed by the next level of support.

In Ready mode, type ****411** to enter the Fax SE menu.

Parts removal

- [“Removal precautions” on page 251](#)
- [“Removal procedures” on page 273](#)
- [“Left side removals” on page 274](#)
- [“Right side removals” on page 288](#)
- [“Front removals” on page 309](#)
- [“Bottom removals” on page 328](#)
- [“Rear side removals” on page 346](#)
- [“Top side removals” on page 352](#)
- [“ADF/scanner removals” on page 367](#)
- [“Options removals” on page 383](#)

Removal precautions

 **CAUTION—SHOCK HAZARD:** For personal safety and to prevent damage to the printer, remove the power cord from the electrical outlet before you connect or disconnect any cable, electronic board, or assembly. Disconnect any connections between the printer and the PCs/peripherals.

 **CAUTION—POTENTIAL INJURY:** The printer weight is greater than 18kg (40 lb) and requires two or more trained personnel to lift it safely. Use the hand holds on the side of the printer. Make sure your fingers are not under the printer when you lift or set the printer on the floor or another stable surface.

Data security notice

- 1 This printer contains various types of memory that are capable of storing device and network settings, information from embedded solutions, and user data. The types of memory, along with the types of data stored by each, are described below.
 - **Volatile memory**—This device utilizes standard Random Access Memory (RAM) to temporarily buffer user data during simple print and copy jobs.
 - **Non-volatile memory**—This device may utilize two forms of non-volatile memory: EEPROM and NAND (flash memory). Both types are used to store the operating system, device settings, network information, scanner and bookmark settings, and embedded solutions.
 - **Hard disk memory**—Some devices have a hard disk drive installed. The printer hard disk is designed for device-specific functionality and cannot be used for long term storage for data that is not print-related. The hard disk does not provide the capability for users to extract information, create folders, create disk or network file shares, or transfer FTP information directly from a client device. The hard disk can retain buffered user data from complex print jobs, as well as form data and font data.

To erase volatile memory, turn off the printer.

To erase non-volatile memory, see the menu item under [“Configuration menu” on page 233](#) pertaining to this.

To erase the printer hard disk, see the menu item under [“Configuration menu” on page 233](#) pertaining to this.

The following parts are capable of storing memory:

- printer control panel
- UICC (User Interface Controller Card)
- controller board
- optional hard drives

Note: The printer control panel and controller board contain NVRAM.

2 After removing the old part, it must be returned to your next level of support.

Handling ESD-sensitive parts

Many electronic products use parts that are known to be sensitive to electrostatic discharge (ESD). To prevent damage to ESD-sensitive parts, use the following instructions in addition to all the usual precautions, such as turning off power before removing logic boards:

- Keep the ESD-sensitive part in its original shipping container (a special “ESD bag”) until you are ready to install the part into the machine.
- Make the least-possible movements with your body to prevent an increase of static electricity from clothing fibers, carpets, and furniture.
- Put the ESD wrist strap on your wrist. Connect the wrist band to the system ground point. This discharges any static electricity in your body to the machine.
- Hold the ESD-sensitive part by its edge connector shroud (cover); do not touch its pins. If you are removing a pluggable module, use the correct tool.
- Do not place the ESD-sensitive part on the machine cover or on a metal table; if you need to put down the ESD-sensitive part for any reason, first put it into its special bag.
- Machine covers and metal tables are electrical grounds. They increase the risk of damage, because they make a discharge path from your body through the ESD-sensitive part. (Large metal objects can be discharge paths without being grounded.)
- Prevent ESD-sensitive parts from being accidentally touched by other personnel. Install machine covers when you are not working on the machine, and do not put unprotected ESD-sensitive parts on a table.
- If possible, keep all ESD-sensitive parts in a grounded metal cabinet (case).
- Be extra careful while working with ESD-sensitive parts when cold-weather heating is used, because low humidity increases static electricity.

Controller board/control panel replacement

This procedure should be followed only if both the controller board and the control panel fail. If you need to replace only one of the FRUs, follow the startup procedure described in the FRU’s removal procedure.



CAUTION—POTENTIAL INJURY

The lithium battery in this product is not intended to be replaced. There is a danger of explosion if a lithium battery is incorrectly replaced. Do not recharge, disassemble, or incinerate a lithium battery. Discard used lithium batteries according to the manufacturer's instructions and local regulations.

Warning—Potential Damage: If the control panel and the controller board are being replaced at the same time, replace the parts in this order to avoid damage to the machine.

1 Replace the controller board first.

Note: Do not replace the control panel and controller card in the machine at the same time.

2 Turn on the printer and enter Diagnostics mode.

3 If the problem is fixed, allow the printer to go through a complete startup cycle and the display to go to Ready.

Note: Proceed to the next step only if the problem is not fixed.

4 Reinstall the old controller card, and do not POR the printer.

5 Replace the control panel, and then enter Diagnostics mode.

6 If the problem is fixed, allow the printer to go through a complete startup cycle and the display to go to Ready.

Note: After this procedure is completed successfully, there is no need to adjust any settings. If the above procedure fails, you must contact the technical support center for further instructions.

Restoring the printer configuration after replacing the controller board

Restore the printer to its correct configuration to complete the replacement service. Use the Service Restore Tool to download the software bundle, and then flash the printer settings and embedded solutions.

Note: The software bundle contains the latest version of the firmware, applications, and software licenses from the Lexmark Virtual Solutions Center (VSC). The printer firmware may be at a different level from what was used before replacing the controller board.

Using the Service Restore Tool

1 Go to <https://cdp.lexmark.com/service-restore-tool/> to access the tool.

2 Log in using your Lexmark or partner login.

If your login fails, then contact your next level of support.

3 Enter the printer serial number, and then submit the information.

Note: Make sure that the serial number that appears on the verification screen is correct.

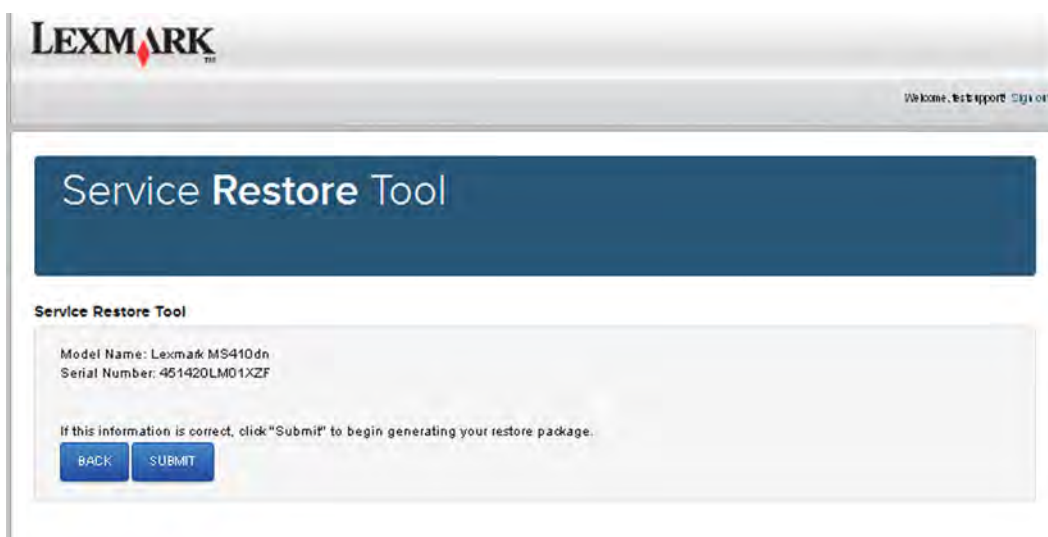

4 Save the zip file.

Note: Make sure that the serial number in the zip file matches the serial number of the printer being restored.

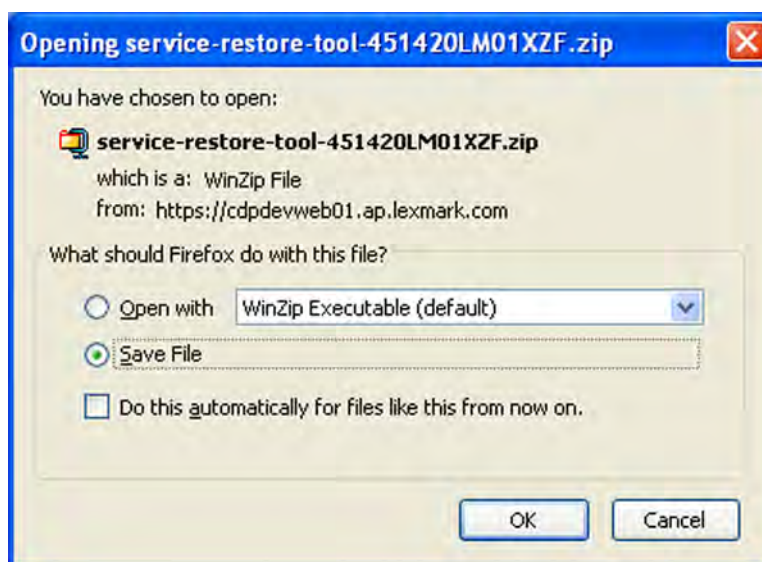

5 Extract the contents of the zip file, open the *Readme* file, and then follow the instructions in the file.

Notes:

- Perform the install instructions on the *Readme* file in the exact order shown. Restart the printer only if the file says so.
- For more information on how to flash the downloaded files, see [“Updating the printer firmware” on page 257](#).
- To load the zip files that are extracted from the Service Restore Tool, see [“Restoring solutions, licenses, and configuration settings” on page 256](#).

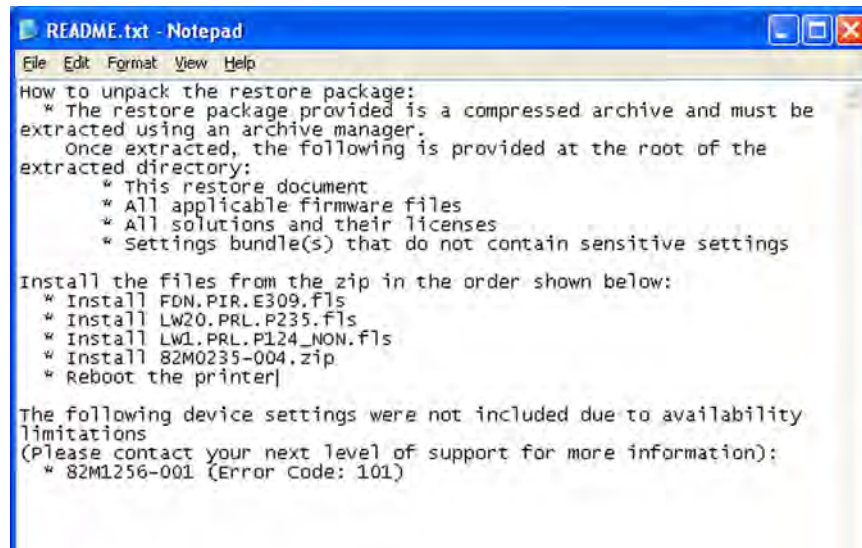

```

README.txt - Notepad
File Edit Format View Help
How to unpack the restore package:
* The restore package provided is a compressed archive and must be
extracted using an archive manager.
Once extracted, the following is provided at the root of the
extracted directory:
* This restore document
* All applicable firmware files
* All solutions and their licenses
* Settings bundle(s) that do not contain sensitive settings

Install the files from the zip in the order shown below:
* Install FDN.PIR.E309.fls
* Install LW20.PRL.P235.fls
* Install LW1.PRL.P124_NON.fls
* Install 82M0235-004.zip
* Reboot the printer

The following device settings were not included due to availability
limitations
(Please contact your next level of support for more information):
* 82M1256-001 (Error Code: 101)

```

- 6 After performing the installation instructions in the *Readme* file, confirm from the customer if all the eSF apps have been installed.

Notes:

- If you are unable to access the administrative menus to verify that the printer is restored, then ask the customer for access rights.
- If a 10.00 error appears after you restart the printer, then contact the next level of support.

Restoring solutions, licenses, and configuration settings

To load the zip files that are extracted from the Service Restore Tool, do the following:

- 1 Open a Web browser, and then type the printer IP address.
- 2 Navigate to **Settings > Configuration Files**.

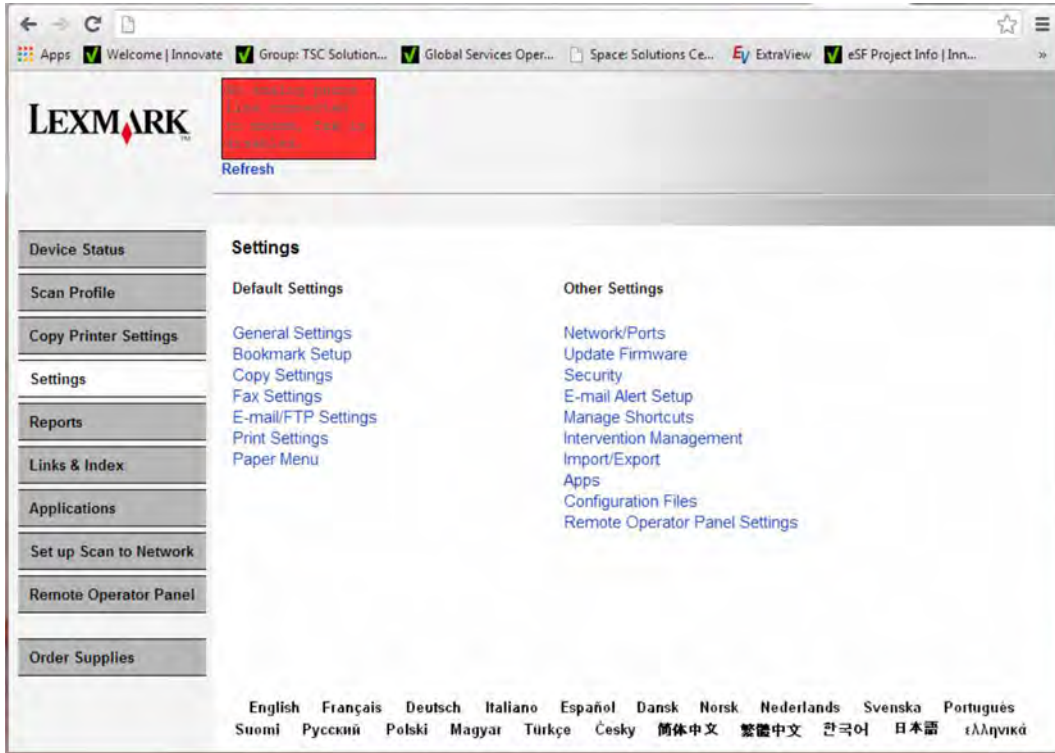

- 3 From the Configuration File History tab, navigate to **Import > Choose File**.
- 4 Select the zip file from the expanded Service Restore Tool package.

5 Click **Import**.

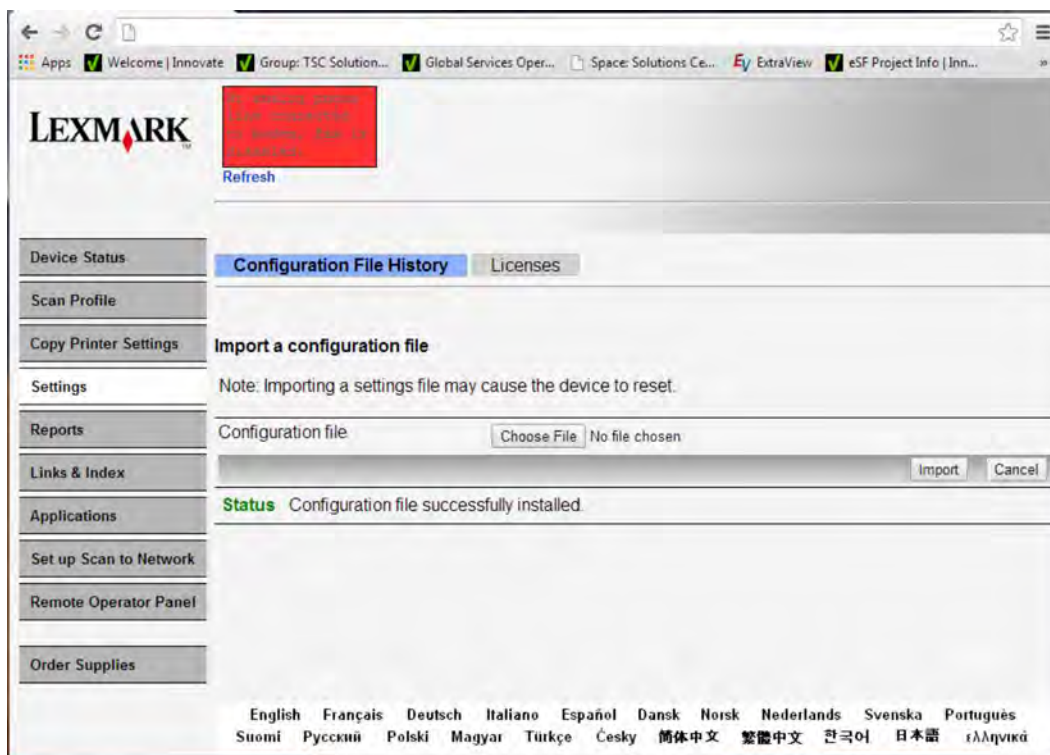

6 Repeat steps 3 through 5 for the other zip files that are included in the expanded zip file.

Updating the printer firmware

Warning—Potential Damage: Before updating the printer firmware, ask the next level of support for the correct code. Using an incorrect code level may damage the printer.

The printer must be in ready state in order to update the firmware.

Using a flash drive

This option is available only in printer models with front USB port.

Make sure to enable the Enable Drive and Update Code settings. You can find the settings in the Flash drive menu under the Settings menu.

- 1 Insert the flash drive into the USB port.
- 2 From the control panel, navigate to **USB Menu: Print from USB > Accept** or **OK**.
- 3 Select the file that you need to flash.

Note: Do not turn off the printer while the update is going on.

Using a network computer

Using the File Transfer Protocol (FTP)

Make sure that the printer is in ready state before flashing the printer.

- 1 Turn on the printer.
- 2 Obtain the IP address:
 - From the home screen
 - From the TCP/IP section of the Network/Ports menu
- 3 From the command prompt of a network computer, open an FTP session to the printer IP address.
- 4 Use a PUT command to place the firmware file on the printer.
The printer performs a POR sequence and terminates the FTP session.
- 5 Repeat step 2 through step 4 for the other files.

Using the Embedded Web Server

Make sure that the printer is in ready state before flashing the printer.

- 1 Open a web browser, and then type the printer IP address.
- 2 From the home page, navigate to **Configuration > Update Firmware**.
- 3 Select the file to use.
The printer performs a POR sequence and terminates the FTP session.
- 4 Repeat step 2 through step 4 for the other files.

Backing up eSF solutions and settings

Note: Export the eSF solutions and settings from the printer before replacing the controller board.

Exporting eSF solutions and settings file

- 1 Reset the printer into Invalid engine mode. See [“Entering Invalid engine mode” on page 247](#).
- 2 Open a web browser, and then type the printer IP address.
Note: If the web page cannot be accessed or an error occurs when starting the printer into Invalid engine mode, then data backup is not an option. Inform the customer that the data cannot be saved.
- 3 Navigate to **Settings > Solutions > Embedded Solutions**.
- 4 From the Embedded Solutions page, select the applications that you want to export.
- 5 Click **Export**.
Note: The size limit of the export file is 128 KB.

Importing eSF solutions and settings file

After replacing the controller board, import back to the printer the eSF solutions and settings that were exported.

- 1 Reset the printer into Invalid engine mode. See [“Entering Invalid engine mode” on page 247](#).
- 2 Open a web browser, and then type the printer IP address.
Note: If the web page cannot be accessed or an error occurs when starting the printer into Invalid engine mode, then data backup is not an option. Inform the customer that the data cannot be saved.
- 3 Navigate to **Settings > Solutions > Embedded Solutions**.
- 4 From the Embedded Solutions page, select the applications that you want to import.
- 5 Click **Import**.

Ribbon cable connectors

Zero Insertion Force (ZIF) connectors

Zero Insertion Force (ZIF) connectors are used on the boards and cards used in this printer. Before inserting or removing a cable from these connectors, read this entire section. Great care must be taken to avoid damaging the connector or cable when inserting or removing the cable.

Warning—Potential Damage: Do not insert the cable so that the contacts are facing the locking actuator. The contacts always face away from the actuator.

Warning—Potential Damage: Do not insert the cable diagonally into the ZIF socket. This can cause damage to the contacts on the cable.

Warning—Potential Damage: Avoid using a fingernail, or sharp object to open the locking mechanism. This could damage the cable.

Warning—Potential Damage: Avoid pressing against the cable when opening the locking mechanism. This can also damage the cable.

These are the types of ZIF connectors used in this printer:

- Horizontal top contact connector
- Horizontal bottom contact connector
- Vertical mount contact connector
- Horizontal sliding connector

Horizontal top contact connector

This FRU contains a horizontal top contact cable connector. Read the instructions before proceeding.

The horizontal top contact connector uses a back flip locking actuator to lock the ribbon cable into the Zero Insertion Force (ZIF) connector. The cable is inserted horizontally into the connector.

Warning—Potential Damage: When opening or closing this type of actuator, gently lift or close the two tabs located on each end of the actuator. The two tabs should be moved simultaneously. Do not close the actuator from the center of the actuator.

Removing a cable from the horizontal top contact connector

- 1 Place a finger at each end of the locking actuator, and then gently lift the actuator to the unlocked position.

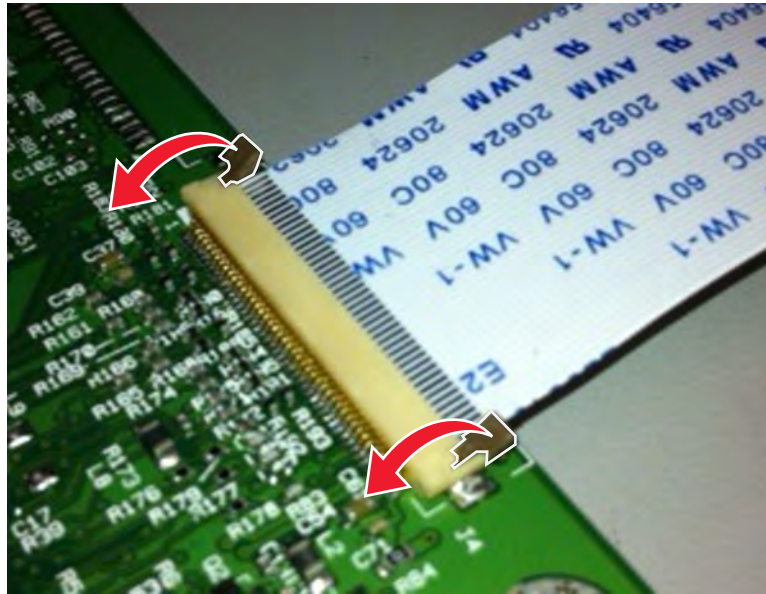

- 2 Slide the cable out of the connector.

Inserting a cable into the horizontal top contact connector

- 1 When installing the cable, check the locking actuator to ensure it is in the unlocked position. The tabs on the ends of the actuator are vertical when the actuator is unlocked.



- 2 Insert the cable with the contacts on the cable facing up. Insert the cable on top of the actuator.

Note: Verify that the cable is installed squarely into the connector. If the cable is not squarely installed, then intermittent failures could occur.

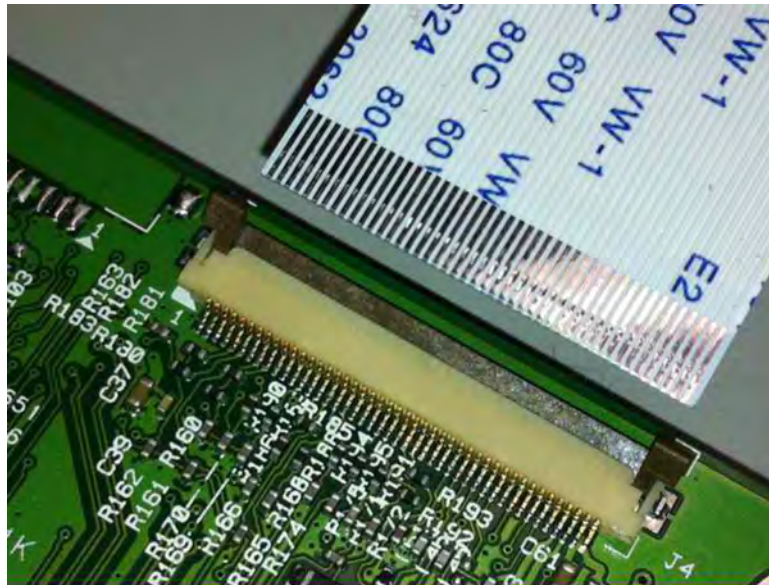

- 3** Rotate the locking actuator to the locked position. The cable should not move while this step is performed. If the cable moves, open the actuator, reposition the cable, and then close the actuator to the down position.

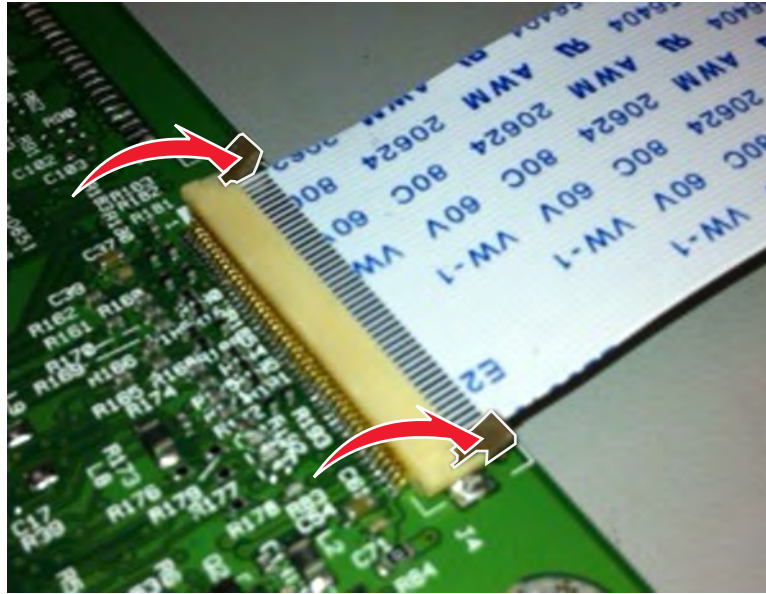

Horizontal bottom contact connector

This FRU contains a horizontal bottom contact cable connector. Read the instructions before proceeding.

The horizontal bottom contact connector uses a flip locking actuator to lock the ribbon cable into the Zero Insertion Force (ZIF) connector. The cable is inserted horizontally into the connector.

Warning—Potential Damage: When opening or closing this type of actuator, gently lift the center of the actuator using your finger. Do not use a fingernail or screwdriver to open the actuator. This could damage the ribbon cable. Do not close the actuator from the ends of the actuator.

Removing a cable from the horizontal bottom contact connector

- 1 Place two fingers towards each end of the locking actuator, and then gently lift the actuator to the unlocked position.

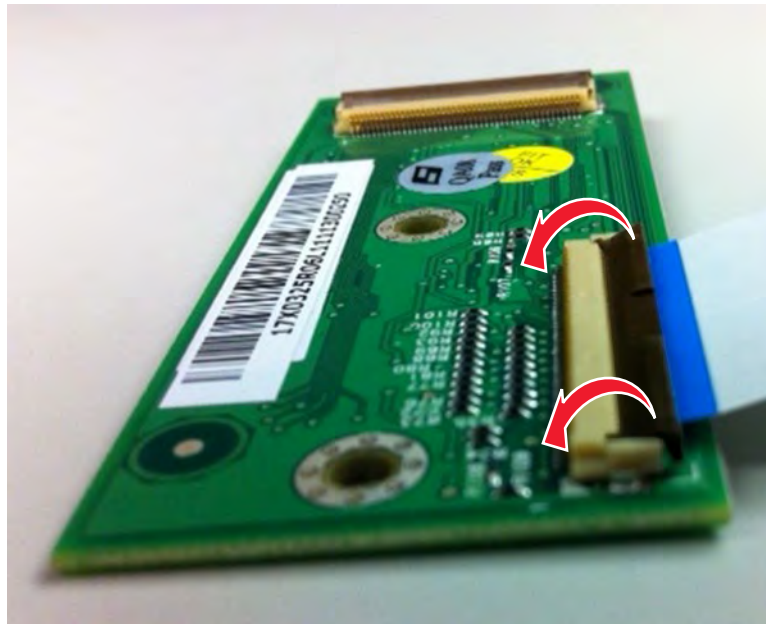

- 2 Slide the cable out of the connector.

Inserting a cable into the horizontal bottom contact connector

- 1 Check the actuator to verify it is in the open position.



- 2 Insert the cable into the ZIF connector with the contacts facing downward and away from the locking actuator. The cable needs to be inserted below the actuator.

Note: Verify that the cable is installed squarely into the connector. If the cable is not squarely installed, then intermittent failures could occur.



- 3 Place your finger in the middle of the actuator, and then rotate the locking actuator to the locked position.

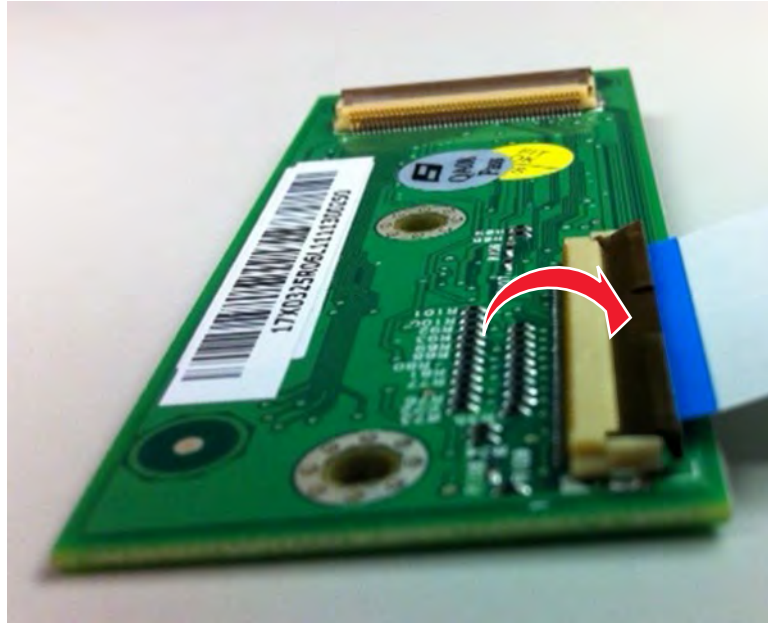

Vertical mount contact connector

This FRU contains a vertical mount contact connector. Read the instructions before proceeding.

The vertical mount contact connector uses a back flip locking actuator to lock the ribbon cable into the Zero Insertion Force (ZIF) connector. The cable is inserted vertically into the connector.

Warning—Potential Damage: When opening or closing this type of actuator, gently lift the center of the actuator using your finger. Do not use a fingernail or screwdriver to open the actuator. This could damage the ribbon cable. Do not close the actuator from the ends of the actuator.

Removing a cable from the vertical mount contact connector

- 1 Gently rotate the locking actuator from the center of the actuator to the unlocked position.

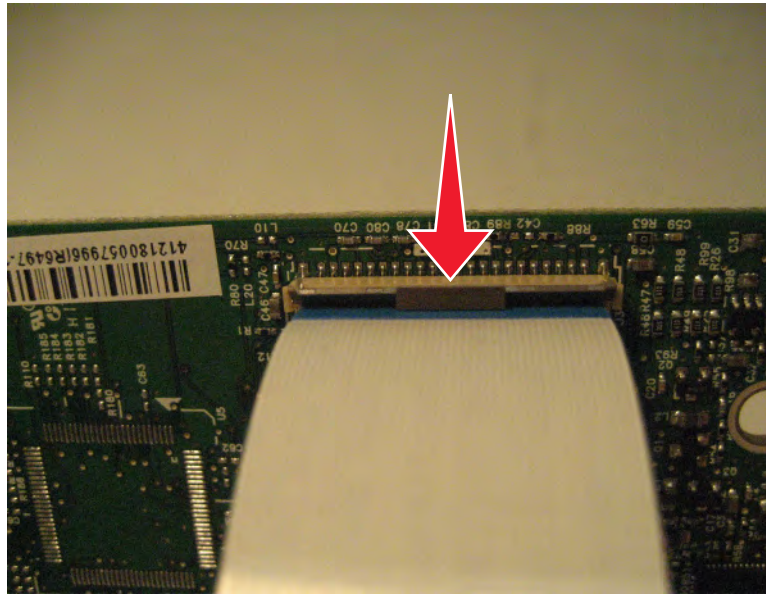

- 2 Slide the cable out of the connector.

Inserting a cable into the vertical mount contact connector

- 1 When installing the cable, check the locking actuator to verify it is in the open position.



- 2 Insert the cable with the contacts on the cable away from the locking actuator. Insert the cable on top of the actuator.

Note: Verify that the cable is installed squarely into the connector. If the cable is not squarely installed, then intermittent failures could occur.



- 3 Rotate the locking actuator to the locked position by pressing down on both ends of the actuator. The cable should not move when this step is performed. If the cable moves, open the actuator, reposition the cable, and then close the actuator to the down position.

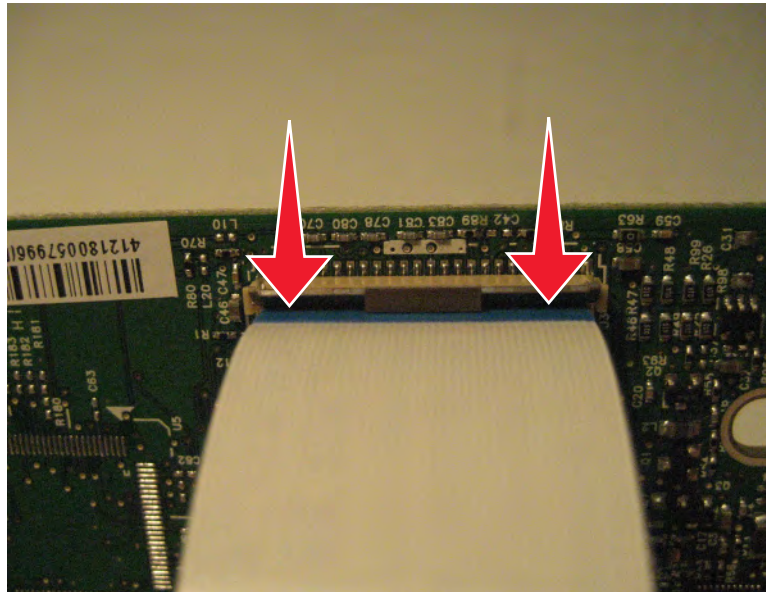

Horizontal sliding contact connector

This FRU contains a horizontal sliding contact connector. Read the instructions before proceeding.

The horizontal sliding contact connector uses a slide locking actuator to lock the ribbon cable into the Zero Insertion Force (ZIF) connector. The cable is inserted horizontally into the connector.

Warning—Potential Damage: When opening or closing this type of actuator, gently push or pull the two tabs located on each end of the actuator. Do not close the actuator from the center of the actuator. Do not use a screwdriver to open or close the actuator. Damage to the cable or connector could occur.

Removing a cable from the horizontal sliding contact connector

- 1 Simultaneously slide the two tabs located on the ends of the locking actuator away from the connector.

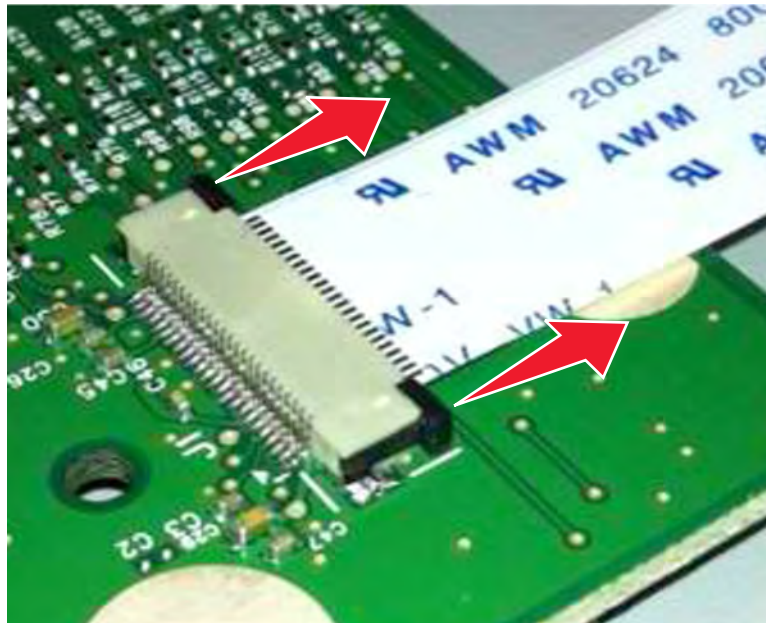

- 2 Slide the cable out of the connector.

Inserting a cable into the horizontal sliding contact connector

- 1 When installing the cable, check the locking actuator to verify it is in the open position. If you are opening the connector, pull back on both end tabs using equal force to avoid breaking the connector.

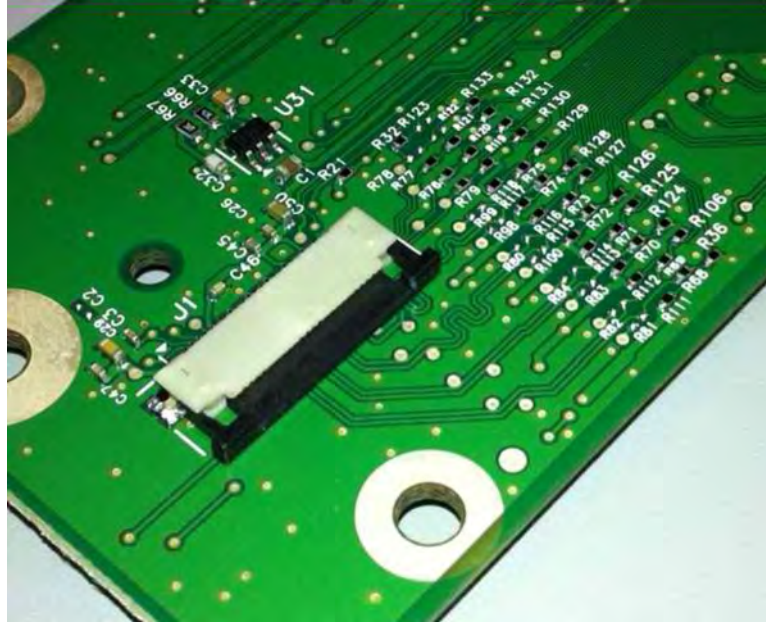

- 2 Insert the cable with the contacts on the cable facing away from the locking actuator. Insert the cable on top of the actuator.



- Slide the locking actuator towards the connector, locking the cable into place. The cable should not move when this step is performed. If the cable moves, open the actuator, reposition the cable, and then close the actuator to the down position.

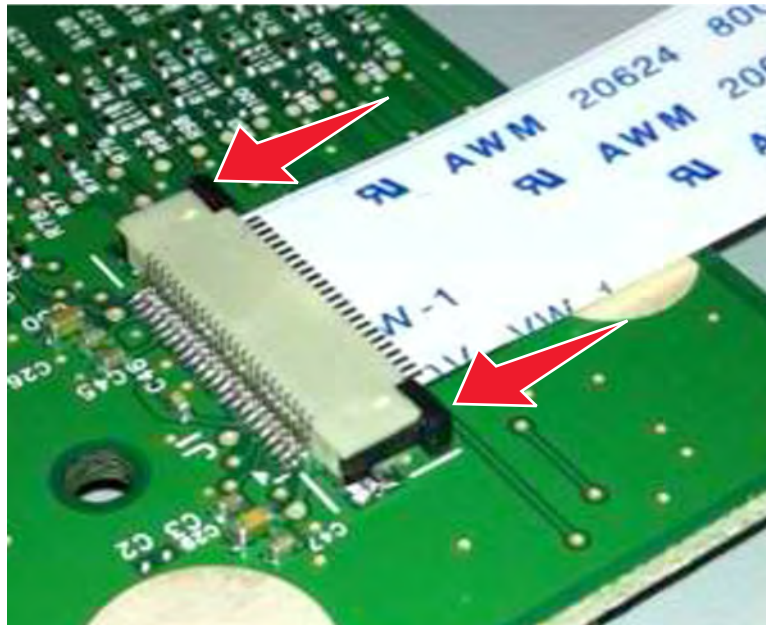

Low Insertion Force (LIF) connector

This FRU contains a Low Insertion Force (LIF) connector. Read the instructions before proceeding.

Warning—Potential Damage: When installing a cable into an LIF connector, care must be taken to avoid bending the edges of the cables and damaging the contacts on the cables.

Inserting a cable into the LIF connector

- 1 Looking at the connector, take note on which side the contacts are located. Many boards will have the word “contacts” stamped on them to indicate which side of the LIF has the contacts. When looking at the board, take note that the contacts from the board to the connector are located on the side of the connector with the contacts.

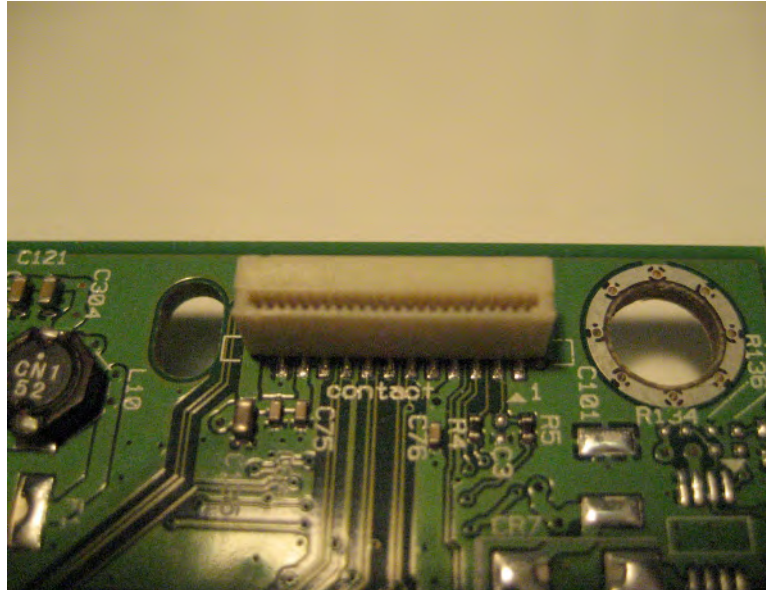

- 2 Insert the cable squarely into the connector.

Note: Verify that the cable is installed straight into the connector. If the cable is not installed properly, then intermittent failures could occur.

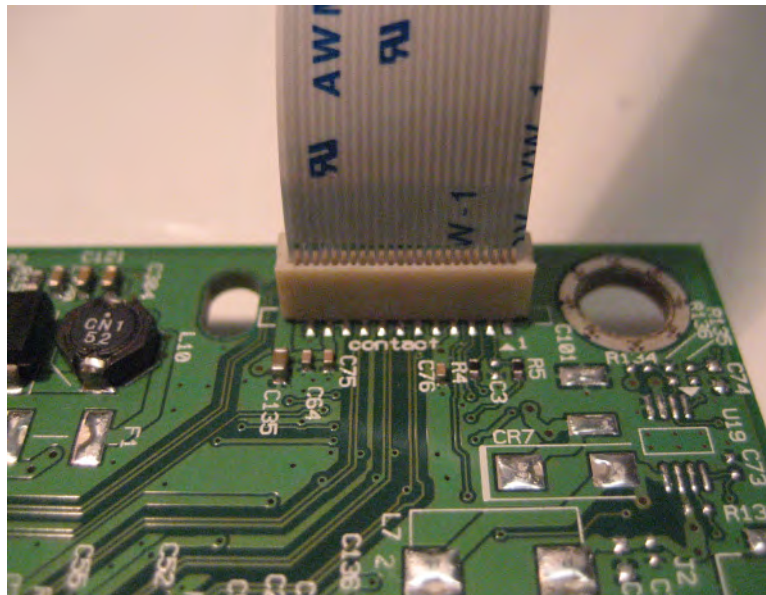

Removal procedures

Keep the following tips in mind as you replace parts:

- Some removal procedures require removing cable ties. You must replace cable ties during reassembly to avoid pinching wires, obstructing the paper path, or restricting mechanical movement.
- Remove the toner cartridges, imaging unit, and media tray before removing other printer parts. The imaging unit should be carefully set on a clean, smooth, and flat surface. It should also be protected from light while out of the device.
- Disconnect all external cables from the printer to prevent possible damage during service.
- Unless otherwise stated, reinstall the parts in reverse order of removal.
- When reinstalling a part held with several screws, start all screws before the final tightening.

Left side removals

Left cover assembly removal

- 1 Remove the two screws (A) from the rear of the printer.

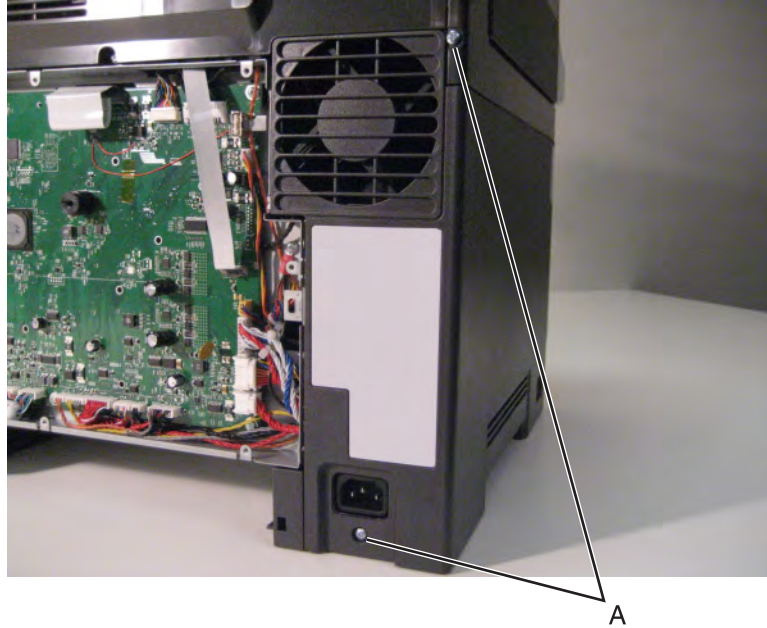

- 2 Remove the screw (B) beneath the right cover.



- 3 Position the right side of the printer over the edge of the table to have enough room to swing the right cover out.

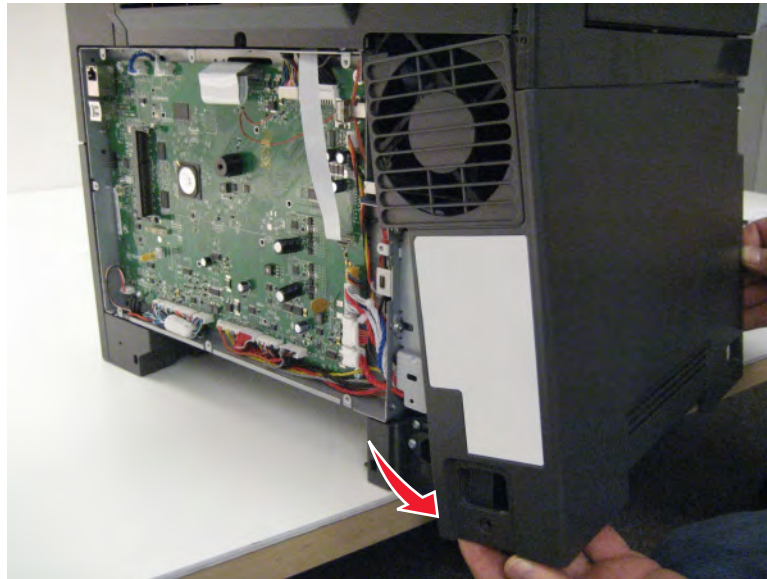

- 4 Disconnect the right cover assembly from the right side of the printer, and remove.

Drive unit motor removal

- 1 Remove the left cover assembly. See [“Left cover assembly removal” on page 274.](#)
- 2 Disconnect the cable (A) from the motor.
- 3 Remove the four screws (B), and then remove the motor.

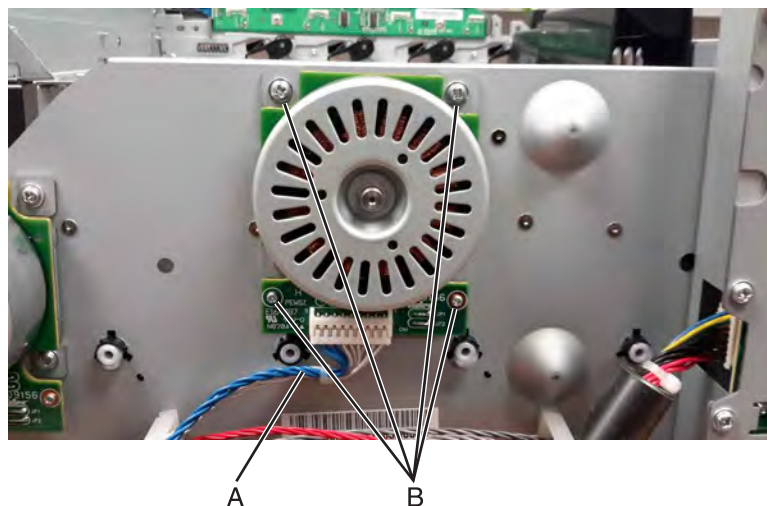

EP drive assembly removal

- 1 Remove the left cover assembly. See [“Left cover assembly removal” on page 274.](#)
- 2 Remove the image transfer unit. See [“Image transfer unit \(ITU\) removal” on page 300.](#)

- 3** Disconnect the three cables (A) from the LVPS.

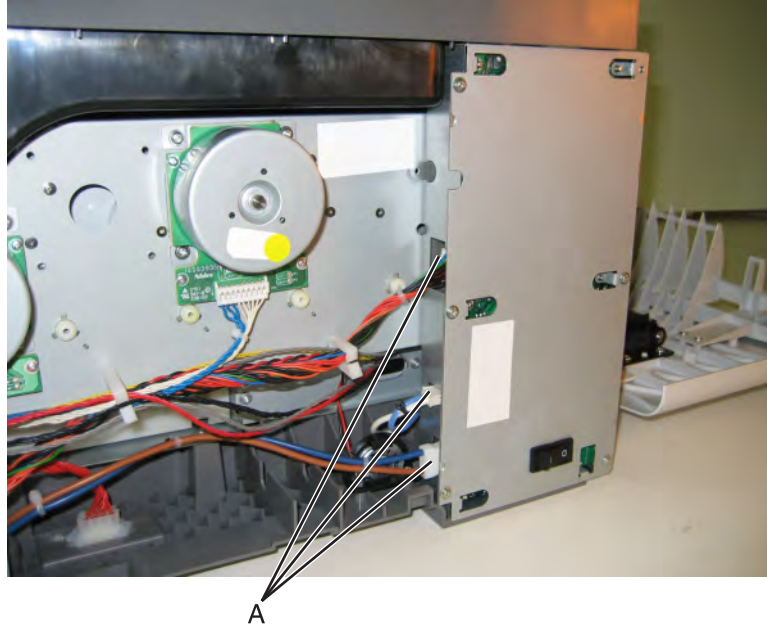

- 4** Remove the ADF assembly. See [“ADF assembly removal” on page 367](#).
- 5** Remove the flatbed scanner assembly. See [“Flatbed scanner assembly removal” on page 374](#).
- 6** Remove the two top screws (B) holding the top cover to the LVPS shield.

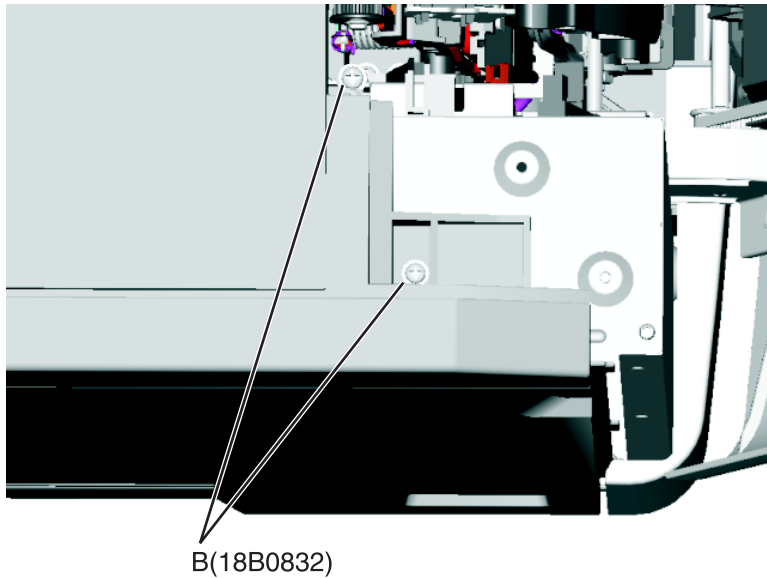

- 7** Remove the narrow media sensor flag. See [“Narrow media sensor flag removal” on page 364](#).
- 8** Press to *unsnap* the tabs (C), and gently rotate the exit deflector to remove.

- 9** Disconnect the cable (D) from the narrow media sensor, and unrout the cable from its retainer.

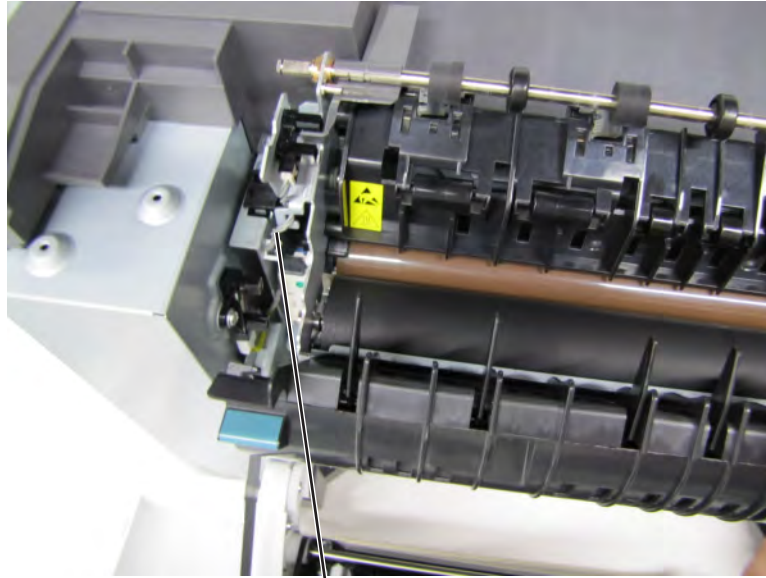

D

- 10** Unhook the springs (E) from both sides of the fuser.

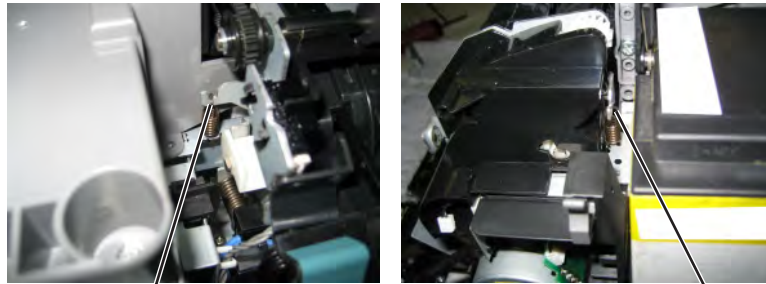

E

E

- 11** Disconnect the thermistor cables (F), and pull them over the retainer.

- 12** Remove the screw and grounding washer (G) on the right side of the frame.

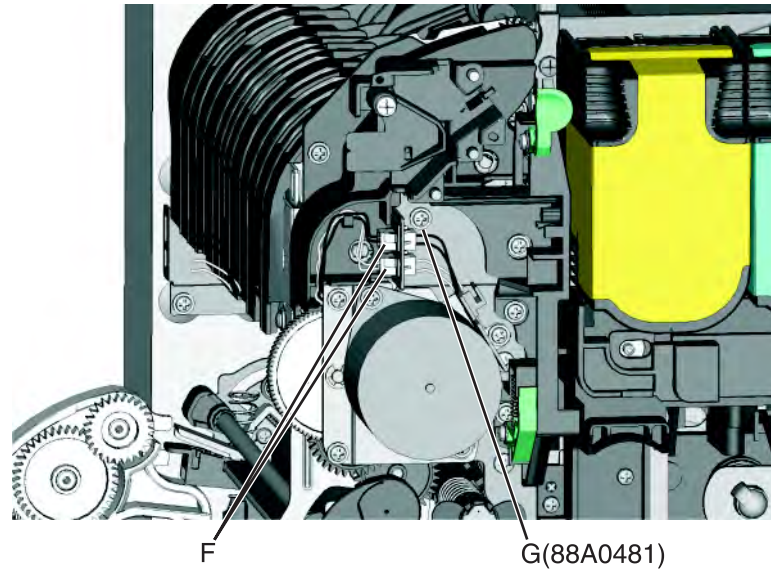

Note: Be careful to not lose the grounding washer.

- 13** Rotate the top of the fuser toward the front, and then slide to the left to align the fuser side frames with the flat area of the shaft.
- 14** Remove the two screws (H).

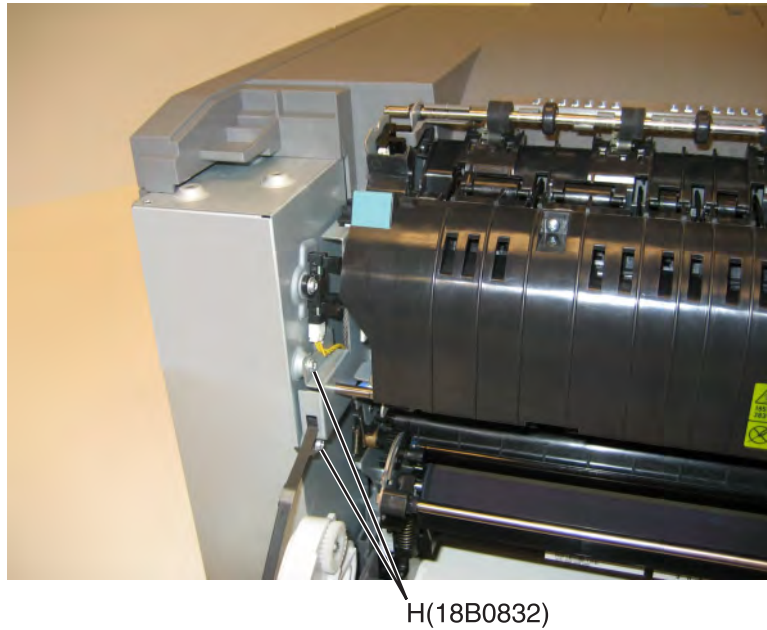

- 15** Disconnect the fuser exit cable (I).

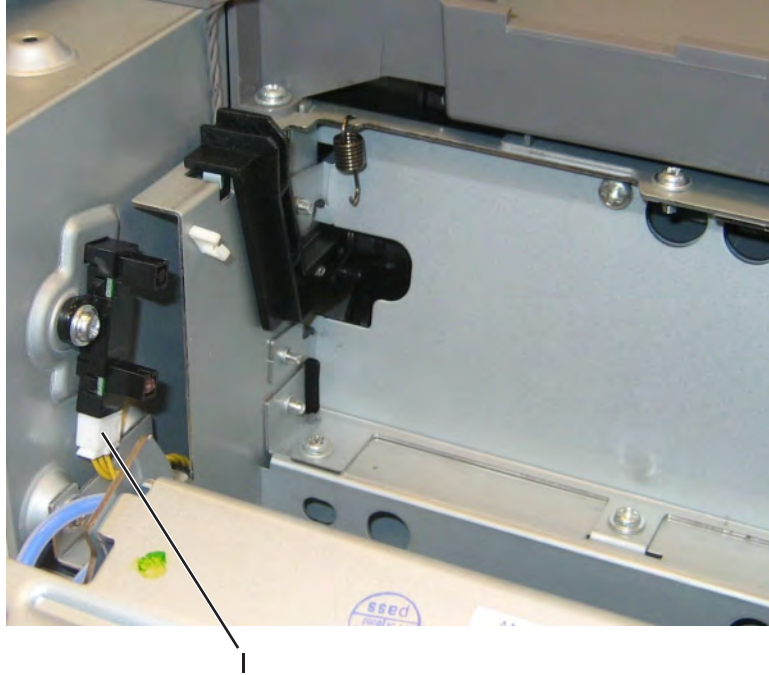

- 16** Lift the front left corner of the top cover, and tilt the LVPS cage (J) to remove. There are two posts at the bottom of the cage on the left side that need to be disengaged.

Note: Be careful to not damage the fuser exit sensor as it remains in the cage.

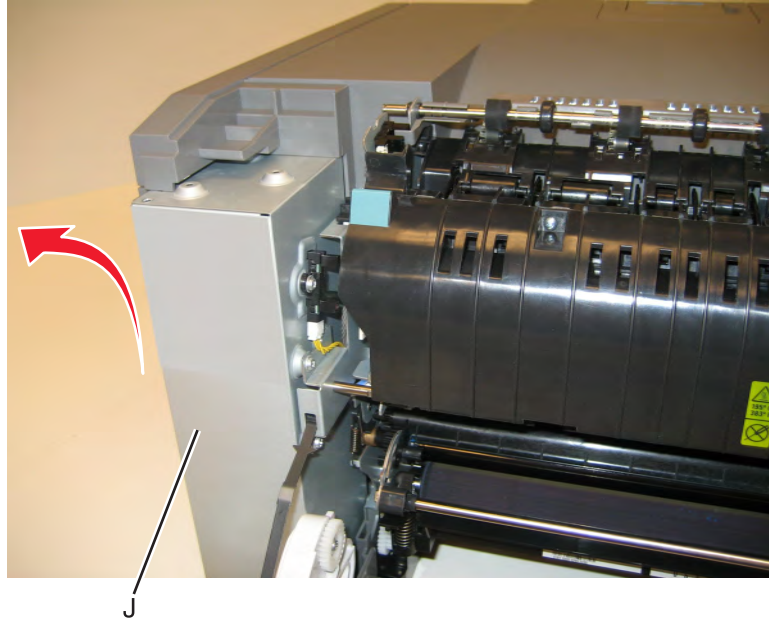

- 17** Disconnect the cables from the motors (K) and the two cables from the retainer (L).

- 18** Remove the two screws (M) from the rear, and unrout all of the cables.

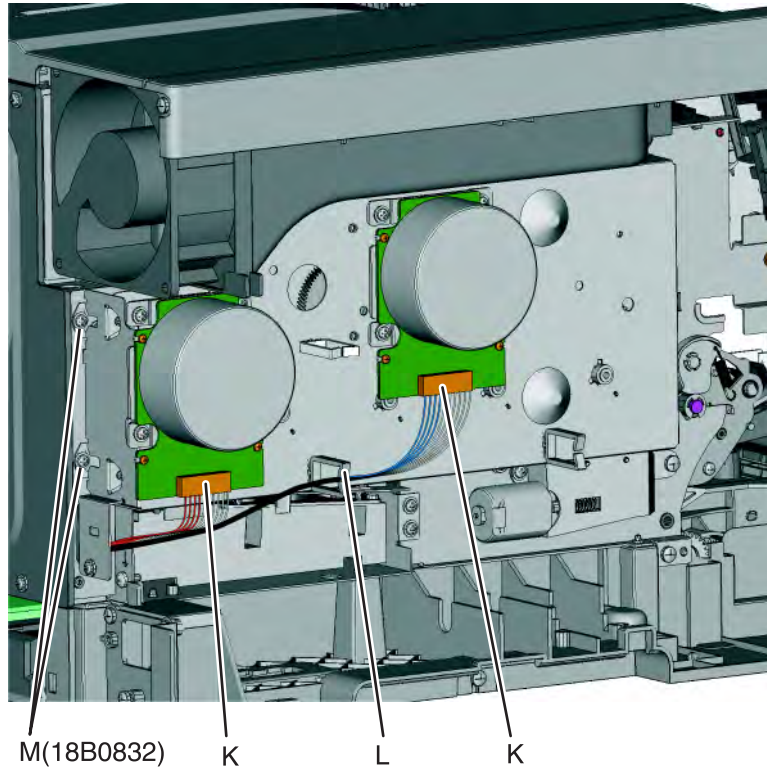

- 19** Remove the two screws (N) from below the EP drive assembly, and the two screws (O) from the right of the EP drive assembly.

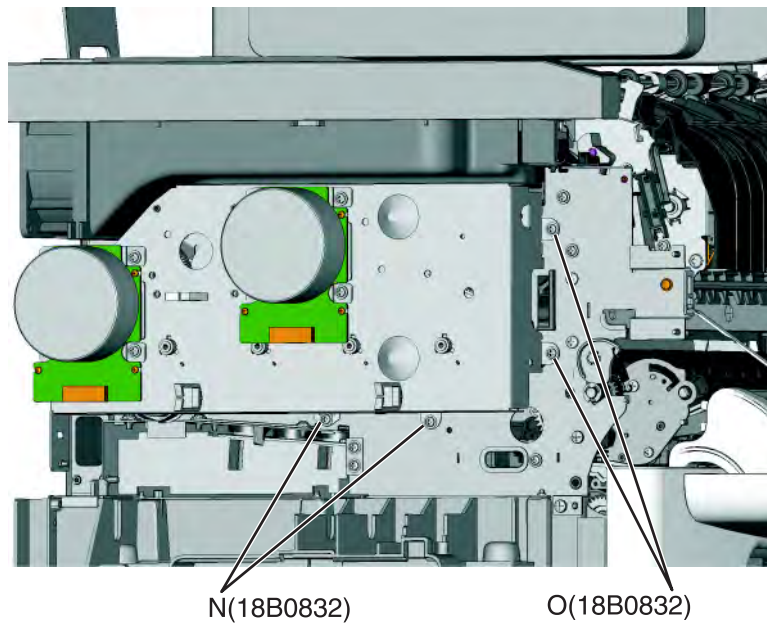

- 20** Lift the EP drive assembly, and remove.

Developer drive coupling removal

- 1 Locate the slit (A) on the coupling.
- 2 Use a spring hook to press the coupling (B) and hold the plastic retainer (C) in place.

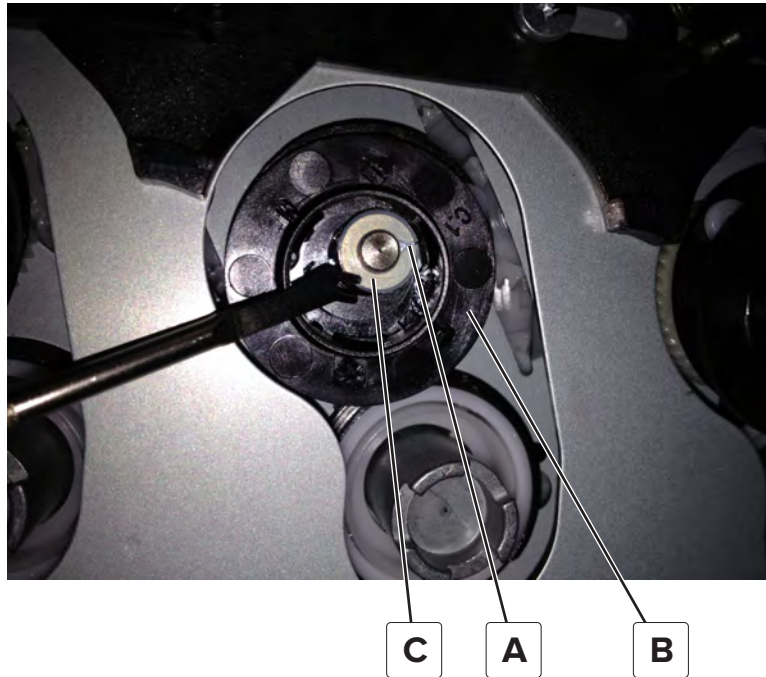

- 3 Use your fingernail to lift the retainer off the stud, and then remove the washer.

Note: Do not reuse the washer from the old coupling when installing the new coupling.

- 4 Remove the old coupling.

Warning—Potential Damage: There is a spring (D) behind the coupling which may come off the gear when the damaged coupling is removed. Make sure not to lose the spring.

**D****Installation notes:**

- a** Use needle-nose pliers to pick up the metal retainer.



- b** In a rotating motion, work the metal retainer into the shaft until it slides in place.



- c Verify that the new coupling moves freely on the stud.



Low-voltage power supply (LVPS) removal

- 1 Remove the left cover assembly. See [“Left cover assembly removal” on page 274.](#)
- 2 Disconnect the three cables (A) from the LVPS.



A

- 3 Remove the seven screws (B), and then remove the LVPS.

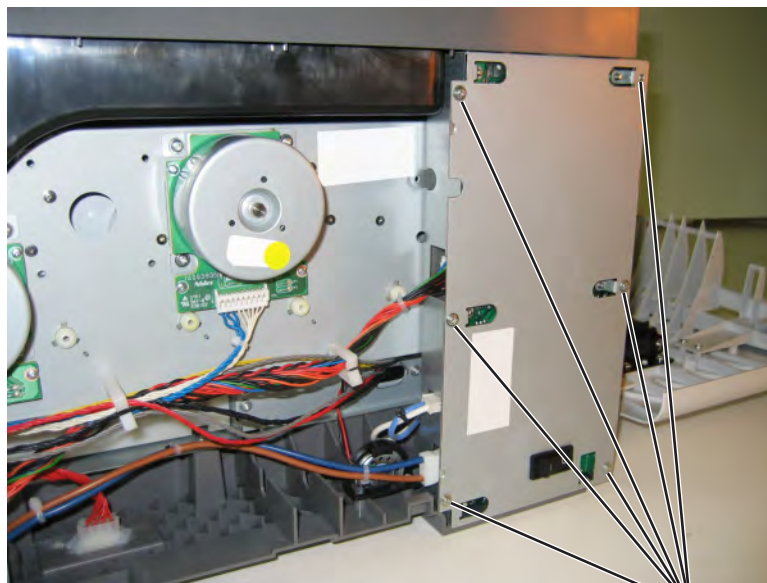

B(18B0832)

Warning—Potential Damage: If you receive a new LVPS with a voltage selector switch (C), then make sure to set the switch to the correct setting for your voltage requirements before installing the LVPS. The switch can be set to either 115 V or 230 V.

Note: If there is no switch, the LVPS automatically senses the line voltage.

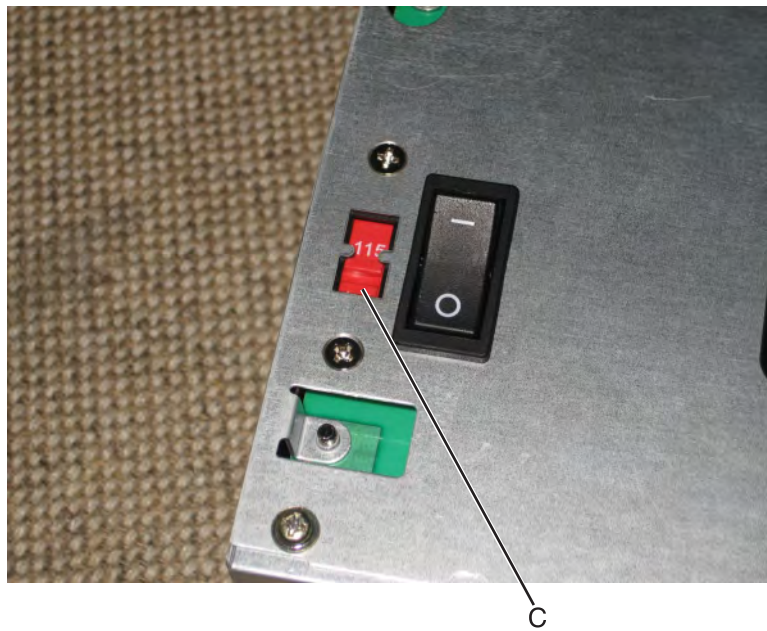

Fuser exit sensor removal

- 1 Remove the left cover assembly. See [“Left cover assembly removal” on page 274.](#)
- 2 Remove the fuser cables from the retainer to give needed slack.
- 3 Disconnect the cable (A) from the bin-full/narrow media sensor, and unrout the cable from its retainer.

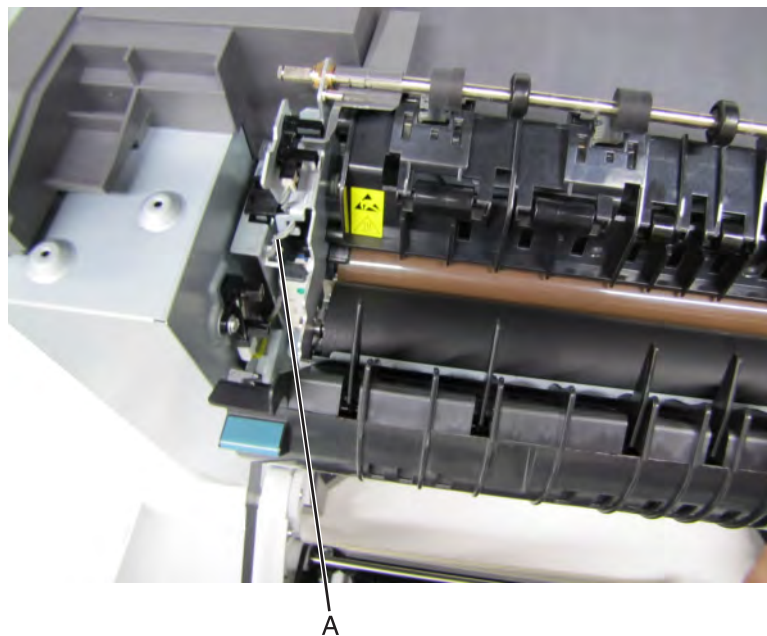

- 4 Unhook the springs (B) from both sides of the fuser.

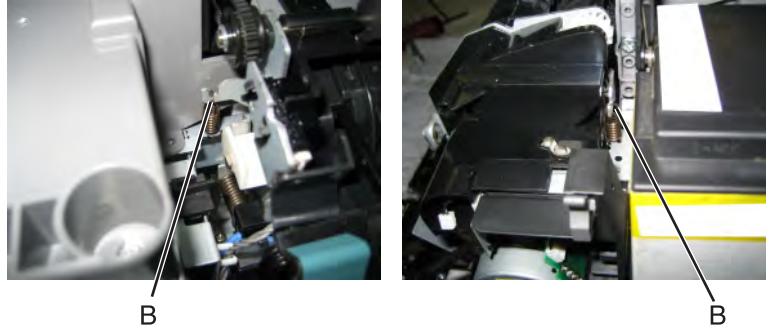

- 5 Disconnect the thermistor cables (C).
- 6 Remove the screw and grounding washer (D) on the right side of the frame.

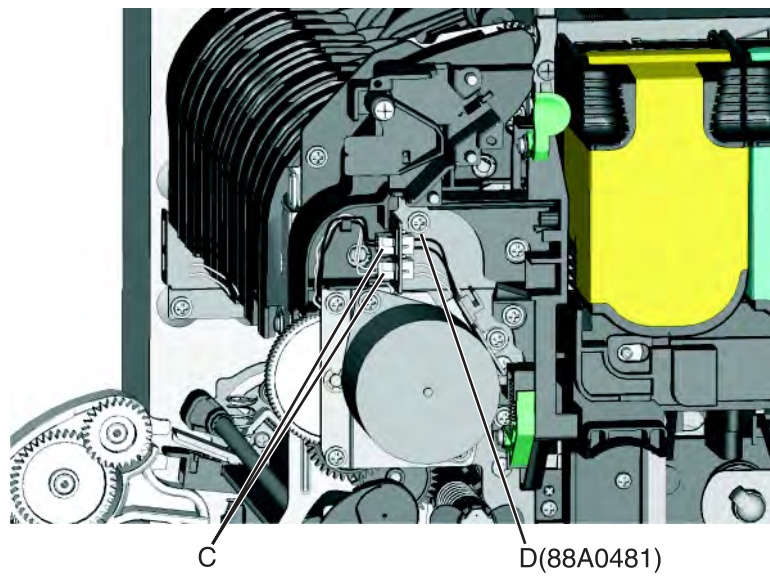

Note: Be careful to not lose the grounding washer.

- 7 Rotate the top of the fuser toward the front to gain access to screw (E).
- 8 Disconnect the cable (F), and remove the screw (E) from the fuser exit sensor.

- 9 Remove the lower end of the sensor with a flat-blade screwdriver, and gently pull the sensor from the frame.

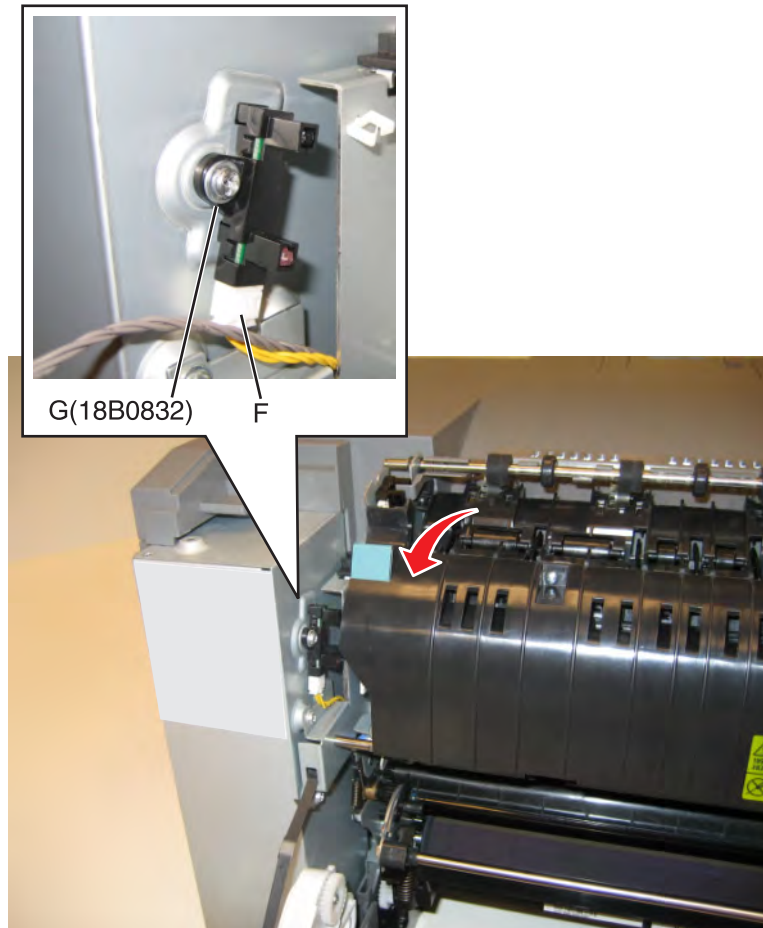

Speaker removal

The speaker (only in the CX410 and CX510) is in the operator panel module. See the following topics:

- 1 [“Operator panel removal \(for CX310 and CX410 models only\)” on page 313.](#)
- 2 [“Operator panel removal \(for CX510 models only\)” on page 320.](#)

Right side removals

Right cover assembly removal

- 1 Open the toner supply door.
- 2 Open the front door.

- 3 Release the latches (A), and lift off the cover.

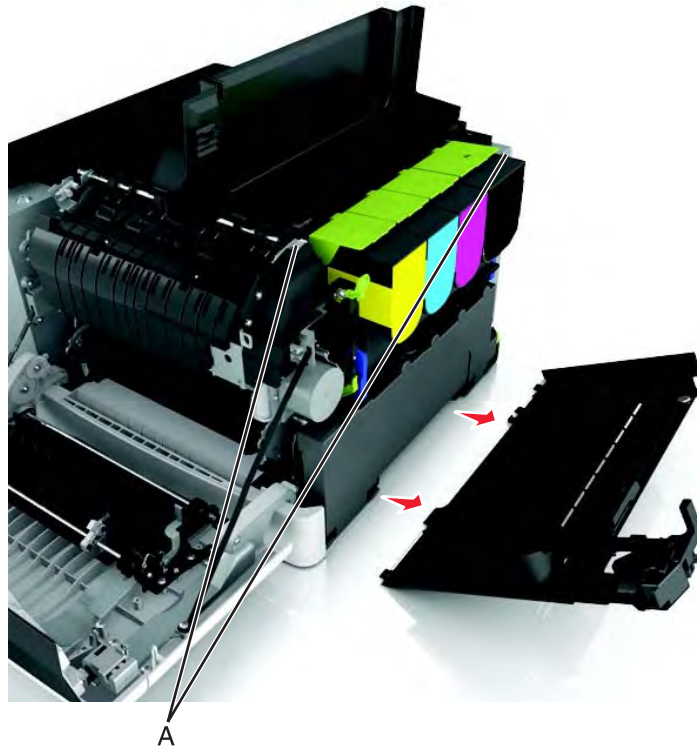

Fuser drive motor assembly removal

- 1 Remove the right cover assembly. See [“Right cover assembly removal” on page 288](#).
- 2 Disconnect the cable (A) from the fuser drive motor assembly.

Note: If you remove the toroid (B) from the cable, be sure to return the toroid to the cable when reinstalling.

- 3 Remove the two screws (C).

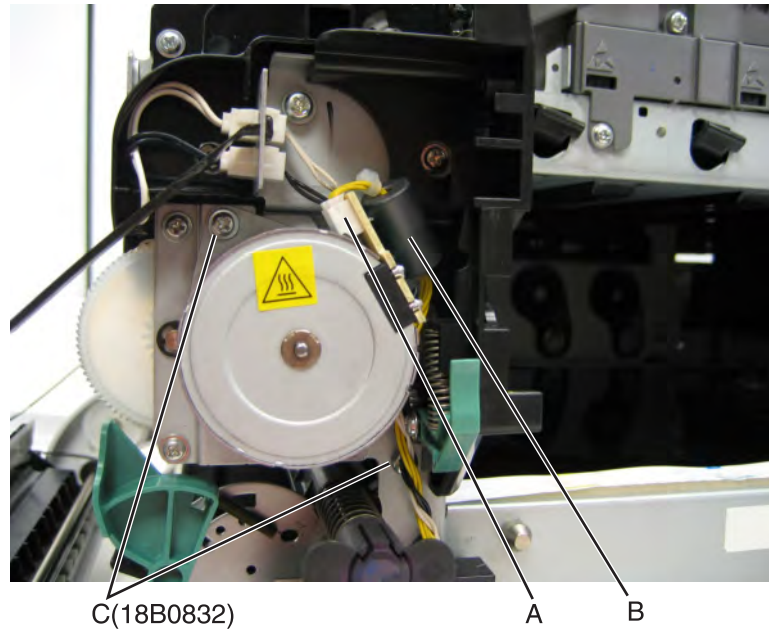

- 4 Remove the fuser drive motor assembly.

Toner meter cycle (TMC) card removal

- 1 Remove the imaging unit. See [“Imaging unit \(IU\) removal” on page 303](#).
- 2 Remove the rear cover. See [“Rear cover removal” on page 346](#).
- 3 Disconnect the TMC cable from JCTM1 connector (A), and push the toner meter cycle card cable through the frame opening.

Note: Pay close attention to the routing of the cable for reinstallation.

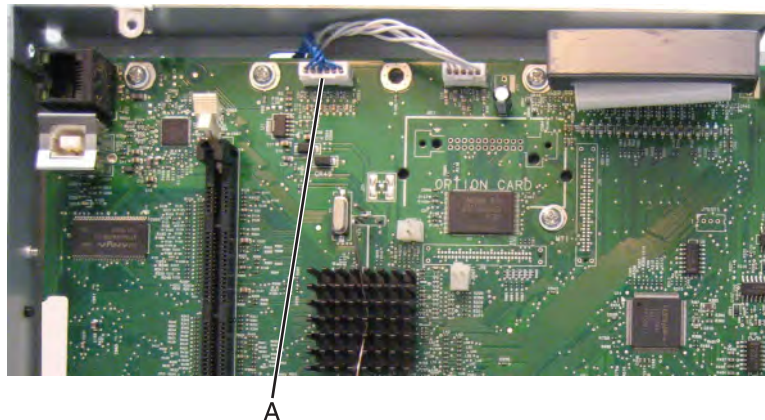

- 4 Remove the two plastic screws (B), and the two metal screws (C).

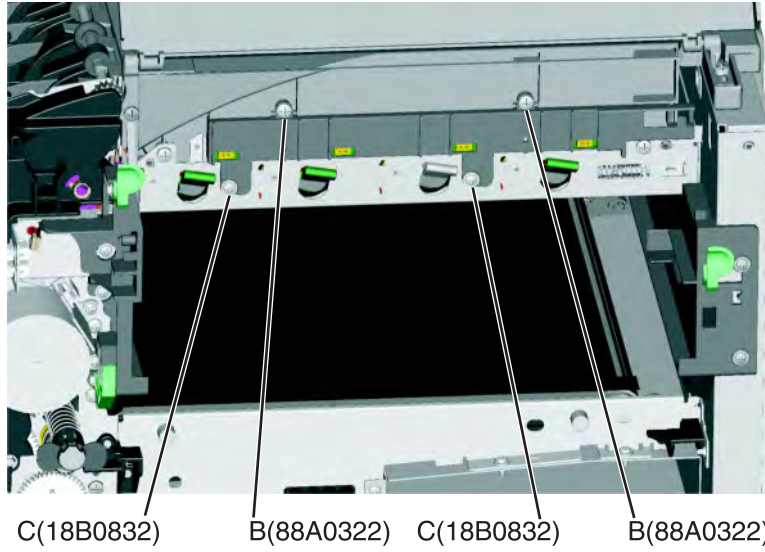

- 5 Slide a flat-blade screwdriver into the left side of the frame, and pry the card loose to remove.



Installation notes:

- Be sure the cable (D) runs through the retainer.
- The toner meter cycle card is a tight fit. Insert the bottom edge inside the frame, and then push down on the top edge to clear the top cover.

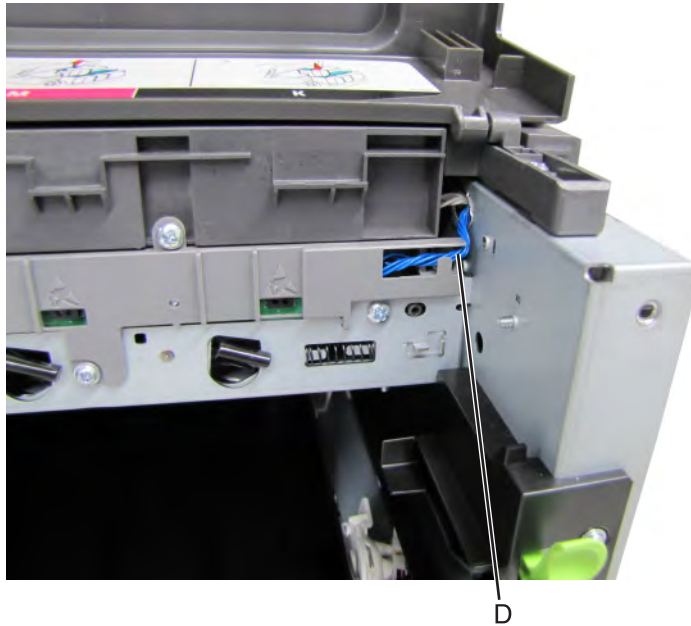
**Thermistor removal**

- 1 Remove the rear (left) TPS sensor. See [“Toner density sensor \(TDS\) \(left or right sensor\) removal” on page 293.](#)
- 2 Carefully route the cables through the tabs on the sensor.

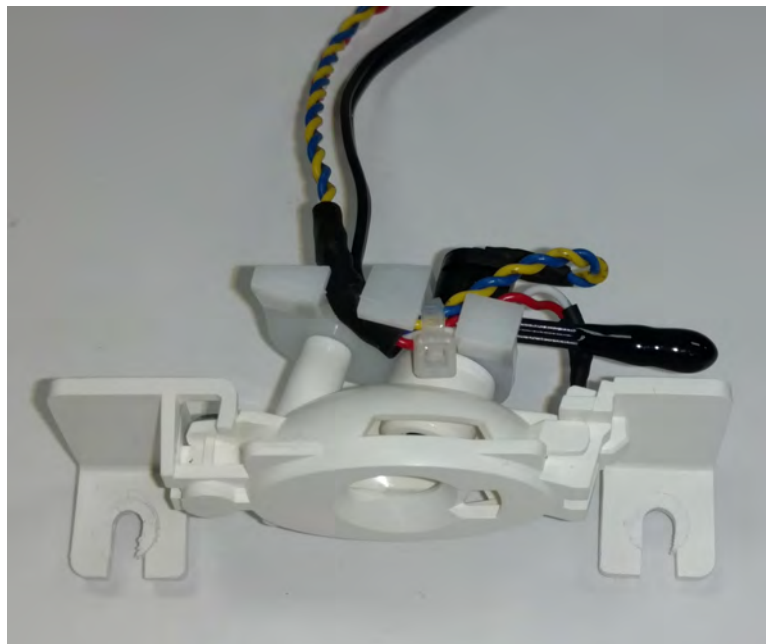

- Carefully cut the wire tie (A).

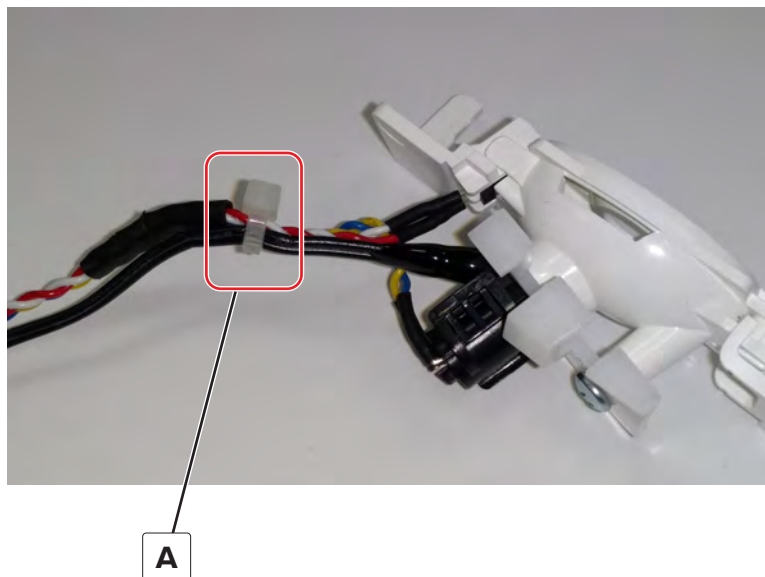

Installation note: You will need a wire tie to attach the thermistor properly.

Toner density sensor (TDS) (left or right sensor) removal

Note: The toner density sensor is also called the toner patch sensor (TPS).

Note: The toner density sensors are the same, but the left sensor has a thermistor attached which needs to be removed when you install a new TDS on the left side. See [“Thermistor removal” on page 292](#). Reinstall the thermistor on the new TDS.

- Remove the image transfer unit. See [“Image transfer unit \(ITU\) removal” on page 300](#).
- Remove the rear cover. See [“Rear cover removal” on page 346](#).
- Disconnect the toner density sensor cable from JTDS1 connector (A) or JTDS2 connector (B) on the controller board. If you are removing the left toner density sensor, also disconnect the thermistor from JFUSES1 connector (C) on the controller board.

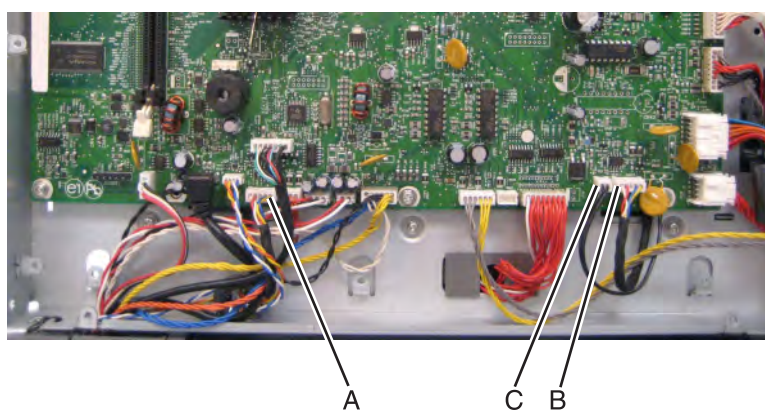

Note: Be sure to pay close attention to the routing of all cables for reinstallation.

- 4 Remove the four screws (D) from the left and right sensors.

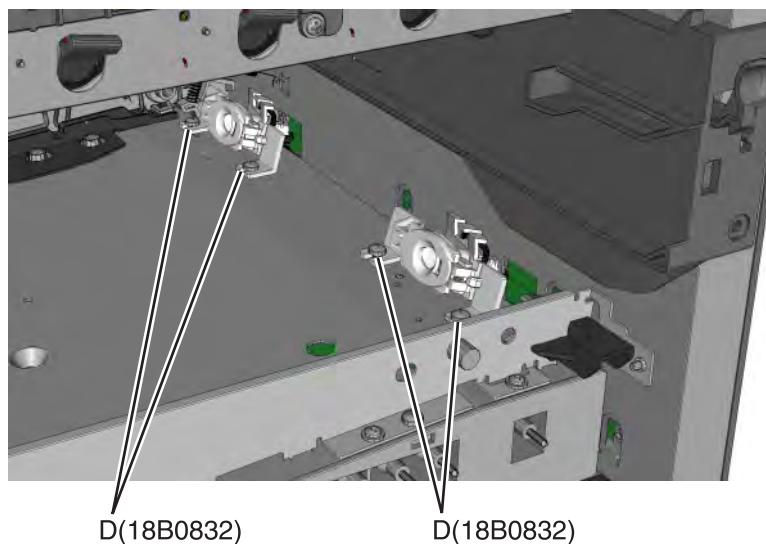

Installation notes:

- Before beginning the installation of the new left or right toner density sensor, note the 32-digit TPS value printed on the barcode on the new FRU.
- After installation, perform the TPS Setup. Enter the factory preset alignment number.
 - a Enter the Diagnostics Menu:
 - 1 Turn the printer off.
 - 2 Press and hold **3** and **6**.
 - 3 Turn the printer on.
 - 4 Release the buttons when the installed memory and processor speed displays.
 - b Select **TPS SETUP** from Diag Menu, and press **Select**.
 - c Select **Right** or **Left**, and press **Select**.
TPS Right 1-16 or **Left 1-16** appears above a blinking 0 in the left position.
 - d To enter a character or digit:
 - 1 Press **Left** to decrease or **Right** to increase the blinking value.
 - 2 Pause for several seconds without pushing any buttons. The blinking value becomes solid. If the value is incorrect, then press **Back** to go back and reenter the number.
 - 3 Continue until the last value is reached.
 - 4 When the last of the 16 values is entered and becomes solid, **TPS Right 17-32** or **TPS Left 17-32** appears.
 - 5 Continue entering and pausing.
 - e After the 32nd number is entered and becomes solid, the number is automatically entered.
 - If the number is incorrect, then **Checksum does not match** appears, and the original screen appears to reenter the value.
 - If the number is correct, then **Saving changes to NVRAM** appears.

Developer unit removal

Note: The developer units are not FRUs.

- 1 Open the toner access door.
- 2 Remove the toner cartridges.

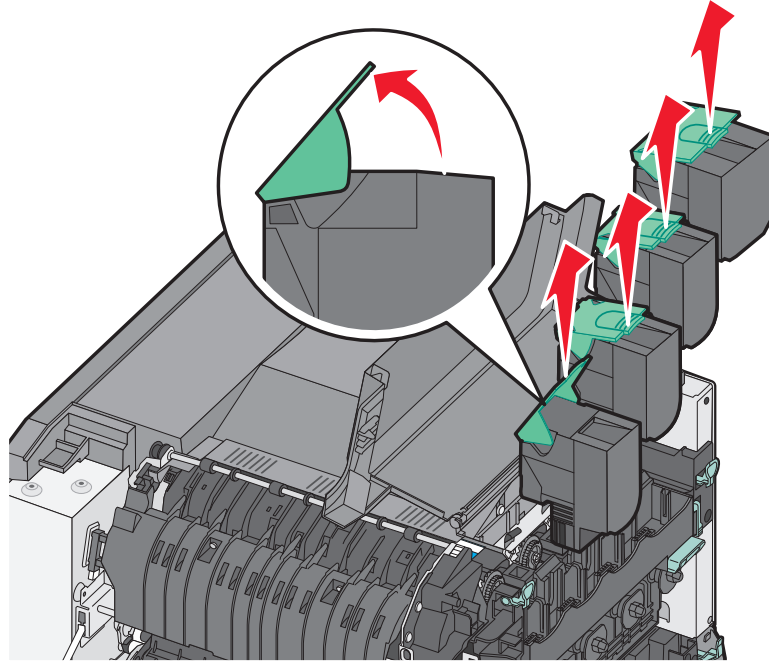

- 3 Remove the imaging unit. See [“Imaging unit \(IU\) removal” on page 303](#).

Warning—Potential Damage: Do not touch the underside of the imaging unit. This could damage it.

- 4 Remove the developer unit(s).

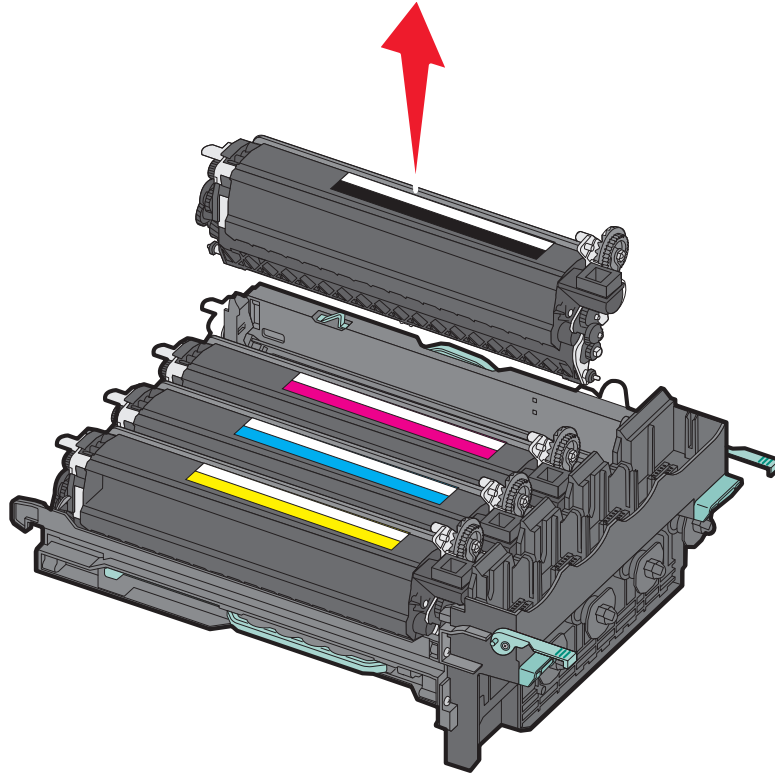

High-voltage power supply (HVPS) removal

- 1 Remove the rear cover. See [“Rear cover removal” on page 346.](#)
- 2 Remove the controller board. See [“Controller board removal” on page 348.](#)

Note: Pay close attention of the routing of the HVPS cable when removing the controller board.

- 3 Remove the cable cover (A).

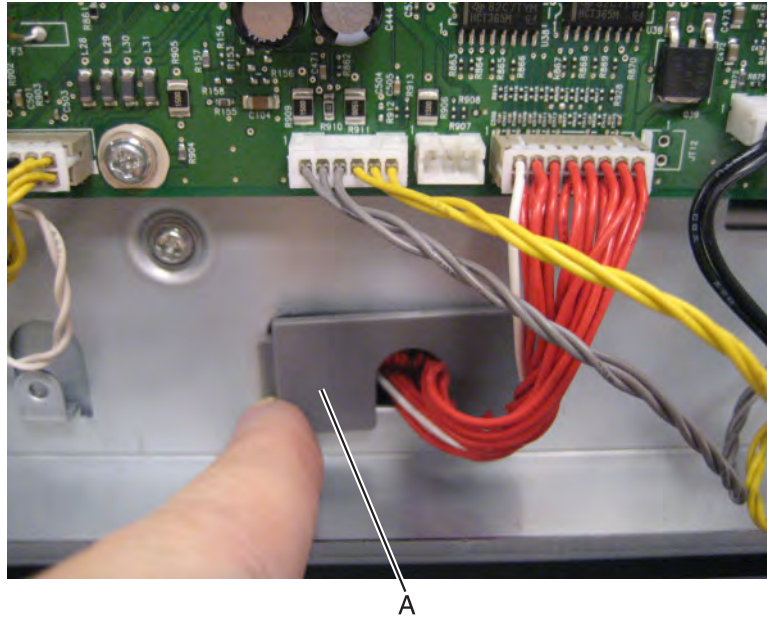

Note: Leave the cable attached to the HVPS until the HVPS has been removed.

- 4 Remove the image transfer unit. See [“Image transfer unit \(ITU\) removal” on page 300](#).
- 5 Remove the waste toner bottle. See [“Waste toner bottle removal” on page 307](#).
- 6 Remove the screw (B) securing the HVPS.

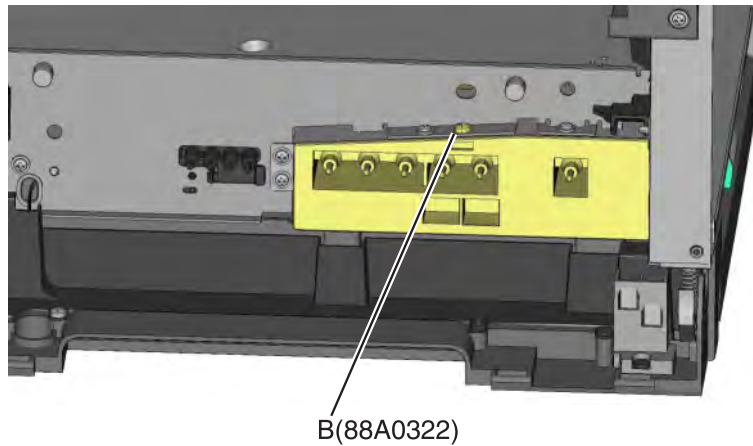

- 7 Remove the left cover assembly. See [“Left cover assembly removal” on page 274](#).

- 8 Press down on the spring mount, and carefully slide the HVPS out by pulling from one side and pushing from the other. Release the pressure on the spring mount, and pull the HVPS the remaining distance.

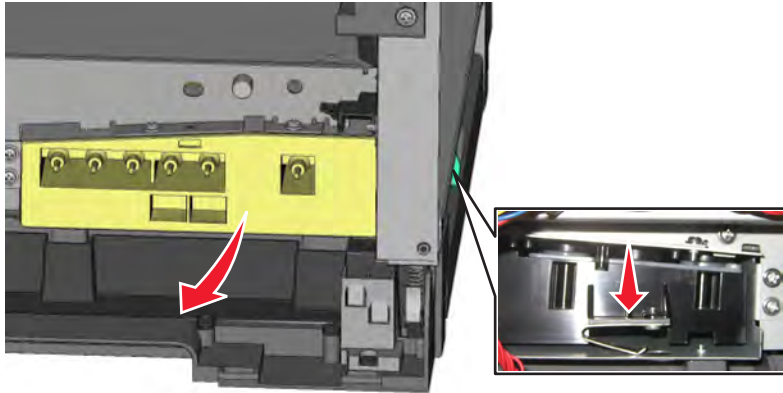

- 9 Slide the HVPS out to remove.
- 10 Press down on the latch (C) to disconnect the cable from the HVPS board.

CAUTION—SHOCK HAZARD: After disconnecting the high-voltage power cable from the controller board, always check that the HVPS connection was not loosened. Make this check anytime you are working near the HVPS cable.

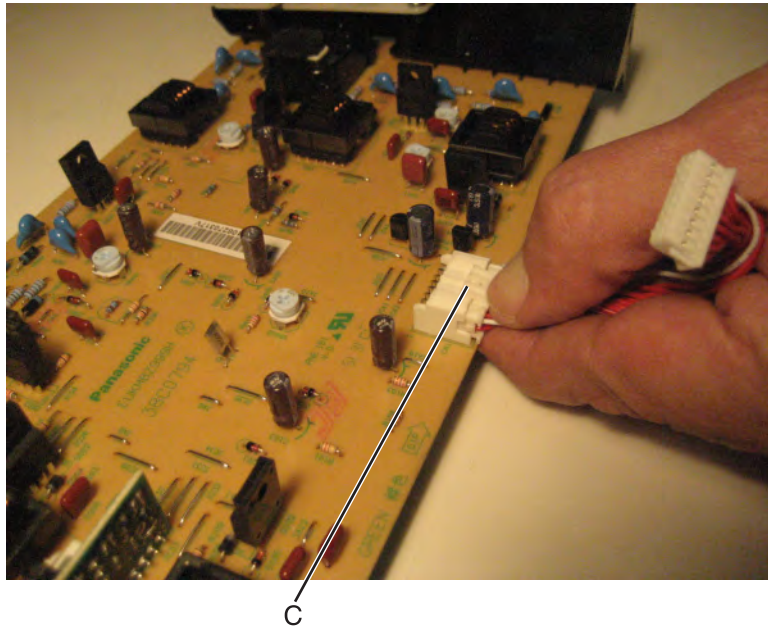

Installation notes:

- a** To install the new HVPS board, insert the spring end of the HVPS board while compressing the spring, as shown below.



- b** Slide the HVPS into position while holding its sides, as shown below. Do not allow the card to flex and touch the cage.

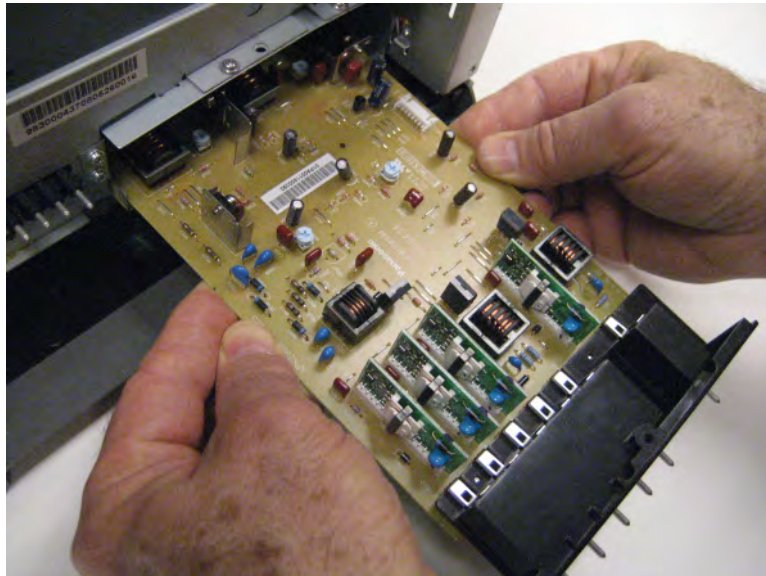

- c Check the position of the card at the left side of the printer. The small vertical post (D) in the endcap has to be positioned in the hole above it, as show below.

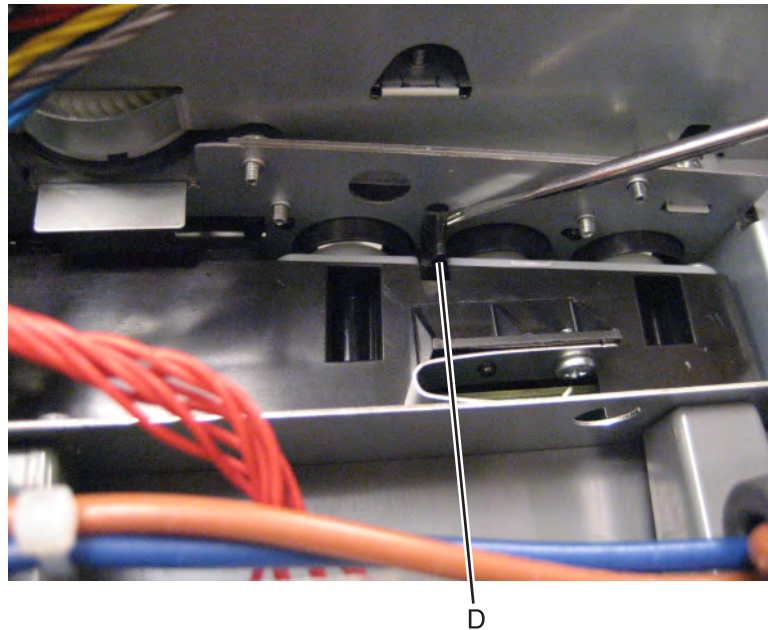

- d Install the new cable, making sure the connector to the board is locked into position.

Note: Reinstall the screw to hold the HVPS to the right side of the printer.

Image transfer unit (ITU) removal

- 1 Write down the number of the new ITU before installing it. You will need the 16-digit numeric value from the barcode after the installation, and it is easier to see at this point.

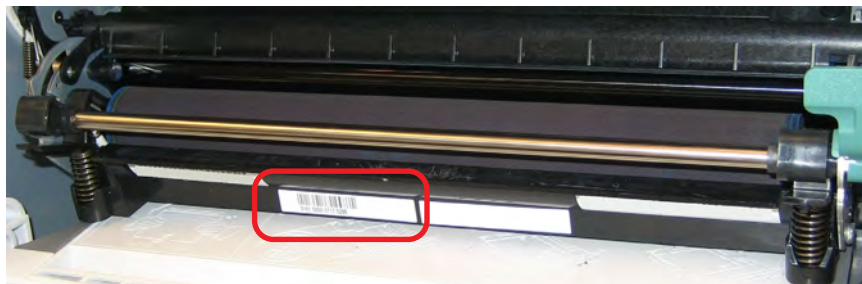

- 2 Remove the right cover assembly. See [“Right cover assembly removal” on page 288](#).
- 3 Remove the waste toner bottle. See [“Waste toner bottle removal” on page 307](#).
- 4 Remove the imaging unit (IU). See [“Imaging unit \(IU\) removal” on page 303](#).

- 5** Disconnect the two springs (A, B) from the side frames, leaving the right one (A) attached to the ITU spring clamp.

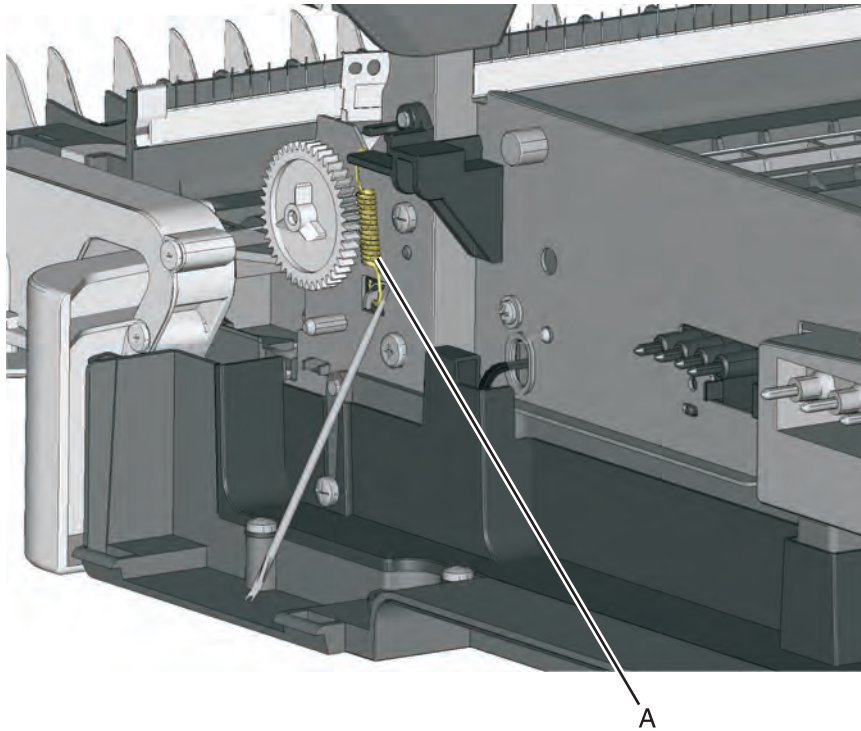

- 6** Unhook the left spring (B), and the cam away from the ITU so the spring is held out of the ITU path.

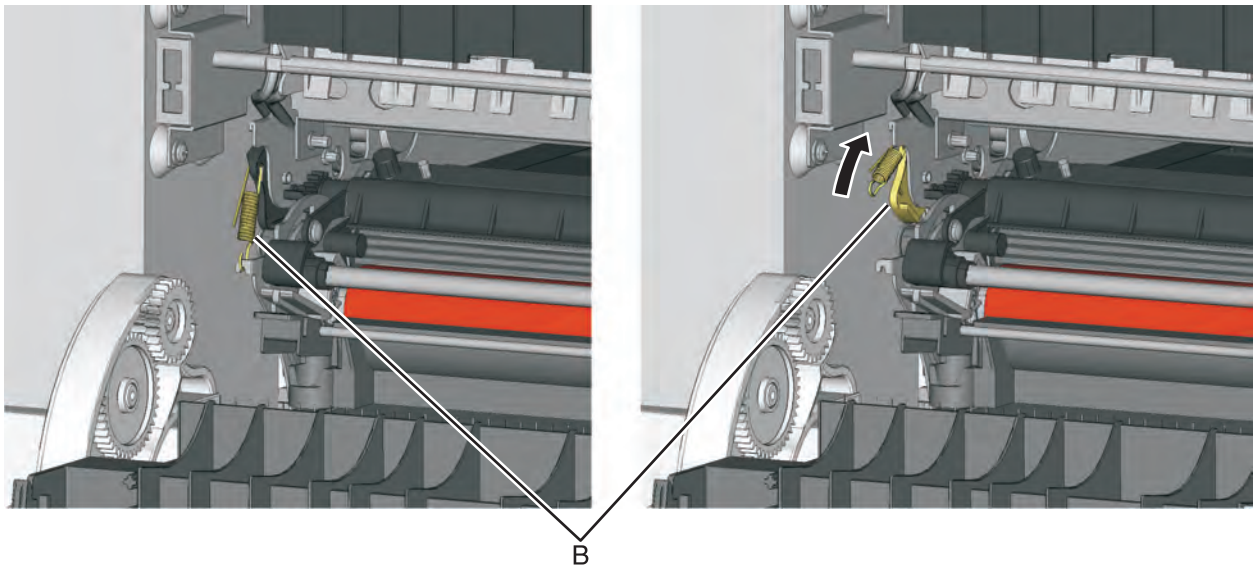

- 7** Place the tip of a flat-head screwdriver in between the release lever (C) and the frame.

- 8 Rotate the screwdriver to rotate the release lever and decouple the ITU while pulling the ITU toward the front.

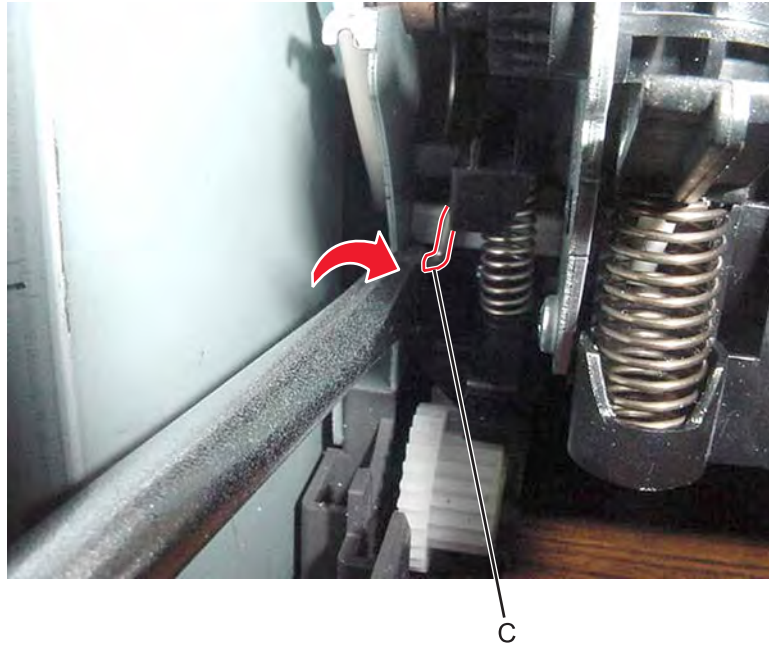

Warning—Potential Damage: Make sure the lever is in the fully released position before removing the ITU drive to avoid damage.



- 9 Hold the release lever as you pull out the ITU for the first four inches (100 mm), but a quick, firm pull should overcome the latch at this point.

Installation notes:

- 1 Write down the 16-digit numeric value of the new FRU before you begin to install it.
- 2 Do not rotate the release lever again to install the new ITU. Doing so could cause the ITU to be seated incorrectly. The coupler will be rotated out of the way as the ITU slides in.

- 3** Rotate the right side spring clamp (D) and left side cam back to their original positions, and then re-hook the springs.

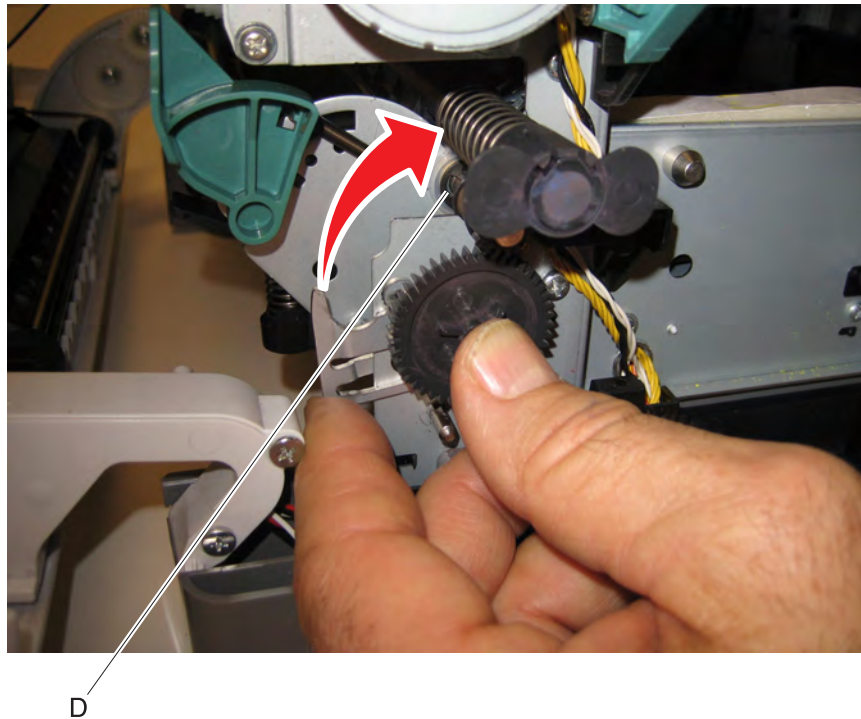

- 4** When you have replaced the ITU, be sure to enter the 16-digit numeric value from the barcode on the new ITU into the printer. See [“ITU Barcode” on page 223](#).

Note: For a video demonstration, see the *Image Transfer Unit Remove and Install Video* at http://infoserve.lexmark.com/videos/CSX_ITU.html

Imaging unit (IU) removal

Note: The imaging unit is a customer replacement unit and is not a FRU.

Note: The imaging unit contains:

- Photoconductor unit
- Developer units

To remove only the photoconductor, remove the entire imaging unit, remove the developer units, place the original developer units in the new photoconductor, and reinstall the imaging unit. When you replace the imaging kit, you are replacing *both* the photoconductor and the developer units.

- 1** Remove the waste toner bottle. See [“Waste toner bottle removal” on page 307](#).
- 2** Remove the toner cartridges.

3 Lift the two latches (A) to unlock the imaging unit.

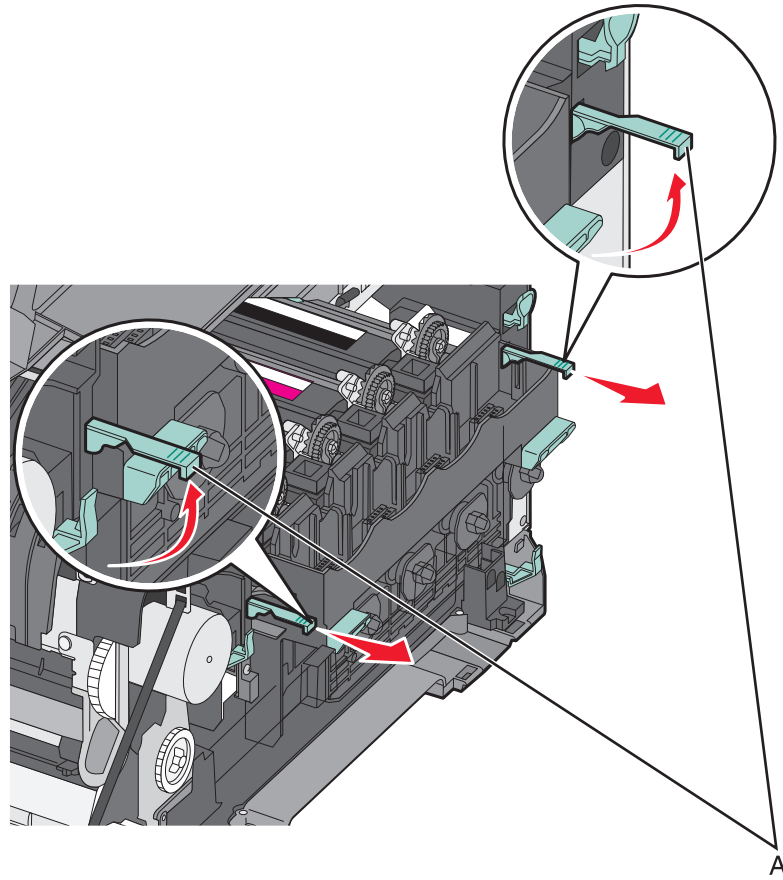

4 Pull the two latches until the imaging unit meets resistance.

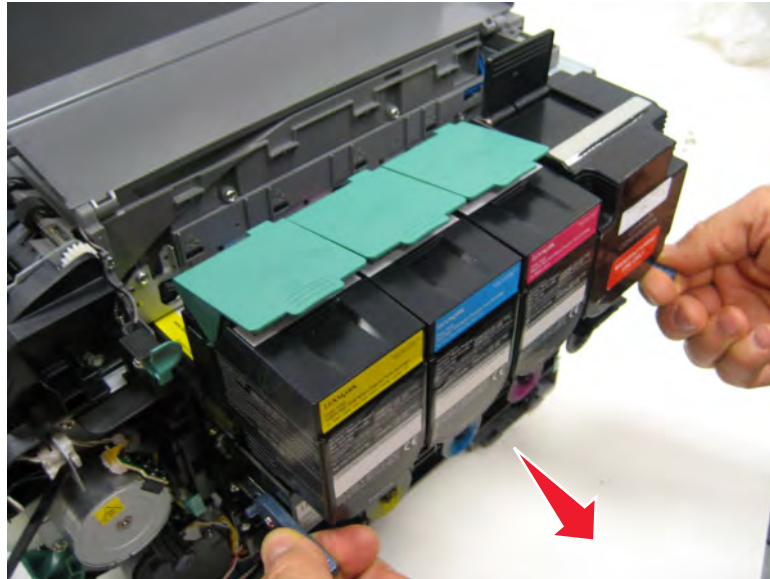

5 Press and hold the handles (B) on the right and left sides, and pull the imaging unit straight out.

Note: Avoid touching the bottom of the imaging unit.

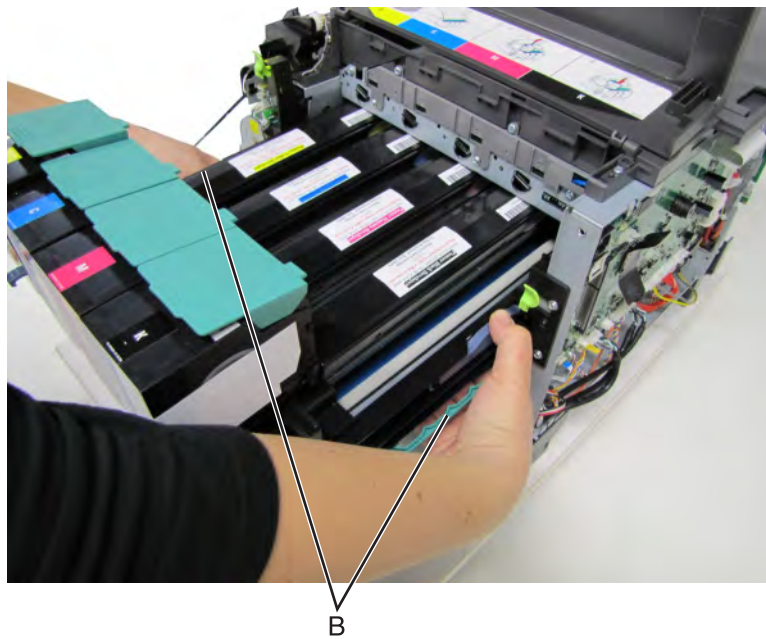

Toner cartridge contacts removal

- 1 Remove the right cover assembly. See [“Right cover assembly removal” on page 288](#).
- 2 Remove the waste toner bottle. See [“Waste toner bottle removal” on page 307](#).
- 3 Remove the imaging unit. See [“Imaging unit \(IU\) removal” on page 303](#).
- 4 Remove the rear cover. See [“Rear cover removal” on page 346](#).
- 5 Remove the rear screw (A) in the waste toner bottle sensor contact to allow access to the cable cover.

Note: The waste toner bottle sensor contact does not need to be unplugged or removed.
- 6 Remove the four screws (B) securing the cable cover, and remove the cable cover.

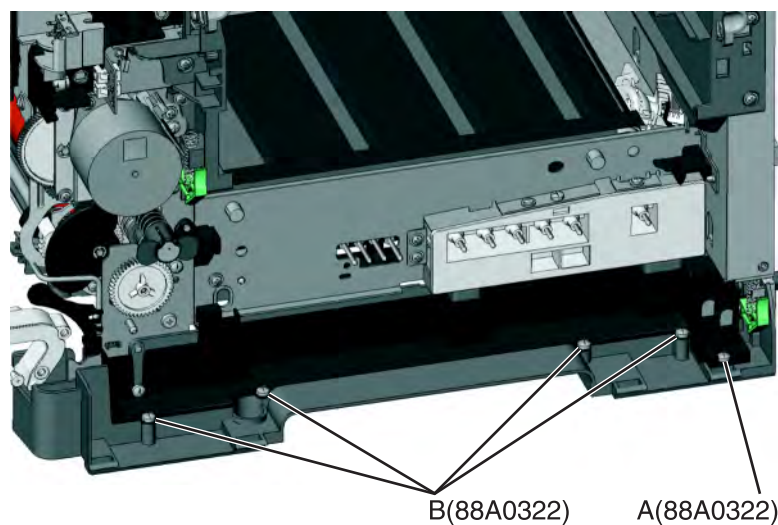

- 7 Rotate the printer to view the right side.
- 8 Lay the printer on its left side, and remove the screw (C) securing the spring contacts.

- 9 Release the tabs (D) on the spring contact, and slide to the left to remove.

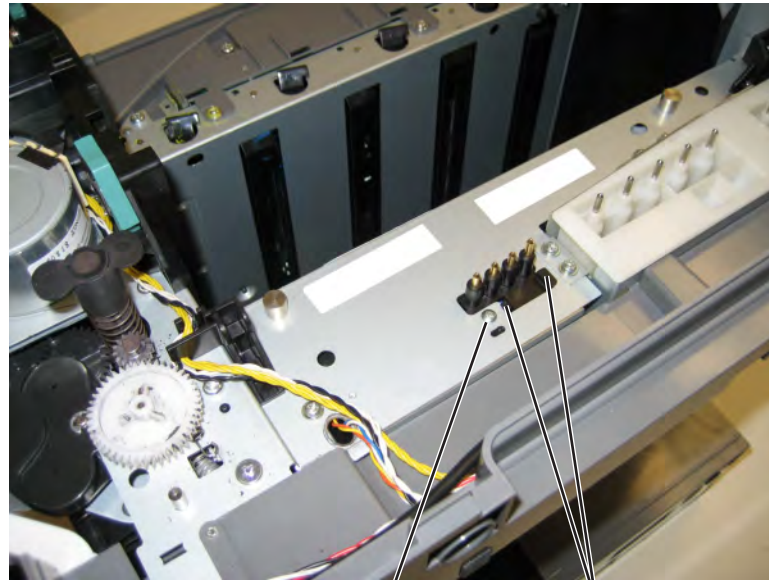

C(88A0313) D

- 10 Disconnect the cable (E) from the controller board at JSC1.

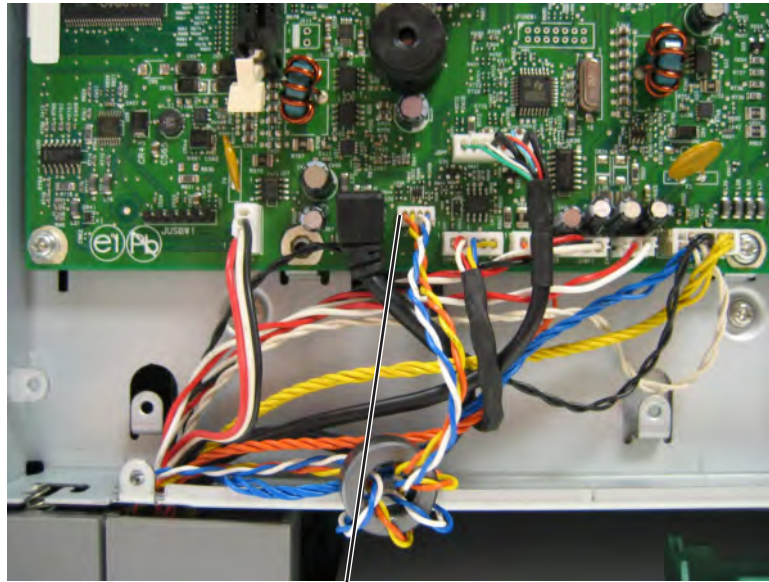

E

Installation note: Notice the assembly of the cable and toroid (if used), and reassemble the new contacts in the same manner.

- 11 Remove the cable from the retainer on the bottom of the printer.

Waste toner bottle removal

Note: The waste toner bottle is not a FRU.

- 1 Remove the right cover assembly. See [“Right cover assembly removal” on page 288](#).
- 2 Press the two tabs (A) to remove the waste toner bottle.

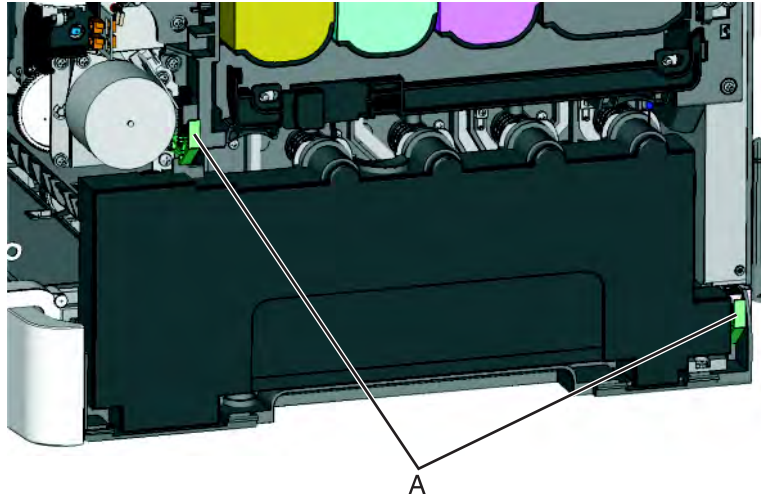

Waste toner bottle contact block removal

Note: The waste toner bottle is not a FRU.

- 1 Remove the waste toner bottle. See [“Waste toner bottle removal” on page 307](#).
- 2 Remove the screw (A) from the back of the waste toner bottle block.

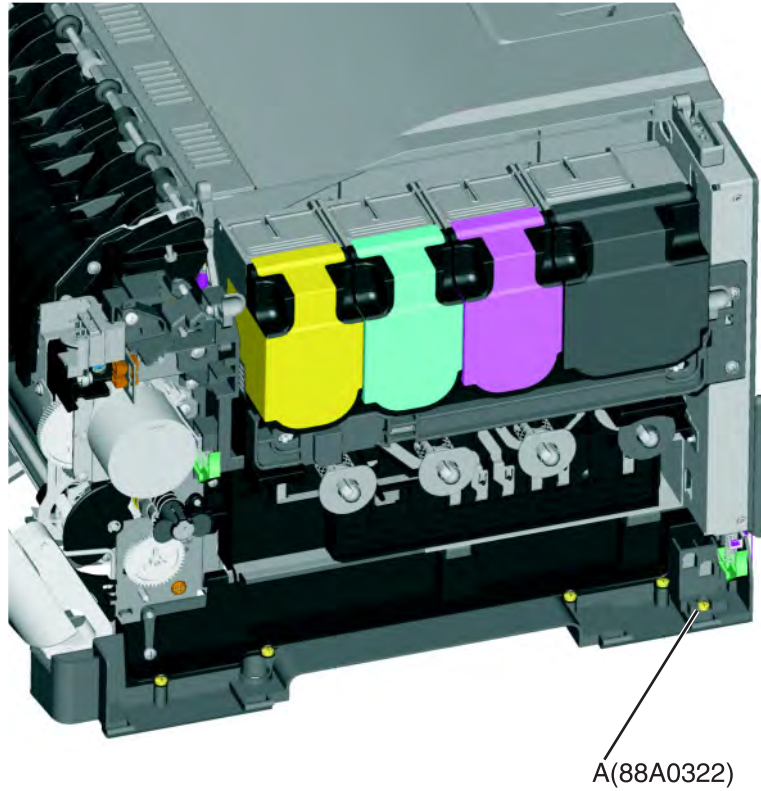

- 3 Remove the rear cover. See [“Rear cover removal” on page 346](#).

- 4 Disconnect the waste toner bottle contact block (B) from the controller board.

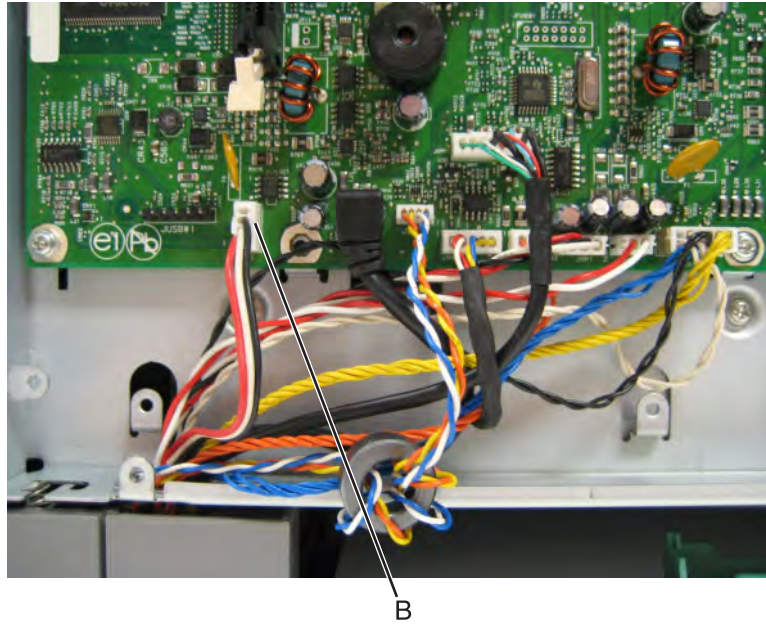

- 5 Remove the waste toner bottle contact block.

Front removals

Front cover assembly removal

- 1 Remove the media tray.
- 2 Open the front cover.
- 3 Remove the front middle cover (optional). See [“Front middle cover removal” on page 312.](#)
- 4 Remove the five screws (A) from the cable cover.
- 5 Remove the cable cover.
- 6 Remove the screw (B) securing the right restraining strap to the front cover.

Note: Support the door with one hand after removing the screw holding the restraining strap. This is the longest screw of the eight. The two flat-head Phillips screws are used in the door hinge.

7 Remove the two screws (C) securing the interlock and cable.

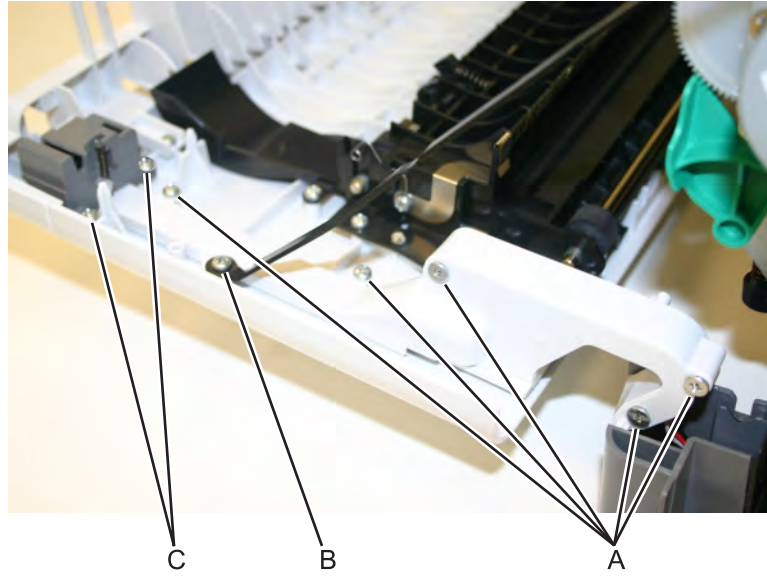

8 Route the cable through the right hinge.

Note: Pay close attention to the routing of the interlock sensor cable through the right hinge and front door.

9 Remove the screw (D) securing the restraining strap to the left side of the front door.

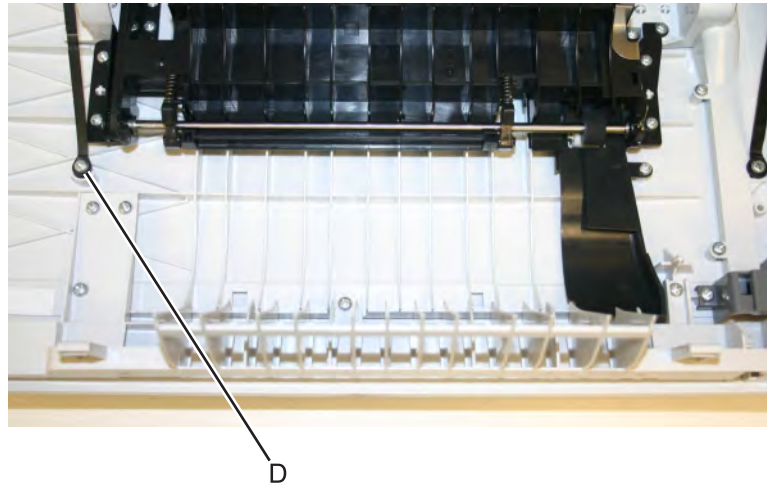

10 Lower the front cover to align the flats on the hinges, and remove the front cover.

Front cover inner deflector removal

- 1 Open the front cover.
- 2 Release the two door straps (A) from the frame.

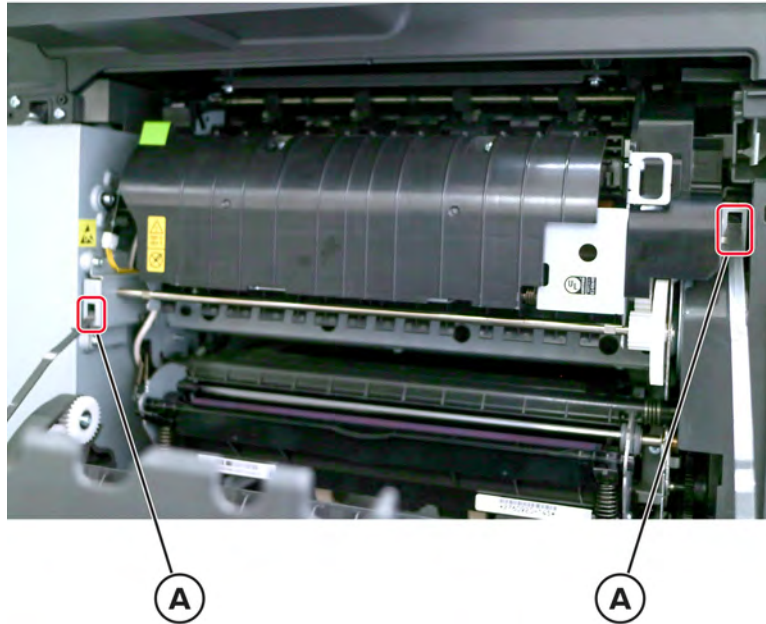

- 3 Remove the nine screws (B), and then remove the deflector.

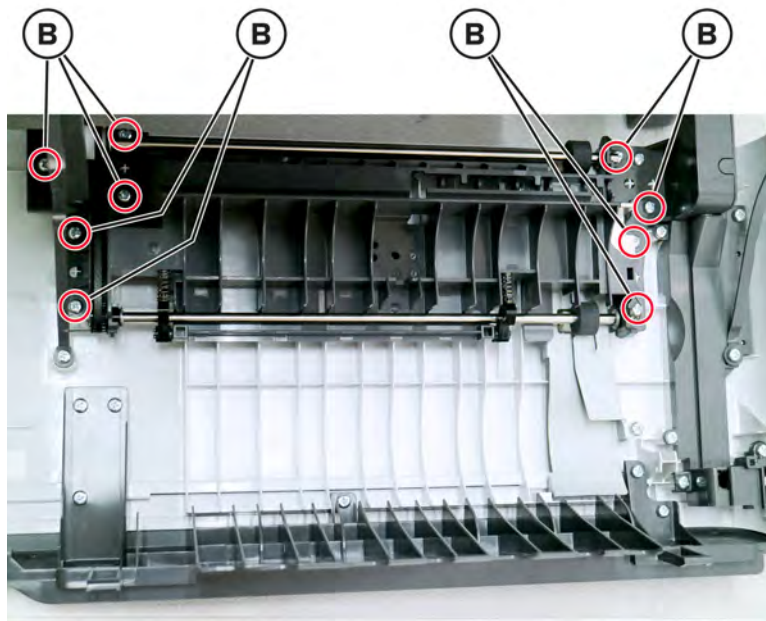

Front middle cover removal

- 1 Open the front cover.
- 2 Remove the five screws (A) attaching the front middle cover to the lower front cover.

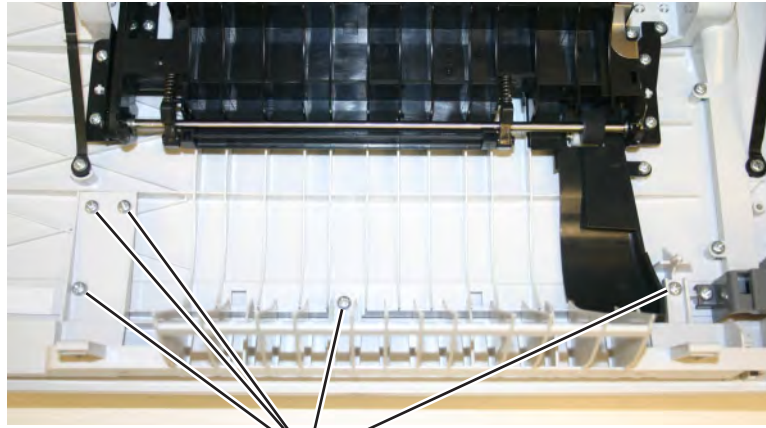

A(88A0322)

- 3 Pull the front middle cover away from the front cover to remove.

Front logo cover removal

- 1 Grasp the front logo.

Note: A flat-tipped screw may have to be used at the outer edges on the CX510. This cover part does not give access to any other part and therefore does not need to be removed except for replacement.

- 2 Sharply pull the front logo.

Operator panel bezel removal

- 1 Lift the flatbed scanner on the right side.
- 2 Lift the bezel away from the operator panel, and remove.

Note: The picture below shows the bezel removal for the CX310 and CX410 models. The bezel for CX510 models is removed the same way.



Operator panel logo plate removal

- 1 Pull the logo plate forward from the bottom to *pop* it loose from the operator panel.



- 2 Remove the operator panel logo plate.

Note: The CX510 bezel is larger and requires a higher force to remove. It does not need to be removed except for replacement.

Operator panel removal (for CX310 and CX410 models only)

Installation warning: Replace one of the following components, and perform a POR before replacing a second component. Never replace both of the components without performing a POR after installing each one, or the printer may be rendered inoperable:

- Operator panel assembly
- Controller board

Note: The UICC card is part of the operator panel.

Note: The following parts (FRUs) can be accessed from this section:

- Operator panel (one for each CX310 and CX410)
- Display and PCBA (CX310)
- Display (CX410)
- UICC PCBA (CX410)
- User interface support bracket (common to CX310 and CX410)
- Front operator panel cover (common to CX310 and CX410)
- Upper front (operator) cover (common to CX310 and CX410)
- Speaker (CX410)

- 1** Lift the flatbed scanner assembly on the right side.
- 2** Remove the three screws (A) from beneath the operator panel.

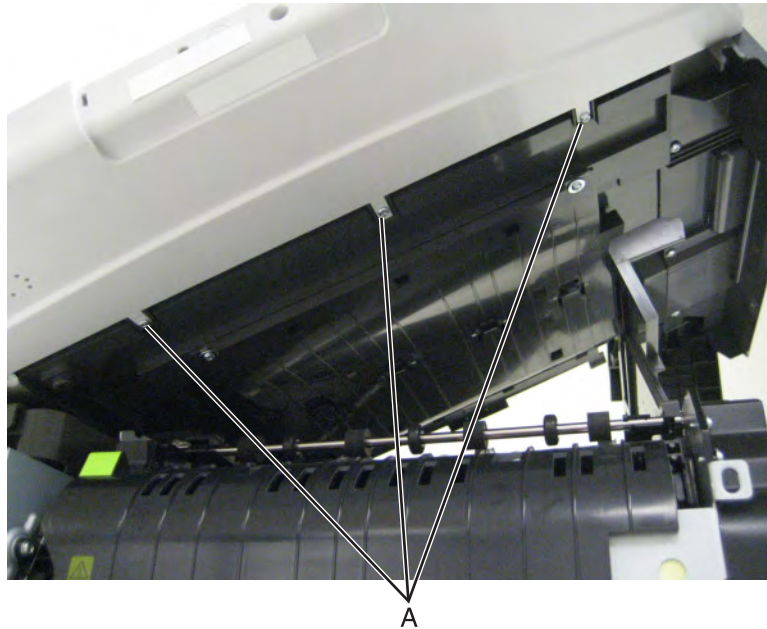

- 3** Remove the two screws (B) from the left top side of the operator panel, and the two screws (C) from the right top side of the operator panel using a #2 Phillips screwdriver.

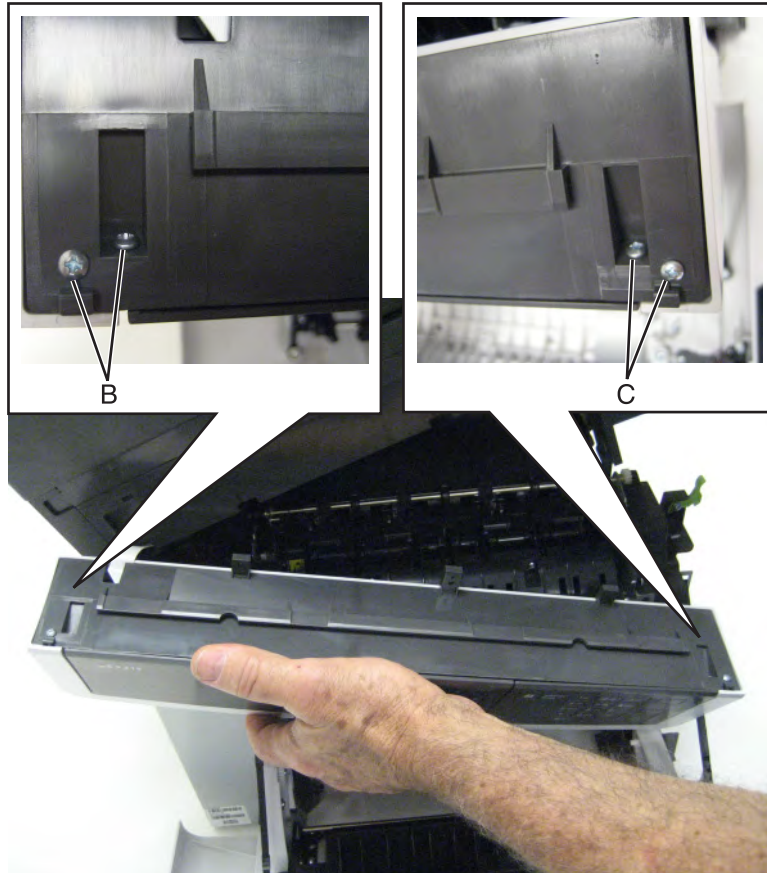

- 4** Disconnect the name plate cover from the operator panel.



- 5** Remove the operator panel bezel. See [“Operator panel bezel removal” on page 312.](#)

- 6 Remove the screw (D) from beneath the logo plate.

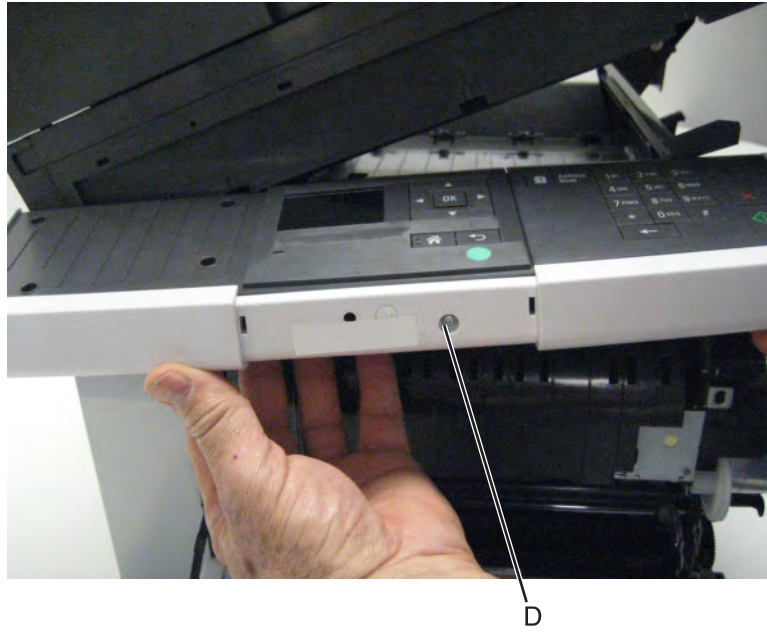

- 7 Remove the operator panel cover from the front of the printer.



- 8** Remove the two screws (E) from the operator panel.

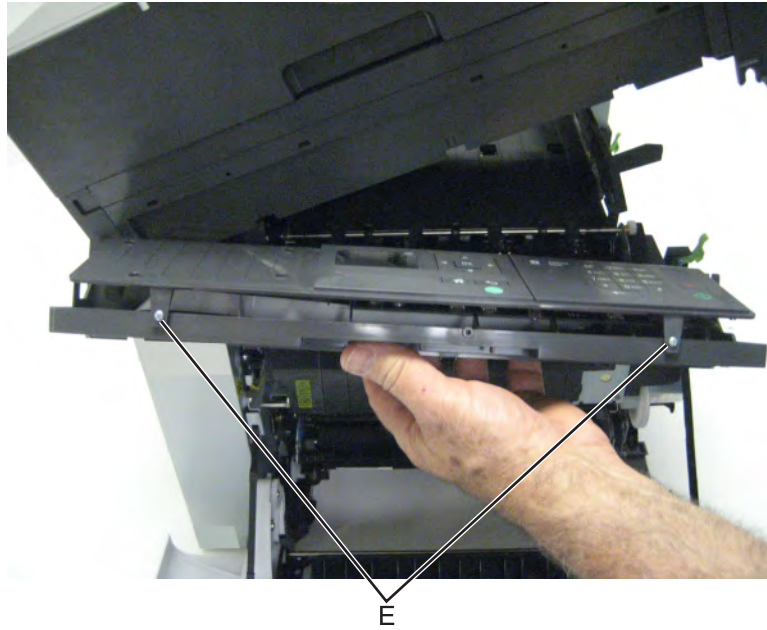

- 9** Lift the operator panel from the user interface support bracket.
- 10** Disconnect the ribbon cable from the cable connector on the operator panel board by sliding the two prongs forward.

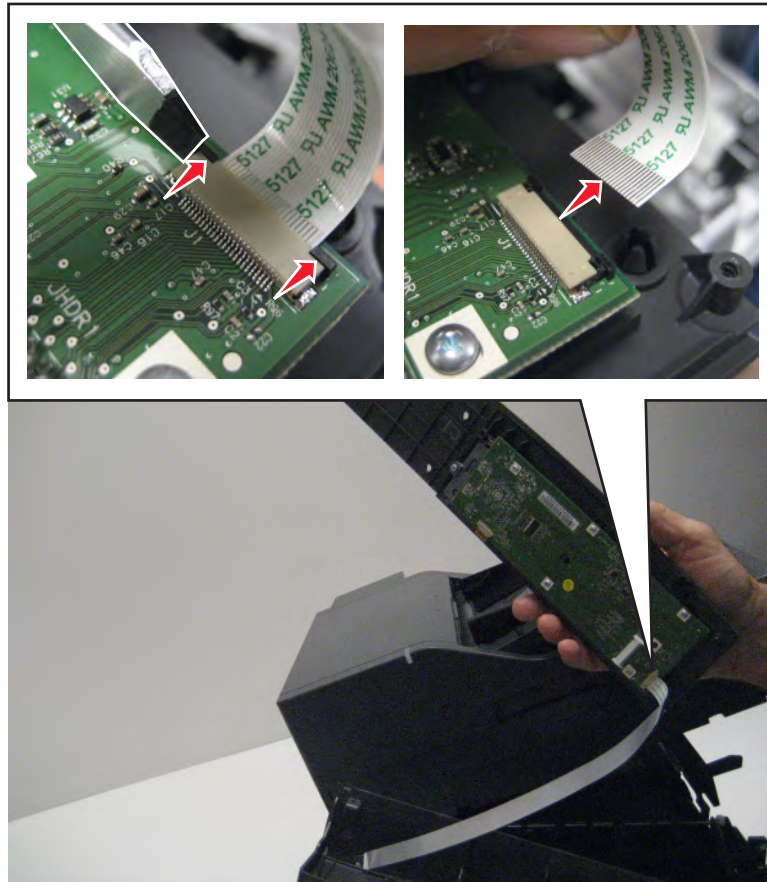

11 Remove the five screws (F) from the operator panel board.

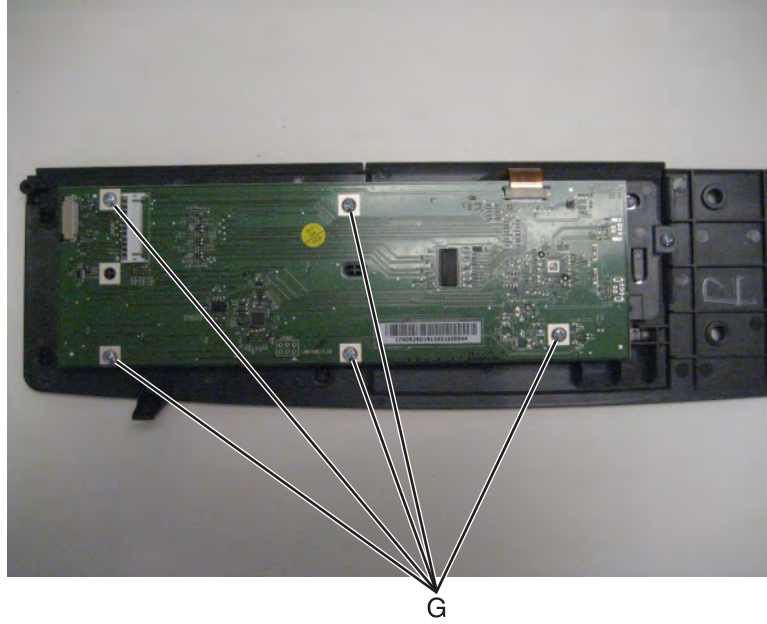

12 Remove the two screws (G) from the display bracket.

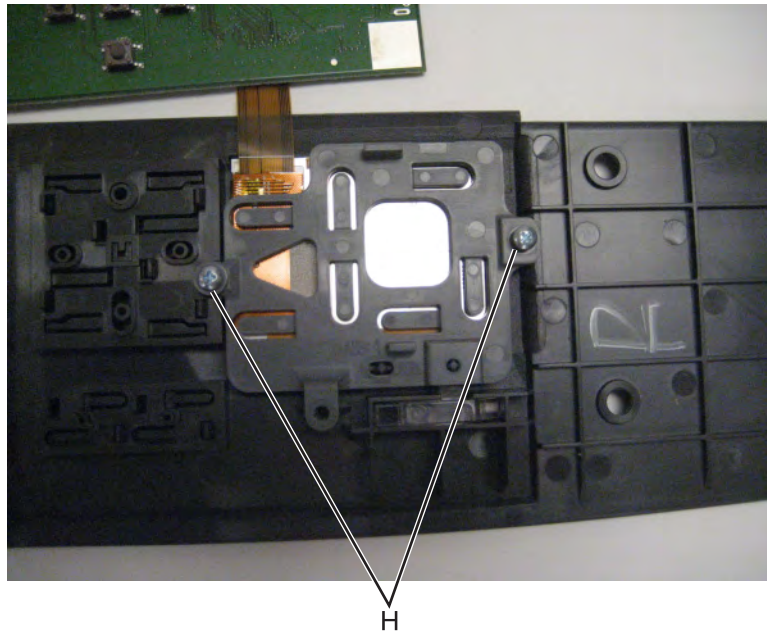

- 13 Disconnect the cable (H) from the operator panel board.

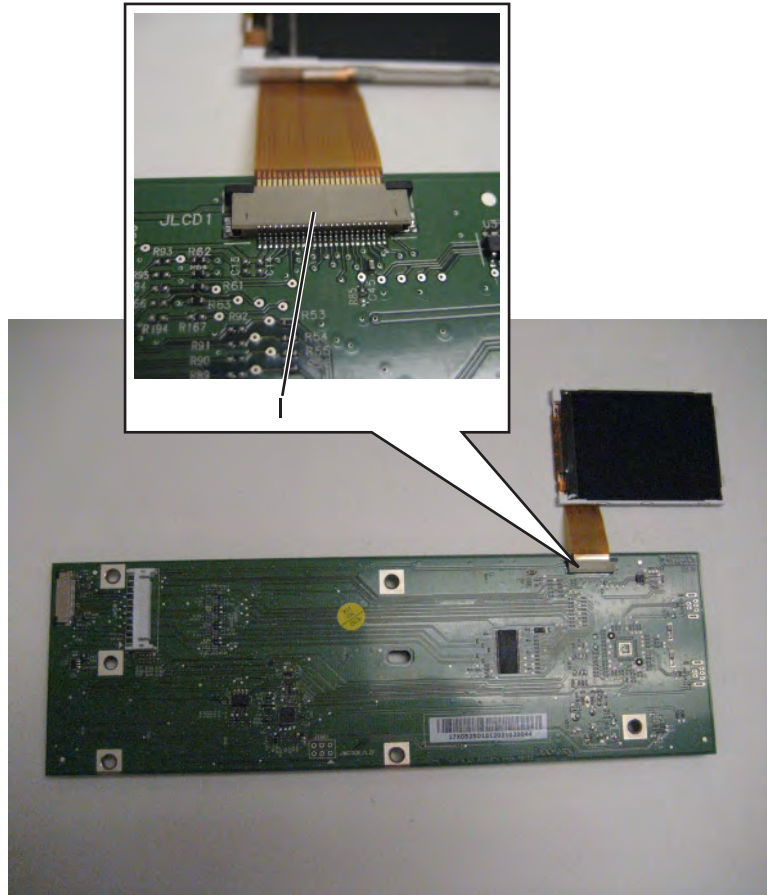

Installation note: When replacing the operator panel board, be sure to also replace the washer (I) that holds the display bracket in place.

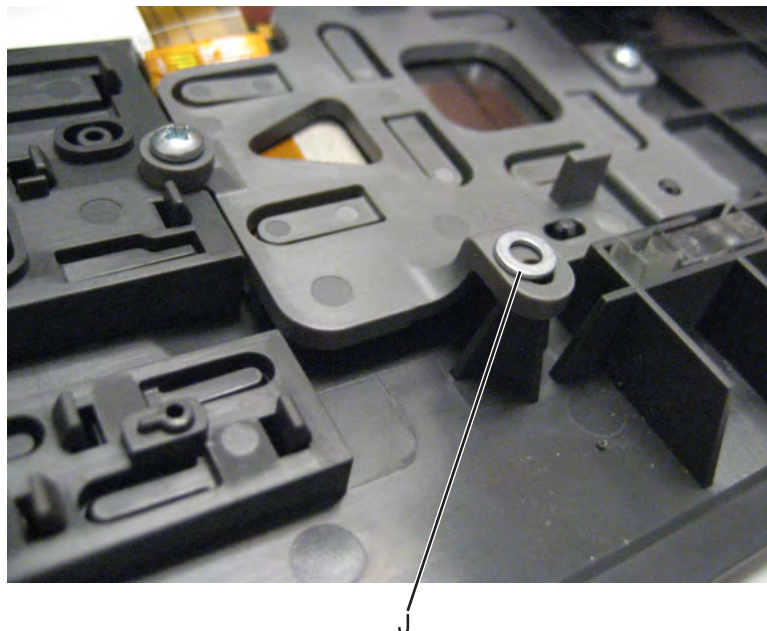

Operator panel removal (for CX510 models only)

Installation warning: Replace one of the following components, and perform a POR before replacing a second component. Never replace both of the components without performing a POR after installing each one, or the printer may be rendered inoperable:

- Operator panel assembly
- Controller board

Note: The UICC card is part of the operator panel.

Note: The following parts (FRUs) can be accessed from this section:

- 7" display
- Small interface card
- Interface cable
- UICC PCBA
- Operator panel for 7" display
- User interface support bracket
- Upper front (operator) cover
- Speaker

- 1 Open the front cover.
- 2 Open the scanner to give access to the bottom operator module.
- 3 Remove the three screws (A).

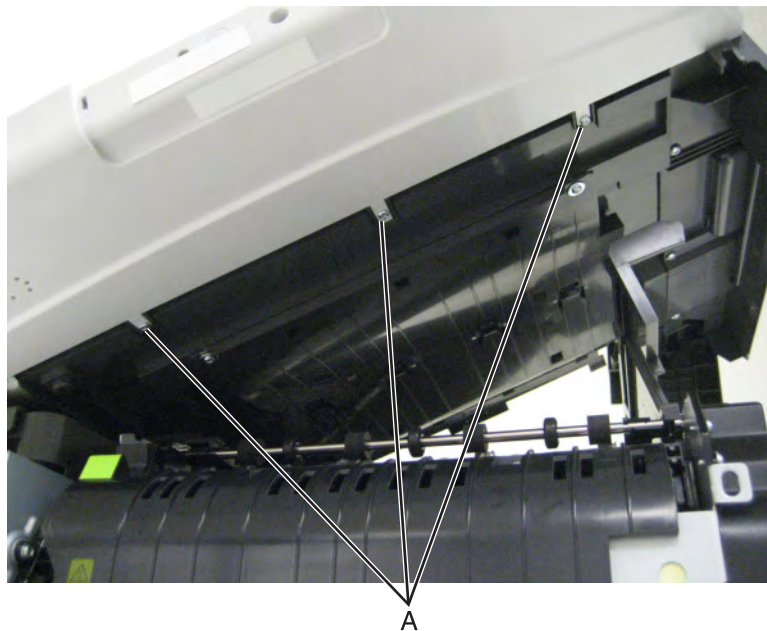

- 4 Carefully separate the module from that scanner and support the right end of the open door without stressing the cables.
- 5 Remove the bezel.
- 6 Remove the screw on the right rear side of the module which secures the bracket to the upper front cover.

- 7 Remove the two screws (B) at the top left and right holding the operator panel assembly, the upper front cover, and the user interface bracket together.
- 8 Pull the left and right sides of the upper front cover out enough to slide the operator panel assembly and bracket away from the cover.
- 9 Remove the two screws (C) holding the operator panel assembly to the user interface bracket.
- 10 Disconnect the flat cable from the controller card to the UICC.

Note: All of the FRUs listed above are now easily accessible.

UICC to controller board cable removal

- 1 Remove the operator panel. See [“Operator panel removal \(for CX310 and CX410 models only\)” on page 313](#) or [“Operator panel removal \(for CX510 models only\)” on page 320](#).
- 2 Remove the flatbed scanner assembly. See [“Flatbed scanner assembly removal” on page 374](#).
- 3 Remove the CCD cable cover (A), and then remove the cable from the tabs (B).

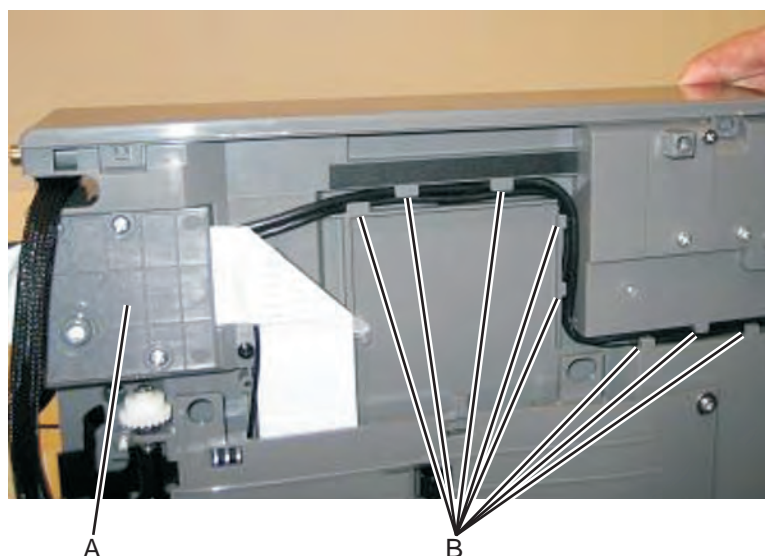

Warning—Potential Damage: When replacing the control panel and USB cables, make sure that there is no overlapping of cables when routing to avoid crimping of the cables. The redrive unit on the scanner might not make proper contact with the redrive rolls on the top cover and cause paper jams.

USB port connector removal

Note: The FRU includes the USB port connector and cable.

- 1 Remove the flatbed scanner assembly. See [“Flatbed scanner assembly removal” on page 374](#).
- 2 Remove the operator panel. See [“Operator panel removal \(for CX310 and CX410 models only\)” on page 313](#) or [“Operator panel removal \(for CX510 models only\)” on page 320](#).
- 3 Remove the USB connector fastened to the operator panel assembly.
- 4 Remove the two screws from the small cover plate.

5 Remove the USB cable from the flatbed scanner assembly, noting the access on each end.

Note: Do not reposition any of the cables.

6 Reinstall the cover plate.

Duplex reference edge removal

1 Open the front door.

2 Remove the two screws (A), the two screws (B), the two screws (C), and the two screws (D) in the back of the duplex aligner.

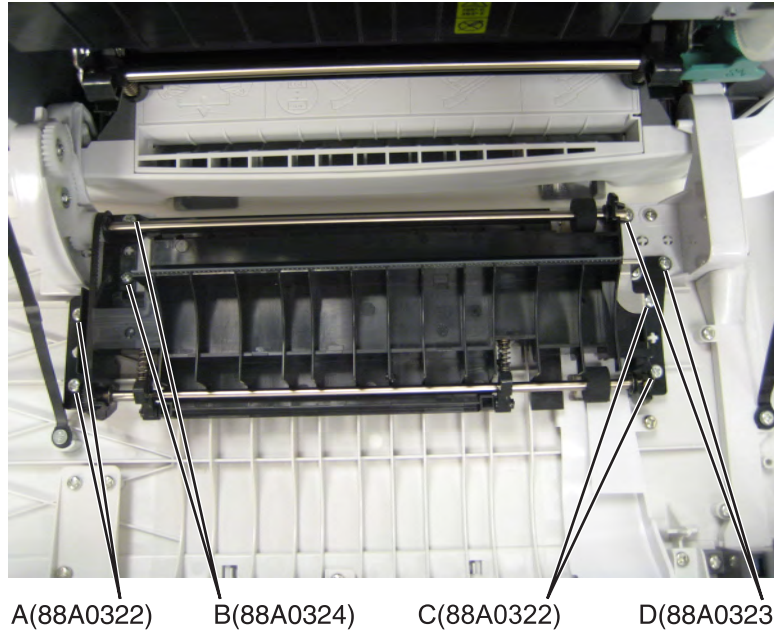

3 Lift the duplex aligner on the right side, and disengage the gears (E) on the left.

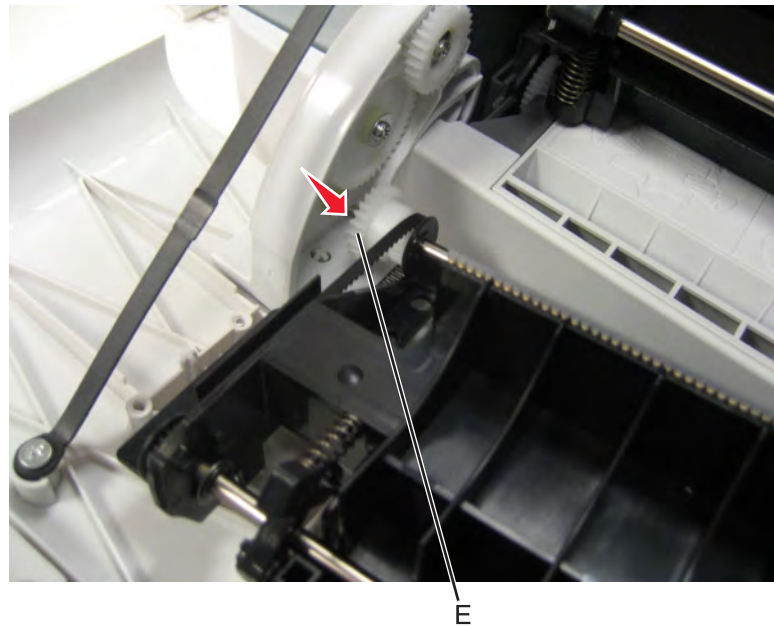

Parts removal

- 4 Remove the three screws (F) from the duplex reference guide, and remove the guide.

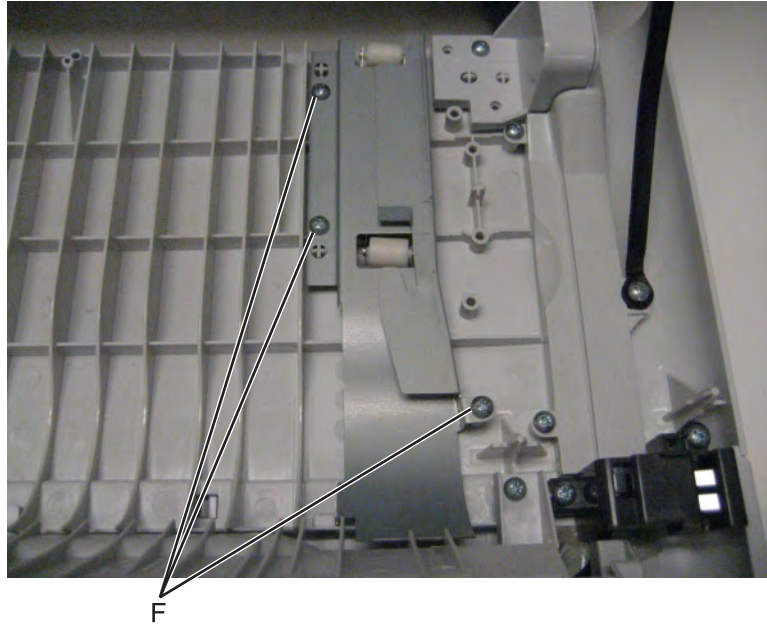

Installation notes:

- a Align the duplex reference guide so that the tabs are inserted into the slots, and the top of the reference guide fits under the door ribs.
- b Replace the three screws in the duplex reference guide.
- c Be sure that the shaft and bearing have not shifted out of the guide. If they have, then make sure that the bearing on the left is aligned with the slot (G) facing down (towards the front door).

Note: Improperly aligned bearings or seated shafts may cause vibration and noise in the front door.

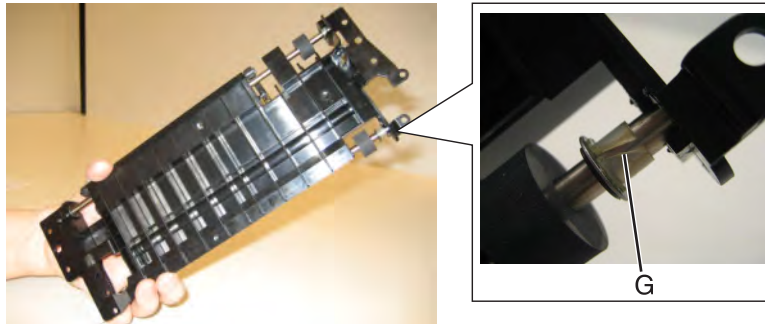

- d Align the duplex aligner guide so that the gears (H) mesh on the left.

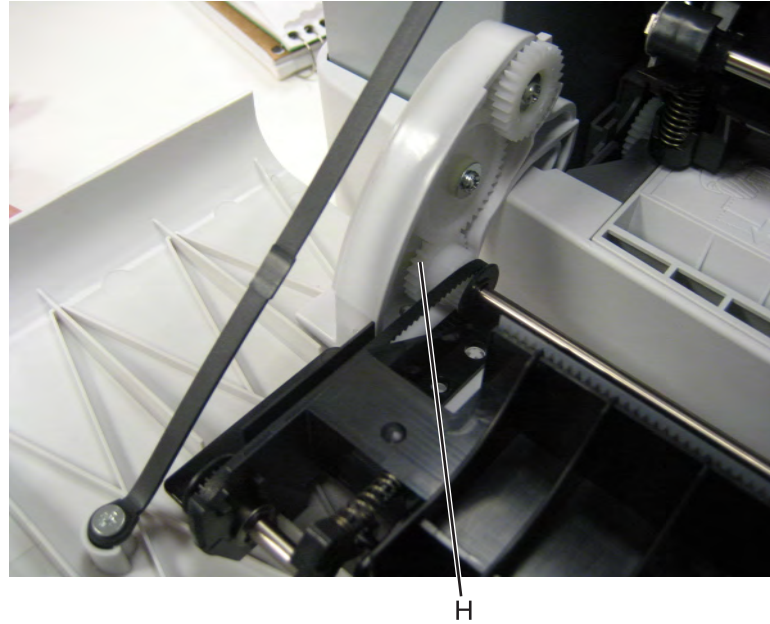

- e Replace the eight screws in the duplex aligner.
f Close the front door.

Fuser assembly removal

- 1 Remove the right cover assembly. See [“Right cover assembly removal” on page 288](#).
- 2 Remove the left cover assembly. See [“Left cover assembly removal” on page 274](#).
- 3 Disconnect the two-wire fuser cable (A) from the LVPS.
- 4 Position the fuser cable so that it can be pulled through from the front of the printer, and guide the cable through to the front.

Warning—Potential Damage: Be careful not to damage the cable by pulling too hard or cutting the cable insulation.

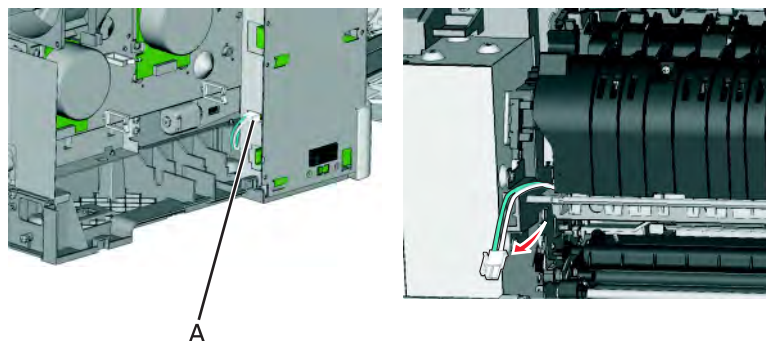

- 5 Remove the redrive belt (B) from the redrive pulley.

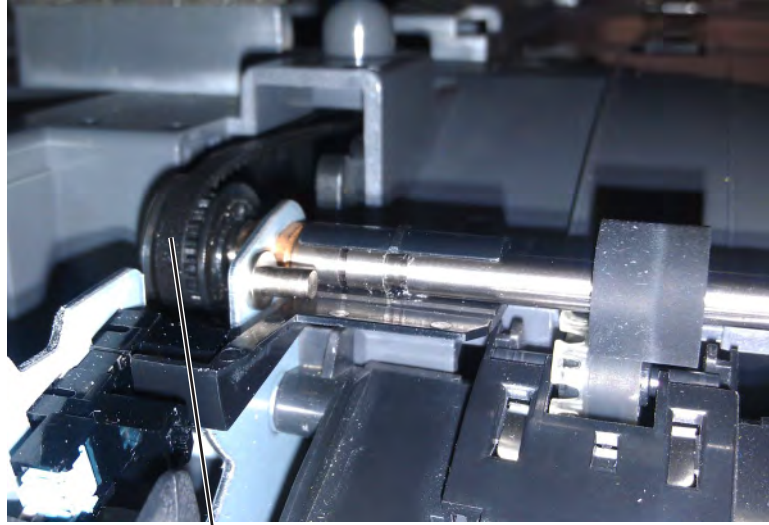

B

- 6 Disconnect the cable (C) from the bin-full/narrow media sensor, and unrout the cable from its retainer.

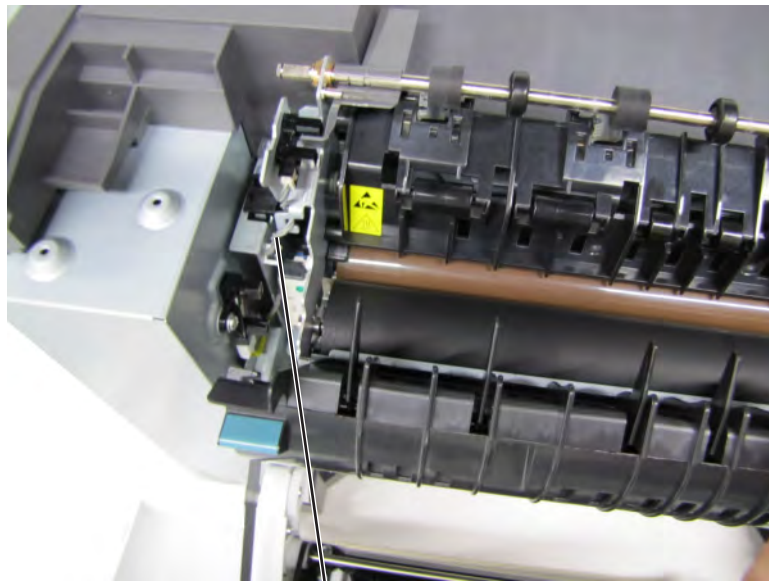

C

- 7 Remove the narrow media flag (D) and fuser deflector flag (E) from the fuser exit shaft. The flags will be used on the new fuser.

Note: Take note of the positions of the flags on the shaft before removing them.

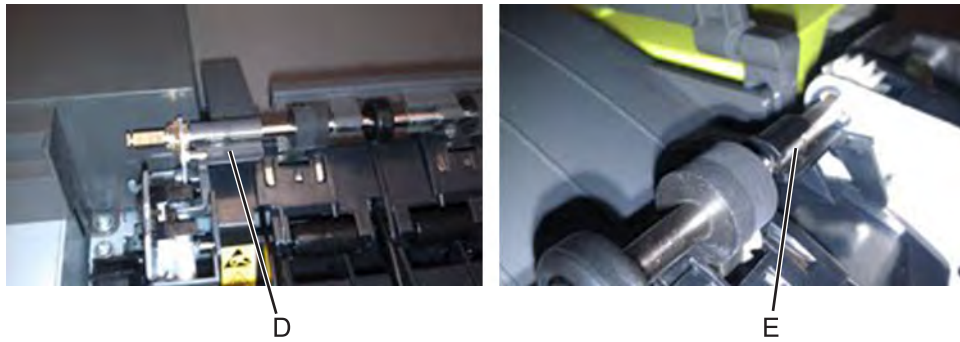

8 Unhook the springs (F) from both sides of the fuser.

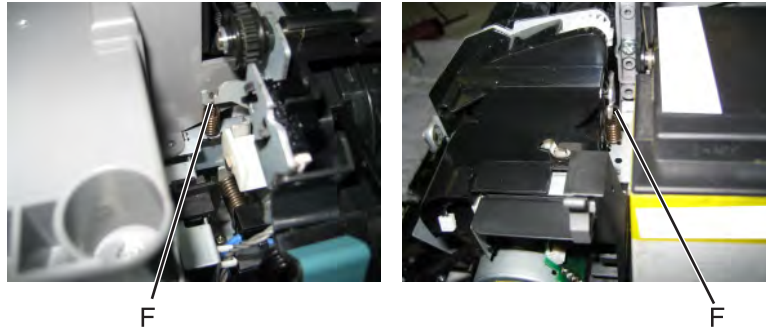

9 Disconnect the thermistor cables (G), and pull them over the retainer.

10 Remove the screw and grounding washer (H) on the right side of the frame.

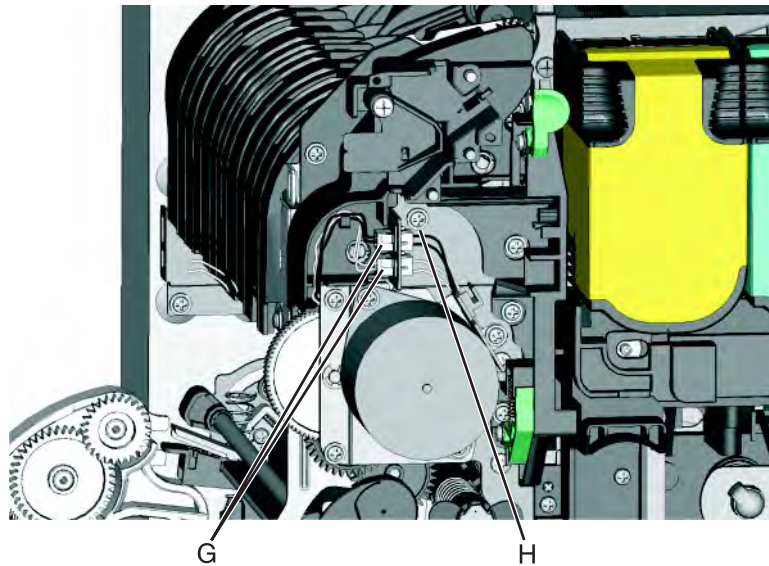

Note: Be careful to not lose the grounding washer.

11 Rotate the top of the fuser toward the front, and then slide to the left to align the fuser side frames with the flat area of the shaft.

12 Lift the fuser, and remove.

13 Remove the redrive pulley from the fuser exit shaft. The pulley and e-clip will be used on the new fuser.

Warning—Potential Damage: Be careful to not interfere with or damage the fuser exit sensor to the left of the fuser when rotating.

Installation notes:

- a Install the two flags (A) from the old fuser into the new fuser.

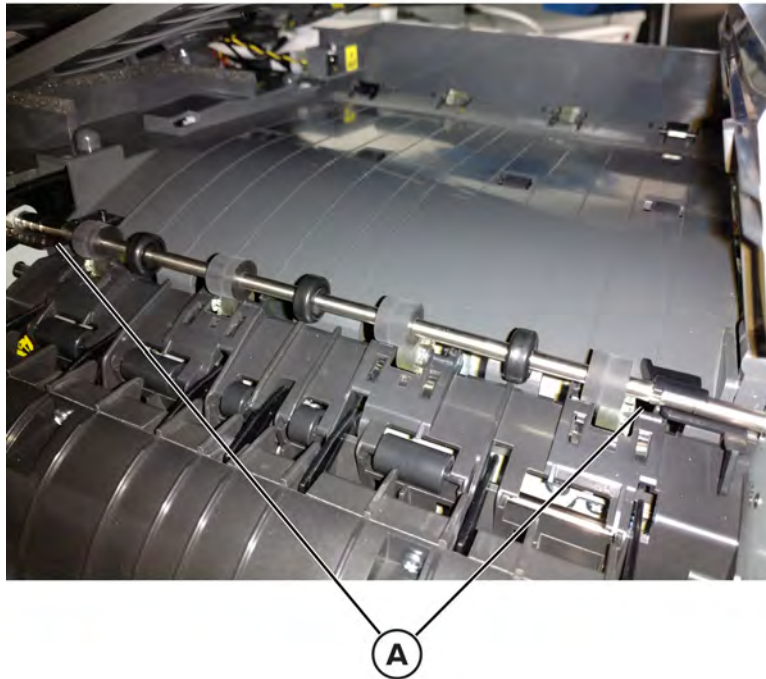

- b Enter the Diagnostics menu, and then navigate to:
Printer Setup > Fuser Reset
- c Select **Reset**.
- d Make sure that the fuser exit redrive belt (B) is properly seated and engaged to the pulley (C).

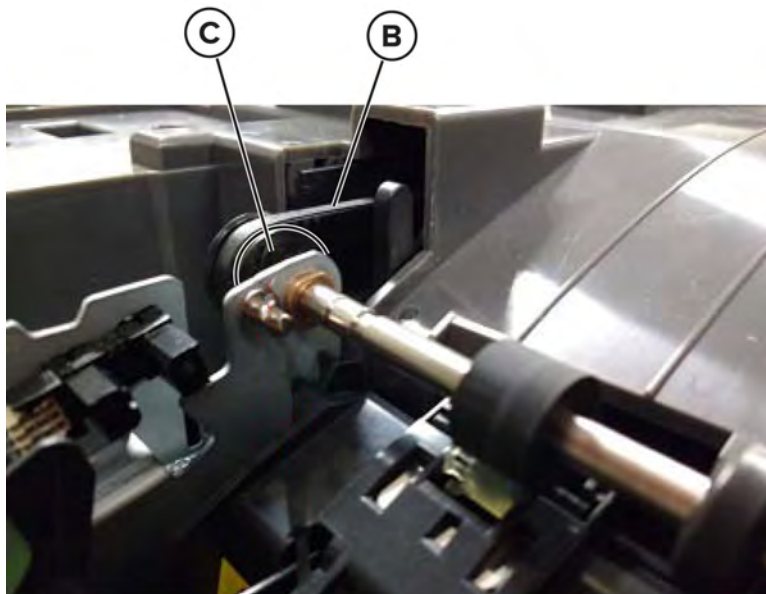

- e Print approximately 15 test pages in simplex and duplex modes to make sure that the belt is properly working and the flags are properly installed.
- f Pay attention to noise that may indicate an improper belt installation.
- g If a **Remove media from output bin** or a 34.04 error appears, check the fuser flags for proper installation.

Note: For a video demonstration, see the *Fuser Remove and Install Video* at http://infoserve.lexmark.com/videos/CSX_fuser.html

Bottom removals

Lower left frame removal

Note: The right and left lower frames are in the same FRU.

- 1 Remove the media tray, and remove the screw (A) from the front.

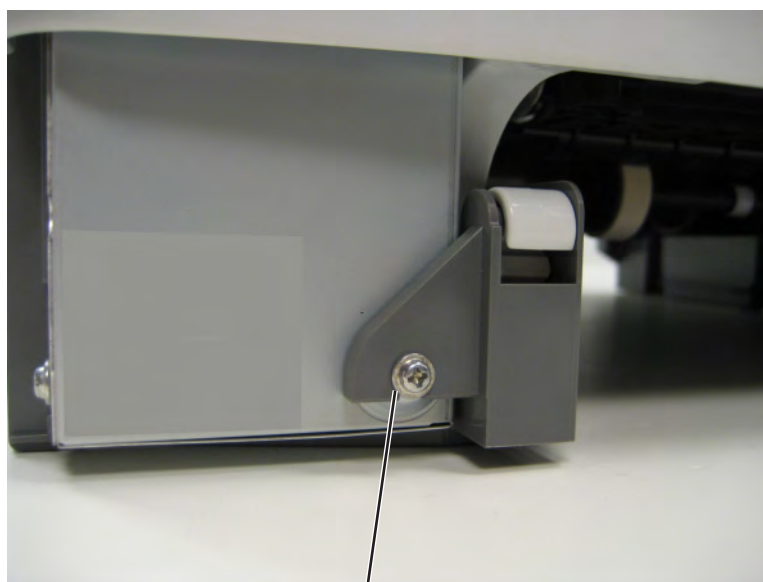

A(18B0832)

- 2 Remove the waste toner bottle. See [“Waste toner bottle removal” on page 307](#).
- 3 Remove the imaging unit. See [“Imaging unit \(IU\) removal” on page 303](#).

- 4 Disconnect the three cables (B) from the LVPS.

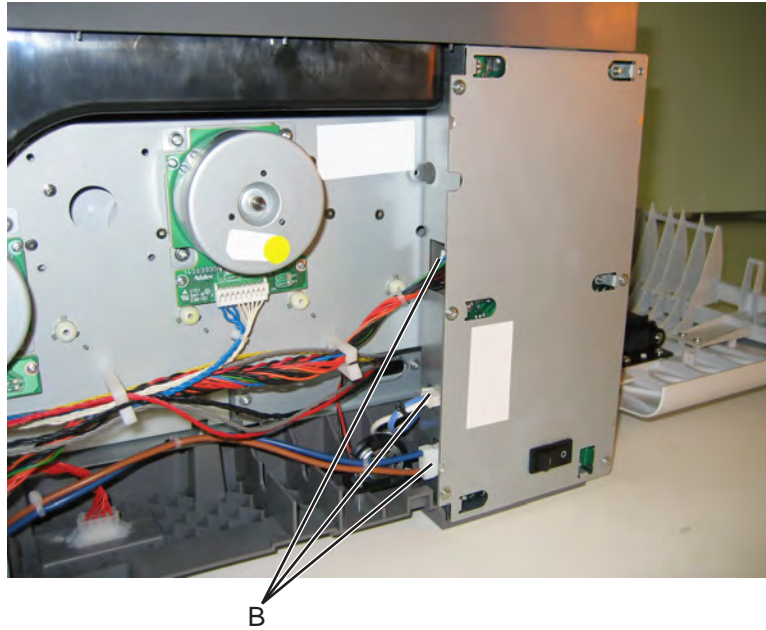

- 5 Remove the flatbed scanner assembly. See [“Flatbed scanner assembly removal” on page 374](#).
- 6 Remove the two top screws (C) near the front holding the top cover to the LVPS shield.

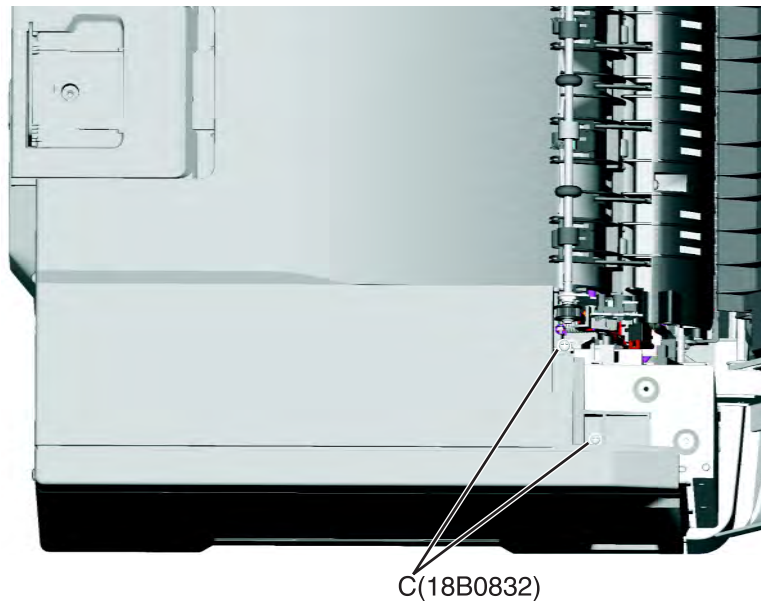

- 7 Position the fuser cable (D) so that it can be pulled through from the front of the printer, and guide the cable through to the front.

Warning—Potential Damage: Be careful not to damage the cable by pulling too hard or cutting the cable insulation.

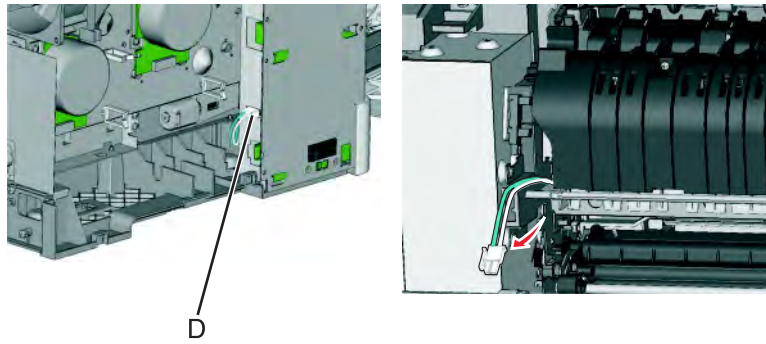

- 8** Disconnect the cable (E) from the bin-full/narrow media sensor, and unrout the cable from its retainer.

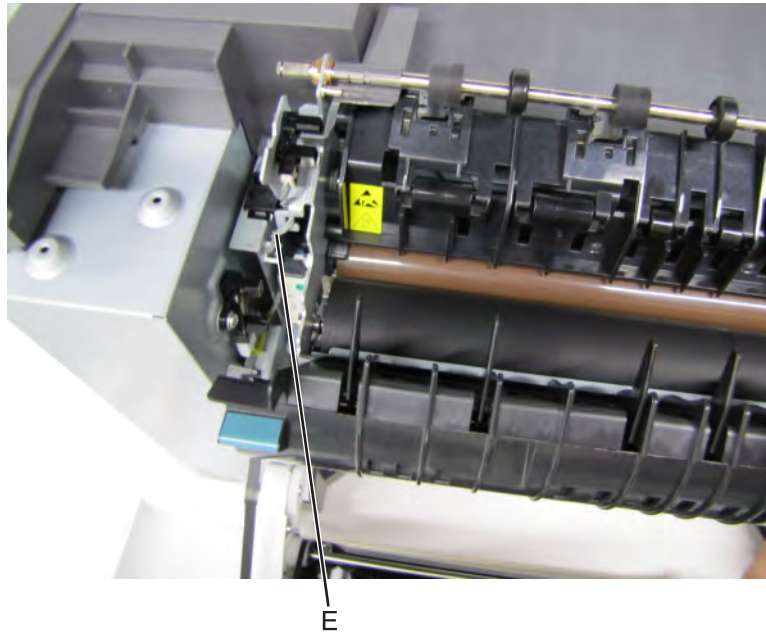

- 9** Unhook the springs (F) from both sides of the fuser.

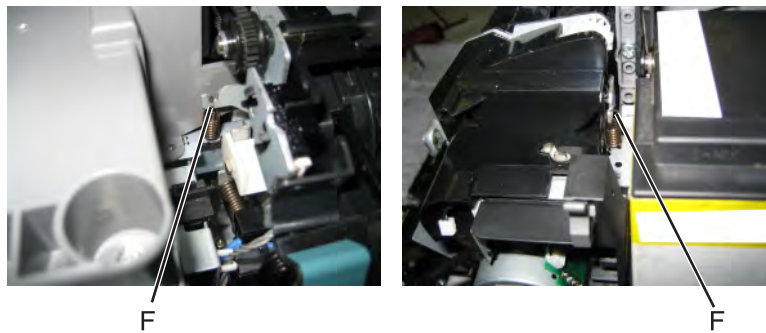

- 10** Disconnect the thermistor cables (G), and pull them over the retainer.

- 11** Remove the screw and grounding washer (H) on the right side of the frame.

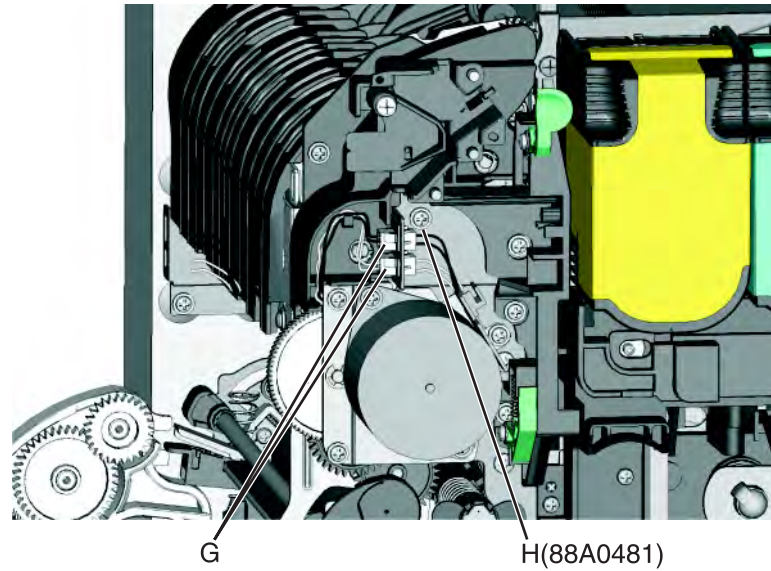

Note: Be careful to not lose the grounding washer.

- 12** Rotate the top of the fuser toward the front, and then slide to the left to align the fuser side frames with the flat area of the shaft.
- 13** Disconnect the fuser exit sensor cable (I).

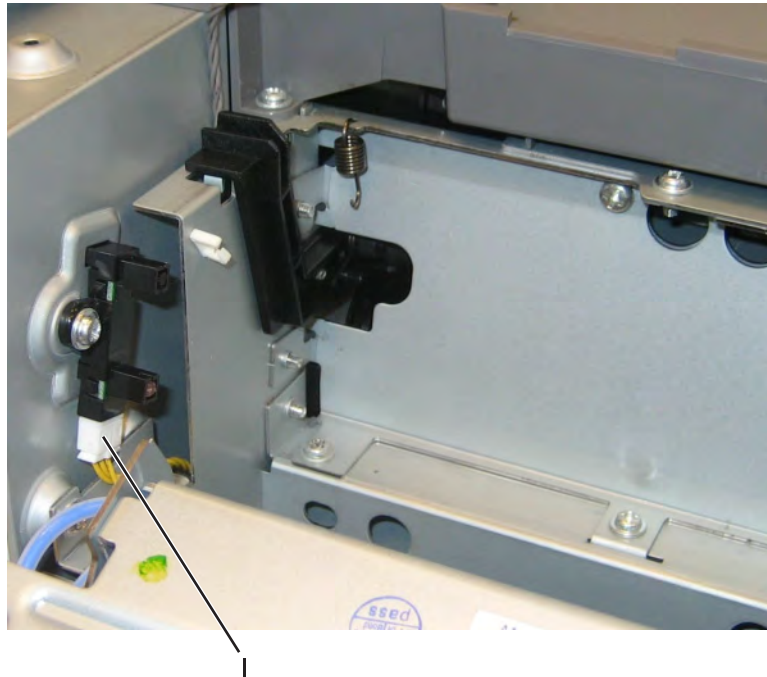

- 14** Lift the front left corner of the top cover, and tilt the LVPS cage (J) to remove. There are two posts at the bottom of the cage on the left side that need to be disengaged.

Note: Be careful with the fuser exit sensor which remains with the cage.

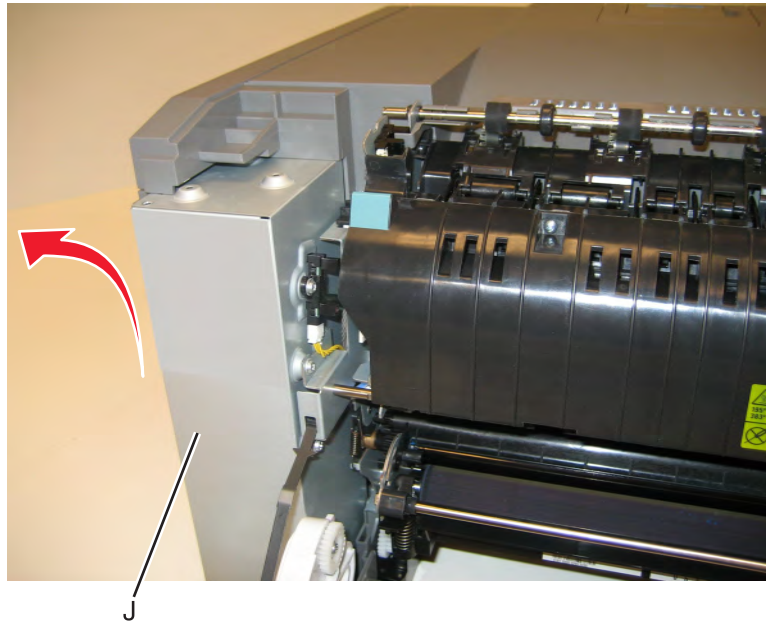

15 Place the printer on its right side.

16 Remove the tray 2 connector (K) by pinching the tabs together and pushing the connector into the printer.

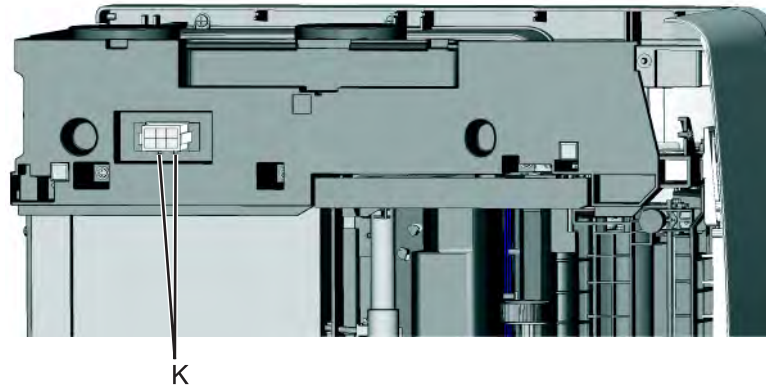

- 17** At the rear of the printer, remove the two screws (L) from the AC receptacle, and the ground screw (M), and the two screws (N) holding the plastic shield.

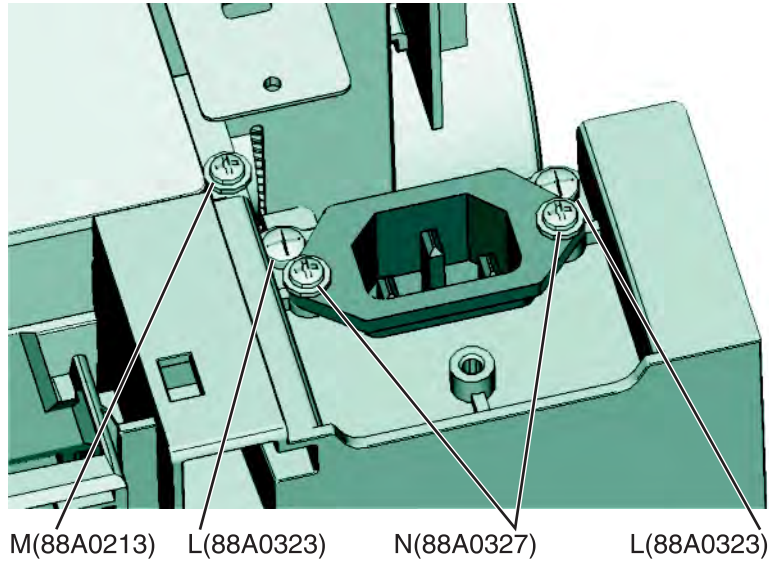

- 18** Remove the AC receptacle from the left lower frame.

- 19** Remove the three screws (O) securing the left lower frame.

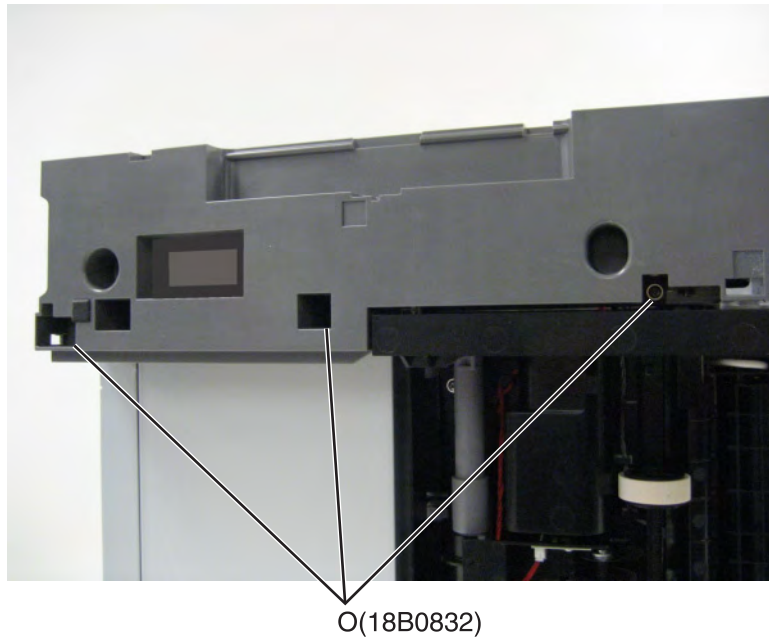

- 20** Remove the screw (P) above the frame.

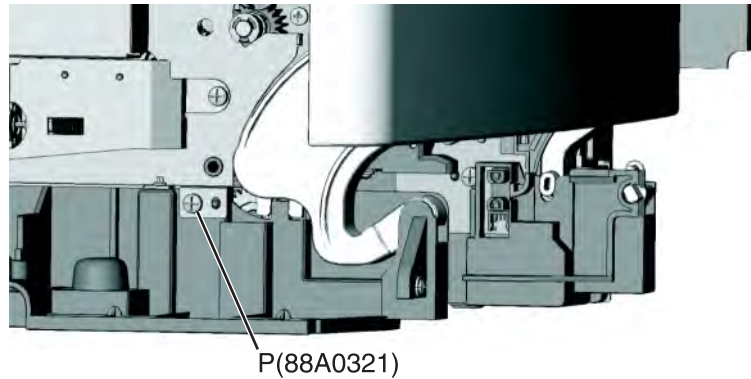

- 21** Swing the left lower frame away from the printer, and remove.

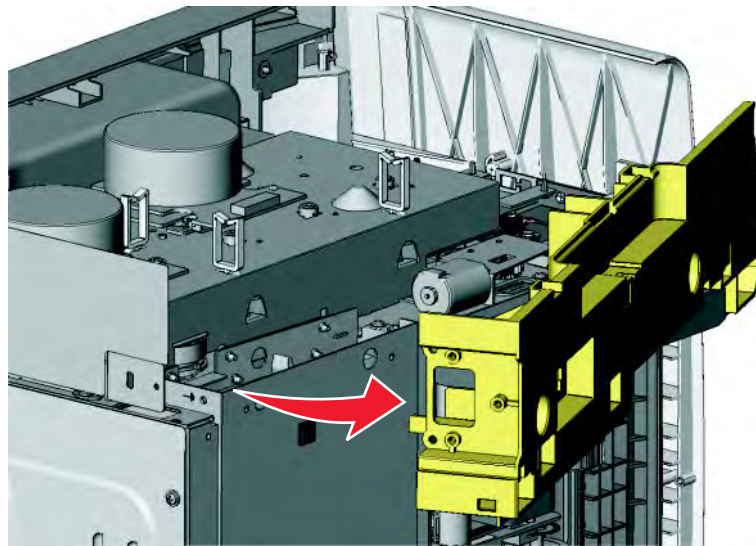

Lower right frame removal

- 1** Remove the waste toner bottle. See [“Waste toner bottle removal” on page 307.](#)
- 2** Remove the imaging unit. See [“Imaging unit \(IU\) removal” on page 303.](#)

- 3** Remove the screw (A) in the waste toner bottle sensor contact to allow access to the cable cover, and remove the four screws (B) securing the cable cover.

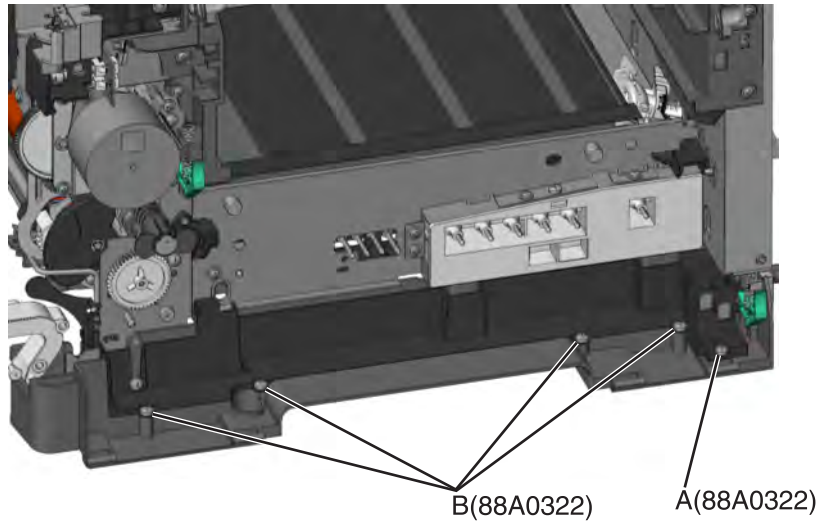

Notes:

- The waste toner bottle sensor contact does not need to be unplugged.
- The cable cover is part of the right lower frame FRU.

- 4** Carefully place the printer on its left side.
- 5** Remove the three screws (C) securing the lower right frame to the printer.
- 6** Remove the screw (D) closer to the front of the printer.

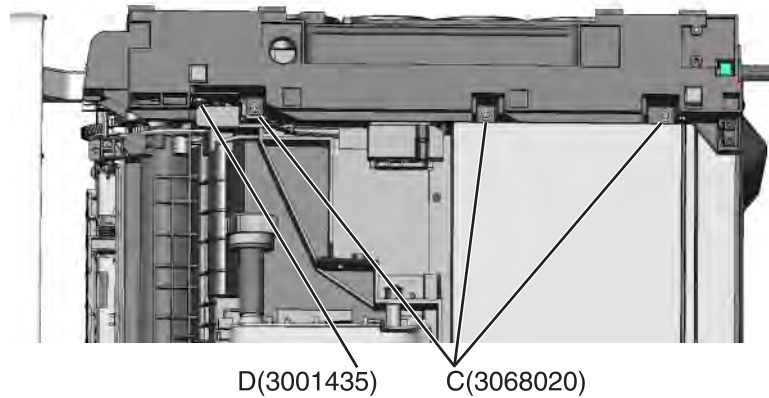

7 Next to screw, lift the right lower frame pin (E) out of the hole in the printer frame.

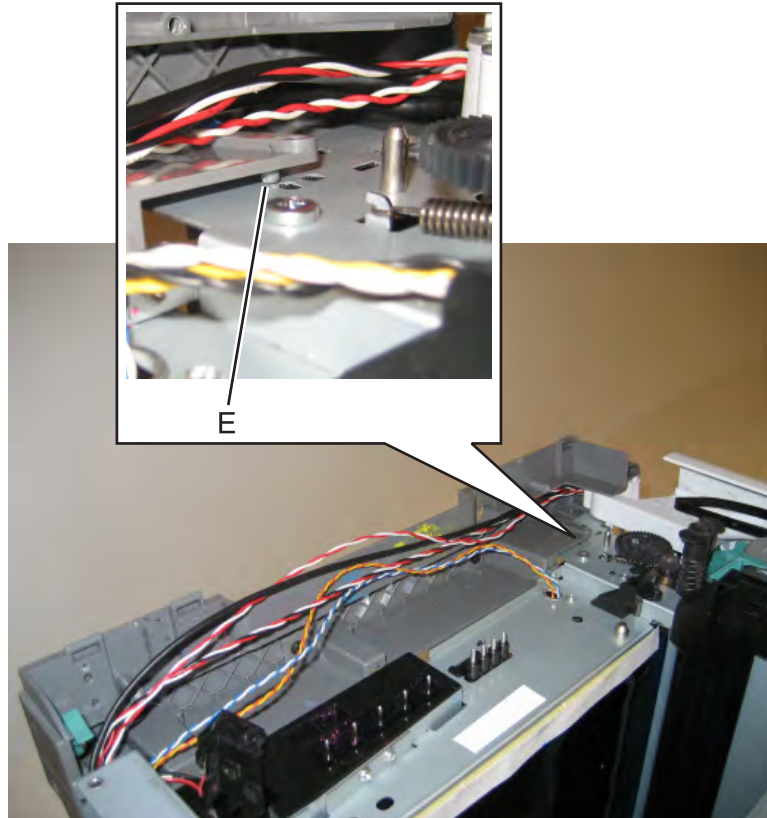

8 Swing the rear part away from the printer to access the spring, and remove the spring (F) from the right lower frame.

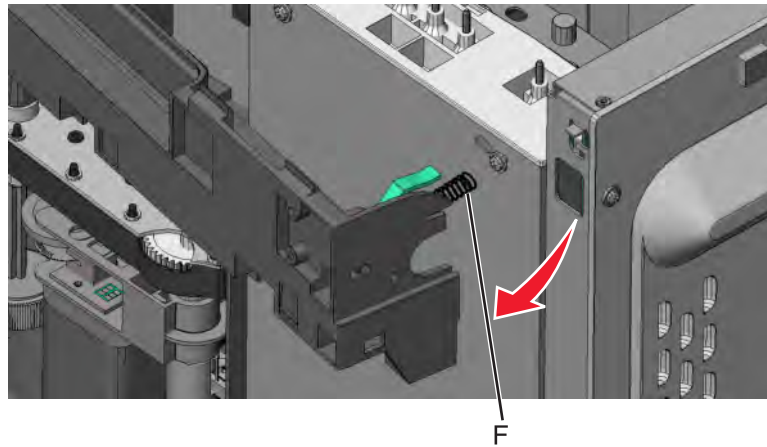

- 9 Disconnect the cable (G) from the tray present sensor.

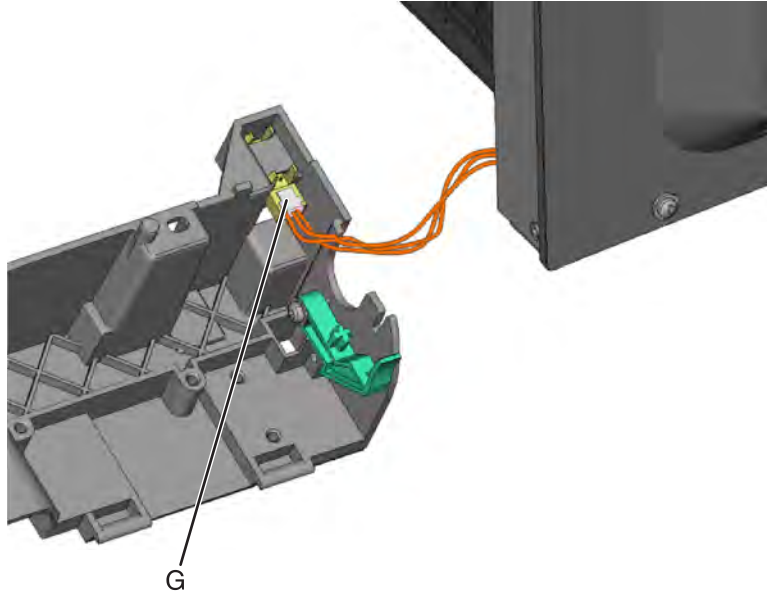

- 10 Swing the rear of the lower frame away from the printer, and remove the right lower frame.

Note: There are parts in the right lower frame that are not included in the frame. The following instructions show how to remove them.

- 11 Remove the screw (H), and remove the spring bracket.

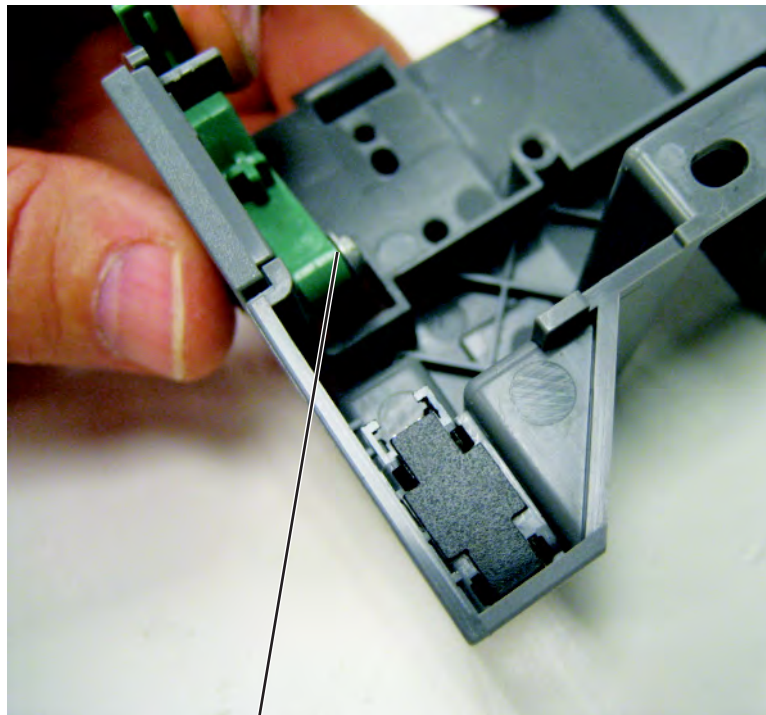

H(18B1236)

Installation notes:

- a Reinstall the spring bracket.
- b Connect the cable to the tray present sensor, and put the spring in place before installing the right lower frame.

Duplex sensor removal

- 1 Remove the imaging unit. See [“Imaging unit \(IU\) removal” on page 303](#).
- 2 Remove the two screws (A) from the cable cover.

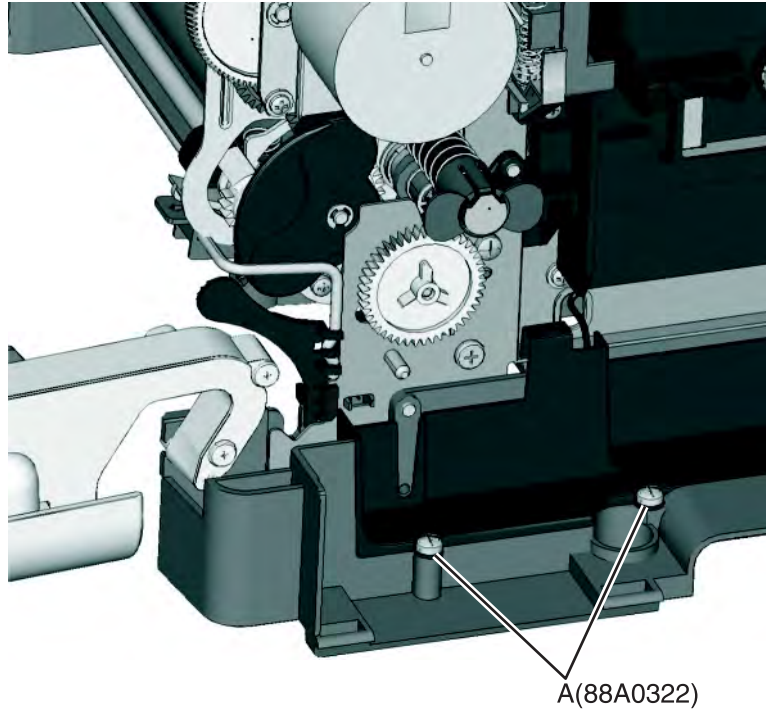

- 3 Pull the corner of the cable cover (B) away from the right side to access the two sensor posts (C).

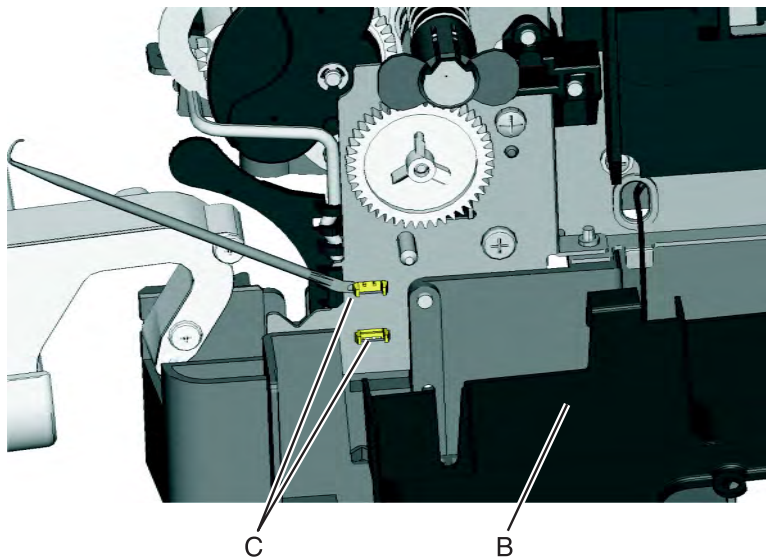

Parts removal

- 4 Remove the sensor plate (D).

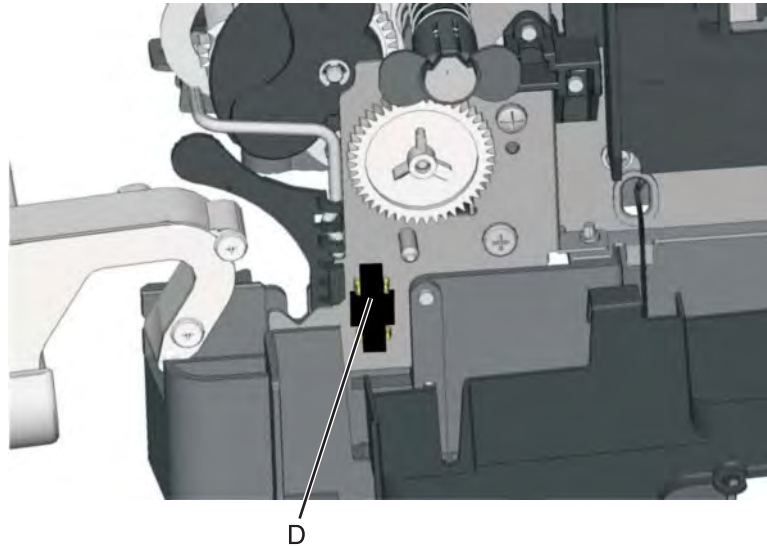

- 5 Push in on the latches to disconnect the duplex sensor from the printer.
6 Disconnect the cable (E) from the duplex sensor.

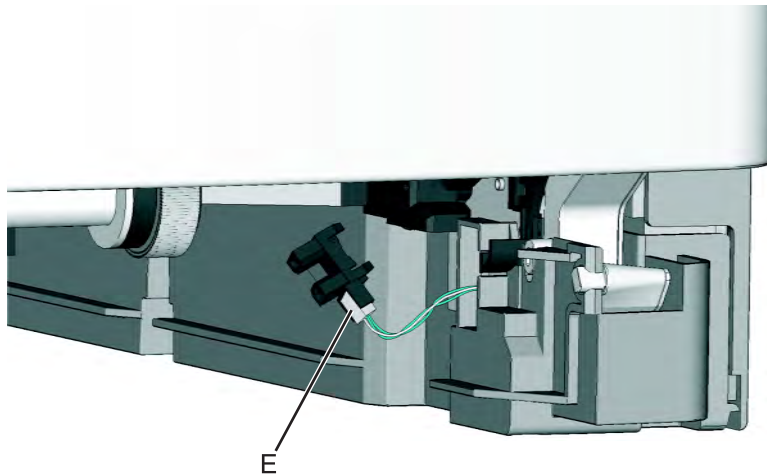

Installation notes:

- a Clean the contact surface where you removed the sensor retaining plate, or where you need to install the new one.
- b Install the new sensor.
 - Note:** Make sure the clamps on the legs of the sensor latch to the metal frame.
- c Remove the backing from the new plate, and place the plate on the surface between the sensor mounting latches.

ITU guide removal

- 1 Remove the paper tray.
- 2 Remove the right cover. See [“Right cover assembly removal” on page 288](#).

- 3 Remove the waste toner bottle. See [“Waste toner bottle removal” on page 307.](#)
- 4 Remove the imaging unit. See [“Imaging unit \(IU\) removal” on page 303.](#)
- 5 Remove the image transfer unit. See [“Image transfer unit \(ITU\) removal” on page 300.](#)
- 6 Remove the fuser. See [“Fuser assembly removal” on page 324.](#)
- 7 Remove the left cover. See [“Left cover assembly removal” on page 274.](#)
- 8 Remove the LVPS. See [“Low-voltage power supply \(LVPS\) removal” on page 285.](#)
- 9 Remove the LVPS cage. See [“EP drive assembly removal” on page 275.](#)
- 10 Remove the screw (A) and spring (B).

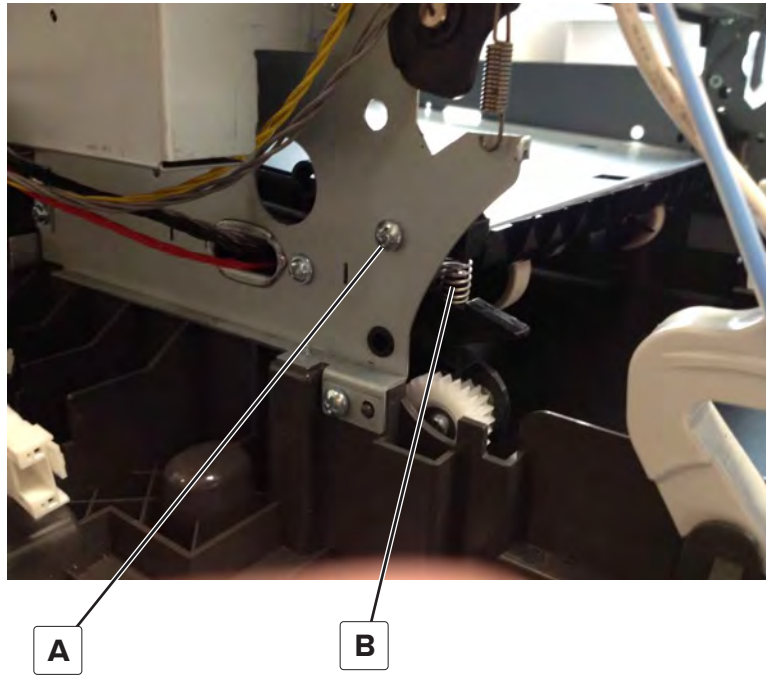

- 11 Remove the two screws securing the ITU guide to the frame.
Note: Use either a short #2 Phillips or a right angle screwdriver.

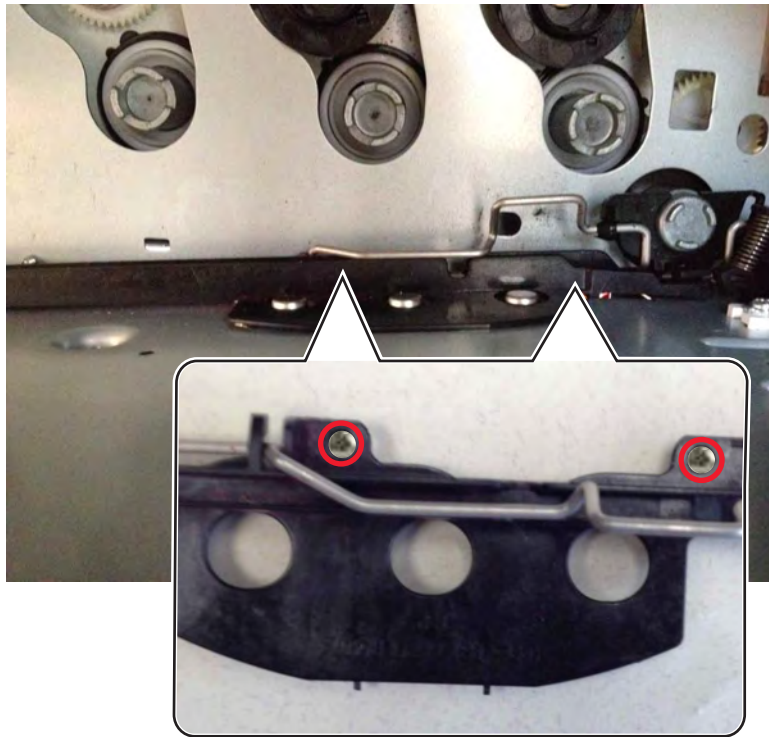

12 Remove the spring (C).

Note: Pay attention on how the spring is attached to the bail.

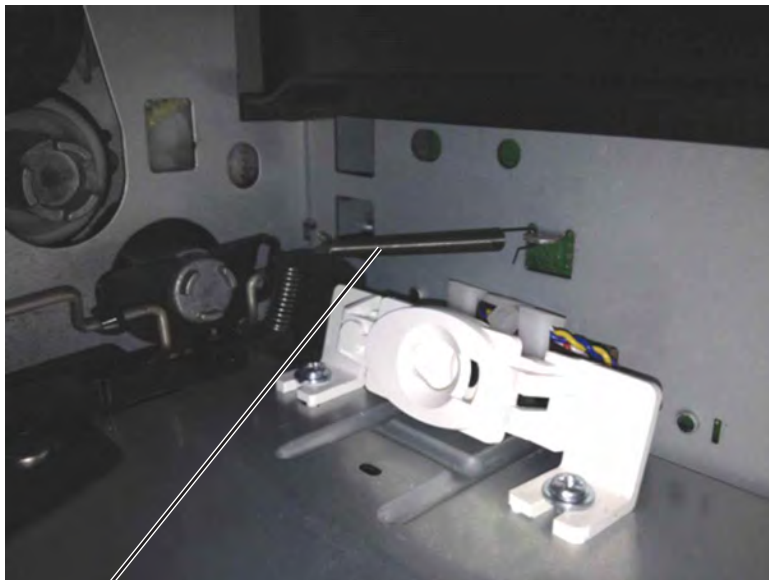

C

- 13** Press and hold the ITU drive coupling (D) using a spring hook or screwdriver, and then tilt the ITU guide up from the side with the screw holes to remove.

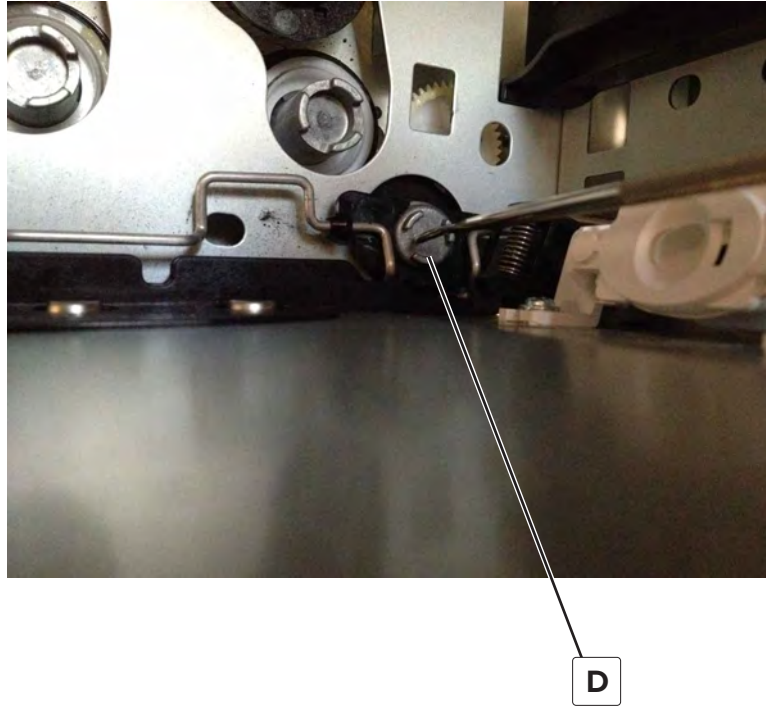

Tray present sensor removal

- 1 Remove the media tray.
- 2 Remove the imaging unit. See [“Imaging unit \(IU\) removal” on page 303](#).
- 3 Remove the rear screw (A) in the waste toner bottle sensor contact to allow access to the cable cover.

Note: The waste toner bottle sensor contact does not need to be unplugged or removed.
- 4 Remove the four screws (B) from the cable cover, and remove the cable cover.

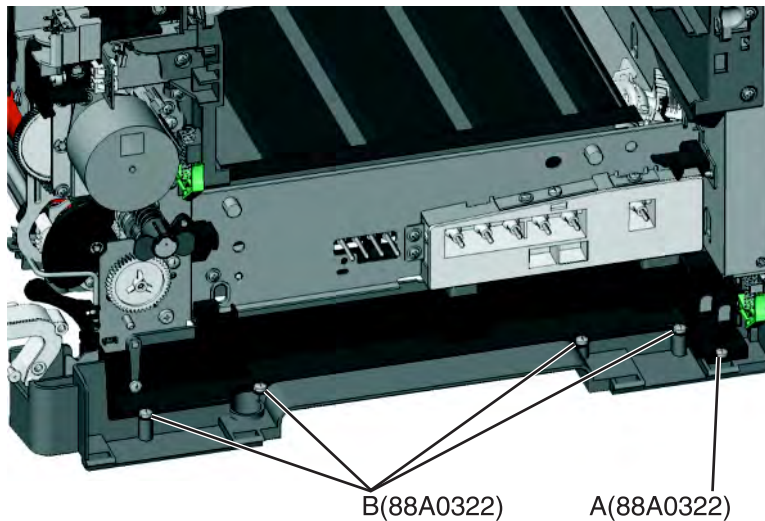

Parts removal

- 5 Remove the sensor retaining plate (C), and then pinch the latches together to remove the tray present sensor.

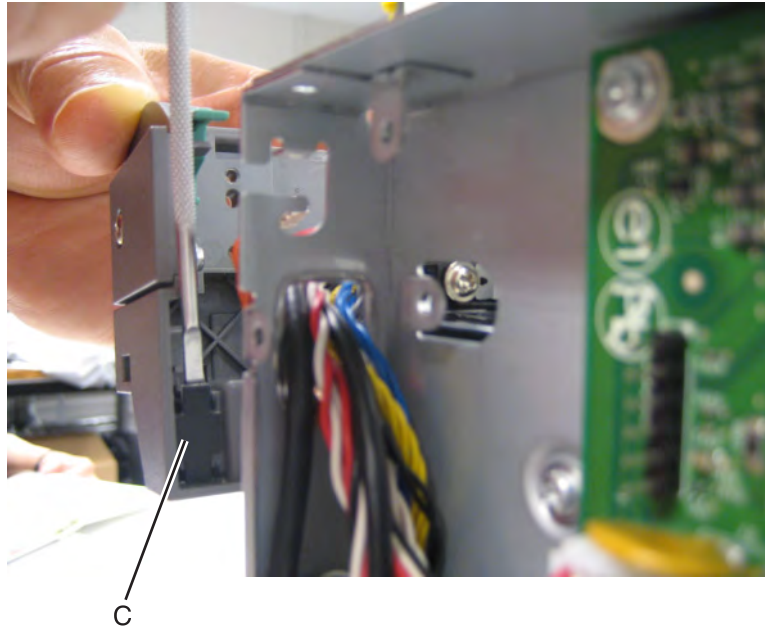

- 6 Disconnect the tray present sensor cable.

Installation notes:

- a Clean the contact surface where you removed the sensor retaining plate, or where you need to install the new one.
Install the sensor.
- b Remove the backing from the new plate, and place the plate on the surface between the sensor mounting posts.
- c Connect the cable to the tray present sensor.
- d Replace the spring.

Paper pick motor drive assembly (standard tray) removal

- 1 Remove the waste toner bottle. See [“Waste toner bottle removal” on page 307.](#)
- 2 Remove the imaging unit. See [“Imaging unit \(IU\) removal” on page 303.](#)
- 3 Remove the left cover assembly. See [“Left cover assembly removal” on page 274.](#)
- 4 Remove the rear cover. See [“Rear cover removal” on page 346.](#)
- 5 Disconnect the paper pick motor drive assembly cable connector (A) from JSP1 on the controller board.

- 6 Pull the cable (B) through the opening, and free the cables from their retainers (C) on the left.

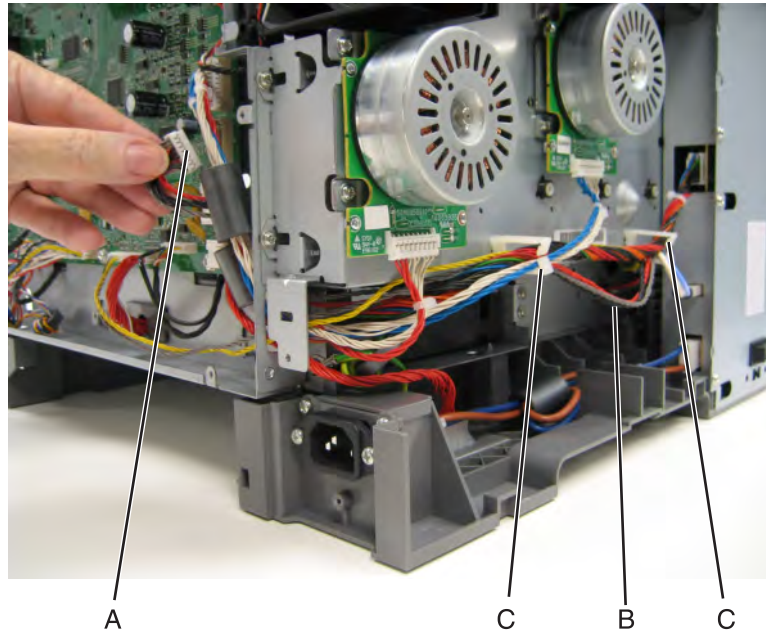

- 7 Partially reinstall the rear cover to protect the controller board, and turn the printer so that the rear cover rests on the table. The bottom should be facing you.

Warning—Potential Damage: For models with a wireless antenna, use supports to prevent the antenna from taking the weight of the printer.

- 8 Place the printer on its rear, and remove the two screws (D) from the bottom.

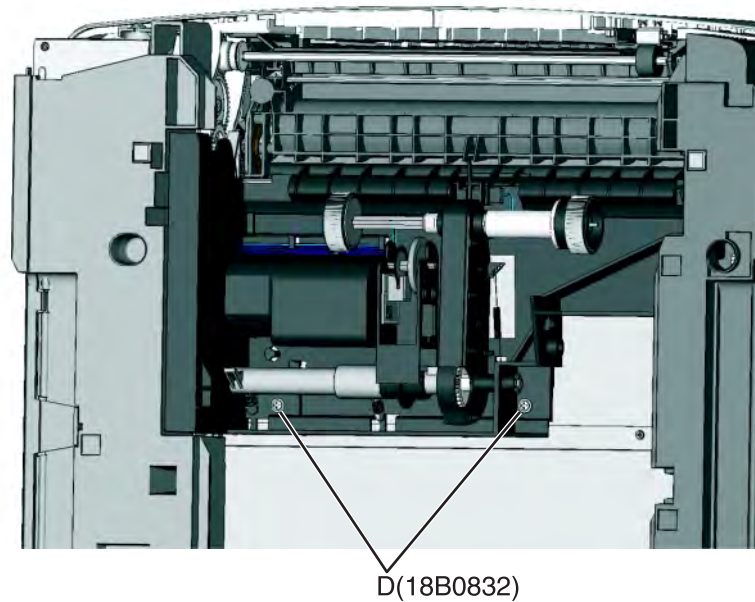

- 9** On the right side, loosen the screw (E) with a screwdriver, and hold the paper feed roller assembly in place as you use your fingers to remove the screw.

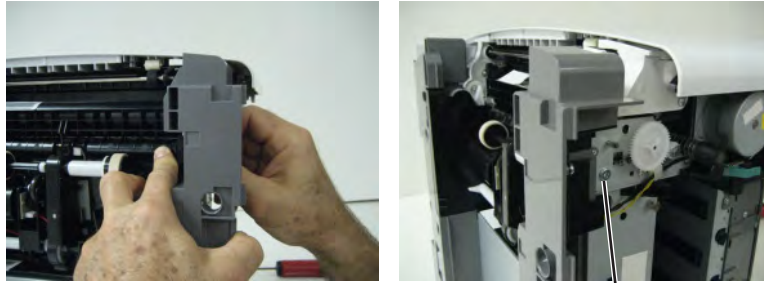

E(3000114)

- 10** Move the right side of the paper feed roller assembly out to free the shaft from the opening in the frame.

Note: Pay close attention to the location of the shaft and opening for reinstallation.

- 11** Remove the paper feed roller assembly.

Note: Be careful not to lose the springs.

Installation notes:

- a** Place the left side of the paper feed roller assembly in the printer. Make sure the shaft on the left side aligns with the hole in the frame.
- b** Install the left spring (F).
- c** Reinstall the three screws holding the paper feed roller assembly to the printer.
- d** Turn the printer to the proper upright position.
- e** Reroute the cable, making sure to place the cables into the two retainers on the left side.
- f** Remove the rear cover, and reconnect the cable.
- g** Replace the rear cover.

h Install the right spring (F).

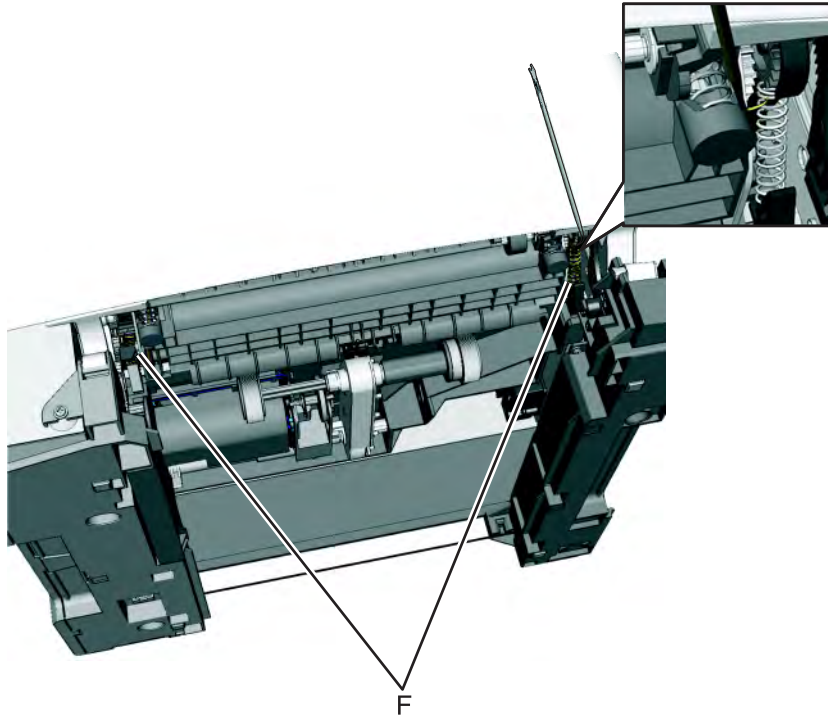

Rear side removals

Rear cover removal

1 Remove the eight screws (A).

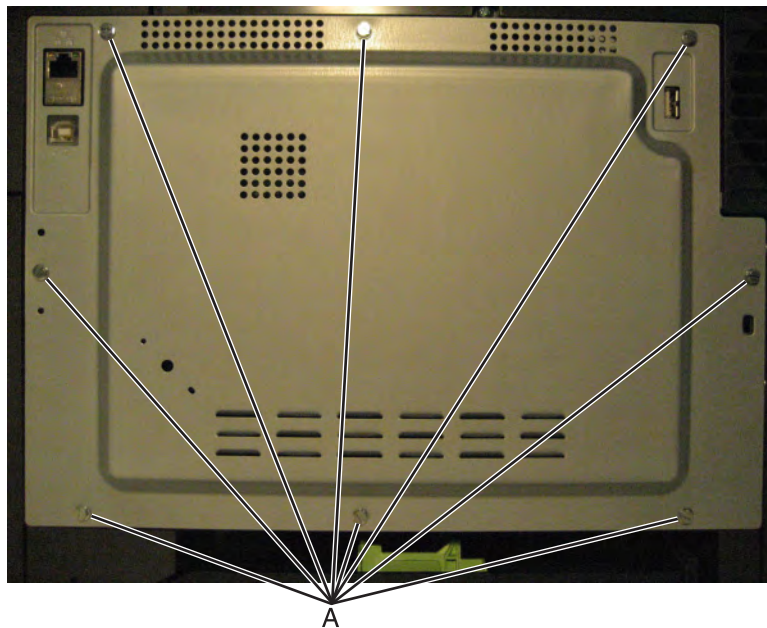

Parts removal

- 2 Swing the side of the cover out, and slide to the right to remove.

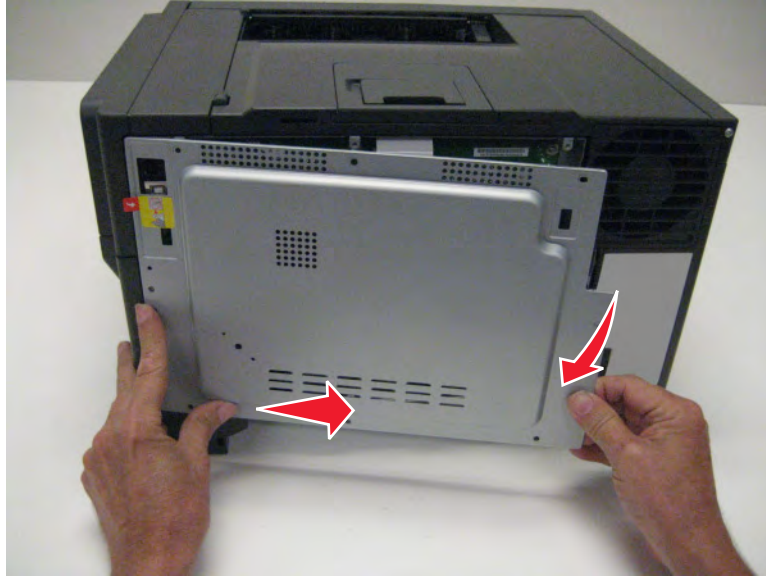

- 3 Remove the rear cover.

Installation note: When installing the rear cover, be sure that the ear (C) is inserted into the bracket (B).

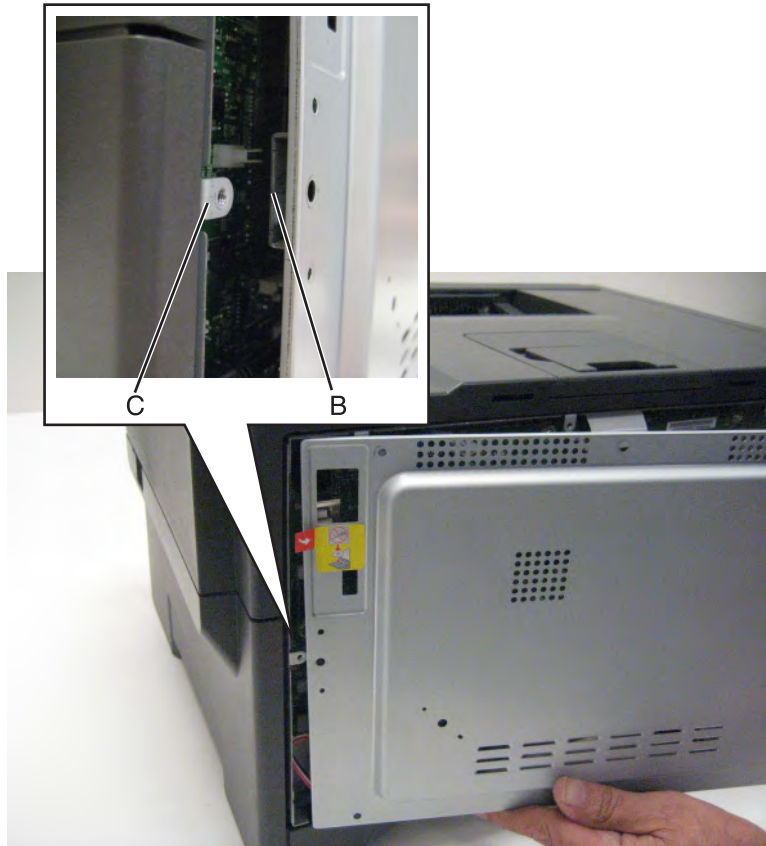

Controller board removal

Note: Back up the eSF solutions and settings before replacing the controller board. For more information, see [“Backing up eSF solutions and settings” on page 258](#).

CAUTION—SHOCK HAZARD: After disconnecting the high-voltage power cable from the controller board, always check that the HVPS connection was not loosened. Make this check anytime you are working near the HVPS cable.

Warning—Potential Damage: Observe all ESD precautions while handling electrostatic discharge sensitive parts. See Handling ESD-sensitive parts on page 4-1.

Warning—Potential Damage: Replace one of the following components, and perform a POR before replacing a second component. Never replace both of the components without performing a POR after installing each one, or the printer may be rendered inoperable:

- UICC
- Controller board

Warning—Potential Damage: Never install and remove components listed above as a method of troubleshooting components. **Once one of these components has been installed in a printer, and the printer is powered on, the component cannot be used in another printer. The component must be returned to the manufacturer.**

- 1 Remove the rear cover. See [“Rear cover removal” on page 346](#).
- 2 Remove the screw (A) securing the ground cable and USB ground contact on the controller board cage.

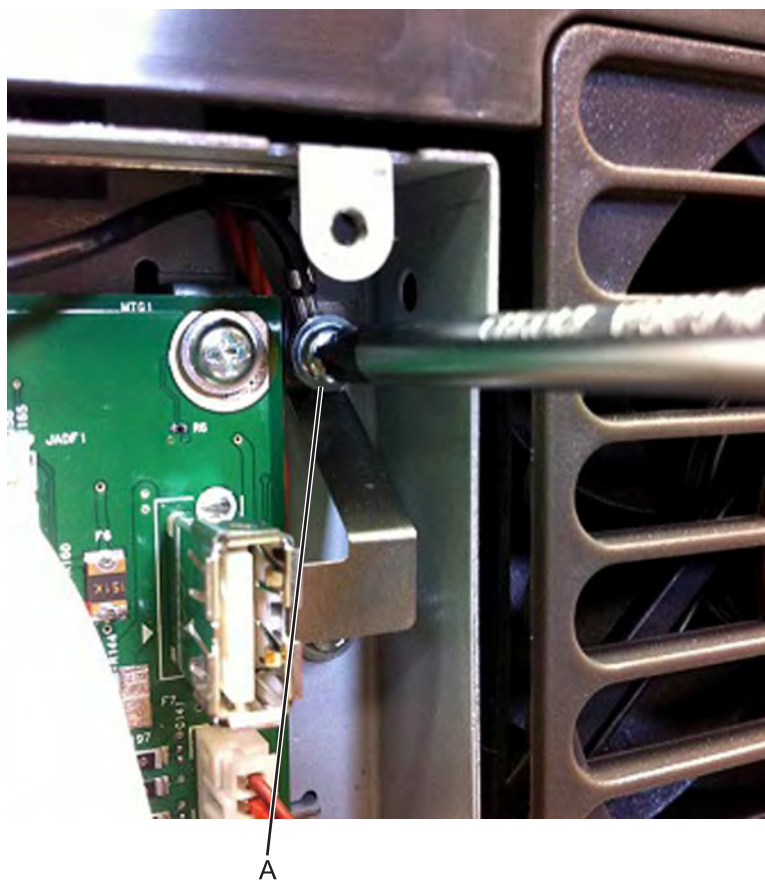

Installation note: Make sure to install the ground cable and USB ground contact on the controller board cage after installing a new controller board.

- 3** Disconnect all cables from the controller board, and then remove the six screws (B).

Note: Do not use tools when disconnecting the ribbon cables from the JPH1 and JLCD1 connectors on the controller board to avoid damage.

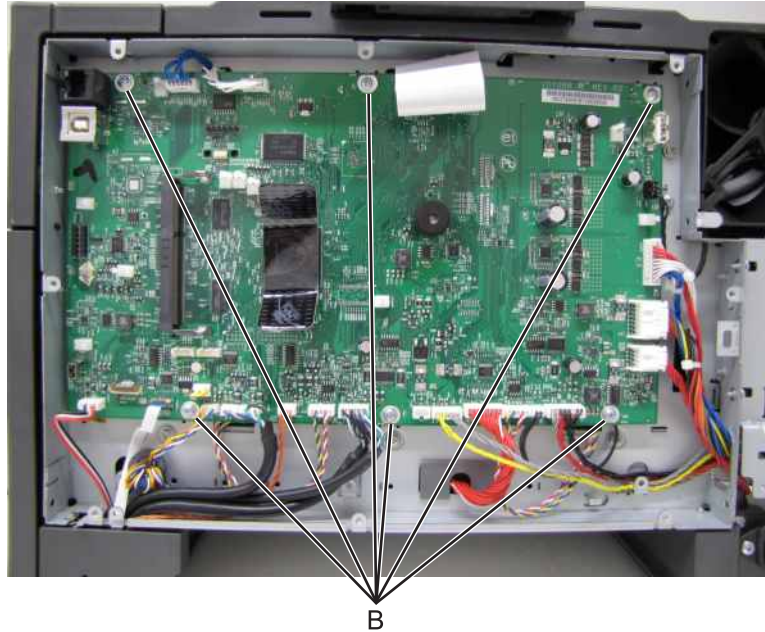

- 4** Remove the controller board.
- 5** Remove all USB grounding contacts (C) from the controller board.

Installation notes:

- Install the USB grounding contacts on the new controller board.

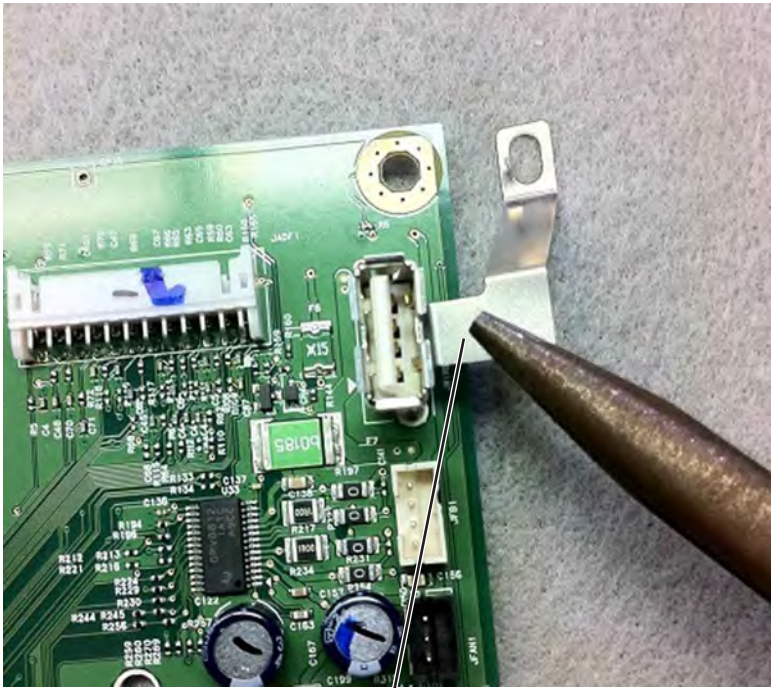

C

- Make sure the ground contact on the JUSB1 connector (D) comes into contact with the controller board cage after installing the controller board.

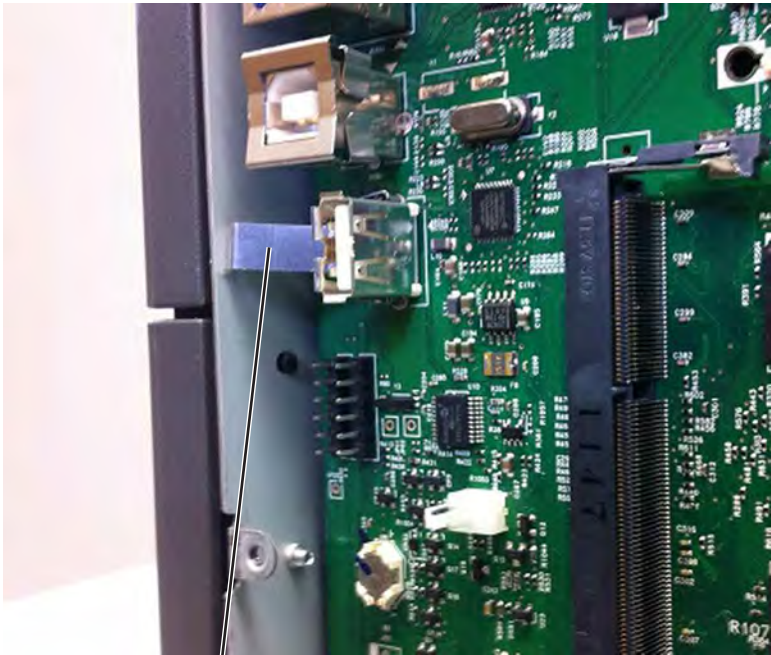

D

Warning—Potential Damage: When replacing the controller board, verify that the cable from the high-voltage power supply is seated properly. The cable may have been loosened from the HVPS. Print a few pages to verify the installation. If the pages are blank, then confirm that the high-voltage power supply cable is properly seated. The connector may have been loosened at the HVPS. A blank page that should have toner on it could be an indication that toner is applied to the ITU belt but is not transferred. Therefore the toner goes into the ITU cleaner which cannot process massive amounts of toner. It is important to prevent extensive blank pages from being processed if they should have toner on them.

Installation note: After replacing the controller board, perform the Motor Detect test (see [“Motor Detect” on page 213](#)), Scanner manual registration (see [“Scanner manual registration” on page 239](#)), and the printer configuration restoration (see [“Restoring the printer configuration after replacing the controller board” on page 253](#)).

System fan removal

- 1 Remove the rear cover. See [“Rear cover removal” on page 346](#).
- 2 Remove the left cover assembly. See [“Left cover assembly removal” on page 274](#).
- 3 Remove the back AIO cable cover.
- 4 Unplug the top of the system fan from the controller board.
- 5 Unsnap the top of the system fan toward the rear.

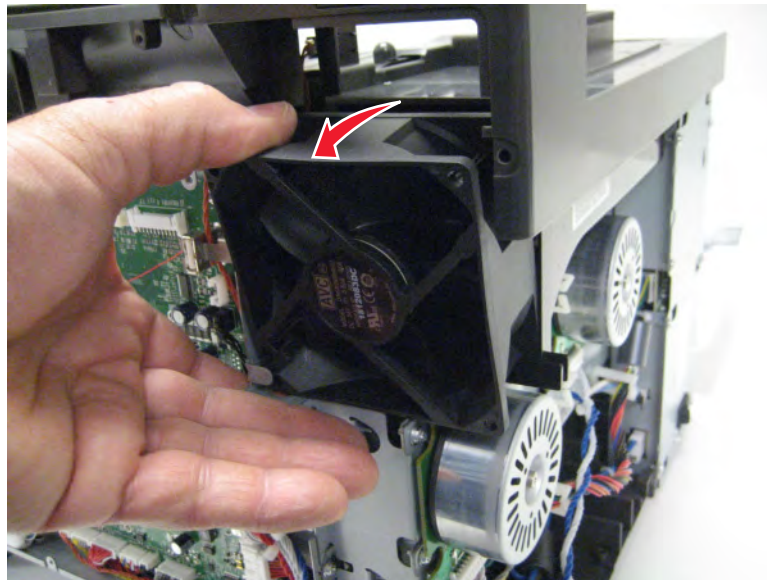

- 6 Lift the system fan out, and remove.

Note: Be careful to not pinch the cables at the top rear corner of the fan when snapping it into place.

Top side removals

Top cover assembly removal

- 1 Remove the rear cover. See [“Rear cover removal” on page 346.](#)
- 2 Remove the flatbed scanner assembly. See [“Flatbed scanner assembly removal” on page 374.](#)
- 3 Remove the two screws (A) from the rear of the top cover assembly.

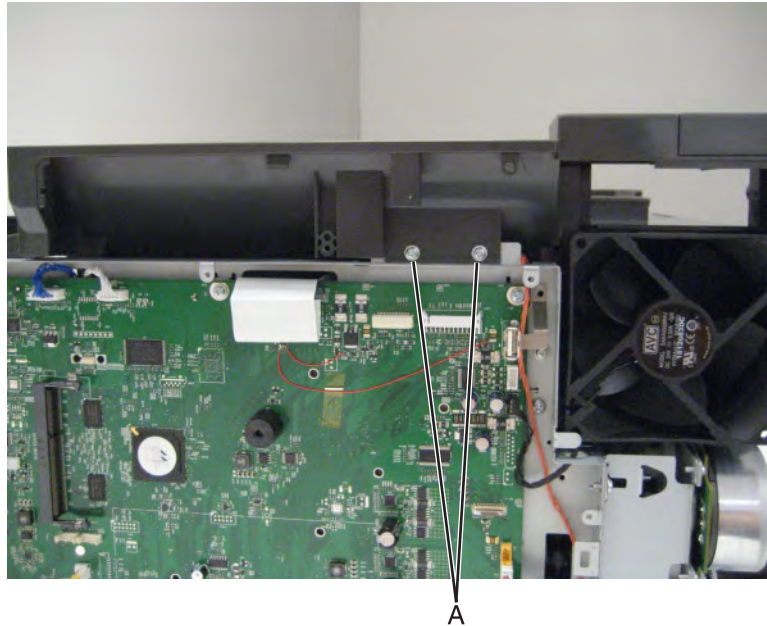

- 4 Remove the six screws (B) from the right side of the top cover assembly.

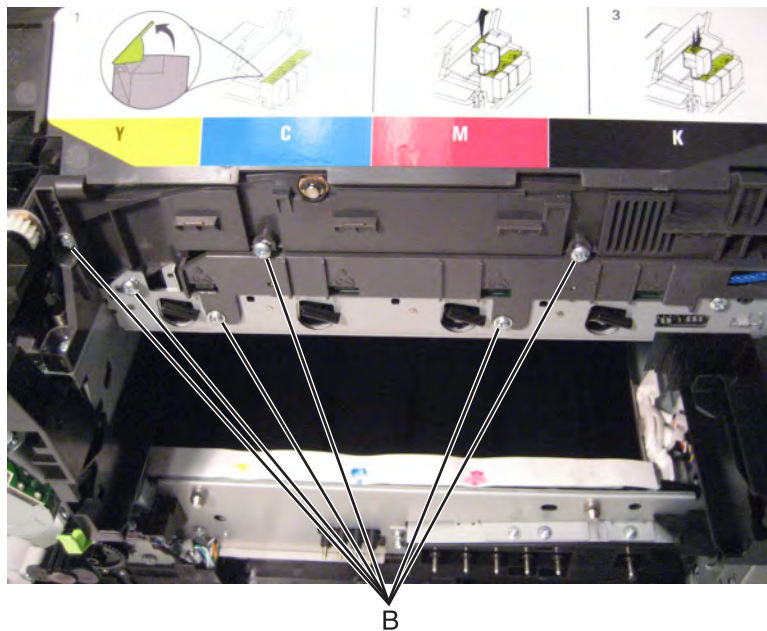

5 Disconnect the belt (C).

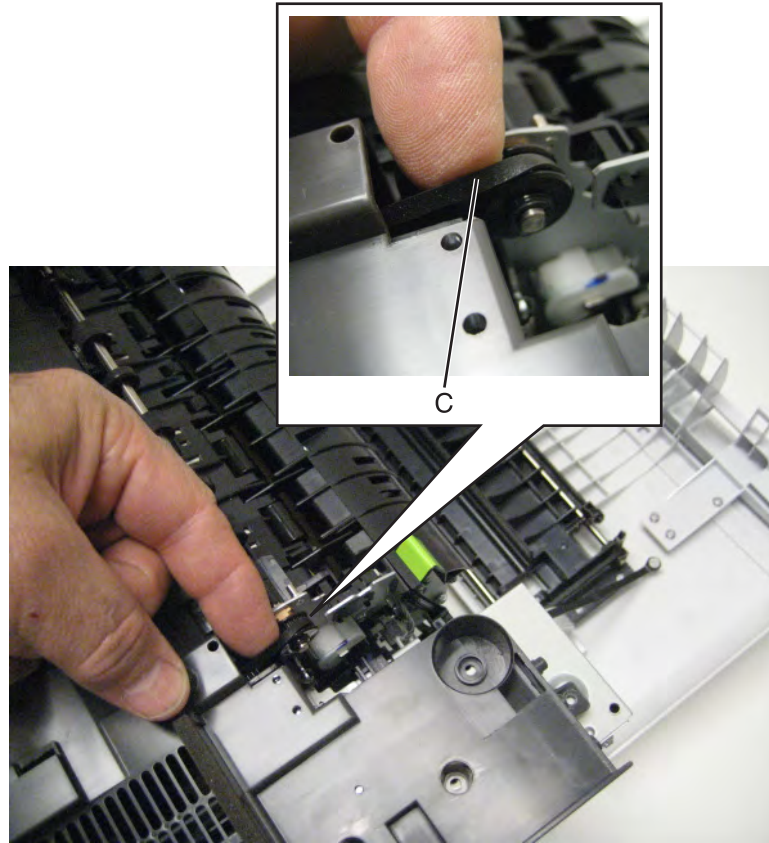

6 Disconnect the fan, and remove.

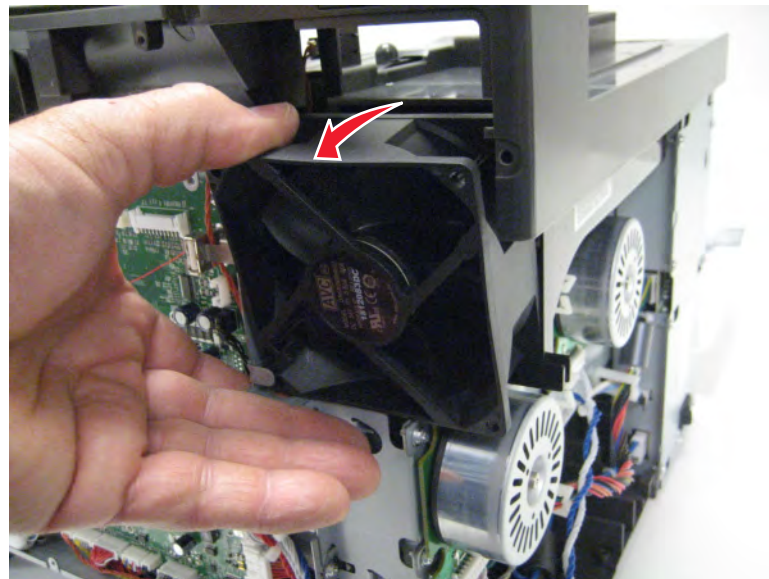

7 Disconnect the left flag (D) and the right flag (E).

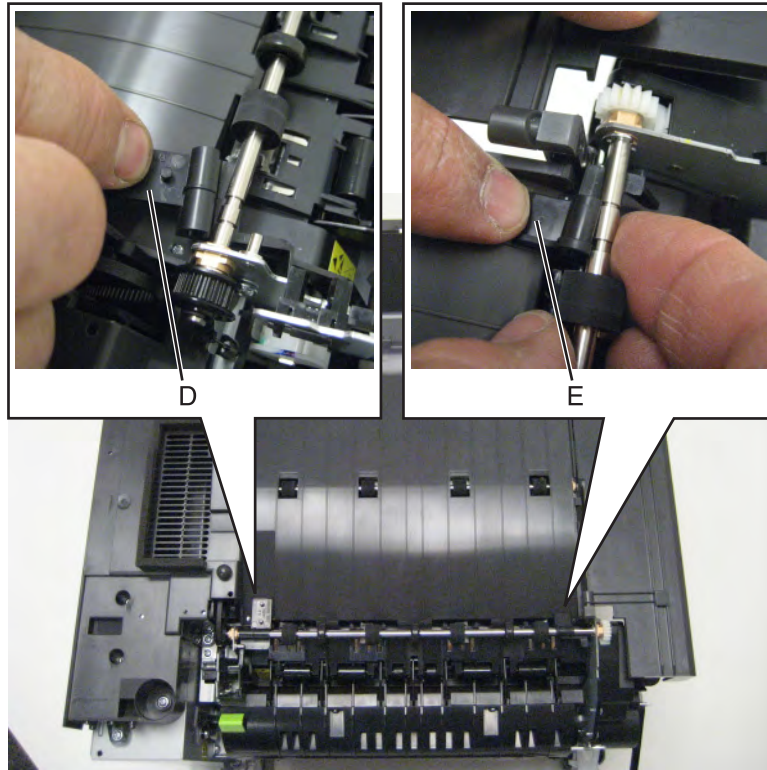

8 Remove the screw (F).

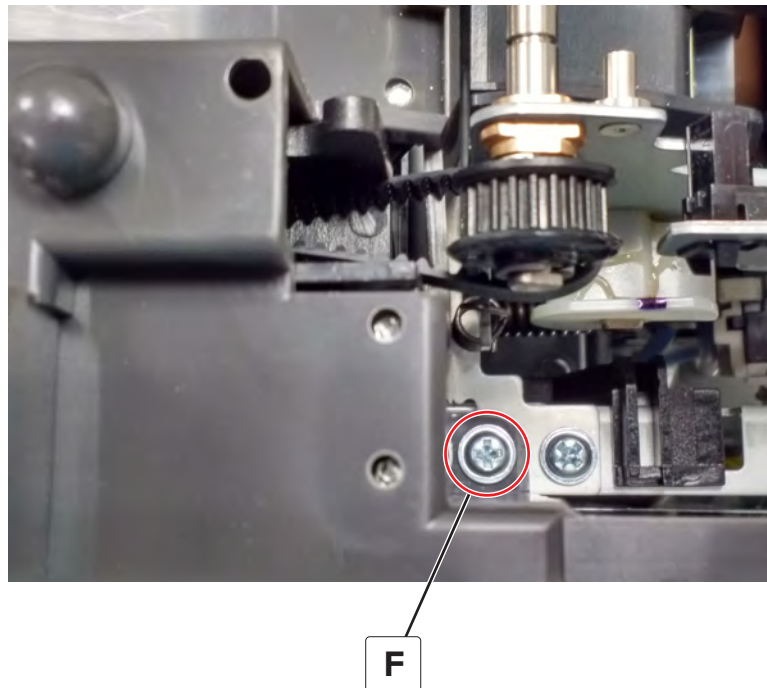

9 Remove the four screws (G).

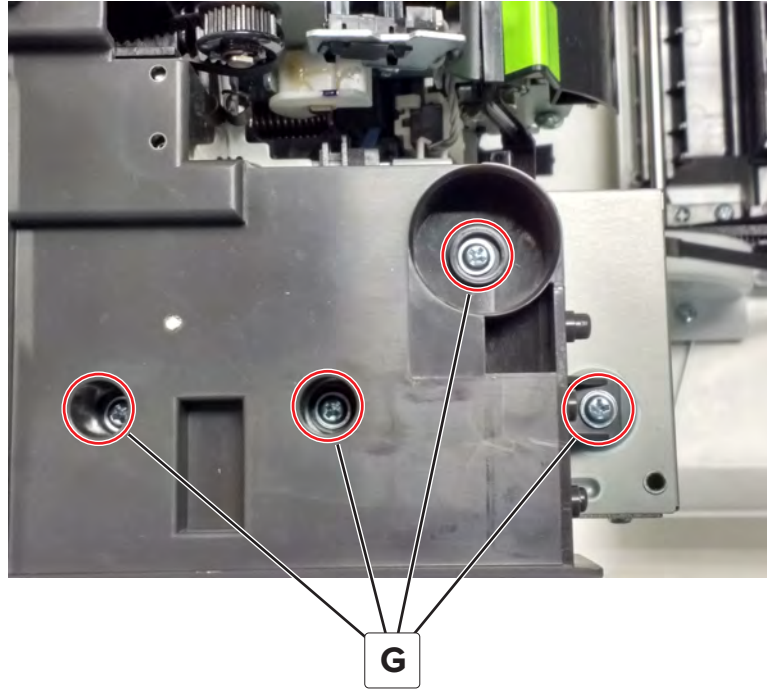

10 Remove the screw (H).

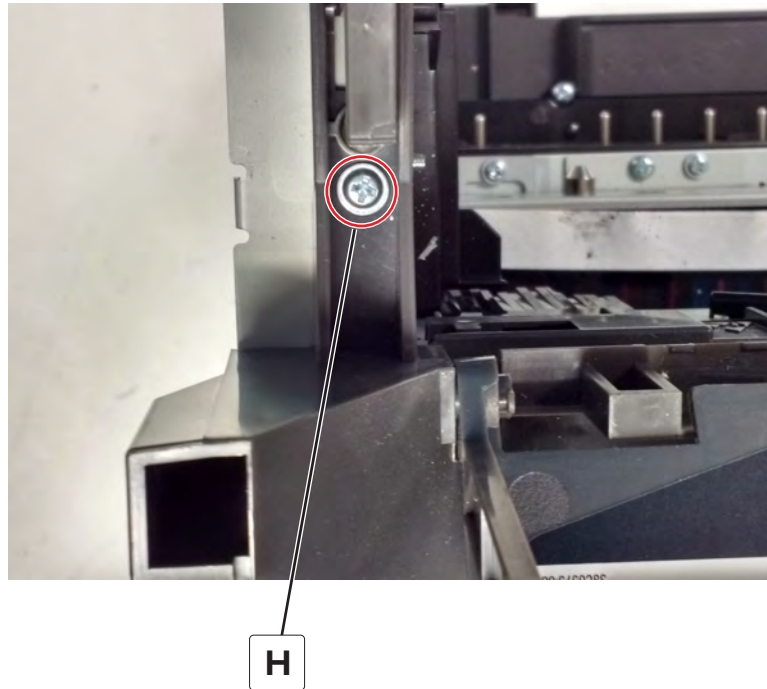

11 Remove the screw (J).

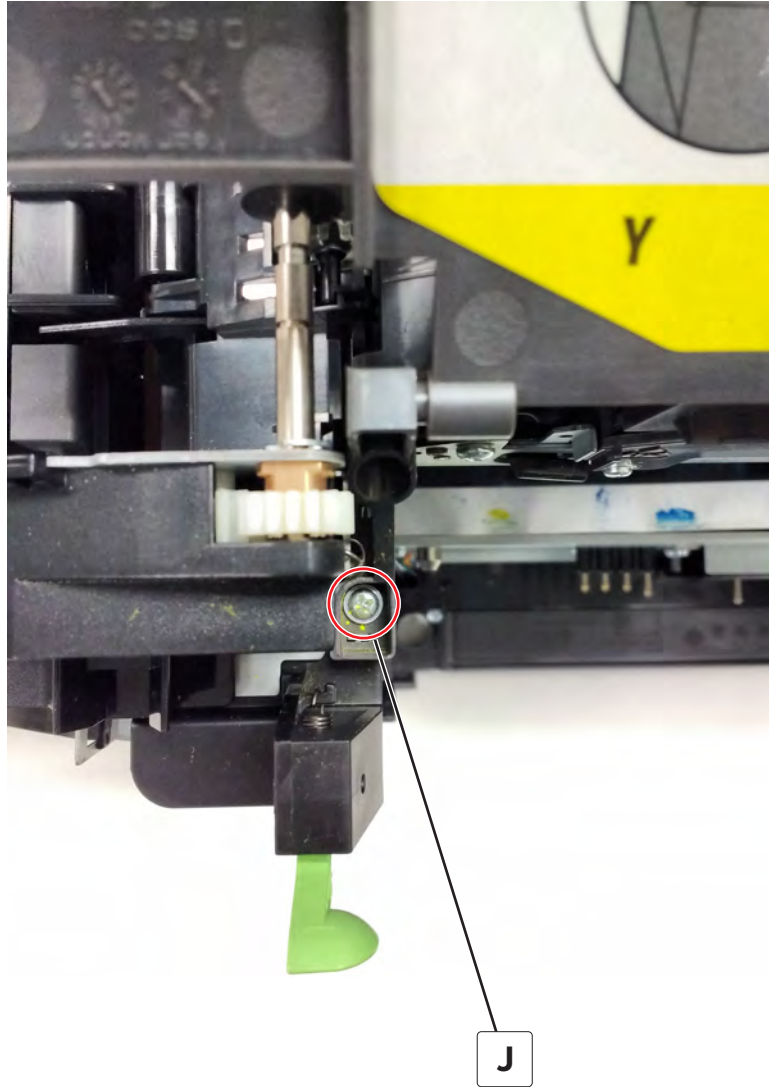

Parts removal

- 12 Lift the top cover up and away from the printer frame to remove.

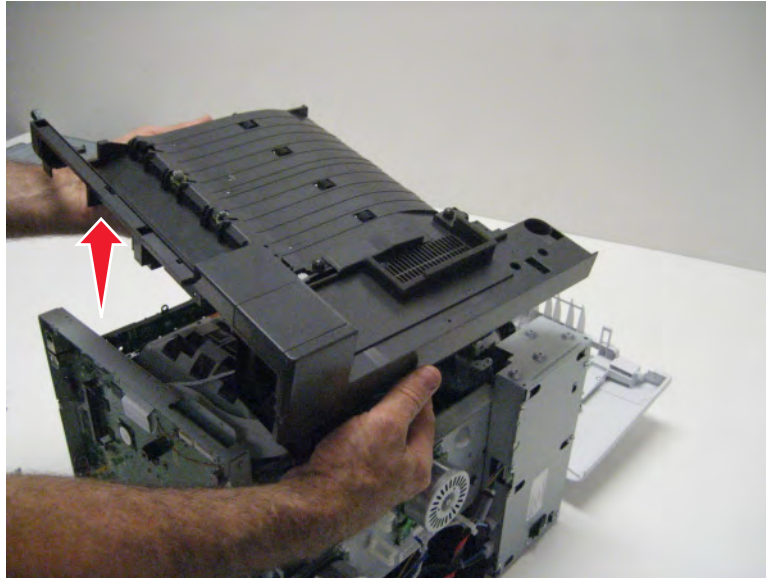

Installation note: Install the narrow media flag to the fuser before rotating the fuser into the printer.

Output bin tray and exit bail removal

- 1 Rotate the output bin tray forward.
- 2 Lift the output bin tray, and remove.

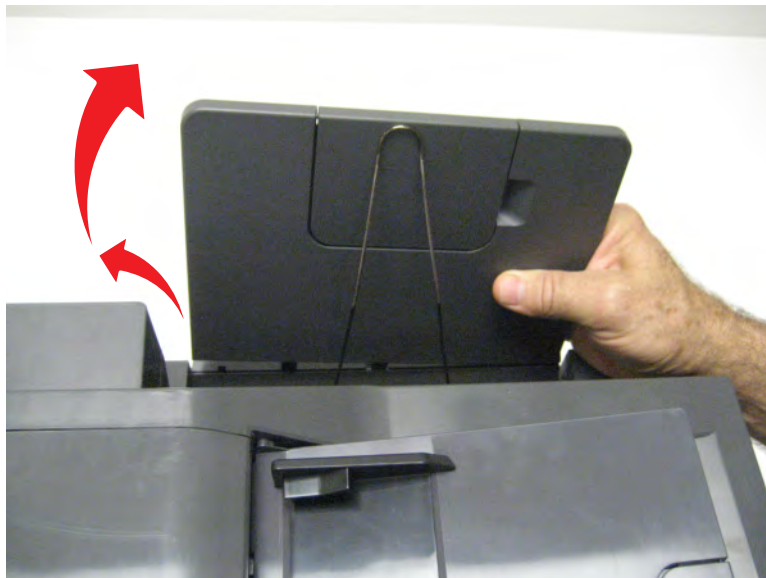

- 3 Pull out the legs of the exit bail one at a time, and lift to remove.

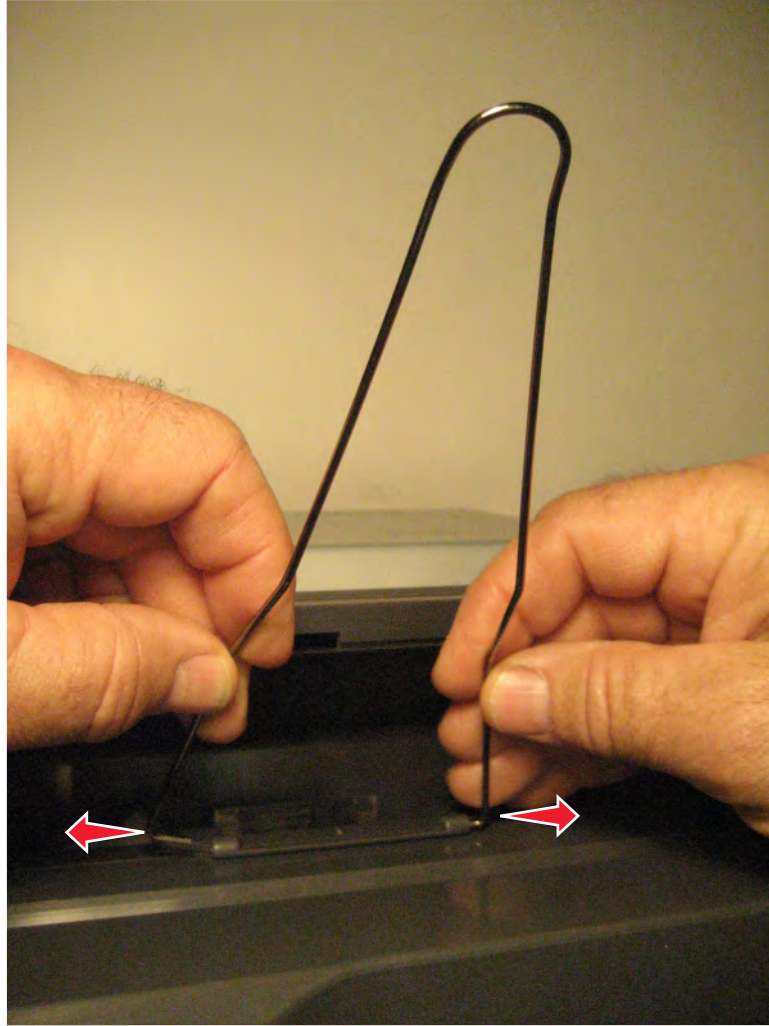

AIO toner cover removal

- 1 Lift the scanner unit to the up position.
- 2 Remove the screw (A) fastening the AIO toner cover to the scanner unit.



- 3 Remove the screws (B) securing the AIO hinge to the MFP.
- 4 Remove the hinge (C). Save this for the new AIO toner cover, or top cover.
- 5 Rotate the AIO toner cover so the tab (D) on the cover lines up with the hole on the AIO toner cover.

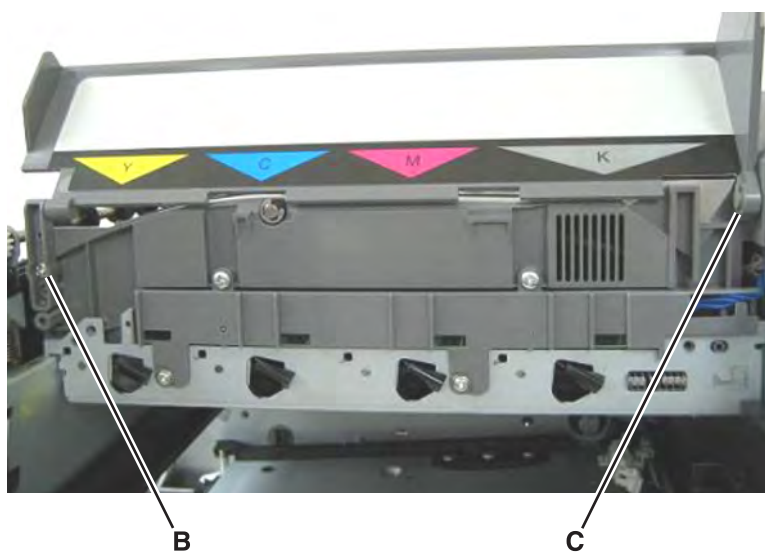

- 6 Pull the AIO toner cover to the left, and remove it from the printer.

AIO link removal

- 1 Lift the scanner to the up position. Use a Phillips screwdriver to remove the screw (A) securing the AIO link to the AIO toner cover.



- 2 Return the flatbed to the down position.
- 3 Remove the screw (B) securing the AIO link to the flatbed unit.

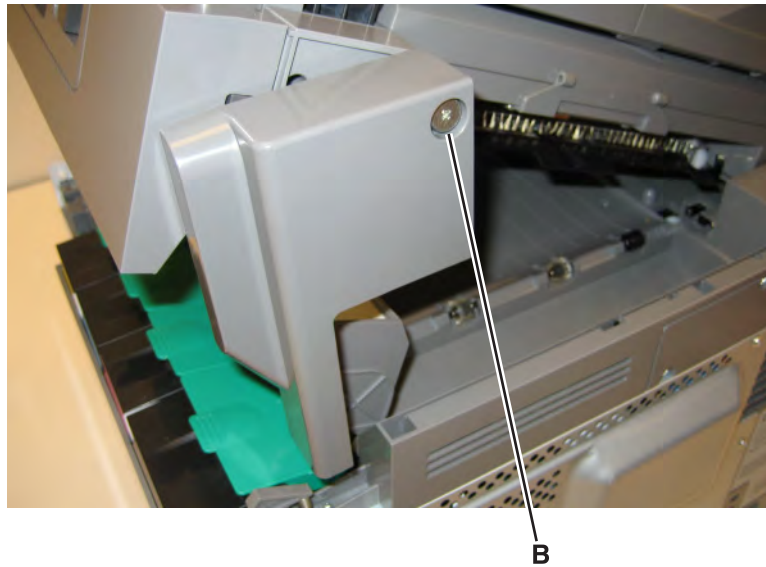

AIO release lever removal

- 1 Remove the right scanner cover. See [“Right scanner cover removal” on page 372.](#)
- 2 Remove the screw (A) securing the AIO link to the flatbed unit.

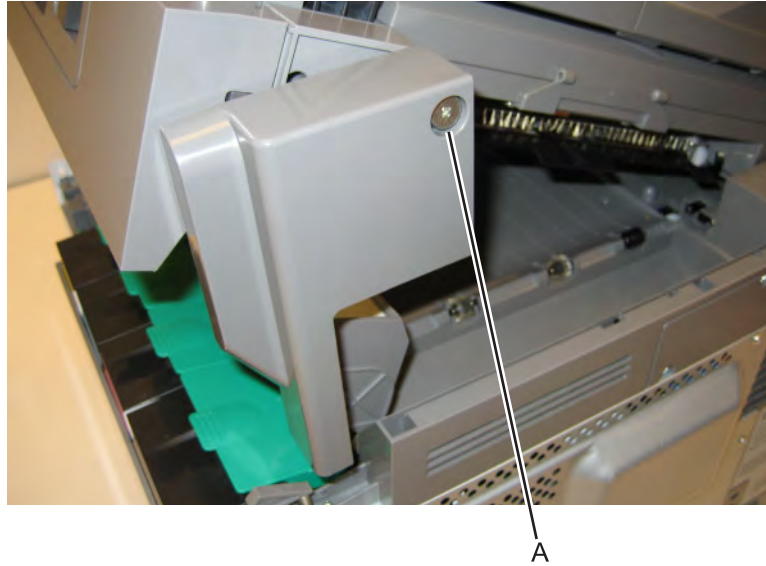

- 3 Disengage the AIO link from the flatbed unit.
- 4 Remove the screw (B) securing the AIO release lever to the flatbed.

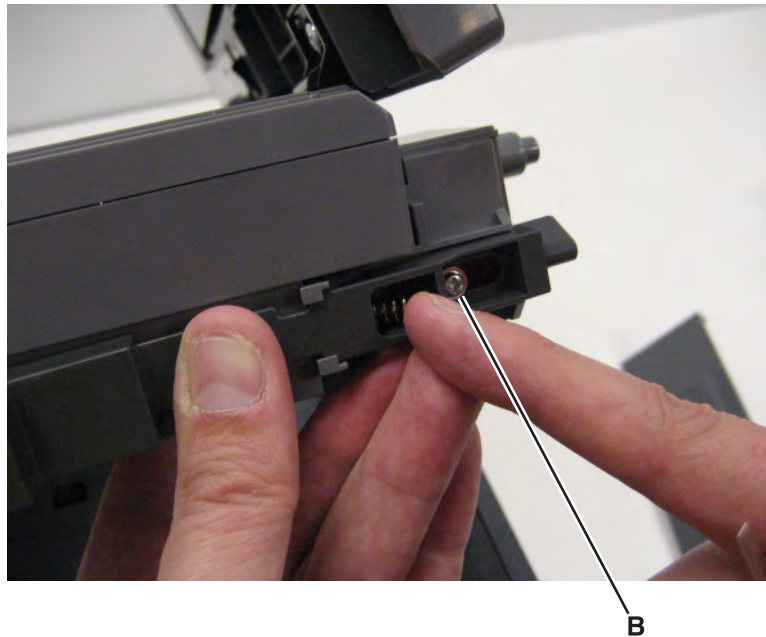

- 5 Slide the AIO release lever towards the back of the flatbed.
- 6 Remove the spring and AIO release lever.

Installation note: When reinstalling the AIO release lever, place the release lever on the flatbed, and then inset the spring before replacing the screw.

Bin-full flag removal

- 1 Lift the scanner assembly and lock it into the up position.
- 2 Gently disconnect the three snaps (A) from the rear shaft of the redrive unit.



MFP fuser deflector flag removal

- 1 Open the front cover.
- 2 Remove the MFP fuser deflector flag (A) from the shaft.



Narrow media sensor removal

- 1 Open the front cover.
- 2 Unroute the cable (A) from its retainer.

Note: Be sure to pay close attention to the routing of the cable for re-installation.

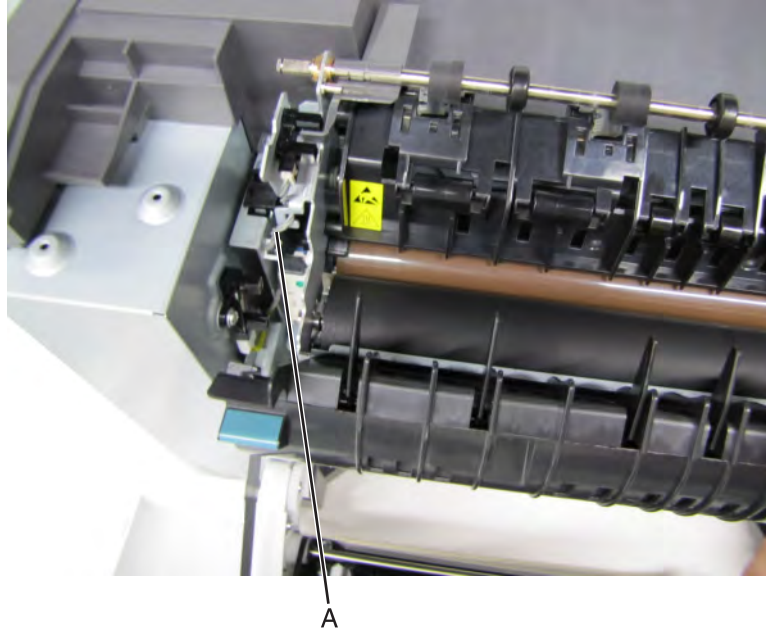

- 3 Disconnect the cable (B) from the narrow media sensor.

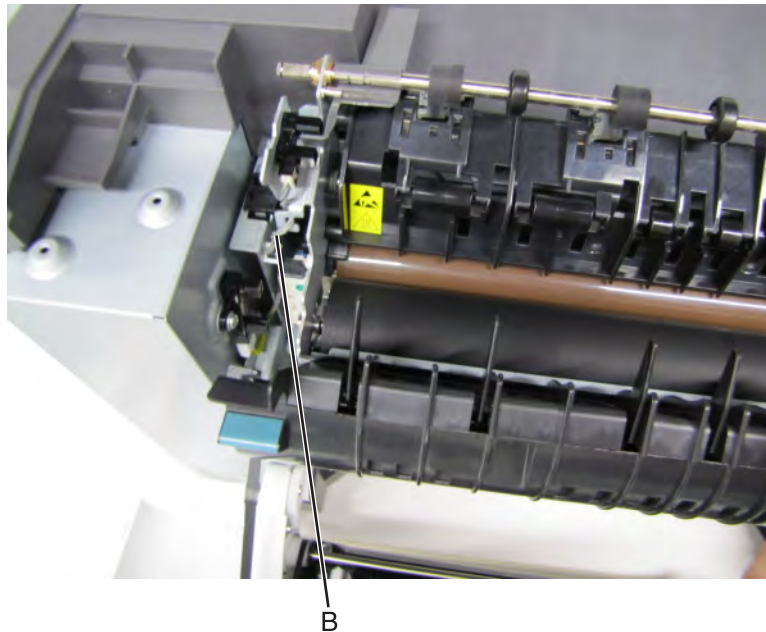

- 4 Remove the sensor retaining plate (C).

- 5 Gently remove the sensor from the bracket by pressing in on the latches (D).

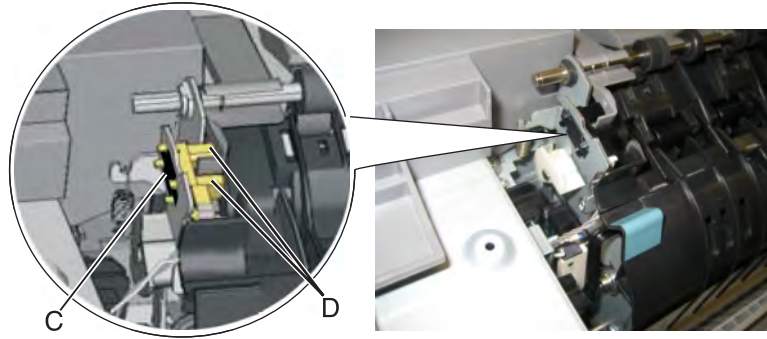

Installation notes:

- Clean the contact surface where you removed the sensor retaining plate, or where you need to install the new one.
- Guide the latches that hold the sensor in the bracket into place.
- Squeeze the latches together until they latch to the metal frame.
- Remove the backing from the new plate, and place the plate on the surface between the sensor mounting legs.
- Reconnect the cable, and reroute the cable through the retainer.

Narrow media sensor flag removal

- 1 Open the front cover.
- 2 Press upward on the tab (A) to *unsnap* the narrow media sensor flag, and remove the flag.

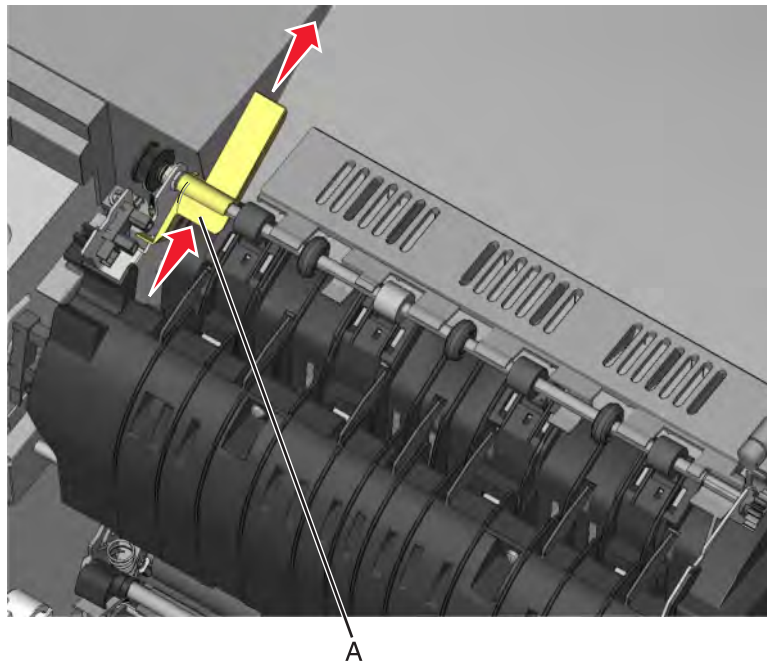

Note: Be careful to not dislodge the sensor. Because of space, this flag should be installed on the fuser while the fuser is out.

Printhead removal

- 1 Remove the top cover assembly. See [“Top cover assembly removal” on page 352.](#)
- 2 Remove the four screws (A).

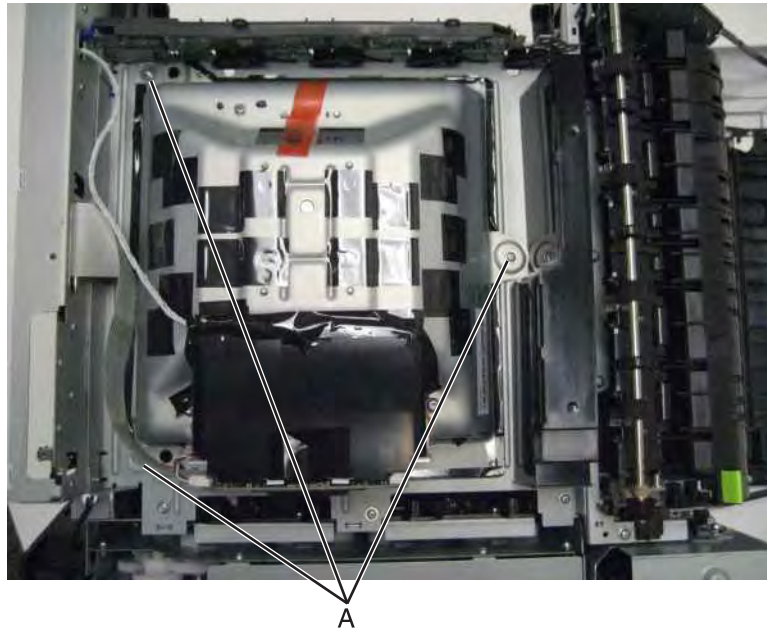

- 3 Remove the printhead.

Installation notes:

- When the printhead is replaced, perform the registration (black planes) and alignment (color planes). See [“REGISTRATION” on page 209](#) and [“Alignment Menu” on page 212.](#)
- Be sure to replace the toroid on the cable when you reinstall the printhead, and push the toroid between the connector and the top frame so that the weight is not supported by the cable.

Redrive unit removal

- 1 Remove the flatbed scanner assembly from the MFP. See [“Flatbed scanner assembly removal” on page 374.](#)
- 2 Place the flatbed facedown on a soft surface to avoid scratching the glass or marring the covers.

- 3** Remove the cable cover plate (A).

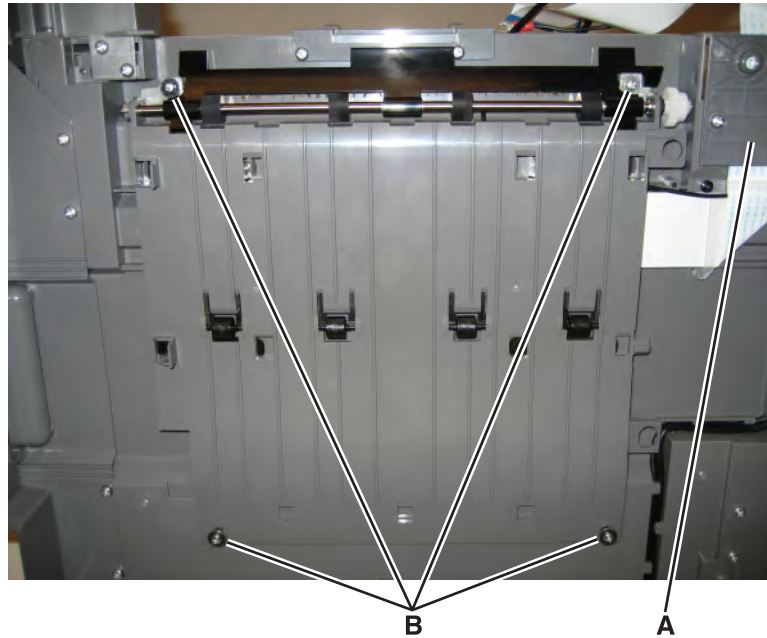

- 4** Remove the four screws (B) securing the redrive to the flatbed unit.

- 5** Remove the bin full sensor flag located on the rear shaft.

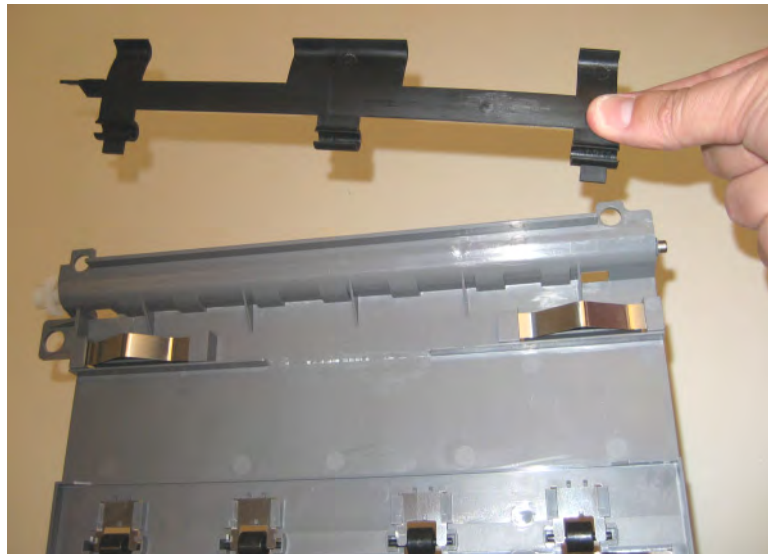

Note: Using a short (under 90mm long) #2 Phillips screwdriver, the redrive unit can be replaced by disconnecting the AIO link at the flatbed and lifting the flatbed just enough to access the left side screws. Be careful to not stress the cables in the left rear hinge.

ADF/scanner removals

ADF assembly removal

- 1 Remove the exit tray. See [“Output bin tray and exit bail removal” on page 357.](#)
- 2 Remove the rear cover. See [“Rear cover removal” on page 346.](#)
- 3 Remove the rear scanner cover. See [“Rear scanner cover removal” on page 374.](#)
- 4 Remove the ground screw (A) from the ADF assembly.

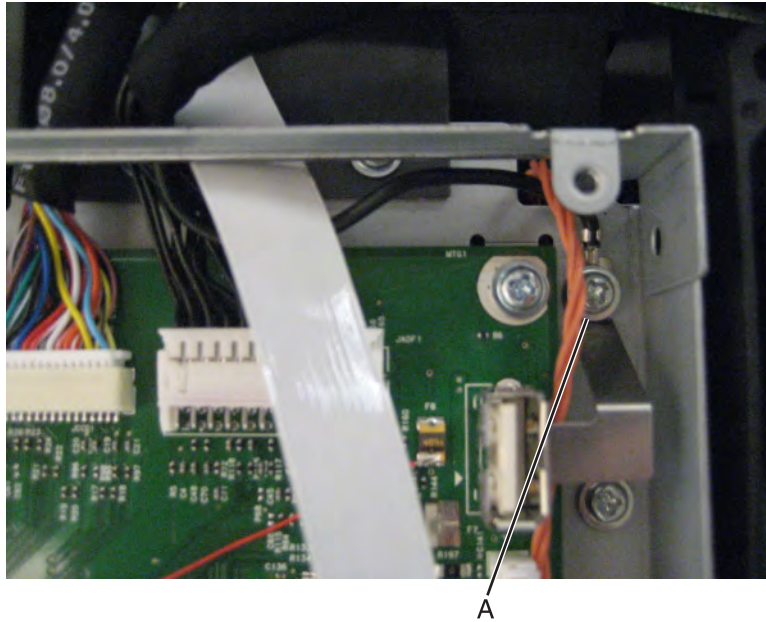

- 5 Disconnect the left hinge (B) and the right hinge (C) from the top of the printer, lift, and let the ADF assembly rest on the top of the printer.

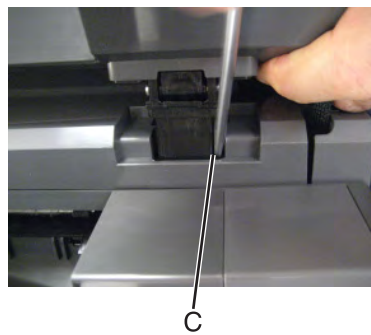
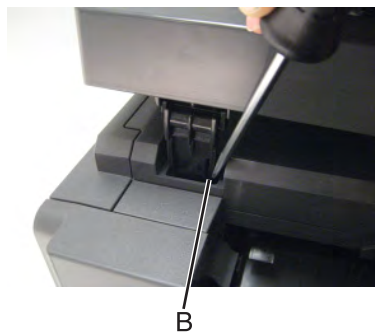

- 6 Fold the cable connector (D) parallel to the cable (E).

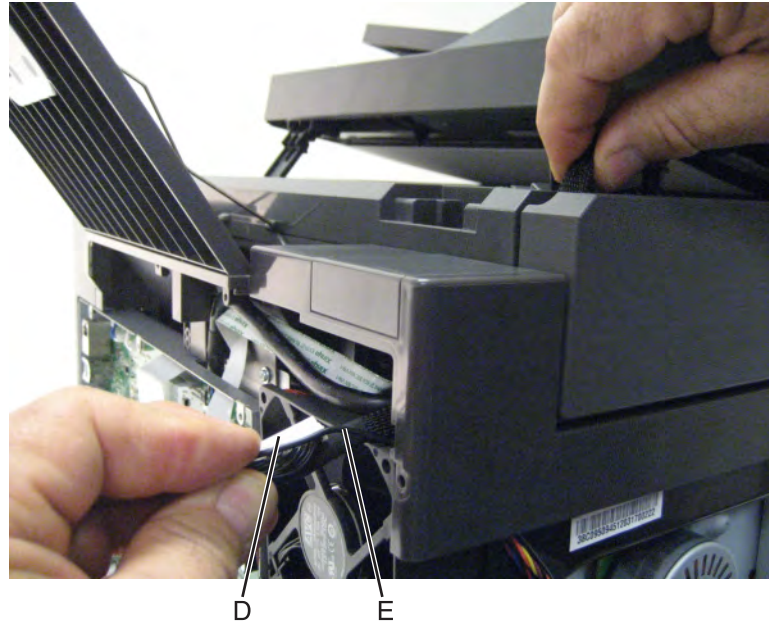

- 7 Pull the cable through the opening in the top of the printer.

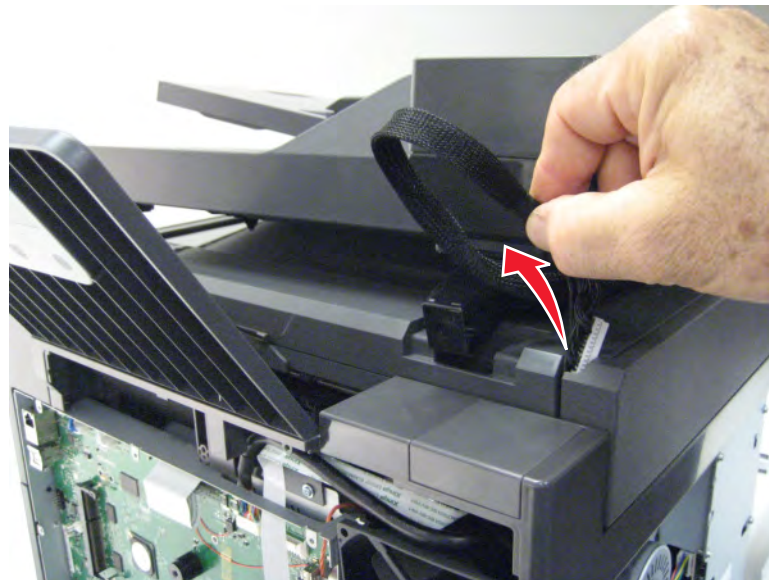

- 8 Lift the ADF assembly, and remove.

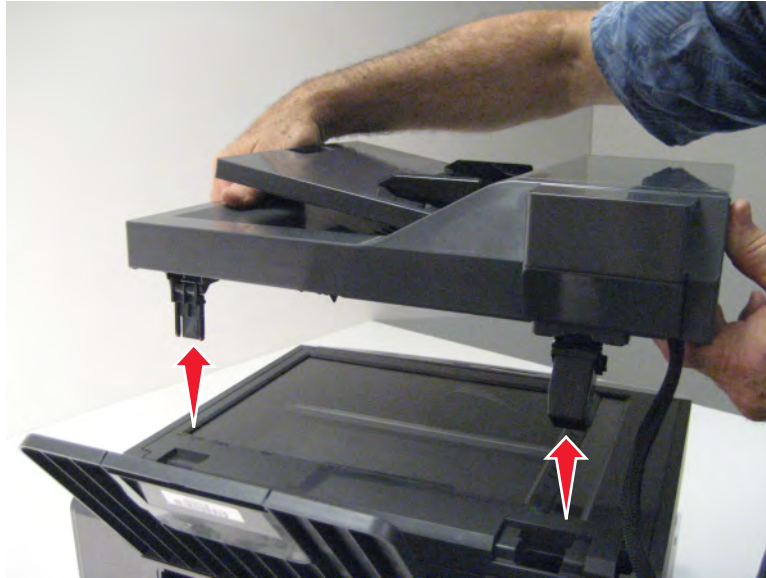

Note: After replacing this part, a scanner manual registration must be performed. See [“Scanner manual registration” on page 239](#). A scanner calibration reset must also be performed. See [“Scanner calibration reset” on page 232](#).

ADF input tray removal

- 1 Push in on the side of the ADF input tray to disconnect it from the top of the printer.



- 2 Remove the ADF input tray.

ADF separator roll removal

- 1 Open the ADF top cover.
- 2 Pinch the ADF separator retaining tabs (A).
- 3 Lift the ADF separator roll to the vertical position.
- 4 Pull the ADF separator roll up and out of the ADF unit.

ADF separator pad removal

- 1 Open the ADF top cover.
- 2 Press in on the separator retaining tabs (A), and rotate the ADF separator roll to the vertical position.

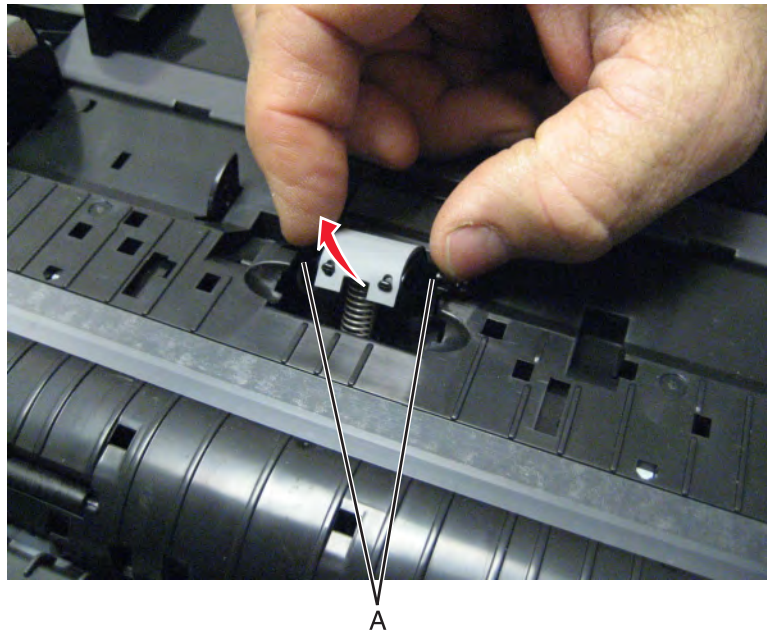

- 3 Disconnect the ADF separator pad tabs (B) from the printer, and remove.

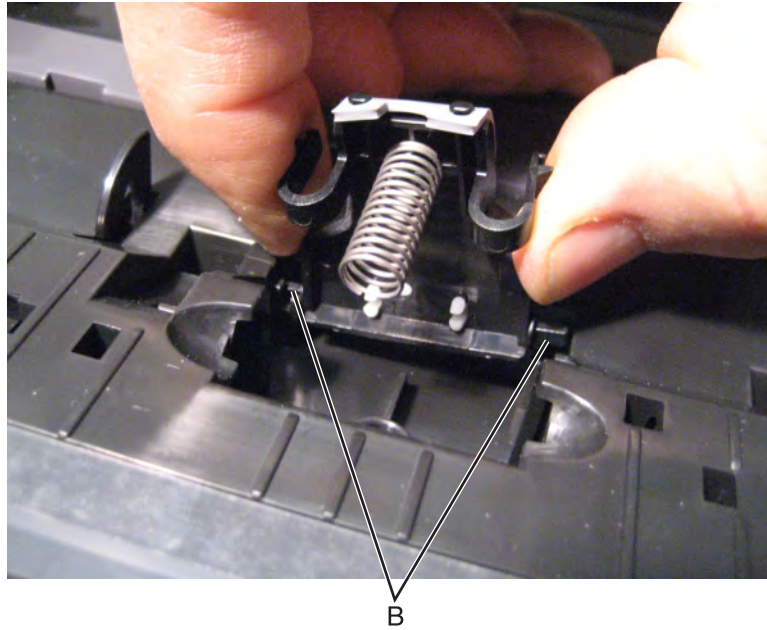

Top cover ADF sheet feed removal

- 1 Separate the top cover sheet feed from the top of the printer.

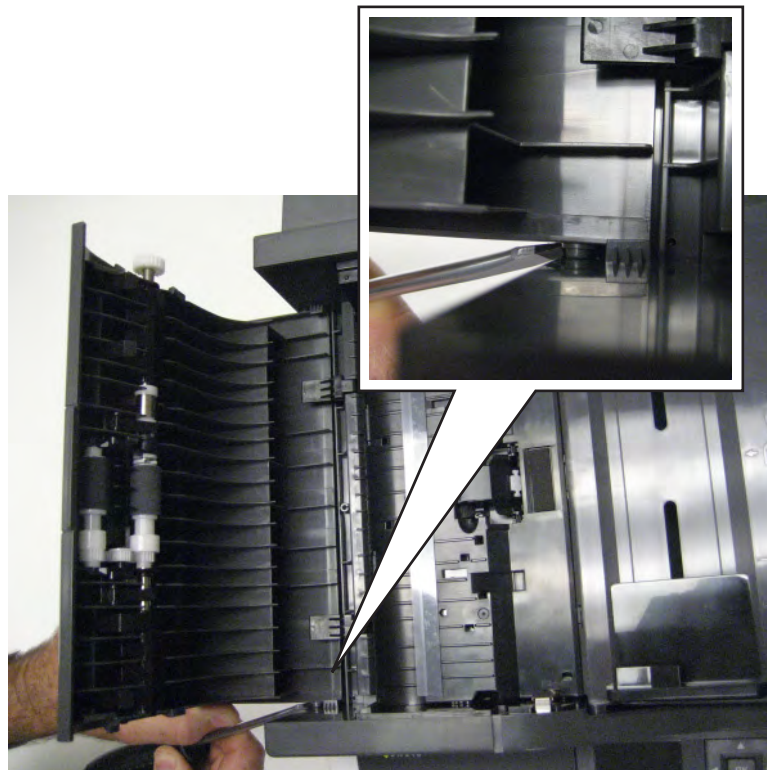

- 2 Remove the top cover sheet feed.

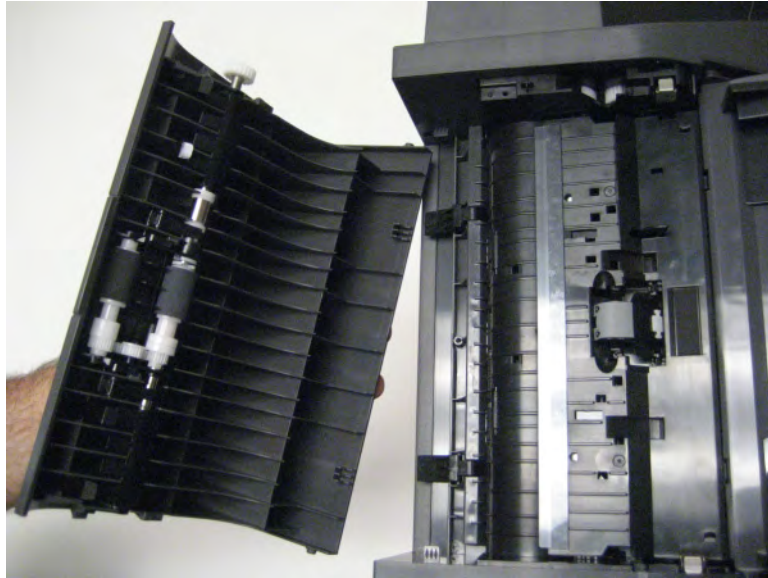

Right scanner cover removal

- 1 Remove the imaging unit in the print engine. See [“Imaging unit \(IU\) removal” on page 303.](#)
- 2 Raise the scanner assembly to the up position, and lock in place.
- 3 Remove the four screws (A) securing the right scanner cover to the flatbed unit.

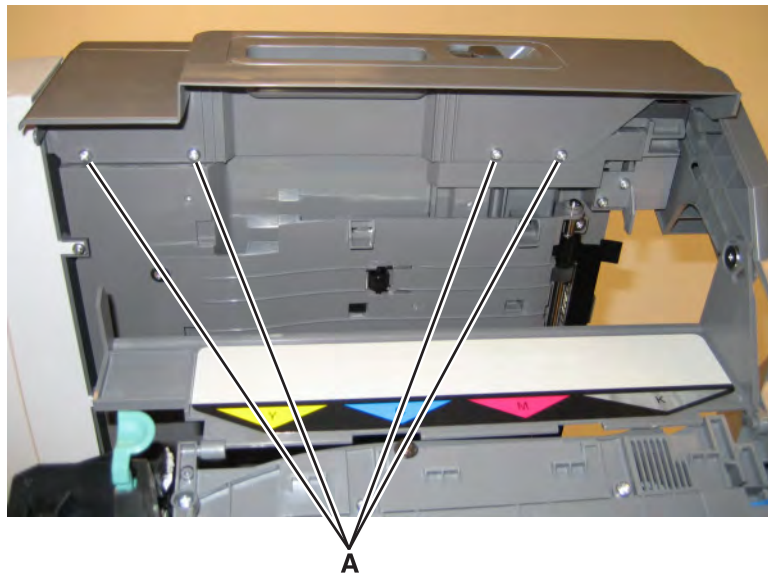

- 4 While holding the ADF away from the flatbed, use the other hand to lift and disengage the right scanner cover from the flatbed unit.



Rear scanner cover removal

- 1 Remove the two screws (A) from the rear scanner cover.



- 2 Use a flat-blade screwdriver to pry the bottom part of the cover out first.
- 3 Remove the rear scanner cover.

Flatbed scanner assembly removal

- 1 Remove the waste toner bottle. See [“Waste toner bottle removal” on page 307.](#)
- 2 Remove the right cover assembly. See [“Right cover assembly removal” on page 288.](#)
- 3 Lift the ADF assembly.

- 4 Remove the screw (A) from the right rear side lift lock.

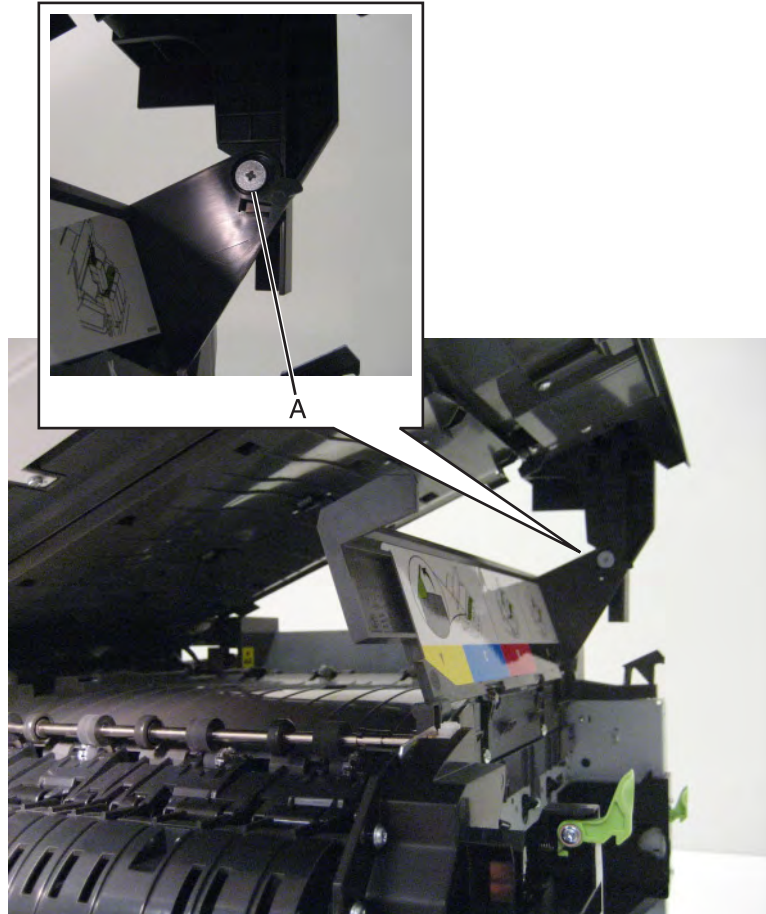

- 5 Unlock the lift lock (B) at the top of the scanner, lower the flatbed scanner assembly until there is resistance, and disconnect the lift lock arm from the joint (C).

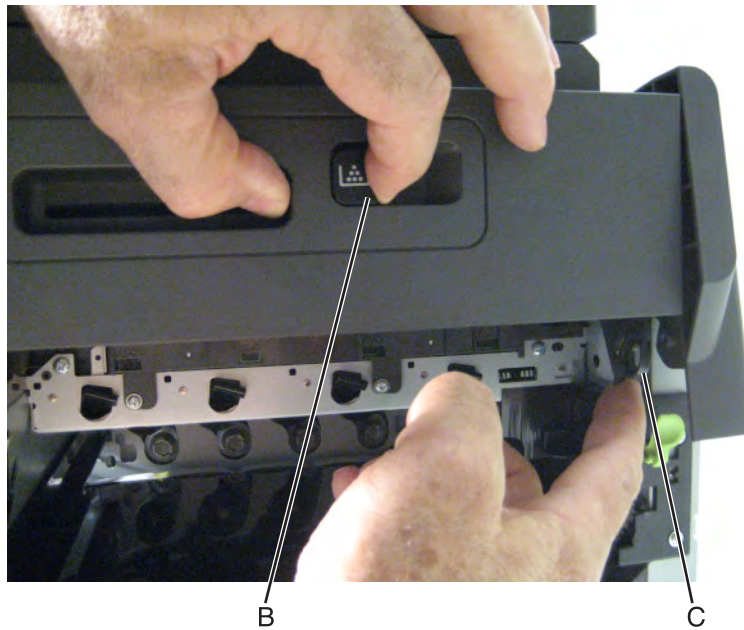

Parts removal

- 6** Remove the two screws (D) from the front left scanner hinge.

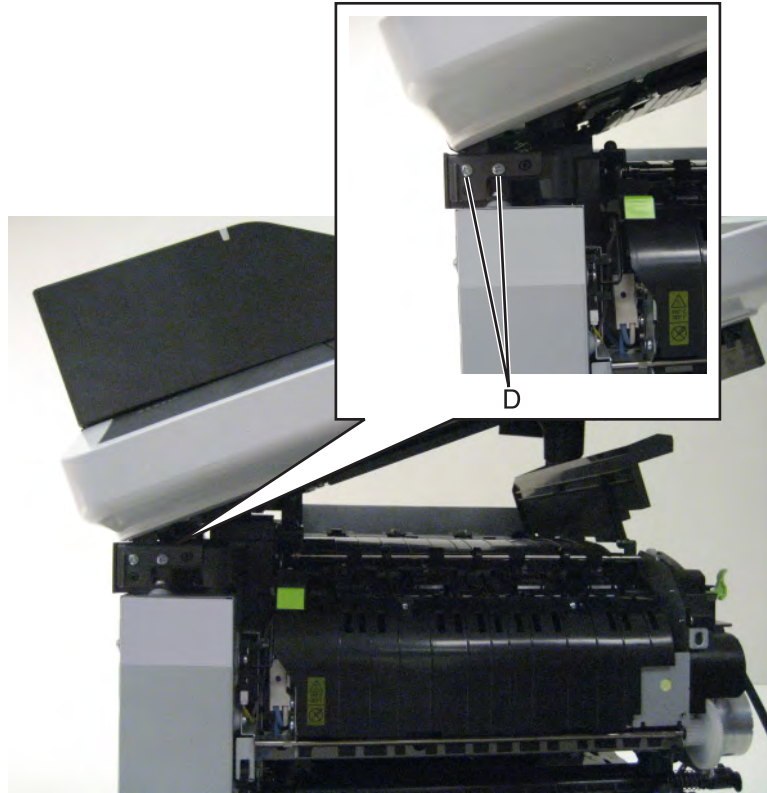

- 7** Use a screwdriver to disconnect the left hinge (E) from the left side of the printer.

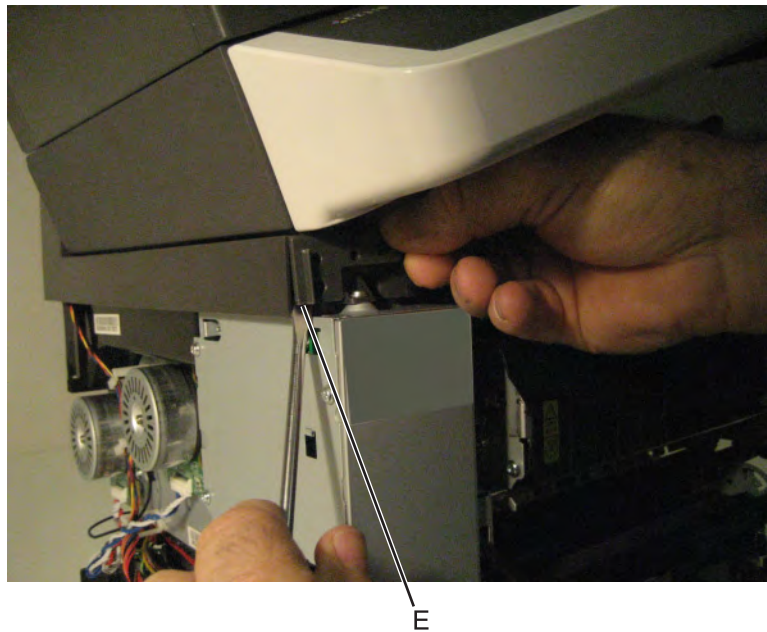

- 8 Remove the ground screw (F), and disconnect the four cables (G) and the ribbon cable (H.)

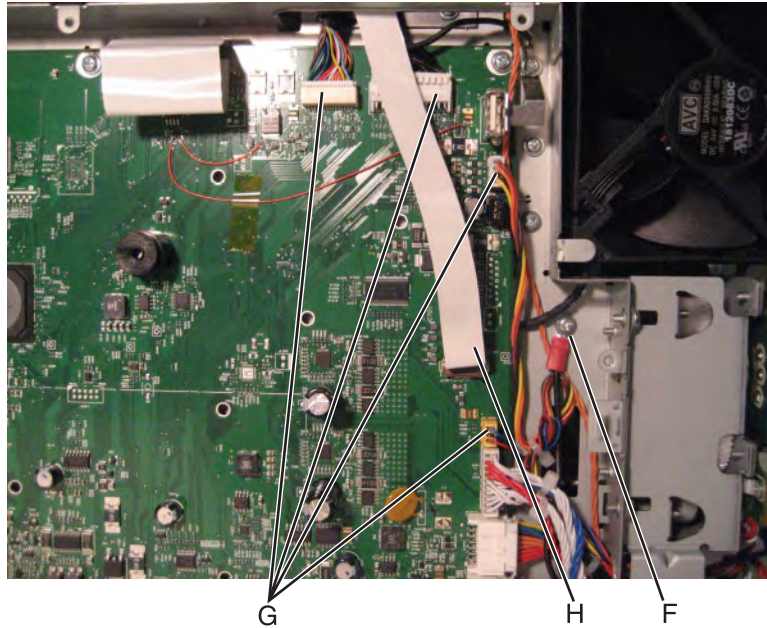

Note: Disconnect the ribbon cable by using a screwdriver to pull the pivot (I) out and rotate up. See [“Ribbon cable connectors” on page 259](#) for the proper way to handle ribbon cables.

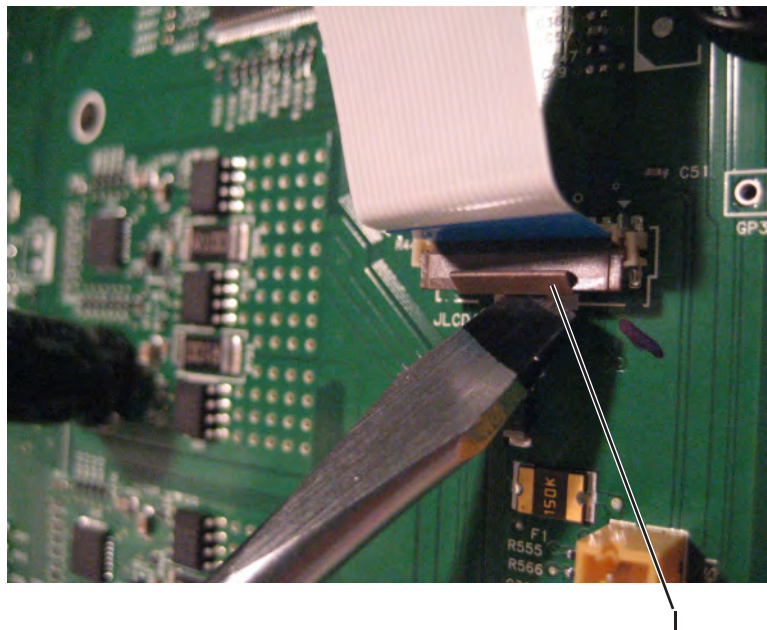

Note: After replacing this part, a scanner manual registration must be performed. See [“Scanner manual registration” on page 239](#). A scanner calibration reset must also be performed. See [“Scanner calibration reset” on page 232](#).

Installation note: To install the ribbon cable, rotate the latch down and push it back into the connector. Be careful to not damage the latch.

- 9 Lift the flatbed scanner assembly, and slide the latch (J) out of place.

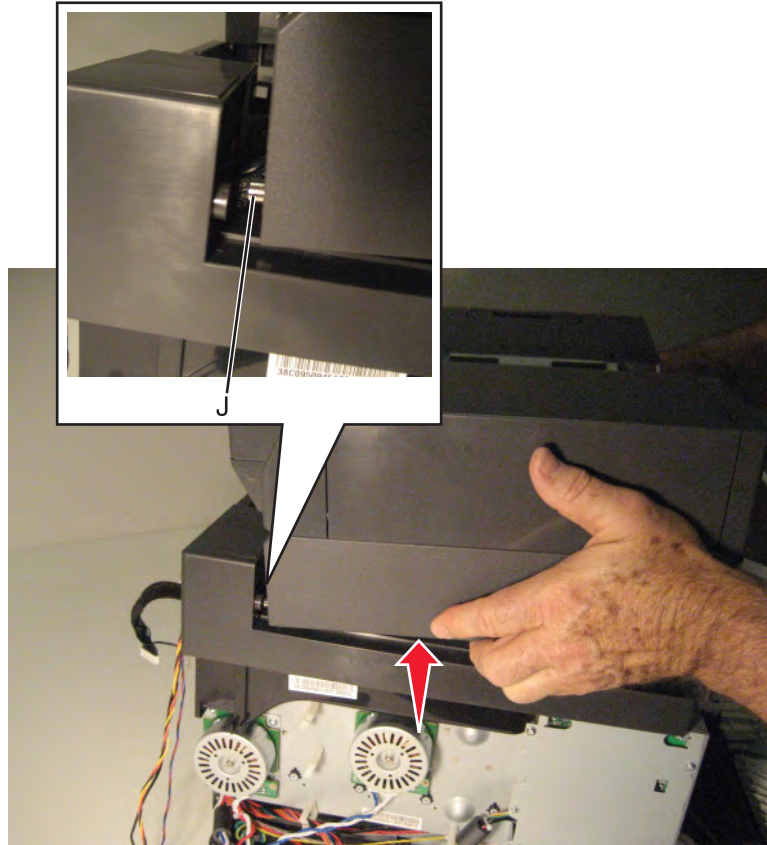

- 10 Remove the flatbed scanner assembly.

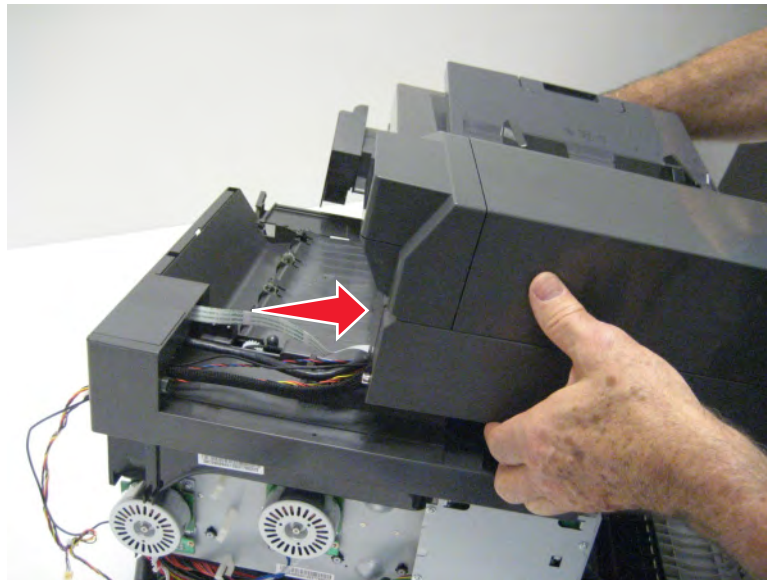

Note: Gently pull the flatbed scanner assembly cables through the opening when removing the flatbed scanner assembly.



Flatbed pivot link (rear right) removal

- 1 Remove the AIO link. See [“AIO link removal” on page 360.](#)
- 2 Remove the right scanner cover. See [“Right scanner cover removal” on page 372.](#)
- 3 Remove the AIO release lever. See [“AIO release lever removal” on page 361.](#)
- 4 Remove the screws (A) securing the pivot link to the flatbed.

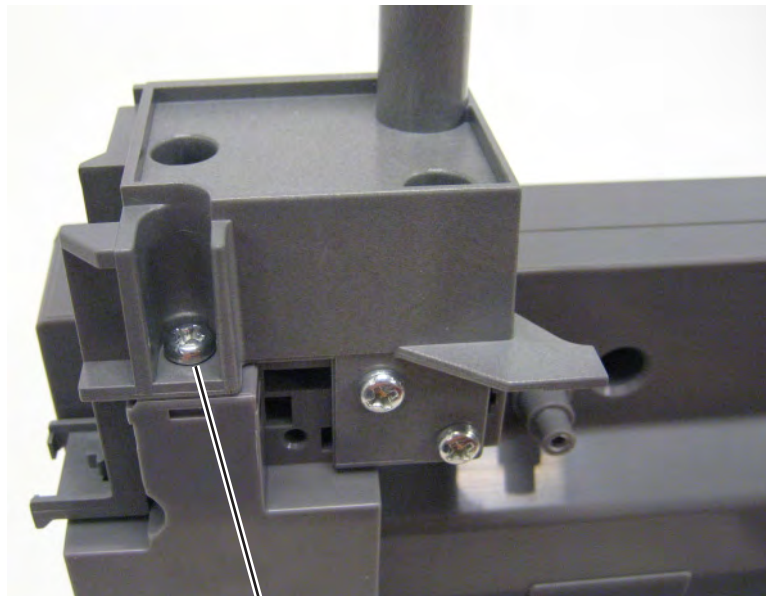

A

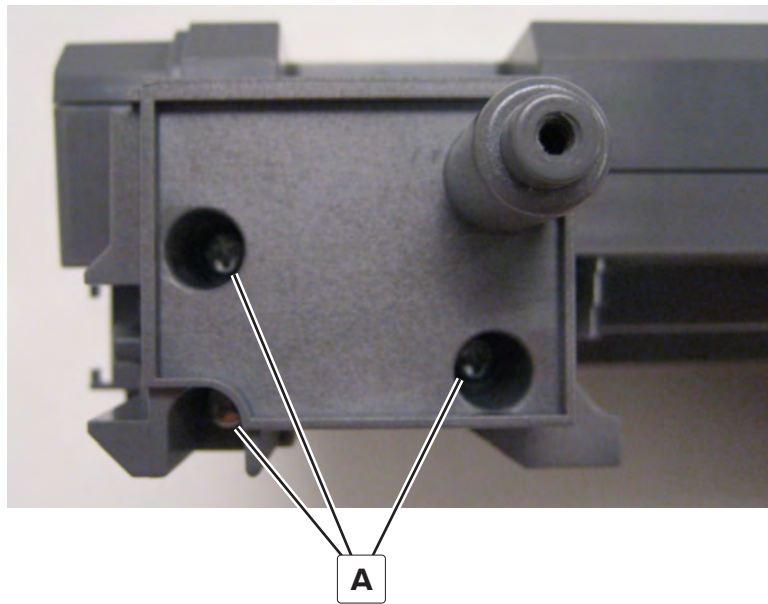

5 Remove the flatbed pivot link.

Flatbed pivot link (front left) removal

- 1 Lift the ADF assembly.
- 2 Remove the screw (A) from the right rear side lift lock.

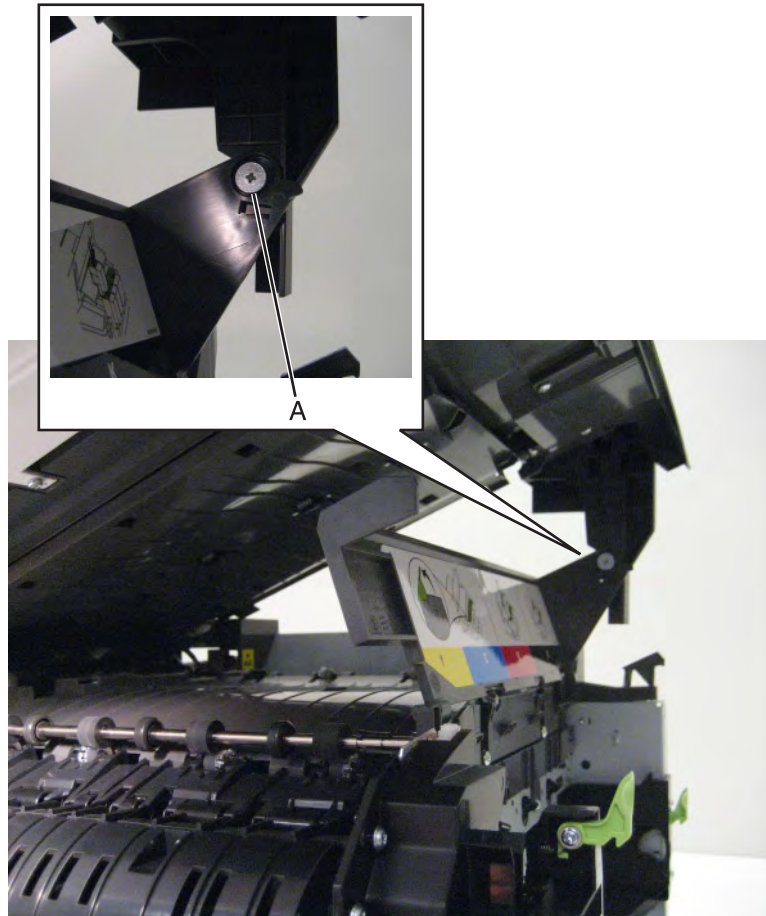

- 3** Unlock the lift lock (B) at the top of the scanner, lower the flatbed scanner assembly until there is resistance, and disconnect the lift lock arm from the joint (C).

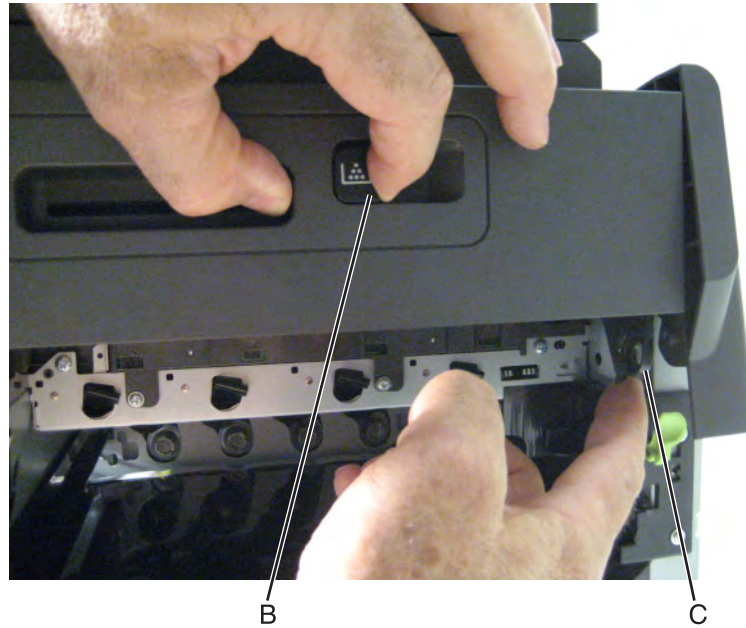

- 4** Remove the two screws (D) from the pivot link, and then detach the pivot link from the printer.

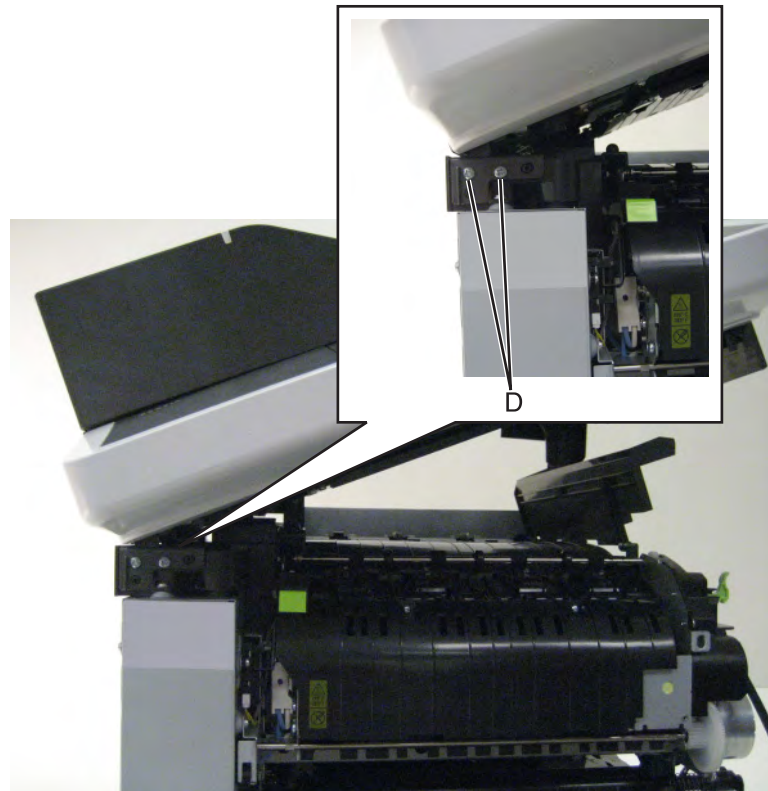

- 5** Remove the left and center screws (E) and loosen the right screw (F) from the control panel.

6 Release the latches (G) to loosen the scanner left cover, and then remove the pivot link.

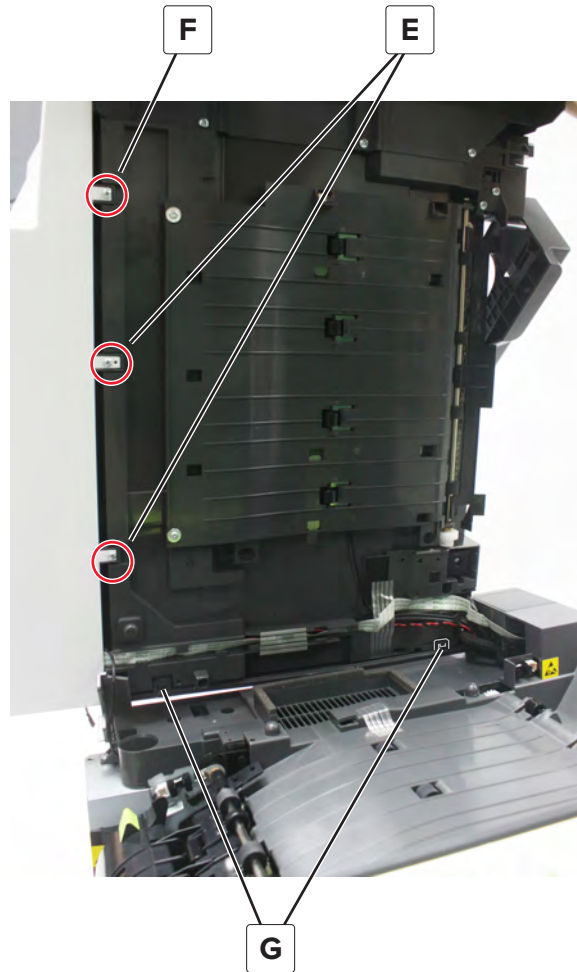

Options removals

- “650-sheet duo drawer tray assembly removal” on page 384
- “650-sheet duo drawer assembly removal” on page 385
- “Dust cover removal” on page 386
- “Pick tire removal” on page 387

650-sheet duo drawer tray assembly removal

- 1 Pull out the drawer tray assembly.
- 2 Remove the tray assembly.

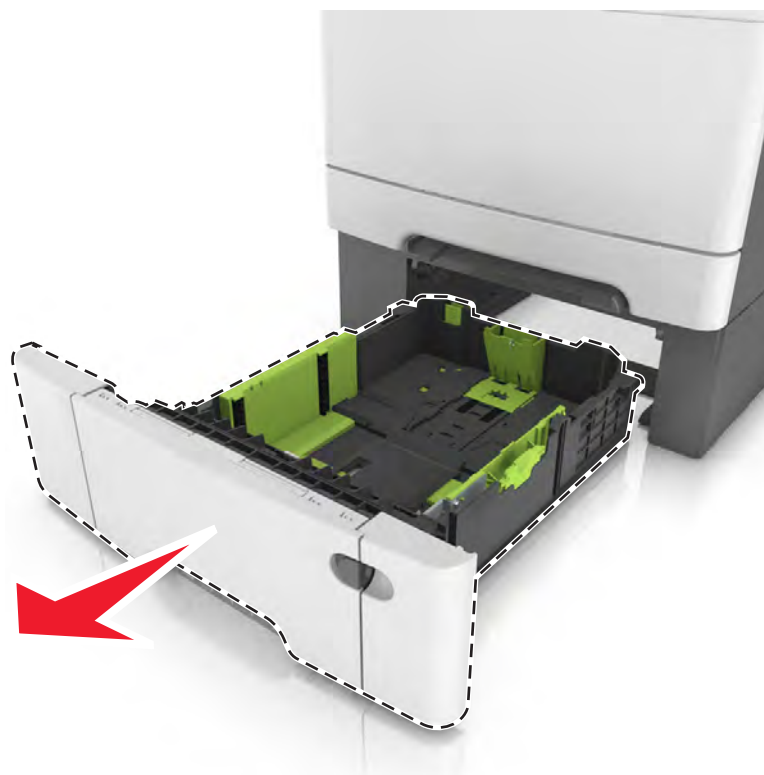

650-sheet duo drawer assembly removal

Warning—Potential Damage: Make sure the printer is turned off before removing the drawer assembly.

- 1 Carefully lift the printer, and set it aside on a flat surface.
- 2 Remove the 650-sheet drawer assembly.

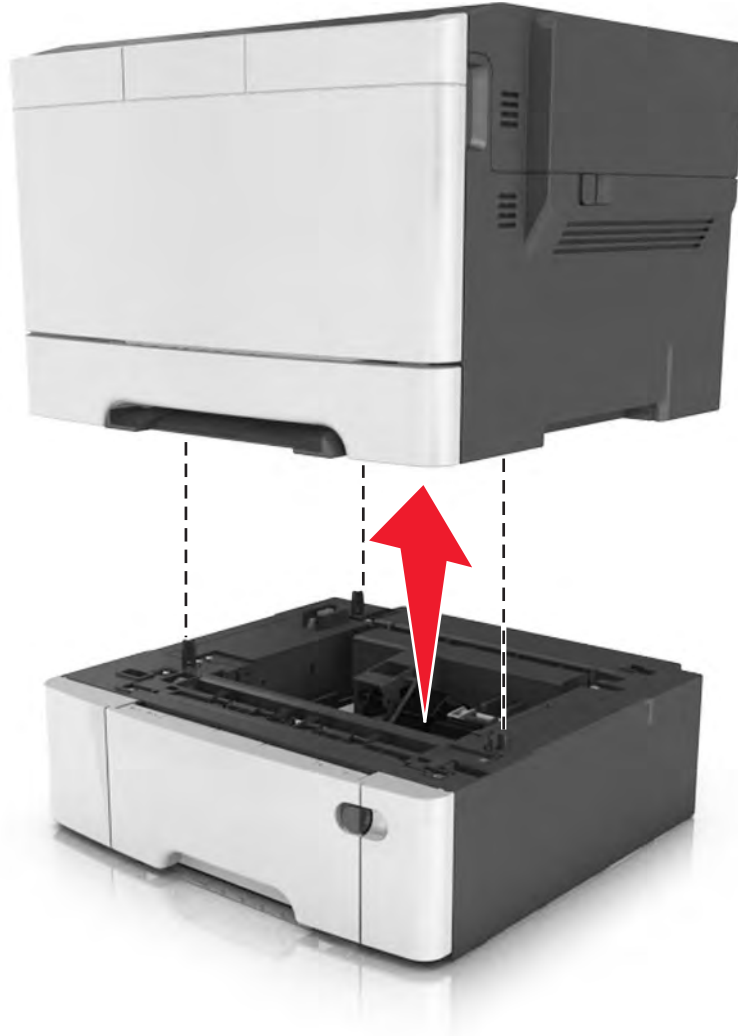

Dust cover removal

- 1 Slightly raise the dust cover.
- 2 Pull the dust cover to remove.

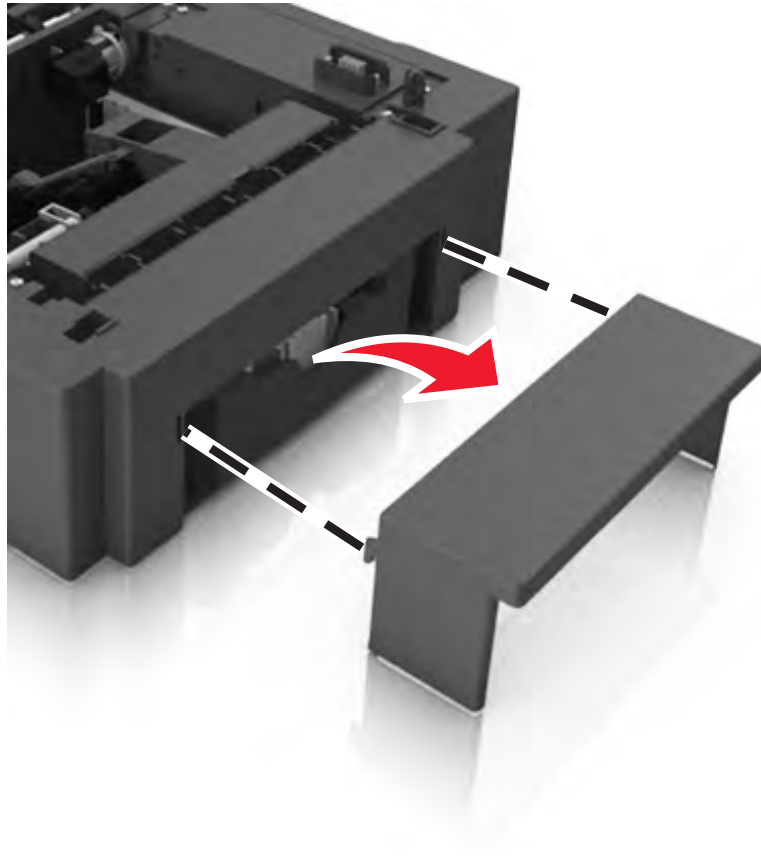

Pick tire removal

- 1 Remove the drawer tray assembly.
- 2 Lower the auto compensator mechanism (A).

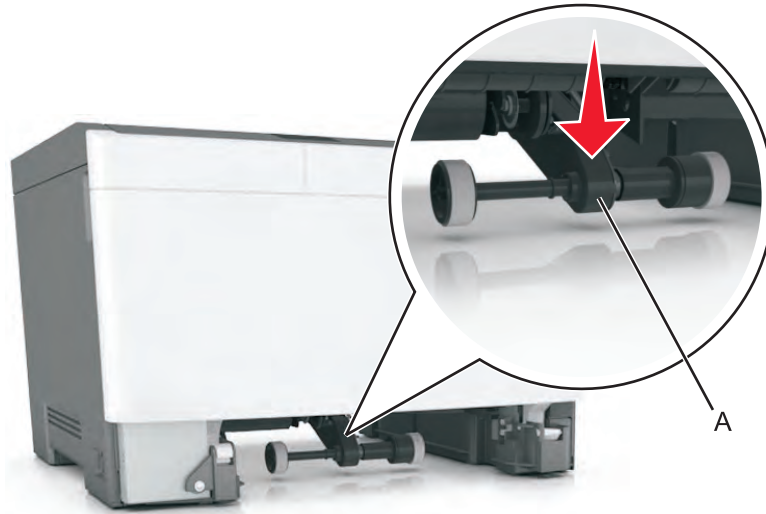

- 3 Remove the rubber tires (B) from the pick roll assembly (C). Repeat for the other tire (D).

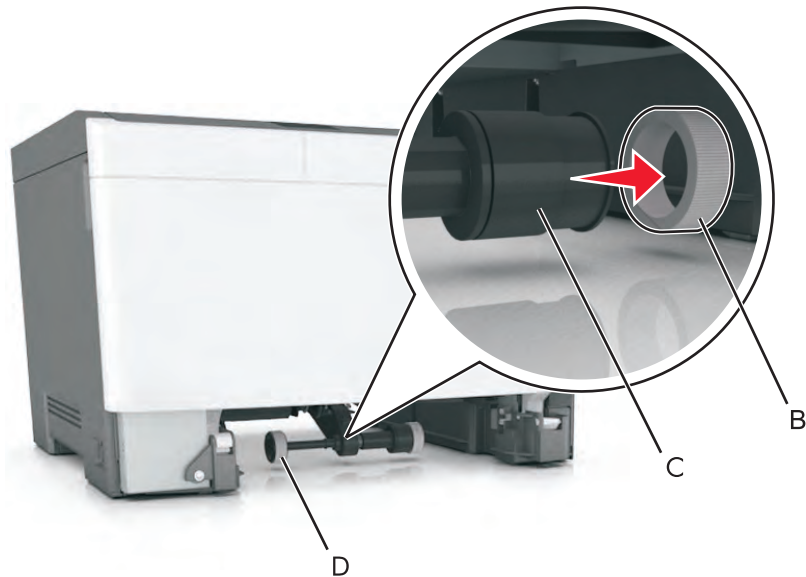

Installation note: Install the new rubber tire with its surface texture turning in the direction as shown.

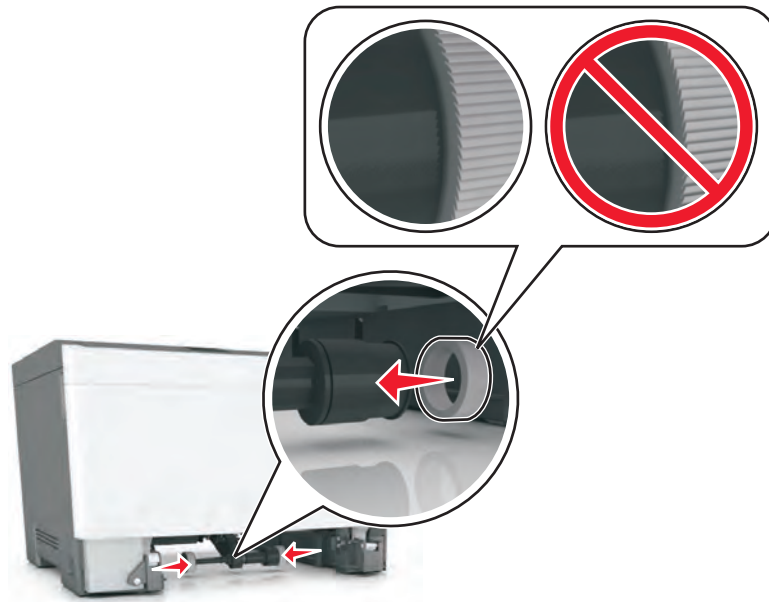

Note: Feel each rubber surface to verify it turns properly in the direction shown.

Component locations

Controller board

CX310 models

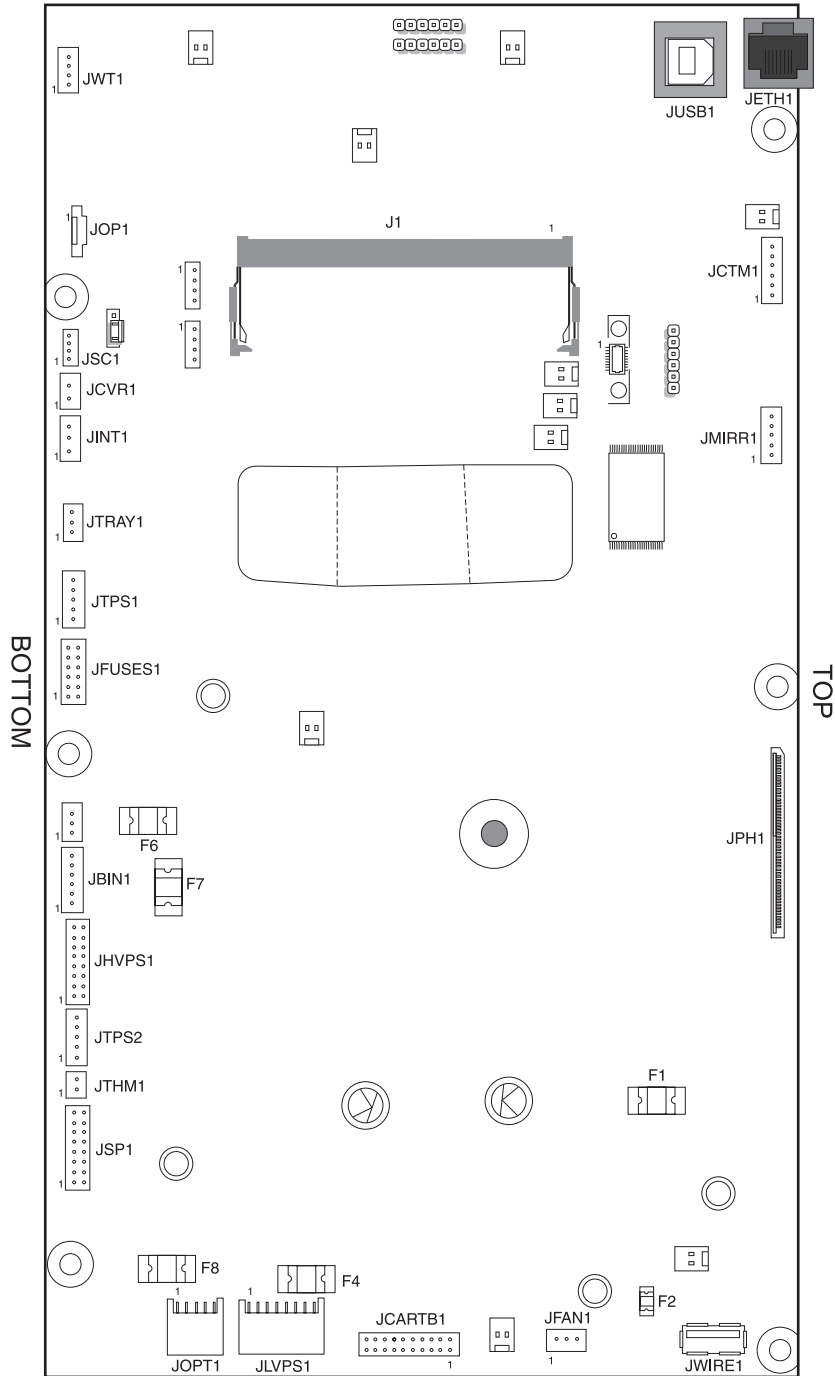

Component locations

CX410 models

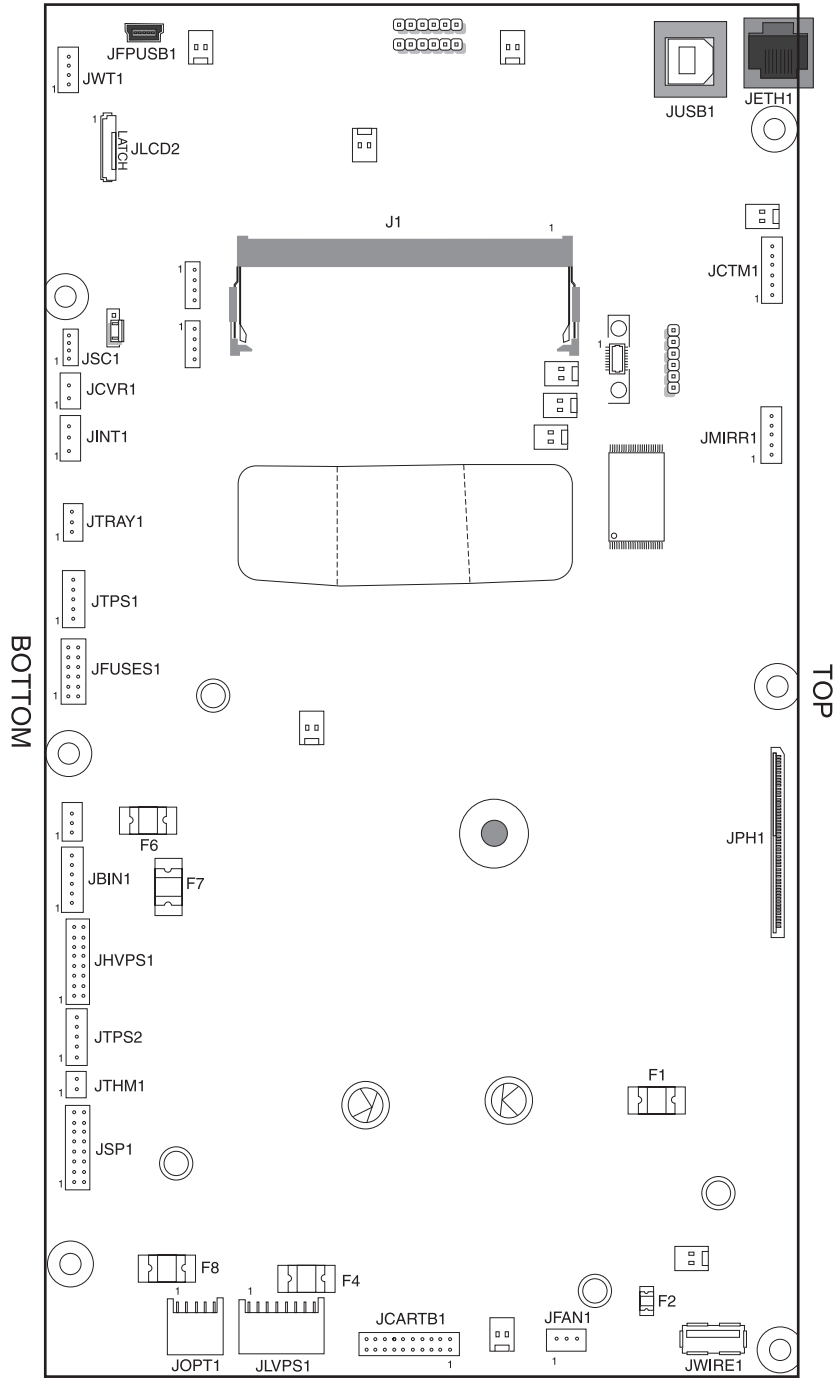

Component locations

CX510 models

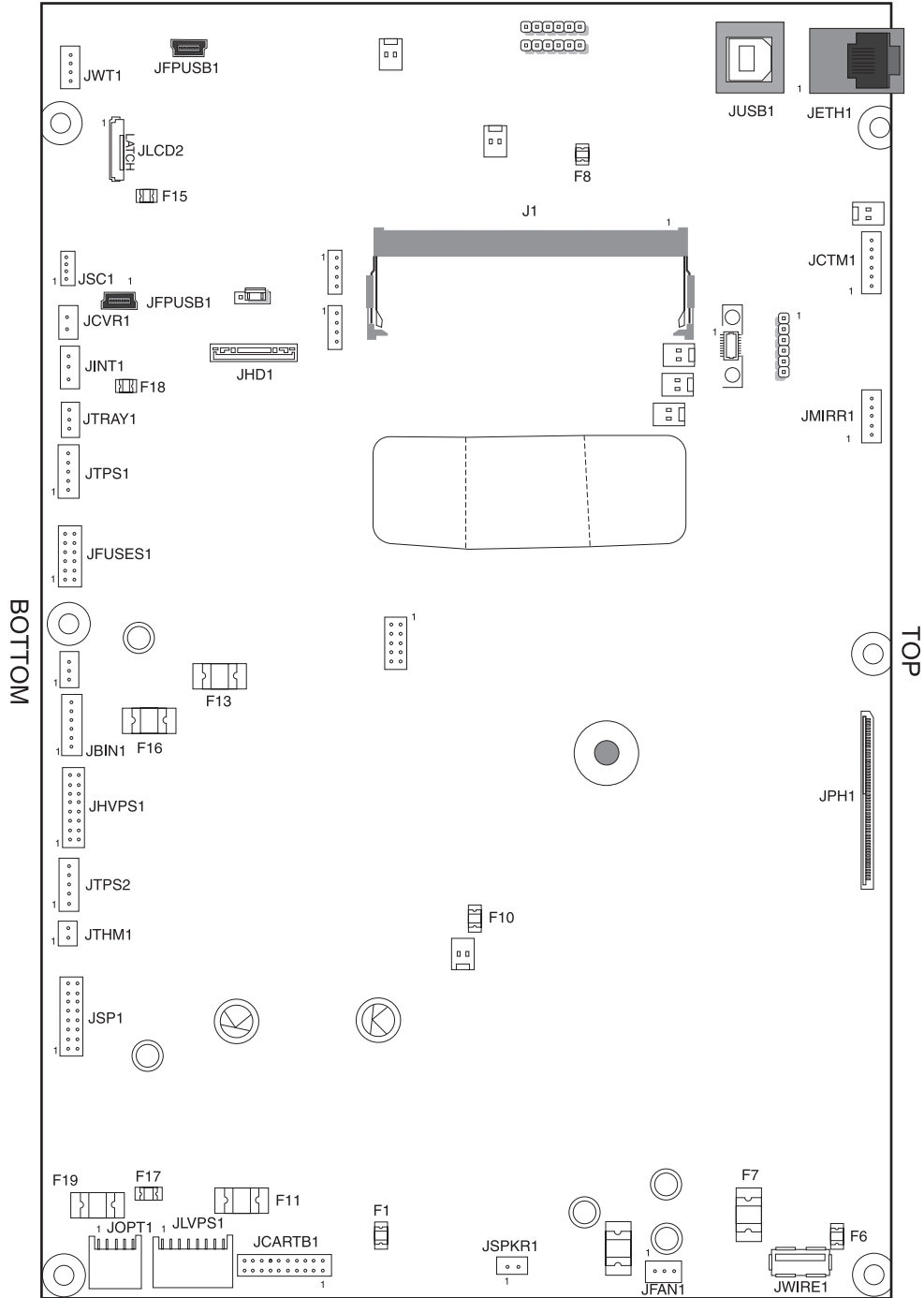

Connector	Connects to	Pin no.	Signal
JADF1	Auto document feeder	15, 22	+3 V
		14, 16	+24 V
		17, 18, 23	Ground

Connector	Connects to	Pin no.	Signal
JBIN1	Narrow media sensor and fuser exit sensor <ul style="list-style-type: none"> • Bin-full/narrow media—pins 1–3 • Fuser exit sensor—pins 4–6 	2	+3.3 V dc S_BIN_FB
		3	Ground
		5	+3.3 V dc FUSER_EXIT_SNSR
		6	Ground
JCARTB1	Drive motor for cartridges <ul style="list-style-type: none"> • Black drive motor (rear motor) even pin numbers 2–20 • CMY (color) drive motor odd pin numbers 1–19 	4	+24 V dc V_CART2_WING_W
		6	+24 V dc V_CART2_WING_V
		8	+24 V dc V_CART2_WIND_U
		9	Ground
		10	+5 V dc_SW
		11	+5V dc_SW
		12	Ground
		13	+24 V dc V_CARTR1_WIND_U
		15	+24 V dc V_CARTR1_WIND_V
		17	+24 V dc V_CARTR1_WIND_W
JCCD1	Scanner	10,12	+5 V dc
		15, 16	+24 V dc
		1, 2, 7, 8, 13, 14, 17, 18, 23, 26, 29	Ground
JCTM1	Toner meter connector	1	+5V_SW
		6	Ground
JCVR1	Cover open switch	1	+24 V dc V_24V_CVR
		2	COVER_OPEN (cover open +0 V dc; cover closed +24 V dc)
JFAN1	System fan	1	+3.3 V dc FAN_FG
		2	Ground
JFAX1	Fax	N/A	Not testable in field
JFB1	FB stepper motor	N/A	Not testable in field

Connector	Connects to	Pin no.	Signal
JFUSES1	<ul style="list-style-type: none"> • Fuser • Motor pins—1–4 • Thermistor—black wire 5–6 • Duplex sensor (S1)—7–9 • Thermistor—white wire 10–11 	1	+24 V dc V_FUSER_PHA+ (doors closed)
		2	+24 V dc V_FUSER_PHA- (doors closed)
		3	+24 V dc V_FUSER_PHB+ (doors closed)
		4	+24 V dc V_FUSER_PHB- (doors closed)
		5	+2.3 V dc FUSER_HQ_THM
		6	FUSER_HK_THM_RTN, ground
		7	+5V_SW, +5 V dc
		8	Ground
		9	+3.3 V dc S1_MPF_SNS
		10	+2.5 V dc BUR_THM
		11	FUSER_BUR_THM_RTN, ground
		12	Ground, (no wire)
JFPUSB1	Front panel USB	N/A	Not testable in field
JHVPS1	Developer/transfer HVPS	7	+3.3 V dc CMY_SRVO_OUT
		10	+3.3 V dc ITM_SRVO_OUT
		11	+3.3 V dc K_SRVO_OUT
		13	+24 V dc
		14	Ground
		16	Ground
JHS1	FB home sensor	1	+5 V dc
		2	Ground
JINT1	+5V safety interlock connector	1	+5 V dc VS_JINT-1
		2	Ground
		3	VS_INT, +5 V dc (door closed), 0 V dc (open)
JLCD1	Operator panel connector for CX410 and CX510 models	N/A	Not testable in the field

Connector	Connects to	Pin no.	Signal
JLVPS1	Low-voltage power supply	1	+5 V dc
		2	Ground
		3	+5 V dc
		4	Ground
		5	+5 V dc
		6	Ground
		7	+24 V dc
		8	Ground
		9	+24 V dc
		10	Ground
		11	+24 V dc
		12	Ground
		14	ZERO_XING_IN
		16	Ground
JMIRR1	Mirror motor connector	2	+3.3 V dc MM_LOCK
		4	Ground
		5	+24 V dc
JOPT1	Optional—Tray(s)	2	Ground
		3	Ground
		5	+24 V dc
		6	Ground
		7	+5 V dc +5V_OPTIONS
		9	Ground
JPH1	Printhead flat cable connector	N/A	Not testable in the field
JPJP1	Bin full sensor	2	3.3 V dc
		3	Ground
JSC1	Smart Chip cartridge	4	Ground

Connector	Connects to	Pin no.	Signal
JSP1	Smart pick drive (paper pick motor drive assembly) <ul style="list-style-type: none"> Encoder—pins 1, 3, 5, 7, and 9 Smart pick—pins 2, 4 Motor—pins 6, 8, 10, 12 Input (S2) sensor—pins 13–16 	1	ANODE (no wire)
		2	+24 V dc M1_OUT1 (0 V dc with door open)
		3	Ground (no wire)
		4	+24 V dc M1_OUT2 (0 V dc with door open)
		6	Ground (no wire)
		7	Ground
		10	+5 V dc
		13	Ground (no wire)
		15	+5 V dc
		16	Ground
JTHM1	TPS thermistor connector	1	+1.5 V dc TPS_THERM_SNS
		2	TPS_SNS_RTN, ground
JSPKR1	Speaker	N/A	Not testable in the field
JTPS1	Toner patch sensor 1	3	Ground (no wire)
		5	Ground
JTPS2	Toner patch sensor 2	3	Ground (no wire)
		5	Ground
JTRAY1	Tray present sensor	2	+3.3 V dc
		3	Ground
JUSB1 Port	USB connector	N/A	N/A
JWIRE1	USB wireless connector	N/A	Not testable in the field
JWT1	Waste toner detection	3	+1.5 V dc
		4	Ground (no wire)

Maintenance

Inspection guide



The purpose of this inspection guide is to aid you in identifying the intervals, based on page count, at which parts must be inspected (for visible physical damage), cleaned, or replaced.

If any unsafe conditions exist, find out how serious the hazard could be and if you can continue before you correct the hazard.

As you service the machine, check for the following:

- Damaged, missing, or altered parts, especially in the area of the On/Off switch and the power supply
- Damaged, missing, or altered covers, especially in the area of the top cover and the power supply cover
- Possible safety exposure from any non-Lexmark attachments
- Printer and input options are sitting flat (for example, not sitting on cables or hanging over a ledge)
- Printer is properly set on any input options

Use the following table to determine when specified parts should be inspected:

Lexmark CX310, CX410, and CX510	Every service call	Every 85K	Notes
Media tray - All			
Media tray side guides	Inspect		Check for correct positioning
Media tray length guides	Inspect		Check for correct positioning
Transfer module (ITM)	Inspect	Replace	Ensure correct installation
Fuser	Inspect	Replace	Ensure correct installation
Media feeders - All			
Media tray pick tires	Inspect, clean if needed		Clean with a damp cloth
MPF pick tires	Inspect, clean if needed		Clean with a damp cloth
Paper path			
Duplex path rollers	Inspect		Check for media fragments and tears Check for excessive toner buildup on white rollers Clean with damp cloth if needed
Miscellaneous			
Toner spillage	Clean		Use a toner vacuum and cloth to remove all toner spillage from the printer

Scheduled maintenance

The operator panel displays the message *80* or *Scheduled Maintenance* when it reaches certain page counts. It is necessary to replace the appropriate maintenance kit at certain intervals to maintain the print quality and reliability of the printer. If needed, reset the maintenance counter after performing scheduled maintenance.

Maintenance kits

After 85,000 printed pages (sides) a maintenance kit may be required.

It is necessary to replace the fuser assembly and ITU to maintain the print quality and reliability of the printer. The parts are available as a maintenance kit with the following part numbers:

Part number and kit	Contents
40X7615—115V Maintenance Kit	<ul style="list-style-type: none"> • 115V fuser • ITU
40X7616—230V Maintenance Kit	<ul style="list-style-type: none"> • 230V fuser • ITU
40X7617—100V Maintenance Kit	<ul style="list-style-type: none"> • 100V fuser • ITU

When performing the scheduled maintenance procedure, the following areas should be cleaned of media dust and toner contamination:

- Media trays
- PC cartridge area
- Developer housings area
- Transfer roll area
- Duplex area
- Standard bin
- Bridge unit area (if equipped)
- Finisher media bins (if equipped)

Preventive maintenance

Between scheduled maintenance intervals, paper feed, paper transport, and image quality problems can occur. Some preventive maintenance procedures can help prevent issues like these.

Device-specific preventive maintenance

To clean the touchscreen and key pad, use the LCD cleaning cloth. A single two-step LCD cleaning cloth is stored in the compartment beneath the exit tray. Additional cleaning cloths are available.

The following table lists the parts needed to perform preventive maintenance:

Part number	Description	Maintenance interval
40X0392	LCD cleaning kit	As needed

Lubrication specification

Lubricate only when parts are replaced or as needed, not on a scheduled basis. Use of lubricants other than those specified in this service manual can cause premature failure. Some unauthorized lubricants might chemically attack polycarbonate parts.

Use the following lubricants:

- IBM no. 10 oil, PN/ 1280443 (Approved equivalents: Mobil DTE27, Shell Tellus 100, Fuchs Renolin MR30)
- IBM no. 23 grease
- Grease P/N 99A0394 and Nyogel type 744—Use this type of lubricant to lubricate the Fuser Drive Assembly.
- Nyogel 744—Use this type of lubricant to lubricate the ITU and Cartridge Drive Assemblies.

The motor drive FRUs contain the proper lubricant in the FRU. Use only the lubricant included.

Cleaning the printer

Cleaning the printer

Note: You may need to perform this task after every few months.

Warning—Potential Damage: Damage to the printer caused by improper handling is not covered by the printer warranty.

- 1 Make sure that the printer is turned off and unplugged from the electrical outlet.



CAUTION—SHOCK HAZARD: To avoid the risk of electrical shock when cleaning the exterior of the printer, unplug the power cord from the electrical outlet and disconnect all cables from the printer before proceeding.

- 2 Remove paper from the standard bin, multipurpose feeder, and manual feeder.
- 3 Remove any dust, lint, and pieces of paper around the printer using a soft brush or vacuum.
- 4 Dampen a clean, lint-free cloth with water, and use it to wipe the outside of the printer.

Warning—Potential Damage: Do not use household cleaners or detergents, as they may damage the finish of the printer.

- 5 Make sure all areas of the printer are dry before sending a new print job.

Cleaning the scanner glass

Clean the scanner glass if you encounter print quality problems, such as streaks on copied or scanned images.

- 1 Slightly dampen a soft, lint-free cloth or paper towel with water.
- 2 Open the scanner cover.



- 3 Clean all the areas shown, and then let them dry.



1	White underside of the ADF cover
2	White underside of the scanner cover
3	Scanner glass
4	ADF glass

- 4 Close the scanner cover.

Cleaning the printhead lenses

- 1 Remove the waste toner bottle.
- 2 Remove the imaging kit.
- 3 Using a lint-free cloth, wipe the printhead lenses (A).

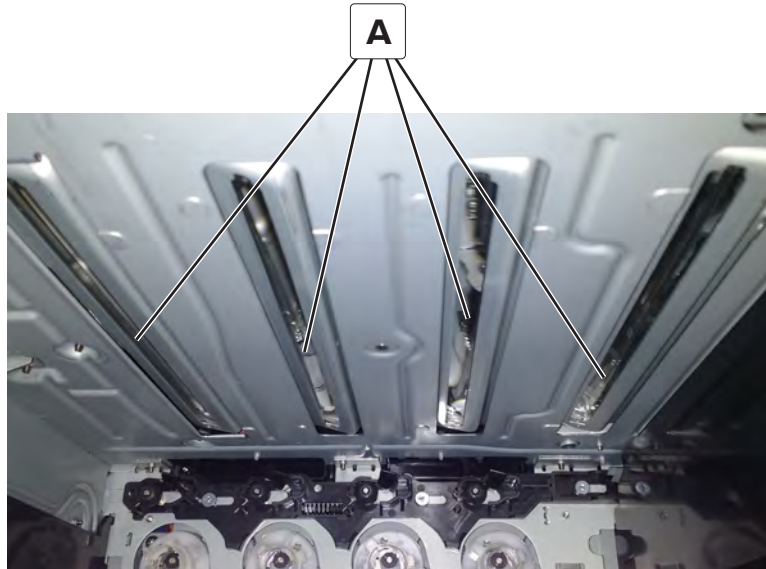

Parts catalog

- “Legend” on page 402
- “Assembly 1: Covers” on page 403
- “Assembly 2: Scanner” on page 405
- “Assembly 3: Paper path” on page 409
- “Assembly 4: Operator panels” on page 413
- “Assembly 5: Electronics” on page 417
- “Assembly 6: Cables and sensors” on page 421
- “Assembly 7: Media drawers and trays” on page 423
- “Assembly 8: Options and miscellaneous” on page 425

Legend

The following column headings are used in the parts catalog:

- **ASM-index**—Identifies the assembly and the item in the diagram. For example, 3-1 indicates Assembly 3 and item 1 in the table.
- **Part number**—Identifies the unique number that correlates with the part.
- **Units/mach**—Refers to the number of units actually used in the base machine or product.
- **Units/option**—Refers to the number of units in a particular option.
- **Units/FRU**—Refers to the number of units in a particular FRU.
- **Description**—A brief description of the part.

The following abbreviations are used in the parts catalog:

- **NS** (not shown) in the Asm-index column indicates that the part is procurable but is not pictured in the illustration.
- **PP** (parts packet) in the Description column indicates that the part is contained in a parts packet.

Assembly 1: Covers

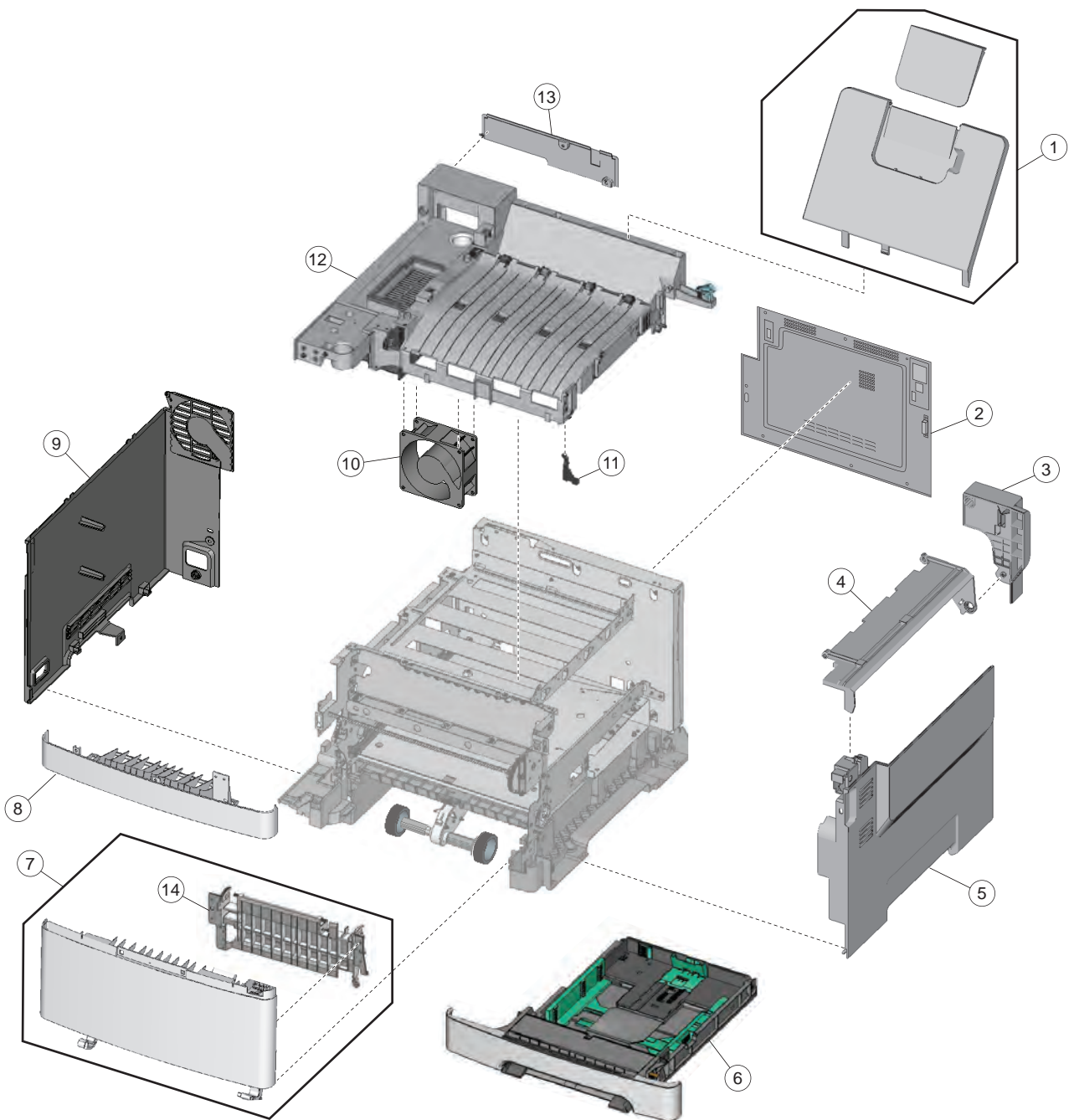

Assembly 1: Covers

Asm-index	P/N	Units/mach	Units/FRU	Description	Removal procedure
1	40X7811	1	1	Output bin tray	“Output bin tray and exit bail removal” on page 357
2	40X7845	1	1	Rear cover (CX310 and CX317dn)	“Rear cover removal” on page 346
2	40X7846	1	1	Rear cover (CX410, CX417de and XC2130)	“Rear cover removal” on page 346
2	40X7814	1	1	Rear cover (CX510, CX517de and XC2132)	“Rear cover removal” on page 346
3	40X7824	1	1	AIO link	“AIO link removal” on page 360
4	40X7802	1	1	Toner AIO cover	“AIO toner cover removal” on page 359
5	40X7823	1	1	Right AIO cover	“Right cover assembly removal” on page 288
6	40X7645	1	1	250-sheet tray assembly	“Paper pick motor drive assembly (standard tray) removal” on page 343
7	40X7801	1	1	Front cover	“Front cover assembly removal” on page 309
8	40X5490	1	1	Front middle cover	“Front middle cover removal” on page 312
9	40X7632	1	1	Left cover	“Left cover assembly removal” on page 274
10	40X7579	1	1	System fan	“System fan removal” on page 351
11	40X8674	1	1	Bracket, front toner door pivot	N/A
12	40X7809	1	1	Top cover assembly (includes fan and redrive belt)	“Top cover assembly removal” on page 352
13	40X7810	1	1	Back AIO cable cover	N/A
14	41X2663	1	1	Front cover inner deflector	“Front cover inner deflector removal” on page 311
NS	40X8089	1	1	650-sheet drawer	“650-sheet duo drawer assembly removal” on page 385
NS	40X8091	1	1	650-sheet tray assembly	“650-sheet duo drawer tray assembly removal” on page 384
NS	40X7812	1	1	Media bail	“Output bin tray and exit bail removal” on page 357
NS	40X7618	1	1	Front and right side interlock switch cover assembly	N/A

Assembly 2: Scanner

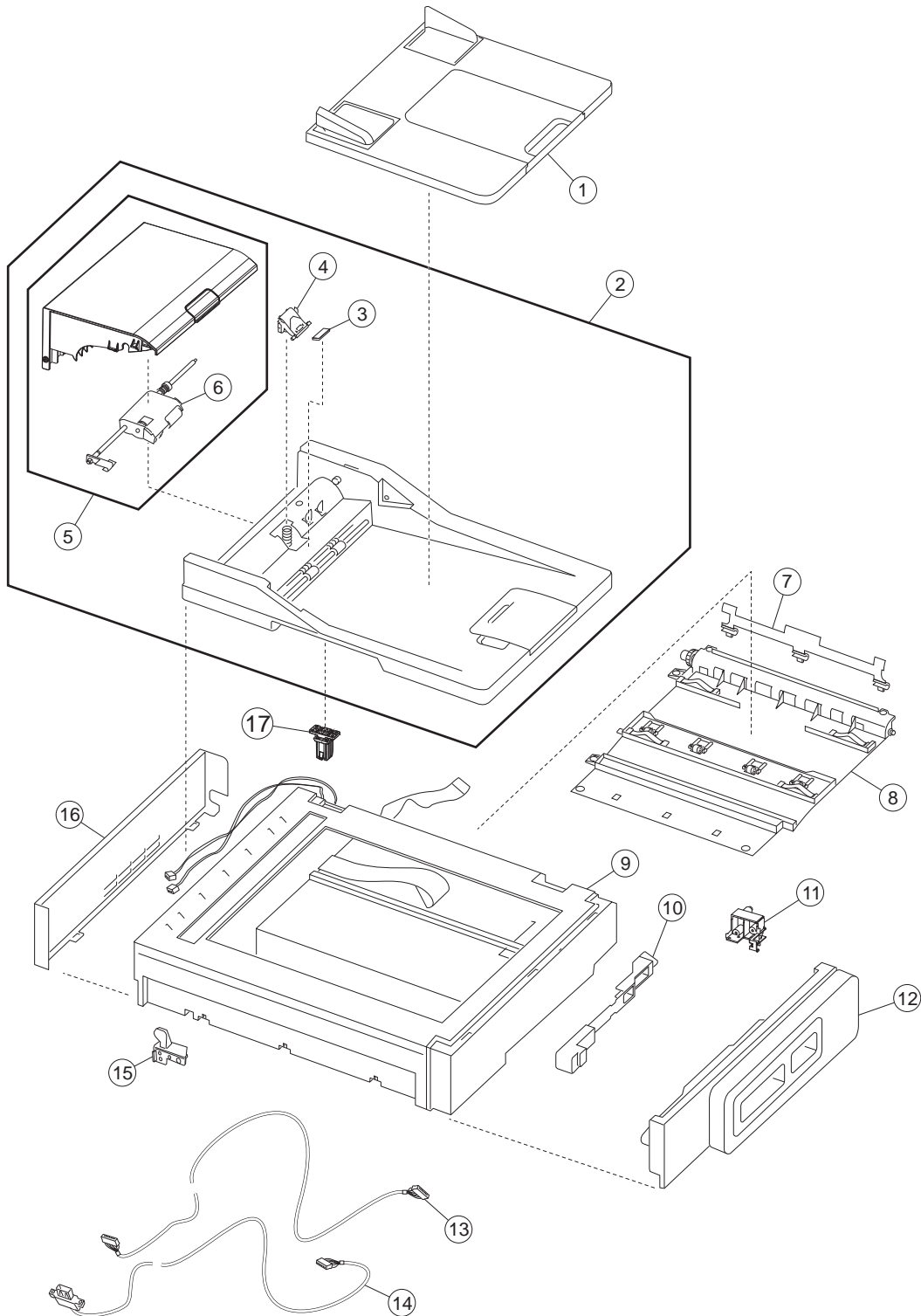

Assembly 2: Scanner

Asm-index	P/N	Units/mach	Units/FRU	Description	Removal procedure
1	40X9054	1	1	ADF input tray	“ADF input tray removal” on page 369
2	40X7830	1	1	Duplex ADF assembly (CX410, CX417de, CX510, CX517de, XC2130, and XC2132)	“ADF assembly removal” on page 367
2	40X7831	1	1	Simplex ADF assembly (CX310 and CX317dn)	“ADF assembly removal” on page 367
3	40X9110	1	1	Restraint pad	N/A
4	40X6247	1	1	Simplex ADF separator pad assembly (CX310 and CX317dn)	“ADF separator pad removal” on page 370
4	41X0917	1	1	Duplex ADF separator roller assembly (CX410, CX417de, CX510, CX517de, XC2130, and XC2132)	“ADF separator roll removal” on page 370
5	40X7842	1	1	Simplex top cover assembly (CX310 and CX317dn)	“Top cover ADF sheet feed removal” on page 371
5	40X7843	1	1	Duplex ADF top cover assembly (CX410, CX417de, CX510, CX517de, XC2130, and XC2132)	“Top cover ADF sheet feed removal” on page 371
6	40X8736	1	1	ADF pick roll	N/A
7	40X5872	1	1	Bin full flag	“Bin-full flag removal” on page 362
8	40X7833	1	1	Redrive assembly	“Redrive unit removal” on page 365
9	40X7829	1	1	Flatbed scanner assembly	“Flatbed scanner assembly removal” on page 374
10	40X7827	1	1	AIO release lever with spring	“AIO release lever removal” on page 361
11	40X7834	1	1	Flatbed pivot link (rear right)	“Flatbed pivot link (rear right) removal” on page 379
12	40X7819	1	1	Right scanner cover	“Right scanner cover removal” on page 372
13	40X7835	1	1	Operator panel cable (CX310, CX317dn, CX410, CX417de and XC2130)	N/A.
13	40X7837	1	1	Operator panel cable (CX510, CX517de and XC2132)	N/A.

Asm-index	P/N	Units/mach	Units/FRU	Description	Removal procedure
14	40X5480	1	1	USB thumbdrive cable (CX510, CX517de and XC2132)	“USB port connector removal” on page 321
14	40X7836	1	1	USB thumbdrive cable (CX410, CX417de and XC2130)	“USB port connector removal” on page 321
15	40X7822	1	1	Flatbed pivot link (front left)	“Flatbed pivot link (front left) removal” on page 381
16	40X7820	1	1	Left scanner cover	“Left cover assembly removal” on page 274
17	40X8735	1	1	Left ADF hinge	N/A
NS	40X6243	1	1	Flatbed cushion	N/A
NS	40X2252	1	4	Redrive spacer screws	N/A

Assembly 3: Paper path

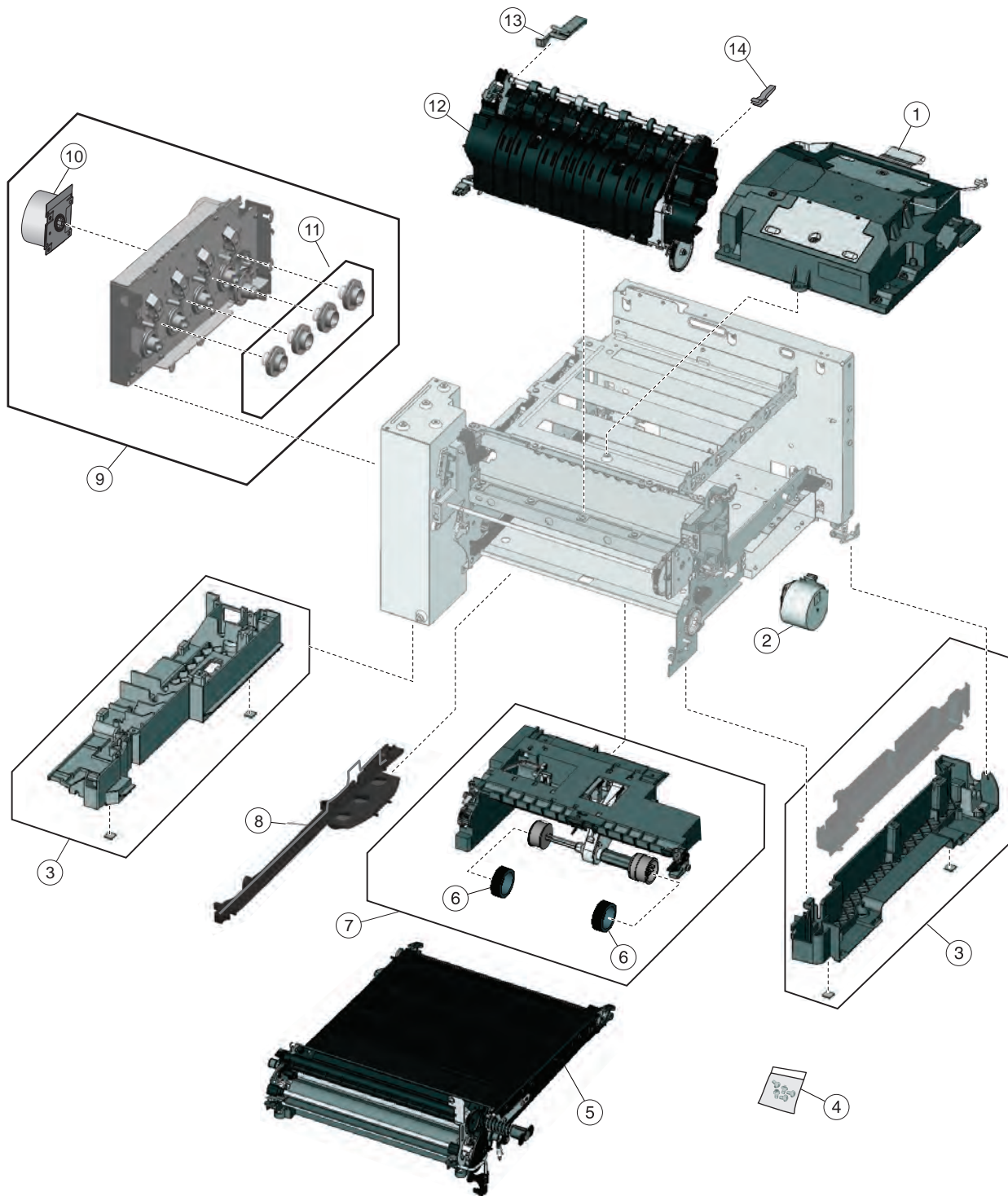

Assembly 3: Paper path

Asm-index	P/N	Units/mach	Units/FRU	Description	Removal procedure
1	40X7627	1	1	Printhead	“Printhead removal” on page 365
2	40X7629	1	1	Fuser drive motor assembly	“Fuser drive motor assembly removal” on page 289
3	40X7646	1	1	Lower left frame and lower right frame with cable cover	“Lower left frame removal” on page 328 , “Lower right frame removal” on page 334
4	40X7648	1	2X	Miscellaneous screws <ul style="list-style-type: none"> • Taptite M3 L6 panhead screw (10) • M3x6 panhead screw (3) • Shoulder screw (1) • M3.5 internal lock washer (3) • M3x8 screw (3) • 3.5x6mm flat top screw (5) • 3.5x8 flat top screw (5) • Taptite M3 L4.5 panhead screw (3) • M3x8LG W-HD machine screw (3) • Metal ROLN M3.5 8L screw (2) • Plastic ROLN 2.9 8L screw (6) • Plastic ROLN 3.5 6L screw (10) • Plastic ROLN 3.5 8L screw (4) • Plastic ROLN 3.5 10L screw (2) • M3.5x8 SEMS machine screw (3) 	N/A
4	40X7652	1	1	Miscellaneous springs <ul style="list-style-type: none"> • Front cover latch (2x) • ITU holddown (2x) • Fuser holddown (2x) • Primary tray bias (2x) 	N/A
5	40X7610	1	1	Image transfer unit	“Image transfer unit (ITU) removal” on page 300
6	40X5168	2	2	Pick tires	“Pick tire removal” on page 387

Asm-index	P/N	Units/mach	Units/FRU	Description	Removal procedure
7	40X7614	1	1	Paper pick motor drive assembly	“Paper pick motor drive assembly (standard tray) removal” on page 343
8	41X0580	1	1	ITU guide	“ITU guide removal” on page 339
9	40X7628	1	1	Main gear drive assembly with motors and coupling	“EP drive assembly removal” on page 275
10	41X0001	1	1	Drive unit motor	“Drive unit motor removal” on page 275
11	41X0826	1	4	Developer drive coupling	“Developer drive coupling removal” on page 281
12	40X7622	1	1	Fuser assembly, 115 V	“Fuser assembly removal” on page 324
12	40X7623	1	1	Fuser assembly, 230 V	“Fuser assembly removal” on page 324
12	40X7624	1	1	Fuser assembly, 100 V	“Fuser assembly removal” on page 324
13	40X0411	1	1	Narrow media flag	“Narrow media sensor flag removal” on page 364
14	40X8819	1	1	MFP fuser deflector flag	“MFP fuser deflector flag removal” on page 362
NS	40X7617	1	1	100 V maintenance kit	N/A
NS	40X7615	1	1	115 V maintenance kit	N/A
NS	40X7616	1	1	230 V maintenance kit	N/A

Assembly 4: Operator panels

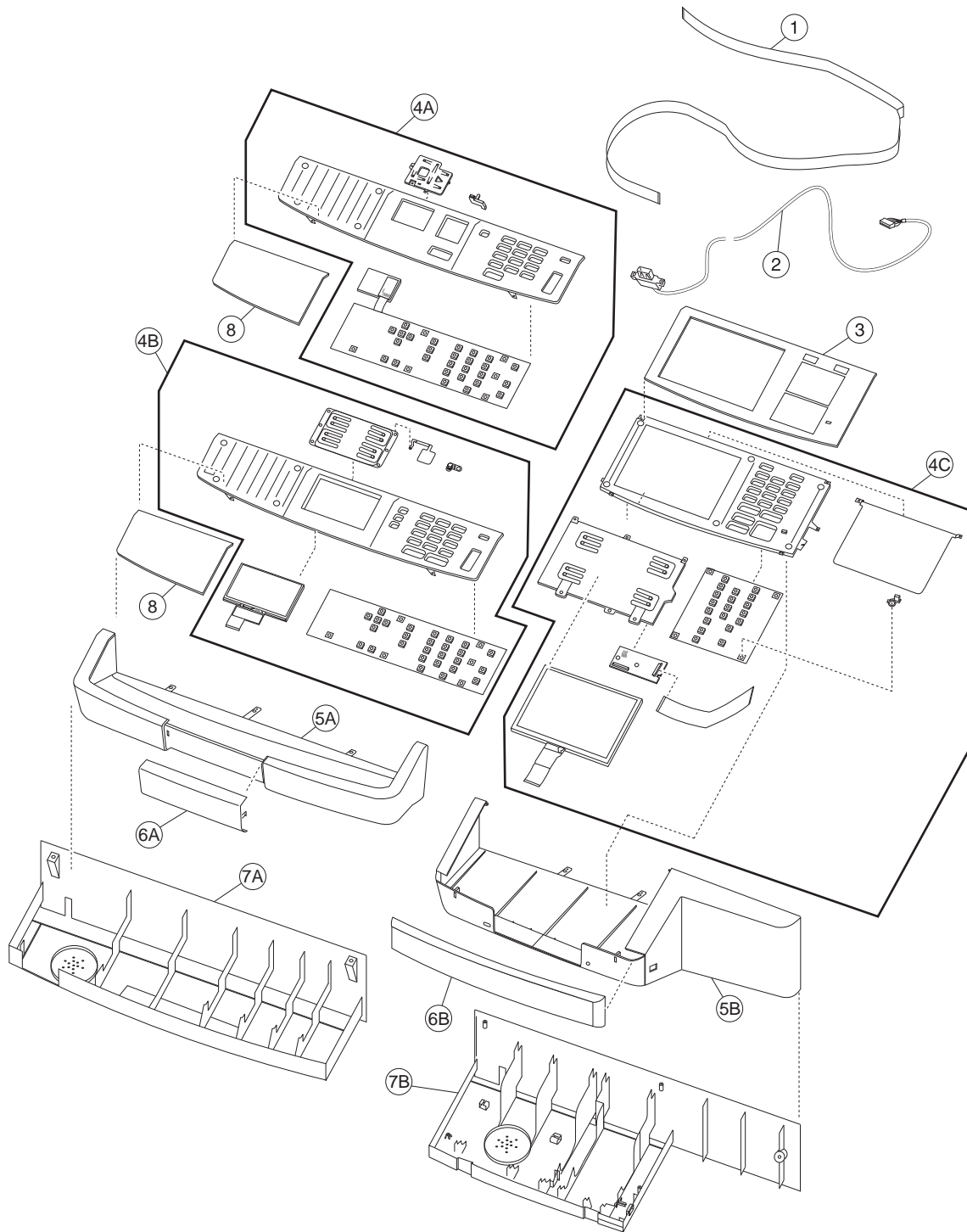

Assembly 4: Operator panels

Asm-index	P/N	Units/mach	Units/FRU	Description	Removal procedure
1	40X7835	1	1	UICC to controller board cable (CX310, CX317dn, CX410 and CX417de)	“UICC to controller board cable removal” on page 321
1	40X7837	1	1	UICC to controller board cable (CX510, CX517de and XC2132)	“UICC to controller board cable removal” on page 321
2	40X7836	1	1	USB cable (CX410, CX417de and XC2130)	“Operator panel removal (for CX310 and CX410 models only)” on page 313
2	40X5480	1	1	USB cable (CX510, CX517de and XC2132)	“Operator panel removal (for CX510 models only)” on page 320
3	40X7818	1	1	Bezel (CX510)	“Operator panel bezel removal” on page 312
3	41X2016	1	1	Bezel (CX517de)	“Operator panel bezel removal” on page 312
3	40X9151	1	1	Blank bezel (CX510, CX517de, XC2132)	“Operator panel bezel removal” on page 312
4A	41X0910	1	1	Operator panel and display assembly (CX310 and CX317dn)	“Operator panel removal (for CX310 and CX410 models only)” on page 313
4B	41X0911	1	1	Operator panel and display assembly (CX410, CX417de and XC2130)	“Operator panel removal (for CX310 and CX410 models only)” on page 313
4C	41X0912	1	1	Operator panel and display assembly (CX510, CX517de and XC2132)	“Operator panel removal (for CX510 models only)” on page 320
5A	40X7839	1	1	Upper front cover (CX310, CX317dn, CX410, CX417de and XC2130)	“Operator panel removal (for CX310 and CX410 models only)” on page 313
5B	40X7838	1	1	Upper front cover (CX510, CX517de and XC2132)	“Operator panel removal (for CX510 models only)” on page 320
6A	40X7808	1	1	Front logo cover (CX310, CX317dn, CX410, CX417de and XC2130)	“Operator panel logo plate removal” on page 313
6B	40X7816	1	1	Front logo cover (CX510, CX517de and XC2132)	“Operator panel logo plate removal” on page 313
7A	40X7840	1	1	User interface support bracket (CX310, CX317dn, CX410, CX417de and XC2130)	“Operator panel removal (for CX310 and CX410 models only)” on page 313

Asm-index	P/N	Units/mach	Units/FRU	Description	Removal procedure
7B	40X7841	1	1	User interface support bracket (CX510, CX517de and XC2132)	“Operator panel removal (for CX510 models only)” on page 320
8	40X7817	1	1	Operator panel bezel (CX310)	“Operator panel bezel removal” on page 312
8	41X1981	1	1	Operator panel bezel (CX317)	“Operator panel bezel removal” on page 312
8	40X7803	1	1	Operator panel bezel (CX410)	“Operator panel bezel removal” on page 312
8	41X1982	1	1	Operator panel bezel (CX417)	“Operator panel bezel removal” on page 312
NS	40X6517	1	1	Speaker	“Speaker removal” on page 288

Assembly 5: Electronics

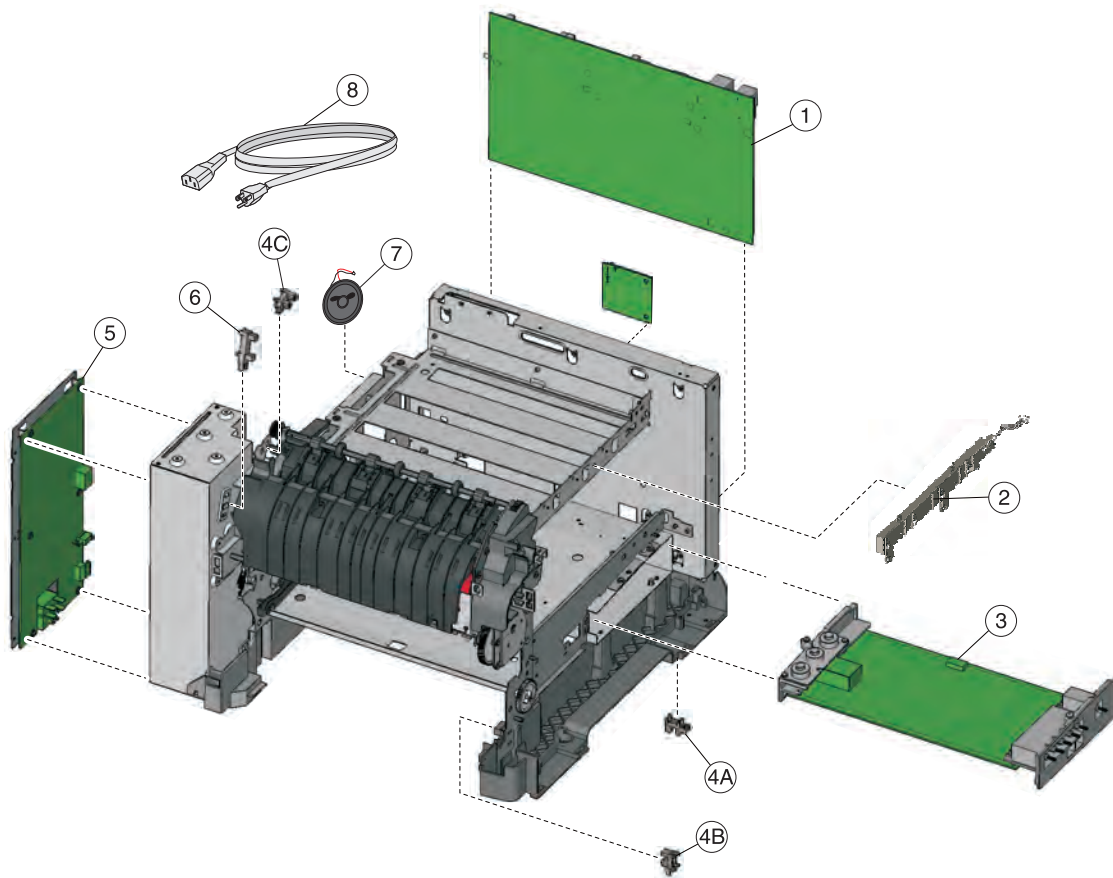

Assembly 5: Electronics

Asm-index	P/N	Units/mach	Units/FRU	Description	Removal procedure
1	40X7804	1	1	Controller board (CX310 and CX317dn)	“Controller board removal” on page 348
1	40X7805	1	1	Controller board (CX410, CX417de and XC2130)	“Controller board removal” on page 348
1	40X7806	1	1	Controller board (CX510, CX517de and XC2132)	“Controller board removal” on page 348
2	40X7620	1	1	Toner meter cycle card assembly	“Toner meter cycle (TMC) card removal” on page 290
3	40X7625	1	1	High-voltage power supply	“High-voltage power supply (HVPS) removal” on page 296
4	40X7301	3	1	Photo sensor and retainer (one per package), used for: <ul style="list-style-type: none"> • Tray present sensor (4A) • Duplex sensor (4B) • Narrow media sensor (4C) 	“Tray present sensor removal” on page 342 , “Duplex sensor removal” on page 338 , “Narrow media sensor removal” on page 363
5	40X7626	1	1	Low-voltage power supply (universal power supply)	“Low-voltage power supply (LVPS) removal” on page 285
6	40X5413	1	1	Fuser exit sensor	“Fuser exit sensor removal” on page 286
7	40X6517	1	1	Speaker	“Speaker removal” on page 288
8	40X1766	1	1	Power cord, 2.5 m (straight): Bolivia, Peru	N/A
8	40X0269	1	1	Power cord, 2.5 m (straight): USA, Canada, APG, LAD	N/A
8	40X0288	1	1	Power cord, 2.5 m (straight): Argentina	N/A
8	40X0301	1	1	Power cord, 2.5 m (straight): Australia	N/A
8	40X4596	1	1	Power cord, 2.5 m (straight): Brazil	N/A
8	40X0273	1	1	Power cord, 2.5 m (straight): Chile, Uruguay, Italy	N/A
8	40X1774	1	1	Power cord, 2.5 m (straight): Denmark	N/A
8	40X0275	1	1	Power cord, 2.5 m (straight): Israel	N/A
8	40X3609	1	1	Power cord, 2.5 m (straight): Japan	N/A

Asm-index	P/N	Units/mach	Units/FRU	Description	Removal procedure
8	40X1792	1	1	Power cord, 2.5 m (straight): Korea	N/A
8	40X3141	1	1	Power cord, 2.5 m (straight): Paraguay, Europe, Middle East, Indonesia, Africa (HV)	N/A
8	40X0303	1	1	Power cord, 2.5 m (straight): PRC	N/A
8	40X1773	1	1	Power cord, 2.5 m (straight): South Africa	N/A
8	40X1772	1	1	Power cord, 2.5 m (straight): Switzerland	N/A
8	40X1791	1	1	Power cord, 2.5 m (straight): Taiwan	N/A
8	40X0271	1	1	Power cord, 2.5 m (straight): United Kingdom	N/A
8	40X7229	1	1	Power cord, 2.5 m (straight): India	N/A
NS	40X7852	1	1	Fax card	N/A
NS	40X8448	1	1	Fax interface cable	N/A
NS	40X7813	1	1	AIO cables <ul style="list-style-type: none"> • Redrive jam or bin full sensor cable • 770 mm ground cable • Speaker cable 	N/A

Assembly 6: Cables and sensors

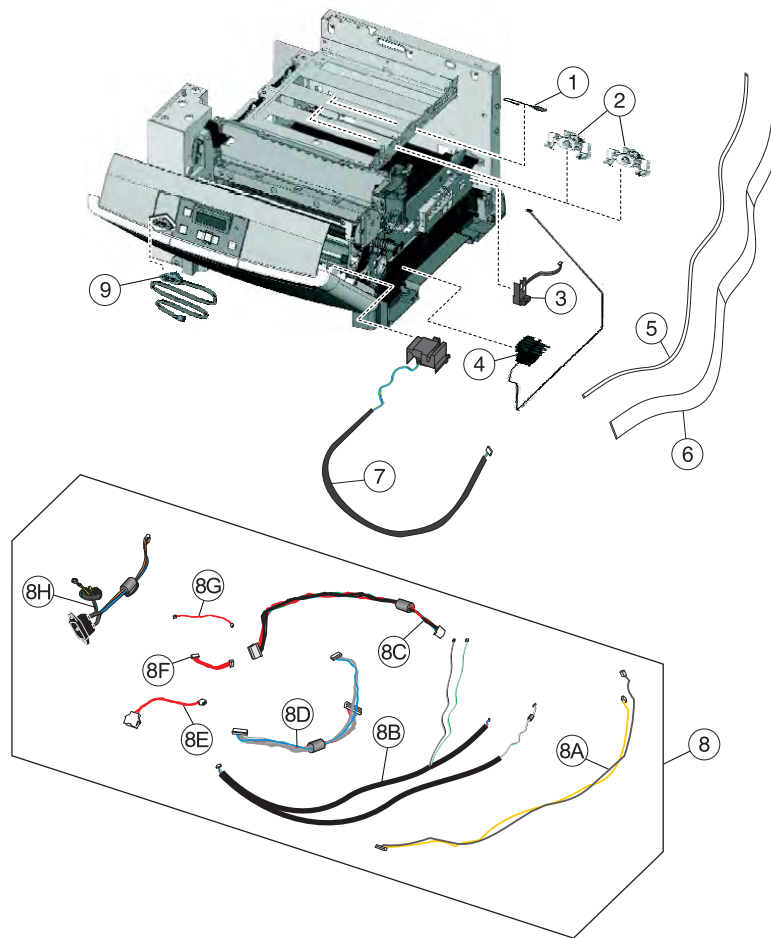

Assembly 6: Cables and sensors

Asm-index	P/N	Units/mach	Units/FRU	Description	Removal procedure
1	40X5429	1	1	ITU paper path thermistor	“Thermistor removal” on page 292
2	40X5414	2	1	Toner density sensors, left or right (one in package)	N/A
3	40X7046	1	1	Waste toner bottle sensor	N/A
4	40X7636	4	1	Toner cartridge contacts (Pogo pin)	N/A
5	40X7835	1	1	UICC to controller board cable (CX310, CX317dn, CX410, CX417de and XC2130)	N/A
5	40X7837	1	1	UICC to controller board cable (CX510, CX517de and XC2132)	N/A
6	40X8670	1	1	Printhead-to-controller board cable	N/A
7	40X7618	1	1	Front and right side interlock switch cover assembly	N/A
8	40X7647	1	1	Cable packet, used for: <ul style="list-style-type: none"> • Fuser exit/narrow media to controller board (8A) • Fuser motor, thermistor, and duplex sensor to controller board (8B) • LVPS to controller board (8C) • CMY/K motors to controller board (8D) • Tray 2 to controller board (8E) • HVPS to controller board (8F) • Tray present sensor to controller board (8G) • AC power to LVPS (8H) • Speaker cable (NS) 	N/A
9	40X7836	1	1	Operator panel USB cable	N/A

Assembly 7: Media drawers and trays

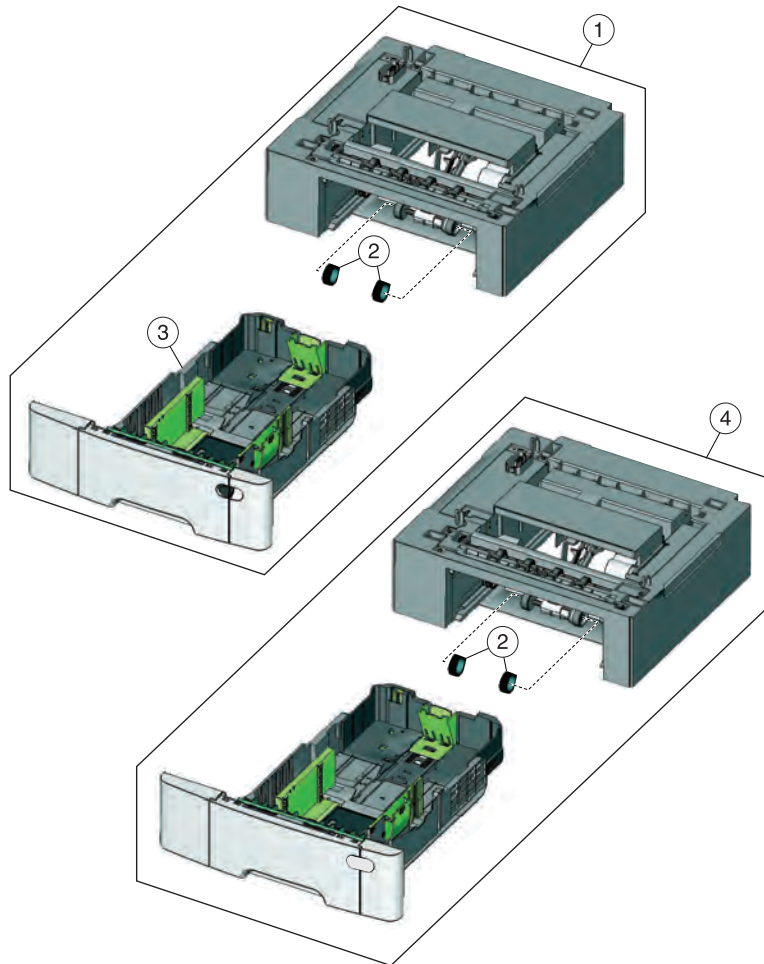

Assembly 7: Media drawers and trays

Asm-index	P/N	Units/mach	Units/FRU	Description	Removal procedure
1	40X8089	1	0	Optional 650-sheet duo drawer (complete) (includes 100-sheet MPF)	“650-sheet duo drawer assembly removal” on page 385
2	40X5168	2	2	Pick tires	“Pick tire removal” on page 387
3	40X8091	1	1	650-sheet Duo Drawer tray assembly	“650-sheet duo drawer tray assembly removal” on page 384
4	40X8090	1	1	Optional 550-sheet drawer (complete) (CX410, CX417de, CX510, CX517de, XC2132, and XC2130 only)	N/A
NS	41X0923	1	1	Dust cover	“Dust cover removal” on page 386

Assembly 8: Options and miscellaneous

Asm-index	P/N	Units/opt	Units/FRU	Description	Removal procedure
NS	40X7615	1	1	115 V Maintenance kit (fuser, ITU)	N/A
NS	40X7616	1	1	230 V Maintenance kit (fuser, ITU)	N/A
NS	40X7617	1	1	100 V Maintenance kit (fuser, ITU)	N/A
NS	40X8555	1	1	256MB Flash memory card	N/A
NS	40X8568	1	1	Korean font card assembly	N/A
NS	40X8557	1	1	Simplified Chinese font card assembly	N/A
NS	40X8556	1	1	Traditional Chinese font card assembly	N/A
NS	40X8569	1	1	Japanese font card assembly	N/A
NS	40X8570	1	1	Arabic font card assembly	N/A
NS	40X8571	1	1	Hebrew font card assembly	N/A
NS	41X0880	1	1	Forms and Bar Code Card (CX310 and CX317dn) Note: This part is obsolete.	N/A
NS	41X0882	1	1	Forms and Bar Code Card (CX410, CX417de and XC2130) Note: This part is obsolete.	N/A
NS	41X0884	1	1	Forms and Bar Code Card (CX510, CX517de and XC2132) Note: This part is obsolete.	N/A
NS	41X0881	1	1	Card for PRESCRIBE (CX310 and CX317dn)	N/A
NS	41X0883	1	1	Card for PRESCRIBE (CX410, CX417de and XC2130) Note: This part is obsolete.	N/A
NS	41X0886	1	1	Card for PRESCRIBE (CX510, CX517de and XC2132) Note: This part is obsolete.	N/A
N/A	40X1368	1	1	USB Cable, packaged (2 m)	N/A
NS	3049485	1	1	Field relocation package assembly	N/A
NS	40X9939	1	1	MarkNet N8352 802.11b/g/n Wireless print server (external)	N/A
NS	40X7445	1	1	2GB x 32 DDR3 RAM	N/A
NS	40X7567	1	1	1GB x 32 DDR3 RAM	N/A
NS	40X7857	1	1	160+ GB hard disk	N/A
NS	40X9652	1	1	Adapter, N8130 10/100 fiber	N/A

Printer specifications

- “Power specifications” on page 427
- “Electrical specifications” on page 427
- “Operating clearances” on page 428
- “Acoustics” on page 429
- “Environment” on page 430
- “Processor” on page 430
- “Enabling the security reset jumper” on page 430

Power specifications

The average nominal power requirements for the base printer configuration are shown in the following table (power levels are shown in watts):

Note: Some modes may not apply to all models.

Printing states	Power
Off	0.0W
Sleep Mode	7W
Hibernate Mode	1W
Standby Mode	50W
Ready Mode	40W
Simplex printing	500W
Duplex printing	550W

Maximum current shown in amp ergs.

Notes:

- Using a power converter or inverter is not recommended.
- The CX310, CX410, and CX510 models are ENERGY STAR Qualified.
- All models ship with Sleep Mode set to On.

Electrical specifications

Low-voltage models

- 100 to 127 V ac at 50 to 60 hertz (Hz) nominal
- 90 to 137 V ac, extreme

High-voltage models

- 220 to 240 V ac at 50 to 60 hertz (Hz) nominal (not available in all countries and regions)

Operating clearances

CX310

Note: Allow additional clearance around the printer for adding options, such as additional input trays.



#	Side	Clearance
1	Right side	152 mm (6 in.)
2	Front	508 mm (20 in.)
3	Left side	76 mm (3 in.)
4	Rear	102 mm (4 in.)
5	Top	254 mm (10 in.)

CX410 and CX510

Note: Allow additional clearance around the printer for adding options, such as additional input trays.



#	Side	Clearance
1	Right side	305 mm (12 in.)
2	Front	508 mm (20 in.)
3	Left side	76 mm (3 in.)
4	Rear	101.02 mm (4 in.)
5	Top	762 mm (30 in.)

Acoustics

All measurements are made in accordance with ISO 7779 and conform with ISO 9296.

Note: Some modes may not apply to all models.

Status	1-meter average sound pressure dBA
Printing	48 dBA
Ready	Inaudible

Status	1-meter average sound pressure dBA
Printing	50 dBA
Ready	Inaudible

Note: Values are subject to change. See <http://support.lexmark.com> for current values.

Environment

Printer Temperature and Humidity

- Operating
 - Temperature: 60 to 90° F (15.6 to 32.2° C)
 - Relative humidity: 8 to 80%
 - Maximum wet bulb temperature: 73° F (22.8° C)
 - Altitude: 10,000 ft. (0 to 3,048 meters)
 - Atmospheric pressure: 74.6 kPa
- Power off
 - Temperature: 50 to 110° F (10 to 43.3° C)
 - Relative humidity: 8 to 80%
 - Maximum wet bulb temperature: 80.1° F (26.7° C)
 - Altitude: 10,000 ft. (0 to 3,048 meters)
 - Atmospheric pressure: 74.6 kPa
- Ambient operating environment*
 - Temperature: 60 to 90° F (15.6 to 32.2° C)
 - Relative humidity: 8 to 80%
- Storage and shipping (packaged printer) with or without print cartridge
 - Temperature: -40 to 110° F (-40 to 43.3° C)

*In some cases, performance specifications (such as paper OCF, EP cartridge usage) are measured at an ambient condition.

Processor

1.2 GHZ Power PC processor

Enabling the security reset jumper

The security reset jumper can reset a printer that is locked due to a forgotten password or lost network connectivity.

Notes:

- Resetting the printer deletes all security settings.
- Before changing the security settings, ask for permission from your administrator.

- 1 Turn off the printer.
- 2 Access the controller board.
- 3 Move the jumper to cover the middle and exposed prongs.

Note: The small yellow jumper is located beside a lock icon on the controller board.

- 4 Turn on the printer.

Invalidating the effects of a jumper reset

1 From the Embedded Web Server, click **Settings > Security > Miscellaneous Security Settings**.

2 From the Security Reset Jumper menu, select **No Effect**.

Warning: This setting disables access to the security menus of a locked printer. To regain access to the menus, replace the controller board.

3 Click **Submit**.

Notes:

- Use a cable lock to secure the controller board and prevent a malicious reset.
- For multifunction products, when the controller board is replaced, the security settings are lost and the LDAP configuration and Copy function are no longer protected.

Options and features

- [“Available internal options” on page 433](#)
- [“Media handling options” on page 433](#)
- [“Option configurations” on page 434](#)

Lexmark CX310, CX410, and CX510 support only Lexmark CX310, CX410, and CX510 paper-handling options. These options are not compatible with any other Lexmark printer. Some of the following options are not available in every country or region.

Available internal options

- Memory cards
 - Printer memory
 - Flash memory
 - Fonts
- Firmware cards
 - Bar Code
 - PrintCryption™
- Printer hard disk
- Lexmark™ Internal Solutions Ports (ISP)
 - RS-232-C Serial ISP
 - Parallel 1284-B ISP
 - MarkNet™ N8250 802.11 b/g/n Wireless ISP
 - MarkNet N8130 10/100 Fiber ISP
 - MarkNet N8120 10/100/1000 Ethernet ISP

Media handling options

Note: Some media handling options may not be available for all models.

Input options:

- Standard integrated 250-sheet tray (Tray 1)
- Standard 100-sheet multipurpose feeder
- Standard 1-sheet manual feed slot
- Optional 550-sheet tray (CX410 and CX510 models only)

Output options

- Standard 100-sheet sensing bin
- Optional 650-sheet duo tray with integrated multipurpose feeder (Tray 2)

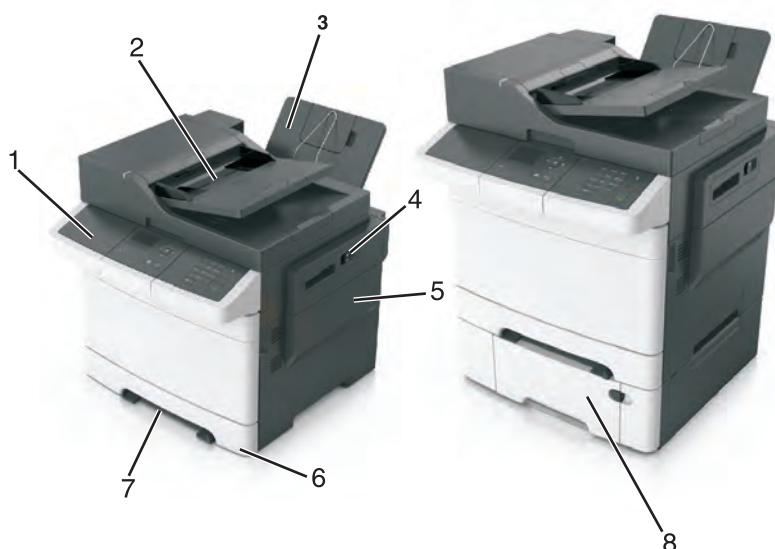

#	Part
1	Printer control panel
2	Automatic document feeder (ADF)
3	Standard bin
4	Top door latch
5	Right side cover
6	Standard 250-sheet tray (Tray 1)
7	Manual feeder
8	Optional 650-sheet duo tray with integrated multipurpose feeder (Tray 2)

Option configurations

The CX310, CX410, and CX510 optional drawers can be configured to run in a stacked configuration. Unlike the C544n and C544dn printers, the CX310, CX410, and CX510 printers support a maximum of two stacked optional drawers—one 650 DuoDrawer at tray 2, and an additional 550 drawer at tray 3. The CX310, CX410, and CX510 DuoDrawers are also designed to be downward compatible with the C544n and C544dn printers. Because the C544n and C544dn 650 DuoDrawer, and the CX310, CX410, and CX510 650 DuoDrawer and 550 drawer share the same autoconnect features, there are several ways in which the drawers can be stacked together. The following describes three types of option configurations.

Supported configurations

These configurations are valid and supported. The options are designed and tested according to these types of configurations.

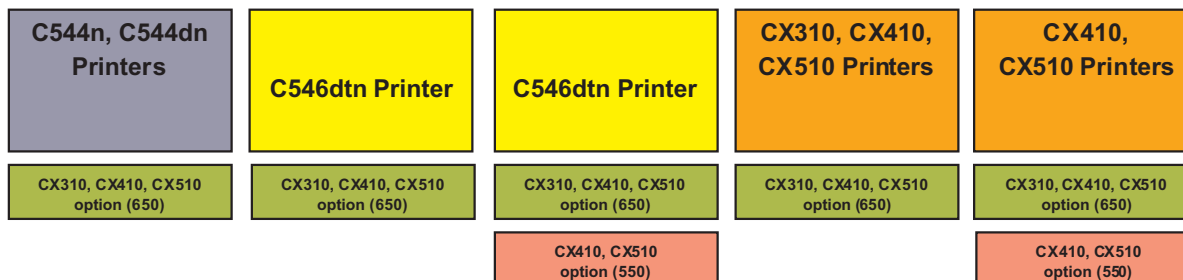

Unsupported configurations

These configurations are invalid and would result to an **Invalid Input Config** error on a CX310, CX410, or CX510 printer, or **Too Many Trays Attached** error on a C544n or C544dn printer.

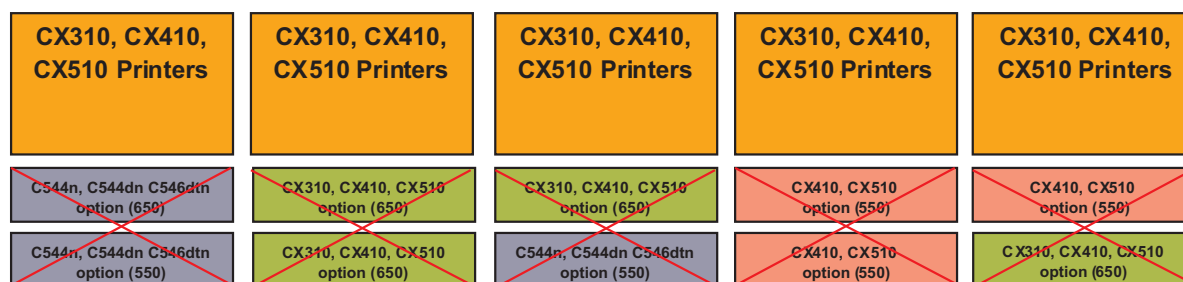

Unclaimed configuration

This configuration is not supported and unclaimed, though the printer may not declare an error. This configuration is functional but is not a valid configuration.

Warning—Potential Damage: The engine code and the options are not designed and tested thoroughly on this configuration. This could result to unpredictable printer operation.

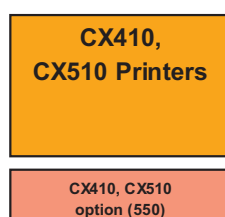

Theory of operation

- [“Paper path and transport components” on page 437](#)
- [“Print engine theory” on page 439](#)
- [“ADF theory” on page 443](#)
- [“Color theory” on page 445](#)

Paper path and transport components

- [“Paper path information” on page 437](#)
- [“Transport components” on page 438](#)
- [“Duplexing” on page 438](#)

For an image to be printed, the paper or specialty media has to be moved from an input source (such as a tray) into the printer and eventually exit into an output source.

The most important component in this process is this paper itself. Old, damaged, or out-of-specification paper can and will cause feed and transport problems. If you encounter problems, you should always check the paper first. See [“Media guidelines” on page 31](#). In addition, it is always good practice to check the printer and driver settings to see if the paper being used matches the user’s settings. It is not uncommon to find a user printing on cardstock with the printer programmed to print on a plain paper setting.

The printer’s feed and transport components can fail and cause paper jams or other feed and transport problems. These components should be examined for damage or wear and replaced if necessary.

Paper path information

The printer has a simple C-shaped paper path. The tray 1 paper is shown in red and the optional 650-sheet duo tray paper path is not shown.

Paper is fed from the rear of the printer and travels upward through the front cover.

The duplex unit is built into the front cover and Tray 1.

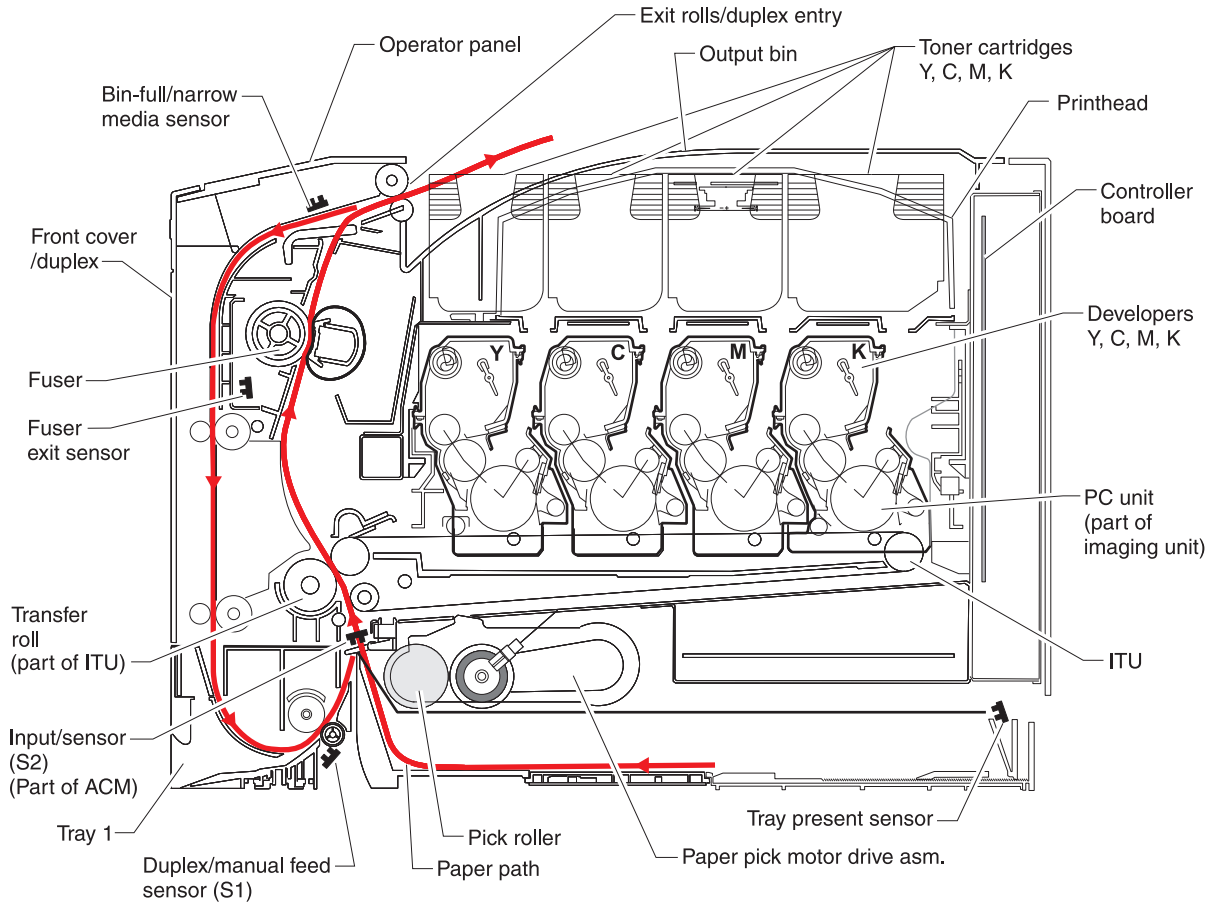

Note: The ACM is also known as the paper feed roller assembly.

Transport components

The paper is fed from the tray into the printer by a pick roll and sent to two sets of feed rollers which time the paper to enter the Electrophotographic Process (EP Process) at just the right moment. The feed rollers push the paper to the transfer module where the image is transferred to the page.

The transfer roller moves the paper to the fuser where heat and pressure are applied to the page. The fuser rollers push the paper toward the exit bin and past the exit sensor. The exit rollers guide the paper into the output bin.

Note: If the printer posts a paper jam message but no paper is found, then paper dust or paper particles may have fallen into one of the sensor eyes. Use a can of compressed air to gently clean the sensor.

Duplexing

Printers with duplex support use a secondary paper path to print on the second side of a sheet of paper. The duplexing process is summarized as follows:

After the first side of the paper is printed and the trailing edge of the paper clears the fuser exit sensor, the fuser motor engages to reverse the paper direction and feed it into the duplex unit. The pick motor also reverses. The pick motor drives the duplex aligner rolls (A), which push the media down to the bottom turnaround in the paper tray and gate aligner (B).

Note: While the sheet is being transported through the duplex unit, it is the only sheet of paper being processed by the print engine. A user should not attempt to insert a sheet of paper into the manual paper feed while a duplex job is being processed. This would cause a paper jam error.

When the trailing edge of the media clears the fuser, the fuser engine rotates forward to prepare the fuser for the page traveling through the duplex unit.

As the media reaches the gate aligner, a sensor (S1) is triggered, indicating the presence of the leading edge.

When the S1 sensor is triggered, the paper continues to the (S2) sensor. When the S2 signal is detected, the speed of the pick motor is adjusted to accommodate the speed of the transfer belt, ensuring the proper registration of the image on the media. The paper travels to the transfer module (C), and the second image is transferred to the reverse side of the media.

Once the image is transferred, the media travels to the fuser (D), the fuser exit rolls (E), and then to the output bin.

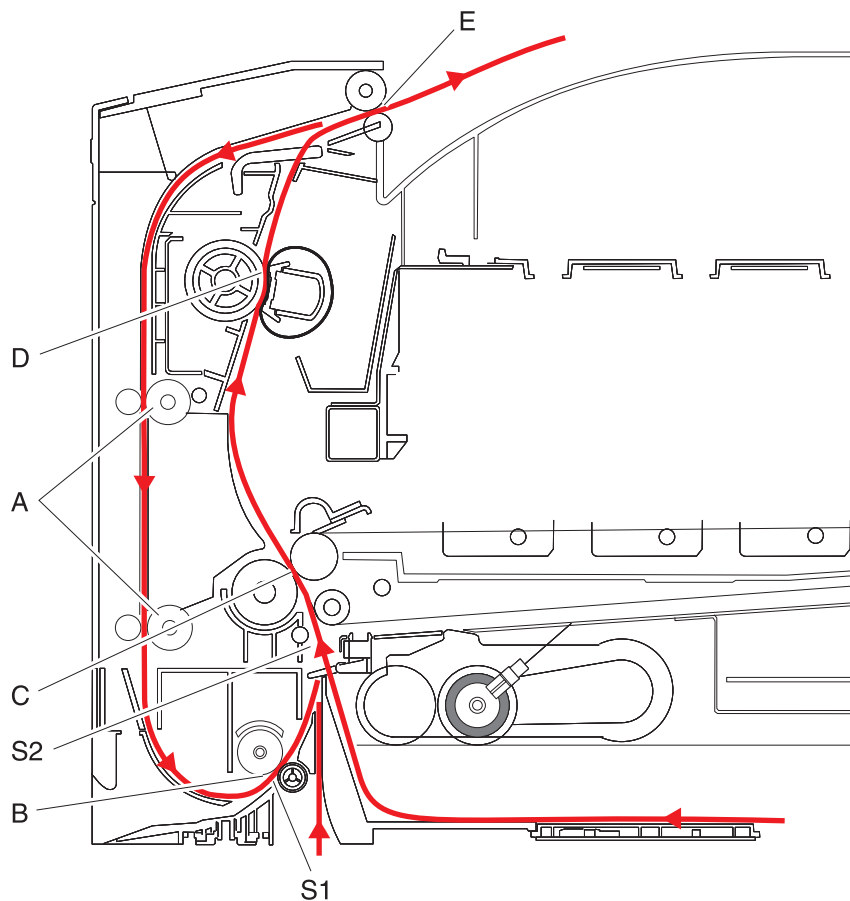

Print engine theory

- [“Electrophotographic process \(EP process\)” on page 440](#)
- [“Electrophotographic process basics” on page 440](#)

Electrophotographic process (EP process)

The method that all laser and LED printers use to print is called the electrophotographic process. These machines use differences in charge to manipulate and move toner from the print cartridge to the printed page.

Even though the basic EP process is the same for every laser and LED printer, the specifics for each printer are different.

Electrophotographic process basics

This printer is a single-laser printer that use four print cartridges (cyan, yellow, magenta, and black) to create text and images on paper.

The printer has four photoconductors (sometimes called a photodeveloper cartridge or PC unit) built into the print cartridges and an image transfer unit (ITU). Each color toner is painted to its respective photoconductor at the same time. The transfer belt passes under the four photoconductors and the four-color image is produced and transferred to the paper in one pass.

During the printing process, the printer follows the six basic EP Process steps to create its output to the page.

- 1 Charge the photoconductor.
- 2 Expose the photoconductor with the laser.
- 3 Develop toner on the photoconductor.
- 4 First transfer to the ITU, and second transfer to the paper.
- 5 Fuse the toner to the paper.
- 6 Clean/erase the photoconductor and the ITU.

In summary, the printer's controller board receives print data and the command to print. The controller board then initiates the print process. The controller board is the command center for the EP process and coordinates the various motors and signals.

The high-voltage power supply (HVPS) sends charge to various components in the EP process. The laser fires on the photoconductors and alters the surface charge relative to the planned image for each photoconductor. Each photoconductor rotates past its respective developer roll, and toner is developed on the surface of each photoconductor. The four separate color images are then transferred to the transfer belt on the ITU as it passes under the photoconductors. After the image is transferred to the transfer belt, the photoconductors are cleaned and recharged.

The transfer belt carries the four-colored image towards the transfer rolls. Paper is picked up from the tray and carried to the transfer roll where the image is transferred from the transfer belt to the paper. The timing of the paper pick is determined by the speed of the transfer belt.

The paper is carried to the fuser rollers where heat and pressure are applied to the page to permanently bond the toner to the page. The fuser rollers push the paper into the output bin. The transfer unit is cleaned and the process begins again for the next page.

Step 1: Charge

During the charge step, voltage is sent from the HVPS to the charge roller beside each of the four photoconductors. In this printer, the charge roll is part of the photoconductor unit in the print cartridges.

The charge roller puts a uniform negative charge over the entire surface of the photoconductor to prepare it for the laser beam.

Service tips

- If the surface of the charge roller is damaged (such as a nick or pit), it will cause the charge on the photoconductor to be uneven. This will cause a repeating mark on the printed page. Check the service manual for the repeating marks table.
- If the charge roller is severely damaged, the surface of the photoconductor will not be properly charged and heavy amounts of toner will be deposited on the photoconductor. This will cause the printed page to be saturated with 100% of each color. The imaging basket will need to be replaced sooner.

Step 2: Expose

During the expose step, the laser fires a focused beam of light at the surface of each photoconductor and writes an invisible image, called a latent image or electrostatic image, for each color.

The laser beam only discharges the surface where the beam hits the photoconductor. This creates a difference in charge potential between the exposed area and the rest of the photoconductor surface.

Service tips

- The laser beam passes through a glass lens as it exits the laser unit. If this lens gets contaminated with toner or other debris, it will cause vertical streaking of white/lightness on the page. Cleaning the lens will solve the problem.
- Never touch the surface of the photoconductor with your bare hand. The oil from your skin may cause a charge differential on the surface, and toner will not properly stick. The result would be repeating blotches of voids/light print on a page. Then the photoconductor will have to be replaced.
- The surface of the photoconductor is coated with an organic substance that makes it sensitive to light. Be sure to cover the photoconductor when you are working on the printer so you don't "burn" it. If exposed to light for too long, it will cause light/dark print quality problems and will have to be replaced.

Step 3: Develop

When the laser exposes the photoconductor, the HVPS sends charge to the developer roll. For each color, the print cartridge engages the photoconductor so it is in contact with the surface. Because of the charge difference between the toner on the developer roller and the electrostatic image created by the laser, the toner is attracted to areas of the photoconductor surface exposed by the laser.

This process would be similar to using glue to write on a can and then rolling it over glitter. The glitter sticks to the glue but won't stick to the rest of the can.

Service tips

- Never touch the surface of the developer roller with your bare hand. The oil from your skin may cause a charge differential on the surface, and toner will not stick properly. The result would be repeating blotches of voids/light print on a page. Then the affected cartridge will have to be replaced.
- If the developer roller is damaged, it will not contact the surface of the photoconductor properly. The result could be repeating marks, thin vertical voids, or thin vertical lines of color on the printed page. Check the surface of the developer for damage.

Step 4a: First transfer

When the latent images are developed on each Photoconductor, the HVPS sends voltage to the 1st Transfer Rollers inside the ITU.

The charge difference between the developed toner image on the Photoconductor surface and the 1st Transfer Roller causes the images to transfer to the surface of the ITU belt for each color. This takes place by a direct surface-to-surface contact between the Photoconductors and the ITU transfer belt.

Service tips

- Never touch the surface of the ITU belt with your bare hand. The oil from your skin will cause a charge differential on the surface, and toner will not stick properly. The result would be repeating blotches of voids/light print on a page. Then the ITU belt will have to be replaced.
- Do not use solvents or other cleaners to clean the ITU belt surface. No matter how careful you are, the surface will be compromised, causing scratches or a charge differential that will produce voids or light blotches on the printed page. Then the ITU belt will need to be replaced.

Step 4b: Second transfer

When the four planes of color are transferred to the transfer belt from the photoconductors, the image is carried toward the transfer roll, which is also part of the ITU. Based on the speed of the transfer belt, the proper time to send the signal to pick the paper from an input source is determined. The pick is timed so that the paper passes between the transfer belt and transfer roll when the image on the belt reaches the second transfer area.

The HVPS sends voltage to the transfer roll to create a positive charge. When the image on the transfer belt reaches the transfer roll, the negatively charged toner clings to the paper and the entire image is transferred from the transfer belt to the paper.

Service tips

- If the transfer roller has nicks, pits, or flat spots on it, the surface doesn't come into contact with the paper and transfer unit. This will cause voids or light spots on the page or repeating voids/light areas.
- If the transfer roller does not engage the transfer unit, or does not have voltage coming from the HVPS, the toner will not fully transfer from the transfer unit; the entire page will be very light or blank. Any toner that does transfer will be due to a "contact" transfer instead of a "charge" transfer. Check the HVPS contacts to the transfer roller.

Step 5: Fuse

When the image has been fully transferred to the paper, the transfer roll helps move the paper into the fuser area.

The fuser applies heat and pressure to the page to melt the toner particles and bond them permanently to the paper. The fuser moves the paper to the redrive rolls which move the paper to the output bin.

Service tips

- If the fuser rollers are damaged, they can cause toner to be pulled off the page or cause paper jams.
- Toner that rubs off a printed page can be a sign of a malfunctioning fuser or an improper paper setting. Always check the paper type setting before replacing the fuser. A common mistake is to print on heavier media (such as cardstock) with the paper type set to plain paper.
- When removing paper jams from the fuser, be sure to use the fuser release tabs to relieve the pressure on the page. In addition, never pull unfused toner through the fuser if you can help it; try to back the jammed page out of the fuser in the opposite direction it was travelling.

Step 6: Clean/Erase

There are two main cleaning processes that take place during the EP Process. One process cleans the transfer belt, and the other cleans the photoconductors.

Transfer unit clean

When the toner image on the transfer belt has been transferred to the page, the transfer belt rotates around and is cleaned by the cleaning blade (G). This occurs for every page that is printed.

After the toner is moved to the cleaning blade, the toner is moved to the waste toner area using an auger system.

Photoconductor clean/erase

After each plane of color has been transferred to the transfer belt from the photoconductors, a cleaning blade (H) scrapes the remaining toner from the surface of each photoconductor. This is the clean/erase process.

Now the photoconductor surface is prepared to restart the EP Process. This cleaning/erasing cycle happens after each plane of color is transferred to the transfer belt.

ADF theory

ADF theory of operation

ADF cross section

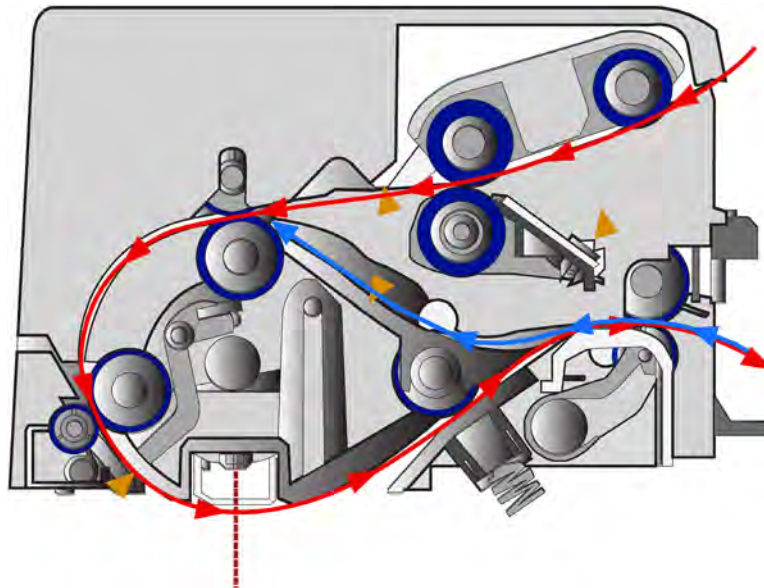

1	Document sensor
2	Pickup roller
3	Separator roller
4	Stage and interval sensors
5	Paperfeed 1 roller
6	Paperfeed 2 roller
7	Feed sensor
8	Scan area
9	Duplex sensor
10	Eject 2 roll
11	Exit roller

The duplex ADF enables the user to create duplex scans automatically, eliminating the need to stop the scanning process to flip the media being duplicated over. The ADF uses DC motors with encoder wheels, and a series of sensors to determine the media's position in the paper path during the scan process. The following steps are performed in creating a duplex scan on the duplex ADF:

Note: The simplex ADF uses only one motor for all paper transport functions, and does not have de-skew capabilities. The scanner control unit, on the controller board receives a command to create a scan, fax, or copy.

- 1** The scanner control unit, on the controller board receives a command to create a scan, fax, or copy.
- 2** A signal is sent to the ADF to poll the document sensor (1) to check if the media to be scanned is in the correct position. The media must be placed in the ADF input tray so it actuates the document sensor. If the ADF document sensor isn't actuated, a flatbed scan is run by default.
- 3** If the media has actuated the document sensor, then an ADF scan is executed. At this point the pickup roller (2) on the pick arm assembly drops and advances the paper into the ADF. To minimize the possibility of multiple sheets being fed, a counter rotating separator roll (3) is used. After passing through pick assembly, the media actuates the stage and interval sensors (4). Actuating these sensors determines that this will be the first side of the document to be scanned.
- 4** In addition the stage sensors are used to determine and correct document skew if it is present. If the stage sensors are actuated at different times, then the paper is slowly fed to the paper feed 1 roller. The feed motor encoder wheel count tracks the paper location in the paper path.
- 5** When the paper reaches the paper feed 1 roller (5), the stationary state of the paper feed 1 roller acts as a registration roll, causing the paper to de-skew.
- 6** When the encoder count reaches a certain count, the paper feed 1 roller advances the now de-skewed paper to the paper feed 2 roller (6) and the feed sensor (7). If the paper does not actuate the feed sensor before a certain encoder count is attained, a paper jam error is generated.
- 7** When the feed sensor is actuated the paper advances to the scan area (8). While the paper is advancing to the scan area, the DC motor encoder generates a count which is stored in an on-board counter. These counts along with the feed sensor ensure that the media is travelling at the correct speed through the scan area. The speed the document travels through the ADF scan area is dependent on the image DPI specified by the user.
- 8** After a predetermined number of counts, the media reaches the scan area and the image acquisition process is initiated. While the image acquisition process is executing, the feed sensor is being polled to determine if the trailing edge of the media has reached the sensor.
- 9** Once the trailing edge of the scan media has reached the feed sensor, that sensor goes to the off position. After the feed sensor is switched off, the image acquisition process continues for a predetermined length of time.
- 10** When the image acquisition process is completed, the trailing edge of the media continues to the reverse point. If the scan job is simplex, then the media continues to the exit roller (11) and exits the ADF.
- 11** If the scan job is a duplex scan job, then the feed motor is reversed with a swing gear when the trailing edge of the media reaches the reverse point. A swing gear moves the diverter gate to the down position.
- 12** The reversed exit roll (10) pulls the paper back into the ADF. The eject 2 roll then moves the media to the duplex sensor. When the duplex sensor (9) is actuated, the exit roll stops. Also, the duplex sensor indicates that this is the second side of the media to be scanned.

- 13** After actuating the duplex sensor, eject2 roll moves the media to the paper feed 1 roll, and the feed sensor. Like the first pass of the media, the image acquisition process is repeated for the second side of the media.
- 14** When the trailing edge of the media reaches the reverse point the second time, the swing gear again moves the diverter gate to the down position and the exit roll reverses. The paper goes back into the ADF unit for a third time. The paper passes through the paper path, but no imaging occurs. This pass is to turn the paper over to the original side up. On the third pass of the media trailing edge over the reverse point, the eject two roller does not reverse and the paper passes out of the ADF.

Color theory

- [“Color theory” on page 445](#)

Color theory

What is RGB color?

Red, green, and blue light can be added together in various amounts to produce a large range of colors observed in nature. For example, red and green can be combined to create yellow. Televisions and computer monitors create colors in this manner. RGB color is a method of describing colors by indicating the amount of red, green, or blue needed to produce a certain color.

What is CMYK color?

Cyan, magenta, yellow, and black inks or toners can be printed in various amounts to produce a large range of colors observed in nature. For example, cyan and yellow can be combined to create green. Printing presses, inkjet printers, and color laser printers create colors in this manner. CMYK color is a method of describing colors by indicating the amount of cyan, magenta, yellow, and black needed to reproduce a particular color.

How is color specified in a document to be printed?

Software programs typically specify document color using RGB or CMYK color combinations. Additionally, they allow users to modify the color of each object in a document. For more information, see the software program Help topics.

How does the printer know what color to print?

When a user prints a document, information describing the type and color of each object is sent to the printer. The color information is passed through color conversion tables that translate the color into the appropriate amounts of cyan, magenta, yellow, and black toner needed to produce the desired color. The object information determines the application of color conversion tables. For example, it is possible to apply one type of color conversion table to text while applying a different color conversion table to photographic images.

Should I use PostScript or PCL emulation? What settings produce the best color?

The PostScript driver is strongly recommended for best color quality. The default settings in the PostScript driver provide the preferred color quality for the majority of printouts.

Why doesn't the printed color match the color I see on the computer screen?

The color conversion tables used in Auto Color Correction mode generally approximate the colors of a standard computer monitor. However, because of technology differences that exist between printers and monitors, there are many colors that can also be affected by monitor variations and lighting conditions.

The printed page appears tinted. Can I adjust the color?

Sometimes a printed page may appear tinted (for example, everything printed seems to be too red). This can be caused by environmental conditions, paper type, lighting conditions, or user preference. In these instances, adjust the Color Balance setting to create a more preferable color. Color Balance provides the user with the ability to make subtle adjustments to the amount of toner being used in each color plane. Selecting positive or negative values for cyan, magenta, yellow, and black (from the Color Balance menu) will slightly increase or decrease the amount of toner used for the chosen color. For example, if a printed page has a red tint, then decreasing both magenta and yellow could potentially improve the color balance.

My color transparencies seem dark when they are projected. Is there anything I can do to improve the color?

This problem most commonly occurs when projecting transparencies with reflective overhead projectors. To obtain the highest projected color quality, transmissive overhead projectors are recommended. If a reflective projector must be used, then adjusting the Toner Darkness setting to 1, 2, or 3 will lighten the transparency. Make sure to print on the recommended type of color transparencies.

What is manual color correction?

When manual color correction is enabled, the printer employs user-selected color conversion tables to process objects. However, Color Correction must be set to Manual, or no user-defined color conversion will be implemented. Manual color correction settings are specific to the type of object being printed (text, graphics, or images), and how the color of the object is specified in the software program (RGB or CMYK combinations).

Notes:

- Manual color correction is not useful if the software program does not specify colors with RGB or CMYK combinations. It is also not effective in situations in which the software program or the computer operating system controls the adjustment of colors.
- The color conversion tables—applied to each object when Color Correction is set to Auto—generate preferred colors for the majority of documents.

To manually apply a different color conversion table:

- 1 Press **Menu** to open the Admin menus.
- 2 Select **Settings**, and press **Select**.
- 3 Select **Quality**, and press **Select**.
- 4 Select **Color Correction**, and press **Select**.
- 5 Select **Manual**, and press **Select**.

The printer is in manual mode, and you need to select a color conversion table.

- 6 Press **Back** to return to the Quality menu, select **Manual Color**, and press **Select**.
- 7 Select the appropriate color conversion table for the affected object type.

Object type	Color conversion tables
RGB Image RGB Text RGB Graphics	<ul style="list-style-type: none"> • Vivid—Produces brighter, more saturated colors and may be applied to all incoming color formats. • sRGB Display—Produces an output that approximates the colors displayed on a computer monitor. Black toner usage is optimized for printing photographs. • Display—True Black—Produces an output that approximates the colors displayed on a computer monitor. Uses only black toner to create all levels of neutral gray. • sRGB Vivid—Provides an increased color saturation for the sRGB Display color correction. Black usage is optimized for printing business graphics. • Off—No color correction is implemented.
CMYK Image CMYK Text CMYK Graphics	<ul style="list-style-type: none"> • US CMYK—Applies color correction to approximate the SWOP (Specifications for Web Offset Publishing) color output. • Euro CMYK—Applies color correction to approximate EuroScale color output. • Vivid CMYK—Increases the color saturation of the US CMYK color correction setting. • Off—No color correction is implemented.

How can I match a particular color (such as a corporate logo)?

From the printer Quality menu, nine types of Color Samples sets are available. These are also available from the Color Samples page of the Embedded Web Server. Selecting any sample set generates a multiple-page printout consisting of hundreds of colored boxes. Either a CMYK or RGB combination is located on each box, depending on the table selected. The observed color of each box is obtained by passing the CMYK or RGB combination labelled on the box through the selected color conversion table.

To print Color samples from the printer:

- 1 Press **Menu** to open the Admin menus.
- 2 Select **Settings**, and press **Select**.
- 3 Select **Quality**, and press **Select**.
- 4 Select **Color Samples**, and press **Select**.
- 5 Select the **Color Conversion** table to print, and press **Select**.

By examining Color Samples sets, a user can identify the box whose color is the closest to the desired color. The color combination labelled on the box can then be used for modifying the color of the object in a software program. For more information, see the software program Help topics. Manual color correction may be necessary to utilize the selected color conversion table for the particular object.

Selecting which Color Samples set to use for a particular color-matching problem depends on the Color Correction setting being used (Auto, Off, or Manual), the type of object being printed (text, graphics, or images), and how the color of the object is specified in the software program (RGB or CMYK combinations). When the printer Color Correction setting is set to Off, the color is based on the print job information; and no color conversion is implemented.

Note: The Color Samples pages are not useful if the software program does not specify colors with RGB or CMYK combinations. Additionally, certain situations exist in which the software program or the computer operating system adjusts the RGB or CMYK combinations specified in the program through color management. The resulting printed color may not be an exact match of the Color Samples pages.

What are detailed Color Samples and how do I access them?

Detailed Color Samples sets are available only through the Embedded Web Server of a network printer. A detailed Color Samples set contains a range of shades (displayed as colored boxes) that are similar to a user-defined RGB or CMYK value. The likeness of the colors in the set are dependent on the value entered in the RGB or CMYK Increment box.

To access a detailed Color Samples set from the Embedded Web Server:

- 1** Open a Web browser.
- 2** In the address bar, type the network printer IP address.
- 3** Click **Configuration**.
- 4** Click **Color Samples**.
- 5** Click **Detailed Options** to narrow the set to one color range.
- 6** When the Detailed Options page appears, select a color conversion table.
- 7** Enter the RGB or CMYK color number.
- 8** Enter an Increment value from 1–255.
Note: The closer the value is to 1, the narrower the color sample range will appear.
- 9** Click **Print** to print the detailed Color Samples set.

Acronyms

Acronyms

ASIC	Application-Specific Integrated Circuit
BLDC	Brushless DC Motor
BOR	Black Only Retract
C	Cyan
CCD	Charge Coupled Device
CCP	Carbonless Copy Paper
CRC	Cyclic Redundancy Check
CSU	Customer Setup
DIMM	Dual Inline Memory Module
DRAM	Dynamic Random Access Memory
EDO	Enhanced Data Out
EP	Electrophotographic Process
EPROM	Erasable Programmable Read-Only Memory
ESD	Electrostatic Discharge
FRU	Field Replaceable Unit
GB	Gigabyte
HCF	High-Capacity Feeder
HCIT	High-Capacity Input Tray
HCOF	High-Capacity Output Finisher
HVPS	High Voltage Power Supply
ITU	Image Transfer Unit
K	Black
LCD	Liquid Crystal Display
LDAP	Lightweight Directory Access Protocol
LED	Light-Emitting Diode
LVPS	Low Voltage Power Supply
M	Magenta
MB	Megabyte
MFP	Multi-Function Printer
MPF	Multipurpose Feeder
MROM	Masked Read Only Memory
MS	Microswitch

NVM	Nonvolatile Memory
NVRAM	Nonvolatile Random Access Memory
OEM	Original Equipment Manufacturer
OPT	Optical Sensor
PC	Photoconductor
pel, pixel	Picture element
POR	Power-On Reset
POST	Power-On Self Test
PSD	Position Sensing Device
PWM	Pulse Width Modulation
RIP	Raster Imaging Processor
ROM	Read Only Memory
SDRAM	Synchronous Dual Random Access Memory
SIMM	Single Inline Memory Module
SRAM	Static Random Access Memory
TPS	Toner Patch Sensing
UICC	User Interface Controller Card
UPR	Used Parts Return
V ac	Volts alternating current
V dc	Volts direct current
VTB	Vacuum Transport Belt
Y	Yellow

Screw and retainer identification table

Screw and retainer identification table



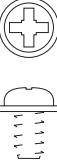
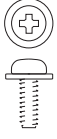

The following table contains screw and fastener descriptions, locations, and quantities necessary to service the printer. Pay careful attention to each screw type location when performing a removal. You must install the correct screw type in each location during reassembly.

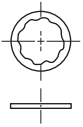
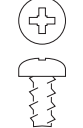
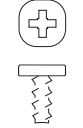
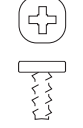
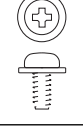
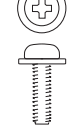
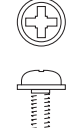
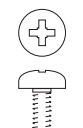
The size of the screws and fasteners are as close to their actual size as possible, as long as the printout is not scaled or resized.

P/N	Screw type	Location	Qty
18B0832 	Taptite M3 L6 panhead screw	Controller board	6
		EP drive	6
		Fuser drive assembly	2
		Fuser sensor	1
		Left cover	1
		Lower left frame	4
		LVPS assembly	6
		LVPS cage	4
		Paper pick motor drive assembly	2
		Rear cover	8
		Toner density sensor	4
		Toner meter cycle	2
		Top cover	5
Wireless antenna	1		
18B1236 	M3x6 panhead screw	Lower right frame	1
3000114 	Shoulder screw	Paper pick motor drive assembly	1

3000167 	M3.5 internal lock washer	Fuser assembly	1
		Top cover	1
3001435 	M3x8 screw	Lower right frame	1
3003334 	3.5x6 mm flat top screw	CX410 and XC2130 display bracket	3
		CX510 and XC2132 UICC card	5
3005980 	3.5x8 mm flat top screw	Front door	5
3068020 	Taptite M3 L4.5 Panhead screw	Lower right frame	3
88A0154 	M3x8LG W-HD MCH screw	Printhead	3
88A0481 	M3.5x8 SEMS MACH screw	Fuser assembly	1
		Top cover	1
88A0213 	Metal ROLN m3.5 8L screw	Lower left frame ground cable	1

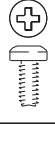
Screw and retainer identification table

88A0313 	Plastic ROLN 2.9 8L screw	Toner cartridge contacts	1
		CX410 and XC2130 UICC card	5
88A0322 	Plastic ROLN 3.5 6L screw	AC receptacle	2
		Cable cover	5
		CX510 and XC2132 Display support bracket	4
		Duplex aligner	4
		Duplex reference edge	3
		Front door	4
		CX410, CX510, XC2130, and XC2132 Front USB connector	2
		HVPS	1
		Left cover	3
		Lower left frame	1
		Control panel	4
		CX510 and XC2132 Control panel back cover	3
		CX510 and XC2132 speaker	2
		Toner meter cycle	2
		Toner supply door	1
		Top cover	4
		Waste toner bottle contact	1
88A0323 	Plastic ROLN 3.5 8L screw	AC receptacle	2
		Duplex aligner	2
88A0324 	Plastic ROLN 3.5 10L screw	Duplex aligner	2

Index

Symbols

[x]-page jam, clear manual feeder [251.xx] 82
 [x]-page jam, clear multipurpose feeder [250.xx] 80
 [x]-page jam, clear standard bin [203.xx] 72
 [x]-page jam, open automatic feeder top cover [28y.xx] 83
 [x]-page jam, open front door [20y.xx] 60
 [x]-page jam, open front door to clear duplex [23y.xx] 75
 [x]-page jam, open front door to clear fuser [20y.xx] 65
 [x]-page jam, open tray [x] [24y.xx] 79

A

acronyms 449
 adf assembly removal 367
 ADF Edge Erase 238
 adf input tray removal 369
 ADF magnification 232
 adf separator pad removal 370
 adf separator roll removal 370
 ADF theory of operation 443
 aio link removal 360
 aio release lever removal 361
 aio toner cover removal 359
 alignment, setting for color 212
 ASIC test 228
 auto align adj 238
 Auto Color Adjustment 238
 avoiding jams 33
 avoiding paper jams 58

B

B5/Executive 238
 bin-full flag removal 362
 Black only model 234
 blank pages 49
 button test 215

C

card stock
 tips 37
 change history 23
 cleaning
 exterior of the printer 399
 interior of the printer 399
 printhead lenses 401

 scanner glass 400
 cleaning the printer 399
 color adjustment 238
 color theory 445
 Color Trapping 235
 configuration
 action for prompts 241
 ADF Edge Erase 238
 B5/Executive 245
 configuration id 223
 configuration menu
 accessing 234
 Auto Color Adjustment 238
 automatically display error screens 244
 clear supply usage history 244
 clearing custom status 244
 Color Trapping 235
 Demo Mode 245
 disable scanner 240
 disk encryption 242
 download emuls 236
 Energy Conserve 236
 envelope prompts 241
 erase hard disk 246
 Exit Config 247
 Factory Defaults 245
 fax low power support 237
 flatbed edge erase 239
 Font Sharpening 242
 format fax storage 237
 jobs on disk 242
 key repeat initial delay 243
 key repeat rate 243
 min copy memory 237
 num pad job assist 237
 Panel Menus 236
 paper prompts 240
 PPDS Emulation 236
 Print Quality Pages 234
 Reports 235
 restore settings 246
 safe mode 236
 scanner manual registration 239
 Tray [x] sensing 245
 UI automation 243
 USB pnp 245
 USB speed 244
 wipe all settings 246

- connectors
 - controller board 389
- control panel
 - controller board, removing with 252
 - using 201
- controller board
 - control panel, removing with 252
- controller board removal 348
- controller board, restoring configuration 253

D

- data security notice 40, 251
- DC Charge Adjust, Bias Adjust, Transfer Adjust 225
- default values 222
- Demo Mode 245
- developer drive coupling removal 281
- developer unit removal 295
- diagnostics
 - alignment for color 212
 - quick test 211
 - registration 209
 - skew 210
- diagnostics menu
 - accessing 209
 - processor ID 224
 - USB HS test mode 216
- disk test/clean 221
- download emuls 236
- DRAM test 216
- drive unit motor removal 275
- duplex
 - left margin setting 218
 - top margin setting 218
- duplex quick test 217
- duplex reference edge removal 322
- duplex sensor removal 338
- duplex support 438
- duplex-left-margin 218
- duplex-top-margin 218

E

- Electrical specifications 427
- electrophotographic process 440
- electrostatic-sensitive parts 252
- embedded solutions 258
- Energy Conserve 236
- engine setting 1 through 4 222
- envelopes
 - tips on using 36
- environment specifications 430
- ep defaults 224

- EP drive assembly removal 275
- EP process 440
- ep setup
 - DC Charge Adjust, Bias Adjust, Transfer Adjust 225
 - ep defaults 224
 - fuser temperature 224
- error codes
 - 200 paper jam messages 61
 - 202 paper jam messages 68
 - 23y.xx paper jam messages 77
 - 24y.xx paper jam messages 80
 - 25y.xx paper jam messages 83
- ESD-sensitive parts 252
- eSF solutions 258
- Even Log
 - display log 226
- Event Log
 - clear log 227
 - print log 227
- Exit Config 247
- exit diagnostics menu
 - exit diagnostics 232
- exterior of the printer
 - cleaning 399

F

- Factory Defaults 245
- fax error log codes 151
- fax issue, escalating 155
- fax service engineer (SE) menu 250
- feed test 229
- feed tests 214, 219
- flash memory test 221
- flatbed edge erase 239
- flatbed magnification 232
- flatbed pivot link (front left) removal 381
- flatbed pivot link (rear right) removal 379
- flatbed scanner assembly removal 374
- Font Sharpening 242
- format fax storage 237
- front cover assembly removal 309
- front logo cover removal 312
- front middle cover removal 312
- fuser assembly removal 324
- fuser cleaning process 234
- fuser drive motor assembly removal 289
- fuser exit sensor removal 286
- fuser temperature 224

H

hardware tests
 USB HS test mode 216
 high-voltage power supply (HVPS) removal 296
 horizontal bottom contact connector 263
 horizontal sliding contact connector 269
 horizontal top contact connector 260

I

imaging unit (IU) removal 303
 inspection guide 397
 interior of the printer
 cleaning 399
 invalid code, fixing 247, 249
 invalid engine mode
 accessing 247
 ITU barcode 223
 ITU guide removal 339

J

jams
 avoiding 58
 locating doors and trays 60
 locations 60
 messages 60
 jams, clearing
 duplex 75
 front door 60
 fuser 65
 in automatic document feeder top cover 83
 in manual feeder 82
 in standard bin 72
 in the multipurpose feeder 80
 Tray 1 79
 Tray 2 79

L

labels, paper
 tips 37
 laser notices **O**
 left cover assembly removal 274
 LES applications 243
 letterhead
 loading, multipurpose feeder 34
 loading, trays 34
 loading letterhead
 paper orientation 34
 low insertion force (LIF) connector 272
 lower left frame removal 328
 lower right frame removal 334

low-voltage power supply (LVPS) assembly
 removal 285
 lubrication
 guidelines 399

M

maintenance kits 398
 menus
 list of 206
 MFP fuser deflector flag 362
 min copy memory 237
 model name 223
 motor detection 213
 motor tests 228

N

narrow media sensor flag removal 364
 narrow media sensor removal 363
 network SE menu
 accessing 249
 notices 2
 num pad job assist 237

O

operating clearances for CX310 models 428
 operating clearances for CX410 and CX510
 models 428
 operator panel
 button function test 215
 display test 215
 operator panel logo plate removal 312, 313
 operator panel removal (for CX310 and CX410
 models only) 313
 operator panel removal (for CX510 models
 only) 320
 option configurations
 supported configurations 434
 unclaimed configurations 434
 unsupported configurations 434
 Options
 Available internal options 433
 options
 media handling options 433
 output bin tray and exit bail removal 357

P

Panel Menus 236
 panel test 215
 paper
 characteristics 32
 letterhead 33

- preprinted forms 33
 - recycled 34
 - selecting 33
 - storing 33
 - unacceptable 33
 - paper jams
 - 28y 84
 - 29y 87
 - avoiding 58
 - paper jams, clearing
 - duplex 75
 - front door 60
 - fuser 65
 - in automatic document feeder top cover 83
 - in manual feeder 82
 - in standard bin 72
 - in the multipurpose feeder 80
 - Tray 1 79
 - Tray 2 79
 - paper path 437
 - paper pick motor drive assembly (standard tray) removal 343
 - paper sizes
 - supported by the printer 37
 - paper types
 - supported by printer 40
 - where to load 40
 - paper weights
 - supported by printer 40
 - parts catalog
 - parts catalog screw and fastener identification table 451
 - parts catalog legend 402
 - PEL Blurring 244
 - POR sequence 44
 - power-on reset sequence 44
 - PPDS Emulation 236
 - preventive maintenance kits 398
 - print quality
 - cleaning the scanner glass 400
 - initial check 46
 - Print Quality Pages 234
 - print quality test pages 215
 - print quality troubleshooting
 - adf cover open service check 87
 - adf duplex service check 144
 - adf feed errors service check 143
 - adf streak service check 143
 - black or blank page copy service check 140
 - blank pages 49
 - blurred or fuzzy print 50
 - ccd service check 138
 - fax reception service check 147
 - fax transmission service check 149
 - flatbed home position service check 141
 - flatbed motor service check 141
 - gray background on prints 48
 - half-color page 51
 - horizontal banding 51
 - horizontal line 51
 - light print on solids 54
 - missing image at edge 52
 - modem/fax card service check 145
 - narrow vertical line 52
 - problems 54
 - random marks 52
 - residual image 53
 - solid color pages 53
 - toner rubs off 47
 - toner specks appear on prints 52
 - vertical banding 54
 - print tests 214
 - printer default values 222
 - printer message
 - [x]-page jam, open front door to clear duplex [23y.xx] 75
 - printer messages
 - [x]-page jam, clear manual feeder [251.xx] 82
 - [x]-page jam, clear multipurpose feeder [250.xx] 80
 - [x]-page jam, clear standard bin [203.xx] 72
 - [x]-page jam, open automatic feeder top cover [28y.xx] 83
 - [x]-page jam, open front door [20y.xx] 60
 - [x]-page jam, open front door to clear fuser [20y.xx] 65
 - [x]-page jam, open tray [x] [24y.xx] 79
 - printer setup
 - configuration id 223
 - engine setting 1 through 4 222
 - ITU barcode 223
 - model name 223
 - page count, total 222
 - reset fuser count 224
 - serial number 222
 - printhead lenses
 - cleaning 401
 - printhead removal 365
 - processor specifications 430
- Q**
- quick disk test 221
 - quick test 211

R

rear cover removal 346
 rear scanner cover removal 374
 recovery mode
 accessing 247
 recycled paper
 using 34
 redrive unit removal 365
 registration 209
 removal procedures
 tips 273
 removals
 650-sheet duo drawer assembly 385
 650-sheet duo drawer tray assembly 384
 adf assembly 367
 adf input tray 369
 adf separator pad 370
 adf separator roll 370
 aio link 360
 aio release lever 361
 aio toner cover 359
 bin-full flag 362
 controller board 348
 developer drive coupling 281
 developer unit 295
 drive unit motor 275
 duplex reference edge 322
 duplex sensor 338
 dust cover 386
 EP drive assembly 275
 flatbed pivot link (front left) 381
 flatbed pivot link (rear right) 379
 flatbed scanner assembly 374
 front cover assembly 309
 front middle cover 312
 fuser assembly 324
 fuser drive motor assembly 289
 fuser exit sensor 286
 high-voltage power supply (HVPS) 296
 image transfer unit (ITU) 300
 imaging unit (IU) 303
 ITU guide 339
 left cover assembly 274
 lower left frame 328
 lower right frame 334
 low-voltage power supply (LVPS) assembly 285
 MFP fuser deflector flag 362
 narrow media sensor 363
 narrow media sensor flag 364
 operator panel (for CX310 and CX410 models only) 313

operator panel (for CX510 models only) 320
 operator panel logo plate 312, 313
 output bin tray and exit bail 357
 paper pick motor drive assembly (standard tray) 343
 pick tire 387
 printhead 365
 rear cover 346
 rear scanner cover 374
 redrive unit 365
 right cover assembly 288
 right scanner cover 372
 system fan 351
 thermistor 292
 toner cartridge contacts 305
 toner density sensor (TDS) (left or right sensor) 293, 342
 toner meter cycle (TMC) card 290
 toner supply door 321
 top cover adf sheet feed 371
 top cover assembly 352
 UICC to controller board cable 321
 waste toner bottle 307
 waste toner bottle contact block 308
 Reports 235
 menu settings page 226
 reports
 installed licenses 226
 require standby 242
 reset fuser count 224
 restoring
 configuration file 256
 license file 256
 right cover assembly removal 288
 right scanner cover removal 372

S

safe mode 44
 safety information 0
 Scanner calibration
 menu settings page 212
 scanner calibration reset 232
 Scanner configuration 237
 scanner glass
 cleaning 400
 scanner manual registration 239
 scanner tests
 ADF magnification 232
 ASIC 228
 feed test 229
 flatbed magnification 232
 motor tests 228

- scanner calibration reset 232
 - sensor tests 229
 - scheduled maintenance 398
 - security reset jumper
 - enabling 430
 - selecting paper 33
 - sensor test 219
 - sensor tests 229
 - serial number 222
 - service checks troubleshooting
 - 110 service error messages 101
 - 121 service error messages 103
 - 126 service error messages 109
 - 133 service error messages 109
 - 141 service error messages 112
 - 147 service error messages 114
 - 171 service error messages 116
 - 200.xx input (S2) sensor service check 62
 - 202.xx fuser exit sensor service check 70
 - 230.xx duplex/manual feed sensor (S1) service check 77
 - 8yy service error messages 134
 - 900 service error messages 119
 - 900.xx system software error service check 120
 - 913.xx error code check 125
 - 91x.xx (910.xx-919.xx) engine software service check 125
 - 91y service error messages 124
 - 938 service error messages 126
 - 950.xx NVRAM failure service check 127
 - 95y service error messages 126
 - 96y service error messages 129
 - 97y service error messages 130
 - 982 service error messages 131
 - 990 service error messages 132
 - cartridge motor error service check 113
 - dead printer service check 157
 - fan error service check 117
 - front door sensor or switches service check 159
 - fuser service check 105
 - narrow media sensor service check 163
 - network service check 174
 - operator panel (display blank) service check 169
 - operator panel (display is dim and unchanging) service check 165
 - operator panel (displays all diamonds, no beeps, or five beeps) service check 167
 - operator panel (one or more operator panel buttons fail) service check 171
 - operator panel USB cable service check 173
 - paper pick motor drive assembly service check 115
 - printhead service check 102
 - replace unsupported cartridge error service check 177
 - toner meter cycle (TMC) card service check 174
 - toner meter sensors (Y, C, M, K) on TMC card service check 110
 - tray (x) sensor service check 179
 - trays 2 and 3 (optional) service check 132
 - usb service check 174
 - service engineer (SE) menu 249
 - accessing 249
 - service manual conventions 0
 - skew 210
 - solid color pages 53
 - speaker removal 288
 - Specifications
 - electrical 427
 - specifications
 - acoustics 429
 - environment 430
 - operating clearances for CX310 models 428
 - operating clearances for CX410 and CX510 models 428
 - power 427
 - storing
 - paper 33
 - symptoms
 - printer 156
 - system fan removal 351
- ## T
- test
 - duplex option top margin 217
 - tests
 - base printer sensors 219
 - feed tests 214, 219
 - flash memory 221
 - motor detection 213
 - print 214
 - print quality test pages 215
 - sensor test 219
 - tips
 - card stock 37
 - labels, paper 37
 - on using envelopes 36
 - on using letterhead 34
 - transparencies 36
 - tips on using envelopes 36
 - tips on using letterhead 34
 - toner cartridge contacts removal 305
 - toner density sensor (TDS) (left or right sensor) removal 293, 342

- toner meter cycle (TMC) card removal 290
- toner supply door removal 321
- tools, required 41
- top cover adf sheet feed removal 371
- top cover assembly removal 352
- TPS Setup
 - Cal Ref Adj 226
 - Reset Color Cal 225
 - right or left TPS 225
- transparencies
 - tips on using 36
- transport components 438
- Tray [x] sensing 245
- tray insert msg 235
- troubleshooting
 - 550-sheet and 650-sheet trays input option
 - symptoms 178
 - adf paper jam service check 85
 - initial check 43
 - scan/fax/copy symptoms 139
- troubleshooting, print quality
 - adf cover open service check 87
 - adf duplex service check 144
 - adf feed errors service check 143
 - adf streak service check 143
 - black or blank page copy service check 140
 - blank pages 49
 - blurred or fuzzy print 50
 - ccd service check 138
 - color problems 54
 - fax reception service check 147
 - fax transmission service check 149
 - flatbed home position service check 141
 - flatbed motor service check 141
 - gray background on prints 48
 - half color page 51
 - horizontal banding 51
 - horizontal line 51
 - light print on solids 54
 - missing image at edge 52
 - modem/fax card service check 145
 - narrow vertical line 52
 - random marks 52
 - residual image 53
 - solid color pages 53
 - toner rubs off 47
 - toner specks appear on prints 52
 - vertical banding 54
- troubleshooting, service checks
 - 110 service error messages 101
 - 121 service error messages 103
 - 126 service error messages 109
 - 133 service error messages 109
 - 141 service error messages 112
 - 147 service error messages 114
 - 171 service error messages 116
 - 200.xx input (S2) sensor service check 62
 - 202.xx fuser exit sensor service check 70
 - 230.xx duplex/manual feed sensor (S1) service check 77
 - 8yy service error messages 134
 - 900 service error messages 119
 - 900.xx system software error service check 120
 - 913.xx error code check 125
 - 91x.xx (910.xx-919,xx) engine software service check 125
 - 91y service error messages 124
 - 938 service error messages 126
 - 950.xx NVRAM failure service check 127
 - 95y service error messages 126
 - 96y service error messages 129
 - 97y service error messages 130
 - 982 service error messages 131
 - 990 service error messages 132
 - cartridge motor error service check 113
 - dead printer service check 157
 - fan error service check 117
 - front door sensor or switches service check 159
 - fuser service check 105
 - narrow media sensor service check 163
 - network service check 174
 - operator panel (display blank) service check 169
 - operator panel (display is dim and unchanging) service check 165
 - operator panel (displays all diamonds, no beeps, or five beeps) service check 167
 - operator panel (one or more operator panel buttons fail) service check 171
 - operator panel USB cable service check 173
 - paper pick motor drive assembly service check 115
 - printhead service check 102
 - replace unsupported cartridge error service check 177
 - toner meter cycle (TMC) card service check 174
 - toner meter sensors (Y, C, M, K) on TMC card service check 110
 - tray (x) sensor service check 179
 - trays 2 and 3 (optional) service check 132
 - usb service check 174
- troubleshooting, understanding the printer messages
 - understanding the printer messages 89

U

- UICC to controller board cable removal 321
- understanding the printer messages
- troubleshooting
 - understanding the printer messages 89
- updating the printer firmware
 - using a flash drive 257
 - using a network computer 257
- USB scan to local 234
- Using the operator panel
 - understanding the colors of the indicator light and sleep button lights 203
 - using the operator panel for CX410 models 203

V

- vertical mount contact connector 266

W

- waste toner bottle contact block removal 308
- waste toner bottle removal 307

Z

- zero insertion force (ZIF) connectors 259

Part number index

P/N	Part name	Page
3049485	Field relocation package assembly.....	425
40X0269	Power cord, 2.5 m (straight): USA, Canada, APG, LAD.....	418
40X0271	Power cord, 2.5 m (straight): United Kingdom.....	419
40X0273	Power cord, 2.5 m (straight): Chile, Uruguay, Italy.....	418
40X0275	Power cord, 2.5 m (straight): Israel.....	418
40X0288	Power cord, 2.5 m (straight): Argentina.....	418
40X0301	Power cord, 2.5 m (straight): Australia.....	418
40X0303	Power cord, 2.5 m (straight): PRC.....	419
40X0411	Narrow media flag.....	411
40X1368	USB Cable, packaged (2 m).....	425
40X1766	Power cord, 2.5 m (straight): Bolivia, Peru.....	418
40X1772	Power cord, 2.5 m (straight): Switzerland.....	419
40X1773	Power cord, 2.5 m (straight): South Africa.....	419
40X1774	Power cord, 2.5 m (straight): Denmark.....	418
40X1791	Power cord, 2.5 m (straight): Taiwan.....	419
40X1792	Power cord, 2.5 m (straight): Korea.....	419
40X2252	Redrive spacer screws.....	407
40X3141	Power cord, 2.5 m (straight): Paraguay, Indonesia, EMEA (HV).....	419
40X3609	Power cord, 2.5 m (straight): Japan.....	418
40X4596	Power cord, 2.5 m (straight): Brazil.....	418
40X5168	Pick tires.....	410, 424
40X5413	Fuser exit sensor.....	418
40X5414	Toner density sensors, left or right (one in package).....	422
40X5429	ITU paper path thermistor.....	422
40X5480	USB cable (CX510, CX517de and XC2132).....	414
40X5480	USB thumbdrive cable (CX510, CX517de and XC2132).....	407
40X5490	Front middle cover.....	404
40X5872	Bin full flag.....	406
40X6243	Flatbed cushion.....	407
40X6247	Simplex ADF separator pad assembly (CX310 and CX317dn).....	406
40X6517	Speaker.....	415, 418
40X7046	Waste toner bottle sensor.....	422

P/N	Part name	Page
40X7229	Power cord, 2.5 m (straight): India.....	419
40X7301	Photo sensor and retainer.....	418
40X7445	2GB x 32 DDR3 RAM.....	425
40X7567	1GB x 32 DDR3 RAM.....	425
40X7579	System fan.....	404
40X7610	Image transfer unit.....	410
40X7614	Paper pick motor drive assembly.....	411
40X7615	115 V maintenance kit.....	411
40X7615	115 V Maintenance kit (fuser, ITU).....	425
40X7616	230 V maintenance kit.....	411
40X7616	230 V Maintenance kit (fuser, ITU).....	425
40X7617	100 V maintenance kit.....	411
40X7617	100 V Maintenance kit (fuser, ITU).....	425
40X7618	Front and right side interlock switch cover assembly.....	404, 422
40X7620	Toner meter cycle card assembly.....	418
40X7622	Fuser assembly, 115 V.....	411
40X7623	Fuser assembly, 230 V.....	411
40X7624	Fuser assembly, 100 V.....	411
40X7625	High-voltage power supply.....	418
40X7626	Low-voltage power supply (universal power supply).....	418
40X7627	Printhead.....	410
40X7628	Main gear drive assembly with motors and coupling.....	411
40X7629	Fuser drive motor assembly.....	410
40X7632	Left cover.....	404
40X7636	Toner cartridge contacts (Pogo pin).....	422
40X7645	250-sheet tray assembly.....	404
40X7646	Lower left frame and lower right frame with cable cover.....	410
40X7647	Cable packet	422
40X7648	Screw packet.....	410
40X7652	Spring parts packet.....	410
40X7801	Front cover.....	404
40X7802	Toner AIO cover.....	404
40X7803	Operator panel bezel (CX410).....	415
40X7804	Controller board (CX310 and CX317dn).....	418

P/N	Part name	Page
40X7805	Controller board (CX410, CX417de and XC2130).....	418
40X7806	Controller board (CX510, CX517de and XC2132).....	418
40X7808	Front logo cover (CX310, CX317dn, CX410, CX417de and XC2130).....	414
40X7809	Top cover assembly (includes fan and redrive belt).....	404
40X7810	Back AIO cable cover.....	404
40X7811	Output bin tray.....	404
40X7812	Media bail.....	404
40X7813	AIO cables.....	419
40X7814	Rear cover (CX510, CX517de and XC2132).....	404
40X7816	Front logo cover (CX510, CX517de and XC2132).....	414
40X7817	Operator panel bezel (CX310).....	415
40X7818	Bezel (CX510).....	414
40X7819	Right scanner cover.....	406
40X7820	Left scanner cover.....	407
40X7822	Flatbed pivot link (front left).....	407
40X7823	Right AIO cover.....	404
40X7824	AIO link.....	404
40X7827	AIO release lever with spring.....	406
40X7829	Flatbed scanner assembly.....	406
40X7830	Duplex ADF assembly (CX410, CX417de, CX510, CX517de, XC2130, and XC2132).....	406
40X7831	Simplex ADF assembly (CX310 and CX317dn).....	406
40X7833	Redrive assembly.....	406
40X7834	Flatbed pivot link (rear right).....	406
40X7835	Operator panel cable (CX310, CX317dn, CX410, CX417de and XC2130).....	406
40X7835	UICC to controller board cable (CX310, CX317dn, CX410 and CX417de).....	414
40X7835	UICC to controller board cable (CX310, CX317dn, CX410, CX417de and XC2130).....	422
40X7836	Operator panel USB cable.....	422
40X7836	USB cable (CX410, CX417de and XC2130).....	414
40X7836	USB thumbdrive cable (CX410, CX417de and XC2130).....	407
40X7837	Operator panel cable (CX510, CX517de and XC2132).....	406
40X7837	UICC to controller board cable (CX510, CX517de and XC2132).....	414
40X7837	UICC to controller board cable (CX510, CX517de and XC2132).....	422
40X7838	Upper front cover (CX510, CX517de and XC2132).....	414
40X7839	Upper front cover (CX310, CX317dn, CX410, CX417de and XC2130).....	414

P/N	Part name	Page
40X7840	User interface support bracket (CX310, CX317dn, CX410, CX417de and XC2130).....	414
40X7841	User interface support bracket (CX510, CX517de and XC2132).....	415
40X7842	Simplex top cover assembly (CX310 and CX317dn).....	406
40X7843	Duplex ADF top cover assembly (CX410, CX417de, CX510, CX517de, XC2130, and XC2132).....	406
40X7845	Rear cover (CX310 and CX317dn).....	404
40X7846	Rear cover (CX410, CX417de and XC2130).....	404
40X7852	Fax card.....	419
40X7857	160+ GB hard disk.....	425
40X8089	650-sheet drawer.....	404
40X8089	Optional 650-sheet duo drawer (complete) - (includes 100-sheet MPF).....	424
40X8090	Optional 550-sheet drawer (complete) - CX410, CX417de, CX510, CX517de, XC2132, and XC2130 only.....	424
40X8091	650-sheet Duo Drawer tray assembly.....	424
40X8091	650-sheet tray assembly.....	404
40X8448	Fax interface cable.....	419
40X8555	256MB Flash memory card.....	425
40X8556	Traditional Chinese font card assembly.....	425
40X8557	Simplified Chinese font card assembly.....	425
40X8568	Korean font card assembly.....	425
40X8569	Japanese font card assembly.....	425
40X8570	Arabic font card assembly.....	425
40X8571	Hebrew font card assembly.....	425
40X8670	Printhead-to-controller board cable.....	422
40X8674	Bracket, front toner door pivot.....	404
40X8735	Left ADF hinge.....	407
40X8736	ADF pick roll.....	406
40X8819	MFP fuser deflector flag.....	411
40X9054	ADF input tray.....	406
40X9110	Restraint pad.....	406
40X9151	Blank bezel (CX510, CX517de, XC2132).....	414
40X9652	Adapter, N8130 10/100 fiber.....	425
40X9939	MarkNet N8352 802.11b/g/n Wireless print server (external).....	425
41X0001	Drive unit motor.....	411
41X0580	ITU guide.....	411

P/N	Part name	Page
41X0826	Developer drive coupling.....	411
41X0880	Forms and Bar Code Card (CX310 and CX317dn).....	425
41X0881	Card for PRESCRIBE (CX310 and CX317dn).....	425
41X0882	Forms and Bar Code Card (CX410, CX417de and XC2130).....	425
41X0883	Card for PRESCRIBE (CX410, CX417de and XC2130).....	425
41X0884	Forms and Bar Code Card (CX510, CX517de and XC2132).....	425
41X0886	Card for PRESCRIBE (CX510, CX517de and XC2132).....	425
41X0910	Operator panel and display assembly (CX310 and CX317dn).....	414
41X0911	Operator panel and display assembly (CX410, CX417de and XC2130).....	414
41X0912	Operator panel and display assembly (CX510, CX517de and XC2132).....	414
41X0917	Duplex ADF separator roller assembly (CX410, CX417de, CX510, CX517de, XC2130, and XC2132).....	406
41X0923	Dust cover.....	424
41X1981	Operator panel bezel (CX317).....	415
41X1982	Operator panel bezel (CX417).....	415
41X2016	Bezel (CX517de).....	414
41X2663	Front cover inner deflector.....	404

Part name index

P/N	Part name	Page
40X7617	100 V maintenance kit.....	411
40X7617	100 V Maintenance kit (fuser, ITU).....	425
40X7615	115 V maintenance kit.....	411
40X7615	115 V Maintenance kit (fuser, ITU).....	425
40X7857	160+ GB hard disk.....	425
40X7567	1GB x 32 DDR3 RAM.....	425
40X7616	230 V maintenance kit.....	411
40X7616	230 V Maintenance kit (fuser, ITU).....	425
40X7645	250-sheet tray assembly.....	404
40X8555	256MB Flash memory card.....	425
40X7445	2GB x 32 DDR3 RAM.....	425
40X8089	650-sheet drawer.....	404
40X8091	650-sheet Duo Drawer tray assembly.....	424
40X8091	650-sheet tray assembly.....	404
40X9652	Adapter, N8130 10/100 fiber.....	425
40X9054	ADF input tray.....	406
40X8736	ADF pick roll.....	406
40X7813	AIO cables.....	419
40X7824	AIO link.....	404
40X7827	AIO release lever with spring.....	406
40X8570	Arabic font card assembly.....	425
40X7810	Back AIO cable cover.....	404
40X7818	Bezel (CX510).....	414
41X2016	Bezel (CX517de).....	414
40X5872	Bin full flag.....	406
40X9151	Blank bezel (CX510, CX517de, XC2132).....	414
40X8674	Bracket, front toner door pivot.....	404
40X7647	Cable packet	422
41X0881	Card for PRESCRIBE (CX310 and CX317dn).....	425
41X0883	Card for PRESCRIBE (CX410, CX417de and XC2130).....	425
41X0886	Card for PRESCRIBE (CX510, CX517de and XC2132).....	425
40X7804	Controller board (CX310 and CX317dn).....	418

P/N	Part name	Page
40X7805	Controller board (CX410, CX417de and XC2130).....	418
40X7806	Controller board (CX510, CX517de and XC2132).....	418
41X0826	Developer drive coupling.....	411
41X0001	Drive unit motor.....	411
40X7830	Duplex ADF assembly (CX410, CX417de, CX510, CX517de, XC2130, and XC2132).....	406
41X0917	Duplex ADF separator roller assembly (CX410, CX417de, CX510, CX517de, XC2130, and XC2132).....	406
40X7843	Duplex ADF top cover assembly (CX410, CX417de, CX510, CX517de, XC2130, and XC2132).....	406
41X0923	Dust cover.....	424
40X7852	Fax card.....	419
40X8448	Fax interface cable.....	419
3049485	Field relocation package assembly.....	425
40X6243	Flatbed cushion.....	407
40X7822	Flatbed pivot link (front left).....	407
40X7834	Flatbed pivot link (rear right).....	406
40X7829	Flatbed scanner assembly.....	406
41X0880	Forms and Bar Code Card (CX310 and CX317dn).....	425
41X0882	Forms and Bar Code Card (CX410, CX417de and XC2130).....	425
41X0884	Forms and Bar Code Card (CX510, CX517de and XC2132).....	425
40X7618	Front and right side interlock switch cover assembly.....	404, 422
40X7801	Front cover.....	404
41X2663	Front cover inner deflector.....	404
40X7808	Front logo cover (CX310, CX317dn, CX410, CX417de and XC2130).....	414
40X7816	Front logo cover (CX510, CX517de and XC2132).....	414
40X5490	Front middle cover.....	404
40X7624	Fuser assembly, 100 V.....	411
40X7622	Fuser assembly, 115 V.....	411
40X7623	Fuser assembly, 230 V.....	411
40X7629	Fuser drive motor assembly.....	410
40X5413	Fuser exit sensor.....	418
40X8571	Hebrew font card assembly.....	425
40X7625	High-voltage power supply.....	418
40X7610	Image transfer unit.....	410
41X0580	ITU guide.....	411

P/N	Part name	Page
40X5429	ITU paper path thermistor.....	422
40X8569	Japanese font card assembly.....	425
40X8568	Korean font card assembly.....	425
40X8735	Left ADF hinge.....	407
40X7632	Left cover.....	404
40X7820	Left scanner cover.....	407
40X7646	Lower left frame and lower right frame with cable cover.....	410
40X7626	Low-voltage power supply (universal power supply).....	418
40X7628	Main gear drive assembly with motors and coupling.....	411
40X9939	MarkNet N8352 802.11b/g/n Wireless print server (external).....	425
40X7812	Media bail.....	404
40X8819	MFP fuser deflector flag.....	411
40X0411	Narrow media flag.....	411
41X0910	Operator panel and display assembly (CX310 and CX317dn).....	414
41X0911	Operator panel and display assembly (CX410, CX417de and XC2130).....	414
41X0912	Operator panel and display assembly (CX510, CX517de and XC2132).....	414
40X7817	Operator panel bezel (CX310).....	415
41X1981	Operator panel bezel (CX317).....	415
40X7803	Operator panel bezel (CX410).....	415
41X1982	Operator panel bezel (CX417).....	415
40X7835	Operator panel cable (CX310, CX317dn, CX410, CX417de and XC2130).....	406
40X7837	Operator panel cable (CX510, CX517de and XC2132).....	406
40X7836	Operator panel USB cable.....	422
40X8090	Optional 550-sheet drawer (complete) - CX410, CX417de, CX510, CX517de, XC2132, and XC2130 only.....	424
40X8089	Optional 650-sheet duo drawer (complete) - (includes 100-sheet MPF).....	424
40X7811	Output bin tray.....	404
40X7614	Paper pick motor drive assembly.....	411
40X7301	Photo sensor and retainer.....	418
40X5168	Pick tires.....	410, 424
40X0288	Power cord, 2.5 m (straight): Argentina.....	418
40X0301	Power cord, 2.5 m (straight): Australia.....	418
40X1766	Power cord, 2.5 m (straight): Bolivia, Peru.....	418
40X4596	Power cord, 2.5 m (straight): Brazil.....	418

P/N	Part name	Page
40X0273	Power cord, 2.5 m (straight): Chile, Uruguay, Italy.....	418
40X1774	Power cord, 2.5 m (straight): Denmark.....	418
40X7229	Power cord, 2.5 m (straight): India.....	419
40X0275	Power cord, 2.5 m (straight): Israel.....	418
40X3609	Power cord, 2.5 m (straight): Japan.....	418
40X1792	Power cord, 2.5 m (straight): Korea.....	419
40X3141	Power cord, 2.5 m (straight): Paraguay, Indonesia, EMEA (HV).....	419
40X0303	Power cord, 2.5 m (straight): PRC.....	419
40X1773	Power cord, 2.5 m (straight): South Africa.....	419
40X1772	Power cord, 2.5 m (straight): Switzerland.....	419
40X1791	Power cord, 2.5 m (straight): Taiwan.....	419
40X0271	Power cord, 2.5 m (straight): United Kingdom.....	419
40X0269	Power cord, 2.5 m (straight): USA, Canada, APG, LAD.....	418
40X7627	Printhead.....	410
40X8670	Printhead-to-controller board cable.....	422
40X7845	Rear cover (CX310 and CX317dn).....	404
40X7846	Rear cover (CX410, CX417de and XC2130).....	404
40X7814	Rear cover (CX510, CX517de and XC2132).....	404
40X7833	Redrive assembly.....	406
40X2252	Redrive spacer screws.....	407
40X9110	Restraint pad.....	406
40X7823	Right AIO cover.....	404
40X7819	Right scanner cover.....	406
40X7648	Screw packet.....	410
40X7831	Simplex ADF assembly (CX310 and CX317dn).....	406
40X6247	Simplex ADF separator pad assembly (CX310 and CX317dn).....	406
40X7842	Simplex top cover assembly (CX310 and CX317dn).....	406
40X8557	Simplified Chinese font card assembly.....	425
40X6517	Speaker.....	415, 418
40X7652	Spring parts packet.....	410
40X7579	System fan.....	404
40X7802	Toner AIO cover.....	404
40X7636	Toner cartridge contacts (Pogo pin).....	422
40X5414	Toner density sensors, left or right (one in package).....	422

P/N	Part name	Page
40X7620	Toner meter cycle card assembly.....	418
40X7809	Top cover assembly (includes fan and redrive belt).....	404
40X8556	Traditional Chinese font card assembly.....	425
40X7835	UICC to controller board cable (CX310, CX317dn, CX410 and CX417de).....	414
40X7835	UICC to controller board cable (CX310, CX317dn, CX410, CX417de and XC2130).....	422
40X7837	UICC to controller board cable (CX510, CX517de and XC2132).....	414, 422
40X7839	Upper front cover (CX310, CX317dn, CX410, CX417de and XC2130).....	414
40X7838	Upper front cover (CX510, CX517de and XC2132).....	414
40X7836	USB cable (CX410, CX417de and XC2130).....	414
40X5480	USB cable (CX510, CX517de and XC2132).....	414
40X1368	USB Cable, packaged (2 m).....	425
40X7836	USB thumbdrive cable (CX410, CX417de and XC2130).....	407
40X5480	USB thumbdrive cable (CX510, CX517de and XC2132).....	407
40X7840	User interface support bracket (CX310, CX317dn, CX410, CX417de and XC2130).....	414
40X7841	User interface support bracket (CX510, CX517de and XC2132).....	415
40X7046	Waste toner bottle sensor.....	422

