



Service Manual

Lexmark™ 5500 MFP

4036-402

- ***Table of Contents***
- ***Start Diagnostics***
- ***Safety and Notices***
- ***Trademarks***
- ***Index***

LEXMARK™

Lexmark and Lexmark with diamond design are trademarks of Lexmark International, Inc., registered in the United States and/or other countries.

Edition: September 7, 2005

The following paragraph does not apply to any country where such provisions are inconsistent with local law:
LEXMARK INTERNATIONAL, INC. PROVIDES THIS PUBLICATION "AS IS" WITHOUT WARRANTY OF ANY KIND, EITHER EXPRESS OR IMPLIED, INCLUDING, BUT NOT LIMITED TO, THE IMPLIED WARRANTIES OF MERCHANTABILITY OR FITNESS FOR A PARTICULAR PURPOSE. Some states do not allow disclaimer of express or implied warranties in certain transactions; therefore, this statement may not apply to you.

This publication could include technical inaccuracies or typographical errors. Changes are periodically made to the information herein; these changes will be incorporated in later editions. Improvements or changes in the products or the programs described may be made at any time.

Comments may be addressed to Lexmark International, Inc., Department D22A/032-2, 740 West New Circle Road, Lexington, Kentucky 40550, U.S.A or e-mail at ServiceInfoAndTraining@Lexmark.com. Lexmark may use or distribute any of the information you supply in any way it believes appropriate without incurring any obligation to you. You can purchase additional copies of publications related to this product by calling 1-800-553-9727. In other countries, contact your point of purchase.

Lexmark and Lexmark with diamond design are trademarks of Lexmark International, Inc., registered in the United States and/or other countries.

Other trademarks are the property of their respective owners.

**© 2003, 2004 Lexmark International, Inc.
All rights reserved.**

UNITED STATES GOVERNMENT RIGHTS

This software and any accompanying documentation provided under this agreement are commercial computer software and documentation developed exclusively at private expense.

U.S.A. P/N 12G9319

Table of contents

Safety information	v
Preface	viii
Definitions	viii
General information	1-1
Overview	1-1
Maintenance approach	1-2
Service guidelines	1-2
Maintenance tools	1-2
Product specifications	1-3
Theory of operation	1-4
System description	1-4
Mechanical operation	1-5
Acronyms	1-6
Diagnostic information	2-1
Start	2-1
Error codes	2-2
MFD controller errors	2-2
Scanner errors	2-4
Symptoms and service checks	2-6
The power does not come on	2-6
Scan module does not move to the lock position	2-6
Scan module does not move to the home position	2-7
Scan module does not move to the flatbed position	2-7
System hangs while booting or displays erratic behavior	2-7
Image does not appear	2-8
Large jitter	2-8
Irregular movement	2-8
Image unclear	2-8
Strange sound generated (flatbed)	2-9
Frequent paper jam, double feed, or skew	2-9
Strange sound generated (ADF)	2-9
Clearing a paper jam	2-10
Repair information	3-1
Parts replacement	3-1
Adjustments	3-2
Scanner calibration	3-2
Hard disk drive refresh	3-4
Code update procedure	3-4

Removals	3-5
Charge-coupled device (CCD) card screws	3-5
ADF assembly	3-6
ADF upper cover	3-8
ADF upper guide	3-9
ADF lower guide	3-10
ADF drive motor	3-13
ADF controller card	3-15
ADF hinge	3-17
Paper input tray	3-18
Internal ADF CCD subassembly	3-20
ADF pick pad	3-24
ADF pick roller	3-26
ADF paper present sensor	3-27
ADF cover open sensor	3-28
User interface	3-30
Upper housing	3-32
Flatbed lamp assembly	3-34
Flatbed CCD optical unit	3-36
Multifunction device (MFD) controller card cage	3-38
Hard disk drive, MFD controller card, power distribution card, memory DIMM, and cooling fan	3-41
Main scanner card	3-42
Connector locations	4-1
Locations	4-1
Paper path and sensors	4-1
Internal view	4-2
Connectors	4-3
Main scanner card	4-3
Power distribution card	4-3
Low voltage power supply	4-4
Preventive maintenance	5-1
Cleaning	5-1
Moving the scanner	5-3
Parts catalog	6-1
How to use this parts catalog	6-1
Assembly 1: Upper Scanner	6-2
Assembly 2: Lower scanner	6-4
Assembly 3: Miscellaneous	6-6
Index	I-1
Part number index	I-5

Safety information

- The safety of this product is based on testing and approvals of the original design and specific components. The manufacturer is not responsible for safety in the event of use of unauthorized replacement parts.
- The maintenance information for this product has been prepared for use by a professional service person and is not intended to be used by others.
- There may be an increased risk of electric shock and personal injury during disassembly and servicing of this product. Professional service personnel should understand this and take necessary precautions.
-  **CAUTION:** When you see this symbol, there is a danger from hazardous voltage in the area of the product where you are working. Unplug the product before you begin, or use caution if the product must receive power in order to perform the task.

Consignes de sécurité

- La sécurité de ce produit repose sur des tests et des agréments portant sur sa conception d'origine et sur des composants particuliers. Le fabricant n'assume aucune responsabilité concernant la sécurité en cas d'utilisation de pièces de rechange non agréées.
- Les consignes d'entretien et de réparation de ce produit s'adressent uniquement à un personnel de maintenance qualifié.
- Le démontage et l'entretien de ce produit pouvant présenter certains risques électriques, le personnel d'entretien qualifié devra prendre toutes les précautions nécessaires.
-  **ATTENTION :** Ce symbole indique la présence d'une tension dangereuse dans la partie du produit sur laquelle vous travaillez. Débranchez le produit avant de commencer ou faites preuve de vigilance si l'exécution de la tâche exige que le produit reste sous tension.

Norme di sicurezza

- La sicurezza del prodotto si basa sui test e sull'approvazione del progetto originale e dei componenti specifici. Il produttore non è responsabile per la sicurezza in caso di sostituzione non autorizzata delle parti.
- Le informazioni riguardanti la manutenzione di questo prodotto sono indirizzate soltanto al personale di assistenza autorizzato.
- Durante lo smontaggio e la manutenzione di questo prodotto, il rischio di subire scosse elettriche e danni alla persona è più elevato. Il personale di assistenza autorizzato deve, quindi, adottare le precauzioni necessarie.
-  **ATTENZIONE:** Questo simbolo indica la presenza di tensione pericolosa nell'area del prodotto. Scollegare il prodotto prima di iniziare o usare cautela se il prodotto deve essere alimentato per eseguire l'intervento.

Sicherheitshinweise

- Die Sicherheit dieses Produkts basiert auf Tests und Zulassungen des ursprünglichen Modells und bestimmter Bauteile. Bei Verwendung nicht genehmigter Ersatzteile wird vom Hersteller keine Verantwortung oder Haftung für die Sicherheit übernommen.
- Die Wartungsinformationen für dieses Produkt sind ausschließlich für die Verwendung durch einen Wartungsfachmann bestimmt.
- Während des Auseinandernehmens und der Wartung des Geräts besteht ein zusätzliches Risiko eines elektrischen Schlags und körperlicher Verletzung. Das zuständige Fachpersonal sollte entsprechende Vorsichtsmaßnahmen treffen.
-  **ACHTUNG:** Dieses Symbol weist auf eine gefährliche elektrische Spannung hin, die in diesem Bereich des Produkts auftreten kann. Ziehen Sie vor den Arbeiten am Gerät den Netzstecker des Geräts, bzw. arbeiten Sie mit großer Vorsicht, wenn das Produkt für die Ausführung der Arbeiten an den Strom angeschlossen sein muß.

Pautas de Seguridad

- La seguridad de este producto se basa en pruebas y aprobaciones del diseño original y componentes específicos. El fabricante no es responsable de la seguridad en caso de uso de piezas de repuesto no autorizadas.
- La información sobre el mantenimiento de este producto está dirigida exclusivamente al personal cualificado de mantenimiento.
- Existe mayor riesgo de descarga eléctrica y de daños personales durante el desmontaje y la reparación de la máquina. El personal cualificado debe ser consciente de este peligro y tomar las precauciones necesarias.
-  **PRECAUCIÓN:** este símbolo indica que el voltaje de la parte del equipo con la que está trabajando es peligroso. Antes de empezar, desenchufe el equipo o tenga cuidado si, para trabajar con él, debe conectarlo.

Informações de Segurança

- A segurança deste produto baseia-se em testes e aprovações do modelo original e de componentes específicos. O fabricante não é responsável pela segurança, no caso de uso de peças de substituição não autorizadas.
- As informações de segurança relativas a este produto destinam-se a profissionais destes serviços e não devem ser utilizadas por outras pessoas.
- Risco de choques eléctricos e ferimentos graves durante a desmontagem e manutenção deste produto. Os profissionais destes serviços devem estar avisados deste facto e tomar os cuidados necessários.
-  **CUIDADO:** Quando vir este símbolo, existe a possível presença de uma potencial tensão perigosa na zona do produto em que está a trabalhar. Antes de começar, desligue o produto da tomada eléctrica ou seja cuidadoso caso o produto tenha de estar ligado à corrente eléctrica para realizar a tarefa necessária.

Informació de Seguretat

- La seguretat d'aquest producte es basa en l'avaluació i aprovació del disseny original i els components específics.
El fabricant no es fa responsable de les qüestions de seguretat si s'utilitzen peces de recanvi no autoritzades.
- La informació pel manteniment d'aquest producte està orientada exclusivament a professionals i no està destinada a ningú que no ho sigui.
- El risc de xoc elèctric i de danys personals pot augmentar durant el procés de desmuntatge i de servei d'aquest producte. El personal professional ha d'estar-ne assabentat i prendre les mesures convenients.
-  **PRECAUCIÓ:** aquest símbol indica que el voltatge de la part de l'equip amb la qual esteu treballant és perillós. Abans de començar, desendolleu l'equip o extremeu les precaucions si, per treballar amb l'equip, l'heu de connectar.

안전 사항

- 본 제품은 원래 설계 및 특정 구성품에 대한 테스트 결과로 안정성이 입증된 것입니다. 따라서 무허가 교체부품을 사용하는 경우에는 제조업체에서 안전에 대한 책임을 지지 않습니다.
- 본 제품에 관한 유지 보수 설명서는 전문 서비스 기술자용으로 작성된 것이므로, 비전문가는 사용할 수 없습니다.
- 본 제품을 해체하거나 정비할 경우, 전기적인 충격을 받거나 상처를 입을 위험이 커집니다. 전문 서비스 기술자는 이 사실을 숙지하고, 필요한 예방 조치를 취하도록 하십시오.
-  **주의:** 이 표시는 해당영역에서 고압전류가 흐른다는 위험 표시입니다. 시작전에 플러그를 뽑으시거나, 주의를 기울여 주시기 바랍니다.

安全信息

本产品的安全性以原来设计和特定产品的测试结果和认证为基础。万一使用未经许可的替换部件，制造商不对安全性负责。

本产品的维护信息仅供专业服务人员使用，并不打算让其他人使用。

本产品在拆卸、维修时，遭受电击或人员受伤的危险性会增高，专业服务人员对这点必须有所了解，并采取必要的预防措施。



切记: 当您看到此符号时，说明在您工作的产品区域有危险电压的存在。请在开始操作前拔掉产品的电源线，或者在产品必须使用电源来执行任务时，小心从事。

Preface

This manual contains maintenance procedures for service personnel. It is divided into the following chapters:

1. **General information** contains a general description of the product and the maintenance approach used to repair it. Special tools and test equipment are listed in this chapter, as well as general environmental and safety instructions.
2. **Diagnostic information** contains an error indicator table, symptom tables, and service checks used to isolate failing field replaceable units (FRUs).
3. **Repair information** provides instructions for making product adjustments and removing and installing FRUs.
4. **Connector locations** uses illustrations to identify the connector locations and test points on the product.
5. **Preventive maintenance** contains the lubrication specifications and recommendations to prevent problems.
6. **Parts catalog** contains illustrations and part numbers for individual FRUs.

Definitions

Note: A note provides additional information.

Warning: A warning identifies something that might damage the product hardware or software.

CAUTION: A caution identifies something that might cause a servicer harm.



CAUTION: When you see this symbol, there is a danger from hazardous voltage in the area of the product where you are working. Unplug the product before you begin, or use caution if the product must receive power in order to perform the task.

1. General information

Overview

The Lexmark X5500 (4036-402) MFP option is a multifunction solution that offers integrated print, copy, fax, and color network-scanning capabilities for increased small workgroup productivity. The option is easy to use and provides low-cost access to key office functions, including fax from workstation, network color copying, scanning, and electronic document routing.

Give your document to the scanner, and in a few steps, it scans to the network and delivers it wherever, to whomever you want. With this scanner, inefficient trips to the mailroom, copier, fax machine, and to your workstation are a thing of the past.

Features

Ease of use

The user interface on the front of the scanner looks like a panel on a copier with standard phone keys added. The operating steps follow the same procedure as that of a copier or fax machine.

Digital copier and full-function fax machine

When the scanner is connected to a Lexmark MFP, it performs convenient digital copying. When connected to a telephone line, the scanner performs a full fax function - to send and to receive faxes.

Network scanning

The scanner uses two color charge-coupled devices (CCD) when scanning. Through a network port at the rear of the scanner, the product is able to do network scanning.

Duplex scanning through the Auto Document Feeder (ADF)

To increase workgroup productivity, the scanner uses a single pass duplex unit within the ADF. The scan speed limit is 35 ppm at 300 dpi resolution. The auto document feeder can hold up to 50 pages at one time.

Maintenance approach

This manual is for maintenance engineers. It describes the maintenance areas, installation, disassembly, and the main troubleshooting guides.

Read this manual thoroughly to obtain comprehensive knowledge about the scanner before servicing the unit.

Service guidelines

CAUTION: The combined scanner and automatic document feeder weighs 25.7 kg (56.6 lb) and requires at least two people to lift it safely. Anytime you move or lift the scanner, make sure you have enough people to help you.

CAUTION: Before disassembling the scanner, make sure the power supply cord is disconnected from the power outlet. Do not remove or install the connectors on the scanner with the power supply turned ON.

- Use care not to drop small parts or screws inside the unit when disassembling and reassembling.
- Do not pull the connector cable when disconnecting it. Hold the connector.
- When carrying the scanning head unit, put it in an anti-static bag.
- Keep the document glass platen surface clean with a dry clean lint free cloth.

Maintenance tools

The following table describes the tools necessary for the maintenance of this scanner.

Name	Description
Flathead screwdriver	Idler pulley module screw
Phillips screwdriver (magnetic)	Nominal No.2 M3, M4
Nut driver	6 mm
Digital voltmeter	With 0.01 V range
Chip puller	Puller for main scanner card chip

In addition there is a special calibration sheet that is included with certain FRUs and must be used after the installation. It can also be ordered separately.

Product specifications

The scanner is designed to meet the following product specifications:

Scanner type	Flatbed scanner with ADF built in	
ADF capacity	50 sheets 75g/m ² (20 lb)	
Media weight	60 g/m ² (16 lb) to 120 g/m ² (32 lb)	
Optical resolution	Flatbed: 600 x 600 dpi ADF: 600 x 600 dpi	
Scan speed	19 ppm for black and white text or mixed input 27 ppm for color input, single page scanning 25 ppm for color input, duplex	
Scan method	Color charge-coupled device (CCD)	
Light source	Cold cathode fluorescent lamp (CCFL)	
Scan area	ADF and flatbed: Max. 297 mm x 432 mm (11.7 x 17 in.)	
Display	640 x 480 color VGA touch screen	
Image types	1-, 8-, 24-bit with image processing	
Scan accuracy	Flatbed	ADF
Leading edge	<-1 ~ +2 mm	<2 ~ +2 mm
Side edge	<-1 ~ +2 mm	<2 ~ +2 mm
Skew	<1 mm	<2 mm
Magnification rate tolerance (horizontal and vertical)	-1.0% ~ +1.0%	-1.5% ~ +1.5%
Physical dimension	Height: 419 mm (16.5 in.), measuring to top of ADF feed tray Width: 660mm (26 in.) Depth: 686mm (27 in.)	
Weight	25.7 kg (56.5 lb)	
Memory	128MB DRAM	
Hard disk drive	10GB or greater	
Fax modem	33.6 bps	
Paper feed	Face up long edge feed (LEF)	

Theory of operation

System description

The Lexmark X5500 is a duplex scanner option which can synchronously scan both the top and bottom of a document in color. The major system components include a main scanner control card, an automatic document feeder, flatbed, two optical CCD modules (one in ADF, one in flatbed), a user interface with a touch screen panel and a multifunction device controller cage located within the base of the scanner. The MFD controller cage includes a MFD controller card to process all jobs performed on the X5500 and communicates with the rest of the scanner, a hard disk drive containing the operational code for the system and providing memory for processing jobs, and a power distribution card. An external power supply provides 5, 12, and 24 V dc to the entire scanner system.

The following figure shows the system block diagram.

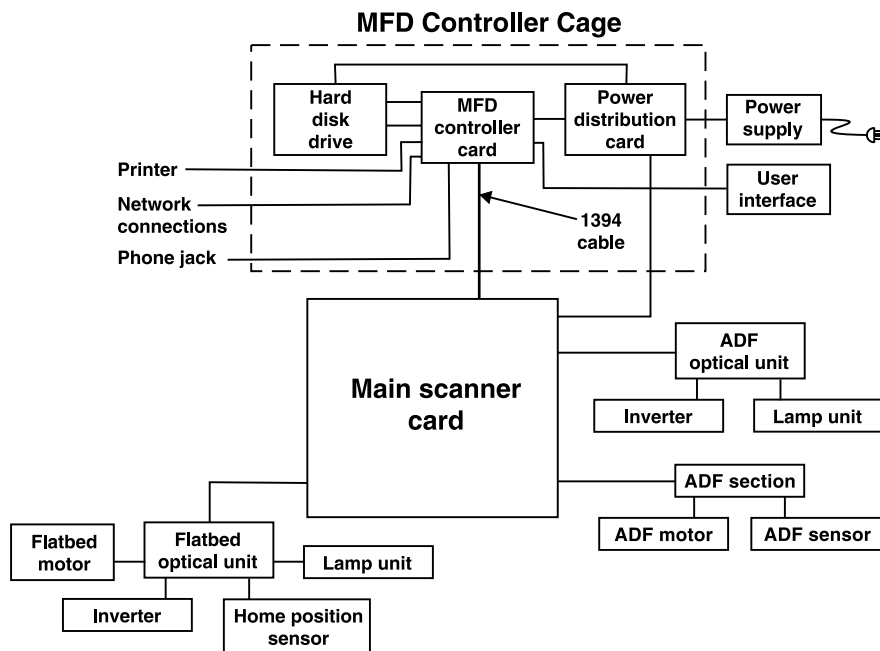

Mechanical operation

Flatbed operation

When scanning, place the document on the flatbed glass platen, the flatbed optical unit/carrier moves across the underside of the glass, and scans the document. A charge-coupled device (CCD) mounts to the carrier and optically reads the image from the page. The carrier is driven by a 2-phase stepping motor which moves the carriage at 1/600 inch each step.

Auto Document Feeder operation

When using the Auto Document Feeder (ADF) mechanism, a page is fed into the ADF by a pick roller and through the ADF by feed rollers. A separation pick pad located opposite the pick rollers is used to properly feed the pages one at a time when placed on the input tray. The flatbed optical unit/carrier is positioned to the far left so when the paper passes through the ADF, the bottom of the page is scanned by the flatbed CCD. The home position sensor detects when the carrier is in the proper position for ADF scanning. In addition, an ADF cover open sensor detects when the upper ADF assembly is open or closed into proper operating position. The scanner cannot operate when this sensor is open.

While the page is fed through and scanned from the bottom via the flatbed CCD, the top of the page is simultaneously scanned via a CCD unit positioned within the ADF unit. As the page feeds between the two CCD units, the page discharges to the exit tray on the left side of the ADF.

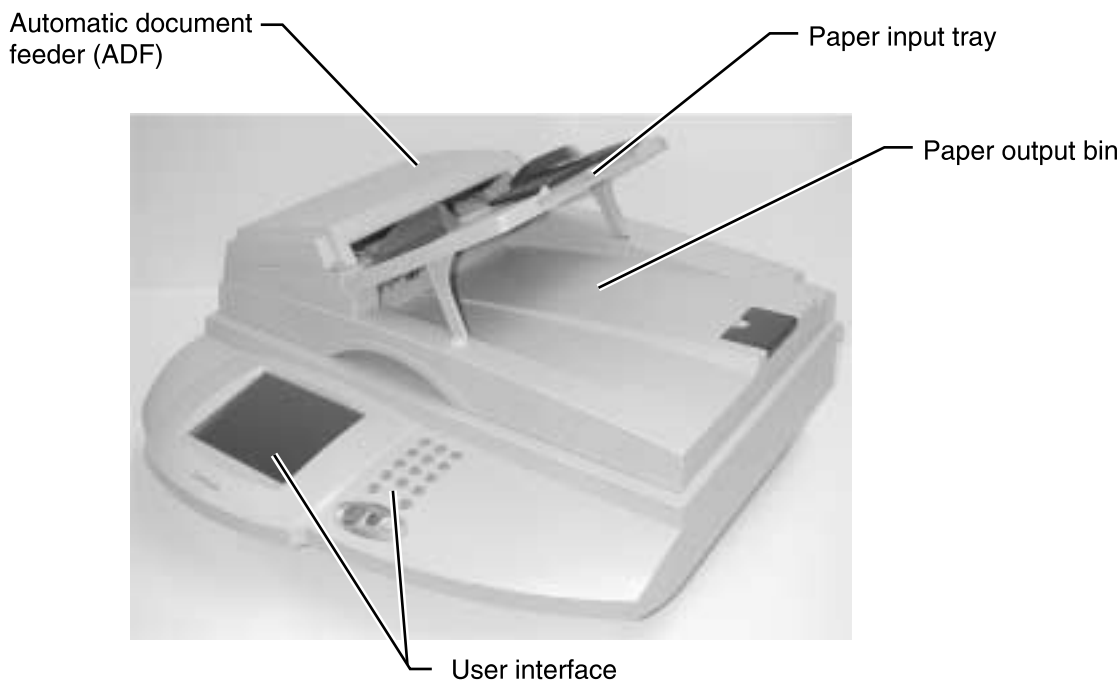

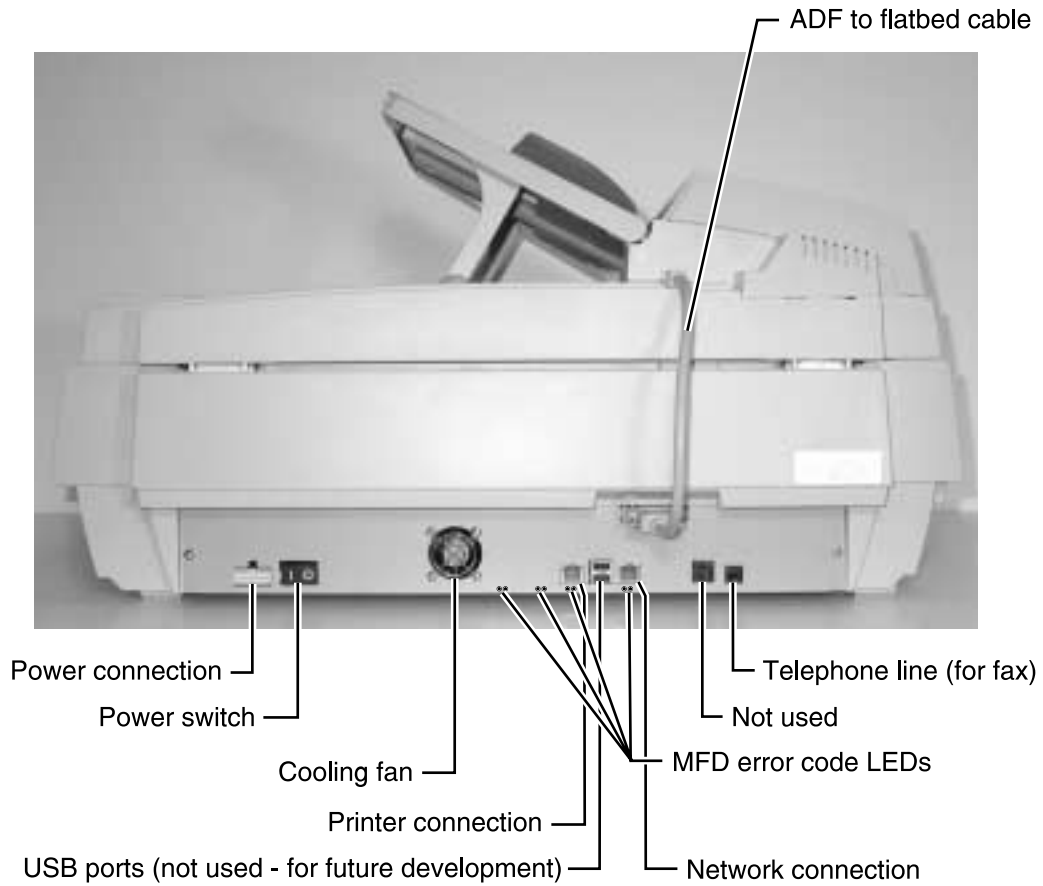

Acronyms

ADF	Auto Document Feeder
CCD	Charge-Coupled Device
CCFL	Cold Cathode Fluorescent Lamp
CDB	Command Data Blocks
DMM	Digital Multimeter
LED	Light Emitting Diode
MFD	Multifunction Device
PCBA	Printed Circuit Board Assembly
SCSI	Small Computer System Interface
UI	User Interface

2. Diagnostic information



CAUTION: When you see this symbol, there is a danger from hazardous voltage in the area of the product where you are working. Unplug the product before you begin, or use caution if the product must receive power in order to perform the task.

Start

This chapter describes two methods to solve the operational problems. The first relies on the scanner internal diagnostics to report error codes. The second uses troubleshooting techniques to isolate the problem. In many cases, the internal error codes will help you to locate the source of the problem quickly. If no error codes are reported, or if the error codes do not locate the source of the problem, see **“Symptoms and service checks” on page 2-6.**

Error codes

MFD controller errors

MFD controller errors are errors detected by the MFD (multifunction device) controller card within the MFD cage pertaining to electronic cards. All MFD controller cage errors are posted to the user interface touch screen along with audible *beep* codes and LED codes. During the Power-On Self Test procedure, errors detected cause a number of audible *beeps* to be produced three times. The corresponding LED pattern continuously displays on the controller card until the system is powered down. Use the following tables to read the *beep*/LED codes and follow the recommended repair action.

There are four pairs of LEDs along the rear edge of the MFD controller card. The LEDs are visible from the rear of the scanner through holes in the metal card cage panel. The LED patterns in the table below depict which LEDs are visible from the rear of the scanner.

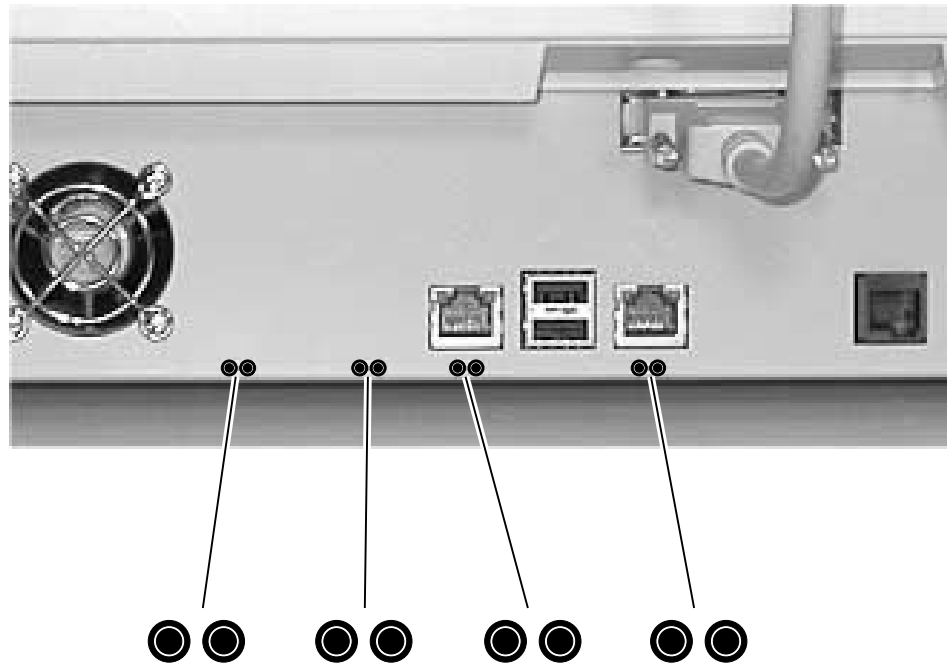

Error message	Number of beeps	LED pattern (on= ☉, off= ●)	Action
Error: 21 - Modem not found	2	● ● ☉ ● ● ● ☉	Modem on the MFD controller card is not found. Replace the MFD controller card.
Error: 22 - PCI Bus failure	2	● ● ☉ ● ● ☉ ●	Replace the MFD controller card.
Error: 23 - Internal Scanner Card Failure	2	● ● ☉ ● ● ☉ ☉	The 1394 controller on the MFD controller card has failed. Replace the MFD controller card.

Error message	Number of beeps	LED pattern (on= ☉, off= ●)	Action
Error: 24 - Serial port failure	2	●● ☉● ●☉ ●●	Problem with TTY/Serial Port. Replace the MFD controller card.
Error: 28 - Problem with the CPU	2	●● ☉● ☉● ●●	Replace the MFD controller card.
Note: Error message not displayed. Only beep code and LED patterns are generated for error 31.	3	●● ☉☉ ●● ●☉	No hard disk drive found. Check connections to the hard disk drive and associated cables for continuity. Check power going to the hard disk drive. Replace the power distribution card if no power is present. If power is present, replace the hard disk drive.
Note: Error message not displayed. Only beep code and LED patterns are generated for error 32.	3	●● ☉☉ ●● ☉●	Corrupt hard disk drive. Replace or reformat the hard disk drive. See “Hard disk drive refresh” on page 3-4.
Error: 34 - Hard Drive failure	3	●● ☉☉ ●☉ ●●	There was an error writing to the hard disk drive. Replace or reformat the hard disk drive. See “Hard disk drive refresh” on page 3-4.
Note: Error message not displayed. Only beep code and LED patterns are generated for error 51.	5	●☉ ●☉ ●● ●☉	No memory found. The memory DIMM was not detected or not functioning. Replace the memory DIMM.
Error: 52 - Not enough memory	5	●☉ ●☉ ●● ☉●	The memory DIMM was found, but not enough memory is present. Replace the memory DIMM.
Error: 71 - User Interface failure	7	●☉ ☉☉ ●● ●☉	A problem was detected with the user interface. Check the connection of all cables connecting the UI to the MFD controller card. If cables are okay, replace the user interface. If problem persists, replace the MFD controller card.

Scanner errors

Scanner errors are errors detected within the scanner mechanism and auto document feeder assembly. When these errors occur, the user interface touch screen posts 1900 Service Error along with a number of flashes of the flatbed CCD lamp (the flash sequence is repeated ten times). See the following table for an explanation of each error code and the corrective action to resolve the problem.

Number of CCD lamp flashes	Error message	Description and action
1	Oasis 1 SDRAM Failure	SDRAM failure in the flatbed. Replace the main scanner card.
2	Oasis 2 SDRAM Failure	SDRAM failure in the ADF. Replace the main scanner card.
3	CPU SDRAM Failure	Replace the main scanner card.
4	Flatbed A/D Dark Calibration Error	Replace the flatbed optical unit assembly. If problem persists, replace the main scanner card.
5	ADF A/D Dark Calibration Error	Replace the ADF internal subassembly. If problem persists, replace the main scanner card.
6	Flatbed Home sensor failure or flatbed motor failure. Please verify that the flatbed is not locked.	Home sensor failure. Check that the flatbed is not locked. See “Moving the scanner” on page 5-3 for information about the locking mechanism. Check the flatbed motor, belt, and home position sensor for proper operation. Replace any defective parts. If no defective parts are found, replace the main scanner card.
7	Flatbed Lamp Failure	Check the flatbed optical unit for proper connection. Replace the flatbed lamp or optical unit, if necessary.
8	ADF Lamp Failure	Check the ADF internal subassembly for proper connection. Replace the ADF optical unit if necessary.
9	Note: Various messages may appear on the user interface.	ADF paper jam. Check the paper feed actuator to verify it is not obstructed and is moving properly. The easiest way to inspect the actuator is from under the ADF assembly. If the actuator is working properly, replace the ADF internal subassembly.
10	Note: Various messages may appear on the user interface.	ADF cover open. Check the ADF cover open sensor for proper connection. Check that the ADF upper cover closes completely and that the actuator passes through the ADF cover open sensor when closed.
11	ADF cable may be loose. Please turn off the system and check that all cables are installed and all screws tight. If this reoccurs, this may be an ADF home sensor failure or ADF motor failure.	Scanner communication error. Check the ADF to flatbed cable. Make sure it is properly connected. If the problem persists, replace the ADF assembly.

Number of CCD lamp flashes	Error message	Description and action
12	Flatbed may be locked. Please check to make sure that the flatbed is unlocked and restart the system. If the flatbed is already unlocked, this may be a Home Sensor Failure.	Unlock the flatbed. See “Moving the scanner” on page 5-3 for information about the locking mechanism. If the flatbed is unlocked and the problem persists, check the connection of the cable to the flatbed optical unit. Replace the optical unit if necessary.
No beeps	SCSI command not supported	Scanner communication error. Check the 1394 cable connections. If the problem remains, replace the main scanner card. If the persists, replace the MFD controller card.
No beeps	Invalid field in CDB	Scanner communication error. Check the 1394 cable connections. If the problem remains, replace the main scanner card. If the persists, replace the MFD controller card.

Symptoms and service checks

The tables in this section provide detailed troubleshooting information.

The power does not come on

Cause	Relevant unit	Check *	Action
Unplugged from outlet	None	Visual check	Insert the ac plug into the outlet.
AC power unplugged at power supply	LVPS	Visual check	Insert the ac cable into power supply.
Power switch is OFF	None	Visual check	Turn the power switch on.
Power supply power distribution card connection failure	None	Visual check	Connect the connector.
Power supply output voltage failure	LVPS	Check the LVPS (+5V +12V, +24V, GND)	Replace the power supply.
Power distribution card	Power distribution card	Check the power distribution card (+5V, GND)	Replace the failed power distribution card.
MFD controller card	MFD controller card	None	If problem still exists, replace MFD controller card.
* Check explains how to check the failed item. To do a visual check, observe the part. To do a tester check, check the voltage levels of the relevant units. (See “Connector locations” on page 4-1.)			

Scan module does not move to the lock position

Cause	Relevant unit	Check	Action
Home position sensor card failure	Flatbed optical unit	Visual check	Replace the flatbed optical unit.
Motor—main scanner card connection failure	None	Visual check	Connect the connector.
Motor failure	Carrier motor	Visual check	Replace the flatbed optical unit.
Power supply—main scanner card connection failure	None	Visual check	Connect the connector.
Power supply fails.	Power supply	Tester check (+24V, GND)	Replace the power supply.

Scan module does not move to the home position

Cause	Relevant unit	Check	Action
Home position sensor—main scanner card connection failure	None	Visual check	Connect the connector.
Home position sensor failure	Sensor in the flatbed optical unit	Visual check	Replace the flatbed optical unit.
Power supply—main scanner card connection failure	None	Visual check	Connect the connector.
Power supply fails	Power supply	Test LVPS (+5V, +24V, GND)	Replace the power supply.
Lamp failure	Lamp	Visual check	Replace the flatbed lamp.
Inverter failure	Inverter	Visual check	Replace the flatbed lamp inverter.
Flatbed optical unit—main scanner card connection failure	None	Visual check	Connect the connector.
CCD card fails	Flatbed optical unit	Visual check	Replace the flatbed optical unit.

Scan module does not move to the flatbed position

Cause	Relevant unit	Check	Action
Power supply.—main scanner card connection failure	None	Visual check	Connect the connector.
Power supply fails	Power supply	Test LVPS (+5V, +24V, GND)	Replace the power supply.
Motor—main scanner card connection failure	None	Visual check	Connect the connector.
Motor failure	Carrier motor	Visual check	Replace the flatbed optical unit.
Belt broken or loose	Carrier belt	Visual check	Reposition belt or replace if defective.

System hangs while booting or displays erratic behavior

Cause	Relevant unit	Check	Action
Corrupt software on hard disk drive	Hard disk drive	Visual check	Refresh the hard disk drive software. See “Hard disk drive refresh” on page 3-4.

Image does not appear

Cause	Relevant unit	Check	Action
ADF cover open	ADF cover	Visual check	Close the ADF cover.
Lamp Inverter failure	Lamp inverter	Visual check	Replace the optical unit, lamp, or inverter.
Optical unit—main scanner card connection failure	None	Visual check	Connect the connector.
CCD card fails	Optical unit	Visual check	Replace the optical unit.

Large jitter

Cause	Relevant unit	Check	Action
Motor—main scanner card connection failure	None	Visual check	Connect the connector.
Motor failure	Carrier motor	Visual check	Replace the carrier motor.

Irregular movement

Cause	Relevant unit	Check	Action
Motor-main scanner PCBA connection failure	None	Visual check	Connect the connector.
Motor failure	Carrier motor	Visual check	Replace the flatbed optical unit.
Loose belt	Flatbed optical unit belt	Visual check	Make sure belt is not worn or improperly installed. Replace if necessary.
Home position sensor—main scanner card cable failure	Flatbed optical unit cable	Visual check	Replace the flatbed optical unit cable.
Home position sensor failure	Flatbed optical unit	Tester check	Replace the flatbed optical unit.

Image unclear

Cause	Relevant unit	Check	Action
Scanner not calibrated properly	Calibration settings on main scanner card	Visual check	Perform scanner calibration procedure. See “Scanner calibration” on page 3-2.
Lamp too dark	Lamp	Visual check	Replace CCD optical unit.
Dirt on calibration reference plate	Calibration reference plate	Visual check	Clean the flatbed glass with isopropyl alcohol.
Dirt on the mirrors	Mirrors	Visual check	Clean the mirrors with isopropyl alcohol.
Dirt on the lens	Lens	Visual check	Clean the lens with isopropyl alcohol.

Strange sound generated (flatbed)

Cause	Relevant unit	Check	Action
Motor unit failure	Motor unit	Visual check	Replace the flatbed optical unit.
Main scanner card failure	Main scanner card	Replace the main scanner card.	Replace the main scanner card.
Dirt on rail	None	Visual check	Clean the rail with isopropyl alcohol.

Frequent paper jam, double feed, or skew

Cause	Relevant unit	Check	Action
Paper setting failure	Operation error	Is the paper correctly set in the paper chute?	Teach users to properly position the paper.
Paper failure	Operation error	Is the specified paper used?	Use specified paper.
Pick pad and rollers failure	Pick pad and rollers	Check the pad and rollers for wear.	Clean/replace the pick pad and rollers.
ADF unit failure	ADF unit	Replace the ADF unit.	Replace the ADF unit.

Strange sound generated (ADF)

Cause	Relevant Unit	Check	Action
ADF motor failure	ADF motor	Is motor turning properly?	Replace the ADF motor.
ADF gear failure, noisy bearings	Internal ADF subassembly	Is noise coming from internal ADF subassembly?	Replace the internal ADF subassembly.

Clearing a paper jam

1. Press the release button on the automatic document feeder and then open the cover.

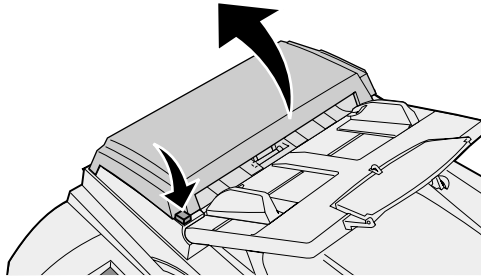

2. Carefully pull out the jam.
If you cannot remove the jam, open the document cover and move the roller lever forward. Then carefully pull out the jam.

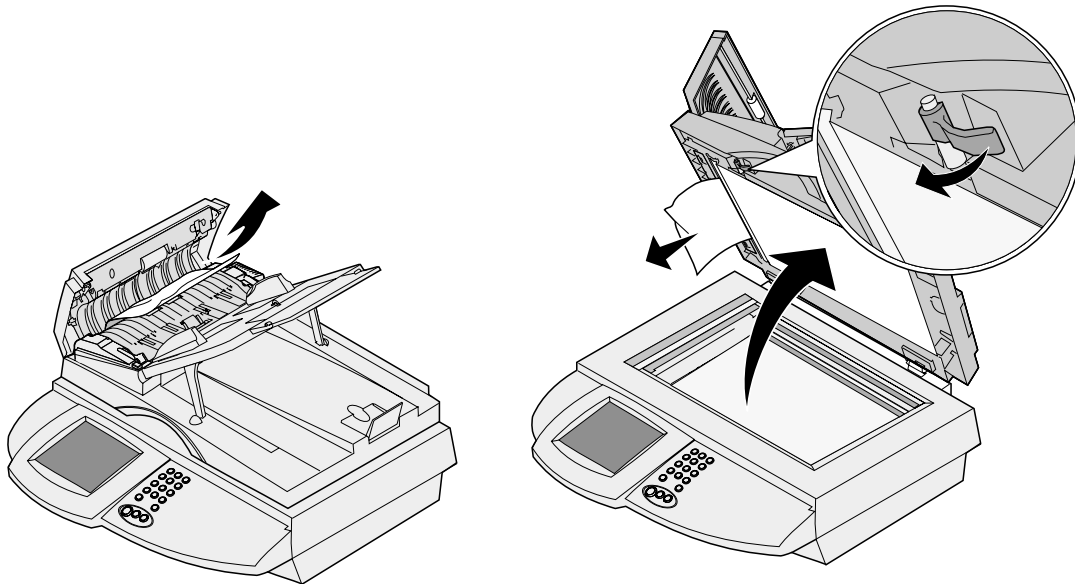

3. Close the document cover.
4. Close the automatic document feeder.
Make sure the cover is closed securely.

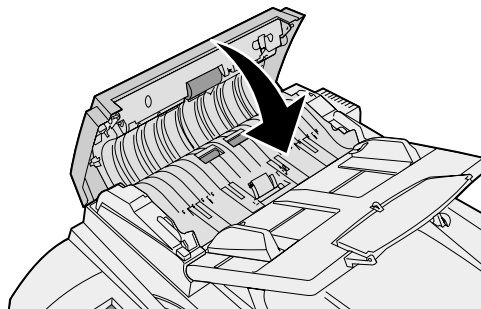

3. Repair information



CAUTION: When you see this symbol, there is a danger from hazardous voltage in the area of the product where you are working. Unplug the product before you begin, or use caution if the product must receive power in order to perform the task.

Parts replacement

1. Clean the disassembly and assembly location.
2. Turn off the power switch and remove the AC plug from the outlet before disassembly and assembly.
3. Follow the disassembly and assembly procedures. Never loosen the screws of parts that must not be disassembled. These screws have a red coating.
4. Store the disassembled parts in a clean place to avoid loss.
5. Assemble in the reverse order of disassembly.
6. After replacement, check the contacts and spare part mounting.

Adjustments

Scanner calibration

This procedure should be performed whenever a *new* ADF assembly, internal ADF CCD subassembly, flatbed optical unit, or main scanner card is installed.

Use this process to calibrate the grayscale adjustments in the scanner. Carefully follow the steps to perform the calibration. The process must be completed from start to finish for successful calibration.

1. Enter the SE menu by pressing * * 4 1 1.
2. Select **Scanner Menu** from the main SE menu.
3. Select **Scan Calibration** from the Scanner menu.
4. Place the special calibration sheet *facedown* on the glass.

Make sure the sheet is oriented with the leading edge band to the left, as shown. Close the document cover.

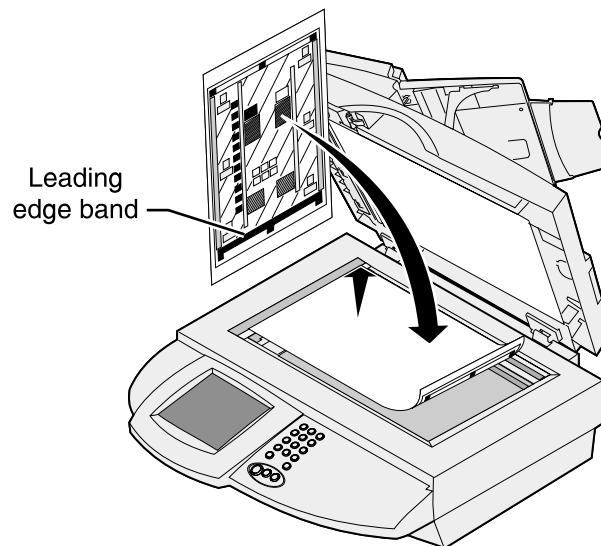

5. Press **Start**.
The calibration sheet is scanned twice.
6. Remove the sheet from the glass.

7. Place the sheet *faceup* in the Automatic Document Feeder (ADF). Make sure the sheet is oriented with the leading edge band to the left, as shown.

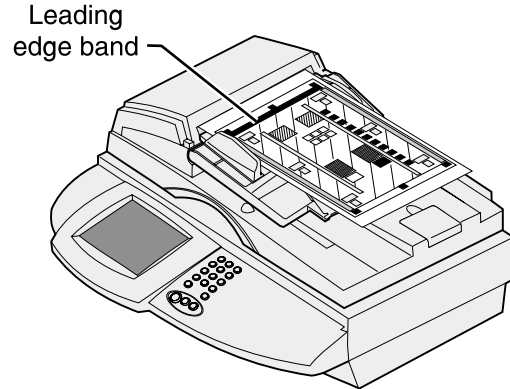

8. Press **Start**.
9. Repeat steps 7 and 8.
10. Place the sheet *facedown* in the ADF. Make sure the sheet is oriented with the leading edge band to the left, as shown.

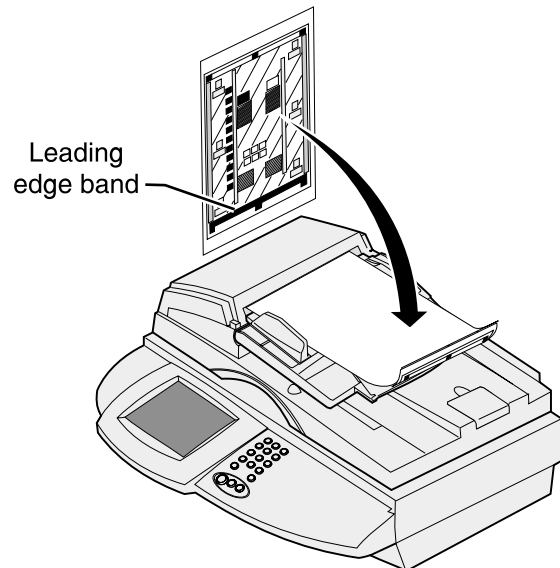

11. Press **Start**.
12. Repeat steps 10 and 11.
13. Remove the sheet.

If the calibration process was successful, the screen on the scanner displays *Successful*. Turn the power off and on.

If the calibration process failed, the screen displays *Failure*. Turn the power off and on. Repeat the scanner calibration.

Hard disk drive refresh

The hard disk drive is divided into three partitions, including one primary and two backup partitions. The two backup partitions contain duplicate information in case the software on the primary partition becomes corrupt. This procedure attempts to refresh the software on the primary partition from one of the backups.

1. Turn off the power.
2. Turn the power on and immediately press **1** or **2** repeatedly
Continue until the following message appears:
Press the # button to perform disk maintenance (35+ minutes).
Otherwise, press the green start button to continue.
3. Press # to begin the disk refresh process.
This process may take as more than 30 minutes, but frequently only takes 10-15 minutes. A message will appear on the screen indicating the refresh is in progress.

Note: Do not turn the power off while the refresh is in progress. If the system is powered off during this process, the refresh procedure is automatically restarted the next time the device is powered on.

If `Please contact service technician.` is displayed, the hard disk drive may be corrupt and should be replaced. This message appears if a refresh fails more than three consecutive times.

Code update procedure

Occasionally, Lexmark may release new code. This file can be obtained from the Customer Support Center. The code file contains a readme file which contains the code update instructions and other information about the software update.

Your MFP may be updated by sending the update file by one of the following means:

- Using MarkVision Professional
- Using the MFP's Web page
- Using FTP
- Local attach via USB or Parallel connection

Removals

Charge-coupled device (CCD) card screws

Screws for the CCD card in the optical unit are as shown. These screws have a red coating indicating they should never be loosened.

Flatbed CCD Optical Unit

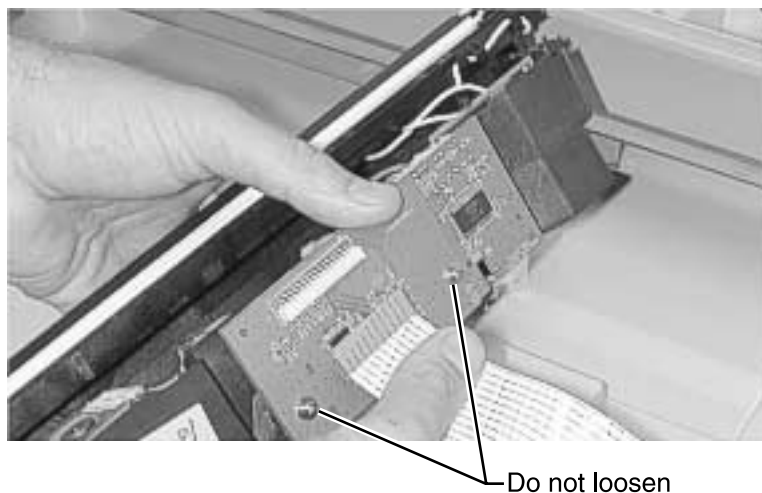

ADF CCD Optical Unit

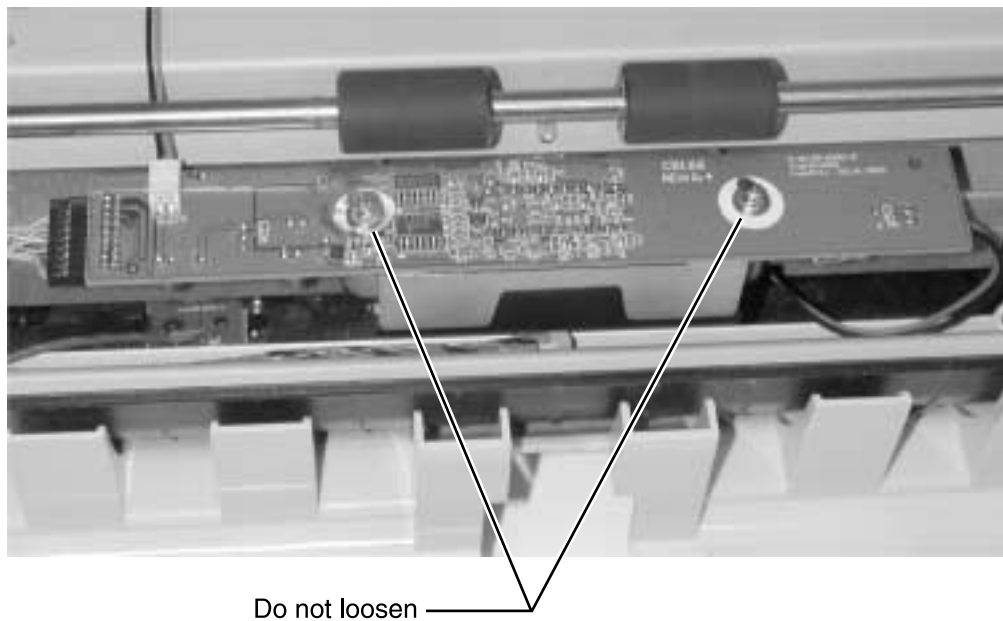

ADF assembly

1. Disconnect the ADF to flatbed cable from the flatbed.



2. Remove the two thumb screws that secure the hinges.

3. Lift the ADF assembly straight up.

CAUTION: Remove the ADF assembly with the cover in the raised position only to ensure the hinges are not energized.



Note: After installing a new ADF assembly, perform the **“Scanner calibration”** on page 3-2.

ADF upper cover

1. Open the ADF.
2. Remove the two screws.

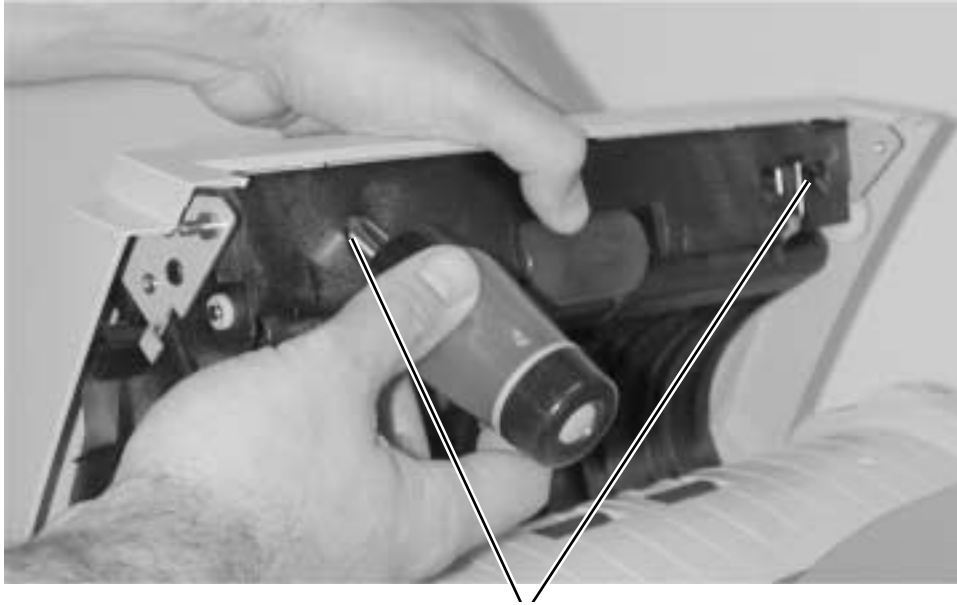

3. Lift the upper cover away from the hinge.

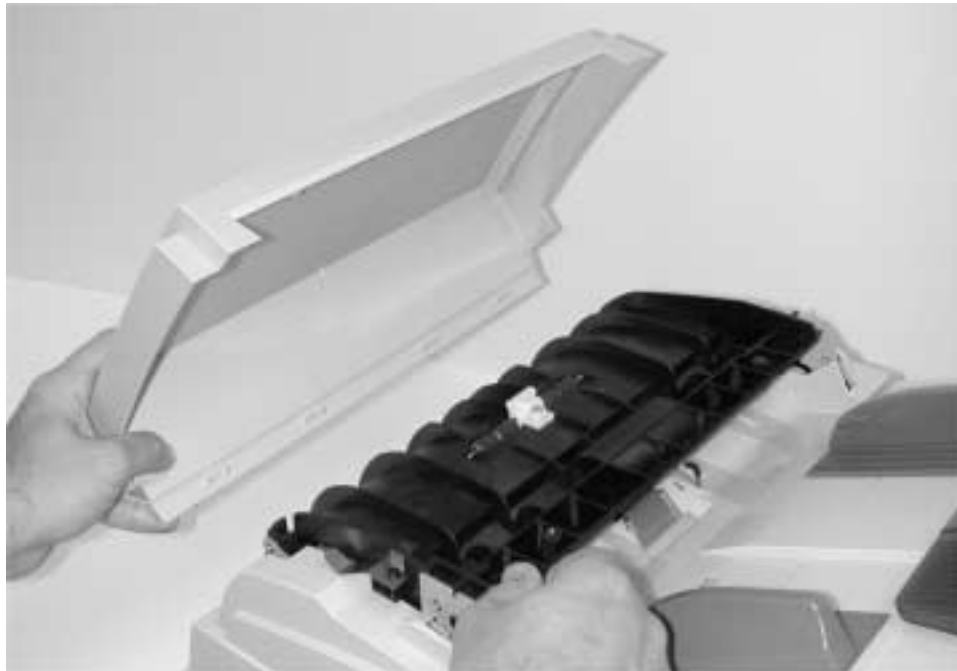

ADF upper guide

1. Remove the ADF upper cover. See **““ADF upper cover” on page 3-8.**
2. Remove the stop guide screw.

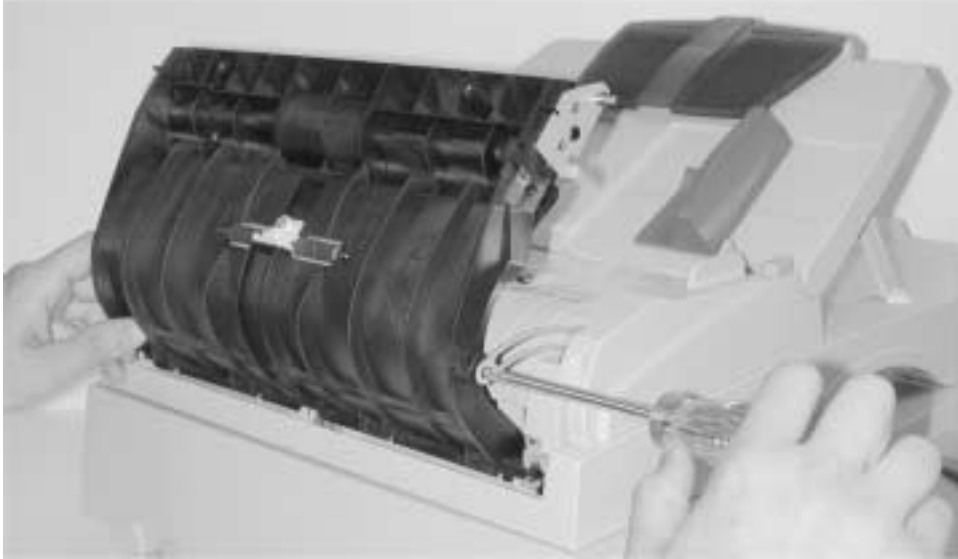

3. Rotate the ADF upper guide and pull the upper guide free.

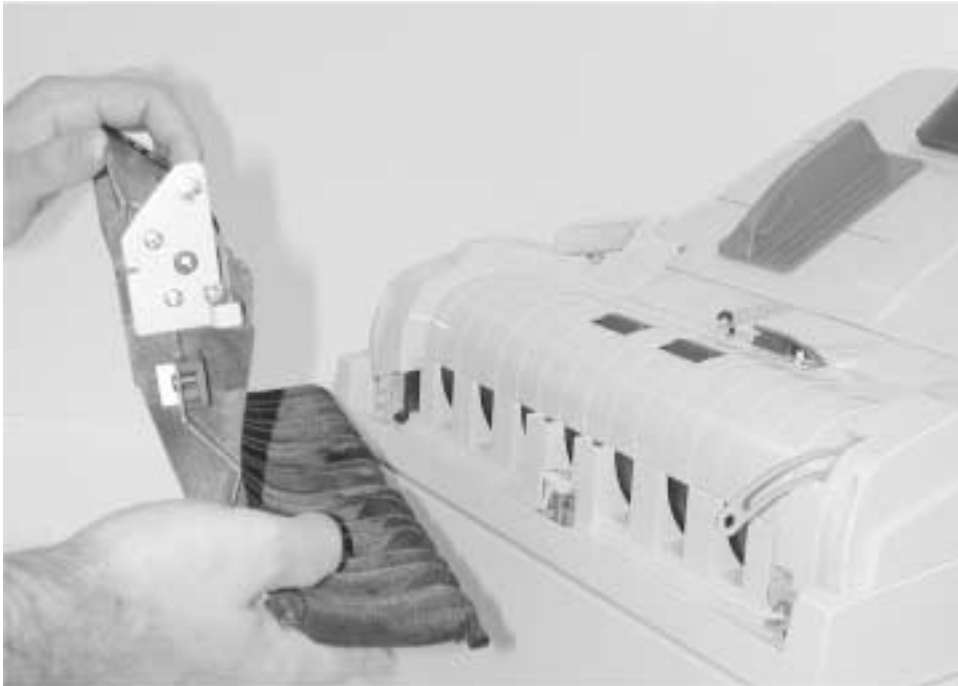

ADF lower guide

1. Remove the ADF upper guide. See **“ADF upper guide”** on page 3-9.
2. Remove the paper input tray. See **“Paper input tray”** on page 3-18.
3. Remove the six screws (A) and (B).

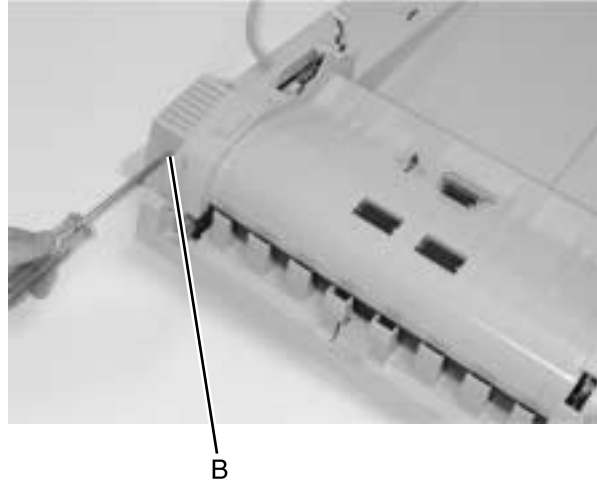
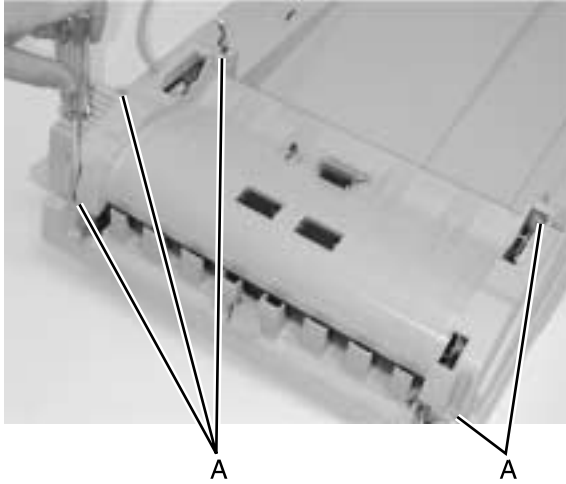

4. Lift the ADF lower guide.

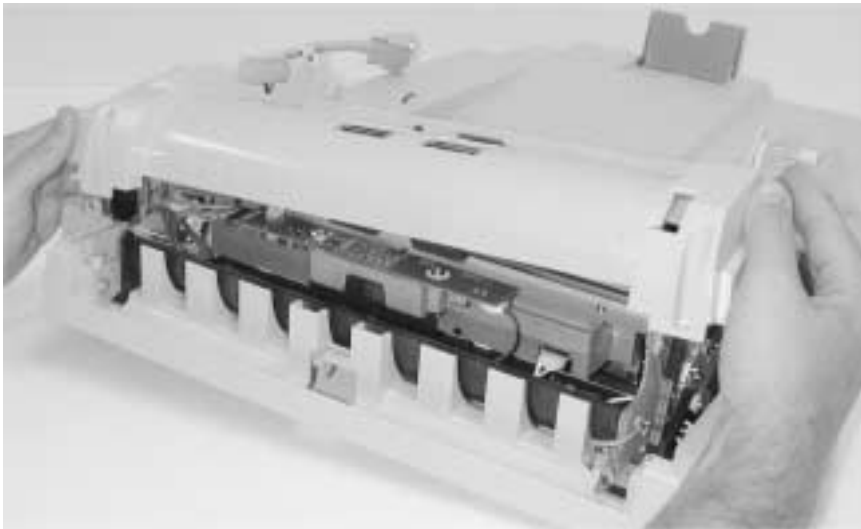

5. Pull the page size sensor cable through the opening in the ADF lower guide.

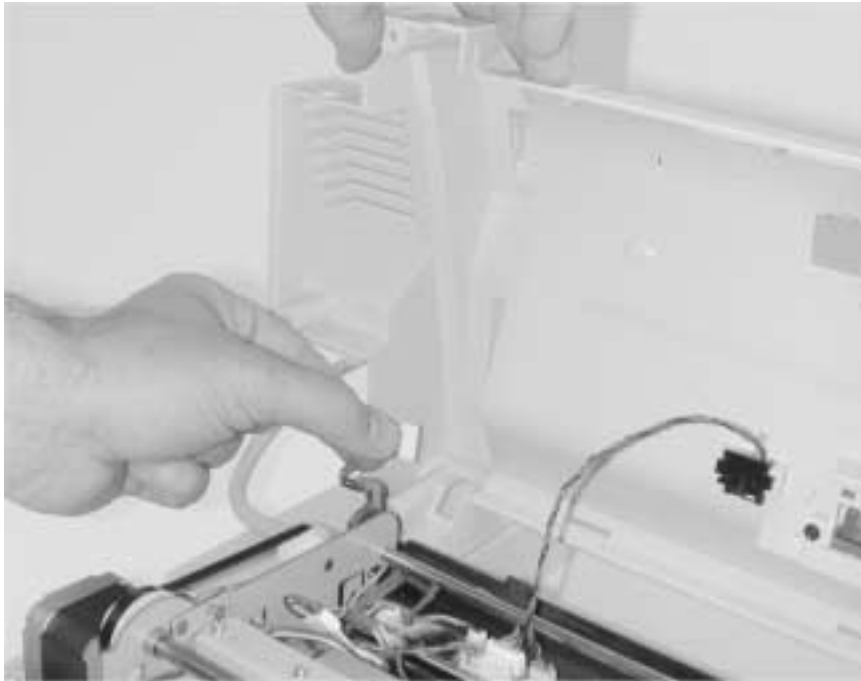

6. Disconnect the paper present sensor cable.

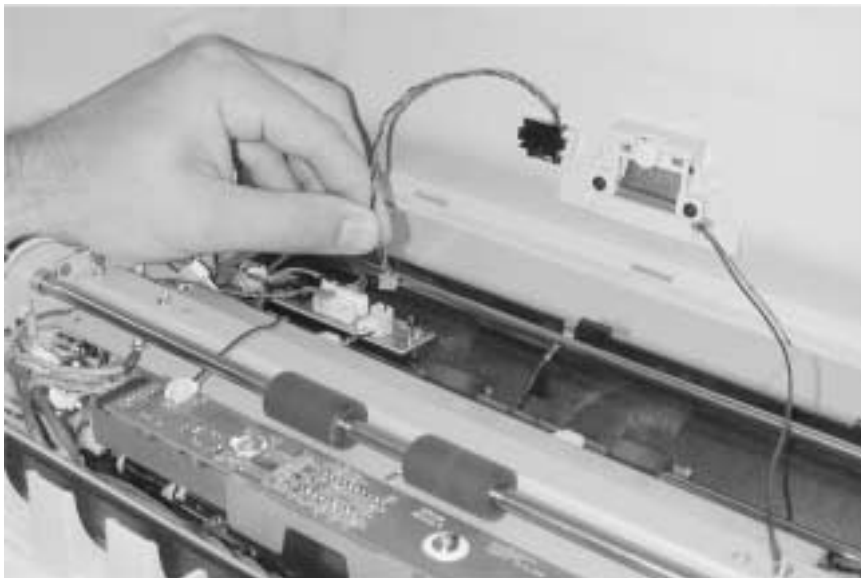

7. Remove the ground screw and washer.



8. Lift off the ADF lower guide.

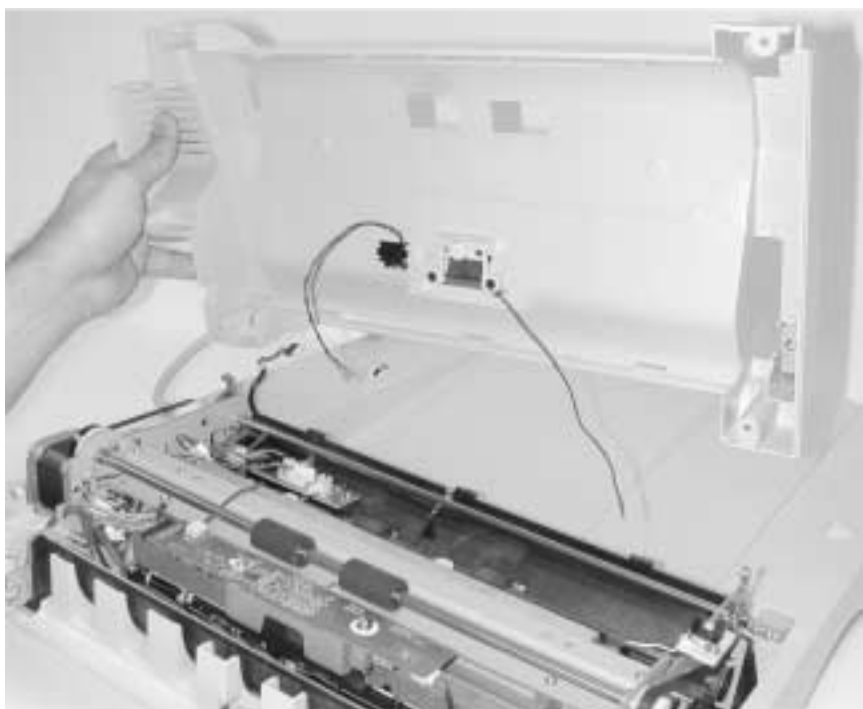

ADF drive motor

1. Remove the ADF lower guide. See **“ADF lower guide”** on page 3-10.
2. Disconnect the cable to the ADF drive motor.

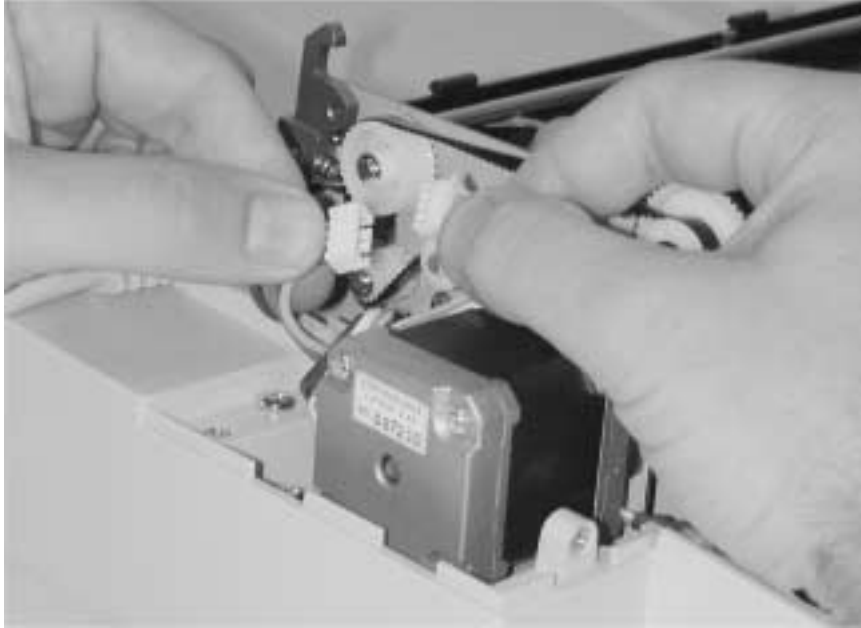

3. Remove the ground screw and disconnect the ground cable.

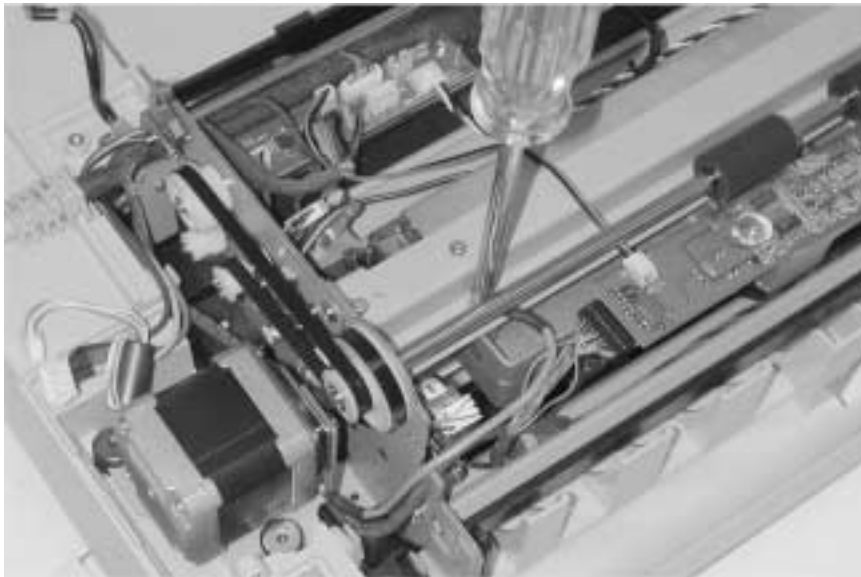

4. Remove the three screws (A) securing the ADF drive motor.



A

5. Remove the motor.

ADF controller card

1. Remove the ADF assembly. See **“ADF assembly”** on page 3-6.
2. Place the ADF unit upside down.
3. Remove the two screws (A) to the controller card access cover.

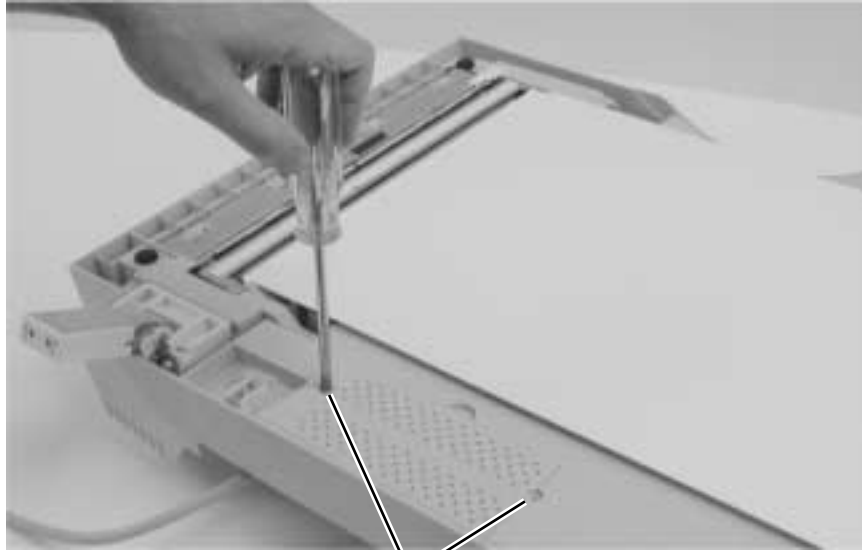

A

4. Remove the cover.

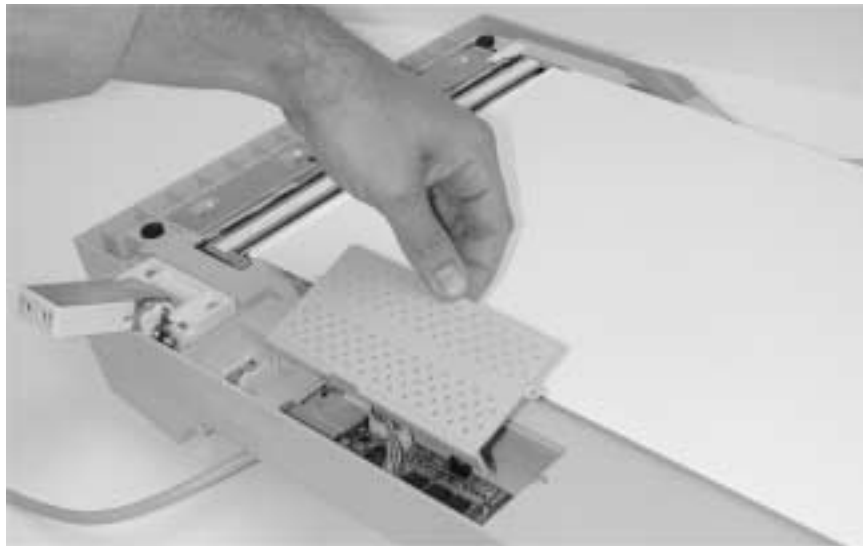

5. Disconnect the four cables from the controller card.

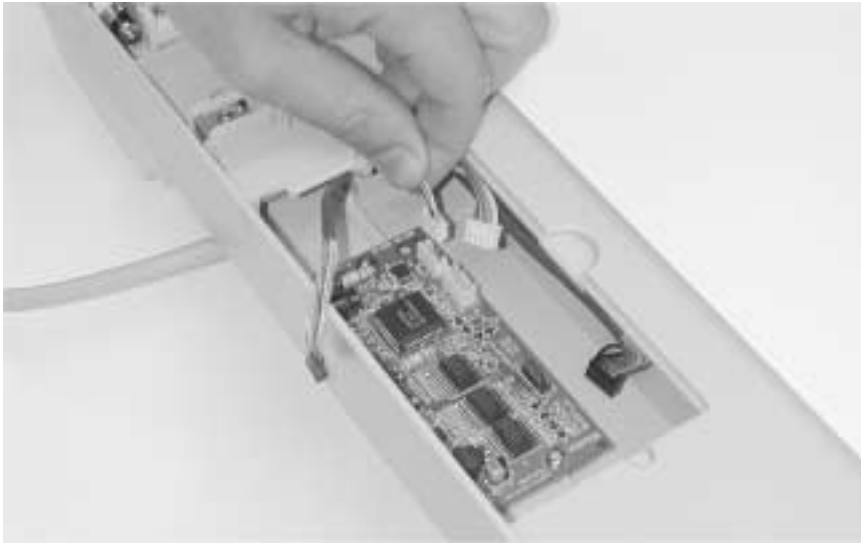

6. Remove the two screws (A) holding the controller card.

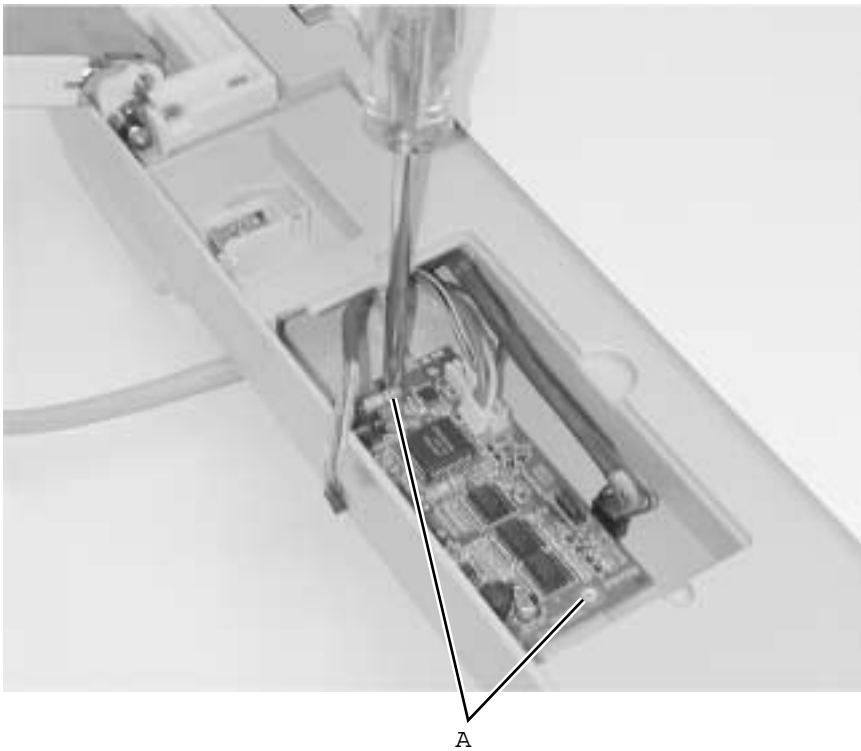

7. Remove the card.

ADF hinge

1. Remove the ADF assembly and place it upside down. See **“ADF assembly”** on page 3-6.
2. Remove the four screws (A) holding the hinge plate.

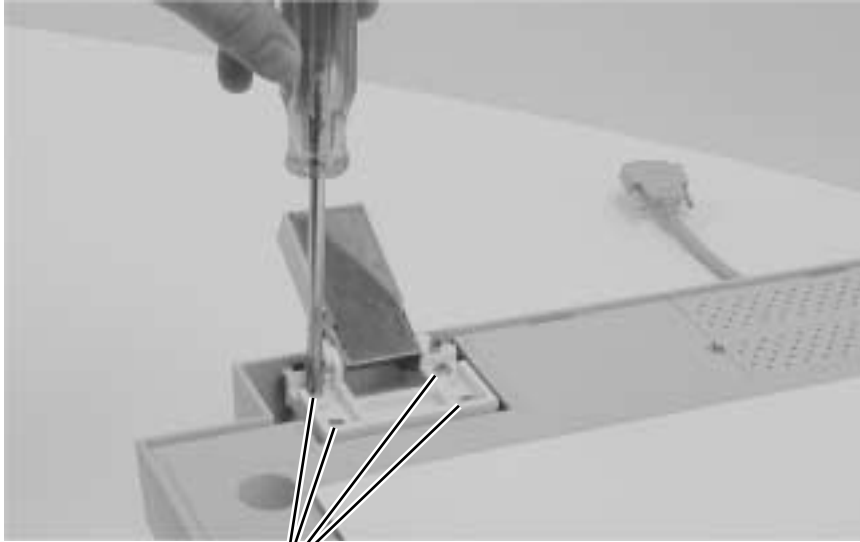

A

3. Lift the hinge.

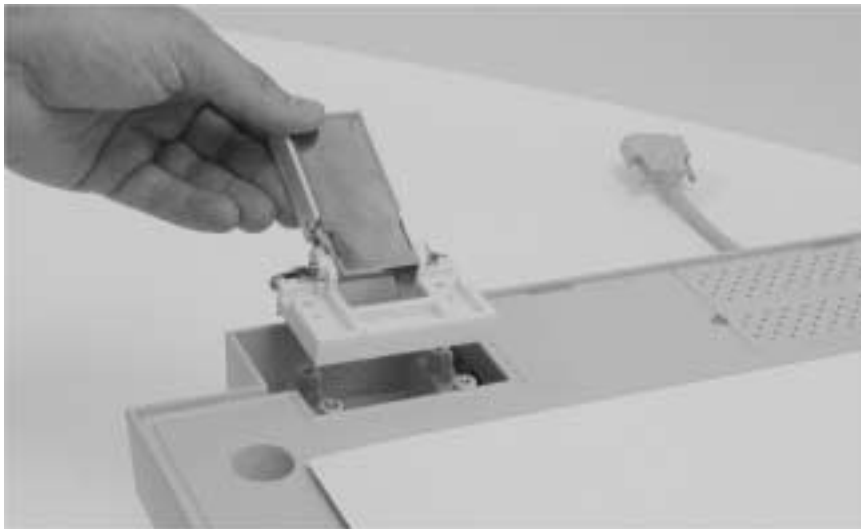

Paper input tray

1. Fold the supports flat against the paper input tray bottom.

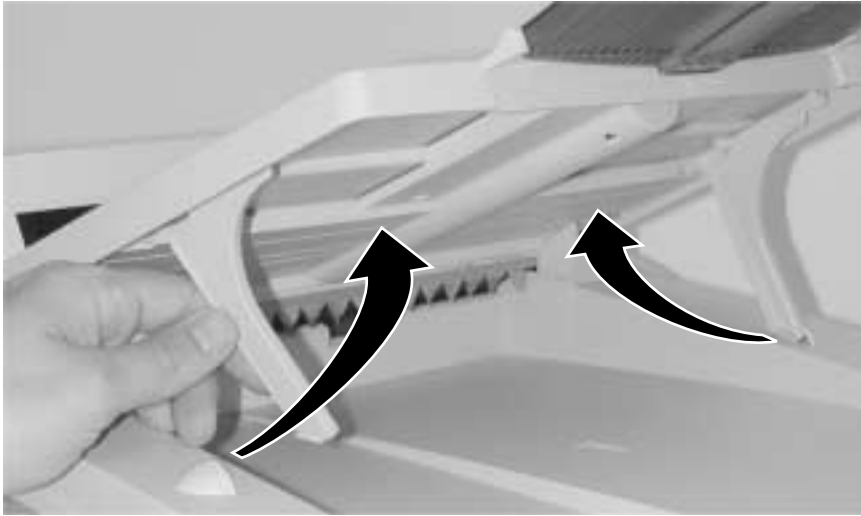

2. Remove the screw.



3. Carefully bend the cover back to access the page size sensor cable.
4. Disconnect the page size sensor cable.

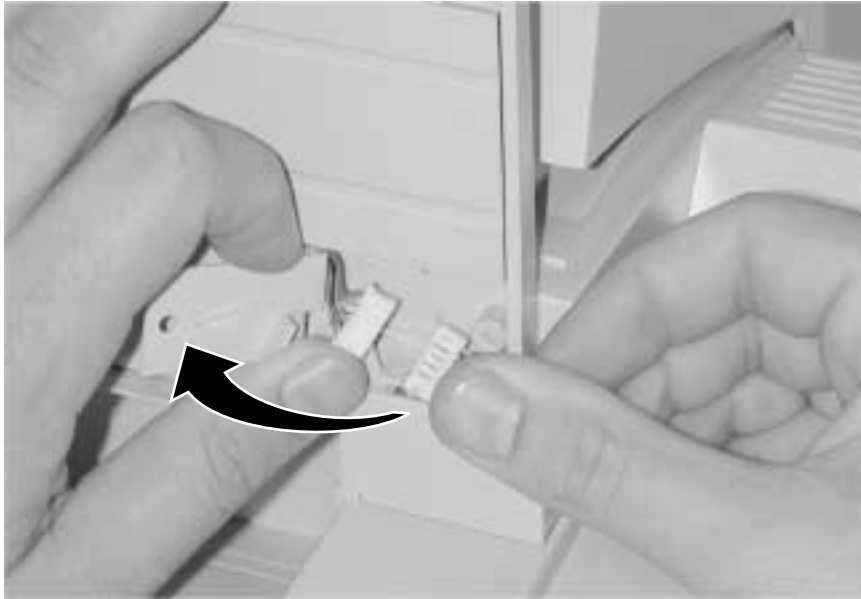

5. Lift to remove the paper input tray.



Internal ADF CCD subassembly

Warning: Screws for the CCD card in the optical unit are as shown in **“Charge-coupled device (CCD) card screws”** on page 3-5. These screws have a red coating indicating they should never be loosened.

1. Remove the ADF drive motor. See **“ADF drive motor”** on page 3-13.
2. Turn the ADF unit upside down.
3. Remove the four screws from the lower ADF frame plate.

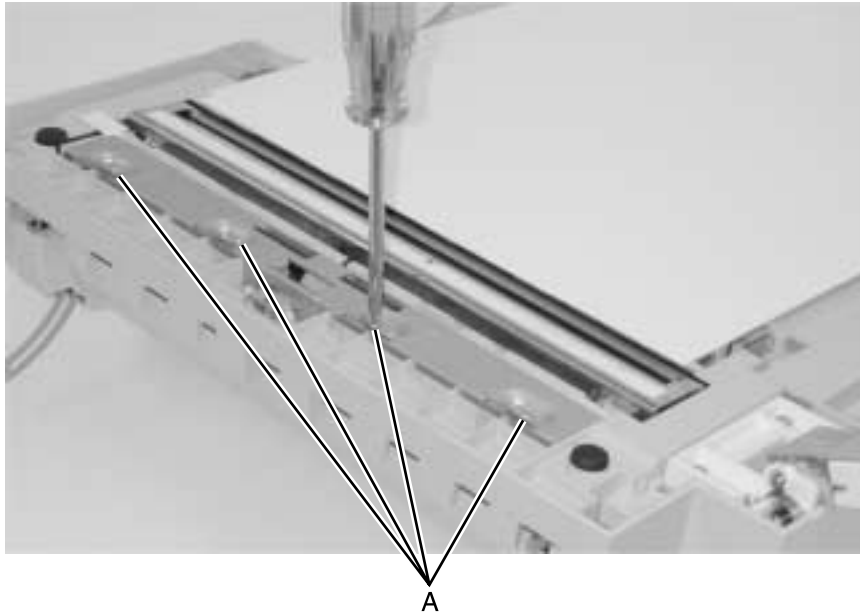

4. Remove the ground screw.

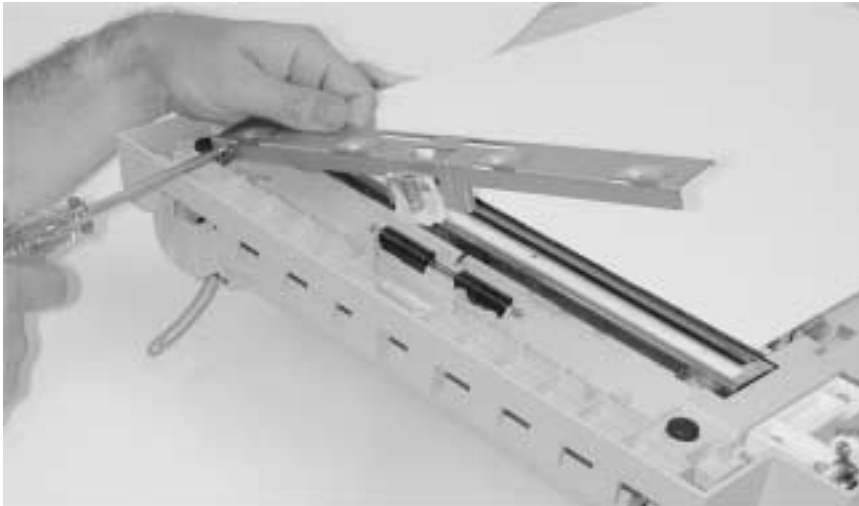

5. Remove the idler rollers.

6. Turn the ADF upright.
7. Remove the four screws.

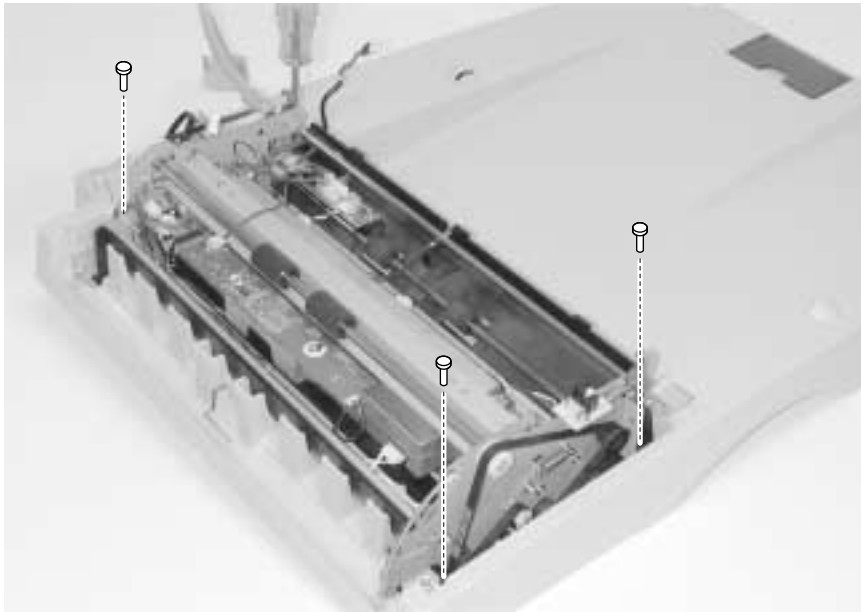

8. Disconnect the cables from the:
 - ADF lamp shutter motor cable
 - ADF controller to ADF sensor card cable from the sensor card
 - ADF paper size sensor



9. Remove the ground screw and disconnect the ground screw cable.

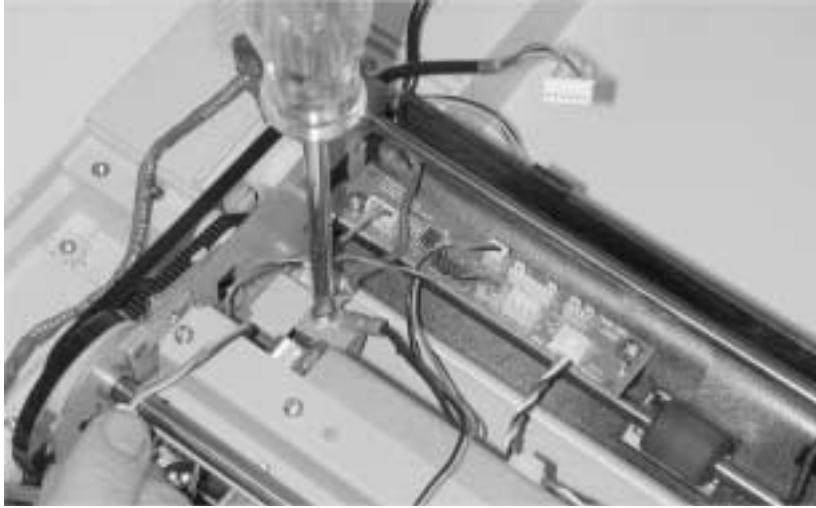

10. Disconnect the ADF CCD optical card subassembly cable and release the cable from the restraining clip.

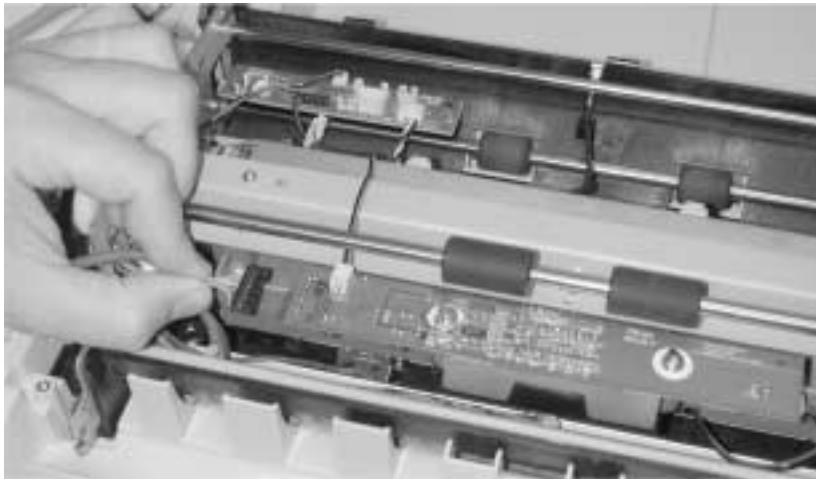

11. Lift the internal ADF CCD subassembly.

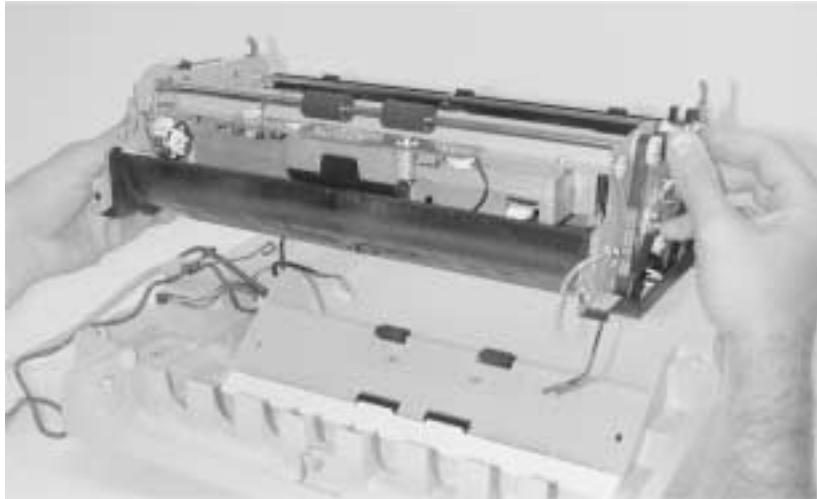

Note: After installing a new internal ADF CCD subassembly, perform the “**Scanner calibration**” on **page 3-2**.

ADF pick pad

1. Press the ADF release button and open the upper cover.



2. Squeeze the ends of the pick pad.



3. Remove the pick pad.

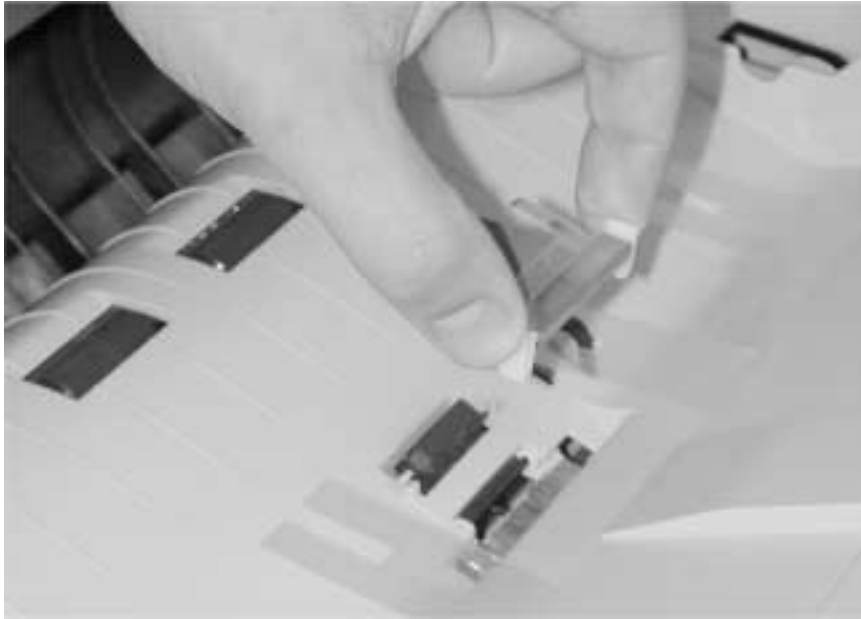

ADF pick roller

1. Press the ADF release and open the upper cover.



2. Release the clip holding the pick roller.



3. Remove the pick roller.



ADF paper present sensor

1. Remove the lower ADF guide. See **“ADF lower guide”** on page 3-10.
2. Press the tabs together to remove the sensor.



ADF cover open sensor

1. Remove the ADF lower guide. See **“ADF lower guide”** on page 3-10.
2. Disconnect the cover open sensor cable from the sensor card.

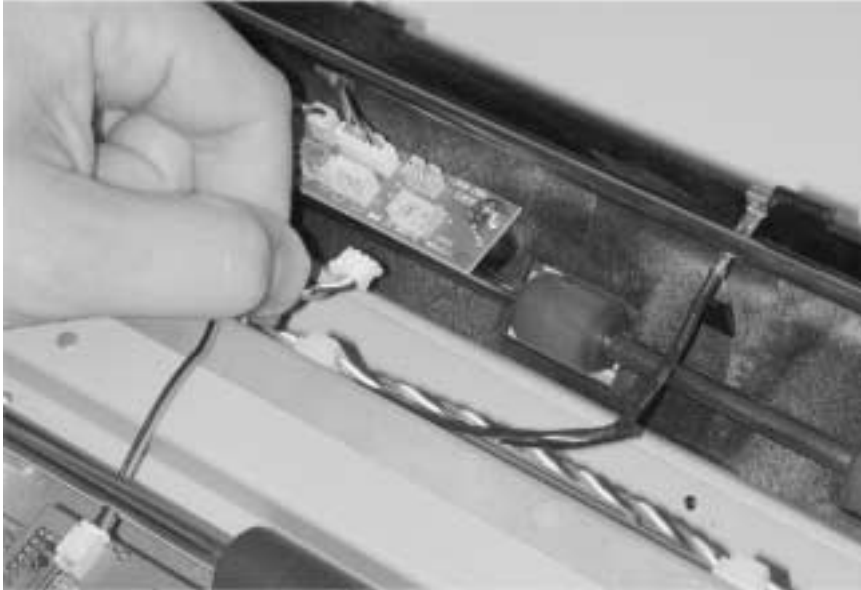

3. Remove the cable from the cable clips.



4. Remove the screw that secures the sensor.



5. Lift the sensor from the bracket.

User interface

1. Remove the ADF assembly. See **“ADF assembly”** on page 3-6.
2. Place the flatbed on its back.
3. Remove the three screws to loosen the user interface from the flatbed.

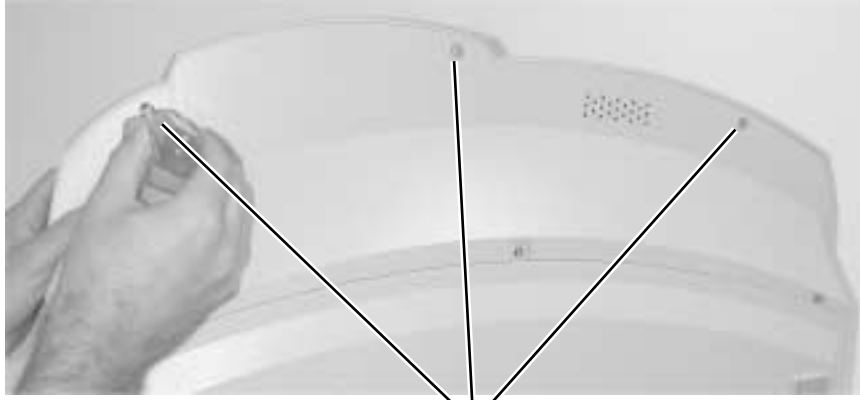

A

4. Place the flatbed upright and slide the user interface off.



5. Disconnect the cables.



6. Remove the user interface.

Upper housing

1. Remove the user interface. See **“User interface”** on page 3-30.
2. Remove the 3 screws on the front of the housing.

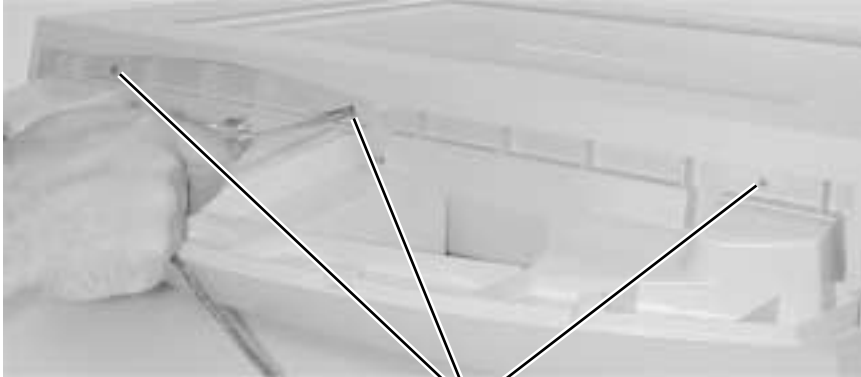

A

3. Remove the five screws from the back of the housing.

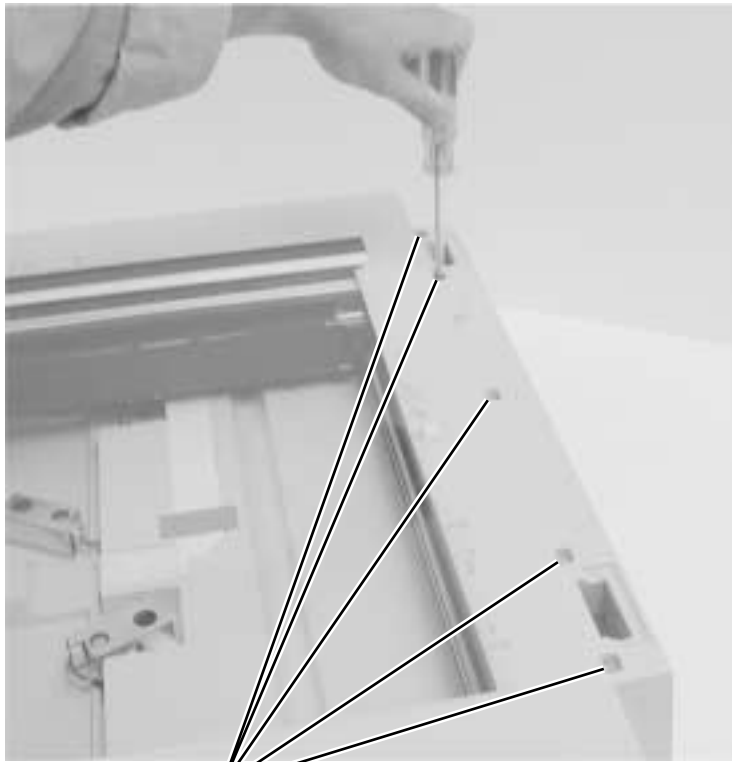

A

4. Pull forward and upward to unlatch the housing. Lift the housing off.



Flatbed lamp assembly

Warning: Do not touch the lamp or you may damage the scanner.

1. Remove the upper housing. See **“Upper housing”** on page 3-32.
2. Remove the two screws.

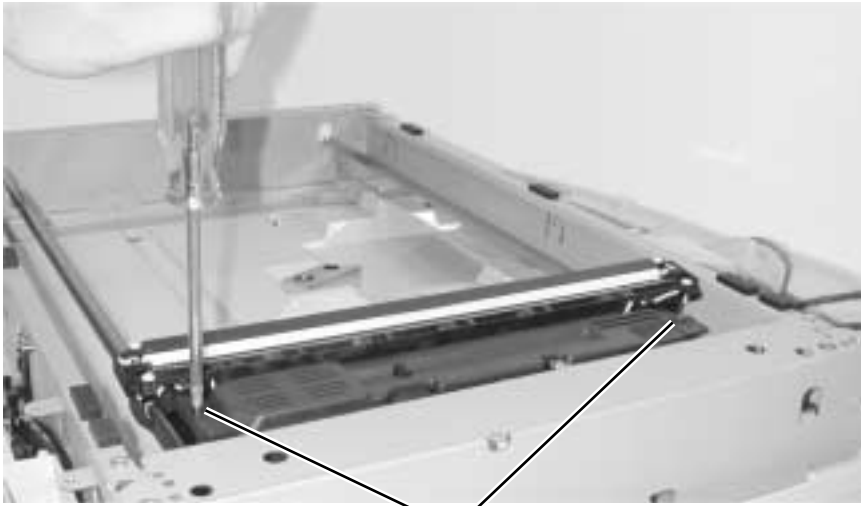

A

3. Remove the flatbed CCD optical unit cover.



4. Unlatch the lamp assembly from the flatbed CCD optical unit and remove the lamp assembly toward the rear of the flatbed.

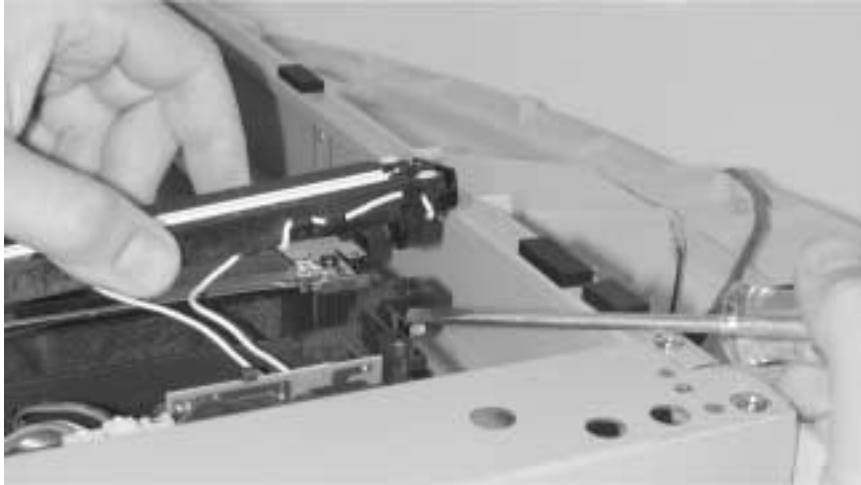

5. Disconnect the lamp cable from the inverter.

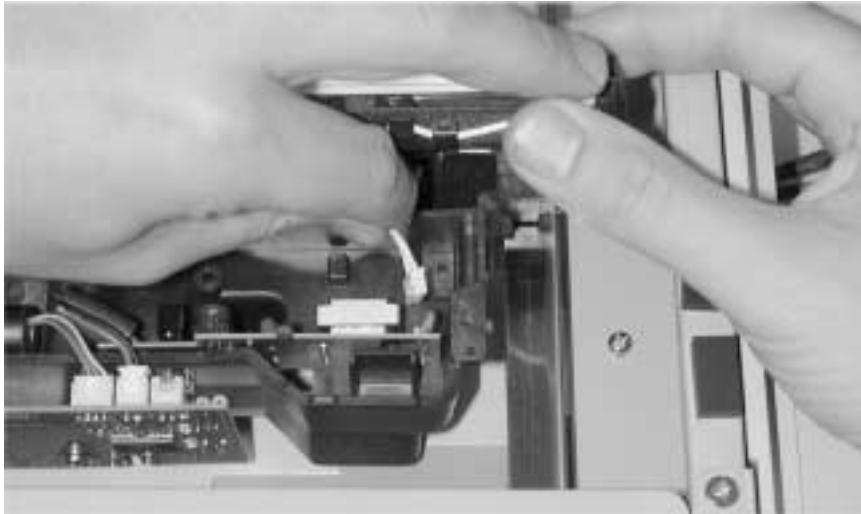

6. Remove the lamp assembly from the wire hooks (A and B).

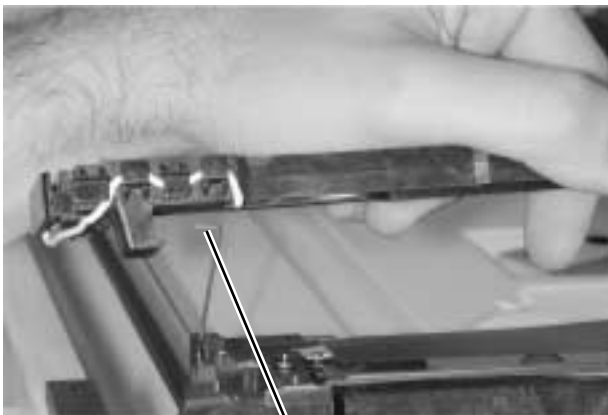

A



B

Flatbed CCD optical unit

Warning: Do not loosen the red coated screws in the CCD optical unit.

1. Remove the upper housing. See **“Upper housing”** on page 3-32.
2. Remove the screw.

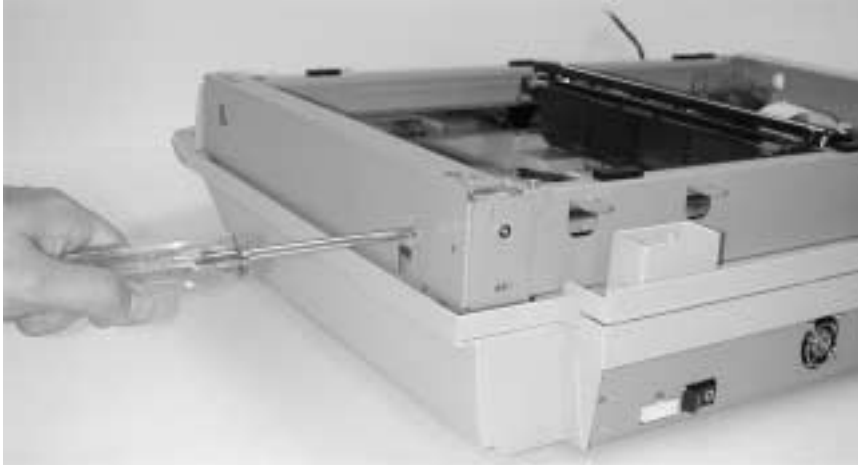

3. Slide the shaft out.

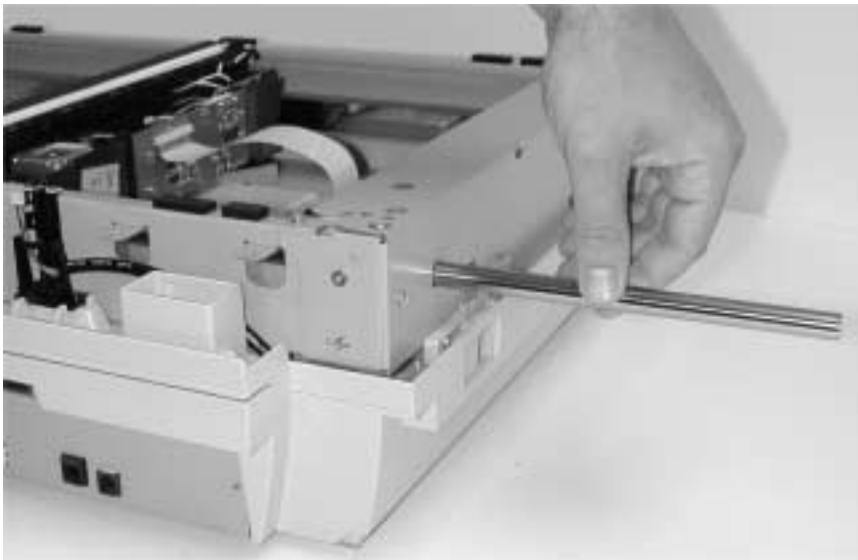

4. Lift the belt from the hook.

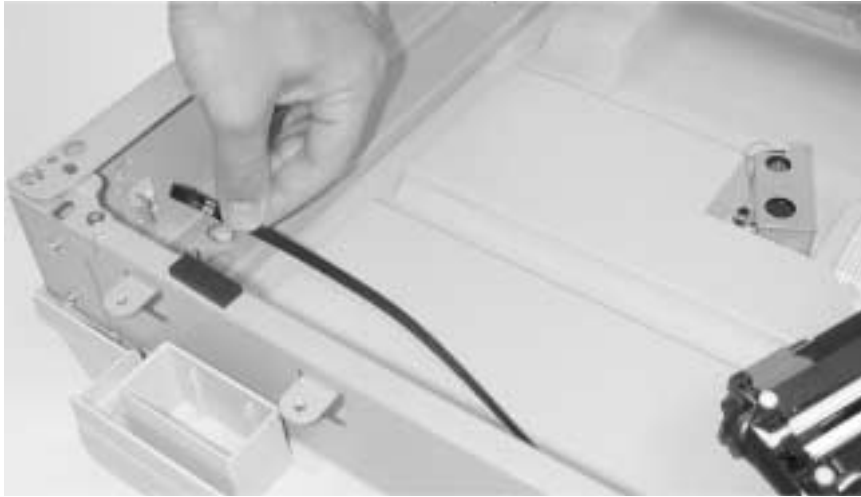

5. Disconnect the ribbon cable from the CCD.



6. Remove the flatbed CCD optical unit.

Installation note

When you reinstall the belt, be sure to route the belt through the belt gears, as shown.



Note: After installing a new optical unit, perform the **“Scanner calibration”** on page 3-2.

Multifunction device (MFD) controller card cage

CAUTION: Controller cage edges are sharp.

1. Remove the ADF assembly. See **“ADF assembly”** on page 3-6
2. Place the flatbed upside down and remove the eight screws (A) from the bottom housing.

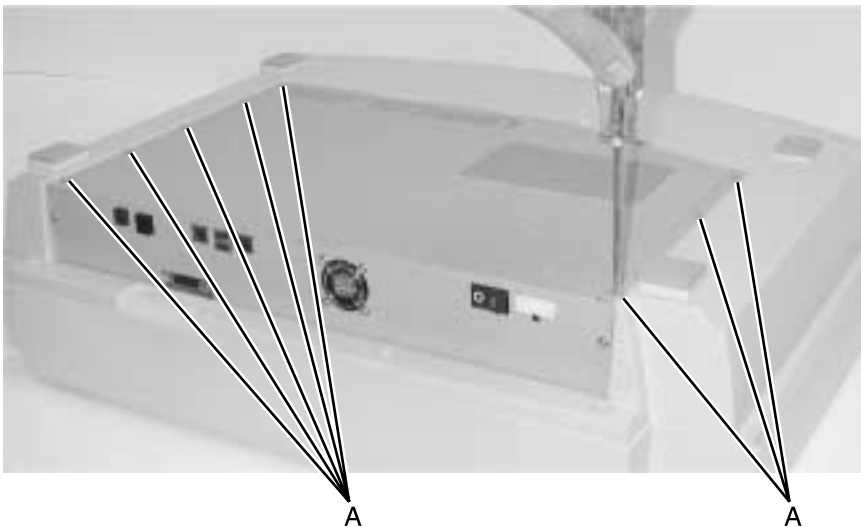

3. Slide the card cage to expose the user interface cables.



4. Turn the unit around and lift the card cage to disconnect the user interface cables.

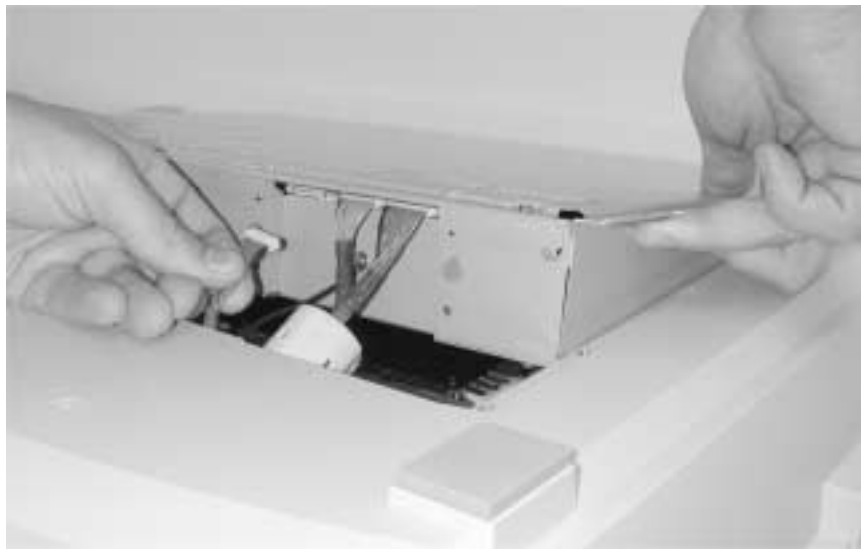

5. Remove the ground screw.



6. Disconnect the two cables from the main scanner card.



7. Remove the MFD controller cage.

Hard disk drive, MFD controller card, power distribution card, memory DIMM, and cooling fan

1. Remove the MFD controller card cage. See **“Multifunction device (MFD) controller card cage” on page 3-38.**
2. With the MFD controller card cage positioned upside down near the edge of a table, remove the two screws (A) from the backside and the three screws (B) from the bottom.

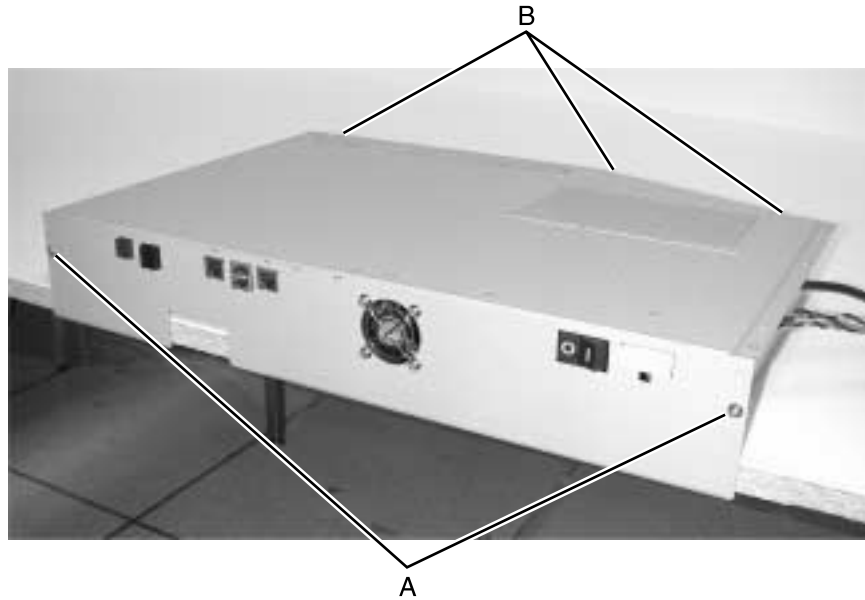

3. Turn the MFD controller card upright and lift the upper shield from the cage.



4. Remove the component you want from within the MFD card cage.

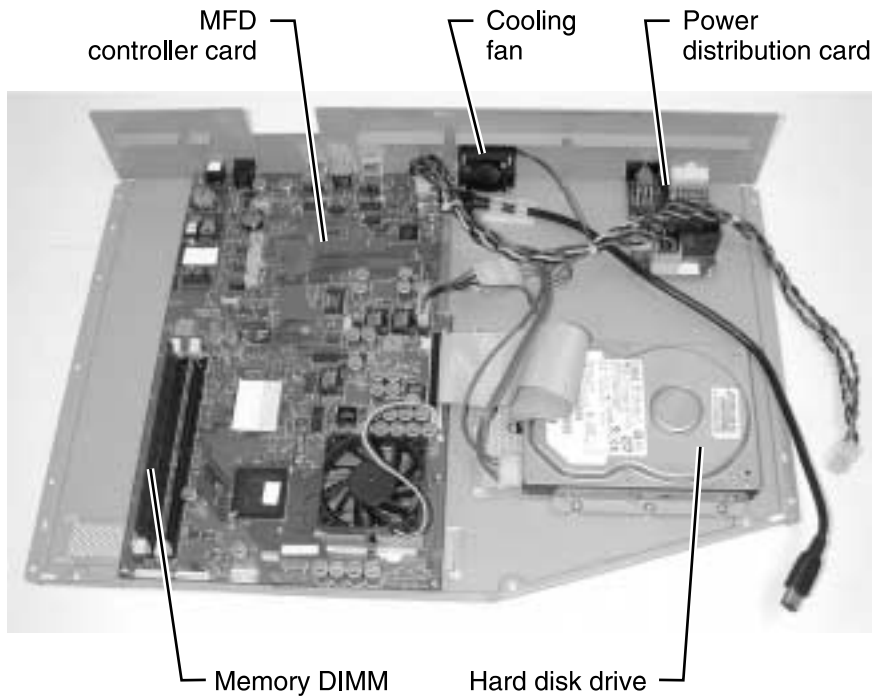

Main scanner card

1. Remove the MFD controller card cage. **“Multifunction device (MFD) controller card cage”** on **page 3-38**.
2. Remove the five cables connected to the main scanner card.

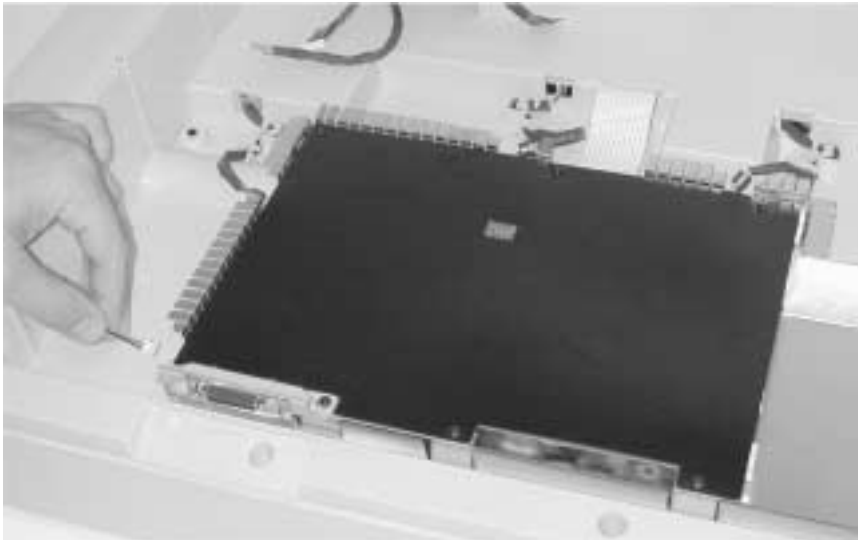

3. Remove the seven screws that secure the shield and the main scanner card.

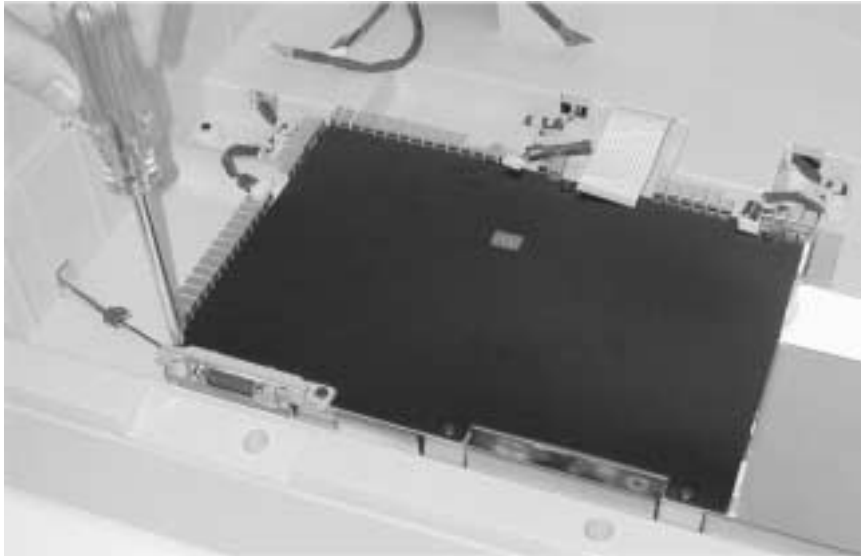

4. Remove the main scanner card.

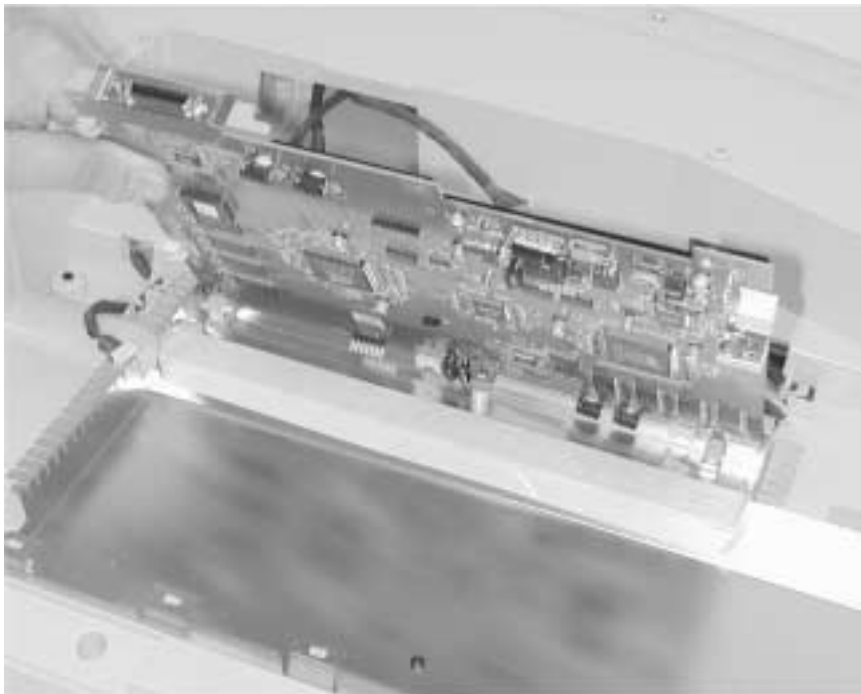

Note: After installing a new main scanner card, perform the **“Scanner calibration”** on page 3-2.

4. Connector locations

Locations

Paper path and sensors

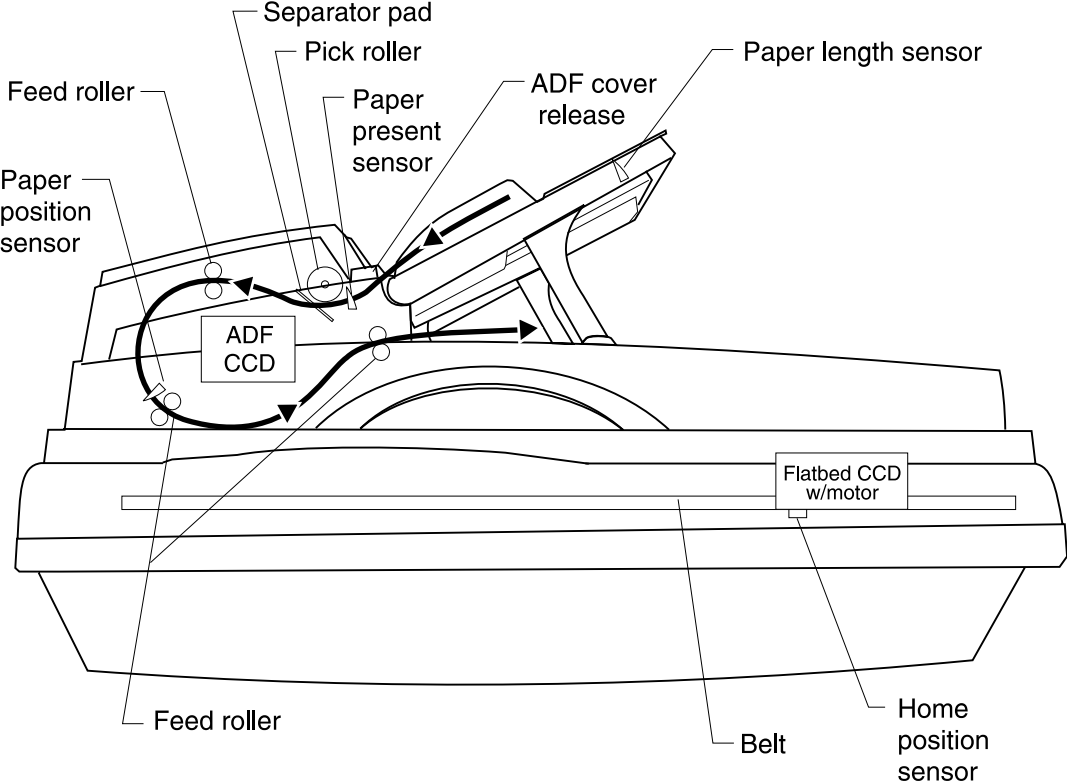

Internal view

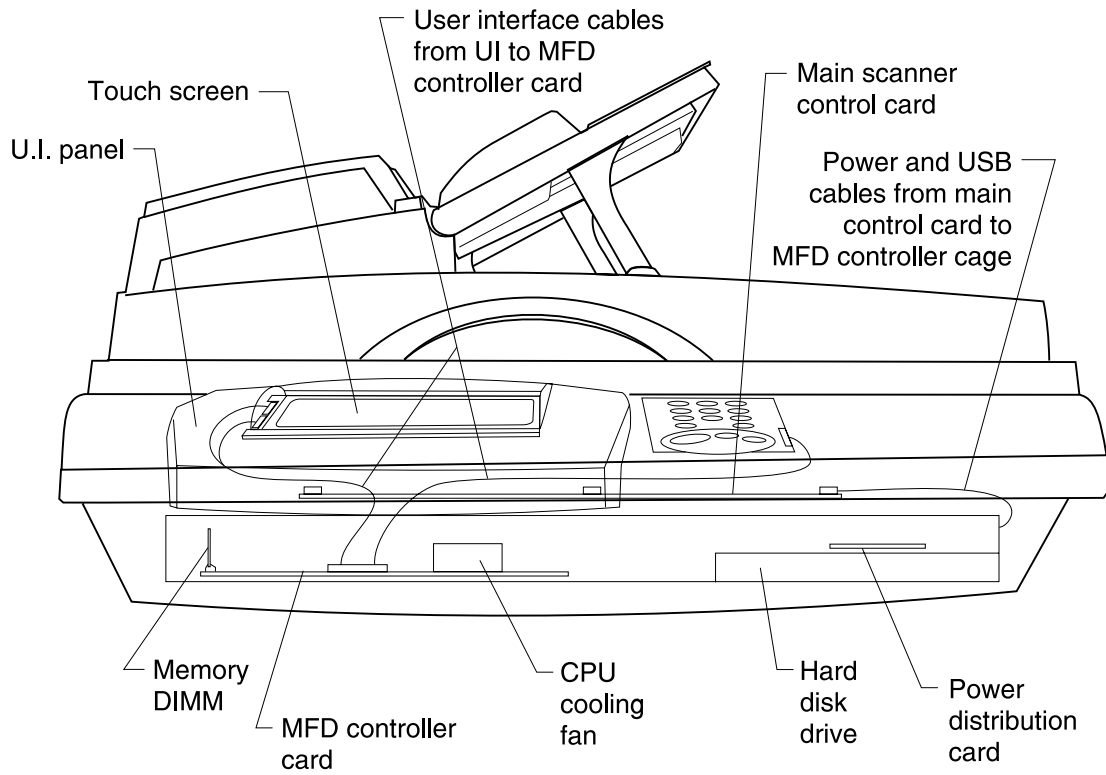

Connectors

The pin assignments shown are voltages and grounds which can be tested in the field. Use a multimeter grounded to the scanner MFD controller cage when measuring the voltage for the main scanner card.

Main scanner card

Main scanner card	Pin no.	Assignment
J3	1	+5V dc
	2	+5V dc
	3	+5V dc
	4	+5V dc
	5	Ground
J6	1	+5V dc
	2	+5V dc
	3	+5V dc
	4	+5V dc
	5	Ground
J9	1	+5V dc
	2	+5V dc
	3	+5V dc
	5	+5V dc
	5	Ground
J10	1	+5V dc
	2	Ground

Power distribution card

Power distribution card	Pin no.	Assignment
J2	1	Ground
	2	Ground
	3	Ground
	4	+24V dc
	5	+5V dc
	6	+5V dc

Low voltage power supply

The following diagram and chart represents the power supply output connector.

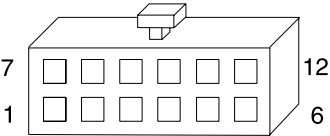
Low voltage power supply	Pin no.	Wire color	Assignment
	1	Black	Ground
	2	Black	Ground
	3	Black	Ground
	4	Black	Ground
	5	Black	Ground
	6	Black	Ground
	7	White	+24V dc
	8	Red	+5V dc
	9	Yellow	+12V dc
	10	Red	+5V dc
	11	Red	+5V dc
	12	Red	+5V dc

5. Preventive maintenance

This chapter describes cleaning methods and procedures for transporting the scanner.

Perform preventative maintenance either every six months or every 60,000 sheets scanning.

Cleaning

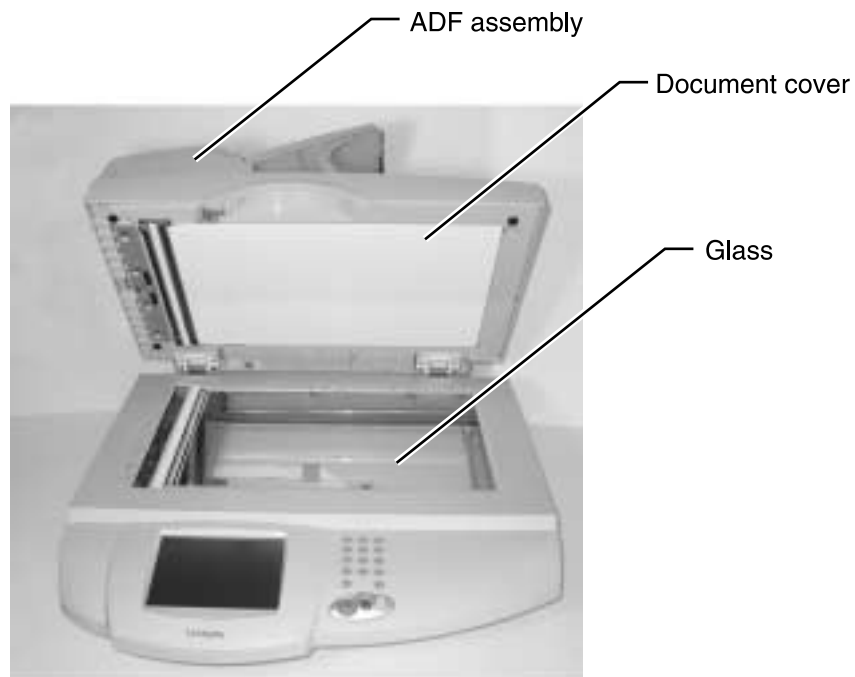

Cover and glass

With soft cloth, wipe the cover and glass. If the dirt is heavy, use a neutral cleanser or alcohol. Wipe the glass carefully so no cleanser remains on the surface.

Touch screen

Wipe the touch screen with a clean, lint-free cotton cloth dampened with water.

ADF unit

Press the release button and lift the upper cover. Clean the pick pad, pick roller, and feed rollers with a lint-free cloth and isopropyl alcohol.

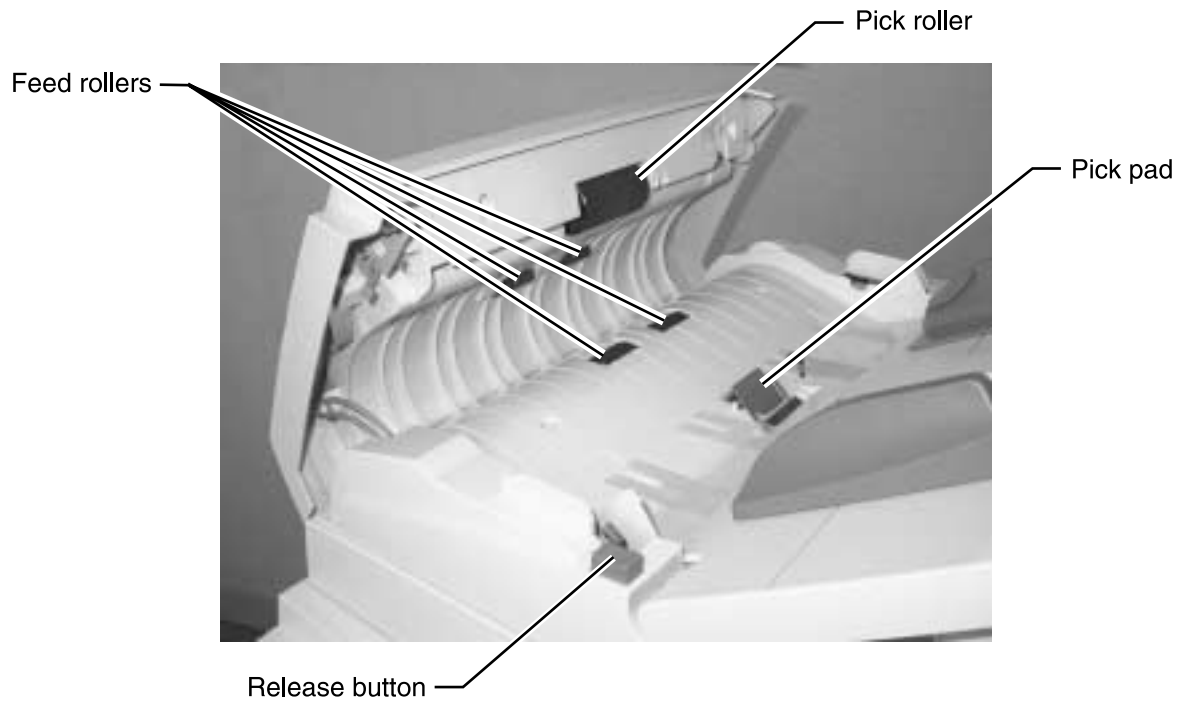

Moving the scanner

CAUTION: The combined scanner and automatic document feeder weighs 25.7 kg (56.6 lb) and requires at least two people to lift it safely. Anytime you move or lift the scanner, make sure you have enough people to help you.

If you need to transport the scanner, follow these instructions to relock the scanner:

Warning: Failure to lock the scan mechanism before moving the scanner can cause internal damage.

1. Turn the scanner off.
2. Open the document cover.
3. Turn the scanner on.

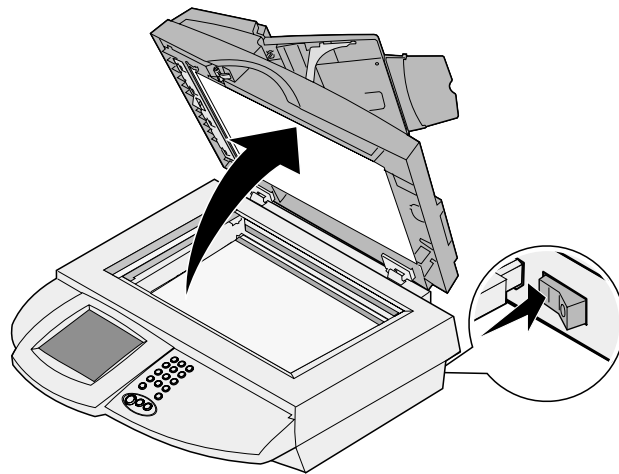

4. When the scanning mechanism reaches the far left side of the scanner glass, quickly turn the scanner off.
5. Move the switch to the locked position.

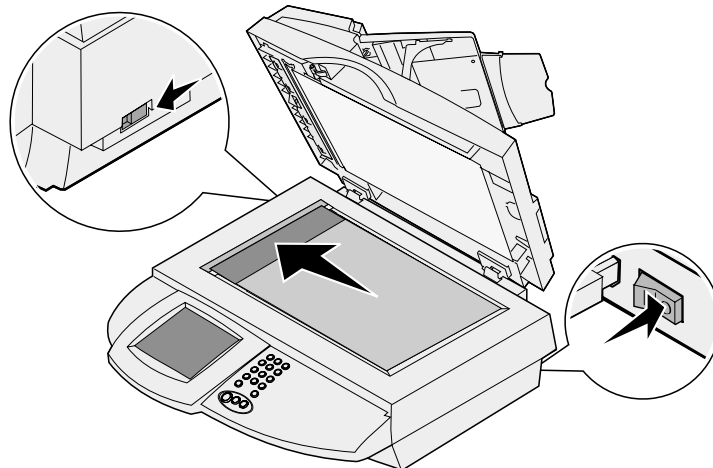

6. Close the document cover.

6. Parts catalog

How to use this parts catalog

- **SIMILAR ASSEMBLIES:** If two assemblies contain a majority of identical parts, they are shown on the same list. Common parts are shown by one index number. Parts peculiar to one or the other of the assemblies are listed separately and identified by description.
- **NS:** (Not Shown) in the Asm—Index column indicates that the part is procurable but is not pictured in the illustration.
- **PP:** (Parts Packet) in the Description column indicates the part is contained in a parts packet.

Assembly 1: Upper Scanner

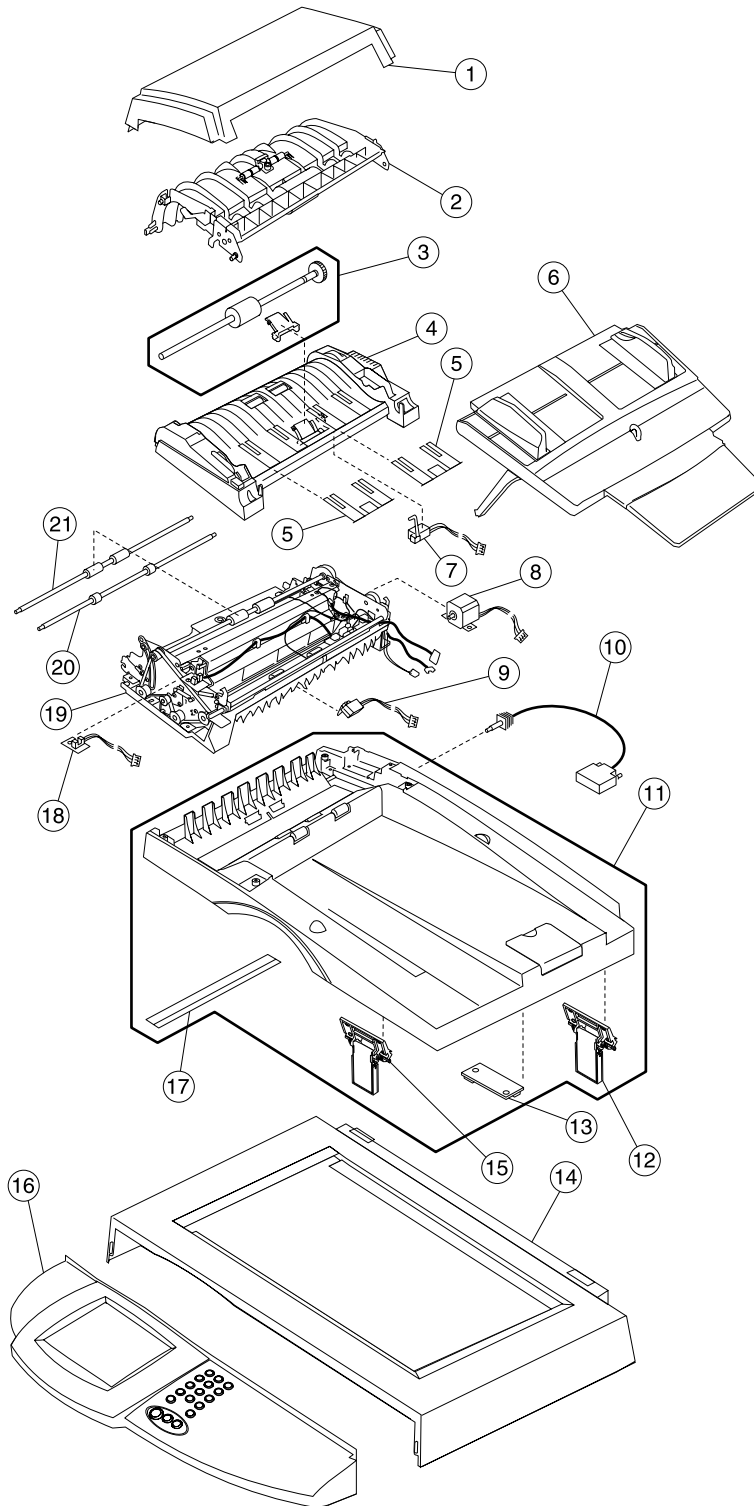

Assembly 1: Upper scanner

Asm-index	Part number	Units	Description
1—1	56P2048	1	Cover, ADF upper
2	56P2045	1	Guide, ADF upper
3	56P2049	1	Kit, ADF pick roller and pad
4	56P2047	1	Guide, ADF lower
5	56P2059	2	Strip, MYLAR, paper entry
6	56P2046	1	Tray, paper input
7	56P2060	1	Sensor, ADF paper present
8	56P2063	1	Motor, ADF drive
9	56P2065	1	Sensor assembly, ADF paper feed
10	56P2050	1	Cable, ADF to flatbed
11	56P2113	1	Base, ADF assembly
12	56P2114	1	Hinge, ADF assembly, right
13	56P2116	1	Card assembly, ADF controller
14	56P2051	1	Housing, flatbed upper
15	56P2115	1	Hinge, ADF assembly, left
16	56P2052	1	Panel assembly, user interface
17	56P2222	1	Strip, MYLAR, paper exit
18	56P2064	1	Sensor assembly, cover open
19	56P2044	1	Sub assembly, internal ADF CCD
20	56P2062	1	Roller, output feed
21	56P2061	1	Roller, input feed
NS	56P2177	1	Assembly, complete ADF

Assembly 2: Lower scanner

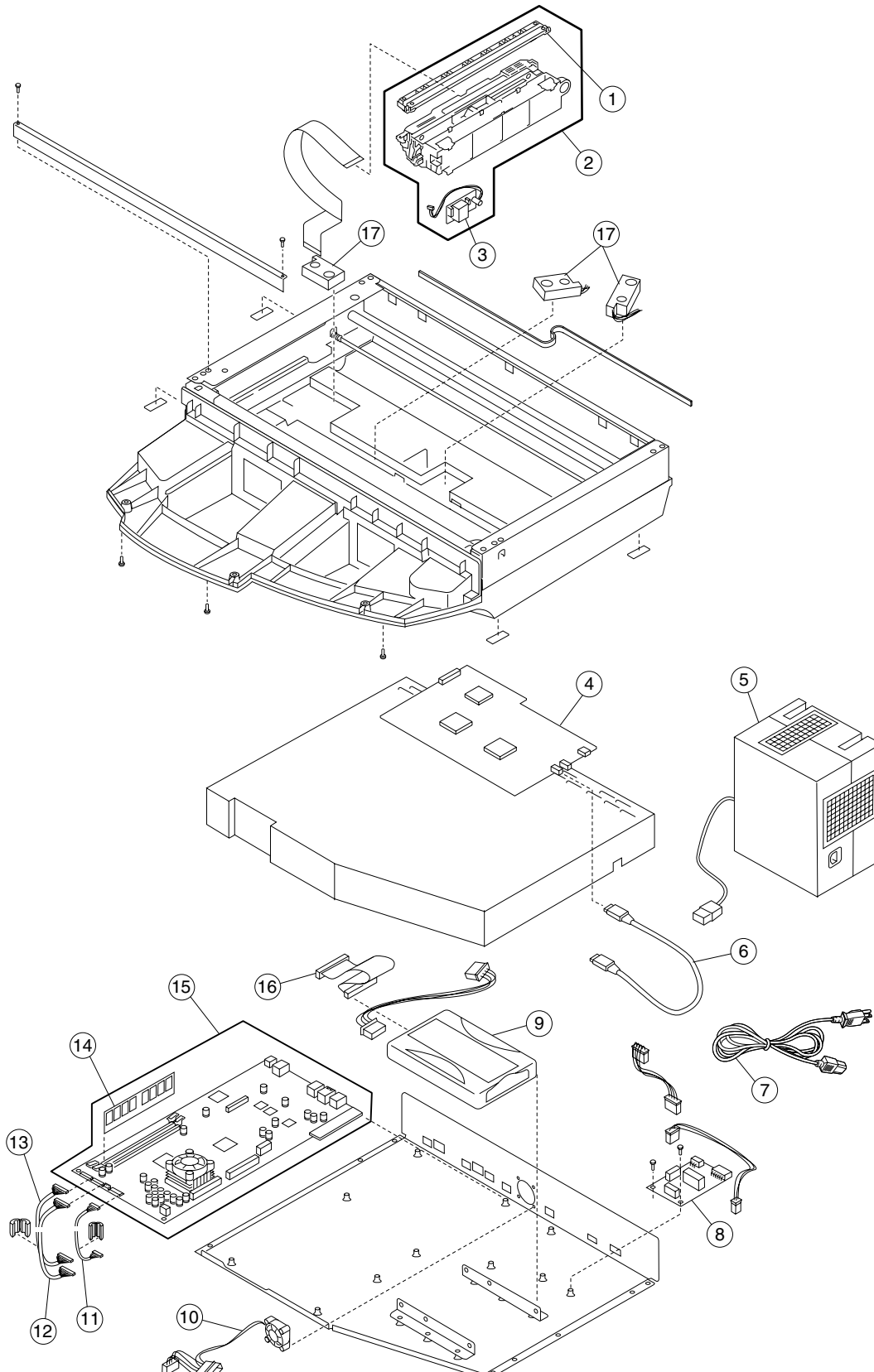

Assembly 2: Lower scanner

Asm-index	Part number	Units	Description
2—1	56P2053	1	Lamp assembly, flatbed
2	56P2055	1	Unit assembly, flatbed CCD/optical
3	56P2054	1	Card assembly, flatbed lamp inverter
4	56P2057	1	Card assembly, main scanner
5	12G6918	1	Power supply, universal, external
6	56P1473	1	Cable, 1394, 16.5 inch
7	11D0328	1	Power cord, U.S., Canada, LAD (LV), and APG (LV)
7	11D0330	1	Power cord, Argentina
7	11D0333	1	Power cord, Denmark
7	11D0334	1	Power cord, Belgium, England, EU, France, Germany, and Spain
7	11D0335	1	Power cord, Italy
7	11D0336	1	Power cord, Switzerland
7	11D0337	1	Power cord, Egypt, Gulf, Ireland, United Kingdom
7	11D0338	1	Power cord, Israel
7	11D0339	1	Power cord, South Africa
7	11D0340	1	Power cord, Australia and New Zealand
8	56P0192	1	Card assembly, power distribution
9	56P2058	1	Drive assembly, hard disk drive
10	56P1808	1	Fan, control cage cooling
11	56P2170	1	Cable, user interface, 7-pin
12	56P2171	1	Cable, user interface, 14-pin
13	56P2172	1	Cable, user interface, 15-pin
14	56P9910	1	Card assembly, 128MB DIMM
15	56P2554	1	Card assembly, MFD controller, worldwide except Australia and New Zealand
15	56P2555	1	Card assembly, MFD controller, only Australia or New Zealand
16	56P1472	1	Cable, hard disk to controller
17	56P2056	3	Sensor, optical paper size
NS	56P0558	1	Cable assembly, RJ11 cable with toroids
NS	56P0559	1	Cable assembly, RJ45 cable with toroid

Assembly 3: Miscellaneous

Asm-index	Part number	Units	Description
3—1	7372358	1	Field replacement kit (packaging)
2	56P2169	1	Scanner calibration sheet

Index

A

acronyms **1-6**
 ADF assembly, removal **3-6**
 ADF CCD cable **4-1**
 ADF cover release **4-1**
 adjustment **3-4**
 hard disk drive refresh **3-4**
 scanner calibration **3-2**
 automatic document feeder (ADF)
 cleaning **5-1**
 operation **1-5**

B

beeps, MDF controller error codes **2-2**

C

CCD optical unit, flatbed
 parts catalog **6-5**
 removal **3-36**
 cleaning
 ADF unit **5-2**
 cover and glass **5-1**
 touch screen **5-1**
 code update **3-4**
 connectors
 low voltage power supply **4-4**
 main scanner card **4-3**
 power distribution card **4-3**
 controller card cage, MFD **3-38**
 controller card, ADF
 parts **6-3**
 removal **3-15**
 cooling fan
 location **3-42, 4-2**
 parts catalog **6-5**
 removal **3-41**
 cover open sensor, ADF
 parts catalog **6-3**
 removal **3-28**
 covers
 ADF assembly **3-6**
 ADF cover release **4-1, 5-2**
 ADF upper
 parts catalog **6-3**
 removal **3-8**
 controller card access cover **3-15**
 upper housing **3-32**

D

description **1-1**
 drive motor, ADF
 parts **6-3**
 removal **3-13**

E

error codes
 CCD lamp flashes **2-4**
 MFD controller **2-2**

F

features **1-1**
 field replacement kit **6-6**
 flashes, lamp **2-4**
 flatbed lamp assembly
 parts catalog **6-5**
 removal **3-34**

H

hard disk drive
 location **3-42, 4-2**
 parts catalog **6-5**
 refresh **3-4**
 removal **3-41**
 hinge, ADF
 parts **6-3**
 removal **3-17**
 home position sensor **4-1**

I

installation note, flatbed CCD optical unit **3-38**
 internal ADF CCD subassembly
 parts catalog **6-3**
 removal **3-20**

L

lamp assembly, flatbed
 parts catalog **6-5**
 removal **3-34**
 lamp flashes, CCD error messages **2-4**
 LEDs, error codes **2-2**
 light patterns, MFD controller card **2-2**
 lights, flashes **2-4**

locations

- ADF cover release [4-1](#)
- ADF motor [4-1](#)
- belt [4-1](#)
- cooling fan [4-2](#)
- feed rollers [4-1](#)
- hard disk drive [4-2](#)
- home position sensor [4-1](#)
- main scanner control card [4-2](#)
- MDF controller card [4-2](#)
- MDF controller card cage [4-2](#)
- memory DIMM [4-2](#)
- paper length sensor [4-1](#)
- paper position sensor [4-1](#)
- paper present sensor [4-1](#)
- pick pad, ADF [4-1](#)
- pick roller [4-1](#)
- pick roller, ADF [4-1](#)
- power distribution card [4-2](#)
- sensor cable [4-1](#)
- user interface [4-2](#)
- user interface cables [4-2](#)

lower guide, ADF

- parts catalog [6-3](#)
- removal [3-10](#)

M

main scanner card

- location [4-2](#)
- parts catalog [6-5](#)
- removal [3-42](#)

maintenance

- approach [1-2](#)
- cleaning [5-1](#)
- moving the flatbed [5-3](#)

maintenance tools [1-2](#)mechanical operation [1-5](#)

memory DIMM

- location [3-42](#), [4-2](#)
- parts catalog [6-5](#)
- removal [3-41](#)

MFD controller card

- location [3-42](#), [4-2](#)
- parts catalog [6-5](#)
- removal [3-41](#)

moving the flatbed [5-3](#)multifunction device (MFD) controller card cage [3-38](#)**O**

operator panel, see user interface

overview [1-1](#)**P**packaging [6-6](#)pad, ADF pick, removal [3-24](#)

paper input tray

- parts catalog [6-3](#)
- removal [3-18](#)

paper jam, clearing [2-10](#)paper length sensor [4-1](#)

paper present sensor, ADF

- location [4-1](#)
- parts catalog [6-3](#)
- removal [3-27](#)

parts catalog

- lower scanner [6-4](#)
- miscellaneous [6-6](#)
- upper scanner [6-2](#)

parts replacement [3-1](#)

pick pad, ADF

- location [4-1](#)
- parts catalog [6-3](#)
- removal [3-24](#)

pick roller, ADF

- location [4-1](#)
- parts catalog [6-3](#)
- removal [3-26](#)

power cords [6-5](#)

power distribution card

- location [3-42](#), [4-2](#)
- parts catalog [6-5](#)
- removal [3-41](#)

Rrelease, ADF cover [4-1](#), [5-2](#)

removals

- ADF assembly [3-6](#)
- ADF controller card [3-15](#)
- ADF cover open sensor [3-28](#)
- ADF drive motor [3-13](#)
- ADF hinge [3-17](#)
- ADF lower guide [3-10](#)
- ADF paper present sensor [3-27](#)
- ADF pick pad [3-24](#)
- ADF pick roller [3-26](#)
- ADF upper cover [3-8](#)
- ADF upper guide [3-9](#)
- CCD card screws [3-5](#)
- cooling fan [3-41](#)
- flatbed CCD optical unit [3-36](#)
- flatbed lamp assembly [3-34](#)
- hard disk drive [3-41](#)
- internal ADF CCD subassembly [3-20](#)
- main scanner card [3-42](#)
- memory DIMM [3-41](#)

MFD controller card **3-41**
 MFD controller card cage **3-38**
 paper input tray **3-18**
 power distribution card **3-41**
 upper housing **3-32**
 user interface **3-30**

S

safety information **v**
 scanner
 moving **5-3**
 operation **1-5**
 specifications **1-3**
 scanner calibration sheet
 adjustment **3-2**
 parts catalog **6-6**
 screws, CCD card screws **3-5**
 sensors
 cover open sensor **3-28**
 home position **4-1**
 paper feed **6-3**
 paper length sensor **4-1**
 paper position **4-1**
 paper present sensor **3-27, 4-1**
 paper size sensor **3-21**
 service checks, see symptoms
 service guidelines **1-2**
 software update **3-4**
 specifications, scanner **1-3**
 start diagnostics **2-1**
 symptoms
 boot failure **2-7**
 double feeds **2-9**
 erratic behavior **2-7**
 image missing **2-8**
 image unclear **2-8**
 irregular movement **2-8**
 jitter **2-8**
 paper jams **2-9**
 power **2-6**
 scanning **2-6, 2-7**
 skew **2-9**
 sound (ADF) **2-9**
 sound (flatbed) **2-9**

T

theory
 mechanical operation **1-5**
 system description **1-4**
 tools, maintenance **1-2**
 touch panel see user interface

U

upper cover, ADF **3-8**
 upper guide, ADF
 parts catalog **6-3**
 removal **3-9**
 upper housing
 parts catalog **6-3**
 removal **3-32**
 user interface
 lamp flashes **2-4**
 location **4-2**
 parts catalog **6-3**
 removal **3-30**
 user interface cables **4-2, 6-5**

Part number index

P/N	Description	Page
11D0328	Power cord, U.S., Canada, LAD (LV), and APG (LV)	6-5
11D0330	Power cord, Argentina	6-5
11D0333	Power cord, Denmark	6-5
11D0334	Power cord, Belgium, England, EU, France, Germany, and Spain	6-5
11D0335	Power cord, Italy	6-5
11D0336	Power cord, Switzerland	6-5
11D0337	Power cord, Egypt, Gulf, Ireland, United Kingdom	6-5
11D0338	Power cord, Israel	6-5
11D0339	Power cord, South Africa	6-5
11D0340	Power cord, Australia and New Zealand	6-5
12G6918	Power supply, universal, external	6-5
56P0192	Card assembly, power distribution	6-5
56P0558	Cable assembly, RJ11 cable with toroids	6-5
56P0559	Cable assembly, RJ45 cable with toroid	6-5
56P1473	Cable, 1394, 16.5 ft.	6-5
56P1492	Cable, hard disk to controller	6-5
56P1808	Fan, control cage cooling	6-5
56P2044	Sub assembly, internal ADF CCD	6-3
56P2045	Guide, ADF upper	6-3
56P2046	Tray, paper input	6-3
56P2047	Guide, ADF lower	6-3
56P2048	Cover, ADF upper	6-3
56P2049	Kit, ADF pick roller and pad	6-3
56P2050	Cable, ADF to flatbed	6-3
56P2051	Housing, flatbed upper	6-3
56P2052	Panel assembly, user interface	6-3
56P2053	Lamp assembly, flatbed	6-5
56P2054	Card assembly, flatbed lamp inverter	6-5
56P2055	Unit assembly, flatbed CCD/optical	6-5
56P2056	Sensor, optical paper size	6-5
56P2057	Card assembly, main scanner	6-5
56P2058	Drive assembly, hard disk drive	6-5
56P2059	Strip, MYLAR, paper entry	6-3
56P2060	Sensor, ADF paper present	6-3
56P2061	Roller, input feed	6-3
56P2062	Roller, output feed	6-3
56P2063	Motor, ADF feed roller	6-3
56P2064	Sensor assembly, cover open	6-3
56P2065	Sensor assembly, ADF paper feed	6-3
56P2113	Base, ADF assembly	6-3
56P2114	Hinge, ADF assembly, right	6-3

4036-402

56P2115 Hinge, ADF assembly, left6-3
56P2116 Card assembly, ADF controller6-3
56P2169 Scanner calibration sheet6-6

56P2170 Cable, user interface, 7-pin6-5
56P2171 Cable, user interface, 14-pin6-5
56P2172 Cable, user interface, 15-pin6-5
56P2177 Assembly, complete ADF6-3

56P2222 Strip, MYLAR, paper exit6-3

56P2554 Card assembly, MFD controller, worldwide except Australia and New Zealand6-5
56P2555 Card assembly, MFD controller, only Australia or New Zealand6-5

56P9910 Card assembly, 128MB DIMM6-5

7372358 Field replacement kit (packaging)6-6