



Service Manual

Lexmark™ X203n, and X204n

7011-2xx

- ***Table of contents***
- ***Start diagnostics***
- ***Safety and notices***
- ***Trademarks***
- ***Index***

LEXMARK™

Lexmark and Lexmark with diamond design are trademarks of Lexmark International, Inc., registered in the United States and/or other countries.

Edition: May 6, 2009

The following paragraph does not apply to any country where such provisions are inconsistent with local law: LEXMARK INTERNATIONAL, INC. PROVIDES THIS PUBLICATION "AS IS" WITHOUT WARRANTY OF ANY KIND, EITHER EXPRESS OR IMPLIED, INCLUDING, BUT NOT LIMITED TO, THE IMPLIED WARRANTIES OF MERCHANTABILITY OR FITNESS FOR A PARTICULAR PURPOSE. Some states do not allow disclaimer of express or implied warranties in certain transactions; therefore, this statement may not apply to you.

This publication could include technical inaccuracies or typographical errors. Changes are periodically made to the information herein; these changes will be incorporated in later editions. Improvements or changes in the products or the programs described may be made at any time.

Comments may be addressed to Lexmark International, Inc., Department D22A/032-2, 740 West New Circle Road, Lexington, Kentucky 40550, U.S.A or e-mail at ServiceInfoAndTraining@Lexmark.com. Lexmark may use or distribute any of the information you supply in any way it believes appropriate without incurring any obligation to you.

References in this publication to products, programs, or services do not imply that the manufacturer intends to make these available in all countries in which it operates. Any reference to a product, program, or service is not intended to state or imply that only that product, program, or service may be used. Any functionally equivalent product, program, or service that does not infringe any existing intellectual property right may be used instead. Evaluation and verification of operation in conjunction with other products, programs, or services, except those expressly designated by the manufacturer, are the user's responsibility.

Lexmark, Lexmark with diamond design, and MarkNet are trademarks of Lexmark International, Inc., registered in the United States and/or other countries.

PCL® is a registered trademark of the Hewlett-Packard Company.

All other trademarks are the property of their respective owners.

**© 2006 Lexmark International, Inc.
All rights reserved.**

UNITED STATES GOVERNMENT RIGHTS

This software and any accompanying documentation provided under this agreement are commercial computer software and documentation developed exclusively at private expense.

Table of contents

Notices and safety information	ix
Laser notice	ix
Safety information	xiii
Preface	xvi
Conventions	xvi
General information	1-1
Maintenance approach	1-1
MFP Specifications	1-1
Minimum clearance requirements	1-1
Dimensions	1-1
Weights	1-1
Memory	1-1
Print speed	1-2
Print resolution	1-2
Connectivity and compatibility	1-2
Supported external network connections	1-2
Fonts	1-2
Media trays and supply capacity	1-3
Types of print media	1-4
Scanner specifications	1-5
Fax Specifications (X204 only)	1-6
Tips on preventing jams	1-6
Tools	1-7
Acronyms	1-8
Diagnostic information	2-1
Start	2-1
Power-On Reset (POR) sequence	2-1
Symptom tables	2-2
POST symptom table	2-2
POST symptom table	2-2
MFP symptom table	2-2
Understand the operator panel	2-5
MFP Menus	2-8
Messages and error codes	2-9
Service error codes	2-9
Fax error codes	2-14
Paper jam messages	2-18
User attendance messages	2-19
Service checks	2-23
ADF service check	2-23
Flatbed service check	2-24
Cold fuser service check	2-24
Cooling fan service check	2-24
Controller card service check	2-25
Cover interlock switch service check	2-26
Dead machine service check	2-26
Fuser service check	2-27
Hot fuser service check	2-28
LVPS/HVPS service check	2-28
Main motor service check	2-29
Modem service check	2-29
Networking service check	2-29

Operator panel service check	2-31
Paperpath sensor service check	2-32
Printhead service check	2-32
Paper feed service checks	2-33
Paper jam error indication during POST	2-33
Paper picks during POST and/or continuously	2-33
Paper picks but stops half way through the MFP	2-33
Paper never picks	2-33
Paper occasionally picks or picks multiple sheets at once	2-34
Paper “trees,” wrinkles, stacks poorly or curls	2-34
A4, oversized paperfeed service check	2-34
Print quality service checks	2-35
Using print quality test pages	2-35
Blank page	2-35
Black page	2-35
Heavy background	2-36
Partial blank image/white spots (no periodic pattern)	2-36
Variation in image density horizontally across page	2-36
Poor fusing of image	2-36
Light print	2-37
White or black lines or bands	2-37
Toner on back of page	2-37
Solving print quality problems	2-38
840.xx service check	2-41
Scan quality service checks	2-43
Image unclear	2-43
Irregular movement	2-43
No image	2-43
Transfer roll service check	2-44
Fax service checks	2-44
Diagnosing fax problems	2-44
Fax transmission service check	2-44
Fax Reception service check	2-46
Escalating a fax issue to second-level support	2-48
Diagnostic aids	3-1
Accessing service menus	3-1
Diagnostics mode	3-2
Available tests	3-2
Registration	3-3
Printer	3-3
Quick test	3-4
Print Tests	3-5
Input source tests	3-5
Print quality test pages (Prt Quality Pgs)	3-5
Hardware Tests	3-5
Panel Test	3-5
Button Test	3-5
DRAM Test	3-6
Input Tray tests	3-7
Feed Tests	3-7
Output bin tests	3-7
Feed Tests	3-7
Base Sensor Test	3-7
Printer setup	3-7
Defaults	3-7
Perm Page Count	3-7
Serial Number	3-8
Engine Setting 1-4	3-8

Model Name	3-8
Configuration ID	3-8
Edge to Edge	3-9
Enable Edge to Edge Copy	3-9
EP Setup	3-9
EP Defaults	3-9
Fuser Temp	3-9
Transfer	3-9
Print contrast	3-9
Charge Roll	3-9
Gap Adjust	3-10
Auto Dark Adjust	3-10
Reports	3-10
Main setting's Page	3-10
Event Log	3-10
Display Log	3-10
Print Log	3-10
Clear Log	3-11
Scanner Tests	3-11
ASIC Test	3-11
Feed Test	3-11
Sensor Test	3-12
Configuration Menu	3-14
Available menus	3-14
USB Scan to Local	3-14
Reset PC Cnt	3-14
Prt Quality Pages	3-14
Reports	3-15
Menu setting's Page	3-15
Event Log	3-15
Panel Menus	3-15
Demo Mode	3-15
Factory defaults	3-15
Energy Conserve	3-16
Format Fax Storage	3-16
ADF Edge Erase	3-16
FB Edge Erase	3-16
Scanner Manual Registration	3-17
Disable Scanner	3-18
Font Sharpening	3-18
Reduced Curl	3-18
USB Speed	3-18
Exit Config Menu	3-18
SE Menu	3-19
Print SE Menus	3-19
General	3-19
Code Revision Info	3-19
History	3-19
MAC	3-19
NVRAM	3-19
NPAP	3-19
TCP/IP	3-19
Paper jams	3-20
Avoiding jams	3-20
200 - 201 paper jam	3-21
200 paper jam	3-21
201 paper jam	3-22
202 paper jam	3-23
241 paper jam	3-25

251 paper jam	3-26
290 - 294 paper jams	3-28

Repair information **4-1**

Handling ESD-sensitive parts	4-1
Removal procedures	4-2
Covers	4-2
Front cover removal	4-2
Left side cover removal	4-4
Rear cover removal	4-5
Right side cover removal	4-7
Top cover removal	4-8
Flatbed front cover removal	4-9
Left and right flatbed cover removals	4-10
Card cage removal	4-11
Controller card removal	4-13
Cover open sensor removal	4-15
Developer drive coupling assembly removal	4-16
Exit sensor removal (on the fuser)	4-17
Fan removal	4-18
Fax modem removal	4-19
Feed rollers (autocompensator tires) removal	4-20
Fuser removal	4-20
Fuser idle gear links removal	4-22
Fuser power cable removal	4-23
Input roller clutch and lever removal (autocompensator clutch)	4-24
Input sensor #1 removal	4-25
Input sensor #2 (manual feed) removal	4-26
LVPS/HVPS card assembly removal	4-27
LVPS/HVPS to controller card cable removal	4-28
Manual feed clutch assembly removal	4-29
Operator panel bezel removal	4-30
Operator panel cable removal	4-30
Operator panel assembly removal	4-32
Paper exit guide assembly removal	4-34
Printhead removal	4-35
Transfer roll removal	4-36
Transport motor cable removal	4-37
Scanner ADF paper tray removal	4-38
Scanner ADF top cover removal	4-39
Scanner ADF pick roll assembly removal	4-40
ADF separator pad removal	4-41
ADF assembly removal	4-42
ADF cable removal	4-43
Flatbed removal	4-44

Locations and connections **5-1**

Locations	5-1
Front view	5-1
Rear view	5-2
Connections	5-3
Power supply board	5-3
Power supply board connections	5-3
Controller card	5-4
Controller card connections	5-5

Preventive maintenance **6-1**

Printer engine	6-1
-----------------------------	------------

Scanner	6-1
Parts catalog	7-1
How to use this parts catalog	7-1
Assembly 1: Covers	7-2
Assembly 2: Scanner	7-4
Assembly 3: Electronics	7-8
Assembly 4: Frame	7-10
Assembly 5: Miscellaneous	7-12
Index	I-1
Part number index	I-5

Notices and safety information

The following laser notice labels may be affixed to this printer as shown:

Laser notice

The printer is certified in the U.S. to conform to the requirements of DHHS 21 CFR Subchapter J for Class I (1) laser products, and elsewhere is certified as a Class I laser product conforming to the requirements of IEC 60825-1.

Class I laser products are not considered to be hazardous. The printer contains internally a Class IIIb (3b) laser that is nominally a 5 milliwatt gallium arsenide laser operating in the wavelength region of 770-795 nanometers. The laser system and printer are designed so there is never any human access to laser radiation above a Class I level during normal operation, user maintenance, or prescribed service condition.

Laser

Der Drucker erfüllt gemäß amtlicher Bestätigung der USA die Anforderungen der Bestimmung DHHS (Department of Health and Human Services) 21 CFR Teil J für Laserprodukte der Klasse I (1). In anderen Ländern gilt der Drucker als Laserprodukt der Klasse I, der die Anforderungen der IEC (International Electrotechnical Commission) 60825-1 gemäß amtlicher Bestätigung erfüllt.

Laserprodukte der Klasse I gelten als unschädlich. Im Inneren des Druckers befindet sich ein Laser der Klasse IIIb (3b), bei dem es sich um einen Galliumarsenlaser mit 5 Milliwatt handelt, der Wellen der Länge 770-795 Nanometer ausstrahlt. Das Lasersystem und der Drucker sind so konzipiert, daß im Normalbetrieb, bei der Wartung durch den Benutzer oder bei ordnungsgemäßer Wartung durch den Kundendienst Laserbestrahlung, die Klasse I übersteigen würde, Menschen keinesfalls erreicht.

Avis relatif à l'utilisation de laser

Pour les Etats-Unis : cette imprimante est certifiée conforme aux provisions DHHS 21 CFR alinéa J concernant les produits laser de Classe I (1). Pour les autres pays : cette imprimante répond aux normes IEC 60825-1 relatives aux produits laser de Classe I.

Les produits laser de Classe I sont considérés comme des produits non dangereux. Cette imprimante est équipée d'un laser de Classe IIIb (3b) (arséniure de gallium d'une puissance nominale de 5 milliwatts) émettant sur des longueurs d'onde comprises entre 770 et 795 nanomètres. L'imprimante et son système laser sont conçus pour impossible, dans des conditions normales d'utilisation, d'entretien par l'utilisateur ou de révision, l'exposition à des rayonnements laser supérieurs à des rayonnements de Classe I.

Avvertenze sui prodotti laser

Questa stampante è certificata negli Stati Uniti per essere conforme ai requisiti del DHHS 21 CFR Sottocapitolo J per i prodotti laser di classe 1 ed è certificata negli altri Paesi come prodotto laser di classe 1 conforme ai requisiti della norma CEI 60825-1.

I prodotti laser di classe non sono considerati pericolosi. La stampante contiene al suo interno un laser di classe IIIb (3b) all'arseniuro di gallio della potenza di 5mW che opera sulla lunghezza d'onda compresa tra 770 e 795 nanometri. Il sistema laser e la stampante sono stati progettati in modo tale che le persone a contatto con la stampante, durante il normale funzionamento, le operazioni di servizio o quelle di assistenza tecnica, non ricevano radiazioni laser superiori al livello della classe 1.

Avisos sobre el láser

Se certifica que, en los EE.UU., esta impresora cumple los requisitos para los productos láser de Clase I (1) establecidos en el subcapítulo J de la norma CFR 21 del DHHS (Departamento de Sanidad y Servicios) y, en los demás países, reúne todas las condiciones expuestas en la norma IEC 60825-1 para productos láser de Clase I (1).

Los productos láser de Clase I no se consideran peligrosos. La impresora contiene en su interior un láser de Clase IIIb (3b) de arseniuro de galio de funcionamiento nominal a 5 milivatios en una longitud de onda de 770 a 795 nanómetros. El sistema láser y la impresora están diseñados de forma que ninguna persona pueda verse afectada por ningún tipo de radiación láser superior al nivel de la Clase I durante su uso normal, el mantenimiento realizado por el usuario o cualquier otra situación de servicio técnico.

Declaração sobre Laser

A impressora está certificada nos E.U.A. em conformidade com os requisitos da regulamentação DHHS 21 CFR Subcapítulo J para a Classe I (1) de produtos laser. Em outros locais, está certificada como um produto laser da Classe I, em conformidade com os requisitos da norma IEC 60825-1.

Os produtos laser da Classe I não são considerados perigosos. Internamente, a impressora contém um produto laser da Classe IIIb (3b), designado laser de arseneto de potássio, de 5 milliwatts, operando numa faixa de comprimento de onda entre 770 e 795 nanómetros. O sistema e a impressora laser foram concebidos de forma a nunca existir qualquer possibilidade de acesso humano a radiação laser superior a um nível de Classe I durante a operação normal, a manutenção feita pelo utilizador ou condições de assistência prescritas.

Laserinformatie

De printer voldoet aan de eisen die gesteld worden aan een laserproduct van klasse I. Voor de Verenigde Staten zijn deze eisen vastgelegd in DHHS 21 CFR Subchapter J, voor andere landen in IEC 60825-1.

Laserprodukten van klasse I worden niet als ongevaarlijk aangemerkt. De printer is voorzien van een laser van klasse IIIb (3b), dat wil zeggen een gallium arsenide-laser van 5 milliwatt met een golflengte van 770-795 nanometer. Het lasergedeelte en de printer zijn zo ontworpen dat bij normaal gebruik, bij onderhoud of reparatie conform de voorschriften, nooit blootstelling mogelijk is aan laserstraling boven een niveau zoals voorgeschreven is voor klasse 1.

Lasermeddelelse

Printeren er godkendt som et Klasse I-laserprodukt, i overensstemmelse med kravene i IEC 60825-1.

Klasse I-laserprodukter betragtes ikke som farlige. Printeren indeholder internt en Klasse IIIB (3b)-laser, der nominelt er en 5 milliwatt galliumarsenid laser, som arbejder på bølgelængdeområdet 770-795 nanometer. Lasersystemet og printeren er udformet således, at mennesker aldrig udsættes for en laserstråling over Klasse I-niveau ved normal drift, brugervedligeholdelse eller obligatoriske servicebetingelser.

Huomautus laserlaitteesta

Tämä kirjoitin on Yhdysvalloissa luokan I (1) laserlaitteiden DHHS 21 CFR Subchapter J -määrityksen mukainen ja muualla luokan I laserlaitteiden IEC 60825-1 -määrityksen mukainen.

Luokan I laserlaitteiden ei katsota olevan vaarallisia käyttäjälle. Kirjoittimessa on sisäinen luokan IIIb (3b) 5 milliwatin galliumarsenidilaser, joka toimii aaltoalueella 770 - 795 nanometriä. Laserjärjestelmä ja kirjoitin on suunniteltu siten, että käyttäjä ei altistu luokan I määrätyksiä voimakkaammalle säteilylle kirjoittimen normaalin toiminnan, käyttäjän tekemien huoltotoimien tai muiden huoltotoimien yhteydessä.

VARO! Avattaessa ja suojalukitus ohitettaessa olet alttiina näkymättömälle lasersäteilylle. Älä katso säteeseen.

VARNING! Osynlig laserstrålning när denna del är öppnad och spärren är urkopplad. Betrakta ej strålen.

Laser-notis

Denna skrivare är i USA certifierad att motsvara kraven i DHHS 21 CFR, underparagraf J för laserprodukter av Klass I (1). I andra länder uppfyller skrivaren kraven för laserprodukter av Klass I enligt kraven i IEC 60825-1.

Laserprodukter i Klass I anses ej hälsovådliga. Skrivaren har en inbyggd laser av Klass IIIb (3b) som består av en laserenhet av gallium-arsenid på 5 milliwatt som arbetar i våglängdsområdet 770-795 nanometer.

Lasersystemet och skrivaren är utformade så att det aldrig finns risk för att någon person utsätts för laserstrålning över Klass I-nivå vid normal användning, underhåll som utförs av användaren eller annan föreskriven serviceåtgärd.

Laser-melding

Skriveren er godkjent i USA etter kravene i DHHS 21 CFR, underkapittel J, for klasse I (1) laserprodukter, og er i andre land godkjent som et Klasse I-laserprodukt i samsvar med kravene i IEC 60825-1.

Klasse I-laserprodukter er ikke å betrakte som farlige. Skriveren inneholder internt en klasse IIIb (3b)-laser, som består av en gallium-arsenlaserenhet som avgir stråling i bølglengdeområdet 770-795 nanometer.

Lasersystemet og skriveren er utformet slik at personer aldri utsettes for laserstråling ut over klasse I-nivå under vanlig bruk, vedlikehold som utføres av brukeren, eller foreskrevne serviceoperasjoner.

Avís sobre el Làser

Segons ha estat certificat als Estats Units, aquesta impressora compleix els requisits de DHHS 21 CFR, apartat J, pels productes làser de classe I (1), i segons ha estat certificat en altres llocs, és un producte làser de classe I que compleix els requisits d'IEC 60825-1.

Els productes làser de classe I no es consideren perillosos. Aquesta impressora conté un làser de classe IIIb (3b) d'arseniür de gal.li, nominalment de 5 mil.liwats, i funciona a la regió de longitud d'ona de 770-795 nanòmetres. El sistema làser i la impressora han sigut concebuts de manera que mai hi hagi exposició a la radiació làser per sobre d'un nivell de classe I durant una operació normal, durant les tasques de manteniment d'usuari ni durant els serveis que satisfacin les condicions prescrites.

レーザーに関するお知らせ

このプリンターは、米国ではDHHS 21 CFRサブチャプターJのクラスI (1)の基準を満たしたレーザー製品であることが証明されています。また米国以外ではIEC 825の基準を満たしたクラスIのレーザー製品であることが証明されています。

クラスIのレーザー製品には危険性はないと考えられています。このプリンターはクラスIII b (3 b)のレーザーを内蔵しています。このレーザーは、波長が770 ~ 795ナノメートルの範囲で、通常5ミリワットのガリウム砒化物を放射するレーザーです。このレーザーシステムとプリンターは、通常の操作、ユーザのメンテナンス、規定された修理においては、人体がクラスIのレベル以上のレーザー放射に晒されることのないよう設計されています。

注意：

本打印机被美国认证合乎 DHHS 21 CFR Subchapter I 对分类 I (1) 激光产品的标准，而在其他地区则被认证合乎 IEC 825 的标准。

分类 I 激光产品一般认为不具危险性，本打印机内部含有分类 IIIb (3b) 的激光，在操作过程中会产生 5 毫瓦含镓及砷的微量激光，其波长范围在 770-795 nm 之间。本激光系统及打印机的设计，在一般操作、使用者维护或规定内的维修情况下，不会使人体接触分类 I 以上等级的辐射。

본프린터는 1등급 레이저 제품들에 대한 DHHS 21 CFR Subchapter 3의 규정을 준수하고 있음을 미국에서 인증받았으며, 그외의 나라에서도 IEC 825 규정을 준수하는 1등급 레이저 제품으로서 인증을 받았습니다.

1등급 레이저 제품들은 안전한 것으로 간주됩니다. 본 프린터는 5 밀리วัต 갈륨 아르세나이드 레이저로서 770-795 나노미터의 파장대에서 활동하는 Class III (3b) 레이저를 내부에 갖고 있습니다. 본 레이저 시스템과 프린터는 정상 작동 중이나 유지 보수 중 또는 규정된 서비스 상태에서 상기의 Class I 수준의 레이저 방출에 사람이 절대 접근할 수 없도록 설계되어 있습니다.

Safety information

- The safety of this product is based on testing and approvals of the original design and specific components. The manufacturer is not responsible for safety in the event of use of unauthorized replacement parts.
- The maintenance information for this product has been prepared for use by a professional service person and is not intended to be used by others.
- There may be an increased risk of electric shock and personal injury during disassembly and servicing of this product. Professional service personnel should understand this and take necessary precautions.
-  **CAUTION:** When you see this symbol, there is a danger from hazardous voltage in the area of the product where you are working. Unplug the product before you begin, or use caution if the product must receive power in order to perform the task.

Consignes de sécurité

- La sécurité de ce produit repose sur des tests et des agrégations portant sur sa conception d'origine et sur des composants particuliers. Le fabricant n'assume aucune responsabilité concernant la sécurité en cas d'utilisation de pièces de rechange non agréées.
- Les consignes d'entretien et de réparation de ce produit s'adressent uniquement à un personnel de maintenance qualifié.
- Le démontage et l'entretien de ce produit pouvant présenter certains risques électriques, le personnel d'entretien qualifié devra prendre toutes les précautions nécessaires.
-  **ATTENTION :** Ce symbole indique la présence d'une tension dangereuse dans la partie du produit sur laquelle vous travaillez. Débranchez le produit avant de commencer ou faites preuve de vigilance si l'exécution de la tâche exige que le produit reste sous tension.

Norme di sicurezza

- La sicurezza del prodotto si basa sui test e sull'approvazione del progetto originale e dei componenti specifici. Il produttore non è responsabile per la sicurezza in caso di sostituzione non autorizzata delle parti.
- Le informazioni riguardanti la manutenzione di questo prodotto sono indirizzate soltanto al personale di assistenza autorizzato.
- Durante lo smontaggio e la manutenzione di questo prodotto, il rischio di subire scosse elettriche e danni alla persona è più elevato. Il personale di assistenza autorizzato deve, quindi, adottare le precauzioni necessarie.
-  **ATTENZIONE:** Questo simbolo indica la presenza di tensione pericolosa nell'area del prodotto. Scollegare il prodotto prima di iniziare o usare cautela se il prodotto deve essere alimentato per eseguire l'intervento.

Sicherheitshinweise

- Die Sicherheit dieses Produkts basiert auf Tests und Zulassungen des ursprünglichen Modells und bestimmter Bauteile. Bei Verwendung nicht genehmigter Ersatzteile wird vom Hersteller keine Verantwortung oder Haftung für die Sicherheit übernommen.
- Die Wartungsinformationen für dieses Produkt sind ausschließlich für die Verwendung durch einen Wartungsfachmann bestimmt.
- Während des Auseinandernehmens und der Wartung des Geräts besteht ein zusätzliches Risiko eines elektrischen Schlags und körperlicher Verletzung. Das zuständige Fachpersonal sollte entsprechende Vorsichtsmaßnahmen treffen.
-  **ACHTUNG:** Dieses Symbol weist auf eine gefährliche elektrische Spannung hin, die in diesem Bereich des Produkts auftreten kann. Ziehen Sie vor den Arbeiten am Gerät den Netzstecker des Geräts, bzw. arbeiten Sie mit großer Vorsicht, wenn das Produkt für die Ausführung der Arbeiten an den Strom angeschlossen sein muß.

Pautas de Seguridad

- La seguridad de este producto se basa en pruebas y aprobaciones del diseño original y componentes específicos. El fabricante no es responsable de la seguridad en caso de uso de piezas de repuesto no autorizadas.
- La información sobre el mantenimiento de este producto está dirigida exclusivamente al personal cualificado de mantenimiento.
- Existe mayor riesgo de descarga eléctrica y de daños personales durante el desmontaje y la reparación de la máquina. El personal cualificado debe ser consciente de este peligro y tomar las precauciones necesarias.
-  **PRECAUCIÓN:** este símbolo indica que el voltaje de la parte del equipo con la que está trabajando es peligroso. Antes de empezar, desenchufe el equipo o tenga cuidado si, para trabajar con él, debe conectarlo.

Informações de Segurança

- A segurança deste produto baseia-se em testes e aprovações do modelo original e de componentes específicos. O fabricante não é responsável pela segurança, no caso de uso de peças de substituição não autorizadas.
- As informações de segurança relativas a este produto destinam-se a profissionais destes serviços e não devem ser utilizadas por outras pessoas.
- Risco de choques eléctricos e ferimentos graves durante a desmontagem e manutenção deste produto. Os profissionais destes serviços devem estar avisados deste facto e tomar os cuidados necessários.
-  **CUIDADO:** Quando vir este símbolo, existe a possível presença de uma potencial tensão perigosa na zona do produto em que está a trabalhar. Antes de começar, desligue o produto da tomada eléctrica ou seja cuidadoso caso o produto tenha de estar ligado à corrente eléctrica para realizar a tarefa necessária.

Informació de Seguretat

- La seguretat d'aquest producte es basa en l'avaluació i aprovació del disseny original i els components específics.
El fabricant no es fa responsable de les qüestions de seguretat si s'utilitzen peces de recanvi no autoritzades.
- La informació pel manteniment d'aquest producte està orientada exclusivament a professionals i no està destinada a ningú que no ho sigui.
- El risc de xoc elèctric i de danys personals pot augmentar durant el procés de desmuntatge i de servei d'aquest producte. El personal professional ha d'estar-ne assabentat i prendre les mesures convenients.
-  **PRECAUCIÓ:** aquest símbol indica que el voltatge de la part de l'equip amb la qual esteu treballant és perillós. Abans de començar, desendolleu l'equip o extremeu les precaucions si, per treballar amb l'equip, l'heu de connectar.

안전 사항

- 본 제품은 원래 설계 및 특정 구성품에 대한 테스트 결과로 안정성이 입증된 것입니다. 따라서 무허가 교체부품을 사용하는 경우에는 제조업체에서 안전에 대한 책임을 지지 않습니다.
- 본 제품에 관한 유지 보수 설명서는 전문 서비스 기술자용으로 작성된 것이므로, 비전문가는 사용할 수 없습니다.
- 본 제품을 해체하거나 정비할 경우, 전기적인 충격을 받거나 상처를 입을 위험이 커집니다. 전문 서비스 기술자는 이 사실을 숙지하고, 필요한 예방 조치를 취하도록 하십시오.
-  **주의:** 이 표시는 해당영역에서 고압전류가 흐른다는 위험 표시입니다. 시작전에 플러그를 뽑으시거나, 주의를 기울여 주시기 바랍니다.

安全信息

- 本产品的安全性以原来设计和特定产品的测试结果和认证为基础。万一使用未经许可的替换部件，制造商不对安全性负责。
- 本产品的维护信息仅供专业服务人员使用，并不打算让其他人使用。
- 本产品在拆卸、维修时，遭受电击或人员受伤的危险性会增高，专业服务人员对这点必须有所了解，并采取必要的预防措施。
-  **切记:** 当您看到此符号时，说明在您工作的产品区域有危险电压的存在。请在开始操作前拔掉产品的电源线，或者在产品必须使用电源来执行任务时，小心从事。

Preface

This manual contains maintenance procedures for service personnel. It is divided into the following chapters:

1. **General information** contains a general description of the printer and the maintenance approach used to repair it. Special tools and test equipment, as well as general environmental and safety instructions, are discussed.
2. **Diagnostic information** contains an error indicator table, symptom tables, and service checks used to isolate failing field replaceable units (FRUs).
3. **Diagnostic aids** contains tests and checks used to locate or repeat symptoms of printer problems.
4. **Repair information** provides instructions for making printer adjustments and removing and installing FRUs.
5. **Connector locations** uses illustrations to identify the connector locations and test points on the printer.
6. **Preventive maintenance** contains the lubrication specifications and recommendations to prevent problems.
7. **Parts catalog** contains illustrations and part numbers for individual FRUs.

Conventions

Note: A note provides additional information.

Warning: A warning identifies something that might damage the product hardware or software.

There are several types of caution statements:

	CAUTION A caution identifies something that might cause a servicer harm.
---	--

	CAUTION This type of caution indicates there is a danger from hazardous voltage in the area of the product where you are working. Unplug the product before you begin, or use caution if the product must receive power in order to perform the task.
---	---

	CAUTION This type of caution indicates a hot surface.
---	---

	CAUTION This type of caution indicates a tipping hazard.
---	--

1. General information

The Lexmark™ X203 and X204 are MFPs that combine print, scan, copy, e-mail, and fax features into a single device designed for small workgroups.

Maintenance approach

The diagnostic information in this manual leads you to the correct field replaceable unit (FRU) or part. Use the error code charts, symptom index, and service checks to determine the symptom and repair the failure. See **“Diagnostic information” on page 2-1** for more information. See **“Repair information” on page 4-1** to help identify parts. After completing the repair, perform tests as needed to verify the repair.

MFP Specifications

Minimum clearance requirements

	X203	X204
Width	15.8”	
Depth	14.1”	
Height	13.4”	15”

Dimensions

Top	12 inches (31 cm)
Left side	12 inches (31 cm)
Right side	12 inches (31 cm)
Rear	6 inches (15 cm)
Front	16 inches (41 cm)

Weights

X203	29.3 lb / 13kg
X204	31 lb / 14.kg

Memory

Item	7011-200 Lexmark X203	7011-215 Lexmark X204
Base memory	64MB	64MB

Note: Optional memory, flash memory, and Lexmark solution cards are not supported on these devices.

Print speed

Media Size	7011-200 Lexmark X203	7011-215 Lexmark X204
Letter—8.5 x 11 in.	24 ppm	24 ppm
A4—210 x 297 mm	23 ppm	23 ppm
Speed measured on media from tray 1 at 600 x 600 dpi.		

Note: Time to first print is 10 seconds.

Print resolution

600 dpi - default, 1200 dpi at half speed.

Connectivity and compatibility

Attachments	
Standard USB 2.0 interface	X203, and X204
Fax Modem	X204 only
10/100 Base - TX	X203, and X204

Supported external network connections

- Lexmark N4000e ethernet 10Base/100BaseTX
- Lexmark N4050e wireless 802.11g
- Lexmark wireless 802.11g print server

Fonts

Fonts/options	# scalable	# bitmapped
PCL 6	89	2
PostScript	89	0

Note: There is no font card support.

Media trays and supply capacity

Item	7011-200 Lexmark X203	7011-215 Lexmark X204
Available input trays		
250-sheet tray	✓	✓
Single-sheet manual feeder	✓	✓
Toner and photoconductor		
Toner cartridge yield	1,500 pages* (X 20X starter toner cartridge) 2,500 pages (X 20X toner cartridge)	
PC kit yield	25,000 pages*	
*Photoconductor yield based on approximately 5% coverage of pages.		

Types of print media

Ensure trays are properly loaded. Never mix media types within a tray.

Source	Sizes	Types	Weight	Input capacity (sheets)
Tray 1 (250-sheet tray)	A4 ^d , A5, JIS B5, letter, legal, executive, folio, statement	Plain paper, transparencies, paper labels ^a	60–90 g/m ² (16–24 lb)	250 paper, 50 labels ^a , 50 transparencies
Manual feeder	A4 ^d , A5, JIS B5, letter, legal, executive, folio, statement	Plain paper, transparencies, paper labels ^a , card stock ^b	60–163 g/m ² (16–43 lb)	1 sheet
	7¼, 9, 10, DL, C5, B5, other ^d	Envelopes		
^a Dual web, integrated, or vinyl labels are not supported. ^b Card stock up to 90# Index. Short grain is recommended. ^c Maximum and minimum sizes for other envelopes are 98.4 x 162 mm to 176 x 250 mm (3.87 x 6.38 in. to 6.93 x 9.84 in). ^d The paper size must be set to A4 in the Size/Type menu item and on the driver to avoid jams.				

Media weights	
Heavy	✓
Normal	✓
Light	✓

Media textures	
Rough	✓
Normal	✓
Smooth	✓

Scanner specifications

General	
Resolution	<ul style="list-style-type: none"> • Optical—1200 dpi • Enhanced—9600X9600 dpi
TWAIN resolution	9600 dpi
WIA resolution	1200 dpi
Color depth	24 bit RGB output (8 bit per channel)
Maximum document width	216 mm (8.5")

ADF	
Scan speed @600x300 dpi	<ul style="list-style-type: none"> • Mono Letter—15 ppm • Color Letter—5 ppm
Paper Capacity	<ul style="list-style-type: none"> • 30 sheets of 20 lb paper • 20 sheets cotton
Scan area	<ul style="list-style-type: none"> • Max 8.5"x14" • Min 5.5"x8.3"
Document width	148mm–216 mm (5.5"–8.5")
Document length	127mm–356mm (8.3"–14")
Time to first copy	<ul style="list-style-type: none"> • From ready/standby –11.5 seconds text or mixed. Up to 20 sec in photo mode. • From power saver–35.5 seconds

Flatbed	
Time to first copy	<ul style="list-style-type: none"> • 10 sec Text or mixed • Photo - 17 to 18.5 sec • From power saver–30 to 31 seconds
Document size	4.5" x 5.5" to 8.5" x 14" SEF

Fax Specifications (X204 only)

Transmission rate	3 seconds per page * When transmitting at 33,600 bps
Compression	MH, MR, MMR
Resolutions	Receive: 200X100 dpi, 200X200 dpi, 300X300 dpi, 400X400 dpi, 204X98 dpi, 204X196 dpi, 204X391 dpi, 408X391 dpi Send: 200X100 dpi, 200X200 dpi, 300X300 dpi
Modem speed	2400–33,600 BPS maximum, V34 half duplex. 7200–14,400 BPS V.17 2400–4800 BPS V.27 7200–9600 BPS V.29
Error correcting	ITU T.30
Speed dial	Maximum of 99 (Based on 10-digit phone numbers)
Group fax	99 locations (Based on 10-digit phone numbers with a maximum of 512 characters)
Broadcast	99 locations
Manual fax	Yes
Fax from PC	Yes

Tips on preventing jams

You can avoid most paper jams by correctly loading paper and specialty media.

The following hints can help you avoid paper jams:

- Do not load wrinkled, creased, or damp paper.
- Never mix media types within a tray.
- Flex, fan, and straighten paper before you load it.
- Do not exceed the maximum stack height.
- Push all trays *firmly* into the printer after loading them.
- Make sure the guides in the trays are positioned snugly against the paper or specialty media.
- Do not remove paper trays while a job is printing. Wait for a **Load Paper** or **Ready** light sequence before you remove the tray.
- Before loading transparencies, fan the stack to prevent sheets from sticking together.
- Do not use envelopes that:
 - Have excessive curl
 - Are stuck together
 - Are damaged in any way
 - Contain windows, holes, perforations, cutouts, or embossing
 - Have metal clasps, string ties, or metal folding bars
 - Have postage stamps attached
 - Have any exposed adhesive when the flap is in the sealed position

- Use only recommended paper. Refer to the *Card Stock & Label Guide* available on the Lexmark Web site at www.lexmark.com for more information about which paper provides optimum results for the current printing environment.

Tools

The removal and adjustment procedures require the following tools and equipment:

- Magnetic tip Phillips screwdrivers, #1 and #2.
- Volt-ohmmeter
- Spring hook
- Needle nose pliers
- Slotted screwdriver

Acronyms

ACM	Autocompensator Mechanism (or paper feed)
ADF	Automatic document feeder
AFE	Analog front end
ASIC	Application Specific Integrated Circuit
CBM	Complete Bill Of Material
CIS	Charge coupled device
CIS	Contact image sensor
CRC	Cyclic redundancy check
DBCS	Double byte character set
DIMM	Dual In-Line Memory Module
ECC	Error correcting code
ECM	Error correction mode
ENA	External Network Adapter
EOL	End of line
FB	Flatbed
FRU	Field Replaceable Unit
HBP	Host Based Printing
HV	High Voltage
HVPS	High Voltage Power Supply
INTL	International
LCD	Liquid crystal diode
LED	Light emitting diode
LVPS	Low Voltage Power Supply
MFP	Multi Function Printer
MH	Message handling
MMR	Modified modified read
MR	Modem ready
NAND	NAND (usage: NAND gate)
NVRAM	Nonvolatile Random Access Memory
OPC	Optical photo conductor
PCL	Printer Control Language
POR	Power-On Reset
POST	Power-On Self Test
PPDS	Personal Printer Data Stream
PRC	Peoples' Republic of China
PSO	Participating Standards Organization
RAM	Random access memory
RIP	Raster Image Processor
SDR	Synchronous Dynamic RAM
SEF	Short edge feed
SRAM	Synchronous RAM
USB	Universal Serial Bus
V ac	Volts alternating current
V dc	Volts direct current

2. Diagnostic information

Start



CAUTION: Unplug power from the MFP before connecting or disconnecting any cable, assembly, or electronic card. This is a precaution for personal safety and to prevent damage to the MFP.

This chapter contains the codes and diagnostic tools to aid in providing corrective action for a malfunctioning MFP. To determine the corrective action to repair an MFP, look for the following information:

- If you do not complete POST, verify the sequence of events during the POST. See **“Power–On Reset (POR) sequence” on page 2-1.**
- If you have a description of a problem, but no error message, see **“Symptom tables” on page 2-2.**
- If you have an error indication, see one of the following:
 - **“Service error codes” on page 2-9**
 - **“User attendance messages” on page 2-19**
 - **“Paper jam messages” on page 2-18**

Power–On Reset (POR) sequence

The following is an example of the events that occur during the POR sequence when the MFP is turned on.

1. The function and scan quality LEDs illuminate for one second and then flash three times.
2. Loading is displayed on the operator panel.
3. CIS lamp illuminates. The scanner performs a calibration.
4. The main motor runs momentarily.
5. The scanner CIS returns to the home position.
6. Close Door will be posted if the cover is open.
7. Any cartridge errors, such as Defective Cartridge, are posted.
8. Applicable maintenance messages are posted. For example, 80 Scheduled Maintenance.
9. Applicable toner low messages are posted.
10. The MFP displays Ready. The function LEDs illuminate.

Symptom tables

POST symptom table

These symptoms may appear during the POST (Power-on Self Test). See **“Power-On Reset (POR) sequence” on page 2-1** for the sequence when the MFP is turned on.

POST symptom table

Symptom	Action
The main motor, cooling fan, and fuser do not come on.	See “Controller card service check” on page 2-25.
POST completes except lights do not come on.	See “Operator panel service check” on page 2-31.
POST complete except display does not function.	See “Operator panel service check” on page 2-31.
Main motor does not come on.	See “Main motor service check” on page 2-29.
Black boxes appear on the display, and the MFP fails to function	Turn off the MFP, wait ten seconds, and restart the MFP.
Fan does not come on.	See “Cooling fan service check” on page 2-24.
Fuser lamp does not come on.	See “Cold fuser service check” on page 2-24.
Fuser lamp never turns off.	See “Hot fuser service check” on page 2-28.
The paper feed picks and tries to feed paper.	See “Paper feed service checks” on page 2-33.
CIS Lamp fails to initialize.	See “Flatbed service check” on page 2-24.

MFP symptom table

Symptom	Action
Front access cover will not close	See “Cover interlock switch service check” on page 2-26.
Fuser parts melted	See “Hot fuser service check” on page 2-28.
Toner not fused to the paper	See “Poor fusing of image” on page 2-36.
Blank page	See “Blank page” on page 2-35.
Black page	See “Black page” on page 2-35.
Heavy background	See “Heavy background” on page 2-36.
Light print	See “Light print” on page 2-37.
White or black lines or bands	See “White or black lines or bands” on page 2-37.
Toner on back of page	See “Toner on back of page” on page 2-37.
Paper jams	See “Paper feed service checks” on page 2-33.

Symptom	Action
Main motor noisy or does not move	See “Main motor service check” on page 2-29.
MFP emits a grinding noise and a 902 error results.	Check the cartridge and PC roll assembly for proper installation. Re-insert it if it is installed incorrectly.
Paper never picks	See “Paper never picks” on page 2-33.
Paper feeds continuously	See “Paper picks during POST and/or continuously” on page 2-33.
Skewed paper	Printhead misalignment results in skewed horizontal lines but a consistent margin top to bottom of page. Paper feed misalignment results in entire image rotated on the paper. See “Paper feed service checks” on page 2-33.
Paper wrinkled or bent	See “Paper “trees,” wrinkles, stacks poorly or curls” on page 2-34.
Top cover will not close	See “Controller card service check” on page 2-25.
Operator panel button does not respond	See “Operator panel service check” on page 2-31 or “Controller card service check” on page 2-25.
Operator panel light does not light or is very dim	See “Controller card service check” on page 2-25.
Fan noisy or not working	See “Cooling fan service check” on page 2-24.
Dead machine (no power)	See “Dead machine service check” on page 2-26.
Paper does not feed into the ADF	See “ADF service check” on page 2-23.
MFP produces a black page when copying a document.	See “Flatbed service check” on page 2-24.
Paper jams in ADF.	See “ADF service check” on page 2-23.
Frequent 202.01 paper jams.	Check the fuser for a stuck fuser exit flag. If the flag is damaged, replace the fuser. See “Fuser removal” on page 4-20.
Device does not power up after flashing firmware.	Do not power the device down. It will automatically reboot. Power the device down, wait a few minutes and reboot.
Device does not show it's status on the operator panel when the firmware is being flashed.	Make sure the device is in Ready mode before flashing the firmware.
Images appear distorted or elongated when scanned from the ADF	Use the flatbed to scan.
Banding or aliasing appears in copied images.	Try copying the image in Text/Photo mode. Photo mode should only be used on very high quality images.

Symptom	Action
<p>Repeating ADF Jams. Paper feeds into the ADF but does not go all the way through.</p>	<p>Verify that the mylar feed strips are properly positioned on the ADF.</p>  <p>If the clear mylar strips are damaged, replace the ADF. See “ADF assembly removal” on page 4-42.</p>

Understand the operator panel

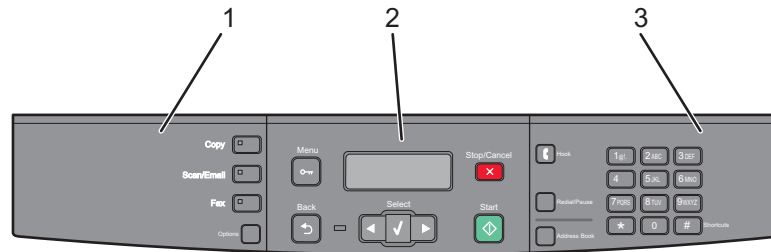

The X203, and X204 op panel is divided into three sections:

Selections and setting's

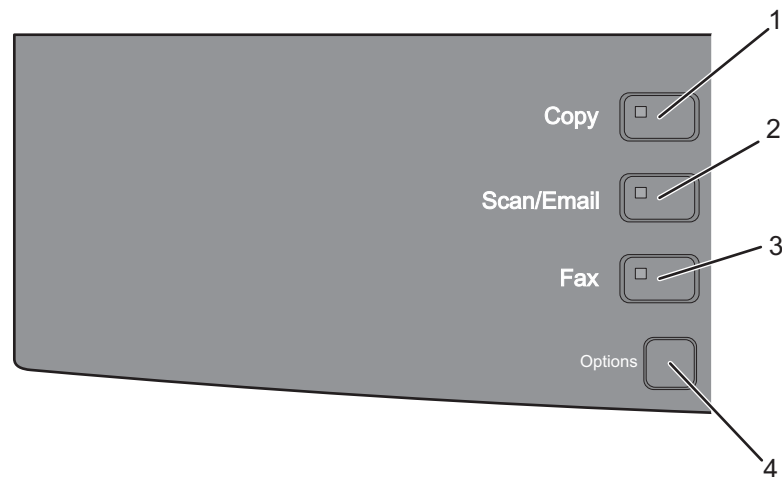

This section of the operator panel is used to select the MFP function for a job

1. Copy - Activate the copy function to copy a document on the flatbed or ADF (X204 only).
2. Scan / Email - Activate the scan / Email function.
3. Fax - Activate the fax function. Fax is not available on all models.
4. Options - Temporarily change size, paper source, and scale for a job.

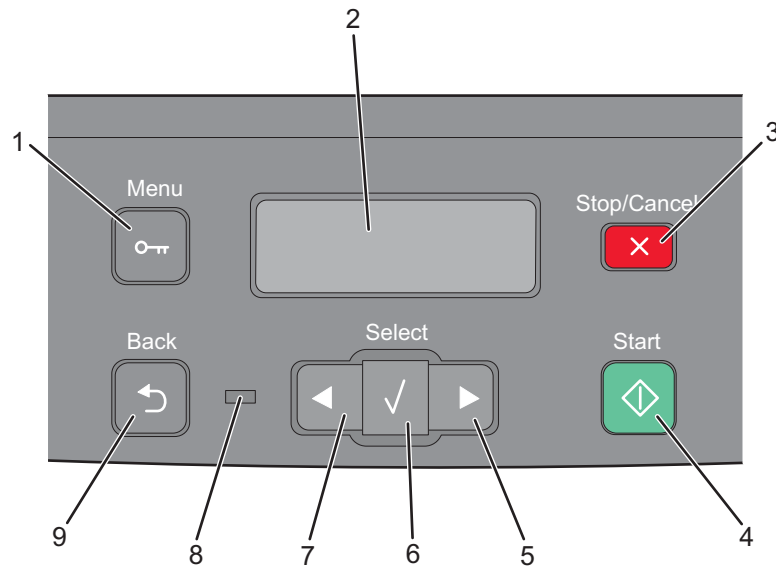

Display / Main control

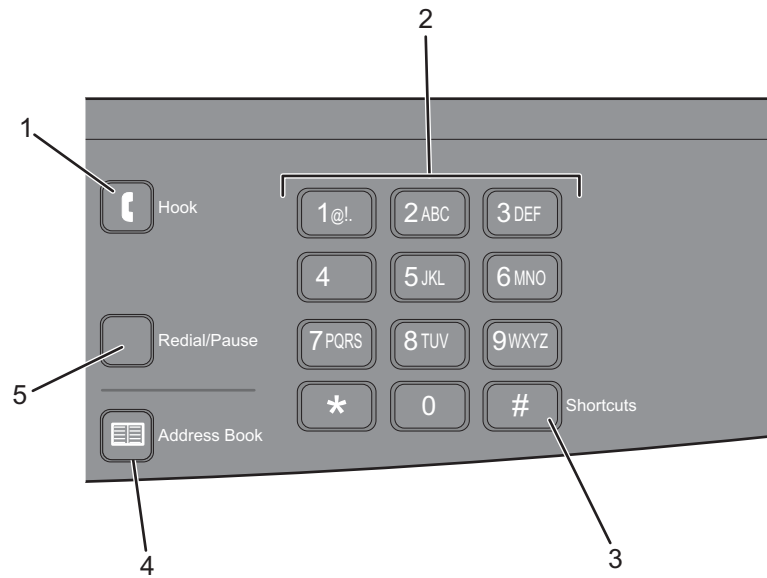

1. Menu - Enters the administration menu
2. Display - View scan, copy, fax and print options, and view status and error messages.
3. Stop/Cancel - Stops print, scan ,and fax jobs. Exits a menu and returns to **Ready**.
4. Start - Start a copy, scan, or fax job.
5. Right arrow - Scroll right
6. Select - Accepts menu selections and setting's
7. Left arrow - Scrolls left
8. Indicator light:
 - a. Off - the power is off
 - b. Blinking green - The printer is warming up, processing data, or printing.
 - c. Solid green - The printer is on, but idle.
 - d. Blinking red - Operator intervention is needed
9. Back - Returns to the previous menu

Keypad area



1. Hook - Press  to take the line off-hook when faxing. Press  a second time to hang up the line.
2. Keypad - Enter numbers, letters, or symbols on the display
3. Shortcuts - Enters the shortcut screen
4. Address Book - Access the stored phone numbers.
5. Redial/Pause - self explanatory.

MFP Menus

The diagram shows the menu index on the operator panel and the menus and items available under each menu. Not all menus or selections will be available in all situations. These are accessed through the driver.

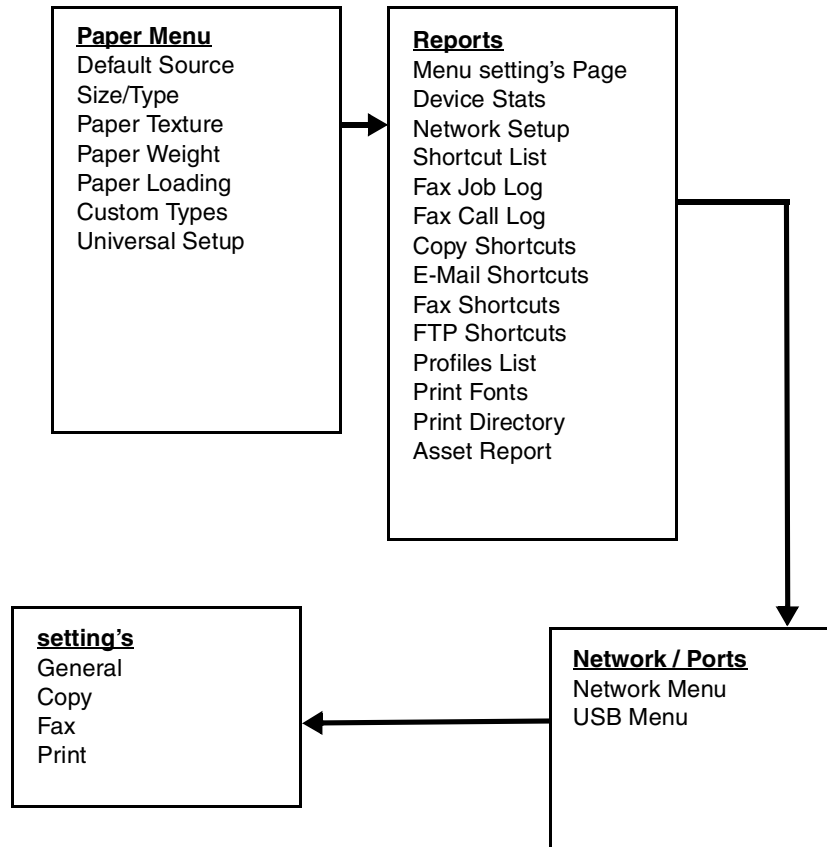

Messages and error codes

Service error codes

Service error codes are generally non-recoverable except in an intermittent condition when you can POR the MFP to temporarily recover from the error condition.

Error	Description	Action
8XX Scanner service errors		
840.01 Scanner disabled	The scanner is disabled and can't be used.	Enter the configuration menu, and re-enable the scanner module. See "840.xx service check" on page 2-41
840.02 Scanner auto disabled	The scanner is disabled and can't be used.	This message is posted when the MFP PORs. Enter the configuration menu, and re-enable the scanner module. See "840.xx service check" on page 2-41
841.00	Image Pipeline	Image pipeline ASIC. See "Flatbed service check" on page 2-24.
841.01	Service image processing unit: AFE register mismatch	
841.02		
841.03	Service image processing unit: SCNCHN DMA	
841.04	Service image processing unit: new line too soon interrupt	
841.07	Service image processing unit: tonal data overrun	
841.09	Service image processing unit: image processing too slow	
841.96	System time out: SIZAR out of band interrupt	
841.97	Service image processing unit: output data uncollected	
841.98	Service image processing unit: SCNCHN DMA underrun	
841.99	Service image processing unit interrupt handler delayed crash	
842	Scanner Failure. Communication failure	
843	Scanner Failure: carriage failed to home or move to desired position	
843.01	Scanner Failure	ADF mechanical failure. Go to "ADF service check" on page 2-23
843.02	Scanner Failure	General mechanical failure. Go to "ADF service check" on page 2-23
843.03	Scanner Failure	Pick Roller engage failure. Go to "ADF service check" on page 2-23
843.04	Scanner Failure	Pick roller disengage failure. Go to "ADF service check" on page 2-23

Error	Description	Action
844.yy	Scanner Failure	Lamp failure. See “Flatbed service check” on page 2-24.
844	Front scan module output level error	See “Flatbed service check” on page 2-24
844.01	Rear scan module output level error	
844.02	Front scan module lamp level too low	Front Mono channel, Front Color channels, Front Red channel, Front Green channel, and/or Front Blue channel is detected to have low lamp level. See “Flatbed service check” on page 2-24
844.03	Rear scan module lamp level too low	Rear Mono channel, Rear Color channels, Rear Red channel, Rear Green channel, and/or Rear Blue channel is detected to have low lamp level. See “Flatbed service check” on page 2-24
845.yy	Scanner Failure	CIS failure See “Flatbed service check” on page 2-24
845	Front scan module cable failure or SCC card failure	CIS channel failure. Check each channel(mono, R, G, B) for identical values indicating bad cable and/or SCC card. Excessive noise test for the dark data indicating some sort of CIS or analog electronics issue on that channel or channels. See “Flatbed service check” on page 2-24
845.01	Rear scan module cable failure or SCC card failure	CIS channel failure. Check each channel(mono, R, G, B) for identical values indicating bad cable and/or SCC card. Excessive noise test for the dark data indicating some sort of CIS or analog electronics issue on that channel or channels. See “Flatbed service check” on page 2-24
845.02	Cable / SCC Failure	Front scan module connector or cable failure See “Flatbed service check” on page 2-24
845.03	Cable / SCC Failure	Rear scan module connector or cable failure See “Flatbed service check” on page 2-24
845.04	Cable Failure	The connector cable is defective. See “Flatbed service check” on page 2-24.
846.07	Front magnification exceeds limits	Rear excessive variability for Mono, Red, Green, or Blue. See “Flatbed service check” on page 2-24
847	Modem Failure	The Configuration ID bit that describes the device’s modem doesn’t match the actual modem installed in the device.
847.01	Fax Storage	The amount of flash storage available on the device is too small. Note: The NAND Flash partition can shrink as bit failures cause blocks to be invalidated. Go to “Format Fax Storage” on page 3-34. If the issue is not fixed, replace the controller board. Go to “Controller board removal” on page 4-16.

Error	Description	Action
847.02	Fax Storage	The devices' flash partition is invalid or unavailable. Go to "Format Fax Storage" on page 3-34 . If the issue is not fixed, replace the controller board. Go to "Controller board removal" on page 4-16 .
848.01	Modem/Config ID Mismatch	A device has a modem installed, but its Configuration ID indicates that a modem shouldn't be present.
Engine software service errors		
902.xx	Engine software error	Unrecoverable engine software error. Rest the MFP (POR). If the problem reoccurs, replace the controller board. See "Controller card service check" on page 2-25
903.xx	Paperport link driver error	
904.xx	Interface violation by RIP	
905.xx	Interface violation by paperport device	
906.xx	RIP interface drive error	
DC pick motor errors		
910.xx	DC pick motor stall	Verify the motor is properly connected to the controller card.
911.xx	DC pick motor excessive PWM	
912.xx	DC pick motor below speed	
913.xx	DC pick motor over speed	
914.00	DC pick motor error	
914.01	Lost encoder feedback	
Transfer service errors		
917.xx	Transfer service error	Replace the transfer roll. See "Transfer roll service check" on page 2-44 .
Fuser service errors		
920.00	Under temperature during steady state control.	Replace the fuser. See "Fuser service check" on page 2-27 .
921.00	Under temperature during standby control.	
922.00	Fuser failed to ramp to target temperature	
923.00	Fuser is over temperature.	
924.00	Open thermistor check.	
925.xx	Wrong fuser installed. The fuser type stored in the cartridge ID does not match the actual fuser installed in the printer.	
Fan service errors		
927.00	Service fan error	Replace the fan. See "Cooling fan service check" on page 2-24 .
Printhead service errors		

Error	Description	Action
930.xx	Wrong printhead installed	Replace the printhead. See “Printhead service check” on page 2-32.
931.xx	No first hsync	
932.xx	Lost hsyncs	
933.xx	Mirror motor locked: No hsync received	
935.xx	Motor unable to reach operating speed	
Transport motor service errors		
936.xx	Transport motor initial lock failure	Replace the main motor gear drive. See “Main motor service check” on page 2-29
937.00	Main transport motor lost lock	Replace the main motor gear drive. See “Main motor service check” on page 2-29
Power supply service errors		
940.00	LVPS service error	Replace the LVPS/HVPS. See “Hot fuser service check” on page 2-28.
Controller board and operator panel service errors		
948.xx	Failed controller board	Replace the controller board. See “Controller card service check” on page 2-25.
949.xx		
950.xx	Mismatch between EEPROM and mirror memory Note: A new controller board or operator panel has been installed, and has not been properly prepared for this use. Install a new note. Do not install both the controller board and the operator panel at the same time without a POR in between.	Install a new controller board or operator panel. See “Controller card service check” on page 2-25 or “Operator panel service check” on page 2-31.
955.xx	The code ROM or NAND flash failed the Cyclic Redundancy Check or the NAND experienced an uncorrectible multi-bit failure.	Replace the controller board. See “Controller card service check” on page 2-25.
956.00	RIP card failure: processor failure	
956.01	Processor overtemp	
957.xx	RIP card failure: ASIC failure	
958.xx	Printer has performed more than 100 “shift and reflash” operations as a result of ECC bit corrections	
Firmware or controller board errors		
959.02	Failure to authenticate Signature Verification Code	Call the next level of support to update the firmware, or replace the controller board. See “Controller card service check” on page 2-25.
959.03	Signature Verification Code failed to authenticate a code partition.	Update firmware and call the next level of support, or replace the controller board. See “Controller card service check” on page 2-25.
959.04	Jump to unverified address	
959.05	Unknown boot failure	Update firmware and call the next level of support, or replace the controller board. See “Controller card service check” on page 2-25

Error	Description	Action
959.20	Hardware failure	Replace the controller board. See “Controller card service check” on page 2-25.
959.21	Controller did not respond to command request.	
959.23	Self test failed during initialization.	Replace the controller board. See “Controller card service check” on page 2-25.
959.24	EEPROM retention error	
959.25	Insufficient device space during HW prog	
959.26	Incremental counter reset exceeds maximum value	
959.27	Increment count failed due to max value limit	
959.28	Invalid SP memory configuration	
Memory and emulation errors		
960.xx	RAM memory error: RAM soldered on the controller board is bad	Replace the controller board. See “Controller card service check” on page 2-25.
964.xx	Download Emulation Cyclic Redundancy Check Error: checksum failure detected in the emulation header or emulation file.	Disable the Download Emulation. Program the download emulation into the firmware card again. If this does not resolve the problem, then replace the firmware card and download the emulation again.
Network errors		
975.xx	Unrecognizable network	Call the next level of support.
976.xx	Unrecoverable software error in network port	
978.xx	Bad checksum while programming network port	
979.xx	Flash parts failed while programing network port	
Other errors		
980.xx	Engine experiencing unreliable communication with the specified device	Call the next level of support.
981.xx	Engine protocol violation detected by the specified device	
982.xx	Communications error detected by the specified device	
983.xx	Invalid command received by the specified device	
984.xx	Invalid command parameter received by the specified device	Call the next level of support.
990.xx	An equipment check condition has occurred in the specified device, but the device is unable to identify the exact component failure.	
991.xx	The specified device has detected an equipment check in its system card.	

Fax error codes**Fax error log codes**

Error code	Description	Action
000	No error occurred during fax transmission	No action needed
200	Error occurred when transmitting training.	<ul style="list-style-type: none"> • Check line quality. • Select a lower 'Max Speed' value under Fax Send setting's • Adjust the transmit level.
3XX	Error occurred when receiving image data.	<ul style="list-style-type: none"> • Check line quality. • Adjust 'Receive Threshold'. • Select a lower 'Max Speed' value under Fax Receive setting's.
4XX	Error occurred when sending image data.	<ul style="list-style-type: none"> • Check line quality. • Adjust 'Transmit Level'. • Select a lower 'Max Speed' value under Fax Receive setting's.
5XX	Received unknown response from remote fax device.	No action needed. Issue is with the other device.
6XX	Error occurred when receiving a frame.	<ul style="list-style-type: none"> • Check line quality. • Adjust 'Receive Threshold'.
7XX	Error occurred when sending a frame.	<ul style="list-style-type: none"> • Check line quality. • Adjust 'Transmit Level'. • Select a lower 'Max Speed' value under Fax Send setting's.
800	Received EOT unexpectedly from the modem in V34 mode.	<ul style="list-style-type: none"> • If error persists disable V34 modulation scheme.
802	Too many timeouts occurred during ECM reception.	<ul style="list-style-type: none"> • If error persists disable ECM mode.
803	Fax canceled by user	No action needed.
804	Unexpectedly received a disconnect command from the remote end.	<ul style="list-style-type: none"> • Check line quality. • Adjust Transmit Level/Receive Threshold values. • Remote device could be requesting an unsupported feature.
805	Remote fax device failed to respond to the DCS command.	<ul style="list-style-type: none"> • Adjust Transmit Level/Receive Threshold values. • Remote device could be malfunctioning.
808	T1 timeout occurred when trying to establish a connection with a remote fax device.	<ul style="list-style-type: none"> • Adjust Transmit Level/Receive Threshold values.
809	T2 Timeout occurred due to loss of command/response synchronization.	<ul style="list-style-type: none"> • Adjust Transmit Level/Receive Threshold values.
80A	T5 Timeout occurred when transmitting image data to remote fax device.	<ul style="list-style-type: none"> • Check line quality. • Adjust 'Transmit Level'. • Select a lower 'Max Speed' value under Fax Send setting's.

Fax error log codes (Continued)

Error code	Description	Action
80B	Too many errors when transmitting in ECM mode.	<ul style="list-style-type: none"> • Check line quality. • Adjust 'Transmit Level'. • Select a lower 'Max Speed' value under Fax Send setting's.
80C	Remote device failed to respond to the CTC command.	<ul style="list-style-type: none"> • Select a lower 'Max Speed' value under Fax Send setting's. • Adjust 'Transmit Level'.
80D	Received too many requests from remote end to repeat the previous command sent.	<ul style="list-style-type: none"> • Check line quality. • Adjust 'Transmit Level'. • Check if line conditions on remote end will facilitate a good connection.
80E	Functional limitation- Remote fax device does not support G3 receive capability.	No action needed. Issue with the remote device.
811	Failed to detect a fax device at the remote end.	<ul style="list-style-type: none"> • Verify MFD is answering to fax call and not a voice call. • Decrease value of 'Rings To Answer' setting.
812	No more data rates available in V34 modulation scheme.	<ul style="list-style-type: none"> • Adjust to a lower modulation scheme.
813	Timeout occurred after waiting too long to receive a good frame.	<ul style="list-style-type: none"> • Adjust "Receive Threshold".
814	Tried too many times at selected speed using V34 modulation scheme.	<ul style="list-style-type: none"> • Adjust 'Transmit Level'. • Adjust to a lower modulation scheme.
815	Fax transmission was interrupted due to power failure.	<ul style="list-style-type: none"> • Troubleshoot MFP if error persists. See "Modem service check" on page 2-29.
818	Fax transmission failed due to insufficient memory to store scanned image.	Adjust 'Memory Use' setting to allocate more memory for send jobs.
819	Fax transmission failed due to insufficient memory to store received image.	Adjust 'Memory Use' setting to allocate more memory for receive jobs.
81A	A timeout occurred during transmission of a page in ECM mode.	Select a lower 'Max Speed' value under Fax Send setting's.
880	Failure to transmit training successfully in V17, V29, V27 terminal modulation schemes.	<ul style="list-style-type: none"> • Select a lower "Max Speed" under Fax Send setting's. • Adjust the "Transmit Level". • Check line quality.
882	Failure to transmit training successfully in V17, V29 terminal modulation schemes.	<ul style="list-style-type: none"> • Select a lower "Max Speed" under Fax Send setting's. • Adjust the "Transmit Level". • Check line quality.
883	Failure to transmit training successfully in V17,V27 terminal modulation schemes.	<ul style="list-style-type: none"> • Select a lower "Max Speed" under Fax Send setting's. • Adjust the "Transmit Level". • Check line quality.

Fax error log codes (Continued)

Error code	Description	Action
884	Failure to transmit training successfully in V29, V27 terminal modulation schemes.	<ul style="list-style-type: none"> • Select a lower “Max Speed” under Fax Send setting’s. • Adjust the “Transmit Level”. • Check line quality.
885	Failure to transmit training successfully in V17 terminal modulation scheme.	<ul style="list-style-type: none"> • Select a lower “Max Speed” under Fax Send setting’s. • Adjust the “Transmit Level”. • Check line quality.
886	Failure to transmit training successfully in V29 terminal modulation scheme.	<ul style="list-style-type: none"> • Select a lower “Max Speed” under Fax Send setting’s. • Adjust the “Transmit Level”. • Check line quality.
887	Failure to transmit training successfully in V27 terminal modulation scheme.	<ul style="list-style-type: none"> • Select a lower “Max Speed” under Fax Send setting’s. • Adjust the “Transmit Level”. • Check line quality.
888	Failure to transmit training successfully at 2400 bps in V27 terminal modulation scheme.	<ul style="list-style-type: none"> • Adjust “Transmit Level”. • Check line quality.
889	Failed to connect at the minimum speed supported by the MFP.	<ul style="list-style-type: none"> • Adjust “Transmit Level”. • Incompatible connection.
88A	Failed to connect using V.34 modulation scheme.	<ul style="list-style-type: none"> • Check line quality. • Adjust to a lower modulation scheme. • Adjust Transmit Level Receive Threshold values.
901	No fax tones detected from remote end.	<ul style="list-style-type: none"> • Verify destination phone number. • Verify that the remote fax is authorized to receive faxes.
902	No dial tone detected.	<ul style="list-style-type: none"> • Check by enabling ‘Behind a PABX’ setting. • Check phone line. • Check MFD modem hardware.
903	Busy tone detected.	Check with remote end if successive attempts fail.
904	Hardware error detected.	See “Modem service check” on page 2-29.
905	A timeout occurred after dialing the number and waiting for a response.	Check with remote end if successive attempts fail.
906	Fax canceled by user.	No action needed.
907	Modem detected a digital line connection.	Verify the MFP is connected to an analog line. See “Fax transmission service check” on page 2-44.
908	Phone line was disconnected	Restore phone line connection.
A00	Received request for unsupported function from remote fax device.	No action needed.

Fax error log codes (Continued)

Error code	Description	Action
A01	Received request for unsupported image width from remote fax device.	No action needed.
A02	Received request for unsupported image resolution from remote fax device.	No action needed.
A03	Received request for unsupported compression type from remote fax device.	No action needed.
A04	Received request for unsupported image length from remote fax device.	No action needed.
F00	Unknown error occurred.	No action needed.

Paper jam messages

Repeating jams or jam messages can be caused by any of the following:

- Faulty pick solenoids or worn cams of the solenoids
- Faulty flags or springs
- Worn backup rollers at the reference guide
- Improperly adjusted reference guide
- Debris in the paper path
- Paper not of the specified length

Note: For more information, see **“Paperpath sensor service check” on page 2-32.**

Paper jam messages

Message	Explanation
200 Paper Jam Remove Cartridge	The input sensor under print cartridge is covered too long or is covered during POR or when START is pressed after clearing a different jam or problem. The exit sensor could also be covered. Remove the print cartridge and open the rear door to remove the media. If the message is displayed after the paper is removed, the MPF sensor or controller card might be faulty.
201 Paper Jam Remove Cartridge	Paper is jammed between the MFP input and exit sensor. Remove the print cartridge to clear the paper path. If the message is displayed after the paper is removed, the input sensor or controller card might be faulty. If there are excessive 201.02 paper jams replace the autocompensator clutch. See “Input roller clutch and lever removal (autocompensator clutch)” on page 4-24.
202 Paper Jam Open Rear Door	The exit sensor is either covered during POR or covered too long. Open the rear door to access the jam area. If the message is displayed after the paper is removed, the exit sensor or controller card might be faulty. Ensure that the rear door to the printer is properly closed.
241 Paper Jam Check Tray 1	Paper is jammed between Tray 1 and the input sensor.
242 Paper Jam Check Tray 2	Tray 2 pass thru sensor is covered during warm-up. Try opening Tray 2. If the tray is difficult to remove, then you may have to remove the tray above or below the tray to remove the jammed pages.
251 Paper Jam Check Manual Feeder	Sensor at the manual feeder indicates paper is stuck in the path. Remove the paper, and check the flag/sensor.
290 Scanner Jam Remove Originals	Paper in the ADF is covering the paper present sensor. See “ADF service check” on page 2-23.
291 Scanner Jam	Paper in the ADF is covering the paper present and paper path sensors. See “ADF service check” on page 2-23.
292 Scanner Jam	Paper in the ADF is covering the paper path sensor. See “ADF service check” on page 2-23.

User attendance messages

The printer control panel displays messages describing the current state of the printer and indicates possible printer problems that must be resolved. This topic provides a list of all printer messages, explains what they mean, and tells how to clear the messages.

The following table lists the messages in alphanumerical order. A message can also be located using the index.









User status and attendance messages

User primary message	Explanation
Close Door	Message clears when upper and lower doors are closed.
Insert Tray <x>	<p>This message is displayed when the printer requests the user to insert tray x before it can continue printing the job. The printer needs to pick media from the missing tray or the trays below it.</p> <p>Tray x=Tray 1</p> <p>Note: This message displays when refilling the trays during a job. Before filling tray a tray, take the printer offline by pressing Stop , and wait for pages to stop feeding into the output bin.</p> <p>The following actions can be taken:</p> <ul style="list-style-type: none"> • Insert the requested tray. • Cancel the current job
No Analog Phone Line	An analog line is not detected as being plugged into the modem. If the device is in Analog mode, this has a source of Fax.
Memory Full, cannot send faxes	After a start, there is no memory to do the fax job. Attempted fax is canceled.
Fax Station Name not set up	Setup fax name. See the user guide for more information.
Fax Station number not set up.	Setup fax number. See the user guide for more information.
Insert Duplex Page in Tray <x>	Reload printed page in tray <x>. Cancel Job appears if the job can be canceled.
Install Tray <x> or Cancel job	Printer detects that tray <x> is missing, where x is 1 or 2. This message appears if the job was begun, but the paper has not yet been retrieved. The tray is no longer detected. Replace the indicated tray.
Load <source> <custom string>	<p>Printer does not detect media meeting the description <custom string> in <source>, where <source> is Tray 1, Multi-Page Feeder (MP feeder), or Envelope Feeder.</p> <ul style="list-style-type: none"> • Load the input source with the correct type and size media. • Cancel the current job.
Load <source> <custom type>	<p>Printer does not detect media meeting the description <custom type> in <source>, where <source> is Tray 1 .</p> <ul style="list-style-type: none"> • Load the input source with the correct type and size media. • Cancel the current job.
Load <source> <size>	<p>Printer does not detect media meeting the size requested in the source indicated.</p> <ul style="list-style-type: none"> • Load the input source with the correct type and size media. • Cancel the current job.
Load <source> <type> <size>	<p>Printer does not detect media meeting the size or type requested in the source indicated.</p> <ul style="list-style-type: none"> • Load the input source with the correct type and size media. • Cancel the current job.



User status and attendance messages (Continued)

User primary message	Explanation
Load Manual <custom type>	Printer does not detect media meeting the description <custom type> in the single sheet feeder (manual feeder). The following actions can be taken: <ul style="list-style-type: none"> • Load paper, and the job continues. • press Select (<input type="checkbox"/>), and choose an alternate source for media. • Cancel the current job.
Load Manual <custom string>	Printer does not detect media meeting the description <custom string> in the single sheet feeder (manual feeder). The following actions can be taken: <ul style="list-style-type: none"> • Load paper and the job continues. • press Select (<input type="checkbox"/>), and choose an alternate source for media. • Cancel the current job.
Load Manual <size>	Printer does not detect media meeting the description <size> in the single sheet feeder (manual feeder). The following actions can be taken: <ul style="list-style-type: none"> • Load paper and the job continues. • press Select (<input type="checkbox"/>), and choose an alternate source for media. • Cancel the current job.
Load Manual <type> <size>	Printer does not detect media meeting the description <type> and <size> in the single sheet feeder (manual feeder). The following actions can be taken: <ul style="list-style-type: none"> • Load paper and the job continues. • press Select (<input type="checkbox"/>), and choose an alternate source for media. • Cancel the current job.
PJL OP Message	
PJL Seed Message	
PJL ST Message	Try one or more of the following: <ul style="list-style-type: none"> • press Select (<input type="checkbox"/>) to clear the message, and continue printing. • Wait for the message to clear.
Remove Paper ADF	This posts when there is paper detected in the ADF upon POR or when the cover is closed (or any other situation that re-initiates the scanner). Message clears when paper is removed.
Remove Paper Standard Bin	The standard output bin is full or nearly full. Remove the media from the bin.
30 Invalid Refill Change Cartridge	Refilled cartridge detected.
31 Defective or Missing Cartridge	This message is displayed when a defective print cartridge is detected. Replace the toner cartridge.
32 Unsupported Toner Cartridge	This message is displayed when an unsupported print cartridge is installed. Replace the toner cartridge.
34 Short Paper	<ul style="list-style-type: none"> • press Select (<input type="checkbox"/>) to clear the message and continue printing. The printer does not automatically reprint the page that prompted the message. • Check tray length and width guides to ensure paper is properly fitted in the tray. • Make sure the print job is requesting the correct size of paper. • Adjust the Paper Size setting for the size paper you are using. If MP Feeder Size is set to Universal, make sure the paper is large enough for the formatted data. • Cancel the current job.

User status and attendance messages (Continued)

User primary message	Explanation
37 Insufficient Collation Area	<p>This message is displayed when the printer memory used to store pages is too full to collate the print job.</p> <p>The following actions can be taken:</p> <ul style="list-style-type: none"> • press Select () to print the portion of the job already stored, and begin collating the rest of the job. • press Menus () to access the Busy/Waiting Menu. <p>The following functions are available.</p> <ul style="list-style-type: none"> - Cancel Job <p>Note: Menu Lockout does NOT prevent access to the Busy/Waiting Menu.</p>
38 Memory Full	<p>This message is displayed when the printer is processing an incoming job and there is not enough memory available to continue processing the job.</p> <p>The following actions can be taken:</p> <ul style="list-style-type: none"> • Determine how to make more memory available to your print job by: <ul style="list-style-type: none"> - Deleting fonts, macros and other data in RAM. - Simplify your print job. - Install additional memory • press Select () to clear the message and continue printing. <p>The job may not print correctly.</p> • press Menus () to access the Busy/Waiting Menu. <p>The following functions may be available:</p> <ul style="list-style-type: none"> - Cancel Job
39 Complex Page	<p>This message is displayed when a page is too complex to print.</p> <p>The following actions can be taken:</p> <ul style="list-style-type: none"> • press Select () to clear the message and continue printing. <p>The job may not print correctly.</p> • Simplify the print job. • press Menus () to access the Busy/Waiting Menu. <p>The following functions may be available:</p> <ul style="list-style-type: none"> - Cancel Job - Reset Printer <p>Note: Menu Lockout does NOT prevent access to the Busy/Waiting Menu.</p>
54 Standard Network Software Error	<p>This message is displayed when the RIP software detects that a network port is installed but cannot establish communications with it.</p> <ul style="list-style-type: none"> • press Select () to clear the message and continue printing. <p>The job may not print correctly.</p> • Program new firmware for the network interface. • Turn the printer power off and then back on to reset the printer.
54 Network <x> Software Error	<p>The printer disables all communications to the associated network interface. No data may be received or sent from or to the associated interface. The user can program new firmware in the network using the parallel port after this message clears.</p> <ul style="list-style-type: none"> • press Select () to clear the message and continue printing. <p>The job may not print correctly.</p> • Program new firmware for the network interface. • Turn the printer power off and then back on to reset the printer.

User status and attendance messages (Continued)

User primary message	Explanation
56 Standard USB Port Disabled	<p>This message may appear when data is sent to the printer across a USB port, but the port is disabled.</p> <p>Note: Once the error is displayed the first time, reporting of further errors is suppressed until the printer is reset or menus are entered.</p> <p>The following actions can be taken:</p> <ul style="list-style-type: none"> • press Select () to clear the message. Any data received on the USB port is discarded. • press Menus () to access the Busy/Waiting Menu. The following functions may be available: <ul style="list-style-type: none"> - Turn the printer power off and then back on to reset the printer. - Reset Active Bin - Check Supply Levels <p>Make sure the USB Buffer menu item is not set to Disabled. (press Menus  to access the Administrative Menus, select Network/Ports, USB Menu, and USB Buffer.)</p>
84 PC Kit Life Warning	Replace the PC kit to ensure print quality.
84 Replace PC Kit	
88 Cartridge Low	This warning is displayed when the cartridge is low. Press Check to continue.
Scan job too long	<p>The scan job exceeds the maximum number of pages</p> <ul style="list-style-type: none"> • Break the scan job into multiple small jobs. • Cancel the scan job.

Service checks



Service checks which involve measuring voltages on the LVPS/HVPS (low voltage power supply/ high voltage power supply board) should be performed with the MFP positioned on its back side.

Note: When you make voltage readings, always use frame ground unless another ground is specified. See the wiring diagram in the back of the book for more information.

ADF service check

FRU	Action
ADF	<p>Ensure that the proper paper size is being used in the ADF.</p> <p>Are the paper guides on the ADF tray properly adjusted?</p> <p>Inspect the ADF separator roll and ADF separator pad for wear. If they are worn, replace them. If they are dirty or have a buildup on them, clean them with a damp cloth.</p> <p>If the ADF fails to pick check to make sure that the paper height in the ADF input tray is beneath the height marker on the ADF paper guides.</p> <p>Inspect the paper present sensor on the ADF.</p> <ul style="list-style-type: none"> • Perform the paper present and scan first sensor tests. See “Sensor Test” on page 3-12 • Check the flags on the sensor. Are they able to move freely? If the sensor flags are damaged, replace the ADF assembly.
ADF cable	<p>Make sure the ADF cable is securely connected to the ADF and the controller card.</p>
Controller card	<p>If the cable is properly connected, perform the following checks:</p> <ul style="list-style-type: none"> • Check the ADF cable for continuity. • Check pin 1 on controller card connector J2 for +5V. • Pin 3 should be ground. <p>If voltages are present, replace the ADF.</p> <p>If replacing the ADF does not fix the problem, replace the controller card.</p>
ADF pick pad	<p>If the ADF is multi feeding, check the ADF pick roller and pad for dirt. Remove them from the MFP, and clean them with a lint free cloth and isopropyl alcohol.</p> <p>If the leading edge of the paper is damaged, instruct the user to lessen the number of documents being copied from the ADF at one time.</p>
ADF separator roller	<p>If there are excessive misfeeds from the ADF, verify the the ADF paper tray and extender are properly installed.</p>
ADF paper tray and extender. ADF cover	<p>Skews and jams at the ADF paper present sensor might be caused by an improperly closed ADF cover. Ensure the ADF cover is closed properly.</p>

Flatbed service check

FRU	Action
Flatbed  Controller card	<p>Ensure that connectors J15, J1, and J5 are properly connected. Inspect the ribbon cable connection on CIS for proper connection.</p> <p>If connector J15 is properly connected, verify the following voltages on the controller card. Check pin 9 for +3.3V, pins 11, 13, and 15 for +5V. Pins 3, 6, and 8 are ground.</p> <p>If connector J1 is properly connected, verify the following voltages on the controller card. Check pin 19 for +12V and pin 20 for +5V.</p> <p>If voltages are present, replace the flatbed FRU. If there are voltage irregularities, replace the controller card.</p>

Cold fuser service check

Make sure the correct voltage lamp is installed. The voltage rating is stamped on one of the lamp contacts.

FRU	Action
 Fuser AC cables LVPS/HVPS Fuser	<p>If the fuser lamp comes on and a fuser failure light error code displays, be sure the thermistor is contacting the hot roll and the thermistor cable is firmly seated in connector J15 on the controller card.</p> <p>Check for excessive toner buildup on the surface of the thermistor. Clean as necessary.</p> <p>With the MFP unplugged, disconnect the thermistor cable from J10 on the controller card.</p> <p>Measure the resistance of the thermistor. The resistance measures from approximately 1K ohms immediately after printing or POR to approximately 240K ohms when thermistor reaches room temperature. (It may take 30 minutes to cool.)</p> <p>Replace the fuser assembly as necessary.</p>

Cooling fan service check

FRU	Action
Cooling fan	<p>Make sure the fan cable plug is properly seated at J19 (controller card).</p> <p>Turn the MFP off, and disconnect the cooling fan cable from connector J9 on the controller card.</p> <p>Turn the MFP on. Within a few seconds, the controller card assembly should apply between +24 V dc to pin 2. See “Controller card” on page 5-4 for more information.</p> <p>If voltage is present and the fan is not turning, replace the cooling fan. If the fan still doesn't function, replace the controller card.</p> <p>Note: The fan speed is controlled by a module on the controller card. Between +8 V and +24 V dc are constantly supplied at pin 2 (J19). Pin 1 is ground while pin 3 receives feedback from the fan motor.</p> <p>If voltage is not present, see “Controller card” on page 5-4 for more information.</p>

Controller card service check

FRU	Action
Controller card assembly	<p>Verify +24 V dc input from the LVPS/HVPS.</p> <ul style="list-style-type: none"> • Turn the MFP off. • Disconnect the LVPS/HVPS cable from the controller card at J22. See “Controller card” on page 5-4 for more information. • Turn the MFP on. <p>Verify +24 V dc from the cable connector of J22, pins 8 and 9.</p> <p>Verify that pins 7, 12, and 14 on both the cable and the card connectors are ground.</p> <ul style="list-style-type: none"> • If voltage is correct, check the continuity in the cable. If the cable is good, see the “Controller card” on page 5-4 for more information. • If grounds are not correct on the cable, first check it for continuity and then check the LVPS/HVPS. See “LVPS/HVPS service check” on page 2-28 • If the grounds are not correct on the controller card, replace the controller card. (Check with one probe on the connector pin and the other on the ground plane of the card found at each screw head.) <p>Note: With all cables connected, the MFP should complete POST within approximately 12–15 seconds in the following sequence:</p> <ol style="list-style-type: none"> 1. The function and scan quality LEDs illuminate for one second and then flash three times. 2. Loading is displayed on the operator panel. 3. The CIS illuminates, and the scanner performs a calibration. 4. The drive motor runs. 5. The scanner CIS returns to the home position. 6. Error messages are displayed if applicable. 7. The MFP cycles down into standby mode/ready. Ready is displayed on the operator panel. <p>If immediately following power-on, the operator panel lights are active but the MFP does not go through steps 1 and 2 above, replace the controller card assembly.</p>

Cover interlock switch service check

Note: Make sure a print cartridge assembly is installed and the cover closes all the way, engaging the cover open switch lever.

FRU	Action
Cover interlock switch	<p>Check the cover interlock cable to make sure it is not plugged into J9, and that the cooling fan cable is not plugged into J11. If they are, switch plug them into their correct connectors.</p> <p>Disconnect the cover interlock cable from the controller card at J11.</p> <p>Verify continuity between cable pin 1 and pin 2 with the door closed but not open.</p> <p>Verify continuity between cable pin 1 and pin 3 with the door open but not closed.</p> <ul style="list-style-type: none"> • If either fail continuity, replace the cover interlock switch. • If both pass continuity, turn the MFP on and verify +5 V dc on pin 2 at J11 on the controller card. • Verify pins 1 and 3 are ground. • If voltage or ground is not present, see “Controller card service check” on page 2-25 for more information. <p>Verify discontinuity between pins 2 and 3 whether the door is open or closed.</p> <p>Replace the cover interlock switch if faulty.</p>

Dead machine service check



CAUTION Check the AC line voltage. The voltage should be within the following limits:

- 100 V ac (volts alternating current) – 127 V ac for the 110 V MFP
- 200 V ac – 240 V ac for the 220 V MFP

FRU	Action
 LVPS/HVPS	<p>Unplug the MFP, and check the fuses on the LVPS/HVPS board for continuity.</p> <ul style="list-style-type: none"> • If open, replace the LVPS/HVPS board. <ul style="list-style-type: none"> - If fuse opens again, see “LVPS/HVPS service check” on page 2-28 for more information. • If not open, unplug the cables at CN102 and CN201 (fuser and controller card respectively). <p>Plug LVPS/HVPS board to source, and turn switch on.</p> <p>Verify 24 V dc on pins 8 and 9 at connector CN201.</p> <p>Verify line voltage (110 or 220 V ac) across pins 1 and 2 of CN102.</p> <ul style="list-style-type: none"> • If either voltage is not correct, replace the LVPS/HVPS board. • If both voltages are correct, check the controller card. See “Controller card service check” on page 2-25 for more information. <p>Verify grounds.</p>

Fuser service check

When toner is partially fused to the paper, it is usually caused by low fuser temperature.

Note: Improper fusing can result from incorrect media setting's in the driver, or on the MFP. Check those setting's before servicing the fuser.

Note: Make sure the correct voltage fuser is being used on the MFP.

Warning: Avoid handling the lamp as much as possible, as it is easily broken. Be careful not to touch the glass housing with bare hands, because skin acids can weaken the glass. The lamp is not a service part.

The line voltage to the MFP must be within the following limits:

- 100 V ac–127 V ac for the 110 V model MFP
- 200 V ac–240 V ac for the 220 V model MFP

Turn the MFP off, and wait a few minutes for the fuser lamp to cool. Turn the MFP on, and observe the lamp turning on during POST.



You can see the light from the lamp by opening the left side cover and observing the upper opening through which the fuser power cables pass.

Fuser service check (continued)

FRU	Action
 <p>Lamp cable LVPS/HVPS Fuser</p>	<p>Unplug the MFP and disconnect the fuser lamp cable plug from the LVPS/HVPS board connector CN102.</p> <p>Check for continuity across the fuser lamp by checking across the connector pins.</p> <ul style="list-style-type: none"> • If there is continuity, go to Step 1: Continuity. • If there is no continuity, go to Step 2: No continuity. <p>Step 1: Continuity Turn the MFP on with only the fuser power disconnected.</p> <p>Measure the voltage at connector CN102 on the LVPS/HVPS. It should match the line voltage.</p> <p>If line voltage is not present, see “LVPS/HVPS service check” on page 2-28 for more information.</p> <p>Make sure the fuser thermistor is correctly connected to the controller board. If the problem persists, disconnect the thermistor cable at J15 and check for less than +5 V dc on pin 1. Pin 2 should be ground.</p> <p>If line voltage is incorrect on pin 1, see “Controller card service check” on page 2-25 for more information.</p> <p>Step 2: No continuity Check the lamp cable for continuity.</p> <ul style="list-style-type: none"> • If correct, replace the fuser. • If incorrect, replace the lamp cable. <p>Disconnect the thermistor cable from J10 on the controller card.</p> <p>Measure the resistance across the ends of the thermistor cable. See “Controller card” on page 5-4 for more information.</p> <p>Replace the fuser assembly if the resistance is lower than 1K ohm or shorted.</p> <p>Note: Resistance measures approximately 240K ohms when cool and 1.4K ohms hot.</p>

Hot fuser service check

Note: Ensure correct fuser is installed.

FRU	Action
 <p>Fuser AC cables LVPS/HVPS Fuser</p>	<p>Measure the resistance of the thermistor. The resistance measures from approximately 1K ohms immediately after printing or POR to approximately 240K ohms when thermistor reaches room temperature. (It may take 30 minutes to cool.)</p> <p>Replace the fuser assembly as necessary.</p>

LVPS/HVPS service check

FRU	Action
 <p>LVPS/HVPS</p>	<p>LVPS portion of board</p> <p>Fuses that open typically indicate a faulty LVPS/HVPS.</p> <p>Use the voltage meter to verify the appropriate voltage at the MFP end of the power cable.</p> <p>Remove the LVPS/HVPS assembly from the MFP.</p> <p>Check continuity on the fuses.</p> <p>If either fuse has opened, replace the card.</p> <p>Ensure the switch is off, and plug the power cord into the card.</p> <p>Turn the switch on.</p> <p>CAUTIONThe card has several points where AC voltage is exposed.</p> <p>Carefully verify the AC voltage between pins 1 and 2 matches the power cable (wall) voltage.</p> <ul style="list-style-type: none"> • If voltage is incorrect, replace the card assembly. • Verify +24 V dc from pins 8 and 9 at CN201. • If voltage is incorrect, replace the card assembly. <p>HVPS portion of board</p> <p>Problems with the HVPS are exhibited in the print quality. See “Print quality service checks” on page 2-35 for more information.</p>

Main motor service check

FRU	Action
 <p>Main motor cable LVPS/HVPS Controller card</p>	<p>Verify +24 V dc at J19, pins 8 and 9, and +5 V dc at pin 6 (controller card).</p> <p>Verify ground at pins 4 and 5 for both the card and cable.</p> <ul style="list-style-type: none"> If these voltages are correct, check the main motor cable for continuity. <ul style="list-style-type: none"> Remove rear cover to access connector on motor. If continuity exists on each wire, call next level of service. If continuity does not exist on one or more of the wires, replace the motor cable. If these voltages are not correct, see the “LVPS/HVPS service check” on page 2-28, or replace the controller card. <p>Note: The main motor is not a service part.</p>

Modem service check

FRU	Action
<p>Modem Controller card</p>	<p>Ensure the phone line is properly connected to the top RJ-11 jack of the modem and phone jack on the wall.</p> <p>Ensure the modem cable is properly connected to the J25 on the modem card and J25 on the controller card. Check the connectors on both cards for damage.</p> <p>Check pin 10 on J25 for +5V. Check pins 12 and 13 for +3.3V. Pins 2, 4, 6, and 8 should be ground. If voltages are present, replace the modem card.</p> <p>If the voltages are not present, replace the controller card.</p>

Networking service check

Note: Before starting this service check, print out the network setup page. This page is found under Menu - Reports - Network setting's. Consult the network administrator to verify that the physical network setting's displayed on the network setting's page for the device are properly configured. For more network troubleshooting information, consult the Lexmark Network Setup Guide.

Step	Questions / actions	Yes	No
1	If the device is physically connected to the network, verify that the ethernet cable is properly connected on both ends. Is the cable properly connected?	Go to step 3.	Go to step 2.
2	Connect the ethernet cable. Did this fix the problem?	Problem resolved	Go to step 3.
3	Check the printer's online status under Printers and Faxes on the host computer. Delete all print jobs in the print queue. Is the printer online and in a Ready state.	Go to step 5.	Go to step 4.
4	Change the printer status to online. Did this fix the issue?	Problem resolved.	Go to step 5.

Step	Questions / actions	Yes	No
5	Does the IP address displayed on the network setting's page match the IP address in the port of the drivers using the printer?	Go to step 10.	Go to step 6.
6	Does the LAN use DHCP? Note: A printer should use a static IP address on a network.	Go to step 7.	Go to step 9.
7	Are the first two segments of the IP address 169.254?	Go to step 8.	Go to step 9.
8	POR the printer. Is the problem resolved?	Problem resolved	Go to step 10.
9	Reset the address on the printer to match the IP address on the driver. Did this resolve the issue?	Problem fixed.	Go to step 10.
10	Have the network admin verify that the printer and PC's IP address have identical subnet addresses. Are the subnet addresses the same?	Go to step 12.	Go to step 11.
11	Using the subnet address supplied by the network admin, assign a unique IP address to the printer. Note: The printer IP address should match the IP address on the printer driver. Did this fix the problem?	Problem resolved.	Go to step 12.
12	Try using a different ethernet cable. Did this remedy the situation?	Problem resolved	Go to step 13.
13	Have the network administrator check the network drop for activity. Is the drop functioning properly?	Replace the controller board. See " Controller card removal " on page 4-13.	Problem with network

Operator panel service check

Inspect the operator panel cable for damage. Make sure the cable is plugged in securely.

POR the MFP, and check each light for proper operation.

Operator panel service check

FRU	Action
Operator panel Controller card	<p>Buttons</p> <p>Check connector J4, pin 2 for 3.3 V. If the voltage is present, replace the operator panel. If the voltage is not present, replace the controller card.</p> <p>Perform the panel test and button tests found in diagnostics. See “Panel Test” on page 3-5 and “Button Test” on page 3-5. If the tests fail, replace the operator panel.</p> <p>Lights</p> <p>If the lights don't illuminate, make sure the cable is properly connected to the controller card and the operator panel. Ensure the controller card has input voltage to it.</p> <p>Verify +24 V dc on cable pins 8 and 9 at J22.</p> <ul style="list-style-type: none"> • Check for +5 V dc at J4, pin 1. See “Controller card service check” on page 2-25 or page 4 for more information. • If these voltages are not correct, replace the controller card. • If these voltages are correct, replace the operator panel. <p>If more than one light does not turn on or an individual light stays on solid during POST, replace the operator panel.</p> <p>If all lights are dim and operate erratically during POST or all lights come on and stay on solid during POST, replace the FRUs in the following order one at a time:</p> <ul style="list-style-type: none"> • Controller card • Operator panel

Paperpath sensor service check

FRU	Action
All sensors	Check all the sensor flags for breakage or if they are jammed. Check all the sensors for dirt.
MPF sensor	Check pin 1 on connector J18 for +5V and pin 2 on J18 for +3.3 V. Pins 3, and 4 should be ground.
Exit sensor	Check pin 1 on connector J8 for +5V and pin2 on J8 for +3.3V. Pin 3 should be ground.
Paper in sensor	Check pin 1 on connector J17 for +5V and pin2 on J17 for +3.3V. Pin 3 should be ground.
Controller card	If any of the readings are incorrect, replace the controller card. If they are correct, replace the malfunctioning sensor.

Printhead service check

FRU	Action
 Printhead	Unplug the MFP. Disconnect the printhead cables from J13 and J12 on the controller card. Turn the MFP on. On the controller card, verify +24 V dc on pin 5 at J13 and +5 V dc on pin 7 at J12. Verify grounds on pin 4 at J13 and on pins 2, 6, and 8 at J12. <ul style="list-style-type: none"> • If voltages or grounds are incorrect, check the controller card. See “Controller card service check” on page 2-25 for more information. • If voltages are correct, replace the printhead (cables are included).

Paper feed service checks

Paper jam error indication during POST

FRU	Action
Exit sensor	If the exit sensor flag is not resting within the paper exit sensor during POST, the MFP displays a paper jam message. Make sure the flag is operating freely and is correctly installed.
Input sensor Input sensor #1 (under print cartridge assembly) and Input sensor #2 (manual)	Make sure the input paper feed sensors are working properly. A stuck or incorrectly installed sensor causes this error.

Paper picks during POST and/or continuously

FRU	Action
ACM (auto comp mechanism or paper feed) clutch Manual feed clutch	<p>Check the ACM clutch for wear. The solenoid interacts with the clutch to control the motion of the pick tires.</p> <p>If the ratchet teeth of the ACM clutch assembly are worn or broken, the solenoid may not stop the ACM from rotating. Replace the ACM clutch assembly if necessary.</p> <p>Check the manual feed clutch for the same damage.</p>

Paper picks but stops half way through the MFP

FRU	Action
Input sensor #1 (under print cartridge assembly) and Input sensor #2 (manual)	<p>Make sure the input sensors are working properly.</p> <p>Check for a broken or stuck flag on the input sensors.</p> <p>Make sure the cables are seated on the controller card at J20 (Tray 1 input) and J18 (manual input).</p> <p>Check for less than +5 V dc on pin 1 at J20 (Tray 1 input) and pin 3 at J18 (manual input sensor).</p> <ul style="list-style-type: none"> • If correct, replace the input paper feed sensor. • If these voltages are not correct, replace the controller card.

Paper never picks

FRU	Action
Paper feed (pick tires)	<p>Open the left cover, and verify the solenoid and clutch are functioning when an attempt is made to feed the paper.</p> <p>Make sure the rubber tires are installed and clean.</p> <p>Replace if necessary.</p>
Paper tray	Check the rear guide in the paper tray for proper adjustment.

Paper occasionally picks or picks multiple sheets at once

FRU	Action
Tray 1	<p>Check tray for paper catch points.</p> <p>If the sheet being fed stops momentarily, the ACM applies additional vertical force causing additional sheets to feed.</p> <p>Do not mix paper types.</p>
Paper pick tires	<p>Check the tires in the ACM assembly for signs of wear or damage.</p> <p>Replace the tires as necessary.</p>
ACM clutch complete bill of material (CBM) Manual feed clutch CBM	<p>Open the left cover, and observe the solenoid and clutch actions at the ACM and manual feed shafts as a print job is attempted.</p> <p>Replace the faulty part.</p>
Controller card	<p>Disconnect the solenoid cable at J101 on the controller card.</p> <p>Measure the resistance across cable pins 1 and 2 and then pins 3 and 4.</p> <ul style="list-style-type: none"> • The resistance should be 180–210 ohms. • If it is not, call the next level of service. • If the resistance is 180–210 ohms, check the controller card. See “Controller card service check” on page 2-25 for more information. <p>Replace controller card as necessary.</p>

Paper “trees,” wrinkles, stacks poorly or curls

FRU	Action
Fuser	<p>This problem is most likely due to a worn backup roll. It causes the MFP to run hotter than required for the media being printed. Excessive heat can cause paper treeing problems, poor stacking, or curl.</p>

A4, oversized paperfeed service check

Symptom	Action
200.20 and 241.18 paper jams when using A4 paper.	<p>Verify that the Size/Type item in the Paper Setup menu is set to A4. Verify A4 is chosen as the paper size in the printer driver. Both of these items need to be set to A4 when printing A4 paper.</p> <p>Note: These jams can also occur if the Size/Type setting and drivers are set to letter, and the paper length exceeds the letter paper length by 1/2 inch.</p>

Print quality service checks

Note: Ensure cover is closed tightly. A gap in the opening may allow light to expose the photoconductor resulting in a 'dirty' print.

Using print quality test pages

Blank page

FRU	Action
Toner cartridge (not a FRU)	Remove the toner cartridge, and gently shake it to evenly distribute the toner. Check for cartridge damage.
 <p>Printhead LVPS/HVPS Controller card Toner electrodes (cable assembly)</p>	<p>Blank pages can be caused by a defective printhead assembly, LVPS/HVPS, or controller card.</p> <ul style="list-style-type: none"> • Printhead errors typically result in MFP service errors. • Blank pages typically are caused by the PC roll not being properly discharged. Try a different PC kit. <p>Unplug the MFP and check continuity between the LVPS/HVPS connection pads marked OPC and the corresponding pin inside the MFP.</p> <p>If there is not continuity, call the next level of service.</p> <p>Try a different toner cartridge and PC kit.</p> <p>If those fail, replace the LVPS/HVPS.</p>

Black page

Note: Incorrect laser exposure or incorrect charging of the photoconductor causes an all-black page. Always verify the same results from a different print cartridge assembly and developer before proceeding.

FRU	Action
Toner electrodes (not a FRU)	Check the electrodes below the print cartridge assembly for contamination or damage. Correct as necessary. Check continuity between the cable connections on the contact tips below the print cartridge assembly. If continuity fails, call the next level of service.
 <p>LVPS/HVPS board Controller card</p>	<p>With the MFP off, disconnect the LVPS/HVPS cable from J22 on the controller card.</p> <p>Turn the MFP on and verify +24 V dc on pins 8 and 9 of the cable.</p> <p>Verify ground on pins 7, 12, and 14.</p> <ul style="list-style-type: none"> • If the voltage is incorrect, replace LVPS/HVPS board. • If voltage is correct and the toner electrodes are good, replace the controller card.
CIS	If the MFP prints a black page when copying a page but prints a job from the host PC properly, see “Flatbed service check” on page 2-24.

Heavy background

Poor development or poorly charged toner particles cause excessive background. This is more noticeable as the toner cartridge nears end-of-life.

FRU	Action
Toner cartridge (not a FRU) PC Kit (not a FRU)	Make sure the toner cartridge and PC Kit are correctly installed and the high voltage contacts are clean. If the toner cartridge and PC Kit are installed correctly, try a new PC Kit first, and then try a new toner cartridge.
 LVPS/HVPS Controller card	<p>Check the contacts for correct installation and contamination where contact is made between the print cartridge assembly and LVPS/HVPS board. Clean as necessary.</p> <p>If this does not correct the problem, replace the following FRUs one at a time in the order shown:</p> <ul style="list-style-type: none"> • LVPS/HVPS board • Controller card

Partial blank image/white spots (no periodic pattern)

FRU	Action
Toner cartridge (not a FRU)	Remove the toner cartridge assembly, and gently shake the assembly to evenly distribute the toner. If toner cartridge is low, try a new toner cartridge.
Paper (not a FRU)	Make sure recommended paper is being used.

Variation in image density horizontally across page

FRU	Action
PC Kit (not a FRU)	The charge roll may have an unbalanced pressure against the photoconductor (PC) drum. Try a new PC Kit.
Transfer roll	<p>Check the springs in the left and right transfer roll bearings. The bearing assemblies should support the transfer roll, applying even pressure to the PC drum.</p> <p>Replace the transfer roll assembly if the springs or bearing show signs of damage or fatigue.</p> <p>Inspect the transfer roll for signs of wear, damage, or contamination.</p> <p>Replace as necessary.</p>

Poor fusing of image

FRU	Action
Paper (not a FRU)	Make sure recommended paper is being used. Check the media type and texture setting's on the MFP and in the driver.
Fuser	The fuser may not be operating at the proper temperature to fuse the toner to the paper. See "Fuser service check" on page 2-27 for more information.

Light print

FRU	Action
Toner cartridge (not a FRU)	<p>Make sure the toner cartridge and PC Kit are installed correctly and that the toner cartridge is not low on toner.</p> <p>If the problem continues, install a new toner cartridge.</p> <p>Recheck condition before replacing PC Kit if necessary.</p>
 Transfer roll LVPS/HVPS board	<p>Check the transfer roll for signs of toner buildup and contamination.</p> <p>Inspect the HVPS contact (transfer roll) for contamination.</p> <p>Verify the high voltage cable is plugged into the LVPS/HVPS.</p> <p>If all components appear free of contamination, replace the following FRUs one at a time in the order shown:</p> <ul style="list-style-type: none"> • Transfer roll • LVPS/HVPS board



White or black lines or bands

FRU	Action
Print cartridge assembly (not a FRU) Developer drive coupling assembly	<p>Banding appears as light or dark horizontal lines on a uniformly gray page or on a page with a large area of graphics. Banding is primarily due to a variation in the speed of the paper as it feeds through the MFP, especially in the developer and transfer process.</p> <p>Inspect the toner cartridge and paper feed components, especially the drive coupler and drive gears for debris, binds, or damage.</p>

Toner on back of page

FRU	Action
PC Kit (not a FRU)	<p>Inspect the overall paper path for signs of spilled toner.</p> <p>Gently clean the contaminated areas with a soft cloth or compressed air.</p>
Fuser	<p>The fuser hot roll can cause toner deposits on the back of the paper if toner is building up on the hot roll. This buildup may transfer to the backup roll, later transferring to the back of the paper.</p> <p>Inspect the hot roll and backup roller for signs of contamination.</p> <p>Replace the fuser as necessary.</p>
Transfer roll	<p>A transfer roll contaminated with toner can cause toner to transfer to the back of printed pages.</p> <p>Inspect the transfer roll for contamination, and replace as necessary.</p>

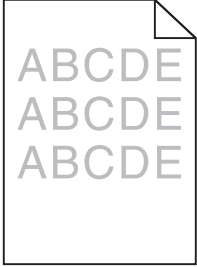
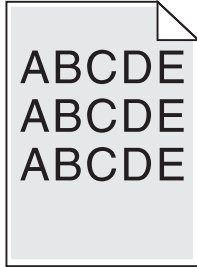
Solving print quality problems

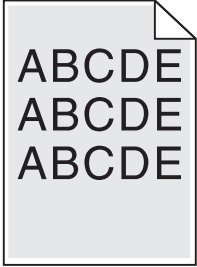
Problem	Action
<p>Light or blurred characters.</p> 	<p>Light print</p> <p>The toner cartridge may be getting low on toner:</p> <ul style="list-style-type: none"> • Remove the toner cartridge and print cartridge assembly. • Shake it from side to side to redistribute the toner. • Reinstall it and recheck for condition. • Make sure you are using recommended print media (see media types and sizes in the <i>User's Reference</i>.) • The toner cartridge or PC Kit may be defective. Replace the PC Kit first and recheck. <p>Blurred characters</p> <p>Blurred images, including blurred characters, are usually caused by a defective printhead. See "Light print" on page 2-37.</p>
<p>Toner smudges appear on the front or back of the page.</p> 	<ul style="list-style-type: none"> • Make sure the paper is straight and unwrinkled. • Make sure you are using recommended print media (see media types and sizes in the <i>User's Reference</i>.) • Replace the PC Kit and recheck before replacing the toner cartridge. See "Toner on back of page" on page 2-37 for more information.
<p>Vertical or horizontal streaks appear on the page.</p> 	<p>Replace the toner cartridge for vertical black streaks.</p> <p>Wipe the glass lens clean with a soft tissue for vertical "white" streaks.</p> <p>For horizontal streaks, see "White or black lines or bands" on page 2-37 for more information.</p>
<p>Toner smears or rubs off the page.</p> 	<ul style="list-style-type: none"> • Replace the fuser. The toner is not being fused. See "Fuser service check" on page 2-27 for more information. • Try a different kind of paper. Paper designed for copiers gives the best quality fusing. • For all media types, check the media type and texture setting's in the driver and on the MFP. • Change the media texture setting. If the setting is not in your driver, you can download the correct Lexmark setup utility from the Lexmark Web site at www.lexmark.com.
<p>The print is getting light but the Toner Low message is not displayed.</p>	<ul style="list-style-type: none"> • Remove the toner cartridge, and gently shake it from side to side to redistribute the toner. • Replace the toner cartridge.

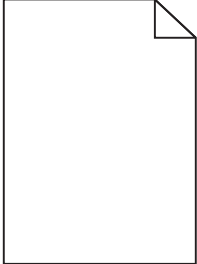
Problem	Action
The Toner Low message is displayed.	<ul style="list-style-type: none"> Remove the toner cartridge, and gently shake it from side to side to redistribute the toner (6K cartridge only). Replace the toner cartridge.
Solid black areas on transparencies or white streaks on paper.	<ul style="list-style-type: none"> Choose a different fill pattern in your software program. Try a different type of paper. Paper designed for copiers gives the best quality. Remove the toner cartridge, and gently shake it from side to side to redistribute the toner. Replace the toner cartridge.
Faint images or repetitive spots appear on the page.	<ul style="list-style-type: none"> Select a different media type or form type setting from your MFP driver. Try a different type of paper. Paper designed for copiers gives the best quality. Replace the toner cartridge.
Groups of black spots appear in grayscale images.	<ul style="list-style-type: none"> Toner cartridge may be damaged. Replace the toner cartridge.
Pages are blank. 	<ul style="list-style-type: none"> The print cartridge may be out of toner or defective. Replace the cartridge. You may have a software error. Try turning the MFP off and back on. Check the printhead. See “Paper feed service checks” on page 2-33 for more information.
The MFP is on, but nothing prints.	<ul style="list-style-type: none"> Make sure the toner cartridge assembly is installed properly. Is the MFP processing a scan job? The MFP does not print while scanning. Make sure the network or USB cable is not damaged and is firmly plugged into the connector on the back of the MFP. Print a menu setting's page just to save space. <ul style="list-style-type: none"> If you cannot print a menu setting's page, call the next level of support. If you can print a menu setting's page, the problem is one of the following: <ul style="list-style-type: none"> Computer Software program Cable (USB only) failed ASIC or controller card. Replace card. <p>Note: Test by unplugging USB and replugging it with the MFP on. If the computer indicates “unknown device,” replace the controller card.</p>
Toner Low message is displayed and printing stops.	Press Start . Print quality will be diminished.
Close Front Door message is displayed.	Make sure the printer cover is closed.
The media skews or buckles.	<ul style="list-style-type: none"> Don't overfill Tray 1 (see media capacities in the media types and sizes table in the <i>User's Reference</i>). Make sure the paper guides are flush against the edges of the media.

Problem	Action
The paper sticks together/MFP feeds multiple sheets of paper.	<ul style="list-style-type: none"> • Remove the paper from Tray 1, and fan it. • Don't overfill Tray 1 (see media capacities in the media types and sizes chart in the <i>User's Reference</i>).
The paper fails to feed from Tray 1.	<ul style="list-style-type: none"> • Remove the paper from Tray 1, and fan the paper. • Make sure Tray 1 is selected from the MFP driver. • Do not overfill the tray. • Check the condition of the rubber on the paper feed rolls. • Verify clutch for ACM is not slipping.
The MFP does not print after a paper jam has been cleared.	<ul style="list-style-type: none"> • Clear all jams. • Press Start or . Open and close the MFP cover to restart the MFP. • Make sure the print cartridge assembly is installed properly.
Unexpected characters print or characters are missing.	<ul style="list-style-type: none"> • Ensure correct MFP driver is being used. • Reset MFP to user default setting's. • Restore factory defaults. • Make sure the USB cable is firmly plugged in at the back of the MFP.
Jobs are not printing, and MFP display shows an error message.	<ul style="list-style-type: none"> • Make sure the print cartridge assembly is installed properly. • Make sure the MFP top cover is closed.

840.xx service check

Step	Questions / actions	Yes	No
1	<p>POR the machine into configuration mode. Go to the disable scanner menu item. See “Disable Scanner” on page 3-18. Touch “Enable ADF/FB -Enabled and press Submit to save the change. POR the MFP to operating mode. Try running a copy from the ADF and flatbed.</p> <p>Did the 840.xx error recur?</p>	Go to step 2.	Stop. Problem resolved.
2	<p>Re-enter Configuration mode, scroll to and select the Disable Scanner menu item.</p> <p>Does the screen display ADF Disabled or Auto Disabled?</p>	Go to step 3.	Go to step 8.
3	<p>Check the ADF cable to ensure it is properly connected to the ADF.</p> <p>Is the cable properly connected?</p>	Go to step 5.	Go to step 4.
4	<p>Properly connect the cable to the ADF unit and controller board. POR the machine into configuration mode. Go to the disable scanner menu item. See “Disable Scanner” on page 3-18. Touch “Enable ADF/FB -Enabled and press Submit to save the change. POR the MFP to operating mode. Try running a copy from the ADF and flatbed.</p> <p>Did the 840.xx error recur?</p>	Go to step 5.	Stop. Problem solved.
5	<p>Check the continuity on the ADF cable.</p> <p>Is there continuity?</p>	Go to step 7	Go to step 6.
6	<p>Replace the ADF cable. POR the machine into configuration mode. Go to the disable scanner menu item. See “Disable Scanner” on page 3-18. Touch “Enable ADF/FB -Enabled and press Submit to save the change. POR the MFP to operating mode. Try running a copy from the ADF and flatbed.</p> <p>Did the 840.xx error recur?</p>	Go to step 7.	Stop. Problem solved.

Step	Questions / actions	Yes	No
7	<p>Replace the ADF unit. See “ADF assembly removal” on page 4-42. POR the machine into configuration mode. Go to the disable scanner menu item. See “Disable Scanner” on page 3-18. Touch “Enable ADF/FB -Enabled and press Submit to save the change. POR the MFP to operating mode. Run a copy from the ADF.</p> <p>Did the 840.xx error recur?</p>	Go to step 8.	Stop. Problem solved.
8	<p>Inspect J15, J2, 1 and J5 on the controller board.</p> <p>Are the connections properly connected?</p>	Go to step 10.	Go to step 9.
9	<p>Properly connect all the connections.</p> <p>Did the 840.xx error recur?</p>	Go to step 10.	Stop Problem solved.
10	<p>Replace the flatbed unit. See “Flatbed removal” on page 4-44. POR the machine into configuration mode. Go to the disable scanner menu item. See “Disable Scanner” on page 3-18. Touch “Enable ADF/FB -Enabled and press Submit to save the change. POR the MFP to operating mode. Run a copy from the flatbed.</p> <p>Did the 840.xx error recur?</p>	Go to step 11	Stop. Problem solved.
11	<p>Replace the controller board. See “Controller card removal” on page 4-13.</p> <p>Did this fix the problem?</p>	Problem solved.	Contact second-level support.

Scan quality service checks

Image unclear

Problem	Action
Dirt on flatbed glass or calibration reference plate	Clean glass with isopropyl alcohol.
Black page	If the MFP can print normal pages from the host PC see “Flatbed service check” on page 2-24.
Lamp too dark	Perform CIS service check. See “Flatbed service check” on page 2-24.
Scanner not properly registered	Perform scanner registration in diagnostics. See Go to “Scanner Manual Registration” on page 3-17.

Irregular movement

Problem	Action
Flatbed motor failure	Check the flatbed cable to see if it is properly connected to J1 on the controller
Loose belt	Visually inspect the belt. If the belt is worn or loose, replace the scanner base assembly.
Scanner Freezes (No message)	Is the user using TWAIN and WIA (Microsoft Windows) scan drivers simultaneously. These drivers cannot be used at the same time.
Home position sensor failure	See “Flatbed service check” on page 2-24.
Skewed images from the ADF	If there is skew on the last 3 or 4 inches of an image, ensure the flatbed cover is properly closed.

No image

Problem	Action
Flatbed cover open	Close the flatbed cover.
Flatbed motor failure	See “Flatbed service check” on page 2-24.
Scanner produces blank pages	Replace the controller card.
Paper in ADF does not feed	Go to “ADF service check” on page 2-23.
Unable to scan to PC	Check to see if the PC and MFP are connected on the network. Go to “Networking service check” on page 2-29.

Transfer roll service check

FRU	Action
 Transfer roll	Check transfer roll area for debris, and clean as necessary. Verify continuity between the spring below the left side bearing and the transfer roll shaft. Verify continuity in the spring and the cable connection on the LVPS/HVPS. Inspect the roll for signs of wear or damage, and replace if necessary.

Fax service checks

Diagnosing fax problems

Problem	Solution
No dial tone	See “Modem service check” on page 2-29.
Ring tone volume for incoming faxes too low	Replace controller card.
Document does not feed in the ADF.	See “ADF service check” on page 2-23.
Lines on documents sent out.	Check the flatbed glass for marks or scratches.
Some words on an incoming fax are stretched.	Fax machine sending the fax had a temporary jam.

Note: Some fax-quality issues might be scanner-related. See **“Scan quality service checks”** on page 2-43.

Fax transmission service check

Note: Before performing this service check, verify that the correct country code for the MFP is selected. This setting must match the country in which the MFP is used to transmit and receive faxes. If the setting is wrong, the modem setting's can be changed in the Fax/SE menu. See step 14. These setting's should only be changed with guidance from your second-level support.

Step	Questions / actions	Yes	No
1	Is the phone line properly connected to the modem card and the wall jack?	Go to step 3.	Go to step 2.
2	Properly connect the phone line to the modem card and wall jack. Did this fix the problem?	Problem resolved	Go to step 3.
3	Test the phone line's ability to send and receive calls. Did the phone line work properly?	Go to step 5.	Go to step 4.
4	Use the MFP on a properly functioning phone jack. Did this fix the problem?	Problem resolved.	Go to step 5.
5	Is the phone line being used by the MFP an analog line?	Go to step 8.	Go to step 6.

Step	Questions / actions	Yes	No
6	Is the line being used a VOIP line?	Go to step 7.	Go to step 8.
7	Have the system administrator verify that the VOIP server is configured to receive faxes. Is the server properly configured?	Go to step 8.	Stop here. The issue is VOIP related. The VOIP provider needs to change the server configuration.
8	Is the MFP on a PABX?	Go to step 9.	Go to step 10.
9	Enable Behind a PABX under fax setting's in the Administration menu. Did this fix the issue?	Problem fixed.	Disable Behind a PABX , and go to step10.
10	Is a dial prefix needed to get an outside line?	Go to step 11.	Go to step 12.
11	Try sending a fax using a dial prefix. Did the fax transmit?	Problem fixed.	Go to step 12.
12	Is the fax failing to send to one specific destination?	Go to step 13.	Go to step 14.
13	Check the device that cannot receive a fax. Can it send a fax?	Go to step 14.	Stop here. The issue is with the other device.
14	Press **411 to enter the Fax/SE Menu. Select "Print Logs". Print the T30 transmission log. Check the error being reported with the fax error code table. See " Fax error codes " on page 2-14 . Perform the suggested resolution for the error. Did this fix the problem?	Problem resolved.	Go to step 15.
15	Adjust the "Transmit Level" setting in the SE menu. Press **411 to enter the SE menu, enter Modem setting's, and select "Transmit Level". Test by adjusting the transmitted signal strength by decreasing/increasing the 'Transmit Level' setting in steps of 1db. For example, if default value is -11 db, changing it to -12db will decrease the signal strength by 1db, and changing it to -10db will increase the signal strength by 1db. Recommended adjustment range is ± 5 db (in 1db steps) from the default value. Did this fix the problem?	Stop. Problem resolved.	Contact your second-level of support. See " Escalating a fax issue to second-level support " on page 2-48 .

Fax Reception service check

Step	Questions / actions	Yes	No
1	Is the phone line properly connected to the modem card and the wall jack?	Go to step 3.	Go to step 2.
2	Properly connect the phone line to the modem card and wall jack. Did this fix the problem?	Problem resolved.	Go to step 3.
3	Check for a dial tone. Is there a dial tone?	Go to step 4.	Go to step 6.
4	Use a telephone to test the phone line's ability to send and receive calls. Did the phone line work properly?	Go to 7.	Go to step 5.
5	Use a telephone handset to verify the phone line is free of static or external noise. Is the phone line noise-free?	Go to step 7.	Go to step 6.
6	Use the MFP on a properly functioning phone jack. Did this fix the problem?	Problem resolved.	Go to step 7.
7	In <administration menu, verify that the Enable Fax Receive setting is on. Is the setting set to on?	Go to step 9.	Go to step 8.
8	Set "Enable Fax Receive" to On. Did this fix the problem?	Problem resolved.	Go to step 9.
9	Is Distinctive Ring enabled?	Go to step 11.	Go to step 10.
10	Turn on Distinctive ring. Did this fix the problem?	Problem resolved.	Go to step 11.
11	Is the phone line analog?	Go to step 13.	Go to step 12.
12	Is the VOIP server configured to support fax?	Go to step 13.	Stop here. This is an issue with the VOIP provider.
13	Does the MFP have reception issues with only a certain remote device?	Go to step 14.	Go to step 15.
14	Verify communications with a different remote device. Can the other device receive faxes?	The issue is with the other device.	Go to step 15.
15	Go to the Administrator menu. Enter the Fax setting's - Analog Fax setting's submenu. Verify the Block No Name Fax user setting. Is it enabled?	Go to step 16.	Go to step 17.
16	Disable Block No Name Fax user setting. Did this fix the issue?	Problem resolved.	Go to step 17.

Step	Questions / actions	Yes	No
17	<p>Go to the Administrator menu. Enter the Fax setting's - Analog Fax setting's submenu.</p> <p>Verify the remote device number is not in the Banned Fax List user setting.</p> <p>Is the remote device number in the banned fax list?</p>	Go to step 18.	Go to step 19.
18	<p>Remove the remote number from the banned fax list.</p> <p>Did this fix the problem?</p>	Problem resolved.	Go to step 19.
19	<p>Adjust the "Receive Threshold" setting in the SE menu. press **411 to enter the SE menu, enter Modem setting's, and select "Receive Threshold".</p> <p>Test by adjusting the received signal level by decreasing/increasing the "Receive Threshold" setting in steps of 2db. For example, if default value is -43 db, changing it to -45db will decrease the received signal level by 2db, and changing it to -41db will increase the received signal level by 2db. Recommended adjustment range is between -33db and -48db (in 2db steps).</p> <p>Did this fix the problem?</p>	Problem resolved	Go to step 20.
20	<p>Press **411 to enter the SE Menu. Select "Print Logs".</p> <p>Print the T30 transmission/ job log. Check the error code being reported. See "Fax error codes" on page 2-14. Perform the suggested resolution for the error.</p> <p>Did this fix the problem?</p>	Problem resolved.	<p>Contact your second-level of support. See "Escalating a fax issue to second-level support" on page 2-48.</p>

Escalating a fax issue to second-level support

Before contacting the second-level support, go to the SE menu on the MFP and generate a Fax error file. This file contains machine setting's information and debug information that will help second-level support determine the cause of a failure.

To generate the fax error file, perform the following steps:

1. In a Web browser, type `http://MFP ip address/se`.
2. The MFP's SE menu page will display. Click the "Dump Job History" link. The following displays:

Fax Job Log							
Wednesday, 2006-02-08 11:25							
Action	Date	Time	Job #	Length	Station Name/Number	Pages	Status
SCAN	1969-12-31	19:00				9	OK
SEND	2006-02-01	13:55	73	17:53	4039	2	CANCELED
SEND	2006-02-01	13:56	74	17:53	4039	0	CANCELED

3. Write down the type of connection, the type of error, and the job in which the error occurred.
4. In the Web browser address bar, type `http://MFP ipaddress/se`.
5. Click **Report a Fax Problem (A)**. The fax check list displays.
6. Fill in the requested information. This is where you will type in the information you retrieved in step 3. Second-level support can assist you if you have questions about the information requested on the page.

Title/Name of Tester	<input type="text" value="Your Name"/>	Date of Event	<input type="text" value="Date of Event"/>	mm/dd/yyyy
Customer	<input type="text" value="Customer Name"/>	Time of Event	<input type="text" value="Time of Event"/>	hh:mm [A,P]M
Job ID	<input type="text" value="Job ID"/>	#####		
Describe the Physical Connection:				
Type:	Description:	Channel Quality:		
<input checked="" type="radio"/> Analog	<input type="checkbox"/> VoIP/FoIP	<input checked="" type="radio"/> Clear		
<input type="radio"/> Digital	<input type="checkbox"/> PAB	<input type="radio"/> OK		
	<input type="checkbox"/> ISD	<input type="radio"/> Some Noise		
		<input type="radio"/> Very Noisy		

Note: The fields requesting the code levels, model number, type of problem are auto-filled. If the information is not in the fields, it can be retrieved from the SE menu. The SE menu can be accessed by pressing ****411** on the keypad or typing `http://MFP ipaddress/se` in a Web browser.

7. After all the requested information is entered into the Fax Checklist Web page, press the **Submit** button on the bottom of the page. A dialogue asking you to save the file will appear.







Note: The file generated by the MFP is not automatically transmitted to second-level support. It is placed on the computer desktop.
8. Enter a name for the file, and indicate where you want to save the file.
9. press **OK**. The file appears on the desktop.
10. E-mail the file to second-level support.

3. Diagnostic aids



This chapter explains the tests and procedures to identify printer failures and verify repairs have corrected the problem.

Accessing service menus

There are different test menus that can be accessed during POR to identify problems with the printer.

Configuration Menu	<p>1. Press and hold  and  .</p>  <p>2. Turn on the printer. 3. Release the buttons when Performing Self Test displays.</p>	<p>The Configuration Menu group contains a set of menus, setting's, and operations which are infrequently required by a user. Generally, the options made available in this menu group are used to configure a printer for operation.</p> <p>See “Configuration Menu” on page 3-14 for more information.</p>
Diagnostics Mode	<p>1. Press and hold  and  .</p>  <p>2. Turn on the printer. 3. Release the buttons when Performing Self Test displays.</p>	<p>The Diagnostics Mode group contains the setting's and operations used while manufacturing and servicing the printer.</p> <p>See “Diagnostics mode” on page 3-2 for more information.</p>

These menus do not require a POR to access them::

Network SE Menu	Press and hold  and  while in the network ports menu.
FAX SE Menu	Enter **411 while in the Home Prime screen
SE Menu	From a Web browser on a host PC, add /se to the printer IP address

Diagnostics mode

When the Diagnostics mode is entered, each Diagnostics main menu item displays on the operator panel. When a diagnostic test is selected from the main menu, a sub menu displays and each individual test displays in the order shown. Any options that are referred to in the menus are displayed when the option is installed.

Available tests

The tests display on the operator panel in the order shown:

Diagnostics mode tests

REGISTRATION	
Top Margin	These tests are performed to adjust the print head registration. See “Registration” on page 3-3
Bottom Margin	
Left Margin	
Right Margin	
Quick Test	See “Quick test” on page 3-4.
PRINT TESTS	
Tray 1	See “Print Tests” on page 3-5.
Manual Feeder (if installed)	
Prt Quality Pgs	See “Print quality test pages (Prt Quality Pgs)” on page 3-5.
HARDWARE TESTS	
Panel Test	See “Panel Test” on page 3-5.
Button Test	See “Button Test” on page 3-5.
DRAM Test	See “DRAM Test” on page 3-6.
INPUT TRAY TESTS	
Feed Tests	See “Feed Tests” on page 3-7.
OUTPUT BIN TESTS	
Feed Tests	See “Feed Tests” on page 3-7.
BASE SENSOR TEST	
Exit	See “Base Sensor Test” on page 3-7.
Front Door	
Input	
PRINTER SETUP	
Defaults	See “Defaults” on page 3-7.
Perm Page Count	See “Perm Page Count” on page 3-7.
Serial Number	See “Serial Number” on page 3-8.
Engine Setting 1 through 4	See “Engine Setting 1-4” on page 3-8.
Model Name	See “Model Name” on page 3-8.
Configuration ID	See “Configuration ID” on page 3-8.
Edge to Edge	See “Edge to Edge” on page 3-9.
Enable Edge to Edge Copy	See “Enable Edge to Edge Copy” on page 3-9.
EP SETUP	
EP Defaults	See “EP Defaults” on page 3-9.
Fuser Temp	See “Fuser Temp” on page 3-9.

Diagnostics mode tests (Continued)

Transfer Adjust	See “Transfer” on page 3-9.
Print Contrast	See “Print contrast” on page 3-9.
Charge Roll	See “Charge Roll” on page 3-9.
Gap Adjust	See “Gap Adjust” on page 3-10
Auto Dark Adj	See “Auto Dark Adjust” on page 3-10.
REPORTS	
Main setting's Page	See “Main setting's Page” on page 3-10.
EVENT LOG	
Display Log	See “Display Log” on page 3-10.
Print Log	See “Print Log” on page 3-10.
Clear Log	See “Clear Log” on page 3-11.
Development Menu	
Scanner Tests	
ASIC Test	See “ASIC Test” on page 3-11.
Feed test	See “Feed Test” on page 3-11.
Scanner sensor tests	See “Sensor Test” on page 3-12.
EXIT DIAGNOSTICS	This selection exits Diagnostics mode, and Resetting the Printer displays. The printer performs a POR, and returns to normal mode.

Registration**Printer**

Print registration makes sure the black printing is properly positioned on the page.

To set print registration:

1. Select **REGISTRATION** from the DIAGNOSTICS menu.
2. Use ◀ or ▶ to select Quick Test, and press . See **“Quick test”** on page 3-4.
The message Quick Test Printing... appears on the display, and the page prints.
Retain this page to determine the changes you need to make to the margin setting's.
3. Use ◀ or ▶ to select the margin setting you need to change, and press .
4. Use ◀ to decrease or ▶ to increase the offset values, and press to confirm the value.
The message Submitting changes displays, and the original margin setting screen appears.

The print registration ranges are:

Description	Value	Direction of change
Top margin	-50 to +50 Each increment corresponds to 8 scans at a 600 dpi scan rate (0.0133 inches or 0.339 mm). The default is 0.	A positive change moves the image down the page and increases the top margin. A negative change moves the image up and decreases the top margin. No compression or expansion occurs.
Bottom margin	-25 to +25 Each increment causes approximately 0.55 mm shift in the bottom margin. The default is 0.	A positive offset moves text down the page and narrows the bottom margin, while a negative offset moves text up the page and narrows the bottom margin. The image is compressed or expanded.

Description	Value	Direction of change
Left margin	-50 to +50 Each increment corresponds to 4 pixels at 600 dpi (0.00666 in. or 0.1693 mm). The default is 0.	A positive change moves the image to the left, and a negative change moves the image to the right. No compression or expansion occurs.
Right margin	-50 to +50 Each increment corresponds to an approximate shift of 4 pixels at 600 dpi. The default is 0.	A positive change moves the image to the left, and a negative change moves the image to the right.

- Print another copy of the Quick Test to verify your changes.
- Continue changing the setting's by repeating steps 3 through 5.

To exit REGISTRATION, press **Back** ().

Quick test

The Quick Test contains the following information:

- Print registration setting's
- Alignment diamonds at the left, right, top. and bottom
- Horizontal lines to check for skew
- General printer information, including current page count, serial number, and code level.

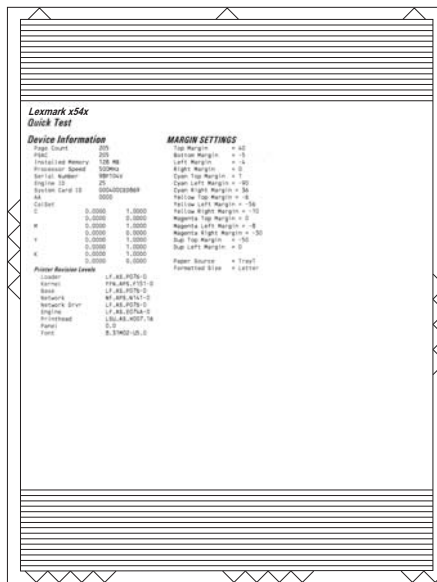

To print the Quick Test page:

Note: Print the Quick Test Page on letter or A4 paper.

- Select **REGISTRATION** from **DIAGNOSTICS**.
- Use **◀** or **▶** to select Quick Test, and press **✓**.

The message Quick Test Printing... appears on the display.

Once the Quick Test Page completes printing, the Registration screen displays again.

Print Tests

Input source tests

The purpose of the diagnostic PRINT TESTS is to verify that the printer can print on media from each of the installed input options. The contents of the Print Test Page vary depending on the media installed in the selected input source.

Check each Test Page from each source to assist in print quality and paper-feed problems.

To run the Print Test Page:

1. Select **PRINT TESTS** from the Diag Menu, and press **Select** (✓).
 2. Select the media source (Tray 1, or Manual Feeder), and press **Select** (✓).
 3. Select **Single** or **Continuous**, and press **Select** (✓).
 - If **Single** is selected, a single page is printed.
 - If **Continuous** is selected, printing continues until **Stop** (✗) is pressed to cancel the test.

If a source is selected that contains envelopes, an envelope test pattern is printed. If Continuous is selected, the test pattern is printed only on the first envelope.
- Note:** The Print Test Page always prints on one side of the paper, regardless of the duplex setting.
4. Press **Back** (↵) to return to PRINT TESTS.

Print quality test pages (Prt Quality Pgs)

The print quality test consists of 4 pages. Pages one and two contain a mixture of graphics and text. The remainder of the pages contain only graphics. The test prints on the media in tray 1.

This test may be printed from either Configuration Menu or the Diagnostics Menu.

To run the print quality pages from the Diagnostics Menu:

1. Select **PRINT TESTS**, and press **Select** (✓).
 2. Select **Print Quality Pgs**, and press **Select** (✓).

The message Printing Quality Test Pages is displayed.
- Note:** Once the test is started, it cannot be canceled.

When the test pages print, the printer returns to the original screen.

Hardware Tests

Panel Test

This test verifies the operator panel LCD function.

To run the Panel Test:

1. Select **Hardware Tests** from Diag Menu, and press **Select** (✓).
2. Select **Panel Test**, and press **Select** (✓).

The Panel Test continually executes.

Press **Stop** (✗) to cancel the test.

Button Test

This test verifies the operator panel button function.

To run the Button Test:

1. Select **Hardware Tests** from Diag Menu, and press **Select** (✓).
2. Select **Button Test**, and press **Select** (✓).
 press count: 0 appears.
 press each operator panel button, and watch to see if the number of press counts increases by one for each press.
Note: If you press **Stop** (✗), you end the test.

Press **Stop** (✗) to cancel the test.

DRAM Test

This test checks the validity of DRAM, both standard and optional. The test writes patterns of data to DRAM to verify that each bit in memory can be set and read correctly.

To run the DRAM Test:

1. Select **Hardware Tests** in Diag Menu, and press **Select** (✓).
2. Select **DRAM Test**, and press **Select** (✓).
 - a. The printer displays:

DRAM Test Testing...
 - b. The printer initiates a POR of the printer, and the following screen is displayed:

Resetting the
Printer
 - c. After the POR, the printer begins testing the memory.

DRAM Test 128M
 P:##### F:#####

P:##### represents the number of times the memory test has passed and finished successfully. Initially, 000000 displays with the maximum pass count being 99,999.

F:##### represents the number of times the memory test has failed and finished with errors. Initially, 0000 displays with the maximum fail count being 99,999.

3. Once all the memory is tested, the test stops.

To stop the test early, turn off the printer.

Input Tray tests

Feed Tests

This test allows you to observe the paper path of media as it passes through the printer. Any installed input tray can be tested. The pages fed through the printer are blank.

To run the Feed Test:

1. Select **INPUT TRAY TESTS** from Diag Menu, and press **Select** (✓).
2. Select **Feed Tests**, and press **Select** (✓).
3. Select the tray to be tested. Choices are installed trays, including Tray 1, and MP Feeder.
4. Open the upper rear door to view the paper path.

Note: Do not open the upper front door. The test will not run if the front door is open.
5. Select **Single** or **Continuous**, and press **Select** (✓).
 - Single—a single sheet of blank paper is fed, and the test stops.
 - Continuous—sheets are fed continuously until **Stop** (✗) is pressed.

To Exit the test, press **Back** (⏪) or **Stop** (✗).

Output bin tests

The **Output bin tests** setting is used to test the printer's output bins and its sensors.

Feed Tests

This test verifies that the media from the printer's default input source feeds to the specific output bin. Press ✓ to select Single, or press ▶ and ✓ to select Continuous. The Single test feeds one sheet of media to the default output bin. No buttons are active during this test. The Continuous test feeds media to the default output bin until ✗ is pressed. The indicator light blinks green, and the operator panel displays [Select Output Bin] Feeding... while either of these tests perform.

Base Sensor Test

These tests allow you to verify the correct functioning of the front door, input, and output sensors.

1. Select **Base Sensor Test** from Diag Menu, and press **Select** (✓).
2. Select the sensor you want to test, and press **Select** (✓).

The following test are available: Exit, Front door, and Input.

Printer setup

Defaults

US/Non-US defaults changes whether the printer uses the US factory defaults or the non-US factory defaults. The setting's affected include paper size, envelope size, PCL symbol set, code pages, and units of measure.

Changing this setting resets the printer to factory defaults, and data may be lost. It cannot be undone.

Perm Page Count

You can view, but not change any of the three counts displayed under PAGE COUNTS.

To view the Prt Color Pg Count, the Prt Mono Pg Count, or the Perm Page Count:

1. Select **PRINTER SETUP** from DIAGNOSTICS, and press **Select** (✓).
2. Select **PAGE COUNTS**, and press **Select** (✓).
3. Select the page count you wish to view:
 - Prt Color Pg Count
 - Prt Mono Pg Count
 - Perm Page Count
4. Press **Select** (✓).
The value of the page count appears.

Press **Back** (↶) to return to PRINTER SETUP.

Serial Number

The serial number can only be viewed. It cannot be changed.

To view or change the serial number:

1. Select **PRINTER SETUP** from DIAGNOSTICS, and press **Select** (✓).
2. Select **Serial number**, and press **Select** (✓).

Press **Back** (↶) to return to PRINTER SETUP.

Engine Setting 1-4

Warning: Do not change these setting's unless requested to do so by your next level of support.

Model Name

The model name can only be viewed and cannot be changed.

Configuration ID

The two configuration IDs are used to communicate information about certain areas of the printer that cannot be determined using hardware sensors. The configuration IDs are originally set at the factory when the printer is manufactured. However, the servicer may need to reset Configuration ID 1 or Configuration ID 2 whenever the system board is replaced. The IDs consist of eight digits. The first seven digits in each ID are hexadecimal numbers, while the last digit is a checksum of the preceding seven digits. Each ID can contain a combination of the digits 0 through 9, and the letters A through F.

Note: When the printer detects a Configuration ID that is not defined or invalid, the following occurs:

- The default standard model Configuration ID is used instead.
- Configuration ID is the only function available in DIAGNOSTICS.
- Unless the menu is in DIAGNOSTICS, Check Config ID displays.

To set the configuration ID:

1. Select **PRINTER SETUP** from DIAGNOSTICS, and press **Select** (✓).
2. Select **Configuration ID**, and press **Select** (✓).
The current value for Configuration ID 1 appears with the left character or digit underlined.
3. Enter the Configuration ID 1.
 - Change the left character or digit first.
 - To change a character or digit, press ◀ to decrease or ▶ to increase the underlined value, and press **Select** (✓).

- To move to the next character or digit, press ◀ or ▶, and press **Select** (✓).
 - When you press **Select** (✓) on the last digit, the value will be submitted.
If Invalid ID appears, the entry is discarded, and the previous Configuration ID 1 is displayed on the screen.
If the process is successful, Submitting Selection appears on the display, followed by the current value for Configuration ID 2.
4. Repeat the steps for entering the Configuration ID 2, and press **Select** (✓).
If the Configuration ID 2 is validated, Submitting Selection appears, and a check (✓) appears next to **Printer Setup**.
 5. Restart the printer. A POR is not automatically performed.

Edge to Edge

Enable Edge to Edge Copy

This setting is set to either on or off. Off is the default setting.

EP Setup

EP Defaults

This setting is used to restore each printer setting listed in EP SETUP to its factory default value. To restore EP Defaults:

1. Select **EP Setup** from Diag Menu, and press **Select** (✓).
2. Select **EP Defaults**, and press **Select** (✓).
3. Select **Restore** to reset the values to the factory setting's, and select **Do Not Restore** to exit without changing the setting's.

To cancel and return to the menus, press **Back** (⏪).

Fuser Temp

This adjustment can be used to help solve some customer problems with paper curl on low-grade papers and problems with letterheads on some types of media.

The fuser temperature can be adjusted to: Low, Normal, High. The default is Normal.

To restore EP Defaults:

1. Select **EP Setup** from Diag Menu, and press **Select** (✓).
2. Select **Fuser Temp**, and press **Select** (✓).
3. Select Normal, High, or Low. The default is Normal.

Transfer

The transfer can be adjusted to **Low**, **Medium**, or **High**. The default setting is Medium.

Print contrast

The print contrast can be adjusted to **Low**, **Medium**, or **High**. The default setting is Medium.

Charge Roll

The charge roll can be adjusted to **Low**, **Medium**, or **High**. The default setting is Medium.

Gap Adjust

Adjusts the minimum gap between sheets during printing. This setting reduces speed (pages per minute), but can be used to reduce curl of printed media and improve stacking in the output bin.

The range is 0 (default) to 255. Adjusting by one results in 9 mm of increased gap.

Auto Dark Adjust

This setting attempts to optimize the amount of toner used when printing with a specific operating point. Each time this setting executes, the printer performs the following:

- Calibrates its toner density sensor
- Measures the reflectivity of its bare drum
- Prints patches on the drum and measures the drum's reflectivity through the patches
- Cleans the transfer roll
- Calculates reflectivity ratios and operating points in order to attain each operating point's darkness target
- Modifies the EP mechanism as necessary to adjust toner darkness.

No messages are displayed on the operator panel to give any indication that this test is running. When deactivated, the printer disables.

Reports

Main setting's Page

To print the Menu setting's Page:

1. Select **Reports** from Diag Menu, and press **Select** (✓).
2. Select **Menu setting's Page**, and press **Select** (✓).

Event Log

Display Log

The event log provides a history of printer errors. It contains the 12 most recent errors that have occurred on the printer. The most recent error displays in position 1, and the oldest error displays in position 12 (if 12 errors have occurred). If an error occurs after the log is full, the oldest error is discarded. Identical errors in consecutive positions in the log are entered, so there may be repetitions. All 2xx and 9xx error messages are stored in the event log.

To view the event log:

1. Select **EVENT LOG** from Diag Menu, and press **Select** (✓).
2. Select **Display Log**, and press **Select** (✓).

Up to three error codes display at a time. press ◀ or ▶ to view additional error codes. press ▶ to view additional details.

Press **Back** (⏪) to return to the EVENT LOG menu.

Print Log

Additional diagnostic information is available when you print the event log from DIAGNOSTICS rather than CONFIG MENU.

The Event Log printed from DIAGNOSTICS includes:

- Detailed printer information, including code versions
- Time and date stamps
- Page counts for most errors
- Additional debug information in some cases

The printed event log can be faxed to your next level of support for verification or diagnosis.

To print the event log:

1. Select **EVENT LOG** from **DIAGNOSTICS**, and press **Select** (✓).
2. Select **Print Log**, and press **Select** (✓).

press **Back** (⏪) to return to **EVENT LOG**.

Clear Log

Use **Clear Log** to remove the current information in the Event Log. This affects both the viewed log and the printed log information.

1. Select **Clear Log** from the Event Log menu, and press **Select** (✓).
2. Select **YES** to clear the Event Log or **NO** to exit the Clear Log menu. If **YES** is selected, **Deleting EVENT LOG** displays on the screen.

Press **Back** (⏪) to return to **EVENT LOG**.

Scanner Tests

ASIC Test

This test initiates a scan of the scanner ASIC's memory.

While this test is executing **ASIC Test Running** is displayed. When the test is complete, **ASIC Test Passed** is displayed if the ASIC memory is ok. **ASIC Test Failed** is displayed if the test fails. press the **Back** or **Stop** buttons to clear the display message

Feed Test

This test executes a continuous feed test from ADF or flatbed.

Note: Neither test produces printed output, or increments any MPS counters.

After selecting this test, **<DISPLAY>** is displayed.

Running. Flatbed:xxxx ADF:xxxx is displayed while the feed test is executing. To stop the test, press **Back** or **Stop**. If an error occurs during the test, **Feed Test failed Flatbed:xxxx ADF:xxxx** is displayed. press **Return** or **Stop** to clear the message.

Sensor Test

A series of sensor tests are available to test the scanner's ADF and flatbed sensor functionality. The following tests are available.

ADF paper present - This test can be used to test the paper present sensor. Open and closed are the two states of the sensor.

To test the sensor:

1. Select the paper present test in the diagnostic menu.
2. Toggle the sensor actuator (A).

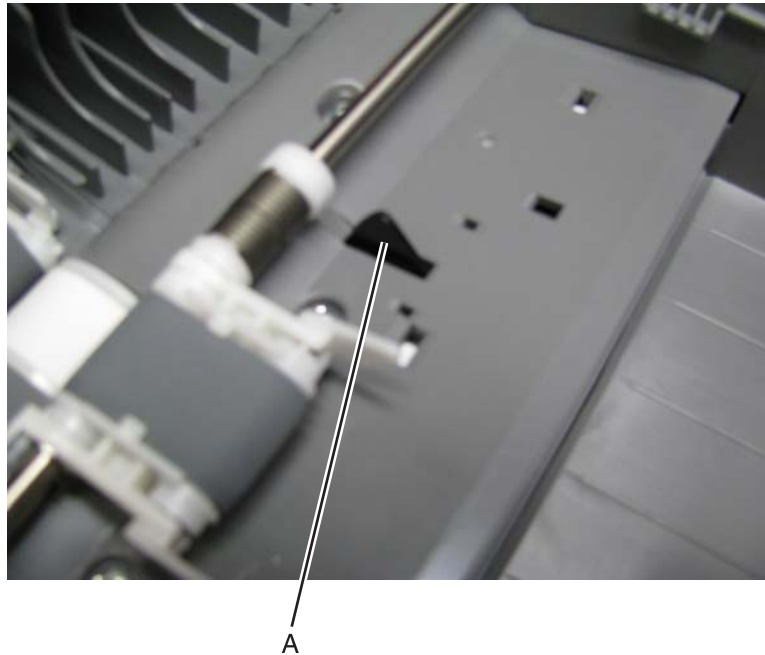

The sensor will switch between the two states listed below if it is working properly:

Closed: Paper not present in ADF

Open: Paper present in ADF

Home Sensor - This test is used to test the home position sensor for the CIS carriage in the flatbed unit. There are two states for this sensor.

Closed: Scanner carriage not positioned over home sensor

Open: Scanner carriage positioned over home sensor

Scan First Sensor - This test is used to test the first scan sensor in the ADF paperpath.

1. Select the scan first sensor test in the diagnostic menu.
2. Toggle the sensor actuator (A).

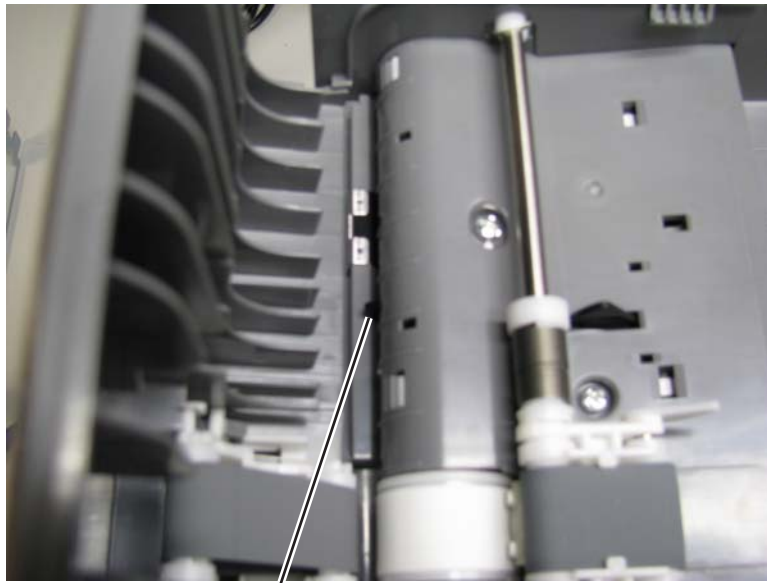

A

The sensor will switch between the two states listed below if it is working properly:

Closed: Paper isn't present above this sensor

Open: Paper is being fed from the ADF and the top edge passes over this sensor

Configuration Menu

Available menus

USB Scan to Local	See “USB Scan to Local” on page 3-14.
Reset PC count	See “Reset PC Cnt” on page 3-14.
Print Quality Pages	See “Prt Quality Pages” on page 3-14.
Reports	See “Reports” on page 3-15.
Panel Menus	See “Panel Menus” on page 3-15.
Demo Mode	See “Demo Mode” on page 3-15.
Factory Defaults	See “Factory defaults” on page 3-15.
Energy Conserve	See “Energy Conserve” on page 3-16.
Format Fax Storage	See “Format Fax Storage” on page 3-16.
ADF Edge Erase	See “ADF Edge Erase” on page 3-16.
FB Edge Erase	See “FB Edge Erase” on page 3-16.
Scanner Manual Registration	See “Scanner Manual Registration” on page 3-17.
Disable Scanner	See “Disable Scanner” on page 3-18.
Font Sharpening	See “Font Sharpening” on page 3-18.
Reduced Curl	See “Reduced Curl” on page 3-18.
USB Speed	See “USB Speed” on page 3-18.
Exit Config Menu	See “Exit Config Menu” on page 3-18.

USB Scan to Local

USB Scan to Local enumerates a USB simple device or USB composite device. In the off position, the simple USB device is enumerated: in the on position, the composite USB device is enumerated.

Reset PC Cnt

The Reset PC count menu item is used to reset the count of the PC unit to zero. It should only be used under the supervision of your second level support center.

Prt Quality Pages

The Prt Quality Pages can be printed from both the Configuration Menu and the Diagnostics Menu. The Configuration Menu is limited in information compared to the pages printed from the Diagnostics Menu.

To help isolate print quality problems, print the Print Quality Test Pages. The pages are formatted. The Printing Quality Test Pages message appears, then the pages print. The message remains on the operator panel until all the pages print.

press **Select** () to print the pages. The Print Quality Test Pages contain several pages. The first page which is printed in English text contains only a mixture of text and graphics. The information includes values of the Quality Menu setting's in setting's and printer and toner cartridge configuration information. The remaining pages contain only graphics. For samples of the pages, see **“Print quality test pages (Prt Quality Pgs)”** on page 3-5.

Reports

Menu setting's Page

Print the menu setting's pages to list the customer setting's and to verify printer options are installed correctly. It is helpful to print the customer setting's before you restore factory defaults or make major changes.

To print the menu setting's:

1. Select **Reports** from the Config Menu, and press **Select** (✓).
2. Select **Menu setting's Page**, and press **Select** (✓).

Event Log

Lets the system support person print a limited set of the information contained in the Diagnostics Menu version of the printed Event Log. For a sample of a printout, see "**Event Log**" on page 3-10. The limited Configuration log and the full Diagnostics log printed versions show the same operator panel messages when they print and follow the same layout guidelines.

To print the event log:

1. Select **Reports** from the Config Menu, and press **Select** (✓).
2. Select **Print Log**, and press **Select** (✓) to begin printing the log.

Panel Menus

Lets the system support person enable or disable the operator panel menus. Selecting **On** (the default) allows users to change values for the printer. **Off** disables the users' access to menus. If a user presses **Menu** (☰), they receive a message that the panel menus are locked. When set to **Off**, this setting restricts all menu access, even to menus or items set for PIN access. However, when set to **On**, all PIN restrictions are in restored.

This menu item appears only when the PJI PASSWORD Environment variable is set to 0.

Demo Mode

Lets marketing personnel or merchandisers demonstrate the printer to potential customers by printing the demo page.

Selections include Deactivate (default) and Activate. Select **Deactivate** to turn Demo Mode off; or select **Activate** to turn Demo Mode on.

Factory defaults

Sets the majority of printer values back to their factory default setting's.

Warning: This selection cannot be reversed, so this operation should be used only as a last resort to fix any printer problem. When factory default setting's are restored:

- All downloaded resources (fonts, macros, symbol sets) in the printer memory (RAM) are deleted.
- All menu setting's return to the factory default setting *except*:
 - The Display Language setting in the Setup Menu.
 - All setting's in the Parallel Menu, Serial Menu, Network Menu, Infrared Menu, Local Talk Menu, and USB Menu.

To print current menu setting's:

It is recommended that you first print the customer's current setting's by printing a copy of the Menu setting's pages. Customer setting's are available from the Ready prompt, Diagnostics Menu setting's are available in the Diagnostics Menu, and Config Menu setting's are available in the Config Menu.

1. Turn off the printer, or select **Exit Config Menu**.
2. At the Ready prompt, select **Menus** (⏪), and press **Select** (✓).
3. Select **Reports**, and press **Select** (✓).
4. Select **Menu setting's Page**, and press **Select** (✓).
5. Enter the Diagnostic Menu, select **Reports, Menu setting's Page**, and press **Select** (✓).
See "**Menu setting's Page**" on page 3-15.
6. Turn off the printer, or select **Exit Diags**.
7. Enter Configuration Menu, select **Reports, Menu setting's Page**, and press **Select** (✓).
See "**Menu setting's Page**" on page 3-15.

To reset factory defaults:

1. Select **Reports** from the Config Menu, and press **Select** (✓).
2. Select **Factory Defaults**, and press **Select** (✓).
3. Select **Restore Base** (for locally attached printers) or **Restore STD NET** (if you have integrated network support).
Submitting Changes... appears on the operator panel, and then the printer PORs (restarts in Ready mode).

Energy Conserve

Affects the values that appear in the Power Saver menu item in the Setup Menu. This menu item appears only when the printer model does not support Automatic Power Saver or has deactivated Automatic Power Saver. The menu item affects only the values that are displayed in the Power Saver menu item.

Select **Off** in Energy Conserve to allow Power Saver in the customer menu to display Disable as an option. If **Disable** is selected in the customer Power Saver, the printer deactivates the Power Saver feature. Select **On** (the default) in Energy Conserve to prevent **Disable** from appearing as an option in the Power Saver setting, and preventing the customer from turning off Power Saver.

Format Fax Storage

This setting allows the user to format non volatile fax storage memory. While formatting is taking place, Formatting Fax Flash DO NOT POWER OFF appears. After formatting is complete, the display reverts to the main menu.

ADF Edge Erase

This menu item sets the size, in millimeters, of the no-print area around an ADF scan job. All copy jobs have a minimum of a two millimeter border. Copy jobs will use the setting or two millimeters, whichever is larger.

To adjust the ADF edge erase setting, perform the following steps:

1. In the Configuration menu, select the ADF Edge Erase menu item.
2. Press ◀ or ▶ to increase or decrease the setting's value.
3. When the desired value is displayed, press (✓) .

FB Edge Erase

This menu item sets the size, in millimeters, of the no print are around a flatbed scan job. Copy jobs will use the setting or two millimeters, whichever is larger.

To adjust the flatbed edge erase setting, perform the following steps:

1. In the Configuration menu, select the FB Edge Erase menu item.
2. Use the ◀ or ▶ to increase or decrease the setting's value.
3. When the desired value is displayed, press .

Scanner Manual Registration

This item is used to manually register the flatbed and ADF on the MFP's scanner unit. Registration should be performed whenever the ADF unit, flatbed unit, or controller card are replaced.

To manually register the ADF perform the following steps:

1. In the Configuration Menu, scroll to the Scanner Manual Registration menu item.
2. Press .
3. Scroll to the Print Quick Test Page menu item.
4. Press .
5. To view and adjust the simplex ADF registration, place the quick test page into the ADF, scroll to the Copy Quick Test Page item and press .
6. After the quick test page copies, scroll to ADF and press .
7. Scroll to Horizontal Adjust, and press .
8. Use the ◀ or ▶ to increase or decrease the setting's value.

Note: Each button press move the margin values one pixel in the respective direction.

9. Press to accept the value.
10. Scroll to Top Edge and press .
11. Use the ◀ or ▶ to increase or decrease the setting's value.

Note: pressing ◀ moves the margin up and pressing ▶ moves the margin down.

12. Press to accept the value.

To manually register the flatbed, perform the following steps:

1. In the Configuration Menu, scroll to the Scanner Manual Registration menu item.
2. Press .
3. Scroll to the Print Quick Test Page menu item.
4. Press .
5. To view and adjust the flatbed registration, place the quick test page into the flatbed, scroll to the Copy Quick Test Page item, and press .
6. After the quick test page copies, scroll to Flatbed, and press .
7. Scroll to Left Edge, and press .
8. Use the ◀ or ▶ to increase or decrease the setting's value.

Note: Each button press moves the margin values one pixel in the respective direction.

9. Press to accept the value.
10. Scroll to Top Edge, and press .
11. Use the ◀ or ▶ to increase or decrease the setting's value.

Note: Pressing ◀ moves the margin up, and pressing ▶ moves the margin down.

12. Press to accept the value.

To exit REGISTRATION, press **BACK** or **STOP** .

Disable Scanner

This menu item is used to disable the MFP scanner if it is malfunctioning. The MFP must be powered off and on for the new setting's to take effect. To change the setting, perform the following steps:

1. In the configuration menu, use the arrow keys to scroll to the Disable Scanner menu item.
2. Press .
3. Use the arrow key to scroll to the desired setting. The options are Enable ADF/FB, Disable ADF/FB, Disable ADF only, Auto Disabled.
4. Press .
5. Press **BACK**.
6. Scroll to **Exit Config Menu**.
7. Press . The device restarts.

Font Sharpening

This setting is used to set a text point size value below which the high frequency screens will be used when printing data. This setting affects only PCL, PostScript and PDF emulators.

setting's are in the range of 0–150 (24 is the default). For example, if the value is set to 24, then all fonts sized 24 points or less use the high frequency screens.

To adjust the Font Sharpening setting, perform the following steps:

1. In the configuration menu, scroll to the Font Sharpening menu item and press .
2. Use the or to increase or decrease the setting's value. pressing decreases the value and pressing increases the value.
3. Press to accept the setting.

Reduced Curl

Note: This only appears on devices with an instant on fuser.

USB Speed

The USB Speed setting is used to set the throughput of the USB port on the MFP. The setting's are Auto, which is the default, and Full. Full forces the USB port to run at full speed.

Exit Config Menu

With the Exit Config menu item displayed, press **Select** () to exit the Configuration Menu. The printer performs a power-on reset and returns to normal mode.

SE Menu

Print SE Menus

General

Copyright - Displays copyright information.
Optra Forms mode - On or off

Code Revision Info

Network Code Level - Displays network code level
Network Compile Info - Displays compile information
Printer Code Level - Displays printer code information
Printer Compile Info - Displays compile information

History

Print History
Mark History
History Mode

MAC

Set Card Speed
LAA
Keep Alive

NVRAM

Dump NVRAM
Re-init NVRAM

NPAP

Print Alerts

TCP/IP

netstat -r
arp -a
Allow SNMP Set
MTU
Meditech Mode
Raw LPR Mode
Gather Debug
Enable Debug

Paper jams

Avoiding jams

The following hints can help you avoid jams:

- Use only recommended paper or specialty media.
For more information, see the *Card Stock & Label Guide* available on the Lexmark Web site at www.lexmark.com/publications.
- Do not load too much paper. Make sure the stack height does not exceed the indicated maximum height.
- Do not load wrinkled, creased, damp, or curled paper.
- Flex, fan, and straighten paper before loading it.
- Do not use paper that has been cut or trimmed by hand.
- Do not mix paper sizes, weights, or types in the same stack.
- Store the paper in an appropriate environment.
- Do not remove trays while the printer is printing. Wait for Load tray <x> or Ready to appear before removing a tray.
- Do not load the manual feeder while the printer is printing. Wait for Load Manual feeder with <x> to appear.
- Push all trays in firmly after loading paper.
- Make sure the guides in the trays are properly positioned, and are not pressing too tightly against the paper.
- Make sure all paper sizes and paper types are set correctly in the operator panel menu.
- Make sure all printer cables are attached correctly.

200 - 201 paper jam

200 paper jam

1. Remove the tray from the printer.

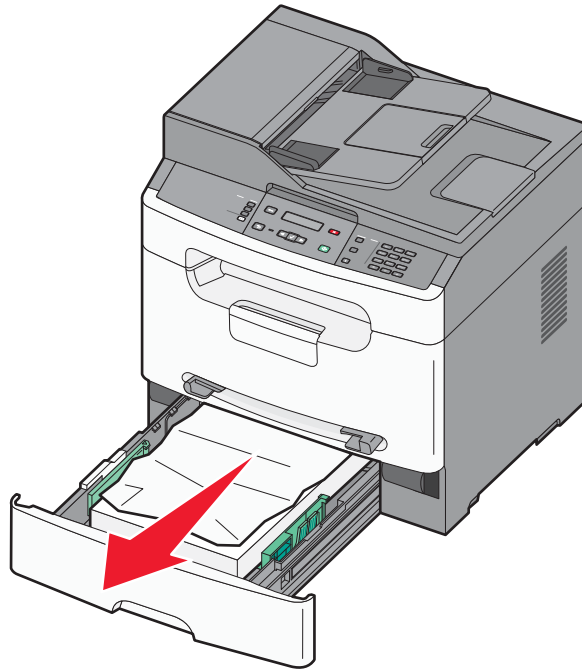

2. Remove the jam if you can see it. If the jam is not visible, see the instructions for a 201 jam.

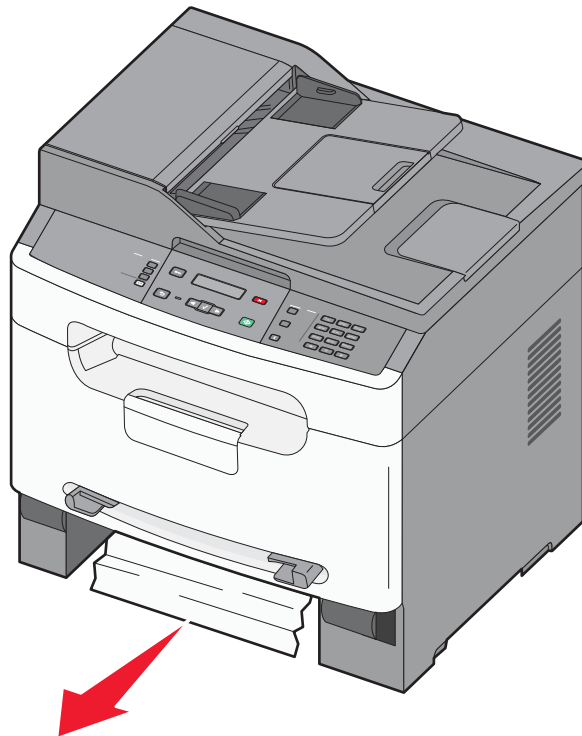

201 paper jam

1. Open the front door, and remove the photoconductor kit and toner cartridge.

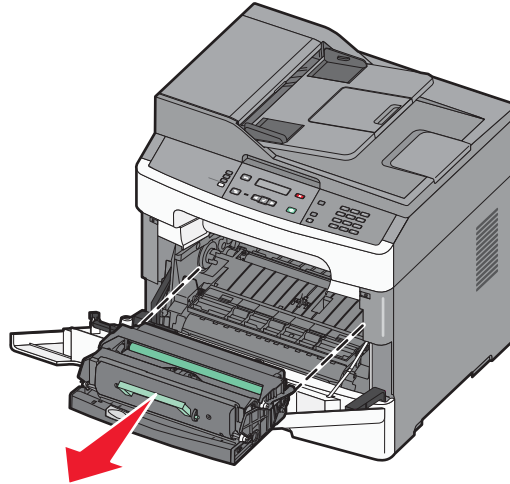

2. Lift the flap at the front of the printer, and remove the jammed media.

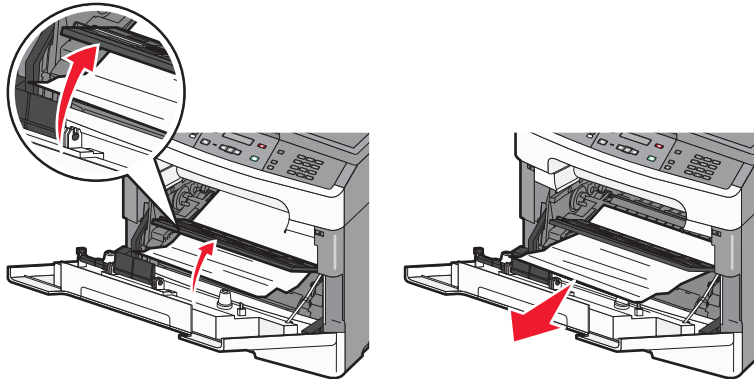

3. Align and insert the photoconductor kit and toner cartridge.
4. Close the front door.
5. Insert the tray.
6. Press .

202 paper jam

1. Open the front door, and remove the photoconductor kit and toner cartridge.

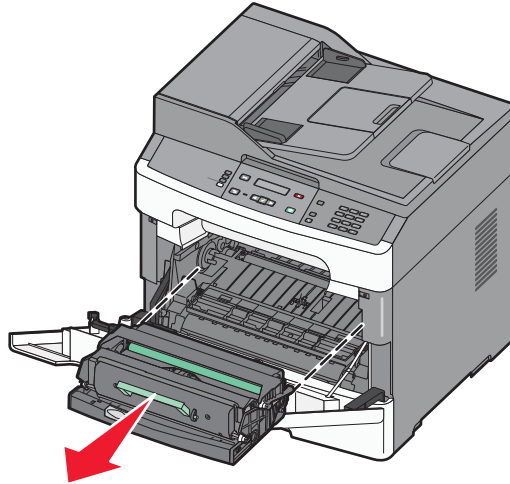

2. Lift the flap at the front of the printer, and remove the jammed media.

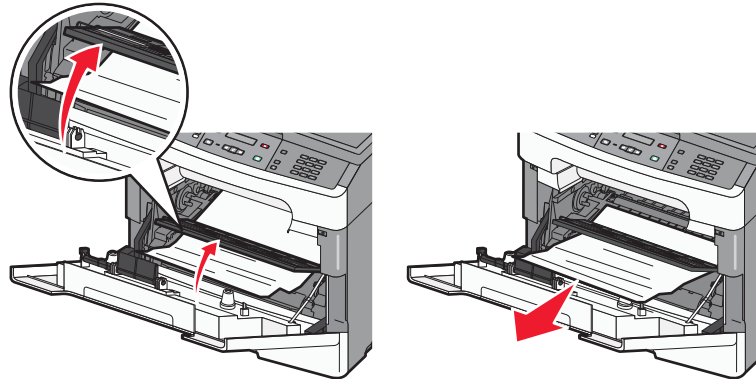

3. Open the rear door.

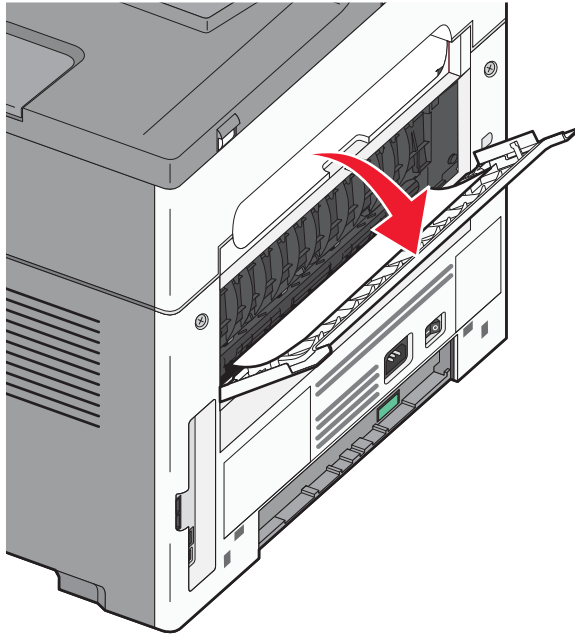

4. Remove any jam.

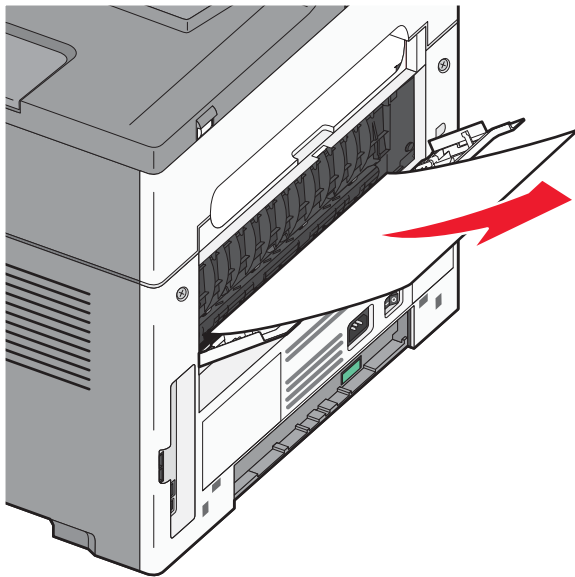

5. Close the rear door.
6. Align and insert the photoconductor kit and toner cartridge.
7. Close the front door.
8. Press .

241 paper jam

1. Remove the tray from the printer.

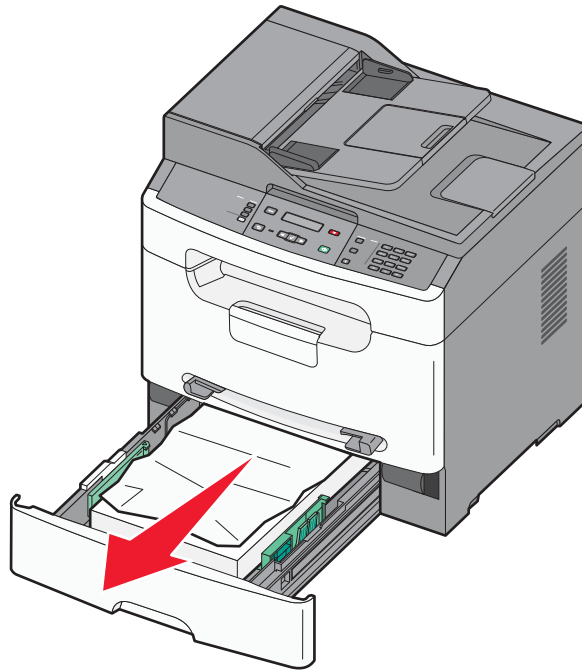

2. Remove the jam.

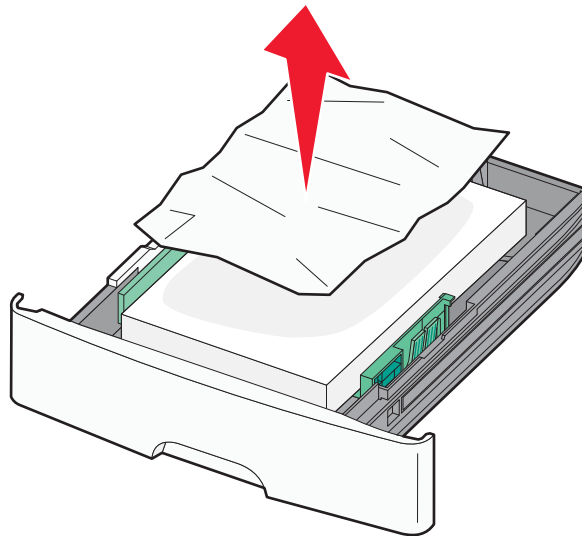

3. Insert the tray.
4. Press .

251 paper jam

A sheet of paper or specialty media failed to feed completely from the manual feeder. Part of it may still be visible. If it is visible, then gently pull the jammed sheet from the front of the manual feeder.

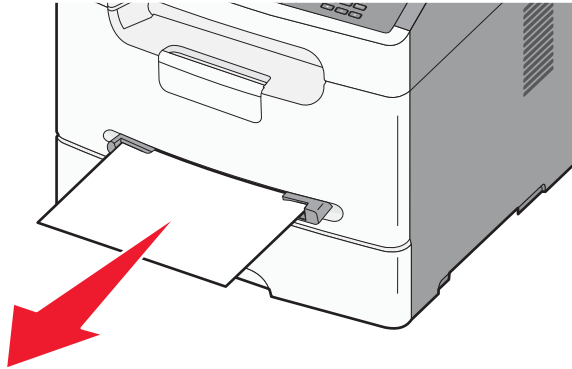

If the sheet is not visible, complete the following steps:

1. Remove the photoconductor kit and cartridge.

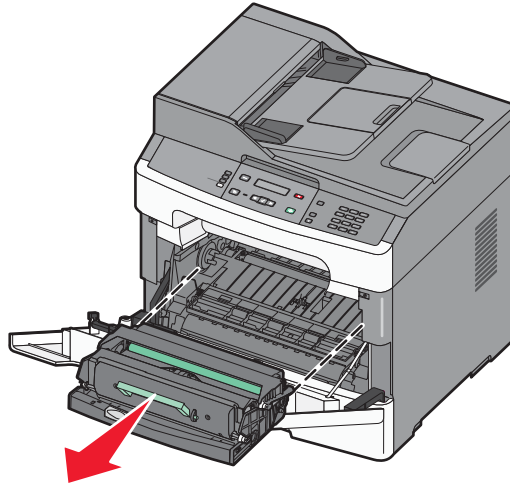

2. Lift the flap at the front of the printer, and remove any jammed media.

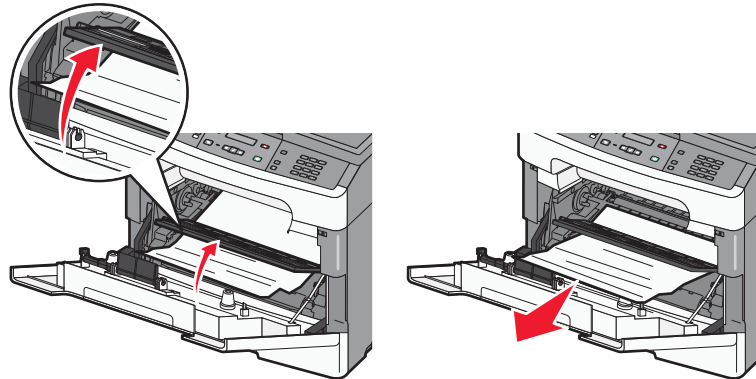

3. Align and insert the photoconductor kit and toner cartridge.
4. Press .

290 - 294 paper jams

1. Remove all original documents from the ADF input tray.
2. Open the ADF cover, and remove any jammed paper.

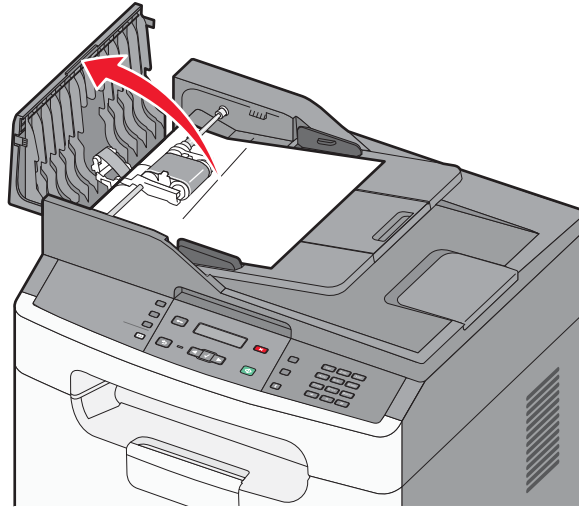

Note: Remove the ADF separator roll assembly if needed.

3. Close the ADF cover.
4. Open the flatbed cover, and remove any jammed pages from the underside of the ADF.

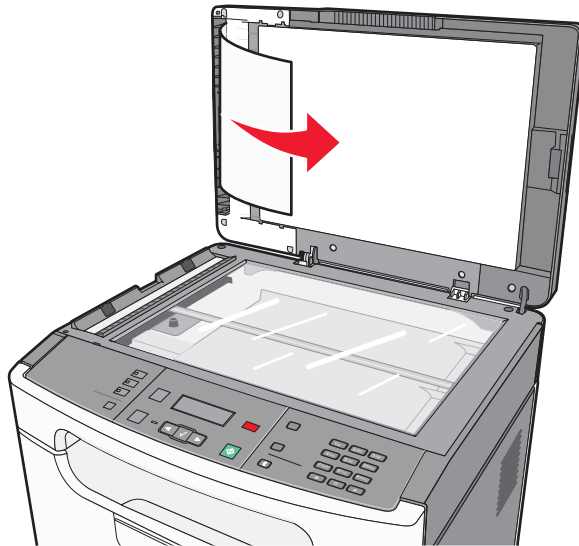

5. Press .

4. Repair information

Warning: Read the following before handling electronic parts.

Handling ESD-sensitive parts

Many electronic products use parts that are known to be sensitive to electrostatic discharge (ESD). To prevent damage to ESD-sensitive parts, follow the instructions below in addition to all the usual precautions, such as turning off power before removing logic cards:

- Keep the ESD-sensitive part in its original shipping container (a special “ESD bag”) until you are ready to install the part into the MFP.
- Make the least-possible movements with your body to prevent an increase of static electricity from clothing fibers, carpets, and furniture.
- Put the ESD wrist strap on your wrist. Connect the wrist band to the system ground point. This discharges any static electricity in your body to the MFP.
- Hold the ESD-sensitive part by its edge connector shroud (cover); do not touch its pins. If you are removing a pluggable module, use the correct tool.
- Do not place the ESD-sensitive part on the MFP cover or on a metal table; if you need to put down the ESD-sensitive part for any reason, first put it into its special bag.
- Machine covers and metal tables are electrical grounds. They increase the risk of damage, because they make a discharge path from your body through the ESD-sensitive part. (Large metal objects can be discharge paths without being grounded.)
- Prevent ESD-sensitive parts from being accidentally touched by other personnel. Install machine covers when you are not working on the machine, and do not put unprotected ESD-sensitive parts on a table.
- If possible, keep all ESD-sensitive parts in a grounded metal cabinet (case).
- Be extra careful in working with ESD-sensitive parts when cold-weather heating is used because low humidity increases static electricity.

Removal procedures

1. Remove the toner cartridge and paper tray before removing other MFP parts. The toner cartridge should be protected from light while out of the MFP.
2. We recommend disconnecting all external cables from the MFP to prevent damage during service.
3. Unless otherwise stated, re-install the parts in reverse order of removal.
4. When re-installing a part held with several screws, start all screws before final tightening.

Covers

Front cover removal

1. Open the front cover.
2. Remove the screw securing the strap to the print engine frame.



3. Place thumbs on the inside of the respective hinge.



4. Force the left hinge out of its socket, and relax it above the socket.
5. Force the right hinge out of its socket, and lift it above the socket.

Warning: Do not pull the fuser link out of the MFP any farther than when the door is fully open. Otherwise, the link extension may dislodge the cartridge coupler.

6. Carefully lift the cover free from the printer base frame.
7. Use your left hand to hold the fuser link (A) at the cover joint while rotating the right side of the cover slightly away from the MFP to disengage the link.

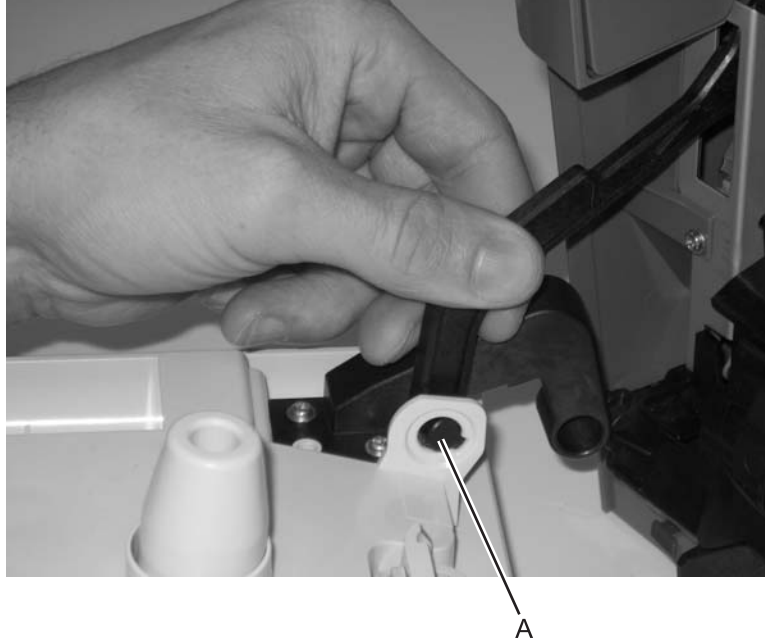

8. Remove the front cover.

Left side cover removal

1. Remove the two screws (A) securing the left cover to the MFP frame.

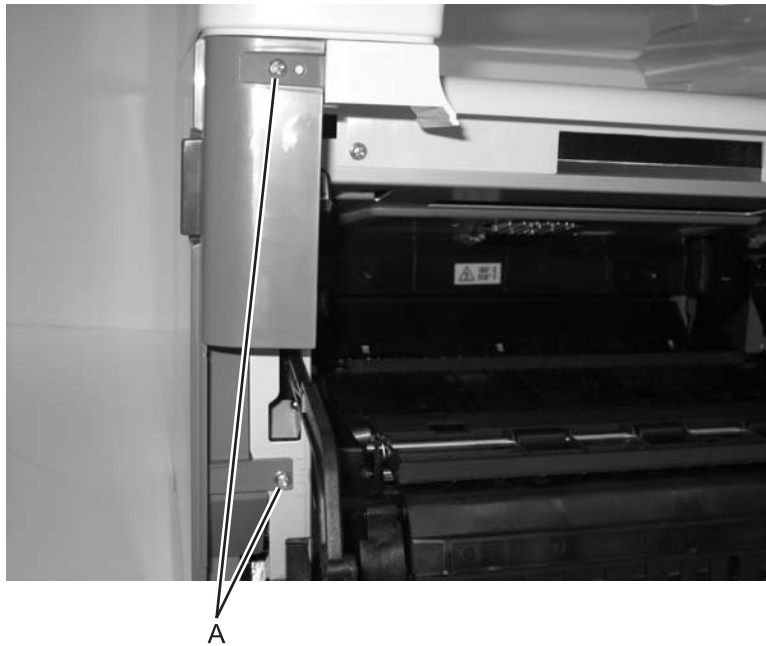

2. Pry the front of the cover away from the frame, and pull outward to disengage the cover from the frame.



3. Remove the cover from the MFP.

Rear cover removal

1. Remove the four screws (A) which secure the rear cover to the printer engine frame.

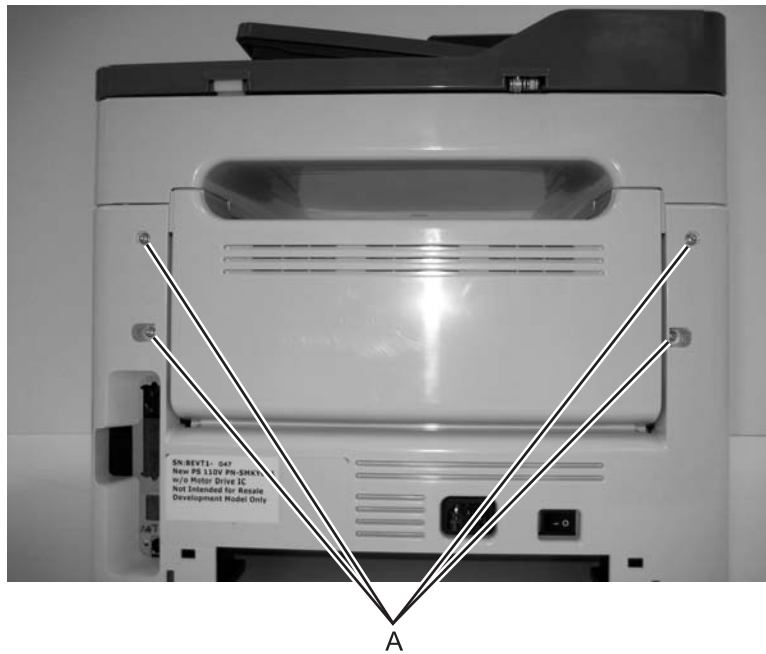

2. Open the fuser access door.



3. Pull the rear cover up and out to disengage it from the frame.

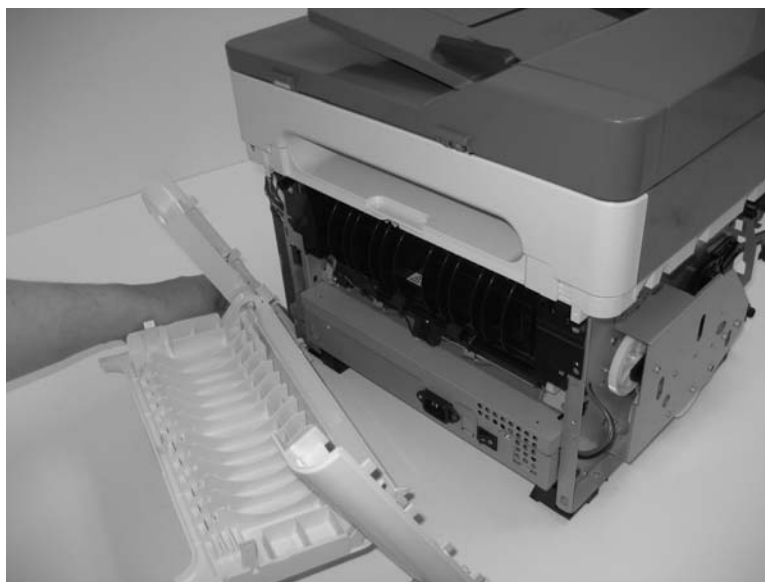

4. Remove cover.

Right side cover removal

1. Remove the two screws (A) securing the right cover to the MFP frame.



A

2. Pry the front of the cover away from the frame, and pull outward to disengage the cover from the frame.



3. Remove the cover from the MFP.

Top cover removal

1. Remove the flatbed assembly. See **“Flatbed removal”** on page 4-44.
2. Remove the cam follower.
3. Remove four screws (A) that secure the top cover to the printer frame.

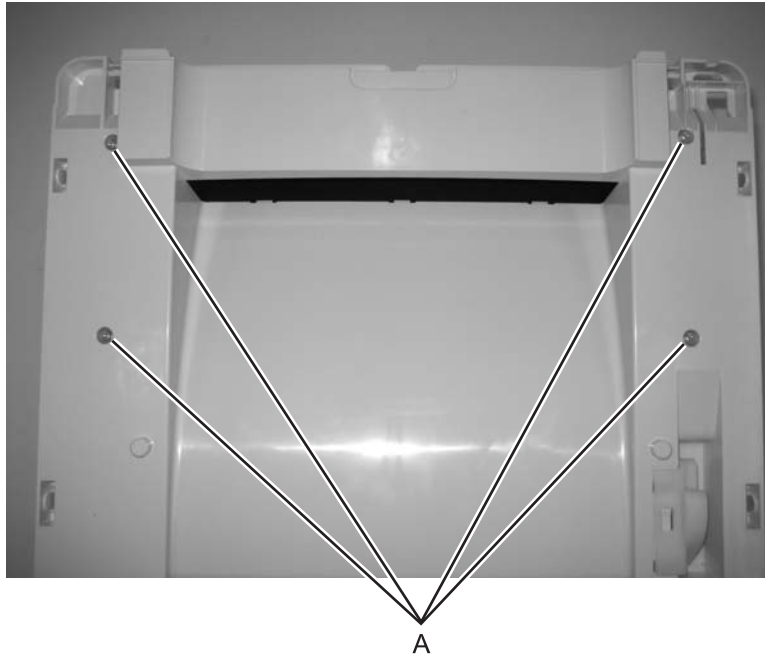

4. Remove two screws (B) at the front of the top cover just behind the access door.

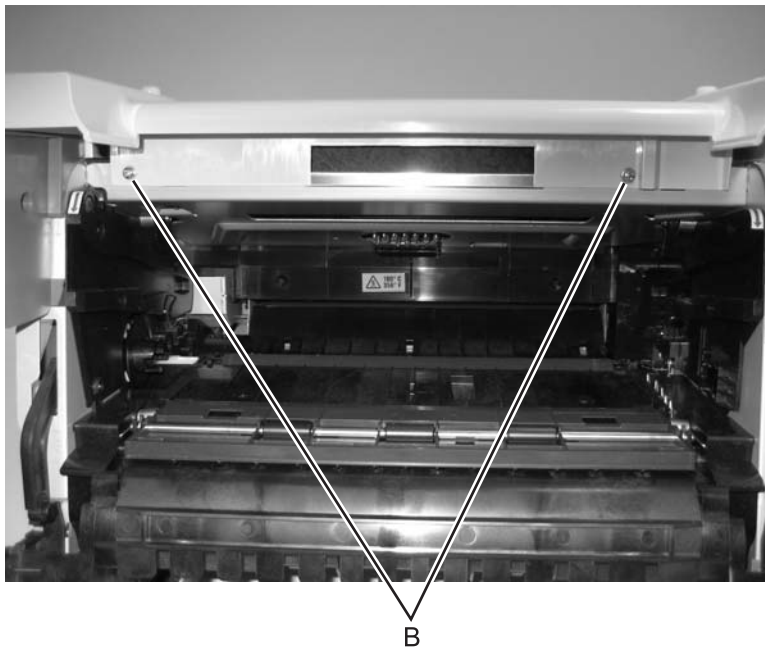

5. Lift and remove the top cover.

Flatbed front cover removal

1. Lift the flatbed assembly to the elevated position.
2. Place your fingers under the two tabs (A) on the flatbed front cover.



3. Disengage the tabs, and pull the cover away from the MFP.
4. Lift the cover up and away, and remove it from the MFP.

Left and right flatbed cover removals

Note: These steps are used for both the left and right flatbed covers.

1. Lift the ADF to the upright position.
2. Disengage the five tabs securing the cover to the flatbed.

Note: The tabs are the same for both covers.



3. Lift the cover up and out.



4. Remove the cover from the MFP.

Card cage removal

1. Remove right cover.
2. Remove screw (A) securing the card cage to the frame.

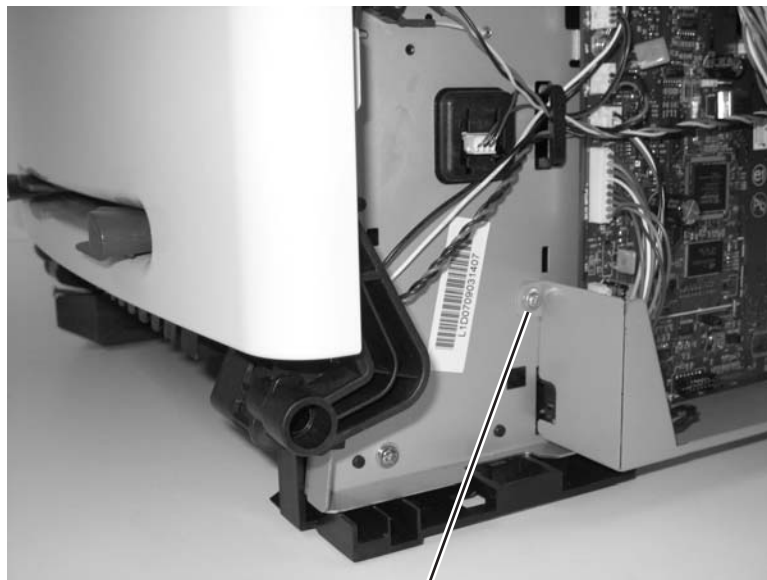

A

3. Press in metal tab, and remove card cage.

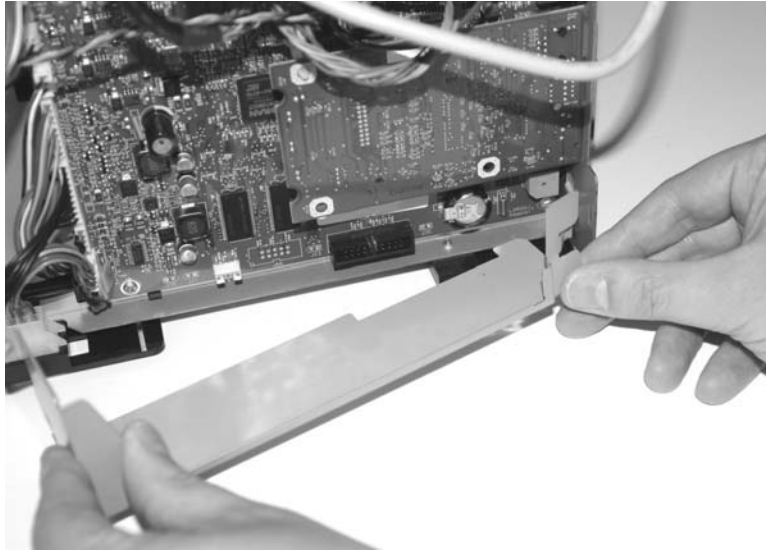

Controller card removal

Warning: Always touch a ground before touching the card.

Warning: Handle the card by the edges.

Note: Use part number 40X5765 for the X203, and 40X5766 for the X204n.

1. Remove the right cover.
2. Remove the card cage. See **"Card cage removal"** on page 4-11.
3. Remove snap on toroid holding the cables at the top of the controller card.



4. Disconnect all the cables to the controller card.
5. Remove the screw (A) securing the USB port at the back of the MFP.

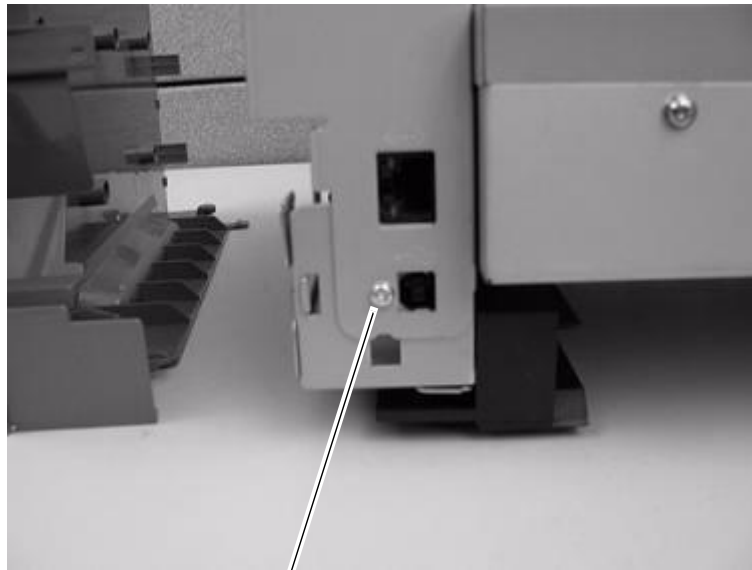

A

6. Remove four screws (B) that secure the controller card to the metal side frame.



7. Carefully lift the card, and remove.

Note: The scanner registration and calibration, as well as printer registration, must be set after replacing the controller card. See **“Registration” on page 3-3** and **“Scanner Manual Registration” on page 3-17**. Also, the serial number, **“Serial Number” on page 3-8** must be set.

Cover open sensor removal

1. Remove right side cover.
2. Remove the toroid from the group of cables located at the top of the controller card.

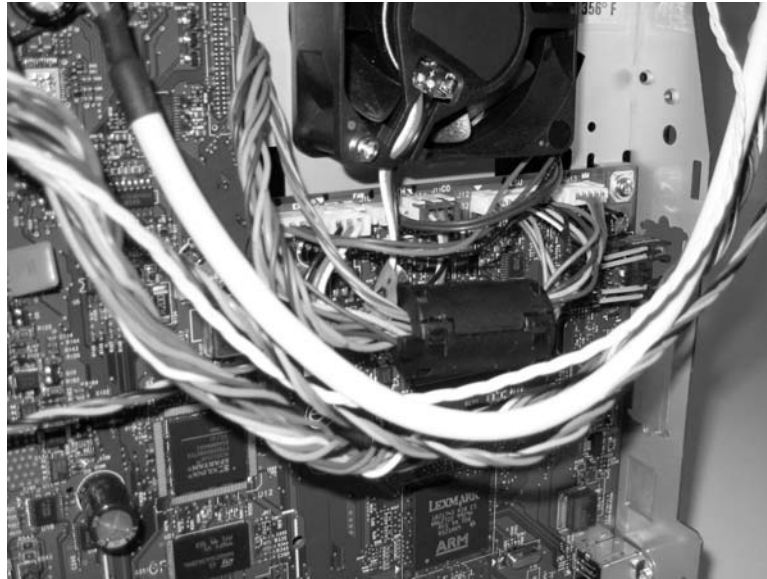

3. Disconnect the cover open switch at J11 on the controller card, and extract the cable.
4. Use a small Phillips screwdriver to remove the screw (A) that secures the sensor to the printer frame.

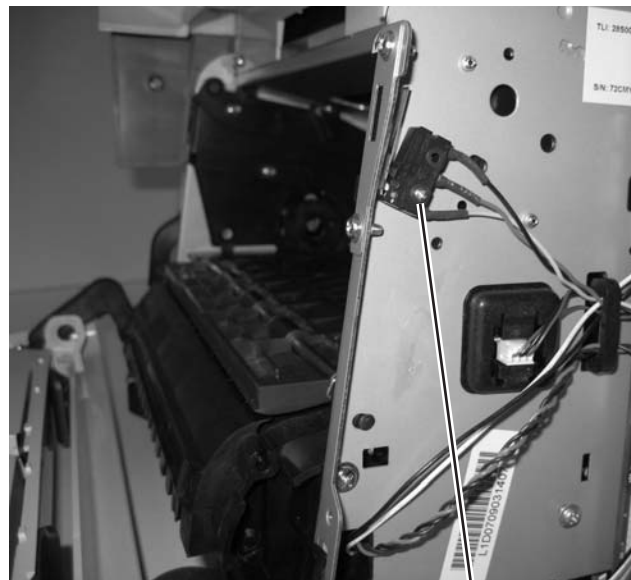

A

5. Slide the sensor from the positioning post.

Developer drive coupling assembly removal

1. Remove the left side cover. See **“Left side cover removal”** on page 4-4.
2. Carefully place the MFP on its right side. Protect the cover from marring.
3. Remove four screws (A) in the gear train metal cover.

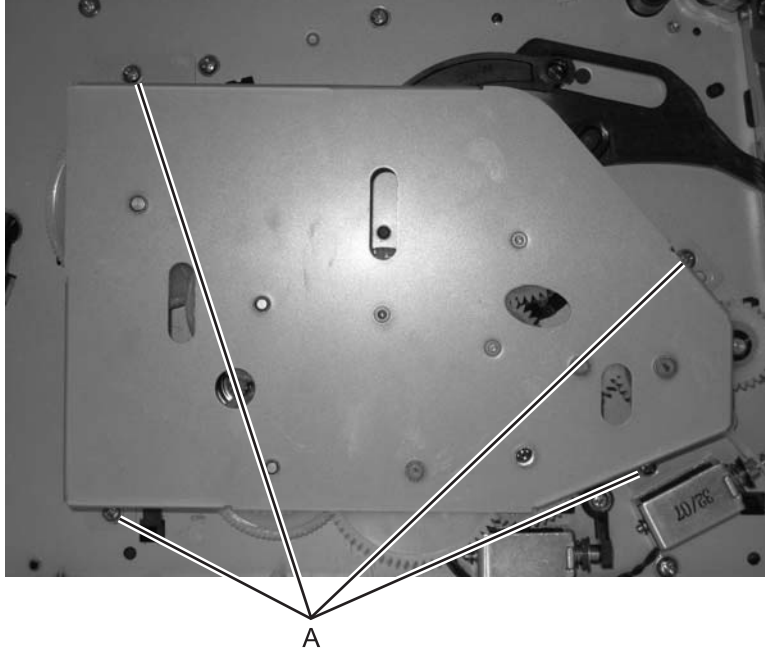

4. Remove the gear train metal cover.
5. Remove the conical spring (B) and the developer drive coupling assembly (C).

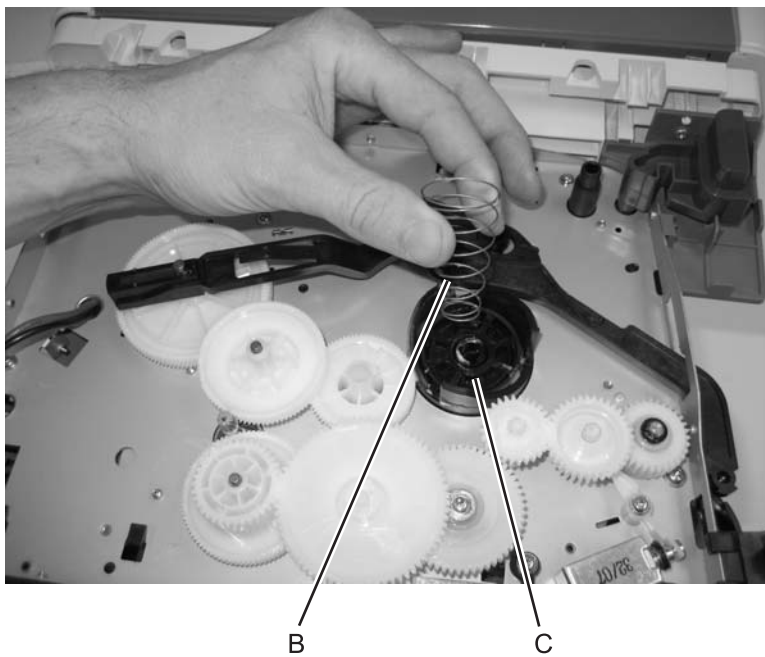

Exit sensor removal (on the fuser)

1. Remove the paper exit guide assembly. See **“Paper exit guide assembly removal”** on page 4-34 for more information.
2. Unplug the exit sensor at J8 on the controller card.
3. Push the shaft (A) to the right using your right thumb against the inside gear surface and left index finger against the opposite end of the shaft.

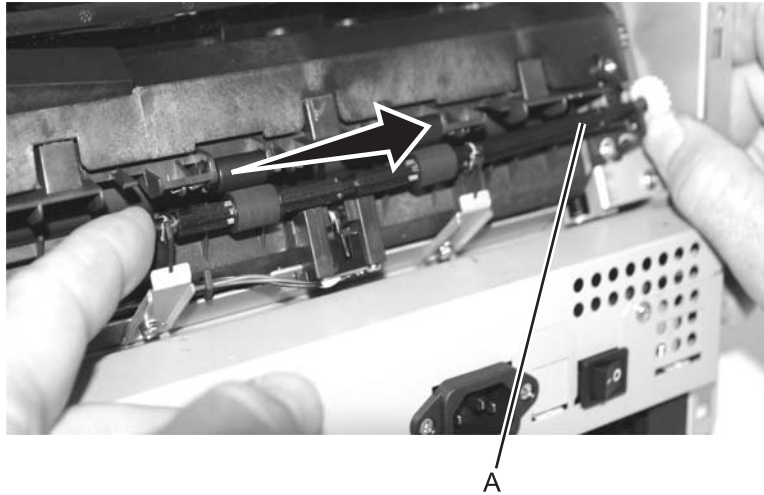

Warning: There will be some lubricant on the gear and shaft. Be sure to wipe hands clean with each contact to prevent spreading lubricant to other areas.

4. Align the two flats with the opening of the bearing support, and lift the right end of the shaft through the support.
5. Swing the shaft away from the MFP to expose the sensor flag.



6. Remove the two screws (B) securing the fuser.

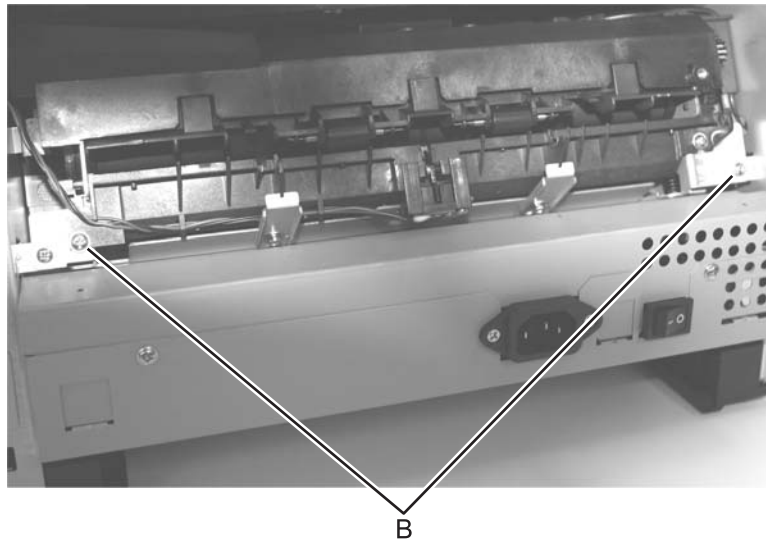

7. Slide the fuser out just enough to access the screw holding the sensor.
8. Remove the sensor and its attached cable.
9. Observe the orientation of the flag and spring before replacing units.

Fan removal

1. Open the right side cover.
2. Unplug the fan from the controller card at J9.
3. Remove two screws (A) holding the fan to the metal side frame.

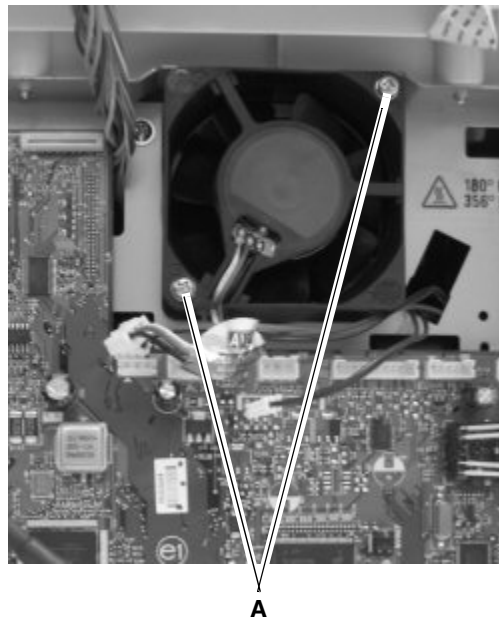

4. Remove the fan from the MFP.

Fax modem removal

1. Remove the rear cover. See **“Rear cover removal”** on page 4-5.
2. Remove the right cover. See **“Right side cover removal”** on page 4-7.
3. Remove the screw (A) securing the modem card bracket to the print engine frame.

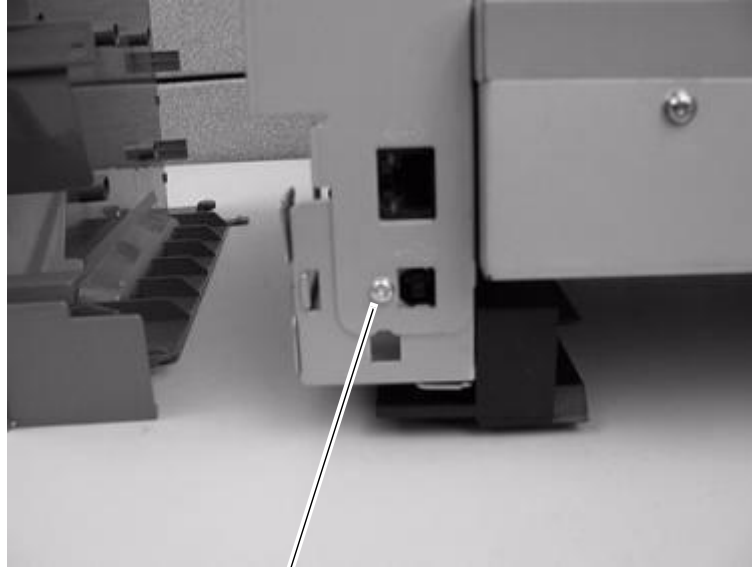

A

4. Disconnect the modem cable (B) from the fax modem.



B

5. Lift the modem card up and away from the MFP.

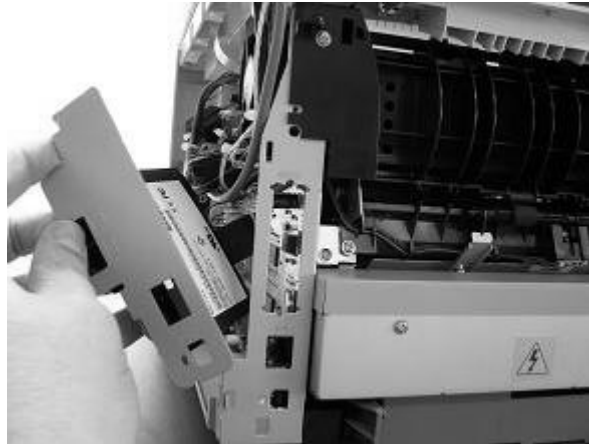

Feed rollers (autocompensator tires) removal

1. Remove the paper tray.
2. Remove the toner cartridge.
3. Tilt the MFP onto its back.
4. Remove old tires from the hubs.

Note: When installing the new tires, ensure the new tires are captured between the rims of the plastic hub.

Fuser removal



1. Remove the paper exit guide assembly. See **“Paper exit guide assembly removal”** on page 4-34 for more information.
2. Remove the two screws (A) securing the fuser.



3. Disconnect the thermistor cable at J10 and exit sensor at J8 on the controller card.

4. Slide the fuser out far enough to expose and disconnect the AC cable connections.

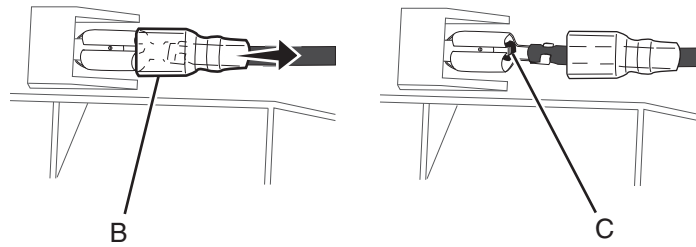

5. To disconnect the fuser power cables, slide the insulation (B) back to expose the connectors. Press the tang (C) on the connector to disconnect the cable connector.
6. Remove the fuser. Avoid damaging the insulation on the exit sensor and thermistor cables.
Note: Be sure to slide the insulation back in place after reconnecting the cables.

Fuser idle gear links removal

1. Remove the front access cover. See **“Front cover removal”** on page 4-2 for more information.
2. Remove the left side cover. See **“Left side cover removal”** on page 4-4.
3. Place MFP on its right side. Protect the cover from being marred.
4. Remove the four screws (A) securing the gear train cover.

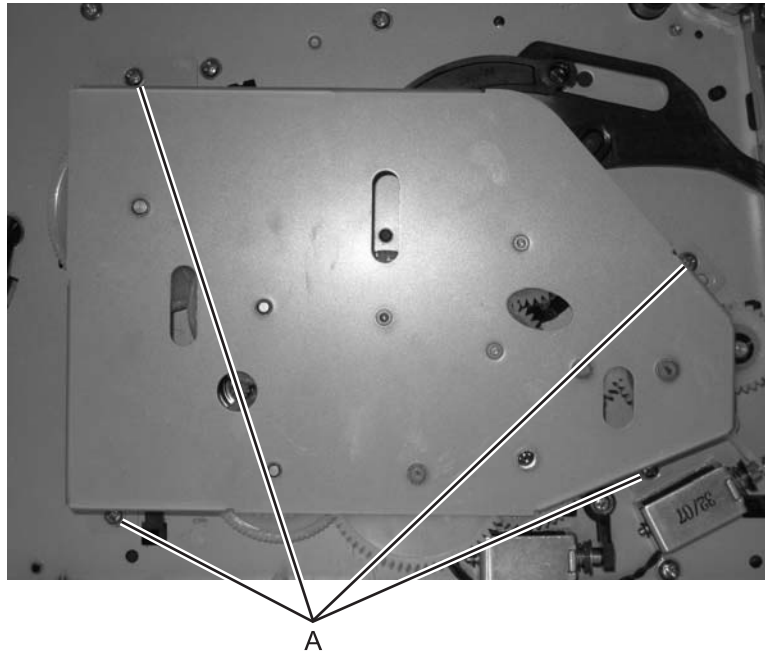

5. Remove the gear train cover.
6. Grasp the rear link with your index fingers and thumb on each side of the shaft, and unsnap the link (B) from the shaft.

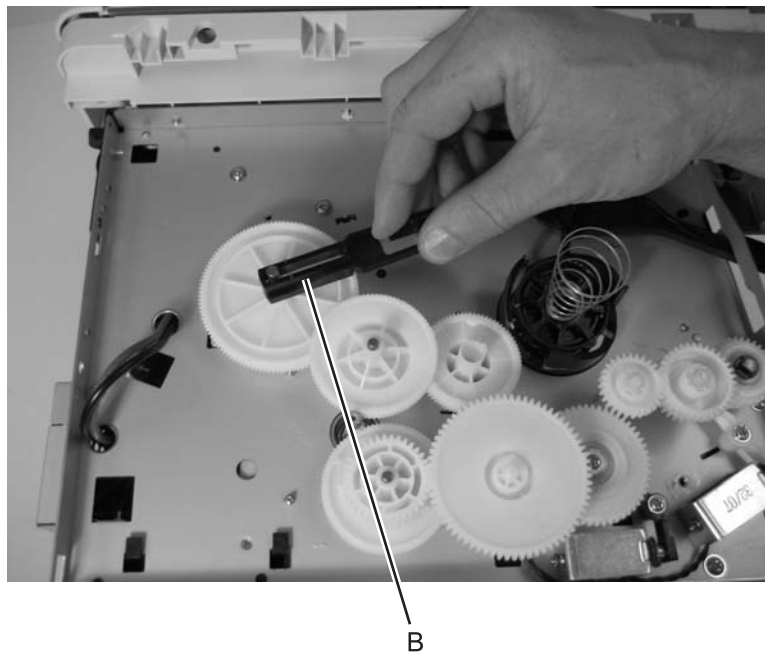

7. Disconnect front link from coupler, and remove links.



Fuser power cable removal

1. Remove the LVPS/HVPS card. See **“LVPS/HVPS card assembly removal” on page 4-27** for more information.
Note: The cable can be reached without fully removing the card.
2. Remove the rear cover. See **“Rear cover removal” on page 4-5** for more information.
3. Remove the exit guide assembly. See **“Paper exit guide assembly removal” on page 4-34** for more information.
4. Remove the two screws (B) from the lower corners of the fuser.

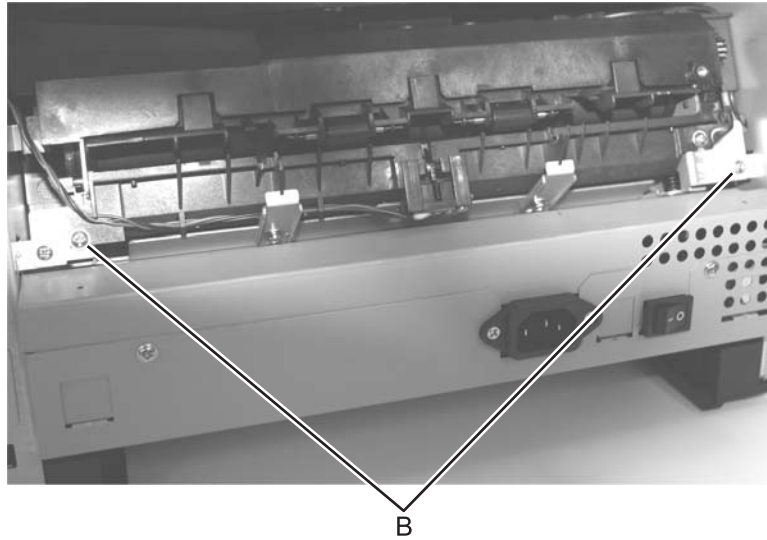

5. Slide the fuser out far enough to expose and disconnect the AC cable connections.
6. Extract the fuser power cable.

Input roller clutch and lever removal (autocompensator clutch)

1. Remove the left side cover. See **“Left side cover removal”** on page 4-4.
2. Place the MFP on its right side. Protect the cover from being marred.
3. Remove four screws (A) in the gear train metal cover.

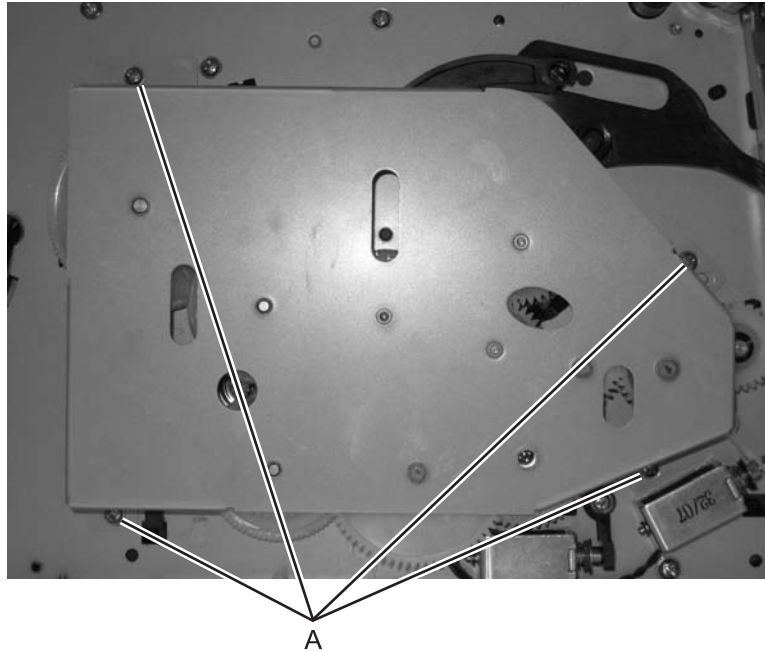

4. Remove the screw (B) from the shaft of the input roller clutch assembly.

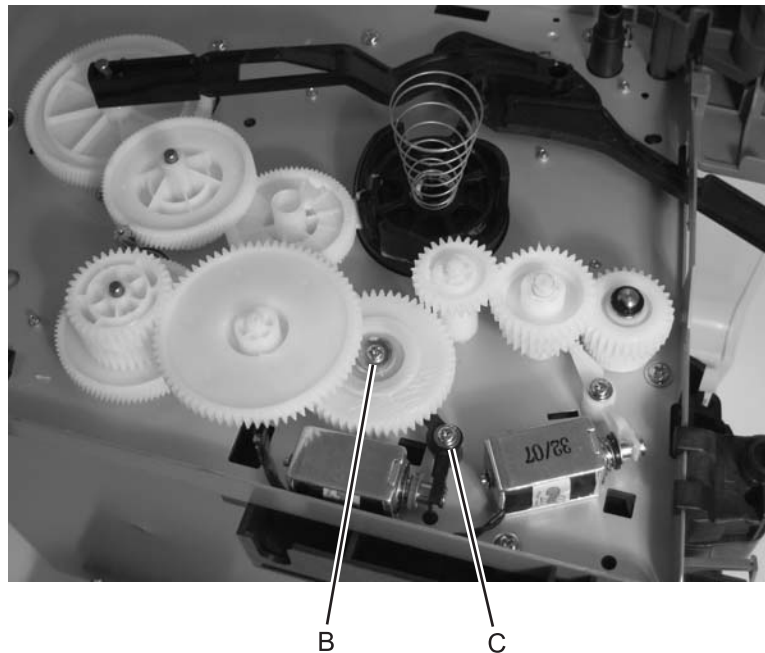

5. Remove the screw and lever (pawl) (C).
6. Remove the clutch assembly. If the pieces come apart, they can be easily reassembled if necessary.

Input sensor #1 removal

1. Remove the right side cover. See **“Right side cover removal”** on page 4-7 for more information.
2. Disconnect the sensor cable at J17 on the controller card (front, near top of card).
3. Carefully place the MFP on its back.
4. Using a small shank screwdriver, remove the screw (A) behind the ACM (auto compensator) pivot that holds the paper sensor in place.

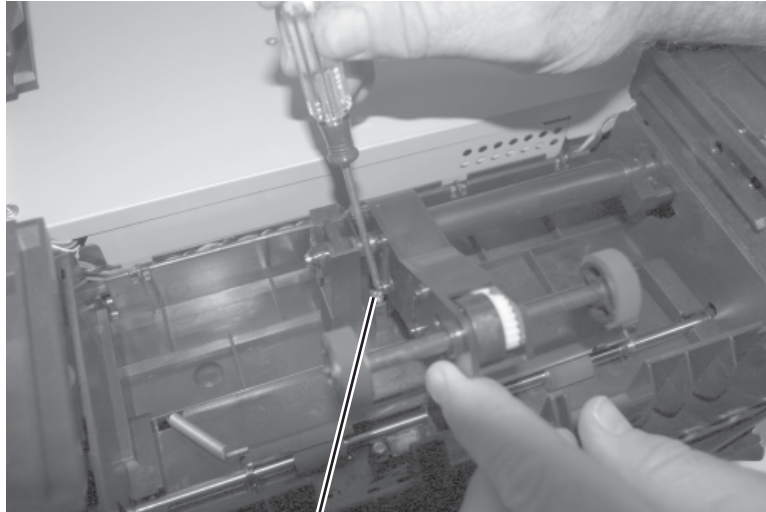

A

5. Remove the sensor and the attached cable, flag, and spring.
6. Re-install the sensor so that the flag is spring loaded against the pages as it advances in its path.
7. Verify the cable is captured and out of the paper path.

Input sensor #2 (manual feed) removal

1. Open the right side cover. See **“Right side cover removal” on page 4-7** for more information.
2. Disconnect the sensor cable at J18 on the controller card (front, top of card).
3. Remove the paper tray.
4. Carefully place the MFP on its back with the bottom of the MFP facing you. Remove the screw (A) beside the left pick tire.

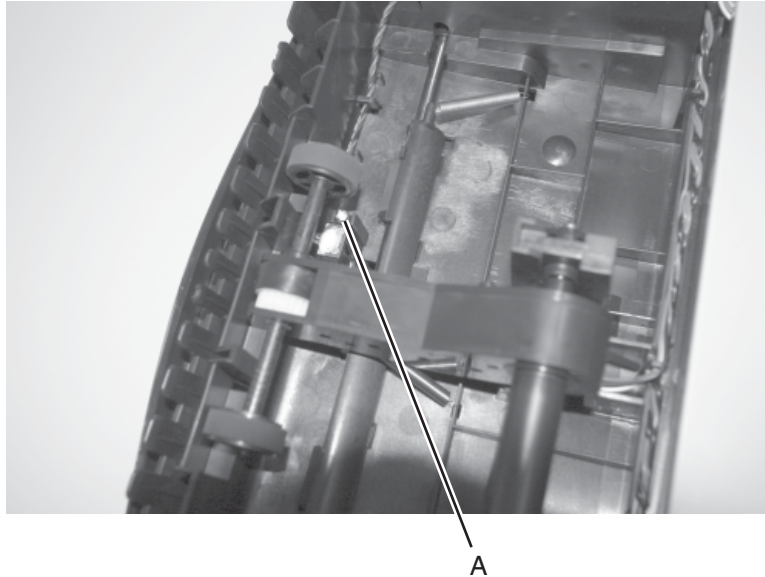

5. Remove the sensor and its attached cable.
6. Re-install the new sensor in the same orientation as the old. The flag should be spring loaded against the leading edge of an advancing sheet.
7. Verify the cable is captured and away from the paper path.



LVPS/HVPS card assembly removal

1. Remove the cover extender (if installed), paper tray, and the rear cover. See **“Rear cover removal”** on **page 4-5** for more information.
2. Remove two screws (A), one left of the power switch and the other at the opposite side of the panel.
3. Place the MFP onto its back with the rear and bottom of the MFP in view.
4. Remove the screws (B) securing the two foot brackets.

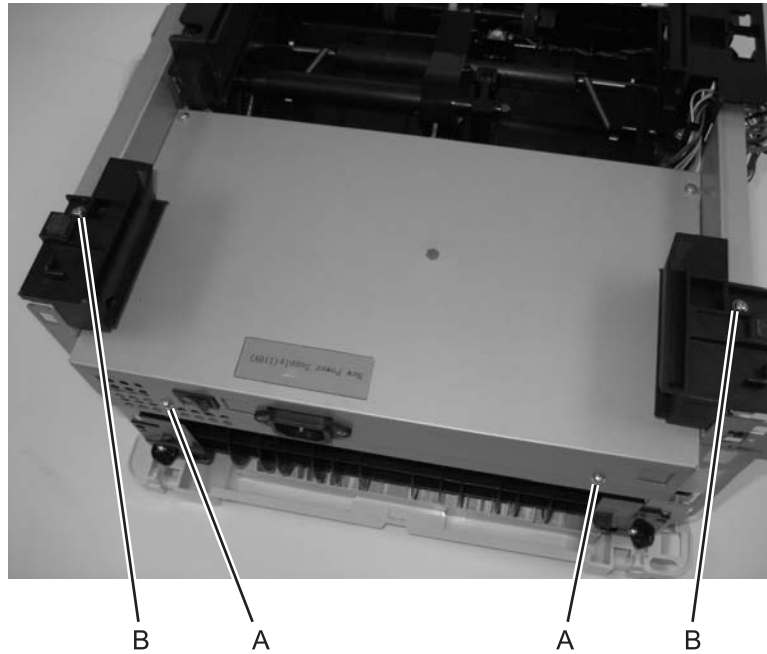

5. Remove four screws (C) in the bottom of the metal cover.

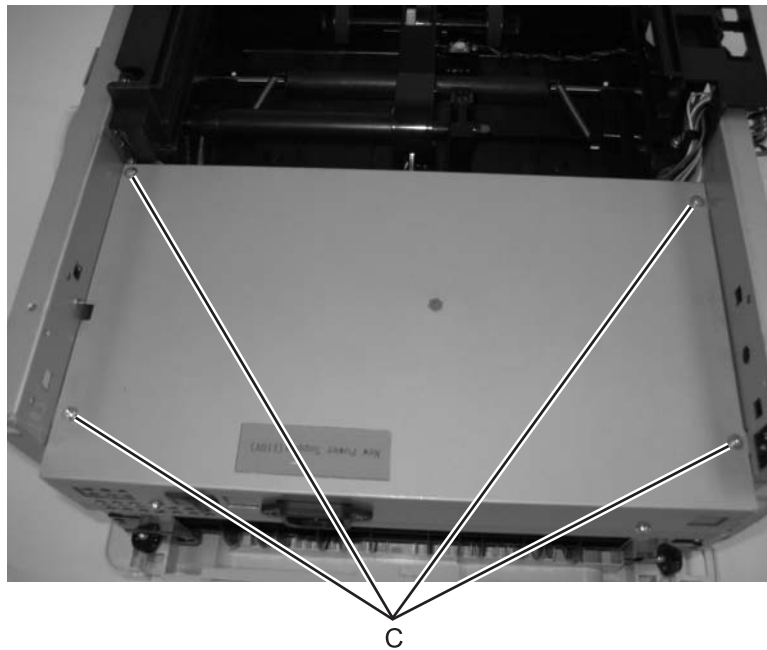

6. Move the cover so the connecting cables can be unplugged.



7. Rotate the power supply assembly so the remaining cables can be removed.

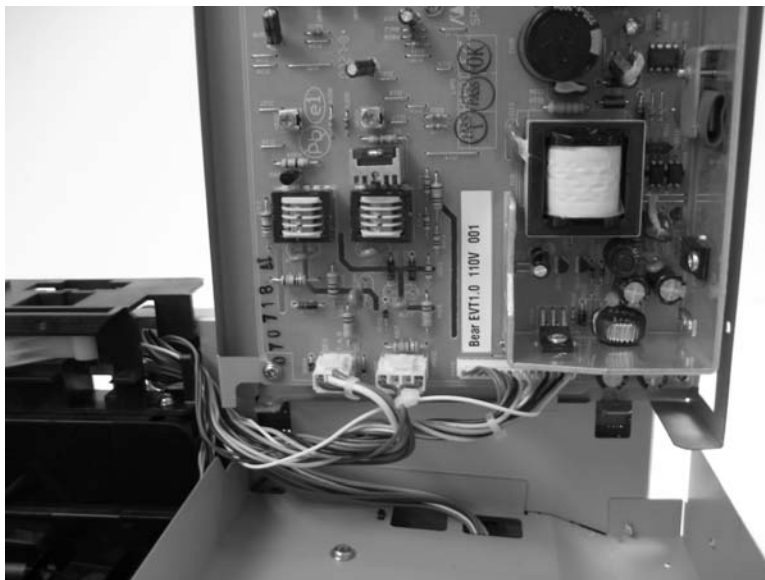

8. Remove the LVPS/HVPS card and cover.

LVPS/HVPS to controller card cable removal



1. Remove the LVPS/HVPS card. See **“LVPS/HVPS card assembly removal”** on page 4-27 for more information.
2. Remove the controller card cover. See **“Controller card removal”** on page 4-13 for more information.
3. Unplug the cable at J22 on the controller card, and extract the cable.

Note: The card may not have to be completely removed to disconnect the cable.

Manual feed clutch assembly removal

1. Remove the left side cover. See **“Left side cover removal”** on page 4-4.
2. Place the MFP on its right side. Protect the cover from being marred.
3. Remove the four screws (A) in the gear train metal cover.

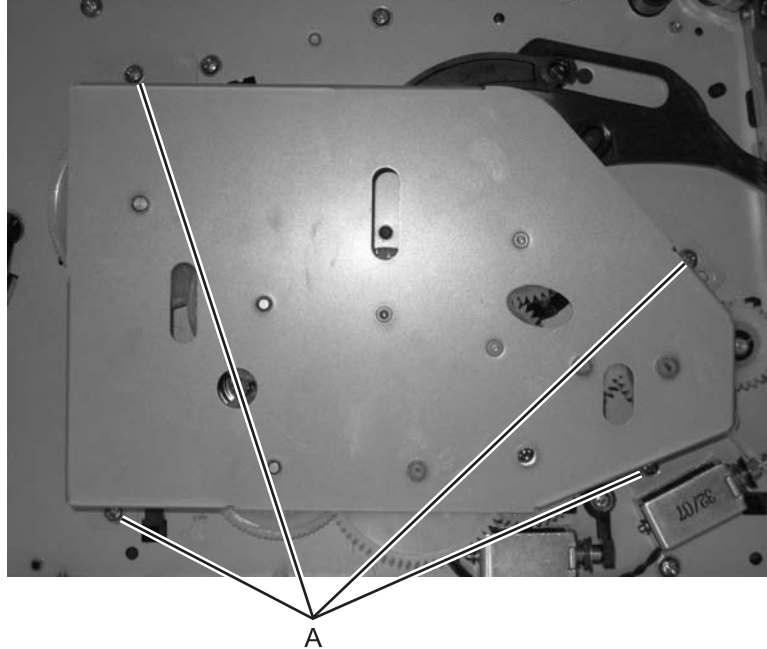

4. Remove the clip (B) from the shaft of the pick up clutch assembly.

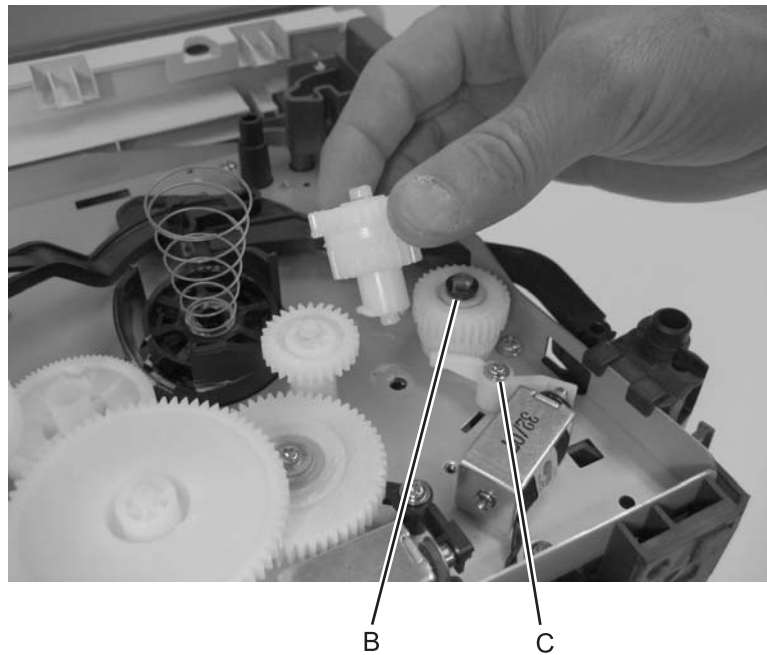

5. Remove the screw (C) and lever (pawl).
6. Remove the clutch assembly. If the pieces come apart, they can be easily reassembled if necessary.

Operator panel bezel removal

1. Remove the front flatbed cover.
2. Gently pry the bezel away from the operator panel, starting at one of the front corners and working across the bezel.



3. Remove the bezel from the MFP.

Operator panel cable removal

1. Remove right cover.
2. Remove operator panel.
3. Disconnect the operator panel cable from the controller card.



4. Route the cable through the flatbed assembly and the base printer top cover.

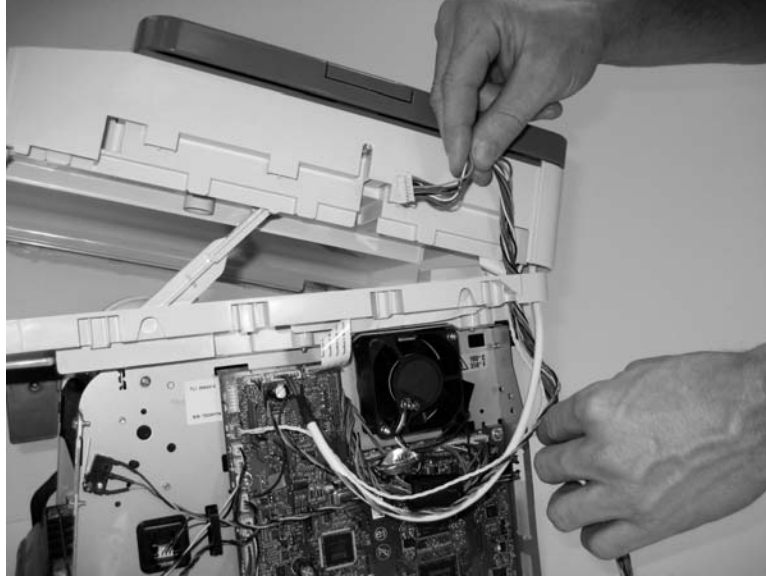

5. Remove the cable from the MFP.

Operator panel assembly removal

1. Remove the left and right flatbed covers.
2. Remove the op panel bezel.
3. Remove the two screws (A) that secure the op panel to the flatbed.

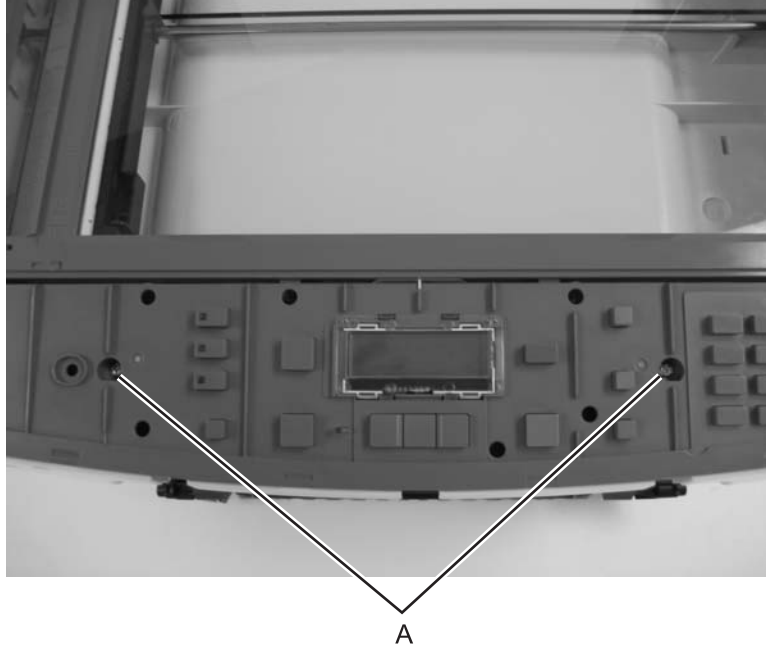

4. Lift the op panel up.



5. Remove the op panel cable (B) from the op panel.

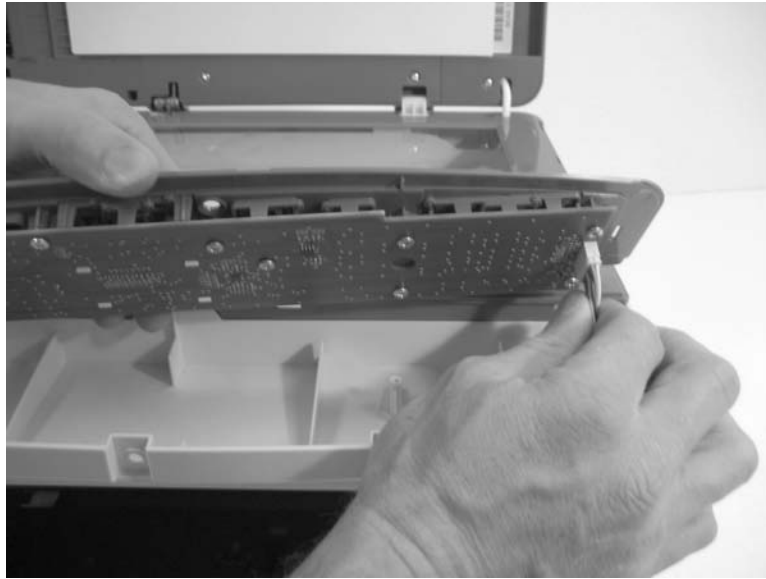

6. Remove the op panel from the MFP.



Paper exit guide assembly removal

1. Remove the rear cover. See **“Rear cover removal”** on page 4-5 for more information.
2. Remove the three screws (A) securing the exit guide.

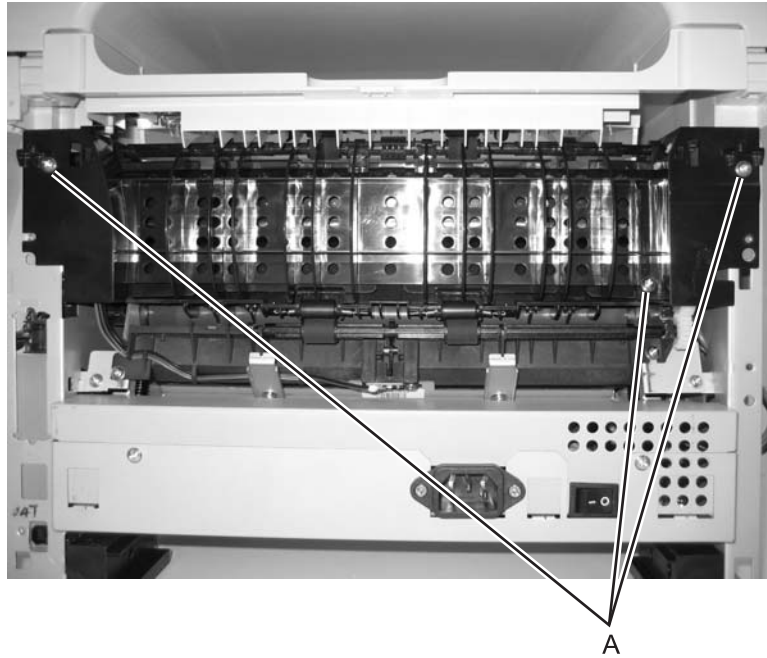

3. Remove the paper exit guide assembly.

Reinstallation note: It may be necessary to rotate the gears to mesh with the fuser and drive gear.

Printhead removal

1. Remove the top cover. See **“Top cover removal”** on page 4-8 for more information.
2. Remove the toroid from the group of cables at the top of the controller card.

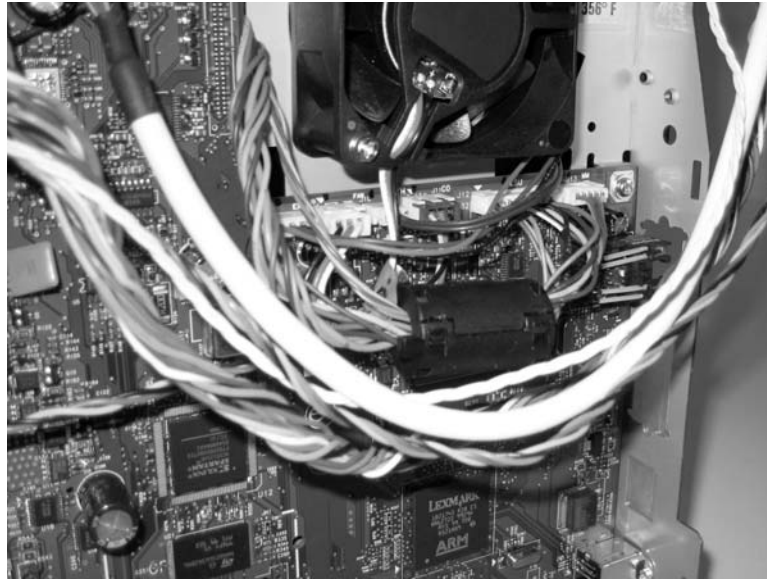

3. Unplug the printhead cables at locations J12 and J13 on the controller card and on the printhead.
4. Remove three screws (A) that secure the printhead to the cross brace, and lift the printhead out.

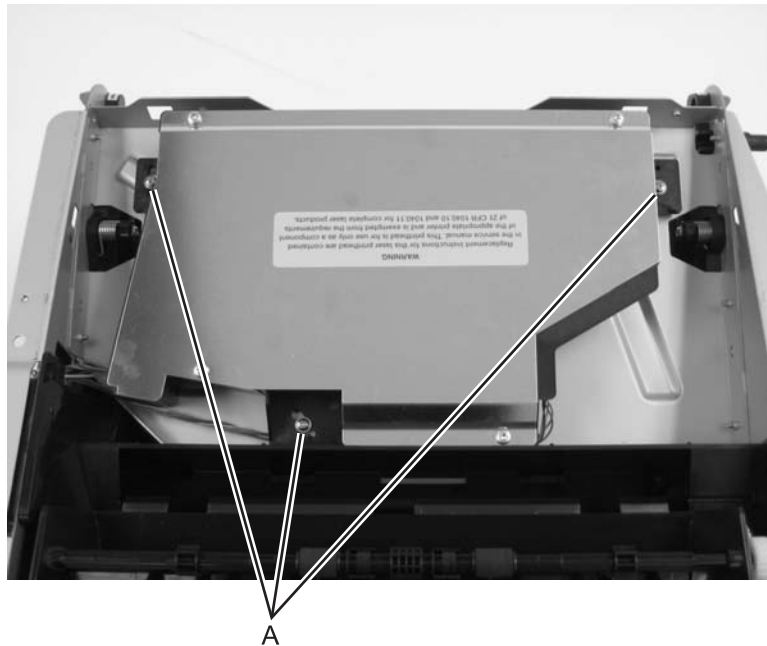

Note: Notice the alignment of the printhead at each screw before removing the screws.

Note: Printer registration must be set after replacing the printhead. See **“Registration”** on page 3-3.

Transfer roll removal

Note: Handle the transfer roll as little as possible.

1. Open the front access cover.
2. Place a sheet of paper around the transfer roll to protect it.
3. At the right side of the transfer roll, squeeze the holder arms with the left hand while lifting with the right. Stop when the holder is unlatched.



4. At the left side of the transfer roll, squeeze the holder arms with the right hand while lifting with the left hand. Stop when the left holder is unlatched.
5. With a hand at each end, lift the transfer roll out. The springs should remain in place.

Reinstallation note: Verify the springs are inserted into the bearings when re-installing.



Transport motor cable removal

1. Remove the right cover. See **“Right side cover removal” on page 4-7** for more information.
2. Unplug the transport motor cable (XPRT) at J19.
3. Remove the LVPS/HVPS card assembly. See **“LVPS/HVPS card assembly removal” on page 4-27** for more information.
4. Extract the cable through the side frame, leaving it free at the opening above the LVPS/HVPS.
5. Remove the fuser. See **“Fuser removal” on page 4-20** for more information.
6. Extract the cable (A) through the side frame, leaving it free at the opening (B) above the LVPS/HVPS.

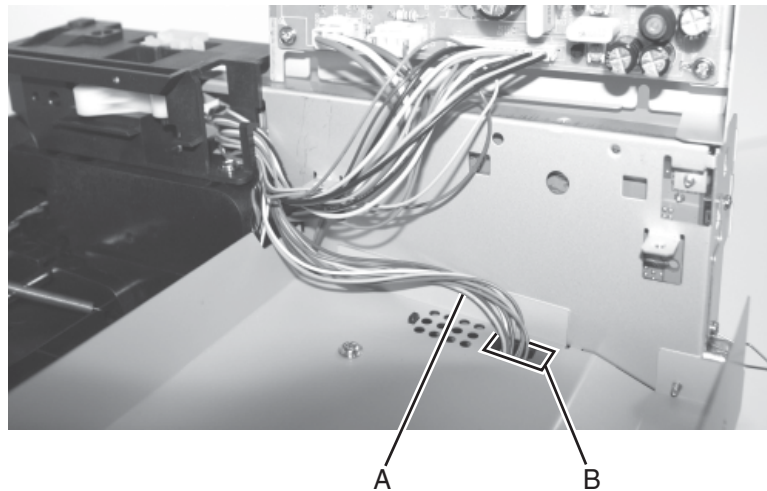

7. Unplug the cable at the motor, and install the new cable.

Scanner ADF paper tray removal

1. Grasp the rear of the tray.



2. Pull the tray up and out.

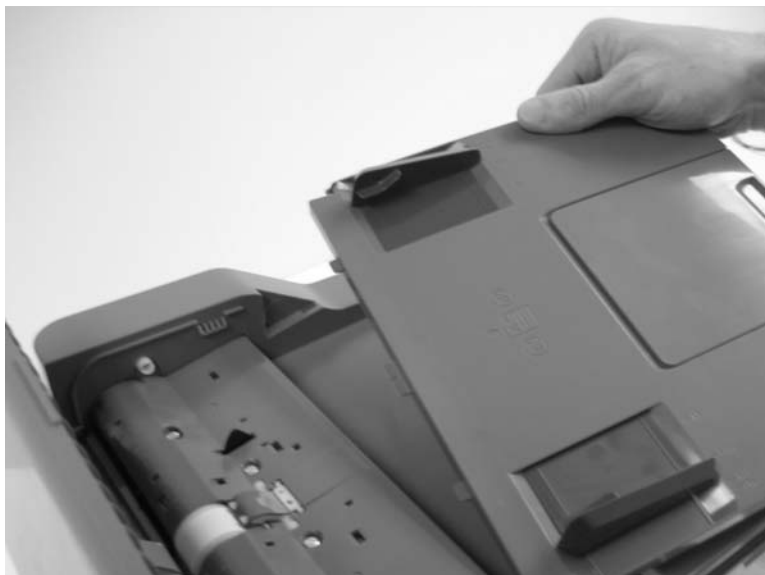

3. Remove the input tray from the MFP.

Scanner ADF top cover removal

1. Insert a screwdriver between the ADF mechanism housing and the ADF top cover.



2. Create a gap between the ADF mechanism and top cover by gently prying with the screw driver.
3. Pull the ADF top cover back.

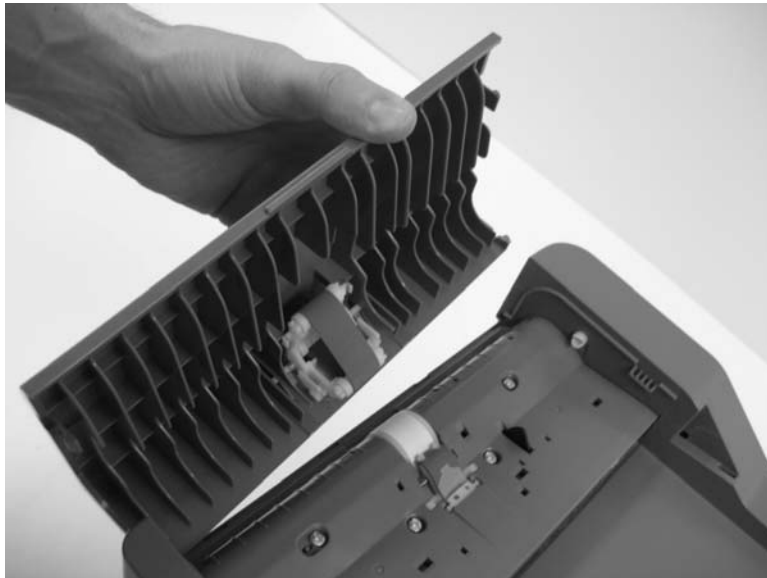

Scanner ADF pick roll assembly removal

1. Open the ADF top cover.
2. Lift the retainer lever to unlock the separator roll from the ADF mechanism.

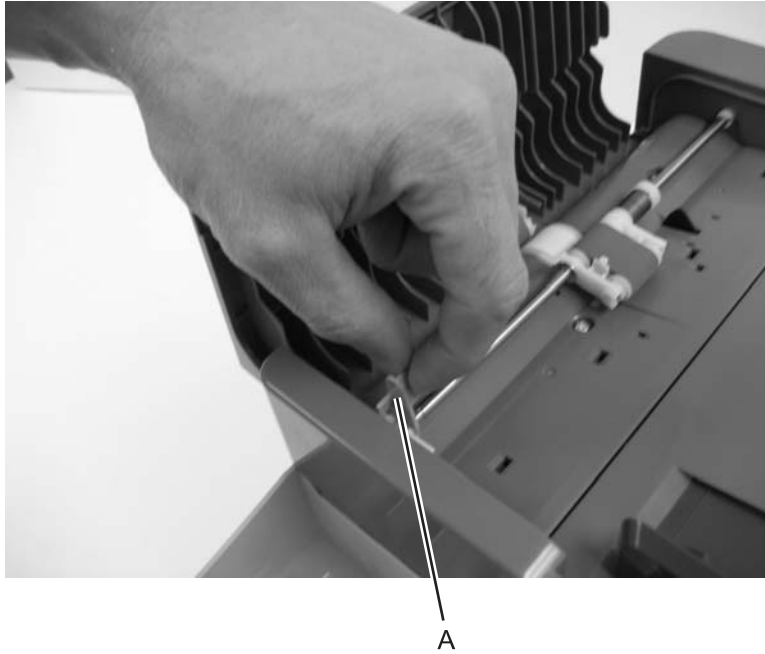

3. Lift the separator roll upward.

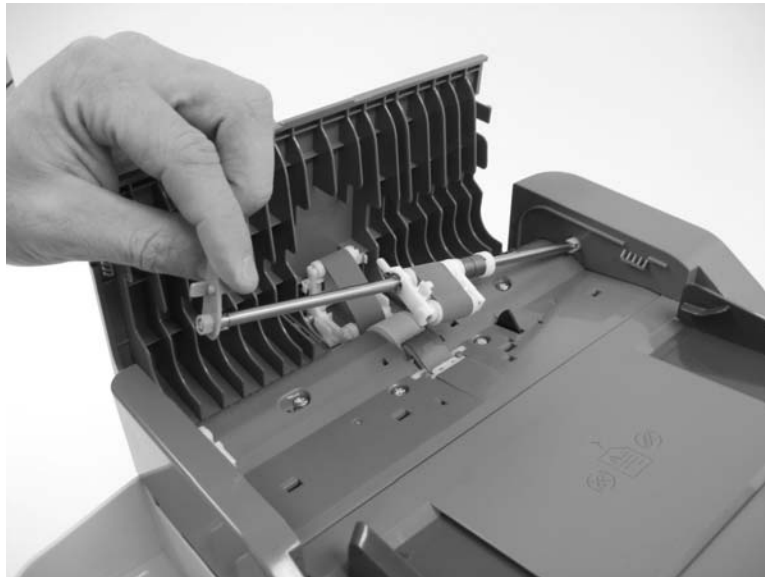

4. Remove the ADF separator roll from the MFP.

ADF separator pad removal

1. Remove the ADF separator pad. See **“ADF separator pad removal” on page 4-41**.
2. Use a small screw driver or spring hook to carefully remove the white nylon clip (A) which fastens the pad to the ADF unit.

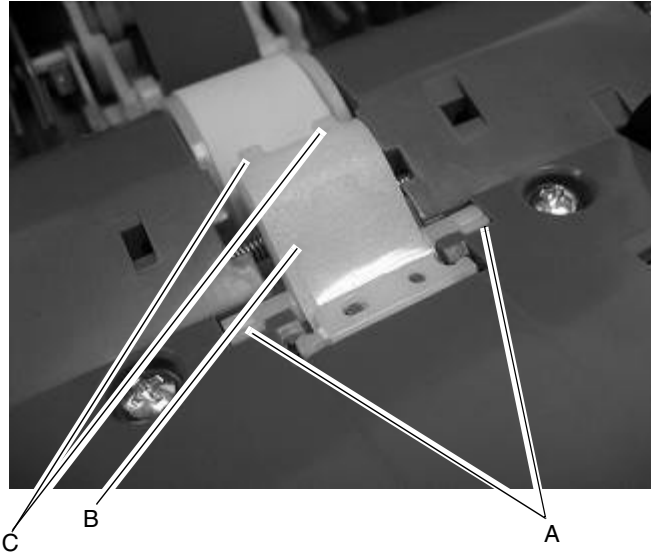

3. Remove the clear mylar sheet (B).
4. Pull the separator pad (B) up and back removing it from the two anchors (C) at the rear of the pad.

ADF assembly removal

1. Remove the screw (A) that secures the ADF cable housing cover to the ADF assembly.

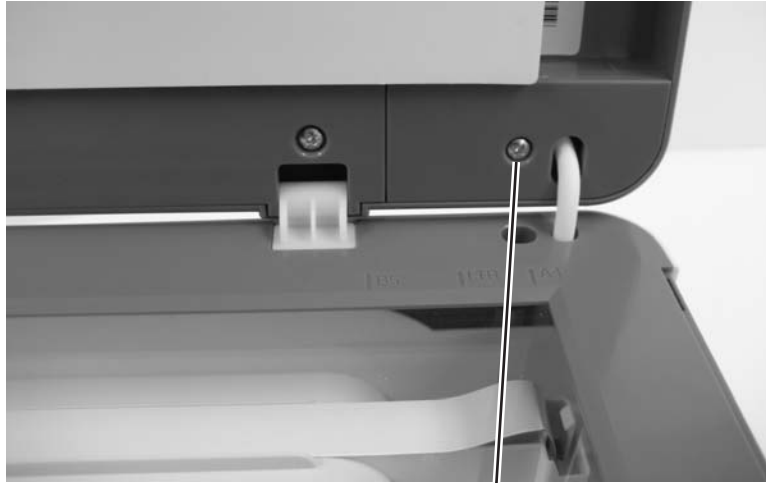

A

2. Disconnect the ADF cable from the ADF unit.

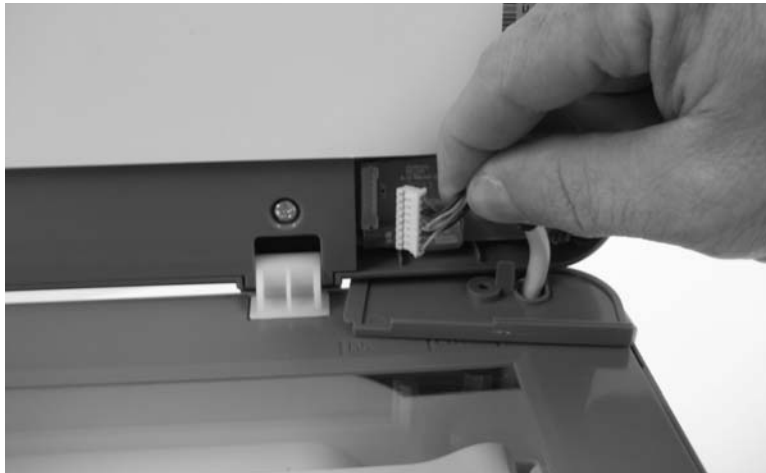

3. Lift the ADF unit up and away from the flatbed.



Note: The scanner registration must be set after replacing the ADF assembly. See **“Scanner Manual Registration” on page 3-17.**

ADF cable removal

1. Remove ADF. See **“ADF assembly removal” on page 4-42.**
2. Disconnect the ADF cable from J2 on the controller board.
3. Remove flatbed. See **“Flatbed removal” on page 4-44.**
4. Route the ADF cable through the flatbed assembly. **(Art Here)**

Flatbed removal

1. Remove the right cover. See **“Right side cover removal”** on page 4-7.
2. Disconnect the flatbed motor cable (A), home sensor cable (B), ADF cable (C), and the CIS cable (D) from the controller board.

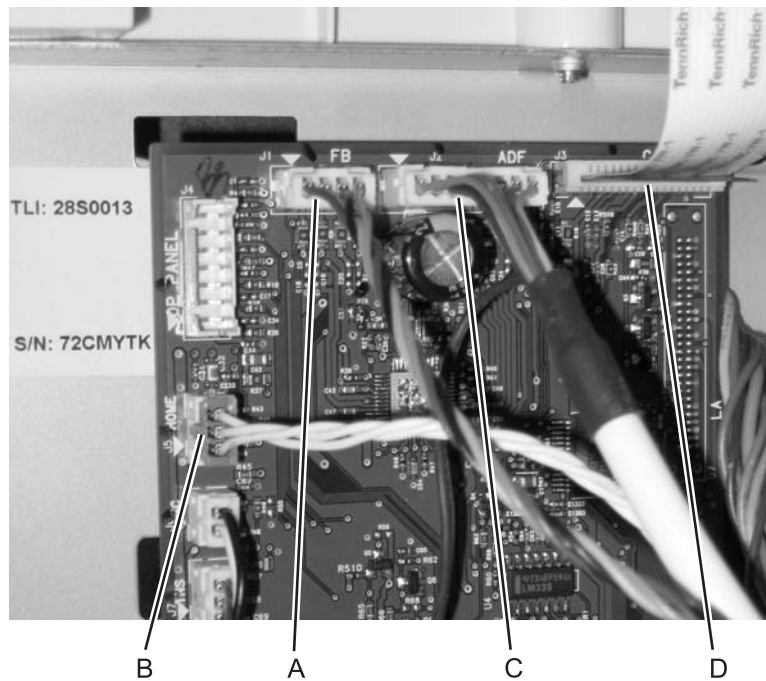

3. Disconnect the ADF ground wire from the printer frame.
4. Carefully disconnect the CIS cable from the top cover.

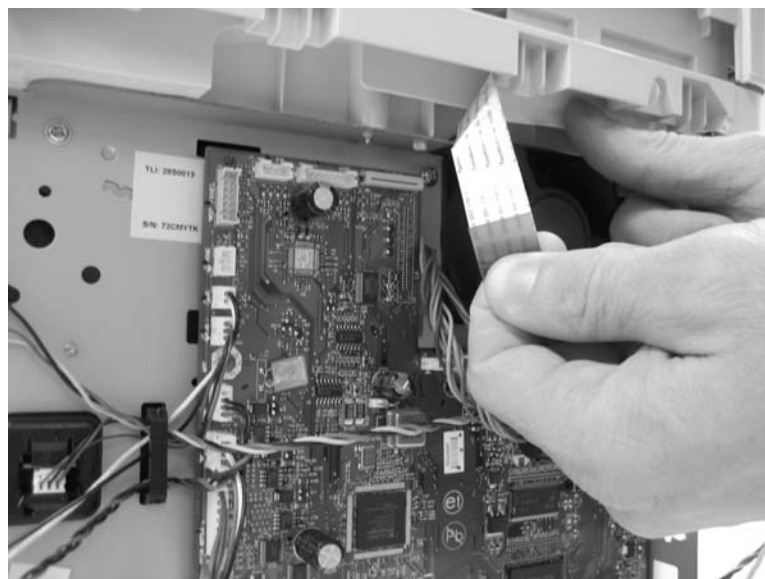

5. Squeeze the top of of the cam follower to disengage it from the flatbed.



6. Tilt the flatbed to the up position.
7. Carefully route all the cables through the top cover.



8. Lift and remove the flatbed from the MFP.

5. Locations and connections

Locations

Front view

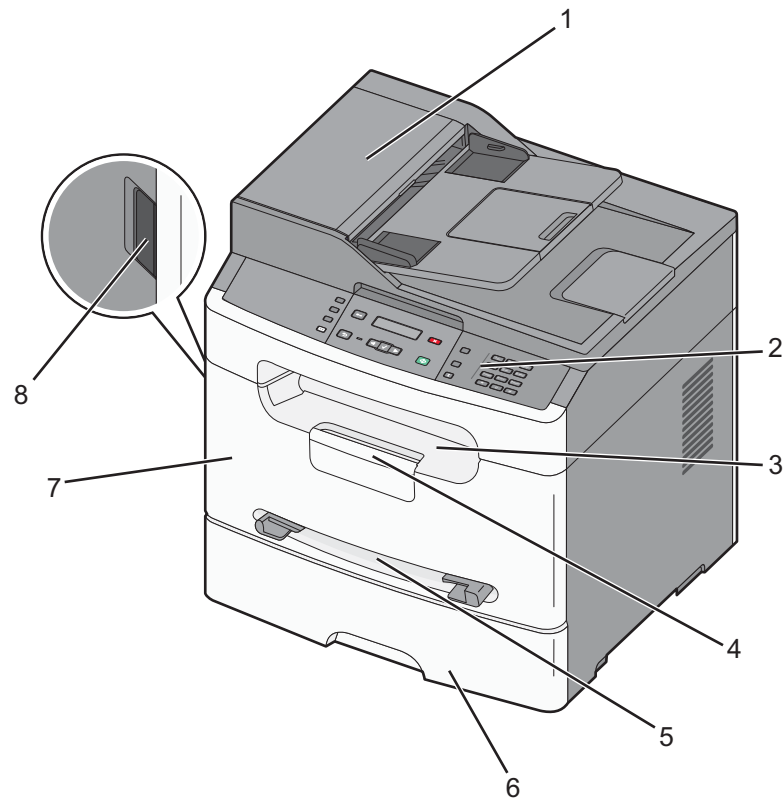

Callout	Description
1	ADF unit - X only
2	Operator panel
3	Paper output bin
4	Output extension
5	Manual feeder
6	Paper tray
7	Front cover
8	Front cover release

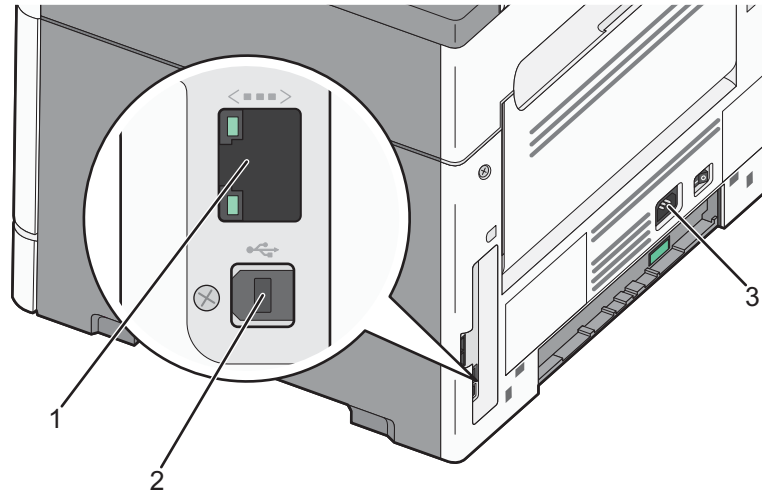
Rear view

Callout	Description
1	Modem Jack
2	USB port
3	Power

Connections

Power supply board

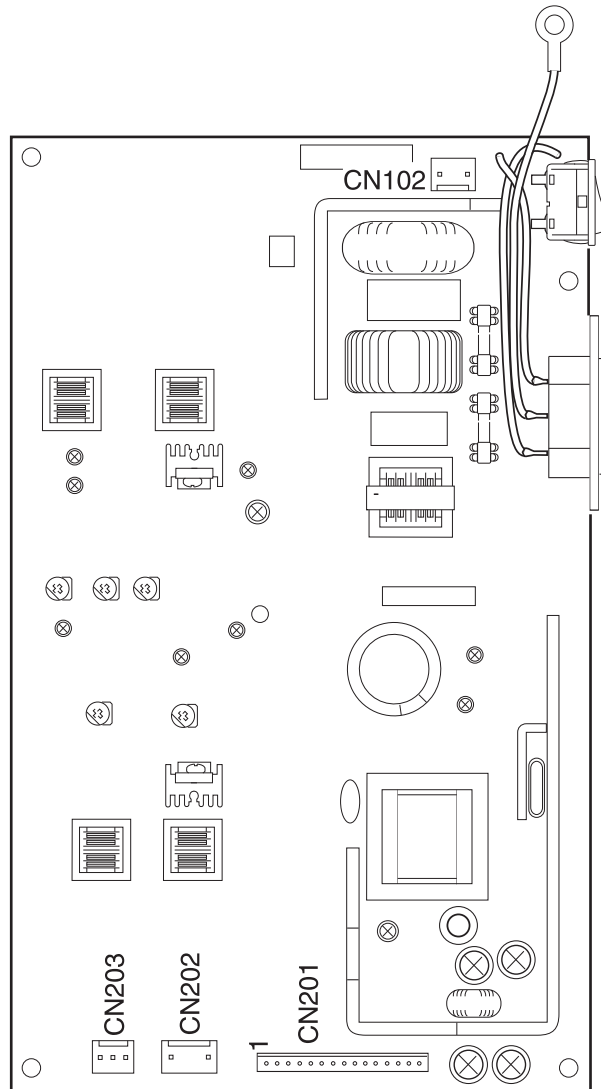

Power supply board connections

Conn	Connects to	# wires	Wire colors
CN102	Fuser	2	Blue, white
CN201	Controller card	15	Black
CN202	Charge roll	2	Red, blue
CN203	Developer	3	Red, white, blue
TAT201	Transfer roll	1	Red

Controller card

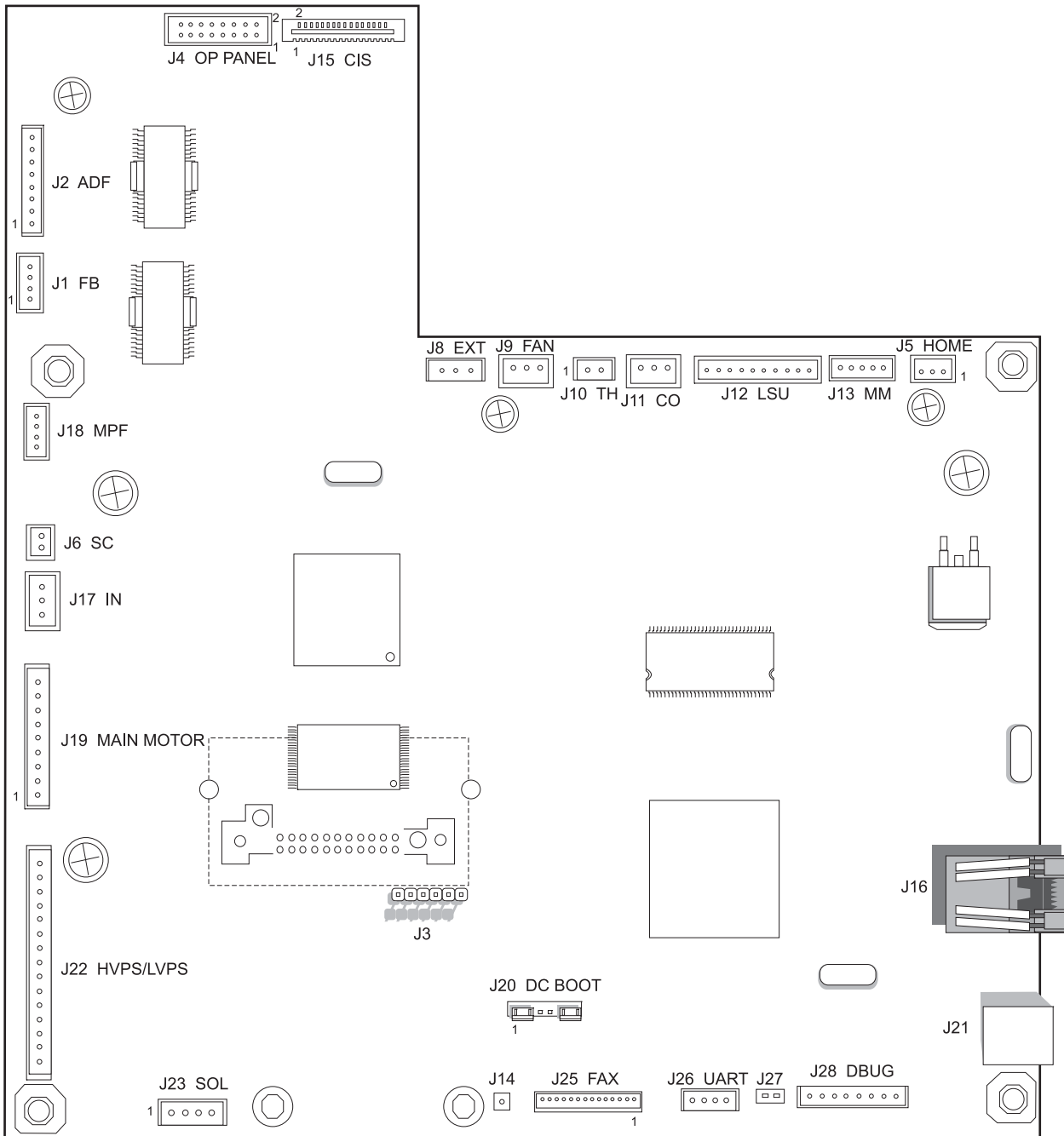

Controller card connections

Conn #	Name	Connects to	Pin #	Signal / voltage
J23	SOL	Paperfeed solenoids	1	FDSOL+, +24V
			2	FDSOL-
			3	MPFSOL+, +24V
			4	MPFSOL-
J22	HVPS/ LVPS	Power Supplies	1	Charge_C
			2	DEV_C
			3	TX_C
			4	TX_ENABLE_C
			5	SERVO_OUT_C
			6	FUSER_ON_C
			7	GND
			8	+24V
			9	+24V
			10	HVPS On/Off
			11	ZEROX_C
			12	GND
			13	+5V
			14	GND
			15	HVPOWERSNS_C
J19	XPRT	Main motor	1	HALL_U
			2	HALL_V
			3	HALL_W
			4	FG
			5	GND
			6	+5V
			7	V_C1_U, 5 VDC
			8	V_C1_V, 24 VDC
			9	V_C1_W, 24 VDC
J17	IN	Input sensor	1	5 VDC
			2	PAPER_IN_C
			3	GND

Conn #	Name	Connects to	Pin #	Signal / voltage
J6	SC	Smart chip	1	SC_DATA_C
			2	GND
J18	MPF	Manual feed sensor	1	+5VDC
			2	MPF_C
			3	GND
			4	GND
J4		Operator panel	1	+5V_FUSE
			2	+3.3V
			3	LCD_SDA
			4	GND
			5	LCD_SCK
			6	LCD_CS
			7	LCD_A0
			8	GND
			9	SDA
			10	LCD_RST
			11	PANEL_INT
			12	GND
			13	SCL
			14	GND
15	BEEP_C			
16	GND			

Conn #	Name	Connects to	Pin #	Signal / voltage
J15	CIS	CIS	1	GND
			2	OS
			3	GND
			4	MODE0
			5	VREF_CIS
			6	GND
			7	CIS_CLK
			8	GND
			9	V33_CIS
			10	CIS_TR
			11	V_LEDCA LED_B (+5V_FUSE)
			12	CIS_LED_B
			13	V_LEDCA LED_G (+5V_FUSE)
			14	CIS_LED_G
			15	V_LEDCA LED_R (+5V_FUSE)
			16	CIS_LED_R
J1	FB	Flatbed motor	1	FB_AA-
			2	FB_AA
			3	FB_BB
			4	FB_BB-
J5	HOME	Home position sensor	1	+5V
			2	GND
			3	HOME_C
J2	ADF	ADF motor/ sensors	1	+5V
			2	ADF_DES
			3	GND
			4	ADF_AA
			5	ADF_AA-
			6	ADF_BB
			7	ADF_BB-
			8	ADF_DS

Conn #	Name	Connects to	Pin #	Signal / voltage
J25	FAX	Modem	1	FAX_CS
			2	GND
			3	SPI_DI
			4	GND
			5	SPI_DOUT
			6	GND
			7	SPI_SCLK
			8	GND
			9	FAX_INT
			10	+5V
			11	RESET_TO_MODEM_C
			12	+3.3V
			13	+3.3V
			14	NC_J25_14
J8	EXIT	Exit sensor	1	+5VDC
			2	PAPER_OUT_C
			3	GND
J9	Fan	Fan	1	GND
			2	+24V
			3	FAN_FB
J10	TH1	Thermistor	1	FUSER_TH
			2	GND
J11	CO	Cover open sensor	1	+5V_LD
			2	+5V_FUSE
			3	GND

Conn #	Name	Connects to	Pin #	Signal / voltage
J12	LSU	Printhead	1	L_POWER_C
			2	GND
			3	VDO_ADJ_C (3.3 VDC)
			4	VIDEO_C
			5	LDEN_C
			6	GND
			7	+5V_LD
			8	GND
			9	HSYNC_C
			10	VIDEO+C
J13	MM	Mirror motor	1	MM_REF_C
			2	MM_LOCK_C (5VDC)
			3	MM_START_C (5VDC)
			4	GND
			5	+24V DC
J21	USB	USB device port	G1	GND
			1	USB_POWER
			2	USB_VM_DEV_C
			3	USB_VP_DEV_C
			4	GND
			G2	GND
J44	NET	Network Card	0	Card mounts directly to the controller card.
J3		USB (to wireless)	1	GND
			2	USB_2H_VP
			3	USB_2H_VM
			4	GND
			5	+5V
			6	WIRELESS_RESET_C

6. Preventive maintenance

Printer engine

The Lexmark X203 and X204n printer engines do not require preventive maintenance.

Scanner

The ADF pick pad (40X5770) should be replaced every 20,000 pages, and the ADF pick roller (40X5768) should be replaced every 60,000 pages.

Clean the flatbed glass using a lint free cloth. If the dirt is heavy, use a neutral cleanser or alcohol. Wipe the glass carefully so no cleanser remains.

If the ADF is multi feeding, check the ADF pick roller and pad for dirt. Remove these parts, and clean them with a lint-free cloth.

7. Parts catalog

How to use this parts catalog

The following legend is used in the parts catalog:

Asm-Index	Part number	Units/mach	Units/FRU	Description
-----------	-------------	------------	-----------	-------------

- **Asm-index:** identifies the assembly and the item in the diagram. For example, 3-1 indicates assembly 3 and the item number 1.
- **Part number:** identifies the unique number that identifies this FRU.
- **Units/mach:** refers to the number of units actually used in the machine or product.
- **Units/FRU:** refers to the number of units packaged together and identified by the part number.
- **NS:** (Not shown) in the Asm-Index column indicates that the part is procurable but is not pictured in the illustration.
- **PP:** (Parts Packet) in the parts description column indicates the part is contained in a parts packet.
- Model information used in the parts catalog.

Machine type and model	Description
7011-200	Lexmark X203n
7011-215	Lexmark X204n

Assembly 1: Covers

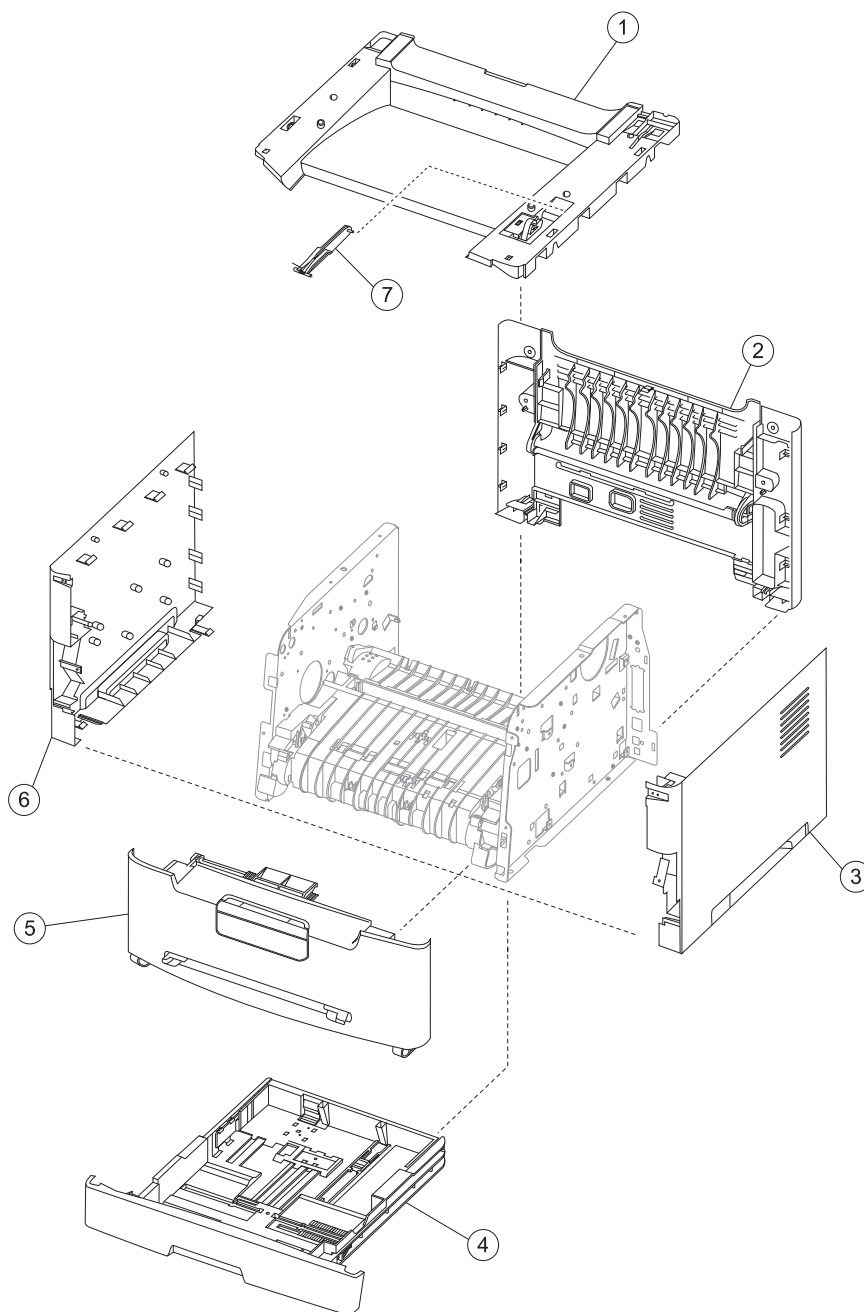

Assembly 1: Covers

Asm-Index	Part number	Units/mach	Units/FRU	Description
1	40X5635	1	1	Top cover
1	40X5764	1	1	Cam follower
2	40X5638	1	1	Rear cover assembly
3	40X5637	1	1	Right cover
4	40X5774	1	1	Main tray
5	40X5640	1	1	Front cover assembly
6	40X5636	1	1	Left cover
7	40X5764	1	1	Cam follower w/spring

Assembly 2: Scanner

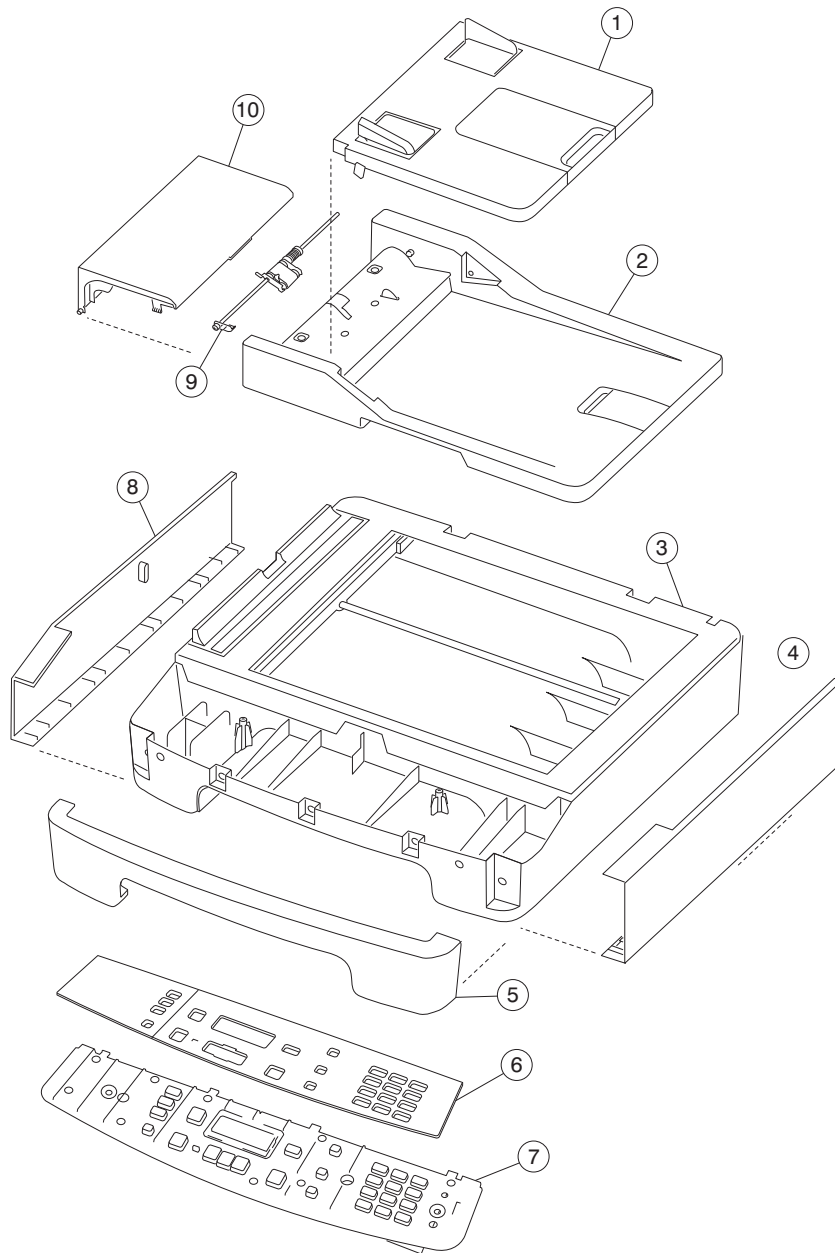

Assembly 2: Scanner

Asm-Index	Part number	Units/mach	Units/FRU	Description
1	40X5632	1	1	ADF input tray assembly
2	40X5761	1	1	ADF assembly (X204 Only)
3	40X5767	1	1	Flatbed assembly
4	40X5759	1	1	Right flatbed cover
5	40X5641	1	1	Scanner front cover
6	40X0384	1	1	X 203 Operator panel overlay (English)
6	40X0385	1	1	X 204 Operator panel overlay (English)
6	40X0354	1	1	X 203 Operator panel overlay (Spanish)
6	40X0355	1	1	X 204 Operator panel overlay (Spanish)
6	40X0348	1	1	X 203 Operator panel overlay (French)
6	40X0349	1	1	X 204 Operator panel overlay (French)
6	40X0356	1	1	X 203 Operator panel overlay (Brazilian Portuguese)
6	40X0357	1	1	X 204 Operator panel overlay (Brazilian Portuguese)
6	40X0352	1	1	X 203 Operator panel overlay (German)
6	40X0353	1	1	X 204 Operator panel overlay (German)
6	40X0350	1	1	X 203 Operator panel overlay (Italian)
6	40X0351	1	1	X 204 Operator panel overlay (Italian)
6	40X0358	1	1	X 203 Operator panel overlay (Dutch)
6	40X0359	1	1	X 204 Operator panel overlay (Dutch)
6	40X0360	1	1	X 203 Operator panel overlay (Danish)
6	40X0361	1	1	X 204 Operator panel overlay (Danish)
6	40X0362	1	1	X 203 Operator panel overlay (Norwegian)
6	40X0363	1	1	X 204 Operator panel overlay (Norwegian)
6	40X0364	1	1	X 203 Operator panel overlay (Swedish)
6	40X0365	1	1	X 204 Operator panel overlay (Swedish)
6	40X0366	1	1	X 203 Operator panel overlay (Finnish)
6	40X0367	1	1	X 204 Operator panel overlay (Finnish)
6	40X0370	1	1	X 203 Operator panel overlay (Russian)
6	40X0371	1	1	X 204 Operator panel overlay (Russian)
6	40X0368	1	1	X 203 Operator panel overlay (Polish)
6	40X0369	1	1	X 204 Operator panel overlay (Polish)
6	40X0372	1	1	X 203 Operator panel overlay (Turkish)
6	40X0373	1	1	X 204 Operator panel overlay (Turkish)
6	40X0374	1	1	X 203 Operator panel overlay (Hungarian)
6	40X0375	1	1	X 204 Operator panel overlay (Hungarian)
6	40X0376	1	1	X 203 Operator panel overlay (Czech)
6	40X0377	1	1	X 204 Operator panel overlay (Czech)
6	40X0378	1	1	X 203 Operator panel overlay (Simplified Chinese)
6	40X0379	1	1	X 204 Operator panel overlay (Simplified Chinese)

Assembly 2 (continued): Scanner

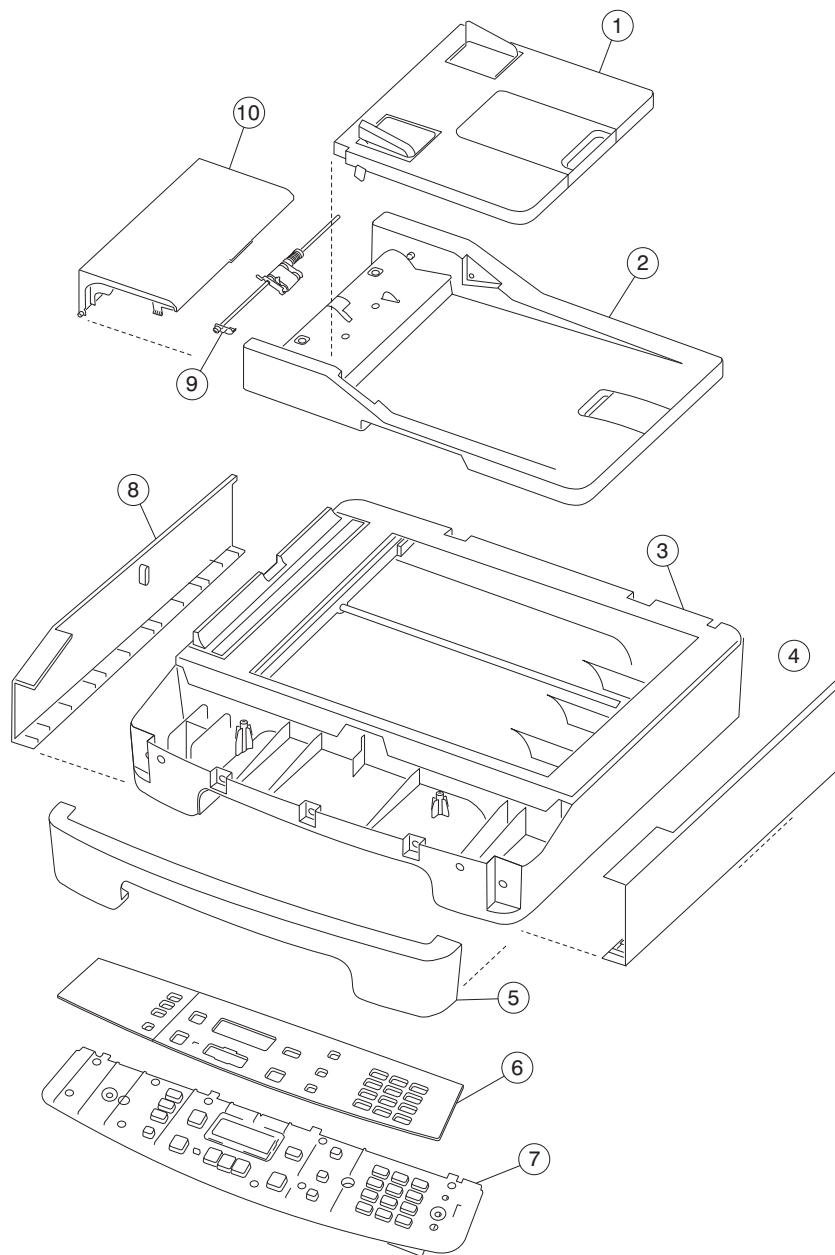

Assembly 2 (continued): Scanner

Asm-Index	Part number	Units/mach	Units/FRU	Description
6	40X0380	1	1	X 203 Operator panel overlay (Traditional Chinese)
6	40X0381	1	1	X 204 Operator panel overlay (Traditional Chinese)
6	40X0382	1	1	X 203 Operator panel overlay (Korean)
6	40X0383	1	1	X 204 Operator panel overlay (Korean)
7	40X5627	1	1	Operator panel assembly X203
7	40X5628	1	1	Operator panel assembly X204
8	40X5758	1	1	Left flatbed cover
9	40X5768	1	1	ADF separator roll assembly
10	40X5631	1	1	ADF top cover
16	40X0386	1	1	Fax card
NS	40X5770	1	1	ADF separator pad
NS	40X5762	1	1	ADF cable
NS	40X5963	1	1	Flatbed cover w/o ADF (X203 only)
NS	40X5763	1	1	Operator panel cable

Assembly 3: Electronics

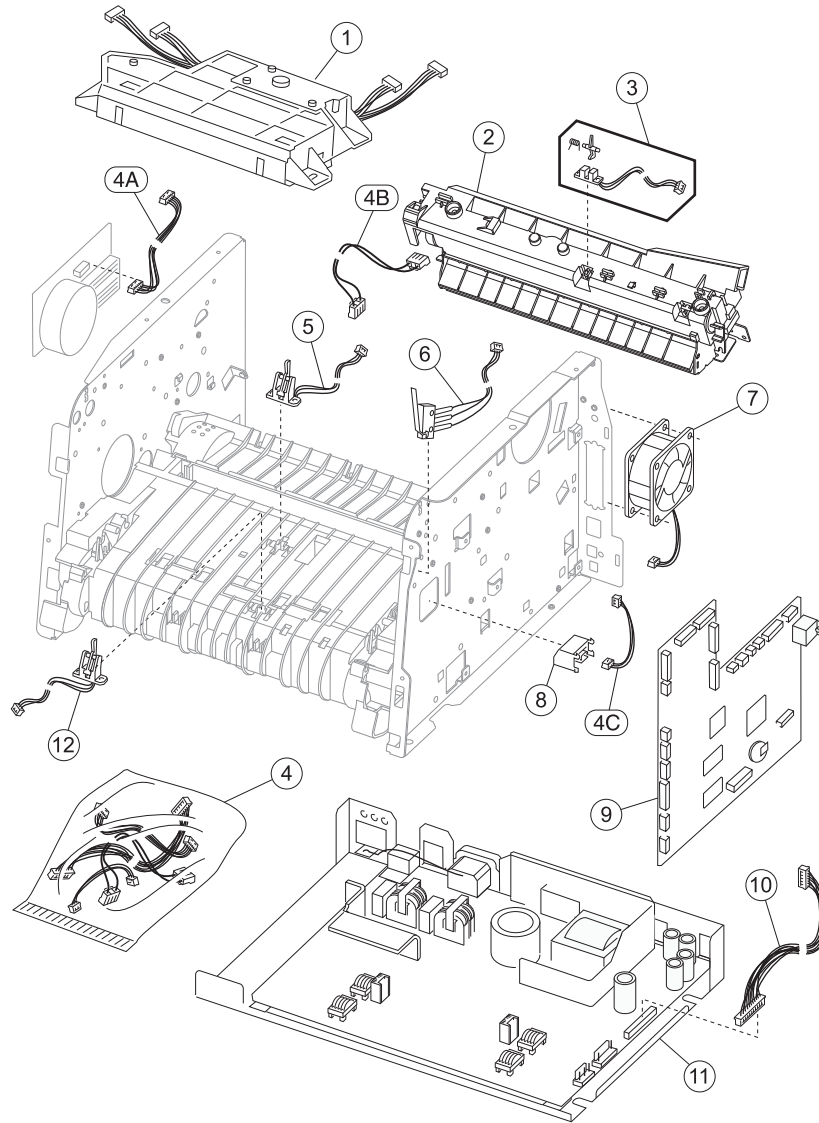



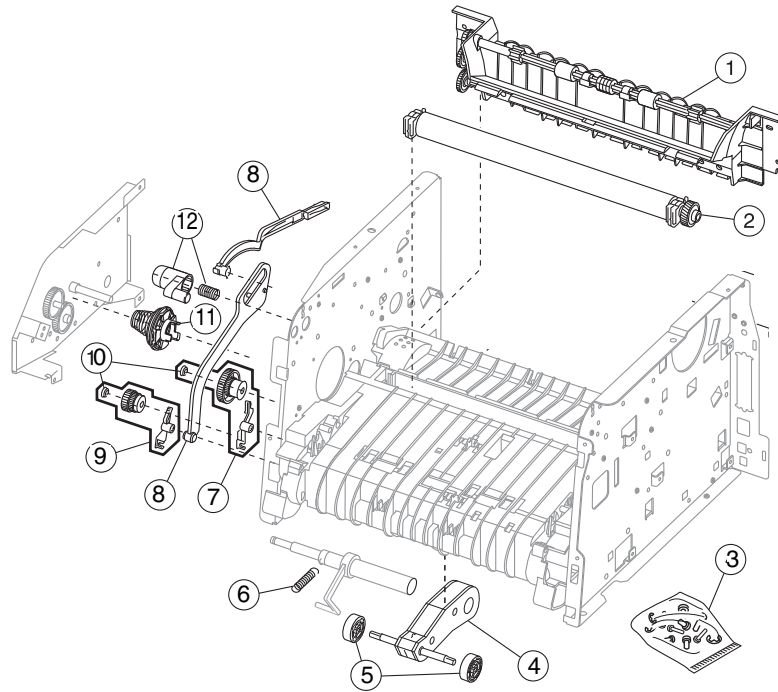

Assembly 3: Electronics

Asm-Index	Part number	Units/mach	Units/FRU	Description
3-1	40X1303	1	1	Laser/mirror print assembly, X203, X204
2	40X4194	1	1	Fuser assembly, 110 V
2	40X4195	1	1	Fuser assembly, 220 V
3	40X1325	1	1	Exit sensor assembly
4	40X1333	1	1	Miscellaneous cable assemblies. <p style="text-align: center;">Note: Use the LVPS cable in part 40X5780.</p> <ul style="list-style-type: none"> • Toner sensor (not used on the X203, and X204) • Fuser power • Main drive motor
5	40X1323	1	1	Input #1 sensor assembly
10	40X5780	1	2	Cable kit (LVPS cable)
	40X5625	1		Print engine cable kit (Laser diode cable, Mirror motor cable, motor cable)
6	40X1326	1	1	Cover open sensor assembly
7	40X1328	1	1	Cooling fan
9	40X5765	1	1	Controller card (X203)
9	40X5766	1	1	Controller card (X204)
11	40X5630	1	1	LVPS/HVPS 110V card
11	40X5629	1	1	LVPS/HVPS 220V card
12	40X1324	1	1	Input #2 sensor assembly (manual feeder)
NS	40X0386	1	1	Fax card

Assembly 4: Frame



Assembly 4: Frame

Asm-Index	Part number	Units/mach	Units/FRU	Description
1	40X1334	1	1	Paper exit guide assembly
2	40X2822	1	1	Transfer, roll, bearings, gear, spring
3	40X1353	N/A	N/A	Screws, miscellaneous (actual size) TP2NC-3.0+6P-Ni (2)   M3.0*0.5+6P-Ni Washer (2) MT3.0*0.5+6PF-Ni (5) TP2NC-3.0+6PF-Ni (4)  
4	40X4731	1	1	ASM, Pick arm
5	40X1319	2	2	Paper feed, rubber tires
6	40X1354	1	1	Front door & ACM spring
7	40X1331	1	1	Autocompensator clutch CBM
8	40X1338	1	1	Door-fuser idle gear link CBM
9	40X1330	1	1	Manual feed clutch CBM
10	40X1355	2	2	Plastic snap rings
11	40X1329	1	1	Developer drive coupling assembly
12	40X5760	1	1	Front access cover latch CBM

Assembly 5: Miscellaneous

Asm-Index	Part number	Units/mach	Units/FRU	Description
NS	12A2405	1	1	USB cable, packaged
NS	40X0289	1	1	Power cord, 1.8M (straight)—USA, Canada
NS	40X0278	1	1	Power cord, 6 foot (straight)—Europe and others
NS	40X0288	1	1	Power cord, 6 foot—Argentina
NS	40X0271	1	1	Power cord, 6 foot—United Kingdom
NS	40X0275	1	1	Power cord, 6 foot (straight)—Israel
NS	40X0274	1	1	Power cord, 6 foot—Switzerland
NS	40X0276	1	1	Power cord, 6 foot—South Africa
NS	40X0287	1	1	Power cord, 6 foot (straight)—Traditional Italy
NS	40X0279	1	1	Power cord, 6 foot (straight)—Danish
NS	40X0277	1	1	Power cord, 6 foot (straight)—Brazil
NS	40X0282	1	1	Power cord, 1.8M (straight)—PRC
NS	40X0270	1	1	Power cord, 1.8M (straight)—Japan
NS	40X0280	1	1	Power cord, 1.8M (straight)—Korea
NS	40X0281	1	1	Power cord, 1.8M (straight)—Taiwan
NS	40X0296	1	1	Power cord, 1.8M (straight)—Australia

Index

Numerics

2xx paper jams **2-18**–??
 200 - 201 paper jam **3-21**
 200 paper jam **3-21**
 201 paper jam **3-22**
 202 paper jam **3-23**
 241 paper jam **3-25**
 251 paper jam **3-26**
 290 - 294 paper jams **3-28**
 840.xx service check **2-41**

A

abbreviations **1-8**
 accessing service menus **3-1**
 acronyms **1-8**
 ADF assembly
 parts catalog **7-5**
 removal **4-42**
 ADF cable
 removal **4-43**
 ADF edge erase **3-16**
 ADF manual registration **3-17**
 ADF pick roll assembly
 removal **4-40**
 ADF separator pad removal **4-41**
 ADF top cover
 removal **4-39**
 autocompensator clutch
 removal **4-24**
 autocompensator tires **4-20**

B

base sensor test **3-7**
 Button Test **3-5**

C

cables
 fuser power cable **4-23**
 LVPS/HVPS to controller card cable **4-28**
 card cage
 removal **4-11**
 Config Menu
 description **3-1**
 configuration menu **3-14**
 ADF edge erase **3-16**
 Demo Mode **3-15**
 disable scanner **3-18**
 Energy Conserve **3-16**
 Event Log **3-15**
 Exit Config Menu **3-18**
 Factory Defaults **3-15**
 FB edge erase **3-16**
 font sharpening **3-18**
 format fax storage **3-16**
 Panel Menus **3-15**

prt quality pages **3-14**
 reduced curl **3-18**
 Reports
 Menu Settings Page **3-15**
 reports **3-15**
 menu settings page **3-15**
 reset PC count **3-14**
 scanner manual registration **3-17**
 USB scan to local **3-14**
 USB speed **3-18**

connections **5-3**
 controller card **5-4**
 power supply **5-3**
 connectivity and compatibility **1-2**
 controller card
 removal **4-13**
 cooling fan
 symptoms **2-2**
 cover open sensor
 removal **4-15**

D

defaults
 factory defaults **3-15**
 Demo Mode **3-15**
 developer drive coupling assembly
 removal **4-16**
 diagnostics menu
 available tests **3-2**
 Base Sensor Test **3-7**
 ep setup **3-9**
 Event Log
 Clear Log **3-11**
 event log **3-10**
 Hardware Tests
 Button Test **3-5**
 DRAM Test **3-6**
 Panel Test **3-5**
 Input Tray tests
 feed tests **3-7**
 Print Tests
 input source tests **3-5**
 Prt Quality Pgs **3-5**
 print tests **3-5**
 Printer Setup
 configuration ID **3-8**
 printer setup **3-7**
 REGISTRATION
 Bottom Margin **3-3**
 Left Margin **3-4**
 Right Margin **3-4**
 Top Margin **3-3**
 registration **3-3**
 reports **3-10**
 Scanner Tests

- ASIC test **3-11**
- Scanner Tests
 - sensor test **3-12**
- Scanner tests
 - feed test **3-11**
- Diagnostics Mode
 - description **3-1**
- Disable scanner **3-18**
- DRAM Test **3-6**

E

- electronics **7-8**
- Energy Conserve **3-16**
- ep setup **3-9**
- error codes **2-9**
- error messages
 - paper jams **2-18**
 - service error codes **2-9**
 - user attendance messages **2-19**
- escalating a fax issue to second level support **2-48**
- ESD-sensitive parts **4-1**
- event log **3-10**
 - configuration menu **3-15**
- Exit config menu **3-18**
- exit sensor
 - removal **4-17**

F

- Factory Defaults **3-15**
- factory defaults **3-15**
- fan
 - removal **4-18**
- fax modem removal **4-19**
- fax reception service check **2-46**
- Fax specifications **1-6**
- fax transmission service check **2-44**
- FB edge erase **3-16**
- Font sharpening **3-18**
- fonts **1-2**
- Format fax storage **3-16**
- frame, parts catalog **7-10**
- front access cover
 - removal **4-2**
- fuser
 - removal **4-20**
 - service check **2-27**
- fuser idle gear links
 - removal **4-22**
- fuser power cable
 - removal **4-23**

G

- general information **1-1**

H

- handling ESD-sensitive parts **4-1**

I

- Input roller clutch and lever
 - removal **4-24**

- Input sensor #1
 - removal **4-25**
- input sensor #2(manual feed)
 - removal **4-26**

L

- left side cover
 - removal **4-4**
- locations **5-1**
 - controller card **5-4**
 - controller card connections **5-5**
 - front view **5-1**
 - power supply board **5-3**
 - power supply board connections **5-3**
 - rear view **5-2**
- Lower right side cover
 - removal **4-7**
- LVPS?HVPS to controller card cable
 - removal **4-28**
- LVPS/HVPS card assembly
 - removal **4-27**

M

- maintenance approach **1-1**
- manual feed
 - clutch assembly **4-29**
 - input sensor #2 **4-26**
 - print media types and sizes **1-4**
- manual feed clutch
 - removal **4-29**
- manually register the flatbed **3-17**
- media jams **3-20**
- Media trays and supply capacity **1-3**
- memory **1-1**
- menu settings page **3-15**
- menus
 - Menu Settings Page **3-15**
- messages
 - paper jam messages **2-18**
 - service error codes **2-9**
 - user attendance messages **2-19**
- MFP specifications **1-1**
 - connectivity and compatibility **1-2**
 - dimensions **1-1**
 - fax specifications **1-6**
 - fonts **1-2**
 - memory **1-1**
 - minimum clearance requirements **1-1**
 - print resolution **1-2**
 - print speed **1-2**
 - scanner specifications **1-5**
 - trays and supply capacities **1-3**
 - types of print media **1-4**
 - weights **1-1**
- mfp symptoms **2-2**
- minimum clearance requirements **1-1**

N

- networking service check **2-29**

O

operator panel
 buttons **2-5**
 service check **2-31**
 operator panel assembly
 removal **4-32**
 operator panel cable removal **4-30**

P

Panel Menus **3-15**
 Panel Test **3-5**
 paper exit guide assembly
 removal **4-34**
 Paper jams **3-20**
 paper jams **2-18**
 200 - 2-1 paper jam **3-21**
 200 paper jam **3-21**
 202 paper jam **3-23**
 241 paper jam **3-25**
 251 paper jam **3-26**
 290 - 294 paper jams **3-28**
 avoiding **3-20**
 tips on preventing **1-6**
 parts catalog
 covers **7-2**
 covers **7-3**
 electronics **7-8**
 electronics **7-9**
 frame **7-10**
 frame **7-11**
 how to use **7-1**
 options **7-10**
 scanner
 scanner **7-5**
 password, panel menus **3-15**
 post symptoms **2-2**
 power-on reset (POR) **2-1**
 power-on self test (POST) **2-2**
 print media
 types **1-4**
 Print quality pages **3-14**
 print quality problems
 solving **2-38**
 print speed **1-2**
 print tests **3-5**
 printer registration **3-3**
 printer setup **3-7**
 printhead
 removal **4-35**
 Prt Quality Pgs
 diagnostic menu **3-5**

Q

quick test page **3-4**

R

rear cover
 removal **4-5**
 Reduced curl **3-18**
 registration

printer **3-3**
 quick test **3-4**

removals

ADF separator pad **4-41**
 autocompensator clutch **4-24**
 card cage **4-11**
 controller card **4-13**
 cover open sensor **4-15**
 covers
 flatbed front cover **4-9**
 front access **4-2**
 left and right flatbed covers **4-10**
 left side **4-4**
 rear **4-5**
 top **4-8**
 developer drive coupling assembly **4-16**
 exit sensor **4-17**
 fan **4-18**
 feed rollers **4-20**
 fuser **4-20**
 fuser idle gear links **4-22**
 fuser power cable **4-23**
 input roller clutch and lever **4-24**
 input sensor #1 **4-25**
 input sensor #2 (manual feed) **4-26**
 lower right side cover **4-7**
 LVPS/HVPS card assembly **4-27**
 LVPS/HVPS to controller card cable **4-28**
 manual feed clutch assembly **4-29**
 modem **4-19**
 operator panel cable **4-30**
 paper exit guide asm. **4-34**
 printhead **4-35**
 scanner
 ADF assembly **4-42**
 ADF cable **4-43**
 ADF pick roll assembly **4-40**
 ADF top cover **4-39**
 operator panel assembly **4-32**
 transfer roll **4-36**

Reports **3-15**

reports **3-10**
 event log **3-15**
 menu settings page **3-15**
 Print Quality Pages **3-5**
 Reset PC count **3-14**

S

safety information **ii-xiii**
 scan quality service checks **2-43**
 scanner
 quality service checks **2-43**
 image unclear **2-43**
 irregular movement **2-43**
 no image **2-43**
 Scanner ASIC test **3-11**
 Scanner manual registration **3-17**
 Scanner specifications **1-5**
 ADF **1-5**
 flatbed **1-5**

- general **1-5**
- sensors
 - cover open **4-15**
 - exit **4-17**
 - input sensor #1 **4-25**
 - input sensor #2 (manual feed) **4-26**
- service checks **2-23**
 - ADF **2-23**
 - controller card **2-25**
 - cooling fan **2-24**
 - cover interlock **2-26**
 - dead machine **2-26**
 - fax **2-44**
 - reception **2-46**
 - transmission **2-44**
 - flatbed **2-24**
 - fuser **2-27**
 - cold **2-24**
 - hot **2-28**
 - LVPS/HVPS **2-28**
 - main motor **2-29**
 - modem **2-29**
 - networking **2-29**
 - operator panel **2-31**
 - operator panel button **2-31**
 - paper feed **2-33**
 - paper jam during POST **2-33**
 - paper never picks **2-33**
 - paper picks but stops **2-33**
 - paper picks during POST **2-33**
 - paper picks sheets **2-34**
 - paper trees, curls **2-34**
 - paper path sensor **2-32**
 - print quality **2-35**
 - black page **2-35**
 - blank page **2-35**
 - heavy background **2-36**
 - image density **2-36**
 - light print **2-37**
 - partial blank image **2-36**
 - poor fusing of image **2-36**
 - toner on back of page **2-37**
 - white or black lines **2-37**
 - scan quality **2-43**
 - scanner, fax, copy
 - 840xx error check **2-41**
 - escalating a fax issue to second-level support **2-48**
 - transfer roll **2-44**
- service error codes **2-9**
- service menus
 - X340642n **3-1**
- special tools **1-7**
- specifications
 - description
 - description **1-1**
 - photoconductor capacity **1-3**
 - toner capacity **1-3**
- start **2-1**
- symptoms

- MFP **2-2**
- MFP POST symptoms **2-2**
- POST symptoms **2-2**

T

- test pages
 - print quality test pages **3-5**
- tires
 - removal **4-20**
- tools **1-7**
- Top cover
 - removal **4-8**
- transfer roll
 - removal **4-36**
- transport cable
 - removal **4-37**

U

- USB scan to local **3-14**
- USB speed **3-18**
- user attendance messages **2-19**

Part number index

P/N	Description	Page
12A2405	USB cable, packaged	7-12
40X0270	Power cord, 1.77M (straight)—Japan	7-12
40X0271	Power cord, 6 foot—United Kingdom	7-12
40X0274	Power cord, 6 foot—Switzerland	7-12
40X0275	Power cord, 6 foot (straight)—Israel	7-12
40X0276	Power cord, 6 foot—South Africa	7-12
40X0277	Power cord, 6 foot (straight)—Brazil	7-12
40X0278	Power cord, 6 foot (straight)—Europe and others	7-12
40X0279	Power cord, 6 foot (straight)—Danish	7-12
40X0280	Power cord, 1.77M (straight)—Korea	7-12
40X0281	Power cord, 1.77M (straight)—Taiwan	7-12
40X0282	Power cord, 1.77M (straight)—PRC	7-12
40X0287	Power cord, 6 foot (straight)—Traditional Italy	7-12
40X0288	Power cord, 6 foot—Argentina	7-12
40X0289	Power cord, 1.77M (straight)—USA, Canada	7-12
40X0296	Power cord, 1.8M (straight)—Australia	7-12
40X0348	X 203 Operator panel overlay (French)	7-5
40X0349	X 204 Operator panel overlay(French)	7-5
40X0350	X 203 Operator panel overlay (Italian)	7-5
40X0351	X 204 Operator panel overlay (Italian)	7-5
40X0352	X 203 Operator panel overlay (German)	7-5
40X0353	X 204 Operator panel overlay (German)	7-5
40X0354	X 203 Operator panel overlay (Spanish)	7-5
40X0355	X 204 Operator panel overlay(Spanish)	7-5
40X0356	X 203 Operator panel overlay (Brazilian Portuguese)	7-5
40X0357	X 204 Operator panel overlay(Brazilian Portuguese)	7-5
40X0358	X 203 Operator panel overlay (Dutch)	7-5
40X0359	X 204 Operator panel overlay (Dutch)	7-5
40X0360	X 203 Operator panel overlay (Danish)	7-5
40X0361	X 204 Operator panel overlay(Danish)	7-5
40X0362	X 203 Operator panel overlay (Norwegian)	7-5
40X0363	X 204 Operator panel overlay (Norwegian)	7-5
40X0364	X 203 Operator panel overlay (Swedish)	7-5
40X0365	X 204 Operator panel overlay (Swedish)	7-5
40X0366	X 203 Operator panel overlay (Finnish)	7-5
40X0367	X 204 Operator panel overlay (Finnish)	7-5
40X0368	X 203 Operator panel overlay (Polish)	7-5
40X0369	X 204 Operator panel overlay (Polish)	7-5
40X0370	X 203 Operator panel overlay(Russian)	7-5
40X0371	X 204 Operator panel overlay (Russian)	7-5
40X0372	X203 operator panel overlay(Turkish)	7-5
40X0373	X204 Operator panel overlay(Turkish)	7-5
40X0374	X203 operator panel overlay(Hungarian)	7-5
40X0375	X204 Operator panel overlay(Hungarian)	7-5
40X0376	X203 operator panel overlay(Czech)	7-5
40X0377	X204 Operator panel overlay(Czech)	7-5
40X0378	X203 operator panel overlay(Simplified Chinese)	7-5
40X0379	X204 Operator panel overlay(Simplified Chinese)	7-5
40X0380	X203 operator panel overlay(Traditional Chinese)	7-7
40X0381	X204 Operator panel overlay(Traditional Chinese)	7-7
40X0382	X203 operator panel overlay(Korean)	7-7
40X0383	X204 Operator panel overlay(Korean)	7-7
40X0384	X 203n Operator panel overlay (English)	7-5
40X0385	X 204 Operator panel overlay (English)	7-5

40X0386	Fax card	7-7, 7-9
40X1303	Laser/mirror print assembly, X203, X204	7-9
40X1319	Paper feed, rubber tires	7-11
40X1323	Input #1 sensor assembly	7-9
40X1324	Input #2 sensor assembly (manual)	7-9
40X1325	Exit sensor assembly	7-9
40X1326	Cover open sensor assembly	7-9
40X1328	Cooling fan	7-9
40X1329	Developer drive coupling assembly	7-11
40X1330	Manual feed clutch CBM	7-11
40X1331	ACM clutch CBM	7-11
40X1333	Cable assembly, misc - fuser power	7-9
40X1333	Cable assembly, misc - main drive motor	7-9
40X1333	Cable assembly, misc.- main drive motor	7-9
40X1333	Cable assembly, misc.- toner sensor	7-9
40X1333	Miscellaneous cable assemblies	7-9
40X1334	Paper exit guide assembly	7-11
40X1338	Door-fuser idle gear link CBM	7-11
40X1353	Screws	7-11
40X1354	Front door & ACM spring	7-11
40X1355	Plastic snap rings	7-11
40X2822	Transfer, roll, bearings, gear, spring	7-11
40X4194	Fuser assembly, 110 V	7-9
40X4195	Fuser assembly, 220 V	7-9
40X4731	ASM, pick arm	7-11
40X5625	Print engine cable kit (Laser diode cable, Mirror motor cable, motor cable)	7-9
40X5627	Operator panel assembly X203	7-7
40X5628	Operator panel assembly X204	7-7
40X5629	Card asm, LVPSHVPS 220V	7-9
40X5630	Card asm, LVPSHVPS 110V	7-9
40X5631	ADF top cover	7-7
40X5632	ADF input tray assembly	7-5
40X5635	Top cover	7-3
40X5636	Left cover	7-3
40X5637	Right cover	7-3
40X5638	Rear cover assembly	7-3
40X5640	Front cover assembly	7-3
40X5641	Scanner front cover	7-5
40X5758	Left flatbed cover	7-7
40X5759	Right flatbed cover	7-5
40X5760??	Front access cover latch CBM	7-11
40X5761	ADF assembly	7-5
40X5762	ADF cable	7-7
40X5763	Operator panel cable	7-7
40X5764	Cam follower	7-3
40X5764??	Cam follower	7-3
40X5765	Card, X203 controller	7-9
40X5766	Card, X204 controller	7-9
40X5767	Flatbed assembly	7-5
40X5768	ADF separator roll assembly	7-7
40X5770	ADF separator pad	7-7
40X5774	Main tray	7-3
40X5780	Cable kit (LVPS cable)	7-9
40X5963	Flatbed cover w/o ADF	7-7