



Mono Laser Printer

ProXpress M332x / M382x / 402x
series

(Ver 1.33)

SERVICE MANUAL

Mono Laser Printer

Contents



1. Precautions
2. Product Specifications
3. Disassembly and Reassembly
4. Troubleshooting
5. System Diagram
6. Reference Information

Refer to the service manual in the GSPN (see the rear cover) for more information.

Contents

1.	Precautions	1 – 1
1.1.	Safety warning	1 – 1
1.2.	Caution for safety	1 – 2
1.2.1.	Toxic material	1 – 2
1.2.2.	Electric shock and fire safety precautions	1 – 2
1.2.3.	Handling precautions	1 – 4
1.2.4.	Assembly and Disassembly precautions	1 – 4
1.2.5.	Disregarding this warning may cause bodily injury	1 – 5
1.3.	ESD precautions	1 – 6
2.	Product Specifications	2 – 1
2.1.	Specifications	2 – 1
2.1.1.	Product Overview	2 – 1
2.1.2.	Specifications	2 – 2
2.1.2.1.	General	2 – 2
2.1.2.2.	Print	2 – 3
2.1.2.3.	Controller and Software	2 – 4
2.1.2.4.	Paper Handling	2 – 5
2.1.2.5.	Consumables	2 – 7
2.1.2.6.	Maintenance Part	2 – 8
2.2.	Product Description	2 – 9
2.2.1.	Front View	2 – 9
2.2.2.	Rear View	2 – 10
2.2.3.	Paper Path	2 – 11
2.2.4.	System layout	2 – 12
2.2.4.1.	Feeding Part	2 – 13
2.2.4.2.	Image Creation	2 – 15
2.2.4.3.	Fuser unit	2 – 17
2.2.4.4.	LSU (Laser Scanning Unit)	2 – 18
2.2.4.5.	Drive Unit	2 – 19
2.2.5.	Hardware configuration	2 – 20
2.2.5.1.	Main Controller (M332x_M382x_M402xND)	2 – 23
2.2.5.2.	Main Controller (M402xNX)	2 – 27
2.2.5.3.	OPE Controller	2 – 29
2.2.5.4.	SO-DIMM PBA	2 – 30
2.2.5.5.	WLAN(M382xDW model only)	2 – 31
2.2.5.6.	SCF PBA - Optional	2 – 31
2.2.5.7.	CRUM PBA	2 – 32
2.2.5.8.	SMPS Board	2 – 33

2.2.5.9.	HVPS board	2 – 34
2.2.6.	Engine Firmware Control Algorithm	2 – 35
2.2.6.1.	Feeding	2 – 35
2.2.6.2.	Transfer.....	2 – 35
2.2.6.3.	Fusing.....	2 – 36
2.2.6.4.	LSU.....	2 – 36
2.2.7.	Software Descriptions	2 – 37
2.2.7.1.	Software system overview	2 – 37
2.2.7.2.	Architecture	2 – 37
2.2.7.3.	Data and Control Flow	2 – 38
3.	Disassembly and Reassembly	3 – 1
3.1.	Precautions when replacing parts	3 – 1
3.1.1.	Precautions when assembling and disassembling	3 – 1
3.1.2.	Precautions when handling PBA.....	3 – 1
3.1.3.	Releasing Plastic Latches	3 – 2
3.2.	Screws used in the printer.....	3 – 3
3.3.	Replacing the Main SVC parts	3 – 4
3.3.1.	Left and Right Cover.....	3 – 4
3.3.2.	Front Cover.....	3 – 5
3.3.3.	Rear and Top Cover	3 – 6
3.3.4.	Main Board	3 – 8
3.3.5.	HVPS board	3 – 9
3.3.6.	SMPS Board.....	3 – 10
3.3.7.	Laser Scanning Unit (LSU)	3 – 10
3.3.8.	Fuser Unit.....	3 – 11
3.3.9.	Main Drive Unit.....	3 – 12
3.3.10.	Feed Drive Unit	3 – 13
3.3.11.	Pick Up_Regi_MP Clutch	3 – 13
3.3.12.	Pick-Up Roller.....	3 – 14
3.3.13.	Transfer Roller.....	3 – 15
3.3.14.	OPE Board.....	3 – 15
3.3.15.	MP Unit	3 – 17
3.3.16.	Bin-full sensor	3 – 17
3.3.17.	Regi_Feed_Empty Sensor	3 – 18
3.3.18.	Reverse Roller	3 – 19
3.3.19.	SCF(Second Cassette Feeder) Unit	3 – 20
3.3.19.1.	SCF Right Cover.....	3 – 20
3.3.19.2.	SCF Main Board	3 – 20
3.3.19.3.	SCF Main Motor.....	3 – 21
3.3.19.4.	SCF Clutch	3 – 21

3.3.19.5.	SCF pick up_forward roller	3 – 22
3.3.19.6.	SCF Reverse Roller	3 – 22
3.3.19.7.	SCF Main Drive Unit	3 – 23
3.3.19.8.	SCF Lift Assy	3 – 23
3.3.19.9.	SCF Pick-Up Unit	3 – 24
3.3.19.10.	SCF Pick-Up_Empty_Feed Sensor	3 – 25
4.	Troubleshooting	4 – 1
4.1.	Alignment and Adjustments	4 – 1
4.1.1.	Control Panel	4 – 1
4.1.2.	Understanding The Status LED	4 – 4
4.1.3.	Clearing paper jams	4 – 5
4.1.4.	Useful menu item for service	4 – 17
4.1.5.	Periodic Defective Image	4 – 19
4.1.6.	Useful management tools	4 – 20
4.1.6.1.	Using Samsung Easy Printer Manager	4 – 20
4.1.6.2.	Using Samsung Printer Status (Windows only)	4 – 22
4.1.6.3.	Using SyncThru Web Service (SWS)	4 – 23
4.1.7.	Updating Firmware	4 – 25
4.1.7.1.	Update the firmware by using the USB port	4 – 25
4.1.7.2.	Update the firmware by using the network	4 – 26
4.1.8.	Service Mode	4 – 28
4.2.	Troubleshooting	4 – 32
4.2.1.	Procedure of checking the symptoms	4 – 32
4.2.1.1.	Basic Check List	4 – 33
4.2.2.	Error Code and Troubleshooting	4 – 34
4.2.3.	Image quality problem	4 – 62
4.2.4.	Other errors	4 – 68
5.	System Diagram	5 – 1
5.1.	Block Diagram (ProXpress M332x_382x_402xND)	5 – 1
5.2.	Block Diagram (ProXpress M402xNX)	5 – 2
5.3.	Connection Diagram (ProXpress M332x_M382x_M402xND)	5 – 3
5.4.	Connection Diagram (ProXpress M402xNX)	5 – 4
6.	Reference Information	6 – 1
6.1.	Tool for Troubleshooting	6 – 1
6.2.	Glossary	6 – 2
6.3.	The Sample Pattern for the Test	6 – 8
6.4.	Model Name and Code	6 – 9
6.5.	Document Revision List	6 – 10

1. Precautions

In order to prevent accidents and damages to the equipment please read the precautions listed below carefully before servicing the product and follow them closely.

1.1. Safety warning

- 1) Only to be serviced by a factory trained service technician.

High voltages and lasers inside this product are dangerous. This product should only be serviced by a factory trained service technician.

- 2) Use only Samsung replacement parts.

There are no user serviceable parts inside the product. Do not make any unauthorized changes or additions to the product as these could cause the product to malfunction and create an electric shocks or fire hazards.

- 3) Laser Safety Statement

The printer is certified in the U.S. to conform to the requirements of DHHS 21 CFR, chapter 1 Subchapter J for Class I(1) laser products, and elsewhere is certified as a Class I laser product conforming to the requirements of IEC/EN 60825-1:2014. Class I laser products are not considered to be hazardous. The laser system and printer are designed so there is never any human access to laser radiation above a Class I level during normal operation, user maintenance or prescribed service condition.

- Wavelength: 800 nm
- Beam divergence
 - Parallel: 11 degrees
 - Perpendicular: 35 degrees
- Maximum power of energy output: 12 mW



WARNING

Never operate or service the product with the protective cover removed from Laser/Scanner assembly. The reflected beam, although invisible, can damage your eyes.

When using this product, these basic safety precautions should always be followed to reduce risk of fire, electric shock, and personal injury.



- 4) Lithium battery not replaceable by user

1.2. Caution for safety

1.2.1. Toxic material

This product contains toxic materials that could cause illness if ingested.

- 1) Please keep imaging unit and toner cartridge away from children. The toner powder contained in the imaging unit and toner cartridge may be harmful, and if swallowed, you should contact a doctor.

1.2.2. Electric shock and fire safety precautions

Failure to follow the following instructions could cause electric shock or potentially cause a fire.

- 1) Use only the correct voltage, failure to do so could damage the product and potentially cause a fire or electric shock.
- 2) Use only the power cable supplied with the product. Use of an incorrectly specified cable could cause the cable to overheat and potentially cause a fire.
- 3) Do not overload the power socket, this could lead to overheating of the cables inside the wall and could lead to a fire.
- 4) Do not allow water or other liquids to spill into the product, this can cause electric shock. Do not allow paper clips, pins or other foreign objects to fall into the product, these could cause a short circuit leading to an electric shock or fire hazard.

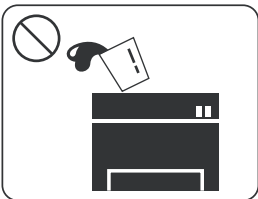

- 5) Never touch the plugs on either end of the power cable with wet hands, this can cause electric shock. When servicing the product, remove the power plug from the wall socket.

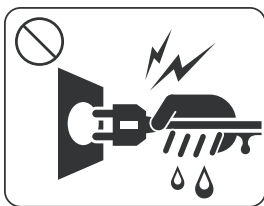

- 6) Use caution when inserting or removing the power cord. When removing the power cord, grip it firmly and pull. The power cord must be inserted completely, otherwise a poor contact could cause overheating leading to a fire.
- 7) Take care of the power cable. Do not allow it to become twisted, bent sharply around corners or power cable may be damaged. Do not place objects on top of the power cable. If the power cable is damaged it could overheat and cause a fire. Exposed cables could cause an electric shock. Replace the damaged power cable immediately, do not reuse or repair the damaged cable. Some chemicals can attack the coating on the power cable, weakening the cover or exposing cables causing fire and shock risks.

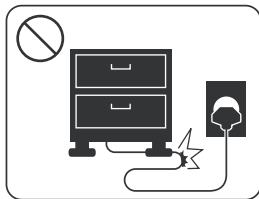

- 8) Ensure that the power sockets and plugs are not cracked or broken in any way. Any such defects should be repaired immediately. Take care not to cut or damage the power cable or plugs when moving the machine.
- 9) Use caution during thunder or lightning storms. Samsung recommends that this machine be disconnected from the power source when such weather conditions are expected. Do not touch the machine or the power cord if it is still connected to the wall socket in these weather conditions.

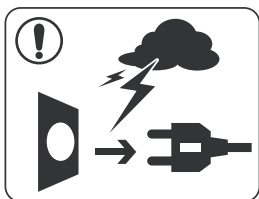

- 10) Avoid damp or dusty areas, install the product in a clean well ventilated location. Do not position the machine near a humidifier or in front of an air conditioner. Moisture and dust built up inside the machine can lead to overheating and cause a fire or cause parts to rust.

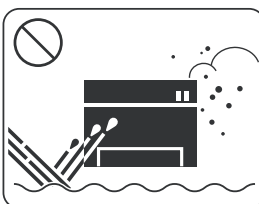

- 11) Do not position the product in direct sunlight. This will cause the temperature inside the product to rise possibly leading to the product failing to work properly and in extreme conditions could lead to a fire.
- 12) Do not insert any metal objects into the machine through the ventilator fan or other part of the casing, it could make contact with a high voltage conductor inside the machine and cause an electric shock.

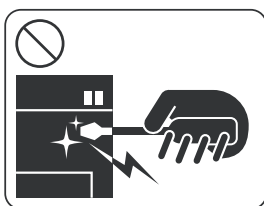

- 13)  When replacing the SMPS board, please wait 5 minutes after unplugging the power cord, then replace it. You can get a shock by the electric discharge.

1.2.3. Handling precautions

The following instructions are for your own personal safety to avoid injury and so as not to damage the product.

- 1) Ensure the product is installed on a level surface, capable of supporting its weight. Failure to do so could cause the product to tip or fall.
- 2) The product contains many rollers, gears and fans. Take great care to ensure that you do not catch your fingers, hair or clothing in any of these rotating devices.
- 3) Do not place any small metal objects, containers of water, chemicals or other liquids close to the product which if spilled could get into the machine and cause damage or a shock or fire hazard.
- 4) Do not install the machine in areas with high dust or moisture levels, beside an open window or close to a humidifier or heater. Damage could be caused to the product in such areas.
- 5) Do not place candles, burning cigarettes, etc on the product, These could cause a fire.
- 6) Ensure that the machine is installed and used in proper area to meet the temperature and humidity specifications.
 - If the machine is stored at below zero Celsius for a long time, do not use the machine instantly after movement. It can malfunction. Take care of the machine storage. If the machine is stored at below zero Celsius for a long time, keep the machine at room temperature and install it.

1.2.4. Assembly and Disassembly precautions

- 1) Replace parts carefully and always use Samsung parts. Take care to note the exact location of parts and also cable routing before dismantling any part of the machine. Ensure all parts and cables are replaced correctly. Please carry out the following procedures before dismantling the product or replacing any parts.
- 2) Ensure that power is disconnected before servicing or replacing any electrical parts.
- 3) Disconnect interface cables and power cables.
- 4) Only use approved spare parts. Ensure that part number, product name, any voltage, current or temperature rating are correct.
- 5) When removing or re-fitting any parts do not use excessive force, especially when fitting screws into plastic.
- 6) Take care not to drop any small parts into the machine.
- 7) Handling of the OPC Drum
 - The OPC Drum can be irreparably damaged if it is exposed to light. Take care not to expose the OPC Drum either to direct sunlight or to fluorescent or incandescent room lighting. Exposure for as little as 5 minutes can damage the surface of the photoconductive properties and will result in print quality degradation. Take extra care when servicing the product. Remove the OPC Drum and store it in a black bag or other lightproof container. Take care when working with the Covers (especially the top cover) open as light is admitted to the OPC area and can damage the OPC Drum.
 - Take care not to scratch the green surface of the OPC Drum Unit. If the green surface of the Drum Cartridge is scratched or touched the print quality will be compromised.

1.2.5. Disregarding this warning may cause bodily injury

- 1) Be careful with the high temperature part.

The fuser unit works at a high temperature. Use caution when working on the printer. Wait for the fuser unit to cool down before disassembly.



- 2) Do not put fingers or hair into the rotating parts.

When operating a printer, do not put hand or hair into the rotating parts (Paper feeding entrance, motor, fan, etc.). If do, you can get harm.



- 3) When you move the printer, use safe lifting and handling techniques.

This printer is heavy. Use the lifting handles located on each side of the machine. Back injury could be caused if you do not lift carefully.

- 4) Ensure the printer is installed safely.

Ensure the printer is installed on a level surface, capable of supporting its weight. Failure to do so could cause the printer to tip or fall possibly causing personal injury or damaging the printer.

- 5) Do not install the printer on a sloping or unstable surface. After installation, double check that the printer is stable.

1.3. ESD precautions

Certain semiconductor devices can be easily damaged by static electricity. Such components are commonly called “Electrostatically Sensitive (ES) Devices” or ESDs. Examples of typical ESDs are: integrated circuits, some field effect transistors, and semiconductor “chip” components. The techniques outlined below should be followed to help reduce the incidence of component damage caused by static electricity.



CAUTION

Be sure no power is applied to the chassis or circuit, and observe all other safety precautions.

- 1) Immediately before handling a semiconductor component or semiconductor-equipped assembly, drain off any electrostatic charge on your body by touching a known earth ground. Alternatively, employ a commercially available wrist strap device, which should be removed for your personal safety reasons prior to applying power to the unit under test.
- 2) After removing an electrical assembly equipped with ESDs, place the assembly on a conductive surface, such as aluminum or copper foil, or conductive foam, to prevent electrostatic charge buildup in the vicinity of the assembly.
- 3) Use only a grounded tip soldering iron to solder or desolder ESDs.
- 4) Use only an “anti-static” solder removal device. Some solder removal devices not classified as “anti-static” can generate electrical charges sufficient to damage ESDs.
- 5) Do not use Freon-propelled chemicals. When sprayed, these can generate electrical charges sufficient to damage ESDs.
- 6) Do not remove a replacement ESD from its protective packaging until immediately before installing it. Most replacement ESDs are packaged with all leads shorted together by conductive foam, aluminum foil, or a comparable conductive material.
- 7) Immediately before removing the protective shorting material from the leads of a replacement ESD, touch the protective material to the chassis or circuit assembly into which the device will be installed.
- 8) Maintain continuous electrical contact between the ESD and the assembly into which it will be installed, until completely plugged or soldered into the circuit.
- 9) Minimize bodily motions when handling unpackaged replacement ESDs. Normal motions, such as the brushing together of clothing fabric and lifting one’s foot from a carpeted floor, can generate static electricity sufficient to damage an ESD.

2. Product Specifications

2.1. Specifications

2.1.1. Product Overview

	<ol style="list-style-type: none"> 1) Speed <ul style="list-style-type: none"> • M332x series : Up to 33 ppm in A4 (35 ppm in Letter) • M382x series : Up to 38 ppm in A4 (40 ppm in Letter) • M402x series : Up to 40 ppm in A4 (42 ppm in Letter) 2) Processor <ul style="list-style-type: none"> • 600 MHz (M332x series / M382x series / M402xND) • 600 MHz + 1GHz (M402xNX) 3) Printer Languages <ul style="list-style-type: none"> • PostScript3, PCL6/5e, IBM ProPrinter, EPSON, SPL 4) Memory (Std / Max) <ul style="list-style-type: none"> • M332xND / M382xD : 128 MB / 128 MB • M382xND/DW : 128 MB / 512 MB • M402xND : 256 MB / 512 MB • M402xNX : 1GB / 1GB 5) Interfaces <ul style="list-style-type: none"> • High-Speed USB 2.0 • Wired Network <ul style="list-style-type: none"> • M382xD : Not Support • M332xND, M382xND, M382xDW : Ethernet 10/100 Base Tx • M402xND, M402xNX : Ethernet 10/100/1G Base Tx • Wireless Network <ul style="list-style-type: none"> • M382xDW Only : 802.11b/g/n 6) Consumables <ul style="list-style-type: none"> • Integrated Toner System <ul style="list-style-type: none"> : M3320ND / M3820D/ M3820ND / M3820DW / M4020ND / M4020NX • Separated Toner System <ul style="list-style-type: none"> : M3325ND / M3825D/ M3825ND / M3825DW / M4025ND / M4025NX
---	---

2.1.2. Specifications

- Product Specifications are subject to change without notice.

2.1.2.1. General

Item		Specification
Temperature	Operating	10 to 30 °C (50 to 86°F)
	Storage	-20 to 40 °C (-4 to 104 °F)
Humidity	Operating	20 to 80% RH
	Storage	10 to 90% RH
Noise Level	Printing	<ul style="list-style-type: none"> M332x/M382x series: Less than 54 dB (A) M402x series: Less than 56 dB (A)
Power Consumption	Ready mode	<ul style="list-style-type: none"> M332x/M382x series & M402xND : Less than 10 Wh M402xNX : Less than 15 Wh
	Average operating mode	Less than 700 W
	Power save mode	<ul style="list-style-type: none"> M332x/M382x series & M402xND : Less than 1.1 Wh (M382xDW - Wi-Fi Direct on: Less than 2.8Wh / off : 1.6Wh) M402xNX : Less than 3.9 Wh
Dimension (W x D x H)	Set (mm)	366.5 x 368 x 256.5 mm (14.42 x 14.48 x 10.09 inches)
Weight	Set (Kg)	10 Kg (22.04 lbs)
Reliability & Service	Recommended Monthly Printing Volume (AMPV)	<ul style="list-style-type: none"> M332xND : 1000 ~ 2500 pages M382x series : 1500 ~ 3500 pages M402x series : 2000 ~ 4000 pages
	Max. Monthly Print Volume	<ul style="list-style-type: none"> M332xND : 50,000 pages M382x series : 80,000 pages M402x series : 100,000 pages

2.1.2.2. Print

Item		Specification
Engine Speed	Simplex	<ul style="list-style-type: none"> • M332x series <ul style="list-style-type: none"> • Up to 33 ppm in A4 (35 ppm in Letter) • M382x series <ul style="list-style-type: none"> • Up to 38 ppm in A4 (40 ppm in Letter) • M402x series <ul style="list-style-type: none"> • Up to 40 ppm in A4 (42 ppm in Letter)
	Duplex	<ul style="list-style-type: none"> • M332x series <ul style="list-style-type: none"> • Up to 16 ipm in A4 (17 ipm in Letter) • M382x series <ul style="list-style-type: none"> • Up to 19 ipm in A4 (20 ipm in Letter) • M402x series <ul style="list-style-type: none"> • Up to 20 ipm in A4 (21 ipm in Letter)
FPOT	Ready Mode	As fast as 6.5 sec
	Sleep Mode	<ul style="list-style-type: none"> • M332x series : Less than 15.5 sec • M382x / 402x series : Less than 18 sec
Resolution	Optical (Standard)	600 x 600 dpi
	Enhanced	Up to 1,200 x 1,200 dpi effective output
Emulation		PostScript3, PCL6/5e, IBM ProPrinter, EPSON, SPL

2.1.2.3. Controller and Software

Item		Specification
Processor		<ul style="list-style-type: none"> M332x/M382x series & M402xND : 600MHz M402xNX : 1GHz
Memory	Standard	<ul style="list-style-type: none"> M332x series : 128 MB M382x series : 128 MB M402xND : 256 MB M402xNX : 1 GB
	Max	<ul style="list-style-type: none"> M332x series : 128 MB M382xD : 128 MB M382xND/DW : 512 MB M402xND : 512 MB M402xNX : 1GB
Driver	Supporting OS	[Window] <ul style="list-style-type: none"> XP (32 / 64 bit) / 2003 Server (32/64 bit) / Vista (32/64 bit) / 2008 server (32/64 bit) / 7 (32/64 bit) / 2008 Server R2 / 8 (32/64bit)
		[Mac] <ul style="list-style-type: none"> X 10.5 ~ 10.8
		[Linux] <ul style="list-style-type: none"> RedHat Enterprise WS 4, 5, 6 (32/64 bit) Fedora 5, 6, 7, 8, 9, 10, 11, 12, 13, 14, 15 (32/64 bit) OpenSuSE 10.2, 10.3, 11.0, 11.1, 11.2, 11.3, 11.4 (32/64 bit) SuSE Linux Enterprise Desktop 10, 11 (32/64 bit) Debian 4.0, 5.0, 6.0 (32/64 bit) Mandriva 2007, 2008, 2009, 2009.1, 2010 (32/64 bit) Ubuntu 6.06, 6.10, 7.04, 7.10, 8.04, 8.10, 9.04, 9.10, 10.04, 10.10, 11.04 (32/64 bit)
		[Unix] <ul style="list-style-type: none"> HP-UX 11.0, 11i v1, 11i v2, 11i v3 (PA-RISC, Itanium) Sun Solaris 9, 10, 11 (x86, SPARC)
Network Protocols		[TCP/IP] <ul style="list-style-type: none"> TCP/IPv4/IPv6, HTTP, SNMPv1/v2c/v3, SMTP, IPSec, DNS/WINS, DDNS, DHCP, SSL/TLS, BOOTP, AutoIP, Standard TCP/IP printing, LPR, IPP,UPnP(SSDP), Bonjour, Telnet, WSD, SLP, SetIP [Others] <ul style="list-style-type: none"> HTTPs,IPPs, 802.1x(EAP-MD5, EAP-MSCHAPv2, PEAP, TLS), IPSec

Item	Specification
Interface	<ul style="list-style-type: none"> High-Speed USB 2.0 Wired Network <ul style="list-style-type: none"> M382xD : Not Support M332xND, M382xND, M382xDW : Ethernet 10/100 Base Tx M402xND, M402xNX : Ethernet 10/100/1G Base Tx Wireless Network <ul style="list-style-type: none"> M382xDW Only : 802.11b/g/n
User Interface	<ul style="list-style-type: none"> M332xND / M382xD : LED Only M382xND / M382xDW / M402xND : 2-Line LCD M402xNX : 4.3 inch LCD
Software and Application	<ul style="list-style-type: none"> Admin Deployment Application Easy Printer Manager

2.1.2.4. Paper Handling

Item	Specification	
Standard Capacity	<ul style="list-style-type: none"> M332xND / M382xD <ul style="list-style-type: none"> 250-sheet Cassette Tray @80g/m² 1-sheet Manual Feeder M382xND / M382xDW / M402xND / M402xNX <ul style="list-style-type: none"> 250-sheet Cassette Tray @80g/m² 50-sheet Multi Purpose Tray @80g/m² 	
Max. Capacity	<ul style="list-style-type: none"> M332xND <ul style="list-style-type: none"> 771 sheet (@80g/m²) with option cassette M382xD <ul style="list-style-type: none"> 251 sheet @80g/m² <div style="background-color: #e0e0e0; padding: 5px; margin: 10px 0;">  NOTE M382xD does not support the option cassette. </div> <ul style="list-style-type: none"> M382xND / M382xDW / M402xND / M402xNX <ul style="list-style-type: none"> 820 sheet (@80g/m²) with option cassette 	
Printing	<ul style="list-style-type: none"> Max. Size : 216 x 356 mm (8.5" x 14") Min. Size : 76 x 127 mm (3.0" x 5.0") 	
Multi-purpose tray	Capacity	[M382xND / M382xDW / M402xND / M402xNX] <ul style="list-style-type: none"> Plain Paper : 50 sheets @ 80g/m² Envelop : 5 sheets
	Media sizes	A4, A5, A6, Letter, Legal, Folio, Oficio, Executive, ISO B5, JIS B5, 3"x5", Envelope (Monarch, No.10, DL, C5, C6), Custom
	Media type	Plain, Thin, Thick, Thicker, Cotton, Colored, Envelope, Transparency, Pre-Printed, Recycled, Labels, Bond, Card stock, Archive
	Media weight	16~58 lb (60 to 220 g/m ²)
	Sensing	Paper Empty

2. Product Specifications

Item		Specification
Standard Cassette Tray	Capacity	250 sheets @ 80 g/m ²
	Media sizes	A4, A5, A6, Letter, Legal, Folio, Oficio, Executive, ISO B5, JIS B5, Custom
	Media types	Plain Paper, Thin, Thick, Recycled, Bond, Cardstock, Archive
	Media weight	16~43 lb (60 to 163 g/m ²)
	Sensing	Paper Empty
Optional Cassette Tray	Capacity	520 sheets @ 80 g/m ²
	Media sizes	A4, A5, A6, Letter, Legal, Folio, Oficio, Executive, ISO B5, JIS B5
	Media types	Plain Paper, Thin, Thick, Recycled, Bond, Cardstock, Archive
	Media weight	16~43 lb (60 to 163 g/m ²)
	Sensing	CST Open, Paper Empty
Output Stacking	Capacity	<ul style="list-style-type: none"> • Face-Down : 150 sheets @ 80 g/m² • Face-Up : 1 sheet
	Output Full sensing	Yes
Duplex	Supporting	Built-in
	Media sizes	A4, Letter, Oficio, Folio, Legal
	Media types	Plain Paper, Thin, Thick, Recycled, Bond
	Media weight	16~32 lb (60 to 120 g/m ²)
Printable Area	Non-Printable Area	<ul style="list-style-type: none"> • Envelop : 10 mm (0.4") from edge (Top, Bottom, Left, Right) • Other Media : 4 mm (0.16") from edge (Top, Bottom, Left, Right)

2.1.2.5. Consumables

NOTE

M332x/ M382x/ M402x series have 2 types of consumable depending on model.

- Integrated Toner System : M3320ND / M3820D/ M3820ND / M3820DW / M4020ND / M4020NX
- Separated Toner System : M3325ND / M3825D/ M3825ND / M3825DW / M4025ND / M4025NX

Integrated Toner System

Item	Model Name	Average yield	M3320ND	M3820D M3820ND M3820DW	M4020ND M4020NX
Laser Toner Cartridge	MLT-D203S	Approx. 3,000 pages	O	O	O
	MLT-D203L	Approx. 5,000 pages	O	O	O
	MLT-D203E	Approx. 10,000 pages	X	O	O
	MLT-D203U	Approx. 15,000 pages	X	X	O

NOTE

- The yield of initial toner cartridge is approx. 3,000 pages.
- Declared cartridge yield in accordance with ISO/IEC 19752.

Separated Toner System

Item	Model Name	Average yield	M3325ND	M3825D M3825ND M3825DW	M4025ND M4025NX
Toner Cartridge	MLT-D204S	Approx. 3,000 pages	O	O	O
	MLT-D204L	Approx. 5,000 pages	O	O	O
	MLT-D204E	Approx. 10,000 pages	X	O	O
	MLT-D204U	Approx. 15,000 pages	X	X	O
Imaging Unit	MLT-R204	Approx. 30,000 pages	O	O	O

NOTE

- The yield of initial toner cartridge is approx. 3,000 pages.
- Declared cartridge yield in accordance with ISO/IEC 19752.

2.1.2.6. Maintenance Part

Some of the machine's parts have shorter life span than machine's life.

To ensure that the machine produces good copies and to extend its service life, it is recommended that these maintenance parts at specific intervals be replaced as instructed.

Item	Part Code	Life
Tray1 Pick up roller	JC73-00340A	Approx. 90,000 pages
Tray1 Separation(Reverse) roller	JC90-01063B	Approx. 60,000 pages
Transfer roller	JC66-02842A	Approx. 100,000 pages
Fuser Unit	<ul style="list-style-type: none">JC91-01023A (110V)JC91-01024A (220V)	Approx. 90,000 pages
Tray2 Pick up / Forward roller (Optional)	JC97-02259A	Approx. 200,000 pages
Tray2 Separation(Reverse) roller (Optional)	JC97-02259A	Approx. 100,000 pages

2.2. Product Description

This chapter describes the functions and operating principal of the main component.

2.2.1. Front View

NOTE

- This illustration may differ from your machine depending on your model. There are various types of machine.
- Some features and optional goods may not be available depending on model or country

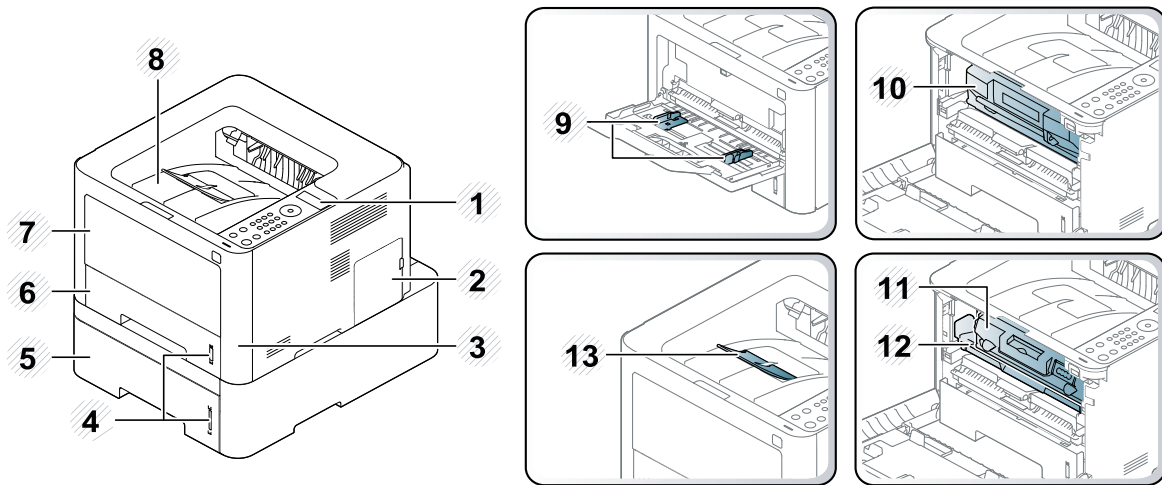

1	Control Panel
2	Control board cover
3	Front cover
4	Paper level indicator
5	Tray 2
6	Tray 1
7	Multi-purpose (or manual feeder) tray
8	Output tray
9	Paper width guides on a multi-purpose (or manual feeder) tray
10	Toner cartridge NOTE M3320/M3820/M4020 series only.

11	Toner cartridge NOTE M3325/M3825/M4025 series only.
12	Imaging unit NOTE M3325/M3825/M4025 series only.
13	Output support

2.2.2. Rear View

NOTE

- This illustration may differ from your machine depending on your model. There are various types of machine.
- Some features and optional goods may not be available depending on model or country

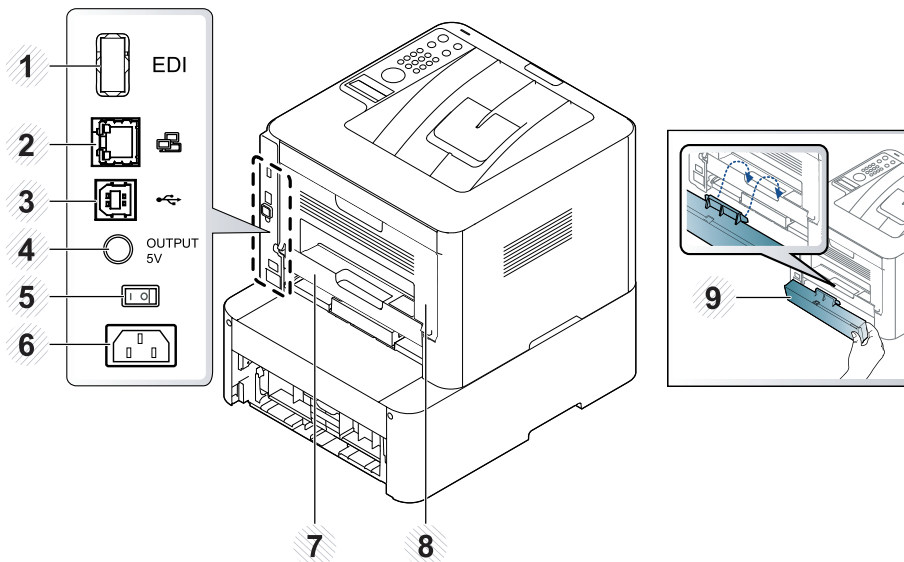

1	EDI port
2	Network port
3	USB port
4	5V output port for IEEE 1284B parallel connector
	<p>NOTE</p> <p>The optional IEEE 1284B parallel connector can be used by plugging in both the USB port and the 5V output port.</p>
5	Power-switch
6	Power receptacle
7	Duplex unit
8	Rear cover
9	Tray back cover

2.2.3. Paper Path

The following diagram displays the path the paper follows during the printing process.

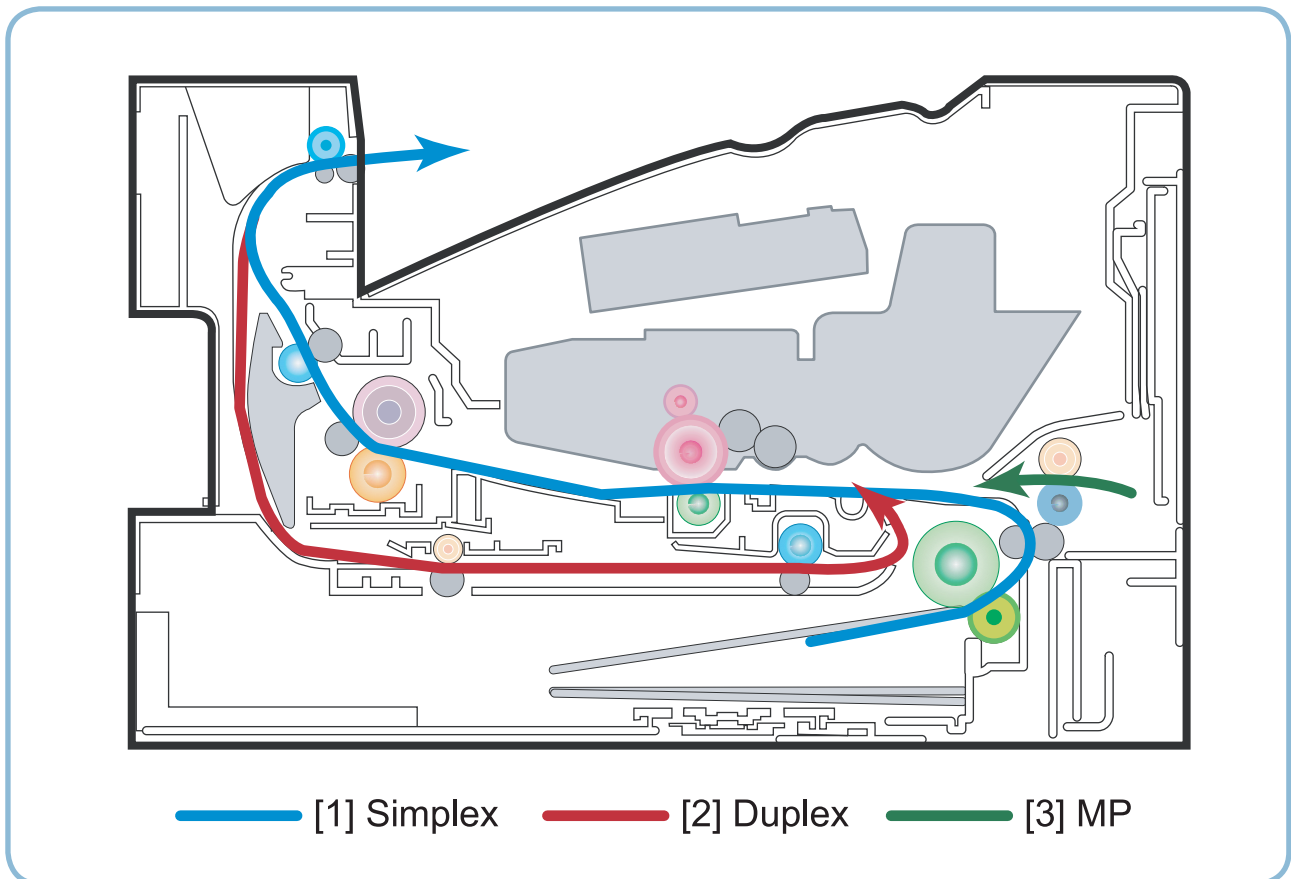

2.2.4. System layout

This model consists of the Engine parts, Hardware and Firmware. The engine parts consists of the mechanical parts comprising Frame, Duplex, Toner cartridge, Drive unit, Transfer roller, Fuser, Cassette. The Hardware part consists of the main control board, power board, operation panel, PC Interface.

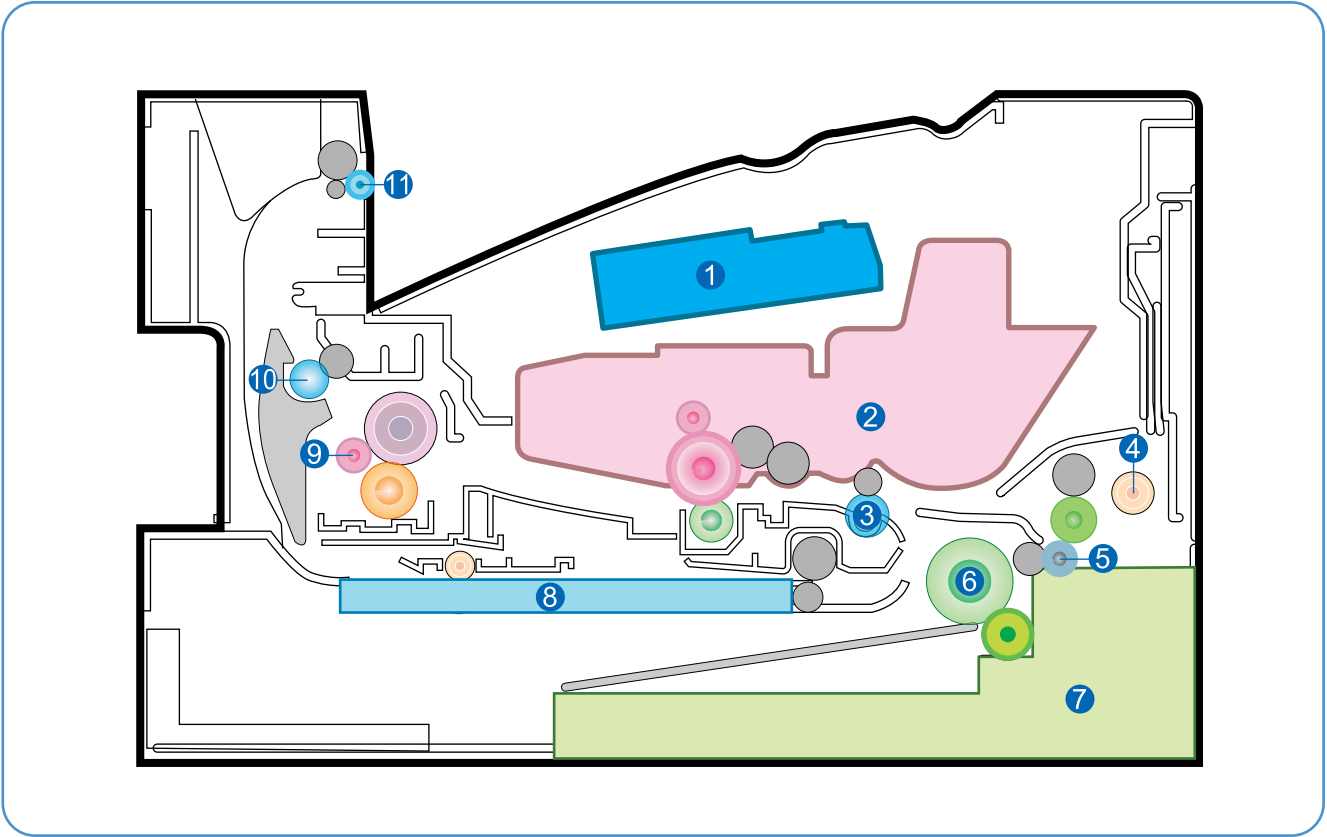

1	LSU (Laser Scanning Unit)
2	Toner Cartridge
3	Regi. Roller
4	MP
5	Feed Roller
6	Pick-Up Roller
7	Cassette
8	Duplex Unit
9	Fuser
10	Exit Roller1
11	Exit Roller2

2.2.4.1. Feeding Part

It consists of a cassette, an MP tray for supplying different types of media (envelope, label, special paper) and parts related to paper feed initialization.

1) Cassette

The paper trays consist of the Main trays, Optional trays (SCF), and one Multi-Purpose (MP) tray. The basic cassette is located on front side of the machine and allows feeding of common paper. Paper size is set using the Size Guides in each tray. Adjust the Paper length/width guides to match the paper size.

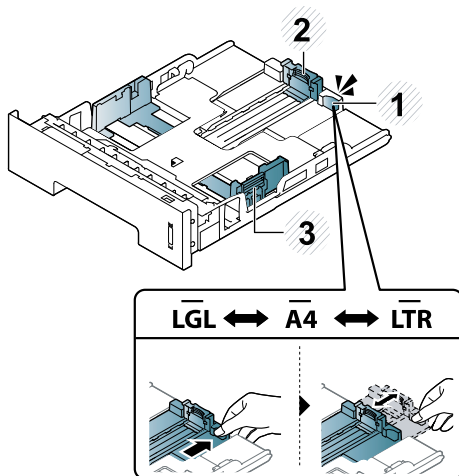

2) Pick up / Reverse(Retard) roller

When pickup takes place, the pickup roller rotates to separate and transport the paper. The pickup roller rotates when the pickup clutch is activated. The retard roller serve to make sure that a single sheet of paper is moved to the paper path, and the paper is moved as far as the registration roller by the work of the feed roller. The following is a diagram of the pickup section :

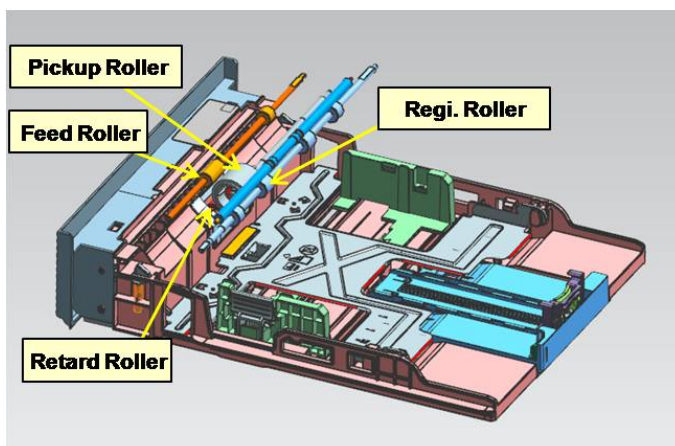

3) Registration roller

It is used as an anti skew device, and to setup proper registration timing with that of the toned image on the drum. It also is used for jam detection to ensure paper has left the paper tray.

4) MP Tray

The multi-purpose tray can hold special sizes and types of print material, such as postcards, note cards, and envelopes. It is useful for single page printing on letterhead or colored paper. It uses 3 rollers feeding method to feed 50 sheets of general papers.

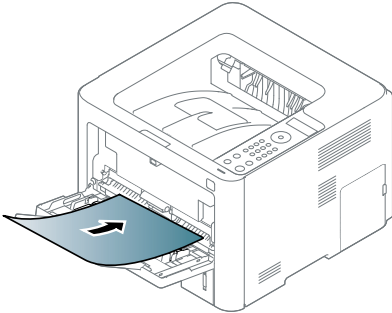

5) Duplex Unit

It has paper transferring function, paper guide function, jam removing function. It is designed for basic attachment, and the duplex feeding takes a side feeding method. Usable papers are A4, letter, and legal size paper. For removing a jam occurred in a front part, it is designed to open a cassette and a guide. It is designed to open a rear cover to remove a jam in a rear part. If a face up tray is open, the duplex option cannot be used.

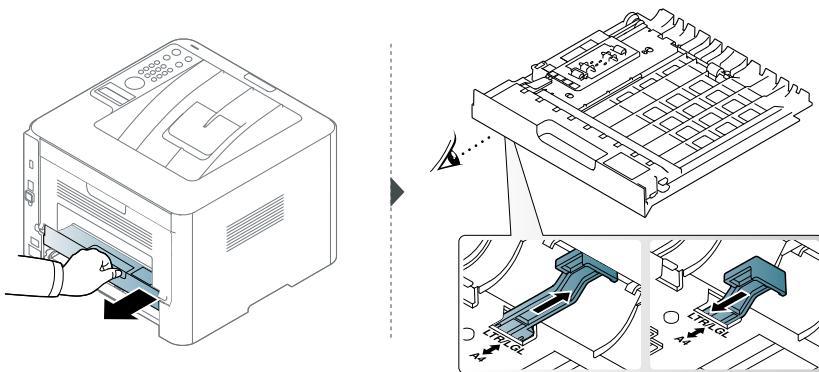

6) SCF (Second Cassette Feeder)

It is the same method with the main cassette, and the capacity is 520 sheets. It has a separate driving mechanism. It is designed for a common use with a main cassette.

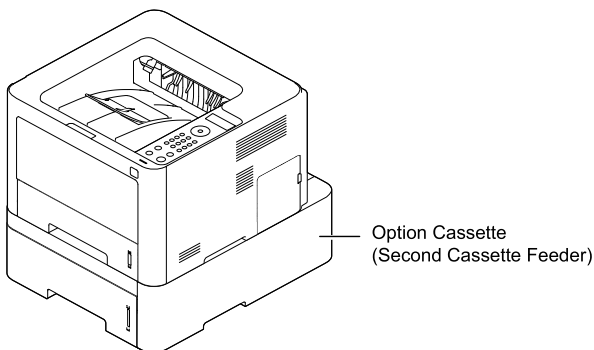

2.2.4.2. Image Creation

1) Printing process overview

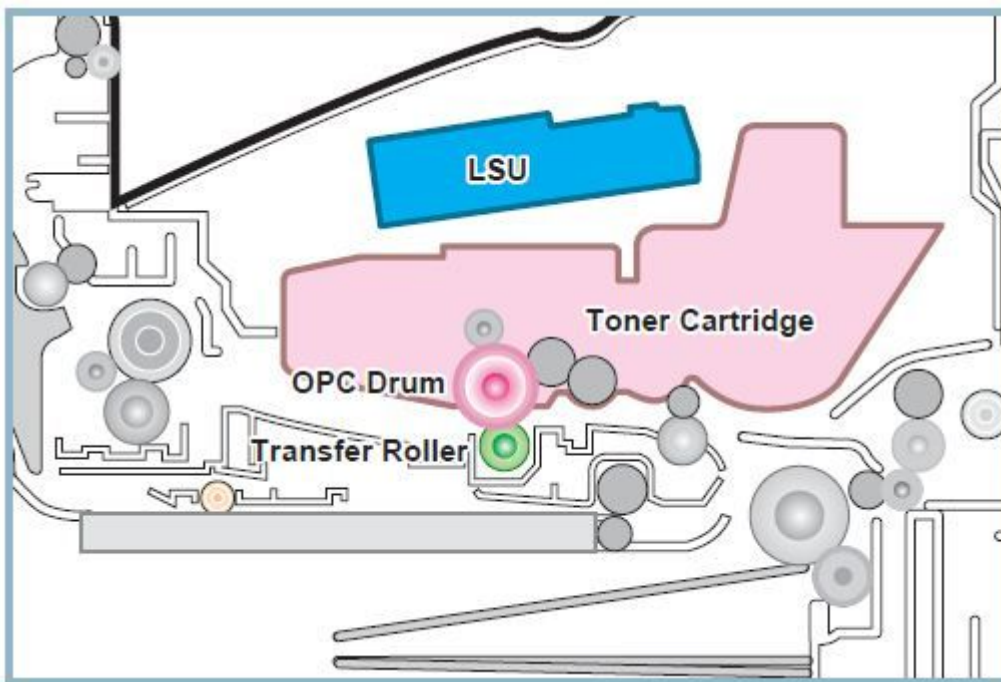

This mono printing system includes the LSU with a laser beam, a toner cartridge and transfer roller.

This machine uses toner cartridge and laser beam for mono printing.

M332x/M382x/M402x series has 2 types of toner cartridge. M3320/M3820/M4020 series has the integrated toner system and M3325/M3825/M4025 series has the separated toner system. The separated toner system consists of toner cartridge and imaging unit. The imaging unit has an OPC drum, cleaning blade etc.

The OPC drum is charged with a negative voltage by the charge roller and is exposed by the light from the LSU (Laser Scanning unit). The light produced by a laser creates a latent image by discharging on the surface of the OPC drum. The negatively charged toners are attracted to the latent image due to an electric field. The toners (real image) on the OPC drum are moved to the transfer media by the positive bias applied to the transfer roller.

- 1) Charging the OPC drum : The scorotron gives the drum negative charges.
- 2) Laser exposure : Light produced by a laser diode irradiates the charged OPC through the lens and mirrors.
- 3) Development : This machine uses a dual-component development system . The magnetic roller carries negatively charged toner to the latent image on the drum surface.
- 4) Transfer : The transfer rollers opposite the OPC drums transfer toner from the drums to the transfer media (e.g. paper, OHP film, etc).
- 5) Cleaning for OPC drum: The cleaning blade removes remaining toners on the drum surface after image transfer to the paper.

2) Integrated / Separated Toner System

By using the electronic photo process, it creates a visual image.

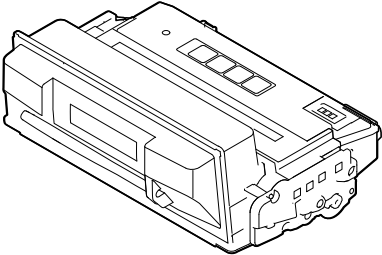
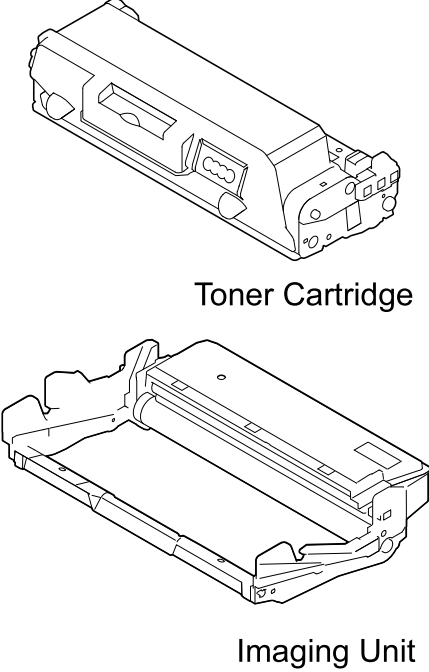
M3320/M3820/M4020 series	M3325/M3825/M4025 series
Integrated Toner System	Separated Toner System
	 <p style="text-align: center;">Toner Cartridge</p> <p style="text-align: center;">Imaging Unit</p>

- Operation condition : Temp 10~30°C, Humidity 20~85% RH
- Developing Method : Non magnetic 1 element contacting method
- Toner : Non magnetic 1 element shatter type toner
- Toner Residual Sensor : Dot count with zCRUM
- OPC Cleaning : Collect the toner by using cleaning blade
- Handling of wasted toner : Collect the wasted toner in the cleaning frame by using cleaning blade
- OPC Drum Protecting Shutter : None
- Classifying device for toner cartridge: ID is classified by CRUM.

2.2.4.3. Fuser unit

It is consisted of a halogen lamp, heat roller, pressure roller, thermistor and thermostat. It sticks the toner on a paper by heat and pressure to complete the printing job.

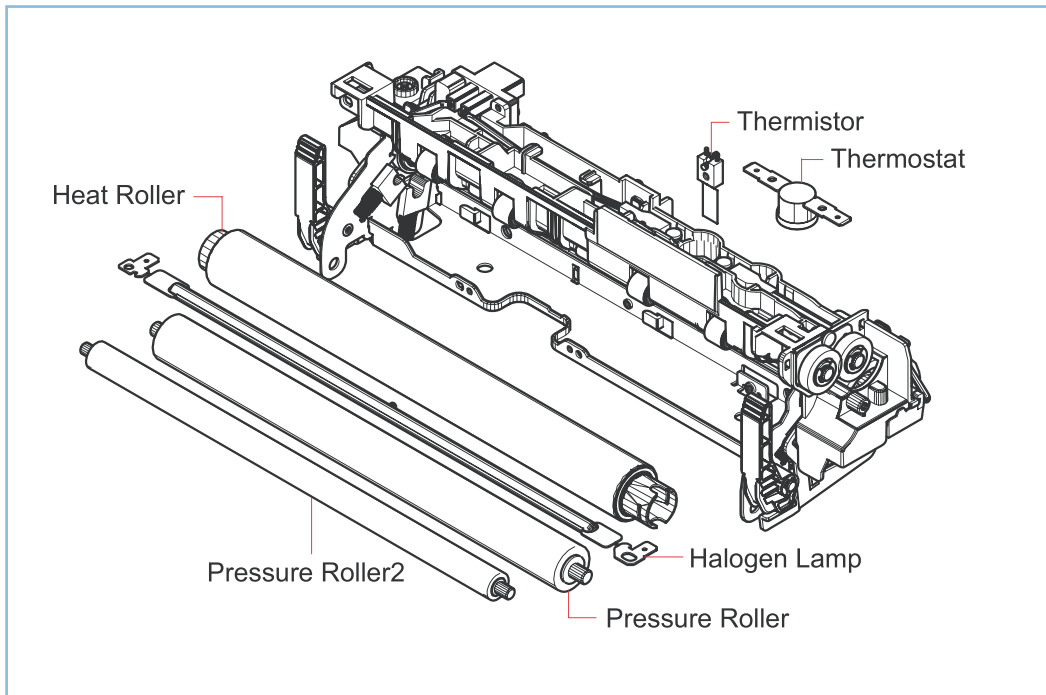

1) Thermostat

When a heat lamp is overheated, a Thermostat cuts off the main power to prevent over- heating.

- Thermostat Type : Non- Contact type
- Control Temperature : $190^{\circ}\text{C} \pm 5^{\circ}\text{C}$

2) Thermistor

It is a temperature detecting sensor.

- Temperature Resistance : $7\text{ K}\Omega(180^{\circ}\text{C})$

3) Heat roller

The heat roller transfers the heat from the lamp to apply a heat on the paper.

The surface of a heat roller is coated with Teflon, so toner does not stick to the surface.

4) Pressure roller

A pressure roller mounted under a heat roller is made of a silicon resin, and the surface also is coated with Teflon. When a paper passes between a heat roller and a pressure roller, toner adheres to the surface of a paper permanently.

5) Halogen Lamp

- Voltage : $120\text{ V}, 115 \pm 5\% / 220\text{ V}, 230 \pm 5\%$
- Capacity : $850\text{ Watt} \pm 42.5\text{W}$

2.2.4.4. LSU (Laser Scanning Unit)

It is the core part of the LBP which switches from the video data received to the controller to the electrostatic latent image on the OPC drum by controlling laser beam, exposing OPC drum, and turning principle of polygon mirror. The OPC drum is turned with the paper feeding speed. The HSYNC signal is created when the laser beam from LSU reaches the end of the polygon mirror, and the signal is sent to the controller. The controller detects the HSYNC signal to adjust the vertical line of the image on paper. In other words, after the HSYNC signal is detected, the image data is sent to the LSU to adjust the left margin on paper. The one side of the polygon mirror is one line for scanning.

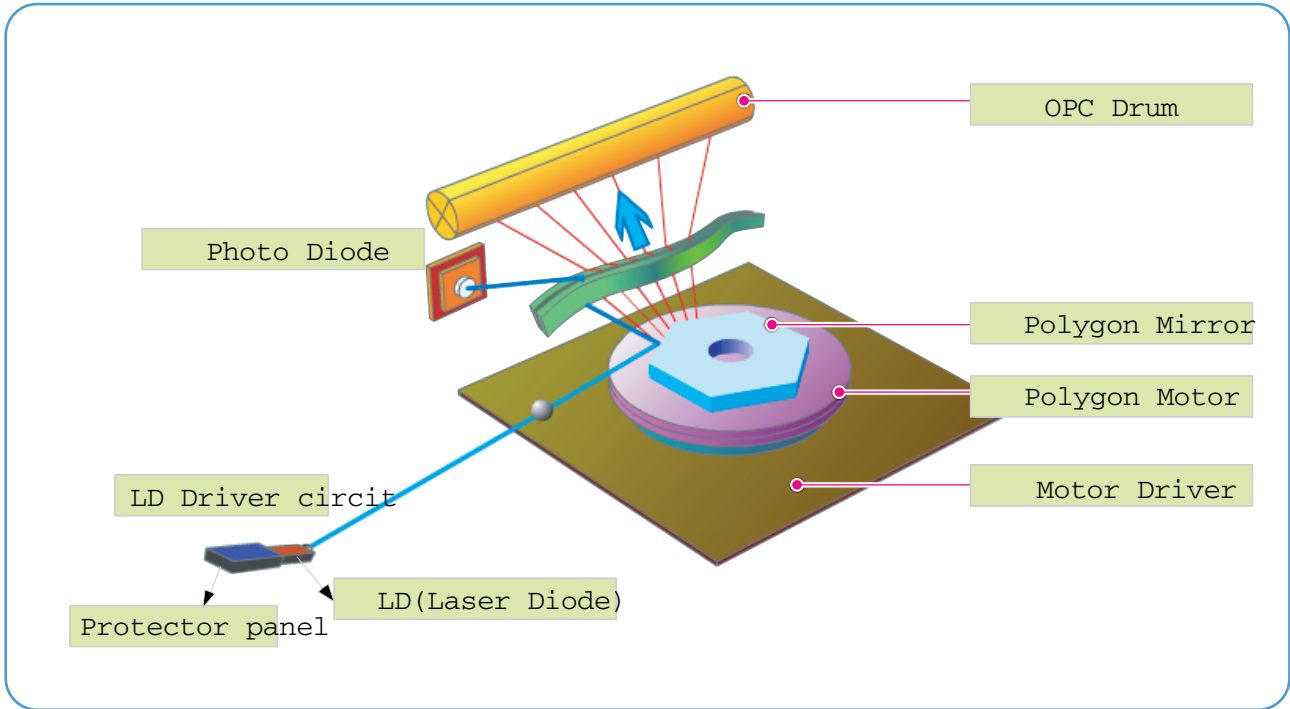

2.2.4.5. Drive Unit

ProXpress M332x/M382x/M402x series has 2 drive units that is assembled to the right side of the machine.

The main drive unit consists of a BLDC motor, a clutch, various gears for OPC, fuser, exit, feed etc.

The feed drive unit consists of 2 gears for MP, feed.

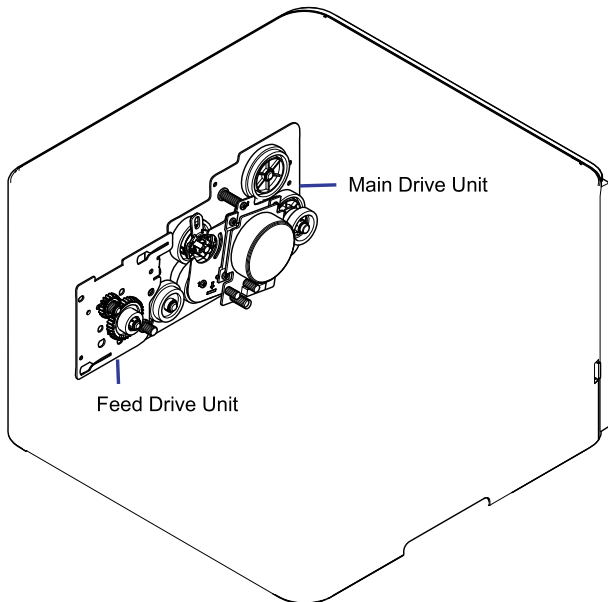

2.2.5. Hardware configuration

ProXpress M332x / M382x / M402x series Electrical Circuit system consists of the following :

- Main controller
- OPE controller
- DDR3 SODIMM
- SCF board (Option)
- SMPS board
- HVPS board
- WLAN Module (M382xDW only)
- MICRO SD 4GB (M402xNX only)

Diagram of the M332xND/382xD/382xND/382xDW/402xND Series Electrical Circuit

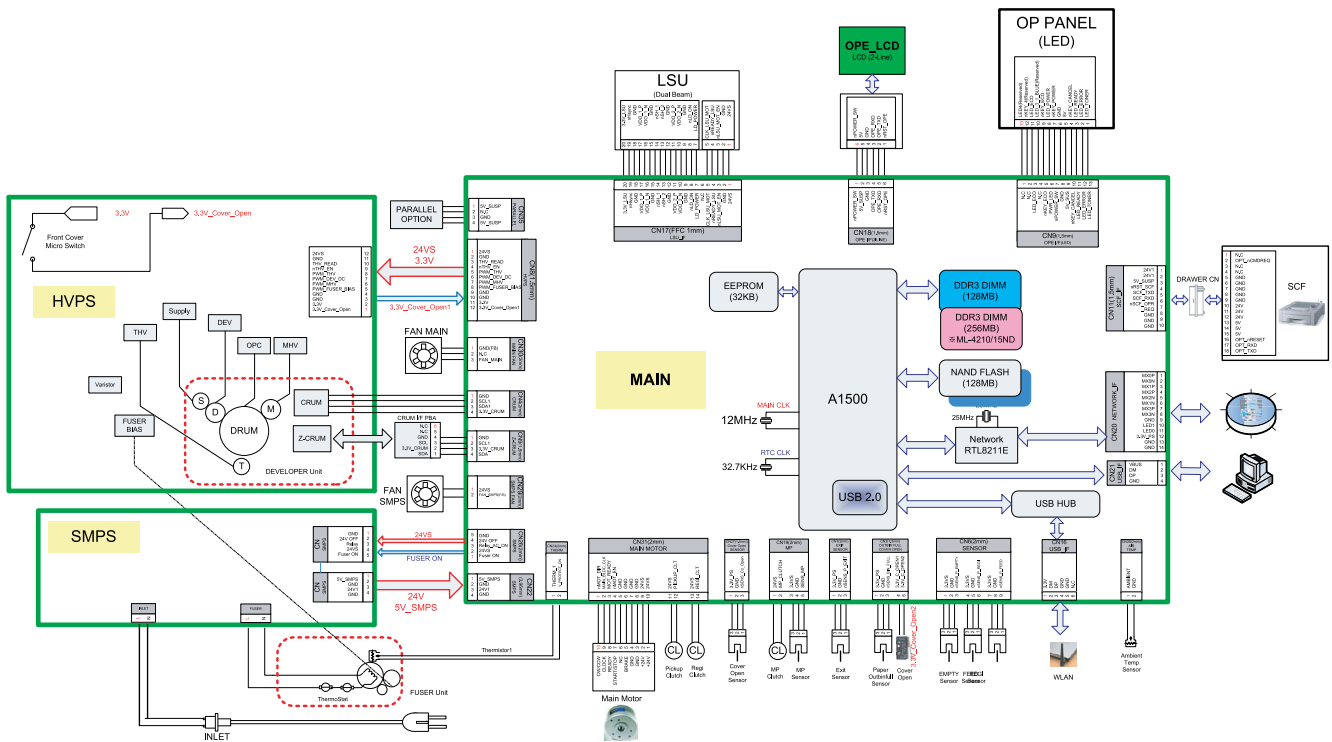

The main controller controls all modules required to print, that is, LSU, HVPS, SMPS, FAN, Fuser, etc.

The main controller receives print data from the host through network or USB Port. It takes this information and generates printable video bitmap data. Engine and Video Controller are not separated.

The Main Controller adopts the A1500(600MHz) CPU, DIMM PBA on DDR3 memory to perform printing jobs successfully.

The OPE controller displays the status of the system using 16 x 2line LCD in response to user actions or the main controller.

M3320ND/ M3325ND/ M3820D/ M3825D model only supports LED OPE without LCD module.

The HVPS supplies high voltage for developing process. High Voltage controlled by PWM signal from CPU.

SMPS makes +5V and +24V DC from 220V or 110 AC.

WLAN module is used for wireless communication.

Diagram of the M402xNX Series Electrical Circuit

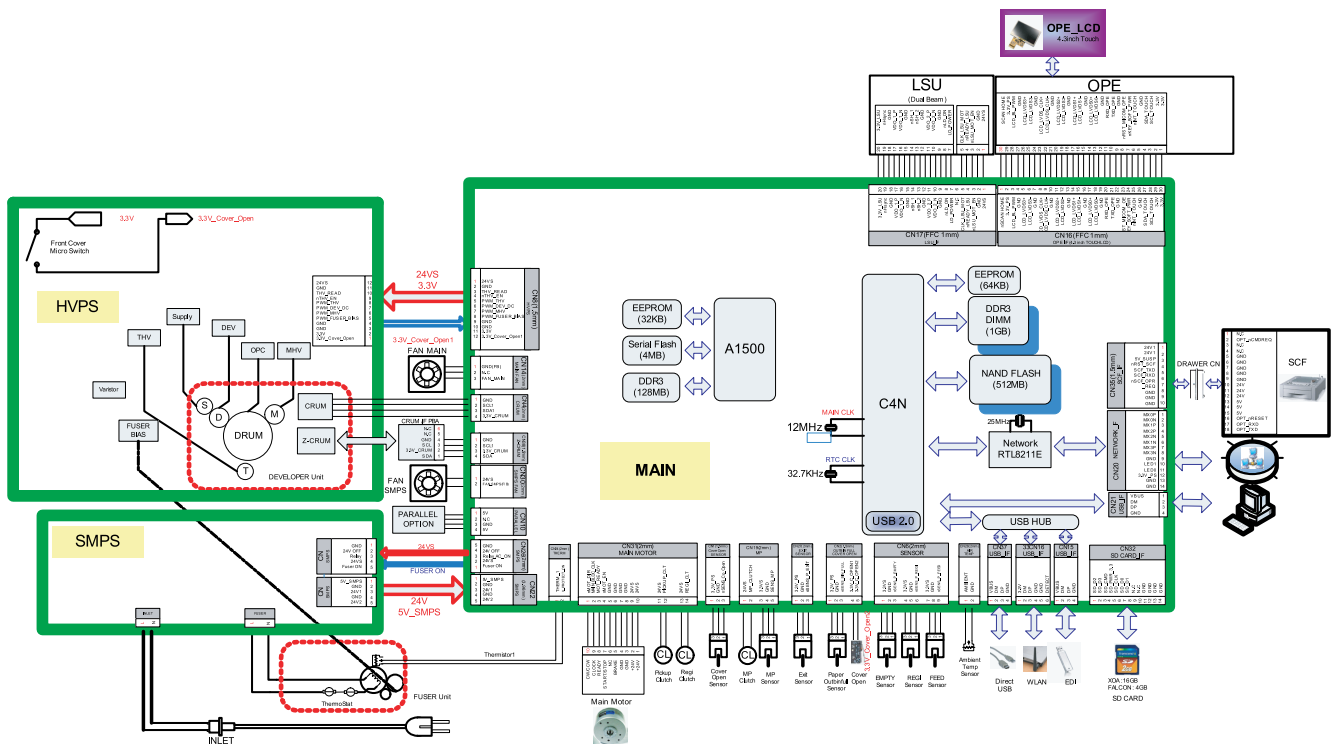

The main controller controls all modules required to print, that is, LSU, HVPS, SMPS, FAN, Fuser, etc.

The main controller receives print data from the host through network or USB Port. It takes this information and generates printable video bitmap data. engine and video controller are not separated.

The main controller adopts the CHORUS4N(1GHz) CPU, A1500(600MHz), DIMM PBA on DDR3 memory to perform printing jobs successfully.

The OPE Controller displays the status of the system using 4.3inch TFT LCD in response to user actions or the Main controller.

The HVPS supplies high voltage for developing process. High Voltage controlled by PWM signal from CPU.

SMPS makes +5V and +24V DC from 220V or 110 AC.

Main Circuit Board Locations

The following diagrams show the locations of the printer circuit boards :

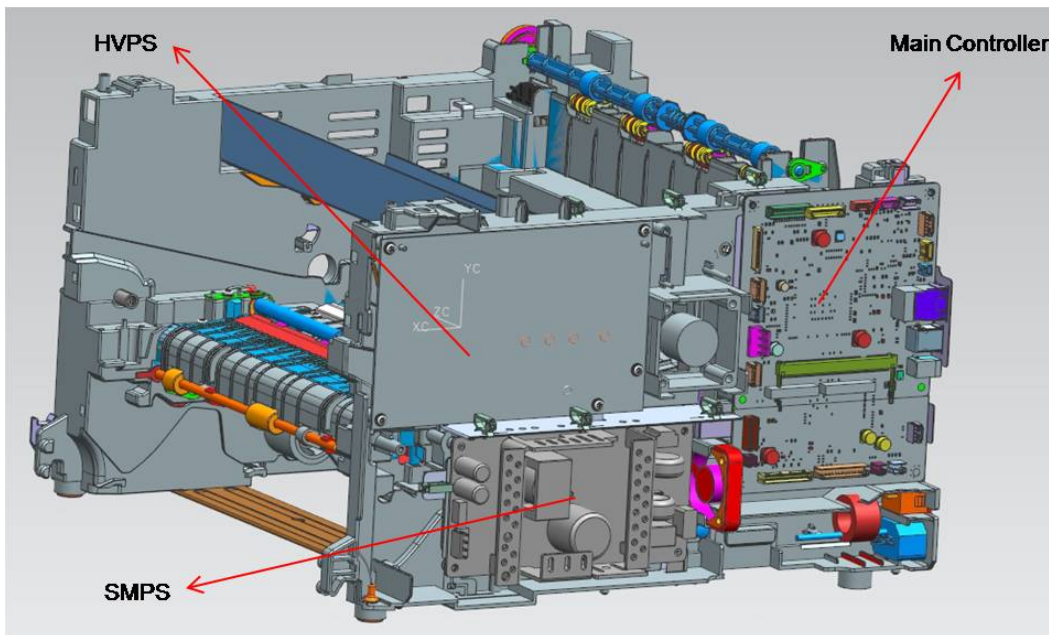

2.2.5.1. Main Controller (M332x_M382x_M402xND)

ProXpress M332x/ M382x/ M402xND series main controller is composed with below components.

- A1500 : To generate the printable video data and control engine / Embedded USB2.0 device
- DDR3 SODIMM : system memory
 - M332x series/ M382x series : 128MB
 - M402xND : 256MB
- External DDR3 SODIMM : 512MB (Not supply for M3820D/3825D)
- Ethernet PHY : Network printing
- NAND Flash : Program memory (128MB)

The Main Controller manages an Electro-photography system, controls the Video Data of printing images from Main Board to LSU, provides high-voltages and PWMs, adjusts temperature in the fusing system, reads sensor signals and controls SCF option.

The Main controller also controls OPE and N/W PHY, USB Device, Wireless Module.

Main Controller Diagram

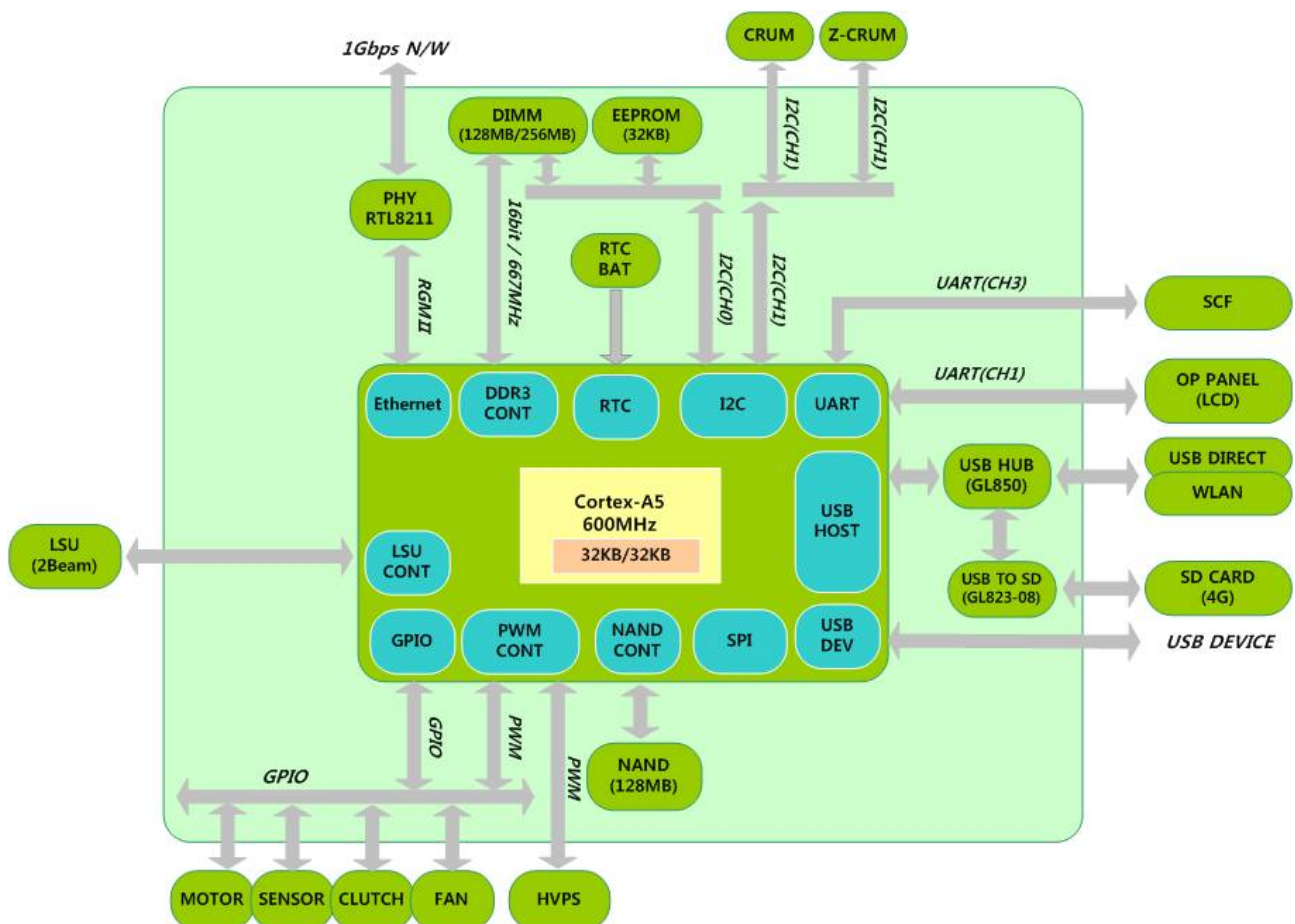

Main Controller connection information

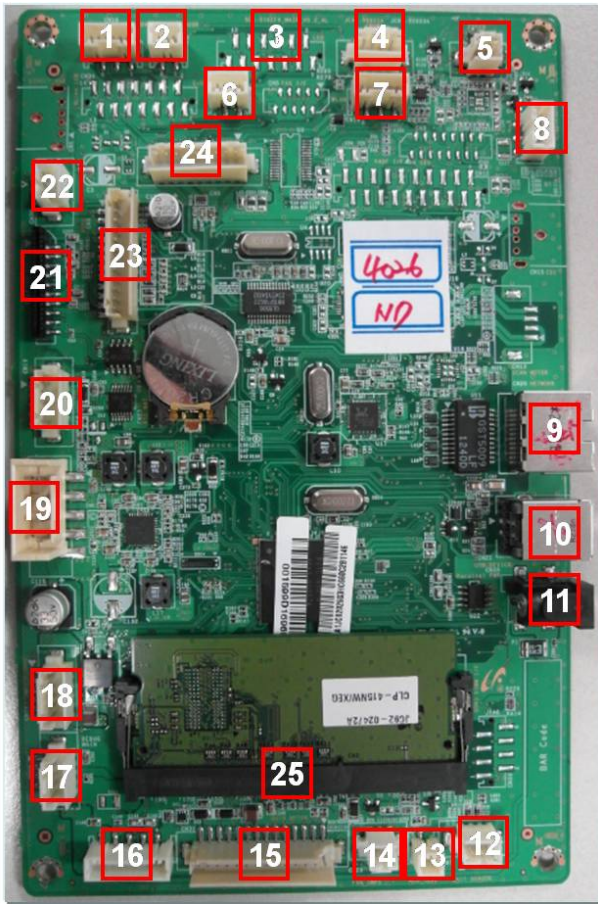

• **Connection**

No	Description
1	2LINE LCD OPE (Except LED OPE model)
2	COVER OPEN SENSOR (Only for M3325ND/3825ND/3825DW/4025ND)
3	LED OPE (Only for M3320ND/3325ND/3820D/3825D)
4	CRUM
5	FUSER
6	TONER CRUM (Only for M3325ND/3825ND/3825DW/4025ND)
7	WLAN (Only for M3820DW/3825DW)
8	OUTBIN FULL / REAR COVER OPEN
9	NETWORK (Not apply for M3820D/3825D)
10	USB DEVICE

No	Description
11	PARALLEL PWR
12	EXIT SENSOR
13	AIR TEMP
14	FAN SMPS
15	MAIN MOTOR
16	SCF (option)
17	DEBUG
18	SMPS SIGNAL
19	SMPS POWER
20	MP (Not apply for M3320ND/3325ND/3820D/3825ND)
21	LSU
22	FAN MAIN
23	HVPS
24	SENSOR I/F
25	DDR3 SO-DIMM

- Part Code Information

Model	Part Code	Remark
SL-M3820DW	JC92-02832G	220V Model
SL-M3820DW/B2B		
SL-M3820DW/SEE		
SL-M3820DW/XSA		
SL-M3321ND/ETS	JC92-02832E	220V Model
SL-M3820ND		
SL-M3820ND/ETS		
SL-M3820ND/SAU		
SL-M3820ND/SEE		
SL-M3820ND/XBG		
SL-M3820ND/XBH		
SL-M3820ND/XEV		
SL-M3820ND/XFA		
SL-M3820ND/XIP		
SL-M3820ND/XSA		
SL-M3820ND/XSG		
SL-M3820ND/XSS		
SL-M3825DW/SEE		
SL-M3825DW/STS		
SL-M3825ND/SEE	JC92-02832D	220V Model
SL-M3825ND/STS		
SL-M3825ND/XIL		
SL-M4020ND	JC92-02832J	220V Model
SL-M4020ND/ETS		
SL-M4020ND/GOV		
SL-M4020ND/KOY		
SL-M4020ND/SAU		
SL-M4020ND/SEE		
SL-M4020ND/STS		
SL-M4020ND/XBG		
SL-M4020ND/XBH		
SL-M4020ND/XEV		
SL-M4020ND/XFA		
SL-M4020ND/XIP		
SL-M4020ND/XSA		
SL-M4020ND/XSG		
SL-M4020ND/XSS		

2. Product Specifications

Model	Part Code	Remark
SL-M4025ND/SEE	JC92-02832H	220V Model
SL-M4025ND/STS		
SL-M4025ND/XEV		
SL-M4025ND/XIL		
SL-M3825ND/XAZ	JC92-02897A	110V Model
SL-M3820ND/TED	JC92-02896A	110V Model
SL-M3820ND/XAA		
SL-M3820ND/XAX		
SL-M3820ND/XAZ		
SL-M3825DW/XAA	JC92-02895A	110V Model
SL-M3820DW/XAA	JC92-02894A	110V Model
SL-M3820DW/XAX		
SL-M3820DW/XAZ		
SL-M4025ND/XAZ	JC92-02893A	110V Model
SL-M4025ND/XBG		
SL-M4020ND/XAA	JC92-02892A	110V Model
SL-M4020ND/XAX		
SL-M4020ND/XAZ		

2.2.5.2. Main Controller (M402xNX)

ProXpress M402xNX main controller is composed with below components.

- C4N : To generate the printable video data and control engine / Embedded USB 2.0 device.
- A1500 : ZCRUM I/F
- DDR3 SODIMM : 1GB system memory
- Ethernet PHY : Network printing
- NAND Flash : Program memory (512MB)
- MicroSD Memory : 4GB

The main controller manages an Electro-photography system, controls the Video Data of printing images from Main Board to LSU, provides high-voltages and PWMs, adjusts temperature in the fusing system, reads sensor signals and controls SCF option.

The main controller also controls OPE and N/W PHY, USB Device.

Main Controller Diagram

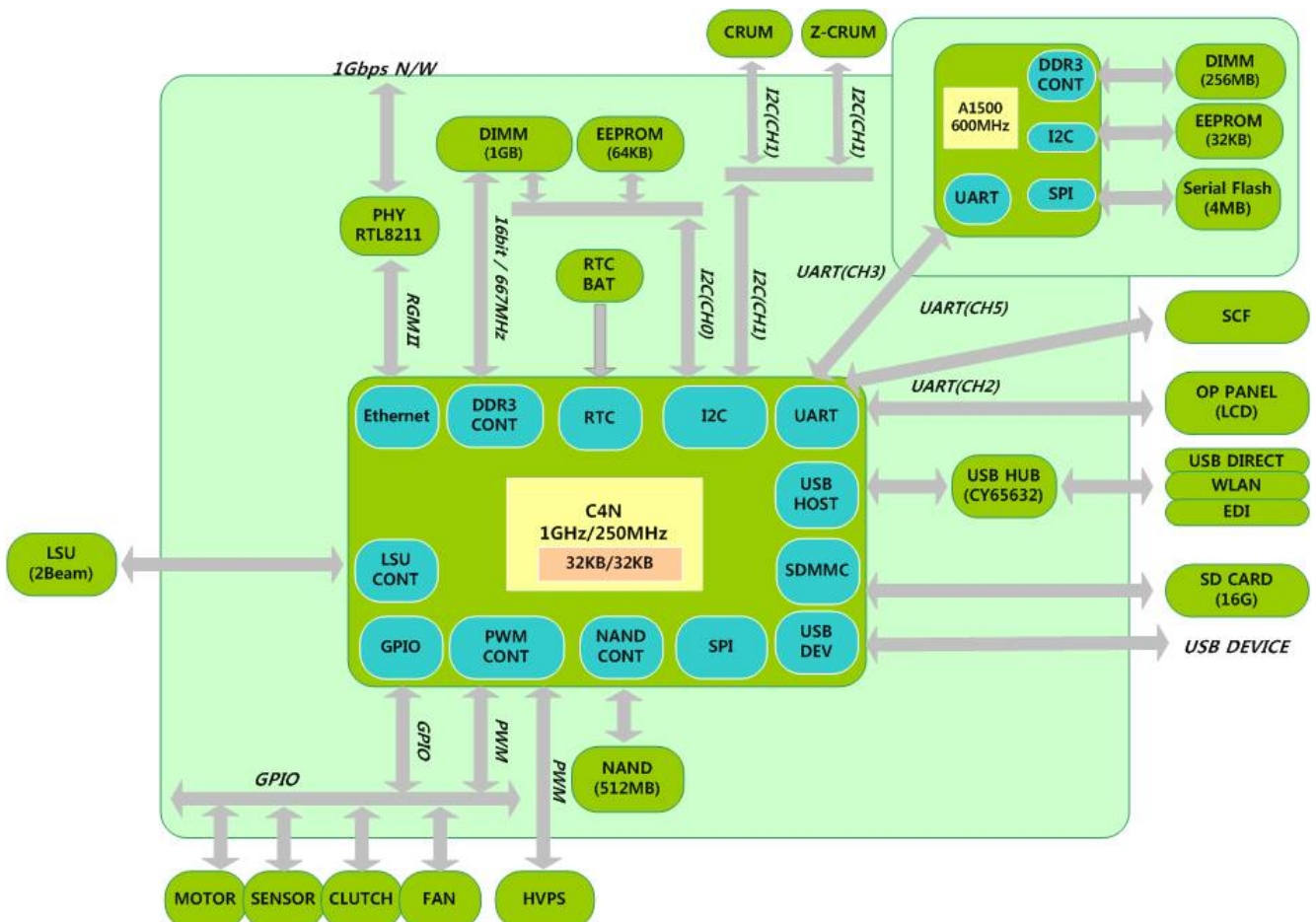

Main Controller connection information

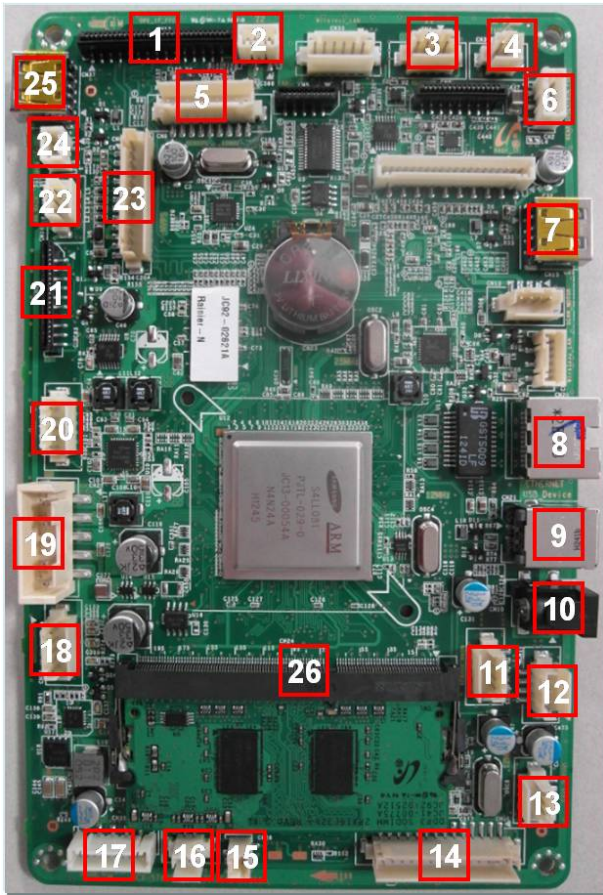

• **Connection**

No	Description
1	OPE IF FFC
2	ZCRUM (only for M4025NX)
3	ZCRUM / EASY CRUM
4	FUSER
5	SENSOR IF
6	OUTBIN FULL / REAR COVER OPEN
7	EDI
8	ETHERNET
9	USB DEVICE
10	PARALLEL PWR
11	DEBUG MAIN
12	DEBUG OPE
13	EXIT SENSOR

No	Description
14	MAIN MOTOR
15	AIR TEMP
16	FAN SMPS
17	SCF
18	SMPS SIGNAL
19	SMPS POWER
20	MP
21	LSU
22	FAN MAIN
23	HVPS
24	COVER OPEN SENSOR
25	DIRECT USB
26	DDR3 SO-DIMM

• **Part Code Information**

- M4020NX : JC92-02679A
- M4025NX : JC92-02678A

2.2.5.3. OPE Controller

The OPE Controller is composed of an OPE MICOM, two status LED, ECO LED, power LED, Navigation LED, WPS LED(M3820DW/3825DW, model only), 16x2line LCD(M382xND/DW, M402xND), 4.3inch TFT LCD(M402xNX), and some keys.

OPE communicates with main controller via UART/USB.

M3320ND/3325ND/3820D/3825D model OPE is composed of LEDs and KEYS without LCD.

OPE Controller Diagram

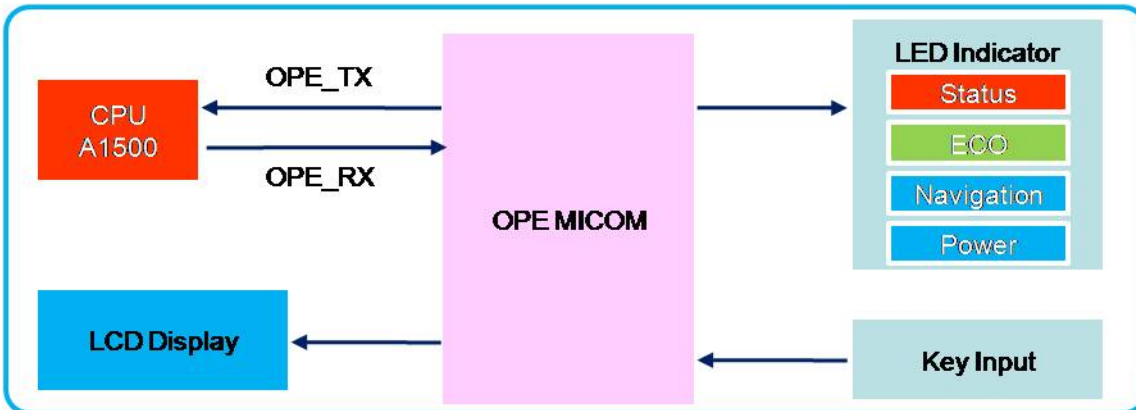

OPE Controller Image

M332xND / M382xD	M382xND,DW / M402xND	M402xNX
<ul style="list-style-type: none"> Part Code : JC92-02609A PBA Name : OPE-LED 	<ul style="list-style-type: none"> Part Code : JC92-02608A PBA Name : OPE-LCD 	<ol style="list-style-type: none"> Part Code : JC92-02610A PBA Name : PBA-OPE MAIN Part Code : JC07-0017A PBA Name : LCD Part Code : JC92-02609A PBA Name : OPE-LED

2.2.5.4. SO-DIMM PBA

SO-DIMM PBA is the system memory module of the main controller. It is used for the operating system, some system application programs, and it stores some print data from the USB and Network port. There are four kinds of SO-DIMM PBA :

- 128MB : M3320ND/3325ND/3820D/3825D/3820ND/3825ND/3820DW/3825DW
- 256MB : M4020ND/4025ND
- 512MB : Option (only for M332xND, M382xND, M382xDW, M402xND)
- 1GB : Option (only for M402xNX)



- **Information**

- Part Code
 - 128MB : JC92-02473A
 - 256MB : JC92-02472A
 - 512MB : JC92-02472B
 - 1GB : JC92-02512A
- Part Name : PBA-RAM DIMM

2.2.5.5. WLAN(M382xDW model only)

The Wireless LAN Module supports 802.11b/g/n at only 3820DW/3825DW model via USB 2.0 high speed. The Module is installed at the USB Host Channel of main controller PBA.



- **Information**

- Part Code : JC92-02510A
- Part Name : PBA-WNPC

2.2.5.6. SCF PBA - Optional

The SCF PBA is the SCF control board. It use UART communication with main controller.

UPD70F3824 is used as a microcontroller.

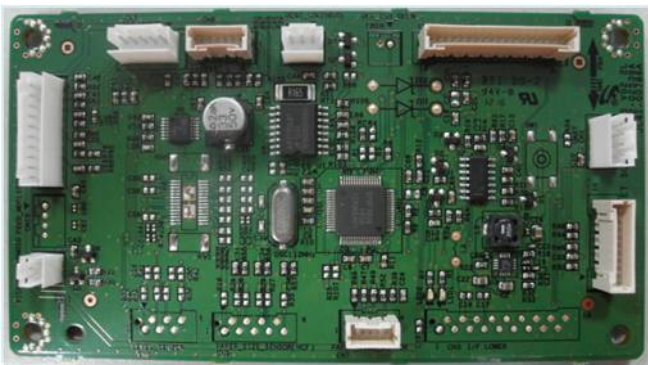

- **Information**





- Part Code : JC92-02539B
- Part Name : PBA-SCF

2.2.5.7. CRUM PBA

ProXpress M3320/M3820/M4020 series use zCRUM PBA.

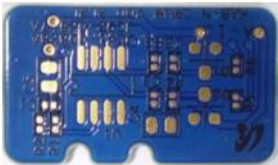
ProXpress M3325/M3825/M4025 series use zCRUM PBA, OPC CRUM and CRUM JOINT PBA.

CRUM PBA uses I2C communication with main controller.

M3320/M3820/M4020 series	M3325/M3825/M4025 series
 <p>PBA-CRUM</p>	 <p>PBA-CRUM</p>  <p>PBA-OPC CRUM</p>  <p>PBA-CRUM JOINT</p>

2.2.5.8. SMPS Board

The SMPS (Switching Mode Power Supply) board supplies electric power to the main board and other boards. The voltage provided includes +5V, and +24V from a 110V/220V power input.

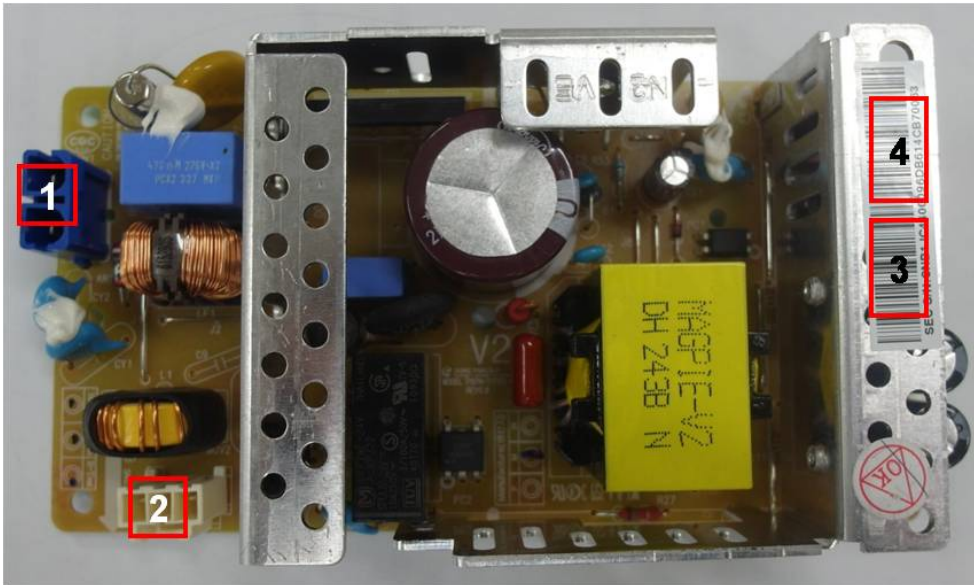

- Specification**

- 1) AC 110V (93.5V ~ 137V) or AC 220V (187V ~ 275V)
- 2) Output Current :
 - +5V : 1.6A
 - +24V : 1.8A
- 3) Output Power
 - +5V : 8.16W
 - +24V : 43.2W
- 4) Heat Lamp Capacity : 850W

- Information**

	110V	220V
SEC CODE	JC44-00095D	JC44-00096D
PBA NAME	SMPS V1	SMPS V2

- Connection**

1	INPUT_AC
2	Fuser_AC Output
3	SMPS Control Signal (from Engine PBA)
4	OUTPUT_5V&24V (to DC POWER PBA)

2.2.5.9. HVPS board

High Voltage Power Supply(HVPS) board generates high-voltage channels which includes MHV, DEV, BLADE, SUPPLY, OPC, THV and FUSER BIAS.

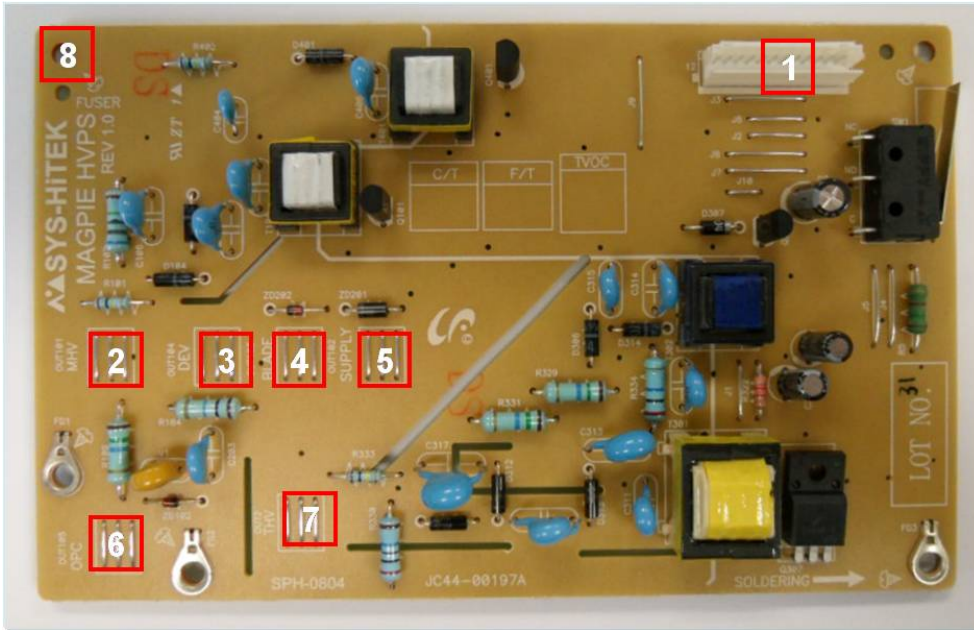

• **Connection**

1	Main Interface
2	MHV(-1240V)
3	DEV(-338V)
4	BLADE(-389V)
5	SUPPLY(-489V)

6	OPC(-51V)
7	THV(+1315V, -1000V)
8	FUSER BIAS(240V)

• **Information**

- Part Code : JC44-00197A
- Part Name : HVPS

2.2.6. Engine Firmware Control Algorithm

2.2.6.1. Feeding

If feeding from a cassette, the drive of the pickup roller is controlled by controlling the clutch. The on/off of the clutch is controlled by controlling the general output port or the external output port. While paper moves, occurrence of Jam is judged as below.

Item	Description
JAM 0	<ul style="list-style-type: none"> After picking up, paper does not reach the Feed Sensor within a predetermined time. After picking up, if the feed sensor is not on, re-pick up will be initiated. . After re-picking up, if the feed sensor is not on after certain time, it is JAM 0. Even though the paper reaches to the feed sensor, the feed sensor does not detect the lead edge of the paper.
JAM 1	<ul style="list-style-type: none"> After the leading edge of the paper passes the feed sensor, the trailing edge of the paper does not clear the sensor after predetermined period of time. After the leading edge of the paper passes the feed sensor, the paper cannot reach the exit sensor after predetermined period of time. <p>* The paper exists between the feed sensor and the exit sensor.</p>
JAM 2	<ul style="list-style-type: none"> The trailing edge of the paper does not clear the exit sensor within a predetermined.

2.2.6.2. Transfer

The charging voltage, developing voltage and the transfer voltage are controlled by PWM (Pulse Width Modulation). The each output voltage is changeable due to the PWM duty. The transfer voltage admitted when the paper passes the transfer roller is decided by environment conditions. The resistance value of the transfer roller is changed due to the surrounding environment or the environment of the set, and the voltage value, which changes due to the environment, is changed through the AD converter. The voltage value for impressing to the transfer roller is decided by the changed value.

2.2.6.3. Fusing

The temperature change of the heat roller's surface is changed to the resistance value through the use of a thermistor. The Main Board uses the resistance value of the Thermistor and converts it to a voltage value through the use of an AD converter, the temperature is decided based on the voltage value read. The AC power is controlled by comparing the target temperature to the value from the thermistor. If the value from the thermistor is out of controlling range while controlling the fusing, the error stated in the below table occurs.

- **Open Heat Error**

When the engine operates the warm-up process, if the temperature of the fixing unit is not higher than a specified temperature within a predetermined time, the engine defines Open Heat Error. When this error is detected, the engine stops all functions and keeps the error state. Also, the engine informs the error status of the main system, so it can take appropriate action; and then the error message is displayed at LCD window or LED informing the error status of the user.

- **Low Heat Error**

When the engine is at stand-by, printing or warm-up mode, if the temperature of the fixing unit is lower than the specified temperature at each state and the lower temperature state is maintained during the specified time, the engine defines Low Heat Error. When this error is detected, the engine stops all functions and keeps it at the error state. Also, the engine informs the error status of the main system, so it can take appropriate action; and then the error message is displayed at LCD window or LED informing the error status of the user.

- **Over Heat Error**

For overall engine state, if the temperature of the fixing unit is higher than the specified temperature and the temperature state is detected for a specific duration, then the engine defines Over Heat Error. When this error is detected, the engine stops all functions and keeps it at the error state. Also, the engine informs the error status of the main system, so it can take appropriate action; and then the error message is displayed at LCD window or LED informing the error status of the user.

2.2.6.4. LSU

LSU receives the image data from PVC or HPVC and make the latent image on OPC surface. It uses the dual beam, LD. The errors related to LSU are as follows:

- **By Lready**

When the printing is started, the engine drives the polygon motor of LSU. After the specified time is elapsed, if the motor is not in a ready status, the engine detects the error that the polygon motor is not in a ready status. If this error happens, the engine stops all functions and keeps it at the error state. Also, the engine informs the error status of the main system and the error message is displayed at LCD window or LED informing the error status of the user.

- **By Hsync**

When the polygon motor is ready, the LSU sends out the signal called Hsync and used to synchronize with each image line. So, if the engine does not detect consecutively the signal for a fixed time, it defines the Hsync Error. If this error happens, the engine stops all functions and keeps it at the error state. Also, the engine informs the error status of the main system and then the error message is displayed at LCD window or LED informing the error status of the user. LSU Error Recovery: If the LReady or Hsync error happens, the paper is exited before the error code is initiated. The engine mode is changed to recovery mode and the engine informs the main system of the engine mode. The engine rechecks the LSU error, if the error does not reoccur printing is resumed.

2.2.7. Software Descriptions

2.2.7.1. Software system overview

The software system of this model is constructed with

- Host Software part that the application software operated in Window and Web Environment
- Firmware parts that is a Embedded software controls printing job.

2.2.7.2. Architecture

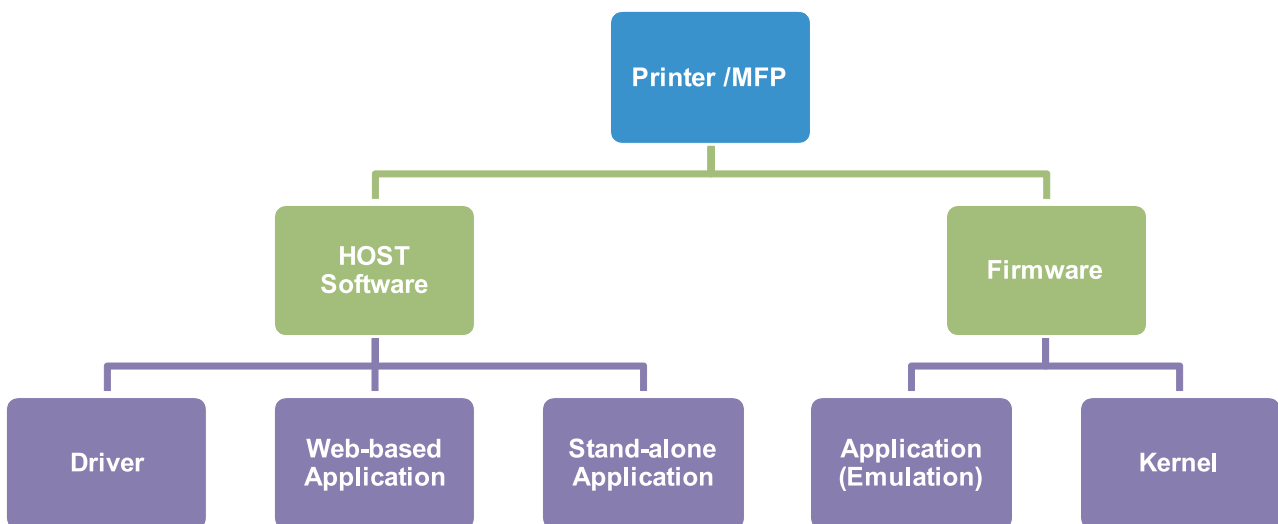

Host Software is made up of

- 1) Graphic User Interface offers the various editing functions to user in Host.
- 2) Driver translates the received document to a Printing Command language which printer can understand and transfers data to spooler.
- 3) Stand-alone Application offers the various printing application such as Easy Printer Manager, Printer Status in Window system.
- 4) Web-based-Application offers the same functions as Stand-alone Application in Web environment.

Firmware is made up of

- 1) Application (Emulation) that is a interpreter translates data received from Host to a printing language (PCL, PS, GDI, etc.) to be able to make the user to take same output as originally one what composed in Host.
- 2) Kernel controls and manage the whole procedure including Control flow and Printing Job before transferring to Engine system.

2.2.7.3. Data and Control Flow

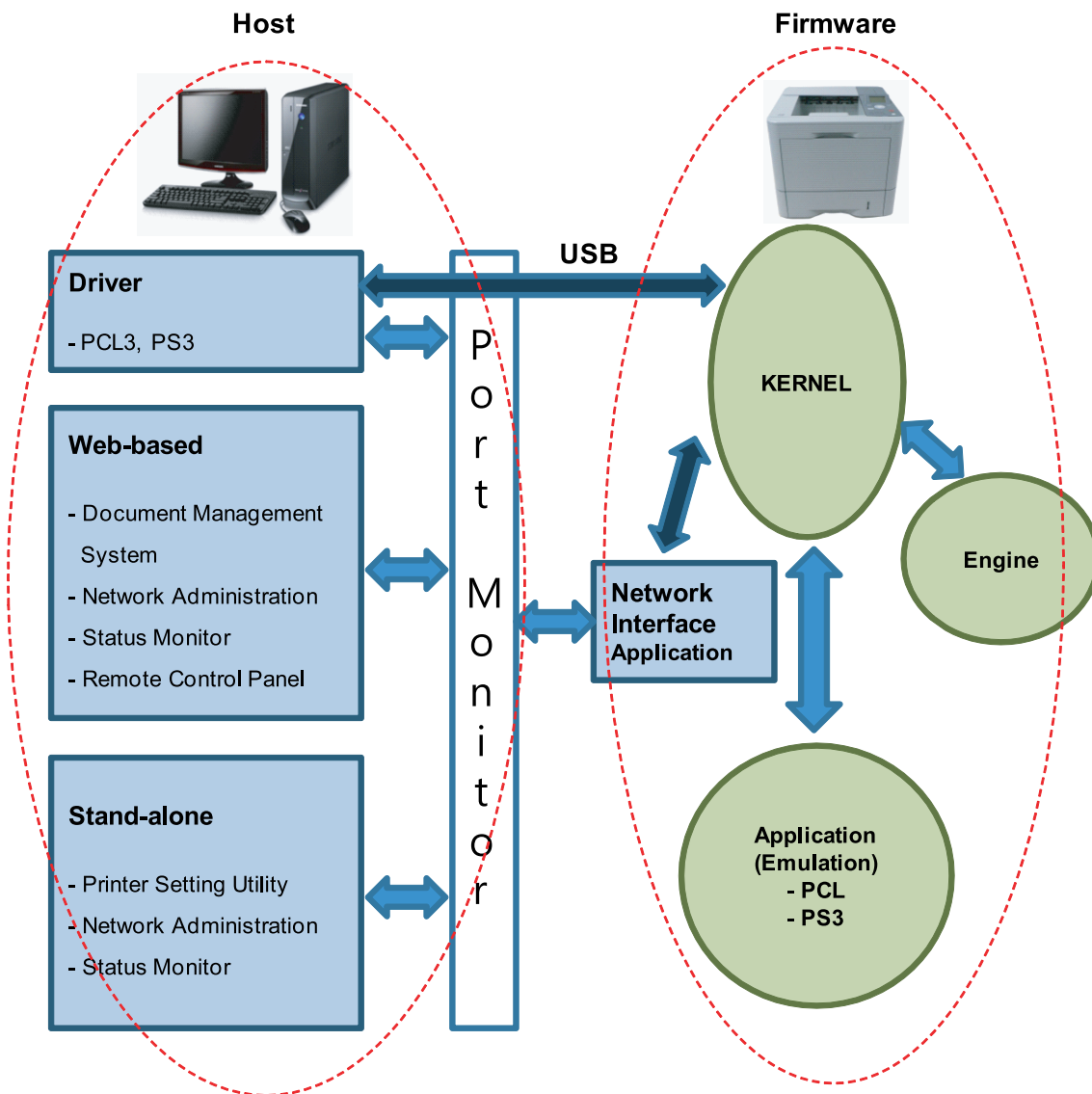

The above Block Diagram is explained that:

Host Side is made up of

- 1) Driver that is Windows application software translate printed data to one of printer language and create spooler file.
- 2) Web-based Application that offer a various printer additional functions, management of printing job, printer administration, Status monitor to monitoring the printer status by real time in Web, independent environment on OS.
- 3) Stand-alone Application that is a similar Window software as same as above 2.
- 4) Port Monitor that manages the network communication between spooler and Network Interface Card, or various additional application and Network Interface Card,(this is, at first, make communication logical port, manage the data, transfer them from spooler to network port, and offer the result of printing).

Firmware Side is made up of

- 1) Network Interface Card is that relay the communication between Host and kernel using various network protocol.
- 2) Kernel is that manages the flow control of emulation procedure, receiving data from Host or Network card and printing with engine & rendering job.

- 3) Emulation is that interprets the various output data from selected emulation.
- 4) Engine is that prints rendered bit-map data to paper with required size and type by Kernel.

And then, for Job Spooling function for Multi-User, Multi-Printing that is occurred in Network printing and various additional printing functions, this Kernel use max. 10 Queuing systems in a memory.

In Printing, the two procedures are

1) Case of using USB Port

- After user start to print the wanted document to PCL string or compressed GDI bit-map data, the Driver translates the all graphic data of the client PC and send data to host spooler. And then the spooler sends the data stream to the printer via USB port.
- Kernel receives this data from Host, and then select emulation fit to data and start selected one. After emulation job end, Kernel sends the output bit-map data to Engine using Printer Video Controller (by clock type for LSU).
- Engine print the received data to required paper with the sequential developing process.

2) Case of using Network Interface Card

- After user start to print the wanted document to PCL string or compressed GDI bit-map data, Driver translate the all graphic data of it and send data to host spooler.
- If so, Port monitor managing network port receives data from spooler and sends a data stream to the Network Interface Card.
- Network interface card receives it and send to Kernel part.
- Kernel receives this data from Host, and then select emulation fit to data and start selected one. After emulation job end, Kernel sends the output bit-map data to Engine using Printer Video Controller (by clock type for LSU).
- Engine print the received data to required paper with the sequential developing process.

3. Disassembly and Reassembly

3.1. Precautions when replacing parts

3.1.1. Precautions when assembling and disassembling

- Use only approved Samsung spare parts. Ensure that part number, product name, any voltage, current or temperature rating are correct. Failure to do so could result in damage to the machine, circuit overload, fire or electric shock.
- Do not make any unauthorized changes or additions to the printer, these could cause the printer to malfunction and create electric shock or fire hazards.
- Take care when dismantling the unit to note where each screw goes. There are 19 different screws. Use of the wrong screw could lead to system failure, short circuit or electric shock.
- Do not disassemble the LSU unit. Once it is disassembled dust is admitted to the mirror chamber and will seriously degrade print quality. There are no serviceable parts inside.
- Regularly check the condition of the power cord, plug and socket. Bad contacts could lead to overheating and fire. Damaged cables could lead to electric shock or unit malfunction.

3.1.2. Precautions when handling PBA

Static electricity can damage a PBA, always use approved anti-static precautions when handling or storing a PBA.

- **Precautions when moving and storing PBA**
 - 1) Please keep PBA in a conductive case, anti-static bag, or wrapped in aluminum foil.
 - 2) Do not store a PBA where it is exposed to direct sunlight.
- **Precautions when replacing PBA**
 - 1) Disconnect power connectors first, before disconnecting other cables.
 - 2) Do not touch any soldered connections, connector terminals or other electronic parts when handling insulated parts.
- **Precautions when checking PBA**
 - 1) Before touching a PBA, please touch other grounded areas of the chassis to discharge any static electrical charge on the body.
 - 2) Take care not to touch the PBA with your bare hands or metal objects as you could create a short circuit or get an electric shock. Take extra care when handling PBAs with moving parts fitted such as sensors, motors or lamps as they may get hot.
 - 3) Take care when fitting, or removing, screws. Look out for hidden screws. Always ensure that the correct screw is used and always ensure that when toothed washers are removed they are refitted in their original positions.

3.1.3. Releasing Plastic Latches

Many of the parts are held in place with plastic latches. The latches break easily; release them carefully.

To remove such parts, press the hook end of the latch away from the part to which it is latched.

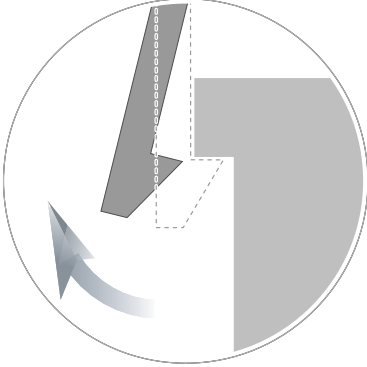

3.2. Screws used in the printer

The screws listed in the table below are used in this printer. Please ensure that, when you disassemble the printer, you keep a note of which screw is used for which part and that, when reassembling the printer, the correct screws are used in the appropriate places.

Part Code	Location	Description	Qty
6002-000440	DUPLEX	SCREW-TAPPING;PWH,+,2,M3,L8,ZPC(BLK),SWRCH18A	5
6003-000196	FRAME MAIN	SCREW-TAPTYPE;PWH,+,B,M3,L10,NI PLT,SWRCH18A	20
6003-000261		SCREW-TAPTYPE;BH,+,-,B,M3,L6,ZPC(WHT),SWRCH18A,-	2
6003-000269		SCREW-TAPTYPE;BH,+,-,S,M3,L6,ZPC(WHT),SWRCH18A,-	3
6003-000196	MP	SCREW-TAPTYPE;PWH,+,B,M3,L10,NI PLT,SWRCH18A	2
6003-000196	FUSER	SCREW-TAPTYPE;PWH,+,B,M3,L10,NI PLT,SWRCH18A	5
6003-000269		SCREW-TAPTYPE;BH,+,-,S,M3,L6,ZPC(WHT),SWRCH18A,-	3
6003-000282		SCREW-TAPTYPE;BH,+,-,B,M3,L8,ZPC(BLK),SWRCH18A,-	4
6003-000269	DRIVE	SCREW-TAPTYPE;BH,+,-,S,M3,L6,ZPC(WHT),SWRCH18A,-	6
6003-000196	FRAME-ETC	SCREW-TAPTYPE;PWH,+,B,M3,L10,NI PLT,SWRCH18A	38
6003-000261		SCREW-TAPTYPE;BH,+,-,B,M3,L6,ZPC(WHT),SWRCH18A,-	3
6003-000301		SCREW-TAPTYPE;BH,+,S,M4,L6,ZPC(WHT),SWRCH18A	1
6006-001078	FRAME-ETC	SCREW-TAPTYPE;PH,+,WSP,B,M3,L10,ZPC(WHT),SWRCH18A	1
6003-000282	LSU	SCREW-TAPTYPE;BH,+,-,B,M3,L8,ZPC(BLK),SWRCH18A,-	5
6003-000196	COVER-TOP	SCREW-TAPTYPE;PWH,+,B,M3,L10,NI PLT,SWRCH18A	3
6003-000196	COVER-FRONT	SCREW-TAPTYPE;PWH,+,B,M3,L10,NI PLT,SWRCH18A	2
6003-000264	MP GUIDE-TRAY	SCREW-TAPTYPE;PWH,+,-,B,M3,L6,ZPC(WHT),SWRCH18A,-	1
6003-000282	CARTRIDGE-TONER	SCREW-TAPTYPE;BH,+,-,B,M3,L8,ZPC(BLK),SWRCH18A,-	5
6003-000196	OPE	SCREW-TAPTYPE;PWH,+,B,M3,L10,NI PLT,SWRCH18A	5
6003-000196	MAINLINE	SCREW-TAPTYPE;PWH,+,B,M3,L10,NI PLT,SWRCH18A	9

3.3. Replacing the Main SVC parts

3.3.1. Left and Right Cover

1. Remove the cassette.



3. Remove the left cover by releasing hooks.



2. Open the front cover. Remove the toner cartridge.



4. Remove the right cover by releasing hooks.



3.3.2. Front Cover

1. Remove the cassette and toner cartridge.
2. Remove the right cover by releasing hooks.



4. Remove the front cover by releasing both hooks.



3. Unplug the connector connecting the front cover.



3.3.3. Rear and Top Cover

1. Remove the left /right cover. (Refer to 3.3.1)
2. Unplug the OPE connector from main board.

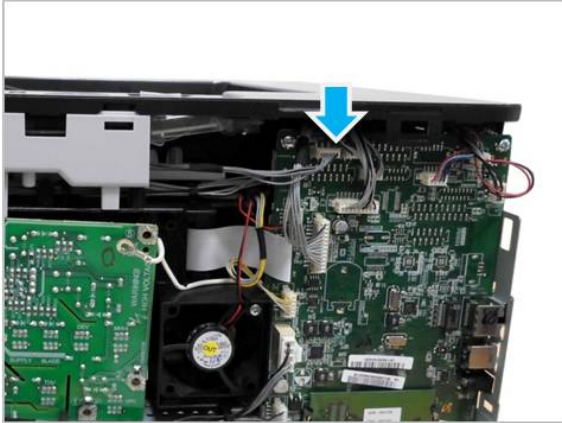

3. Remove 2 screws from the front.



4. Remove the duplex unit.



5. Remove the rear cover by releasing the right hook.



6. Remove 2 screws.



7. Lift up and release the top cover.



8. Remove the top-inner cover after removing 4 screws.

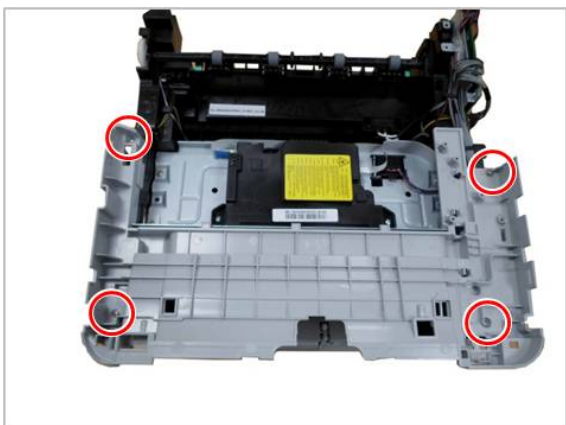

3.3.4. Main Board

1. Remove the right cover. (**Refer to 3.3.1**)
2. Unplug all connectors on the main board.
3. Remove 4 screws.

4. Release the main board.



3.3.5. HVPS board

1. Remove the right cover. (**Refer to 3.3.1**)

2. Remove 5 screws.

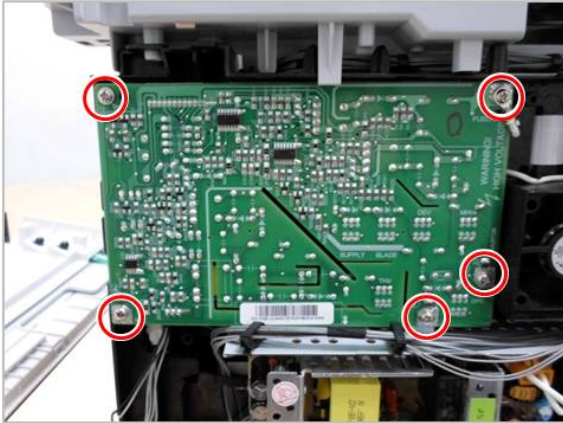

3. Unplug the connector on the HVPS board.

4. Release the HVPS board.

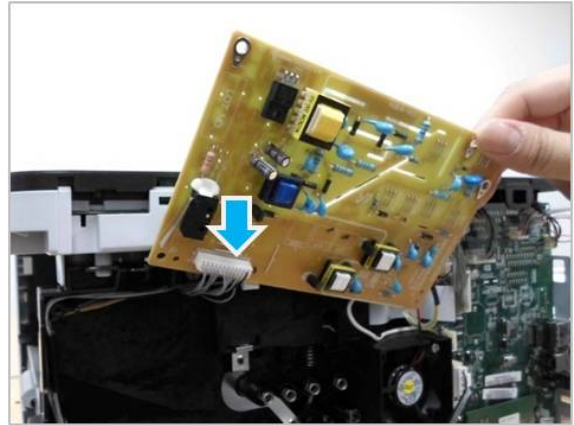

3.3.6. SMPS Board

1. Remove the right cover. (Refer to 3.3.1)
2. Unplug all connectors on the SMPS board.
3. Remove 4 screws.

4. Release the SMPS board.

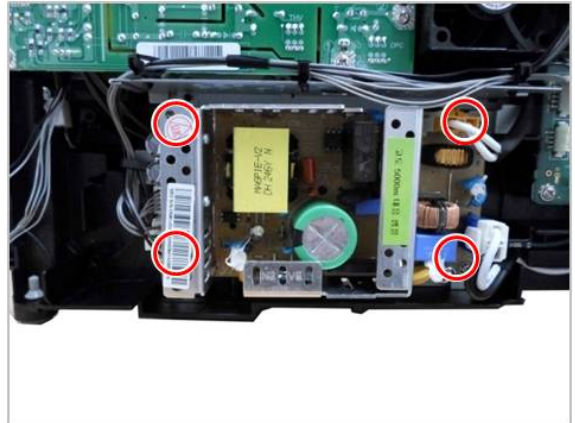

3.3.7. Laser Scanning Unit (LSU)

1. Remove the top cover. (Refer to 3.3.3)
2. Unplug 2 flat cables from the LSU.
3. Remove 3 screws.

4. Release the LSU.

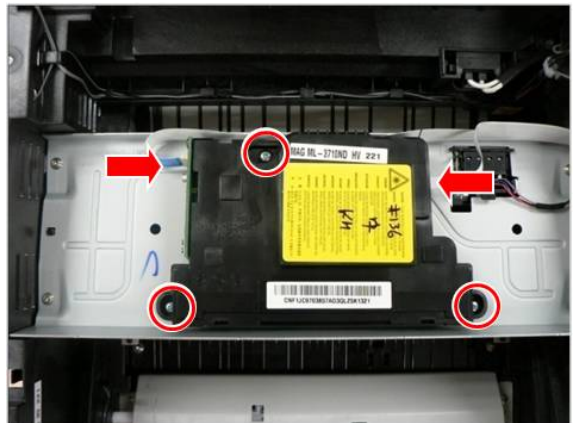

3.3.8. Fuser Unit

CAUTION

The temperature gets high in the vicinity of the fuser unit. When replacing it, you may get burned. Before replacing it, make sure that fuser unit has cooled.

1. Remove the rear cover. (Refer to 3.3.3)
2. Open the Frame-Rear by pushing both green points.

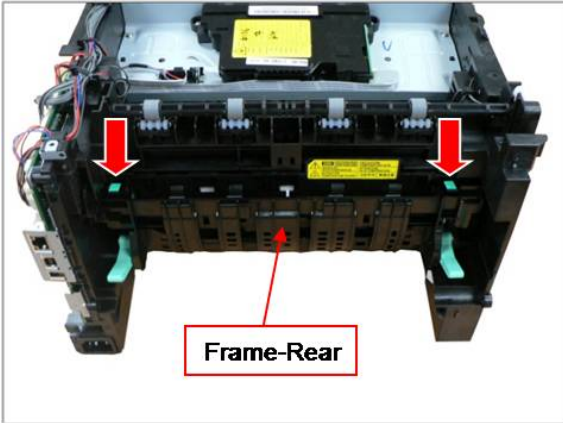

3. Remove the Frame-Rear by releasing both hooks.

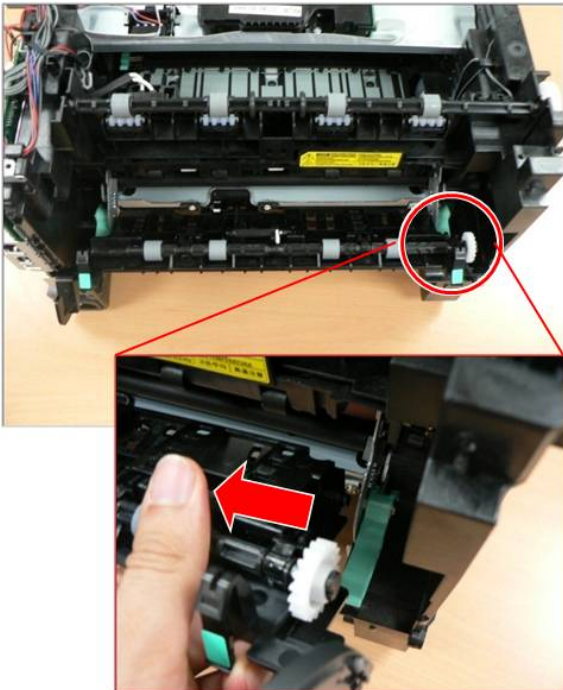

4. Remove the exit sensor holder after removing 2 screws.

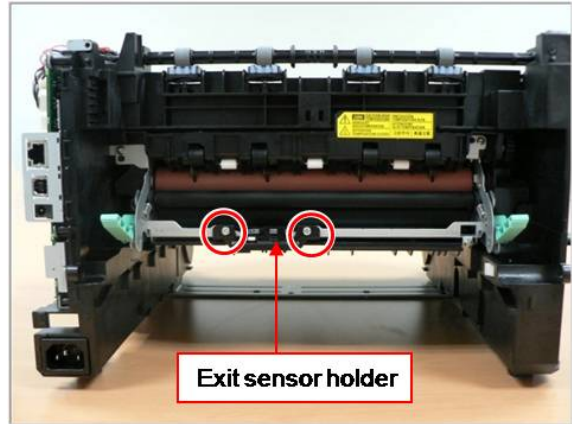

5. Remove 4 screws.
6. Release the fuser unit.

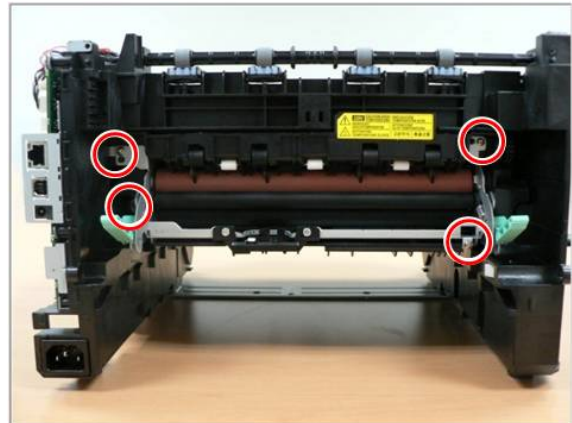

CAUTION

When reassembling the fuser unit, do not forget to tighten these screws.

3.3.9. Main Drive Unit

1. Remove the left cover. (Refer to 3.3.1)
2. Remove the Bar coupler.

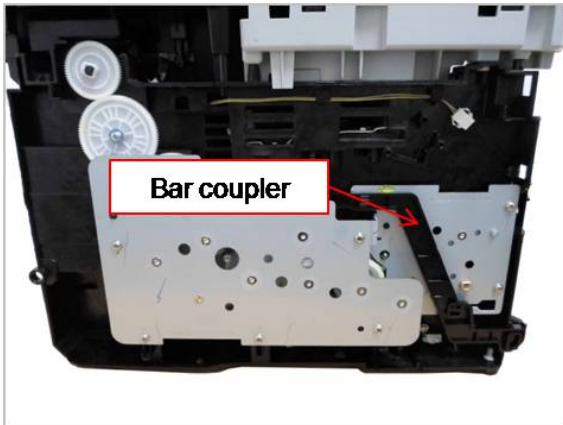

3. Remove the main drive unit after removing 6 screws.

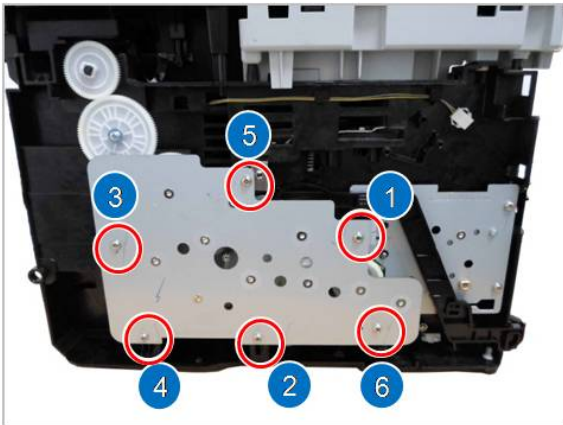

 **NOTE**

When reassembling the main drive unit, tighten 6 screws in order as shown above.

4. Unplug the connector from the main motor.
5. Release the main drive unit.

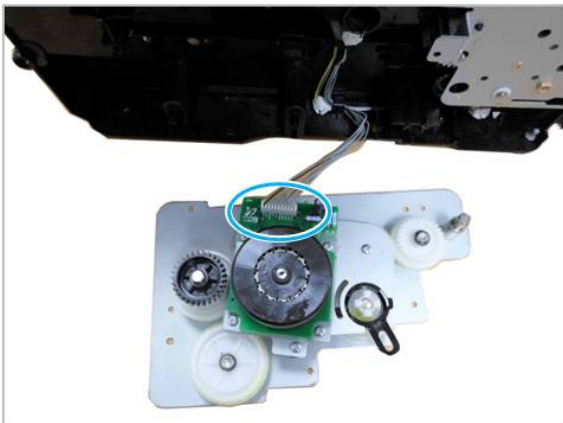

3.3.10. Feed Drive Unit

1. Remove the main drive unit. (Refer to 3.3.9)
2. Release the feed drive unit after removing 2 screws and 1 E-ring.

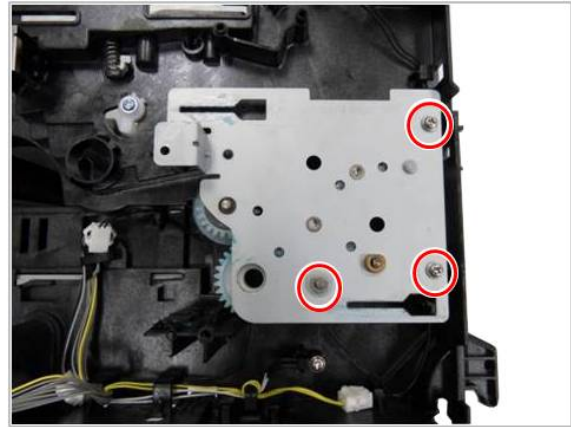

3.3.11. Pick Up_Regi_MP Clutch

1. Remove the feed drive unit. (Refer to 3.3.10)
2. For the clutch to require replacement, unplug the connector then replace it.

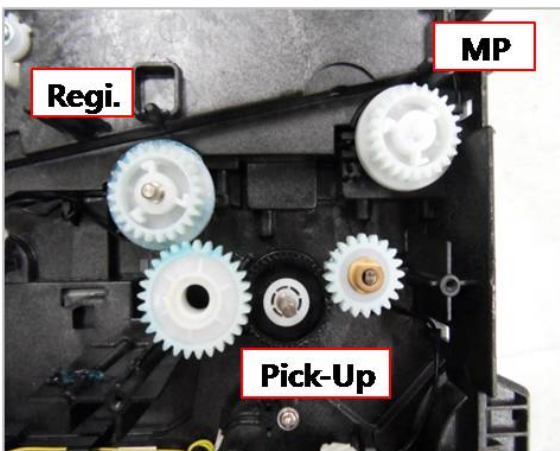

3.3.12. Pick-Up Roller

1. Remove the cassette.



3. Pull the small tap down, then release the pick up roller.

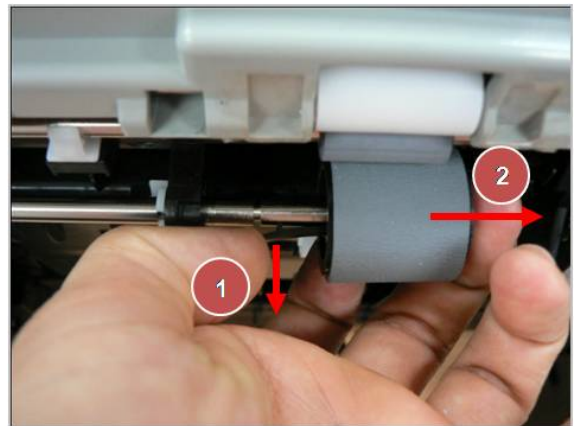

2. Remove the duplex unit.



3.3.13. Transfer Roller

1. Remove the top cover. (Refer to 3.3.3)
2. Remove the top-inner cover after removing 4 screws.

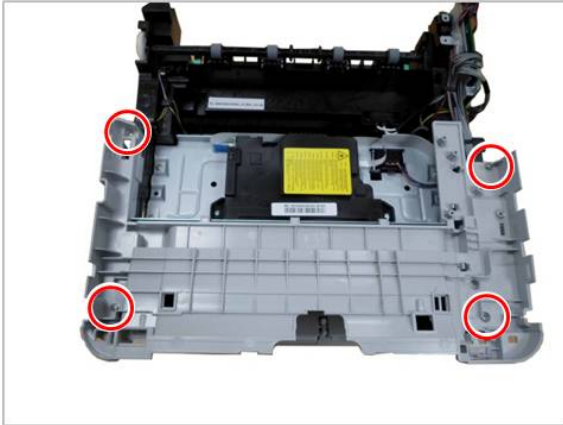

3. Release the LSU bracket after removing 4 screws.

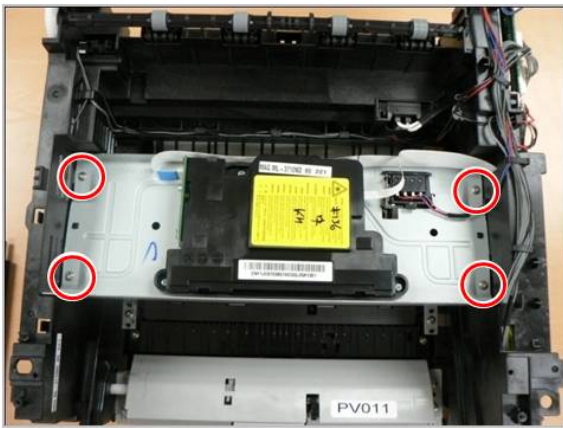

4. Push the transfer roller holder to the center and release it.
5. Remove the transfer roller.

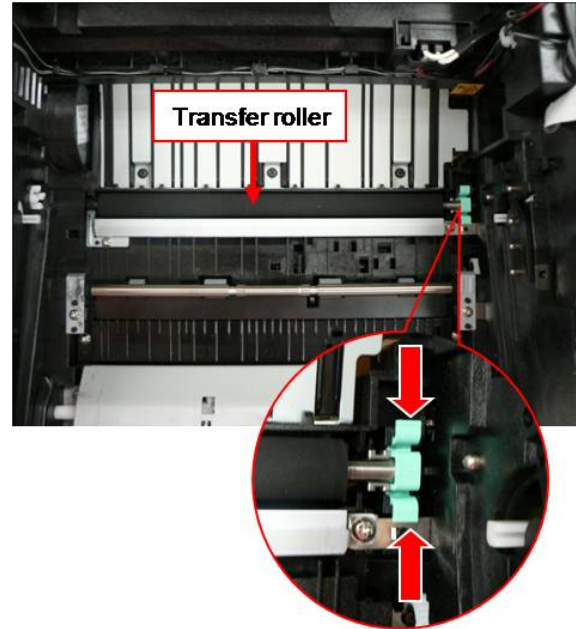

3.3.14. OPE Board

First, remove the top cover. (Refer to 3.3.3)

[Except NX model]

- 1) Release the OPE board after removing 5 screws.

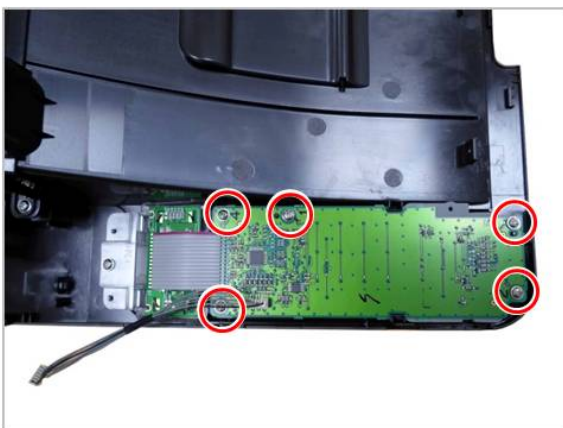

[NX model]

- 1) Remove 7 screws. Separate the COVER-EXIT from COVER-PATH.

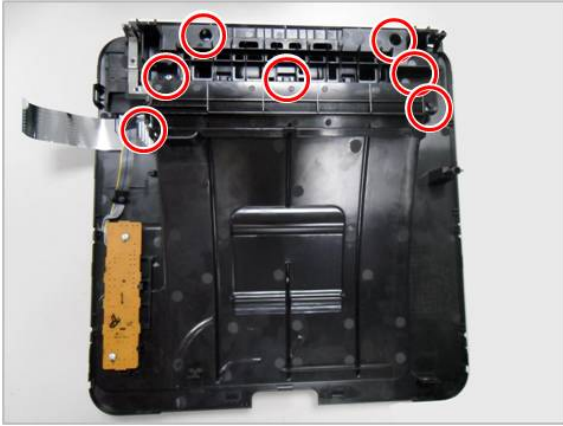

- 2) Release the FFC cable from the COVER-TOP. Separate the OPE ASSY from the COVER-TOP.

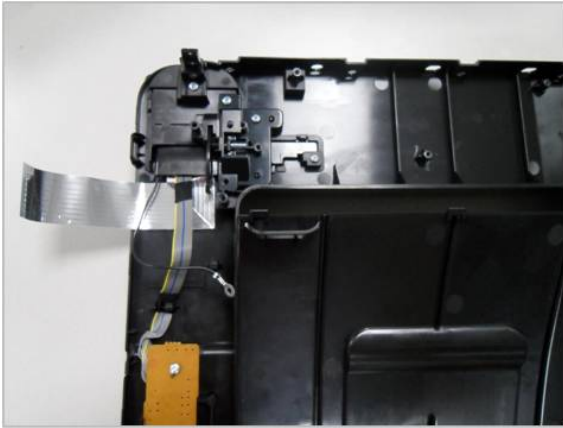

- 3) Release the OPE cover after removing 4 screws.

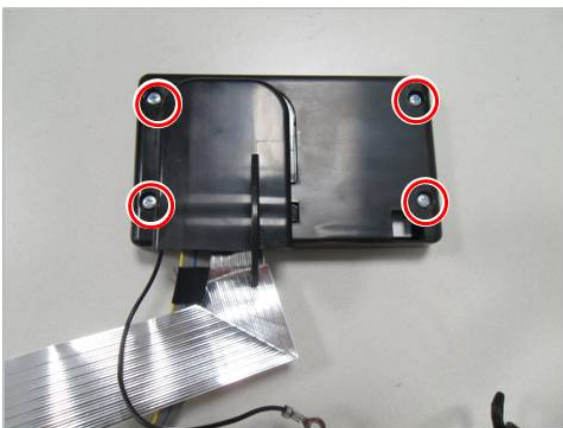

- 4) Disconnect the FFC cable and harness.

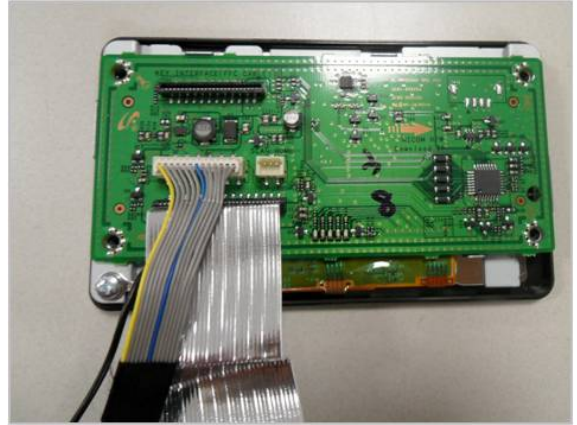

- 5) Disconnect the LCD FFC cable.

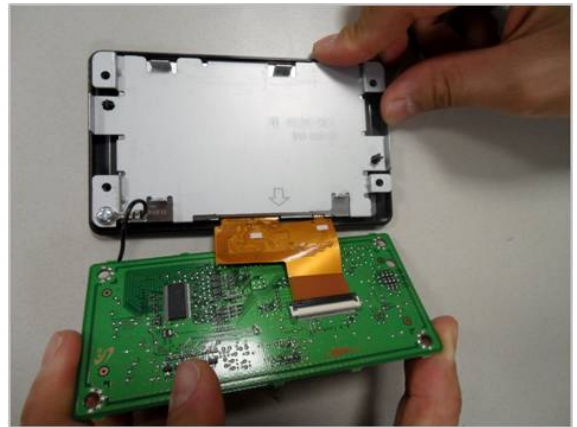

- 6) Remove the GROUND-OPE.

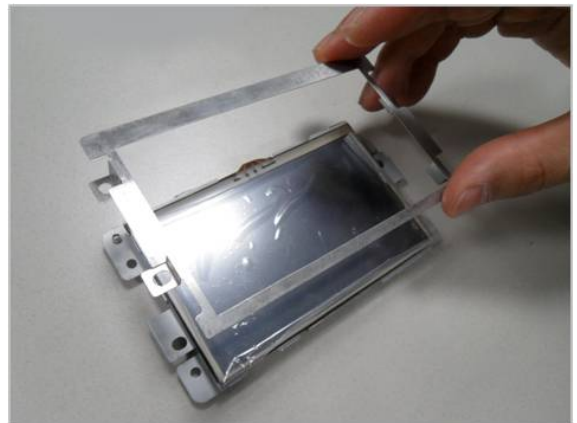

3.3.15. MP Unit

1. Remove the right / front cover. (Refer to 3.3.1~3.3.2)
2. Remove the top / top-inner cover. (Refer to 3.3.3)
3. Remove 3 screws.



5. Separate the MP lower from the MP upper.

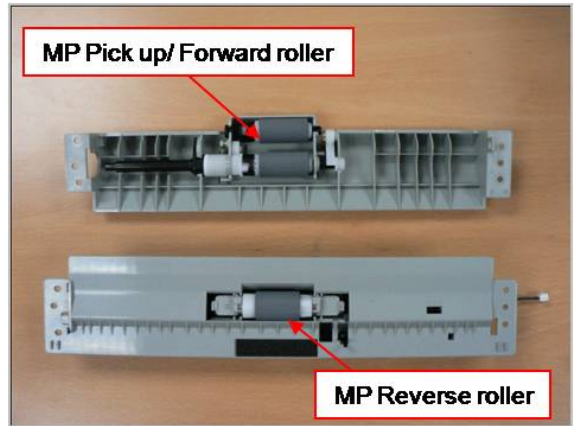

4. Unplug the connector then release the MP unit.

3.3.16. Bin-full sensor

1. Remove the top cover. (Refer to 3.3.3)
2. Release the bin-full sensor after unplugging the connector.



3.3.17. Regi_Feed_Empty Sensor

1. Remove the cassette and duplex unit.
2. Remove the PLATE-FRAME BOTTOM after removing 4 screws.

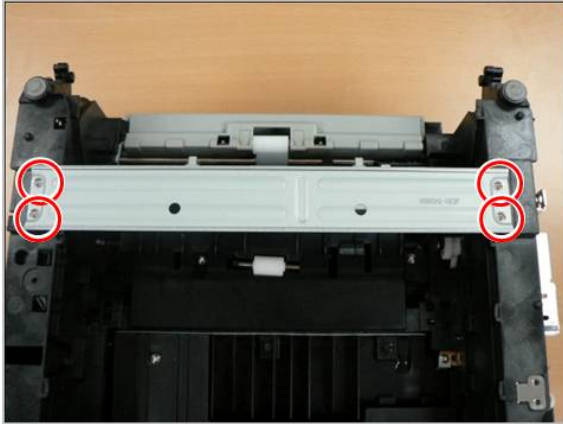

3. Remove the sensor cover after removing 2 screws.

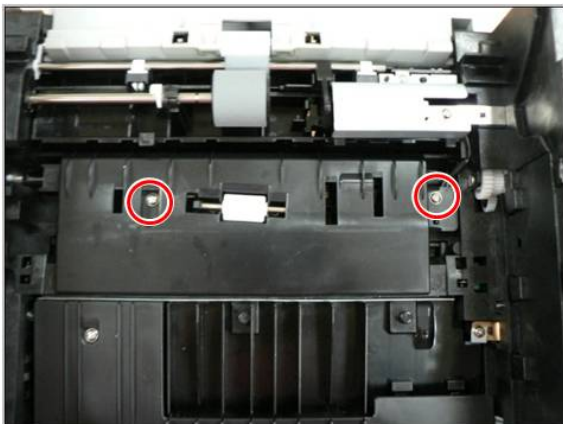

4. For the sensor to require replacement, unplug the connector then replace it.

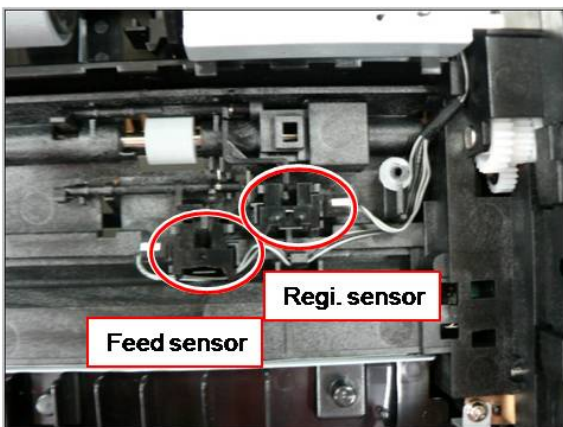

5. Remove the sensor cover after removing 2 screws.

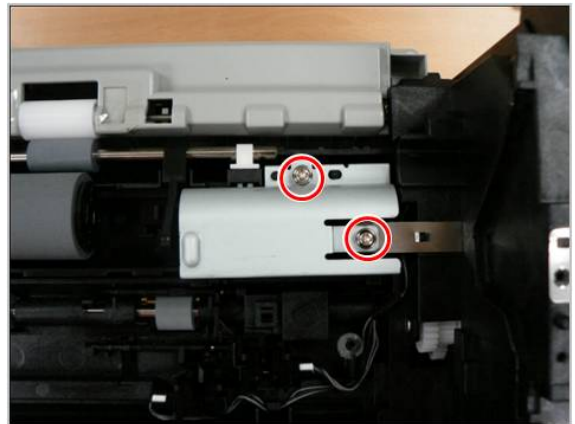

6. Unplug the connector then release the empty sensor.

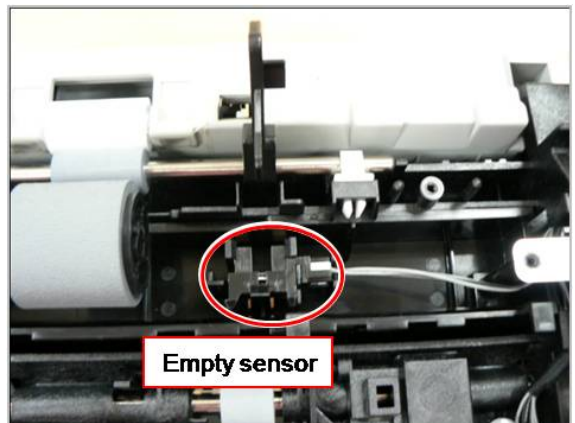

3.3.18. Reverse Roller

1. Remove the cassette.



2. Open the COVER-CASSETTE.

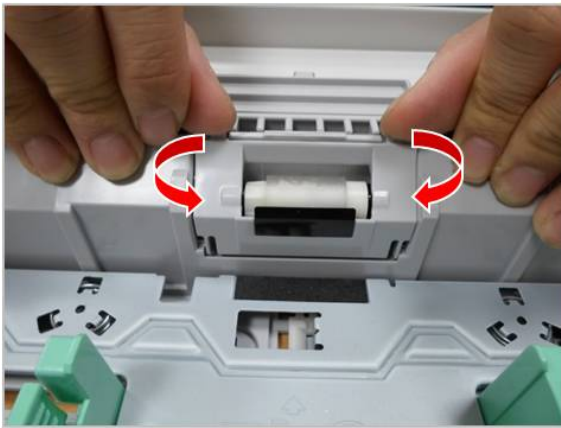

3. Release the reverse roller Assy.

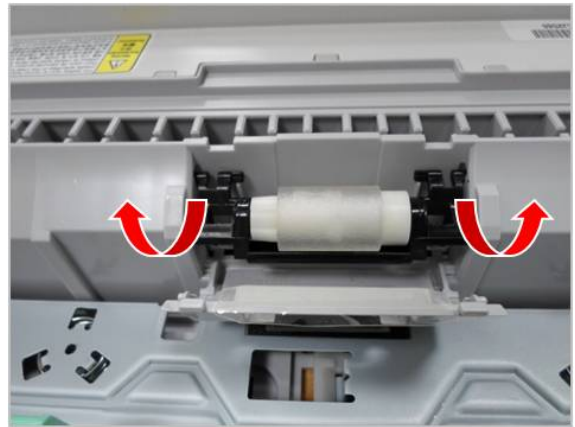

4. Release the reverse roller from its holder.

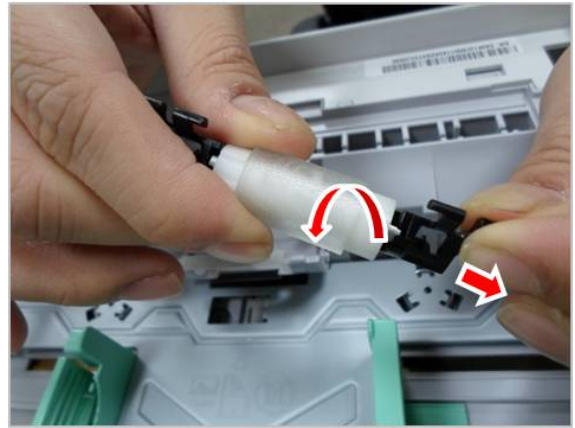

3.3.19. SCF(Second Cassette Feeder) Unit

3.3.19.1. SCF Right Cover

1. Remove 2 screws.



2. Release the SCF right cover.



3.3.19.2. SCF Main Board

1. Remove the SCF right cover. (Refer to 3.3.19.1)
2. Unplug all connectors on SCF main board.
3. Remove 4 screws.
4. Release the SCF main board.

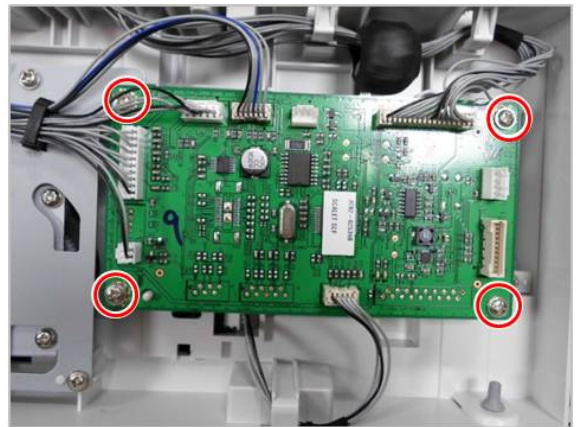

3.3.19.3. SCF Main Motor

1. Remove the SCF right cover. (Refer to 3.3.19.1)
2. Unplug the motor connector.
3. Remove 4 screws.

4. Release the SCF main motor.

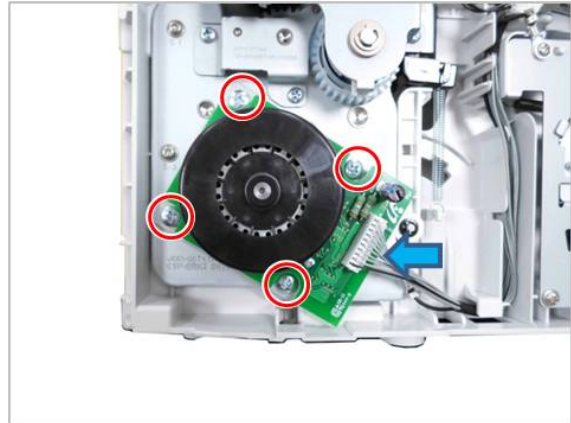

3.3.19.4. SCF Clutch

1. Remove the SCF right cover. (Refer to 3.3.19.1)
2. Unplug the clutch connector.
3. Remove 2 E-Rings and 2 Bushes.
4. Remove 2 screws.
5. Release the clutch bracket.

6. Remove the SCF clutch.

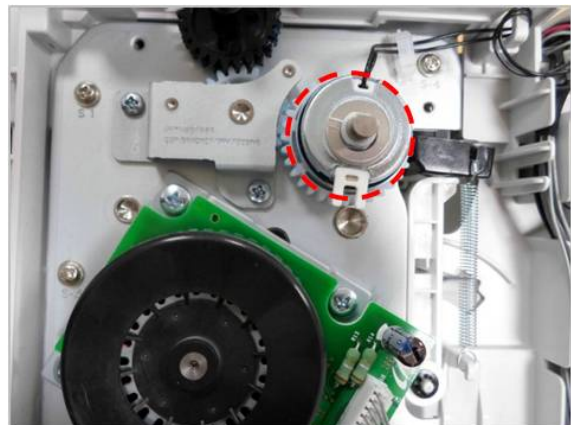
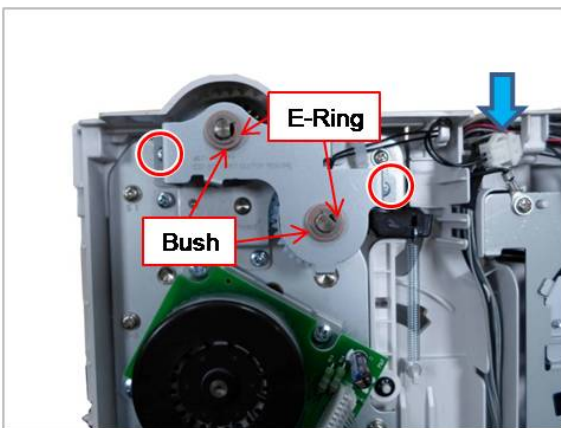

3.3.19.5. SCF pick up_forward roller

1. Remove the SCF cassette.
2. See the bottom of the SCF Unit.
3. Release the pick up / forward roller while pulling the small tap.

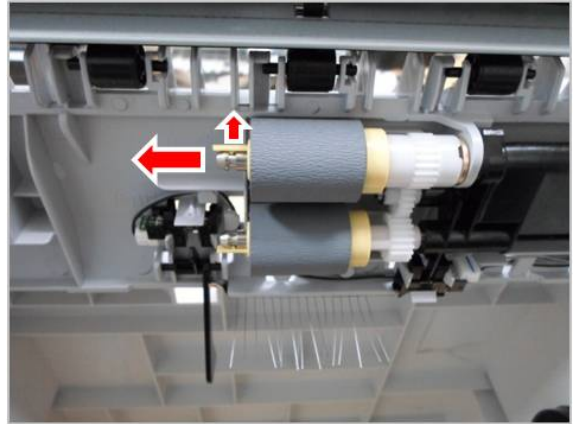

3.3.19.6. SCF Reverse Roller

1. Remove the SCF cassette.
2. Open the cassette cover.
3. Release the reverse roller while pulling the small tap.



3.3.19.7. SCF Main Drive Unit

1. Remove the SCF right cover. ([Refer to 3.3.19.1](#))
2. Remove the SCF clutch bracket. ([Refer to 3.3.19.4](#))
3. Unplug the main motor connector.
4. Remove 4 screws.

5. Remove the SCF main drive unit.

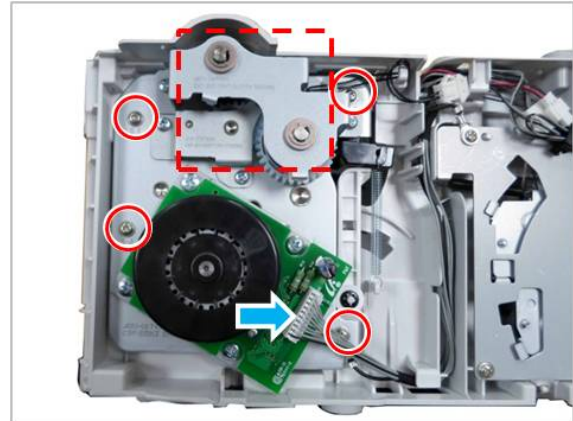

3.3.19.8. SCF Lift Assy

1. Remove the SCF right cover. ([Refer to 3.3.19.1](#))
2. Remove the SCF main board. ([Refer to 3.3.20.2](#))
3. Open the harness clamp.
4. Remove 4 screws.

5. Release the SCF Lift Assy.

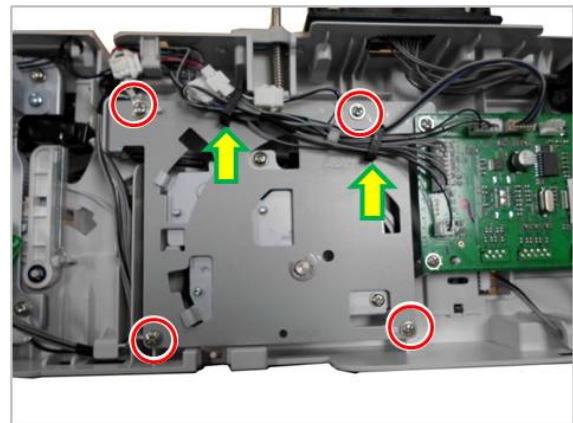

3.3.19.9. SCF Pick-Up Unit

1. Remove the SCF right cover. ([Refer to 3.3.19.1](#))
2. Remove the SCF main drive unit. ([Refer to 3.3.19.7](#))
3. Unplug the connectors from the right side.

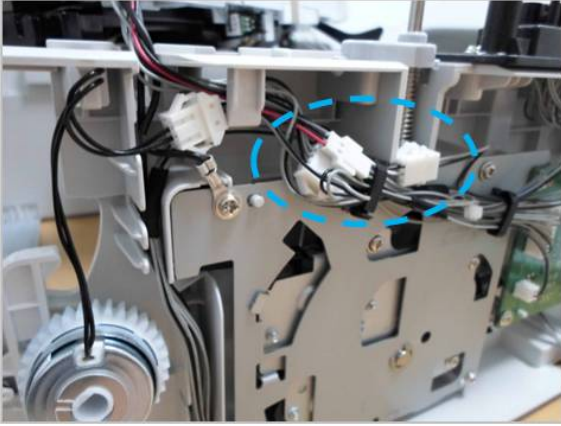

4. Remove the front cover.

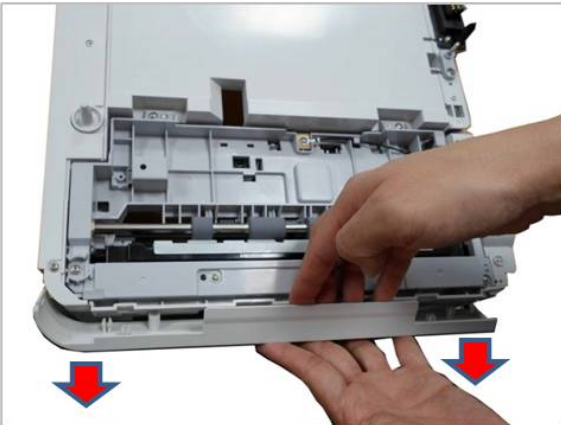

5. Remove 4 screws.

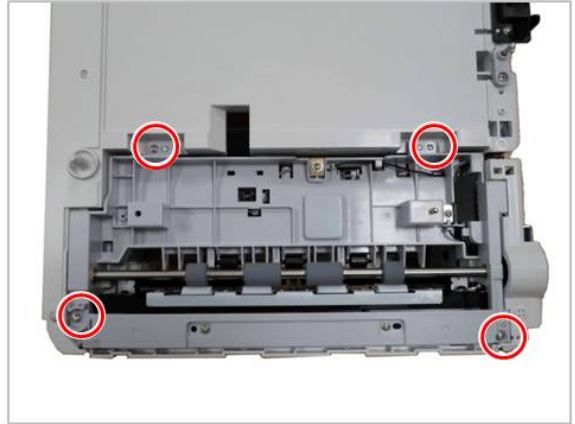

6. Release the SCF Pick-Up Unit.

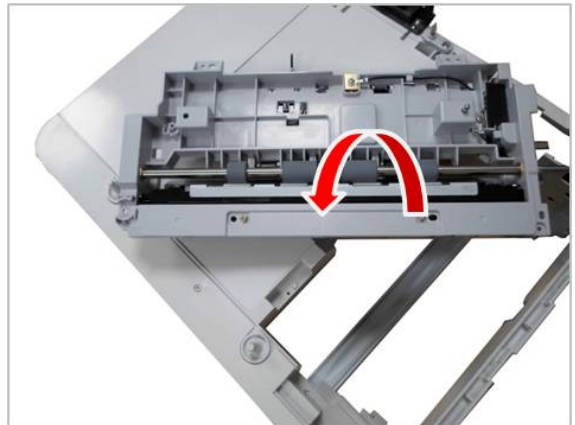

3.3.19.10. SCF Pick-Up_Empty_Feed Sensor

1. Remove the SCF Pick-Up Unit. (Refer to 3.3.19.9)
2. Remove the sensor after unplugging the connector.

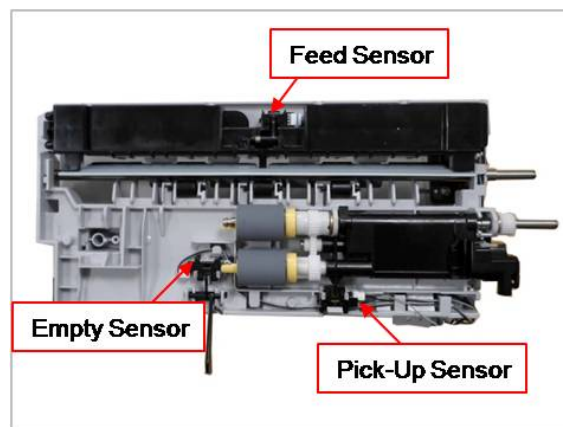

4. Troubleshooting

4.1. Alignment and Adjustments

This chapter describes the main functions for service, such as the product maintenance method, the test output related to maintenance and repair, Jam removing method, and so on.





4.1.1. Control Panel

NOTE

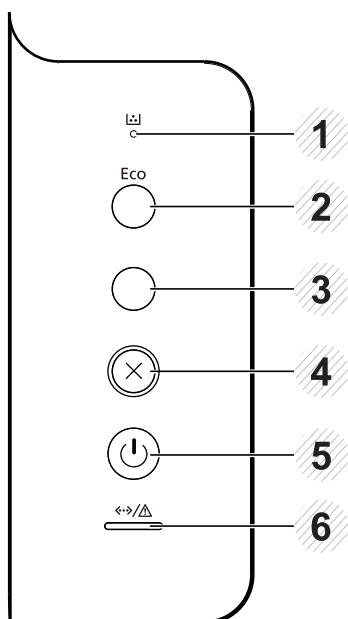
- This control panel may differ from your machine depending on its model. There are various types of control panels.
- Some features and optional goods may not be available depending on model or country

M332xND/M382xD



1	Toner LED		Shows the status of the toner.
2	Eco		Enters eco mode to reduce toner consumption and paper usage.
3	Configuration sheet		Prints a demo page by pressing this button.
4	Cancel		Stops current operation.
5	Power		You can turn the power on and off with this button. Or wake up from the power save mode.
6	Status LED		Indicates the status of your machine.

M382xND/M382xDW/M402xND

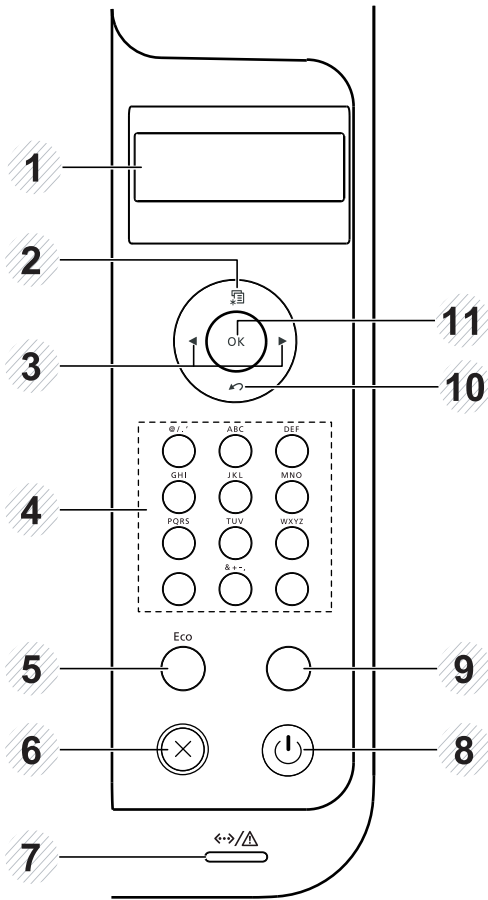

1	Display screen		Shows the current status and prompts during an operation.
2	Menu		Enters menu mode and scrolls through the available menus.
3	Arrow		Navigates available values by moving to the next or previous options.
4	Numeric keypad		Use the keypad to enter numbers and characters.
5	Eco		Enters eco mode to reduce toner consumption and paper usage.
6	Cancel		Stops current operation.
7	Status LED		Indicates the status of your machine.
8	Power		You can turn the power on and off with this button. Or wake up from the power save mode.
	Configuration sheet		Prints a demo page by pressing this button.
9	WPS		Configures the wireless network connection easily without a computer.
	Back		Sends you back to the upper menu level.
10	Back		Sends you back to the upper menu level.
11	OK		Confirms the selection on the screen.

M402xNX**NOTE**

When using the touch screen, only use your finger. Sharp objects can damage the screen.

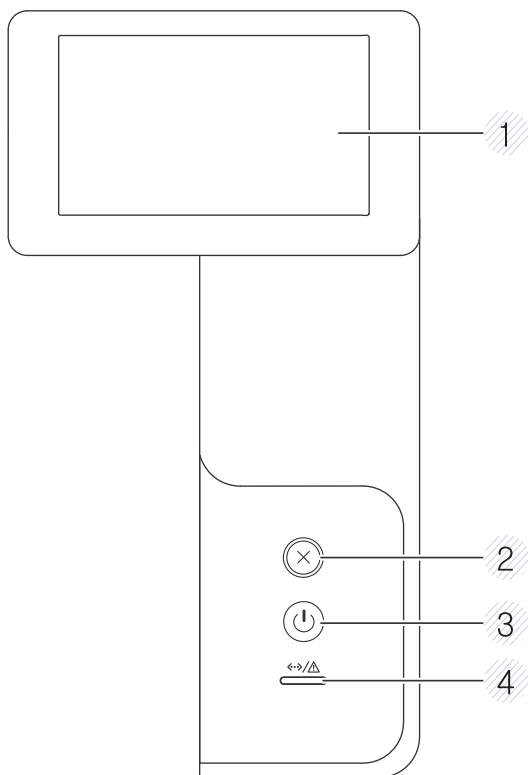



1	Display screen		Displays the current status and allows you to access available menus.
2	Cancel		Stops current operation.
3	Power		Turns the power on or off, or wakes up the machine from the power save mode.
4	Status LED		Indicates the status of your machine.

4.1.2. Understanding The Status LED

The color of the Status indicates the machine’s current status.

 **NOTE**

- Some LEDs may not be available depending on model or country
- To resolve the error, look at the error message and its instructions from the troubleshooting part.
- You also can resolve the error with the guideline from the computers’s Samsung Printing Status program window.

LED	Status	Description	
 Status	Off	The machine is off-line.	
	Green	Blinking	When the backlight blinks, the machine is receiving or printing data.
		On	The machine is on-line and can be used.
	Red	Blinking	<ul style="list-style-type: none"> • A minor error has occurred and the machine is waiting for the error to be cleared. Check the display message. When the problem is cleared, the machine resumes. • Small amount of toner is left in the cartridge. The estimated cartridge life of toner is close. Prepare a new cartridge for replacement. You may temporarily increase the printing quality by redistributing the toner.
On		<ul style="list-style-type: none"> • A toner cartridge has almost reached its estimated cartridge life. It is recommended to replace the toner cartridge. • The cover is opened. Close the cover. • There is no paper in the tray when receiving or printing data. Load paper in the tray. • The machine has stopped due to a major error. Check the display message and refer to troubleshooting chapter. • A paper jam has occurred. 	
 WPS	Blue	Blinking	The machine is connecting to a wireless network.
		On	The machine is connected to a wireless network.
		Off	The machine is disconnected from a wireless network.
 Power	Blue	On	The machine is in power save mode.
		Off	The machine is in ready mode or machine’s power is off.
Eco	Green	On	Eco mode is on.
		Off	Eco mode is off.

 **NOTE**

- 1) Estimated cartridge life means the expected or estimated toner cartridge life, which indicates the average capacity of print-outs and is designed pursuant to ISO/IEC 19798. The number of pages may be affected by operating environment, percentage of image area, printing interval, graphics, media and media size. Some amount of toner may remain in the cartridge even when red LED is on and the printer stops printing.
- 2) Some LEDs may not be available depending on model or country.

4.1.3. Clearing paper jams

! NOTE

To avoid tearing the paper, pull the jammed paper out slowly and gently.

In tray 1

- 1) Pull out tray 1 .

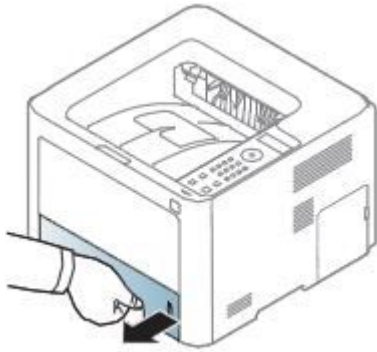

- 2) Remove the jammed paper by gently pulling it straight out.

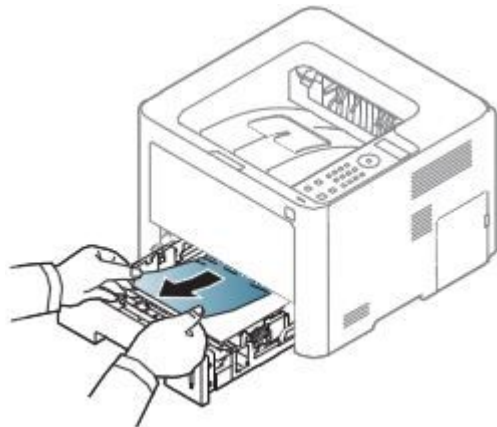

- 3) Insert tray 1 back into the machine until it snaps into place.

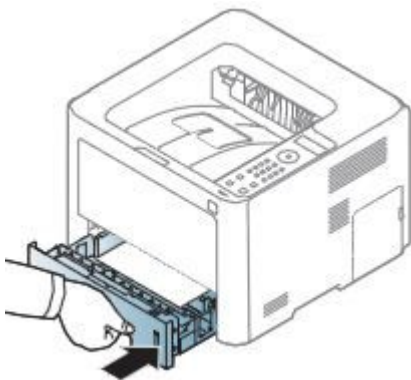

In optional tray (Tray 2)

- 1) Pull out tray 2.



- 2) Remove the jammed paper from the machine.

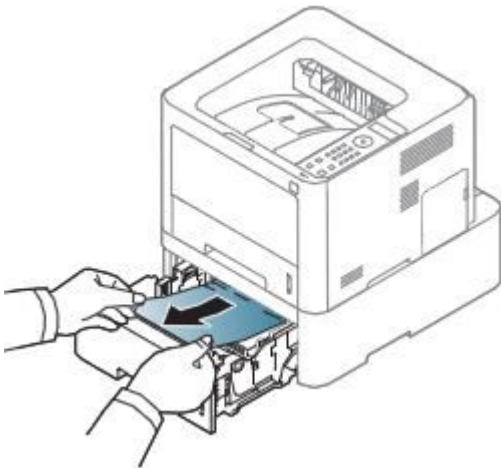

If the paper does not move when you pull or if you do not see the paper in this area, stop and go to the next step.

- 3) Pull tray 1 half-way out.

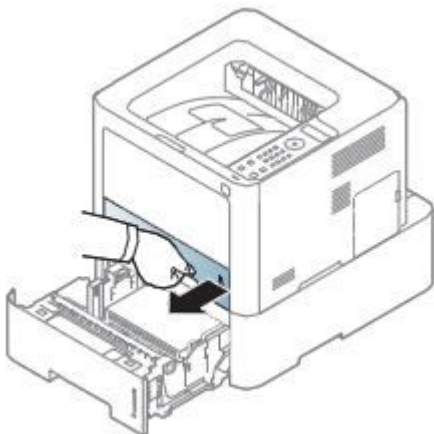

- 4) Pull the paper straight up and out.

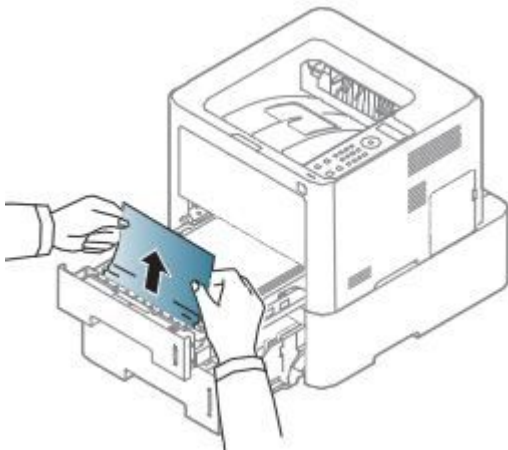

- 5) Insert the trays back into the machine.

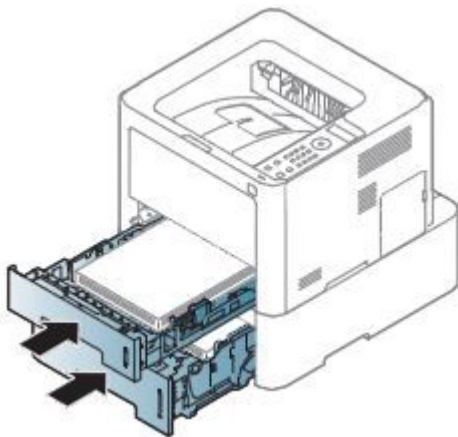

In the multi-purpose tray

- 1) If the paper is not feeding properly, pull the paper out of the machine.

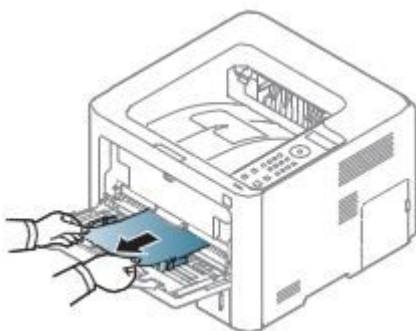

- 2) Open and close the front cover.

Inside the machine (M3320/M3820/M4020 series)

 **NOTE**

- 1) Open the front cover.

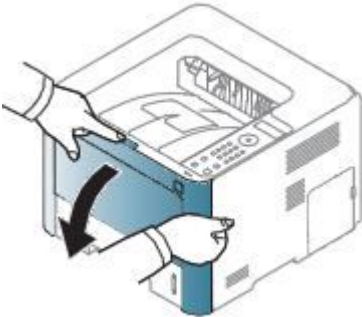

- 2) Pull the laser toner cartridge out.

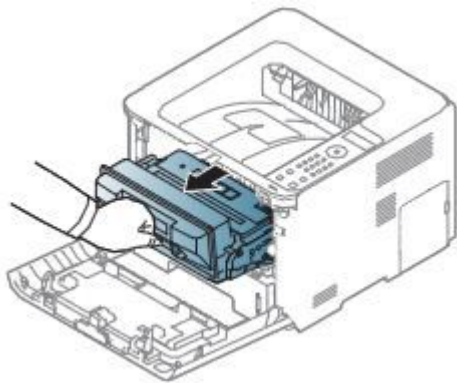

- 3) Remove the jammed paper by gently pulling it straight out.

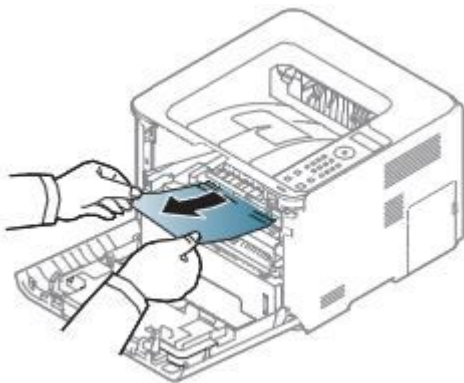

- 4) Insert the laser toner cartridge.

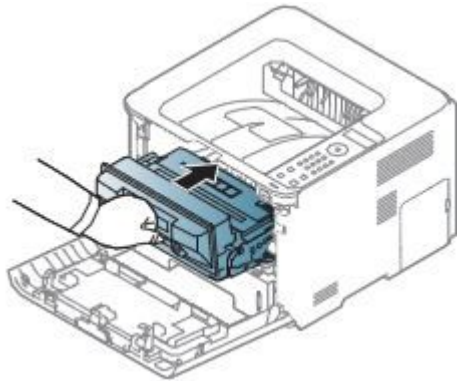

- 5) Close the front cover.

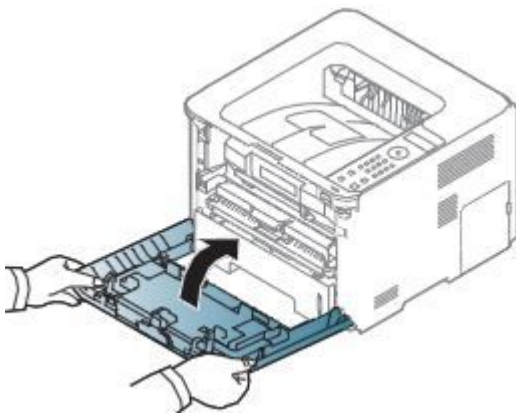

Inside the machine (M3325/M3825/M4025 series)



- 1) Open the front cover.

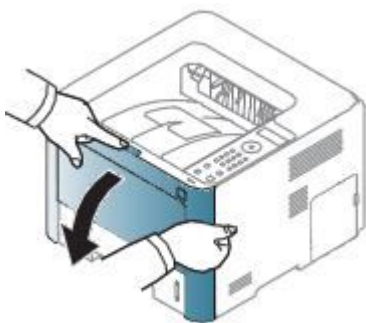

- 2) Pull out the toner cartridge and imaging unit.

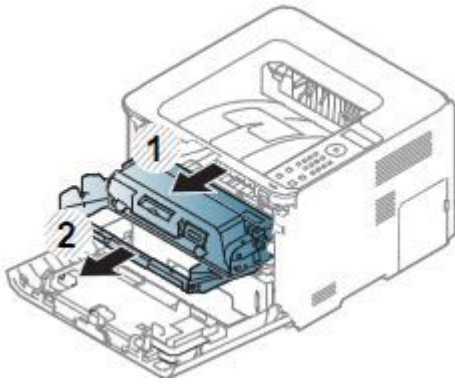

3) Remove the jammed paper by gently pulling it straight out.

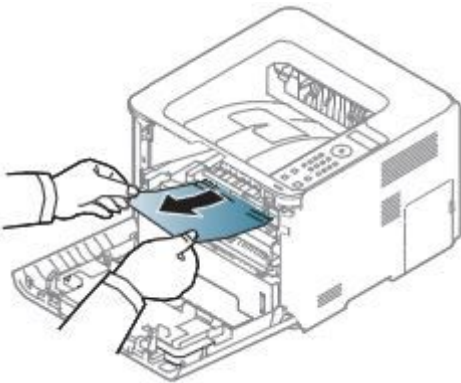

4) Insert the imaging unit and toner cartridge.

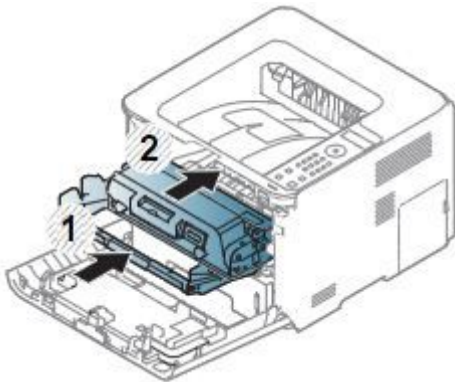

5) Close the front cover.

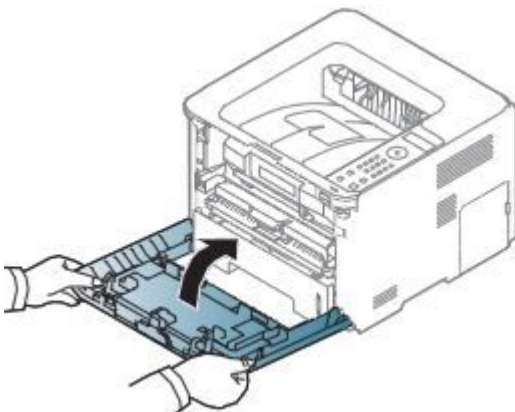

In exit area**NOTE**

The fuser area is hot. Take care when removing paper from the machine.

- 1) Open the MP Tray

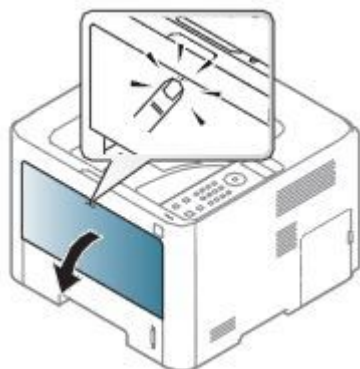

- 2) Close the MP Tray to eject the jammed paper from the machine.

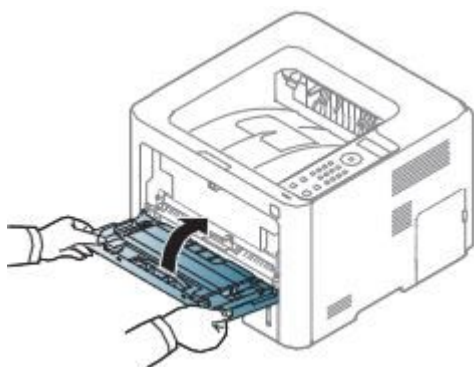

- 3) Gently pull the paper out of the output tray.

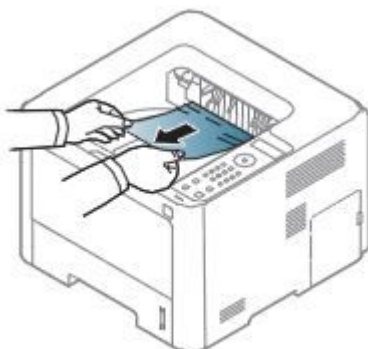

If you do not see the jammed paper or if there is any resistance when you pull, stop and go to the next step.

4. Troubleshooting

- 4) Open the rear cover.



- 5) Pull down the both fuser levers.

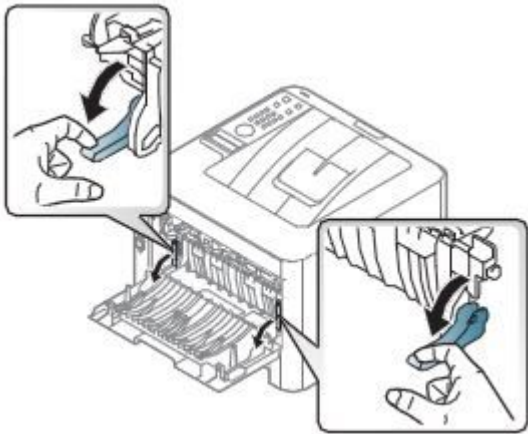

- 6) Open the fuser jam cover.

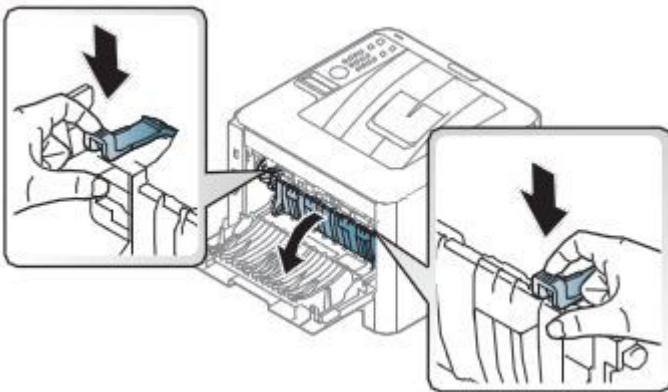

- 7) Remove the jammed paper by gently pulling it straight out.

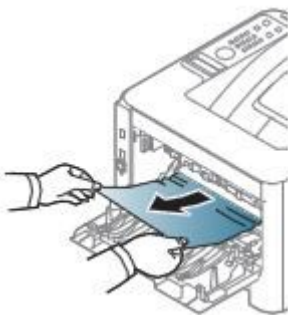

8) Close the fuser jam cover.

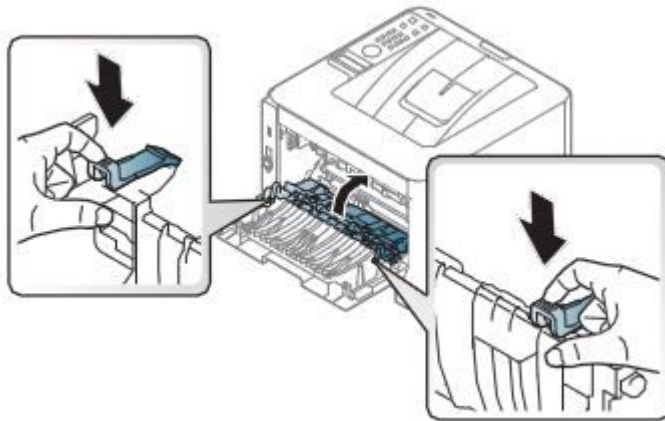

9) Pull up the both fuser levers.

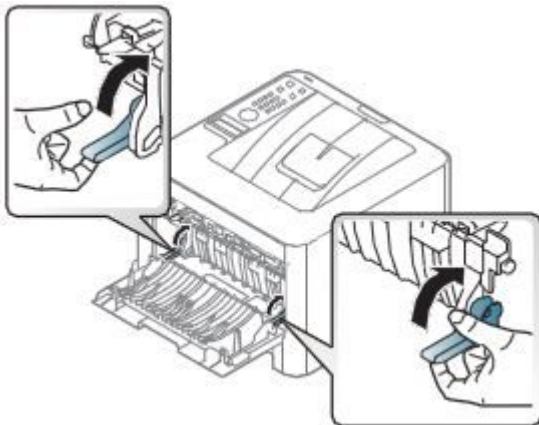

10) Close the rear cover.

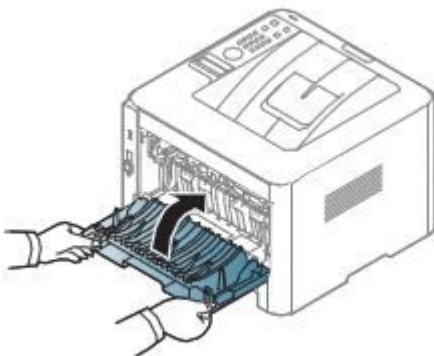

In the duplex unit area

- 1) Pull the duplex unit out of the machine.



- 2) Remove the jammed paper from the duplex unit.



If the paper does not come out with the duplex unit, remove the paper from the bottom of the machine.



- 3) Insert the duplex unit into the machine.



If you still do not see the paper, go to the next step.

- 4) Open the rear cover.



- 5) Pull down the both fuser levers.

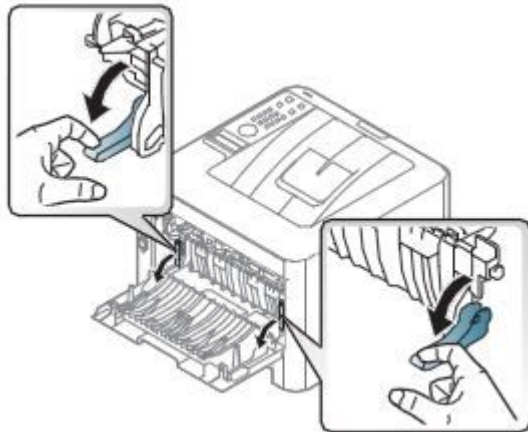

- 6) Open the fuser jam cover.

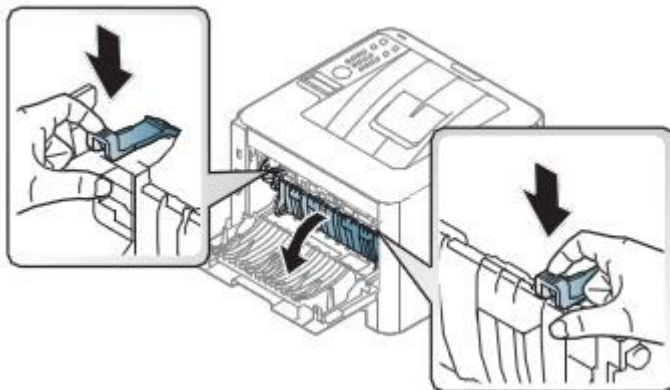

- 7) Remove the jammed paper by gently pulling it straight out.



4. Troubleshooting

8) Close the fuser jam cover.

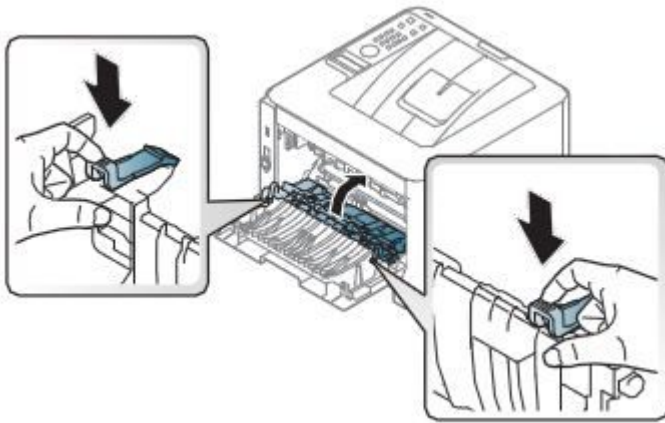

9) Pull up the both fuser levers.

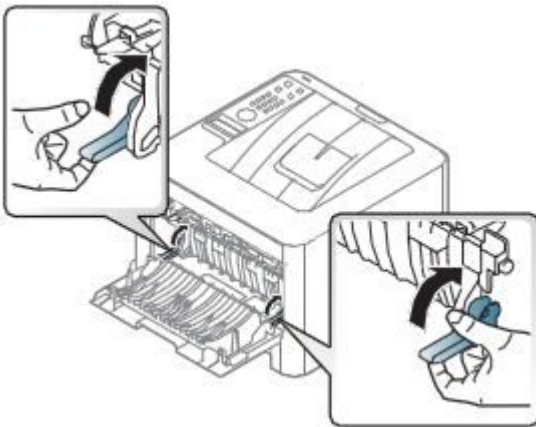

10) Close the rear cover.

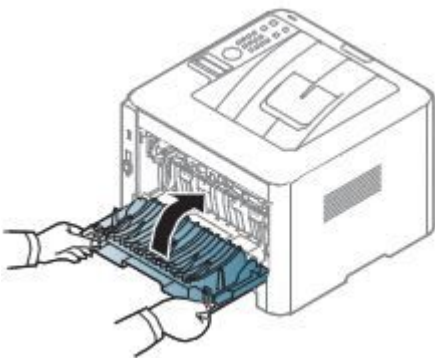

4.1.4. Useful menu item for service

a) Monitoring the supplies life.

If you experience frequent paper jams or printing problems, check the number of pages the machine has printed or scanned. Replace the corresponding parts, if necessary.



NOTE

It may be necessary to press OK to navigate to lower-level menus for some models.

- 1) Select “**Menu > System Setup > Maintenance > Supplies Life**” on the control panel.
- 2) Select the option you want and press **OK**.
- 3) Press “**Cancel button**” to return to ready mode.

b) Printing a report

This product provides several printable reports for maintenance purposes.

These reports can be used to aid the diagnosis of print quality problems.

- **Configuration report**

You can print a report on the machine’s overall configuration. It shows various SW version and current machine setting status.

- M332xND/M382xD : Press and hold “Cancel” button for about 4 seconds until the green LED blinks quickly, and release
- M382xND/M382xDW/M402xND : Select “**Menu > Information > Configuration**” on the control panel.

- **Supplies Information report**

You can print supplies’ information page. It shows consumable unit life status and toner using status.

- M332xND/M382xD : Press and hold “Cancel” button for about 6 seconds until the green LED stops blinking, and release
- M382xND/M382xDW/M402xND : Select “**Menu > Information > Supplies Info.**” on the control panel.

- **Usage Counter**

You can print a usage page. The usage page contains the total number of pages printed.

- M332xND/M382xD : Press and hold “Cancel” button for about 6 seconds until the green LED stops blinking, and release
- M382xND/M382xDW/M402xND : Select “**Menu > Information > Usage Counter**” on the control panel.

c) Maintenance menu

This menu allows you to maintain your machine. (**Menu > System setup > Maintenance**)

- **CLR Empty Msg.** : This option appears only when toner cartridge is empty.
- **Supplies Life** : This item allows you to check how many pages are printed and how much toner are left in the cartridge.
- **TonerLow Alert** : If toner in the cartridge has run out, a message informing user to change the toner cartridge appears. You can set the option for this message to appear or not.

- **ImgU.Low Alert** : If imaging unit has run out, a message informing user to change the imaging unit appears. You can set the option for this message to appear or not.



This menu is for M3325/3825/4025 series

- **Ram Disk**: Enables/disables RAM disk to manage jobs.

d) Altitude adjustment

Print quality is affected by atmospheric pressure, which is determined by the height of the machine above sea level. The following information will guide you on how to set your machine for the best print quality.

Before you set the altitude value, determine the altitude where you are.

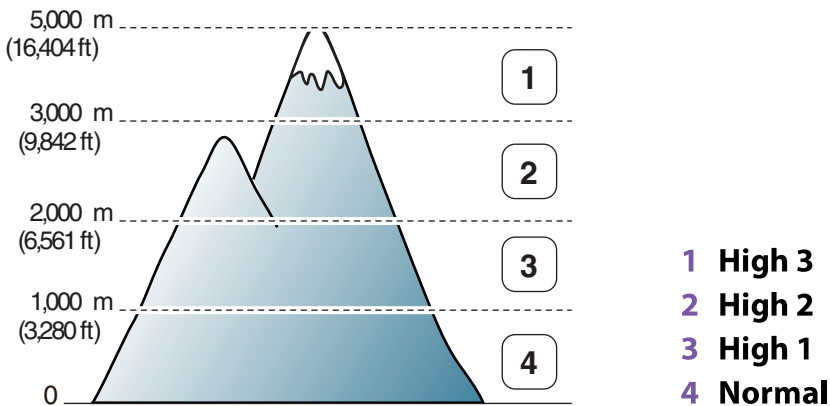

You can set the altitude value from **Device Settings** in Samsung Easy Printer Manager program.

- For Windows and Mac users, you set from **Samsung Easy Printer Manager > (Switch to advanced mode) > Device Settings**.



- If your machine is connected to the network, you can set the altitude via SyncThru™ Web Service.
- You can also set the altitude in “**Menu > System Setup > Altitude Adj.**” option on the machine’s display.

4.1.5. Periodic Defective Image

If an image defects appears at regular intervals on the printed-paper, it is due to a faulty or damaged roller. Refer to the table below and check the condition of the appropriate roller.

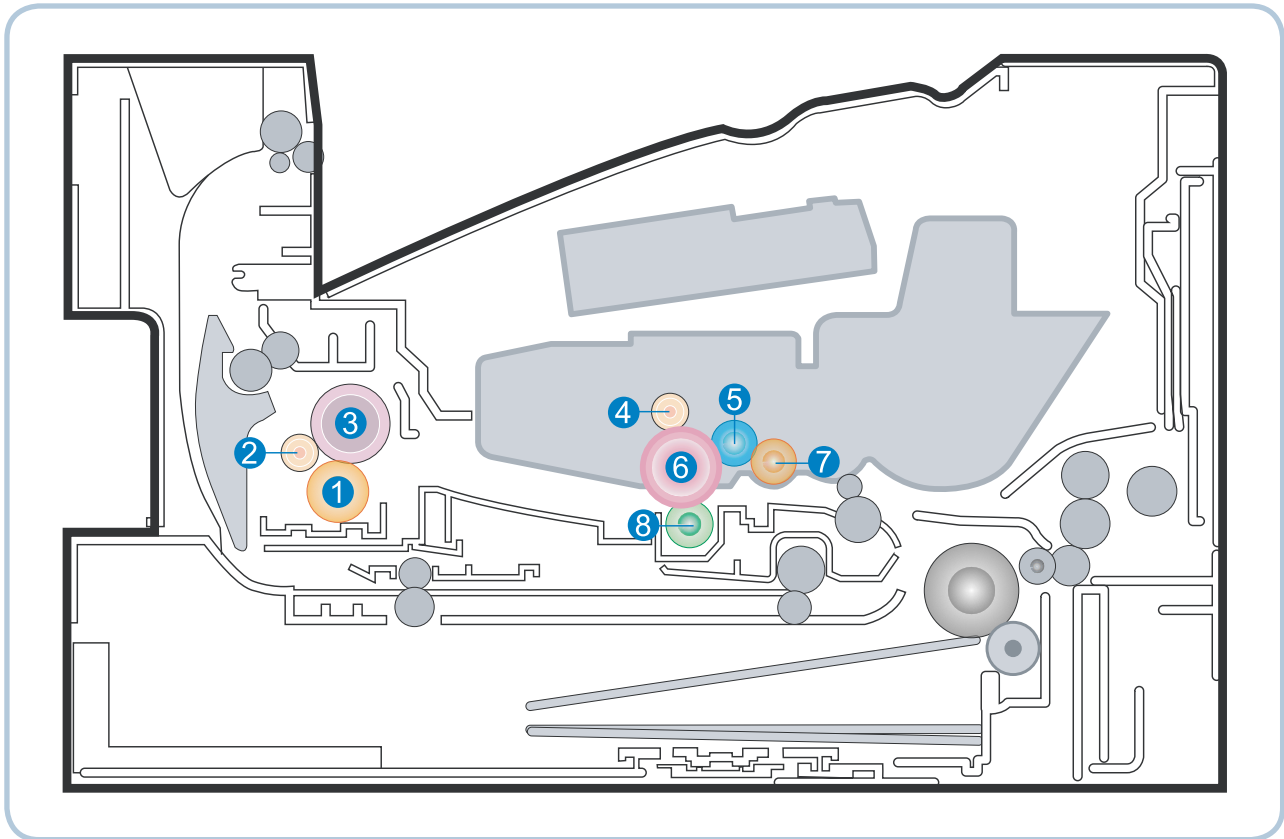

No	Roller Description	Band Period (mm)	Phenomenon	Defective part
1	1st Pressure roller	62.8 mm	Background	Fuser unit
2	2nd Pressure roller	37.7 mm	Background	
3	Heat roller	77.8 mm	Black spot and fuser ghost	
4	Charge roller	34.5 mm	Black spot	Laser Toner cartridge or Imaging Unit
5	Developer roller	37 mm	Horizontal band	
6	OPC drum	76 mm	White and Black spots	
7	Supply roller	69.57 mm	Horizontal band	Transfer Roller
8	Transfer roller	47.1 mm	Ghost, Damaged image	

4.1.6. Useful management tools

4.1.6.1. Using Samsung Easy Printer Manager

NOTE

- This feature may not be available depending on model or optional goods.
- Available for Windows or Macintosh OS users only.
- For Windows, Internet Explorer 6.0 or higher is the minimum requirement for Samsung Easy Printer Manager.

Samsung Easy Printer Manager is an application that combines Samsung machine settings into one location. Samsung Easy Printer Manager combines device settings as well as printing environments, settings/actions and launching. All of these features provide a gateway to conveniently use your Samsung machine. Samsung Easy Printer Manager provides two different user interfaces for the user to choose from: the basic user interface and the advanced user interface. Switching between the two interfaces is easy: just click a button.

Understanding Samsung Easy Printer Manager

To open the program:



- For Windows, Select Start > Programs or All Programs > Samsung Printers > Samsung Easy Printer Manager > Samsung Easy Printer Manager.
- For Macintosh, Open the Applications folder > Samsung folder > Samsung Easy Printer Manager.

The Samsung Easy Printer Manager interface is comprised of various basic sections as described in the table that follows:

NOTE

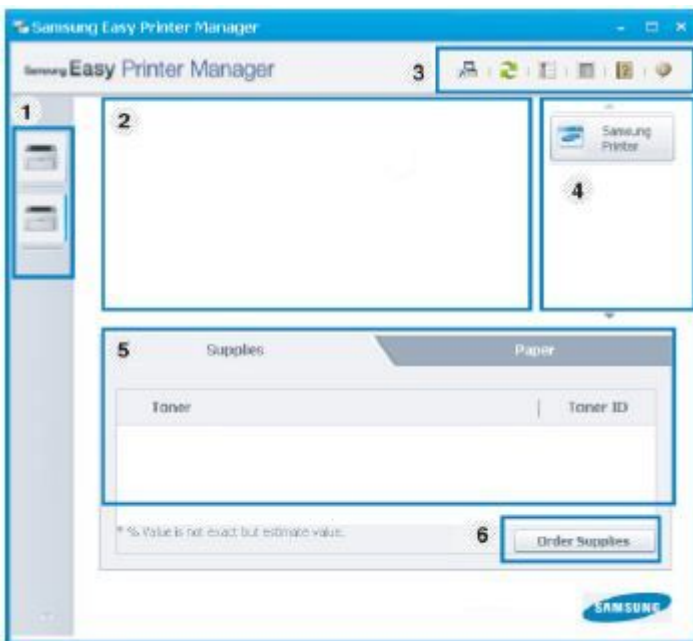
The screenshot may differ depending on operating system you are using.



No	Area	Description
1	Printer List	The Printer List displays printers installed on your computer and network printers added by network discovery (Windows only).
2	Printer Information	<p>This area gives you general information about your machine. You can check information, such as the machine's model name, IP address (or Port name), and machine status.</p> <p> NOTE</p> <p>Troubleshooting button: This button opens Troubleshooting Guide when an error occurs. You can directly open the necessary section in the user's guide.</p>
3	Application Information	Includes links for changing to the advanced settings, preference, help, and about.
4	Quick links	<p>Displays Quick links to machine specific functions. This section also includes links to applications in the advanced settings.</p> <p> NOTE</p> <p>If you connect your machine to a network, the SyncThru™ Web Service icon is enabled.</p>
5	Contents Area	Displays information about the selected machine, remaining toner level, and paper. The information will vary based on the machine selected. Some machines do not have this feature.
6	Order Supplies	Click on the Order button from the supply ordering window. You can order replacement toner cartridge(s) from online.

Advanced settings user interface overview

The advanced user interface is intended to be used by the person responsible for managing the network and machines.

- **Device Settings**

You can configure various machine settings such as machine setup, paper, layout, emulation, network, and print information.

- **Alert Settings**

This menu includes settings related to error alerting.

- **Printer Alert** : Provides settings related to when alerts will be received.
- **Email Alert** : Provides options relating to receiving alerts via email.
- **History Alert** : Provides a history of device and toner related alerts.

- **Job Accounting**

Provides querying of quota information of the specified job accounting user. This quota information can be created and applied to devices by job accounting software such as SyncThru™ or CounThru™ admin software.

4.1.6.2. Using Samsung Printer Status (Windows only)

The Samsung Printer Status is a program that monitors and informs you of the machine status.

NOTE



- The Samsung Printer Status window and its contents shown in this user’s guide may differ depending on the machine or operating system in use.
- Check the operating system(s) that are compatible with your machine.

Samsung Printer Status overview

If an error occurs while operating, you can check the error from the Samsung Printer Status. Samsung Printer Status is installed automatically when you install the machine software.

You can also launch Samsung Printer Status manually. Go to the **Printing Preferences** , click the **Basic** tab > **Printer Status** button.

These icons appear on the Windows task bar:

Icon	Mean	Description
	Normal	The machine is in ready mode and experiencing no errors or warnings.
	Warning	The machine is in a state where a soft error has occurred. For example, a toner low status, which may lead to toner empty status.
	Error	The machine has at least one hard error, such as out of paper, fuser error, etc. Machine does not have ability to come to ready without customer intervention.

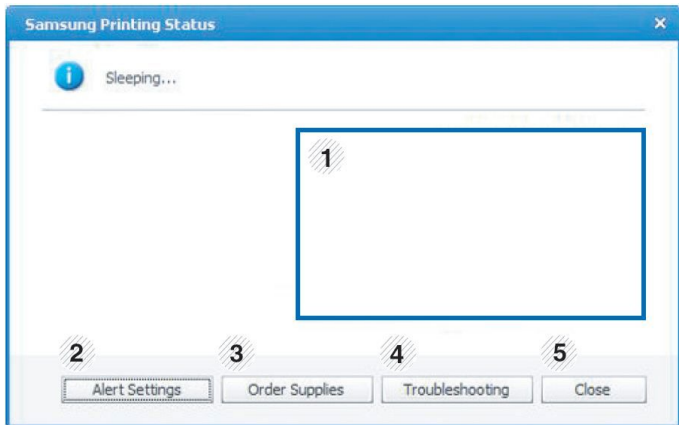

1	Toner Level	You can view the level of toner remaining in each toner cartridge. The machine and the number of toner cartridge(s) shown in the above window may differ depending on the machine in use. Some machines do not have this feature.
2	Alert Settings	Select the settings you want from the options window.
3	Order Supplies	You can order replacement toner cartridge(s) from online.
4	Troubleshooting	You can directly open the troubleshooting section in the user’s guide.
5	Close	Close the window.

4.1.6.3. Using SyncThru Web Service (SWS)

SWS is an embedded web server in the machine. This web server informs you of machine configuration, version, status and allows you to customize the machine's settings. You can contact this server via wired and wireless network using your web browser in the remote place.

Connecting preparations

- Wired or Wireless Network connection is established.
- Browser (Ex> Internet Explorer) Program on your PC network connected

SWS overview

SyncThru Web Service (SWS)

- accepts HTTP request via port 80 as normal web servers.
- provides interface to users information of networked printers and allow to configure the setting of printers.
- is able to provide more complicated options than Local UI for printer configuration.



Connection Procedure

- 1) Open the Web-browser and input IP address of machine. Click "Login".
- 2) Log-in Admin Mode. (ID: admin, PW: sec00000)
- 3) Select pages to check the configuration and customize the settings.



CAUTION

Please, change SWS Default ID and Password for system security in case of your first connection.

 **NOTE**

If the machine supports 'Direct Print', you can enable this function using the SWS menu. The default configuration is 'Disabled' for your security.

Firstly, you have to login to SWS.

- 1) Click 'Direct Print Configuration' in the pop up windows when clicking 'Direct Print'.
- 2) In the 'Services' Menu, check 'Direct Print'.

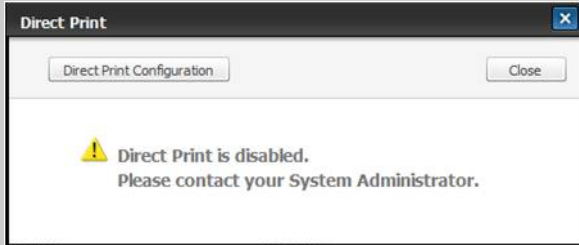

Or,

- 1) Click 'System Security' in the 'Security' menu.
- 2) Select 'Feature Management' in the left frame.
- 3) In the 'Services' Menu, check 'Direct Print'.

4.1.7. Updating Firmware

This chapter includes instructions for updating the printer firmware. You can update the printer firmware by using one of the following methods :

- Update the firmware by using the USB port.
- Update the firmware by using the Network.

4.1.7.1. Update the firmware by using the USB port

Upgrading preparations

- usblast2.exe : Tool which sends firmware data to printer.
- Firmware file to update.

Upgrade Procedure

- 1) Turn the machine off.
- 2) Connect USB cable to printer.
- 3) Turn the machine on. Check if the printer is the ready status.
- 4) Drag the firmware file and Drop down on the usblast2.exe.

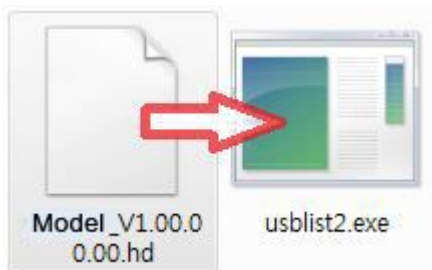

And then firmware update will be started automatically.

- 5) When upgrading is completed, machine is automatically re-booting.

4.1.7.2. Update the firmware by using the network

Upgrading preparations

- Wired or Wireless Network connection is established.
- Firmware file to update

Upgrade Procedure

1) Open the Web-browser and input IP address of machine. Click “Login”.

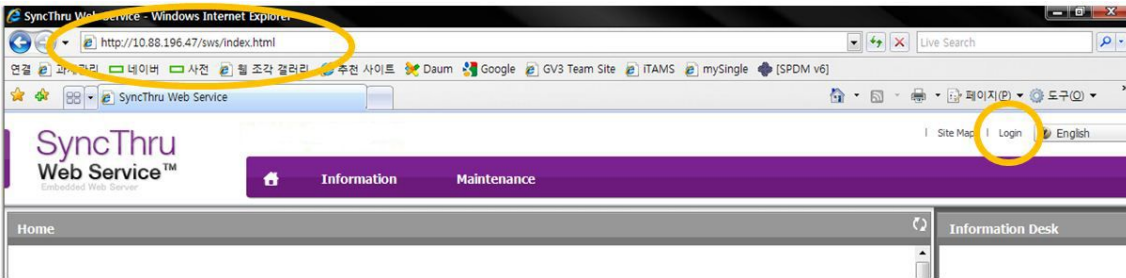

2) Log-in Admin Mode. (ID: admin, PW: sec00000)

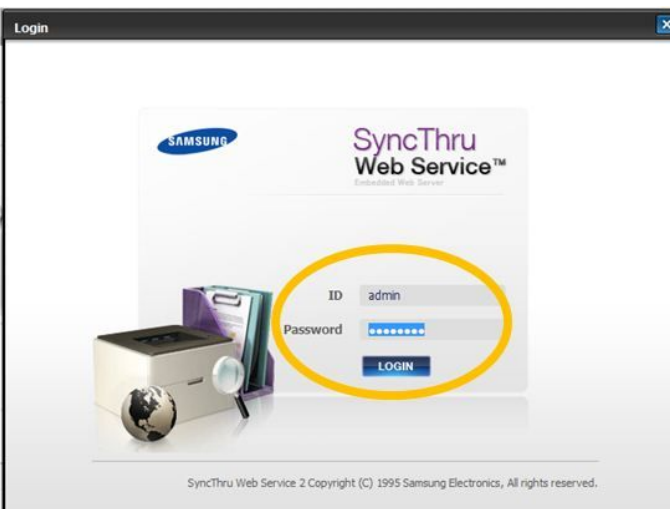

3) Select Maintenance menu and click “upgrade wizard”

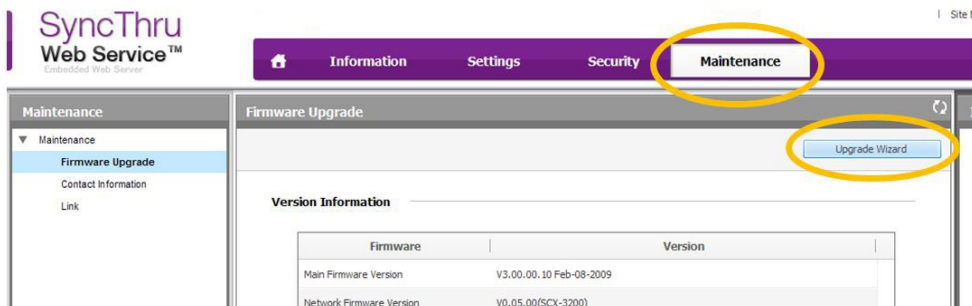

- 4) Select firmware file using “browser” button and press next button.

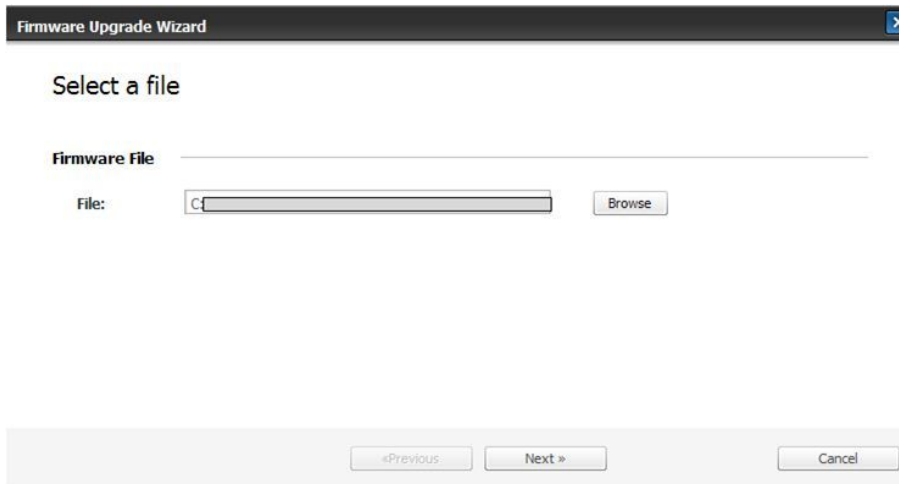

- 5) SyncThru will check verify firmware file and compare version and press next button.

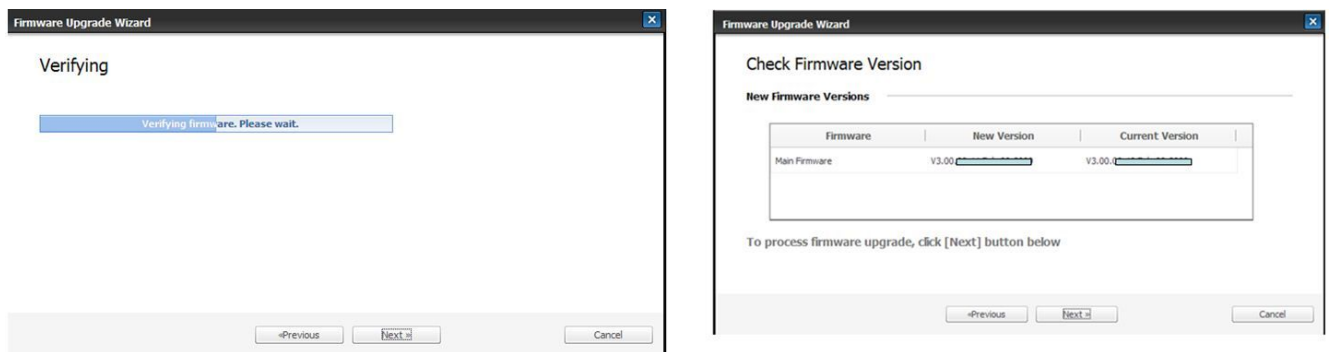

- 6) Machine starts upgrading. SyncThru will return home page after upgrading is completed.

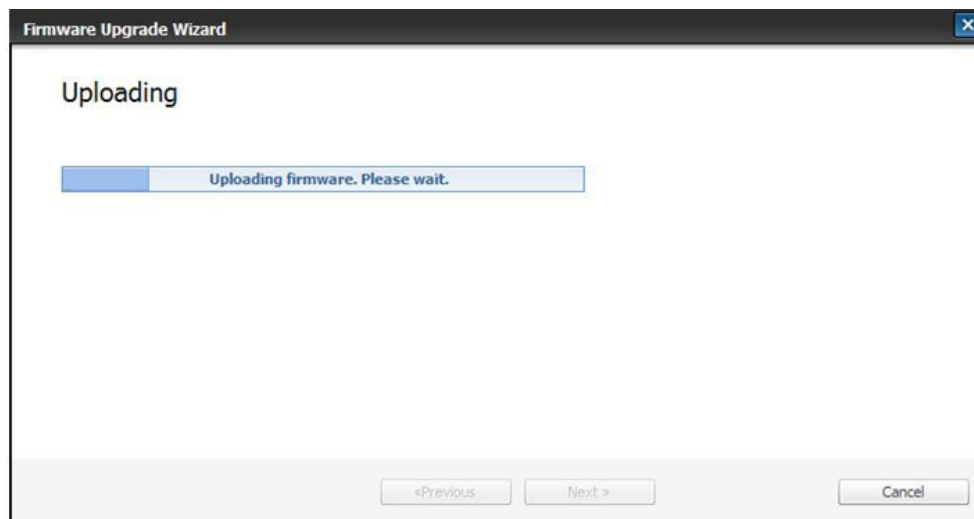

4.1.8. Service Mode

In service (tech) mode, the technician can check the machine and perform various test to isolate the cause of a malfunction. While in Tech mode, the machine still performs all normal operations.

a) Entering Service mode

[M382xND/M382xDW/M402xND]

- 1) Press “Menu > # > 1 > 9 > 3 > 4” on the control panel continuously.
- 2) Press Menu.
- 3) Select “Tech Mode”.

[M402xNX]

- 1) Push the  on the touch screen while pushing the stop button.
- 2) Select the “Diagnostics”.
- 3) Input the password (1934).

b) Tech mode menu

Depth1	Depth2	Depth3	Depth4
Information	Report	Menu Map	
		Configuration	
		Supplies Info.	
		Usage Counter	
		Error Info.	
		Job Duty	
		Memory Usage	
		Assert History	
Diagnostics	Engine	NVM Read/Write	106-Dev Bias
			107-ATTR Bias
		Test Routine	100-Motor
			101-Clutch
			102-Sensor
			105-MHV Bias
			106-Dev Bias
			107-ATTR Bias
			109-Fuser Heat
	110-LSU		
RestartMachine			

Depth1	Depth2	Depth3	Depth4	
Service Func.	Clear All Mem.			
	Clear Admin PW	Reset? Yes/No	Resetting...	
	TonerLow Level	[1-30]%;10		
	ImgU.Low Level	[1-30]%;10		
	Clear Counts	Enter Passcode [????]	Fuser	
			TransferRoller	
			Tray 1 Roller	
			T1RetardRoller	
			Tray 2 Roller	
			T2RetardRoller	
	Engine Footer		Off *	
			On	
	F/W Upgrade		Off *	
On				

c) Report

- **Configuration**

It shows current machine status for software version, hardware version, paper setting etc.

- **Supplies Info**

It shows consumable unit life status and toner using status.

- **Usage Counter**

It contains the total number of pages printed.

- **Error Info.**

It shows various kinds of errors which can be occurred in machine. It also store history error count how many errors are issued.

- **Job Duty**

It shows printing usage by print job duty.

- **Memory Usage**

It shows memory usage.

d) Diagnostics

- **NVRAM Read/Write**

This menu can change a configuration value for engine firmware.

Code	LCD	Meaning	Default	Max/Min
106-0030	0030-Deve DC K	Deve DC Black	1	0~3
107-0030	0030-THV K	Transfer1 HV Black Duty	1	0~3

- **Test Routines**

This menu can perform the operation test for the main components.

Code	LCD	Meaning	State Displayed
100-0000	0000-Main BLDC	Main BLDC Motor is On/Off	On[Off]
100-0010	0010-Main BLDC Rdy	Detect if Main BLDC Motor runs at normal speed	High[Low]
100-0260	0260-SMPS Fan	Start/Stop Deve. Fan run	On[Off]
101-0000	0000-MP Feed Clutch	Engages drive to pick up a paper from bypass Tray(MP Tray).	On[Off]
101-0010	0010-Tray1 Pickup	Engages drive to pick up a paper from tray1.	On[Off]
101-0020	0020-Tray2 Pickup	Engages drive to pick up a paper from tray2. (Optional)	On[Off]
101-0050	0050-Registration	Engages drive to registartion rolls.	On[Off]
101-0190	0190-OutBin Full	Detect when a paper is at Out-Bin Full Sensor	High[Low]
102-0010	0010-Tray1 Empty	Detect when paper is in Tray1.	High[Low]
102-0080	0080-Tray2 Empty	Detect when paper is in tray2.	High[Low]
102-0280	0280-MP Empty	Detects when paper is in Bypass Tray(MP Tray).	High[Low]
102-0290	0290-Feed Sensor	Detect when a paper is at Feed sensor.	High[Low]
102-0300	0300-T2 Feed Sens	Detect when a paper is at T2 Feed sensor. (optional)	High[Low]
102-0360	0360-Regi Sens	Detect when a paper is at Regi. sensor.	High[Low]
102-0370	0370-Exit Sens	Detect when a paper is at Exit. sensor.	High[Low]
105-0030	0030-K MHV Bias	Black MHV bias voltage on at normal drive level	On[Off]
106-0030	0030-K Dev Bias	Black Dev bias voltage on at normal drive level	On[Off]
107-0030	0030-K THV Bias	Black THV bias voltage on at normal drive level	On[Off]
107-0031	0031-K THV- Bias	Black THV bias voltage on at normal drive level	On[Off]
107-0070	0070-K THV Bias R	Detect what the THV value is on the THV Roller	Numeric 3 digits
109-0000	0000-Temp A	Detects what the temperature A is on fuser.	Numeric 3 digits
109-0040	0040-Fuser Fan Run	Fuser Fan Motor On/Off	On[Off]
109-0050	0050-Fuser Bias	Fuser bias voltage on at normal drive level	On[Off]
110-0000	0000-LSU Mot1 Rdy	Detects if LSU motor1 runs at normal speed.	High[Low]
110-0060	0060-LSU Mot1 Run	LSU Motor1 On/Off	On[Off]
110-0110	0110-LD Power4	LSU LD4 Power On/Off (black)	On[Off]
110-0170	0170-LSU HSync4	Detect LSU HSync4 (black)	High[Low]

e) Service Function

- **Clear All Mem.**

The function resets the system to factory default settings. This function is used to reset the system to the initial value when the product is functioning abnormally. All the values are returned to the default values, and all the information, which was set by the user, will be erased.



NOTE

Always perform a memory clear after replacing the main board. Otherwise, the system may not operate properly.

- **Clear Admin PW**

This menu resets the Admin password.

- **Toner Low Level**

The function is to set up the time to inform toner low status. This function can provide user convenience for replacing the toner cartridge.

- **ImgU. Low Level**

The function is to set up the time to inform imaging unit low status. This function can provide user convenience for replacing the imaging unit.

- **Clear Counts**

This function resets the count information for selected item.

- **Engine Footer**

This function is for monitoring of the engine status. If you perform this function, at printing, the setting value for engine is shown on the bottom of the printed page.

- **F/W Upgrade**

The function is to upgrade the firmware by using “usblist.exe” file. When updating firmware, you must select “On” for this menu.

4.2. Troubleshooting

4.2.1. Procedure of checking the symptoms

Before attempting to repair the printer first obtain a detailed description of the problem from the customer.

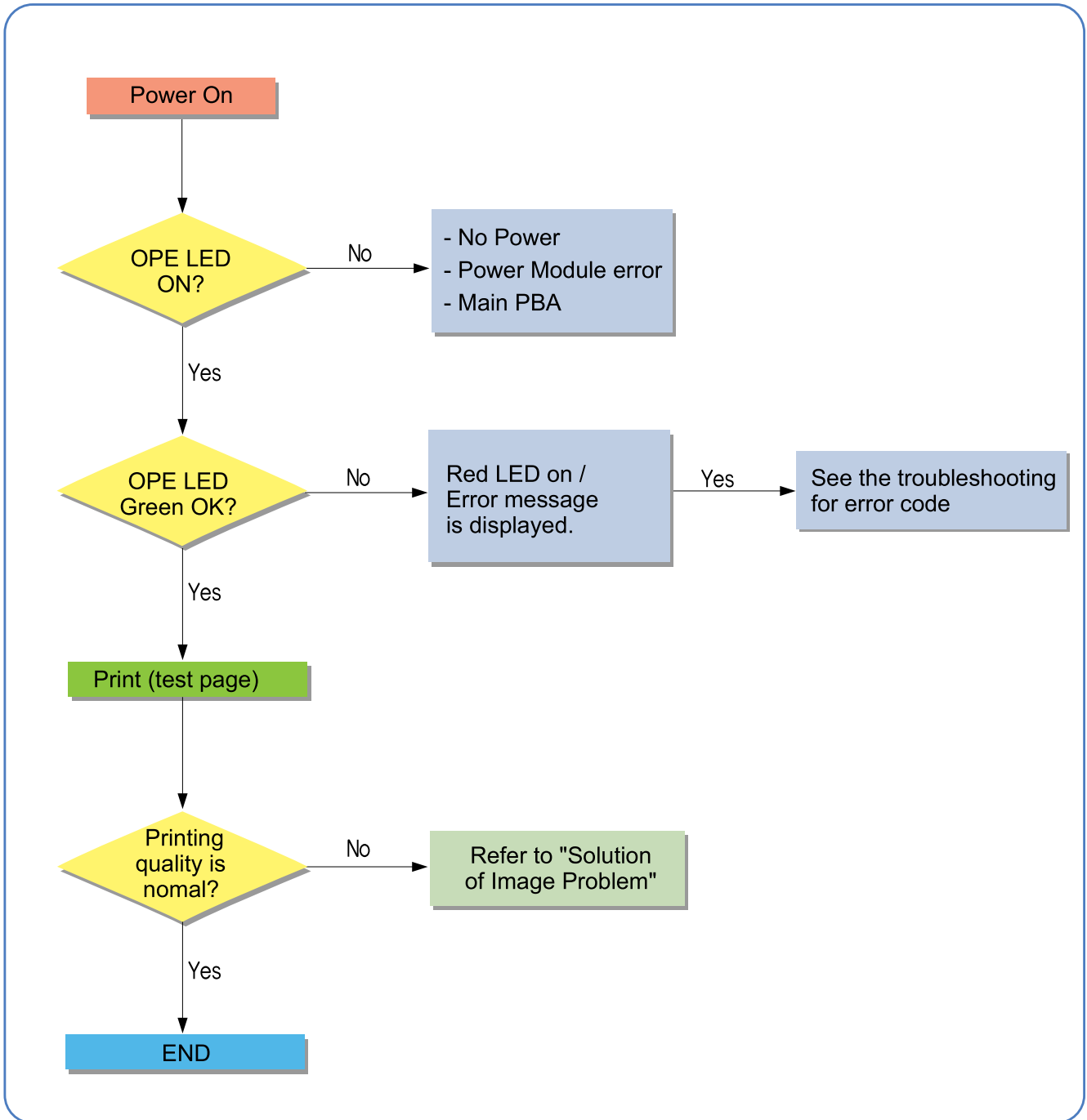

4.2.1.1. Basic Check List

1) Check the Power.

- Check that the power switch is turned on.
- Check that the power cable is plugged into the outlet and the printer.
- Check the voltage of the power outlet.

2) Check the LED of Panel.

- Is there OPE LED ON?
 - › If not check power cable, switch SMPS or Main board.
- Is the abnormal Lamp?
 - › Check the Main board and cable harness.

3) Check the Paper Path

- Is there a Paper Jam?
 - › Remove any paper fragments caught in the paper path.
- Paper Jam occurs repeatedly at a specific point in the Paper Path
 - › Open the fuser cover, Jam clear.
 - › Dismantle the machine and carefully inspect the region where the jam occurs.
(Especially, check if paper fragments are caught in the Fuser)

4) Print the Information Page (Configuration).

- Try printing a test page from a computer.
 - › If there is an error check cables and driver installation.

5) Check the Print Quality.

- Is there are a Print Quality Problem?
 - › Refer to image quality problem section.

6) Check consumables (toner etc.).

- Using the keys print the Test Pattern.
 - › Expected life of various consumable parts, compare this with the figures printed and replace as required

4.2.2. Error Code and Troubleshooting

Messages appear the Easy Printer Manager window or on the control panel to indicate machine status or errors. Refer to the tables below to correct the problem.



NOTE

Some messages may not appear on the display depending on the options or models.

Error Code	Error Message	Troubleshooting page
A1-1110	Error: #A1-1110 Turn off then on	P.4-36
C1-1110	Prepare new cartridge	P.4-37
C1-1120	Replace new cartridge	P.4-37
C1-1144	Replace new cartridge	P.4-37
C1-1150	Replace new cartridge	P.4-37
C1-1160	Replace new cartridge	P.4-37
C1-1170	Replace new cartridge	P.4-37
C1-1310	Error: #C1-1310 Install toner	P.4-37
C1-1411	Install toner	P.4-37
C1-1512	Not Compatible Toner cartridge	P.4-38
C1-1710	Error: #C1-1710 Call for Service	P.4-38
C1-1711	Error: #C1-1711 Call for Service	P.4-38
C1-1712	Error: #C1-1712 Call for Service	P.4-38
C2-1110	Prepare new cartridge	P.4-39
C2-1120	Replace new cartridge	P.4-39
C2-1150	Replace new cartridge	P.4-39
C2-1160	Replace new cartridge	P.4-39
C2-1170	Replace new cartridge	P.4-39
C2-1411	Install toner	P.4-39
C2-1512	Not Compatible Toner cartridge	P.4-40
C2-1710	Error: #C2-1710 Call for Service	P.4-40
C2-1711	Error: #C2-1711 Call for Service	P.4-40
C2-1712	Error: #C2-1712 Call for Service	P.4-40
C3-1110	Prepare new Image unit	P.4-41
C3-1120	Replace new Image unit	P.4-41
C3-1144	Replace new Image unit	P.4-41
C3-1150	Replace new Image unit	P.4-41
C3-1160	Replace new Image unit	P.4-41
C3-1170	Replace new Image unit	P.4-41
C3-1410	Not Installed Imaging unit	P.4-41
C3-1510	Not compatible Imaging unit	P.4-42
C9-1112	Replace new tray 1 roller	P.4-42
C9-1115	Replace new tray 1 roller	P.4-43
C9-1122	Replace new tray 2 roller	P.4-44

Error Code	Error Message	Troubleshooting page
C9-1125	Replace new tray 2 roller	P.4-44
H1-1210	Paper jam in tray 2	P.4-45
H1-1220	Tray 2 Door Open. Close it	P.4-46
H1-1230	Error: #H1-1230 Check Tray 2	P.4-47
H1-1240	Tray2 Not Install	P.4-48
H1-1252	Paper empty in tray 2	P.4-49
H1-1254	Paper empty in tray 2	P.4-49
M1-1110	Paper jam in tray 1	P.4-50
M1-1610	Paper jam in MP tray	P.4-51
M1-5112	Paper empty in tray 1	P.4-52
M1-5113	Paper empty in tray 1	P.4-52
M1-5120	Paper empty in all tray	P.4-52
M1-5612	Paper empty in MP tray	P.4-53
M1-5712	Paper Empty in manual feeder	P.4-53
M2-1110	Paper jam inside machine	P.4-54
M2-2210	Paper jam inside of duplex	P.4-55
M3-1110	Paper jam in exit area	P.4-55
M3-2130	Output bin full. Remove paper	P.4-56
S2-3310	Error: #S2-3310 Turn off then on	P.4-57
S2-3311	Error: #S2-3311 Turn off then on	P.4-57
S2-3312	Error: #S2-3312 Turn off then on	P.4-57
S2-3313	Error: #S2-3313 Turn off then on	P.4-57
S2-3314	Error: #S2-3314 Turn off then on	P.4-57
S2-3315	Error: #S2-3315 Turn off then on	P.4-57
S2-3316	Error: #S2-3316 Turn off then on	P.4-57
S2-3317	Error: #S2-3317 Turn off then on	P.4-57
S2-3318	Error: #S2-3318 Turn off then on	P.4-57
S2-4120	Door Open. Close it	P.4-58
S6-3123	Network Problem: IP Conflict	P.4-59
S6-3128	802.1x Network Error	P.4-60
U1-2315	Error: #U1-2315 Turn off then on	P.4-60
U1-2320	Error: #U1-2320 Turn off then on	P.4-60
U1-2330	Error: #U1-2330 Turn off then on	P.4-60
U1-2334	Error: #U1-2334 Turn off then on	P.4-60
U1-2340	Error: #U1-2340 Turn off then on	P.4-60
U2-1112	Error: #U2-1112 Turn off then on	P.4-61
U2-1113	Error: #U2-1113 Turn off then on	P.4-61

▶ **Error Code**

A1-1110

▶ **Error message**

Error #A1-1110: Turn off then on.

▶ **Symptom**

Harness or main BLDC motor or main board is defective. / OPC coupler in the toner cartridge(or imaging unit) has overloaded.

▶ **Troubleshooting method**

- 1) Turn the machine off then on. If the error persists, refer to the following.
- 2) Remove the right cover.
- 3) Check if the motor connector on main board is connected properly. Reconnect it.
- 4) OPC coupler has overloaded. After removing the toner cartridge/imaging unit, rotate the OPC coupler. If there is any damage, the OPC coupler can't rotate well. Replace the toner cartridge/imaging unit.
- 5) Remove the left cover.
- 6) Remove the main drive unit. (**Refer to 3.3.9**)
- 7) The main BLDC motor is defective.
 - a) Unplug the connector from the motor carefully.
 - b) Replace the main BLDC motor ([JC31-00075A](#)) with new one.

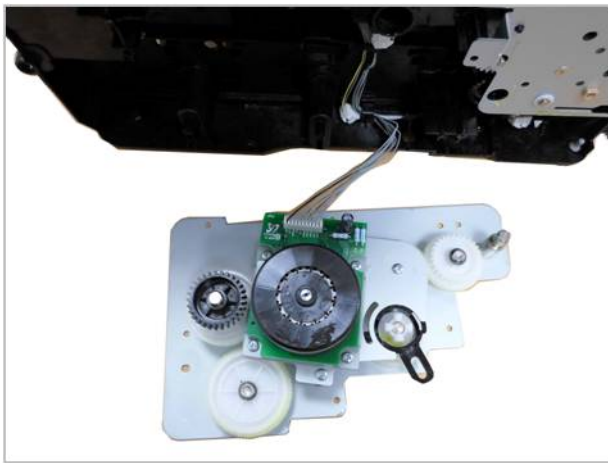

- 8) If the problem persists, replace the main board.

▶ Error Code

C1-1110

C1-1120

C1-1144

C1-1150

C1-1160

C1-1170

▶ Error message

Prepare new cartridge.

Replace new cartridge.

▶ Symptom

The remaining toner cartridge is less than 10% / The toner cartridge is at the end of its life.

▶ Troubleshooting method**NOTE**

These errors are for M3325/3825/4025.

Check the life remaining of the toner cartridge.

If its life is at the end, turn the machine off and replace the toner cartridge with new one.

▶ Error Code

C1-1310

C1-1411

▶ Error message

Error: #C1-1310 Install toner

Install toner.

▶ Symptom

The toner cartridge is not installed.

▶ Troubleshooting method**NOTE**

These errors are for M3325/3825/4025.

- 1) Turn the machine off then on.
- 2) Open the front cover.
- 3) Check if the toner cartridge is installed. If yes, remove and reinstall it.
- 4) If the problem persists, replace the toner cartridge with new one.

▶ **Error Code**

C1-1512

▶ **Error message**

Not Compatible Toner cartridge.

▶ **Symptom**

Toner cartridge is not compatible.

▶ **Troubleshooting method**



This error is for M3325/3825/4025.

- 1) Open the front cover.
- 2) Remove the toner cartridge.
- 3) If the toner cartridge is not a Samsung genuine toner cartridge, replace with new one.

▶ **Error Code**

C1-1710

C1-1711

C1-1712

▶ **Error message**

Error: #C1-1710 Call for Service

Error: #C1-1711 Call for Service

Error: #C1-1712 Call for Service

▶ **Symptom**

The machine can't detect the CRUM chip of the toner cartridge.

▶ **Troubleshooting method**



These errors are for M3325/3825/4025.

- 1) Open the front cover.
- 2) Remove the toner cartridge.
- 3) Check if the CRUM terminal is contaminated. Clean it.
- 4) If the toner cartridge is not a Samsung genuine toner cartridge, replace with new one.

▶ Error Code

C2-1110

C2-1120

C2-1150

C2-1160

C2-1170

▶ Error message

Prepare new cartridge.

Replace new cartridge.

▶ Symptom

The remaining toner cartridge is less than 10% / The toner cartridge is at the end of its life.

▶ Troubleshooting method**NOTE**

These errors are for M3320/3820/4020.

Check the life remaining of the toner cartridge.

If its life is at the end, turn the machine off and replace the toner cartridge with new one.

▶ Error Code

C2-1411

▶ Error message

Install toner.

▶ Symptom

The toner cartridge is not installed.

▶ Troubleshooting method**NOTE**

This error is for M3320/3820/4020.

- 1) Turn the machine off then on.
- 2) Open the front cover.
- 3) Check if the toner cartridge is installed. If yes, remove and reinstall it.
- 4) If the problem persists, replace the toner cartridge with new one.

▶ **Error Code**

C2-1512

▶ **Error message**

Not Compatible Toner cartridge.

▶ **Symptom**

Toner cartridge is not compatible.

▶ **Troubleshooting method**



This error is for M3320/3820/4020.

- 1) Open the front cover.
- 2) Remove the toner cartridge.
- 3) If the toner cartridge is not a Samsung genuine toner cartridge, replace with new one.

▶ **Error Code**

C2-1710

C2-1711

C2-1712

▶ **Error message**

Error: #C2-1710 Call for Service

Error: #C1-1711 Call for Service

Error: #C1-1712 Call for Service

▶ **Symptom**

The machine can't detect the CRUM chip of the toner cartridge.

▶ **Troubleshooting method**



These errors are for M3320/3820/4020.

- 1) Open the front cover.
- 2) Remove the toner cartridge.
- 3) Check if the CRUM terminal is contaminated. Clean it.
- 4) If the toner cartridge is not a Samsung genuine toner cartridge, replace with new one.

▶ Error Code

C3-1110

C3-1120

C3-1144

C3-1150

C3-1160

C3-1170

▶ Error message

Prepare new cartridge.

Replace new cartridge.

▶ Symptom

The remaining imaging unit is less than 10% / The imaging unit is at the end of its life.

▶ Troubleshooting method**NOTE**

These errors are for M3325/3825/4025.

Check the life remaining of the imaging unit.

If its life is at the end, turn the machine off and replace the imaging unit with new one.

▶ Error Code

C3-1410

▶ Error message

Not Installed Imaging unit

▶ Symptom

The imaging unit is not installed.

▶ Troubleshooting method**NOTE**

This error is for M3325/3825/4025.

- 1) Turn the machine off then on.
- 2) Open the front cover.
- 3) Check if the imaging unit is installed. If yes, remove and reinstall it.
- 4) If the problem persists, replace the imaging unit with new one.

▶ **Error Code**

C3-1510

▶ **Error message**

Not compatible Imaging unit

▶ **Symptom**

Imaging unit is not compatible.

▶ **Troubleshooting method**



NOTE

This error is for M3320/3820/4020.

- 1) Open the front cover.
- 2) Remove the toner cartridge and imaging unit.
- 3) If the imaging unit is not a Samsung genuine imaging unit, replace with new one.

▶ **Error Code**

C9-1112

▶ **Error message**

Replace new tray 1 roller

▶ **Symptom**

Tray1 pick up roller is worn out.

▶ **Troubleshooting method**

- 1) Remove the tray 1 cassette.
- 2) Remove the duplex unit.
- 3) Pull the small tap down, then release the pick up roller([JC73-00340A](#)).

(Refer to 3.3.12)

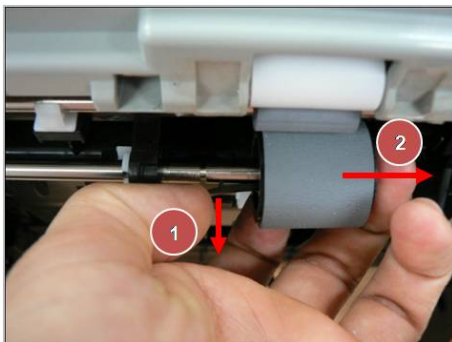

▶ Error Code

C9-1115

▶ Error message

Replace new tray 1 roller

▶ Symptom

Tray1 reverse roller is worn out.

▶ Troubleshooting method

- 1) Remove the tray1 cassette.
- 2) Remove the reverse roller([JC90-01032A](#)).

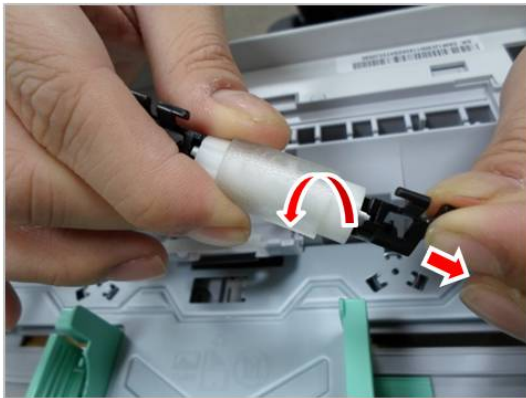
(Refer to 3.3.18)

▶ **Error Code**

C9-1122

▶ **Error message**

Replace new tray 2 roller

▶ **Symptom**

Tray2 pick up roller is worn out.

▶ **Troubleshooting method**

- 1) Remove the Tray 2 cassette.
- 2) See the bottom of the SCF Unit.
- 3) Pull the small tap down, then release the pick up roller([JC97-02259A](#)).
(Refer to 3.3.19.5)

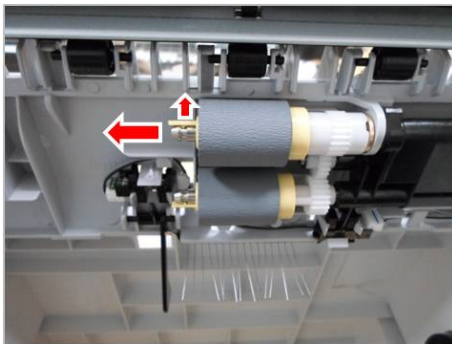

▶ **Error Code**

C9-1125

▶ **Error message**

Replace new tray 2 roller

▶ **Symptom**

Tray2 reverse roller is worn out.

▶ **Troubleshooting method**

- 1) Remove the Tray 2 cassette.
- 2) Open the cassette cover.
- 3) Pull the small tap down, then release the reverse roller([JC97-02259A](#)).
(Refer to 3.3.19.6)

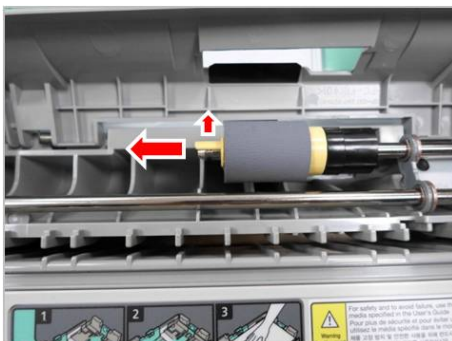

► **Error Code**

H1-1210

► **Error message**

Paper jam in Tray2.

► **Symptom**

A paper jam was detected in the feed area of the tray2.

► **Troubleshooting method**

- 1) Remove the Tray2 cassette.
- 2) Find and remove the jammed paper.
- 3) If the problem persists, check the following.
 - Check if the pick up/forward/reverse roller(*JC97-02259A*) is contaminated or worn out.

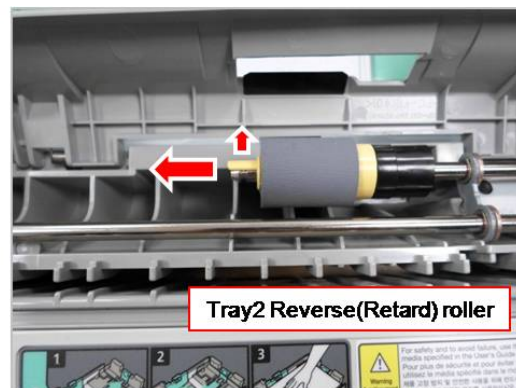
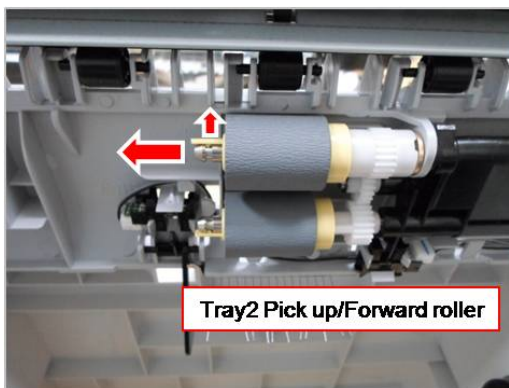

- Check if the feed sensor connector is connected properly.
- If the feed sensor(*0604-001325*) is defective replace it.

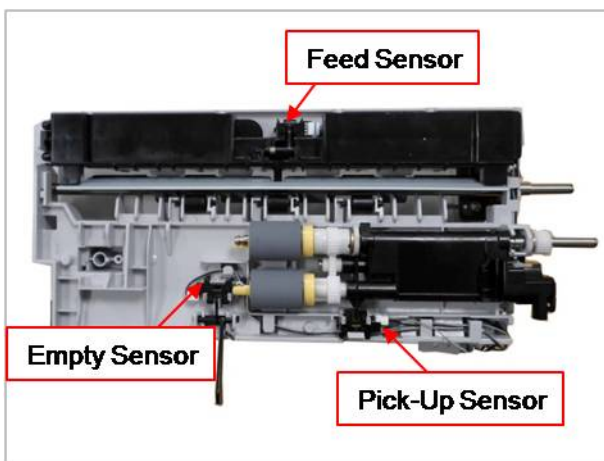

▶ **Error Code**

H1-1220

▶ **Error message**

Tray 2 Door Open. Close it

▶ **Symptom**

Optional cassette is not installed properly.

▶ **Troubleshooting method**

- 1) Remove and reinstall the Tray2 cassette.
- 2) Check the cassette detection sensor.
 - Check if the connection between sensor and main board is OK. Reconnect the harness.
 - If the sensor(*JC34-00001A*) is defective, replace it.

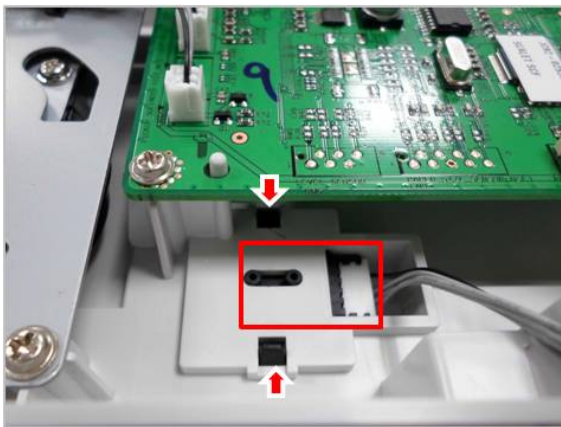

- 3) If the problem persists, replace the SCF main board(*JC92-02636A*).

► **Error Code**

H1-1230

► **Error message**

Error: #H1-1230 Check Tray 2

► **Symptom**

Communication error has occurred.

► **Troubleshooting method**

- 1) Turn the machine off then on.
- 2) If the problem persists, turn the machine off.
- 3) Remove the SCF right cover. (**Refer to 3.3.19.1**)
- 4) Check if the interface connector is connected to the SCF main board. If the interface connector is defective, replace it.

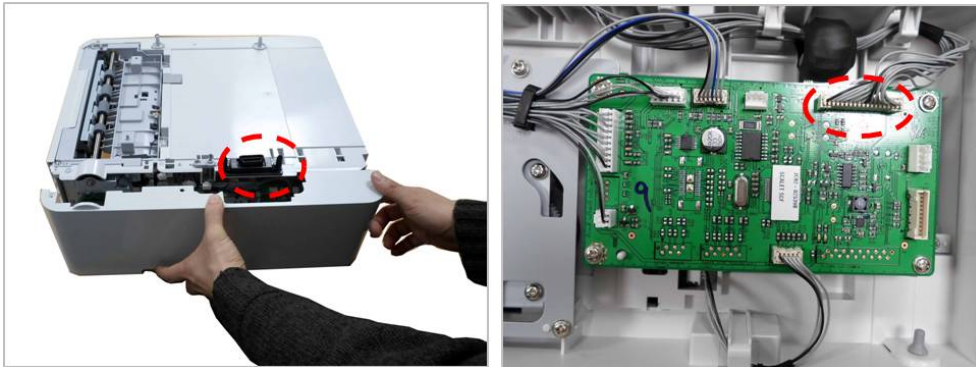

- 5) If the problem persists, replace the SCF main board.([JC92-02636A](#))

▶ **Error Code**

H1-1240

▶ **Error message**

Tray2 Not Install

▶ **Symptom**

Optional cassette is not installed properly.

▶ **Troubleshooting method**

- 1) Remove and reinstall the Tray2 cassette.
- 2) Check the cassette detection sensor.
 - Check if the connection between sensor and main board is OK. Reconnect the harness.
 - If the sensor(*JC34-00001A*) is defective, replace it.

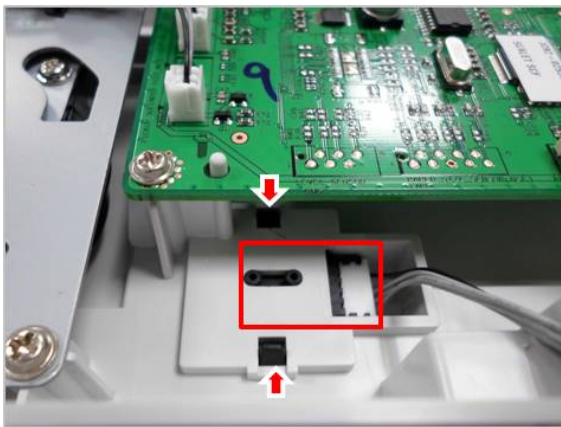

- 3) If the problem persists, replace the SCF main board(*JC92-02636A*).

► **Error Code**

H1-1252

H1-1254

► **Error message**

Paper is empty in Tray2.

► **Symptom**

There is no paper in the tray2. / Actuator-Paper Empty or photo sensor is defective.

► **Troubleshooting method**

- 1) Load the paper in the tray2.
- 2) If the problem persists, turn the machine off and check the following.
- 3) If the Actuator-Paper Empty is defective, replace it.
- 4) If the Photo Sensor([0604-001325](#)) is defective, replace it. Check if the connector is connected properly.

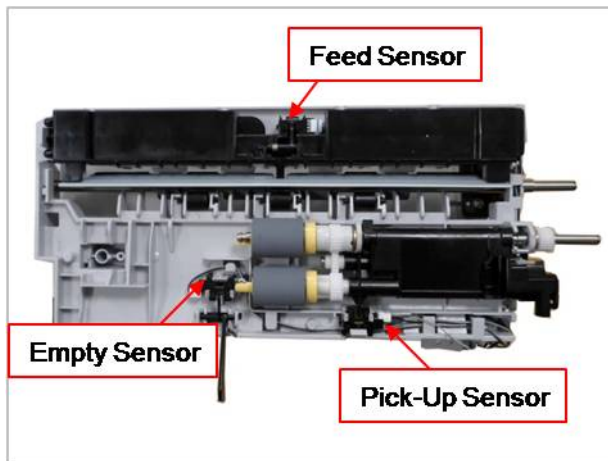

- 5) If the problem persists, replace the SCF main board.([JC92-02636A](#))

▶ **Error Code**

M1-1110

▶ **Error message**

Paper Jam in Tray1.

▶ **Symptom**

The jammed paper has occurred in the tray1.

▶ **Troubleshooting method**

- 1) Clear the jammed paper. (**Refer to 4.1.3**)
If the problem persists, check the following.
- 2) While pushing the Paper Empty Sensor, send the printing data. Check if the pick up roller is rotating normally.
- 3) Check if there is any obstacles in the paper path (from Pick-Up to Feed Sensor). The feed roller should be especially checked.

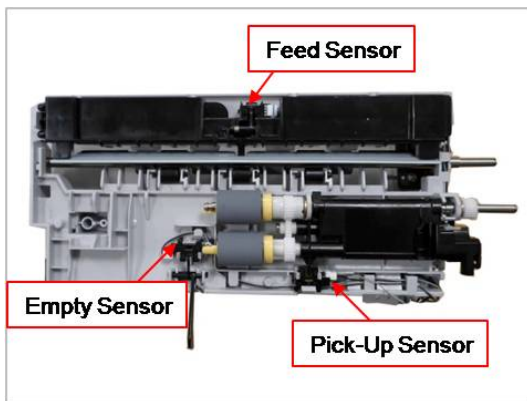

- 4) Print out the Supplies Information. Check the Tray 1 Roller Life and Tray1 Reverse(Retard) roller Life. If the life came to the end, replace the relative roller.

[Pick up roller]

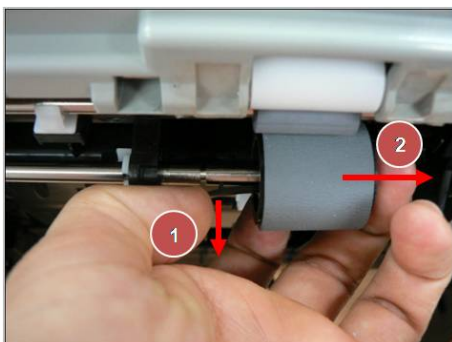

[Reverse roller]

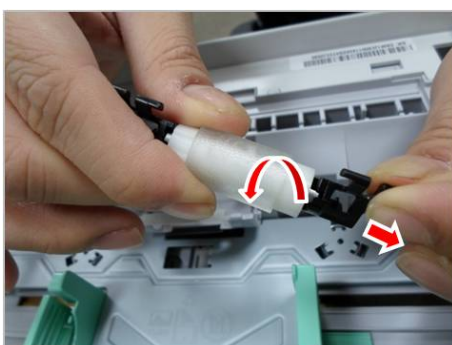

► **Error Code**

M1-1610

► **Error message**

Paper Jam in MP tray.

► **Symptom**

The jammed paper has occurred in the MP tray.

► **Troubleshooting method**

- 1) Clear the jammed paper. (**Refer to 4.1.3**)
If the problem persists, check the following.
- 2) Turn the machine off.
- 3) Remove the right cover.
- 4) Check if the MP Unit connector is connected properly.



- 5) Remove the MP Unit. (**Refer to 3.3.14**)
- 6) Check if the MP rollers are worn out. If necessary, replace the defective roller or MP unit.

▶ **Error Code**

M1-5112

M1-5113

M1-5120

▶ **Error message**

Paper is empty in tray 1.

Paper empty in all tray

▶ **Symptom**

There is no paper in the tray1. / Actuator-Paper Empty or photo sensor is defective.

▶ **Troubleshooting method**

- 1) Load the paper in the tray1.

If the problem persists, check the followings after turning the machine off.

- 2) If the Actuator-Paper Empty(*JC66-02762A*) is defective, replace it.

(Refer to 3.3.17)

- 3) If the photo sensor(*0604-001393*) is defective, replace it. Check if the connector is connected properly.

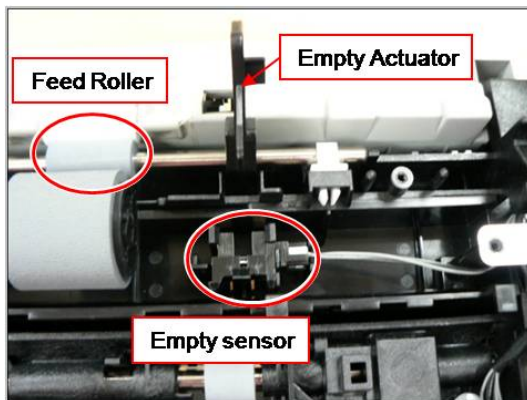

- 4) If the problem persists, replace the main board.

▶ **Error Code**

M1-5612

M1-5712

▶ **Error message**

Paper Empty in MP Tray.

▶ **Symptom**

There is no paper in the MP tray. / Actuator-Paper Empty or photo sensor is defective.

▶ **Troubleshooting method**

1) Load the paper in the tray1.

If the problem persists, check the followings after turning the machine off.

2) If the Actuator-Paper Empty([JC66-02762A](#)) is defective, replace it.

(Refer to 3.3.17)

3) If the photo sensor([0604-001393](#)) is defective, replace it. Check if the connector is connected properly.

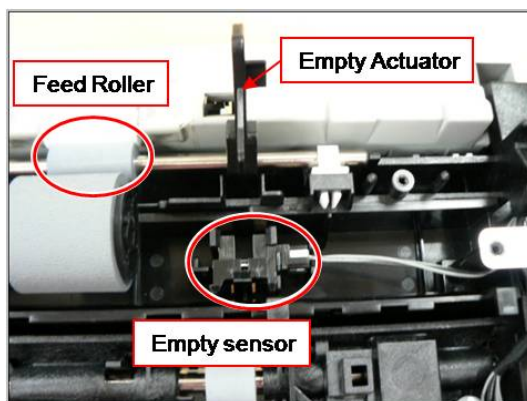

4) If the problem persists, replace the main board.

▶ **Error Code**

M2-1110

▶ **Error message**

Paper Jam inside machine.

▶ **Symptom**

A paper jam was detected at the feed sensor.

▶ **Troubleshooting method**

- 1) Remove the jammed paper. (**Refer to 4.1.3**)
If the error persists, check the followings.
- 2) Check if the feed sensor connector is connected properly.
(**Refer to 3.3.17**)

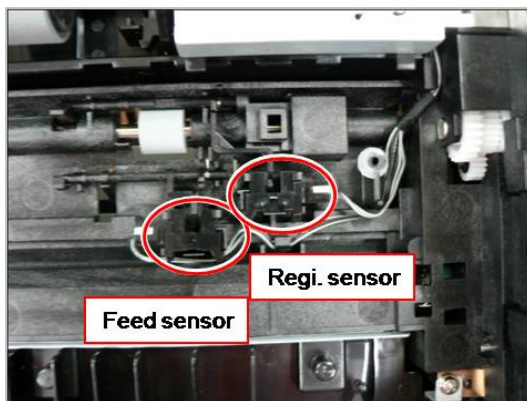

- 3) Check if the Regi roller is contaminated or worn out. If yes, replace it.
- 4) Check if there is any obstacles or contamination in the paper path. If yes, clean or remove it.

▶ Error Code

M2-2210

▶ Error message

Paper Jam bottom of duplex.

▶ Symptom

A paper jam was detected in the bottom of duplex.

▶ Troubleshooting method

- 1) Remove the jammed paper. (**Refer to 4.1.3**)
- 2) Remove the contamination or obstacles in the paper path.
- 3) If this jam error occur continually, replace the duplex unit.

▶ Error Code

M3-1110

▶ Error message

Paper Jam in exit area.

▶ Symptom

A paper jam was detected in the exit area.

▶ Troubleshooting method

- 1) Remove the jammed paper. (**Refer to 4.1.3**)
- 2) Check if there is any obstacles or contamination in the paper path. If yes, clean or remove it.
- 3) Check if the exit roller rubber is worn out. Replace the exit roller(*JC93-00323A*).
- 4) Check if the exit sensor connector is connected properly. If the connection is OK, replace the exit sensor.

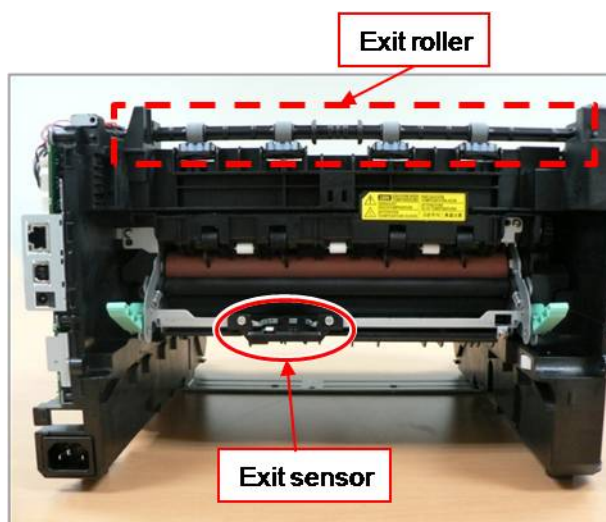

▶ **Error Code**

M3-2130

▶ **Error message**

Output bin full. Remove paper.

▶ **Symptom**

The machine detected that the output tray has got full or the bin-full sensor is defective.

▶ **Troubleshooting method**

- 1) Remove the paper on the output tray.
- 2) If the problem persists, check the followings.
- 3) Remove top cover.
- 4) Check if the Bin-full Sensor connector is connected properly. Reconnect it or replace the Bin-full sensor(
(Refer to 3.3.16))

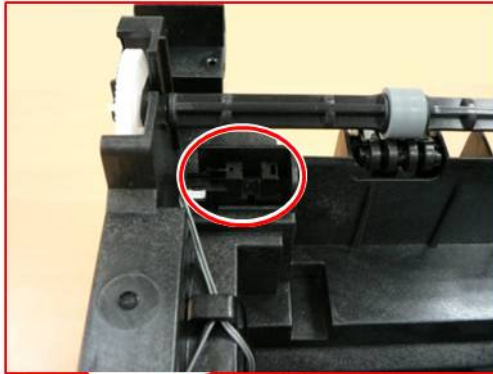

▶ Error Code

S2-331x

▶ Error message

Error: #S2-331x Turn off then on

▶ Symptom

This error shows the engine status.

▶ Troubleshooting method

- 1) S2-3310 : Warm-up status
- 2) S2-3311 : Ready status
- 3) S2-3312 : Printing status
- 4) S2-3313 : Power Save status
- 5) S2-3314 : Error status
- 6) S2-3315 : Recovery status
- 7) S2-3316 : Wait status
- 8) S2-3317 : EDC mode status
- 9) S2-3318 : Low power status

When these errors display, wait until the message will be disappeared or turn the machine off then on.

▶ **Error Code**

S2-4120

▶ **Error message**

Door open. Close it.

▶ **Symptom**

Door is open or the cover open switch is defective.

▶ **Troubleshooting method**

- 1) Check if the front door is closed correctly.
- 2) Check if the rear door is closed correctly.
- 3) Check if the connection between the main board and HVPS board is correct.
- 4) Check if the cover open switch on HVPS board is operated properly. If it is defective, replace the HVPS board([JC44-00197A](#)).

(Refer to 3.3.5)

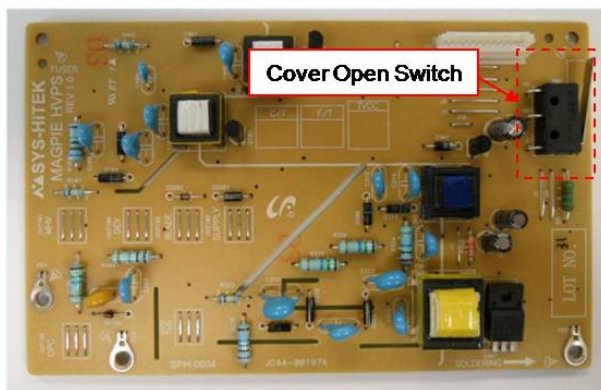

▶ Error Code

S6-3123

▶ Error message

Network Problem: IP Conflict.

▶ Symptom

IP address conflicts with that of other system. / There is no response when checking the ping test.

▶ Troubleshooting method

Change the machine's IP address.

- Set-up the IP address in this order, Network -> TCP/IP (IPv4) -> STATIC.
- In case of DHCP or Bootp, reboot the machine to receive a new IP address.

▶ Error Code

S6-3128

▶ Error message

802.1x Network Error.

▶ Symptom

The confirmation was requested for wired port, the server has rejected. / The confirmation protocol is not the same or user information (ID/Password) is wrong.

▶ Troubleshooting method

Check the setting-up for 802.1x confirmation server.

- Re-enter the server information and confirmation protocol.
- Re-enter the user information.

▶ Error Code

U1-2315

U1-2320

U1-2330

U1-2334

U1-2340

▶ Error message

Error #U1-2315 Turn off then on.

Error #U1-2320 Turn off then on.

Error #U1-2330 Turn off then on.

Error #U1-2334 Turn off then on.

Error #U1-2340 Turn off then on.

▶ Symptom

The temperature control of fuser unit is abnormal.

▶ Troubleshooting method

- 1) Turn the machine off. Re-install the fuser unit. Then turn the machine on. Is the error message is disappeared?
- 2) If the problem persists, turn the machine off and remove the fuser unit.

(Refer to 3.3.8)

- a) Check if the fuser connector is connected properly.
 - b) Check if the input voltage is normal.
 - c) Check if the thermistor is twisted or contaminated.
- 3) After confirming continuity in the fuser connector and the problem still exists; order an SMPS/HVPS and Fuser Unit and install as is necessary.
 - HVPS : *JC44-00197A*
 - SMPS : *JC44-00095D (110V) / JC44-00096D (220V)*
 - Fuser Unit : *JC91-01023A (110V) / JC91-01024A (220V)*

► Error Code

U2-1112

U2-1113

► Error message

Error #U2-1111 Turn off then on.

Error #U2-1113 Turn off then on.

► Symptom

LSU Motor does not work normally.

► Troubleshooting method

- 1) Execute the LSU motor test in EDC mode. Check LSU motor operation sound.
- 2) If there is no sound, remove the right cover. Check if the LSU harness is connected on the main board properly. (picture-1)
- 3) If it is OK, remove the top cover. Check if the LSU harness is connected on LSU board properly. (picture- 2,3)
- 4) Check if the LSU harness is defective. (picture-4)
- 5) Reconnect the LSU harness and then execute the LSU motor test again.
- 6) If the problem persists, replace the LSU([JC97-04065A](#)).
- 7) If the problem persists after replacing LSU, replace the main board.

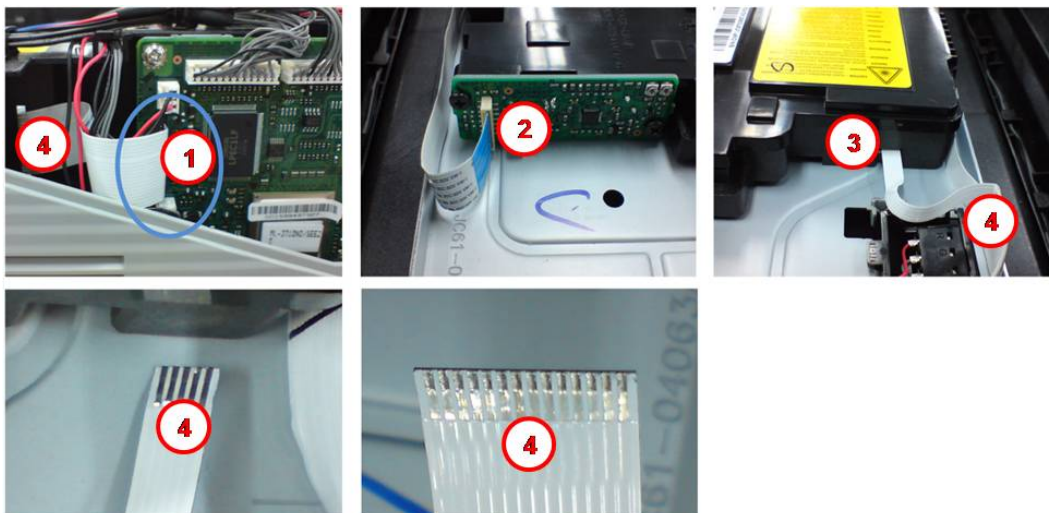

4.2.3. Image quality problem

1) **Vertical Black Line and Band**

Description : Straight thin black vertical line occurs in the printed image.



Check and cause	Solution
<ul style="list-style-type: none"> • Damaged develop roller in the toner system. Deformed Doctor-blade or cleaning-blade. • Scratched surface of the charge roller in the toner system. 	Replace the laser toner cartridge or imaging unit.
Partly depression or deformation on the surface of the transfer roller.	Replace the transfer roller.

2) **Vertical White Line**

Description : White vertical voids occurs in the printed image.



Check and cause	Solution
Foreign matter sticks onto the window of internal lenses of LSU mirror.	Clean the LSU window with recommended cleaner (IPA). Clean the window with a clean cotton swab.
The life of the laser toner cartridge or imaging unit has been expired	Replace the laser toner cartridge or imaging unit.
Some foreign substances are on the window of the imaging unit frame.	Remove the foreign matter of the exposure window.
If the fuser is defective, voids occur periodically at the top of a black image.	Open the rear cover. Reinstall the fuser unit.

3) Horizontal Black Band

Description : Dark or blurry horizontal stripes occur in the printing periodically.



Check and cause	Solution
Bad contacts of the voltage terminals to toner system.	Clean each voltage terminal of the Charge, Developing roller and Transfer roller. (remove the toner particles and paper particles)
The rollers of developer may be stained. <ul style="list-style-type: none"> • OPC Drum = 76 mm • Charge Roller = 34.5 mm • Developing Roller = 37 mm 	Replace the laser toner cartridge or imaging unit.

4) Black and White spot

Description : Dark or blurry black spots occur periodically in the printing.



Check and cause	Solution
If dark or blurry black spots occur periodically, the rollers in the Imaging unit may be contaminated with foreign matter or paper particles. <ul style="list-style-type: none"> • OPC Drum = 76 mm • Charge Roller = 34.5 mm • Developing Roller = 37 mm 	Clean each voltage terminal of the Charge, Developing roller and Transfer roller. (remove the toner particles and paper particles)
If faded areas or voids occur in a black image at intervals of 76 mm, the OPC drum surface is damaged.	Replace the laser toner cartridge or imaging unit.
If a black image is partially broken, the transfer voltage is abnormal or the transfer roller's life has expired.	<ul style="list-style-type: none"> • If the transfer roller's life is expired, replace it. • Clean the inside of the set against the paper particles and foreign matter in order not to cause the trouble.

5) **Light image**

Description : The printed image is light, with no ghost.



Check and cause	Solution
Toner cartridge life is expired.	Replace the toner cartridge.
HVPS terminal is contaminated.	Clean the contaminated terminal.
The output from the HVPS is abnormal.	Replace the HVPS board.

6) **Dark or Black page**

Description : The printed image is dark or black.



Check and cause	Solution
Check if the high voltage terminal is contaminated.	Clean the high voltage terminal.
The charging roller is defective.	Replace the laser toner cartridge or imaging unit.
The output from the HVPS is abnormal.	Replace the HVPS board.

7) **Uneven Density**

Description : Print density is uneven between left and right.



Check and cause	Solution
<ul style="list-style-type: none"> The pressure force on the left and right springs of the transfer roller is not even. The springs are damaged. The transfer roller is improperly installed. 	<ol style="list-style-type: none"> Remove the transfer roller Assy. Check if the transfer roller Assy has any wrong part. Replace the transfer roller Assy.
The toner level is not even on the imaging unit roller due to the bad blade.	Replace the laser toner cartridge or imaging unit.

8) **Background**

Description : Light dark background appears in whole area of the printing.



Check and cause	Solution
Does recycle paper be used?	Use the proper papers.
The life of the laser toner cartridge or imaging unit has been expired	Replace the laser toner cartridge or imaging unit.
The output from the HVPS is abnormal.	Replace the HVPS board.

9) **Ghost**

Description : Ghost occurs at 76 mm intervals of the OPC drum.



Check and cause	Solution
The high voltage terminal is contaminated.	Clean the high voltage terminals.
The life of the laser toner cartridge or imaging unit has been expired	Replace the laser toner cartridge or imaging unit.
The life of the transfer roller has been expired.	Replace the transfer roller.

10) **Stains on back of page**

Description : The back of the page is stained.



Check and cause	Solution
Transfer roller is contaminated.	Replace the transfer roller.

11) **Blank page**

Description : The back of the page is stained.



Check and cause	Solution
The ground contact of laser toner cartridge or imaging unit is bad.	Clean the ground terminal of laser toner cartridge or imaging unit. If the problem persists, replace it.
LSU is defective.	Replace the LSU.
The connection between the main board and HVPS board is bad.	Reconnect the harness. If the main board or HVPS board is defective, replace it.

12) **Partial image void**

Description : The partial void occurs in the printed page.



Check and cause	Solution
The printer is not installed on flat ground.	Install the printer on flat ground. Print 10 sample pages for test.
The developer circulation in the laser toner cartridge or imaging unit is bad.	<ol style="list-style-type: none"> 1) Shake the laser toner cartridge or imaging unit 2~3 times from right to left. Reinstall it. Print 10 sample pages for test. 2) If the problem persists, replace the laser toner cartridge or imaging unit.
The contact between imaging unit and transfer roller is bad.	Check if the imaging unit and transfer roller are installed properly.

4.2.4. Other errors

1) Multi-feeding

- Description : Multiple sheet of paper are fed at once.

Check and cause	Solution
Pick clutch or Regi clutch does not work properly.	Replace the defective clutch if necessary.
Pick up/ Forward / Retard roller is worn out or contaminated.	Clean or replace the defective roller.

2) No-Power

- Description : When system power is turned on, LED and LCD on the operator panel do not come on.

Check and cause	Solution
The connection between main board and OPE board is bad.	Reconnect or replace the harness.
HVPS/SMPS output is abnormal.	Replace the HVPS/SMPS board.

3) Calibrating the touch screen (Touch screen model only)

- Description : Touch screen does not operate properly.

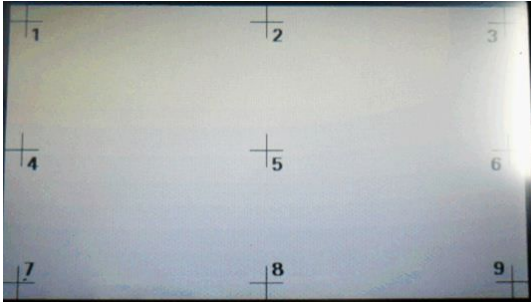
Check and cause	Solution
The linearity value for touch panel has changed due to using a machine long hours or surroundings.	<ol style="list-style-type: none"> 1) Turn off the machine. 2) While pressing the number 0 on numeric keys, turn the machine on. Wait until calibration screen appears. 3) Press centre of mark + following order 1~9. Use your finger. Perform 2 times.  <ol style="list-style-type: none"> 4) If there is no problem, "Complete" will appear on LCD and reboot the machine. When making a mistake, start again from the step 1.

5. System Diagram

5.1. Block Diagram (ProXpress M332x_382x_402xND)

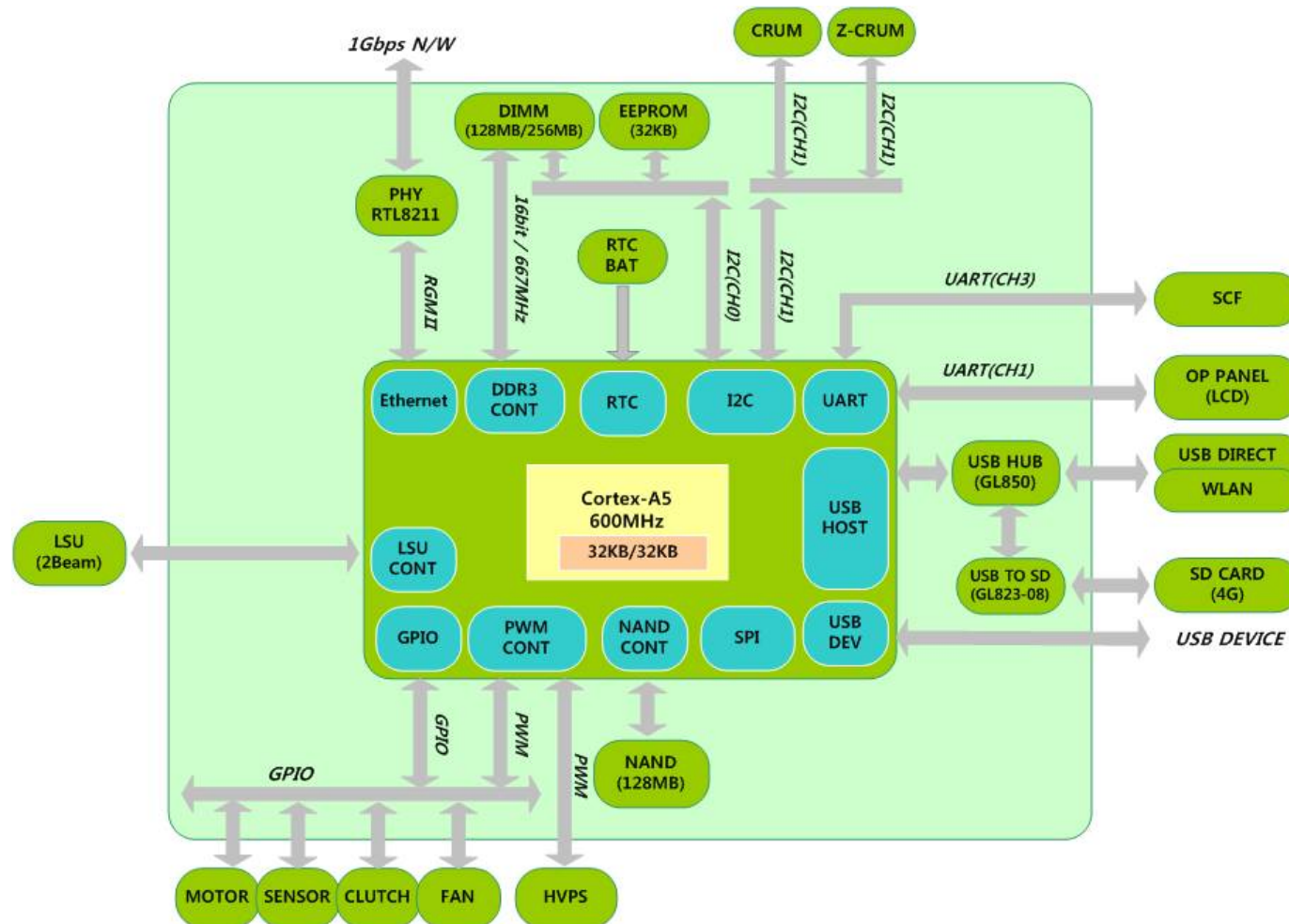

5.2. Block Diagram (ProXpress M402xNX)

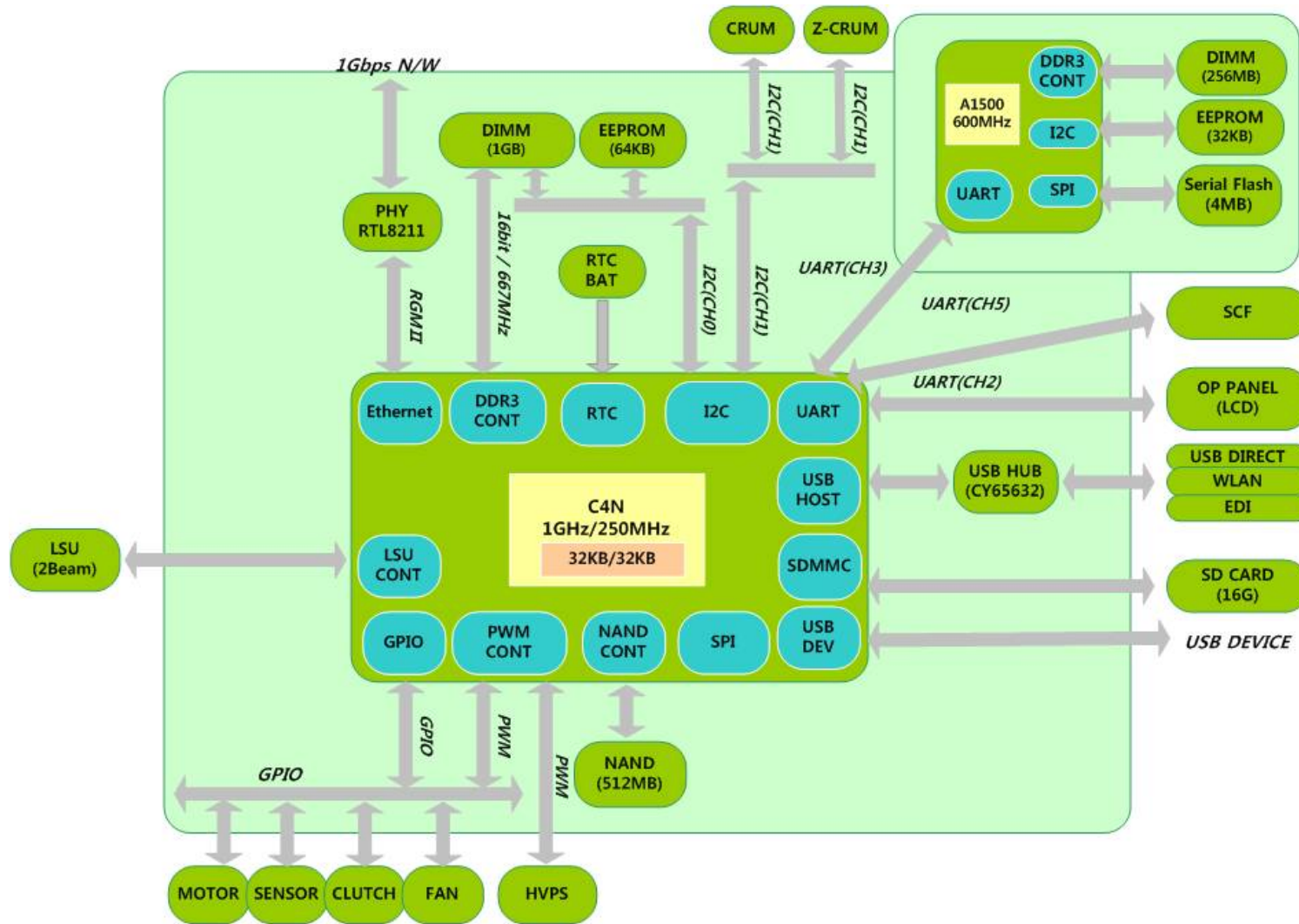

5.3. Connection Diagram (ProXpress M332x_M382x_M402xND)

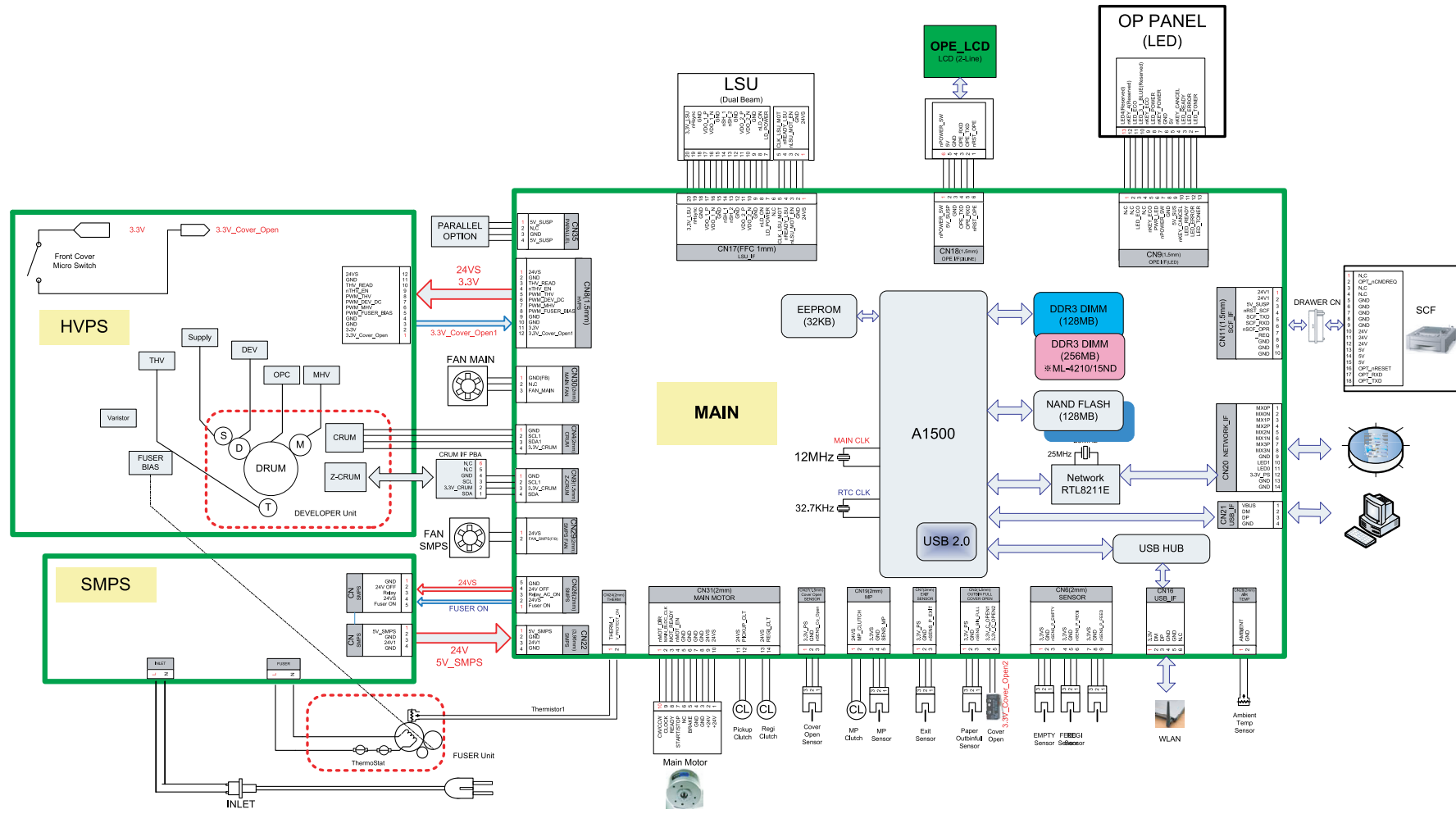

5.4. Connection Diagram (ProXpress M402xNX)

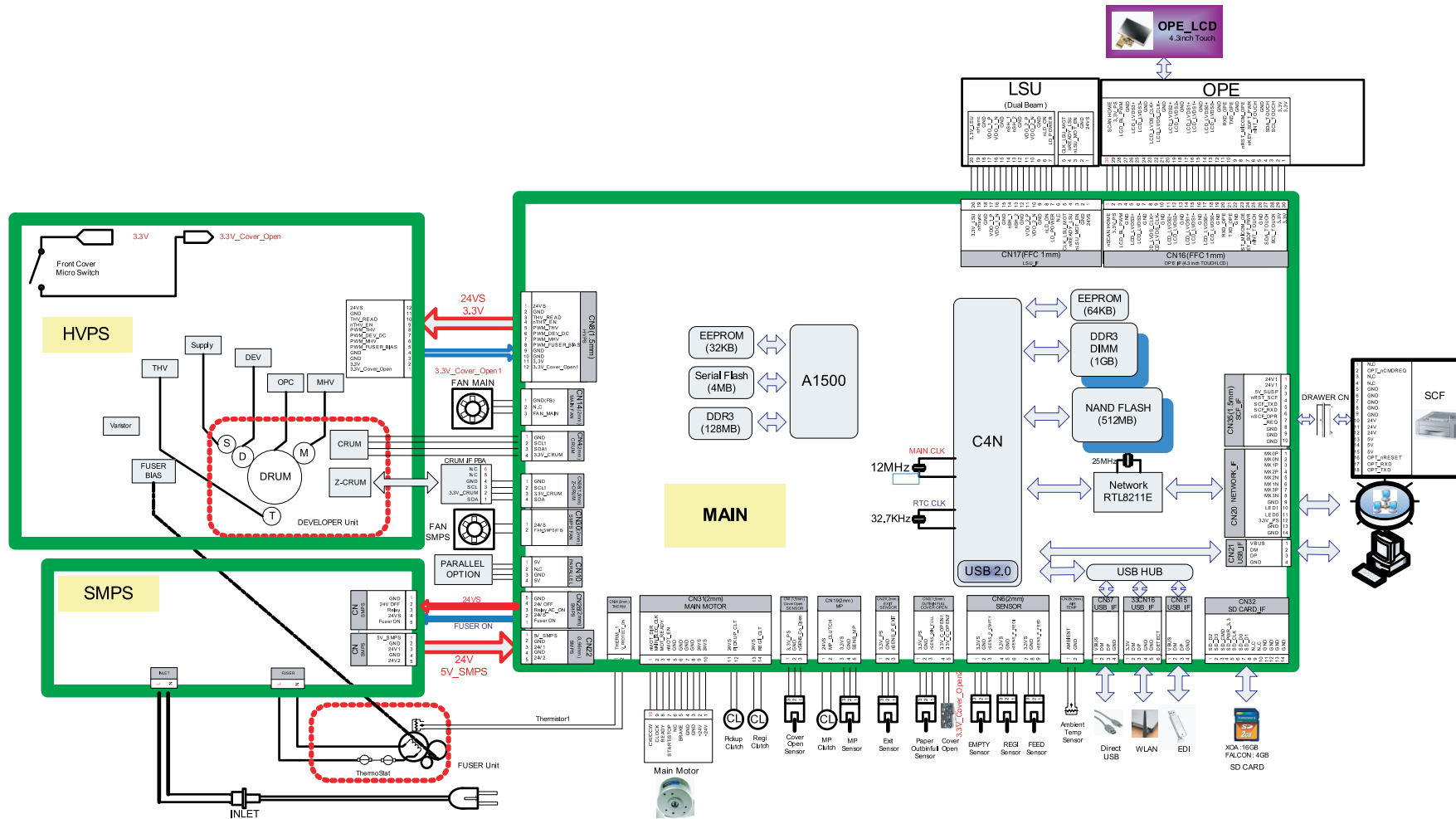





6. Reference Information

This chapter contains the tools list, list of abbreviations used in this manual, and a guide to the location space required when installing the printer. A definition of test pages and Wireless Network information definition is also included.

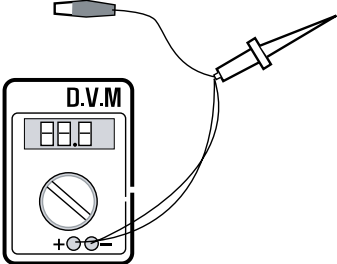
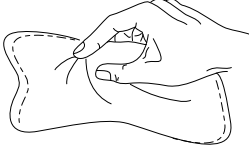
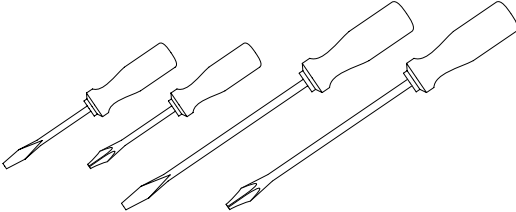
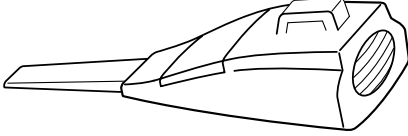
6.1. Tool for Troubleshooting

The following tools are recommended safe and easy troubleshooting as described in this service manual.

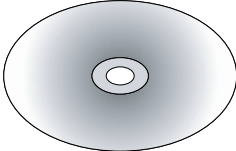
<p>DVM (Digital Volt Meter) Standard : Indicates more than 3 digits.</p> 	<p>Cleaning Equipments Standard : An IPA (Isopropyl Alcohol) dry wipe tissue or a gentle neutral detergent and lint-free cloth.</p> 
<p>Driver Standard : “-” type, “+” type (M3 long, M3 short, M2 long, M2 short).</p> 	<p>Vacuum Cleaner</p> 
<p>Tweezers Standard : For general home use, small type.</p> 	<p>Spring Hook Standard : For general use</p> 
<p>Cotton Swab Standard : For general home use, for medical service.</p> 	<p>Software (Driver) installation CD ROM</p> 

6.2. Glossary

The following glossary helps you get familiar with the product by understanding the terminologies commonly used with printing as well as mentioned in this user's guide and service manual.

802.11	802.11 is a set of standards for wireless local area network (WLAN) communication, developed by the IEEE LAN/MAN Standards Committee (IEEE 802).
802.11b/g/n	802.11b/g/n can share same hardware and use the 2.4 GHz band. 802.11b supports bandwidth up to 11 Mbps, 802.11n supports bandwidth up to 150 Mbps. 802.11b/g/n devices may occasionally suffer interference from microwave ovens, cordless telephones, and Bluetooth devices.
Access point	Access Point or Wireless Access Point (AP or WAP) is a device that connects wireless communication devices together on wireless local area networks (WLAN), and acts as a central transmitter and receiver of WLAN radio signals.
ADF	An Automatic Document Feeder (ADF) is a scanning unit that will automatically feed an original sheet of paper so that the machine can scan some amount of the paper at once.
AppleTalk	AppleTalk is a proprietary suite of protocols developed by Apple, Inc for computer networking. It was included in the original Macintosh (1984) and is now deprecated by Apple in favor of TCP/IP networking.
BIT Depth	A computer graphics term describing the number of bits used to represent the color of a single pixel in a bitmapped image. Higher color depth gives a broader range of distinct colors. As the number of bits increases, the number of possible colors becomes impractically large for a color map. 1-bit color is commonly called as monochrome or black and white.
BMP	A bitmapped graphics format used internally by the Microsoft Windows graphics subsystem (GDI), and used commonly as a simple graphics file format on that platform.
BOOTP	Bootstrap Protocol. A network protocol used by a network client to obtain its IP address automatically. This is usually done in the bootstrap process of computers or operating systems running on them. The BOOTP servers assign the IP address from a pool of addresses to each client. BOOTP enables 'diskless workstation' computers to obtain an IP address prior to loading any advanced operating system.
CCD	Charge Coupled Device (CCD) is a hardware which enables the scan job. CCD Locking mechanism is also used to hold the CCD module to prevent any damage when you move the machine.
Collation	Collation is a process of printing a multiple-copy job in sets. When collation is selected, the device prints an entire set before printing additional copies.
Control Panel	A control panel is a flat, typically vertical, area where control or monitoring instruments are displayed. They are typically found in front of the machine.
Coverage	It is the printing term used for a toner usage measurement on printing. For example, 5% coverage means that an A4 sided paper has about 5% image or text on it. So, if the paper or original has complicated images or lots of text on it, the coverage will be higher and at the same time, a toner usage will be as much as the coverage.
CSV	Comma Separated Values (CSV). A type of file format, CSV is used to exchange data between disparate applications. The file format, as it is used in Microsoft Excel, has become a de facto standard throughout the industry, even among non-Microsoft platforms.
DADF	A Duplex Automatic Document Feeder (DADF) is a scanning unit that will automatically feed and turn over an original sheet of paper so that the machine can scan on both sides of the paper.
Default	The value or setting that is in effect when taking a printer out of its box state, reset, or initialized.
DHCP	A Dynamic Host Configuration Protocol (DHCP) is a client-server networking protocol. A DHCP server provides configuration parameters specific to the DHCP client host requesting, generally, information required by the client host to participate on an IP network. DHCP also provides a mechanism for allocation of IP addresses to client hosts.
DIMM	Dual Inline Memory Module (DIMM), a small circuit board that holds memory. DIMM stores all the data within the machine like printing data, received fax data.

DLNA	The Digital Living Network Alliance (DLNA) is a standard that allows devices on a home network to share information with each other across the network.
DNS	The Domain Name Server (DNS) is a system that stores information associated with domain names in a distributed database on networks, such as the Internet.
Dot Matrix Printer	A dot matrix printer refers to a type of computer printer with a print head that runs back and forth on the page and prints by impact, striking an ink-soaked cloth ribbon against the paper, much like a typewriter.
DPI	Dots Per Inch (DPI) is a measurement of resolution that is used for scanning and printing. Generally, higher DPI results in a higher resolution, more visible detail in the image, and a larger file size.
DRPD	Distinctive Ring Pattern Detection. Distinctive Ring is a telephone company service which enables a user to use a single telephone line to answer several different telephone numbers.
Duplex	A mechanism that will automatically turn over a sheet of paper so that the machine can print (or scan) on both sides of the paper. A printer equipped with a Duplex Unit can print on both sides of paper during one print cycle.
Duty Cycle	Duty cycle is the page quantity which does not affect printer performance for a month. Generally the printer has the lifespan limitation such as pages per year. The lifespan means the average capacity of print-outs, usually within the warranty period. For example, if the duty cycle is 48,000 pages per month assuming 20 working days, a printer limits 2,400 pages a day.
ECM	Error Correction Mode (ECM) is an optional transmission mode built into Class 1 fax machines or fax modems. It automatically detects and corrects errors in the fax transmission process that are sometimes caused by telephone line noise.
Emulation	Emulation is a technique of one machine obtaining the same results as another. An emulator duplicates the functions of one system with a different system, so that the second system behaves like the first system. Emulation focuses on exact reproduction of external behavior, which is in contrast to simulation, which concerns an abstract model of the system being simulated, often considering its internal state.
Ethernet	Ethernet is a frame-based computer networking technology for local area networks (LANs). It defines wiring and signaling for the physical layer, and frame formats and protocols for the media access control (MAC)/data link layer of the OSI model. Ethernet is mostly standardized as IEEE 802.3. It has become the most widespread LAN technology in use during the 1990s to the present.
EtherTalk	A suite of protocols developed by Apple Computer for computer networking. It was included in the original Macintosh (1984) and is now deprecated by Apple in favor of TCP/IP networking.
FDI	Foreign Device Interface (FDI) is a card installed inside the machine to allow a third party device such as a coin operated device or a card reader. Those devices allow the pay-for-print service on your machine.
FTP	A File Transfer Protocol (FTP) is a commonly used protocol for exchanging files over any network that supports the TCP/IP protocol (such as the Internet or an intranet).
Fuser Unit	The part of a laser printer that fuses the toner onto the print media. It consists of a heat roller and a pressure roller. After toner is transferred onto the paper, the fuser unit applies heat and pressure to ensure that the toner stays on the paper permanently, which is why paper is warm when it comes out of a laser printer.
Gateway	A connection between computer networks, or between a computer network and a telephone line. It is very popular, as it is a computer or a network that allows access to another computer or network.
Grayscale	A shades of gray that represent light and dark portions of an image when color images are converted to grayscale; colors are represented by various shades of gray.
Halftone	An image type that simulates grayscale by varying the number of dots. Highly colored areas consist of a large number of dots, while lighter areas consist of a smaller number of dots.
HDD	Hard Disk Drive (HDD), commonly referred to as a hard drive or hard disk, is a non-volatile storage device which stores digitally-encoded data on rapidly rotating platters with magnetic surfaces.

IEEE	The Institute of Electrical and Electronics Engineers (IEEE) is an international non-profit, professional organization for the advancement of technology related to electricity.
IEEE 1284	The 1284 parallel port standard was developed by the Institute of Electrical and Electronics Engineers (IEEE). The term "1284-B" refers to a specific connector type on the end of the parallel cable that attaches to the peripheral (for example, a printer).
Intranet	A private network that uses Internet Protocols, network connectivity, and possibly the public telecommunication system to securely share part of an organization's information or operations with its employees. Sometimes the term refers only to the most visible service, the internal website.
IP address	An Internet Protocol (IP) address is a unique number that devices use in order to identify and communicate with each other on a network utilizing the Internet Protocol standard.
IPM	The Images Per Minute (IPM) is a way of measuring the speed of a printer. An IPM rate indicates the number of single-sided sheets a printer can complete within one minute.
IPP	The Internet Printing Protocol (IPP) defines a standard protocol for printing as well as managing print jobs, media size, resolution, and so forth. IPP can be used locally or over the Internet to hundreds of printers, and also supports access control, authentication, and encryption, making it a much more capable and secure printing solution than older ones.
IPX/SPX	IPX/SPX stands for Internet Packet Exchange/Sequenced Packet Exchange. It is a networking protocol used by the Novell NetWare operating systems. IPX and SPX both provide connection services similar to TCP/IP, with the IPX protocol having similarities to IP, and SPX having similarities to TCP. IPX/SPX was primarily designed for local area networks (LANs), and is a very efficient protocol for this purpose (typically its performance exceeds that of TCP/IP on a LAN).
ISO	The International Organization for Standardization (ISO) is an international standard-setting body composed of representatives from national standards bodies. It produces world-wide industrial and commercial standards.
ITU-T	The International Telecommunication Union is an international organization established to standardize and regulate international radio and telecommunications. Its main tasks include standardization, allocation of the radio spectrum, and organizing interconnection arrangements between different countries to allow international phone calls. A -T out of ITU-T indicates telecommunication.
ITU-T No. 1 chart	Standardized test chart published by ITU-T for document facsimile transmissions.
JBIG	Joint Bi-level Image Experts Group (JBIG) is an image compression standard with no loss of accuracy or quality, which was designed for compression of binary images, particularly for faxes, but can also be used on other images.
JPEG	Joint Photographic Experts Group (JPEG) is a most commonly used standard method of lossy compression for photographic images. It is the format used for storing and transmitting photographs on the World Wide Web.
LDAP	The Lightweight Directory Access Protocol (LDAP) is a networking protocol for querying and modifying directory services running over TCP/IP.
LED	A Light-Emitting Diode (LED) is a semiconductor device that indicates the status of a machine.
MAC address	Media Access Control (MAC) address is a unique identifier associated with a network adapter. MAC address is a unique 48-bit identifier usually written as 12 hexadecimal characters grouped in pairs (e. g., 00-00-0c-34-11-4e). This address is usually hard-coded into a Network Interface Card (NIC) by its manufacturer, and used as an aid for routers trying to locate machines on large networks.
MFP	Multi Function Peripheral (MFP) is an office machine that includes the following functionality in one physical body, so as to have a printer, a copier, a fax, a scanner and etc.
MH	Modified Huffman (MH) is a compression method for decreasing the amount of data that needs to be transmitted between the fax machines to transfer the image recommended by ITU-T T.4. MH is a codebook-based run-length encoding scheme optimized to efficiently compress white space. As most faxes consist mostly of white space, this minimizes the transmission time of most faxes.
MMR	Modified Modified READ (MMR) is a compression method recommended by ITU-T T.6.

Modem	A device that modulates a carrier signal to encode digital information, and also demodulates such a carrier signal to decode transmitted information.
MR	Modified Read (MR) is a compression method recommended by ITUT T.4. MR encodes the first scanned line using MH. The next line is compared to the first, the differences determined, and then the differences are encoded and transmitted.
NetWare	A network operating system developed by Novell, Inc. It initially used cooperative multitasking to run various services on a PC, and the network protocols were based on the archetypal Xerox XNS stack. Today NetWare supports TCP/IP as well as IPX/SPX.
OPC	Organic Photo Conductor (OPC) is a mechanism that makes a virtual image for print using a laser beam emitted from a laser printer, and it is usually green or rust colored and has a cylinder shape. An imaging unit containing a drum slowly wears the drum surface by its usage in the printer, and it should be replaced appropriately since it gets worn from contact with the cartridge development brush, cleaning mechanism, and paper.
Originals	The first example of something, such as a document, photograph or text, etc, which is copied, reproduced or translated to produce others, but which is not itself copied or derived from something else.
OSI	Open Systems Interconnection (OSI) is a model developed by the International Organization for Standardization (ISO) for communications. OSI offers a standard, modular approach to network design that divides the required set of complex functions into manageable, self-contained, functional layers. The layers are, from top to bottom, Application, Presentation, Session, Transport, Network, Data Link and Physical.
PABX	A private automatic branch exchange (PABX) is an automatic telephone switching system within a private enterprise.
PCL	Printer Command Language (PCL) is a Page Description Language (PDL) developed by HP as a printer protocol and has become an industry standard. Originally developed for early inkjet printers, PCL has been released in varying levels for thermal, dot matrix printer, and laser printers.
PDF	Portable Document Format (PDF) is a proprietary file format developed by Adobe Systems for representing two dimensional documents in a device independent and resolution independent format.
PostScript(PS)	PostScript (PS) is a page description language and programming language used primarily in the electronic and desktop publishing areas. - that is run in an interpreter to generate an image.
Printer Driver	A program used to send commands and transfer data from the computer to the printer.
Print Media	The media like paper, envelopes, labels, and transparencies which can be used in a printer, a scanner, a fax or, a copier.
PPM	Pages Per Minute (PPM) is a method of measurement for determining how fast a printer works, meaning the number of pages a printer can produce in one minute.
PRN file	An interface for a device driver, this allows software to interact with the device driver using standard input/output system calls, which simplifies many tasks.
Protocol	A convention or standard that controls or enables the connection, communication, and data transfer between two computing endpoints.
PSTN	The Public-Switched Telephone Network (PSTN) is the network of the world's public circuit-switched telephone networks which, on industrial premises, is usually routed through the switchboard.
RADIUS	Remote Authentication Dial In User Service (RADIUS) is a protocol for remote user authentication and accounting. RADIUS enables centralized management of authentication data such as usernames and passwords using an AAA (authentication, authorization, and accounting) concept to manage network access.
Resolution	The sharpness of an image, measured in Dots Per Inch (DPI). The higher the dpi, the greater the resolution.
SMB	Server Message Block (SMB) is a network protocol mainly applied to share files, printers, serial ports, and miscellaneous communications between nodes on a network. It also provides an authenticated Interprocess communication mechanism.

SMTP	Simple Mail Transfer Protocol (SMTP) is the standard for e-mail transmissions across the Internet. SMTP is a relatively simple, text based protocol, where one or more recipients of a message are specified, and then the message text is transferred. It is a client server protocol, where the client transmits an email message to the server.
SSID	Service Set Identifier (SSID) is a name of a wireless local area network (WLAN). All wireless devices in a WLAN use the same SSID in order to communicate with each other. The SSIDs are case-sensitive and have a maximum length of 32 characters.
Subnet Mask	The subnet mask is used in conjunction with the network address to determine which part of the address is the network address and which part is the host address.
TCP/IP	The Transmission Control Protocol (TCP) and the Internet Protocol (IP); the set of communications protocols that implement the protocol stack on which the Internet and most commercial networks run.
TCR	Transmission Confirmation Report (TCR) provides details of each transmission such as job status, transmission result and number of pages sent. This report can be set to print after each job or only after failed transmissions.
TIFF	Tagged Image File Format (TIFF) is a variable-resolution bitmapped image format. TIFF describes image data that typically come from scanners. TIFF images make use of tags, keywords defining the characteristics of the image that is included in the file. This flexible and platform-independent format can be used for pictures that have been made by various image processing applications.
Toner Cartridge	A kind of bottle or container used in a machine like a printer which contains toner. Toner is a powder used in laser printers and photocopiers, which forms the text and images on the printed paper. Toner can be fused by a combination of heat/pressure from the fuser, causing it to bind to the fibers in the paper.
TWAIN	An industry standard for scanners and software. By using a TWAIN-compliant scanner with a TWAIN-compliant program, a scan can be initiated from within the program. It is an image capture API for Microsoft Windows and Apple Macintosh operating systems.
UNC Path	Uniform Naming Convention (UNC) is a standard way to access network shares in Window NT and other Microsoft products. The format of a UNC path is: \\<servername>\<sharename>\<Additional directory>
URL	Uniform Resource Locator (URL) is the global address of documents and resources on the Internet. The first part of the address indicates what protocol to use, the second part specifies the IP address or the domain name where the resource is located.
USB	Universal Serial Bus (USB) is a standard that was developed by the USB Implementers Forum, Inc., to connect computers and peripherals. Unlike the parallel port, USB is designed to concurrently connect a single computer USB port to multiple peripherals.
Watermark	A watermark is a recognizable image or pattern in paper that appears lighter when viewed by transmitted light. Watermarks were first introduced in Bologna, Italy in 1282; they have been used by papermakers to identify their product, and also on postage stamps, currency, and other government documents to discourage counterfeiting.
WEP	Wired Equivalent Privacy (WEP) is a security protocol specified in IEEE 802.11 to provide the same level of security as that of a wired LAN. WEP provides security by encrypting data over radio so that it is protected as it is transmitted from one end point to another.
WIA	Windows Imaging Architecture (WIA) is an imaging architecture that is originally introduced in Windows Me and Windows XP. A scan can be initiated from within these operating systems by using a WIA-compliant scanner.
WPA	Wi-Fi Protected Access (WPA) is a class of systems to secure wireless (Wi-Fi) computer networks, which was created to improve upon the security features of WEP.
WPA-PSK	WPA-PSK (WPA Pre-Shared Key) is special mode of WPA for small business or home users. A shared key, or password, is configured in the wireless access point (WAP) and any wireless laptop or desktop devices. WPA-PSK generates a unique key for each session between a wireless client and the associated WAP for more advanced security.

WPS	The Wi-Fi Protected Setup (WPS) is a standard for establishing a wireless home network. If your wireless access point supports WPS, you can configure the wireless network connection easily without a computer.
XPS	XML Paper Specification (XPS) is a specification for a Page Description Language (PDL) and a new document format, which has benefits for portable document and electronic document, developed by Microsoft. It is an XML-based specification, based on a new print path and a vector-based device-independent document format.

6.3. The Sample Pattern for the Test

The life of the toner cartridge and the printing speed are measured using the pattern shown below.

Stephen J. Singel
Labanda Sinpat Abarress
Tendar, BSF
URANGLE

23 January 2004

Jonathan Q. Maderia

Inpert Mampem Abareess
2343 Stantin Dawer Lank
Benhibe, SDF

Mr.Maderia:

Nam liber tempor cum soluta nobis eleifend ption cogue nihil consequat, velillum.
Dolore eu zril feugiat nulla acilisis at vero eros accumsan et iusto odio dignis sim qui blandit
praesent lutatum ril lobortis nisl ut aliquip exea commodo consequat. Duis autem vel eum ireure
dolor in hendreritin vulputate velit esse molestie tincidunt ut laoreet dolore magna aliquam erat
volutpat. Ut wisi enim ad minim veniam, quis nostrud exerci tation ullam corpersus cipit lotis nisi
ut aliquip ex ea commodo consequat. Lorem ipsum dolor sit.

Amet, consectetuer adipiscing elit, sud diam nonummy nibh veniam,
recneps adipiscing elit, sed diam nonummy nibtil laoreet dolore mag
aliam erat volutpat. Ut wisi enim minim veniam, quisient nostrud. Sol
uta nobis eleifendoptn cogue nihil imerdiet domg id quod mzim plera
facer posim aum. Lorem ipsm dolor sit amet, consectuer. Duis autem
eum iriure dolor in hendreritin vulputate velit cesse ea commodo mol

Category	Value
B	High
C	Medium-High
D	Medium
E	Low

Nam liber tempor cum soluta nobis eleifend option cogue nihil consequat, velillum.
Dolore eu zril feugiat nulla facilisis at vero eros accumsan et iusto odio dignissim qui blandit
praesent.

Singabet,

Stephen J. Singel
Demperta Aminerimum
Labanda Sinpat Abarress

SJS:dwg
FINAL

6.4. Model Name and Code

1) Sub brand name Information

- Applying Independent sub brand name by Segment : Xpress / ProXpress / MultiXpress



2) Model code Information

- Basic Structure : [SL-●○○■□◆◆]

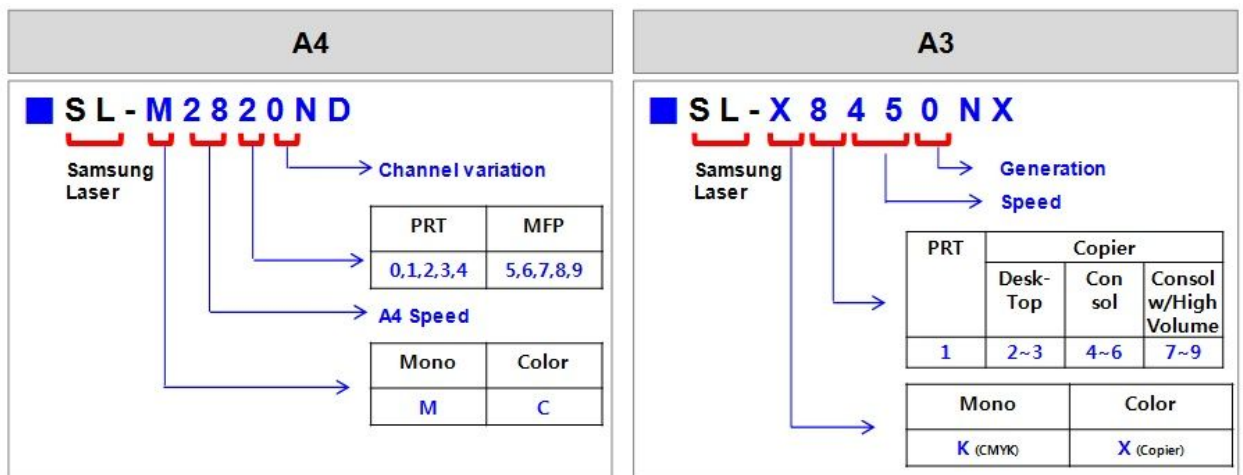

- ◆◆ : Function Information

	Function
N	Network
W	Wireless Network
D	Duplex Printing
R	Reverse Type ADF
F	Fax
X	XOA (eXtensible Open Architecture)
H	Handset
A	Auto Document Feeder

6.5. Document Revision List

Version	Date	Page	Description
1.00	22/Mar/2013	-	Release
1.10	26/Apr/2013	P.4-28	Modify tech mode menu.
1.20	08/Jul/2013	-	XOA update
1.30	18/Nov/2013	P.4-57	Engine Status error code(S2-331x) add
1.31	26/May/2015	P.2-25	Main PBA code is changed.
1.32	05/Jan/2016	P.2-8	Modify separation roller part code. (JC90-01032A → JC90-01063B)
1.33	23/Jan/2017	P.1-1	Change LSU label image.



GSPN (GLOBAL SERVICE PARTNER NETWORK)

Area	Web Site
Europe, MENA, CIS, Africa	https://gspn1.samsungcsportal.com
E.Asia, W.Asia, China, Japan	https://gspn2.samsungcsportal.com
N.America, S.America	https://gspn3.samsungcsportal.com

This Service Manual is a property of Samsung Electronics Co.,Ltd.
Any unauthorized use of Manual can be punished under applicable International and/or domestic law.

© 2016 Samsung Electronics Co.,Ltd.
All rights reserved.
Printed in Korea