



# Mono Laser Printer

ProXpress M4030 series

**SL-M4030ND**

(Ver 1.00)

# ***SERVICE*** *MANUAL*

Mono Laser Printer

Contents



1. Precautions
2. Product Specifications and Description
3. Disassembly and Reassembly
4. Troubleshooting
5. System Diagram
6. Reference Information

Refer to the service manual in the GSPN (see the rear cover) for more information.

# Contents

---

1.	Precautions .....	1 – 1
1.1.	Safety warning .....	1 – 1
1.2.	Caution for safety .....	1 – 2
1.2.1.	Toxic material.....	1 – 2
1.2.2.	Electric shock and fire safety precautions .....	1 – 2
1.2.3.	Handling precautions .....	1 – 4
1.2.4.	Assembly and Disassembly precautions .....	1 – 4
1.2.5.	Disregarding this warning may cause bodily injury .....	1 – 5
1.3.	ESD precautions.....	1 – 6
2.	Product Specifications and Description.....	2 – 1
2.1.	Product Overview .....	2 – 1
2.2.	Specifications.....	2 – 2
2.2.1.	General .....	2 – 2
2.2.2.	Print specification.....	2 – 4
2.2.3.	Paper Handling specification.....	2 – 5
2.2.4.	Software and Solution .....	2 – 7
2.2.5.	Supplies.....	2 – 8
2.2.6.	Maintenance Part.....	2 – 8
2.2.7.	Option.....	2 – 9
2.3.	System Configuration .....	2 – 10
2.4.	Feeding System .....	2 – 14
2.4.1.	Feeding System Overview.....	2 – 14
2.4.2.	Cassette .....	2 – 17
2.4.3.	Pick-Up Unit .....	2 – 18
2.4.4.	MPF(Multi-Purpose Feeder) Unit .....	2 – 18
2.5.	Image Creation.....	2 – 19
2.5.1.	Printing process overview .....	2 – 19
2.5.2.	Toner Cartridge .....	2 – 20
2.6.	Fuser unit.....	2 – 21
2.7.	Laser Scanning Unit (LSU).....	2 – 22
2.7.1.	Laser Scanning Unit Overview.....	2 – 22
2.7.2.	Laser Scanning Optical path .....	2 – 23
2.8.	Drive System .....	2 – 24
2.8.1.	Drive Motors .....	2 – 24
2.8.2.	Main Drive Unit.....	2 – 25
2.8.3.	Exit Drive Unit .....	2 – 26
2.8.4.	Tray Lifting Drive Unit.....	2 – 27
2.9.	Hardware Configuration.....	2 – 28

2.9.1.	Main board.....	2 – 30
2.9.2.	OPE.....	2 – 31
2.9.3.	SO-DIMM PBA.....	2 – 33
2.9.4.	CRUM PBA.....	2 – 33
2.9.5.	SCF board.....	2 – 34
2.9.6.	NFC Optional Board (SL-NWE001X).....	2 – 35
2.9.7.	SMPS board.....	2 – 36
2.9.8.	HVPS board.....	2 – 38
2.9.9.	Electrical Parts Location.....	2 – 40
3.	Disassembly and Reassembly.....	3 – 1
3.1.	Precautions when replacing parts.....	3 – 1
3.1.1.	Precautions when assembling and disassembling.....	3 – 1
3.1.2.	Precautions when handling PBA.....	3 – 1
3.1.3.	Releasing Plastic Latches.....	3 – 2
3.2.	Replacing the maintenance part.....	3 – 3
3.2.1.	Fuser Unit.....	3 – 3
3.2.2.	Transfer Roller.....	3 – 5
3.2.3.	Separation Roller.....	3 – 6
3.2.4.	Pick-up Roller and Forward Roller.....	3 – 7
3.2.5.	SCF Separation Roller.....	3 – 8
3.2.6.	SCF Pick-up Roller and Forward Roller.....	3 – 9
3.3.	Replacing the main SVC part.....	3 – 10
3.3.1.	Right Cover.....	3 – 10
3.3.2.	Left Cover.....	3 – 11
3.3.3.	Rear Cover.....	3 – 12
3.3.4.	Main Board.....	3 – 13
3.3.5.	HVPS Board.....	3 – 14
3.3.6.	SMPS Board.....	3 – 15
3.3.7.	Duplex Motor.....	3 – 16
3.3.8.	Fuser Drive Unit.....	3 – 17
3.3.9.	Main Drive Unit.....	3 – 18
3.3.10.	CST-Lifting Drive Unit.....	3 – 19
3.3.11.	Paper Size Sensor.....	3 – 20
3.3.12.	OPE Board.....	3 – 21
3.3.13.	LSU.....	3 – 22
3.3.14.	Exit Unit.....	3 – 23
3.3.15.	Bin-Full Sensor.....	3 – 24
3.3.16.	MP Unit.....	3 – 25
3.3.17.	MP Roller.....	3 – 27
3.3.18.	Second Cassette Feeder (Optional Tray).....	3 – 28

3.3.18.1.	PBA-SCF .....	3 – 28
3.3.18.2.	Lift Unit .....	3 – 29
3.3.18.3.	Clutch .....	3 – 30
3.3.18.4.	Drive Unit .....	3 – 31
4.	Troubleshooting .....	4 – 1
4.1.	Control panel .....	4 – 1
4.2.	Understanding the LEDs .....	4 – 2
4.3.	Updating Firmware .....	4 – 3
4.3.1.	Update the firmware by using the USB port .....	4 – 3
4.3.2.	Updating from the Network .....	4 – 4
4.4.	Clearing paper jams.....	4 – 8
4.5.	Useful management tools .....	4 – 22
4.5.1.	SyncThru™ Web Service .....	4 – 22
4.5.2.	Samsung Easy Printer Manager .....	4 – 25
4.6.	Service Mode.....	4 – 27
4.7.	Troubleshooting .....	4 – 32
4.7.1.	Procedure of checking the symptoms.....	4 – 32
4.7.2.	Error Code and Troubleshooting.....	4 – 33
4.7.2.1.	11–2Txx (Paper Mismatch error).....	4 – 37
4.7.2.2.	Ax-xxxx (Motor_Fan_Sensor error).....	4 – 38
4.7.2.3.	Cx-xxxx (Toner Cartridge error).....	4 – 41
4.7.2.4.	H1-xxxx (Optional Cassette error).....	4 – 44
4.7.2.5.	Mx-xxxx (Jam_Paper handling error).....	4 – 55
4.7.2.6.	Sx-xxxx (System error) .....	4 – 62
4.7.2.7.	U1-xxxx (Fuser error) .....	4 – 67
4.7.2.8.	U2-xxxx type (LSU) error code.....	4 – 68
4.7.3.	Image quality problem.....	4 – 69
4.7.4.	Other errors.....	4 – 83
5.	System Diagram.....	5 – 1
5.1.	Block Diagram.....	5 – 1
5.2.	Connection Diagram.....	5 – 2
6.	Reference Information.....	6 – 1
6.1.	Tool for Troubleshooting.....	6 – 1
6.2.	Glossary.....	6 – 2
6.3.	The Sample Pattern for the Test .....	6 – 8
6.4.	Model Name and Code .....	6 – 9
6.5.	Document Revision List.....	6 – 10

# 1. Precautions

In order to prevent accidents and damages to the equipment please read the precautions listed below carefully before servicing the product and follow them closely.

## 1.1. Safety warning

- 1) Only to be serviced by a factory trained service technician.

High voltages and lasers inside this product are dangerous. This product should only be serviced by a factory trained service technician.

- 2) Use only Samsung replacement parts.

There are no user serviceable parts inside the product. Do not make any unauthorized changes or additions to the product as these could cause the product to malfunction and create an electric shocks or fire hazards.

- 3) Laser Safety Statement

The printer is certified in the U.S. to conform to the requirements of DHHS 21 CFR, chapter 1 Subchapter J for Class I(1) laser products, and elsewhere is certified as a Class I laser product conforming to the requirements of IEC/EN 60825-1:2014. Class I laser products are not considered to be hazardous. The laser system and printer are designed so there is never any human access to laser radiation above a Class I level during normal operation, user maintenance or prescribed service condition.

- Wavelength: 800 nm
- Beam divergence
  - Parallel: 11 degrees
  - Perpendicular: 35 degrees
- Maximum power of energy output: 12 mW



### WARNING

**Never operate or service the product with the protective cover removed from Laser/Scanner assembly. The reflected beam, although invisible, can damage your eyes.**

**When using this product, these basic safety precautions should always be followed to reduce risk of fire, electric shock, and personal injury.**



- 4) Lithium battery not replaceable by user

## 1.2. Caution for safety

---

### 1.2.1. Toxic material

---

This product contains toxic materials that could cause illness if ingested.

- 1) Please keep imaging unit and toner cartridge away from children. The toner powder contained in the imaging unit and toner cartridge may be harmful, and if swallowed, you should contact a doctor.

### 1.2.2. Electric shock and fire safety precautions

---

Failure to follow the following instructions could cause electric shock or potentially cause a fire.

- 1) Use only the correct voltage, failure to do so could damage the product and potentially cause a fire or electric shock.
- 2) Use only the power cable supplied with the product. Use of an incorrectly specified cable could cause the cable to overheat and potentially cause a fire.
- 3) Do not overload the power socket, this could lead to overheating of the cables inside the wall and could lead to a fire.
- 4) Do not allow water or other liquids to spill into the product, this can cause electric shock. Do not allow paper clips, pins or other foreign objects to fall into the product, these could cause a short circuit leading to an electric shock or fire hazard.

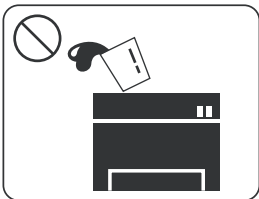

- 5) Never touch the plugs on either end of the power cable with wet hands, this can cause electric shock. When servicing the product, remove the power plug from the wall socket.

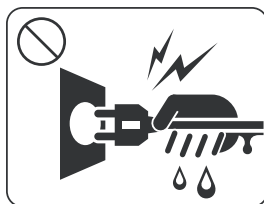

- 6) Use caution when inserting or removing the power cord. When removing the power cord, grip it firmly and pull. The power cord must be inserted completely, otherwise a poor contact could cause overheating leading to a fire.
- 7) Take care of the power cable. Do not allow it to become twisted, bent sharply around corners or power cable may be damaged. Do not place objects on top of the power cable. If the power cable is damaged it could overheat and cause a fire. Exposed cables could cause an electric shock. Replace the damaged power cable immediately, do not reuse or repair the damaged cable. Some chemicals can attack the coating on the power cable, weakening the cover or exposing cables causing fire and shock risks.

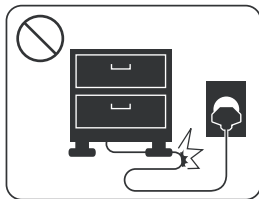

- 8) Ensure that the power sockets and plugs are not cracked or broken in any way. Any such defects should be repaired immediately. Take care not to cut or damage the power cable or plugs when moving the machine.
- 9) Use caution during thunder or lightning storms. Samsung recommends that this machine be disconnected from the power source when such weather conditions are expected. Do not touch the machine or the power cord if it is still connected to the wall socket in these weather conditions.

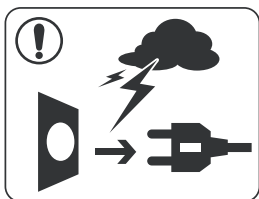

- 10) Avoid damp or dusty areas, install the product in a clean well ventilated location. Do not position the machine near a humidifier or in front of an air conditioner. Moisture and dust built up inside the machine can lead to overheating and cause a fire or cause parts to rust.

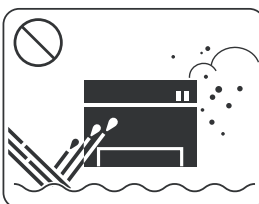

- 11) Do not position the product in direct sunlight. This will cause the temperature inside the product to rise possibly leading to the product failing to work properly and in extreme conditions could lead to a fire.
- 12) Do not insert any metal objects into the machine through the ventilator fan or other part of the casing, it could make contact with a high voltage conductor inside the machine and cause an electric shock.

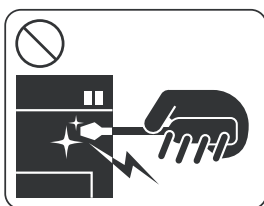

- 13)  When replacing the SMPS board, please wait 5 minutes after unplugging the power cord, then replace it. You can get a shock by the electric discharge.

### 1.2.3. Handling precautions

---

The following instructions are for your own personal safety to avoid injury and so as not to damage the product.

- 1) Ensure the product is installed on a level surface, capable of supporting its weight. Failure to do so could cause the product to tip or fall.
- 2) The product contains many rollers, gears and fans. Take great care to ensure that you do not catch your fingers, hair or clothing in any of these rotating devices.
- 3) Do not place any small metal objects, containers of water, chemicals or other liquids close to the product which if spilled could get into the machine and cause damage or a shock or fire hazard.
- 4) Do not install the machine in areas with high dust or moisture levels, beside an open window or close to a humidifier or heater. Damage could be caused to the product in such areas.
- 5) Do not place candles, burning cigarettes, etc on the product, These could cause a fire.
- 6) Ensure that the machine is installed and used in proper area to meet the temperature and humidity specifications.
  - If the machine is stored at below zero Celsius for a long time, do not use the machine instantly after movement. It can malfunction. Take care of the machine storage. If the machine is stored at below zero Celsius for a long time, keep the machine at room temperature and install it.

### 1.2.4. Assembly and Disassembly precautions

---

- 1) Replace parts carefully and always use Samsung parts. Take care to note the exact location of parts and also cable routing before dismantling any part of the machine. Ensure all parts and cables are replaced correctly. Please carry out the following procedures before dismantling the product or replacing any parts.
- 2) Ensure that power is disconnected before servicing or replacing any electrical parts.
- 3) Disconnect interface cables and power cables.
- 4) Only use approved spare parts. Ensure that part number, product name, any voltage, current or temperature rating are correct.
- 5) When removing or re-fitting any parts do not use excessive force, especially when fitting screws into plastic.
- 6) Take care not to drop any small parts into the machine.
- 7) Handling of the OPC Drum
  - The OPC Drum can be irreparably damaged if it is exposed to light. Take care not to expose the OPC Drum either to direct sunlight or to fluorescent or incandescent room lighting. Exposure for as little as 5 minutes can damage the surface of the photoconductive properties and will result in print quality degradation. Take extra care when servicing the product. Remove the OPC Drum and store it in a black bag or other lightproof container. Take care when working with the Covers (especially the top cover) open as light is admitted to the OPC area and can damage the OPC Drum.
  - Take care not to scratch the green surface of the OPC Drum Unit. If the green surface of the Drum Cartridge is scratched or touched the print quality will be compromised.



---

### 1.2.5. Disregarding this warning may cause bodily injury

---

- 1) Be careful with the high temperature part.

The fuser unit works at a high temperature. Use caution when working on the printer. Wait for the fuser unit to cool down before disassembly.



- 2) Do not put fingers or hair into the rotating parts.

When operating a printer, do not put hand or hair into the rotating parts (Paper feeding entrance, motor, fan, etc.). If do, you can get harm.



- 3) When you move the printer, use safe lifting and handling techniques.

This printer is heavy. Use the lifting handles located on each side of the machine. Back injury could be caused if you do not lift carefully.

- 4) Ensure the printer is installed safely.

Ensure the printer is installed on a level surface, capable of supporting its weight. Failure to do so could cause the printer to tip or fall possibly causing personal injury or damaging the printer.

- 5) Do not install the printer on a sloping or unstable surface. After installation, double check that the printer is stable.

## 1.3. ESD precautions

---

Certain semiconductor devices can be easily damaged by static electricity. Such components are commonly called “Electrostatically Sensitive (ES) Devices” or ESDs. Examples of typical ESDs are: integrated circuits, some field effect transistors, and semiconductor “chip” components. The techniques outlined below should be followed to help reduce the incidence of component damage caused by static electricity.



### CAUTION

**Be sure no power is applied to the chassis or circuit, and observe all other safety precautions.**

- 1) Immediately before handling a semiconductor component or semiconductor-equipped assembly, drain off any electrostatic charge on your body by touching a known earth ground. Alternatively, employ a commercially available wrist strap device, which should be removed for your personal safety reasons prior to applying power to the unit under test.
- 2) After removing an electrical assembly equipped with ESDs, place the assembly on a conductive surface, such as aluminum or copper foil, or conductive foam, to prevent electrostatic charge buildup in the vicinity of the assembly.
- 3) Use only a grounded tip soldering iron to solder or desolder ESDs.
- 4) Use only an “anti-static” solder removal device. Some solder removal devices not classified as “anti-static” can generate electrical charges sufficient to damage ESDs.
- 5) Do not use Freon-propelled chemicals. When sprayed, these can generate electrical charges sufficient to damage ESDs.
- 6) Do not remove a replacement ESD from its protective packaging until immediately before installing it. Most replacement ESDs are packaged with all leads shorted together by conductive foam, aluminum foil, or a comparable conductive material.
- 7) Immediately before removing the protective shorting material from the leads of a replacement ESD, touch the protective material to the chassis or circuit assembly into which the device will be installed.
- 8) Maintain continuous electrical contact between the ESD and the assembly into which it will be installed, until completely plugged or soldered into the circuit.
- 9) Minimize bodily motions when handling unpackaged replacement ESDs. Normal motions, such as the brushing together of clothing fabric and lifting one’s foot from a carpeted floor, can generate static electricity sufficient to damage an ESD.

## 2. Product Specifications and Description

### 2.1. Product Overview

	<ol style="list-style-type: none"><li>1) <b>Speed</b><ul style="list-style-type: none"><li>• Up to 40 ppm in A4 (42 ppm in Letter)</li></ul></li><li>2) <b>Processor</b><ul style="list-style-type: none"><li>• Dual Core 1GHz</li></ul></li><li>3) <b>Memory (Std / Max)</b><ul style="list-style-type: none"><li>• 256 MB / 2 GB</li></ul></li><li>4) <b>Interfaces</b><ul style="list-style-type: none"><li>• High-Speed USB 2.0</li><li>• 10/100/1000 Base TX Ethernet</li><li>• 4 Line LCD</li></ul></li><li>5) <b>Toner cartridge yield</b><ul style="list-style-type: none"><li>• Initial : 6,000 pages</li><li>• Standard : 10,000 pages</li><li>• High yield : 20,000 pages</li></ul></li></ol>
---	--

## 2.2. Specifications

Product Specifications are subject to change without notice.



### NOTE

The specification in this manual is the reference information for service engineer. Do not use this specification for sales.

### 2.2.1. General

Item		Specification
Processor	CPU	Dual Core 1GHz (C4N + A1000 )
User Interface	Operational Panel	4 Line LCD
	LED	7 EA (Power Key / ECO / Status / Navigation)
	Key / Button	18 EA (3 x 4 Numeric key, Power, ECO, Menu, OK, Start, Stop)
Memory	Standard	256 MB
	Max. (Option)	2 GB
Interface	USB (Device)	Hi-Speed USB 2.0
	USB (Host)	Hi-Speed USB 2.0
	USB (EDI)	Yes
	Wired LAN	Std (Ethernet 10/100/1000 Base TX)
	Wireless LAN	Option (IEEE 802.11b/g/n)
	NFC	Option (Active)
	RJ11 Connector	Yes
Warmup Time	From Sleep	Less than 16 sec
	Power Off	Less than 35 sec
Temperature	Operating	10 to 30 °C (50 to 86°F)
	Storage	-20 to 40 °C (-4 to 104°F)
Humidity	Operating	20 to 80% RH
	Storage	10 to 90% RH
Noise Level	Standby	Less than 30 dB (A)
	Print Mode	Less than 53 dB (A)
Power Consumption	Ready	Less than 50 W
	Normal operation	700 W
	Max/Peak	1100 W
	Sleep	1.21 W
	Power Off	0.1 W
	TEC	1.9 KWh/week
Dimension	(W x D x H)	421.4 x 405.9 x 351 mm (16.6 x 16 x 13.8 inches)
Weight	Machine with supplies	16.6 kg (36.6 lb)

Item		Specification
Reliability & Service	Recommended Monthly Printing Volume (AMPV)	1,500 - 14,000 pages
	Max. Monthly Print Volume	120,000 pages

## 2.2.2. Print specification

Item		Specification
Print Speed	Simplex	Up to 40 ppm in A4 (42 ppm in Letter)
	Duplex	Up to 20 ipm in A4 (20 ipm in Letter)
FPOT	Ready Mode	As fast as 7 sec
	Sleep Mode	Less than 18.5 sec
Resolution	Optical (Standard)	1200 x 600 dpi
	Enhanced	Up to 1,200 x 1,200dpi effective output (1,200 x 600 x 2bit)
Printer Languages		PCL5e / PCL6 / PostScript3 / PDF Direct V1.7 / XPS / TIFF / URF / PWG
Font	PCL	96 Scalable Fonts (Include OCR-A / OCR-B) / 1 Bitmap
	Postscript3	136 Scalable Fonts
Client OS Support	Windows	Window XP(32/64bit) / Vista(32/64bit) / 2003 Server(32/64bit) / 2008 Server(32/64bit) / Win7(32/64bit) / 2008 Server R2(64bit) / Win8(32/64bit) / Win8.1(32bit/64bit) / 2012 Server(64bit) / 2012 Server R2(64bit)
	Linux	<ul style="list-style-type: none"> <li>• Red Hat Enterprise Linux 5, 6, 7</li> <li>• Fedora 13, 14, 15, 16, 17, 18, 19, 20, 21</li> <li>• openSUSE 11.3, 11.4, 12.1, 12.2, 12.3, 13.1, 13.2</li> <li>• Ubuntu 10.04, 10.10, 11.04, 11.10, 12.04, 12.10, 13.04, 13.10, 14.04, 14.10</li> <li>• SUSE Linux Enterprise Desktop 11, 12</li> <li>• Debian 6, 7</li> <li>• Mint 13, 14, 15, 16, 17</li> </ul>
	UNIX	<ul style="list-style-type: none"> <li>• Sun Solaris 9,10,11 (x86, SPARC)</li> <li>• HP-UX 11.0, 11i v1, 11i v2, 11i v3 (PA-RISC, Itanium)</li> <li>• IBM AIX 5.1, 5.2, 5.3, 5.4, 6.1, .7.1 (PowerPC)</li> </ul>
	Mac OS	Mac OS: X 10.6 - 10.10
Network Protocol	Basic	Standard TCP/IP (Raw), IP assign(DHCP,BOOTP,AutoIP), HTTP,HTTPs,IPP,IPPs, WSD, SNMPv1/v2c/v3, SetIP,SLP,DNS, DDNS, Bongjour, WINS, LPD/LPR, ThinPrint, Google Cloud Print, SMTP,SMTPs, UPnP,LDAP, Kerberos, SMB, IPSec, 802.1x
	Advanced	(Wi-Fi support : Open system, Shared Key,WPA Personal, WPA2 Personal (PSK), WPA Enterprise, WPA2 Enterprise, WEP64, WEP128, TKIP, AES)

### 2.2.3. Paper Handling specification

Item		Specification
Standard Capacity		<ul style="list-style-type: none"> <li>• 550 sheet Cassette Tray @75g/m<sup>2</sup></li> <li>• 100 sheet Multi Purpose Tray @75g/m<sup>2</sup></li> </ul>
Max. Capacity		2850 sheet (550 standard cassette + 100 MP + 4 x 550 SCF)
Standard Cassette Tray	Capacity	550 sheet @75g/m <sup>2</sup> (520 sheet @80g/m <sup>2</sup> )
	Media sizes	A4 / A5 / A6 / Letter / Legal / Oficio / Folio / JIS B5 / ISO B5 / Executive / Statement / PostCard 4x6 / Envelope Monarch / Envelope No 9 / Envelope No 10 / Envelope DL / Envelope C5 / Envelope C6 / Custom
	Media types	Plain / Thin / Bond / Punched / Pre-Printed / Recycled / Envelope / Label / CardStock / Letterhead / Thick / Colored / Archive / Cotton
	Media weight	Supported Weight : 60 to 163 g/m <sup>2</sup> (16~ 43 lb) <ul style="list-style-type: none"> <li>• Thin Paper (60 ~ 69 g/m<sup>2</sup>)</li> <li>• Plain Paper (70 ~ 90 g/m<sup>2</sup>)</li> <li>• Thick Paper (91 ~ 105 g/m<sup>2</sup>)</li> <li>• Bond Paper (105 ~ 120 g/m<sup>2</sup>)</li> <li>• Cardstock (106 ~ 163 g/m<sup>2</sup>)</li> </ul>
	Sensing	<ul style="list-style-type: none"> <li>• H/W Install Detect : Yes</li> <li>• Paper Empty : Yes</li> <li>• Paper low level detect : Yes</li> <li>• Paper Type Detect: No</li> <li>• Paper Size Detect: Yes</li> </ul>
Multi-purpose tray	Capacity	<ul style="list-style-type: none"> <li>• Plain Paper : 100 sheets @ 75g/m<sup>2</sup></li> <li>• Envelope : 10 sheets</li> </ul>
	Media sizes	Min : 76.2 mm x 127 mm (3" x 5") Max : 216 mm x 356 mm (8.5" x 14.0")
	Media type	Plain / Thin / Bond / Pre-printed / Recycled / Envelope / Label / Cardstock / Thick / Cotton / Colored / Archive / Thicker / Punched / Letterhead
	Media weight	Supported Weight : 60 - 220 g/m <sup>2</sup> (16 ~ 59 lb) <ul style="list-style-type: none"> <li>• Thin Paper (60 - 69 g/m<sup>2</sup>)</li> <li>• Plain Paper (70 - 90 g/m<sup>2</sup>)</li> <li>• Thick Paper (91 - 105 g/m<sup>2</sup>)</li> <li>• Bond Paper (105 - 120 g/m<sup>2</sup>)</li> <li>• Cardstock (106 - 163 g/m<sup>2</sup>)</li> <li>• Thicker Paper (164 - 220 g/m<sup>2</sup>)</li> </ul>
	Sensing	Paper Empty

2. Product Specifications and Description

Item		Specification
Optional Cassette Tray	Capacity	550 sheet @75g/m <sup>2</sup> (520 sheet @80g/m <sup>2</sup> )
	Media sizes	A4 / A5 / Letter / Legal / Oficio / Folio / JIS B5 / ISO B5 / Executive / Statement / Envelope No 9 / Envelope No 10 / Envelope DL / Envelope C5 / Custom
	Media types	Plain / Thin / Bond / Punched / Pre-Printed / Recycled / Envelope / Label / CardStock / Letterhead / Thick / Colored / Archive / Cotton
	Media weight	Supported Weight : 60 - 163 g/m <sup>2</sup> (16 - 43 lb) <ul style="list-style-type: none"> <li>• Thin Paper (60 - 69 g/m<sup>2</sup>)</li> <li>• Plain Paper (70 - 90 g/m<sup>2</sup>)</li> <li>• Thick Paper (91 - 105 g/m<sup>2</sup>)</li> <li>• Bond Paper (105 - 120 g/m<sup>2</sup>)</li> <li>• Cardstock: (106 - 163 g/m<sup>2</sup>)</li> </ul>
	Sensing	<ul style="list-style-type: none"> <li>• H/W Install Detect : Yes</li> <li>• Paper Empty : Yes</li> <li>• Paper low level detect : Yes</li> <li>• Paper Type Detect : No</li> <li>• Paper Size Detect : Yes</li> </ul>
Output Stacking	Capacity	Face-Down : 250 sheets @ 80 g/m <sup>2</sup>
	Output Full sensing	Yes
Printing size	Max. Size	216 x 356 mm (8.5" x 14")
	Min. Size	76.2 x 127 mm (3" x 5")
	Margin(T/B/L/R)	T/B/L/R : 1 mm
Duplex Printing	Support	Built-in
	Media sizes	A4 / Letter / Oficio / Folio / Legal / JIS B5 / ISO B5 / Executive / Statement / A5
	Media types	Plain / Thin / Thick / Recycled / Bond / Pre-printed / Cotton / Colored
	Media weight	60 ~ 120 g/m <sup>2</sup> (16 - 32 lb)



## 2.2.4. Software and Solution

Item		Specification
Application	Anyweb Print	N/A
	Easy Printer Manager	Windows / Mac
	Easy Color Manager	N/A
	Easy Document Creator	N/A
	Net PC Fax	N/A
	Direct Printing Utility	Windows
	Easy Deployment Manager	Windows
	Easy Eco Driver	Windows
	Universal Printer Driver	Windows / Mac
Mobile Printing	GCP (Google Cloud Print)	Yes
	AirPrint	Yes
Solution	Device Management	SyncThru
	Output Management	CounThru
	Document Management and Distribution	SmarThruWorkFlow
	Security	SecuThru
	Mobility	Any#
Security	Authentication (Local)	Yes
	Authentication (Network)	Yes (Kerberos / SMB / LDAP)
	IP Address Filtering	IPv4 Filtering / IPv6 Filtering / MAC Filtering
	HDD Overwrite (Standard)	N/A
	HDD Overwrite (Max. Overwrites)	N/A
	Secure Print	Yes
	Encrypted Secure Print	N/A
	Encrypted PDF Mode (Encrypted Scanning)	N/A
	IP Sec	Yes
	Smart Card Authentication	N/A

### 2.2.5. Supplies

Items		Model Name	Life
Toner Cartridge	Initial	-	Approx. 6,000 pages
	Standard	MLT-D201S	Approx. 10,000 pages
	High Yield	MLT-D201L	Approx. 20,000 pages

 **NOTE**

Declared yield value in accordance with ISO/IEC 19752. The number of pages may be affected by operating environment, printing interval, graphics, media type and media size.

Depending on the options, percentage of image area and job mode used, the toner cartridge’s lifespan may differ.

### 2.2.6. Maintenance Part

Some of the machine’s parts have shorter life span than machine’s life.

To ensure that the machine produces good copies and to extend its service life, it is recommended that these maintenance parts at specific intervals be replaced as instructed.

Item	Part Code	Life
Pick up / Forward roller (for Tray1)	JC93-00540B	200,000 pages
Separation roller (for Tray1)	JC93-00540B	100,000 pages
MP Pick up / Forward roller	JC90-01540A	100,000 pages
MP Separation roller	JC73-00328A	100,000 pages
Transfer roller	JC66-02842A	100,000 pages
Fuser Unit	<ul style="list-style-type: none"> <li>• JC91-01023A (110V)</li> <li>• JC91-01024A (220V)</li> </ul>	90,000 pages
Pick up / Forward roller (for Optional Tray)	JC97-02259A	200,000 pages
Separation roller (for Optional Tray)	JC97-02259A	100,000 pages

 **NOTE**

- Depending on the print patterns and job mode used, the lifespan may differ.
- Refer to Chapter 3.2.2 for replacing the maintenance parts.

## 2.2.7. Option

### Option List

Item	Model	Remark
Optional trays (Tray2, Tray3, Tray4)	SL-SCF4000	550 Sheets (Plain paper 75g/m <sup>2</sup> (20 lb bond))
Stand	SL-DSK065S	-
Memory module	SL-MEM001	2 GB
Wireless/NFC kit	SL-NWE001X	Wireless + NFC

## 2.3. System Configuration

### 1) Front View

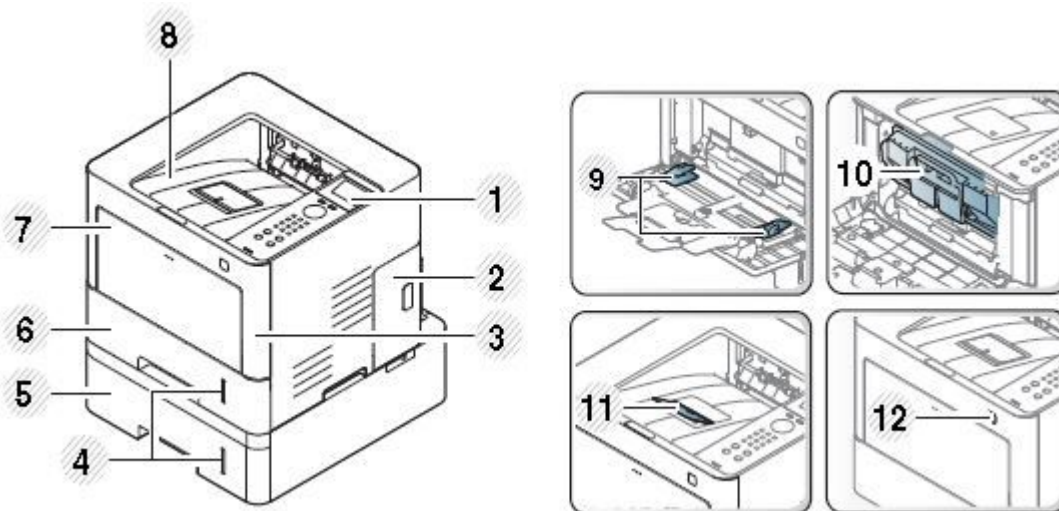

1	Control panel
2	Cover for optional memory *
3	Front cover
4	Paper level indicator
5	Optional trays **
6	Tray 1
7	Multi-purpose tray

8	Output tray
9	Paper width guides on a multi-purpose tray
10	Toner cartridge
11	Output support
12	USB memory port

\* Open this cover to install the optional memory and optional tray.

\*\* Install the optional tray if it is necessary.

## 2) Rear view

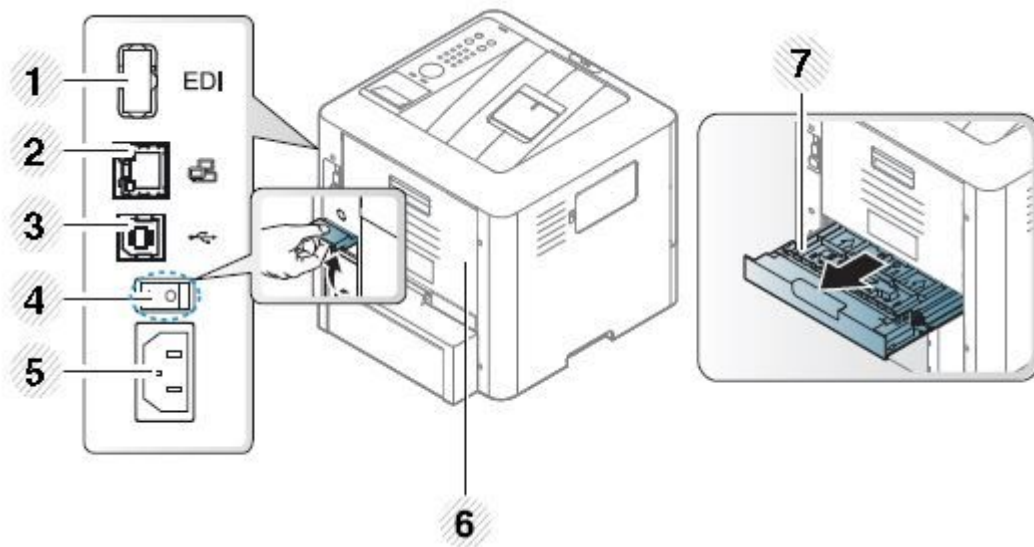

1	EDI port for card reader
2	Network port
3	USB port
4	Power-switch
5	Power receptacle
6	Rear cover
7	Duplex unit

3) System Layout

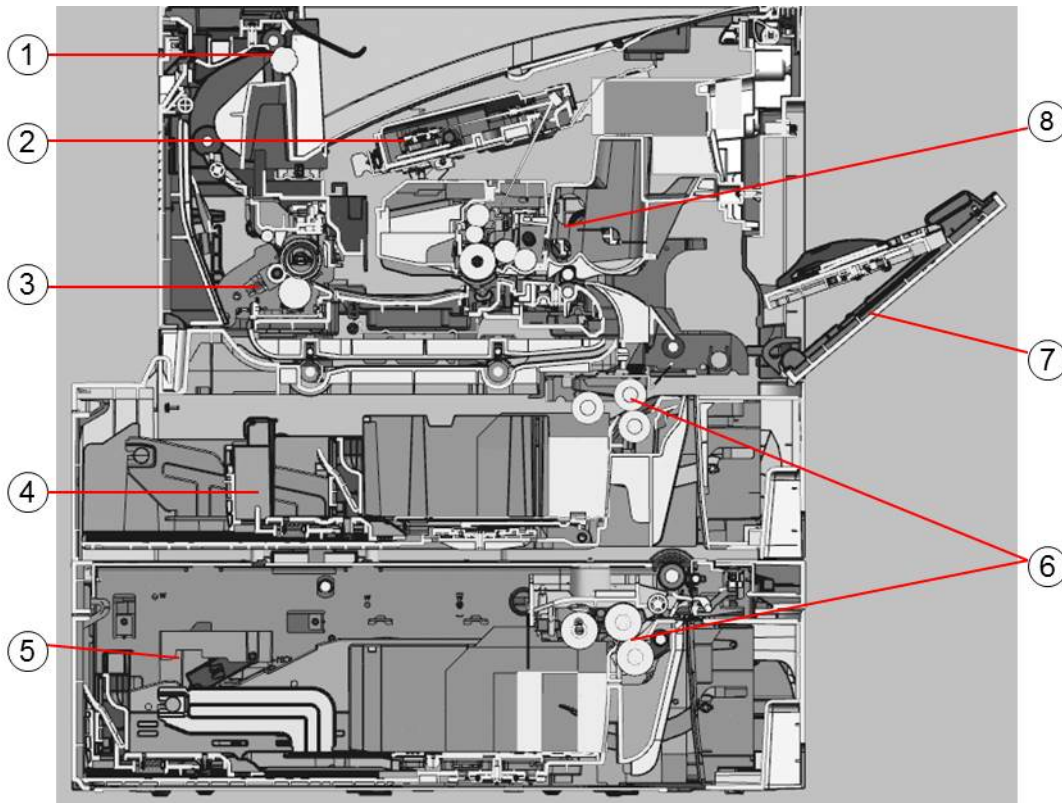

1	Exit
2	LSU
3	Fuser Unit
4	Cassette
5	Optional tray (SCF 2nd, 3th, 4th, 5th)
6	Pick up roller / Separation roller/ Forward roller
7	MP tray
8	Toner Cartridge

#### 4) Paper Path

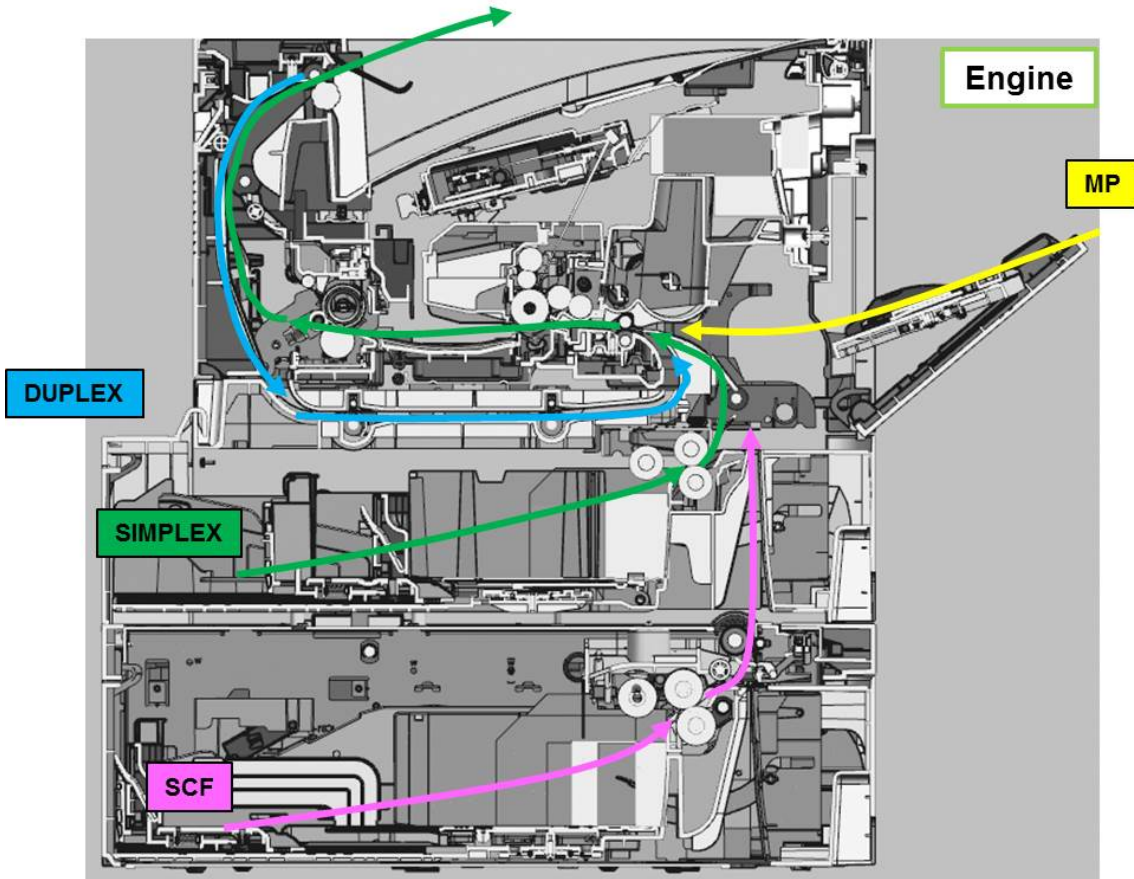

## 2.4. Feeding System

### 2.4.1. Feeding System Overview

The feeding system picks up a paper from the cassette or MP tray and transports it to the machine inside. It mainly consists of the cassette, pick up/forward/reverse(separation) roller, feed roller, registration roller, transfer roller unit, exit unit, duplex unit and drive unit.

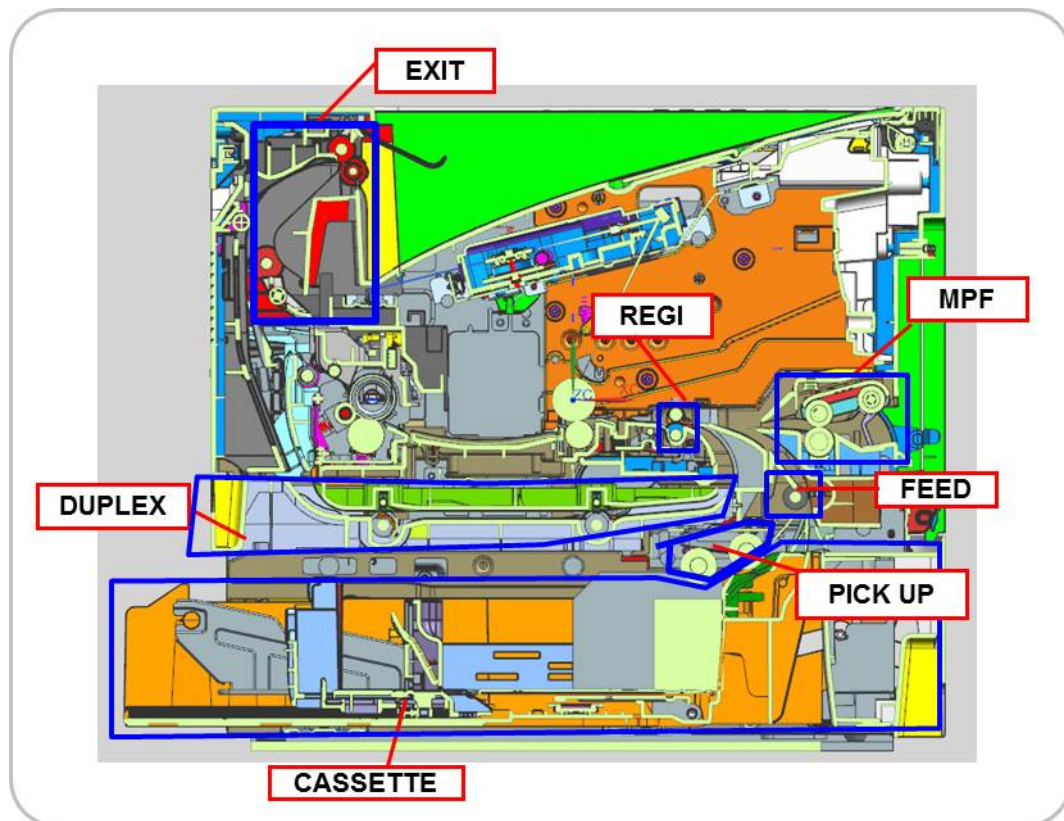



[ Feeding System Component ]

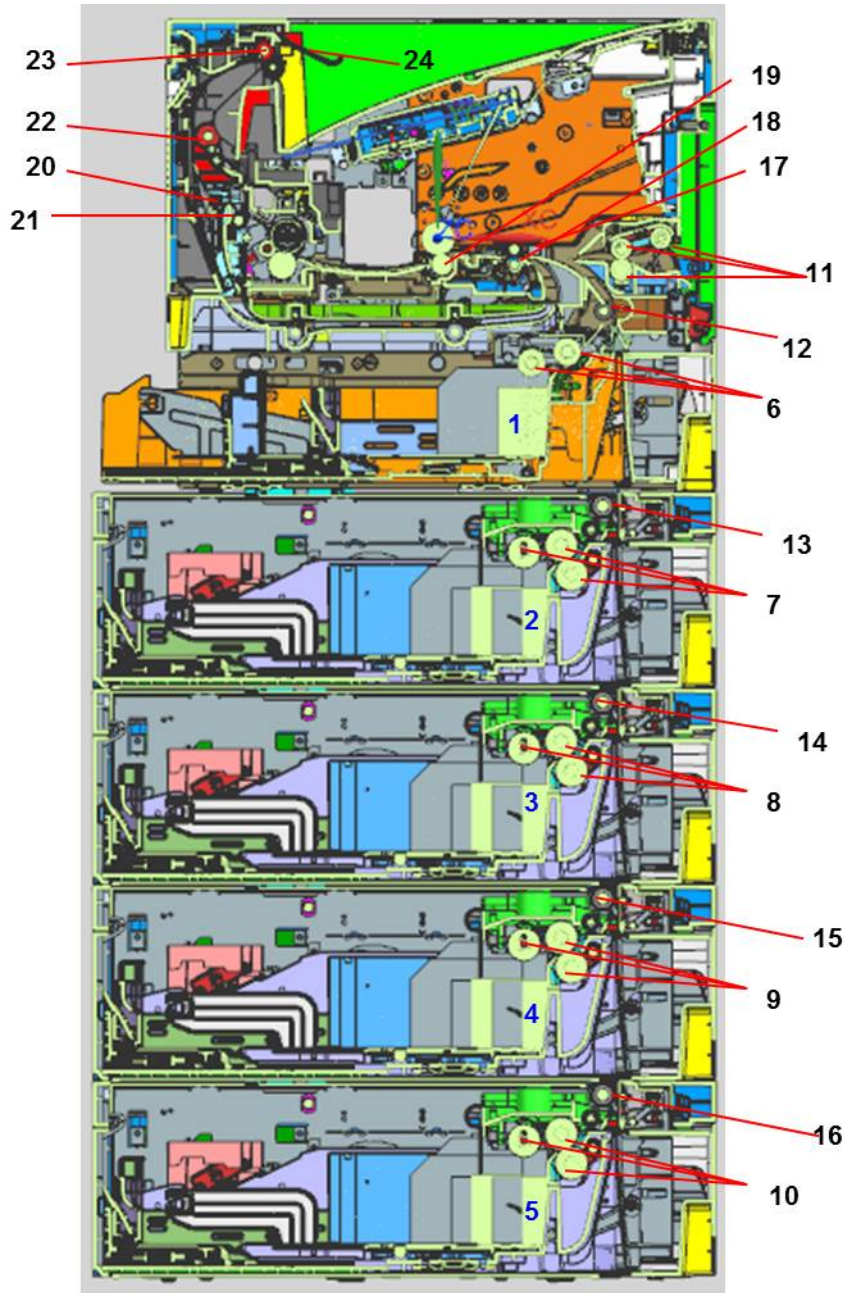

No.	Description
1	Tray 1 Paper tray
2	Tray 2 Paper tray
3	Tray 3 Paper tray
4	Tray 4 Paper tray
5	Tray 5 Paper tray
6	Tray 1 pick up / separation / forward rollers
7	Tray 2 pick up / separation / forward rollers
8	Tray 3 pick up / separation / forward rollers
9	Tray 4 pick up / separation / forward rollers
10	Tray 5 pick up / separation / forward rollers

No.	Description
11	MP Tray pick up / separation / forward rollers
12	Tray 1 feed roller
13	Tray 2 feed roller
14	Tray 3 feed roller
15	Tray 4 feed roller
16	Tray 5 feed roller
17	Registration sensor
18	Registration roller
19	Transfer roller
20	Exit sensor

No.	Description
21	Exit roller 1
22	Exit roller 2

No.	Description
23	Exit roller 3
24	Bin full sensor

- **Pick-Up roller (Tray 1,2,3,4 and MP Tray)**
  - This roller picks up the paper from the tray.
- **Forward roller (Tray 1,2,3,4 and MP Tray)**
  - This roller is placed against the reverse roller. It transports the paper from the pick up roller to feed roller.
- **Reverse roller (Tray 1,2,3,4 and MP Tray)**
  - This roller is placed against the forward roller and transports only one sheet to the feed roller. When two sheets of paper or more are transported from the pick up roller, the load of the torque limiter of the reverse roller is heavier than the frictional force between the sheets. As a result, the reverse roller is stopped and the lower paper does not advance any further.
- **Feed roller**
  - This roller transports the paper sent from the forward/reverse roller to the registration roller.
- **Registration roller**
  - This roller aligns the leading edge of the paper and transports the paper to the transfer roller Assy.
- **Registration sensor**
  - This sensor detects that the leading edge of the paper is arrived to the registration roller and the tail edge passed by the registration roller.
- **Exit Sensor**
  - This sensor detects that the leading edge of the paper is arrived to the exit roller 1 and the tail edge passed by the exit roller 1.

## 2.4.2. Cassette

The cassette stores papers.

Paper size is set using the paper guide in tray.

### Basic Cassette (Tray1)

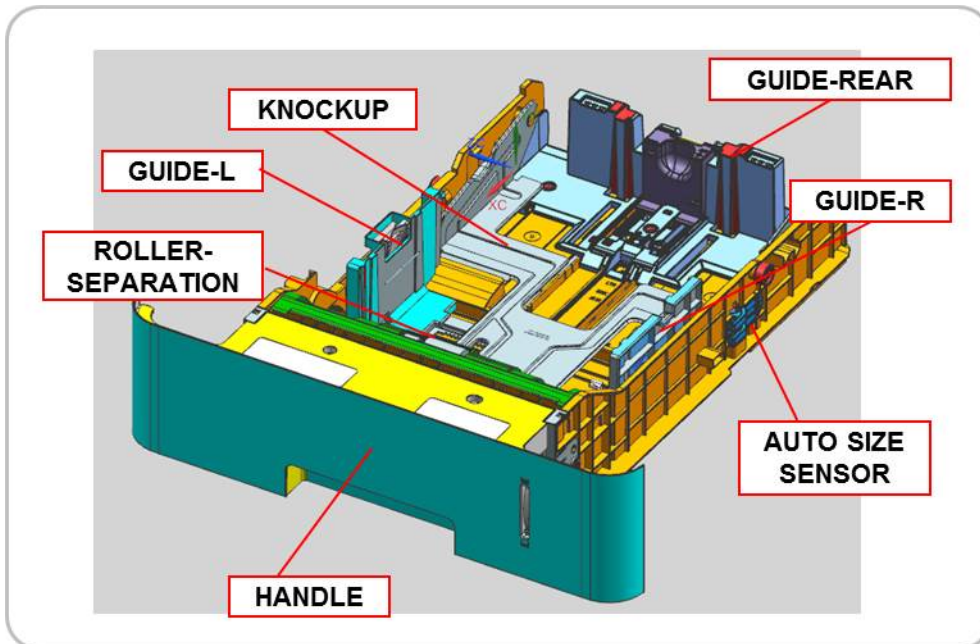

- **Specification**

- 1) Structure : Drawer Type
- 2) Paper separation : Reverse roller type
- 3) Capacity : 550 Sheets ( 80 g/m<sup>2</sup> paper standard)
- 4) Paper
  - Plain paper : A6, Statement, A5, Executive, B5, A4, Letter, Folio, Oficio, Legal
  - Auto detect: A5, Executive, B5, A4, Letter, Folio, Legal, Oficio (8 Types)
  - Special Paper : Envelope, Label, Cardstock
- 5) Weight : plain paper 60 ~ 163 g/m<sup>2</sup>
- 6) Plate knock up lift type : Lift Motor + Up Limit Sensor

### 2.4.3. Pick-Up Unit

When pickup takes place, the pickup roller transports the paper. The KNOCK-UP moves up by the elevating motor and the pick up roller comes into contact with the paper. The forward roller and the separation roller serve to make sure that a single sheet of paper is moved to the paper path, and the paper is moved as far as the registration roller by the work of the vertical path roller.

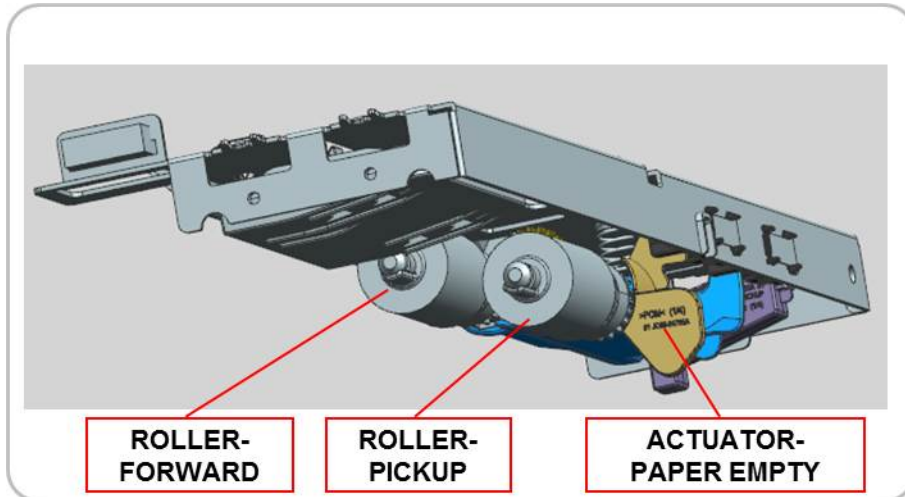

### 2.4.4. MPF(Multi-Purpose Feeder) Unit

The MPF Unit allows feeding of specialty media stock, envelopes, and custom size paper.

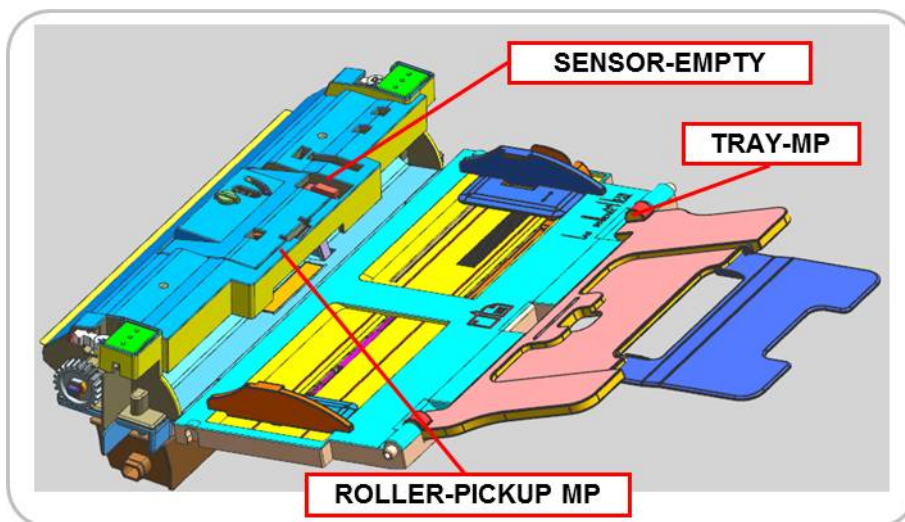

#### ■ Specification

- 1) Tray capacity : 100 sheets ( 80 g/m<sup>2</sup> standard paper)
- 2) Media Size : Max 8.5"×14" (215.9 x 355.67 mm) / Min 3"×5" (76.2 x 127 mm)
- 3) Media weight : Plain paper 60 ~ 220 g/m<sup>2</sup>

## 2.5. Image Creation

### 2.5.1. Printing process overview

This machine uses a toner cartridge, transfer roller, and LSU for mono printing.

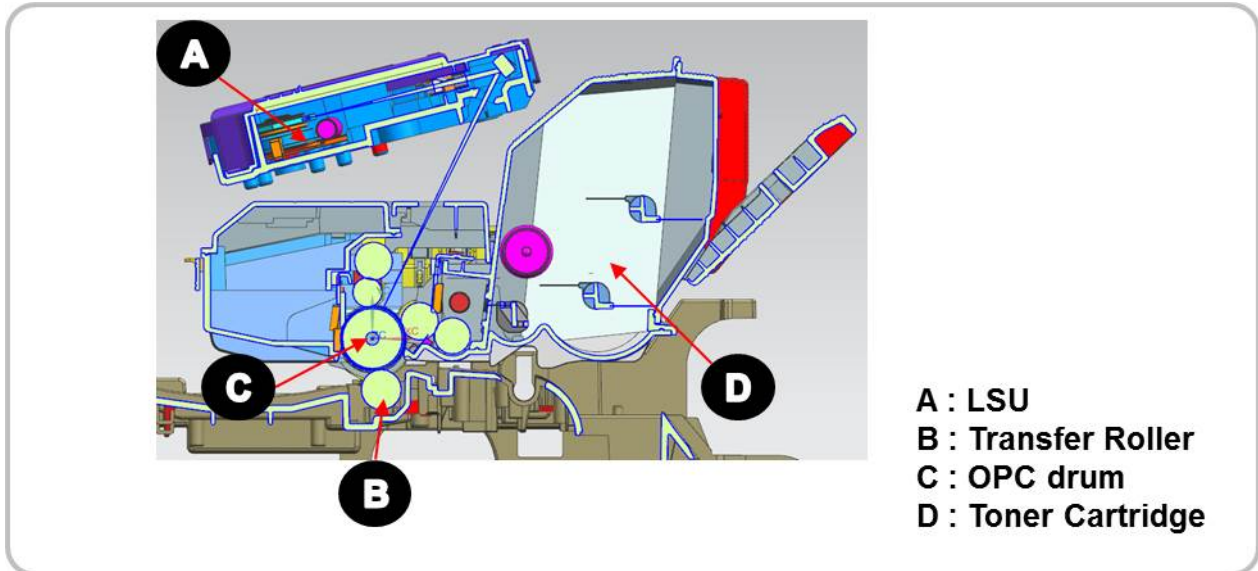

The toner cartridge as integrated type consists of the toner bottle, drum unit and development unit. The drum unit consists of an OPC drum, charge roller, cleaning roller, and cleaning blade. The development unit consists of the deve. roller, supply roller, Dr.blade, and agitator.

The OPC drum is charged with a negative voltage by the charge roller and is exposed by the light from the LSU (Laser Scanning unit).

The light produced by a laser creates a latent image by discharging on the surface of the OPC drum. The negatively charged toners are attracted to the latent image due to the electric field. The toner(real image) on the OPC drum are moved to the paper by the positive bias applied to the transfer roller.

- 1) **OPC drum charge** : The charge roller gives the OPC drum a negative charge.
- 2) **Laser exposure** : Light produced by a laser diode(LD) hits the charged OPC drum through the lens and mirrors. The machine controls the laser beam on/off for the latent image.
- 3) **Development** : The developing roller carries the negatively charged toner to the latent image on the OPC drum surface.
- 4) **Transfer** : The negatively charged toner is transferred to the paper by transfer voltage.
- 5) **Cleaning for OPC drum** : The cleaning blade remove remaining toner on the OPC drum surface after image transfer to the paper.

### 2.5.2. Toner Cartridge

The toner cartridge as integrated type consists of the toner bottle, drum unit and development unit.

The OPC drum diameter is 24.03 mm (circumference : about 75.4mm). / Deve roller diameter is 14.07mm (circumference : about 37mm).

The toner cartridge uses non magnetic 1 element shatter type toner, the remaining toner is detected by CRUM as Dot Count method.

After the image is moved to transfer roller, the remaining toner on the OPC drum is removed by the cleaning blade.

The CRUM chip in toner cartridge stores information like a serial number, count.

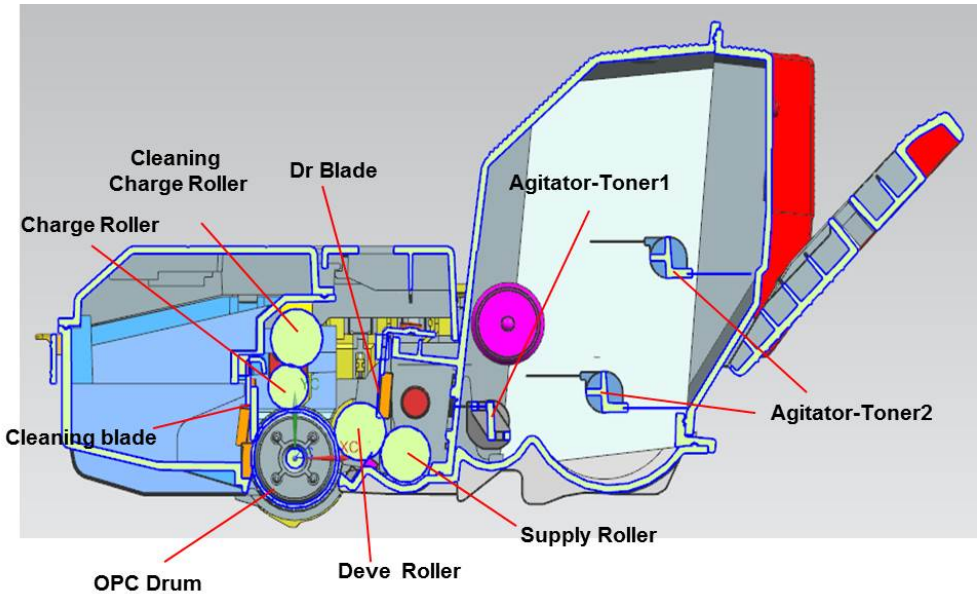

#### Development

The toner is supplied to the Agitator-Toner 1 by the Agitator-Toner2 and moves from the supply roller to deve roller.

After the supplied toner on deve roller exits from the Dr.blade, it forms a developer brush. Then toner is attracted to the surface of the OPC drum only in areas the corresponds to the image area.

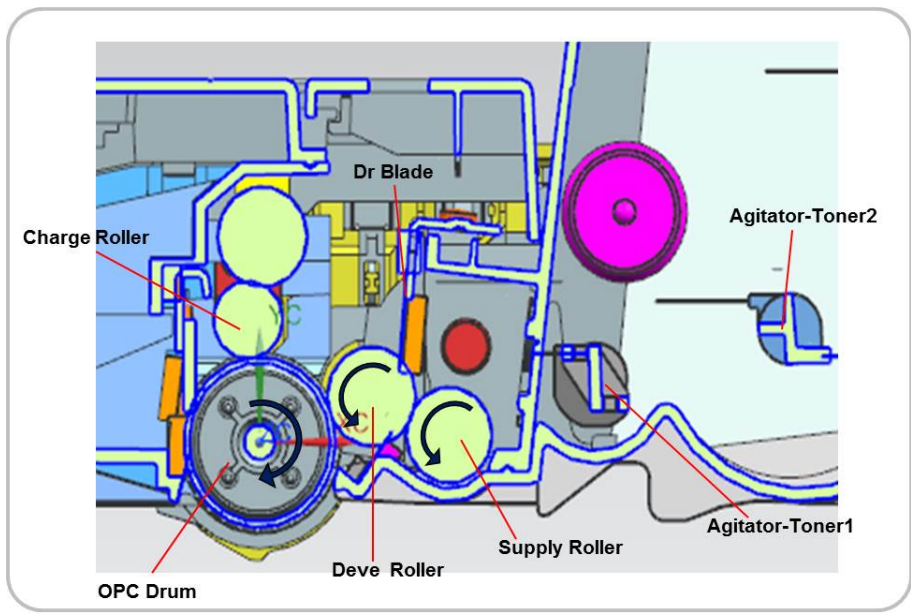

## 2.6. Fuser unit

It is consisted of a halogen lamp, heat roller, pressure roller, thermistor and thermostat. It fuses the toner on a paper by heat and pressure to complete the printing job.

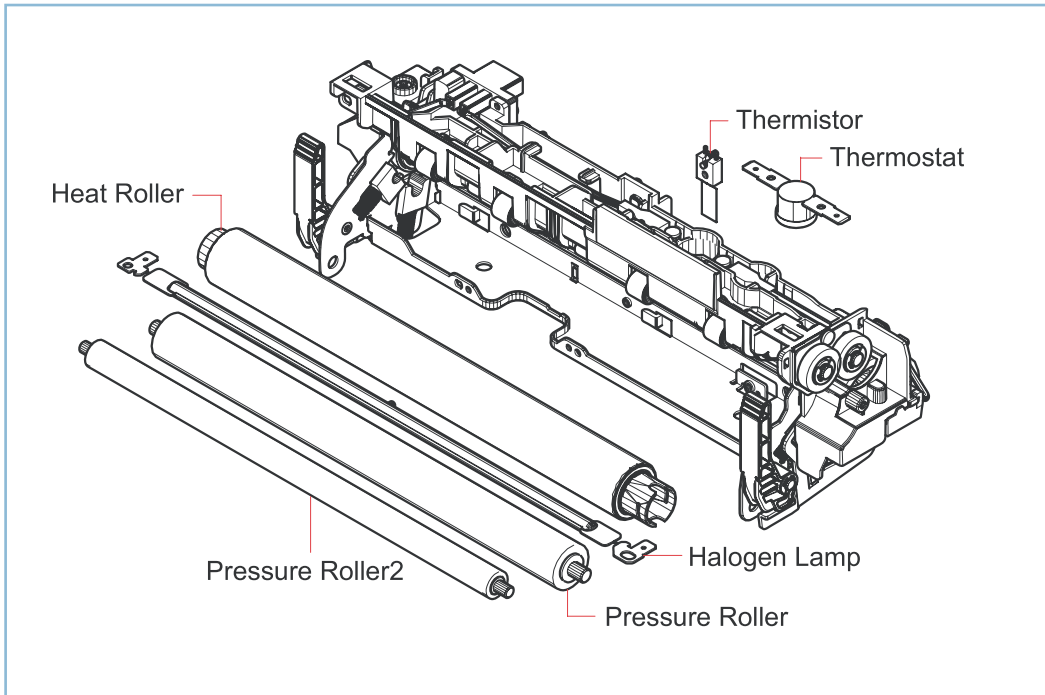

### 1) Thermostat

When a heat lamp is overheated, a Thermostat cuts off the main power to prevent over- heating.

- Thermostat Type : Non- Contact type
- Control Temperature :  $190^{\circ}\text{C} \pm 5^{\circ}\text{C}$

### 2) Thermistor

It is a temperature detecting sensor.

- Temperature Resistance :  $7\text{ K}\Omega(180^{\circ}\text{C})$
- Rated B-value  $R_{25}/85\ 3370\text{K}\pm 3\%$  (The Rated B-value is calculated from the zero-power resistance measured at  $25^{\circ}\text{C}$  and  $85^{\circ}\text{C}$ )

### 3) Heat roller

The heat roller transfers the heat from the lamp to apply heat on to the paper.

The surface of a heat roller is coated with Teflon, so toner does not stick to the surface.

### 4) Pressure roller

A pressure roller mounted under a heat roller is made of a silicon resin, and the surface also is coated with Teflon.

When a paper passes between a heat roller and a pressure roller, the toner fuses to the surface of a paper permanently through this combination of heat and pressure.

### 5) Halogen Lamp

- Voltage :  $120\text{ V}, 115 \pm 5\% / 220\text{ V}, 230 \pm 5\%$
- Capacity :  $850\text{ Watt} \pm 42.5\text{W}$

## 2.7. Laser Scanning Unit (LSU)

### 2.7.1. Laser Scanning Unit Overview

The Laser Scanning Unit (LSU) consists of one polygon motor and one LD (Laser Diode), and forms a latent image on the surface of OPC drum. For this process, there are a C-DOE lens, F-Theta Lens, reflection mirror (that changes laser beam path). Also, LD PBA is located to the front of the LSU for interface.

The PD sensor located in LD PBA detects the scanning start line and generates the horizontal sync signal (Hsync).

The picture below shows the main components for LSU.

**NOTE**

The LSU is the optical precision device. Please handle it carefully and do not remove the cover.

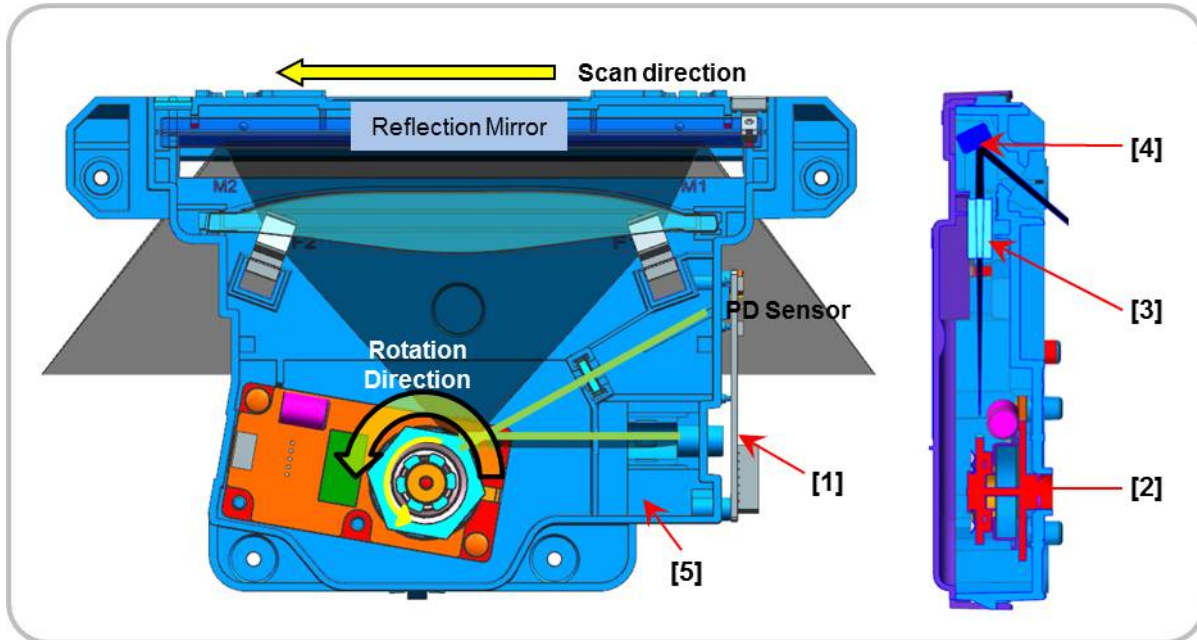

1	LD PBA
2	P/Mirror Motor
3	F- Lens
4	Reflection Mirror
5	C-DOE Lens

• **Information**

- Part Code : JC97-04699A [LSU]



## 2.7.2. Laser Scanning Optical path

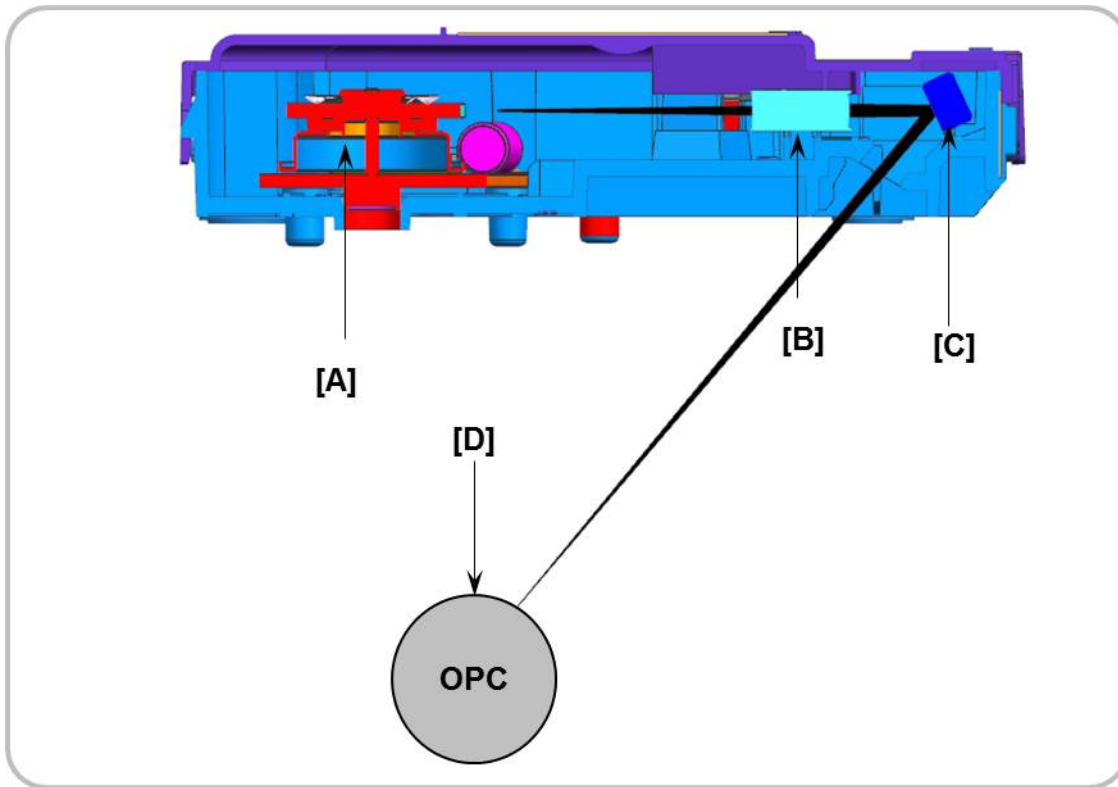

The laser beam is reflected from the mirror [A] and passes through F-theta lens[B]. And then its direction is changed by the reflection mirror [C]. It is transferred to OPC[D].

The polygon motor speed is controlled by the main CPU.

The LD unit generating the laser beam has the dual beam laser diode with 780nm wavelength. It is controlled by the LD drive IC.

Item	Specification
LD Unit	<ul style="list-style-type: none"> <li>Laser Diode : Dual Beam</li> <li>Driving IC for Dual LD</li> </ul>
P/Motor speed	28,587 rpm
Process Speed	242.04 mm/sec
H/W interface	<ul style="list-style-type: none"> <li>LD Harness : 14 Pin FFC</li> <li>P/Motor Harness : 5 Pin FFC</li> </ul>

## 2.8. Drive System

### 2.8.1. Drive Motors

The following diagram displays the locations of the printer drive motors.

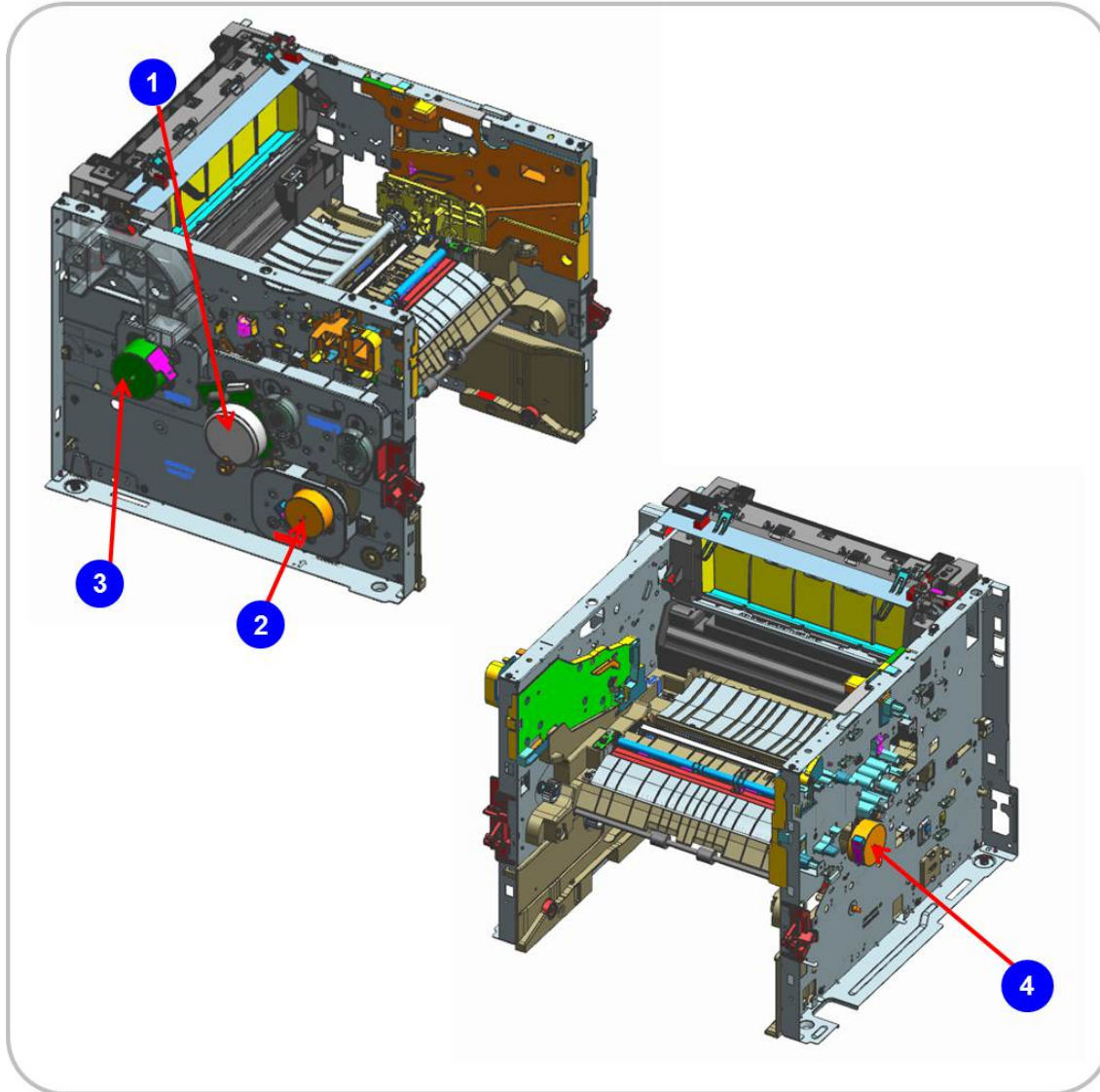

No.	Motor	Motor type	Qty	Function
1	DRIVE MAIN	BLDC Motor	1	OPC driving
		E-Clutch	1	Regi Shaft driving
		E-Clutch	1	MP Pick-Up Shaft driving
2	CST LIFT	PM-STEP Motor	1	Pick-Up driving
3	DRIVE FUSER	PM-STEP Motor	1	Fuser and Exit driving
4	DUPLEX	PM-STEP Motor	1	Duplex driving

## 2.8.2. Main Drive Unit

### Front View

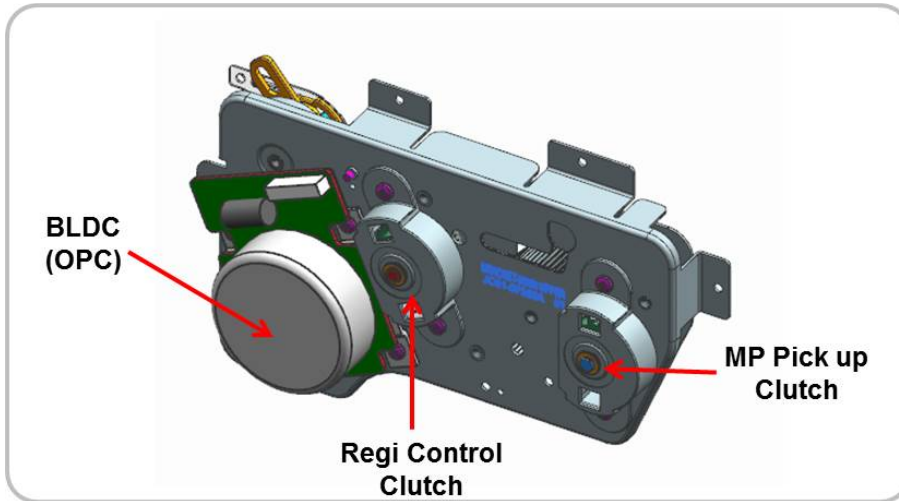

### Rear View

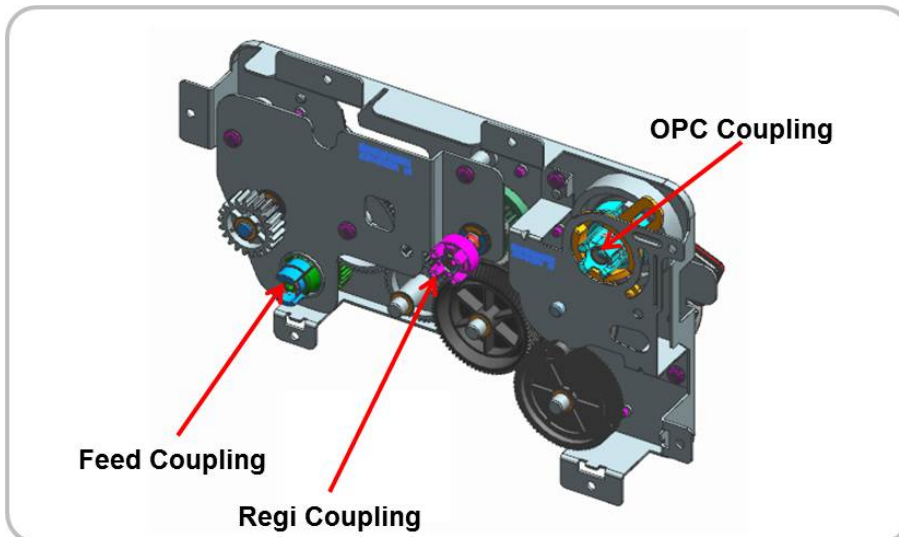

- **Information**
  - Part Code : JC93-00923A [DRIVE MAIN]

### 2.8.3. Exit Drive Unit

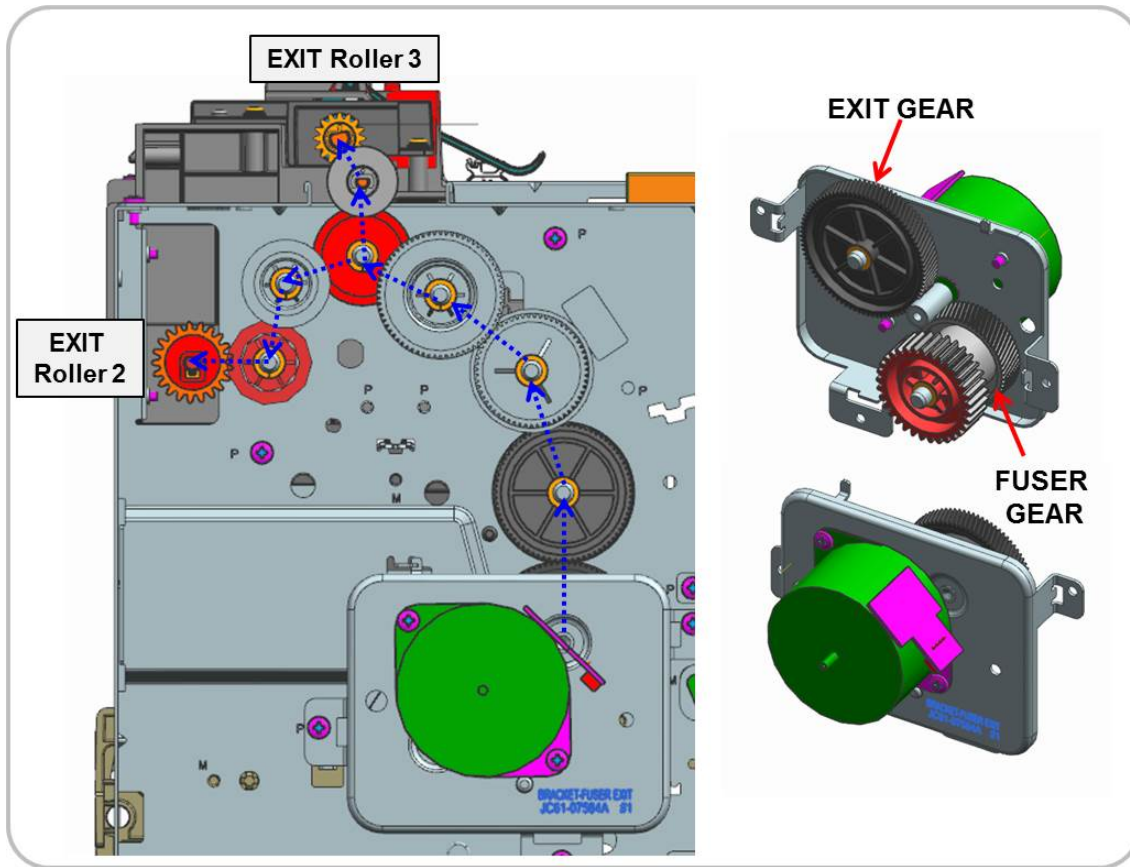

• **Information**

- Part Code : JC93-01230A [DRIVE-FUSER]

Power Train	Simplex/Duplex : Forward / Reverse Driving by STEP motor
<ul style="list-style-type: none"> <li>• Step motor → Gear → Gear → Gear → Gear → Gear → Gear → Gear → Exit Roller 3 driving</li> <li>• Step motor → Gear → Gear → Gear → Gear → Gear → Gear → Gear → Gear → Exit Roller 2 driving</li> <li>• Step motor → Gear → Hub-Clutch → Gear → Fuser pressure driving</li> </ul>	

## 2.8.4. Tray Lifting Drive Unit

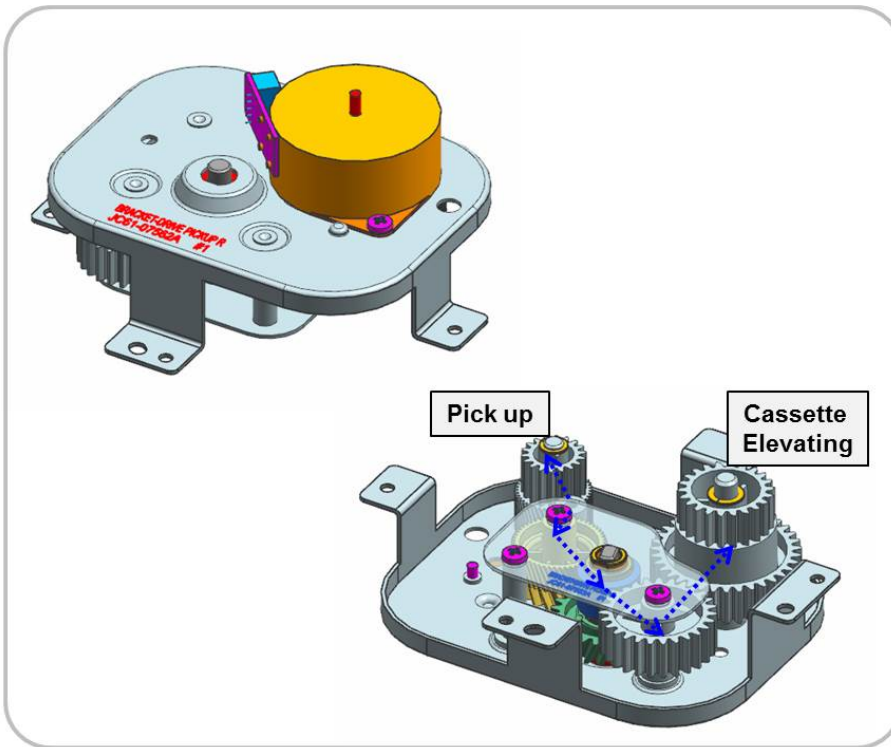

- Information**

- Part Code : JC93-01231A [DRIVE-CST LIFT]

Power Train	Pick-Up (Forward rotation) / Cassette Lifting (Reverse rotation)
<ul style="list-style-type: none"> <li>• Step motor → Gear → Gear → Pick-Up driving</li> <li>• Step motor → Gear → Gear → Gear → Gear → Gear → Cassette Lifting driving</li> </ul>	

## 2.9. Hardware Configuration

M4030 series Electrical Circuit System consists of the following :

- Main board
- OPE board
- HVPS board
- SMPS board, etc.

### Diagram of the M4030 Series Electrical Circuit

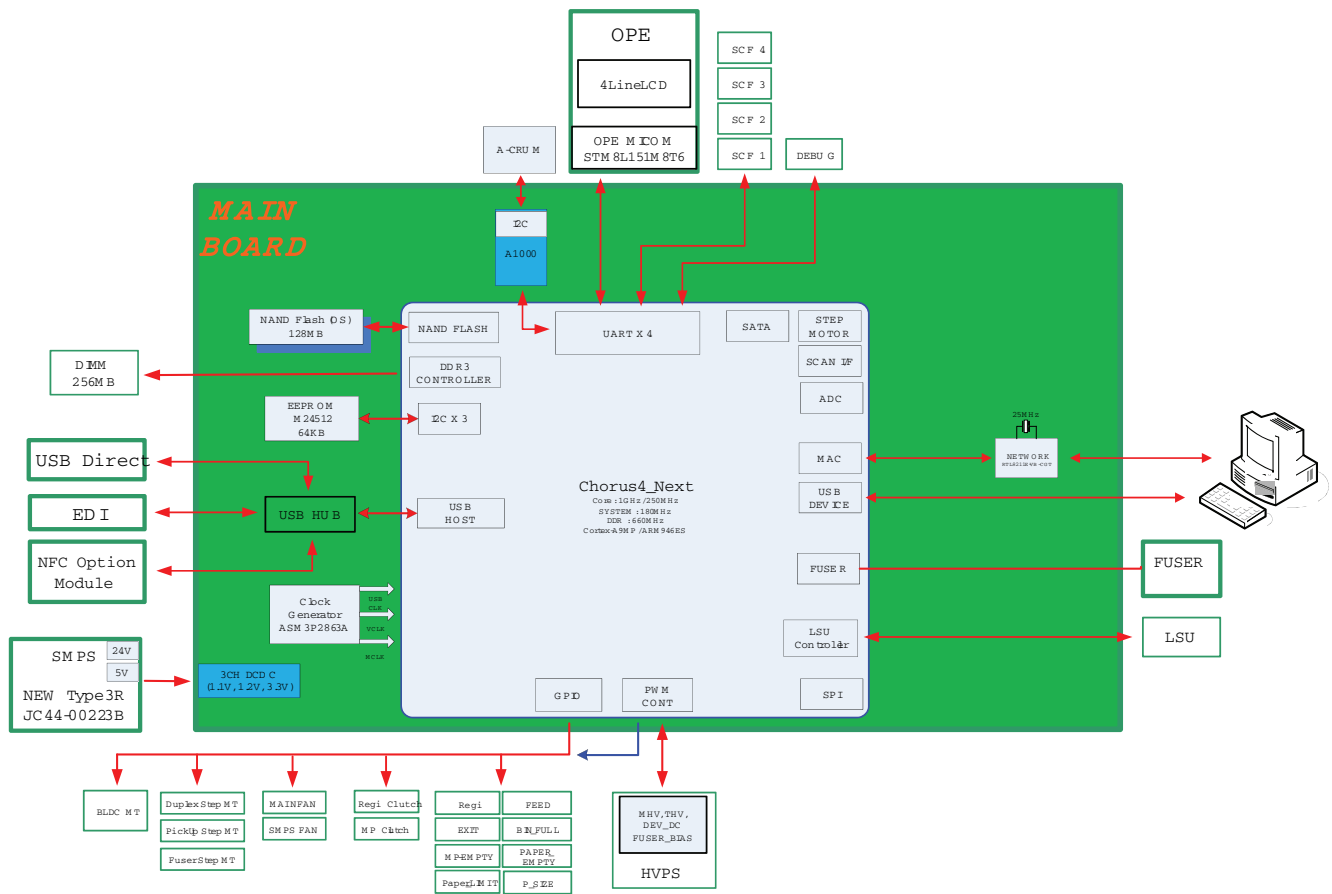

The main board handles the video control, engine control.

The main board receives the print data from the host through the network or USB port. It takes this information and generates printable video bitmap data. It controls all modules required to print, that is, LSU, HVPS, fan, Fuser unit, Drive Unit, etc.

### Circuit Board Locations

The following diagrams show the locations of the printer circuit boards:

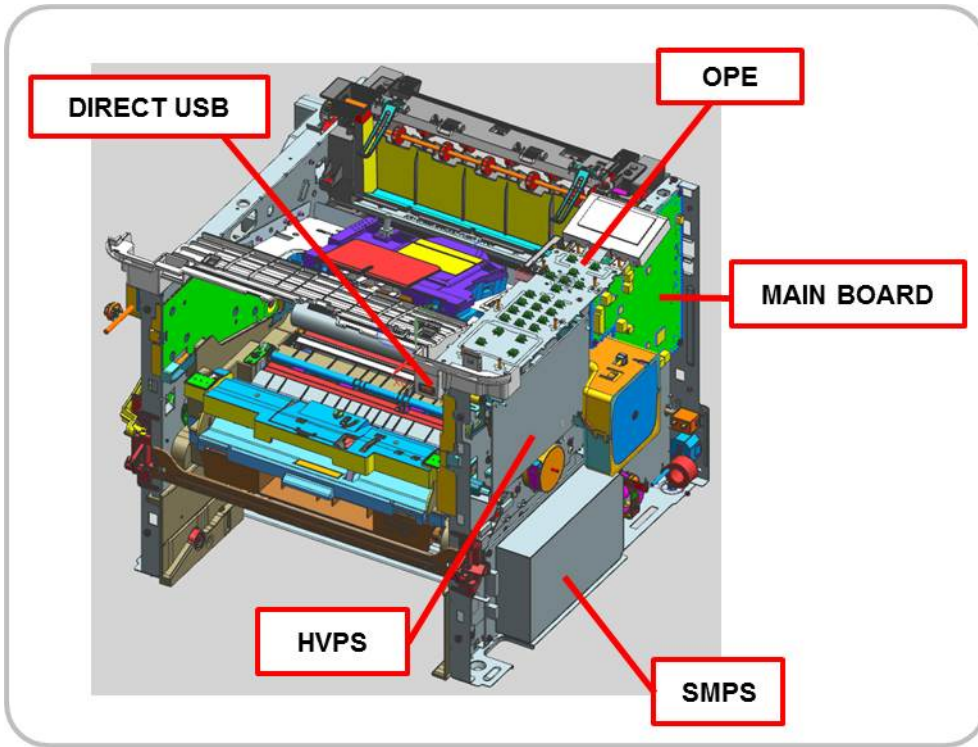

### 2.9.1. Main board

The main board consists of the main processor(1GHz dual core CPU), memory(DDR3 256MB), flash(128MB), 1G Ethernet PHY, USB2.0 HUB, video signal interface connection, motor driving IC, engine signal interface connection, power interface.

The main processor controls video, engine, UI display and communicates the various devices. The main board is connected to the HDD by SATA2 and to the SCF by UART.

#### Main Board Connection Information

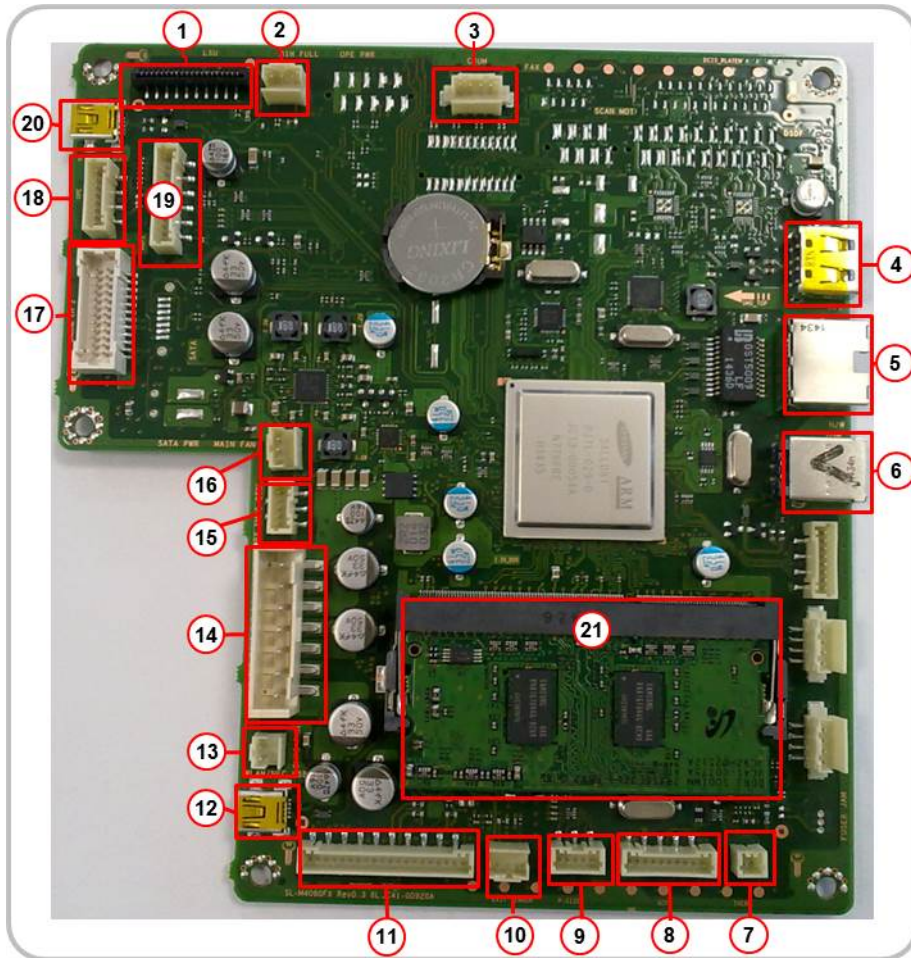

• **Connection**

1	LSU Interface
2	Outbin Full Sensor
3	CRUM
4	EDI
5	Giga RJ45
6	USB Device
7	Fuser Thermistor
8	SCF

9	Paper Size Sensor
10	Exit Sensor
11	Duplex Motor / Sensor
12	WLAN / NFC
13	SMPS Fan
14	SMPS Power
15	SMPS Control
16	Main Fan

17	Engine Interface
18	OPE Interface
19	HVPS
20	OPE USB HOST
21	DIMM

• **Information**

- Part Code : JC92-02807A
- Part Name : PBA-MAIN



## 2.9.2. OPE

Control panel uses 4 line LCD panel for user interface.

### 1) OPE PBA

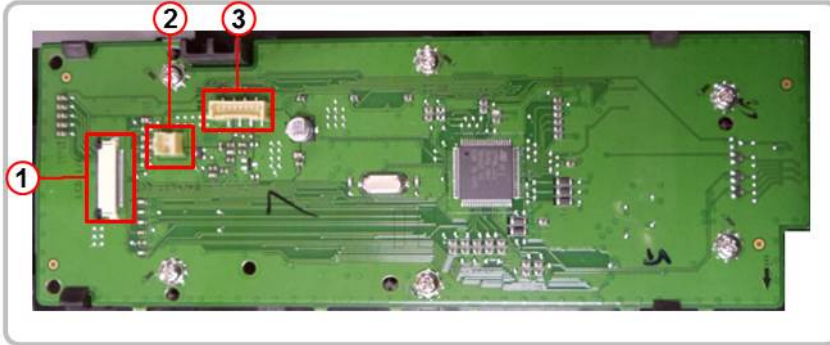

- **Information**

- Part Code : JC92-02812A
- Part Name : PBA-OPE

- **Connection**

1	LCD Interface
2	BackLight LCD
3	Main Interface

### 2) LCD

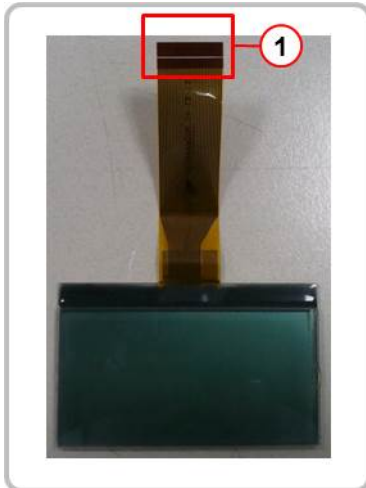

- **Information**

- Part Code : JC07-00020A
- Part Name : LCD

- **Connection**

1	LCD Interface
---	---------------

### 3) PBA BLU

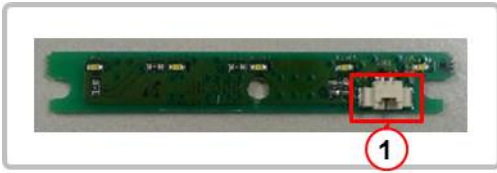

- **Information**

- Part Code : JC92-02523A
- Part Name : PBA-BLU

- **Connection**

1	BackLight LCD
---	---------------

### 2.9.3. SO-DIMM PBA

The SO-DIMM PBA is the system memory module of the main board. It is used for the operating system, some system application programs, and it stores some print data from the USB and Network port (scanned images, copy data, fax data and printable video data, etc.). The SO-DIMM PBA includes the following features:

- 256 MB standard (2GB optional)

#### NOTE

Only this memory can be installed to the main board. A wise use memory can not be installed.



### 2.9.4. CRUM PBA

The CRUM PBA includes CRU memory for toner cartridge life cycle counting.

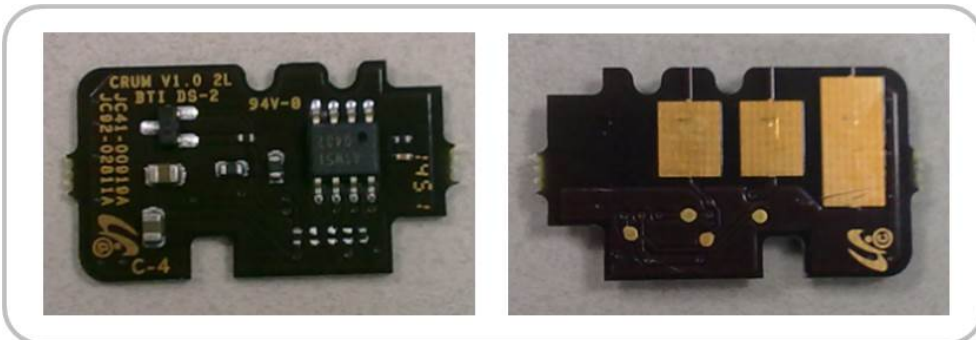

### 2.9.5. SCF board

SCF board controls the optional cassette. SCF can be installed Max 3 for M4080 series. SCF board consists of a controller(S3F443FX), motor drive IC for controlling the feeding timing with the main board.

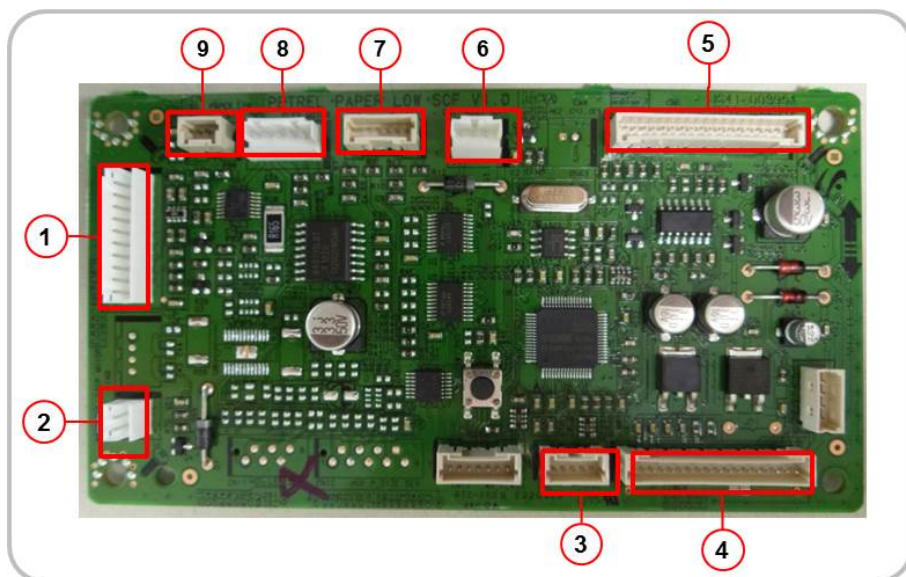

• **Information**

- Part Code : JC92-02754A
- PBA Name : PBA-SCF

• **Connection**

1	BLDC motor
2	Main solenoid
3	Paper size sensor
4	Interface lower
5	Interface upper
6	Regi solenoid
7	Paper empty sensor
8	Elevator motor
9	Paper low sensor

### 2.9.6. NFC Optional Board (SL-NWE001X)

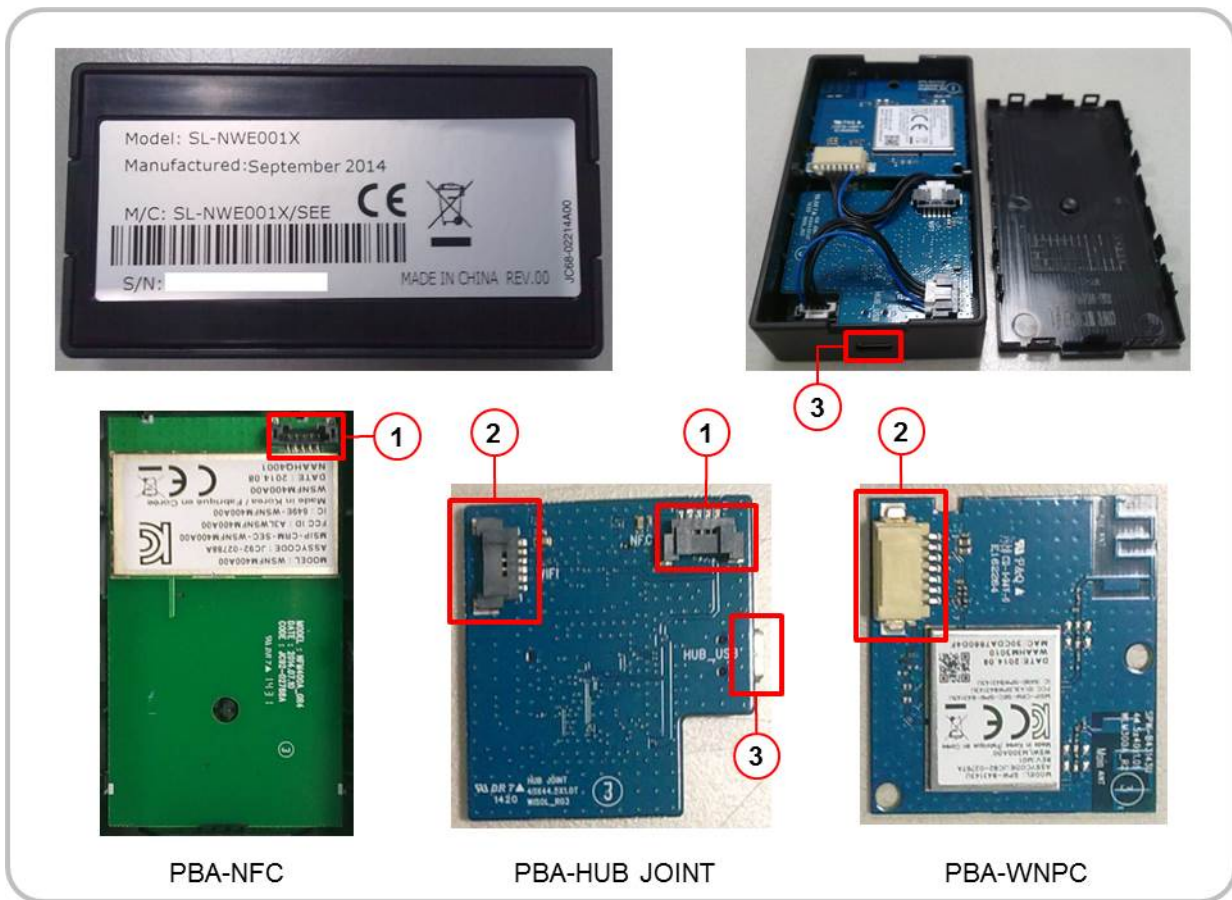

• **Information**

- PBA-NFC (Part Code : JC92-02788A)
- PBA-HUB JOINT (Part Code : JC92-02787A)
- PBA-WNPC (Part Code : JC92-02767A)

• **Connection**

1	NFC Interface
2	External USB connection
3	USB HUB

### 2.9.7. SMPS board

SMPS (Switching Mode Power Supply) board supplies electric power to the main board and other boards. It includes FDB(Fuser Drive Board) function. The voltage provided includes +5V, and +24V from a 110V/220V power input. It has safety protection modes for over current and overload.



• **Specification**

General Input / Output Voltage

1) Input

- AC 110V (93.5V ~ 137V) / 10A
- AC 220V (187V ~ 275V) / 6.3A

2) Output

- DC +5V / 4.0A
- DC +24V / 6.0A

3) Output Power

- DC +5V : 20W
- DC +24V : 144W
- FDB : 850W

• **Information**

	110V	220V
Part Code	JC44-00222B	JC44-00223B
Part Name	SMPS V1	SMPS V2

• **Connection**

1	Input_AC
2	Output_AC(to Fuser)
3	Output_DC(to Main PBA)
4	Control Signal (from Main PBA)

- **Input / Output connector**

- **SMPS, AC Input Connector( CON1 )**

PIN ASSIGN	PIN NO	Description
1	AC_L	AC Input
2	AC_N	

- **SMPS, AC Output Connector( CON2 )**

PIN ASSIGN	PIN NO	Description
1	AC_L	AC Output
2	AC_N	For Fuser

- **SMPS,DC Output Connector( CON3 )**

PIN ASSIGN	PIN NAME	Description
1	+5V1	+5.1V Power
2	GND	Power Ground
3	+24V1	+24V Power
4	+GND	Power Ground
5	+24V2	+24V Power
6	GND	Power Ground
7	+24V3	+24V Power

- **SMPS, Signal Connector2( CON4 )**

PIN ASSIGN	PIN NAME	Description
1	GND	Ground
2	24V_ON/OFF	24V ON/OFF
3	Relay on	Fuser Relay
4	24VS	Photo Triac Bias
5	Fuser on	Fuser on

### 2.9.8. HVPS board

HVPS(High Voltage Power Supply) board generates high-voltage channels, which include THV, MHV, DEVE DC, Fuser-bias.

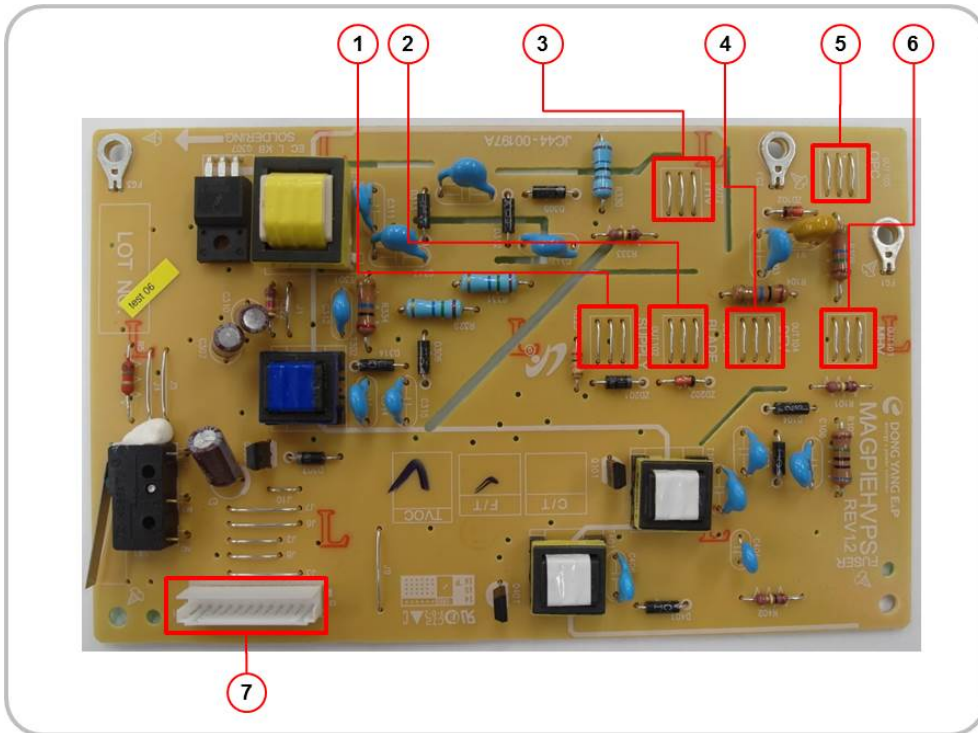

**Information**

- Part Code : JC44-00197A
- Part Name : HVPS

**Connection**

1	SUPPLY
2	DR.BLADE
3	THV
4	DEVE DC

5	OPC
6	MHV
7	HVPS INPUT (CN1)

**Connection (HVPS Input)**

HVPS INPUT (CN1)		
Description	PIN NAME	PIN ASSIGN
Input Voltage	3.3VS	1
Input Voltage	3.3V	2
DGND	DGND	3
DGND	DGND	4
PWM signal	PWM_FUSER_BIAS	5
PWM signal	PWM_MHV	6
PWM signal	PWM_DEVE_DC	7
PWM signal	PWN_THV	8
nEN signal	nTHV_EN	9



HVPS INPUT (CN1)		
Description	PIN NAME	PIN ASSIGN
Output voltage	THV_READ	10
DGND	DGND	11
Input Voltage	24VS	12

- **Specification**

- 1) Input Voltage : DC 24V, 3.3V
- 2) Output Voltage
  - MHV : -1240V
  - DEVE DC : -338V
  - BLADE : -389V
  - SUPPLY : -489V
  - THV+ : 1315V
  - THV- : -1000V
  - FUSER : -240V

### 2.9.9. Electrical Parts Location

#### 1) Sensor

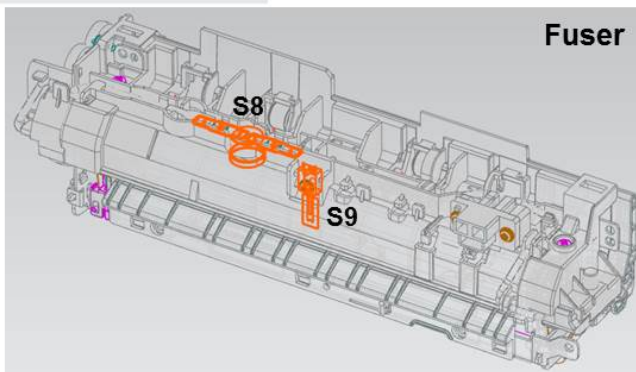
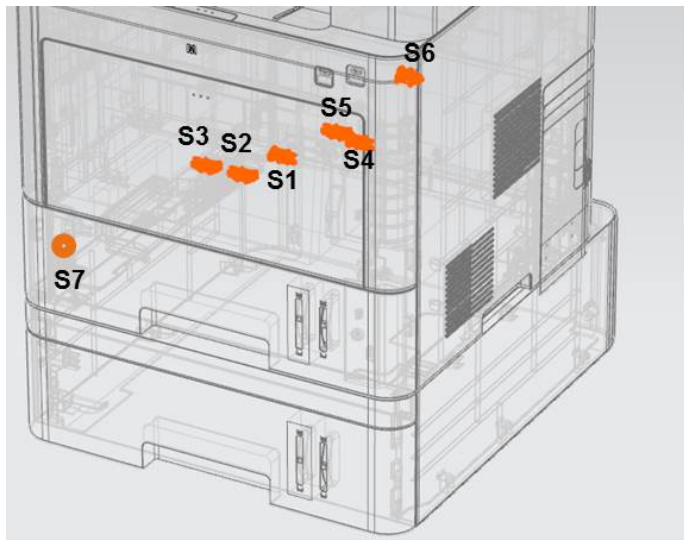

Ref.	Description	Part Code
S1	PHOTO-INTERRUPTER (MP)	0604-001393
S2	PHOTO-INTERRUPTER (PICK-UP)	0604-001393
S3	PHOTO-INTERRUPTER (PICK-UP)	0604-001393
S4	PHOTO-INTERRUPTER (FRAME-MIDDLE)	0604-001393
S5	PHOTO-INTERRUPTER (FRAME-MIDDLE)	0604-001393
S6	PHOTO-INTERRUPTER (FRAME-MIDDLE)	0604-001393
S7	THERMISTOR-NTC ASSY (FRAME)	1404-001417
S8	THERMOSTAT (FUSER)	4712-001091
S9	THERMISTOR-NTC (FUSER)	1404-001640

## 2) Motor, Clutch, and Fan

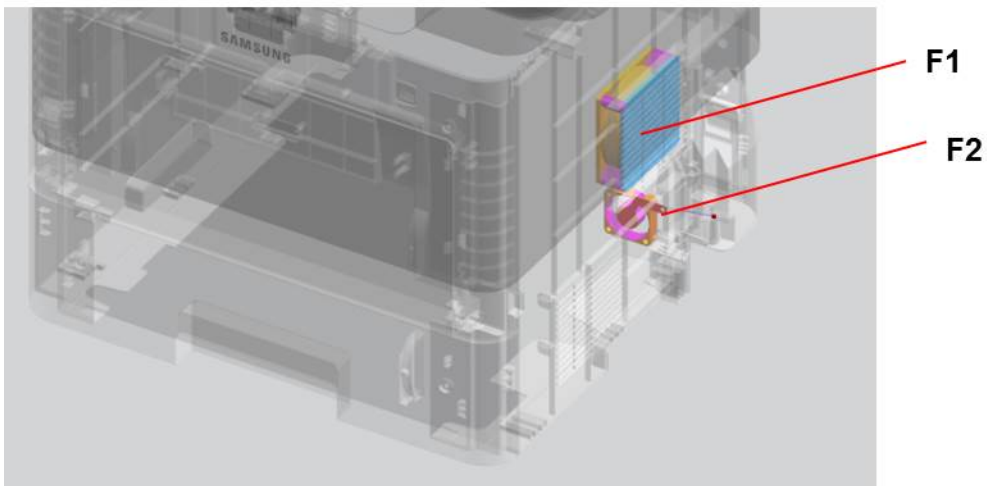
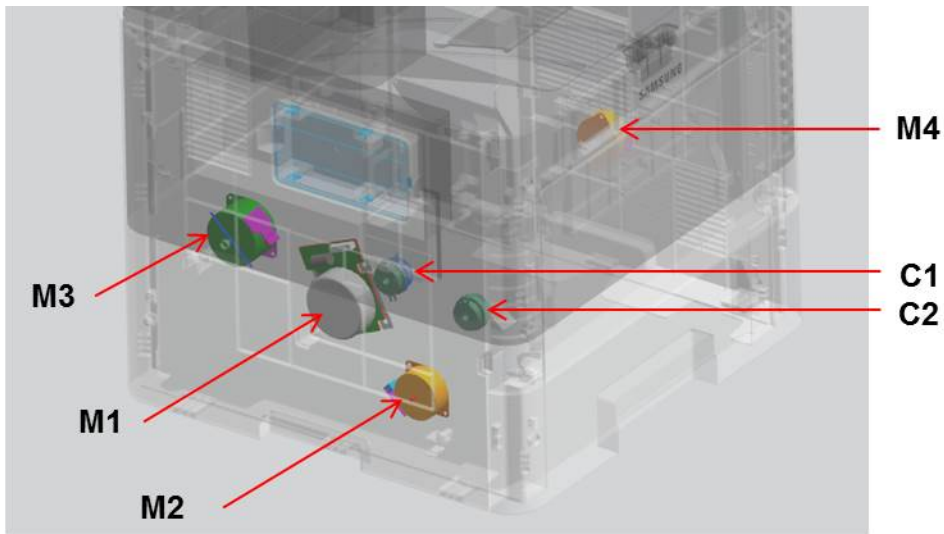

Ref.	Description	Part Code
M1	Main motor	JC31-00075D
M2	Lift / Pickup motor	JC93-00336A
M3	Exit / Fuser motor	JC93-00812A
M4	Duplex motor	JC93-00336A
C1	Registration clutch	JC47-00035C
C2	MP pickup clutch	JC47-00035C
F1	Main Fan	JC31-00161A
F2	SMPS Fan	JC31-00152B

## 3. Disassembly and Reassembly

---

### 3.1. Precautions when replacing parts

---

#### 3.1.1. Precautions when assembling and disassembling

---

- Use only approved Samsung spare parts. Ensure that part number, product name, any voltage, current or temperature rating are correct. Failure to do so could result in damage to the machine, circuit overload, fire or electric shock.
- Do not make any unauthorized changes or additions to the printer, these could cause the printer to malfunction and create electric shock or fire hazards.
- Take care when dismantling the unit to note where each screw goes. There are 19 different screws. Use of the wrong screw could lead to system failure, short circuit or electric shock.
- Do not disassemble the LSU unit. Once it is disassembled dust is admitted to the mirror chamber and will seriously degrade print quality. There are no serviceable parts inside.
- Regularly check the condition of the power cord, plug and socket. Bad contacts could lead to overheating and fire. Damaged cables could lead to electric shock or unit malfunction.

#### 3.1.2. Precautions when handling PBA

---

Static electricity can damage a PBA, always use approved anti-static precautions when handling or storing a PBA.

- **Precautions when moving and storing PBA**
  - 1) Please keep PBA in a conductive case, anti-static bag, or wrapped in aluminum foil.
  - 2) Do not store a PBA where it is exposed to direct sunlight.
- **Precautions when replacing PBA**
  - 1) Disconnect power connectors first, before disconnecting other cables.
  - 2) Do not touch any soldered connections, connector terminals or other electronic parts when handling insulated parts.
- **Precautions when checking PBA**
  - 1) Before touching a PBA, please touch other grounded areas of the chassis to discharge any static electrical charge on the body.
  - 2) Take care not to touch the PBA with your bare hands or metal objects as you could create a short circuit or get an electric shock. Take extra care when handling PBAs with moving parts fitted such as sensors, motors or lamps as they may get hot.
  - 3) Take care when fitting, or removing, screws. Look out for hidden screws. Always ensure that the correct screw is used and always ensure that when toothed washers are removed they are refitted in their original positions.

### 3.1.3. Releasing Plastic Latches

Many of the parts are held in place with plastic latches. The latches break easily; release them carefully.

To remove such parts, press the hook end of the latch away from the part to which it is latched.

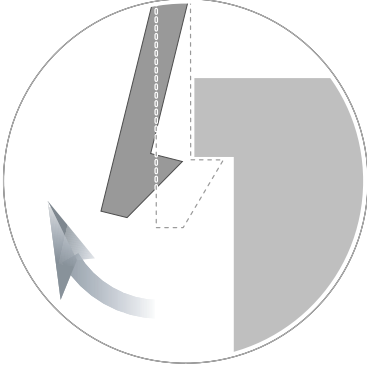

## 3.2. Replacing the maintenance part

### 3.2.1. Fuser Unit



#### CAUTION

The temperature gets hot around the Fuser Unit. To prevent burns, make sure the Fuser Unit area is cool before performing any maintenance.

1. Turn the machine off.
2. Remove the duplex unit.



3. Lift up the left side of the rear cover to release it from the holder. Then remove the rear cover.

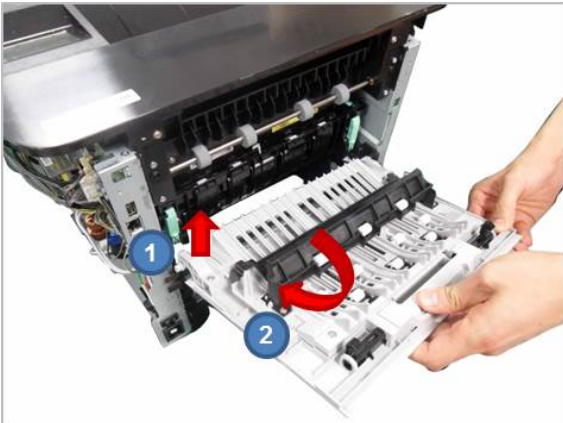

4. Push down on both fuser levers.

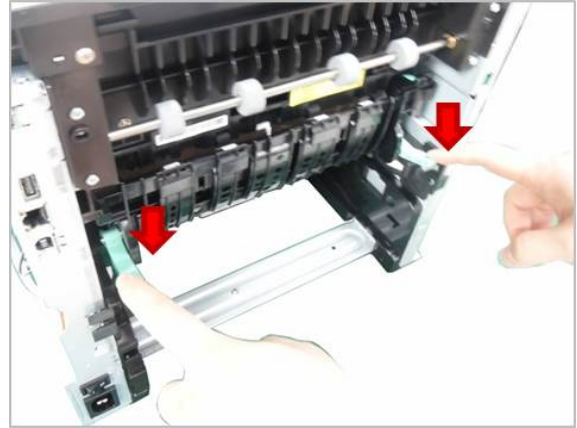

5. Push down on both green points of the FRAME-REAR.

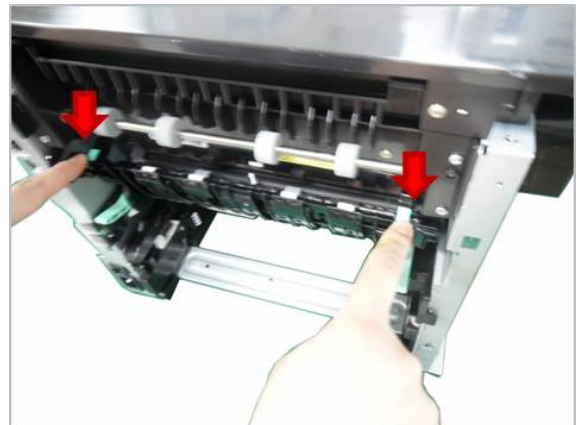

6. Release the FRAME-REAR while pushing it to the left.

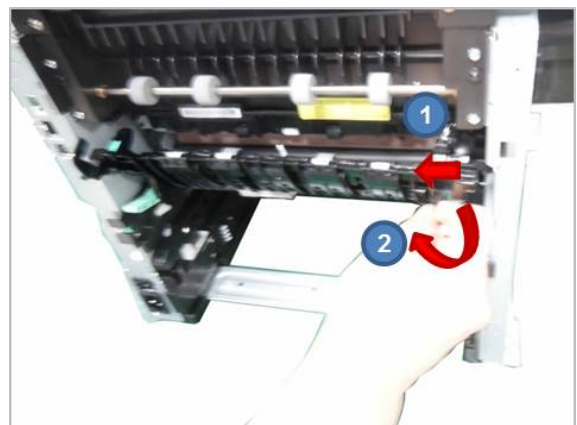

7. Remove 6 screws. Remove the HOLDER-EXIT SENSOR. Then, release the fuser unit.

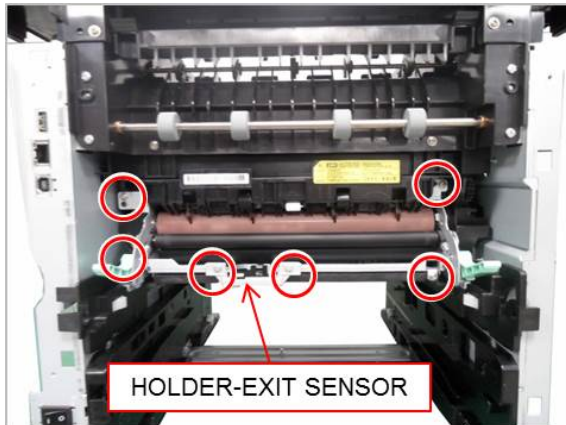

### 3.2.2. Transfer Roller

---

1. Open the front cover. Remove the toner cartridge.
2. Remove the transfer roller holder while pushing its hooks to the middle. Then, release the transfer roller.

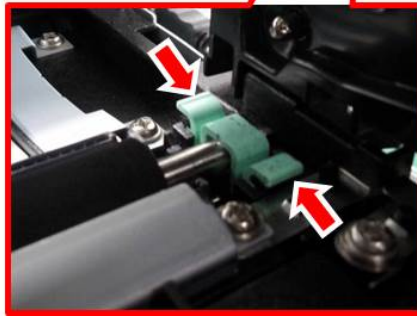



### 3.2.3. Separation Roller

1. Remove the cassette.



3. Lift small tap, then remove the separation roller.

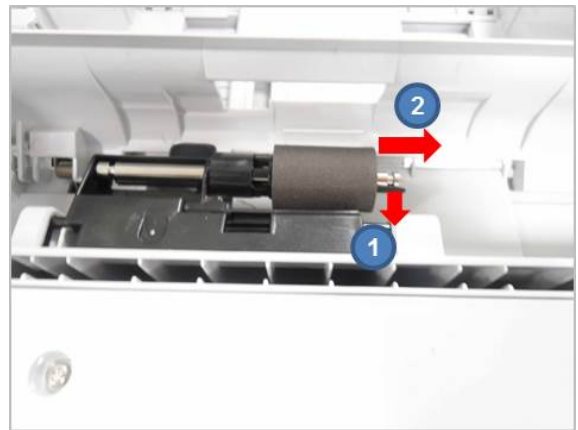

2. Open the separation roller cover.



### 3.2.4. Pick-up Roller and Forward Roller

---

1. Remove the cassette.



2. Lift small tap, then remove the pick up and forward roller.

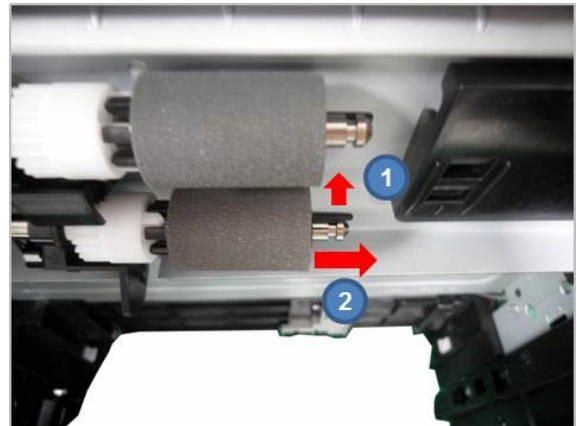

### 3.2.5. SCF Separation Roller

1. Remove the SCF cassette.



3. Lift small tap, then remove the separation roller.

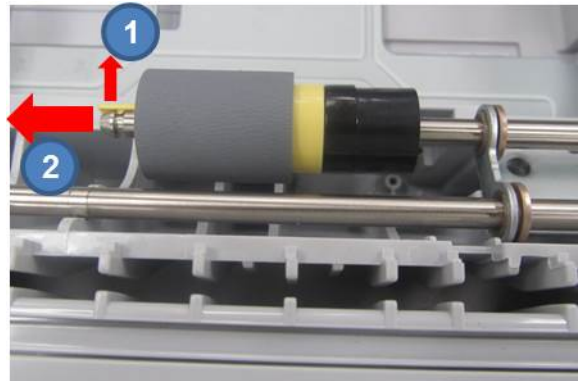

2. Open the separation roller cover.



### 3.2.6. SCF Pick-up Roller and Forward Roller

---

1. Remove the cassette.



2. Lift small tap, then remove the pick up and forward roller.

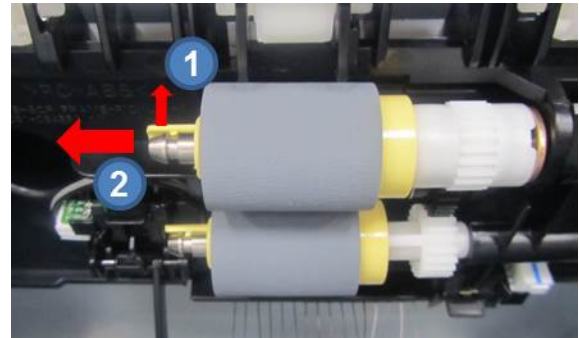

## 3.3. Replacing the main SVC part

### 3.3.1. Right Cover

1. Open the front cover. Remove 2 screws.



3. Remove the right cover by releasing the side hooks.

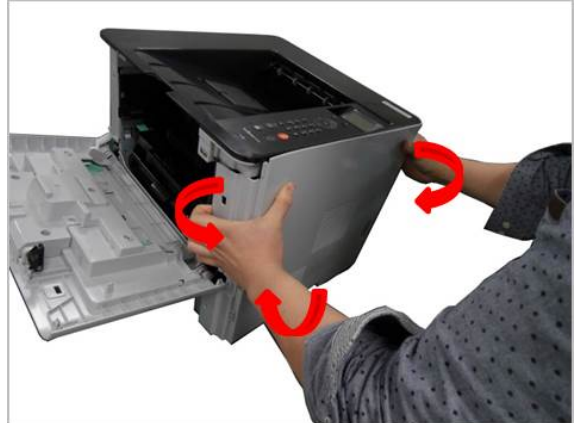

2. Remove 2 screws from the rear.



### 3.3.2. Left Cover

---

1. Open the front cover. Remove 2 screws.

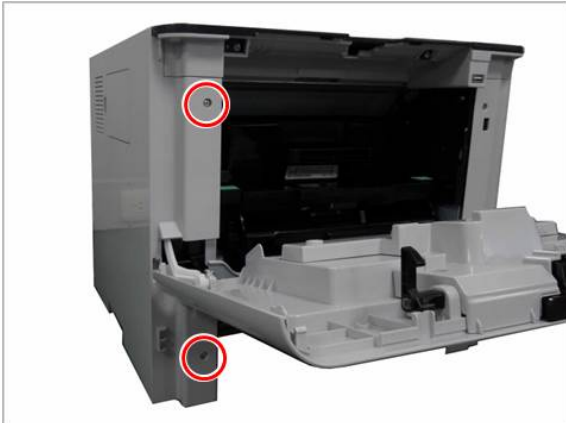

2. Remove 2 screws from the rear.



3. Remove the right cover by releasing the side hooks.



### 3.3.3. Rear Cover

1. Remove the duplex unit.



2. Lift up the left side of the rear cover to release it from the holder. Then remove the rear cover.

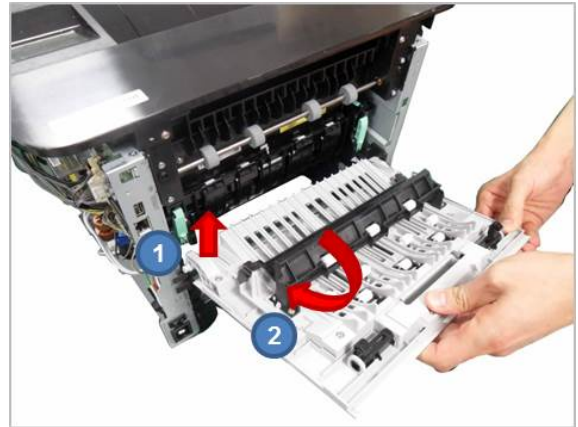

### 3.3.4. Main Board

---

1. Remove the right cover. (**Refer to 3.3.1.**)
2. Unplug all harness on the main board. Remove 5 screws. Then, release the main board.

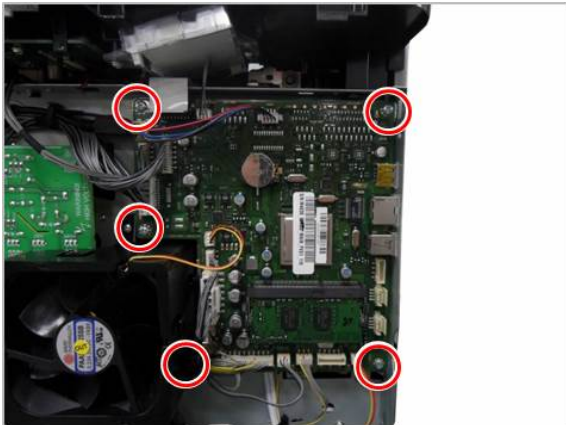



### 3.3.5. HVPS Board

1. Remove the right cover. (Refer to 3.3.1.)
2. Remove 1 screw and unplug the fan connector.

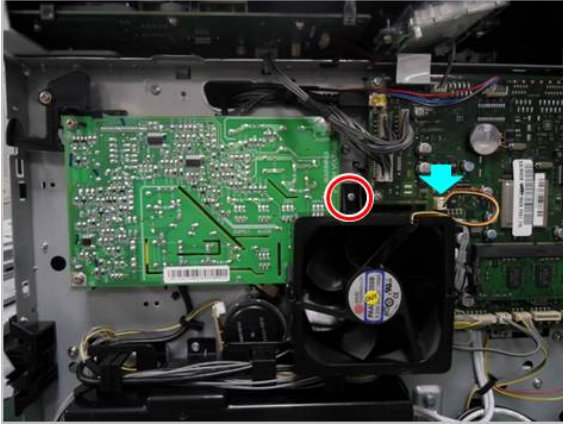

4. Remove 5 screws. Unplug the harness. Then, release the HVPS board.

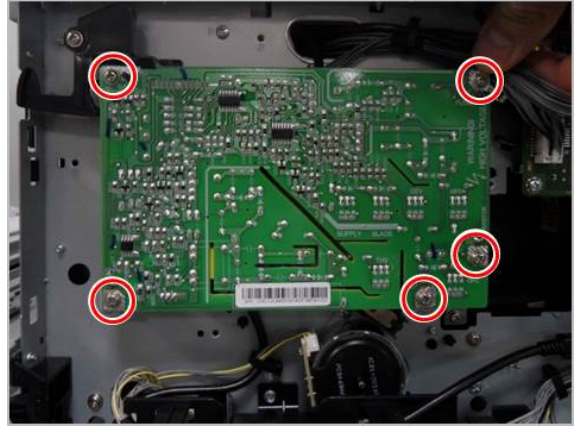

3. Remove the FRAME-DUCT MAIN.

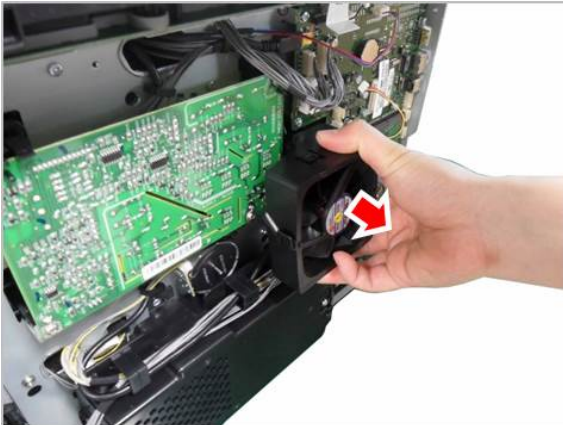

### 3.3.6. SMPS Board

---

1. Remove the right cover. (**Refer to 3.3.1.**)
2. Release the harness from the holder of the SMPS cover. Remove 3 screws and unplug the fan connector. Then, release the SMPS cover.

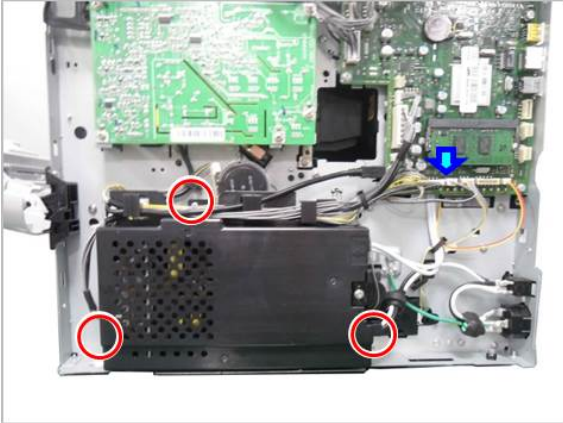

3. Unplug the harness on the SMPS board. Remove 4 screws. Then, release the SMPS board.

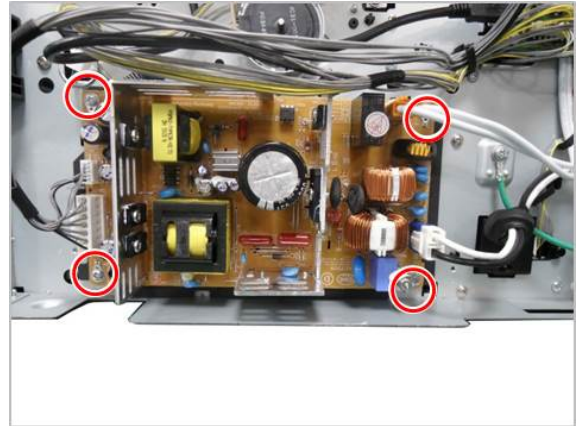

### 3.3.7. Duplex Motor

1. Remove the right cover. (**Refer to 3.3.1.**)
2. Release the harness from the holder of the SMPS cover. Remove 3 screws and unplug the fan connector. Then, release the SMPS cover.

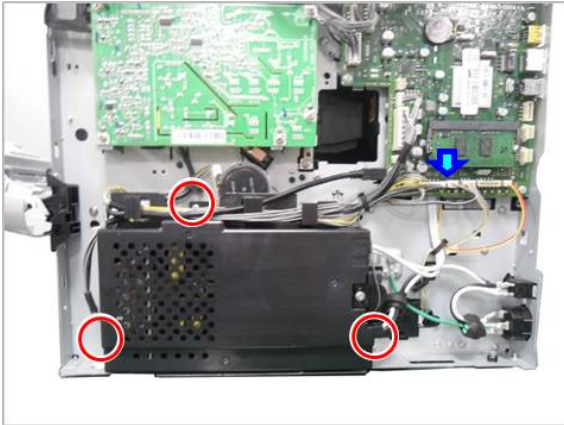

3. Unplug the motor connector. Remove 2 screws. Then, release the duplex motor.

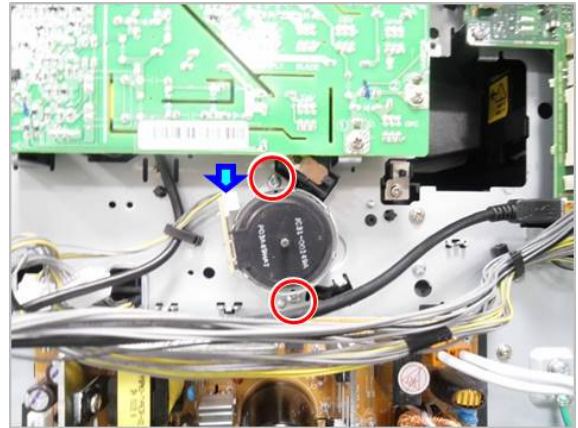

### 3.3.8. Fuser Drive Unit

---

1. Remove the left cover. (**Refer to 3.3.2.**)
2. Unplug the motor connector. Remove 3 screws. Then, release the Fuser Drive Unit.

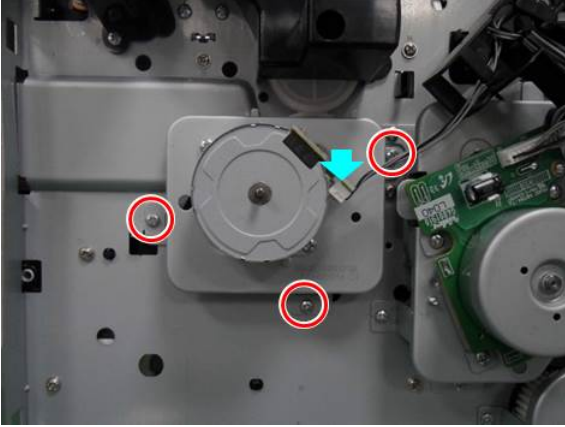

### 3.3.9. Main Drive Unit

1. Remove the left cover. (Refer to 3.3.2.)
2. Release the harness from the guide. Remove 2 screws. Then, release the harness guide.

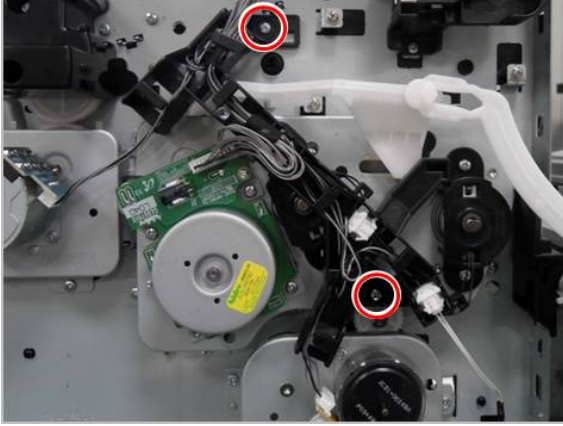

3. Unplug the motor and clutch connectors. Remove 7 screws. Then, release the main drive unit.

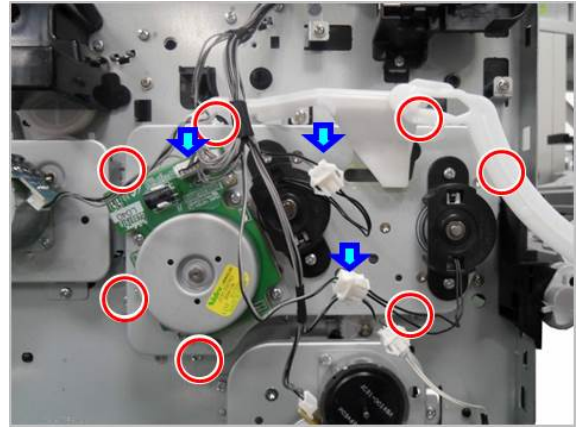

### 3.3.10. CST-Lifting Drive Unit

---

1. Remove the left cover. (**Refer to 3.3.2.**)
2. Unplug the motor. Remove 3 screws. Then, release the CST-Lifting Drive Unit.

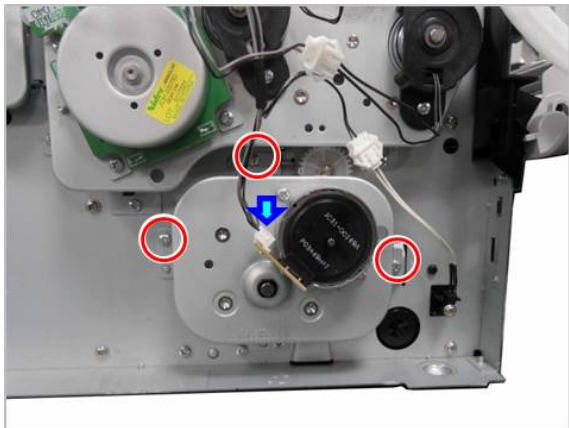

### 3.3.11. Paper Size Sensor

1. Remove the right cover. (**Refer to 3.3.1.**)
2. Remove the cassette.
3. Unplug the sensor connector. Then, release the hook while pushing it to the middle.

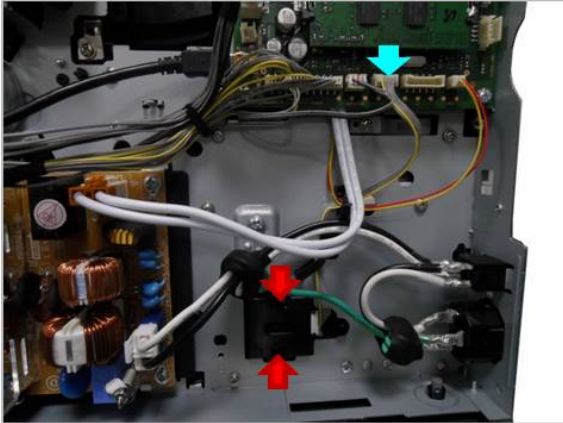

4. Remove the paper size sensor on the opposite side.

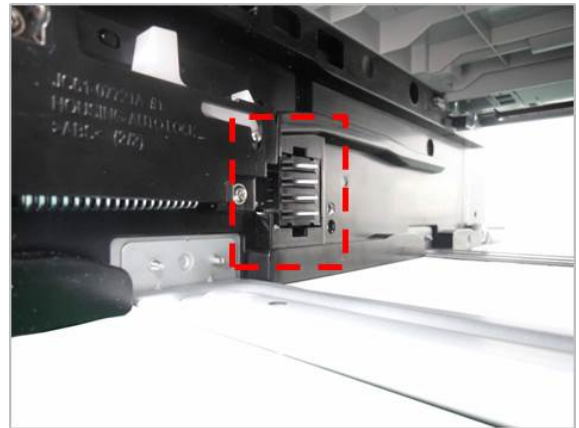

### 3.3.12. OPE Board

1. Remove the left and right cover. (Refer to 3.3.1 ~ 2.)
2. Unplug the OPE harness from the main board.



3. Remove 2 screws from the front side.



4. Remove 2 screws from the rear side.



5. Release the rear hook of the top cover.



6. Lift up and release the top cover.



7. Remove 6 screws. Then, release the OPE board.





### 3.3.13. LSU

1. Remove the right cover. (Refer to 3.3.1.)
2. Remove the top cover. (Refer to 3.3.12.)
3. Unplug the LSU harness.

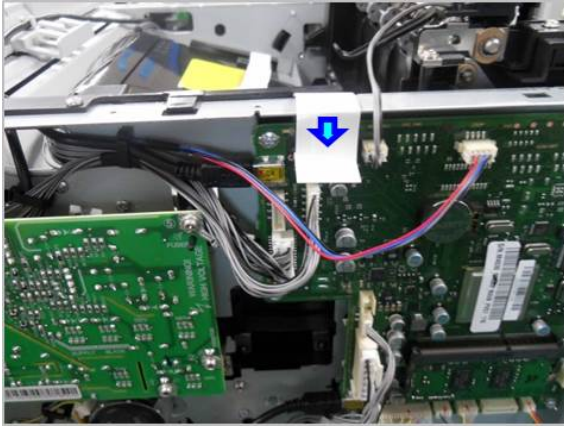

4. Remove 4 screws. Then, release the LSU.

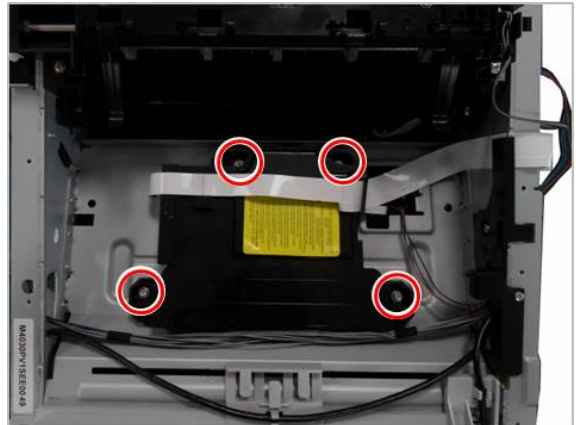

### 3.3.14. Exit Unit

1. Remove the right cover. (Refer to 3.3.1.)
2. Remove the rear cover. (Refer to 3.3.3.)
3. Remove the top cover. (Refer to 3.3.12.)
4. Remove the Exit Gear.



5. Remove 2 screws.

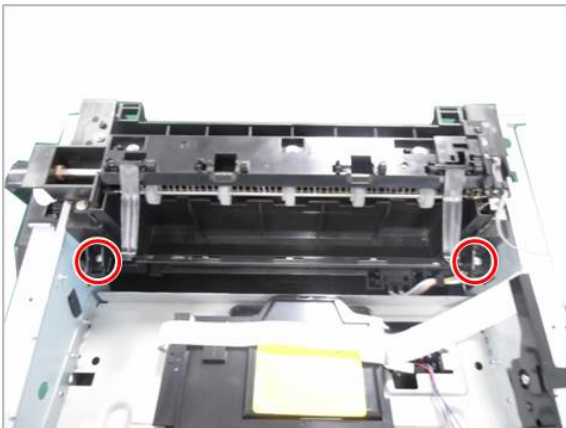

6. Remove 4 screws.

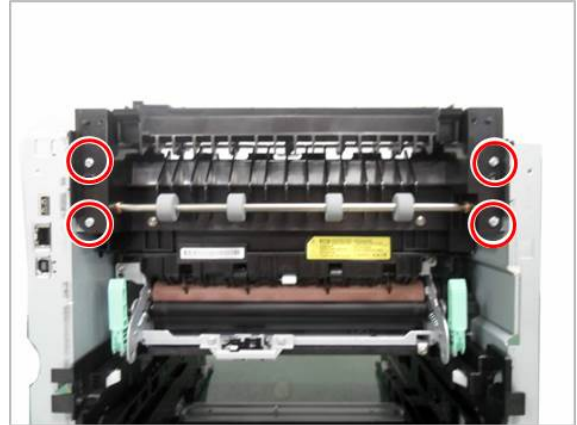

7. Remove the Exit Unit.

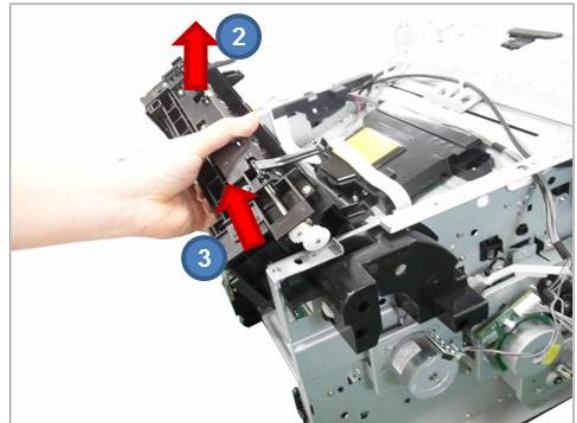
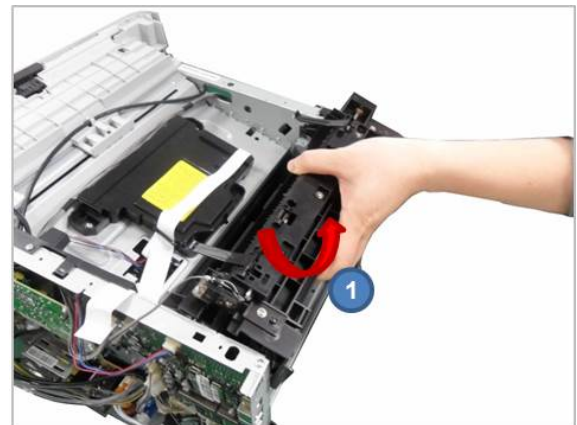

### 3.3.15. Bin-Full Sensor

1. Remove the Exit Unit. (Refer to 3.3.14.)
2. Remove 3 screws. Then, remove the FRAME-BINFULL.



3. Remove the Bin-Full sensor.



### 3.3.16. MP Unit

1. Remove the right cover. (**Refer to 3.3.1.**)
2. Release the linker between MP-TRAY and COVER-MP.

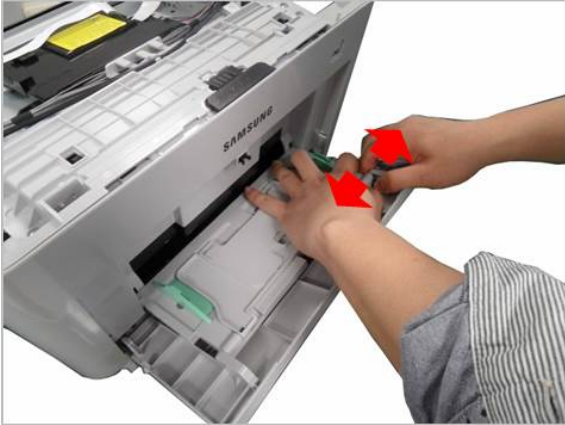

3. Remove the MP-TRAY.



4. Remove the COVER-MP.



5. Remove the COVER-FRONT.

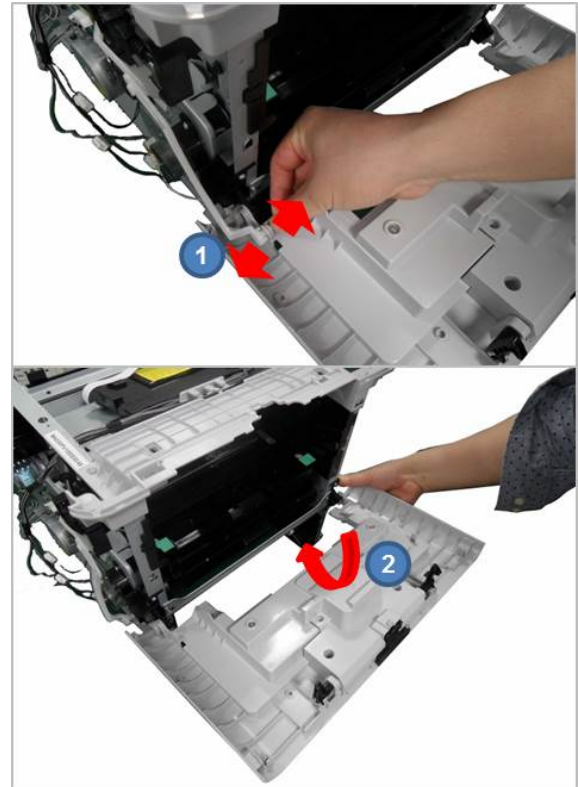

6. Remove 2 screws. Then, release the bracket.



7. Pull down on both green point of the MP Unit.

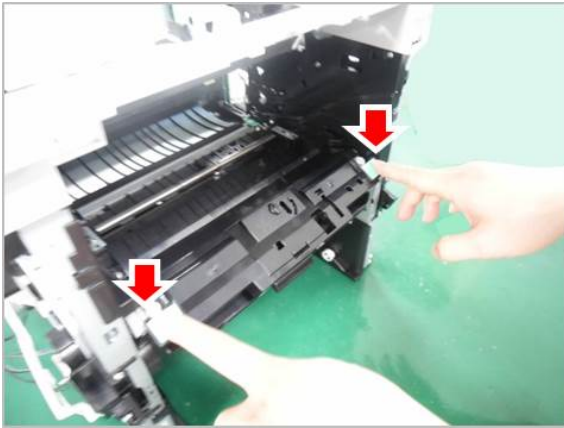

9. Remove the MP Unit.

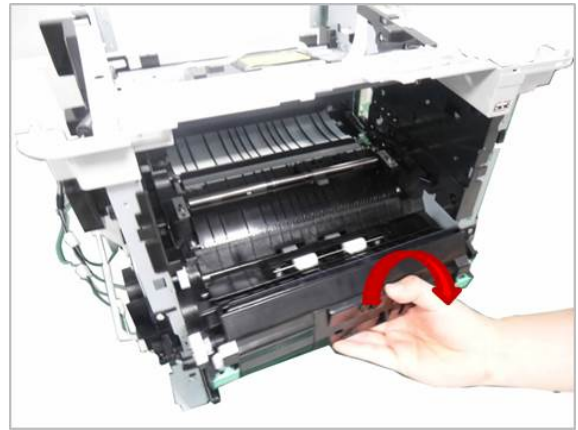

8. Unplug the MP connector.

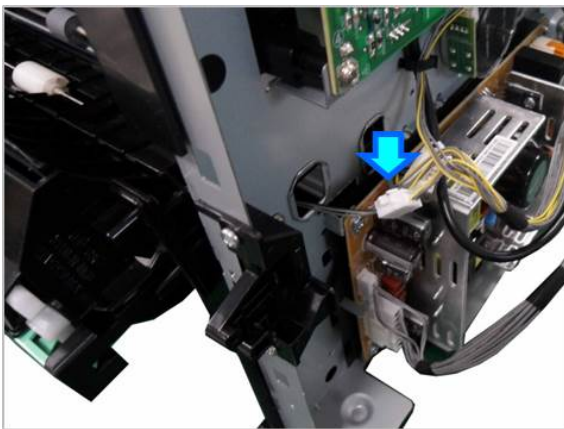

### 3.3.17. MP Roller

---

1. Open the front cover.

2. Remove the MP roller cover.



3. Release the MP roller Assy while pushing it to the left.

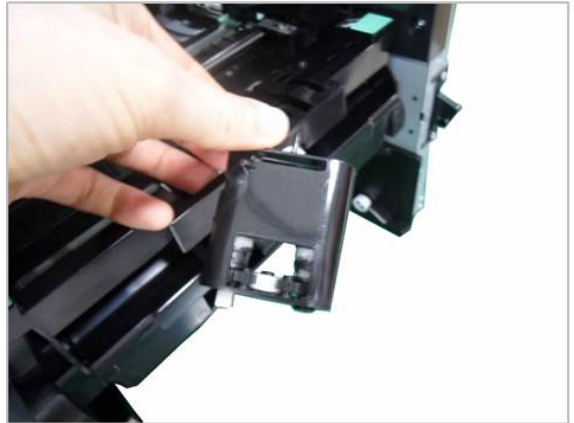
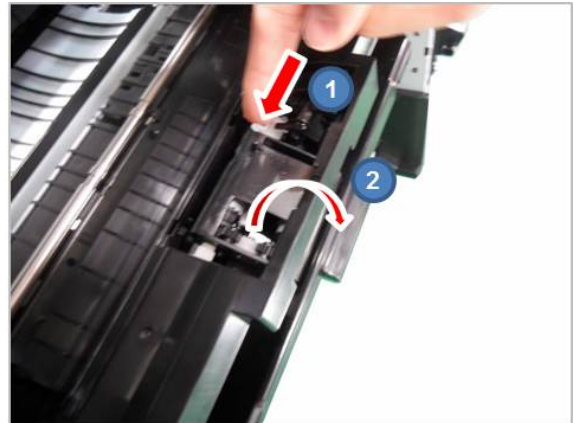

### 3.3.18. Second Cassette Feeder (Optional Tray)

#### 3.3.18.1. PBA-SCF

1. Remove the SCF cassette.

2. Remove 3 screws.

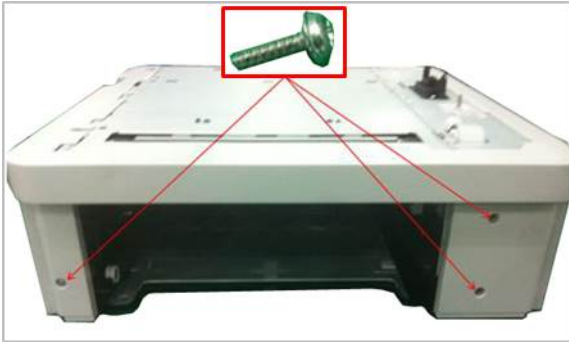

3. Remove the Cover Dummy Front.



4. Remove 2 screws. Then, remove the Cover-Right.

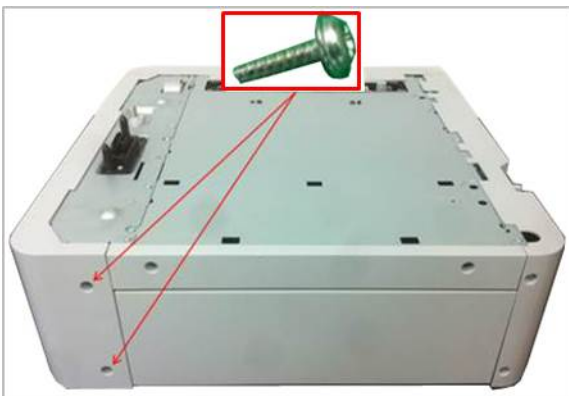

5. Remove 7 screws. Then, remove the Frame Dummy Right.

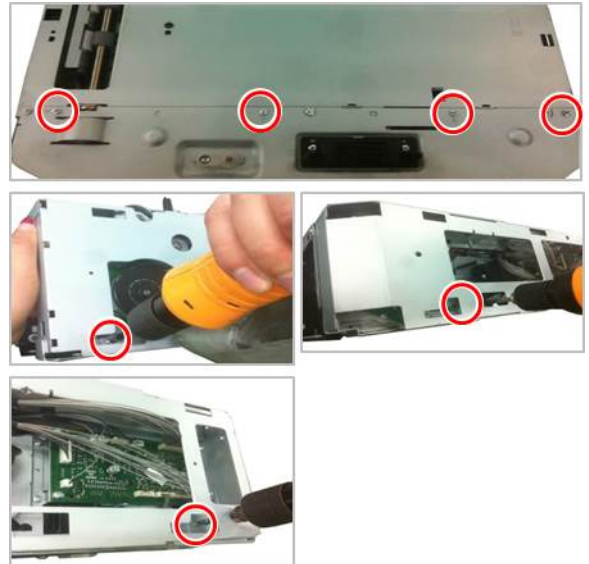

6. Remove 3 screws. Then, release the PBA-SCF.

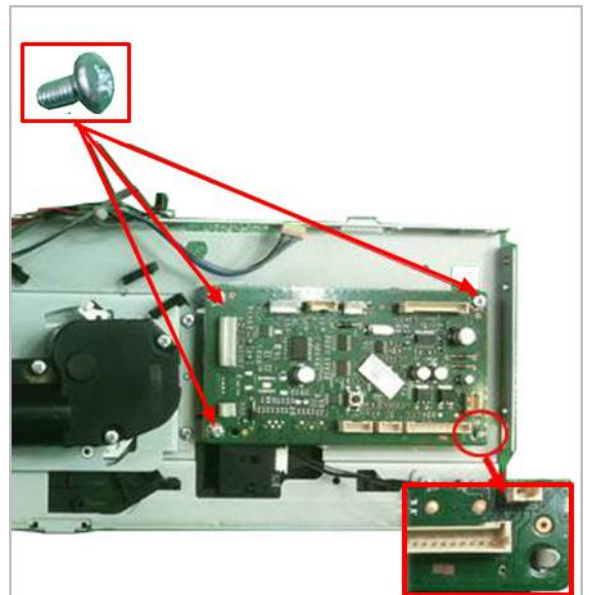

**3.3.18.2. Lift Unit**

1. Remove the SCF cassette.

2. Remove 3 screws.

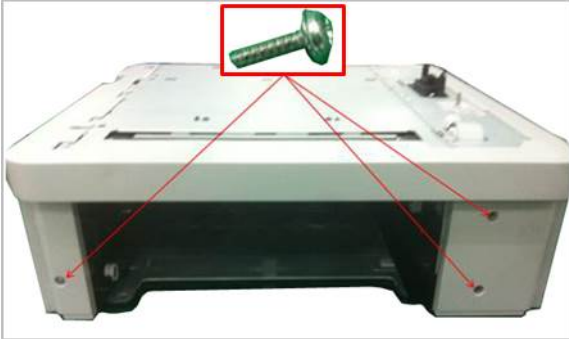

3. Remove the Cover Dummy Front.



4. Remove 2 screws. Then, remove the Cover-Right.

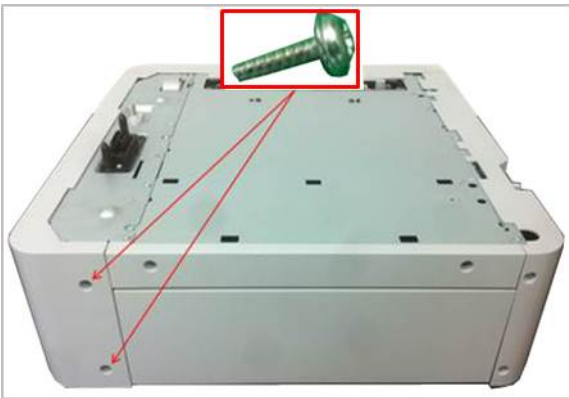

5. Remove 7 screws. Then, remove the Frame Dummy Right.

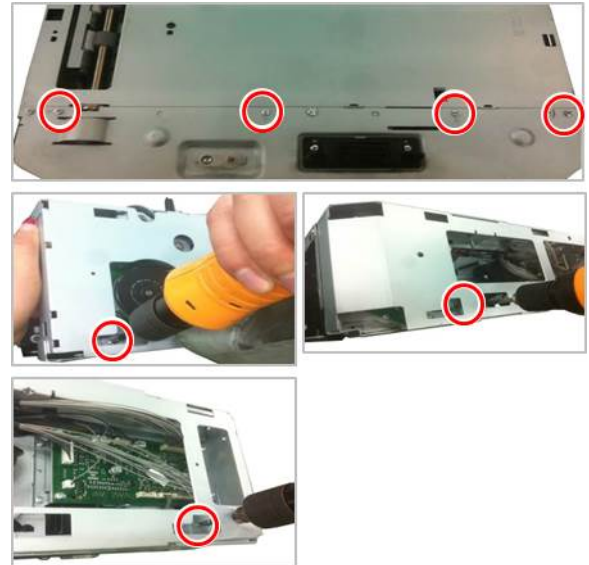

6. Remove 4 screws. Then, release the Lift Unit.

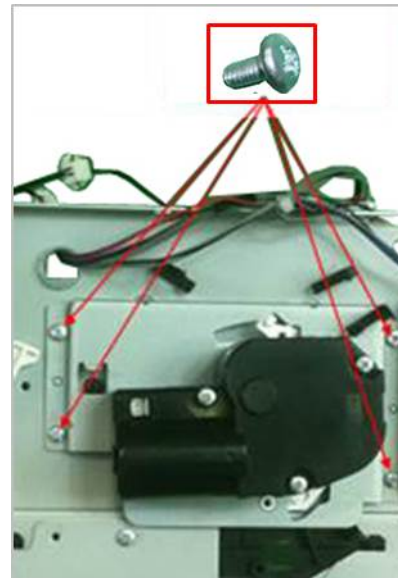



**3.3.18.3. Clutch**

1. Remove the SCF cassette.

2. Remove 3 screws.

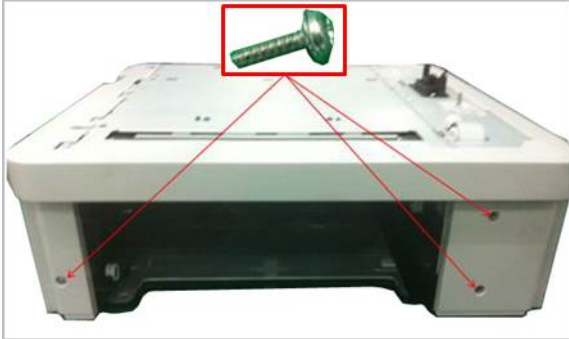

3. Remove the Cover Dummy Front.



4. Remove 2 screws. Then, remove the Cover-Right.

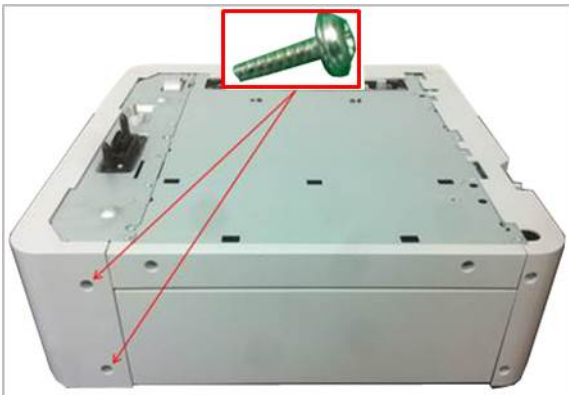

5. Remove 7 screws. Then, remove the Frame Dummy Right.

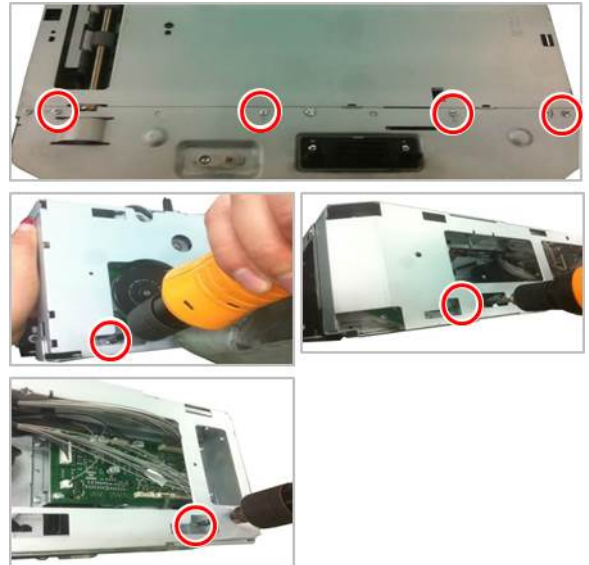

6. Remove 2 E-RINGS and 2 BUSHs. Remove 2 screws. And then, remove the bracket.

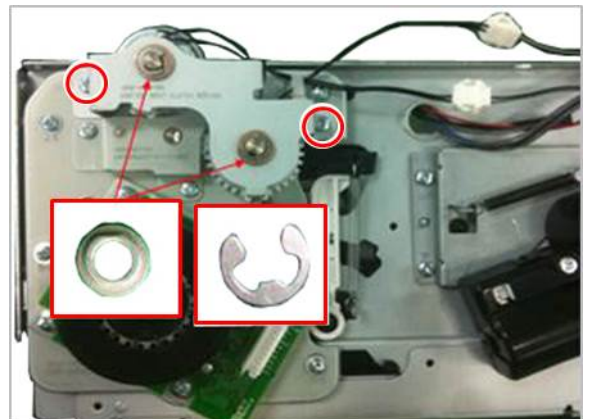

7. Open the harness clamp. Unplug the clutch connector. And then, release the clutch.

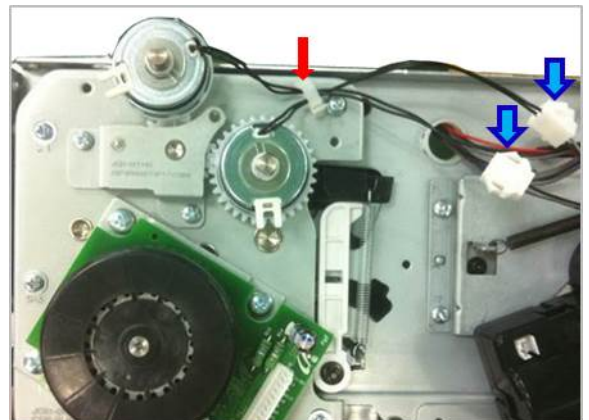

### 3.3.18.4. Drive Unit

1. Remove the SCF cassette.

2. Remove 3 screws.

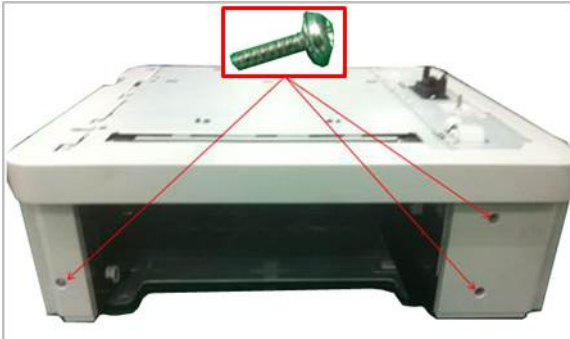

3. Remove the Cover Dummy Front.



4. Remove 2 screws. Then, remove the Cover-Right.

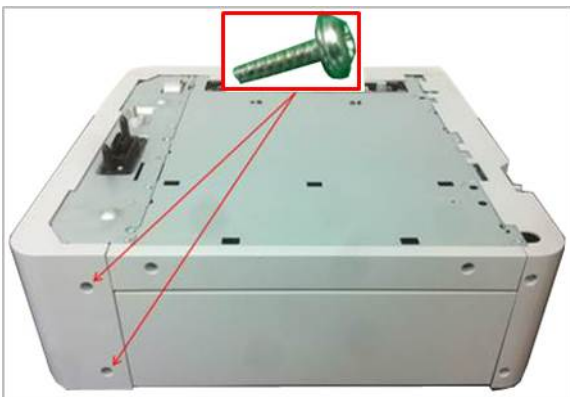

5. Remove 7 screws. Then, remove the Frame Dummy Right.

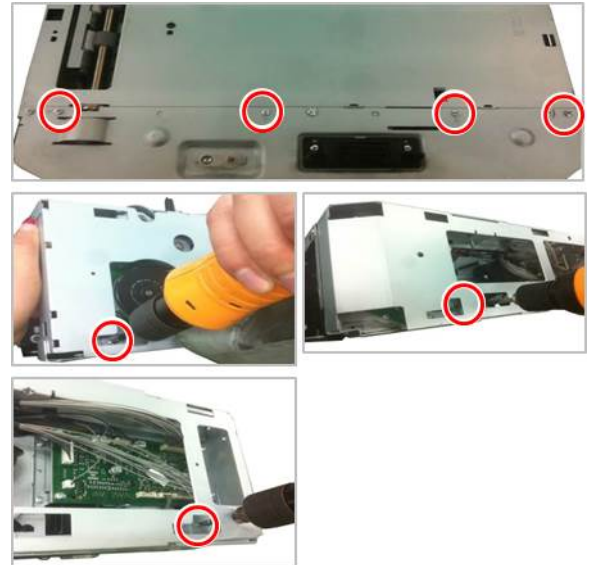

6. Remove 4 screws. Then, release the Drive Unit.

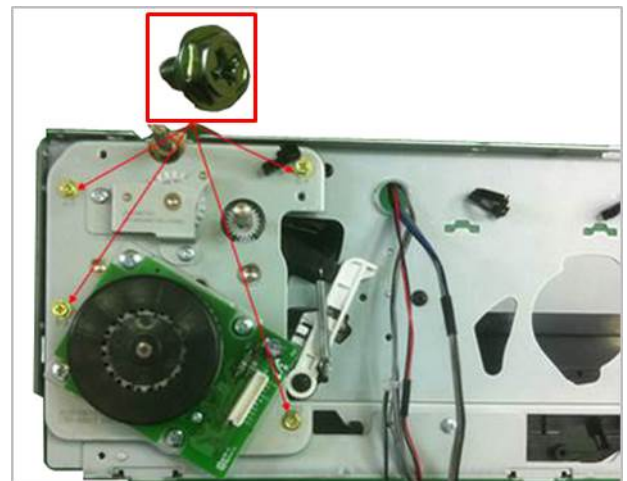

## 4. Troubleshooting

### 4.1. Control panel

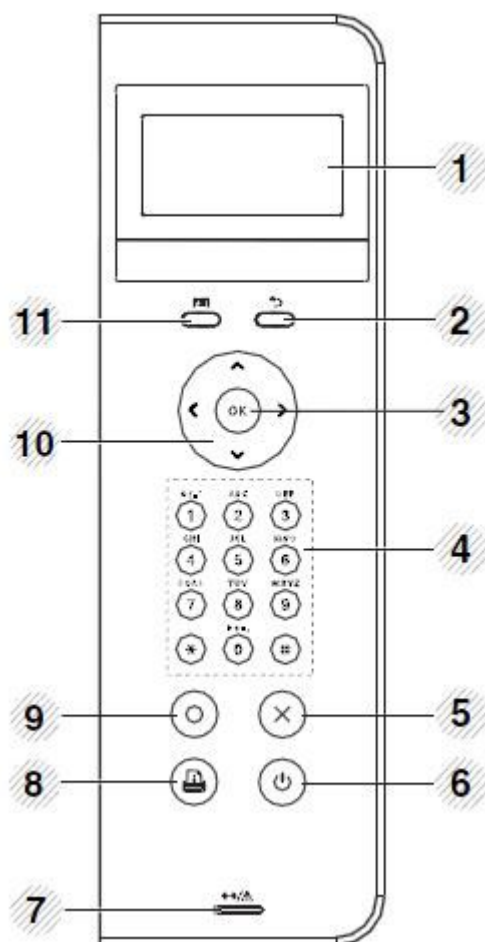

1	Display screen	Shows the current status and prompts during an operation.
2	Back	Sends you back to the upper menu level.
3	OK	Confirms the selection on the screen.
4	Numeric keypad	Use the keypad to enter numbers and characters.
5	Stop/ Clear	Stops current operation.
6	Power/ Wake Up	You can turn the power on and off with this button. Or wake up from the power save mode.
7	Status LED	Indicates the status of your machine.
8	Demo Page	Prints a demo page by pressing this button.
9	Eco	Turn on the Eco mode to reduce toner consumption and paper usage.
10	Arrow	Navigates available values by moving to the next or previous options.
11	Menu	Enters menu mode and scrolls through the available menus.

## 4.2. Understanding the LEDs

The color of the Status indicates the machine's current status.



### NOTE

- Some LEDs may not be available depending on model or country
- To resolve the error, look at the error message and its instructions from the troubleshooting part.
- You also can resolve the error with the guideline from the computers's Samsung Printing Status program window.

Status		Description	
Status	Off	The machine is off-line.	
	Green	Blinking	When the backlight blinks, the machine is receiving or printing data.
		On	The machine is on-line and can be used.
	Orange	Blinking	<ul style="list-style-type: none"> <li>• A minor error has occurred and the machine is waiting for the error to be cleared. For models that supports display screen on the control panel, check the display message. When the problem is cleared, the machine resumes.</li> <li>• Small amount of toner is left in the cartridge. The estimated cartridge life of toner is close. Prepare a new cartridge for replacement. You may temporarily increase the printing quality by redistributing the toner.</li> </ul>
		On	<ul style="list-style-type: none"> <li>• A toner cartridge has almost reached its estimated cartridge life.</li> <li>• The cover is opened. Close the cover.</li> <li>• There is no paper in the tray when receiving or printing data. Load paper in the tray.</li> <li>• The machine has stopped due to a major error. Check the display message.</li> <li>• A paper jam has occurred.</li> </ul>
	Power/ Wake Up	Blue	On
Off			The machine is in ready mode or machine's power is off.
Eco	Green	On	Eco mode is on.
		Off	Eco mode is off.



### NOTE

Estimated cartridge life means the expected or estimated toner cartridge life, which indicates the average capacity of print-outs and is designed pursuant to ISO/IEC 19752. The number of pages may be affected by operating environment, printing interval, media type, and media size. Some amount of toner may remain in the cartridge even when the orange LED is on and the printer stops printing.

## 4.3. Updating Firmware

---

This chapter includes instructions for updating the printer firmware. You can update the printer firmware by using one of the following methods :

- Update the firmware by using the USB cable.
- Update the firmware by using the network.

### 4.3.1. Update the firmware by using the USB port

---

#### Upgrading preparations

- usblast2.exe : Tool which sends firmware data to printer.
- Firmware file to update.

#### Upgrade Procedure

- 1) Turn the machine off.
- 2) Connect USB cable to printer.
- 3) Turn the machine on. Check if the printer is the ready status.
- 4) Drag the SWUPGRADE\_ON.prn file and drop down on the usblast2.exe.
- 5) Drag the firmware file and drop down on the usblast2.exe icon.

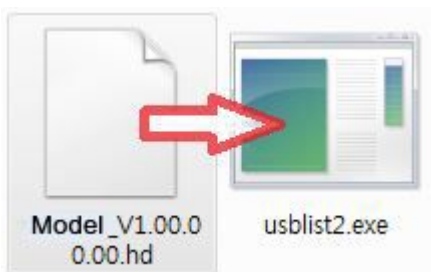

And then firmware update will be started automatically.

- 6) When upgrading is completed, the machine will automatically reboot.

### 4.3.2. Updating from the Network

**WARNING**

Failure to follow these instructions could lead to corruption issues and prevent the proper operation of this printer. Follow all of the instructions carefully.

Perform the following procedure to update the printer firmware from the network.

- 1) Access a web browser, such as Internet Explorer, from Windows. Enter the machine IP address (<http://xxx.xxx.xxx.xxx>) in the address field and press the Enter key or click Go. When the main page of the SyncThruWeb Service (SWS) displays, login as Admin in Sync Thru Web Service.

**NOTE**

- Login using the Administrator ID and Password established during initial machine setup.
- If Admin ID and password is not established, use the default value. (ID: admin / Password: sec00000)

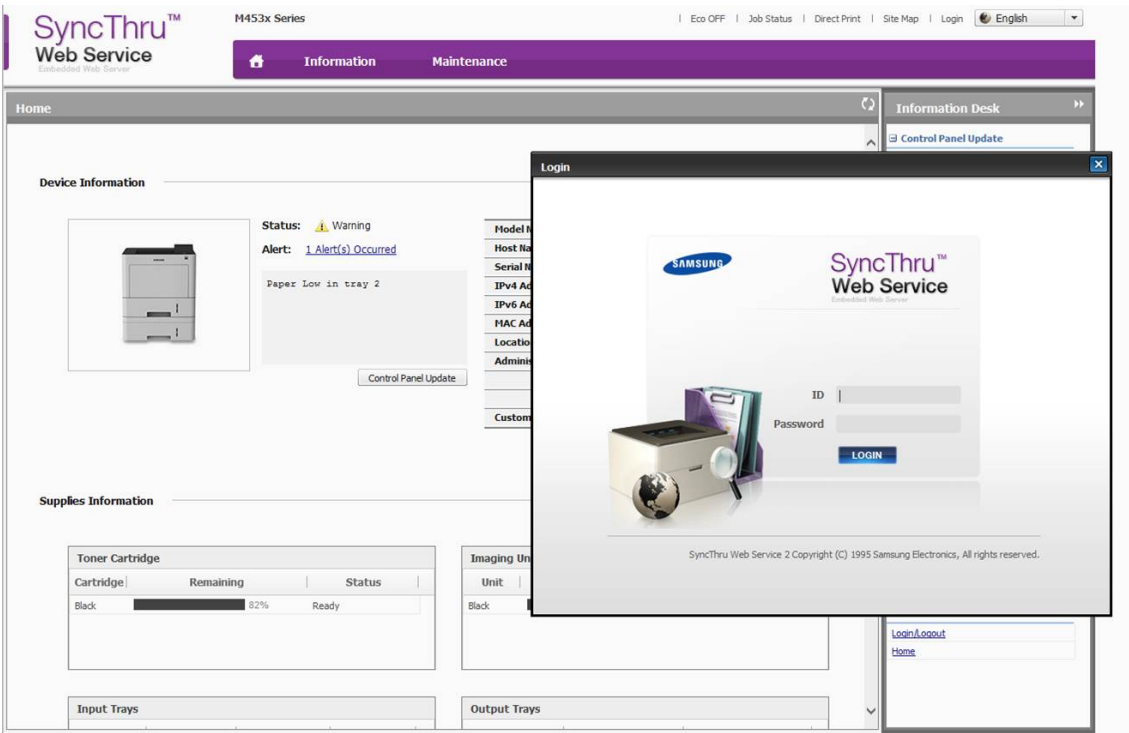

2) Click on **Maintenance > Firmware Upgrade > Upgrade Wizard**.

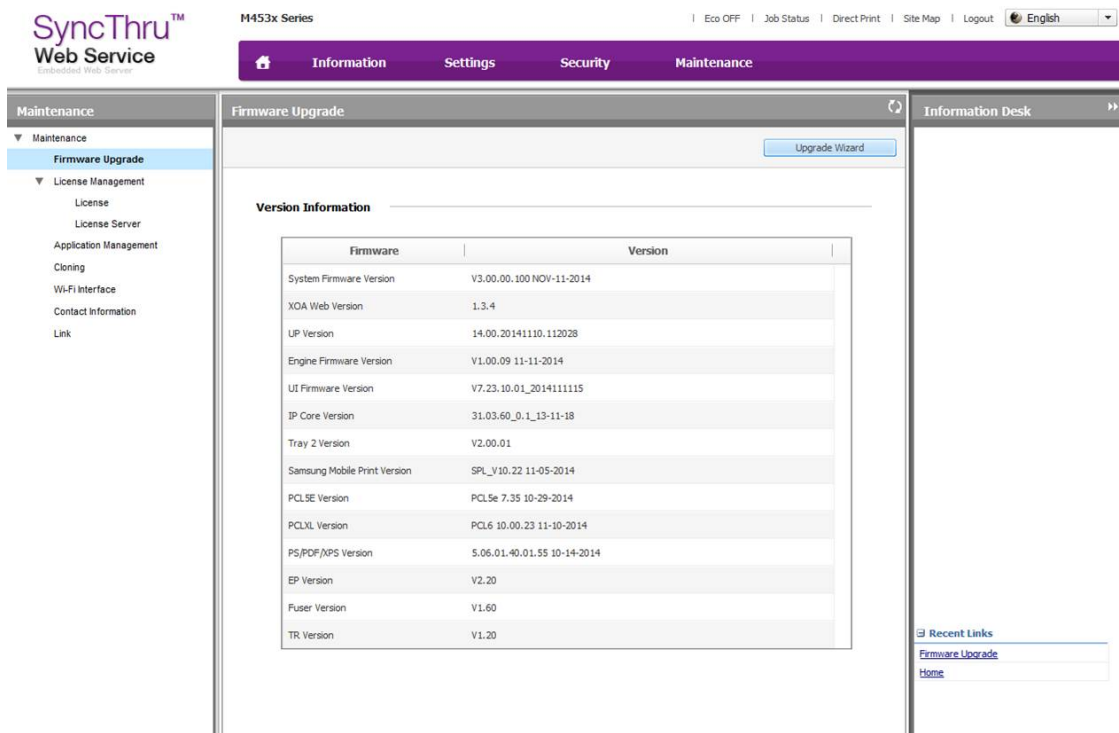

The screenshot shows the SyncThru Web Service interface for an M453x Series device. The 'Maintenance' menu is expanded to 'Firmware Upgrade', and the 'Upgrade Wizard' button is highlighted. The 'Version Information' table is displayed below.

Firmware	Version
System Firmware Version	V3.00.00.100 NOV-11-2014
XOA Web Version	1.3.4
UP Version	14.00.20141110.112028
Engine Firmware Version	V1.00.09 11-11-2014
UI Firmware Version	V7.23.10.01_2014111115
IP Core Version	31.03.60_0_1_13-11-18
Tray 2 Version	V2.00.01
Samsung Mobile Print Version	SPL_V10.22 11-05-2014
PCLSE Version	PCLSe 7.35 10-29-2014
PCLXL Version	PCL6 10.00.23 11-10-2014
PS/PDF/XPS Version	5.06.01.40.01.55 10-14-2014
EP Version	V2.20
Fuser Version	V1.60
TR Version	V1.20

3) Choose installation file (F/W file) by browsing the file system and click **[OK]**.

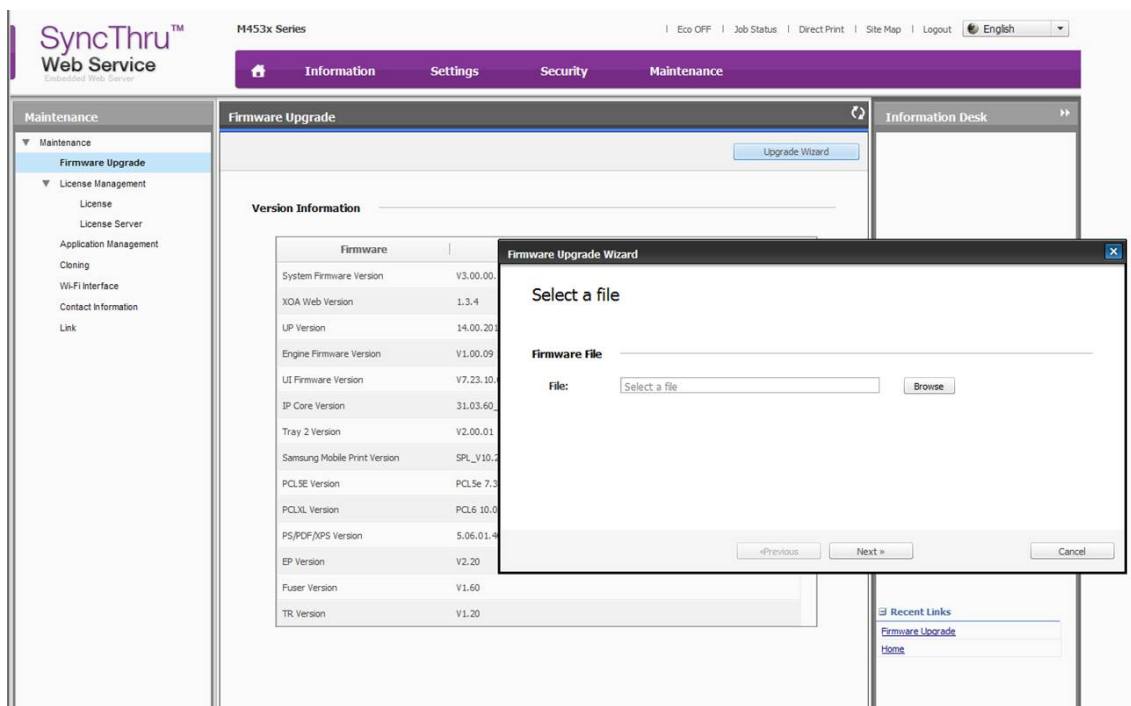

The screenshot shows the same SyncThru Web Service interface as above, but with a 'Select a file' dialog box open over the 'Version Information' table. The dialog box has a title bar 'Firmware Upgrade Wizard' and a close button. It contains the text 'Select a file' and 'Firmware File'. Below this, there is a 'File:' label, a text input field containing 'Select a file', and a 'Browse' button. At the bottom of the dialog box, there are three buttons: '<Previous', 'Next >', and 'Cancel'.

4. Troubleshooting

4) The uploading step will start and verify installation file (F/W file).

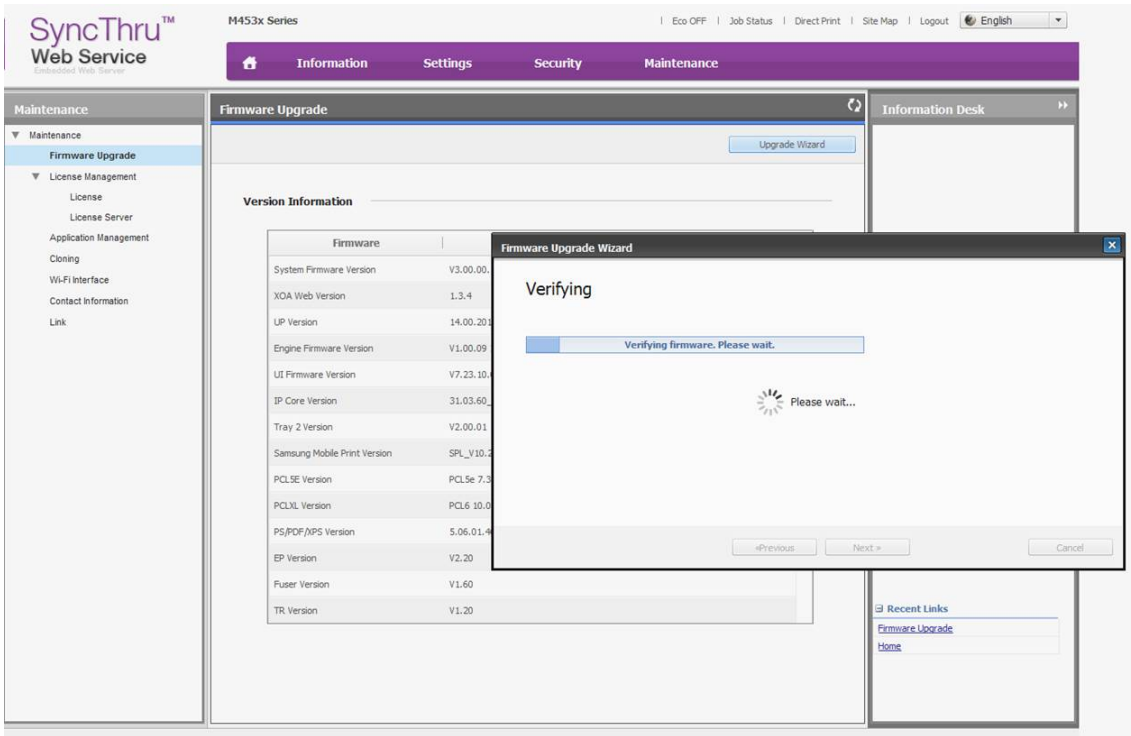

5) After uploading the f/w file on printer, validation information will appear. Check Firmware version and click Next to upgrade Firmware and press [Next] to start the firmware upgrade.

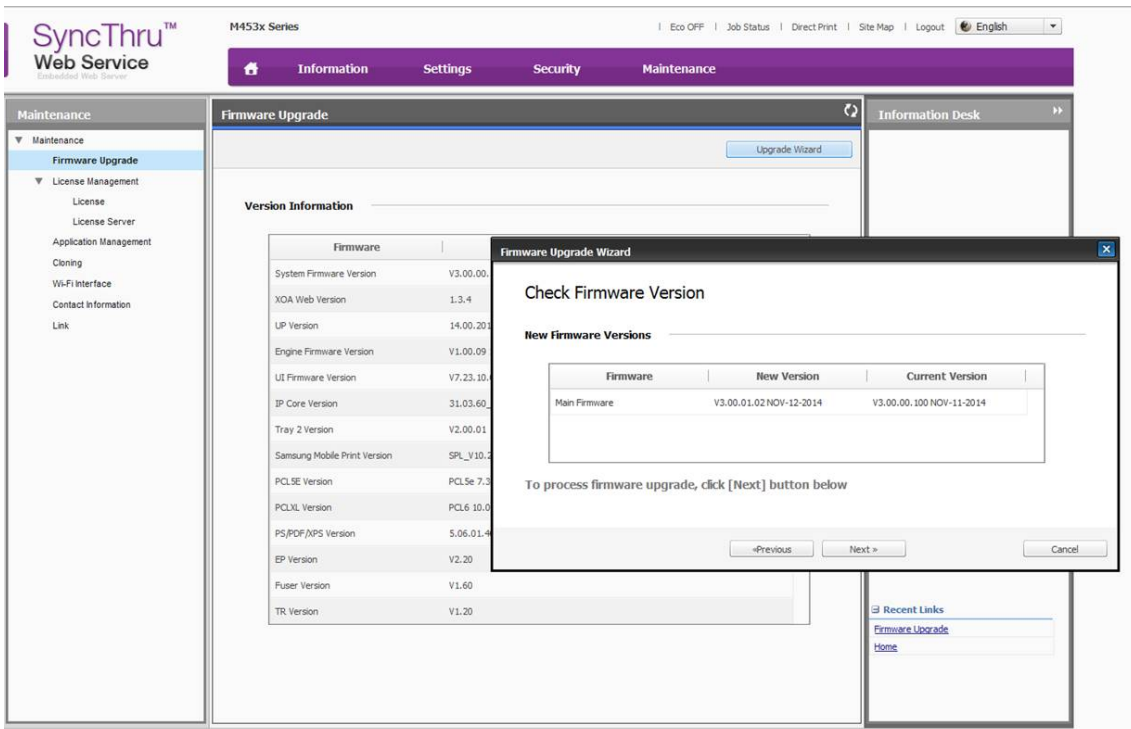



6) The firmware update will start.

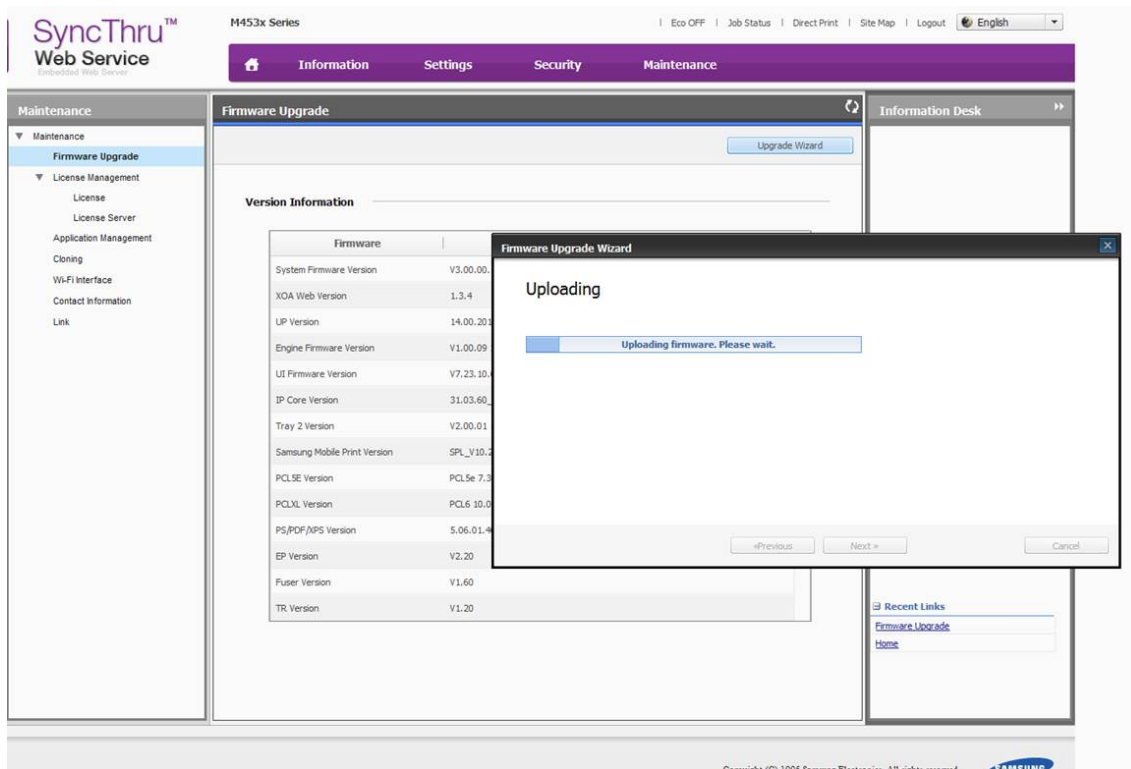

7) Once the installation is complete, the machine power-off and power-on automatically.

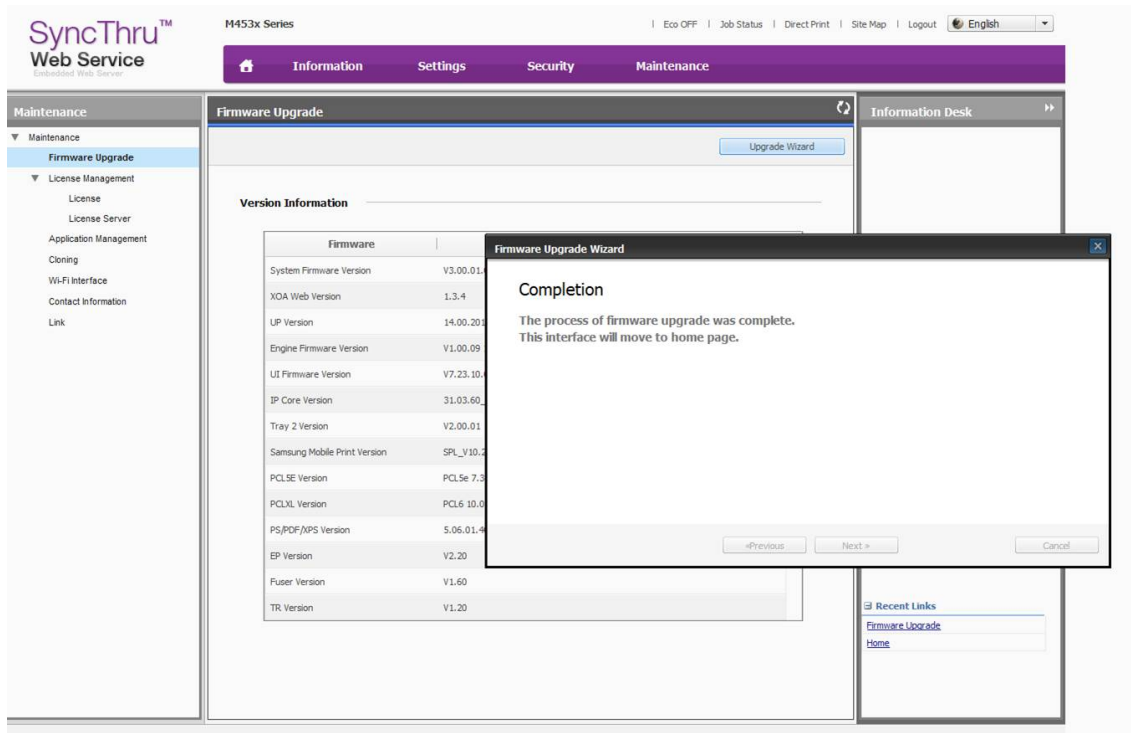

## 4.4. Clearing paper jams

---

 **NOTE**

To avoid tearing the paper, pull the jammed paper out slowly and gently.

### In tray 1

- 1) Pull out tray 1 .

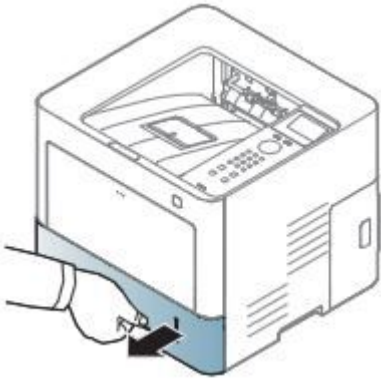

- 2) Remove the jammed paper by gently pulling it straight out.

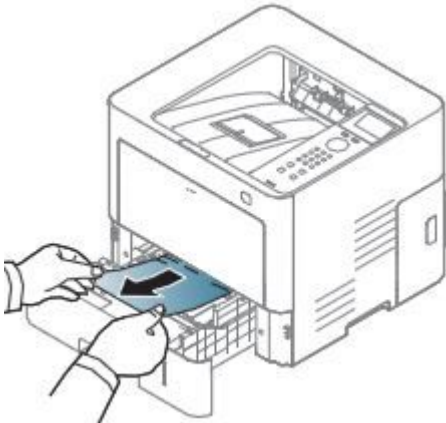

- 3) Insert tray 1 back into the machine until it snaps into place.

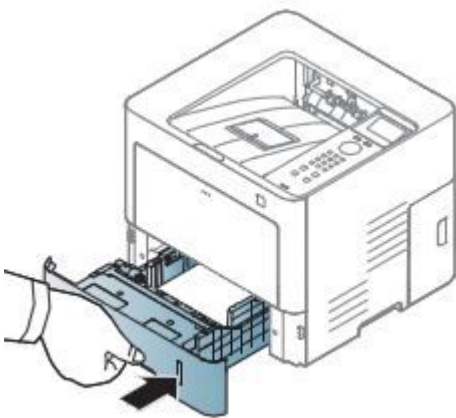

If you do not see the paper in this area, stop and go to next step:

- 4) Open the front cover.



- 5) Remove the toner cartridge.

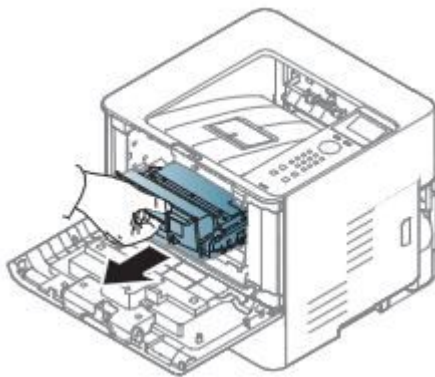

- 6) Open the jam cover.

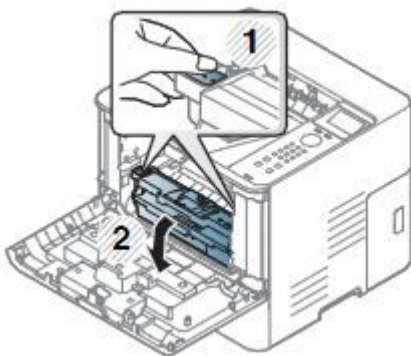

- 7) Remove the jammed paper by gently pulling it straight out. Then, close the jam cover.

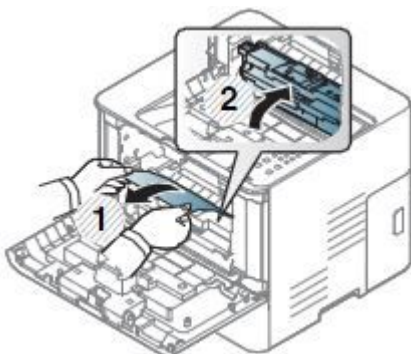

## 4. Troubleshooting

---

- 8) Install the toner cartridge.

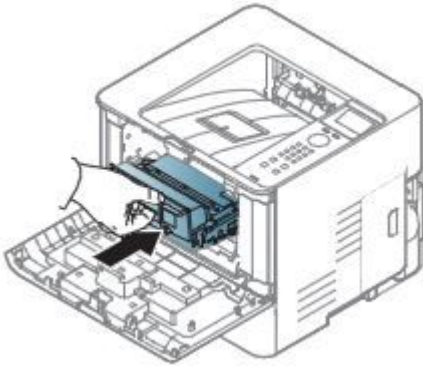

- 9) Close the front cover.

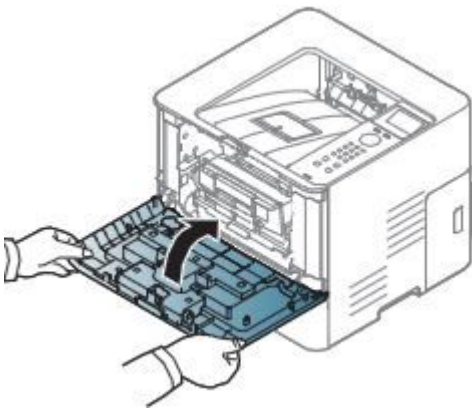

### In optional trays

#### **NOTE**

The procedure is same for all optional trays.

- 1) Pull out the optional tray.



- 2) Remove the jammed paper from the machine.

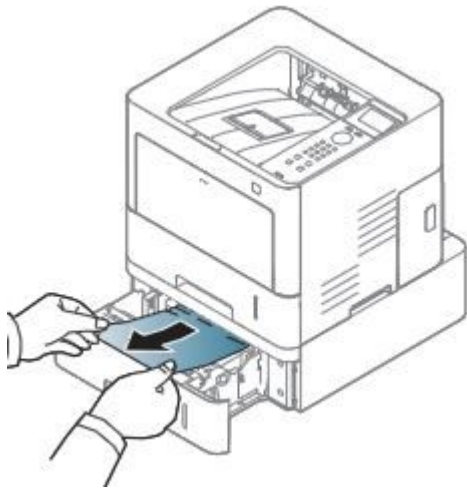

- 3) Insert the optional tray.

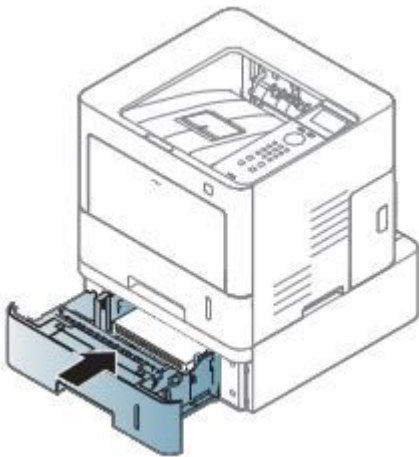

If you do not see the paper in this area, stop and go to next step :

- 4) Pull tray 1 half-way out.

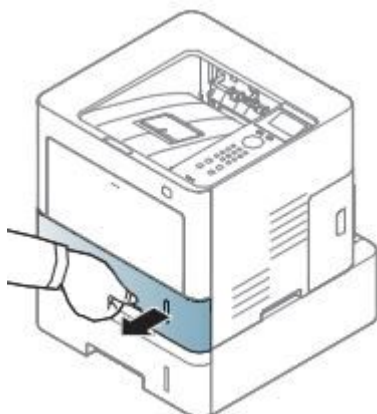

#### 4. Troubleshooting

---

- 5) Pull the paper straight up and out.

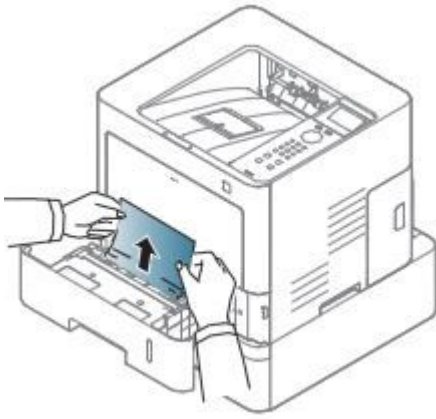

- 6) Insert the trays back into the machine.

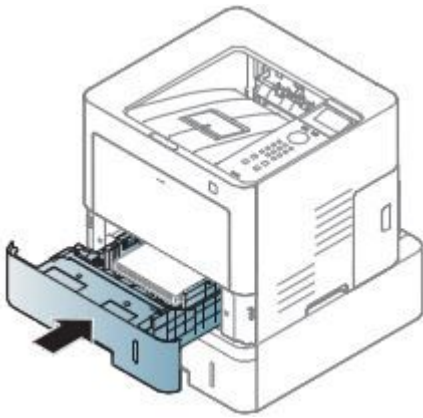

If you do not see the paper in this area, stop and go to next step:

- 7) Open the rear cover.

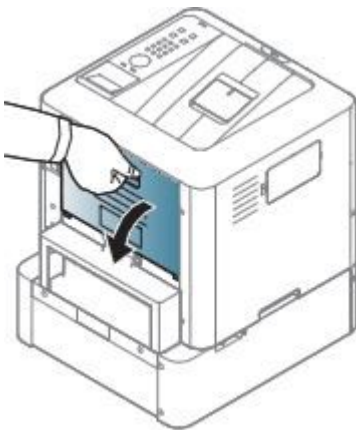

- 8) Remove the jammed paper from the machine.

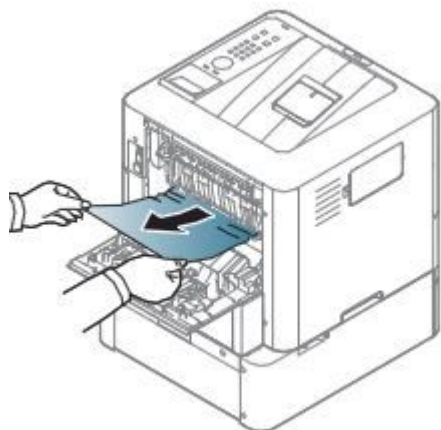

- 9) Close the rear cover.

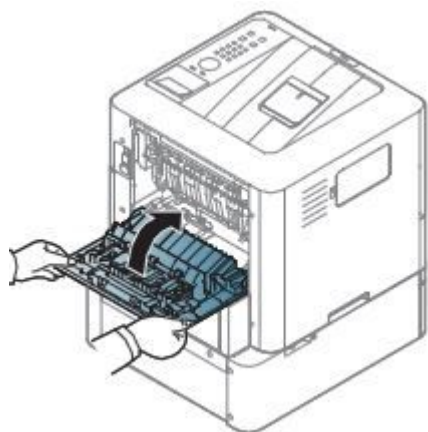

### In the multi-purpose tray

- 1) If the paper is not feeding properly, pull the paper out of the machine.

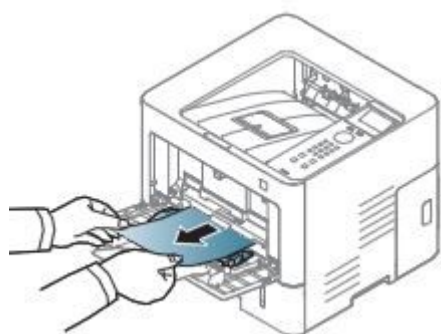

### Inside the machine

#### CAUTION

The Fuser area is hot. Please wait until device cools down before accessing this area. Turn power off to cool the machine down. Take care when removing paper from the machine.

- 1) Open the front cover.



2) Pull the toner cartridge out.

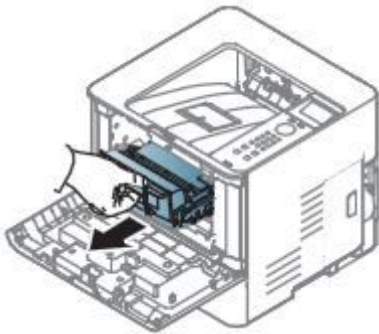

3) Remove the jammed paper by gently pulling it straight out.

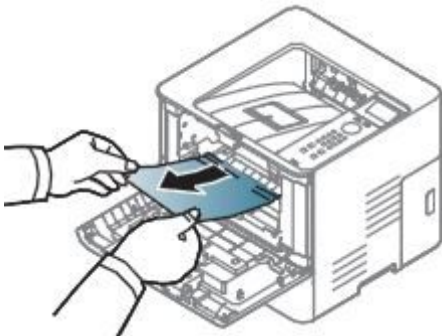

4) Open the jam cover.

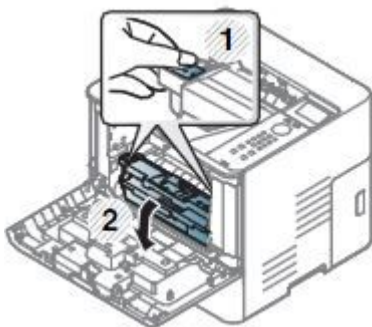



- 5) Remove the jammed paper by gently pulling it straight out. Then, close the jam cover.

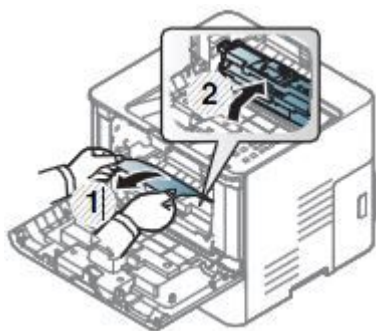

- 6) Insert the toner cartridge.

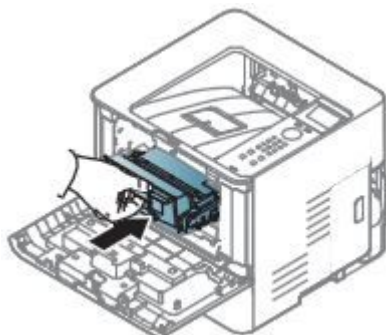

- 7) Close the front cover.

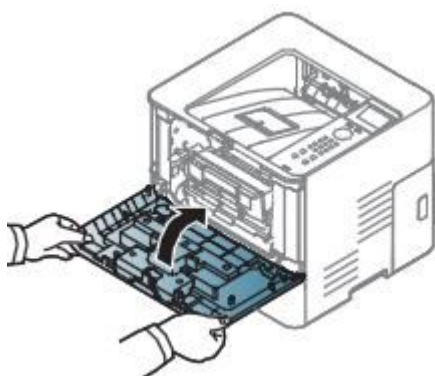

### In exit area



#### CAUTION

The Fuser area is hot. Please wait until device cools down before accessing this area. Turn power off to cool the machine down. Take care when removing paper from the machine.

- 1) Remove the jammed paper from the exit tray.



If you do not see the paper in this area, stop and go to next step :

- 2) Open the rear cover.

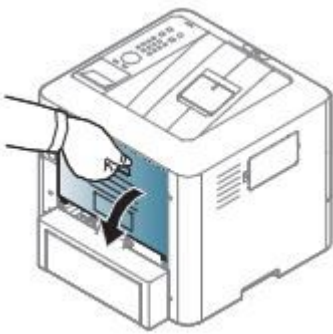

- 3) Pull down the both fuser levers.

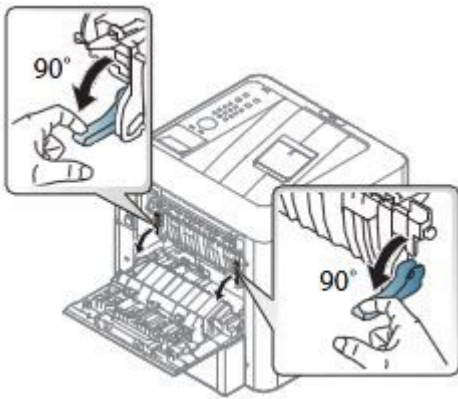

- 4) Open the fuser jam cover.

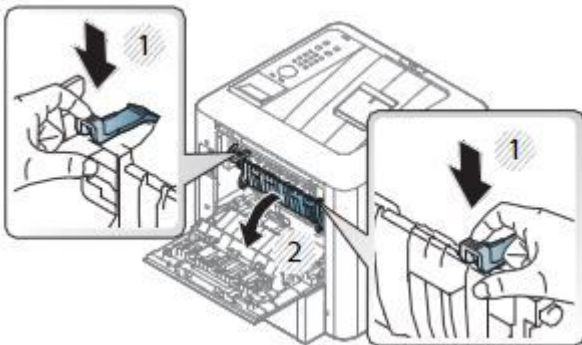

- 5) Remove the jammed paper gently by pulling it straight out.

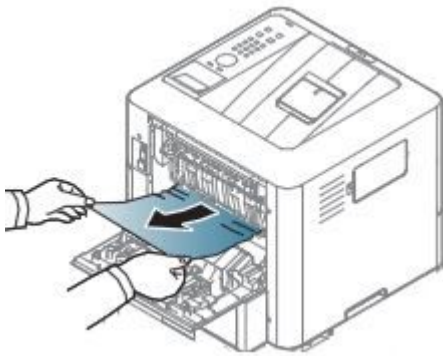

- 6) Close the fuser jam cover.

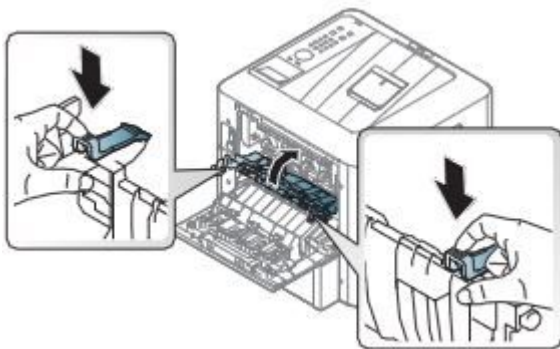

- 7) Pull up the both fuser levers.

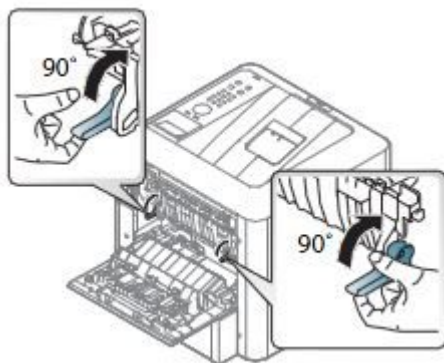

- 8) Close the rear cover.

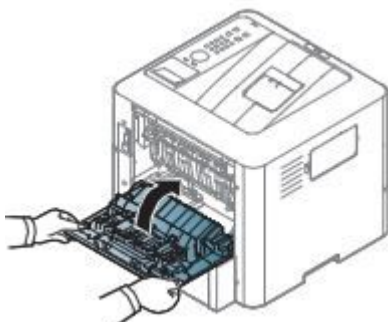

### In the duplex unit area

- 1) Pull the duplex unit out of the machine.

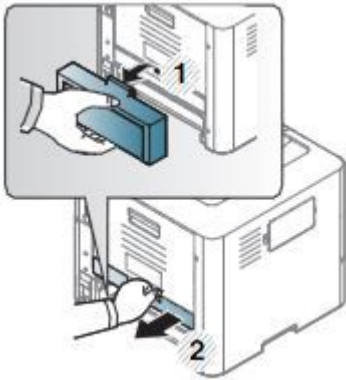

- 2) Release the lock and open the duplex jam guide.

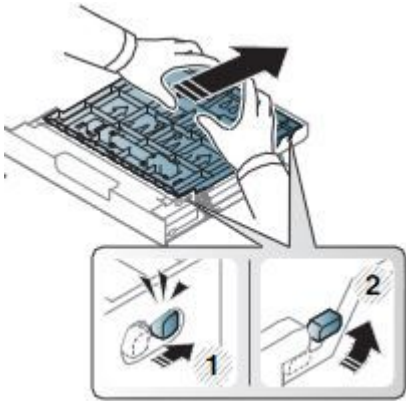

- 3) Remove the jammed paper from the duplex unit.

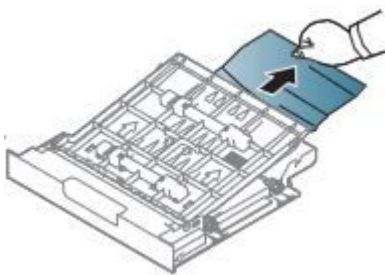

- 4) Close the duplex jam guide.

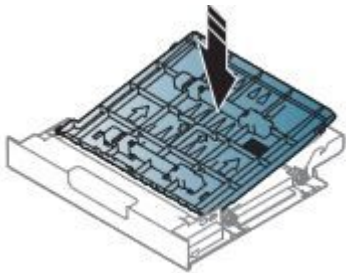

- 5) Fix the lock.

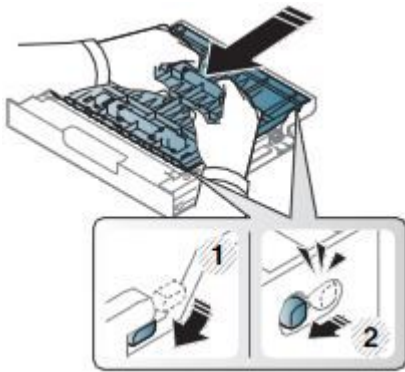

- 6) Remove the jammed paper by gently pulling it straight out.



- 7) Insert the duplex unit into the machine.

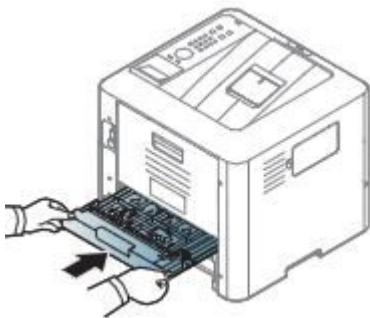

- 8) Install the rear dummy cover.

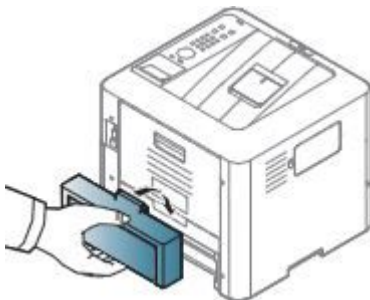

If you do not see the paper in this area, stop and go to next step:

#### 4. Troubleshooting

---

9) Open the rear cover.

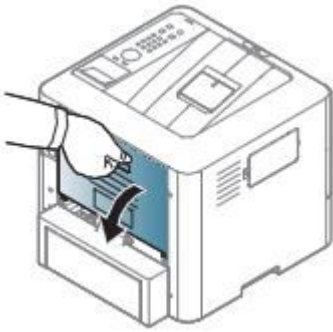

10) Pull down the both fuser levers.

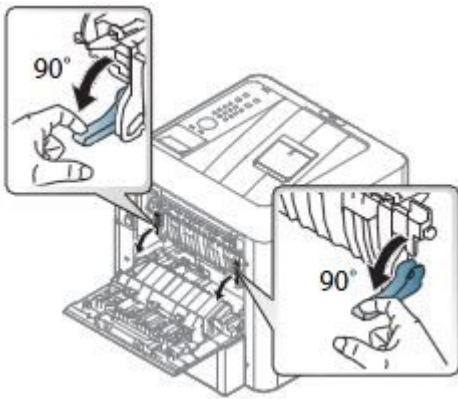

11) Open the fuser jam cover.

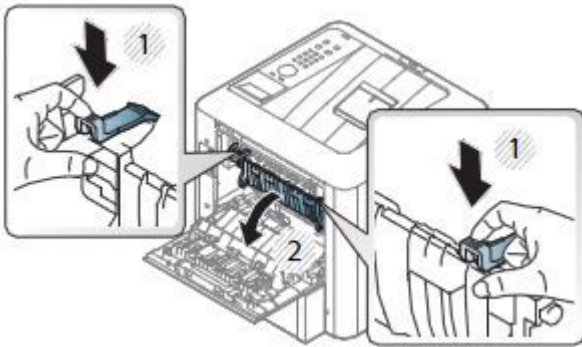

12) Remove the jammed paper gently by pulling it straight out.

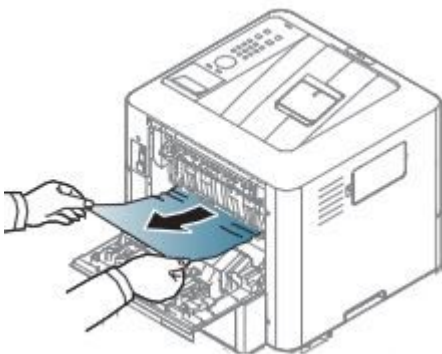

13) Close the fuser jam cover.

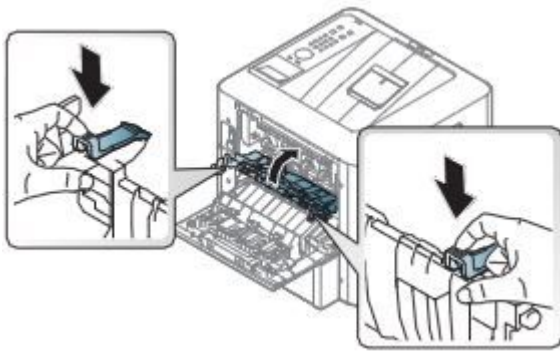

14) Pull up the both fuser levers.

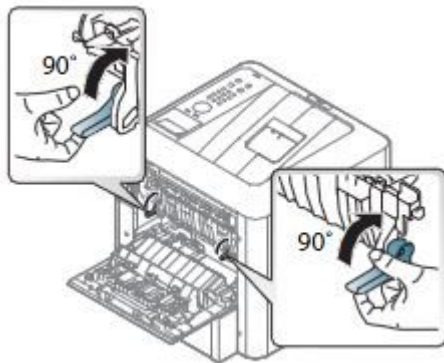

15) Close the rear cover.

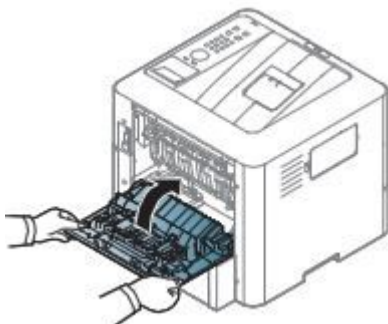

## 4.5. Useful management tools

---

### 4.5.1. SyncThru™ Web Service

---

This chapter gives you step-by-step instructions for setting up the network environment through SyncThru™ Web Service.



**NOTE**

- Internet Explorer 8.0 or higher is the minimum requirement for SyncThru™ Web Service.
- Some menus may not appear on the display screen depending on the settings or models. If so, it is not applicable to your machine.

#### What is SyncThru™ Web Service?

If you have connected your machine to a network and set up TCP/IP network parameters correctly, you can manage the machine via SyncThru™ Web Service. Use SyncThru™ Web Service to :

- View the machine's device information and check its current status.
- Change TCP/IP parameters and set up other network parameters.
- Change the printer preference.
- Set the email notifications advising of the machine's status.
- Get support for using the machine.
- Upgrade machine firmware.

#### Connecting to SyncThru™ Web Service

##### [ IPv4 supported web browser ]

- 1) Start a web browser, such as Internet Explorer®, that supports IPv4 addressing as a URL.  
Enter the machine's IP address (<http://xxx.xxx.xxx.xxx>) in the address field and press the Enter key or click Go.



**NOTE**

You can get the machine's IP address from the machine report.

- 2) Your machine's SyncThru™ Web Service website opens.

##### [ IPv6 supported web browser ]

- 1) Start a web browser, such as Internet Explorer®, that supports IPv6 addressing as a URL.
- 2) Select one of the IPv6 addresses (Stateless Address, Stateful Address, Manual Address) from Network Configuration Report.



**NOTE**

You can get the machine's IPv6 address from the machine report.

- 3) Enter the IPv6 addresses (eg., [http://\[3ffe:10:88:194:213:77ff:fe82:75b\]](http://[3ffe:10:88:194:213:77ff:fe82:75b])).



**NOTE**

The address must be enclosed in '[' ]' brackets.



- 4) Your machine's SyncThru™ Web Service website opens.

## Logging into SyncThru™ Web Service

Before configuring options in SyncThru™ Web Service, you need to log-in as an administrator. You can still use SyncThru™ Web Service without logging in but you won't have access to Settings tab and Security tab.

- 1) Click Login on the upper right of the SyncThru™ Web Service website.
- 2) Type in the ID and Password then click Login. Type in the below default ID and password. We recommend you to change the default password for security reasons.
  - ID: admin
  - Password: sec00000

## Information tab

This tab gives you general information about your machine. You can check things, such as remaining amount of toner. You can also print reports, such as an error report.

- **Active Alerts:** Shows the alerts that have occurred in the machine and their severity.
- **Supplies:** Shows how many pages are printed and amount of toner left in the cartridge.
- **Usage Counters:** Shows the usage count by print types: simplex and duplex.
- **Current Settings:** Shows the machine's and network's information.
- **Security Information:** Shows the machine's security information.
- **Print Information:** Prints reports such as system related reports, e-mail address, and font reports.

## Settings tab

This tab allows you to set configurations provided by your machine and network. You need to log-in as an administrator to view this tab.

- **Machine Settings:** Sets options provided by your machine.
- **Network Settings:** Shows options for the network environment. Sets options such as TCP/IP and network protocols.

## Security tab

This tab allows you to set system and network security information. You need to log-in as an administrator to view this tab.

- **System Security:** Sets the system administrator's information and also enables or disables machine features.
  - **Information Hiding :** You can enable/disable network features. Check the features you want to enable and click Apply.
- **Network Security:** Sets settings for HTTPs, IPSec, IPv4/IPv6 filtering, 802.1x, and Authentication servers.
- **User Access Control:** You can choose authentication methods/modes for user authentication. You can add/delete/modify the user profile used for Local Authentication.
- **System Log:** Contains settings related to logs of device events.
  - **Log configuration:** Contains settings related to saving logs.
  - **Log Viewer :** Contains options to view logs stored locally on the device.

## Maintenance tab

This tab allows you to maintain your machine by upgrading firmware and setting contact information for sending emails. You can also connect to Samsung website or download drivers by selecting the Link menu.

- **Firmware Upgrade** : Upgrade your machine's firmware.
- **License Management** : License management provides settings for or settings of installed applications and application license.
- **Wi-Fi Interface**: You can enable or disable the Wi-Fi menu.
- **Cloning**: You can import or export (transfer) various settings (machine setting, network information, address book, etc.) between devices that have the Cloning feature in SyncThru™ Web Service.
- **Contact Information**: Shows the contact information.
- **Link**: Shows links to useful sites where you can download or check information.

### E-mail notification setup

You can receive emails about your machine's status by setting this option. By setting information such as IP address, host name, e-mail address and SMTP server information, the machine status (toner cartridge shortage or machine error) will be sent to a certain person's e-mail automatically. This option may be used more frequently by a machine administrator.



#### NOTE

Some menus may not appear in the display depending on options or models. If so, it is not applicable to your machine.

- 1) Start a web browser, such as Internet Explorer, from Windows. E  
Enter the machine IP address (<http://xxx.xxx.xxx.xxx>) in the address field and press the Enter key or click Go.
- 2) Your machine's embedded website opens.
- 3) From the Settings tab, select Machine Settings > E-mail Notification.



#### NOTE

If you have not configured outgoing server environment, go to Settings > Network Settings > Outgoing Mail Server(SMTP) to configure network environment before setting e-mail notification.

## 4.5.2. Samsung Easy Printer Manager

Samsung Easy Printer Manager is an application that combines Samsung machine settings into one location. Samsung Easy Printer Manager combines device settings as well as printing environments, settings/actions and launching. All of these features provide a gateway to conveniently use your Samsung machine.

### NOTE

- Available for Windows and Mac OS users only.
- For Windows, Internet Explorer 6.0 or higher is the minimum requirement for Samsung Easy Printer Manager.

### Understanding Samsung Easy Printer Manager

To open the program :

#### For Windows,

Select Start > Programs or All Programs > Samsung Printers > Samsung Easy Printer Manager .





#### For Mac,

The Samsung Easy Printer Manager interface is comprised of various basic sections as described in the table that follows:

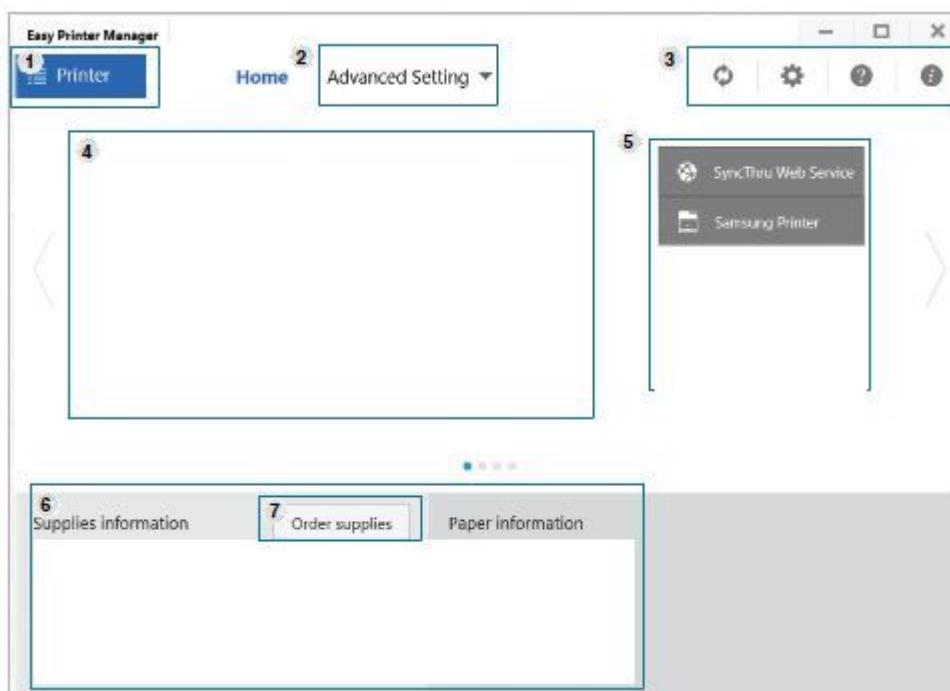
### NOTE

The screenshot may differ depending on operating system you are using.



1	Printer list	The Printer List displays printers installed on your computer and network printers added by network discovery (Windows only).
2	Advanced Setting	<p>The advanced user interface is intended to be used by the person responsible for managing the network and machines.</p> <div style="background-color: #e0e0e0; padding: 5px;">  <b>NOTE</b>                      Some menus may not appear in the display depending on options or models. If so, it is not applicable to your machine.                 </div> <ul style="list-style-type: none"> <li>• <b>Device Settings</b> : You can configure various machine settings such as machine setup, paper, layout, emulation, network, and print information.</li> </ul> <div style="background-color: #e0e0e0; padding: 5px;">  <b>NOTE</b>                      If you connect your machine to a network, the SyncThru™ Web Service icon is enabled.                 </div> <ul style="list-style-type: none"> <li>• <b>Scan to PC Settings</b> : This menu includes settings to create or delete scan to PC profiles.                         <ul style="list-style-type: none"> <li>• <b>Scan Activation</b> : Determines whether or not scanning is enabled on the device.</li> <li>• <b>Basic tab</b> : Contains settings related general scan and device settings.</li> </ul> </li> <li>• <b>Alert Settings (Windows only)</b> : This menu includes settings related to error alerting.                         <ul style="list-style-type: none"> <li>• <b>Printer Alert</b> : Provides settings related to when alerts will be received.</li> <li>• <b>Email Alert</b> : Provides options relating to receiving alerts via email.</li> <li>• <b>Alert History</b> : Provides a history of device and toner related alerts.</li> </ul> </li> </ul>
3	Application information	Includes links for changing to the refresh, preference setting, help, and about.
4	Printer information	<p>This area gives you general information about your machine. You can check information, such as the machine’s model name, IP address (or Port name), and machine status.</p> <div style="background-color: #e0e0e0; padding: 5px;">  <b>NOTE</b>                      This button opens the Troubleshooting Guide when an error occurs. You can directly open the troubleshooting section in the user’s guide.                 </div>
5	Quick links	<p>Displays Quick links to machine specific functions. This section also includes links to applications in the advanced settings.</p> <div style="background-color: #e0e0e0; padding: 5px;">  <b>NOTE</b>                      If you connect your machine to a network, the SyncThru™ Web Service icon is enabled.                 </div>
6	Contents area	Displays information about the selected machine, remaining toner level, and paper. The information will vary based on the machine selected. Some machines do not have this feature.
7	Order supplies	Click on the Order button from the supply ordering window. You can order replacement toner cartridge(s) from online.

## 4.6. Service Mode

In service (tech) mode, the technician can check the machine and perform various test to isolate the cause of a malfunction. While in Tech mode, the machine still performs all normal operations.

### a) Entering Service mode

- 1) Press “Menu > # > 1 > 9 > 3 > 4” on the control panel continuously.
- 2) Press Menu.
- 3) Select “Tech Mode”.

### b) Service mode menu

Depth1	Depth2	Depth3	Depth4
Information	Report	Supplies Information	
		Usage Counter	
		Error Information	
		Maintenance	
		Toner Event Log	
	Export Reports	PDF Format	Export
Maintenance Counts	Clear Counts	Enter Passcode	Fuser / Transfer Roller / Tray 1 Roller etc.
Diagnostics	Engine	NVM Initialize	
		NVM Read/Write	
		Test Routines	
	Print Test Patterns	Skew Pattern	A4/Letter
Service Functions	Clear All Memory		
	Clear Admin Password	Reset?	
	Engine Footer		
	F/W Upgrade	Select File	Upgrade Only New FW
			Upgrade Whole FW
	Capture Log		
	Envelope Rotate		
SFE			

### c) Report

- **Supplies Info**  
It shows consumable unit life status and toner using status.
- **Usage Counter**  
It contains the total number of pages printed.
- **Error Info.**  
It shows various kinds of errors which can be occurred in machine. It also store history error count how many errors are issued.

**d) Diagnostics**

- **NVM Initialize**

This menu initializes all engine NVM value to the default.

- **NVRAM Read/Write**

This menu changes a configuration value for engine firmware.

Code	Display	Meaning	Default	Max/Min
105-0030	MHV DC Black (MHV Bias Control)	Charger HV Black DC Duty	10	20 / 0
106-0030	Deve DC Black (Deve Bias Control)	Deve DC Black	10	20 / 0
107-0030	Transfer1 High Voltage(THV) Black (THV Bias Control)	Transfer1 HV Black Duty	10	20 / 0
107-0170	Transfer1 High Voltage(THV) Duplex Black (THV Bias Control)	Transfer1 HV Black Duplex Duty	10	20 / 0
109-0010	Run Temperature offset	Target Temperature during run mode.	10	20 / 0
110-0070	LD Power Black (LD Light Level Black)	Black LD Power at Normal Speed	10	20 / 0

- **Test Routines**

This menu can perform the operation test for the main components.

Code	LCD	Meaning
100-0000	Main BLDC Motor	Main BLDC Motor is On/Off
100-0010	Main BLDC Motor Ready	Detect if Main BLDC Motor runs at normal speed
100-0120	Exit Motor Forward Fast	Exit Motor Forward Fast On/Off
100-0131	Exit Motor Backward	Exit Motor Forward Backward On/Off
100-0140	Duplex Motor Forward	Duplex Motor Forward On/Off
100-0200	T1 Elevating Motor	T1 Elevate Motor On/Off
100-0260	SMPS Fan Run	Start/Stop SMPS Fan run
100-0270	SMPS Fan Run Ready	Detects if SMPS Fan runs at normal speed.
100-0370	Tray1 Pickup Motor	Tray1 Motor is On/Off
101-0000	Bypass Feed Clutch	Engages drive to pick up a paper from bypass Tray(MP Tray).
101-0020	T2 Pick-Up Clutch	Engages drive to pick up a paper from tray2. (Optional)
101-0030	T3 Pick-Up Clutch	Engages drive to pick up a paper from tray3. (Optional)
101-0040	T4 Pick-Up Clutch	Engages drive to pick up a paper from tray4. (Optional)
101-0041	T5 Pick-Up Clutch	Engages drive to pick up a paper from tray5. (Optional)
101-0050	Registration Clutch	Engages drive to registration rolls.
101-0171	Cover Open Sensor	Detect if the front cover is opened or closed.
101-0190	Out-Bin Full Sensor	Detect when a paper is at Out-Bin Full Sensor
102-0000	Tray1 Home Position	Detect when tray1 is closed.
102-0010	T1 Paper Empty Sensor	Detect when paper is in Tray1.
102-0020	T1 Size1 sensor	Detects whether auto size1 sensor of tray1 is high or low.
102-0030	T1 Size2 sensor	Detects whether auto size2 sensor of tray1 is high or low.
102-0040	T1 Size3 sensor	Detects whether auto size3 sensor of tray1 is high or low.
102-0050	T1 Stack Height Sensor	Detects if paper in tray1 is elevated to the sensor.

Code	LCD	Meaning
102-0070	Tray2 Home Position	Detect when tray2 is closed.
102-0080	T2 Paper Empty Sensor	Detect when paper is in tray2.
102-0090	T2 Size1 sensor	Detects whether auto size1 sensor of tray2 is high or low.
102-0100	T2 Size2 sensor	Detects whether auto size2 sensor of tray2 is high or low.
102-0110	T2 Size3 sensor	Detects whether auto size3 sensor of tray2 is high or low.
102-0120	T2 Stack Height Sensor	Detects if paper in tray2 is elevated to the sensor.
102-0140	Tray3 Home Position	Detect when tray3 is closed.
102-0150	T3 Paper Empty Sensor	Detect when paper is in tray3.
102-0160	T3 Size1 sensor	Detects whether auto size1 sensor of tray3 is high or low.
102-0170	T3 Size2 sensor	Detects whether auto size2 sensor of tray3 is high or low.
102-0180	T3 Size3 sensor	Detects whether auto size3 sensor of tray3 is high or low.
102-0190	T3 Stack Height Sensor	Detects if paper in tray3 is elevated to the sensor.
102-0210	Tray4 Home Position	Detect when tray4 is closed.
102-0220	T4 Paper Empty Sensor	Detect when paper is in tray4.
102-0230	T4 Size1 sensor	Detects whether auto size1 sensor of tray4 is high or low.
102-0240	T4 Size2 sensor	Detects whether auto size2 sensor of tray4 is high or low.
102-0250	T4 Size3 sensor	Detects whether auto size3 sensor of tray4 is high or low.
102-0260	T4 Stack Height Sensor	Detects if paper in tray4 is elevated to the sensor.
102-0280	Bypass Paper Empty Sensor	Detects when paper is in Bypass Tray(MP Tray).
102-0290	Feed Sensor	Detect when a paper is at Feed sensor.
102-0300	T2 Feed Sensor (or Door Open)	Detect when a paper is at T2 Feed sensor. (optional)
102-0320	T3 Feed Sensor (or Door Open)	Detect when a paper is at T3 Feed sensor. (optional)
102-0340	T4 Feed Sensor (or Door Open)	Detect when a paper is at T4 Feed sensor. (optional)
102-0341	T5 Feed Sensor (or Door Open)	Detect when a paper is at T5 Feed sensor. (optional)
102-0360	Regi. Sensor	Detect when a paper is at Regi. sensor.
102-0370	Exit Sensor	Detect when a paper is at Exit. sensor.
102-0470	Tray5 Home Position	Detect when tray4 is closed.
102-0480	T5 Paper Empty Sensor	Detect when paper is in tray4.
102-0490	T5 Size1 sensor	Detects whether auto size1 sensor of tray4 is high or low.
102-0500	T5 Size2 sensor	Detects whether auto size2 sensor of tray4 is high or low.
102-0510	T5 Size3 sensor	Detects whether auto size3 sensor of tray4 is high or low.
102-0520	T5 Stack Height Sensor	Detects if paper in tray4 is elevated to the sensor.
105-0030	Black MHV Bias	Black MHV bias voltage on at normal drive level
106-0030	Black Dev Bias	Black Dev bias voltage on at normal drive level
107-0030	Black THV Bias	Black THV bias voltage on at normal drive level
107-0031	Black THV(-) Bias	Black THV bias voltage on at normal drive level
107-0070	Black THV Bias Read	Detect what the THV value is on the THV Roller

Code	LCD	Meaning
109-0000	Fuser Temperature A	Detects what the temperature A is on fuser.
109-0013	Outer Temperature	Outer Temperature
109-0020	Fuser Fan Run Ready	Detects if Fuser Fan Motor runs at normal speed.
109-0040	Fuser Fan Run	Fuser Fan Motor On/Off
109-0050	Fuser Bias	Fuser bias voltage on at normal drive level
110-0000	LSU Motor1 Run Ready	Detects if LSU motor1 runs at normal speed.
110-0060	LSU Motor1 Run	LSU Motor1 On/Off
110-0110	LSU LD Power4	LSU LD4 Power On/Off (black)
110-0170	LSU HSync4	Detect LSU HSync4 (black)

### e) Service Function

- **Clear All Mem.**

The function resets the system to factory default settings. This function is used to reset the system to the initial value when the product is functioning abnormally . All the values are returned to the default values, and all the information, which was set by the user, will be erased.



#### NOTE

Always perform a memory clear after replacing the main board. Otherwise, the system may not operate properly.

- **Clear Admin PW**

This menu resets the Admin password.

- **Engine Footer**

This function is for monitoring of the engine status. If you perform this function, at printing, the setting value for engine is shown on the bottom of the printed page.

- **F/W Upgrade**

The function is to upgrade the firmware.

- **Capture Log**

This function copies all the saved log in the system to a UBS memory as a zip file.

- **Envelope Rotate**

This menu is enabling rotate when printing on envelope. The machine usually guides to load envelope with SEF direction. If this function is enabled, the user can load envelope with LEF direction and the machine shall rotate image for printing exactly on envelope.

This function shall provide the setting options as follows:

- Off (default) : Load envelope SEF direction
- 90 degrees : Load envelope LEF direction
- 180 degrees : Load envelope SEF direction with flap is bottom side





 **NOTE**

- 1) If the paper source is 'Auto', the device shall feed from MP Tray. Because the LEF envelope can be loaded only in MP Tray according to Paper Specification.
- 2) If the length of envelope is over max size of custom width, the device shall not rotate image and just determine the direction of envelope is SEF.  
For example, the A4 model support custom size like W 98-216 ~ L148-356. This model doesn't support C5 Env.(162x229) DL Env.(110x220), No9 Env.(98x225), No10 Env.(105x241) rotation.

• **SFE**

Special Feature Enablement (SFE) means to provide the configurable options (On/Off) in service mode for technicians or dealers to satisfy the requirements from B2B sites easily without changing the firmware installed in a device.

SFE Code	Description
001	In case of printing in directional media (Letterhead/Preprinted/Punched), the device prints as the same output direction regardless of simplex or duplex.
007	[PCL6] The device prints as original 1 dot line without 2 dot line compensation.
008	[PCL5] The device ignores paper size command in PRN and prints as paper size in tray.
009	PJL readback response is changed with HPOS. 1) Add <CR><LF> to EOJ response. 2) No EOJ job but EOJ response occurs. 3) Device uses Job name instead of EOJ name.
010	Maximum value of 'Power save time' is increased as 240 min.
012	If the device is in jam status, all print jobs except secure or stored jobs are deleted automatically.
013	The device ignores the USB memory stick and detects only card reader.
017	The device enables XOA web
033	The device shall draw Letter Gothic font as previous thickness.
035	The device shall provide auto scale for A3/Ledger to A4/Letter in case of A4 Models that doesn't support A3/Ledger size.

## 4.7. Troubleshooting

### 4.7.1. Procedure of checking the symptoms

Before attempting to repair the printer first obtain a detailed description of the problem from the customer.

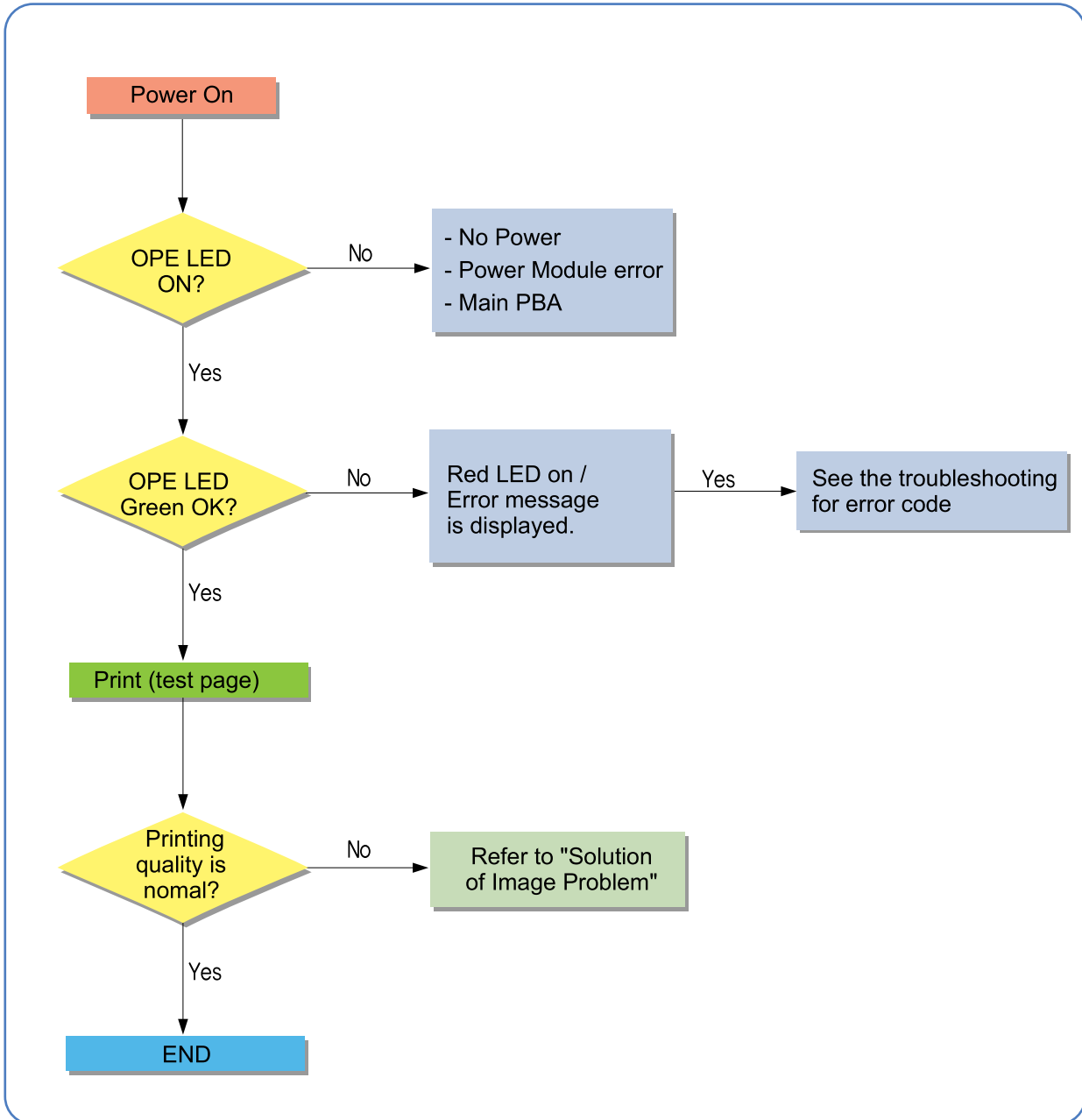

## 4.7.2. Error Code and Troubleshooting

Messages appear on the control panel display to indicate the machine's status or errors.



### NOTE

Some messages may not appear on the display depending on the options or models.

Error Code	Error Message	Troubleshooting Page
11-2T11	Paper mismatch Tray 1 Load [A4] [Plain] Continue ⊙ Cancel X	P.4-37
11-2T21	Paper mismatch Tray 2 Load [A4] [Plain] Continue ⊙ Cancel X	P.4-37
11-2T31	Paper mismatch Tray 3 Load [A4] [Plain] Continue ⊙ Cancel X	P.4-37
11-2T41	Paper mismatch Tray 4 Load [A4] [Plain] Continue ⊙ Cancel X	P.4-37
11-2T51	Paper mismatch Tray 5 Load [A4] [Plain] Continue ⊙ Cancel X	P.4-37
11-2T61	Paper mismatch MPT Load [A4] [Plain] Continue ⊙ Cancel X	P.4-37
A1-1112	Error: #A1-1112 / Motor Failure: #A1-1112. Turn off then on. Call for service if the problem persists	P.4-38
A1-1113	Error: #A1-1113 / Motor Failure: #A1-1113. Turn off then on. Call for service if the problem persists	P.4-38
A2-1210	Error: #A2-1210 / Fan Failure: #A2-1210. Turn off then on. Call for service if the problem persists	P.4-39
A2-2110	Error: #A2-2110 / Fan Failure: #A2-2110. Turn off then on. Call for service if the problem persists	P.4-39
A3-3311	Error: #A3-3311 / Sensor Failure: #A3-3311. Turn off then on. Call for service if the problem persists	P.4-40
A3-3312	Error: #A3-3312 / Sensor Failure: #A3-3312. Turn off then on. Call for service if the problem persists	P.4-40
A3-3320	Not proper Room Temp / The room temperature is not suitable for this set use. Please adjust room temperature	P.4-40
C2-1110	Prepare new toner / Prepare new toner cartridge	P.4-41
C2-1120	Replace new toner / Replace with new toner cartridge	P.4-41
C2-1150	Replace new toner / Replace with new toner cartridge	P.4-41
C2-1160	Replace new toner / Replace with new toner cartridge	P.4-41
C2-1170	Replace new toner / End of life, Replace with new toner cartridge	P.4-41
C2-1323	Error: #C2-1323 / Toner Failure: #C2-1323: Install toner again	P.4-42
C2-1411	Toner Not Installed / Toner cartridge is not installed. Install it	P.4-42
C2-1512	Toner Not Compatible / Toner cartridge is not compatible. Check guide	P.4-42
C2-1710	Error: #C2-1710 / Toner Cart Failure: #C2-1710. Call for service	P.4-43
C2-1711	Error: #C2-1711 / Toner Cart Failure: #C2-1711. Call for service	P.4-43
C2-1712	Error: #C2-1712 / Toner Cart Failure: #C2-1712. Call for service	P.4-43
C6-1110	Prepare fuser unit / Prepare new fuser unit	P.4-43
C6-1120	Replace Fuser unit / Replace with new fuser unit	P.4-43
H1-1210	Paper jam in tray 2	P.4-44
H1-1211	Paper jam in tray 2	P.4-44
H1-1220	Tray 2 door is open. Close it	P.4-44

#### 4. Troubleshooting

Error Code	Error Message	Troubleshooting Page
H1-1222	Tray 2 cassette Out / Tray 2 cassette is pulled out. Insert it properly	P.4-45
H1-1230	Error: #H1-1230 / Tray Failure: #H1-1230. Check tray 2 connection & turn off then on. Call for service if the problem persists	P.4-45
H1-1251	Paper Low in tray 2 / Paper is low in tray 2. Load paper	P.4-46
H1-1252	Paper Empty in tray 2 / Paper is empty in tray 2. Load paper	P.4-46
H1-1253	Error: #H1-1253 / Tray Failure: #H1-1253. Pull tray 2 out and insert it. Call for service if the problem persists	P.4-46
H1-1310	Paper jam in tray 3	P.4-47
H1-1311	Paper jam in tray 3	P.4-47
H1-1320	Tray 3 door is open. Close it	P.4-47
H1-1322	Tray 3 cassette Out / Tray 3 cassette is pulled out. Insert it properly	P.4-48
H1-1332	Error: #H1-1332 / Tray Failure: #H1-1332. Check tray 3 connection & turn off then on. Call for service if the problem persists	P.4-48
H1-1351	Paper Low in tray 3 / Paper is low in tray 3. Load paper	P.4-49
H1-1352	Paper Empty in tray 3 / Paper is empty in tray 3. Load paper	P.4-49
H1-1353	Error: #H1-1353 / Tray Failure: #H1-1353. Pull tray 3 out and insert it. Call for service if the problem persists	P.4-49
H1-1410	Paper jam in tray 4	P.4-50
H1-1411	Paper jam in tray 4	P.4-50
H1-1420	Tray 4 door is open. Close it	P.4-50
H1-1422	Tray 4 cassette Out / Tray 4 cassette is pulled out. Insert it properly	P.4-51
H1-1434	Error: #H1-1434 / Tray Failure: #H1-1434. Check tray connection & turn off then on. Call for service if the problem persists	P.4-51
H1-1451	Paper Low in tray 4 / Paper is low in tray 4. Load paper	P.4-52
H1-1452	Paper Empty in tray 4 / Paper is empty in tray 4. Load paper	P.4-52
H1-1453	Error: #H1-1453 / Tray Failure: #H1-1453. Pull tray 4 out and insert it. Call for service if the problem persists	P.4-52
H1-1510	Paper jam in tray 5	P.4-53
H1-1511	Paper jam in tray 5	P.4-53
H1-1551	Paper Low in tray 5 / Paper is low in tray 5. Load paper	P.4-53
H1-1553	Error: #H1-1553 / Tray Failure: #H1-1553. Pull tray 5 out and insert it. Call for service if the problem persists	P.4-54
M1-1110	Paper jam in tray 1	P.4-55
M1-1610	Paper jam in MP tray	P.4-56
M1-3122	Tray 1 cassette Out / Tray 1 cassette is pulled out. Insert it properly	P.4-56
M1-4111	Error: #M1-4111 / Tray Failure: #M1-4111. Pull tray 1 out and insert it. Call for service if the problem persists	P.4-57
M1-5111	Paper Low in tray 1 / Paper is low in tray 1. Load paper	P.4-58
M1-5112	Paper Empty in tray 1 / Paper is empty in tray 1. Load paper	P.4-58
M1-5612	Paper Empty in MP tray / Paper is empty in MP tray. Load paper	P.4-58
M2-1111	Jam inside of machine	P.4-59
M2-1114	Jam inside of machine	P.4-59
M2-2210	Jam inside of duplex	P.4-59

Error Code	Error Message	Troubleshooting Page
M2-2310	Jam bottom of duplex	P.4-59
M3-1110	Jam in exit area	P.4-60
M3-1112	Jam inside of machine	P.4-60
M3-2130	Output bin is full / Paper in output bin is full. Remove printed paper	P.4-61
S2-1110	Error: #S2-1110 / Engine System Failure: #S2-1110. Call for service	P.4-62
S2-331C	Calibrating density	P.4-62
S2-331D	Waiting for low temp	P.4-62
S2-3321	Supplying Toner...	P.4-62
S2-4120	Door is open. Close it	P.4-63
S2-4210	Front door is open. Close it	P.4-63
S6-3113	Error: #S6-3113 / Network Failure: #S6-3113. Turn off then on. Call for service if the problem persists	P.4-64
S6-3123	IP Conflict / This IP address conflicts with that of other system	P.4-64
S6-3128	802.1x Network Error / 802.1x Network Error. Contact the Admin	P.4-64
S6-3231	Error: #S6-3231 / Can not find a wireless network. Please check the wireless environment	P.4-65
S6-3232	Error: #S6-3232 / Wireless security settings are incorrect. Please change the settings	P.4-65
S6-3233	Error: #S6-3233 / Not connected from the wireless AP. If you do not reconnect automatically, check the wireless settings	P.4-65
S6-3234	Error: #S6-3234 / Failed connection to WPS. Try again or set up other wireless connection	P.4-66
S6-3235	Error: #S6-3235 / Wi-Fi Direct is not ready. Turn off then on. Call for service if the problem persists	P.4-66
S6-3236	Error: #S6-3236 / Failed to connect to Wi-Fi Direct. Turn off your mobile device and turn it on	P.4-66
S7-2110	Error #S7-2110 / Fuser Unit Failure: #S7-2110. Turn off then on. Call for service if the problem persists	P.4-66
U1-2112	Error: #U1-2112 / Fuser Unit Failure: #U1-2112. Turn off then on. Call for service if the problem persists	P.4-67
U1-2132	Error: #U1-2132 / Fuser Unit Failure: #U1-2132. Turn off then on. Call for service if the problem persists	P.4-67
U1-2315	Error: #U1-2315 / Fuser Unit Failure: #U1-2315. Turn off then on. Call for service if the problem persists	P.4-67
U1-2333	Error: #U1-2333 / Fuser Unit Failure: #U1-2333. Turn off then on. Call for service if the problem persists	P.4-67
U1-2334	Error: #U1-2334 / Fuser Unit Failure: #U1-2334. Turn off then on. Call for service if the problem persists	P.4-67
U1-2339	Error #U1-2339 / Fuser Unit Failure: #U1-2339. Turn off then on. Call for service if the problem persists	P.4-67
U1-2341	Error: #U1-2341 / Fuser Unit Failure: #U1-2341. Turn off then on. Call for service if the problem persists	P.4-67
U1-2342	Error: #U1-2342 / Fuser Unit Failure: #U1-2342. Turn off then on. Call for service if the problem persists	P.4-67

#### 4. Troubleshooting

---

<b>Error Code</b>	<b>Error Message</b>	<b>Troubleshooting Page</b>
U1-2343	Error: #U1-2343 / Fuser Unit Failure: #U1-2343. Turn off then on. Call for service if the problem persists	P.4-67
U1-2345	Fuser Unit Failure: #U1-2345. Turn off then on. Call for service if the problem persists	P.4-67
U1-2348	Error: #U1-2348 / Fuser Unit Failure: #U1-2348. Turn off then on. Call for service if the problem persists	P.4-67
U1-234H	Error: #U1-234H / Fuser Unit Failure: #U1-234H. Turn off then on. Call for service if the problem persists	P.4-67
U2-1111	Error: #U2-1111 / LSU Failure: #U2-1111. Turn off then on. Call for service if the problem persists	P.4-68
U2-1112	Error: #U2-1112 / LSU Failure: #U2-1112. Turn off then on. Call for service if the problem persists	P.4-68
U2-1113	Error: #U2-1113 / LSU Failure: #U2-1113. Turn off then on. Call for service if the problem persists	P.4-68

---

#### 4.7.2.1. 11-2Txx (Paper Mismatch error)

---

▶ **Error Code**

11-2T11

11-2T21

11-2T31

11-2T41

11-2T51

11-2T61

▶ **Error message**

Paper mismatch

▶ **Symptom**

Paper in tray is not matched to the machine paper setting.

▶ **Troubleshooting method**

- 1) Check and change the paper setting of the corresponding tray properly.

#### 4.7.2.2. Ax-xxxx (Motor\_Fan\_Sensor error)

---

▶ **Error Code**

A1-1112

A1-1113

▶ **Error message**

Error: #A1-1112 / Motor Failure: #A1-1112. Turn off then on. Call for service if the problem persists

Error: #A1-1113 / Motor Failure: #A1-1113. Turn off then on. Call for service if the problem persists

▶ **Symptom**

Main (OPC) motor operation is abnormal.

▶ **Troubleshooting method**

- A1-1112 : Main motor is not operated for print-job.
  - A1-1113 : Main motor is operating but machine recognizes status as "Stopped".
- 1) Turn the machine off then on. If the error persists, check the following.
  - 2) Remove the side cover.
  - 3) Check the connection between the main motor and main board.
  - 4) If the connection is OK, enter SVC mode. Execute the motor test.

**(Diagnostics > Engine Diagnostics > Engine Test Routines)**

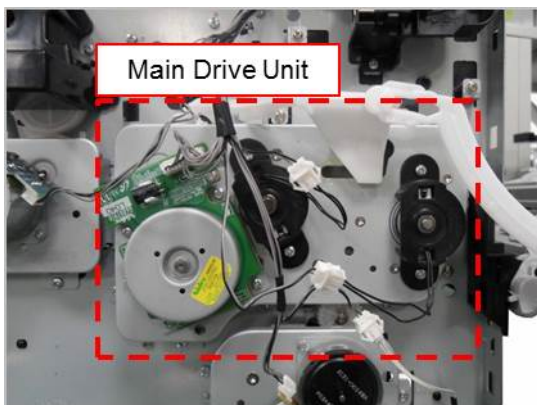

- a) If the motor is not operational,
  - i) Check the motor signal(3.3V). If the signal is abnormal, replace the main board.
  - ii) Check the power(24V). If the power is abnormal, check the SMPS board. If the SMPS board is defective, replace it.
  - iii) If the motor signal and power is normal, replace the main motor or main drive unit.
- b) If the motor is operational, replace the main board.



► **Error Code**

A2-1210

A2-2110

► **Error message**

Error: #A2-1210 / Fan Failure: #A2-1210. Turn off then on. Call for service if the problem persists

Error: #A2-2110 / Fan Failure: #A2-2110. Turn off then on. Call for service if the problem persists

► **Symptom**

Main fan or SMPS fan is not operational.

► **Troubleshooting method**



**NOTE**

- SMPS fan error : A2-1210
- Main fan error : A2-2110

- 1) Turn the machine off then on.
- 2) Check if the corresponding fan connector is connected correctly.

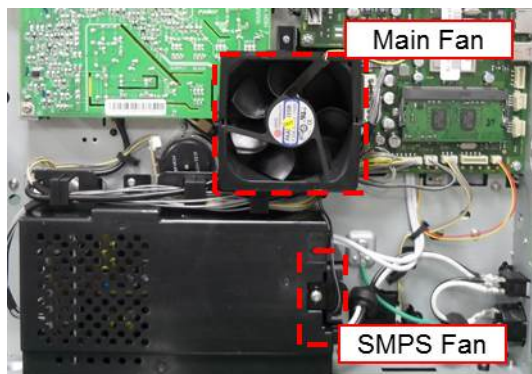

- 3) If the connection is OK, Enter SVC mode and execute fan test.  
(**Diagnostics > Engine Diagnostics > Engine Test Routines**)
- 4) If the fan is not operational, measure the fan power.
  - a) If 24V power is generated, replace the defective fan.
    - SMPS fan : *JC31-00152B*
    - Main fan : *JC31-00161A*
  - b) If 24V power is not generated,
    - Measure the 24V power on the SMPS board. If the SMPS board is defective, replace it.
    - If the SMPS board is normal, replace the main board.
- 5) If the fan operation is normal but the error persists,
  - a) Replace the fan.
  - b) If the error persists after replacing the fan, replace the main board.

▶ **Error Code**

A3-3311

A3-3312

A3-3320

▶ **Error message**

Error: #A3-3311 / Sensor Failure: #A3-3311. Turn off then on. Call for service if the problem persists

Error: #A3-3312 / Sensor Failure: #A3-3312. Turn off then on. Call for service if the problem persists

Not proper Room Temp / The room temperature is not suitable for this set use. Please adjust room temperature

▶ **Symptom**

Outer temperature sensor is defective.

▶ **Troubleshooting method**

- 1) Turn the machine off then on.
- 2) Check if the machine is installed in proper environment.
- 3) Check the harness connection between main board and temperature sensor. Reconnect the sensor harness.
- 4) If the problem persists, replace the main board.

---

### 4.7.2.3. Cx-xxxx (Toner Cartridge error)

---

▶ **Error Code**

C2-1110

▶ **Error message**

Prepare new toner / Prepare new toner cartridge

▶ **Symptom**

Toner cartridge is almost empty.

▶ **Troubleshooting method**

- 1) Open the front cover.
- 2) Remove the toner cartridge.
- 3) Shake the toner cartridge horizontally to distribute the toner evenly inside the cartridge.
- 4) Reinstall the toner cartridge.
- 5) Close the front cover.
- 6) Prepare new toner cartridge because it will be exhausted soon.

▶ **Error Code**

C2-1120 / C2-1150 / C2-1160 / C2-1170

▶ **Error message**

Replace new toner / Replace with new toner cartridge

Replace new toner / End of life, Replace with new toner cartridge

▶ **Symptom**

Toner cartridge is at the end of its life.

▶ **Troubleshooting method**

- 1) Open the front cover.
- 2) Remove the toner cartridge.
- 3) Install the new toner cartridge.
- 4) Close the front cover.

▶ **Error Code**

C2-1323 / C2-1411

▶ **Error message**

Error: #C2-1323 / Toner Failure: #C2-1323: Install toner again  
Toner Not Installed / Toner cartridge is not installed. Install it

▶ **Symptom**

The toner cartridge is not installed properly.

▶ **Troubleshooting method**

- 1) Open the front cover.
- 2) If the toner cartridge is not installed, install it. Try to test the machine again.
- 3) If the toner cartridge is installed, remove it. Check if the contact terminal is contaminated or broken.
- 4) Clean the contact terminal or replace the toner cartridge.
- 5) Check if the CRUM harness is connected correctly. Reconnect it.
- 6) If the harness is defective, replace it.
- 7) Turn the machine off then on. Try to test the machine.

▶ **Error Code**

C2-1512

▶ **Error message**

Toner Not Compatible / Toner cartridge is not compatible. Check guide

▶ **Symptom**

Toner cartridge is not compatible.

▶ **Troubleshooting method**

- 1) Open the front cover. Remove the toner cartridge.
- 2) Check if the label information of the toner cartridge is same with the machine's one. (ex. /SEE)
- 3) If label information is different from the machine or the toner cartridge is not a samsung genuine, replace it with a new one.

**▶ Error Code**

C2-1710 / C2-1711 / C2-1712

**▶ Error message**

Error: #C2-1710 / Toner Cart Failure: #C2-1710. Call for service

Error: #C2-1711 / Toner Cart Failure: #C2-1711. Call for service

Error: #C2-1712 / Toner Cart Failure: #C2-1712. Call for service

**▶ Symptom**

The data of CRUM is not detected. / CRUM is defective.

**▶ Troubleshooting method**

- 1) Open the front cover. Check if the toner cartridge is installed.
- 2) Remove and reinstall the toner cartridge.
- 3) Check if the contact terminal is contaminated or broken. Clean the contact terminal.
- 4) Check if the CRUM harness is connected correctly. Reconnect it.
- 5) If the harness is defective, replace it.
- 6) If the problem persists, replace the toner cartridge with new one.

**▶ Error Code**

C6-1110

**▶ Error message**

Prepare fuser unit / Prepare new fuser unit

**▶ Symptom**

Fuser unit life will be expired soon.

**▶ Troubleshooting method**

- 1) Prepare new fuser unit.

**▶ Error Code**

C6-1120

**▶ Error message**

Replace Fuser unit / Replace with new fuser unit

**▶ Symptom**

Fuser unit is at the end of its life.

**▶ Troubleshooting method**

- 1) Turn the machine off.
- 2) Open and remove the rear cover.
- 3) Remove the fuser unit and replace it with new one.
- 4) Close the rear cover.

#### 4.7.2.4. H1-xxxx (Optional Cassette error)

---

▶ **Error Code**

H1-1210 / H1-1211

▶ **Error message**

Paper jam in tray 2

▶ **Symptom**

Paper jam has occurred in tray2.

▶ **Troubleshooting method**

- 1) Remove the jammed paper. If the problem persists, check the followings.
- 2) Check if the paper is loaded in the tray2 properly.
- 3) Check if the pick up/forward/separation rollers of the tray2 are defective or worn out.
- 4) Check if the Empty/ Pick up/ Regi-Act sensor of the tray2 is working properly.
- 5) Check the connection between the motor/clutch and the SCF board. Reconnect the harness.
- 6) If the problem persists after checking No. 1~5, replace the SCF board.

▶ **Error Code**

H1-1220

▶ **Error message**

Tray 2 door is open. Close it

▶ **Symptom**

Tray 2 door is open.

▶ **Troubleshooting method**

- 1) Check if the tray2 door is closed. If not, close it.
- 2) If the problem persists, check the door open sensor. If it is defective, replace it.
- 3) If the sensor is normal, replace the SCF board.

**▶ Error Code**

H1-1222

**▶ Error message**

Tray 2 cassette Out / Tray 2 cassette is pulled out. Insert it properly

**▶ Symptom**

Tray 2 cassette is pulled out.

**▶ Troubleshooting method**

- 1) Insert the tray 2 cassette correctly.
- 2) If the problem persists, check the cassette detection sensor. If it is defective, replace it.
- 3) If the sensor is normal, replace the SCF board.

**▶ Error Code**

H1-1230

**▶ Error message**

Error: #H1-1230 / Tray Failure: #H1-1230. Check tray 2 connection &amp; turn off then on. Call for service if the problem persists

**▶ Symptom**

Connection between the main machine and the SCF unit is abnormal.

**▶ Troubleshooting method**

- 1) Check the harness connection between the main machine and the SCF unit.  
Reconnect the harness.
- 2) If the problem persists, replace the SCF board.
- 3) If the SCF board is normal, replace the Main board.

▶ **Error Code**

H1-1251 / H1-1252

▶ **Error message**

Paper Low in tray 2 / Paper is low in tray 2. Load paper

Paper Empty in tray 2 / Paper is empty in tray 2. Load paper

▶ **Symptom**

Paper in the tray2 is less than 10% of specification or empty. / The photo sensor is defective.

▶ **Troubleshooting method**

- 1) Remove tray2. Load the paper in tray2.
- 2) If paper is loaded but error message has not disappeared, check the following.
  - a) Check if the paper empty sensor is contaminated. If so, clean it.
  - b) If the paper empty sensor is defective, replace it.
  - c) If the empty actuator is defective, replace it.

▶ **Error Code**

H1-1253

▶ **Error message**

Error: #H1-1253 / Tray Failure: #H1-1253. Pull tray 2 out and insert it. Call for service if the problem persists

▶ **Symptom**

The paper is not fed from tray2.

▶ **Troubleshooting method**

- 1) Check if the cassette detection sensor cable is connected correctly. Unplug and reconnect it.
- 2) If the connection is OK, replace the cassette detection sensor.
- 3) Check if the Lift-Motor connector is connected properly.
- 4) If the problem persists, replace the Lift-Motor.



**▶ Error Code**

H1-1310 / H1-1311

**▶ Error message**

Paper jam in tray 3

**▶ Symptom**

Paper jam has occurred in tray3.

**▶ Troubleshooting method**

- 1) Remove the jammed paper. If the problem persists, check the followings.
- 2) Check if the paper is loaded in the tray3 properly.
- 3) Check if the pick up/forward/separation rollers of the tray3 are defective or worn out.
- 4) Check if the Empty/ Pick up/ Regi-Act sensor of the tray3 is working properly.
- 5) Check the connection between the motor/clutch and the SCF board. Reconnect the harness.
- 6) If the problem persists after checking No. 1~5, replace the SCF board.

**▶ Error Code**

H1-1320

**▶ Error message**

Tray 3 door is open. Close it

**▶ Symptom**

Tray 3 door is open.

**▶ Troubleshooting method**

- 1) Check if the tray3 door is closed. If not, close it.
- 2) If the problem persists, check the door open sensor. If it is defective, replace it.
- 3) If the sensor is normal, replace the SCF board.

▶ **Error Code**

H1-1322

▶ **Error message**

Tray 3 cassette Out / Tray 3 cassette is pulled out. Insert it properly

▶ **Symptom**

Tray 3 cassette is pulled out.

▶ **Troubleshooting method**

- 1) Insert the tray 3 cassette correctly.
- 2) If the problem persists, check the cassette detection sensor. If it is defective, replace it.
- 3) If the sensor is normal, replace the SCF board.

▶ **Error Code**

H1-1332

▶ **Error message**

Error: #H1-1332 / Tray Failure: #H1-1332. Check tray 3 connection & turn off then on. Call for service if the problem persists

▶ **Symptom**

Connection between the main machine and the SCF unit is abnormal.

▶ **Troubleshooting method**

- 1) Check the harness connection between the main machine and the SCF unit.  
Reconnect the harness.
- 2) If the problem persists, replace the SCF board.
- 3) If the SCF board is normal, replace the Main board.

**▶ Error Code**

H1-1351 / H1-1352

**▶ Error message**

Paper Low in tray 3 / Paper is low in tray 3. Load paper

Paper Empty in tray 3 / Paper is empty in tray 3. Load paper

**▶ Symptom**

Paper in the tray3 is less than 10% of specification or empty. / The photo sensor is defective.

**▶ Troubleshooting method**

- 1) Remove tray3. Load the paper in tray3.
- 2) If paper is loaded but error message has not disappeared, check the following.
  - a) Check if the paper empty sensor is contaminated. If so, clean it.
  - b) If the paper empty sensor is defective, replace it.
  - c) If the empty actuator is defective, replace it.

**▶ Error Code**

H1-1353

**▶ Error message**

Error: #H1-1353 / Tray Failure: #H1-1353. Pull tray 3 out and insert it. Call for service if the problem persists

**▶ Symptom**

The paper is not fed from tray3.

**▶ Troubleshooting method**

- 1) Check if the cassette detection sensor cable is connected correctly. Unplug and reconnect it.
- 2) If the connection is OK, replace the cassette detection sensor.
- 3) Check if the Lift-Motor connector is connected properly.
- 4) If the problem persists, replace the Lift-Motor.

▶ **Error Code**

H1-1410 / H1-1411

▶ **Error message**

Paper jam in tray 4

▶ **Symptom**

Paper jam has occurred in tray4.

▶ **Troubleshooting method**

- 1) Remove the jammed paper. If the problem persists, check the followings.
- 2) Check if the paper is loaded in the tray4 properly.
- 3) Check if the pick up/forward/separation rollers of the tray4 are defective or worn out.
- 4) Check if the Empty/ Pick up/ Regi-Act sensor of the tray4 is working properly.
- 5) Check the connection between the motor/clutch and the SCF board. Reconnect the harness.
- 6) If the problem persists after checking No. 1~5, replace the SCF board.

▶ **Error Code**

H1-1420

▶ **Error message**

Tray 4 door is open. Close it

▶ **Symptom**

Tray 4 door is open.

▶ **Troubleshooting method**

- 1) Check if the tray4 door is closed. If not, close it.
- 2) If the problem persists, check the door open sensor. If it is defective, replace it.
- 3) If the sensor is normal, replace the SCF board.

**▶ Error Code**

H1-1422

**▶ Error message**

Tray 4 cassette Out / Tray 4 cassette is pulled out. Insert it properly

**▶ Symptom**

Tray 4 cassette is pulled out.

**▶ Troubleshooting method**

- 1) Insert the tray 4 cassette correctly.
- 2) If the problem persists, check the cassette detection sensor. If it is defective, replace it.
- 3) If the sensor is normal, replace the SCF board.

**▶ Error Code**

H1-1434

**▶ Error message**

Error: #H1-1434 / Tray Failure: #H1-1434. Check tray 4 connection &amp; turn off then on. Call for service if the problem persists

**▶ Symptom**

Connection between the main machine and the SCF unit is abnormal.

**▶ Troubleshooting method**

- 1) Check the harness connection between the main machine and the SCF unit.  
Reconnect the harness.
- 2) If the problem persists, replace the SCF board.
- 3) If the SCF board is normal, replace the Main board.

▶ **Error Code**

H1-1451 / H1-1452

▶ **Error message**

Paper Low in tray 4 / Paper is low in tray 4. Load paper

Paper Empty in tray 4 / Paper is empty in tray 4. Load paper

▶ **Symptom**

Paper in the tray4 is less than 10% of specification. / The photo sensor is defective.

▶ **Troubleshooting method**

- 1) Remove tray4. Load the paper in tray4.
- 2) If paper is loaded but error message has not disappeared, check the following.
  - a) Check if the paper empty sensor is contaminated. If so, clean it.
  - b) If the paper empty sensor is defective, replace it.
  - c) If the empty actuator is defective, replace it.

▶ **Error Code**

H1-1453

▶ **Error message**

Error: #H1-1453 / Tray Failure: #H1-1453. Pull tray 4 out and insert it. Call for service if the problem persists

▶ **Symptom**

The paper is not fed from tray4.

▶ **Troubleshooting method**

- 1) Check if the cassette detection sensor cable is connected correctly. Unplug and reconnect it.
- 2) If the connection is OK, replace the cassette detection sensor.
- 3) Check if the Lift-Motor connector is connected properly.
- 4) If the problem persists, replace the Lift-Motor.

**▶ Error Code**

H1-1510 / H1-1511

**▶ Error message**

Paper jam in tray 5

**▶ Symptom**

Paper jam has occurred in tray5.

**▶ Troubleshooting method**

- 1) Remove the jammed paper. If the problem persists, check the followings.
- 2) Check if the paper is loaded in the tray5 properly.
- 3) Check if the pick up/forward/separation rollers of the tray5 are defective or worn out.
- 4) Check if the Empty/ Pick up/ Regi-Act sensor of the tray5 is working properly.
- 5) Check the connection between the motor/clutch and the SCF board. Reconnect the harness.
- 6) If the problem persists after checking No. 1~5, replace the SCF board.

**▶ Error Code**

H1-1551

**▶ Error message**

Paper Low in tray 5 / Paper is low in tray 5. Load paper

**▶ Symptom**

Paper in the tray5 is less than 10% of specification. / The photo sensor is defective.

**▶ Troubleshooting method**

- 1) Remove tray5. Load the paper in tray5.
- 2) If paper is loaded but error message has not disappeared, check the following.
  - a) Check if the paper empty sensor is contaminated. If so, clean it.
  - b) If the paper empty sensor is defective, replace it.
  - c) If the empty actuator is defective, replace it.

▶ **Error Code**

H1-1553

▶ **Error message**

Error: #H1-1553 / Tray Failure: #H1-1553. Pull tray 5 out and insert it. Call for service if the problem persists

▶ **Symptom**

The paper is not fed from tray5.

▶ **Troubleshooting method**

- 1) Check if the cassette detection sensor cable is connected correctly. Unplug and reconnect it.
- 2) If the connection is OK, replace the cassette detection sensor.
- 3) Check if the Lift-Motor connector is connected properly.
- 4) If the problem persists, replace the Lift-Motor.



#### 4.7.2.5. Mx-xxxx (Jam\_Paper handling error)

► **Error Code**

M1-1110

► **Error message**

Paper jam in tray 1

► **Symptom**

The jammed paper has occurred in the tray1.

► **Troubleshooting method**

- 1) Clear the jammed paper.  
If the problem persists, check the following.
- 2) Check if there is any obstacles in the paper path.
- 3) Check the connection between the pick up sensor and the main board. Reconnect the sensor harness.
- 4) Check if the pick up / forward / separation rollers are contaminated or worn out. If necessary, replace the defective roller.

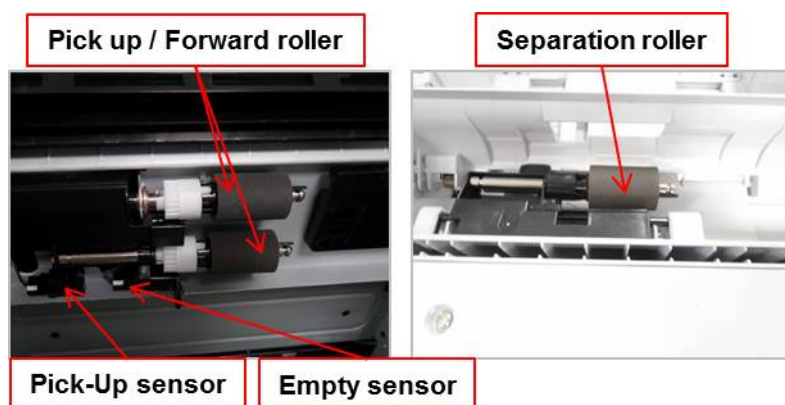

- 5) Check the connection between the pick up motor and the main board. Reconnect the motor harness.
- 6) If the pick up motor is defective, replace the pick up motor or pick up drive unit.



▶ **Error Code**

M1-1610

▶ **Error message**

Paper jam in MP tray

▶ **Symptom**

The jammed paper has occurred in the MP tray.

▶ **Troubleshooting method**

- 1) Clear the jammed paper.  
If the problem persists, check the following.
- 2) Check if the MP Unit connector is connected properly. Reconnect it.
- 3) Check if the MP roller is contaminated or worn out. If necessary, replace it.

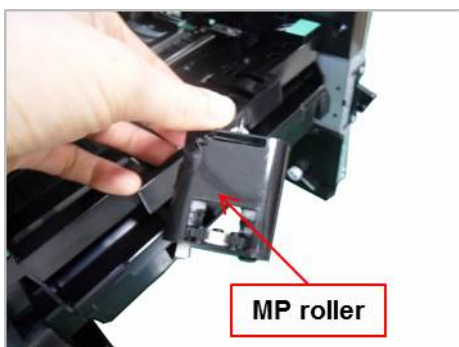

- 4) Check if the MP clutch harness is connected correctly. Reconnect the harness.
- 5) If the MP clutch is defective, replace it.
- 6) If the problem persists, replace the MP Unit.

▶ **Error Code**

M1-3122

▶ **Error message**

Tray 1 cassette Out / Tray 1 cassette is pulled out. Insert it properly

▶ **Symptom**

Tray 1 cassette is pulled out.

▶ **Troubleshooting method**

- 1) Remove and reinstall the tray 1 cassette.
- 2) Check if the cassette detection sensor harness is connected correctly.
- 3) If the cassette detection sensor is defective, replace it with new one.
- 4) If the problem persists, replace the main board.

► **Error Code**

M1-4111

► **Error message**

Error: #M1-4111 / Tray Failure: #M1-4111. Pull tray 1 out and insert it. Call for service if the problem persists

► **Symptom**

The machine can not pick up the paper from the tray.

► **Troubleshooting method**

- 1) Check if the pick up / forward / separation rollers are contaminated or worn out. If necessary, replace the defective roller.

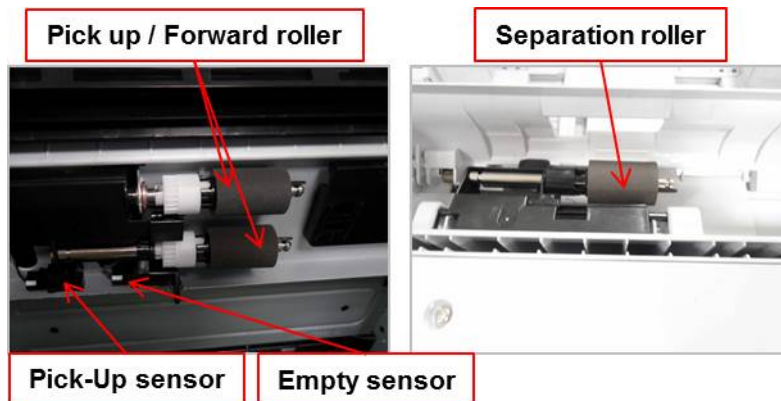

- 2) Remove the side cover.
- 3) Check the connection between the pick up motor and the main board. Reconnect the motor harness.
- 4) If the pick up motor is defective, replace the pick up motor or pick up drive unit.



- 5) Check the connection between the pick up sensor and the main board. Reconnect the sensor harness.
- 6) If the pick up sensor is defective, replace it.

▶ **Error Code**

M1-5111 / M1-5112

▶ **Error message**

Paper Low in tray 1 / Paper is low in tray 1. Load paper

Paper Empty in tray 1 / Paper is empty in tray 1. Load paper

▶ **Symptom**

There is no paper in the tray1. / Actuator-Paper Empty or photo sensor is defective.

▶ **Troubleshooting method**

- 1) Load the paper in the tray1.

If the problem persists, check the followings after turning the machine off.

- 2) If the ACTUATOR-EMPTY PICK UP is defective, replace it.
- 3) Check if the empty sensor harness is connected correctly. Reconnect it.
- 4) If the empty sensor is defective, replace it. Check if the connector is connected properly.

▶ **Error Code**

M1-5612

▶ **Error message**

Paper Empty in MP tray / Paper is empty in MP tray. Load paper

▶ **Symptom**

There is no paper in the MP tray (or Manual Feeder). / Actuator-Paper Empty or photo sensor is defective.

▶ **Troubleshooting method**

- 1) Load the paper in the tray1.

If the problem persists, check the followings after turning the machine off.

- 2) If the LEVER-MP EMPTY(*JC66-04790A*) is defective, replace it.
- 3) Check if the MP empty sensor harness is connected correctly. Reconnect it.
- 4) If the MP empty sensor(*0604-001393*) is defective, replace it.
- 5) If necessary, replace the MP Unit.

**▶ Error Code**

M2-1111 / M2-1114

**▶ Error message**

Jam inside of machine

**▶ Symptom**

A paper jam was detected at the feed sensor.

**▶ Troubleshooting method**

- 1) Remove the jammed paper.  
If the error persists, check the followings.
- 2) Check if there is any obstacles or contamination in the paper path. If yes, clean or remove it.
- 3) Check if the feed sensor harness is connected properly. Reconnect the harness.
- 4) If the feed sensor is defective, replace it.
- 5) Check if the feed roller is contaminated or worn out. If yes, replace it.
- 6) Check the main drive unit operation. If necessary, replace the main drive unit.

**▶ Error Code**

M2-2210 / M2-2310

**▶ Error message**

Jam inside of duplex

Jam bottom of duplex

**▶ Symptom**

A paper jam was detected in the bottom of duplex.

**▶ Troubleshooting method**

- 1) Remove the jammed paper.
- 2) Remove the contamination or obstacles in the paper path.
- 3) If this jam error occur continually, replace the duplex unit.
- 4) Check if the duplex motor harness is connected correctly. Reconnect the harness.
- 5) If the duplex motor operation is abnormal, replace it.

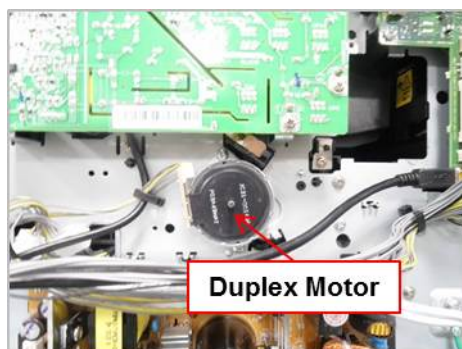

▶ **Error Code**

M3-1110 / M3-1112

▶ **Error message**

Jam in exit area

Jam inside of machine

▶ **Symptom**

A paper jam was detected in the exit area.

▶ **Troubleshooting method**

- 1) Remove the jammed paper.
- 2) Check if there is any obstacles or contamination in the paper path. If yes, clean or remove it.
- 3) Check the connection between the exit/fuser drive unit and the main board. Reconnect the motor harness.
- 4) If the exit/fuser drive unit operation is abnormal, replace it.

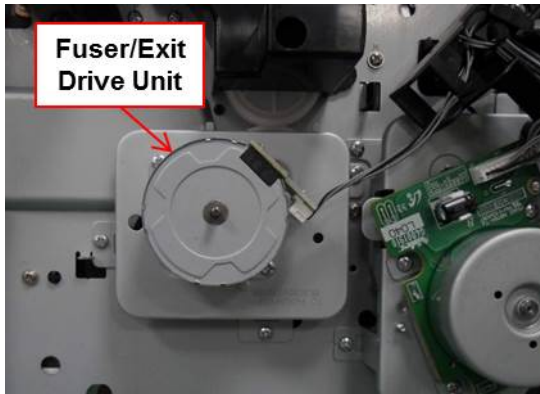

- 5) If the paper is jammed in the exit unit continually, replace the exit unit.
- 6) If the paper is jammed in the fuser unit continually, replace the fuser unit.

**▶ Error Code**

M3-2130

**▶ Error message**

Output bin is full / Paper in output bin is full. Remove printed paper

**▶ Symptom**

The machine detected that the output tray has got full or the bin-full sensor is defective.

**▶ Troubleshooting method**

- 1) Remove the paper on the output tray.
- 2) If the problem persists, check the followings.
- 3) Check if the Bin-full Sensor connector is connected properly. Reconnect it or replace the Bin-full sensor.

**[ Exit Unit ]**

#### 4.7.2.6. Sx-xxxx (System error)

---

▶ **Error Code**

S2-1110

▶ **Error message**

Error: #S2-1110 / Engine System Failure: #S2-1110. Call for service

▶ **Symptom**

CPU in the main board has some problem.

▶ **Troubleshooting method**

- 1) Turn the machine off then on.
- 2) If the problem persists, replace the main board.

▶ **Error Code**

S2-33xx

▶ **Error message**

Error: #S2-33xx

Calibrating... Please Wait

Wait delay time for lower fixing temperature...

Supplying and mixing toner to developer unit. Please wait...

▶ **Symptom**

This error shows the engine status.

▶ **Troubleshooting method**

- S2-3310 : Warm-up status
- S2-3311 : Ready status
- S2-3312 : Printing status
- S2-3313 : Power Save status
- S2-3314 : Error status
- S2-3315 : Recovery status
- S2-3316 : Wait status
- S2-3317 : EDC mode status
- S2-3318 : Low power status
- S2-331C : Temperature in machine is overheated.
- S2-331D : Temperature in fuser is overheated.
- S2-3321 : Toner is supplying.

When these errors display, wait until the message will be disappeared or turn the machine off then on.



**▶ Error Code**

S2-4120

S2-4210

**▶ Error message**

Door is open. Close it

Front door is open. Close it

**▶ Symptom**

Door is open or the cover open switch is defective.

**▶ Troubleshooting method**

- 1) Check if the front door is closed correctly.
- 2) Check if the rear door is closed correctly.
- 3) Check if the connection between the main board and HVPS board is correct.
- 4) Check if the cover open switch on HVPS board is operated properly. If it is defective, replace the HVPS board.

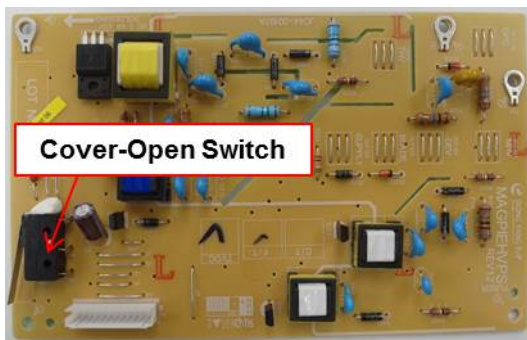

▶ **Error Code**

S6-3113

▶ **Error message**

Error: #S6-3113 / Network Failure: #S6-3113. Turn off then on. Call for service if the problem persists

▶ **Symptom**

Network PHY chip is defective.

▶ **Troubleshooting method**

- 1) Turn the machine off then on.
- 2) If the problem persists, replace the main board.

▶ **Error Code**

S6-3123

▶ **Error message**

IP Conflict / This IP address conflicts with that of other system

▶ **Symptom**

IP address conflicts with that of other system. / There is no response when checking the ping test.

▶ **Troubleshooting method**

Change the machine's IP address.

- Set-up the IP address in this order, Network -> TCP/IP (IPv4) -> STATIC.
- In case of DHCP or Bootp, reboot the machine to receive a new IP address.

▶ **Error Code**

S6-3128

▶ **Error message**

802.1x Network Error / 802.1x Network Error. Contact the Admin

▶ **Symptom**

The confirmation was requested for wired port, the server has rejected. / The confirmation protocol is not the same or user information (ID/Password) is wrong.

▶ **Troubleshooting method**

Check the setting-up for 802.1x confirmation server.

- Re-enter the server information and confirmation protocol.
- Re-enter the user information.

**▶ Error Code**

S6-3231

**▶ Error message**

Error: #S6-3231 / Can not find a wireless network. Please check the wireless environment

**▶ Symptom**

The machine can not find the SSID (Service Set Identifier).

**▶ Troubleshooting method**

- 1) Check the setting-up for wireless network.

**▶ Error Code**

S6-3232

**▶ Error message**

Error: #S6-3232 / Wireless security settings are incorrect. Please change the settings

**▶ Symptom**

Wireless security settings like a WEP/WPA/WPA2 are incorrect.

**▶ Troubleshooting method**

- 1) Turn the machine and AP off then on.
- 2) Change the wireless network settings.

**▶ Error Code**

S6-3233

**▶ Error message**

Error: #S6-3233 / Not connected from the wireless AP. If you do not reconnect automatically, check the wireless settings

**▶ Symptom**

Wireless BSSID value is 0 or wireless module is disconnected.

**▶ Troubleshooting method**

- 1) Turn the machine and AP off then on.
- 2) Change the wireless network settings.

▶ **Error Code**

S6-3234

▶ **Error message**

Error: #S6-3234 / Failed connection to WPS. Try again or set up other wireless connection

▶ **Symptom**

WPS connection to AP is failed.

▶ **Troubleshooting method**

- 1) Retry the connection with WPS button.

▶ **Error Code**

S6-3235

S6-3236

▶ **Error message**

Error: #S6-3235 / Wi-Fi Direct is not ready. Turn off then on. Call for service if the problem persists

Error: #S6-3236 / Failed to connect to Wi-Fi Direct. Turn off your mobile device and turn it on

▶ **Symptom**

Wi-Fi Direct library is initialized.

▶ **Troubleshooting method**

- 1) Turn the machine off then on.
- 2) Change the wireless network settings. Retry it.

▶ **Error Code**

S7-2110

▶ **Error message**

Error #S7-2110 / Fuser Unit Failure: #S7-2110. Turn off then on. Call for service if the problem persists

▶ **Symptom**

Heat control relay operation is abnormal.

▶ **Troubleshooting method**

- 1) Turn the machine off. Re-install the fuser unit. Then turn the machine on. Is the error message is disappeared?
- 2) If the problem persists, turn the machine off and remove the fuser unit.
  - a) Check if the fuser connector is connected properly.
  - b) Check if the input voltage is normal.
  - c) Check if the thermistor is twisted or contaminated; and is in contact with the Heat Roller.
- 3) After confirming continuity in the fuser connector and the problem still exists; order an SMPS and Fuser Unit and install as is necessary.

---

#### 4.7.2.7. U1-xxxx (Fuser error)

---

▶ **Error Code**

U1-21xx / U1-23xx

▶ **Error message**

Error: #U1-2xxx / Fuser Unit Failure: #U1-2xxx. Turn off then on. Call for service if the problem persists

▶ **Symptom**

The temperature control of fuser unit is abnormal.

▶ **Troubleshooting method**

- 1) Turn the machine off. Re-install the fuser unit. Then turn the machine on. Is the error message is disappeared?
- 2) If the problem persists, turn the machine off and remove the fuser unit.
  - a) Check if the fuser connector is connected properly.
  - b) Check if the input voltage is normal.
  - c) Check if the thermistor is twisted or contaminated; and is in contact with the Heat Roller.
- 3) After confirming continuity in the fuser connector and the problem still exists; order an SMPS and Fuser Unit and install as is necessary.

#### 4.7.2.8. U2-xxxx type (LSU) error code

---

▶ **Error Code**

U2-1111 / U2-1112 / U2-1113

▶ **Error message**

Error: #U2-111x / LSU Failure: #U2-111x. Turn off then on. Call for service if the problem persists

▶ **Symptom**

LSU Motor does not work normally.

▶ **Troubleshooting method**

- 1) Execute the LSU motor test in SVC mode. Check LSU motor operation sound.
- 2) If there is no sound, remove the right cover. Check if the LSU harness is connected on the main board properly.
- 3) If it is OK, remove the top cover. Check if the LSU harness is connected on LSU board properly.
- 4) Check if the LSU harness is defective.
- 5) Reconnect the LSU harness and then execute the LSU motor test again.
- 6) If the problem persists, replace the LSU.
- 7) If the problem persists after replacing LSU, replace the main board.

### 4.7.3. Image quality problem

Print-quality defects can be attributed to printer components, supplies, media, internal software, external software applications and environmental conditions.

To successfully troubleshoot print-quality problems, as many variables as possible must be eliminated.

The first step is to generate prints using printable pages embedded in the printer on laser paper. The paper should be from an unopened ream that has been acclimated to room temperature and you should ensure that genuine Samsung Toner is installed in the printer.

#### How to analysis the defect image



**TIP**

- According to the part remain life, cause can vary. Check the part remain life.
- Check the defect whether periodic or not.

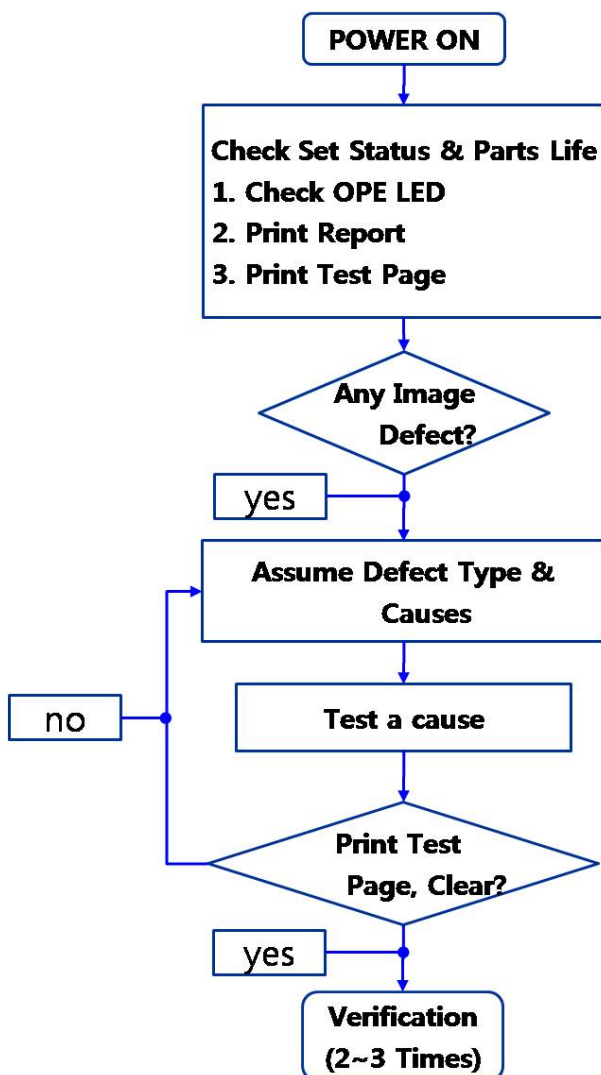

1) **Vertical Black Line and Band**

Description : Straight thin black vertical line occurs in the printed image.



Probable Cause	Solution
The paper is not the proper type.	Replace the paper.
The paper path is contaminated by toner residue, debris etc.	Clean the paper path.
The toner cartridge is defective.	Replace the toner cartridge.
The transfer roller is contaminated or worn out.	Replace the transfer roller.
The pressure roller or heat roller in fuser unit defective.	1) Turn the machine off. 2) Remove and replace the fuser unit. 3) Turn the machine on. <div style="background-color: #cccccc; padding: 5px; margin-top: 10px;">  <b>WARNING</b>  <b>Do not touch the fuser unit while it is hot.</b> </div>



2) **Vertical White Line, Band**

Description : White vertical voids occurs in the printed image.



Probable Cause	Solution
The paper is not the proper type.	Replace the paper.
The paper path is contaminated by toner residue, debris etc.	Clean the paper path.
The toner cartridge is defective.	Replace the toner cartridge.
The transfer roller is contaminated or worn out.	Replace the transfer roller.
The LSU window is contaminated.	1) Clean the LSU window. 2) Replace the LSU
The connection between the LSU and main board is defective.	1) Disconnect and reconnect the harness. 2) Replace the harness.

3) **Horizontal Black Band**

Description : Dark of blurry horizontal stripes occur in the printing periodically.



Probable Cause	Solution
The paper is dirty or not the proper type.	Replace the paper.
The paper path is contaminated by toner residue, debris etc.	Clean the paper path.
The contact terminal of the toner cartridge is bad.	1) Clean the contact terminal of the toner cartridge. 2) Replace the toner cartridge.
The surface of transfer roller is contaminated or worn out.	Replace the transfer roller.
The LSU window is contaminated.	1) Clean the LSU window.
The pressure roller or heat roller in fuser unit defective.	1) Turn the machine off. 2) Remove and replace the fuser unit. 3) Turn the machine on.  <div style="background-color: #cccccc; padding: 5px; border: 1px solid black;">  <b>WARNING</b>  <b>Do not touch the fuser unit while it is hot.</b> </div>
HVPS terminal is contaminated.	Clean the contaminated terminal.
The output from the HVPS is abnormal.	Replace the HVPS board.

 **NOTE**

Roller Period for Horizontal Problem

Roller Description	Band Period (mm)	Defective part
1st Pressure roller	62.8 mm	Fuser unit
2nd Pressure roller	37.7 mm	
Heat roller	77.8 mm	
Charge roller	34.5 mm	Toner Cartridge
Developer roller	37 mm	
OPC drum	76 mm	
Supply roller	69.57 mm	
Transfer roller	47.1 mm	Transfer roller

4) **Black and White spot**

Description : Dark or blurry black spots occur periodically in the printing.



Probable Cause	Solution
The paper path is contaminated by toner residue, debris etc.	Clean the paper path.
The rollers in the toner cartridge may be contaminated with foreign matter or paper particles.	Replace the toner cartridge.
The transfer roller is contaminated or worn out.	Replace the transfer roller.
The pressure roller or heat roller in fuser unit defective.	1) Turn the machine off. 2) Remove and replace the fuser unit. 3) Turn the machine on. <div style="background-color: #cccccc; padding: 5px; margin-top: 10px;">  <b>WARNING</b>  <b>Do not touch the fuser unit while it is hot.</b> </div>

5) **Light image**

Description : The printed image is light, with no ghost.



Probable Cause	Solution
The toner cartridge life is expired.	Replace the toner cartridge.
The surface of transfer roller is contaminated or worn out.	Replace the transfer roller.
HVPS terminal is contaminated.	Clean the contaminated terminal.
The output from the HVPS is abnormal.	Replace the HVPS board.

**6) Dark or Black page**

Description : The printed image is dark or black.



Probable Cause	Solution
The charging roller in the toner cartridge is defective.	Replace the toner cartridge.
The HVPS contact terminal is contaminated.	Clean the HVPS contact terminal.
The output from the HVPS is abnormal.	Replace the HVPS board.
The LSU is defective.	Replace the LSU.

7) **Uneven Density**

Description : Print density is uneven between left and right.



Probable Cause	Solution
<ul style="list-style-type: none"><li>• The pressure force on the left and right springs of the transfer roller is not even.</li><li>• The springs are damaged.</li><li>• The transfer roller is improperly installed.</li></ul>	<ol style="list-style-type: none"><li>1) Remove the transfer roller Assy.</li><li>2) Check if the transfer roller Assy has any wrong part.</li><li>3) Replace the transfer roller Assy.</li></ol>
The toner level is not even on the toner cartridge roller due to the bad blade.	Replace the toner cartridge.

**8) Background**

Description : Light dark background appears in whole area of the printing.



Probable Cause	Solution
Does recycle paper be used?	Use the proper papers.
The life of the toner cartridge has been expired	Replace the toner cartridge.
The output from the HVPS is abnormal.	Replace the HVPS board.

9) **Ghost**

Description : Ghost occurs.



Probable Cause	Solution
The residual toner on the rollers exists.	Print 10 test prints.
The contact terminal of the toner cartridge is bad.	1) Clean the contact terminal of the toner cartridge. 2) Replace the toner cartridge.
The transfer roller is contaminated or worn out.	Replace the transfer roller.
The pressure roller or heat roller in fuser unit defective.	1) Turn the machine off. 2) Remove and replace the fuser unit. 3) Turn the machine on.  <div style="background-color: #cccccc; padding: 5px; border: 1px solid black;">  <b>WARNING</b>  <b>Do not touch the fuser unit while it is hot.</b> </div>
The HVPS contact terminal is contaminated.	Clean the HVPS contact terminal.
The output from the HVPS is abnormal.	Replace the HVPS board.



10) **Stains on back of page**

Description : The back of the page is stained.



Probable Cause	Solution
The transfer roller is contaminated or worn out.	Replace the transfer roller.
The pressure roller or heat roller in fuser unit defective.	1) Turn the machine off. 2) Remove and replace the fuser unit. 3) Turn the machine on. <div style="background-color: #cccccc; padding: 5px; margin-top: 10px;">  <b>WARNING</b>  <b>Do not touch the fuser unit while it is hot.</b> </div>

11) **Blank page**

Description : No visible image anywhere on the output.



Probable Cause	Solution
The contact terminal of the toner cartridge is bad.	1) Clean the contact terminal of the toner cartridge. 2) Replace the toner cartridge.
The surface of transfer roller is contaminated or worn out.	Replace the transfer roller.
The LSU window is contaminated.	1) Clean the LSU window. 2) Replace the LSU
The connection between the LSU and main board is defective.	1) Disconnect and reconnect the harness. 2) Replace the harness.
The connection between the main board and HVPS board is bad.	Reconnect the harness. If the main board or HVPS board is defective, replace it.

12) **Partial image void**

Description : The partial void occurs in the printed page.



Probable Cause	Solution
The printer is not installed on flat ground.	Install the printer on flat ground. Print 10 sample pages for test.
The developer circulation in the toner cartridge is bad.	1) Shake the toner cartridge 2~3 times from right to left. Reinstall the toner cartridge. Print 10 sample pages for test. 2) If the problem persists, replace the toner cartridge.
The contact between toner cartridge and transfer roller is bad.	Check if the toner cartridge and transfer roller are installed properly.

13) **Unfused image**

Description : The printed image is not fully fused to the paper. The image rubs off easily

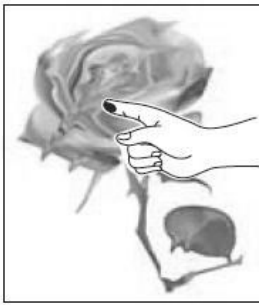

Probable Cause	Solution
The papers are wet with moisture.	Replace the paper.
The fuser unit is not installed properly.	1) Turn the machine off. 2) Remove and reinstall the fuser unit. 3) Turn the machine on.
The fuser connection is bad.	Check the connection between the fuser unit and main board.
The fuser unit defective.	1) Turn the machine off. 2) Remove and replace the fuser unit. 3) Turn the machine on.

 **WARNING**  
**Do not touch the fuser unit while it is hot.**

#### 4.7.4. Other errors

##### 1) Multi-feeding

- Description : Multiple sheets of paper are fed at once.

Check and cause	Solution
Pick clutch or Regi clutch does not work properly.	Replace the defective clutch if necessary.
Pick up/ Forward / Separation roller is worn out or contaminated.	Clean or replace the defective roller.

##### 2) No-Power

- Description : When system power is turned on, LED and LCD on the operator panel do not come on.

Check and cause	Solution
The connection between main board and OPE board is bad.	Reconnect or replace the harness.
SMPS output is abnormal.	Replace the SMPS board.

# 5. System Diagram

## 5.1. Block Diagram

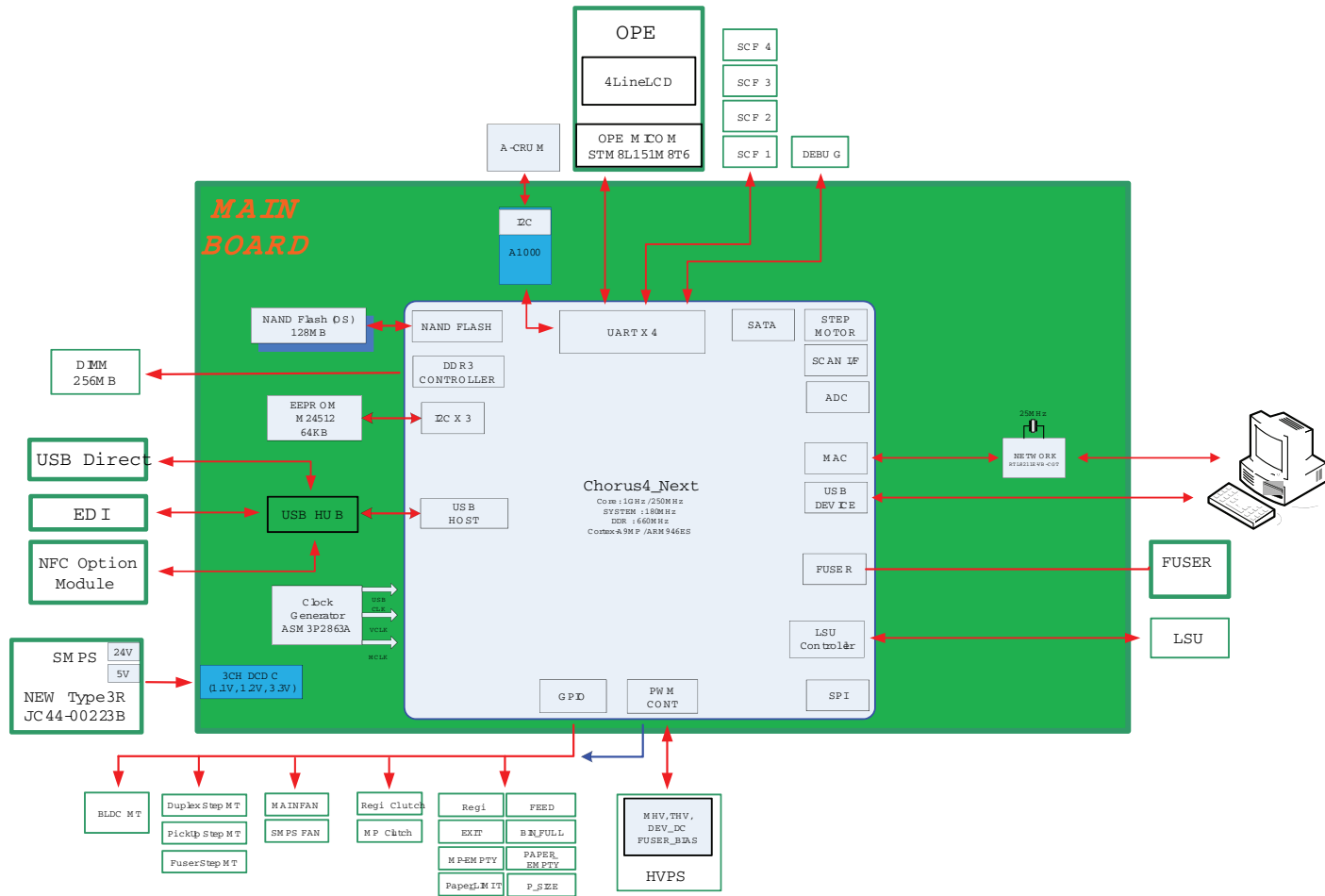

# 5.2. Connection Diagram

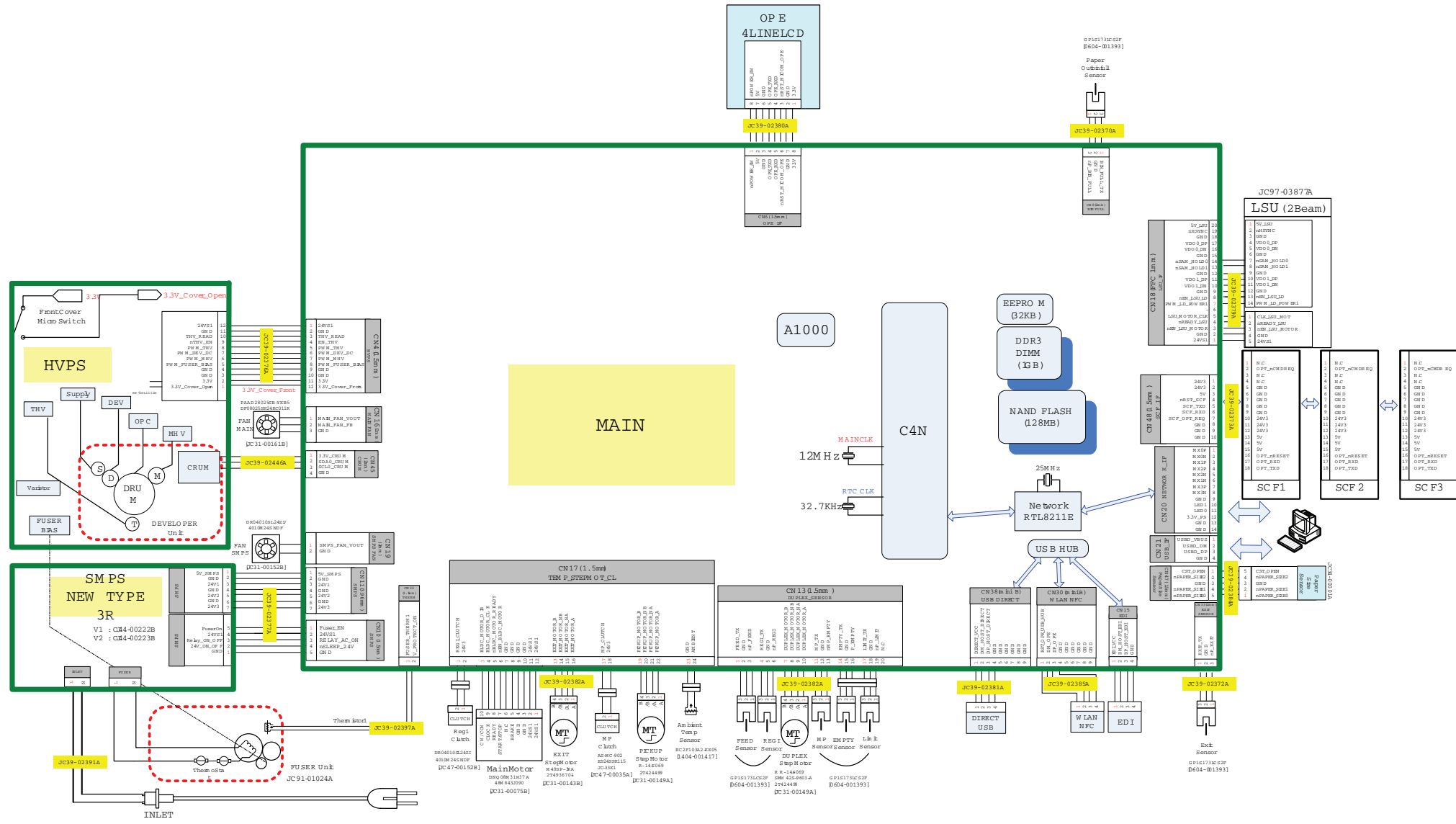





# 6. Reference Information

This chapter contains the tools list, list of abbreviations used in this manual, and a guide to the location space required when installing the printer. A definition of test pages and Wireless Network information definition is also included.

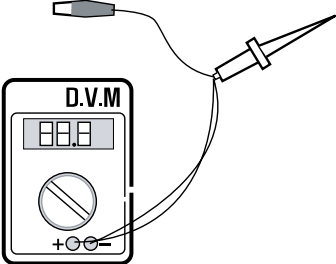
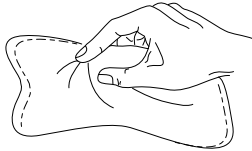
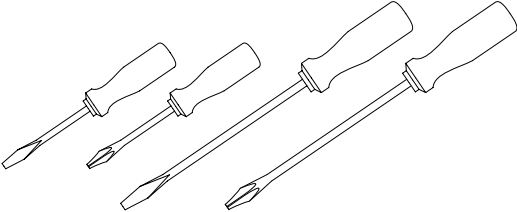
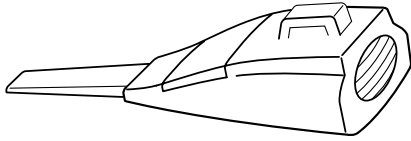
## 6.1. Tool for Troubleshooting

The following tools are recommended safe and easy troubleshooting as described in this service manual.

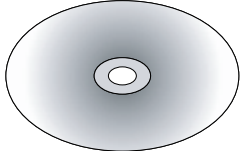
<p><b>DVM (Digital Volt Meter)</b> Standard : Indicates more than 3 digits.</p> 	<p><b>Cleaning Equipments</b> Standard : An IPA (Isopropyl Alcohol) dry wipe tissue or a gentle neutral detergent and lint-free cloth.</p> 
<p><b>Driver</b> Standard : “-” type, “+” type (M3 long, M3 short, M2 long, M2 short).</p> 	<p><b>Vacuum Cleaner</b></p> 
<p><b>Tweezers</b> Standard : For general home use, small type.</p> 	<p><b>Spring Hook</b> Standard : For general use</p> 
<p><b>Cotton Swab</b> Standard : For general home use, for medical service.</p> 	<p><b>Software (Driver) installation CD ROM</b></p> 



## 6.2. Glossary

The following glossary helps you get familiar with the product by understanding the terminologies commonly used with printing as well as mentioned in this user's guide and service manual.

802.11	802.11 is a set of standards for wireless local area network (WLAN) communication, developed by the IEEE LAN/MAN Standards Committee (IEEE 802).
802.11b/g/n	802.11b/g/n can share same hardware and use the 2.4 GHz band. 802.11b supports bandwidth up to 11 Mbps, 802.11n supports bandwidth up to 150 Mbps. 802.11b/g/n devices may occasionally suffer interference from microwave ovens, cordless telephones, and Bluetooth devices.
Access point	Access Point or Wireless Access Point (AP or WAP) is a device that connects wireless communication devices together on wireless local area networks (WLAN), and acts as a central transmitter and receiver of WLAN radio signals.
ADF	An Automatic Document Feeder (ADF) is a scanning unit that will automatically feed an original sheet of paper so that the machine can scan some amount of the paper at once.
AppleTalk	AppleTalk is a proprietary suite of protocols developed by Apple, Inc for computer networking. It was included in the original Macintosh (1984) and is now deprecated by Apple in favor of TCP/IP networking.
BIT Depth	A computer graphics term describing the number of bits used to represent the color of a single pixel in a bitmapped image. Higher color depth gives a broader range of distinct colors. As the number of bits increases, the number of possible colors becomes impractically large for a color map. 1-bit color is commonly called as monochrome or black and white.
BMP	A bitmapped graphics format used internally by the Microsoft Windows graphics subsystem (GDI), and used commonly as a simple graphics file format on that platform.
BOOTP	Bootstrap Protocol. A network protocol used by a network client to obtain its IP address automatically. This is usually done in the bootstrap process of computers or operating systems running on them. The BOOTP servers assign the IP address from a pool of addresses to each client. BOOTP enables 'diskless workstation' computers to obtain an IP address prior to loading any advanced operating system.
CCD	Charge Coupled Device (CCD) is a hardware which enables the scan job. CCD Locking mechanism is also used to hold the CCD module to prevent any damage when you move the machine.
Collation	Collation is a process of printing a multiple-copy job in sets. When collation is selected, the device prints an entire set before printing additional copies.
Control Panel	A control panel is a flat, typically vertical, area where control or monitoring instruments are displayed. They are typically found in front of the machine.
Coverage	It is the printing term used for a toner usage measurement on printing. For example, 5% coverage means that an A4 sided paper has about 5% image or text on it. So, if the paper or original has complicated images or lots of text on it, the coverage will be higher and at the same time, a toner usage will be as much as the coverage.
CSV	Comma Separated Values (CSV). A type of file format, CSV is used to exchange data between disparate applications. The file format, as it is used in Microsoft Excel, has become a de facto standard throughout the industry, even among non-Microsoft platforms.
DADF	A Duplex Automatic Document Feeder (DADF) is a scanning unit that will automatically feed and turn over an original sheet of paper so that the machine can scan on both sides of the paper.
Default	The value or setting that is in effect when taking a printer out of its box state, reset, or initialized.
DHCP	A Dynamic Host Configuration Protocol (DHCP) is a client-server networking protocol. A DHCP server provides configuration parameters specific to the DHCP client host requesting, generally, information required by the client host to participate on an IP network. DHCP also provides a mechanism for allocation of IP addresses to client hosts.
DIMM	Dual Inline Memory Module (DIMM), a small circuit board that holds memory. DIMM stores all the data within the machine like printing data, received fax data.

DLNA	The Digital Living Network Alliance (DLNA) is a standard that allows devices on a home network to share information with each other across the network.
DNS	The Domain Name Server (DNS) is a system that stores information associated with domain names in a distributed database on networks, such as the Internet.
Dot Matrix Printer	A dot matrix printer refers to a type of computer printer with a print head that runs back and forth on the page and prints by impact, striking an ink-soaked cloth ribbon against the paper, much like a typewriter.
DPI	Dots Per Inch (DPI) is a measurement of resolution that is used for scanning and printing. Generally, higher DPI results in a higher resolution, more visible detail in the image, and a larger file size.
DRPD	Distinctive Ring Pattern Detection. Distinctive Ring is a telephone company service which enables a user to use a single telephone line to answer several different telephone numbers.
Duplex	A mechanism that will automatically turn over a sheet of paper so that the machine can print (or scan) on both sides of the paper. A printer equipped with a Duplex Unit can print on both sides of paper during one print cycle.
Duty Cycle	Duty cycle is the page quantity which does not affect printer performance for a month. Generally the printer has the lifespan limitation such as pages per year. The lifespan means the average capacity of print-outs, usually within the warranty period. For example, if the duty cycle is 48,000 pages per month assuming 20 working days, a printer limits 2,400 pages a day.
ECM	Error Correction Mode (ECM) is an optional transmission mode built into Class 1 fax machines or fax modems. It automatically detects and corrects errors in the fax transmission process that are sometimes caused by telephone line noise.
Emulation	Emulation is a technique of one machine obtaining the same results as another. An emulator duplicates the functions of one system with a different system, so that the second system behaves like the first system. Emulation focuses on exact reproduction of external behavior, which is in contrast to simulation, which concerns an abstract model of the system being simulated, often considering its internal state.
Ethernet	Ethernet is a frame-based computer networking technology for local area networks (LANs). It defines wiring and signaling for the physical layer, and frame formats and protocols for the media access control (MAC)/data link layer of the OSI model. Ethernet is mostly standardized as IEEE 802.3. It has become the most widespread LAN technology in use during the 1990s to the present.
EtherTalk	A suite of protocols developed by Apple Computer for computer networking. It was included in the original Macintosh (1984) and is now deprecated by Apple in favor of TCP/IP networking.
FDI	Foreign Device Interface (FDI) is a card installed inside the machine to allow a third party device such as a coin operated device or a card reader. Those devices allow the pay-for-print service on your machine.
FTP	A File Transfer Protocol (FTP) is a commonly used protocol for exchanging files over any network that supports the TCP/IP protocol (such as the Internet or an intranet).
Fuser Unit	The part of a laser printer that fuses the toner onto the print media. It consists of a heat roller and a pressure roller. After toner is transferred onto the paper, the fuser unit applies heat and pressure to ensure that the toner stays on the paper permanently, which is why paper is warm when it comes out of a laser printer.
Gateway	A connection between computer networks, or between a computer network and a telephone line. It is very popular, as it is a computer or a network that allows access to another computer or network.
Grayscale	A shades of gray that represent light and dark portions of an image when color images are converted to grayscale; colors are represented by various shades of gray.
Halftone	An image type that simulates grayscale by varying the number of dots. Highly colored areas consist of a large number of dots, while lighter areas consist of a smaller number of dots.
HDD	Hard Disk Drive (HDD), commonly referred to as a hard drive or hard disk, is a non-volatile storage device which stores digitally-encoded data on rapidly rotating platters with magnetic surfaces.

IEEE	The Institute of Electrical and Electronics Engineers (IEEE) is an international non-profit, professional organization for the advancement of technology related to electricity.
IEEE 1284	The 1284 parallel port standard was developed by the Institute of Electrical and Electronics Engineers (IEEE). The term "1284-B" refers to a specific connector type on the end of the parallel cable that attaches to the peripheral (for example, a printer).
Intranet	A private network that uses Internet Protocols, network connectivity, and possibly the public telecommunication system to securely share part of an organization's information or operations with its employees. Sometimes the term refers only to the most visible service, the internal website.
IP address	An Internet Protocol (IP) address is a unique number that devices use in order to identify and communicate with each other on a network utilizing the Internet Protocol standard.
IPM	The Images Per Minute (IPM) is a way of measuring the speed of a printer. An IPM rate indicates the number of single-sided sheets a printer can complete within one minute.
IPP	The Internet Printing Protocol (IPP) defines a standard protocol for printing as well as managing print jobs, media size, resolution, and so forth. IPP can be used locally or over the Internet to hundreds of printers, and also supports access control, authentication, and encryption, making it a much more capable and secure printing solution than older ones.
IPX/SPX	IPX/SPX stands for Internet Packet Exchange/Sequenced Packet Exchange. It is a networking protocol used by the Novell NetWare operating systems. IPX and SPX both provide connection services similar to TCP/IP, with the IPX protocol having similarities to IP, and SPX having similarities to TCP. IPX/SPX was primarily designed for local area networks (LANs), and is a very efficient protocol for this purpose (typically its performance exceeds that of TCP/IP on a LAN).
ISO	The International Organization for Standardization (ISO) is an international standard-setting body composed of representatives from national standards bodies. It produces world-wide industrial and commercial standards.
ITU-T	The International Telecommunication Union is an international organization established to standardize and regulate international radio and telecommunications. Its main tasks include standardization, allocation of the radio spectrum, and organizing interconnection arrangements between different countries to allow international phone calls. A -T out of ITU-T indicates telecommunication.
ITU-T No. 1 chart	Standardized test chart published by ITU-T for document facsimile transmissions.
JBIG	Joint Bi-level Image Experts Group (JBIG) is an image compression standard with no loss of accuracy or quality, which was designed for compression of binary images, particularly for faxes, but can also be used on other images.
JPEG	Joint Photographic Experts Group (JPEG) is a most commonly used standard method of lossy compression for photographic images. It is the format used for storing and transmitting photographs on the World Wide Web.
LDAP	The Lightweight Directory Access Protocol (LDAP) is a networking protocol for querying and modifying directory services running over TCP/IP.
LED	A Light-Emitting Diode (LED) is a semiconductor device that indicates the status of a machine.
MAC address	Media Access Control (MAC) address is a unique identifier associated with a network adapter. MAC address is a unique 48-bit identifier usually written as 12 hexadecimal characters grouped in pairs (e. g., 00-00-0c-34-11-4e). This address is usually hard-coded into a Network Interface Card (NIC) by its manufacturer, and used as an aid for routers trying to locate machines on large networks.
MFP	Multi Function Peripheral (MFP) is an office machine that includes the following functionality in one physical body, so as to have a printer, a copier, a fax, a scanner and etc.
MH	Modified Huffman (MH) is a compression method for decreasing the amount of data that needs to be transmitted between the fax machines to transfer the image recommended by ITU-T T.4. MH is a codebook-based run-length encoding scheme optimized to efficiently compress white space. As most faxes consist mostly of white space, this minimizes the transmission time of most faxes.
MMR	Modified Modified READ (MMR) is a compression method recommended by ITU-T T.6.

Modem	A device that modulates a carrier signal to encode digital information, and also demodulates such a carrier signal to decode transmitted information.
MR	Modified Read (MR) is a compression method recommended by ITUT T.4. MR encodes the first scanned line using MH. The next line is compared to the first, the differences determined, and then the differences are encoded and transmitted.
NetWare	A network operating system developed by Novell, Inc. It initially used cooperative multitasking to run various services on a PC, and the network protocols were based on the archetypal Xerox XNS stack. Today NetWare supports TCP/IP as well as IPX/SPX.
OPC	Organic Photo Conductor (OPC) is a mechanism that makes a virtual image for print using a laser beam emitted from a laser printer, and it is usually green or rust colored and has a cylinder shape. An imaging unit containing a drum slowly wears the drum surface by its usage in the printer, and it should be replaced appropriately since it gets worn from contact with the cartridge development brush, cleaning mechanism, and paper.
Originals	The first example of something, such as a document, photograph or text, etc, which is copied, reproduced or translated to produce others, but which is not itself copied or derived from something else.
OSI	Open Systems Interconnection (OSI) is a model developed by the International Organization for Standardization (ISO) for communications. OSI offers a standard, modular approach to network design that divides the required set of complex functions into manageable, self-contained, functional layers. The layers are, from top to bottom, Application, Presentation, Session, Transport, Network, Data Link and Physical.
PABX	A private automatic branch exchange (PABX) is an automatic telephone switching system within a private enterprise.
PCL	Printer Command Language (PCL) is a Page Description Language (PDL) developed by HP as a printer protocol and has become an industry standard. Originally developed for early inkjet printers, PCL has been released in varying levels for thermal, dot matrix printer, and laser printers.
PDF	Portable Document Format (PDF) is a proprietary file format developed by Adobe Systems for representing two dimensional documents in a device independent and resolution independent format.
PostScript(PS)	PostScript (PS) is a page description language and programming language used primarily in the electronic and desktop publishing areas. - that is run in an interpreter to generate an image.
Printer Driver	A program used to send commands and transfer data from the computer to the printer.
Print Media	The media like paper, envelopes, labels, and transparencies which can be used in a printer, a scanner, a fax or, a copier.
PPM	Pages Per Minute (PPM) is a method of measurement for determining how fast a printer works, meaning the number of pages a printer can produce in one minute.
PRN file	An interface for a device driver, this allows software to interact with the device driver using standard input/output system calls, which simplifies many tasks.
Protocol	A convention or standard that controls or enables the connection, communication, and data transfer between two computing endpoints.
PSTN	The Public-Switched Telephone Network (PSTN) is the network of the world's public circuit-switched telephone networks which, on industrial premises, is usually routed through the switchboard.
RADIUS	Remote Authentication Dial In User Service (RADIUS) is a protocol for remote user authentication and accounting. RADIUS enables centralized management of authentication data such as usernames and passwords using an AAA (authentication, authorization, and accounting) concept to manage network access.
Resolution	The sharpness of an image, measured in Dots Per Inch (DPI). The higher the dpi, the greater the resolution.
SMB	Server Message Block (SMB) is a network protocol mainly applied to share files, printers, serial ports, and miscellaneous communications between nodes on a network. It also provides an authenticated Interprocess communication mechanism.

SMTP	Simple Mail Transfer Protocol (SMTP) is the standard for e-mail transmissions across the Internet. SMTP is a relatively simple, text based protocol, where one or more recipients of a message are specified, and then the message text is transferred. It is a client server protocol, where the client transmits an email message to the server.
SSID	Service Set Identifier (SSID) is a name of a wireless local area network (WLAN). All wireless devices in a WLAN use the same SSID in order to communicate with each other. The SSIDs are case-sensitive and have a maximum length of 32 characters.
Subnet Mask	The subnet mask is used in conjunction with the network address to determine which part of the address is the network address and which part is the host address.
TCP/IP	The Transmission Control Protocol (TCP) and the Internet Protocol (IP); the set of communications protocols that implement the protocol stack on which the Internet and most commercial networks run.
TCR	Transmission Confirmation Report (TCR) provides details of each transmission such as job status, transmission result and number of pages sent. This report can be set to print after each job or only after failed transmissions.
TIFF	Tagged Image File Format (TIFF) is a variable-resolution bitmapped image format. TIFF describes image data that typically come from scanners. TIFF images make use of tags, keywords defining the characteristics of the image that is included in the file. This flexible and platform-independent format can be used for pictures that have been made by various image processing applications.
Toner Cartridge	A kind of bottle or container used in a machine like a printer which contains toner. Toner is a powder used in laser printers and photocopiers, which forms the text and images on the printed paper. Toner can be fused by a combination of heat/pressure from the fuser, causing it to bind to the fibers in the paper.
TWAIN	An industry standard for scanners and software. By using a TWAIN-compliant scanner with a TWAIN-compliant program, a scan can be initiated from within the program. It is an image capture API for Microsoft Windows and Apple Macintosh operating systems.
UNC Path	Uniform Naming Convention (UNC) is a standard way to access network shares in Window NT and other Microsoft products. The format of a UNC path is: \\<servername>\<sharename>\<Additional directory>
URL	Uniform Resource Locator (URL) is the global address of documents and resources on the Internet. The first part of the address indicates what protocol to use, the second part specifies the IP address or the domain name where the resource is located.
USB	Universal Serial Bus (USB) is a standard that was developed by the USB Implementers Forum, Inc., to connect computers and peripherals. Unlike the parallel port, USB is designed to concurrently connect a single computer USB port to multiple peripherals.
Watermark	A watermark is a recognizable image or pattern in paper that appears lighter when viewed by transmitted light. Watermarks were first introduced in Bologna, Italy in 1282; they have been used by papermakers to identify their product, and also on postage stamps, currency, and other government documents to discourage counterfeiting.
WEP	Wired Equivalent Privacy (WEP) is a security protocol specified in IEEE 802.11 to provide the same level of security as that of a wired LAN. WEP provides security by encrypting data over radio so that it is protected as it is transmitted from one end point to another.
WIA	Windows Imaging Architecture (WIA) is an imaging architecture that is originally introduced in Windows Me and Windows XP. A scan can be initiated from within these operating systems by using a WIA-compliant scanner.
WPA	Wi-Fi Protected Access (WPA) is a class of systems to secure wireless (Wi-Fi) computer networks, which was created to improve upon the security features of WEP.
WPA-PSK	WPA-PSK (WPA Pre-Shared Key) is special mode of WPA for small business or home users. A shared key, or password, is configured in the wireless access point (WAP) and any wireless laptop or desktop devices. WPA-PSK generates a unique key for each session between a wireless client and the associated WAP for more advanced security.

## 6. Reference Information

---

WPS	The Wi-Fi Protected Setup (WPS) is a standard for establishing a wireless home network. If your wireless access point supports WPS, you can configure the wireless network connection easily without a computer.
XPS	XML Paper Specification (XPS) is a specification for a Page Description Language (PDL) and a new document format, which has benefits for portable document and electronic document, developed by Microsoft. It is an XML-based specification, based on a new print path and a vector-based device-independent document format.

### 6.3. The Sample Pattern for the Test

The life of the toner cartridge and the printing speed are measured using the pattern shown below.

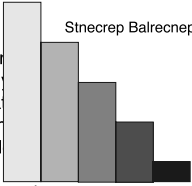
ABCDEFGHIJKLMNOPQRSTUVWXYZ0123456789ABCDEFGHIJKLMNOPQRSTUVWXYZ  
 ABCDEFGHIJKLMNOPQRSTUVWXYZ0123456789ABCDEFGHIJKLMNOPQRSTUVWXYZ  
 Stephen J. Singel  
 Labanda Sinpat Abarress  
 Tendar, BSF  
 URANGLE  
  
 23 January 2004  
 Jonathan Q. Maderia  
 Inpert Mampem Abareess  
 2343 Stantin Dawer Lank  
 Benhibe, SDF  
 Mr.Maderia:  
 Nam liber tempor cum soluta nobis eleifend ptiom cogue nihil consequat, velillum.  
 Dolore eu zril feugiat nulla acilisis at vero eros accumsan et iusto odio dignis sim qui blandit  
 praesent lutatum ril lobortis nisl ut aliquip exea commodo consequat. Duis autem vel eum ireure  
 dolor in hendreritin vulputate velit esse molestie tincidunt ut laoreet dolore magna aliquam erat  
 volutpat. Ut wisi enim ad minim viniam, quis nostrud exerci tation ullam corpersus cipit lotis nisl  
 ut aliquip ex ea commodo consequat. Lorem ipsum dolor sit.  
 Amet, consectetuer adipiscing elit, sud diam nonummy nibh veniam,  
 recneps adipiscing elit, sed diam nonummy nibtil laoreet dolore magr  
 aliam erat volutpat. Ut wisi enim minim veniam, quisient nostrud. Sol  
 uta nobis eleifendoptn cogue nihil imerdiet domg id quod mzim plera  
 facer posim aum. Lorem ipsm dolor sit amet, consectuer. Duis autem  
 eum iriure dolor in hendreritin vulputate velit cesse ea commodo mol  
  
 Nam liber tempor cum soluta nobis eleifend option cogue nihil consequat,  
 velillum. Dolore eu zril feugiat nulla facilisis at vero eros accumsan et iusto odio dignissim qui bla  
 praesent.  
 Singabet,  
 Stephen J. Singel  
 Demperta Aminerimum  
 Labanda Sinpat Abarress  
 SJS:dwg  
 FINAL  
 ABCDEFGHIJKLMNOPQRSTUVWXYZ0123456789ABCDEFGHIJKLMNOPQRSTUVWXYZ  
 ABCDEFGHIJKLMNOPQRSTUVWXYZ0123456789ABCDEFGHIJKLMNOPQRSTUVWXYZ

## 6.4. Model Name and Code

1) Sub brand name Information

- Applying Independent sub brand name by Segment : Xpress / ProXpress / MultiXpress



2) Model code Information

- Basic Structure : [SL-●○○■□◆◆]

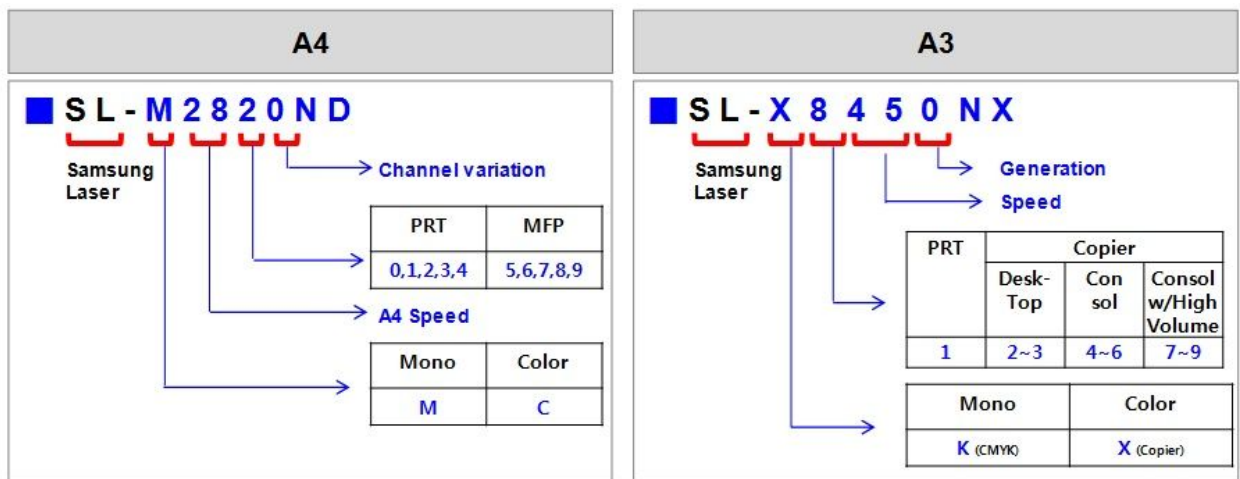

- ◆◆ : Function Information

	Function
N	Network
W	Wireless Network
D	Duplex Printing
R	Reverse Type ADF
F	Fax
X	XOA (eXtensible Open Architecture)
H	Handset
A	Auto Document Feeder



## 6.5. Document Revision List

Version	Date	Page	Description
1.00	22/Jun/2015	-	Release



### **GSPN (GLOBAL SERVICE PARTNER NETWORK)**

<b>Area</b>	<b>Web Site</b>
Europe, MENA, CIS, Africa	<a href="https://gspn1.samsungcsportal.com">https://gspn1.samsungcsportal.com</a>
E.Asia, W.Asia, China, Japan	<a href="https://gspn2.samsungcsportal.com">https://gspn2.samsungcsportal.com</a>
N.America, S.America	<a href="https://gspn3.samsungcsportal.com">https://gspn3.samsungcsportal.com</a>

This Service Manual is a property of Samsung Electronics Co.,Ltd.  
Any unauthorized use of Manual can be punished under applicable International and/or domestic law.

© 2017 Samsung Electronics Co.,Ltd.  
All rights reserved.  
Printed in Korea