



**SAMSUNG**

# Mono Laser Printer

ProXpress M453x series

**SL-M4530NX / SL-M4530ND**

(Ver 1.02)

# ***SERVICE*** MANUAL

**Mono Laser Printer**

**Contents**



**M4530NX**



**M4530ND**

1. Precautions
2. Product Specifications and Description
3. Disassembly and Reassembly
4. Troubleshooting
5. Block Diagram and Connection Diagram
6. Reference Information

Refer to the service manual in the GSPN (see the rear cover) for more information.

# Contents

---

- 1. Precautions ..... 1 – 1
  - 1.1. Safety warning ..... 1 – 1
  - 1.2. Caution for safety ..... 1 – 2
    - 1.2.1. Toxic material ..... 1 – 2
    - 1.2.2. Electric shock and fire safety precautions ..... 1 – 2
    - 1.2.3. Handling precautions ..... 1 – 4
    - 1.2.4. Assembly and Disassembly precautions ..... 1 – 4
    - 1.2.5. Disregarding this warning may cause bodily injury ..... 1 – 5
  - 1.3. ESD precautions ..... 1 – 6
  - 1.4. Caution for Data Loss ..... 1 – 7
- 2. Product Specifications and Description ..... 2 – 1
  - 2.1. Product Overview ..... 2 – 1
  - 2.2. Specifications ..... 2 – 2
    - 2.2.1. General Specification ..... 2 – 2
    - 2.2.2. Print Specifications ..... 2 – 4
    - 2.2.3. Paper Handling specification ..... 2 – 5
    - 2.2.4. Software and solution specification ..... 2 – 7
    - 2.2.5. Supplies ..... 2 – 8
    - 2.2.6. Maintenance Parts ..... 2 – 9
    - 2.2.7. Option ..... 2 – 10
  - 2.3. System Configuration ..... 2 – 11
  - 2.4. Feeding System ..... 2 – 15
    - 2.4.1. Feeding System Overview ..... 2 – 15
    - 2.4.2. Cassette ..... 2 – 18
    - 2.4.3. Pick-Up Unit ..... 2 – 19
    - 2.4.4. Registration Unit ..... 2 – 20
    - 2.4.5. MPF(Multi-Purpose Feeder) Unit ..... 2 – 21
  - 2.5. Image Creation ..... 2 – 22
    - 2.5.1. Printing process overview ..... 2 – 22
    - 2.5.2. Toner Cartridge ..... 2 – 23
    - 2.5.3. Imaging Unit ..... 2 – 24
      - 2.5.3.1. Development ..... 2 – 25
  - 2.6. Fuser unit ..... 2 – 26
    - 2.6.1. Fuser unit overview ..... 2 – 26
    - 2.6.2. Fuser unit drive ..... 2 – 27
    - 2.6.3. Fuser unit temperature control ..... 2 – 28
  - 2.7. Laser Scanning Unit (LSU) ..... 2 – 29
    - 2.7.1. Laser Scanning Unit Overview ..... 2 – 29

2.7.2.	Laser Scanning Optical path .....	2 – 30
2.8.	Drive System .....	2 – 31
2.8.1.	Drive Motors .....	2 – 31
2.8.2.	Main Drive Unit .....	2 – 33
2.8.3.	Exit Drive Unit .....	2 – 34
2.8.4.	Tray Lifting Drive Unit .....	2 – 35
2.9.	Hardware Configuration .....	2 – 36
2.9.1.	Main board .....	2 – 38
2.9.2.	MSOK .....	2 – 40
2.9.3.	SO-DIMM PBA .....	2 – 41
2.9.4.	USB Host PBA .....	2 – 42
2.9.5.	SMPS board .....	2 – 43
2.9.6.	Fuser Drive Board (FDB) .....	2 – 45
2.9.7.	HVPS board .....	2 – 47
2.9.8.	SCF board .....	2 – 48
2.9.9.	Eraser PBA .....	2 – 49
2.9.10.	Cover-Open PBA .....	2 – 49
2.9.11.	Deve_Toner Crum Joint PBA .....	2 – 50
2.9.12.	Toner Remain Sensor PBA .....	2 – 50
2.9.13.	Joint PBA .....	2 – 51
2.9.14.	EEPROM PBA .....	2 – 52
2.9.15.	CRUM PBA .....	2 – 52
3.	Disassembly and Reassembly .....	3 – 1
3.1.	Precautions when replacing parts .....	3 – 1
3.1.1.	Precautions when assembling and disassembling .....	3 – 1
3.1.2.	Precautions when handling PBA .....	3 – 1
3.1.3.	Releasing Plastic Latches .....	3 – 2
3.2.	Replacing the maintenance part .....	3 – 3
3.2.1.	Fuser Unit .....	3 – 3
3.2.2.	Transfer Roller .....	3 – 4
3.2.3.	Pick-Up_Forward roller .....	3 – 5
3.2.4.	SCF Separation Roller .....	3 – 6
3.2.5.	SCF Pick-up Roller and Forward Roller .....	3 – 7
3.3.	Replacing the main SVC part .....	3 – 8
3.3.1.	Rear Cover .....	3 – 8
3.3.2.	Front Cover .....	3 – 9
3.3.3.	Right_Left Cover .....	3 – 10
3.3.4.	Top Cover .....	3 – 11
3.3.5.	OPE Unit .....	3 – 12
3.3.6.	HDD (Hard Disk Drive) .....	3 – 13

3.3.7.	Main Board .....	3 – 14
3.3.8.	Joint PBA .....	3 – 15
3.3.9.	SMPS and FDB (Fuser Drive Board).....	3 – 16
3.3.10.	OPC motor and Main motor .....	3 – 17
3.3.11.	Main Drive Unit .....	3 – 18
3.3.12.	Duplex clutch and Pick up clutch.....	3 – 19
3.3.13.	HVPS board .....	3 – 20
3.3.14.	Exit Unit.....	3 – 21
3.3.15.	LSU.....	3 – 22
3.3.16.	Eraser Lamp PBA.....	3 – 23
3.3.17.	Cover Open PBA.....	3 – 24
3.3.18.	Pick up Assy .....	3 – 25
3.3.19.	Second Cassette Feeder (Optional Tray).....	3 – 28
3.3.19.1.	PBA-SCF .....	3 – 28
3.3.19.2.	Lift Unit .....	3 – 29
3.3.19.3.	Clutch.....	3 – 30
3.3.19.4.	Drive Unit .....	3 – 31
4.	Troubleshooting.....	4 – 1
4.1.	Control panel .....	4 – 1
4.2.	Understanding the status LED .....	4 – 3
4.3.	Updating Firmware .....	4 – 4
4.3.1.	Updating with the USB cable.....	4 – 4
4.3.2.	Updating from the Network .....	4 – 5
4.4.	JAM removal .....	4 – 9
4.5.	Service Mode.....	4 – 18
4.5.1.	Entering the Service Mode .....	4 – 18
4.5.2.	Service Mode Menu.....	4 – 19
4.5.3.	Tech Mode Menu description.....	4 – 21
4.6.	Error Code and Troubleshooting .....	4 – 27
4.6.1.	11–2Txx (Paper mismatch error) .....	4 – 28
4.6.2.	Ax-xxxx (Motor_Fan_Sensor Error).....	4 – 29
4.6.3.	Cx-xxxx (Supplies_Maintenance Part Error).....	4 – 38
4.6.4.	H1-xxxx (Optional Cassette Feeder Error).....	4 – 47
4.6.5.	Mx-xxxx (Paper Handling Error(Jam_Paper Empty etc)).....	4 – 72
4.6.6.	Sx-xxxx (System Error) .....	4 – 85
4.6.7.	U1-xxxx (Fuser error) .....	4 – 94
4.6.8.	U2-xxxx type (LSU) error code.....	4 – 103
4.7.	Image quality problem .....	4 – 104
4.8.	SPDS (Smart Printer Diagnostic System) Application .....	4 – 118
4.8.1.	SPDS App Installation and Login .....	4 – 119

---

4.8.1.1.	SPDS App Installation .....	4 – 119
4.8.1.2.	User Registration Request.....	4 – 120
4.8.1.3.	Change_Reset Password.....	4 – 121
4.8.1.4.	Login.....	4 – 122
4.8.1.5.	Select Connect Method .....	4 – 124
4.8.1.6.	Consent to customer information.....	4 – 127
4.8.2.	SPDS Menu Introduction .....	4 – 128
4.8.2.1.	Error Mode .....	4 – 128
4.8.2.2.	Diagnosis Mode.....	4 – 133
4.8.2.3.	Test Mode.....	4 – 134
4.8.2.4.	Information Mode .....	4 – 135
4.8.2.5.	Service Mode .....	4 – 137
4.8.3.	Corrective Upload .....	4 – 142
4.8.4.	Exceptions .....	4 – 143
5.	Block Diagram and Connection Diagram .....	5 – 1
5.1.	Block Diagram.....	5 – 1
5.2.	Connection Diagram.....	5 – 2
5.2.1.	Connection Diagram (1) .....	5 – 2
5.2.2.	Connection Diagram (2) .....	5 – 3
5.2.3.	Connection Diagram (3) .....	5 – 4
6.	Reference Information.....	6 – 1
6.1.	Tool for Troubleshooting.....	6 – 1
6.2.	Glossary.....	6 – 2
6.3.	The Sample Pattern for the Test .....	6 – 8
6.4.	Model Name and Code .....	6 – 9
6.5.	Document Revision List.....	6 – 10

# 1. Precautions

In order to prevent accidents and damages to the equipment please read the precautions listed below carefully before servicing the product and follow them closely.

## 1.1. Safety warning

1) Only to be serviced by a factory trained service technician.

High voltages and lasers inside this product are dangerous. This product should only be serviced by a factory trained service technician.

2) Use only Samsung replacement parts.

There are no user serviceable parts inside the product. Do not make any unauthorized changes or additions to the product as these could cause the product to malfunction and create an electric shocks or fire hazards.

3) Laser Safety Statement

The printer is certified in the U.S. to conform to the requirements of DHHS 21 CFR, chapter 1 Subchapter J for Class I(1) laser products, and elsewhere is certified as a Class I laser product conforming to the requirements of IEC/EN 60825-1:2014. Class I laser products are not considered to be hazardous. The laser system and printer are designed so there is never any human access to laser radiation above a Class I level during normal operation, user maintenance or prescribed service condition.

- Wavelength: 800 nm
- Beam divergence
  - Parallel: 11 degrees
  - Perpendicular: 35 degrees
- Maximum power of energy output: 12 mW



### WARNING

**Never operate or service the product with the protective cover removed from Laser/Scanner assembly. The reflected beam, although invisible, can damage your eyes.**

**When using this product, these basic safety precautions should always be followed to reduce risk of fire, electric shock, and personal injury.**



4) Lithium battery not replaceable by user

## 1.2. Caution for safety

### 1.2.1. Toxic material

This product contains toxic materials that could cause illness if ingested.

- 1) Please keep imaging unit and toner cartridge away from children. The toner powder contained in the imaging unit and toner cartridge may be harmful, and if swallowed, you should contact a doctor.

### 1.2.2. Electric shock and fire safety precautions

Failure to follow the following instructions could cause electric shock or potentially cause a fire.

- 1) Use only the correct voltage, failure to do so could damage the product and potentially cause a fire or electric shock.
- 2) Use only the power cable supplied with the product. Use of an incorrectly specified cable could cause the cable to overheat and potentially cause a fire.
- 3) Do not overload the power socket, this could lead to overheating of the cables inside the wall and could lead to a fire.
- 4) Do not allow water or other liquids to spill into the product, this can cause electric shock. Do not allow paper clips, pins or other foreign objects to fall into the product, these could cause a short circuit leading to an electric shock or fire hazard.

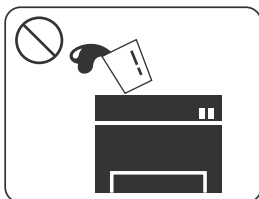

- 5) Never touch the plugs on either end of the power cable with wet hands, this can cause electric shock. When servicing the product, remove the power plug from the wall socket.

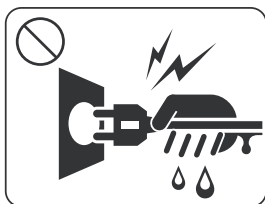

- 6) Use caution when inserting or removing the power cord. When removing the power cord, grip it firmly and pull. The power cord must be inserted completely, otherwise a poor contact could cause overheating leading to a fire.
- 7) Take care of the power cable. Do not allow it to become twisted, bent sharply around corners or power cable may be damaged. Do not place objects on top of the power cable. If the power cable is damaged it could overheat and cause a fire. Exposed cables could cause an electric shock. Replace the damaged power cable immediately, do not reuse or repair the damaged cable. Some chemicals can attack the coating on the power cable, weakening the cover or exposing cables causing fire and shock risks.

## 1. Precautions

---

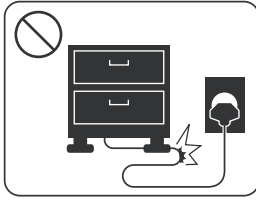

- 8) Ensure that the power sockets and plugs are not cracked or broken in any way. Any such defects should be repaired immediately. Take care not to cut or damage the power cable or plugs when moving the machine.
- 9) Use caution during thunder or lightning storms. Samsung recommends that this machine be disconnected from the power source when such weather conditions are expected. Do not touch the machine or the power cord if it is still connected to the wall socket in these weather conditions.

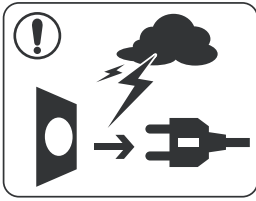

- 10) Avoid damp or dusty areas, install the product in a clean well ventilated location. Do not position the machine near a humidifier or in front of an air conditioner. Moisture and dust built up inside the machine can lead to overheating and cause a fire or cause parts to rust.

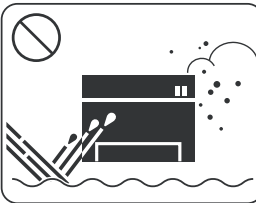

- 11) Do not position the product in direct sunlight. This will cause the temperature inside the product to rise possibly leading to the product failing to work properly and in extreme conditions could lead to a fire.
- 12) Do not insert any metal objects into the machine through the ventilator fan or other part of the casing, it could make contact with a high voltage conductor inside the machine and cause an electric shock.

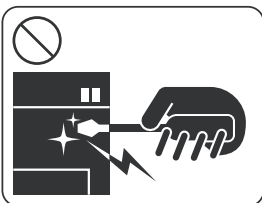

- 13)  When replacing the SMPS board, please wait 5 minutes after unplugging the power cord, then replace it. You can get a shock by the electric discharge.



---

### 1.2.3. Handling precautions

---

The following instructions are for your own personal safety to avoid injury and so as not to damage the product.

- 1) Ensure the product is installed on a level surface, capable of supporting its weight. Failure to do so could cause the product to tip or fall.
- 2) The product contains many rollers, gears and fans. Take great care to ensure that you do not catch your fingers, hair or clothing in any of these rotating devices.
- 3) Do not place any small metal objects, containers of water, chemicals or other liquids close to the product which if spilled could get into the machine and cause damage or a shock or fire hazard.
- 4) Do not install the machine in areas with high dust or moisture levels, beside an open window or close to a humidifier or heater. Damage could be caused to the product in such areas.
- 5) Do not place candles, burning cigarettes, etc on the product, These could cause a fire.
- 6) Ensure that the machine is installed and used in proper area to meet the temperature and humidity specifications.
  - If the machine is stored at below zero Celsius for a long time, do not use the machine instantly after movement. It can malfunction. Take care of the machine storage. If the machine is stored at below zero Celsius for a long time, keep the machine at room temperature and install it.

---

### 1.2.4. Assembly and Disassembly precautions

---

- 1) Replace parts carefully and always use Samsung parts. Take care to note the exact location of parts and also cable routing before dismantling any part of the machine. Ensure all parts and cables are replaced correctly. Please carry out the following procedures before dismantling the product or replacing any parts.
- 2) Ensure that power is disconnected before servicing or replacing any electrical parts.
- 3) Disconnect interface cables and power cables.
- 4) Only use approved spare parts. Ensure that part number, product name, any voltage, current or temperature rating are correct.
- 5) When removing or re-fitting any parts do not use excessive force, especially when fitting screws into plastic.
- 6) Take care not to drop any small parts into the machine.
- 7) Handling of the OPC Drum
  - The OPC Drum can be irreparably damaged if it is exposed to light. Take care not to expose the OPC Drum either to direct sunlight or to fluorescent or incandescent room lighting. Exposure for as little as 5 minutes can damage the surface of the photoconductive properties and will result in print quality degradation. Take extra care when servicing the product. Remove the OPC Drum and store it in a black bag or other lightproof container. Take care when working with the Covers (especially the top cover) open as light is admitted to the OPC area and can damage the OPC Drum.
  - Take care not to scratch the green surface of the OPC Drum Unit. If the green surface of the Drum Cartridge is scratched or touched the print quality will be compromised.

### 1.2.5. Disregarding this warning may cause bodily injury

---

- 1) Be careful with the high temperature part.

The fuser unit works at a high temperature. Use caution when working on the printer. Wait for the fuser unit to cool down before disassembly.



- 2) Do not put fingers or hair into the rotating parts.

When operating a printer, do not put hand or hair into the rotating parts (Paper feeding entrance, motor, fan, etc.). If do, you can get harm.



- 3) When you move the printer, use safe lifting and handling techniques.

This printer is heavy. Use the lifting handles located on each side of the machine. Back injury could be caused if you do not lift carefully.

- 4) Ensure the printer is installed safely.

Ensure the printer is installed on a level surface, capable of supporting its weight. Failure to do so could cause the printer to tip or fall possibly causing personal injury or damaging the printer.

- 5) Do not install the printer on a sloping or unstable surface. After installation, double check that the printer is stable.

## 1.3. ESD precautions

Certain semiconductor devices can be easily damaged by static electricity. Such components are commonly called “Electrostatically Sensitive (ES) Devices” or ESDs. Examples of typical ESDs are: integrated circuits, some field effect transistors, and semiconductor “chip” components. The techniques outlined below should be followed to help reduce the incidence of component damage caused by static electricity.



### CAUTION

**Be sure no power is applied to the chassis or circuit, and observe all other safety precautions.**

- 1) Immediately before handling a semiconductor component or semiconductor-equipped assembly, drain off any electrostatic charge on your body by touching a known earth ground. Alternatively, employ a commercially available wrist strap device, which should be removed for your personal safety reasons prior to applying power to the unit under test.
- 2) After removing an electrical assembly equipped with ESDs, place the assembly on a conductive surface, such as aluminum or copper foil, or conductive foam, to prevent electrostatic charge buildup in the vicinity of the assembly.
- 3) Use only a grounded tip soldering iron to solder or desolder ESDs.
- 4) Use only an “anti-static” solder removal device. Some solder removal devices not classified as “anti-static” can generate electrical charges sufficient to damage ESDs.
- 5) Do not use Freon-propelled chemicals. When sprayed, these can generate electrical charges sufficient to damage ESDs.
- 6) Do not remove a replacement ESD from its protective packaging until immediately before installing it. Most replacement ESDs are packaged with all leads shorted together by conductive foam, aluminum foil, or a comparable conductive material.
- 7) Immediately before removing the protective shorting material from the leads of a replacement ESD, touch the protective material to the chassis or circuit assembly into which the device will be installed.
- 8) Maintain continuous electrical contact between the ESD and the assembly into which it will be installed, until completely plugged or soldered into the circuit.
- 9) Minimize bodily motions when handling unpackaged replacement ESDs. Normal motions, such as the brushing together of clothing fabric and lifting one’s foot from a carpeted floor, can generate static electricity sufficient to damage an ESD.

## **1.4. Caution for Data Loss**

---

To prevent loss of customers data the SVC engineer provides end-user with relevant information in advance.

## 2. Product Specifications and Description

### 2.1. Product Overview

 <p><b>M4530NX</b></p> <p><b>M4530ND</b></p>	<ul style="list-style-type: none"><li>• <b>Printing Speed (Mono)</b><ul style="list-style-type: none"><li>• Up to 45 ppm in A4 (47 ppm in Letter)</li></ul></li><li>• <b>Processor</b><ul style="list-style-type: none"><li>• Dual core CPU 1GHz</li></ul></li><li>• <b>Memory (Std. / Max)</b><ul style="list-style-type: none"><li>• M4530ND : 512 MB / 2 GB</li><li>• M4530NX : 1GB / 2 GB</li></ul></li><li>• <b>320 GB HDD</b><ul style="list-style-type: none"><li>• M4530ND : Optional</li><li>• M4530NX : Standard</li></ul></li><li>• <b>OPE Display</b><ul style="list-style-type: none"><li>• M4530ND : 4-line LCD</li><li>• M4530NX : 4.3 inch Touch Screen Panel</li></ul></li></ul>
---	---

## 2.2. Specifications

Product Specifications are subject to change without notice.

### 2.2.1. General Specification

Item		Specification
Processor	CPU	1GHz (C4N + A1000 )
User Interface	Display	<ul style="list-style-type: none"> <li>M4530ND : 4-line LCD</li> <li>M4530NX : 4.3 inch Touch Screen Panel</li> </ul>
Memory (Std. / Max)		<ul style="list-style-type: none"> <li>M4530ND : 512 MB / 2 GB</li> <li>M4530NX : 1GB / 2 GB</li> </ul>
Storage (HDD)		<ul style="list-style-type: none"> <li>M4530ND : Optional</li> <li>M4530NX : Standard</li> </ul>
Interface	USB (Device)	Hi-Speed USB 2.0
	USB (Host)	Hi-Speed USB 2.0
	USB (EDI)	Yes
	Wired LAN	Std (Ethernet 10/100/1000 Base TX)
	Additional Wired LAN Support	N/A
	Wireless LAN	Option (IEEE 802.11b/g/n)
	NFC	Option (Active)
Warmup Time	From Sleep	Less than 23 sec
	Power Off	Less than 25 sec
Power Consumption	Ready	less than 16W
	Average operating mode	Less than 850 W
	Power save mode	Less than 1.3 W
	Power Off	Less than 0.45 W
Default Sleep Delay Time		1 min
Max. Sleep Delay Time		120 min
Power Requirement	Input Voltage	Europe : AC 220~240V / 50Hz / 5A
		USA : AC 100~127V / 60Hz / 10A
		Korea : AC 220~240V / 50/60Hz / 5A
Acoustic Noise Level (Sound Power / Pressure)	Printing Simplex / Duplex	Less than 54 dBA (Sound Pressure)
	Standby	Less than 30 dBA (Sound Pressure, Background Noise Only)
	Sleep	Background Noise Level
Dimension (W x D x H)	Set (mm) (without any options)	433 x 460 x 368 mm (17.05 x 18.11 x 14.49 inches)

Item		Specification
Weight	Set (Kg) (with supplies / without any options)	<ul style="list-style-type: none"> <li>• 4530NX : 27.32 Kg [60.23 lbs]</li> <li>• 4530ND : 27.19 Kg [59.94 lbs]</li> </ul>
	Recommended Monthly Print Volume	2,000 ~ 10,000 Images
Reliability & Service	Max Monthly Duty Cycle	200,000 Images
	Operating	10 to 30 °C (50 to 86°F)
Temperature	Storage	-20 to 40 °C (-4 to 104 °F)
	Operating	20 to 80% RH
Humidity	Storage	10 to 90% RH

## 2.2.2. Print Specifications

Item		Specification
Print Speed	Simplex	45 ppm in A4 (47 ppm in Letter)
	Duplex (Simplex to Duplex)	27 ipm in A4 (28 ipm in Letter)
FPOT	From Ready	As fast as 6.5 sec
	From Sleep	Less than 23 sec
	From Coldboot	Less than 36 sec
Resolution	Optical	Up to 1,200 x 600 dpi
	Enhanced	Up to 1,200 x 1,200 dpi effective output (1,200 x 600 x 2 bit)
Printer Languages		PCL5e / PCL6 / PostScript3 / PDF Direct V1.7
Font	PCL	111 Scalable Fonts (Include OCR-A / OCR-B) / 1 Bitmap
	Postscript3	136 Scalable Fonts
Client OS Support	Windows	XP(32/64bit) / Vista(32/64bit) / 2003 Server(32/64bit) / 2008 Server(32/64bit) / Win7(32/64bit) / 2008 Server R2(64bit) / Win8(32/64bit) / Win8.1(32bit/64bit) / 2012 Server(64bit) / 2012 Server R2(64bit)
	Linux	<ul style="list-style-type: none"> <li>• RedHat Enterprise Linux WS 5, 6</li> <li>• Fedora 12, 13, 14, 15, 16, 17, 18, 19, 20</li> <li>• OpenSuSE 11.2, 11.3, 11.4, 12.1, 12.2, 12.3</li> <li>• Ubuntu 10.04, 10.10, 11.04, 11.10, 12.04, 12.10, 13.04, 13.10, 14.04</li> <li>• SuSE Linux Enterprise Desktop 10, 11</li> <li>• Debian 6, 7</li> <li>• Mint 13, 14, 15, 16</li> </ul>
	UNIX	<ul style="list-style-type: none"> <li>• Sun Solaris 9,10,11 (x86, SPARC)</li> <li>• HP-UX 11.0, 11i v1, 11i v2, 11i v3 (PA-RISC, Itanium)</li> <li>• IBM AIX 5.1, 5.2, 5.3, 5.4, 6.1, .7.1 (PowerPC)</li> </ul>
	Mac OS	Mac OS: X 10.5 - 10.9,
Network Protocol	Basic	IP assign(Ethernet speed, DHCP), SWS, SNMP, SNTP, SetIP,SLP, DDNS, Mdns, WINS, LPD/LPR, SMB, FTP, SMTP, UPnP
	Advanced	LDAP, Kerberos, IPSec, 802.1x, IPP, WSD
Duplex Print		Built-in
Direct Print		Yes
Max. Print Area		<ul style="list-style-type: none"> <li>• Ltr : 208 x 270 mm (8.18" x 10.6")</li> <li>• A4 : 201 x 289 mm (7.91" x 11.37")</li> </ul>
Print Features		Direct Print / Secure Print



### 2.2.3. Paper Handling specification

Item		Specification
Input Capacity	Standard	550-sheet cassette Tray (20 lb or 75 g/m <sup>2</sup> ) (520 Sheets @ 80 g/m <sup>2</sup> )
	Multipurpose	100-sheet MP tray (80 g/m <sup>2</sup> )
	Other Options	550-sheet cassette Tray (20 lb or 75 g/m <sup>2</sup> ) (520 Sheets @ 80 g/m <sup>2</sup> )
	Maximum	2,850 Sheet Cassette Tray (550 Std + 100 MP + 4 x 550 SCF) (@ 75 g/m <sup>2</sup> ) (2,700 @ 80 g/m <sup>2</sup> )
Standard Cassette Tray	Capacity	550 sheets @ 20 lb (75 g/m <sup>2</sup> ) (520 Sheets @ 80 g/m <sup>2</sup> )
	Media sizes	A4 / Letter / Legal / Oficio / Folio / JIS B5 / ISO B5 / Executive / A5 SEF/LEF / Statement / A6 / PostCard 4x6 / Envelope B5 / Envelope Monarch / Envelope COM-10-> Envelope No 10 / Envelope DL / Envelope C5 / Envelope C6 / Custom
	Media types	Plain Paper / Thin Paper / Bond / Punched / Pre-Printed / Recycled / Envelope / Label / CardStock / Letterhead / Thick / Colored->Color / Archive / Cotton
	Media weight	<ul style="list-style-type: none"> <li>Supported Weight : 60 - 163 g/m<sup>2</sup> (16 - 43 lb)</li> <li>Thin Paper (60 - 69 g/m<sup>2</sup>)</li> <li>Plain Paper (70 - 90 g/m<sup>2</sup>)</li> <li>Thick Paper (91 - 120 g/m<sup>2</sup>)</li> <li>Bond Paper (105 - 120 g/m<sup>2</sup>)</li> <li>Cardstock (121 - 163 g/m<sup>2</sup>)</li> </ul>
	Sensing	<ul style="list-style-type: none"> <li>H/W Install Detect: Yes</li> <li>Paper Empty &amp; Low Level Detect: Yes</li> <li>Paper Type Detect: No</li> <li>Paper Size Detect: Yes</li> </ul>
MP(Multipurpose) Tray	Capacity	<ul style="list-style-type: none"> <li>Plain Paper: 100 sheets</li> </ul>
	Media sizes	Min : 76.2 mm x 127 mm (3" x 5") Max : 216 mm x 356 mm (8.5" x 14.0")
	Media type	Plain / Thin / Bond / Pre-printed / Recycled / Envelope / Label / Cardstock / Thick / Cotton / Color / Archive / Thicker
	Media weight	<ul style="list-style-type: none"> <li>Supported Weight : 60 - 220 g/m<sup>2</sup> (16 ~ 59 lb)</li> <li>Thin Paper (60 - 69 g/m<sup>2</sup>)</li> <li>Plain Paper (70 - 90 g/m<sup>2</sup>)</li> <li>Thick Paper (90 - 120 g/m<sup>2</sup>)</li> <li>Bond Paper (105 - 120 g/m<sup>2</sup>)</li> <li>Cardstock (121 - 163 g/m<sup>2</sup>)</li> <li>Thicker Paper (164 - 220 g/m<sup>2</sup>)</li> </ul>
	Sensing	<ul style="list-style-type: none"> <li>Paper Empty Detect: Yes</li> <li>Paper Type Detect: No</li> <li>Paper Size Detect: No</li> </ul>

## 2. Product Specifications and Description

Item		Specification
Output Capacity	Stacking Capacity (Face Down)	500 sheets @ 20 lb (75 g/m <sup>2</sup> )
	Output Full sensing	Yes
Printing size	Max. Size	216 x 356 mm (8.5" x 14")
	Min. Size	76 x 127 mm (3" x 5")
	Margin(T/B/L/R)	T/B/L/R : 1 mm
Duplex Printing	Support	Built-in
	Media sizes	A4, Letter, Legal, Oficio, Folio
	Media types	Plain, Thin, Thick, Recycled, Pre-Printed, punched, Letterhead
	Media weight	16~32 lb (60 ~ 120 g/m <sup>2</sup> )

## 2.2.4. Software and solution specification

Item		Specification
Application	Anyweb Print	Windows
	Easy Printer Manager	Windows / Mac
	Easy Color Manager	N/A
	Easy Document Creator	N/A
	Direct Printing Utility	Windows
	Easy Deployment Manager	Windows
	Easy Eco Driver	Windows
	Universal Printer Driver	Windows
Mobile Printing	GCP (Google Cloud Print)	Yes
	AirPrint	Yes
Solution	Device Management	SyncThru
	Output Management	CounThru
	Document Management and Distribution	SmarThruWorkFlow
	Security	SecuThru
	Mobility	SCP
Security	Authentication (Local)	Yes
	Authentication (Network)	Yes (Kerberos / SMB / LDAP)
	IP Address Filtering	IPv4 Filtering / IPv6 Filtering / MAC Filtering
	HDD Overwrite (Standard)	MIO Only (Manual Image Overwrite)
	HDD Overwrite (Max. Overwrites)	9
	Secure Print	Yes
	Encrypted Secure Print	Yes
	Encrypted PDF Mode (Encrypted Scanning)	Yes
	IP Sec	Yes
	Smart Card Authentication	N/A
	Others	Watermark

### 2.2.5. Supplies

Items		Model Name	Life
Toner Cartridge *	Initial	-	Approx. 7,000 pages
	Standard	MLT-D304S	Approx. 7,000 pages
	High Yield	MLT-D304L	Approx. 20,000 pages
	Extra High Yield	MLT-D304E	Approx. 40,000 pages
Imaging Unit		MLT-R304	Approx. 100,000 pages



**NOTE**

\* Declared yield value in accordance with ISO/IEC 19752. The number of pages may be affected by operating environment, printing interval, graphics, media type and media size.

\*\* Based on simplex 3 average letter/A4-size pages per print job and 5% coverage. Actual Yield may vary based on other factors such as device speed, media type, media size, toner coverage, tray source, average print job complexity, ratio of simplex / duplex printing and operating environment.

## 2.2.6. Maintenance Parts

Items	Part Code	Life
Fuser Unit	<ul style="list-style-type: none"> <li>• JC91-01177A (220V)</li> <li>• JC91-01176A (110V)</li> </ul>	150,000 pages
Transfer Roller Assy	JC93-00393A	200,000 pages
Tray 1 Roller (Pick up/Forward)	JC97-02259A	200,000 pages
Tray 1 Reverse roller	JC97-02259A	100,000 pages
Pick up/ Forward roller (for Tray2~4)	JC97-02259A	200,000 pages
Reverse roller (for Tray2~4)	JC97-02259A	100,000 pages
MP Roller	JC73-00295A	100,000 pages
MP Reverse roller	JC73-00328A	100,000 pages



### NOTE

Life of part may vary because of the paper sheet type, the print patterns, and job types used.

## 2.2.7. Option

### Option List

Item	Model	Remark
Second Cassette Feeder	SL-SCF4500	550 Sheets (@75gsm)
Stand	SL-DSK001S	-
Memory Upgrade Kit	SL-MEM001	2 GB
Wireless LAN	SL-NWE001X	Wireless + NFC

### Option Specification

Model	Item	Specification
Second Cassette Tray(Feeder)	Model Name	SL-SCF4500
	Capacity	550 Sheets (@75gsm) (520sh @80gsm)
	Media Sizes	A4 / Letter / Legal / Oficio / Folio / JIS B5 / ISO B5 / Executive / A5 / Statement / A6 / Custom
	Media types	Plain / Thin / Recycled / Thick / Archive / Bond / Cardstock
	Media weight	<ul style="list-style-type: none"> <li>• Supported Weight: 60 - 163 g/ (16 - 43 lb)</li> <li>• Thin Paper (60 - 70 g/)</li> <li>• Plain Paper (70 - 90 g/)</li> <li>• Thick Paper (90 - 105 g/)</li> <li>• Bond Paper (105 - 120 g/)</li> <li>• Cardstock: (121 - 163 g/)</li> </ul>
	Sensing	<ul style="list-style-type: none"> <li>• H/W Install Detect : Yes</li> <li>• Paper Empty : Yes</li> <li>• Paper Type Detect : No</li> <li>• Paper Size Detect : No</li> </ul>
	Dimension (W x D x H)	433 x 459.3 x 145.8 mm
	Weight	9.8 kg (21.6 lb)
Stand	Model Name	SL-DSK001S
	Dimension (W x D x H)	480 x 553 x 120 mm
	Weight	13.3 kg (29.3 lb)
Memory Upgrade Kit	Model Name	SL-MEM001
	Size	2 GB
Wireless LAN	Model Name	SL-NWE001X (Wireless + NFC)

## 2.3. System Configuration

### 1) Front View

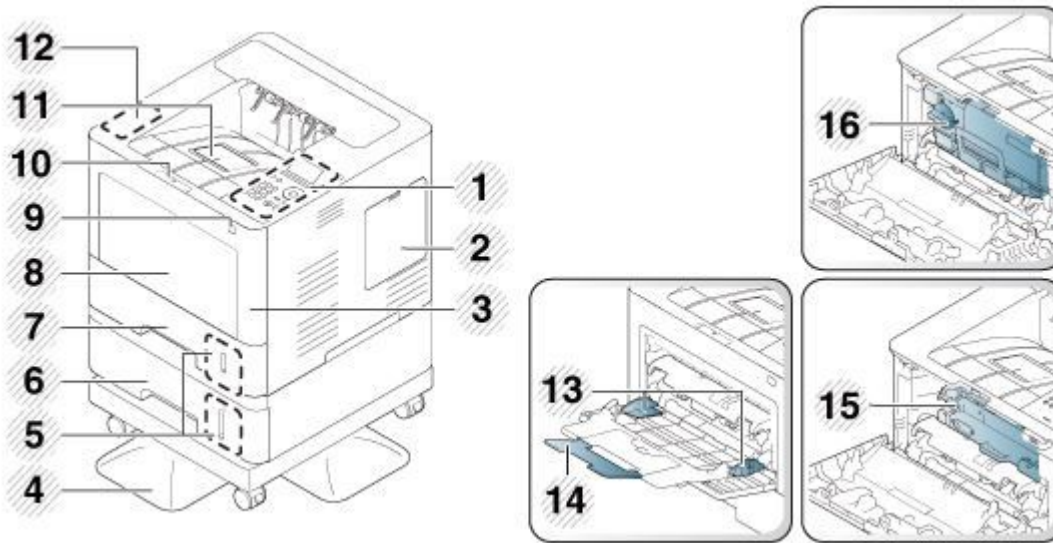

1	Control panel
2	Memory Module(DIMM) cover
3	Front cover
4	Short stand
5	Paper level indicator
6	Optional tray
7	Tray1
8	Multi-purpose tray cover
9	USB memory port

10	Front cover button
11	Output tray
12	Wireless/NFC kit area
13	Multi-purpose tray paper width guides
14	Multi-purpose tray paper extension
15	Imaging unit
16	Toner cartridge

**2) Rear View**

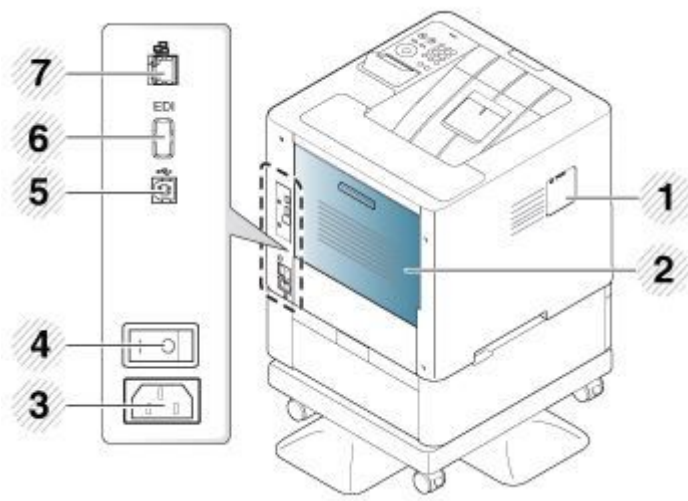

1	Wireless/NFC kit port cover
2	Rear cover
3	Power receptacle
4	Power-switch
5	USB port

6	EDI port for card reader
7	Network port



### System Layout

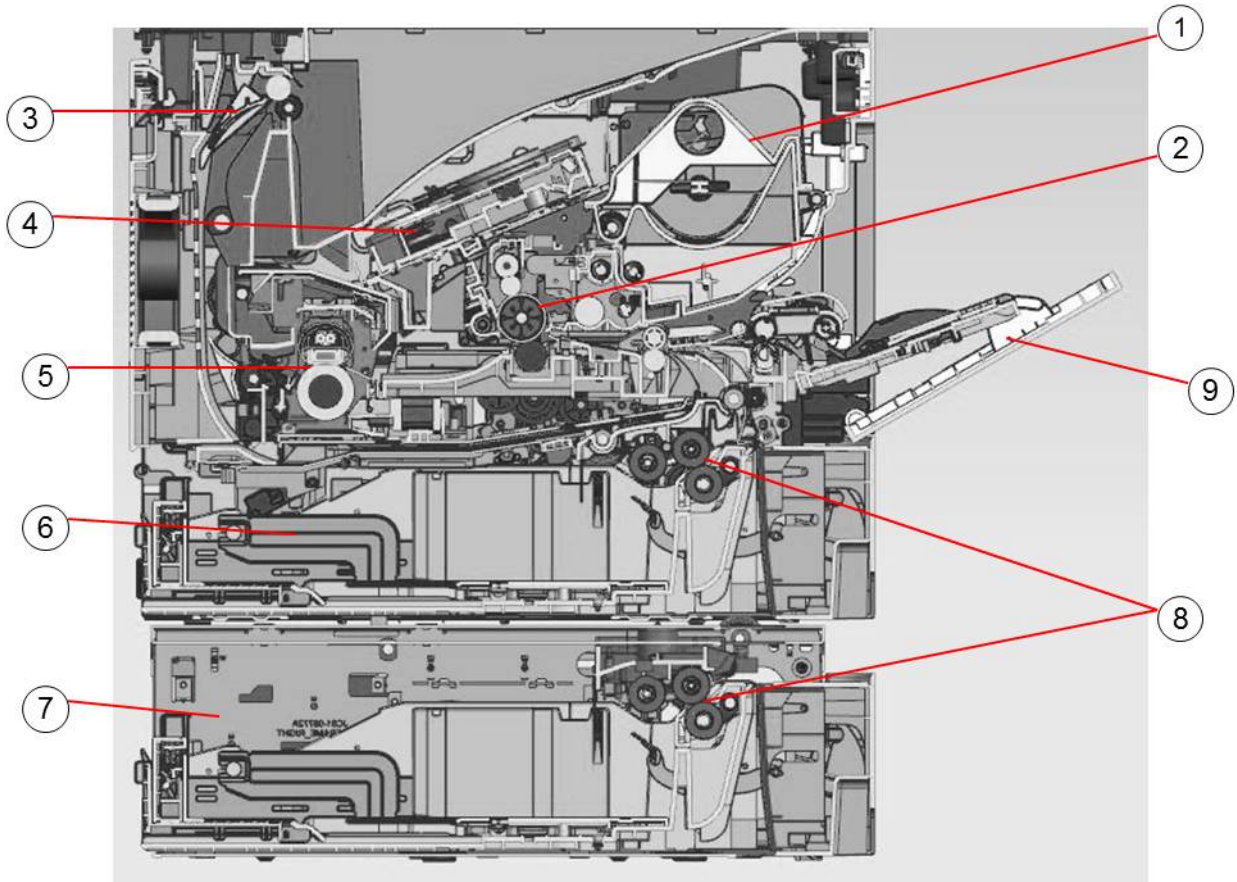

1	Toner Cartridge
2	Imaging Unit
3	Exit
4	LSU
5	Fuser Unit

6	Cassette
7	Optional tray
8	Pick up roller / Reverse roller / Forward roller
9	MP tray

## Paper Path

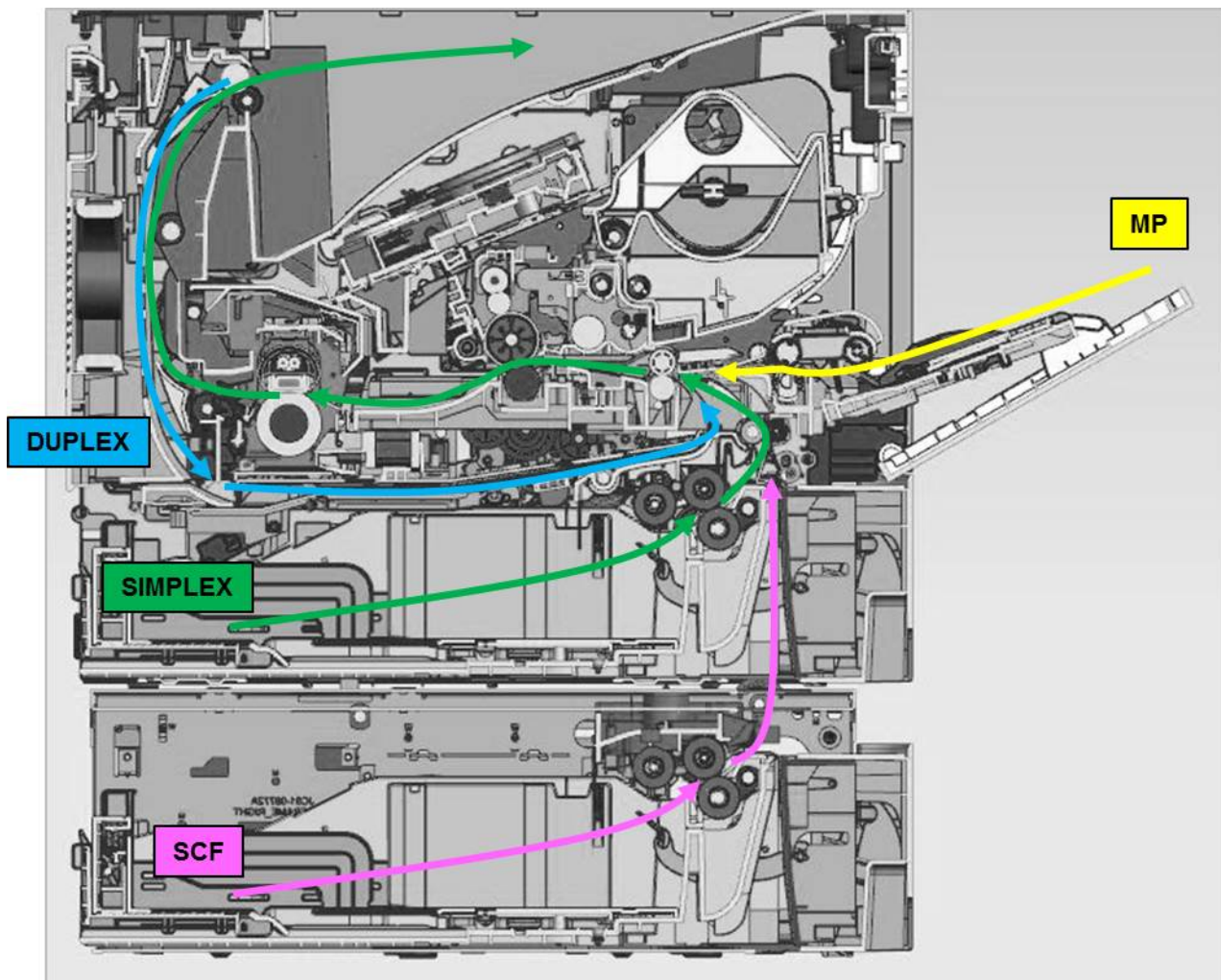

## 2.4. Feeding System

### 2.4.1. Feeding System Overview

The feeding system picks up a paper from the cassette or MP tray and transports it to the machine inside. It mainly consists of the cassette, pick up roller, feed roller, registration roller, transfer roller unit, exit unit, and drive unit.

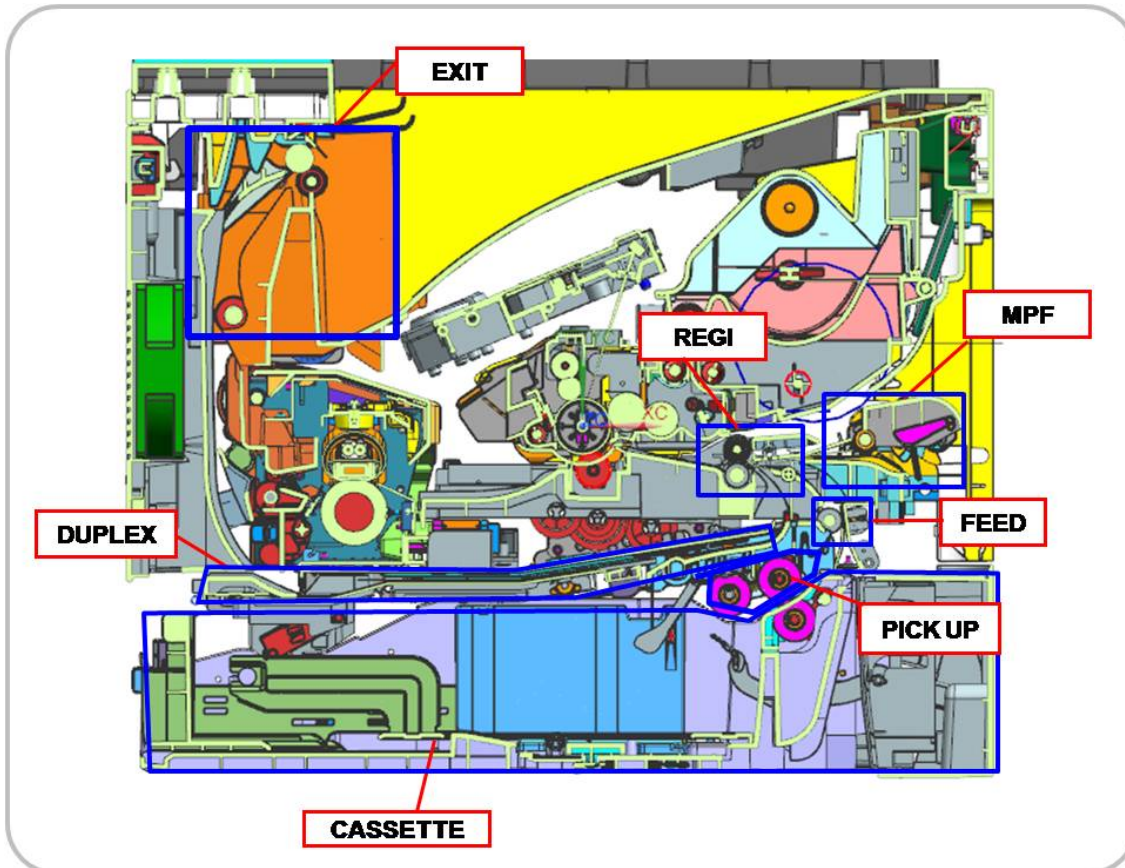

[ Feeding System Component ]

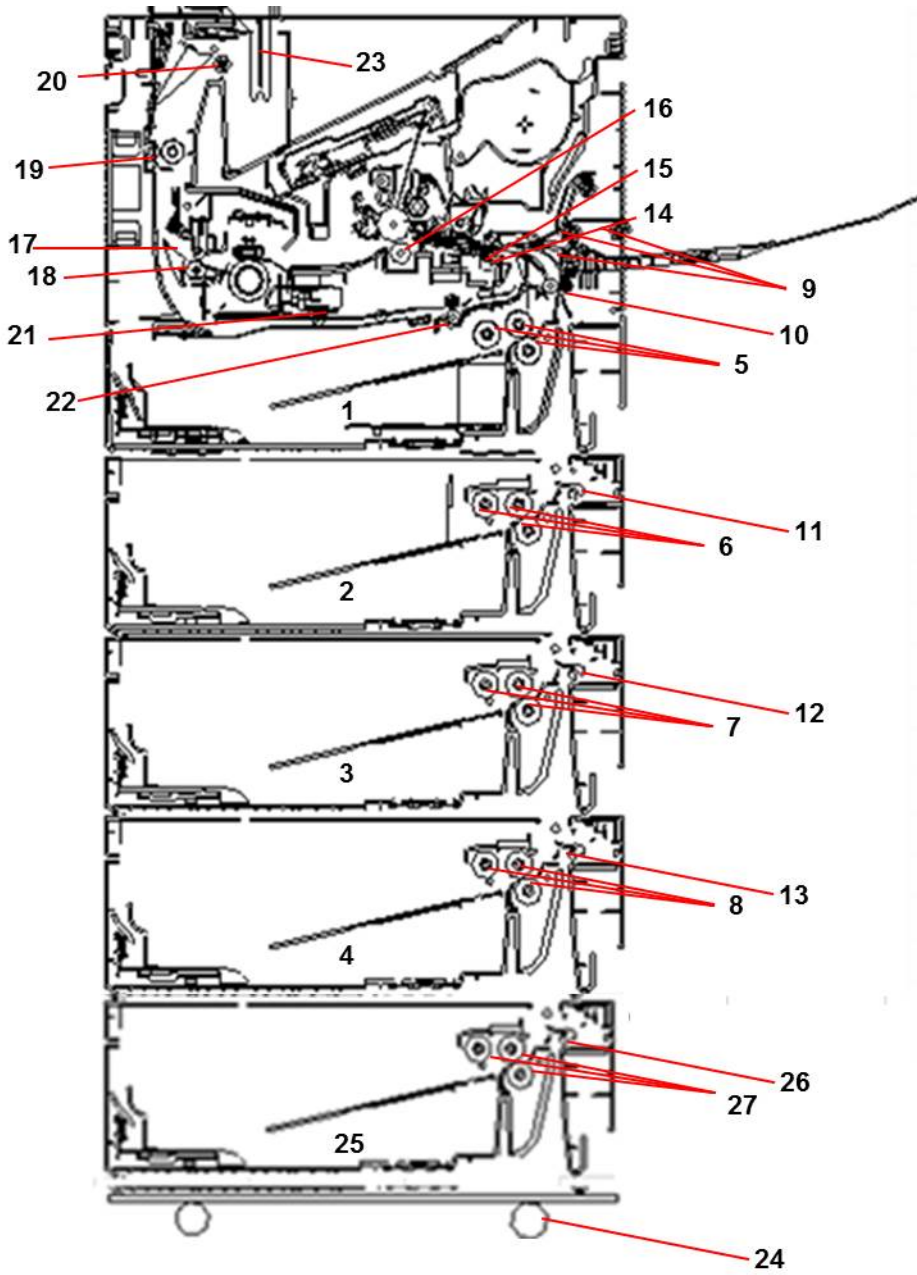

No.	Description
1	Tray 1 Paper tray
2	Tray 2 Paper tray
3	Tray 3 Paper tray
4	Tray 4 Paper tray
5	Tray 1 pick up / reverse / forward rollers
6	Tray 2 pick up / reverse / forward rollers
7	Tray 3 pick up / reverse / forward rollers
8	Tray 4 pick up / reverse / forward rollers
9	MP Tray pick up / reverse / forward rollers
10	Tray 1 feed roller
11	Tray 2 feed roller

No.	Description
12	Tray 3 feed roller
13	Tray 4 feed roller
14	Registration sensor
15	Registration roller
16	Transfer roller
17	Exit sensor
18	Exit roller 1
19	Exit roller 2
20	Exit roller 3
21	Duplex drive roller
22	Duplex sensor

No.	Description
23	Main bin full sensor
24	Stand
25	Tray 5 Paper tray

No.	Description
26	Tray 5 feed roller
27	Tray 5 pick up / reverse / forward rollers

- **Pick-Up roller (Tray 1~5 and MP Tray)**
  - This roller picks up the paper from the tray.
- **Forward roller (Tray 1~5 and MP Tray)**
  - This roller is placed against the reverse roller. It transports the paper from the pick up roller to feed roller.
- **Reverse roller (Tray 1~5 and MP Tray)**
  - This roller is placed against the forward roller and transports only one sheet to the feed roller. When two sheets of paper or more are transported from the pick up roller, the load of the torque limiter of the reverse roller is heavier than the frictional force between the sheets. As a result, the reverse roller is stopped and the lower paper does not advance any further.
- **Feed roller**
  - This roller transports the paper sent from the forward/reverse roller to the registration roller.
- **Registration roller**
  - This roller aligns the leading edge of the paper and transports the paper to the transfer roller Assy.

## 2.4.2. Cassette

The cassette stores papers.

Paper size is set using the paper guide in tray.

### Basic Cassette (Tray1)

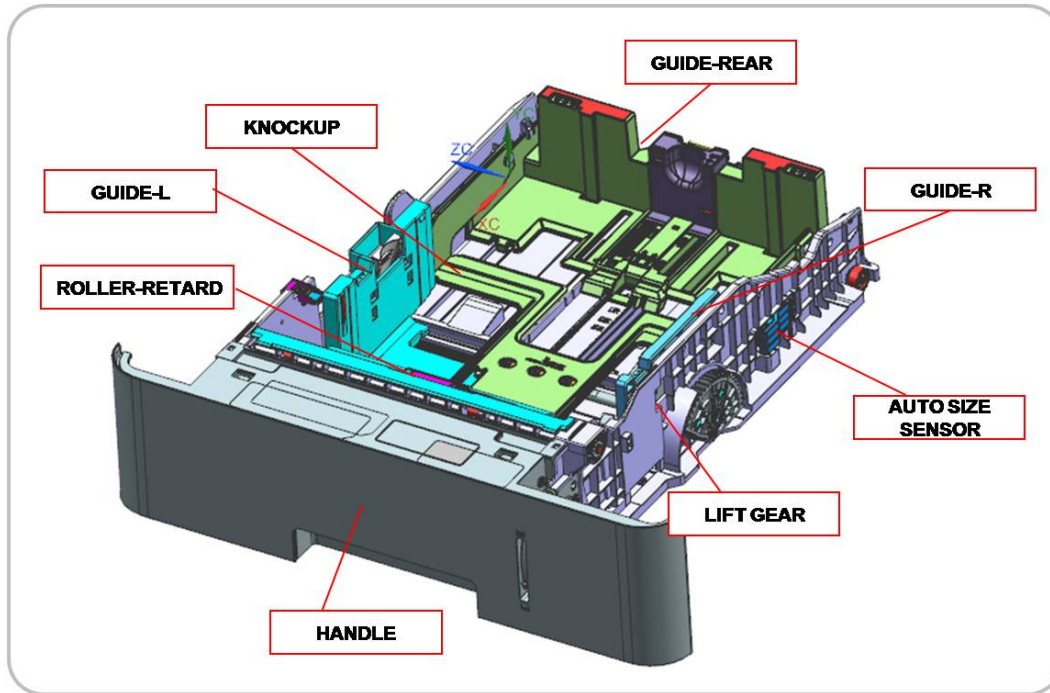

- **Specification**

- 1) Structure : Drawer Type
- 2) Paper separation : Reverse roller type
- 3) Capacity : 550 Sheets ( 75 g/m<sup>2</sup> paper standard)
- 4) Paper
  - Plain paper : A6, Statement, A5 SEF/LEF, Executive, B5, A4, Letter, Folio, Officio, Legal
  - Auto detect: A5, Executive, B5, A4, Letter, Folio, Legal ( 7 Types)
  - Special Paper : Envelop, Label, Cardstock
- 5) Weight : plain paper 60 ~ 163 g/m<sup>2</sup>
- 6) Plate knock up lift type : Lift Motor + Up Limit Sensor

### 2.4.3. Pick-Up Unit

When pickup takes place, the pickup roller transports the paper. The KNOCK-UP moves up by the elevating motor and the pick up roller comes into contact with the paper. The forward roller and the reverse roller serve to make sure that a single sheet of paper is moved to the paper path, and the paper is moved as far as the registration roller by the work of the vertical path roller.

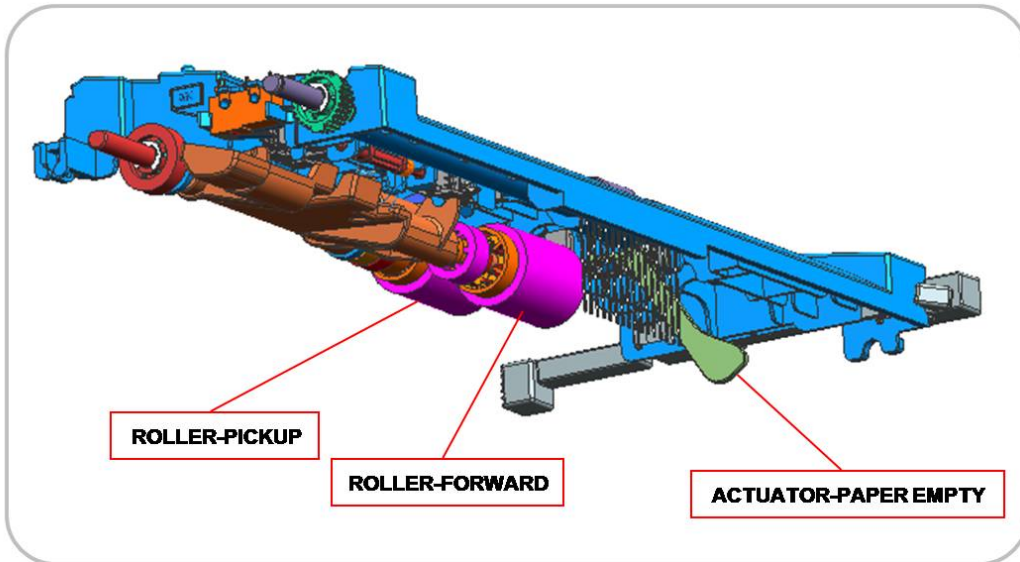

### 2.4.4. Registration Unit

---

The registration (Regi.) roller is driven by the Main Drive Motor. The registration clutch is located between the registration roller and the main motor, and controls the leddge paper timing with that of the leddge toned image on the OPC Drum.

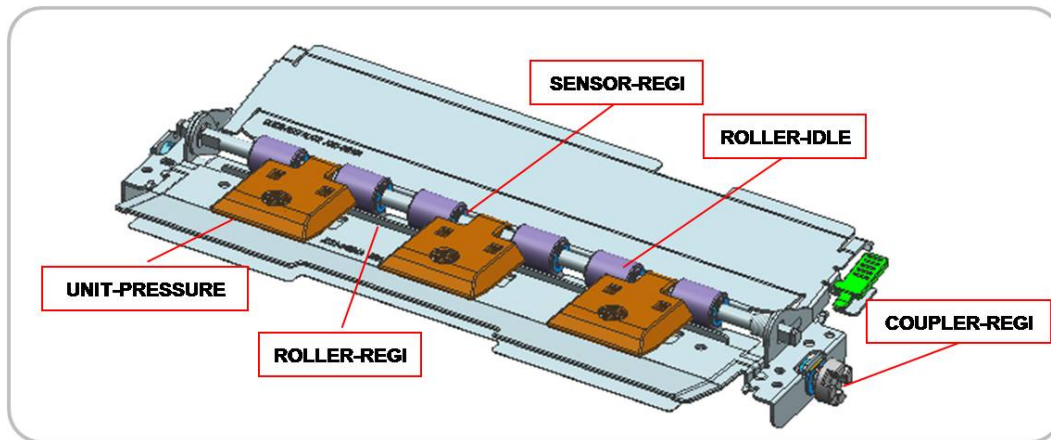



### 2.4.5. MPF(Multi-Purpose Feeder) Unit

The MPF Unit allows feeding of specialty media stock, envelopes, and custom size paper.

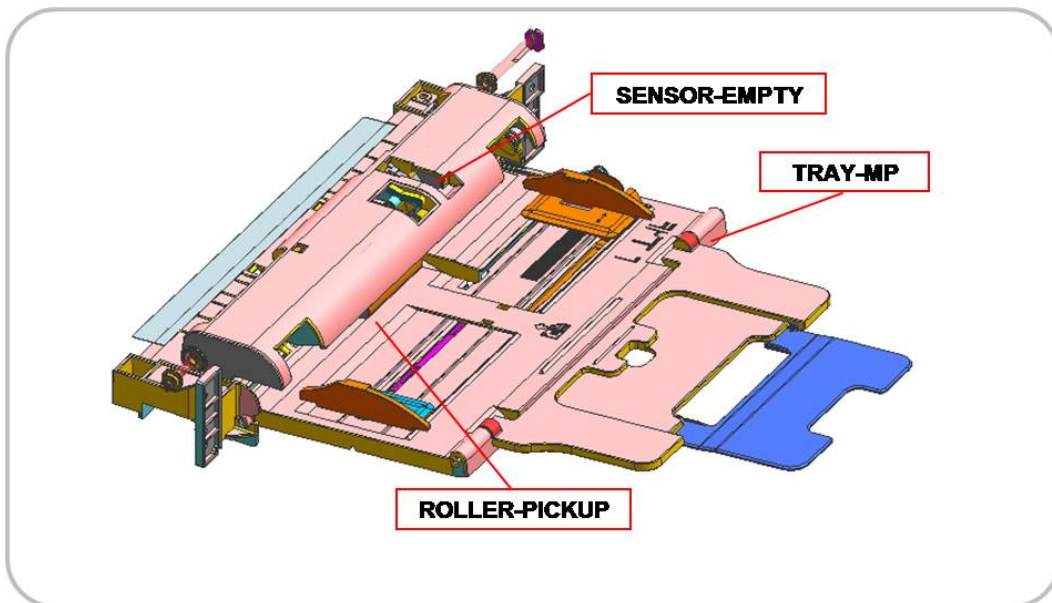

#### ■ Specification

- 1) Tray capacity : 100 sheets ( 75g/m<sup>2</sup> standard paper)
- 2) Media Size : Max 8.5"×14" (215.9×355.67) / Min 3"×5" (76.2x127)
- 3) Media weight : Plain paper 60 ~ 220g/m<sup>2</sup>

## 2.5. Image Creation

### 2.5.1. Printing process overview

This machine uses a toner cartridge, an imaging unit, transfer roller, and two laser beams in the LSU for mono printing.

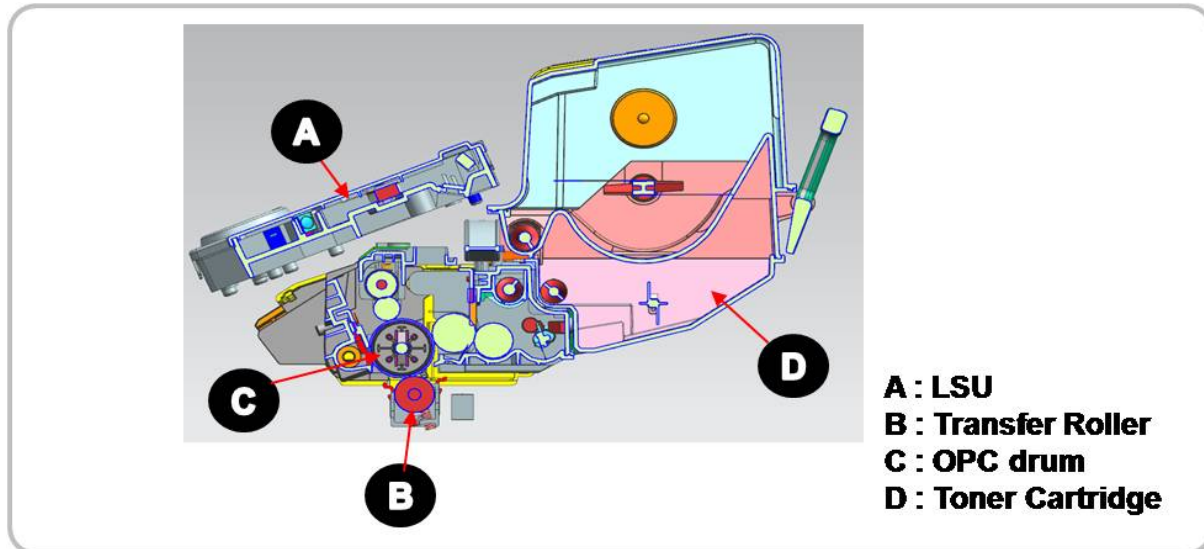

The imaging unit consists of a drum unit and developer unit. The drum unit consists of an OPC drum, charge roller, cleaning roller, and cleaning blade. The developer unit consists of the dev. roller, supply roller, Dr.blade, and agitator.

The OPC drum is charged with a negative voltage by the charge roller and is exposed by the light from the LSU (Laser Scanning unit).

The light produced by a laser creates a latent image by discharging on the surface of the OPC drum. The negatively charged toners are attracted to the latent image due to the electric field. The toner(real image) on the OPC drum are moved to the paper by the positive bias applied to the transfer roller.

- 1) **OPC drum charge** : The charge roller gives the OPC drum a negative charge.
- 2) **Laser exposure** : Light produced by a laser diode(LD) hits the charged OPC drum through the lens and mirrors. The machine controls the laser beam on/off for the latent image.
- 3) **Development** : The developing roller carries the negatively charged toner to the latent image on the OPC drum surface.
- 4) **Transfer** : The negatively charged toner is transferred to the paper by transfer voltage.
- 5) **Cleaning for OPC drum** : The cleaning brush and blade remove remaining toner on the OPC drum surface after image transfer to the paper.
- 6) **Quenching for OPC drum** : Quenching is done by illuminating the whole area of the OPC drum with the laser at the end of every job.

## 2.5.2. Toner Cartridge

The toner cartridge supplies toner.

The photo sensor in the toner cartridge detects the toner level. If it is defective, a serious image defect can happen.

The CRUM chip stores the toner cartridge information.

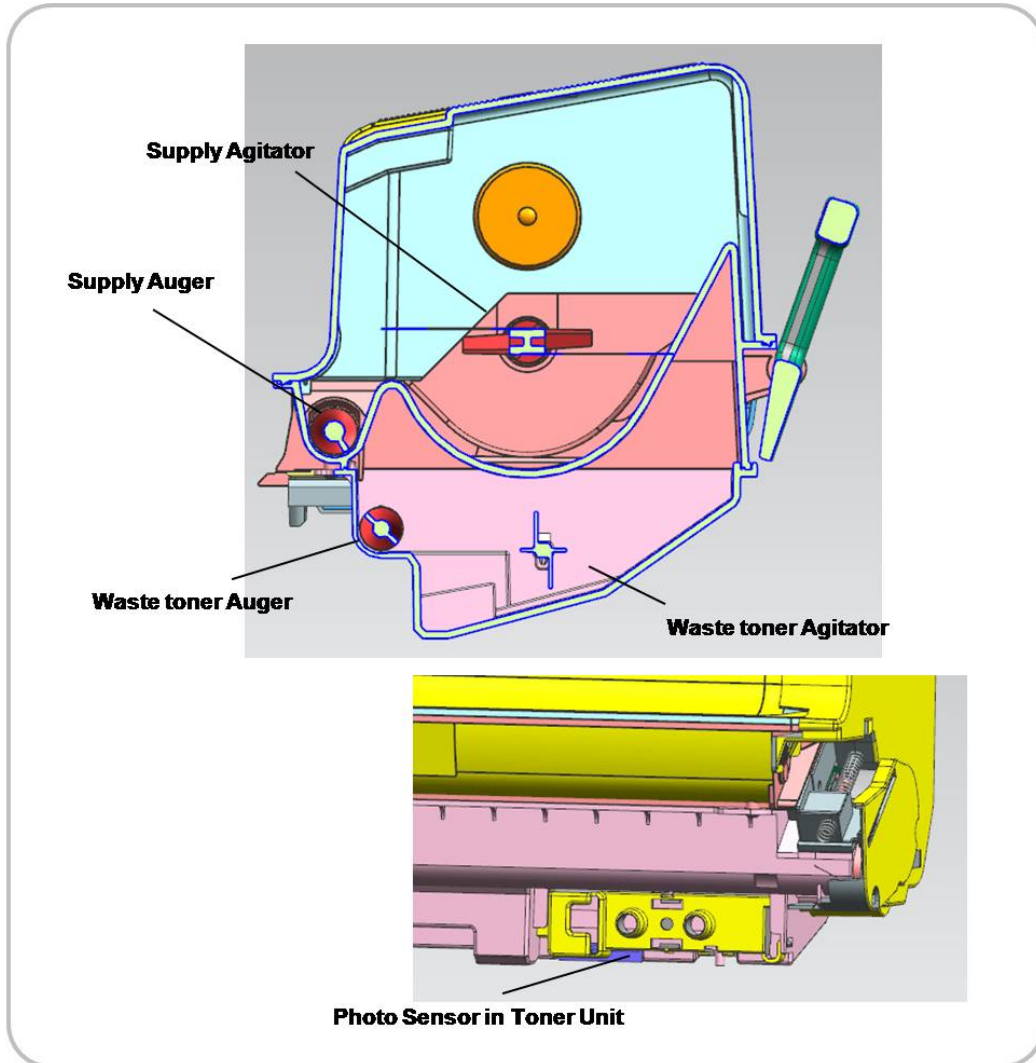

### 2.5.3. Imaging Unit

---

The imaging unit is an integrated type. The Imaging Unit consists of the drum, developer, and Drum Cleaning Sections. Each section is constructed together at the time of production and is not designed to be disassembled. Therefore the Imaging Unit must be ordered as an assembled part. Since it is a "Sales Option", please order through our sales channel.

The OPC drum diameter is 30 mm (circumference: about 94.2 mm).

The deve roller must keep the regular Nip to prevent the image defect. The Nip Ring is used for this.

After the image is moved to transfer roller, the remaining toner on the OPC drum is removed by the cleaning blade.

The imaging unit has a CRUM that stores the series number and maintenance count information.

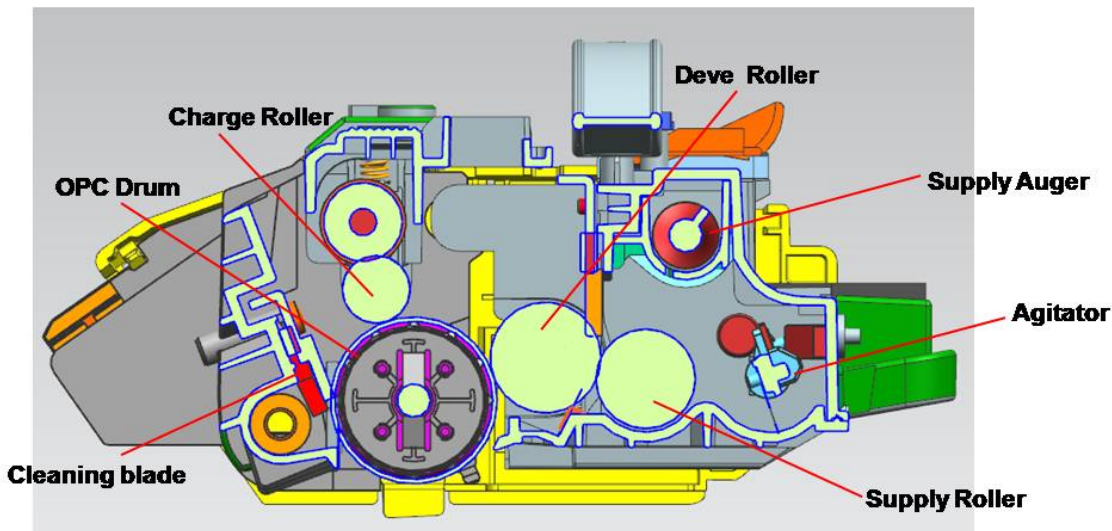

### 2.5.3.1. Development

This machine uses a single-component development system and has a developing unit (which is included in the drum unit), making it a single Imaging Unit.

The developer unit portion contains 20g of toner that is supplied to the supply roller by the agitator. Toner is supplied to the deve roller by the supply roller. After the toner exits from the Dr.blade, it forms a developer brush. Then toner is attracted to the surface of the OPC Drum only in areas the corresponds to the image area. The diameter of the deve roller is 20 mm.

The upper augers function is to supply toner to the both sides evenly.

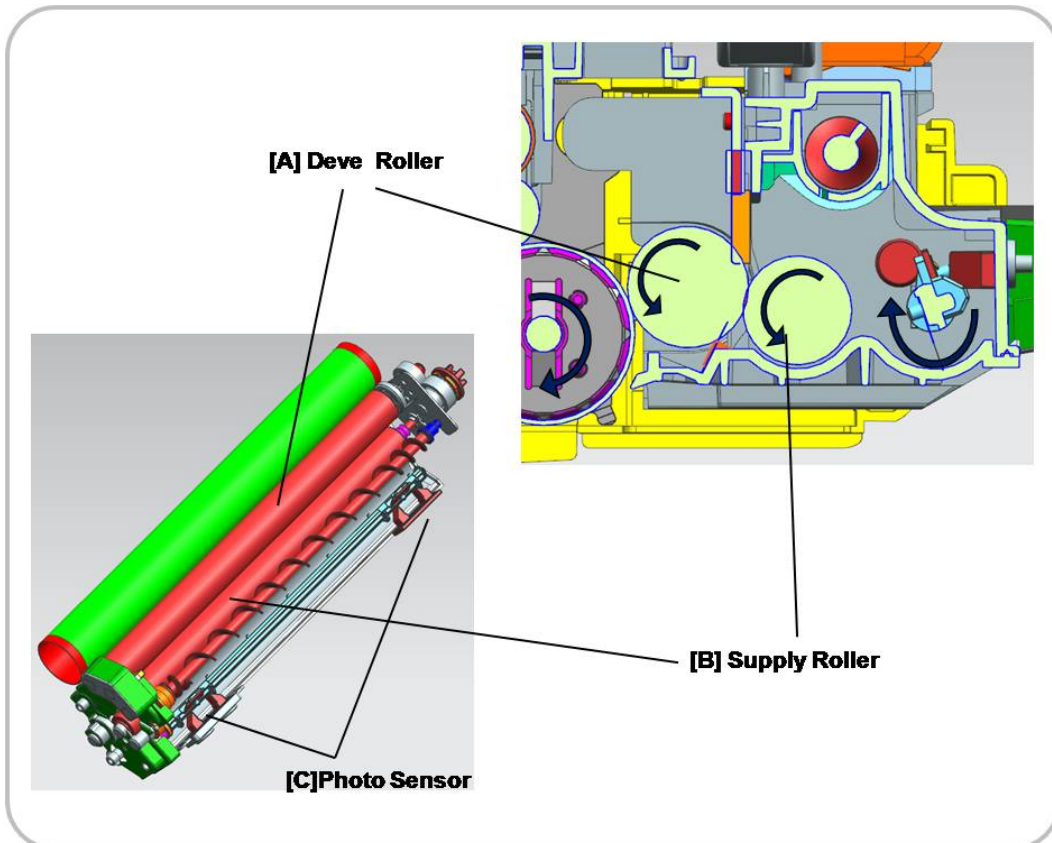

## 2.6. Fuser unit

This section describes the fuser unit structure and the image fusing process.

### 2.6.1. Fuser unit overview

This model uses two Heater Lamps which provides for a much faster warm-up time than that of a conventional fusing system, therefore it fits in the category of an instant fusing system.

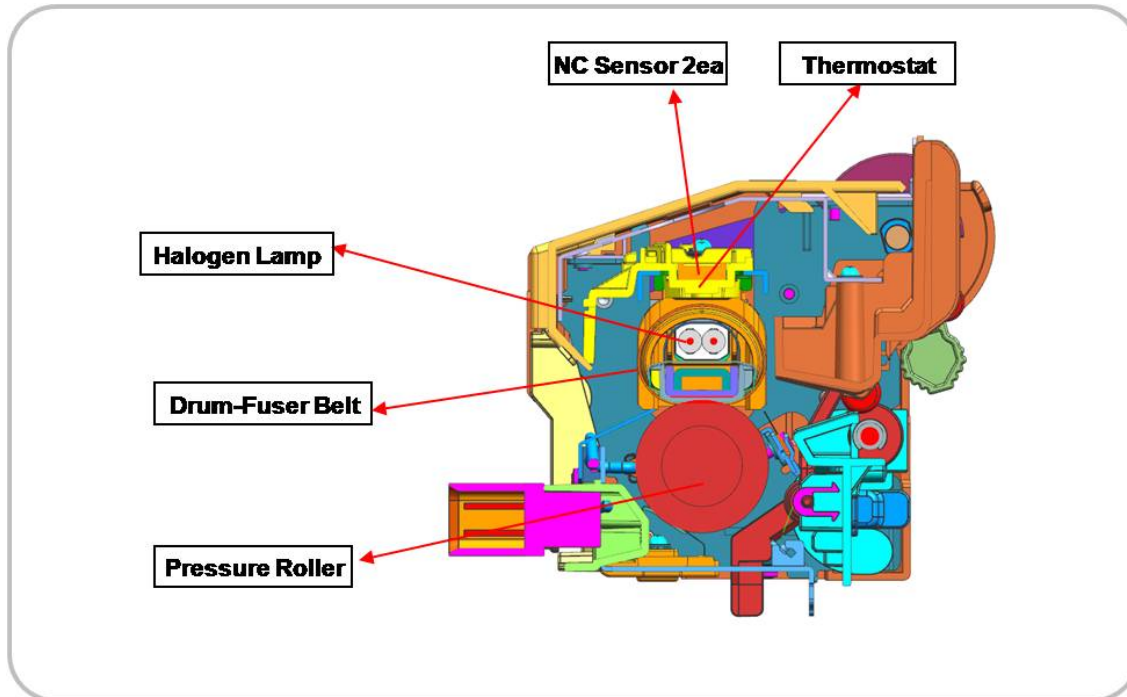

#### 1) Drum-fuser belt

The Fuser Belt is made of 3 thin layers that can be heated by the halogen lamp inside more quickly. The drum-fuser belt contains 2 fusing lamps. One lamp, center heating lamp, heats the center and the other lamp, side heating lamp, heats the ends in the axial direction.

#### 2) Pressure Roller

The pressure roller is made of soft silicone rubber, which flatten slightly creates the fusing nip.

#### 3) NC sensor

NC sensors (non-contact type thermistors) are located in the front area and the side area of the drum-fuser belt and controls the temperature. They protects the fusing system from overheating.

#### 4) Thermostat

Thermostats cut off the power supply to the halogen lamp by opening the circuit when the fuser belt becomes abnormally hot as a result of problems such as NC sensor malfunction. These thermostats are used to prevent abnormal operation.

## 2.6.2. Fuser unit drive

The Drive Motor [A] drives the Pressure roller [B] through the gear train. The fuser belt [C] is driven by contact with the pressure roller.

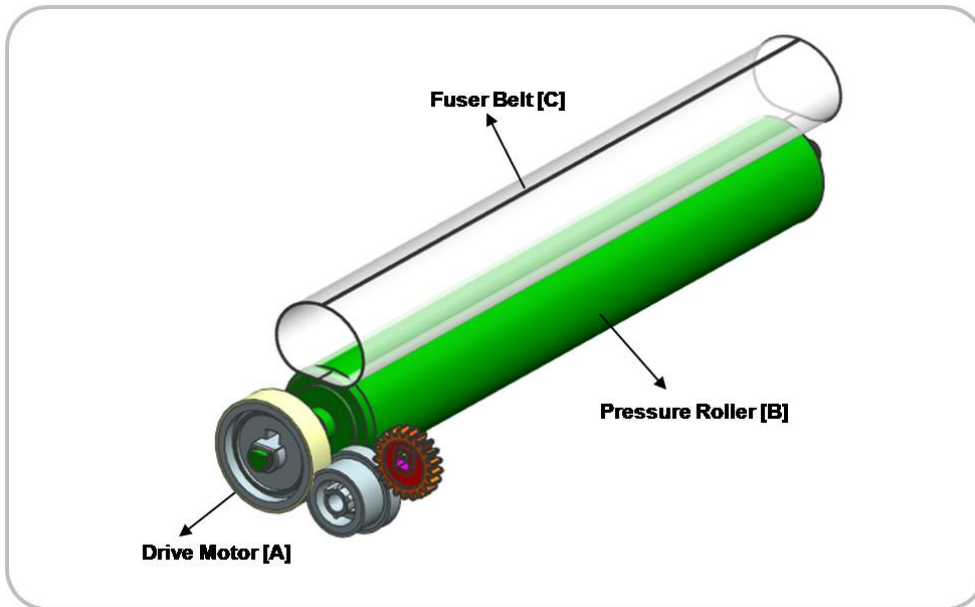

### 2.6.3. Fuser unit temperature control

When the main switch turns on, the CPU turns on the fusing lamp. The lamp stays on until the NC sensors detect the standby temperature. Then the CPU raises the temperature up to the printing temperature.

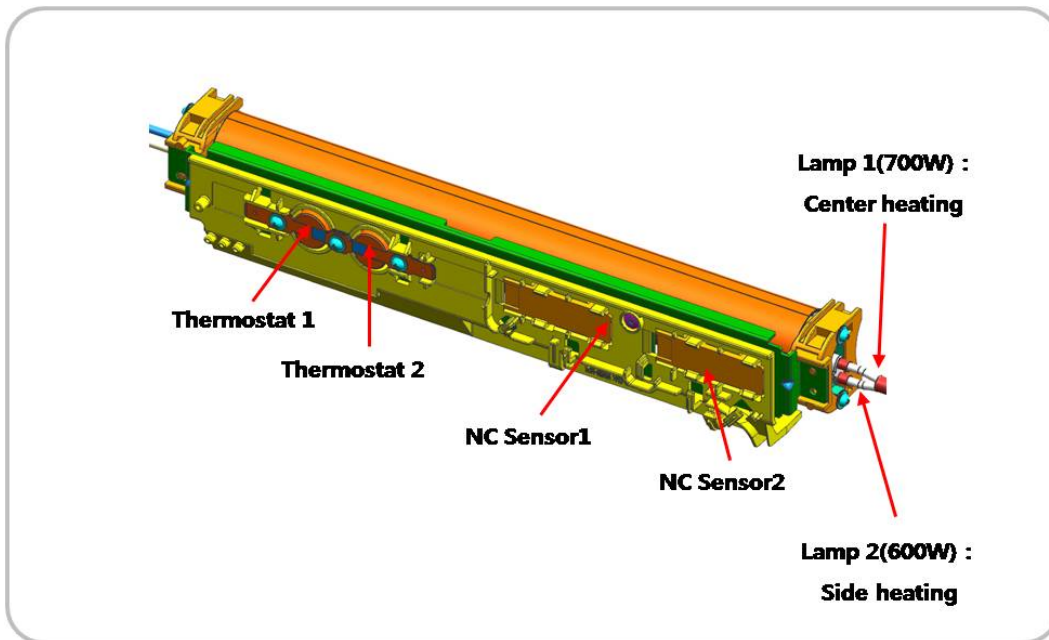

#### ■ Overheat Protection

The CPU cuts power to the fusing lamp in the following cases :

- The Fuser Belt temperature is detected by the NC sensor, and if it detects an overheat condition it will shut down AC power to the Fuser.
- The heating temperature is detected by a thermistor and if resistance is so low that the Main Board detects an overheat condition; it will disable the Control Circuit for the Fuser on the Main Board.

The following components are used when thermistor overheat protection fails :

- Two thermostats for the fuser belt are on the neutral side of the AC line of the fusing lamp.
- If either one of the thermostats detect temperatures that become higher than 190°C, it opens and cuts AC power to both fusing lamp.



## 2.7. Laser Scanning Unit (LSU)

### 2.7.1. Laser Scanning Unit Overview

The Laser Scanning Unit (LSU) consists of one polygon motor and one LD (Laser Diode), and forms a latent image on the surface of OPC drum. For this process, there is a C-DOE lens, F-Theta Lens, reflective mirror (that changes laser beam path), the cover glass for protecting the LSU from contamination. Also, LD PBA is located to the front for interface.

The PD sensor located in LD PBA detects the scanning start line and generates the horizontal sync signal (Hsync).

The picture below shows the main components for LSU.

#### NOTE

The LSU is the optical precision device. Please handle it carefully and do not remove the cover.

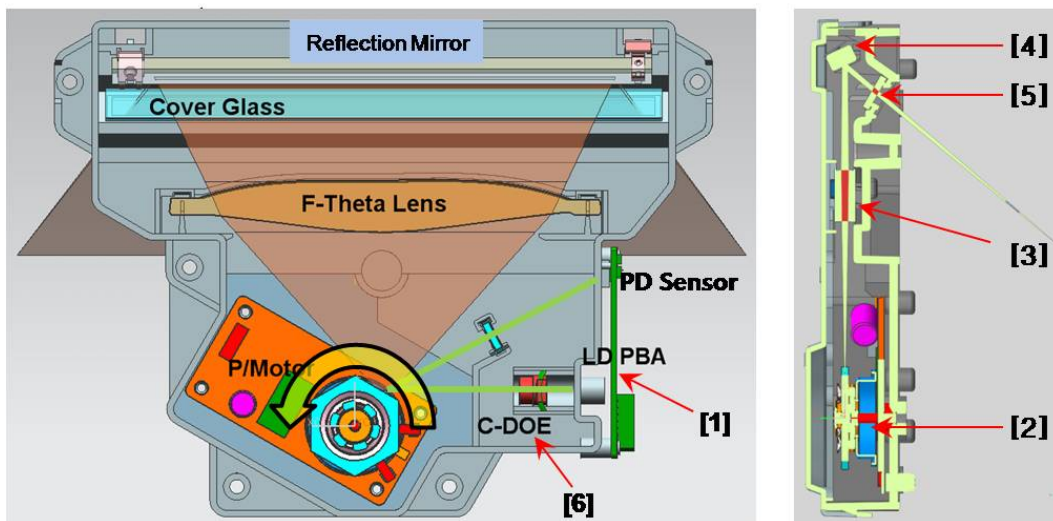

1	LD PBA
2	P/Mirror Motor
3	F- Lens
4	Reflect Mirror
5	Cover glass
6	C-DOE Lens

- Information**

- Part Code : JC97-03877A [LSU]

### 2.7.2. Laser Scanning Optical path

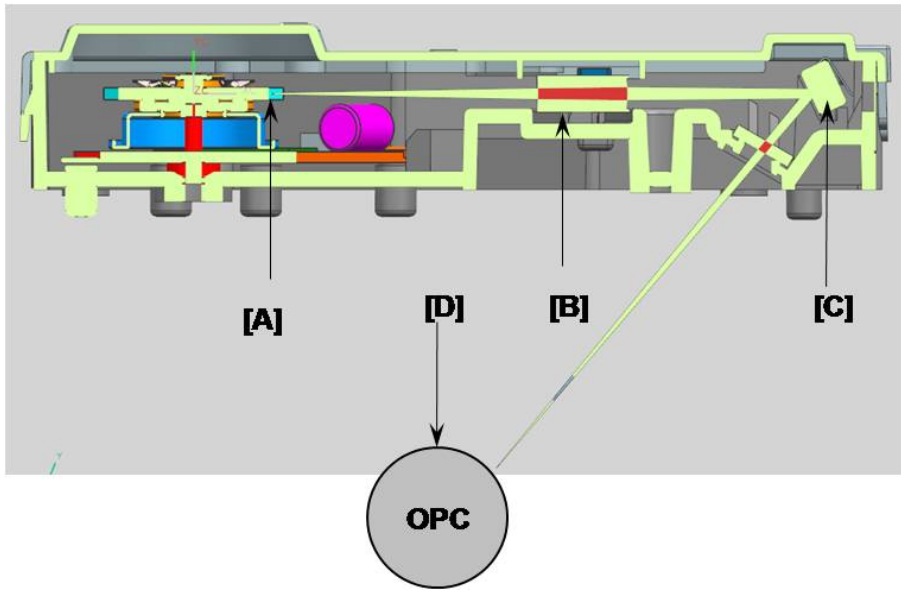

The laser beam is reflected from the mirror [A] and passes through F-theta lens. And then its direction is changed by the reflection mirror [C]. It is transferred to OPC.

The polygon motor speed is controlled by the main CPU.

The LD unit generating the laser beam has the dual beam laser diode with 780nm wavelength. It is controlled by the LD drive IC.

Item	Specification
LD Unit	<ul style="list-style-type: none"> <li>• Laser Diode : Dual Beam</li> <li>• Driving IC for Dual LD</li> </ul>
P/Motor speed	32,055 rpm
Process Speed	271.40 mm/sec
H/W interface	<ul style="list-style-type: none"> <li>• LD Harness : 14 Pin FFC</li> <li>• P/Motor Harness : 5 Pin FFC</li> </ul>

## 2.8. Drive System

### 2.8.1. Drive Motors

The following diagram displays the locations of the printer drive motors.

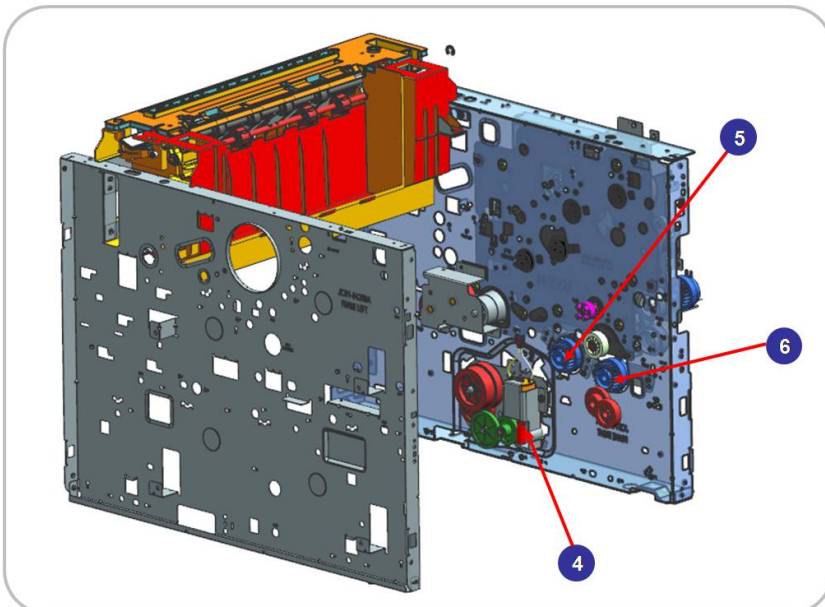
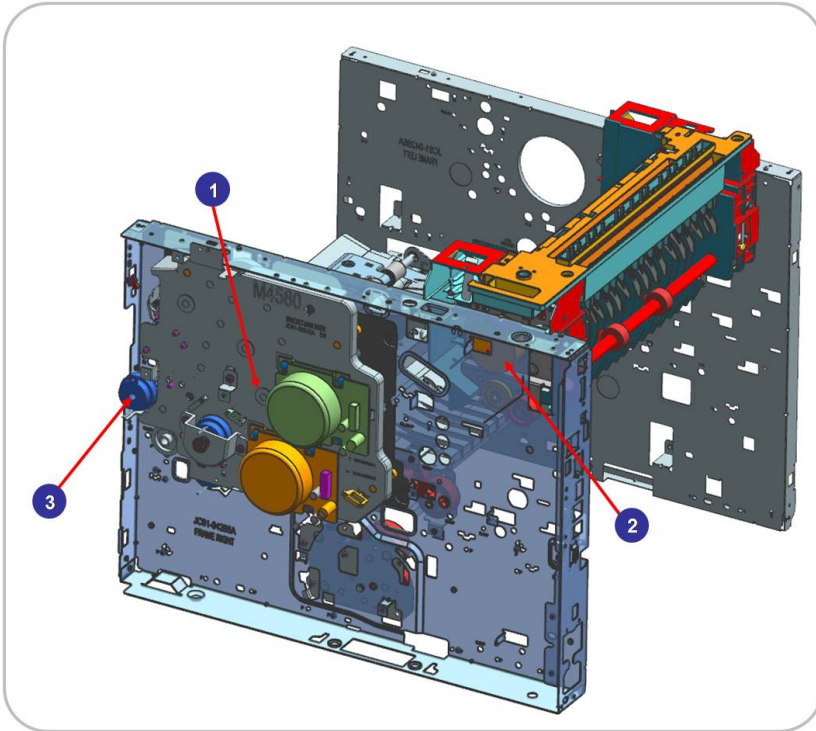

## 2. Product Specifications and Description

No.	Motor	Motor type	Qty	Function
1	DRIVE MAIN	BLDC motor	1	OPC, Deve driving
		BLDC motor	1	Feed and Fuser driving
		DC motor	1	Toner supply
		E-clutch	1	Regi. shaft driving
2	DRIVE EXIT	PM-STEP	1	Exit roller driving
		E-clutch	1	Fuser pressure control
3	MP	E-clutch	1	MP pick-up shaft driving
4	DRIVE FEED	DC motor	1	Cassette elevating driving
5	DUPLEX	E-clutch	1	Duplex driving
6	PICK UP	E-clutch	1	PICK-UP

## 2.8.2. Main Drive Unit

### Front View

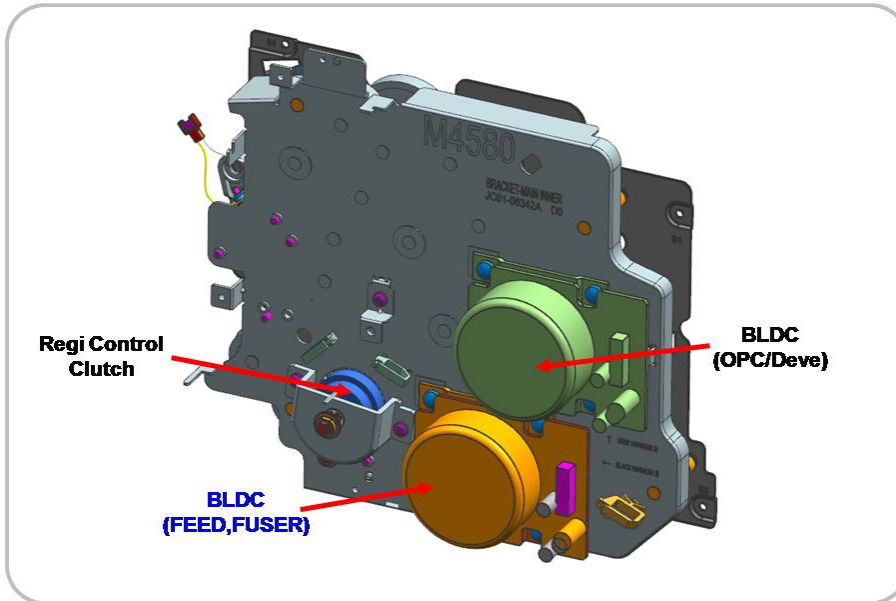

### Rear View

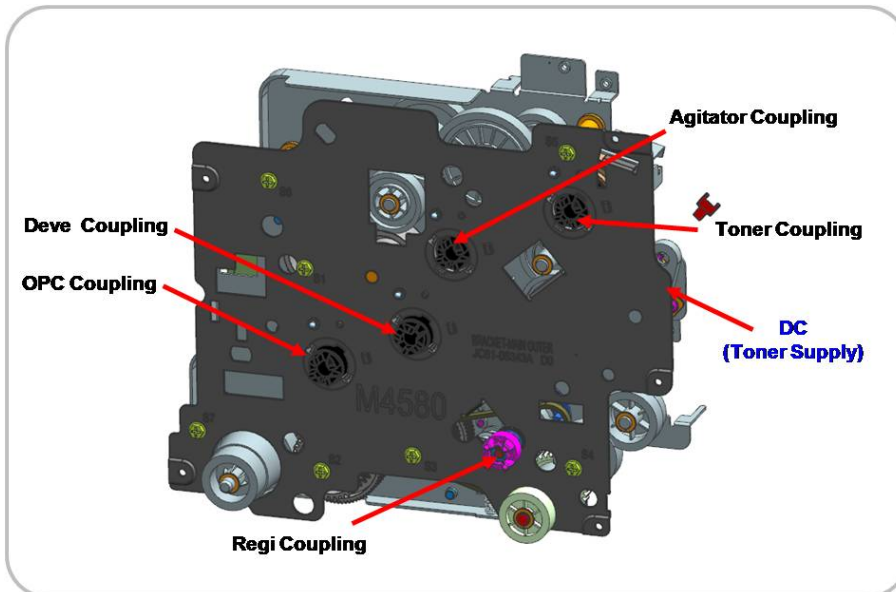

- **Information**

- Part Code : JC93-00923A [DRIVE MAIN]

### 2.8.3. Exit Drive Unit

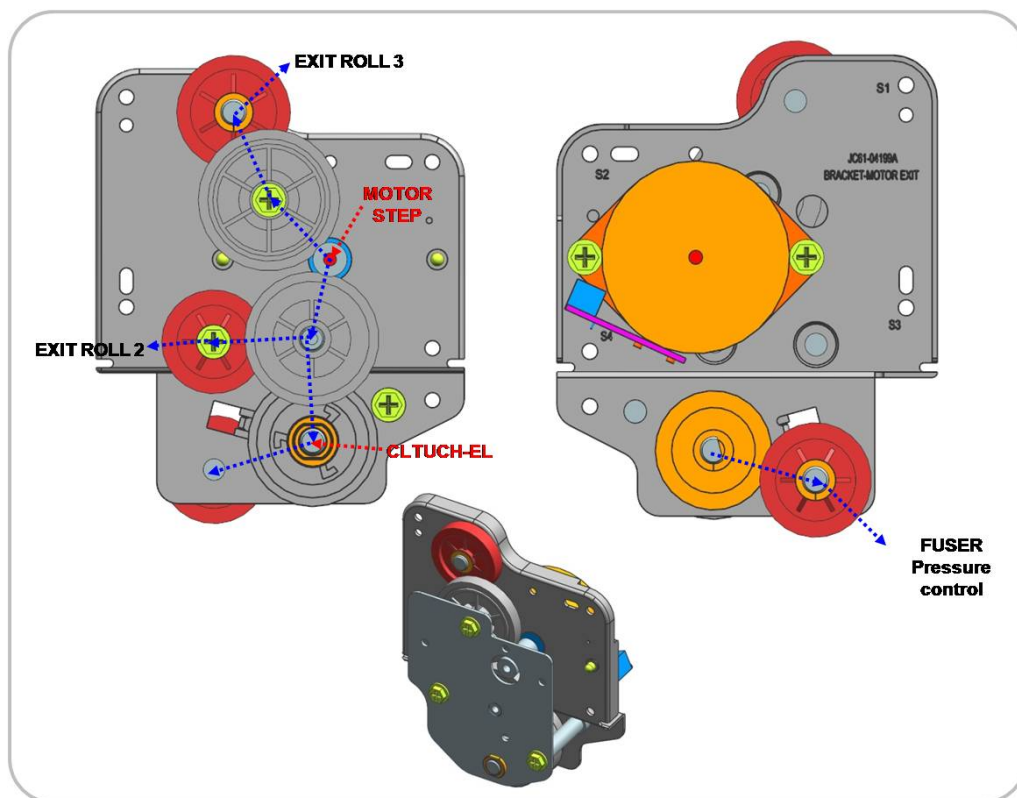

• **Information**

- Part Code : JC93-00349A [DRIVE EXIT]

Power Train	<ul style="list-style-type: none"> <li>• Simplex/Duplex : Driving by STEP motor</li> <li>• Tray 1 : E-clutch</li> </ul>
<ul style="list-style-type: none"> <li>• Step motor → Gear → Gear → Exit Roller 3 driving</li> <li>• Step motor → Gear → Gear → Exit Roller 2 driving</li> <li>• Step motor → Gear → E-Clutch → Gear → Gear → Fuser pressure driving</li> </ul>	

## 2.8.4. Tray Lifting Drive Unit

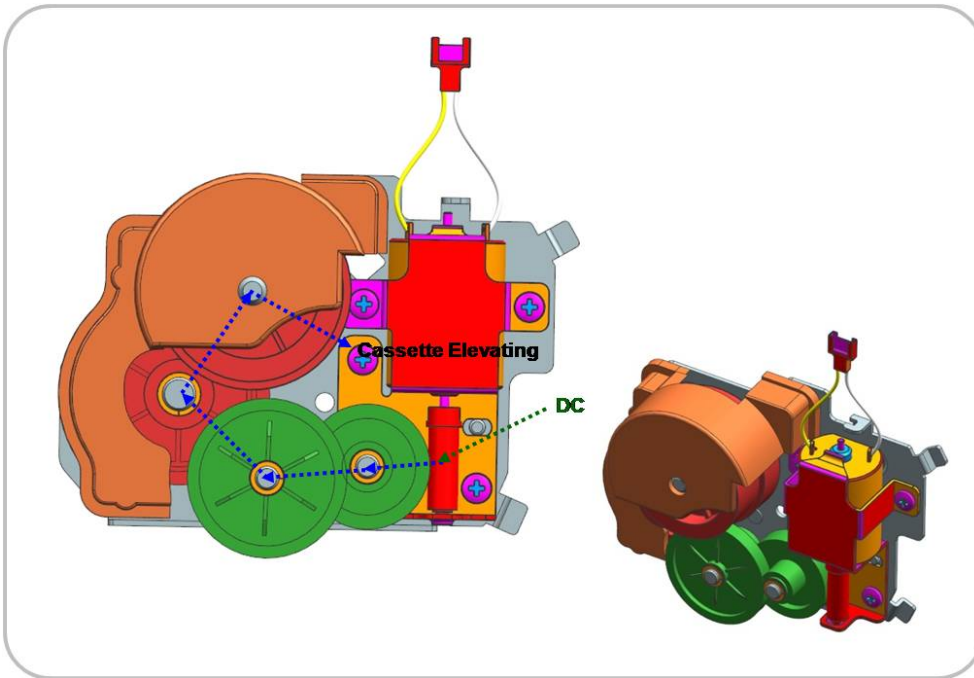

- Information**

- Part Code : JC93-00350A [DRIVE-FEED]

Power Train	<ul style="list-style-type: none"> <li>• Tray lifting : DC motor</li> </ul>
<ul style="list-style-type: none"> <li>• DC motor → Gear → Gear → Gear → Gear → Tray lifting</li> </ul>	

## 2.9. Hardware Configuration

M453x series Electrical Circuit System consists of the following :

- Main board
- DSDF board
- OPE board
- HVPS board
- SMPS board
- Fuser Drive Board (FDB)

### Diagram of the M4530 Series Electrical Circuit

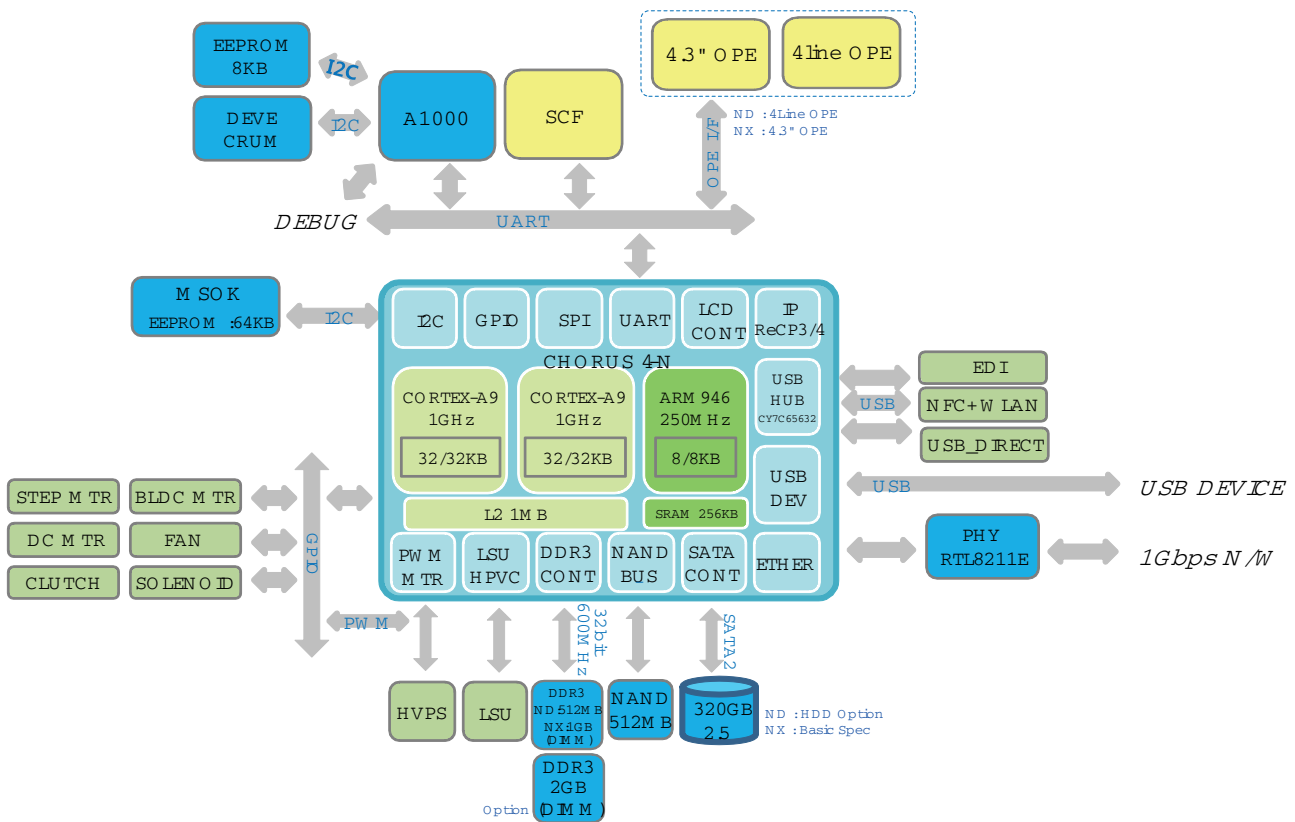

The main board handles the video control, engine control.

The main board receives the print data from the host through the network or USB port. It takes this information and generates printable video bitmap data. It controls all modules required to print, that is, LSU, HVPS, fan, fuser, scan function, LCD display, touch screen.

The main board communicates with the drive system and other devices through UART. It communicates with the toner cartridge and imaging unit through I2C to check their life.

The main board adopted the dual core CPU 1GHz, DDR3 2GB memory, Flash NAND 128MB, 320GB SATA HDD(4530NX(std), 4530ND(opt.)) to control the engine driving, video signal processing, interface, etc. successfully.



### Circuit Board Locations

The following diagrams show the locations of the printer circuit boards:

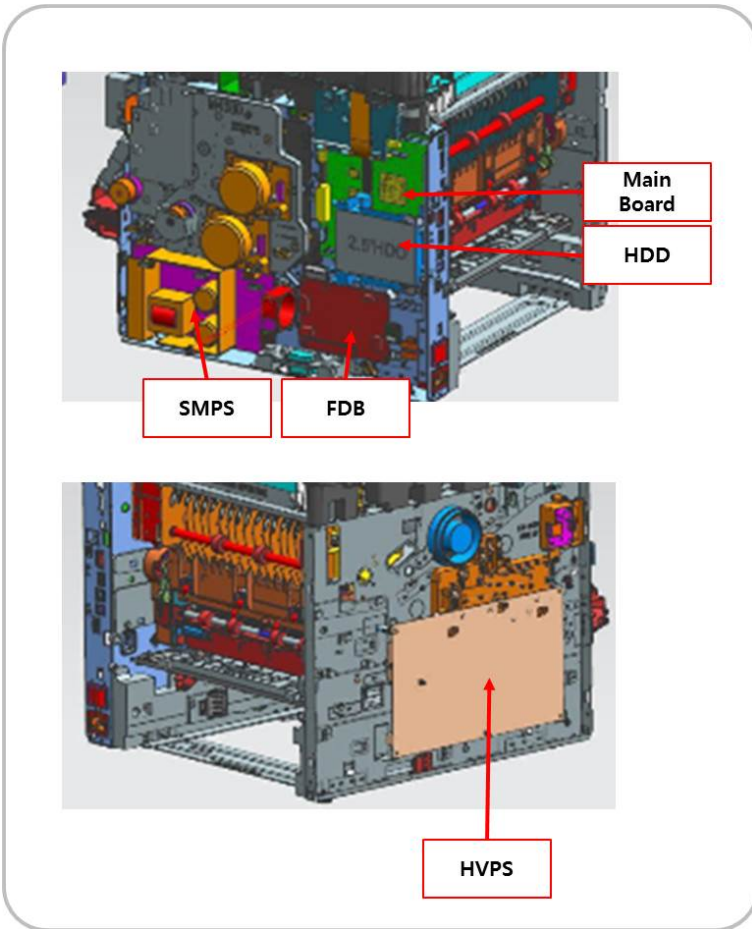

### 2.9.1. Main board

The main board consists of the main processor(1GHz dual core CPU), memory(DDR3 2GB), 1G Ethernet PHY, USB2.0 HUB, scan/video/UI/fax signal interface connection, motor driving IC, engine signal interface connection, power interface.

The main processor controls video, engine, UI display and communicates the various devices. The HDD is connected to the main board by SATA2 and to the SCF by UART.

#### Main Board Connection Information (M4530ND)

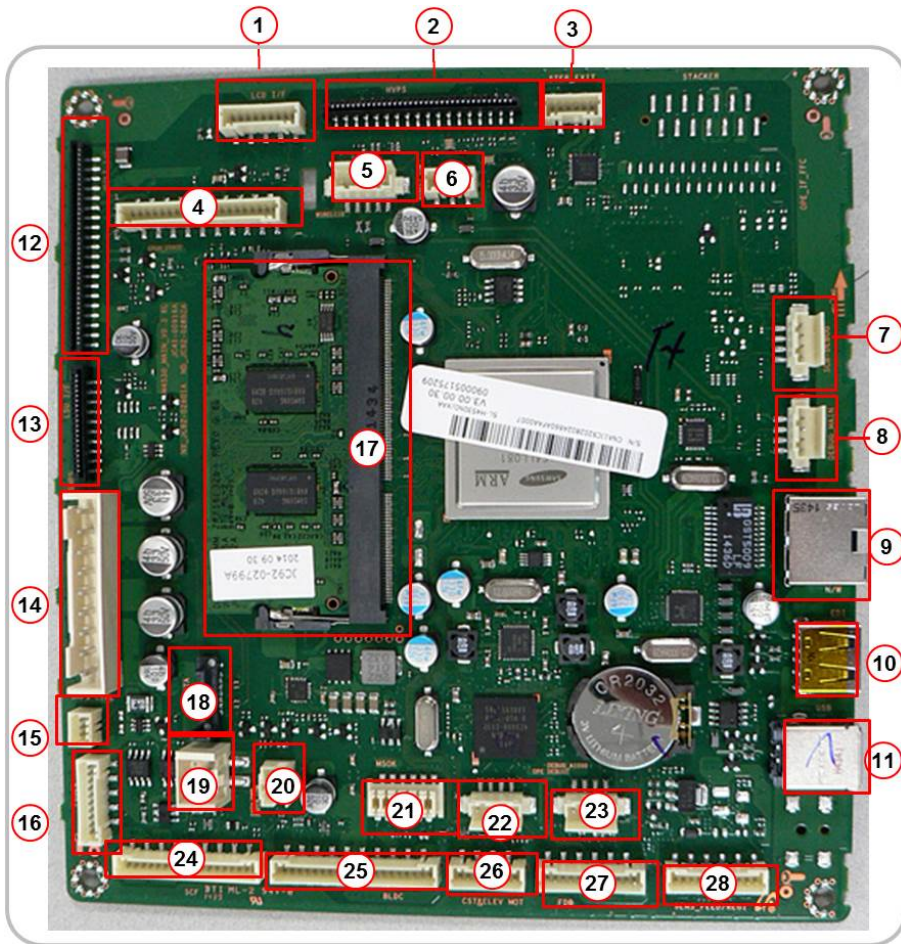

• **Connection**

1	OPE Interface(4line LCD)
2	HVPS Interface
3	Exit Motor Interface
4	CRUM/Toner Remain
5	Option(Wireless)
6	Direct_USB
7	Debug_SCB
8	Debug_Main
9	Giga RJ45
10	EDI

11	USB Device
12	Joint PBA Interface
13	LSU Interface
14	SMPS POWER
15	SMPS_CONTROL
16	FUSER_THERMISTOR
17	DIMM
18	SATA Signal
19	SATA Power
20	PAPER_LOW_SEN

21	MSOK
22	Debug_OPE
23	Debug_A1000
24	SCF
25	BLDC
26	ELEV_MOT / PAPER_SIZE
27	FDB
28	FEED / REGI SENSOR

• **Information**

- Part Code : JC92-02802A

- Part Name : PBA-MAIN

**Main Board Connection Information (M4530NX)**

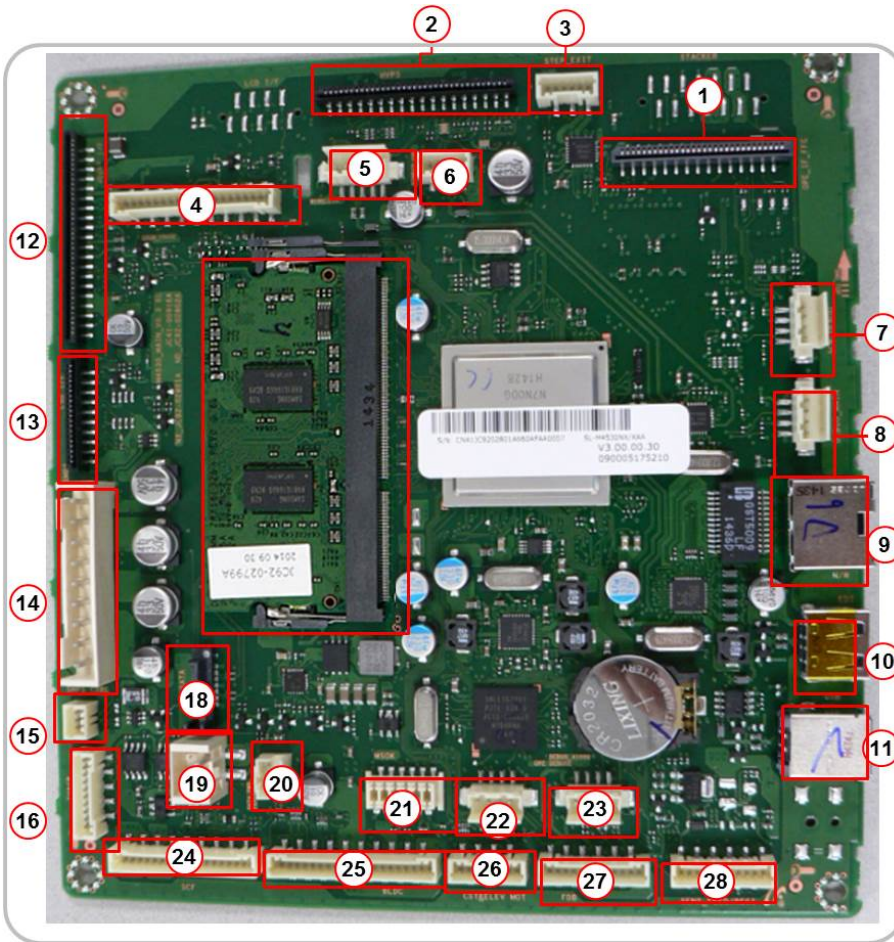

• **Connection**

1	OPE Interface(4.3" LCD)
2	HVPS Interface
3	Exit Motor Interface
4	CRUM/Toner Remain
5	Option(Wireless)
6	Direct_USB
7	Debug_SCB
8	Debug_Main
9	Giga RJ45
10	EDI

11	USB Device
12	Joint PBA Interface
13	LSU Interface
14	SMPS POWER
15	SMPS_CONTROL
16	FUSER_THERMISTOR
17	DIMM
18	SATA Signal
19	SATA Power
20	PAPER_LOW_SEN

21	MSOK
22	Debug_OPE
23	Debug_A1000
24	SCF
25	BLDC
26	ELEV_MOT / PAPER_SIZE
27	FDB
28	FEED / REGI SENSOR

• **Information**

- Part Code : JC92-02801A
- Part Name : PBA-MAIN

### 2.9.2. MSOK

---

MSOK PBA consists of a EEPROM(512K-bit) that stores all the systems operation information such as system parameters, device status, tech information, and service information which includes the device serial number.

 **NOTE**

When a main board needs to be exchanged, the MSOK PBA should be re-installed to the new main board to retain the system information.



### 2.9.3. SO-DIMM PBA

The SO-DIMM PBA is the system memory module of the main board. It is used for the operating system, some system application programs, and it stores some print data from the USB and Network port (scanned images, copy data, fax data and printable video data, etc.). The SO-DIMM PBA includes the following features:

- 1GB capacity (expandable to 2GB)
- 32-bit non ECC DDR3 266MHz speed.

**NOTE**

Only Samsung genuine DIMM memory can be installed to the main board.



### 2.9.4. USB Host PBA

USB Host PBA is used to interface with main board, external USB memory, NFC, wireless.

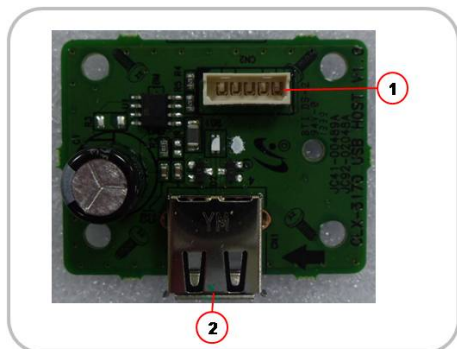

- **Information**

- Part Code : JC92-02048A
- Part Name : PBA-USB HOST

- **Connection for Direct USB**

1	Main Board Interface Connector
2	External USB connection

- **Connection for Option**

1	Main Board Interface Connector
2	Option Connection (NFC & Wireless)

## 2.9.5. SMPS board

SMPS (Switching Mode Power Supply) board supplies electric power to the main board and other boards. The voltage provided includes +5V, and +24V from a 110V/220V power input. It has safety protection modes for over current and overload.



- **Specification**

General Input / Output Voltage

- 1) AC 110V (90V ~ 135V)
- 2) AC 220V (180V ~ 270V)
- 3) Output Current
  - +5V : 4.0A
  - +24V : 7.5A
- 4) Output Power: 1500W (SMPS:200W, FDB:1300W)
  - DC 5V : 20W
  - DC 24V : 180W

- **Information**

	110V	220V
Part Code	JC44-00091C	JC44-00092C
Part Name	SMPS V1	SMPS V2

- **Connection**

1	Input_AC
2	OUTPUT_DC(to DC POWER PBA)
3	SMPS Control Signal (from main board)

- **Input / Output connector**

- **AC Input Connector (CON1)**

Description	PIN NAME	PIN ASSIGN
AC Input	AC_L	1
AC Input	AC_N	2

- **DC Output Connector (CON2)**

Description	PIN NAME	PIN ASSIGN
Power	+5V1	1
5V Ground	GND	2
Power	+5V2	3
24V Ground	+GND	4
Power	+24V1	5
24V Ground	GND	6
Power	+24V2	7
24V Ground	GND	8
Power	+24V3	9

- **Signal Connector (CON3)**

Description	PIN NAME	PIN ASSIGN
Ground	GND	1
SMPS Control	24V_ON_OFF	2
Ground	GND	3



## 2.9.6. Fuser Drive Board (FDB)

This board supplies 110V/220V power to the heat lamp. It help keep the stable power control.

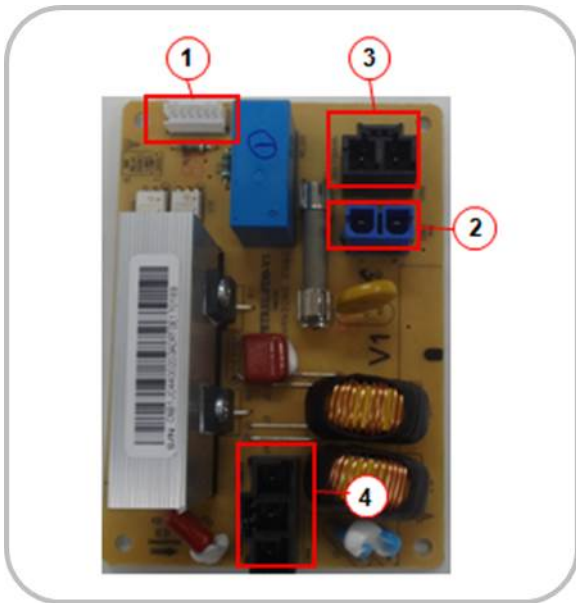

- **Specification**

- Output Power : 1300W
- AC Lamp1 : 700W
- AC Lamp2 : 600W

- **Information**

	110V	220V
Part Code	JC44-00203A	JC44-00204A
Part Name	FDB V1	FDB V2

- **Connection**

1	Fuser_Control Signal
2	OUTPUT_AC(to SMPS)
3	INPUT_AC
4	OUTPUT_AC( to AC Lamp1,2)

- **Input / Output connector**

- **AC Input Connector (CON2)**

Description	PIN NAME	PIN ASSIGN
AC Input	AC_L	1
AC Input	AC_N	2

- **AC Output Connector (CON3)**

Description	PIN NAME	PIN ASSIGN
AC Output	AC_L	1

Description	PIN NAME	PIN ASSIGN
AC Output	AC_N	2

- AC Output Connector (CON4)

Description	PIN NAME	PIN ASSIGN
AC OUTPUT (to Lamp)	LAMP1	1
	LAMP2	2
	COMMON	3

- Signal Connector (CON1)

Description	PIN NAME	PIN ASSIGN
Power	24VS1	1
Lamp1 Control Signal	Heater_ON1	2
Lamp2 Control Signal	Heater_ON2	3
Phase_Control Signal	Zero_Crossing_N.C	4
FDB ON_OFF	Relay_ON/OFF	5
Ground	GND	6

## 2.9.7. HVPS board

HVPS(High Voltage Power Supply) board generates high-voltage channels, which include THV, MHV, DEVE DC, Fuser-bias, SAW.

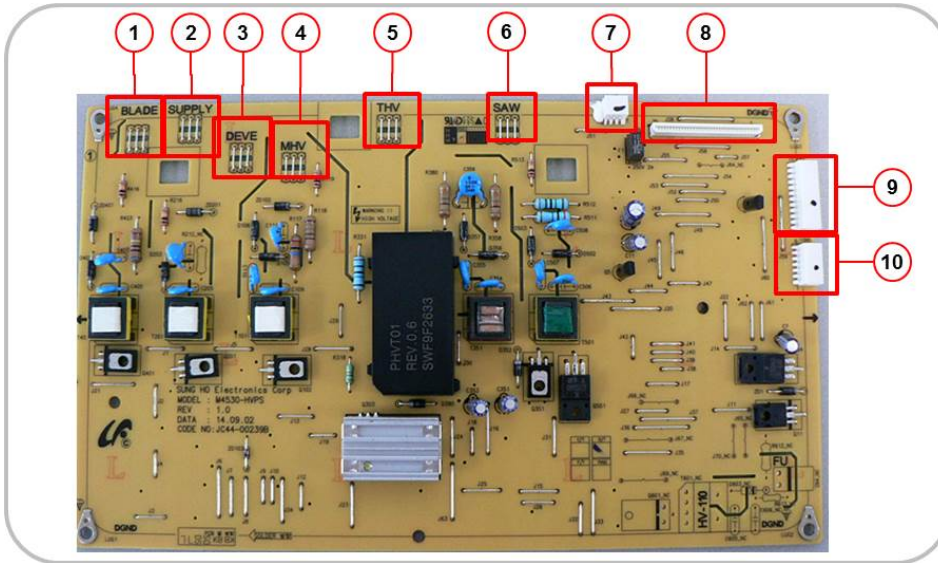

- **Information**

- Part Code : JC44-00239A
- Part Name : HVPS

- **Connection**

1	DR.BLADE
2	SUPPLY
3	DEVE
4	MHV
5	THV
6	SAW
7	LSU FAN
8	HVPS INPUT
9	REAR FAN / COVER OPEN
10	EXIT / ENV SENSOR

### 2.9.8. SCF board

SCF board controls the optional cassette. It consists of a controller(S3F443FX), motor drive IC for controlling the feeding timing with the main board.

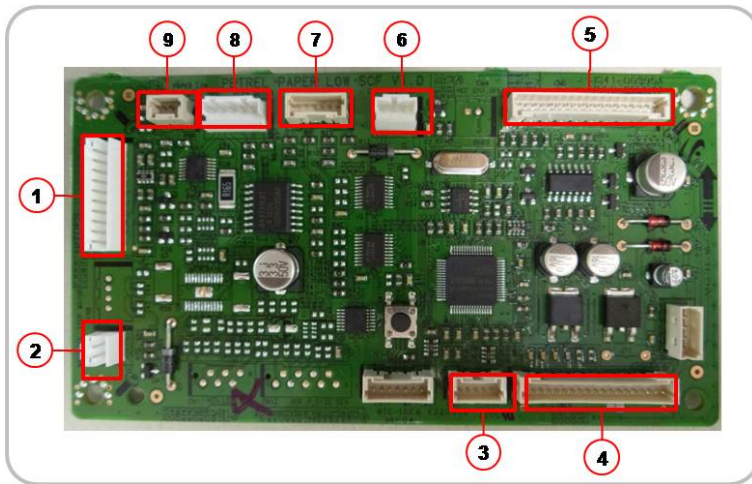

• **Information**

- Part Code : JC92-02754A
- PBA Name : PBA-SCF

• **Connection**

1	BLDC motor
2	Main solenoid
3	Paper size sensor
4	IF lower
5	IF upper
6	Regi solenoid
7	Paper empty sensor
8	Elevator motor
9	Paper low sensor

### 2.9.9. Eraser PBA

Eraser PBA is comprised of many LED components. Each LED is used for erasing negative charges on the surface of the drum after printing.

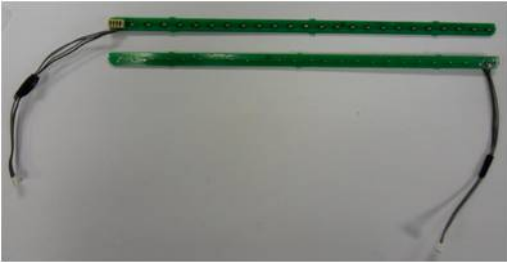

- **Information**

- Part Code : JC92-02373A
- Part Name : ERASER

### 2.9.10. Cover-Open PBA

This board cuts off and supply DC power when the front cover is opened or closed. It has the 24V power interlock function for safety.

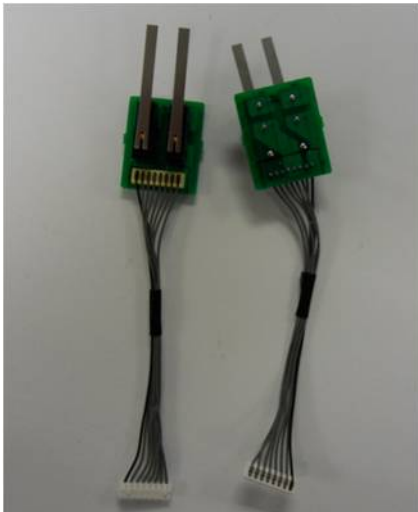

- **Information**

- Part Code : JC92-02371A
- Part Name : PBA-COVER OPEN SENSOR

- **Connection**

1	5VS
2	5V
3.4.5	24VS1
6.7.8	24V1

### 2.9.11. Deve\_Toner Crum Joint PBA

---

The Deve Crum Joint PBA is the interface PBA between the Imaging Unit and the system.



- **Information**

- Part Code : JC92-02163A
- Part Name : DEVE CRUM JOINT

### 2.9.12. Toner Remain Sensor PBA

---

This board detects the toner supply status for the toner cartridge and imaging unit.

It checks the toner supply level through the optical path and send the information to the main board.

When the toner level is low, the main board controls the toner supply motor for toner supplement.



- **Information**

- Part Code : JC92-02752A

### 2.9.13. Joint PBA

The Joint PBA provides the interface for clutch, sensor and motors.

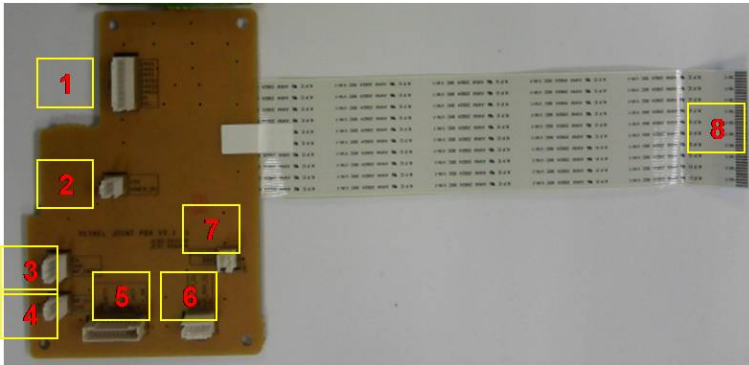

- **Connection**

1	Cover-Open IF
2	Toner DC Motor IF
3	MP Sensor IF
4	MP Clutch IF
5	Paper Sensor IF
6	Pickup & Dulpex Clutch IF
7	Regi Clutch IF
8	Main IF FFC Cable

- **Information**

- Part Code : JC92-02374A
- Part Name : JOINT-PBA

### 2.9.14. EEPROM PBA

---

The EEPROM PBA includes CRU memory for imaging unit life cycle counting.



### 2.9.15. CRUM PBA

---

The CRUM PBA includes CRU memory for toner cartridge life cycle counting.





---

## 3. Disassembly and Reassembly

---

### 3.1. Precautions when replacing parts

---

#### 3.1.1. Precautions when assembling and disassembling

---

- Use only approved Samsung spare parts. Ensure that part number, product name, any voltage, current or temperature rating are correct. Failure to do so could result in damage to the machine, circuit overload, fire or electric shock.
- Do not make any unauthorized changes or additions to the printer, these could cause the printer to malfunction and create electric shock or fire hazards.
- Take care when dismantling the unit to note where each screw goes. There are 19 different screws. Use of the wrong screw could lead to system failure, short circuit or electric shock.
- Do not disassemble the LSU unit. Once it is disassembled dust is admitted to the mirror chamber and will seriously degrade print quality. There are no serviceable parts inside.
- Regularly check the condition of the power cord, plug and socket. Bad contacts could lead to overheating and fire. Damaged cables could lead to electric shock or unit malfunction.

#### 3.1.2. Precautions when handling PBA

---

Static electricity can damage a PBA, always use approved anti-static precautions when handling or storing a PBA.

- **Precautions when moving and storing PBA**
  - 1) Please keep PBA in a conductive case, anti-static bag, or wrapped in aluminum foil.
  - 2) Do not store a PBA where it is exposed to direct sunlight.
- **Precautions when replacing PBA**
  - 1) Disconnect power connectors first, before disconnecting other cables.
  - 2) Do not touch any soldered connections, connector terminals or other electronic parts when handling insulated parts.
- **Precautions when checking PBA**
  - 1) Before touching a PBA, please touch other grounded areas of the chassis to discharge any static electrical charge on the body.
  - 2) Take care not to touch the PBA with your bare hands or metal objects as you could create a short circuit or get an electric shock. Take extra care when handling PBAs with moving parts fitted such as sensors, motors or lamps as they may get hot.
  - 3) Take care when fitting, or removing, screws. Look out for hidden screws. Always ensure that the correct screw is used and always ensure that when toothed washers are removed they are refitted in their original positions.

### 3.1.3. Releasing Plastic Latches

---

Many of the parts are held in place with plastic latches. The latches break easily; release them carefully.

To remove such parts, press the hook end of the latch away from the part to which it is latched.

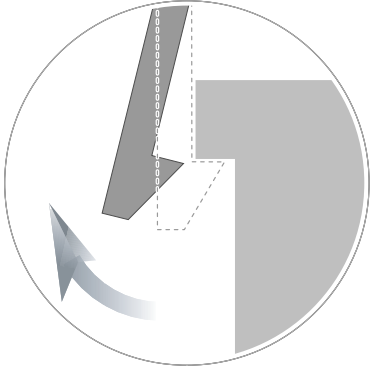

## 3.2. Replacing the maintenance part

### 3.2.1. Fuser Unit

1. Turn the machine off.
2. Open the rear cover.



3. While opening the rear cover at a 45° angle, lift up the right side of the rear cover, Then take off the rear cover.



4. Remove 4 screws.

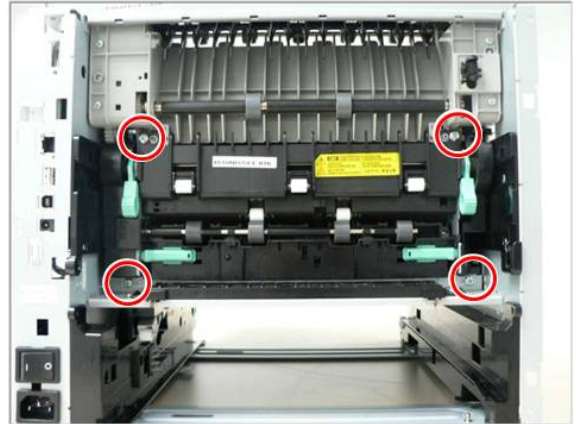

5. Lift up both levers. Then release the fuser unit.

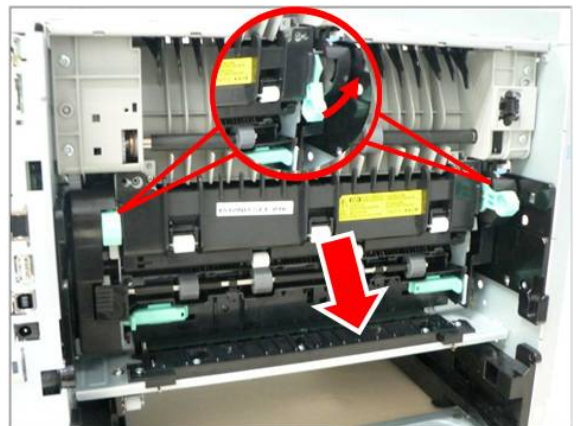

 **CAUTION**

The fuser area is hot. Take care when removing paper from the machine.

### 3.2.2. Transfer Roller

1. Turn the machine off.
2. Open the front cover. Remove the toner cartridge and imaging unit.

**NOTE**

When replacing the toner cartridge, you have to unlock its locking lever.

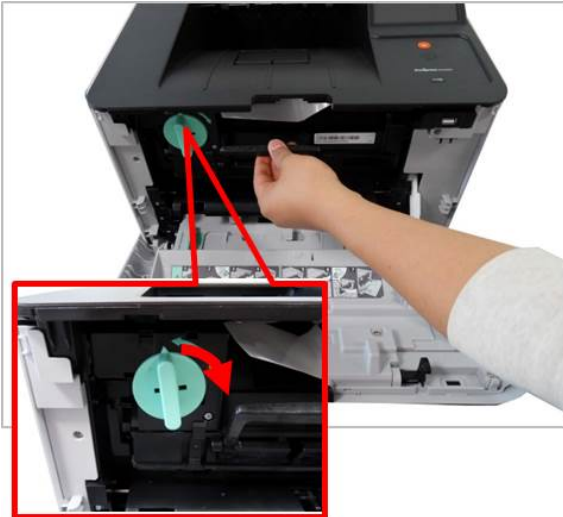

3. Release the transfer roller Assy while pushing the both side holder to the direction of arrow.

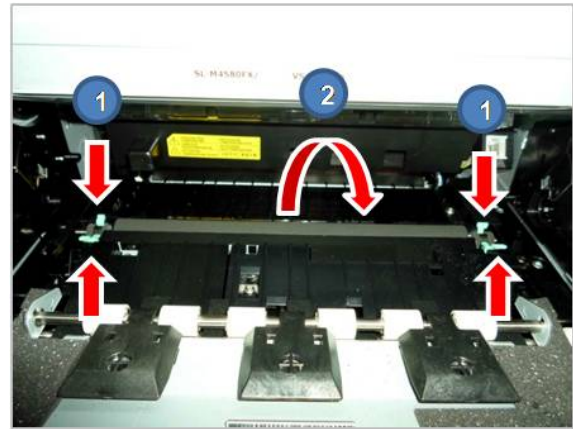

4. Insert the toner cartridge and imaging unit.
5. Close the front cover.
6. Turn the machine on.

### 3.2.3. Pick-Up\_Forward roller

1. Remove the cassette.



2. Lift small tap, then remove the pick up / forward roller.

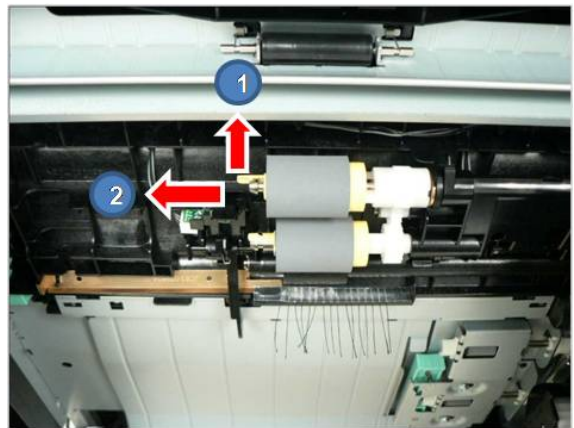

 **NOTE**

When replacing these rollers, it is recommended that you replace all rollers at the same time.

### 3.2.4. SCF Separation Roller

---

1. Remove the SCF cassette.



2. Open the separation roller cover.



3. Lift small tap, then remove the separation roller.

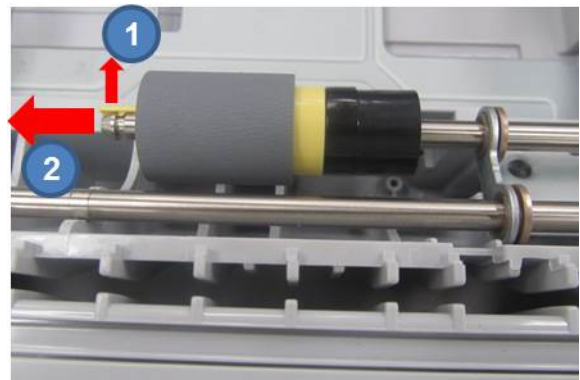

### 3.2.5. SCF Pick-up Roller and Forward Roller

1. Remove the cassette.



2. Lift small tap, then remove the pick up and forward roller.

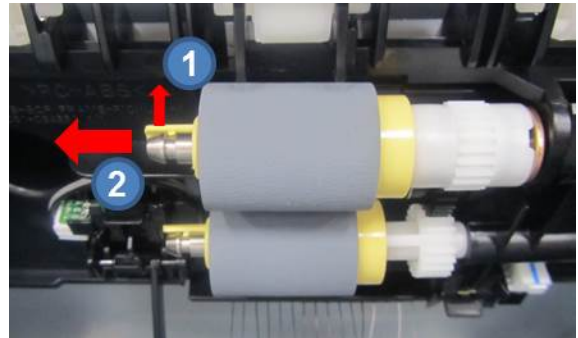

### 3.3. Replacing the main SVC part

---

#### 3.3.1. Rear Cover

---

1. Open the rear cover.



2. While opening the rear cover at a 45° angle, lift up the right side of the rear cover, Then take off the rear cover.





### 3.3.2. Front Cover

1. Remove the cassette. Open the MP tray.



2. Release the linker from the right of the MP tray.



3. Remove the MP tray by releasing the hook of the COVER-MP.

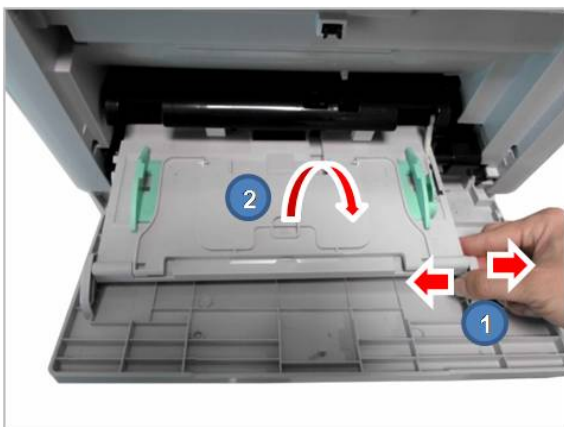

4. Remove the COVER-MP.



5. Release the linker from the right of the front cover. Then remove the front cover.

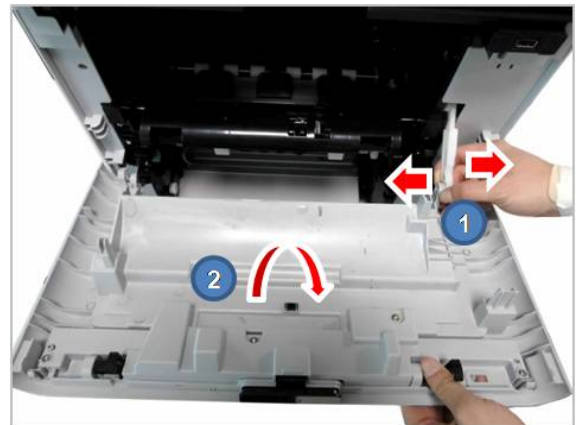

### 3.3.3. Right\_Left Cover

1. Remove the cassette.
2. Remove 3 screws from the rear.



5. Remove 2 screws from the rear.



3. Remove 2 screws from the front.

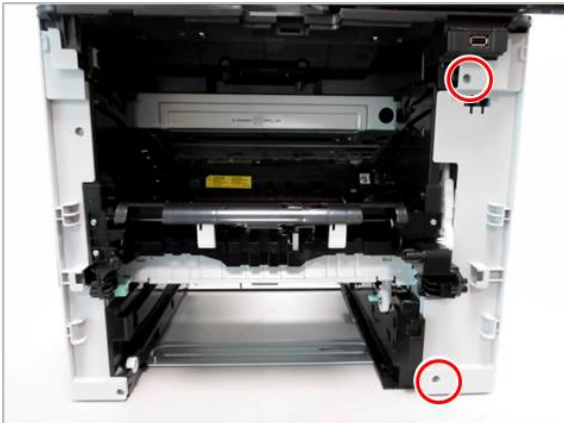

6. Remove 2 screws from the front.

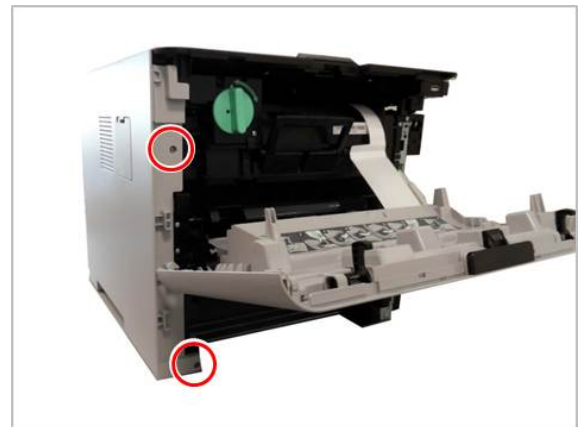

4. Release the right cover.



7. Release the left cover.



### 3.3.4. Top Cover

1. Remove the Top-Dummy cover.



2. Remove 3 screws.



3. Remove 2 screws.

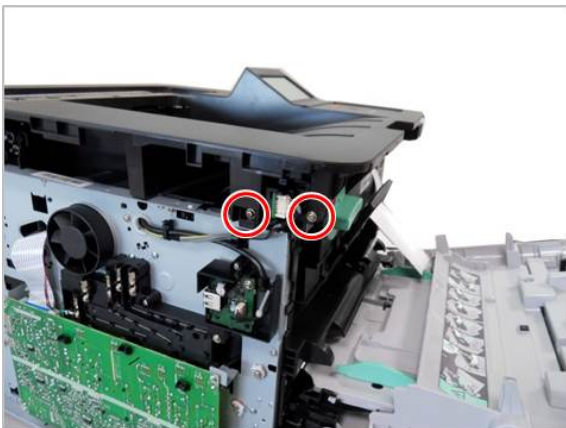

4. Remove 1 screw. Unplug the harness from the main board.



5. Unlock the locking lever of the toner cartridge. Then, remove 1 screw.



6. Pull the rear of the ton cover up and release it.

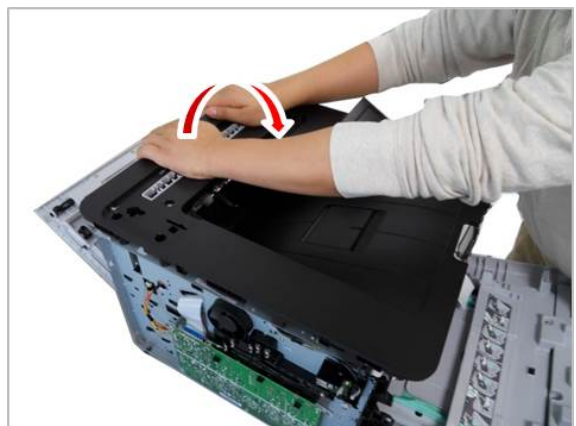

### 3.3.5. OPE Unit

---

1. Remove the top cover. (**Refer to 3.3.4.**)
2. Remove 7 screws. Then, remove the Cover-USB.

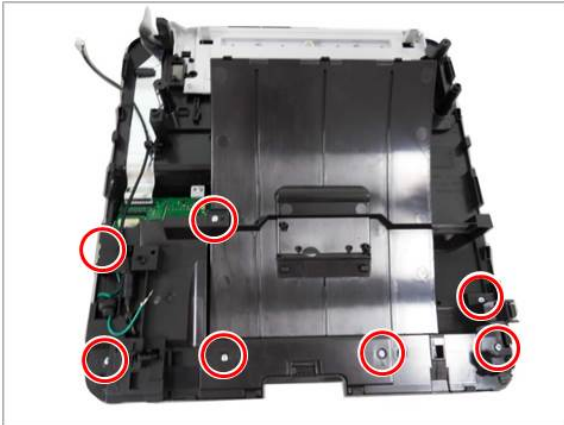

4. Remove 4 screws. Release the LCD Assy with the bracket. And remove the LCD.



3. Remove 4 screws. Then, remove the OPE-Key PBA.



### 3.3.6. HDD (Hard Disk Drive)

1. Remove the right cover. (Refer to 3.3.3.)
2. Remove 3 screws.
3. Unplug 2 cables. Then remove the HDD Assy.

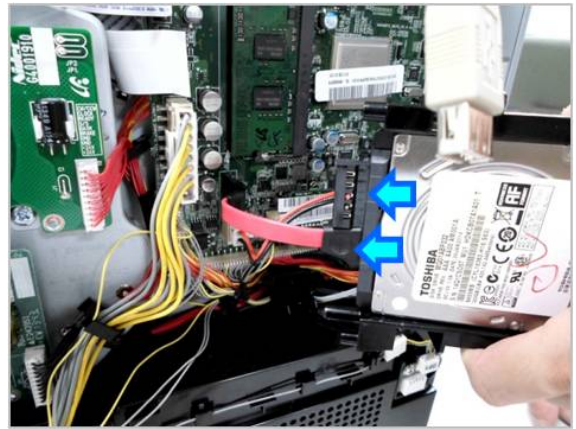

### 3.3.7. Main Board

---

1. Remove the right cover. (**Refer to 3.3.3.**)
2. Remove the HDD. (**Refer to 3.3.6.**)
3. Unplug all harness from the main board. Remove 4 screws. Then release the main board.

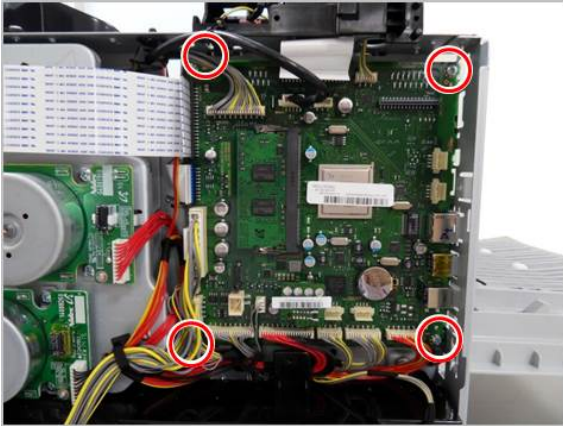

 **NOTE**

- When a main board needs to be exchanged, the MSOK PBA should be re-installed to the new main board to retain the system information.

### 3.3.8. Joint PBA

---

1. Remove the right cover. (**Refer to 3.3.3.**)
2. Unplug all cables on the joint PBA.
3. Remove 4 screws. Then release the joint PBA.

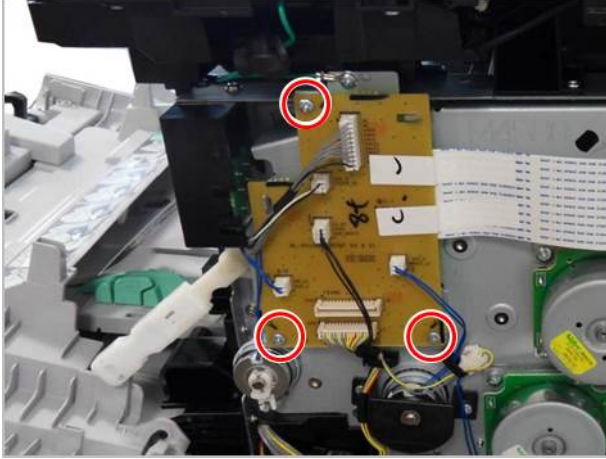

### 3.3.9. SMPS and FDB (Fuser Drive Board)

1. Remove the right cover. (Refer to 3.3.3.)

2. Remove 4 screws.

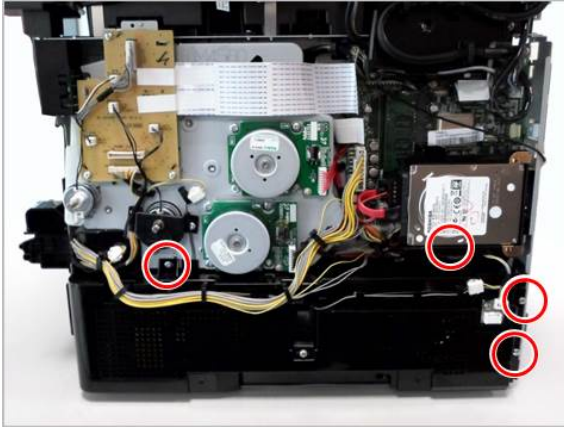

3. Unplug the cable. Then release the SMPS cover.



4. Unplug all cables on FDB. Remove 3 screws. And release the FDB.

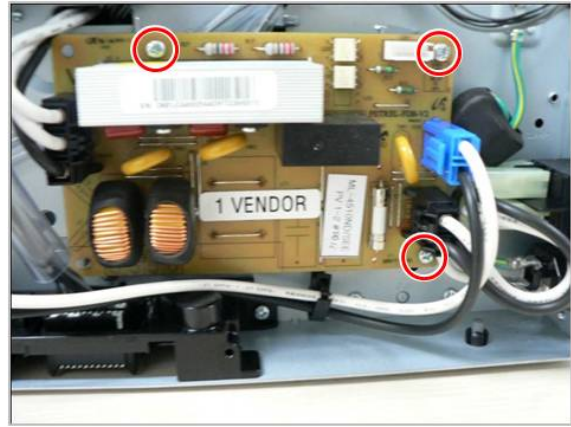

5. Unplug all cables on SMPS. Remove 3 screws. And release the SMPS.





### 3.3.10. OPC motor and Main motor

1. Remove the right cover. (Refer to 3.3.3.)
2. Unplug the cable on the OPC motor. Remove 4 screws. Then release the OPC motor.

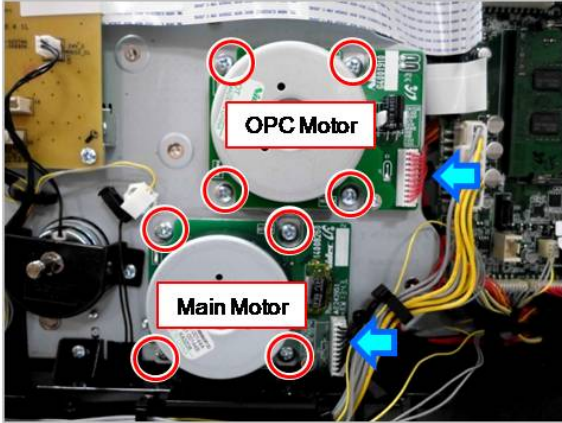

### 3.3.11. Main Drive Unit

1. Remove the right cover. (**Refer to 3.3.3.**)
2. Remove the Joint PBA. (**Refer to 3.3.8.**)
3. Remove the SMPS cover. (**Refer to 3.3.9.**)
4. Remove the MP clutch after removing the E-clip. And remove the gear after removing the E-clip.

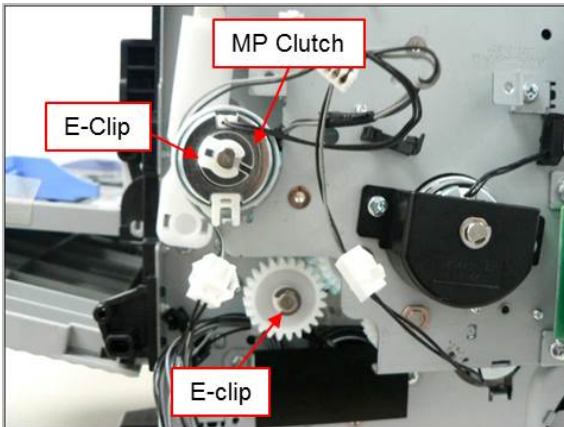

5. Remove 5 screws. Then release the main drive unit.

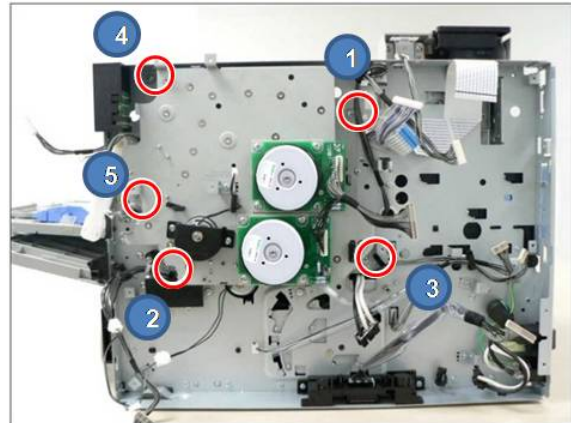

**NOTE**

When reassembling the main drive unit, tighten 5 screws in order as shown above.

### 3.3.12. Duplex clutch and Pick up clutch

1. Remove the right cover. (**Refer to 3.3.3.**)
2. Remove the main drive unit. (**Refer to 3.3.11.**)
3. Release the bracket after removing 2 screws. Then, remove the pick up clutch.

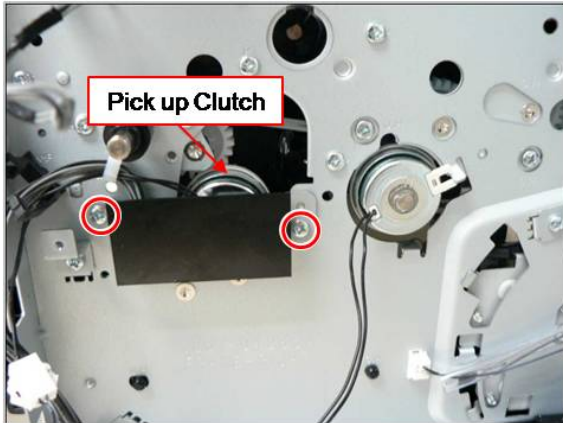

4. Remove the E-ring. Then, remove the duplex clutch.

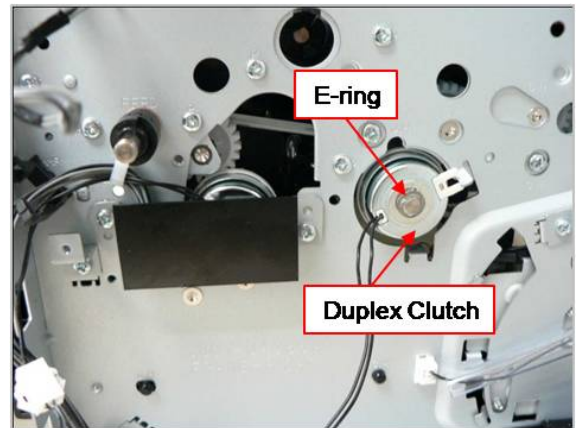

### 3.3.13. HVPS board

---

1. Remove the left cover. (**Refer to 3.3.3.**)
2. Unplug all cables from the HVPS board.

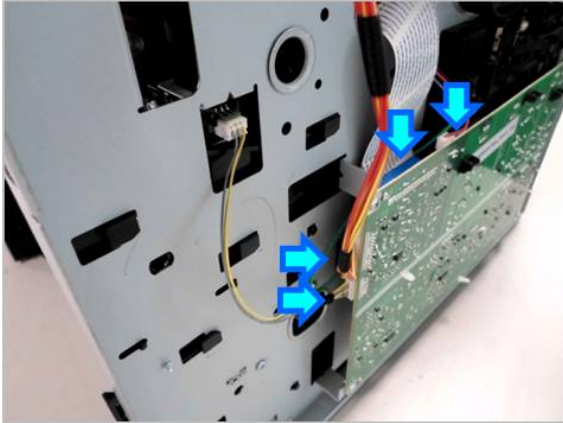

3. Remove 4 screws. Then release the HVPS board.

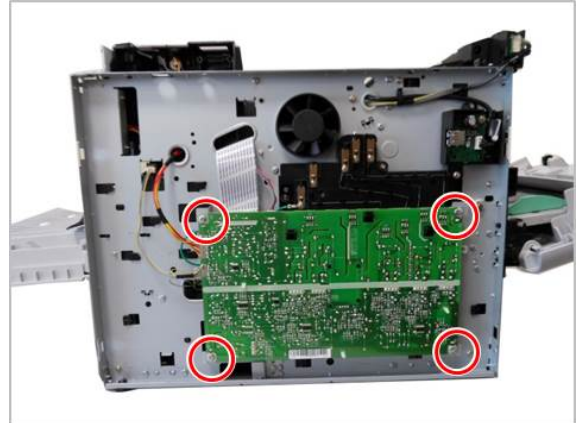

### 3.3.14. Exit Unit

1. Remove the rear/front/left/right cover. (**Refer to 3.3.1~3.**)
2. Remove the fuser unit. (**Refer to 3.2.1.**)
3. Remove the top cover. (**Refer to 3.3.4.**)
4. Remove 2 screws. Then release the bracket.



#### NOTE

When reassembling the exit unit, first tighten these screws to secure the frame and bracket.

5. Remove 4 screws from the rear.



6. Remove 2 screws. Release the Exit unit after pull it to the rear slightly.

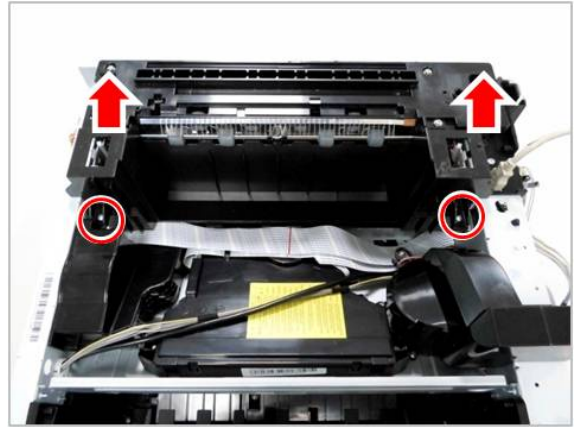

### 3.3.15. LSU

---

1. Remove the top cover. (**Refer to 3.3.4.**)
2. Remove the flat cable on the LSU.
3. Remove 4 screws. Unplug the cable. And release the LSU.

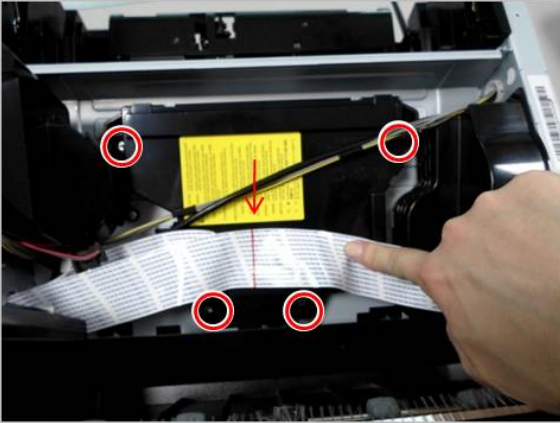

#### NOTE

When reassembling the LSU, place the harness center line to the arrow on the LSU.

### 3.3.16. Eraser Lamp PBA

1. Remove the LSU. (Refer to 3.3.15.)
2. Remove 1 screw and push 1 hook.



3. Pull the eraser lamp PBA to the left slightly. And then release it.

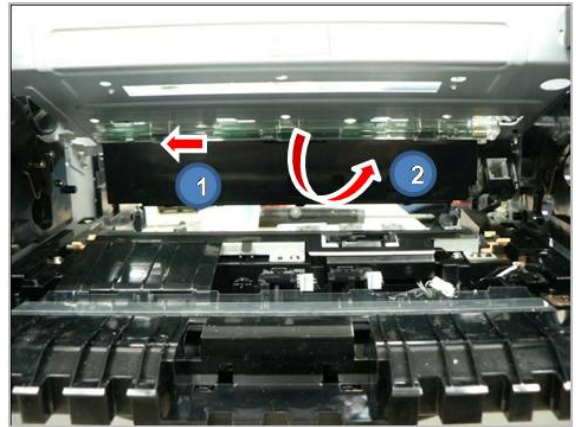

### 3.3.17. Cover Open PBA

---

1. Remove the right cover. (**Refer to 3.3.3.**)
2. Remove the top cover. (**Refer to 3.3.4.**)
3. Remove 2 screws. Then release the Cover Open PBA.

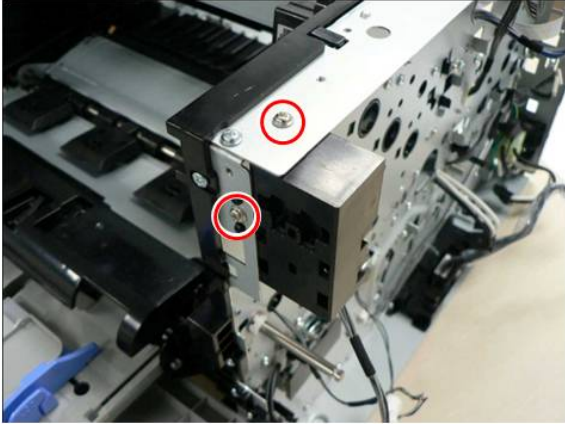



### 3.3.18. Pick up Assy

1. Remove the right / left cover. (Refer to 3.3.3.)
2. Remove 4 screws securing the HVPS board.

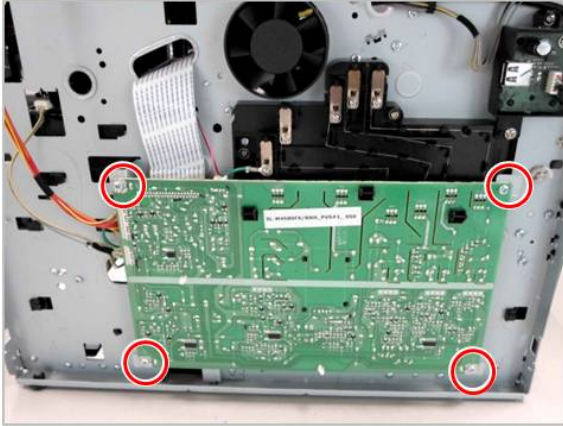

3. Remove 5 screws.

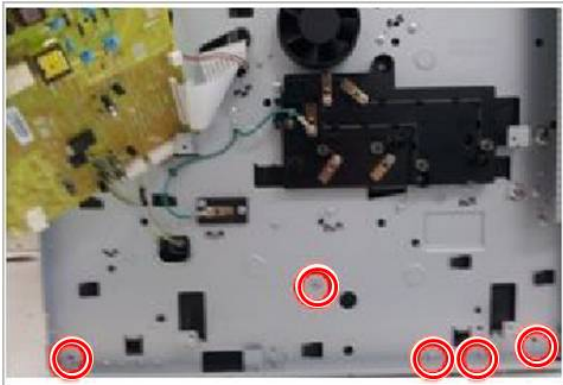

4. Pull and release the Cassette Guide L while pushing its 2 poles.

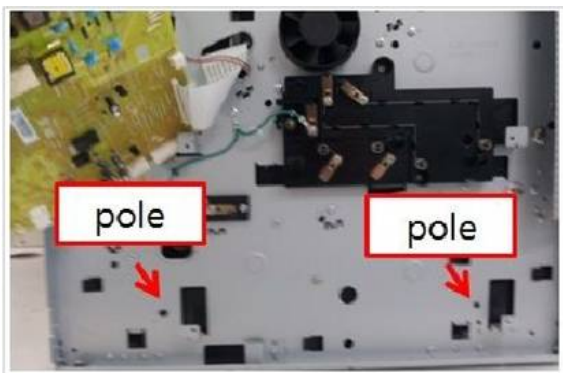

5. Remove 4 screws. Then remove the SMPS cover.

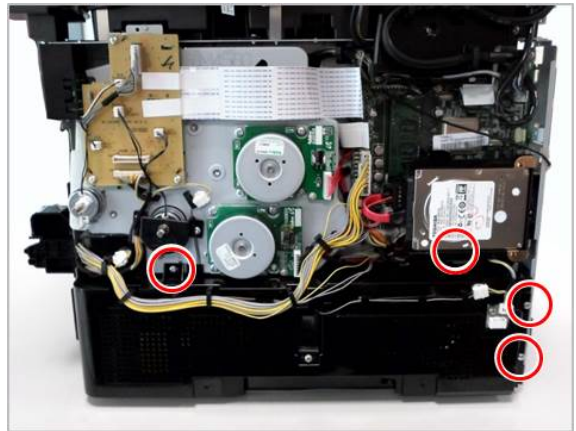

6. Remove 3 screws. Then release the SMPS board.



7. Remove 2 screws.

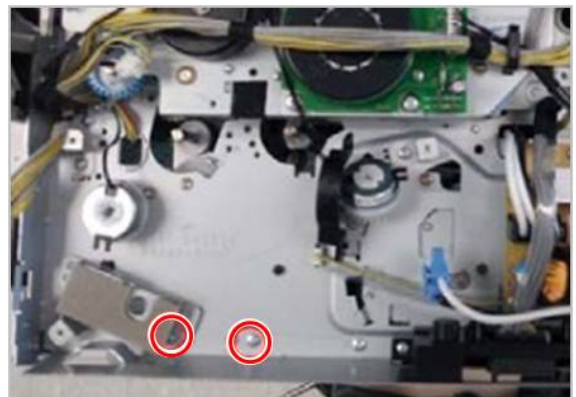

8. Remove the Joint PBA after removing 3 screws.

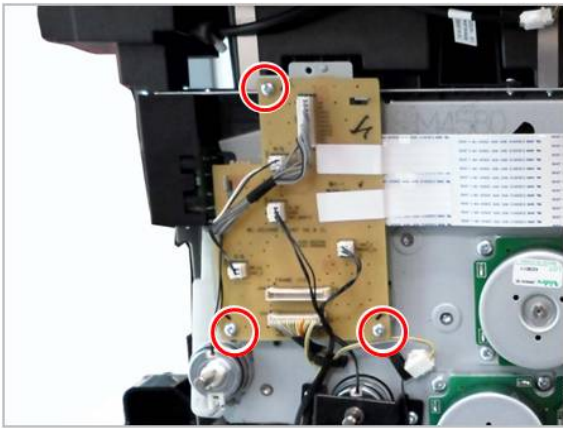

9. Remove the MP clutch. Remove the gear after removing the E-Ring.

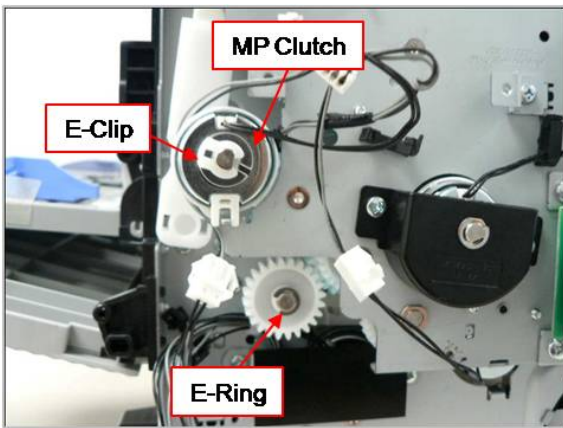

10. Remove the main drive unit after removing 5 screws.

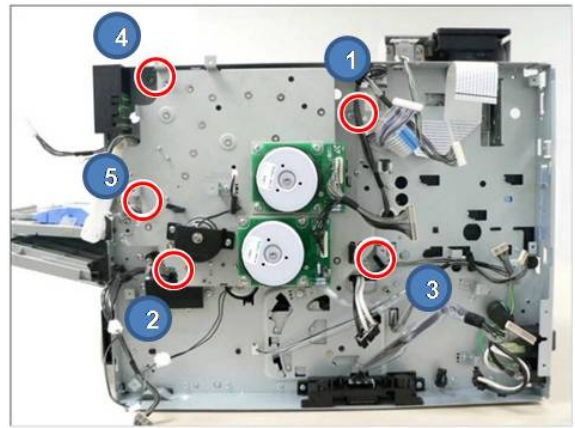

**! NOTE**

When reassembling the main drive unit, tighten 5 screws in order as shown above.

11. Remove the duplex clutch and pick up clutch.

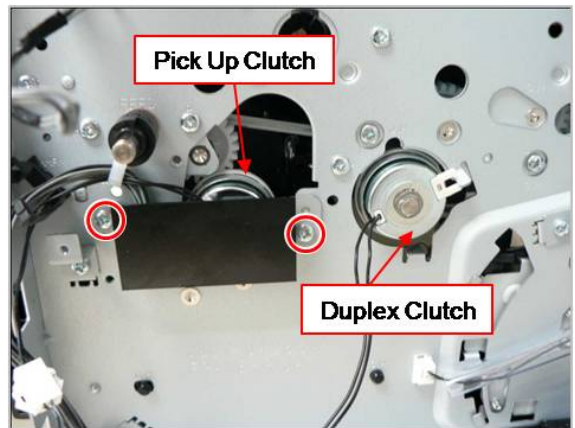

12. Release the duplex belt.



13. Remove 2 washers. Then release 2 gears.



14. Remove 4 screws. Then release the Pick up Assy.

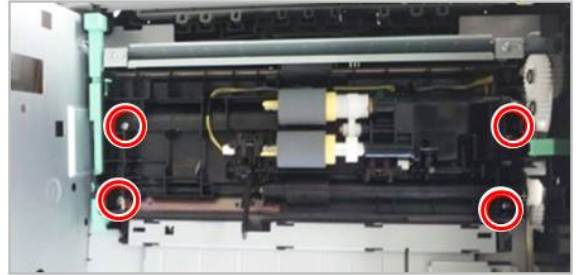

### 3.3.19. Second Cassette Feeder (Optional Tray)

#### 3.3.19.1. PBA-SCF

1. Remove the SCF cassette.
2. Remove 3 screws.

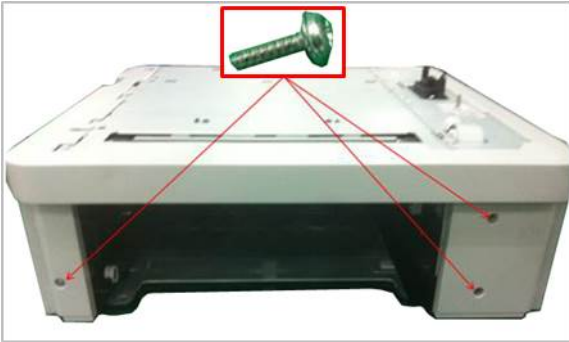

3. Remove the Cover Dummy Front.



4. Remove 2 screws. Then, remove the Cover-Right.

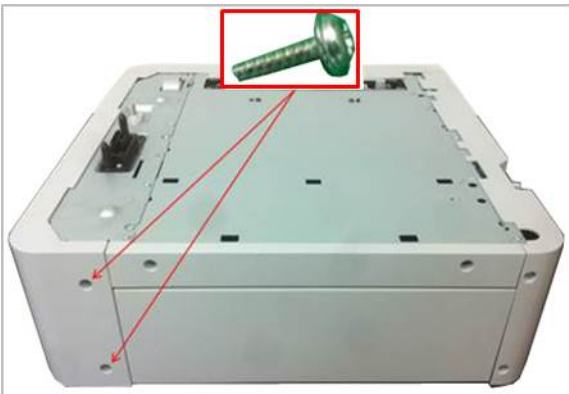

5. Remove 7 screws. Then, remove the Frame Dummy Right.



6. Remove 3 screws. Then, release the PBA-SCF.

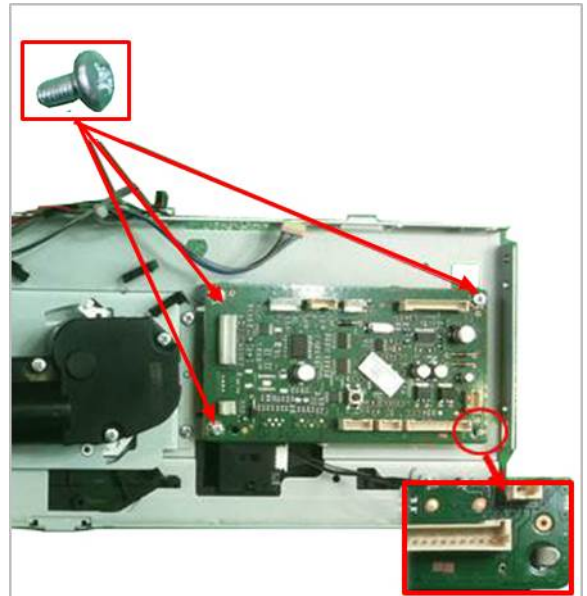

### 3.3.19.2. Lift Unit

1. Remove the SCF cassette.

2. Remove 3 screws.

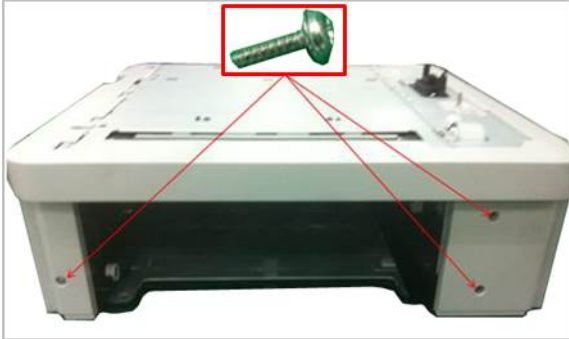

3. Remove the Cover Dummy Front.



4. Remove 2 screws. Then, remove the Cover-Right.

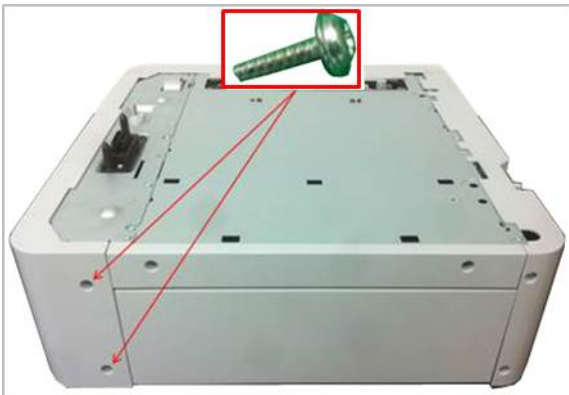

5. Remove 7 screws. Then, remove the Frame Dummy Right.

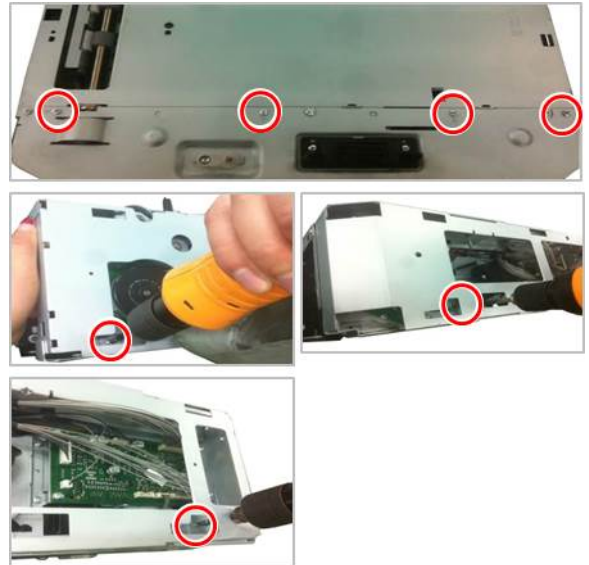

6. Remove 4 screws. Then, release the Lift Unit.

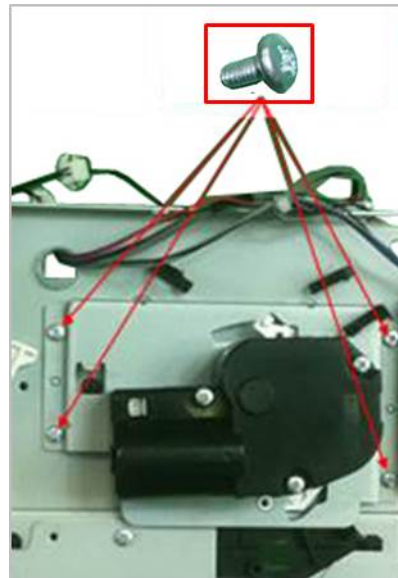

### 3.3.19.3. Clutch

1. Remove the SCF cassette.
2. Remove 3 screws.

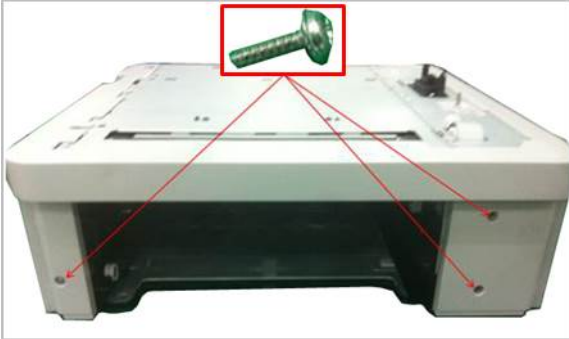

3. Remove the Cover Dummy Front.



4. Remove 2 screws. Then, remove the Cover-Right.

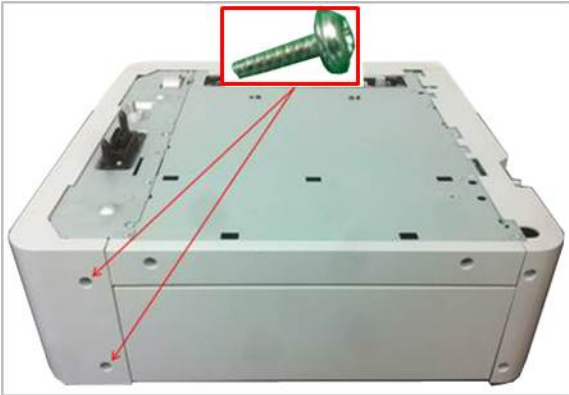

5. Remove 7 screws. Then, remove the Frame Dummy Right.

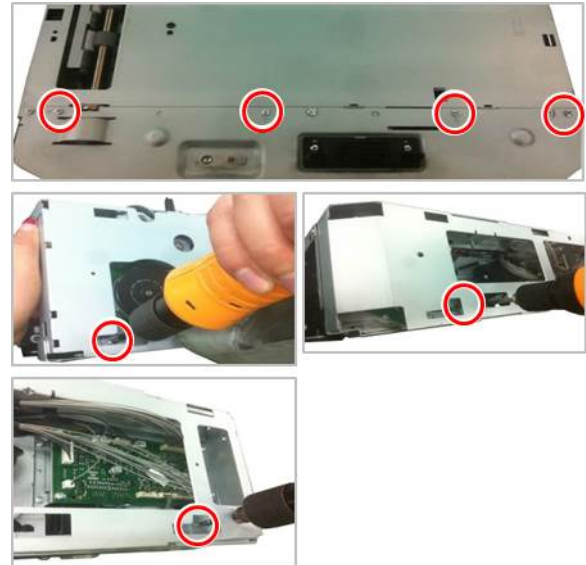

6. Remove 2 E-RINGS and 2 BUSHs. Remove 2 screws. And then, remove the bracket.

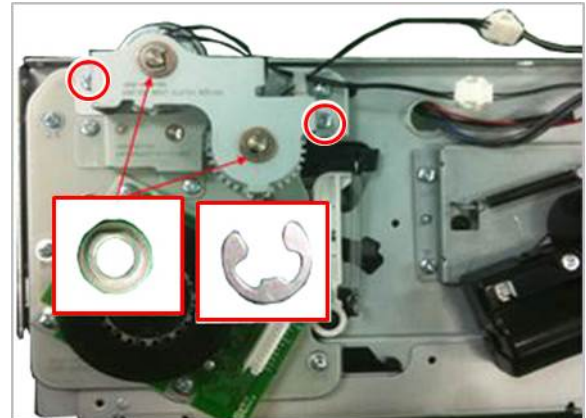

7. Open the harness clamp. Unplug the clutch connector. And then, release the clutch.

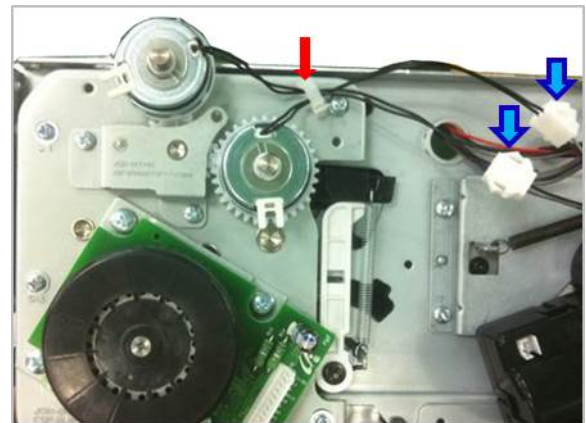

### 3.3.19.4. Drive Unit

1. Remove the SCF cassette.

2. Remove 3 screws.

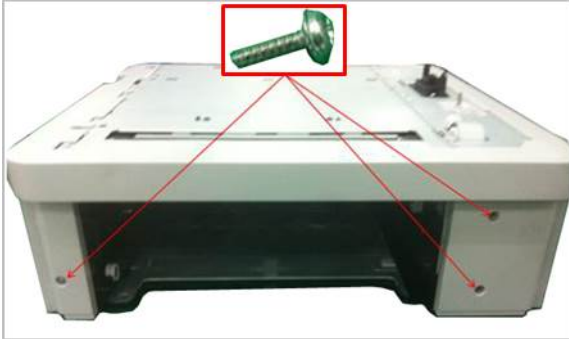

3. Remove the Cover Dummy Front.



4. Remove 2 screws. Then, remove the Cover-Right.

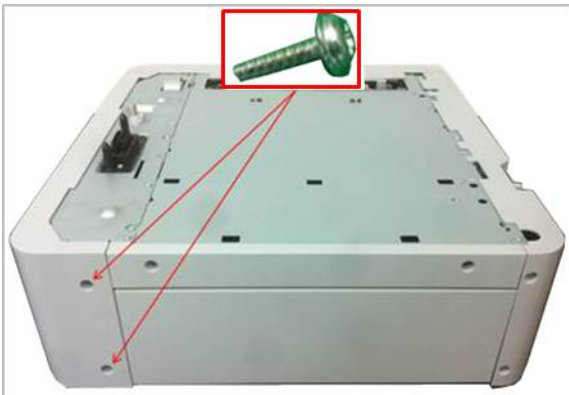

5. Remove 7 screws. Then, remove the Frame Dummy Right.

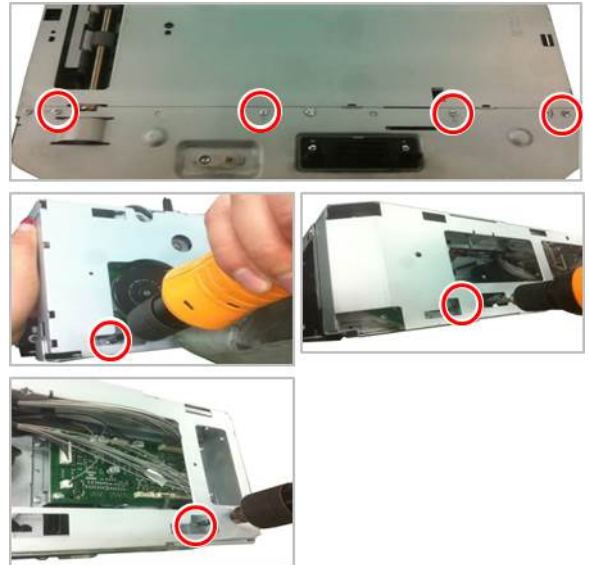

6. Remove 4 screws. Then, release the Drive Unit.

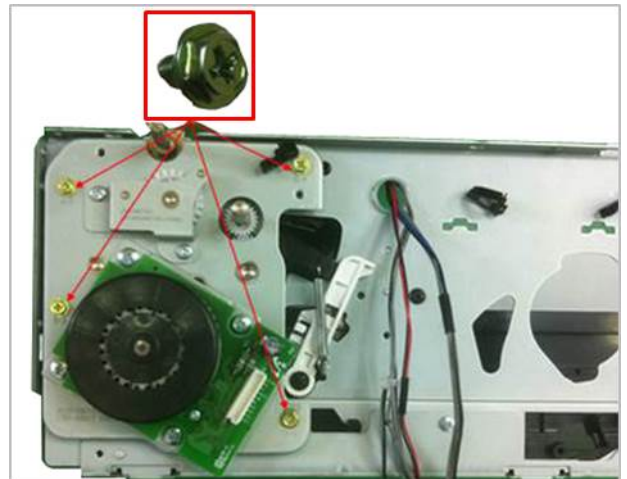

# 4. Troubleshooting

## 4.1. Control panel

### M453xND series

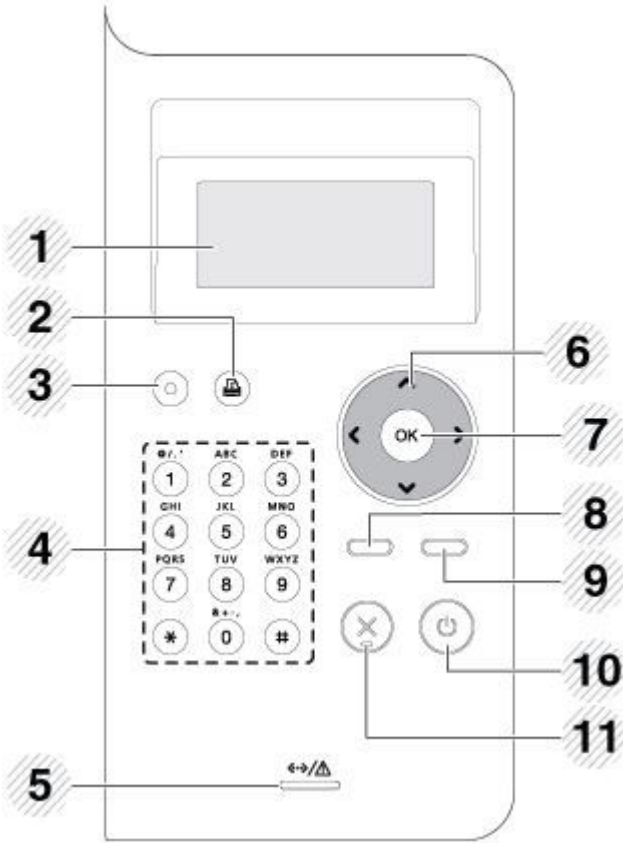

1	Display screen	Shows the current status and prompts during an operation.
2	Demo sheet	Prints a demo page by pressing this button.
3	Eco	Turn on the Eco mode to reduce toner consumption and paper usage.
4	Numeric keypad	Use the keypad to enter numbers and characters.
5	Status LED	Indicates the status of your machine.
6	Arrow	Navigates available values by moving to the next or previous options.
7	OK	Confirms the selection on the screen.
8	Menu	Enters menu mode and scrolls through the available menus.
9	Back	Sends you back to the upper menu level.
10	Power/ Wake Up	You can turn the power on and off with this button. Or wake up from the power save mode.
11	Stop/Clear	Stops current operation.

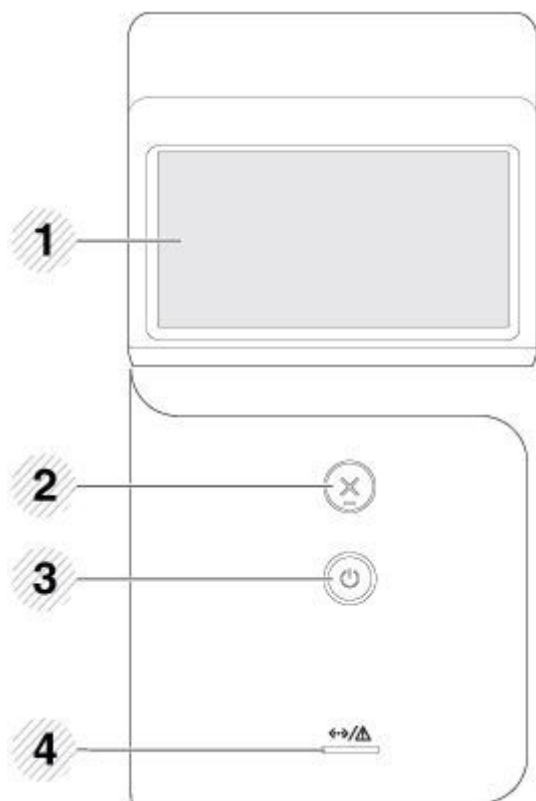

**M453xNX series**

1	Touch screen	Displays the current status and allows you to access available menus.
2	Stop/Clear	Stops current operation.
3	Power/ Wake Up	You can turn the power on and off with this button. Or wake up from the power save mode.
4	LED	Indicates the status of your machine.

## 4.2. Understanding the status LED

The color of the status LED indicates the machine's current status.

LED	Status	Description	
Status LED	Off	The machine is off-line.	
	Blue	Blinking	When the backlight blinks, the machine is receiving or printing data.
		On	The machine is on-line and can be used.
	Red	Blinking	<ul style="list-style-type: none"> <li>A minor error has occurred and the machine is waiting for the error to be cleared. Check the display message. When the problem is cleared, the machine resumes.</li> <li>Small amount of toner is left in the cartridge. The estimated cartridge life of toner is close. Prepare a new cartridge for replacement. You may temporarily increase the printing quality by redistributing the toner.</li> </ul>
		On	<ul style="list-style-type: none"> <li>A toner cartridge has almost reached its estimated cartridge life. It is recommended to replace the toner cartridge.</li> <li>The cover is opened. Close the cover.</li> <li>There is no paper in the tray when receiving or printing data. Load paper in the tray.</li> <li>The machine has stopped due to a major error. Check the display message.</li> <li>A paper jam has occurred.</li> </ul>
	Power LED	Blue	On
Off			The machine is in ready mode or machine's power is off.



### NOTE

Estimated cartridge life means the expected or estimated toner cartridge life, which indicates the average capacity of print-outs and is designed pursuant to ISO/IEC 19752. The number of pages may be affected by operating environment, percentage of image area, printing interval, graphics, media and media size.

## 4.3. Updating Firmware

This chapter includes instructions for updating the printer firmware. You can update the printer firmware by using one of the following methods :

- Update the firmware by using the printer control panel
- Update the firmware by using the network.

### NOTE

After FW upgrade with memory clear, DSDF CIS Shading required. About DSDF Shading, please refer to “[4.5.5.3. Scanner Diagnostics](#)”

### 4.3.1. Updating with the USB cable

#### WARNING

**Failure to follow these instructions could lead to corruption issues and prevent the proper operation of this printer. Follow all of the instructions carefully.**

- 1) Download the firmware file from the Global Service Partner Network (GSPN) or Technical Support Portal (TSP) website.
- 2) Unzip the firmware file to a folder on your PC.
- 3) Make sure that the machine is connected to the PC with a USB cable.
- 4) Make sure that “Firmware Upgrade” option is on.
  - M4530NX : Setup > Admin Setup > Firmware Upgrade
  - M4530ND : Menu > Admin Setup > Firmware Upgrade
- 5) Drag the firmware file(\*.hd) and drop the file down on usblast2 icon; then the firmware will be update automatically.
- 6) If completed, the firmware update will be rebooted automatically.

### 4.3.2. Updating from the Network



#### WARNING

Failure to follow these instructions could lead to corruption issues and prevent the proper operation of this printer. Follow all of the instructions carefully.

Perform the following procedure to update the printer firmware from the network.

- 1) Access a web browser, such as Internet Explorer, from Windows. Enter the machine IP address (<http://xxx.xxx.xxx.xxx>) in the address field and press the Enter key or click Go. When the main page of the SyncThruWeb Service (SWS) displays, login as Admin in Sync Thru Web Service.



#### NOTE

- Login using the Administrator ID and Password established during initial machine setup.
- If Admin ID and password is not established, use the default value. (ID: admin / Password: sec00000)

The screenshot displays the Samsung SyncThru Web Service interface for an M453x Series printer. The main page includes sections for Device Information (showing a warning for 'Paper Low in tray 2'), Supplies Information (showing a toner cartridge at 82% remaining), and a navigation menu with options like Information and Maintenance. A 'Login' dialog box is overlaid on the page, featuring the Samsung logo and the text 'SyncThru Web Service'. The dialog box has input fields for 'ID' and 'Password' and a 'LOGIN' button. The background page also shows a 'Control Panel Update' button and a 'Home' link.

2) Click on **Maintenance > Firmware Upgrade**.

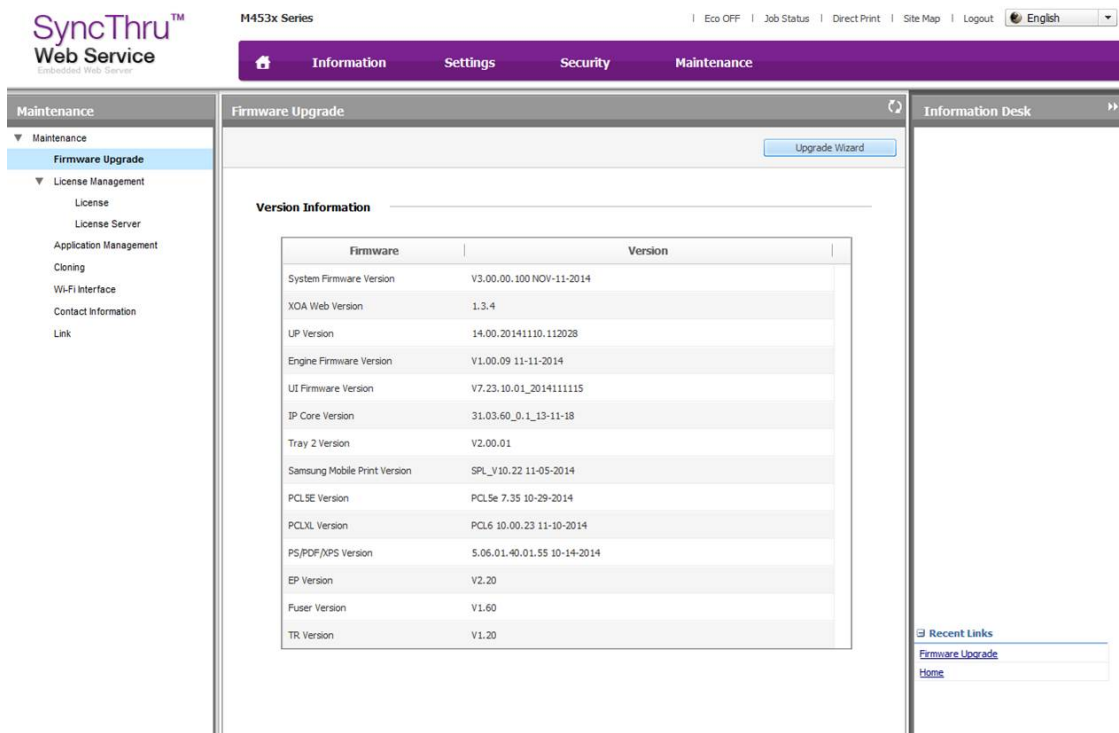

The screenshot shows the SyncThru Web Service interface for an M453x Series device. The 'Maintenance' menu is expanded to 'Firmware Upgrade'. The main content area displays 'Version Information' with the following table:

Firmware	Version
System Firmware Version	V3.00.00.100 NOV-11-2014
XOA Web Version	1.3.4
UP Version	14.00.20141110.112028
Engine Firmware Version	V1.00.09 11-11-2014
UI Firmware Version	V7.23.10.01_2014111115
IP Core Version	31.03.60_0_1_13-11-18
Tray 2 Version	V2.00.01
Samsung Mobile Print Version	SPL_V10.22 11-05-2014
PCLSE Version	PCLSe 7.35 10-29-2014
PCLXL Version	PCL6 10.00.23 11-10-2014
PS/PDF/XPS Version	5.06.01.40.01.55 10-14-2014
EP Version	V2.20
Fuser Version	V1.60
TR Version	V1.20

An 'Upgrade Wizard' button is visible in the top right corner of the main content area. The left sidebar contains a navigation menu with options like License Management, Application Management, Cloning, Wi-Fi interface, Contact Information, and Link. The right sidebar shows 'Recent Links' with 'Firmware Upgrade' and 'Home' links.

3) Choose installation file (F/W file) by browsing the file system and click **[OK]**.

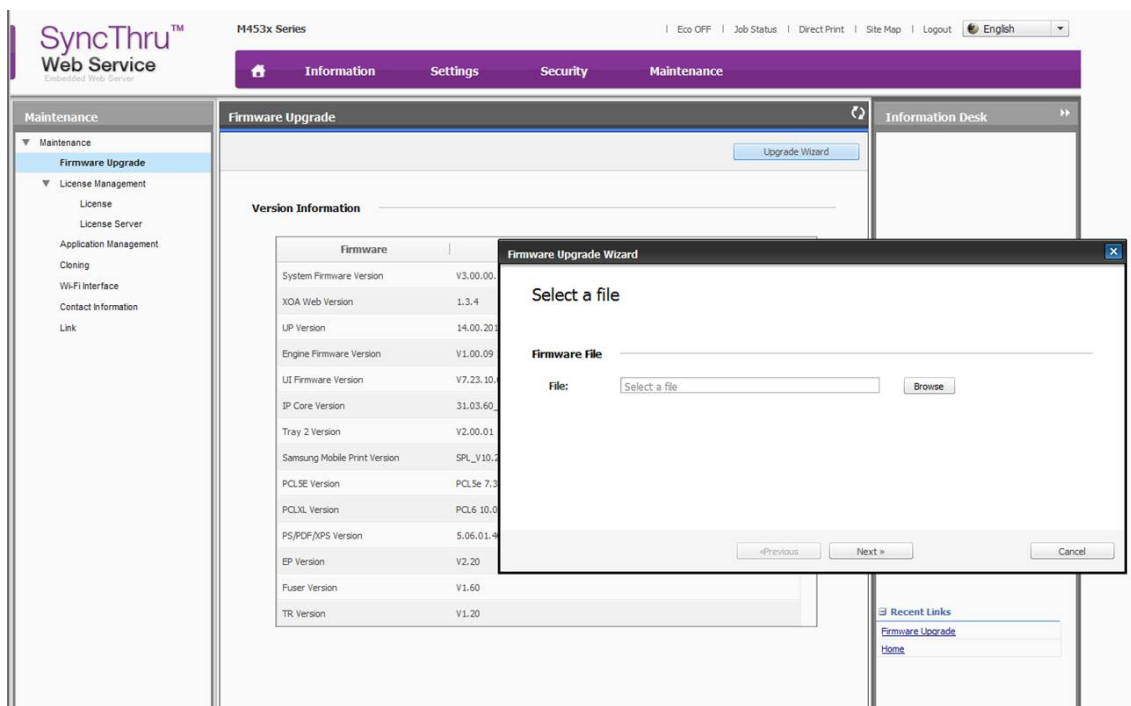

The screenshot shows the same SyncThru Web Service interface as above, but with a 'Firmware Upgrade Wizard' dialog box open. The dialog box is titled 'Select a file' and contains the following elements:

- A label 'Firmware File' followed by a text input field containing 'Select a file'.
- A 'Browse' button to the right of the input field.
- Navigation buttons at the bottom: '<Previous', 'Next >', and 'Cancel'.

The background 'Version Information' table is partially visible behind the dialog box.

4. Troubleshooting

4) The uploading step will start and verify installation file (F/W file).

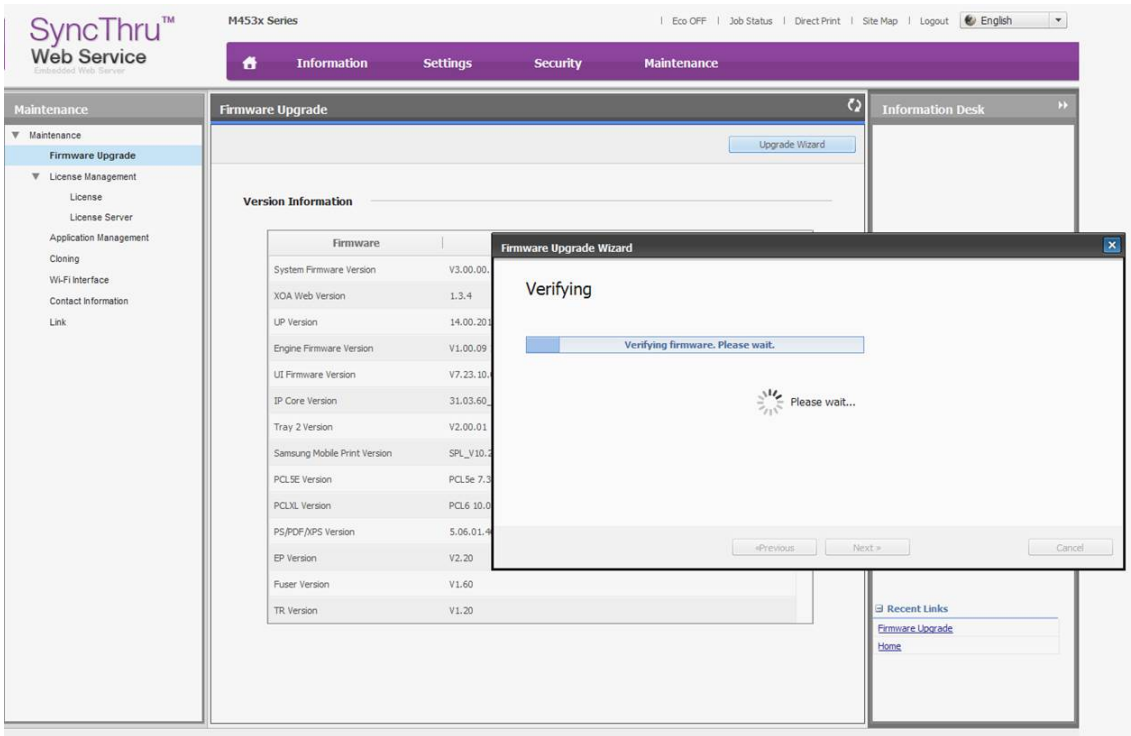

5) After uploading the f/w file on printer, validation information will appear. Check Firmware version and click Next to upgrade Firmware and press [Next] to start the firmware upgrade.

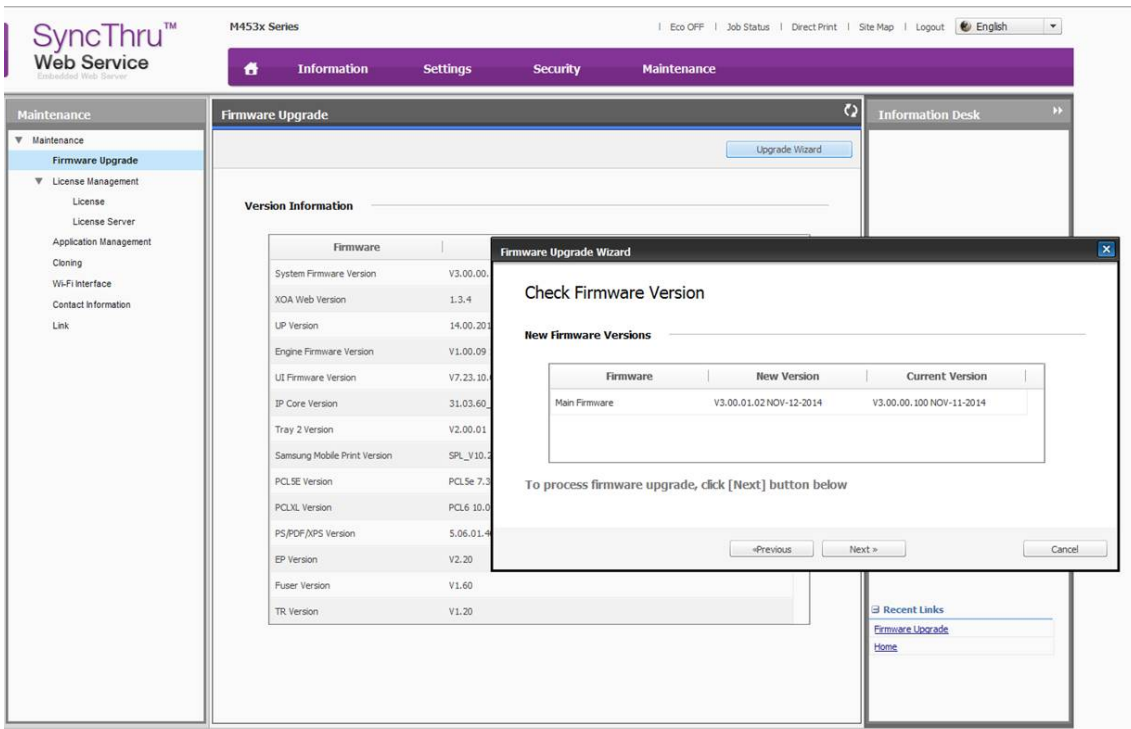

6) The firmware update will start.

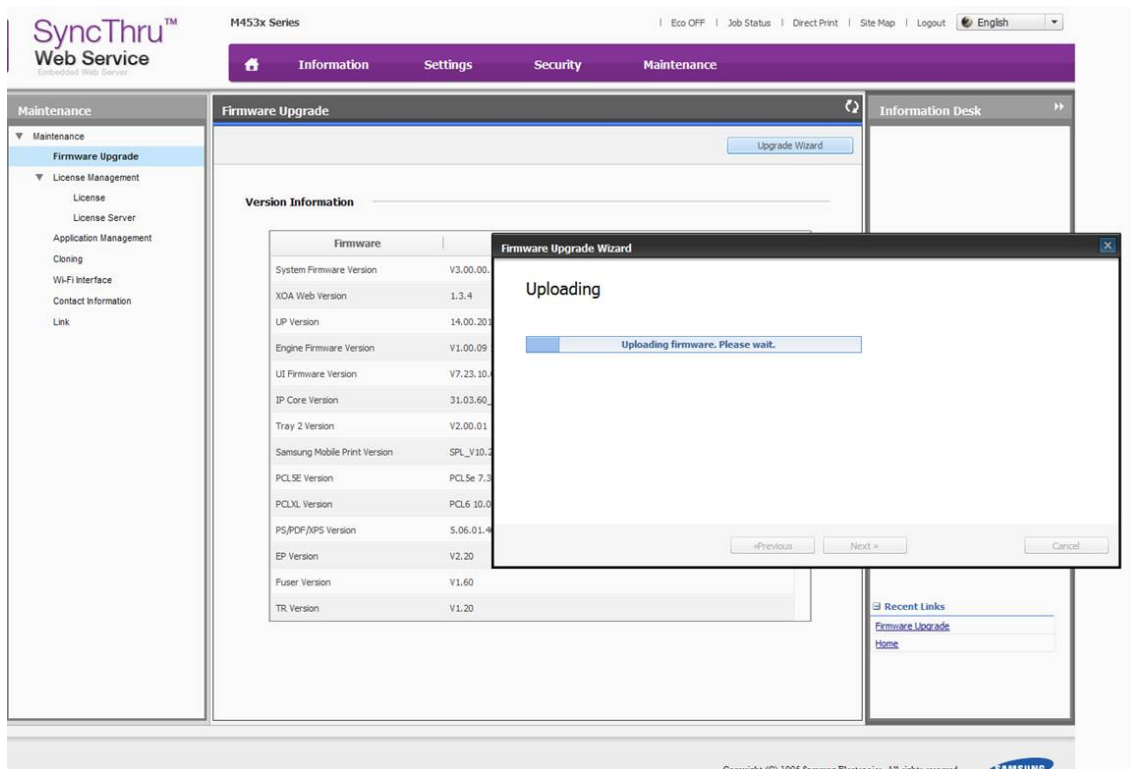

7) Once the installation is complete, the machine power-off and power-on automatically.

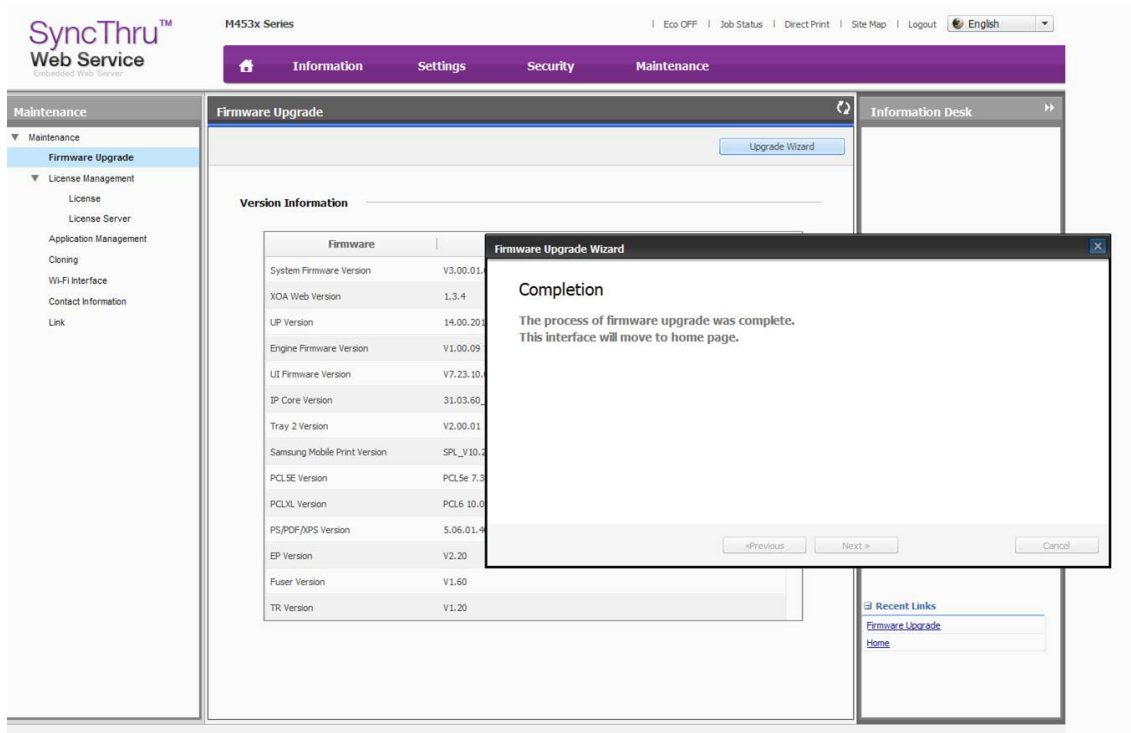

## 4.4. JAM removal

When a paper jam occurs, a warning message appears on the display screen.



### NOTE

To avoid tearing the paper, pull the jammed paper out slowly and gently. Follow the instructions in the following sections to clear the jam.

### Paper jam in tray 1

1) Pull out tray 1.

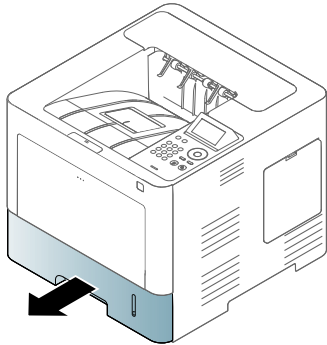

2) Remove the jammed paper from the machine.

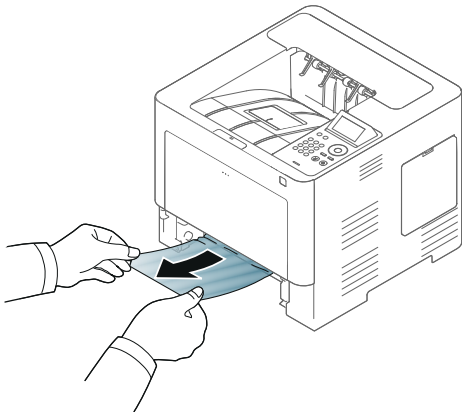

3) Insert the tray 1.

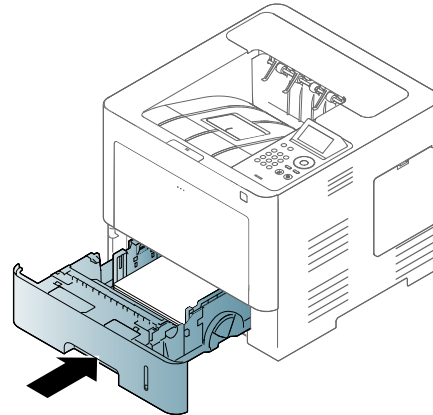



**Paper jam in optional tray**

1) Pull out tray 2.



2) Remove the jammed paper from the machine.

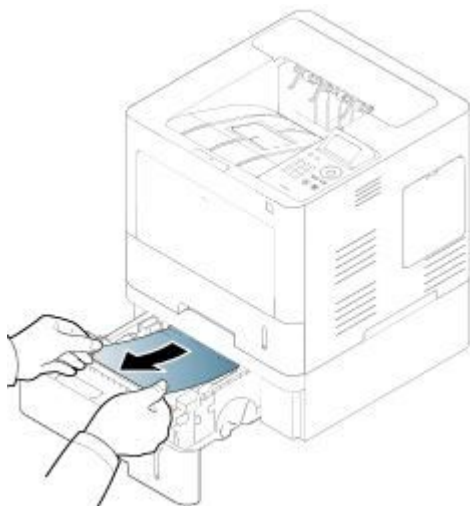

3) Insert tray 2.

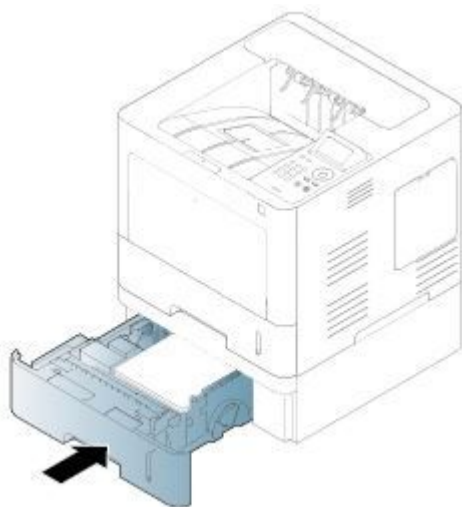

If you do not see the paper in this area, stop and go to next step:

4) Pull out tray 1.

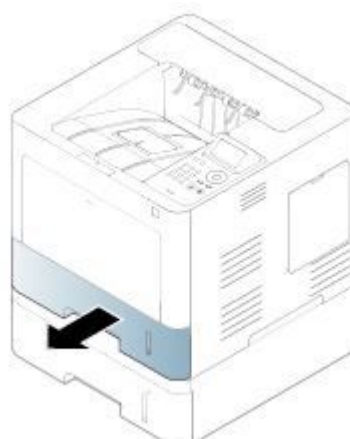

5) Remove the jammed paper by gently pulling it straight out.

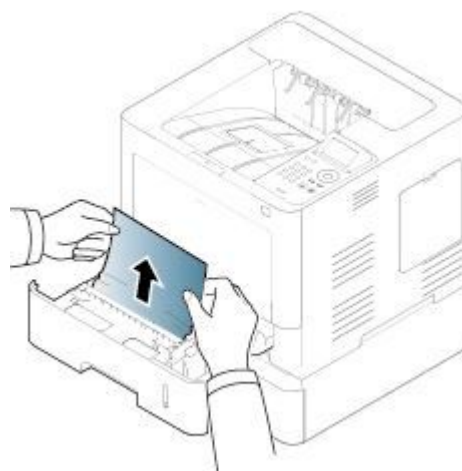

6) Insert the tray 1.

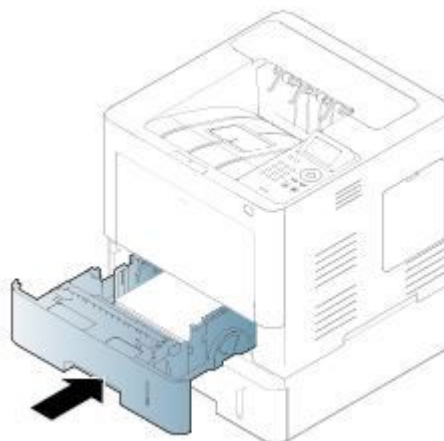

If you do not see the paper in this area, stop and go to next step:

7) Open the rear cover.

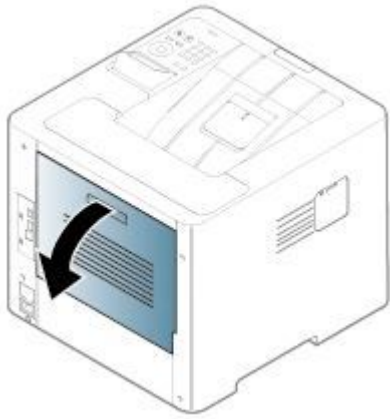

9) Close the rear cover.

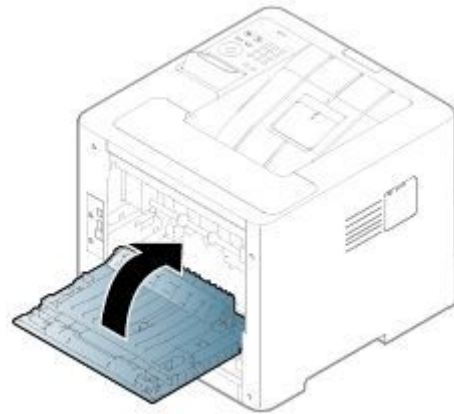

8) Remove the jammed paper by gently pulling it straight out.

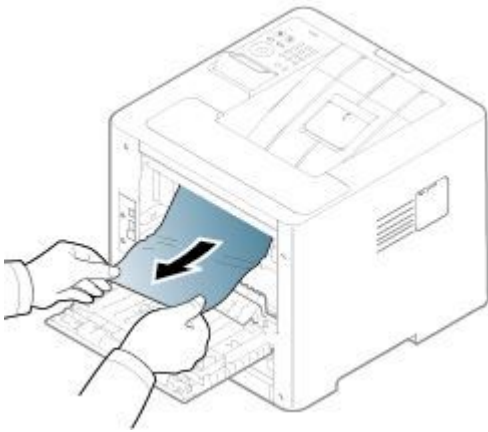

### Paper jam in the multi-purpose tray

1) Remove the jammed paper while lifting up the MP cover.

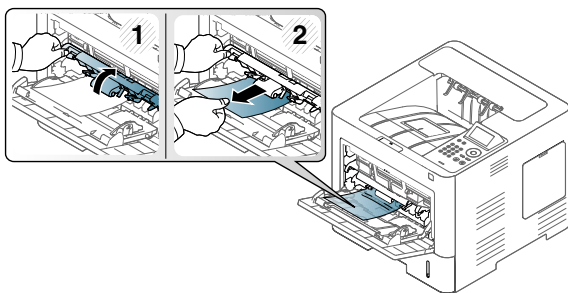

## Paper jam inside the machine



### CAUTION

The fuser area is hot. Take care when removing paper from the machine.

- 1) Open the front cover.

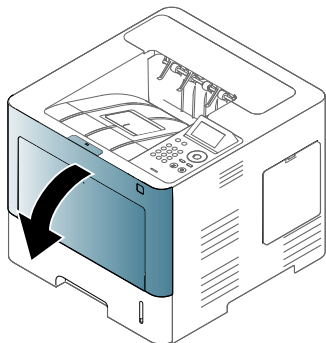

- 2) Remove the toner cartridge.

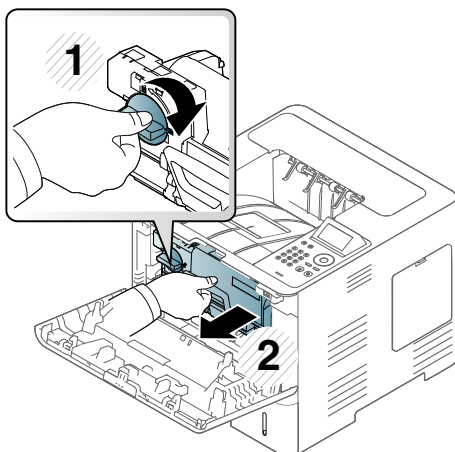

- 3) Remove the imaging unit.

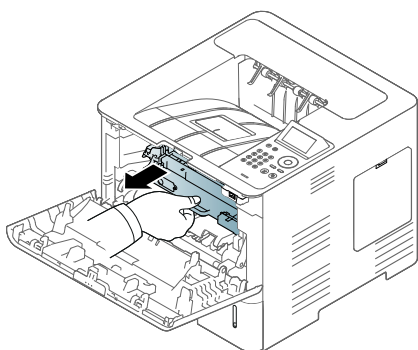

- 4) Remove the jammed paper by gently pulling it straight out.

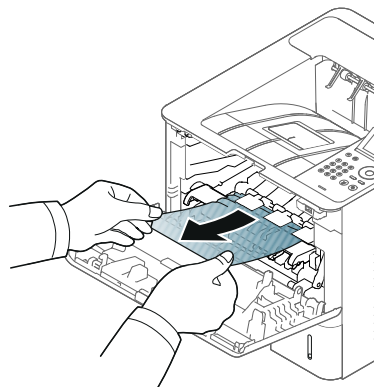

- 5) Insert the imaging unit.

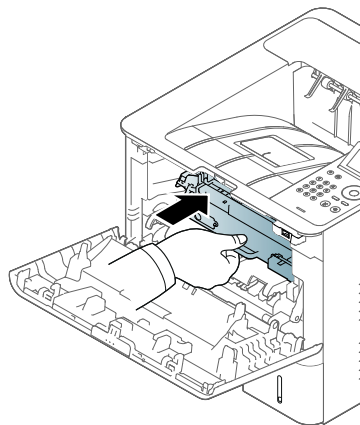

- 6) Insert the toner cartridge.

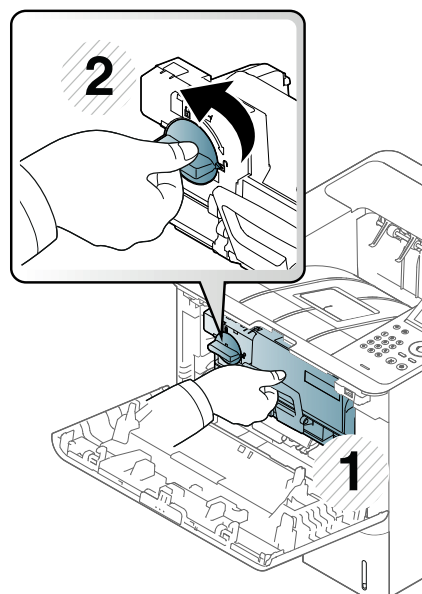

7) Close the front cover.

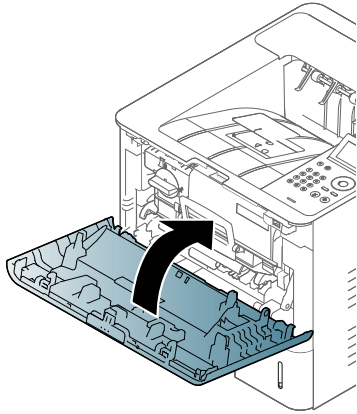

If you do not see the paper in this area, stop and go to next step:

8) Pull out the tray 1.

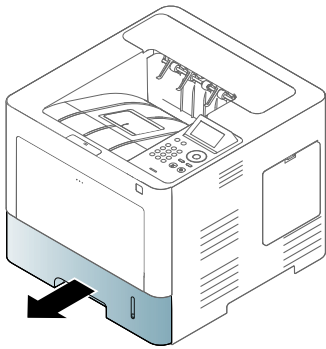

9) Remove the jammed paper by gently pulling it straight out.

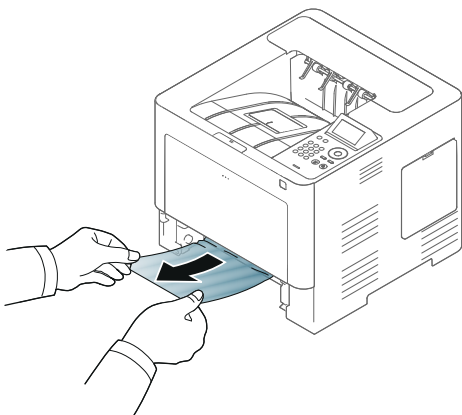

10) Insert the tray 1.

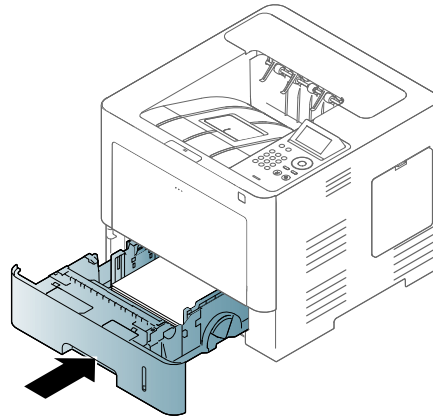

If you do not see the paper in this area, stop and go to next step:

11) Pull out the tray 1.

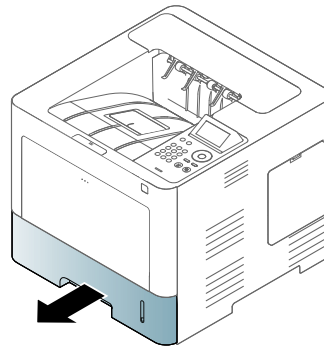

12) Remove the jammed paper by gently pulling it straight out.

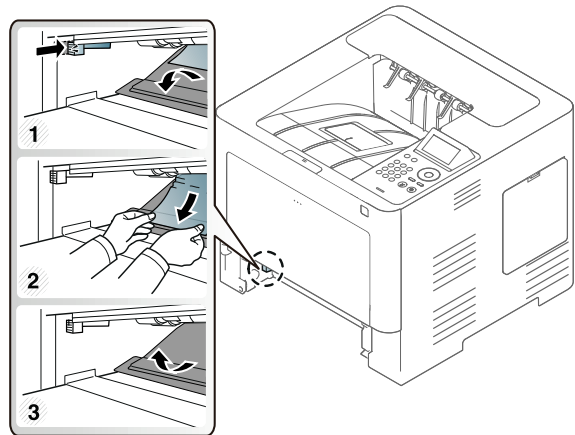

13) Insert the tray 1.

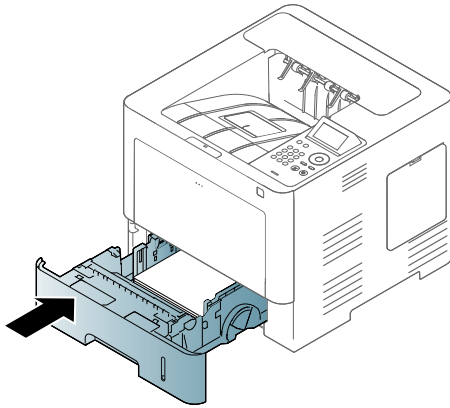

## Paper jam in exit area



### CAUTION

The Fuser area is hot, please wait until device cools down before accessing this area. Turn power off to cool the machine down. Take care when removing paper from the machine.

- 1) Gently pull the paper out of the output tray.

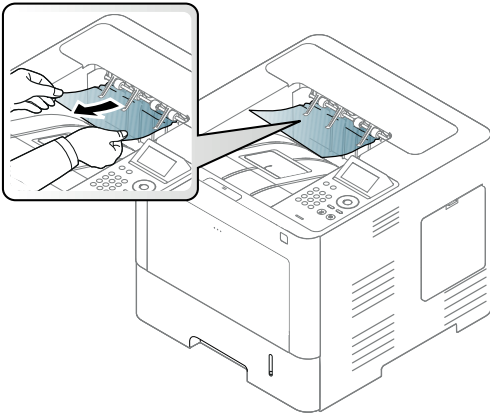

If you do not see the paper in this area, stop and go to next step:

- 2) Open the rear cover.



- 3) Remove the jammed paper by gently pulling it straight out.

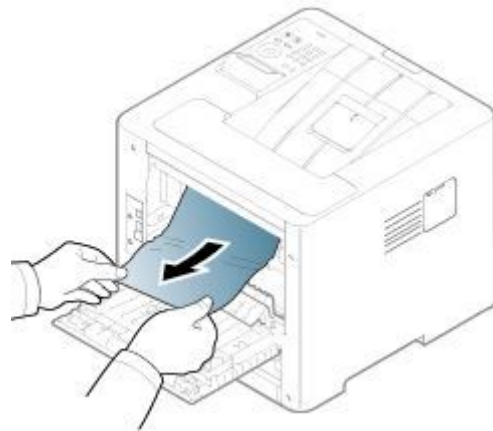

- 4) Close the rear cover.

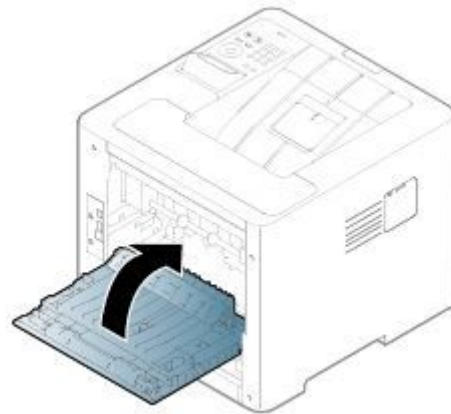

## Paper jam in duplex unit area

1) Open the rear cover.

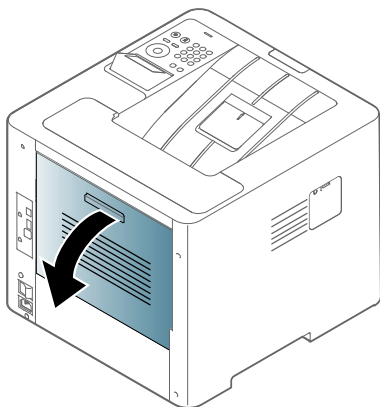

2) Open the jam cover.

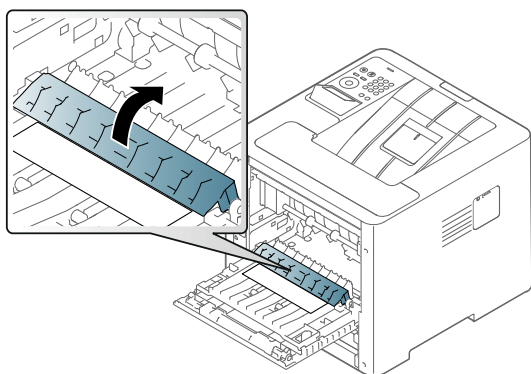

3) Remove the jammed paper by gently pulling it straight out.

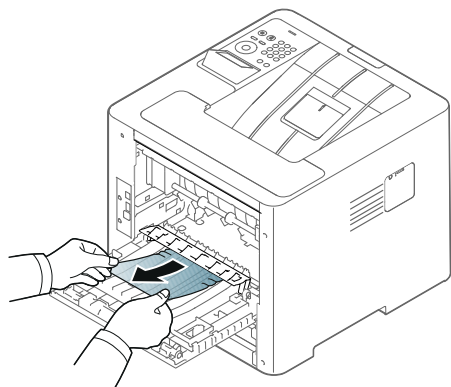

If you do not see the paper in this area, stop and go to next step:

4) Pull out the tray 1.

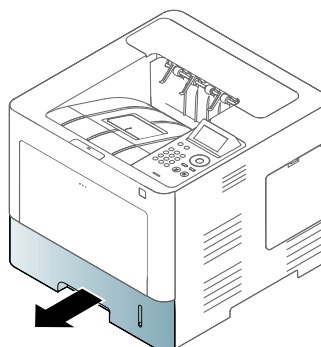

5) Push the duplex jam removal button.

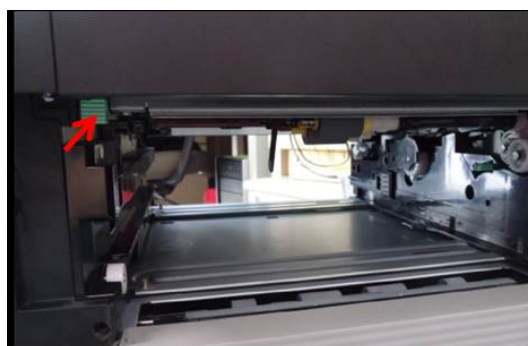

6) Remove the jammed paper by gently pulling it straight out.

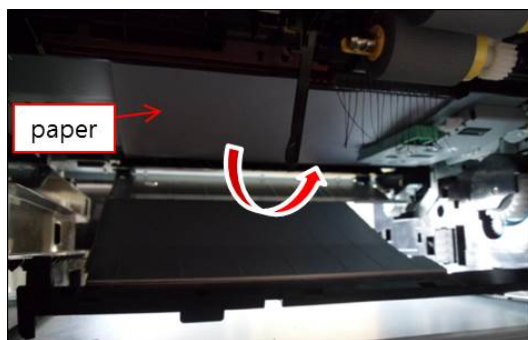

7) Close the duplex plate.



#### 4. Troubleshooting

---

8) Insert the tray 1.

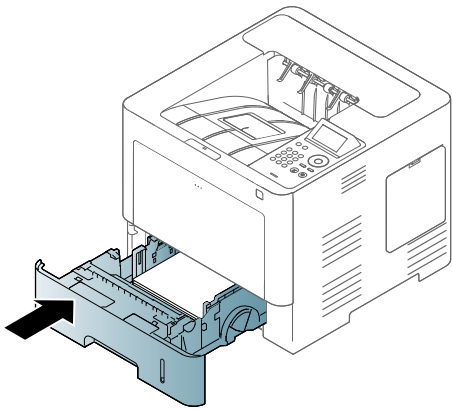



## 4.5. Service Mode

### 4.5.1. Entering the Service Mode

To enter the Service Mode

- M4530ND

Press “Menu + # + 1 + 9 + 3 + 4 + Menu” in sequence

- M4530NX

- 1) While pressing the “Cancel” button, press the triangle button on LCD.



- 2) Select “Service Mode” menu.



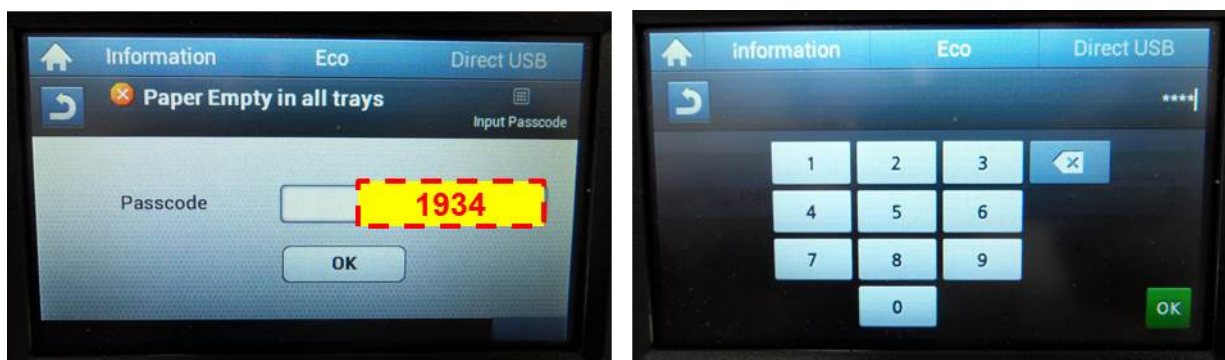

- 3) When the passcode window appears, input “1934” and touch OK button.





**4.5.2. Service Mode Menu**

- M4530ND

Depth 1	Depth 2	Depth 3	Depth 4	
Data Setup	Storage Device Setup	Storage Device Format	Formatting...	
	Counter Reset	Fuser		
		Pickup Roller	Tray 1	
			Tray 2	
			Tray 3	
			Tray 4	
			Tray 5	
			MP Tray	
		Retard Roller	Tray 1	
			Tray 2	
Tray 3				
Tray 4				
Tray 5				
	Transfer Roller			
Toner Low Level	[1~30]: 10 %*			
Paper Substitution	Off *			
	On			
Report	Configuration	Printing...		
	Supplies Info	Printing...		
	Usage Counter	Printing...		
	Error Information	Printing...		
	Job Duty	Printing...		
	ID Control History	Printing...		
EDC Mode	NVM Read/ Write	 <b>NOTE</b> Refer to NVM Read/Write table.		
	NVM Initialize	Initialize Now		
	Test Routines	 <b>NOTE</b> Refer to Test Routines table.		

- M4530NX

Depth 1	Depth 2	Depth 3	Depth 4	Depth 5	
Information	General	Machine Serial Number			
		Network IP Address			
	Software Version	Set Version			
		Main Controller			
		User Interface			
		Network Controller			
	Report	Configuration			
		Supplies Information			
		Usage Counter			
		Error Information			
		Job Duty			
	ID Control History				
Test Routine	Copier	NVM Read/Write	 <b>NOTE</b> Refer to NVM Read/Write table.		
		Test Routine	 <b>NOTE</b> Refer to Test Routines table.		
	Other	Toner Low Level	[1-30]% : 10		
		Counter Reset	Fuser		
			Pickup Roller	Tray 1	
				Tray 2	
				Tray 3	
				Tray 4	
				Tray 5	
		MP Tray			
	Transfer Roller				
Paper Substitution	Off				
	On				
Format Mass Storage Device					

### 4.5.3. Tech Mode Menu description

#### 1) Data Setup

- **Storage Device Setup (Format mass storage device)**

This menu can format the storage device in the machine.

- **Counter Reset**

This menu can reset the counts for the Fuser, Pickup roller, Retard roller, or Transfer roller. When replacing these parts, you must do this menu.

- **Toner Low Level**

When the toner remains less than setting up level, the machine notify user of toner low.

- **Paper Substitution**

Between A4 and Letter size paper, print job can be executed without paper mismatch message, when the setting value is "On".

#### 2) Report

- **Configuration**

It shows various SW version and current machine setting status.

- **Supplies Information**

It shows consumable unit life status and toner using status.

- **Usage Counter**

It shows printing usage by paper size and type.

- **Error Information**

It shows various kinds of errors which can be occurred in machine. It also store history error count how many errors are issued.

- **Job Duty**

It shows printing usage by print job duty.

#### 3) EDC Mode

- **NVRAM Read/Write**

This menu can change a configuration value for engine firmware.

Code	Display		Meaning	Default	Max/Min	Remark
	GUI	4-Line LUI				
104-0000	Pick up roller Life Page Counter	0000-Pick Rol Life	Pick up roller Life Page Counter	0	100K/0	
104-0020	Retard Roller Life Page Counter	Retard Rol Life	Retard roller Life Page Counter	0	100K	
104-0021	T2 Retard Roller Life Page Counter	T2 Retard Rol Life	T2 Retard Roller Life Page Counter	0	100K	
104-0022	T3 Retard Roller Life Page Counter	T3 Retard Rol Life	T3 Retard Roller Life Page Counter	0	100K	
104-0023	T4 Retard Roller Life Page Counter	T4 Retard Rol Life	T4 Retard Roller Life Page Counter	0	100K	
104-0024	T5 Retard Roller Life Page Counter	T5 Retard Rol Life	T5 Retard Roller Life Page Counter	0	100K	

Code	Display		Meaning	Default	Max/Min	Remark
	GUI	4-Line LUI				
104-0030	T2 Pick-Up Roller Life Page Counter	0030-T2 Pick Rol Life	T2 Pick-Up Roller Life Page Counter	0	200K/0	
104-0040	T3 Pick-Up Roller Life Page Counter	0040-T3 Pick Rol Life	T3 Pick-Up Roller Life Page Counter	0	200K/0	
104-0050	T4 Pick-Up Roller Life Page Counter	0050-T4 Pick Rol Life	T4 Pick-Up Roller Life Page Counter	0	200K/0	
104-0051	T5 Pick-Up Roller Life Page Counter	0051-T5 Pick Rol Life	T5 Pick-Up Roller Life Page Counter	0	200K/0	
104-0061	Bypass PickUp Roller Life Page Counter	0061-MP Pick Rol Life	Bypass PickUp Roller Life Page Counter	0	100K	
104-0190	Transfer Roller Life Page Counter	0190-Trans Rol Page	Transfer Roller Life Page Counter	0	100K	
104-0210	Fuser Life Page Counter	0210-Fuse Life Page	Fuser Life Page Counter	0	100K/0	100000 / 0
105-0030	MHV DC Black (MHV Bias Control)	0030-MHV DC K	Charger HV Black DC Duty	300	600/0	0 = -300, 600 = 300
106-0030	Deve DC Black (Deve Bias Control)	0030-Deve DC K	Deve DC Black	300	600/0	0 = -300, 600 = 300
106-0070	Deve VPP Black	0070-Deve VPP K	Deve VPP Black	300	600/0	0 = -300, 600 = 300
106-0110	Deve AC Black	0110-Deve AC K	Deve AC Black	300	600/0	0 = -300, 600 = 300
106-0120	Deve AC Frequency	0120-Deve AC Freq	Deve AC Frequency	3000	6000/0	0 = -3000, 600 = 3000
107-0030	Transfer1 High Voltage(THV) Black (THV Bias Control)	0030-THV K	Transfer1 HV Black Duty	300	600/0	0 = -300, 600 = 300
107-0120	Saw Plate Duty (Detack Bias Control)	0120-Saw Plate	Saw Plate Duty	250	900/50	
107-0170	Transfer1 High Voltage(THV) Duplex Black (THV Bias Control)	0170-THV K_Dup	Transfer1 HV Black Duplex Duty	300	600/0	0 = -300, 600 = 300
110-0070	LD Power Black (LD Light Level Black)	0070-LD Power K	Black LD Power at Normal Speed	200	400/0	0 = -200, 400 = 200
111-0030	Toner Vcon Black	0030-Toner Vcon K	Toner Vcon Black	665	900/50	

#### 4. Troubleshooting

Code	Display		Meaning	Default	Max/Min	Remark
	GUI	4-Line LUI				
111-0170	Toner Target Black	0170-Toner Target K	Black target TC sensor value	558	900/50	
111-0230	ID Sensor Control Voltage	0230-ID Con Voltage	ID Sensor Control Voltage	755	900/50	
111-0240	ID Control 100% Target	0240-ID Con Compen 100%	ID Control Compensation 100% Target	300	600/0	0 = -300, 600 = 300
111-0250	ID Control 60% Target	0250-ID Con Compen 60%	ID Control Compensation 60% Target	300	600/0	0 = -300, 600 = 300
111-0260	ID Control 30% Target	0260-ID Con Compen 30%	ID Control Compensation 30% Target	300	600/0	0 = -300, 600 = 300

- **Test Routines**

This menu can perform the operation test for the main components.

Code	Display	Meaning	State Displayed	Related Components
100-0000	Main BLDC Motor	Main BLDC Motor is On/Off	On[Off]	Engine
100-0010	Main BLDC Motor Ready	Detect if Main BLDC Motor runs at normal speed	High[Low]	Engine
100-0061	Black DEV Motor	Black DEV BLDC Motor is On/Off	On[Off]	Engine
100-0071	Black DEV Motor Ready	Detect if Black DEV BLDC Motor runs at normal speed	High[Low]	Engine
100-0120	Exit Motor Forward Fast	Exit Motor Forward Fast On/Off	On[Off]	Engine
100-0131	Exit Motor Backward	Exit Motor Forward Backward On/Off	On[Off]	Engine
100-0140	Duplex Motor Forward	Duplex Motor Forward On/Off	On[Off]	Engine
100-0200	T1 Elevating Motor	T1 Elevate Motor On/Off	On[Off]	Engine
100-0260	SMPS Fan Run	Start/Stop Deve. Fan run	On[Off]	Engine
101-0000	Bypass Feed Clutch	Engages drive to pick up a paper from bypass Tray(MP Tray).	On[Off]	Engine
101-0010	T1 Pick-Up Clutch	Engages drive to pick up a paper from tray1.	On[Off]	Engine
101-0020	T2 Pick-Up Clutch	Engages drive to pick up a paper from tray2. (Optional)	On[Off]	Engine
101-0030	T3 Pick-Up Clutch	Engages drive to pick up a paper from tray3. (Optional)	On[Off]	Engine
101-0040	T4 Pick-Up Clutch	Engages drive to pick up a paper from tray4. (Optional)	On[Off]	Engine
101-0041	T5 Pick-Up Clutch	Engages drive to pick up a paper from tray5. (Optional)	On[Off]	Engine
101-0050	Registration Clutch	Engages drive to registartion rolls.	On[Off]	Engine
101-0190	Out-Bin Full Sensor	Detect when a paper is at Duplex Ready sensor.	High[Low]	Engine

Code	Display	Meaning	State Displayed	Related Components
102-0000	Tray1 Home Position	Detect when tray1 is closed.	Closed[Opened]	Engine
102-0010	T1 Paper Empty Sensor	Detect when paper is in Tray1.	High[Low]	Engine
102-0020	T1 Size1 sensor	Detects whether auto size1 sensor of tray1 is high or low.	High[Low]	Engine
102-0030	T1 Size2 sensor	Detects whether auto size2 sensor of tray1 is high or low.	High[Low]	Engine
102-0040	T1 Size3 sensor	Detects whether auto size3 sensor of tray1 is high or low.	High[Low]	Engine
102-0050	T1 Stack Height Sensor	Detects if paper in tray1 is elevated to the sensor.	High[Low]	Engine
102-0070	Tray2 Home Position	Detect when tray2 is closed.	Closed[Opened]	Engine
102-0080	T2 Paper Empty Sensor	Detect when paper is in tray2.	High[Low]	Engine
102-0090	T2 Size1 sensor	Detects whether auto size1 sensor of tray2 is high or low.	High[Low]	Engine
102-0100	T2 Size2 sensor	Detects whether auto size2 sensor of tray2 is high or low.	High[Low]	Engine
102-0110	T2 Size3 sensor	Detects whether auto size3 sensor of tray2 is high or low.	High[Low]	Engine
102-0120	T2 Stack Height Sensor	Detects if paper in tray2 is elevated to the sensor.	High[Low]	Engine
102-0140	Tray3 Home Position	Detect when tray3 is closed.	Closed[Opened]	Engine
102-0150	T3 Paper Empty Sensor	Detect when paper is in tray3.	High[Low]	Engine
102-0160	T3 Size1 sensor	Detects whether auto size1 sensor of tray3 is high or low.	High[Low]	Engine
102-0170	T3 Size2 sensor	Detects whether auto size2 sensor of tray3 is high or low.	High[Low]	Engine
102-0180	T3 Size3 sensor	Detects whether auto size3 sensor of tray3 is high or low.	High[Low]	Engine
102-0190	T3 Stack Height Sensor	Detects if paper in tray3 is elevated to the sensor.	High[Low]	Engine
102-0210	Tray4 Home Position	Detect when tray4 is closed.	Closed[Opened]	Engine
102-0220	T4 Paper Empty Sensor	Detect when paper is in tray4.	High[Low]	Engine
102-0230	T4 Size1 sensor	Detects whether auto size1 sensor of tray4 is high or low.	High[Low]	Engine
102-0240	T4 Size2 sensor	Detects whether auto size2 sensor of tray4 is high or low.	High[Low]	Engine
102-0250	T4 Size3 sensor	Detects whether auto size3 sensor of tray4 is high or low.	High[Low]	Engine
102-0260	T4 Stack Height Sensor	Detects if paper in tray4 is elevated to the sensor.	High[Low]	Engine

4. Troubleshooting

Code	Display	Meaning	State Displayed	Related Components
102-0280	Bypass Paper Empty Sensor	Detects when paper is in Bypass Tray(MP Tray).	High[Low]	Engine
102-0290	Feed Sensor	Detect when a paper is at Feed sensor.	High[Low]	Engine
102-0300	T2 Feed Sensor (or Door Open)	Detect when a paper is at T2 Feed sensor. (optional)	High[Low]	Engine
102-0320	T3 Feed Sensor (or Door Open)	Detect when a paper is at T3 Feed sensor. (optional)	High[Low]	Engine
102-0340	T4 Feed Sensor (or Door Open)	Detect when a paper is at T4 Feed sensor. (optional)	High[Low]	Engine
102-0341	T5 Feed Sensor (or Door Open)	Detect when a paper is at T5 Feed sensor. (optional)	High[Low]	Engine
102-0360	Regi. Sensor	Detect when a paper is at Regi. sensor.	High[Low]	Engine
102-0370	Exit Sensor	Detect when a paper is at Exit. sensor.	High[Low]	Engine
102-0380	Duplex Jam1 Sensor	Detect when a paper is at Duplex Jam1 sensor.	High[Low]	Engine
102-0440	Rear Cover Sensor	Detect status of Rear cover.	Closed[Opened]	Engine
102-0470	Tray5 Home Position	Detect when tray4 is closed.	Closed[Opened]	Engine
102-0480	T5 Paper Empty Sensor	Detect when paper is in tray4.	High[Low]	Engine
102-0490	T5 Size1 sensor	Detects whether auto size1 sensor of tray4 is high or low.	High[Low]	Engine
102-0500	T5 Size2 sensor	Detects whether auto size2 sensor of tray4 is high or low.	High[Low]	Engine
102-0510	T5 Size3 sensor	Detects whether auto size3 sensor of tray4 is high or low.	High[Low]	Engine
102-0520	T5 Stack Height Sensor	Detects if paper in tray4 is elevated to the sensor.	High[Low]	Engine
105-0030	Black MHV Bias	Black MHV bias voltage on at normal drive level	On[Off]	Engine
105-0070	Black MHV Bias Read	Black Detect what the MHV value is on the MHV Roller	Numeric 3 digits	Engine
106-0030	Black Dev Bias	Black Dev bias voltage on at normal drive level	On[Off]	Engine
107-0030	Black THV Bias	Black THV bias voltage on at normal drive level	On[Off]	Engine
107-0031	Black THV(-) Bias	Black THV bias voltage on at normal drive level	On[Off]	Engine
107-0070	Black THV Bias Read	Detect what the THV value is on the THV Roller	Numeric 3 digits	Engine
107-0150	PTL1	Pre Transfer Lamp 1	On[Off]	Engine
107-0200	Eraser Abnormal Sensor	Eraser Abnormal Sensor Value	High[Low]	Engine
109-0000	Fuser Temperature A	Detects what the temperature A is on fuser.	Numeric 3 digits	Engine



Code	Display	Meaning	State Displayed	Related Components
109-0010	Fuser Temperature B	Detects what the temperature B is on fuser.	Numeric 3 digits	Engine
109-0012	Inner Temperature	Inner Temperature	Numeric 3 digits	Engine
109-0013	Outer Temperature	Outer Temperature	Numeric 3 digits	Engine
109-0014	Humidity	Humidity	Numeric 3 digits	Engine
109-0020	Fuser Fan Run Ready	Detects if Fuser Fan Motor runs at normal speed.	High[Low]	Engine
109-0030	Fuser Motor Forward	Fuser Motor Forward On/Off	On[Off]	Engine
109-0040	Fuser Fan Run	Fuser Fan Motor On/Off	On[Off]	Engine
109-0050	Fuser Bias	Fuser bias voltage on at normal drive level	On[Off]	Engine
109-0052	Fuser Bias Minus	Fuser bias voltage on at normal drive level	On[Off]	Engine
109-0110	Fuser Crum Read1	Detect if the life of fuser1 is exhausted.	High[Low]	Engine
109-0140	Fuser Gap Home Sensor	Detect if the fuser press is located Home position.	High[Low]	Engine
110-0000	LSU Motor1 Run Ready	Detects if LSU motor1 runs at normal speed.	High[Low]	Engine
110-0060	LSU Motor1 Run	LSU Motor1 On/Off	On[Off]	Engine
110-0110	LSU LD Power4	LSU LD4 Power On/Off (black)	On[Off]	Engine
110-0120	LSU Fan1 Run	Start/Stop LSU Fan Run	On[Off]	Engine
110-0170	LSU HSync4	Detect LSU HSync4 (black)	High[Low]	Engine
111-0030	Toner Dispense Motor Black	Toner Dispense(Supply) Motor On/Off	On[Off]	Engine
111-0070	Toner Sensor Black	TC sensor in developer tank.	Numeric 3 digits	Engine
111-0071	Toner Sensor Black2	TC sensor in developer tank.	Numeric 3 digits	Engine

## 4.6. Error Code and Troubleshooting

---

Messages appear on the control panel display to indicate the machine's status or errors.



### NOTE

Some messages may not appear on the display depending on the options or models.

### 4.6.1. 11-2Txx (Paper mismatch error)

Error Code	Error Message	Troubleshooting Page
11-2T11	Paper mismatch Tray 1 Load [A4] [Plain] Continue ⊙ Cancel X	P.4-27
11-2T21	Paper mismatch Tray 2 Load [A4] [Plain] Continue ⊙ Cancel X	P.4-27
11-2T31	Paper mismatch Tray 3 Load [A4] [Plain] Continue ⊙ Cancel X	P.4-27
11-2T41	Paper mismatch Tray 4 Load [A4] [Plain] Continue ⊙ Cancel X	P.4-27
11-2T51	Paper mismatch Tray 5 Load [A4] [Plain] Continue ⊙ Cancel X	P.4-27
11-2T61	Paper mismatch MPT Load [A4] [Plain] Continue ⊙ Cancel X	P.4-27

▶ **Error Code**

11-2T11 / 11-2T21 / 11-2T31 / 11-2T41 / 11-2T51 / 11-2T61

▶ **Error message**

Paper mismatch Tray X

Paper mismatch MPT

▶ **Symptom**

Paper in tray is not matched to the machine paper setting.

▶ **Troubleshooting method**

- 1) Check and change the paper setting of the corresponding tray properly.

**4.6.2. Ax-xxxx (Motor\_Fan\_Sensor Error)**

<b>Error Code</b>	<b>Error Message</b>	<b>Troubleshooting Page</b>
A1-1112	Error: #A1-1112 / Motor Failure: #A1-1112. Turn off then on. Call for service if the problem persists	P.4-29
A1-1113	Error: #A1-1113 / Motor Failure: #A1-1113. Turn off then on. Call for service if the problem persists	P.4-29
A1-2112	Error: #A1-2112 / Motor Failure: #A1-2112. Turn off then on. Call for service if the problem persists	P.4-30
A1-2113	Error: #A1-2113 / Motor Failure: #A1-2113. Turn off then on. Call for service if the problem persists	P.4-30
A1-5110	Error: #A1-5110 / Motor Failure: #A1-5110. Turn off then on. Call for service if the problem persists	P.4-31
A2-1210	Error: #A2-1210 / Fan Failure: #A2-1210. Turn off then on. Call for service if the problem persists	P.4-32
A2-2110	Error: #A2-2110 / Fan Failure: #A2-2110. Turn off then on. Call for service if the problem persists	P.4-32
A2-2410	Error: #A2-2410 / Fan Failure: #A2-2410. Turn off then on. Call for service if the problem persists	P.4-32
A2-2610	Error: #A2-2610 / Fan Failure: #A2-2610. Turn off then on. Call for service if the problem persists	P.4-32
A3-3212	Error: #A3-3212 / Sensor Failure: #A3-3212. Turn off then on. Call for service if the problem persists	P.4-34
A3-3312	Error: #A3-3312 / Sensor Failure: #A3-3312. Turn off then on. Call for service if the problem persists	P.4-35
A3-3320	Not proper Room Temp / The room temperature is not suitable for this set use. Please adjust room temperature	P.4-35
A4-1110	Error: #A4-1110 / Lamp Failure: #A4-1110. Open the door, then close it	P.4-36

► **Error Code**

A1-1112

A1-1113

► **Error message**

Motor Failure: #A1-1112. Turn off then on. Call for service if the problem persists

Motor Failure: #A1-1113. Turn off then on. Call for service if the problem persists

► **Symptom**

Main(Feed/Fuser) motor operation is abnormal.

► **Troubleshooting method**

- A1-1112 : Main motor is not operated for print-job.
  - A1-1113 : Main motor is operating but machine recognizes status as "Stopped".
- 1) Turn the machine off then on. If the error persists, check the following.
  - 2) Remove the right cover.
  - 3) Check the connection between the main(feed/fuser) motor and main board.
  - 4) If the connection is OK, enter SVC mode. Execute the motor test.

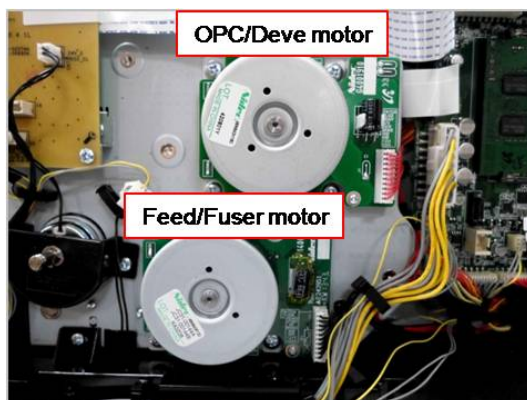

- a) If the motor is not operational,
  - i) Check the motor signal(3.3V). If the signal is abnormal, replace the main board([JC92-02802A\(M4530ND\)](#) / [JC92-02801A\(M4530NX\)](#)).
  - ii) Check the power(24V). If the power is abnormal, check the SMPS board. If the SMPS board([JC44-00092C \(220V\)](#) / [JC44-00091C \(110V\)](#)) is defective, replace it.
  - iii) If the motor signal and power is normal, replace the main(feed/fuser) motor([JC31-00144B](#)).
- b) If the motor is operational, replace the main board.

▶ **Error Code**

A1-2112

A1-2113

▶ **Error message**

Motor Failure: #A1-1112. Turn off then on. Call for service if the problem persists

Motor Failure: #A1-1113. Turn off then on. Call for service if the problem persists

▶ **Symptom**

OPC/Deve motor operation is abnormal.

▶ **Troubleshooting method**

- A1-2112 : OPC/Deve motor is not operated for print-job.
  - A1-2113 : OPC/Deve motor is operating but machine recognizes status as "Stopped".
- 1) Turn the machine off then on. If the error persists, check the following.
  - 2) Remove the right cover.
  - 3) Check the connection between the OPC/Deve motor and main board.
  - 4) If the connection is OK, enter SVC mode. Execute the motor test.

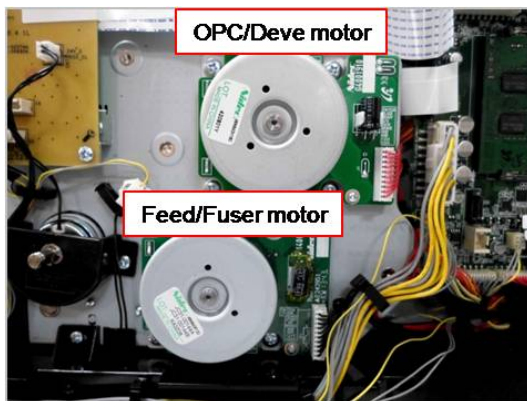

- a) If the motor is not operational,
  - i) Check the motor signal(3.3V). If the signal is abnormal, replace the main board([JC92-02802A\(M4530ND\)](#) / [JC92-02801A\(M4530NX\)](#)).
  - ii) Check the power(24V). If the power is abnormal, check the SMPS board. If the SMPS board([JC44-00092C \(220V\)](#) / [JC44-00091C \(110V\)](#)) is defective, replace it.
  - iii) If the motor signal and power is normal, replace the OPC/Deve motor([JC31-00075C](#)).
- b) If the motor is operational, replace the main board.

**► Error Code****A1-5110****► Error message****Motor Failure: #A1-5110. Turn off then on. Call for service if the problem persists****► Symptom**

Supply motor operation is abnormal.

**► Troubleshooting method**

- 1) Turn the machine off then on. If the error persists, check the following.
- 2) Remove the right cover.
- 3) Check the connection between the Toner Supply(DC) motor and main board.
- 4) If the connection is OK, enter SVC mode. Execute the motor test.



- a) If the motor is not operational,
  - i) Check the motor signal(3.3V). If the signal is abnormal, replace the main board([JC92-02802A\(M4530ND\)](#) / [JC92-02801A\(M4530NX\)](#)).
  - ii) Check the power(24V). If the power is abnormal, check the SMPS board. If the SMPS board([JC44-00092C \(220V\)](#) / [JC44-00091C \(110V\)](#)) is defective, replace it.
  - iii) If the motor signal and power is normal, replace the DC motor([JC31-00078A](#)) or the main drive unit([JC93-00923A](#)).
- b) If the motor is operational, replace the main board.

► **Error Code**

- A2-1210
- A2-2110
- A2-2410
- A2-2610

► **Error message**

Fan Failure: #A2-xxxx. Turn off then on. Call for service if the problem persists

► **Symptom**

SMPS or Fuser or LSU or Deve fan is not operational.

► **Troubleshooting method**

 **NOTE**

- SMPS fan error : A2-1210
- Main(Fuser) fan error : A2-2110
- LSU fan error : A2-2410
- Deve fan error : A2-2610

- 1) Turn the machine off.
- 2) Check if the corresponding fan connector is connected correctly.

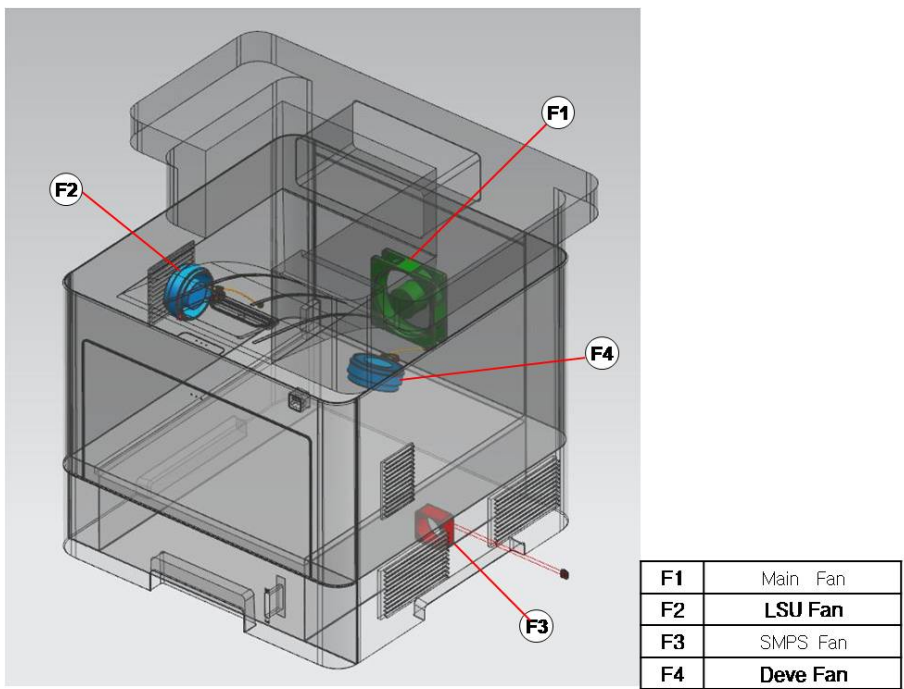

- 3) If the connection is OK, Enter SVC mode and execute fan test.
- 4) If the fan is not operational, measure the fan power.
  - a) If 24V power is generated, replace the defective fan.
    - SMPS fan : *JC31-00153A*
    - Main(Fuser) fan : *JC31-00088A*
    - LSU fan : *JC31-00086A*



- Deve fan : *JC31-00086A*
- b) If 24V power is not generated,
- Measure the 24V power on the SMPS board. If the SMPS board(*JC44-00092C (220V) / JC44-00091C (110V)*) is defective, replace it.
  - If the SMPS board is normal, replace the main board(*JC92-02802A(M4530ND) / JC92-02801A(M4530NX)*).
- 5) If the fan operation is normal but the error persists,
- a) Check the yellow line signal with DVM.

Fan Lock Signal (Yellow)	Measurement Value (Fan is connected)	Measurement Value (Fan is removed)
At operation	0 V	3.3V
At stop	3.3 V	3.3V

- b) Check fan operation as connected or disconnected.
- If the Lock signal is 0V continually, check the harness. If the harness is OK, replace the main board.
  - If the signal value is different from the table above, replace the fan.

▶ **Error Code**

A3-3212

▶ **Error message**

Sensor Failure: #A3-3212. Turn off then on. Call for service if the problem persists

▶ **Symptom**

Inner temperature sensor is defective.

▶ **Troubleshooting method**

- 1) Turn the machine off then on.
- 2) Check the connection between the inner temp sensor and main board. If the connection is OK, replace the inner temp sensor([1404-001417](#)) .
- 3) If the sensor is normal, replace the main board([JC92-02802A\(M4530ND\)](#) / [JC92-02801A\(M4530NX\)](#)).

**▶ Error Code**

A3-3312

A3-3320

**▶ Error message**

Sensor Failure: #A3-3312. Turn off then on. Call for service if the problem persists

The room temperature is not suitable for this set use. Please adjust room temperature

**▶ Symptom**

Outer temperature/humidity sensor is defective.

**▶ Troubleshooting method**

- 1) Turn the machine off then on.
- 2) Check the connection between the outer temp sensor and main board. If the connection is OK, replace the outer temp sensor([JC32-00005A](#)).

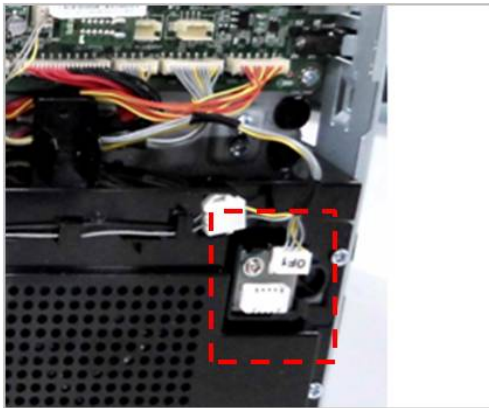

- 3) If the sensor is normal, replace the main board([JC92-02802A\(M4530ND\)](#) / [JC92-02801A\(M4530NX\)](#)).

▶ **Error Code**

A4-1110

▶ **Error message**

Lamp Failure: #A4-1110. Open the door, then close it. Call for service if the problem persists

▶ **Symptom**

Erase Lamp does not turn on.

▶ **Troubleshooting method**

- 1) Enter SVC mode. Execute the erase lamp test.
- 2) If the erase lamp does not turn on, replace it([JC92-02373A](#)).

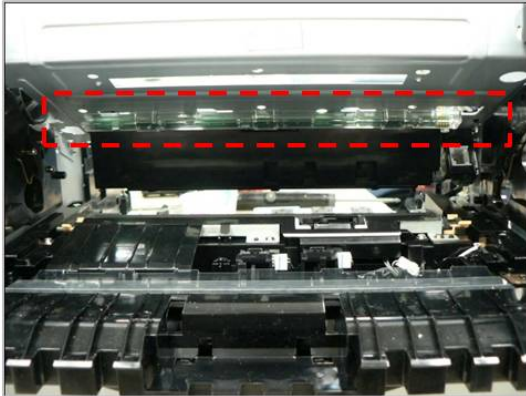

### 4.6.3. Cx-xxxx (Supplies\_Maintenance Part Error)

Error Code	Error Message	Troubleshooting Page
C1-1110	Prepare new toner / Prepare new toner cartridge	P.4-38
C1-111A	Shake toner cart. / Shake toner cartridge and then install. Replace toner cartridge if the problem persists	P.4-38
C1-1140	Replace new toner / End of life, Replace with new toner cartridge	P.4-38
C1-1150	Replace new toner / Replace with new toner cartridge	P.4-38
C1-1170	Replace new toner / End of life, Replace with new toner cartridge	P.4-38
C1-1311	Error: #C1-1311 / Toner Failure: #C1-1311. Install toner again	P.4-39
C1-1313	Shake toner cart. / Shake toner cartridge and then install. Call for service if the problem persists	P.4-39
C1-1314	Remove seal tape / Did not supply enough toner. Remove seal tape of toner cartridge or shake it. Call for service if the problem persists	P.4-39
C1-1411	Toner Not Installed / Toner cartridge is not installed. Install it	P.4-40
C1-1512	Toner Not Compatible / Toner cartridge is not compatible. Check guide	P.4-41
C1-1712	Error: #C1-1712 / Toner Cart Failure: #C1-1712. Call for service	P.4-42
C3-1110	Prepare IMG. unit / Prepare new imaging unit	P.4-43
C3-1140	Replace IMG. unit / End of life, Replace with new imaging unit	P.4-43
C3-1150	Replace IMG. unit / Replace with new imaging unit	P.4-43
C3-1170	Replace IMG. unit / End of life, Replace with new imaging unit	P.4-43
C3-1312	Error: #C3-1312 / Imaging Unit Failure: #C3-1312. Install IMG. unit	P.4-44
C3-1411	IMG. Not Installed / Imaging unit is not installed. Install the unit	P.4-44
C3-1414	Error: #C3-1414 / Imaging Unit Failure: #C3-1414. Install imaging unit again	P.4-44
C3-1512	IMG. Not compatible / Imaging unit is not compatible. Check guide	P.4-45
C3-1712	Error: #C3-1712 / Imaging Unit Failure: #C3-1712. Call for service	P.4-45
C6-1120	Replace Fuser unit / Replace with new fuser unit	P.4-45

▶ **Error Code**

C1-1110 / C1-111A

▶ **Error message**

Prepare new toner cartridge

Shake toner cartridge and then install. Replace toner cartridge if the problem persists

▶ **Symptom**

Toner cartridge is almost empty.

▶ **Troubleshooting method**

- 1) Open the front cover.
- 2) Remove the toner cartridge.
- 3) Shake the toner cartridge horizontally to distribute the toner evenly inside the cartridge.

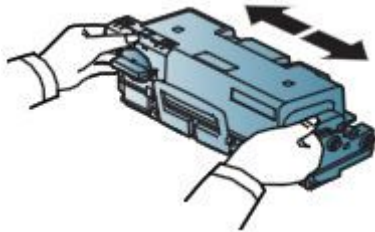

- 4) Reinstall the toner cartridge.
- 5) Close the front cover.
- 6) Prepare new toner cartridge because it will be exhausted soon.

▶ **Error Code**

C1-1140 / C1-1150 / C1-1170

▶ **Error message**

Replace with new toner cartridge.

End of life, Replace with new toner cartridge.

▶ **Symptom**

Toner cartridge is at the end of its life.

▶ **Troubleshooting method**

- 1) Open the front cover.
- 2) Remove the toner cartridge.
- 3) Install the new toner cartridge.
- 4) Close the front cover.

**▶ Error Code**

C1-1311

C1-1313

C1-1314

**▶ Error message**

Toner Cartridge Failure: #C1-1311. Install toner cartridge again.

Shake toner cartridge and then install. Call for service if the problem persists

Did not supply enough toner. Remove seal tape of toner cartridge or shake it. Call for service if the problem persists

**▶ Symptom**

The toner supply is abnormal.

**▶ Troubleshooting method**

- 1) Turn the machine off then on.
- 2) Open the front cover.
- 3) Remove the toner cartridge.  
Thoroughly roll the cartridge three or four times to distribute the toner evenly inside the cartridge. And reinstall the toner cartridge.
- 4) Try to print out the sample page more than 20 pages.
- 5) Check the toner cartridge.
  - Check if the toner cartridge is installed correctly.
  - Check if the toner seal is removed perfectly.
  - Check if the toner supply shutter between the toner cartridge and the imaging unit works normally.
- 6) Replace the toner cartridge. Print out the sample page.
- 7) Check the toner supply motor operation.
  - Check the signal and power with the DVM.
  - If the checked result is normal, replace the DC motor([JC31-00078A](#)) or the main drive unit([JC93-00923A](#)).



▶ **Error Code**

C1-1411

▶ **Error message**

Toner cartridge is not installed. Install the cartridge.

▶ **Symptom**

The toner cartridge is not installed properly.

▶ **Troubleshooting method**

- 1) Open the front cover.
- 2) If the toner cartridge is not installed, install it. Try to test the machine again.
- 3) If the toner cartridge is installed, remove it. Check if the modular jack is contaminated or broken.
- 4) Clean the modular jack or replace the toner cartridge.
- 5) If it is OK, check the toner connector on the main board.
- 6) If the harness is defective, replace it.
- 7) Turn the machine off then on. Try to test the machine.



**▶ Error Code**

C1-1512

**▶ Error message**

Toner cartridge is not compatible. Check users guide.

**▶ Symptom**

Toner cartridge is not compatible.

**▶ Troubleshooting method**

- 1) Open the front cover. Remove the toner cartridge.
- 2) Check if the label information of the toner cartridge is same with the machine's one. (ex. /SEE)
- 3) If label information is different from the machine or the toner cartridge is not a samsung genuine, replace it with a new one.

▶ **Error Code**

C1-1712

▶ **Error message**

Toner Cartridge Failure: #C1-1712. Call for service

▶ **Symptom**

The data of CRUM is not detected. / CRUM is defective.

▶ **Troubleshooting method**

- 1) Open the front cover. Check if the toner cartridge is installed.
- 2) Remove and reinstall the toner cartridge.
- 3) If the problem persists, check if the toner cartridge modular jack is contaminated or deformed.
- 4) Replace the toner cartridge with new one.

**▶ Error Code**

C3-1110

**▶ Error message**

Prepare new imaging unit.

**▶ Symptom**

Imaging unit has almost reached the end of its life.

**▶ Troubleshooting method**

- 1) Prepare the new imaging unit because it will be exhausted soon.

**▶ Error Code**

C3-1140

C3-1150

C3-1170

**▶ Error message**

Replace with new imaging unit

End of life, Replace with new imaging unit.

**▶ Symptom**

Imaging unit is at the end of its life.

**▶ Troubleshooting method**

- 1) Open the front cover.
- 2) Remove the imaging unit and replace it with new one.
- 3) Close the front cover.

▶ **Error Code**

C3-1312

▶ **Error message**

Imaging Unit Failure: #C3-1312. Install imaging unit again.

▶ **Symptom**

Toner sensor is defective. The machine can't detect the sensor signal in the imaging unit normally.

▶ **Troubleshooting method**

- 1) Install the genuine samsung imaging unit.
- 2) If the imaging unit is already installed, check the following.
  - Reinstall the toner cartridge and imaging unit.
  - Check if the CRUM connector is normal.
  - Turn the machine off then on.

▶ **Error Code**

C3-1411

C3-1414

▶ **Error message**

Imaging Unit Failure: #C3-1330. Install imaging unit again.

Imaging unit is not installed. Install the unit

Imaging Unit Failure: #C3-1414. Install imaging unit again.

▶ **Symptom**

The imaging unit is not installed properly.

▶ **Troubleshooting method**

- 1) Open the front cover.
- 2) If the imaging unit is not installed, install it. Try to test the machine again.
- 3) If the imaging unit is installed, remove it. Check if the modular jack is contaminated or broken.
- 4) Clean the modular jack or replace the imaging unit.
- 5) If it is OK, check the imaging unit connector on the main board.
- 6) If the harness is defective, replace it.
- 7) Turn the machine off then on. Try to test the machine.

**▶ Error Code****C3-1512****▶ Error message**

Imaging unit is not compatible. Check users guide.

**▶ Symptom**

Imaging unit is not compatible.

**▶ Troubleshooting method**

- 1) Open the front cover.
- 2) Remove and reinstall the imaging unit.
- 3) Close the front cover.
- 4) If the problem persists, replace the imaging unit with new one.

**▶ Error Code****C3-1712****▶ Error message**

Imaging unit Failure: #C3-1712. Call for service.

**▶ Symptom**

The data of CRUM is not detected.

**▶ Troubleshooting method**

- 1) Open the front cover.
- 2) Remove the imaging unit check that its modular jack is contaminated or deformed.
- 3) If it is defective, replace it with new one.
- 4) Close the front cover.

**▶ Error Code****C6-1120****▶ Error message**

Replace with new fuser unit

**▶ Symptom**

Fuser unit is at the end of its life.

**▶ Troubleshooting method**

- 1) Turn the machine off.
- 2) Open and remove the rear cover.
- 3) Remove the fuser unit(*JC91-01177A (220V) / JC91-01176A (110V)*) and replace it with new one.
- 4) Close the rear cover.

**4.6.4. H1-xxxx (Optional Cassette Feeder Error)**

Error Code	Error Message	Troubleshooting Page
H1-1210	Paper Jam in tray 2	P.4-47
H1-1211	Paper Jam in tray 2	P.4-47
H1-1222	Tray 2 cassette Out / Tray 2 cassette is pulled out. Insert it properly	P.4-49
H1-1230	Error: #H1-1230 / Tray Failure: #H1-1230. Check tray 2 connection & turn off then on. Call for service if the problem persists	P.4-50
H1-1251	Paper Low in tray 2 / Paper is low in tray 2. Load paper	P.4-51
H1-1252	Paper Empty in tray 2 / Paper is empty in tray 2. Load paper	P.4-51
H1-1253	Error: #H1-1253 / Tray Failure: #H1-1253. Pull tray 2 out and insert it. Call for service if the problem persists	P.4-52
H1-1254	Paper Empty in tray 2 / Paper is empty in tray 2. Load paper	P.4-51
H1-1310	Paper Jam in tray 3	P.4-53
H1-1311	Paper Jam in tray 3	P.4-53
H1-1322	Tray 3 cassette Out / Tray 3 cassette is pulled out. Insert it properly	P.4-55
H1-1330	Error: #H1-1330 / Tray Failure: #H1-1330. Check tray 3 connection & turn off then on. Call for service if the problem persists	P.4-56
H1-1351	Paper Low in tray 3 / Paper is low in tray 3. Load paper	P.4-57
H1-1352	Paper Empty in tray 3 / Paper is empty in tray 3. Load paper	P.4-57
H1-1353	Error: #H1-1353 / Tray Failure: #H1-1353. Pull tray 3 out and insert it. Call for service if the problem persists	P.4-58
H1-1354	Paper Empty in tray 3 / Paper is empty in tray 3. Load paper	P.4-57
H1-1410	Paper Jam in tray 4	P.4-59
H1-1411	Paper Jam in tray 4	P.4-59
H1-1422	Tray 4 cassette Out / Tray 4 cassette is pulled out. Insert it properly	P.4-61
H1-1430	Error: #H1-1430 / Tray Failure: #H1-1430. Check tray 4 connection & turn off then on. Call for service if the problem persists	P.4-62
H1-1451	Paper Low in tray 4 / Paper is low in tray 4. Load paper	P.4-63
H1-1452	Paper Empty in tray 4 / Paper is empty in tray 4. Load paper	P.4-63
H1-1453	Error: #H1-1453 / Tray Failure: #H1-1453. Pull tray 4 out and insert it. Call for service if the problem persists	P.4-64
H1-1454	Paper Empty in tray 4 / Paper is empty in tray 4. Load paper	P.4-63
H1-1510	Paper Jam in tray 5	P.4-65
H1-1511	Paper Jam in tray 5	P.4-65
H1-1522	Tray 5 cassette Out / Tray 5 cassette is pulled out. Insert it properly	P.4-67
H1-1530	Error: #H1-1530 / Tray Failure: #H1-1530. Check tray 5 connection & turn off then on. Call for service if the problem persists	P.4-68
H1-1551	Paper Low in tray 5 / Paper is low in tray 5. Load paper	P.4-69
H1-1552	Paper Empty in tray 5 / Paper is empty in tray 5. Load paper	P.4-69
H1-1553	Error: #H1-1553 / Tray Failure: #H1-1553. Pull tray 5 out and insert it. Call for service if the problem persists	P.4-70
H1-1554	Paper Empty in tray 5 / Paper is empty in tray 5. Load paper	P.4-69

► **Error Code**

H1-1210

H1-1211

► **Error message**

Paper jam in Tray 2.

► **Symptom**

Paper jam has occurred in tray2.

► **Troubleshooting method**

- 1) Remove the jammed paper. If the problem persists, check the followings.
- 2) Check if the paper is loaded in the tray2 properly.
- 3) Check if the pick up/forward/reverse rollers([JC97-02259A](#)) of the tray2 are defective or worn out.

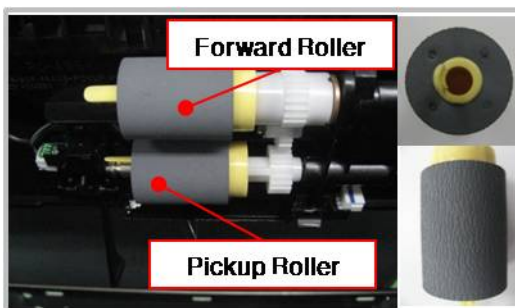

- 4) Check if the Empty/ Pick up/ Regi-Act sensor of the tray2 is working properly.

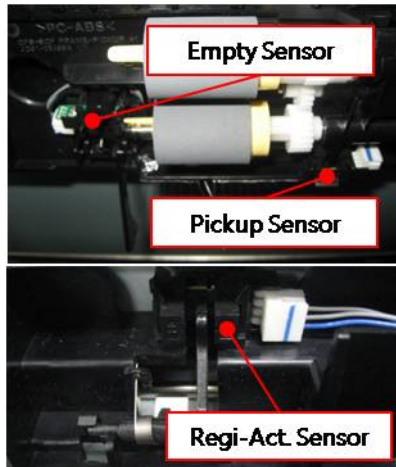

- 5) Check the connection between the motor/clutch and the SCF board. Reconnect the harness.

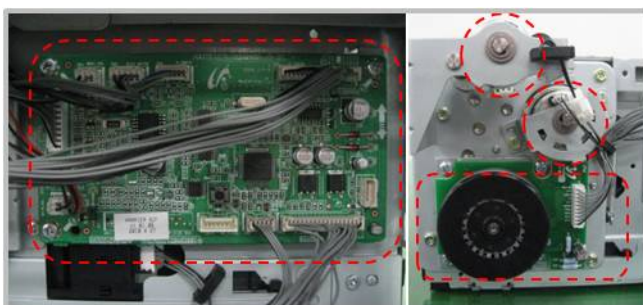

- 6) Check if the AS-SPRING\_ES is deformed or assembled properly.

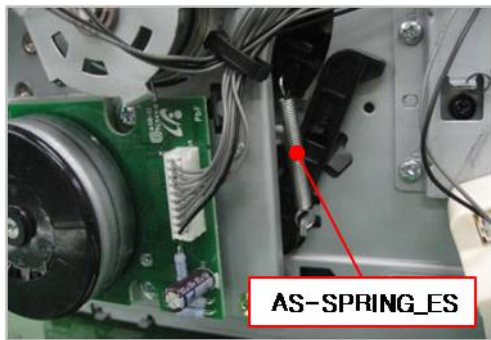

- 7) If the problem persists after checking No. 1~7, replace the SCF board([JC92-02754A](#)).
- 8) If the problem persists, replace the Drop connector harness.



**▶ Error Code**

H1-1222

**▶ Error message**

Tray 2 cassette is pulled out. Insert it properly.

**▶ Symptom**

Tray 2 is pulled out or the cassette detection sensor connector is not connected or broken.

**▶ Troubleshooting method**

- 1) Remove and insert tray2 correctly.
- 2) If the problem persists, remove tray2 again.
- 3) Check if the cassette detection sensor cable is connected correctly. Unplug and reconnect it.
- 4) If the connection is OK, replace the cassette detection sensor([JC34-00001A](#)).

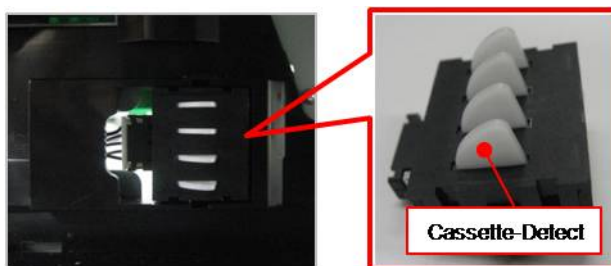

- 5) If the problem persists, replace the SCF board([JC92-02754A](#)).

▶ **Error Code**

H1-1230

▶ **Error message**

Input System Failure: #H1-1230. Check tray 2 connection.

▶ **Symptom**

The communication error between the tray 2 and the main machine has occurred.

▶ **Troubleshooting method**

- 1) Turn the machine off.
- 2) Check the connection on SCF board. Reconnect the harness.

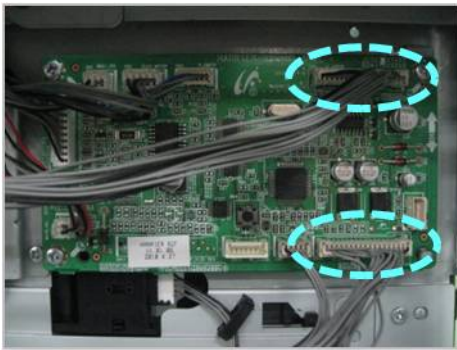

- 3) If the drawer connector is deformed or broken, replace it.

(*AS-HARNESS HSCF : JC81-09742A / HOLDER-CONNECTOR\_SCF : JC61-01742A*)

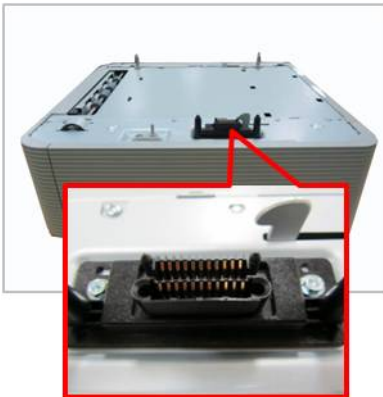

- 4) If the problem persists, replace the SCF main board(*JC92-02754A*).

**▶ Error Code**

H1-1251

H1-1252

H1-1254

**▶ Error message**

Paper is low in Tray 2. Load paper.

Paper is empty in tray 2. Load paper.

**▶ Symptom**

Paper in the tray2 is less than 10% of specification. / The photo sensor is defective.

**▶ Troubleshooting method**

- 1) Remove tray2. Load the paper in tray2.
- 2) If paper is loaded but error message has not disappeared, check the following.
  - a) Check if the paper empty sensor is contaminated. If so, clean it.
  - b) If the paper empty sensor([0604-001325](#)) is defective, replace it.

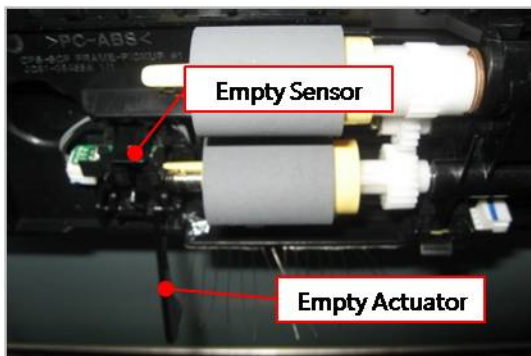

- 
- 
- c) If the empty actuator([JC66-02613A](#)) is defective, replace it.

▶ **Error Code**

H1-1253

▶ **Error message**

Input System Failure #H1-1253 : Pull Tray 2 out and insert it.

▶ **Symptom**

The paper is not fed from tray2.

▶ **Troubleshooting method**

- 1) Check if the Gear-Idle Lift is broken.

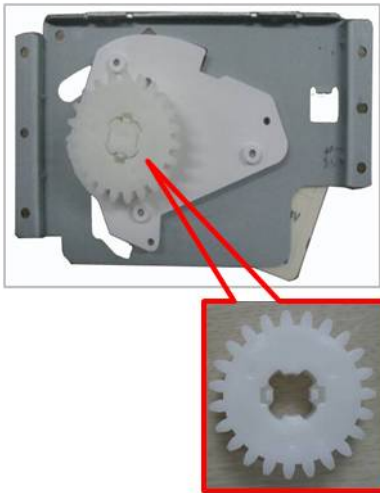

- 2) Check if the cassette detection sensor cable is connected correctly. Unplug and reconnect it.

- 3) If the connection is OK, replace the cassette detection sensor(*JC34-00001A*).

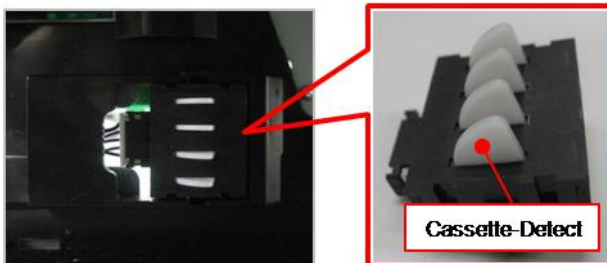

- 4) Check if the Lift-Motor connector is connected properly.



- 5) If the problem persists, replace the Lift-Motor(*JC81-08705A*).

▶ **Error Code**

H1-1310

H1-1311

▶ **Error message**

Paper jam in Tray 3.

▶ **Symptom**

Paper jam has occurred in tray3.

▶ **Troubleshooting method**

- 1) Remove the jammed paper. If the problem persists, check the followings.
- 2) Check if the paper is loaded in the tray3 properly.
- 3) Check if the pick up/forward/reverse rollers([JC97-02259A](#)) of the tray3 are defective or worn out.

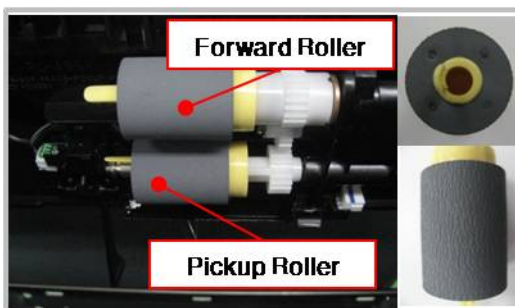

- 4) Check if the Empty/ Pick up/ Regi-Act sensor of the tray3 is working properly.

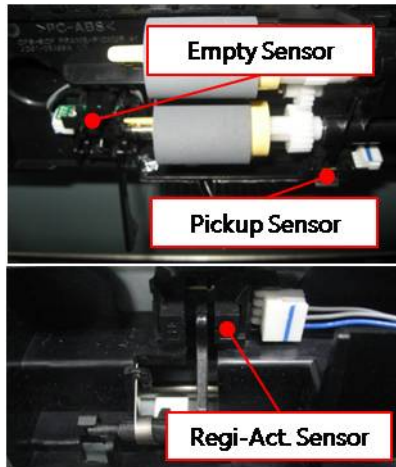

- 5) Check the connection between the motor/clutch and the SCF board. Reconnect the harness.



- 6) Check if the AS-SPRING\_ES is deformed or assembled properly.

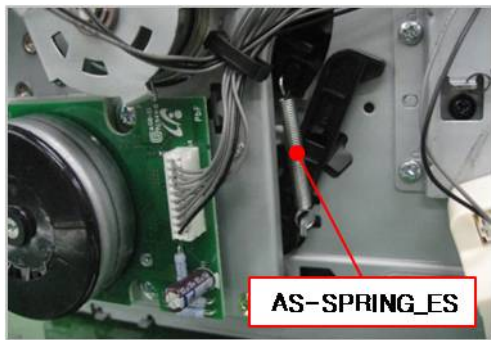

- 7) If the problem persists after checking No. 1~7, replace the SCF board([JC92-02754A](#)).
- 8) If the problem persists, replace the Drop connector harness.

**▶ Error Code**

H1-1322

**▶ Error message**

Tray 3 cassette is pulled out. Insert it properly.

**▶ Symptom**

Tray 3 is pulled out or the cassette detection sensor connector is not connected or broken.

**▶ Troubleshooting method**

- 1) Remove and insert tray3 correctly.
- 2) If the problem persists, remove tray3 again.
- 3) Check if the cassette detection sensor cable is connected correctly. Unplug and reconnect it.
- 4) If the connection is OK, replace the cassette detection sensor(*JC34-00001A*).

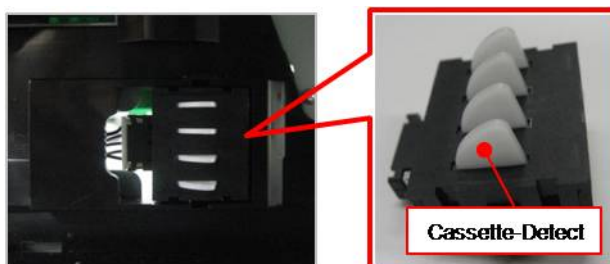

- 5) If the problem persists, replace the SCF board(*JC92-02754A*).

▶ **Error Code**

H1-1330

▶ **Error message**

Input System Failure: #H1-1330. Check tray 3 connection.

▶ **Symptom**

The communication error between the tray 3 and the main machine has occurred.

▶ **Troubleshooting method**

- 1) Turn the machine off.
- 2) Check the connection on SCF board. Reconnect the harness.

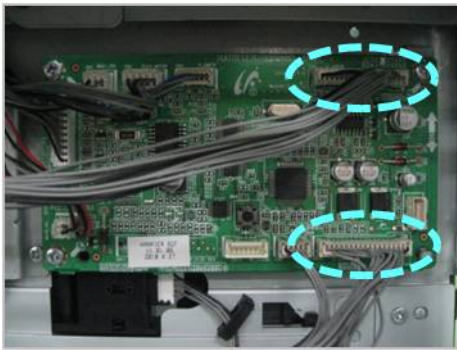

- 3) If the drawer connector is deformed or broken, replace it.

(*AS-HARNESS HSCF : JC81-09742A / HOLDER-CONNECTOR\_SCF : JC61-01742A*)



- 4) If the problem persists, replace the SCF main board(*JC92-02754A*).



**▶ Error Code**

H1-1351

H1-1352

H1-1354

**▶ Error message**

Paper is low in Tray 3. Load paper.

Paper is empty in tray 3. Load paper.

**▶ Symptom**

Paper in the tray3 is less than 10% of specification. / The photo sensor is defective.

**▶ Troubleshooting method**

- 1) Remove tray3. Load the paper in tray3.
- 2) If paper is loaded but error message has not disappeared, check the following.
  - a) Check if the paper empty sensor is contaminated. If so, clean it.
  - b) If the paper empty sensor([0604-001325](#)) is defective, replace it.

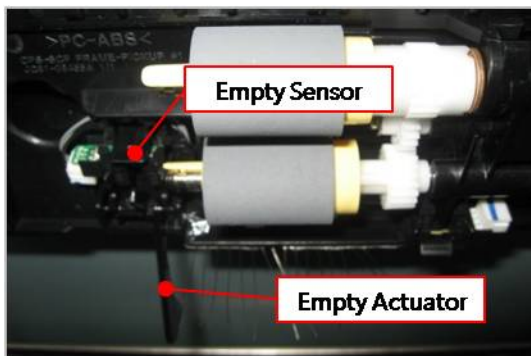

- c) If the empty actuator([JC66-02613A](#)) is defective, replace it.

▶ **Error Code**

H1-1353

▶ **Error message**

Input System Failure #H1-1353 : Pull Tray 3 out and insert it.

▶ **Symptom**

The paper is not fed from tray3.

▶ **Troubleshooting method**

- 1) Check if the Gear-Idle Lift is broken.

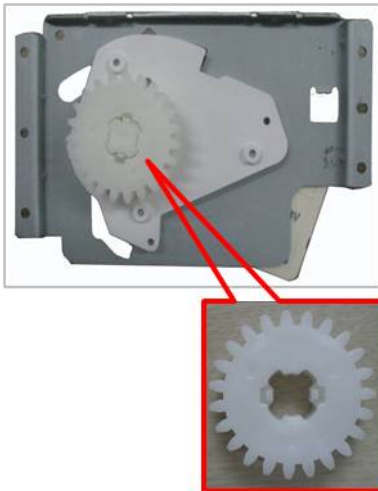

- 2) Check if the cassette detection sensor cable is connected correctly. Unplug and reconnect it.

- 3) If the connection is OK, replace the cassette detection sensor(*JC34-00001A*).

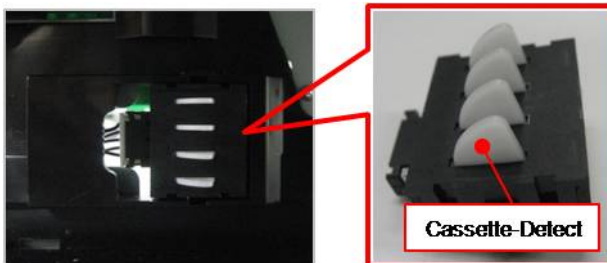

- 4) Check if the Lift-Motor connector is connected properly.



- 5) If the problem persists, replace the Lift-Motor(*JC81-08705A*).

► **Error Code**

H1-1410

H1-1411

► **Error message**

Paper jam in Tray 4.

► **Symptom**

Paper jam has occurred in tray4.

► **Troubleshooting method**

- 1) Remove the jammed paper. If the problem persists, check the followings.
- 2) Check if the paper is loaded in the tray4 properly.
- 3) Check if the pick up/forward/reverse rollers([JC97-02259A](#)) of the tray4 are defective or worn out.

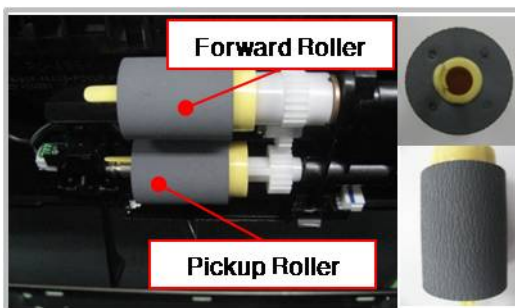

- 4) Check if the Empty/ Pick up/ Regi-Act sensor of the tray4 is working properly.

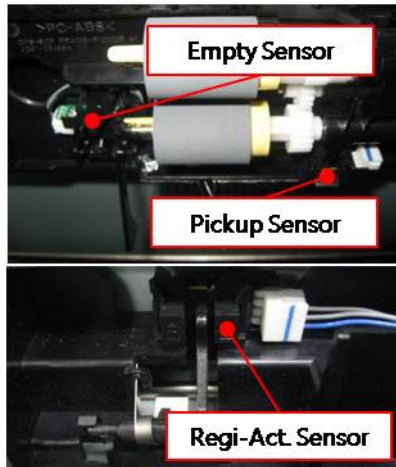

- 5) Check the connection between the motor/clutch and the SCF board. Reconnect the harness.

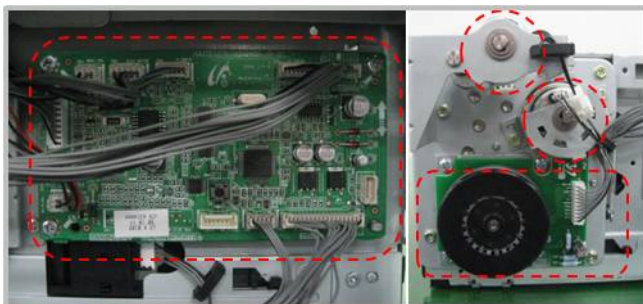

- 6) Check if the AS-SPRING\_ES is deformed or assembled properly.

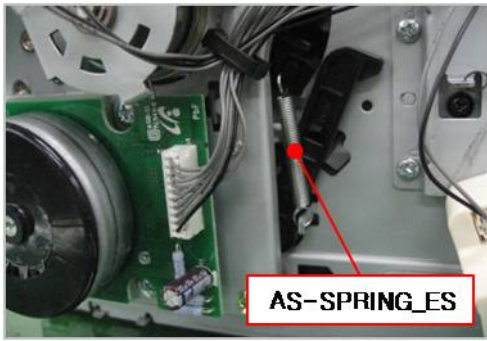

- 7) Check if the Press D-cut of the Gear-Lifting([JC81-08478A](#)) is broken.

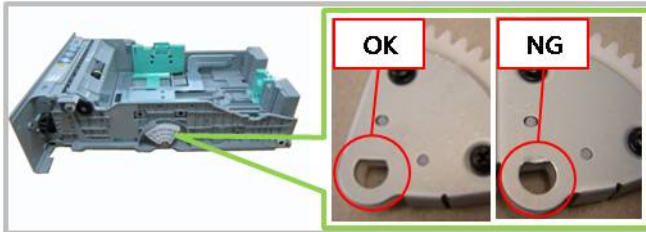

- 8) If the problem persists after checking No. 1~7, replace the SCF board([JC92-02754A](#)).
- 9) If the problem persists, replace the Drop connector harness.

**▶ Error Code**

H1-1422

**▶ Error message**

Tray 4 cassette is pulled out. Insert it properly.

**▶ Symptom**

Tray 4 is pulled out or the cassette detection sensor connector is not connected or broken.

**▶ Troubleshooting method**

- 1) Remove and insert tray4 correctly.
- 2) If the problem persists, remove tray4 again.
- 3) Check if the cassette detection sensor cable is connected correctly. Unplug and reconnect it.
- 4) If the connection is OK, replace the cassette detection sensor(*JC34-00001A*).

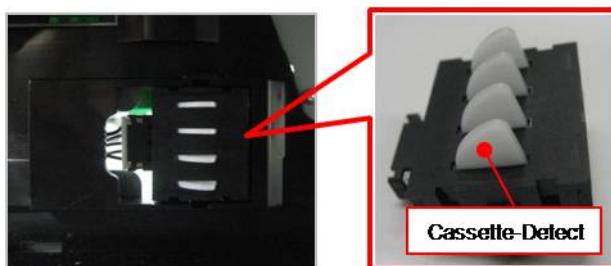

- 5) If the problem persists, replace the SCF board(*JC92-02754A*).

▶ **Error Code**

H1-1430

▶ **Error message**

Input System Failure: #H1-1430. Check tray 4 connection.

▶ **Symptom**

The communication error between the tray 4 and the main machine has occurred.

▶ **Troubleshooting method**

- 1) Turn the machine off.
- 2) Check the connection on SCF board. Reconnect the harness.

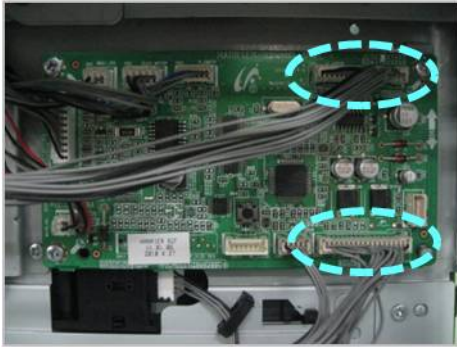

- 3) If the drawer connector is deformed or broken, replace it.

(*AS-HARNESS HSCF : JC81-09742A / HOLDER-CONNECTOR\_SCF : JC61-01742A*)

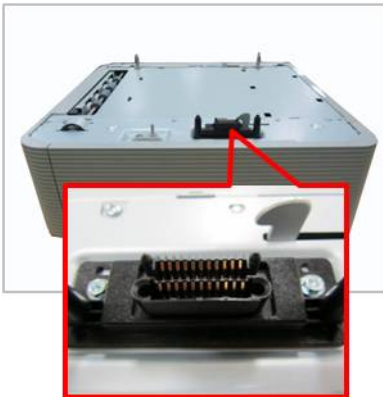

- 4) If the problem persists, replace the SCF main board(*JC92-02754A*).

**▶ Error Code**

H1-1451

H1-1452

H1-1454

**▶ Error message**

Paper is low in Tray 4. Load paper.

Paper is empty in tray 4. Load paper.

**▶ Symptom**

Paper in the tray4 is less than 10% of specification. / The photo sensor is defective.

**▶ Troubleshooting method**

- 1) Remove tray4. Load the paper in tray4.
- 2) If paper is loaded but error message has not disappeared, check the following.
  - a) Check if the paper empty sensor is contaminated. If so, clean it.
  - b) If the paper empty sensor([0604-001325](#)) is defective, replace it.

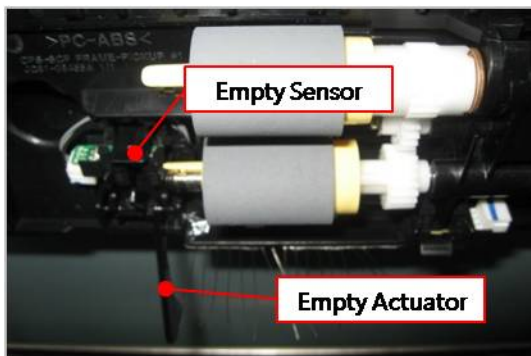

- c) If the empty actuator([JC66-02613A](#)) is defective, replace it.

▶ **Error Code**

H1-1453

▶ **Error message**

Input System Failure #H1-1453 : Pull Tray 4 out and insert it.

▶ **Symptom**

The paper is not fed from tray4.

▶ **Troubleshooting method**

- 1) Check if the Gear-Idle Lift is broken.

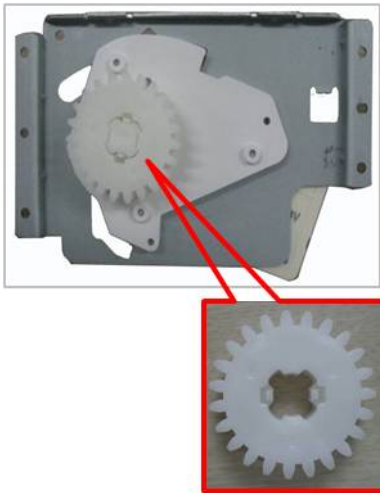

- 2) Check if the cassette detection sensor cable is connected correctly. Unplug and reconnect it.

- 3) If the connection is OK, replace the cassette detection sensor(*JC34-00001A*).

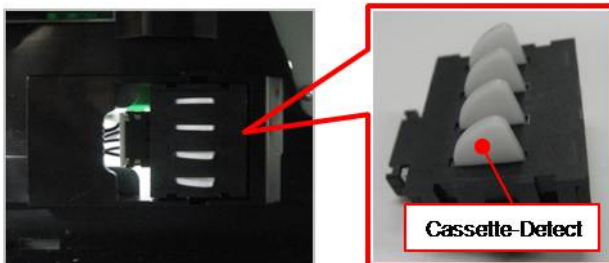

- 4) Check if the Lift-Motor connector is connected properly.



- 5) If the problem persists, replace the Lift-Motor(*JC81-08705A*).



▶ **Error Code**

H1-1510

H1-1511

▶ **Error message**

Paper jam in Tray 5.

▶ **Symptom**

Paper jam has occurred in tray5.

▶ **Troubleshooting method**

- 1) Remove the jammed paper. If the problem persists, check the followings.
- 2) Check if the paper is loaded in the tray5 properly.
- 3) Check if the pick up/forward/reverse rollers([JC97-02259A](#)) of the tray5 are defective or worn out.

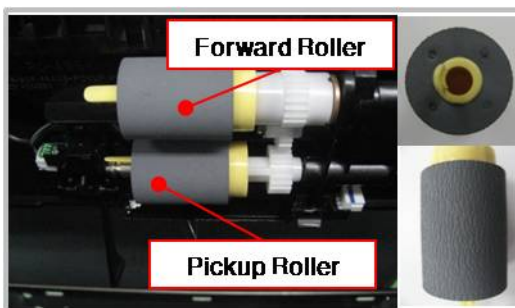

- 4) Check if the Empty/ Pick up/ Regi-Act sensor of the tray4 is working properly.

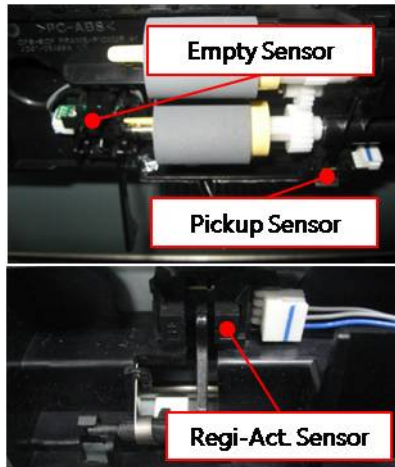

- 5) Check the connection between the motor/clutch and the SCF board. Reconnect the harness.

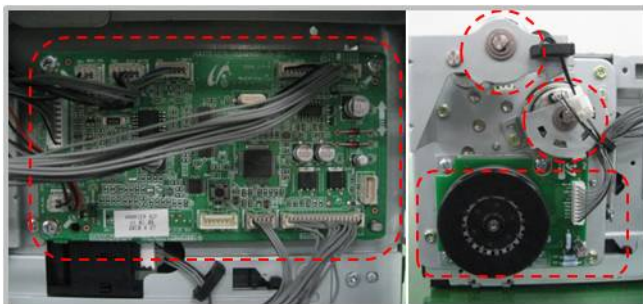

- 6) Check if the AS-SPRING\_ES is deformed or assembled properly.

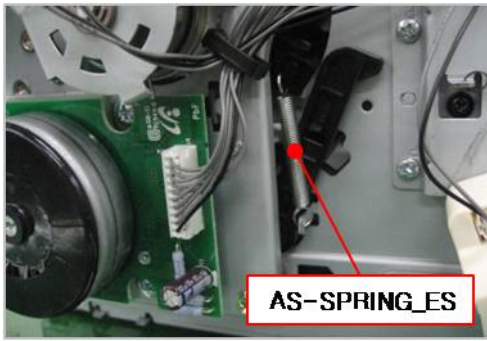

- 7) Check if the Press D-cut of the Gear-Lifting([JC81-08478A](#)) is broken.

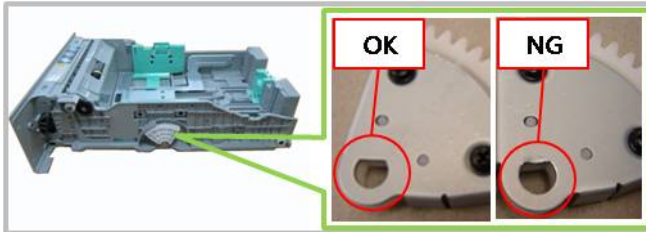

- 8) If the problem persists after checking No. 1~7, replace the SCF board([JC92-02754A](#)).
- 9) If the problem persists, replace the Drop connector harness.

**▶ Error Code**

H1-1522

**▶ Error message**

Tray 5 cassette is pulled out. Insert it properly.

**▶ Symptom**

Tray 5 is pulled out or the cassette detection sensor connector is not connected or broken.

**▶ Troubleshooting method**

- 1) Remove and insert tray5 correctly.
- 2) If the problem persists, remove tray5 again.
- 3) Check if the cassette detection sensor cable is connected correctly. Unplug and reconnect it.
- 4) If the connection is OK, replace the cassette detection sensor([JC34-00001A](#)).

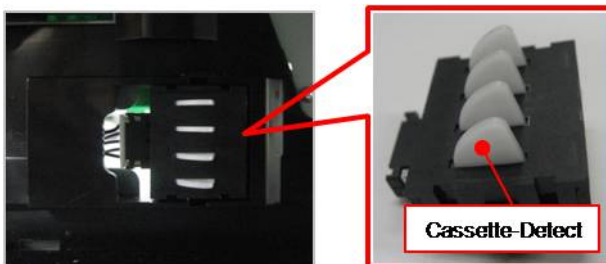

- 5) If the problem persists, replace the SCF board([JC92-02754A](#)).

▶ **Error Code**

H1-1530

▶ **Error message**

Input System Failure: #H1-1530. Check tray 5 connection.

▶ **Symptom**

The communication error between the tray 5 and the main machine has occurred.

▶ **Troubleshooting method**

- 1) Turn the machine off.
- 2) Check the connection on SCF board. Reconnect the harness.

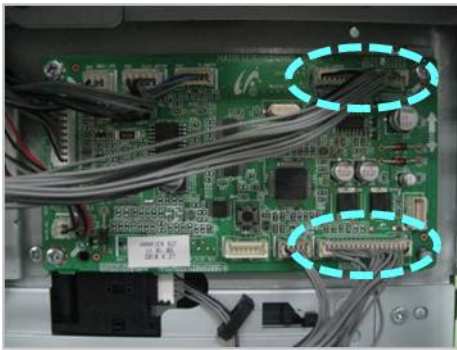

- 3) If the drawer connector is deformed or broken, replace it.  
(*AS-HARNESS HSCF : JC81-09742A / HOLDER-CONNECTOR\_SCF : JC61-01742A*)



- 4) If the problem persists, replace the SCF main board(*JC92-02754A*).

**► Error Code**

H1-1551

H1-1552

H1-1554

**► Error message**

Paper is low in Tray 5. Load paper.

Paper is empty in tray 5. Load paper.

**► Symptom**

Paper in the tray5 is less than 10% of specification. / The photo sensor is defective.

**► Troubleshooting method**

- 1) Remove tray5. Load the paper in tray5.
- 2) If paper is loaded but error message has not disappeared, check the following.
  - a) Check if the paper empty sensor is contaminated. If so, clean it.
  - b) If the paper empty sensor([0604-001325](#)) is defective, replace it.

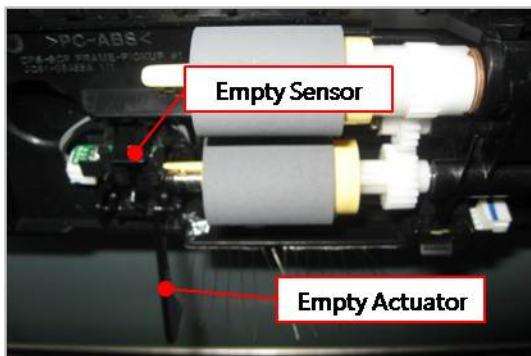

- 
- 
- c) If the empty actuator([JC66-02613A](#)) is defective, replace it.

▶ **Error Code**

H1-1553

▶ **Error message**

Input System Failure #H1-1553 : Pull Tray 5 out and insert it.

▶ **Symptom**

The paper is not fed from tray5.

▶ **Troubleshooting method**

- 1) Check if the Gear-Idle Lift is broken.

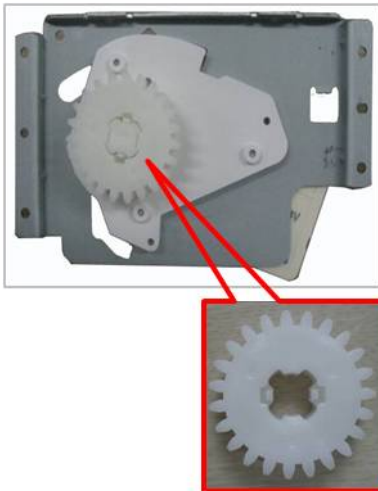

- 2) Check if the cassette detection sensor cable is connected correctly. Unplug and reconnect it.

- 3) If the connection is OK, replace the cassette detection sensor(*JC34-00001A*).

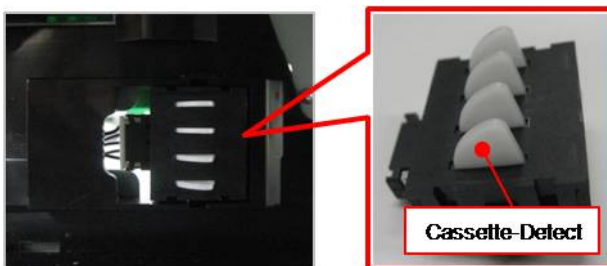

- 4) Check if the Lift-Motor connector is connected properly.



- 5) If the problem persists, replace the Lift-Motor(*JC81-08705A*).

### 4.6.5. Mx-xxxx (Paper Handling Error(Jam\_Paper Empty etc))

Error Code	Error Message	Troubleshooting Page
M1-1110	Paper jam in tray 1	P.4-72
M1-1610	Paper jam in MP tray	P.4-74
M1-3122	Tray 1 cassette Out / Tray 1 cassette is pulled out. Insert it properly	P.4-75
M1-4111	Error: #M1-4111 / Tray Failure: #M1-4111. Pull tray 1 out and insert it. Call for service if the problem persists	P.4-76
M1-5111	Paper Low in tray 1 / Paper is low in tray 1. Load paper	P.4-77
M1-5112	Paper Empty in tray 1 / Paper is empty in tray 1. Load paper	P.4-77
M1-5113	Paper Empty in tray 1 / Paper is empty in tray 1. Load paper	P.4-77
M1-5120	Paper Empty in all trays / Paper is empty in all trays. Load paper	P.4-77
M1-5612	Paper Empty in MP tray / Paper is empty in MP tray. Load paper	P.4-78
M2-1110	Jam inside of machine	P.4-79
M2-1111	Jam inside of machine	P.4-79
M2-1114	Jam inside of machine	P.4-79
M2-1214	Jam inside of machine	P.4-79
M2-2211	Jam inside of duplex	P.4-81
M2-2212	Jam top of duplex	P.4-81
M2-2214	Jam inside of duplex	P.4-81
M2-2310	Jam bottom of duplex	P.4-81
M3-1110	Jam in exit area	P.4-82
M3-1111	Jam in exit area	P.4-82
M3-1112	Jam inside of machine	P.4-82
M3-2130	Output bin is full / Paper in output bin is full. Remove printed paper	P.4-83

▶ **Error Code**

M1-1110

▶ **Error message**

Paper jam in Tray 1.

▶ **Symptom**

Paper jam has occurred in tray1.

▶ **Troubleshooting method**

- 1) Remove Cassette Tray1 and remove the jammed paper, then reinstall Cassette Tray1.
- 2) If the problem persists, check the followings.
- 3) Check if the proper paper is loaded in the tray. If not, replace the paper.
- 4) Check if the pick up/forward/reverse roller([JC97-02259A](#)) are contaminated or worn out. Replace these rollers.



- 5) Check if the cassette lifting is working normally. If not, check the feed drive unit([JC93-00350A](#)).

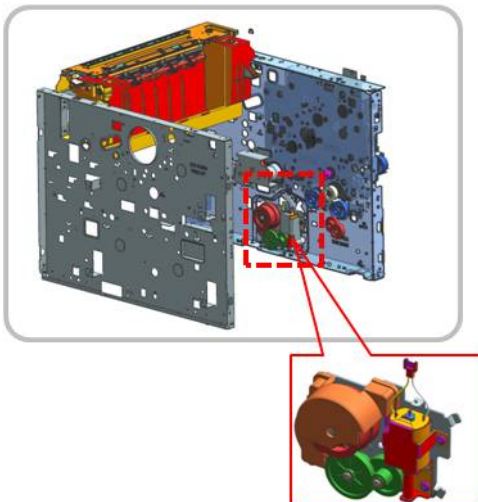

- 6) Check the connection between the main(feed/fuser) motor and main board.



7) If the connection is OK, enter SVC mode. Execute the motor test.

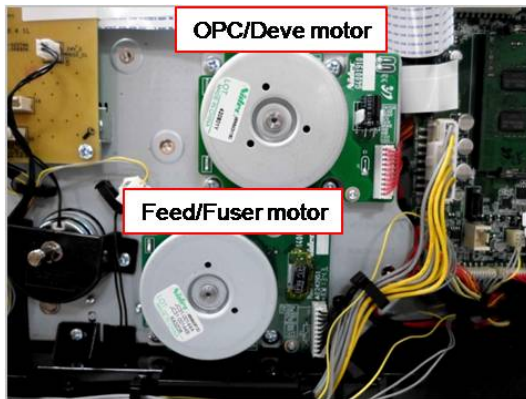

- a) If the motor is not operational,
    - i) Check the motor signal(3.3V). If the signal is abnormal, replace the main board([JC92-02802A\(M4530ND\)](#) / [JC92-02801A\(M4530NX\)](#)).
    - ii) Check the power(24V). If the power is abnormal, check the SMPS board. If the SMPS board([JC44-00092C \(220V\)](#) / [JC44-00091C \(110V\)](#)) is defective, replace it.
    - iii) If the motor signal and power is normal, replace the main(feed/fuser) motor([JC31-00144B](#)).
  - b) If the motor is operational, replace the main board.
- 8) Check the pick up clutch connection. If the pick up clutch([JC47-00033E](#)) is defective, replace it.

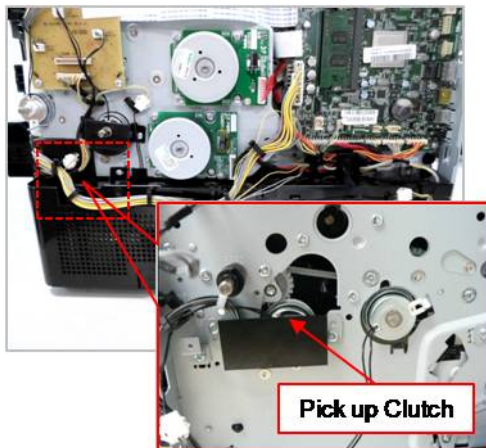

▶ **Error Code**

M1-1610

▶ **Error message**

Paper jam in MP Tray.

▶ **Symptom**

Paper jam has occurred in MP tray.

▶ **Troubleshooting method**

- 1) Remove the jammed paper from the MP tray.
- 2) If the problem persists, check the following:
  - a) Check if the proper paper is loaded in the tray. If not, replace the paper.
  - b) Check if the MP pick up roller is contaminated or worn out. Replace the MP pick up roller Assy.
  - c) Check the MP pick up clutch connection. If the MP pick up clutch is defective, replace it.

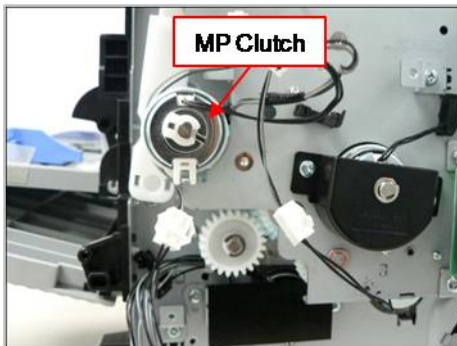

- d) Check the connection between the main(feed/fuser) motor and main board.
- e) If the connection is OK, enter SVC mode. Execute the motor test.

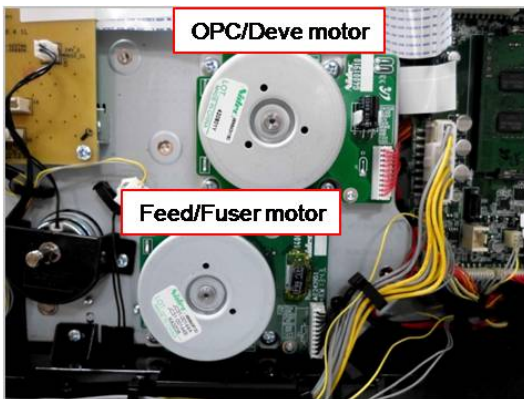

- i) If the motor is not operational,
  - 1) Check the motor signal(3.3V). If the signal is abnormal, replace the main board([JC92-02802A\(M4530ND\)](#) / [JC92-02801A\(M4530NX\)](#)).
  - 2) Check the power(24V). If the power is abnormal, check the SMPS board. If the SMPS board([JC44-00092C \(220V\)](#) / [JC44-00091C \(110V\)](#)) is defective, replace it.
  - 3) If the motor signal and power is normal, replace the main(feed/fuser) motor([JC31-00144B](#)).
- ii) If the motor is operational, replace the main board.

**▶ Error Code**

M1-3122

**▶ Error message**

Tray 1 cassette is pulled out. Insert it properly.

**▶ Symptom**

Tray1 is not installed properly.

**▶ Troubleshooting method**

- 1) Install the tray1. If the tray1 is already installed, remove and reinstall it.
- 2) Check if the harness connection for cassette detection is normal. Reconnect it. If the harness is defective, replace it.
- 3) Check if the cassette detection sensor(*JC34-00001A*) is defective, replace it.

▶ **Error Code**

M1-4111

▶ **Error message**

Tray Failure: #M1-4111. Pull tray 1 out and insert it. Call for service if the problem persists.

▶ **Symptom**

The paper has jammed in the path or can't be fed.

▶ **Troubleshooting method**

- 1) Check if the pick up/ forward/ retard roller([JC97-02259A](#)) are contaminated or worn out. Replace the defective roller.



- 2) Check the feed drive unit for cassette lifting.

- Check if the gear is worn out or broken.
- Check if the DC motor is working normally.
- If any part is defective, replace it or the feed drive unit([JC93-00350A](#)).

- 3) Check the pick up clutch connection. If the pick up clutch([JC47-00033E](#)) is defective, replace it.

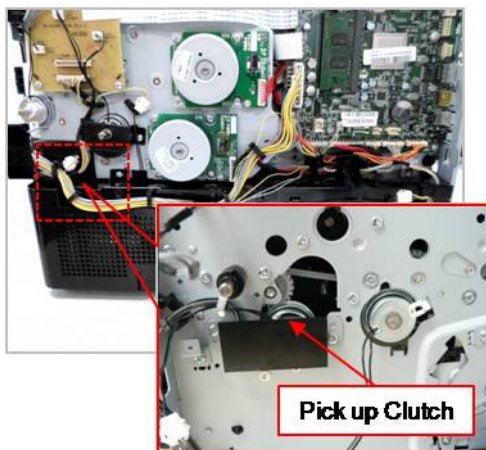

▶ **Error Code**

M1-5111

M1-5112

M1-5113

▶ **Error message**

Paper is low in tray 1. Load paper

Paper is empty in tray 1. Load paper.

▶ **Symptom**

Paper is low (M1-5111) or empty(M1-5112, M1-5113) in Tray1.

▶ **Troubleshooting method**

- 1) Check if the paper is loaded in tray1. Load the paper.
- 2) Check if the empty actuator(*JC66-02905A*) of the pick up Assy is assembled correctly. If it is broken or deformed, replace it.

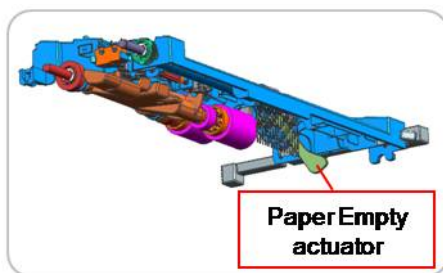

- 3) Check if the empty sensor is connected correctly. If the harness is defective, replace it.
- 4) Check if the empty sensor(*0604-001325*) is defective, if so replace it.

▶ **Error Code**

M1-5120

▶ **Error message**

Paper is empty in all tray. Load paper

▶ **Symptom**

Paper is empty in all tray.

▶ **Troubleshooting method**

- 1) Check if the paper is loaded in tray1 and MP tray. Load the paper.
- 2) Check if the empty actuator is assembled correctly. If it is broken or deformed, replace it.
- 3) Check if the empty sensor is connected correctly. If the harness is defective, replace it.
- 4) Check if the empty sensor is defective, if so replace it.

▶ **Error Code**

M1-5612

▶ **Error message**

Paper is empty in all tray. Load paper

▶ **Symptom**

Paper is empty in MP tray.

▶ **Troubleshooting method**

- 1) Check if the paper is loaded in MP tray. Load the paper.
- 2) Check if the MP empty actuator is assembled correctly. If it is broken or deformed, replace it.
- 3) Check if the MP empty sensor is connected correctly. If the harness is defective, replace it.
- 4) Check if the MP empty sensor is defective, if so replace it.

**► Error Code**

M2-1110 / M2-1111 / M2-1114 / M2-1214

**► Error message**

Paper jam in tray.

Paper jam inside of machine.

**► Symptom**

The paper has jammed at the feed sensor.

**► Troubleshooting method**

- 1) Remove the tray1. Remove the jammed paper. And install the tray.
- 2) If the problem persists, check the followings.
- 3) Check if the feed sensor connector is connected correctly.

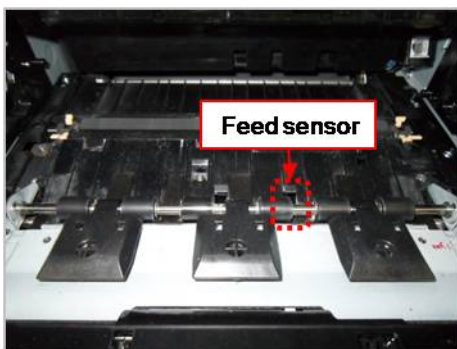

- 4) Check if the regi. roller is contaminated or worn out.

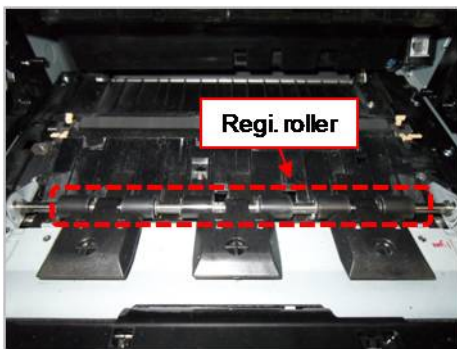

- 5) Check the regi. clutch connection. If the regi. clutch([JC47-00033E](#)) is defective, replace it.

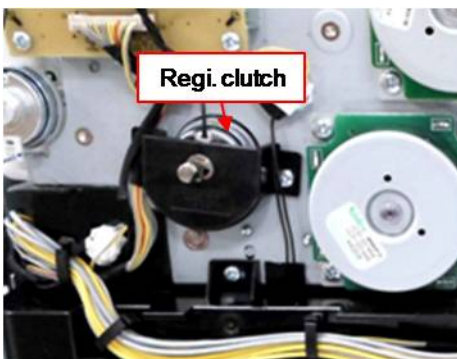

- 6) Check the pick up clutch connection. If the pick up clutch(*JC47-00033E*) is defective, replace it.

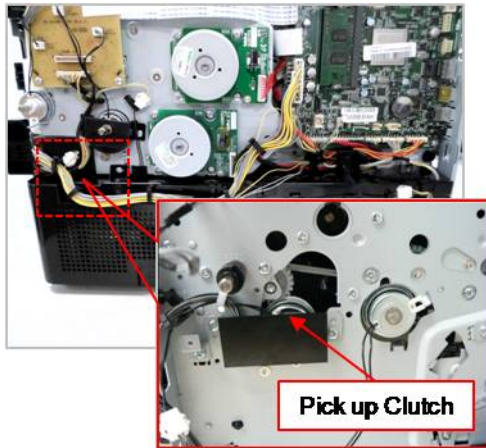



**▶ Error Code**

M2-2211 / M2-2212 / M2-2214 / M2-2310

**▶ Error message**

Paper jam inside of duplex path

Paper jam at the top of duplex path

Paper jam at the bottom of duplex path

**▶ Symptom**

The paper did not enter the duplex path and has jammed.

**▶ Troubleshooting method**

- 1) Remove the jammed paper. If the same error occurs continually, check the following.
- 2) Check if there are any obstacles or contamination in the duplex path.
- 3) Check if the exit actuator([JC66-02850A](#)) of the fuser unit works normally.



- 4) Check if the exit motor works normally and its connector is connected properly.
- 5) If the exit motor is defective, replace it or exit drive unit([JC93-00349A](#)).
- 6) Check if the duplex clutch works normally and its connector is connected properly.
- 7) If the duplex clutch([JC47-00033E](#)) is defective, replace it.

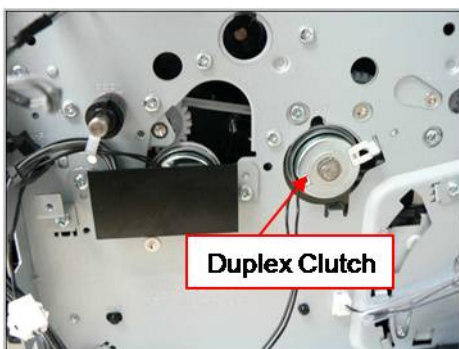

▶ **Error Code**

M3-1110 / M3-1111 / M3-1112

▶ **Error message**

Paper jam in exit area.

Paper jam inside of machine

▶ **Symptom**

Paper jam has occurred around the exit area.

▶ **Troubleshooting method**

- 1) Remove the jammed paper. If the same error occurs continually, check the following.
- 2) Check if there are any obstacles or contamination in the duplex path.
- 3) Check if the exit actuator([JC66-02850A](#)) of the fuser unit works normally.



- 4) Check if the exit motor works normally and its connector is connected properly.
- 5) If the exit motor is defective, replace it or exit drive unit([JC93-00349A](#)).
- 6) Remove the exit drive unit. Check if the gear is worn out or broken. If necessary, replace the exit drive unit.
- 7) Remove the fuser unit. If there is any broken or defective part of the fuser unit. Replace it or fuser unit([JC91-01177A \(220V\)](#) / [JC91-01176A \(110V\)](#)).

**▶ Error Code**

M3-2130

**▶ Error message**

Too much paper in output bin tray. Remove printed paper

**▶ Symptom**

There are too much paper in output bin tray.

**▶ Troubleshooting method**

- 1) Remove the paper on exit tray.
- 2) If this error occurs continually, check the following.
  - a) Check if the bin-full sensor and actuator is assembled correctly.
  - b) Check if the bin-full sensor is defective.

**4.6.6. Sx-xxxx (System Error)**

Error Code	Error Message	Troubleshooting Page
S1-2411	Error: #S1-2411 / HDD System Failure: #S1-2411. Turn off then on. Call for service if the problem persists	P.4-85
S1-2511	Error: #S1-2511 / MSOK System Failure: #S1-2511. Call for service	P.4-85
S2-1110	Error: #S2-1110 / Engine System Failure: #S2-1110. Call for service	P.4-86
S2-331C	Idle Warning Area Calibrating density	P.4-86
S2-331D	Idle Warning Area Waiting for low temp	P.4-86
S2-3321	Idle Warning Area Supplying Toner...	P.4-86
S2-4210	Front door is open. Close it	P.4-87
S2-4310	Rear door is open. Close it	P.4-88
S6-3113	Error: #S6-3113 / Network Failure: #S6-3113. Turn off then on. Call for service if the problem persists	P.4-89
S6-3123	IP Conflict / This IP address conflicts with that of other system	P.4-89
S6-3128	802.1x Network Error / 802.1x Network Error. Contact the Admin	P.4-89
S6-3231	Error: #S6-3231 / Can not find a wireless network. Please check the wireless environment	P.4-90
S6-3232	Error: #S6-3232 / Wireless security settings are incorrect. Please change the settings	P.4-90
S6-3233	Error: #S6-3233 / Not connected from the wireless AP. If you do not reconnect automatically, check the wireless settings	P.4-90
S6-3234	Error: #S6-3234 / Failed connection to WPS. Try again or set up other wireless connection	P.4-91
S6-3235	Error: #S6-3235 / Wi-Fi Direct is not ready. Turn off then on. Call for service if the problem persists	P.4-91
S6-3236	Error: #S6-3236 / Failed to connect to Wi-Fi Direct. Turn off your mobile device and turn it on	P.4-91
S7-2110	Error #S7-2110 / Fuser Failure: #S7-2110. Turn off then on. Call for service if the problem persists	P.4-92

**▶ Error Code**

S1-2411

**▶ Error message**

Error: #S1-2411 / HDD System Failure: #S1-2411. Turn off then on. Call for service if the problem persists

**▶ Symptom**

Hard Disk is not installed in the machine. / Hard Disk is defective.

**▶ Troubleshooting method**

- 1) Turn the machine off then on. If the problem persists, check the followings.
- 2) Check if the HDD cable is connected correctly. Reconnect it.
- 3) If the problem persists, replace the HDD.

**▶ Error Code**

S1-2511

**▶ Error message**

Error: #S1-2511 / MSOK System Failure: #S1-2511.Call for service

**▶ Symptom**

MSOK is not installed properly. / MSOK is defective.

**▶ Troubleshooting method**

- 1) Turn the machine off then on. If the problem persists, check the followings.
- 2) Check if the MSOK is inserted correctly. Remove and reinstall it.
- 3) If the problem persists, replace the main board.

▶ **Error Code**

S2-1110

▶ **Error message**

Engine Failure: #S2-1110. Call for service if the problem persists

▶ **Symptom**

The CPU in main board has some problem. (Booting error, Communication error etc.)

▶ **Troubleshooting method**

- 1) Turn the machine off then on.
- 2) If the problem persists, replace the main board.

▶ **Error Code**

S2-331C

S2-331D

S2-3321

▶ **Error message**

Calibrating... Please Wait

Wait delay time for lower fixing temperature...

Supplying and mixing toner to developer unit. Please wait...

▶ **Symptom**

These errors show the engine status.

▶ **Troubleshooting method**

- 1) Please wait until this error will disappear.

**▶ Error Code**

S2-4210

**▶ Error message**

Front door is open. Close it

**▶ Symptom**

Front cover is opened.

**▶ Troubleshooting method**

- 1) Open the front cover and close it correctly.
- 2) Open the front cover.
- 3) Check if the switch contact of the front cover is deformed.
- 4) Remove the right cover.
- 5) Check the connection between the cover open sensor and the joint board. Reconnect the harness. If the harness is defective, replace it.
- 6) Open the front cover. Check if the message is changed when pushing the micro switch(cover open sensor).
- 7) If the cover open sensor is defective, replace it.

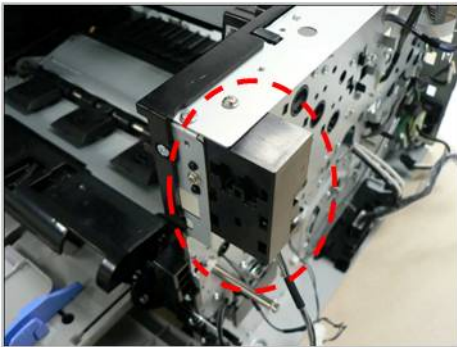

▶ **Error Code**

S2-4310

▶ **Error message**

Rear door is open. Close the door

▶ **Symptom**

Rear cover is opened.

▶ **Troubleshooting method**

- 1) Open the rear cover and close it correctly.
- 2) Open the rear cover.
- 3) Check if the switch contact of the rear cover is deformed.

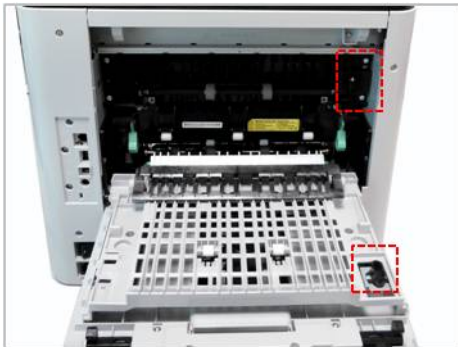

- 4) Remove the left cover.
- 5) Check the connection between the cover open sensor and HVPS board. Reconnect the harness. If the harness is defective, replace it.
- 6) Open the rear cover. Check if the message is changed when pushing the micro switch(cover open sensor).
- 7) If the cover open sensor is defective, replace it.



**▶ Error Code**

S6-3113

**▶ Error message**

Error: #S6-3113 / Network Failure: #S6-3113. Turn off then on. Call for service if the problem persists

**▶ Symptom**

Network PHY Chip on the main board is defective.

**▶ Troubleshooting method**

- 1) Turn the machine off then on.
- 2) If the problem persists, replace the main board.

**▶ Error Code**

S6-3123

**▶ Error message**

IP Conflict / This IP address conflicts with that of other system

**▶ Symptom**

IP address conflicts with that of another system.

**▶ Troubleshooting method**

- 1) Change the machine's IP address.
  - a) Select "Machine Setup" on the menu.
  - b) Select "Networking Setting".
  - c) "Log-In". d) Select "TCP/IP".
  - d) Select the proper item for your machine.
  - e) Select "IP Setting".
  - f) Select the proper item for your machine.
  - g) Change the IP address.
- 2) If the IP address setting has no problem, replace the main board.

**▶ Error Code**

S6-3128

**▶ Error message**

802.1x / 802.1x .

**▶ Symptom**

Server authentication is failed because of the authentication protocol or wrong user information(ID/Passworkd).

**▶ Troubleshooting method**

- 1) Check the authentication protocol and user authentication information.

▶ **Error Code**

S6-3231

▶ **Error message**

802.1x Network Error / 802.1x Network Error. Contact the Admin

▶ **Symptom**

NOT FOUND SSID(Service Set Identifier) event has occurred.

▶ **Troubleshooting method**

- 1) Check the user wireless environment. (AP power on/off, AP setting)
- 2) Check if there is any device to disturb the wireless communication like a microwave, bluetooth device around the printer.

▶ **Error Code**

S6-3232

▶ **Error message**

Error: #S6-3232 / Wireless security settings are incorrect. Please change the settings

▶ **Symptom**

Wireless security settings such as WEP/WPA/WPA2 are incorrect.

▶ **Troubleshooting method**

- 1) Set up the wireless network.
- 2) Change the setting method. (UI, Installer, SWS)
- 3) Turn off the AP device and printer then on.
- 4) Set up the AP. (WPA2-PSK/AES is recommended.)

▶ **Error Code**

S6-3233

▶ **Error message**

Error: #S6-3233 / Not connected from the wireless AP. If you do not reconnect automatically, check the wireless settings

▶ **Symptom**

Wireless connection is cut off or wireless BSSID value is 0.

▶ **Troubleshooting method**

- 1) Check the user wireless environment. (AP power on/off, AP setting)
- 2) Check if there is any device to disturb the wireless communication like a microwave, bluetooth device around the printer.

**▶ Error Code**

S6-3234

**▶ Error message**

Error: #S6-3234 / Failed connection to WPS. Try again or set up other wireless connection

**▶ Symptom**

Failed connection to WPS.

**▶ Troubleshooting method**

- 1) In case of using the WPS button, push the WPS button for 2 seconds and try again.
- 2) In case of using the WPS PIN, push the WPS button for 4 seconds and try again.
- 3) Set up other wireless connection

**▶ Error Code**

S6-3235

**▶ Error message**

Error: #S6-3235 / Wi-Fi Direct is not ready. Turn off then on. Call for service if the problem persists

**▶ Symptom**

Wi-Fi Direct is not ready because of library initialization.

**▶ Troubleshooting method**

- 1) Turn the machine off then on.
- 2) If the problem persist, initialize the wireless setting and try again.

**▶ Error Code**

S6-3236

**▶ Error message**

Error: #S6-3236 / Failed to connect to Wi-Fi Direct. Turn off your mobile device and turn it on

**▶ Symptom**

Failed to connect to Wi-Fi Direct.

**▶ Troubleshooting method**

- 1) Turn off Wi-Fi Direct function then on.
- 2) Turn off your mobile device and turn it on.
- 3) Turn off the printer and turn it on.

▶ **Error Code**

S7-2110

▶ **Error message**

Fuser Failure: #S7-2110. Turn off then on

▶ **Symptom**

Heater control relay is abnormal.

▶ **Troubleshooting method**

- 1) Turn the machine off. Re-install the fuser unit, then turn the machine on.
- 2) If the problem persists, replace the fuser drive board([JC44-00204A\(220V\)](#) / [JC44-00203A\(110V\)](#)).
- 3) If the problem persists, replace the fuser unit([JC91-01177A \(220V\)](#) / [JC91-01176A \(110V\)](#)).

### 4.6.7. U1-xxxx (Fuser error)

Error Code	Error Message	Troubleshooting Page
U1-2112	Error: #U1-2112 / Fuser Unit Failure: #U1-2112. Turn off then on. Call for service if the problem persists	P.4-95
U1-2115	Error: #U1-2115 / Fuser Unit Failure: #U1-2115. Turn off then on. Call for service if the problem persists.	P.4-98
U1-2116	Error: #U1-2116 / Fuser Unit Failure: #U1-2116. Turn off then on. Call for service if the problem persists.	P.4-98
U1-2117	Error: #U1-2117 / Fuser Unit Failure: #U1-2117. Turn off then on. Call for service if the problem persists	P.4-100
U1-2120	Error: #U1-2120 / Fuser Unit Failure: #U1-2120. Turn off then on. Call for service if the problem persists	P.4-95
U1-2132	Error: #U1-2132 / Fuser Unit Failure: #U1-2132. Turn off then on. Call for service if the problem persists	P.4-95
U1-2135	Error: #U1-2135 / Fuser Unit Failure: #U1-2135. Turn off then on. Call for service if the problem persists	P.4-95
U1-2316	Error #U1-2316 / Fuser Failure: #U1-2316. Turn off then on. Call for service if the problem persists	P.4-95
U1-2317	Error #U1-2317 / Fuser Failure: #U1-2317. Turn off then on. Call for service if the problem persists	P.4-95
U1-2320	Error: #U1-2320 / Fuser Unit Failure: #U1-2320. Turn off then on. Call for service if the problem persists	P.4-95
U1-2321	Error: #U1-2321 / Fuser Unit Failure: #U1-2321. Turn off then on. Call for service if the problem persists	P.4-95
U1-2323	Error: #U1-2323 / Fuser Unit Failure: #U1-2323. Turn off then on. Call for service if the problem persists	P.4-95
U1-2327	Error: #U1-2327 / Fuser Unit Failure: #U1-2327. Turn off then on. Call for service if the problem persists	P.4-95
U1-2332	Error: #U1-2332 / Fuser Unit Failure: #U1-2332. Turn off then on. Call for service if the problem persists	P.4-95
U1-2333	Error: #U1-2333 / Fuser Unit Failure: #U1-2333. Turn off then on. Call for service if the problem persists	P.4-95
U1-2334	Error: #U1-2334 / Fuser Unit Failure: #U1-2334. Turn off then on. Call for service if the problem persists	P.4-95
U1-2339	Error #U1-2339 / Fuser Failure: #U1-2339. Turn off then on. Call for service if the problem persists	P.4-95
U1-233F	Error #U1-233F / Fuser Failure: #U1-233F. Turn off then on. Call for service if the problem persists	P.4-95
U1-2341	Error: #U1-2341 / Fuser Unit Failure: #U1-2341. Turn off then on. Call for service if the problem persists	P.4-95
U1-2342	Error: #U1-2342 / Fuser Unit Failure: #U1-2342. Turn off then on. Call for service if the problem persists	P.4-95
U1-2343	Error: #U1-2343 / Fuser Unit Failure: #U1-2343. Turn off then on. Call for service if the problem persists	P.4-95
U1-2345	Fuser Unit Failure: #U1-2345. Please turn off then on. Call for service if the problem persists	P.4-95

#### 4. Troubleshooting

---

<b>Error Code</b>	<b>Error Message</b>	<b>Troubleshooting Page</b>
U1-2348	Error: #U1-2348 / Fuser Unit Failure: #U1-2348. Turn off then on. Call for service if the problem persists	P.4-95
U1-234H	Error: #U1-234H / Fuser Unit Failure: #U1-234H. Turn off then on. Call for service if the problem persists	P.4-95
U1-234R	Error #U1-234R / Fuser Failure: #U1-234R. Turn off then on. Call for service if the problem persists	P.4-95

▶ **Error Code**

U1-2112 / U1-2120 / U1-2132 / U1-2135 / U1-23xx

▶ **Error message**

Fuser unit Failure: #U1-2xxx. Turn off then on. Call for service if the problem persists

▶ **Symptom**

The temperature control of fuser unit is abnormal. (Open Heat Error or Low Heat Error or Over Heat Error) / Thermistor is defective. / Fuser unit connection is bad.

▶ **Troubleshooting method**



**CAUTION**

The temperature gets hot around the fuser unit. To prevent burns, make sure the fuser unit area is cool before performing this procedure.

- 1) After checking the fuser installation, turn the machine off then on.
- 2) Open the rear cover. Lift up the right side and release the rear cover.



- 3) If there is no problem, remove 4 screws.



- 4) Lift up the both levers. Then take off the fuser unit.

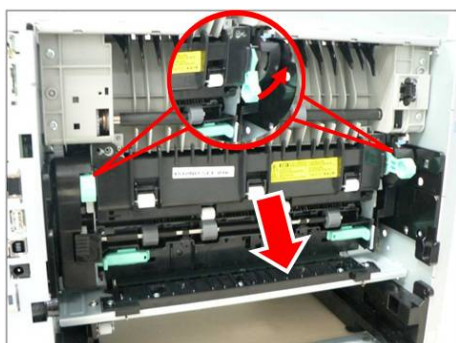

- 5) Remove the Frame-cover-upper after removing 2 screws. And measure the thermostat continuity. Check if the thermostat is opened.

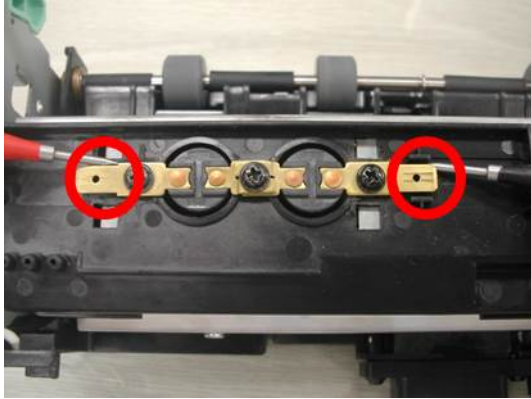

- 6) Measure the LAMP-HALOGEN resistance value from the center and both sides. Check if it has the continuity.

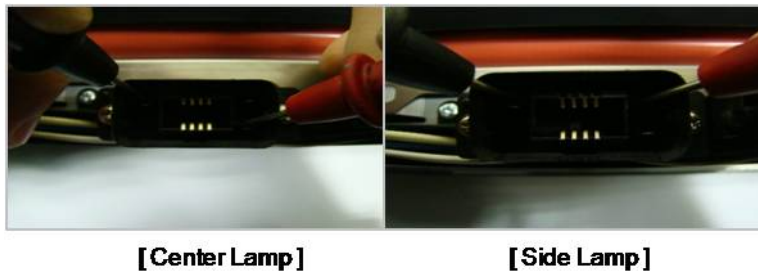

- 7) Check if the Draw-connector harness is correct. Check its color.

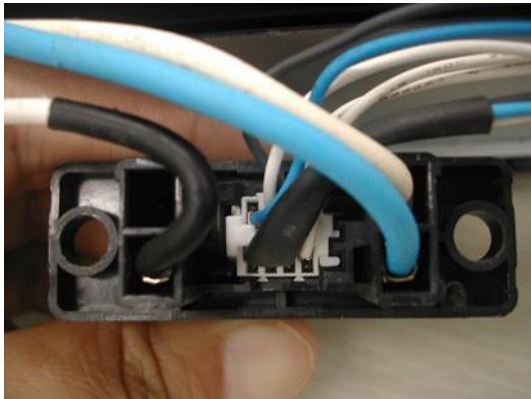

- 8) Check if 2 thermistor connectors are connected properly.

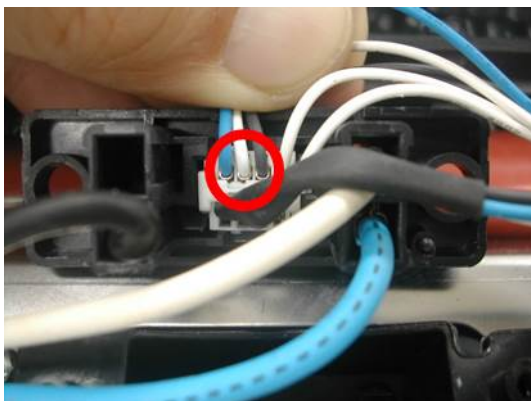

- 9) Measure the Thermistor resistance value from the center and both sides. Check if it has the continuity. (3 Red Circles)

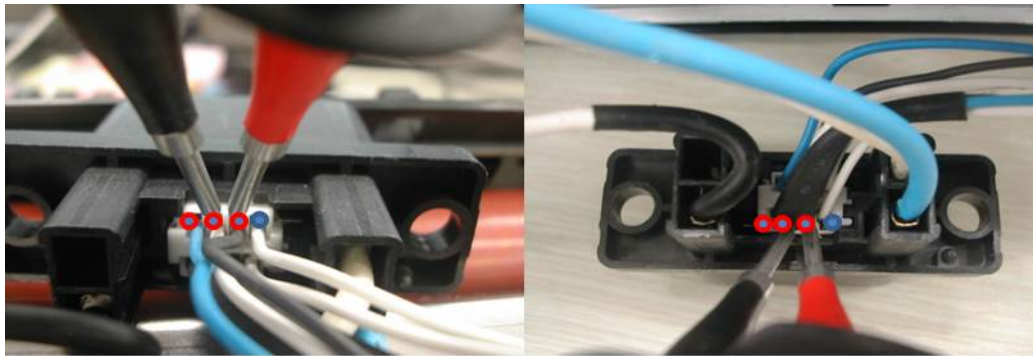

**Center Thermistor****Side Thermistor**

- 10) Check if the thermistor connector on the main board is connected properly.
- 11) Check if the FDB connector is connected properly.
- 12) Check if the voltage in user environment is in this range (80V ~ 140V, 160V ~ 260V).
- 13) If there is no problems for above steps, update the firmware.
- 14) Replace the FDB([JC44-00204A\(220V\)](#)/[JC44-00203A\(110V\)](#)).  
If the problem persists, replace the SMPS([JC44-00092C\(220V\)](#)/[JC44-00091C\(110V\)](#))  
If the problem persists, replace the main board.

▶ **Error Code**

U1-2115

U1-2116

▶ **Error message**

Fuser unit Failure: #U1-2115. Turn off then on. Call for service if the problem persists

Fuser unit Failure: #U1-2116. Turn off then on. Call for service if the problem persists

▶ **Symptom**

The pressure control unit(Cam unit)of the fuser is abnormal.

▶ **Troubleshooting method**



**CAUTION**

The temperature gets hot around the fuser unit. To prevent burns, make sure the fuser unit area is cool before performing this procedure.

- 1) After checking the fuser installation, turn the machine off then on.
- 2) Open the rear cover. Lift up the right side and release the rear cover.



- 3) If there is no problem, remove 4 screws.



- 4) Lift up the both levers. Then take off the fuser unit.

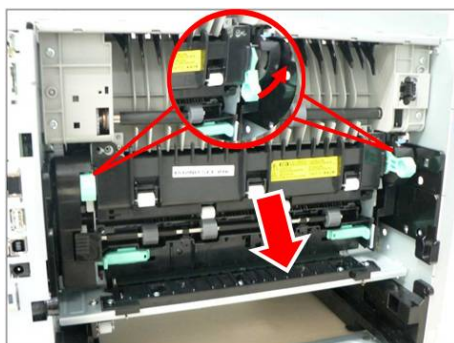

- 5) Remove the fuser side cover L/R. Check if the Actuator cam, Gear cam are assembled correctly.
- 6) If there is no problem for above steps, assemble and reinstall fuser unit. Then turn the machine on.
- 7) If the same error persists, perform a Memory Clear (backup data in SWS first); if that does not work try reinstalling the firmware.
- 8) If the same error persists, replace the fuser unit(*JC91-01177A (220V) / JC91-01176A (110V)*) with new one.
- 9) If the same error persists, replace the main board.

▶ **Error Code**

U1-2117

▶ **Error message**

Fuser unit Failure: #U1-2117. Turn off then on.

▶ **Symptom**

The machine can't detect that the fuser unit is installed.

▶ **Troubleshooting method**



**CAUTION**

The temperature gets hot around the fuser unit. To prevent burns, make sure the fuser unit area is cool before performing this procedure.

- 1) After checking the fuser installation, turn the machine off then on.
- 2) Open the rear cover. Lift up the right side and release the rear cover.



- 3) If there is no problem, remove 4 screws.



- 4) Lift up the both levers. Then take off the fuser unit.

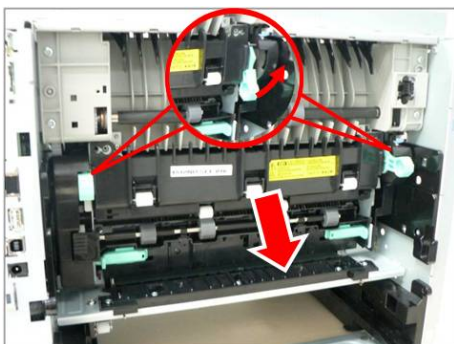

- 5) If there is no problem for above steps, assemble and reinstall fuser unit. Then turn the machine on.

- 6) If the same error persists, execute the memory clear.
- 7) If the same error persists, replace the fuser unit(*JC91-01177A (220V) / JC91-01176A (110V)*) with new one.
- 8) If the same error persists, replace the main board.

### 4.6.8. U2-xxxx type (LSU) error code

Error Code	Error Message	Troubleshooting Page
U2-1111	Error: #U2-1111 / LSU Failure: #U2-1111.Turn off then on. Call for service if the problem persists	P.4-101
U2-1112	Error: #U2-1112 / LSU Failure: #U2-1112.Turn off then on. Call for service if the problem persists	P.4-101
U2-1113	Error: #U2-1113 / LSU Failure: #U2-1113.Turn off then on. Call for service if the problem persists	P.4-101
U2-1114	Error: #U2-1114 / LSU Failure: #U2-1114.Turn off then on. Call for service if the problem persists	P.4-101

► **Error Code**

U2-1111

U2-1112

U2-1113

U2-1114

► **Error message**

LSU Failure: #U2-1111. Please turn off then on.

LSU Failure: #U2-1112. Please turn off then on.

LSU Failure: #U2-1113. Please turn off then on.

LSU Failure: #U2-1114. Please turn off then on.

► **Symptom**

LSU motor does not operate or it operates abnormally. / LSU Motor ready signal is abnormal.

► **Troubleshooting method**

- 1) Turn the machine off then on. Check for the LSU motor operation sound during warm-up.
- 2) Print a demo page to check that the machine operates normally.
- 3) If the problem persists, check the following :
  - If the LSU motor makes a sound,
    - a) Enter SVC mode to check the LSU motor ready signal.
    - b) Select “LSU Motor1 Run Ready”.
    - c) Press ‘Start’ button. Check that the status has changed to ‘Executing -> Low -> High’.
    - d) If the status has not changed, the motor ready signal is abnormal. Replace the LSU.
  - If the LSU motor does not makes a sound,
    - a) Turn the machine off and open the side cover. Unplug and reconnect the LSU cable. Check that the LSU motor make a sound after turning the machine on.
    - b) If the LSU cable is defective, replace it. Check that the LSU motor make a sound after turning the machine on.
    - c) If the problem persists, replace the LSU([JC97-03877A](#)).

## 4.7. Image quality problem

Print-quality defects can be attributed to printer components, supplies, media, internal software, external software applications and environmental conditions.

To successfully troubleshoot print-quality problems, as many variables as possible must be eliminated.

The first step is to generate prints using printable pages embedded in the printer on laser paper. The paper should be from an unopened ream that has been acclimated to room temperature and you should ensure that genuine Samsung Toner is installed in the printer.

### How to analysis the defect image



**TIP**

- According to the part remain life, cause can vary. Check the part remain life.
- Check the defect whether periodic or not.

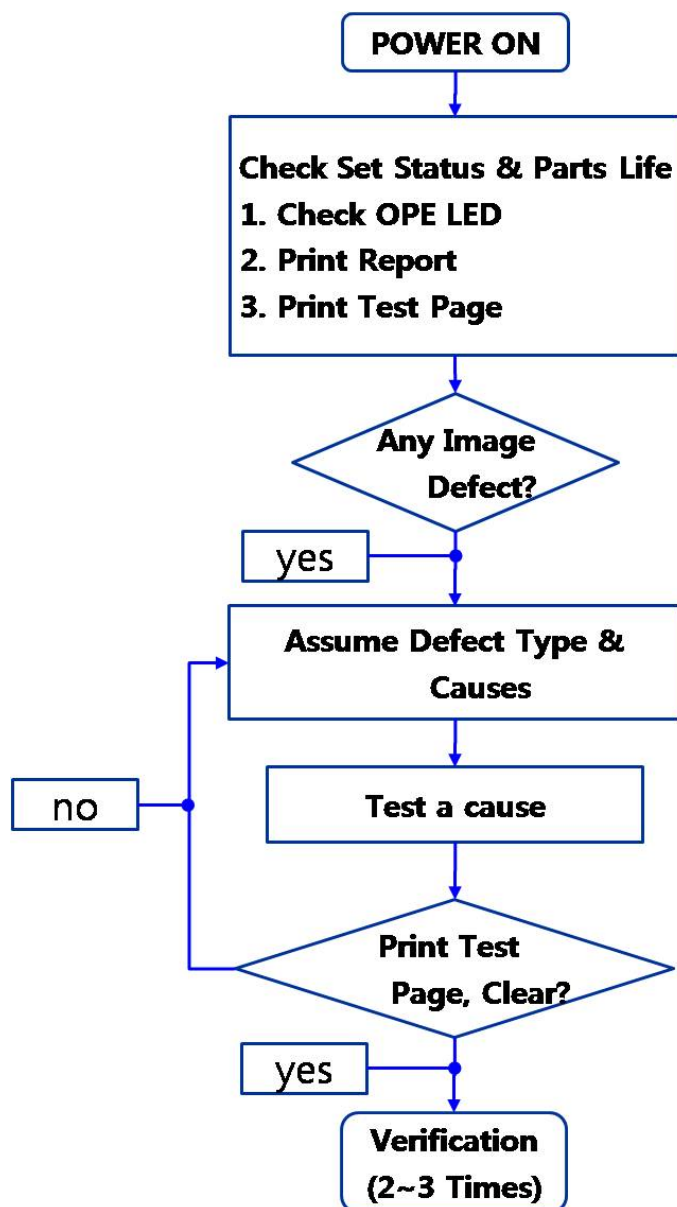

### 1) Vertical Black Line and Band

Description : Straight thin black vertical line occurs in the printed image.



Probable Cause	Solution
The paper is not the proper type.	Replace the paper.
The paper path is contaminated by toner residue, debris etc.	Clean the paper path.
The imaging unit is defective.	Replace the imaging unit.
The transfer roller is contaminated or worn out.	Replace the transfer roller.
The pressure roller or heat roller in fuser unit defective.	<ol style="list-style-type: none"> <li>1) Turn the machine off.</li> <li>2) Remove and replace the fuser unit.</li> <li>3) Turn the machine on.</li> </ol> <div style="background-color: #cccccc; padding: 5px; margin-top: 10px;">  <b>WARNING</b>  <b>Do not touch the fuser unit while it is hot.</b> </div>



## 2) Vertical White Line, Band

Description : White vertical voids occurs in the printed image.



Probable Cause	Solution
The paper is not the proper type.	Replace the paper.
The paper path is contaminated by toner residue, debris etc.	Clean the paper path.
The imaging unit is defective.	Replace the imaging unit.
The transfer roller is contaminated or worn out.	Replace the transfer roller.
The LSU window is contaminated.	1) Clean the LSU window. 2) Replace the LSU
The connection between the LSU and main board is defective.	1) Disconnect and reconnect the harness. 2) Replace the harness.

### 3) Horizontal Black Band

Description : Dark or blurry horizontal stripes occur in the printing periodically.



Probable Cause	Solution
The paper is dirty or not the proper type.	Replace the paper.
The paper path is contaminated by toner residue, debris etc.	Clean the paper path.
The contact terminal of the imaging unit is bad.	1) Clean the contact terminal of the imaging unit. 2) Replace the imaging unit.
The surface of transfer roller is contaminated or worn out.	Replace the transfer roller.
The LSU window is contaminated.	1) Clean the LSU window.
The pressure roller or heat roller in fuser unit defective.	1) Turn the machine off. 2) Remove and replace the fuser unit. 3) Turn the machine on.  <div style="background-color: #cccccc; padding: 5px;">  <b>WARNING</b>            Do not touch the fuser unit while it is hot.         </div>
HVPS terminal is contaminated.	Clean the contaminated terminal.
The output from the HVPS is abnormal.	Replace the HVPS board.

#### NOTE

Roller period table

Roller	Period	Replacement part
Charge roller	38.31 mm	Imaging unit
OPC drum	94.20 mm	
Developing roller	62.49 mm	
Supply roller	56.21 mm	
Pressure roller	54.95 mm	Fuser unit
Transfer roller	28.89 mm	Transfer roller

#### 4) Black and White spot

Description : Dark or blurry black spots occur periodically in the printing.



Probable Cause	Solution
The paper path is contaminated by toner residue, debris etc.	Clean the paper path.
The rollers in the imaging unit may be contaminated with foreign matter or paper particles.	Replace the imaging unit.
The transfer roller is contaminated or worn out.	Replace the transfer roller.
The pressure roller or heat roller in fuser unit defective.	1) Turn the machine off. 2) Remove and replace the fuser unit. 3) Turn the machine on.  <div style="background-color: #cccccc; padding: 5px;">  <b>WARNING</b>  <b>Do not touch the fuser unit while it is hot.</b> </div>

### 5) Light image

Description : The printed image is light, with no ghost.



Probable Cause	Solution
The toner cartridge life is expired.	Replace the toner cartridge.
The imaging unit life is expired.	Replace the imaging unit.
The surface of transfer roller is contaminated or worn out.	Replace the transfer roller.
HVPS terminal is contaminated.	Clean the contaminated terminal.
The output from the HVPS is abnormal.	Replace the HVPS board.

## 6) Dark or Black page

Description : The printed image is dark or black.



Probable Cause	Solution
The charging roller in the imaging unit is defective.	Replace the imaging unit.
The HVPS contact terminal is contaminated.	Clean the HVPS contact terminal.
The output from the HVPS is abnormal.	Replace the HVPS board.
The LSU is defective.	Replace the LSU.

## 7) Uneven Density

Description : Print density is uneven between left and right.



Probable Cause	Solution
<ul style="list-style-type: none"> <li>• The pressure force on the left and right springs of the transfer roller is not even.</li> <li>• The springs are damaged.</li> <li>• The transfer roller is improperly installed.</li> </ul>	<ol style="list-style-type: none"> <li>1) Remove the transfer roller Assy.</li> <li>2) Check if the transfer roller Assy has any wrong part.</li> <li>3) Replace the transfer roller Assy.</li> </ol>
<p>The toner level is not even on the imaging unit roller due to the bad blade.</p>	<p>Replace the imaging unit.</p>

## 8) Background

Description : Light dark background appears in whole area of the printing.



Probable Cause	Solution
Does recycle paper be used?	Use the proper sheet for the job at hand.
The life of the imaging unit has been expired	Replace the imaging unit.
The output from the HVPS is abnormal.	Replace the HVPS board.

**9) Ghost**

Description : Ghost occurs.





Probable Cause	Solution
The residual toner on the rollers exists.	Print 10 test prints.
The contact terminal of the imaging unit is bad.	1) Clean the contact terminal of the imaging unit. 2) Replace the imaging unit.
The transfer roller is contaminated or worn out.	Replace the transfer roller.
The pressure roller or heat roller in fuser unit defective.	1) Turn the machine off. 2) Remove and replace the fuser unit. 3) Turn the machine on.  <div style="background-color: #cccccc; padding: 5px;">  <b>WARNING</b>  <b>Do not touch the fuser unit while it is hot.</b> </div>
The HVPS contact terminal is contaminated.	Clean the HVPS contact terminal.
The output from the HVPS is abnormal.	Replace the HVPS board.

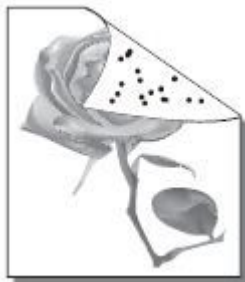

## 10) Stains on back of page

Description : The back of the page is stained.



Probable Cause	Solution
The transfer roller is contaminated or worn out.	Replace the transfer roller.
The pressure roller or heat roller in fuser unit defective.	1) Turn the machine off. 2) Remove and replace the fuser unit. 3) Turn the machine on. <div style="background-color: #cccccc; padding: 5px; margin-top: 10px;">  <b>WARNING</b>  <b>Do not touch the fuser unit while it is hot.</b> </div>

**11) Blank page**

Description : No visible image anywhere on the output.



Probable Cause	Solution
The contact terminal of the imaging unit is bad.	1) Clean the contact terminal of the imaging unit. 2) Replace the imaging unit.
The surface of transfer roller is contaminated or worn out.	Replace the transfer roller.
The LSU window is contaminated.	1) Clean the LSU window. 2) Replace the LSU
The connection between the LSU and main board is defective.	1) Disconnect and reconnect the harness. 2) Replace the harness.
The connection between the main board and HVPS board is bad.	Reconnect the harness. If the main board or HVPS board is defective, replace it.

## 12) Partial image void

Description : The partial void occurs in the printed page.



Probable Cause	Solution
The printer is not installed on flat ground.	Install the printer on flat ground. Print 10 sample pages for test.
The developer circulation in the imaging unit is bad.	1) Shake the imaging unit 2~3 times from right to left. Reinstall the imaging unit. Print 10 sample pages for test. 2) If the problem persists, replace the imaging unit.
The contact between imaging unit and transfer roller is bad.	Check if the imaging unit and transfer roller are installed properly.

**13) Unfused image**

Description : The printed image is not fully fused to the paper. The image rubs off easily

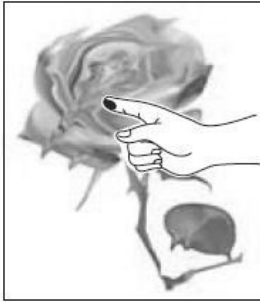

Probable Cause	Solution
The papers are wet with moisture.	Replace the paper.
The fuser unit is not tight.	1) Turn the machine off. 2) Remove and reinstall the fuser unit. 3) Turn the machine on.
The fuser connection is bad.	Check the connection between the fuser unit and main board.
The fuser unit defective.	1) Turn the machine off. 2) Remove and replace the fuser unit. 3) Turn the machine on. <div style="background-color: #cccccc; padding: 5px; margin-top: 10px;">  <b>WARNING</b>  <b>Do not touch the fuser unit while it is hot.</b> </div>

---

## 4.8. SPDS (Smart Printer Diagnostic System) Application

---

This application is based on Android and the purpose of SPDS is to help the service engineer when repairing a machine.

### Specification of SPDS App.

- 1) **Mobile**
  - a) Support model : Galaxy series, All android phone.
    - Galaxy S series (S2, S3, S4,...)
    - Galaxy Note series (Note1, Note2, Note3,...)
    - Galaxy Tab series (Tab7.0, Tab7.7, Tab8.9, Tab10.1,...)
  - b) Android version
    - Android 4.0 or later (Ice Cream Sandwich)
- 2) **Printer**
  - a) USB support model
  - b) Wifi-Direct support model

### 4.8.1. SPDS App Installation and Login

#### 4.8.1.1. SPDS App Installation

1) **Run Google Play Store**

- Run Google Play Store to download SPDS App.

2) **Search SPDS App**

- SPDS App can be found by searching ‘SPDS’.

3) **Start Installation**

- Press ‘INSTALL’ after checking App information.

4) **Check Authority**

- Press ‘ACCEPT’ after checking required authority.

5) **Installing**

- SPDS App will be installed.

6) **Installation Complete**

- After completing install App you can see installation result. If you want to run App press ‘OPEN’.



[Run Google Play Store]

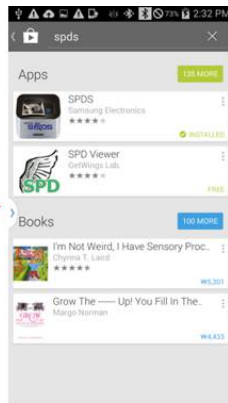

[Search SPDS App]



[Start Installation]

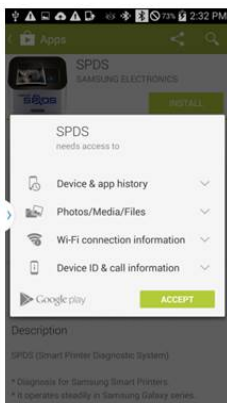

[Check Authority]

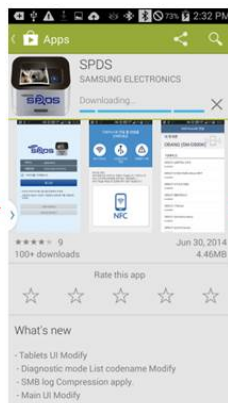

[Installing]

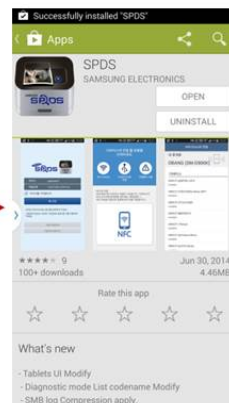

[Installation Complete]

### 4.8.1.2. User Registration Request

#### 1) Screen that is running

- User registration is required for first time users. Press 'User Registration Request'.

#### 2) Input User Information

- Input ID, Name, E-mail, Partner ID. ID is required more than 4 characters. Blank spaces are not allowed. Utilize capital and small letters.



#### NOTE

If E-mail address is invalid you cannot progress to the next step.

- If Partner ID is invalid you cannot receive approval of administrator.

#### 3) Request User Registration

- After request of user registration wait for approval of administrator.
- If approved by the administrator email notification will be sent out.

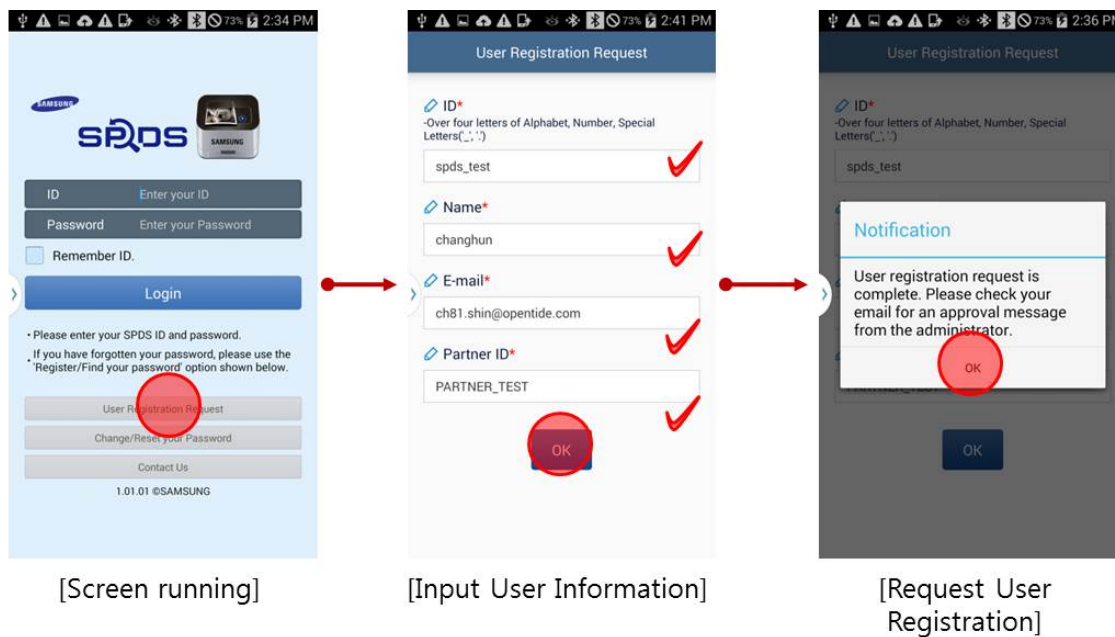

### 4.8.1.3. Change\_Reset Password

1) **Screen is running**

- After approval of 'User Request Registration', you can proceed 'Change/Reset your Password'.
- Press 'Change/Reset your Password' at the bottom of screen.

2) **Registration Password**

- Press 'OK' after ID input 'User Request Registration'.

3) **Send Authentication Code**

- Confirm Authentication Code to e-mail of registered user.

4) **Input Authentication Code**

- Press 'OK' after input authentication code.

5) **Registration Password**

- Input your password.

6) **Complete Registration**

- Press 'OK' and then login at login screen.

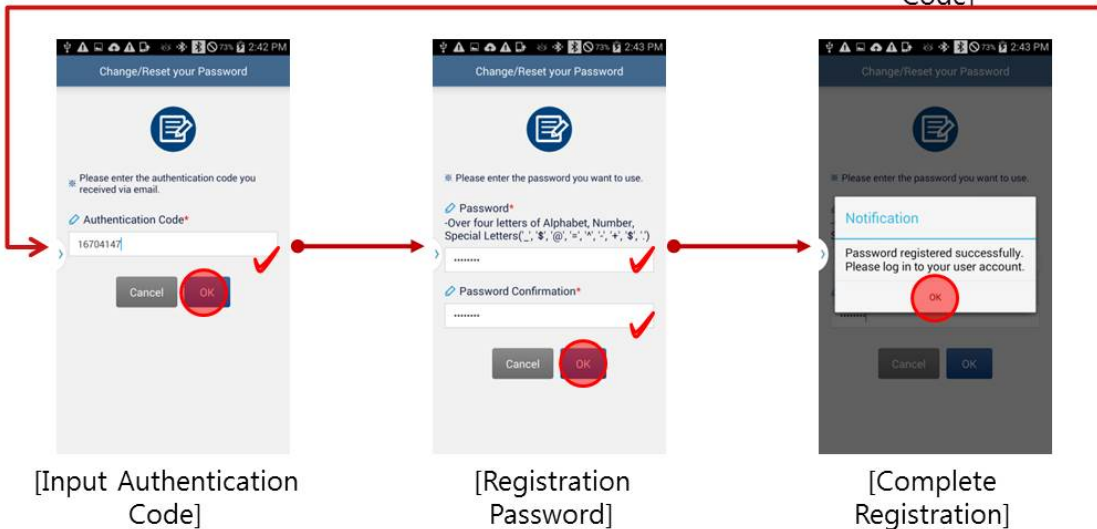
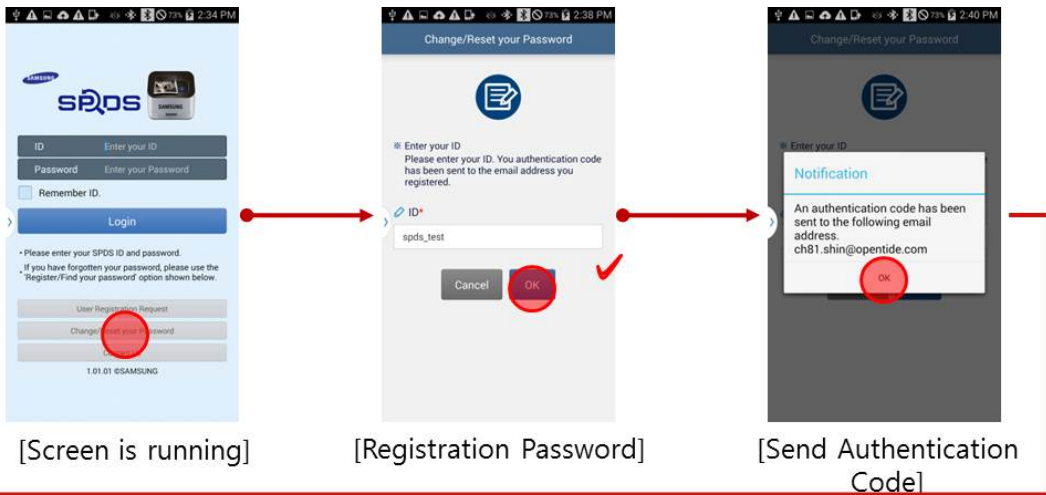



#### 4.8.1.4. Login

##### 1) Screen is running

- Input ID and password that registered at 'User Request Registration', 'Change/Reset your Password'.

##### 2) Try login

- Try login after input ID and Password.
- If you forget your password, press 'Change/Reset your Password'.

##### 3) Success login

- If you have successful login you can see the four device connectivity method.

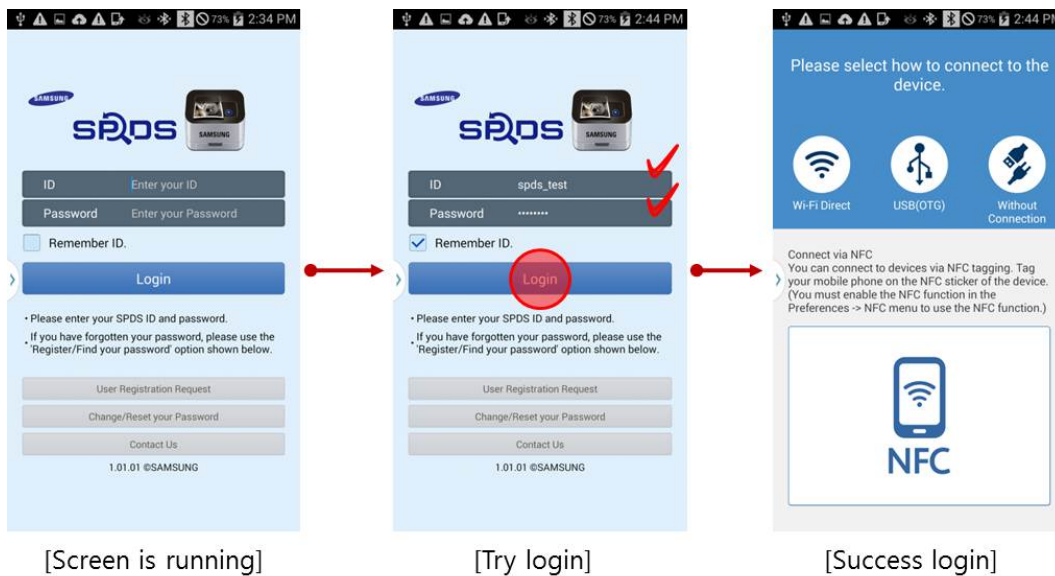

### Login (USIM Change)

1) Screen that is running

- Utilize your ID and password to login.

2) USIM Certification Error

- When present device USIM and USIM that used at sign up are different you can login after USIM Change Request.

3) USIM Change Request

- You can login via new ID and password after administrator approve USIM change.
- USIM information will be updated you cannot login with existing USIM.

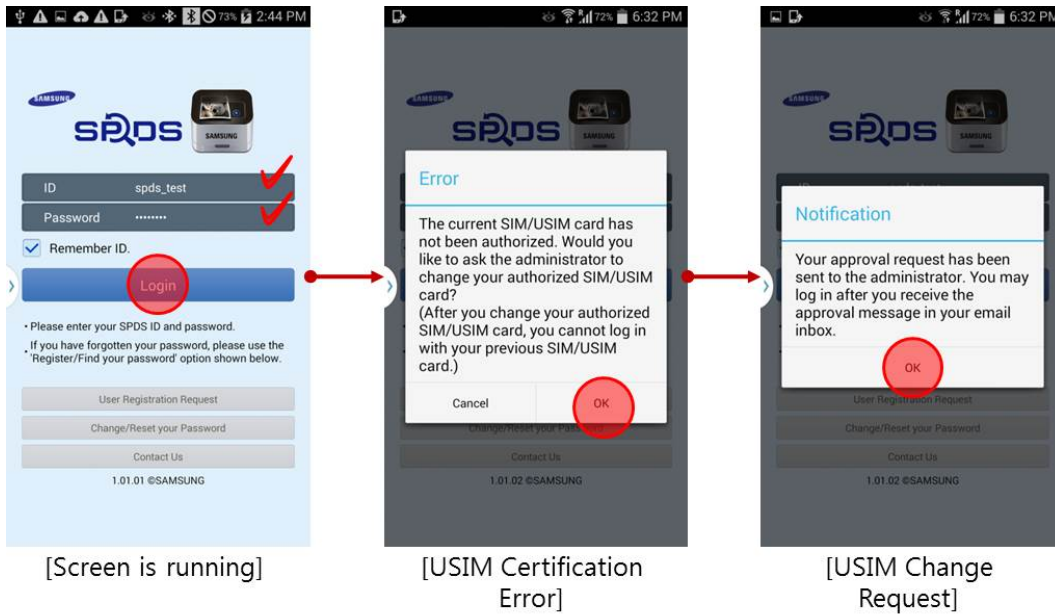

### 4.8.1.5. Select Connect Method

#### WIFI-Direct

##### 1) Device Connect Method

- Press 'Wi-Fi Direct'. If 'Wi-Fi' is disabled 'Wi-Fi' will be turn on automatically.

##### 2) Select Device

- After searching Peer you can see printer list that is available.
- Select printer for connectivity.

##### 3) Device Connect

- Press WPS or Connect button of printer for connectivity.
- Once SPDS has connected you can see User Information Consent Screen.

##### 4) Fail Device Connect

- When your printer firmware is not supported by SPDS a temporary device error pop-up message will occur.

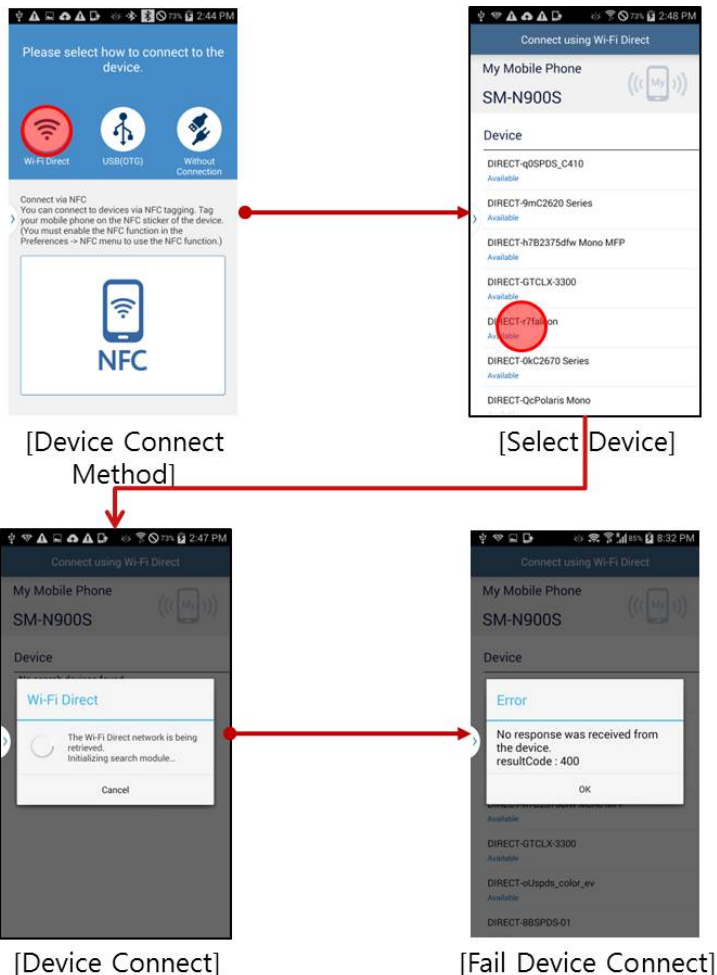

## WIFI-Direct with NFC

### 1) Preparation

- After checking NFC availability of your device find NFC Tag.
- Go to Setting of your Phone, enable the NFC function.

### 2) NFC Tag

- After login select NFC protocol on your device at 'Device Connect Method'.

### 3) Connect Device

- When NFC tagging 'Wi-Fi Direct' device connection is made confirmation window pops up.
- Unlike 'Wi-Fi Direct' NFC Tagging method is directly connected to the printer. The list of available devices is omitted.



[Preparation]

[NFC Tag]

[Connect Device]

## USB-OTG

### 1) Device Connect Method

- Connect to Printer using USB (OTG) cable.
- Press 'USB OTG' after 'printer is connected' message at the top of screen.

### 2) Confirm USB Authority

- Press 'OK' when pop-up occurs. Once SPDS has connected you can see User Information Consent Screen.

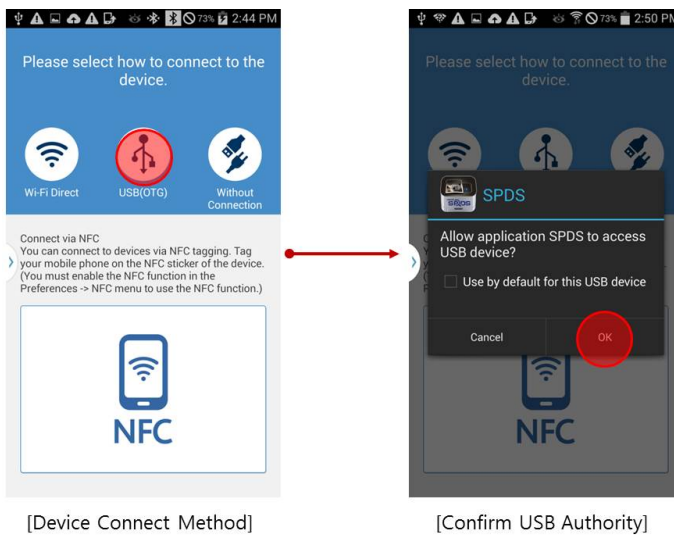

## Without Connection

### 1) Device Connect Method

- Press 'Without Connection'.
- Need no connection to device 'Approval process of user information' is omitted.

### 2) Initial Screen

- -You can see initial screen does not include any device information.

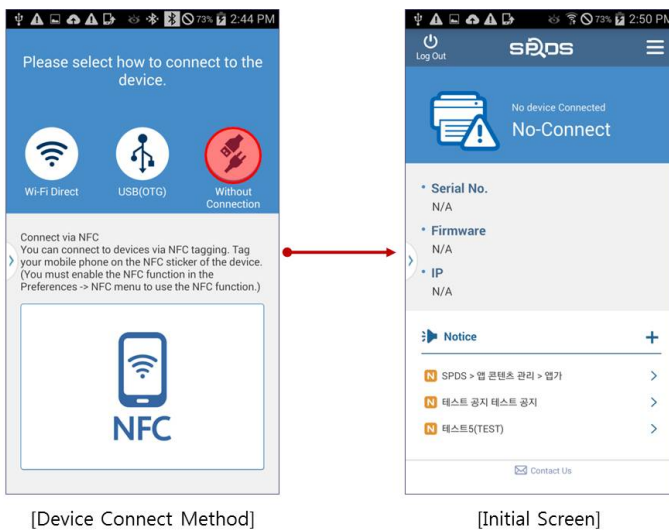

### 4.8.1.6. Consent to customer information

1) **Confirm Registered User Information**

- When customer consent has been completed this screen comes out.
- If user information is correct press 'YES'. Press 'NO' for customer consent.

2) **Customer Information Consent**

- Customer consent has not been completed this screen comes out.

3) **Input information**

- Check the checkbox after reading terms.
- Input name, company, e-mail of customer, and then press 'Consent'.

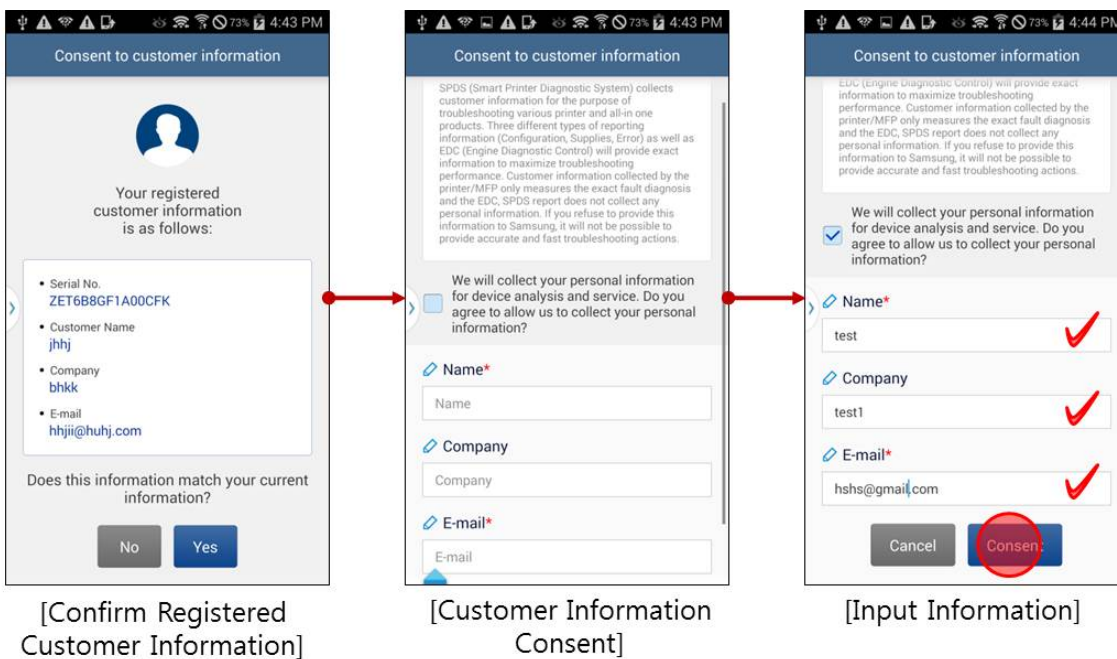

## 4.8.2. SPDS Menu Introduction

### 4.8.2.1. Error Mode

#### Device Error Inquiry

##### 1) Menu Screen

- At menu screen error mode menu comes out by press error icon.
- As a subordinate menu of error mode there are Device Error, Action Guide, Corrective History, Requesting Statistics, and Movie Guide.

##### 2) Error Inquiry

- Error Code of Connected device shows by pressing 'device error inquiry'.

##### 3) Detailed Inquiry

- You can see detailed information of connected device by selecting Error code.

##### 4) When there is no error

- If connected device has no error code pop-up comes out.

##### 5) Auto Complete

- If you input more than two characters, Error Code auto complete function is offered.

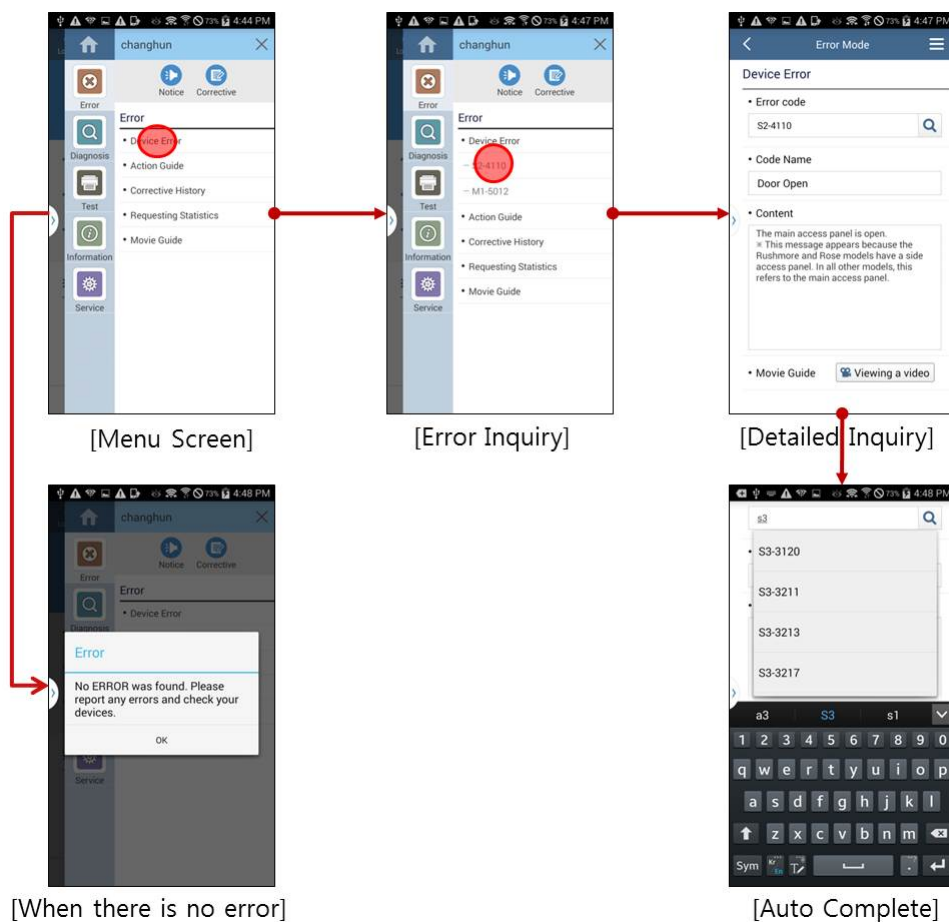

### Action Guide

#### 1) Menu Screen

- Select Error → Action Guide → Service Bulletin.

#### 2) Search Condition

- You can search by input Basic model, Title, Doc No, Start Date, End Date.
- Start Date and End date is requirement condition.

#### 3) Select Date

- When click Start Date or End date, calendar comes out, you can select date.

#### 4) Conduct Search

- After input search condition conduct search.

#### 5) Result list

- The results of search condition comes out as a list.

#### 6) See the detail

- By selecting items from list you can see detail.

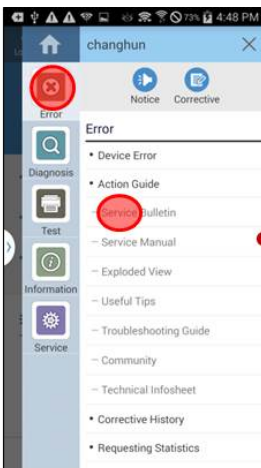

[Menu Screen]

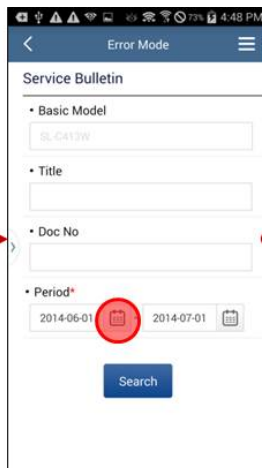

[Search Condition]

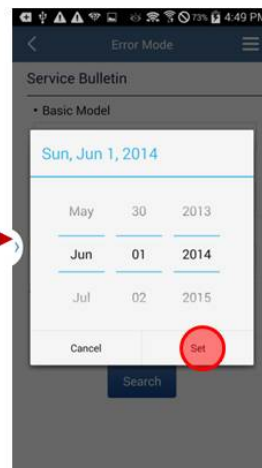

[Select Date]

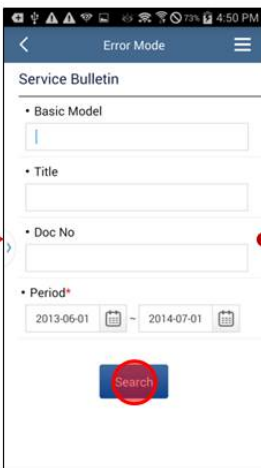

[Conduct Search]

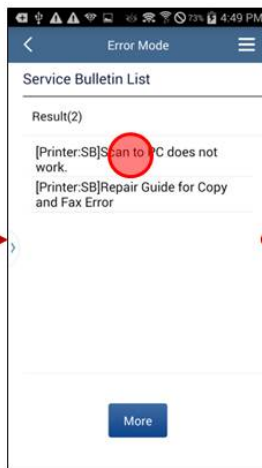

[Result list]

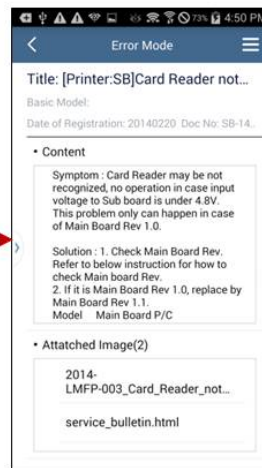

[See the detail]



## Connected Device History

### 1) Menu Screen

- Press Error → Corrective History → Connected Device History.

### 2) Initial Screen

- As a subordinate menu of Connected Device History there are History of Each Error Code, History of Each Corrective Part and History of Each Service Engineer.

### 3) Subordinate Menu Selection

- Corrective Histories are listed by selecting menu.

### 4) See the detail

- Detailed Action comes out by selecting Corrective history list.

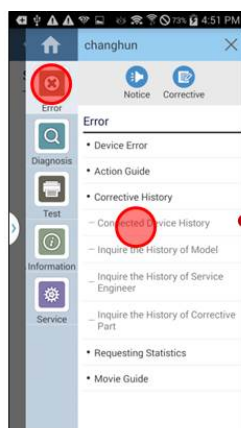

[Menu Screen]

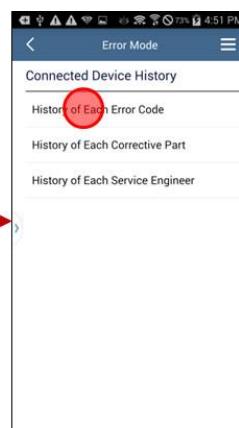

[Initial Screen]

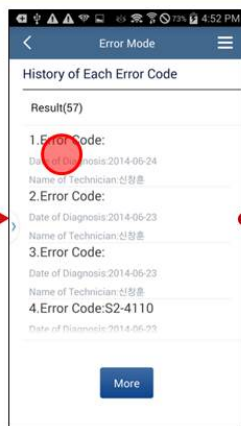

[Subordinate Menu Selection]

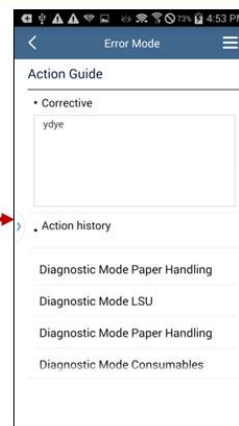

[See the detail]

## Requesting Statistics

### 1) Menu Screen

- Press 'Requesting Statistics' of Error mode.

### 2) Authority Confirm

- Requesting Statistics require administrator authority. So if you have no administrator authority, you cannot use this function.

### 3) Requesting Statistics

- Usage/Statistics History will be sent to e-mail of requester.

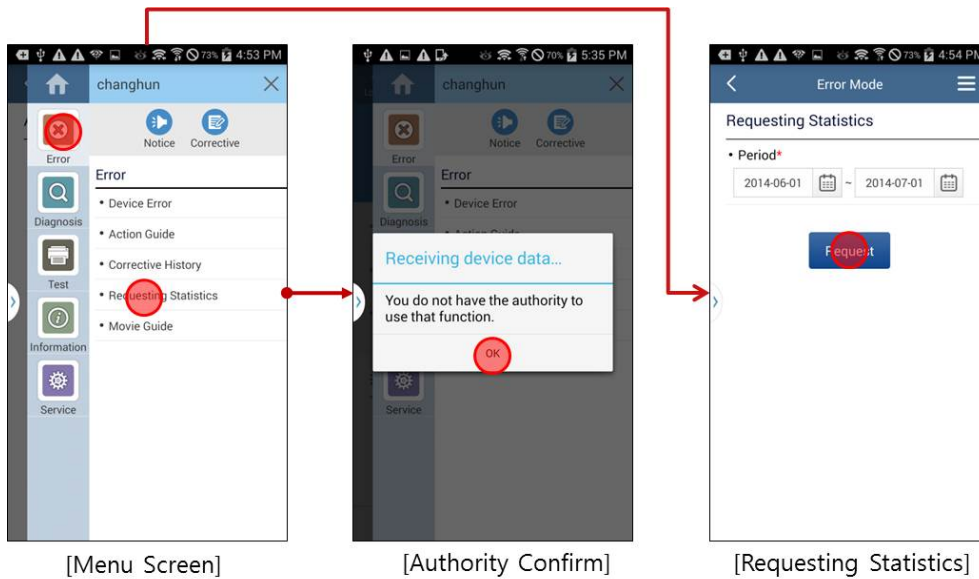

## Movie Guide

### 1) Menu Screen

- Press 'Movie Guide' of Error Mode.

### 2) Search Condition

- Movie list comes out related to Error Code. Select movie that you want.

### 3) Check SD Card

- Check whether selected movie exist.



#### NOTE

If SD Card of the mobile phone does not exist it is not downloaded.

- If there is movie at SD Card, movie will be played.
- If movie does not exist a download confirmation pop-up comes out.



#### NOTE

Movie is saved to SD Card. (/Card/Android/data/com.sec.spds/files/video/)

### 4) Play Movie

- Play Movie that exist in SD card.
- Movie support landscape mode.

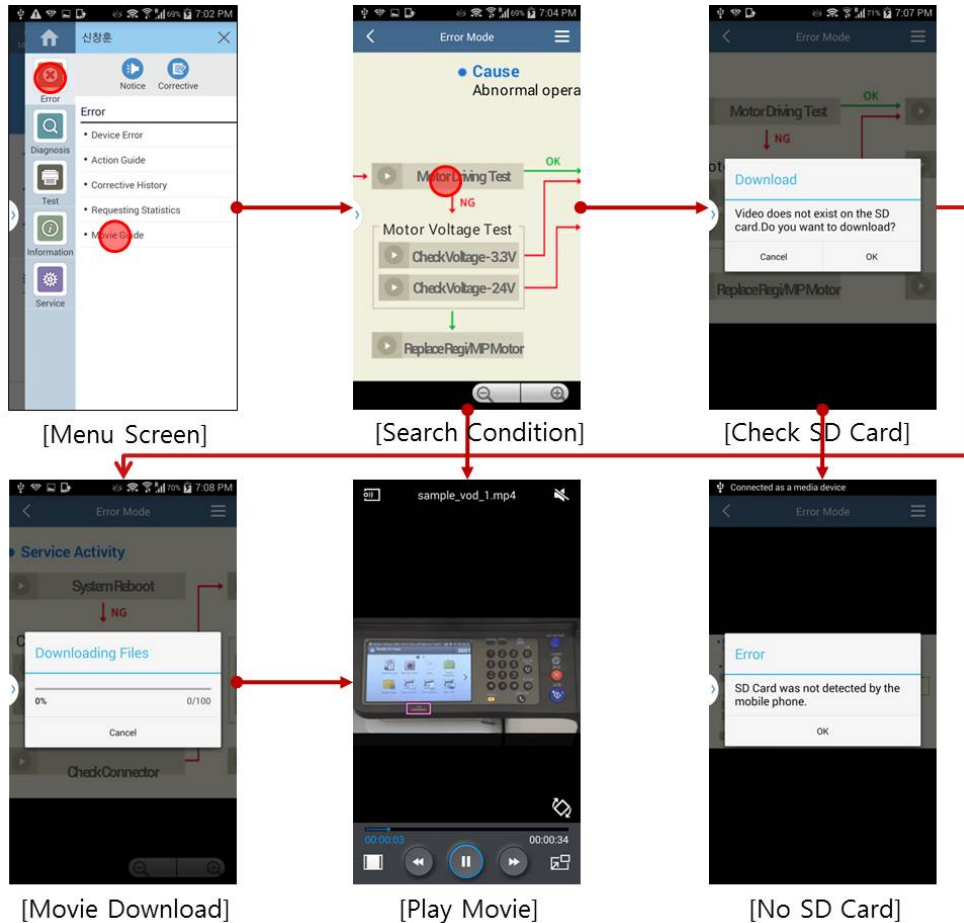

### 4.8.2.2. Diagnosis Mode

1) **Menu Screen**

- Diagnosis mode allows user to diagnosis or check status of connected device.
- SHADING TEST is menu that report status of SCANNER.

2) **Subordinate Menu Selection**

- Diagnosis mode consist of ON/OFF, HIGH/LOW, OPEN/CLOSE, INSTALL/UNINSTALL, 3DIGI.
- Only ON/OFF run diagnosis by Start Button.
- Other function except ON/OFF Diagnosis Mode indicate status value of connected device.

3) **Device Sleep Mode**

- If device status is sleep you can use diagnosis mode after wake-up process.

4) **Device in use**

- However, wake-up device you cannot use diagnosis before status become ready.

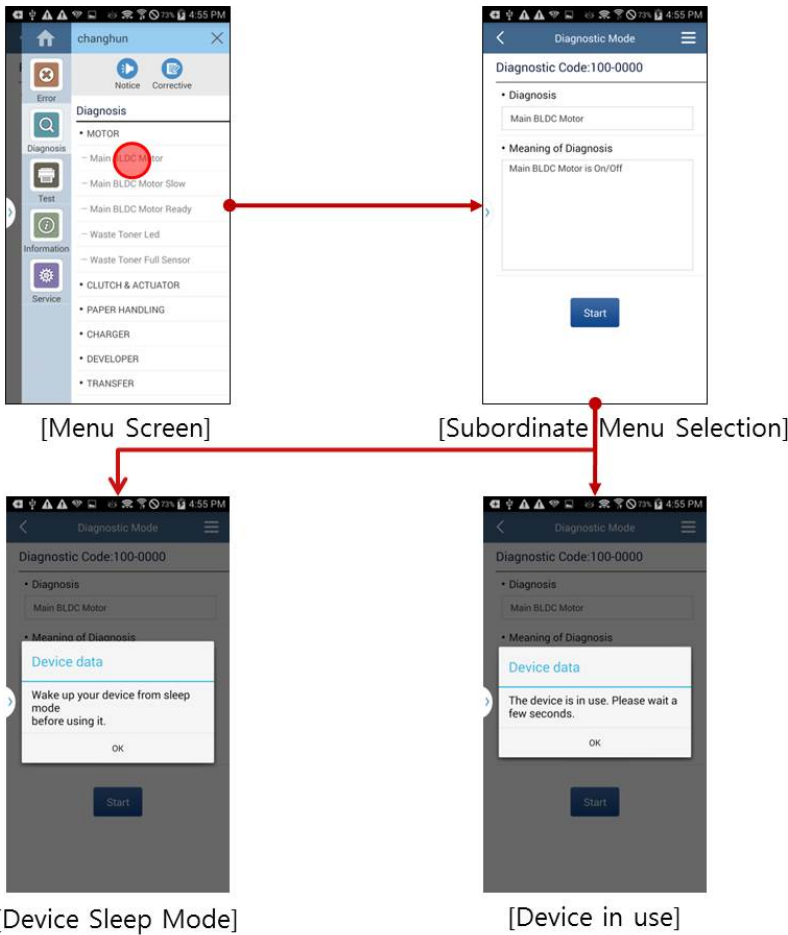

### 4.8.2.3. Test Mode

#### 1) Menu Screen

- Press Test → Printout Pattern.

#### 2) Printout Pattern

- You can print by selecting Printout pattern, Paper size, 1 sided, Simplex/2 sided, Duplex, Number of Pages to Print.
- There are five types of pattern. 5%, Skew, Black, Solid, Prints out a blank sheet.
- There are four types of pattern. A4, Letter, A3, Ledger.
- 1 sided, Simplex/2 sided, Duplex, Number of Pages to Print is only enable at 'Prints out a blank sheet'.
- 'Prints out a blank sheet' 1 to 100 can be entered.

#### 3) Print

- When press Print, options set in the print are utilized.

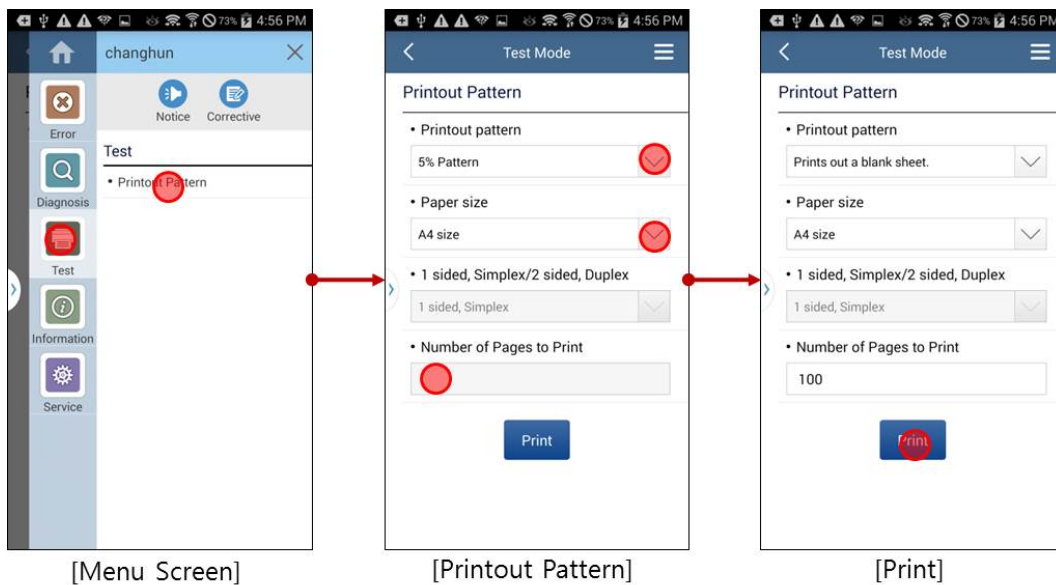

### 4.8.2.4. Information Mode

#### Configuration Menu

1) Menu Screen

- Information Mode consist of Configuration, Supplies, Network, Fax report, Tech mode.

2) Configuration

- Configuration mode consist of Preferences Information, Date of First Set Installation, Firmware information.

3) Preferences Information

- Preferences Information indicates Model Name, Device Serial Number, Date of Installation, Firmware Version.

4) Date of First Set Installation

- Date of First Set Installation, Firmware information indicate each information.

5) Print

- Press 'Print', information indicated on UI will print out.

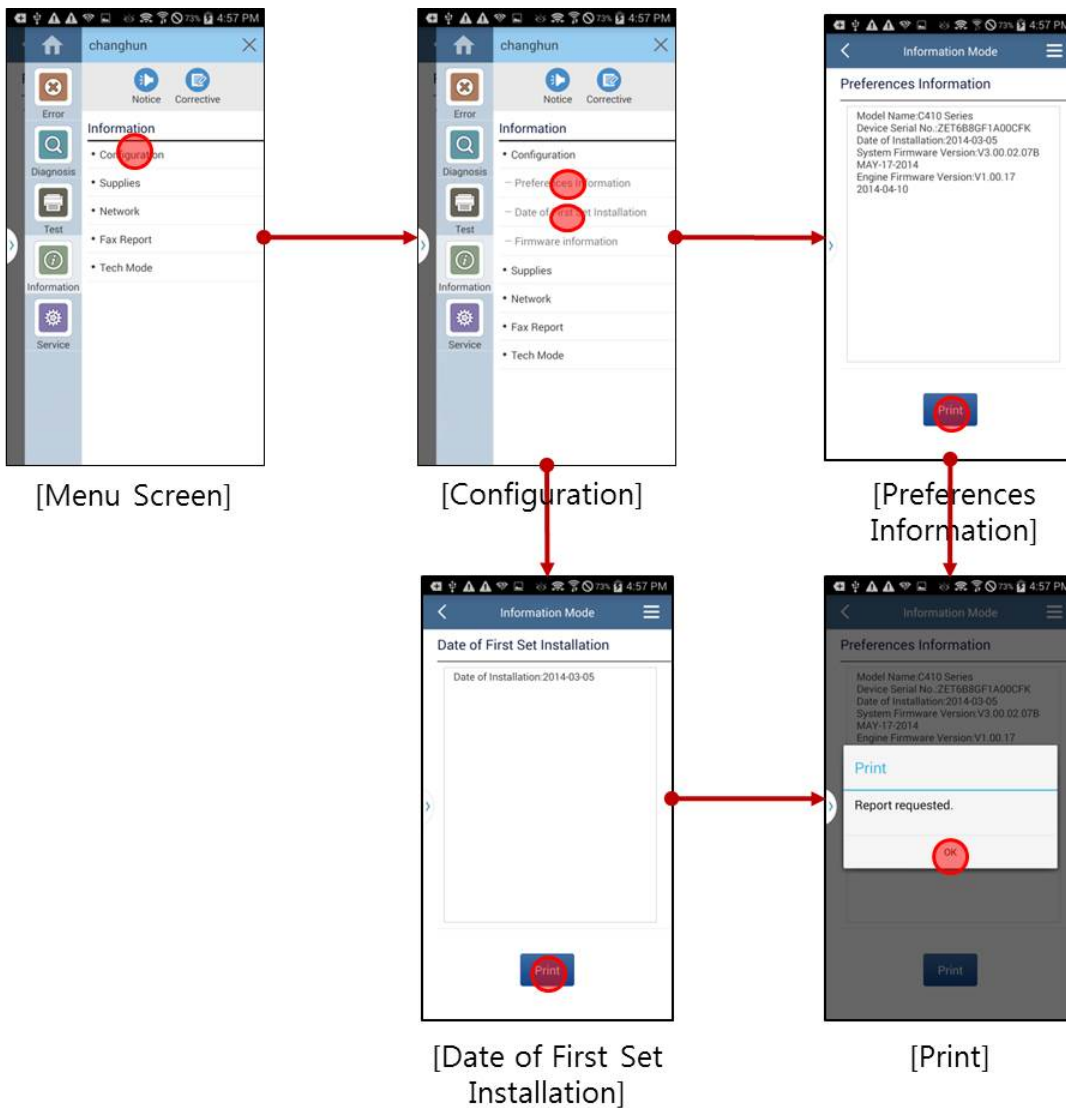

## Other Menu

### 1) Supplies

- Supplies indicate Supplies information of connected device.

### 2) Network

- Network indicate Network information of connected device.

### 3) Fax Report

- FAX REPORT Fax Sent, Fax Received, Fax Protocol Dump, Fax Diagnostics .

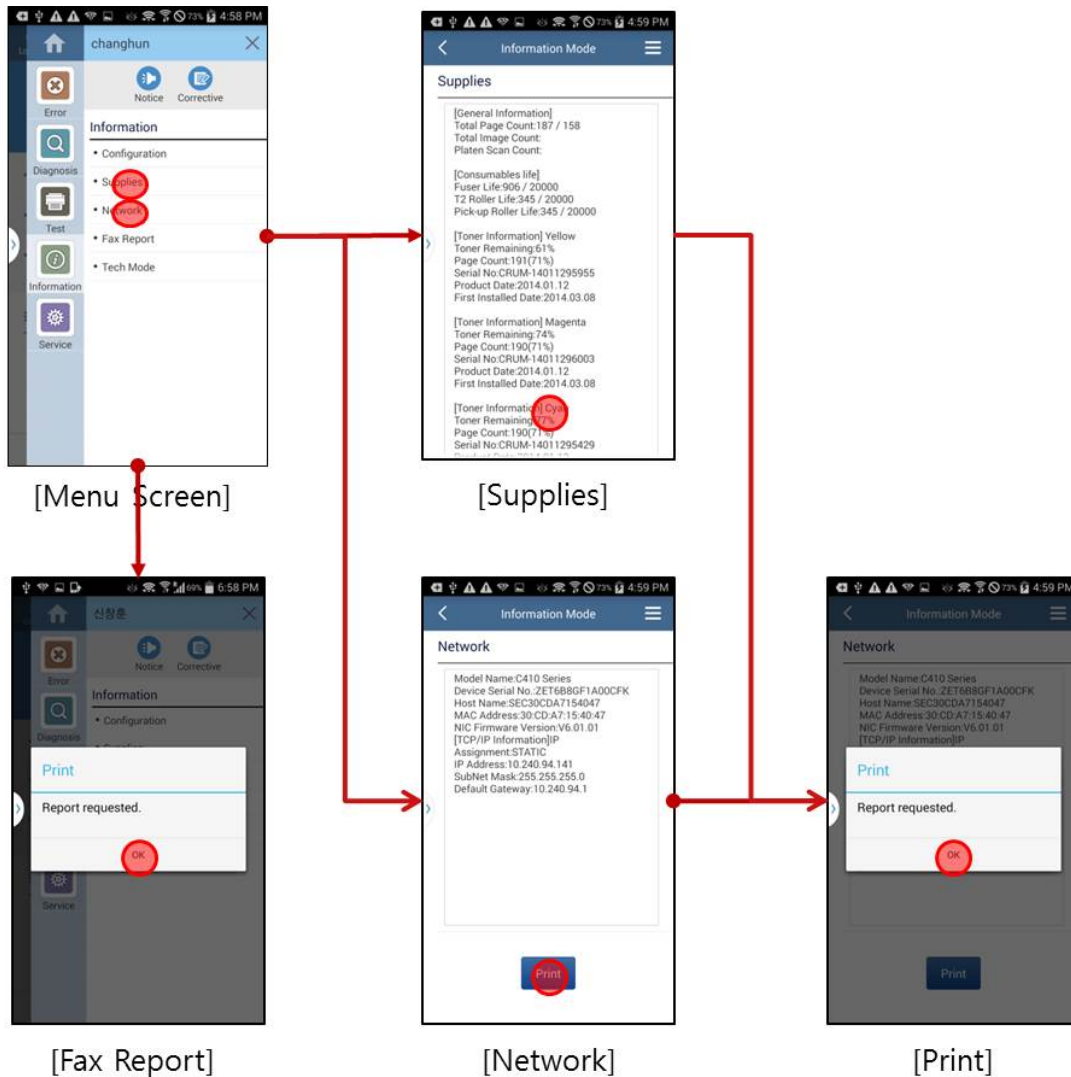

### 4.8.2.5. Service Mode

#### Cloning Menu

1) **Menu Screen**

- Press Service button
- Press Cloning menu.

2) **Admin Login**

- Input admin account of connected device and press Login Button.

3) **Export**

- Export data of printer press 'OK'.

4) **Import**

- Importing data of data that exported from connected printer press 'OK'.

5) **Complete**

- After end of Import press 'OK', Export menu ends.
- Device will reboot.

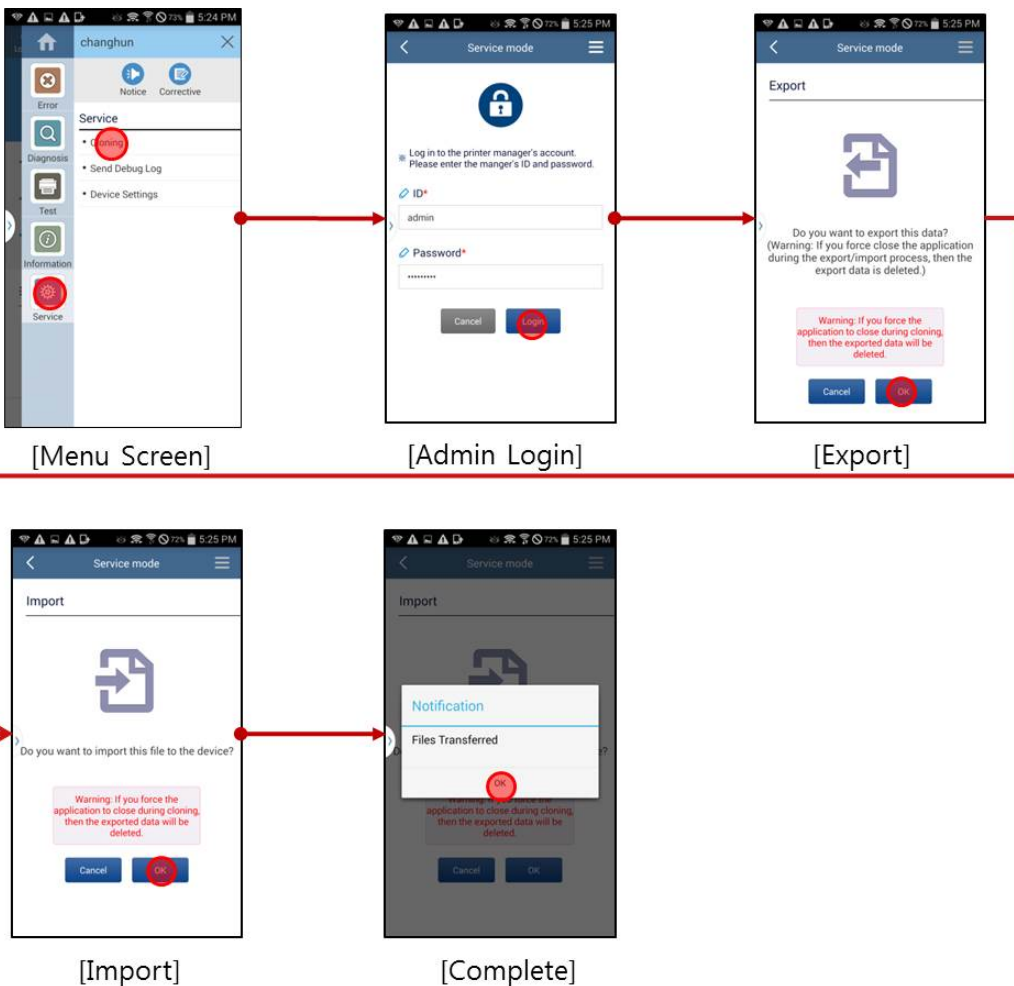



## Send Debug Log

### 1) Menu Screen

- Press 'Service'.
- Press 'Send Debug Log'.

### 2) Select Date

- Select Date. Press request button.

### 3) Transport Position Selection-1

- Log names that can transport are indicated on screen.
- Select save method (SD Card)

### 4) SD Card Transport Complete

- If you select SD Memory, Log will be saved at "/Phone/SPDS/DEBUGLOG".
- Press 'OK', then 'Send Debug Log' Menu end.

### 5) Transport Position Selection-2

- Log names that can transport are indicated on screen. Select save method(Server)

### 6) Server Transport Complete

- After completing upload pop-up comes out.
- Press 'OK' then 'Send Debug Log' Menu end.



## IP Settings

### 1) Menu Screen

- Press Service → Device Settings. Press IP Settings.

### 2) IP Setting

- Input IP Address, Subnet Mask, Gateway.
- Press OK.

### 3) Change Complete

- If IP changing complete normally, above pop-up comes out.
- Press 'OK', then 'IP Setting' Menu end.

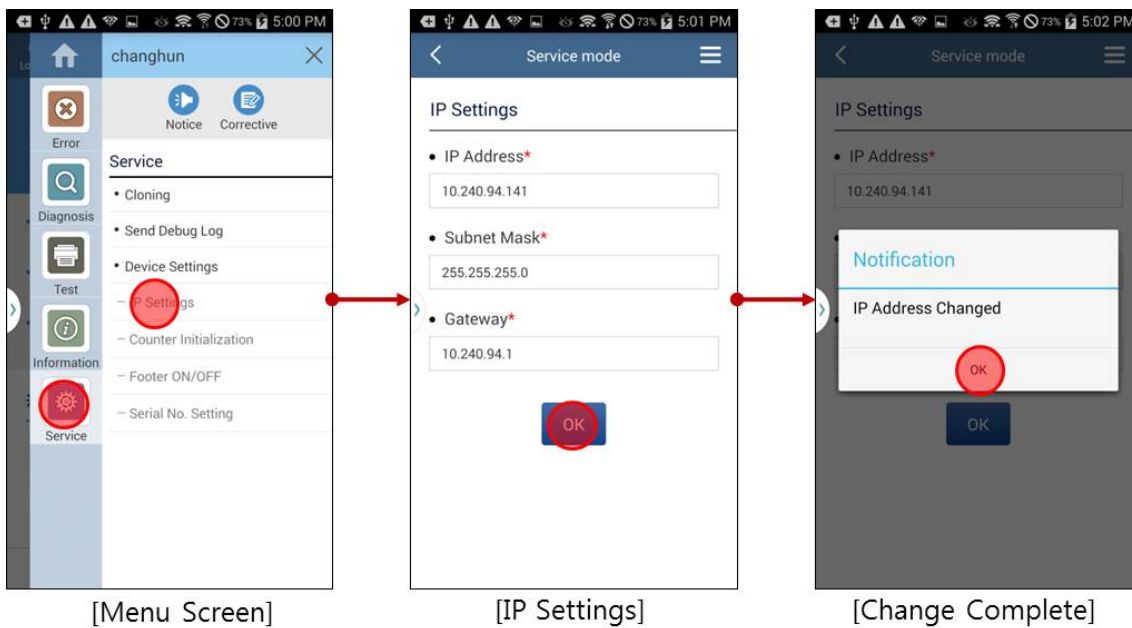

## Counter Initialization

### 1) Menu Screen

- Press Service → Device Settings. Press Counter Initialization

### 2) Counter Initialization

- Select item to initialize.

### 3) Initialization Complete

- If initialization complete normally, pop-up comes out. Press 'OK' you can initialize other counter value.

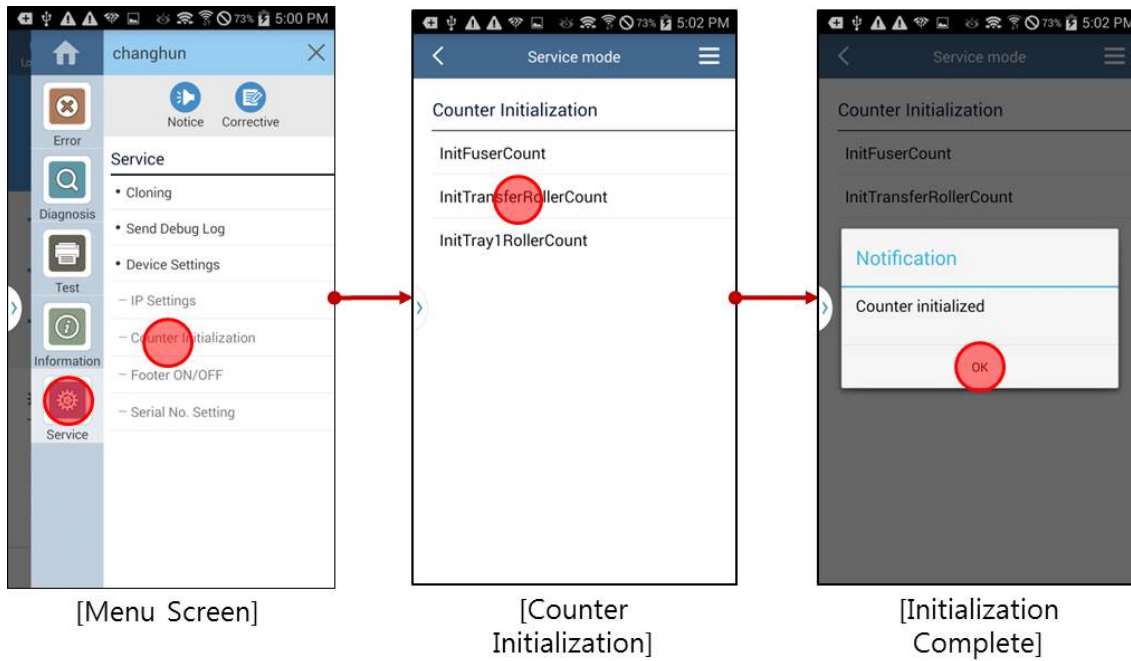

## Footer ON/OFF

### 1) Menu Screen

- Press Service → Device Settings. Press Footer ON/OFF.

### 2) Footer Setting

- When press 'ON' button, activate Footer value.
- When press 'OFF' button, inactivate Footer value.

### 3) Footer Change Request

- If Footer Setting is requested normally toast message will occur.

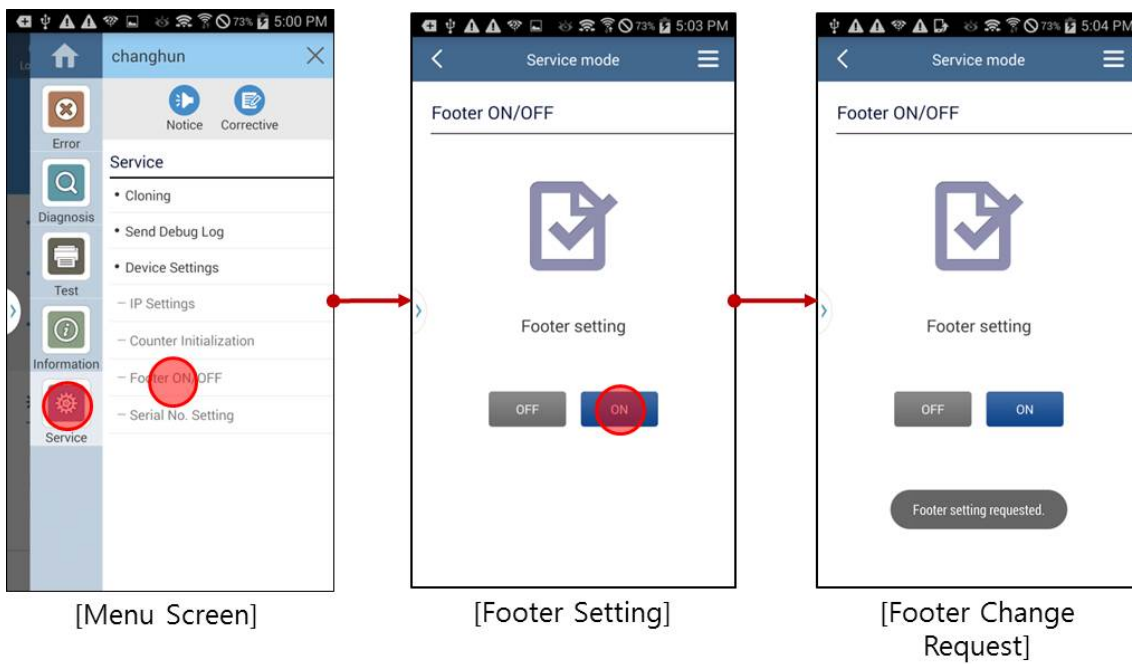

### 4.8.3. Corrective Upload

#### 1) Menu Screen

- You can go to Corrective Screen by pressing 'Corrective'.

#### 2) Confirmation Window before Shutdown.

- Before shutdown App. upload Corrective is required.
- You can go to Corrective Screen by Press 'OK'.
- If you shutdown App forcibly without upload Corrective will be aggregated with abnormal action.

#### 3) Corrective

- In the Corrective you can input Part of Action, Detailed Action, Attached Image.

#### 4) Select Part for Action

- Part for Actions are Feeding, Main board, Delivery, Belt, Scan, Sensor, Power, Fixing, Option, Fax, Frame, Phenomenon, LSU, Application, Driver, Firmware, Others.

#### 5) Input Detailed Action

- Part of Action and Detailed Action are required.
- Input requirements and press 'Upload' button



### 4.8.4. Exceptions

#### Exceptions (Device Interface)

1) **Menu Screen**

- Need to I/F the device menu first check the connection status of the device.
- If connection between App and device ( e.g. device reboot, Timeout ), go to device connection menu.

2) **Disconnected Devices**

- For App reconnect to device go to device connection menu before indicate subordinate menu.

3) **Subordinate Menu**

- If device connection perform normally you can see subordinate menu.

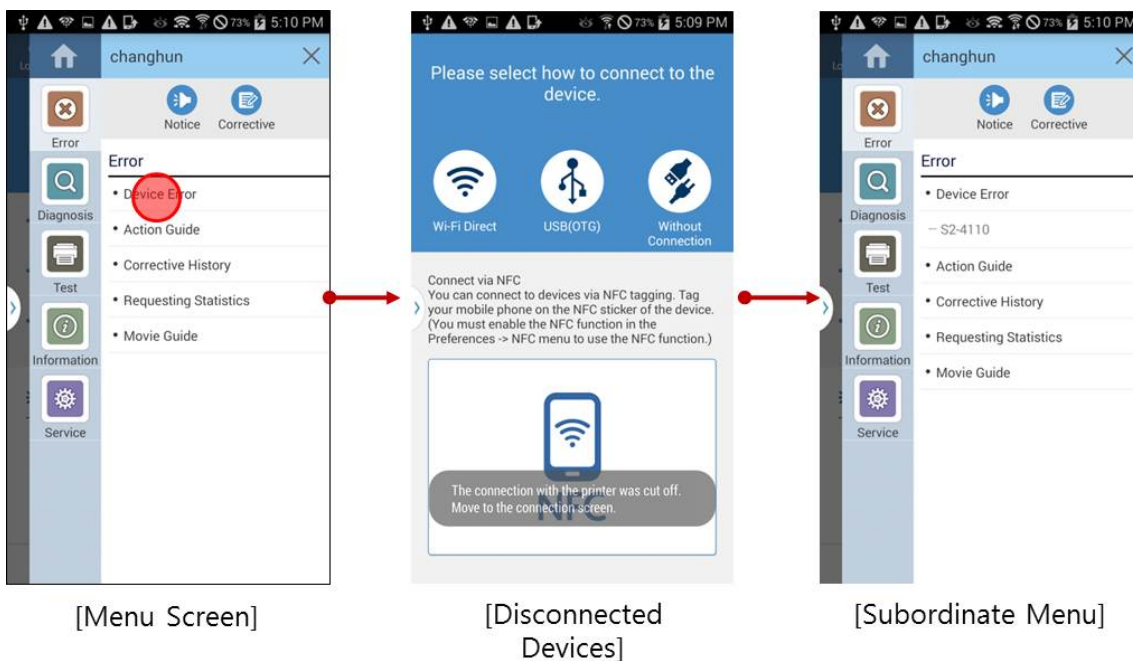

## Exceptions (Server Interface)

### 1) Menu Screen

- Need to Server I/F the device menu first check the connection status of network (3G, LTE, WIFI).

### 2) Network Error Occurrence

- When network isn't connected (3G, LTE, WIFI), try search.

### 3) Error Message

- If network error (3G, LTE, WIFI) occur, error message pop-up print out and cannot proceed.
- In this case it is necessary to check the network.

### 4) Network Normal

- When network (3G, LTE, WIFI) is connected normally, try search.

### 5) Normal Result

- Because there is no problem with the network App will show normal results.

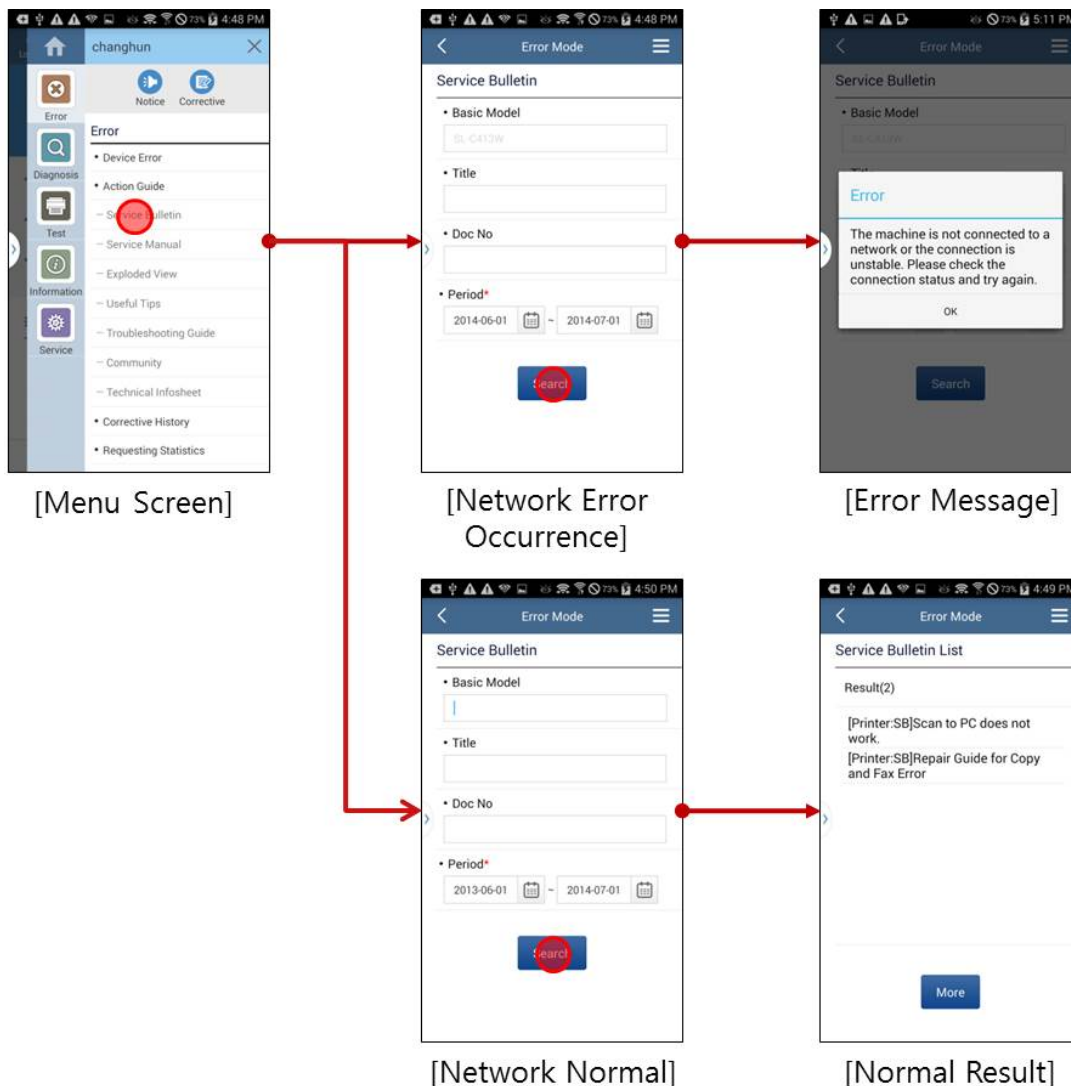

# 5. Block Diagram and Connection Diagram

## 5.1. Block Diagram

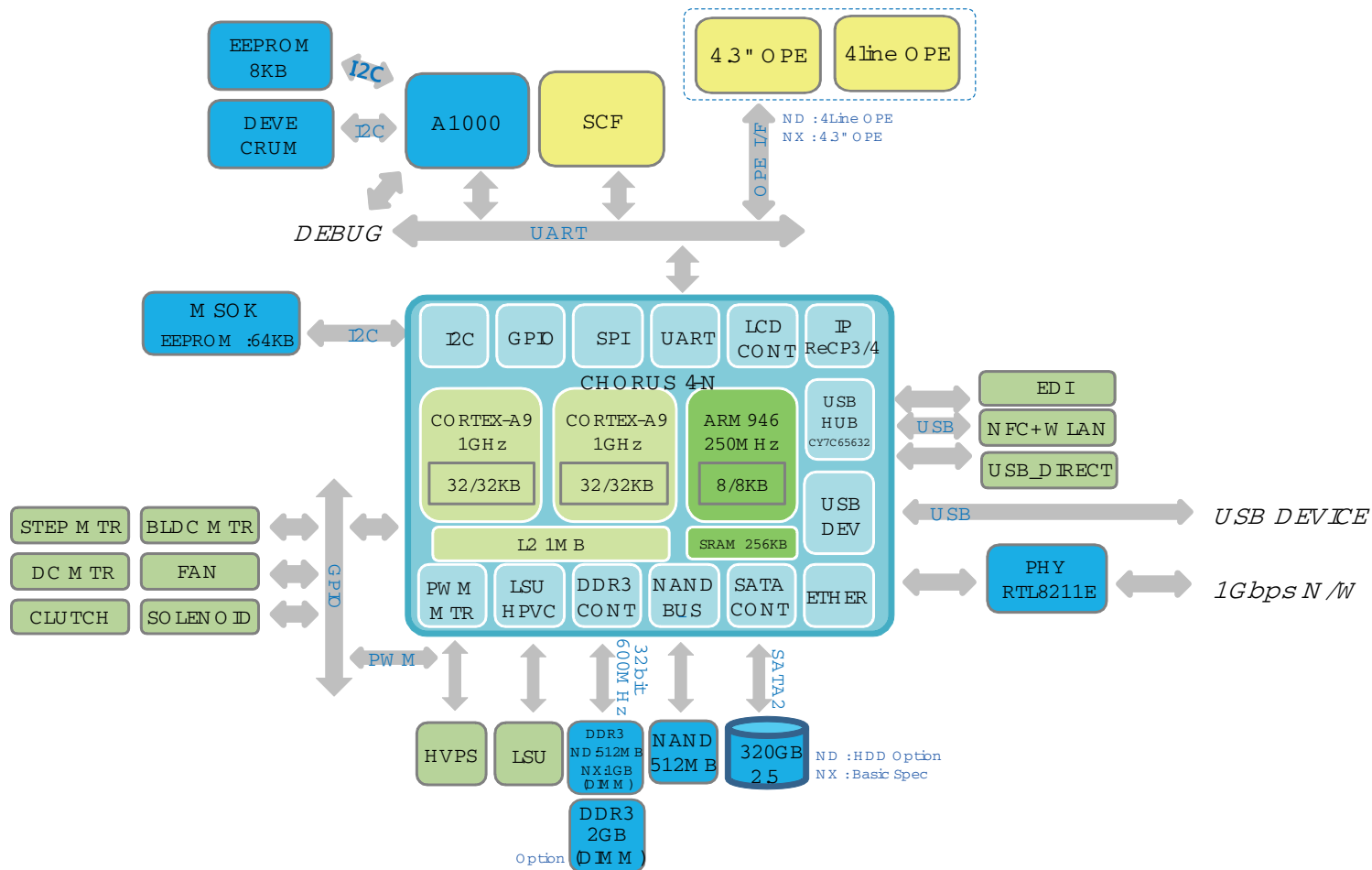



## 5.2. Connection Diagram

### 5.2.1. Connection Diagram (1)

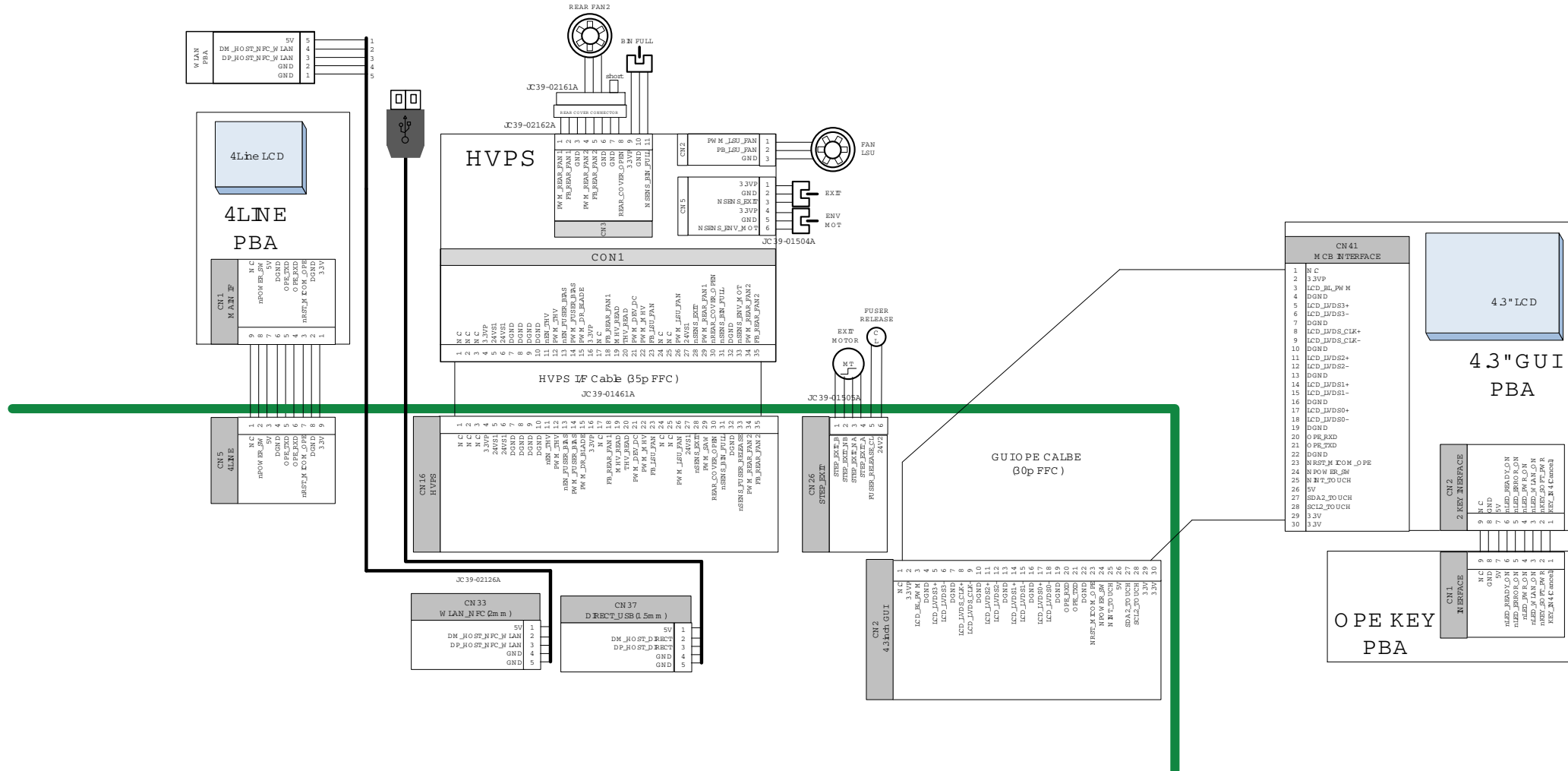

### 5.2.2. Connection Diagram (2)

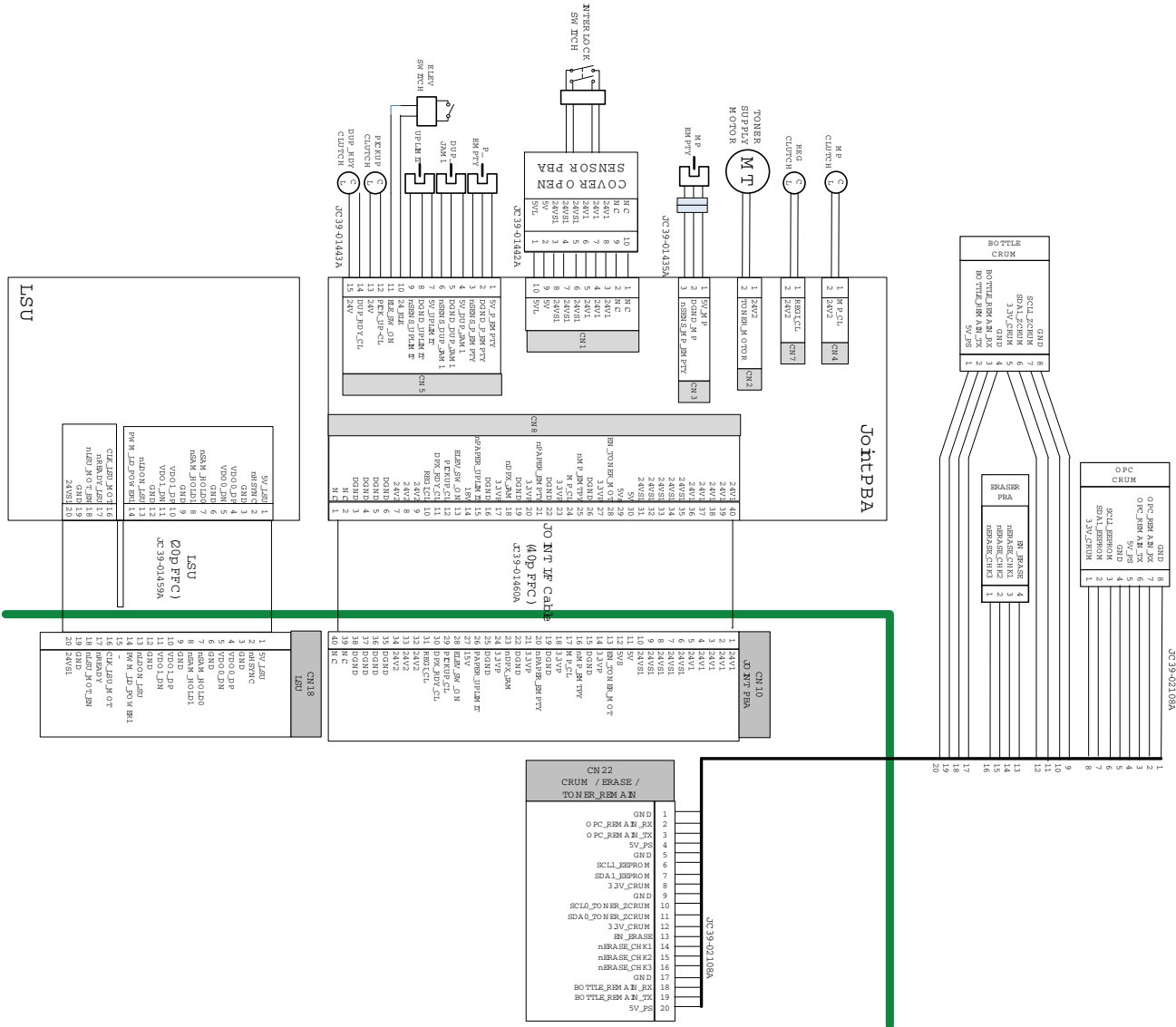

### 5.2.3. Connection Diagram (3)

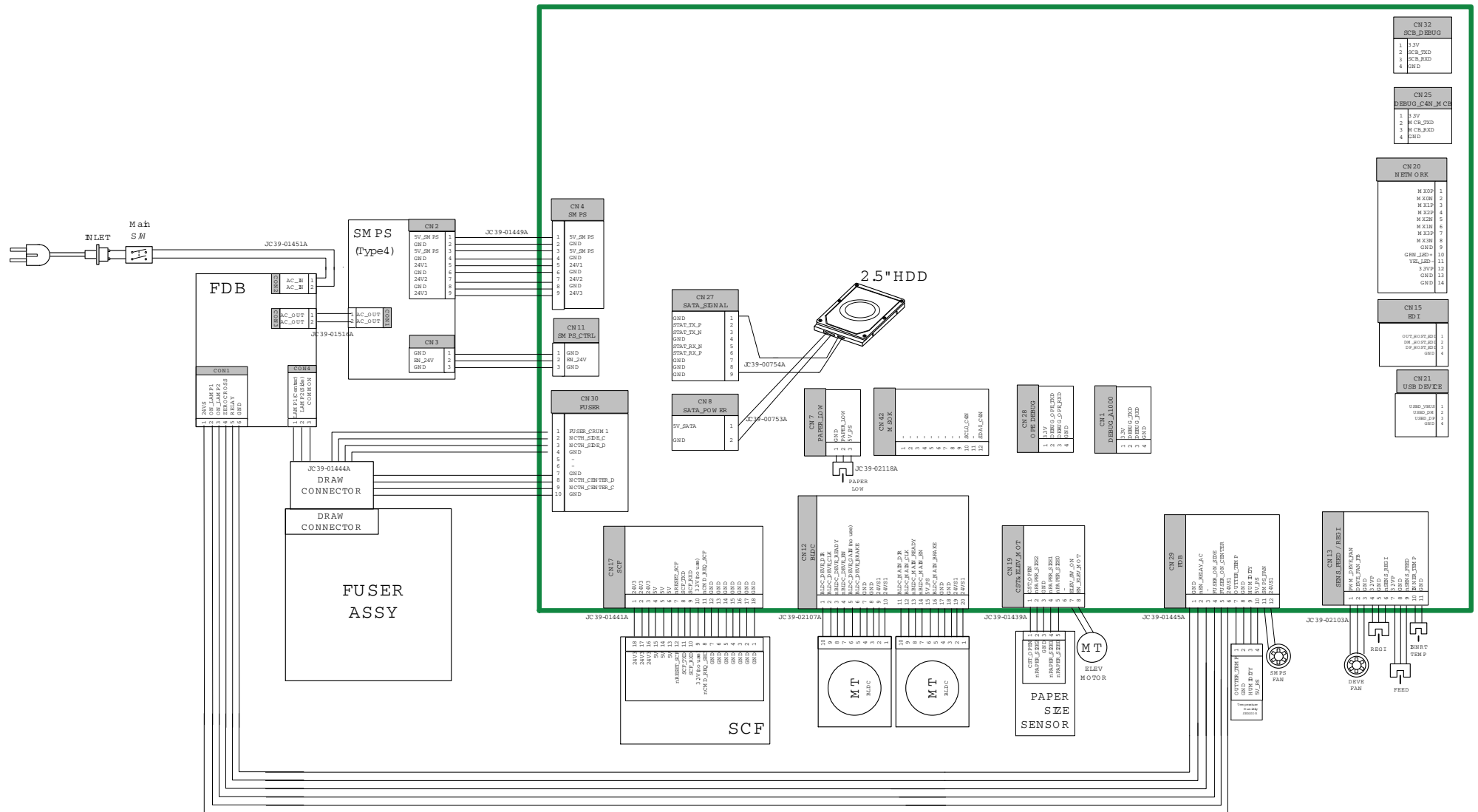





# 6. Reference Information

This chapter contains the tools list, list of abbreviations used in this manual, and a guide to the location space required when installing the printer. A definition of test pages and Wireless Network information definition is also included.

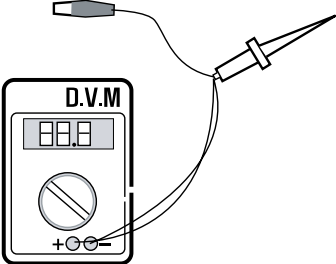
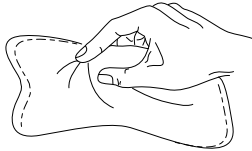
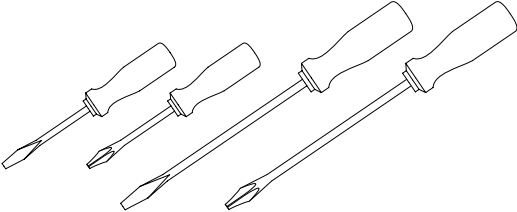
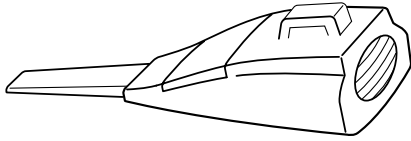
## 6.1. Tool for Troubleshooting

The following tools are recommended safe and easy troubleshooting as described in this service manual.

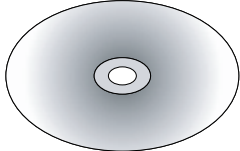
<p><b>DVM (Digital Volt Meter)</b> Standard : Indicates more than 3 digits.</p> 	<p><b>Cleaning Equipments</b> Standard : An IPA (Isopropyl Alcohol) dry wipe tissue or a gentle neutral detergent and lint-free cloth.</p> 
<p><b>Driver</b> Standard : “-” type, “+” type (M3 long, M3 short, M2 long, M2 short).</p> 	<p><b>Vacuum Cleaner</b></p> 
<p><b>Tweezers</b> Standard : For general home use, small type.</p> 	<p><b>Spring Hook</b> Standard : For general use</p> 
<p><b>Cotton Swab</b> Standard : For general home use, for medical service.</p> 	<p><b>Software (Driver) installation CD ROM</b></p> 

## 6.2. Glossary

The following glossary helps you get familiar with the product by understanding the terminologies commonly used with printing as well as mentioned in this user's guide and service manual.

802.11	802.11 is a set of standards for wireless local area network (WLAN) communication, developed by the IEEE LAN/MAN Standards Committee (IEEE 802).
802.11b/g/n	802.11b/g/n can share same hardware and use the 2.4 GHz band. 802.11b supports bandwidth up to 11 Mbps, 802.11n supports bandwidth up to 150 Mbps. 802.11b/g/n devices may occasionally suffer interference from microwave ovens, cordless telephones, and Bluetooth devices.
Access point	Access Point or Wireless Access Point (AP or WAP) is a device that connects wireless communication devices together on wireless local area networks (WLAN), and acts as a central transmitter and receiver of WLAN radio signals.
ADF	An Automatic Document Feeder (ADF) is a scanning unit that will automatically feed an original sheet of paper so that the machine can scan some amount of the paper at once.
AppleTalk	AppleTalk is a proprietary suite of protocols developed by Apple, Inc for computer networking. It was included in the original Macintosh (1984) and is now deprecated by Apple in favor of TCP/IP networking.
BIT Depth	A computer graphics term describing the number of bits used to represent the color of a single pixel in a bitmapped image. Higher color depth gives a broader range of distinct colors. As the number of bits increases, the number of possible colors becomes impractically large for a color map. 1-bit color is commonly called as monochrome or black and white.
BMP	A bitmapped graphics format used internally by the Microsoft Windows graphics subsystem (GDI), and used commonly as a simple graphics file format on that platform.
BOOTP	Bootstrap Protocol. A network protocol used by a network client to obtain its IP address automatically. This is usually done in the bootstrap process of computers or operating systems running on them. The BOOTP servers assign the IP address from a pool of addresses to each client. BOOTP enables 'diskless workstation' computers to obtain an IP address prior to loading any advanced operating system.
CCD	Charge Coupled Device (CCD) is a hardware which enables the scan job. CCD Locking mechanism is also used to hold the CCD module to prevent any damage when you move the machine.
Collation	Collation is a process of printing a multiple-copy job in sets. When collation is selected, the device prints an entire set before printing additional copies.
Control Panel	A control panel is a flat, typically vertical, area where control or monitoring instruments are displayed. They are typically found in front of the machine.
Coverage	It is the printing term used for a toner usage measurement on printing. For example, 5% coverage means that an A4 sided paper has about 5% image or text on it. So, if the paper or original has complicated images or lots of text on it, the coverage will be higher and at the same time, a toner usage will be as much as the coverage.
CSV	Comma Separated Values (CSV). A type of file format, CSV is used to exchange data between disparate applications. The file format, as it is used in Microsoft Excel, has become a de facto standard throughout the industry, even among non-Microsoft platforms.
DADF	A Duplex Automatic Document Feeder (DADF) is a scanning unit that will automatically feed and turn over an original sheet of paper so that the machine can scan on both sides of the paper.
Default	The value or setting that is in effect when taking a printer out of its box state, reset, or initialized.
DHCP	A Dynamic Host Configuration Protocol (DHCP) is a client-server networking protocol. A DHCP server provides configuration parameters specific to the DHCP client host requesting, generally, information required by the client host to participate on an IP network. DHCP also provides a mechanism for allocation of IP addresses to client hosts.
DIMM	Dual Inline Memory Module (DIMM), a small circuit board that holds memory. DIMM stores all the data within the machine like printing data, received fax data.

DLNA	The Digital Living Network Alliance (DLNA) is a standard that allows devices on a home network to share information with each other across the network.
DNS	The Domain Name Server (DNS) is a system that stores information associated with domain names in a distributed database on networks, such as the Internet.
Dot Matrix Printer	A dot matrix printer refers to a type of computer printer with a print head that runs back and forth on the page and prints by impact, striking an ink-soaked cloth ribbon against the paper, much like a typewriter.
DPI	Dots Per Inch (DPI) is a measurement of resolution that is used for scanning and printing. Generally, higher DPI results in a higher resolution, more visible detail in the image, and a larger file size.
DRPD	Distinctive Ring Pattern Detection. Distinctive Ring is a telephone company service which enables a user to use a single telephone line to answer several different telephone numbers.
DSDF	Dual Scan Document Feeder (DSDF) is a scanning unit that will automatically feed an original sheet of paper so that the machine can scan on both sides of the paper at once.
Duplex	A mechanism that will automatically turn over a sheet of paper so that the machine can print (or scan) on both sides of the paper. A printer equipped with a Duplex Unit can print on both sides of paper during one print cycle.
Duty Cycle	Duty cycle is the page quantity which does not affect printer performance for a month. Generally the printer has the lifespan limitation such as pages per year. The lifespan means the average capacity of print-outs, usually within the warranty period. For example, if the duty cycle is 48,000 pages per month assuming 20 working days, a printer limits 2,400 pages a day.
ECM	Error Correction Mode (ECM) is an optional transmission mode built into Class 1 fax machines or fax modems. It automatically detects and corrects errors in the fax transmission process that are sometimes caused by telephone line noise.
Emulation	Emulation is a technique of one machine obtaining the same results as another. An emulator duplicates the functions of one system with a different system, so that the second system behaves like the first system. Emulation focuses on exact reproduction of external behavior, which is in contrast to simulation, which concerns an abstract model of the system being simulated, often considering its internal state.
Ethernet	Ethernet is a frame-based computer networking technology for local area networks (LANs). It defines wiring and signaling for the physical layer, and frame formats and protocols for the media access control (MAC)/data link layer of the OSI model. Ethernet is mostly standardized as IEEE 802.3. It has become the most widespread LAN technology in use during the 1990s to the present.
EtherTalk	A suite of protocols developed by Apple Computer for computer networking. It was included in the original Macintosh (1984) and is now deprecated by Apple in favor of TCP/IP networking.
FDI	Foreign Device Interface (FDI) is a card installed inside the machine to allow a third party device such as a coin operated device or a card reader. Those devices allow the pay-for-print service on your machine.
FTP	A File Transfer Protocol (FTP) is a commonly used protocol for exchanging files over any network that supports the TCP/IP protocol (such as the Internet or an intranet).
Fuser Unit	The part of a laser printer that fuses the toner onto the print media. It consists of a heat roller and a pressure roller. After toner is transferred onto the paper, the fuser unit applies heat and pressure to ensure that the toner stays on the paper permanently, which is why paper is warm when it comes out of a laser printer.
Gateway	A connection between computer networks, or between a computer network and a telephone line. It is very popular, as it is a computer or a network that allows access to another computer or network.
Grayscale	A shades of gray that represent light and dark portions of an image when color images are converted to grayscale; colors are represented by various shades of gray.
Halftone	An image type that simulates grayscale by varying the number of dots. Highly colored areas consist of a large number of dots, while lighter areas consist of a smaller number of dots.

HDD	Hard Disk Drive (HDD), commonly referred to as a hard drive or hard disk, is a non-volatile storage device which stores digitally-encoded data on rapidly rotating platters with magnetic surfaces.
IEEE	The Institute of Electrical and Electronics Engineers (IEEE) is an international non-profit, professional organization for the advancement of technology related to electricity.
IEEE 1284	The 1284 parallel port standard was developed by the Institute of Electrical and Electronics Engineers (IEEE). The term "1284-B" refers to a specific connector type on the end of the parallel cable that attaches to the peripheral (for example, a printer).
Intranet	A private network that uses Internet Protocols, network connectivity, and possibly the public telecommunication system to securely share part of an organization's information or operations with its employees. Sometimes the term refers only to the most visible service, the internal website.
IP address	An Internet Protocol (IP) address is a unique number that devices use in order to identify and communicate with each other on a network utilizing the Internet Protocol standard.
IPM	The Images Per Minute (IPM) is a way of measuring the speed of a printer. An IPM rate indicates the number of single-sided sheets a printer can complete within one minute.
IPP	The Internet Printing Protocol (IPP) defines a standard protocol for printing as well as managing print jobs, media size, resolution, and so forth. IPP can be used locally or over the Internet to hundreds of printers, and also supports access control, authentication, and encryption, making it a much more capable and secure printing solution than older ones.
IPX/SPX	IPX/SPX stands for Internet Packet Exchange/Sequenced Packet Exchange. It is a networking protocol used by the Novell NetWare operating systems. IPX and SPX both provide connection services similar to TCP/IP, with the IPX protocol having similarities to IP, and SPX having similarities to TCP. IPX/SPX was primarily designed for local area networks (LANs), and is a very efficient protocol for this purpose (typically its performance exceeds that of TCP/IP on a LAN).
ISO	The International Organization for Standardization (ISO) is an international standard-setting body composed of representatives from national standards bodies. It produces world-wide industrial and commercial standards.
ITU-T	The International Telecommunication Union is an international organization established to standardize and regulate international radio and telecommunications. Its main tasks include standardization, allocation of the radio spectrum, and organizing interconnection arrangements between different countries to allow international phone calls. A -T out of ITU-T indicates telecommunication.
ITU-T No. 1 chart	Standardized test chart published by ITU-T for document facsimile transmissions.
JBIG	Joint Bi-level Image Experts Group (JBIG) is an image compression standard with no loss of accuracy or quality, which was designed for compression of binary images, particularly for faxes, but can also be used on other images.
JPEG	Joint Photographic Experts Group (JPEG) is a most commonly used standard method of lossy compression for photographic images. It is the format used for storing and transmitting photographs on the World Wide Web.
LDAP	The Lightweight Directory Access Protocol (LDAP) is a networking protocol for querying and modifying directory services running over TCP/IP.
LED	A Light-Emitting Diode (LED) is a semiconductor device that indicates the status of a machine.
MAC address	Media Access Control (MAC) address is a unique identifier associated with a network adapter. MAC address is a unique 48-bit identifier usually written as 12 hexadecimal characters grouped in pairs (e. g., 00-00-0c-34-11-4e). This address is usually hard-coded into a Network Interface Card (NIC) by its manufacturer, and used as an aid for routers trying to locate machines on large networks.
MFP	Multi Function Peripheral (MFP) is an office machine that includes the following functionality in one physical body, so as to have a printer, a copier, a fax, a scanner and etc.
MH	Modified Huffman (MH) is a compression method for decreasing the amount of data that needs to be transmitted between the fax machines to transfer the image recommended by ITU-T T.4. MH is a codebook-based run-length encoding scheme optimized to efficiently compress white space. As most faxes consist mostly of white space, this minimizes the transmission time of most faxes.

MMR	Modified Modified READ (MMR) is a compression method recommended by ITU-T T.6.
Modem	A device that modulates a carrier signal to encode digital information, and also demodulates such a carrier signal to decode transmitted information.
MR	Modified Read (MR) is a compression method recommended by ITUT T.4. MR encodes the first scanned line using MH. The next line is compared to the first, the differences determined, and then the differences are encoded and transmitted.
NetWare	A network operating system developed by Novell, Inc. It initially used cooperative multitasking to run various services on a PC, and the network protocols were based on the archetypal Xerox XNS stack. Today NetWare supports TCP/IP as well as IPX/SPX.
NFC Printing	The NFC(Near Field Communication) printer allows you to directly print/scan from your cell phone just by holding your cell phone over the NFC tag on your printer. It does not require installing print driver or connecting to an access point. You just need NFC supported cell phone. In order to use this feature, Samsung Mobile Print app needs to be installed on your cell phone.
OPC	Organic Photo Conductor (OPC) is a mechanism that makes a virtual image for print using a laser beam emitted from a laser printer, and it is usually green or rust colored and has a cylinder shape. An imaging unit containing a drum slowly wears the drum surface by its usage in the printer, and it should be replaced appropriately since it gets worn from contact with the cartridge development brush, cleaning mechanism, and paper.
Originals	The first example of something, such as a document, photograph or text, etc, which is copied, reproduced or translated to produce others, but which is not itself copied or derived from something else.
OSI	Open Systems Interconnection (OSI) is a model developed by the International Organization for Standardization (ISO) for communications. OSI offers a standard, modular approach to network design that divides the required set of complex functions into manageable, self-contained, functional layers. The layers are, from top to bottom, Application, Presentation, Session, Transport, Network, Data Link and Physical.
PABX	A private automatic branch exchange (PABX) is an automatic telephone switching system within a private enterprise.
PCL	Printer Command Language (PCL) is a Page Description Language (PDL) developed by HP as a printer protocol and has become an industry standard. Originally developed for early inkjet printers, PCL has been released in varying levels for thermal, dot matrix printer, and laser printers.
PDF	Portable Document Format (PDF) is a proprietary file format developed by Adobe Systems for representing two dimensional documents in a device independent and resolution independent format.
PostScript(PS)	PostScript (PS) is a page description language and programming language used primarily in the electronic and desktop publishing areas. - that is run in an interpreter to generate an image.
Printer Driver	A program used to send commands and transfer data from the computer to the printer.
Print Media	The media like paper, envelopes, labels, and transparencies which can be used in a printer, a scanner, a fax or, a copier.
PPM	Pages Per Minute (PPM) is a method of measurement for determining how fast a printer works, meaning the number of pages a printer can produce in one minute.
PRN file	An interface for a device driver, this allows software to interact with the device driver using standard input/output system calls, which simplifies many tasks.
Protocol	A convention or standard that controls or enables the connection, communication, and data transfer between two computing endpoints.
PSTN	The Public-Switched Telephone Network (PSTN) is the network of the world's public circuit-switched telephone networks which, on industrial premises, is usually routed through the switchboard.
RADIUS	Remote Authentication Dial In User Service (RADIUS) is a protocol for remote user authentication and accounting. RADIUS enables centralized management of authentication data such as usernames and passwords using an AAA (authentication, authorization, and accounting) concept to manage network access.



Resolution	The sharpness of an image, measured in Dots Per Inch (DPI). The higher the dpi, the greater the resolution.
SMB	Server Message Block (SMB) is a network protocol mainly applied to share files, printers, serial ports, and miscellaneous communications between nodes on a network. It also provides an authenticated Interprocess communication mechanism.
SMTP	Simple Mail Transfer Protocol (SMTP) is the standard for e-mail transmissions across the Internet. SMTP is a relatively simple, text based protocol, where one or more recipients of a message are specified, and then the message text is transferred. It is a client server protocol, where the client transmits an email message to the server.
SSID	Service Set Identifier (SSID) is a name of a wireless local area network (WLAN). All wireless devices in a WLAN use the same SSID in order to communicate with each other. The SSIDs are case-sensitive and have a maximum length of 32 characters.
Subnet Mask	The subnet mask is used in conjunction with the network address to determine which part of the address is the network address and which part is the host address.
TCP/IP	The Transmission Control Protocol (TCP) and the Internet Protocol (IP); the set of communications protocols that implement the protocol stack on which the Internet and most commercial networks run.
TCR	Transmission Confirmation Report (TCR) provides details of each transmission such as job status, transmission result and number of pages sent. This report can be set to print after each job or only after failed transmissions.
TIFF	Tagged Image File Format (TIFF) is a variable-resolution bitmapped image format. TIFF describes image data that typically come from scanners. TIFF images make use of tags, keywords defining the characteristics of the image that is included in the file. This flexible and platform-independent format can be used for pictures that have been made by various image processing applications.
Toner Cartridge	A kind of bottle or container used in a machine like a printer which contains toner. Toner is a powder used in laser printers and photocopiers, which forms the text and images on the printed paper. Toner can be fused by a combination of heat/pressure from the fuser, causing it to bind to the fibers in the paper.
TWAIN	An industry standard for scanners and software. By using a TWAIN-compliant scanner with a TWAIN-compliant program, a scan can be initiated from within the program. It is an image capture API for Microsoft Windows and Apple Macintosh operating systems.
UNC Path	Uniform Naming Convention (UNC) is a standard way to access network shares in Window NT and other Microsoft products. The format of a UNC path is: \\<servername>\<sharename>\<Additional directory>
URL	Uniform Resource Locator (URL) is the global address of documents and resources on the Internet. The first part of the address indicates what protocol to use, the second part specifies the IP address or the domain name where the resource is located.
USB	Universal Serial Bus (USB) is a standard that was developed by the USB Implementers Forum, Inc., to connect computers and peripherals. Unlike the parallel port, USB is designed to concurrently connect a single computer USB port to multiple peripherals.
Watermark	A watermark is a recognizable image or pattern in paper that appears lighter when viewed by transmitted light. Watermarks were first introduced in Bologna, Italy in 1282; they have been used by papermakers to identify their product, and also on postage stamps, currency, and other government documents to discourage counterfeiting.
WEP	Wired Equivalent Privacy (WEP) is a security protocol specified in IEEE 802.11 to provide the same level of security as that of a wired LAN. WEP provides security by encrypting data over radio so that it is protected as it is transmitted from one end point to another.
WIA	Windows Imaging Architecture (WIA) is an imaging architecture that is originally introduced in Windows Me and Windows XP. A scan can be initiated from within these operating systems by using a WIA-compliant scanner.
Wi-Fi	Wi-Fi is a popular technology that allows an electronic device to exchange data wirelessly over a computer network, including high-speed Internet connections.

WPA	Wi-Fi Protected Access (WPA) is a class of systems to secure wireless (Wi-Fi) computer networks, which was created to improve upon the security features of WEP.
WPA-PSK	WPA-PSK (WPA Pre-Shared Key) is special mode of WPA for small business or home users. A shared key, or password, is configured in the wireless access point (WAP) and any wireless laptop or desktop devices. WPA-PSK generates a unique key for each session between a wireless client and the associated WAP for more advanced security.
WPS	The Wi-Fi Protected Setup (WPS) is a standard for establishing a wireless home network. If your wireless access point supports WPS, you can configure the wireless network connection easily without a computer.
XPS	XML Paper Specification (XPS) is a specification for a Page Description Language (PDL) and a new document format, which has benefits for portable document and electronic document, developed by Microsoft. It is an XML-based specification, based on a new print path and a vector-based device-independent document format.

# 6.3. The Sample Pattern for the Test

The life of the toner cartridge and the printing speed are measured using the pattern shown below.

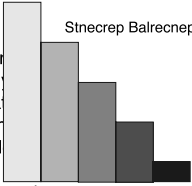
ABCDEFGHIJKLMNOPQRSTUVWXYZ0123456789ABCDEFGHIJKLMNOPQRSTUVWXYZ  
 ABCDEFGHIJKLMNOPQRSTUVWXYZ0123456789ABCDEFGHIJKLMNOPQRSTUVWXYZ  
 Stephen J. Singel  
 Labanda Sinpat Abarress  
 Tendar, BSF  
 URANGLE  
  
 23 January 2004  
 Jonathan Q. Maderia  
 Inpert Mampem Abareess  
 2343 Stantin Dawer Lank  
 Benhibe, SDF  
 Mr.Maderia:  
 Nam liber tempor cum soluta nobis eleifend ption cogue nihil consequat, velillum.  
 Dolore eu zril feugiat nulla acilisis at vero eros accumsan et iusto odio dignis sim qui blandit  
 praesent lutatum ril lobortis nisl ut aliquip exea commodo consequat. Duis autem vel eum ireure  
 dolor in hendreritin vulputate velit esse molestie tincidunt ut laoreet dolore magna aliquam erat  
 volutpat. Ut wisi enim ad minim viniam, quis nostrud exerci tation ullam corpersus cipit lotis nisl  
 ut aliquip ex ea commodo consequat. Lorem ipsum dolor sit.  
  
 Stnecrep Balrecreps  
 Amet, consectetuer adipiscing elit, sud diam nonummy nibh veniam,  
 recneps adipiscing elit, sed diam nonummy nibtil laoreet dolore magr  
 aliam erat volutpat. Ut wisi enim minim veniam, quisient nostrud. Sol  
 uta nobis eleifendoptn cogue nihil imerdiet domg id quod mzim plera  
 facer posim aum. Lorem ipsm dolor sit amet, consectuer. Duis autem  
 eum iriure dolor in hendreritin vulputate velit cesse ea commodo mol  
 Nam liber tempor cum soluta nobis eleifend option cogue nihil consequat,  
 velillum. Dolore eu zril feugiat nulla facilisis at vero eros accumsan et iusto odio dignissim qui bla  
 praesent.  
 Singabet,  
 Stephen J. Singel  
 Demperta Aminerimum  
 Labanda Sinpat Abarress  
 SJS:dwg  
 FINAL  
 ABCDEFGHIJKLMNOPQRSTUVWXYZ0123456789ABCDEFGHIJKLMNOPQRSTUVWXYZ  
 ABCDEFGHIJKLMNOPQRSTUVWXYZ0123456789ABCDEFGHIJKLMNOPQRSTUVWXYZ

## 6.4. Model Name and Code

1) Sub brand name Information

- Applying Independent sub brand name by Segment : Xpress / ProXpress / MultiXpress



2) Model code Information

- Basic Structure : [SL-●○○■□◆◆]

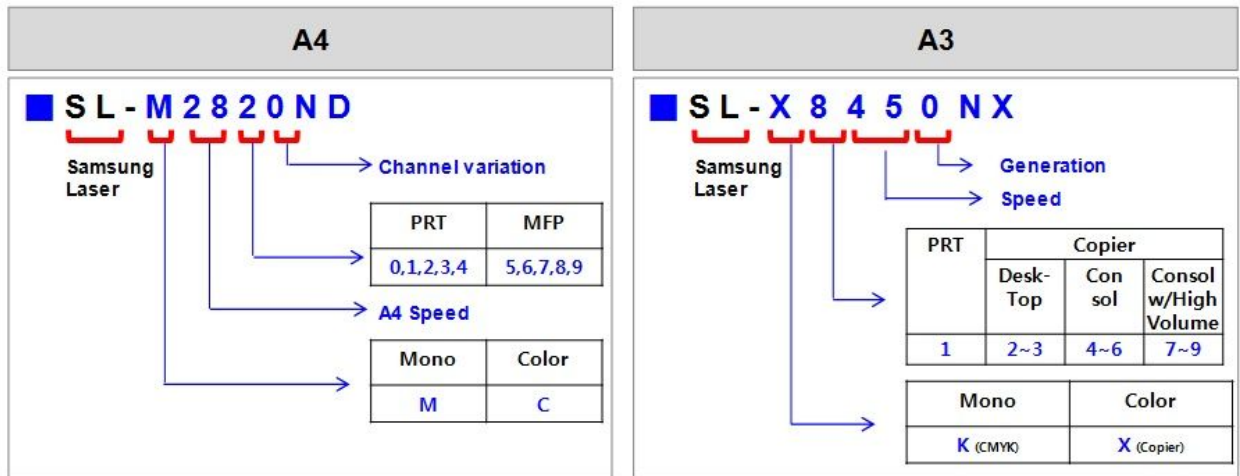

- ◆◆ : Function Information

	Function
N	Network
W	Wireless Network
D	Duplex Printing
R	Reverse Type ADF
F	Fax
X	XOA (eXtensible Open Architecture)
H	Handset
A	Auto Document Feeder

## 6.5. Document Revision List

Version	Date	Page	Description
1.00	03/Jun/2014	-	Release
1.01	11/Sep/2014	P.4-134	Add troubleshooting for touch panel malfunction.
1.02	28/Oct/2014	-	Memory size is changed from 1GB to 2GB. (The machine produced after 1st. Nov. is applied.)
1.03	19/Nov/2014	P.2-1,2	Modify memory size expression. (2GB → 4GB (2GB for Android OS))
1.04	09/Jan/2015	P.4-52	Delete SFE menu description by R&D policy.
1.05	23/Mar/2015	P.4-51	Add SFE menu again.
1.06	16/Apr/2015	P.4-40	Update shading test description.
1.07	27/May/2015	P.2-6	Modify copy speed error. (SDMC : 35 cpm → 45 cpm)
1.08	01/Jun/2015	P.3-33	Add SCF disassembly.
1.09	09/Sep/2016	P.2-11	Modify supplies table.
1.10	23/Jan/2017	P.1-1	Change LSU label image.



### GSPN (GLOBAL SERVICE PARTNER NETWORK)

Area	Web Site
Europe, MENA, CIS, Africa	<a href="https://gspn1.samsungcsportal.com">https://gspn1.samsungcsportal.com</a>
E.Asia, W.Asia, China, Japan	<a href="https://gspn2.samsungcsportal.com">https://gspn2.samsungcsportal.com</a>
N.America, S.America	<a href="https://gspn3.samsungcsportal.com">https://gspn3.samsungcsportal.com</a>

This Service Manual is a property of Samsung Electronics Co.,Ltd.  
Any unauthorized use of Manual can be punished under applicable International and/or domestic law.

© 2017 Samsung Electronics Co.,Ltd.  
All rights reserved.  
Printed in Korea