

Samsung MultiXpress Laser MFP SCX-8123, SCX-8128 - Error Code and Troubleshooting

 [A1-1111 / A1-1113](#)

 [A1-1211 / A1-1213](#)

 [A1-2111 / A1-2113](#)

 [A1-5113 / A1-5512 / A1-5513 / A1-5610](#)

 [A2-2810 / A2-2811 / A2-2910 / A2-2911](#)

 [A3-3111 / A3-3112 / A3-3113 / A3-3114](#)

 [A3-3210 / A3-3211 / A3-3212](#)

 [A3-3310 / A3-3311 / A3-3312 / A3-3410 / A3-3411 / A3-3412](#)

 [C1-1110](#)

 [C1-1130 / C1-1140](#)

 [C1-1311](#)

 [C1-1411](#)

 [C1-1512](#)

 [C3-1110 / C3-1130 / C3-1140](#)

 [C3-1211](#)

 [C3-1411](#)

 [C3-1422](#)

 [C3-1512](#)

 [C6-1310](#)

 [C7-1110 / C7-1130](#)

 [C7-1311](#)

 [C9-2110 / C9-2120](#)

 [C9-2220](#)

 [H1-1311 / H1-1312 / H1-1313 / H1-1314 / H1-1315 / H1-1317 / H1-1318](#)

 [H1-1322](#)

 [H1-1351 / H1-1352](#)

 [H1-1353](#)

 [H1-1411 / H1-1412 / H1-1417 / H1-1418](#)

 [H1-1422](#)

 [H1-1451 / H1-1452](#)

 [H1-1453](#)

 [H1-5323](#)

 [H1-5330](#)

 [H2-6705](#)

 [H2-6706](#)

 [H2-6707 / H2-6725](#)

 [H2-6726 / H2-6727](#)

 [H2-6728 / H2-6729 / H2-6730 / H2-6731](#)

 [H2-6732 / H2-6733](#)

 [H2-6734](#)

 [H2-6735](#)

 [H2-6736 / H2-6743](#)

 [H2-6744](#)

 [H2-6A50](#)

 [H2-6A63](#)

 M1-1113 / M2-1121

 M1-1213 / M2-1131

 M1-1610

 M1-3122

 M1-3222

 M1-4111

 M1-4211

 M1-5111 / M1-5112

 M1-5211 / M1-5212

 M1-5612

 M2-1124 / M2-1125

 M2-1134 / M2-1135

 M2-1211 / M2-1213 / M2-1214

 M2-1331 / M2-1333 / M2-1334 / M2-2111 / M2-2113 / M2-2114

 M3-1411

 M3-1413 / M3-1414

 M3-2230 / M3-2430

 S1-1113

 S1-1114

 S1-1313

 S1-1411 / S1-1413

 S1-2111

 S1-2411 / S1-2421 / S1-2422

 S1-2510 / S1-2511 / S1-2521 / S1-2523 / S1-2540

 [S1-4111](#)

 [S1-4311](#)

 [S1-5521](#)

 [S2-1211](#)

 [S2-2311](#)

 [S2-4210](#)

 [S2-4410](#)

 [S3-3111](#)

 [S3-3121](#)

 [S3-3211 / S3-3213 / S3-3214 / S3-3215 / S3-3216 / S3-3217](#)

 [S5-3111](#)

 [S6-3122](#)

 [S6-3123](#)

 [S6-3128](#)

 [S7-2110](#)

 [U1-2113 / U1-2119](#)

 [U1-2115](#)

 [U1-2132 / U1-2135](#)

 [U1-2141 / U1-2142](#)

 [U1-2316 / U1-2317](#)

 [U1-2335 / U1-233A](#)

 [U1-2337 / U1-233D](#)

 [U2-1111 / U2-1112 / U2-1113 / U2-1114](#)

 [U3-3113 / U3-3211 / U3-3212 / U3-3213 / U3-3214 / U3-3312 / U3-3314](#)

 [U3-3411 / U3-3413 / U3-3414](#)

 [U3-3311 / U3-3313](#)

 [U3-3711 / U3-3713 / U3-3714](#)

 [U3-4210](#)

Error Code and Troubleshooting

Messages display on the control panel to indicate the machine's status or errors. Refer to the information below to resolve these errors.

 **NOTE:**

Some messages might not display on the control panel depending on the options or model.

A1-1111 / A1-1113

Description

Motor Failure: #A1-1111. Turn off and then on, call for service if the problem persists

Motor Failure: #A1-1113. Turn off and then on, call for service if the problem persists

The regi/MP motor is not working normally. / The regi/MP motor is working normally but registers its status as stopped.

Recommended action

1. Turn the machine off and then on. If the error persists, turn the machine off.
2. Open the right door. Check to see if there are any obstacles or paper around the regi/MP unit.
3. Remove the rear cover.
4. Check to see if the regi/MP motor connector is connected correctly.

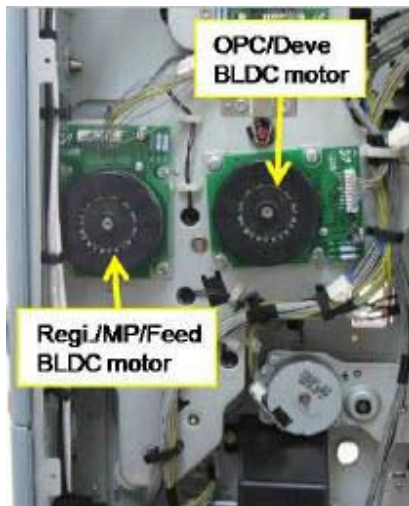

5. If the connection is OK, turn the machine on. Enter the SVC mode, and then select the motor test.

Diagnostics > Engine Diagnostics > Engine Test Routines > 100-0000

- a. If the motor is not working normally, check the following:
 - i. Check the signal and power with the DVM.

Pin Num	Name	Value (Measurement error ±5%)
1, 2	24V	24V
3, 4	GND	0V
5	Brake	-
6	Gain	-
7	Enable	Operate : 0V, Stop : 3.3V
8	Ready	Operate : 0V, Stop : 3.3V
9	CLK	Operate : 1.5~1.8V, Stop : 0V or 3.3V
10	DIR	-

- ii. If the checked result is normal, replace the BLDC motor (JC93-00448A) with a new one.
- iii. If the checked result is abnormal, check the following:

If 24V power is not being generated, replace the SMPS PCA (JC44-00100A (220V) / JC44-00093A (110V)) with a new one.



- If the control signal is abnormal, replace the main PCA (JC92-02452A) with a new one.

NOTE:

Install the MSOK to the new main PCA with a new one.

- b. If the motor is working normally, check the Pin Num 8.
 - i. If the value is abnormal, replace the main PCA (JC92-02452A) with a new one.

SCX-8123 Series	SCX-8128ND / SCX-8128NA	SCX-8128NX
JC92-02452A	JC92-02452A	JC92-02461A

NOTE:

Install the MSOK to the new main PCA.

- ii. If the value is normal, replace the cable with a new one.

A1-1211 / A1-1213

Description

Motor Failure: #A1-1211: Turn off and then on, call for service if the problem persists

Motor Failure: #A1-1213: Turn off and then on, call for service if the problem persists

The fuser motor is not working normally. / The fuser motor is working normally but registers its status as stopped.

Recommended action

1. Turn the machine off and then on. If the error persists, turn the machine off.
2. Open the right door. Check to see if there are any obstacles or paper around the fuser unit.
3. Remove the rear cover
4. Check to see if the fuser motor connector is connected correctly.

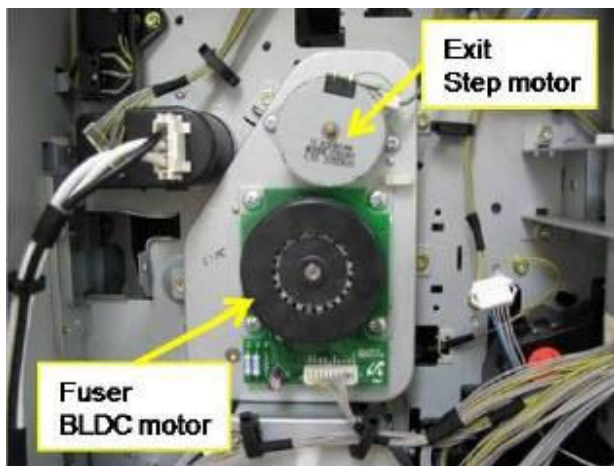

5. If the connection is OK, turn the machine on. Enter the SVC mode, and then select the motor test.

Diagnostics > Engine Diagnostics > Engine Test Routines > 100-0120

- a. If the motor is not working normally, check the following:
 - i. Check the signal and power with the DVM.

Pin Num	Name	Value (Measurement error ± 5%)
1, 2	24V	24V
3, 4	GND	0V
5	Brake	-
6	Gain	-
7	Enable	Operate : 0V, Stop : 3.3V
8	Ready	Operate : 0V, Stop : 3.3V
9	CLK	Operate : 1.5~ 1.8V, Stop : 0V or 3.3V
10	DIR	-

- ii. If the checked result is normal, replace the BLDC motor (JC93-00448A) with a new one.
- iii. If the checked result is abnormal, check the following:
 - If 24V power is not being generated, replace the SMPS PCA (JC44-00100A (220V) / JC44-00093A (110V)) with a new one.



- If the control signal is abnormal, replace the main PCA (JC92-02452A) with a new one.

NOTE:

Install the MSOK to the new main PCA.

- b. If the motor is working normally, check the Pin Num 8.
 - i. If the value is abnormal, replace the main PCA (JC92-02452A) with a new one.

SCX-8123 Series	SCX-8128ND / SCX-8128NA	SCX-8128NX
JC92-02452A	JC92-02452A	JC92-02461A

NOTE:

Install the MSOK to the new main PCA.

- ii. If the value is normal, replace the cable with new one.

A1-2111 / A1-2113

Description

Motor Failure: #A1-2111: Turn off and then on, call for service if the problem persists

Motor Failure: #A1-2113: Turn off and then on, call for service if the problem persists

The OPC motor is not working normally. / The OPC motor is working normally but registers its status as stopped.

Recommended action

1. Turn the machine off and then on. If the error persists, turn the machine off.
2. Open the right door. Check to see if there are any obstacles or paper around the drum drive unit.
3. Remove the rear cover
4. Check to see if the OPC motor connector is connected correctly.

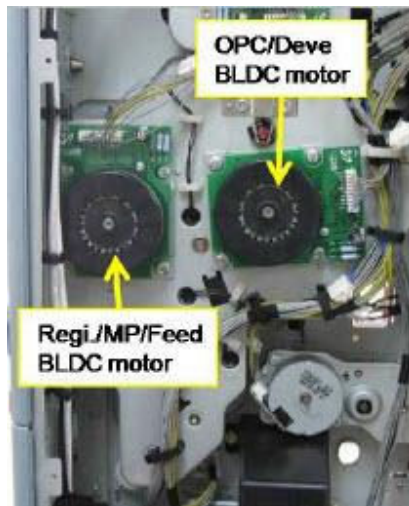

5. If the connection is OK, turn the machine on. Enter the SVC mode, and then select the OPC motor test.

Diagnostics > Engine Diagnostics > Engine Test Routines > 100-0000

- a. If the motor is not working normally, check the following:
 - i. Check the signal and power with the DVM.

Pin Num	Name	Value (Measurement error ± 5%)
1, 2	24V	24V
3, 4	GND	0V
5	Brake	-
6	Gain	-
7	Enable	Operate : 0V, Stop : 3.3V
8	Ready	Operate : 0V, Stop : 3.3V
9	CLK	Operate : 1.5~ 1.8V, Stop : 0V or 3.3V
10	DIR	-

- ii. If the checked result is normal, replace the BLDC motor (JC31-00123B) with a new one.
- iii. If the checked result is abnormal, check the following:
 - If 24V power is not being generated, replace the SMPS PCA (JC44-00100A (220V) / JC44-00093A (110V)) with a new one.



- if the control signal is abnormal, replace the main PCA (JC92-02452A) with a new one.

NOTE:

Install the MSOK to the new main PCA.

- b. If the motor is operational, check the Pin Num 8.
 - i. If the value is abnormal, replace the main PCA (JC92-02452A) with a new one.

NOTE:

Install the MSOK to the new main PCA.

SCX-8123 Series	SCX-8128ND / SCX-8128NA	SCX-8128NX
JC92-02452A	JC92-02452A	JC92-02461A

- ii. If the value is normal, replace the cable with a new one.

A1-5113 / A1-5512 / A1-5513 / A1-5610

Description

Motor Failure: #A1-5113: Turn off and then on, call for service if the problem persists

Motor Failure: #A1-5512: Turn off and then on, call for service if the problem persists

Motor Failure: #A1-5513: Turn off and then on, call for service if the problem persists

Motor Failure: #A1-5610. Turn off and then on, call for service if the problem persists

The toner is not being supplied.

Recommended action

1. Open the front door. If the toner pipe is blocked, open it.
2. Turn the machine off and then on. If the error persists, check the following:
3. Enter the SVC mode, and then select the toner supply motor test.

Diagnostics > Engine Diagnostics > Engine Test Routines > 111-0040

4. If the motor is not working normally, measure the motor power with DVM.

Measure 2 points together.



- a. If 24V power is being generated, replace the toner supply motor (JC31-00123B) with a new one.
- b. If 24V power is not generated , check the SMPS and main PCA.
 - i. If 24V power is not generated, replace the SMPS PCA (JC44-00100A (220V) / JC44-00093A (110V)) with a new one.



- ii. If the control signal is abnormal, replace the main PCA (JC92-02452A) with a new one.

SCX-8123 Series	SCX-8128ND / SCX-8128NA	SCX-8128NX
JC92-02452A	JC92-02452A	JC92-02461A

NOTE:

Install the MSOK to the new main PCA.

A2-2810 / A2-2811 / A2-2910 / A2-2911

Description

Fan Failure: #A2-2810: Turn off and then on, call for service if the problem persists

Fan Failure: #A2-2811: Turn off and then on, call for service if the problem persists

Fan Failure: #A2-2910: Turn off and then on, call for service if the problem persists

Fan Failure: #A2-2911: Turn off and then on, call for service if the problem persists

The ozone fan or OPC in fan is not working normally.

Recommended action

NOTE:

Ozone fan error : A2-2810 / A2-2811

OPC In fan error : A2-2910 / A2-2911

1. Turn the machine off.
2. Remove the rear cover.
3. Check to see if the corresponding fan connector are connected correctly.

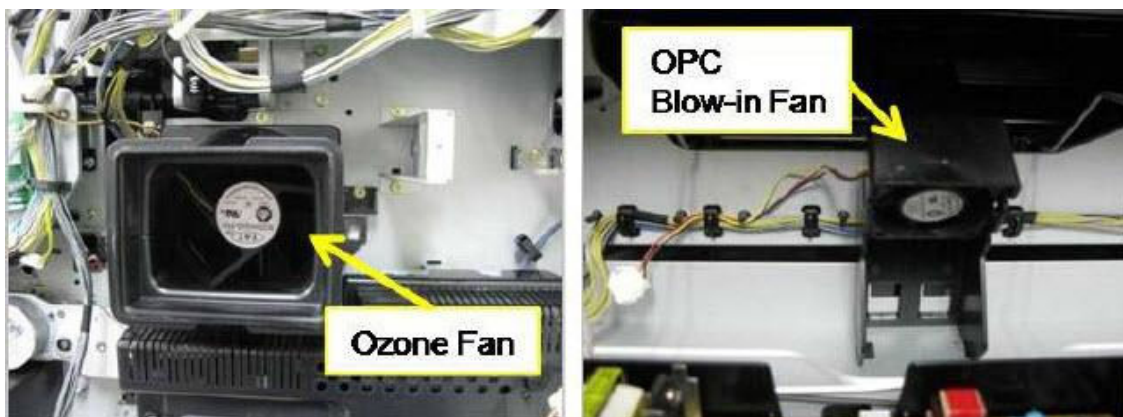

4. If the connection is OK, enter the SVC mode, and then execute fan test.

Diagnostics > Engine Diagnostics > Engine Test Routines > 100-0260, 109-0040

5. If the fan is not working normally, measure the fan power (red line).

Measure the red line

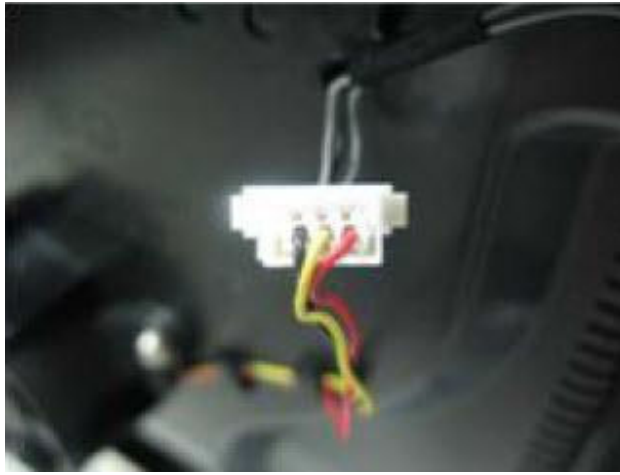

- a. If 24V power is being generated, replace the defective fan.
- b. If 24V power is not being generated, check the SMPS and main PCA.
 - i. Measure 24V power on the SMPS PCA. If the SMPS PCA JC44-00100A (220V) / JC44-00093A (110V) is not working normally, replace SMPS PCA with a new one.



- ii. If the SMPS board is working normally, replace the main PCA (JC92-02452A) with a new one.

NOTE:

Install the MSOK to the new main PCA.

6. If the fan operation is working normally but the error persists, check the following:
 - a. Check the yellow line signal with DVM.

Pin Num	Name	Value (Measurement error ±5%)
1, 2	24V	24V
3, 4	GND	0V
5	Brake	-
6	Gain	-
7	Enable	Operate : 0V, Stop : 3.3V
8	Ready	Operate : 0V, Stop : 3.3V
9	CLK	Operate : 1.5~1.8V, Stop : 0V or 3.3V
10	DIR	-

- b. Check to see if fan is connected correctly.
 - i. If the lock signal is 0V constantly, check the cable.
 - ii. If the cable is OK, replace the main board (JC92-02452A) with a new one.

SCX-8123 Series	SCX-8128ND / SCX-8128NA	SCX-8128NX
JC92-02452A	JC92-02452A	JC92-02461A

 **NOTE:**

Install the MSOK to the new main PCA.

- iii. If the signal value is different from the table above, replace the fan (JC93-00500A) with a new one.

A3-3111 / A3-3112 / A3-3113 / A3-3114

Description

Sensor Failure: #A3-3111: Turn off and then on, call for service if the problem persists

Sensor Failure: #A3-3112: Turn off and then on, call for service if the problem persists

Sensor Failure: #A3-3113: Turn off and then on, call for service if the problem persists

Sensor Failure: #A3-3114: Turn off and then on, call for service if the problem persists

The NC sensor in the fuser unit is not working normally. / The sensor signal is abnormal due to a defective cable.

Recommended action

1. Enter the SVC mode, and then execute the sensor test to check the sensor operation.

Diagnostics > Engine Diagnostics > Engine Test Routines

- 109-0000 : Fuser Temperature A

- 109-0010 : Fuser Temperature B

2. Remove and disassemble the fuser unit.



3. Measure the resistance value of the thermistor (1404-001453). If the measured value is out of range of 307K Ω ~430K Ω @25°C, replace the thermistor with a new one.

Check	Resistance(Ω)
1-2 (Blue - Black)	307K Ω ~430K Ω
1-3 (Blue -White)	307K Ω ~430K Ω

4. If the error persists, replace the fuser unit (JC91-01049A(220V) / JC91-01050A (110V)) with a new one.
5. If the error persists after replacing fuser unit, replace the main PCA (JC92-02452A) with a new one.

NOTE:

Install the MSOK to the new main PCA.

SCX-8123 Series	SCX-8128ND / SCX-8128NA	SCX-8128NX
JC92-02452A	JC92-02452A	JC92-02461A

A3-3210 / A3-3211 / A3-3212

Description

Sensor Failure: #A3-3210: Turn off and then on, call for service if the problem persists

Sensor Failure: #A3-3211: Turn off and then on, call for service if the problem persists

Sensor Failure: #A3-3212: Turn off and then on, call for service if the problem persists

The inner temperature sensor is not working normally.

Recommended action

1. Turn the machine off.
2. Enter SVC mode, and then execute sensor test to check the sensor operation.

Diagnostics > Engine Diagnostics > Engine Test Routines > 109-0012

3. Open the right door. Measure the resistance value of the connector at both ends.

If the values is not in the range of $10K\Omega \pm 1\%$ (@ 25 °C), replace the photo sensor (1404-001417) with a new one.

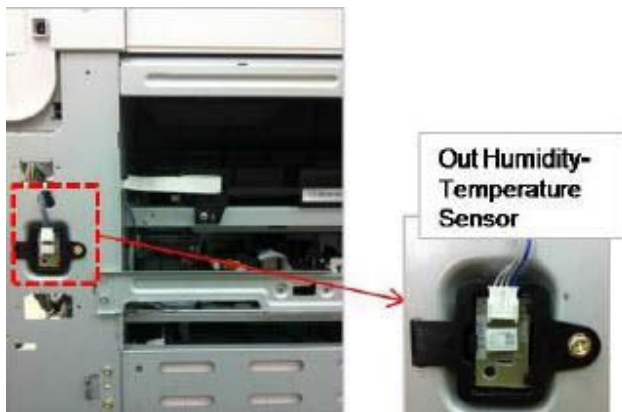

4. If the sensor is working normally, replace the main PCA (JC92-02452A) with a new one.

NOTE:

Install the MSOK to the new main PCA.

SCX-8123 Series	SCX-8128ND / SCX-8128NA	SCX-8128NX
JC92-02452A	JC92-02452A	JC92-02461A

A3-3310 / A3-3311 / A3-3312 / A3-3410 / A3-3411 / A3-3412

Description

Sensor Failure: #A3-3310:Turn off and then on, call for service if the problem persists

Sensor Failure: #A3-3311:Turn off and then on, call for service if the problem persists

Sensor Failure: #A3-3312:Turn off and then on, call for service if the problem persists

Sensor Failure: #A3-3410:Turn off and then on, call for service if the problem persists

Sensor Failure: #A3-3411:Turn off and then on, call for service if the problem persists

Sensor Failure: #A3-3412:Turn off and then on, call for service if the problem persists

The external temperature sensor is not working normally. / Humidity sensor is not working normally.

- A3-3310, A3-3311, A3-3312 : External temperature sensor
- A3-3410, A3-3411, A3-3412 : Humidity sensor

Recommended action

1. Turn the machine off.
2. Enter SVC mode, and then execute sensor test to check the sensor operation.

Diagnostics > Engine Diagnostics > Engine Test Routines > 109-0013

3. Open the right door. Measure the resistance value of the connector at both ends.

If the values is not in the range of $10K\Omega \pm 1\%$ (@ 25 °C), replace the photo sensor (JC93-00486A) with a new one.

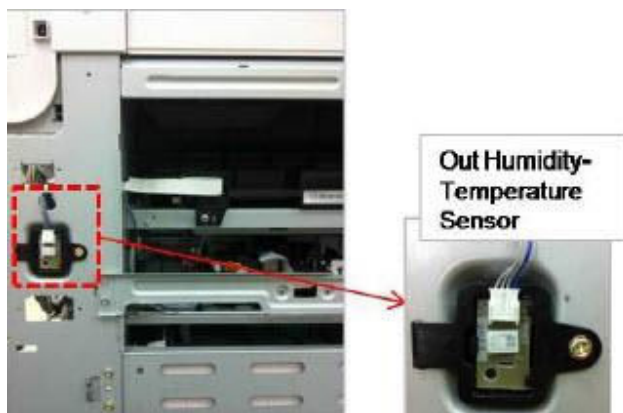

4. If the sensor is normal, replace the main PCA (JC92-02452A) with a new one.

 **NOTE:**

Install the MSOK to the new main PCA.

SCX-8123 Series	SCX-8128ND / SCX-8128NA	SCX-8128NX
JC92-02452A	JC92-02452A	JC92-02461A

C1-1110

Description

Prepare new black toner cartridge

The toner remaining is 5 ~ 30% of its life. The toner cartridge is almost empty.

Recommended action

1. Open the front door.
2. Remove the black toner cartridge (MLT-D709S).

Toner cartridge with level of "Low" will be empty soon.



C1-1130 / C1-1140

Description

End of life, replace with new toner cartridge

End of life, replace with new toner cartridge

The toner cartridge is at the end of its life. Toner cartridge is empty, replace toner cartridge.

Recommended action

1. Print the supply information report.
2. Check to see the remaining life of the toner cartridge.
3. If its at end of life, then turn the machine off and open the front door.
4. Replace the toner cartridge with new one (MLT-D709S).



C1-1311

Description

Imaging Unit Failure: #C3-1312: Install imaging unit again

The toner supply is inefficient or not working normally.

Recommended action

1. Turn the machine off. Open the front door.
2. Remove the toner cartridge. Lightly shake the toner cartridge five or six times to distribute the toner evenly inside the cartridge.
3. If the error persists, check the following:
 - a. Check to see if the toner supply drive unit (JC93-00436A) is working normally.
 - b. Check to see if the toner duct drive unit (JC93-00451A) is working normally.
4. If the error persists, replace the toner cartridge (MLT-D709S) with a new one.



C1-1411

Description

Toner cartridge is not installed, install it

The toner cartridge is not installed. / The CRUM data was not detected.

Recommended action

1. Open the front door. Check to see if the toner cartridge is installed.



2. Remove and reinstall the toner cartridge.
3. If the error persists, check to see if the toner cartridge modular jack is contaminated or damaged.



4. Replace the toner cartridge with a new one (MLT-D709S).

C1-1512

Description

Toner cartridge is not compatible, check the users guide

The toner cartridge is not compatible.

Recommended action

1. Open the front door. Remove the toner cartridge and reinstall it.
2. Print the supply information report. Check the toner cartridge supply information.
3. If the toner cartridge is not a genuine Samsung, replace it with a genuine Samsung toner cartridge (MLT-D709S).



C3-1110 / C3-1130 / C3-1140

Description

Prepare new imaging unit

Replace with new imaging unit

The imaging unit has almost reached the end of its life.

Recommended action

1. Open the front door and remove the waste toner container.
2. Remove the drum unit.
3. If imaging unit is at its end of life, turn the machine off and replace the imaging unit (MLT-R709) with new one.



C3-1211

Description

Imaging Unit Failure:#C3-1211: Please turn off and then on

A sensor calibration error has occurred that detects the toner density for image stabilization control.

Recommended action

1. Open the front door and remove the waste toner container.
2. Remove the drum unit and reinstall it.
3. If the error persists, replace the imaging unit (MLT-R709) with new one.



C3-1411

Description

Imaging unit is not installed, install the unit

The imaging unit is not installed. / The data of CRUM was not detected.

Recommended action

1. Open the front door and remove the waste toner container.
2. Remove the drum unit and reinstall it.
3. If the error persists, replace the imaging unit (MLT-R709) with new one.



C3-1422

Description

Imaging unit is not installed, install the unit

The imaging unit needs to be cleaned.

Recommended action

1. Open the front door and remove the waste toner container.
2. Remove the drum unit and reinstall it.
3. If the error persists, clean the drum unit by using the charger cleaner.

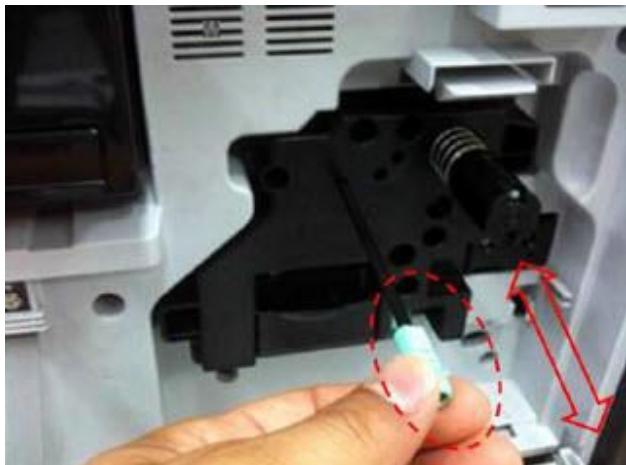

4. If the error persists, replace the drum unit.(MLT-R709) with a new one.

C3-1512

Description

Imaging unit is not compatible, check the user's guide

The imaging unit is not compatible.

Recommended action

1. Open the front door and remove the waste toner container.
2. Remove the drum unit and reinstall.
3. If the error persists, replace the imaging unit (MLT-R709) with new one.



C6-1310

Description

Fuser unit is not installed, install it

The fuser unit was not detected.

Recommended action

1. Turn the machine off. Open right door, and then reinstall the fuser unit. Then turn the machine on.
2. If the error persists, print the supply Information report and check whether fuser unit is at its end of life.

NOTE:

The fuser unit can print up to 150,000 pages.

3. If the error persists, replace the fuser unit (110V : JC91-01049A, 220V : JC91-01050A) with a new one.

C7-1110 / C7-1130

Description

Waste toner container is almost full, order new one

Waste toner container is full, replace it

The life of the waste toner container is either near full or it is full.

Recommended action

1. Open the front door and remove the waste toner container.
2. Reinstall the waste toner container.
3. If the error persists, remove the waste toner container.
4. If the error persists, replace the waste toner container (MLT-W709) with a new one.

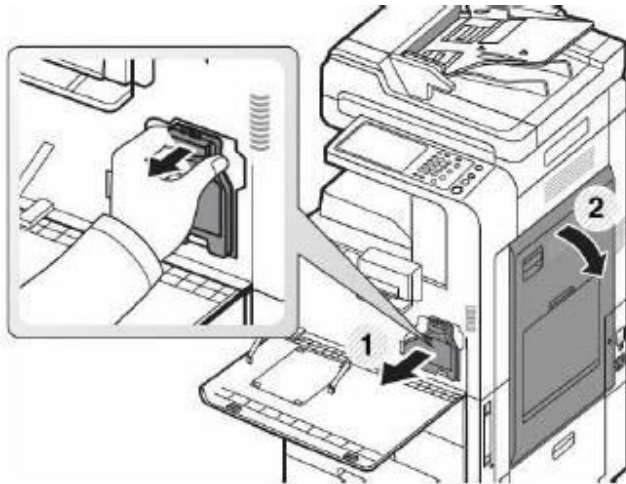

C7-1311

Description

Waste toner container is not installed, install it

The waste toner container is not installed.

Recommended action

1. Open the front door and check to see if the waste toner container is installed correctly.
2. Check to see if the waste toner container sensor is working normally.



3. If the error persists, remove the waste toner container.
4. If the error persists, replace the waste toner container (MLT-W709) with a new one.

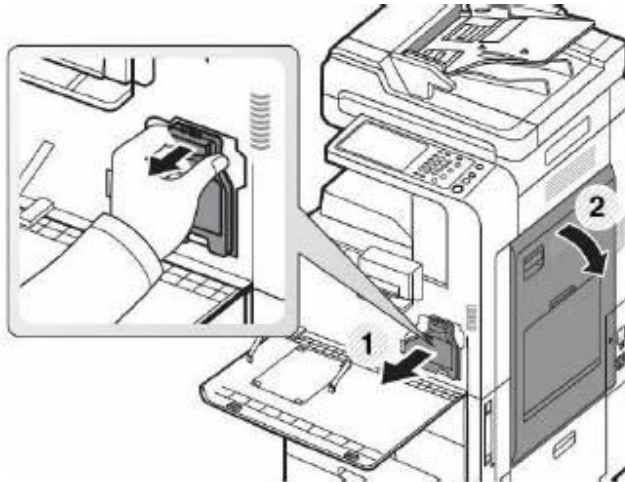

C9-2110 / C9-2120

Description

Replace with new transfer roller

The transfer roller is at the end of its life.

Recommended action

1. Open the right door.
2. Replace the transfer roller (JC95-01520A) with a new one.



C9-2220

Description

TR Failure: #C9-2220: Install transfer roller again

The resistance value of the transfer roller is abnormal.

Recommended action

1. Open the right door.
2. Replace the transfer roller (JC95-01520A) with a new one.



3. If the error persists, replace the HVPS PCA.

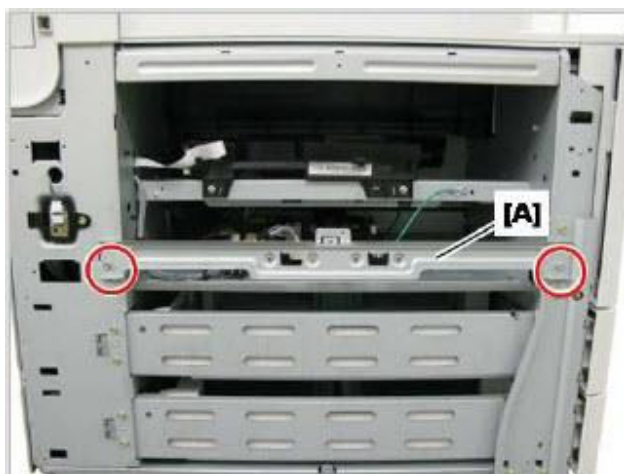

H1-1311 / H1-1312 / H1-1313 / H1-1314 / H1-1315 / H1-1317 / H1-1318

Description

Paper jam in Tray 3

A paper jam has occurred in Tray 3. / The pickup unit connection is defective. / The pickup rollers are defective. / The feed sensor is defective.

Recommended action

1. Open the DCF take-away-door. Remove the paper jam.

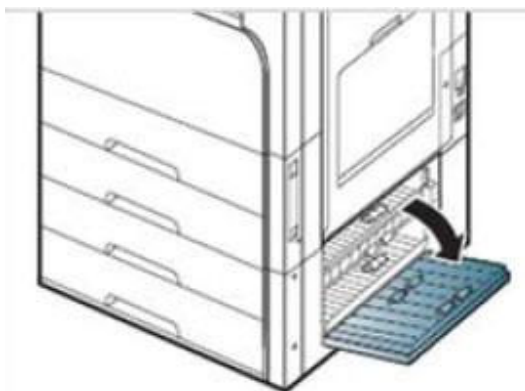

2. Remove Tray 3. Remove the paper jam. Close the DCF take-away-door and reinstall Tray 3.
3. If paper jam error persists, check the following:
 - a. Remove both Tray 3 and Tray 4.
 - b. Check to see if the pickup/ reverse/ forward rollers are assembled correctly.

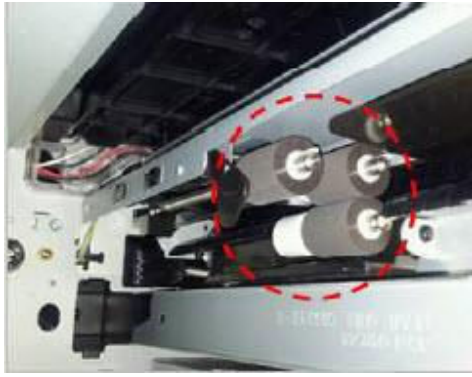

- c. If the pickup/ reverse/ forward rollers are worn or contaminated, clean rollers with a soft, lint-free cloth or replace the defective roller (JC93-00540A) with a new one.
4. If pickup/ reverse/ forward rollers have no issues, check the following:
 - a. Remove the DCF pickup unit 1. Check to see if the feed sensor cable is connected correctly.
 - b. Check to see if the sensor cable on DCF PCA is connected correctly.
 - c. If the connection is OK, replace the feed sensor (0604-001381) with a new one.
 - d. Reinstall the DCF pickup unit 1.
5. If the error persists, check the following:
 - a. Remove the DCF pickup unit 1. Check to see if the sensor and actuator are assembled correctly.
 - b. While pushing the pickup lever, check to see if the pickup rollers are in the down position.
 - c. Replace the DCF pickup unit 1 (JC93-00513A) with a new one or replace the defective part.
6. Check the DCF feed motor:
 - a. Check to see if the DCF feed motor cable is connected correctly.
 - b. If the connection is OK, replace the DCF feed drive unit (JC93-00447A) with a new one.
7. Check the DCF pick up motor:
 - a. Check to see if the DCF pick-up motor cable is connected correctly.

- b. If the connection is OK, replace the DCF pickup drive unit 1 (JC93-00442A) with a new one.

H1-1322

Description

Tray 3 cassette is pulled out, insert it properly

Tray 3 is opened or the auto size sensor connector is not connected or it's damaged.

Recommended action

1. Remove and reinstall Tray 3.
2. If the error persists, remove both Tray 3 and Tray 4. Look inside the cavity of the machine.
3. Check to see if the auto size sensor cable is connected correctly. Disconnect and reconnect it.



4. If the connection is OK, replace the auto size sensor (JC93-00018A) with a new one.
5. If the error persists, replace the DCF PCA (JC92-02453A) with a new one.

H1-1351 / H1-1352

Description

Paper is low in Tray 3, load paper

Paper is empty in Tray 3, load paper

The paper in the tray is less than 10% of the machines specifications. / The photo sensor is not working normally.

Recommended action

1. Remove Tray 3. Load paper into Tray 3.
2. If paper is loaded but error persists, check the following:
 - a. Remove the DCF pickup unit 1.
 - b. Check to see if the photo sensor in the DCF pick up unit 1 is contaminated. If so, clean it with a soft, lint-free cloth.
 - c. If the photo sensor (0604-001393) is not working normally, replace the photo sensor with a new one.
 - d. If the actuator (JC66-03199A) is not working normally, replace actuator with a new one.

**H1-1353****Description**

Input System Failure #H1-1353: Pull Tray 3 out and insert it

The paper did not feed from Tray 3.

Recommended action

1. Remove and reinstall Tray 3.
2. Turn the machine off and then on.
3. If the error persists, turn the machine off.
4. Remove 6 screws, and then remove the bracket rear cover.



5. Check to see if the connection between the DCF pickup drive and DCF PCA is connected correctly.

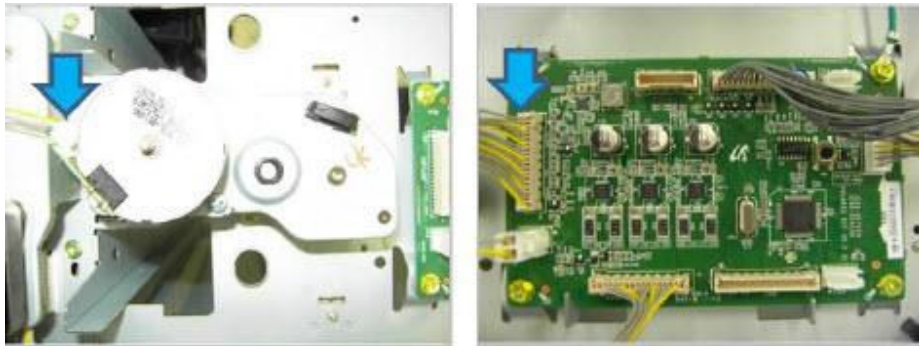

6. If the connection is OK, replace the pickup drive unit (JC93-00442A) with a new one.
7. If the error persists, check the following:
 - a. Remove the DCF pick up unit 1.
 - b. Check to see if the photo sensor in the DCF pickup unit 1 is contaminated. If so, clean it with a soft, lint-free cloth.
 - c. If the photo sensor (0604-001393) is not working normally, replace the photo sensor with a new one.



H1-1411 / H1-1412 / H1-1417 / H1-1418

Description

Paper jam in Tray 4

A paper jam has occurred in Tray 4. / The pickup unit connection is defective. / The pickup rollers are defective. / The feed sensor is defective.

Recommended action

1. Open the DCF take-away-door. Remove the paper jam.

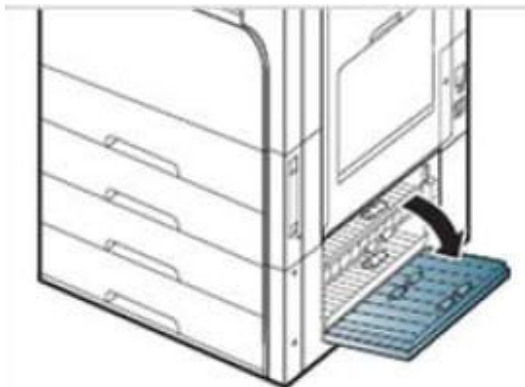

2. Remove Tray 4. Remove the paper jam. Close the DCF take-away-door and reinstall Tray 4.
3. If this jam error persists, check the following:
 - a. Remove both Tray 3 and Tray 4.
 - b. Check to see if the pickup/ reverse/ forward rollers are assembled correctly.

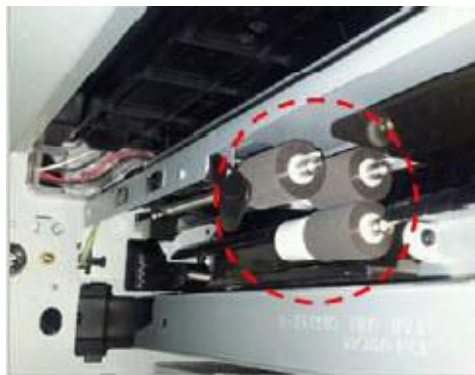

- c. If the pickup/ reverse/ forward rollers are worn or contaminated, clean rollers with a soft, lint-free cloth or replace the defective roller (JC93-00540A) with a new one.
4. If pickup/ reverse/ forward rollers have no issues, check the following:
 - a. Remove the DCF pick up unit 2. Check to see if the feed sensor cable is connected correctly.
 - b. Check to see if the sensor cable on DCF PCA is connected correctly.

- c. If the connection is OK, replace the feed sensor (0604-00138)1 with a new one.
 - d. Reinstall the DCF pickup unit 2.
5. If the error persists, check the following:
- a. Remove the DCF pickup unit 2. Check to see if the sensor and actuator are assembled correctly.
 - b. While pushing the pickup lever, check if the pick up rollers are in the down position.
 - c. Replace the DCF pickup unit 2 (JC93-00513A) with a new one or replace the defective part.
6. Check the DCF feed motor:
- a. Check to see if the DCF feed motor cable is connected correctly.
 - b. If the connection is OK, replace the DCF feed drive unit (JC93-00447A) with a new one.
7. Check the DCF pickup motor:
- a. Check to see if the DCF pick up motor cable is connected correctly.
 - b. If the connection is OK, replace the DCF pickup drive unit (JC93-00442A with a new one.

H1-1422

Description

Tray 4 cassette is pulled out, insert it properly

The Tray 4 is opened or the auto size sensor connector is not connected or it's damaged.

Recommended action

1. Remove and reinstall Tray 4 correctly.
2. If the error persists, remove both Tray 3 and Tray 4. Look inside the machines cavity.
3. Check to see if the auto size sensor cable is connected correctly. Disconnect and reconnect it.



4. If the connection is OK, replace the auto size sensor (JC93-00018A) with a new one.
5. If the error persists, replace the DCF PCA (JC92-02453A) with a new one.

H1-1451 / H1-1452

Description

Paper is low in Tray 4, load paper

Paper is empty in Tray 4, load paper

The paper in Tray 4 is less than 10% of the machines specifications. / The photo sensor is not working normally.

Recommended action

1. Remove Tray 4. Load paper into Tray 4.
2. If paper is loaded but error persists, check the following:
 - a. Remove the DCF pickup unit 2.
 - b. Check if the photo sensor in the DCF pickup unit 2 is contaminated. If so, clean it with a soft, lint-free cloth.
 - c. If the photo sensor (0604-001393) is not working normally, replace the photo sensor with a new one.
 - d. If the actuator (JC66-03199A) is not working normally, replace the actuator with a new one.



H1-1453

Description

Input System Failure #H1-1453: Pull Tray 4 out and insert it

The paper did not feed from Tray 4.

Recommended action

1. Remove and reinstall Tray 4.
2. Turn the machine off and then on.
3. If the error persists, turn the machine off.
4. Remove 6 screws, and then remove the bracket rear cover.



5. Check to see if the connection between the DCF pickup drive and DCF PCA is connected correctly.

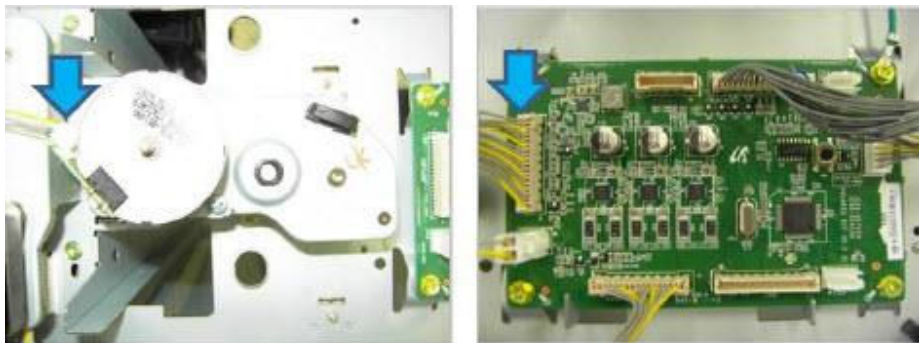

6. If the connection is OK, replace the pickup drive unit 2 (JC93-00442A) with a new one.
7. If the error persists, check the following:
 - a. Remove the DCF pickup unit 2.
 - b. Check to see if the photo sensor in the DCF pickup unit 2 is contaminated. If so, clean it with a soft, lint-free cloth.
 - c. If the photo sensor (0604-001393) is not working normally, replace the photo sensor with a new one.



H1-5323

Description

Tray door is open, close the door

The DCF take-away-door is open. / I/L-switch cable or connector is damaged.

Recommended action

1. Open and close the DCF take-away-door.



2. If the error persists, check the following:
 - a. Check to see if I/L-switch (cable-DCF door open) (JC39-01696A) is working normally. If it is not working normally, replace the I/L switch with a new one.

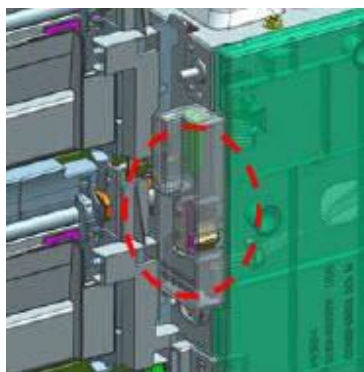

- b. If the I/L switch is OK, replace the DCF PCA (JC92-02453A) with a new one.

H1-5330

Description

DCF Failure #H1-5330: Check internal DCF connection

A communication error has occurred between the optional tray and the main machine.

Recommended action

1. Lift up and release the DCF unit from the machine.
2. Remove 6 screws, and then remove the bracket rear cover.

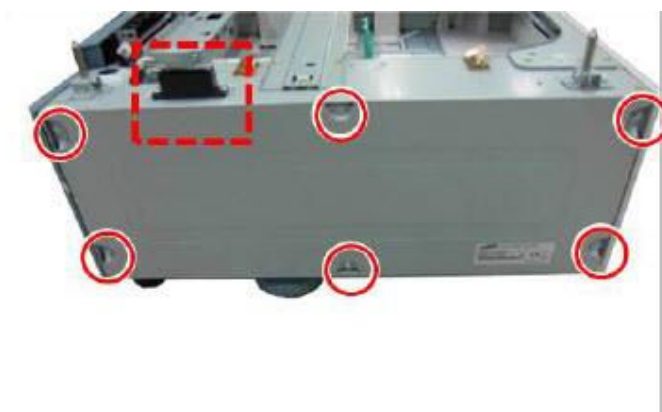

3. Check to see if the interface connector is connected to the DCF PCA. If the interface connector (JC39-1609A) is not working normally, replace the interface connector with a new one.
4. If the error persists, replace the DCF PCA with a new one.

H2-6705

Description

Paper jam inside of finisher

Paper jam at exit of finisher

The paper failed to pass the finisher's paper transportation path within the specified time.

Recommended action

1. Open the finisher jam cover, and check to see if there is paper in the paper path. If there is paper, manually remove the jammed paper.
2. If the error persists after removing the paper and closing the finisher jam door, check the following:
 - a. Is the finisher input sensor working normally?
 - i. Make sure the finisher input sensor cable is connected to the sensor connector correctly.
 - ii. Make sure the finisher input sensor cable is connected to the main PCA connector correctly.
 - iii. Replace the finisher input sensor (JC81-09686A) with a new one.

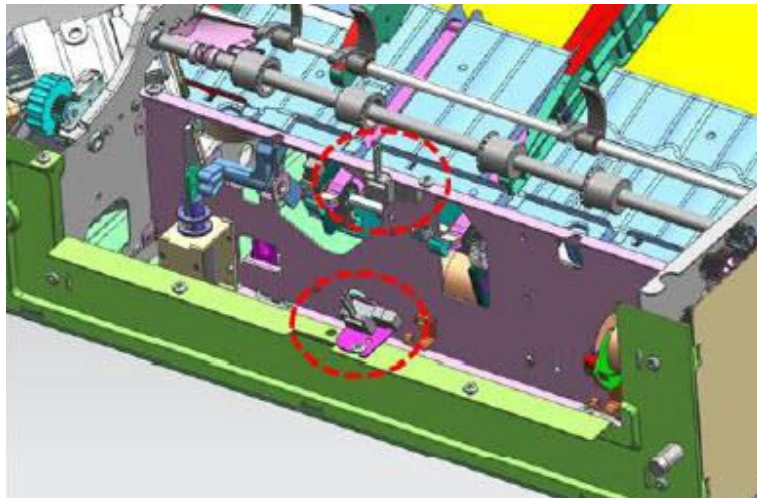

- iv. Replace the finisher main PCA (JC81-09692A) with a new one.
 - b. Check if any debris exists. Remove all debris.

H2-6706

Description

Finisher Failure: #H2-6706: Check the finisher

The transport motor is not working normally.

Recommended action

1. Open the finisher's jam cover to check to see if there is a paper jam. If there is a paper jam, manually remove the jammed paper. Then close door to allow the finisher to initialize.
2. If transport motor is still not working normally and the error persists, check the following:
 - a. Is the finisher transport motor working normally?
 - i. Make sure the finisher transport motor cable is connected to the transport motor connector correctly.
 - ii. Make sure the finisher transport motor cable is connected to the main PCA connector correctly.
 - iii. Replace the finisher transport motor (JC81-09677A) with a new one.
 - iv. Replace the finisher main PCA (JC81-09692A) with a new one.
 - b. Is the finisher input sensor working normally?
 - i. Make sure the finisher input sensor cable is connected to the sensor connector correctly.
 - ii. Make sure the finisher input sensor cable is connected to the main PCA connector correctly.
 - iii. Replace the finisher input sensor (JC81-09686A) with a new one.
 - iv. Replace the finisher main PCA (JC81-9692A) with a new one.
 - c. Is the finisher motor gear set working normally?
 - i. Make sure the gear set can rotate smoothly.
 - ii. Make sure each gear is not damaged.
 - iii. Replace the gear set (JC81-09592A / J81-09593A / JC81-09595A / JC81-09596A) with a new one.

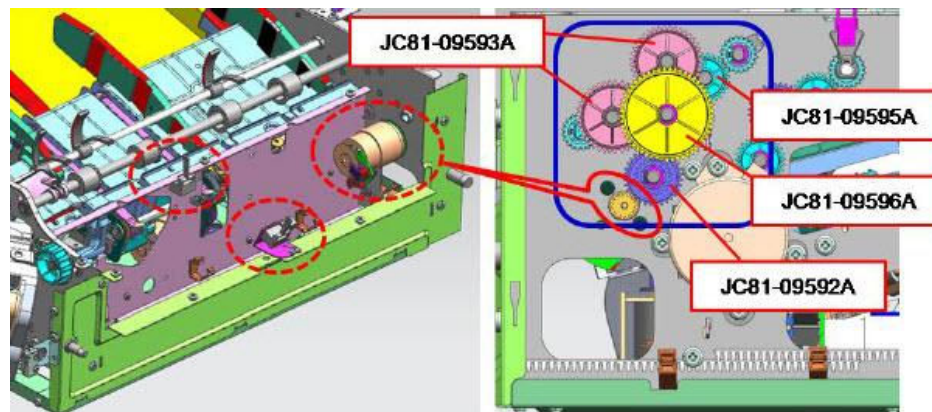

- d. Check if any debris exists. Remove all debris.

H2-6707 / H2-6725

Description

Finisher Failure: #H2-67xx: Check the finisher

The component does not move to or leave home position.

Recommended action

1. If there is a paper jam in the paper path, manually remove the jammed paper. Open and close the finisher stapler door or jam cover to check to see if finisher executes the initialization process.
2. If the component still doesn't go back to home position and the error persists, check the following:
 - a. Is the finisher input sensor working normally?
 - i. Make sure the finisher input sensor cable is connected to the sensor connector correctly.
 - ii. Make sure the finisher input sensor cable is connected to the main PCA connector correctly.
 - iii. Replace the finisher input sensor (JC81-09686A) with a new one.
 - iv. Replace the finisher main PCA (JC81-09692A) with a new one.
 - b. Is the finisher component motor working normally?
 - i. Make sure the finisher component motor cable is connected to the motor connector correctly.

- ii. Make sure the finisher component motor cable is connected to the main PCA connector correctly.
 - iii. Replace the finisher component motor (JC81-09680A / JC81-09681A) with a new one.
 - iv. Replace the finisher main PCA (JC81-09692A) with a new one.
- c. Is the finisher component parts working normally?
- i. Make sure the component parts can move or rotate smoothly.
 - ii. Make sure there is not any mechanical interference to stop component parts from moving or rotating.
 - iii. If there is a belt, make sure the belt is on tight and in the correct position.
- d. Is the finisher component motor gear set working normally?
- i. Make sure the gear set can rotate smoothly.
 - ii. Make sure each gear is not damaged.
 - iii. Replace the eject-sub assembly with a new one.
- e. Check if any debris exists. Remove all debris.

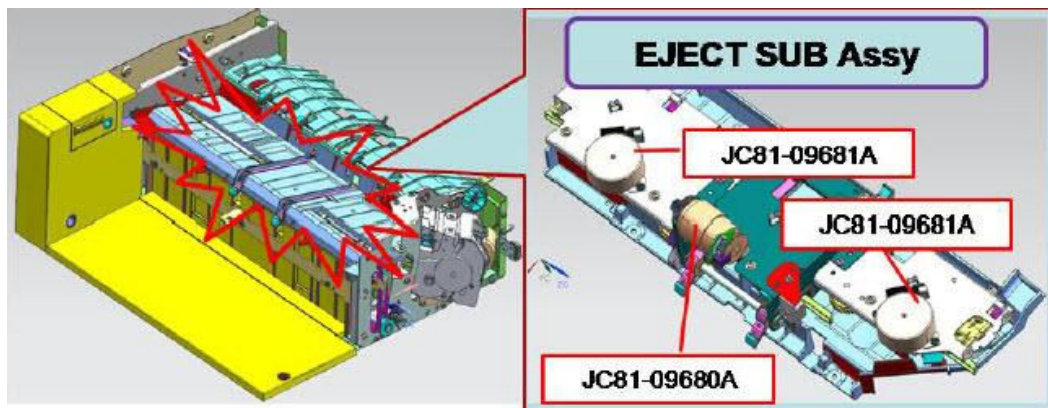

H2-6726 / H2-6727

Description

Finisher Stapler door is open, close it

Finisher Jam door is open, close it

The finisher door is open.

Recommended action

1. Close the door to perform finisher initialization. If the error persists, check the following:
 - a. Is the finisher door cover close?
 - i. Close the finisher door.
 - ii. The finisher door cover can contact and push input sensor switch.
 - iii. The finisher input sensor switch can be pushed.
 - iv. Replace the finisher cover door (JC81-09577A) or switch (JC81-09687A) with a new one.

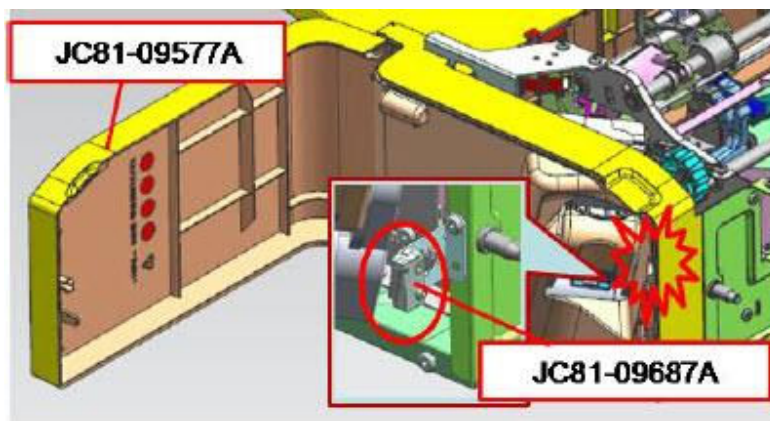

- b. Is the finisher input sensor working normally?
 - i. Make sure the finisher input sensor cable is connected to the sensor connector correctly.
 - ii. Make sure the finisher input sensor cable is connected to the main PCA connector correctly.
 - iii. Replace the finisher input sensor (JC81-09686A with a new one).

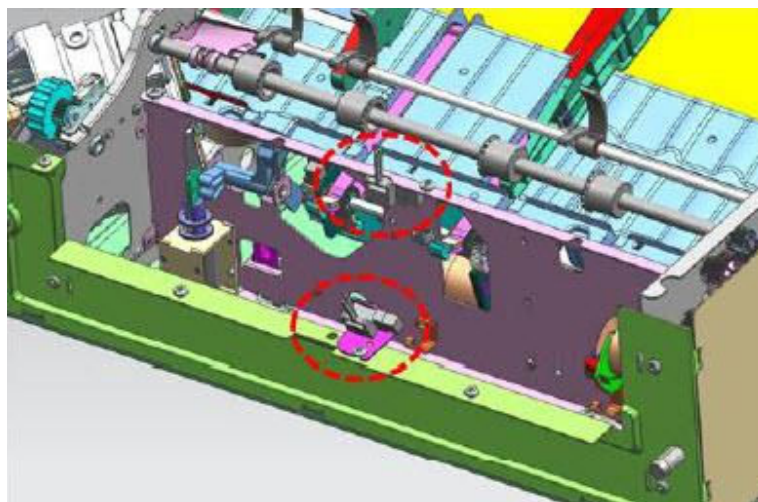

- iv. Replace the finisher main PCA (JC81-09692A) with a new one.
- c. Check if any debris exists. Remove all debris.

H2-6728 / H2-6729 / H2-6730 / H2-6731

Description

Finisher Failure: #H2-67xx: Check the finisher

The finisher stapler head is not moving to or leaving home position.

Recommended action

1. If there is paper jam in the stapler, removing paper manually. Open and close finisher stapler door or jam cover to check to see if finisher executes the initialization process.
2. If stapler still doesn't go back to home position and error persists, check the following:
 - a. Can finisher's stapler cartridge be removed?
 - i. Rotate the stapler gear manually to move stapler head back to home (top) position.
 - ii. Remove the staples completely from stapler cartridge.
 - iii. Remove staples from inside stapler.
 - b. Is the finisher stapler input sensor working normally?
 - i. Make sure the finisher input sensor cable is connected to the sensor connector correctly.

- ii. Make sure the finisher input sensor cable is connected to the main PCA connector correctly.
 - iii. Replace the finisher stapler (JC81-07376A) with a new one.
 - iv. Replace the finisher main PCA (JC81-09692A) with a new one.
- c. Is the finisher stapler motor working normally?
- i. Make sure the finisher stapler motor cable is connected to the stapler motor connector correctly.
 - ii. Make sure the finisher stapler motor cable is connected to the main PCA connector correctly.
 - iii. Replace the finisher stapler (JC81-07376A) with a new one.
 - iv. Replace the finisher main PCA (JC81-07376A) with a new one.
- d. Check if any debris (staple) exists. Remove all debris.

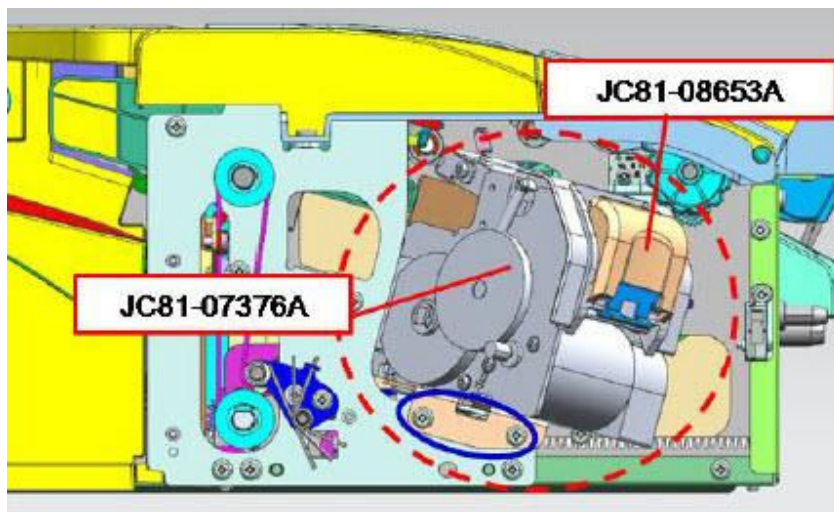

H2-6732 / H2-6733

Description

Staple cartridge is low, replace it

Staple cartridge is empty, replace it

The finisher stapler cartridge needs to be refilled.

Recommended action

1. Open the finisher stapler door to refill cartridge, and then close door. If necessary, self-priming will execute automatically. If the stapler error or warning persists, check the following:
 - a. Does the finisher stapler cartridge refill box fit in the cartridge?
 - i. Make sure the stapler refill box fits into the cartridge.
 - ii. Make sure the staples do not jam near the stapler head.
 - b. Is the finisher stapler input sensor working normally?
 - i. Make sure the finisher input sensor cable is connected to the sensor connector correctly.
 - ii. Make sure finisher input sensor cable is connected to the main PCA connector correctly.
 - iii. Replace the finisher stapler (JC81-07376A) with a new one.
 - iv. Replace the finisher main PCA (JC81-09692A) with a new one.
 - c. Check if any debris (staple) exists. Remove all debris.

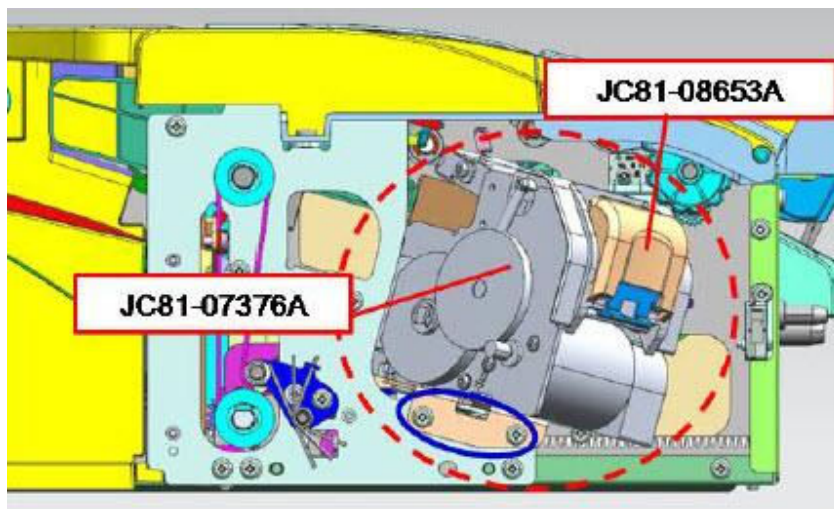

H2-6734

Description

Finisher Failure: #H2-6734: Check the finisher

The finisher stapler cartridge refill failed.

Recommended action

1. Open the finisher stapler door to refill cartridge and then close door. If necessary, self-priming will execute automatically. If stapler error or warning persists, check the following:
 - a. Does the finisher stapler cartridge refill box fit in cartridge?
 - i. Make sure the stapler refill box fits into cartridge.
 - ii. Make sure the staples do not jam near stapler head.
 - b. Is the finisher stapler input sensor working normally?
 - i. Make sure the finisher input sensor cable is connected to the sensor connector correctly.
 - ii. Make sure the finisher input sensor cable is connected to the main PCA connector correctly.
 - iii. Replace the finisher stapler (JC81-07376A) with a new one.
 - iv. Replace the finisher main PCA (JC81-09692A) with a new one.
 - c. Is the finisher stapler motor working normally?
 - i. Make sure the finisher stapler motor cable is connected to the stapler motor connector correctly.
 - ii. Make sure the finisher stapler motor cable is connected to the main PCA connector correctly.
 - iii. Replace the finisher stapler (JC81-07376A) with a new one.
 - iv. Replace the finisher main PCA (JC81-09692A) with a new one.
 - d. Check if any debris (staple) exists. Remove all debris.

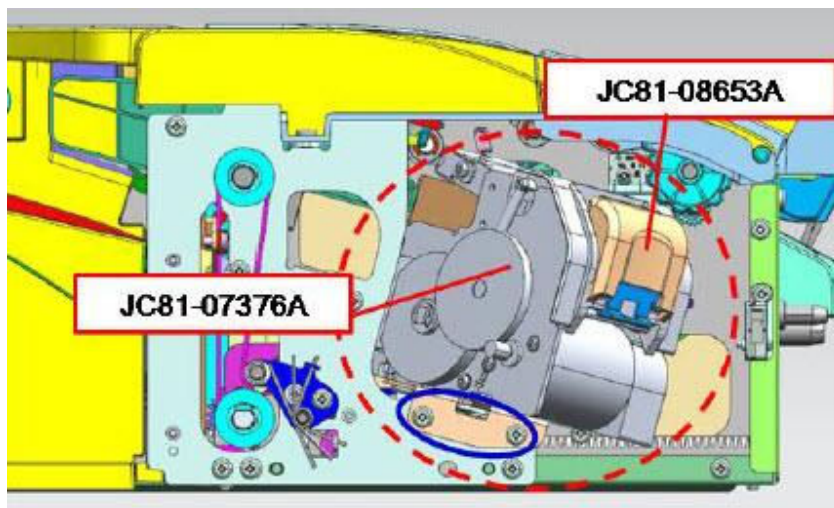

H2-6735

Description

Too much paper in finisher stacker, remove printed paper

The finisher output tray is full.

Recommended action

1. Remove printed paper from the finisher main tray. The main tray will move up and down to clear stack full warning.
2. If warning persists, check the following:
 - a. Does the finisher main tray input sensor (standby & home sensor) working normally?
 - i. Make sure the finisher input sensor cable is connected to the sensor connector correctly.
 - ii. Make sure the finisher input sensor cable is connected to the main PCA connector correctly.
 - iii. Replace the finisher input sensor (JC81-09686A) with a new one.

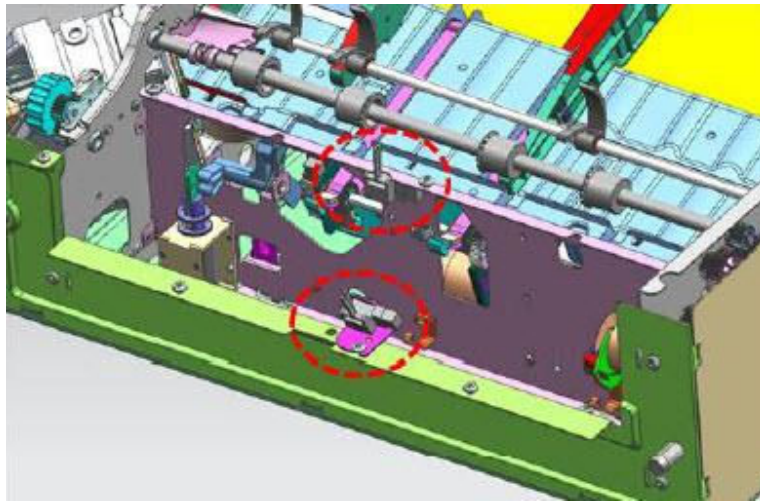

- iv. Replace the finisher main PCA (JC81-09692A) with a new one.
- b. Is the finisher main tray motor working normally?
- i. Make sure the finisher main tray motor cable is connected to the main tray motor connector correctly.
 - ii. Make sure the finisher main tray motor cable is connected to the main PCA connector correctly.
 - iii. Replace the finisher main tray motor (JC81-09679A) with a new one.

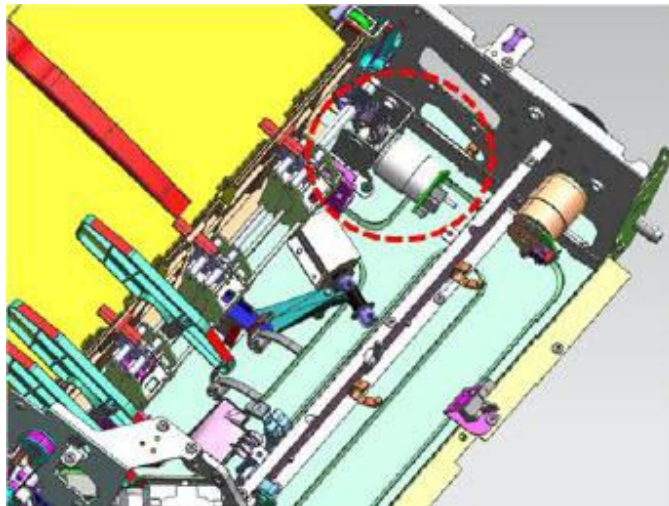

- iv. Replace the finisher main PCA (JC81-09692A) with a new one.
- c. Check if any debris (staple) exists. Remove all debris.

H2-6736 / H2-6743

Description

Finisher Failure: #H2-67xx: Check the finisher

The main Tray does not move to or leave home position.

Recommended action

1. If there is paper jam in the main Tray, remove the paper manually. Open and close finisher stapler door or jam cover to check to see if finisher executes the initialization process.
2. If the main Tray still doesn't go back to the home position and the error persists, check the following:
 - a. Is the finisher input sensor (standby & home sensor) working normally?
 - i. Make sure the finisher input sensor cable is connected to the sensor connector correctly.
 - ii. Make sure the finisher input sensor cable is connected to the main PCA connector correctly.
 - iii. Replace the finisher input sensor (JC81-09686A) with a new one.

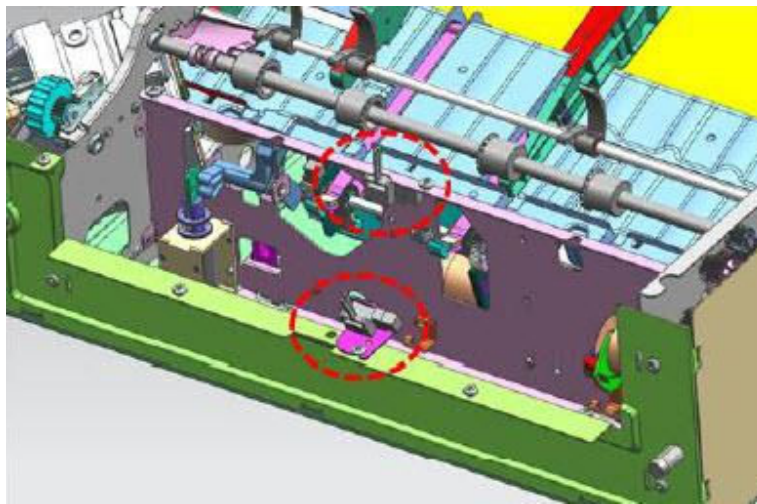

- iv. Replace the finisher main PCA (JC81-09692A) with a new one.
 - b. Is the finisher main Tray motor working normally?
 - i. Make sure the finisher main Tray motor cable is connected to the motor connector correctly.
 - ii. Make sure the finisher main Tray motor cable is connected to the main PCA connector correctly.
 - iii. Replace the finisher main Tray motor (JC81-09679A) with a new one.
 - iv. Replace the finisher main PCA (JC81-09692A) with a new one.

 **NOTE:**

Install the MSOK to the new main PCA.

- c. Is the finisher main Tray parts working normally?
 - i. Make sure the main Tray parts can move or rotate smoothly.
 - ii. Make sure there are no mechanical interference to stop the main Tray parts from moving or rotating.
 - iii. If there is a belt, make sure the belt is on tight and in the correct position.
- d. Is the finisher main Tray motor gear set working normally?
 - i. Make sure the gear set can rotate smoothly.
 - ii. Make sure each gear is not damaged.
 - iii. Replace the gear set (JC81-9585A / JC81-09586A) with a new one.

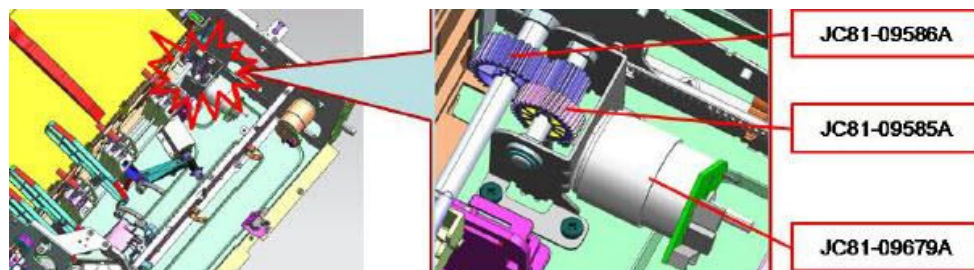

- e. Check if any debris exists. Remove all debris.

H2-6744

Description

Staple Cartridge not install, install it

The finisher stapler cartridge is not installed into the stapler.

Recommended action

1. Open the finisher stapler door to put the cartridge into stapler and then close the door. If necessary, self-priming will be execute automatically.
2. If the stapler warning does not disappear, check the following:

- a. Is the finisher stapler input sensor working normally?
 - i. Make sure the finisher input sensor cable is connected to the sensor connector correctly.
 - ii. Make sure the finisher input sensor cable is connected to the main PCA connector correctly.
 - iii. Replace the finisher stapler cartridge (JC81-08653A) with a new one.

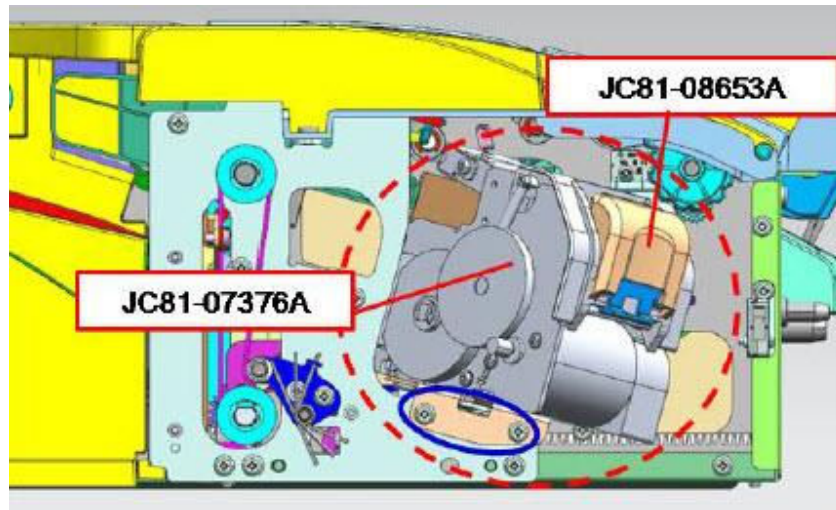

- iv. Replace the finisher stapler (JC81-07376A) with a new one
 - v. Replace the finisher main PCA (JC81-09692A) with a new one.

NOTE:

Install the MSOK to the new main PCA.

- b. Check if any debris exists. Remove all debris.

H2-6A50

Description

Finisher Failure: #H2-6A50: Check the finisher

A communication error has occurred with the finisher.

Recommended action

1. Power off and then on. If the error persists, check the following:

2. Is the finisher working normally?
 - a. Make sure the finisher interface cable is connected with the main PCA.
 - b. Replace the finisher main PCA (JC81-09692A) with a new one.

H2-6A63

Description

Finisher Failure: #H2-6A63: Check the finisher

The finisher stapler cartridge is not installed into stapler or the staples are empty.

Recommended action

1. Replace the finisher stapler (JC81-07376A) with a new one.

M1-1113 / M2-1121

Description

Paper jam in Tray 1

A paper jam has occurred in Tray 1.

Recommended action

1. Open the right door and check to see if there are any obstacles or paper jam inside the unit.
2. Remove Tray 1 and remove the paper jam.
3. If the jam error persists, check the rollers of the pickup-roller unit.

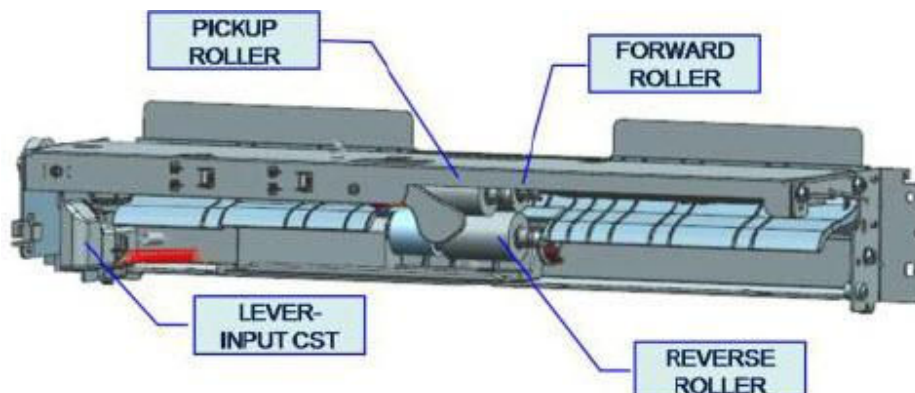

- a. Check to see if the pickup/ reverse/ forward rollers are assembled correctly.

- b. If the pickup/ reverse/ forward rollers are worn or contaminated, clean the rollers with a lint free cloth or replace the defective roller (JC93-00540A) with a new one.
4. If the error persists, check the pickup unit and the feed sensor.
 - a. Check to see if the pickup unit and the feed sensor are working normally.
 - b. Check to see if the cable from the pickup unit to main PCA is connected correctly.
 - c. Check to see if the connector of the guide-feed assembly is connected correctly.
 - d. Check to see if the cable of pickup unit and feed sensor is disconnected.



5. If the error persists, check the pickup unit.
 - a. Remove the pickup unit and check the connection of the actuator and the actuator-sensor.
 - b. Push the pickup-lever and check to see if it is working normally.

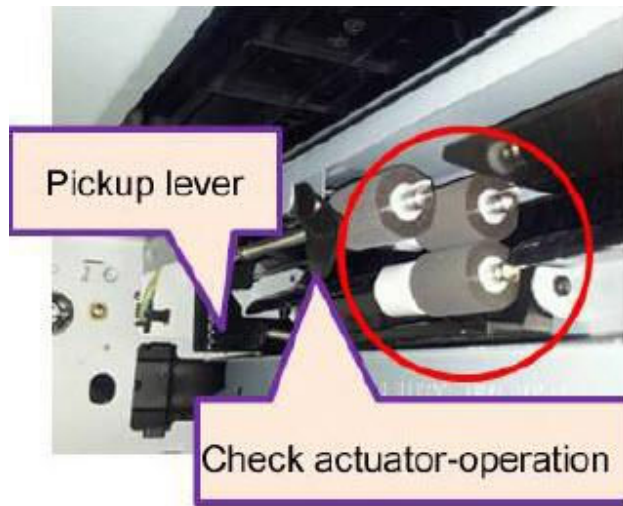

6. If the error persists, replace the pickup drive unit (JC93-00422A) or Pickup unit (JC93-00540A) with a new one.



M1-1213 / M2-1131

Description

Paper jam in Tray 2

A paper jam has occurred in Tray 2.

Recommended action

1. Open the right door and check if there are any obstacles or a paper jam inside the unit.
2. Remove Tray 2, and then remove the paper jam.
3. If the jam error persists, check the rollers of the pickup-roller unit.

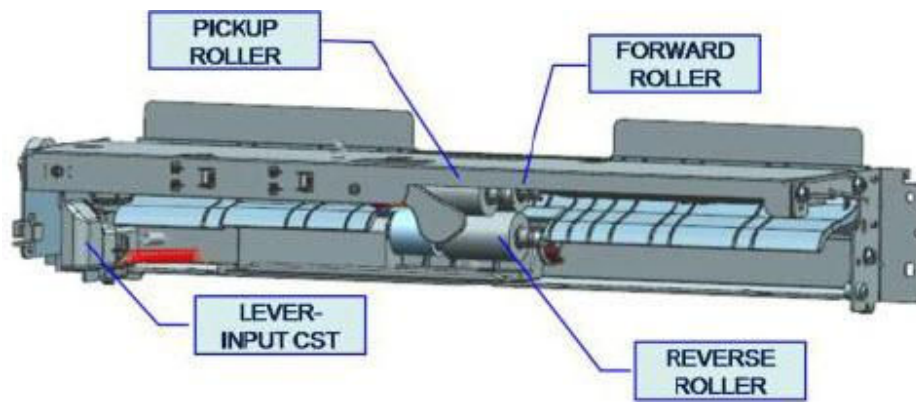

- a. Check to see if the pickup/ reverse/ forward rollers are assembled correctly.
 - b. If the pickup/ reverse/ forward rollers are worn or contaminated, clean the rollers with a soft, lint-free cloth or replace the defective roller (JC93-00540A) with a new one.
4. If the error persists, check the pickup unit and the feed sensor.
- a. Check to see if the pickup unit and feed sensor is working normally.
 - b. Check to see if the cable from pickup unit to main PCA is connected correctly.
 - c. Check to see if the connector of the guide-feed assembly is connected correctly.
 - d. Check to see if the cable of pickup unit and feed sensor is disconnected.



5. If the error persists, check the pickup unit.
- a. Remove the pickup unit and check the connection of the actuator and the actuator-sensor.
 - b. Push the pickup-lever and check if it is working normally.

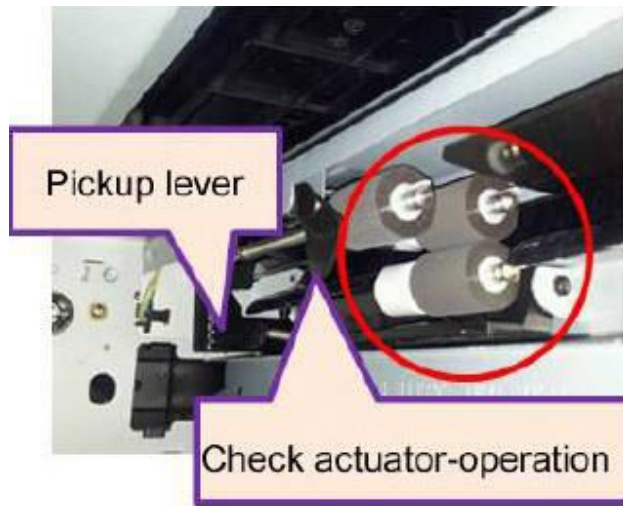

- If the error persists, replace the pickup drive unit (JC93-00422A) or pickup unit (JC93-00540A).



M1-1610

Description

Paper jam in MP Tray

A paper jam has occurred in the MP Tray.

Recommended action

- Open the right door. Remove the paper jam from the MP tray.
- If this jam error persists, check the rollers of the MP unit.

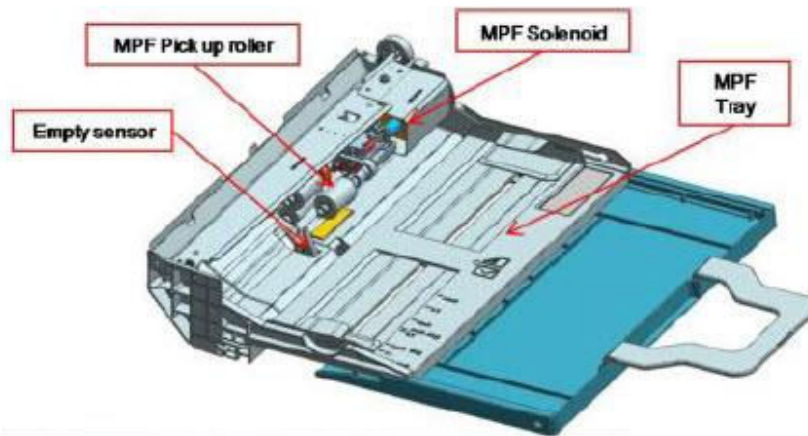

- a. Check to see if the MP pickup/ reverse/ forward rollers are assembled correctly.
 - b. If the MP pickup/ reverse/ forward rollers are worn or contaminated, clean the rollers with a soft, lint-free cloth or replace the defective roller (JC93-00540A) with a new one.
3. If the error persists, check to see if the MP solenoid is working normally.
- a. Enter the Service-mode, and then check to see if solenoid is working normally.

(Diagnostics > Engine Diagnostics > Engine Test Routines > 101-0271)

- b. If the MP solenoid is not working normally, check the connection of MP unit.
- c. If the cable has no defects, replace the solenoid (JC33-00029B) with a new one.

If the error persists, check the main drive unit.

- a. Check the cable from the ragi/MP drive unit to the main PCA.
- b. Enter the service-mode, and then check to see if the drive motor and clutch are working normally.

(Diagnostics > Engine Diagnostics > Engine Test Routines > 100-0010)

(Diagnostics > Engine Diagnostics > Engine Test Routines > 101-0270)

- c. If the error persists, replace the drive main (JC93-00448A) with a new one.

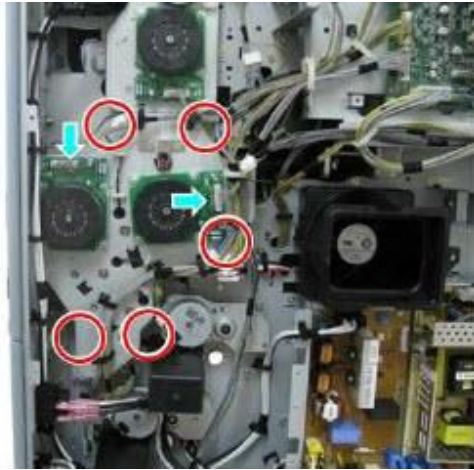
**M1-3122****Description**

Tray 1 cassette is pulled out, insert it properly

Tray 1 is opened or the auto size sensor connector is not connected or damaged.

Recommended action

1. Remove Tray 1 .
2. Reinstall Tray 1.
3. If Tray 1 is not locked or opened without holding the locking lever, remove Tray 1.
4. Check to see if there are any obstacles or paper is inside Tray 1. If so, please all paper or obstacles.
5. If the error persists, check that auto size sensor is connected correctly.



6. If the error persists, replace the main PCA (JC92-02430A) with a new one.

SCX-8123 Series	SCX-8128ND / SCX-8128NA	SCX-8128NX
JC92-02452A	JC92-02452A	JC92-02461A

NOTE:

Install the MSOK to the new main PCA.

M1-3222

Description

Tray 2 cassette is pulled out, insert it properly

Tray 2 is opened or the auto size sensor connector is not connected or damaged.

Recommended action

1. Remove Tray 2.
2. Reinstall Tray 2.
3. If Tray 2 is not locked or opened without holding the locking lever, remove Tray 2.
4. Check to see if there are any obstacle or paper is inside the Tray 2. If so, remove all paper and obstacles.
5. If the error persists, check that auto size sensor is connected correctly.



6. If the error persists, replace the main PCA (JC92-02430A) with a new one.

SCX-8123 Series	SCX-8128ND / SCX-8128NA	SCX-8128NX
JC92-02452A	JC92-02452A	JC92-02461A

NOTE:

Install the MSOK to the new main PCA.

M1-4111

Description

Input System Failure #M1-4111: Pull Tray 1 out and insert it

The paper did not feed from Tray 1.

Recommended action

1. Remove and reinstall Tray 1.
2. If the error persists, Turn the machine off and than on.
3. Check to see if the connection between the pickup drive unit and the main PCA is connected correctly.
4. Check to see the pickup drive unit is working normally.
 - a. Check the cable connection between the pickup drive unit to the main PCA is connected correctly.

- b. Enter the service-mode, and then check to see if the pickup drive unit is working normally.

(Diagnostics > Engine Diagnostics > Engine Test Routines > 100-0370)

- c. If the error persists, replace the pickup drive unit (JC93-00442A) with a new one.
5. If the error persists, check the pickup unit.
 - a. Check the photo sensor in the pickup unit is working normally.



- b. Check to see if the sensor is working normally.
- c. If the error persists, replace the photo sensor (0604-001393) with a new one.

M1-4211

Description

Input System Failure #M1-4211: Pull Tray 2 out and insert it

The paper did not feed from tray 2.

Recommended action

1. Remove Tray 2 and reinstall Tray 2.
2. If the error persists, Turn the machine off and than on.
3. Check to see if the connection between the pickup drive unit and the main PCA is connected correctly.
4. Check to see if the pickup drive unit is working normally.
 - a. Check to see if the cable connection between the pickup drive unit to the main PCA is connected correctly.
 - b. Enter the service-mode, and then check to see if the pickup drive unit is working normally.

(Diagnostics > Engine Diagnostics > Engine Test Routines > 100-0370)

- c. If the error persists, replace the pickup drive unit (JC93-00442A with a new one.
5. If the error persists, check the pickup unit.
 - a. Check to see if the photo sensor in the pickup unit is not working normally.

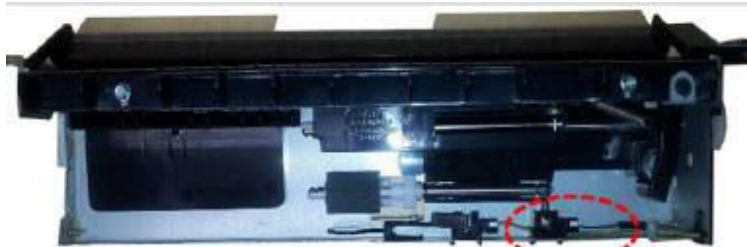

- b. Check to see if the sensor is working normally.
- c. If the error persists, replace the photo sensor (0604-001393) with a new one.

M1-5111 / M1-5112**Description**

Paper is low in Tray 1, load paper

Paper is empty in Tray 1, load paper

The paper in the tray is less than 10% of the machines specification. / The photo sensor is not working normally.

Recommended action

1. Remove Tray 2 and reinstall Tray 2.
2. Load the paper into Tray 2.
3. If paper is loaded but error message persists, check the following:
 - a. If the photo sensor is contaminated, clean it with a soft, lint-free cloth.



- b. If the photo sensor is not working normally, replace the sensor (0604-001393) with a new one.
- c. If the actuator is not working, replace the actuator (JC66-03199A) with a new one.

M1-5211 / M1-5212

Description

Paper is low in Tray 2, load paper

Paper is empty in Tray 2, load paper

The paper in the tray is less than 10% of the machines specification. / The photo sensor is not working normally.

Recommended action

1. Remove Tray 2 and reinstall Tray 2
2. Load the paper in Tray 2.
3. If paper is loaded but error message persists, check the following:
 - a. If the photo sensor is contaminated, clean it with a soft, lint-free cloth.



- b. If the photo sensor is not working normally, replace the sensor (0604-001393) with a new one.
- c. If the actuator is not working normally, replace the actuator (JC66-03199A) with a new one.

M1-5612

Description

Paper is empty in MP Tray, load paper

The paper in the MP tray is less than 10% of the machines specification. / The photo sensor is not working normally.

Recommended action

1. Remove the MP Tray and reinstall the MP Tray.
2. Load the paper in the MP Tray.
3. If paper is loaded but error message persists, check the following:
 - a. If the photo sensor is contaminated, clean it with a soft, lint-free cloth.



- b. If the photo sensor is not working normally, replace the sensor (0604-001393) with a new one.



- c. If the actuator is not working normally, replace the actuator (JC66-03217A) with a new one.

M2-1124 / M2-1125

Description

Paper jam inside of machine.

A paper jam has occurred inside the machine. / The feed drive unit is not working normally. / The feed 1 sensor is not working normally.

- M2-1124 : The leading edge of the paper has not reached the feed 1 sensor within the specified time.
- M2-1125 : The paper has not left from the feed 1 sensor within the specified time.

Recommended action

1. Open the right door, and then remove the paper jam.
2. If the paper jam error persists, check the following:
 - a. Enter the SVC mode, and then execute feed motor test. If the motor operation is working normally, go to step d.
 - b. Remove the rear cover. Check to see if the feed motor cable is connected correctly.
 - c. If the connection is OK, replace the feed drive unit (JC93-00448A) with a new one.

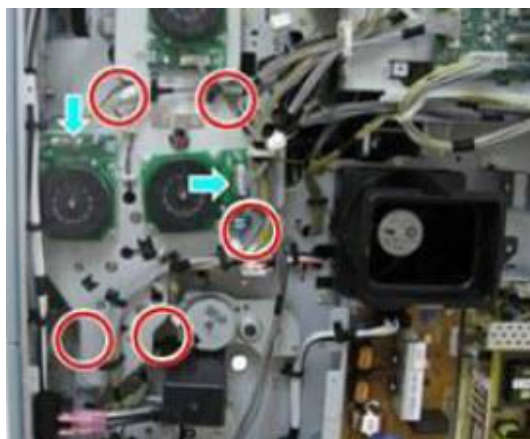

- d. If the feed motor operation is working normally, check the feed 1 sensor.
- e. If the sensor operation is not working normally, check the cable.

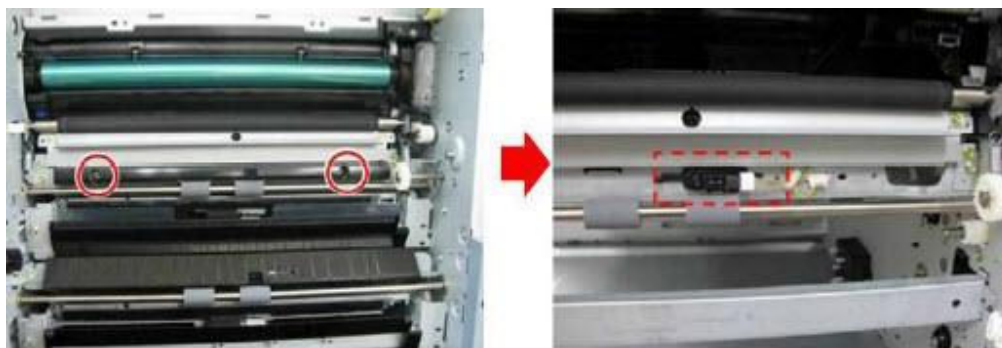

- f. If the connection is OK, replace the feed sensor (0604-001381) with a new one.

M2-1134 / M2-1135

Description

Paper jam inside of machine

A paper jam has occurred inside the machine. / The feed drive unit is not working normally. / The feed 2 sensor is not working normally.

- M2-1134 : The leading edge of the paper has not reached the feed 2 sensor within the specified time.
- M2-1135 : The paper has not left from the feed 2 sensor within the specified time.

Recommended action

1. Open the right door, and then remove the paper jam.
2. If paper jam error persists, check the following:
 - a. Enter the SVC mode, and then execute feed motor test. If the motor operation is normal, go to step d.
 - b. Remove the rear cover. Check to see if the feed motor cable is connected correctly.
 - c. If the connection is OK, replace the feed drive unit (JC93-00448A) with a new one.

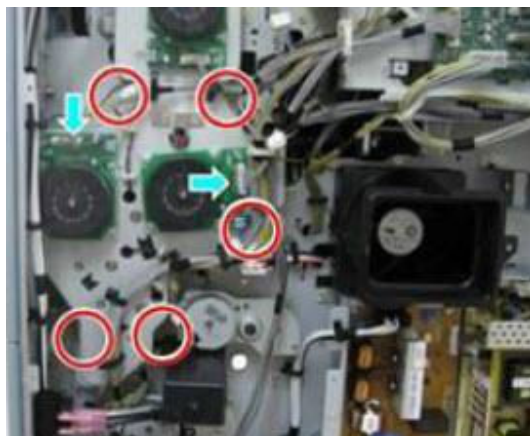

- d. If the feed motor operation is working normally, check the feed 2 sensor.
- e. If the sensor operation is not working normally, check the cable.



- f. If the connection is OK, replace the feed sensor 2 (0604-001381) with a new one.

M2-1211 / M2-1213 / M2-1214

Description

Paper jam inside of machine

A paper jam has occurred inside the machine. / The ragi roller drive is not working normally. / The ragi sensor is not working normally.

- M2-1211 : When the machine was warming-up, a paper jam occurred inside machine.
- M2-1213 : The leading edge of the paper has not reached the ragi sensor within the specified time.
- M2-1214 : The paper has not left the ragi sensor within the specified time.

Recommended action

1. Open the right door. Remove the paper jam.
2. If the paper jam error persists, check the following:
 - a. Enter the SVC mode, and then execute the ragi motor test. If the motor operation is working normally, go to step d.
 - b. Remove the rear cover. Check to see if the ragi/MP motor cable is connected correctly.
 - c. If the connection is OK, replace the feed drive unit (JC93-00448A) with a new one.

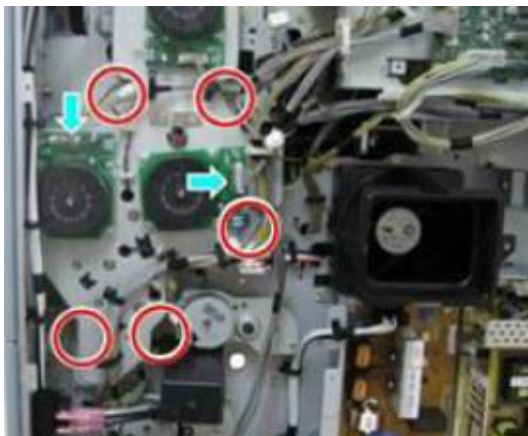

- d. If the motor operation is working normally, check the ragi sensor.
- e. If the sensor operation is not working normally, check the cable.
- f. If the connection is OK, replace the ragi sensor (0604-001381) with a new one.

M2-1331 / M2-1333 / M2-1334 / M2-2111 / M2-2113 / M2-2114

Description

Paper jam inside of machine

Paper jam at the top of duplex path

A paper jam has occurred inside the machine.

Recommended action

1. Open the right door, and then remove the paper jam.
2. If the error persists, check the following:
 - a. Check the ragi sensor cable. If the cable is normal, replace the ragi sensor (0604-001381) with a new one.
 - b. Check the sensors in the right door. If the cable is normal, replace the defective sensor (0604-001393) with a new one.

M3-1411

Description

Paper jam in exit area

A paper jam has occurred around the fuser unit. / At power-on/warm up, the machine detected paper jam in the inner tray exit sensor.

- M3-1413 : The leading edge of the paper has not reached the feed 1 sensor within the specified time.
- M3-1414 : The paper has not escaped from the feed 1 sensor within the specified time.

Recommended action

1. Open the right door, and then remove the paper jam.
2. If the error persists, check the following:
 - a. Open the right door. Check to see if the connector is connected correctly.



- b. Remove the job separator. Check to see if the photo sensor is assembled correctly.

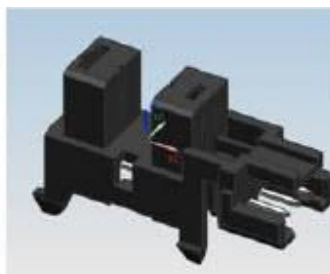
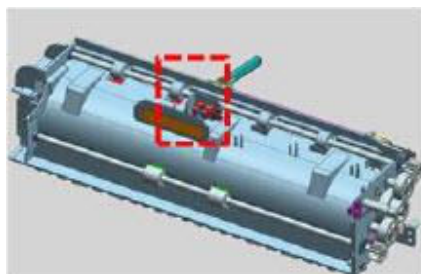

- c. Check to see if the actuator-exit is assembled correctly. If the actuator-exit (JC66-02533A) is deformed or damaged, replace the actuator-exit with a new one..

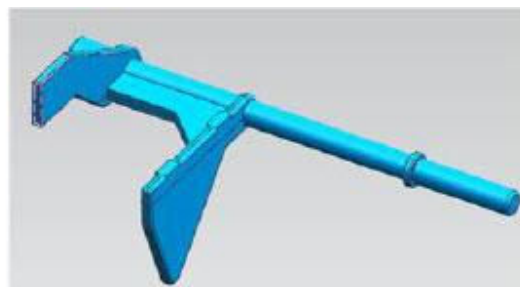
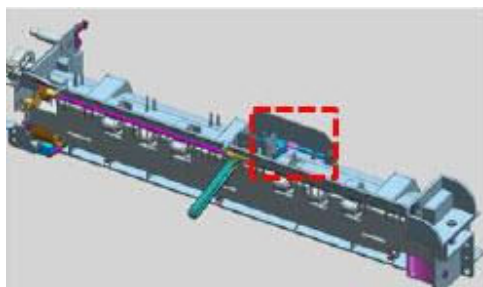

- d. If the photo sensor (0604-001393) is not working normally, replace the photo sensor with a new one.

M3-1413 / M3-1414

Description

Paper jam in exit area

A paper jam has occurred around the fuser unit. / The job separator connection is defective. / The actuator-exit is defective.

Recommended action

1. Open the right door, and then remove the paper jam.
2. If the error persists, check the following:
 - a. Open the right door. Check to see if the connector is connected correctly.



- b. Remove the job separator. Check to see if the photo sensor is assembled correctly.

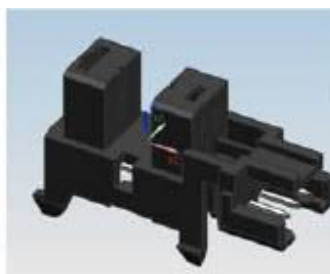
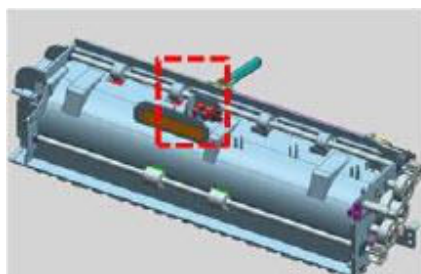

- c. Check if actuator-exit is assembled correctly. If the actuator-exit (JC66-02533A) is deformed or damaged, replace the actuator-exit with a new one.

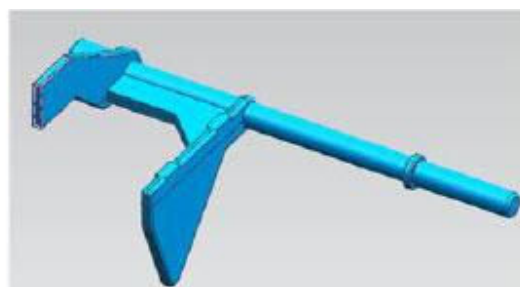
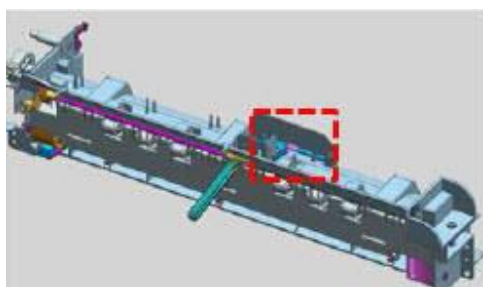

- d. If the photo sensor (0604-001393) is not working normally, replace the photo sensor with a new one.

M3-2230 / M3-2430

Description

Output tray is full, remove printed media

There is too much paper in the output bin tray or the inner tray.

- M3-2230 : There is too much paper in the output bin tray.
- M3-2430 : There is too much paper in the inner tray.

Recommended action

1. Remove the paper in the output bin tray or the inner tray.



2. If the error persists, check the following:

- a. Check to see if the bin-full sensor and actuator is assembled correctly.

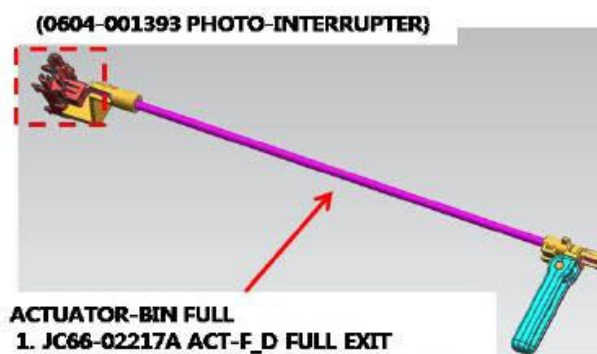
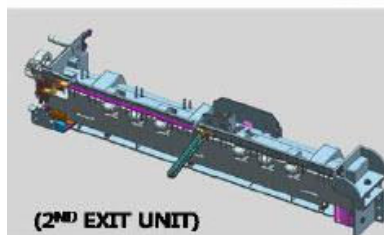
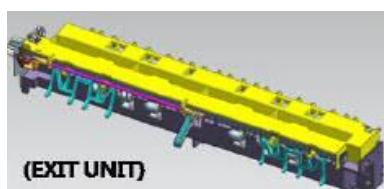

1. JC66-02217A ACT-F_D FULL EXIT
2. JC66-02423A SHAFT-ACT F_D FULL EXIT
3. JC66-02218A LEVER-ACT F_D FULL
4. JC66-02278A LEVER-ACT FULL EXIT
5. 6107-002654 SPRING-TS

- b. Check to see if the bin-full sensor (0604-001393) is working normally.

S1-1113

Description

Video System Failure #S1-1113: Turn off and then on

The system has some issues due to the CPU overheating.

Recommended action

1. Turn the machine off.
2. Wait until the machine is cool, and then turn the machine on.
3. If the error persists, replace the main PCA (JC92-02452A) with a new one..

SCX-8123 Series	SCX-8128ND / SCX-8128NA	SCX-8128NX
JC92-02452A	JC92-02452A	JC92-02461A

NOTE:

Install the MSOK to the new main PCA.

S1-1114

Description

Video System Failure #S1-1114: Turn off and then on

The CPU fan is not working normally.

Recommended action

1. Turn the machine off.
2. Wait until the machine is cool. Then turn the machine on.
3. If the error persists, replace the CPU fan.

S1-1313

Description

The clock became initial time, set a time again

The saved time is now invalid.

Recommended action

1. Set up the time, and then reboot the machine.

(Machine Setup > General Setting > Date and Time)

2. if the error persists, measure the battery voltage.
 - a. Remove the rear cover.
 - b. Remove the cover from the main PCA.

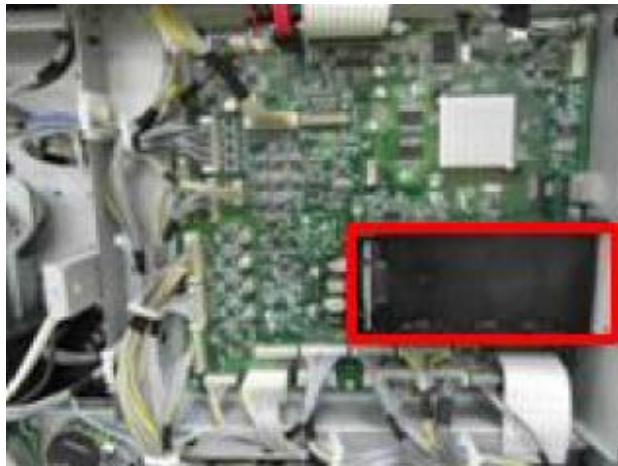

- c. Measure the battery voltage. If value is under 3V, then battery is not working normally.

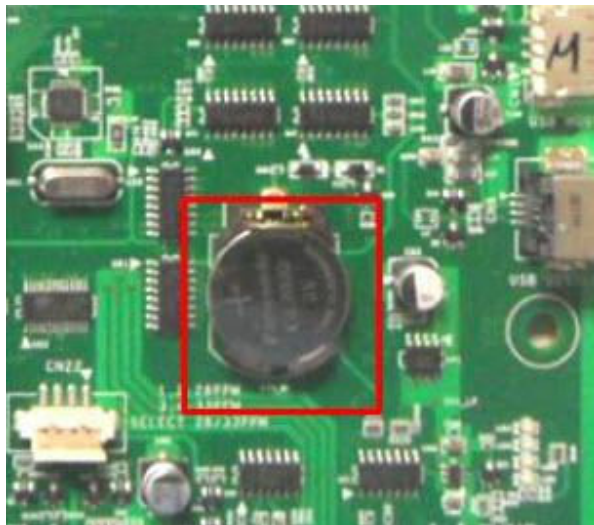

3. If battery has no issues, replace the main PCA (JC92-02452A)

SCX-8123 Series	SCX-8128ND / SCX-8128NA	SCX-8128NX
JC92-02452A	JC92-02452A	JC92-02461A

NOTE:

Install the MSOK to the new main PCA.

S1-1411 / S1-1413**Description**

Video System Failure #S1-1411: Turn off and then on

Video System Failure #S1-1413: Turn off and then on

The SPGPv4 chip is not working normally.

Recommended action

1. Turn the machine off and then on.
2. If the error persists, replace the main PCA (JC92-02452A) with a new one.

SCX-8123 Series	SCX-8128ND / SCX-8128NA	SCX-8128NX
JC92-02452A	JC92-02452A	JC92-02461A

NOTE:

Install the MSOK to the new main PCA.

S1-2111**Description**

Video System Failure #S1-2111: Turn off and then on

The machine can't detect the memory during boot time.

Recommended action

1. Turn the machine off and then on.
2. If the error persists, replace the main PCA (JC92-02452A) with a new one.

SCX-8123 Series	SCX-8128ND / SCX-8128NA	SCX-8128NX
JC92-02452A	JC92-02452A	JC92-02461A

NOTE:

Install the MSOK to the new main PCA.

S1-2411 / S1-2421 / S1-2422

Description

HAD System Failure #S1-2411: Turn off and then on

HAD System Failure #S1-2421: Turn off and then on

HAD System Failure #S1-2422: Turn off and then on

The hard disk is not installed in the machine. / The hard disk is not working normally.

Recommended action

1. Check to see if the HAD is installed correctly.
 - a. Remove the rear cover.
 - b. Check the cable connection.

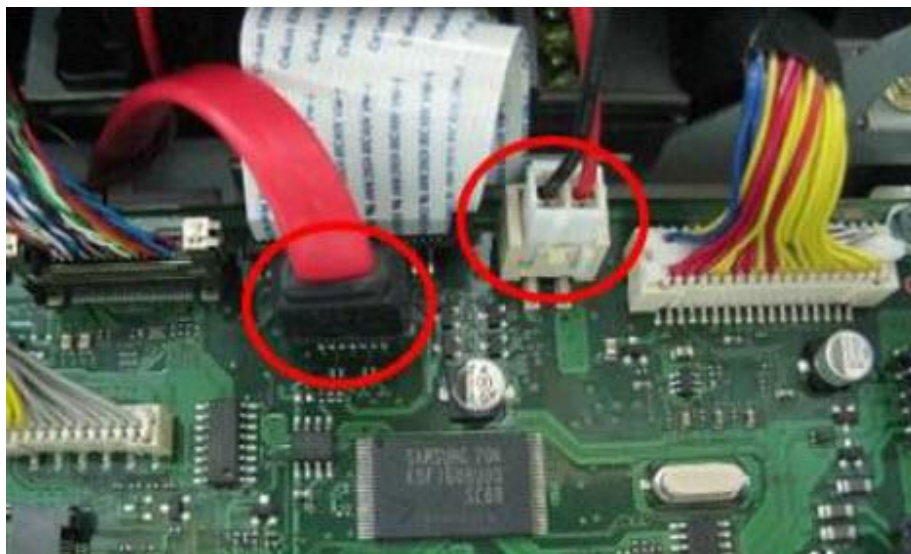

2. If the error persists, replace the HAD (JC59-00035A) with a new one.

S1-2510 / S1-2511 / S1-2521 / S1-2523 / S1-2540

Description

MSOK System Failure #S1-2510: Turn off and then on

MSOK System Failure #S1-2511: Turn off and then on

MSOK Failure: #S1-2521: Call for service

P.M. data is incorrect: Call for service & change MSOK

MSOK Failure: #S1-2540: Call for service & change MSOK

A communication error occurred between the data storage device of the MSOK and the main PCA.

Recommended action

1. Check to see if the MSOK is installed correctly. Remove MSOK and reinstall the MSOK.
 - a. Remove the rear cover.
 - b. Check to see if the MSOK is connected correctly.

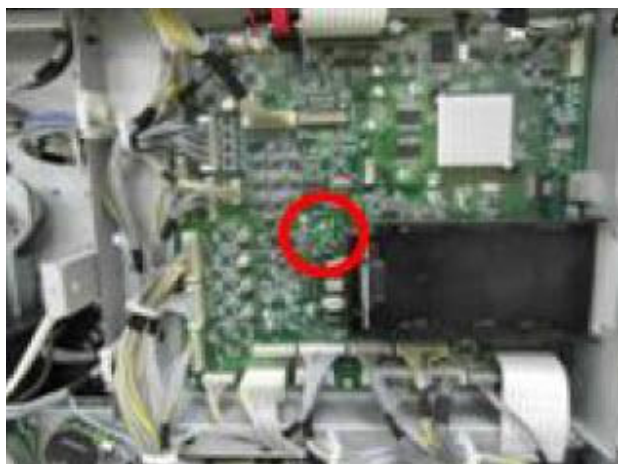

- c. Check to see if the connector and cable are connected correctly.
2. If the error persists, replace the main PCA (JC92-02452A) with a new one.

SCX-8123 Series	SCX-8128ND / SCX-8128NA	SCX-8128NX
JC92-02452A	JC92-02452A	JC92-02461A

 **NOTE:**

Install the MSOK to the new main PCA.

S1-4111**Description**

Video System Failure #S1-4111: Turn off and then on

The main PCA is unable to send the data through the network channel. / The network cable is not connected.

Recommended action

1. Turn the machine off and then on.
2. Check to see if the network cable and connector are correctly connected.
 - a. Connect the network cable to connector correctly.
 - b. Check the LED light near the network connector.
 - If it is connected correctly, green lamp will turn on.
 - If not, the orange LED flickers.

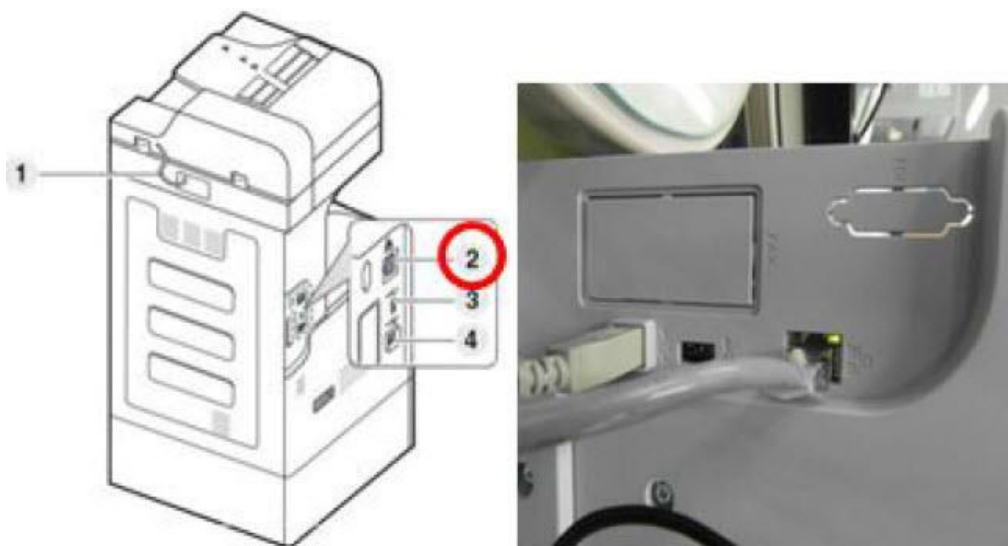

3. If the error persists, replace the main PCA (JC92-02452A) with a new one..

SCX-8123 Series	SCX-8128ND / SCX-8128NA	SCX-8128NX
JC92-02452A	JC92-02452A	JC92-02461A

NOTE:

Install the MSOK to the new main PCA.

S1-4311

Description

Video System Failure #S1-4311: Turn off and then on

The USB unit chip is not working normally.

Recommended action

1. Turn the machine off and then on.
2. If the error persists, replace the main PCA (JC92-02452A) with a new one.

SCX-8123 Series	SCX-8128ND / SCX-8128NA	SCX-8128NX
JC92-02452A	JC92-02452A	JC92-02461A

 **NOTE:**

Install the MSOK to the new main PCA.

S1-5521**Description**

FBI device is not installed. Install the device.

The machine is unable to detect the FBI device.

Recommended action

1. Install the FBI device.
2. If the FBI device is already installed, update the firmware for the main PCA.
3. Check the connection between FBI device and main PCA.
 - a. Remove the rear cover.
 - b. Check the connection between FBI unit and main PCA are connected correctly.



4. If FBI unit is not working normally, replace the FBI unit (CL-KIT10) with a new one.
5. If the error persists, replace the main PCA (JC92-02452A) with a new one.

SCX-8123 Series	SCX-8128ND / SCX-8128NA	SCX-8128NX
JC92-02452A	JC92-02452A	JC92-02461A

NOTE:

Install the MSOK to the new main PCA.

S2-1211

Description

Engine System Failure #S2-1211: Turn off and then on

The power chip on the main PCA is not working normally.

Recommended action

1. Turn the machine off then on.
2. If the error persists, replace the main PCA with a new one.

SCX-8123 Series	SCX-8128ND / SCX-8128NA	SCX-8128NX
JC92-02452A	JC92-02452A	JC92-02461A

NOTE:

Install the MSOK to the new main PCA.

S2-2311

Description

Engine System Failure #S2-2311: Turn off and then on

The EEPROM on the main PCA is not working normally.

Recommended action

1. Turn the machine off then on.
2. If the Error persists, replace the main PCA with a new one.

SCX-8123 Series	SCX-8128ND / SCX-8128NA	SCX-8128NX
JC92-02452A	JC92-02452A	JC92-02461A

NOTE:

Install the MSOK to the new main PCA.

S2-4210

Description

Front door is open, close it

The front door is opened.

Recommended action

1. Close the front door.
2. Check to see if the cover open sensor connector is connected correctly. If not, reconnect it.
3. If the sensor is not working normally, replace the cover open sensor with a new one.

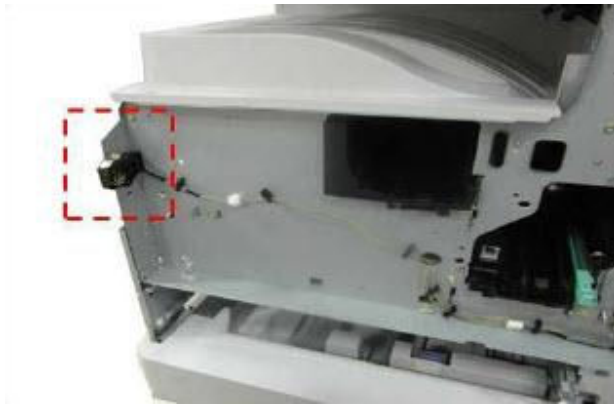

S2-4410

Description

Right door is open, close it

The right door is opened.

Recommended action

1. Close the right door.
2. Check to see if the cover open sensor connector is connected correctly. If not, reconnect it.
3. If the sensor is not working normally, replace the cover open sensor with a new one.



S3-3111

Description

Scan System Failure #S3-3111: Turn off and then on

A error occurred at the scanner connection.

Recommended action

1. Turn the power off and then turn on.
2. If the error persists, remove the DAD unit.
3. Open the scan rear cover.
4. Check the connection on the scanner PCA.

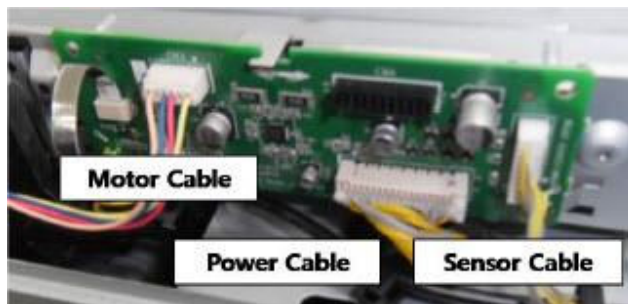

5. If there are no issues, replace the main PCA (JC92-02452A) or scan joint PCA (JC92-02447A) with a new one.

SCX-8123 Series	SCX-8128ND / SCX-8128NA	SCX-8128NX
JC92-02452A	JC92-02452A	JC92-02461A

NOTE:

Install the MSOK to the new main PCA.

S3-3121

Description

Scanner locked or another problem occurred (no switch case), scanner is locked

The scanner module is not moving..

Recommended action

1. Turn the power off and then turn on.

2. If the error persists, remove the DAD unit.
 - a. Press the cover-open sensor.
 - b. If the error persists, open the scanner glass and check the scanner module.
 - c. If the scanner module is able to move, check to see if the motor is connected correctly.

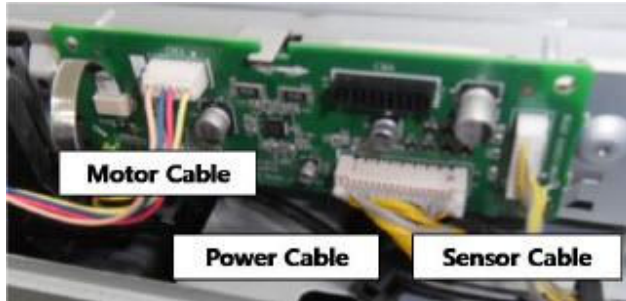

- d. If the connection is OK, replace the main PCA (JC92-02452A) or scan joint PCA (JC92-02447A) with a new one.

SCX-8123 Series	SCX-8128ND / SCX-8128NA	SCX-8128NX
JC92-02452A	JC92-02452A	JC92-02461A

 **NOTE:**

Install the MSOK to the new main PCA.

S3-3211 / S3-3213 / S3-3214 / S3-3215 / S3-3216 / S3-3217

Description

Scan System Failure #S3-3211: Turn off and then on

Scan System Failure #S3-3213: Turn off and then on

Scan System Failure #S3-3214: Turn off and then on

Scan System Failure #S3-3215: Turn off and then on

Scan System Failure #S3-3216: Turn off and then on

Scan System Failure #S3-3217: Turn off and then on

The DAD is not connected or communication error occurred with CIP6 PCA.

Recommended action

1. Turn the power off and then turn on.
2. If the error persists, check the DAD unit connection.



3. If the error persists, remove the DAD unit then locate the parts that are not working normally.
4. Remove the DAD rear cover. Check to see if the connector on DAD PCA is connected correctly.



5. If the connection is OK, replace the DAD PCA (JC92-02446A) with a new one.

S5-3111

Description

UI System Failure #S5-3111: Turn off and then on

A communication error has occurred between main PCA and OPE PCA.

Recommended action

1. Turn the power off and then turn on.
2. If the error persists, check the following:

3. Check the connection between main PCA and OPE PCA.
4. If the connection is OK, replace the main PCA (JC92-02452A) or OPE PCA (JC97-04006B) with a new one.

(Main PCA part code)

SCX-8123 Series	SCX-8128ND / SCX-8128NA	SCX-8128NX
JC92-02452A	JC92-02452A	JC92-02461A

 **NOTE:**

Install the MSOK to the new main PCA.

(OPE PCA part code)

SCX-8123 Series	SCX-8128ND / SCX-8128NA	SCX-8128NX
JC92-02428A	JC92-02428A	JC92-02436A

S6-3122

Description

Network cable is disconnected, check it

The network cable is disconnected.

Recommended action

1. Turn the machine off and then on.
2. Check to see if the network cable and connector are connected correctly.
 - a. Insert the network cable to connector.
 - b. Check the LED light near the network connector.
 - If it is connected correctly, a green lamp will be turn on.
 - If not, the orange lamp will flicker.

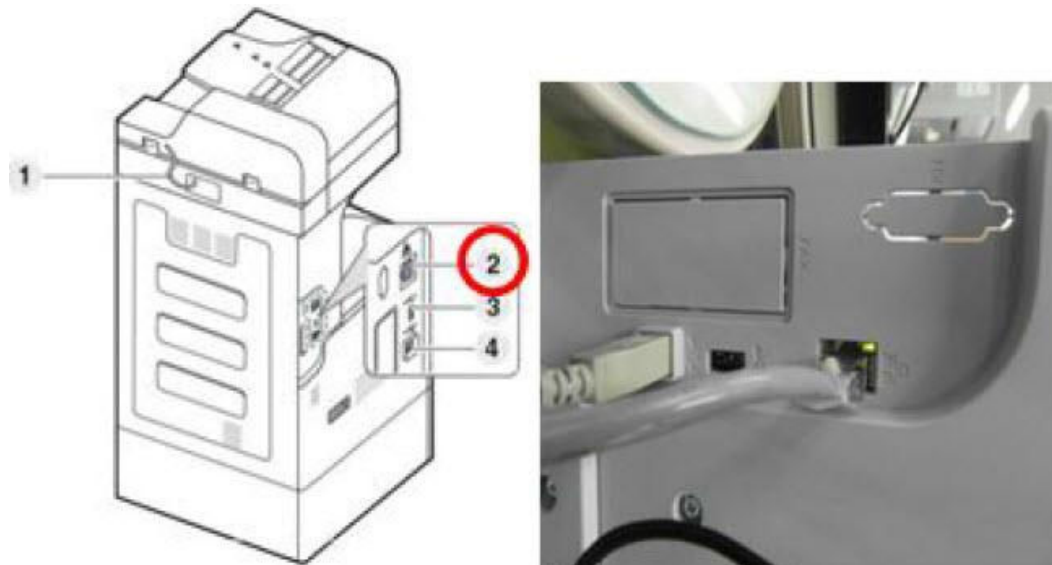

3. If the error persists, replace the main PCA (JC92-02452A) with a new one.

SCX-8123 Series	SCX-8128ND / SCX-8128NA	SCX-8128NX
JC92-02428A	JC92-02428A	JC92-02436A

NOTE:

Install the MSOK to the new main PCA.

S6-3123

Description

The IP address conflicts with that of other system, check it

A network error. / The IP address conflicts with that of another system or there is a communication error.

Recommended action

- Change the IP address:

Machine Setup > Network Setting > Login > TCP/IP > Select the network protocol > IP Setting

S6-3128

Description

802.1x authentication failed. Please Contact the System Administrator

There is no response when checking the ping test. / The ID or password are incorrect.

Recommended action

1. Change the IP address:

Machine Setup > Network Setting > Login > TCP/IP > Select the network protocol > IP Setting

2. Input the correct network login ID and password.

S7-2110

Description

Fuser Failure: #S7-2110: Turn off and then on

The fuser unit has overheated.

Recommended action

1. Turn the machine off. Reinstall the fuser unit. Then turn the machine on.
2. Remove the fuser unit. Open the jam cover, check for paper jam or a wrapped paper jam in the fuser unit.

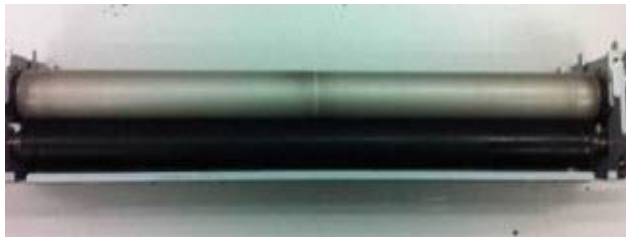

3. Check to see if the contact type thermistor (1404-001567) or non-contact type thermistor is damaged.



4. If the error persists, replace the fuser unit (110V : JC91-01049A / 220V : JC91-01050A).

5. If the error persists, replace the main PCA (JC92-02452A) or F.B. PCA (110V : JC44-00210A, 220V : JC44-00211A), SMPS (110V : JC44-00093A, 220V : JC44-00100A) with a new one.

(Main PCA part code)

SCX-8123 Series	SCX-8128ND / SCX-8128NA	SCX-8128NX
JC92-02428A	JC92-02428A	JC92-02436A

U1-2113 / U1-2119

Description

Fuser Unit Failure: #U1-2113

Fuser Unit Failure: #U1-2119

The thermistor is unable to measure the temperature. / The heat-roller is not able to heat-up.

- U1-2113 : An error occurred at the non-contact type thermistor.
- U1-2119 : An error occurred at the contact type thermistor.

Recommended action

1. Turn the machine off. Reinstall the fuser unit, then turn the machine on.
2. Remove the fuser unit. Open the jam cover, check to see if there is a paper jam or wrapped paper jam in the fuser unit.

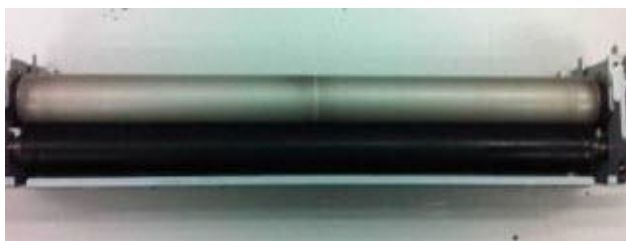

3. If the error persists, check the following:
 - a. Check to see if the halogen lamp (110V : 4713-001632 / 220V : 4713-001633) is damaged or disconnected.
 - b. Check to see if the AC connection on the halogen lamp is disconnected or contaminated.



- c. Check to see if the thermostat (4712-001098) is disconnected.



- d. Check to see if the contact type thermistor (1404-001567) or non-contact type thermistor (1404-001453) is damaged.



4. If the error persists, replace the fuser unit (110V : JC91-01049A / 220V : JC91-01050A) with a new one.
5. If the error persists, replace the main PCA (JC92-02452A) or FDB PCA (110V : JC44-00210A, 220V : JC44-00211A), SMPS (110V : JC44-00093A, 220V : JC44-00100A) with a new one.

(Main PCA part code)

SCX-8123 Series	SCX-8128ND / SCX-8128NA	SCX-8128NX
JC92-02428A	JC92-02428A	JC92-02436A

NOTE:

Install the MSOK to the new main PCA.

U1-2115

Description

Fuser Unit Failure: #U1-2115: Turn off and then on

The pressure control unit (cam unit) of the fuser is not working normally.

Recommended action

1. Turn the machine off. Reinstall the fuser unit, then turn the machine on.
2. If the error persists, check the following:
 - a. When closing the right door, check to see if the pressure control unit makes noise.
 - b. Check to see if the parts on the pressure control unit are damaged.
 - Check to see if the shape of the cam-rear (JC66-03178A) is damaged.
 - Check to see if there are any damaged parts on the pressure control unit.



- c. Check to see if the fuser-motor is working normally via the service-mode.

(Diagnostics > Engine Diagnostics > Engine Test Routines > 109-0140)

3. If the error persists, replace the fuser unit (110V : JC91-01063A, 220V : JC91-01064A) with a new one.
4. If the error persists, replace the pressure control unit or cam-motor or main PCA (JC92-02452A) with a new one.

(Main PCA part code)

SCX-8123 Series	SCX-8128ND / SCX-8128NA	SCX-8128NX
JC92-02428A	JC92-02428A	JC92-02436A

 **NOTE:**

Install the MSOK to the new main PCA.

U1-2132 / U1-2135

Description

Fuser Unit Failure: #U1-2132

Fuser Unit Failure: #U1-2135

The temperature of the fuser increased abnormally.

- U1-2132 : Error occurred at the non-contact type thermistor.
- U1-2135 : Error occurred at the contact type thermistor.

Recommended action

1. Turn the machine off. Reinstall the fuser unit, then turn the machine on.
2. Check to see if the power voltage is normal. Is the voltage during the normal operation $\pm 10\%$ of the rated voltage?
3. Remove the fuser unit. Open the jam cover, check to see if there is a paper jam or wrapped paper jam in the fuser unit.

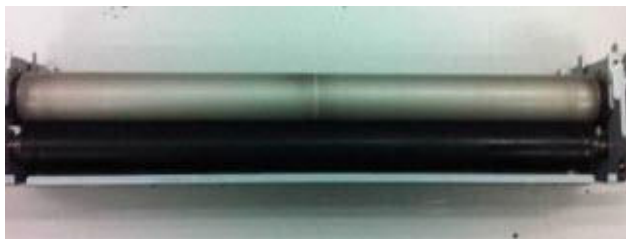

4. If the error persists, check the following:
 - a. Check if the halogen lamp (110V : 4713-001632 / 220V : 4713-001633) is damaged or disconnected.
 - b. Check if the AC connection on the halogen lamp is disconnected or contaminated.



- c. Check to see if the thermostat (4712-001098) is disconnected.



- d. Check to see if the contact type thermistor (1404-001567) or non-contact type thermistor (1404-001453) is damaged.



5. If the error persists, replace the fuser unit (110V : JC91-01049A / 220V : JC91-01050A) with a new one
6. If the error persists, replace the main PCA (JC92-02452A) or FDB PCA (110V : JC44-00210A, 220V : JC44-00211A), SMPS (110V : JC44-00093A, 220V : JC44-00100A) with a new one.

(Main PCA part code)

SCX-8123 Series	SCX-8128ND / SCX-8128NA	SCX-8128NX
JC92-02428A	JC92-02428A	JC92-02436A

NOTE:

Install the MSOK to the new main PCA.

U1-2141 / U1-2142

Description

Fuser Unit Failure: #U1-2141**Fuser Unit Failure: #U1-2142**

The temperature of the thermistor is higher than the maximum allowable temperature.

- U1-2141 : An error occurred at the non-contact type thermistor.
- U1-2142 : An error occurred at the contact type thermistor.

Recommended action

1. Turn the machine off. Reinstall the fuser unit, then turn the machine on.
2. Check to see if the power voltage is normal. Is the voltage during the normal operation $\pm 10\%$ of the rated voltage?
3. Remove the fuser unit. Open the jam cover, check to see if there is a paper jam or wrapped paper jam in the fuser unit.

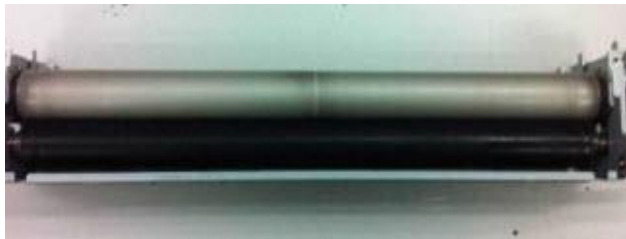

4. If the error persists, check the following:
 - a. Check to see if the contact type thermistor (1404-001567) or non-contact type thermistor is damaged.



5. If the error persists, replace the fuser unit (110V : JC91-01049A / 220V : JC91-01050A) with a new one.
6. If the error persists, replace the main PCA (JC92-02452A) or FDB PCA (110V : JC44-00210A, 220V : JC44-00211A), SMPS (110V : JC44-00093A, 220V : JC44-00100A) with a new one.

Main PCA part code)

SCX-8123 Series	SCX-8128ND / SCX-8128NA	SCX-8128NX
JC92-02428A	JC92-02428A	JC92-02436A

NOTE:

Install the MSOK to the new main PCA.

U1-2316 / U1-2317

Description

Fuser Unit Failure: #U1-2316 / Fuser Unit Failure: #U1-2317

The temperature of the fuser changed abnormally.

- U1-2316 : An error occurred at the non-contact type thermistor.
- U1-2317 : An error occurred at the contact type thermistor.

Recommended action

1. Turn the machine off. Reinstall the fuser unit, then turn the machine on.
2. Check if the power voltage is normal. Is the voltage during the normal operation $\pm 10\%$ of the rated voltage?
3. If the error persists, check the following:
 - a. Check to see if the halogen lamp (110V : 4713-001632 / 220V : 4713-001633) is damaged or disconnected.
 - b. Check to see if the AC connection on the halogen lamp is disconnected or contaminated.



- c. Check to see if the thermostat (4712-001098) is disconnected.



- d. Check to see if the contact type thermistor (1404-001567) or non-contact type thermistor is damaged.



4. If the error persists, replace the fuser unit (110V : JC91-01049A / 220V : JC91-01050A) with a new one.
5. If the problem persists, replace the main PCA (110V : JC92-02452A) or FDB PCA (110V : JC44-00210A, 220V : JC44-00211A), SMPS (110V : JC44-00093A, 220V : JC44-00100A) with a new one.

(Main PCA part code)

SCX-8123 Series	SCX-8128ND / SCX-8128NA	SCX-8128NX
JC92-02428A	JC92-02428A	JC92-02436A

NOTE:

Install the MSOK to the new main PCA.

U1-2335 / U1-233A

Description

Fuser Unit Failure: #U1-2335

Fuser Unit Failure: #U1-233A

The temperature of the thermistor is abnormally low.

- U1-2335 : An error occurred at the non-contact type thermistor.

- U1-233A : An error occurred at the contact type thermistor.

Recommended action

1. Turn the machine off. Reinstall the fuser unit, then turn the machine on.
2. Check to see if the power voltage is normal. Is the voltage during normal operation $\pm 10\%$ of the rated voltage?
3. Remove the fuser unit. Open the jam cover, check to see if there is a paper jam or wrapped paper jam in the fuser unit.

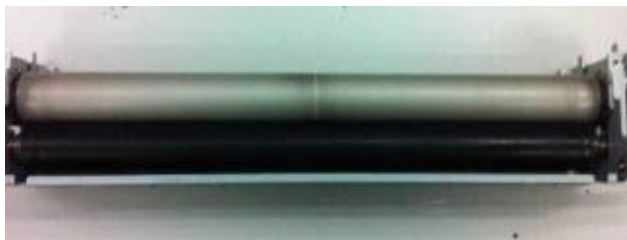

4. If the error persists, check the following:
 - a. Check to see if the halogen lamp (110V : 4713-001632 / 220V : 4713-001633) is damaged or disconnected.
 - b. Check to see if the AC connection on the halogen lamp is disconnected or contaminated.



- c. Check to see if the thermostat (4712-001098) is disconnected.



- d. Check to see if the contact type thermistor (1404-001567) or non-contact type thermistor is damaged.



5. If the error persists, replace the fuser unit (110V : JC91-01049A / 220V : JC91-01050A) with a new one.
6. If the error persists, replace the main PCA (JC92-02452A) or FDB PCA (110V : JC44-00210A, 220V : JC44-00211A), SMPS (110V : JC44-00093A, 220V : JC44-00100A) with a new one.

(Main PCA part code)

SCX-8123 Series	SCX-8128ND / SCX-8128NA	SCX-8128NX
JC92-02428A	JC92-02428A	JC92-02436A

NOTE:

Install the MSOK to the new main PCA.

U1-2337 / U1-233D

Description

Fuser Unit Failure: #U1-2337

Fuser Unit Failure: #U1-233D

When the fuser warms-up, the temperature of the thermistor is abnormally low.

- U1-2337 : An error occurred at the non-contact type thermistor.
- U1-233D : An error occurred at the contact type thermistor.

Recommended action

1. Turn the machine off. Reinstall the fuser unit, then turn the machine on.
2. Check to see if the power voltage is normal. Is the voltage during normal operation $\pm 10\%$ of the rated voltage?

3. Remove the fuser unit. Open the jam cover, check to see if there is a paper jam or wrapped paper jam in the fuser unit.

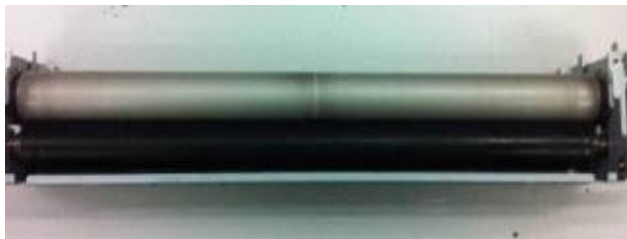

4. If the error persists, check the following:
 - a. Check to see if the halogen lamp (110V : 4713-001632 / 220V : 4713-001633) is damaged or disconnected.
 - b. Check to see if the AC connection on the halogen lamp is disconnected or contaminated.



- c. Check to see if the thermostat (4712-001098) is disconnected.



- d. Check to see if the contact type thermistor (1404-001567) or non-contact type thermistor (1404-001453) is damaged.



5. If the error persists, replace the fuser unit (110V : JC91-01049A / 220V : JC91-01050A) with a new one.
6. If the error persists, replace the main PCA (JC92-02452A) or FDB PCA (110V : JC44-00210A, 220V : JC44-00211A), SMPS (110V : JC44-00093A, 220V : JC44-00100A)

with a new one.

(Main PCA part code)

SCX-8123 Series	SCX-8128ND / SCX-8128NA	SCX-8128NX
JC92-02428A	JC92-02428A	JC92-02436A

 **NOTE:**

Install the MSOK to the new main PCA.

U2-1111 / U2-1112 / U2-1113 / U2-1114

Description

LSU Failure: #U2-1111: Turn off and then on

LSU Failure: #U2-1112: Turn off and then on

LSU Failure: #U2-1113: Turn off and then on

LSU Failure: #U2-1113: Turn off and then on

LSU Failure: #U2-1113: Turn off and then on

LSU Failure: #U2-1114: Turn off and then on

The LSU motor is not working normally. / The motor ready signal is not working normally.

Recommended action

1. Turn the machine off and then on. Check to see if the LSU motor is making noise during warm-up.
2. Print a Demo page and check to see if the printout is normal.
3. If the error persists, check the following:
 - a. If the LSU motor makes a noise, check the following:
 - i. By the SVC mode, check to see if the motor ready signal has occurred.

(Diagnostics > Engine Diagnostics > Engine Test Routines > 110-0000)

- ii. If not, open the side-cover and replace the LSU (JC97-04017A) a new one.
- b. If the LSU motor does not make a noise, check the following:
- i. Disconnect and reconnect the LSU flat cable connection on the LSU. Then check to see if there is any operation noise from the LSU.

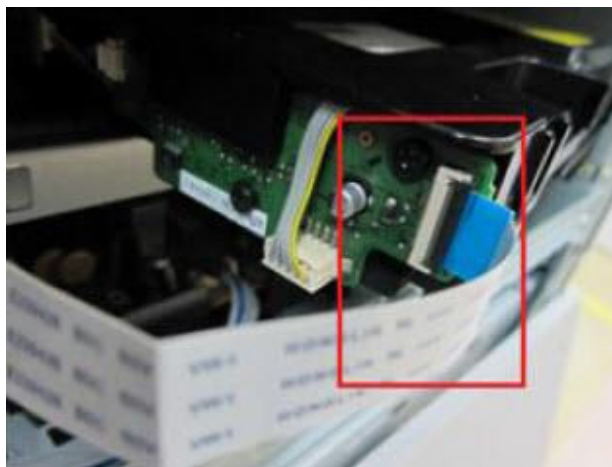

- ii. Disconnect and reconnect the LSU flat cable on the main PCA. Then check to see if there is any operation noise from the LSU.

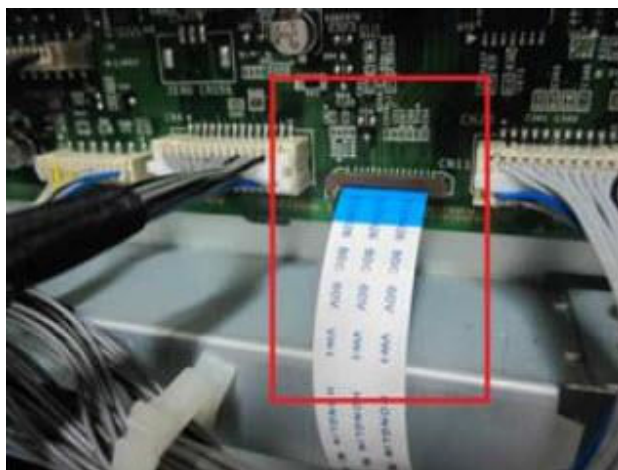

- iii. If the LSU flat cable is defective, replace FFC (JC39-01657A) with a new one.
- iv. If the LSU cable is OK, replace the LSU (JC97-04017A) with a new one.

U3-3113 / U3-3211 / U3-3212 / U3-3213 / U3-3214 / U3-3312 / U3-3314

Description

Original paper jam inside of scanner

A jam has occurred inside the DADF unit.

Recommended action

1. Open the DADF cover. If there is a paper jam, remove the paper jam.
2. If the error persists, check the DADF regi-sensor (0604-001393) and regi-actuator (JC66-03148A). If either is not working normally, replace a defective part with a new one.



3. If the regi-sensor is OK, check the scan-sensor (0604-001393) and scan-actuator (JC66-03210A). If either is not working normally, replace a defective part with a new one.



4. Check to see if the regi-clutch is working normally. Check to see if the clutch cable is connected correctly. If the clutch (JC47-00033A) is not working normally, replace the clutch with a new one.

U3-3411 / U3-3413 / U3-3414

Description

Original paper jam inside of scanner

A jam has occurred inside the DADF unit.

Recommended action

1. Open the DADF cover. If there is a paper jam, remove the paper jam.
2. If this error persists, check the following:
 - a. Check to see if the regi-actuator (JC66-03148A) is working normally.



- b. Check to see if the regi-sensor cable is connected correctly.
 - c. If the connection is OK, replace the regi-sensor (0604-001393) with a new one.

U3-3311 / U3-3313**Description**

Original paper jam inside of scanner

A jam has occurred inside the DADF unit.

Recommended action

1. Open the DADF cover. If there is a paper jam, remove the paper jam.
2. If this error persists, check the following:
 - a. Check to see if the scan-actuator (JC66-03210A) is working normally.



- b. Check to see if the scan-sensor cable is connected correctly.
- c. If the connection is OK, replace the scan-sensor (0604-001393) with a new one.

U3-3711 / U3-3713 / U3-3714

Description

Original paper jam in the exit area of scanner

An original jam has occurred inside the DADF unit.

Recommended action

1. Open the DADF cover. If there is a paper jam, remove the paper jam.
2. If this error permits, check the following:
 - a. Check to see if the exit actuator (JC66-03184A) is working normally.



- b. Check to see if the exit sensor cable is connected correctly.

- c. If the connection is OK, replace the exit sensor (0604-001393) with a new one.

U3-4210

Description

Top door of scanner is open

The DADF cover is opened.

Recommended action

1. Close the DADF cover.
2. If this error persists, check the following:
 - a. Check the DADF cover open sensor (0604-001393) and its cable connection. If there is a defective part, replace the defective part with a new one.
 - b. If both of them are working normally, check the cover-open rib. If it is damaged, replace the cover-open (JC63-03273A) with the new one.