



Mono Laser Printer

Xpress M3015 Series

SL-M3015ND / SL-M3015DW

(Ver 1.00)

SERVICE *MANUAL*

Mono Laser Printer

Contents



1. Precautions
2. Product Specifications and Description
3. Disassembly and Reassembly
4. Troubleshooting
5. System Diagrams
6. Reference Information

Refer to the service manual in the GSPN (see the rear cover) for more information.

Contents

- 1. Precautions 1 – 1
 - 1.1. Safety warning 1 – 1
 - 1.2. Caution for safety 1 – 2
 - 1.2.1. Toxic material 1 – 2
 - 1.2.2. Electric shock and fire safety precautions 1 – 2
 - 1.2.3. Handling precautions 1 – 4
 - 1.2.4. Assembly and Disassembly precautions 1 – 4
 - 1.2.5. Disregarding this warning may cause bodily injury 1 – 5
 - 1.3. ESD precautions 1 – 6
 - 1.4. Caution for Data Loss 1 – 7
- 2. Product Specifications and Description 2 – 1
 - 2.1. Product Specifications 2 – 1
 - 2.1.1. Product Overview 2 – 1
 - 2.1.2. Specifications 2 – 2
 - 2.1.2.1. Printer Specification 2 – 2
 - 2.1.2.2. Controller and Software 2 – 3
 - 2.1.2.3. Paper Handling 2 – 4
 - 2.1.2.4. Reliability and Service 2 – 5
 - 2.1.2.5. Environment 2 – 5
 - 2.1.2.6. Supplies 2 – 6
 - 2.1.2.7. Maintenance parts 2 – 6
 - 2.1.2.8. Options 2 – 7
 - 2.2. System Overview 2 – 8
 - 2.2.1. Front View 2 – 8
 - 2.2.2. Rear View 2 – 9
 - 2.2.3. Paper Path 2 – 10
 - 2.2.4. System Layout 2 – 11
 - 2.2.4.1. Feeding Part 2 – 12
 - 2.2.4.2. Transfer Roller 2 – 14
 - 2.2.4.3. Drive Unit 2 – 14
 - 2.2.4.4. Fuser 2 – 15
 - 2.2.4.5. LSU (Laser Scanner Unit) 2 – 16
 - 2.2.4.6. Toner System 2 – 17
 - 2.2.5. Hardware configuration 2 – 18
 - 2.2.5.1. Main board 2 – 19
 - 2.2.5.2. OPE board 2 – 21
 - 2.2.5.3. Wireless LAN board (SL-M3015DW only) 2 – 22
 - 2.2.5.4. Joint PBA 2 – 23

2.2.5.5.	SMPS Board	2 – 24
2.2.5.6.	HVPS Board	2 – 26
2.2.5.7.	NFC Tag Sticker (SL-M3015DW only)	2 – 27
2.2.5.8.	Electrical Parts Location	2 – 28
2.2.6.	Engine Firmware Control Algorithm	2 – 30
2.2.6.1.	Feeding	2 – 30
2.2.6.2.	Transfer	2 – 30
2.2.6.3.	Fusing	2 – 31
2.2.6.4.	LSU	2 – 31
2.2.7.	Software Descriptions	2 – 32
2.2.7.1.	Software system overview	2 – 32
2.2.7.2.	Architecture	2 – 32
2.2.7.3.	Data and Control Flow	2 – 33
3.	Disassembly and Reassembly	3 – 1
3.1.	Precautions when replacing parts	3 – 1
3.1.1.	Precautions when assembling and disassembling	3 – 1
3.1.2.	Precautions when handling PBA	3 – 1
3.1.3.	Releasing Plastic Latches	3 – 2
3.2.	Replacing Preventive Maintenance Parts	3 – 3
3.2.1.	Fuser Unit	3 – 3
3.2.2.	Pick-up and Forward Roller Assy	3 – 5
3.2.3.	Separation Roller	3 – 6
3.3.	Replacing the main SVC part	3 – 7
3.3.1.	Side Cover	3 – 7
3.3.2.	Rear Cover	3 – 8
3.3.3.	Front Cover	3 – 9
3.3.4.	Top Cover	3 – 10
3.3.5.	Main Board	3 – 10
3.3.6.	SMPS Board	3 – 11
3.3.7.	HVPS Board	3 – 11
3.3.8.	Bin-Full Sensor	3 – 12
3.3.9.	Main Drive unit	3 – 12
3.3.10.	Pick up and Regi Clutch	3 – 13
3.3.11.	Duplex Unit	3 – 14
3.3.12.	Transfer Roller	3 – 15
3.3.13.	LSU	3 – 15
3.3.14.	Exit Sensor	3 – 16
3.3.15.	Feed and Regi sensor PBA	3 – 17
3.3.16.	OPE PBA	3 – 18
3.3.17.	WLAN PBA (SL-M3015DW only)	3 – 18

- 3.3.18. Main Motor 3 – 19
- 4. Troubleshooting 4 – 1
 - 4.1. Control panel 4 – 1
 - 4.2. Understanding the LEDs 4 – 3
 - 4.3. Updating Firmware 4 – 5
 - 4.3.1. Update the firmware by using the USB port 4 – 6
 - 4.3.2. Updating from the Network 4 – 7
 - 4.4. Clearing paper jams 4 – 11
 - 4.5. Useful management tools 4 – 17
 - 4.5.1. SyncThru™ Web Service 4 – 17
 - 4.5.2. Samsung Easy Printer Manager 4 – 19
 - 4.6. EDC program 4 – 21
 - 4.7. Troubleshooting 4 – 23
 - 4.7.1. Procedure of checking the symptoms 4 – 23
 - 4.7.2. Error Code and Troubleshooting 4 – 24
 - 4.7.3. Image quality problem 4 – 40
- 5. System Diagrams 5 – 1
 - 5.1. Block Diagram 5 – 1
 - 5.2. Connection Diagram 5 – 2
- 6. Reference Information 6 – 1
 - 6.1. Tool for Troubleshooting 6 – 1
 - 6.2. Glossary 6 – 2
 - 6.3. The Sample Pattern for the Test 6 – 8
 - 6.4. Model Name and Code 6 – 9
 - 6.5. Document Revision List 6 – 10

1. Precautions

In order to prevent accidents and damages to the equipment please read the precautions listed below carefully before servicing the product and follow them closely.

1.1. Safety warning

- 1) Only to be serviced by a factory trained service technician.

High voltages and lasers inside this product are dangerous. This product should only be serviced by a factory trained service technician.

- 2) Use only Samsung replacement parts.

There are no user serviceable parts inside the product. Do not make any unauthorized changes or additions to the product as these could cause the product to malfunction and create an electric shocks or fire hazards.

- 3) Laser Safety Statement

The printer is certified in the U.S. to conform to the requirements of DHHS 21 CFR, chapter 1 Subchapter J for Class I(1) laser products, and elsewhere is certified as a Class I laser product conforming to the requirements of IEC/EN 60825-1:2014. Class I laser products are not considered to be hazardous. The laser system and printer are designed so there is never any human access to laser radiation above a Class I level during normal operation, user maintenance or prescribed service condition.

- Wavelength: 800 nm
- Beam divergence
 - Parallel: 11 degrees
 - Perpendicular: 35 degrees
- Maximum power of energy output: 12 mW



WARNING

Never operate or service the product with the protective cover removed from Laser/Scanner assembly. The reflected beam, although invisible, can damage your eyes.

When using this product, these basic safety precautions should always be followed to reduce risk of fire, electric shock, and personal injury.



- 4) Lithium battery not replaceable by user

1.2. Caution for safety

1.2.1. Toxic material

This product contains toxic materials that could cause illness if ingested.

- 1) Please keep imaging unit and toner cartridge away from children. The toner powder contained in the imaging unit and toner cartridge may be harmful, and if swallowed, you should contact a doctor.

1.2.2. Electric shock and fire safety precautions

Failure to follow the following instructions could cause electric shock or potentially cause a fire.

- 1) Use only the correct voltage, failure to do so could damage the product and potentially cause a fire or electric shock.
- 2) Use only the power cable supplied with the product. Use of an incorrectly specified cable could cause the cable to overheat and potentially cause a fire.
- 3) Do not overload the power socket, this could lead to overheating of the cables inside the wall and could lead to a fire.
- 4) Do not allow water or other liquids to spill into the product, this can cause electric shock. Do not allow paper clips, pins or other foreign objects to fall into the product, these could cause a short circuit leading to an electric shock or fire hazard.

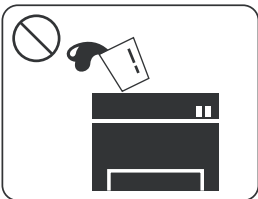

- 5) Never touch the plugs on either end of the power cable with wet hands, this can cause electric shock. When servicing the product, remove the power plug from the wall socket.

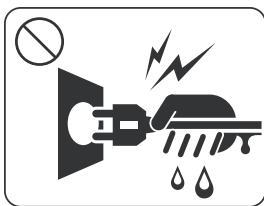

- 6) Use caution when inserting or removing the power cord. When removing the power cord, grip it firmly and pull. The power cord must be inserted completely, otherwise a poor contact could cause overheating leading to a fire.
- 7) Take care of the power cable. Do not allow it to become twisted, bent sharply around corners or power cable may be damaged. Do not place objects on top of the power cable. If the power cable is damaged it could overheat and cause a fire. Exposed cables could cause an electric shock. Replace the damaged power cable immediately, do not reuse or repair the damaged cable. Some chemicals can attack the coating on the power cable, weakening the cover or exposing cables causing fire and shock risks.

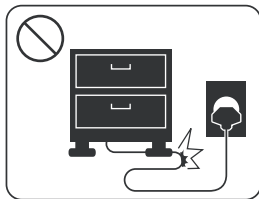

- 8) Ensure that the power sockets and plugs are not cracked or broken in any way. Any such defects should be repaired immediately. Take care not to cut or damage the power cable or plugs when moving the machine.
- 9) Use caution during thunder or lightning storms. Samsung recommends that this machine be disconnected from the power source when such weather conditions are expected. Do not touch the machine or the power cord if it is still connected to the wall socket in these weather conditions.

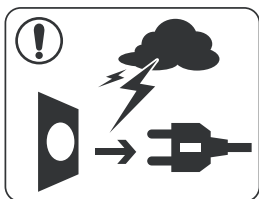

- 10) Avoid damp or dusty areas, install the product in a clean well ventilated location. Do not position the machine near a humidifier or in front of an air conditioner. Moisture and dust built up inside the machine can lead to overheating and cause a fire or cause parts to rust.

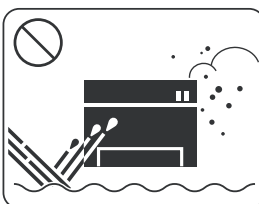

- 11) Do not position the product in direct sunlight. This will cause the temperature inside the product to rise possibly leading to the product failing to work properly and in extreme conditions could lead to a fire.
- 12) Do not insert any metal objects into the machine through the ventilator fan or other part of the casing, it could make contact with a high voltage conductor inside the machine and cause an electric shock.

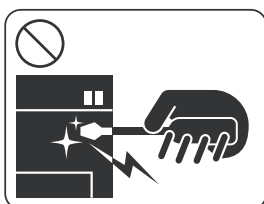

- 13)  When replacing the SMPS board, please wait 5 minutes after unplugging the power cord, then replace it. You can get a shock by the electric discharge.

1.2.3. Handling precautions

The following instructions are for your own personal safety to avoid injury and so as not to damage the product.

- 1) Ensure the product is installed on a level surface, capable of supporting its weight. Failure to do so could cause the product to tip or fall.
- 2) The product contains many rollers, gears and fans. Take great care to ensure that you do not catch your fingers, hair or clothing in any of these rotating devices.
- 3) Do not place any small metal objects, containers of water, chemicals or other liquids close to the product which if spilled could get into the machine and cause damage or a shock or fire hazard.
- 4) Do not install the machine in areas with high dust or moisture levels, beside an open window or close to a humidifier or heater. Damage could be caused to the product in such areas.
- 5) Do not place candles, burning cigarettes, etc on the product, These could cause a fire.
- 6) Ensure that the machine is installed and used in proper area to meet the temperature and humidity specifications.
 - If the machine is stored at below zero Celsius for a long time, do not use the machine instantly after movement. It can malfunction. Take care of the machine storage. If the machine is stored at below zero Celsius for a long time, keep the machine at room temperature and install it.

1.2.4. Assembly and Disassembly precautions

- 1) Replace parts carefully and always use Samsung parts. Take care to note the exact location of parts and also cable routing before dismantling any part of the machine. Ensure all parts and cables are replaced correctly. Please carry out the following procedures before dismantling the product or replacing any parts.
- 2) Ensure that power is disconnected before servicing or replacing any electrical parts.
- 3) Disconnect interface cables and power cables.
- 4) Only use approved spare parts. Ensure that part number, product name, any voltage, current or temperature rating are correct.
- 5) When removing or re-fitting any parts do not use excessive force, especially when fitting screws into plastic.
- 6) Take care not to drop any small parts into the machine.
- 7) Handling of the OPC Drum
 - The OPC Drum can be irreparably damaged if it is exposed to light. Take care not to expose the OPC Drum either to direct sunlight or to fluorescent or incandescent room lighting. Exposure for as little as 5 minutes can damage the surface of the photoconductive properties and will result in print quality degradation. Take extra care when servicing the product. Remove the OPC Drum and store it in a black bag or other lightproof container. Take care when working with the Covers (especially the top cover) open as light is admitted to the OPC area and can damage the OPC Drum.
 - Take care not to scratch the green surface of the OPC Drum Unit. If the green surface of the Drum Cartridge is scratched or touched the print quality will be compromised.

1.2.5. Disregarding this warning may cause bodily injury

- 1) Be careful with the high temperature part.

The fuser unit works at a high temperature. Use caution when working on the printer. Wait for the fuser unit to cool down before disassembly.



- 2) Do not put fingers or hair into the rotating parts.

When operating a printer, do not put hand or hair into the rotating parts (Paper feeding entrance, motor, fan, etc.). If do, you can get harm.



- 3) When you move the printer, use safe lifting and handling techniques.

This printer is heavy. Use the lifting handles located on each side of the machine. Back injury could be caused if you do not lift carefully.

- 4) Ensure the printer is installed safely.

Ensure the printer is installed on a level surface, capable of supporting its weight. Failure to do so could cause the printer to tip or fall possibly causing personal injury or damaging the printer.

- 5) Do not install the printer on a sloping or unstable surface. After installation, double check that the printer is stable.

1.3. ESD precautions

Certain semiconductor devices can be easily damaged by static electricity. Such components are commonly called “Electrostatically Sensitive (ES) Devices” or ESDs. Examples of typical ESDs are: integrated circuits, some field effect transistors, and semiconductor “chip” components. The techniques outlined below should be followed to help reduce the incidence of component damage caused by static electricity.



CAUTION

Be sure no power is applied to the chassis or circuit, and observe all other safety precautions.

- 1) Immediately before handling a semiconductor component or semiconductor-equipped assembly, drain off any electrostatic charge on your body by touching a known earth ground. Alternatively, employ a commercially available wrist strap device, which should be removed for your personal safety reasons prior to applying power to the unit under test.
- 2) After removing an electrical assembly equipped with ESDs, place the assembly on a conductive surface, such as aluminum or copper foil, or conductive foam, to prevent electrostatic charge buildup in the vicinity of the assembly.
- 3) Use only a grounded tip soldering iron to solder or desolder ESDs.
- 4) Use only an “anti-static” solder removal device. Some solder removal devices not classified as “anti-static” can generate electrical charges sufficient to damage ESDs.
- 5) Do not use Freon-propelled chemicals. When sprayed, these can generate electrical charges sufficient to damage ESDs.
- 6) Do not remove a replacement ESD from its protective packaging until immediately before installing it. Most replacement ESDs are packaged with all leads shorted together by conductive foam, aluminum foil, or a comparable conductive material.
- 7) Immediately before removing the protective shorting material from the leads of a replacement ESD, touch the protective material to the chassis or circuit assembly into which the device will be installed.
- 8) Maintain continuous electrical contact between the ESD and the assembly into which it will be installed, until completely plugged or soldered into the circuit.
- 9) Minimize bodily motions when handling unpackaged replacement ESDs. Normal motions, such as the brushing together of clothing fabric and lifting one’s foot from a carpeted floor, can generate static electricity sufficient to damage an ESD.

1.4. Caution for Data Loss

To prevent loss of customers data the SVC engineer provides end-user with relevant information in advance.

2. Product Specifications and Description

2.1. Product Specifications

2.1.1. Product Overview

	<ol style="list-style-type: none">1) Printing Speed<ul style="list-style-type: none">• Up to 30 ppm in A4 (31 ppm in Letter)2) Printing Resolution<ul style="list-style-type: none">• Optical : 600 x 600 dpi• Enhanced : 4,800 x 600 dpi effective3) Processor<ul style="list-style-type: none">• 600 MHz4) Printer Language (Emulation)<ul style="list-style-type: none">• SPL / PCL5e / PCL65) Memory<ul style="list-style-type: none">• DDR3 128 MB6) Interface<ul style="list-style-type: none">• Hi-Speed USB 2.0• Ethernet 10/100 Base TX Interface• 802.11b/g/n wireless LAN (Only SL-M3015DW)• NFC printing (Only SL-M3015DW)7) Control Panel<ul style="list-style-type: none">• No LCD, 4 keys and LEDs8) Toner cartridge yield<ul style="list-style-type: none">• Initial : Approx. 700 pages• Standard / High yield : Approx. 1,200 pages / 4,000 pages
--	---

2.1.2. Specifications

Product Specifications are subject to change without notice.



NOTE

The specification in this manual is the reference information for service engineer. Do not use this specification for sales.

2.1.2.1. Printer Specification

Item		Specification
Engine Speed	Simplex	Up to 30 ppm in A4 (31 ppm in Letter)
	Duplex	Up to 15 ppm in A4 (16 ppm in Letter)
Warmup time	From Sleep	Less than 15 seconds
	From Power off	Less than 25 seconds
FPOT	From Ready	Less than 8.5 seconds
	From Sleep	Less than 15 seconds
Resolution	Optical	600 x 600 dpi
	Enhanced	4,800 x 600 dpi effective (600 x 600 x 3 bit)

2.1.2.2. Controller and Software

Item		Specification
Processor		600 MHz
Memory	Std.	128 MB
	Max.	128 MB
Printer Languages		SPL / PCL5e / PCL6
Supporting OS	Windows	10 / 8.1 / 8 / 7 / Vista / XP / 2012 Server R2 / 2012 Server / 2008 Server R2 / 2008 server / 2003 Server
	Linux	<ul style="list-style-type: none"> • RedHat Enterprise Linux WS 5, 6, 7 (32/64 bit) • Fedora 13, 14, 15, 16, 17, 18, 19, 20, 21, 22 (32/64 bit) • OpenSuSE 11.3, 11.4, 12.1, 12.2, 12.3, 13.1, 13.2 (32/64 bit) • Ubuntu 10.04, 10.10, 11.04, 11.10, 12.04, 12.10, 13.04, 13.10, 14.04, 14.10, 15.04 (32/64 bit) • SuSE Linux Enterprise Desktop 11, 12 (32/64 bit) • Debian 6, 7, 8 (32/64 bit) • Mint 13, 14, 15, 16, 17
	Mac OS	Mac OS: X 10.6 ~ 10.11
	UNIX	<ul style="list-style-type: none"> • Sun Solaris 9,10,11 (x86, SPARC) • HP-UX 11.0, 11i v1, 11i v2, 11i v3 (PA-RISC, Itanium) • IBM AIX 5.1, 5.2, 5.3, 5.4, 6.1, .7.1 (PowerPC)
Fonts		PCL : 95 Scalable Fonts (Include OCR-A / OCR-B) / 1 Bitmap
Interface	USB	Hi-speed USB 2.0
	USB Host (Direct USB)	No
	Wired LAN	Ethernet 10/100 Base Tx
	Wireless LAN	Wireless 802.11 b/g/n
 NOTE SL-M3015DW only		
User Interface	Display	LED
	LED	5EA (Toner, Eco, WPS, Power, Status)
	Key / Button	4EA (Eco, WPS, Cancel, Power)

2.1.2.3. Paper Handling

Item		Specification
Input Capacity	Standard Capacity	250-sheet Cassette @ 80g/m ² , 1-sheet Multi Purpose Tray
	Max. Capacity	251-sheet
Output Capacity		<ul style="list-style-type: none"> • Face-Down : 150 sheets @ 80 g/m² • Face-Up : 1 sheet
Printing	Max. Size	216 x 356 mm (8.5" x 14")
	Min. Size	76 x 127 mm (3.0" x 5.0")
Standard Cassette Tray	Capacity	250-sheet
	Media Sizes	A4, A5, A6, Letter, Legal, Executive, Folio, Oficio, ISO B5, JIS B5
	Media Types	Plain, Thin, Thick, Cardstock, Recycled, Archive, Bond
	Media Weight	60 ~ 163 g/m ² (16 ~ 43 lb)
	Sensing	<ul style="list-style-type: none"> • H/W Install Detect : No • Paper Empty : Yes • Paper Type Detect : No • Paper Size Detect : No
Multi-purpose tray	Capacity	1-sheet
	Media Sizes	A4, A5, A6, Letter, Legal, Executive, Folio, Oficio, ISO B5, JIS B5, Envelope (Monarch/No-10/DL/C5/C6), Custom 76 x 127 mm ~ 216 x 356 mm (3" x 5" ~ 8.5" x 14")
	Media Type	Plain, Thin, Thick, Thicker, Cardstock, Transparency, Pre-Printed, Recycled, Archive, Bond, Label, Envelope, Thick Envelope, Cotton, Colored
	Media Weight	60 ~ 220 g/m ² (16 ~ 58 lb)
	Sensing	Yes
Duplex	Media sizes	A4, Letter, Legal, US Folio, Oficio

2.1.2.4. Reliability and Service

Item	Specification
Max. Monthly Duty	12,000 pages

2.1.2.5. Environment

Item	Specification	
Acoustic Noise Level (Sound Power/Pressure)	Printing	Less than 50 dBA
	Standby	Less than 26 dBA
	Sleep	Less than 26 dBA
Power Consumption	Ready	Less than 45 W
	Normal operation	Less than 420 W
	Max / Peak	Less than 450 W
	Sleep	Less than 1.4 W (If Wi-fi direct-on is disabled, less than 1.3W)
	Power Off	Less than 0.2 W
	TEC	Less than 1.3Kwh/week (If Wi-fi direct-on is disabled, less than 1.2Kwh/week)
Dimension (W x D x H)	SET	368 x 334.5 x 202 mm (14.5" x 13.2" x 8.0" inches)
Weight	SET (With Toner cartridge)	7.2 kg (16.0 lbs)

2.1.2.6. Supplies

Items		Model Name	Average yield
Toner Cartridge	Initial	-	Approx. 700 pages
	Standard Yield	MLT-D118S	Approx. 1,200 pages
	High Yield	MLT-D118L	Approx. 4,000 pages
Imaging Unit		MLT-R116	Approx. 9,000 pages





NOTE

Declared yield value in accordance with ISO/IEC 19752. The number of pages may be affected by operating environment, printing interval, graphics, media type and media size.

Depending on the options, percentage of image area and job mode used, the toner cartridge's lifespan may differ.

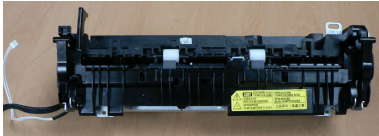
2.1.2.7. Maintenance parts

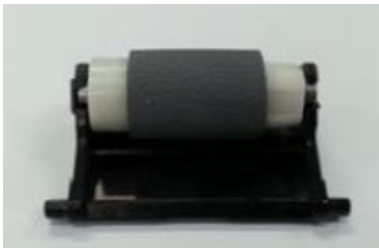
Item	Image	Part Code	Life
Fuser Unit		JC91-01034A (for 110V) JC91-01034B (for 220V)	Approx. 50,000 pages
Pick-Up/ Feed/ Forward Roller Assy		JC93-00405A	Approx. 50,000 pages
Separation Roller		JC90-01107B	Approx. 50,000 pages

2.1.2.8. Options

Item	Specification
Memory	N/A
Second Cassette	N/A
Hard Disk	N/A

2.2. System Overview

This chapter describes the functions and operating principal of the main component.

2.2.1. Front View

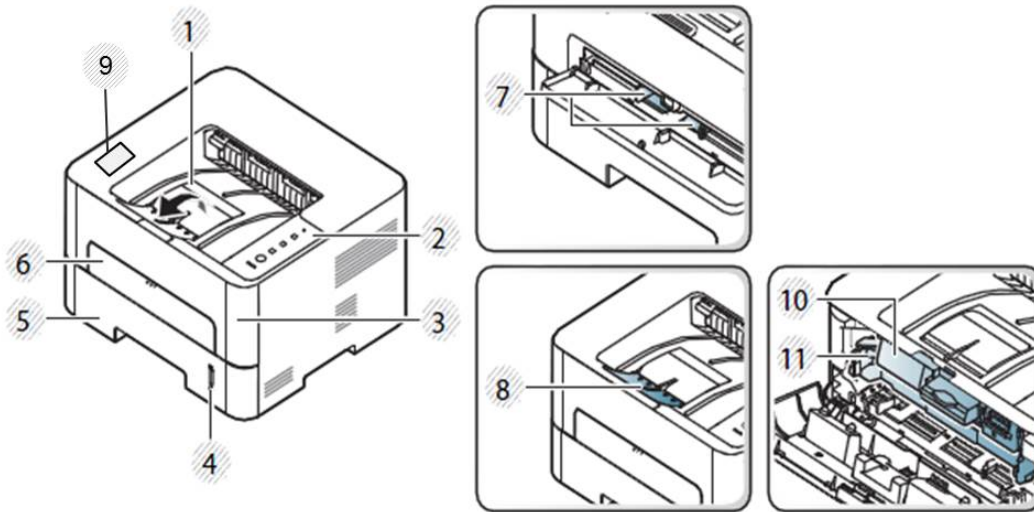

1	Output Tray
2	Control panel
3	Front cover
4	Paper level indicator
5	Tray 1
6	Manual Feeder
7	Paper width guides on a manual feeder
8	Output support
9	NFC (Near Field Communication) tag *
10	Toner cartridge
11	Imaging Unit

* M3015DW only

2.2.2. Rear View

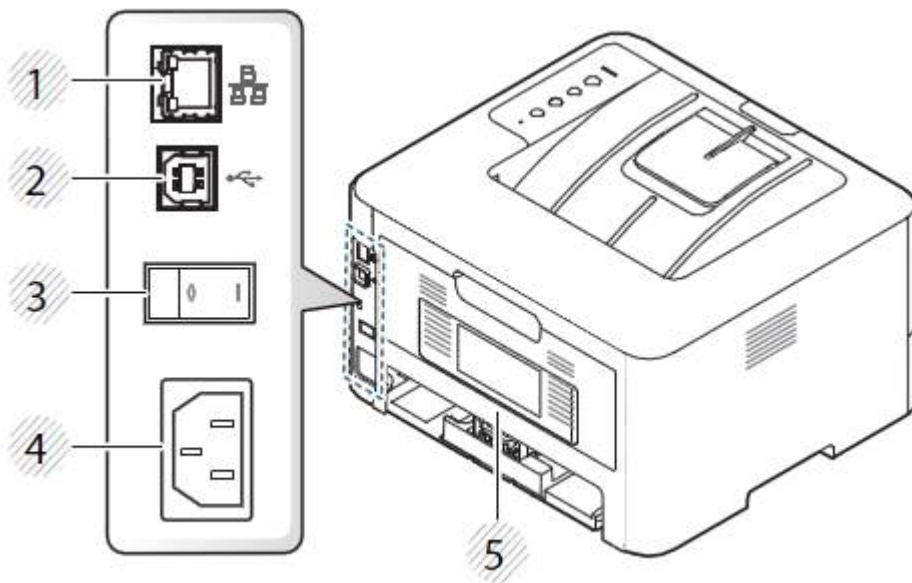

1	Network Port
2	USB Port
3	Power Switch
4	Power Receptacle
5	Rear Cover

2.2.3. Paper Path

The following diagram displays the path the paper follows during the printing process.

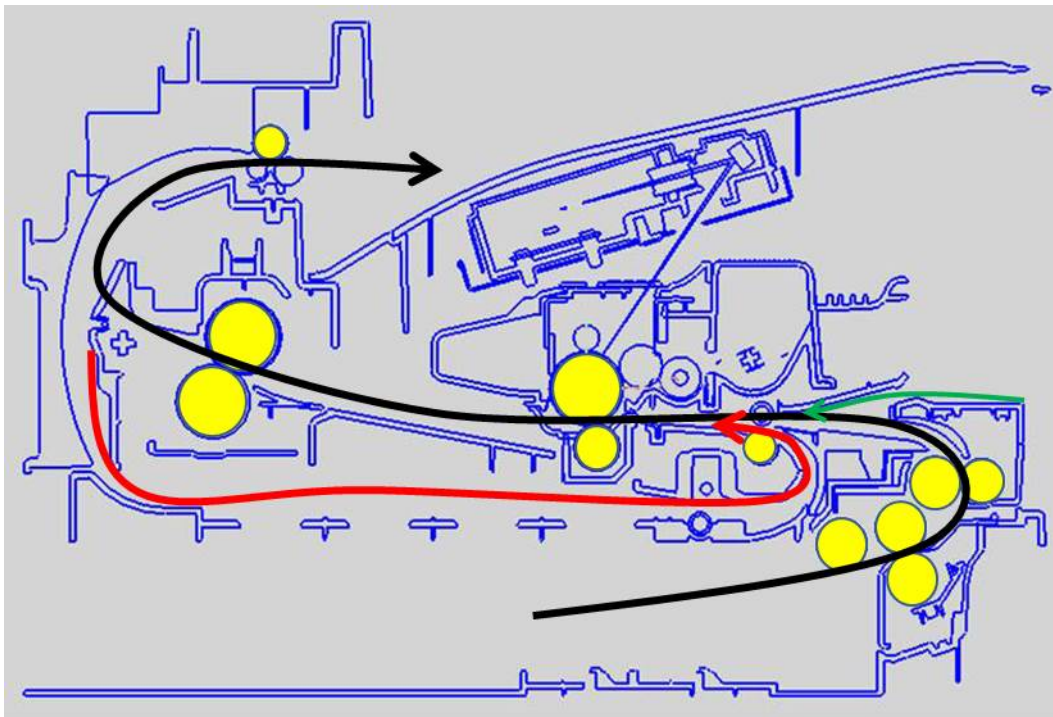

— Simplex Path — Duplex Path — MP Path

2.2.4. System Layout

This model consists of the Engine parts, Hardware and Firmware. The engine parts consists of the mechanical parts comprising Frame, Duplex, Toner cartridge, Imaging Unit, Drive unit, Transfer roller, Fuser, Cassette etc. The Hardware part consists of the main control board, power board, operation panel etc.

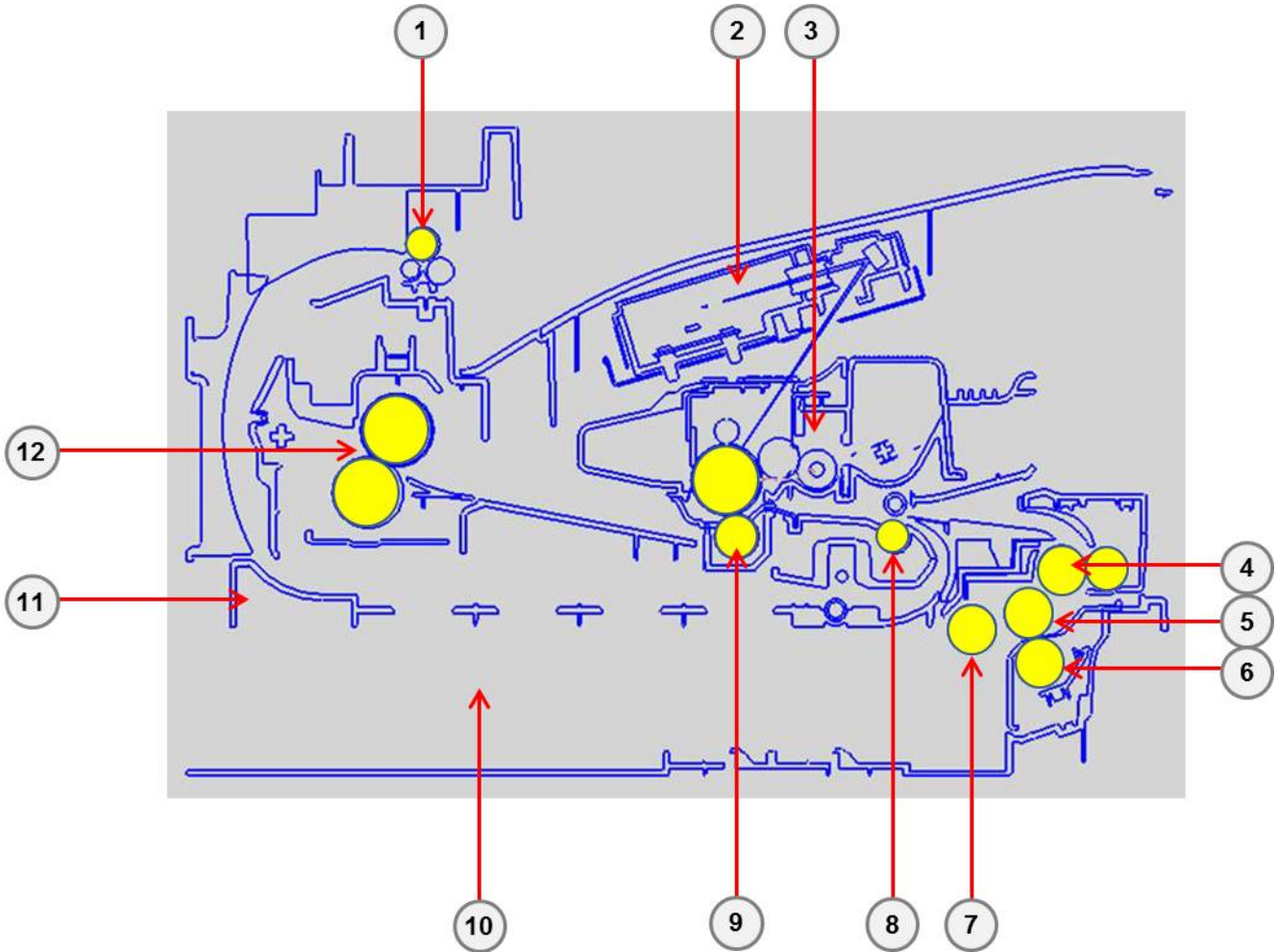

1	Exit Roller
2	LSU
3	Toner Cartridge & Imaging Unit
4	Feed Roller
5	Forward Roller
6	Separation Roller
7	Pick-up Roller

8	Regi Roller
9	Transfer Roller
10	Cassette
11	Duplex Unit
12	Fuser Unit

2.2.4.1. Feeding Part

It consists of a cassette, an MP tray for supplying different types of media (envelope, label, special paper) and parts related to paper transferring.

1) Cassette

The cassette stores the paper (Capacity: 250 sheets (80g/m² paper standard). Both the side guide and the rear guide can be adjusted for various types of papers from A6 to legal size paper. It has a paper existence sensing function, paper arranging function, various size papers accepting function.

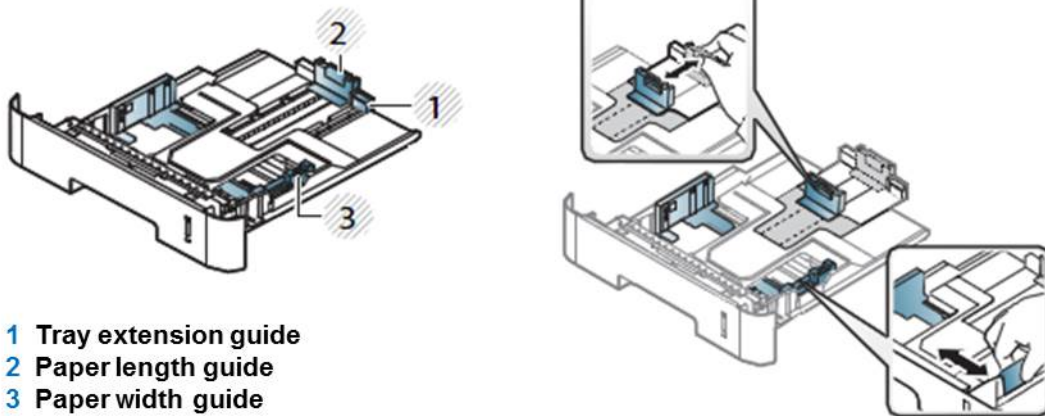

2) Pick-Up / Forward / Separation roller

When pickup takes place, the pickup roller moves down to come into contact with the surface of the paper. The pickup roller moves down when the pickup clutch is activated. The forward roller and the separation roller serve to make sure that a single sheet of paper is moved to the paper path, and the paper is moved as far as the registration roller by the work of the feed roller.

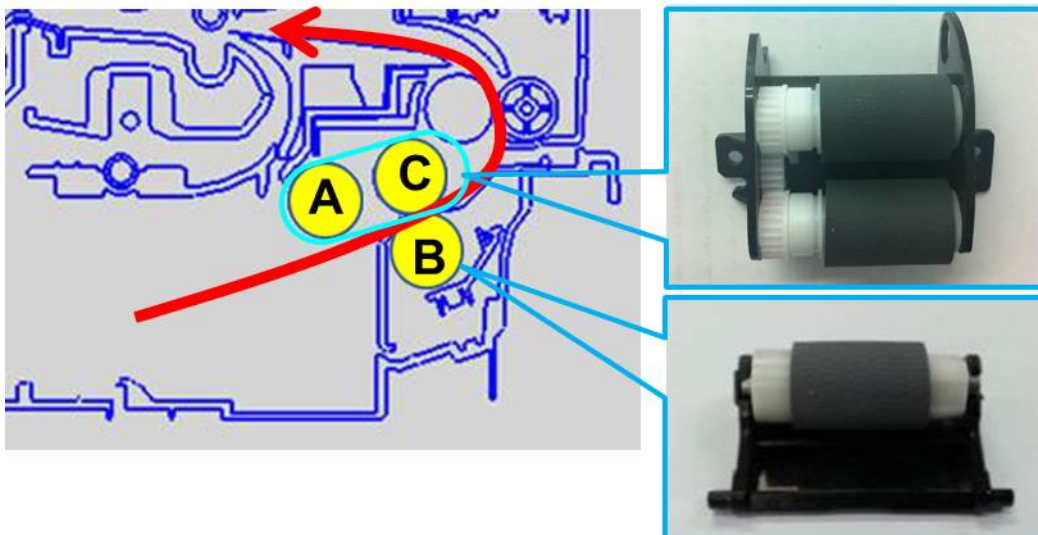

- A : Pick up roller
- B : Separation roller
- C : Forward roller

3) Registration roller

It is used as an anti skew device, and to setup proper registration timing with that of the toned image on the drum. It also is used for jam detection to ensure paper has left the paper tray.

4) Manual Feeder

The manual feeder can hold special sizes and types of print material, such as postcards, note cards, and envelopes.

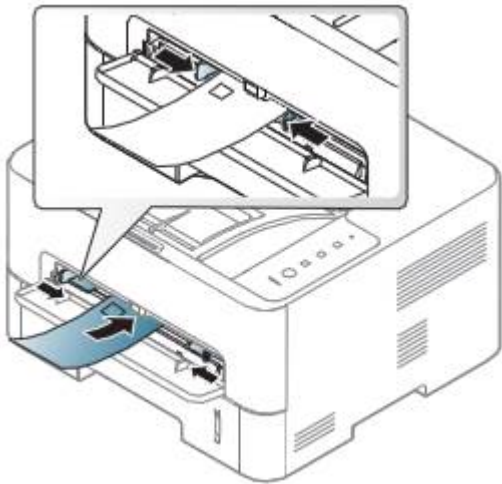

2.2.4.2. Transfer Roller

The transfer roller delivers the toner off the OPC drum to the paper.



2.2.4.3. Drive Unit

In this model, the driving device consists of BLDC motor, Regi./Pick up clutches, various gears for OPC, Fuser, Pick-up, Feed, Regi, Exit.

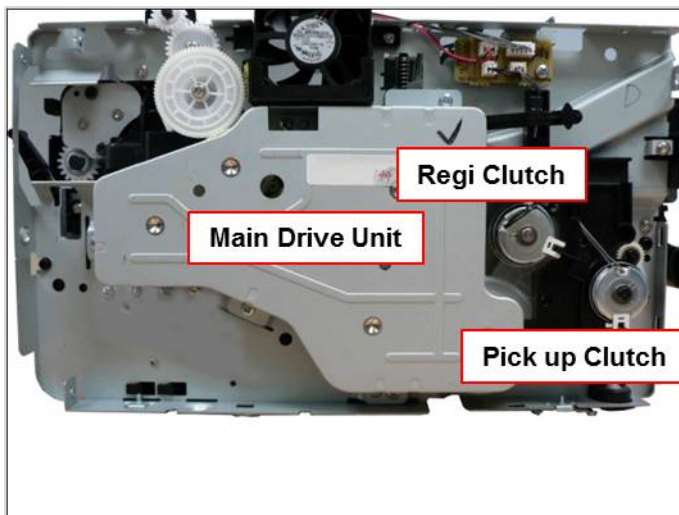

2.2.4.4. Fuser

This unit consists of Heat Roller, a Thermostat, and Thermistors, etc. It fuses the toner that was transferred by the transfer roller onto the paper, by applying pressure and high temperature to complete fusing process.

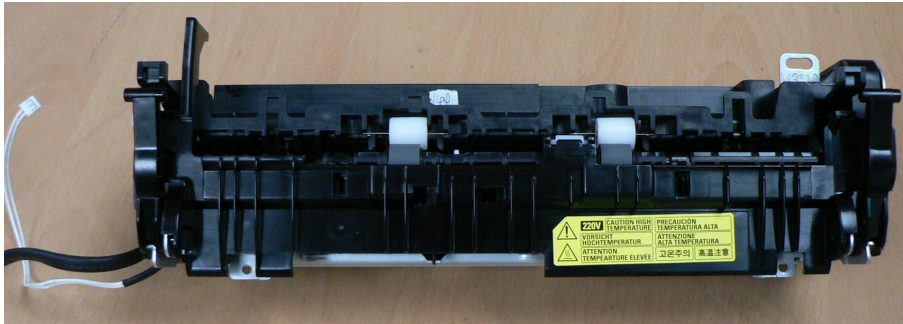

1) **Thermostat**

When a heat lamp is overheated, a Thermostat cuts off the main power to prevent over- heating.

- Thermostat Type : Non- Contact type Thermostat
- Control Temperature : $195^{\circ}\text{C} \pm 5^{\circ}\text{C}$

2) **Thermistor**

It is a temperature detecting sensor.

- Temperature Resistance : $7\text{ K}\Omega(180^{\circ}\text{C})$

3) **Heat roller**

The heat roller transfers the heat from the lamp to apply a heat on the paper.

The surface of a heat roller is coated with Teflon, so toner does not stick to the surface.

4) **Pressure roller**

A pressure roller mounted under a heat roller is made of a silicon resin, and the surface also is coated with Teflon. When a paper passes between a heat roller and a pressure roller, toner adheres to the surface of a paper and is permanently fused.

5) **Halogen Lamp**

- Voltage : $120\text{ V} (115 \pm 5\%) / 220\text{ V} : 230 \pm 5\%$
- Capacity : $850\text{ Watt} \pm 5\%$

2.2.4.5. LSU (Laser Scanner Unit)

The LSU (Laser Beam Printer) is a sealed factory assembly in which the video data received to the controller is used to form an electrostatic latent image on the OPC drum. It is accomplished by use of a polygon mirror and laser beam. The OPC drum is turned with the paper feeding speed. The HSYNC signal is created when the laser beam from LSU reaches the end of the polygon mirror, and the signal is sent to the controller. The controller detects the HSYNC signal to adjust the vertical line of the image on paper. In other words, after the HSYNC signal is detected, the image data is sent to the LSU to adjust the left margin on paper. The one side of the polygon mirror is one line for scanning.

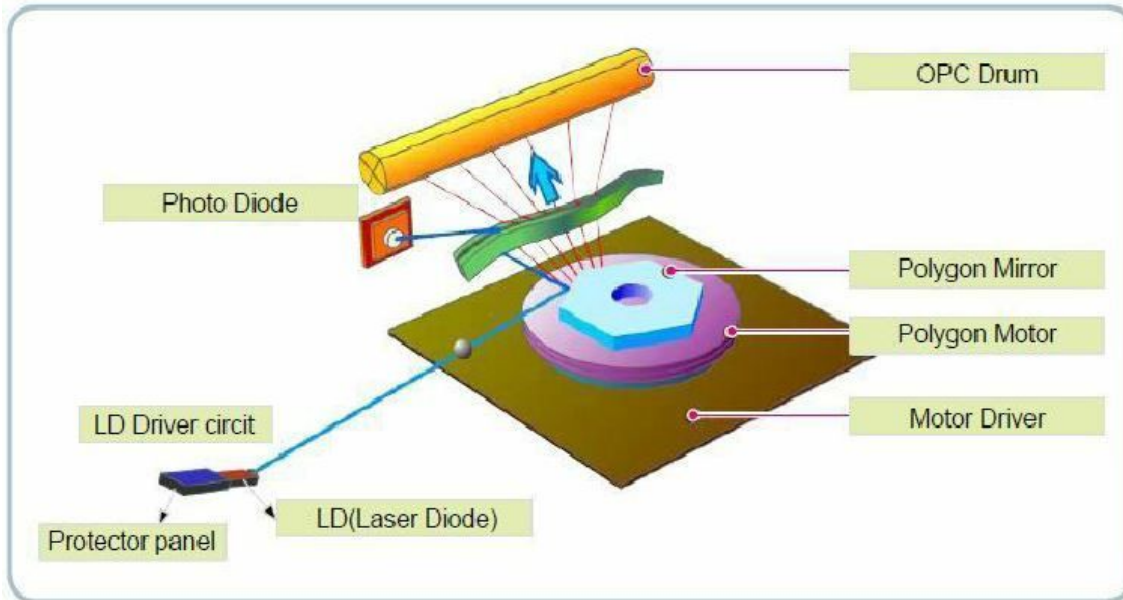

2.2.4.6. Toner System

By using the electronic photo process, it creates a visual image. SL-M3015 series uses the separated toner system that consists of toner cartridge and imaging unit. The imaging unit has OPC drum, charge roller, and cleaning blade.

- Developing Method : Non magnetic 1 element contacting method
- Toner : Non magnetic 1 element shatter type toner
- OPC Cleaning : Collect the toner by using cleaning blade
- Handling of wasted toner : Collect the wasted toner in the cleaning frame by using cleaning blade
- Classifying device for toner cartridge: ID is classified by CRUM.

[Separated Toner System]

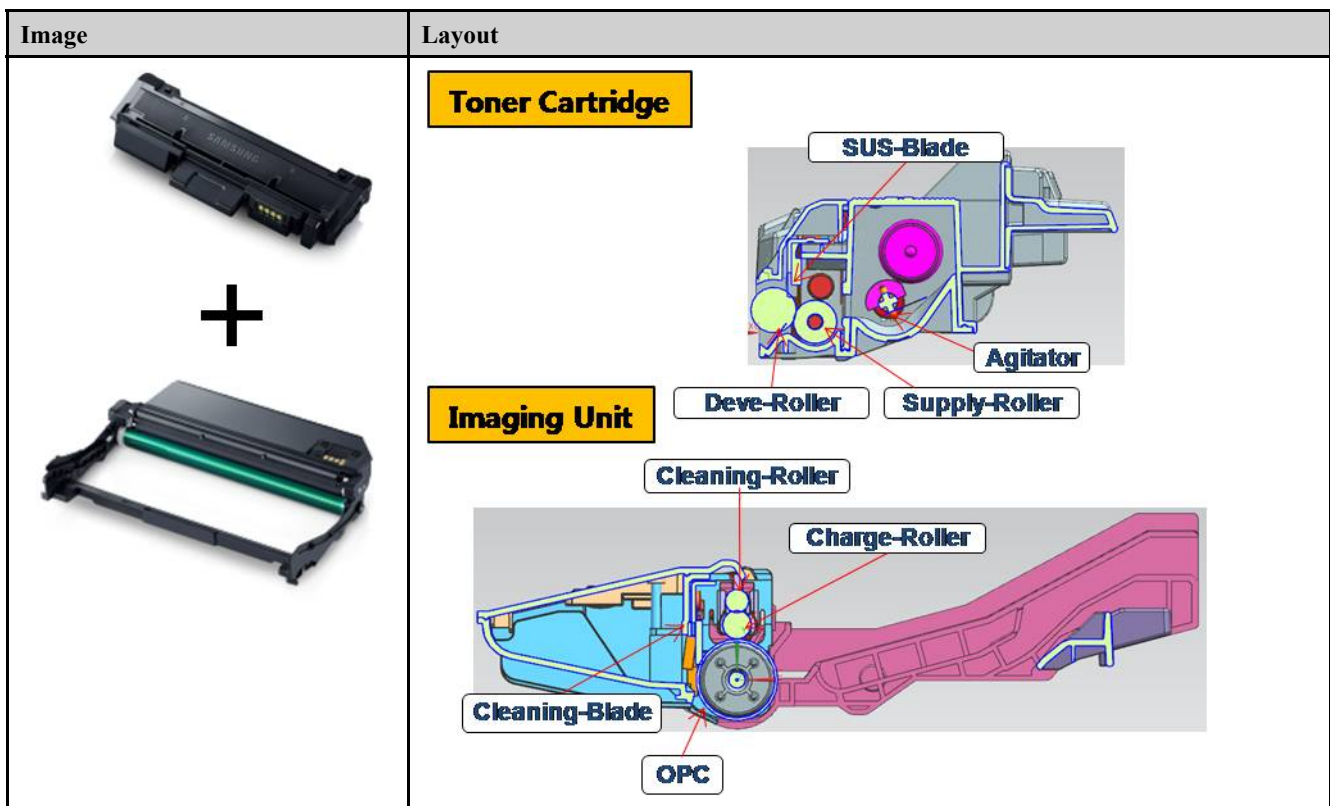

2.2.5. Hardware configuration

SL-M3015 series Electrical Circuit System consists of the following:

- Main board (System board)
- OPE board
- SMPS board
- HVPS board

Diagram of the SL-M3015 series Electrical Circuit

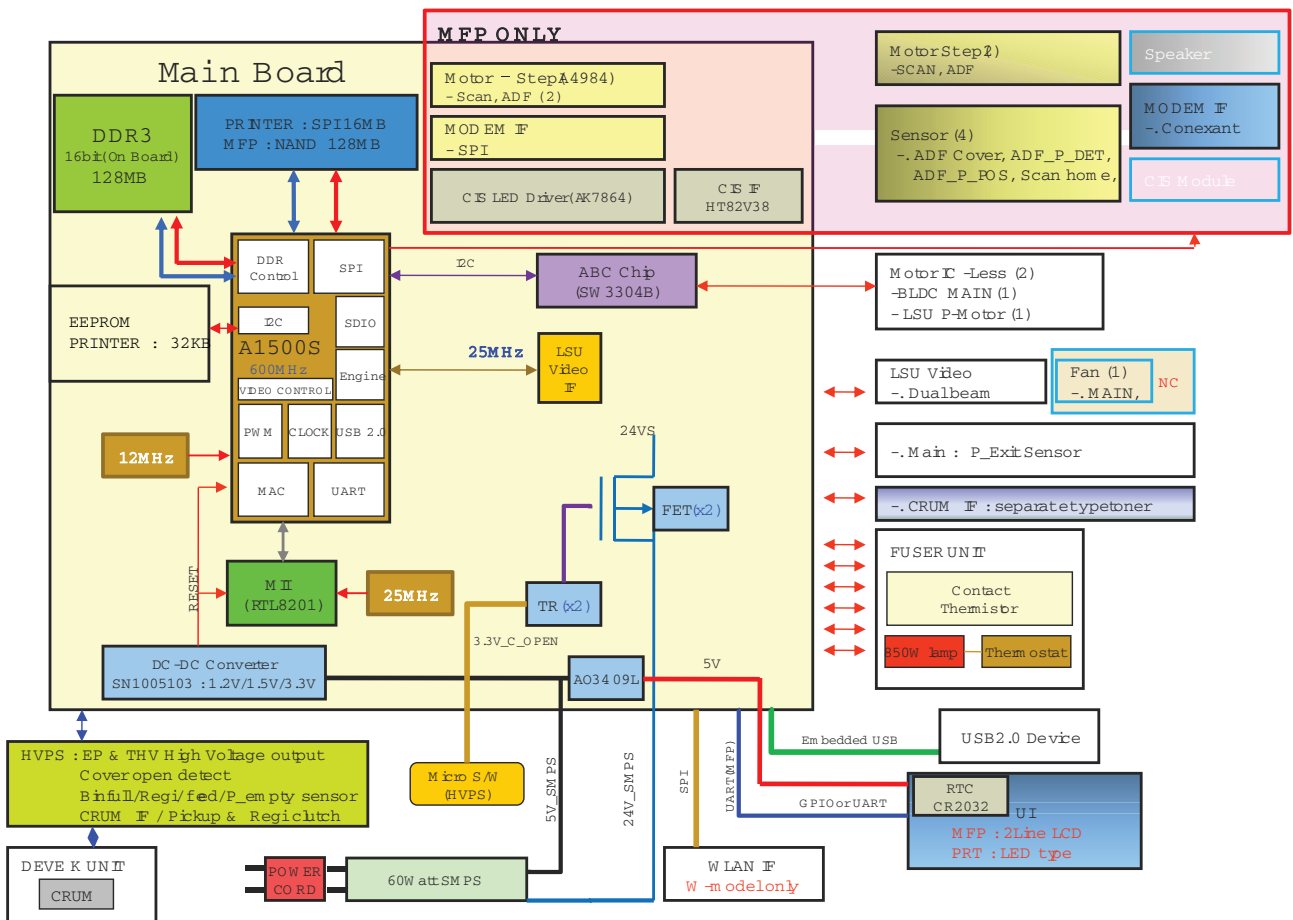

SL-M3015 series has a system board of integrated engine controller and video controller.

The engine controller controls all modules required to print, that is, LSU, HVPS, SMPS, FAN, Fuser, etc.

It communicates with the video control block inside CPU for printing. And it has the interface for all video sync signal to print out the video data.

The video controller receives print data from the host through network or USB Port. It takes this information and generates printable video bitmap data.

The main board adopts the 600 MHz CPU, on board DDR3 memory (128MB) to perform printing jobs successfully.

2.2.5.1. Main board

A1500 chip is adopted as the main processor. Its process speed is 600 MHz. It is integrated engine controller and video controller.

DDR3 128MB is adopted for high speed data processing. Boot has 16MB SPI.

USB is the embedded type and wired network supports 100M full duplex.

[Main board diagram]

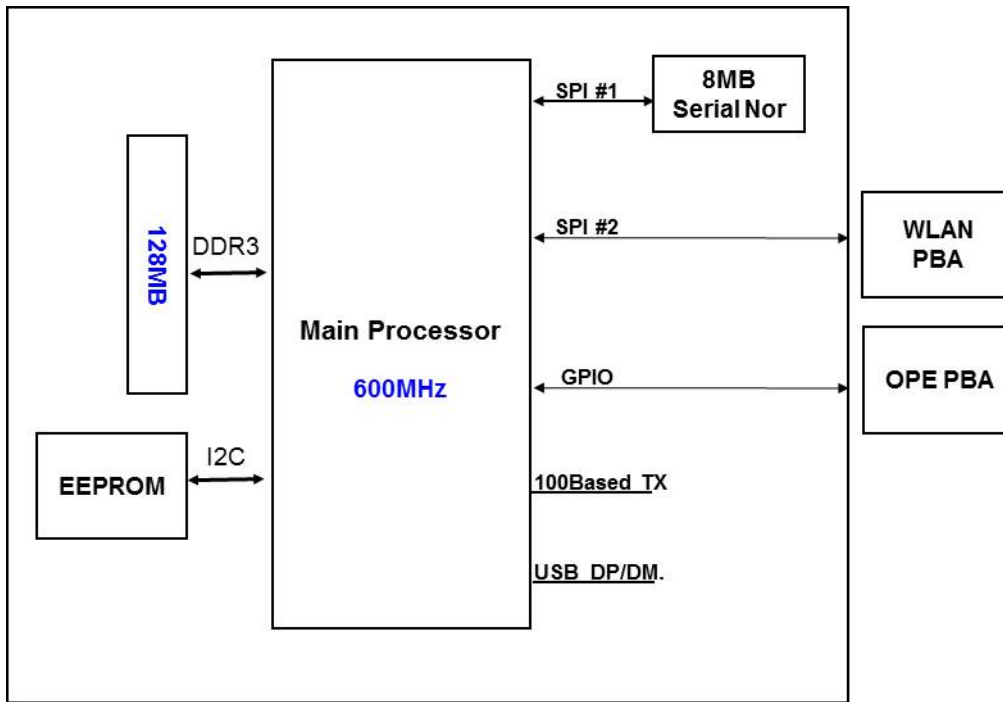

[Main board image]

- **Connection**

1	LSU Video connector
2	LSU Motor connector
3	HVPS interface connector
4	OPE connector
5	SMPS interface connector
6	Main BLDC Motor connector
7	Paper Exit sensor connector

8	Fuser thermistor interface connector
9	Wired network connector
10	USB device connector
11	Wireless module interface connector (SL-M3015DW only)
12	CRUM interface connector

- **Information**

- Part Code : JC92-02916A (SL-M3015DW) / JC92-02915A (SL-M3015ND)
- PBA name : PBA-MAIN

2.2.5.2. OPE board

The OPE Controller is composed of an OPE MICOM(STM8SP103K3MAFTR), Status LED, Mode LED, Power LED, WPS LED. OPE communicates with main controller via UART. The power LED is controlled by the main board.

[OPE board diagram]

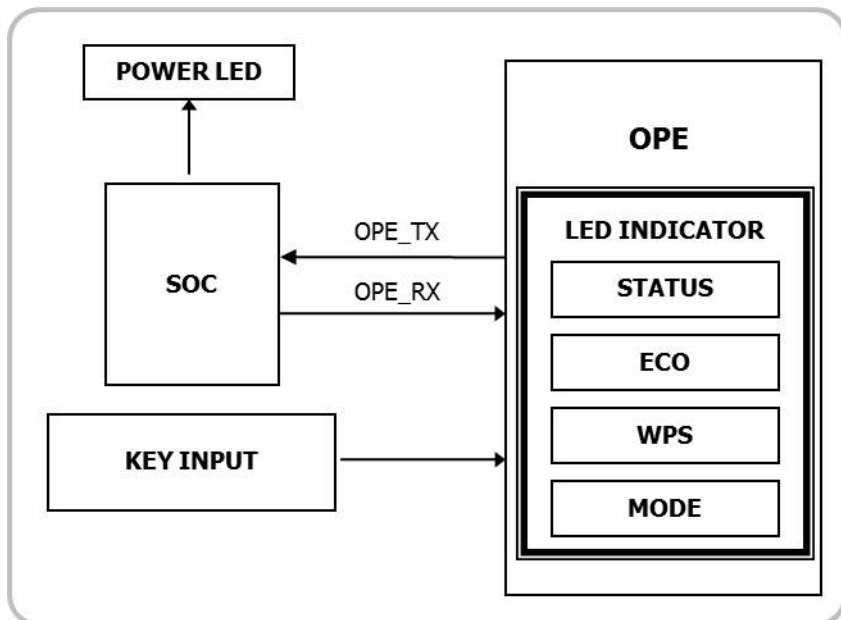

[OPE board image]

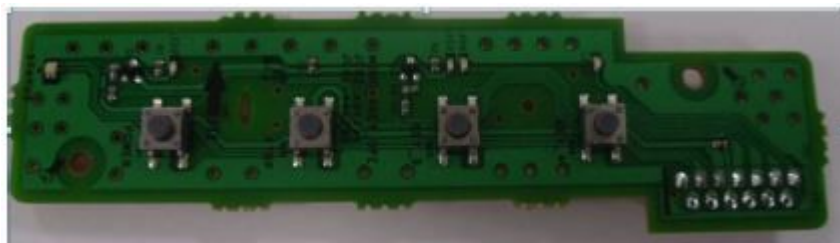

• **Information**

- Part Code : JC92-02609A
- PBA name : PBA OPE

• **Connection**

1	MAIN PBA I/F HARNESS (JC39-01990A)
---	------------------------------------

2.2.5.3. Wireless LAN board (SL-M3015DW only)

The Wireless LAN Module supports 802.11b/g/n. It communicates with video controller via SPI.

[WLAN board image]



- **Information**

- Part Code : JC92-02517A
- PBA name : PBA-WNPC

- **Connection**

1	Interface connector to main board (JC39-01984A , FFC CABLE-WLAN)
---	---

2.2.5.4. Joint PBA

The Joint PBA is the interface connection board for Regi. clutch, Pick-up clutch, Fan.

[Joint PBA image]

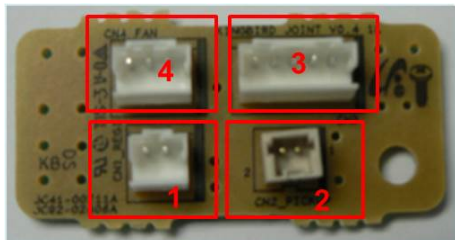

- **Information**

- Part Code : JC92-02406A
- PBA name : JOINT PBA

- **Connection**

1	Regi. Clutch
2	Pick-Up Clutch
3	HVPS I/F
4	Fan

2.2.5.5. SMPS Board

The SMPS (Switching Mode Power Supply) Board supplies electric power to the Main Board and other boards through a Main Controller. The voltage provided includes +5V, and +24V from a 110V/220V power input.

[SMPS board image]

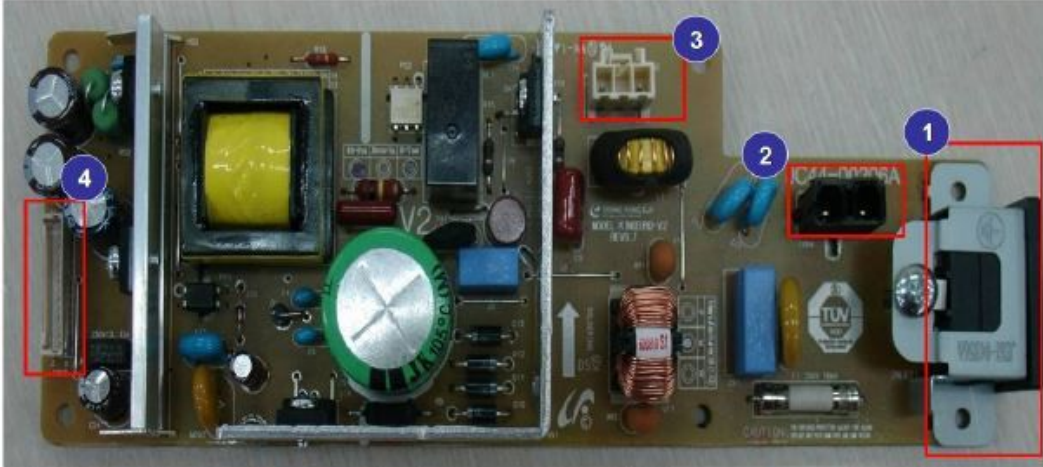

- **Specification**

General Input / Output Voltage

- AC 110V (90V ~ 135V)
- AC 220V (180V ~ 270V)
- Input Current : 10.0A (110V) / 8.0A (220V)
- Output Power: 58W
 - DC 5V : 10W
 - DC 24V : 48W

- **Information**

	110V	220V
Part Code	JC44-00206A	JC44-00207A
PBA name	SMPS V1	SMPS V2

- **Connection**

1	AC_Inlet
2	INPUT_AC Switch
3	FUSER_AC Output
4	OUTPUT_DC

• **Input / Output connector**

AC Input Connector (CON2)		
Pin Assign	Pin No	Description
1	AC_L	AC Output for Heater Controller
2	AC_N	

AC Input Connector (CON4)		
Pin Assign	Pin No	Description
1	AC_N	AC Input Switch
2	AC_N	

DC Output Connector (CON3)					
Pin Assign	Pin No	Description	Pin Assign	Pin No	Description
1	GND	Ground	8	5V	+5V Power
2	GND	Ground	9	5V	+5V Power
3	GND	Ground	10	GND	Ground
4	24V	+24V Power	11	24V_OFF	Sleep mode
5	24V	+24V Power	12	RELAY ON	Fuser Relay
6	24V	+24V Power	13	24V_F	Photo Triac Bias
7	GND	Ground	14	Fuser on	Fuser On

2.2.5.6. HVPS Board

This board generates high-voltage channels which includes MHV, DEV, BLADE, SUPPLY, THV.

[HVPS board image]

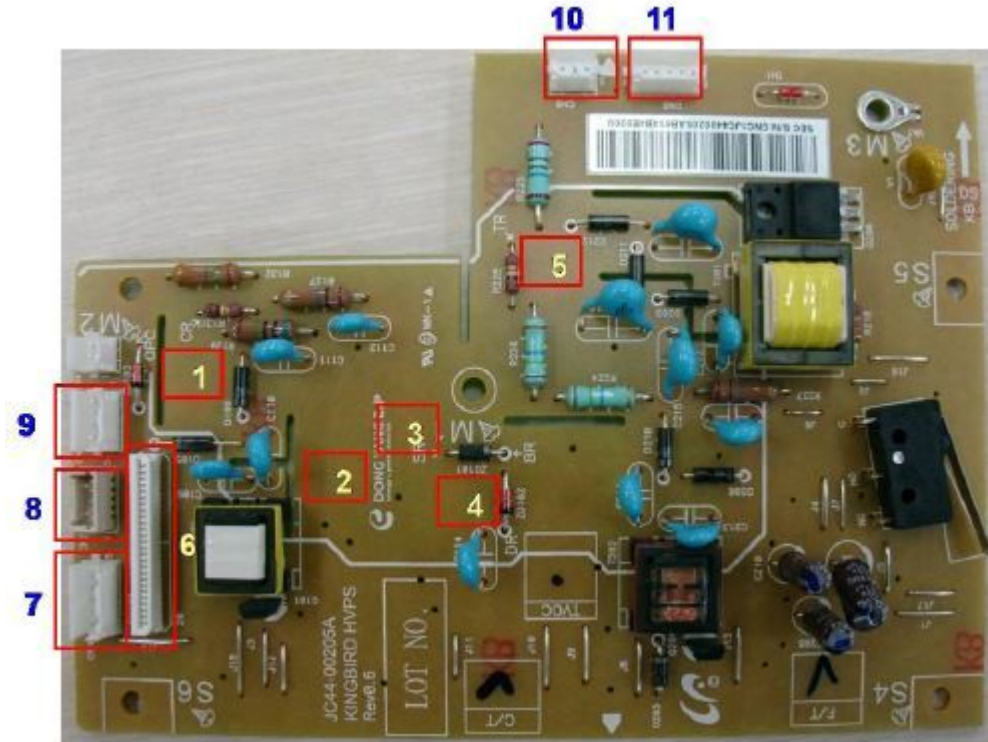

- **Information**

- Part Code : JC44-00205A
- PBA name : HVPS

- **Connection**

1	Charger
2	DEV
3	SUP
4	Blade
5	THV
6	HVPS I/F
7	Clutch I/F
8	Outbin Full I/F
9	Crum I/F
10	Empty sensor I/F
11	Regi, Feed sensor I/F

2.2.5.7. NFC Tag Sticker (SL-M3015DW only)

Near field communication (NFC) is a set of standards for smartphones and similar devices to establish radio communication with each other by touching them together or bringing them into close proximity, usually no more than a few centimeters. Present and anticipated applications include contactless transactions, data exchange, and simplified setup of more complex communications such as Wi-Fi. Communication is also possible between an NFC device and an unpowered NFC chip, called a "tag". NFC tag sticker stores Mac, PIN, Mobile Print App URL of Printer/MFP.



Front - label



Rear – Inlay & NFC chip

- **Information**

- Part Code : JC68-03012A
- Part Name : LABEL ETC-NFC TECTILE STICKER (25x25mm)

2.2.5.8. Electrical Parts Location

1) Sensor, Motor and Clutch

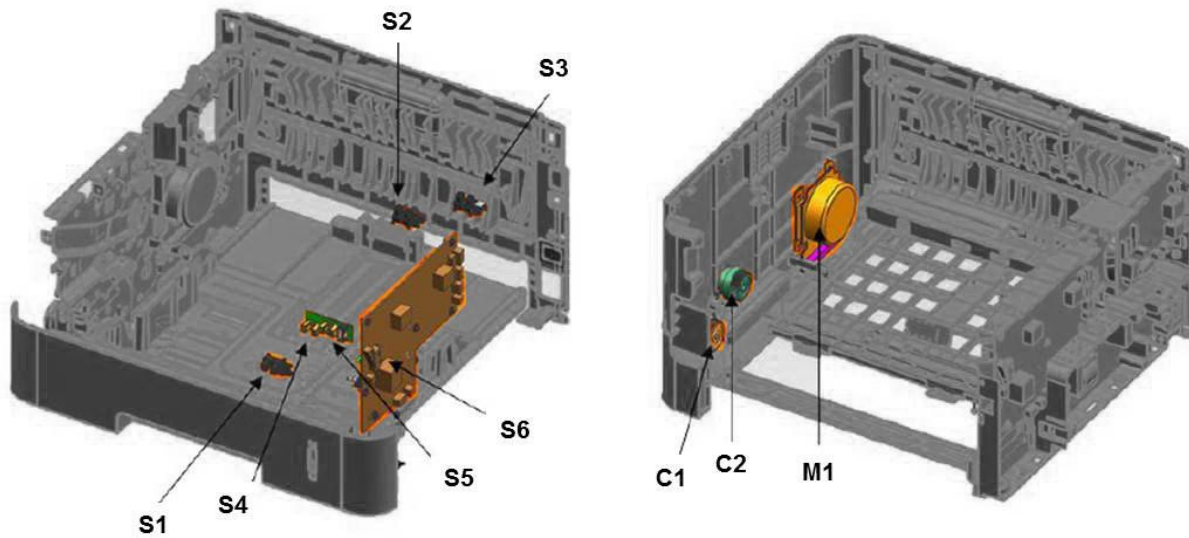

Ref.	Description	Function
S1	Photo interrupter (Paper empty sensor)	Paper empty detection
S2	Photo interrupter (Exit Sensor)	Paper detection
S3	Photo interrupter (Bin full sensor)	Bin Full detection
S4	Photo interrupter (Regi sensor)	Paper detection
S5	Photo interrupter (Feed Sensor)	Paper detection
S6	Switch Front Cover	Cover open detection
M1	Main Motor	OPC drum, Fuser Unit, Pick up, Feed, Regi driving.
C1	Pick up clutch	Pick up driving control
C2	Registration clutch	Regi driving control

2) PBA (Board)

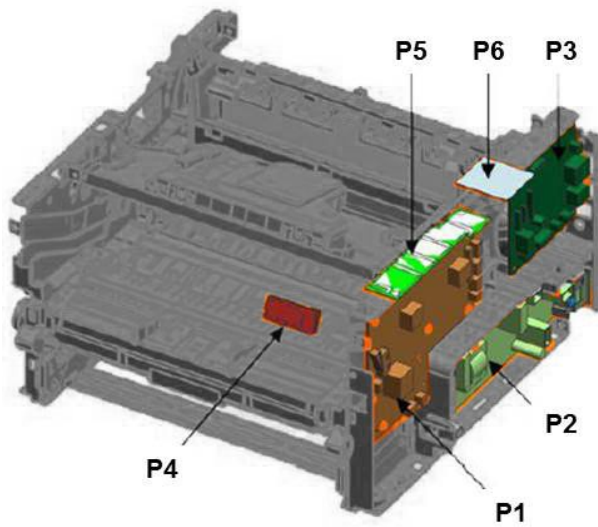

Ref.	Description	Function
P1	HVPS	High Voltage Generation
P2	SMPS	Constant Voltage Generation
P3	Main Board	Main Controller
P4	CRUM Board	Toner Cartridge Check
P5	OPE Board	Toner status display / Machine Operation for power, cancel.
P6	WLAN Board	Wi-Fi (SL-M3015DW only)

2.2.6. Engine Firmware Control Algorithm

2.2.6.1. Feeding

If feeding from a cassette, the drive of the pickup roller is controlled by controlling the solenoid. The on/off of the solenoid is controlled by controlling the general output port or the external output port. Provided below are the jam conditions for the device:

Item	Description
JAM 0	<ul style="list-style-type: none"> After paper pick up initialization, the paper is not fed. After picking up the paper the lead edge does not reach to the feed sensor within a predetermined period of time, due roller slippage, etc. After picking up the paper from the cassette, if the feed sensor is not detected, a re-pick up initialization occurs. After re-picking up, if the feed sensor is still not on after a predetermined amount of time, JAM 0 occurs. Even though the paper reaches to the feed sensor, the feed sensor doesn't be ON.
JAM 1	<ul style="list-style-type: none"> Even though the paper reaches to the feed sensor, the feed sensor doesn't not change state. After the tail edge of the paper passes the feed sensor, the lead edge of paper is not detected by the exit sensor within a predetermined period of time.
JAM 2	The trail edge of the paper does not clear the exit sensor within a predetermined period of time.

2.2.6.2. Transfer

The charging voltage, developing voltage and the transfer voltage are controlled by PWM (Pulse Width Modulation). Each output voltage is changeable due to the PWM duty. The transfer voltage admitted when the paper passes the transfer roller is decided by environment conditions. The resistance value of the transfer roller is changed when the Temperature and Humidity Sensor in the device senses a change in the environment. The current to the Transfer Roller is changed through the AD converter on the HVPS. The voltage value for impressing to the transfer roller is decided by the changed value.

2.2.6.3. Fusing

The temperature change of the heat roller's surface is changed to the resistance value through the use of a thermistor. The Main Board uses the resistance value of a negative coefficient Thermistor and converts it to a voltage value through the use of an AD converter, the temperature is decided based on the voltage value read. The AC power is controlled by comparing the target temperature to the value from the thermistor. If the value from the thermistor is out of controlling range, or does not change after a predetermined amount of time an error is displayed and the Fuser Power is cut off. An error occurs based on the bullets below:

- Open Heat Error

When the engine operates the warm-up process, if the temperature of the fixing unit is not higher than a specified temperature, the engine defines Open Heat Error. When this error is detected, the engine stops all functions and keeps the error state. Also, the engine informs the error status of the main system, so it can take appropriate action; and then the error message is displayed at LCD window or LED informing the error status of the user.

- Low Heat Error

When the engine is at stand-by, printing or warm-up mode, if the temperature of the fixing unit is lower than the specified temperature at each state and the lower temperature state is maintained during the specified time, the engine defines Low Heat Error. When this error is detected, the engine stops all functions and keeps it at the error state. Also, the engine informs the error status of the main system, so it can take appropriate action; and then the error message is displayed at LCD window or LED informing the error status of the user.

- Over Heat Error

For overall engine state, if the temperature of the fixing unit is higher than the specified temperature and the temperature state is detected for a specific duration, then the engine defines Over Heat Error. When this error is detected, the engine stops all functions and keeps it at the error state. Also, the engine informs the error status of the main system, so it can take appropriate action; and then the error message is displayed at LCD window or LED informing the error status of the user.

2.2.6.4. LSU

LSU receives the image data from PVC or HPVC and make the latent image on OPC surface. It uses the single beam, LD. The errors related to LSU are as follows:

- By Lready

When the printing is started, the engine drives the polygon motor of LSU. After the specified time is elapsed, if the motor is not in a ready status, the engine detects the error that the polygon motor is not in a ready status. If this error happens, the engine stops all functions and keeps it at the error state. Also, the engine informs the error status of the main system and the error message is displayed at LCD window to inform the error status of the user.

- By Hsync

When the polygon motor is ready, the LSU sends out the signal called Hsync and used to synchronize with each image line. So, if the engine does not detect consecutively the signal for a fixed time, it defines the Hsync Error. If this error happens, the engine stops all functions and keeps it at the error state. Also, the engine informs the error status of the main system and then the error message is displayed at LCD window to inform the error status of the user. LSU Error Recovery: If the LReady or Hsync error happens, the paper is exited before the error code is initiated. The engine mode is changed to recovery mode and the engine informs the main system of the engine mode. And the engine checks the LSU error. If the error doesn't happen, the printing job resumes.

2.2.7. Software Descriptions

2.2.7.1. Software system overview

The software system of this model is constructed in the following manner:

- Host Software part that the application software operated in Window and Web Environment
- Firmware parts that is a Embedded software controls printing job.

2.2.7.2. Architecture

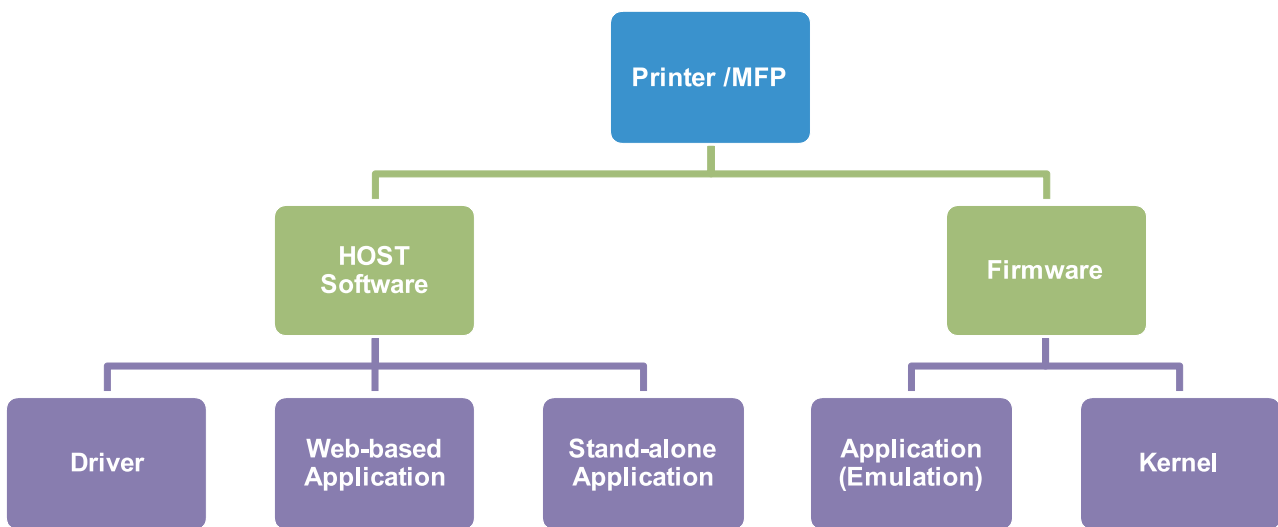

Host Software is made up of

- 1) Graphic User Interface offers the various editing functions to user in Host.
- 2) Driver translates the received document to a Printing Command language which printer can understand and transfers data to spooler.
- 3) Stand-alone Application offers the various printing application such as Easy Printer Manager, Printer Status in Window system.
- 4) Web-based-Application offers the same functions as Stand-alone Application in Web environment.

Firmware is made up of

- 1) The Application (Emulation) interprets and translates data received from the Host to a printing language to complete the users job.
- 2) The Kernel controls and manages the whole procedure including Control flow and the Printing Job before transferring it to the Engine for printing.

2.2.7.3. Data and Control Flow

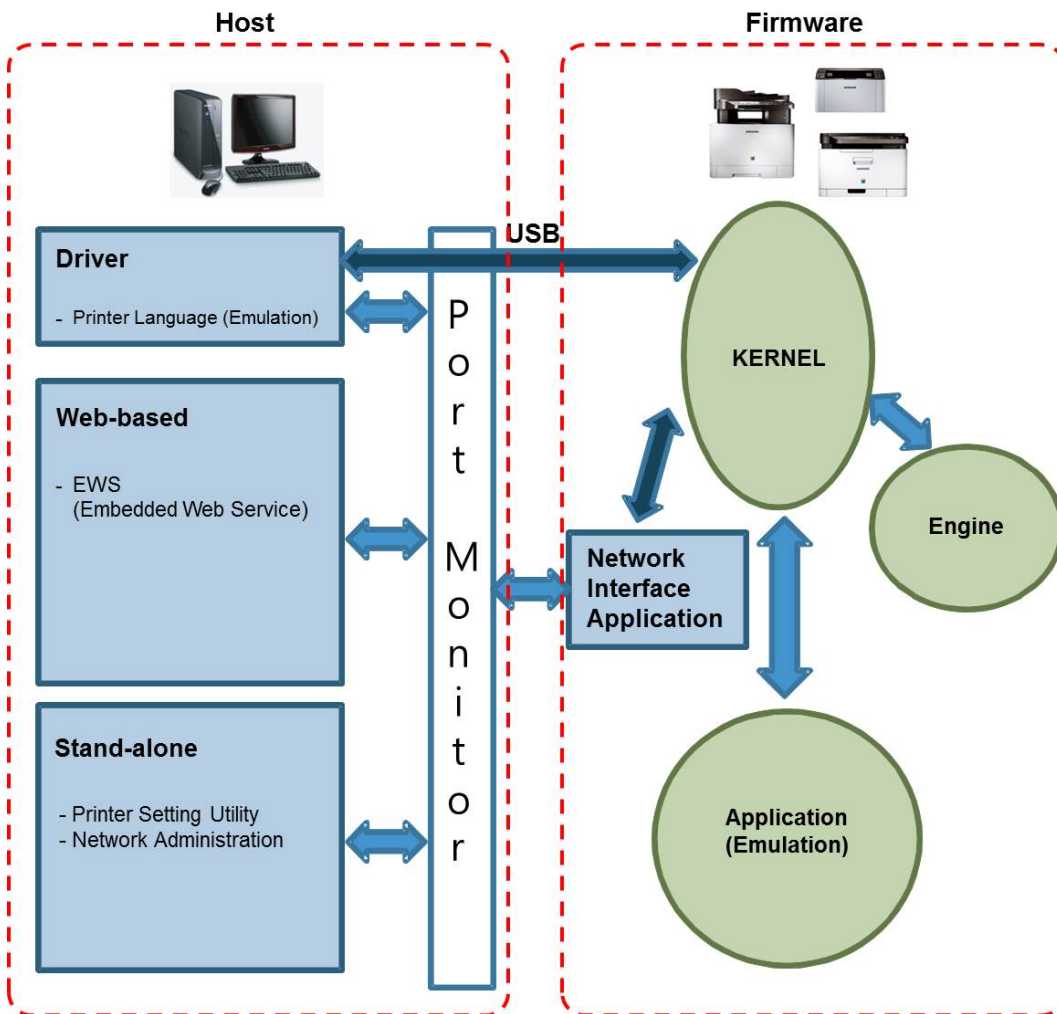

The above Block Diagram is explained that:

Host Side is made up of

- 1) Driver that is Windows application software translate printed data to one of printer language and create spooler file.
- 2) Web-based Application that offer a various printer additional functions, management of printing job, printer administration, Status monitor to monitoring the printer status by real time in Web, independent environment on OS.
- 3) Stand-alone Application that is a similar Window software as same as above 2.
- 4) The Port Monitor facilitates the flow of information between the Host and Firmware.

Firmware Side is made up of

- 1) The Network Interface Card is used to relay the communication between Host and Kernel using various network protocol.
- 2) The Kernel is manages the flow control emulation as it receives data from Host or Network card; then manages the printing of the image by the engine.
- 3) The Application Layer containing the Emulation portion interprets the data from the selected emulation [PCL, PS], and transfers the data to the Kernel Layer.
- 4) The Engine prints the rendered bit-map data to paper with required size and type by Kernel.

3. Disassembly and Reassembly

3.1. Precautions when replacing parts

3.1.1. Precautions when assembling and disassembling

- Use only approved Samsung spare parts. Ensure that part number, product name, any voltage, current or temperature rating are correct. Failure to do so could result in damage to the machine, circuit overload, fire or electric shock.
- Do not make any unauthorized changes or additions to the printer, these could cause the printer to malfunction and create electric shock or fire hazards.
- Take care when dismantling the unit to note where each screw goes. There are 19 different screws. Use of the wrong screw could lead to system failure, short circuit or electric shock.
- Do not disassemble the LSU unit. Once it is disassembled dust is admitted to the mirror chamber and will seriously degrade print quality. There are no serviceable parts inside.
- Regularly check the condition of the power cord, plug and socket. Bad contacts could lead to overheating and fire. Damaged cables could lead to electric shock or unit malfunction.

3.1.2. Precautions when handling PBA

Static electricity can damage a PBA, always use approved anti-static precautions when handling or storing a PBA.

- **Precautions when moving and storing PBA**
 - 1) Please keep PBA in a conductive case, anti-static bag, or wrapped in aluminum foil.
 - 2) Do not store a PBA where it is exposed to direct sunlight.
- **Precautions when replacing PBA**
 - 1) Disconnect power connectors first, before disconnecting other cables.
 - 2) Do not touch any soldered connections, connector terminals or other electronic parts when handling insulated parts.
- **Precautions when checking PBA**
 - 1) Before touching a PBA, please touch other grounded areas of the chassis to discharge any static electrical charge on the body.
 - 2) Take care not to touch the PBA with your bare hands or metal objects as you could create a short circuit or get an electric shock. Take extra care when handling PBAs with moving parts fitted such as sensors, motors or lamps as they may get hot.
 - 3) Take care when fitting, or removing, screws. Look out for hidden screws. Always ensure that the correct screw is used and always ensure that when toothed washers are removed they are refitted in their original positions.

3.1.3. Releasing Plastic Latches

Many of the parts are held in place with plastic latches. The latches break easily; release them carefully.

To remove such parts, press the hook end of the latch away from the part to which it is latched.

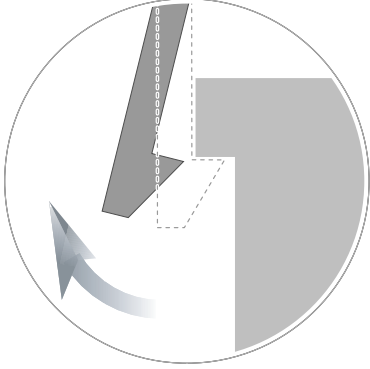

3.2. Replacing Preventive Maintenance Parts

3.2.1. Fuser Unit



CAUTION

The temperature gets hot around the Fuser Unit. To prevent burns, make sure the Fuser Unit area is cool before performing any maintenance.

1. Turn the machine off.
2. Remove the cassette.



3. Open the Front-Cover, then pull out the Toner Cartridge and Imaging Unit.



4. Remove the right cover by releasing the hooks.



5. Remove 4 screws of the rear side of the machine.



6. Open the Lower Rear Cover.

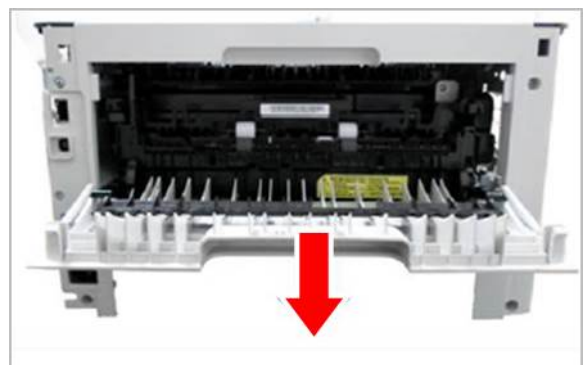

3. Disassembly and Reassembly

7. Release both hooks from the Lower Rear cover. And then, remove the Rear Cover.

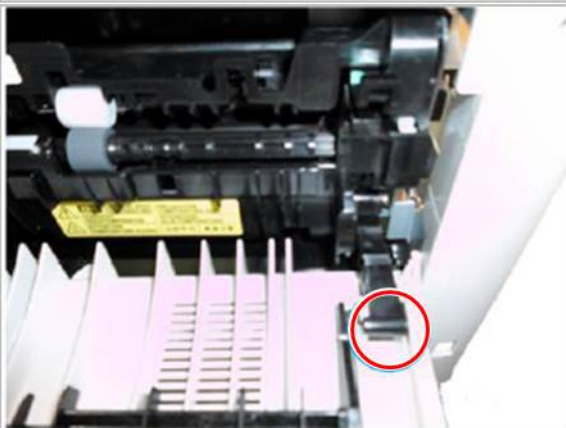

8. Unplug 2 connectors. (SMPS board x 1, Main board x 1)



9. Remove the fuser unit after removing 4 screws.

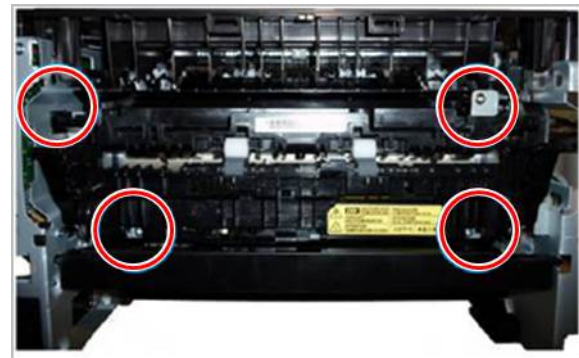

3.2.2. Pick-up and Forward Roller Assy

1. Open the front cover. And then, remove the toner cartridge and imaging unit.
2. Remove the cassette.
3. Remove the bottom bar after removing 2 screws.



4. Remove 2 screws.



5. Remove the Pick-up and Forward Roller Assy.



3.2.3. Separation Roller

1. Remove the cassette.
2. Open the separation roller cover.



3. Release the separation roller holder. Then release the separation roller from its holder.

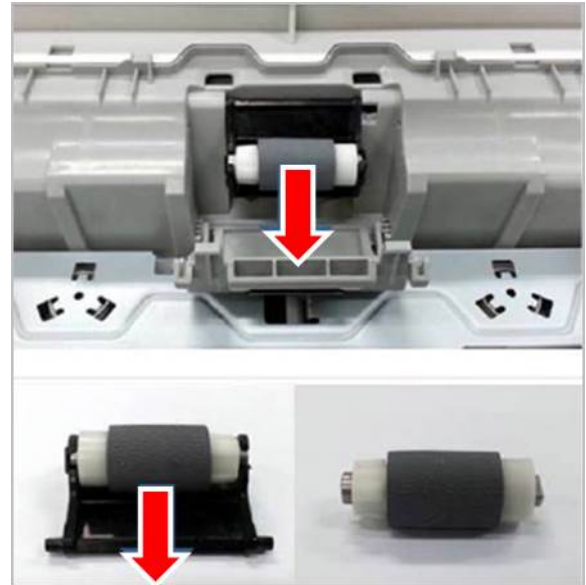

! NOTE

When reassembling the separation roller holder, place two springs on the bottom hole.

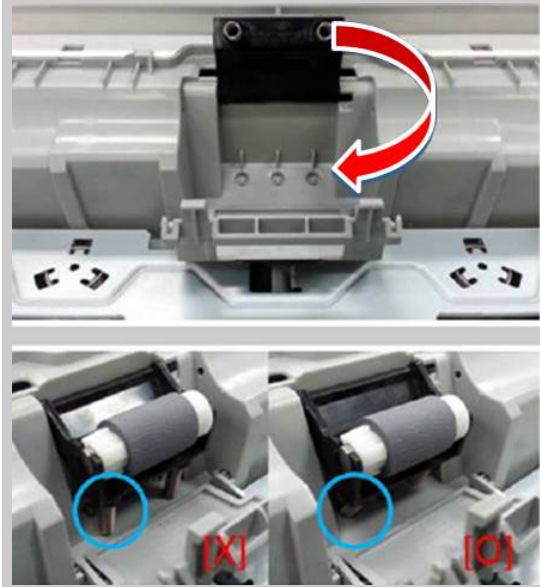

3.3. Replacing the main SVC part

3.3.1. Side Cover

1. Remove the cassette.



2. Open the front cover, then remove the toner cartridge and imaging unit.



3. Remove the left cover and right cover by releasing the hooks.



3.3.2. Rear Cover

1. Remove the side covers. (**Refer to 3.3.1.**)

2. Remove 4 screws from the rear side.



3. Open the Lower Rear Cover.

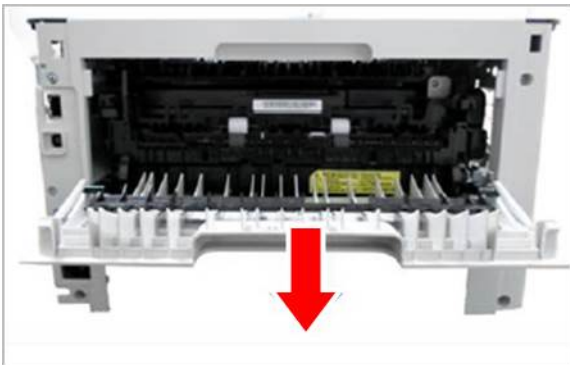

4. Remove both hooks of the Lower Rear Cover. And then, release the Rear Cover.

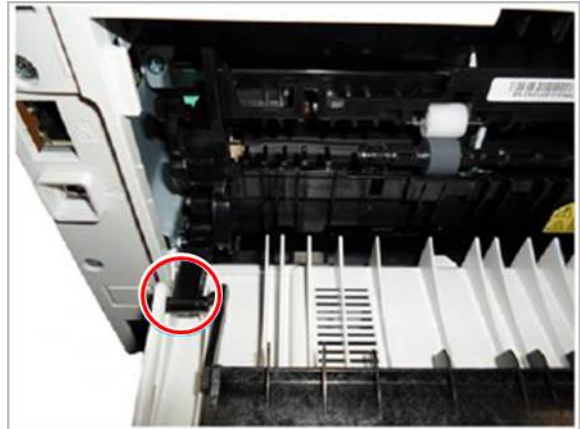

3.3.3. Front Cover

1. Remove the side covers and rear cover. (Refer to 3.3.1 ~ 3.3.2)

2. Unplug the harness from the right side.

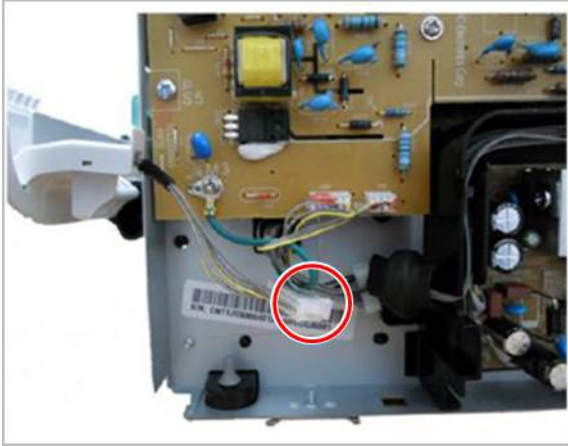

3. Release the hook of the front cover.

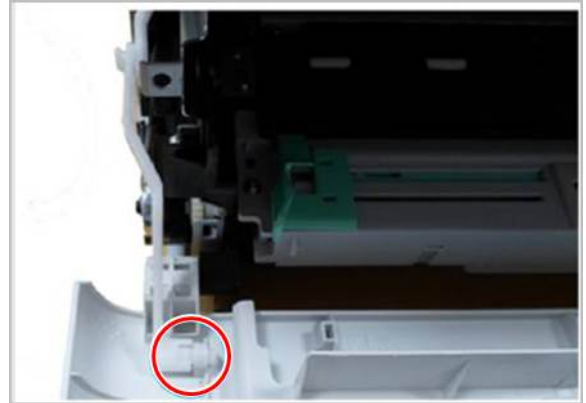

4. Remove the front cover.

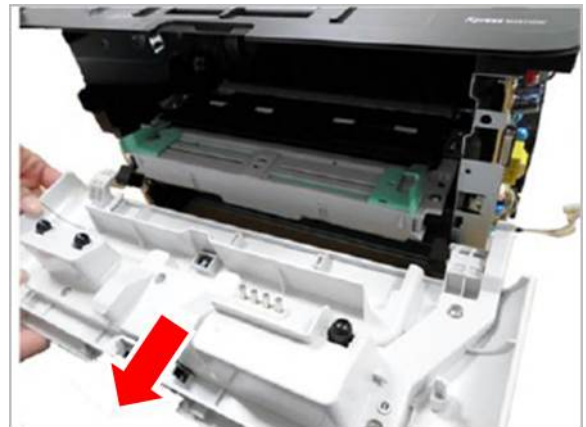

3.3.4. Top Cover

1. Remove the side covers, rear cover, and front cover.
(Refer to 3.3.1 ~ 3.3.3)
2. Remove 2 screws from the front-upper of the machine.

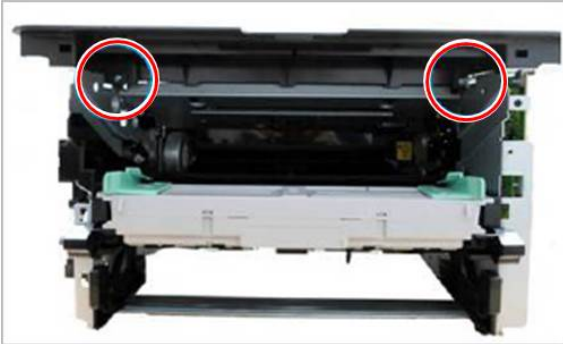

3. Lift up and release the top cover.

3.3.5. Main Board

1. Remove the right cover. (Refer to 3.3.1)
2. Unplug all harness from the main board.
3. Remove 4 screws. And then, release the main board.

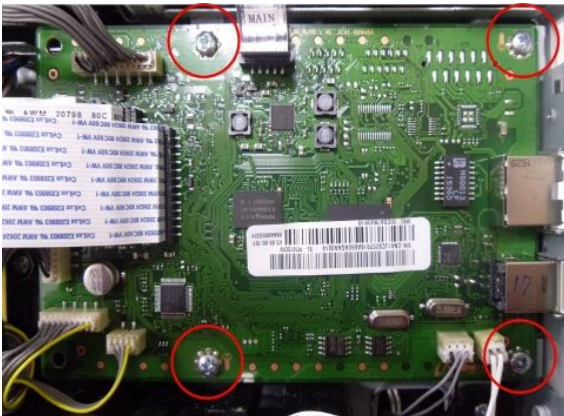

3.3.6. SMPS Board

1. Remove the right cover. (**Refer to 3.3.1**)
2. Unplug all harness from the SMPS board.
3. Remove 6 screws. And then, release the SMPS board.



3.3.7. HVPS Board

1. Remove the right cover. (**Refer to 3.3.1**)
2. Unplug all harness from the HVPS board.
3. Remove 6 screws. And then, release the HVPS board.

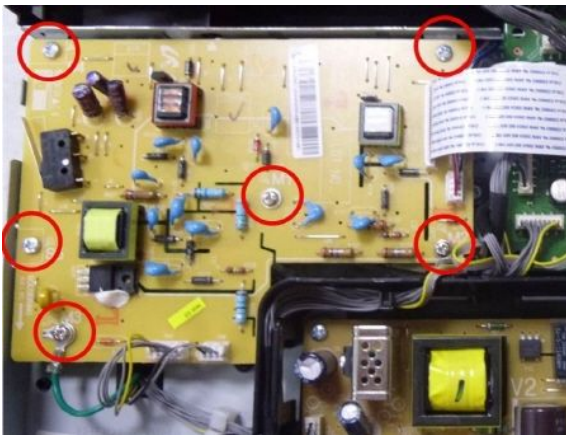

3.3.8. Bin-Full Sensor

1. Remove the right cover and top cover. (Refer to 3.3.1, 3.3.4)
2. Remove the main board. (Refer to 3.3.5)
3. Unplug the sensor harness.

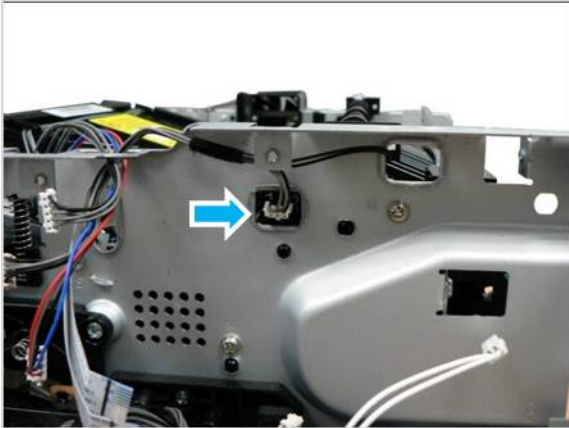

4. Remove the Bin-Full sensor.

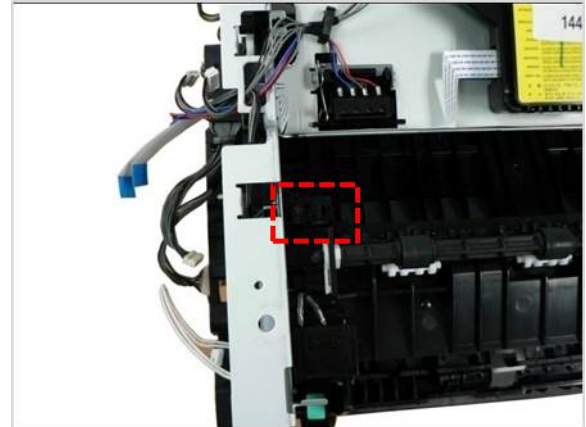

3.3.9. Main Drive unit

1. Remove the left cover. (Refer to 3.3.1)
2. Remove 5 screws

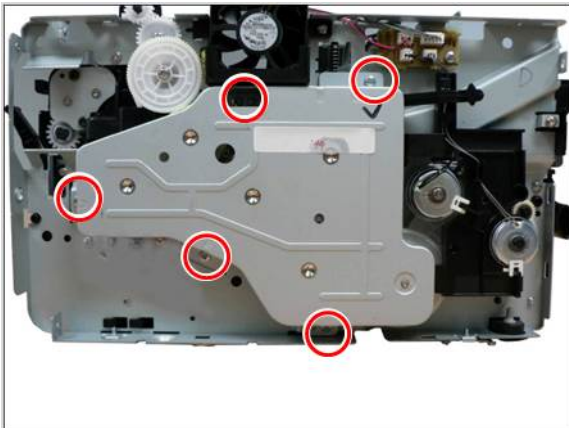

3. Release the main drive unit after moving the fixer to the right.

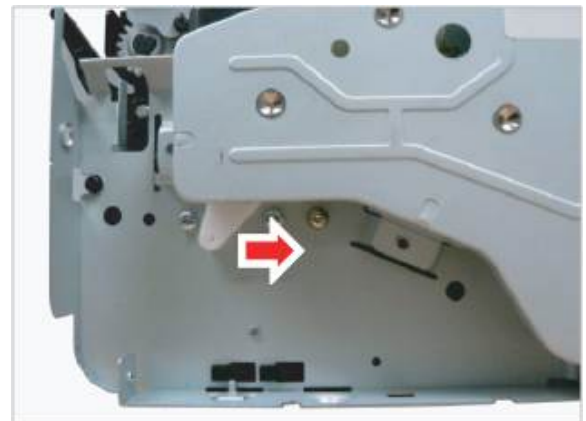

3.3.10. Pick up and Regi Clutch

1. Remove the left cover. (Refer to 3.3.1)
2. Remove the washer securing the clutch. Unplug the connector on Joint PBA. And release the clutch.

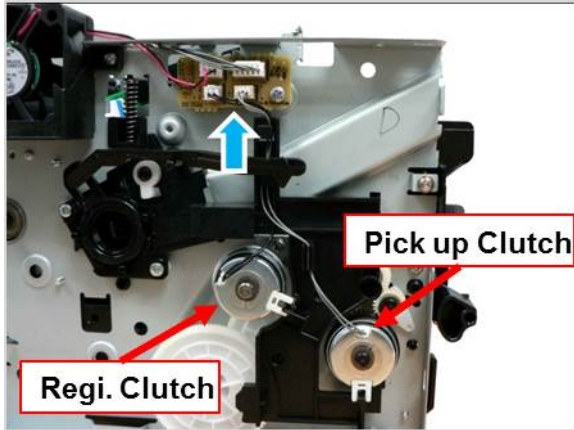

3.3.11. Duplex Unit

1. Remove the cassette, toner cartridge, and imaging unit. And then, remove 4 screws securing the rear cover.



2. Open the rear cover. Release both hooks of the rear cover. And remove the rear cover.

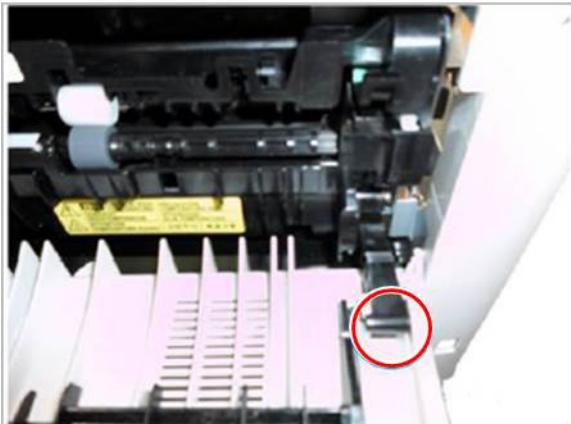
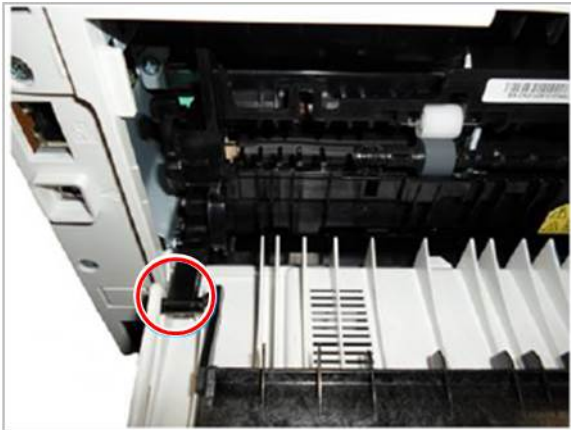

3. Stand the machine. Push the green handle to release the duplex unit.



4. Pull off the hinge, then remove the Duplex Unit to upward.

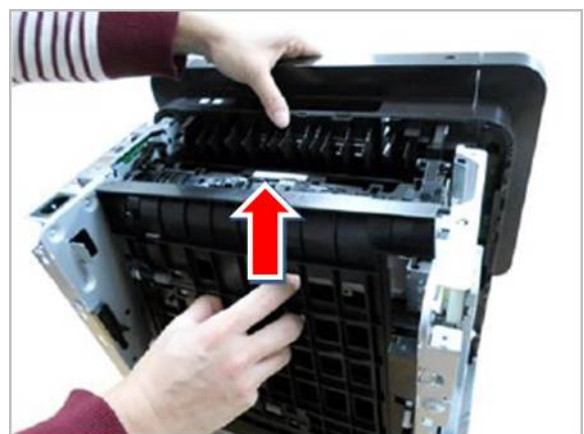

3.3.12. Transfer Roller

1. Open the front cover. Remove the toner cartridge and imaging unit.
2. Remove the green holder. And the, remove the transfer roller.

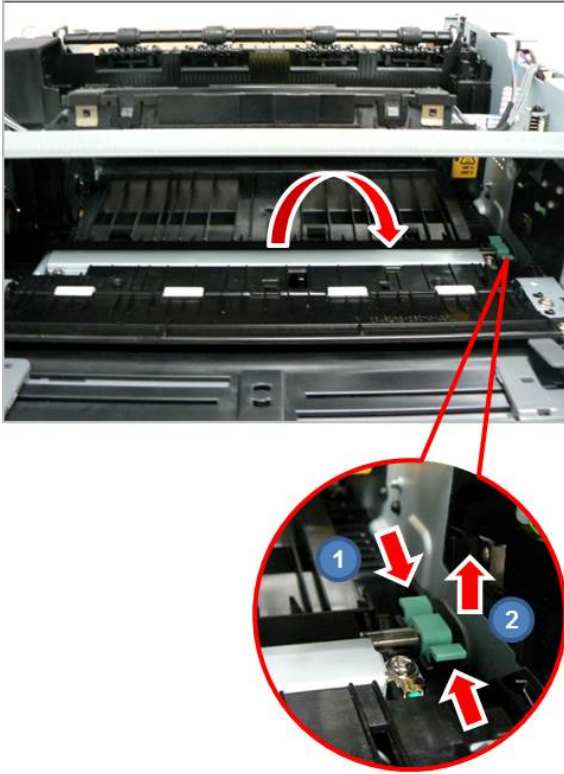

3.3.13. LSU

1. Remove the top cover. (Refer to 3.3.4)
2. Unplug 2 flat cables. Remove 3 screws. And release the LSU.



3.3.14. Exit Sensor

1. Remove the fuser unit. (**Refer to 3.2.1**)
2. Release the exit sensor after unplugging the harness.



3.3.15. Feed and Regi sensor PBA

1. Remove the duplex unit. (Refer to 3.3.11)
2. Remove 1 screw.



4. Remove the sensor PBA after unplugging the harness.

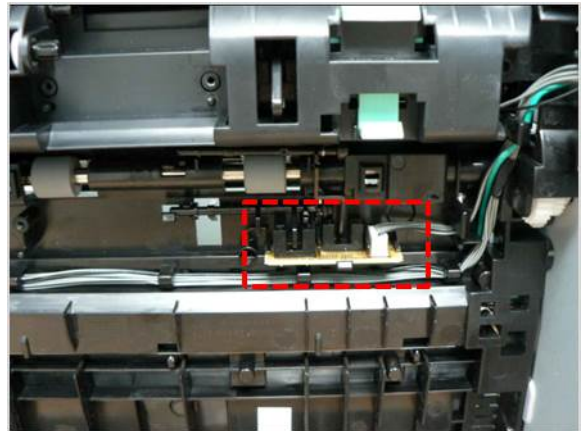

3. Remove the sensor cover while pushing the hook.

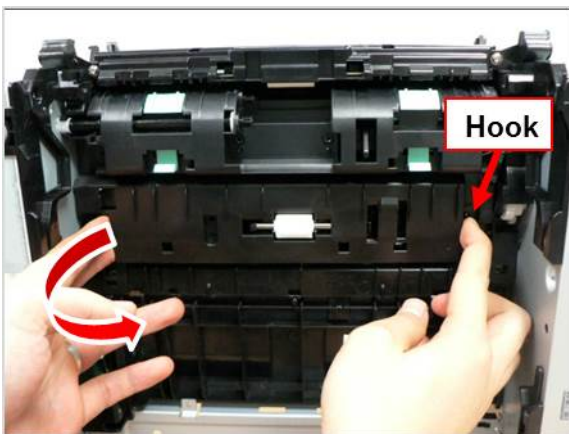

3.3.16. OPE PBA

1. Remove the top cover. (**Refer to 3.3.4**)
2. Remove 2 screws securing the OPE PBA.
3. Unplug the harness. And then, release the OPE PBA from the top cover.

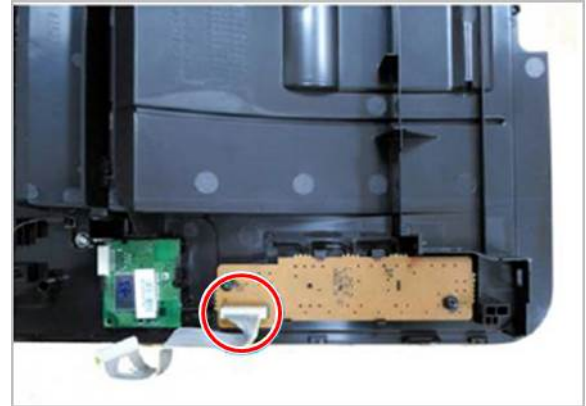
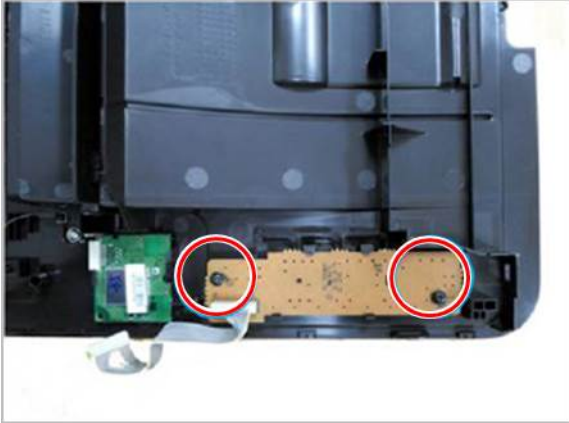

3.3.17. WLAN PBA (SL-M3015DW only)

1. Remove the top cover. (**Refer to 3.3.4**)
2. Release the WLAN PBA.

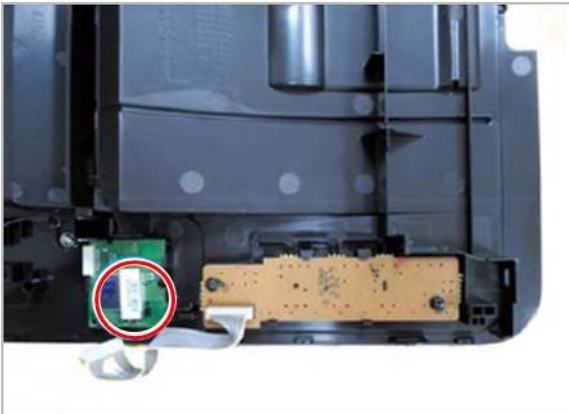

3.3.18. Main Motor

1. Remove the toner cartridge and imaging unit.
2. Remove the all covers. (Refer to 3.3.1 ~ 3.3.4)
3. Stand the machine. Remove 2 screws. And remove PLATE-BOTTOM.



4. Remove the Duplex unit while pushing green buttons.

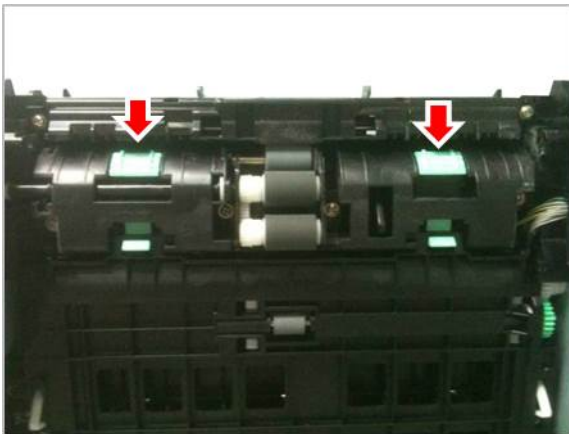

5. Remove 1 screw and GROUND-SAW. And unplug the motor harness.

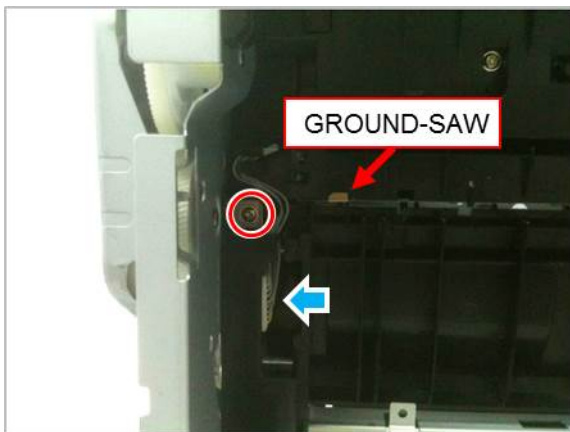

6. Remove GEAR-RDCN EXIT, GEAR-IDLE EXIT, GEAR-EXT. And then, remove the pick up clutch, regi clutch, and GEAR-FEED.

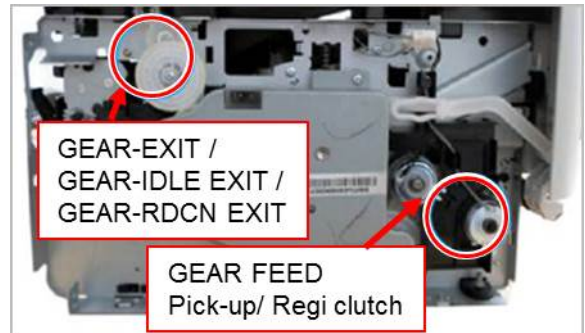

7. Remove 10 screws.

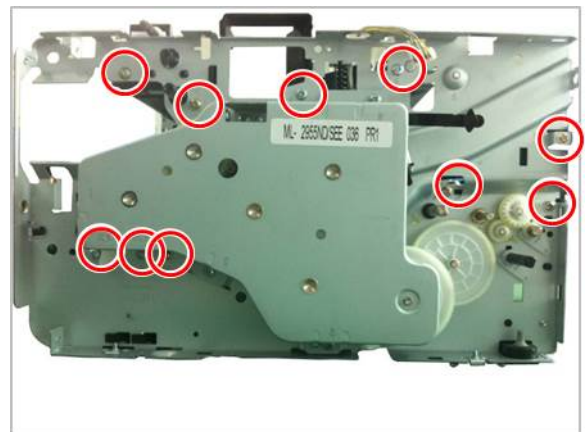

8. Separate the left frame from the machine.

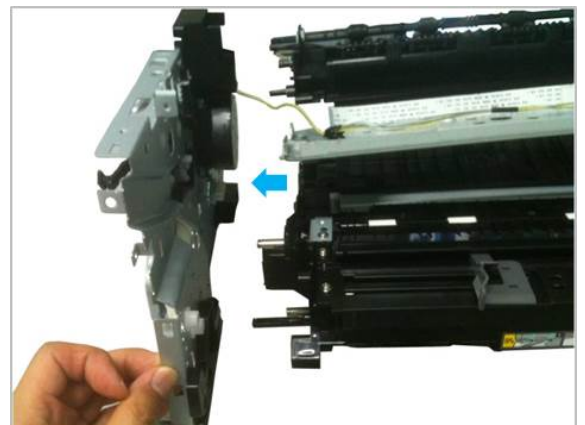

9. Remove 4 screws. And then, release the main motor.

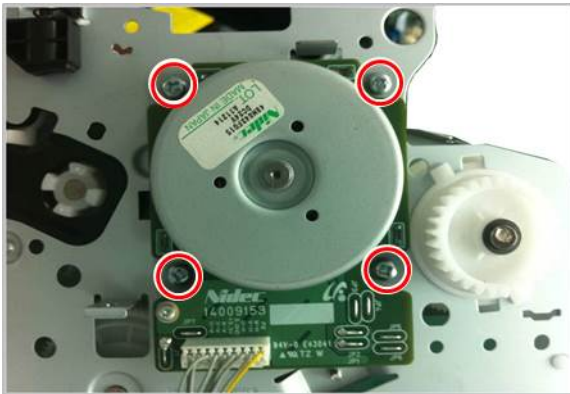

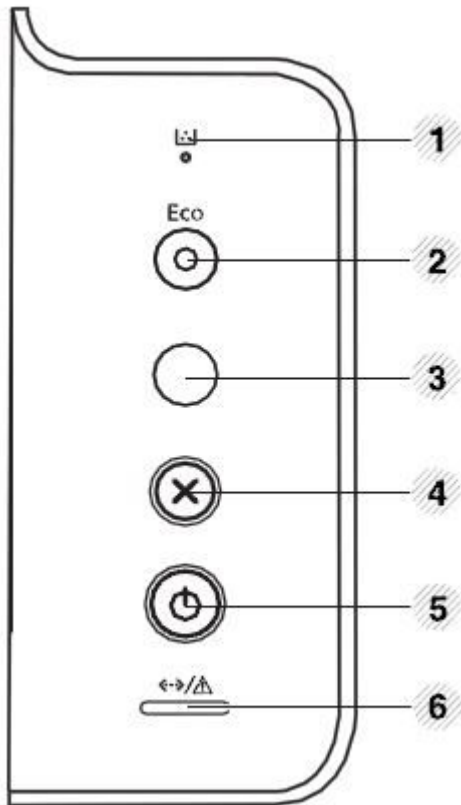

4. Troubleshooting

4.1. Control panel



1		Toner	Shows the status of the toner.
2		Eco	Enters Eco mode to reduce toner consumption and paper usage.
3		Info sheet	Prints a demo page and network configuration report.
		WPS	Configures the wireless network connection easily without a computer.
4		Cancel	Stops an operation at any time and there are more functions. <ul style="list-style-type: none"> • Cancels the current job. • Prints demo page: Press and hold this button for about 2 seconds until the status LED blinks slowly, and release. • Supplies Info & Usage Counter: Press and hold this button for about 6 seconds and release. • Prints configuration reports/network configuration reports: Press and hold this button for about 4 seconds until the status LED blinks fast, and release.

4. Troubleshooting

5		Power	You can turn the power on/off or wake the machine up from the power save mode with this button.
6		Status LED	Indicates the status of your machine.

4.2. Understanding the LEDs

The color of the Status indicates the machine's current status.

NOTE

- Some LEDs may not be available depending on model or country
- To resolve the error, look at the error message and its instructions from the troubleshooting part.
- You also can resolve the error with the guideline from the computers's Samsung Printing Status program window.





Status LED

Status	Description		
 (Status LED)	Off	<ul style="list-style-type: none"> • The machine is off-line. • The machine is in power save mode. 	
	Green	Blinking	<ul style="list-style-type: none"> • When the backlight slowly blinks, the machine is receiving data from the computer. • When the backlight blinks rapidly, the machine is printing data.
		On	<ul style="list-style-type: none"> • The machine is on-line and can be used.
	Red	Blinking	<ul style="list-style-type: none"> • A minor error has occurred and the machine is waiting for the error to be cleared. When the problem is cleared, the machine resumes.
		On	<ul style="list-style-type: none"> • The cover is opened. Close the cover. • There is no paper in the tray when receiving or printing data. Load paper in the tray. • The machine has stopped due to a major error. Reboot the power and try the printing job again. • An imaging unit has almost reached its estimated cartridge life. It is recommended to replace the imaging unit
	Orange	Blinking	<ul style="list-style-type: none"> • Upgrading firmware.
		On	<ul style="list-style-type: none"> • A paper jam has occurred.

NOTE

When the imaging unit has reached its end of life, the machine will stop printing. In this case, you can choose to stop or continue printing from the SyncThru™Web Service (Settings > Machine Settings > System > Setup > Supplies Management > Imaging Unit Stop) or Samsung Easy Printer Manager (Device Settings > System > Supplies Management > Imaging Unit Stop). Turning off this option and continuing to print may damage the device's system.

Toner LED/ WPS LED/ Power LED/ Eco LED

Status		Description	
 (Toner LED)	Orange	Blinking	Small amount of toner is left in the cartridge. The estimated cartridge life of toner is close. Prepare a new cartridge for replacement. You may temporarily increase the printing quality by redistributing the toner.
		On	A toner cartridge has almost reached its estimated cartridge life. It is recommended to replace the toner cartridge.
		Off	All toner cartridges are at normal capacity.
 (WPS LED)	Blue	Blinking	The machine is connecting to a wireless network.
		On	The machine is connected to a wireless network.
		Off	The machine is disconnected from a wireless network.
 NOTE Wireless model only			
 (Power LED)	Blue	On	The machine is in power save mode.
		Off	The machine is in ready mode or the machine's power is off.
 (Eco LED)	Green	On	Eco mode is on.
		Off	Eco mode is off.

 **NOTE**

- Estimated cartridge life means the expected or estimated toner cartridge life, which indicates the average capacity of print-outs and is designed pursuant to ISO/IEC 19752. The number of pages may be affected by operating environment, printing interval, graphics, media type and media size. Some amount of toner may remain in the cartridge even when orange LED is on and the printer stops printing.

4.3. Updating Firmware

This chapter includes instructions for updating the printer firmware. You can update the printer firmware by using one of the following methods :

- Update the firmware by using the USB cable.
- Update the firmware by using the network.

 **NOTE**

Please do not turn off the printer/MFP and your computer until firmware update finishes.

If you are using USB connection, disconnect all other USB printers from the PC.

The firmware update you are about to install has been tested for compatibility with Samsung toner cartridge products **ONLY**. Installing The upgrade may cause a non-Samsung toner cartridge to malfunction.

Do not run your printer during the firmware update.(Do not have any print job)

4.3.1. Update the firmware by using the USB port

How to update the firmware using a USB cable

- 1) Make sure that the machine is connected to the PC with a USB cable. Check if the printer is the ready status.
- 2) Download the firmware file to your PC. Unzip the file.
- 3) Drag the SWUPGRADE_ON.prn file and drop down it on the usblast2.exe.

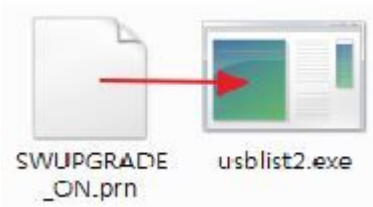

- 4) Drag the firmware file(*.hd) and drop down it on the usblast2.exe.

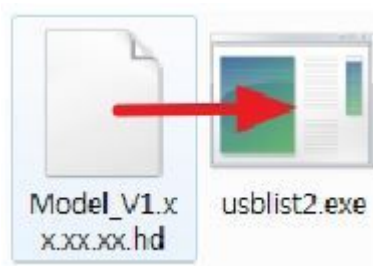

And then firmware update will be started automatically.

- 5) Once the firmware update is complete, the machine will be rebooted automatically.

4.3.2. Updating from the Network



WARNING

Failure to follow these instructions could lead to corruption issues and prevent the proper operation of this printer. Follow all of the instructions carefully.

Perform the following procedure to update the printer firmware from the network.

- 1) Access a web browser, such as Internet Explorer, from Windows. Enter the machine IP address (<http://xxx.xxx.xxx.xxx>) in the address field and press the Enter key or click Go. When the main page of the SyncThruWeb Service (SWS) displays, login as Admin in Sync Thru Web Service.



NOTE

- Login using the Administrator ID and Password established during initial machine setup.
- If Admin ID and password is not established, use the default value. (ID: admin / Password: sec00000)

The screenshot displays the Samsung SyncThru Web Service interface for an M453x Series printer. The main page shows a warning icon and the text "Status: Warning" and "Alert: 1 Alert(s) Occurred" with the message "Paper Low in tray 2". A "Control Panel Update" button is visible. A "Login" dialog box is overlaid on the page, prompting for "ID" and "Password" with a "LOGIN" button. The background interface includes sections for "Supplies Information" (Toner Cartridge) and "Input Trays".

4. Troubleshooting

2) Click on **Maintenance > Firmware Upgrade > Upgrade Wizard**.

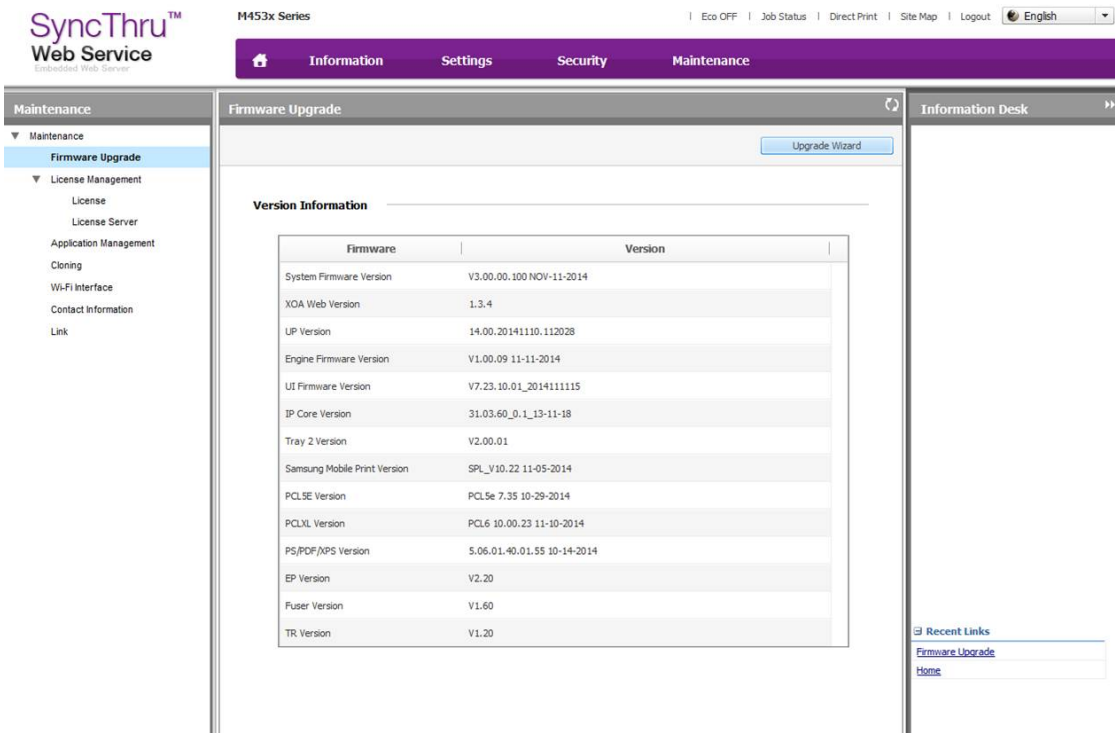

3) Choose installation file (F/W file) by browsing the file system and click [OK].

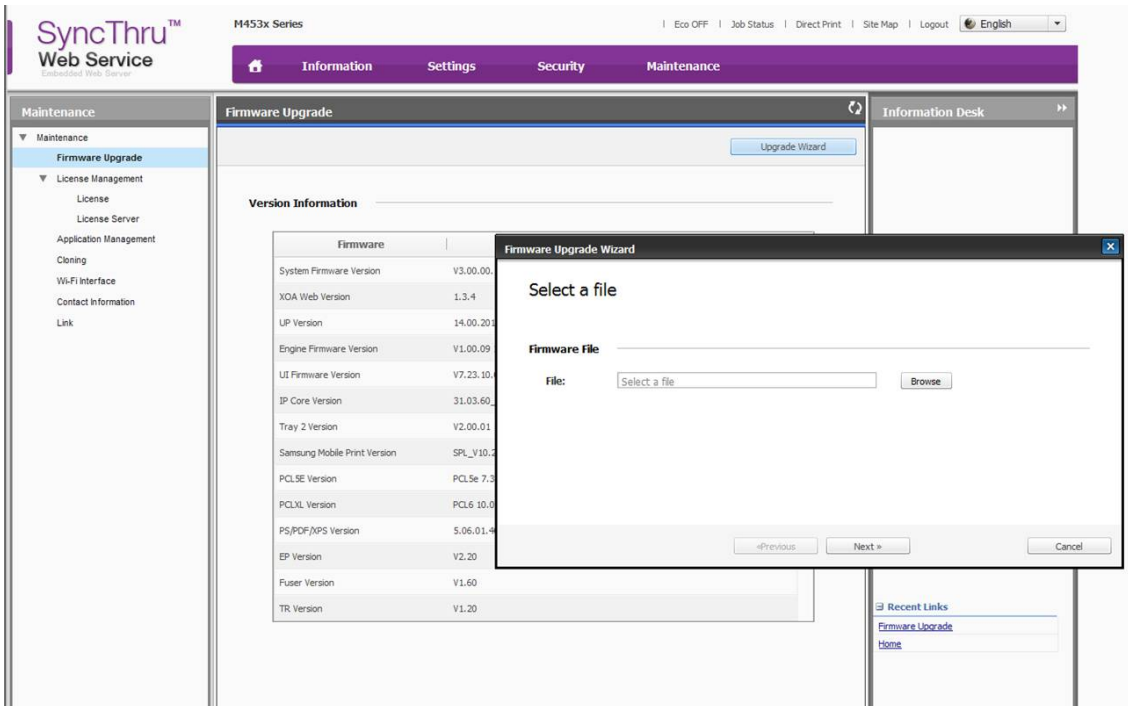

- 4) The uploading step will start and verify installation file (F/W file).

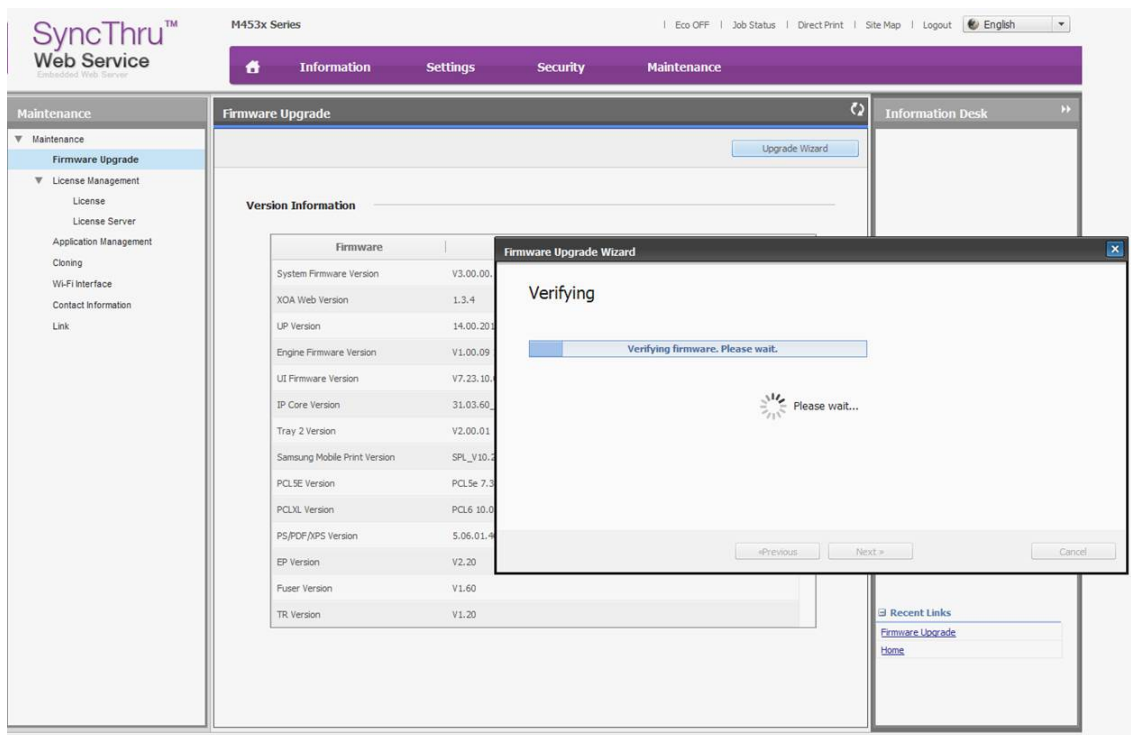

- 5) After uploading the f/w file on printer, validation information will appear. Check Firmware version and click Next to upgrade Firmware and press **[Next]** to start the firmware upgrade.

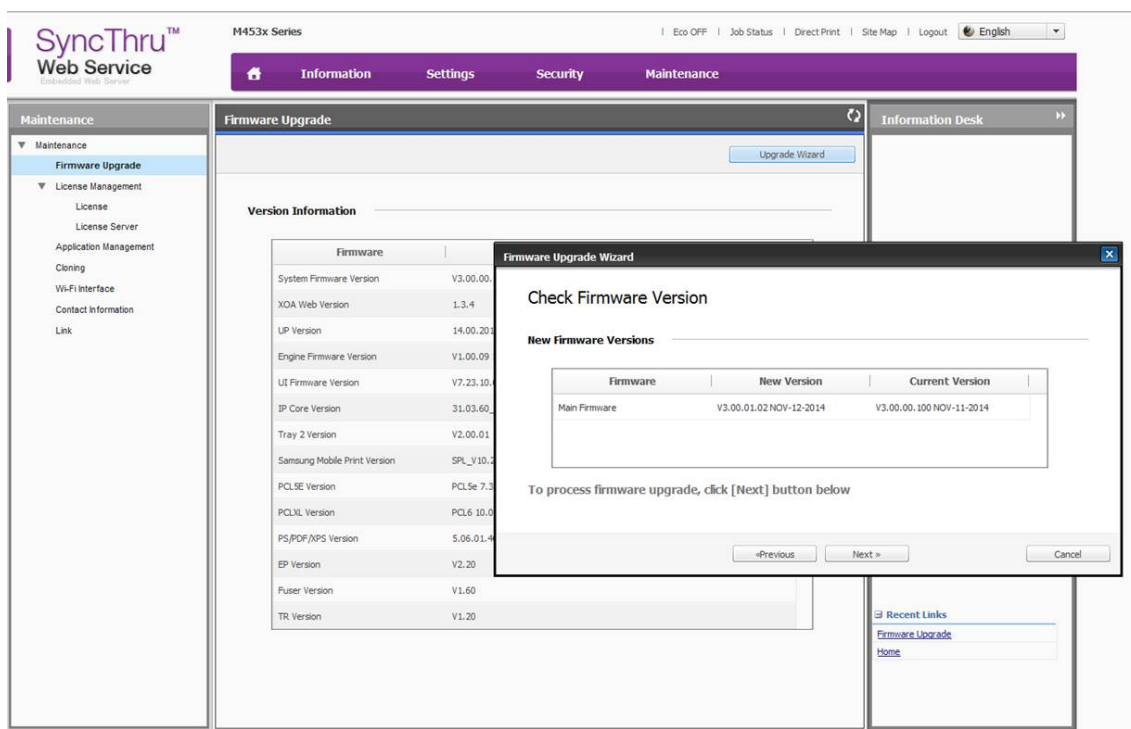

4. Troubleshooting

6) The firmware update will start.

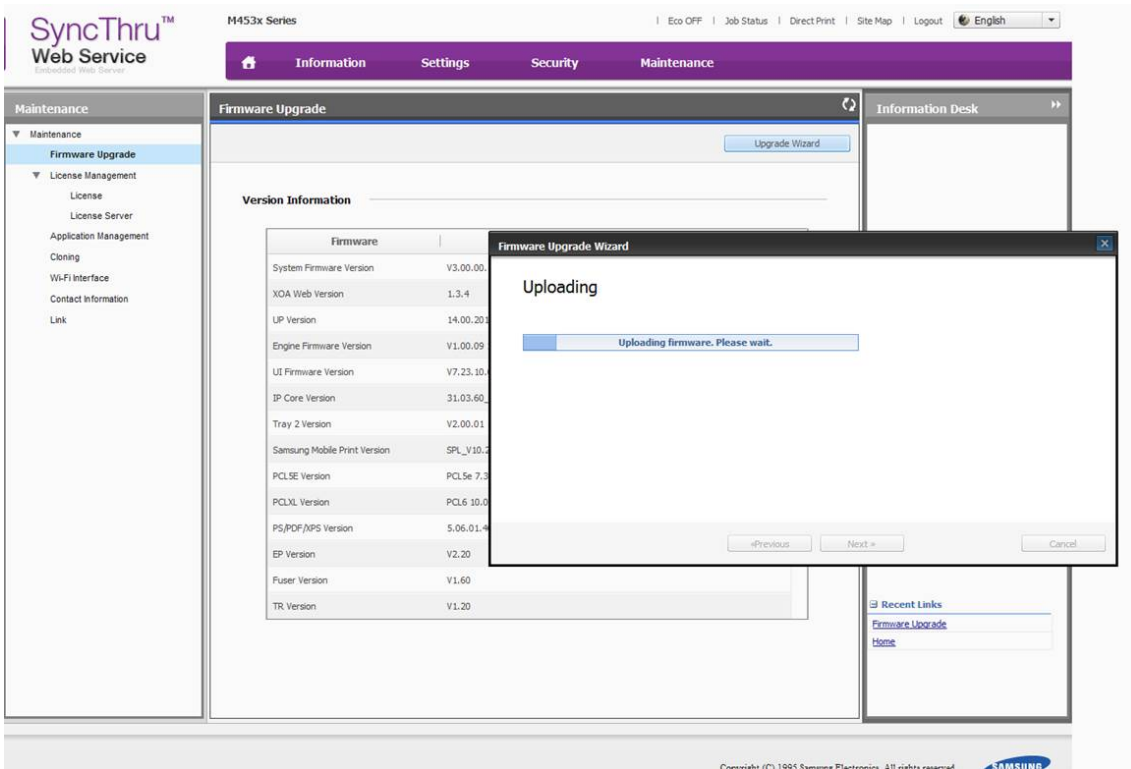

7) Once the installation is complete, the machine power-off and power-on automatically.

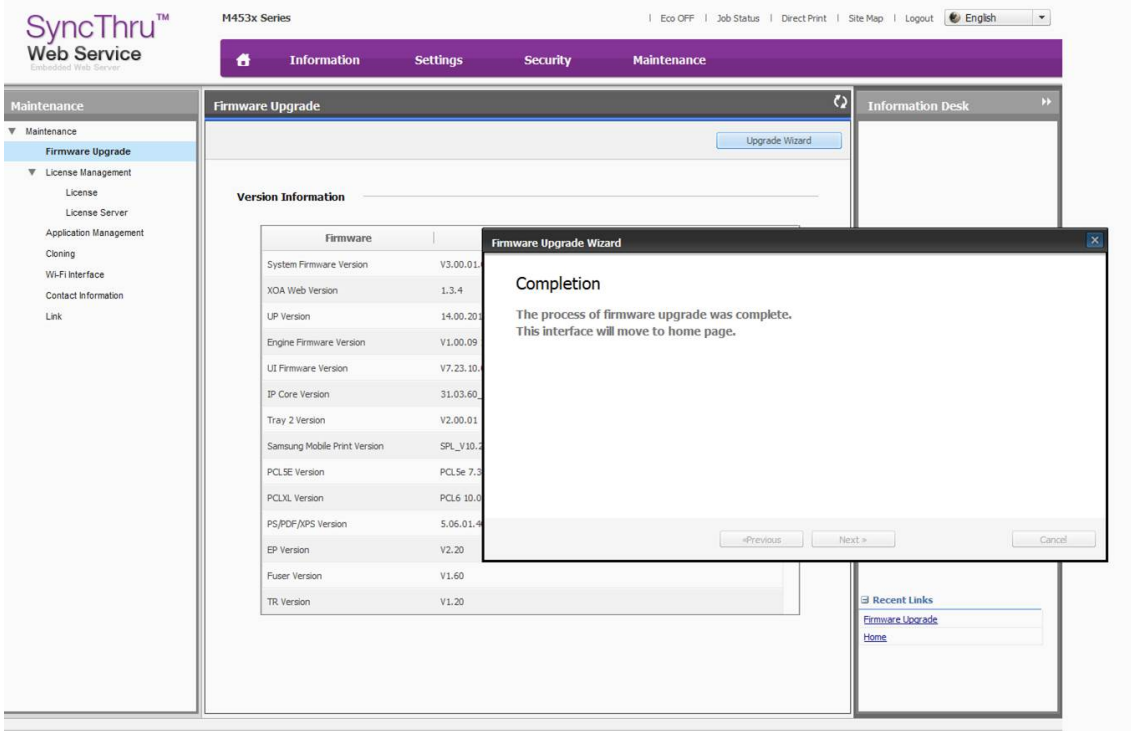

4.4. Clearing paper jams

If a paper jam occurs, the status LED on the control panel lights orange. Find and remove the jammed paper. To resume printing after clearing paper jams, you must open and close the front cover.

 **NOTE**

To avoid tearing the paper, pull the jammed paper out slowly and gently.

In tray 1

- 1) Pull out tray 1 .

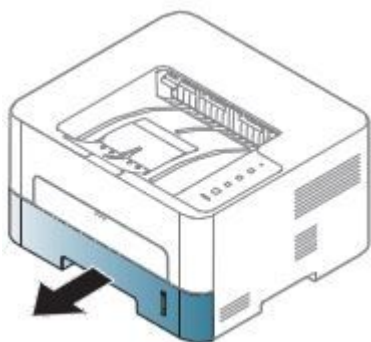

- 2) Remove the jammed paper by gently pulling it straight out.

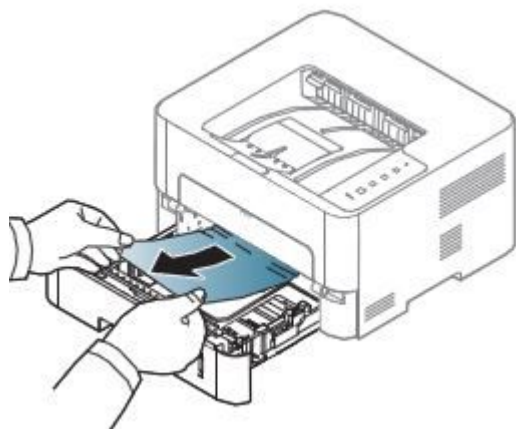

- 3) Insert tray 1 back into the machine until it snaps into place.

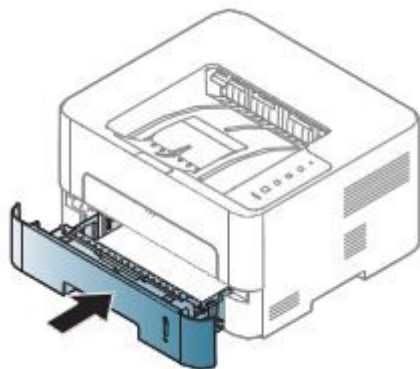

In the multi-purpose tray

- 1) If the paper is not feeding properly, pull the paper out of the machine.

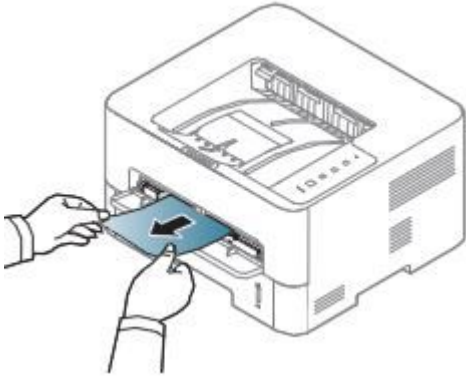

Inside the machine



CAUTION

The Fuser area is hot. Please wait until device cools down before accessing this area. Turn power off to cool the machine down. Take care when removing paper from the machine.

- 1) Open the front cover. And then, pull the toner cartridge out.

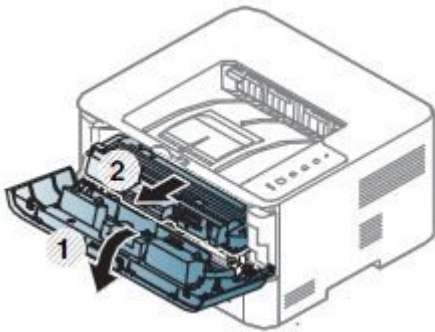

- 2) Open the jam guide. And then, remove the jammed paper by gently pulling it straight out.

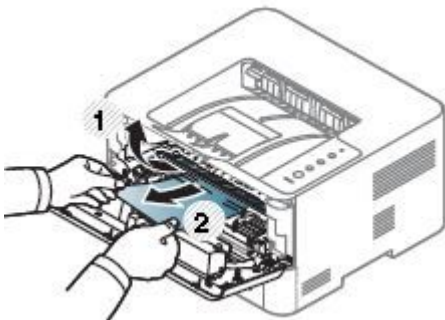

- 3) Close the jam guide.

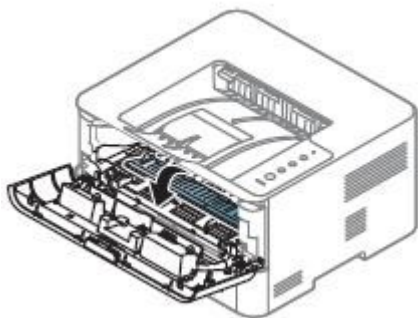

- 4) Insert the toner cartridge and close the front cover.

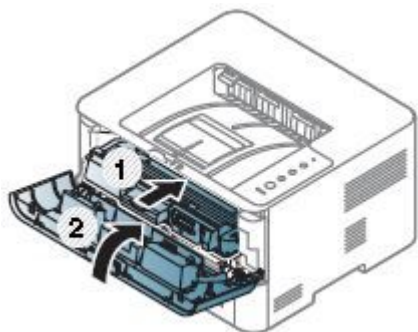

In exit area



CAUTION

The Fuser area is hot. Please wait until device cools down before accessing this area. Turn power off to cool the machine down. Take care when removing paper from the machine.

- 1) Remove the jammed paper from the exit tray.

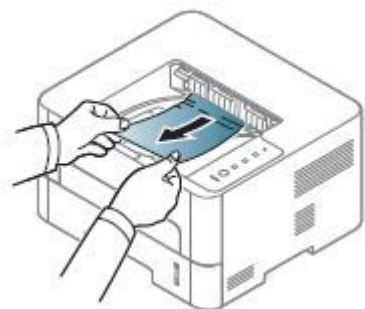

If you do not see the paper in this area, stop and go to next step :

- 2) Open the rear cover.

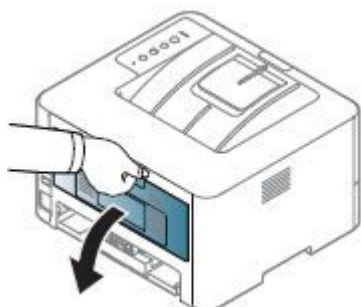

4. Troubleshooting

- 3) Open the fuser jam cover.

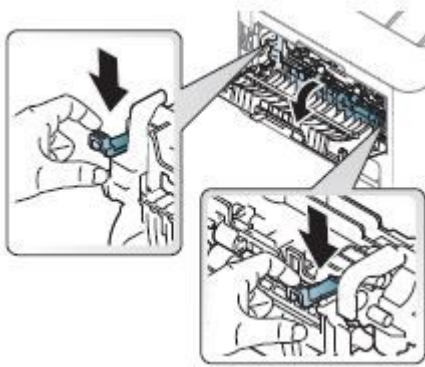

- 4) Remove the jammed paper gently by pulling it straight out.

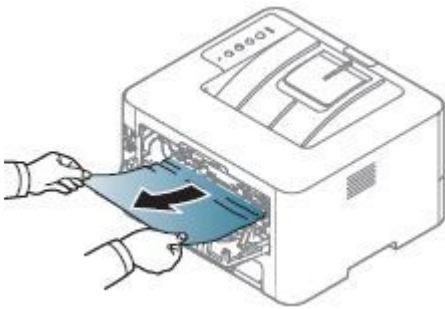

- 5) Close the fuser jam cover.

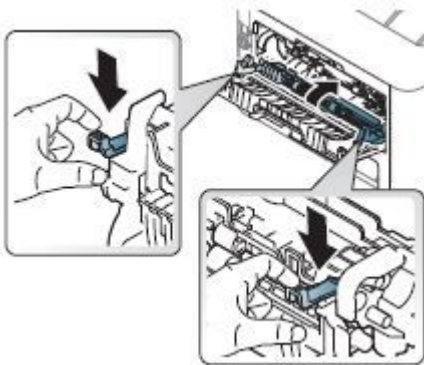

- 6) Close the rear cover.



In the duplex unit area

- 1) Open the rear cover.

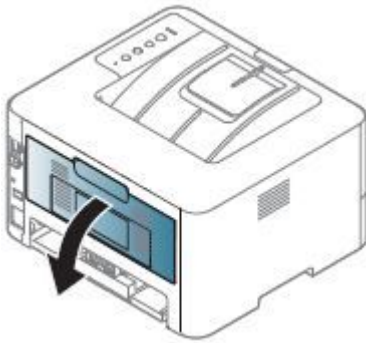

- 2) Remove the jammed paper by gently pulling it straight out.

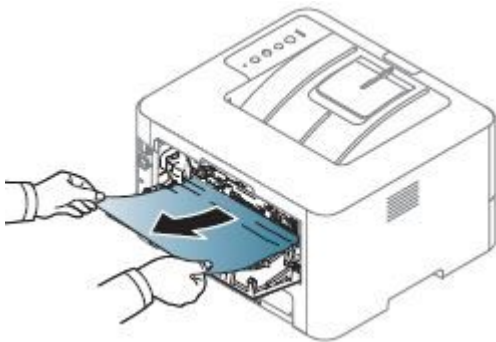

- 3) Close the rear cover.

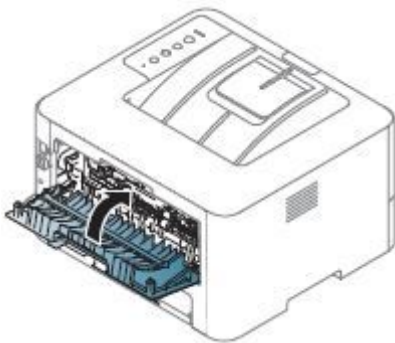

If you do not see the paper in this area, stop and go to next step:

- 4) Pull out the tray.

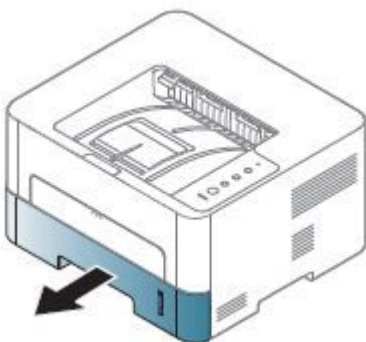

4. Troubleshooting

- 5) Open the duplex unit by pushing both buttons.

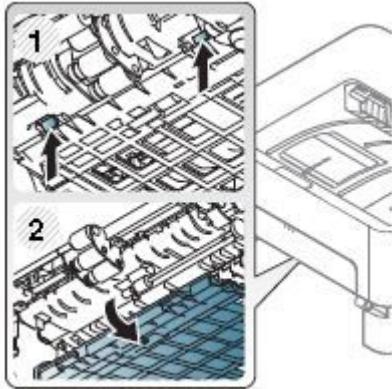

- 6) Remove the jammed paper gently by pulling it straight out.

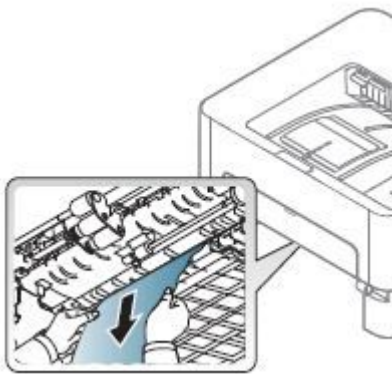

- 7) Close the duplex unit.

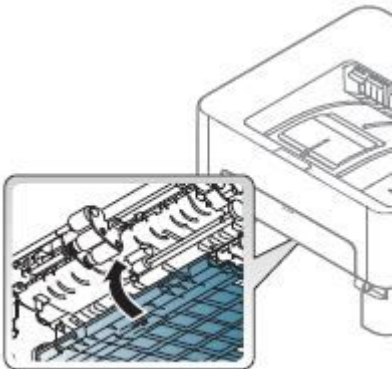

- 8) Insert the tray.

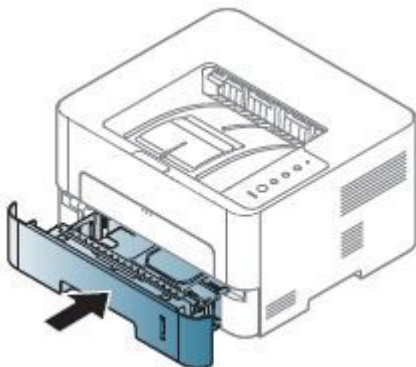

4.5. Useful management tools

4.5.1. SyncThru™ Web Service

This chapter gives you step-by-step instructions for setting up the network environment through SyncThru™ Web Service.

**NOTE**

- Internet Explorer 8.0 or higher is the minimum requirement for SyncThru™ Web Service.
- Some menus may not appear on the display screen depending on the settings or models. If so, it is not applicable to your machine.

What is SyncThru™ Web Service?

If you have connected your machine to a network and set up TCP/IP network parameters correctly, you can manage the machine via SyncThru™ Web Service. Use SyncThru™ Web Service to :

- View the machine's device information and check its current status.
- Change TCP/IP parameters and set up other network parameters.
- Change the printer preference.
- Get support for using the machine.
- Upgrade machine firmware.

Accessing SyncThru™ Web Service

- 1) Access a web browser, such as Internet Explorer, from Windows. Enter the machine IP address of your printer (<http://xxx.xxx.xxx.xxx>) in the address field and press the Enter key or click Go.
- 2) Your machine's SyncThru™ Web Service website opens.

Logging into SyncThru™ Web Service

Before configuring options in SyncThru™ Web Service, you need to log-in as an administrator. You can still use SyncThru™ Web Service without logging in but you won't have access to Settings tab and Security tab.

- 1) Click Login on the upper right of the SyncThru™ Web Service website.
- 2) Type in the ID and Password then click Login. Type in the below default ID and password. We recommend you to change the default password for security reasons.
 - ID: admin
 - Password: sec00000

Information tab

This tab gives you general information about your machine. You can check things, such as remaining amount of toner. You can also print reports, such as an error report.

- **Active Alerts:** Shows the alerts that have occurred in the machine and their severity.
- **Supplies:** Shows how many pages are printed and amount of toner left in the cartridge.
- **Usage Counters:** Shows the usage count by print types: simplex and duplex.
- **Current Settings:** Shows the machine's and network's information.

- **Print Information:** Prints reports such as system related reports, e-mail address, and font reports.

Settings tab

This tab allows you to set configurations provided by your machine and network. You need to log-in as an administrator to view this tab.

- **Machine Settings:** Sets options provided by your machine.
- **Network Settings:** Shows options for the network environment. Sets options such as TCP/IP and network protocols.

Security tab

This tab allows you to set system and network security information. You need to log-in as an administrator to view this tab.

- **System Security:** Sets the system administrator's information and also enables or disables machine features.
- **Network Security:** Sets settings for HTTPs, IPsec, IPv4/IPv6 filtering, 802.1x, and Authentication servers.

Maintenance tab

This tab allows you to maintain your machine by upgrading firmware and setting contact information for sending emails. You can also connect to Samsung website or download drivers by selecting the Link menu.

- **Firmware Upgrade :** Upgrade your machine's firmware.
- **Contact Information:** Shows the contact information.
- **Link:** Shows links to useful sites where you can download or check information.

4.5.2. Samsung Easy Printer Manager

Samsung Easy Printer Manager is an application that combines Samsung machine settings into one location. Samsung Easy Printer Manager combines device settings as well as printing environments, settings/actions and launching. All of these features provide a gateway to conveniently use your Samsung machine.

NOTE

- Available for Windows and Mac OS users only.
- For Windows, Internet Explorer 6.0 or higher is the minimum requirement for Samsung Easy Printer Manager.

Understanding Samsung Easy Printer Manager

To open the program :

For Windows,

Select Start > Programs or All Programs > Samsung Printers > Samsung Easy Printer Manager .





For Mac,

Applications Folder > Samsung Folder > Samsung Easy Printer Manager

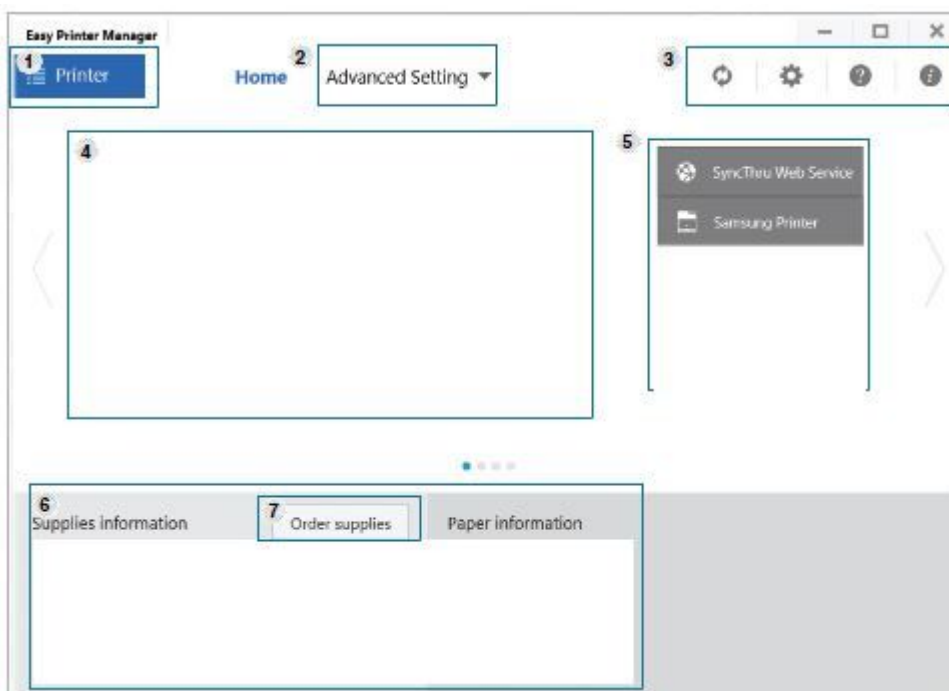
NOTE

The screenshot may differ depending on operating system you are using.



1	Printer list	The Printer List displays printers installed on your computer and network printers added by network discovery (Windows only).
2	Advanced Setting	<p>The advanced user interface is intended to be used by the person responsible for managing the network and machines.</p> <div data-bbox="603 360 1430 510" style="background-color: #e0e0e0; padding: 5px;">  NOTE Some menus may not appear in the display depending on options or models. If so, it is not applicable to your machine. </div> <ul style="list-style-type: none"> • Device Settings : You can configure various machine settings such as machine setup, paper, layout, emulation, network, and print information. <div data-bbox="647 618 1430 768" style="background-color: #e0e0e0; padding: 5px;">  NOTE If you connect your machine to a network, the SyncThru™ Web Service icon is enabled. </div> <ul style="list-style-type: none"> • Alert Settings (Windows only) : This menu includes settings related to error alerting. <ul style="list-style-type: none"> • Printer Alert : Provides settings related to when alerts will be received. • Email Alert : Provides options relating to receiving alerts via email. • Alert History : Provides a history of device and toner related alerts.
3	Application information	Includes links for changing to the refresh, preference setting, help, and about.
4	Printer information	<p>This area gives you general information about your machine. You can check information, such as the machine's model name, IP address (or Port name), and machine status.</p> <div data-bbox="603 1189 1430 1339" style="background-color: #e0e0e0; padding: 5px;">  NOTE This button opens the Troubleshooting Guide when an error occurs. You can directly open the troubleshooting section in the user's guide. </div>
5	Quick links	<p>Displays Quick links to machine specific functions. This section also includes links to applications in the advanced settings.</p> <div data-bbox="603 1442 1430 1592" style="background-color: #e0e0e0; padding: 5px;">  NOTE If you connect your machine to a network, the SyncThru™ Web Service icon is enabled. </div>
6	Contents area	Displays information about the selected machine, remaining toner level, and paper. The information will vary based on the machine selected. Some machines do not have this feature.
7	Order supplies	Click on the Order button from the supply ordering window. You can order replacement toner cartridge(s) from online.

4.6. EDC program

The EDC program can check the machine status and perform various test to isolate the cause of a malfunction.

1) How to use the EDC program

- 1) Download the EDC program in your PC.
- 2) Connect the printer to the computer using USB cable.
- 3) Turn on the printer and wait for the printer to finish initializing.
- 4) Start EDC program. Press the “Menu” Button

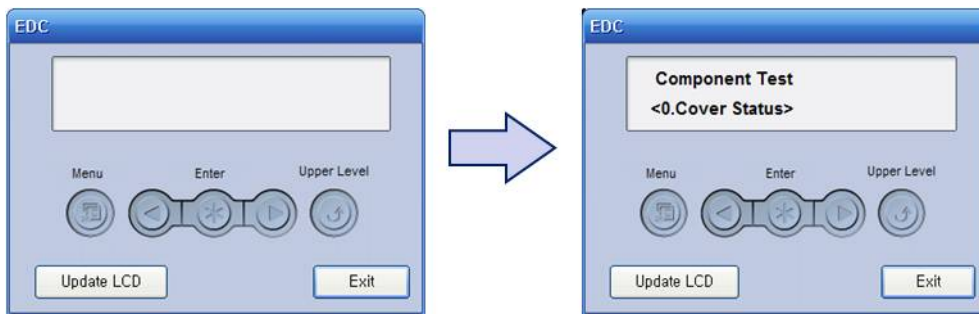

- 5) To exit the EDC Mode, press the “Exit” button.

EDC mode menu (Engine Diagnostic Test)

Code	Displayed Name	Meaning	I/O	Status
100-0000	Main BLDC Motor	Main BLDC Motor is On/Off	Output	On[Off]
100-0010	Main BLDC Motor Ready	Detect if Main BLDC Motor runs at normal speed	Input	High[Low]
101-0010	T1 Pick-Up Clutch	Engages drive to pick up a paper from tray1.	Output	On[Off]
101-0050	Registration Clutch	Engages drive to registration rolls.	Output	On[Off]
101-0190	Out-Bin Full Sensor	Detect when a paper is at Out bin full sensor.	Input	High[Low]
102-0010	T1 Paper Empty Sensor	Detect when paper is in Tray1	Input	High[Low]
102-0290	Feed Sensor	Detect when a paper is at Feed sensor.	Input	High[Low]
102-0360	Regi. Sensor	Detect when a paper is at Regi. sensor.	Input	High[Low]
102-0370	Exit Sensor	Detect when a paper is at Exit. sensor.	Input	High[Low]
105-0030	Black MHV Bias	Black MHV bias voltage on at normal drive level	Output	On[Off]
106-0030	Black Dev Bias	Black Dev bias voltage on at normal drive level	Output	On[Off]
107-0030	Black THV Bias	Black THV bias voltage on at normal drive level	Output	On[Off]
107-0031	Black THV(-) Bias	Black THV bias voltage on at normal drive level	Output	On[Off]
107-0070	Black THV Bias Read	Detect what the THV value is on the THV Roller	Input	Numeric 3 digits
109-0000	Fuser Temperature A	Detects what the temperature A is on fuser	Input	Numeric 3 digits
110-0000	LSU Motor1 Run Ready	Detects if LSU motor1 runs at normal speed	Input	High[Low]

4. Troubleshooting

Code	Displayed Name	Meaning	I/O	Status
110-0060	LSU Motor1 Run	LSU Motor1 On/Off	Output	On[Off]
110-0110	LSU LD Power4	LSU LD4 Power On/Off (black)	Output	On[Off]
110-0170	LSU Hsync4	Detect LSU Motor Hsync Signal	Input	High[Low]



NOTE

Acronyms and Abbreviations

- DEV Bias- Developing High Voltage Bias
- EDC - Embedded Diagnostic Control
- LD – Laser Diode
- LSU – Laser Scanning Unit
- MHV - Main High Voltage (Charge Voltage)
- THV - Transfer High Voltage

4.7. Troubleshooting

4.7.1. Procedure of checking the symptoms

Before attempting to repair the printer first obtain a detailed description of the problem from the customer.

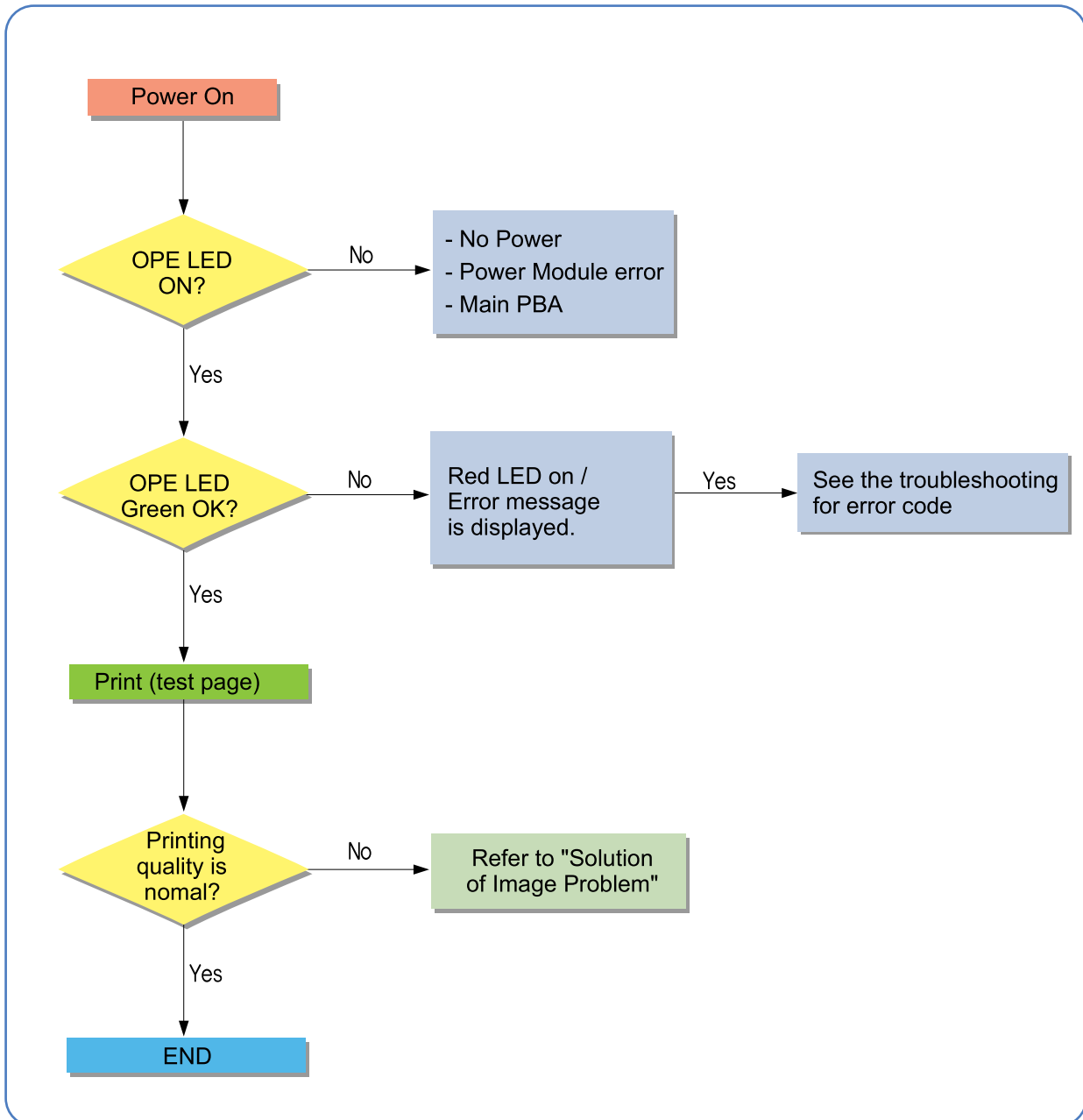

4.7.2. Error Code and Troubleshooting

Error in machine can be checked through “Event Log Information” report.

Error Code	Error Message	Troubleshooting
11-2T11	Tray 1 paper mismatch	P.4-33
11-2T71	Manual Paper Mismatch	P.4-33
A1-1110	Main Motor Failure: #A1-1110. Turn off then on. Call for service if the problem persists	P.4-34
C1-1110	Prepare new toner cartridge	P.4-35
C1-1150	Replace with new toner cartridge.	P.4-35
C1-1411	Toner cartridge is not installed. Install the cartridge	P.4-35
C1-1511	You are using a non-genuine cartridge now. It might cause malfunctioning or breakdown of this printer	P.4-36
C1-1512	Toner cartridge is not compatible. Check the user guide	P.4-36
C1-1711	Toner Cartridge Failure: #C1-1711. Call for service	P.4-36
C1-1712	Toner Cartridge Failure: #C1-1712. Call for service	P.4-36
C3-1110	Prepare new imaging unit	P.4-37
C3-1140	End of life, Replace with new imaging unit	P.4-37
C3-1150	Replace with new imaging unit	P.4-37
C3-1170	End of life. Replace with new imaging unit	P.4-37
C3-1411	Imaging unit is not installed. Install the unit	P.4-37
C3-1512	Imaging unit is not compatible. Check the user guide	P.4-37
M1-1110	Paper jam in tray 1. Please remove the paper	P.4-38
M1-1710	Paper jam in manual feeder. Please remove the paper	P.4-38
M1-5112	Paper is empty in tray 1. Load paper	P.4-39
M1-5113	Paper is empty in tray 1. Load paper	P.4-39
M1-5120	Paper is empty in all tray. Load paper	P.4-39
M1-5612	Paper is empty in MP tray. Load paper	P.4-39
M1-5712	Paper is empty in manual feeder. Load paper	P.4-39
M2-1110	Paper jam inside of machine. Please remove the paper	P.4-40
M2-2110	Paper jam at the top of duplex path. Please remove the paper	P.4-41
M2-2310	Paper jam at the bottom of duplex path. Please remove the paper	P.4-41
M3-1110	Paper jam in exit area. Please remove the paper	P.4-41
M3-1112	Paper jam inside of machine. Please remove the paper	P.4-41
M3-2130	Paper in output bin is full. Remove printed paper	P.4-42
S1-3212	Video Failure: #S1-3212. Please turn off then on. Call for service if the problem persists	P.4-43
S2-4110	Door is open. Close it.	P.4-43
S6-3123	This IP address conflicts with that of other system. Check it	P.4-44
S6-3210	Network Failure: #S6-3210. Turn off then on. Call for service if the problem persists	P.4-44
U1-2132	Fuser Unit Failure: #U1-2132. Turn off then on. Call for service if the problem persists	P.4-45

Error Code	Error Message	Troubleshooting
U1-2315	Fuser Unit Failure: #U1-2315. Turn off then on. Call for service if the problem persists	P.4-45
U1-2320	Fuser Unit Failure: #U1-2320. Turn off then on. Call for service if the problem persists	P.4-45
U1-2330	Fuser Unit Failure: #U1-2330. Turn off then on. Call for service if the problem persists	P.4-45
U1-2334	Fuser Unit Failure: #U1-2334. Turn off then on. Call for service if the problem persists	P.4-45
U1-2340	Fuser Unit Failure: #U1-2340. Turn off then on. Call for service if the problem persists	P.4-45
U1-234H	Fuser Unit Failure: #U1-234H. Turn off then on. Call for service if the problem persists	P.4-45
U2-1112	LSU Failure: #U2-1112. Turn off then on. Call for service if the problem persists	P.4-46
U2-1113	LSU Failure: #U2-1113. Turn off then on. Call for service if the problem persists	P.4-46

▶ **Error Code**

11-2T11 / 11-2T71

▶ **Error message**

Tray 1 paper mismatch

Manual Paper Mismatch

▶ **Symptom**

Paper in tray is not matched to the machine paper setting.

▶ **Troubleshooting method**

- 1) Check and change the paper setting of the corresponding tray properly.

► Error Code**A1-1110****► Error message****Main Motor Failure: #A1-1110. Turn off then on. Call for service if the problem persists****► Symptom**

After working the main BLDC motor, the Ready signal has not occurred within 1 sec.

► Troubleshooting method

- 1) Turn the machine off then on. If the error persists, refer to the following.
- 2) Check if the motor connector on the main board is connected properly. Reconnect it.
- 3) OPC coupler has overloaded. After removing the imaging unit, rotate the OPC coupler. (Spec : 6 kgf.cm) If there is any damage, the OPC coupler can't rotate well. Replace the imaging unit.
- 4) The main BLDC motor is defective.
 - Unplug the connector from the motor carefully.
 - Replace the main BLDC motor with new one.

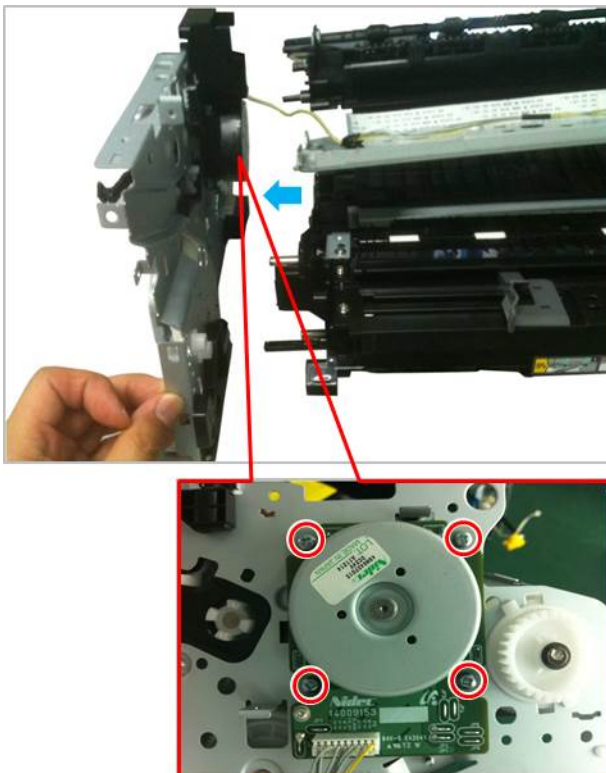

- 5) If the problem persists, replace the main board.

▶ **Error Code**

C1-1110 / C1-1150

▶ **Error message**

Prepare new toner cartridge.

Replace with new toner cartridge.

▶ **Symptom**

The remaining toner cartridge is less than 10% / The toner cartridge is at the end of its life.

▶ **Troubleshooting method**

Check the life remaining of the toner cartridge.

If its life is at the end, turn the machine off and replace the toner cartridge with new one.

▶ **Error Code**

C1-1411 / C1-1414

▶ **Error message**

Toner cartridge is not installed. Install the cartridge.

▶ **Symptom**

The toner cartridge is not installed. / The machine can't detect the toner cartridge.

▶ **Troubleshooting method**

- 1) Turn the machine off then on.
- 2) Remove the toner cartridge. Thoroughly roll the cartridge five or six times to distribute the toner evenly inside the cartridge. And reinstall the toner cartridge.
- 3) Check if the CRUM contact area is contaminated. Clean it.

▶ Error Code

C1-1511 / C1-1512 / C1-1515 / C1-1517 / C1-1518

▶ Error message

You are using a non-genuine cartridge now. It might cause malfunctioning or breakdown of this printer
Toner cartridge is not compatible. Check the user guide

▶ Symptom

Toner cartridge is not compatible.

▶ Troubleshooting method

- 1) Open the front cover. Remove the toner cartridge.
- 2) Check if the label information of the toner cartridge is same with the machine's one. (ex. /SEE)
- 3) If label information is different from the machine or the toner cartridge is not a samsung genuine, replace it with a new one.

▶ Error Code

C1-1711 / C1-1712 / C1-1713 / C1-1714

▶ Error message

Toner Cartridge Failure: #C1-171x. Call for service

▶ Symptom

The data of CRUM is not detected. / CRUM is defective.

▶ Troubleshooting method

- 1) Open the front cover. Check if the toner cartridge is installed.
- 2) Remove and reinstall the toner cartridge.
- 3) Check if the contact terminal is contaminated or broken. Clean the contact terminal.
- 4) Check if the CRUM harness is connected correctly. Reconnect it.
- 5) If the harness is defective, replace it.
- 6) If the problem persists, replace the toner cartridge with new one.

▶ **Error Code**

C3-1110 / C3-1140 / C3-1150 / C3-1170

▶ **Error message**

Prepare new imaging unit

End of life, Replace with new imaging unit

Replace with new imaging unit

▶ **Symptom**

Imaging unit is at the end of its life.

▶ **Troubleshooting method**

Check the life remaining of the imaging unit.

If its life is at the end, turn the machine off and replace the imaging unit with new one.

▶ **Error Code**

C3-1411

▶ **Error message**

Imaging unit is not installed. Install the unit

▶ **Symptom**

The imaging unit is not installed. / The machine can't detect the imaging unit.

▶ **Troubleshooting method**

- 1) Open the front cover. Check if the imaging unit is installed.
- 2) Remove and reinstall the imaging unit.
- 3) Check if the contact terminal is contaminated or broken. Clean the contact terminal.
- 4) Check if the CRUM harness is connected correctly. Reconnect it.
- 5) If the harness is defective, replace it.
- 6) If the problem persists, replace the imaging unit with new one.

▶ **Error Code**

C3-1512

▶ **Error message**

Imaging unit is not compatible. Check the user guide

▶ **Symptom**

Imaging unit is not compatible.

▶ **Troubleshooting method**

- 1) Open the front cover. Remove the imaging unit.
- 2) Check if the label information of the imaging unit is same with the machine's one. (ex. /SEE)
- 3) If label information is different from the machine or the imaging unit is not a samsung genuine, replace it with a new one.

▶ Error Code**M1-1110****▶ Error message**

Paper jam in tray 1. Please remove the paper

▶ Symptom

The jammed paper has occurred in the tray.

▶ Troubleshooting method

- 1) Clear the jam from the tray1.
- 2) Remove the tray. Check if the loaded paper is in proper place. Align it.
- 3) If the jammed paper occurred before entering it to the separation roller, check the Sheet Retard / Pickup roller / Forward roller / CST Knock up / CST Knock up Spring.
- 4) If the jammed paper occurred after entering it to the separation roller, check the Ribs in paper path.

▶ Error Code**M1-1710****▶ Error message**

Paper jam in manual feeder. Please remove the paper

▶ Symptom

The jammed paper has occurred in the manual feeder.

▶ Troubleshooting method

- 1) Clear the jam from the manual feeder.
- 2) If the jammed paper in the manual feeder occurred continually, replace the MP unit.

▶ **Error Code**

M1-5112 / M1-5113 / M1-5120 / M1-5612 / M1-5712

▶ **Error message**

Paper is empty in tray 1. Load paper

Paper is empty in all tray. Load paper

Paper is empty in MP tray. Load paper

Paper is empty in manual feeder. Load paper

▶ **Symptom**

Paper is empty in tray1 or manual feeder. / Paper is loaded in tray but the machine detects empty status.

▶ **Troubleshooting method**

- 1) Load the paper in tray1 or manual feeder.
- 2) If the problem persists, check the following.
- 3) Check if the empty actuator works normally. If it is defective or broken, replace it.
- 4) If the actuator operation is OK, check the empty sensor. Reconnect the sensor connector. If the sensor is defective, replace it.

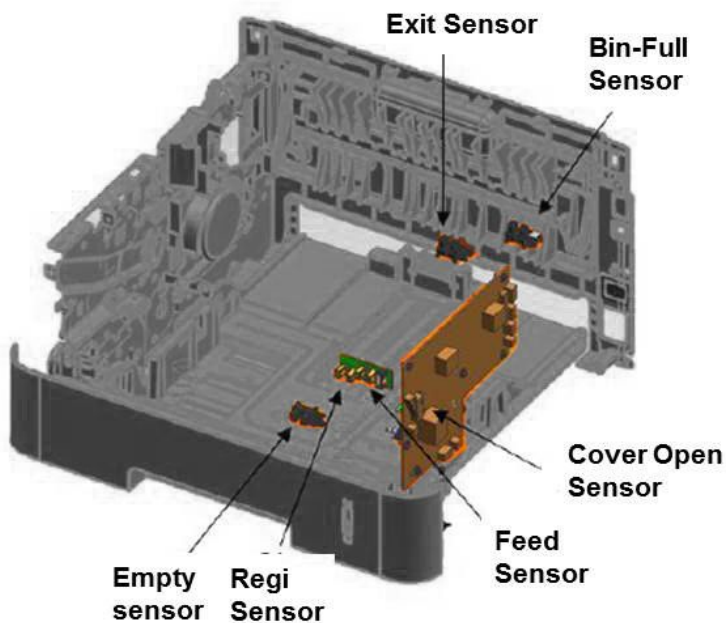

▶ **Error Code**

M2-1110

▶ **Error message**

Paper jam inside of machine. Please remove the paper

▶ **Symptom**

A paper jam was detected at the feed sensor.

▶ **Troubleshooting method**

- 1) Remove the jammed paper. If the error persists, check the followings.
- 2) Check if the feed/regi sensor connector is connected properly. Reconnect the harness.

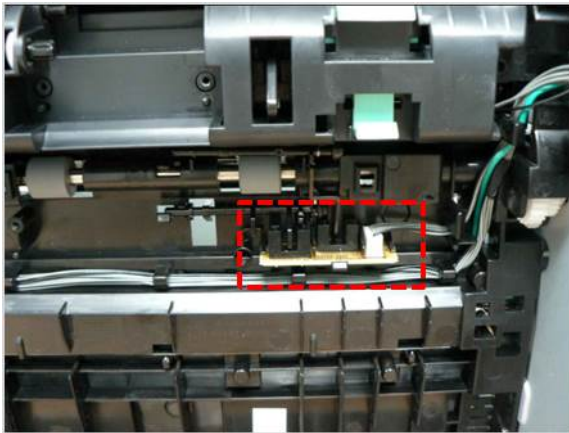

- 3) Check if the regi./feed actuator works normally. If it is defective or broken, replace it.
- 4) If the photo sensor is defective, replace the regi/feed sensor PBA.

▶ **Error Code**

M2-2110 / M2-2310

▶ **Error message**

Paper jam at the top of duplex path

Paper jam at the bottom of duplex path

▶ **Symptom**

A paper jam was detected in the duplex area.

▶ **Troubleshooting method**

- 1) Remove the jammed paper.
- 2) Check if the paper in tray is loaded properly. Adjust the guide. Check the machine setting is normal for paper.
- 3) Check if the Guide-Change Duplex of the rear cover is defective or broken. Check if the rib form of the rear cover is normal.

▶ **Error Code**

M3-1110 / M3-1112

▶ **Error message**

Paper jam in exit area. Please remove the paper

▶ **Symptom**

A paper jam was detected in the exit area.

▶ **Troubleshooting method**

- 1) Open the rear cover. Remove the jammed paper.
- 2) Check if the Guide-Change Duplex of the rear cover is defective.
- 3) Check if the exit sensor and actuator is working normally.



▶ Error Code

M3-2130

▶ Error message

Paper in output bin is full. Remove printed paper

▶ Symptom

The machine detected that the output tray has got full or the bin-full sensor is defective.

▶ Troubleshooting method

- 1) Remove the paper on the output tray.
(The maximum loading capacity is 150 sheets based on standard paper (80 g/m².)
- 2) Check if the Bin-full Sensor connector is connected properly. Reconnect it or replace the Bin-full sensor.

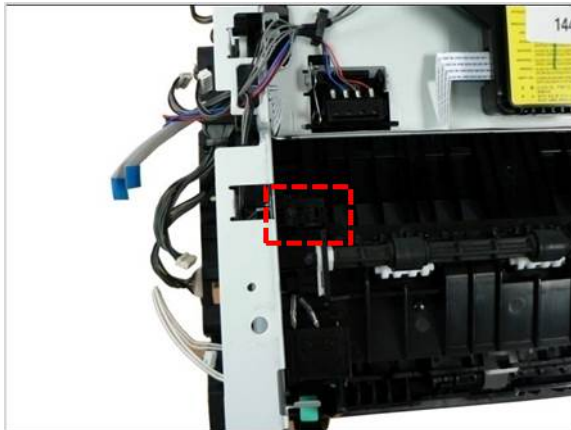

▶ **Error Code**

S1-3212 / S1-2000

▶ **Error message**

Error #S1-3212 Turn off then on.

▶ **Symptom**

The main board does not work normally.

▶ **Troubleshooting method**

- 1) Turn the machine off then on.
- 2) If the problem persists, replace the main board.

▶ **Error Code**

S2-4110

▶ **Error message**

Door is open. Close it.

▶ **Symptom**

Door is open or the cover open switch is defective.

▶ **Troubleshooting method**

- 1) Check if the front cover is closed perfectly.
- 2) Check if the connection between the main board and HVPS board is correct.
- 3) Check if the cover open switch on HVPS board is operated properly. If it is defective, replace the HVPS board.

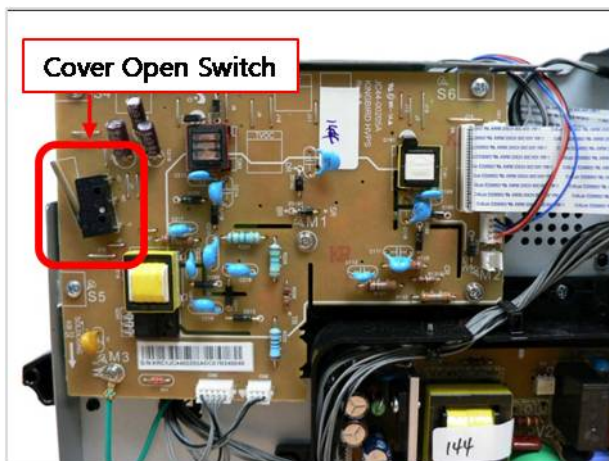

▶ Error Code

S6-3123

▶ Error message

This IP address conflicts with that of other system. Check it.

▶ Symptom

Network has some problem. (IP address conflicts with that of other system. / Communication error / There is no response when checking the ping test.)

▶ Troubleshooting method

Change the machine's IP address.

- Execute the Samsung Easy Printer Manager program. (Device setting > Network > IP address). Change the IP address.
- In case of DHCP or Bootp, reboot the machine to receive a new IP address.

▶ Error Code

S6-3210 / S6-3231 / S6-3232 / S6-3233 / S6-3234 / S6-3235 / S6-3236

▶ Error message

Network Failure: #S6-3210. Turn off then on. Call for service if the problem persists.

▶ Symptom

Wireless network has some problem.

▶ Troubleshooting method

- 1) Turn the machine off then on.
- 2) Check the wireless network setting. If the setting in printer and AP device is abnormal, change it and retry the job.
- 3) Check if the connection between the main board and WLAN PBA is normal. Reconnect the harness.
- 4) If the harness connection is OK, replace the WLAN PBA.

▶ **Error Code**

U1-2132 / U1-23xx

▶ **Error message**

Fuser Unit Failure: #U1-2xxx. Turn off then on. Call for service if the problem persists

▶ **Symptom**

The temperature control of fuser unit is abnormal.

▶ **Troubleshooting method**

- 1) Turn the machine off. Re-install the fuser unit. Then turn the machine on. Is the error message is disappeared?
- 2) If the problem persists, turn the machine off and remove the fuser unit.
 - a) Check if the fuser connector is connected properly.
 - b) Check if the input voltage is normal.
 - c) Check if the thermistor is twisted or contaminated; and is in contact with the Heat Roller.
- 3) After confirming continuity in the fuser connector and the problem still exists; order an SMPS and Fuser Unit and install as is necessary.

► **Error Code**

U2-1112 / U2-1113

► **Error message**

LSU Failure: #U2-111x. Turn off then on. Call for service if the problem persists

► **Symptom**

LSU Motor does not work normally. / H Sync signal is abnormal.

► **Troubleshooting method**

- 1) Execute the LSU motor test in EDC program. Check the LSU motor operation sound.
- 2) If there is no sound, remove the right cover. Check if the LSU harness on the main board is connected properly. (picture- 1,2)
- 3) If it is OK, remove the top cover. Check if the LSU harness on LSU board is connected properly. (picture- 3,4)
- 4) Check if the LSU harness is defective. (picture- 5,6)
- 5) Reconnect the LSU harness and then execute the LSU motor test in EDC program again.
- 6) If the problem persists, replace the LSU.
- 7) If the problem persists after replacing LSU, replace the main board.



4.7.3. Image quality problem

Print-quality defects can be attributed to printer components, supplies, media, internal software, external software applications and environmental conditions.

To successfully troubleshoot print-quality problems, as many variables as possible must be eliminated.

The first step is to generate prints using printable pages embedded in the printer on laser paper. The paper should be from an unopened ream that has been acclimated to room temperature and you should ensure that genuine Samsung Toner is installed in the printer.

How to analysis the defect image



TIP

- According to the part remain life, cause can vary. Check the part remain life.
- Check the defect whether periodic or not.

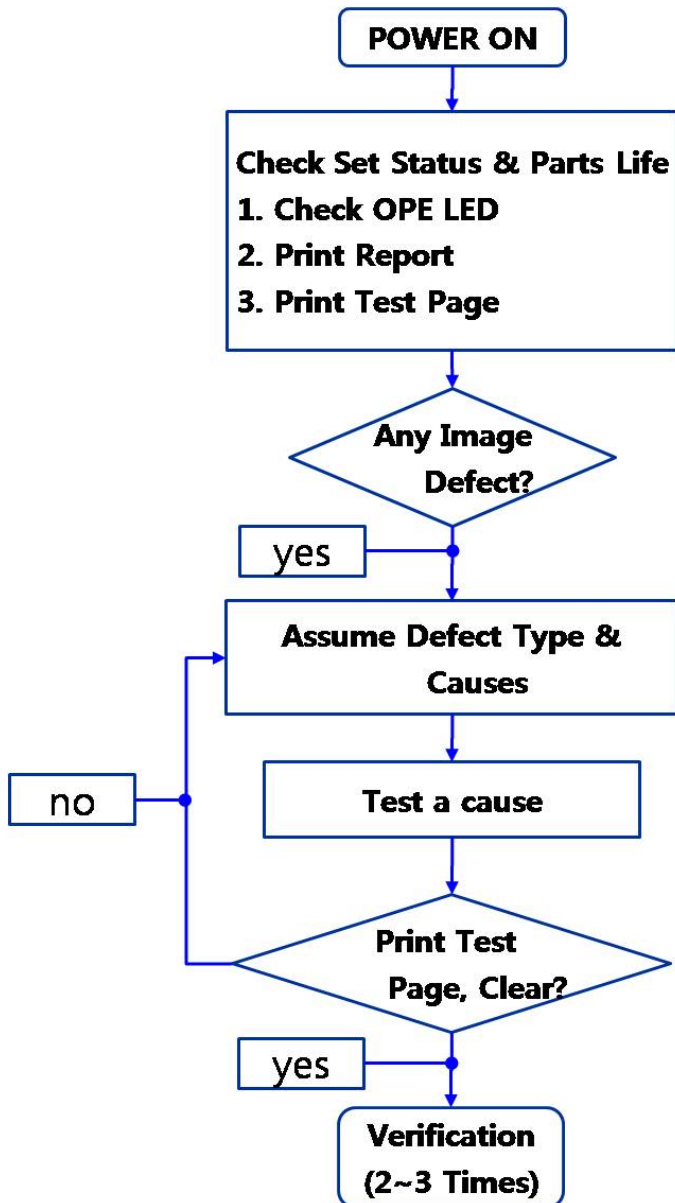

1) **Vertical Black Line and Band**

Description : Straight thin black vertical line occurs in the printed image.



Probable Cause	Solution
The paper is not the proper type.	Replace the paper.
The paper path is contaminated by toner residue, debris etc.	Clean the paper path.
The imaging unit is defective.	Replace the imaging unit.
The transfer roller is contaminated or worn out.	Replace the transfer roller.
The pressure roller or heat roller in fuser unit defective.	1) Turn the machine off. 2) Remove and replace the fuser unit. 3) Turn the machine on. <div style="background-color: #cccccc; padding: 5px; margin-top: 10px;">  WARNING Do not touch the fuser unit while it is hot. </div>

2) **Vertical White Line, Band**

Description : White vertical voids occurs in the printed image.



Probable Cause	Solution
The paper is not the proper type.	Replace the paper.
The paper path is contaminated by toner residue, debris etc.	Clean the paper path.
The imaging unit is defective.	Replace the imaging unit.
The transfer roller is contaminated or worn out.	Replace the transfer roller.
The LSU window is contaminated.	1) Clean the LSU window. 2) Replace the LSU
The connection between the LSU and main board is defective.	1) Disconnect and reconnect the harness. 2) Replace the harness.

3) **Horizontal Black Band**

Description : Dark or blurry horizontal stripes occur in the printing periodically.



Probable Cause	Solution
The paper is dirty or not the proper type.	Replace the paper.
The paper path is contaminated by toner residue, debris etc.	Clean the paper path.
The contact terminal of the imaging unit is bad.	1) Clean the contact terminal of the imaging unit. 2) Replace the imaging unit.
The surface of transfer roller is contaminated or worn out.	Replace the transfer roller.
The LSU window is contaminated.	1) Clean the LSU window.
The pressure roller or heat roller in fuser unit defective.	1) Turn the machine off. 2) Remove and replace the fuser unit. 3) Turn the machine on. <div style="background-color: #cccccc; padding: 5px;">  WARNING Do not touch the fuser unit while it is hot. </div>
HVPS terminal is contaminated.	Clean the contaminated terminal.
The output from the HVPS is abnormal.	Replace the HVPS board.

 **NOTE**

Roller Period for Horizontal Problem

Roller Description	Band Period (mm)	Defective part
Pressure Roller	75.4 mm	Fuser Unit
Heat roller	77.6 mm	
Charge roller	26.7 mm	Imaging Unit
OPC drum	75.49 mm	
Supply roller	63.22 mm	Toner Cartridge
Transfer roller	47.12 mm	Transfer Roller

4) **Black and White spot**

Description : Dark or blurry black spots occur periodically in the printing.



Probable Cause	Solution
The paper path is contaminated by toner residue, debris etc.	Clean the paper path.
The rollers in the imaging unit may be contaminated with foreign matter or paper particles.	Replace the imaging unit.
The transfer roller is contaminated or worn out.	Replace the transfer roller.
The pressure roller or heat roller in fuser unit defective.	<ol style="list-style-type: none"> 1) Turn the machine off. 2) Remove and replace the fuser unit. 3) Turn the machine on. <div style="background-color: #cccccc; padding: 5px; margin-top: 10px;">  WARNING Do not touch the fuser unit while it is hot. </div>

5) **Light image**

Description : The printed image is light, with no ghost.



Probable Cause	Solution
The toner cartridge life is expired.	Replace the toner cartridge.
The surface of transfer roller is contaminated or worn out.	Replace the transfer roller.
HVPS terminal is contaminated.	Clean the contaminated terminal.
The output from the HVPS is abnormal.	Replace the HVPS board.

6) **Dark or Black page**

Description : The printed image is dark or black.



Probable Cause	Solution
The charging roller in the imaging unit is defective.	Replace the imaging unit.
The HVPS contact terminal is contaminated.	Clean the HVPS contact terminal.
The output from the HVPS is abnormal.	Replace the HVPS board.
The LSU is defective.	Replace the LSU.

7) **Uneven Density**

Description : Print density is uneven between left and right.



Probable Cause	Solution
<ul style="list-style-type: none"> • The pressure force on the left and right springs of the transfer roller is not even. • The springs are damaged. • The transfer roller is improperly installed. 	<ol style="list-style-type: none"> 1) Remove the transfer roller Assy. 2) Check if the transfer roller Assy has any wrong part. 3) Replace the transfer roller Assy.
<p>The toner level is not even on the toner cartridge roller due to the bad blade.</p>	<p>Replace the toner cartridge.</p>

8) **Background**

Description : Light dark background appears in whole area of the printing.



Probable Cause	Solution
Does recycle paper be used?	Use the proper papers.
The life of the toner cartridge has been expired	Replace the toner cartridge.
The output from the HVPS is abnormal.	Replace the HVPS board.

9) **Ghost**

Description : Ghost occurs.



Probable Cause	Solution
The residual toner on the rollers exists.	Print 10 test prints.
The contact terminal of the imaging unit is bad.	1) Clean the contact terminal of the imaging unit. 2) Replace the imaging unit.
The transfer roller is contaminated or worn out.	Replace the transfer roller.
The pressure roller or heat roller in fuser unit defective.	1) Turn the machine off. 2) Remove and replace the fuser unit. 3) Turn the machine on. <div style="background-color: #cccccc; padding: 5px;">  WARNING Do not touch the fuser unit while it is hot. </div>
The HVPS contact terminal is contaminated.	Clean the HVPS contact terminal.
The output from the HVPS is abnormal.	Replace the HVPS board.

10) **Stains on back of page**

Description : The back of the page is stained.



Probable Cause	Solution
The transfer roller is contaminated or worn out.	Replace the transfer roller.
The pressure roller or heat roller in fuser unit defective.	1) Turn the machine off. 2) Remove and replace the fuser unit. 3) Turn the machine on. <div style="background-color: #cccccc; padding: 5px;">  WARNING Do not touch the fuser unit while it is hot. </div>

11) **Blank page**

Description : No visible image anywhere on the output.



Probable Cause	Solution
The contact terminal of the imaging unit is bad.	1) Clean the contact terminal of the imaging unit. 2) Replace the toner cartridge.
The surface of transfer roller is contaminated or worn out.	Replace the transfer roller.
The LSU window is contaminated.	1) Clean the LSU window. 2) Replace the LSU
The connection between the LSU and main board is defective.	1) Disconnect and reconnect the harness. 2) Replace the harness.
The connection between the main board and HVPS board is bad.	Reconnect the harness. If the main board or HVPS board is defective, replace it.

12) **Partial image void**

Description : The partial void occurs in the printed page.



Probable Cause	Solution
The printer is not installed on flat ground.	Install the printer on flat ground. Print 10 sample pages for test.
The developer circulation in the toner cartridge is bad.	1) Shake the toner cartridge 2~3 times from right to left. Reinstall the toner cartridge. Print 10 sample pages for test. 2) If the problem persists, replace the toner cartridge.
The contact between the imaging unit and transfer roller is bad.	Check if the imaging unit and transfer roller are installed properly.

13) **Unfused image**

Description : The printed image is not fully fused to the paper. The image rubs off easily

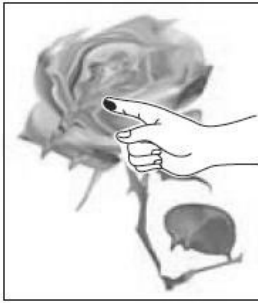

Probable Cause	Solution
The papers are wet with moisture.	Replace the paper.
The fuser unit is not installed properly.	1) Turn the machine off. 2) Remove and reinstall the fuser unit. 3) Turn the machine on.
The fuser connection is bad.	Check the connection between the fuser unit and main board.
The fuser unit defective.	1) Turn the machine off. 2) Remove and replace the fuser unit. 3) Turn the machine on. <div style="background-color: #cccccc; padding: 5px;">  WARNING Do not touch the fuser unit while it is hot. </div>

5. System Diagrams

5.1. Block Diagram

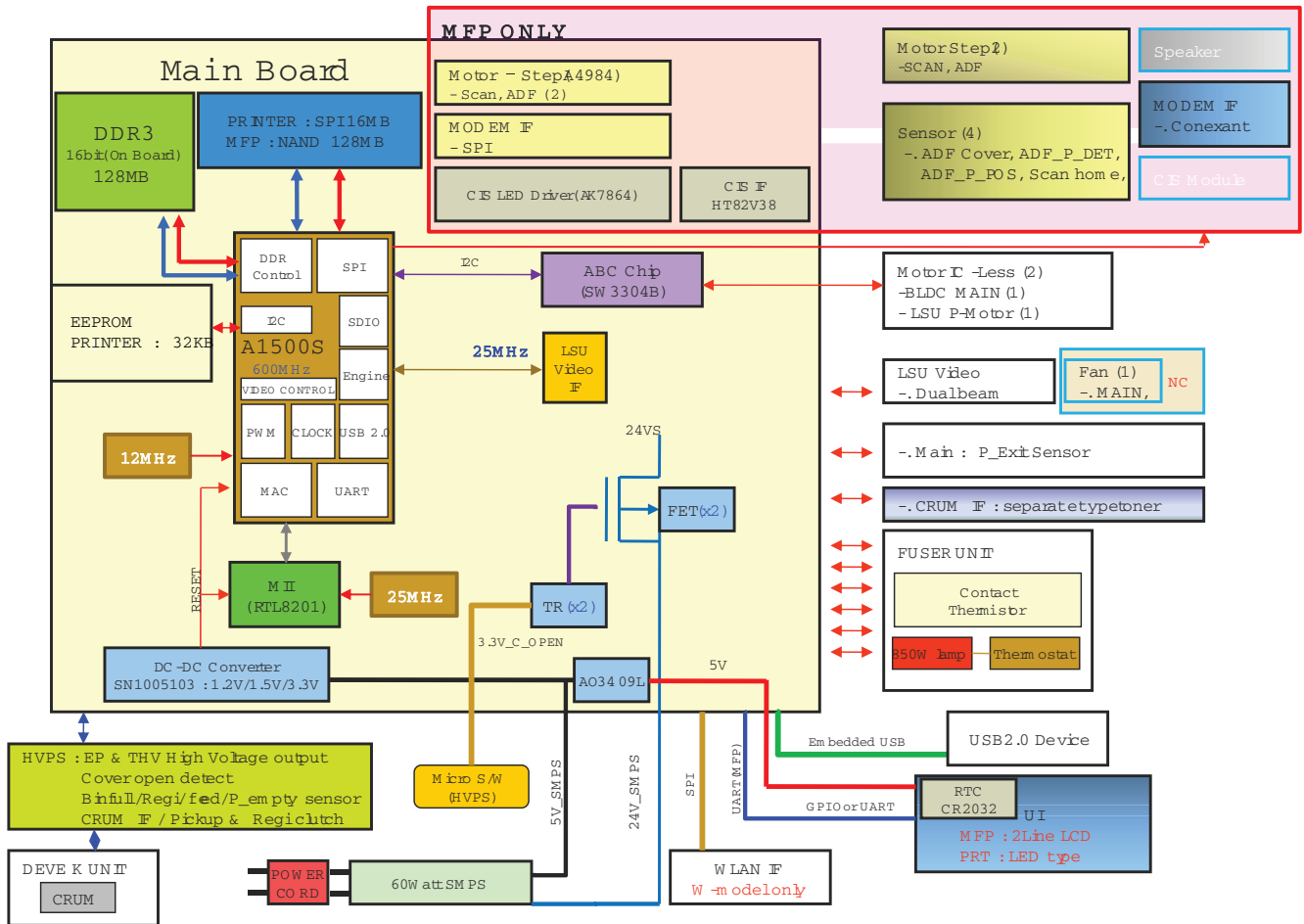

5.2. Connection Diagram

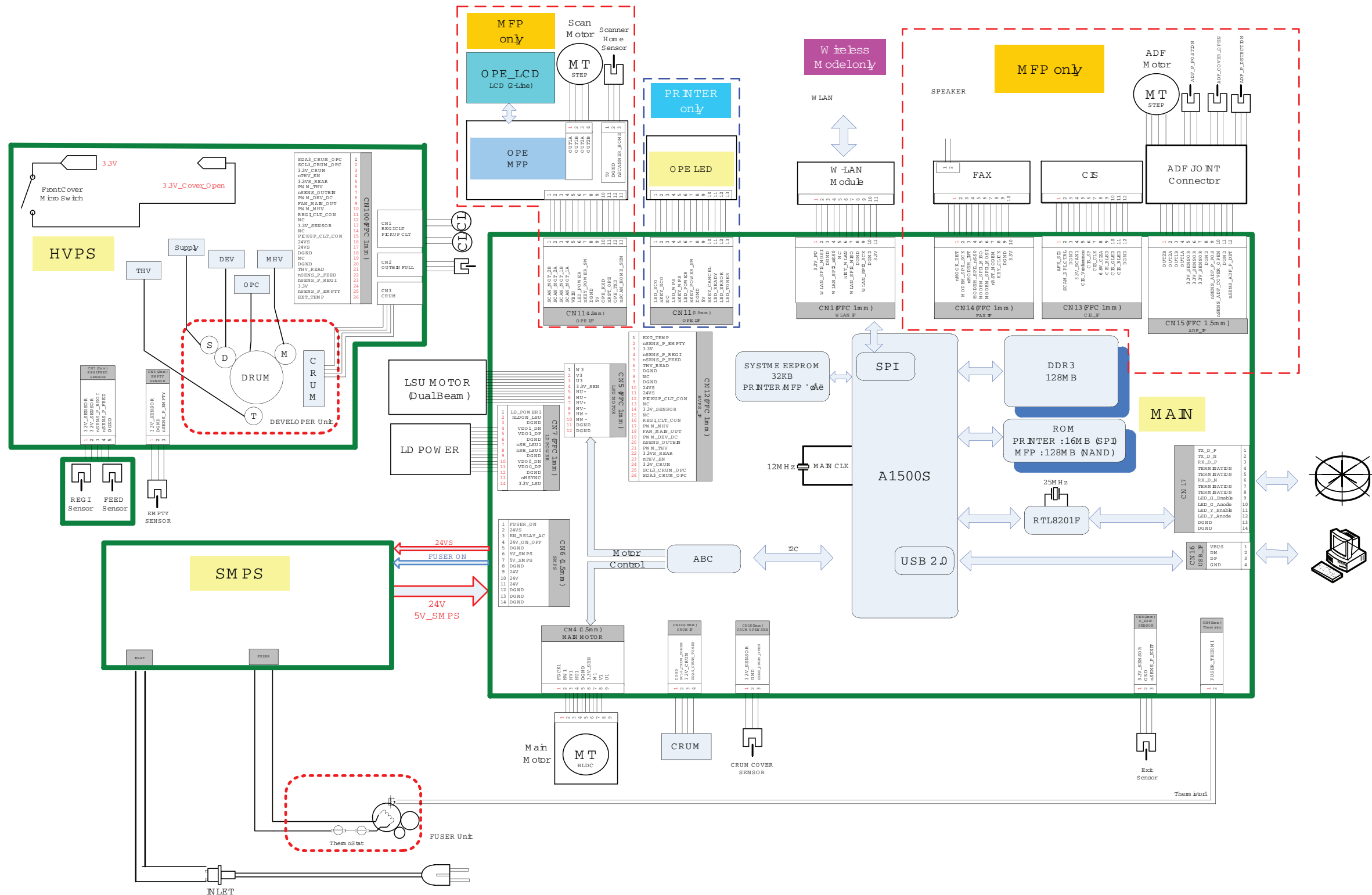





6. Reference Information

This chapter contains the tools list, list of abbreviations used in this manual, and a guide to the location space required when installing the printer. A definition of test pages and Wireless Network information definition is also included.

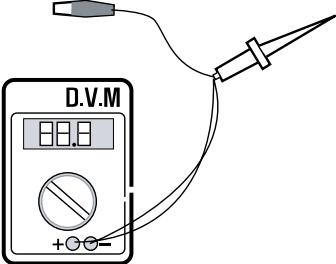
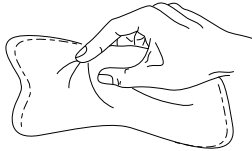
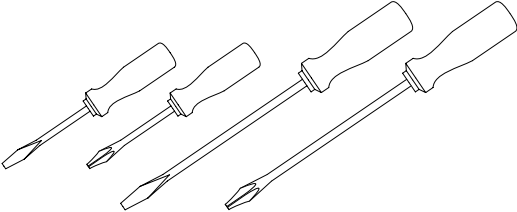
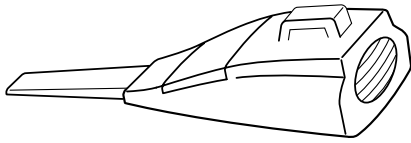
6.1. Tool for Troubleshooting

The following tools are recommended safe and easy troubleshooting as described in this service manual.

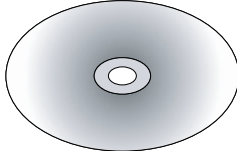
<p>DVM (Digital Volt Meter) Standard : Indicates more than 3 digits.</p> 	<p>Cleaning Equipments Standard : An IPA (Isopropyl Alcohol) dry wipe tissue or a gentle neutral detergent and lint-free cloth.</p> 
<p>Driver Standard : “-” type, “+” type (M3 long, M3 short, M2 long, M2 short).</p> 	<p>Vacuum Cleaner</p> 
<p>Tweezers Standard : For general home use, small type.</p> 	<p>Spring Hook Standard : For general use</p> 
<p>Cotton Swab Standard : For general home use, for medical service.</p> 	<p>Software (Driver) installation CD ROM</p> 

6.2. Glossary

The following glossary helps you get familiar with the product by understanding the terminologies commonly used with printing as well as mentioned in this user's guide and service manual.

802.11	802.11 is a set of standards for wireless local area network (WLAN) communication, developed by the IEEE LAN/MAN Standards Committee (IEEE 802).
802.11b/g/n	802.11b/g/n can share same hardware and use the 2.4 GHz band. 802.11b supports bandwidth up to 11 Mbps, 802.11n supports bandwidth up to 150 Mbps. 802.11b/g/n devices may occasionally suffer interference from microwave ovens, cordless telephones, and Bluetooth devices.
Access point	Access Point or Wireless Access Point (AP or WAP) is a device that connects wireless communication devices together on wireless local area networks (WLAN), and acts as a central transmitter and receiver of WLAN radio signals.
ADF	An Automatic Document Feeder (ADF) is a scanning unit that will automatically feed an original sheet of paper so that the machine can scan some amount of the paper at once.
AppleTalk	AppleTalk is a proprietary suite of protocols developed by Apple, Inc for computer networking. It was included in the original Macintosh (1984) and is now deprecated by Apple in favor of TCP/IP networking.
BIT Depth	A computer graphics term describing the number of bits used to represent the color of a single pixel in a bitmapped image. Higher color depth gives a broader range of distinct colors. As the number of bits increases, the number of possible colors becomes impractically large for a color map. 1-bit color is commonly called as monochrome or black and white.
BMP	A bitmapped graphics format used internally by the Microsoft Windows graphics subsystem (GDI), and used commonly as a simple graphics file format on that platform.
BOOTP	Bootstrap Protocol. A network protocol used by a network client to obtain its IP address automatically. This is usually done in the bootstrap process of computers or operating systems running on them. The BOOTP servers assign the IP address from a pool of addresses to each client. BOOTP enables 'diskless workstation' computers to obtain an IP address prior to loading any advanced operating system.
CCD	Charge Coupled Device (CCD) is a hardware which enables the scan job. CCD Locking mechanism is also used to hold the CCD module to prevent any damage when you move the machine.
Collation	Collation is a process of printing a multiple-copy job in sets. When collation is selected, the device prints an entire set before printing additional copies.
Control Panel	A control panel is a flat, typically vertical, area where control or monitoring instruments are displayed. They are typically found in front of the machine.
Coverage	It is the printing term used for a toner usage measurement on printing. For example, 5% coverage means that an A4 sided paper has about 5% image or text on it. So, if the paper or original has complicated images or lots of text on it, the coverage will be higher and at the same time, a toner usage will be as much as the coverage.
CSV	Comma Separated Values (CSV). A type of file format, CSV is used to exchange data between disparate applications. The file format, as it is used in Microsoft Excel, has become a de facto standard throughout the industry, even among non-Microsoft platforms.
DADF	A Duplex Automatic Document Feeder (DADF) is a scanning unit that will automatically feed and turn over an original sheet of paper so that the machine can scan on both sides of the paper.
Default	The value or setting that is in effect when taking a printer out of its box state, reset, or initialized.
DHCP	A Dynamic Host Configuration Protocol (DHCP) is a client-server networking protocol. A DHCP server provides configuration parameters specific to the DHCP client host requesting, generally, information required by the client host to participate on an IP network. DHCP also provides a mechanism for allocation of IP addresses to client hosts.
DIMM	Dual Inline Memory Module (DIMM), a small circuit board that holds memory. DIMM stores all the data within the machine like printing data, received fax data.

DLNA	The Digital Living Network Alliance (DLNA) is a standard that allows devices on a home network to share information with each other across the network.
DNS	The Domain Name Server (DNS) is a system that stores information associated with domain names in a distributed database on networks, such as the Internet.
Dot Matrix Printer	A dot matrix printer refers to a type of computer printer with a print head that runs back and forth on the page and prints by impact, striking an ink-soaked cloth ribbon against the paper, much like a typewriter.
DPI	Dots Per Inch (DPI) is a measurement of resolution that is used for scanning and printing. Generally, higher DPI results in a higher resolution, more visible detail in the image, and a larger file size.
DRPD	Distinctive Ring Pattern Detection. Distinctive Ring is a telephone company service which enables a user to use a single telephone line to answer several different telephone numbers.
DSDF	Dual Scan Document Feeder (DSDF) is a scanning unit that will automatically feed an original sheet of paper so that the machine can scan on both sides of the paper at once.
Duplex	A mechanism that will automatically turn over a sheet of paper so that the machine can print (or scan) on both sides of the paper. A printer equipped with a Duplex Unit can print on both sides of paper during one print cycle.
Duty Cycle	Duty cycle is the page quantity which does not affect printer performance for a month. Generally the printer has the lifespan limitation such as pages per year. The lifespan means the average capacity of print-outs, usually within the warranty period. For example, if the duty cycle is 48,000 pages per month assuming 20 working days, a printer limits 2,400 pages a day.
ECM	Error Correction Mode (ECM) is an optional transmission mode built into Class 1 fax machines or fax modems. It automatically detects and corrects errors in the fax transmission process that are sometimes caused by telephone line noise.
Emulation	Emulation is a technique of one machine obtaining the same results as another. An emulator duplicates the functions of one system with a different system, so that the second system behaves like the first system. Emulation focuses on exact reproduction of external behavior, which is in contrast to simulation, which concerns an abstract model of the system being simulated, often considering its internal state.
Ethernet	Ethernet is a frame-based computer networking technology for local area networks (LANs). It defines wiring and signaling for the physical layer, and frame formats and protocols for the media access control (MAC)/data link layer of the OSI model. Ethernet is mostly standardized as IEEE 802.3. It has become the most widespread LAN technology in use during the 1990s to the present.
EtherTalk	A suite of protocols developed by Apple Computer for computer networking. It was included in the original Macintosh (1984) and is now deprecated by Apple in favor of TCP/IP networking.
FDI	Foreign Device Interface (FDI) is a card installed inside the machine to allow a third party device such as a coin operated device or a card reader. Those devices allow the pay-for-print service on your machine.
FTP	A File Transfer Protocol (FTP) is a commonly used protocol for exchanging files over any network that supports the TCP/IP protocol (such as the Internet or an intranet).
Fuser Unit	The part of a laser printer that fuses the toner onto the print media. It consists of a heat roller and a pressure roller. After toner is transferred onto the paper, the fuser unit applies heat and pressure to ensure that the toner stays on the paper permanently, which is why paper is warm when it comes out of a laser printer.
Gateway	A connection between computer networks, or between a computer network and a telephone line. It is very popular, as it is a computer or a network that allows access to another computer or network.
Grayscale	A shades of gray that represent light and dark portions of an image when color images are converted to grayscale; colors are represented by various shades of gray.
Halftone	An image type that simulates grayscale by varying the number of dots. Highly colored areas consist of a large number of dots, while lighter areas consist of a smaller number of dots.

HDD	Hard Disk Drive (HDD), commonly referred to as a hard drive or hard disk, is a non-volatile storage device which stores digitally-encoded data on rapidly rotating platters with magnetic surfaces.
IEEE	The Institute of Electrical and Electronics Engineers (IEEE) is an international non-profit, professional organization for the advancement of technology related to electricity.
IEEE 1284	The 1284 parallel port standard was developed by the Institute of Electrical and Electronics Engineers (IEEE). The term "1284-B" refers to a specific connector type on the end of the parallel cable that attaches to the peripheral (for example, a printer).
Intranet	A private network that uses Internet Protocols, network connectivity, and possibly the public telecommunication system to securely share part of an organization's information or operations with its employees. Sometimes the term refers only to the most visible service, the internal website.
IP address	An Internet Protocol (IP) address is a unique number that devices use in order to identify and communicate with each other on a network utilizing the Internet Protocol standard.
IPM	The Images Per Minute (IPM) is a way of measuring the speed of a printer. An IPM rate indicates the number of single-sided sheets a printer can complete within one minute.
IPP	The Internet Printing Protocol (IPP) defines a standard protocol for printing as well as managing print jobs, media size, resolution, and so forth. IPP can be used locally or over the Internet to hundreds of printers, and also supports access control, authentication, and encryption, making it a much more capable and secure printing solution than older ones.
IPX/SPX	IPX/SPX stands for Internet Packet Exchange/Sequenced Packet Exchange. It is a networking protocol used by the Novell NetWare operating systems. IPX and SPX both provide connection services similar to TCP/IP, with the IPX protocol having similarities to IP, and SPX having similarities to TCP. IPX/SPX was primarily designed for local area networks (LANs), and is a very efficient protocol for this purpose (typically its performance exceeds that of TCP/IP on a LAN).
ISO	The International Organization for Standardization (ISO) is an international standard-setting body composed of representatives from national standards bodies. It produces world-wide industrial and commercial standards.
ITU-T	The International Telecommunication Union is an international organization established to standardize and regulate international radio and telecommunications. Its main tasks include standardization, allocation of the radio spectrum, and organizing interconnection arrangements between different countries to allow international phone calls. A -T out of ITU-T indicates telecommunication.
ITU-T No. 1 chart	Standardized test chart published by ITU-T for document facsimile transmissions.
JBIG	Joint Bi-level Image Experts Group (JBIG) is an image compression standard with no loss of accuracy or quality, which was designed for compression of binary images, particularly for faxes, but can also be used on other images.
JPEG	Joint Photographic Experts Group (JPEG) is a most commonly used standard method of lossy compression for photographic images. It is the format used for storing and transmitting photographs on the World Wide Web.
LDAP	The Lightweight Directory Access Protocol (LDAP) is a networking protocol for querying and modifying directory services running over TCP/IP.
LED	A Light-Emitting Diode (LED) is a semiconductor device that indicates the status of a machine.
MAC address	Media Access Control (MAC) address is a unique identifier associated with a network adapter. MAC address is a unique 48-bit identifier usually written as 12 hexadecimal characters grouped in pairs (e. g., 00-00-0c-34-11-4e). This address is usually hard-coded into a Network Interface Card (NIC) by its manufacturer, and used as an aid for routers trying to locate machines on large networks.
MFP	Multi Function Peripheral (MFP) is an office machine that includes the following functionality in one physical body, so as to have a printer, a copier, a fax, a scanner and etc.
MH	Modified Huffman (MH) is a compression method for decreasing the amount of data that needs to be transmitted between the fax machines to transfer the image recommended by ITU-T T.4. MH is a codebook-based run-length encoding scheme optimized to efficiently compress white space. As most faxes consist mostly of white space, this minimizes the transmission time of most faxes.

MMR	Modified Modified READ (MMR) is a compression method recommended by ITU-T T.6.
Modem	A device that modulates a carrier signal to encode digital information, and also demodulates such a carrier signal to decode transmitted information.
MR	Modified Read (MR) is a compression method recommended by ITUT T.4. MR encodes the first scanned line using MH. The next line is compared to the first, the differences determined, and then the differences are encoded and transmitted.
NetWare	A network operating system developed by Novell, Inc. It initially used cooperative multitasking to run various services on a PC, and the network protocols were based on the archetypal Xerox XNS stack. Today NetWare supports TCP/IP as well as IPX/SPX.
NFC Printing	The NFC(Near Field Communication) printer allows you to directly print/scan from your cell phone just by holding your cell phone over the NFC tag on your printer. It does not require installing print driver or connecting to an access point. You just need NFC supported cell phone. In order to use this feature, Samsung Mobile Print app needs to be installed on your cell phone.
OPC	Organic Photo Conductor (OPC) is a mechanism that makes a virtual image for print using a laser beam emitted from a laser printer, and it is usually green or rust colored and has a cylinder shape. An imaging unit containing a drum slowly wears the drum surface by its usage in the printer, and it should be replaced appropriately since it gets worn from contact with the cartridge development brush, cleaning mechanism, and paper.
Originals	The first example of something, such as a document, photograph or text, etc, which is copied, reproduced or translated to produce others, but which is not itself copied or derived from something else.
OSI	Open Systems Interconnection (OSI) is a model developed by the International Organization for Standardization (ISO) for communications. OSI offers a standard, modular approach to network design that divides the required set of complex functions into manageable, self-contained, functional layers. The layers are, from top to bottom, Application, Presentation, Session, Transport, Network, Data Link and Physical.
PABX	A private automatic branch exchange (PABX) is an automatic telephone switching system within a private enterprise.
PCL	Printer Command Language (PCL) is a Page Description Language (PDL) developed by HP as a printer protocol and has become an industry standard. Originally developed for early inkjet printers, PCL has been released in varying levels for thermal, dot matrix printer, and laser printers.
PDF	Portable Document Format (PDF) is a proprietary file format developed by Adobe Systems for representing two dimensional documents in a device independent and resolution independent format.
PostScript(PS)	PostScript (PS) is a page description language and programming language used primarily in the electronic and desktop publishing areas. - that is run in an interpreter to generate an image.
Printer Driver	A program used to send commands and transfer data from the computer to the printer.
Print Media	The media like paper, envelopes, labels, and transparencies which can be used in a printer, a scanner, a fax or, a copier.
PPM	Pages Per Minute (PPM) is a method of measurement for determining how fast a printer works, meaning the number of pages a printer can produce in one minute.
PRN file	An interface for a device driver, this allows software to interact with the device driver using standard input/output system calls, which simplifies many tasks.
Protocol	A convention or standard that controls or enables the connection, communication, and data transfer between two computing endpoints.
PSTN	The Public-Switched Telephone Network (PSTN) is the network of the world's public circuit-switched telephone networks which, on industrial premises, is usually routed through the switchboard.
RADIUS	Remote Authentication Dial In User Service (RADIUS) is a protocol for remote user authentication and accounting. RADIUS enables centralized management of authentication data such as usernames and passwords using an AAA (authentication, authorization, and accounting) concept to manage network access.

Resolution	The sharpness of an image, measured in Dots Per Inch (DPI). The higher the dpi, the greater the resolution.
SMB	Server Message Block (SMB) is a network protocol mainly applied to share files, printers, serial ports, and miscellaneous communications between nodes on a network. It also provides an authenticated Interprocess communication mechanism.
SMTP	Simple Mail Transfer Protocol (SMTP) is the standard for e-mail transmissions across the Internet. SMTP is a relatively simple, text based protocol, where one or more recipients of a message are specified, and then the message text is transferred. It is a client server protocol, where the client transmits an email message to the server.
SSID	Service Set Identifier (SSID) is a name of a wireless local area network (WLAN). All wireless devices in a WLAN use the same SSID in order to communicate with each other. The SSIDs are case-sensitive and have a maximum length of 32 characters.
Subnet Mask	The subnet mask is used in conjunction with the network address to determine which part of the address is the network address and which part is the host address.
TCP/IP	The Transmission Control Protocol (TCP) and the Internet Protocol (IP); the set of communications protocols that implement the protocol stack on which the Internet and most commercial networks run.
TCR	Transmission Confirmation Report (TCR) provides details of each transmission such as job status, transmission result and number of pages sent. This report can be set to print after each job or only after failed transmissions.
TIFF	Tagged Image File Format (TIFF) is a variable-resolution bitmapped image format. TIFF describes image data that typically come from scanners. TIFF images make use of tags, keywords defining the characteristics of the image that is included in the file. This flexible and platform-independent format can be used for pictures that have been made by various image processing applications.
Toner Cartridge	A kind of bottle or container used in a machine like a printer which contains toner. Toner is a powder used in laser printers and photocopiers, which forms the text and images on the printed paper. Toner can be fused by a combination of heat/pressure from the fuser, causing it to bind to the fibers in the paper.
TWAIN	An industry standard for scanners and software. By using a TWAIN-compliant scanner with a TWAIN-compliant program, a scan can be initiated from within the program. It is an image capture API for Microsoft Windows and Apple Macintosh operating systems.
UNC Path	Uniform Naming Convention (UNC) is a standard way to access network shares in Window NT and other Microsoft products. The format of a UNC path is: \\<servername>\<sharename>\<Additional directory>
URL	Uniform Resource Locator (URL) is the global address of documents and resources on the Internet. The first part of the address indicates what protocol to use, the second part specifies the IP address or the domain name where the resource is located.
USB	Universal Serial Bus (USB) is a standard that was developed by the USB Implementers Forum, Inc., to connect computers and peripherals. Unlike the parallel port, USB is designed to concurrently connect a single computer USB port to multiple peripherals.
Watermark	A watermark is a recognizable image or pattern in paper that appears lighter when viewed by transmitted light. Watermarks were first introduced in Bologna, Italy in 1282; they have been used by papermakers to identify their product, and also on postage stamps, currency, and other government documents to discourage counterfeiting.
WEP	Wired Equivalent Privacy (WEP) is a security protocol specified in IEEE 802.11 to provide the same level of security as that of a wired LAN. WEP provides security by encrypting data over radio so that it is protected as it is transmitted from one end point to another.
WIA	Windows Imaging Architecture (WIA) is an imaging architecture that is originally introduced in Windows Me and Windows XP. A scan can be initiated from within these operating systems by using a WIA-compliant scanner.
Wi-Fi	Wi-Fi is a popular technology that allows an electronic device to exchange data wirelessly over a computer network, including high-speed Internet connections.

WPA	Wi-Fi Protected Access (WPA) is a class of systems to secure wireless (Wi-Fi) computer networks, which was created to improve upon the security features of WEP.
WPA-PSK	WPA-PSK (WPA Pre-Shared Key) is special mode of WPA for small business or home users. A shared key, or password, is configured in the wireless access point (WAP) and any wireless laptop or desktop devices. WPA-PSK generates a unique key for each session between a wireless client and the associated WAP for more advanced security.
WPS	The Wi-Fi Protected Setup (WPS) is a standard for establishing a wireless home network. If your wireless access point supports WPS, you can configure the wireless network connection easily without a computer.
XPS	XML Paper Specification (XPS) is a specification for a Page Description Language (PDL) and a new document format, which has benefits for portable document and electronic document, developed by Microsoft. It is an XML-based specification, based on a new print path and a vector-based device-independent document format.

6.3. The Sample Pattern for the Test

The life of the toner cartridge and the printing speed are measured using the pattern shown below.

Stephen J. Singel
 Labanda Sinpat Abarress
 Tendar, BSF
 URANGLE

23 January 2004

Jonathan Q. Maderia

Inpert Mampem Abaress
 2343 Stantin Dawer Lank
 Benhibe, SDF

Mr.Maderia:

Nam liber tempor cum soluta nobis eleifend ption cogue nihil consequat, velillum. Dolore eu zril feugiat nulla acilisis at vero eros accumsan et iusto odio dignis sim qui blandit praesent lutatum ril lobortis nisl ut aliquip exea commodo consequat. Duis autem vel eum ireure dolor in hendreritin vulputate velit esse molestie tincidunt ut laoreet dolore magna aliquam erat volutpat. Ut wisi enim ad minim viniam, quis nostrud exerci tation ullam corpersus cipit lotis nisl ut aliquip ex ea commodo consequat. Lorem ipsum dolor sit.

Amet, consectetuer adipiscing elit, sud diam nonummy nibh veniam, recneps adipiscing elit, sed diam nonummy nibtil laoreet dolore magn aliam erat volutpat. Ut wisi enim minim veniam, quisient nostrud. Soluta nobis eleifendoptn cogue nihil imerdiet domg id quod mzim plera facer posim aum. Lorem ipsm dolor sit amet, consectuer. Duis autem eum iriure dolor in hendreritin vulputate velit cesse ea commodo mol

Nam liber tempor cum soluta nobis eleifend option cogue nihil consequat, velillum. Dolore eu zril feugiat nulla facilisis at vero eros accumsan et iusto odio dignissim qui blandit praesent.

Singabet,

Stephen J. Singel
 Demperta Aminerimum
 Labanda Sinpat Abarress

SJS:dwg
 FINAL

LSA
 Funtres Solber Netener

Category	Value
A	100
B	80
C	60
D	40
E	20

6.4. Model Name and Code

1) Sub brand name Information

- Applying Independent sub brand name by Segment : Xpress / ProXpress / MultiXpress



2) Model code Information

- Basic Structure : [SL-●○○■□◆◆]

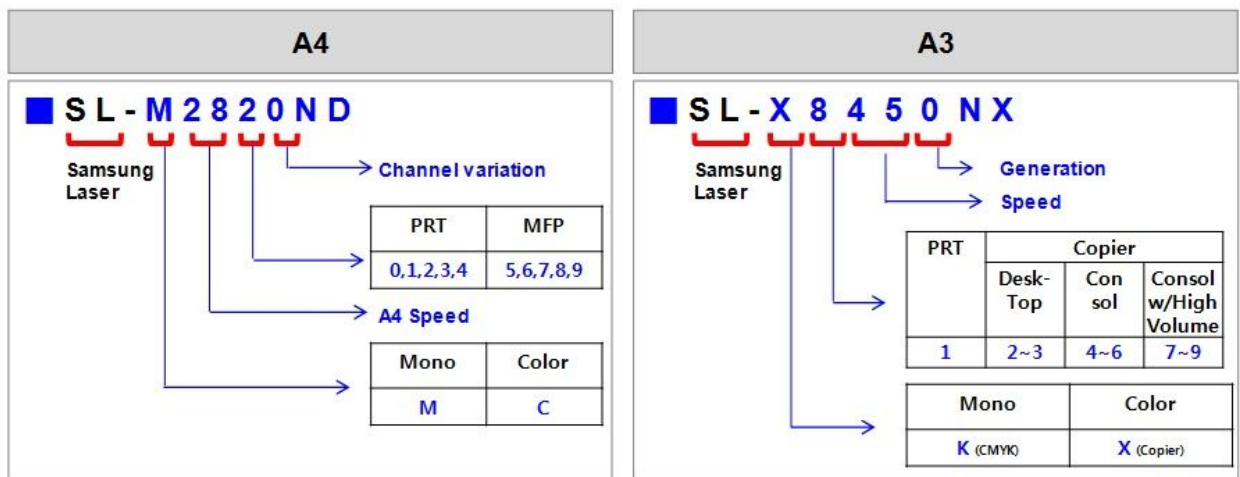

- ◆◆ : Function Information

	Function
N	Network
W	Wireless Network
D	Duplex Printing
R	Reverse Type ADF
F	Fax
X	XOA (eXtensible Open Architecture)
H	Handset
A	Auto Document Feeder

6.5. Document Revision List

Version	Date	Page	Description
1.00	15/Dec/2015	-	Release



GSPN (GLOBAL SERVICE PARTNER NETWORK)

Area	Web Site
Europe, MENA, CIS, Africa	https://gspn1.samsungcsportal.com
E.Asia, W.Asia, China, Japan	https://gspn2.samsungcsportal.com
N.America, S.America	https://gspn3.samsungcsportal.com

This Service Manual is a property of Samsung Electronics Co.,Ltd.
Any unauthorized use of Manual can be punished under applicable International and/or domestic law.

© 2017 Samsung Electronics Co.,Ltd.
All rights reserved.
Printed in Korea